

# 10-NE-22 FOR FENDL-3.2 FROM TENDL-2019 WITH NJOY2016.60

## Principal cross sections

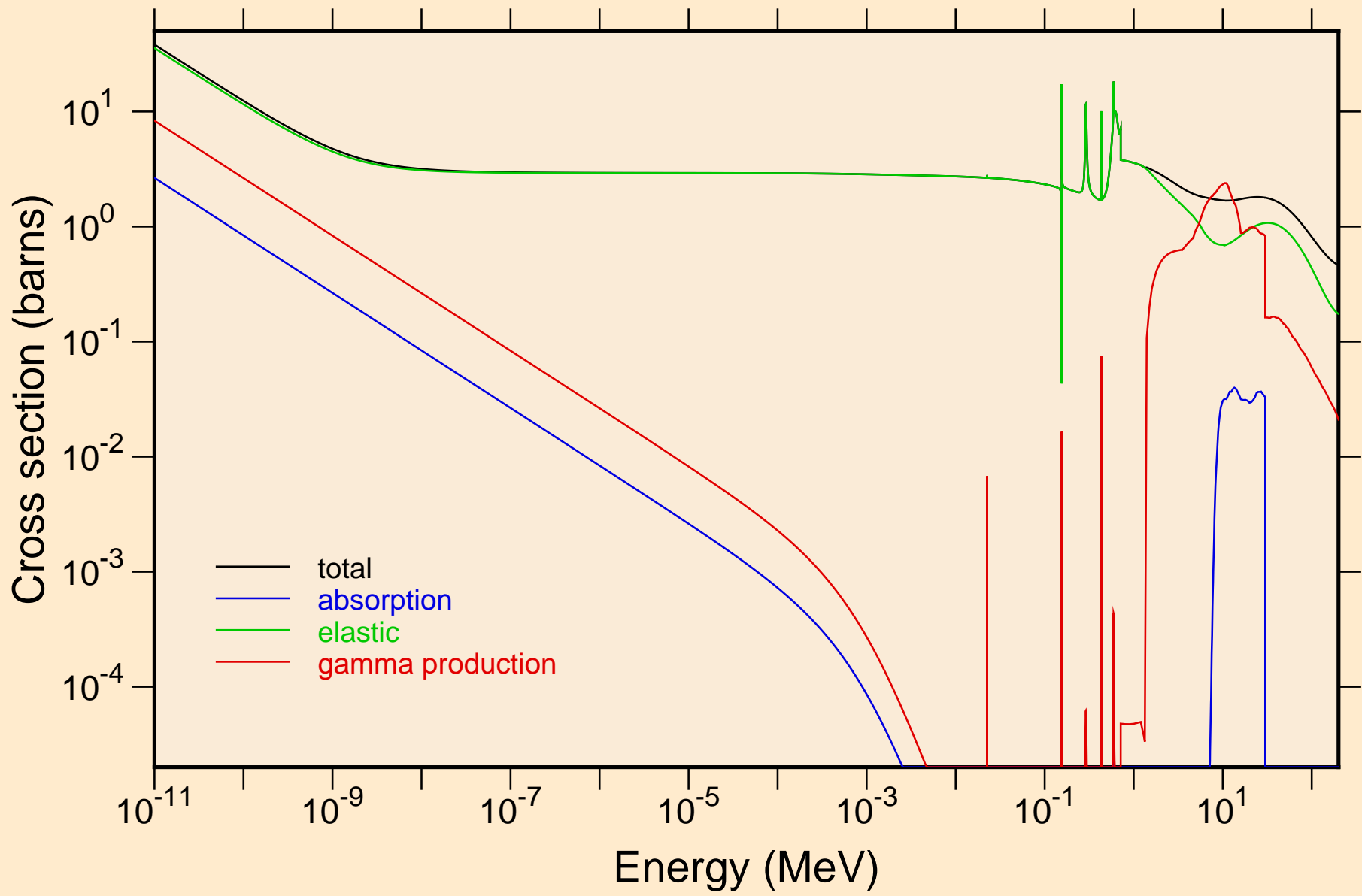

10-NE-22 FOR FENDL-3.2 FROM TENDL-2019 WITH NJOY2016.60  
resonance total cross section

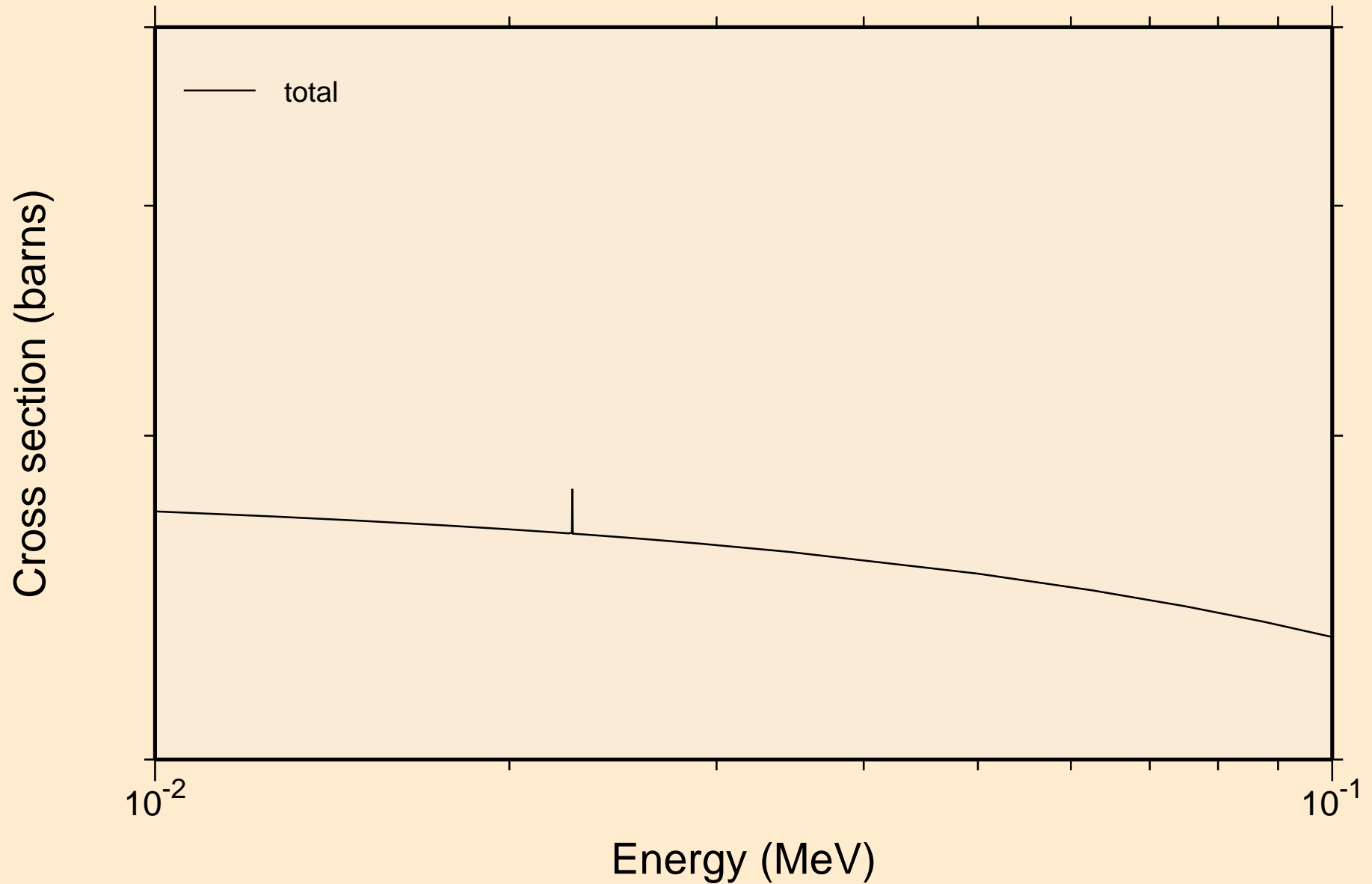

10-NE-22 FOR FENDL-3.2 FROM TENDL-2019 WITH NJOY2016.60  
resonance total cross section

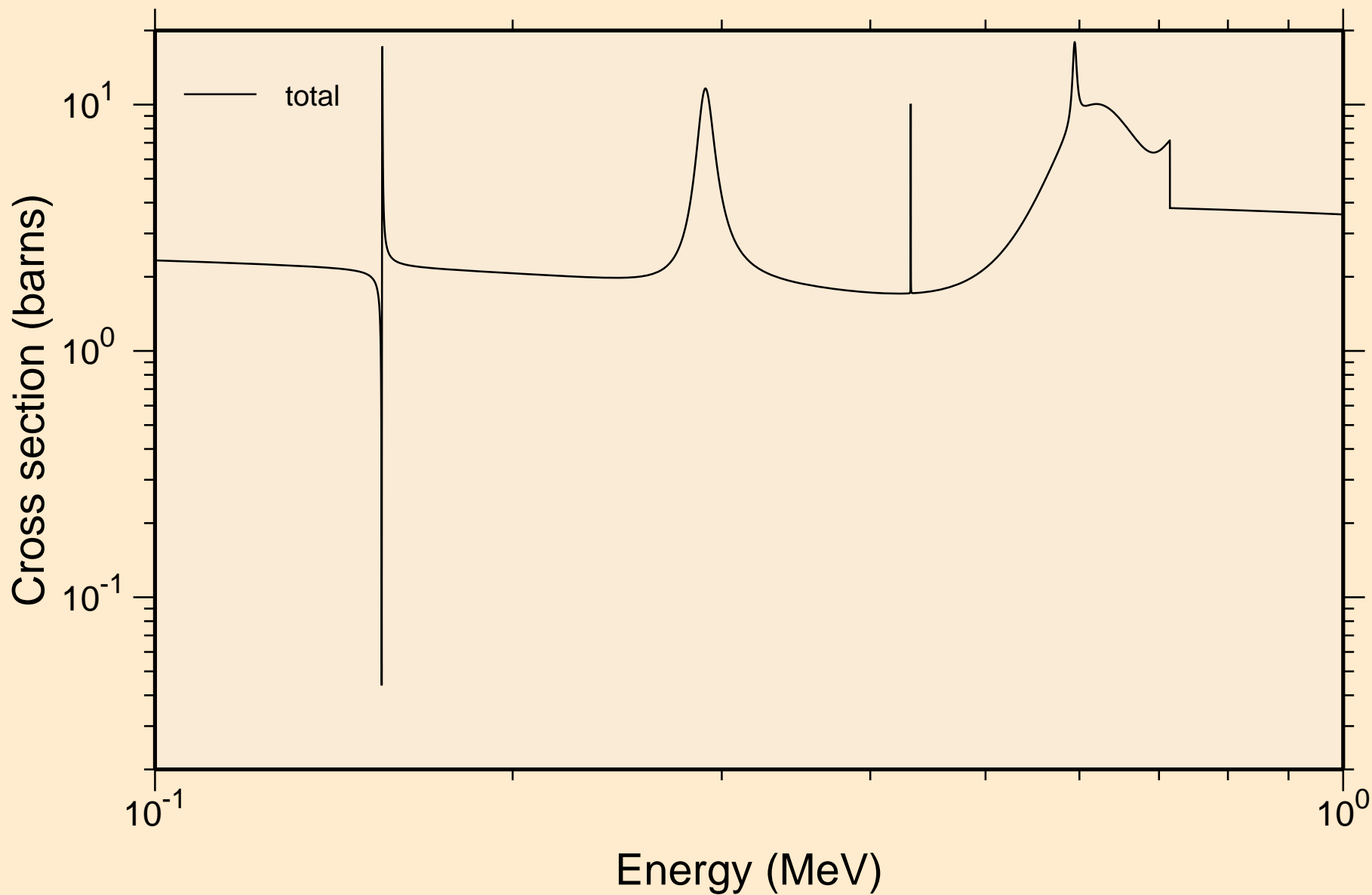

10-NE-22 FOR FENDL-3.2 FROM TENDL-2019 WITH NJOY2016.60  
resonance total cross section

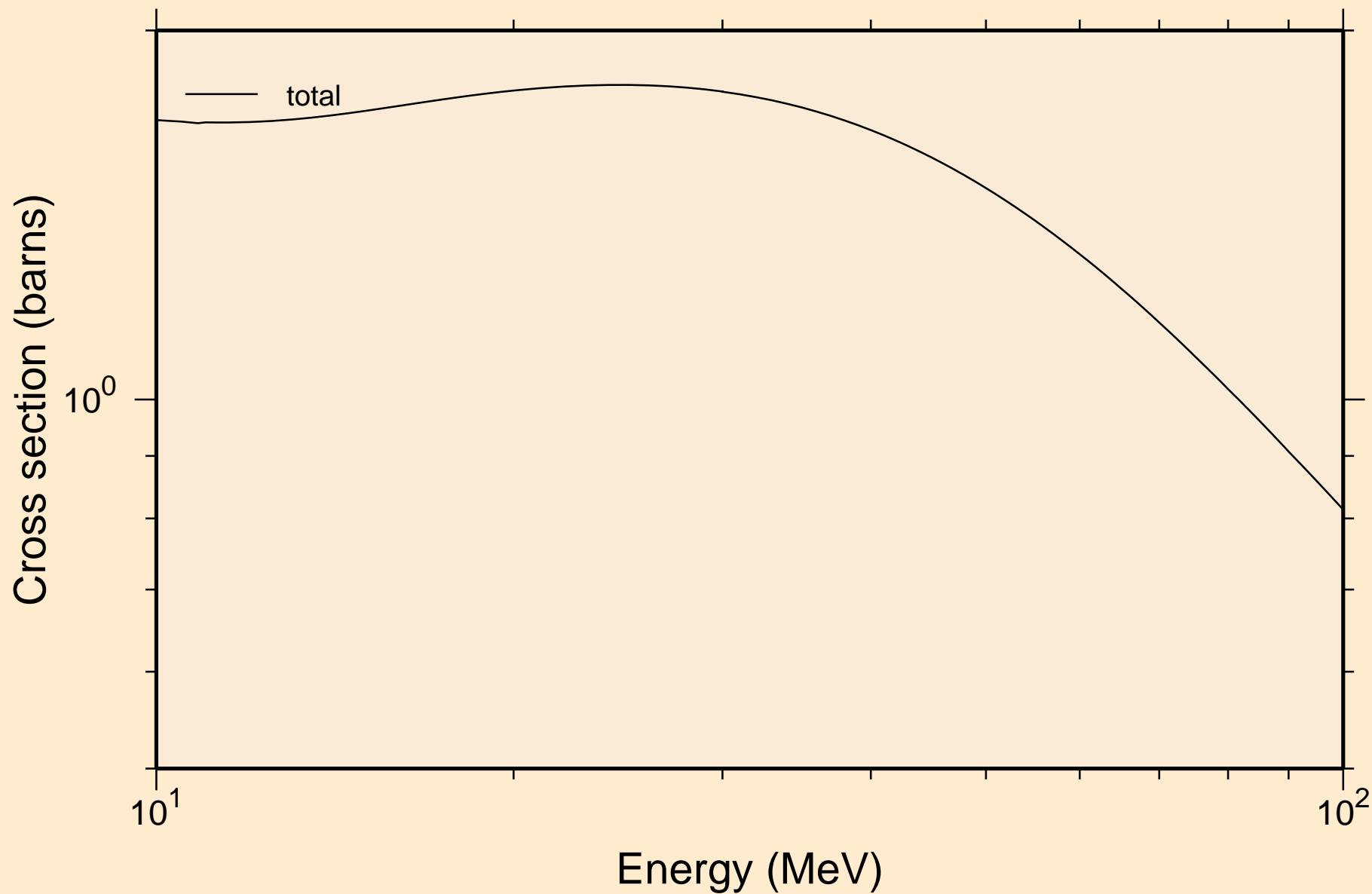

10-NE-22 FOR FENDL-3.2 FROM TENDL-2019 WITH NJOY2016.60  
resonance absorption cross sections

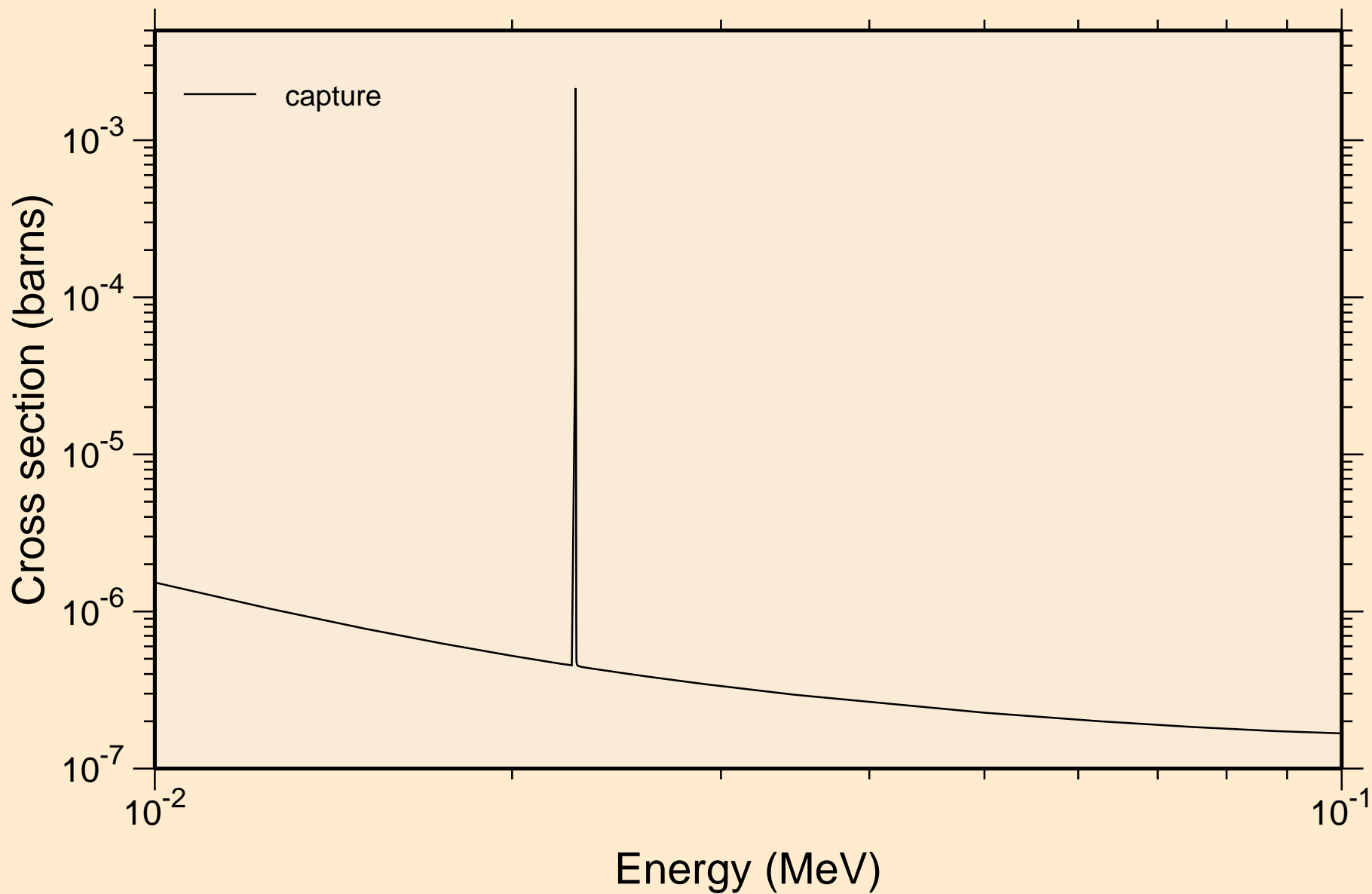

10-NE-22 FOR FENDL-3.2 FROM TENDL-2019 WITH NJOY2016.60  
resonance absorption cross sections

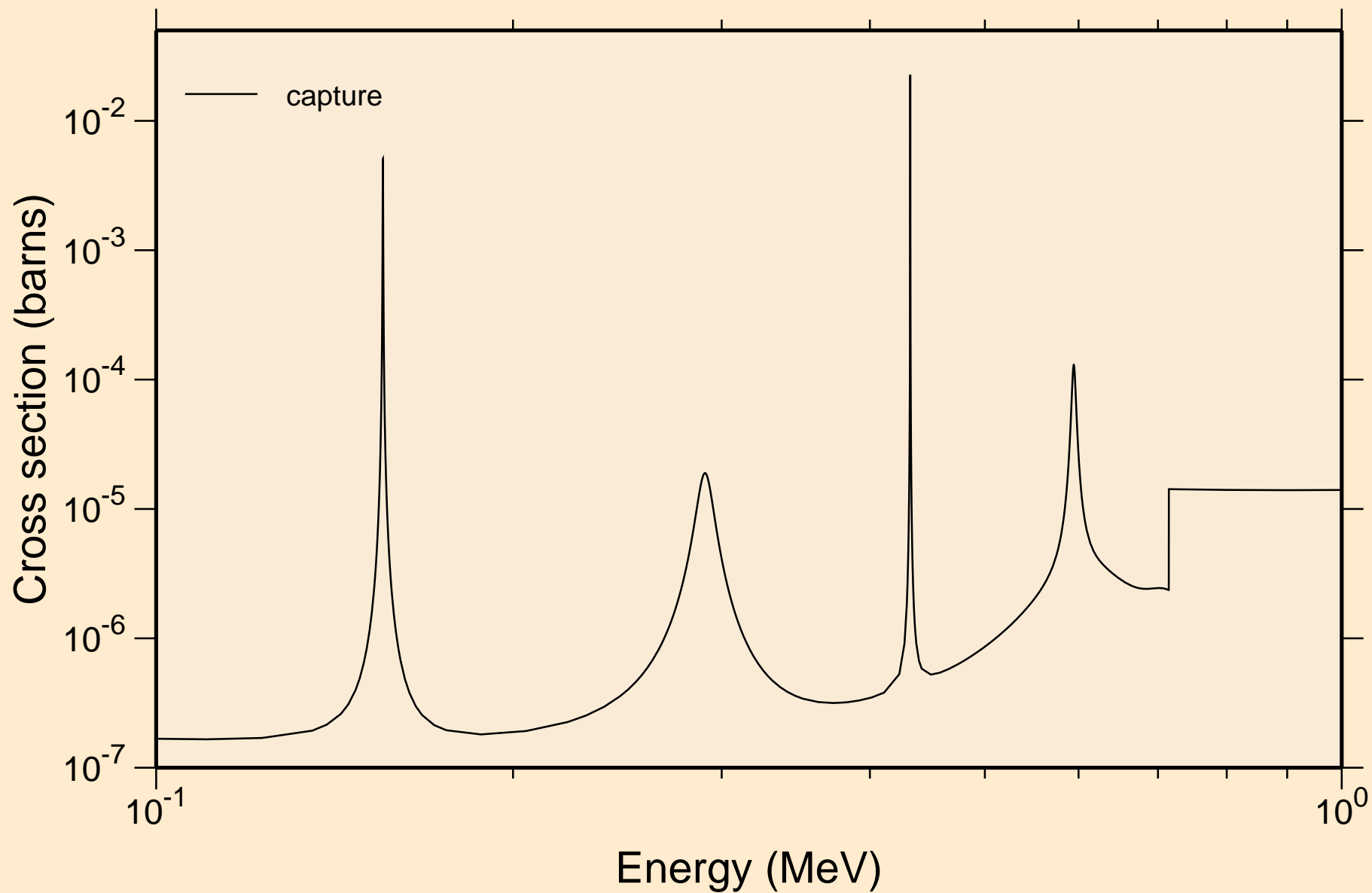

10-NE-22 FOR FENDL-3.2 FROM TENDL-2019 WITH NJOY2016.60  
resonance absorption cross sections

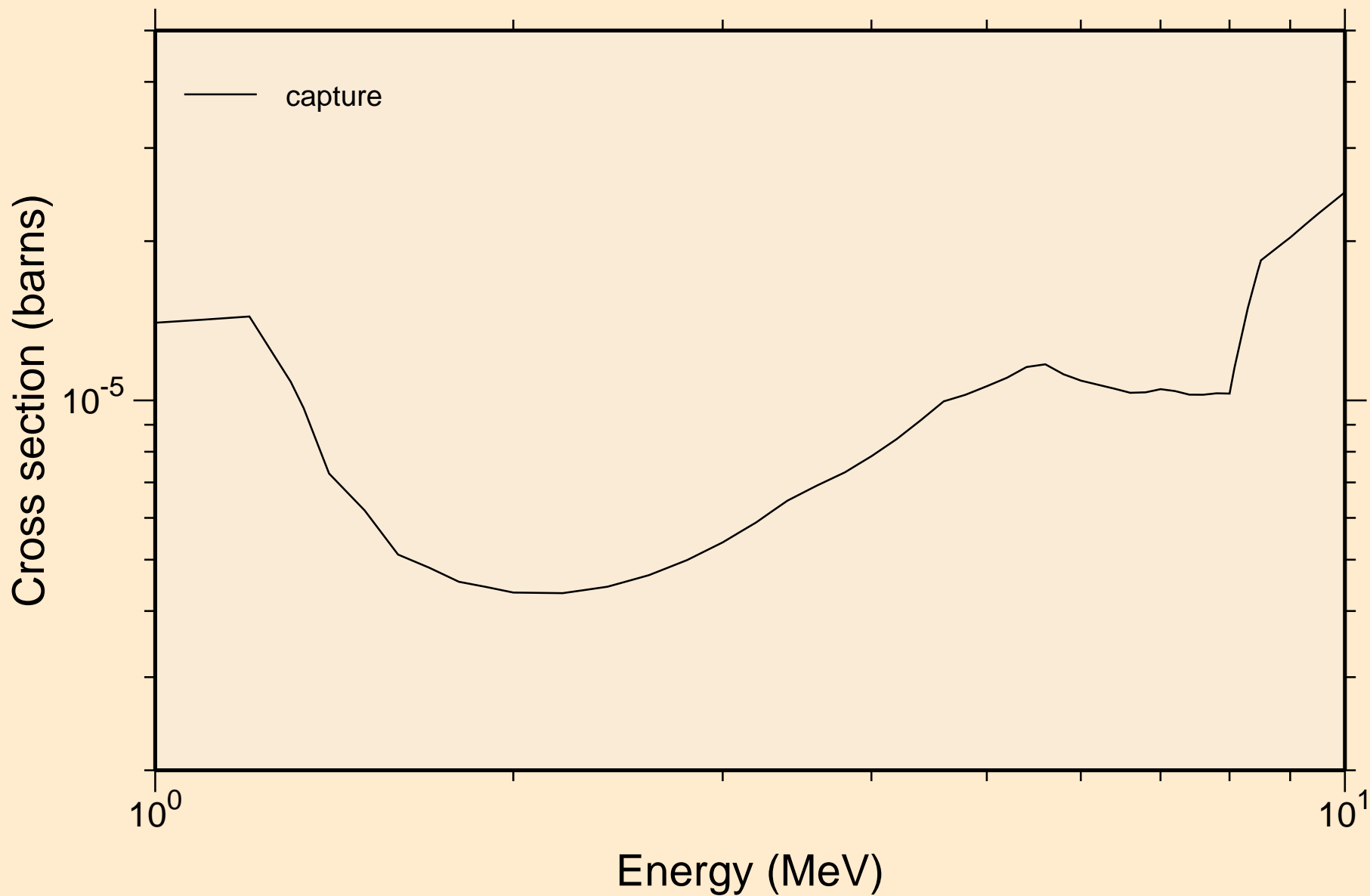

10-NE-22 FOR FENDL-3.2 FROM TENDL-2019 WITH NJOY2016.60  
UR total cross section

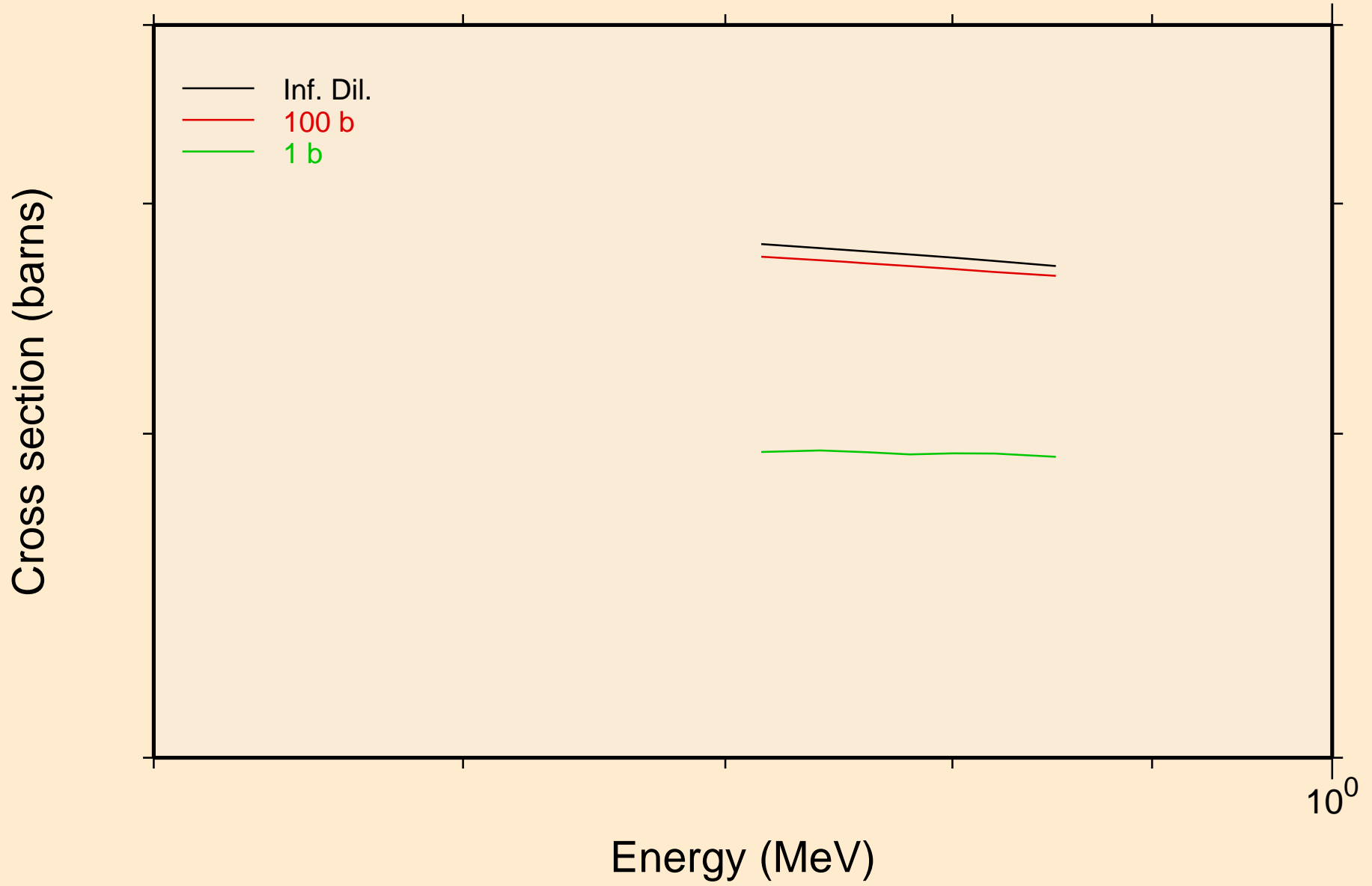



10-NE-22 FOR FENDL-3.2 FROM TENDL-2019 WITH NJOY2016.60  
UR elastic cross section

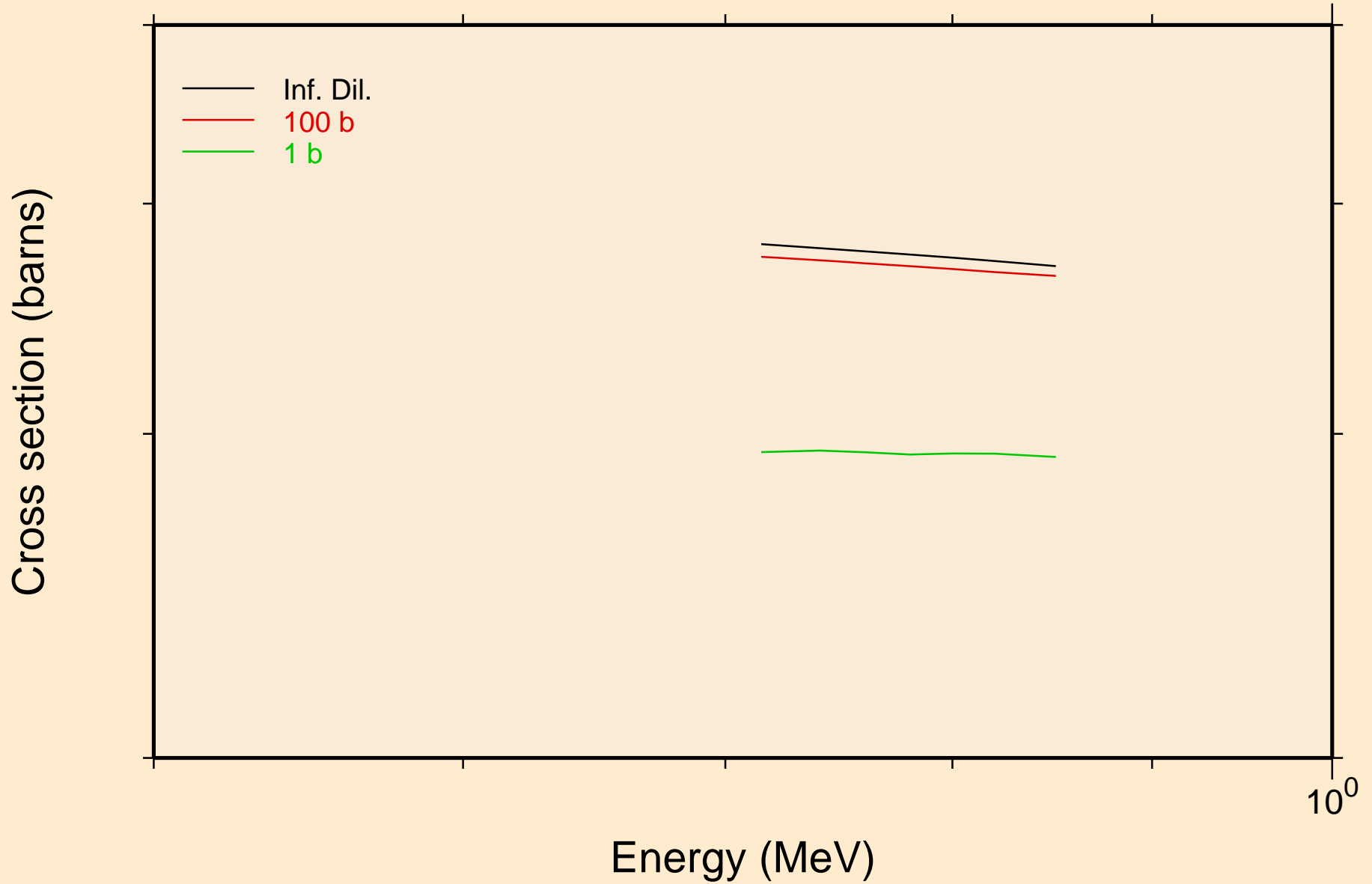

10-NE-22 FOR FENDL-3.2 FROM TENDL-2019 WITH NJOY2016.60  
UR capture cross section

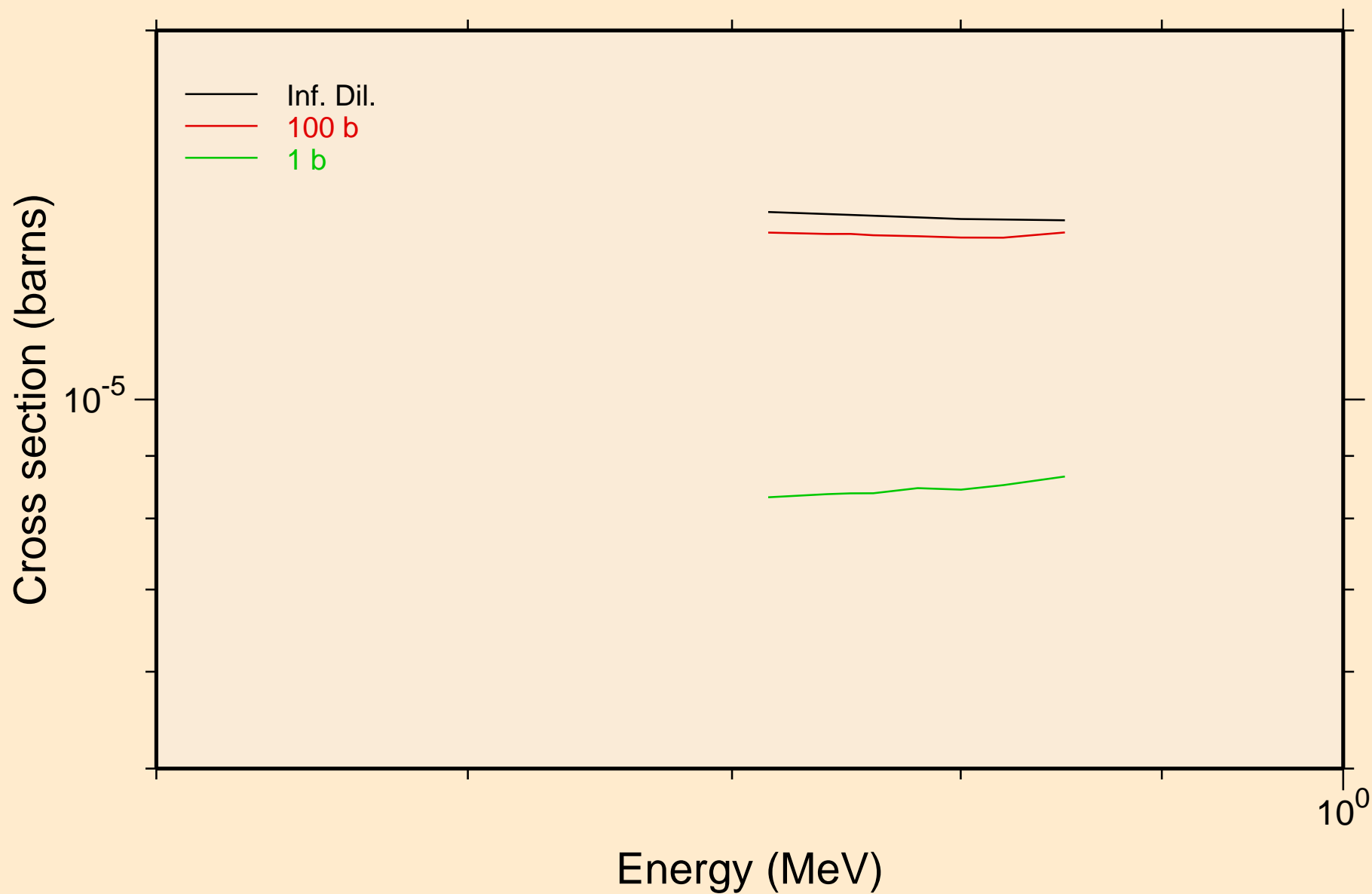

10-NE-22 FOR FENDL-3.2 FROM TENDL-2019 WITH NJOY2016.60  
Heating

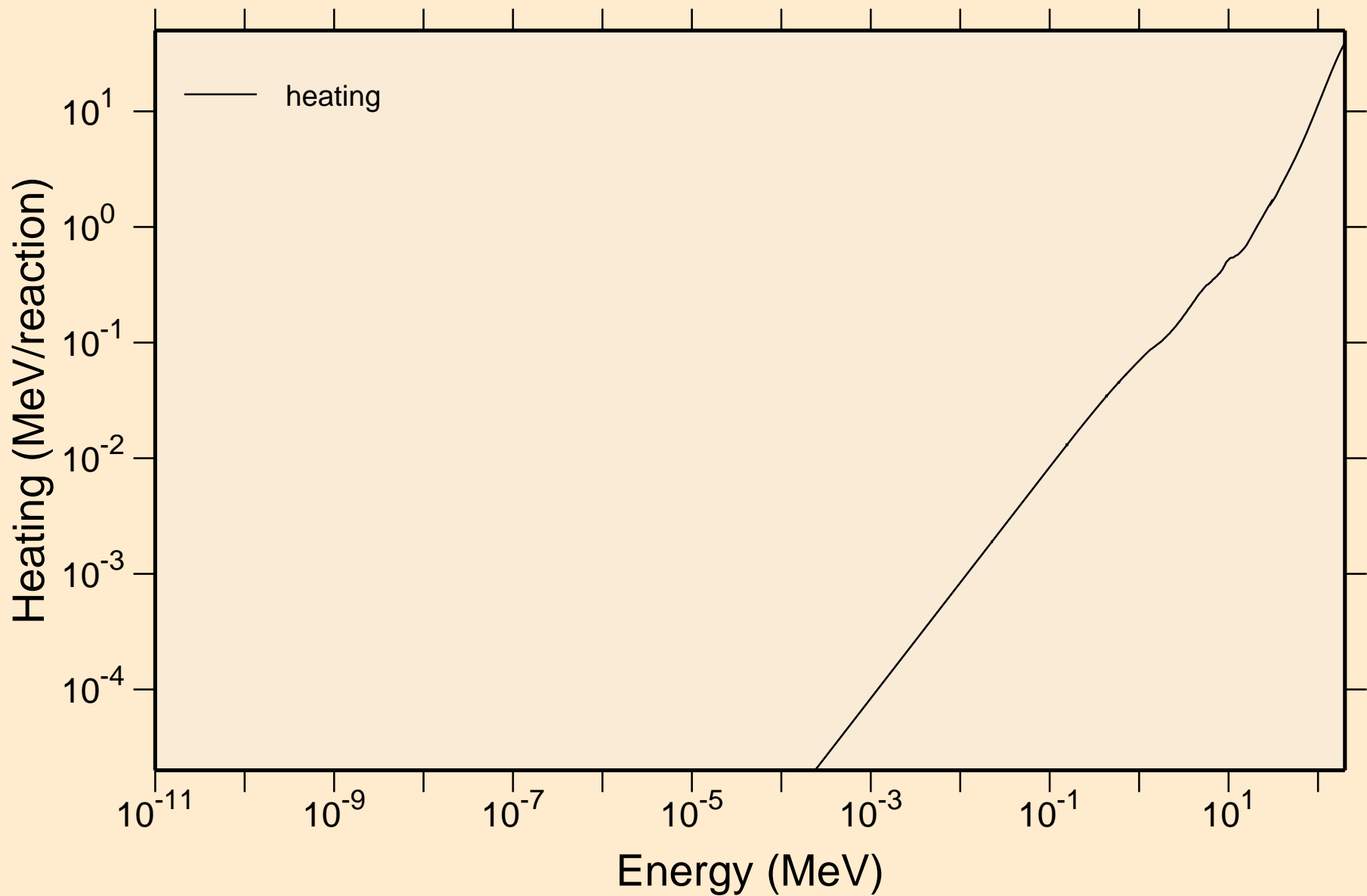

# 10-NE-22 FOR FENDL-3.2 FROM TENDL-2019 WITH NJOY2016.60

## Damage

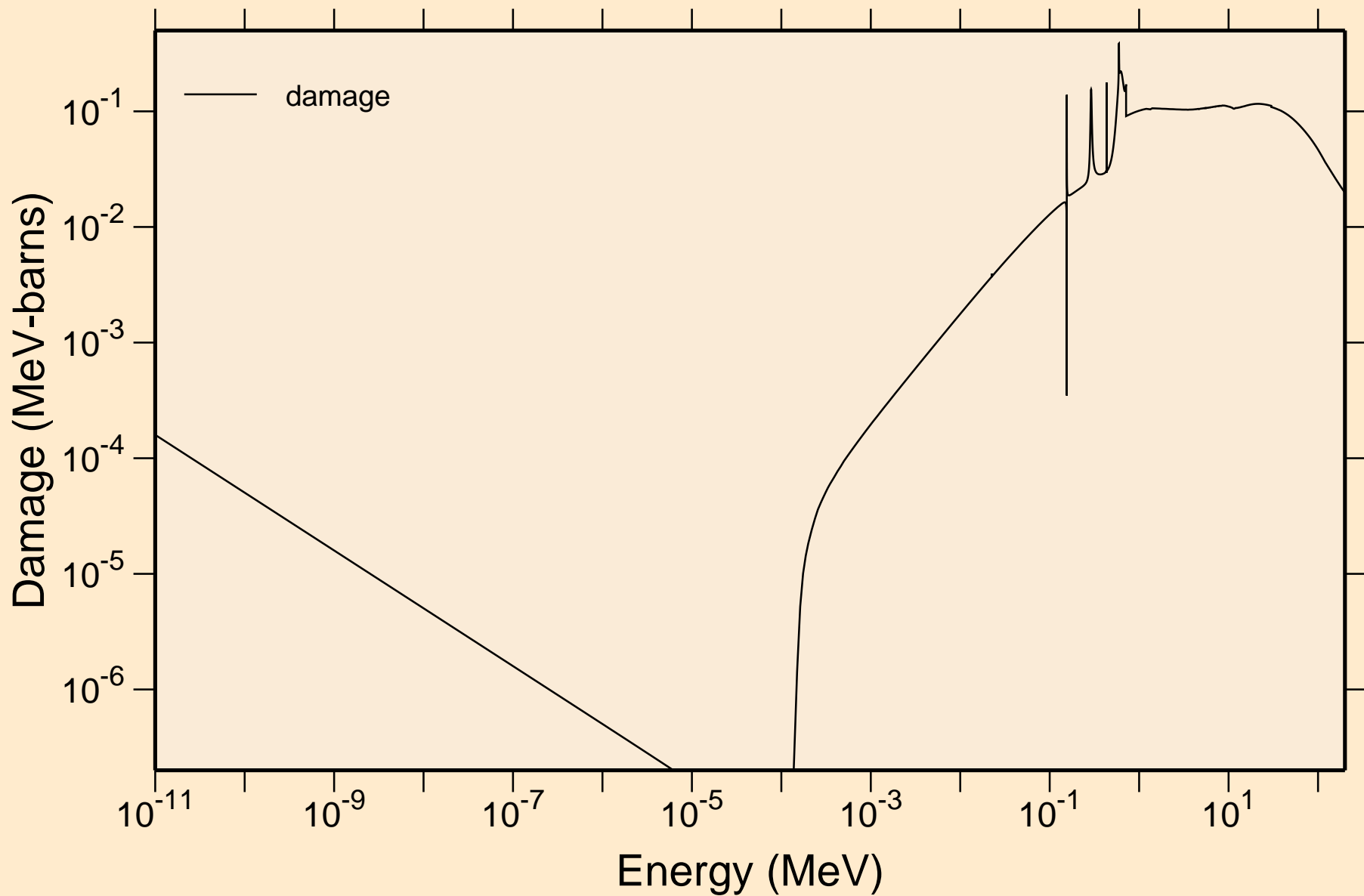

10-NE-22 FOR FENDL-3.2 FROM TENDL-2019 WITH NJOY2016.60  
Non-threshold reactions

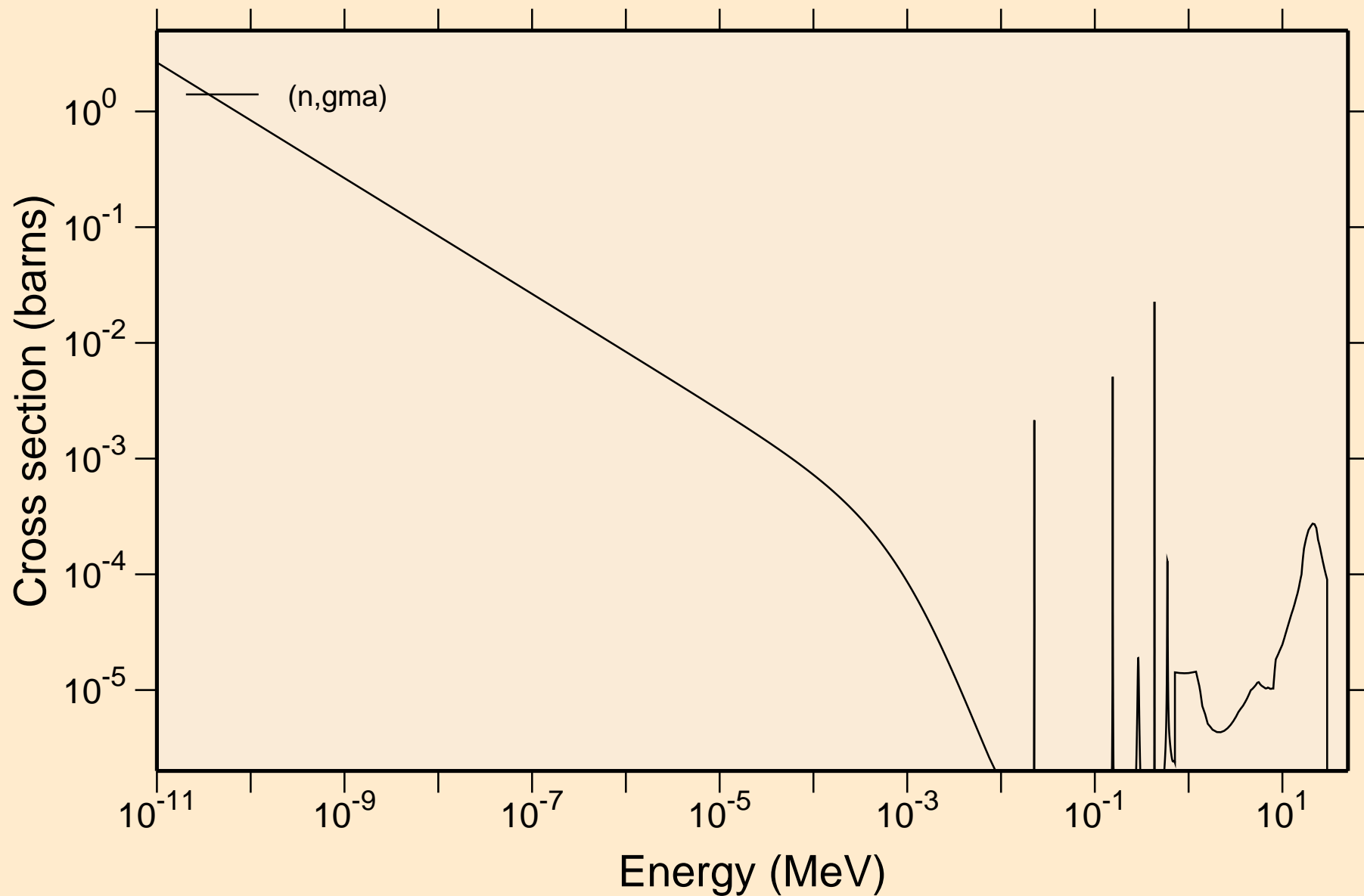

# 10-NE-22 FOR FENDL-3.2 FROM TENDL-2019 WITH NJOY2016.60

## Principal cross sections

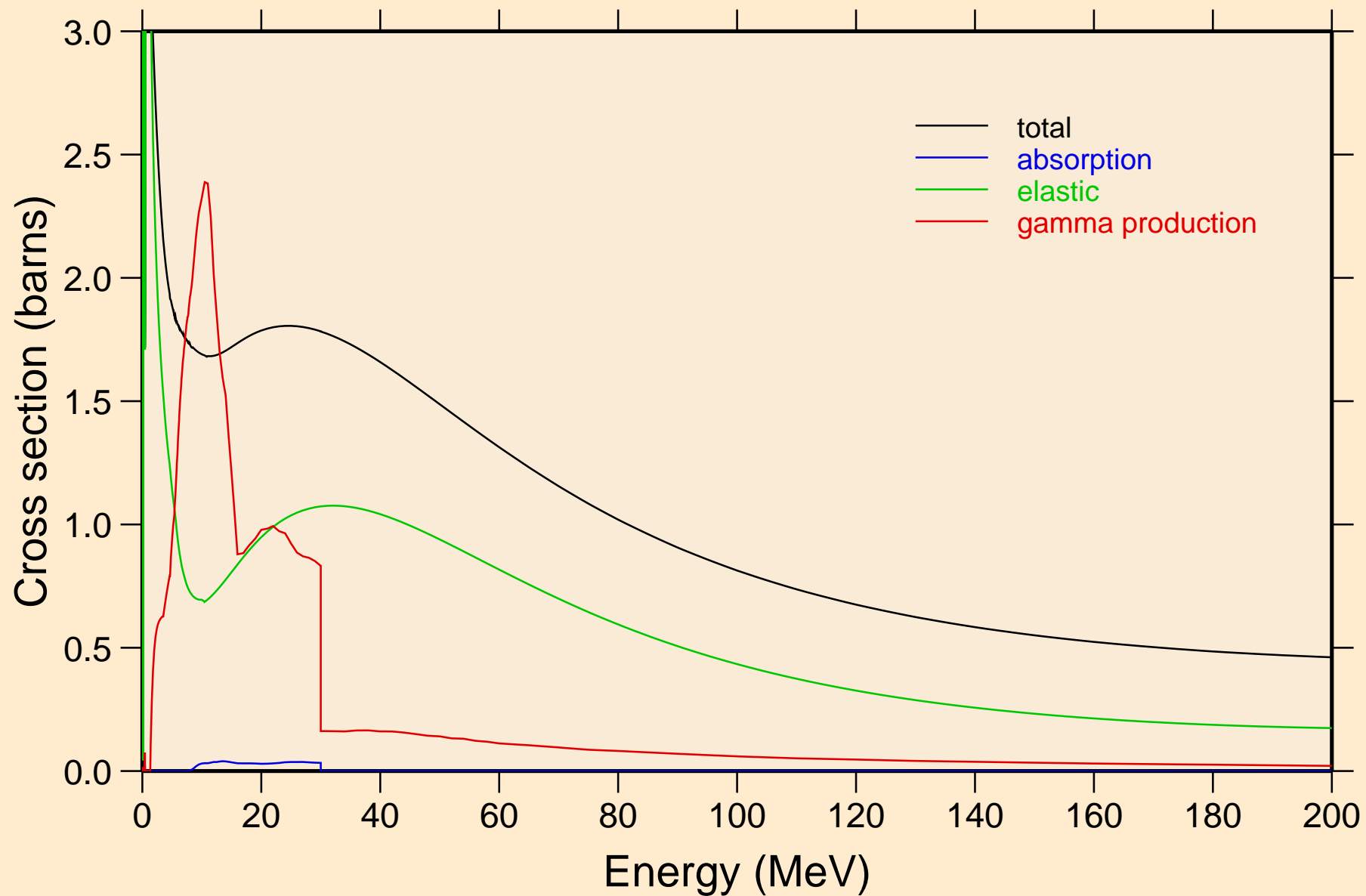

10-NE-22 FOR FENDL-3.2 FROM TENDL-2019 WITH NJOY2016.60  
Heating

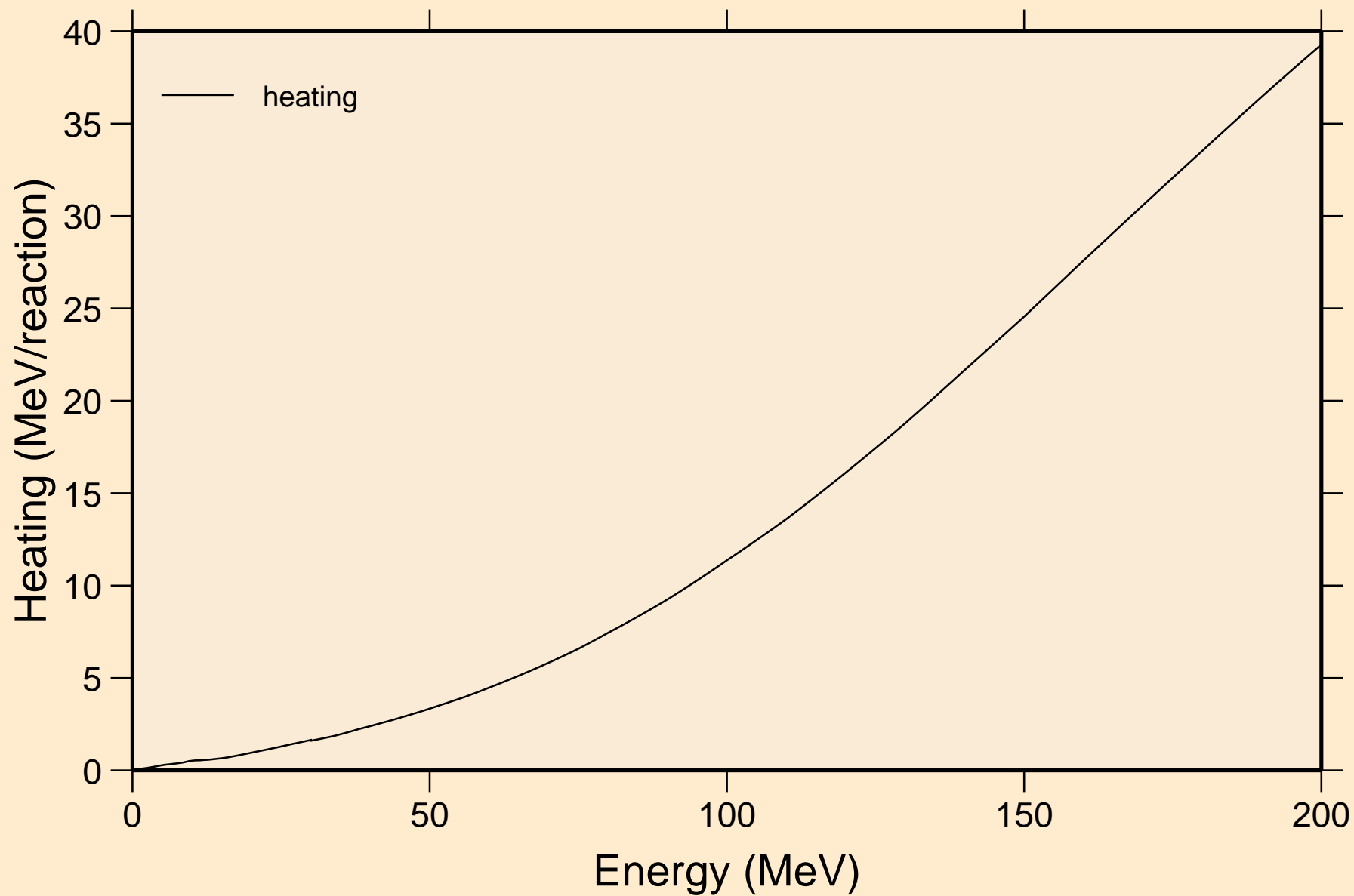

10-NE-22 FOR FENDL-3.2 FROM TENDL-2019 WITH NJOY2016.60  
Damage

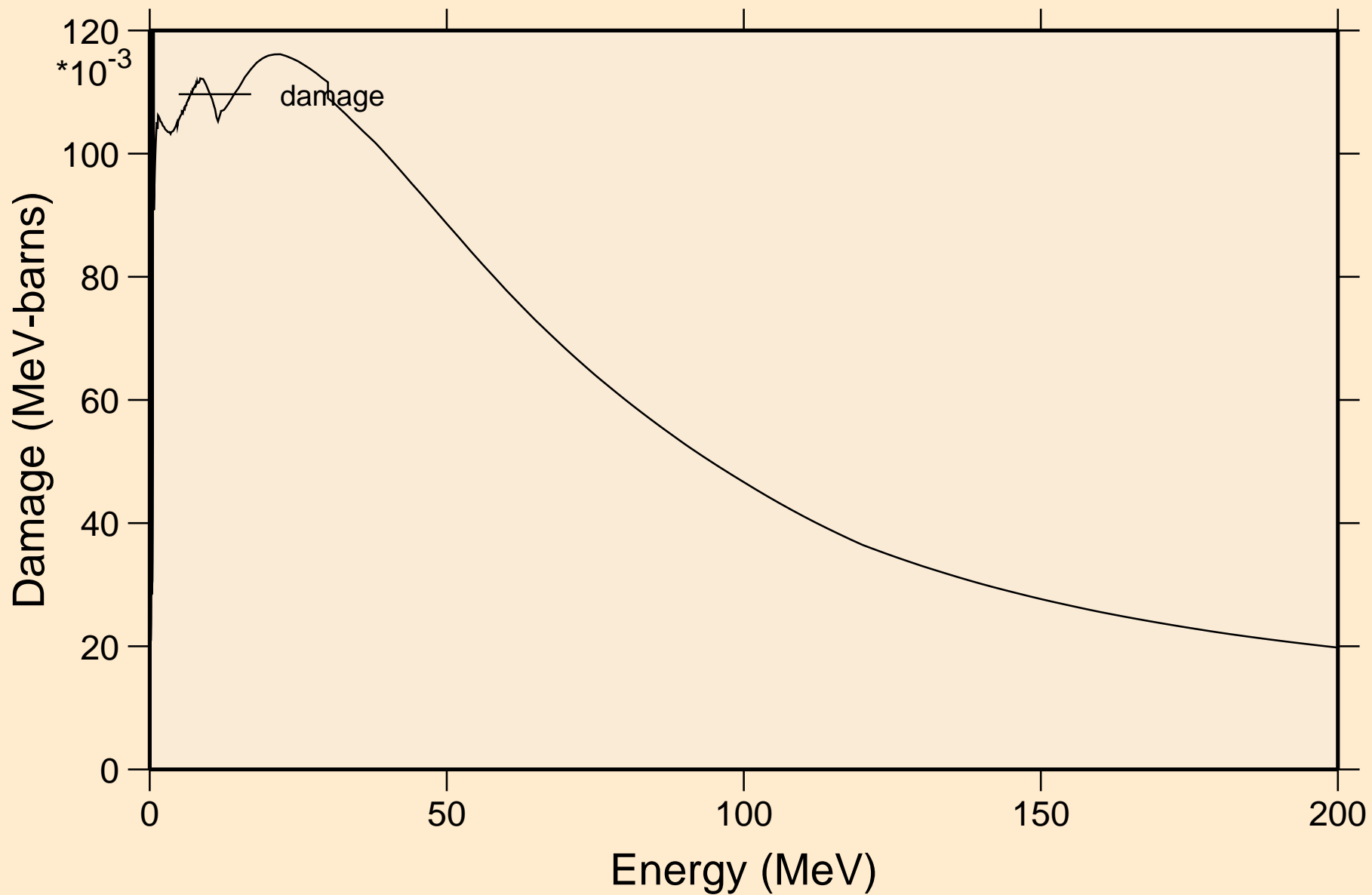



10-NE-22 FOR FENDL-3.2 FROM TENDL-2019 WITH NJOY2016.60  
Non-threshold reactions

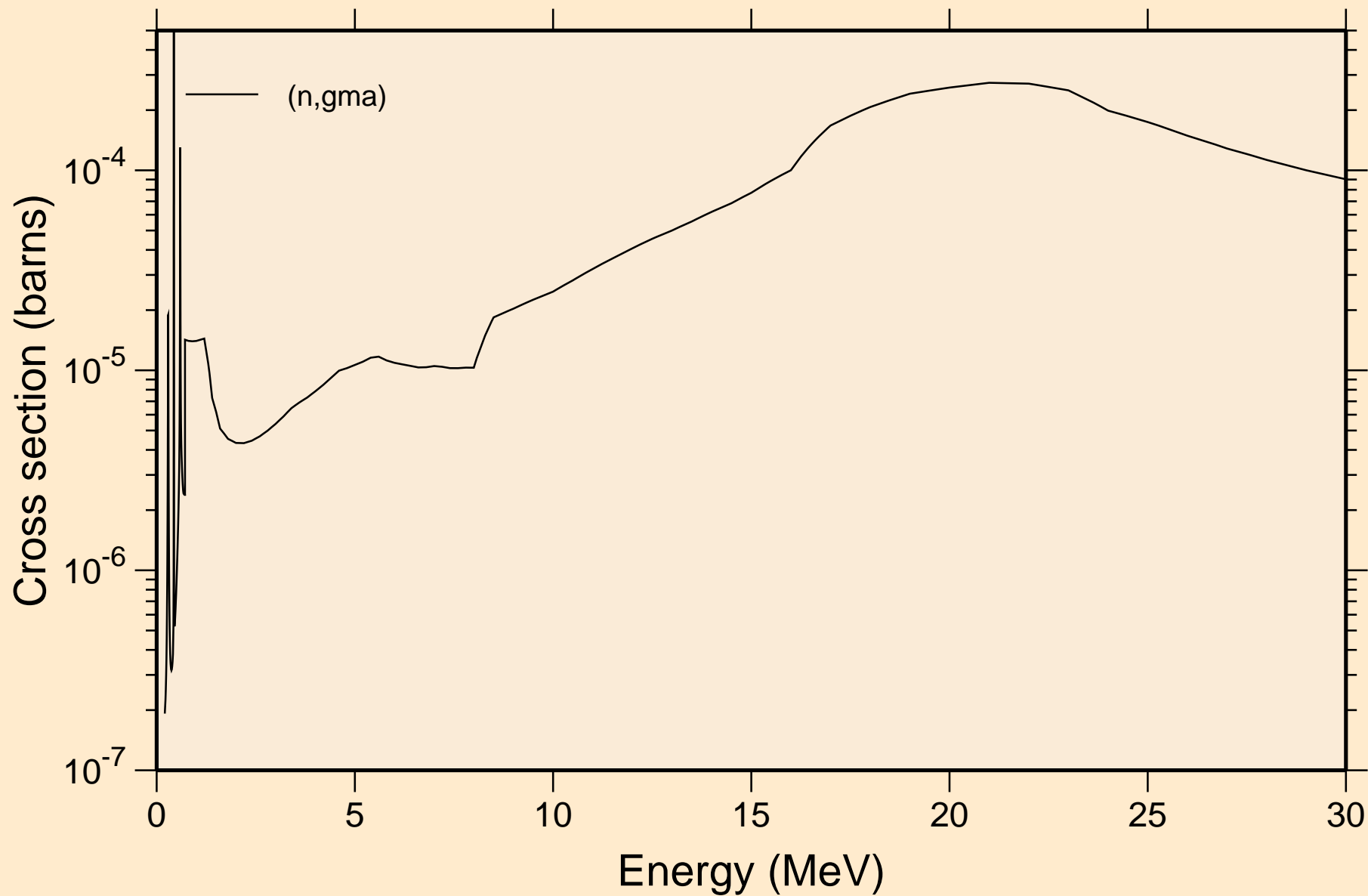

10-NE-22 FOR FENDL-3.2 FROM TENDL-2019 WITH NJOY2016.60  
Inelastic levels

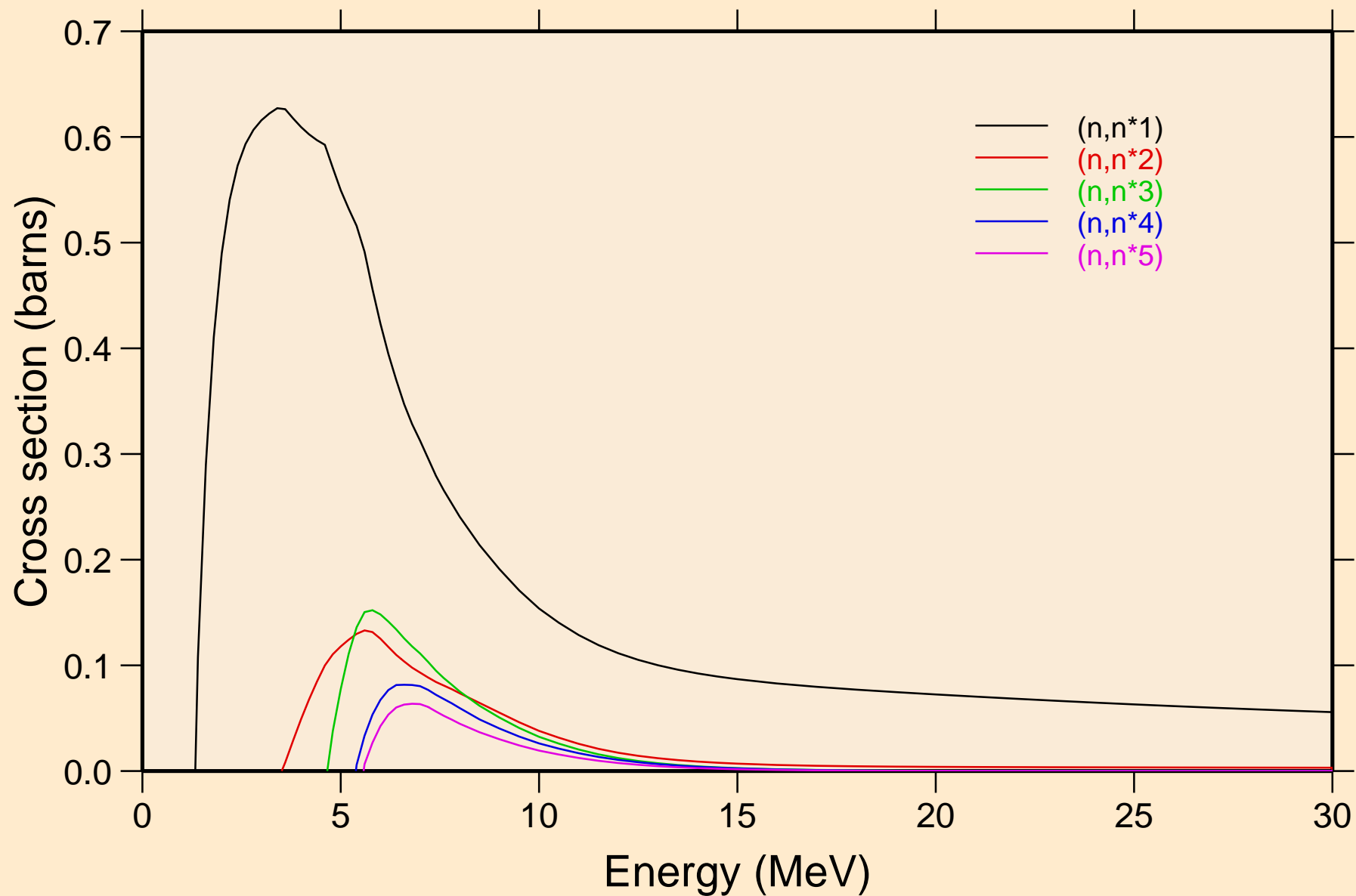

# 10-NE-22 FOR FENDL-3.2 FROM TENDL-2019 WITH NJOY2016.60

## Inelastic levels

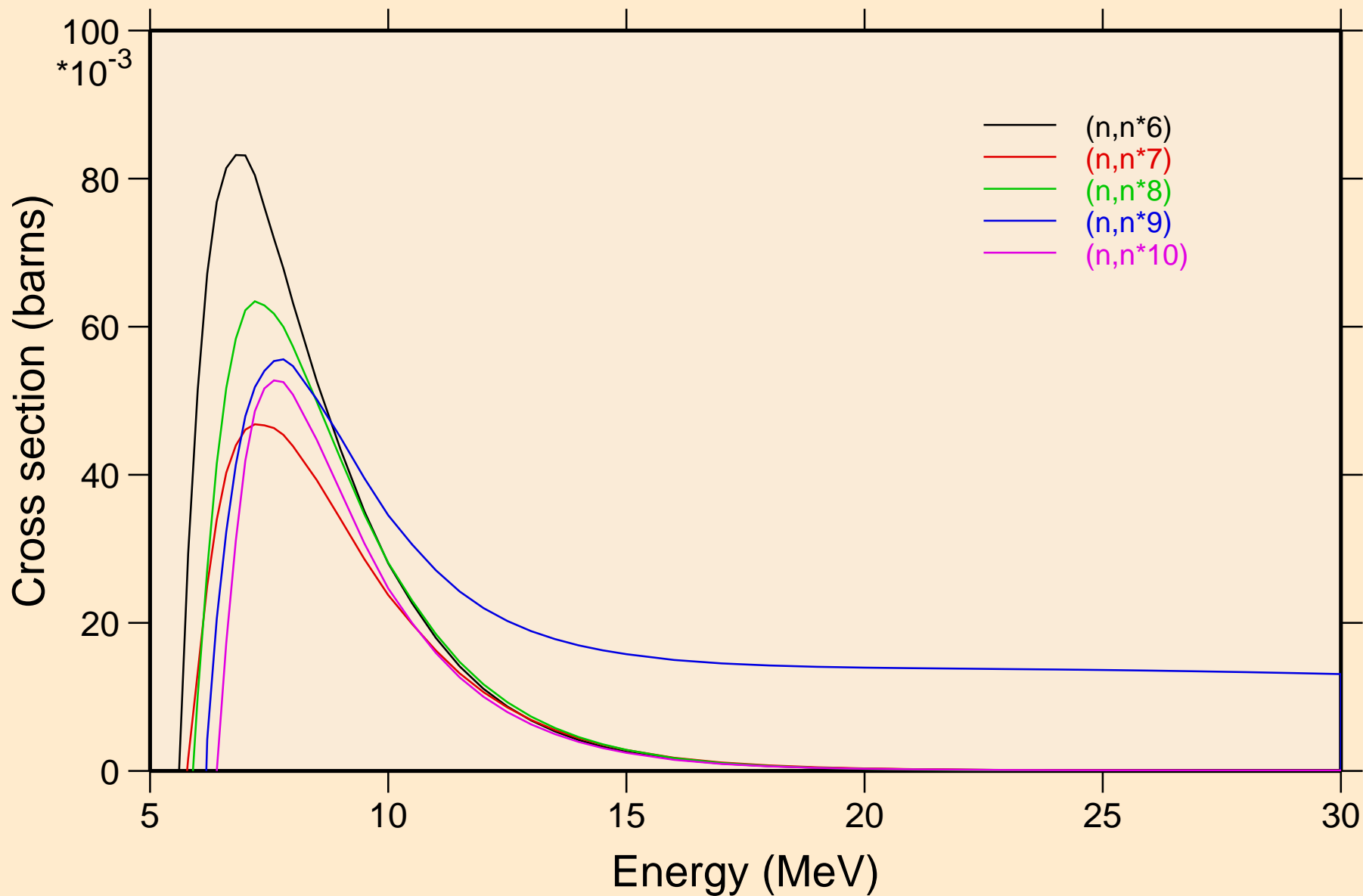

# 10-NE-22 FOR FENDL-3.2 FROM TENDL-2019 WITH NJOY2016.60

## Inelastic levels

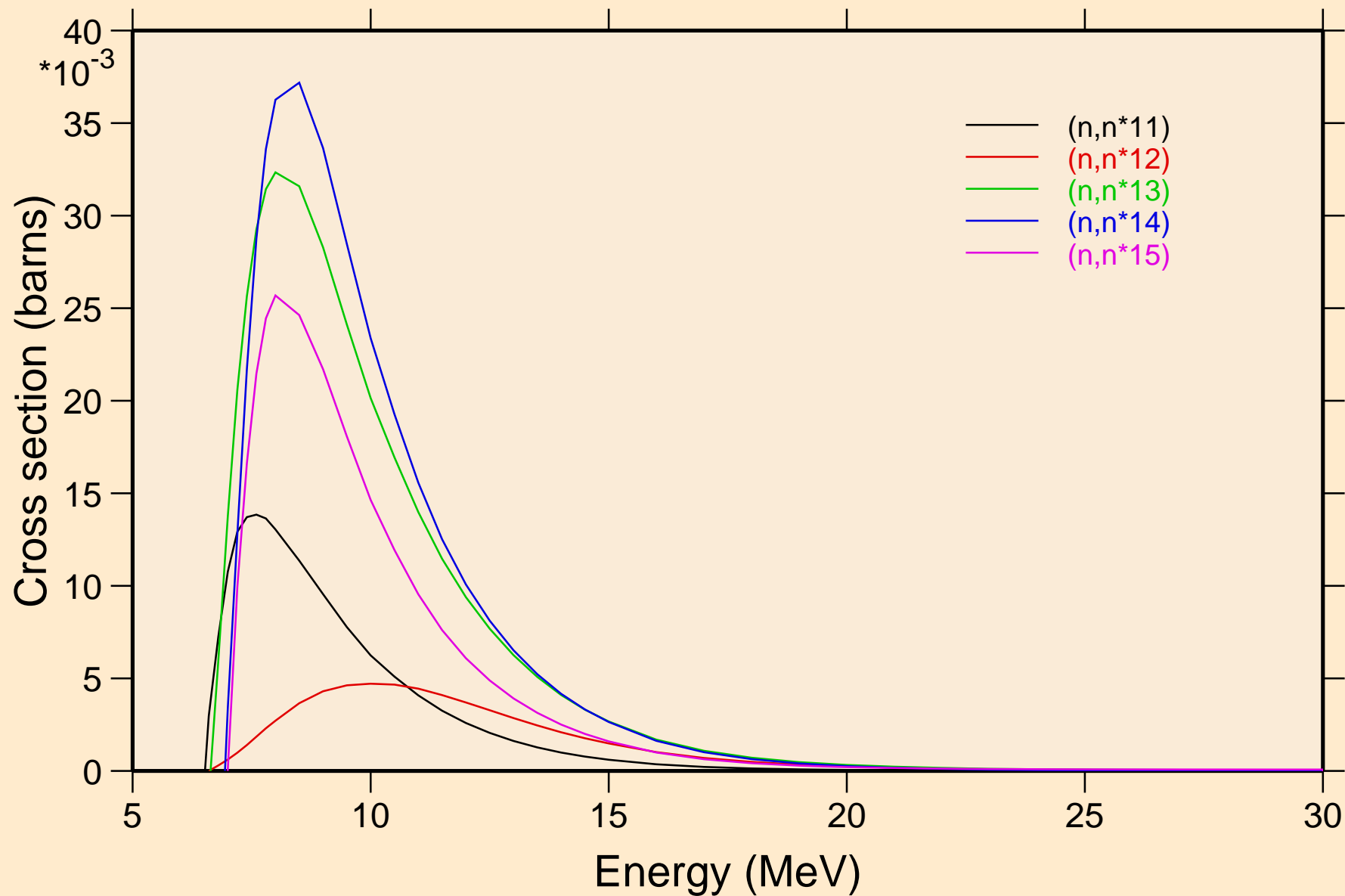

# 10-NE-22 FOR FENDL-3.2 FROM TENDL-2019 WITH NJOY2016.60

## Inelastic levels

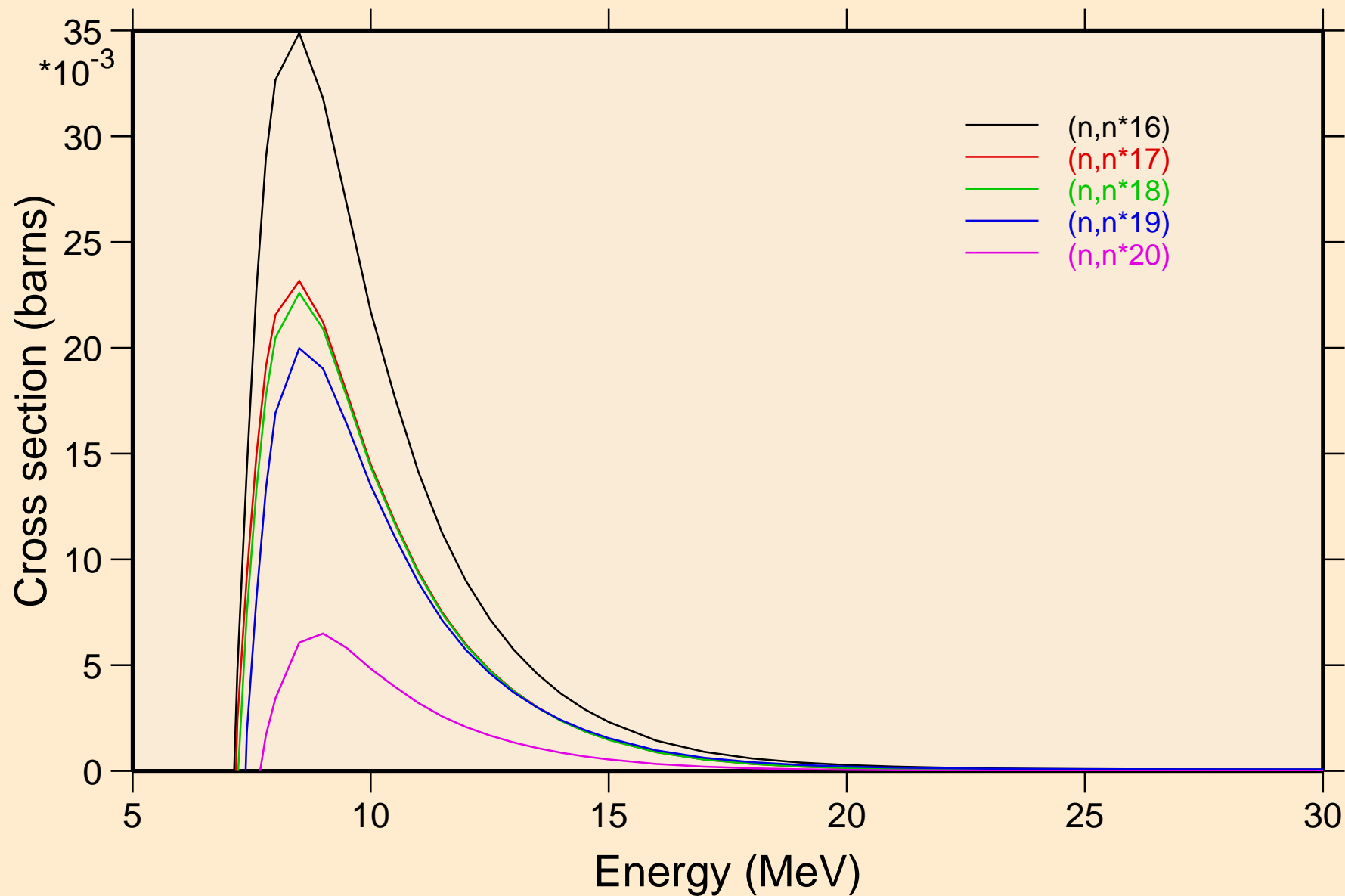

10-NE-22 FOR FENDL-3.2 FROM TENDL-2019 WITH NJOY2016.60  
Inelastic levels

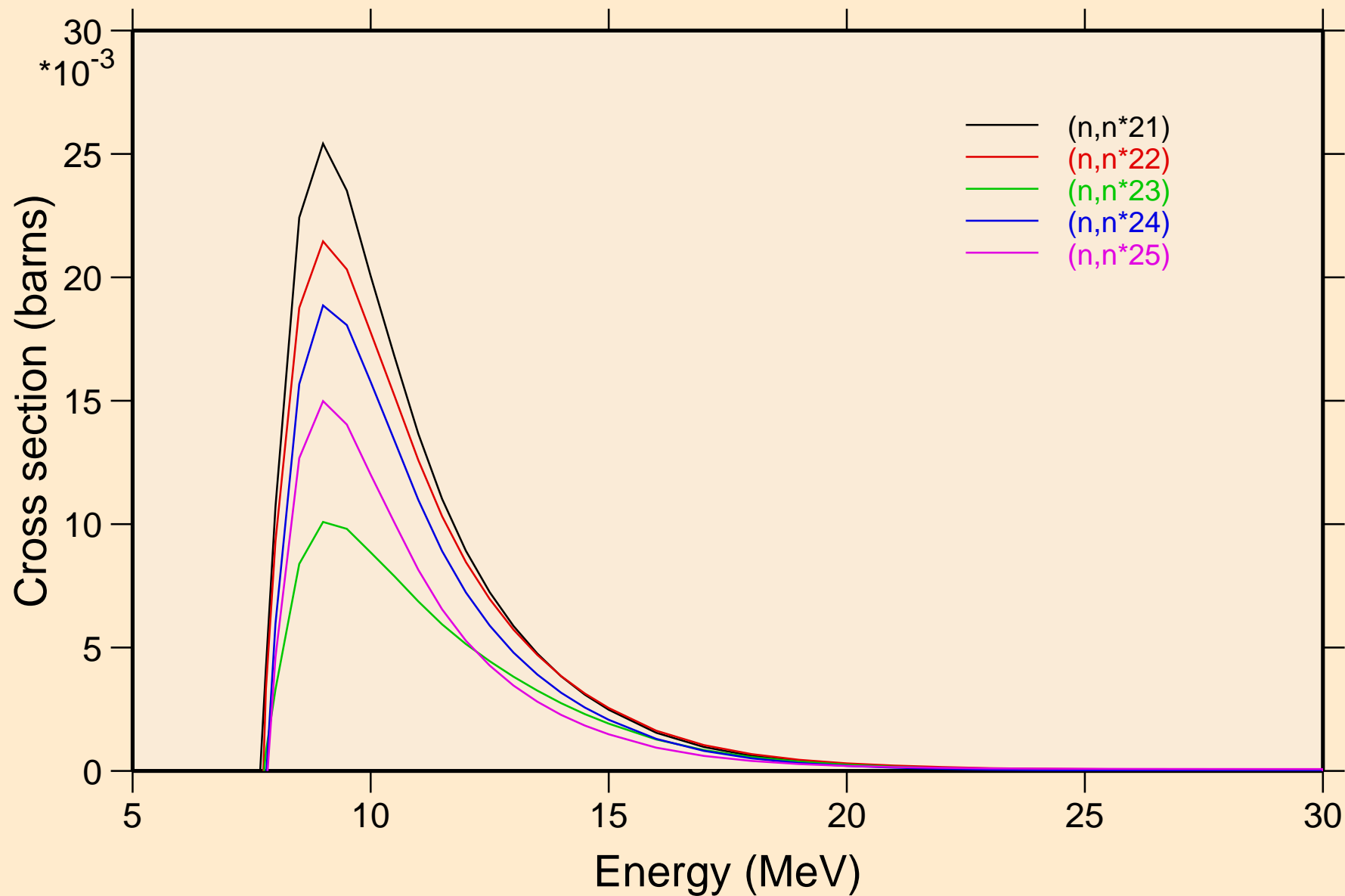

10-NE-22 FOR FENDL-3.2 FROM TENDL-2019 WITH NJOY2016.60  
Inelastic levels

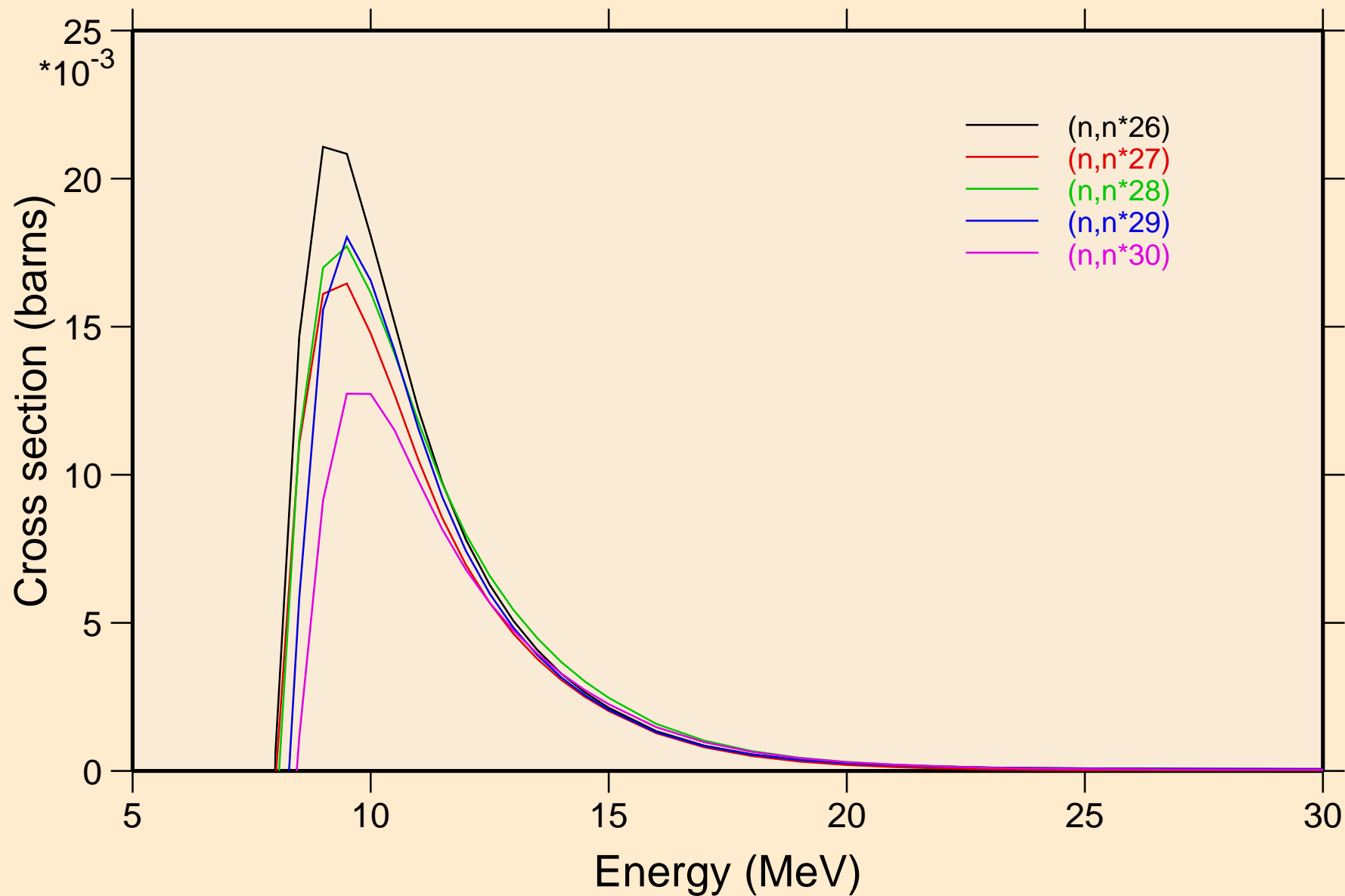

# 10-NE-22 FOR FENDL-3.2 FROM TENDL-2019 WITH NJOY2016.60

## Threshold reactions

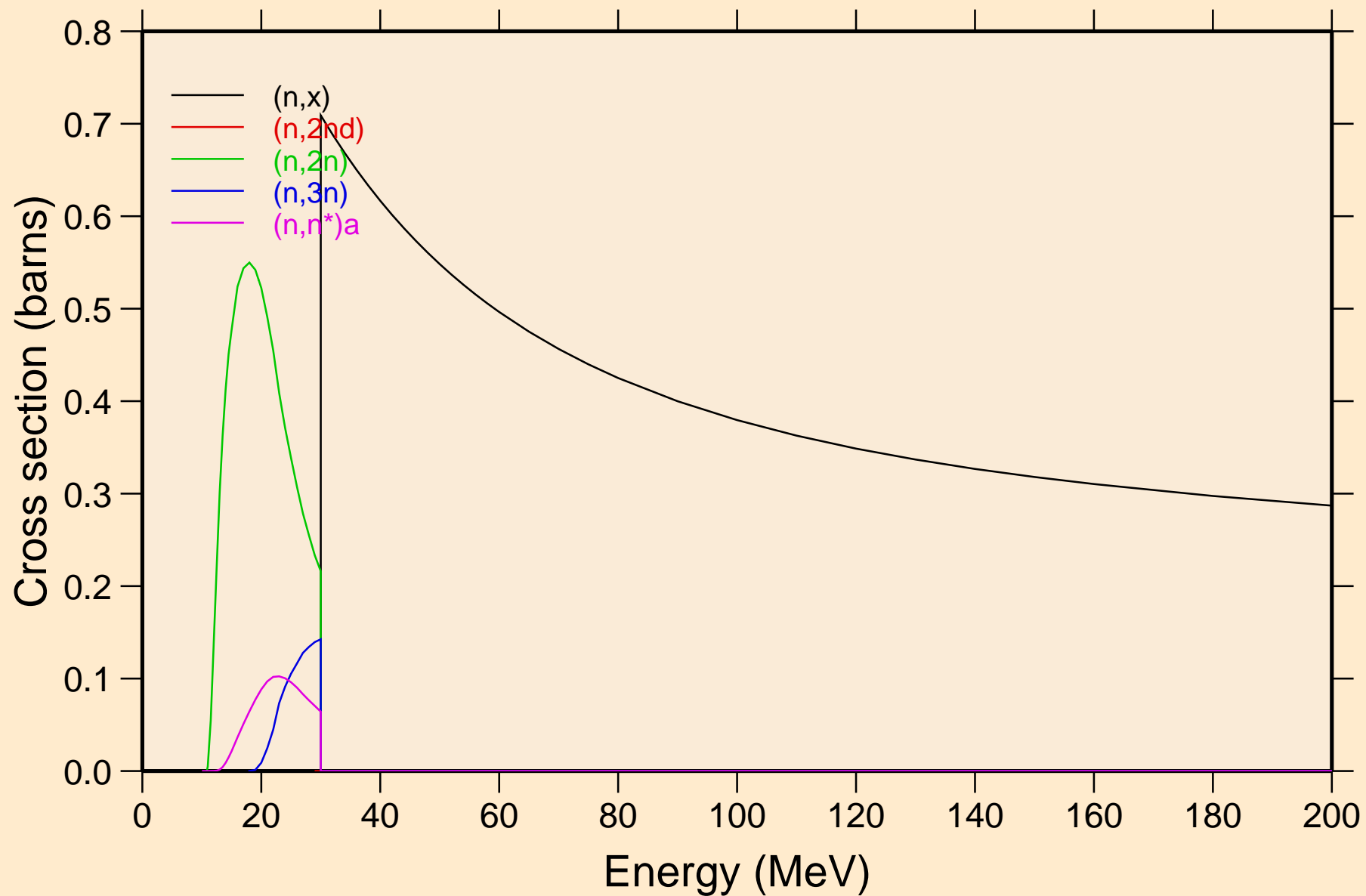



# 10-NE-22 FOR FENDL-3.2 FROM TENDL-2019 WITH NJOY2016.60

## Threshold reactions

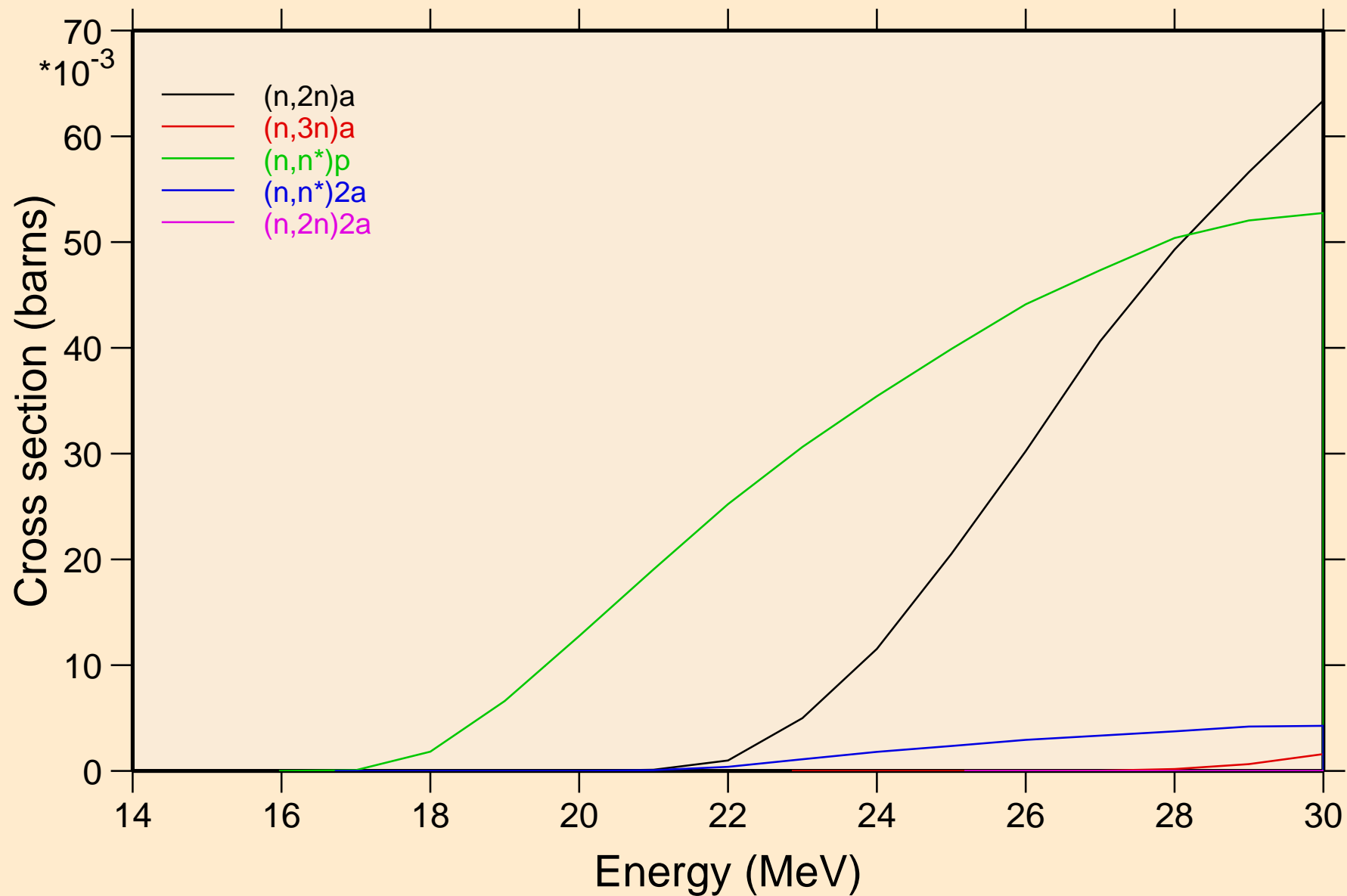

10-NE-22 FOR FENDL-3.2 FROM TENDL-2019 WITH NJOY2016.60  
Threshold reactions

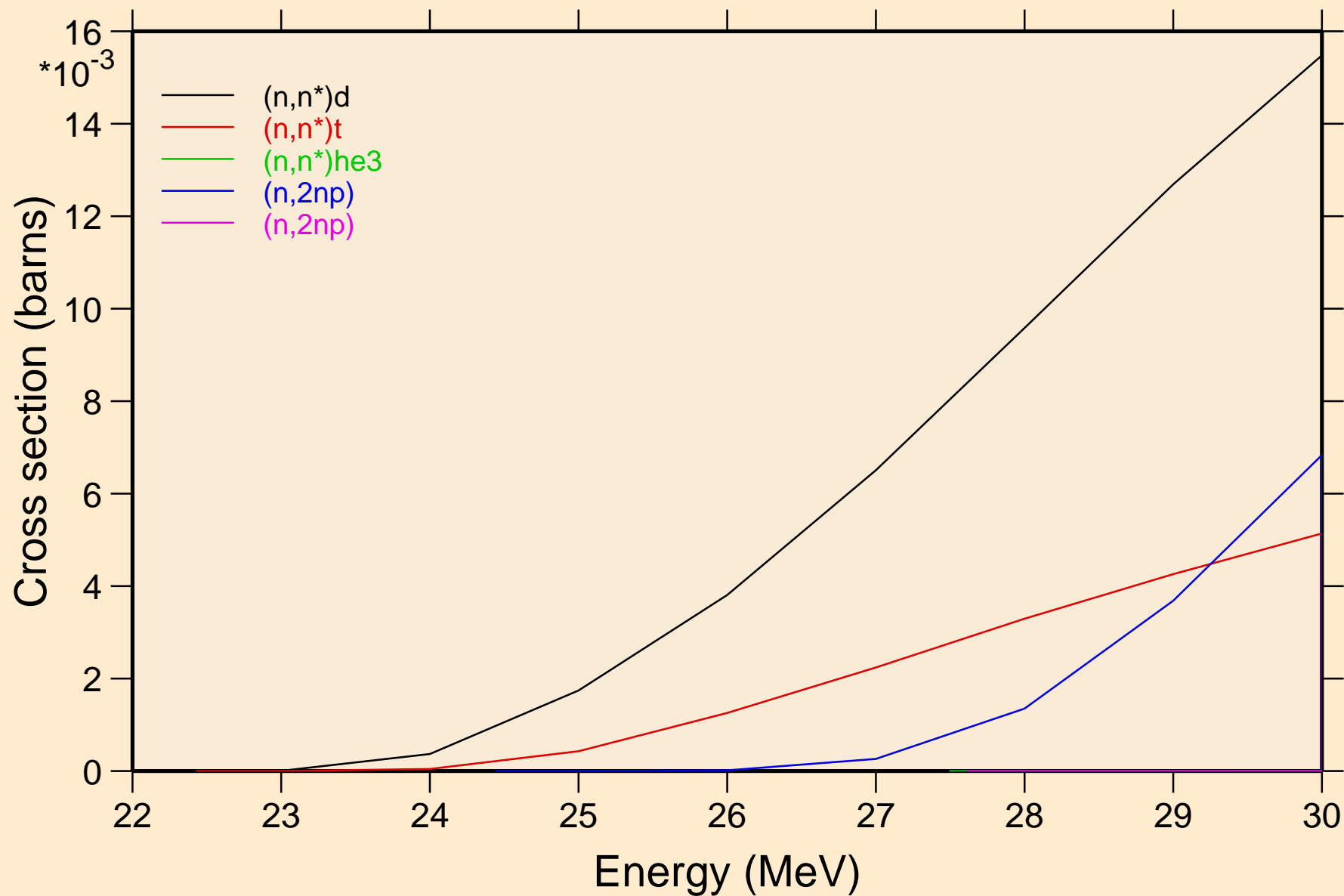

# 10-NE-22 FOR FENDL-3.2 FROM TENDL-2019 WITH NJOY2016.60

## Threshold reactions

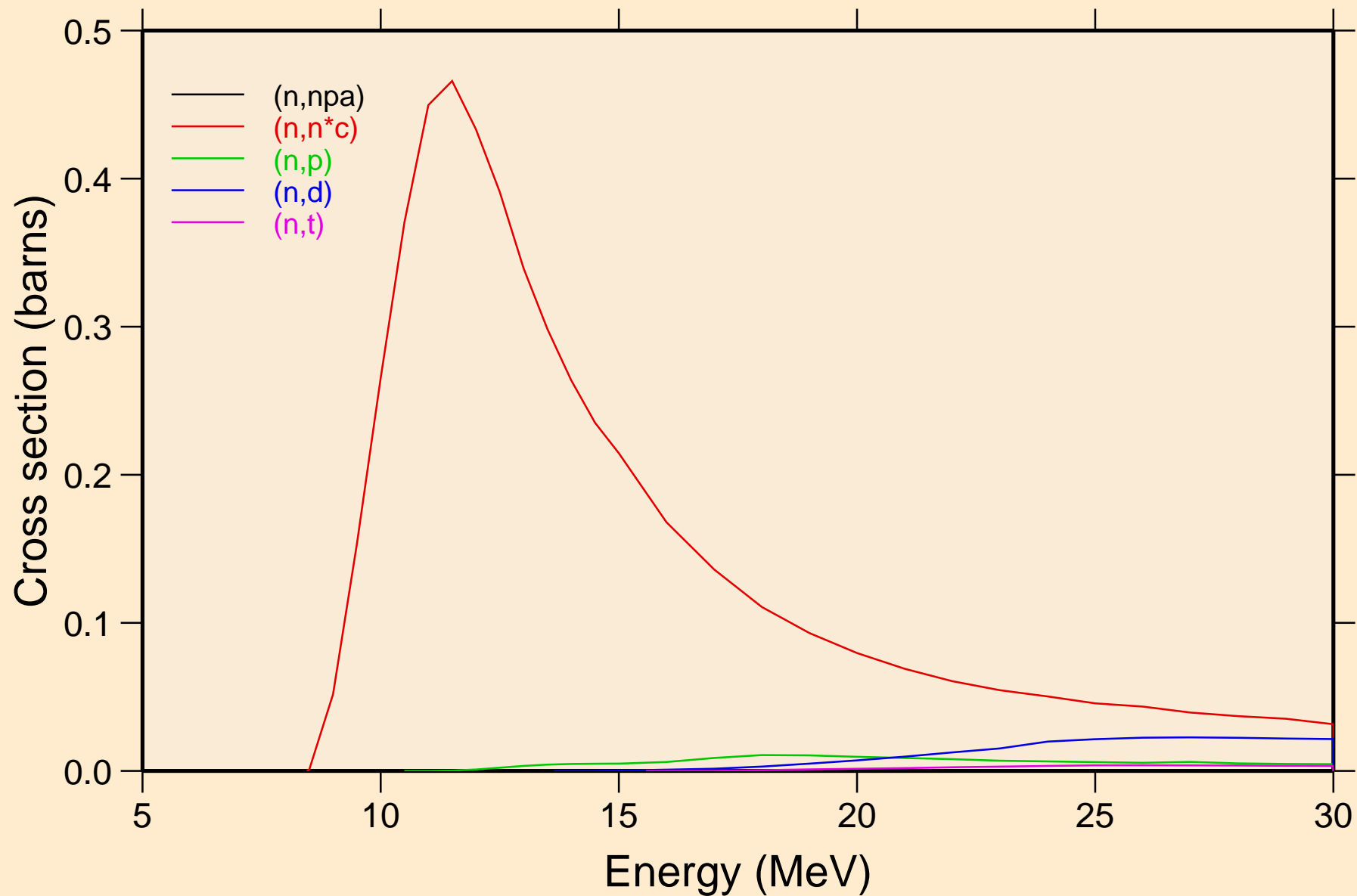

10-NE-22 FOR FENDL-3.2 FROM TENDL-2019 WITH NJOY2016.60  
Threshold reactions

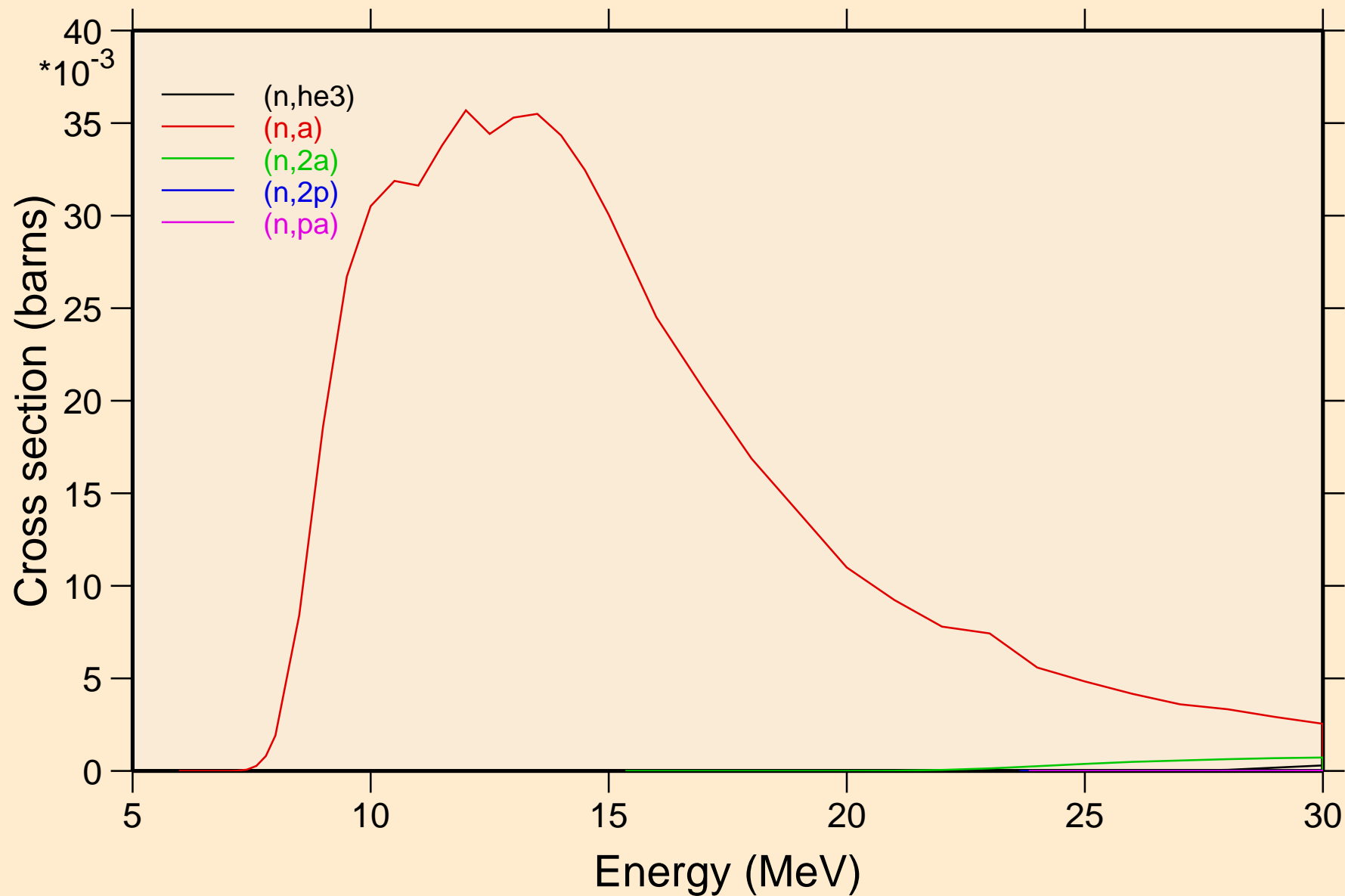

10-NE-22 FOR FENDL-3.2 FROM TENDL-2019 WITH NJOY2016.60  
Threshold reactions

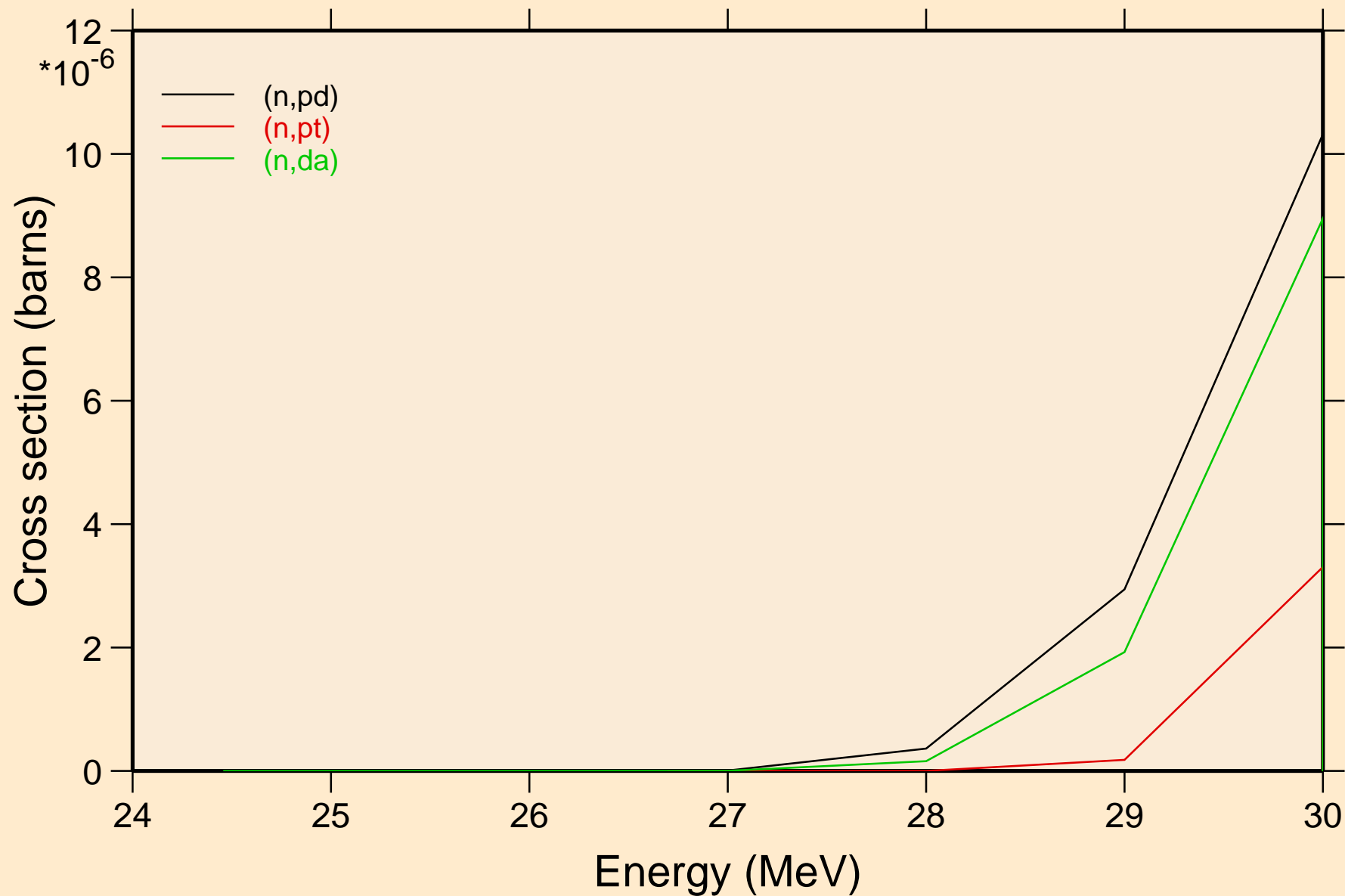

# 10-NE-22 FOR FENDL-3.2 FROM TENDL-2019 WITH NJOY2016.60

## Threshold reactions

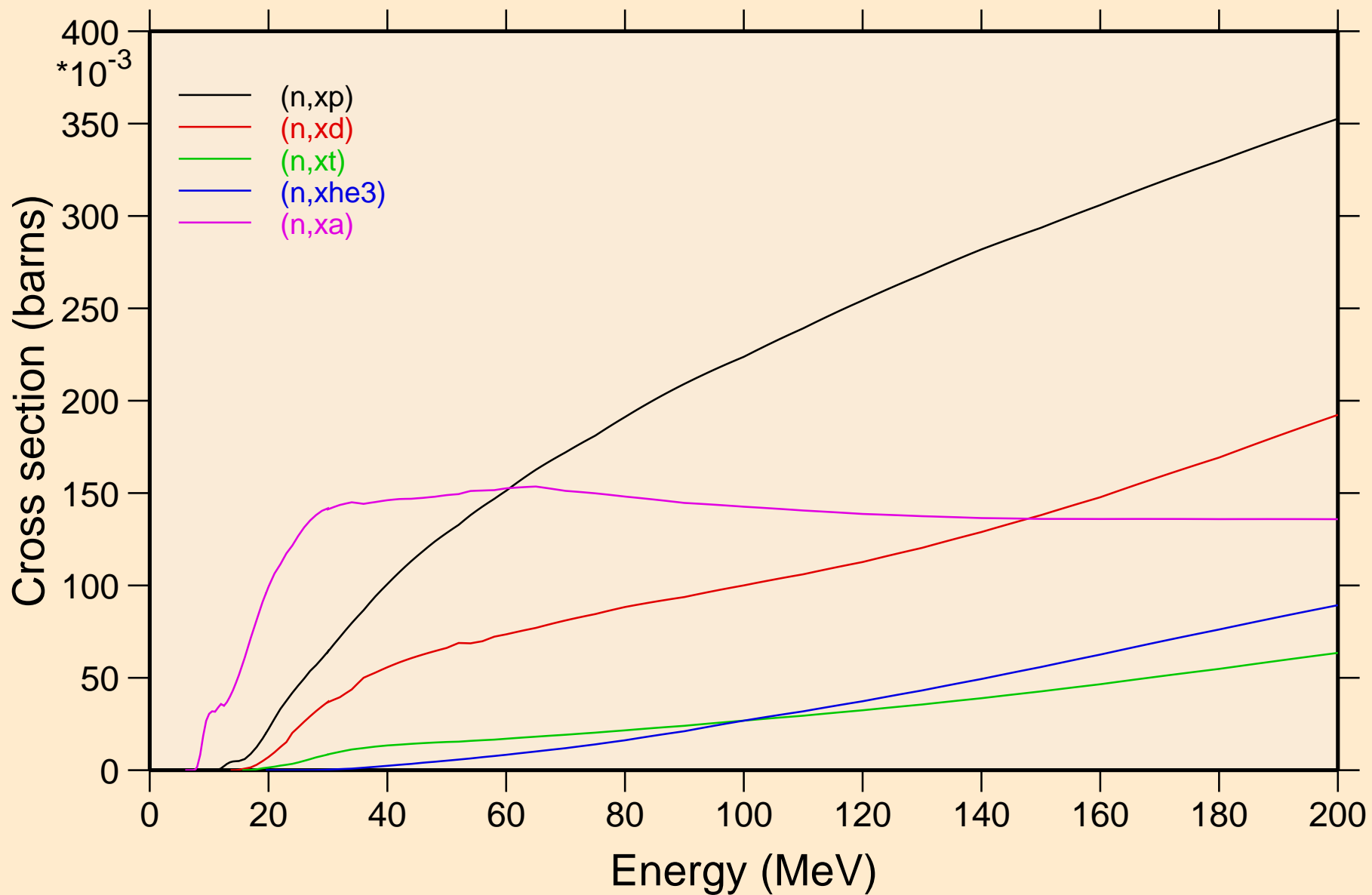

10-NE-22 FOR FENDL-3.2 FROM TENDL-2019 WITH NJOY2016.60  
angular distribution for elastic

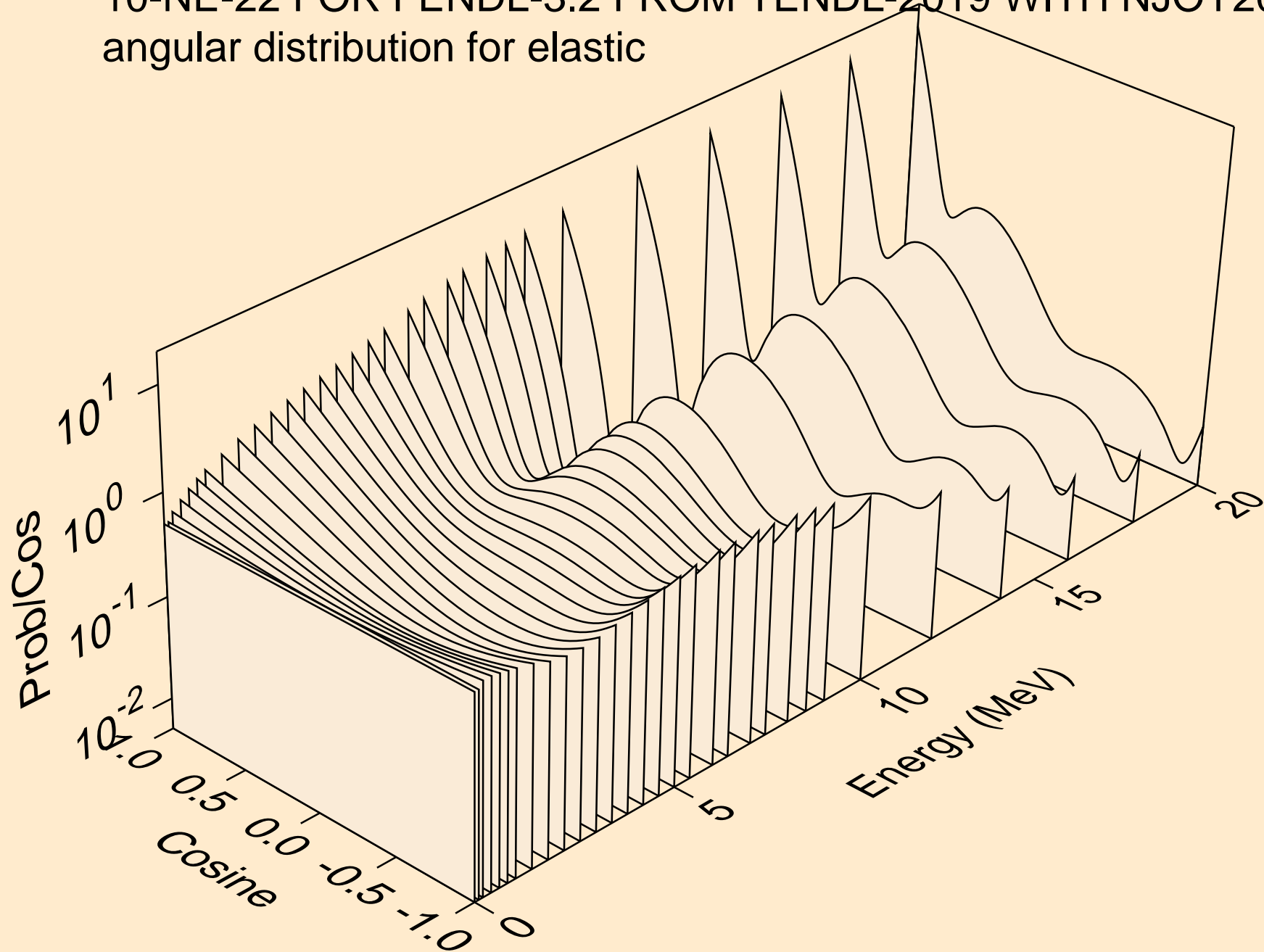

10-NE-22 FOR FENDL-3.2 FROM TENDL-2019 WITH NJOY2016.60  
angular distribution for elastic

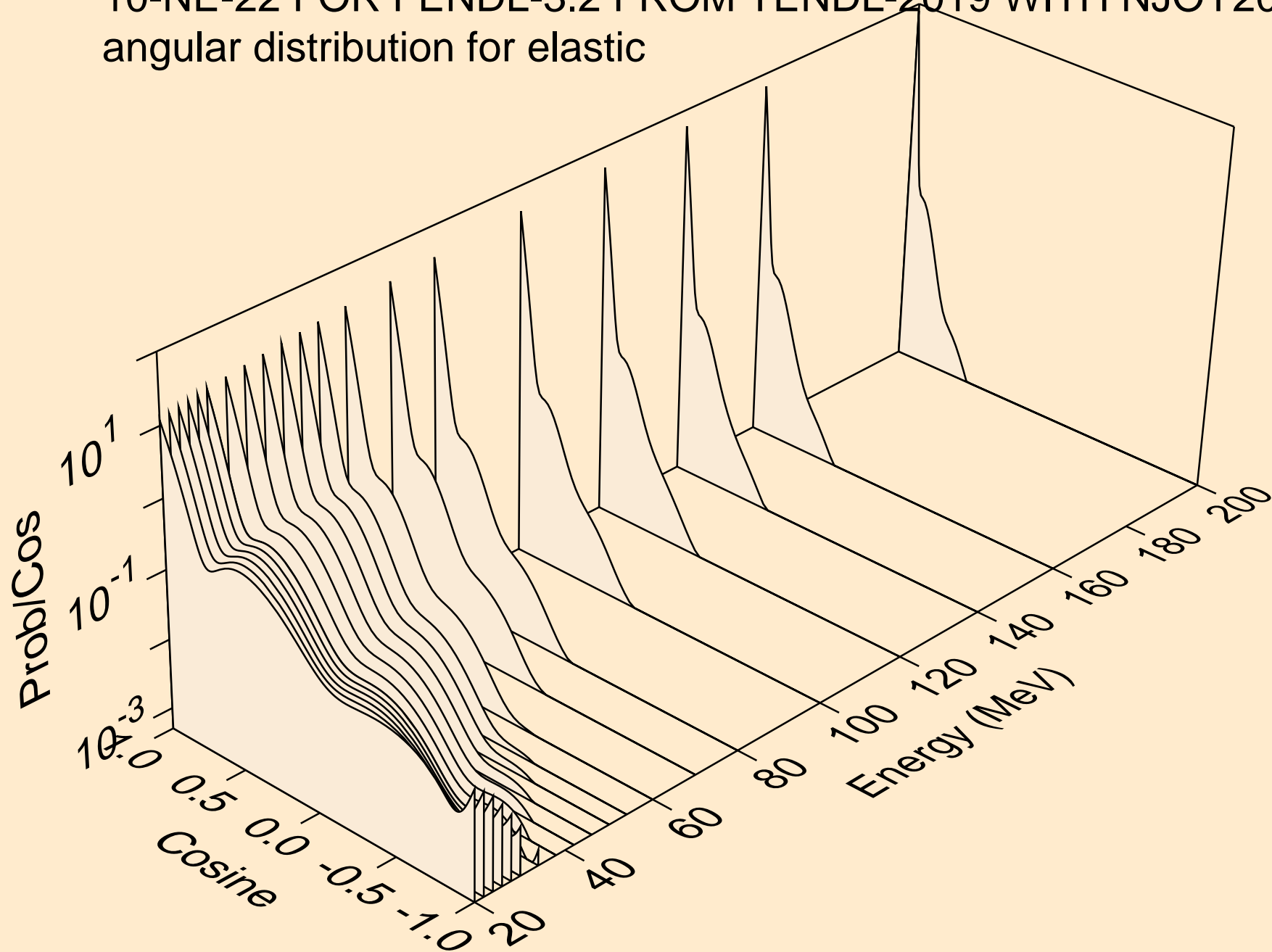



10-NE-22 FOR FENDL-3.2 FROM TENDL-2019 WITH NJOY2016.60  
angular distribution for (n,n\*1)

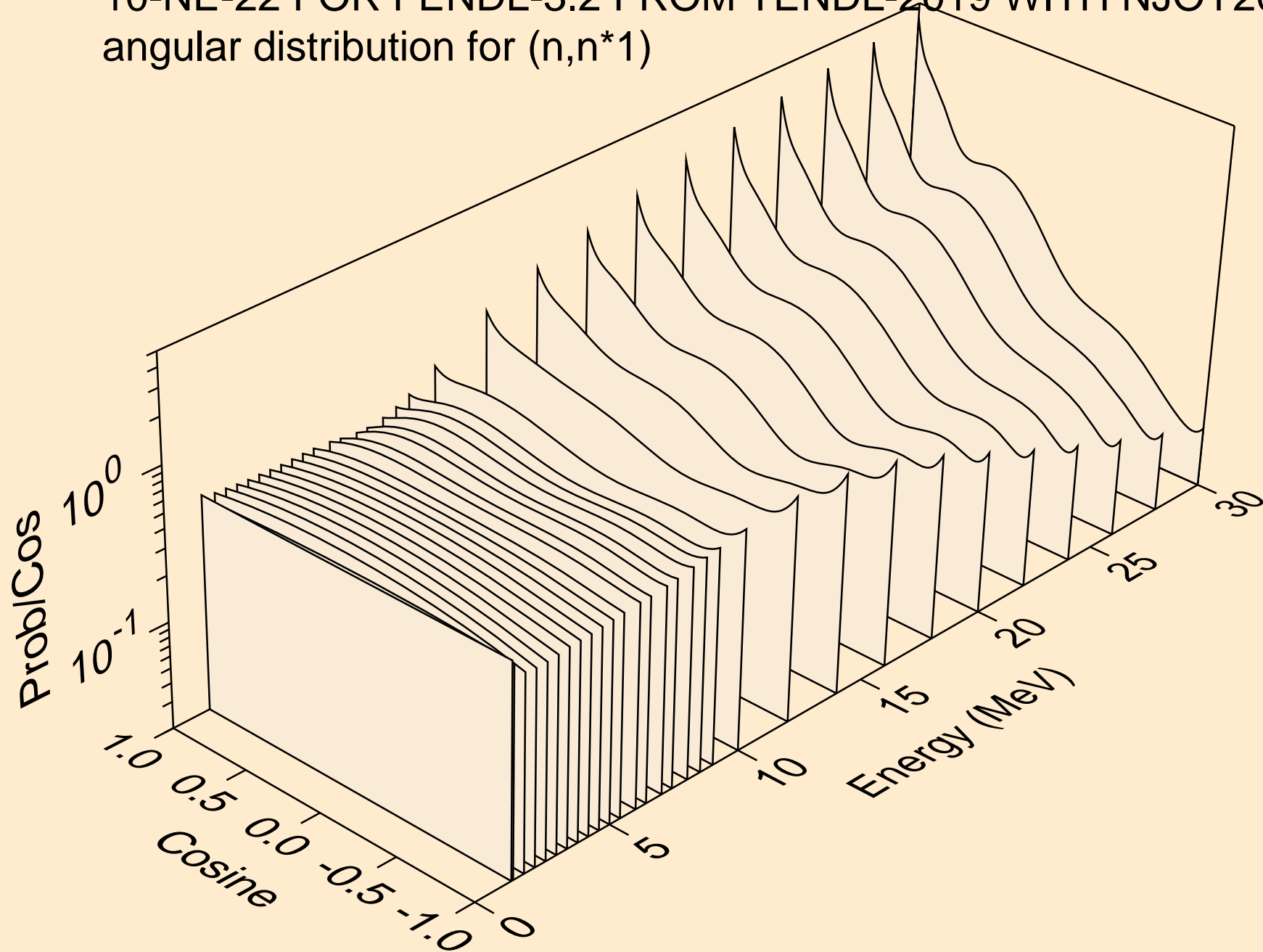

10-NE-22 FOR FENDL-3.2 FROM TENDL-2019 WITH NJOY2016.60  
angular distribution for (n,n\*2)

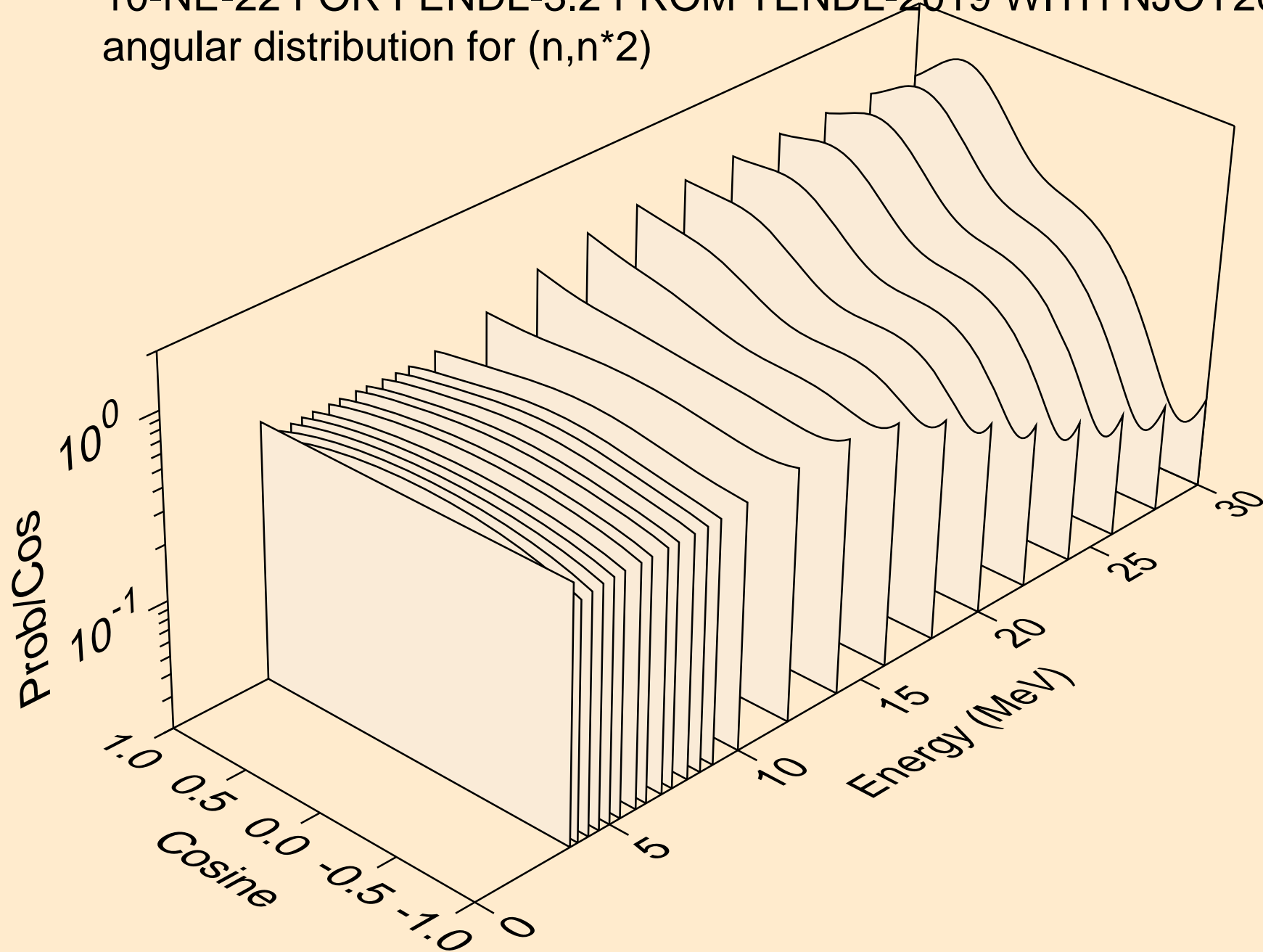

10-NE-22 FOR FENDL-3.2 FROM TENDL-2019 WITH NJOY2016.60  
angular distribution for (n,n\*3)

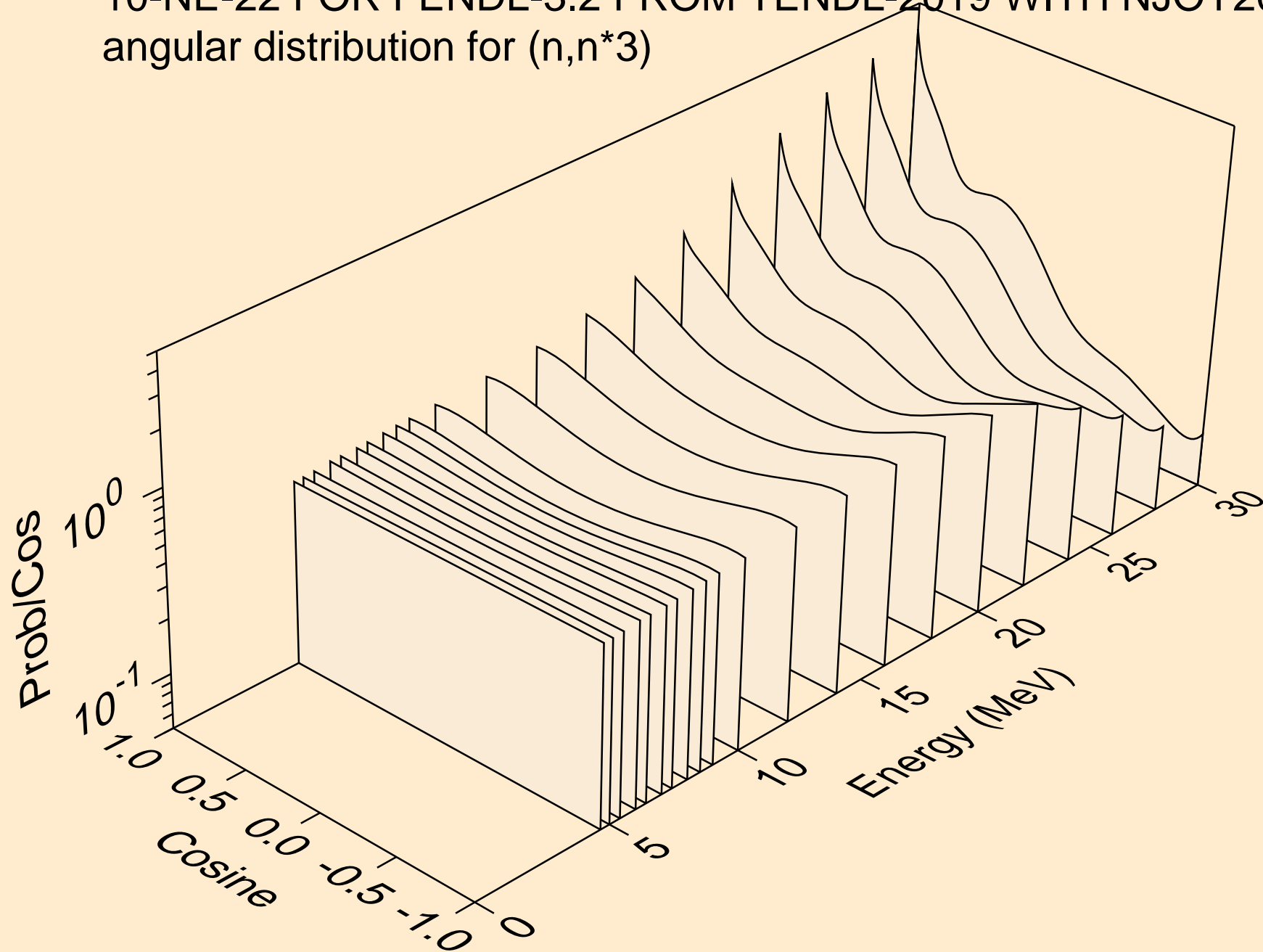

10-NE-22 FOR FENDL-3.2 FROM TENDL-2019 WITH NJOY2016.60  
angular distribution for (n,n\*4)

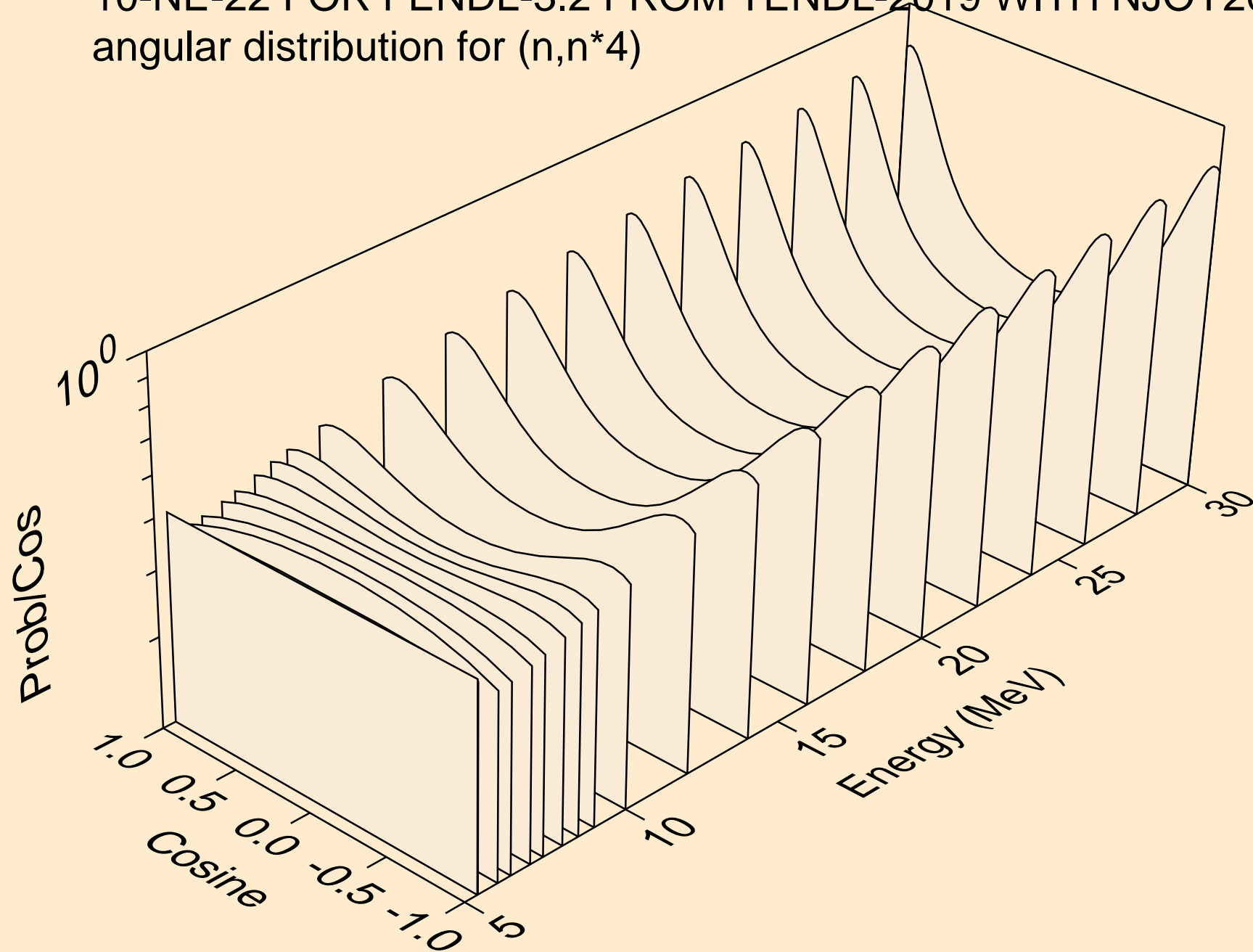

10-NE-22 FOR FENDL-3.2 FROM TENDL-2019 WITH NJOY2016.60  
angular distribution for (n,n\*5)

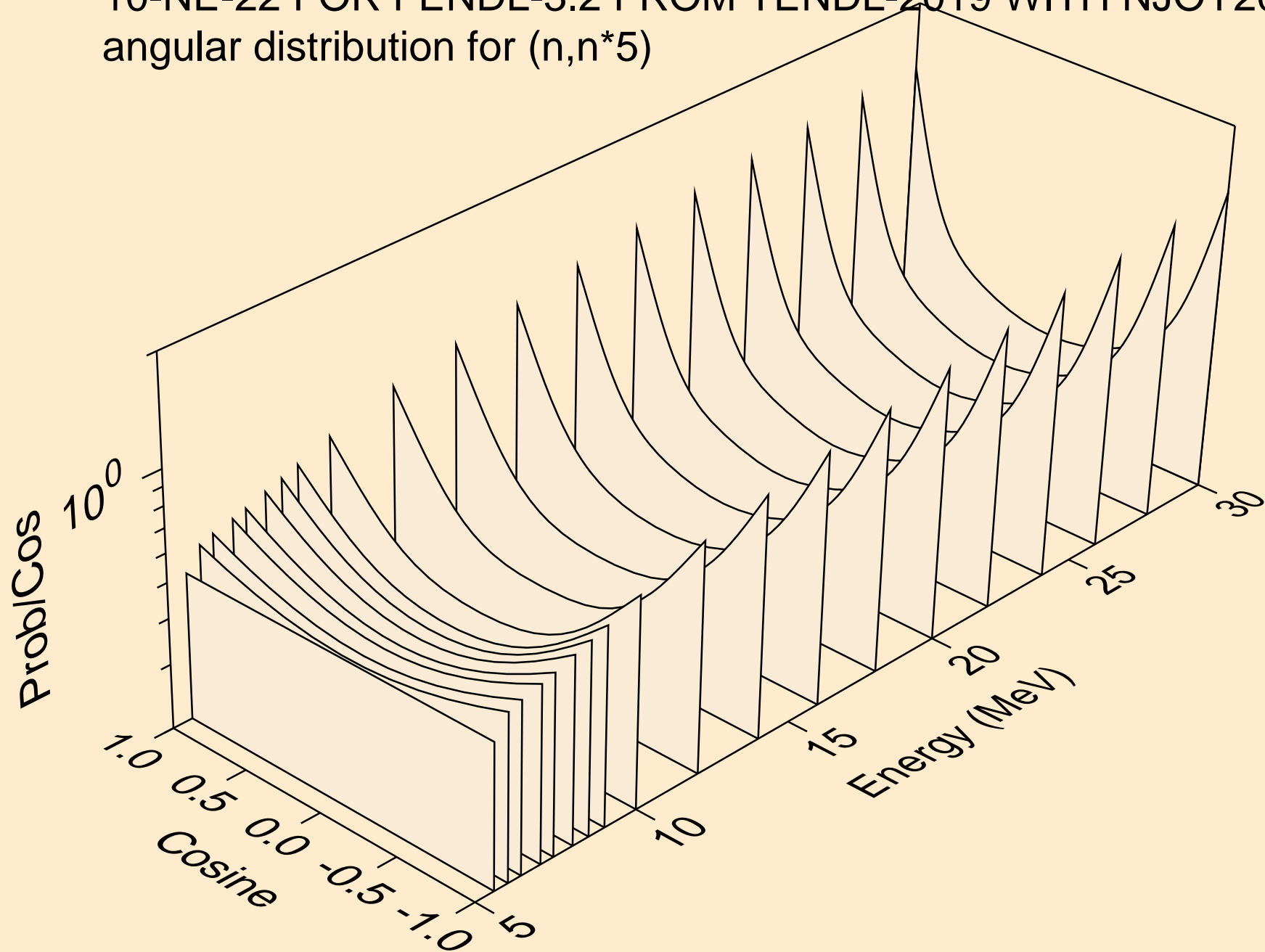

10-NE-22 FOR FENDL-3.2 FROM TENDL-2019 WITH NJOY2016.60  
angular distribution for (n,n\*6)

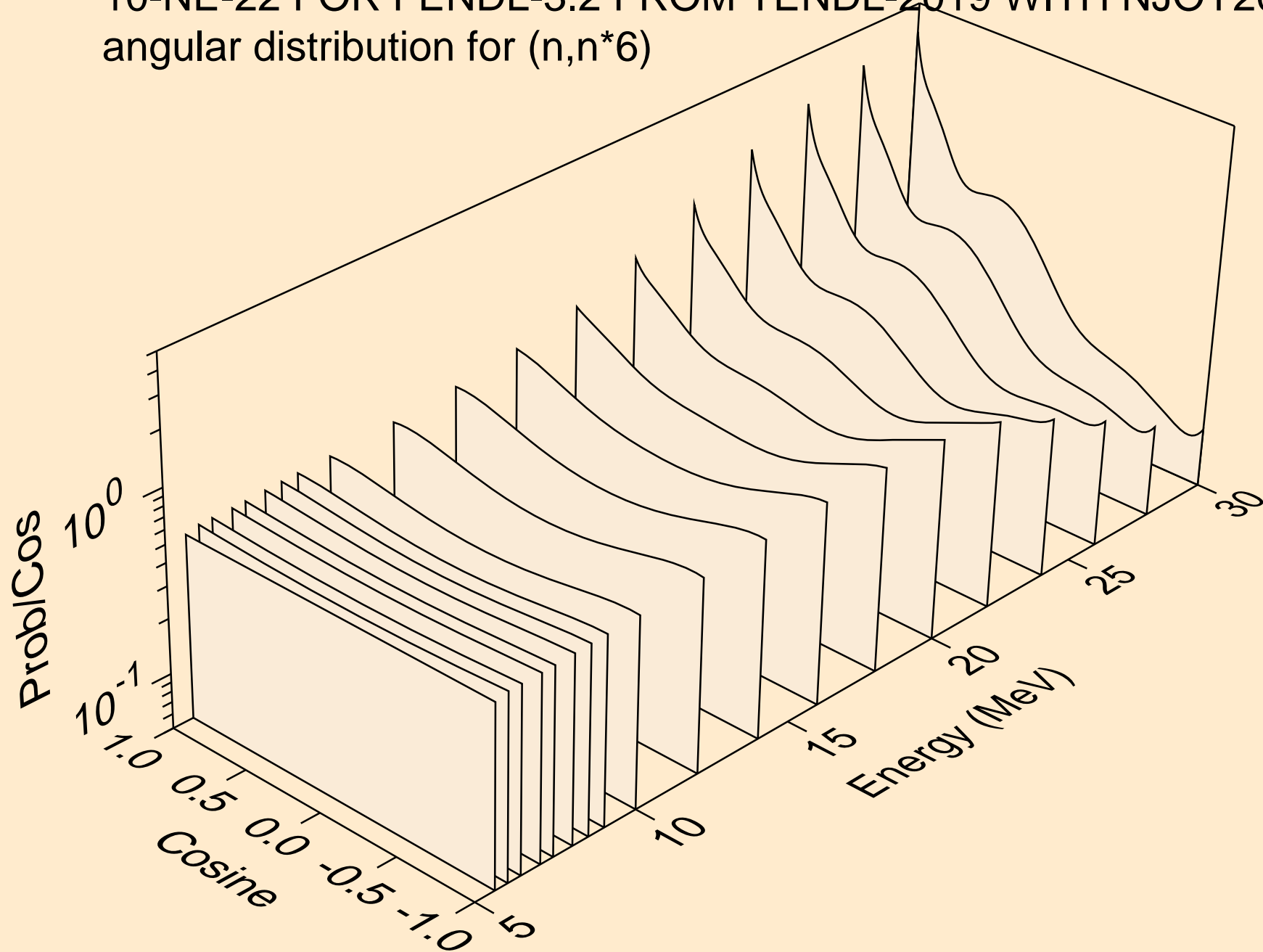

10-NE-22 FOR FENDL-3.2 FROM TENDL-2019 WITH NJOY2016.60  
angular distribution for (n,n\*7)

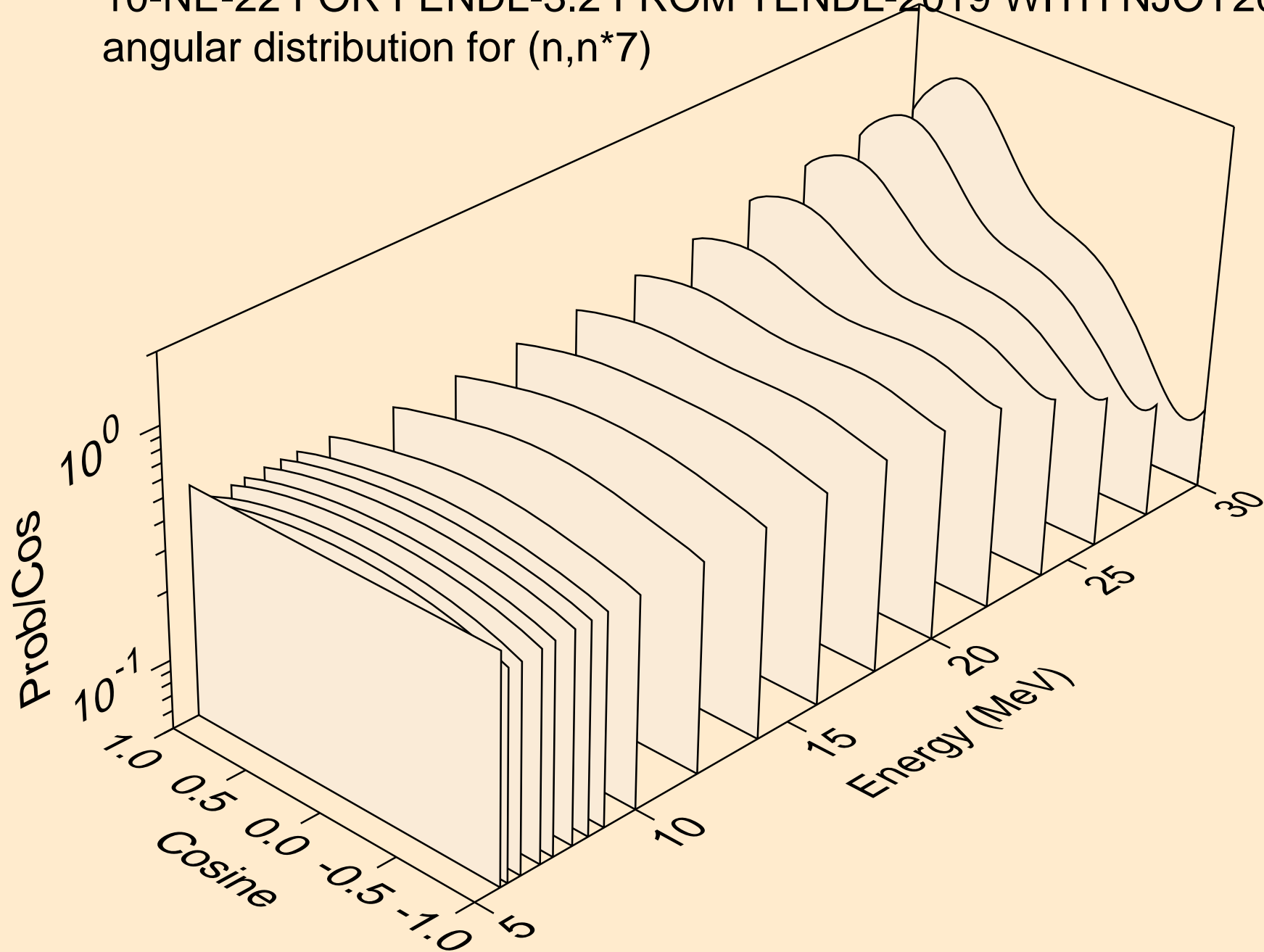

10-NE-22 FOR FENDL-3.2 FROM TENDL-2019 WITH NJOY2016.60  
angular distribution for (n,n\*8)

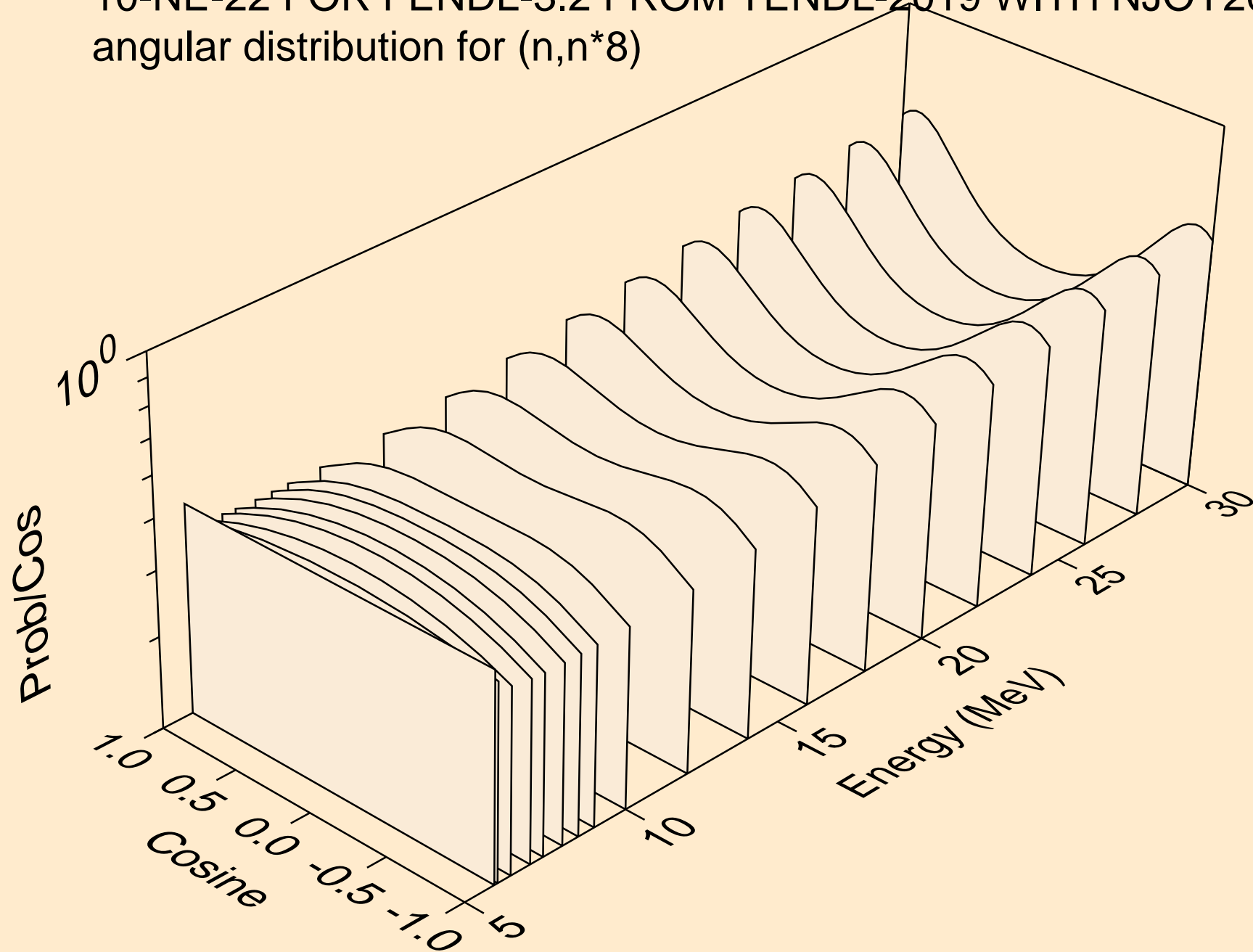



10-NE-22 FOR FENDL-3.2 FROM TENDL-2019 WITH NJOY2016.60  
angular distribution for (n,n\*9)

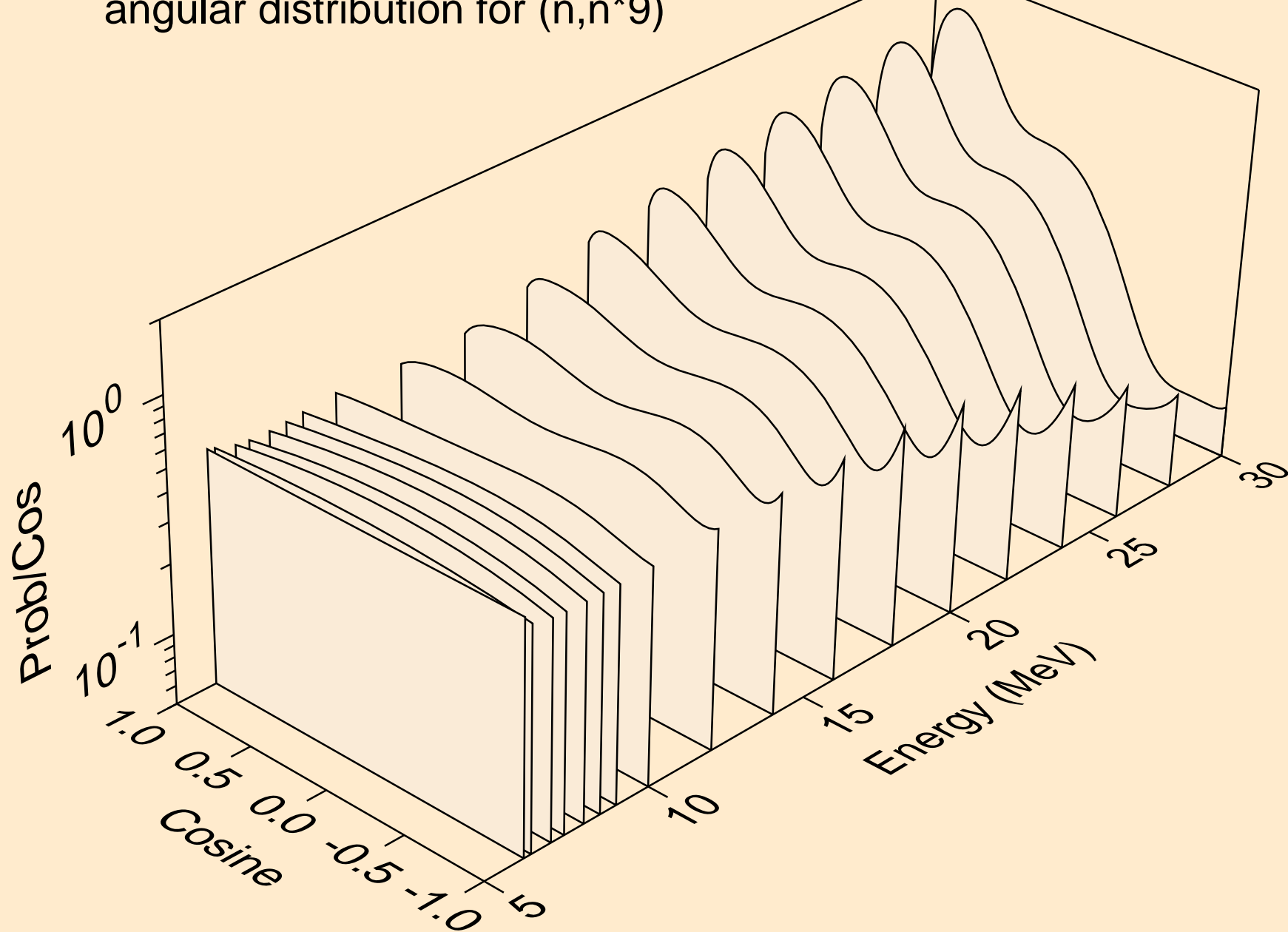

10-NE-22 FOR FENDL-3.2 FROM TENDL-2019 WITH NJOY2016.60  
angular distribution for (n,n\*10)

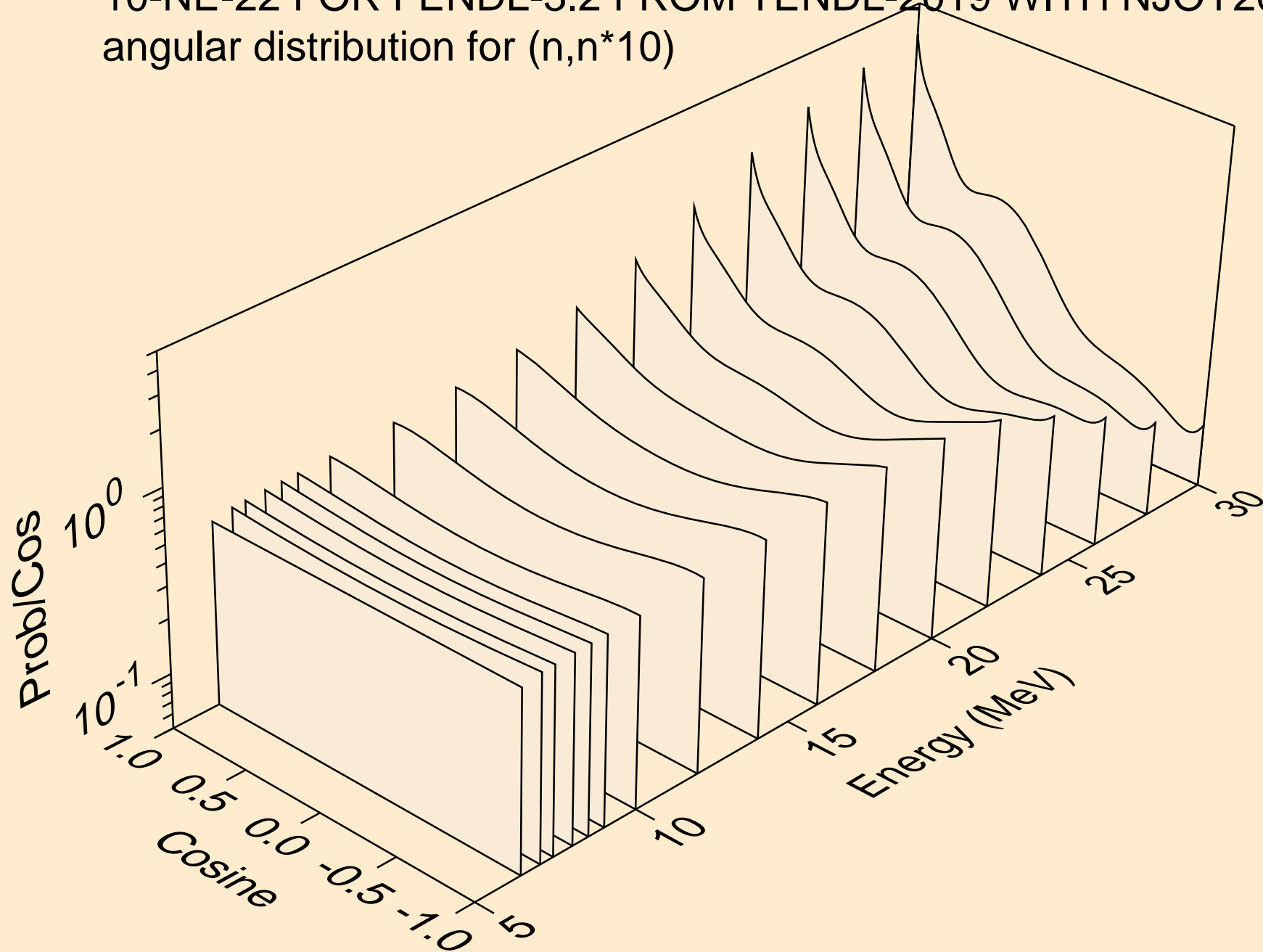

10-NE-22 FOR FENDL-3.2 FROM TENDL-2019 WITH NJOY2016.60  
angular distribution for (n,n\*11)

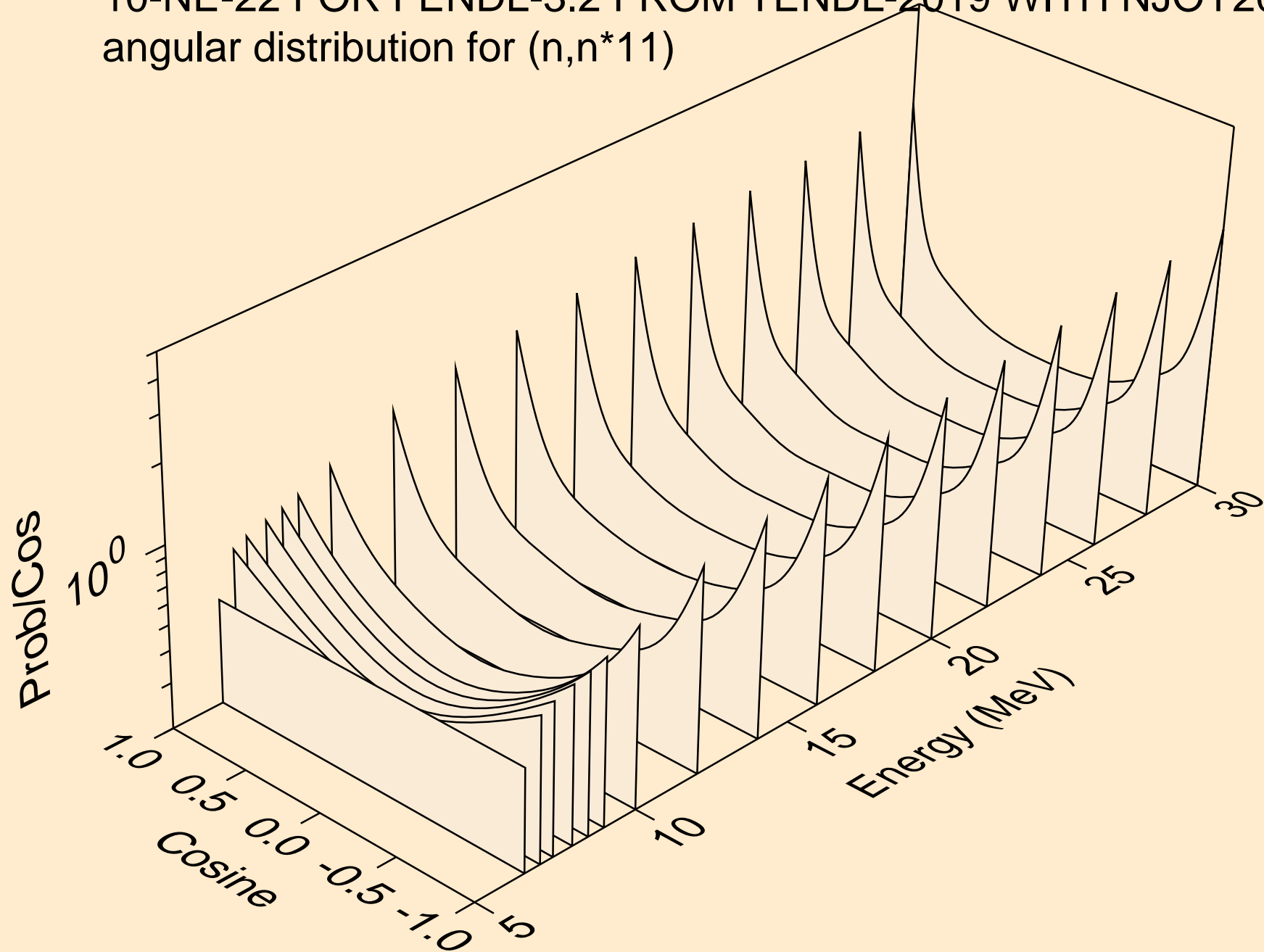

10-NE-22 FOR FENDL-3.2 FROM TENDL-2019 WITH NJOY2016.60  
angular distribution for (n,n\*12)

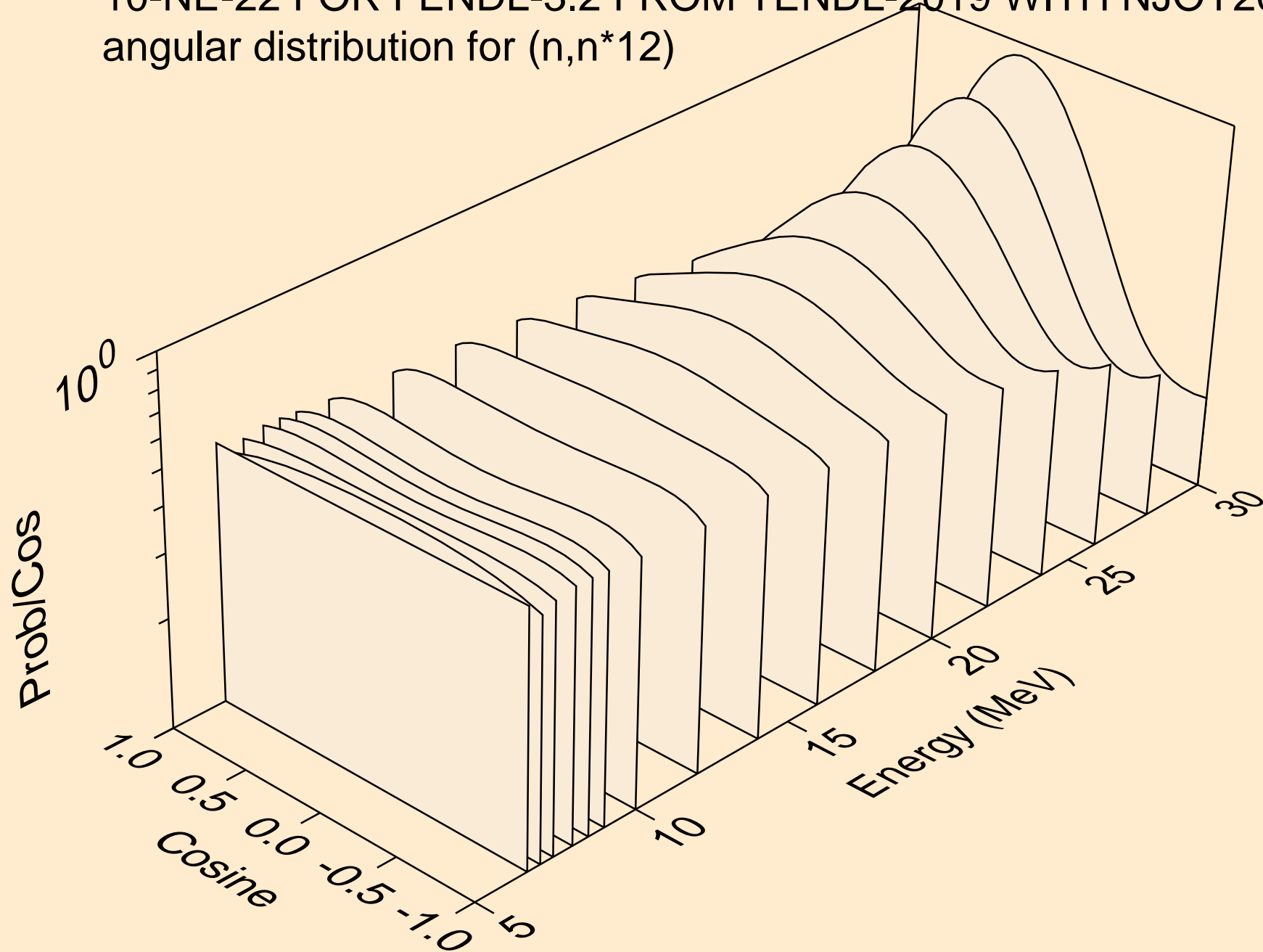

10-NE-22 FOR FENDL-3.2 FROM TENDL-2019 WITH NJOY2016.60  
angular distribution for (n,n\*13)

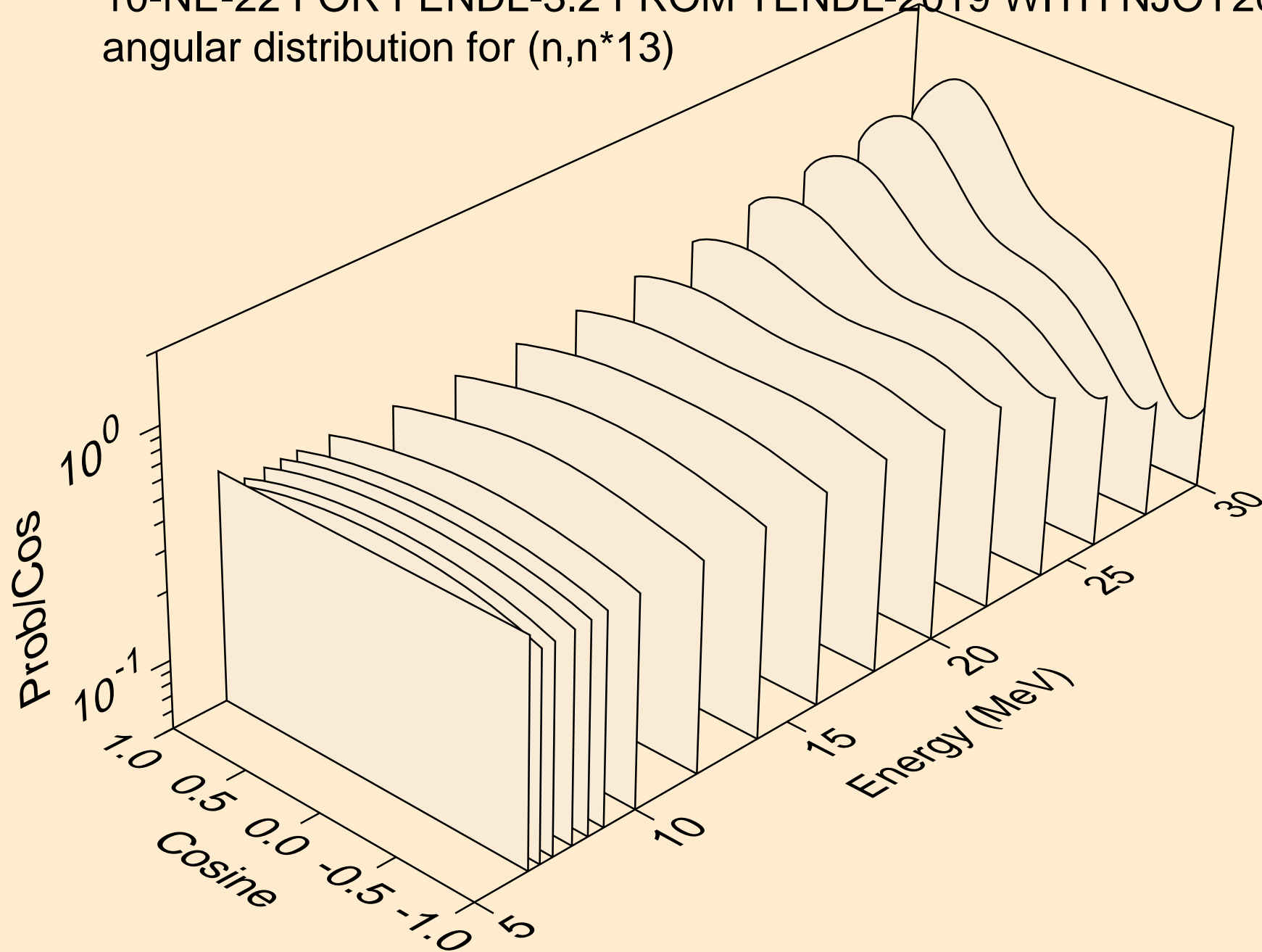

10-NE-22 FOR FENDL-3.2 FROM TENDL-2019 WITH NJOY2016.60  
angular distribution for (n,n\*14)

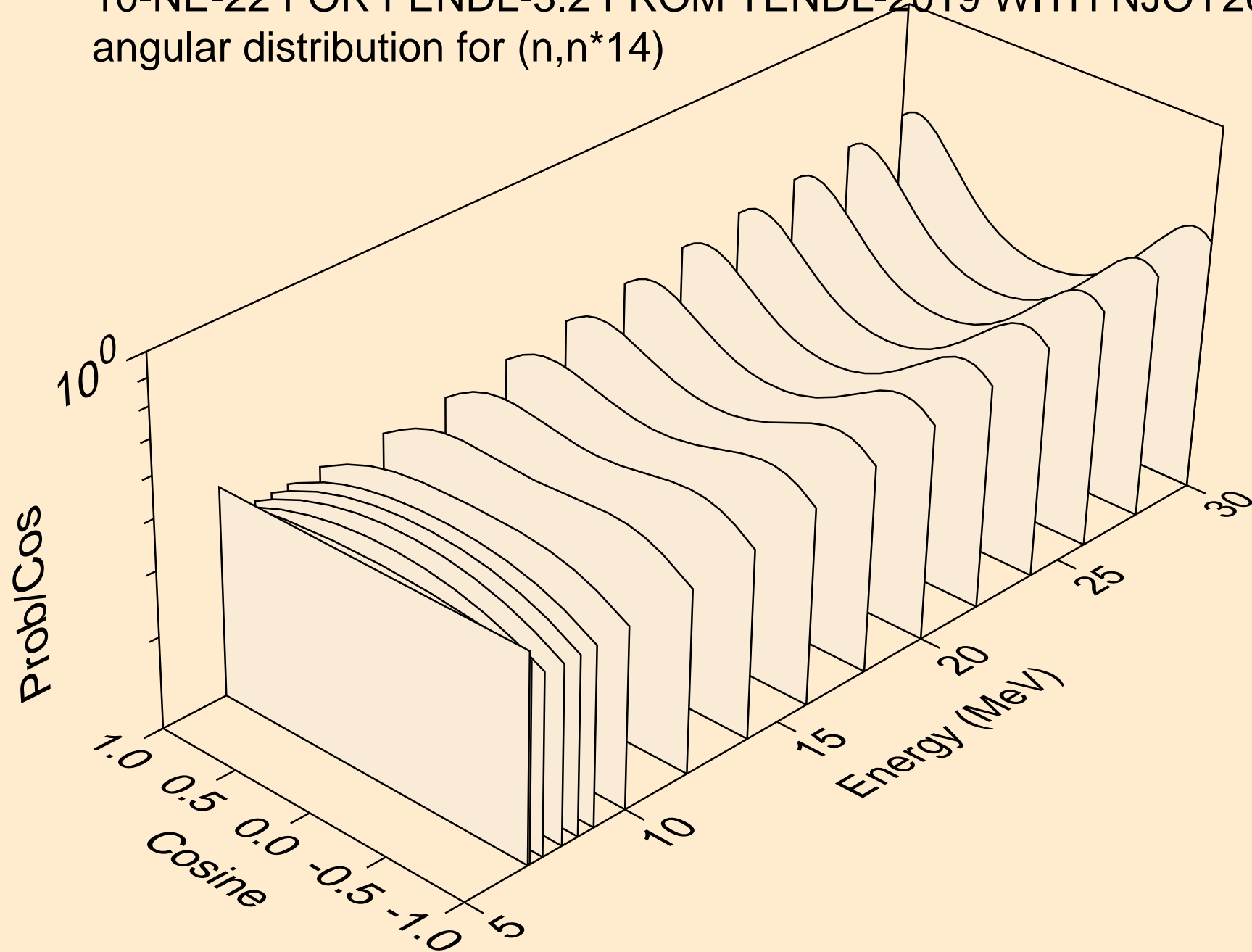

10-NE-22 FOR FENDL-3.2 FROM TENDL-2019 WITH NJOY2016.60  
angular distribution for (n,n\*15)

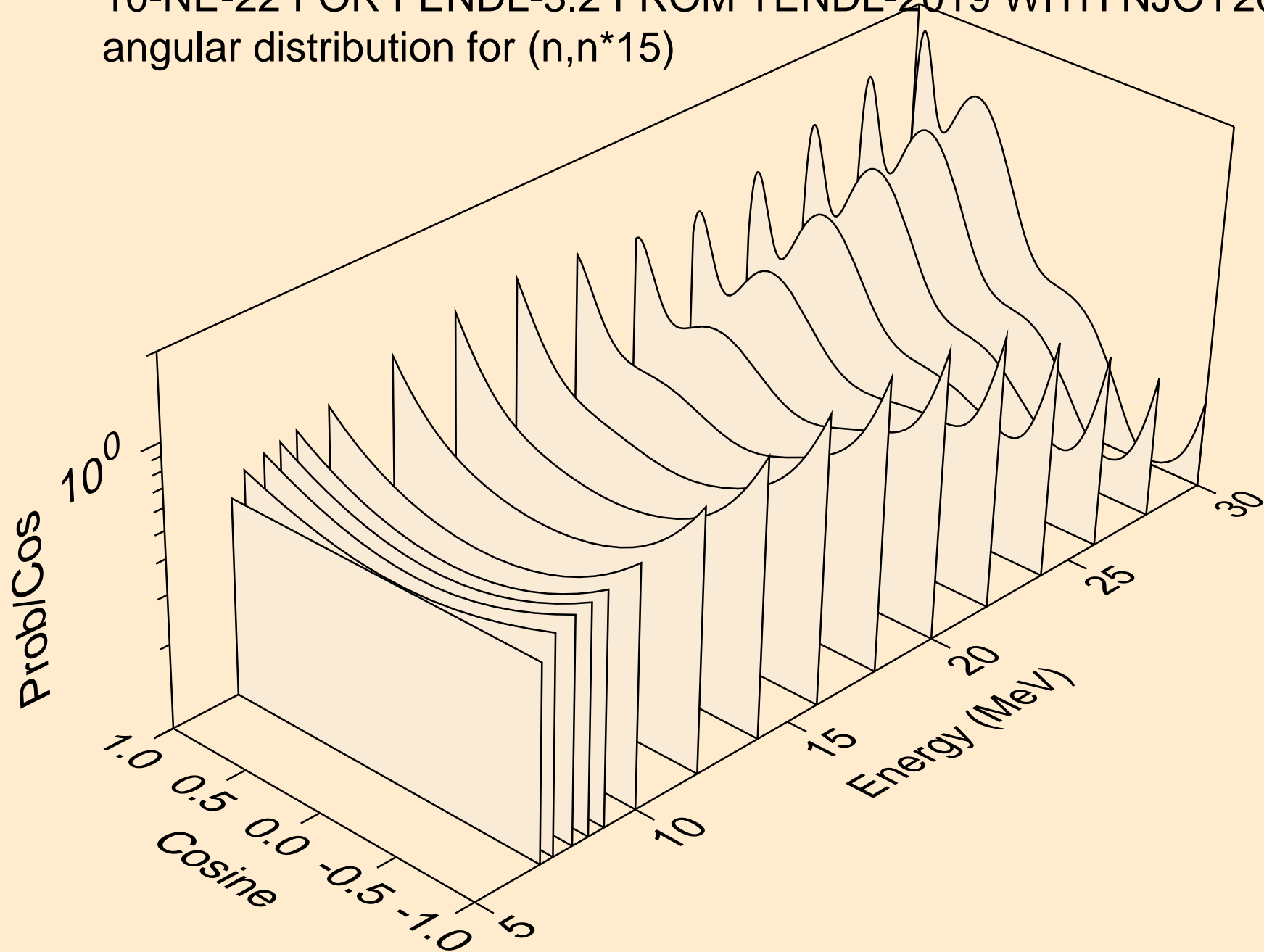

10-NE-22 FOR FENDL-3.2 FROM TENDL-2019 WITH NJOY2016.60  
angular distribution for (n,n\*16)

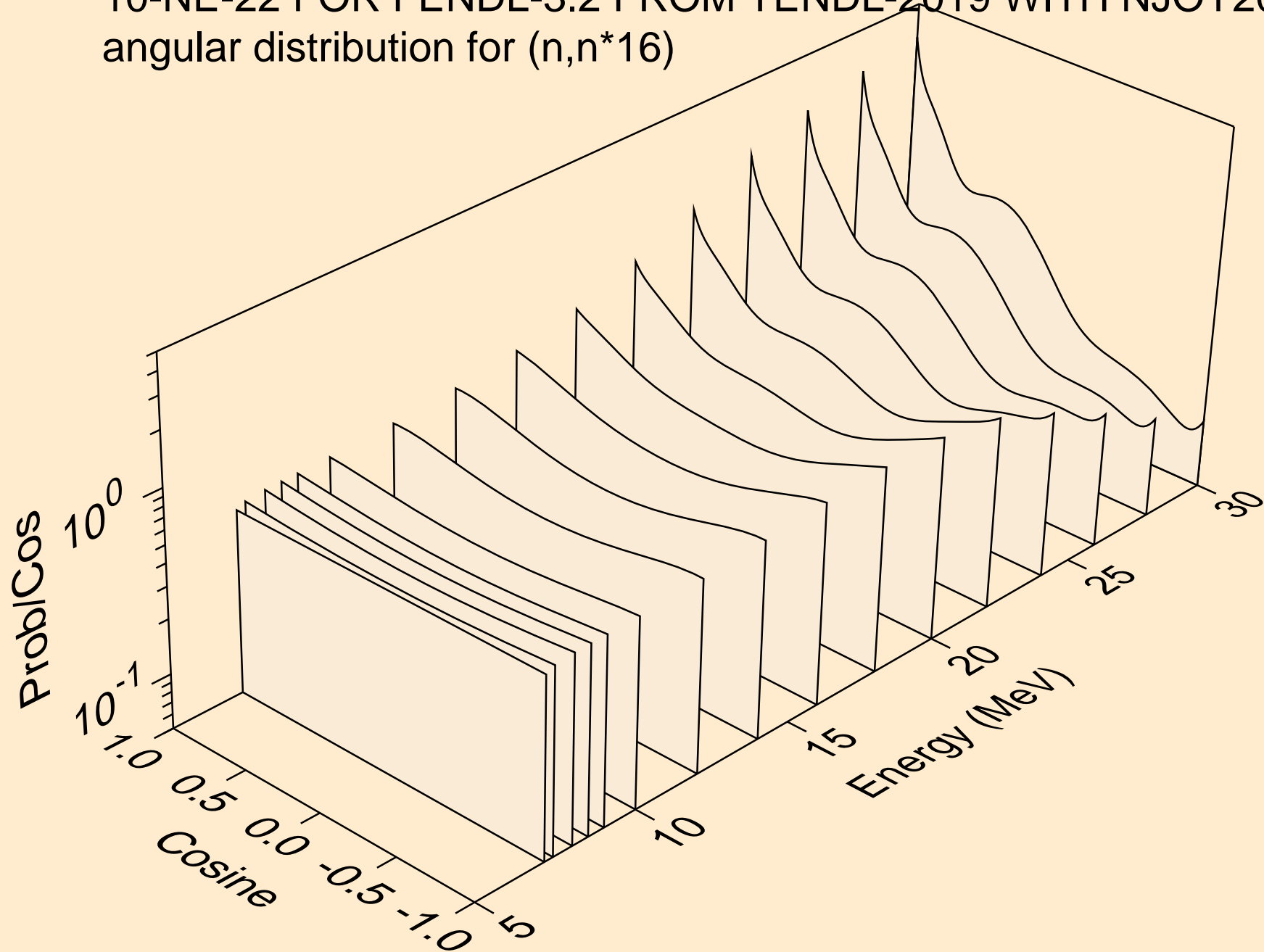



10-NE-22 FOR FENDL-3.2 FROM TENDL-2019 WITH NJOY2016.60  
angular distribution for (n,n\*17)

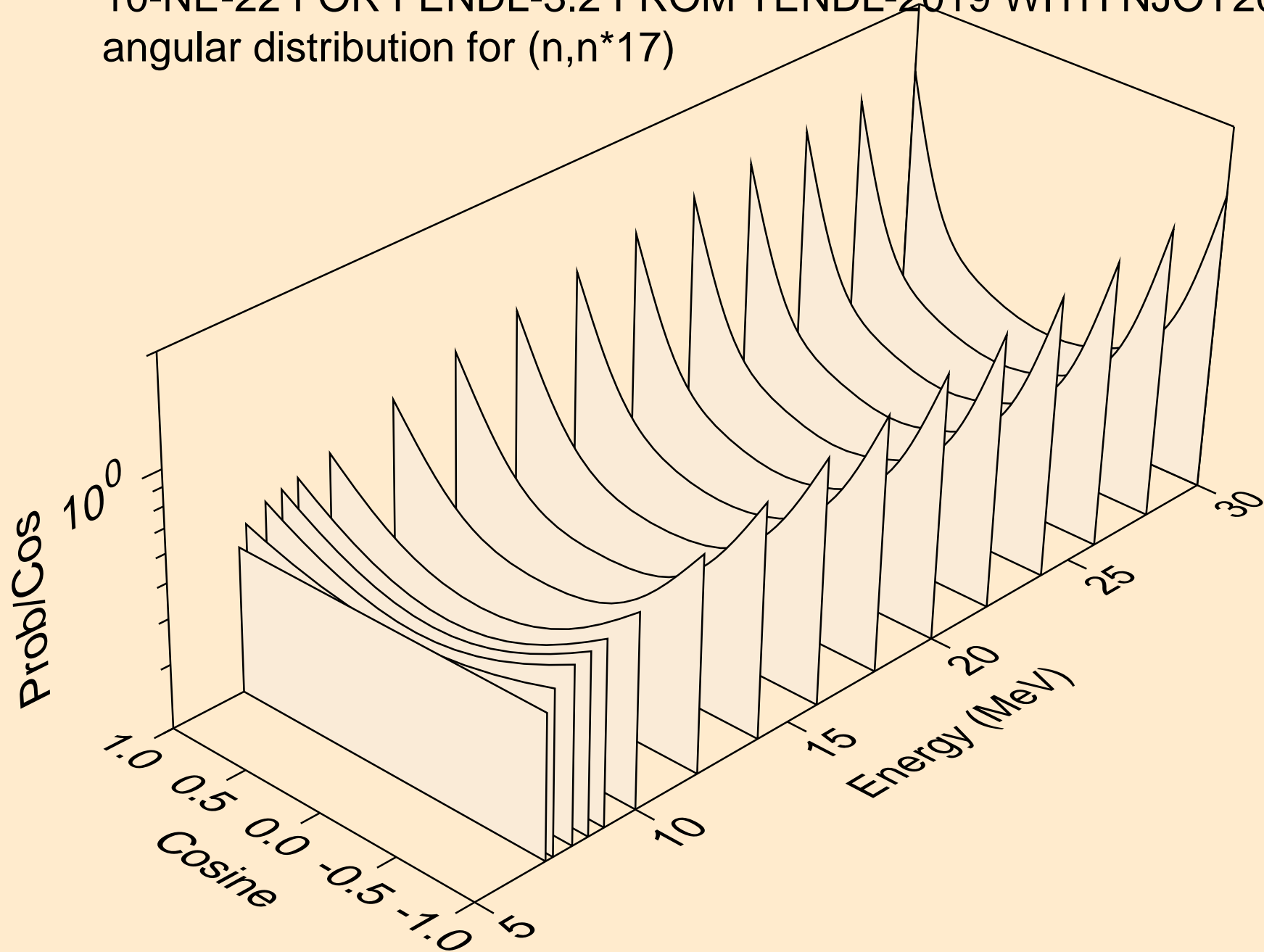

10-NE-22 FOR FENDL-3.2 FROM TENDL-2019 WITH NJOY2016.60  
angular distribution for (n,n\*18)

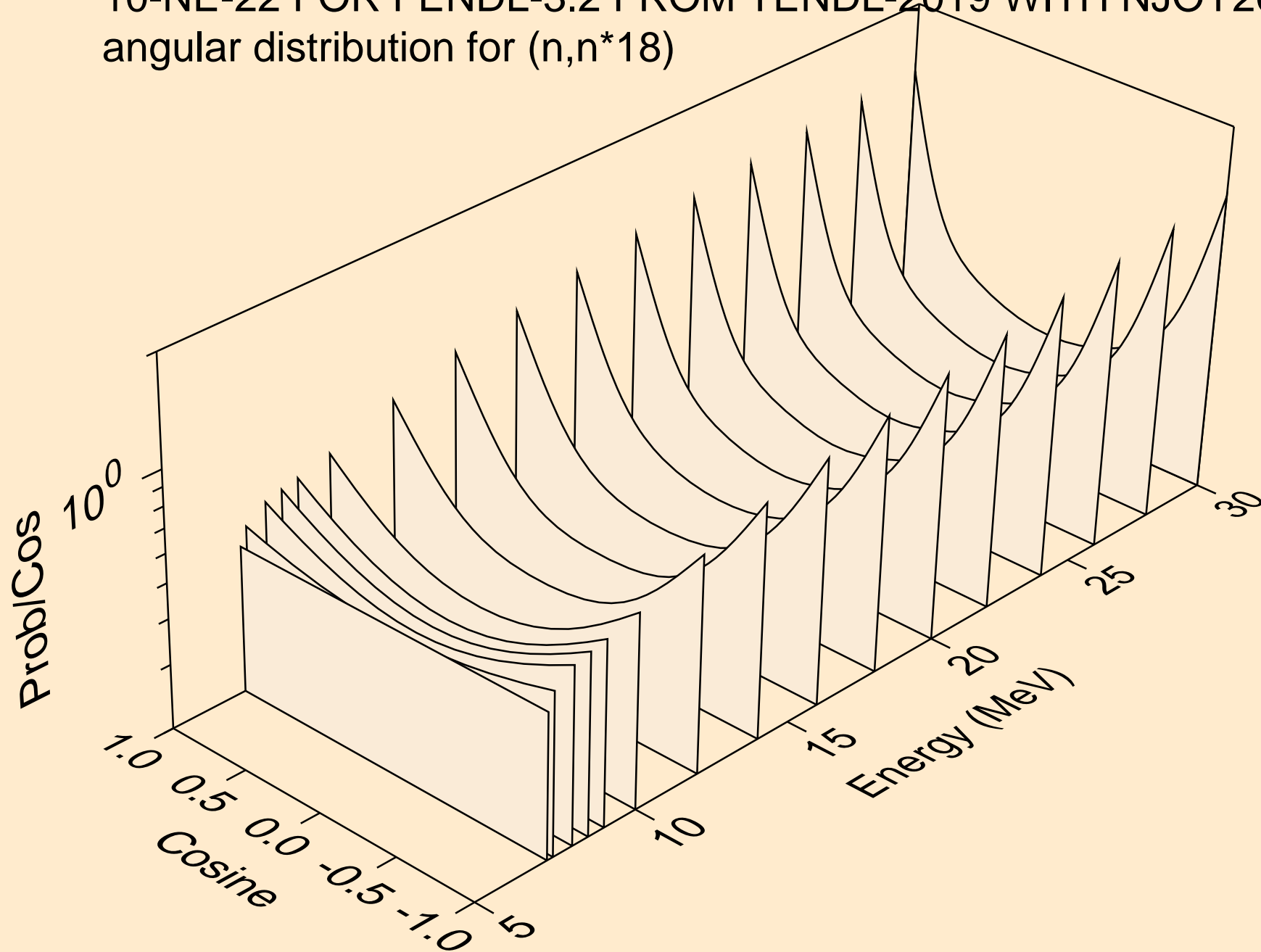

10-NE-22 FOR FENDL-3.2 FROM TENDL-2019 WITH NJOY2016.60  
angular distribution for (n,n\*19)

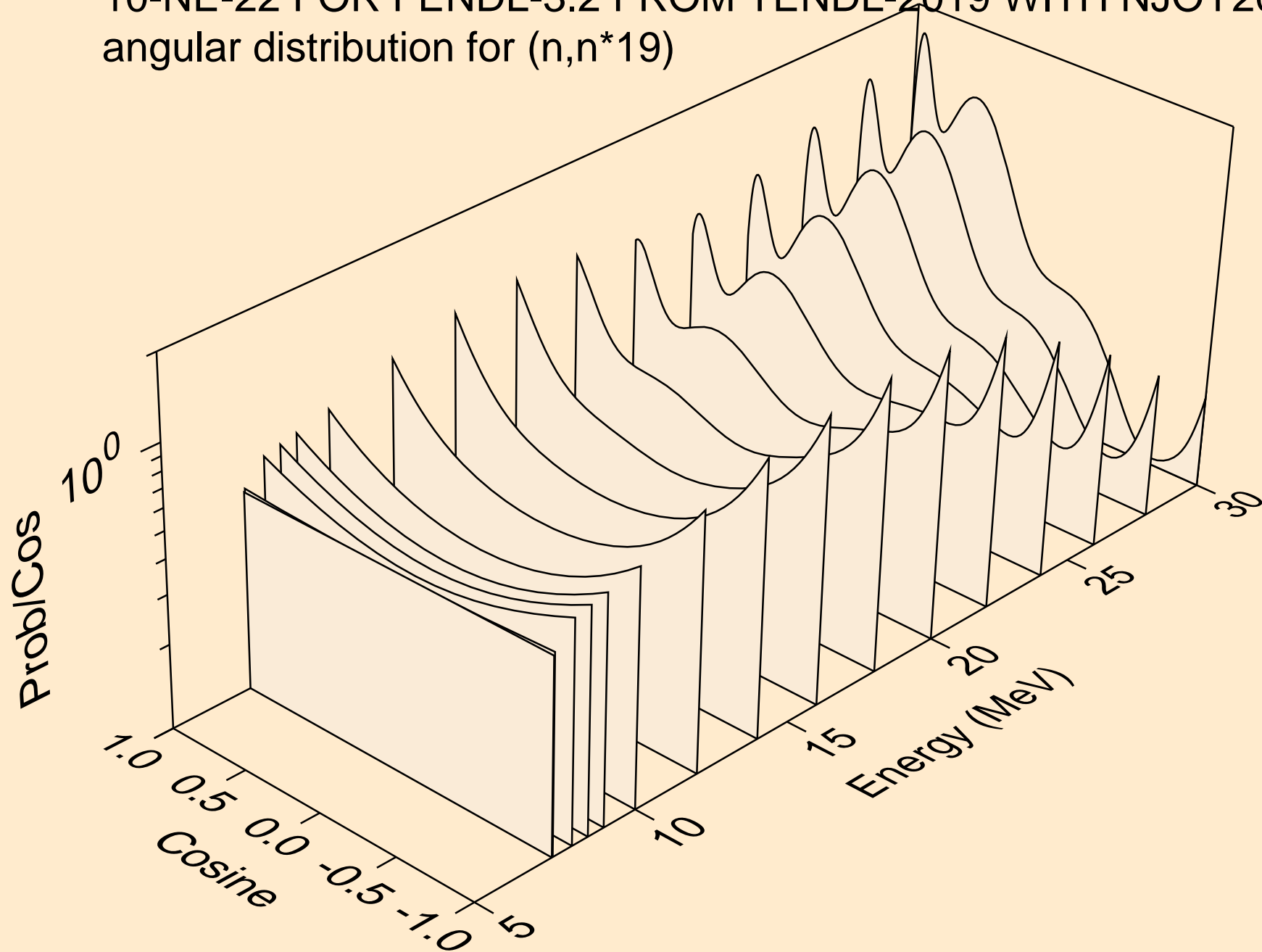

10-NE-22 FOR FENDL-3.2 FROM TENDL-2019 WITH NJOY2016.60  
angular distribution for (n,n\*20)

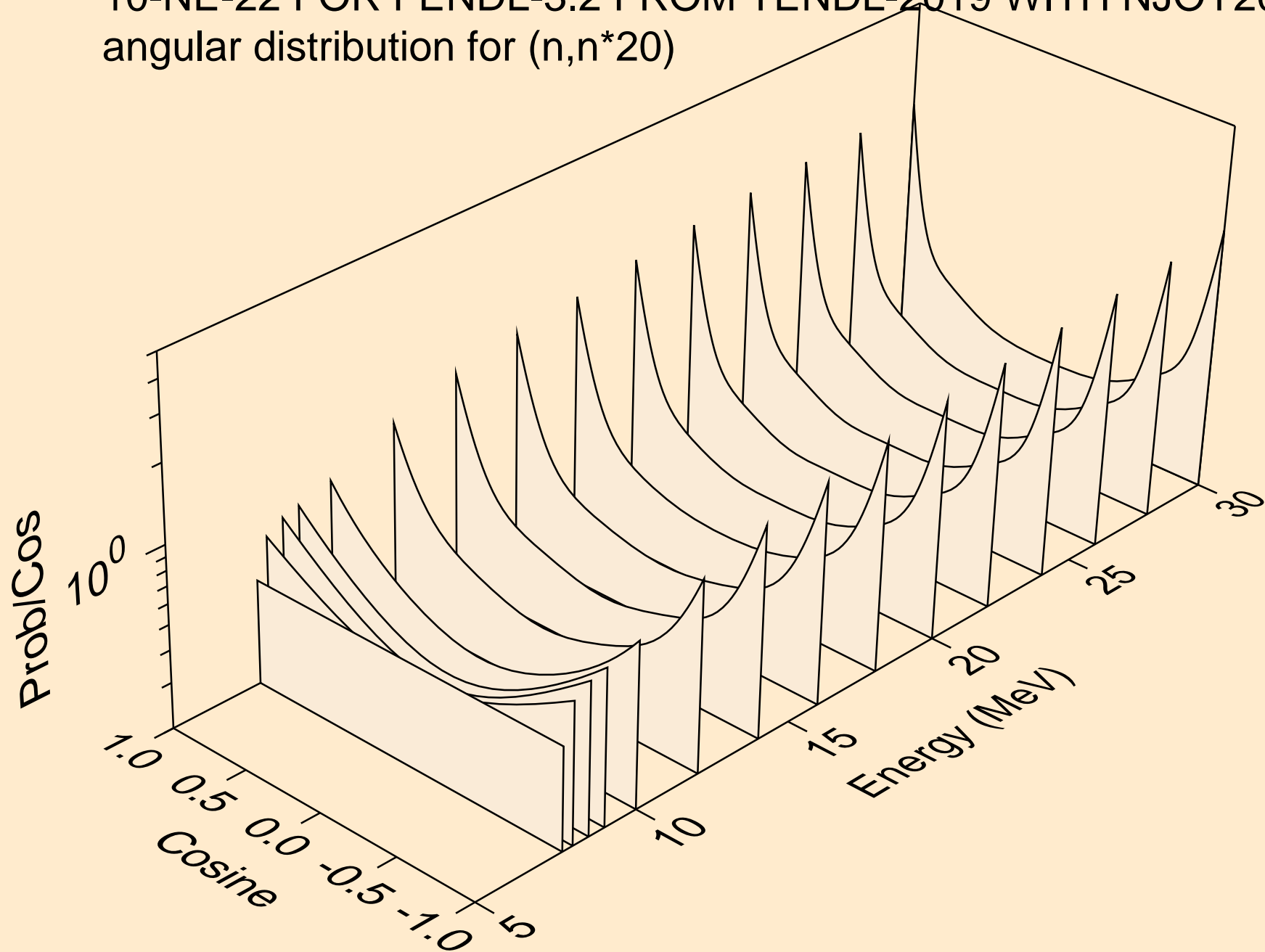

10-NE-22 FOR FENDL-3.2 FROM TENDL-2019 WITH NJOY2016.60  
angular distribution for (n,n\*21)

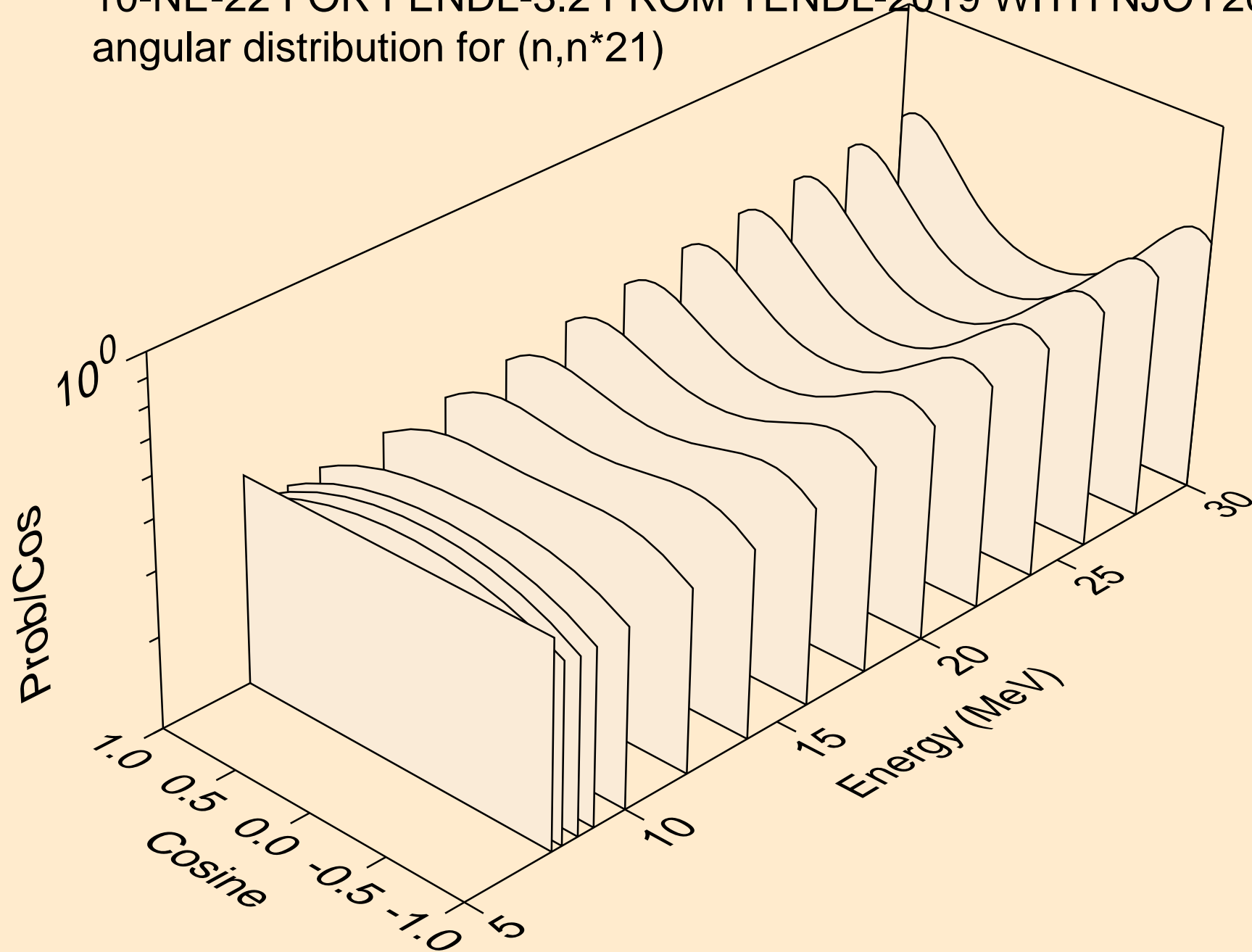

10-NE-22 FOR FENDL-3.2 FROM TENDL-2019 WITH NJOY2016.60  
angular distribution for (n,n\*22)

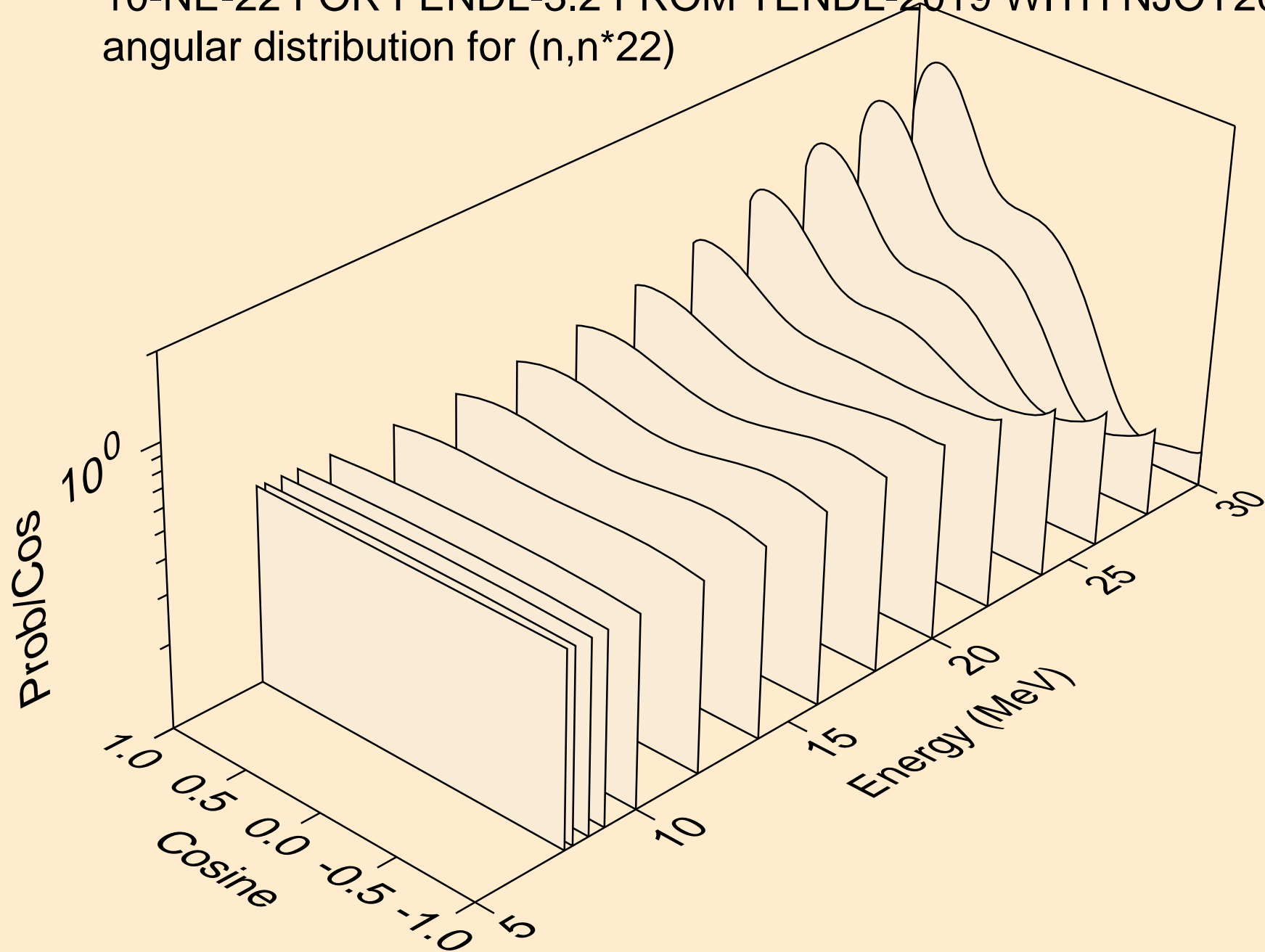

10-NE-22 FOR FENDL-3.2 FROM TENDL-2019 WITH NJOY2016.60  
angular distribution for (n,n\*23)

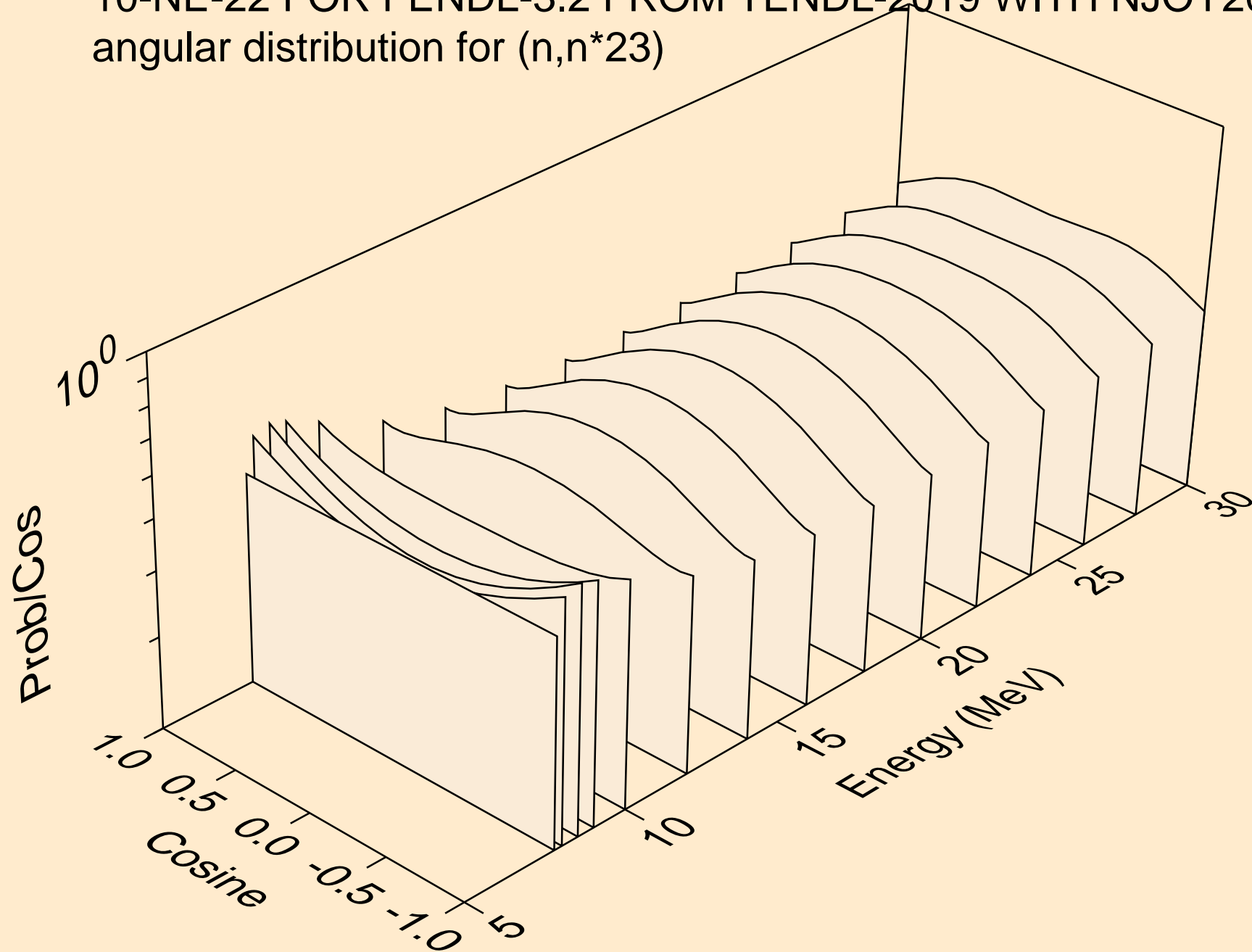

10-NE-22 FOR FENDL-3.2 FROM TENDL-2019 WITH NJOY2016.60  
angular distribution for (n,n\*24)

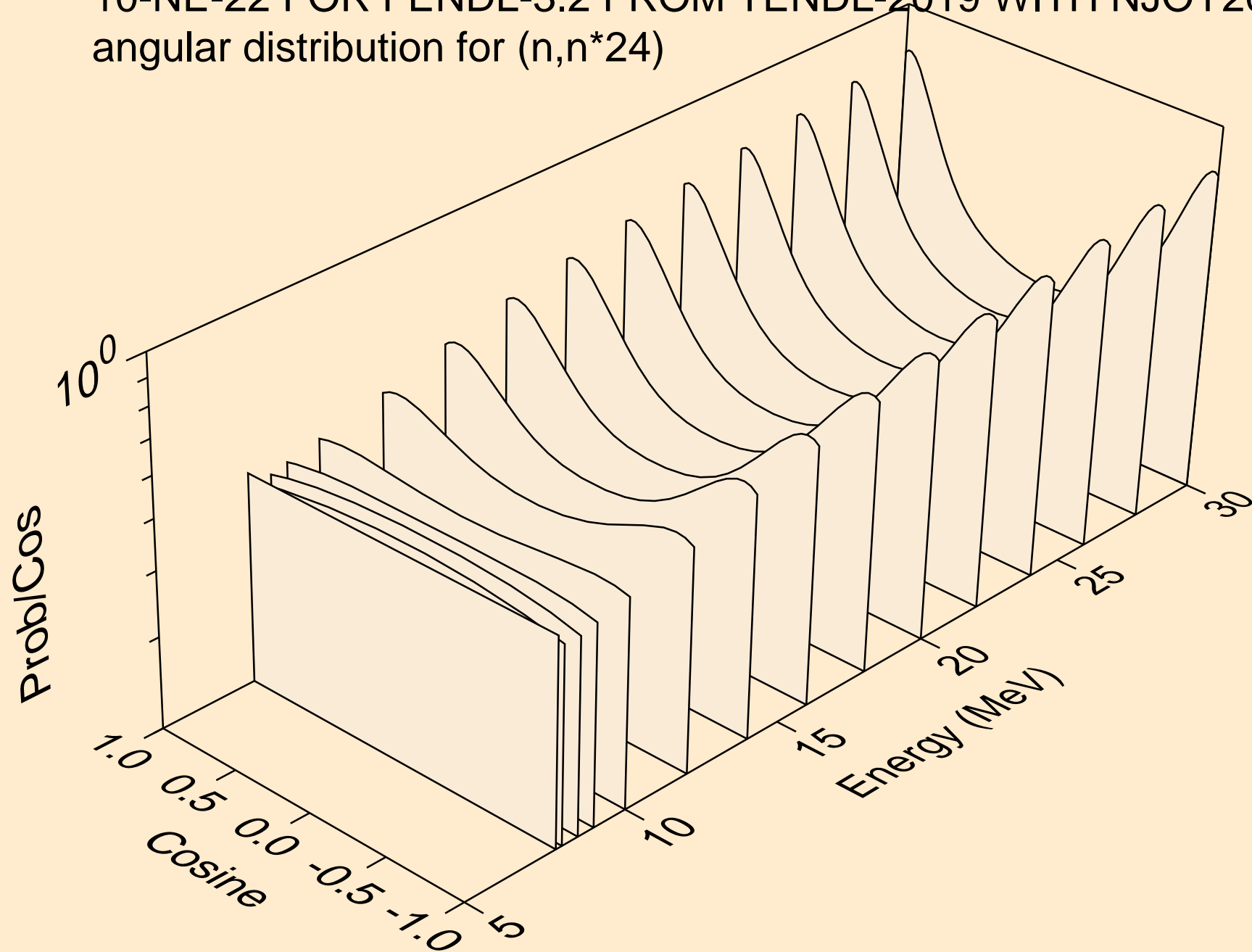



10-NE-22 FOR FENDL-3.2 FROM TENDL-2019 WITH NJOY2016.60  
angular distribution for (n,n\*25)

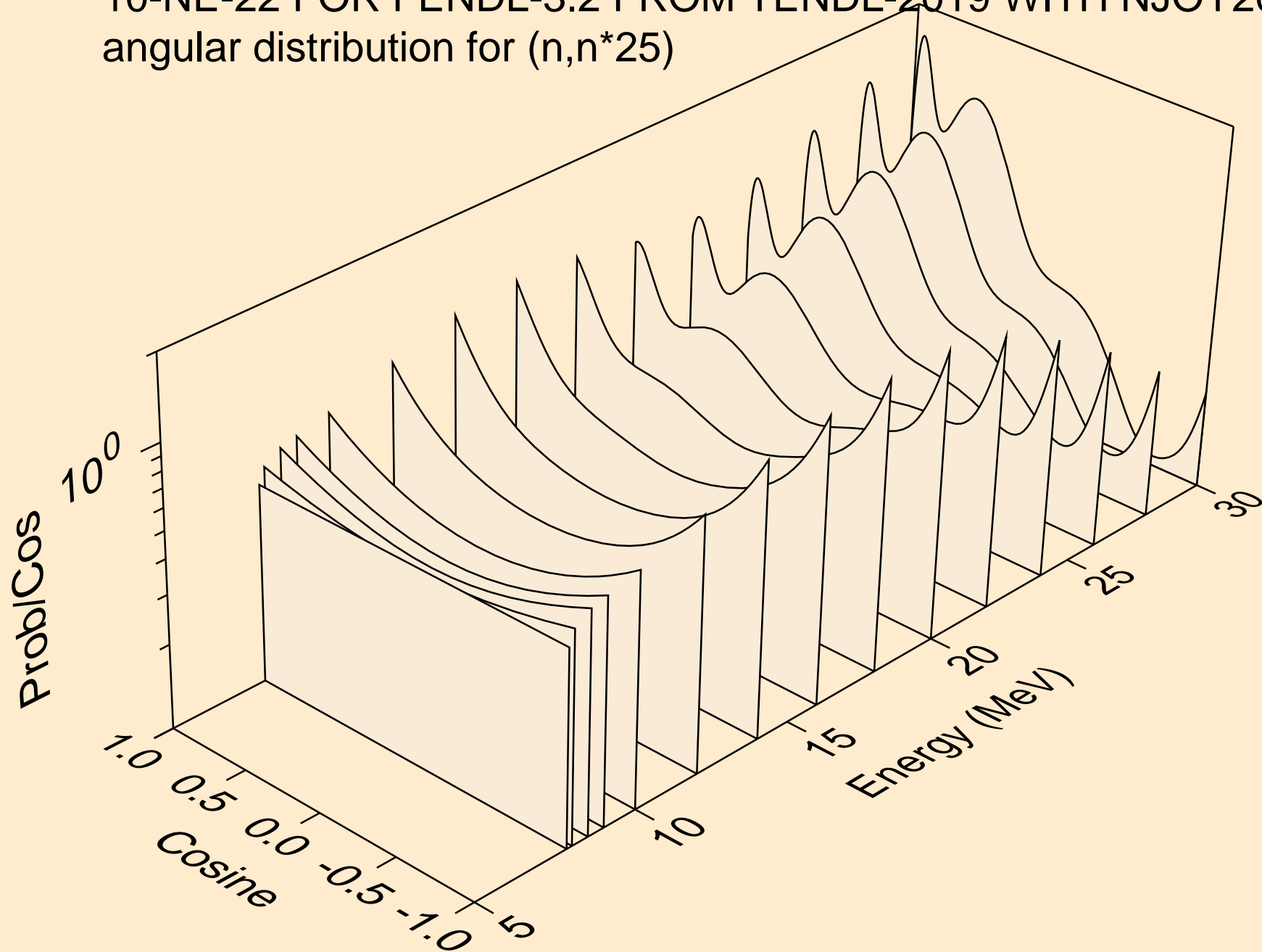

10-NE-22 FOR FENDL-3.2 FROM TENDL-2019 WITH NJOY2016.60  
angular distribution for (n,n\*26)

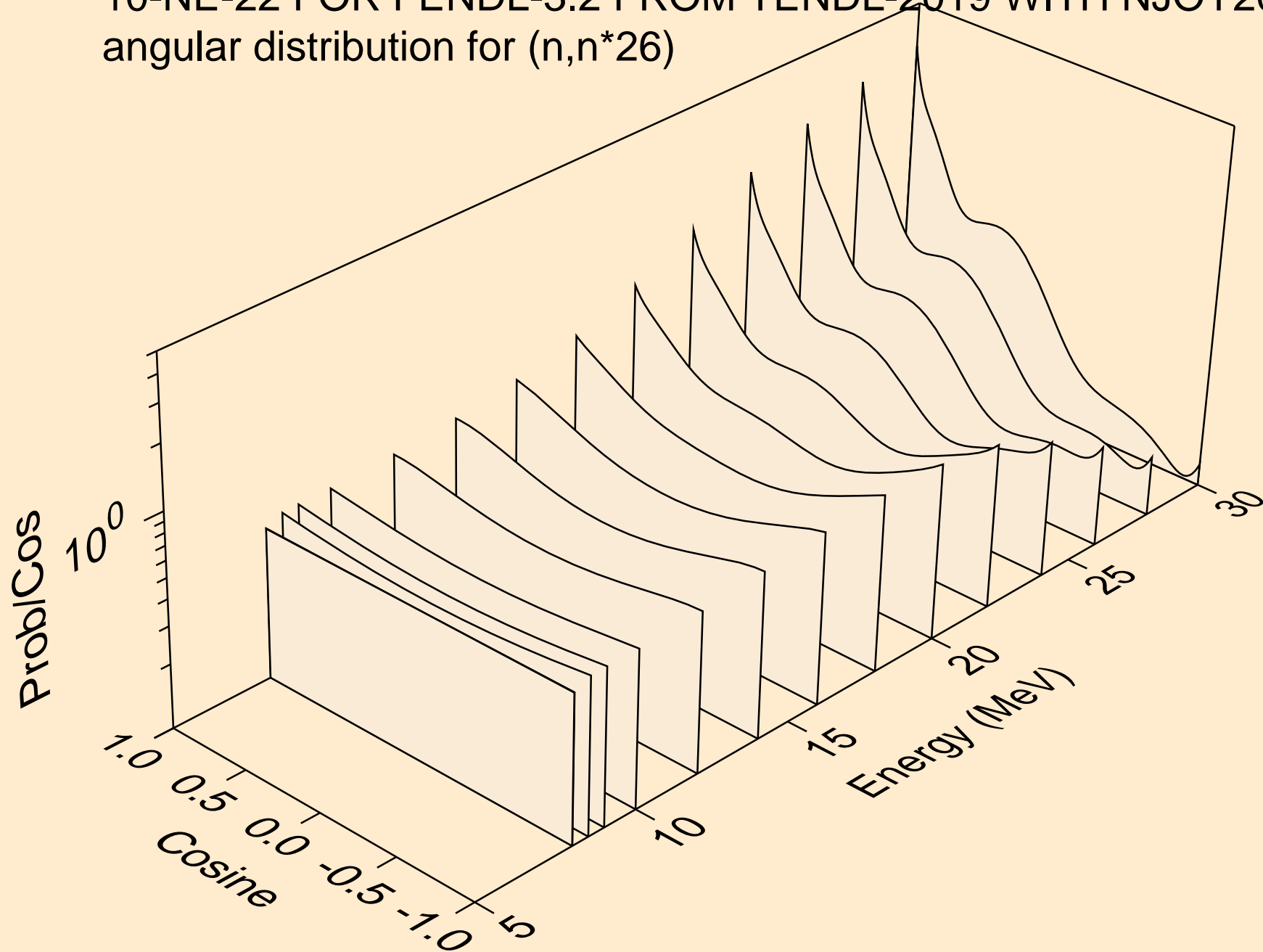

10-NE-22 FOR FENDL-3.2 FROM TENDL-2019 WITH NJOY2016.60  
angular distribution for (n,n\*27)

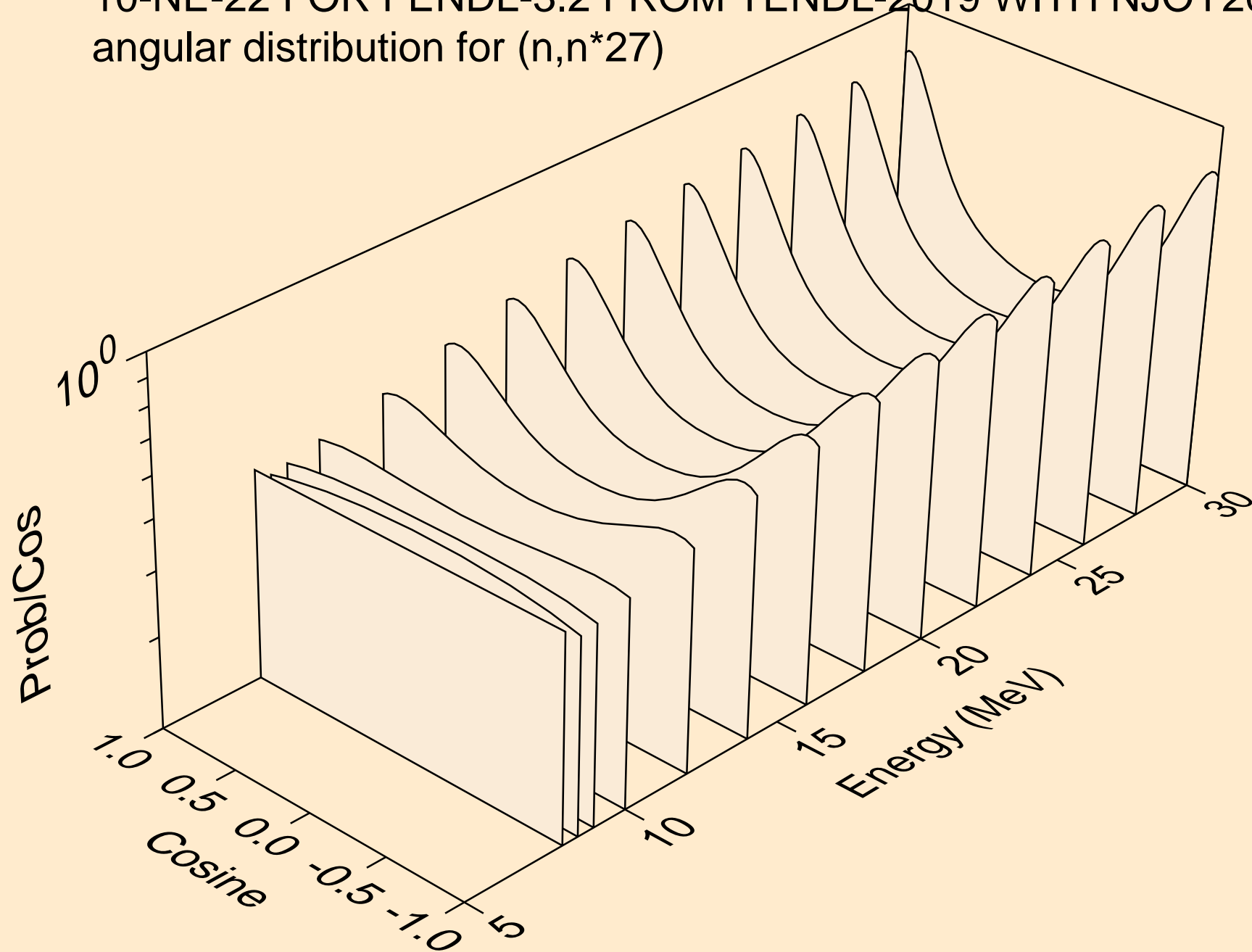

10-NE-22 FOR FENDL-3.2 FROM TENDL-2019 WITH NJOY2016.60  
angular distribution for (n,n\*28)

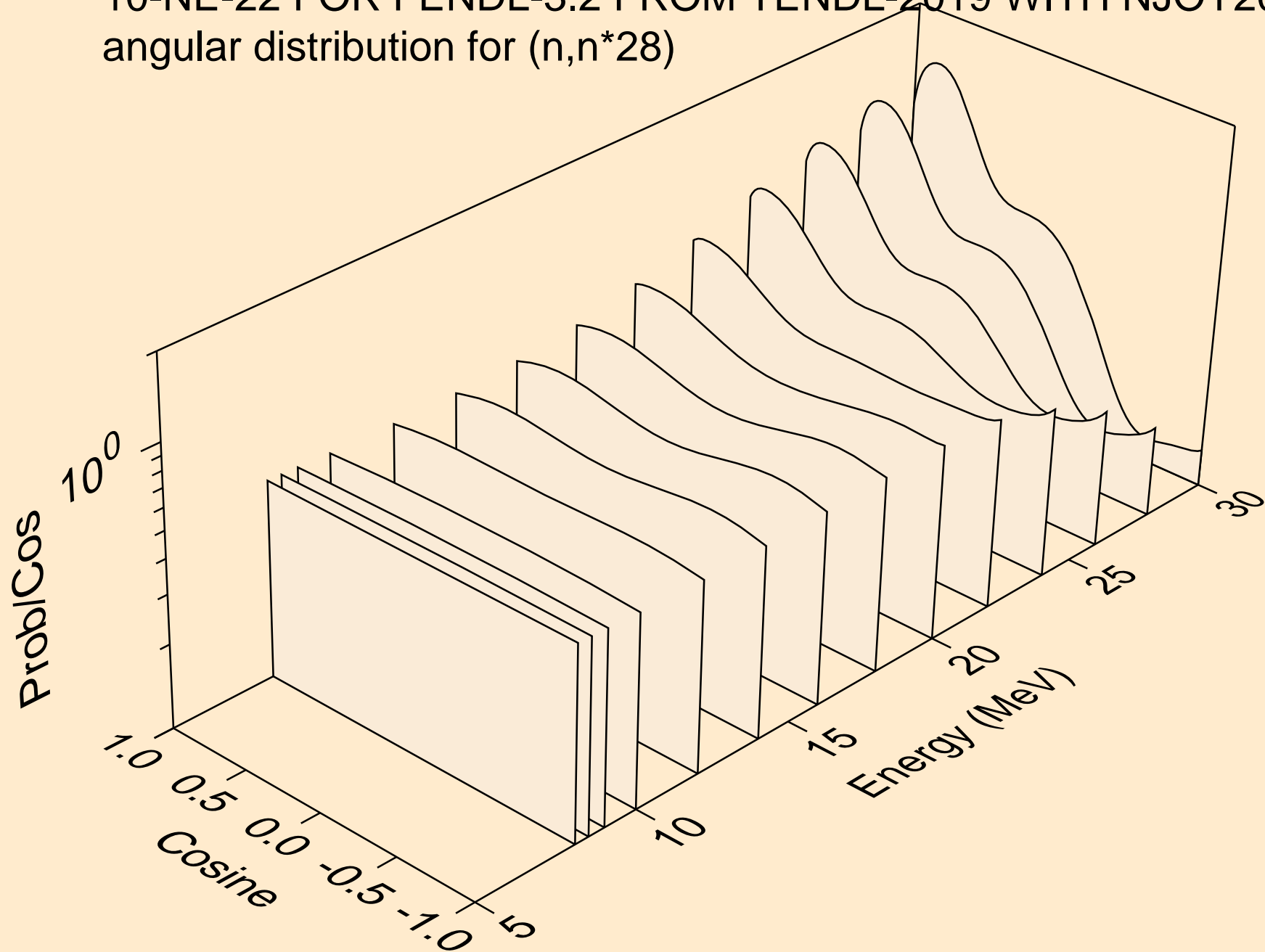

10-NE-22 FOR FENDL-3.2 FROM TENDL-2019 WITH NJOY2016.60  
angular distribution for (n,n\*29)

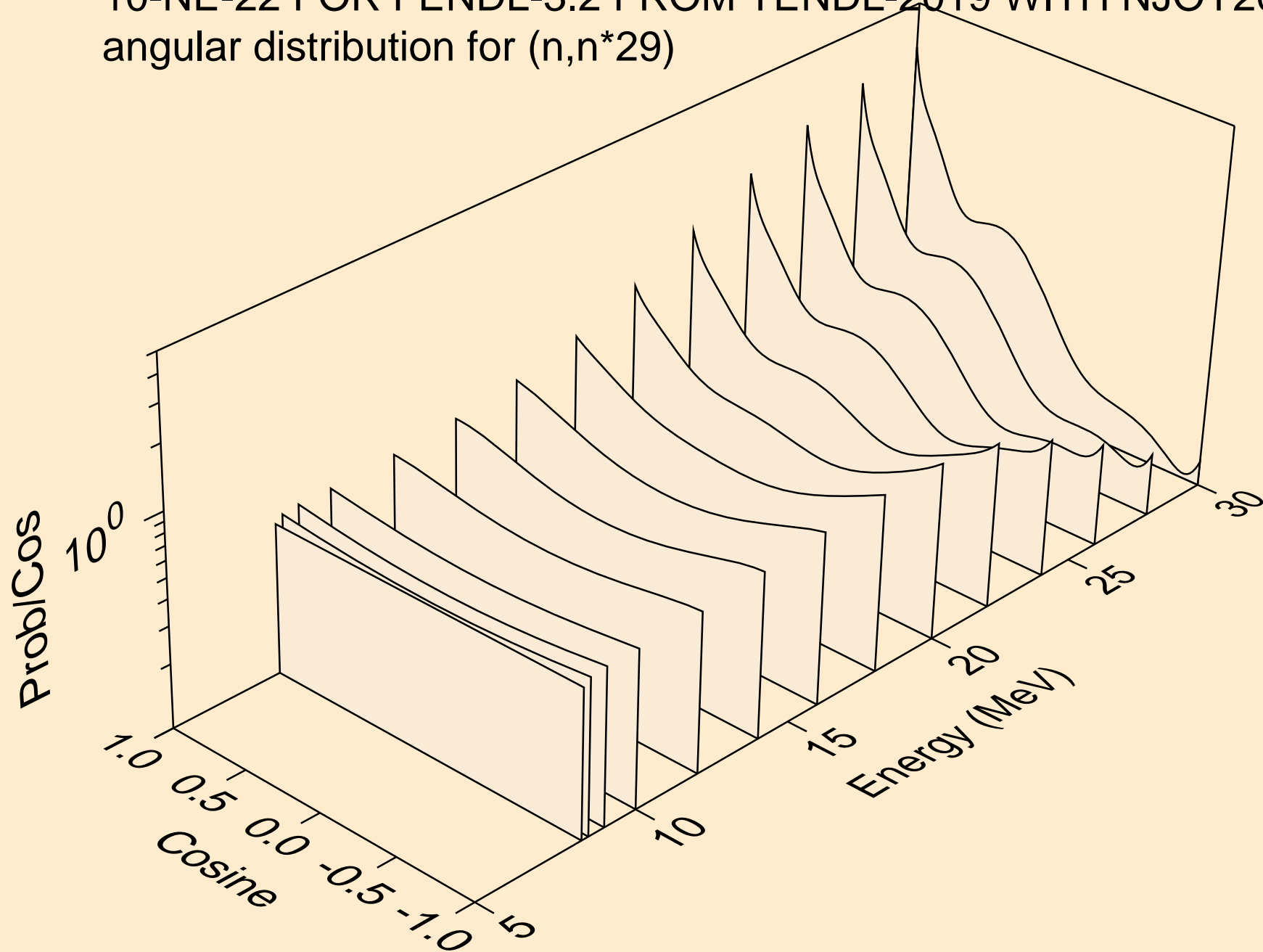

10-NE-22 FOR FENDL-3.2 FROM TENDL-2019 WITH NJOY2016.60  
angular distribution for (n,n\*30)

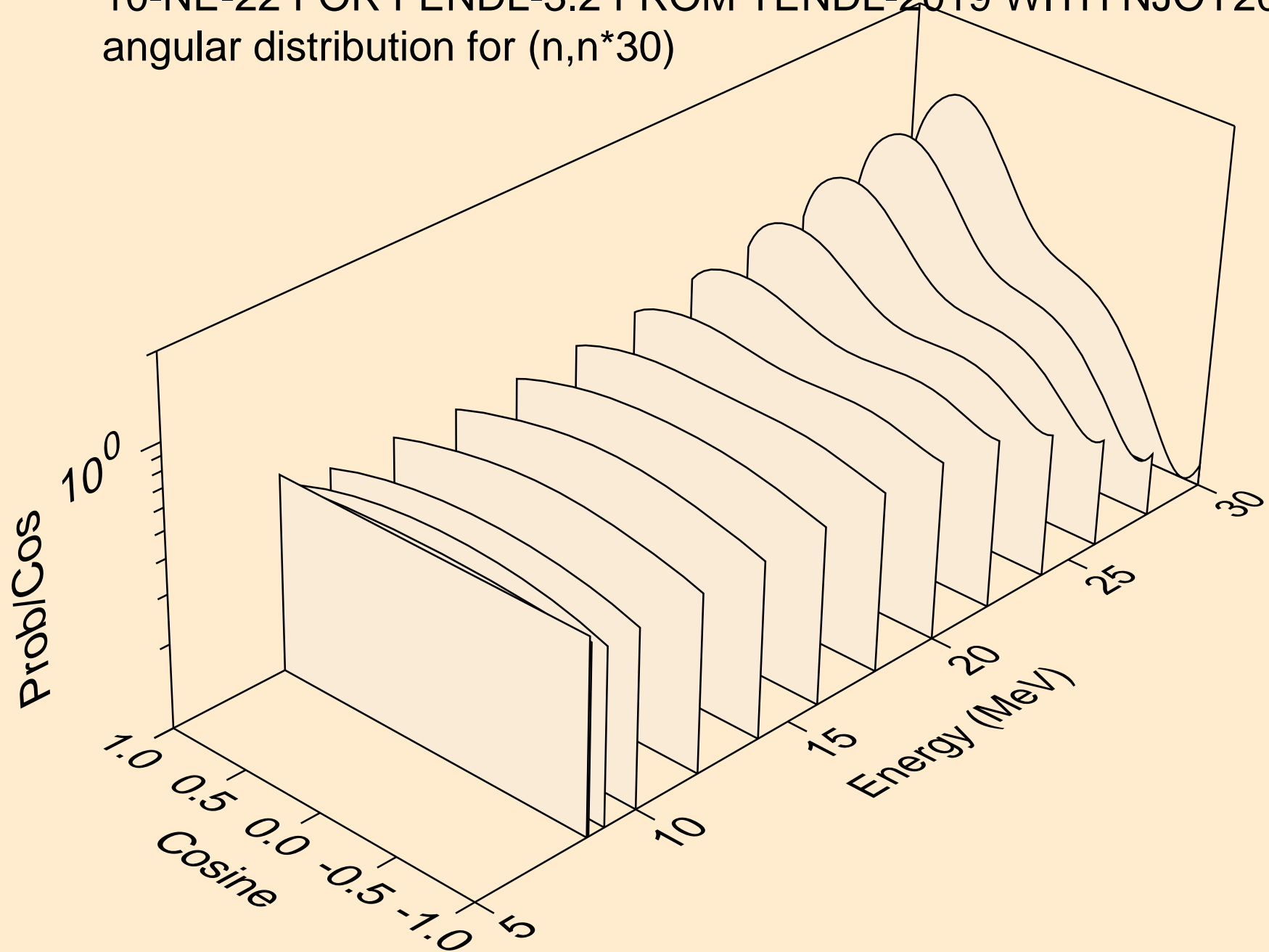

10-NE-22 FOR FENDL-3.2 FROM TENDL-2019 WITH NJOY2016.60  
Neutron emission for (n,x)

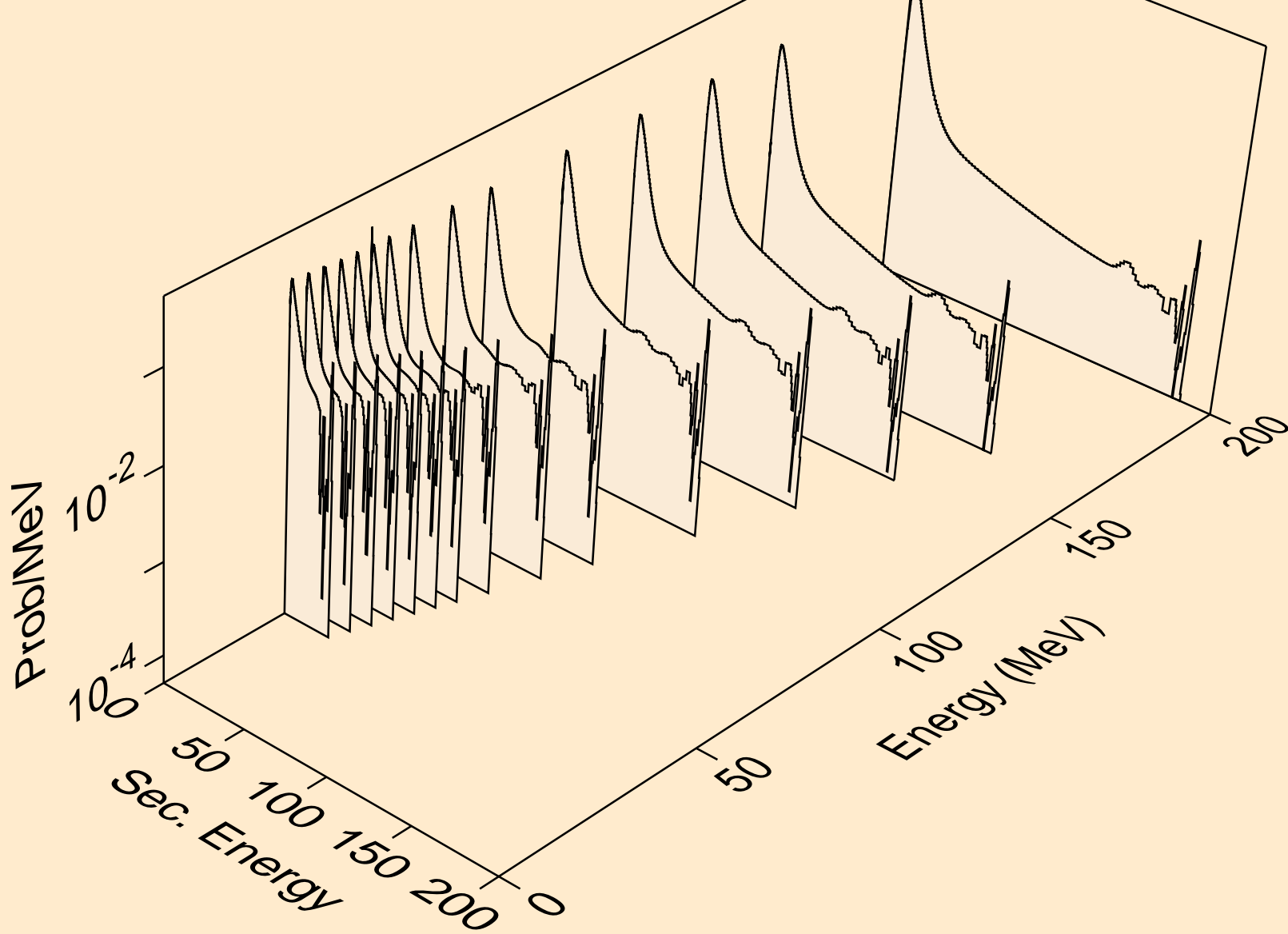

10-NE-22 FOR FENDL-3.2 FROM TENDL-2019 WITH NJOY2016.60  
Neutron emission for (n,2nd)

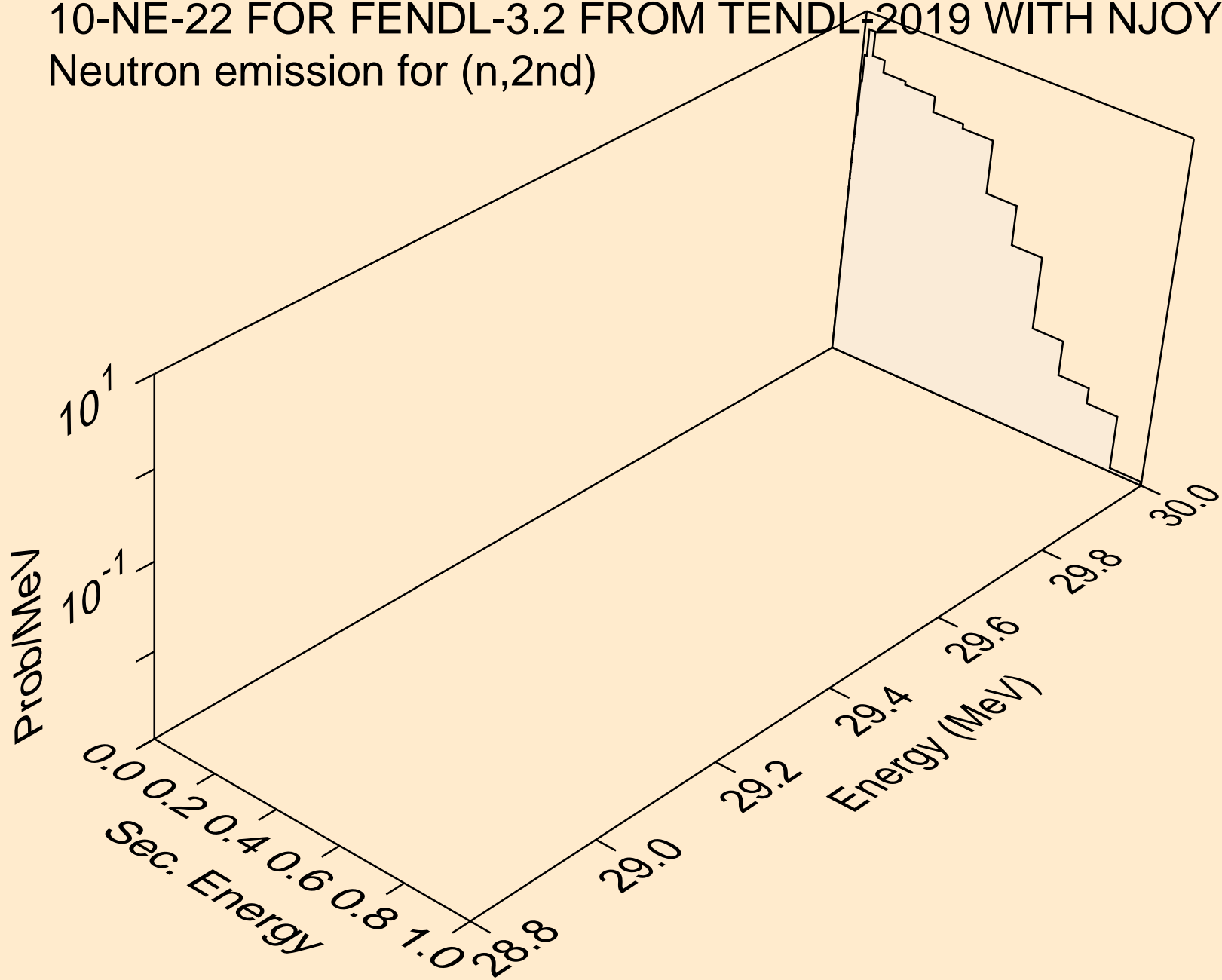



10-NE-22 FOR FENDL-3.2 FROM TENDL-2019 WITH NJOY2016.60  
Neutron emission for (n,2n)

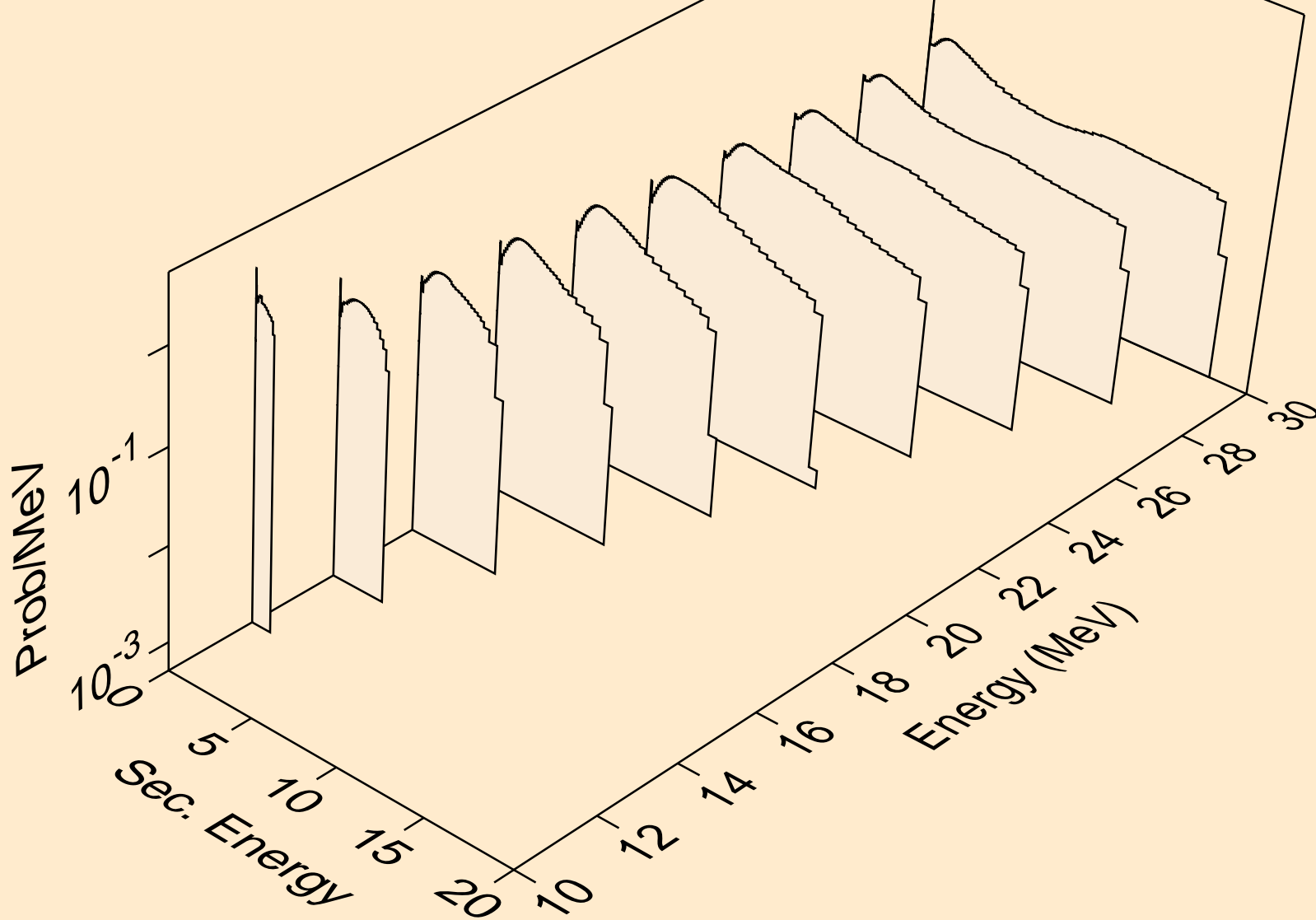

10-NE-22 FOR FENDL-3.2 FROM TENDL-2019 WITH NJOY2016.60  
Neutron emission for (n,3n)

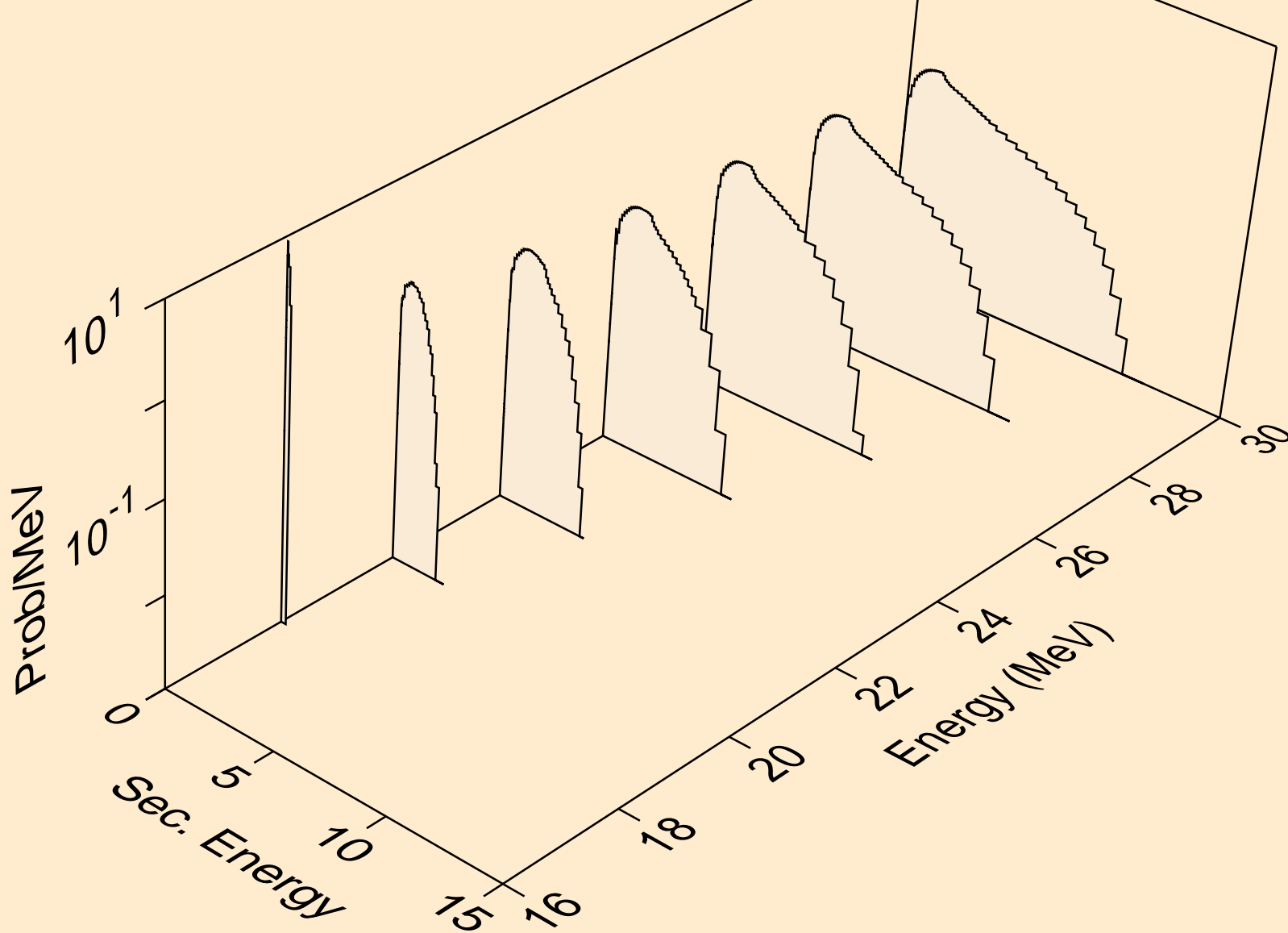

10-NE-22 FOR FENDL-3.2 FROM TENDL-2019 WITH NJOY2016.60  
Neutron emission for (n,n\*)a

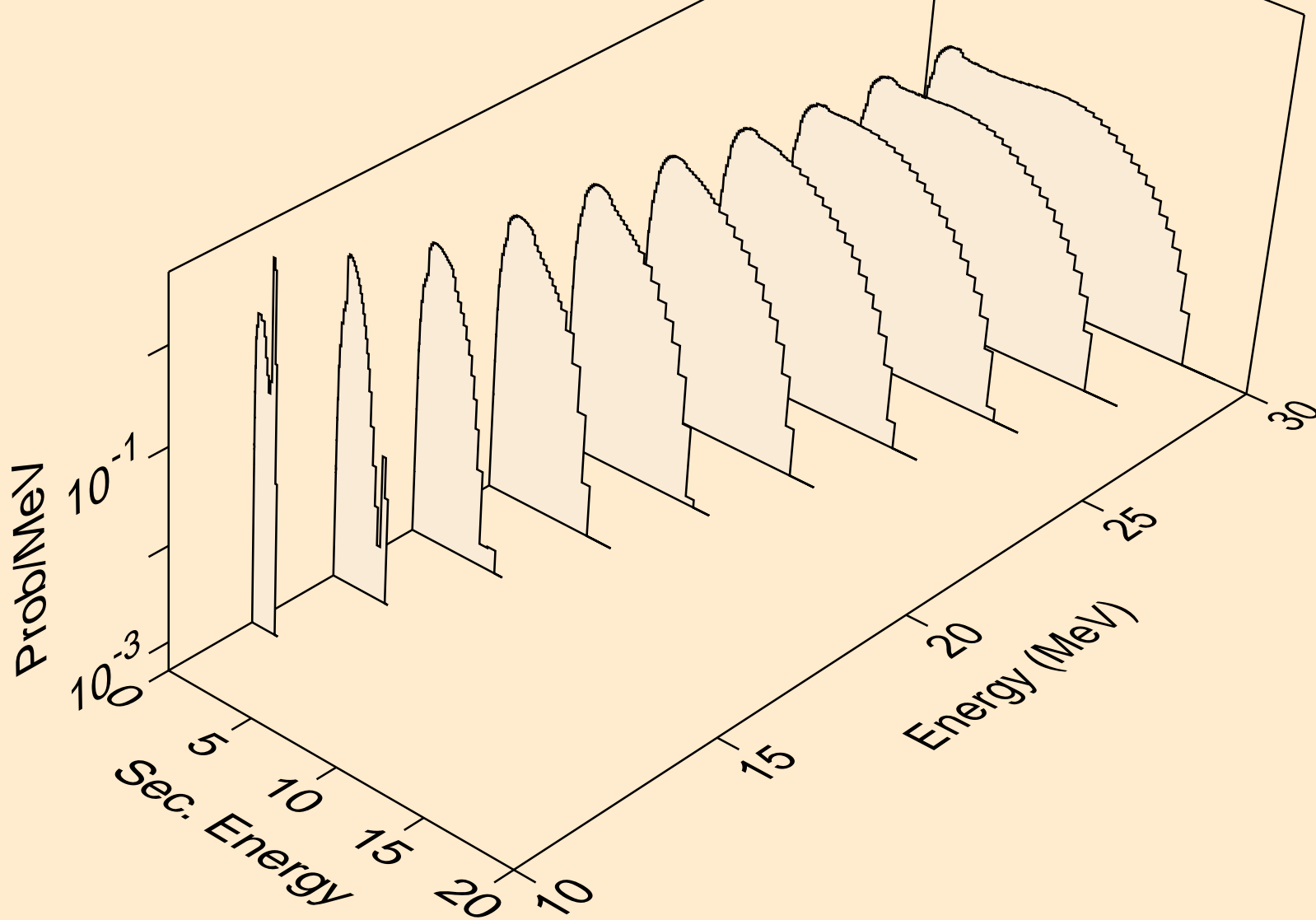

10-NE-22 FOR FENDL-3.2 FROM TENDL-2019 WITH NJOY2016.60  
Neutron emission for (n,2n)a

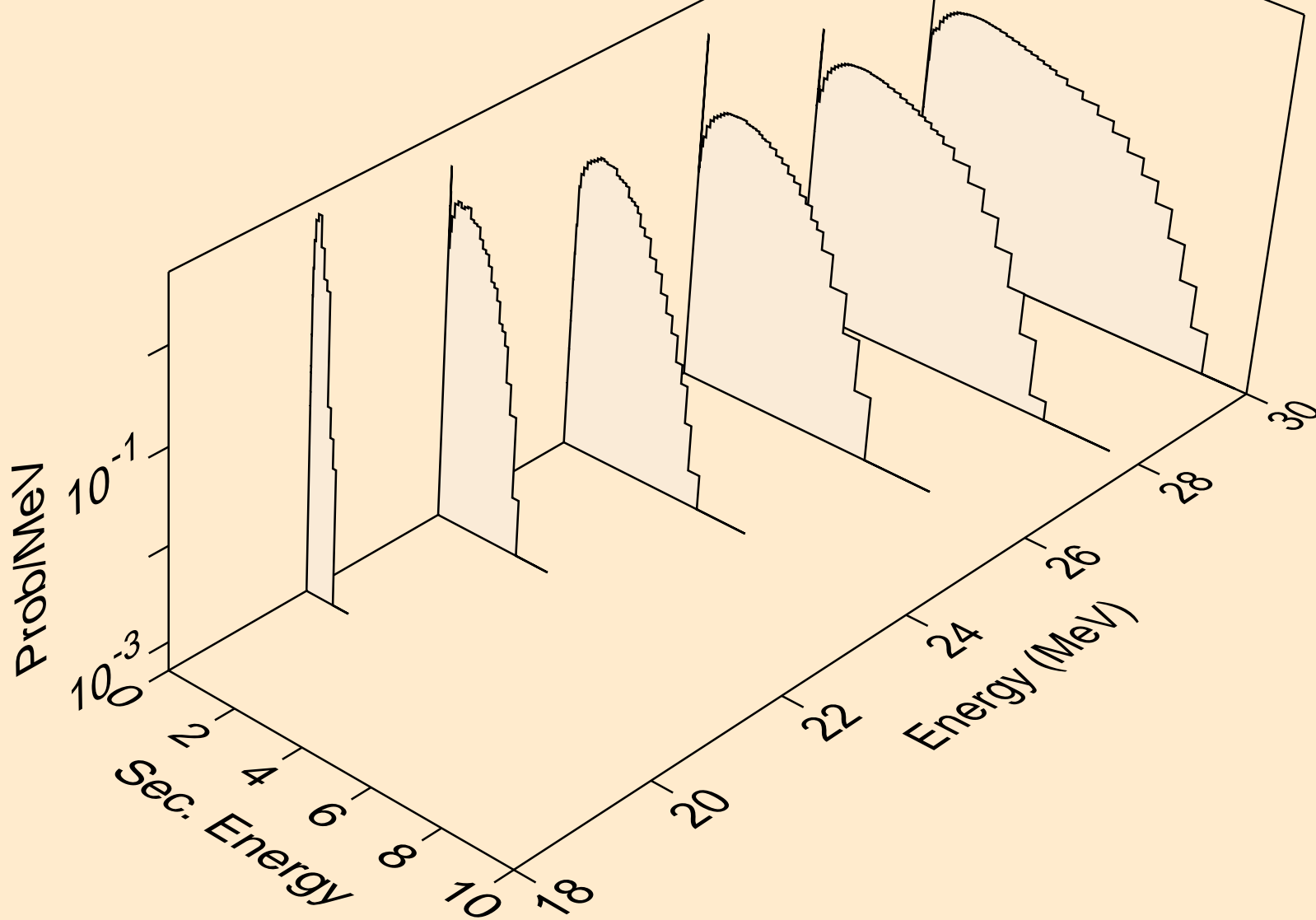

10-NE-22 FOR FENDL-3.2 FROM TENDL-2019 WITH NJOY2016.60  
Neutron emission for (n,3n)a

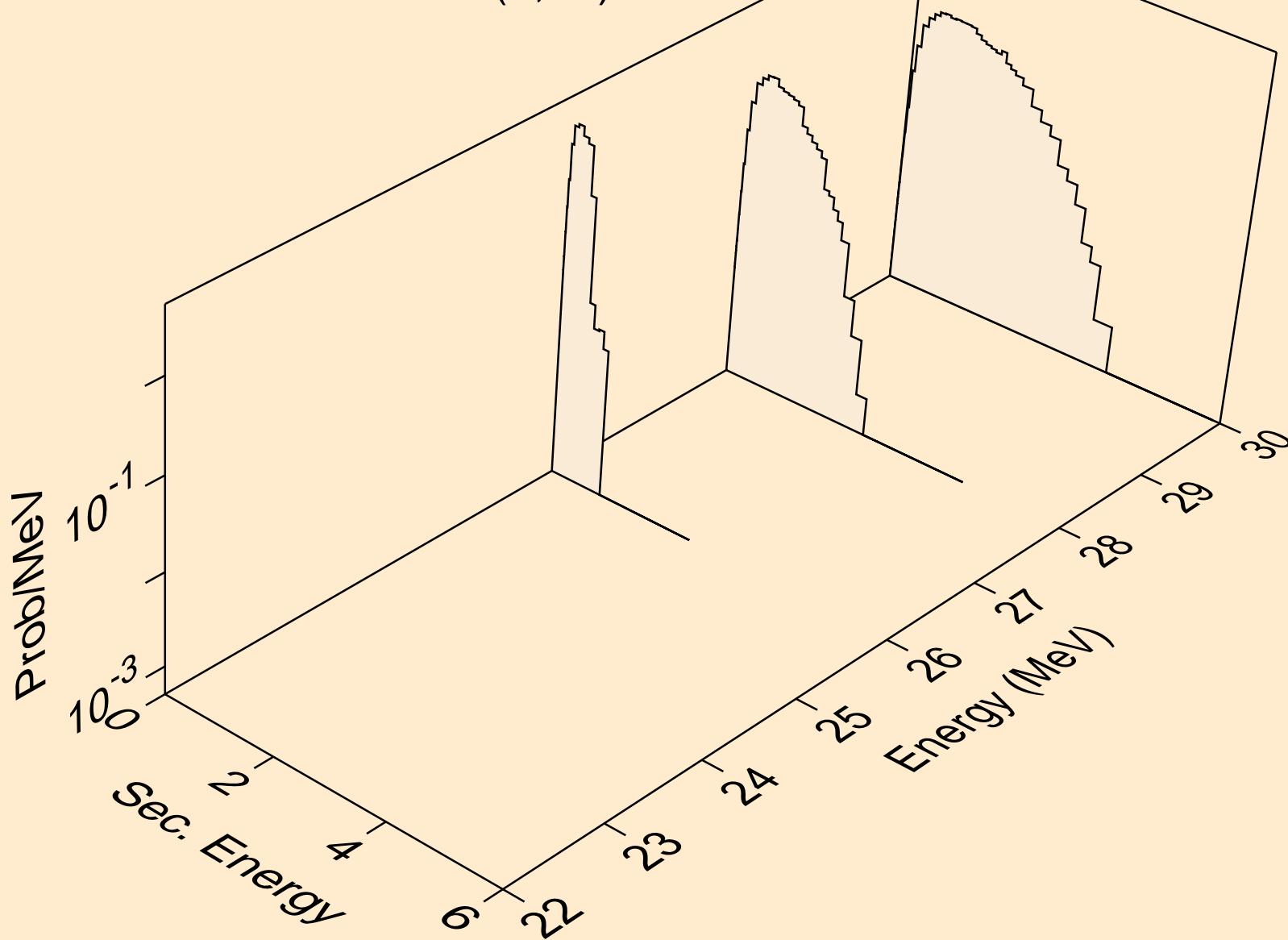

10-NE-22 FOR FENDL-3.2 FROM TENDL-2019 WITH NJOY2016.60  
Neutron emission for (n,n\*)p

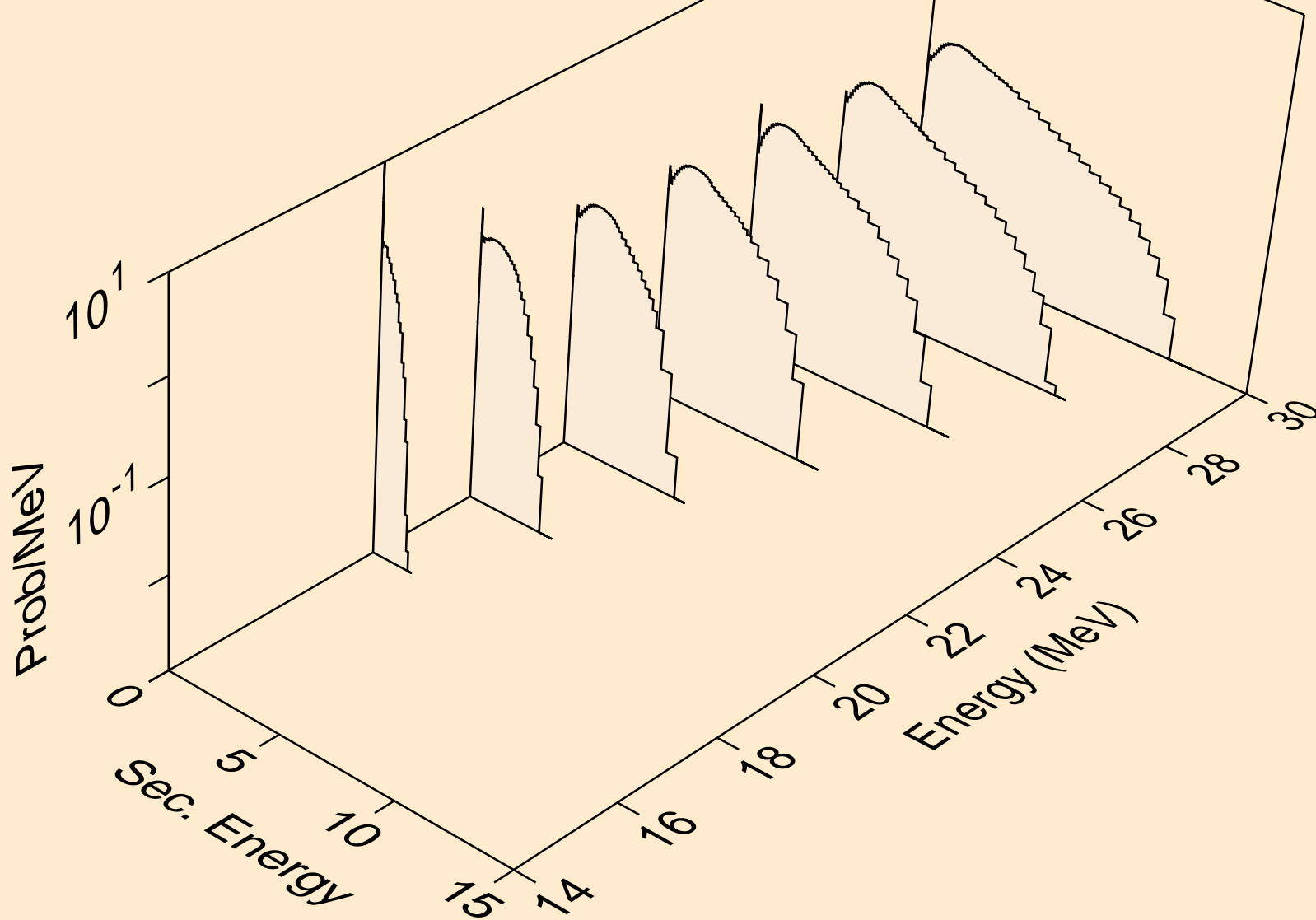

10-NE-22 FOR FENDL-3.2 FROM TENDL-2019 WITH NJOY2016.60  
Neutron emission for (n,n\*)2a

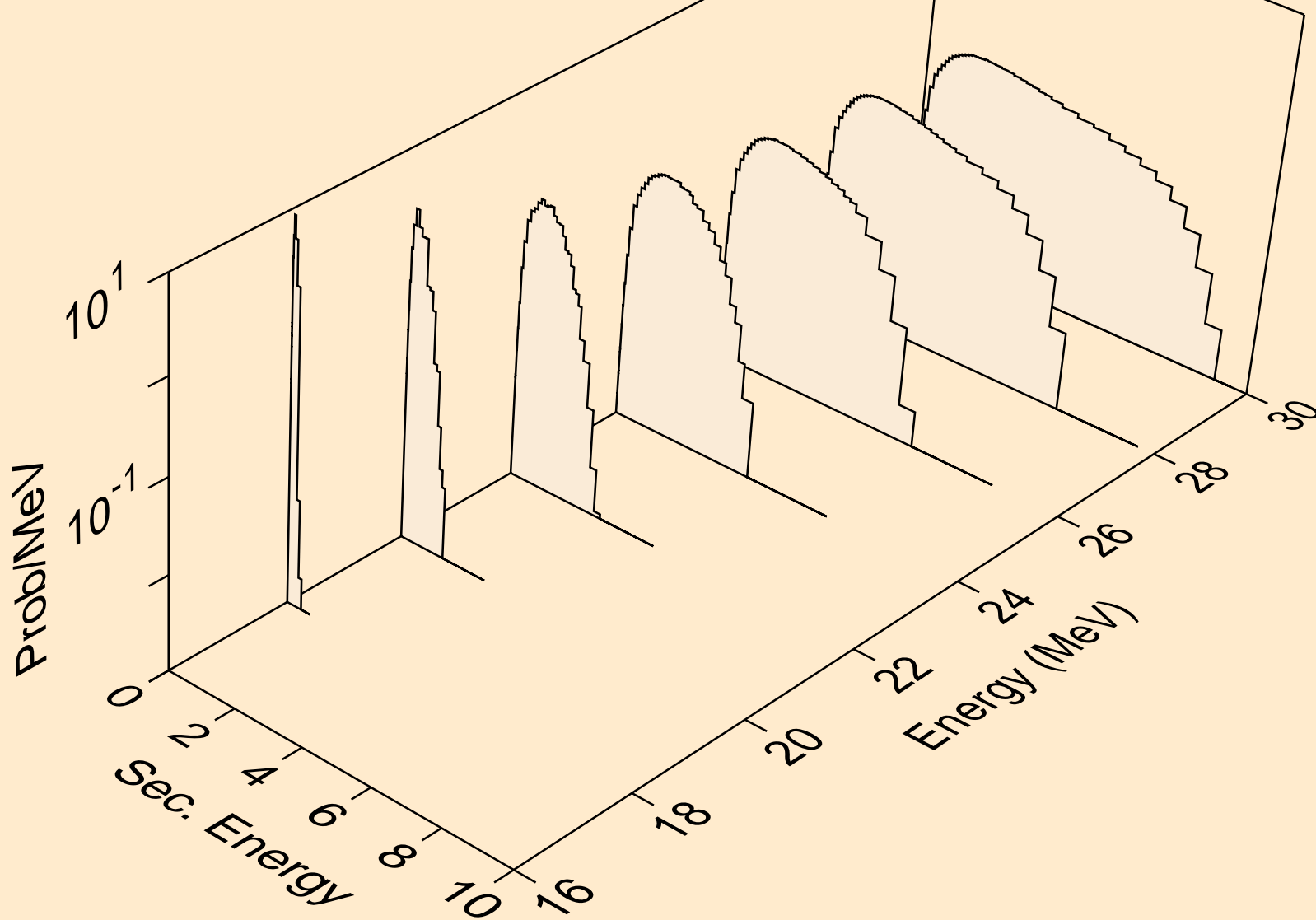

10-NE-22 FOR FENDL-3.2 FROM TENDL-2019 WITH NJOY2016.60  
Neutron emission for (n,2n)2a

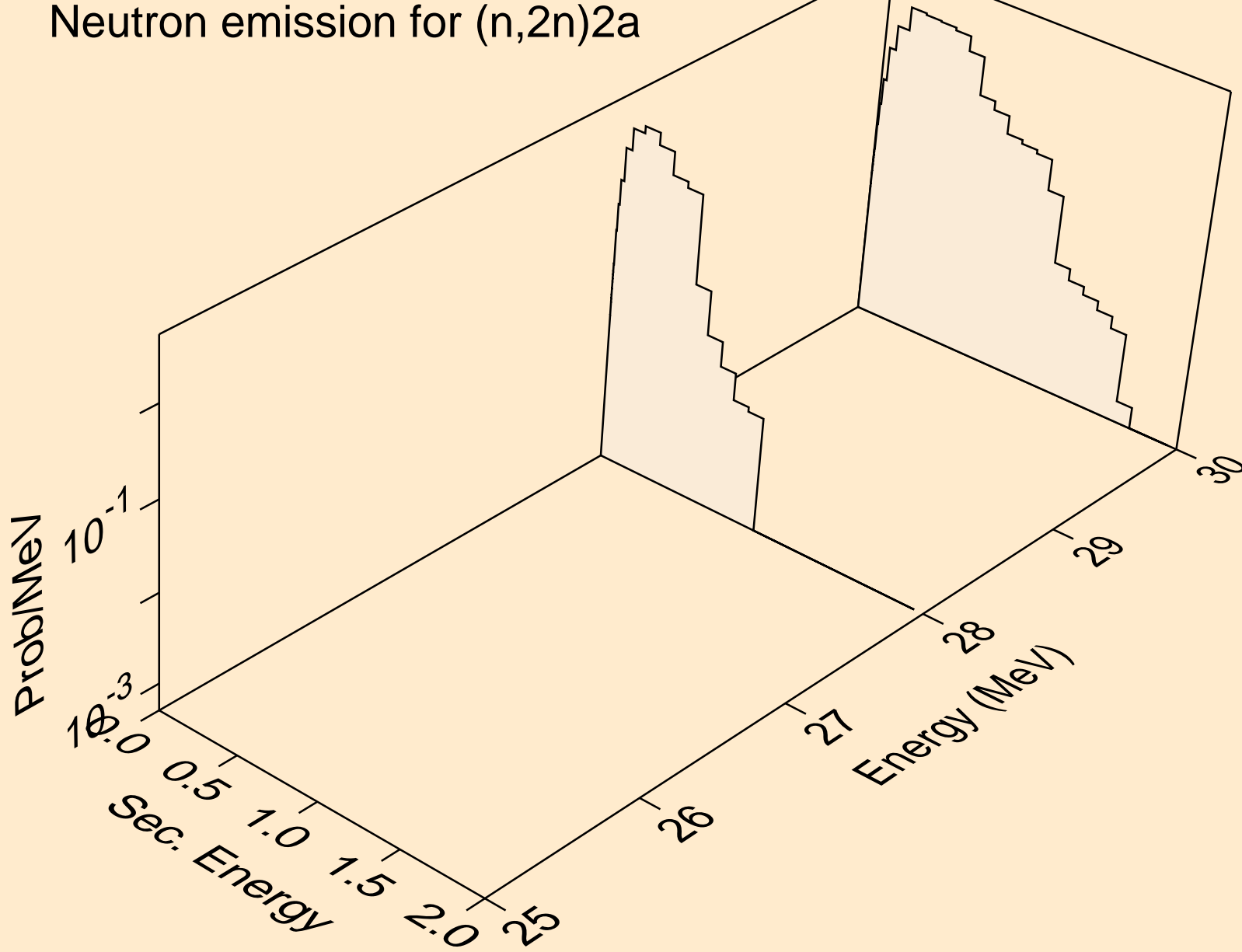



10-NE-22 FOR FENDL-3.2 FROM TENDL-2019 WITH NJOY2016.60  
Neutron emission for (n,n\*)d

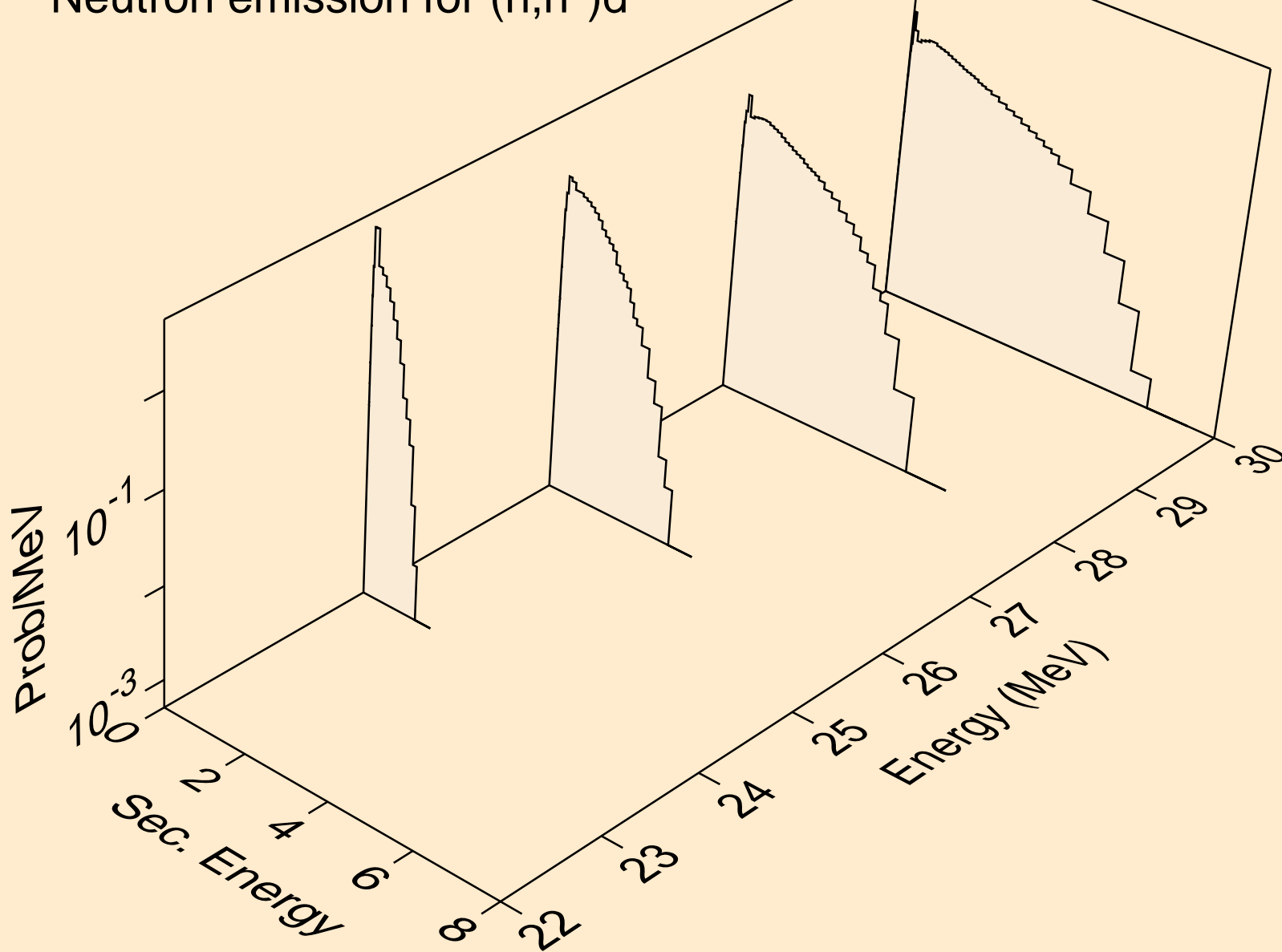

10-NE-22 FOR FENDL-3.2 FROM TENDL-2019 WITH NJOY2016.60  
Neutron emission for (n,n\*)t

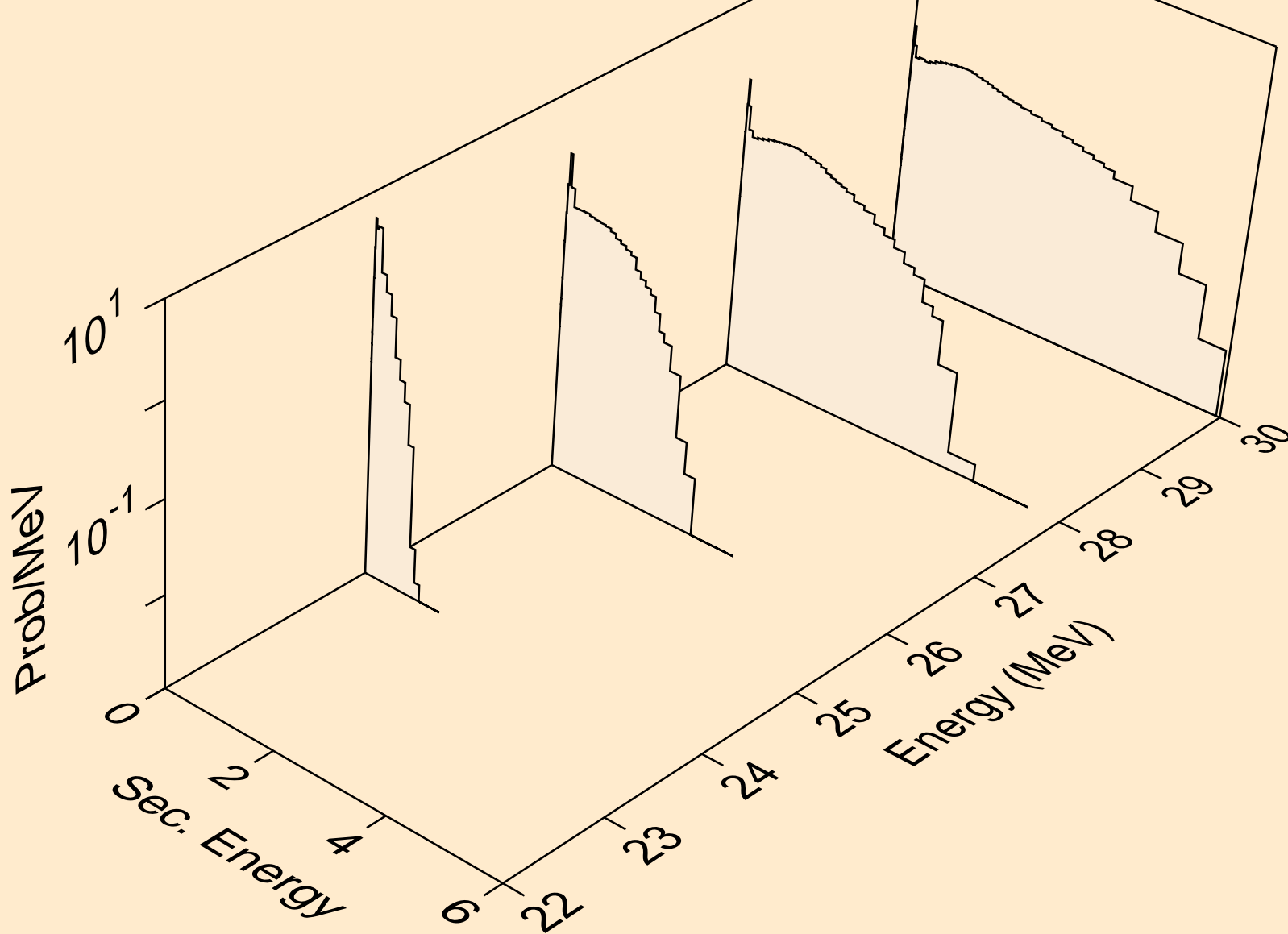

10-NE-22 FOR FENDL-3.2 FROM TENDL-2019 WITH NJOY2016.60  
Neutron emission for (n,n\*)he3

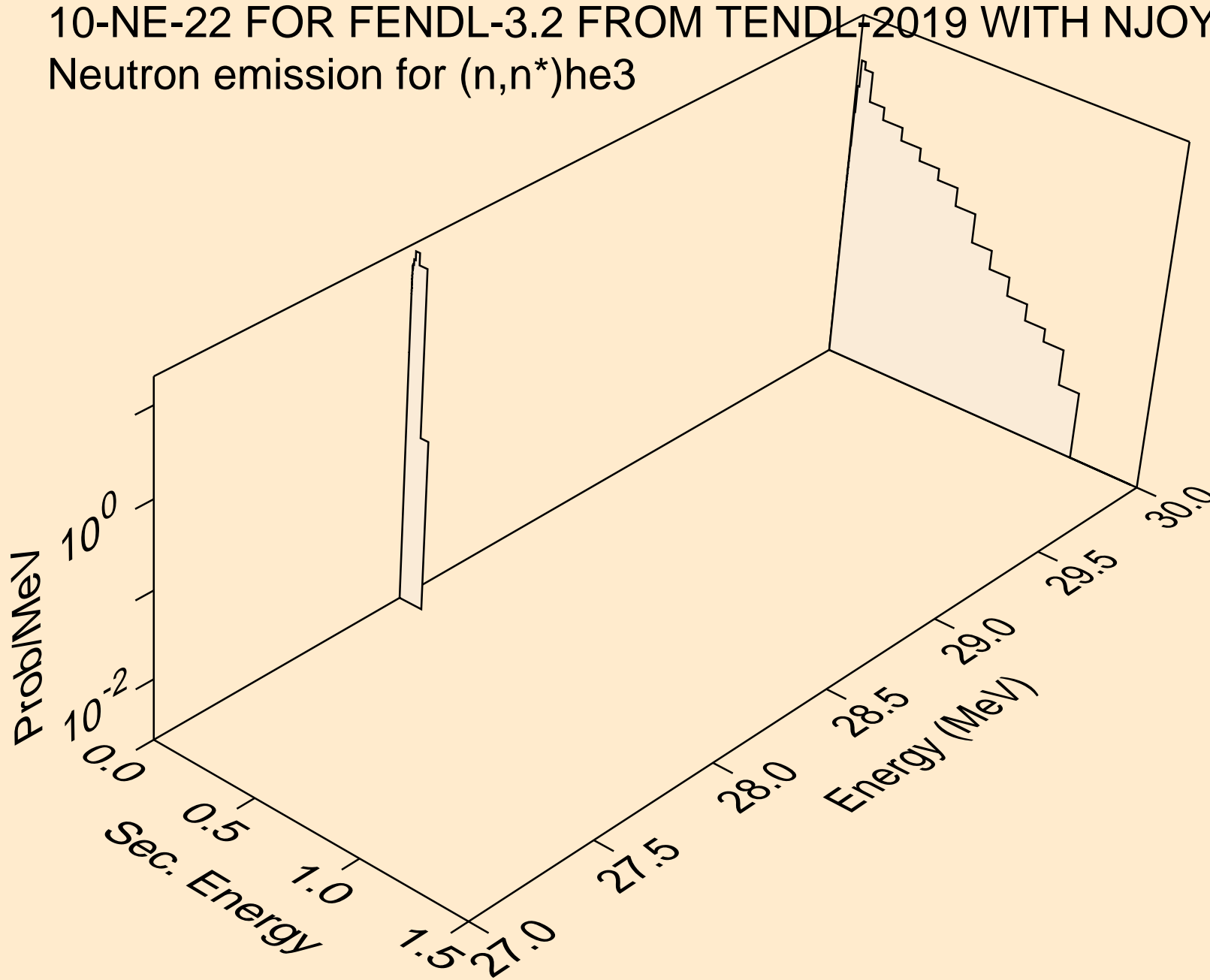

10-NE-22 FOR FENDL-3.2 FROM TENDL-2019 WITH NJOY2016.60  
Neutron emission for (n,2np)

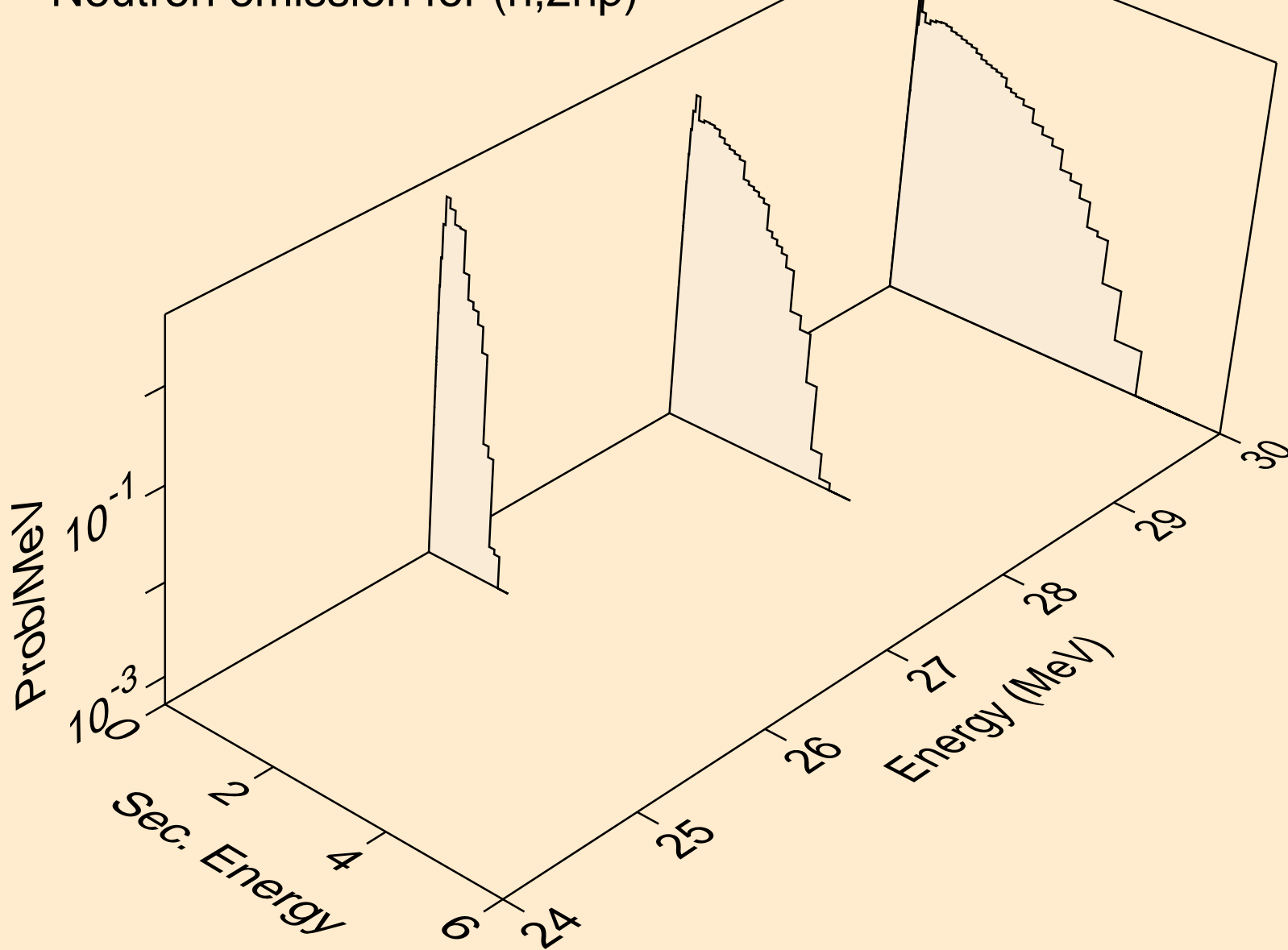

10-NE-22 FOR FENDL-3.2 FROM TENDL-2019 WITH NJOY2016.60  
Neutron emission for (n,2np)

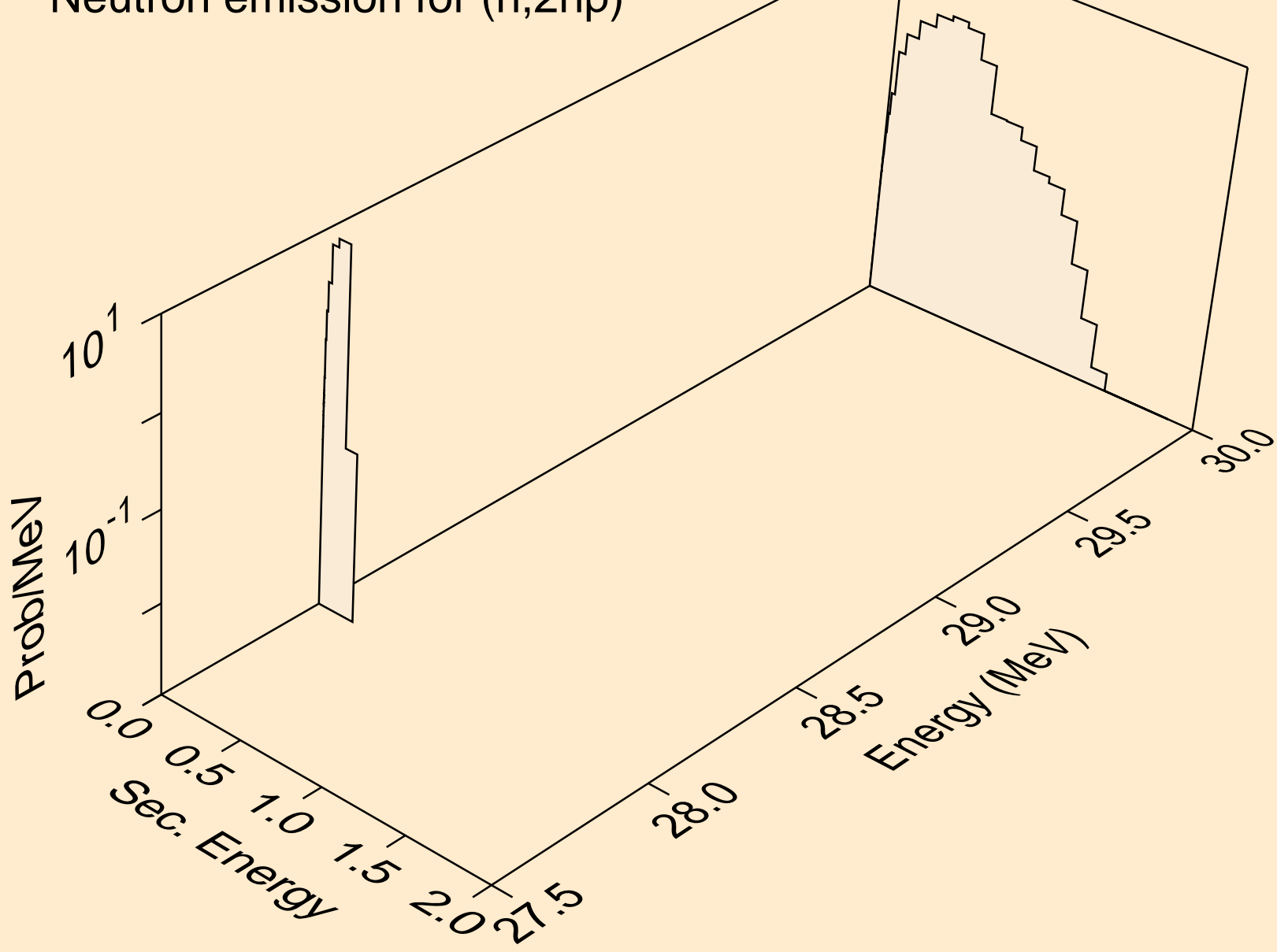

10-NE-22 FOR FENDL-3.2 FROM TENDL-2019 WITH NJOY2016.60  
Neutron emission for (n,npa)

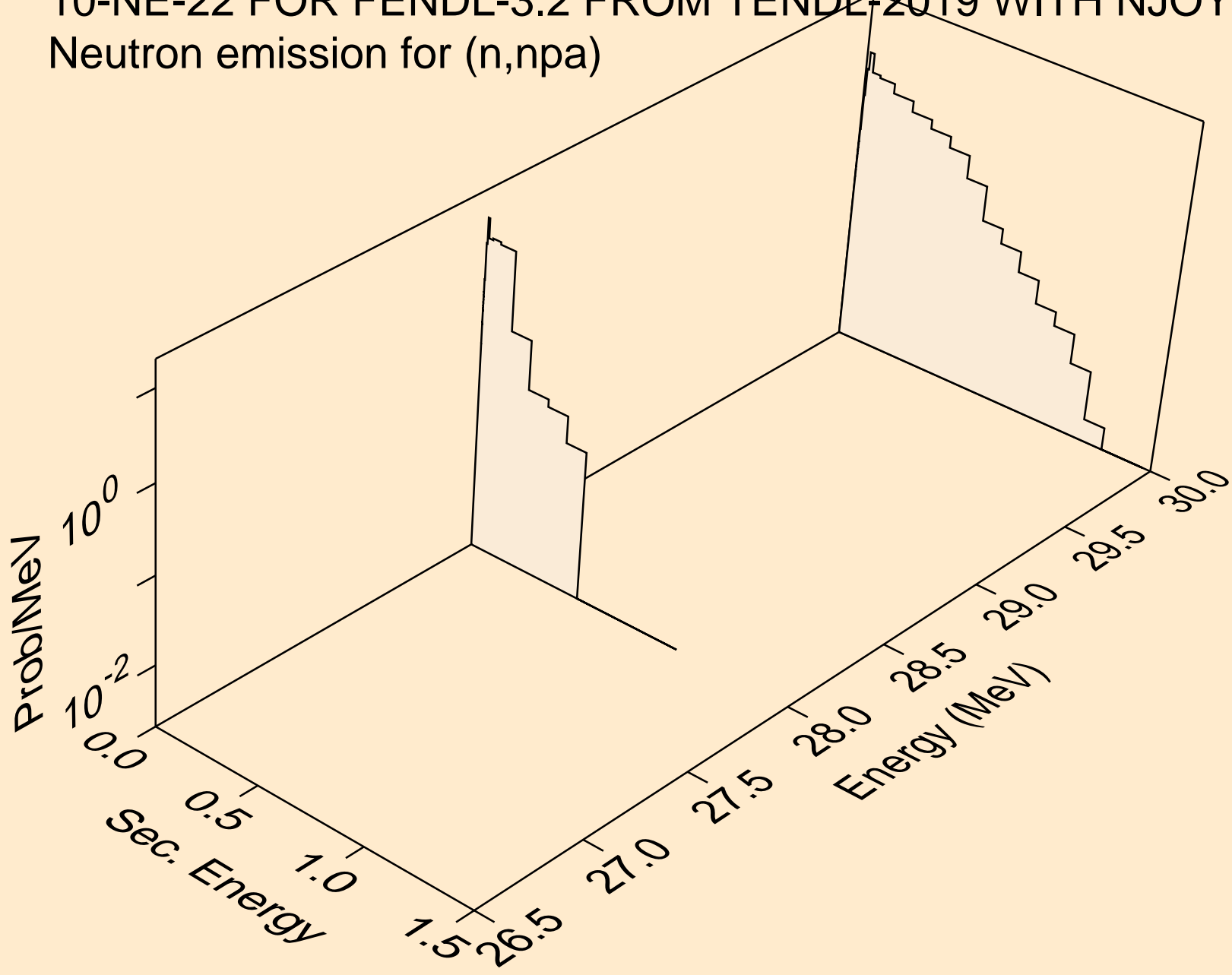

10-NE-22 FOR FENDL-3.2 FROM TENDL-2019 WITH NJOY2016.60  
Neutron emission for (n,n\*c)

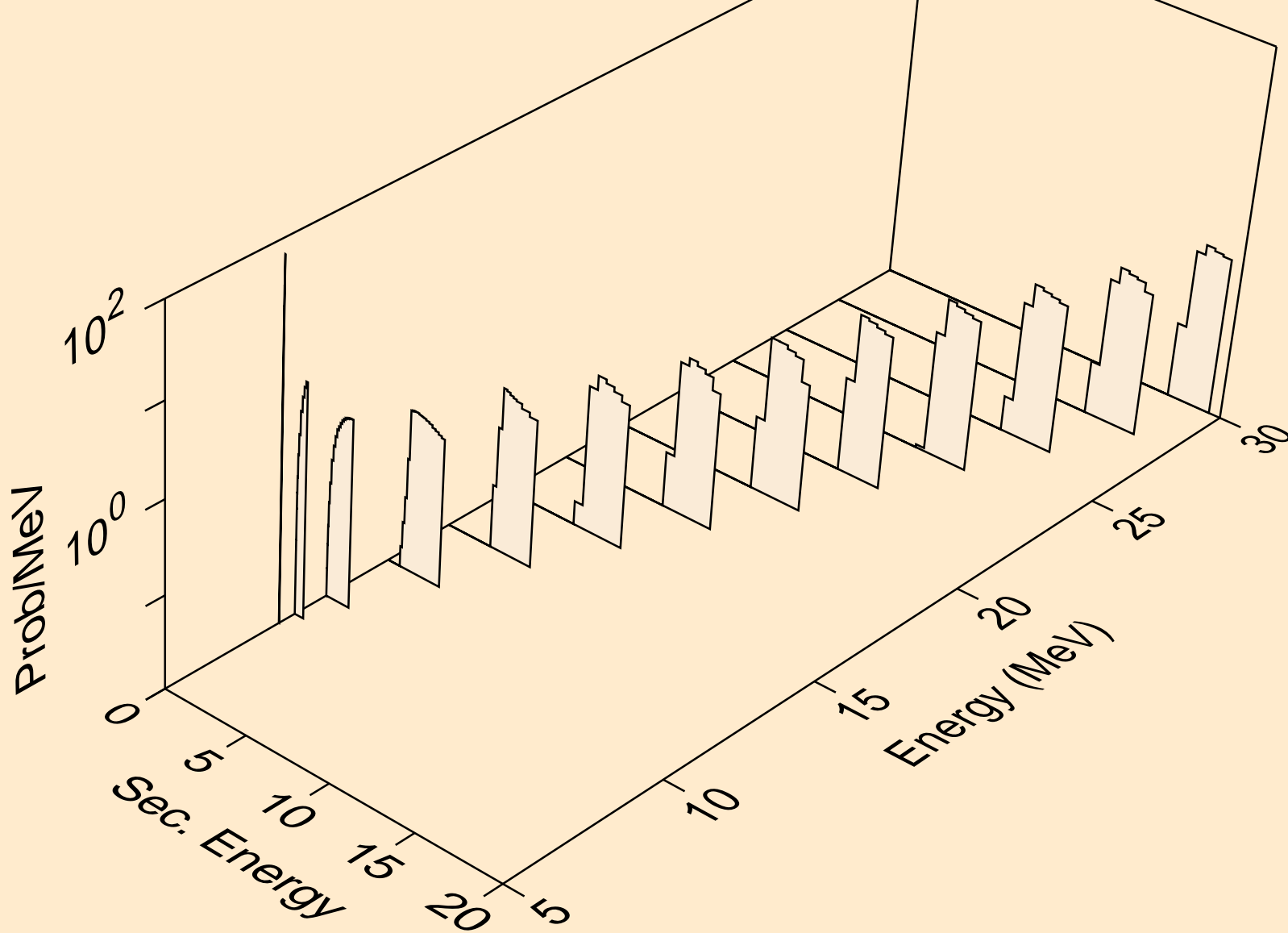

10-NE-22 FOR FENDL-3.2 FROM TENDL-2019 WITH NJOY2016.60  
Photon emission for (n,x)

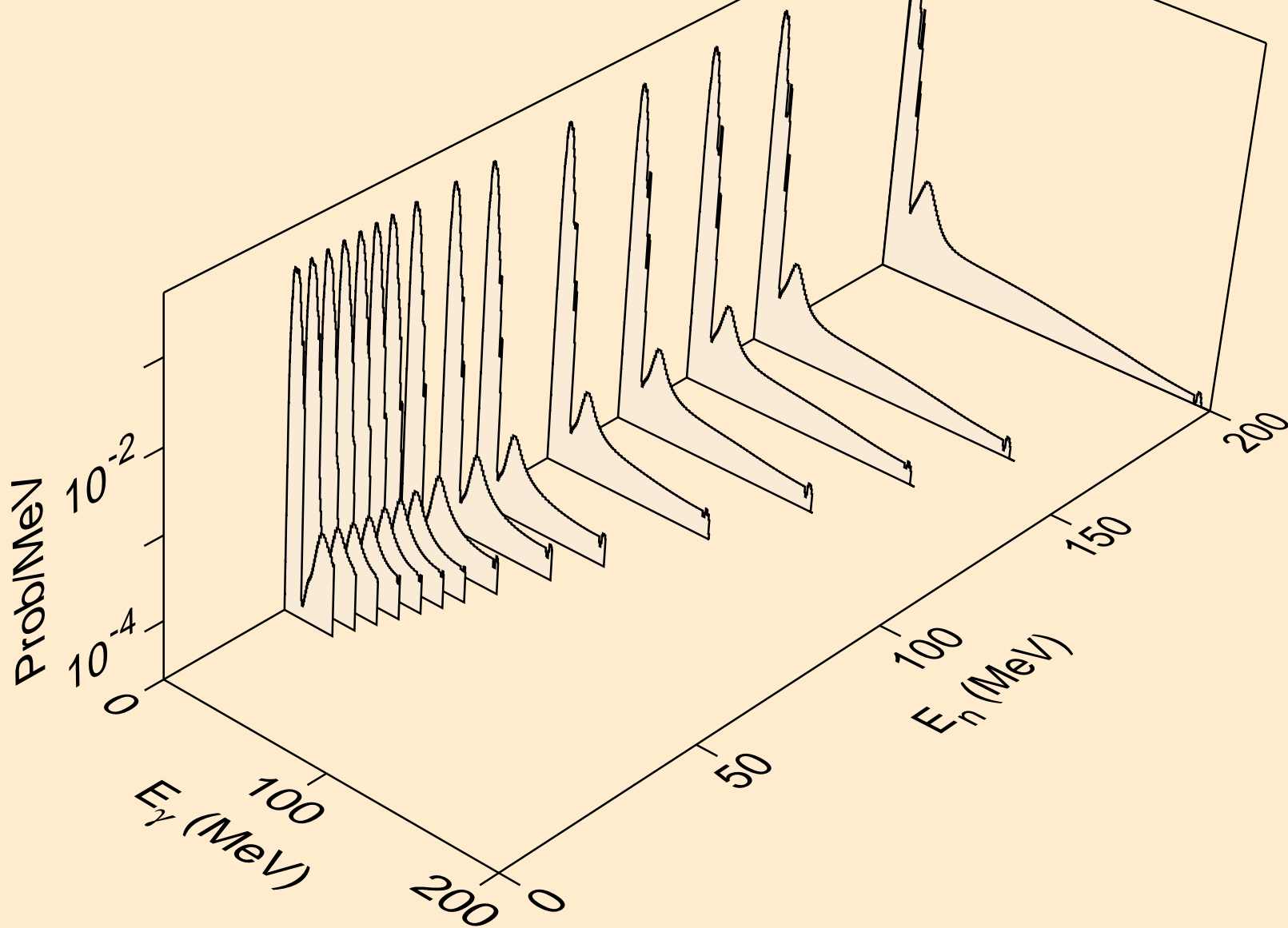



10-NE-22 FOR FENDL-3.2 FROM TENDL-2019 WITH NJOY2016.60  
Photon emission for (n,2nd)

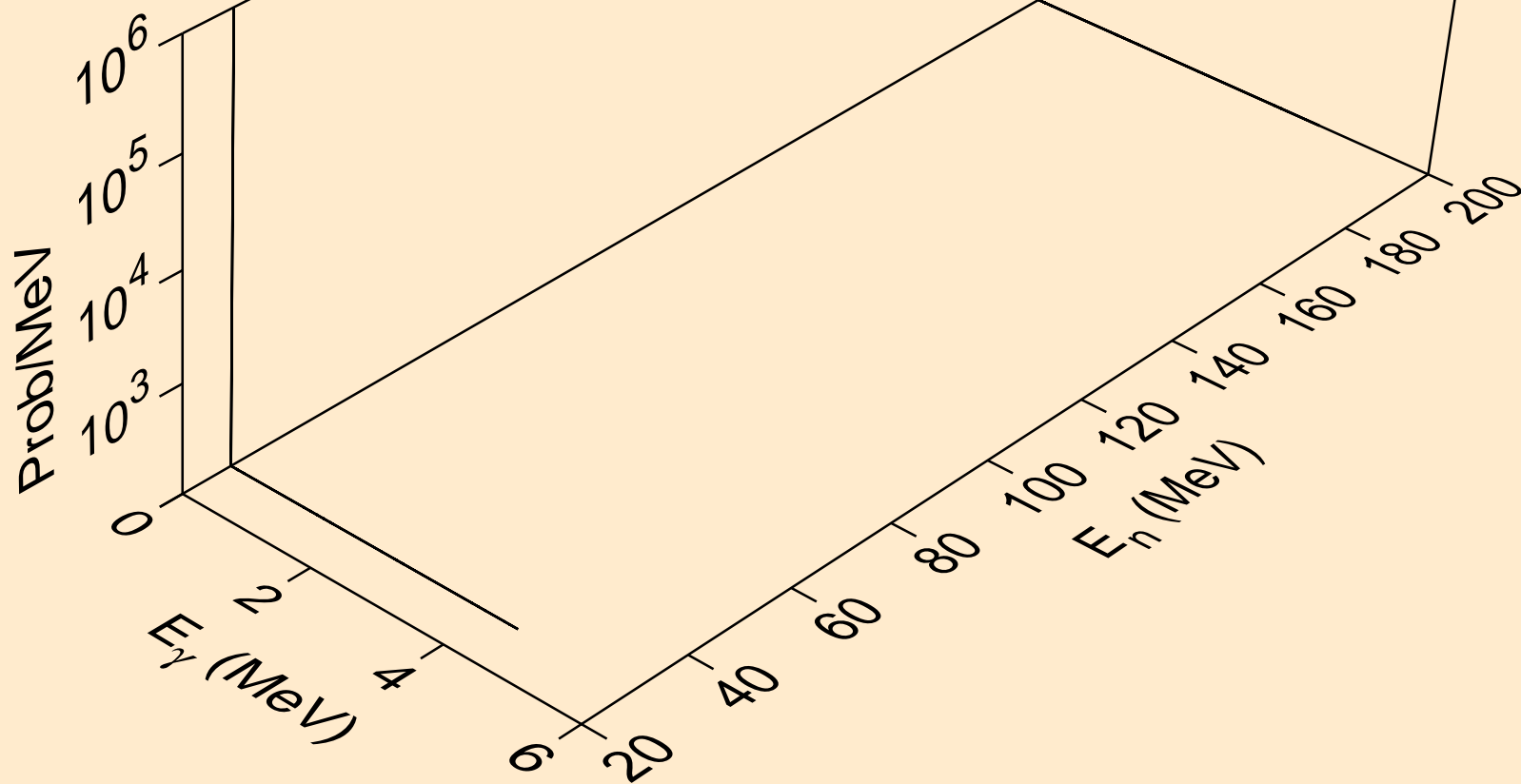

10-NE-22 FOR FENDL-3.2 FROM TENDL-2019 WITH NJOY2016.60  
Photon emission for (n,2n)

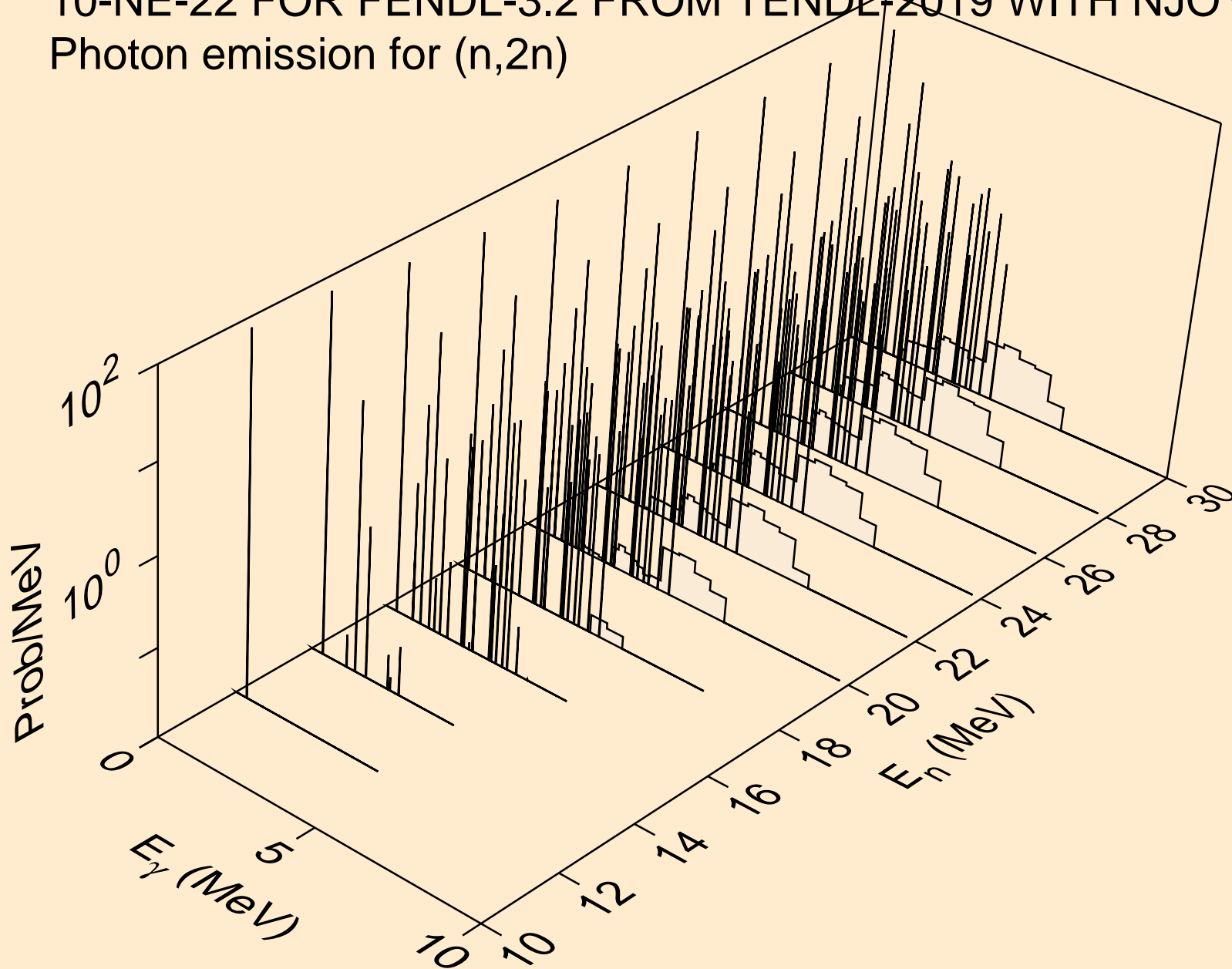

10-NE-22 FOR FENDL-3.2 FROM TENDL-2019 WITH NJOY2016.60  
Photon emission for (n,3n)

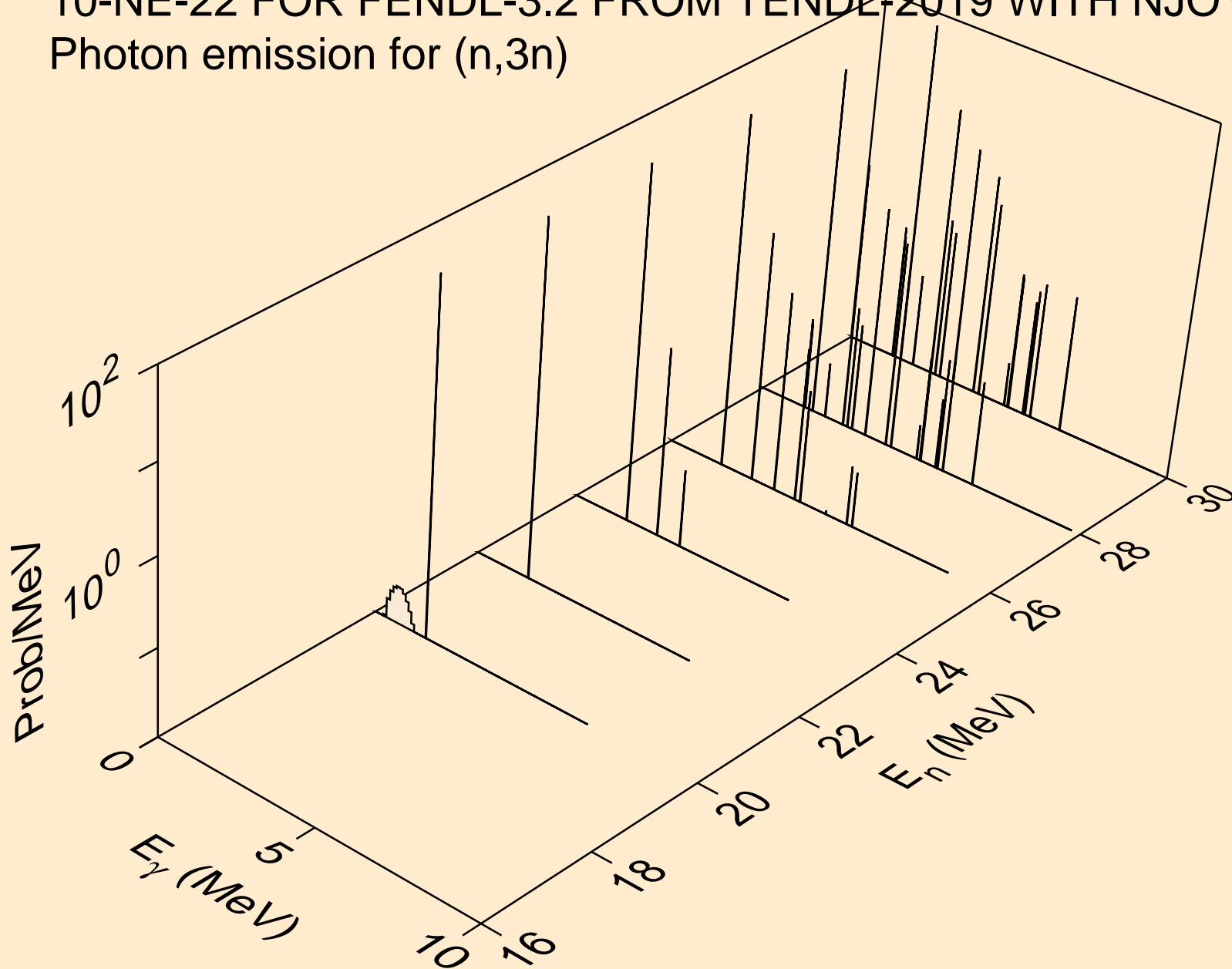

10-NE-22 FOR FENDL-3.2 FROM TENDL-2019 WITH NJOY2016.60  
Photon emission for (n,n\*)a

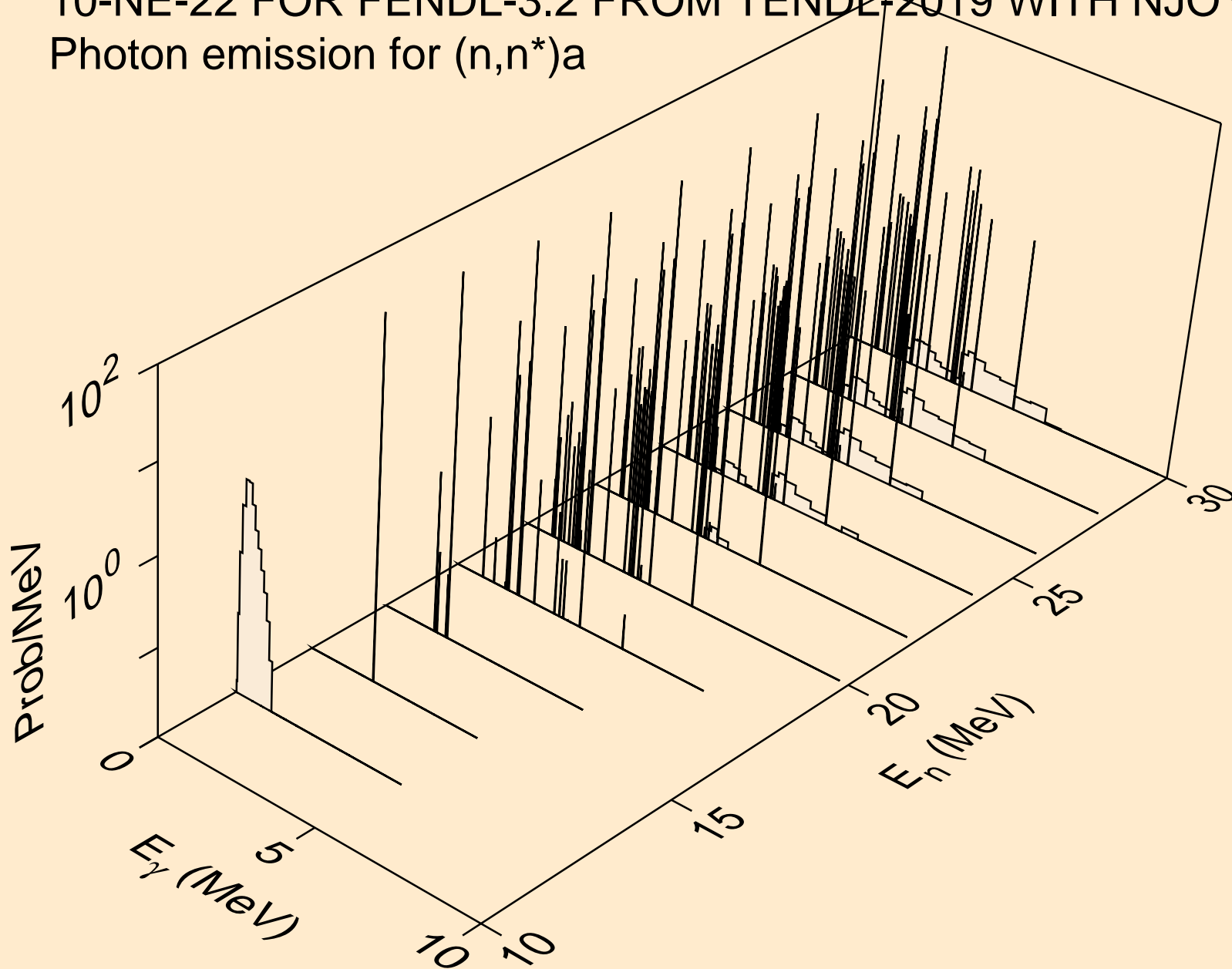

10-NE-22 FOR FENDL-3.2 FROM TENDL-2019 WITH NJOY2016.60  
Photon emission for (n,2n)a

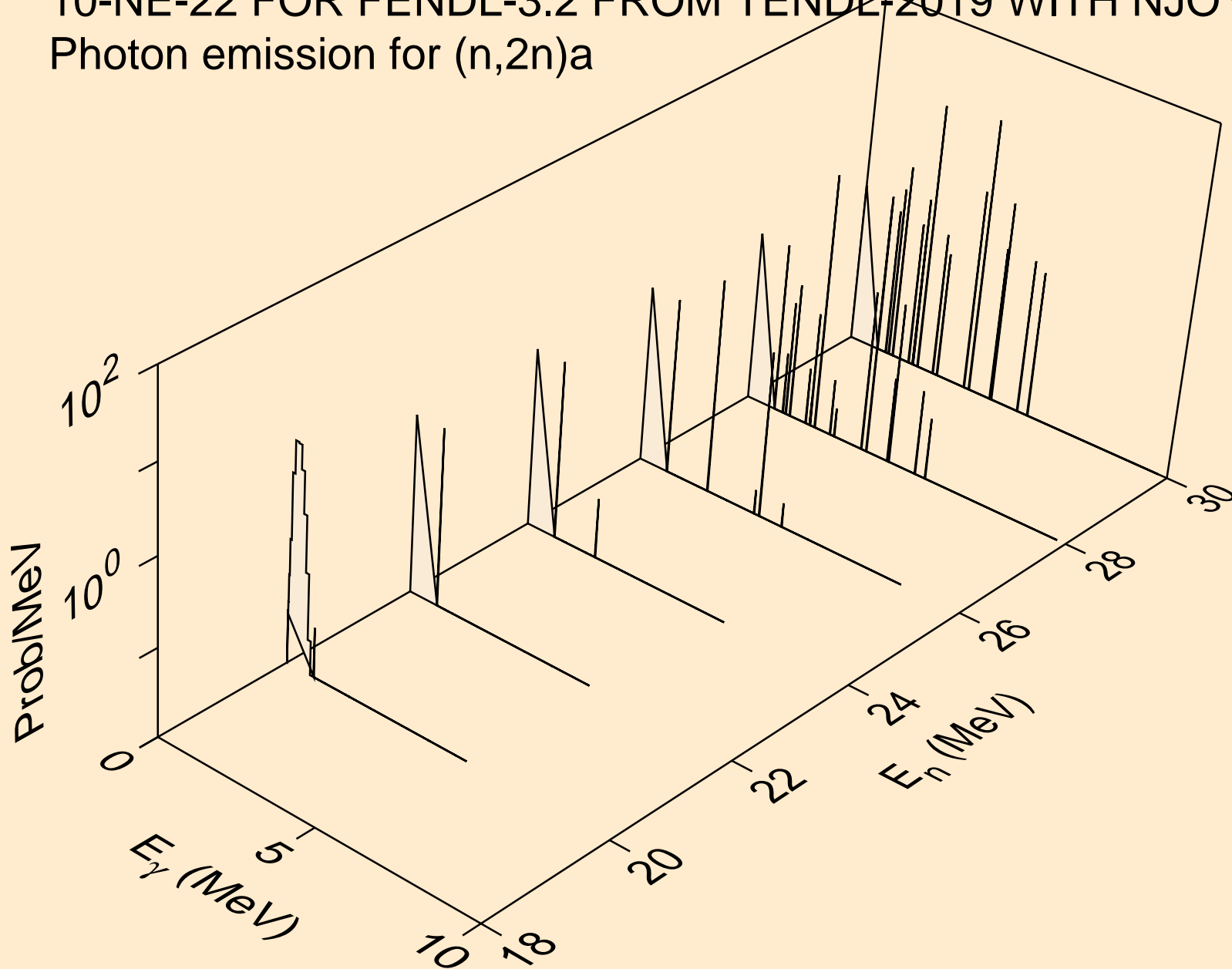

10-NE-22 FOR FENDL-3.2 FROM TENDL-2019 WITH NJOY2016.60  
Photon emission for (n,3n)a

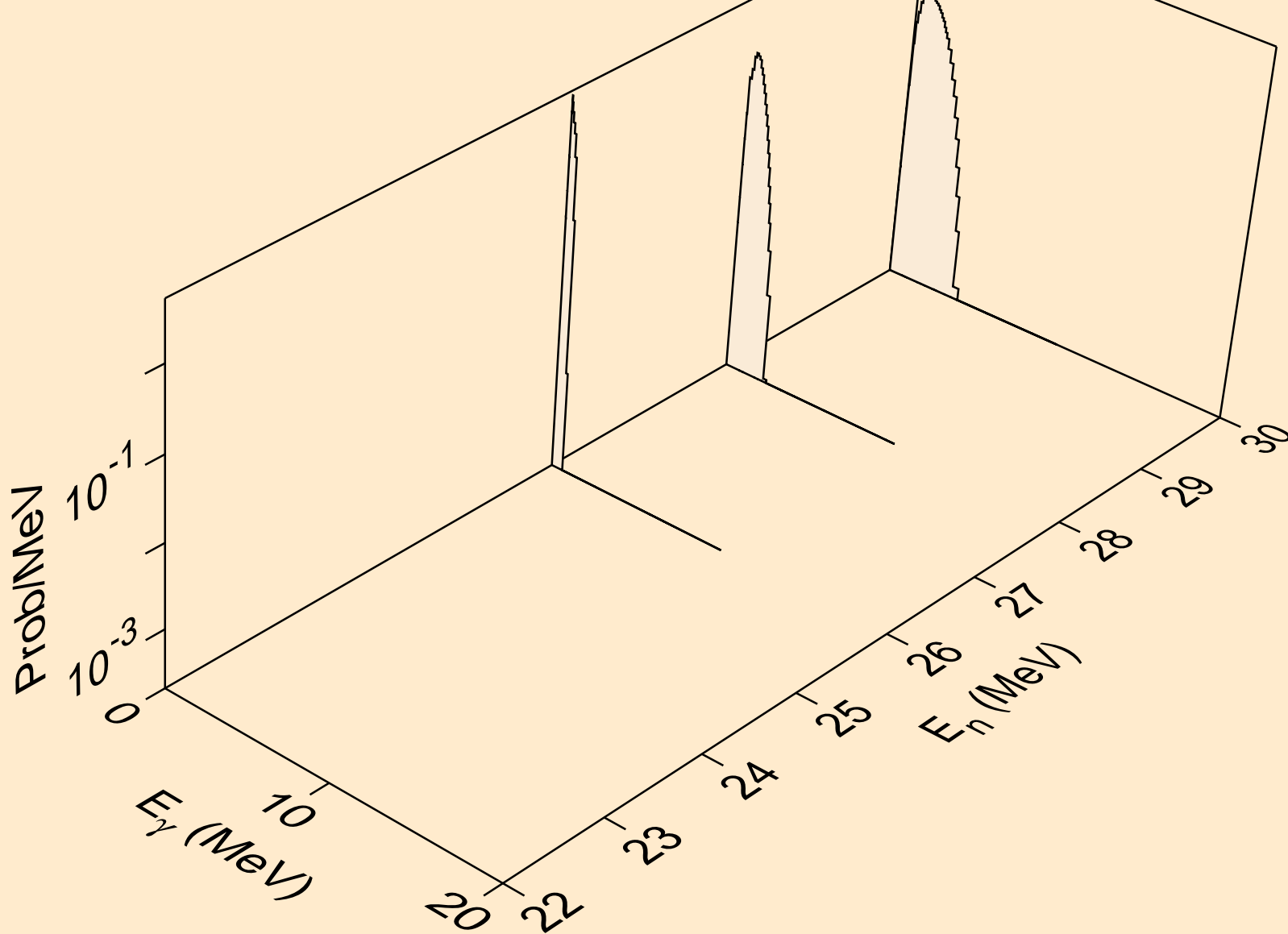

10-NE-22 FOR FENDL-3.2 FROM TENDL-2019 WITH NJOY2016.60  
Photon emission for (n,n\*)p

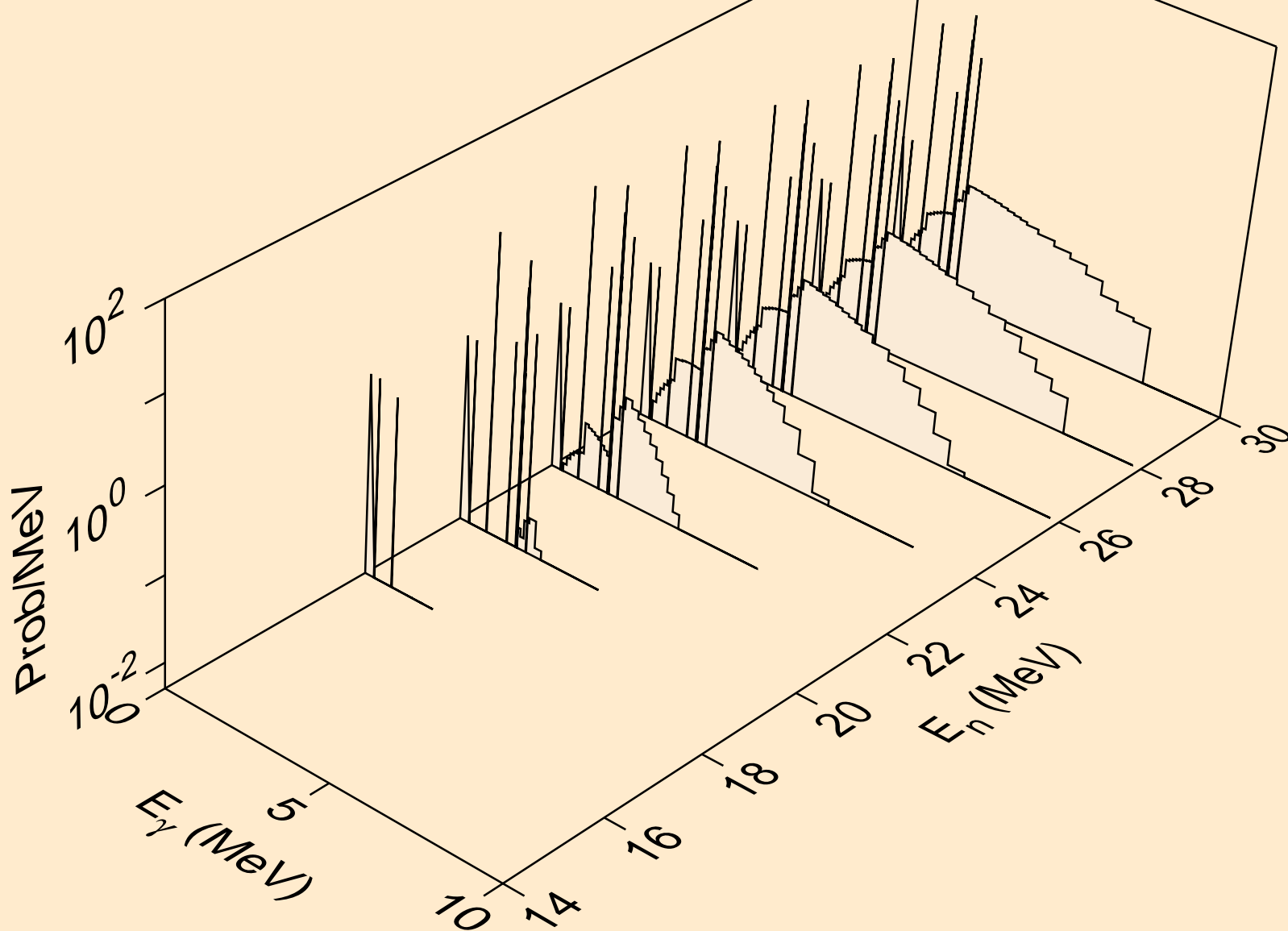

10-NE-22 FOR FENDL-3.2 FROM TENDL-2019 WITH NJOY2016.60  
Photon emission for (n,n\*)2a

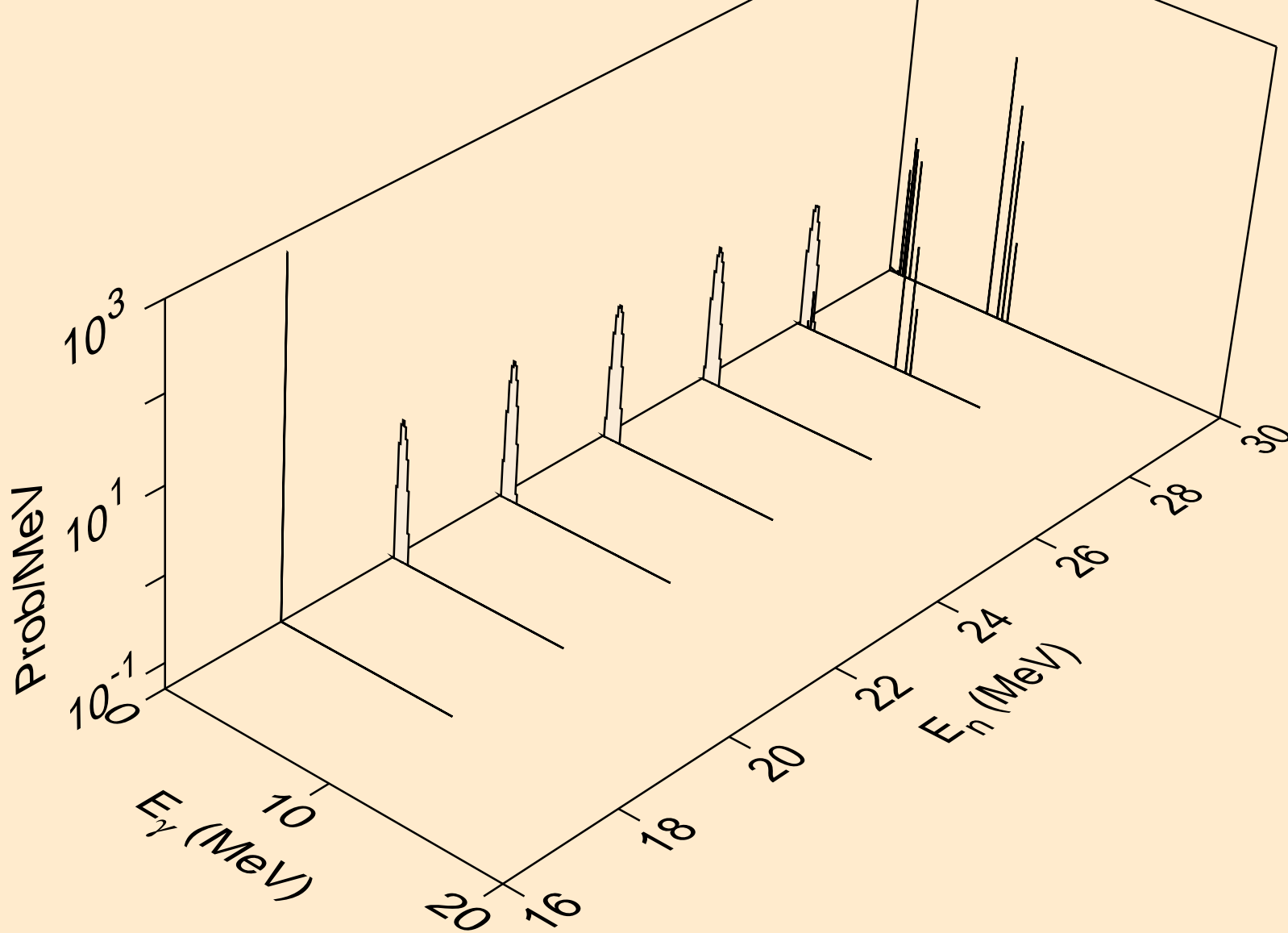



10-NE-22 FOR FENDL-3.2 FROM TENDL-2019 WITH NJOY2016.60  
Photon emission for (n,2n)2a

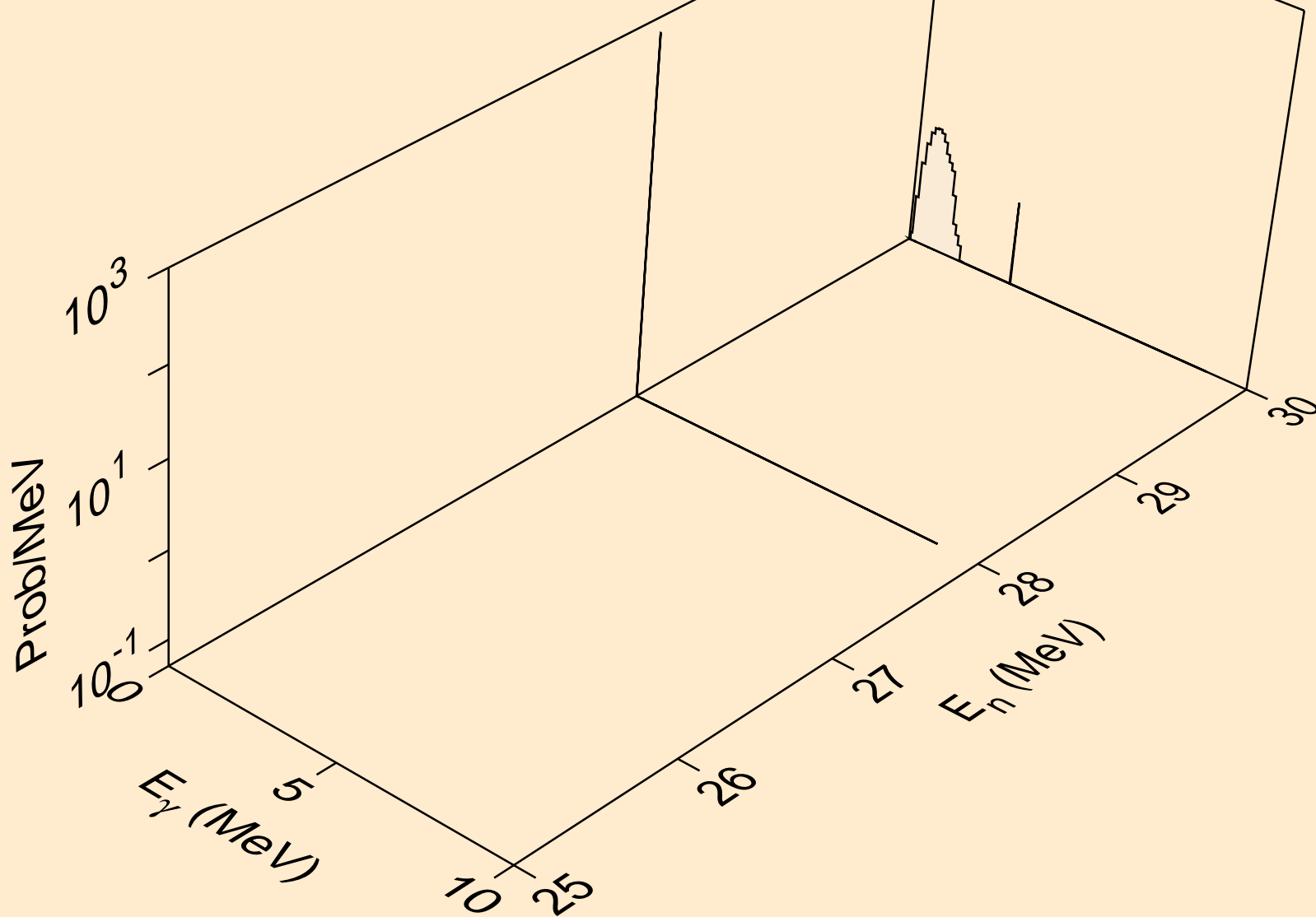

10-NE-22 FOR FENDL-3.2 FROM TENDL-2019 WITH NJOY2016.60  
Photon emission for (n,n\*)d

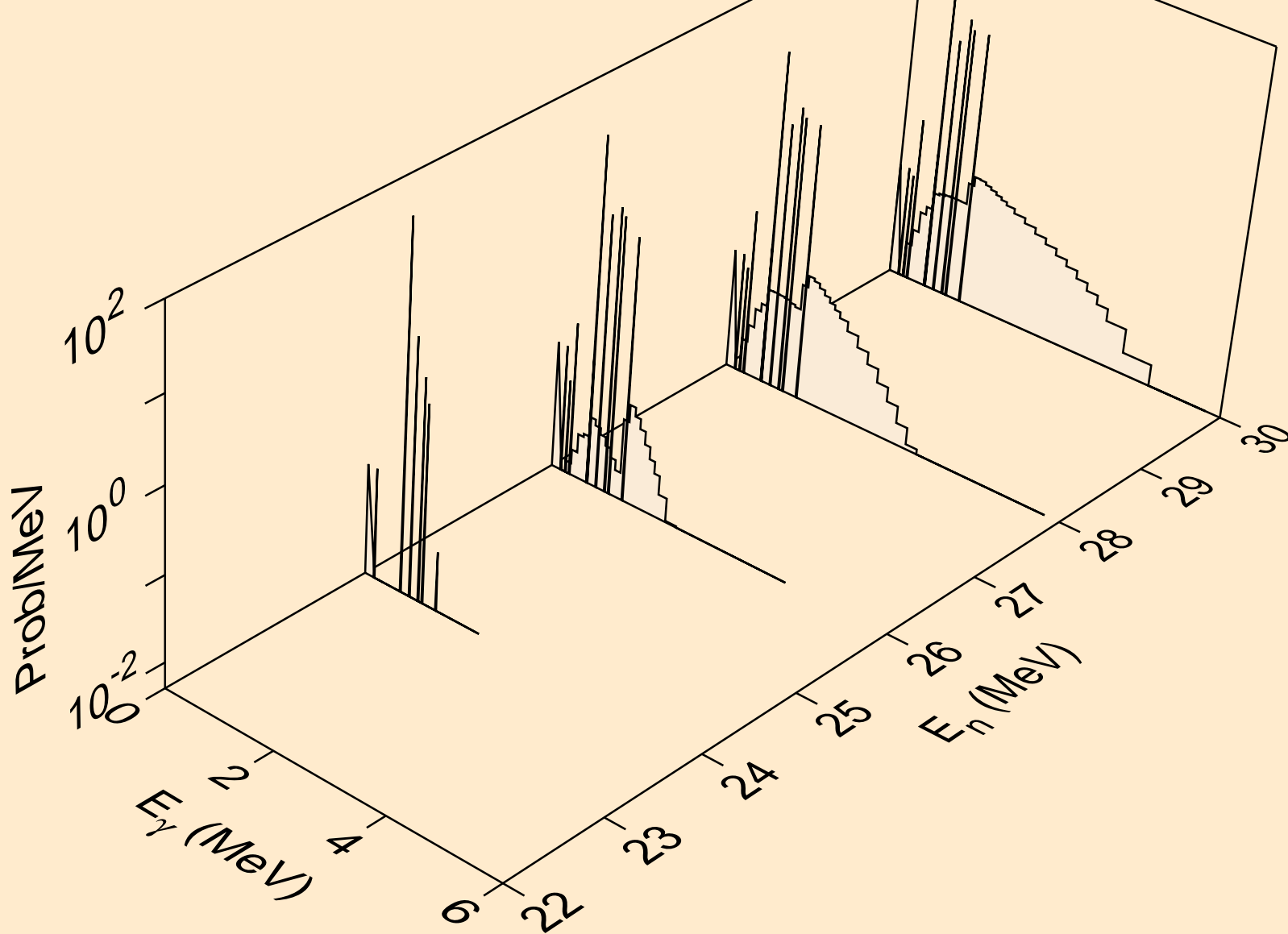

10-NE-22 FOR FENDL-3.2 FROM TENDL-2019 WITH NJOY2016.60  
Photon emission for (n,n\*)t

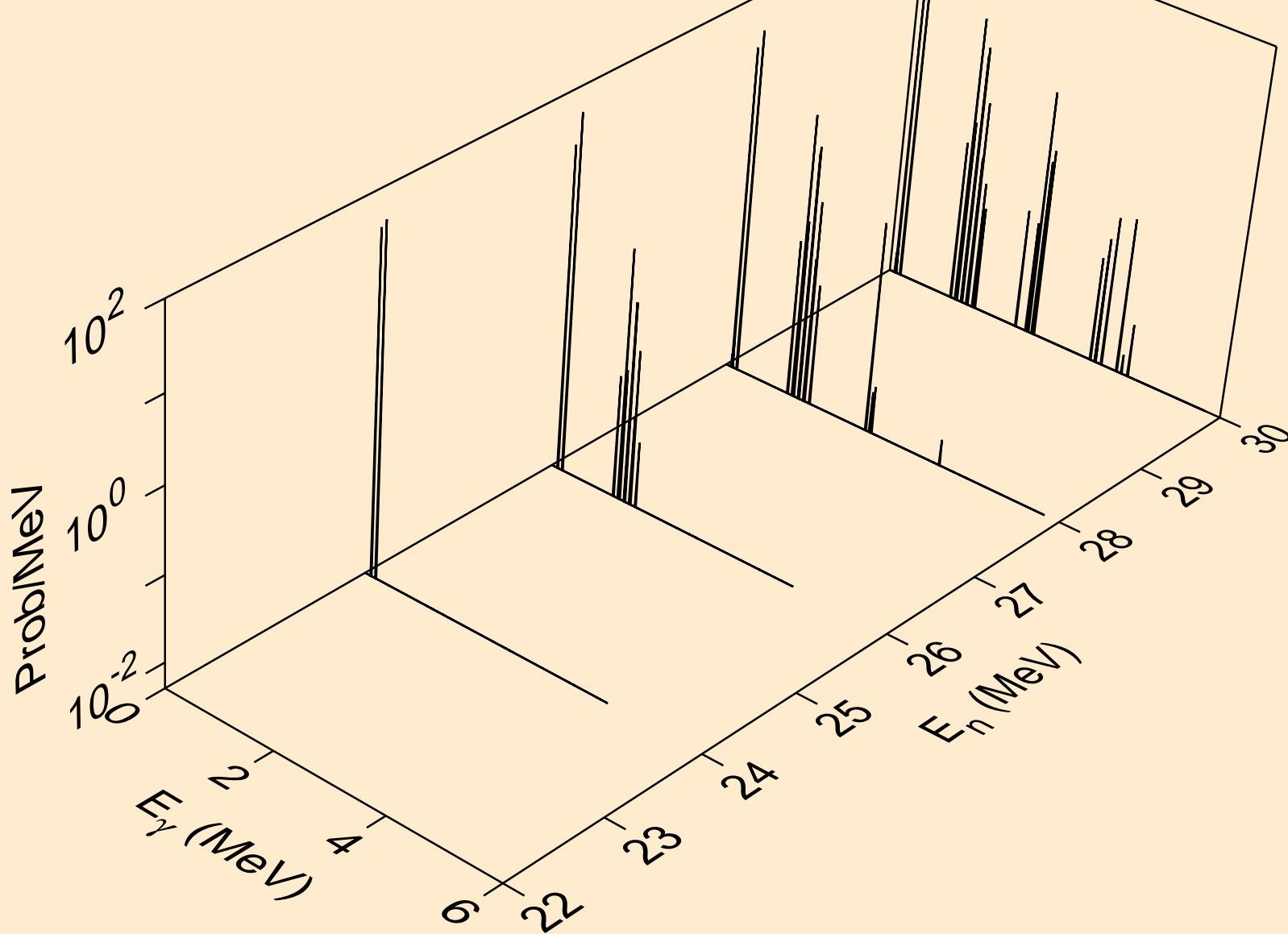

10-NE-22 FOR FENDL-3.2 FROM TENDL-2019 WITH NJOY2016.60  
Photon emission for (n,n\*)he3

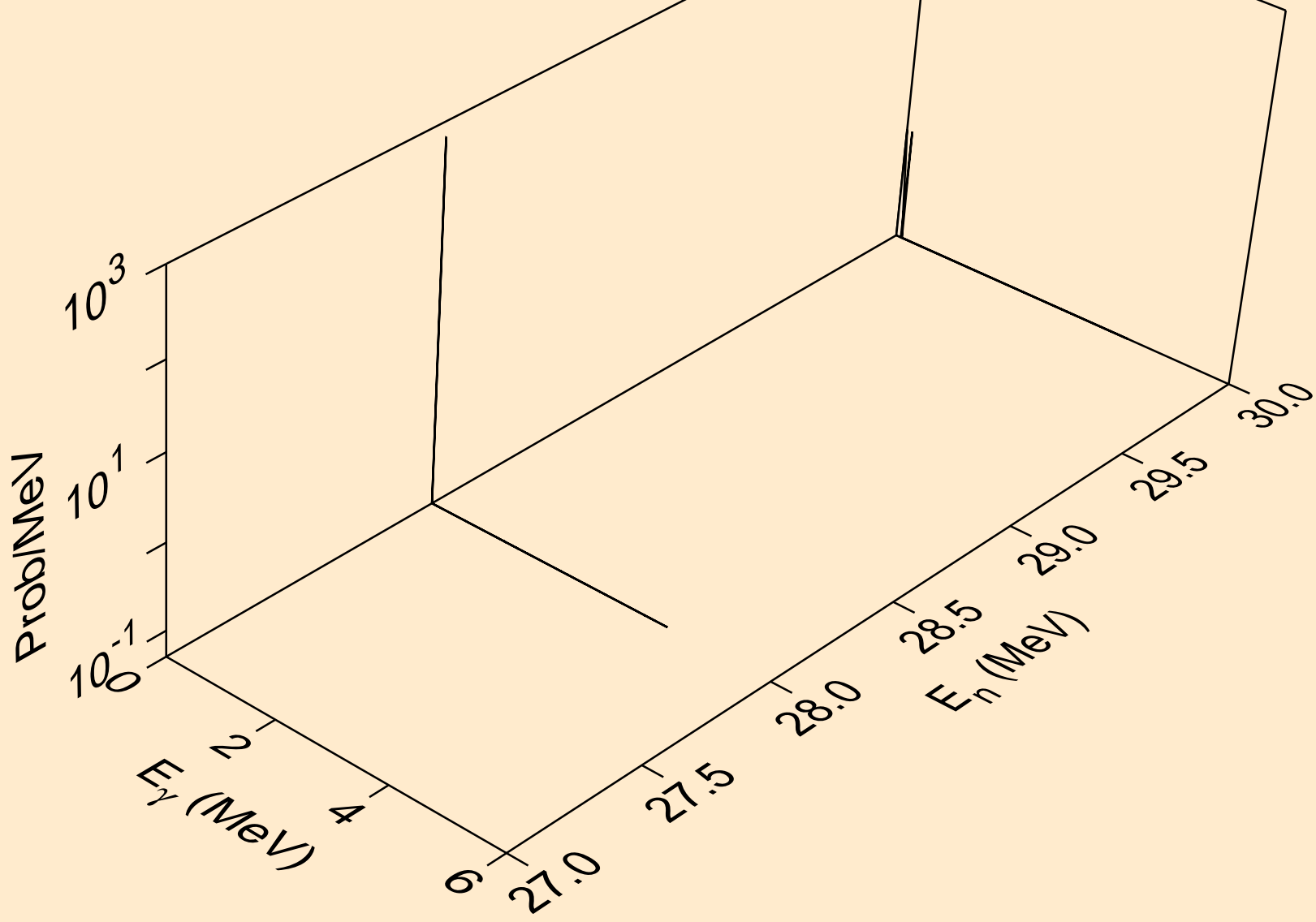

10-NE-22 FOR FENDL-3.2 FROM TENDL-2019 WITH NJOY2016.60  
Photon emission for (n,2np)

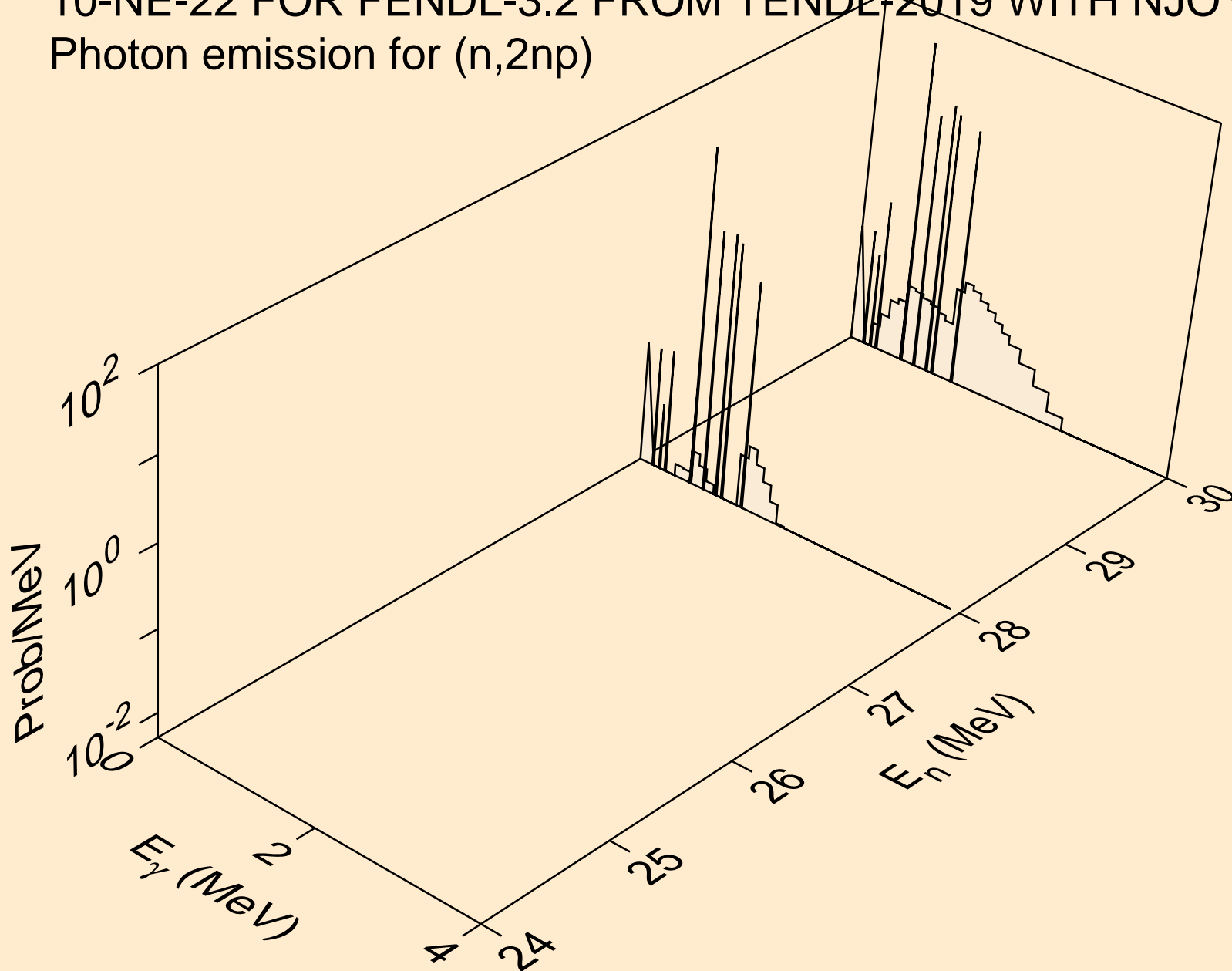

10-NE-22 FOR FENDL-3.2 FROM TENDL-2019 WITH NJOY2016.60  
Photon emission for (n,2np)

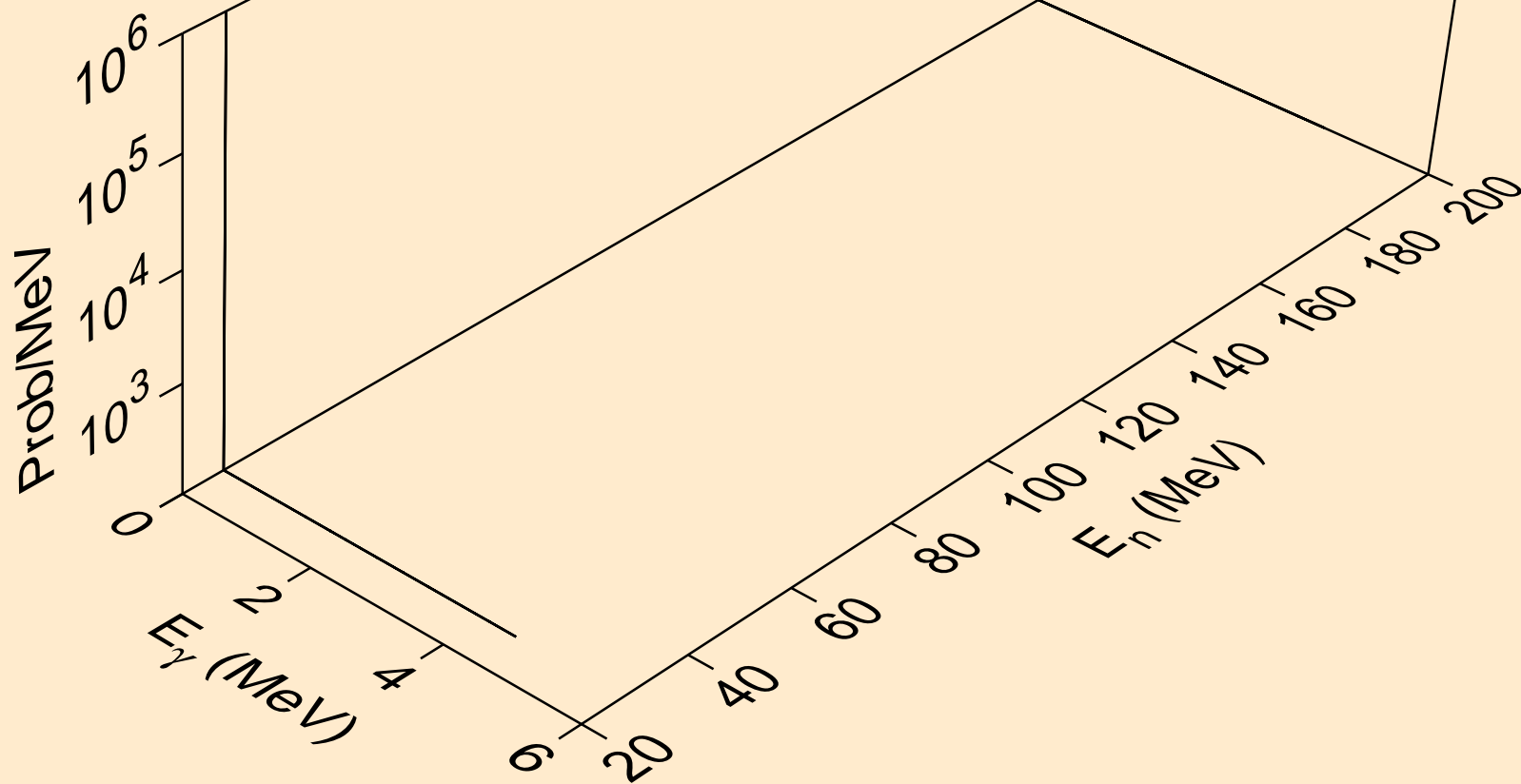

10-NE-22 FOR FENDL-3.2 FROM TENDL-2019 WITH NJOY2016.60  
Photon emission for (n,npa)

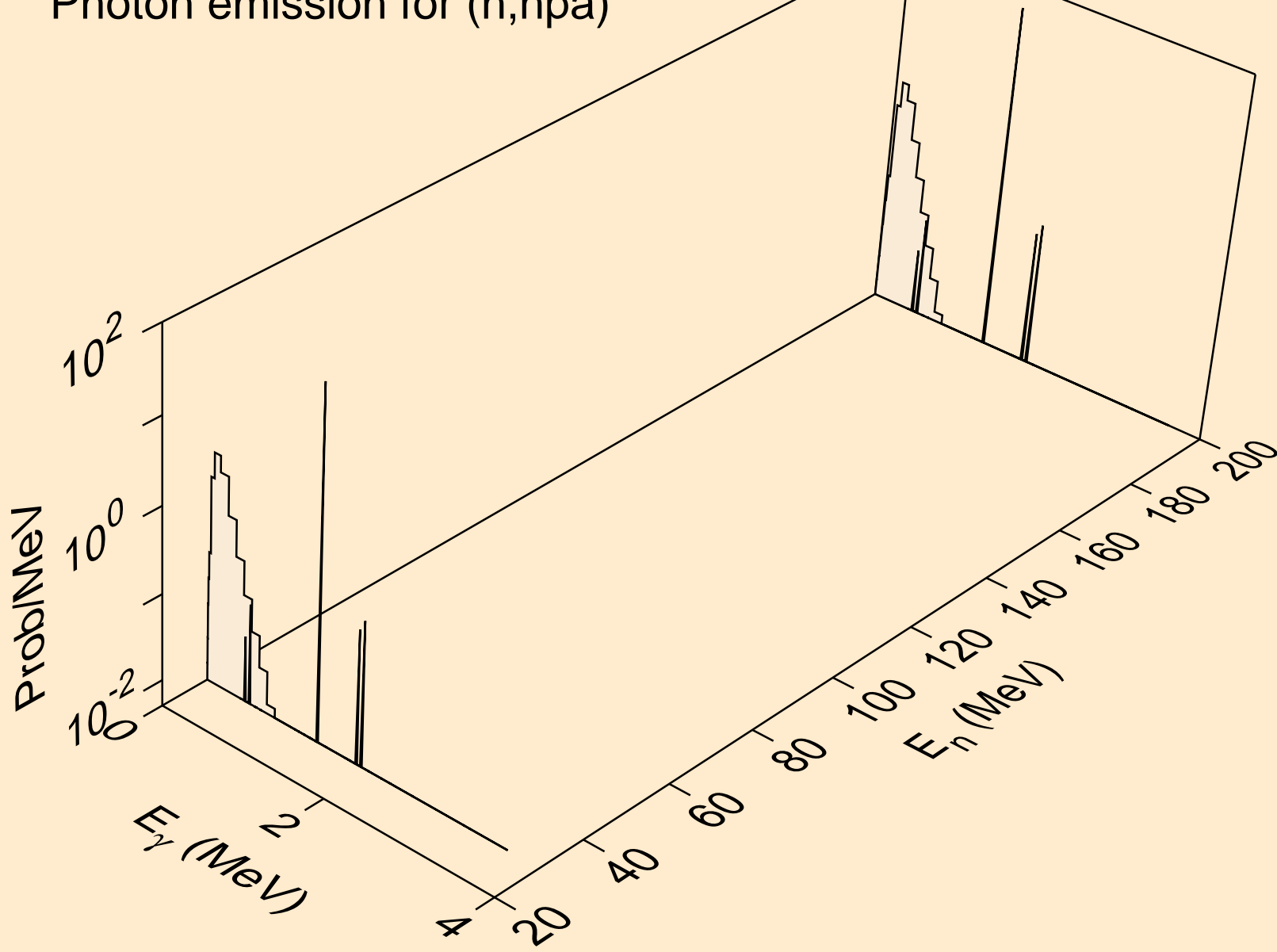

10-NE-22 FOR FENDL-3.2 FROM TENDL-2019 WITH NJOY2016.60  
Photon emission for (n,n\*c)

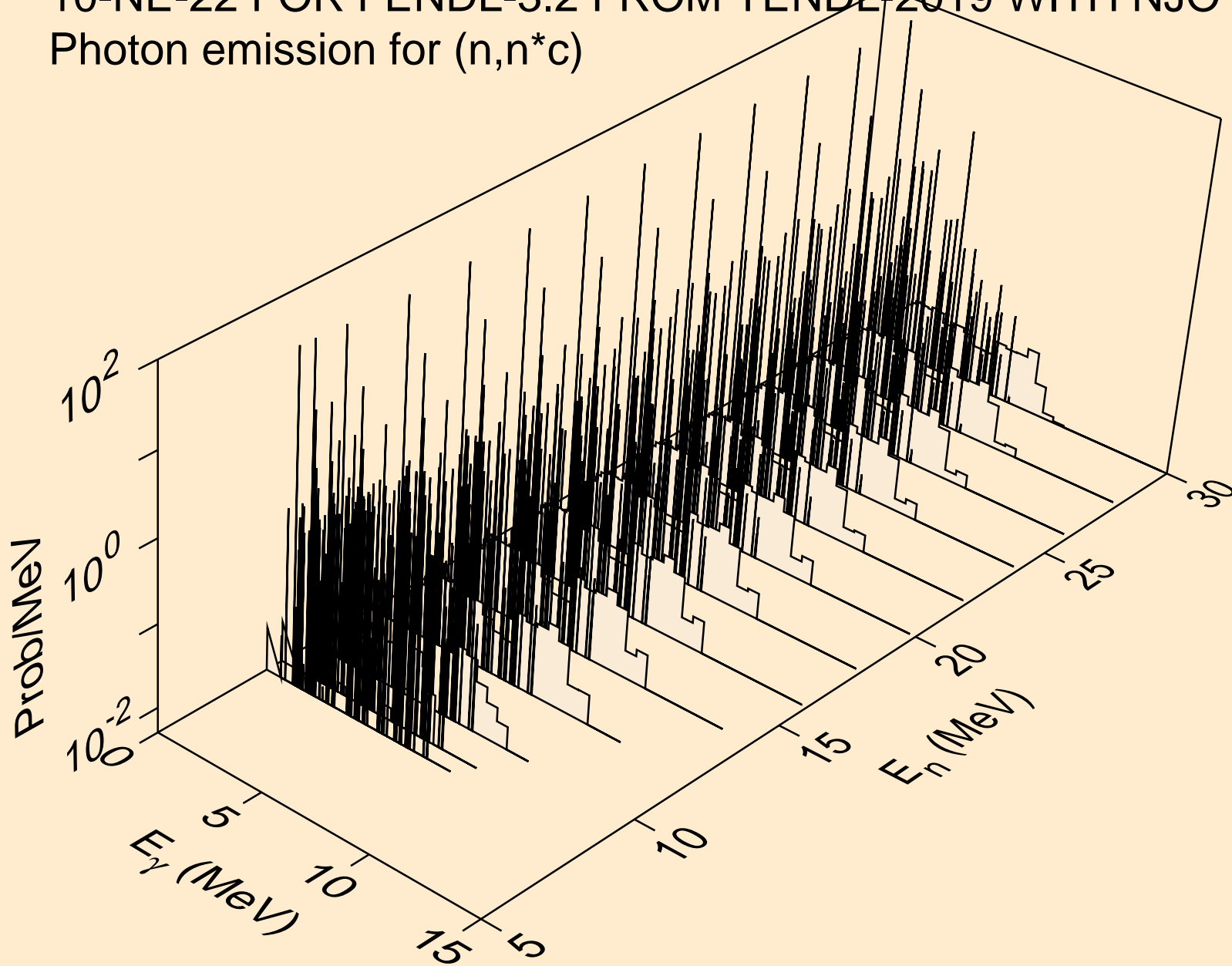



10-NE-22 FOR FENDL-3.2 FROM TENDL-2019 WITH NJOY2016.60  
Photon emission for (n,gma)

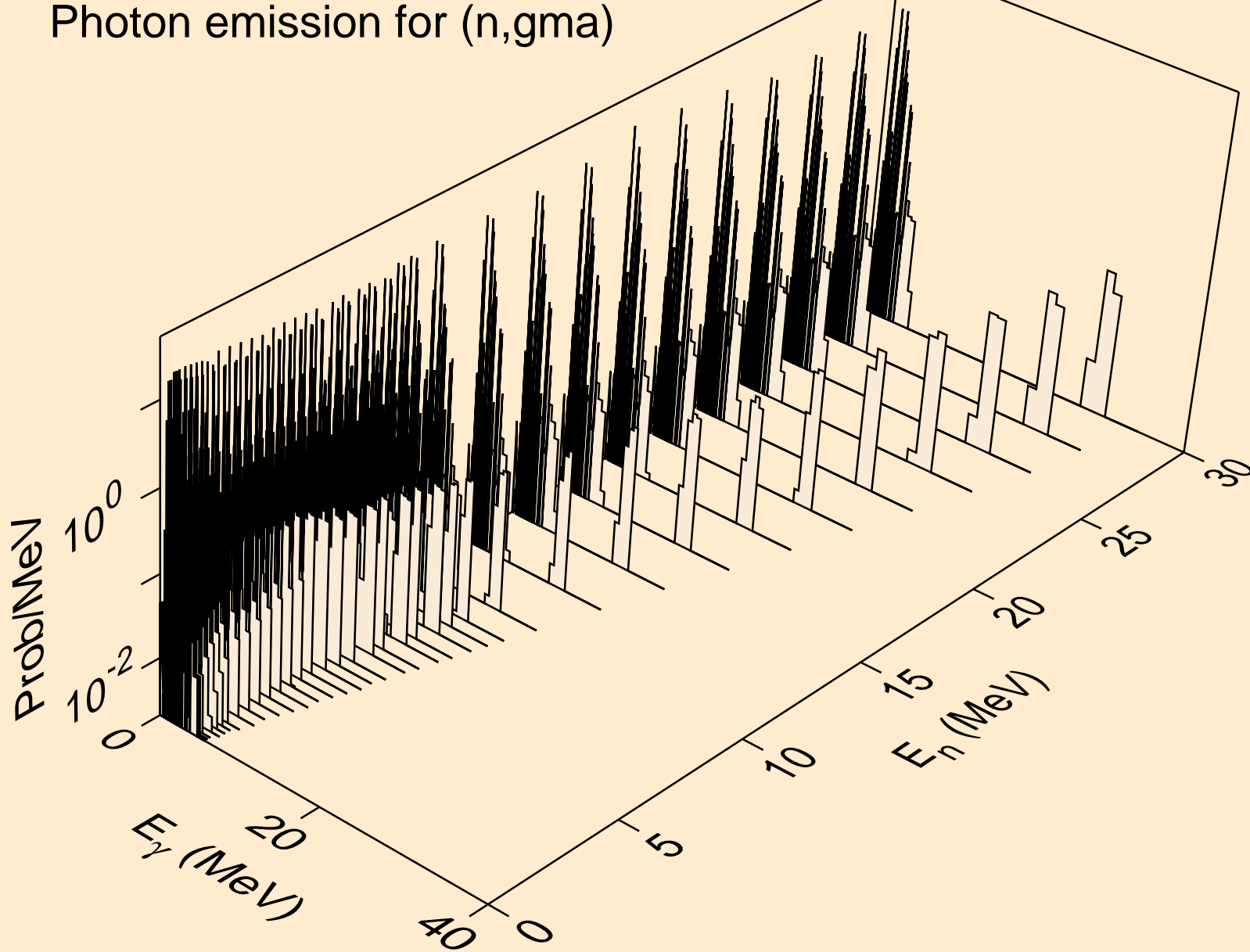

10-NE-22 FOR FENDL-3.2 FROM TENDL-2019 WITH NJOY2016.60  
Photon emission for (n,p)

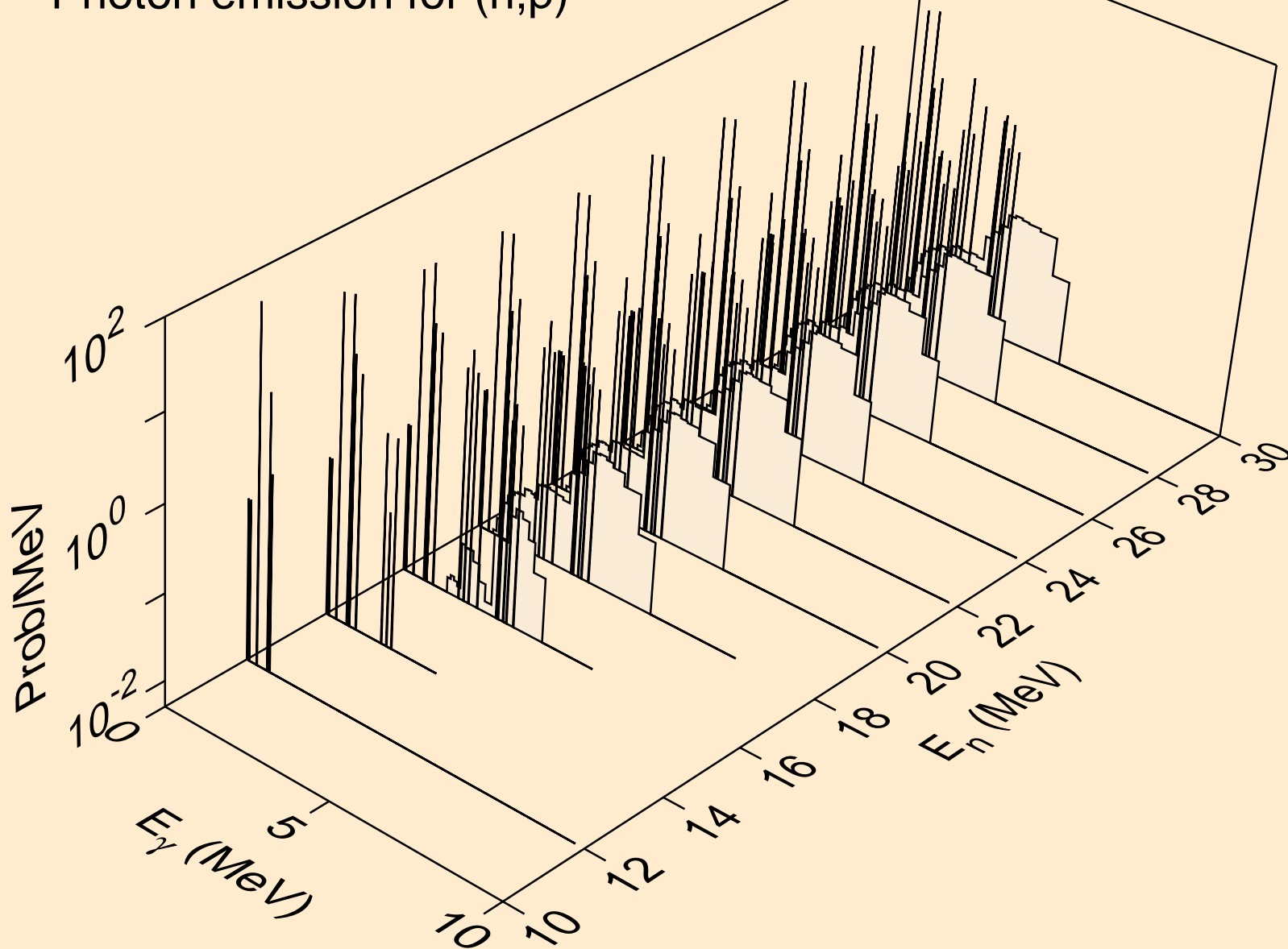

10-NE-22 FOR FENDL-3.2 FROM TENDL-2019 WITH NJOY2016.60  
Photon emission for (n,d)

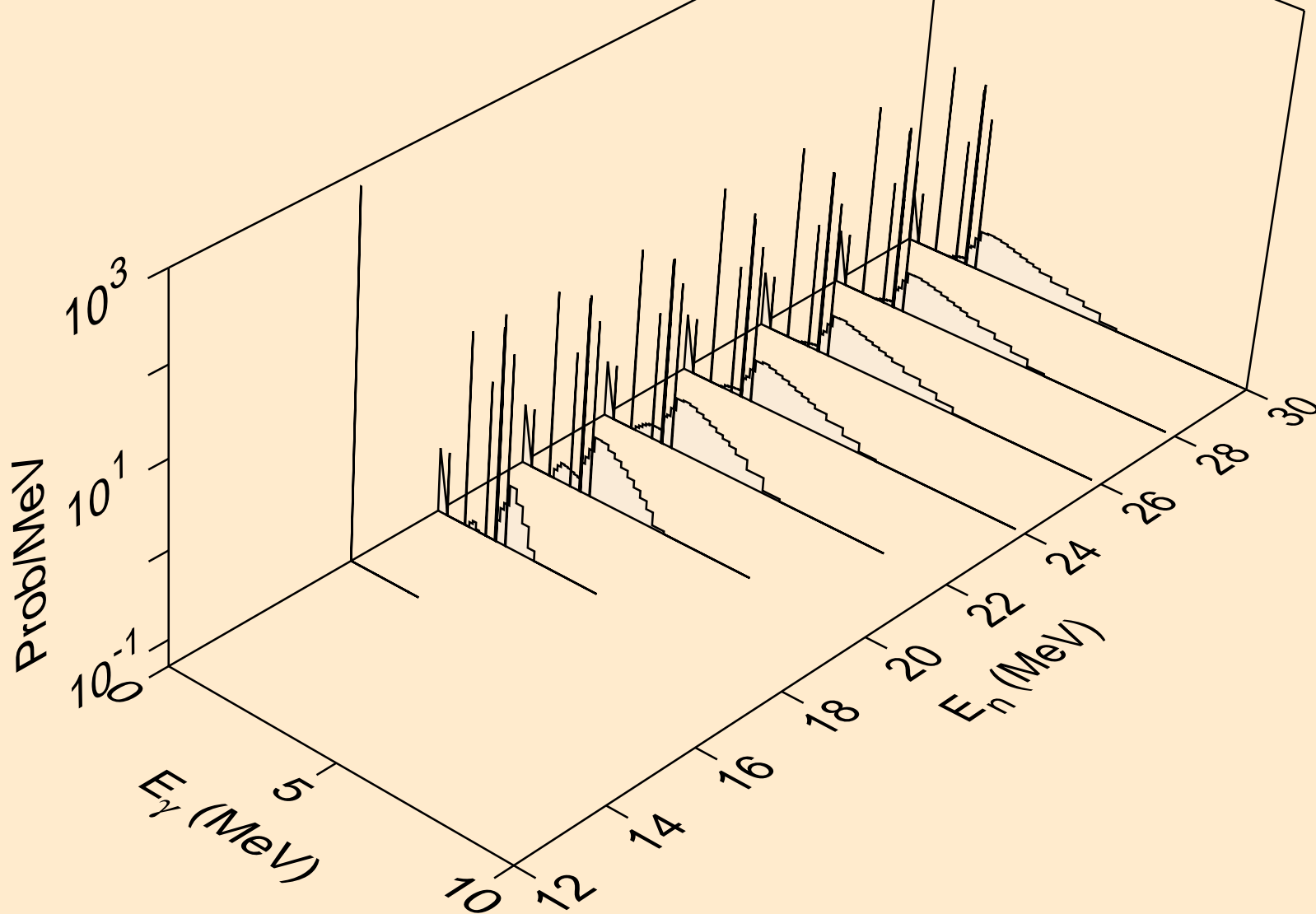

10-NE-22 FOR FENDL-3.2 FROM TENDL-2019 WITH NJOY2016.60  
Photon emission for (n,t)

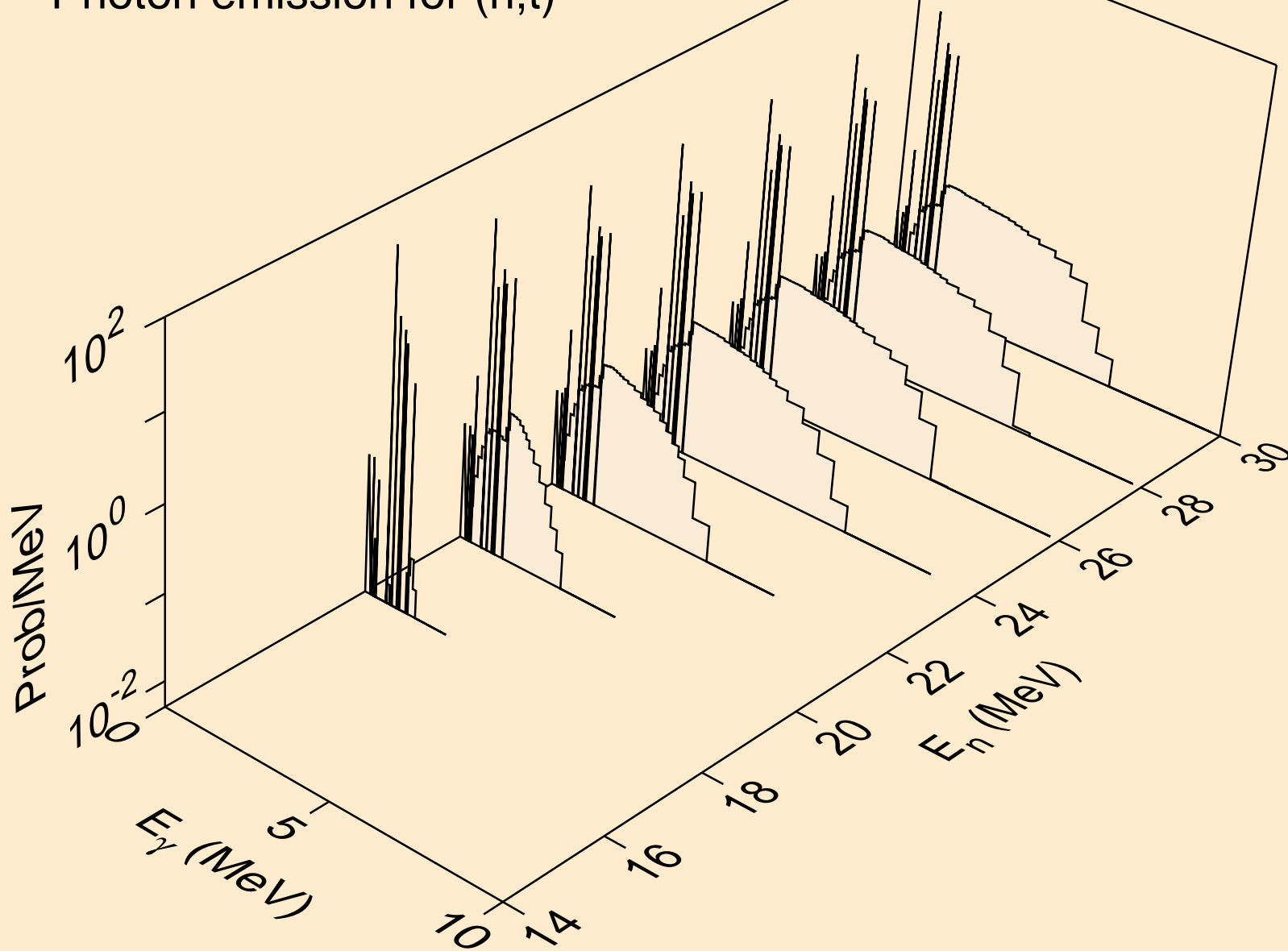

10-NE-22 FOR FENDL-3.2 FROM TENDL-2019 WITH NJOY2016.60  
Photon emission for (n,he3)

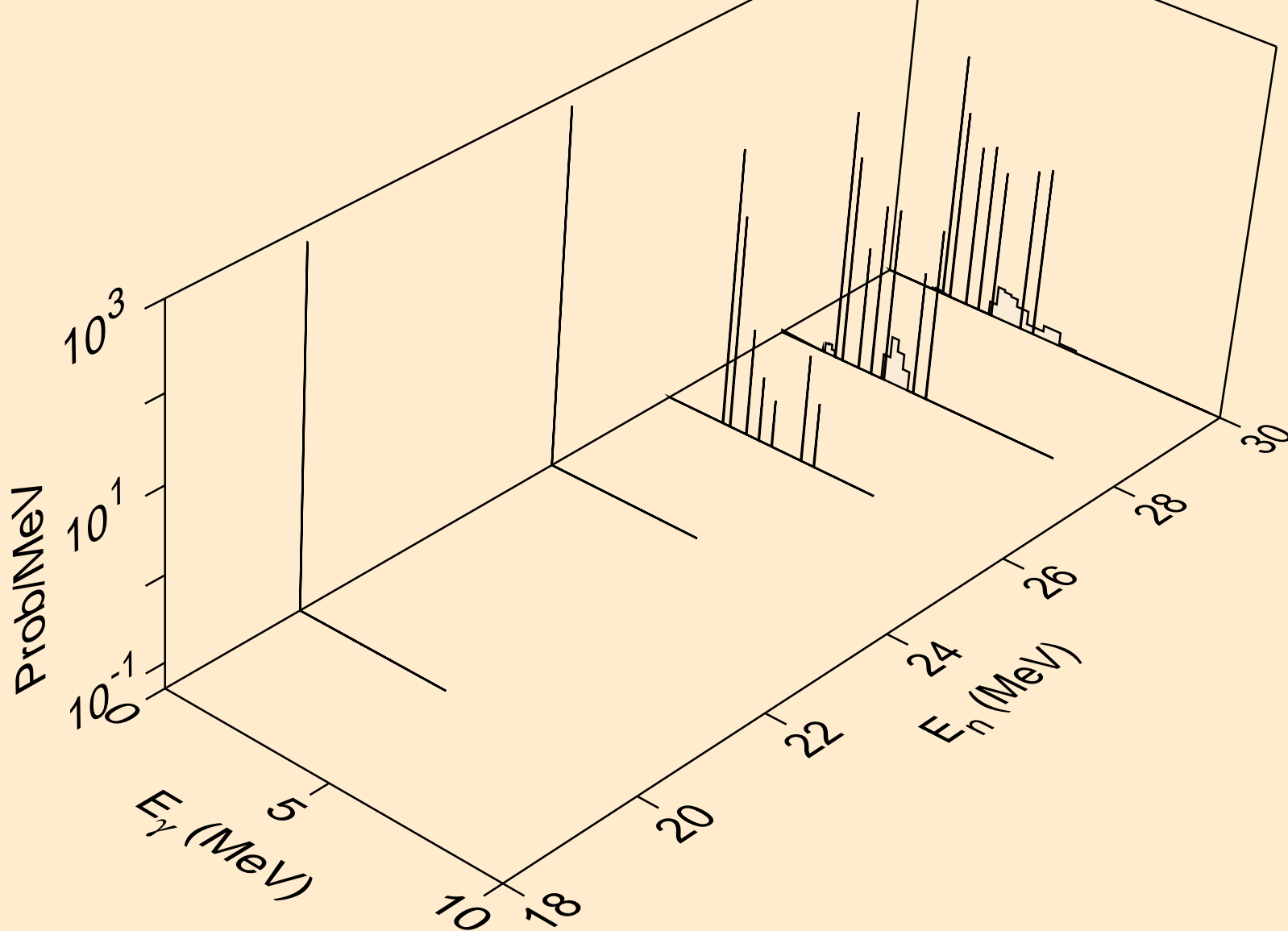

10-NE-22 FOR FENDL-3.2 FROM TENDL-2019 WITH NJOY2016.60  
Photon emission for (n,a)

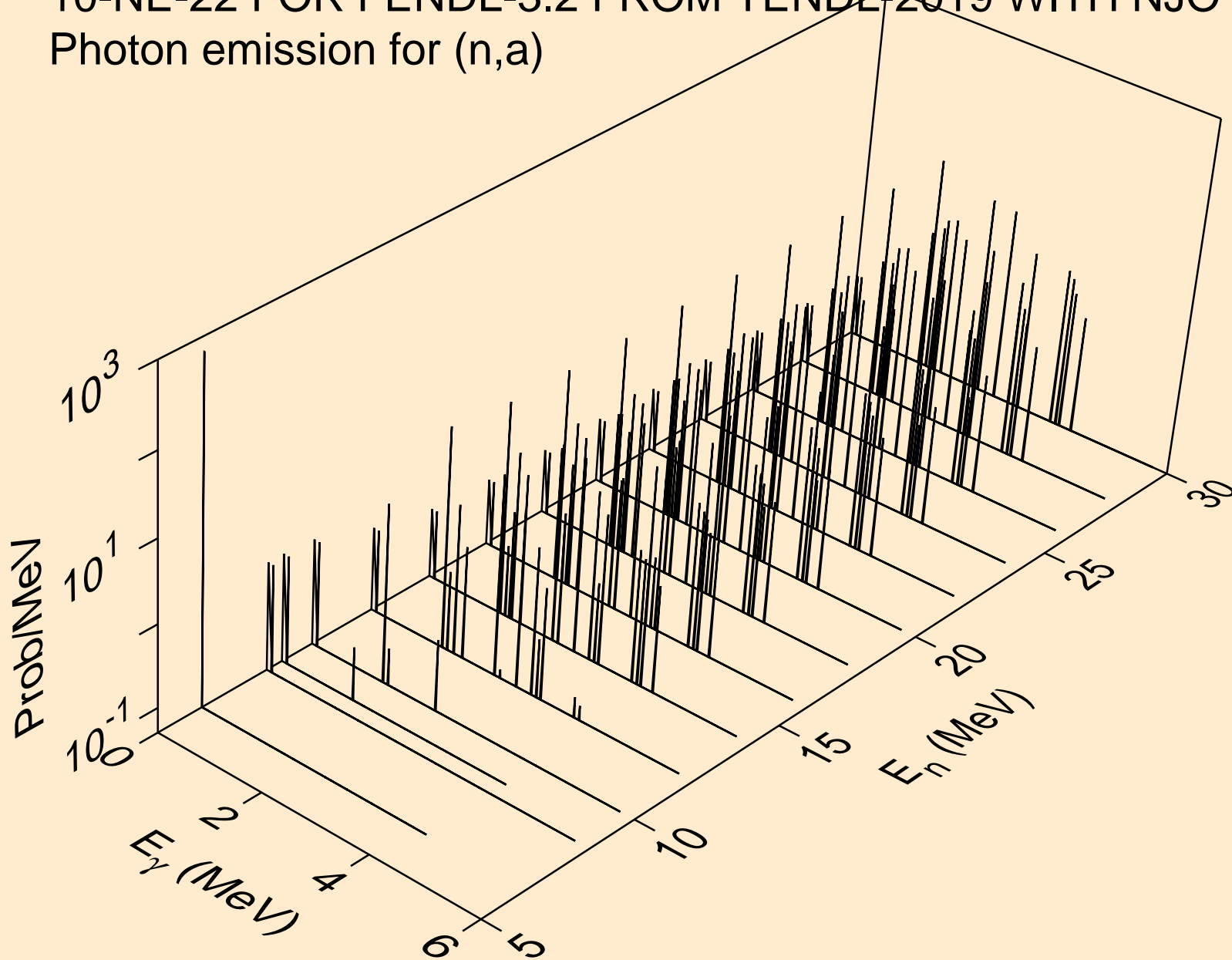

10-NE-22 FOR FENDL-3.2 FROM TENDL-2019 WITH NJOY2016.60  
Photon emission for (n,2a)

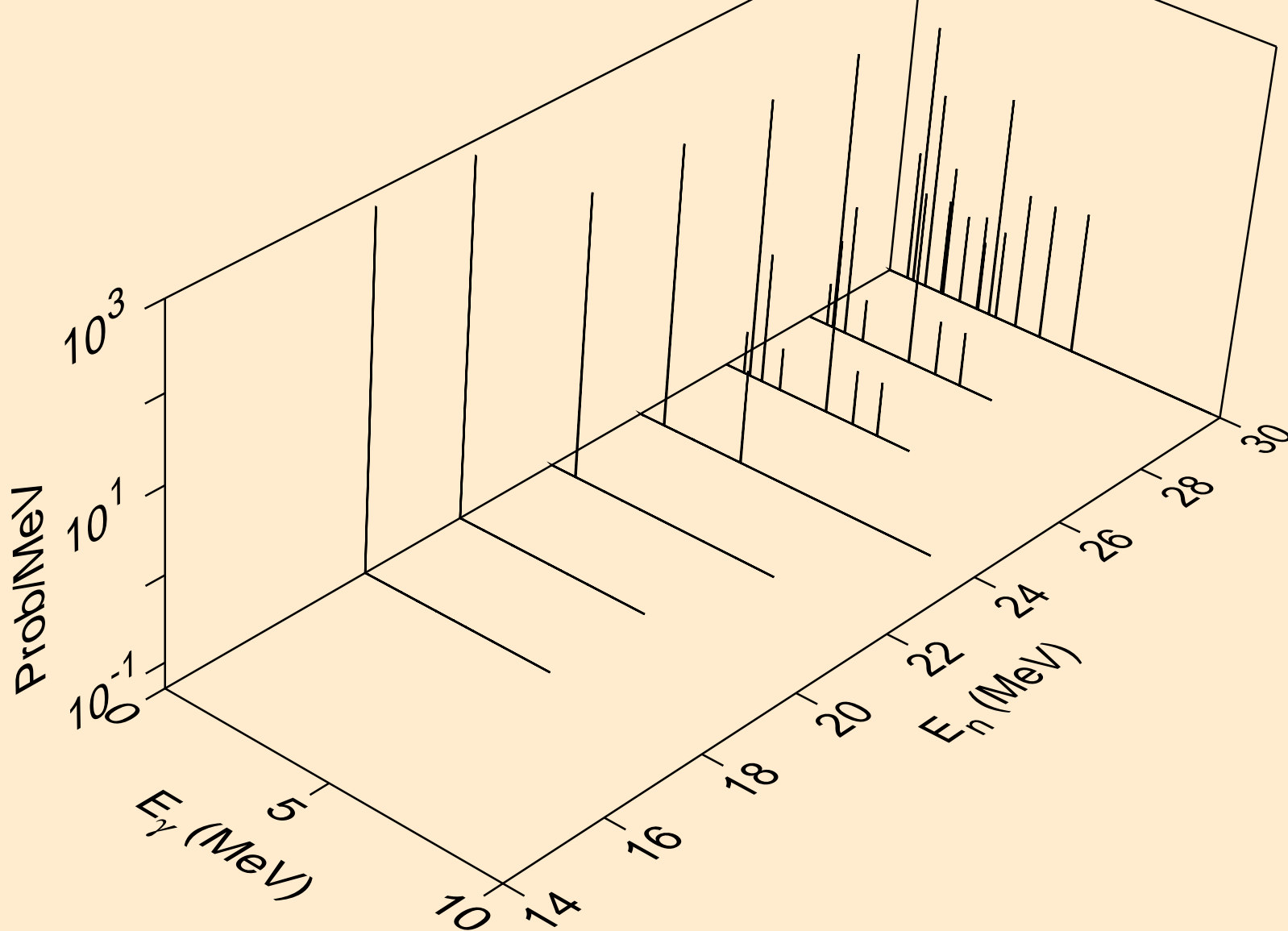

10-NE-22 FOR FENDL-3.2 FROM TENDL-2019 WITH NJOY2016.60  
Photon emission for (n,2p)

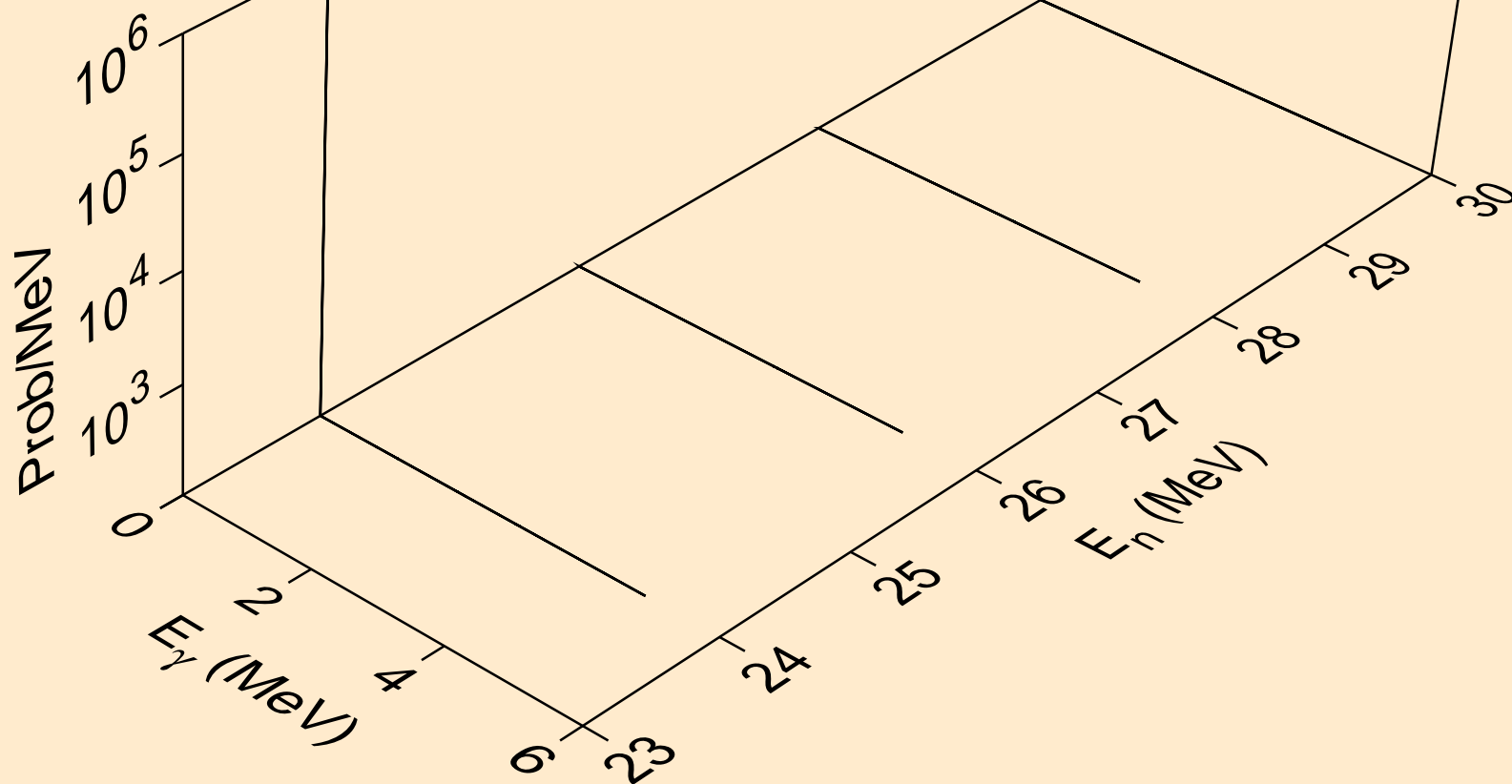



10-NE-22 FOR FENDL-3.2 FROM TENDL-2019 WITH NJOY2016.60  
Photon emission for (n,pa)

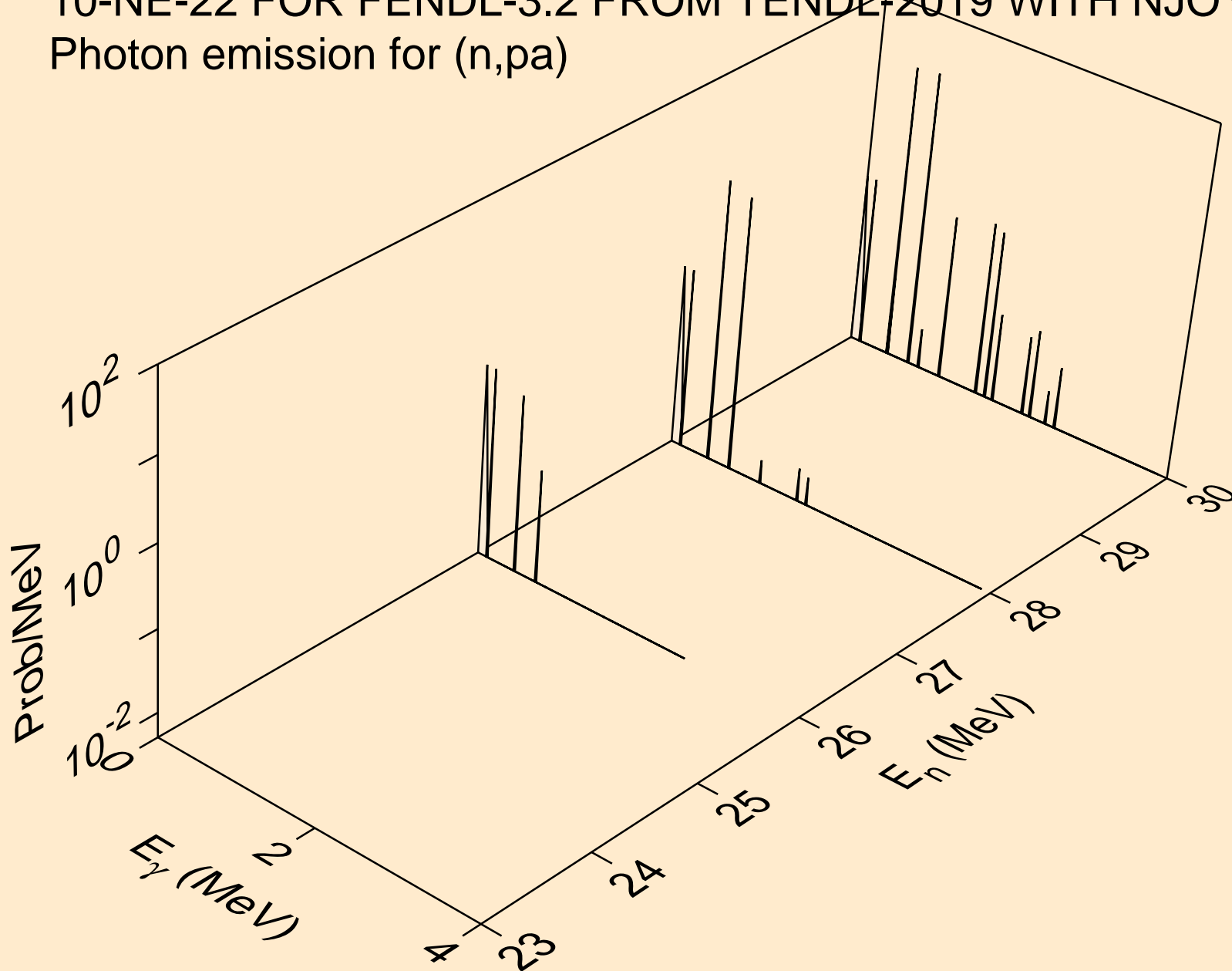

10-NE-22 FOR FENDL-3.2 FROM TENDL-2019 WITH NJOY2016.60  
Photon emission for (n,pd)

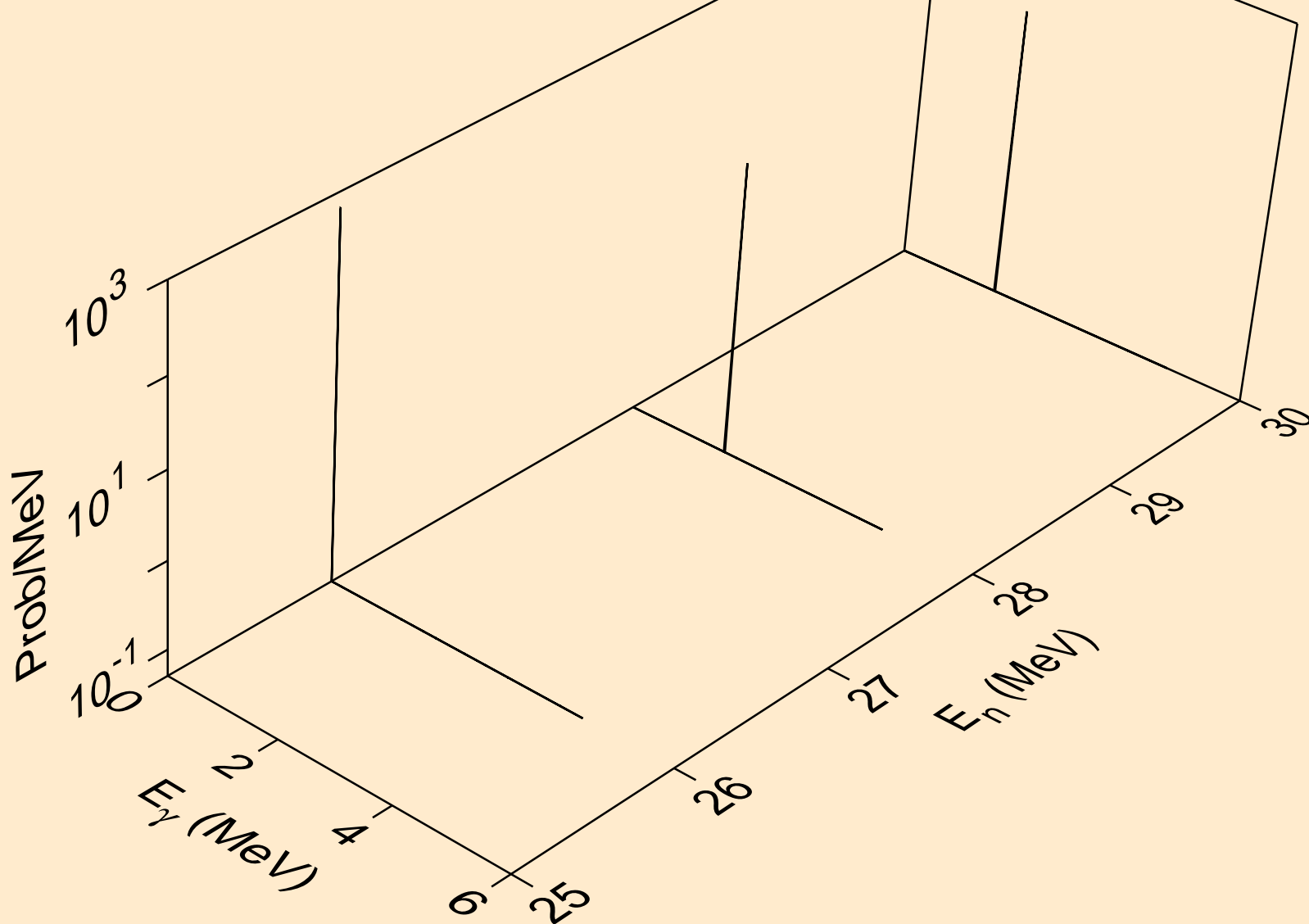

10-NE-22 FOR FENDL-3.2 FROM TENDL-2019 WITH NJOY2016.60  
Photon emission for (n,pt)

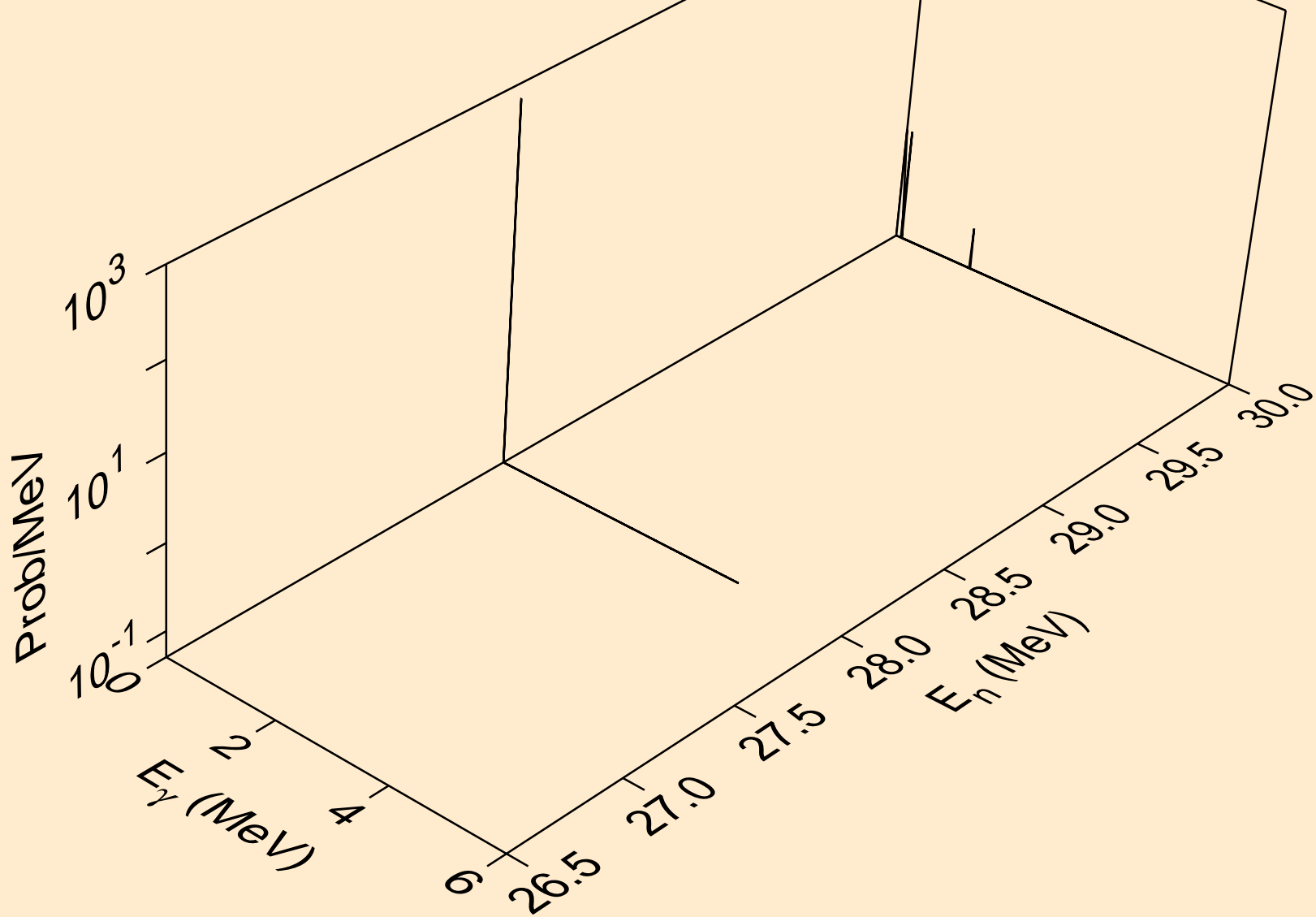

10-NE-22 FOR FENDL-3.2 FROM TENDL-2019 WITH NJOY2016.60  
Photon emission for (n,da)

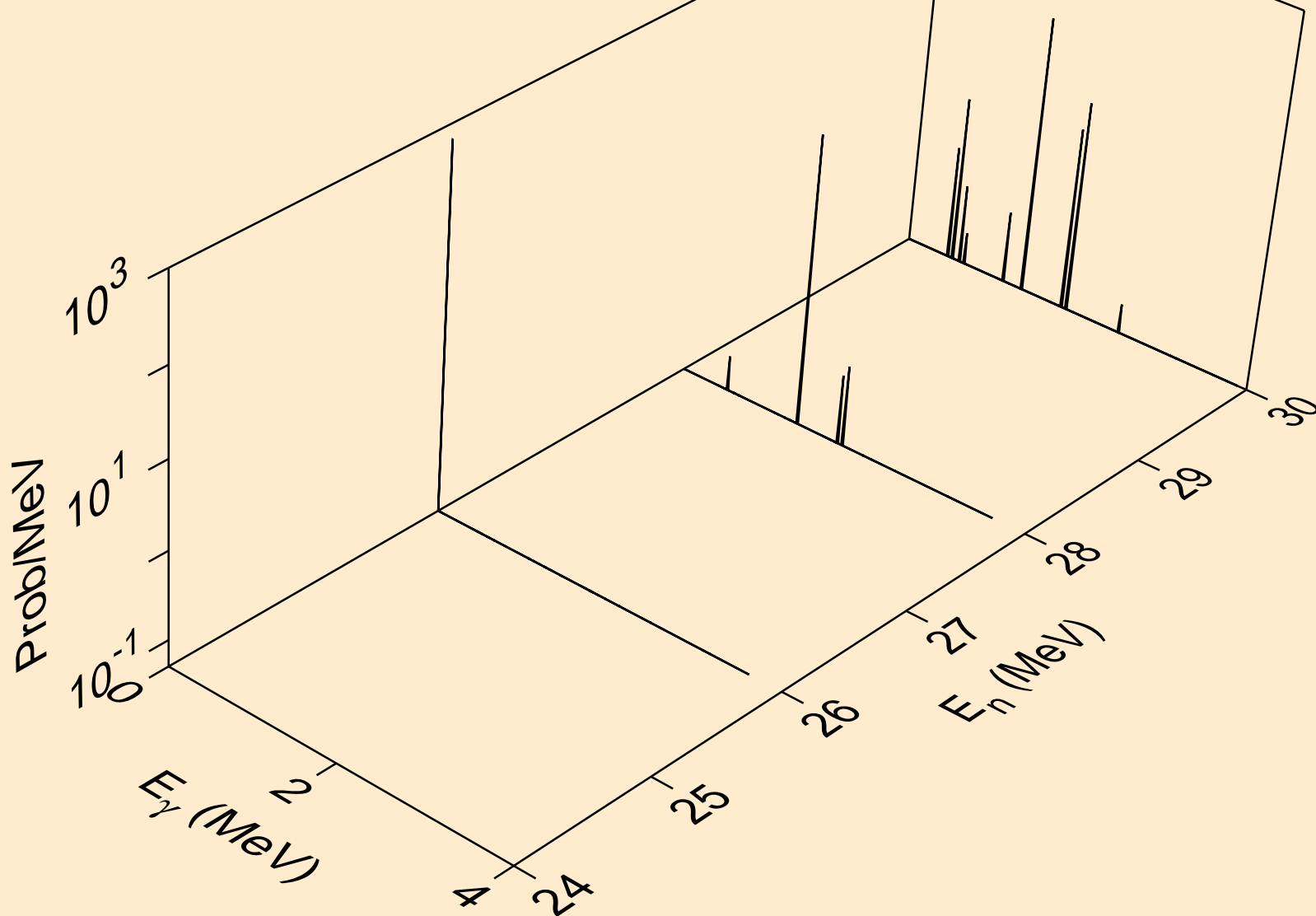

10-NE-22 FOR FENDL-3.2 FROM TENDL-2019 WITH NJOY2016.60  
thermal capture photon spectrum

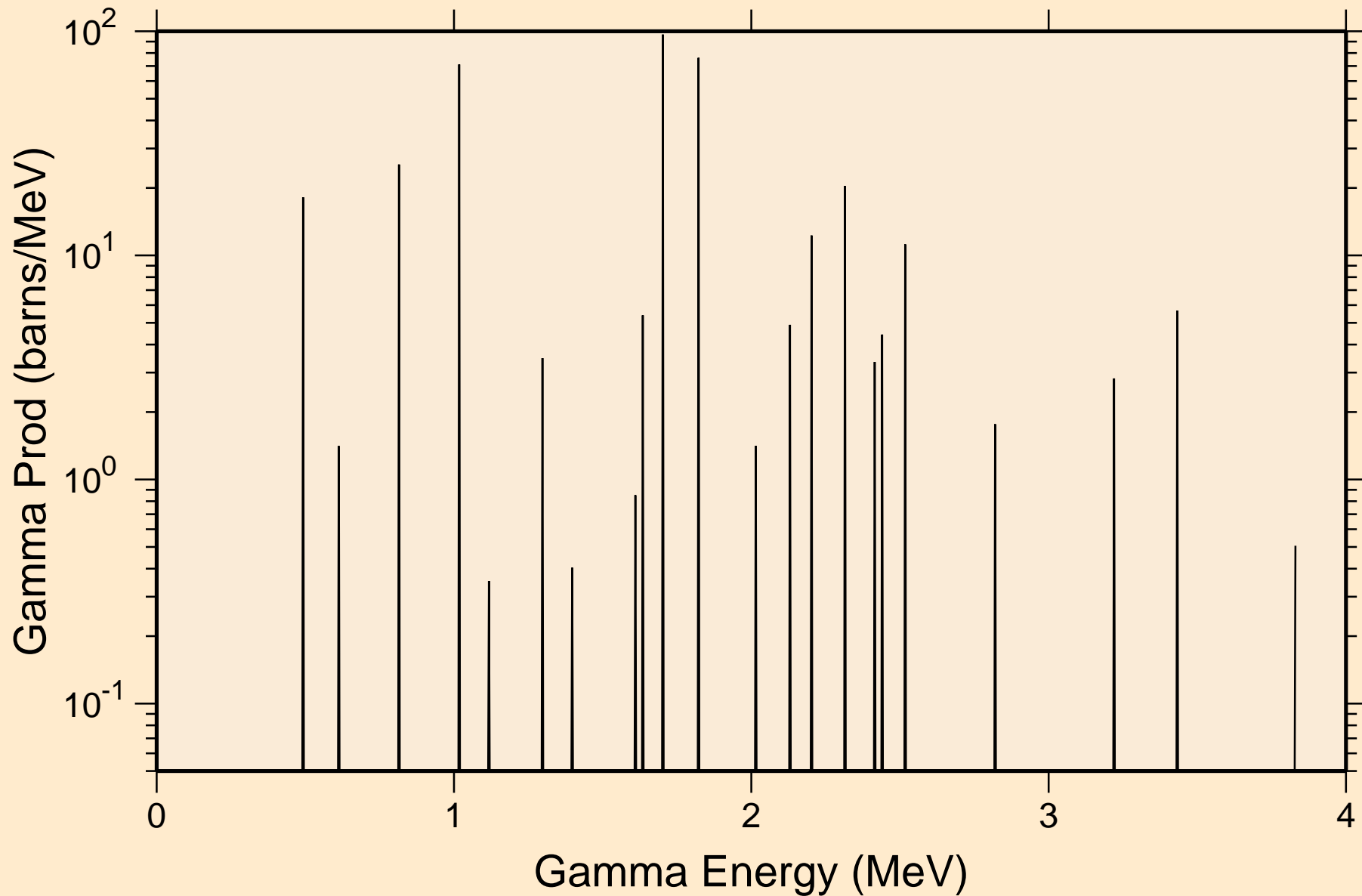

10-NE-22 FOR FENDL-3.2 FROM TENDL-2019 WITH NJOY2016.60  
14 MeV photon spectrum

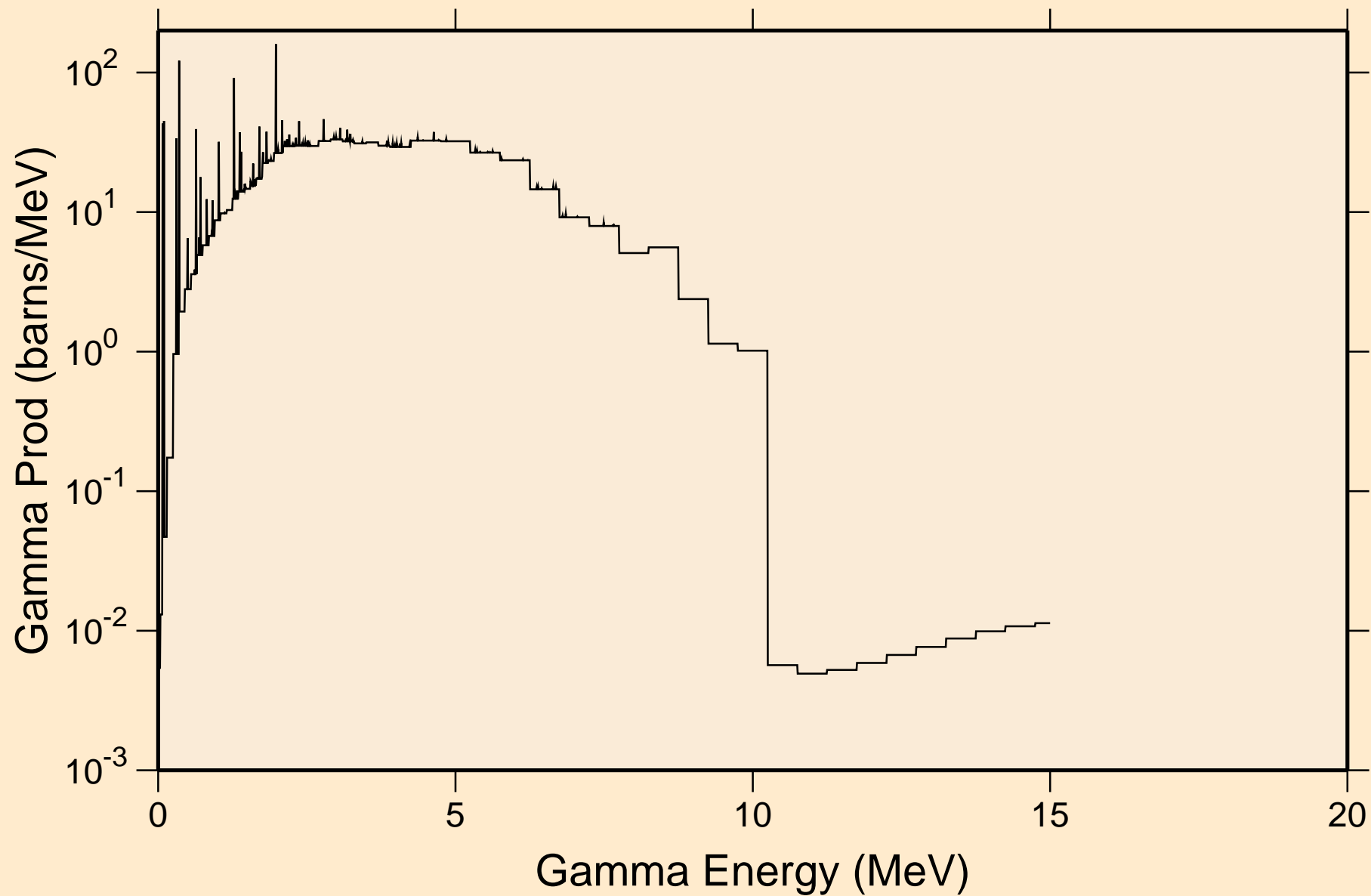

# 10-NE-22 FOR FENDL-3.2 FROM TENDL-2019 WITH NJOY2016.60

## Particle heating contributions

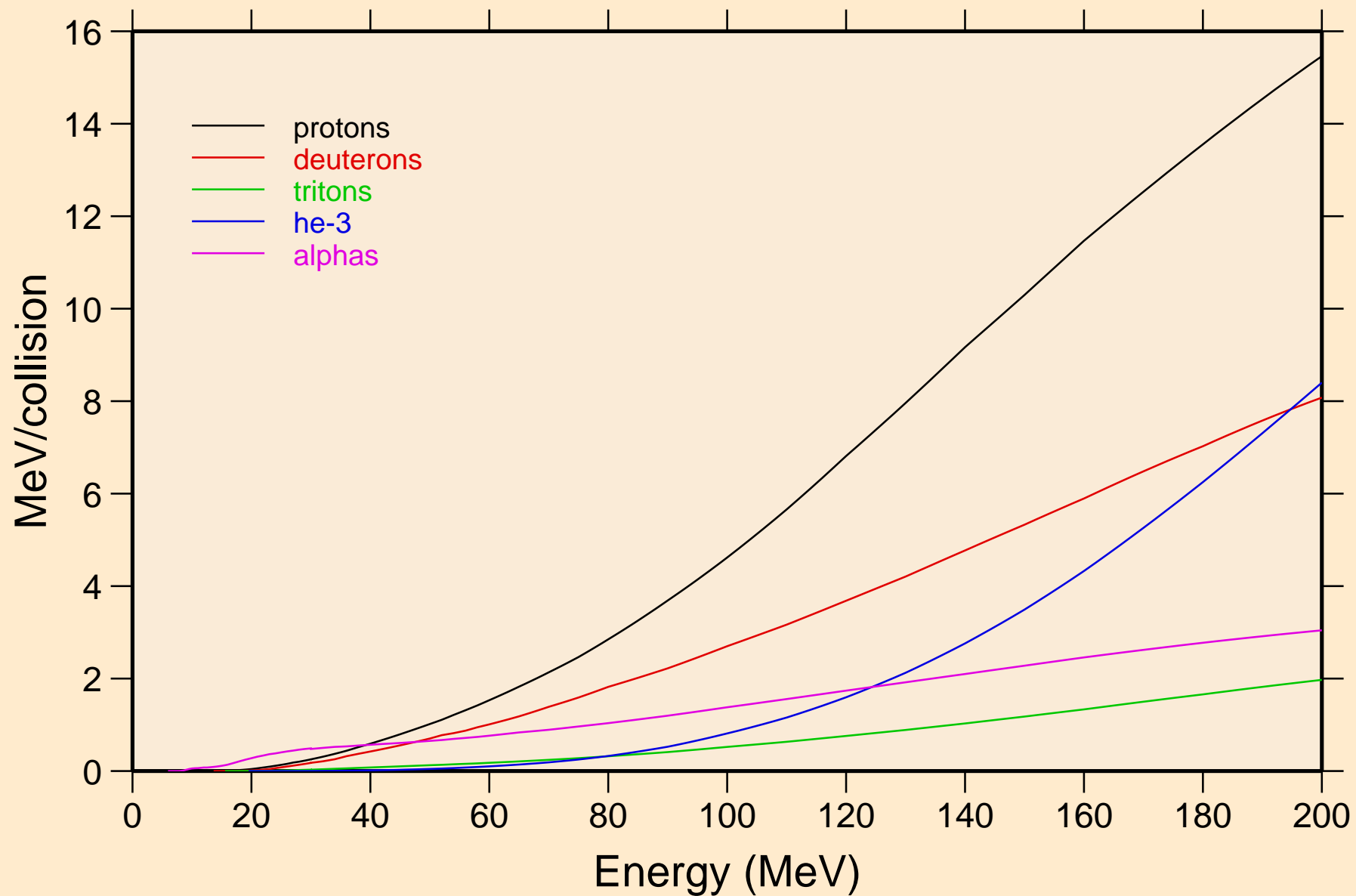

10-NE-22 FOR FENDL-3.2 FROM TENDL-2019 WITH NJOY2016.60  
Recoil Heating

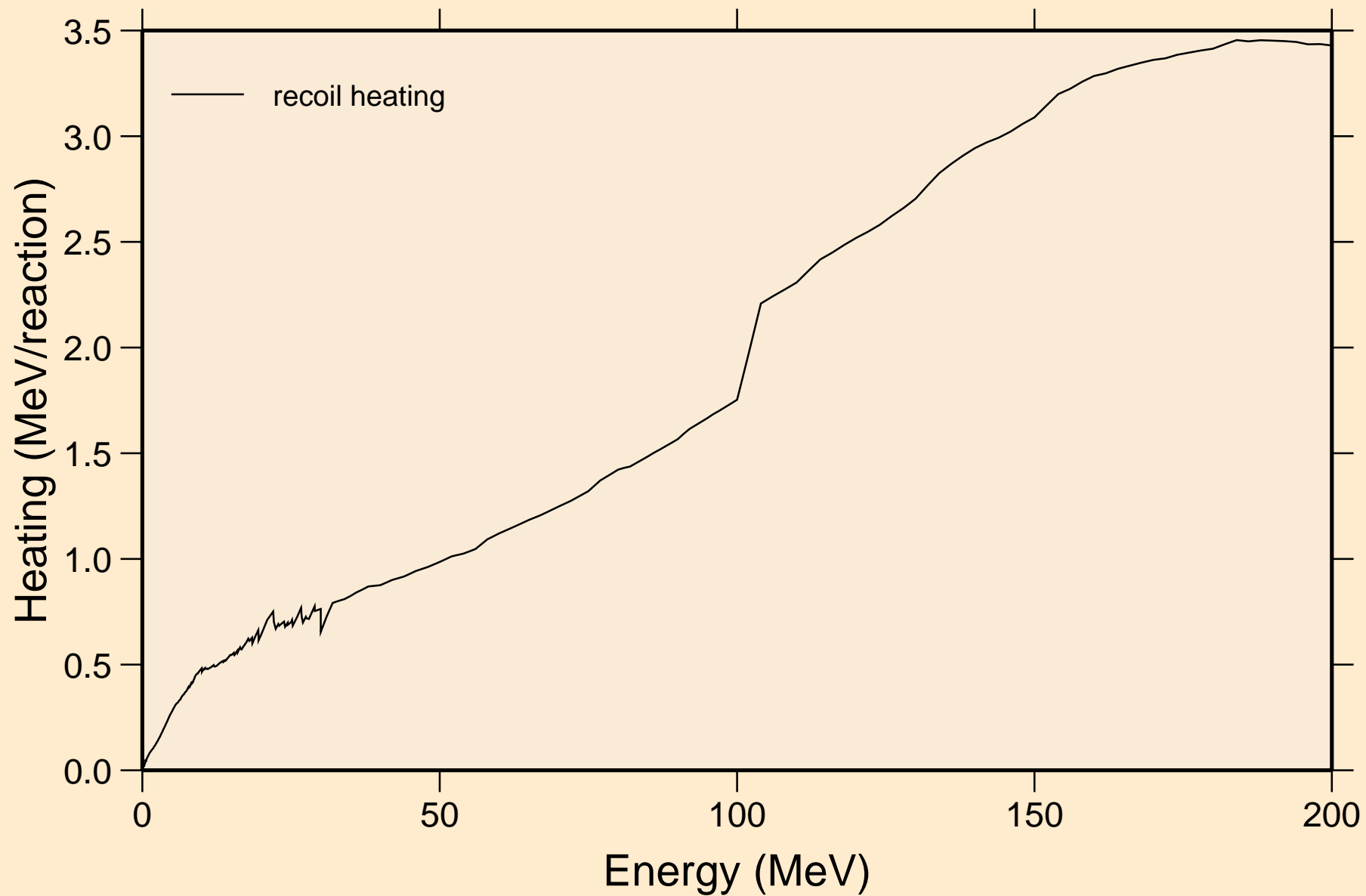



10-NE-22 FOR FENDL-3.2 FROM TENDL-2019 WITH NJOY2016.60  
Particle production cross sections

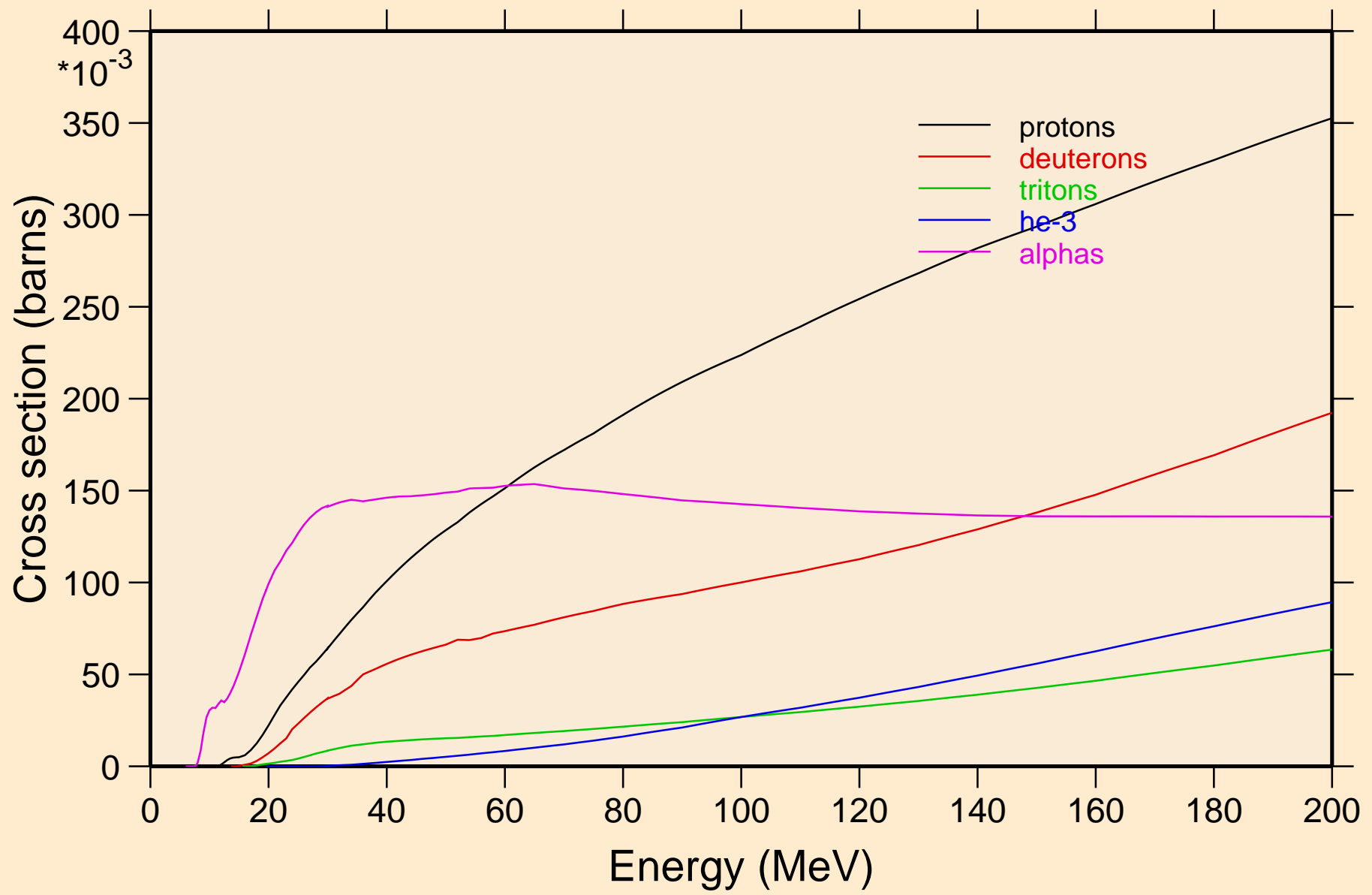

10-NE-22 FOR FENDL-3.2 FROM TENDL-2019 WITH NJOY2016.60  
protons from (n,x)

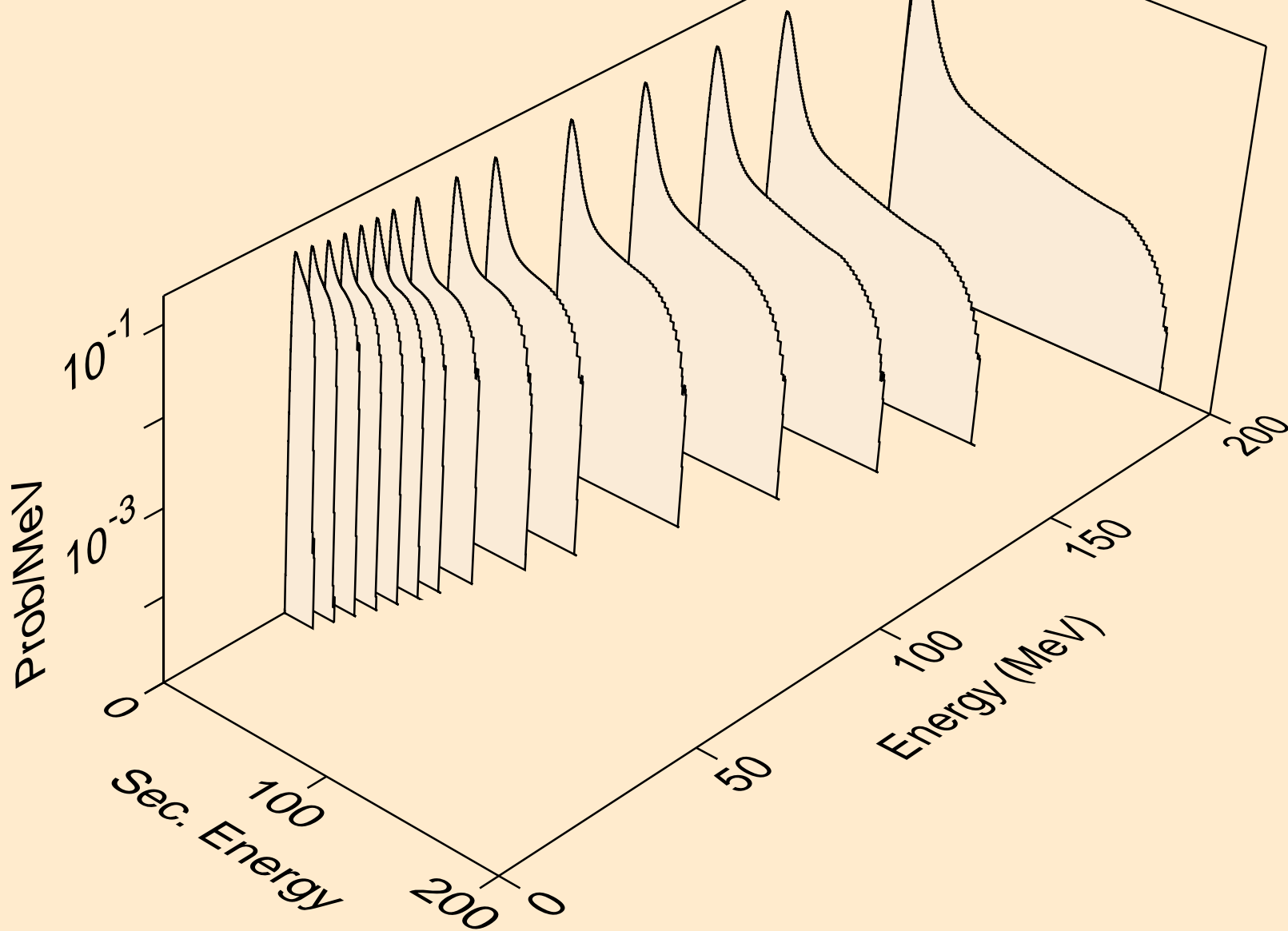

10-NE-22 FOR FENDL-3.2 FROM TENDL-2019 WITH NJOY2016.60  
protons from (n,n\*)p

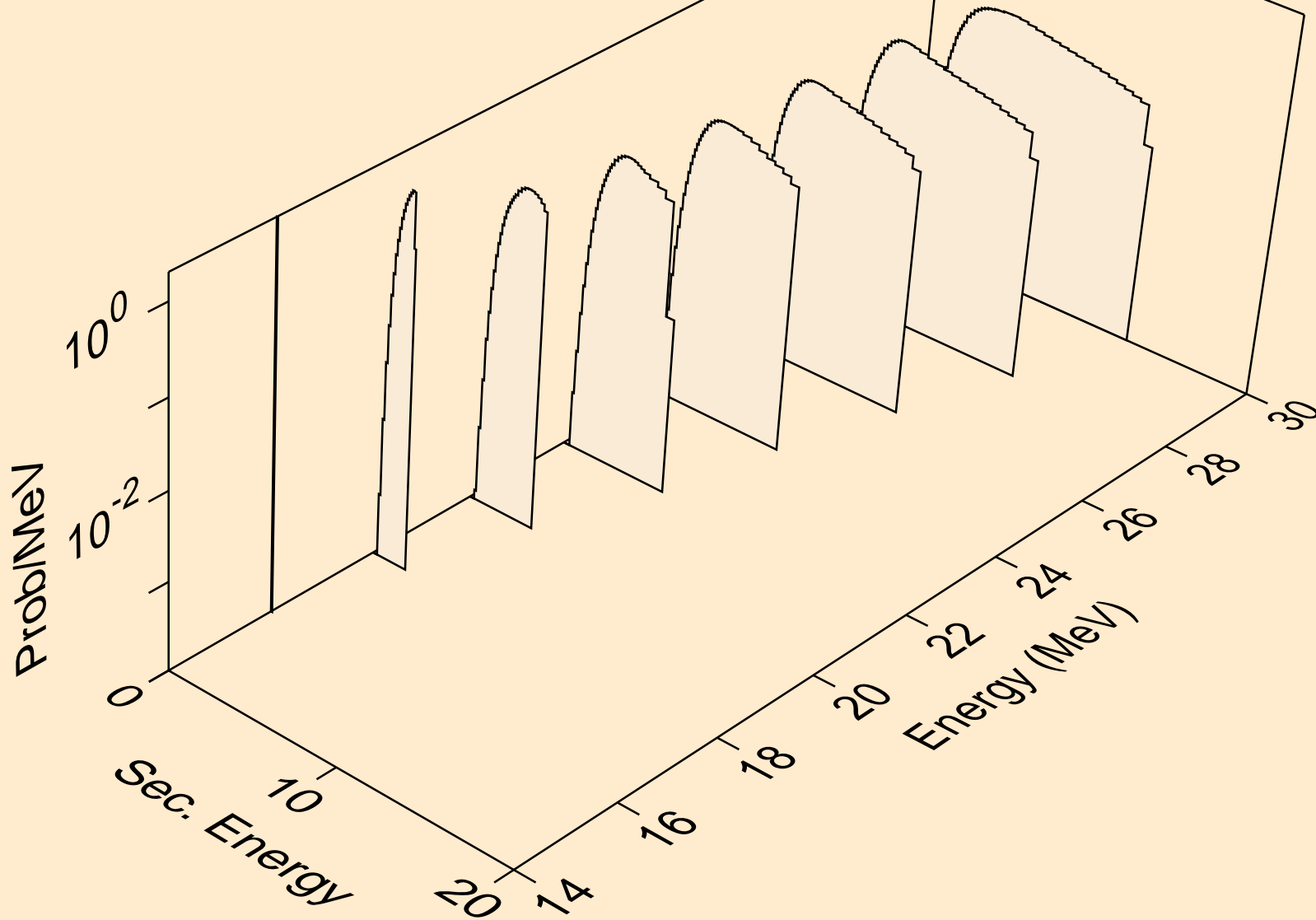

10-NE-22 FOR FENDL-3.2 FROM TENDL-2019 WITH NJOY2016.60  
protons from (n,2np)

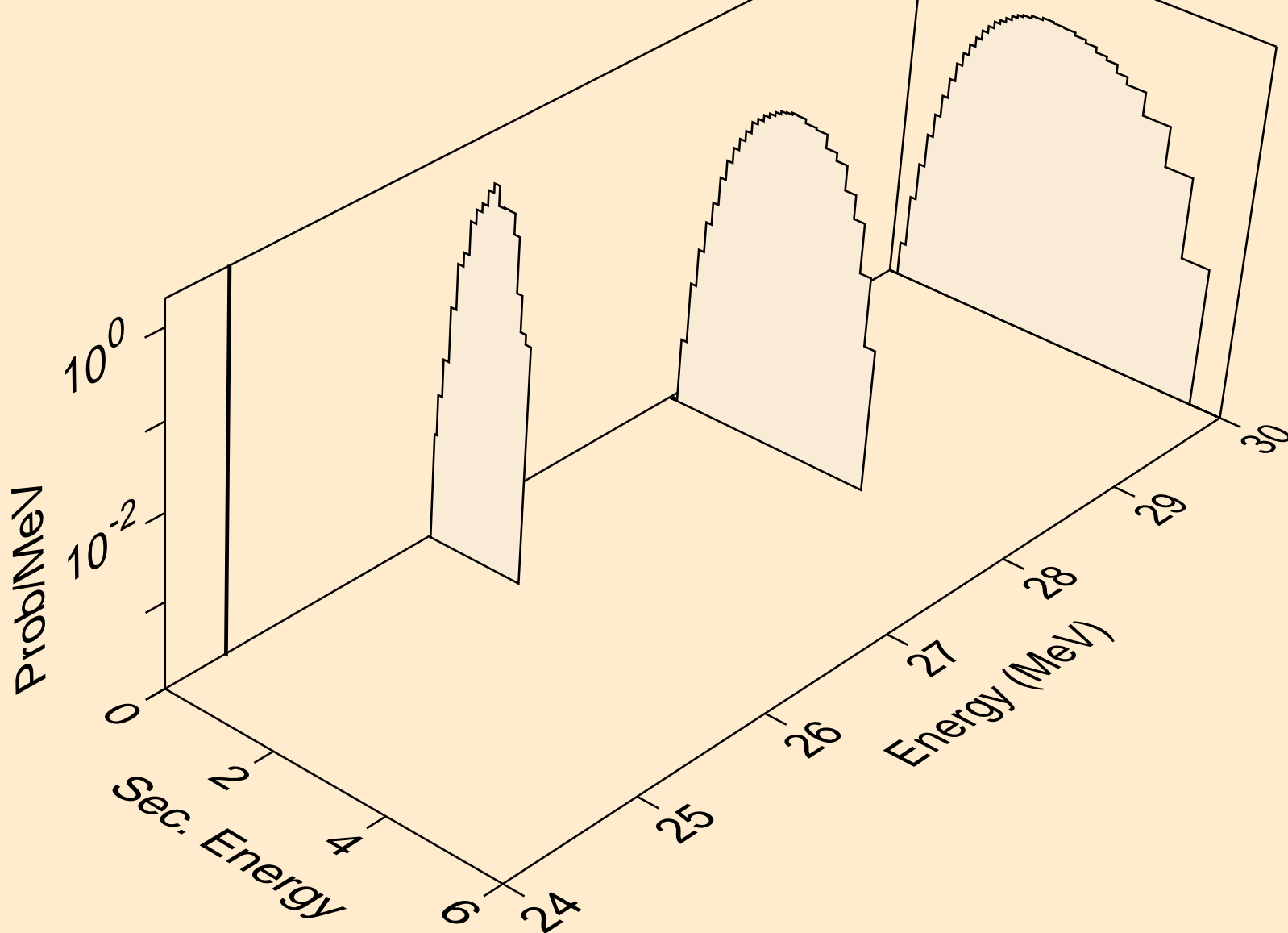

10-NE-22 FOR FENDL-3.2 FROM TENDL-2019 WITH NJOY2016.60  
protons from (n,2np)

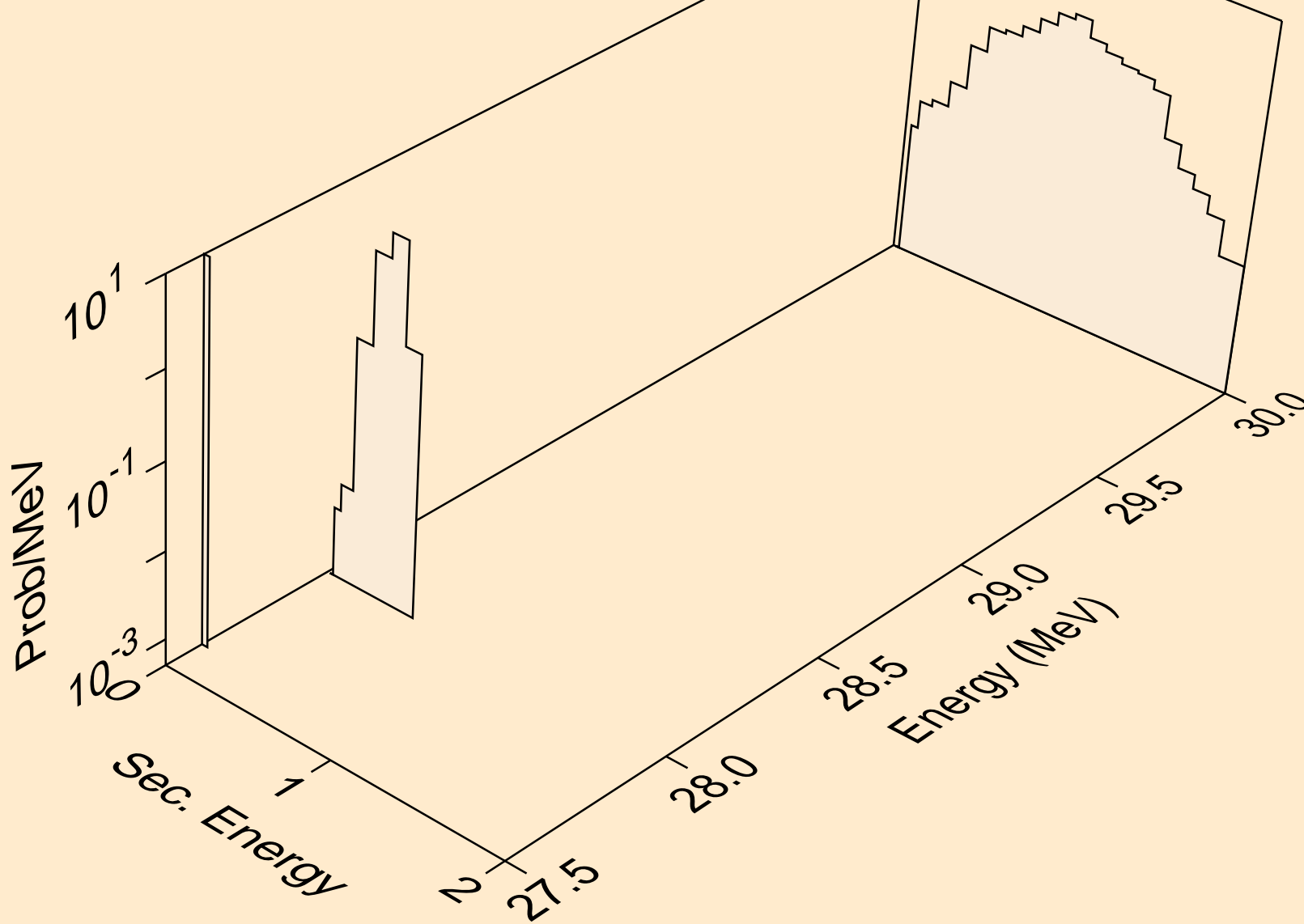

10-NE-22 FOR FENDL-3.2 FROM TENDL-2019 WITH NJOY2016.60  
protons from (n,npa)

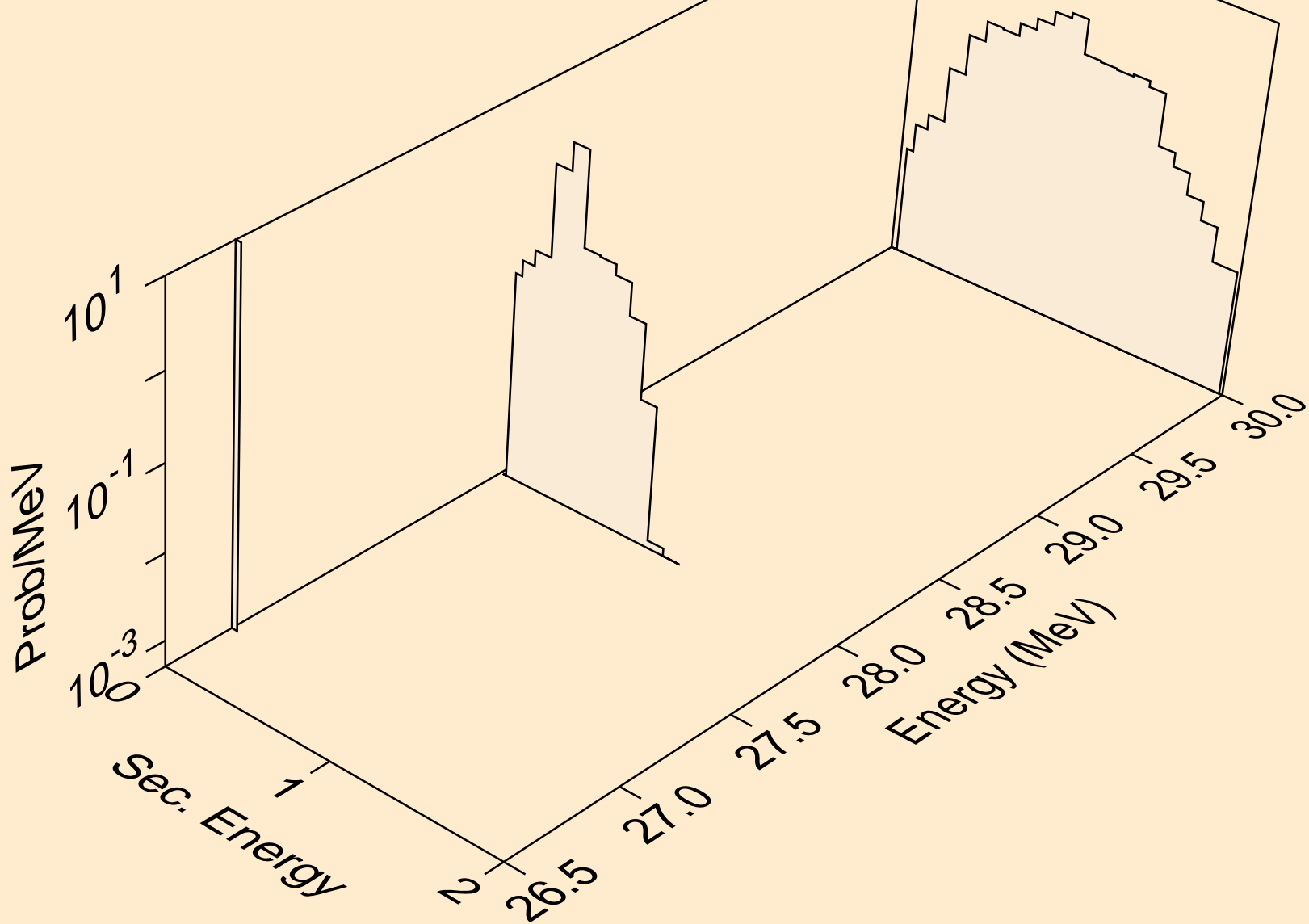

10-NE-22 FOR FENDL-3.2 FROM TENDL-2019 WITH NJOY2016.60  
protons from (n,p)

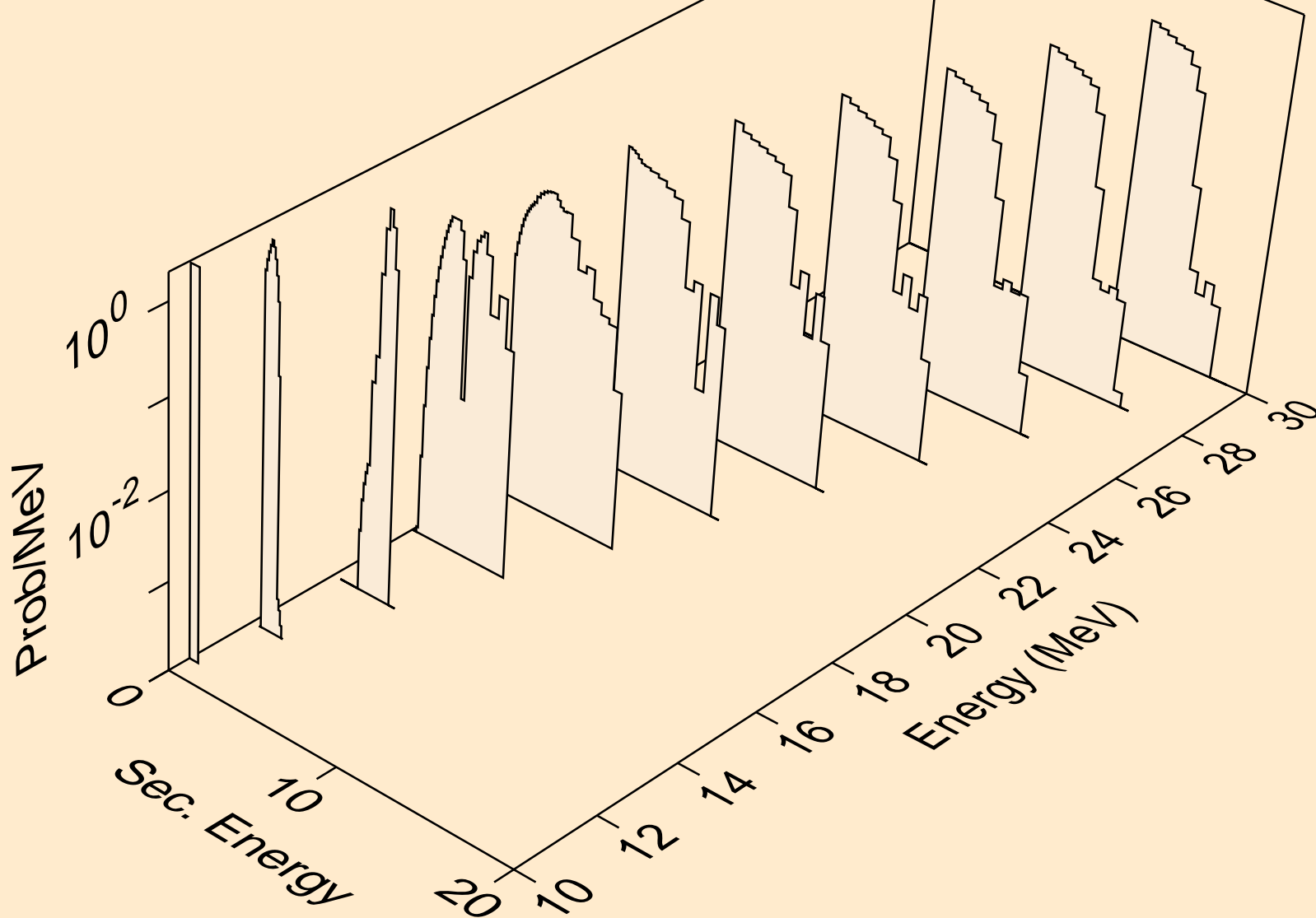

10-NE-22 FOR FENDL-3.2 FROM TENDL-2019 WITH NJOY2016.60  
protons from (n,2p)

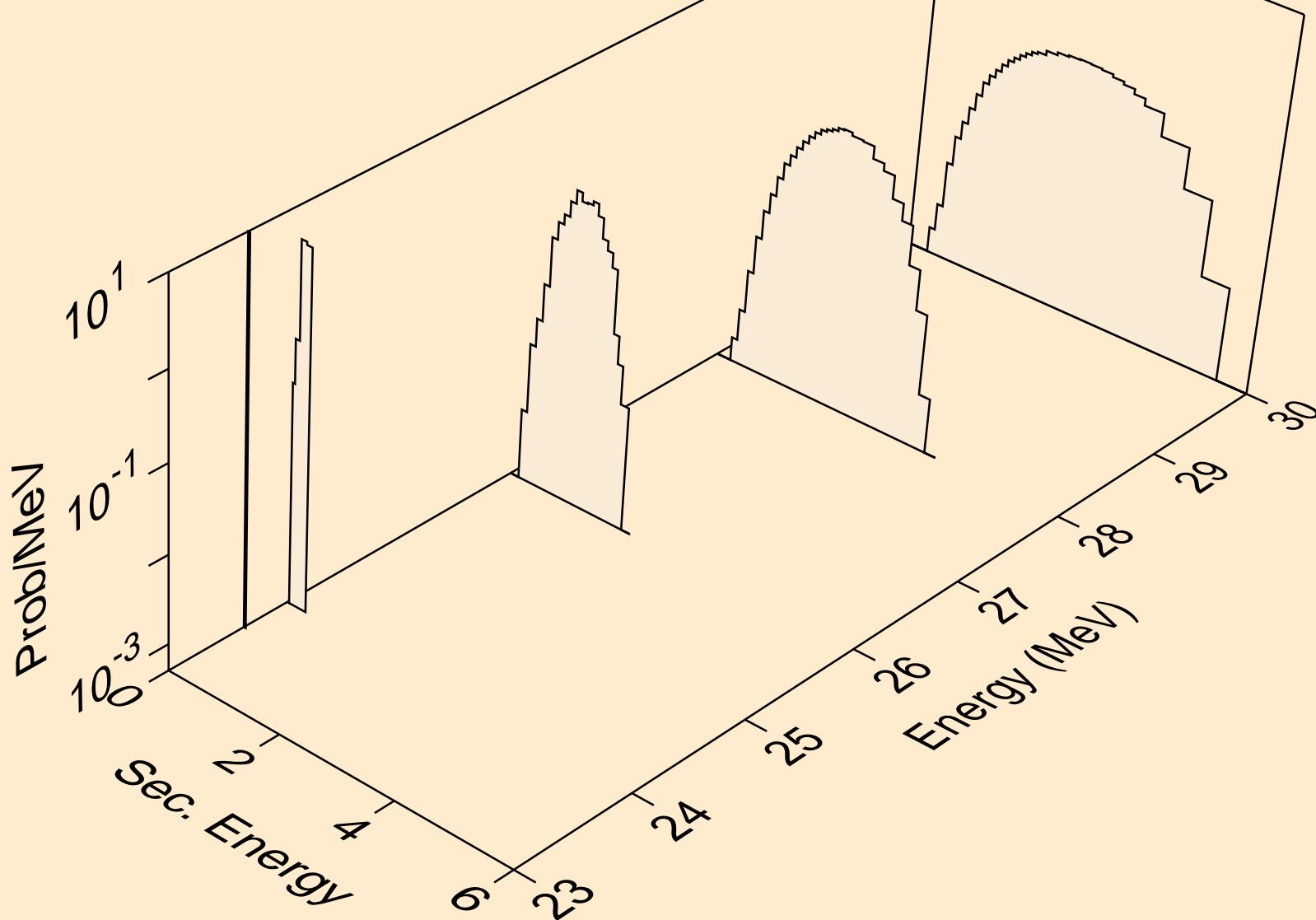



10-NE-22 FOR FENDL-3.2 FROM TENDL-2019 WITH NJOY2016.60  
protons from (n,pa)

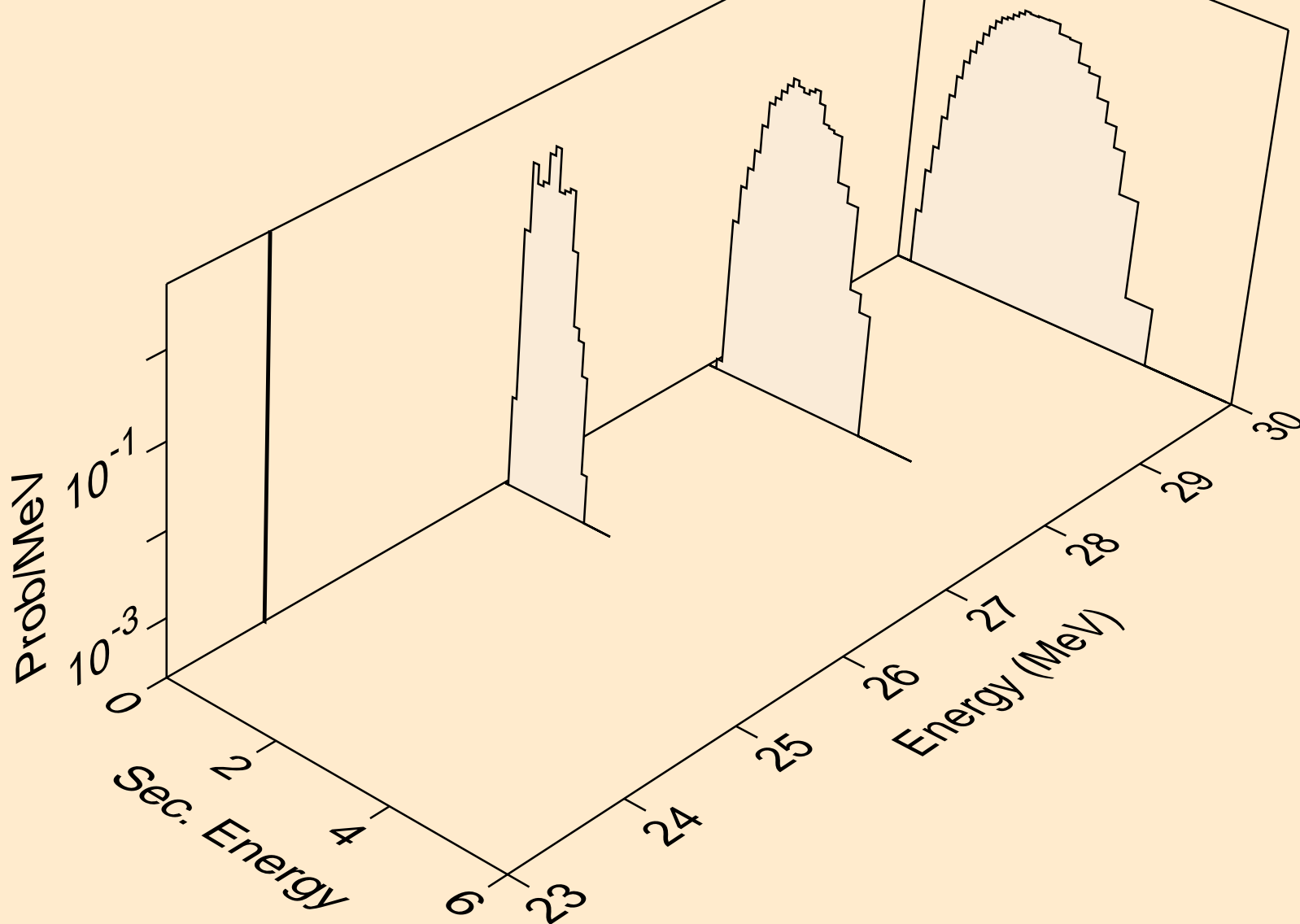

10-NE-22 FOR FENDL-3.2 FROM TENDL-2019 WITH NJOY2016.60  
protons from (n,pd)

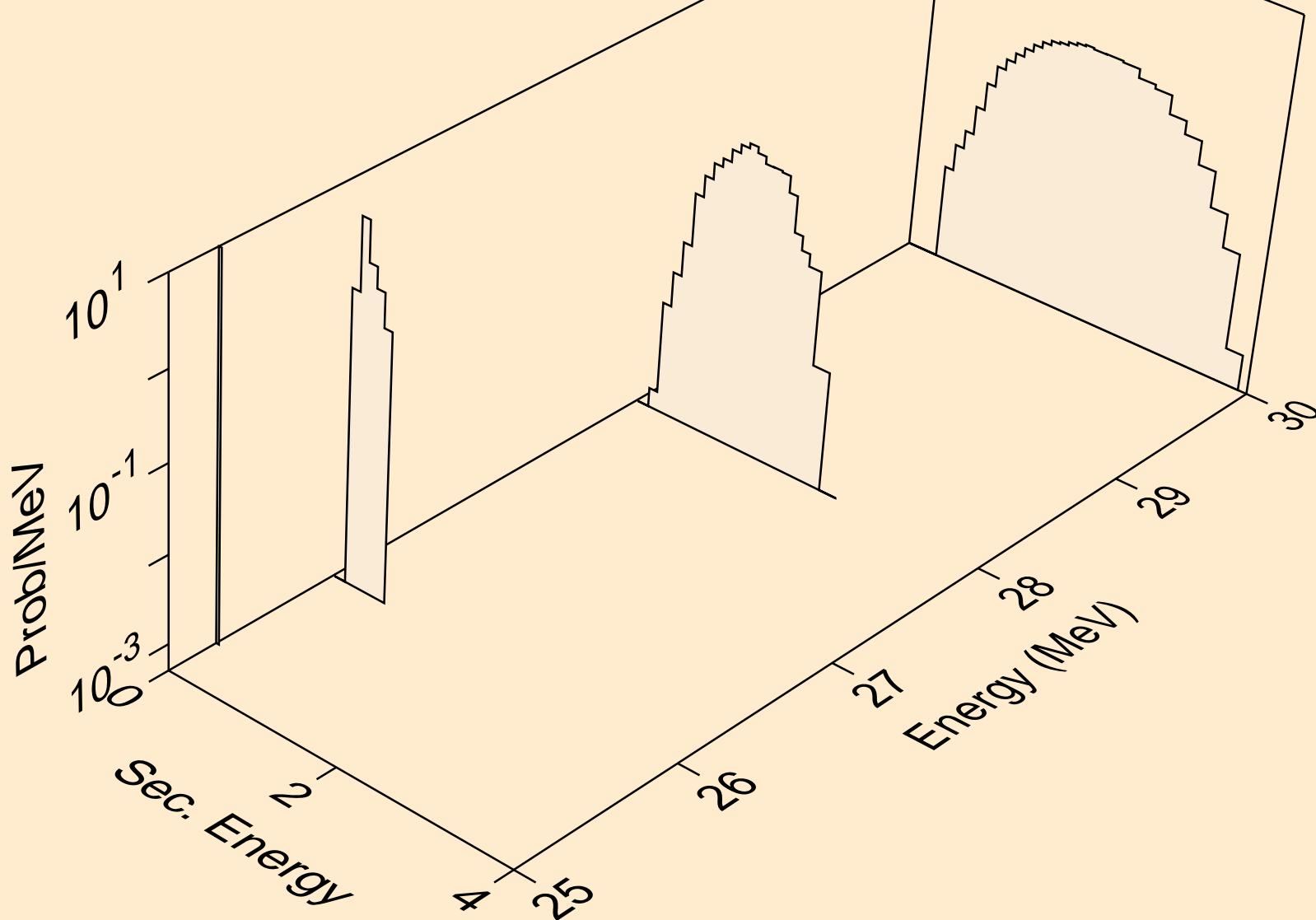

10-NE-22 FOR FENDL-3.2 FROM TENDL-2019 WITH NJOY2016.60  
protons from (n,pt)

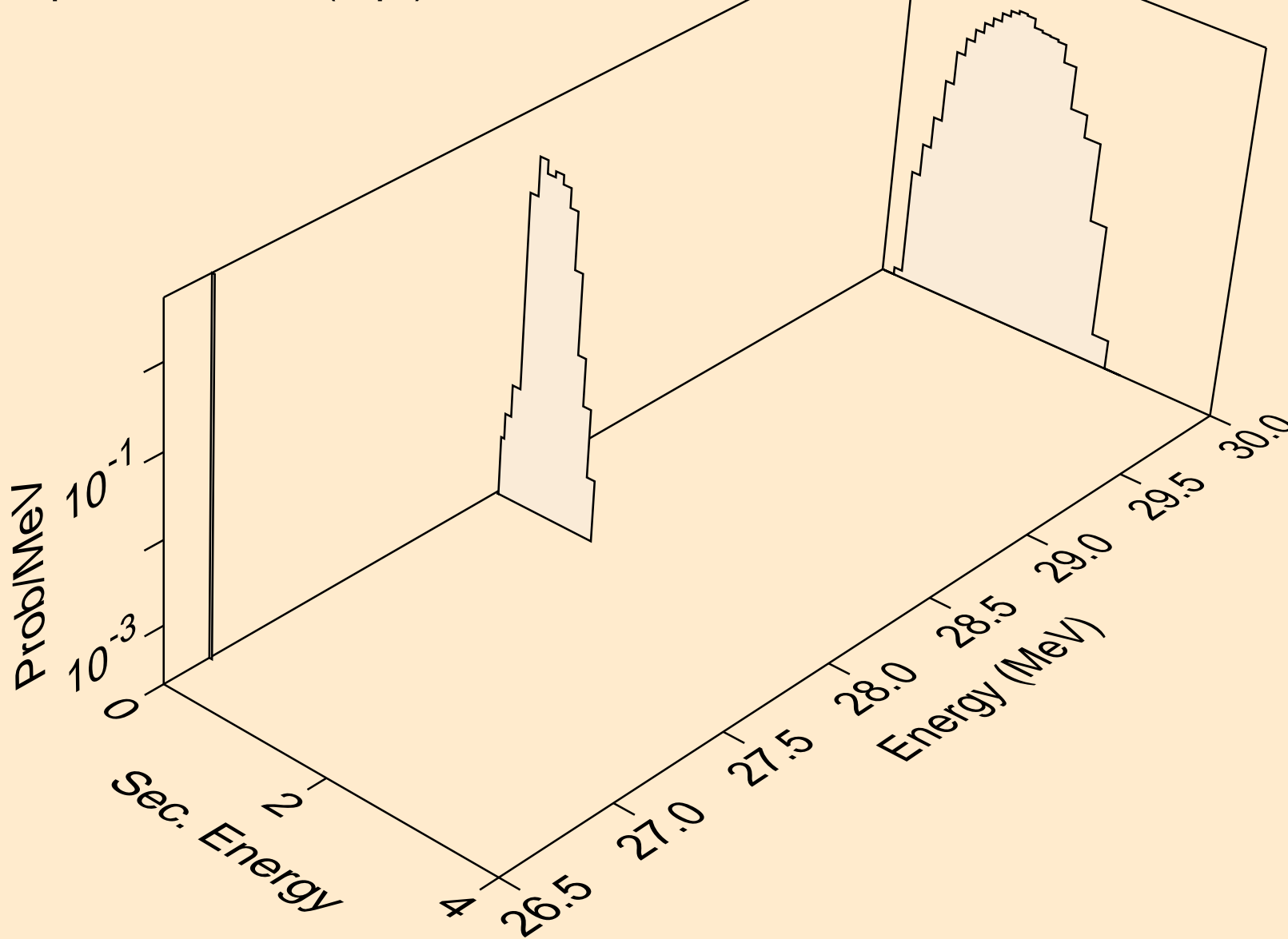

10-NE-22 FOR FENDL-3.2 FROM TENDL-2019 WITH NJOY2016.60  
deuterons from (n,x)

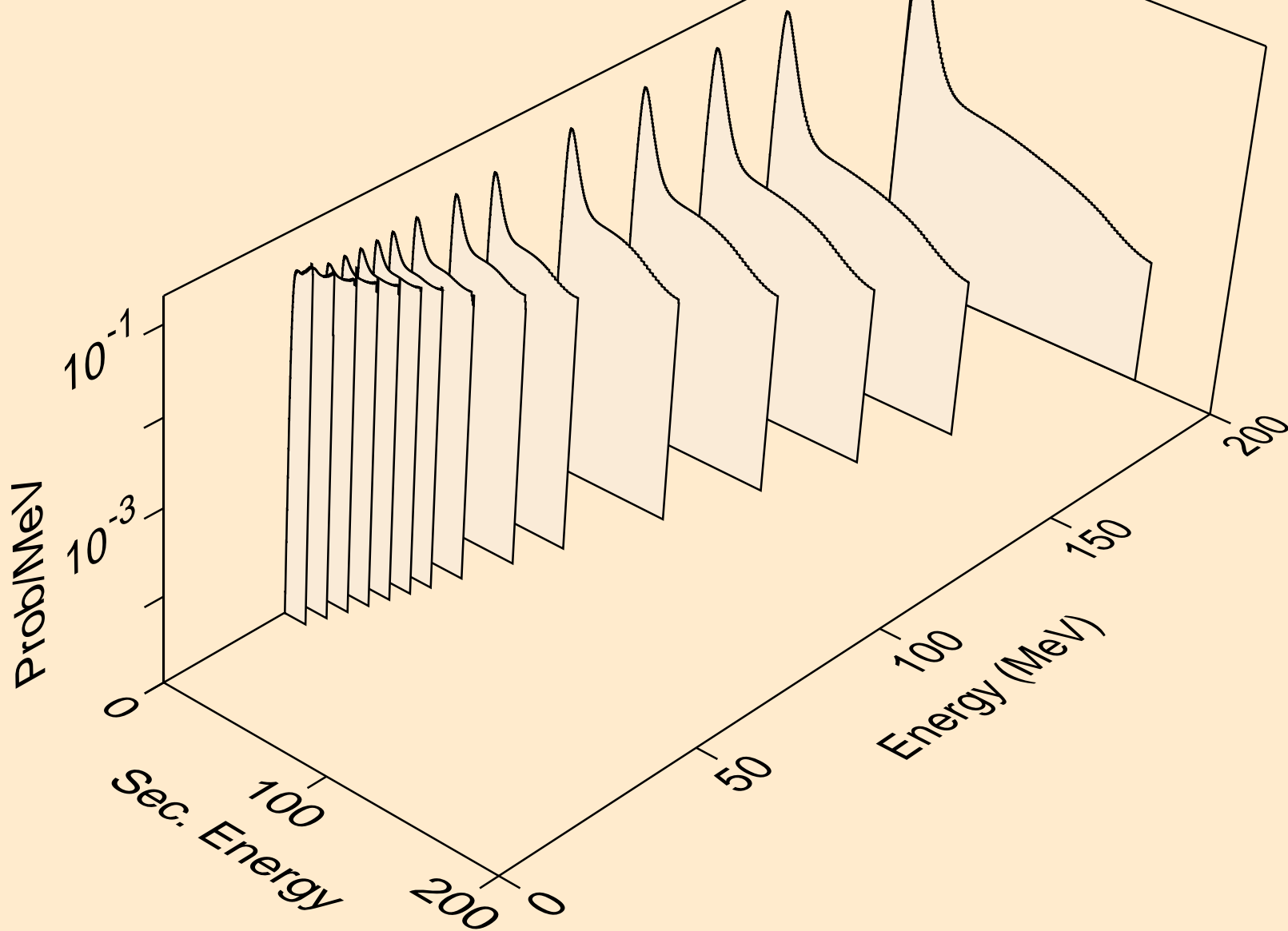

10-NE-22 FOR FENDL-3.2 FROM TENDL-2019 WITH NJOY2016.60  
deuterons from (n,2nd)

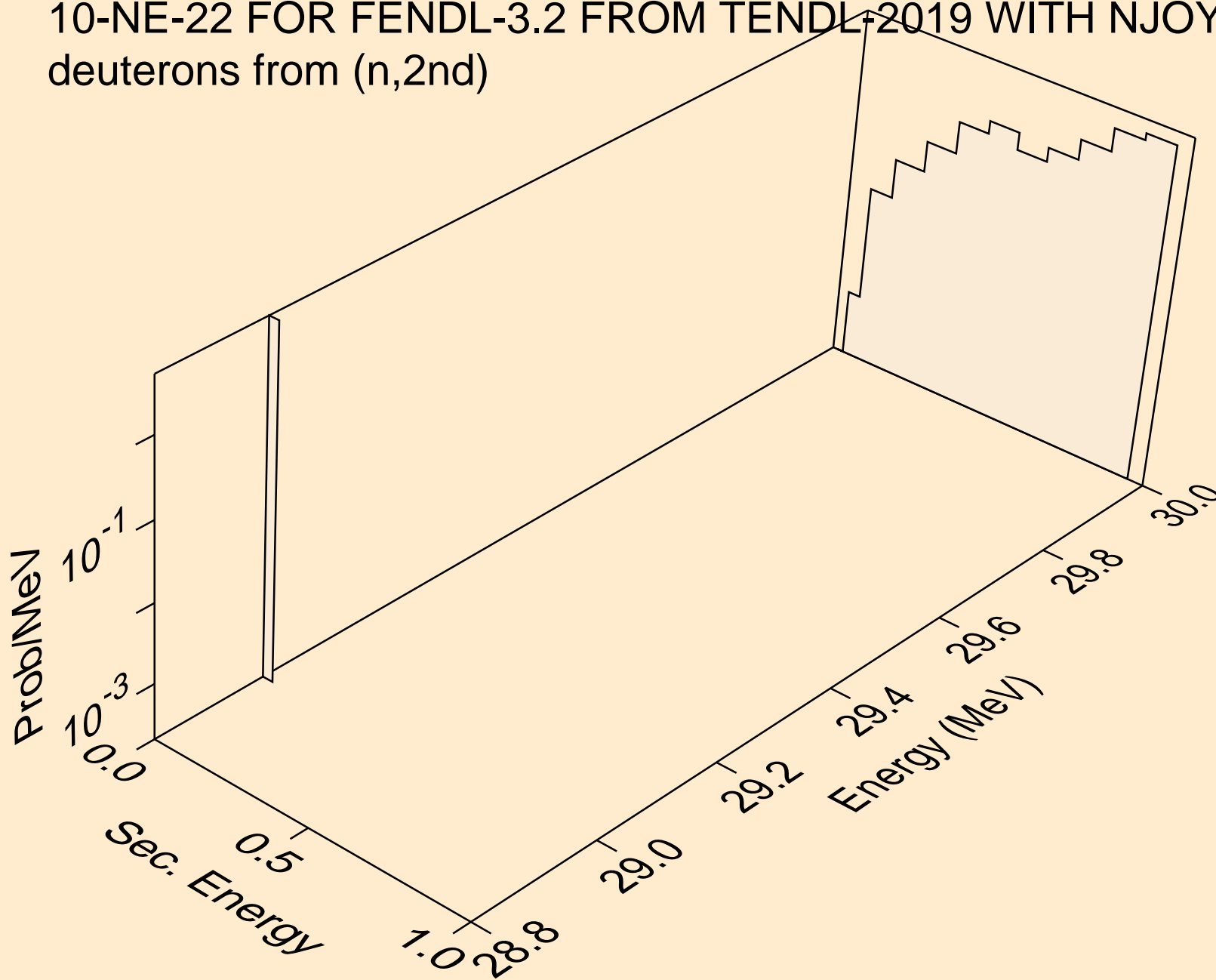

10-NE-22 FOR FENDL-3.2 FROM TENDL-2019 WITH NJOY2016.60  
deuterons from (n,n\*)d

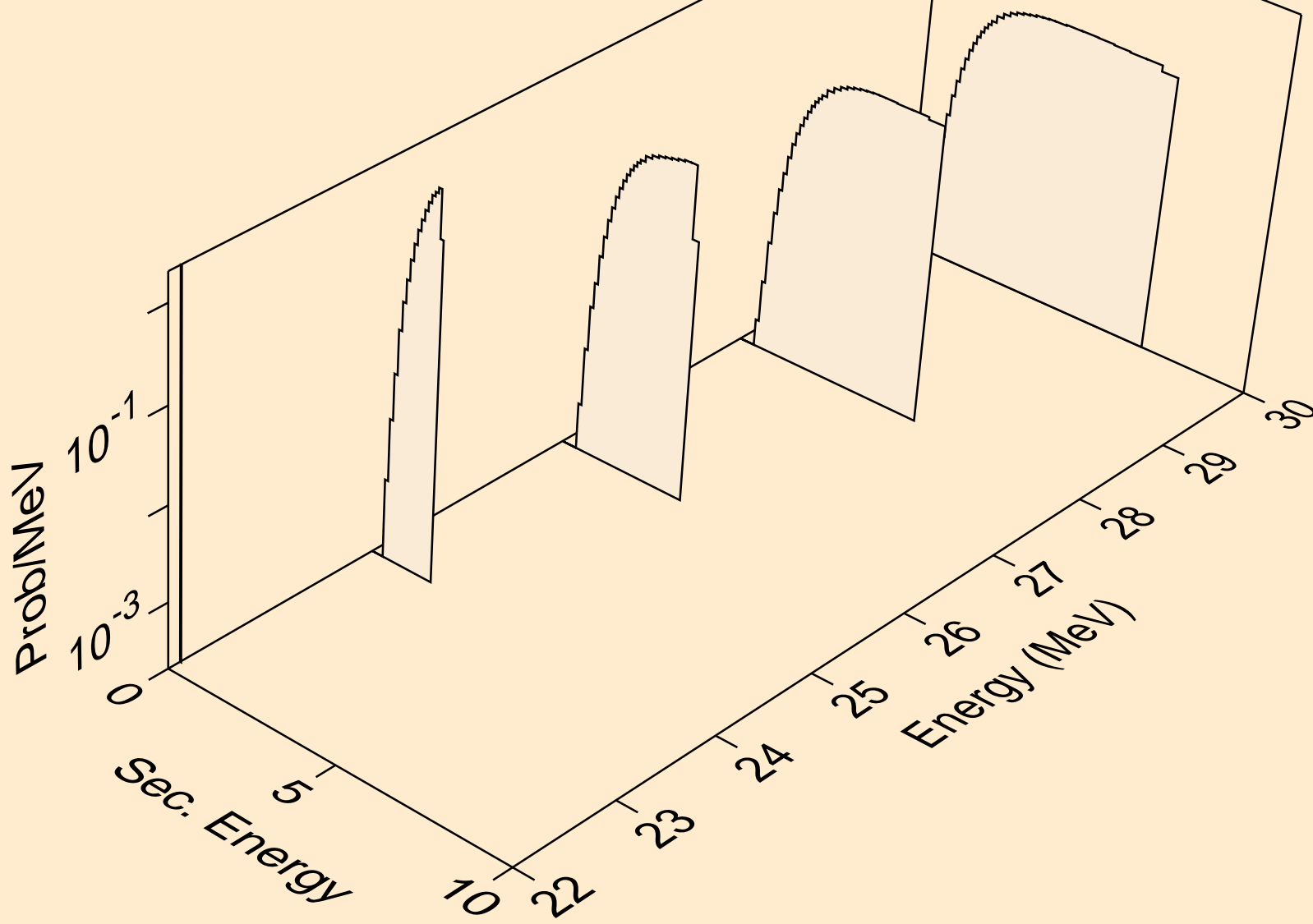

10-NE-22 FOR FENDL-3.2 FROM TENDL-2019 WITH NJOY2016.60  
deuterons from (n,d)

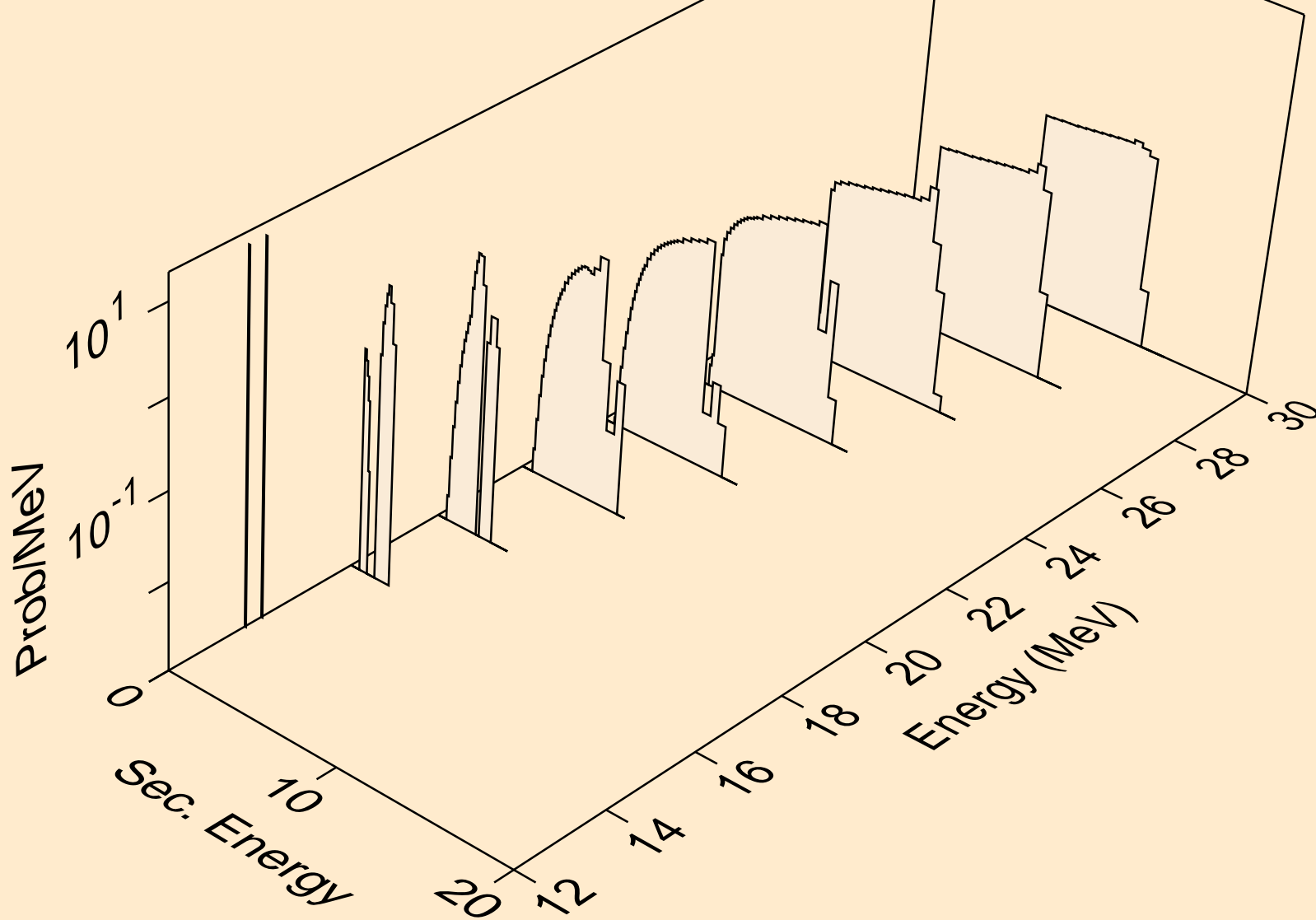

10-NE-22 FOR FENDL-3.2 FROM TENDL-2019 WITH NJOY2016.60  
deuterons from (n,pd)

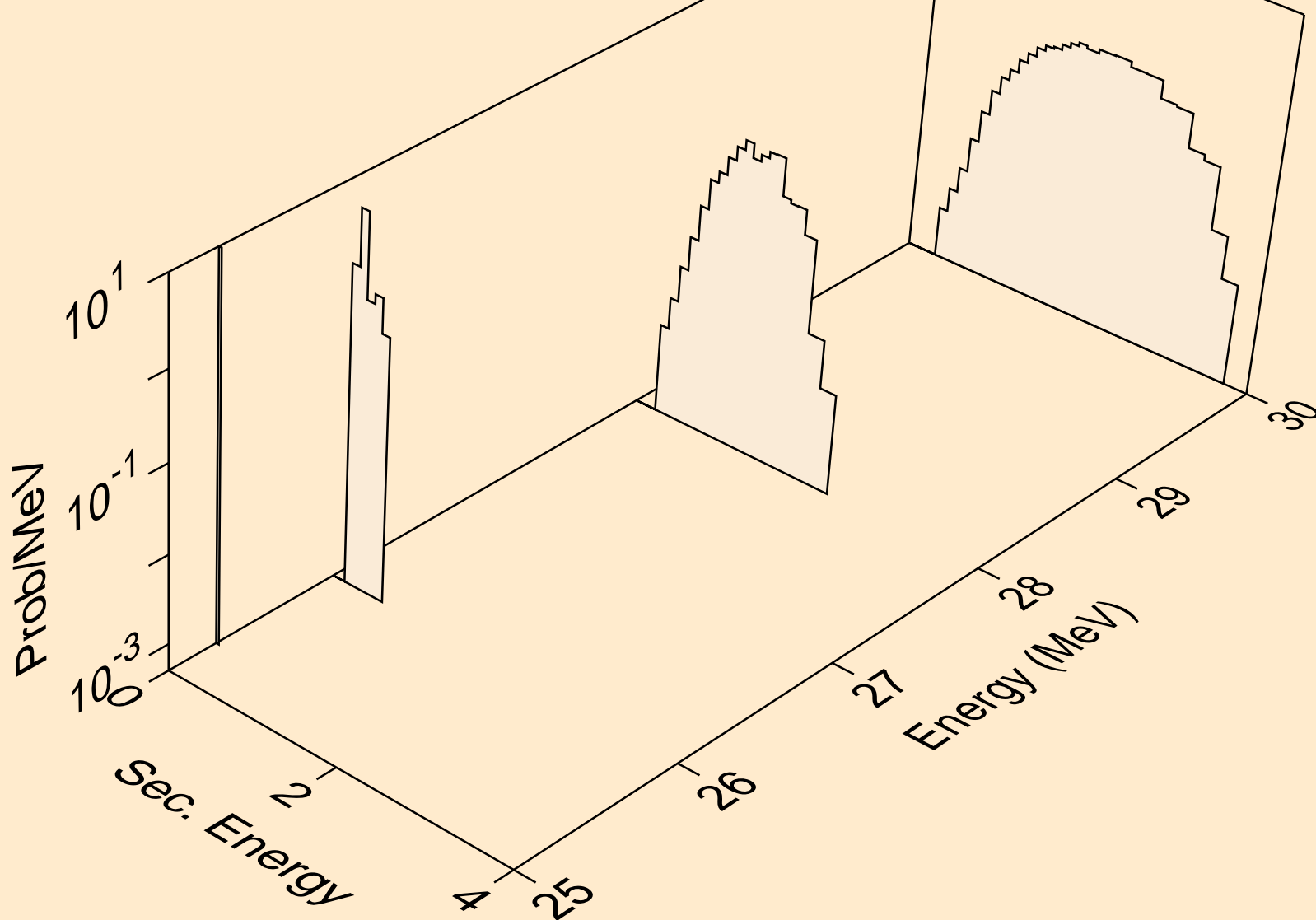



10-NE-22 FOR FENDL-3.2 FROM TENDL-2019 WITH NJOY2016.60  
deuterons from (n,da)

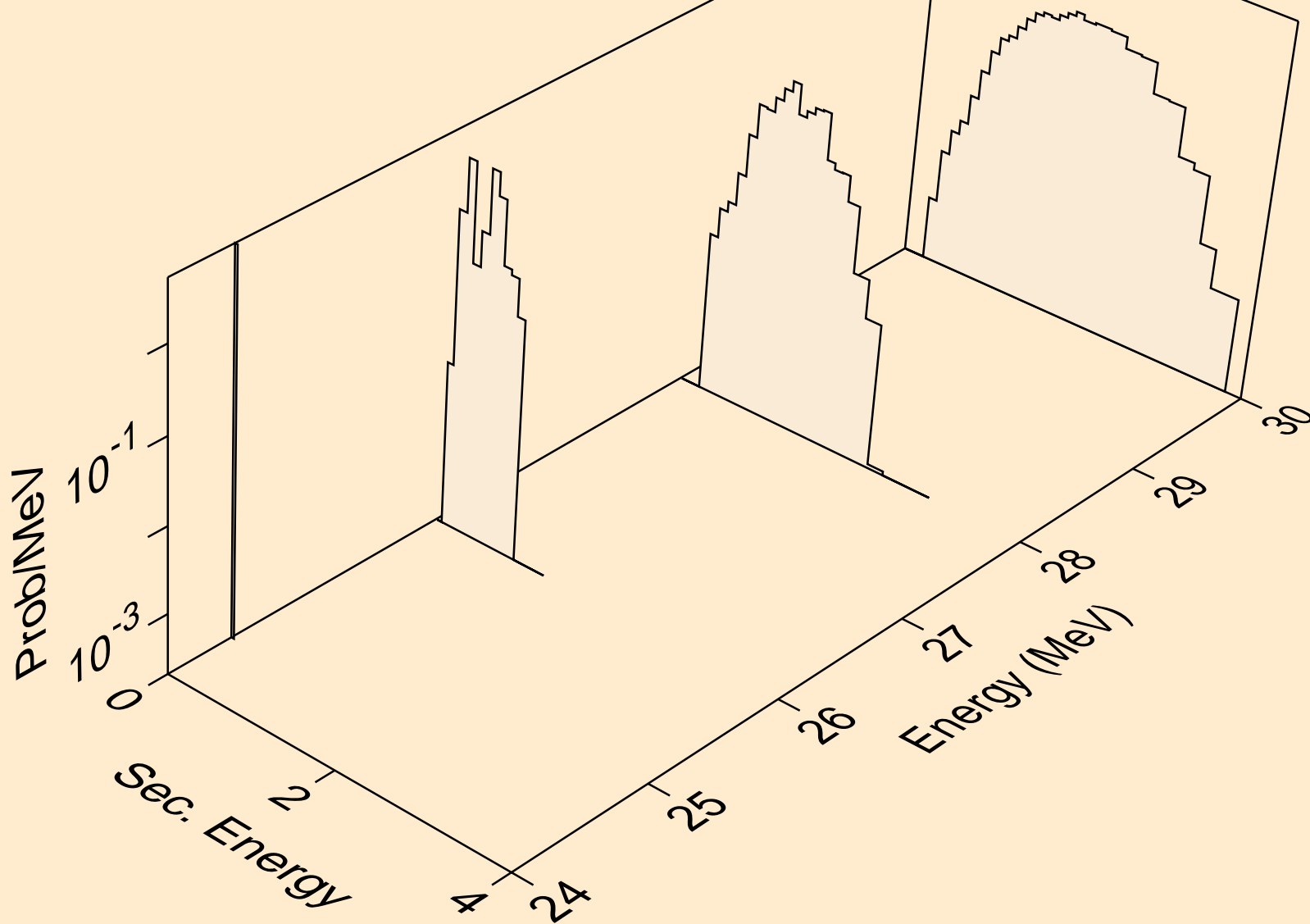

10-NE-22 FOR FENDL-3.2 FROM TENDL-2019 WITH NJOY2016.60  
tritons from (n,x)

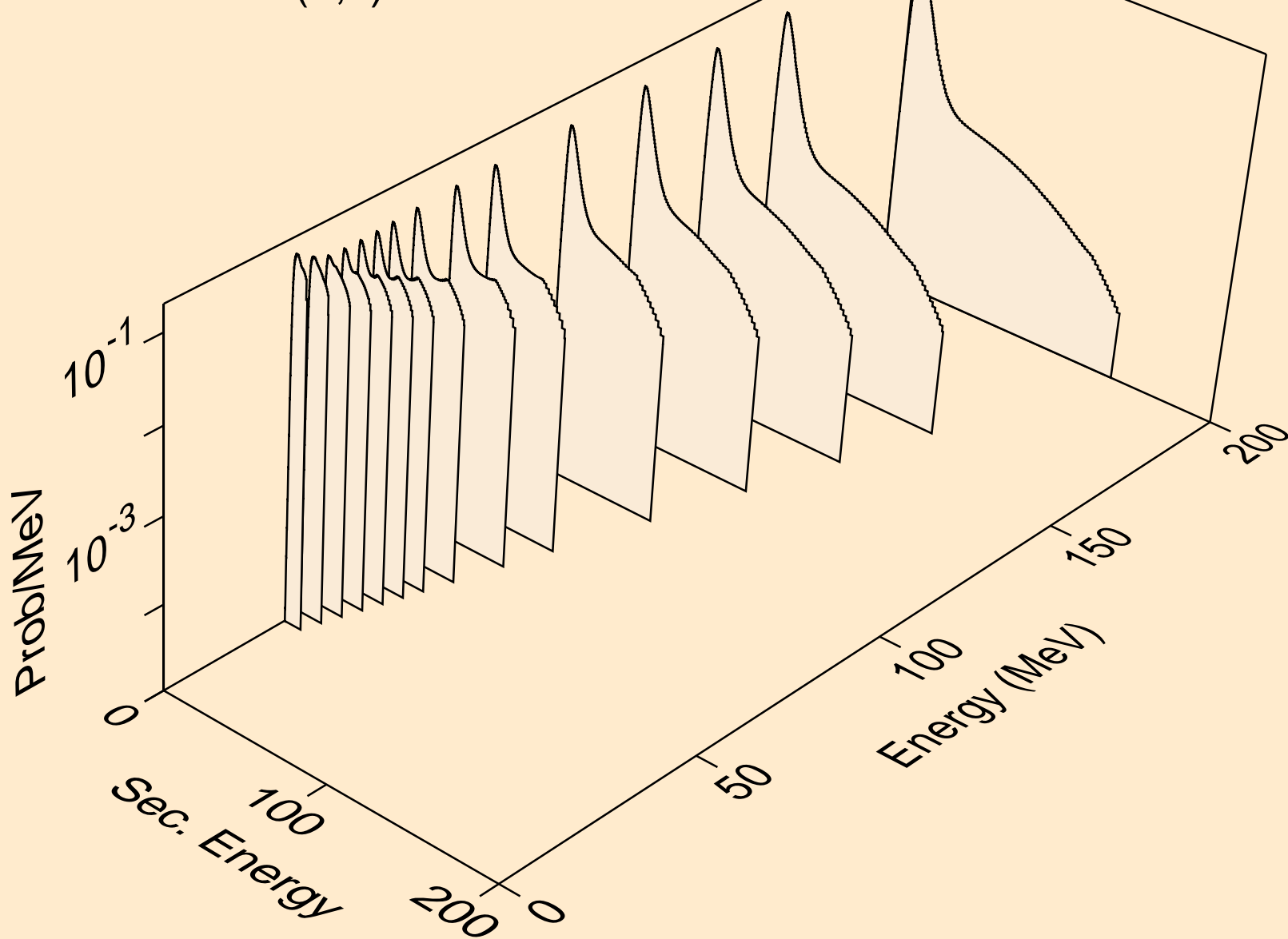

10-NE-22 FOR FENDL-3.2 FROM TENDL-2019 WITH NJOY2016.60  
tritons from (n,n\*)t

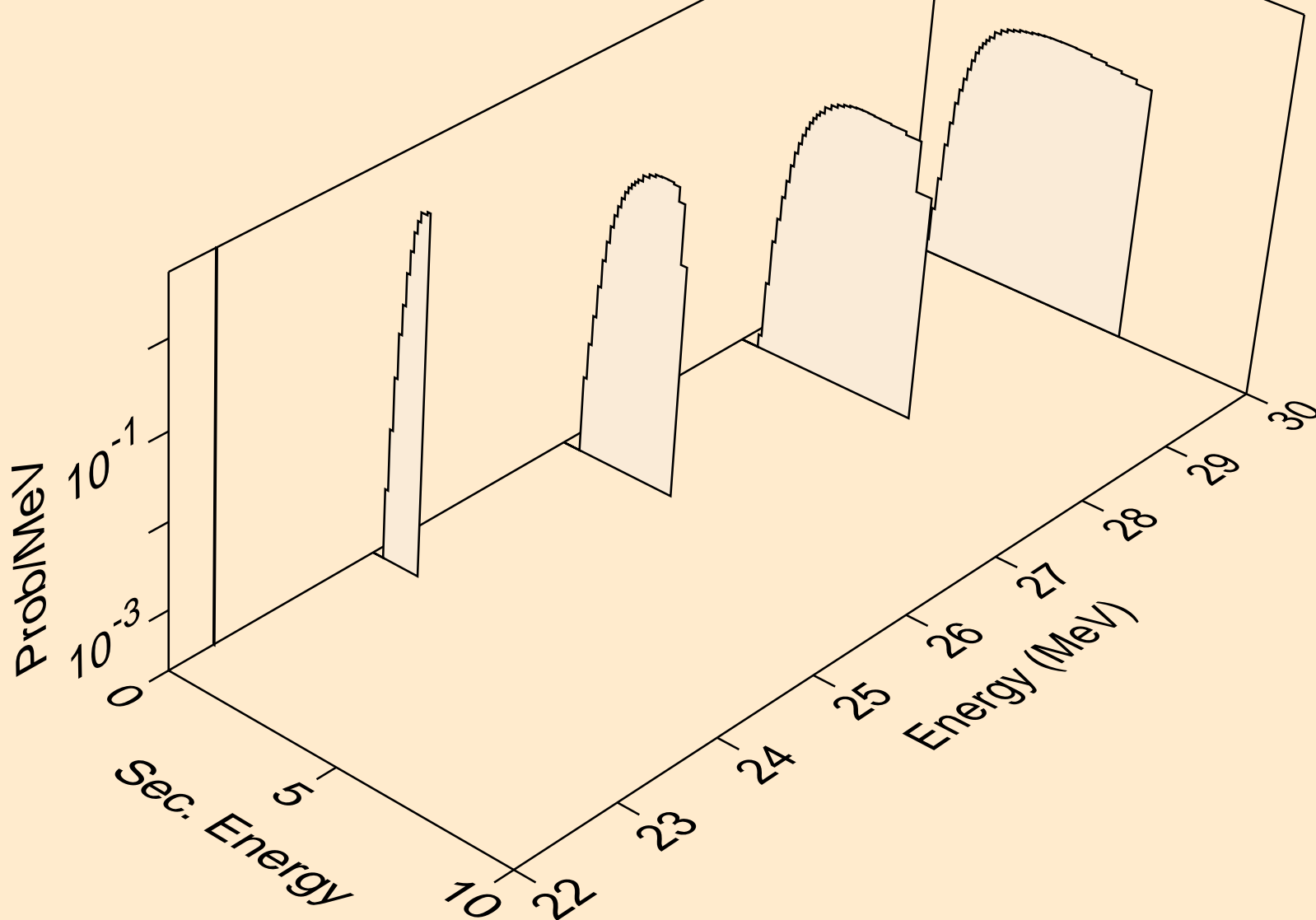

10-NE-22 FOR FENDL-3.2 FROM TENDL-2019 WITH NJOY2016.60  
tritons from (n,t)

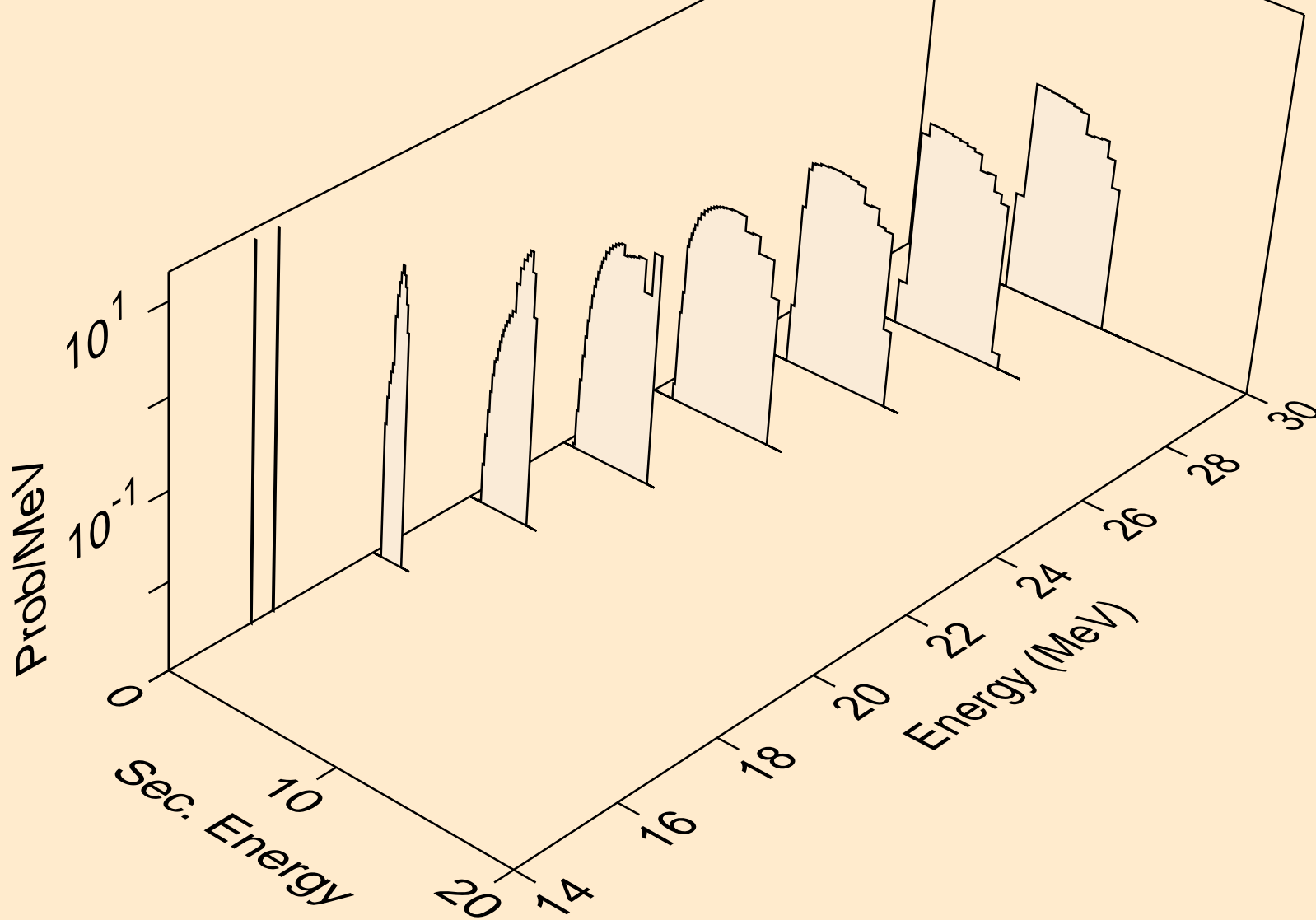

10-NE-22 FOR FENDL-3.2 FROM TENDL-2019 WITH NJOY2016.60  
tritons from (n,pt)

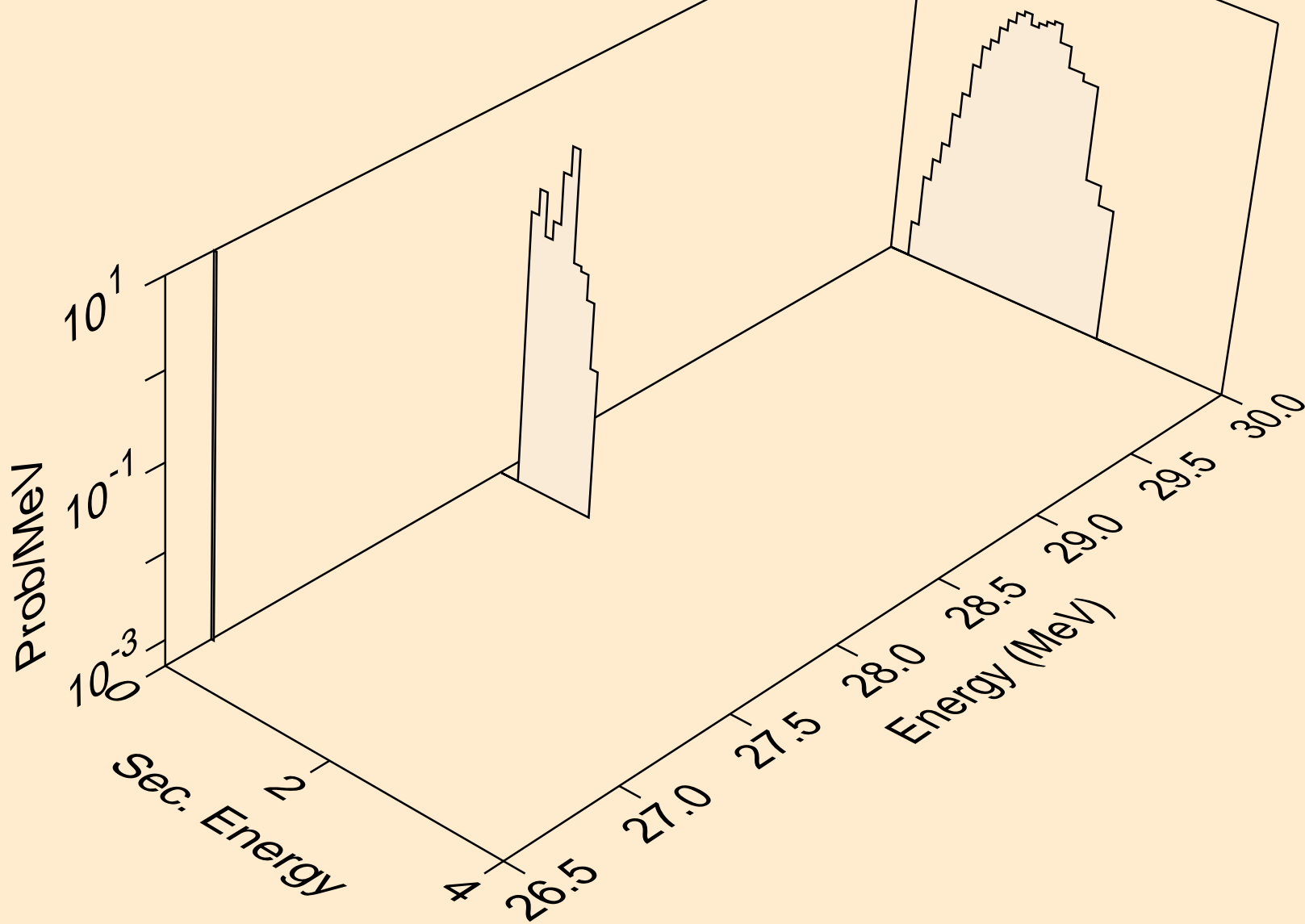

10-NE-22 FOR FENDL-3.2 FROM TENDL-2019 WITH NJOY2016.60  
he3s from (n,x)

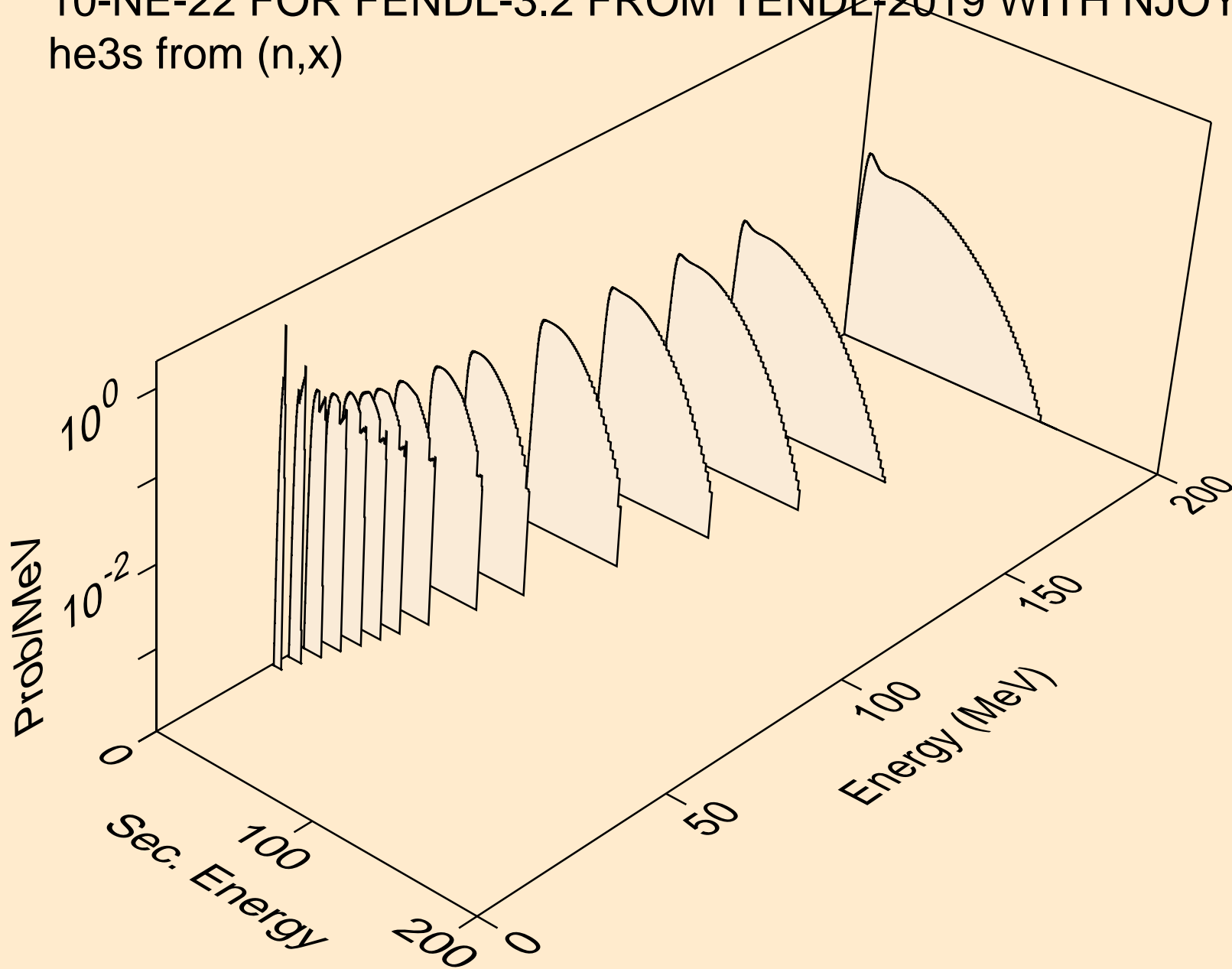

10-NE-22 FOR FENDL-3.2 FROM TENDL-2019 WITH NJOY2016.60  
he3s from (n,n\*)he3

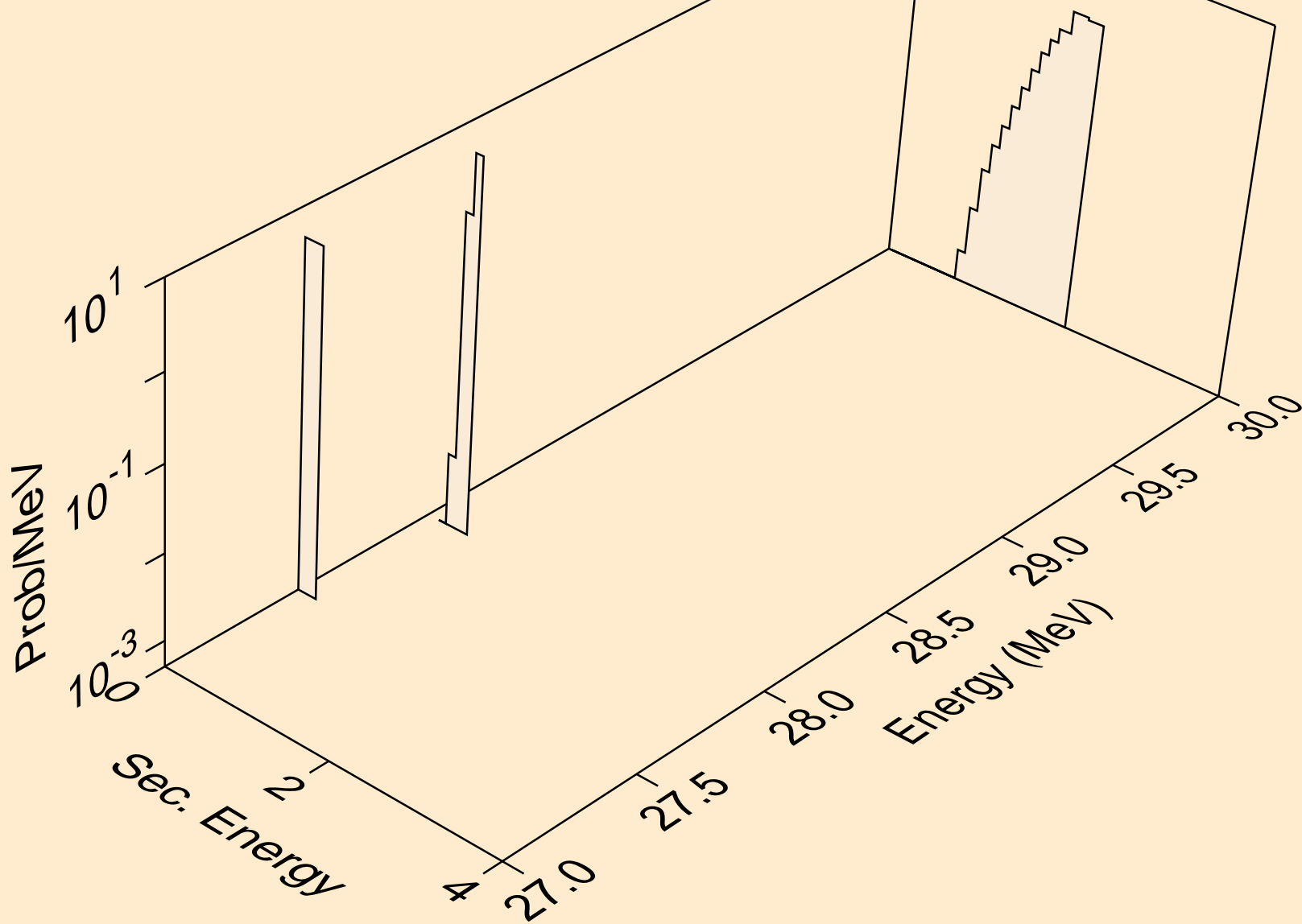

10-NE-22 FOR FENDL-3.2 FROM TENDL-2019 WITH NJOY2016.60  
he3s from (n,he3)

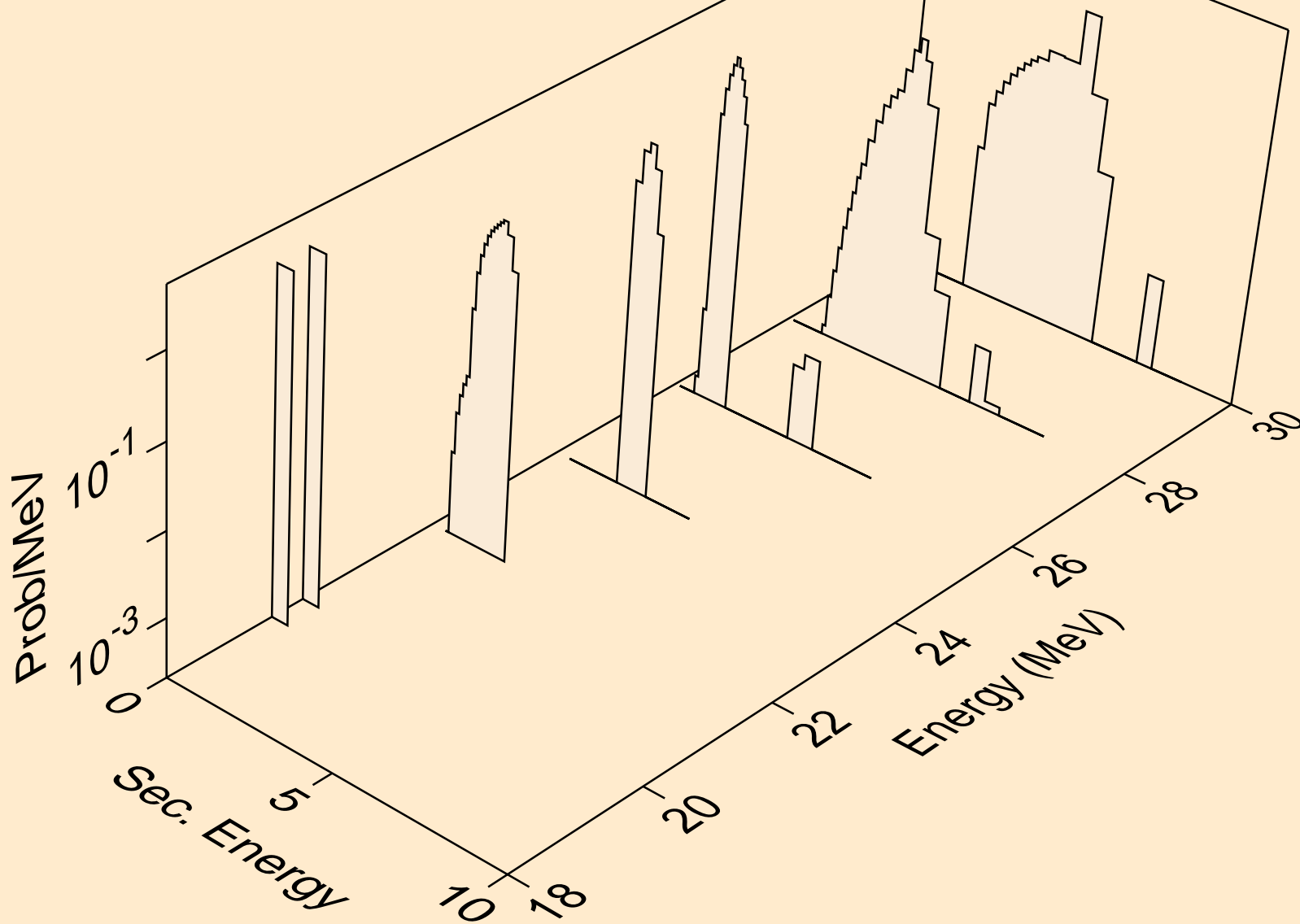



10-NE-22 FOR FENDL-3.2 FROM TENDL-2019 WITH NJOY2016.60  
alphas from (n,x)

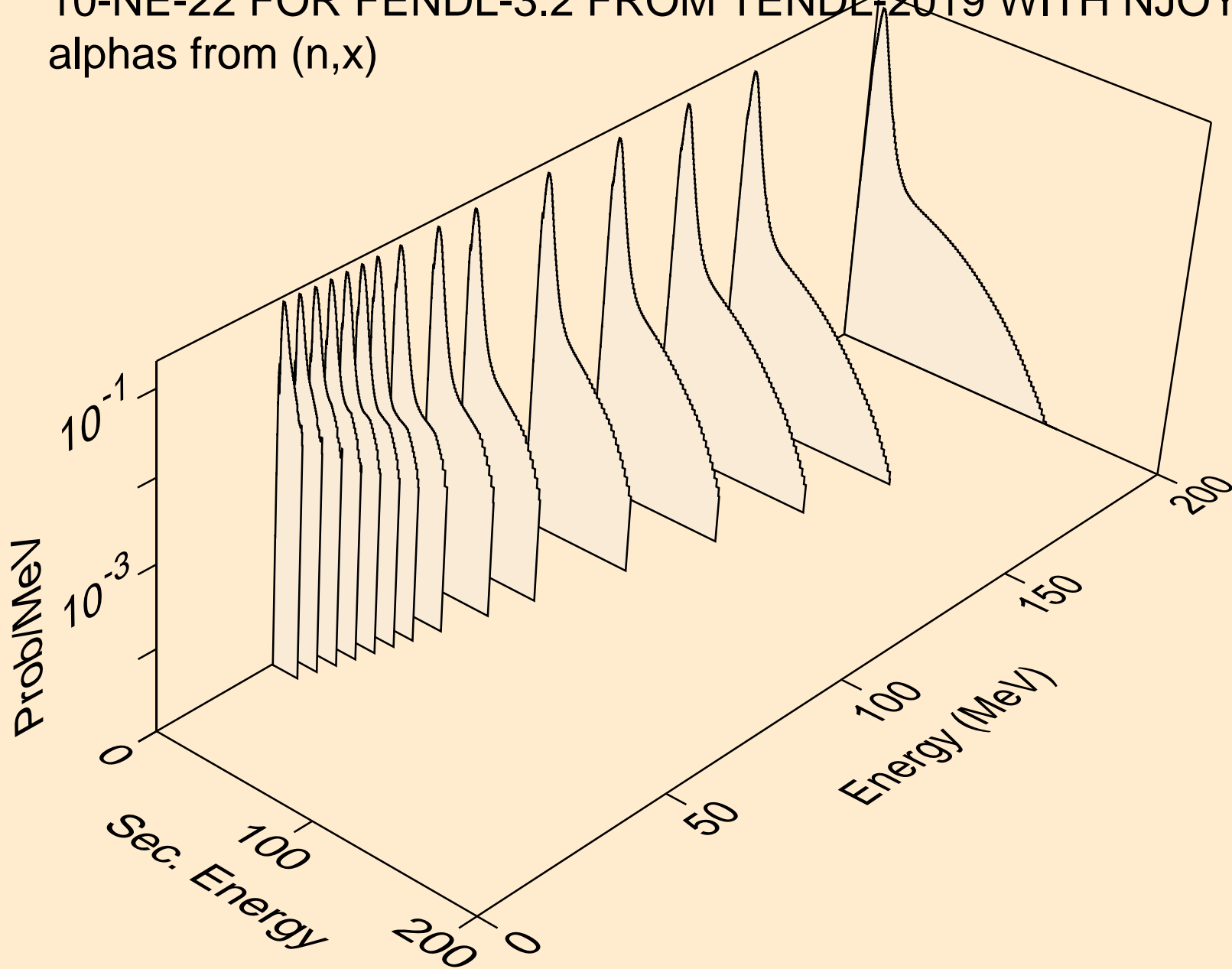

10-NE-22 FOR FENDL-3.2 FROM TENDL-2019 WITH NJOY2016.60  
alphas from (n,n\*)a

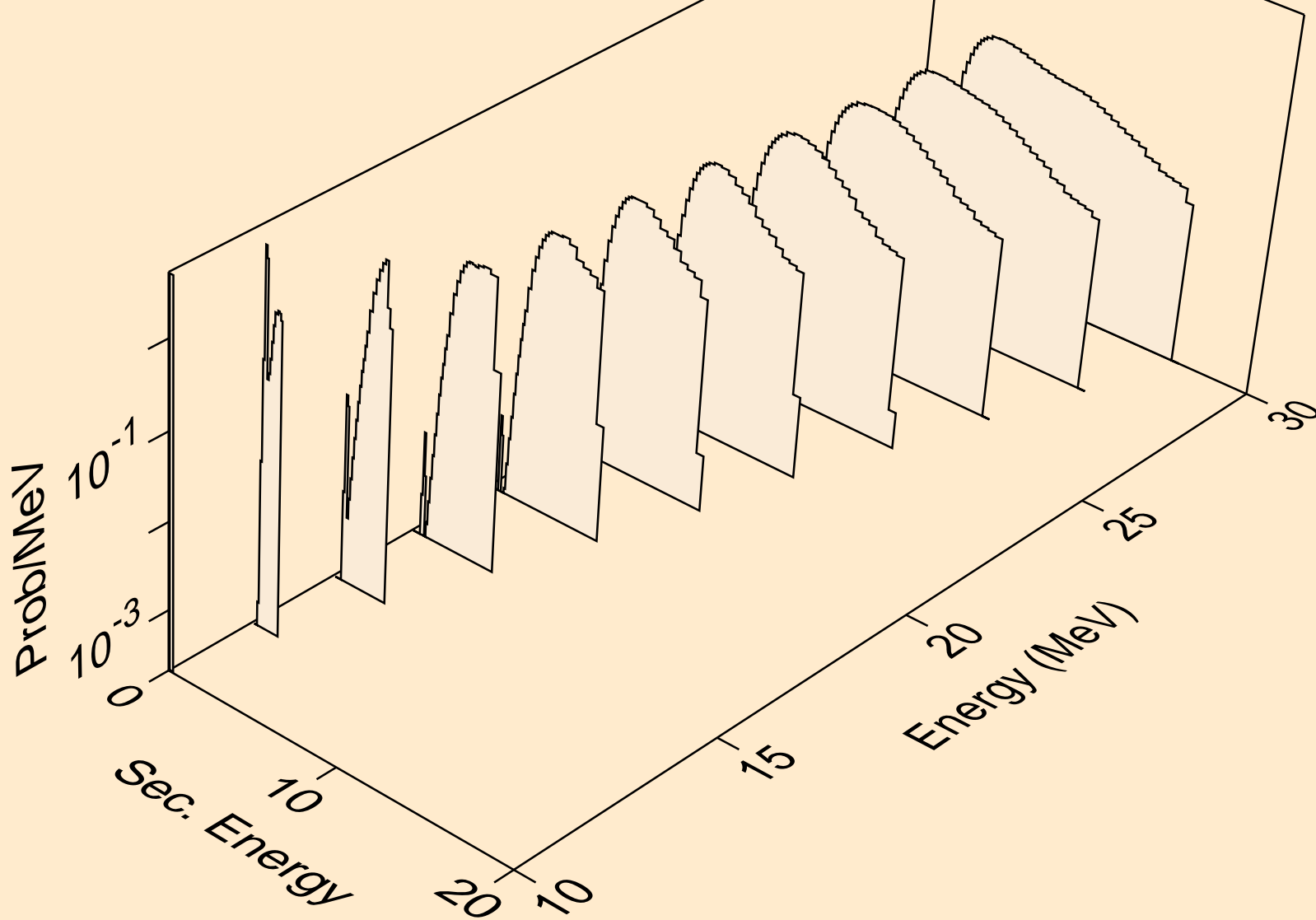

10-NE-22 FOR FENDL-3.2 FROM TENDL-2019 WITH NJOY2016.60  
alphas from (n,2n)a

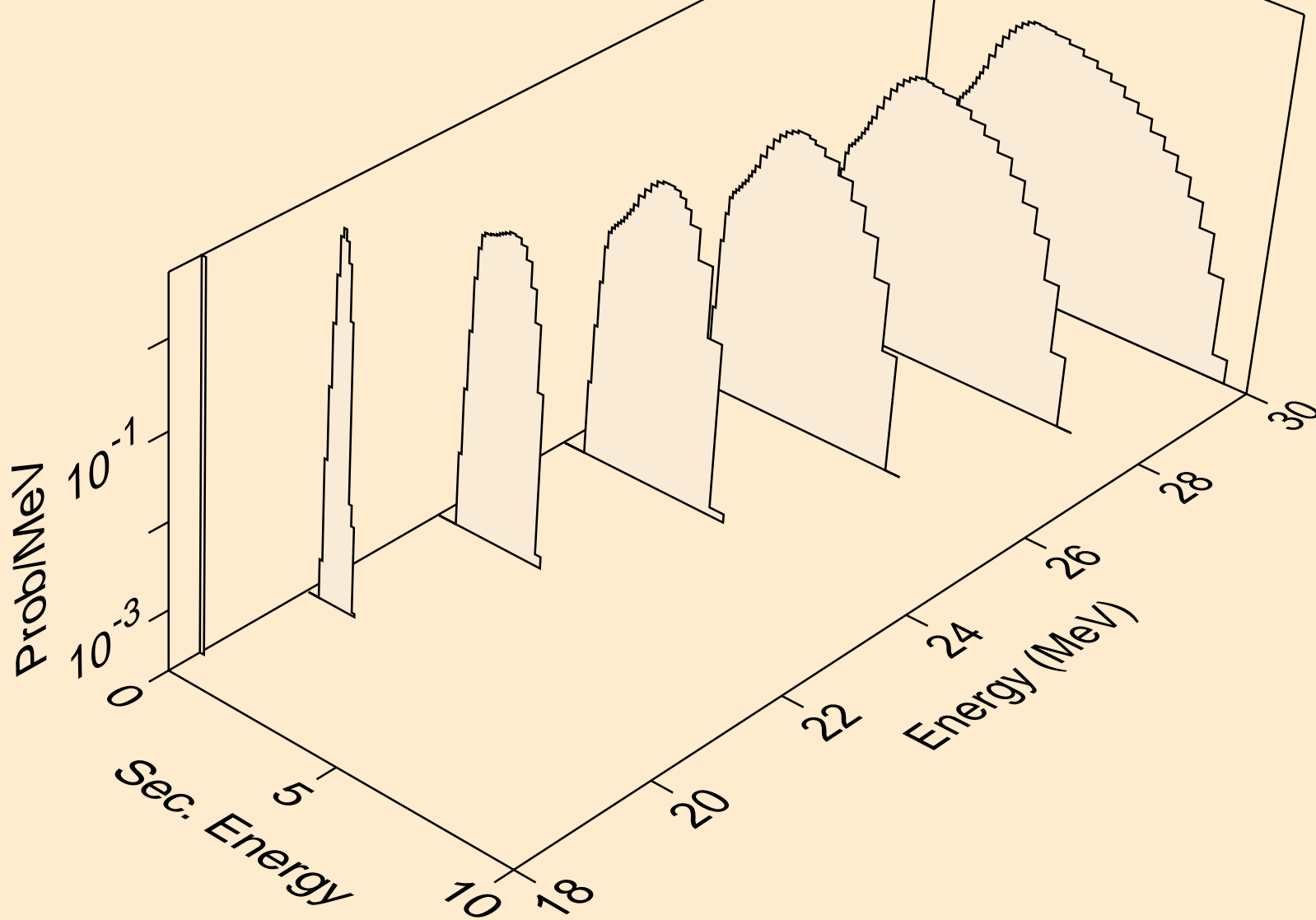

10-NE-22 FOR FENDL-3.2 FROM TENDL-2019 WITH NJOY2016.60  
alphas from (n,3n)a

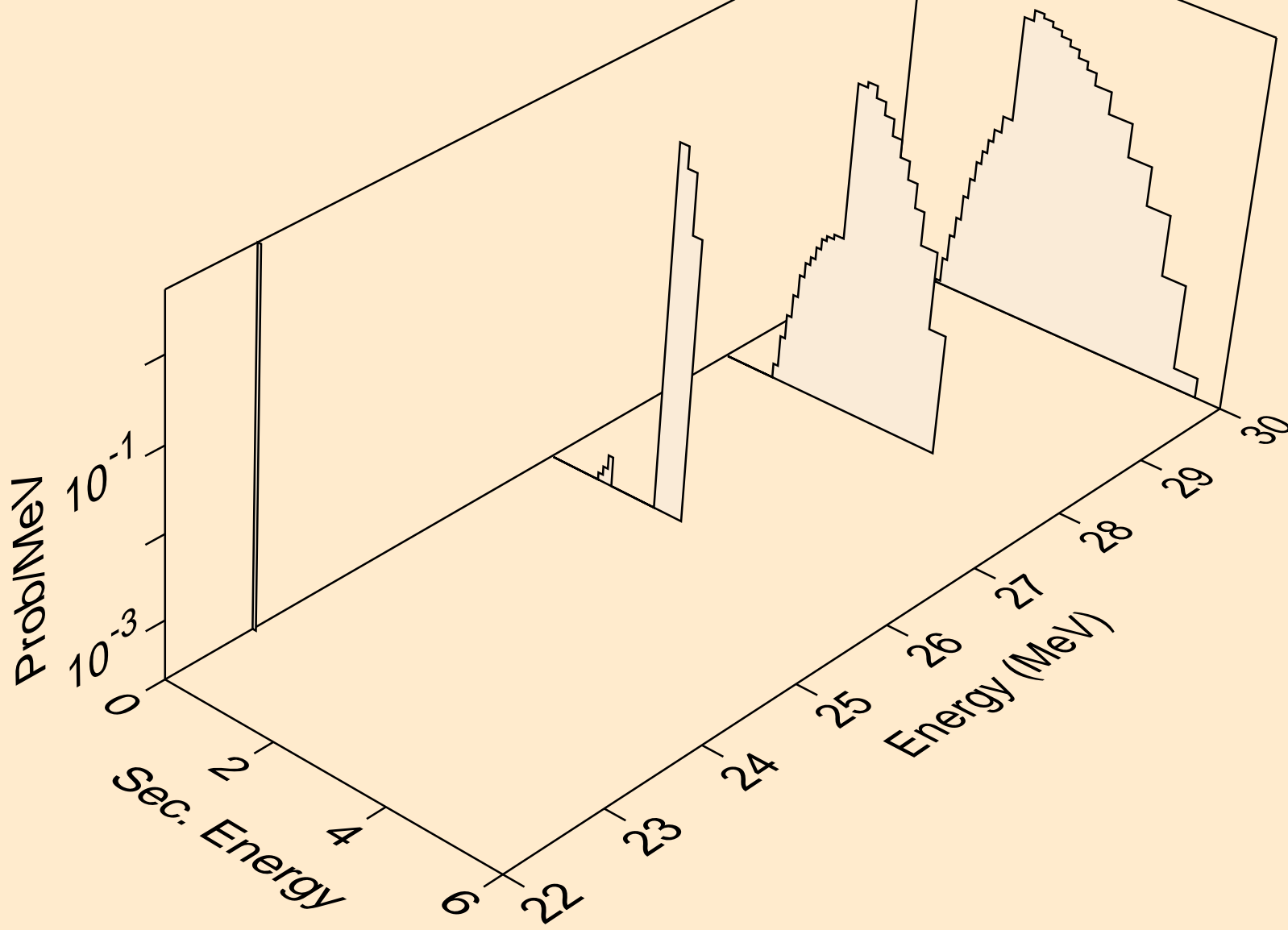

10-NE-22 FOR FENDL-3.2 FROM TENDL-2019 WITH NJOY2016.60  
alphas from (n,n\*)2a

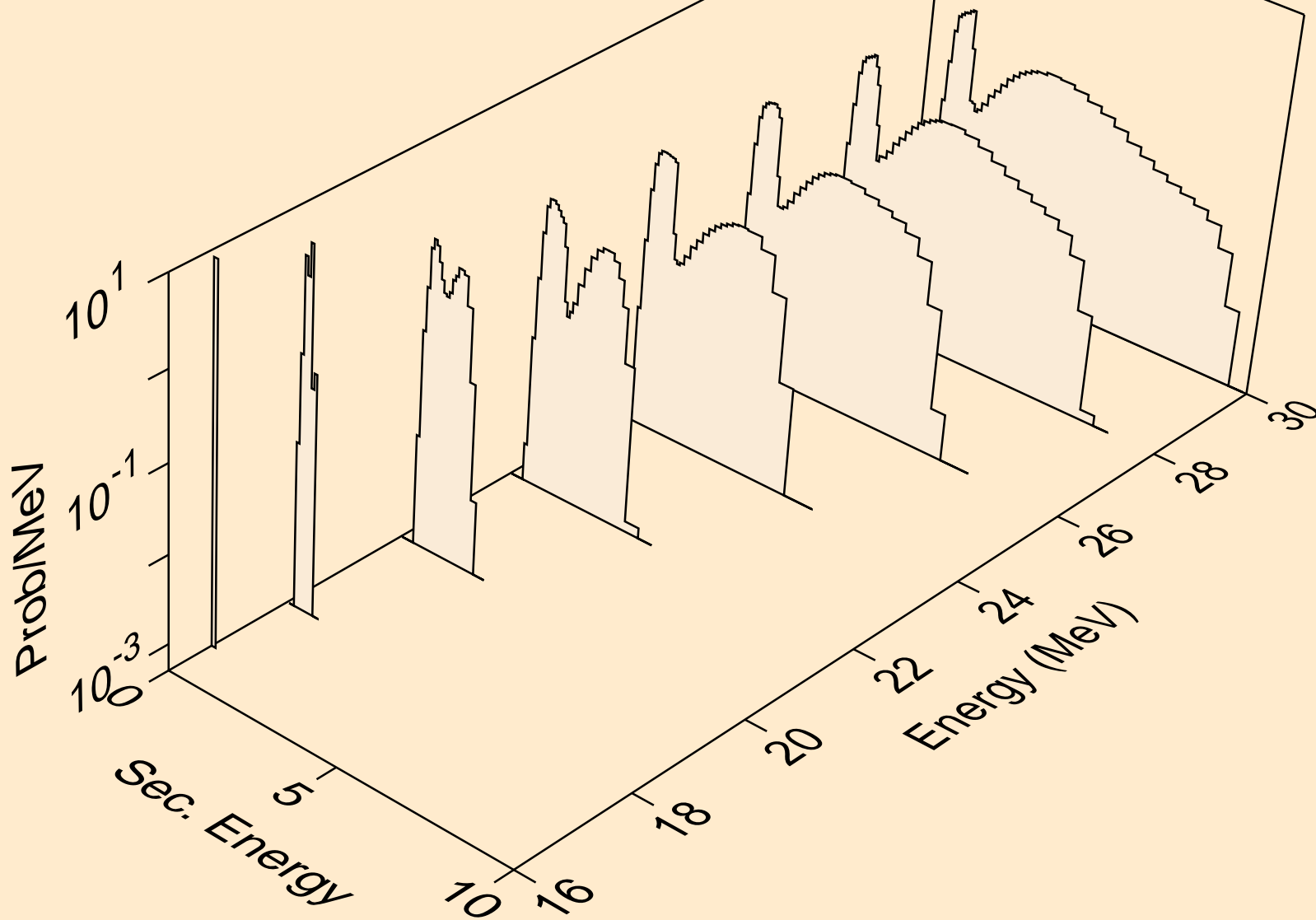

10-NE-22 FOR FENDL-3.2 FROM TENDL-2019 WITH NJOY2016.60  
alphas from (n,2n)2a

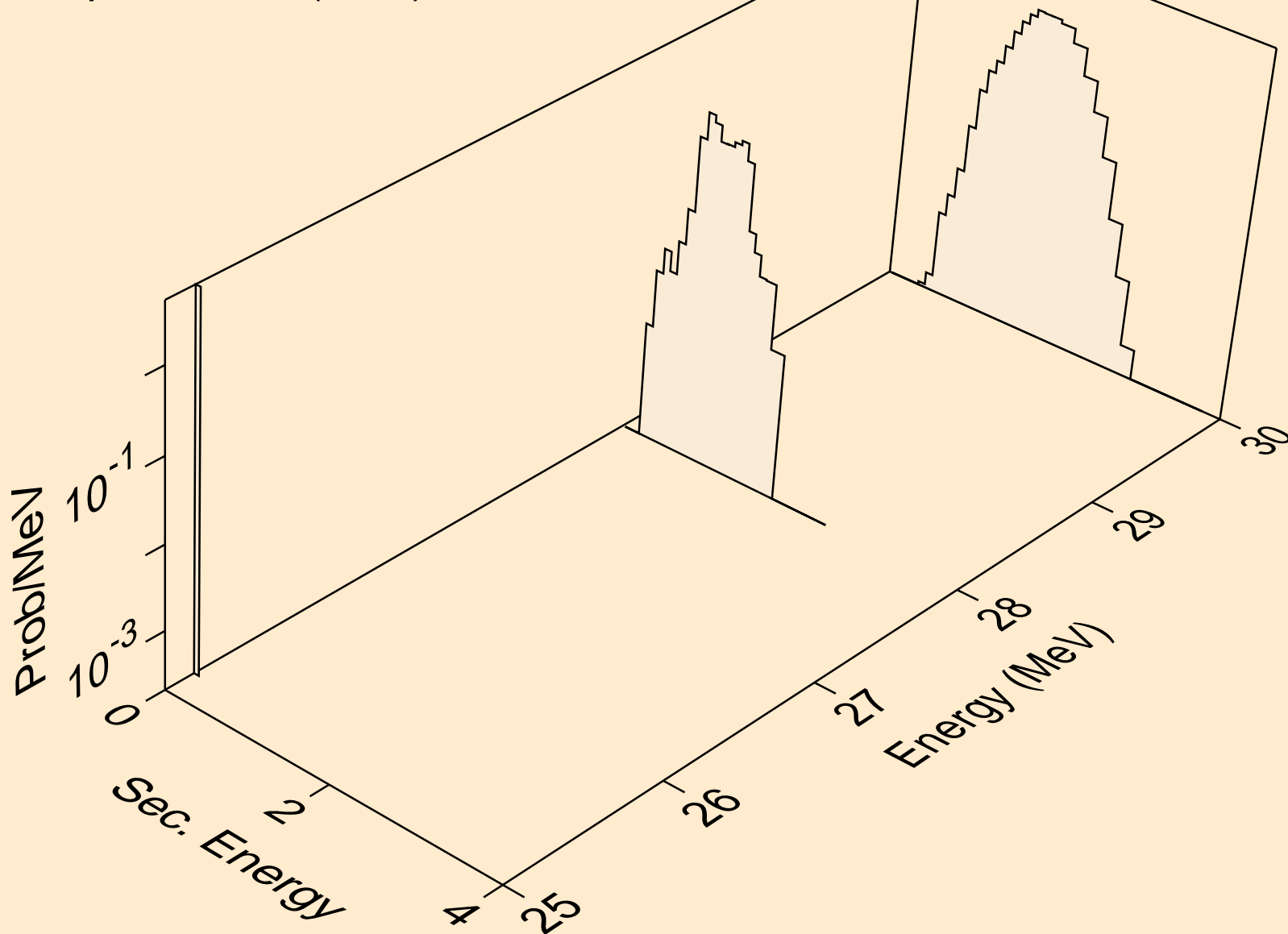

10-NE-22 FOR FENDL-3.2 FROM TENDL-2019 WITH NJOY2016.60  
alphas from (n,npa)

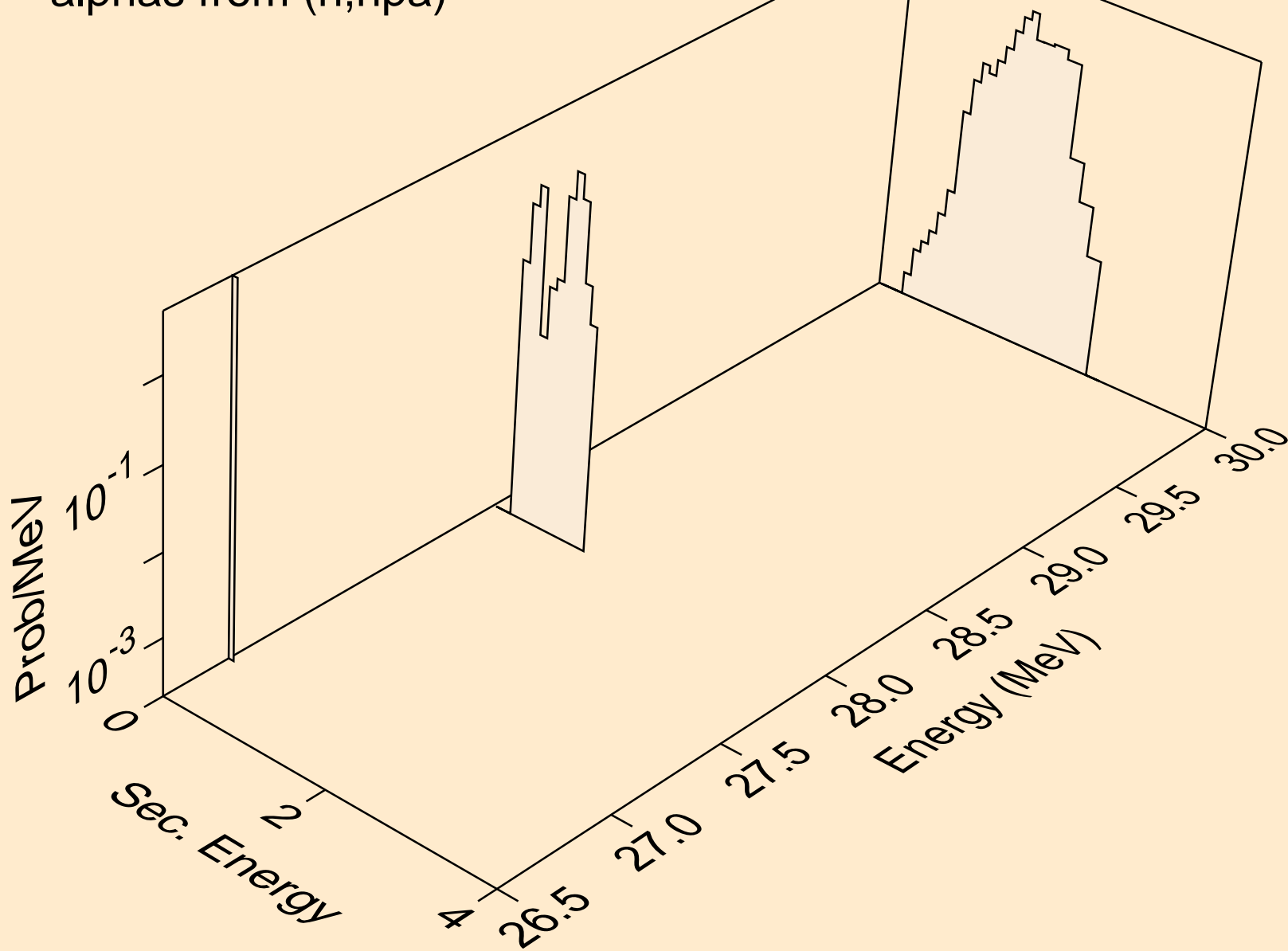

10-NE-22 FOR FENDL-3.2 FROM TENDL-2019 WITH NJOY2016.60  
alphas from (n,a)

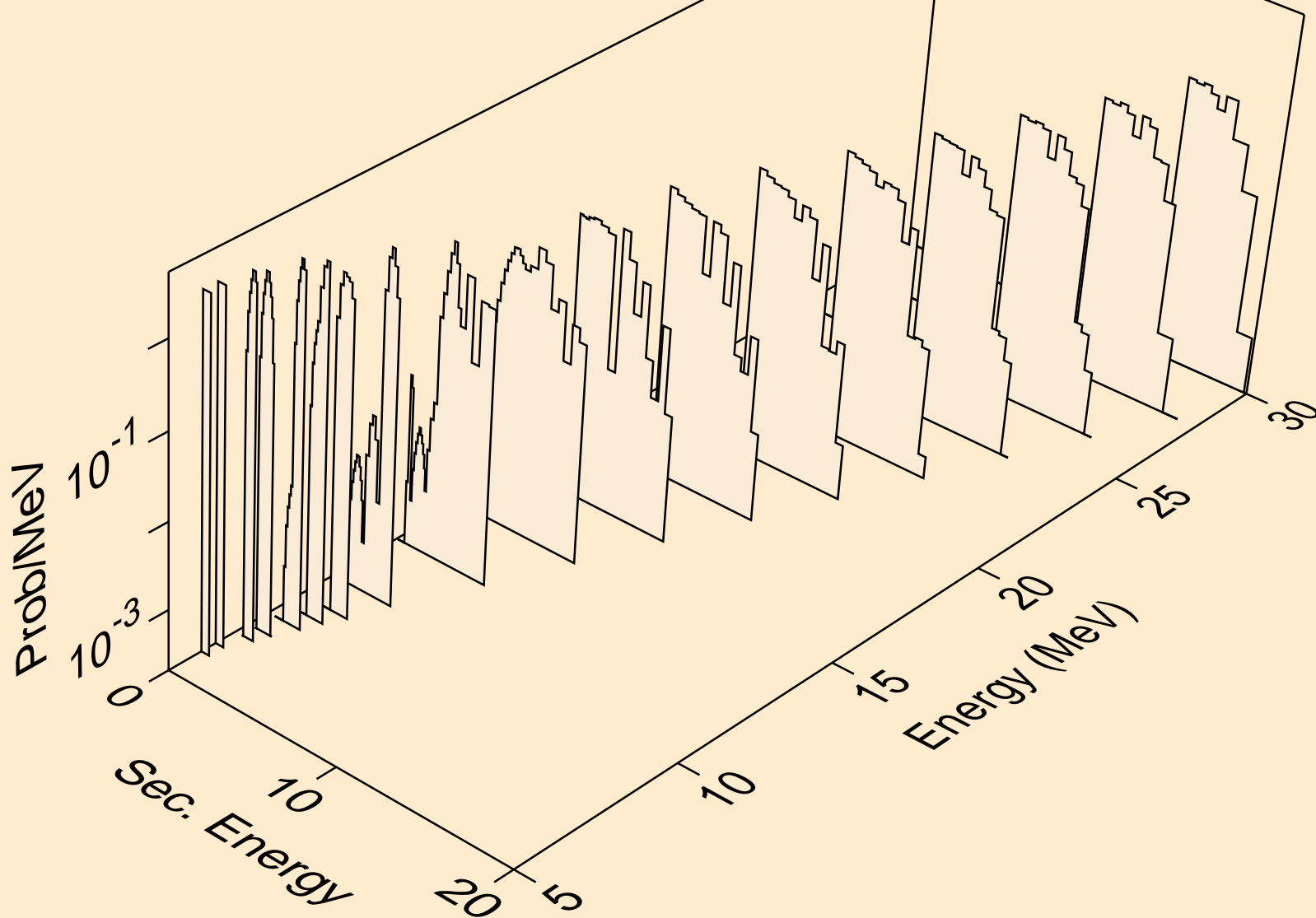



10-NE-22 FOR FENDL-3.2 FROM TENDL-2019 WITH NJOY2016.60  
alphas from (n,2a)

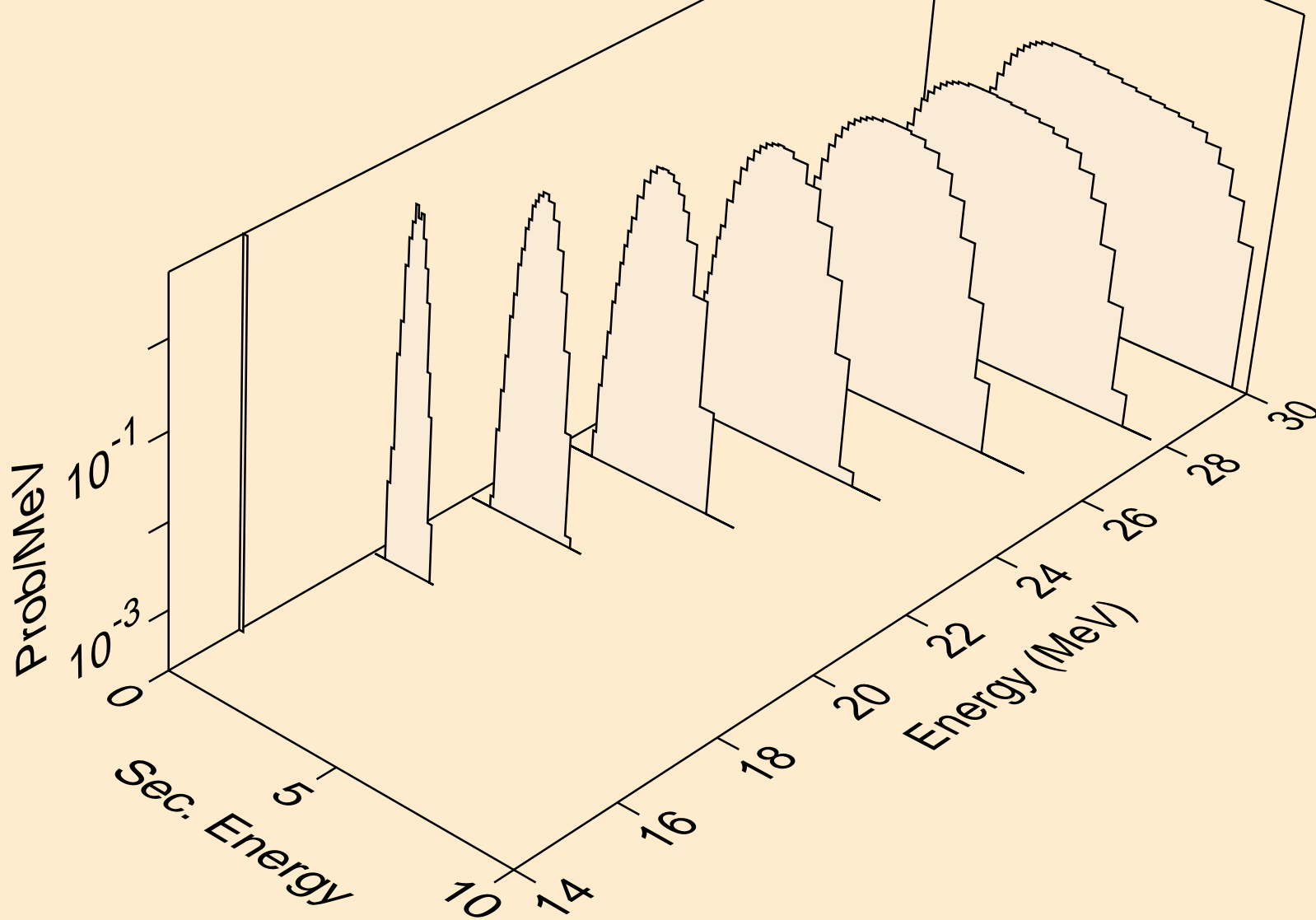

10-NE-22 FOR FENDL-3.2 FROM TENDL-2019 WITH NJOY2016.60  
alphas from (n,pa)

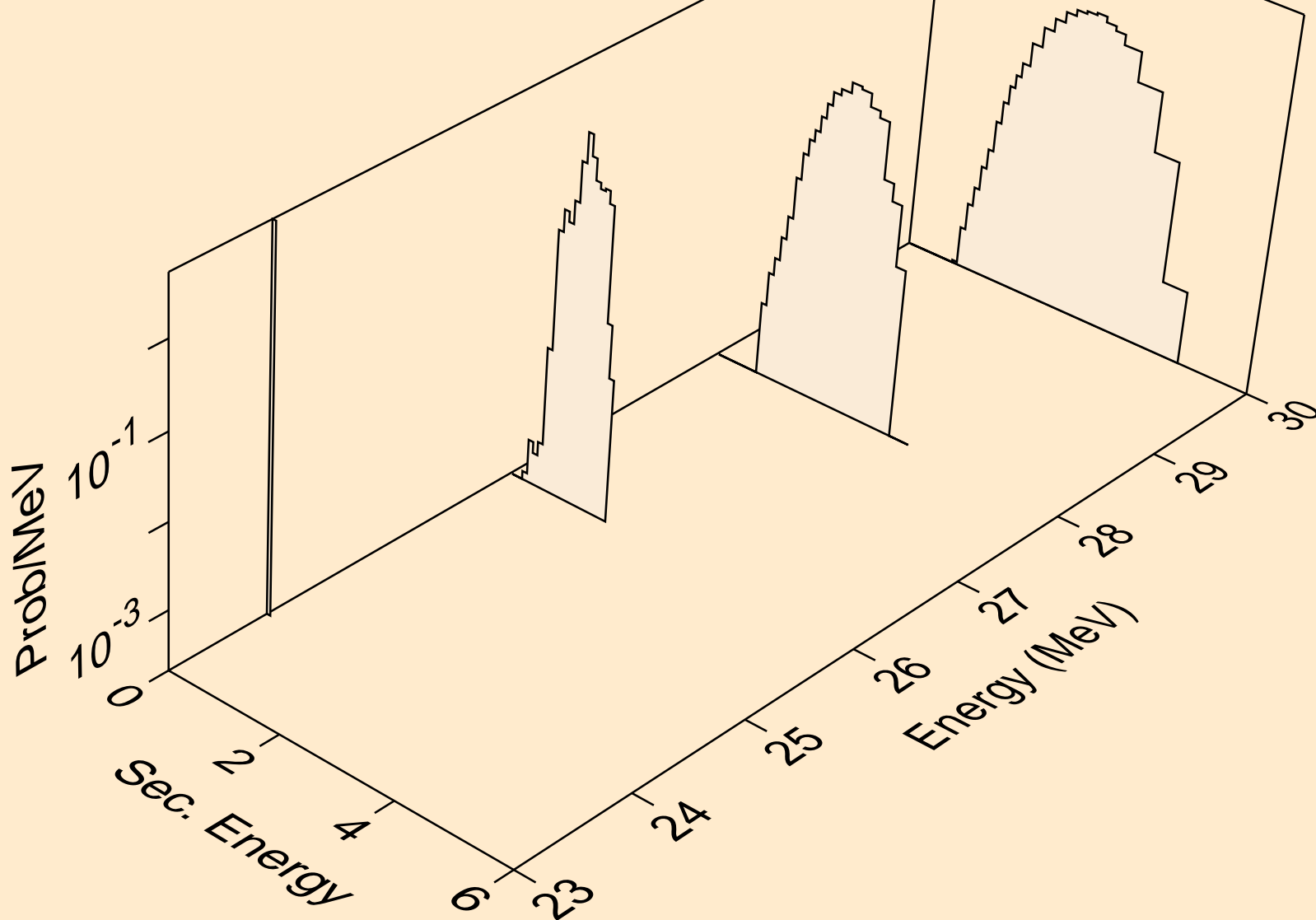

10-NE-22 FOR FENDL-3.2 FROM TENDL-2019 WITH NJOY2016.60  
alphas from (n,da)

