

14-SI-28 FOR FENDL-3.2 FROM ENDF/B-VII WITH NJOY2016.60+

Principal cross sections

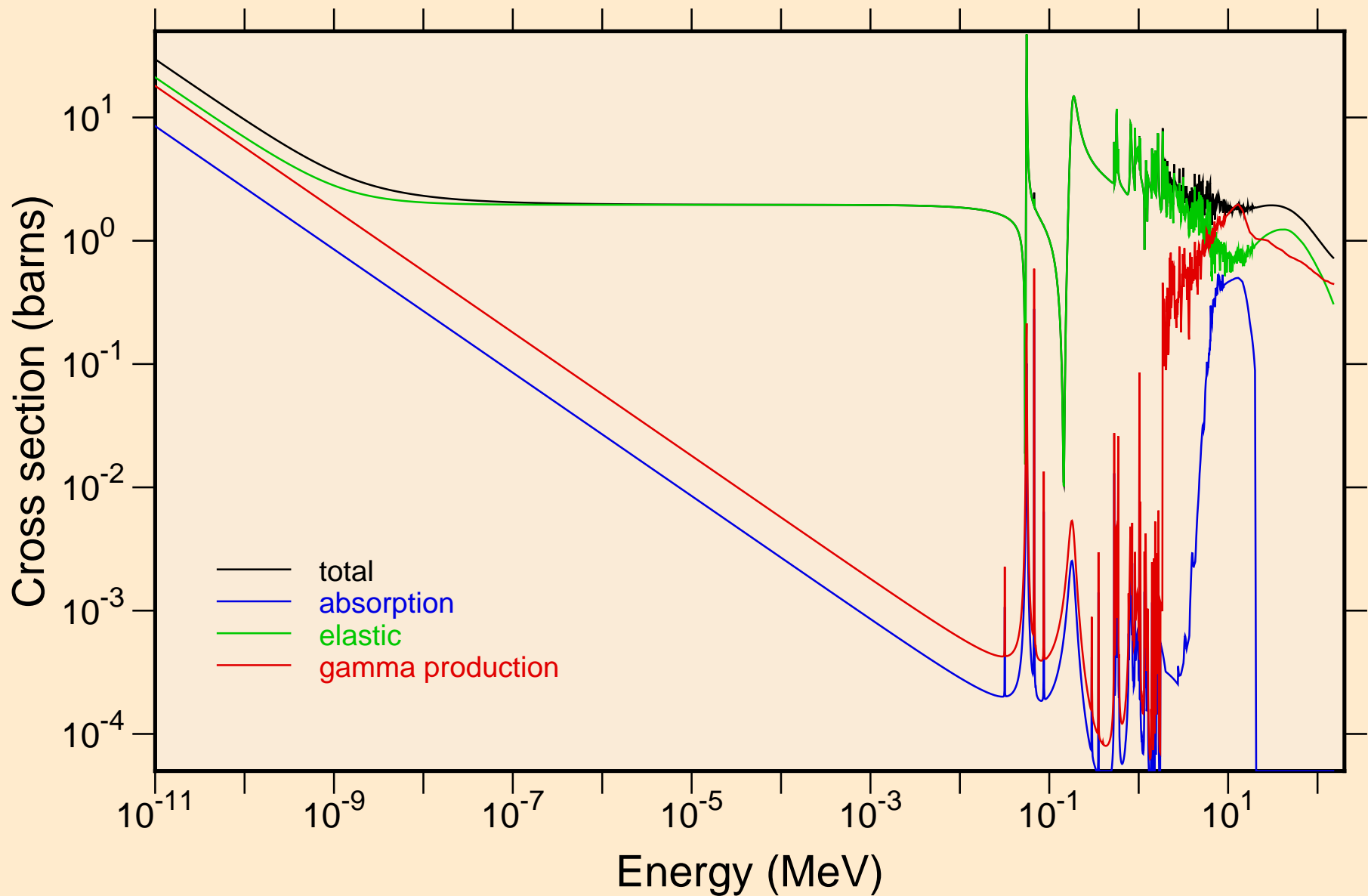

14-SI-28 FOR FENDL-3.2 FROM ENDF/B-VII WITH NJOY2016.60+
resonance total cross section

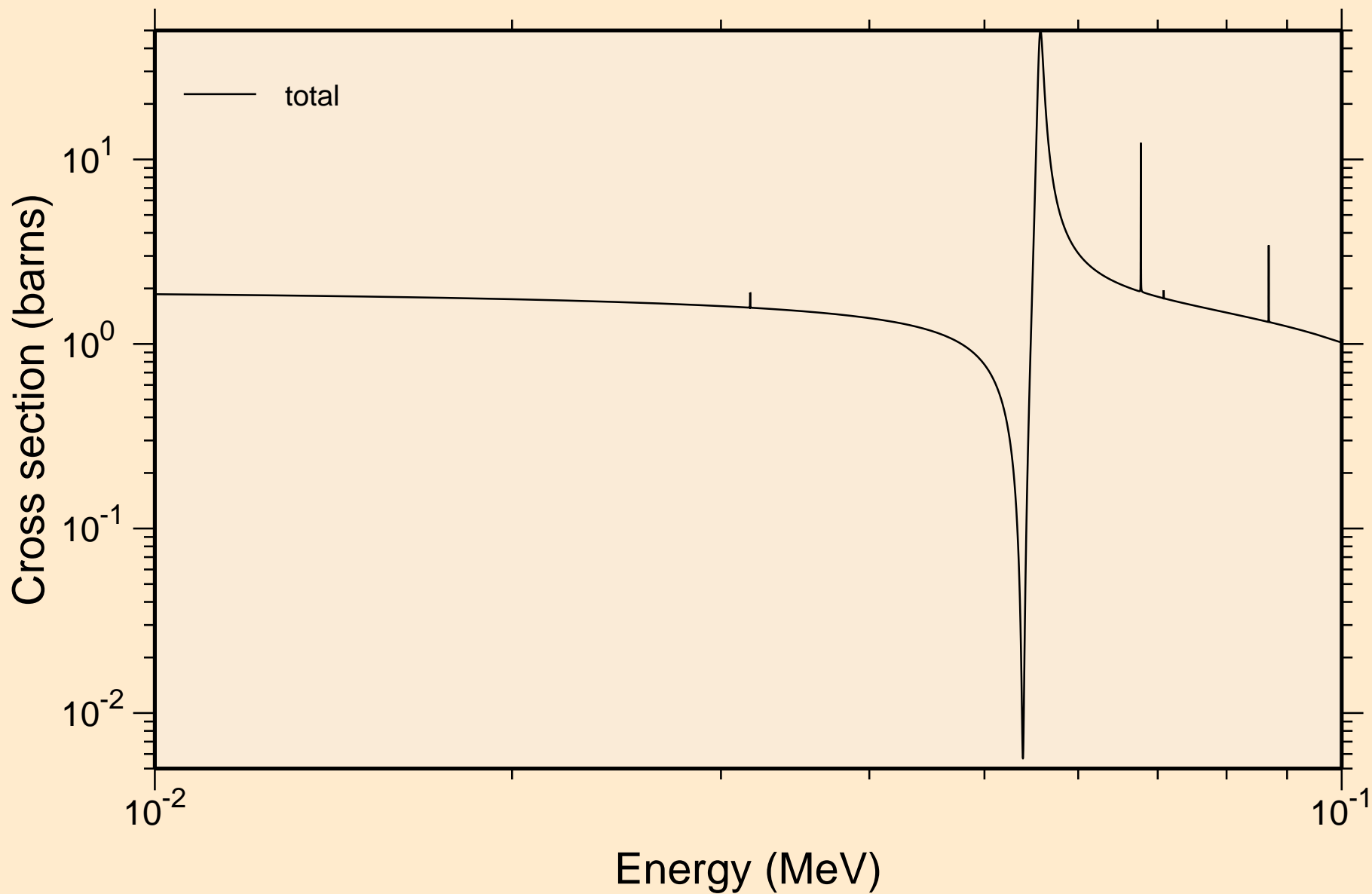

14-SI-28 FOR FENDL-3.2 FROM ENDF/B-VII WITH NJOY2016.60+
resonance total cross section

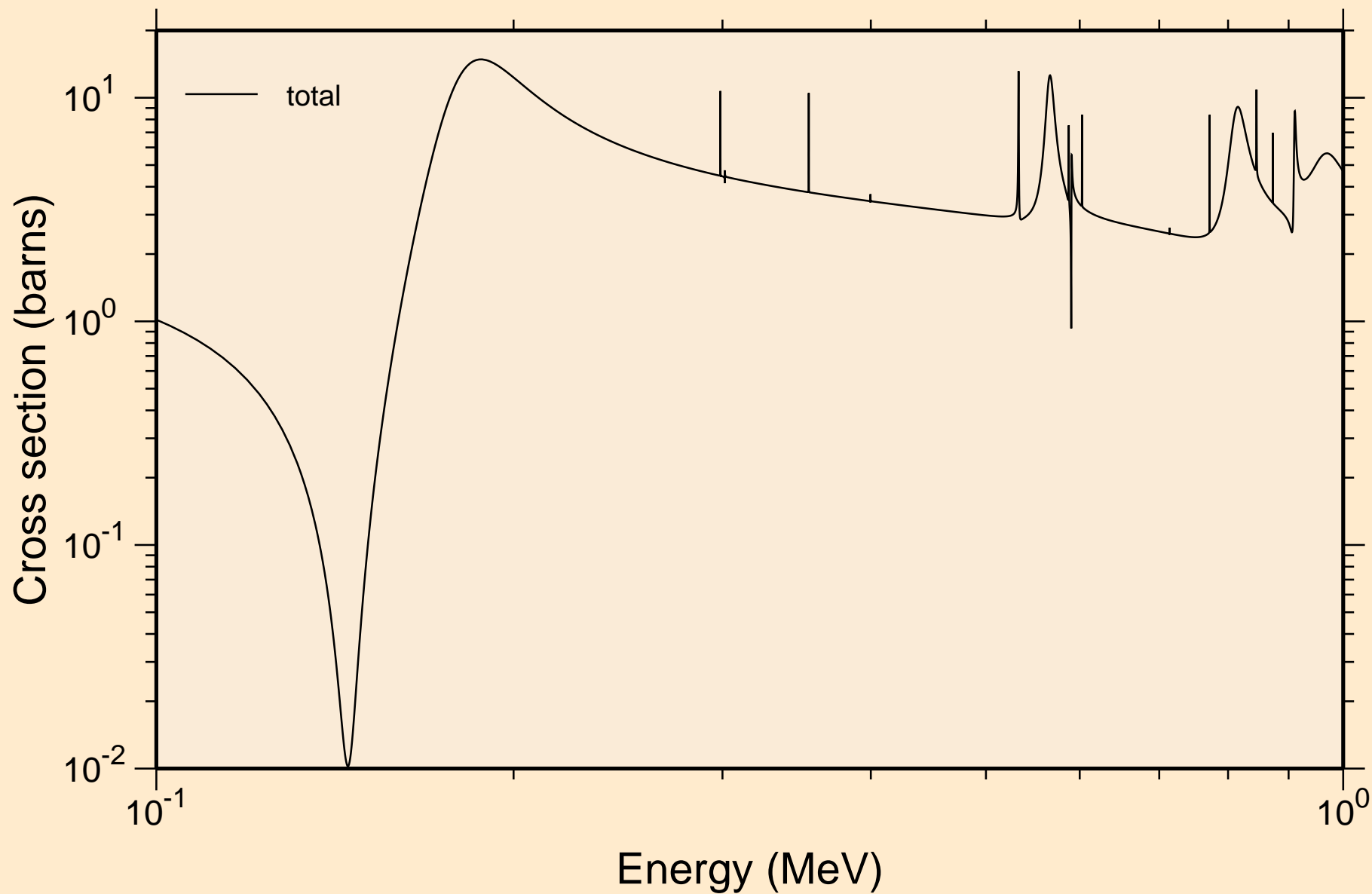

14-SI-28 FOR FENDL-3.2 FROM ENDF/B-VII WITH NJOY2016.60+
resonance total cross section

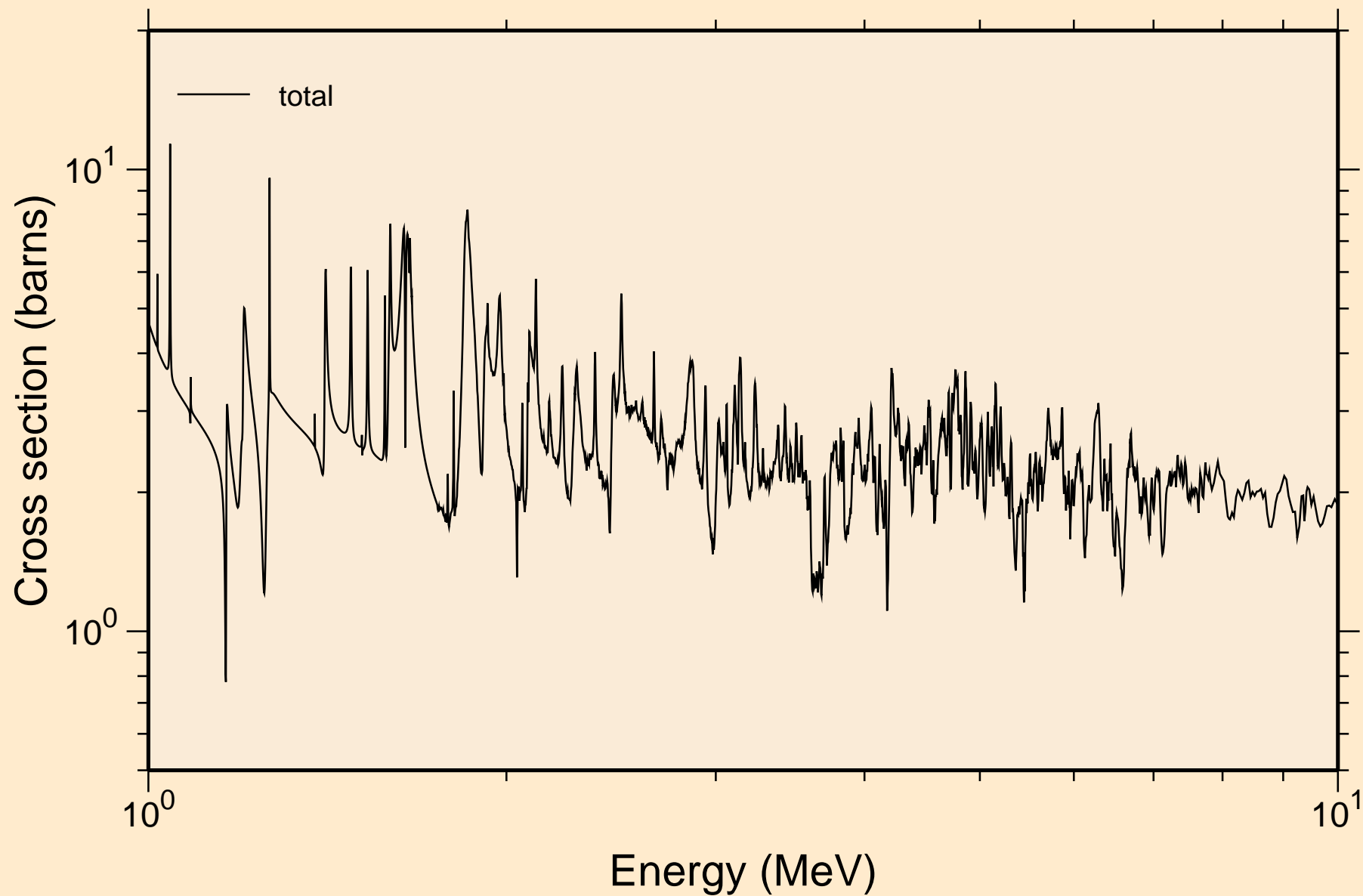

14-SI-28 FOR FENDL-3.2 FROM ENDF/B-VII WITH NJOY2016.60+
resonance absorption cross sections

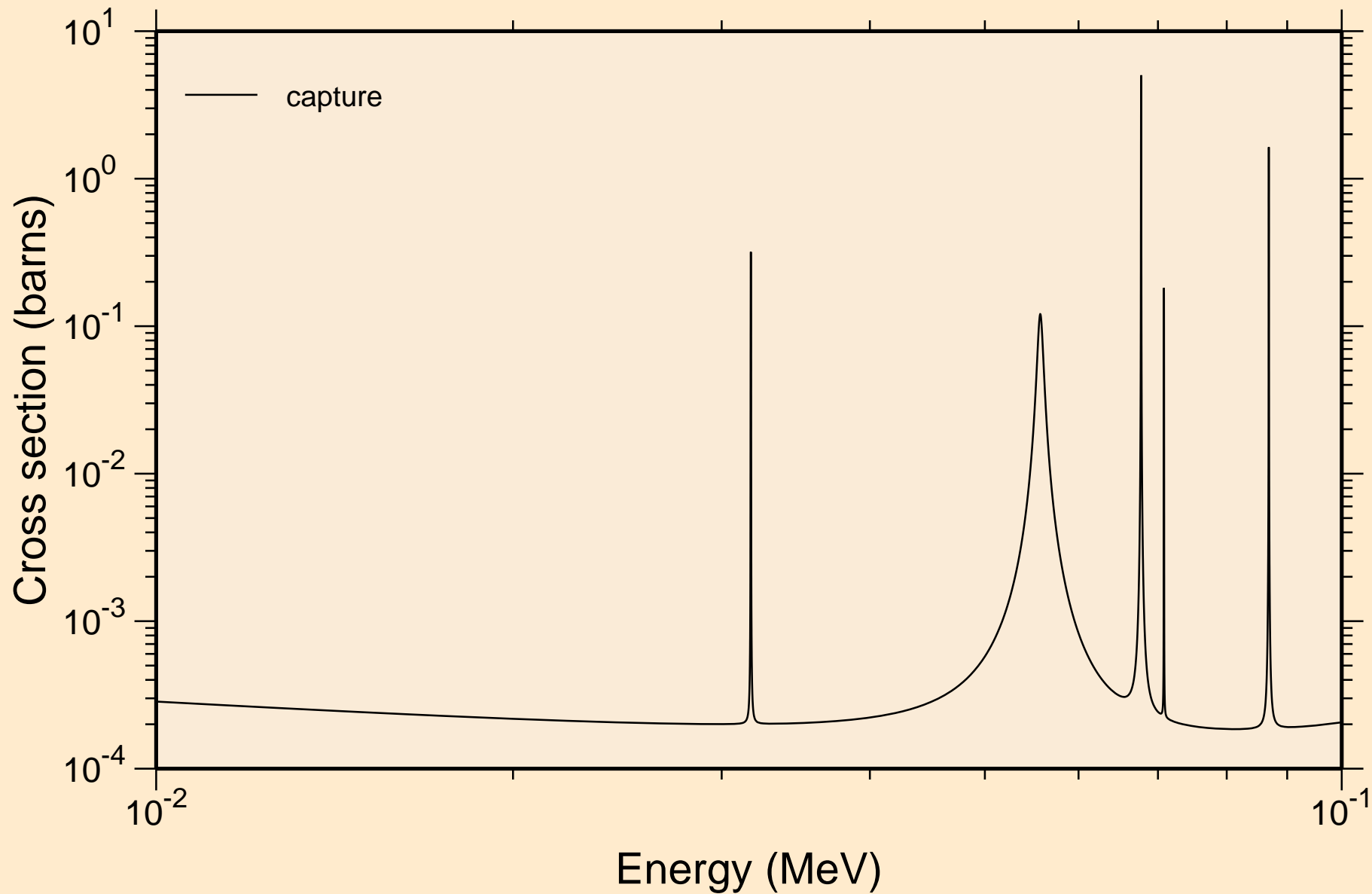

14-SI-28 FOR FENDL-3.2 FROM ENDF/B-VII WITH NJOY2016.60+ resonance absorption cross sections

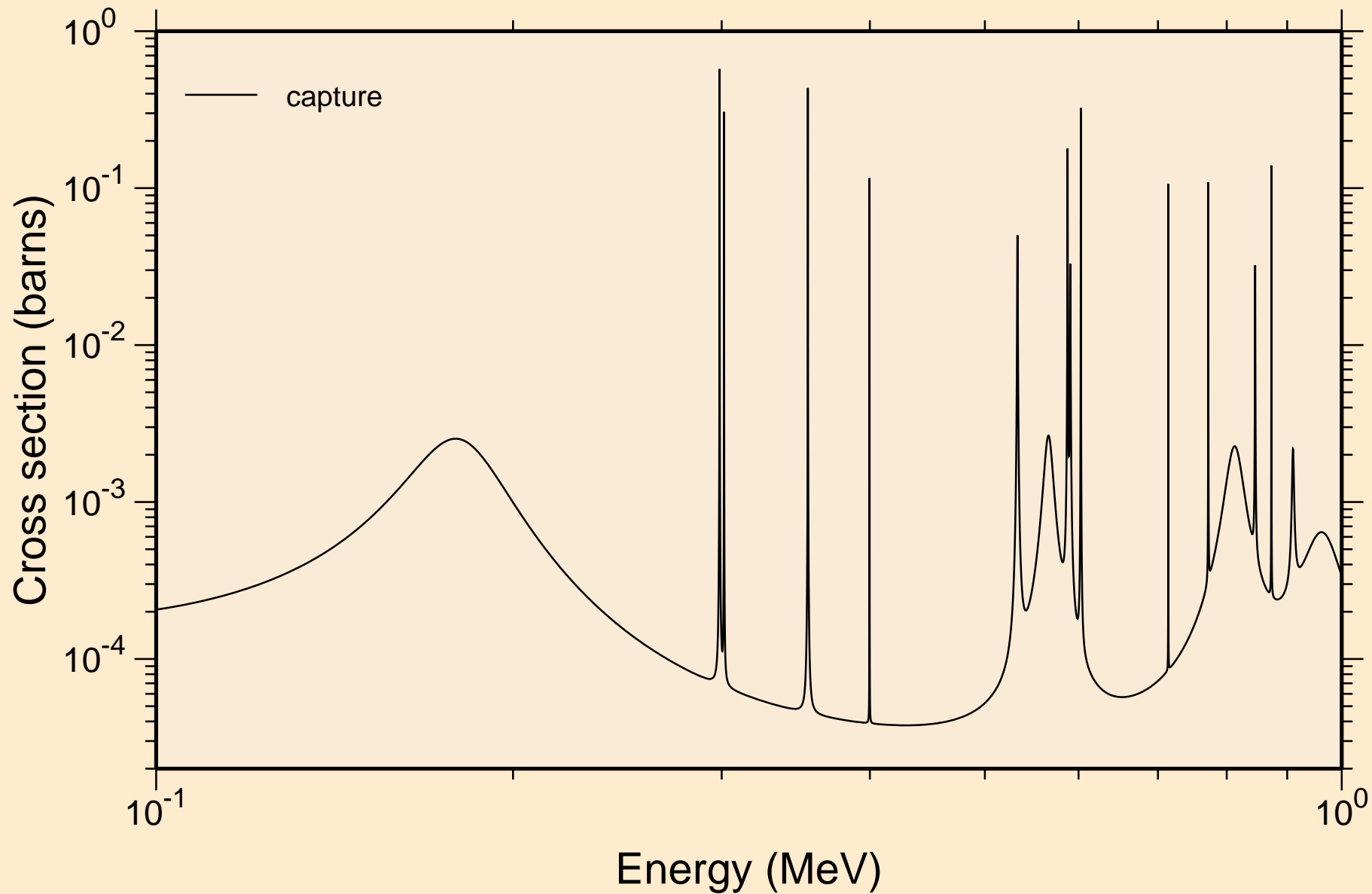

14-SI-28 FOR FENDL-3.2 FROM ENDF/B-VII WITH NJOY2016.60+ resonance absorption cross sections

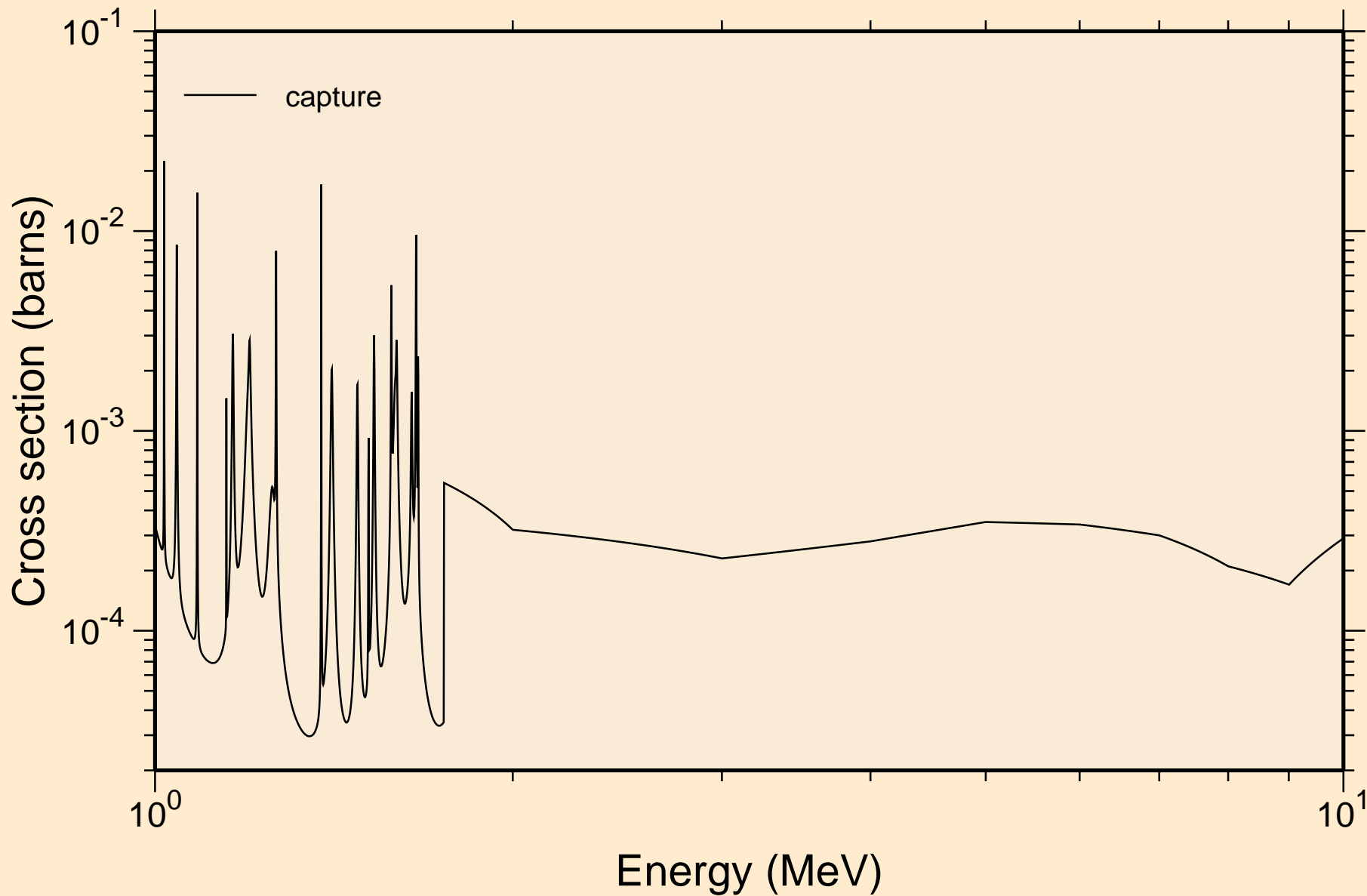

14-SI-28 FOR FENDL-3.2 FROM ENDF/B-VII WITH NJOY2016.60+ Heating

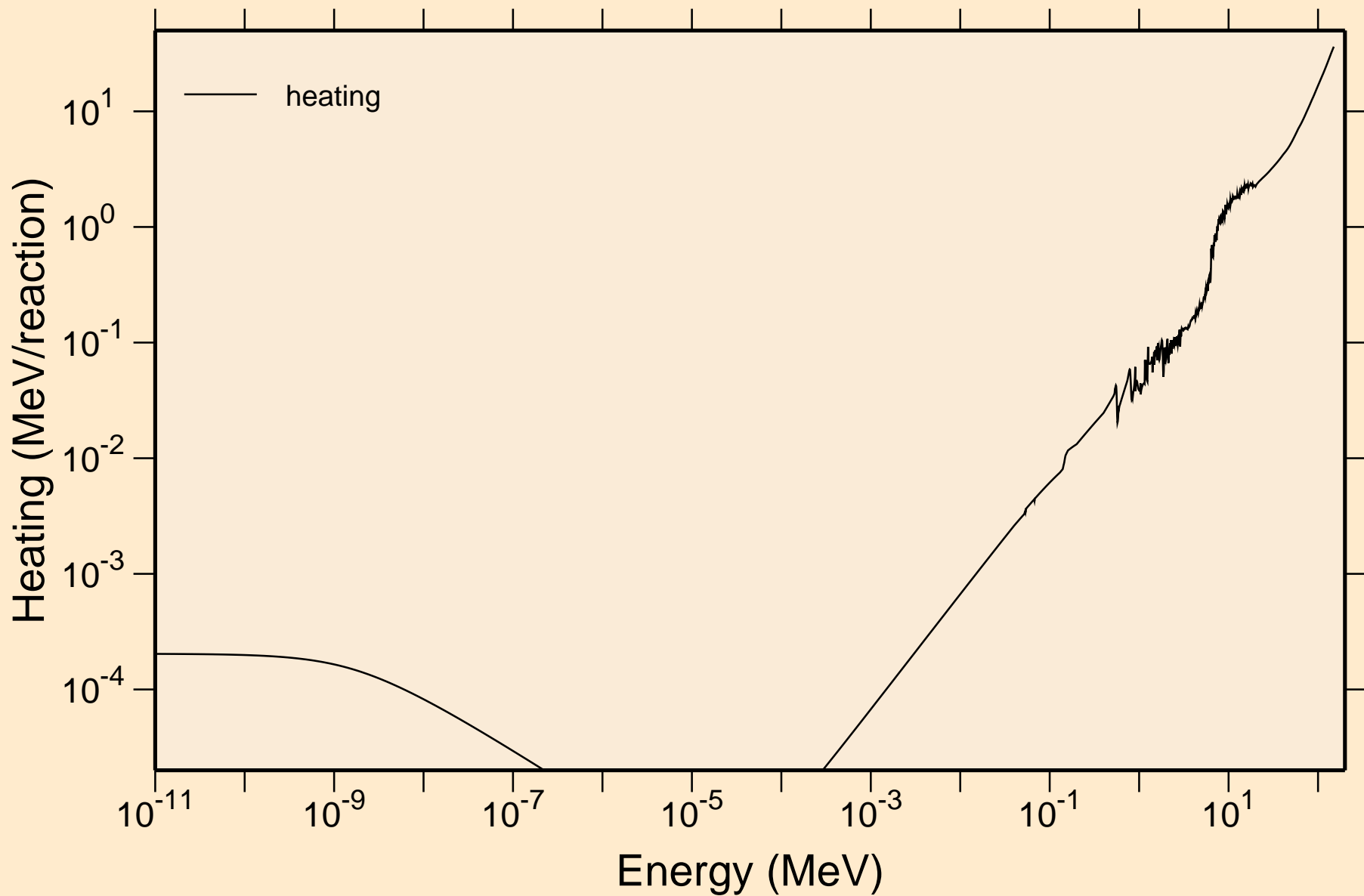

14-SI-28 FOR FENDL-3.2 FROM ENDF/B-VII WITH NJOY2016.60+ Damage

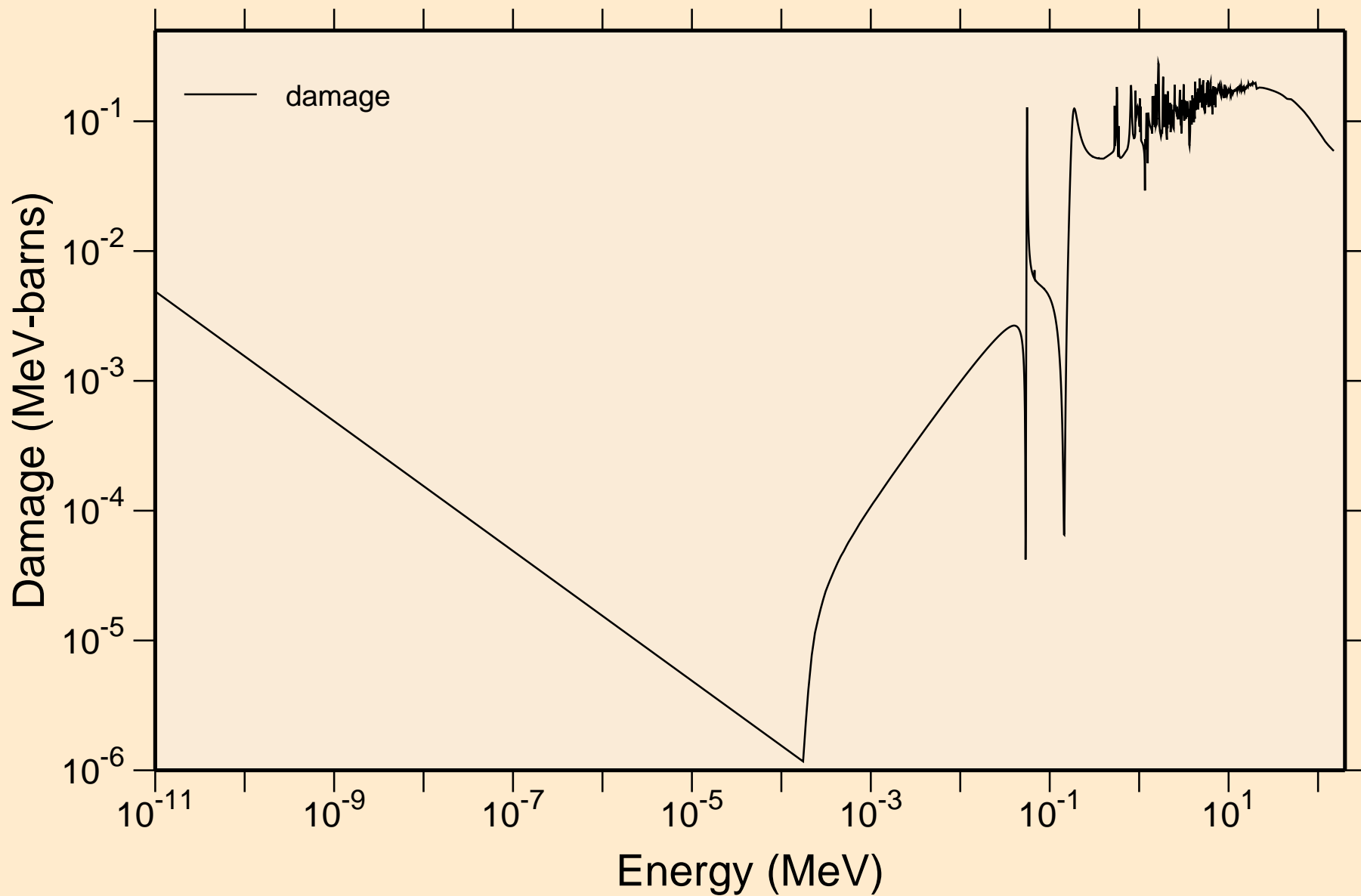

14-SI-28 FOR FENDL-3.2 FROM ENDF/B-VII WITH NJOY2016.60+
Non-threshold reactions

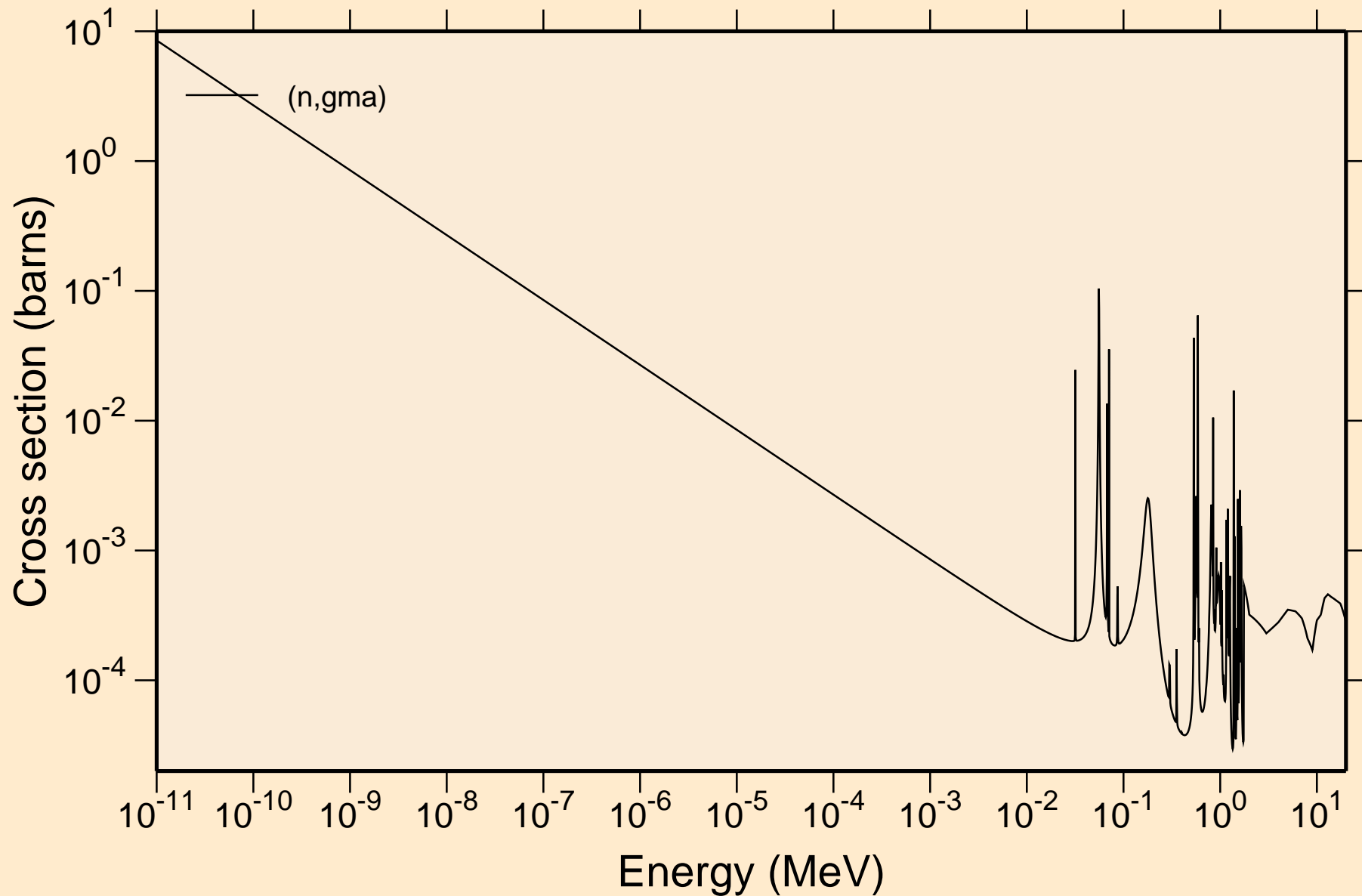

14-SI-28 FOR FENDL-3.2 FROM ENDF/B-VII WITH NJOY2016.60+
Principal cross sections

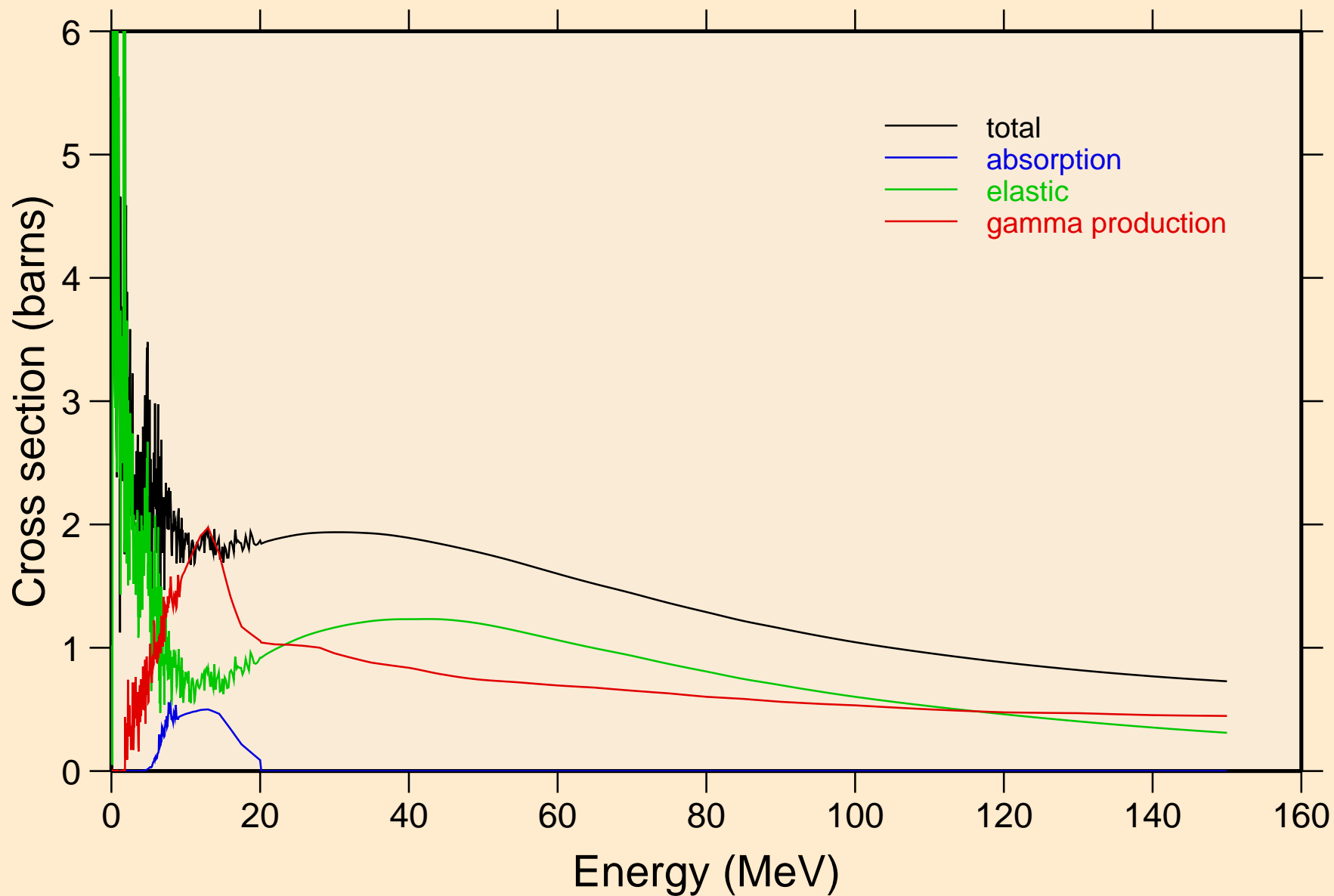

14-SI-28 FOR FENDL-3.2 FROM ENDF/B-VII WITH NJOY2016.60+ Heating

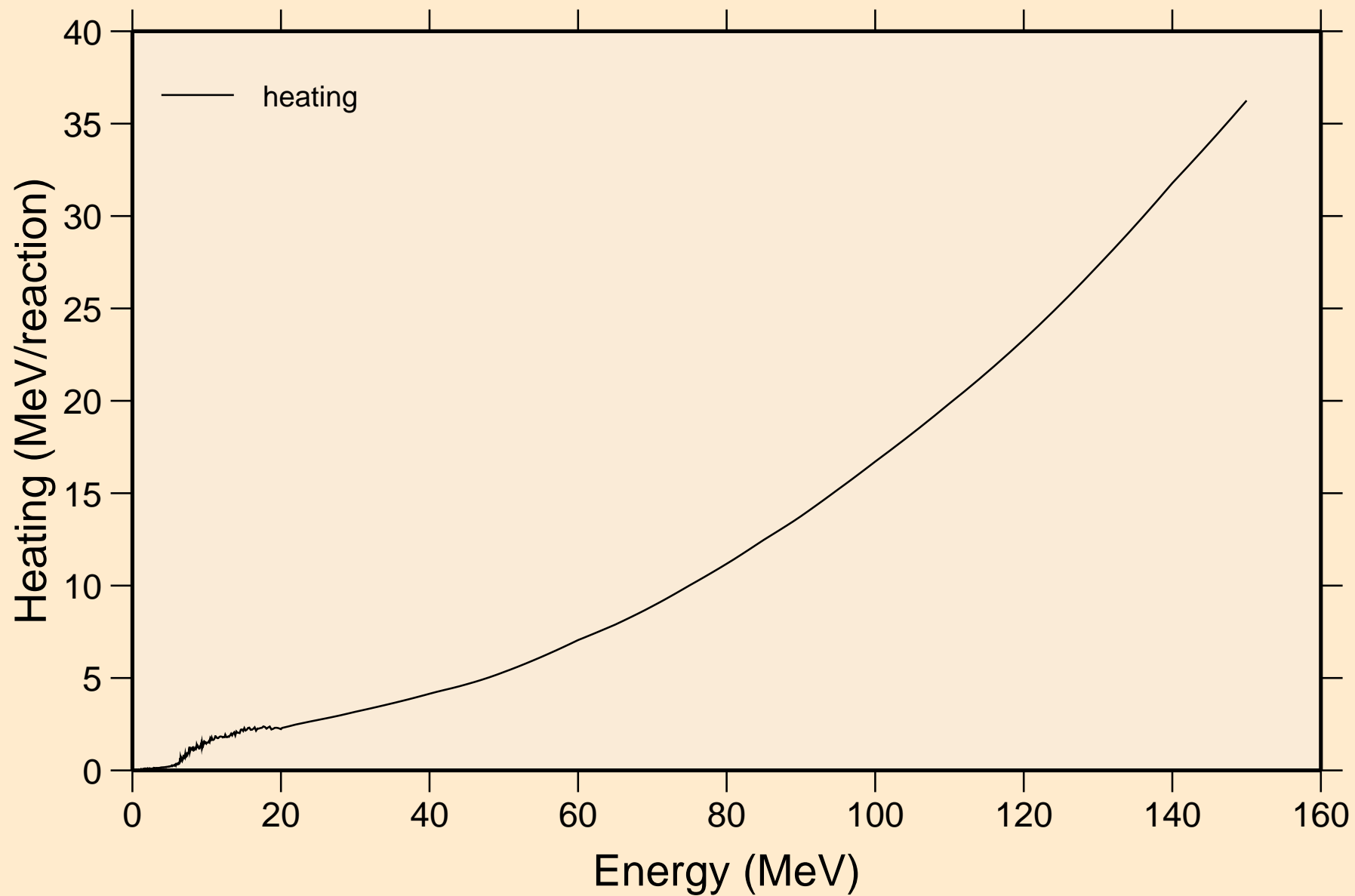

14-SI-28 FOR FENDL-3.2 FROM ENDF/B-VII WITH NJOY2016.60+ Damage

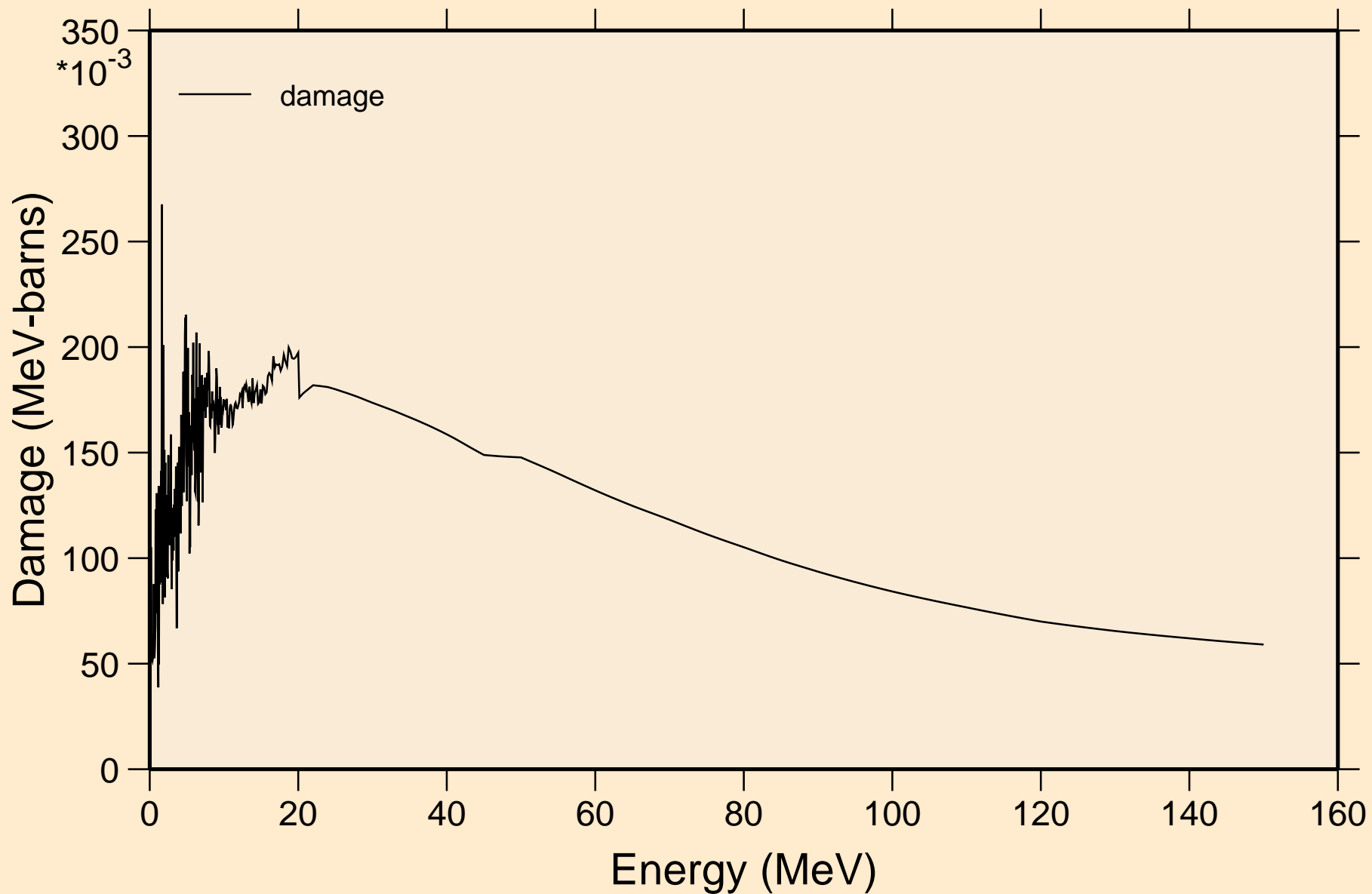

14-SI-28 FOR FENDL-3.2 FROM ENDF/B-VII WITH NJOY2016.60+
Non-threshold reactions

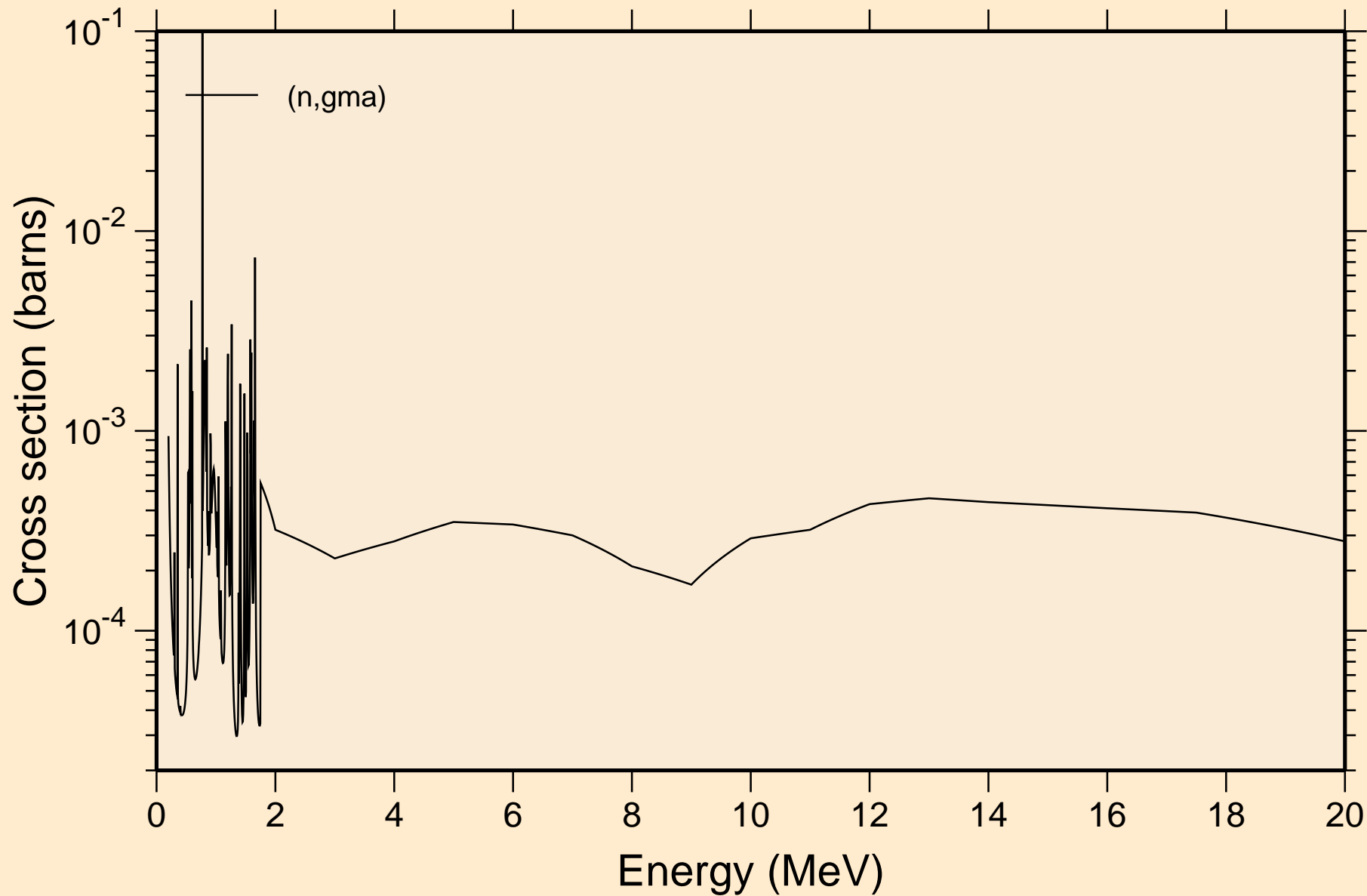

14-SI-28 FOR FENDL-3.2 FROM ENDF/B-VII WITH NJOY2016.60+ Inelastic levels

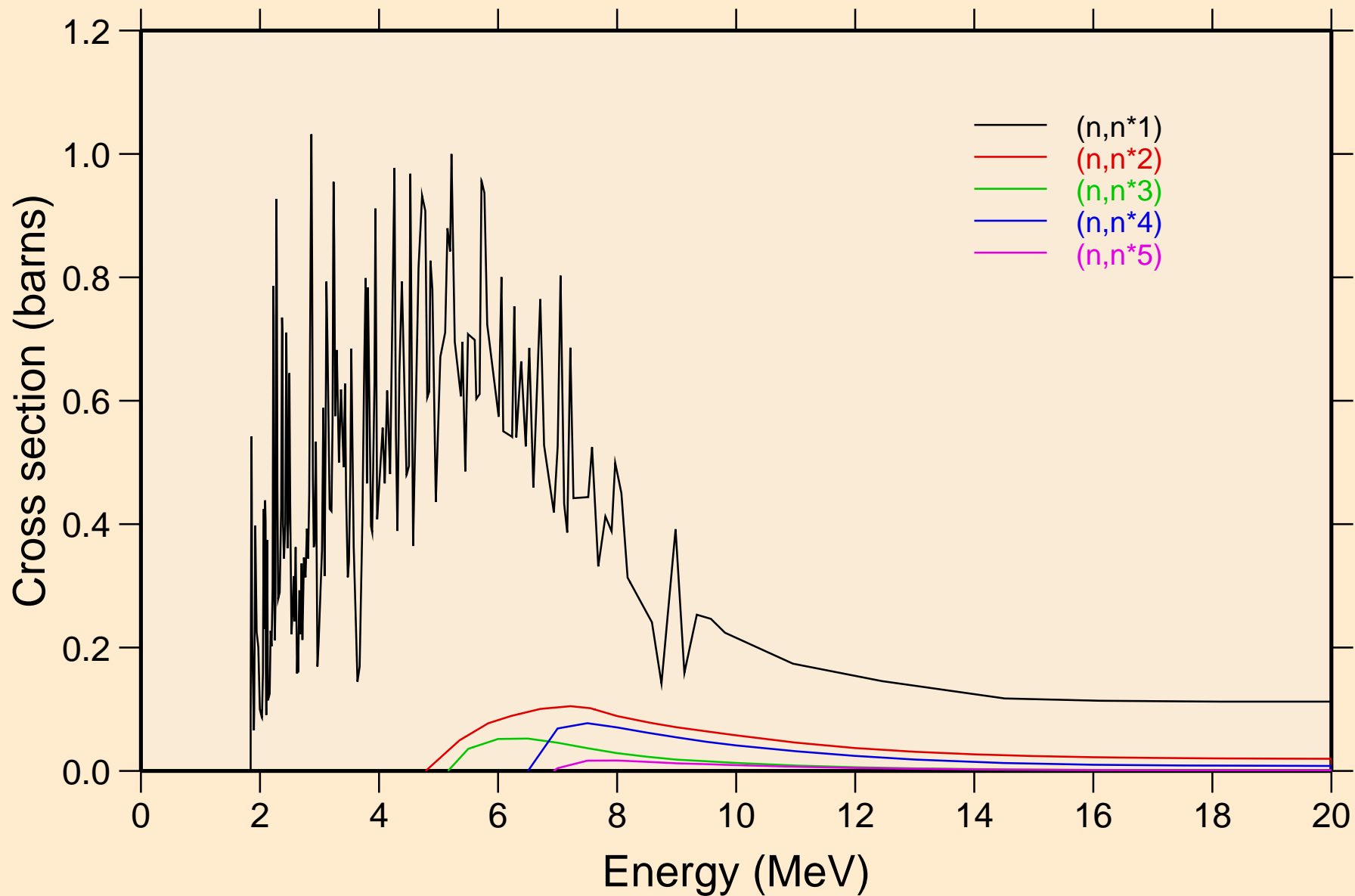

14-SI-28 FOR FENDL-3.2 FROM ENDF/B-VII WITH NJOY2016.60+ Inelastic levels

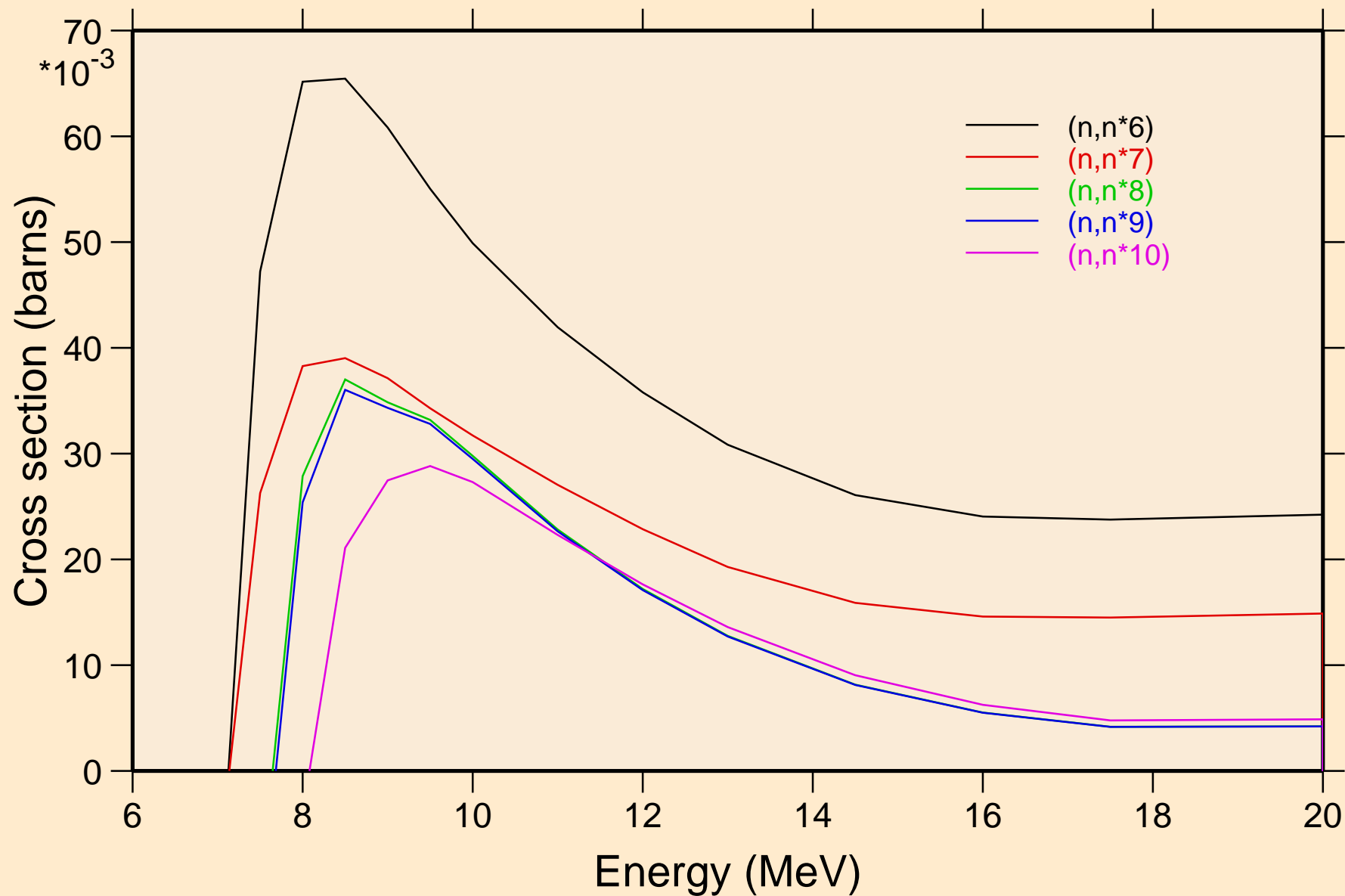

14-SI-28 FOR FENDL-3.2 FROM ENDF/B-VII WITH NJOY2016.60+ Inelastic levels

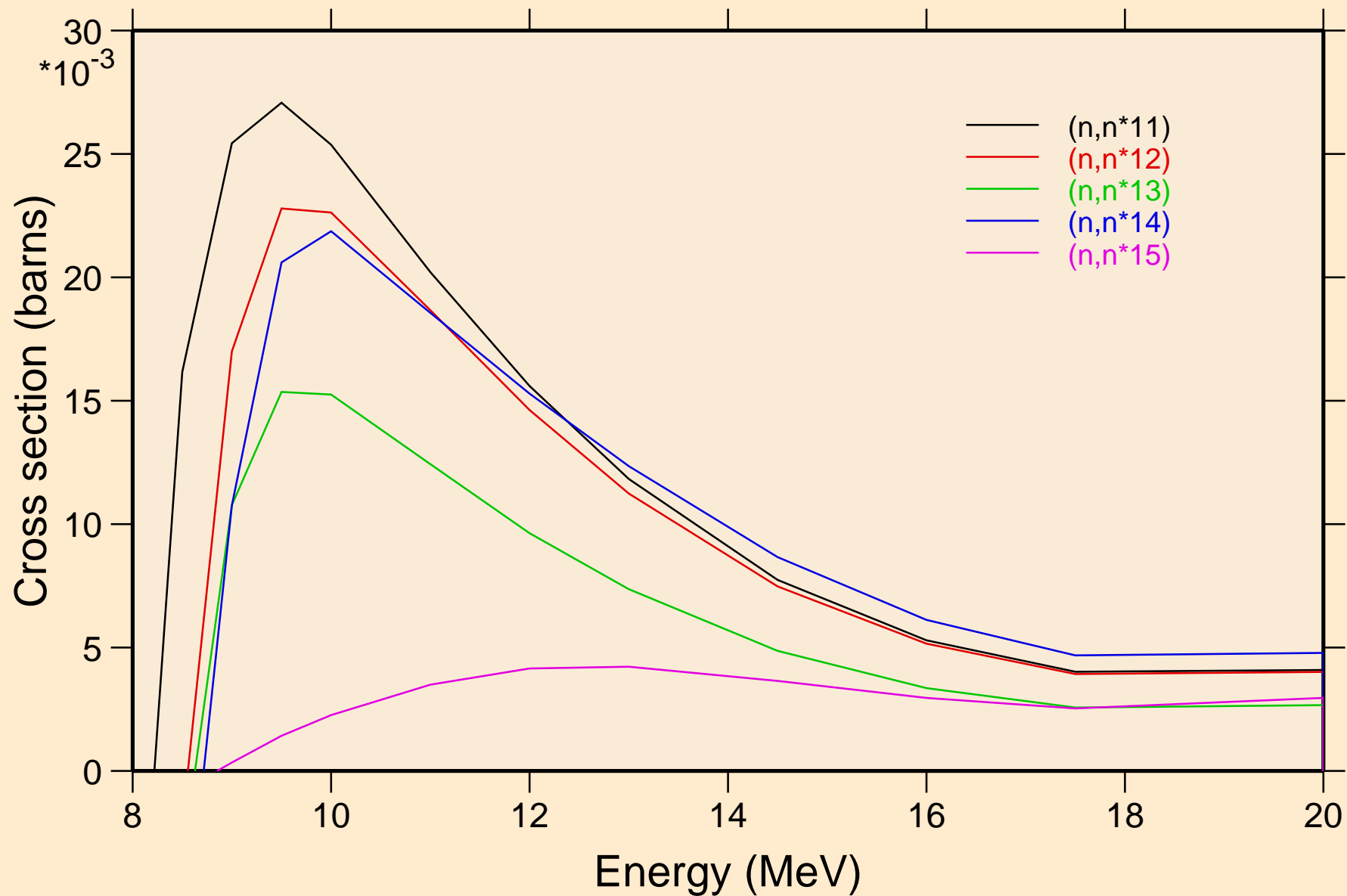

14-SI-28 FOR FENDL-3.2 FROM ENDF/B-VII WITH NJOY2016.60+ Inelastic levels

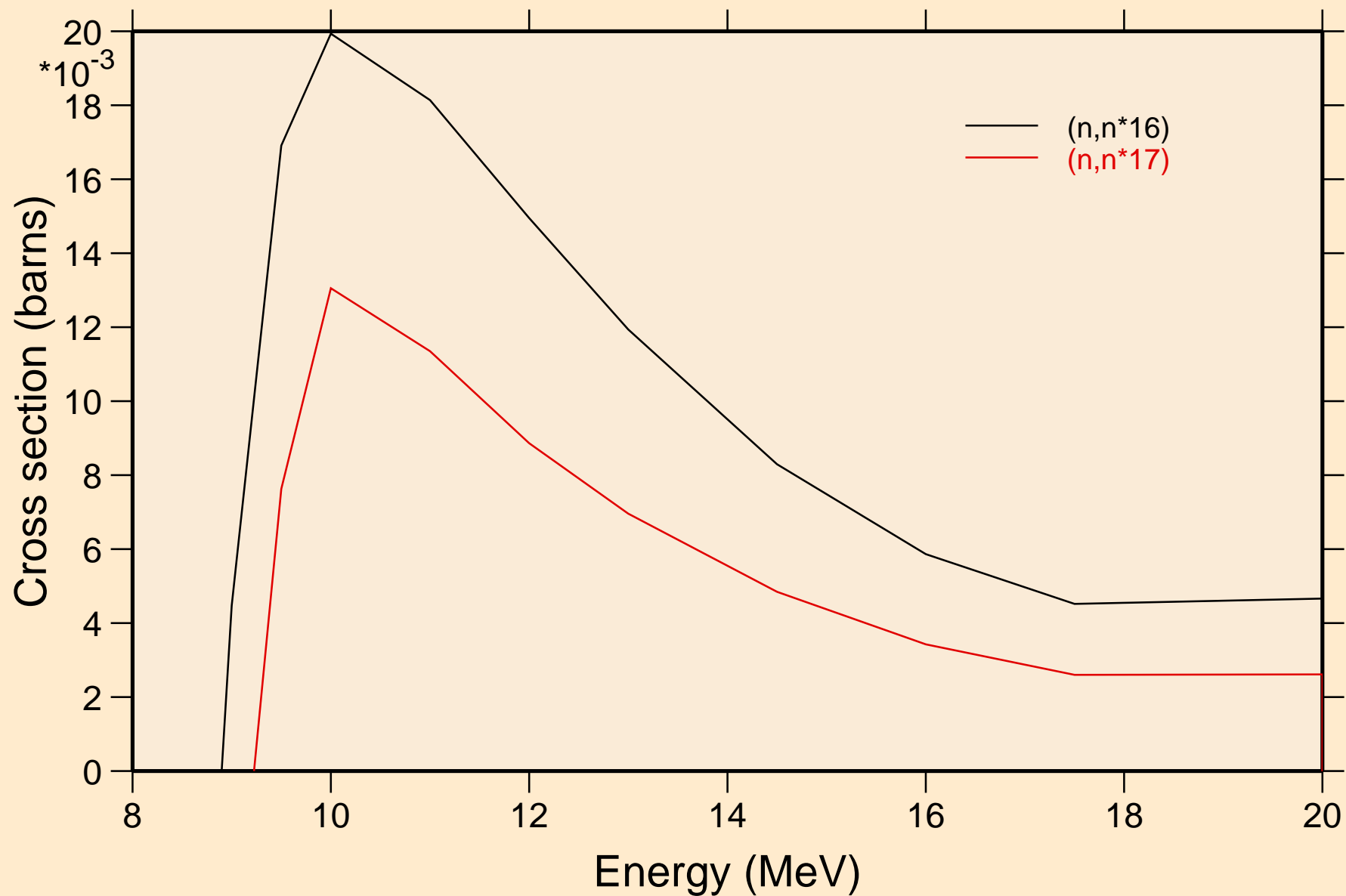

14-SI-28 FOR FENDL-3.2 FROM ENDF/B-VII WITH NJOY2016.60+ Threshold reactions

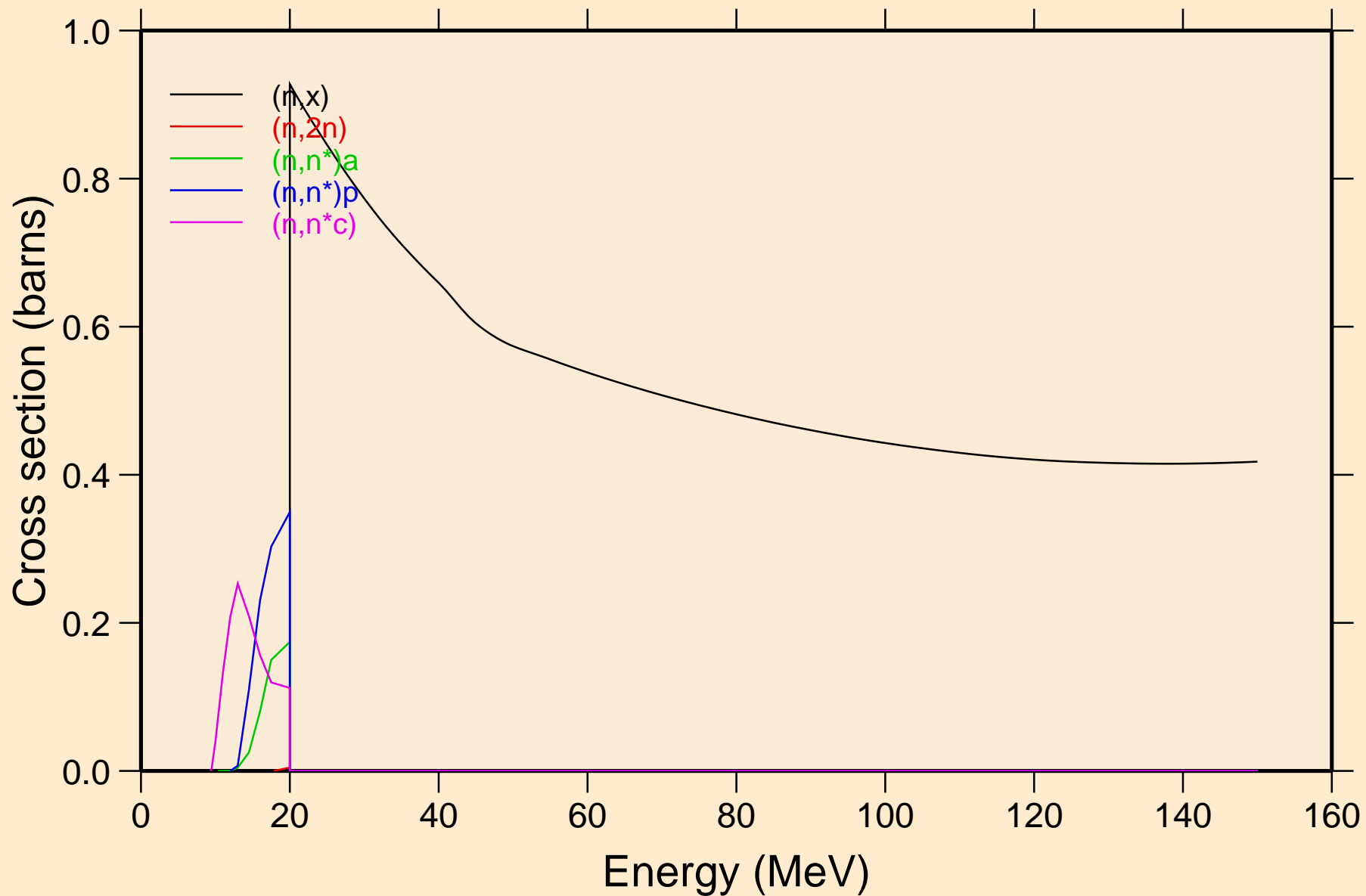

14-SI-28 FOR FENDL-3.2 FROM ENDF/B-VII WITH NJOY2016.60+ Threshold reactions

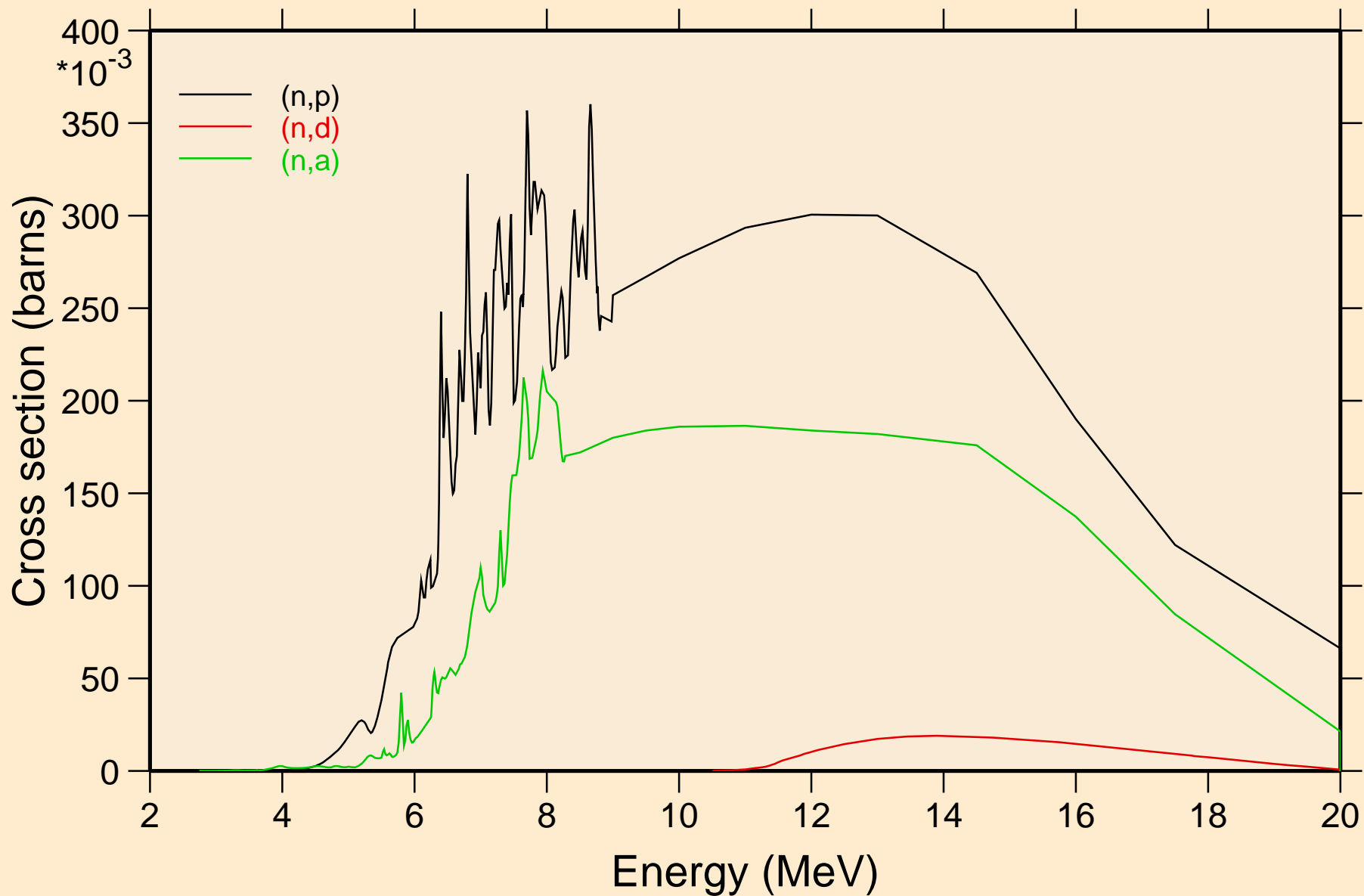

14-SI-28 FOR FENDL-3.2 FROM ENDF/B-VII WITH NJOY2016.60+ Threshold reactions

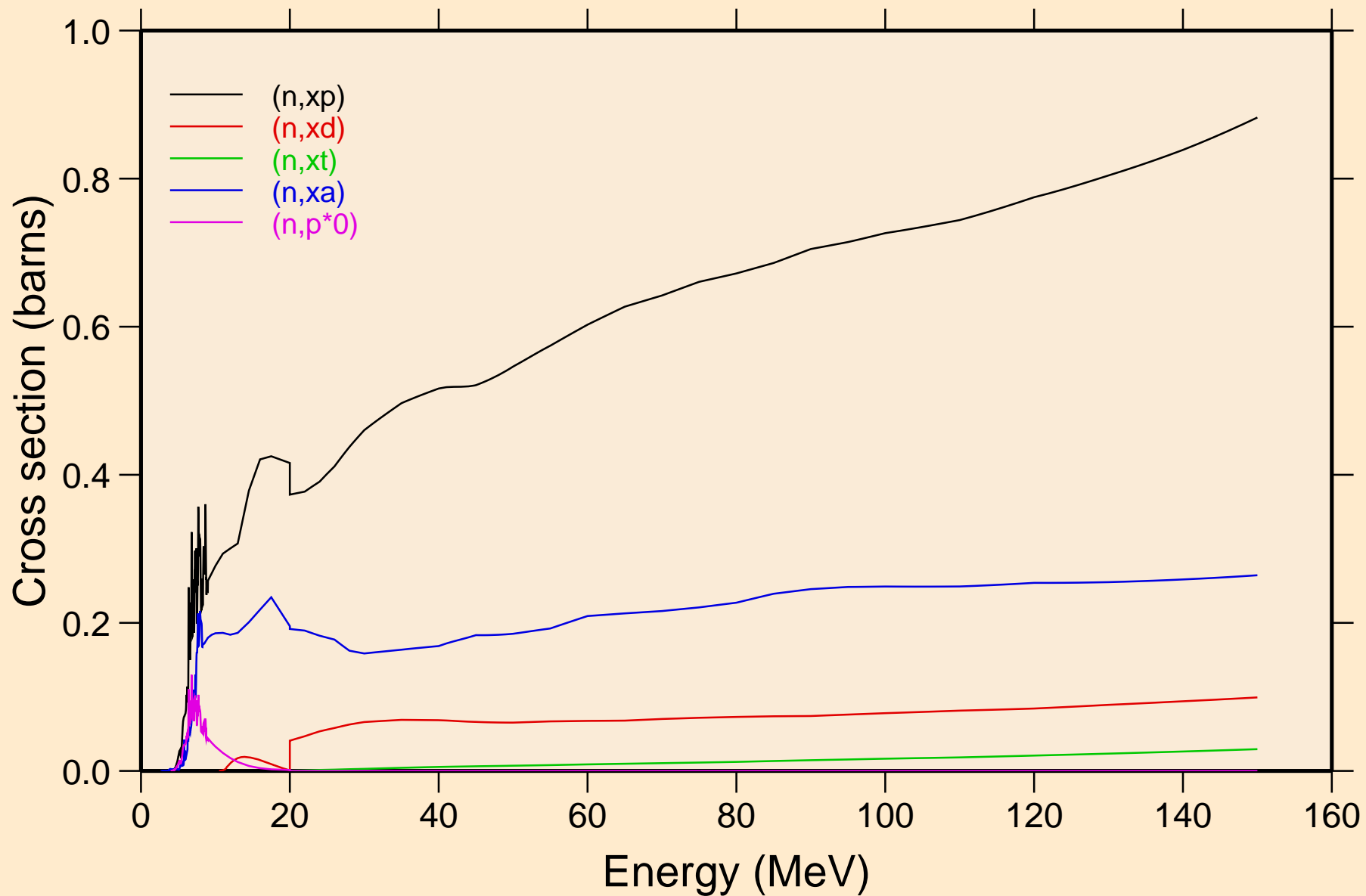

14-SI-28 FOR FENDL-3.2 FROM ENDF/B-VII WITH NJOY2016.60+ Threshold reactions

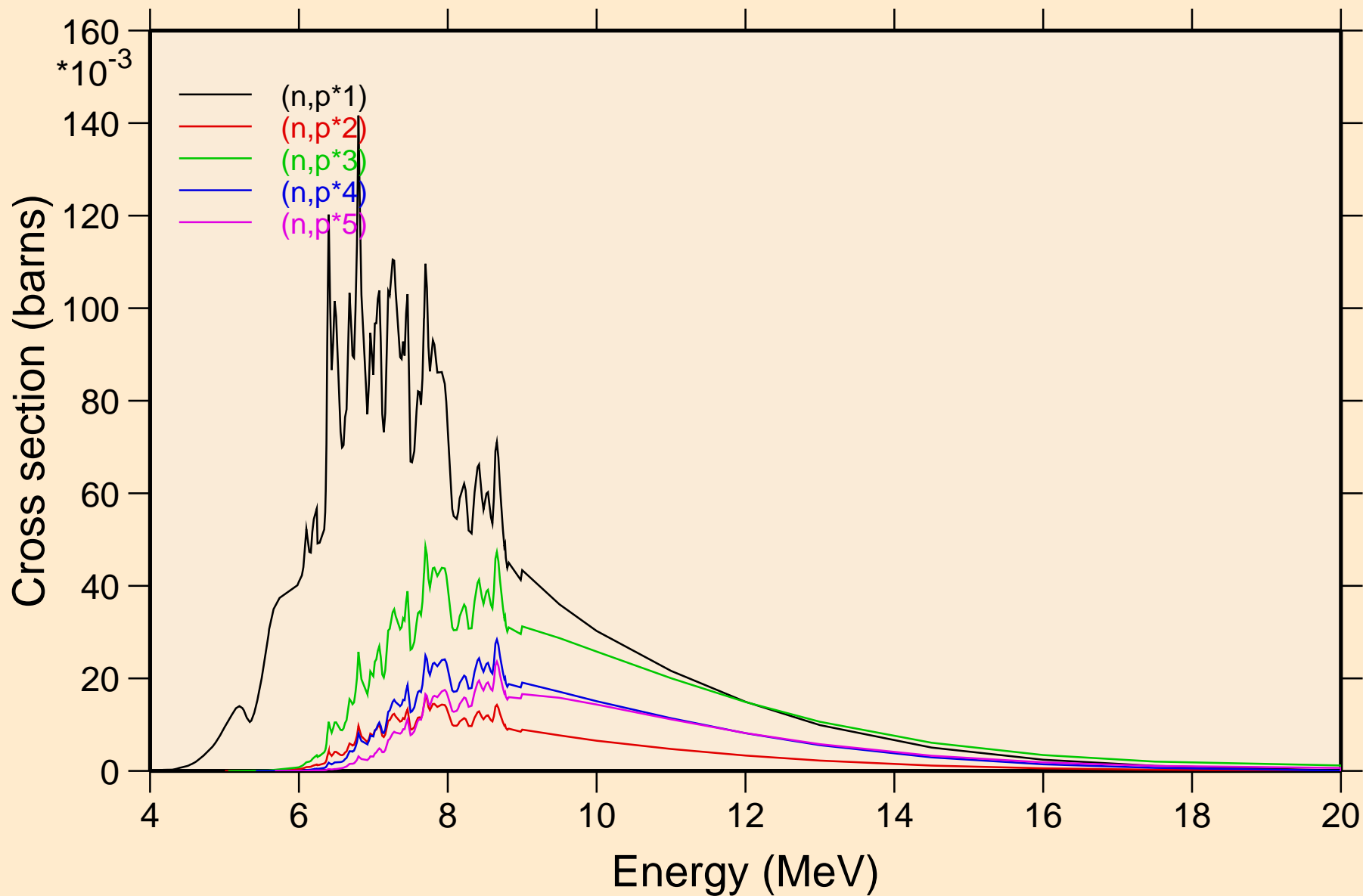

14-SI-28 FOR FENDL-3.2 FROM ENDF/B-VII WITH NJOY2016.60+ Threshold reactions

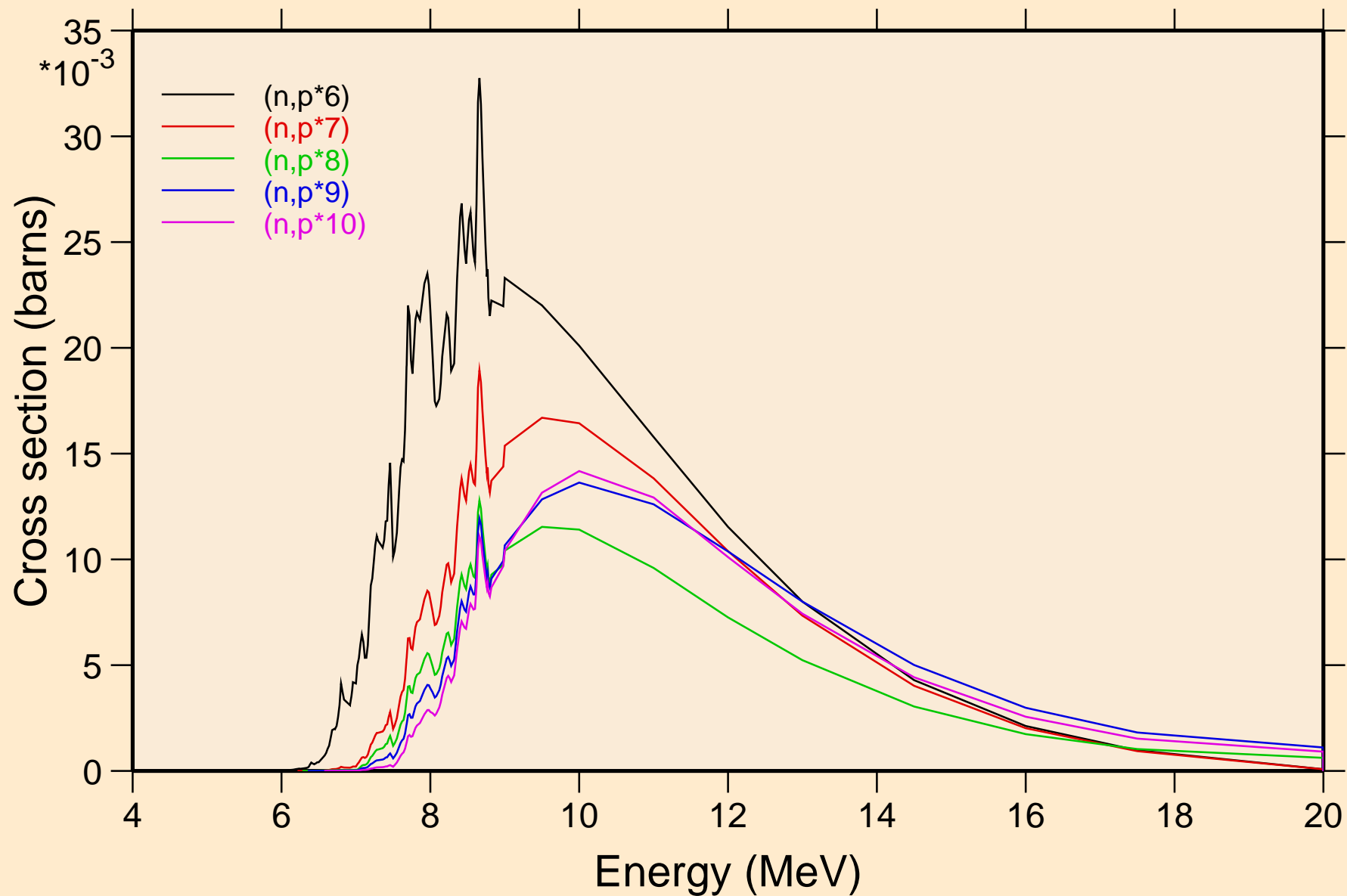

14-SI-28 FOR FENDL-3.2 FROM ENDF/B-VII WITH NJOY2016.60+ Threshold reactions

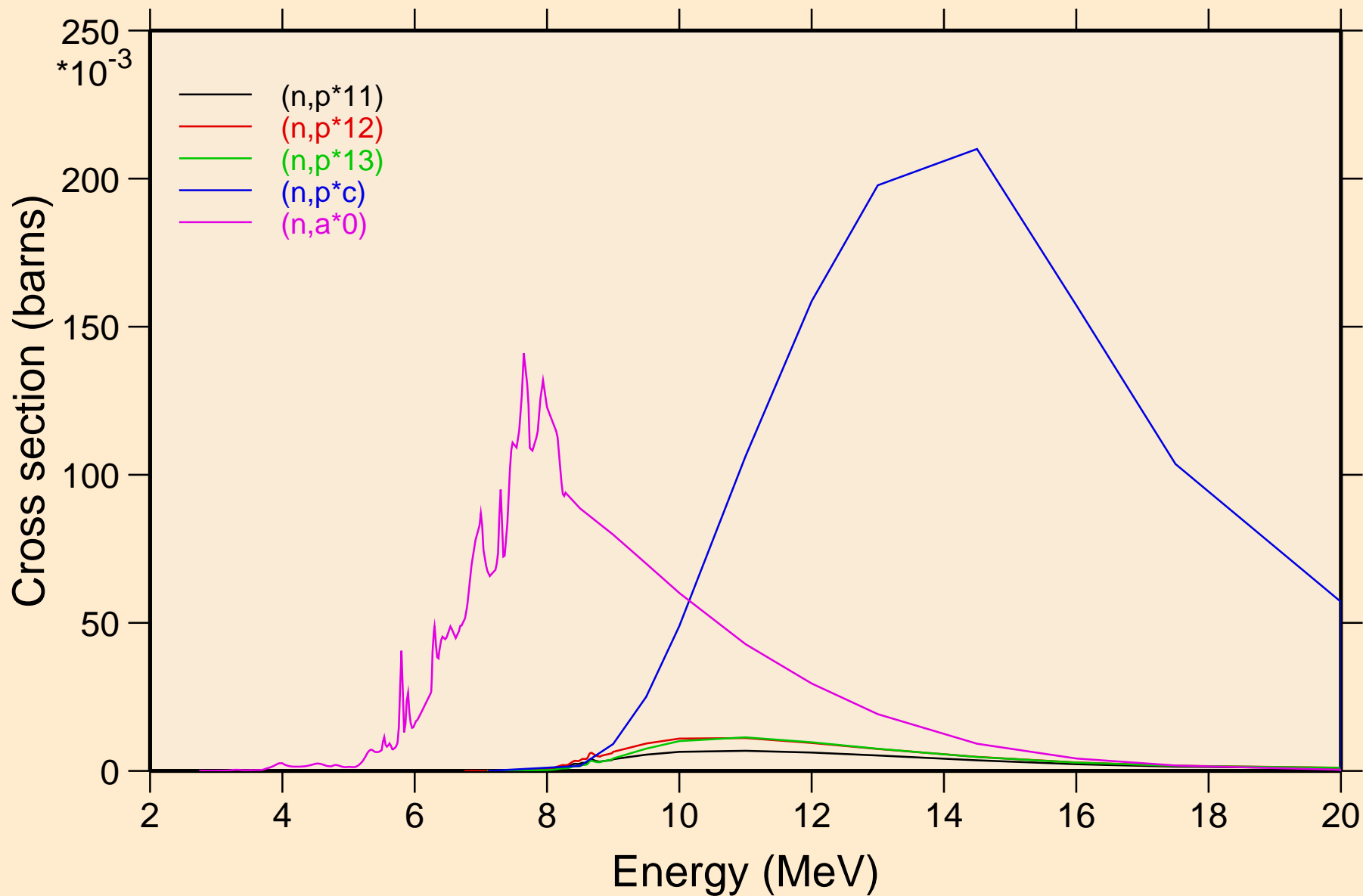

14-SI-28 FOR FENDL-3.2 FROM ENDF/B-VII WITH NJOY2016.60+ Threshold reactions

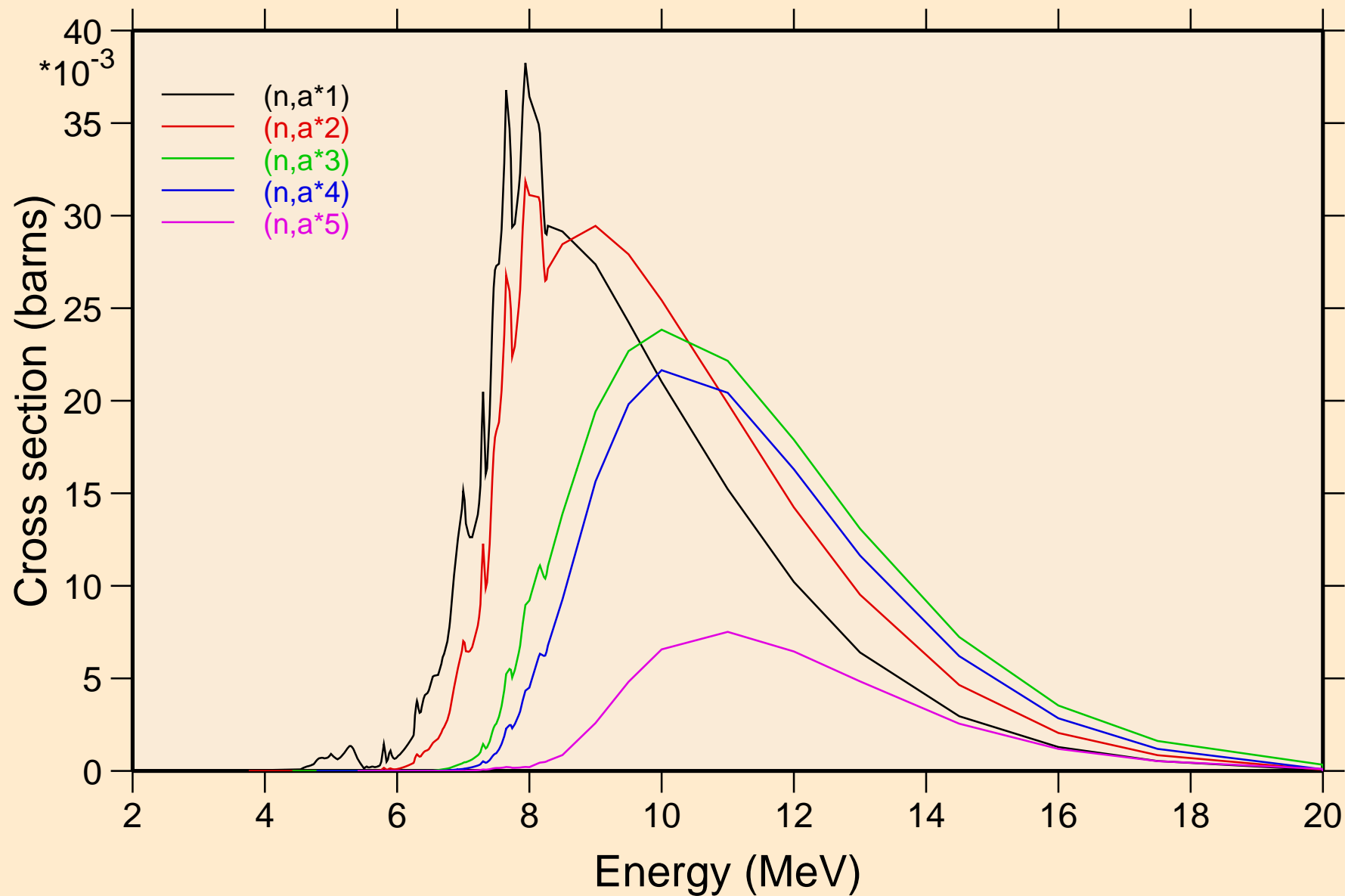

14-SI-28 FOR FENDL-3.2 FROM ENDF/B-VII WITH NJOY2016.60+ Threshold reactions

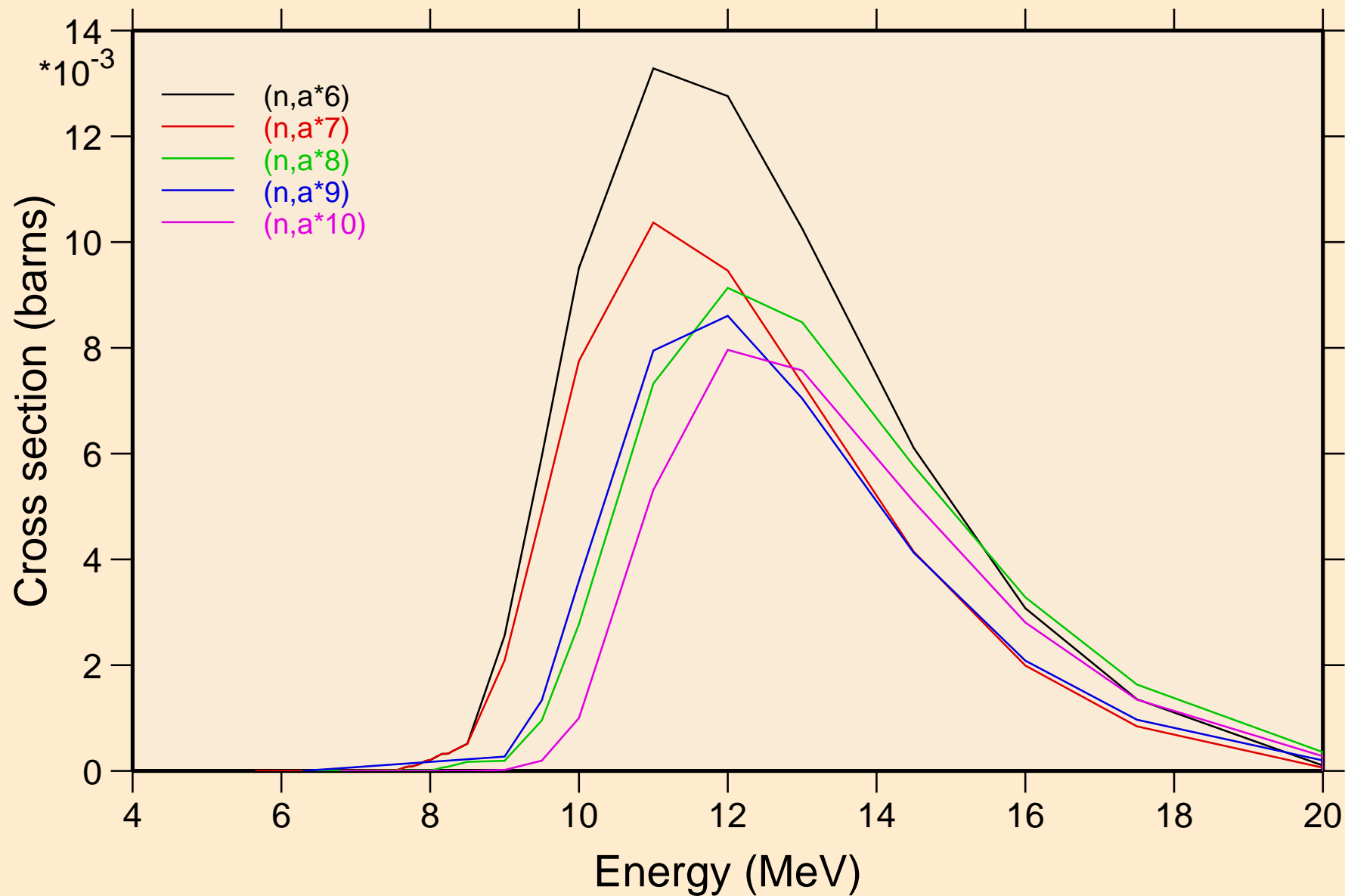

14-SI-28 FOR FENDL-3.2 FROM ENDF/B-VII WITH NJOY2016.60+ Threshold reactions

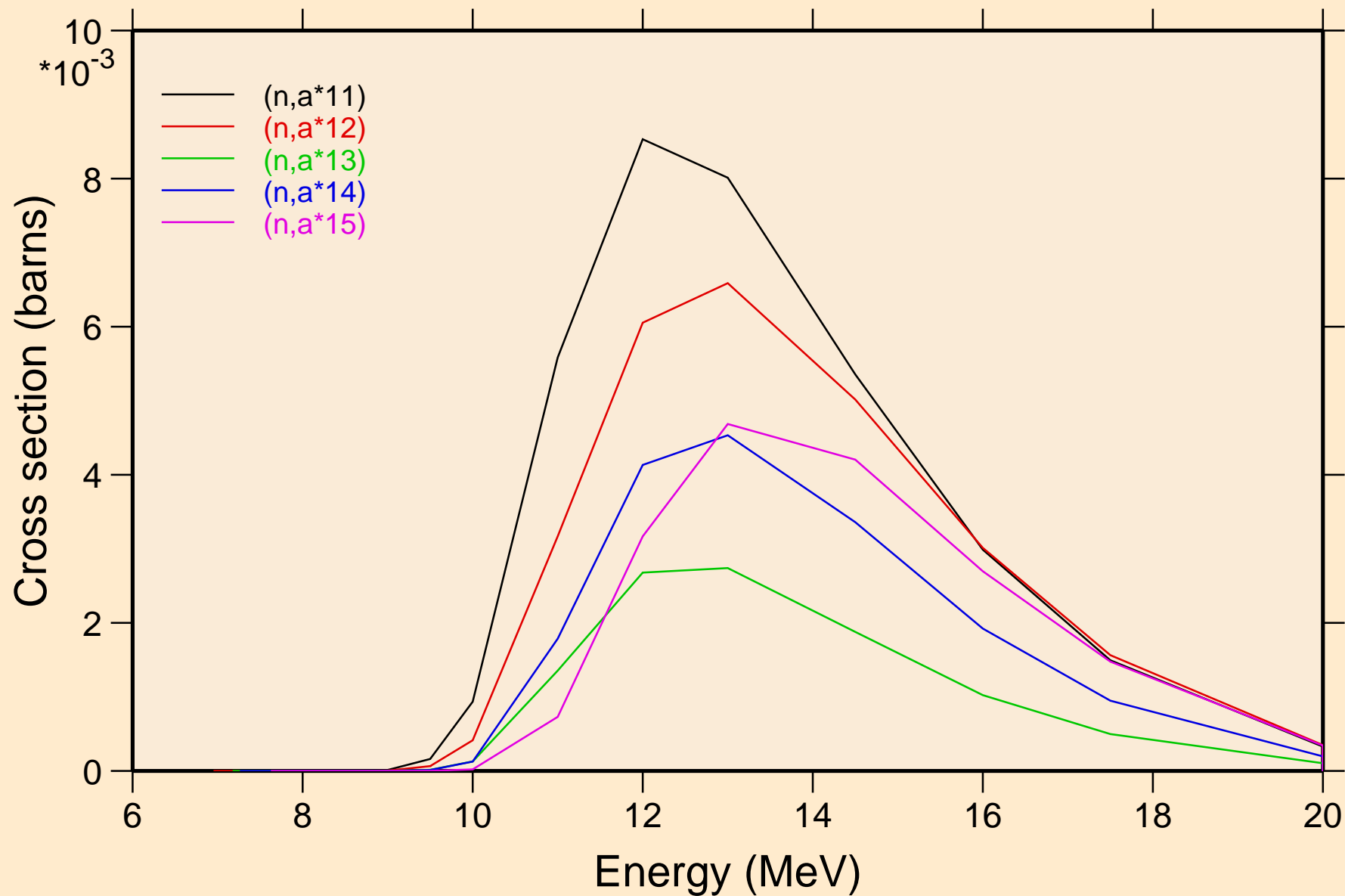

14-SI-28 FOR FENDL-3.2 FROM ENDF/B-VII WITH NJOY2016.60+
Threshold reactions

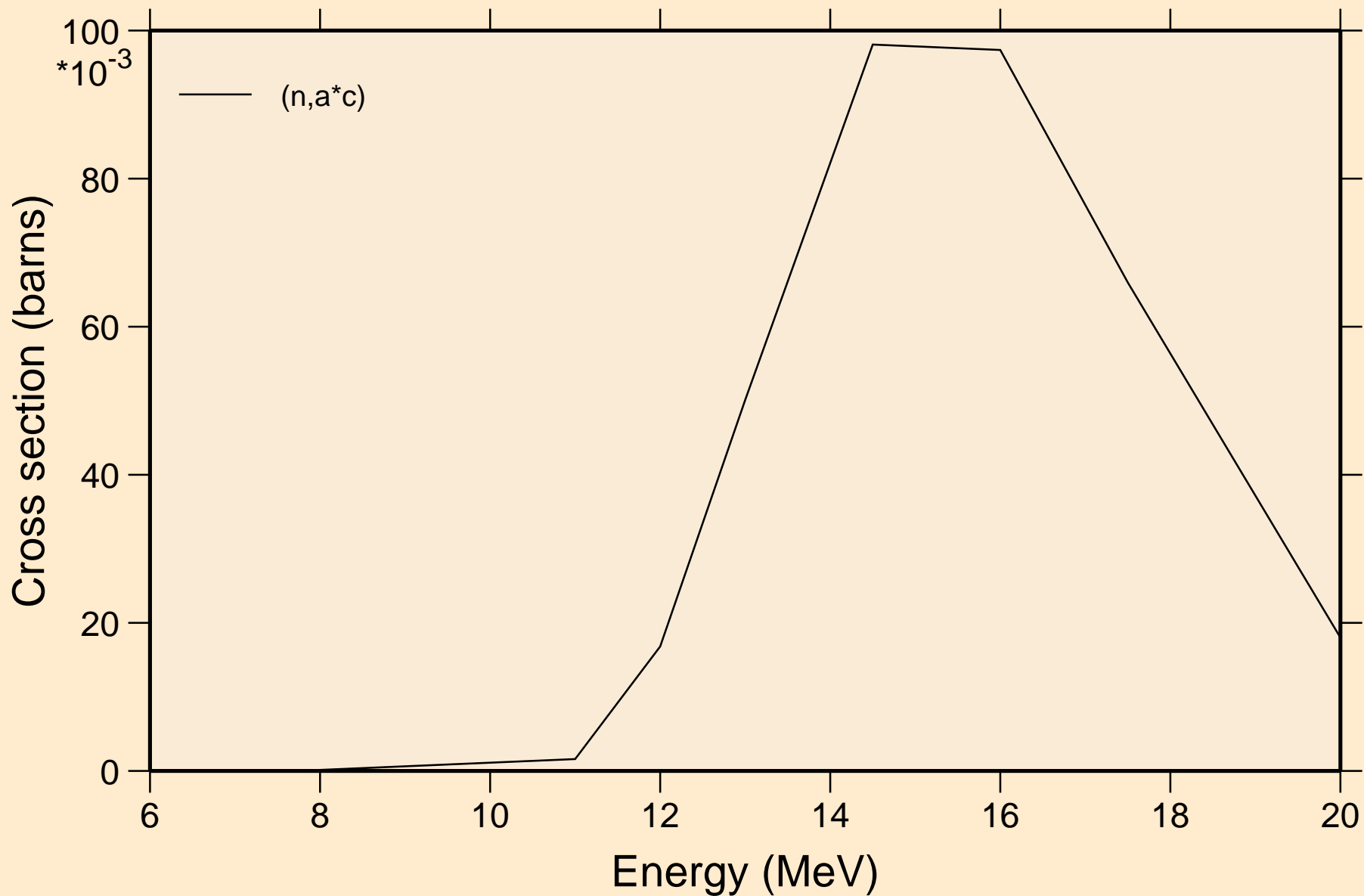

14-SI-28 FOR FENDL-3.2 FROM ENDF/B-VII WITH NJOY2016.60+
angular distribution for elastic

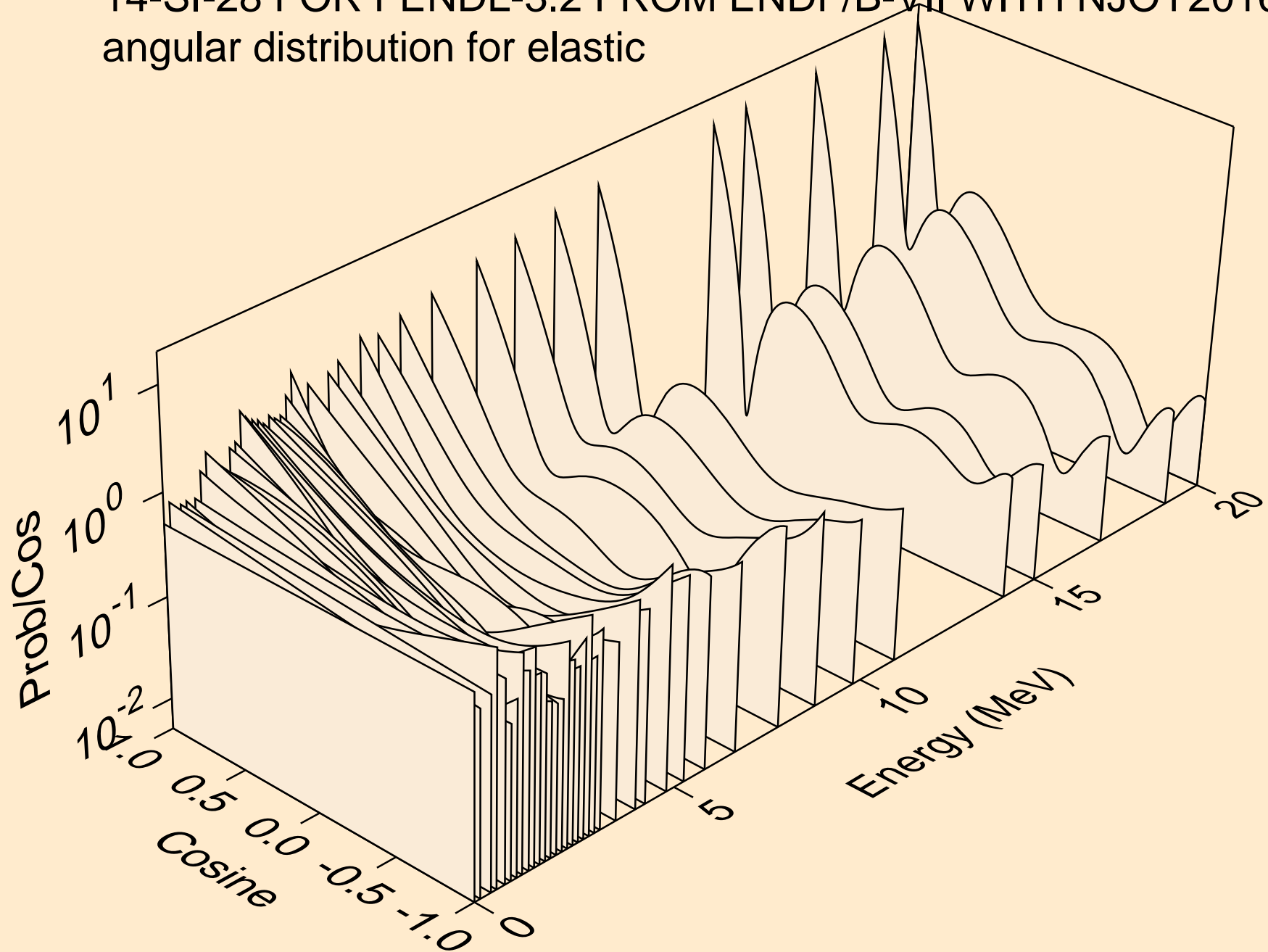

14-SI-28 FOR FENDL-3.2 FROM ENDF/B-VII WITH NJOY2016.60+
angular distribution for elastic

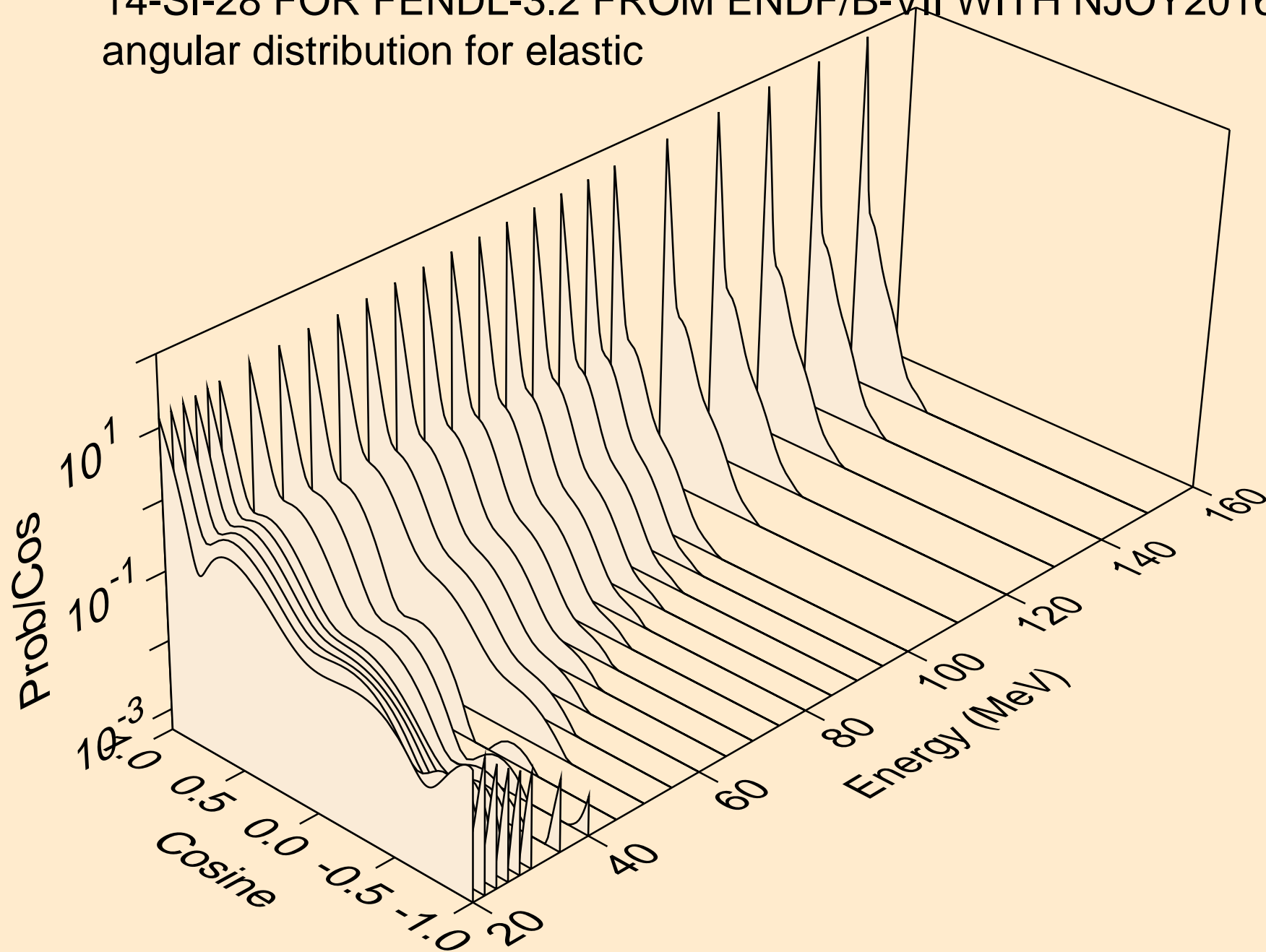

14-SI-28 FOR FENDL-3.2 FROM ENDF/B-VII WITH NJOY2016.60+
angular distribution for (n,n*1)

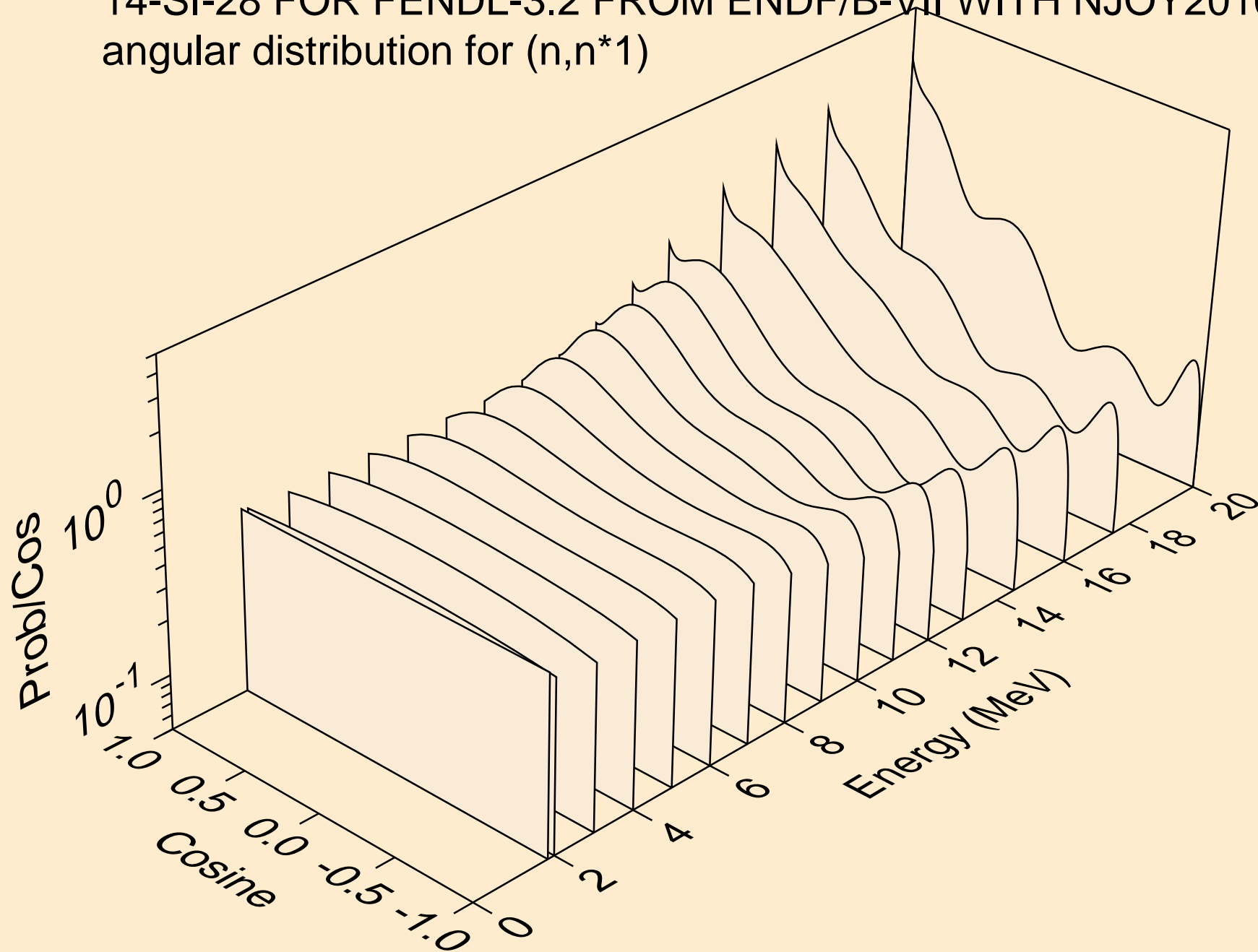

14-SI-28 FOR FENDL-3.2 FROM ENDF/B-VII WITH NJOY2016.60+
angular distribution for (n,n*2)

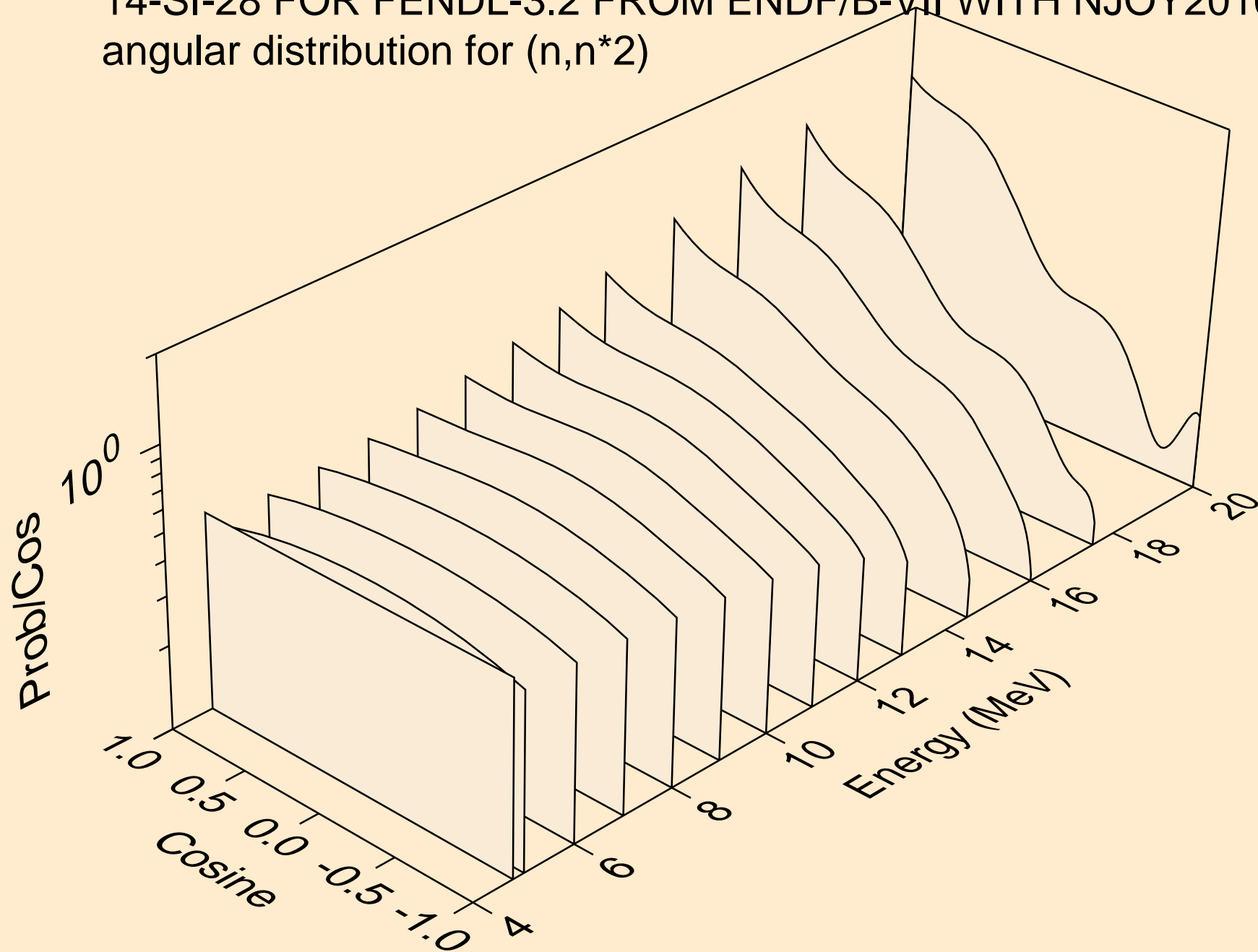

14-SI-28 FOR FENDL-3.2 FROM ENDF/B-VII WITH NJOY2016.60+
angular distribution for (n,n*3)

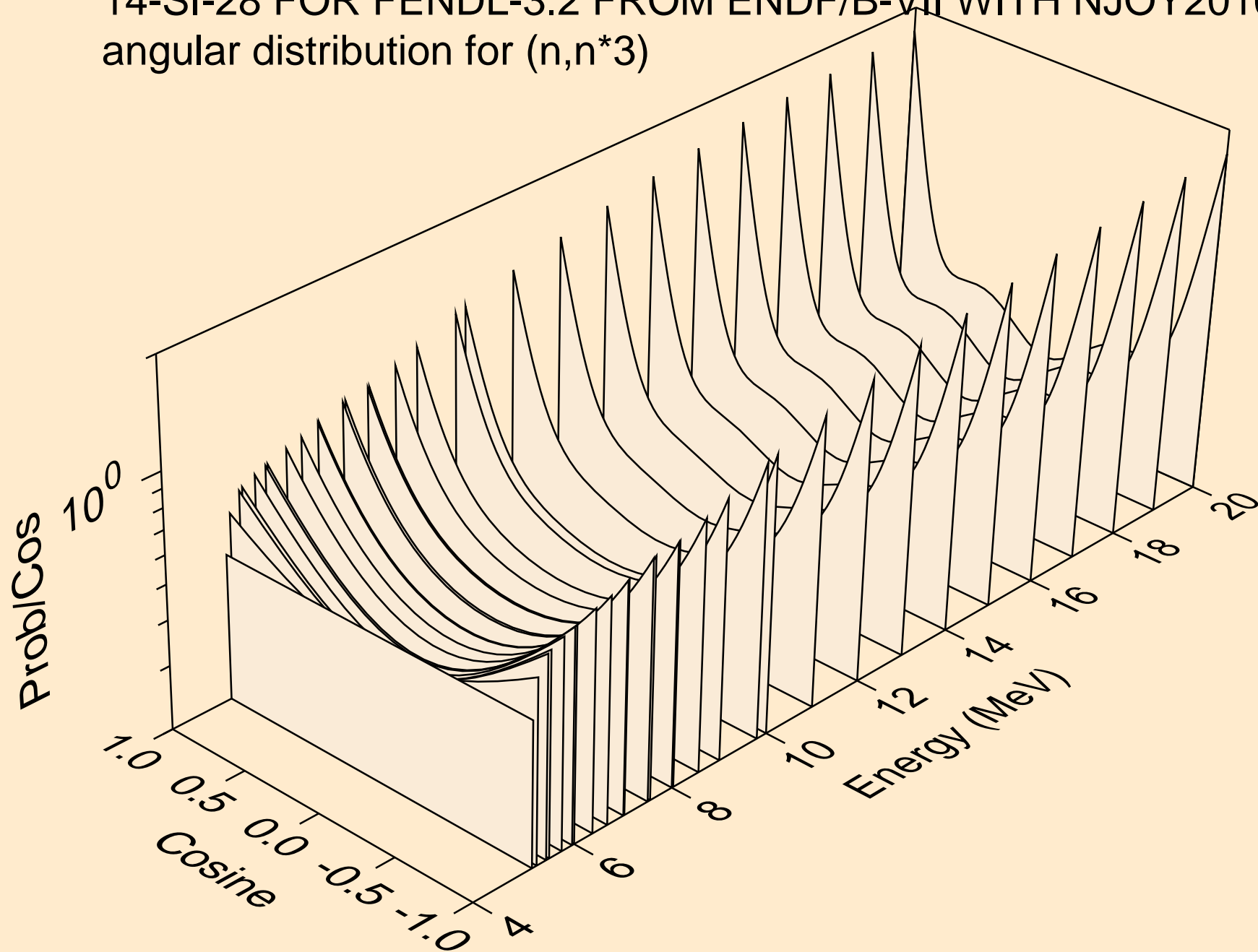

14-SI-28 FOR FENDL-3.2 FROM ENDF/B-VII WITH NJOY2016.60+
angular distribution for (n,n*4)

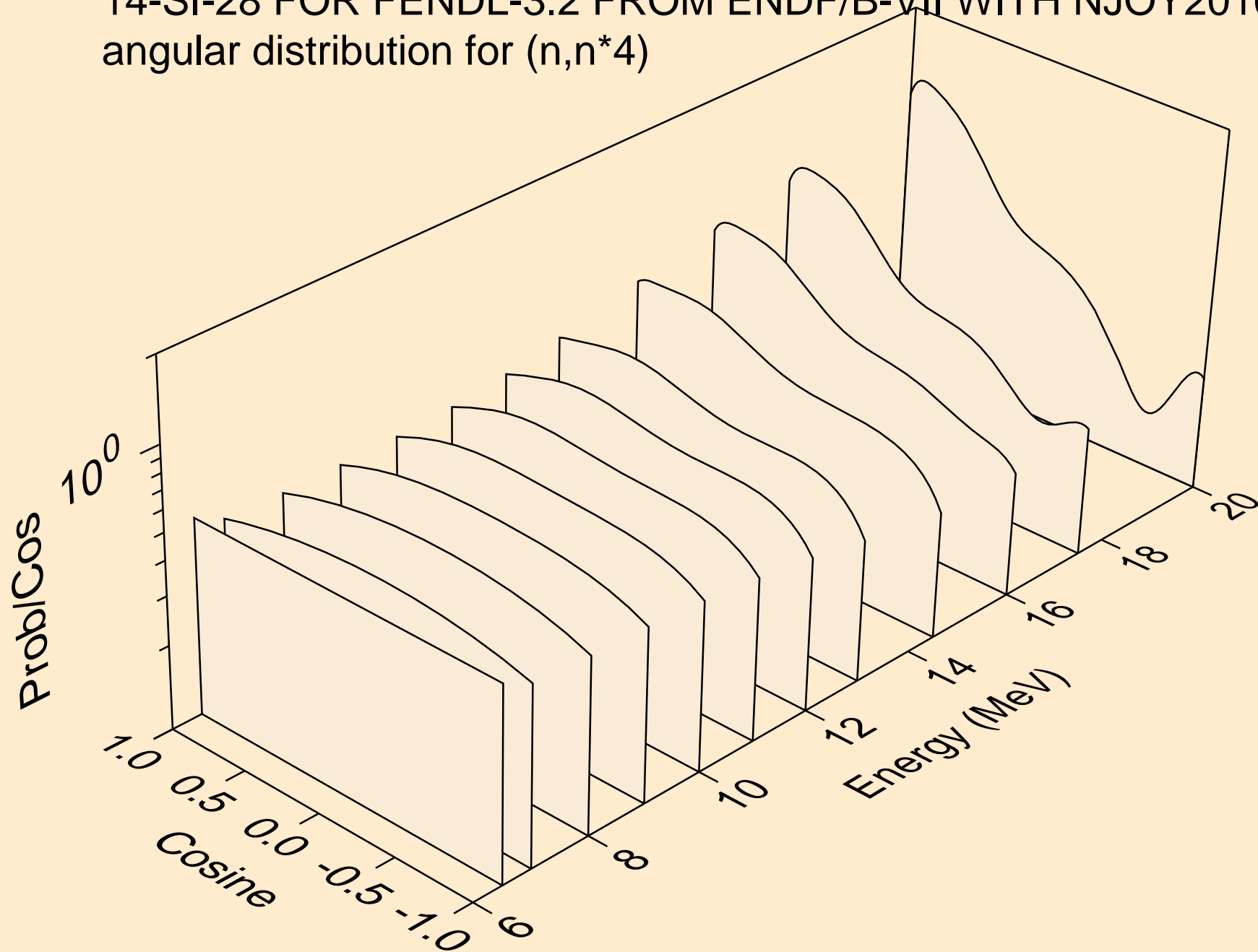

14-SI-28 FOR FENDL-3.2 FROM ENDF/B-VII WITH NJOY2016.60+
angular distribution for (n,n*5)

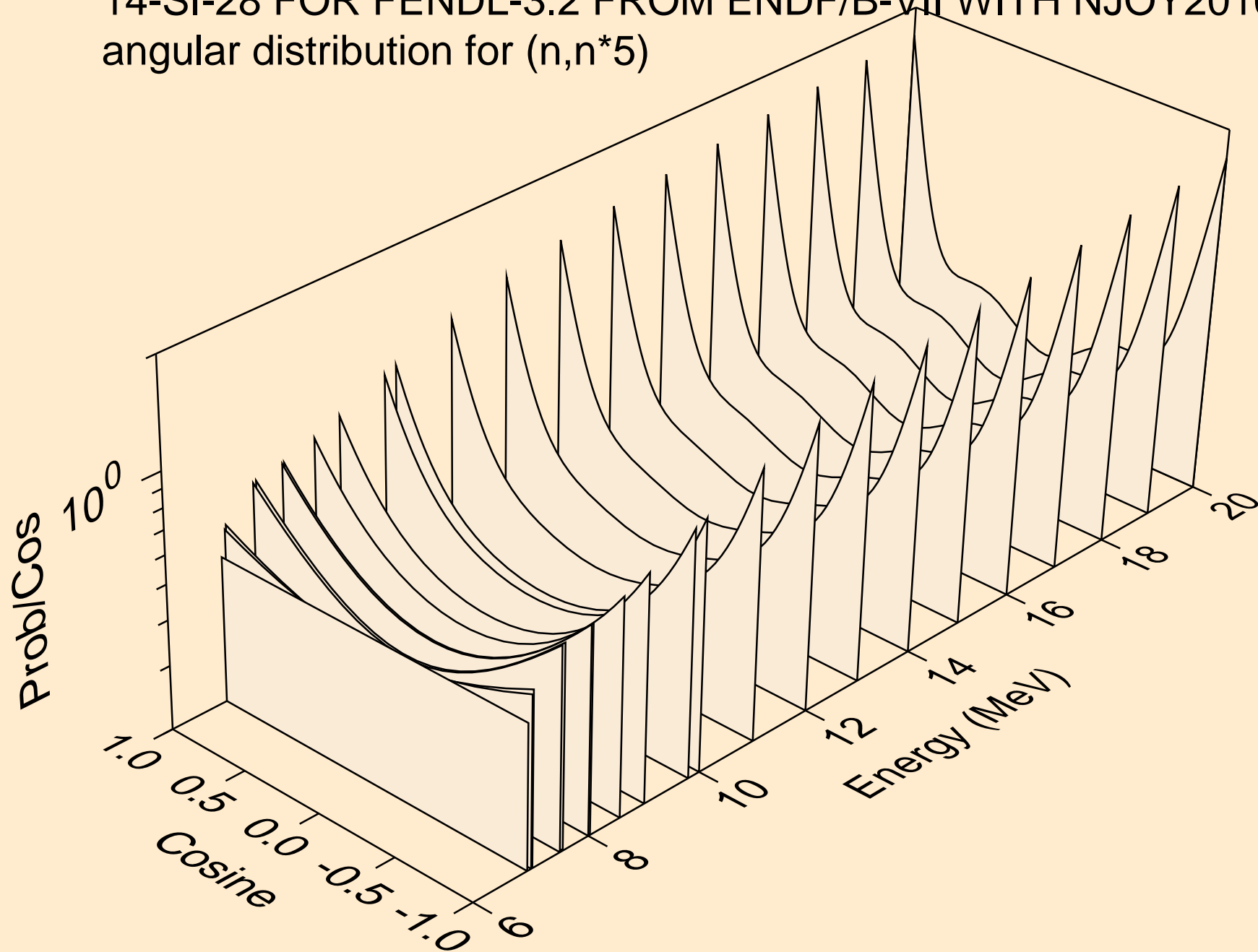

14-SI-28 FOR FENDL-3.2 FROM ENDF/B-VII WITH NJOY2016.60+
angular distribution for (n,n*6)

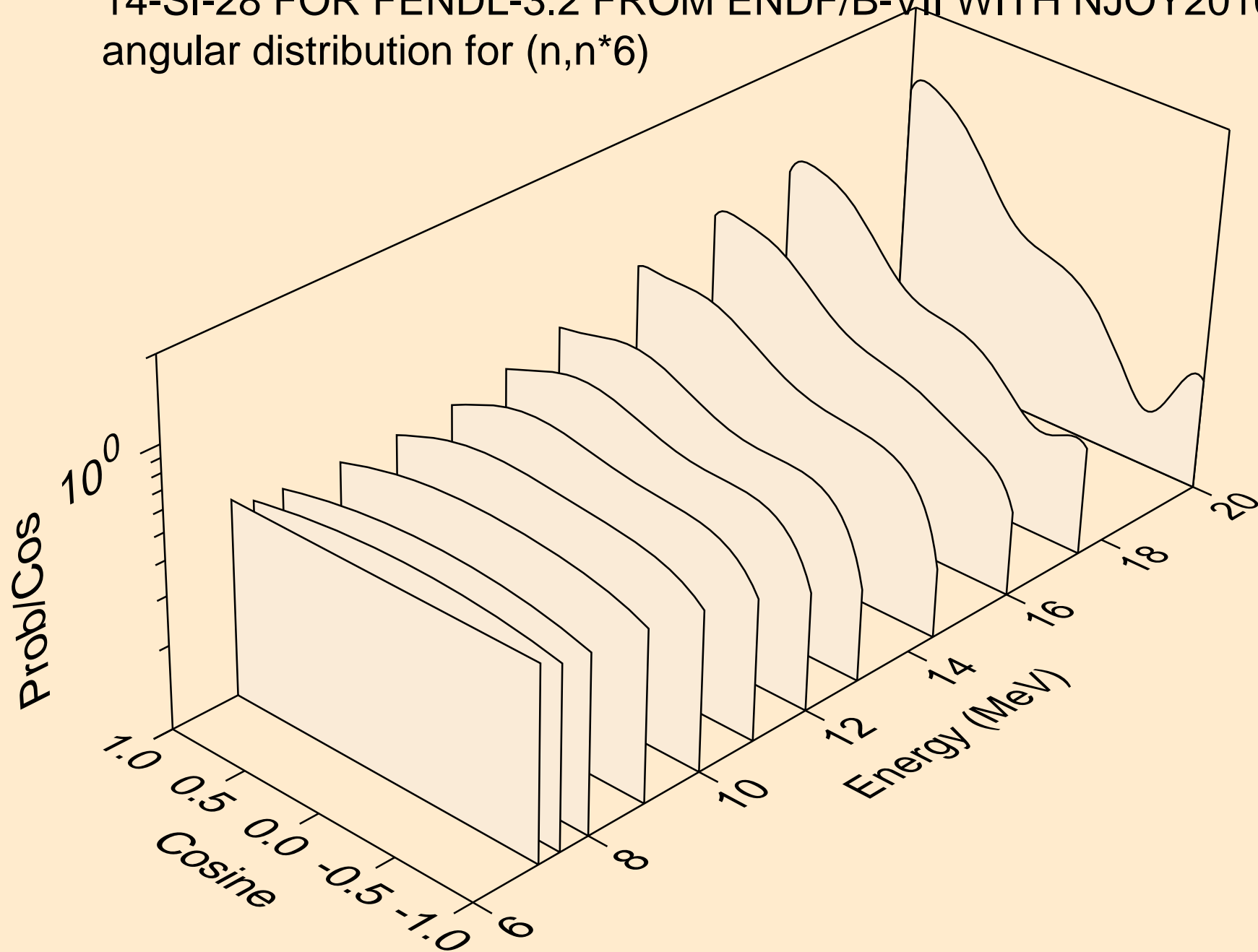

14-SI-28 FOR FENDL-3.2 FROM ENDF/B-VII WITH NJOY2016.60+
angular distribution for (n,n*7)

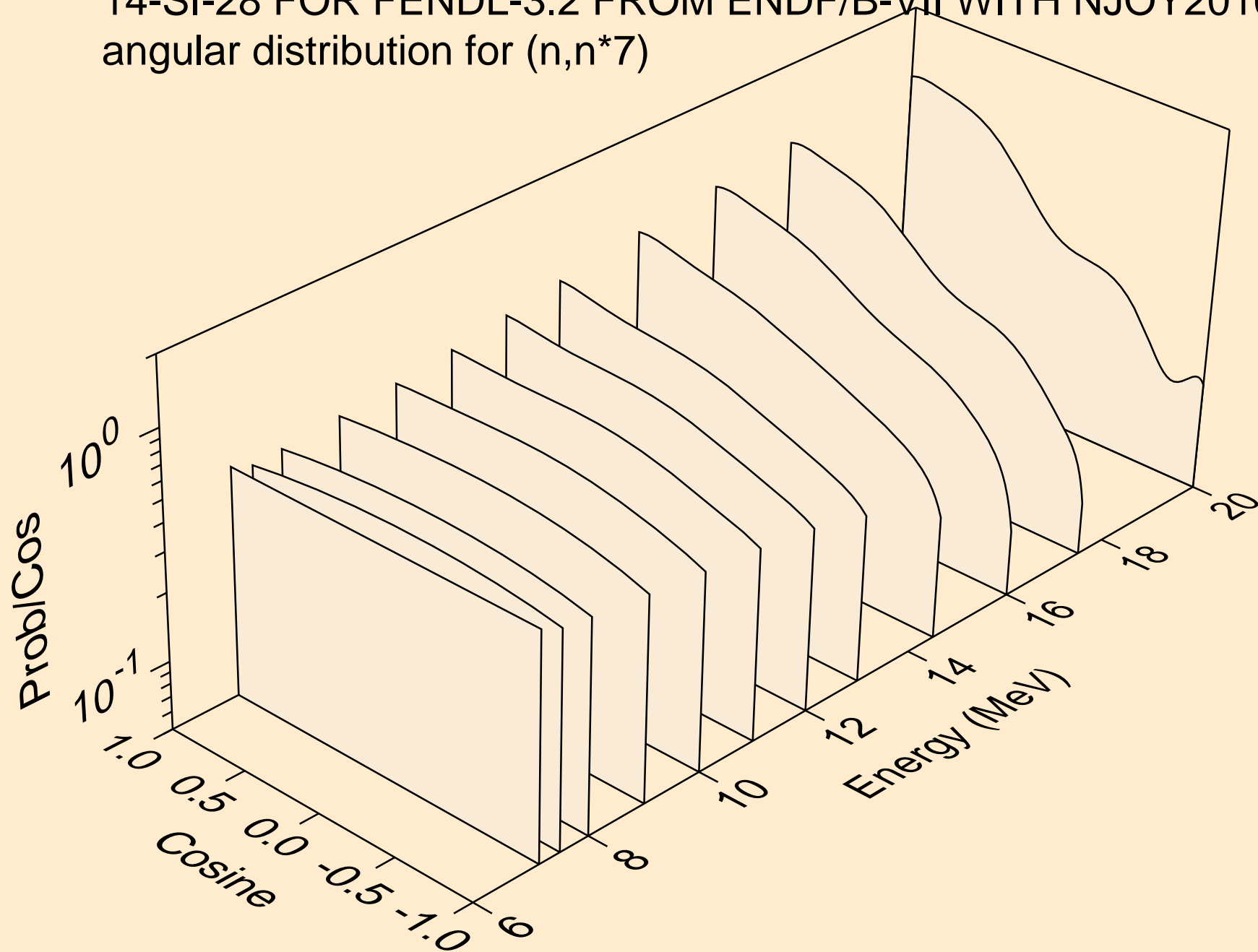

14-SI-28 FOR FENDL-3.2 FROM ENDF/B-VII WITH NJOY2016.60+
angular distribution for (n,n*8)

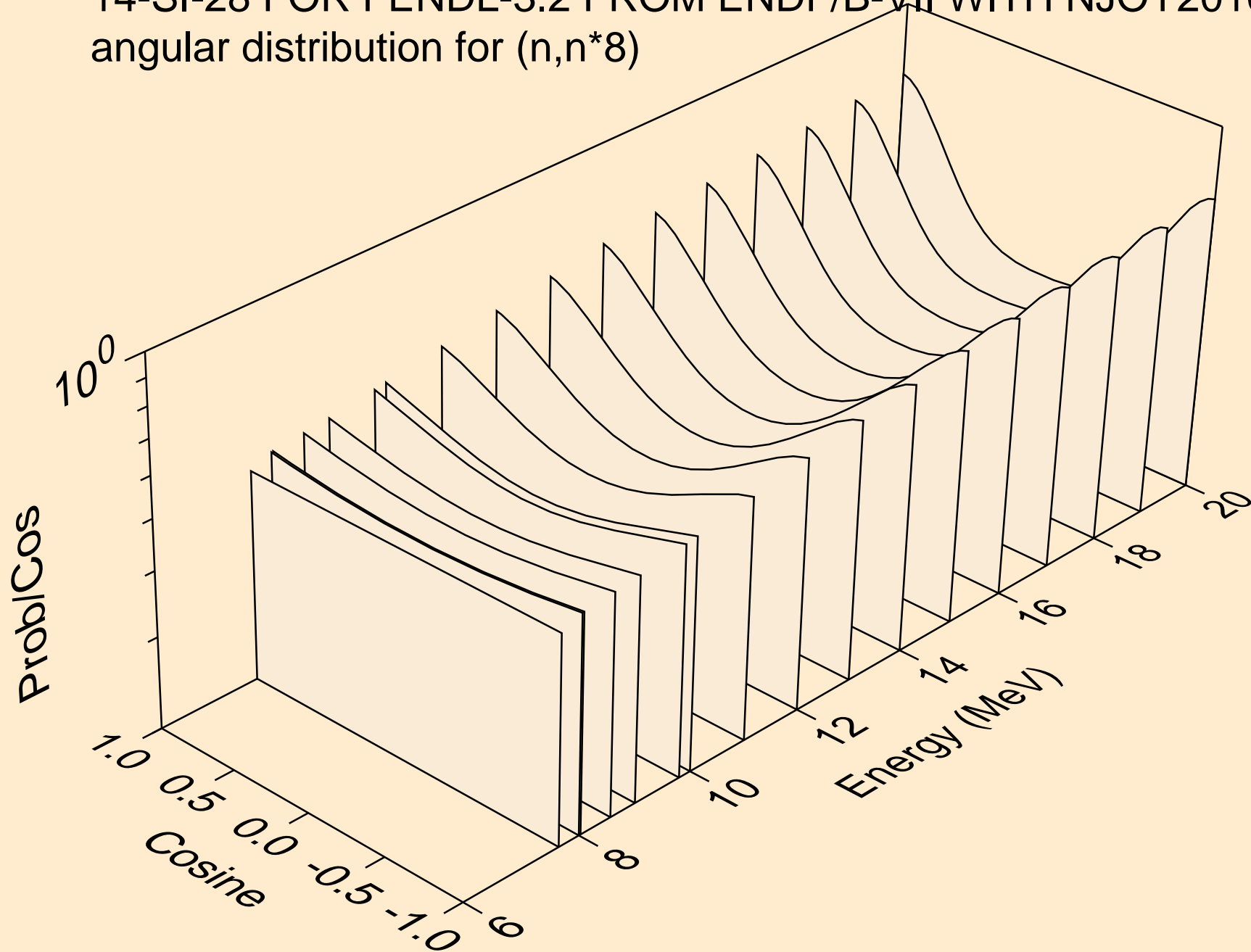

14-SI-28 FOR FENDL-3.2 FROM ENDF/B-VII WITH NJOY2016.60+
angular distribution for (n,n*9)

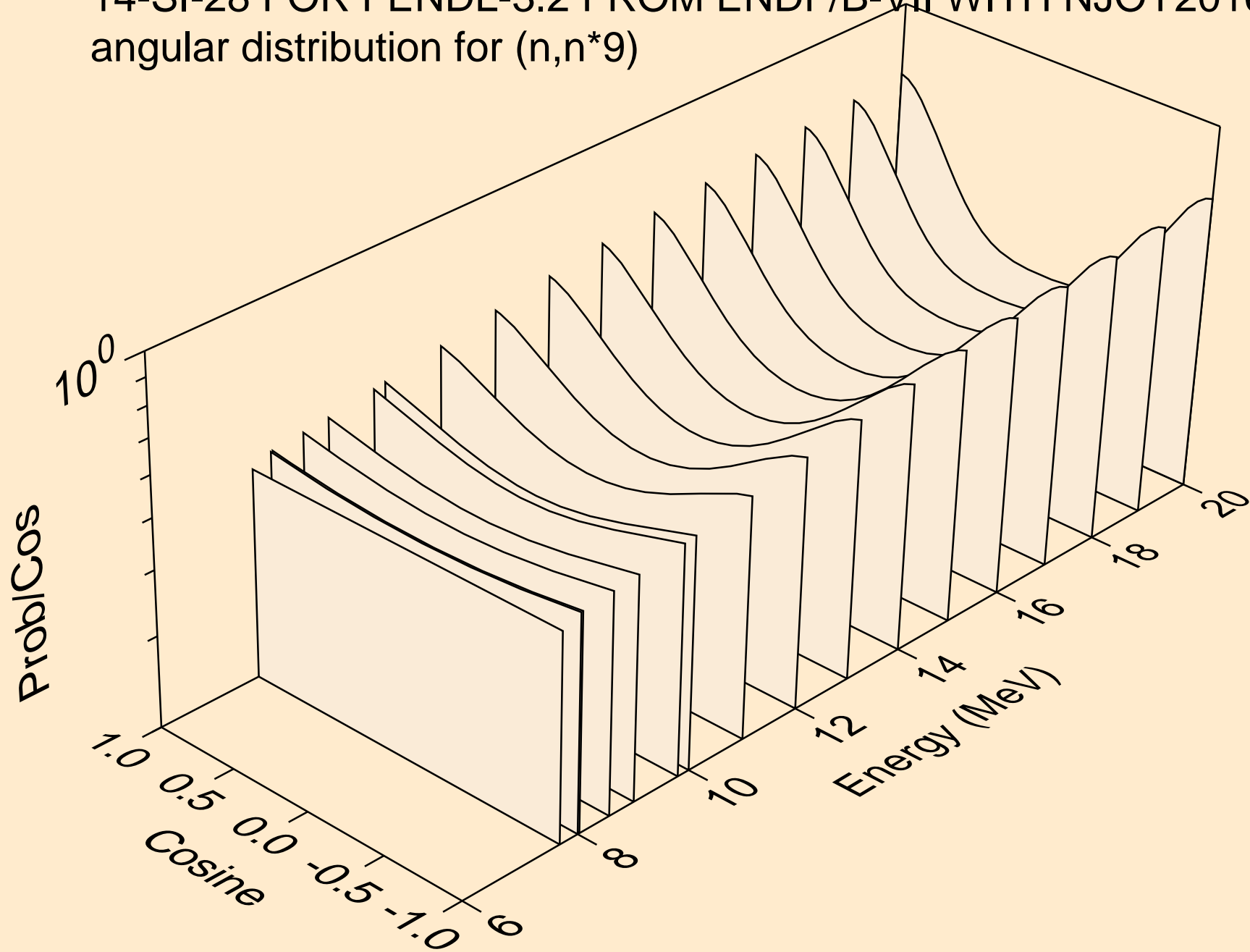

14-SI-28 FOR FENDL-3.2 FROM ENDF/B-VII WITH NJOY2016.60+
angular distribution for (n,n*10)

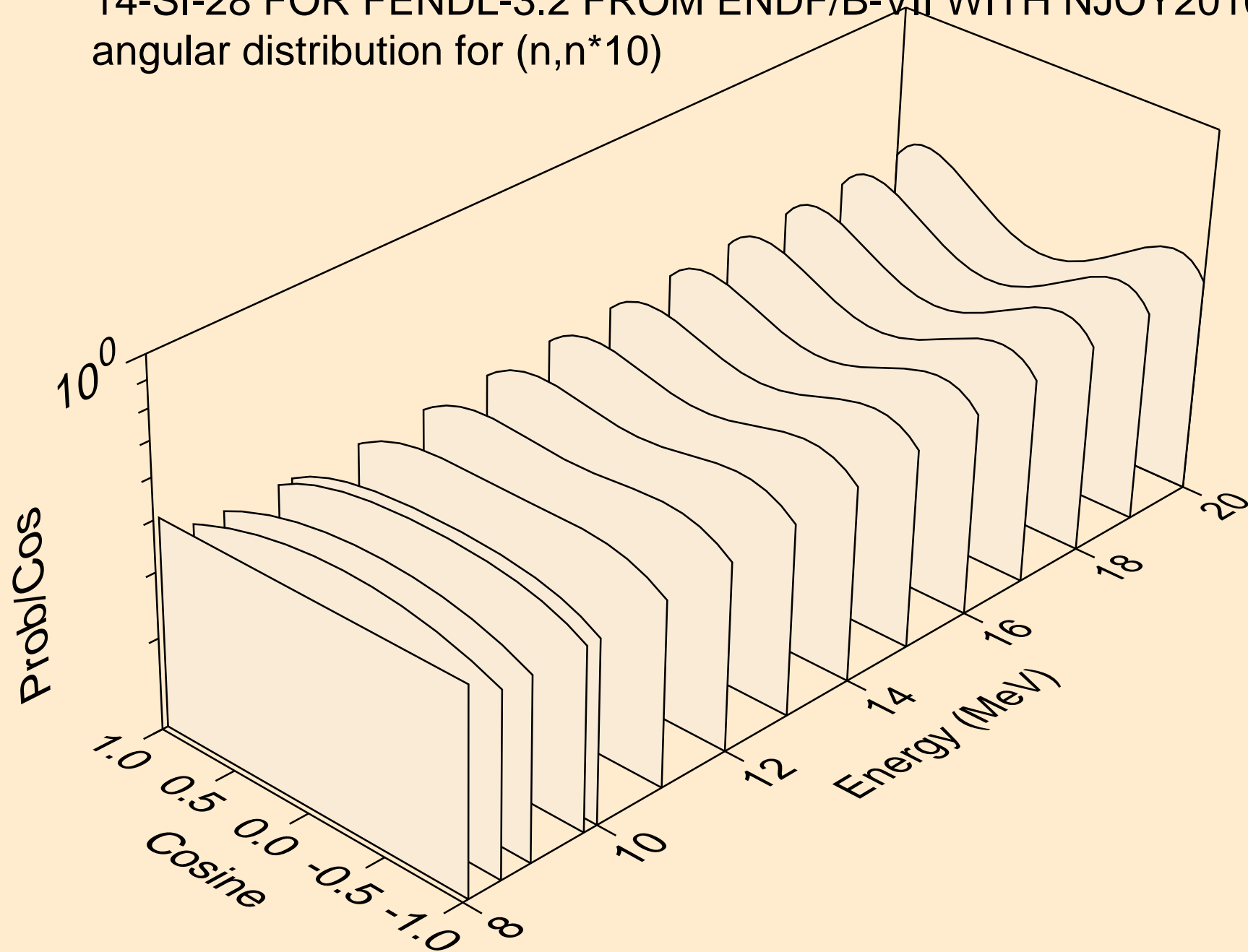

14-SI-28 FOR FENDL-3.2 FROM ENDF/B-VII WITH NJOY2016.60+
angular distribution for (n,n*11)

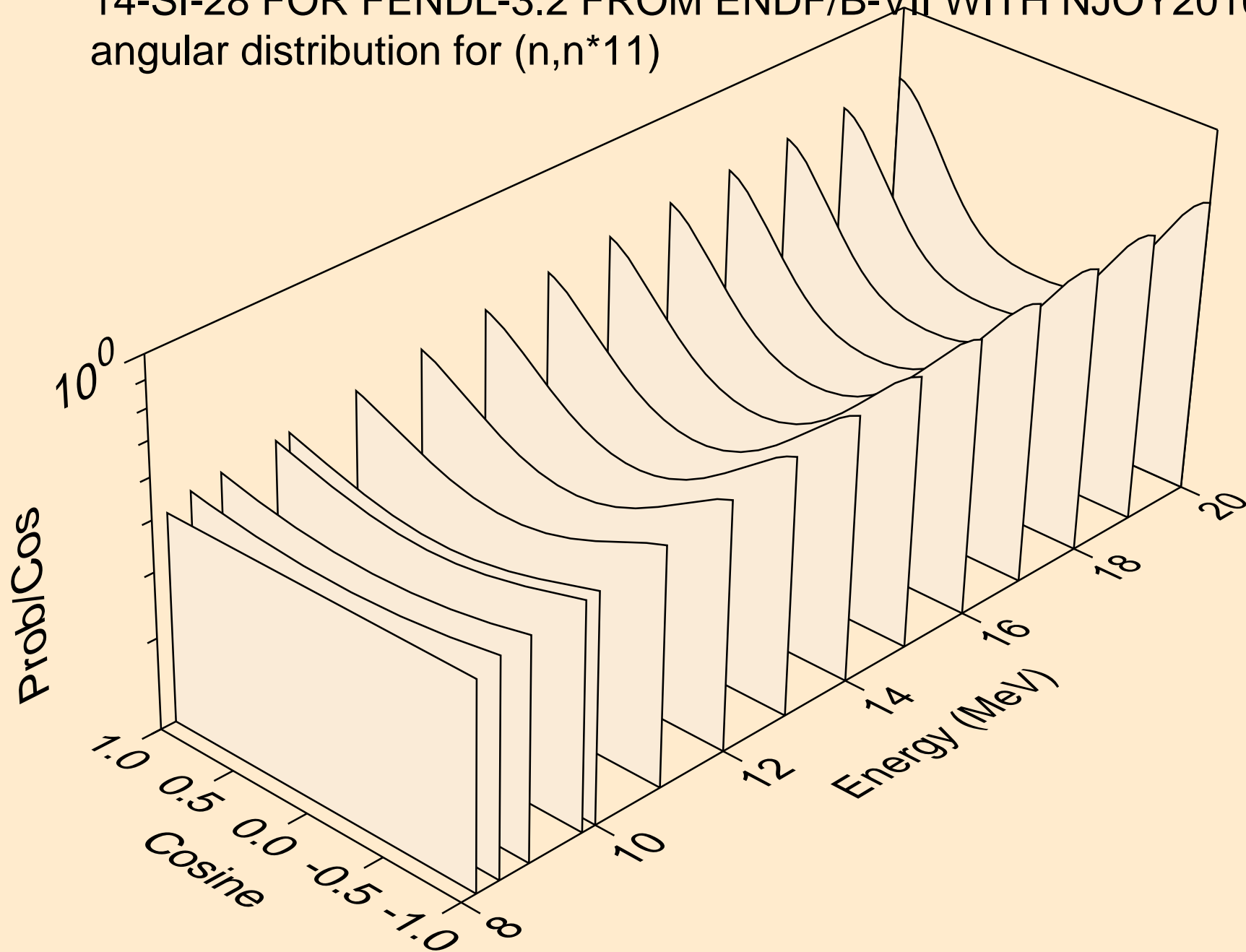

14-SI-28 FOR FENDL-3.2 FROM ENDF/B-VII WITH NJOY2016.60+
angular distribution for (n,n*12)

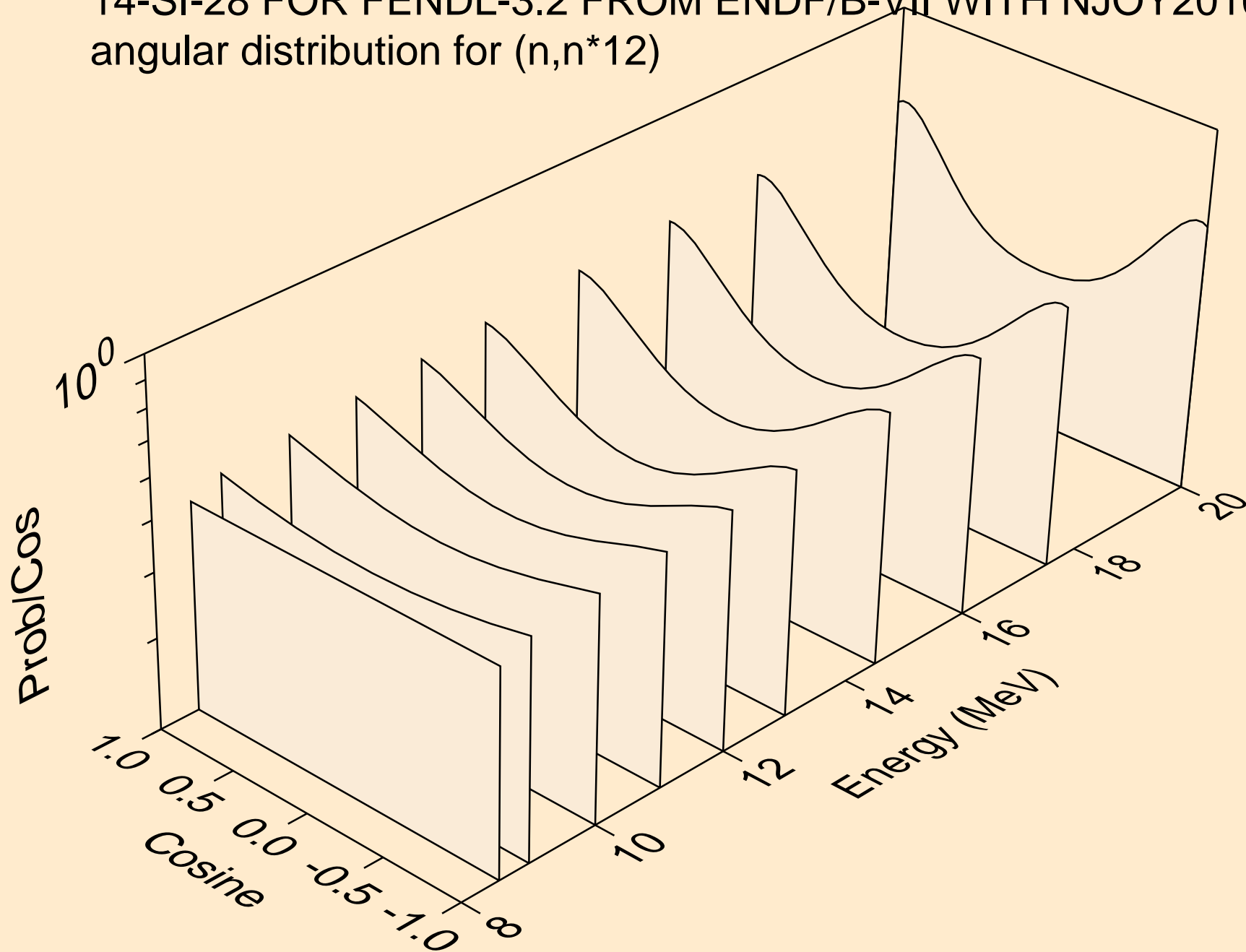

14-SI-28 FOR FENDL-3.2 FROM ENDF/B-VII WITH NJOY2016.60+
angular distribution for (n,n*13)

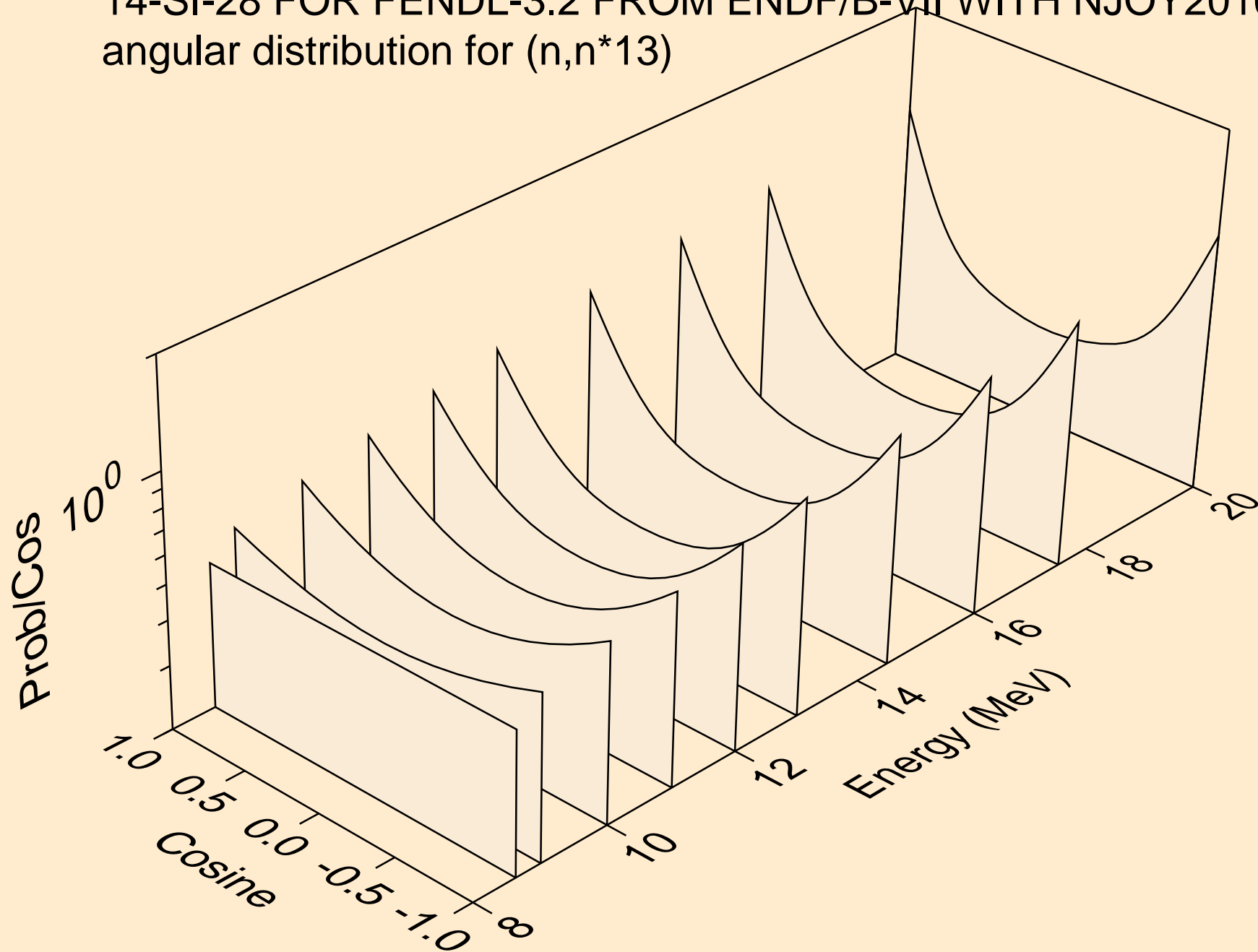

14-SI-28 FOR FENDL-3.2 FROM ENDF/B-VII WITH NJOY2016.60+
angular distribution for (n,n*14)

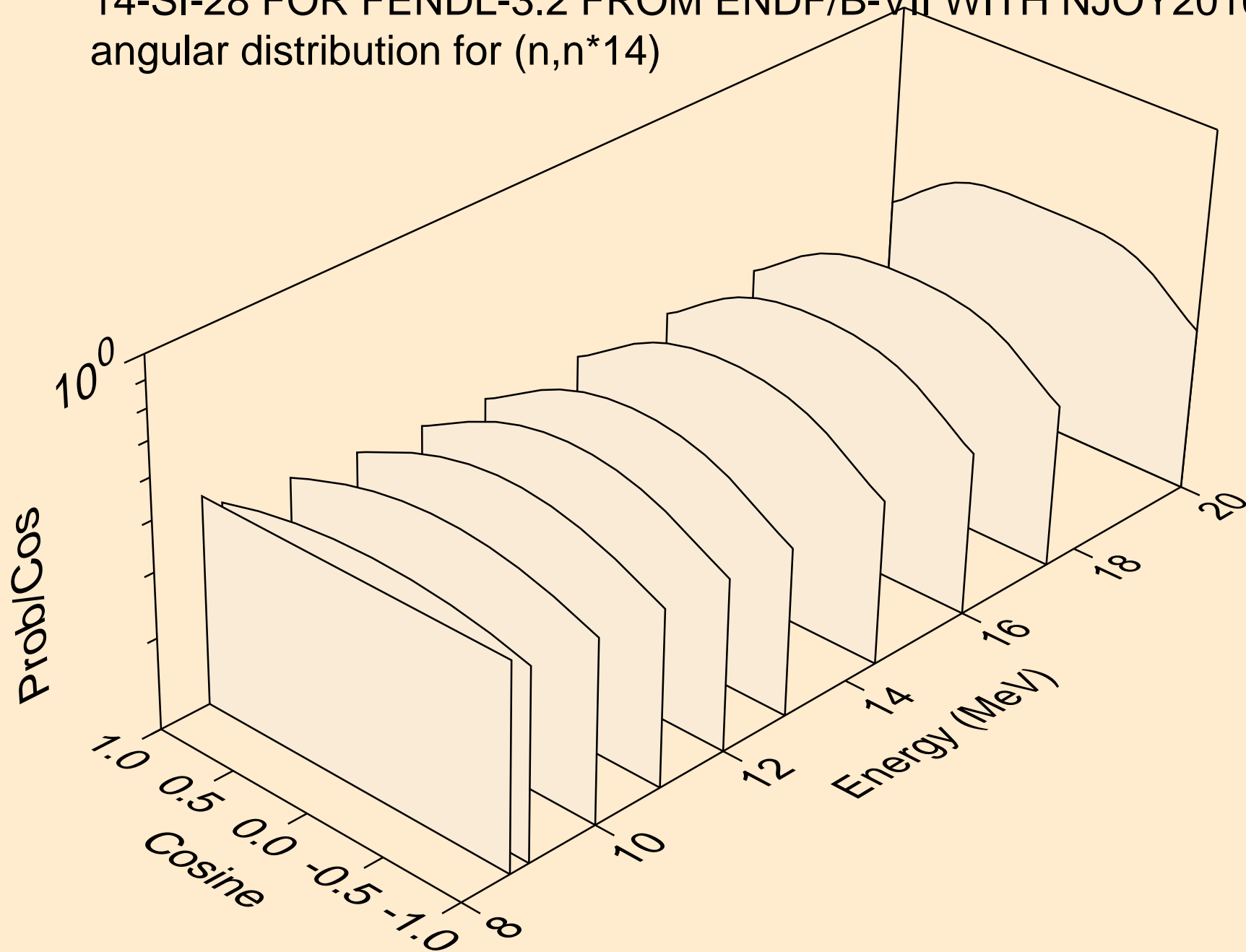

14-SI-28 FOR FENDL-3.2 FROM ENDF/B-VII WITH NJOY2016.60+
angular distribution for (n,n*15)

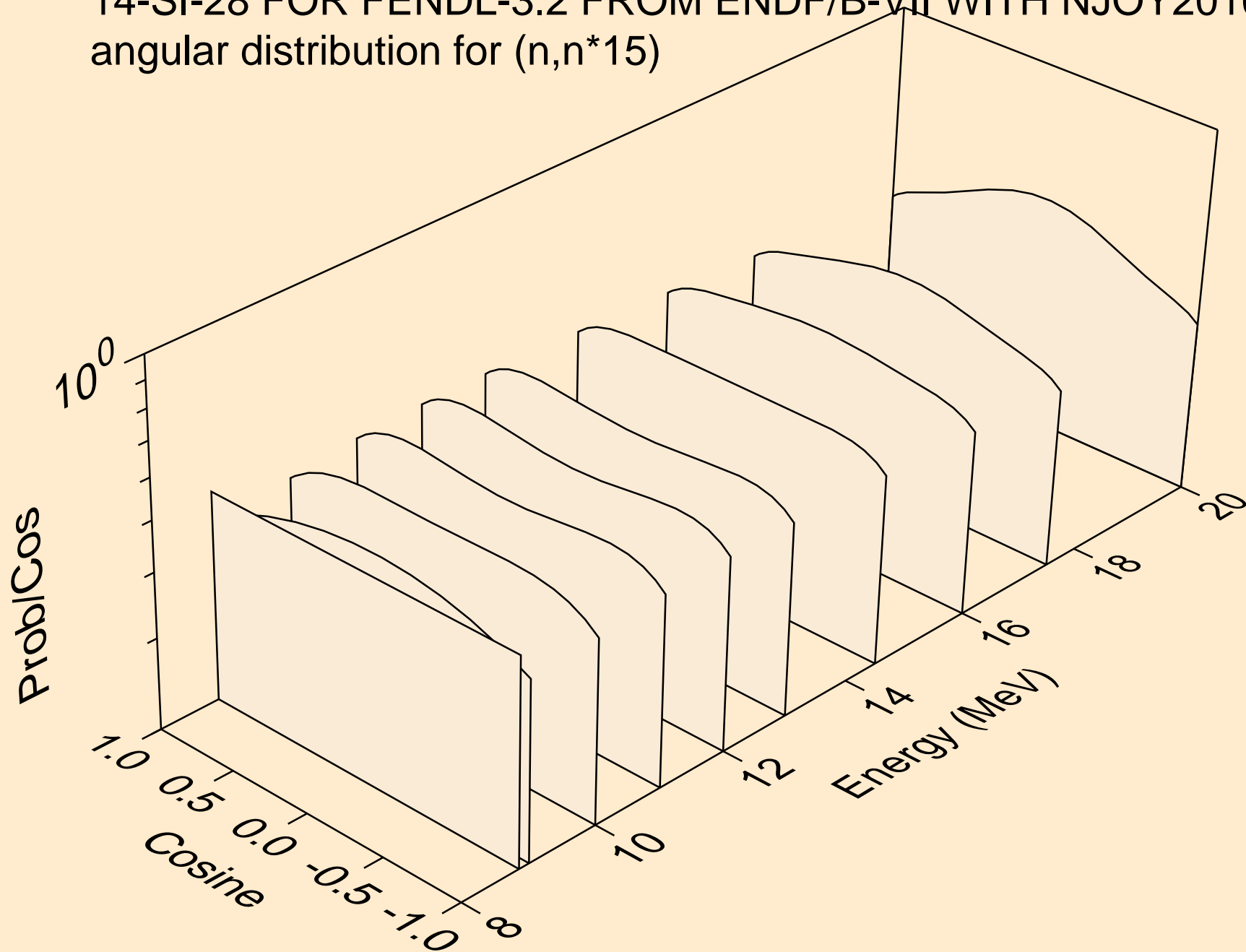

14-SI-28 FOR FENDL-3.2 FROM ENDF/B-VII WITH NJOY2016.60+
angular distribution for (n,n*16)

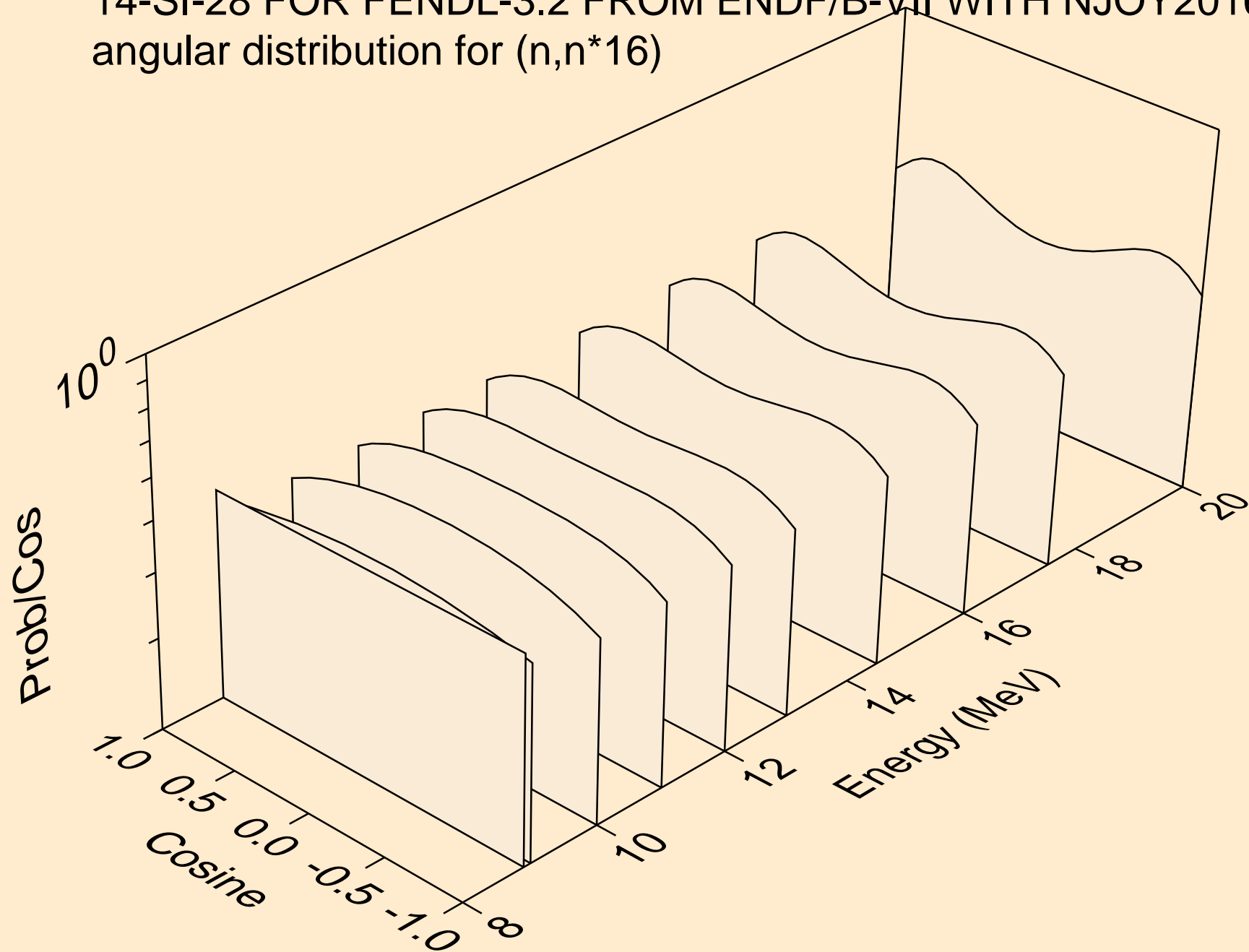

14-SI-28 FOR FENDL-3.2 FROM ENDF/B-VII WITH NJOY2016.60+
angular distribution for (n,n*17)

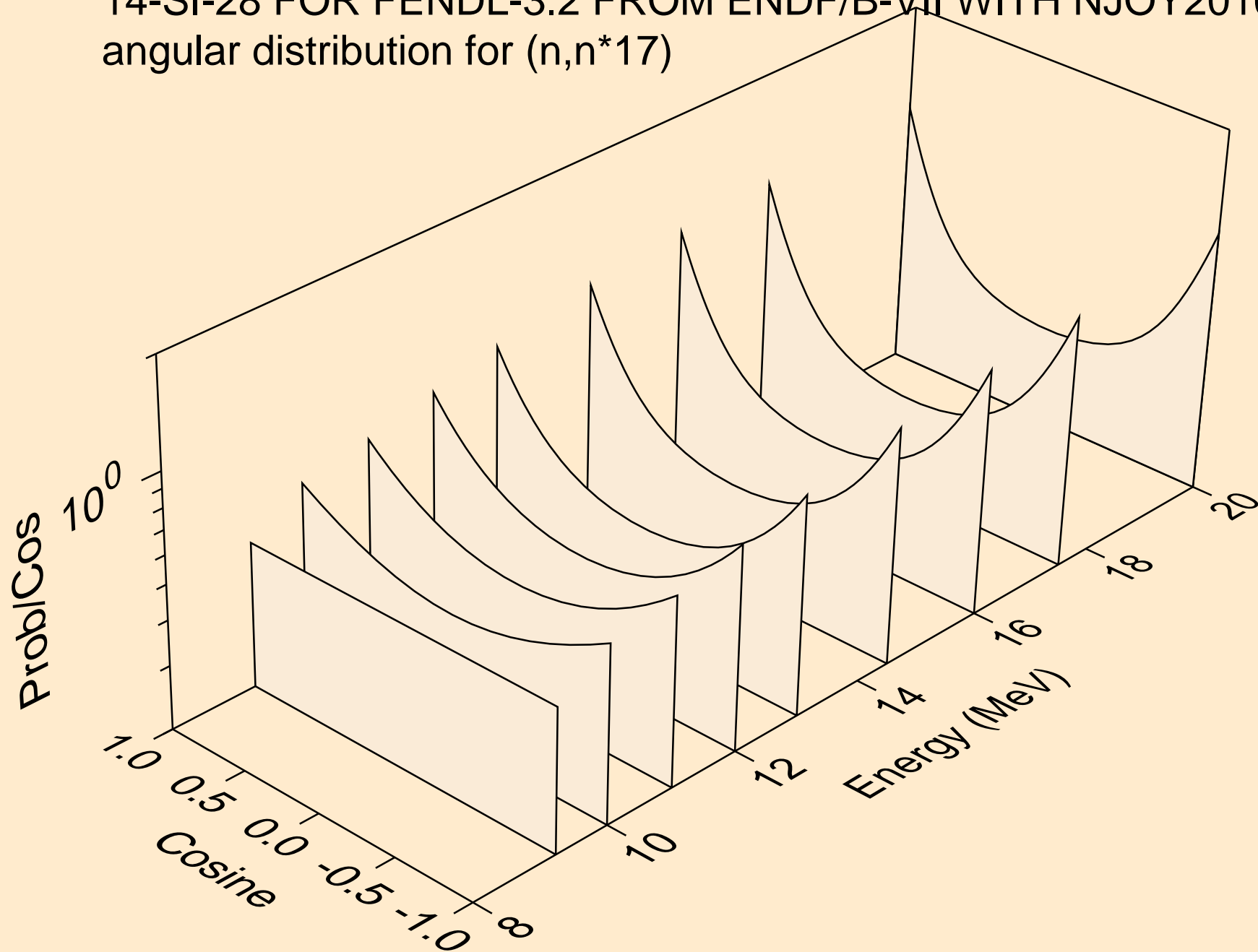

14-SI-28 FOR FENDL-3.2 FROM ENDF/B-VII WITH NJOY2016.60+
Neutron emission for (n,x)

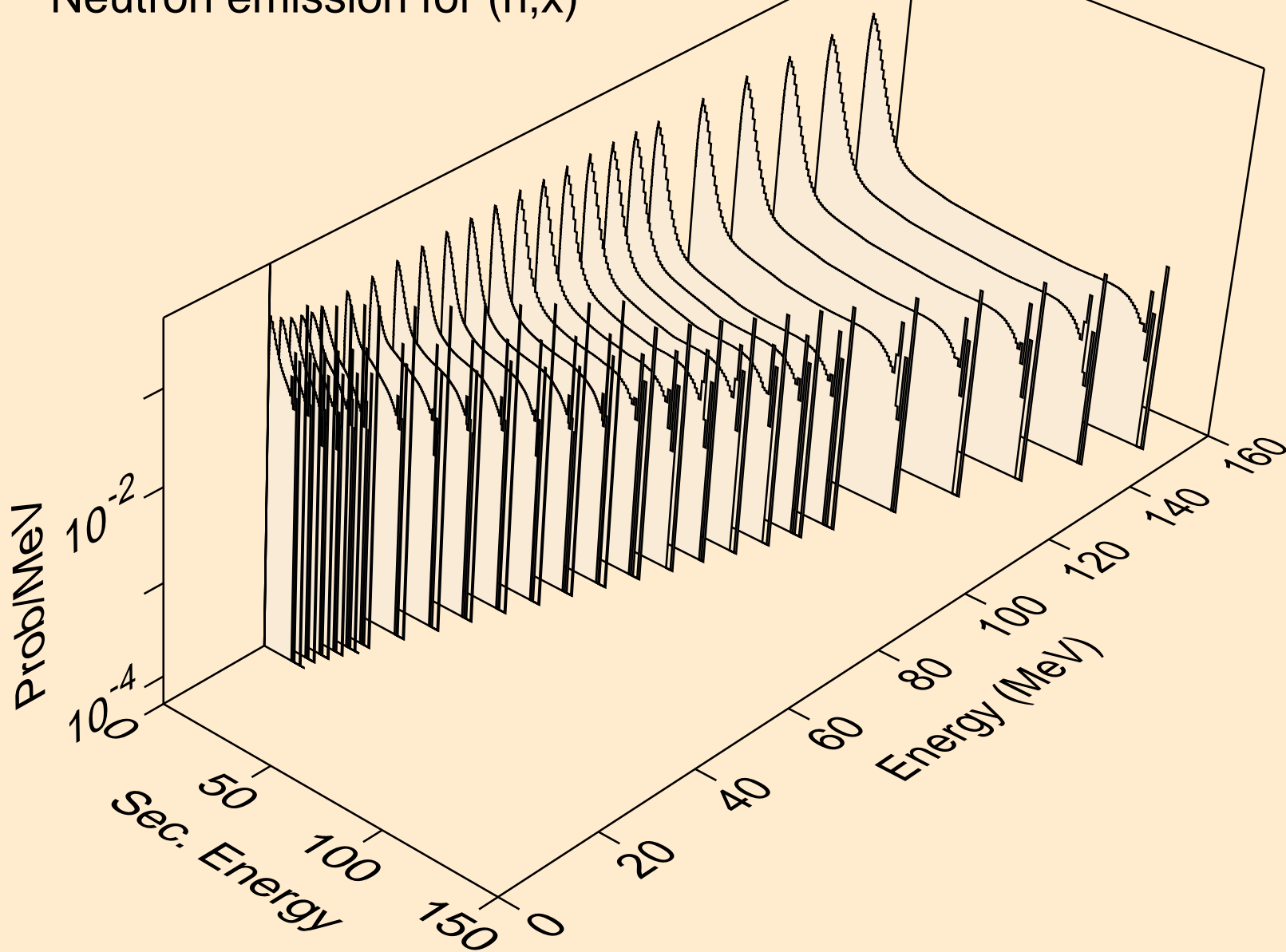

14-SI-28 FOR FENDL-3.2 FROM ENDF/B-VII WITH NJOY2016.60+
Neutron emission for (n,2n)

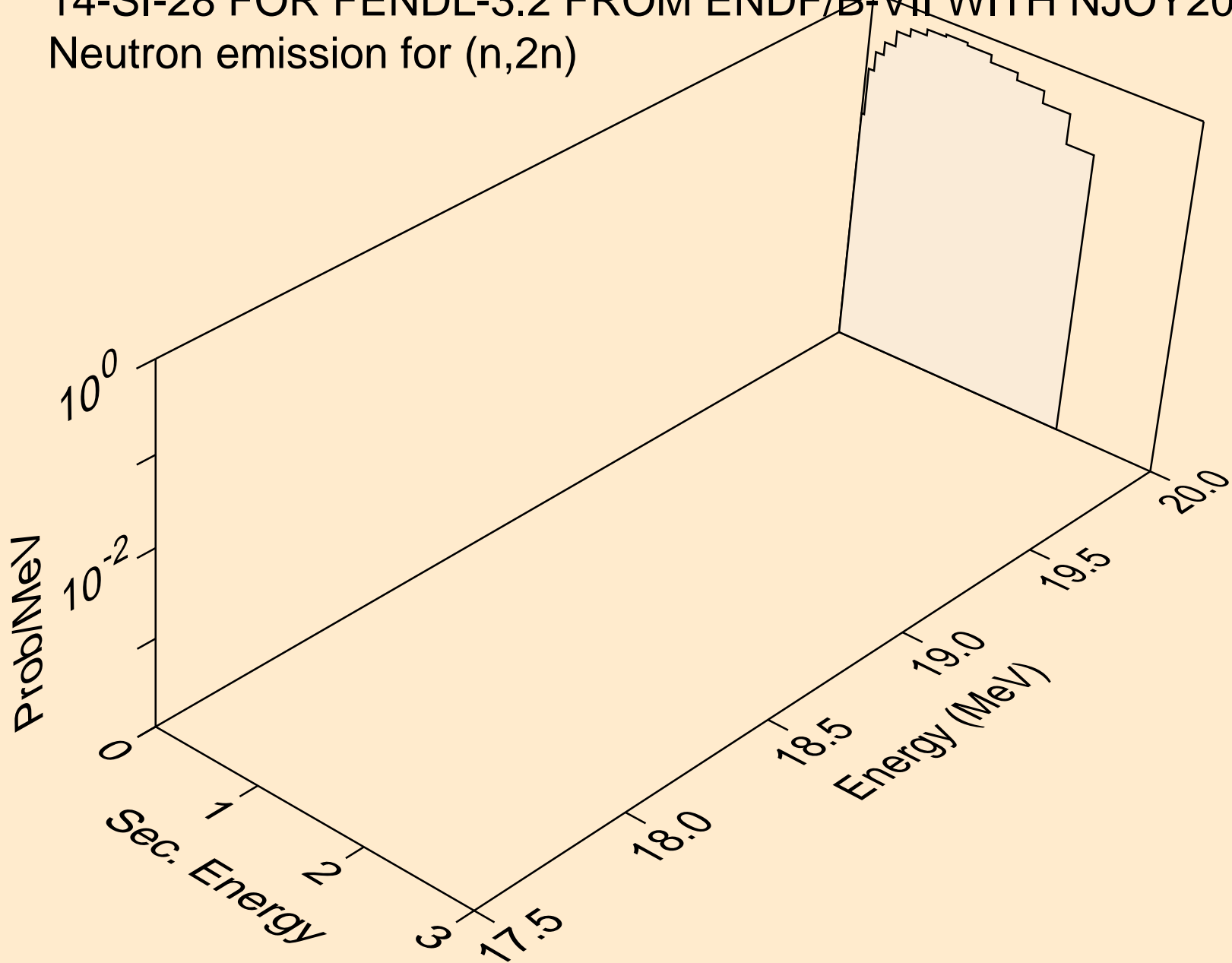

14-SI-28 FOR FENDL-3.2 FROM ENDF/B-VII WITH NJOY2016.60+
Neutron emission for (n,n*)a

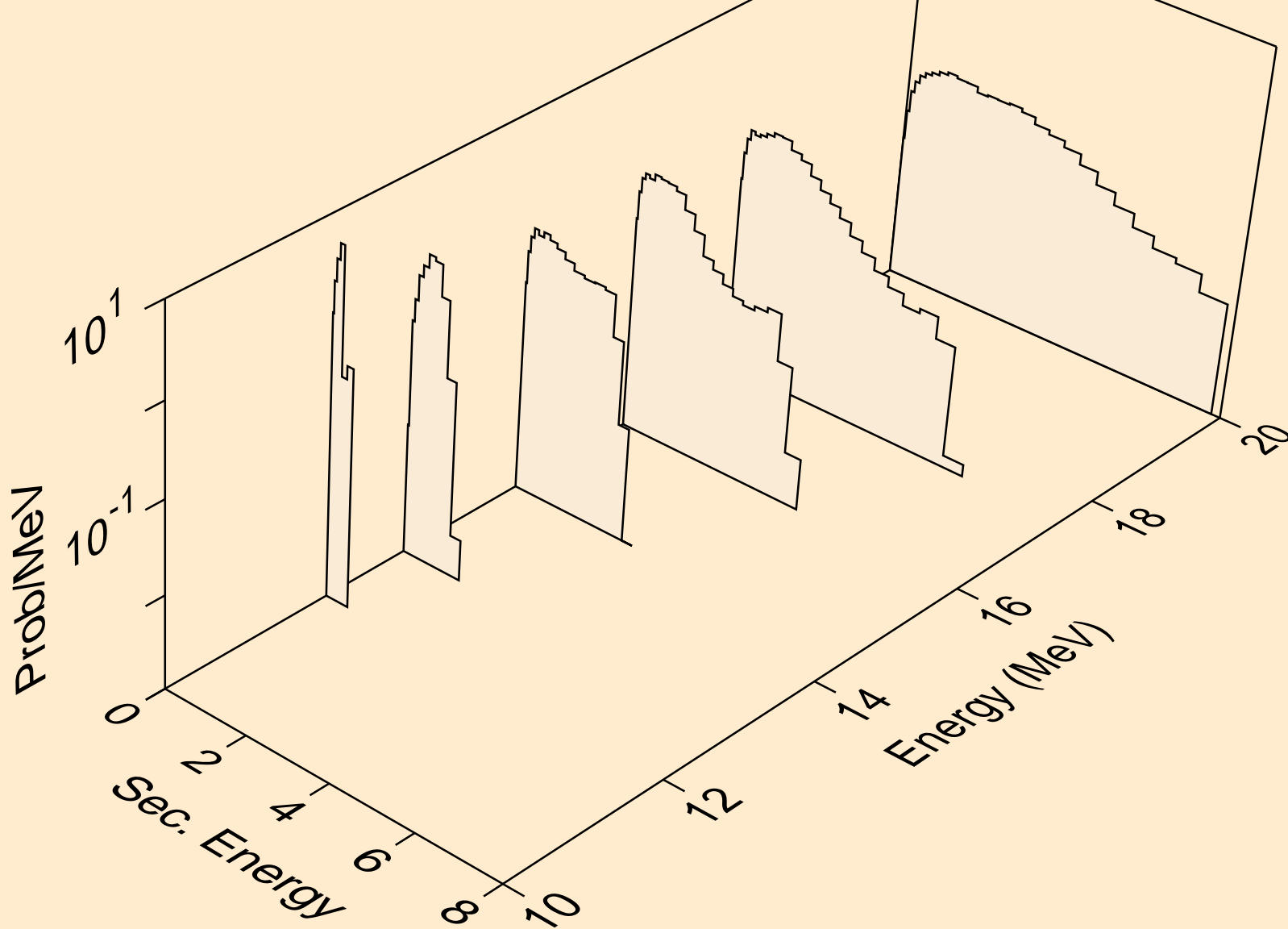

14-SI-28 FOR FENDL-3.2 FROM ENDF/B-VII WITH NJOY2016.60+
Neutron emission for (n,n*)p

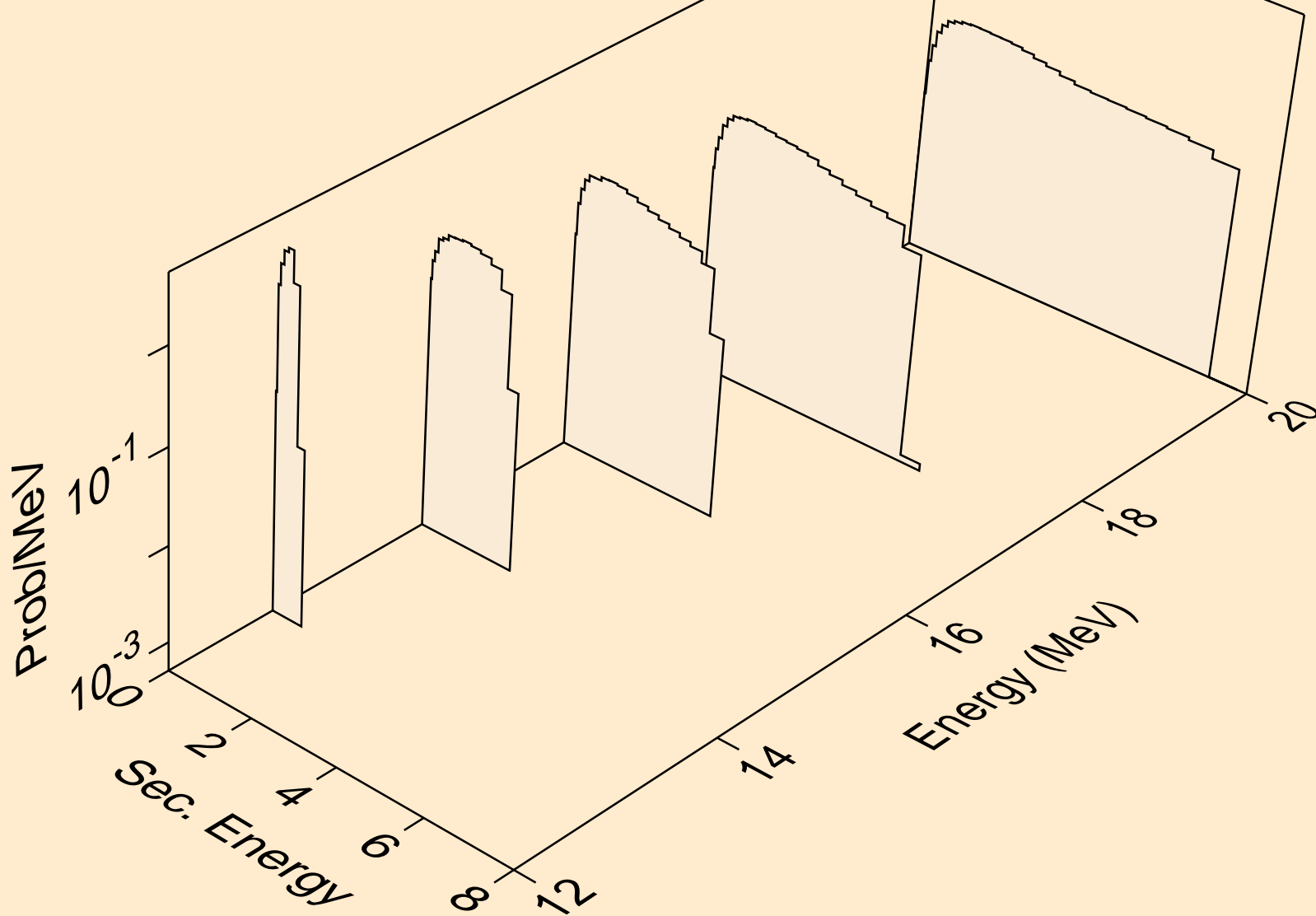

14-SI-28 FOR FENDL-3.2 FROM ENDF/B-VII WITH NJOY2016.60+
Neutron emission for (n,n*c)

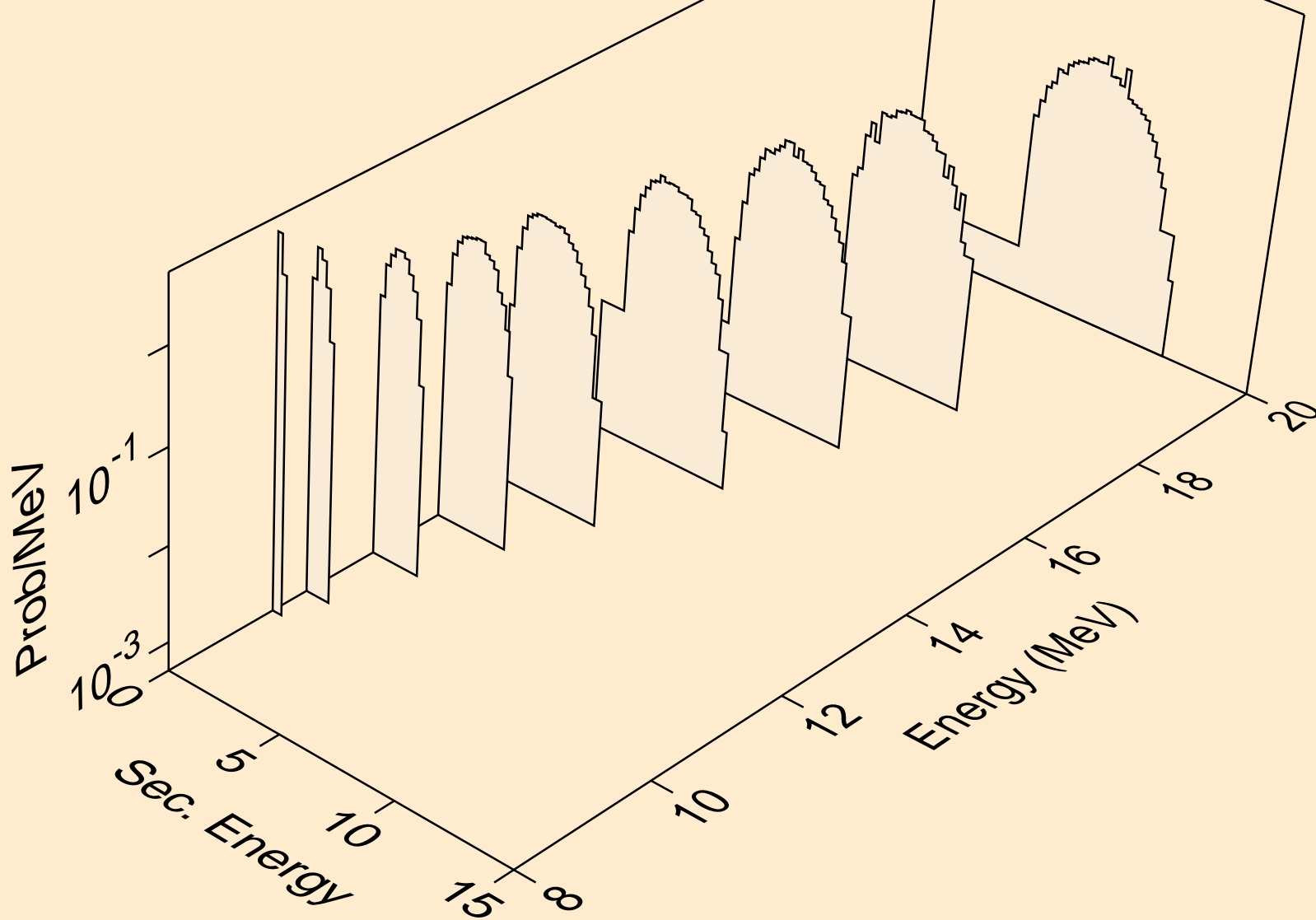

14-SI-28 FOR FENDL-3.2 FROM ENDF/B-VII WITH NJOY2016.60+
Photon emission for (n,x)

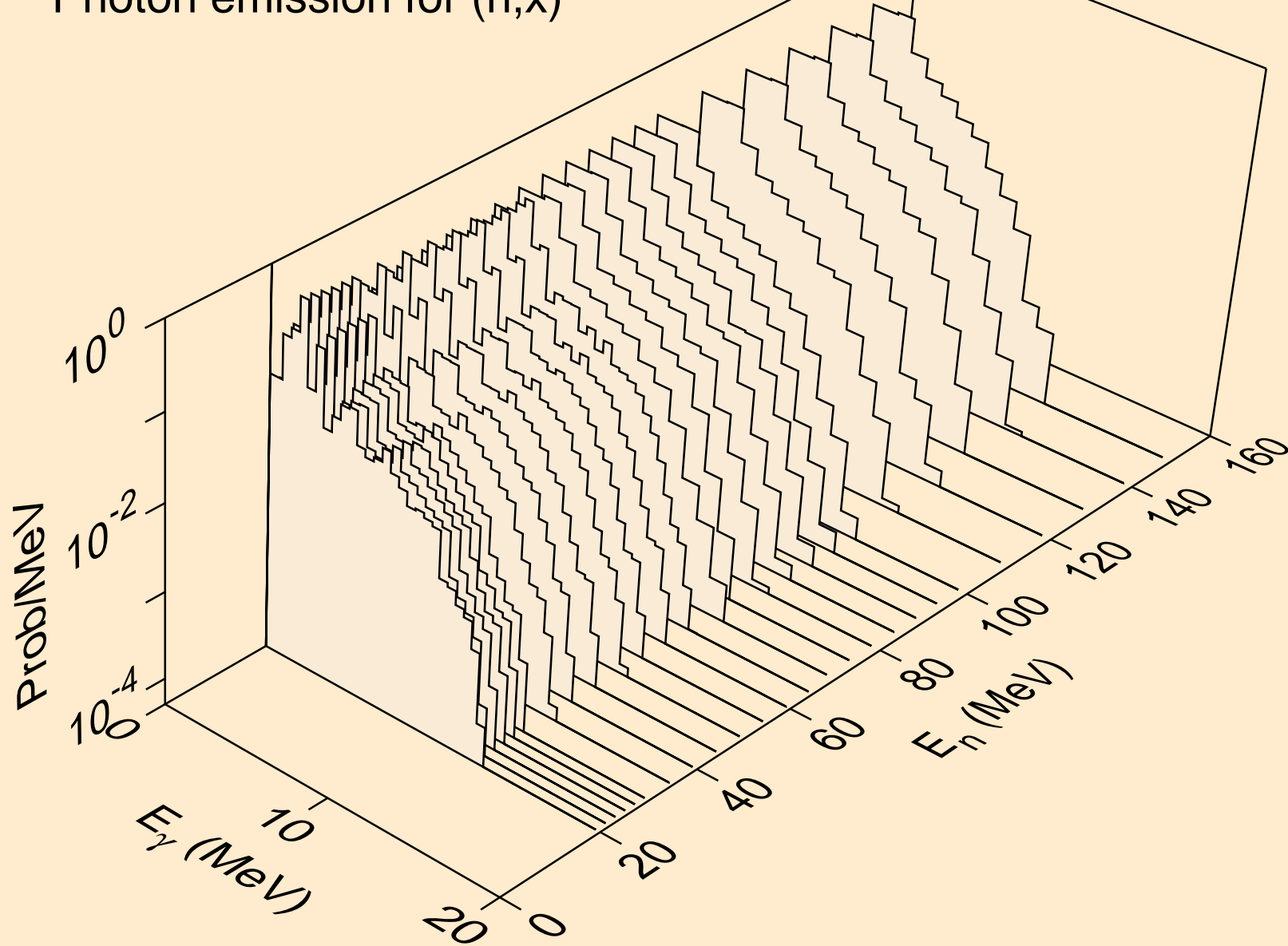

14-SI-28 FOR FENDL-3.2 FROM ENDF/B-VII WITH NJOY2016.60+
Photon emission for (n,2n)

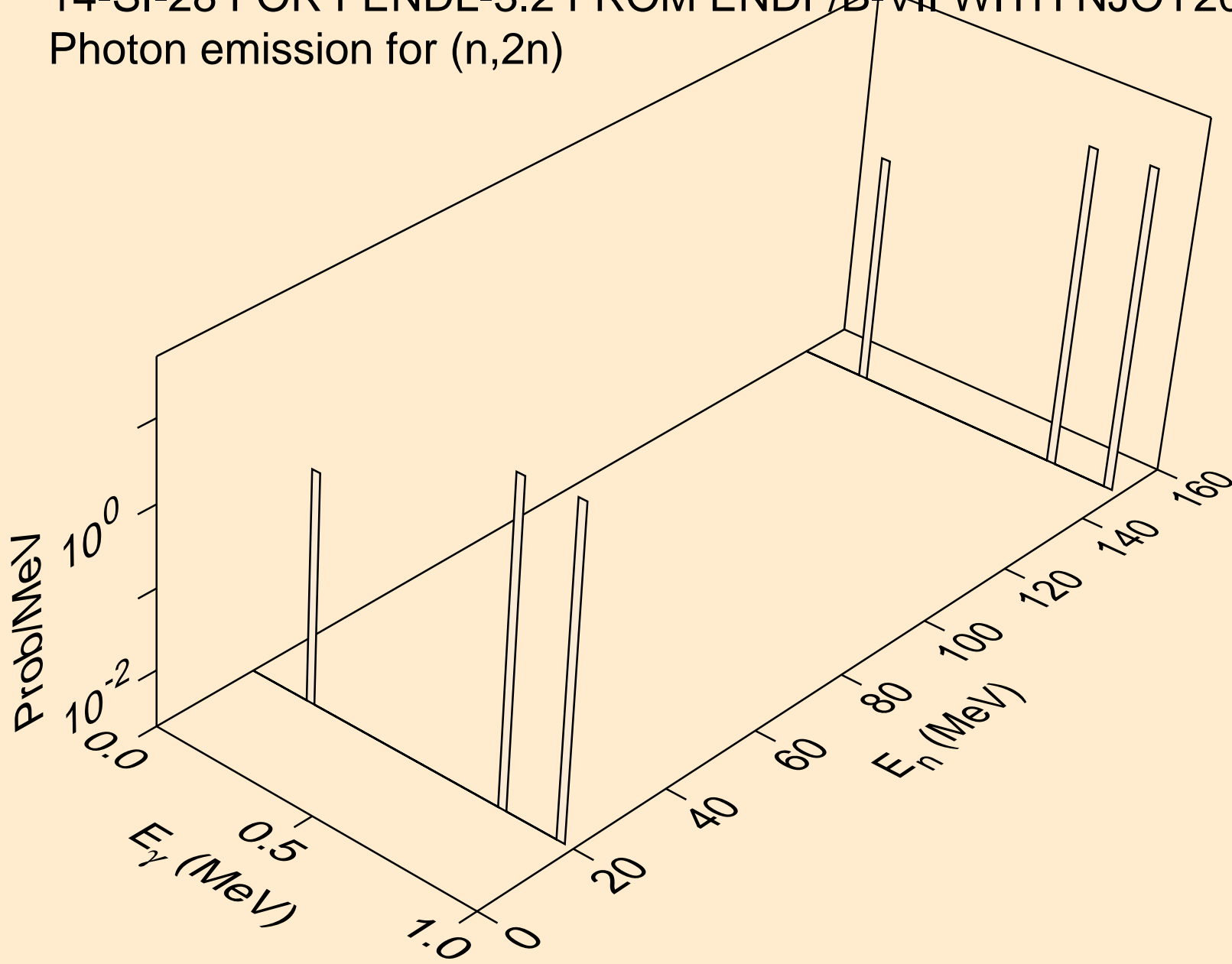

14-SI-28 FOR FENDL-3.2 FROM ENDF/B-VII WITH NJOY2016.60+
Photon emission for (n,n*)a

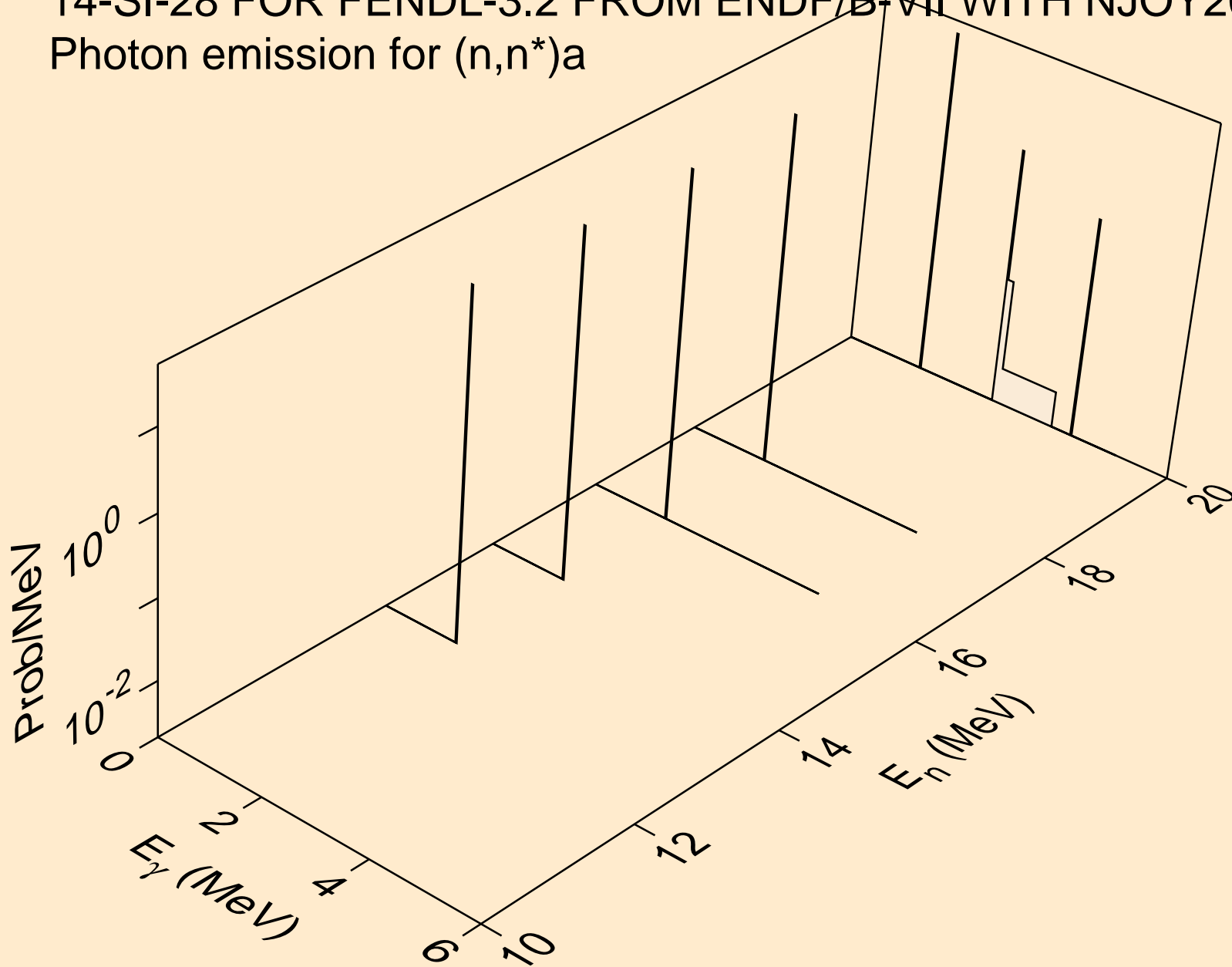

14-SI-28 FOR FENDL-3.2 FROM ENDF/B-VII WITH NJOY2016.60+
Photon emission for (n,n*)p

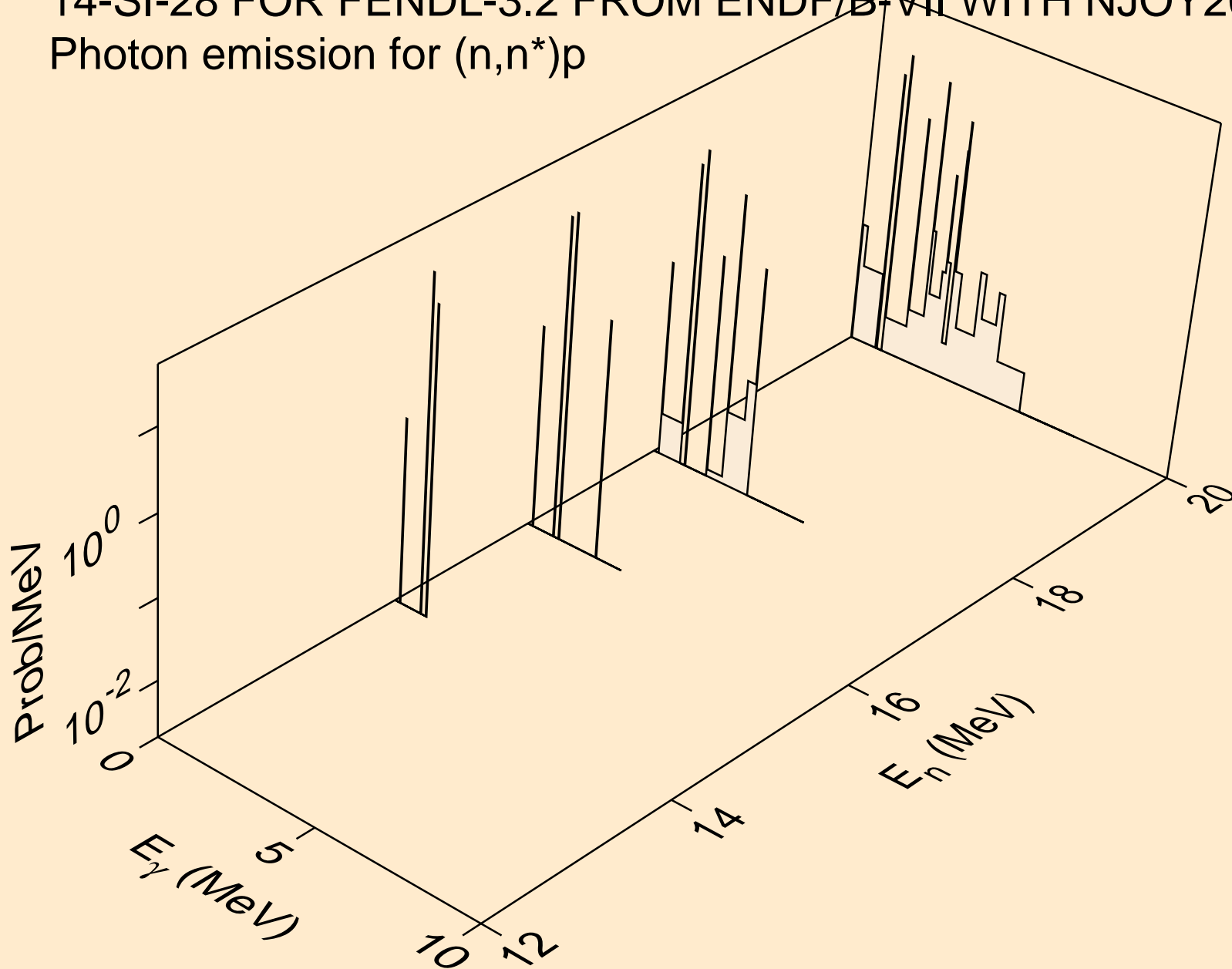

14-SI-28 FOR FENDL-3.2 FROM ENDF/B-VII WITH NJOY2016.60+
Photon emission for (n,n*c)

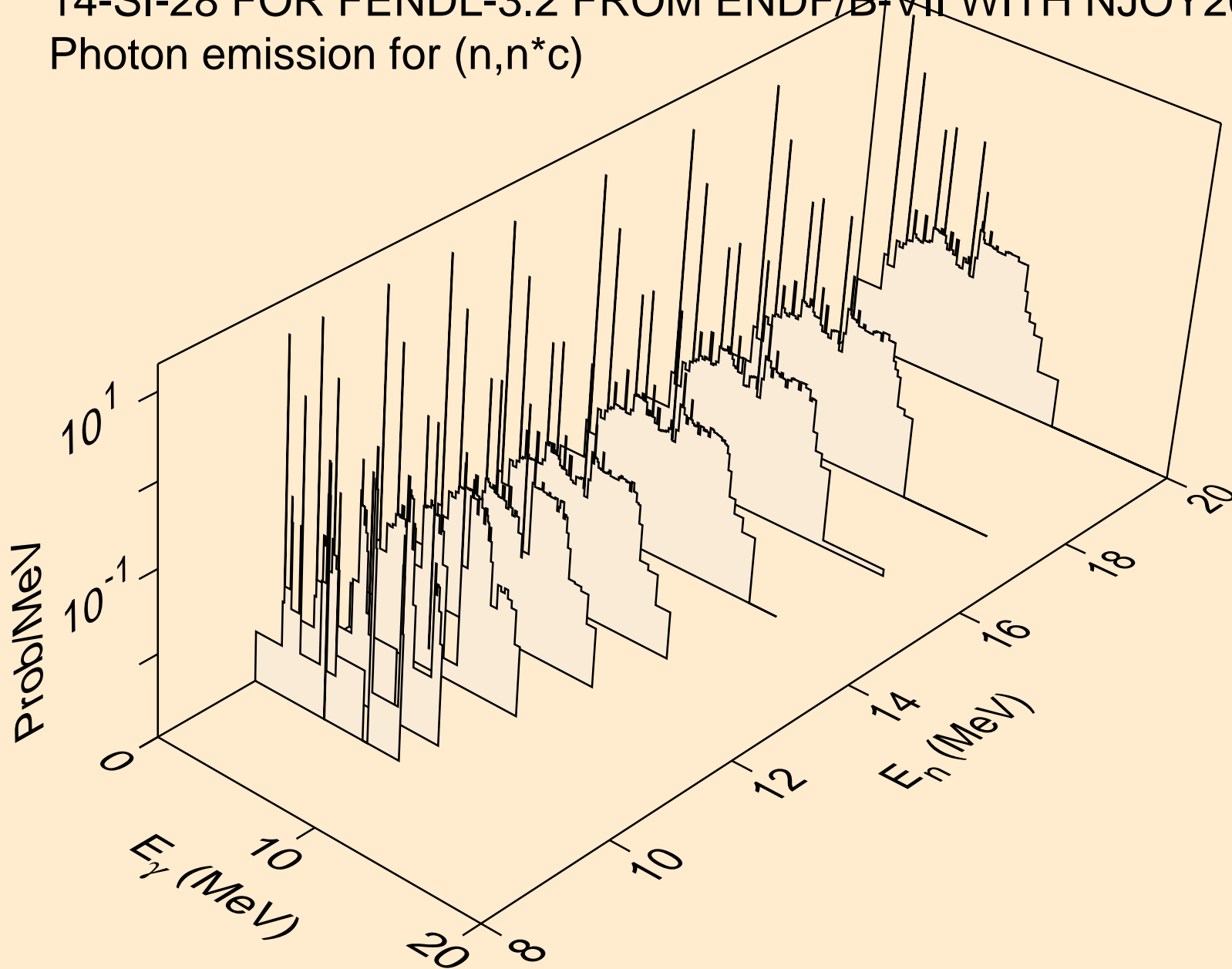

14-SI-28 FOR FENDL-3.2 FROM ENDF/B-VII WITH NJOY2016.60+
Photon emission for (n,p*c)

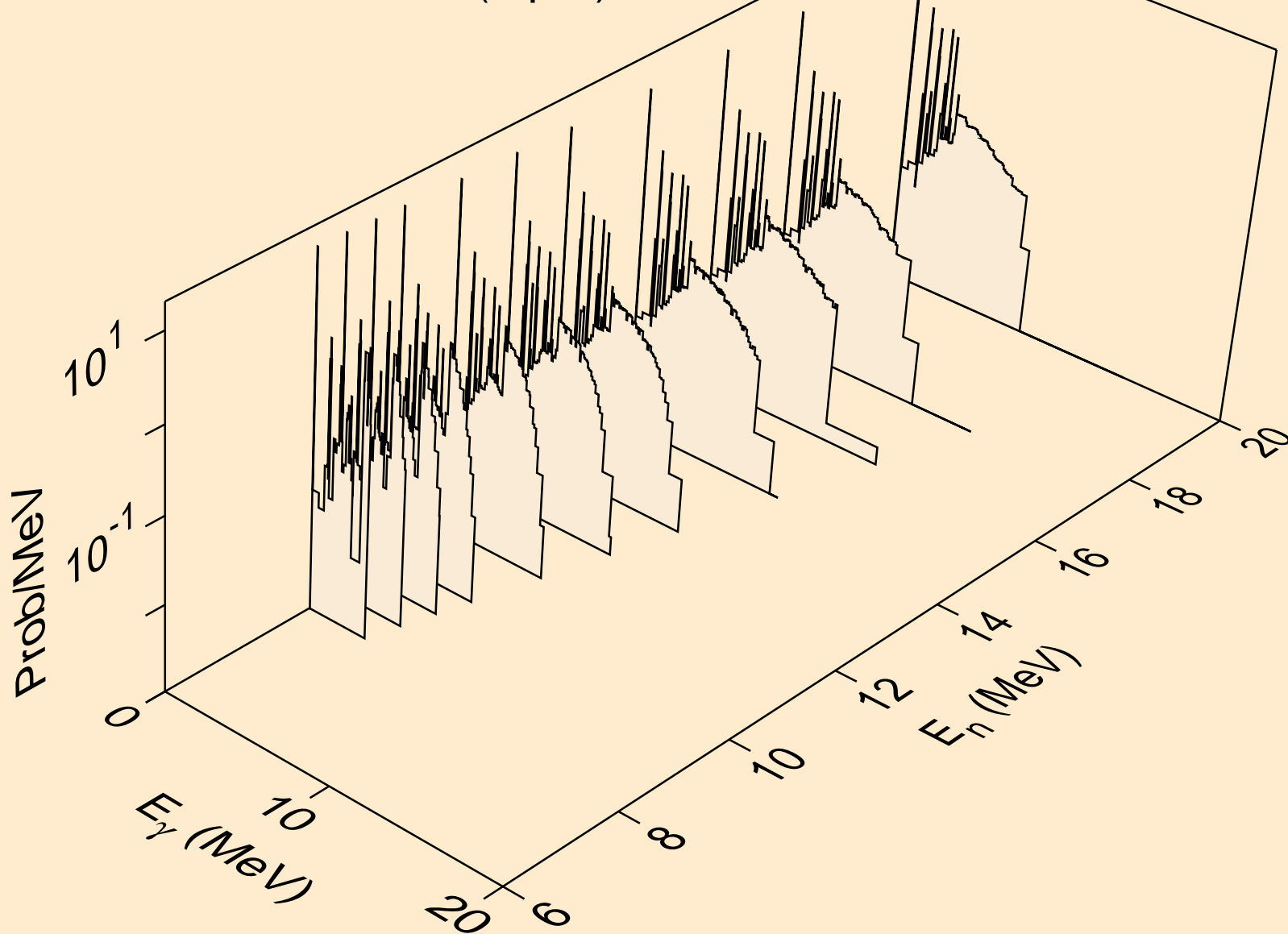

14-SI-28 FOR FENDL-3.2 FROM ENDF/B-VII WITH NJOY2016.60+
Photon emission for (n,a*c)

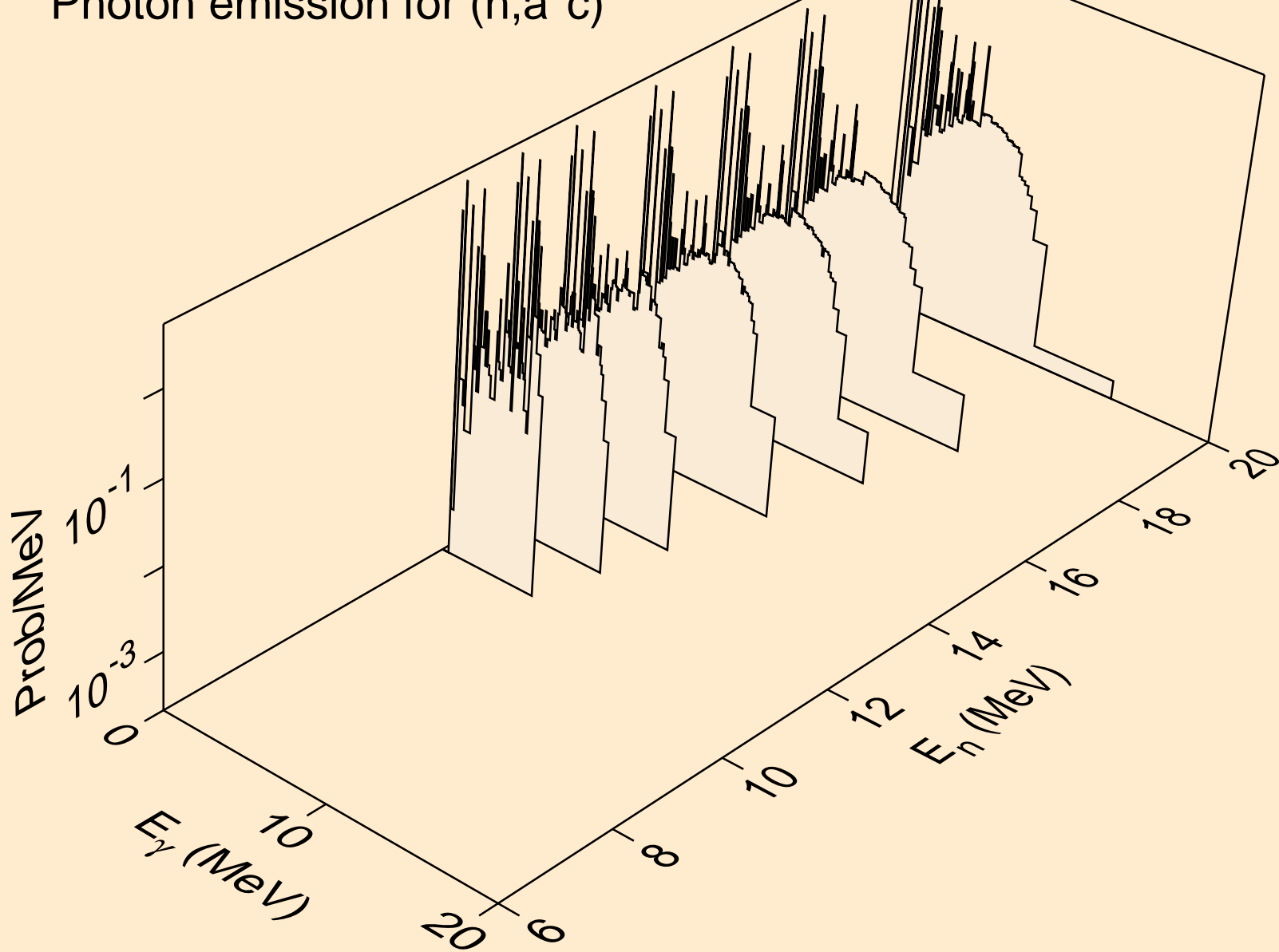

14-SI-28 FOR FENDL-3.2 FROM ENDF/B-VII WITH NJOY2016.60+
thermal capture photon spectrum

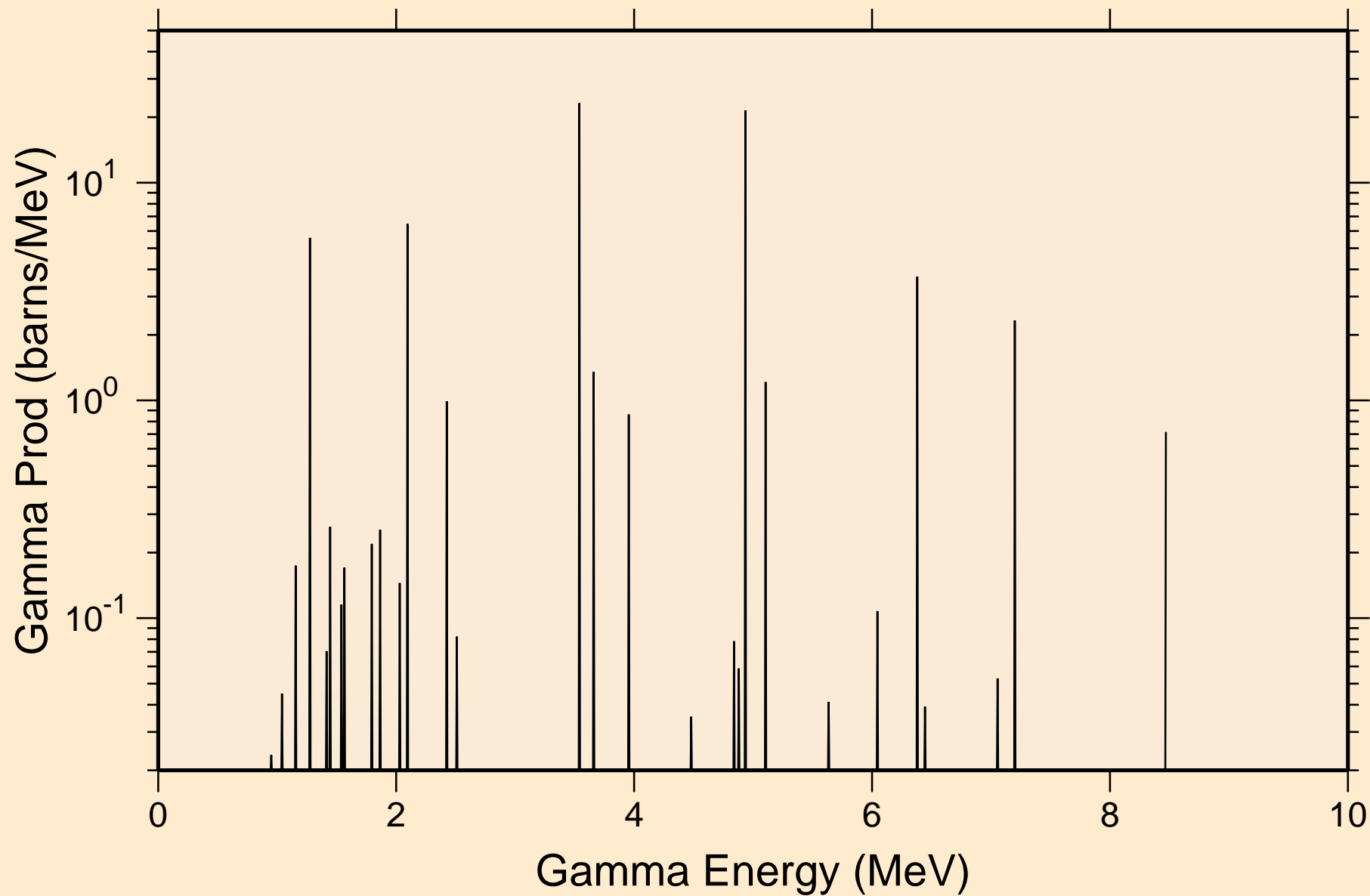

14-SI-28 FOR FENDL-3.2 FROM ENDF/B-VII WITH NJOY2016.60+
14 MeV photon spectrum

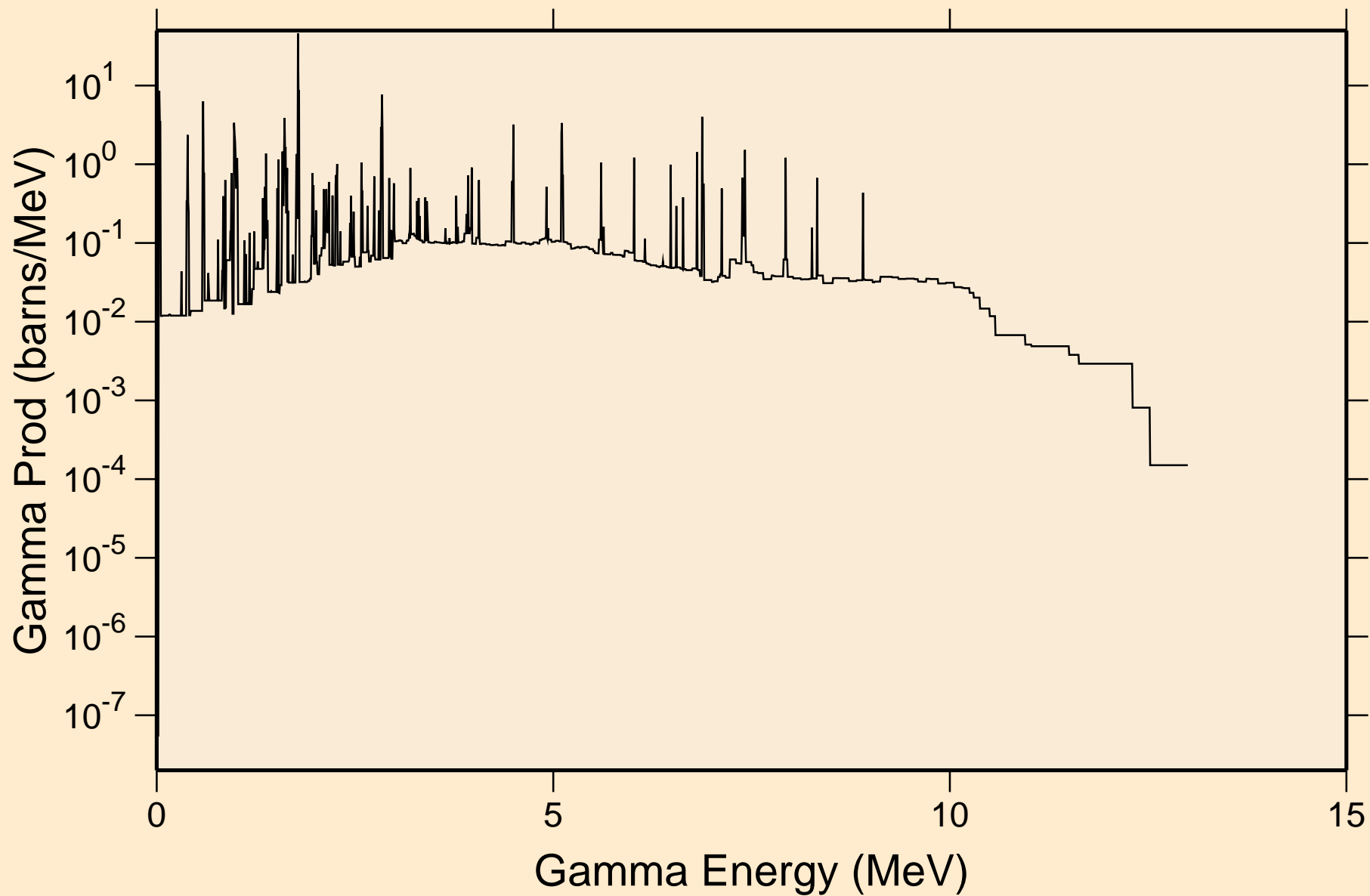

14-SI-28 FOR FENDL-3.2 FROM ENDF/B-VII WITH NJOY2016.60+

Particle heating contributions

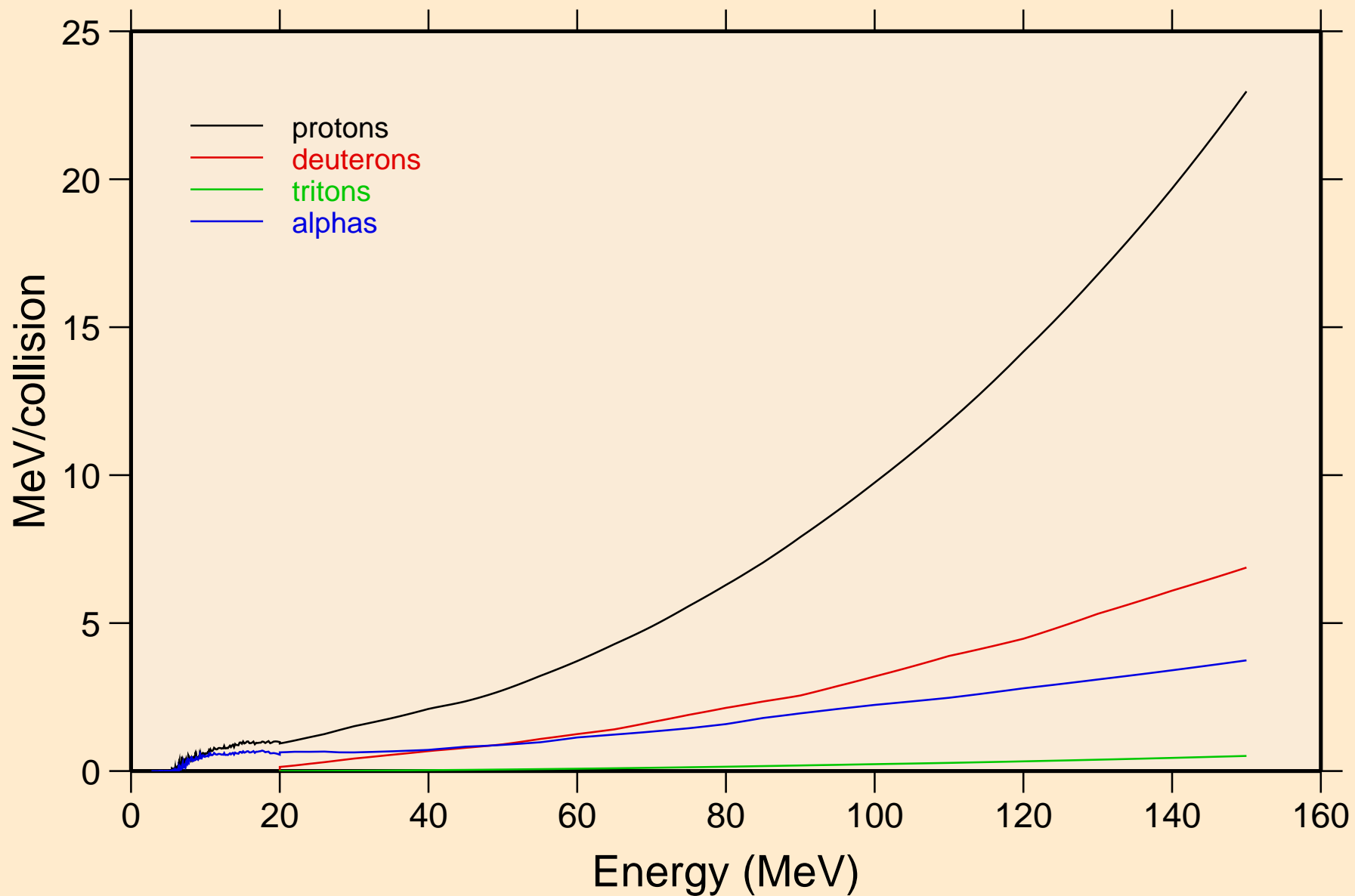

14-SI-28 FOR FENDL-3.2 FROM ENDF/B-VII WITH NJOY2016.60+ Recoil Heating

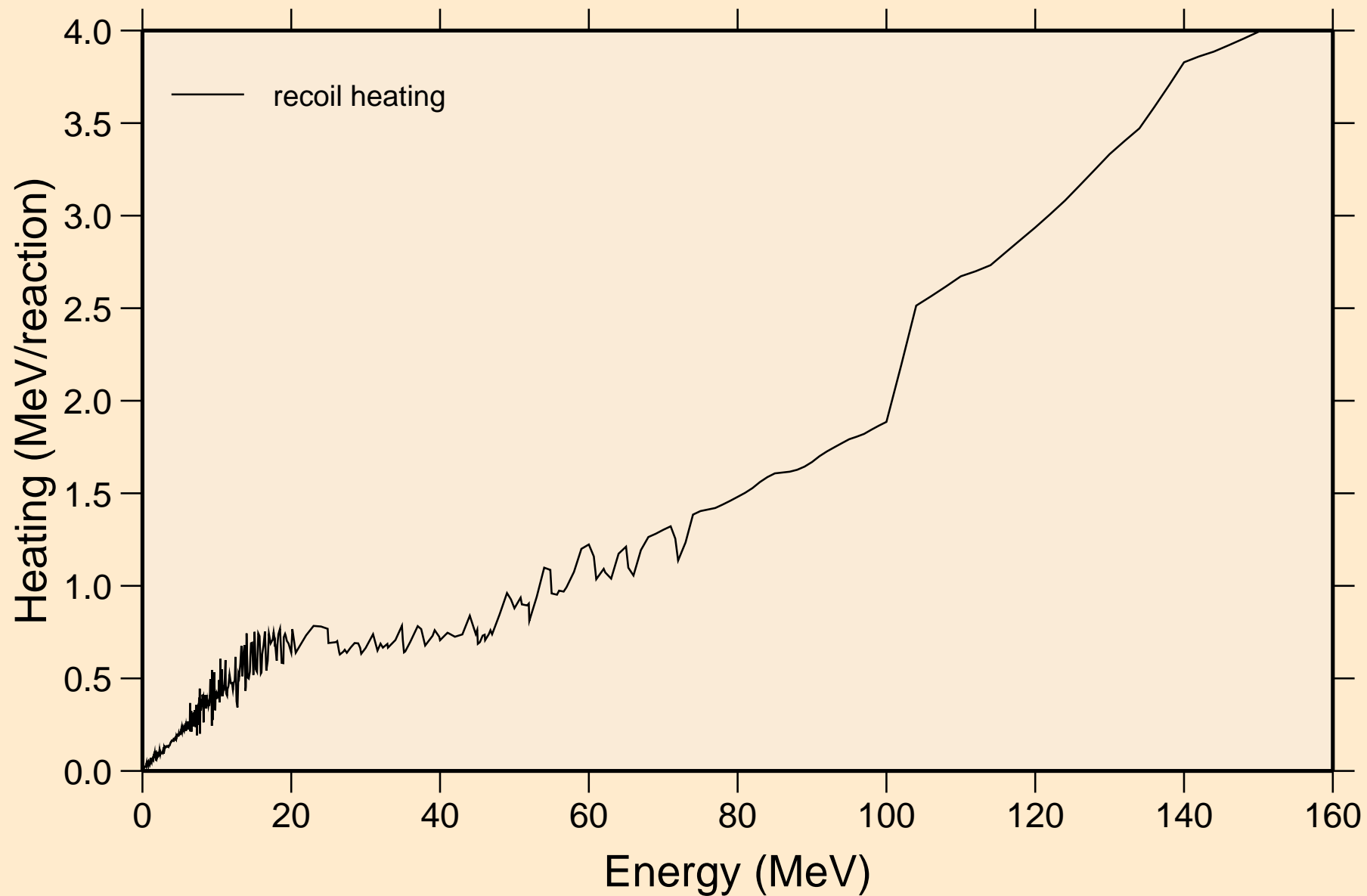

14-SI-28 FOR FENDL-3.2 FROM ENDF/B-VII WITH NJOY2016.60+

Particle production cross sections

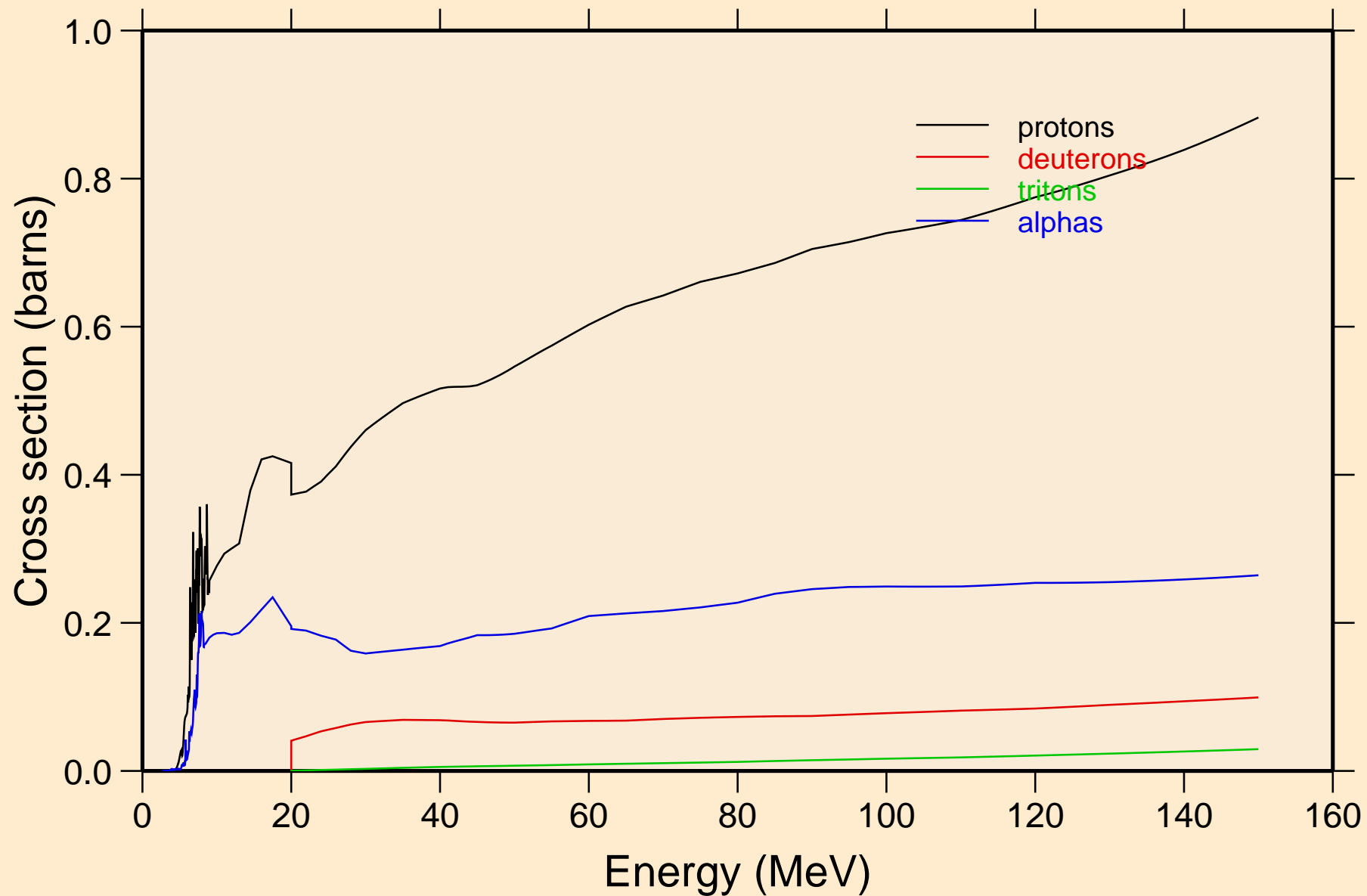

14-SI-28 FOR FENDL-3.2 FROM ENDF/B-VII WITH NJOY2016.60+
protons from (n,x)

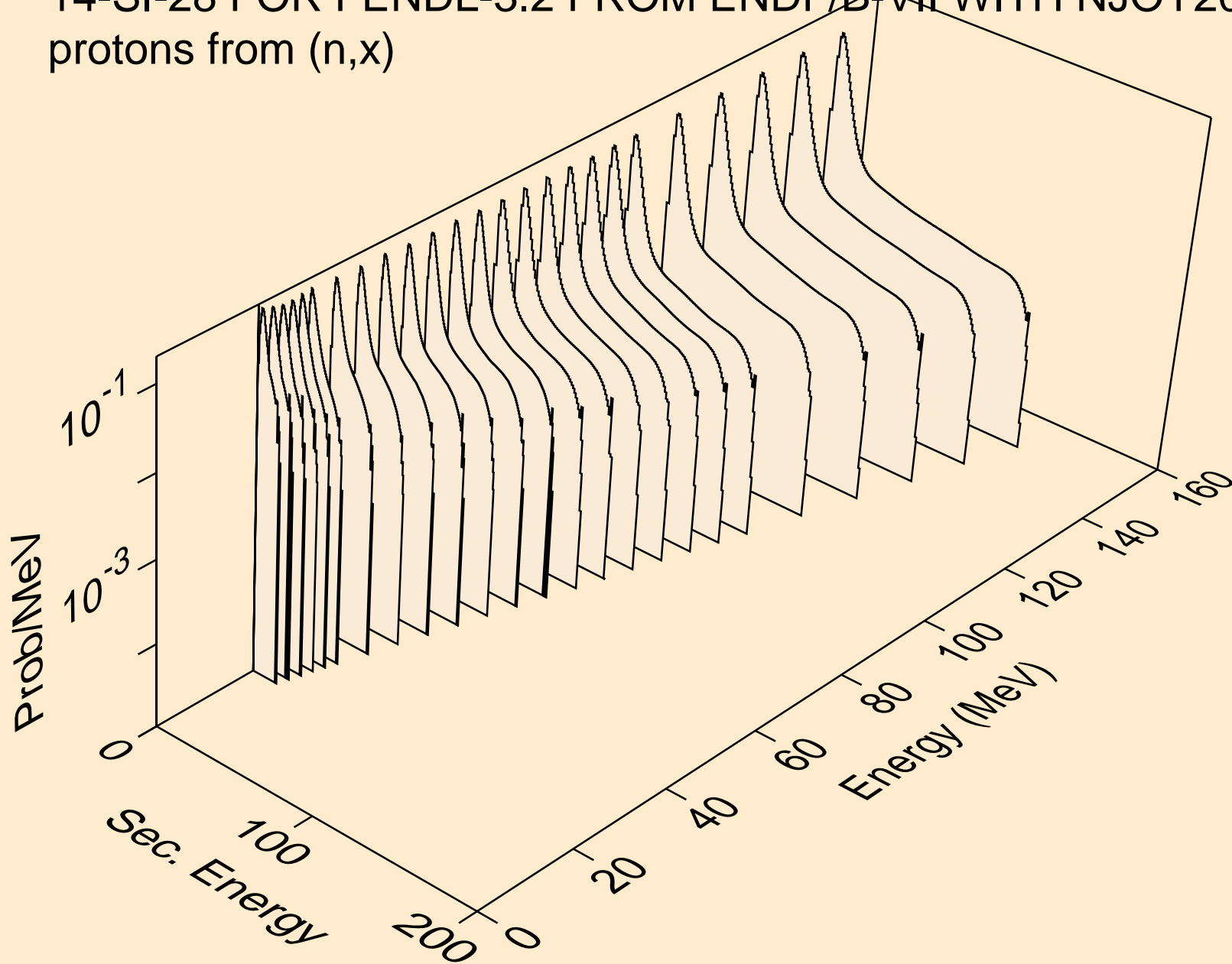

14-SI-28 FOR FENDL-3.2 FROM ENDF/B-VII WITH NJOY2016.60+
protons from (n,n*)p

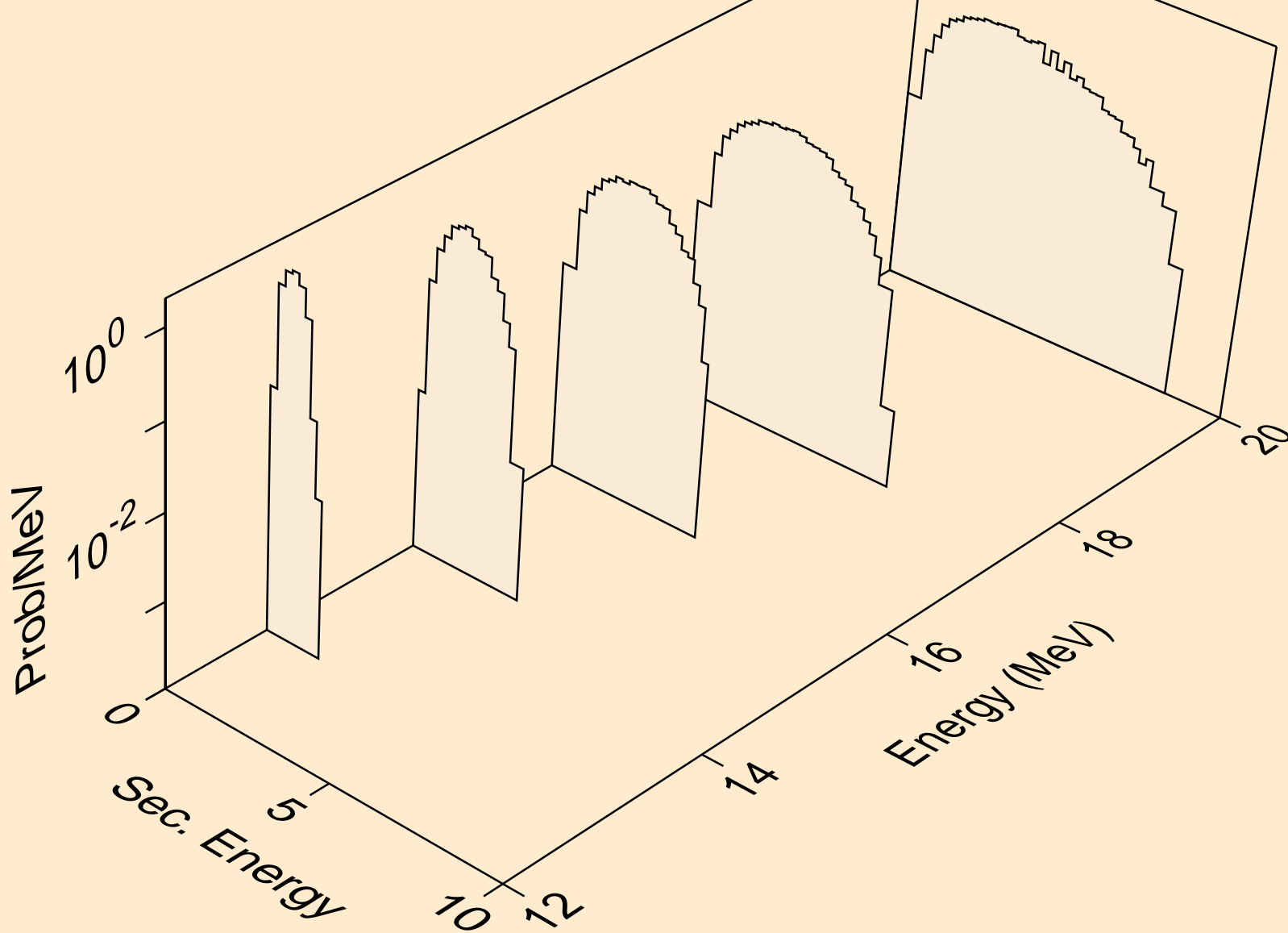

14-SI-28 FOR FENDL-3.2 FROM ENDF/B-VII WITH NJOY2016.60+
angular distribution for (n,p*0) proton

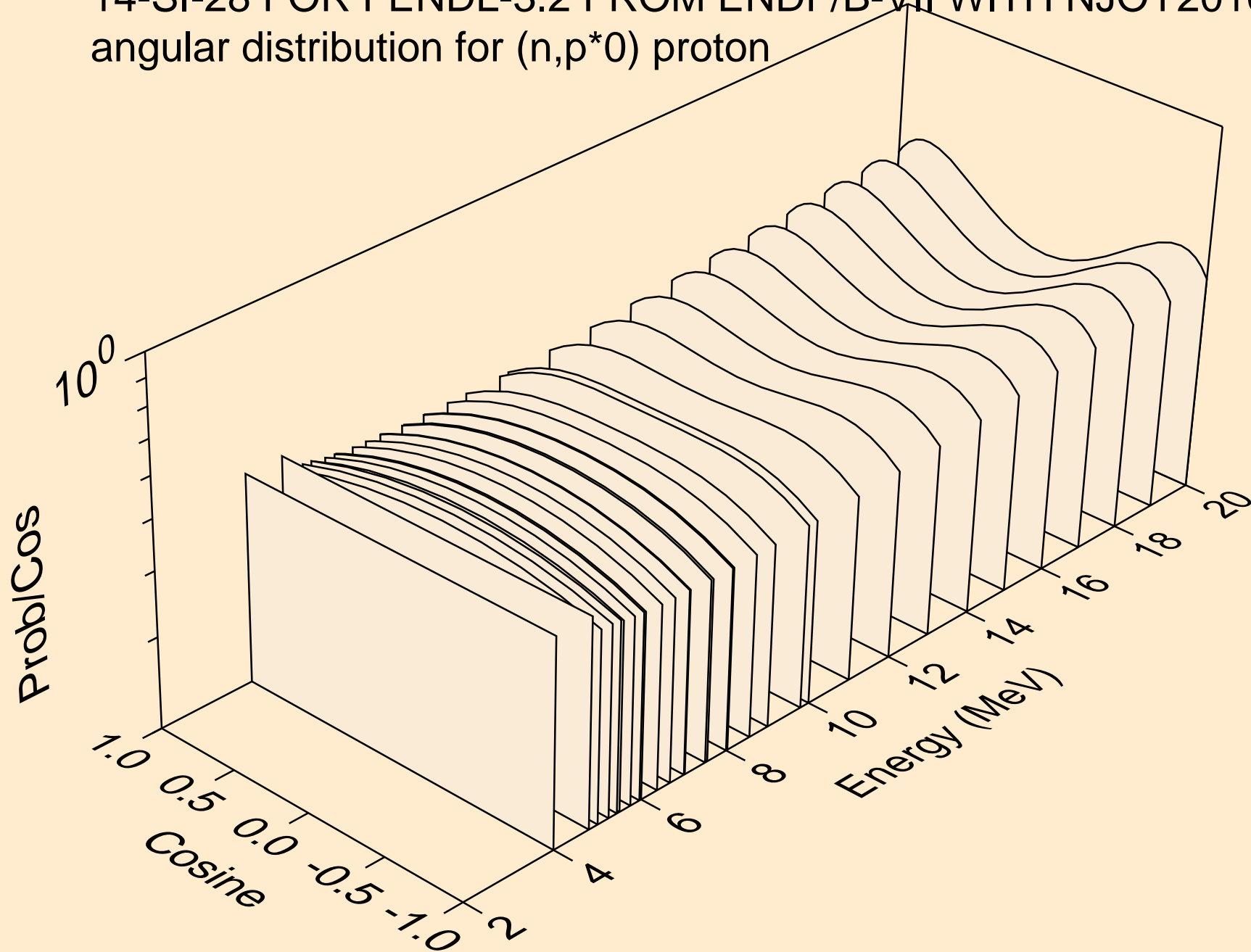

14-SI-28 FOR FENDL-3.2 FROM ENDF/B-VII WITH NJOY2016.60+
angular distribution for (n,p*1) proton

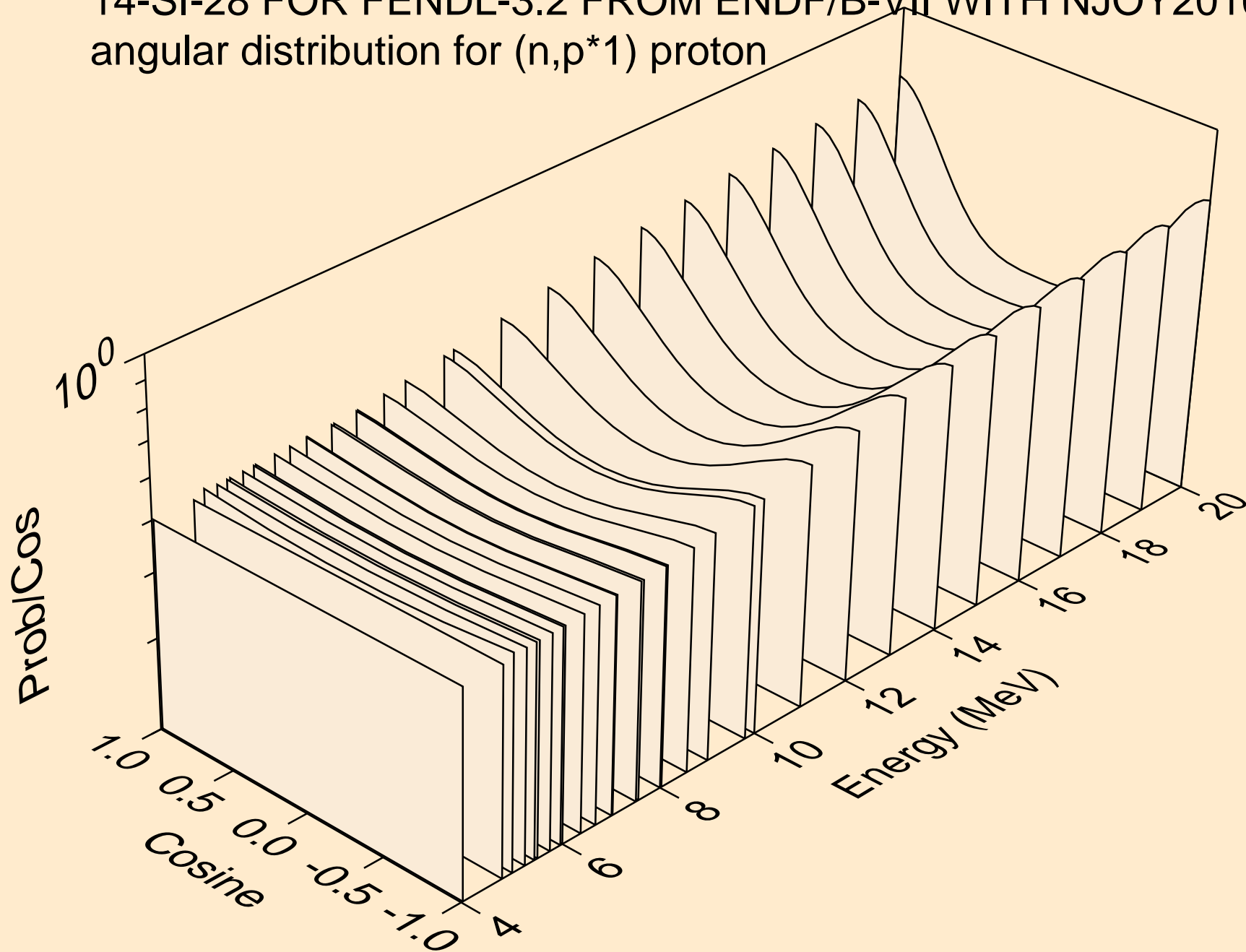

14-SI-28 FOR FENDL-3.2 FROM ENDF/B-VII WITH NJOY2016.60+
angular distribution for (n,p*2) proton

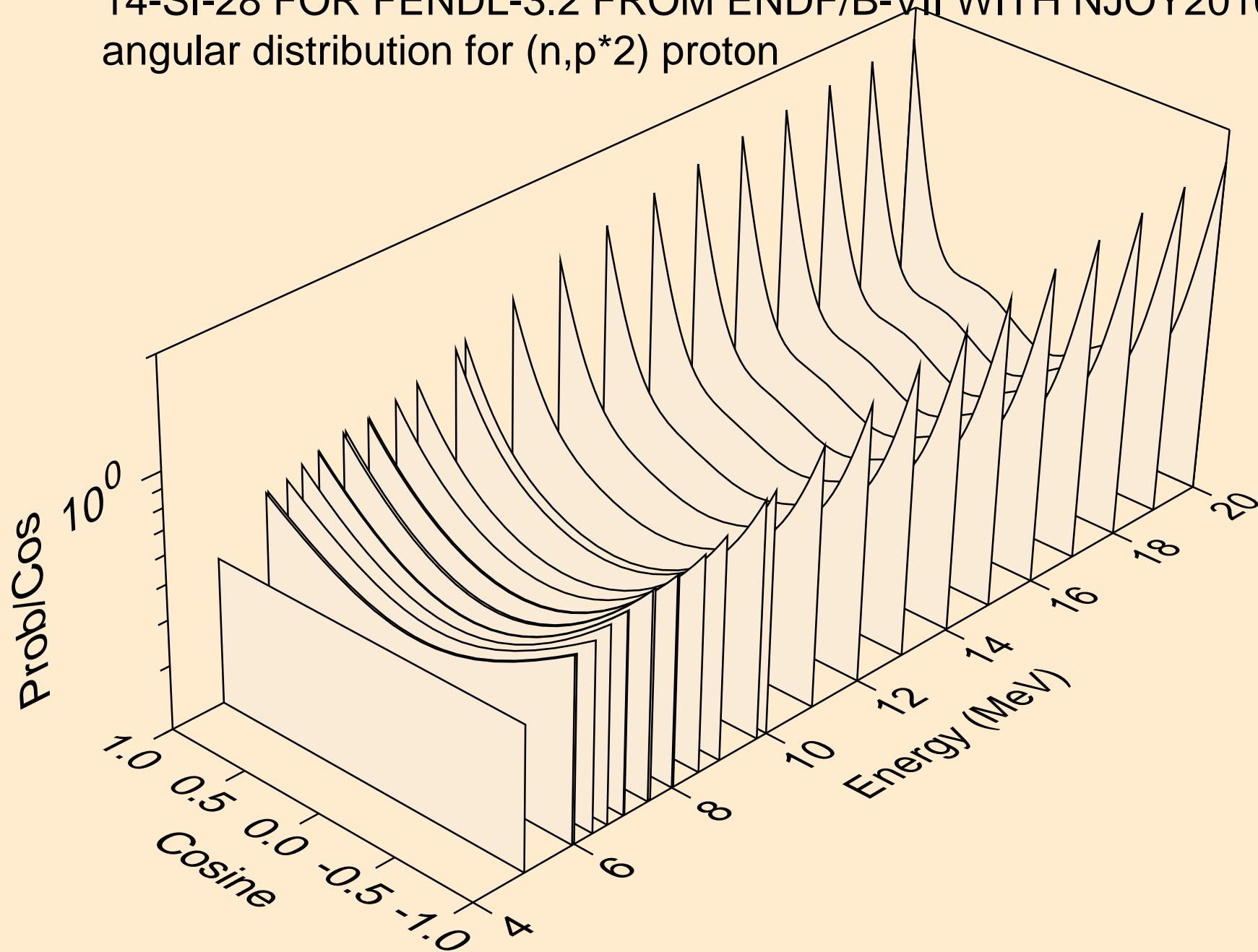

14-SI-28 FOR FENDL-3.2 FROM ENDF/B-VII WITH NJOY2016.60+
angular distribution for (n,p*3) proton

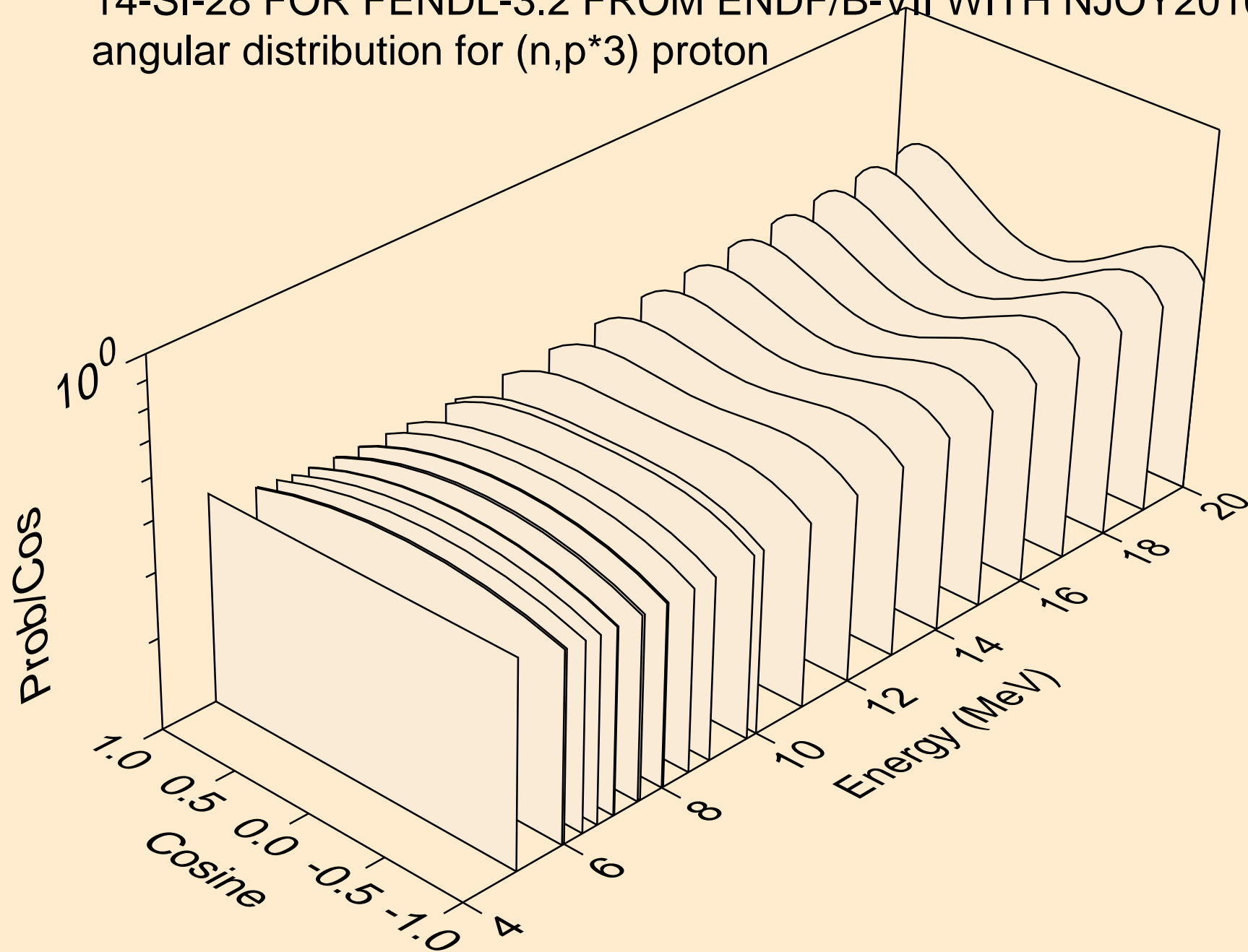

14-SI-28 FOR FENDL-3.2 FROM ENDF/B-VII WITH NJOY2016.60+
angular distribution for (n,p*4) proton

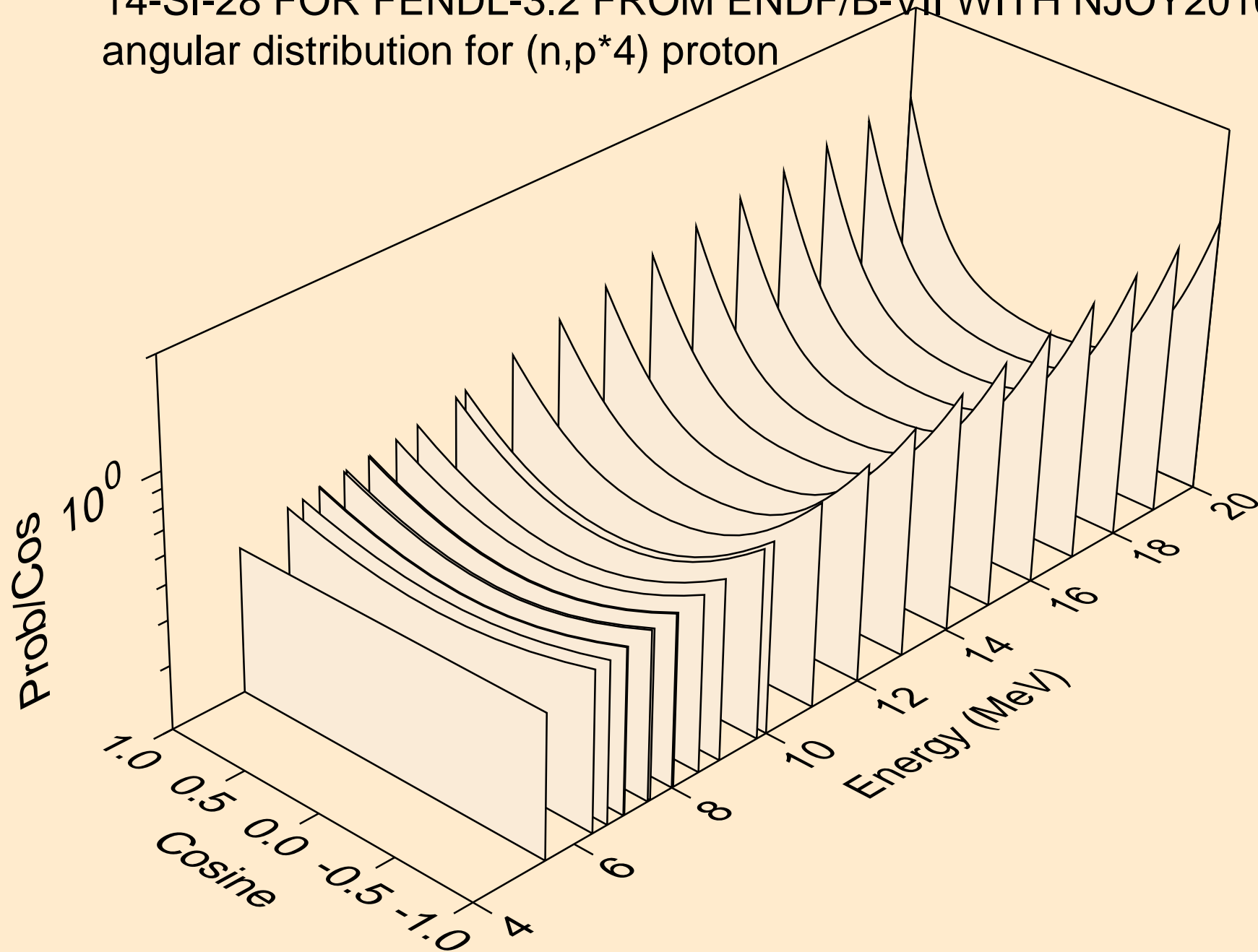

14-SI-28 FOR FENDL-3.2 FROM ENDF/B-VII WITH NJOY2016.60+
angular distribution for (n,p*5) proton

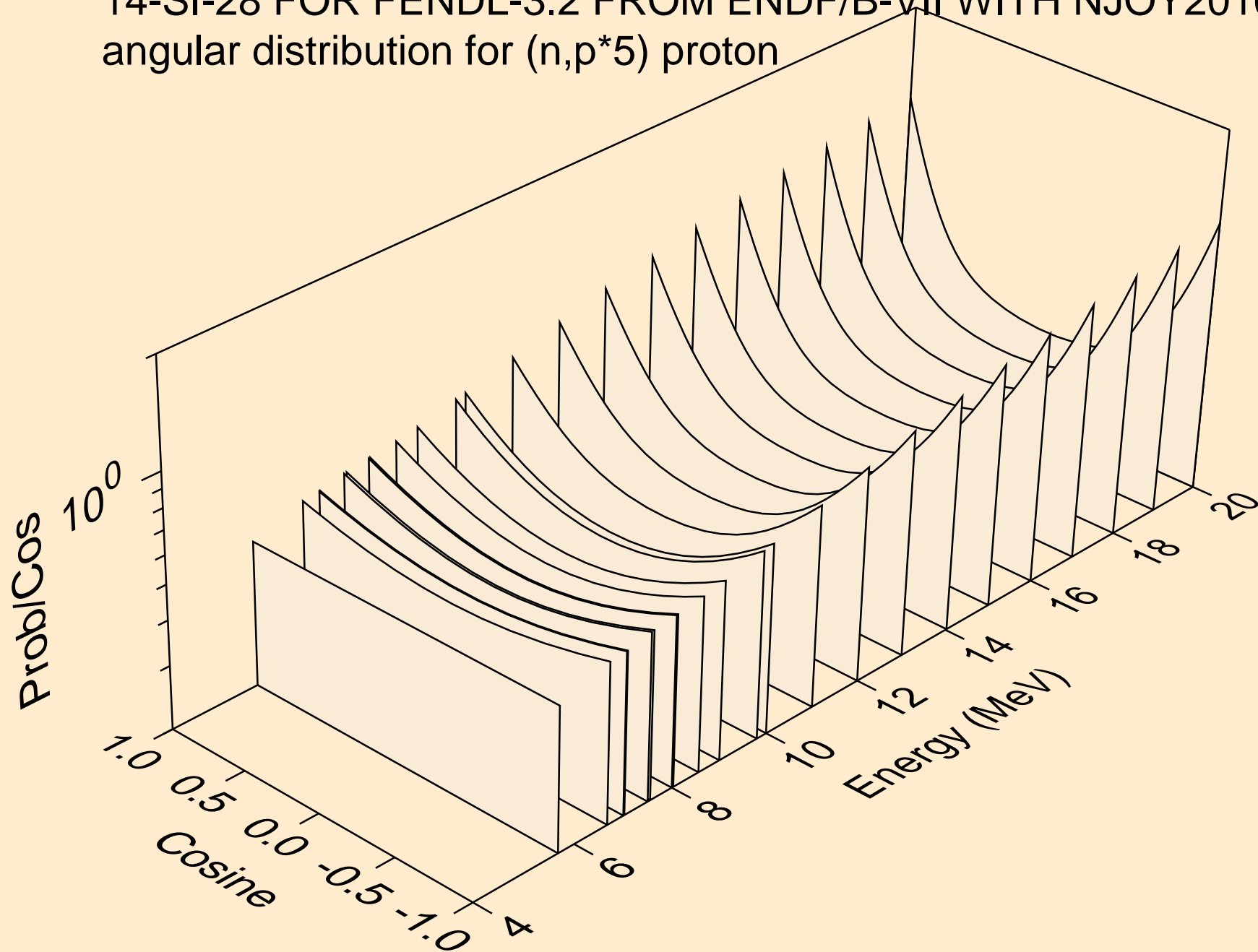

14-SI-28 FOR FENDL-3.2 FROM ENDF/B-VII WITH NJOY2016.60+
angular distribution for (n,p*6) proton

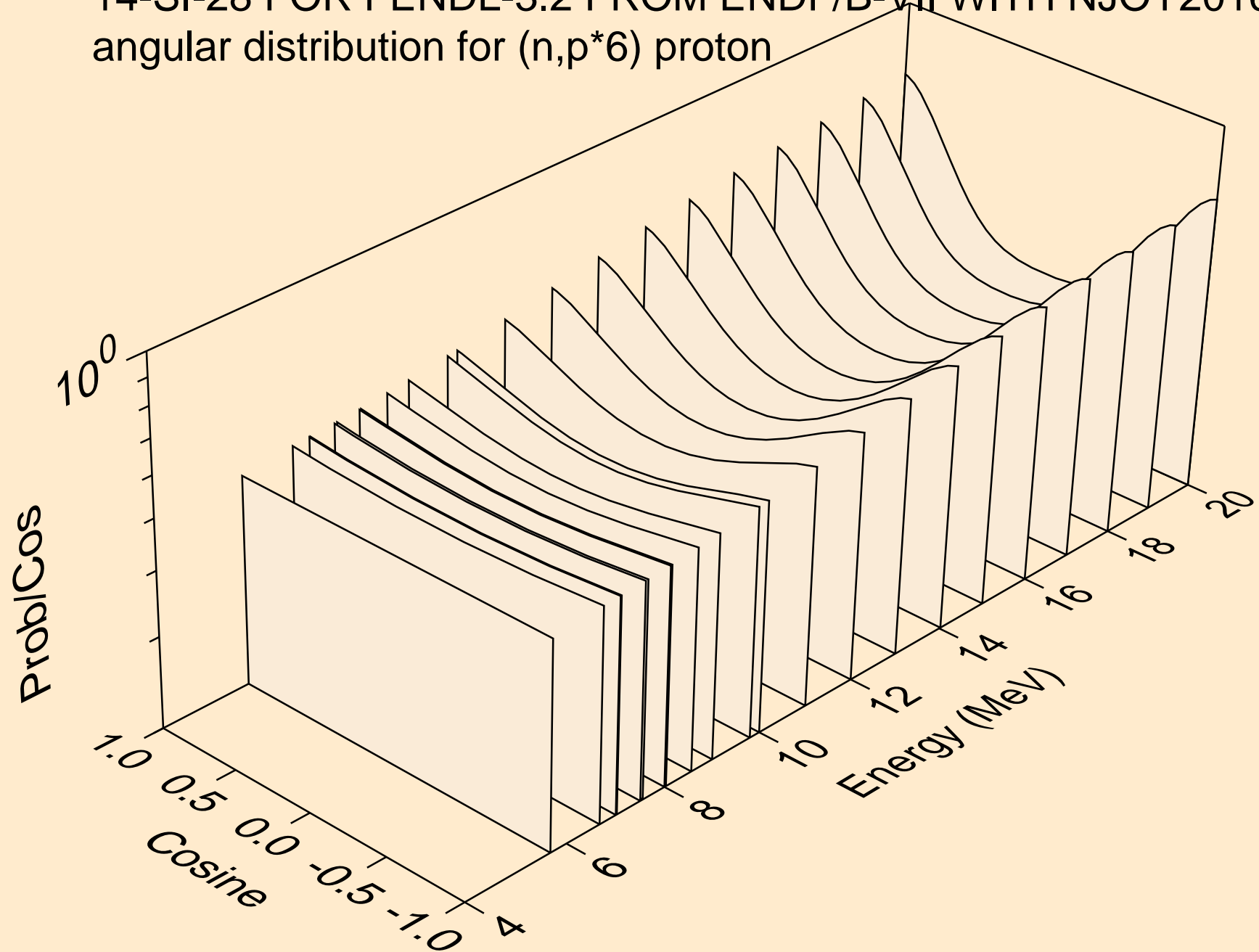

14-SI-28 FOR FENDL-3.2 FROM ENDF/B-VII WITH NJOY2016.60+
angular distribution for (n,p*7) proton

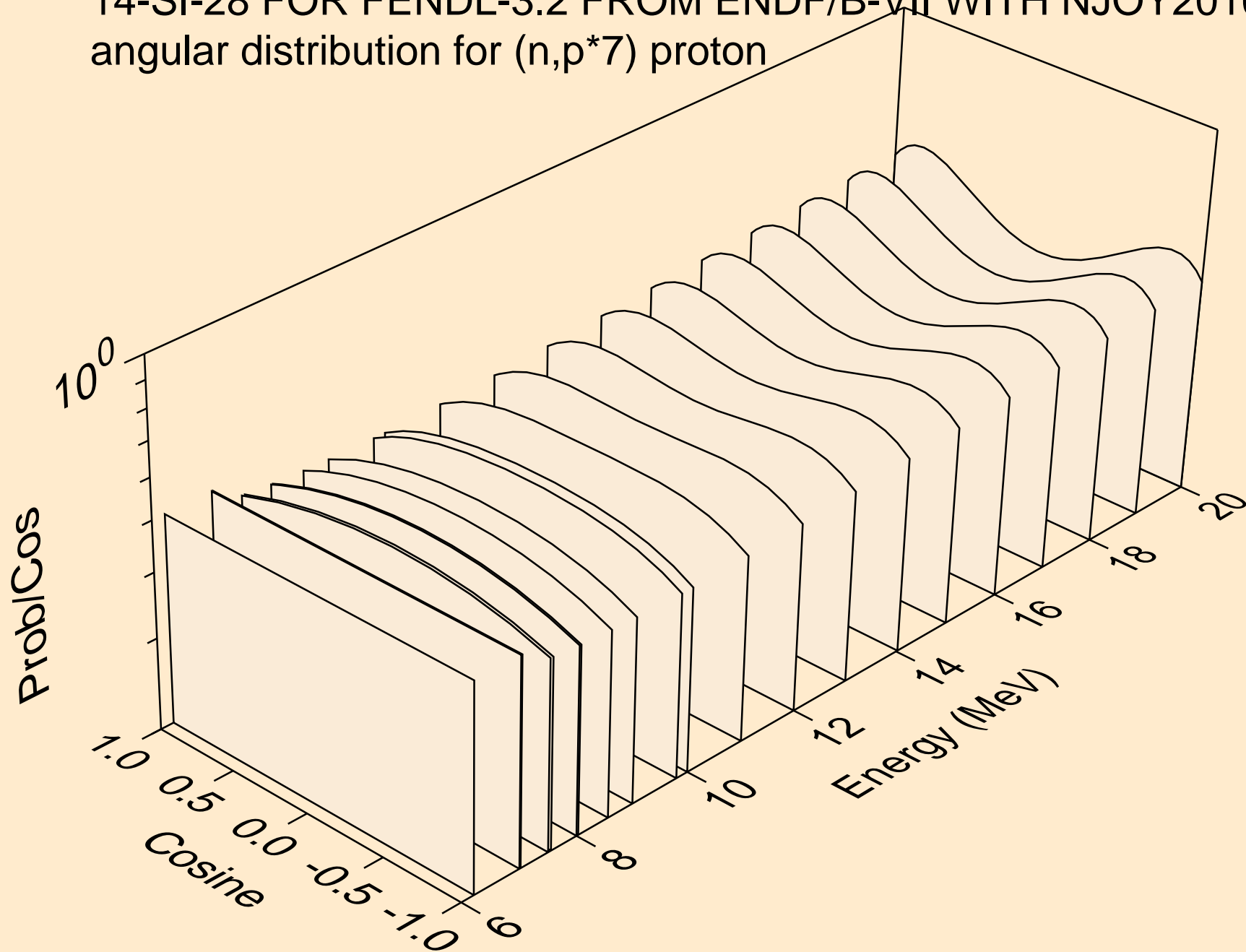

14-SI-28 FOR FENDL-3.2 FROM ENDF/B-VII WITH NJOY2016.60+
angular distribution for (n,p*8) proton

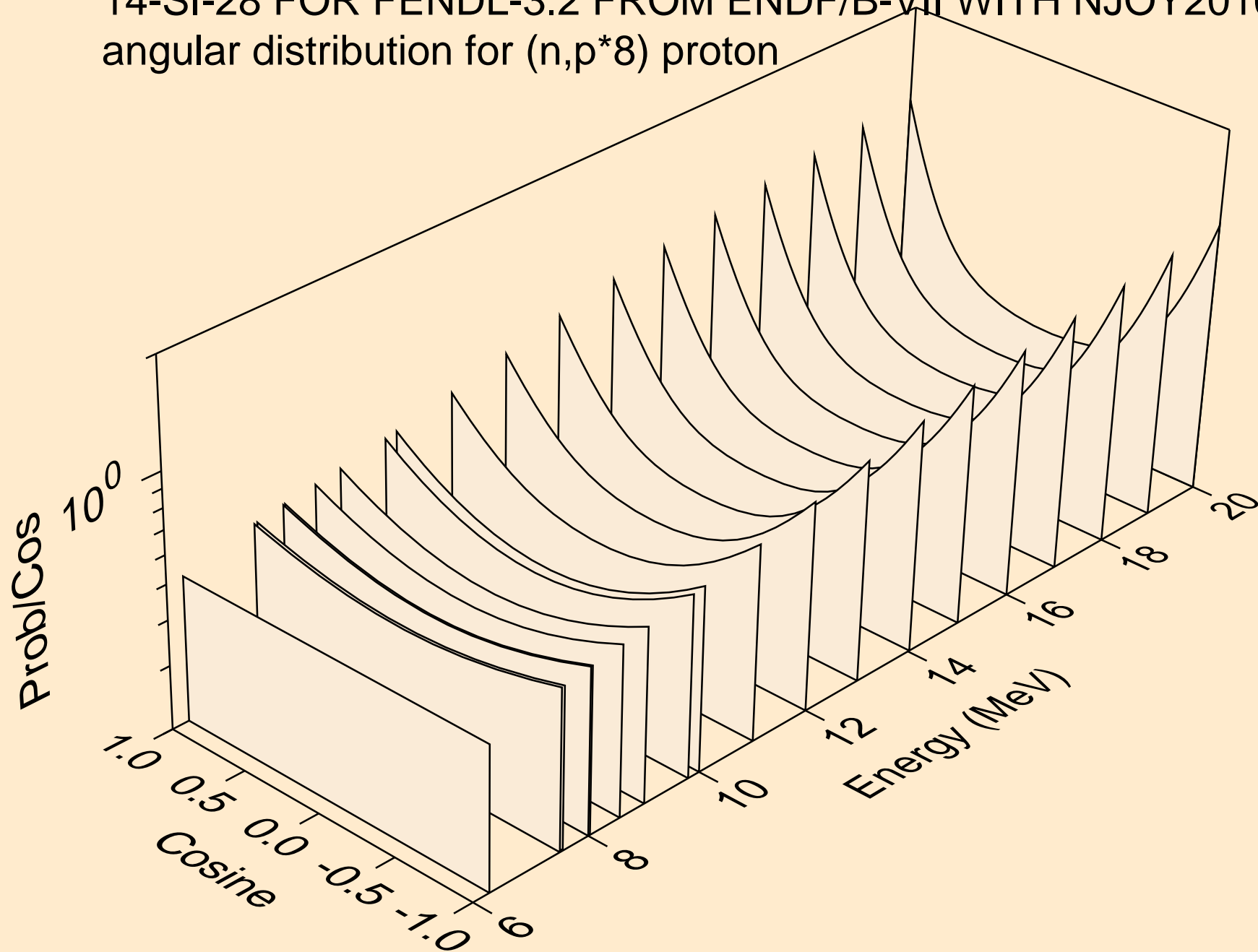

14-SI-28 FOR FENDL-3.2 FROM ENDF/B-VII WITH NJOY2016.60+
angular distribution for (n,p*9) proton

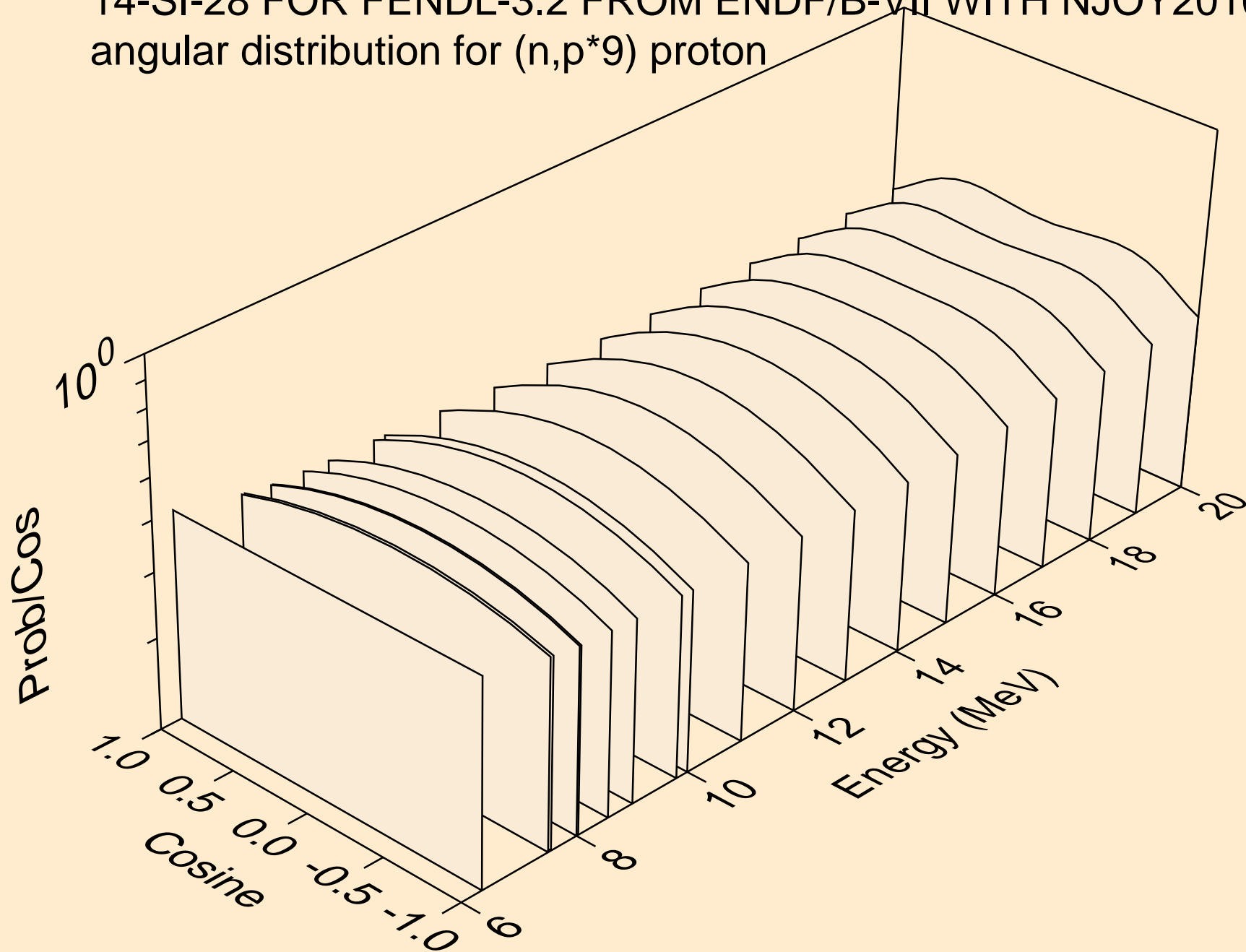

14-SI-28 FOR FENDL-3.2 FROM ENDF/B-VII WITH NJOY2016.60+
angular distribution for (n,p*10) proton

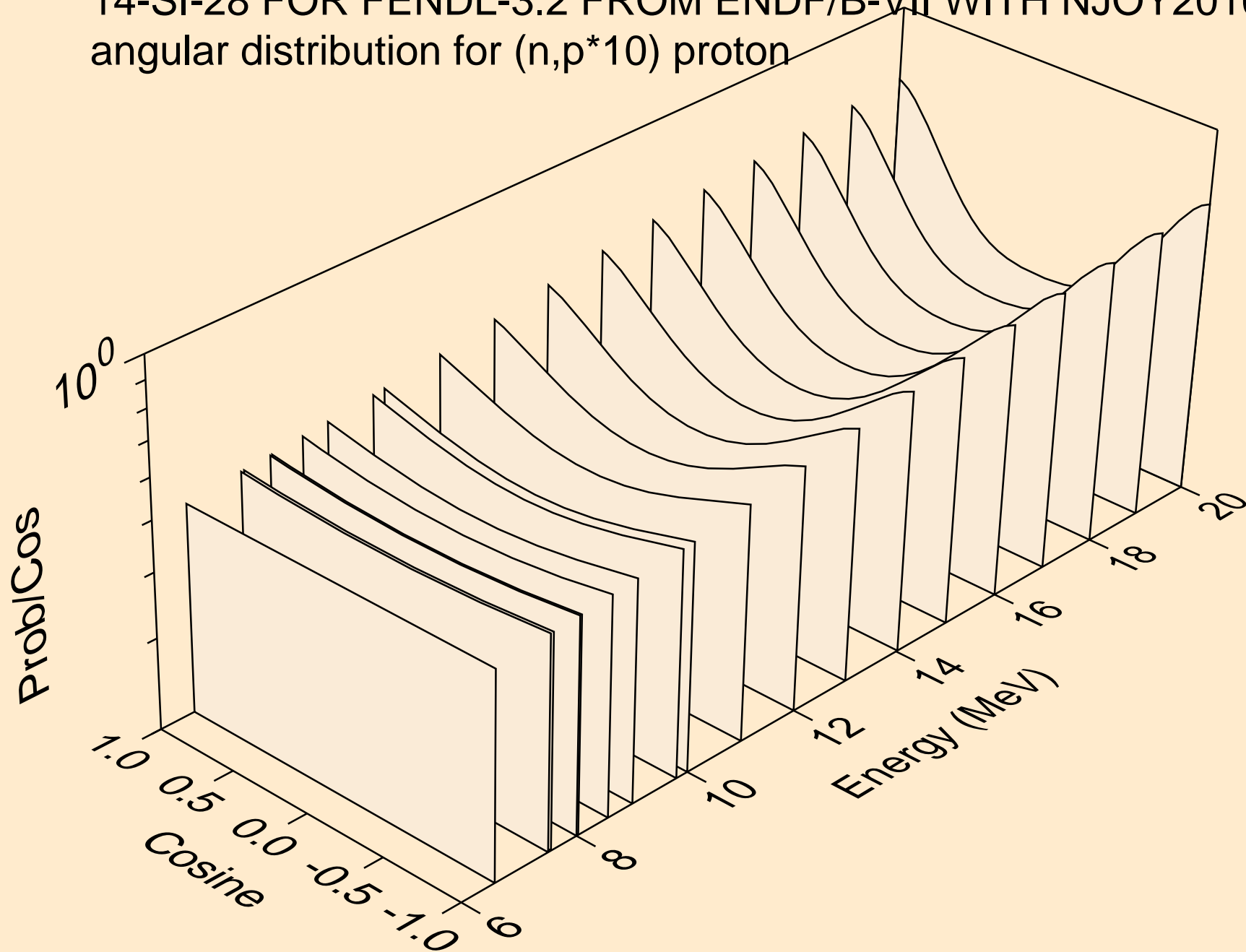

14-SI-28 FOR FENDL-3.2 FROM ENDF/B-VII WITH NJOY2016.60+
angular distribution for (n,p*11) proton

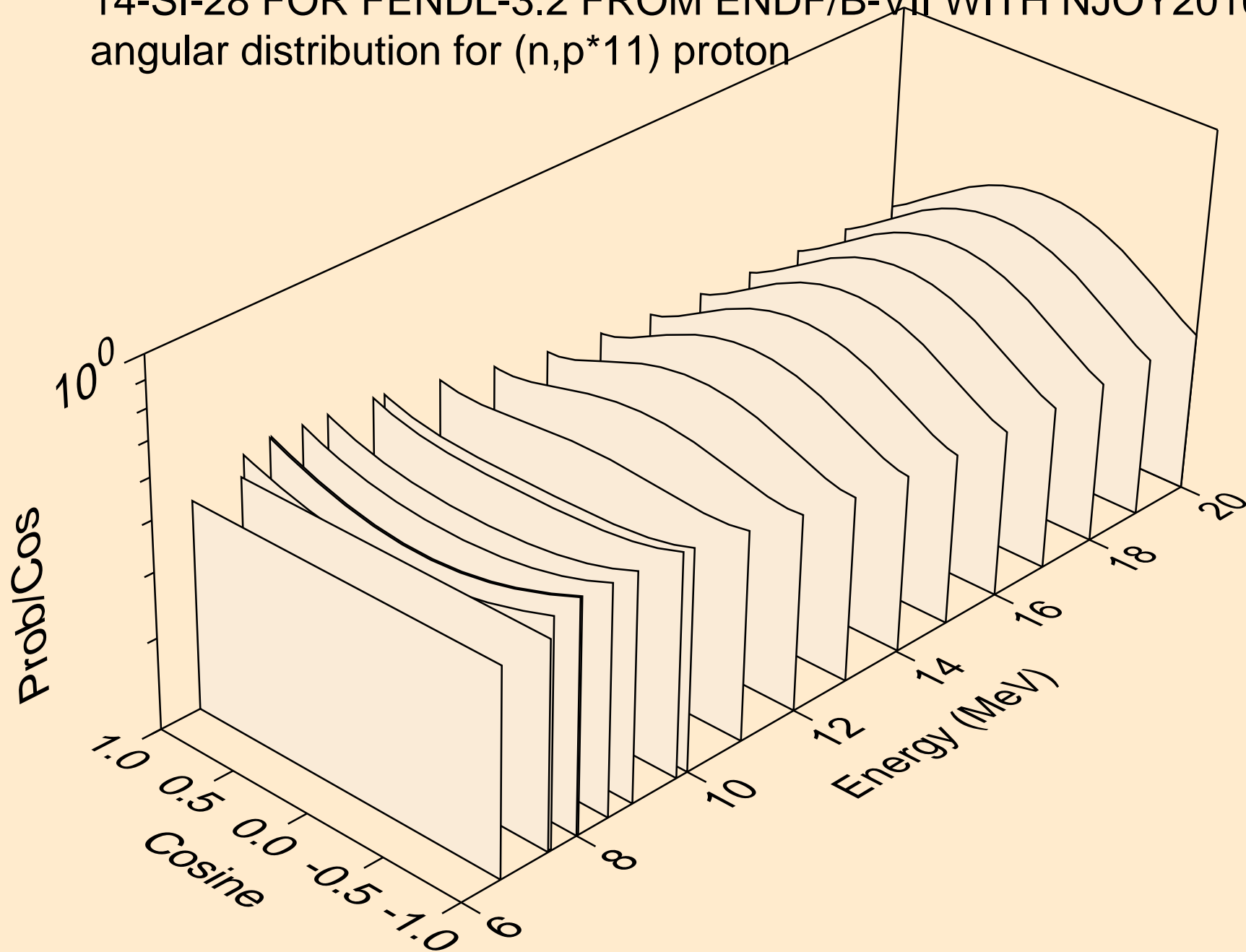

14-SI-28 FOR FENDL-3.2 FROM ENDF/B-VII WITH NJOY2016.60+
angular distribution for (n,p*12) proton

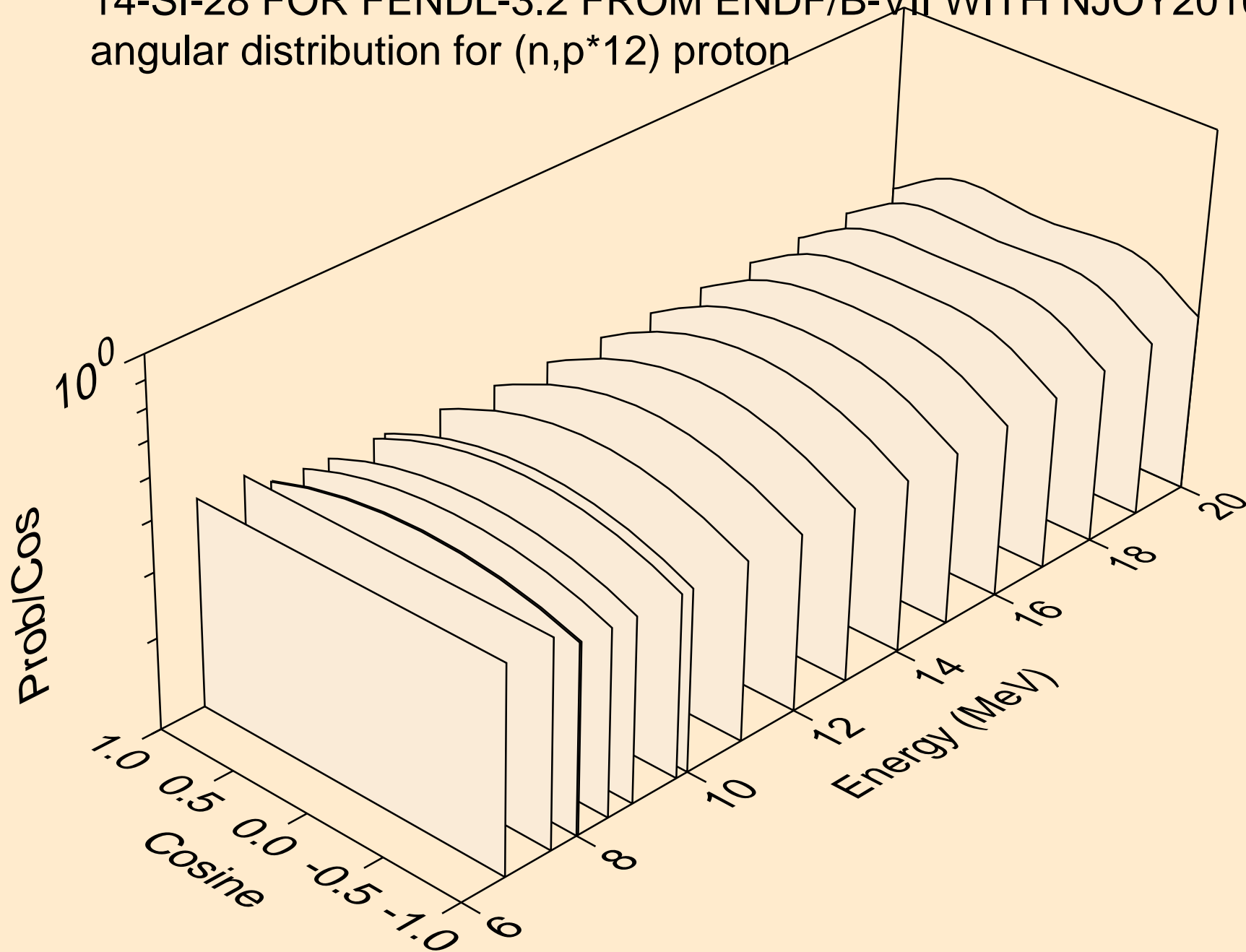

14-SI-28 FOR FENDL-3.2 FROM ENDF/B-VII WITH NJOY2016.60+
angular distribution for (n,p*13) proton

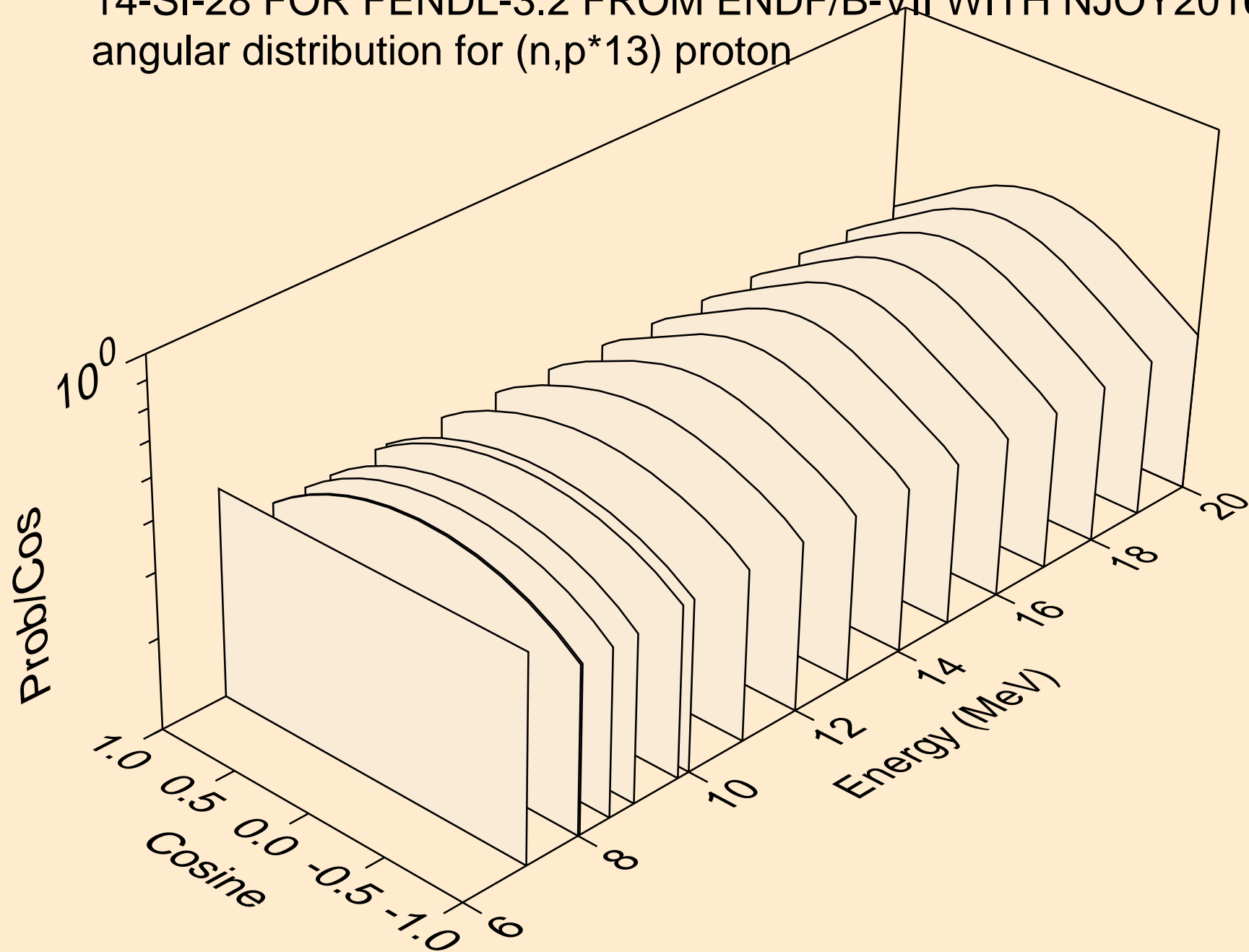

14-SI-28 FOR FENDL-3.2 FROM ENDF/B-VII WITH NJOY2016.60+
protons from (n,p*c)

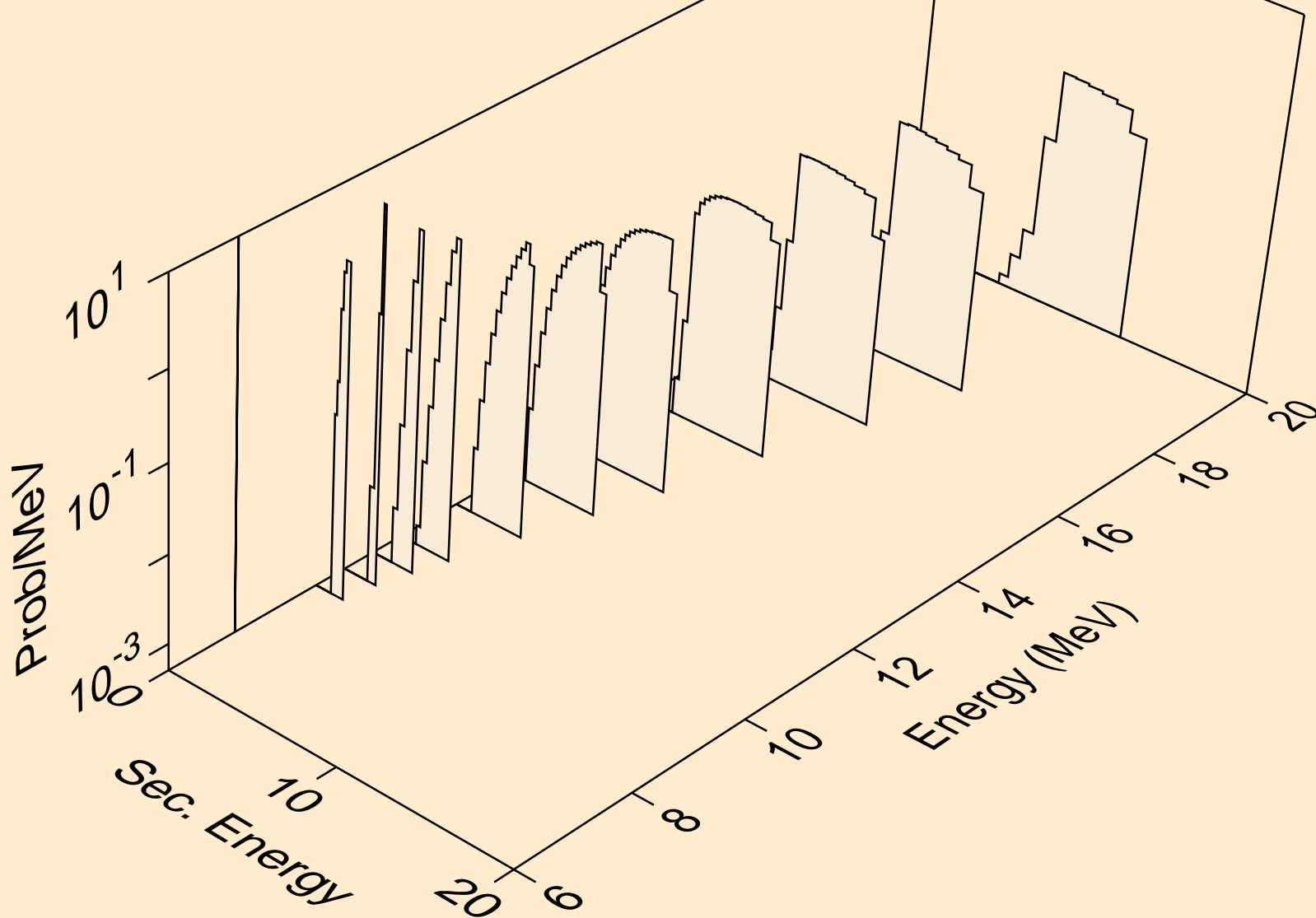

14-SI-28 FOR FENDL-3.2 FROM ENDF/B-VII WITH NJOY2016.60+
deuterons from (n,x)

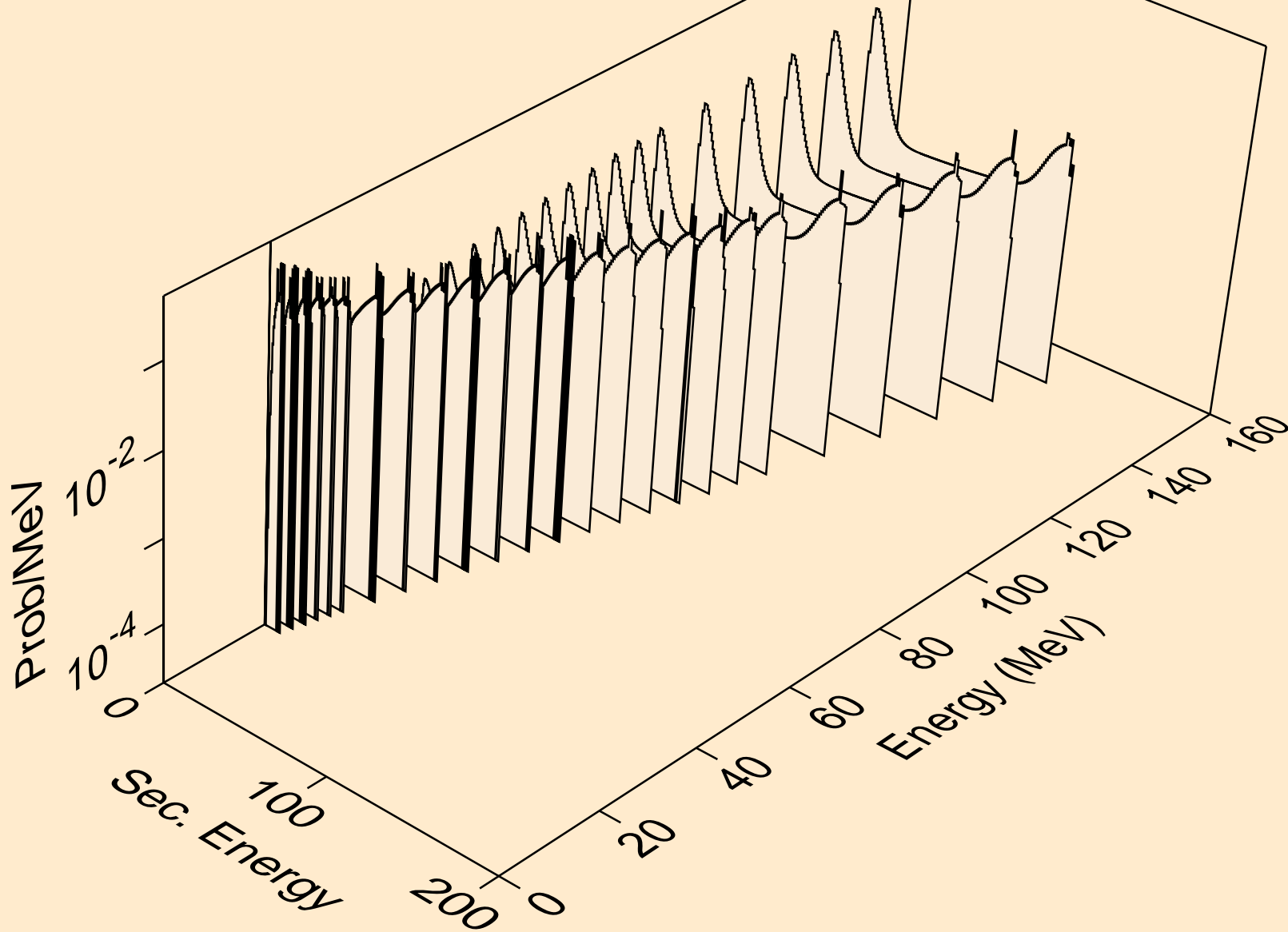

14-SI-28 FOR FENDL-3.2 FROM ENDF/B-VII WITH NJOY2016.60+
tritons from (n,x)

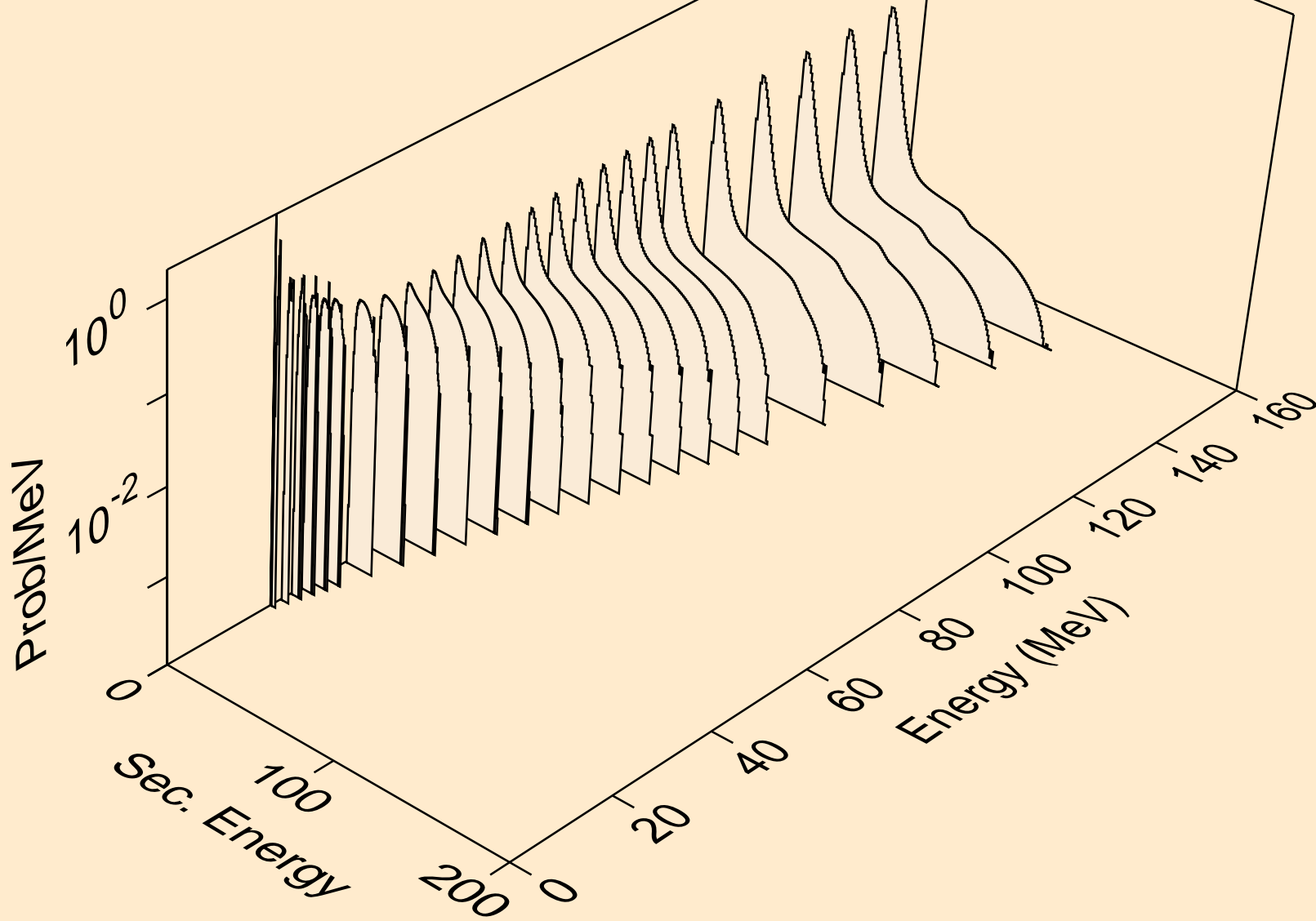

14-SI-28 FOR FENDL-3.2 FROM ENDF/B-VII WITH NJOY2016.60+
alphas from (n,x)

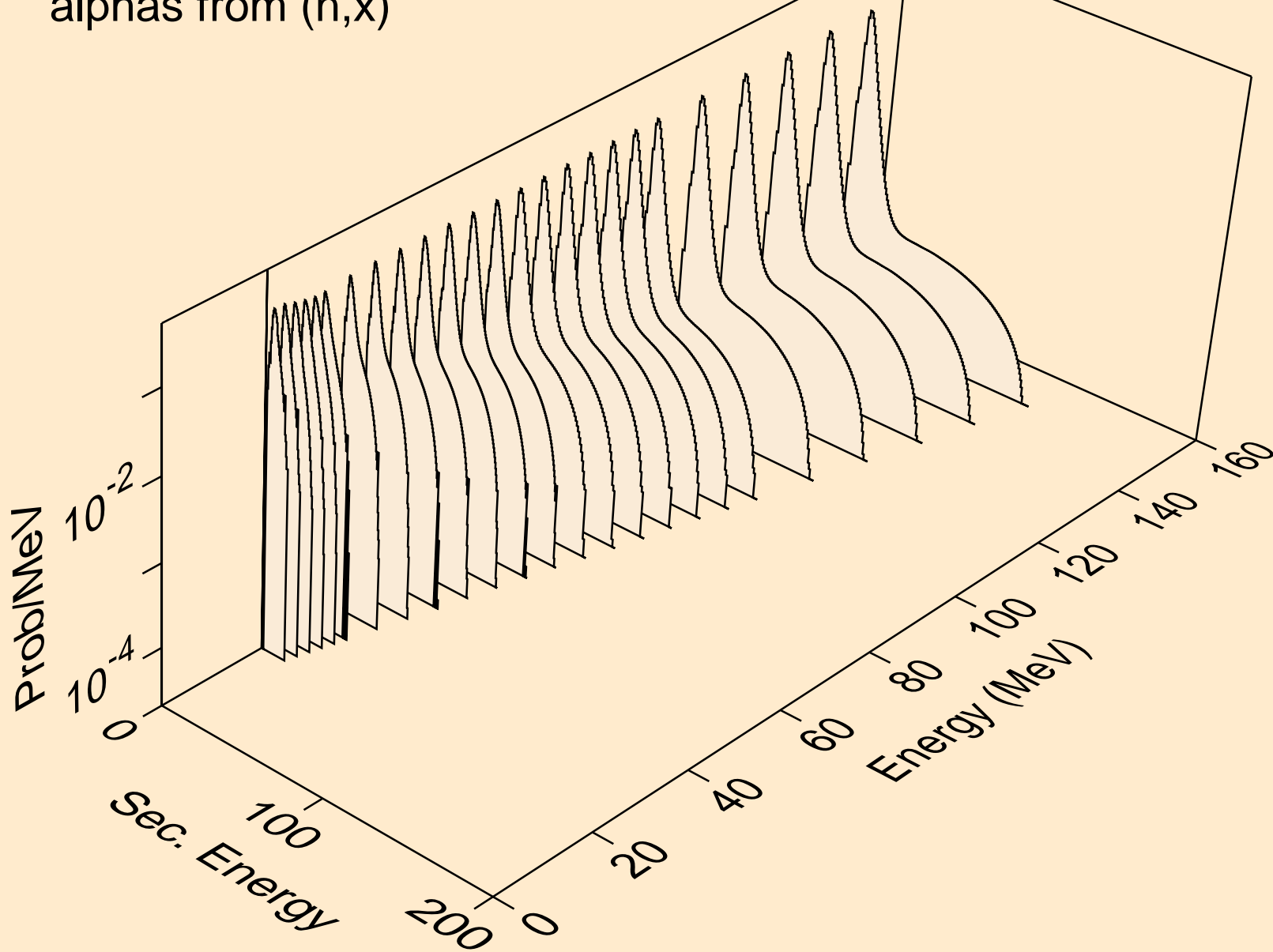

14-SI-28 FOR FENDL-3.2 FROM ENDF/B-VII WITH NJOY2016.60+
alphas from (n,n*)a

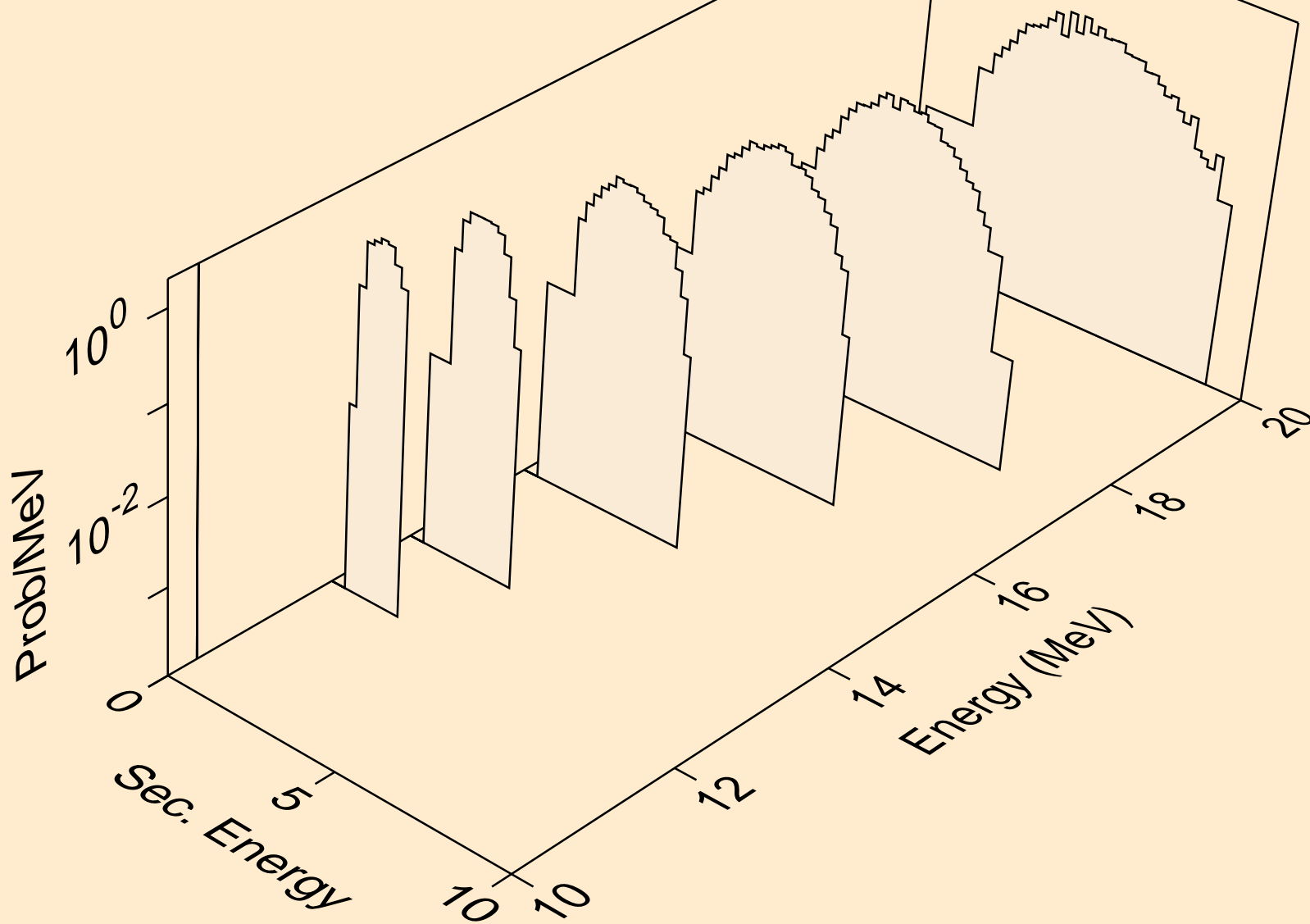

14-SI-28 FOR FENDL-3.2 FROM ENDF/B-VII WITH NJOY2016.60+
angular distribution for (n,a*0) alpha

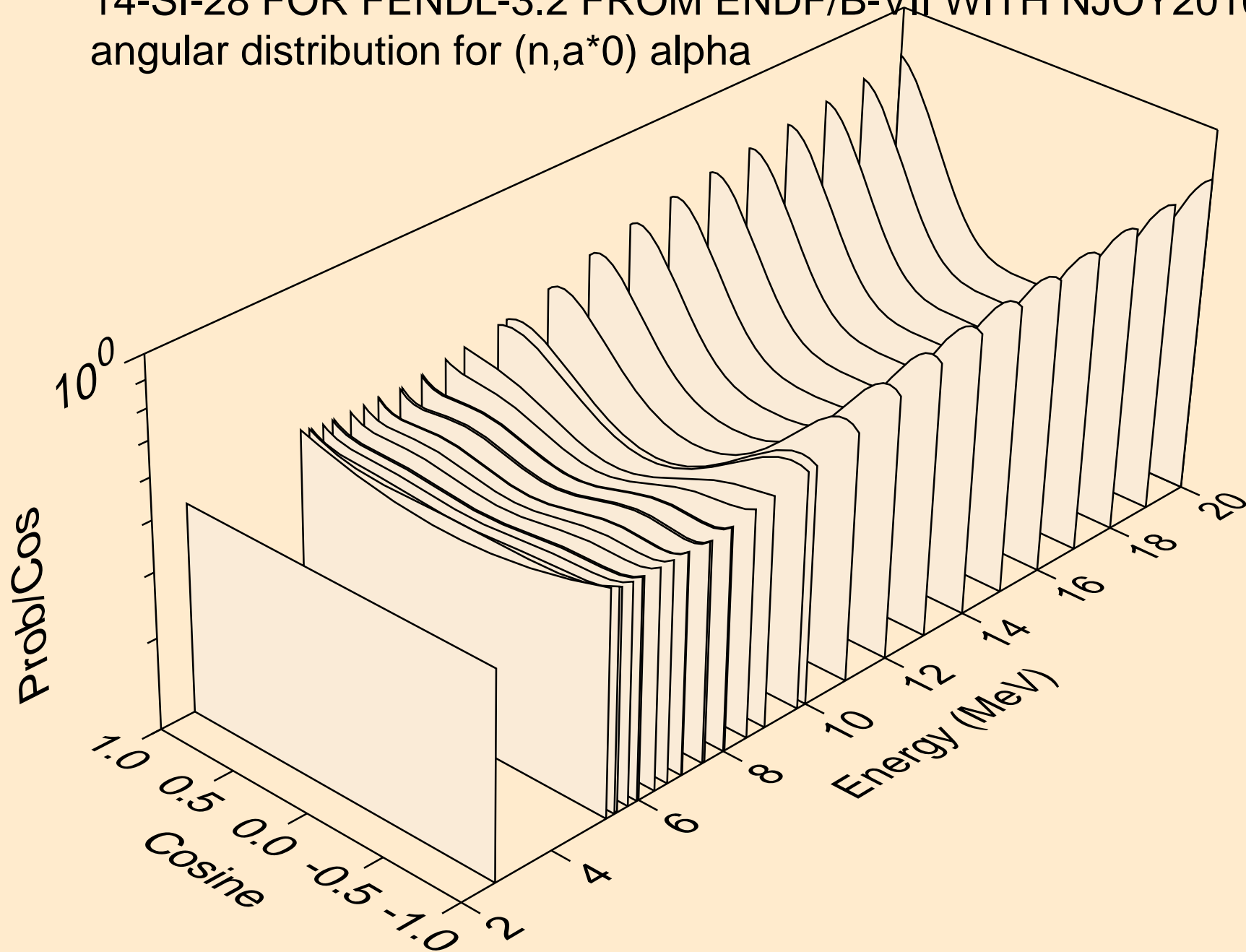

14-SI-28 FOR FENDL-3.2 FROM ENDF/B-VII WITH NJOY2016.60+
angular distribution for (n,a*1) alpha

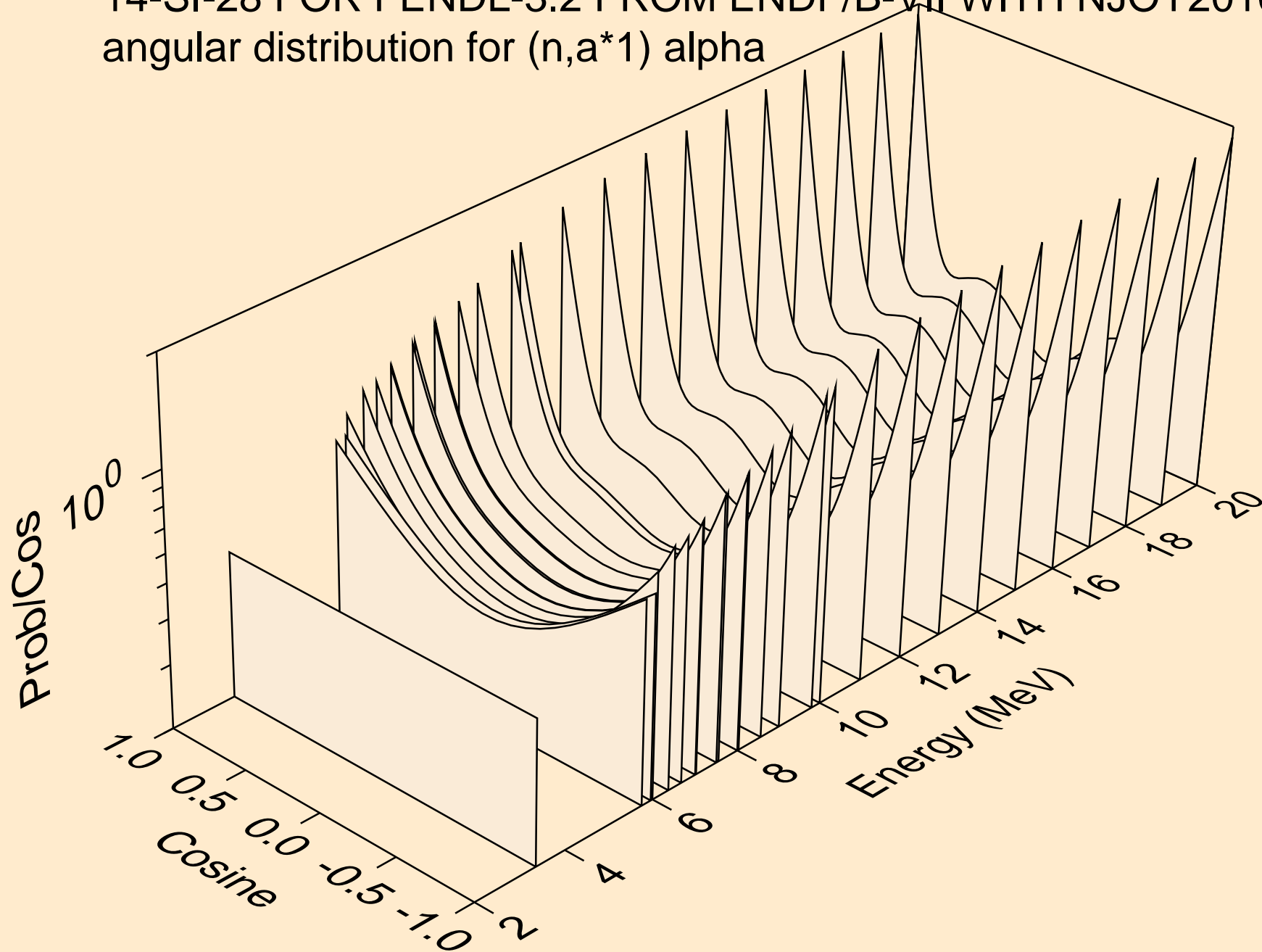

14-SI-28 FOR FENDL-3.2 FROM ENDF/B-VII WITH NJOY2016.60+
angular distribution for (n,a*2) alpha

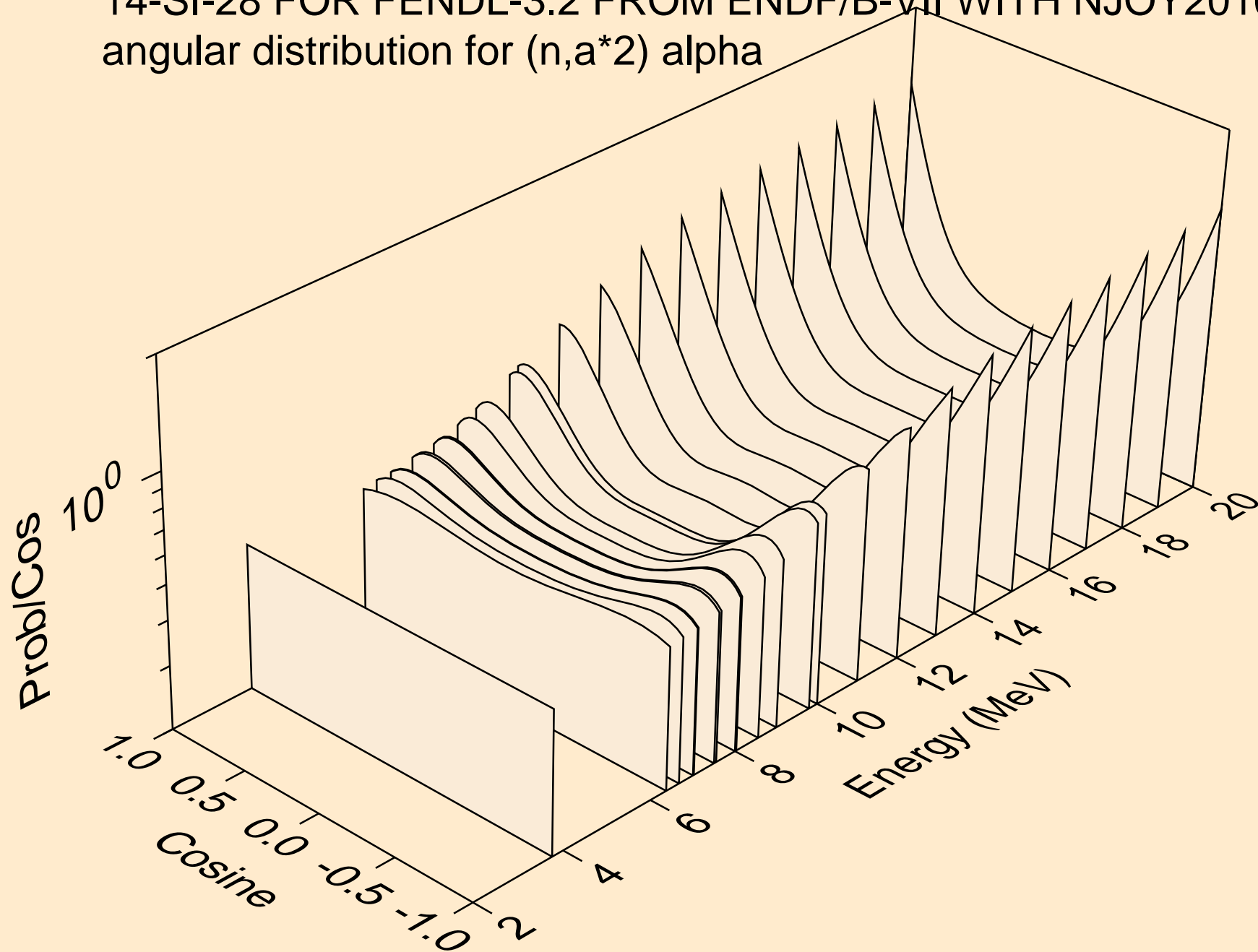

14-SI-28 FOR FENDL-3.2 FROM ENDF/B-VII WITH NJOY2016.60+
angular distribution for (n,a*3) alpha

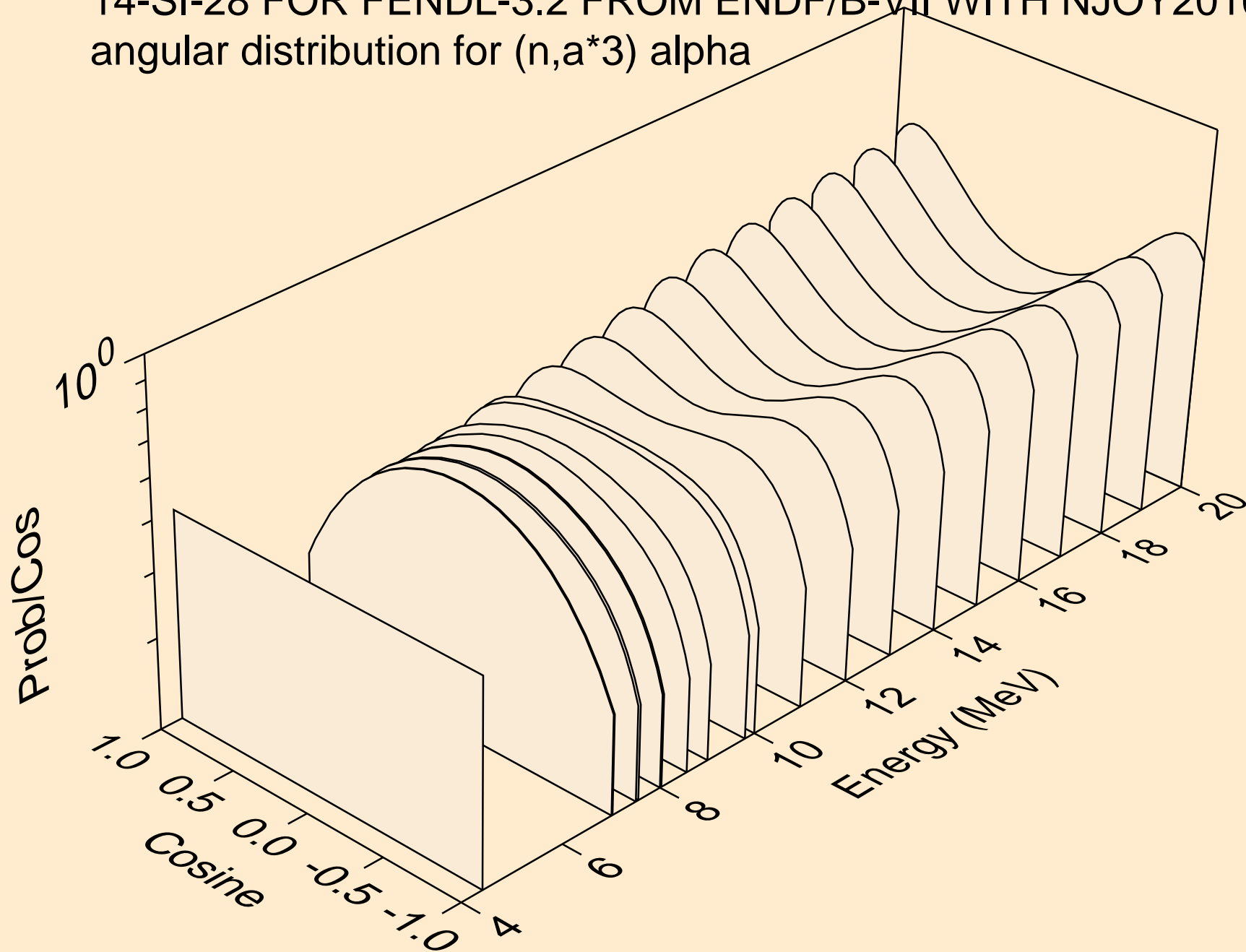

14-SI-28 FOR FENDL-3.2 FROM ENDF/B-VII WITH NJOY2016.60+
angular distribution for (n, α *4) alpha

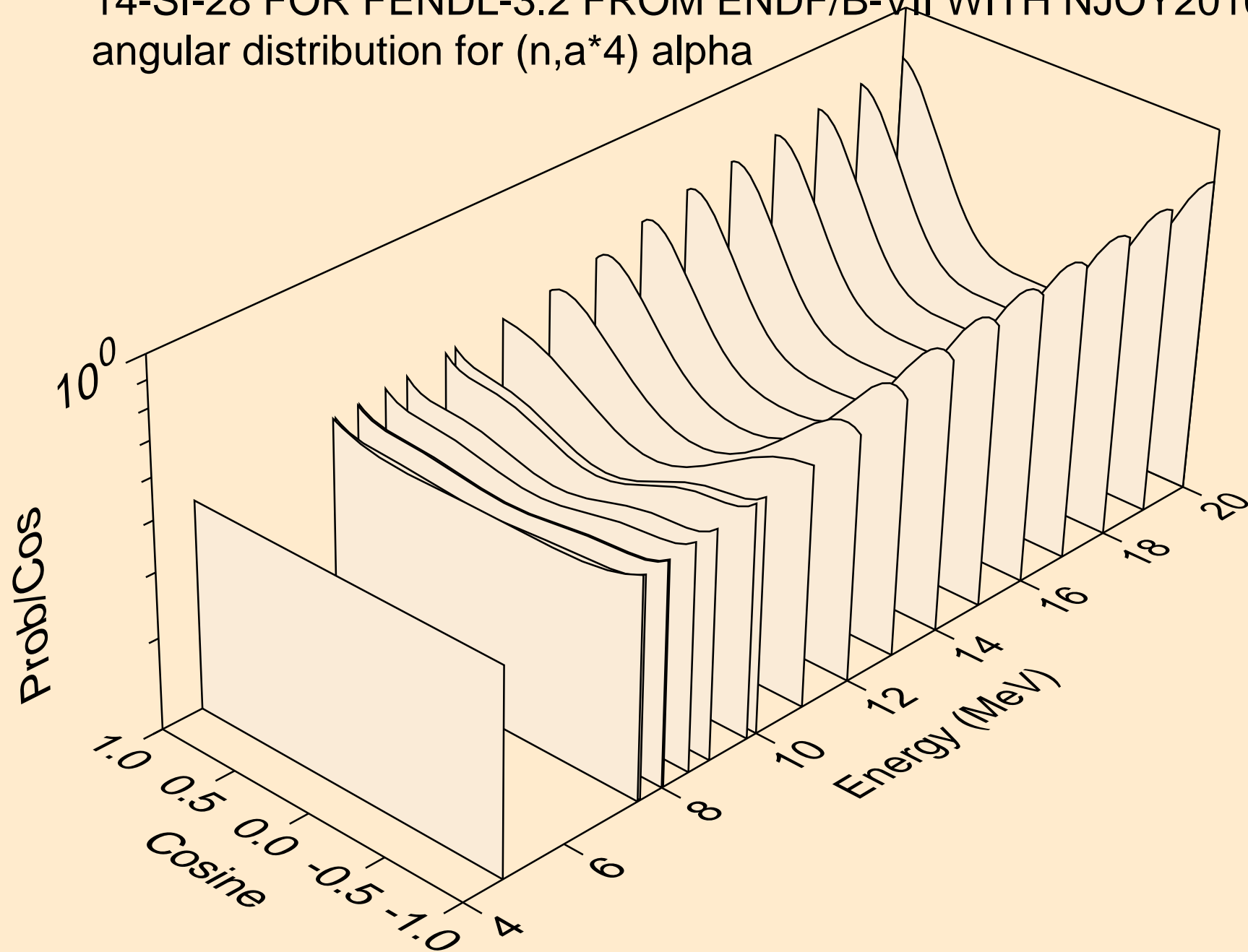

14-SI-28 FOR FENDL-3.2 FROM ENDF/B-VII WITH NJOY2016.60+
angular distribution for (n, α *5) alpha

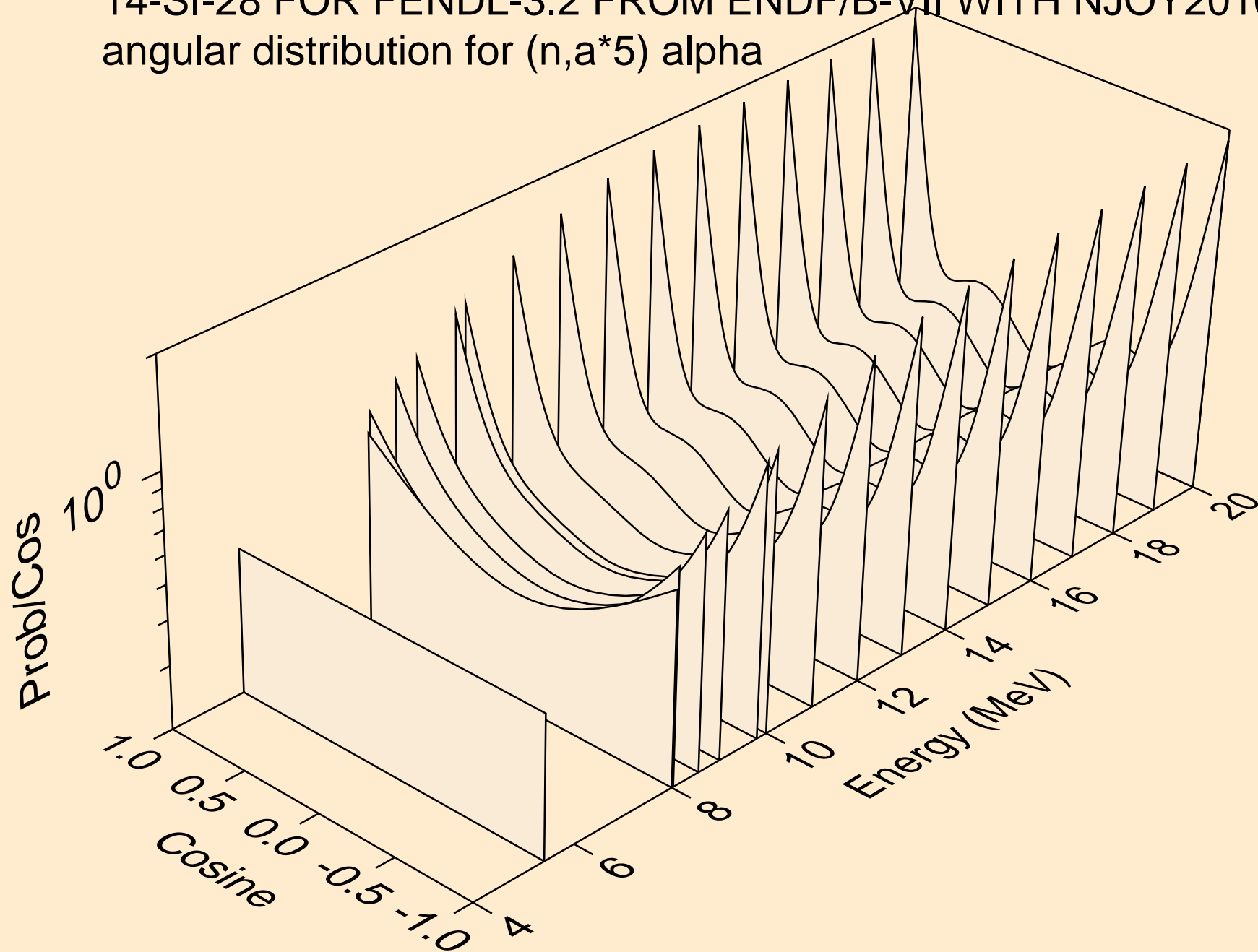

14-SI-28 FOR FENDL-3.2 FROM ENDF/B-VII WITH NJOY2016.60+
angular distribution for (n, α *6) alpha

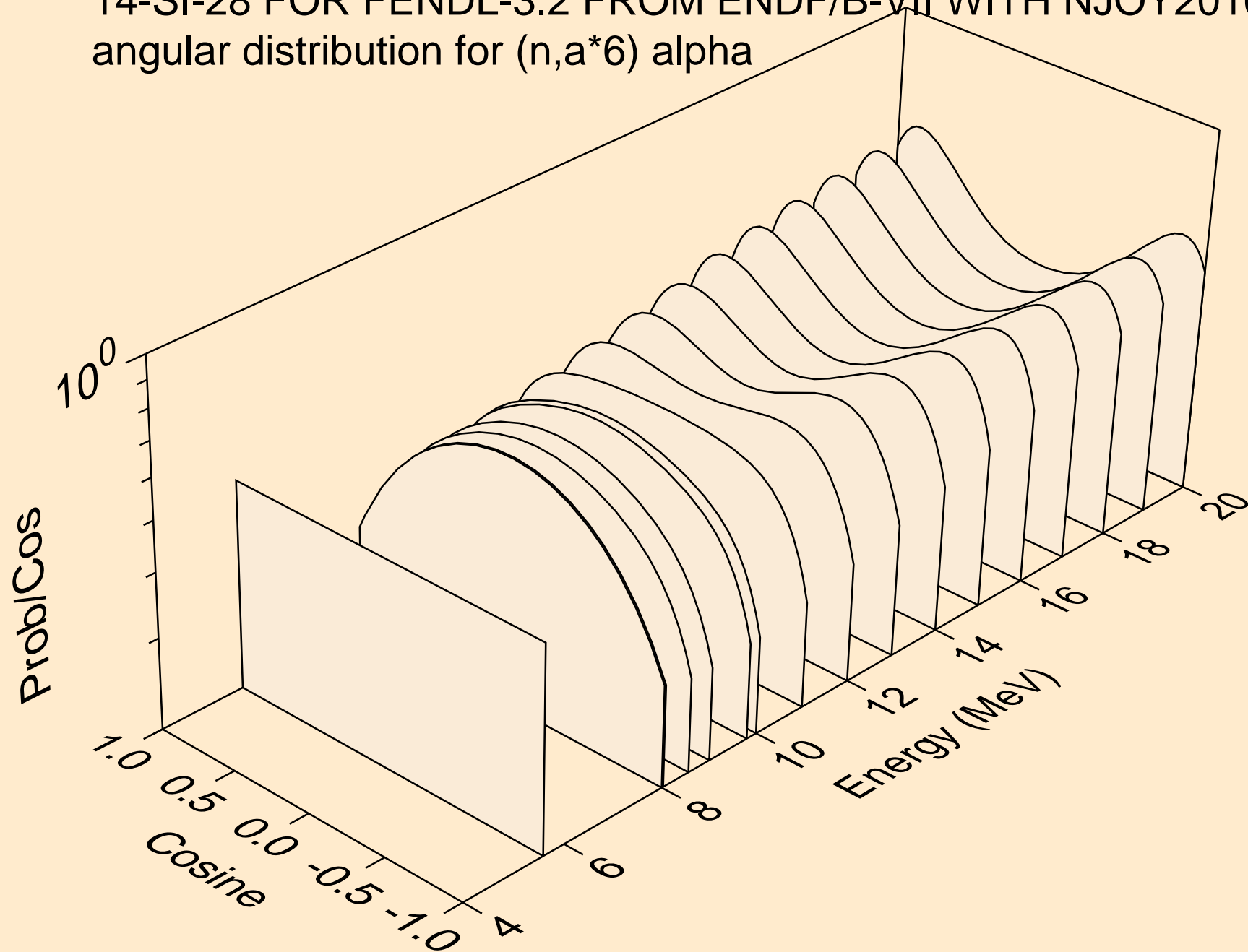

14-SI-28 FOR FENDL-3.2 FROM ENDF/B-VII WITH NJOY2016.60+
angular distribution for (n, α *7) alpha

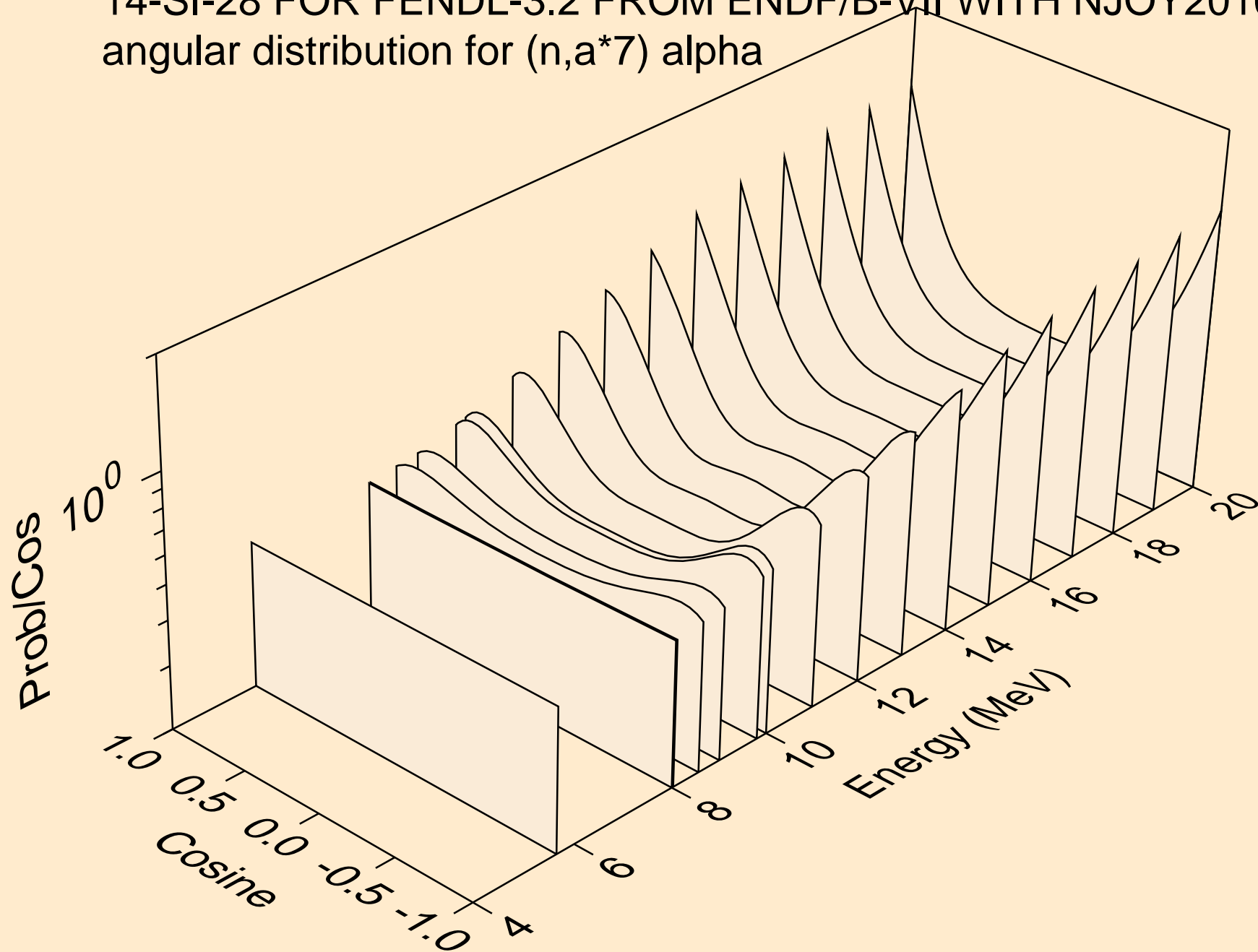

14-SI-28 FOR FENDL-3.2 FROM ENDF/B-VII WITH NJOY2016.60+
angular distribution for (n, α *8) alpha

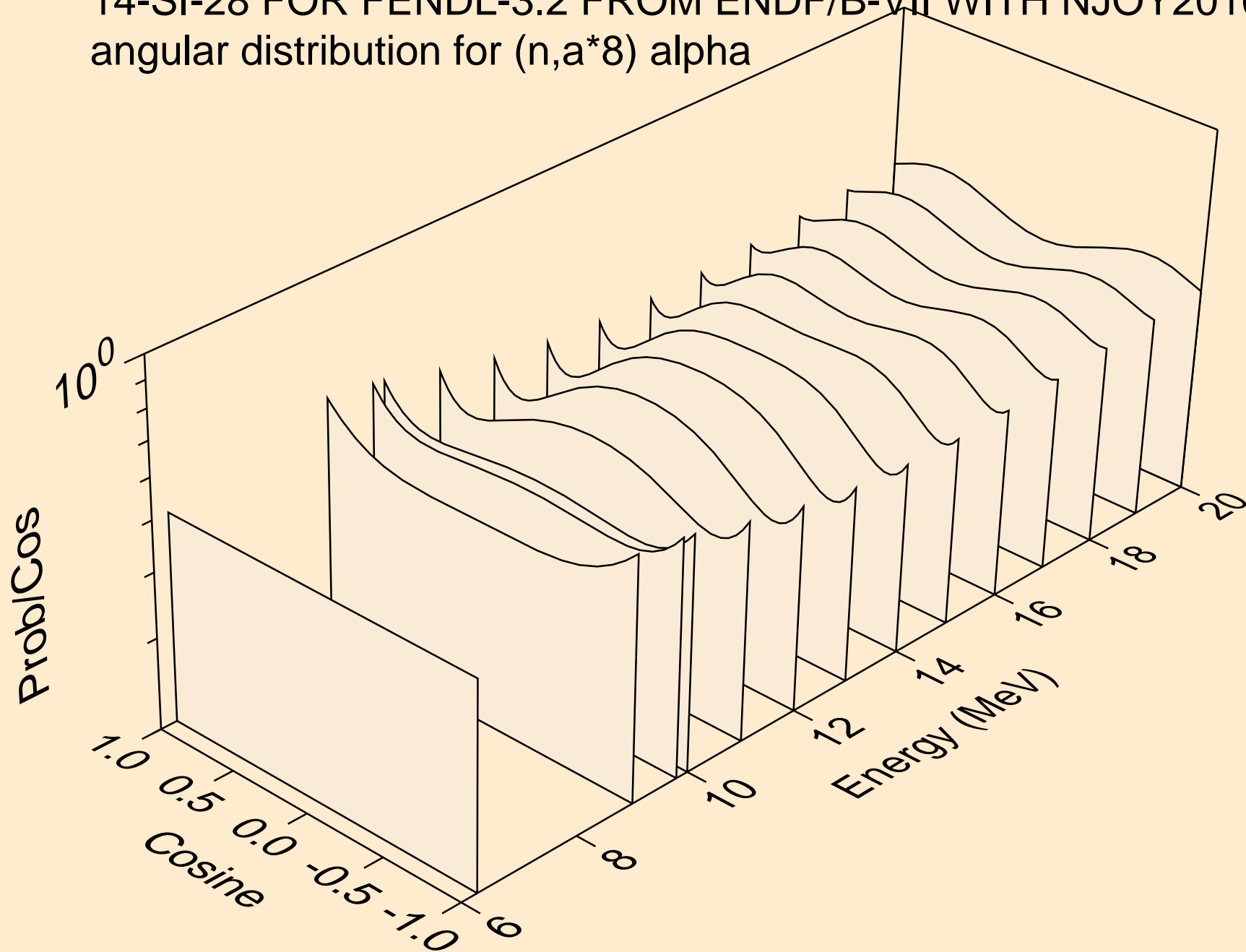

14-SI-28 FOR FENDL-3.2 FROM ENDF/B-VII WITH NJOY2016.60+
angular distribution for (n, α *9) alpha

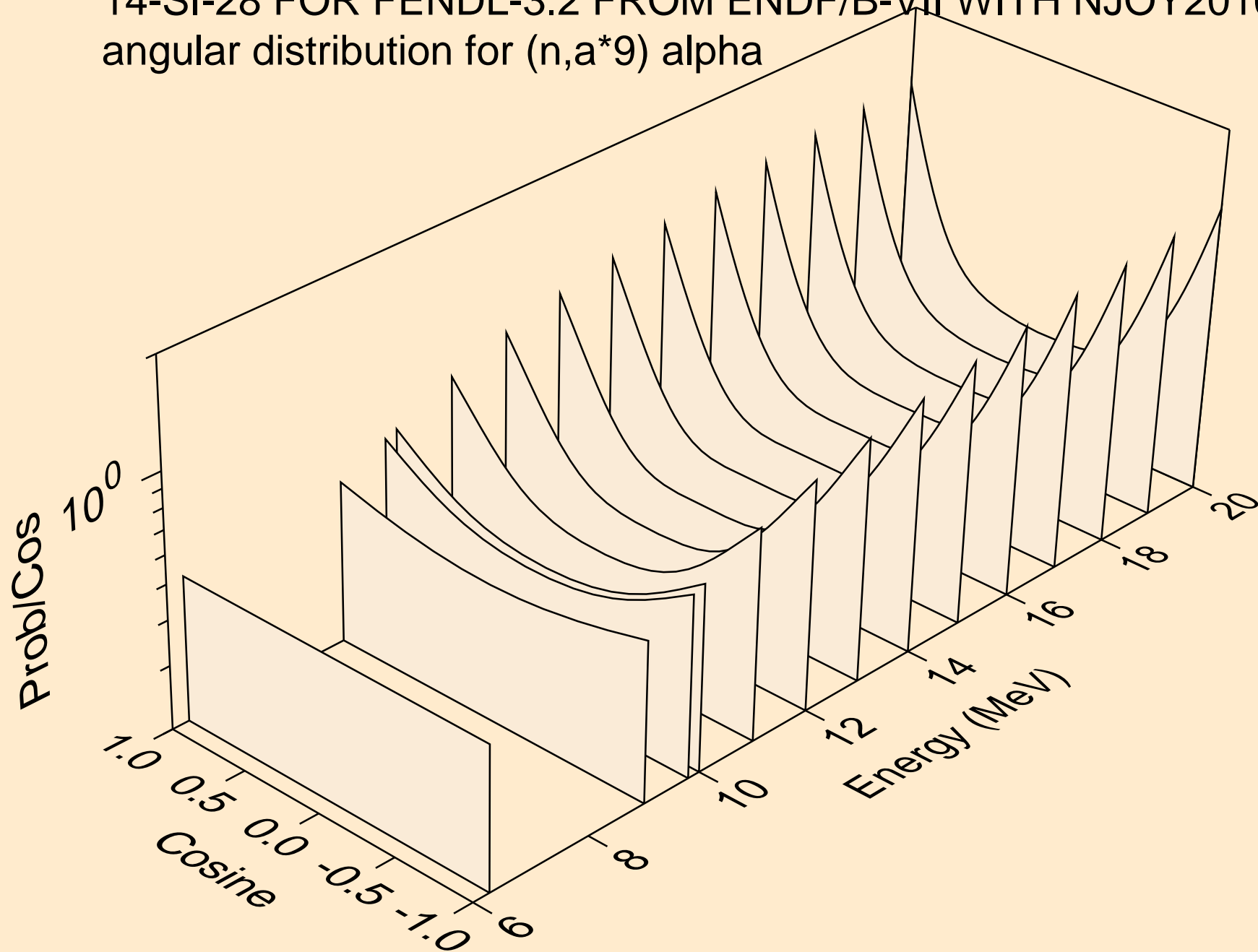

14-SI-28 FOR FENDL-3.2 FROM ENDF/B-VII WITH NJOY2016.60+
angular distribution for (n,a*10) alpha

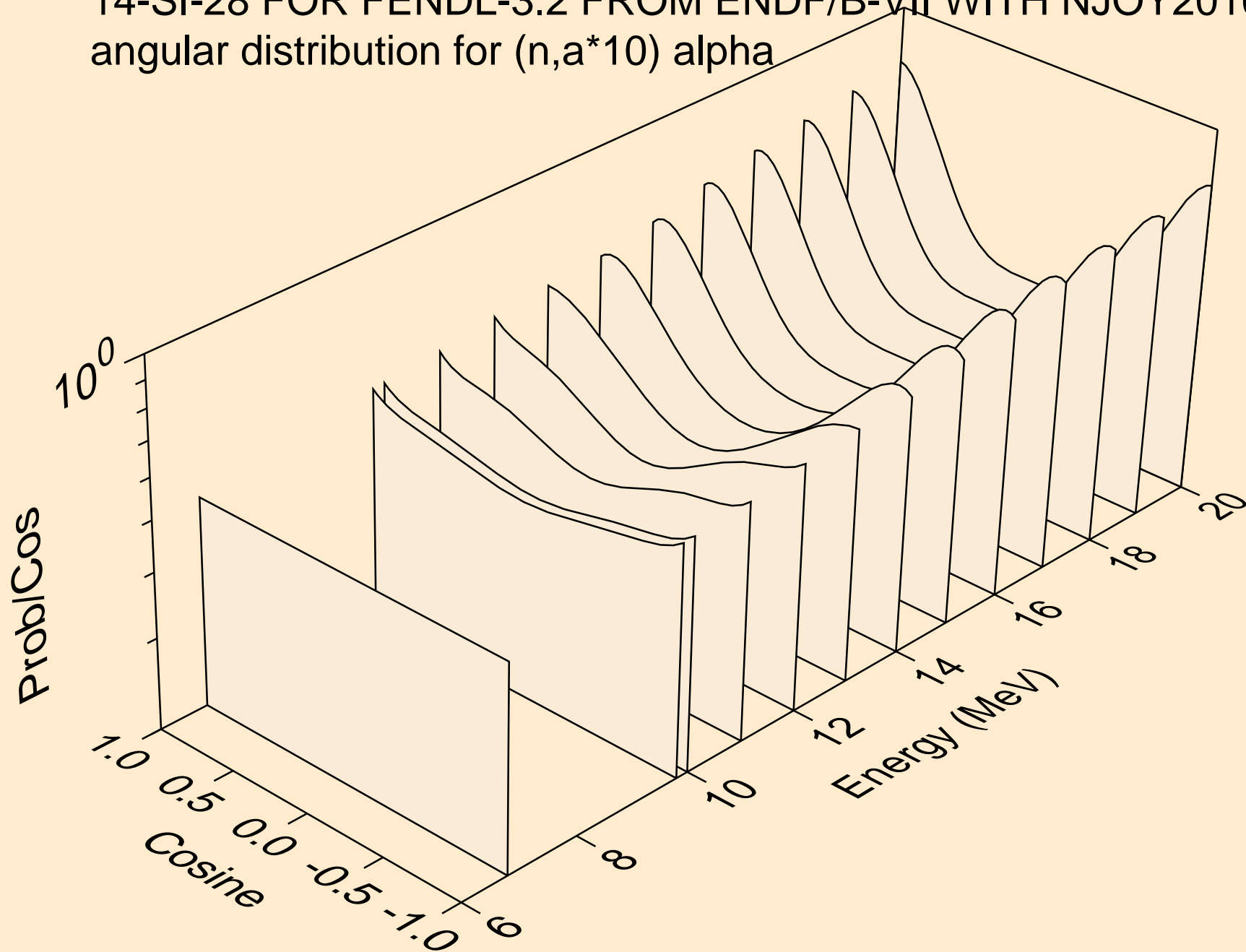

14-SI-28 FOR FENDL-3.2 FROM ENDF/B-VII WITH NJOY2016.60+
angular distribution for (n, α *11) alpha

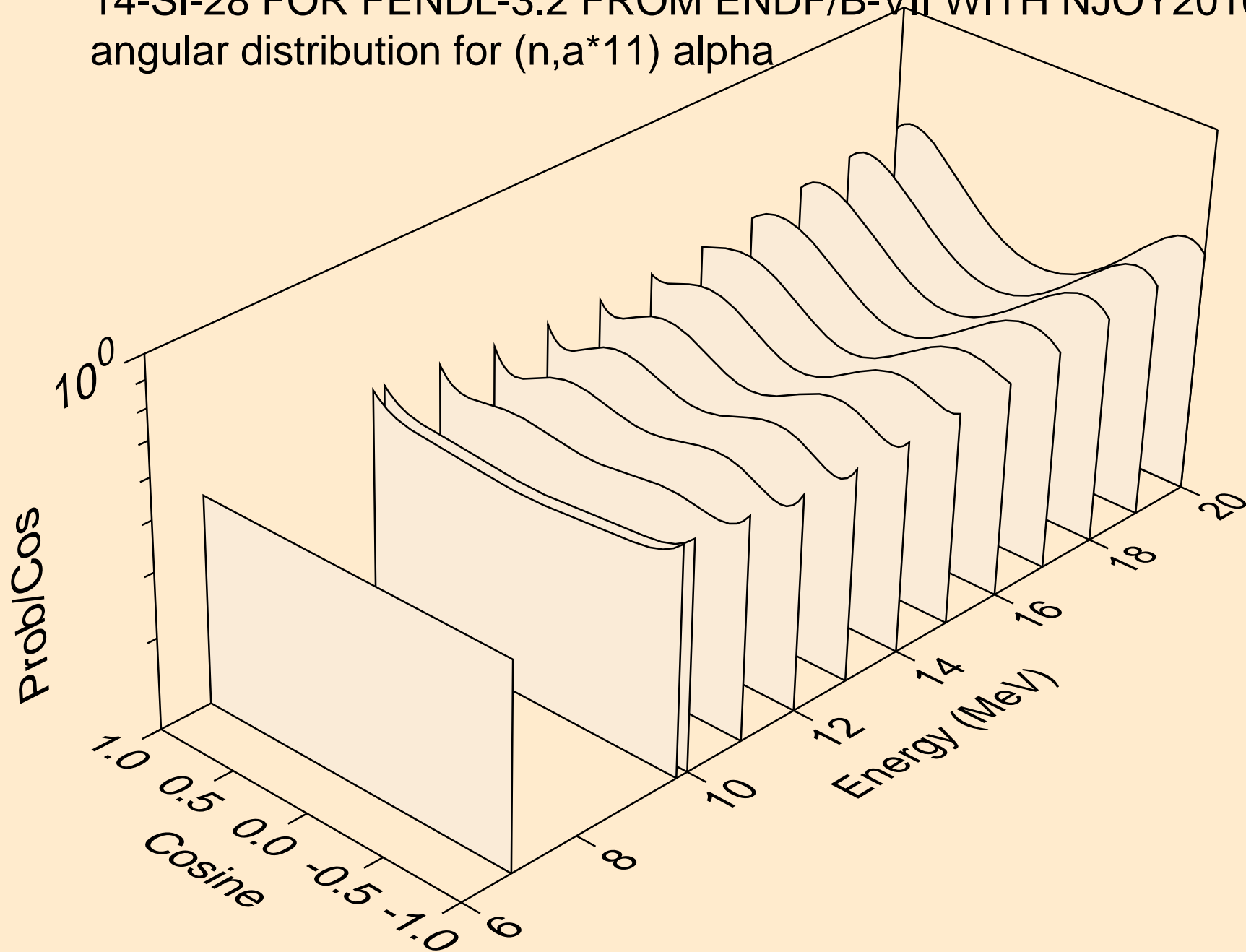

14-SI-28 FOR FENDL-3.2 FROM ENDF/B-VII WITH NJOY2016.60+
angular distribution for (n, α *12) alpha

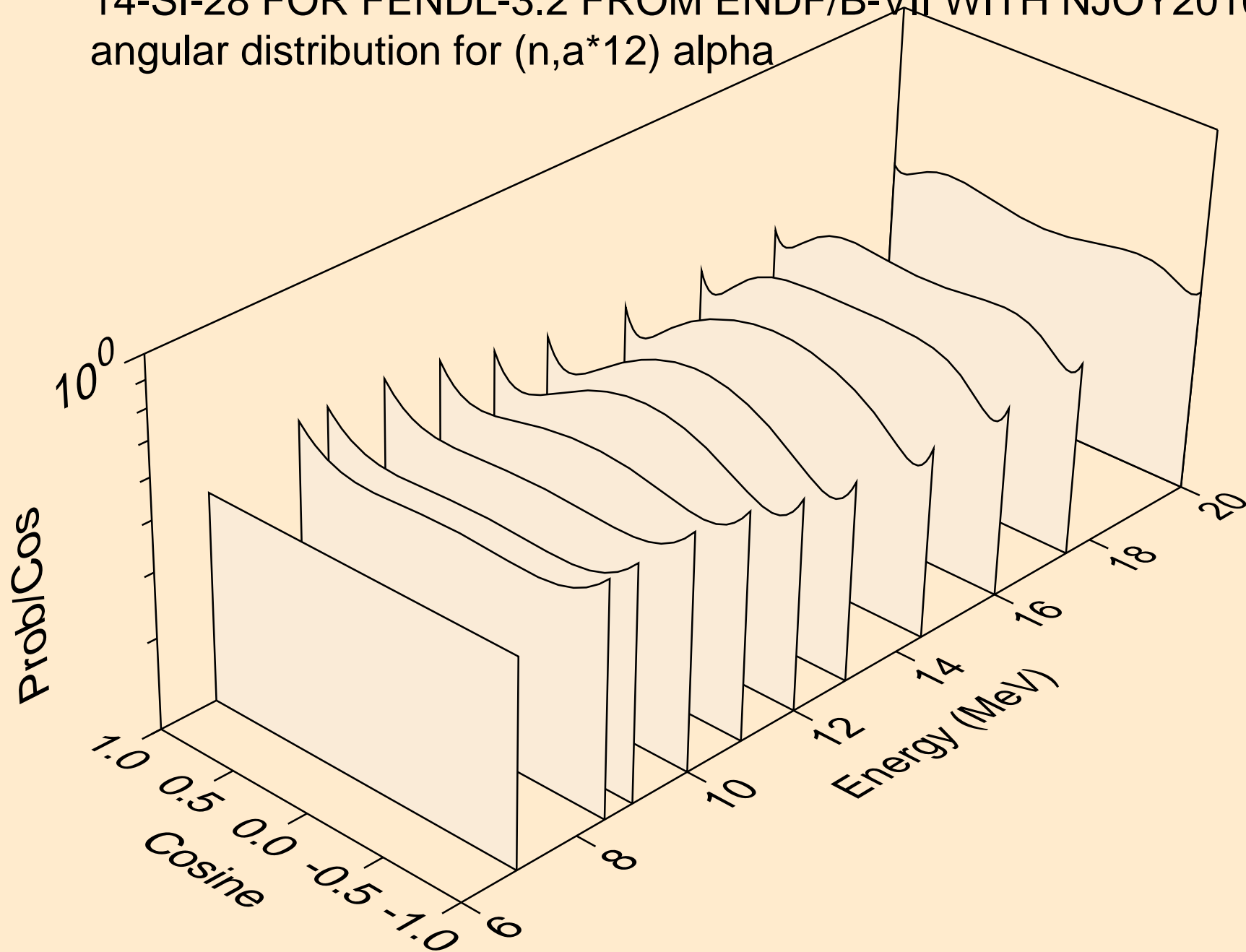

14-SI-28 FOR FENDL-3.2 FROM ENDF/B-VII WITH NJOY2016.60+
angular distribution for (n, α *13) alpha

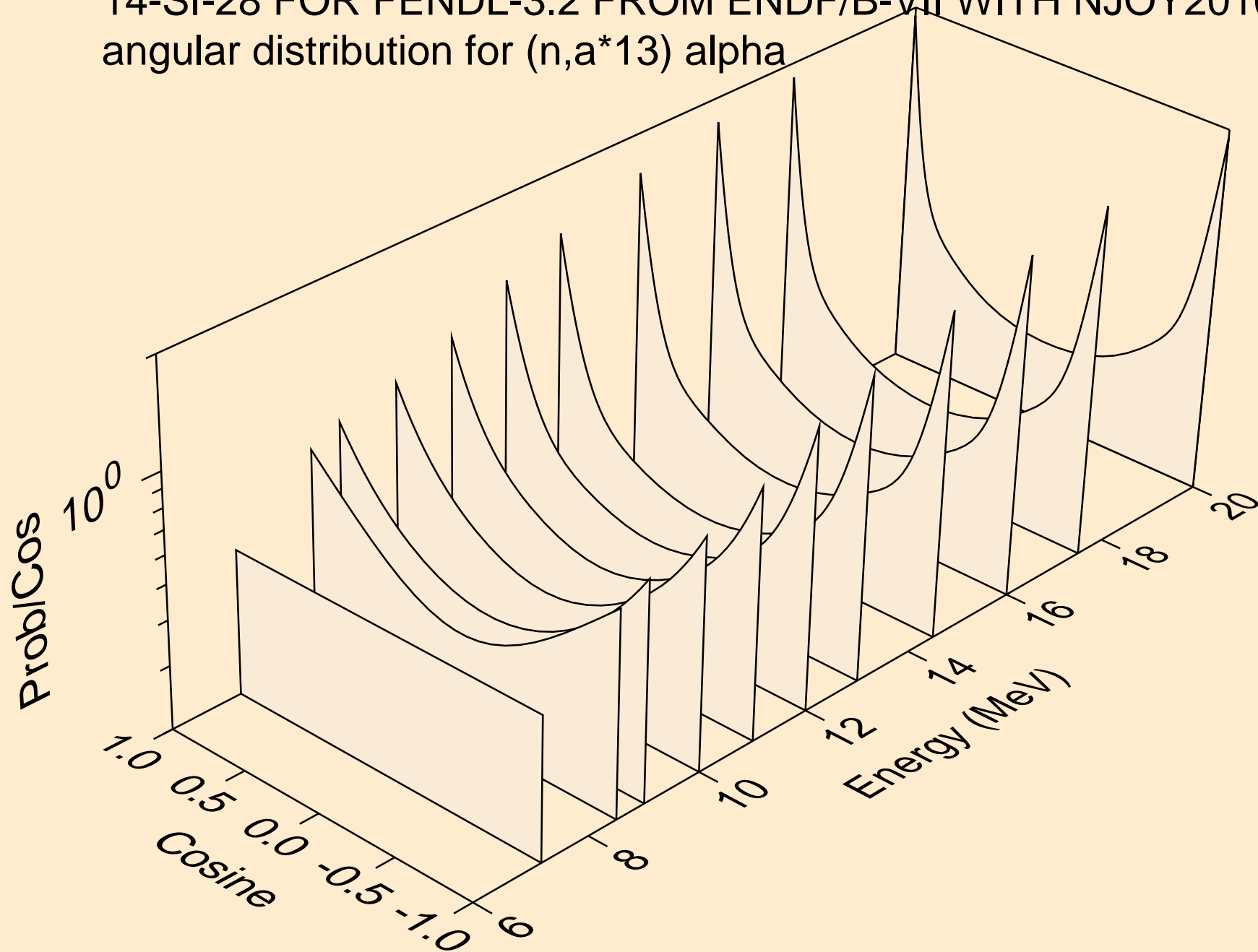

14-SI-28 FOR FENDL-3.2 FROM ENDF/B-VII WITH NJOY2016.60+
angular distribution for (n, α *14) alpha

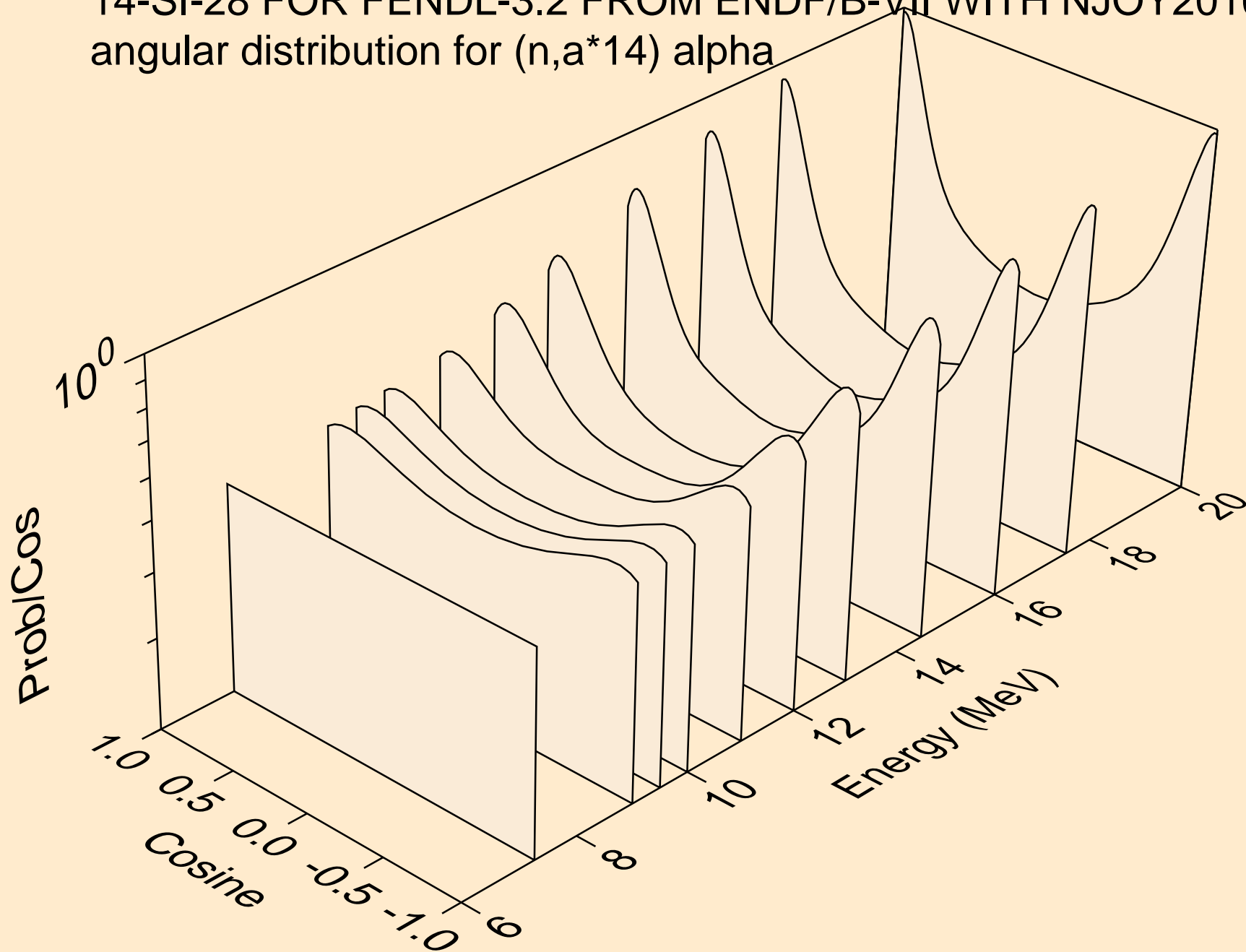

14-SI-28 FOR FENDL-3.2 FROM ENDF/B-VII WITH NJOY2016.60+
angular distribution for (n, α *15) alpha

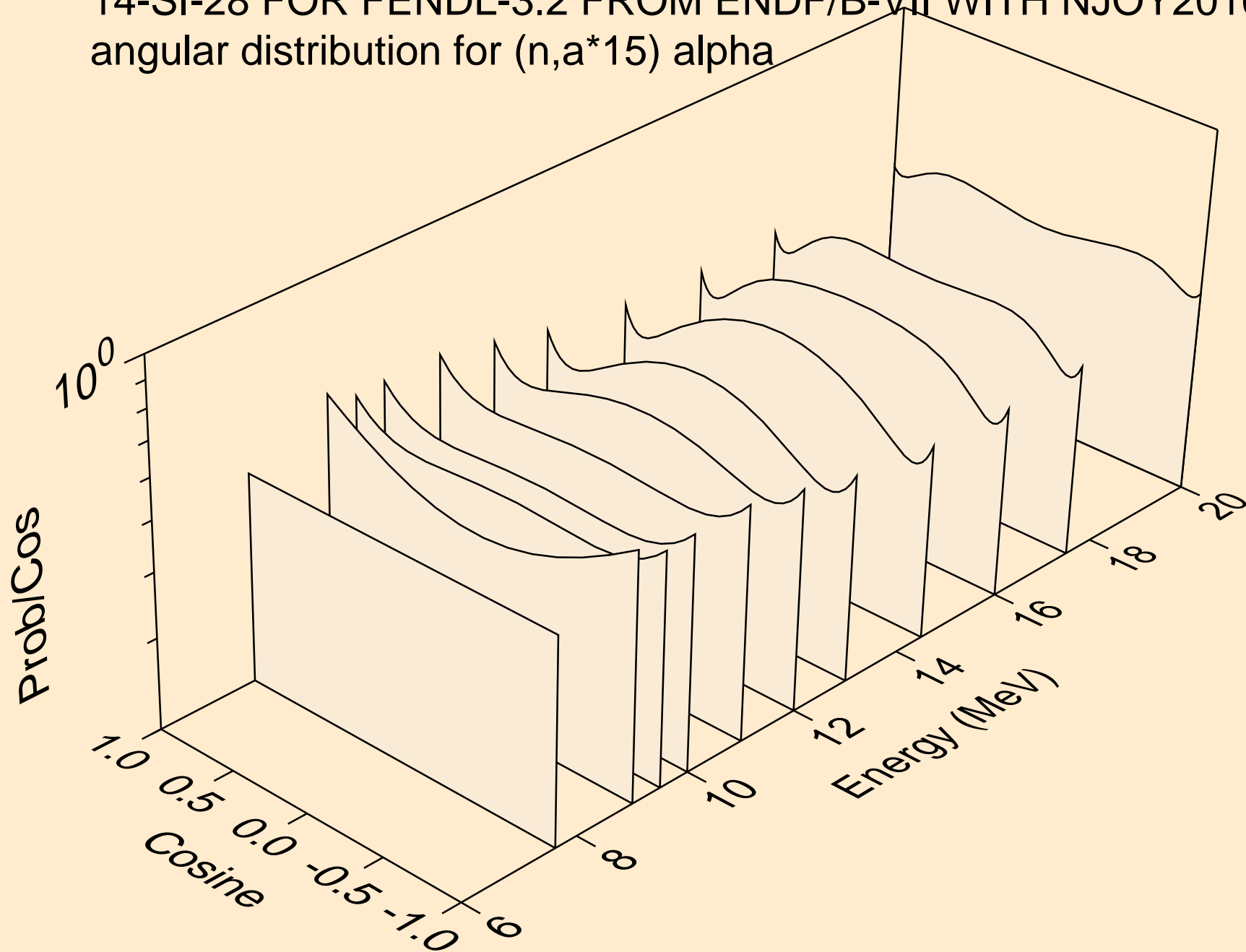

14-SI-28 FOR FENDL-3.2 FROM ENDF/B-VII WITH NJOY2016.60+
alphas from (n,a*c)

