

40-ZR-90 FOR FENDL-3.2 FROM FENDL-3.2 WITH NJOY2016.60+

Principal cross sections

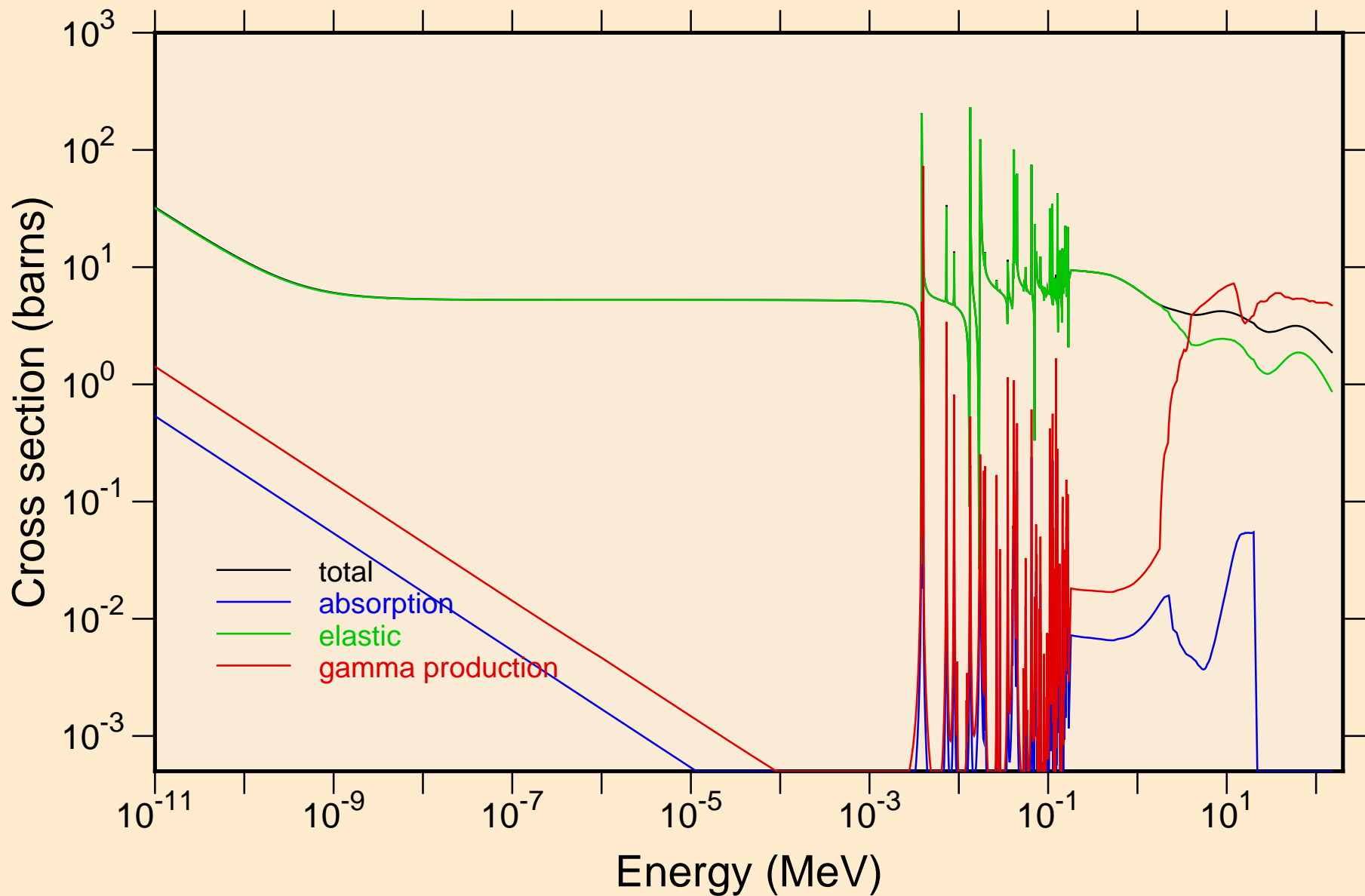

40-ZR-90 FOR FENDL-3.2 FROM FENDL-3.2 WITH NJOY2016.60+
resonance total cross section

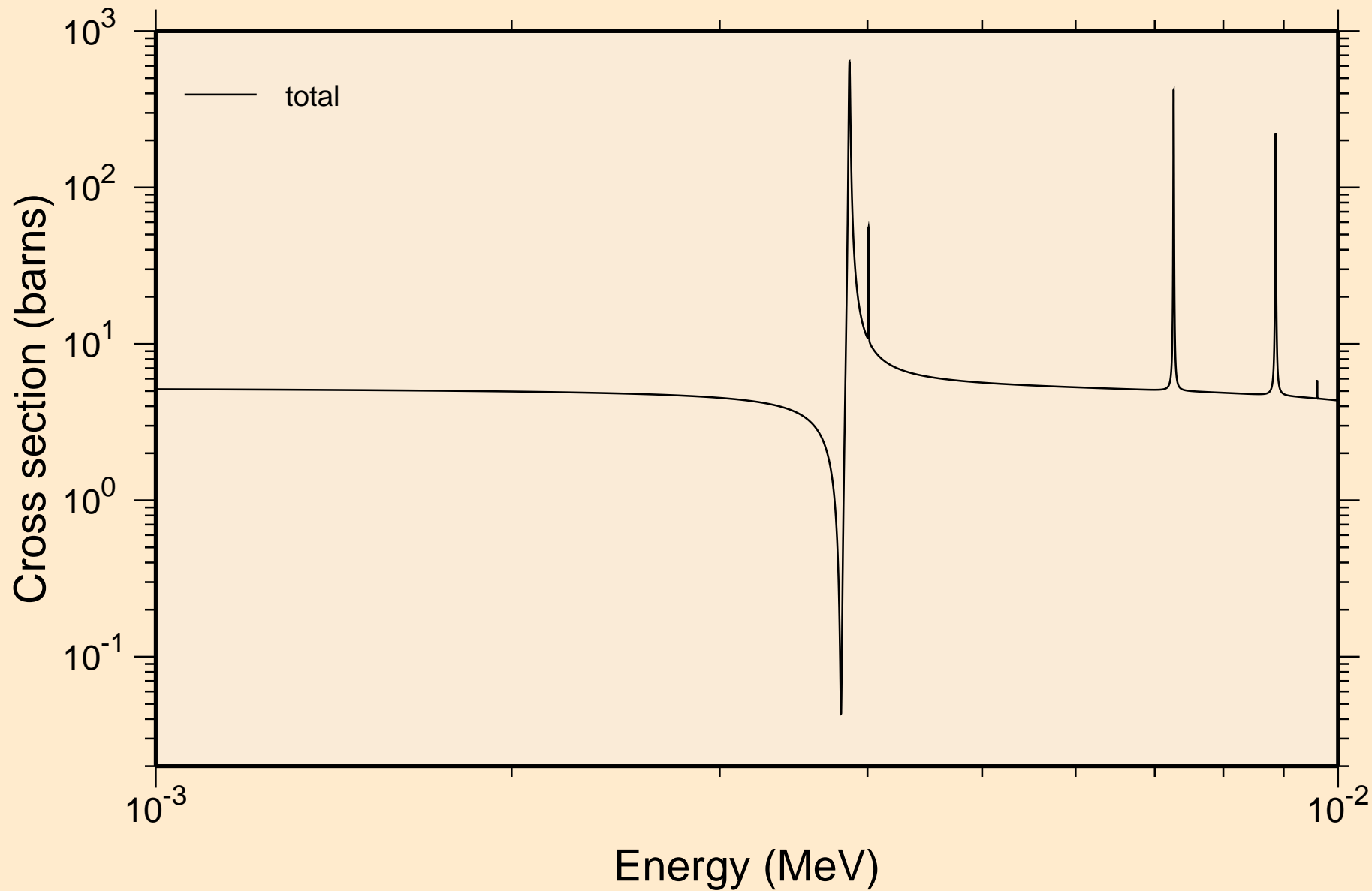

40-ZR-90 FOR FENDL-3.2 FROM FENDL-3.2 WITH NJOY2016.60+
resonance total cross section

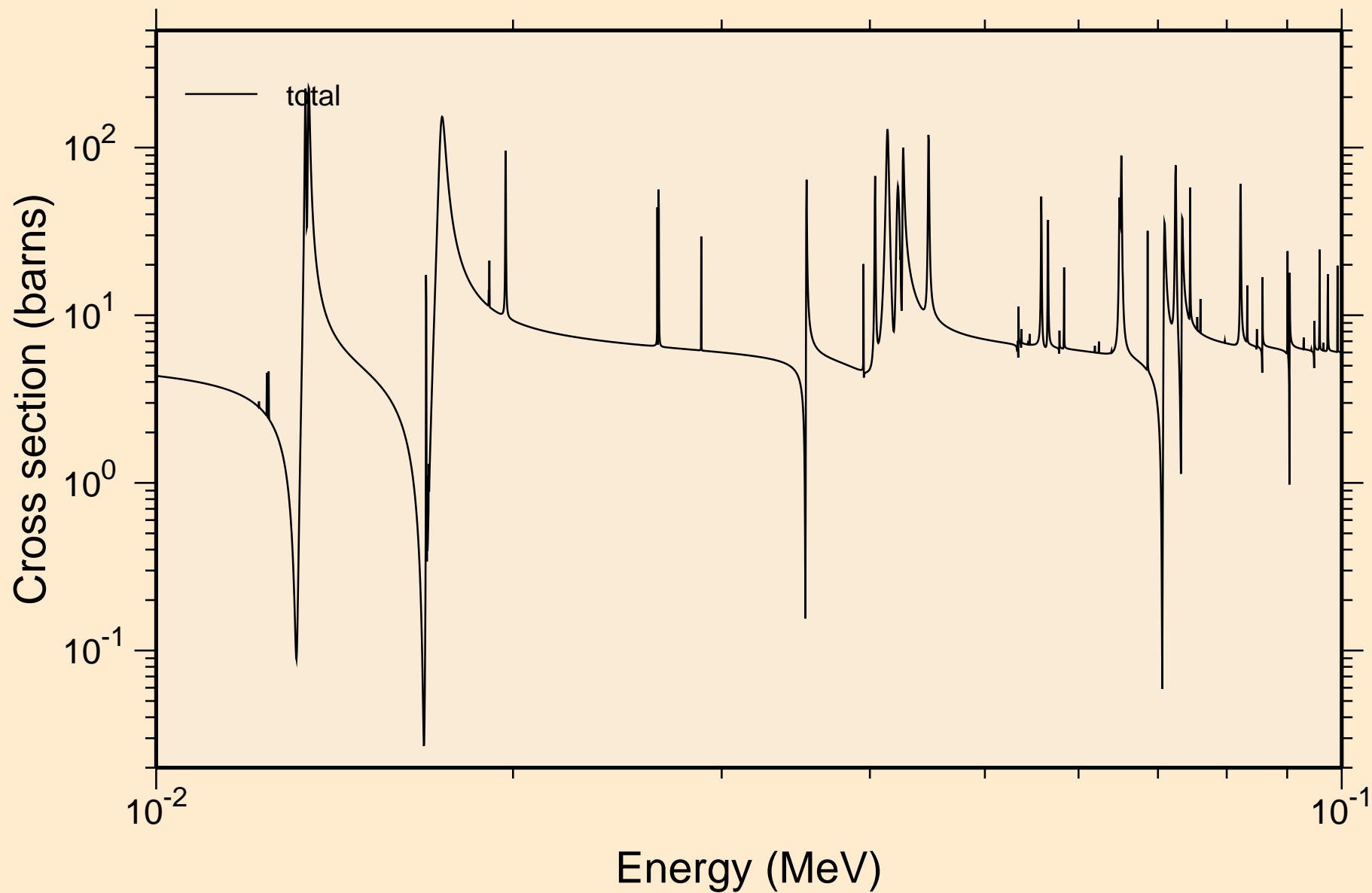

40-ZR-90 FOR FENDL-3.2 FROM FENDL-3.2 WITH NJOY2016.60+
resonance total cross section

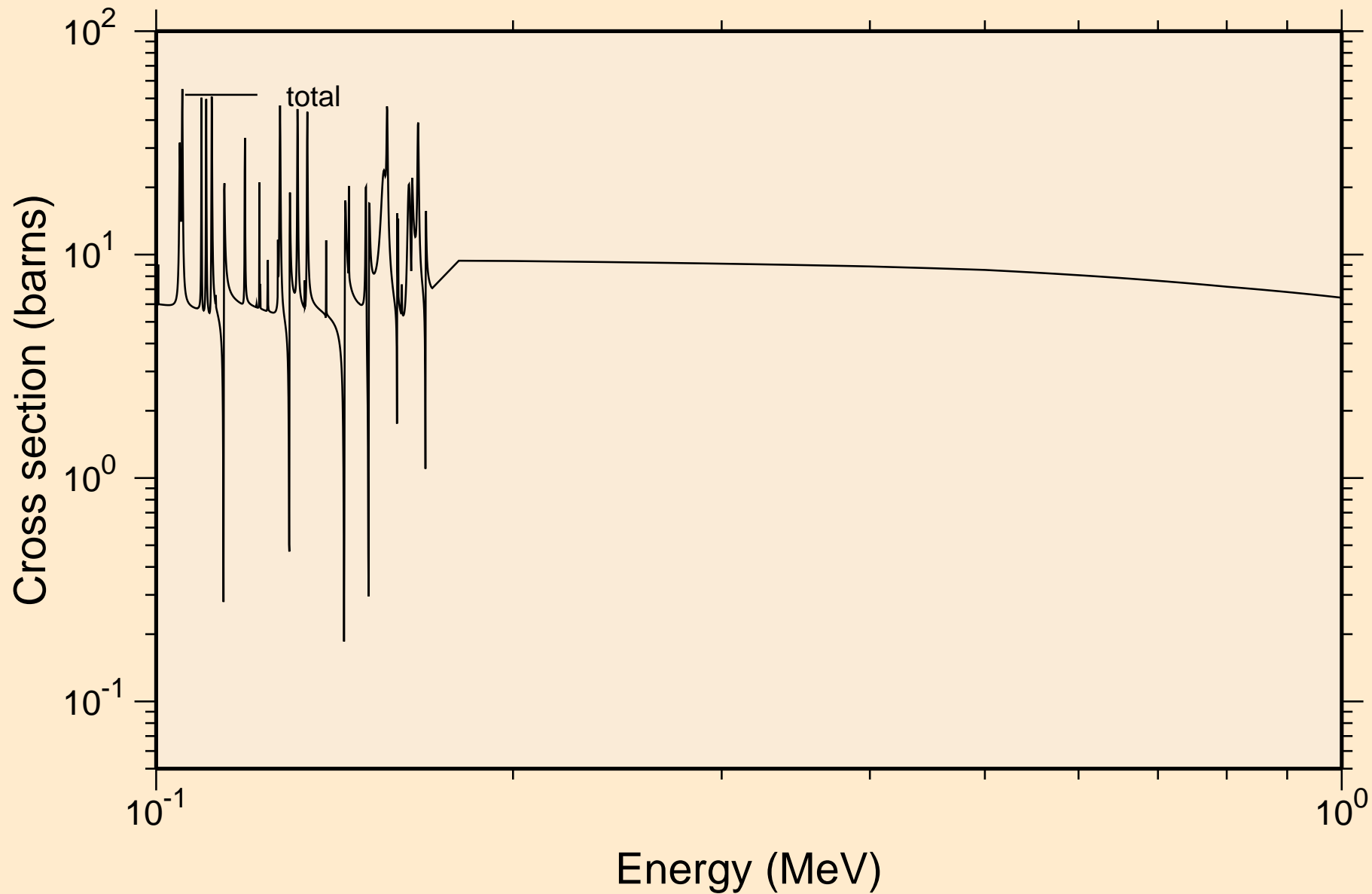

40-ZR-90 FOR FENDL-3.2 FROM FENDL-3.2 WITH NJOY2016.60+
resonance total cross section

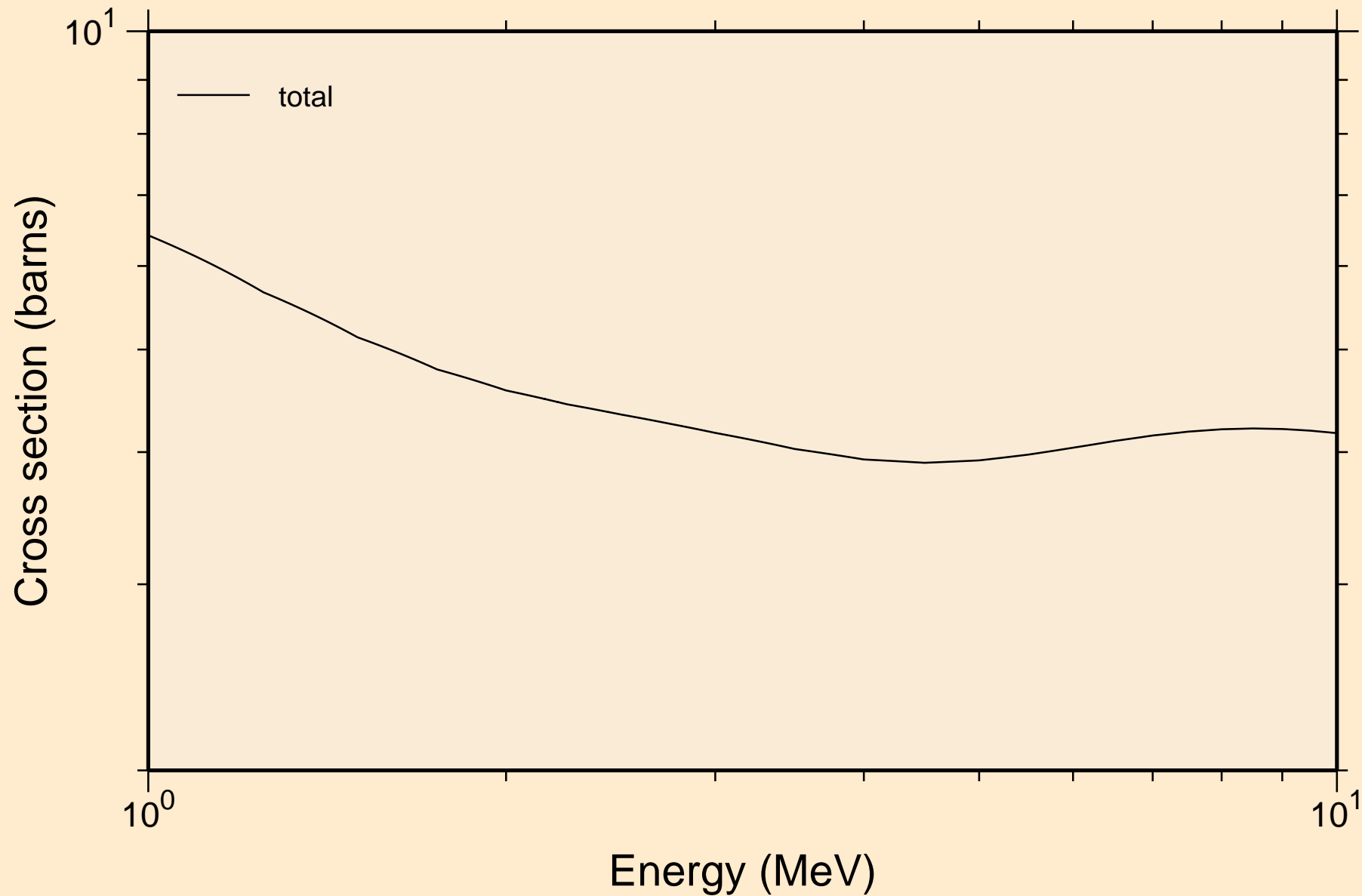

40-ZR-90 FOR FENDL-3.2 FROM FENDL-3.2 WITH NJOY2016.60+
resonance absorption cross sections

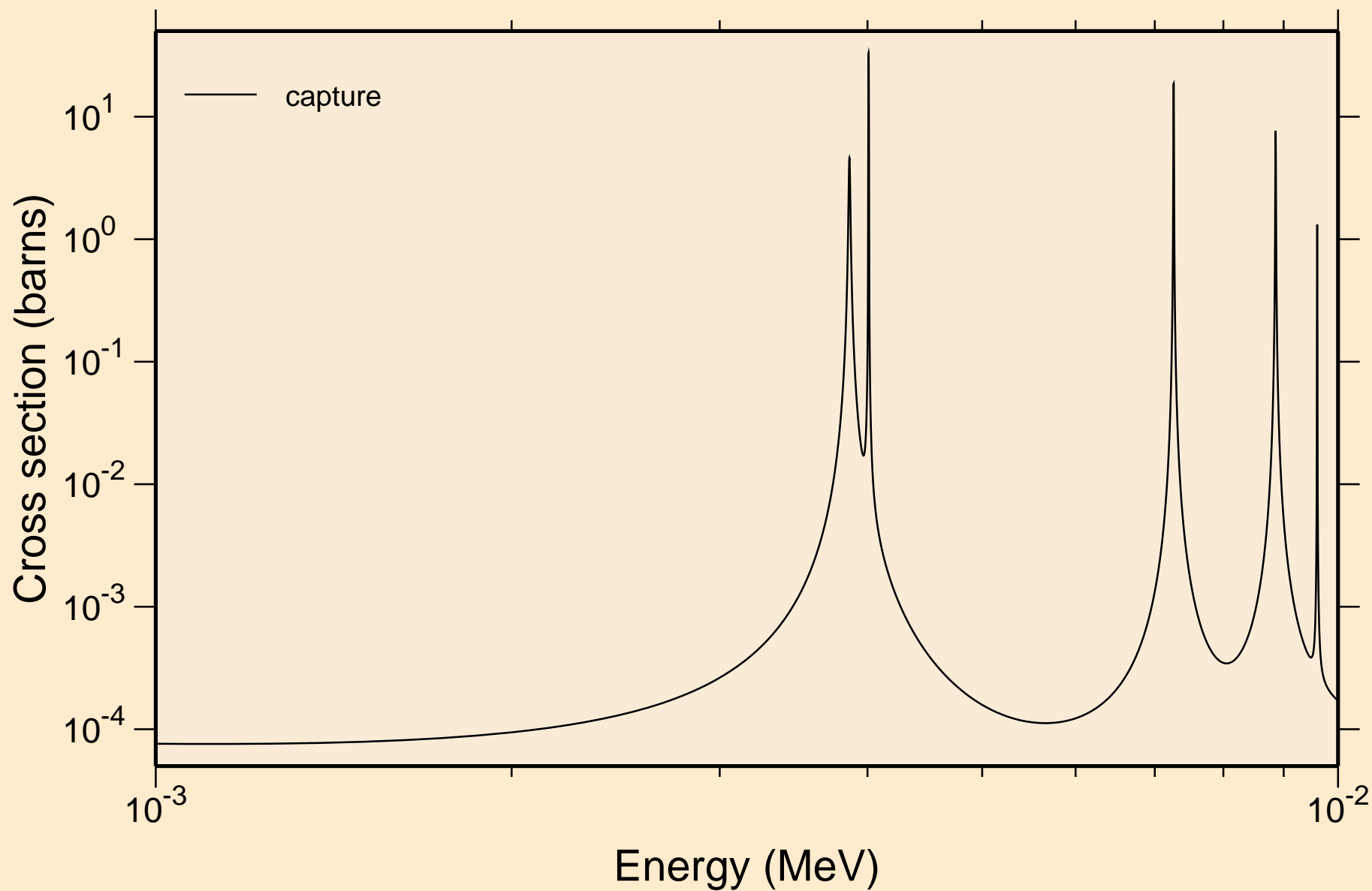

40-ZR-90 FOR FENDL-3.2 FROM FENDL-3.2 WITH NJOY2016.60+
resonance absorption cross sections

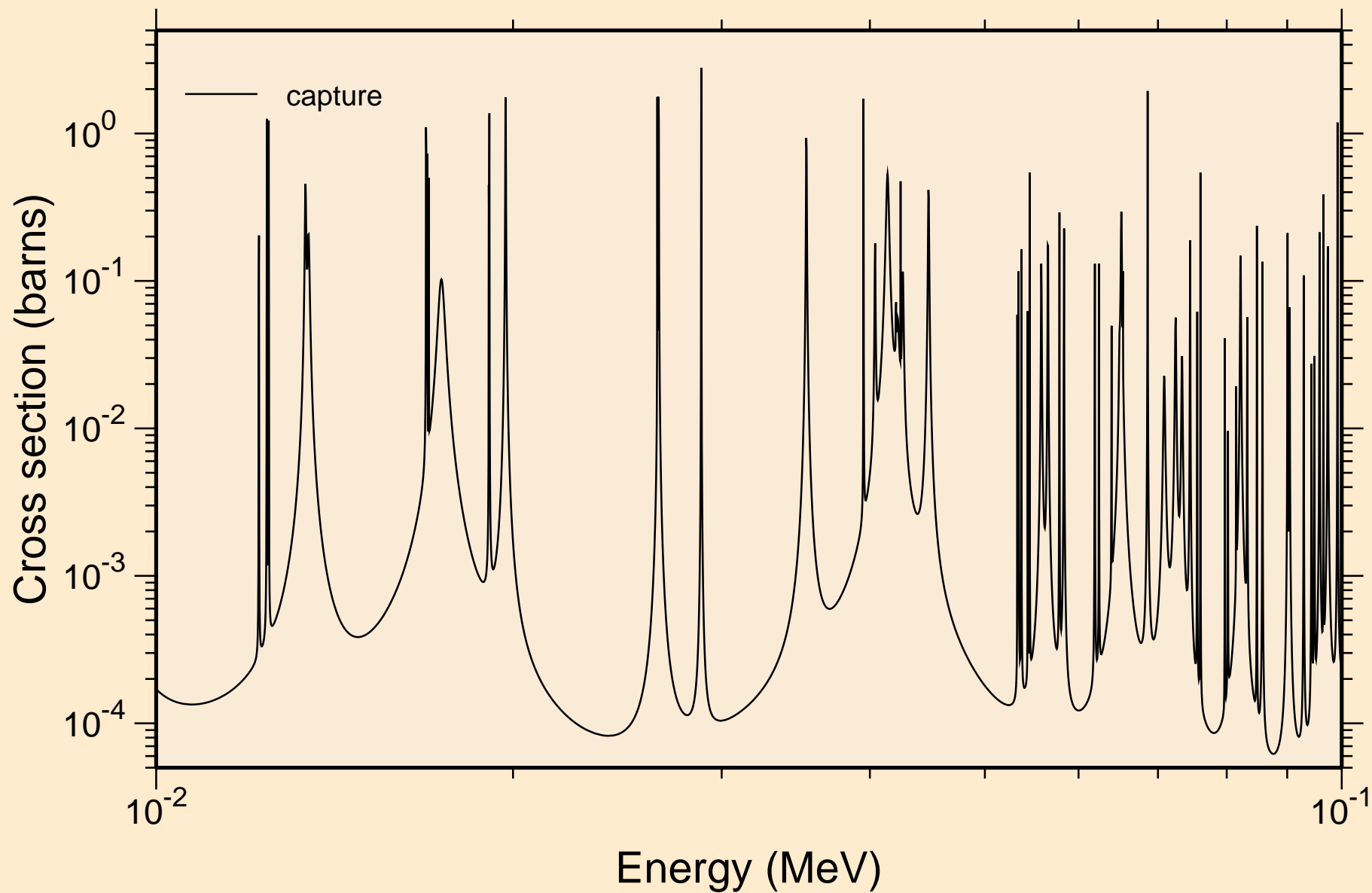

40-ZR-90 FOR FENDL-3.2 FROM FENDL-3.2 WITH NJOY2016.60+
resonance absorption cross sections

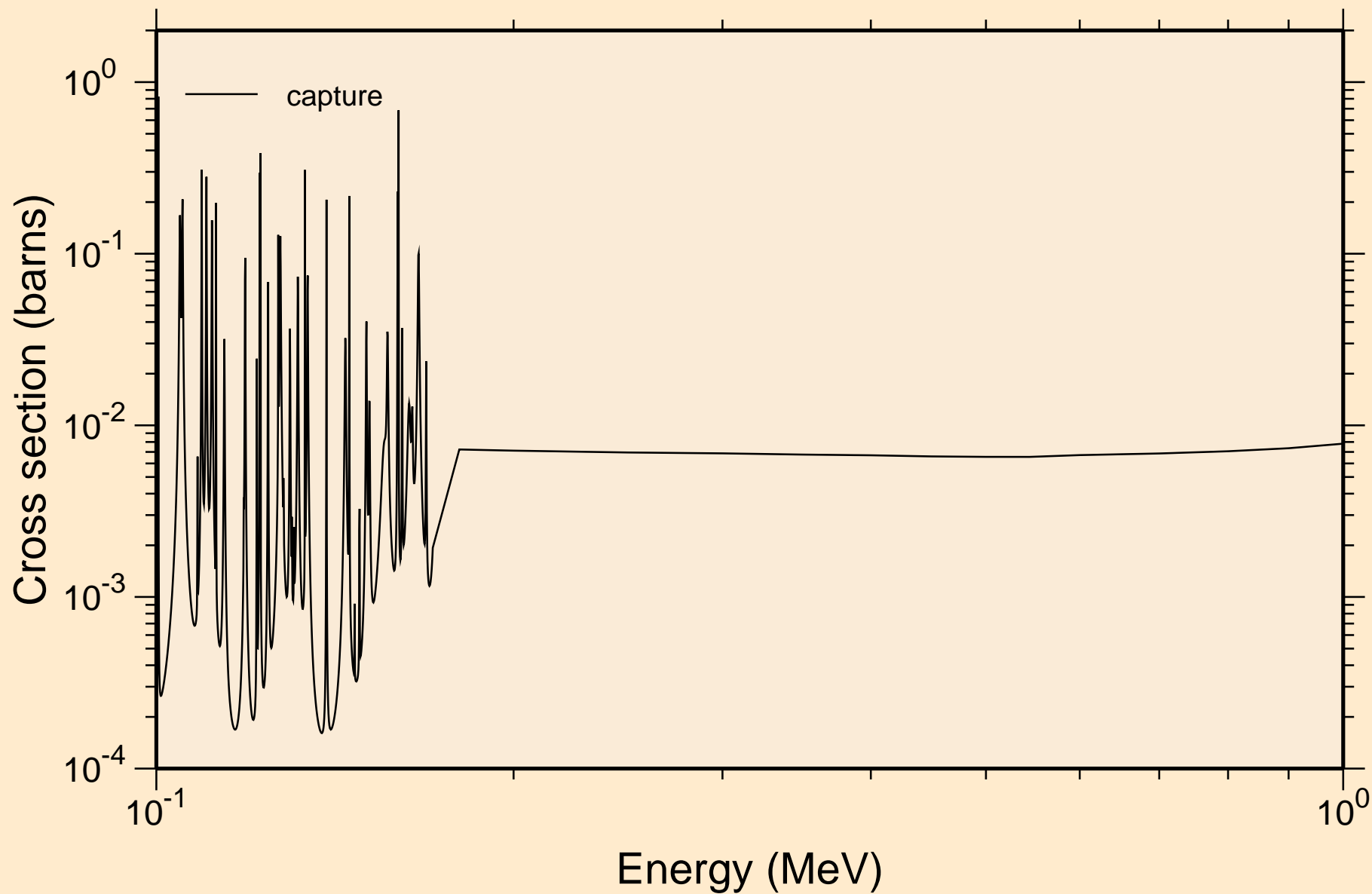

40-ZR-90 FOR FENDL-3.2 FROM FENDL-3.2 WITH NJOY2016.60+
resonance absorption cross sections

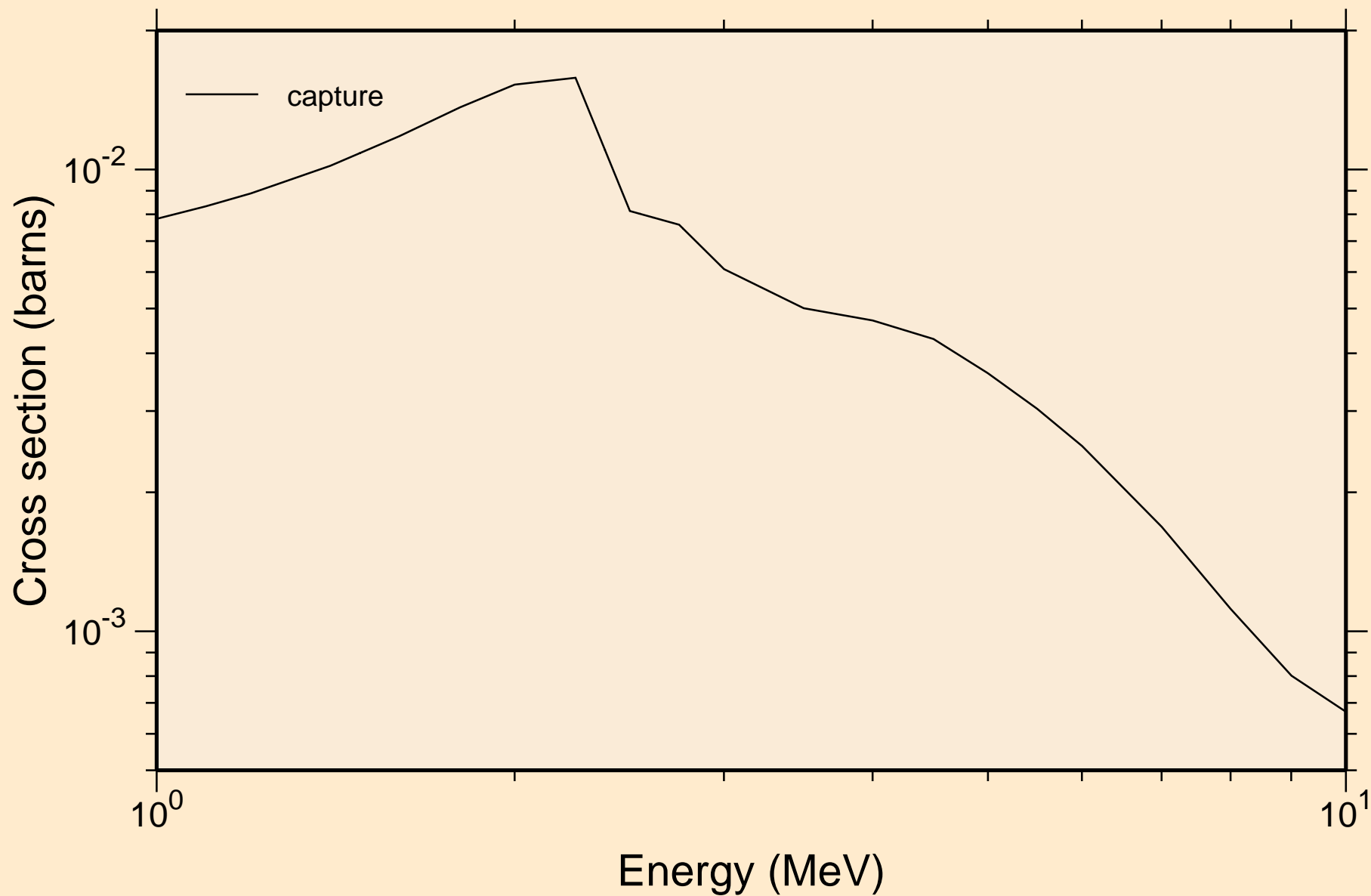

40-ZR-90 FOR FENDL-3.2 FROM FENDL-3.2 WITH NJOY2016.60+
UR total cross section

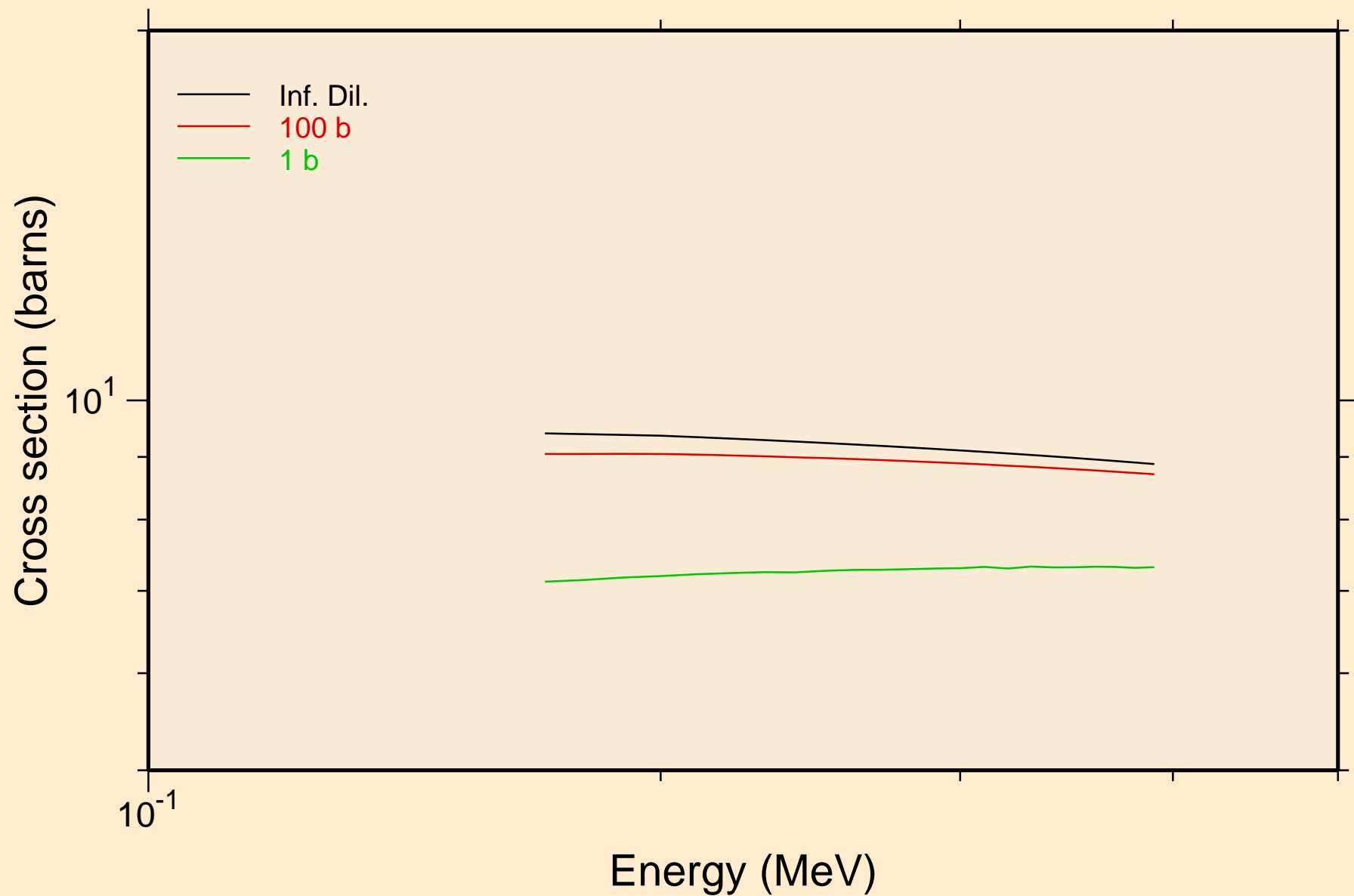

40-ZR-90 FOR FENDL-3.2 FROM FENDL-3.2 WITH NJOY2016.60+
UR elastic cross section

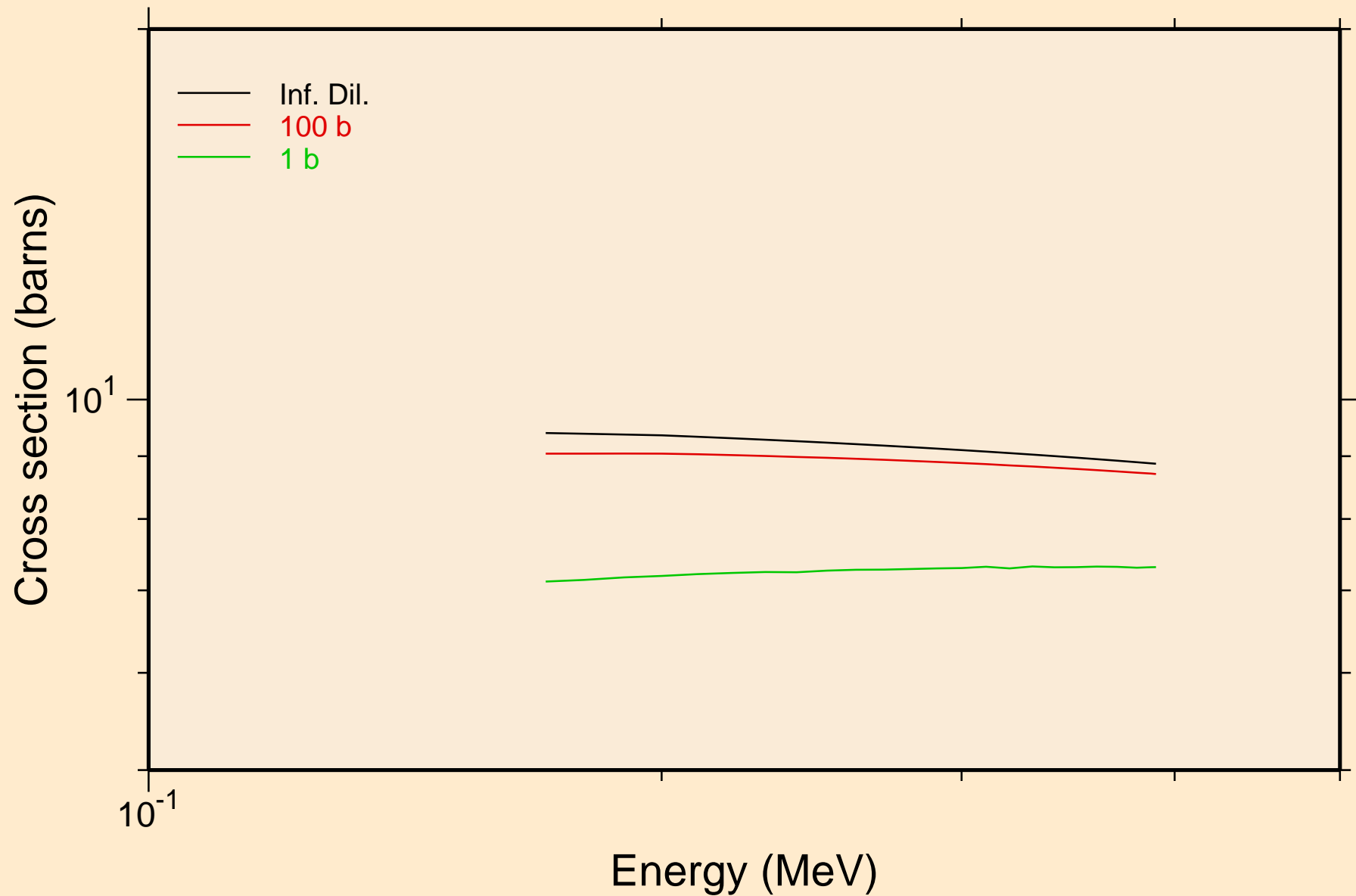

40-ZR-90 FOR FENDL-3.2 FROM FENDL-3.2 WITH NJOY2016.60+
UR capture cross section

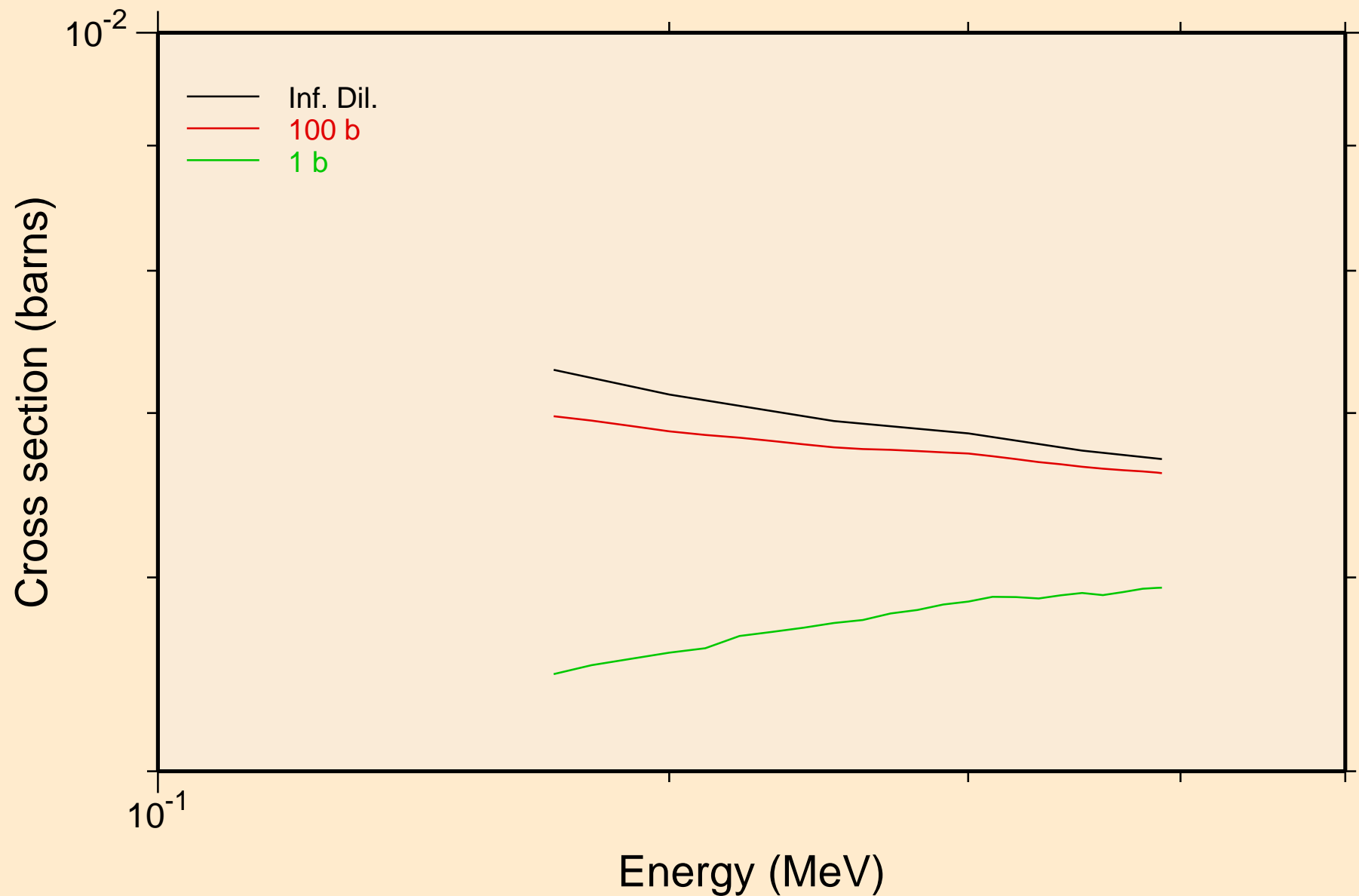

40-ZR-90 FOR FENDL-3.2 FROM FENDL-3.2 WITH NJOY2016.60+ Heating

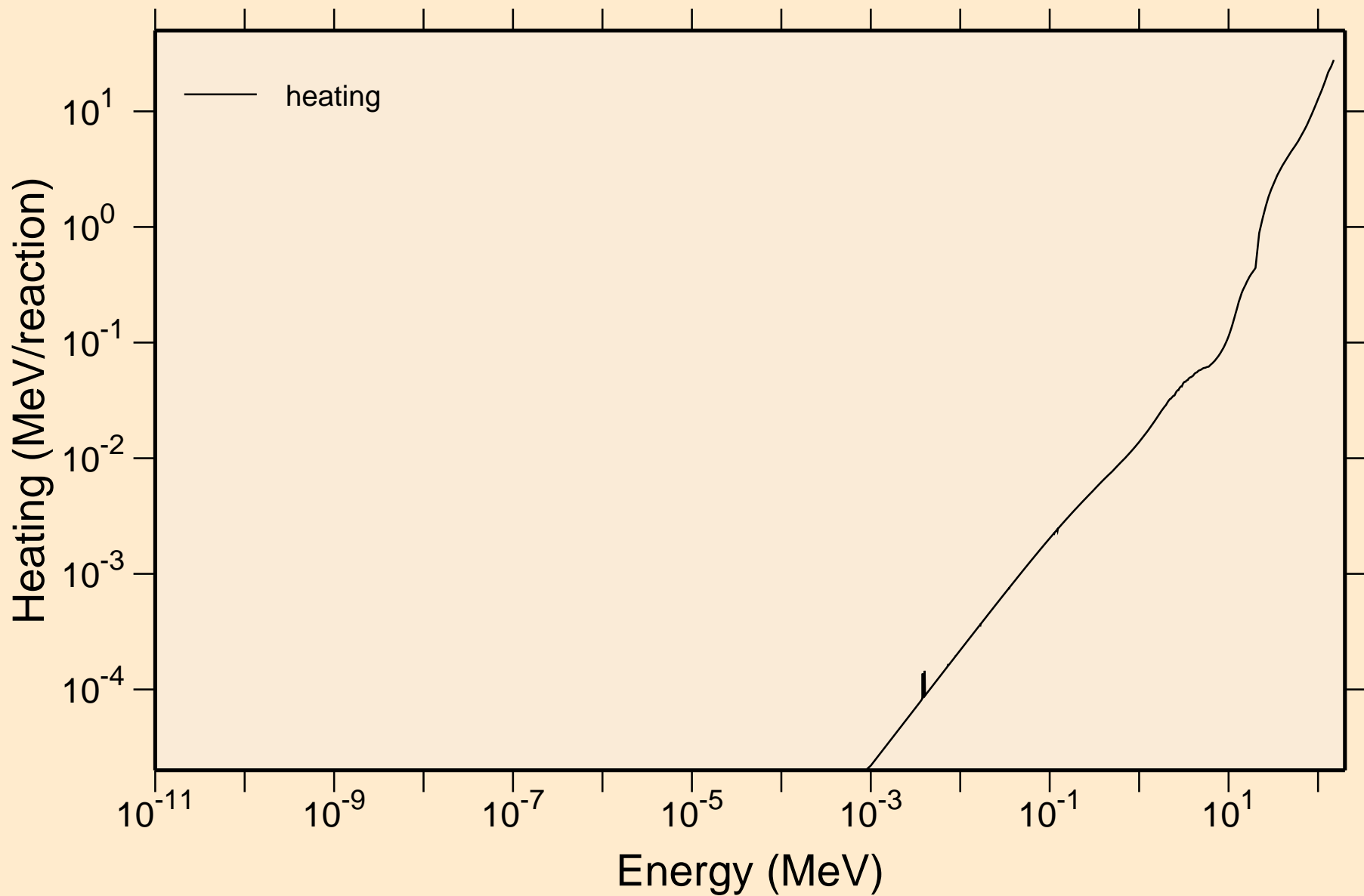

40-ZR-90 FOR FENDL-3.2 FROM FENDL-3.2 WITH NJOY2016.60+ Damage

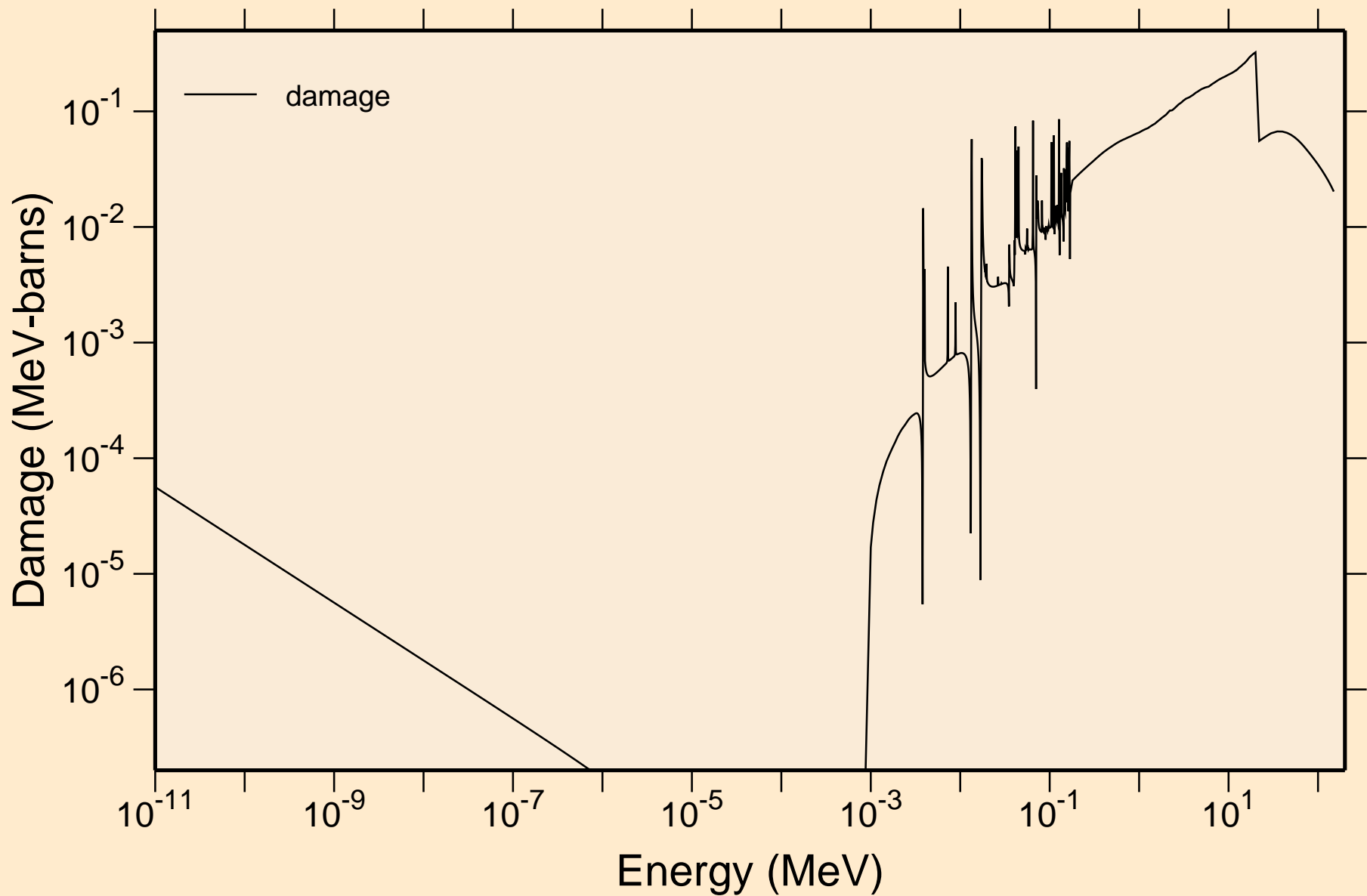

40-ZR-90 FOR FENDL-3.2 FROM FENDL-3.2 WITH NJOY2016.60+
Non-threshold reactions

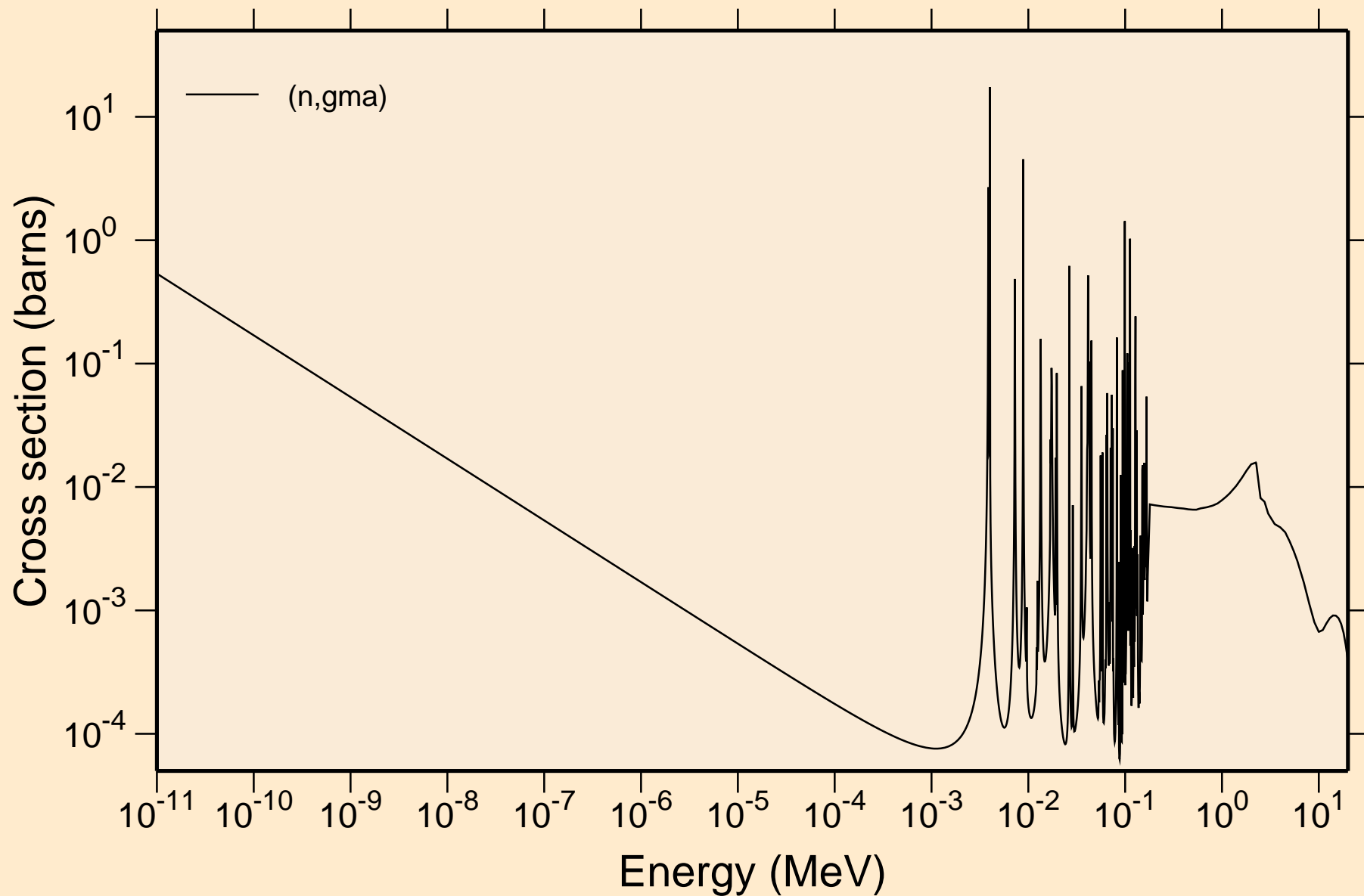

40-ZR-90 FOR FENDL-3.2 FROM FENDL-3.2 WITH NJOY2016.60+

Principal cross sections

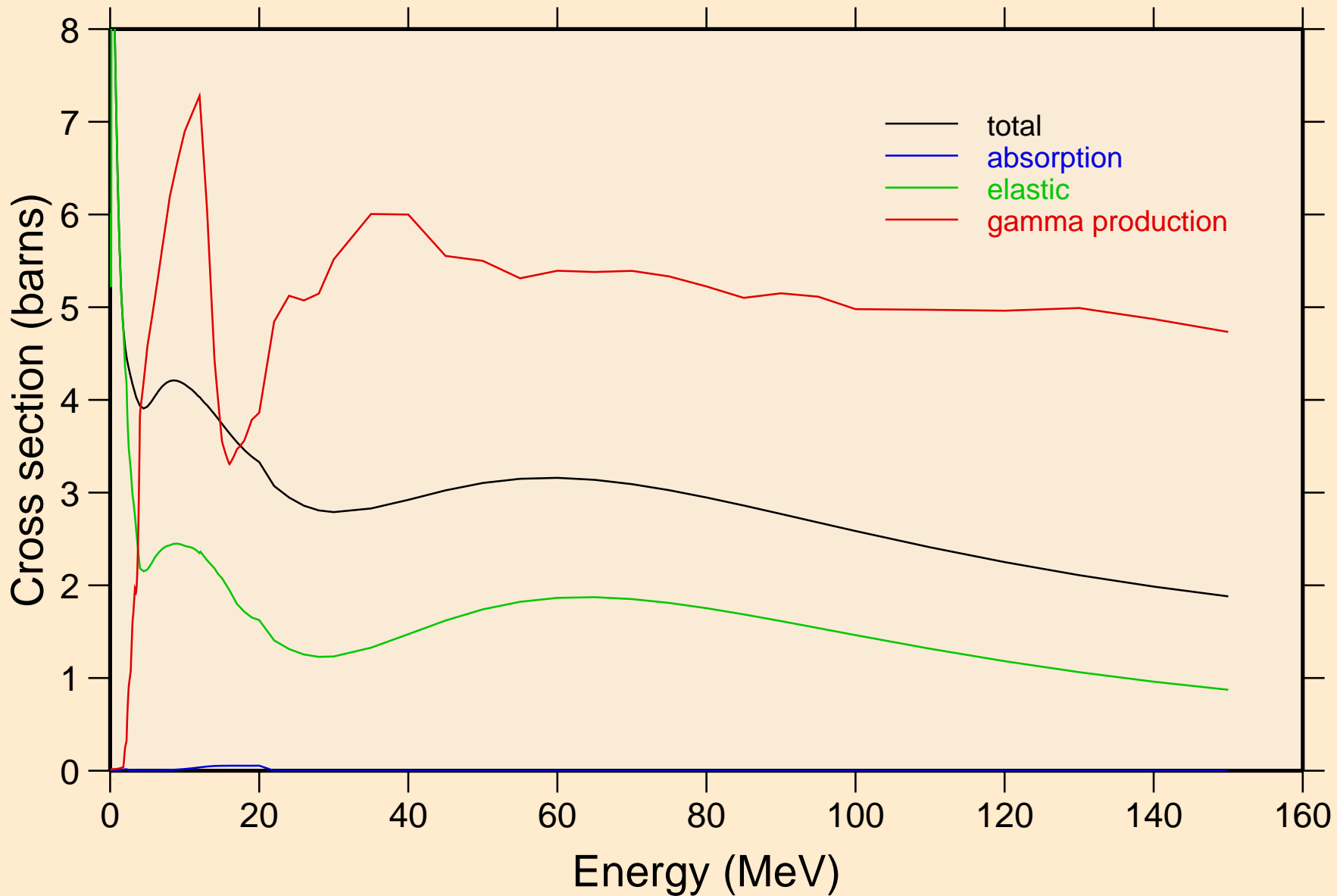

40-ZR-90 FOR FENDL-3.2 FROM FENDL-3.2 WITH NJOY2016.60+ Heating

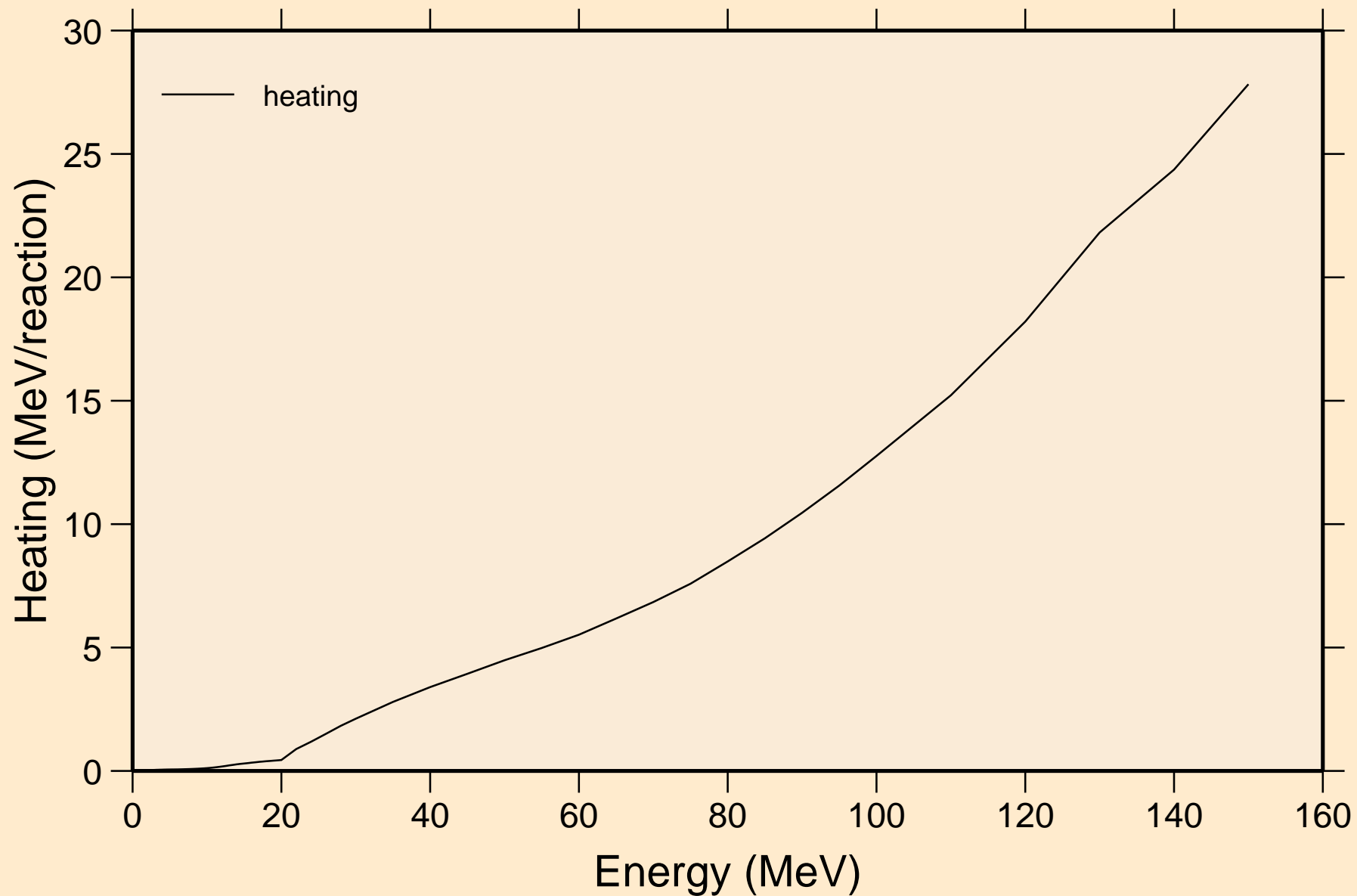

40-ZR-90 FOR FENDL-3.2 FROM FENDL-3.2 WITH NJOY2016.60+ Damage

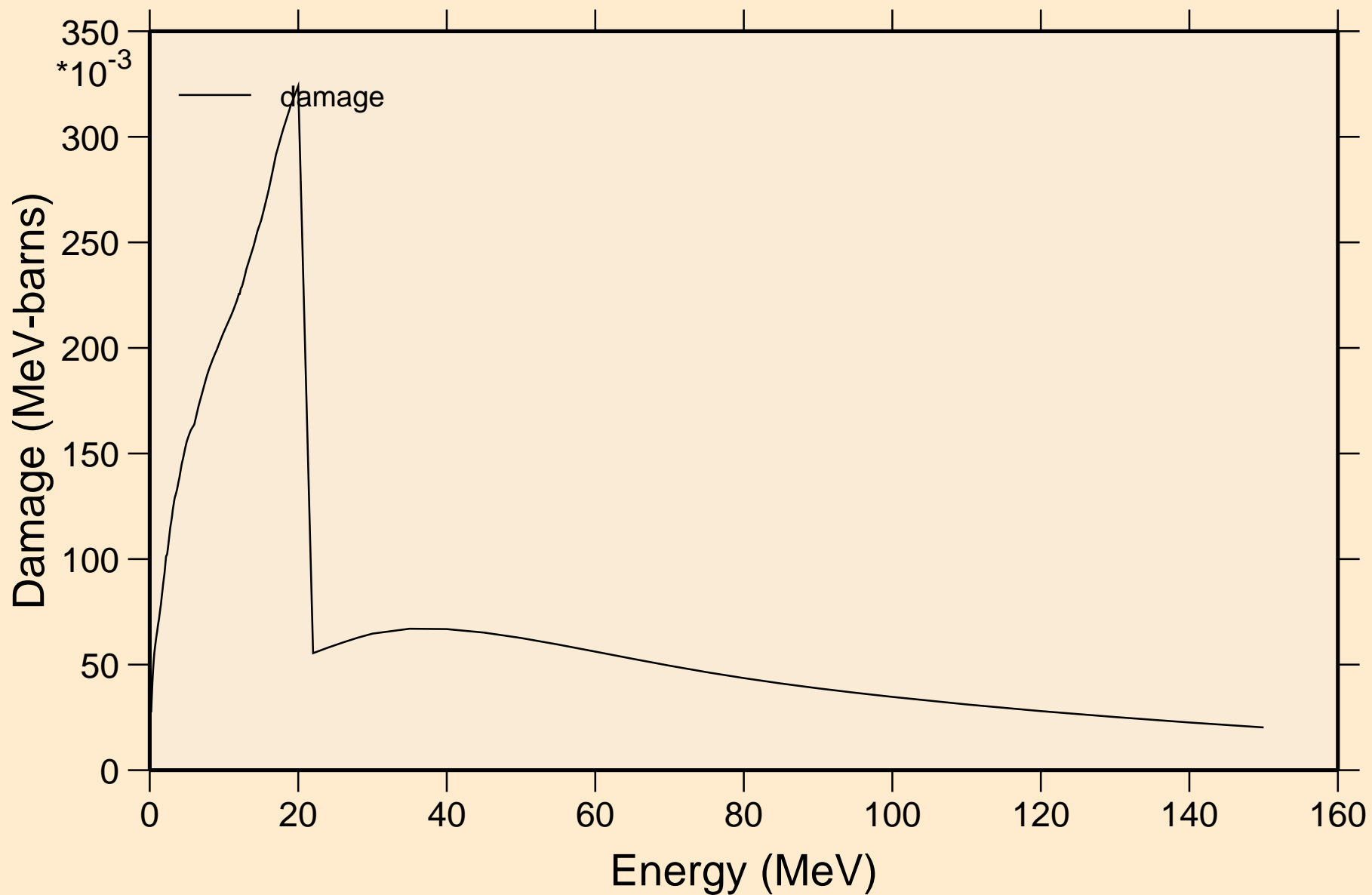

40-ZR-90 FOR FENDL-3.2 FROM FENDL-3.2 WITH NJOY2016.60+
Non-threshold reactions

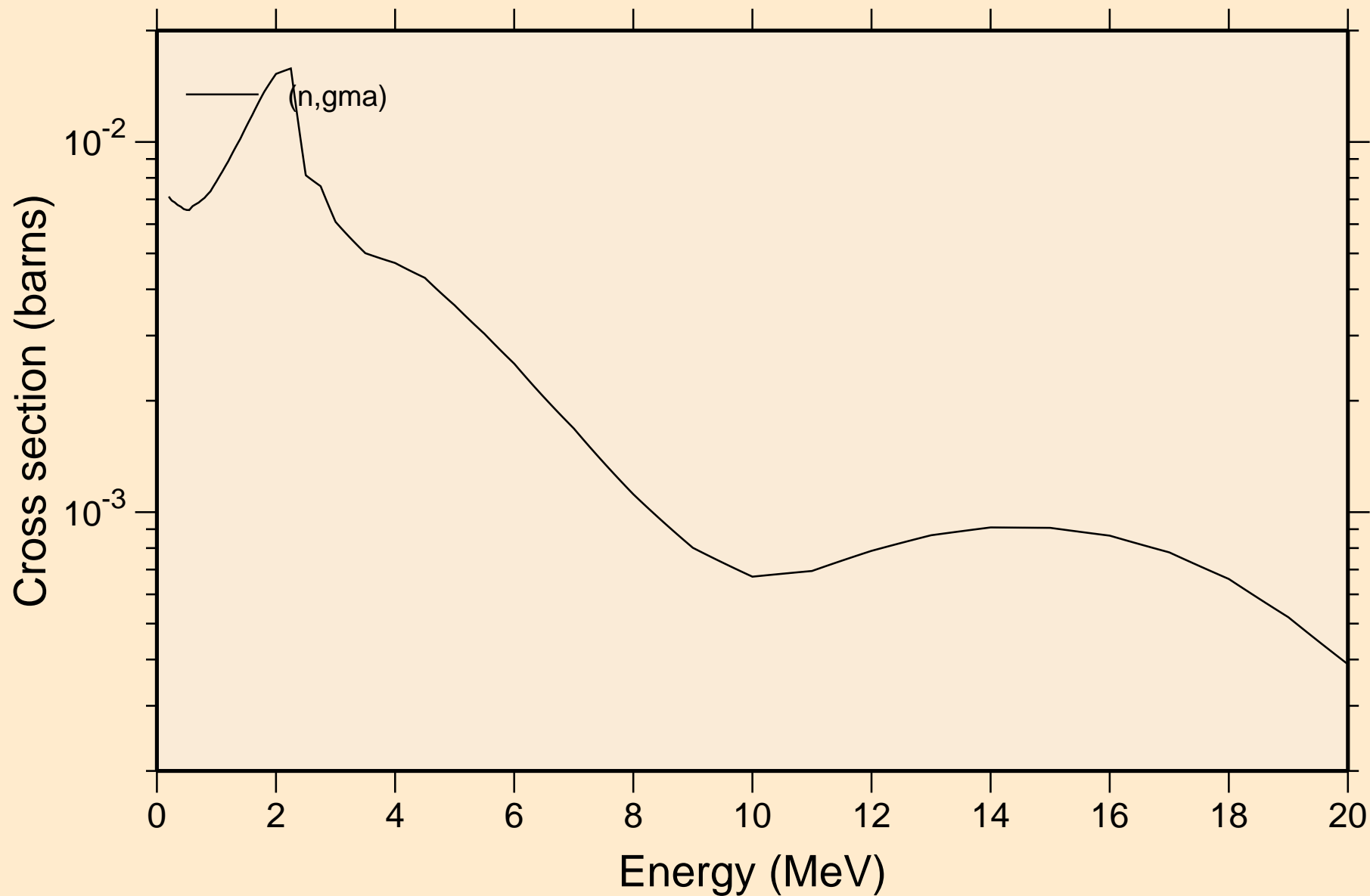

40-ZR-90 FOR FENDL-3.2 FROM FENDL-3.2 WITH NJOY2016.60+
Inelastic levels

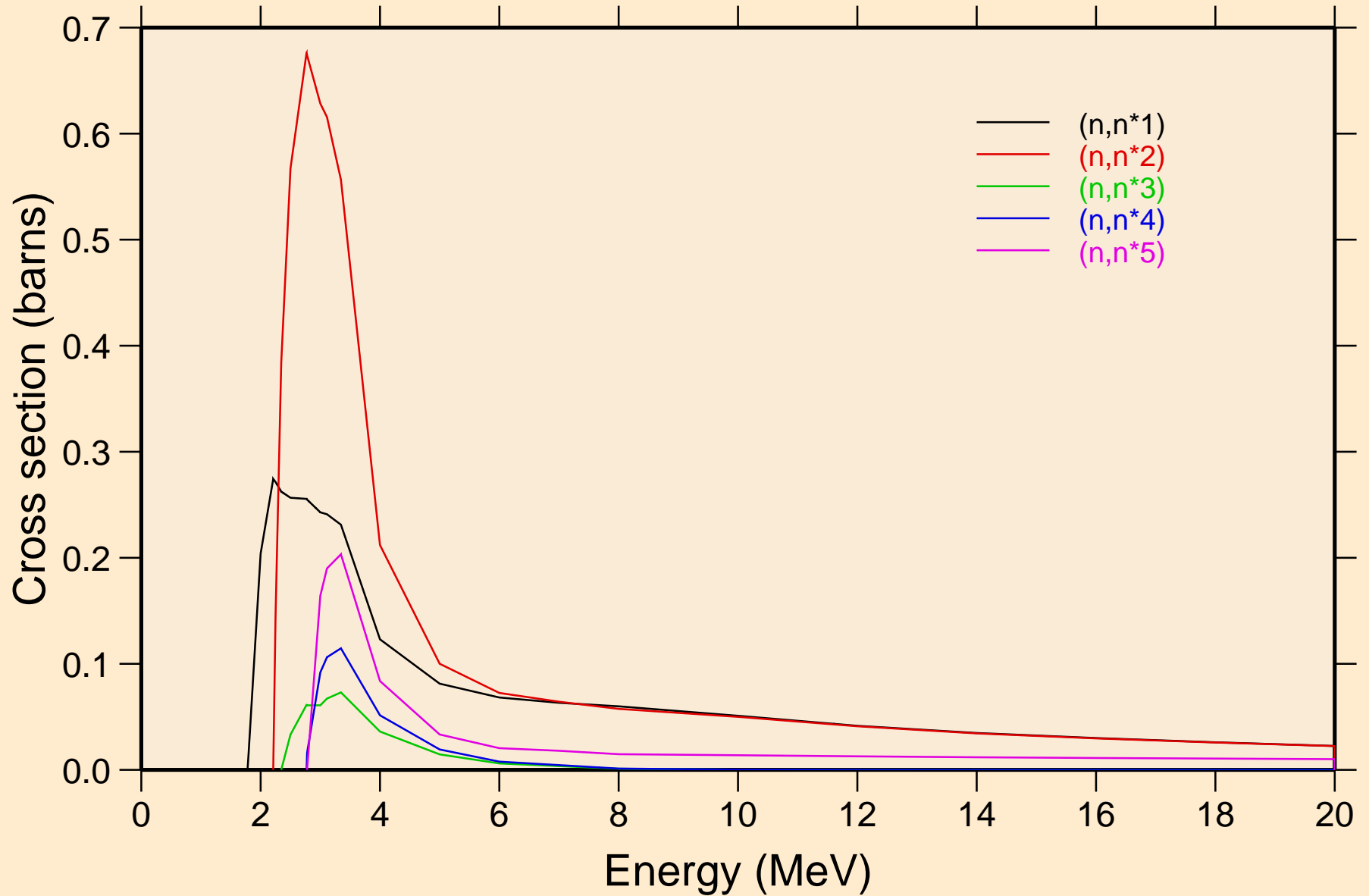

40-ZR-90 FOR FENDL-3.2 FROM FENDL-3.2 WITH NJOY2016.60+ Inelastic levels

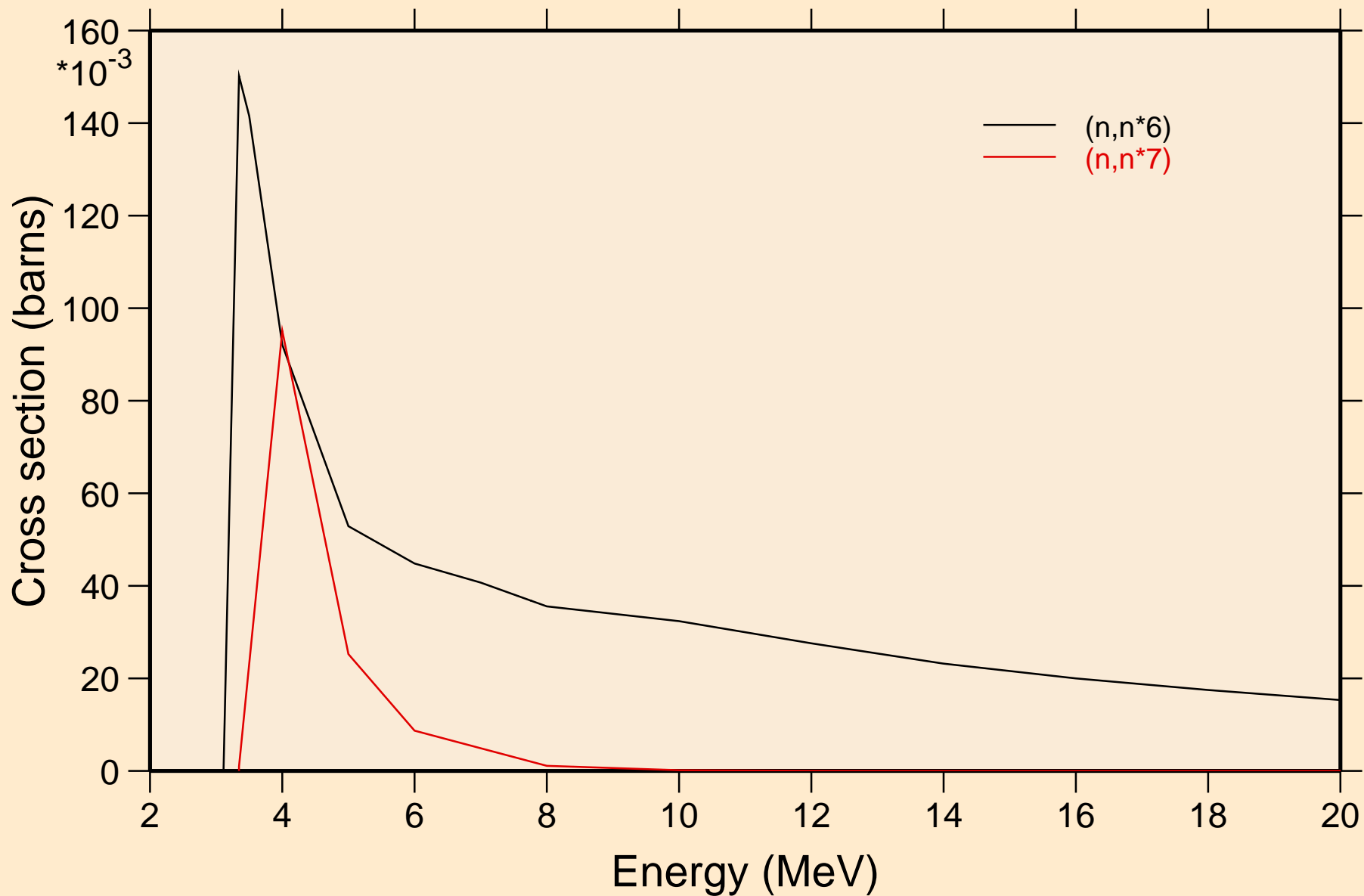

40-ZR-90 FOR FENDL-3.2 FROM FENDL-3.2 WITH NJOY2016.60+
Threshold reactions

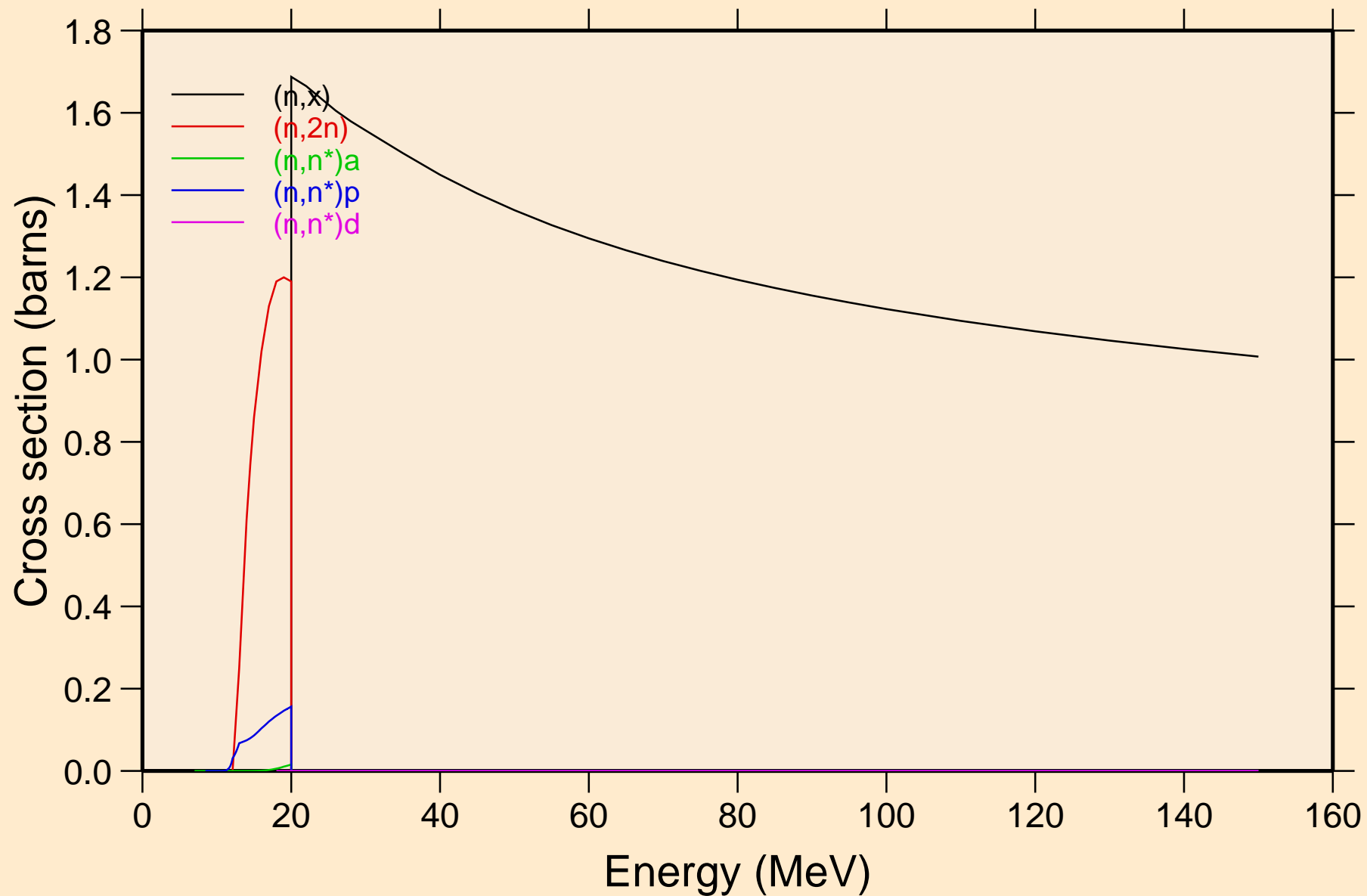

40-ZR-90 FOR FENDL-3.2 FROM FENDL-3.2 WITH NJOY2016.60+ Threshold reactions

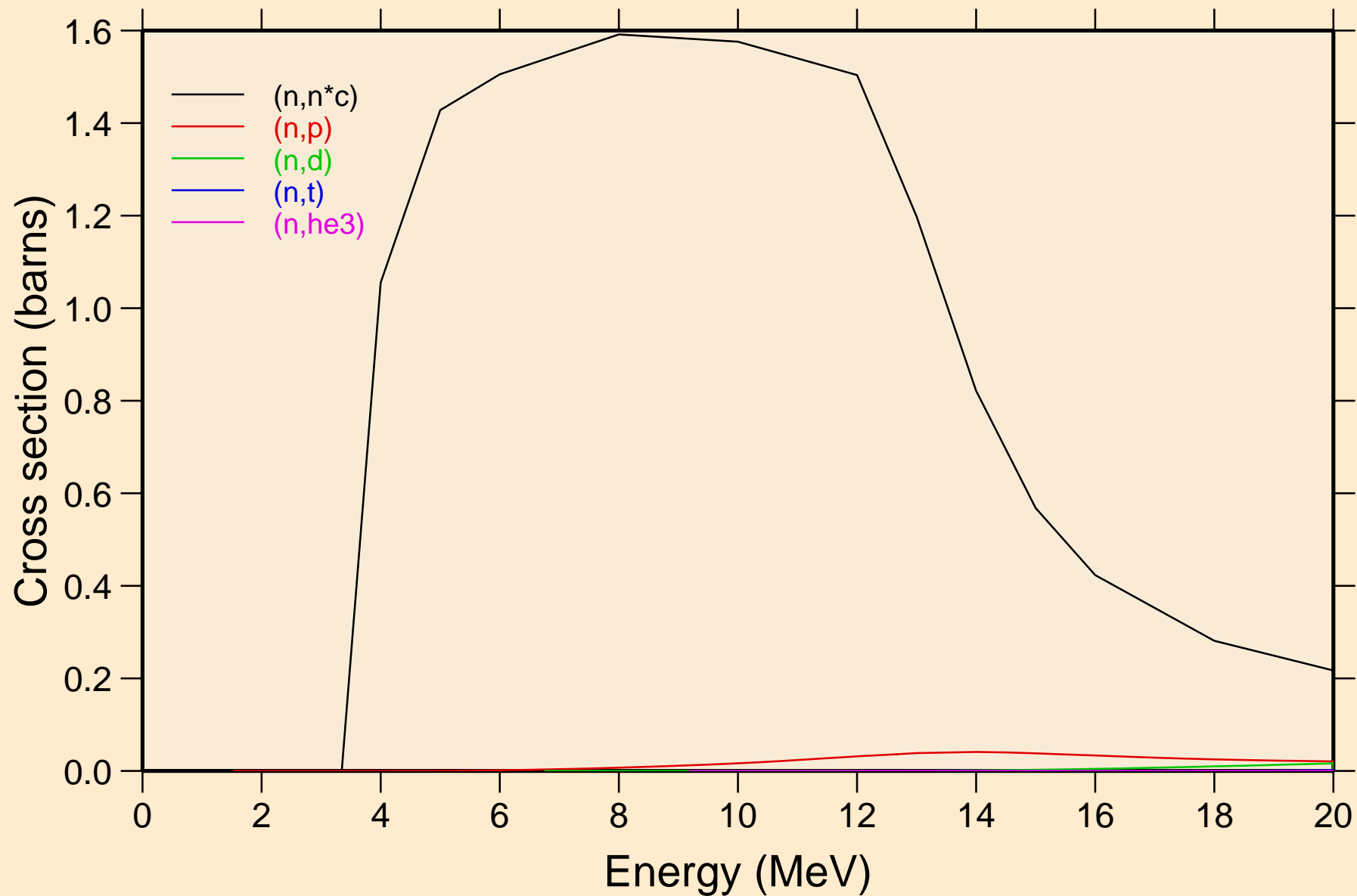

40-ZR-90 FOR FENDL-3.2 FROM FENDL-3.2 WITH NJOY2016.60+
Threshold reactions

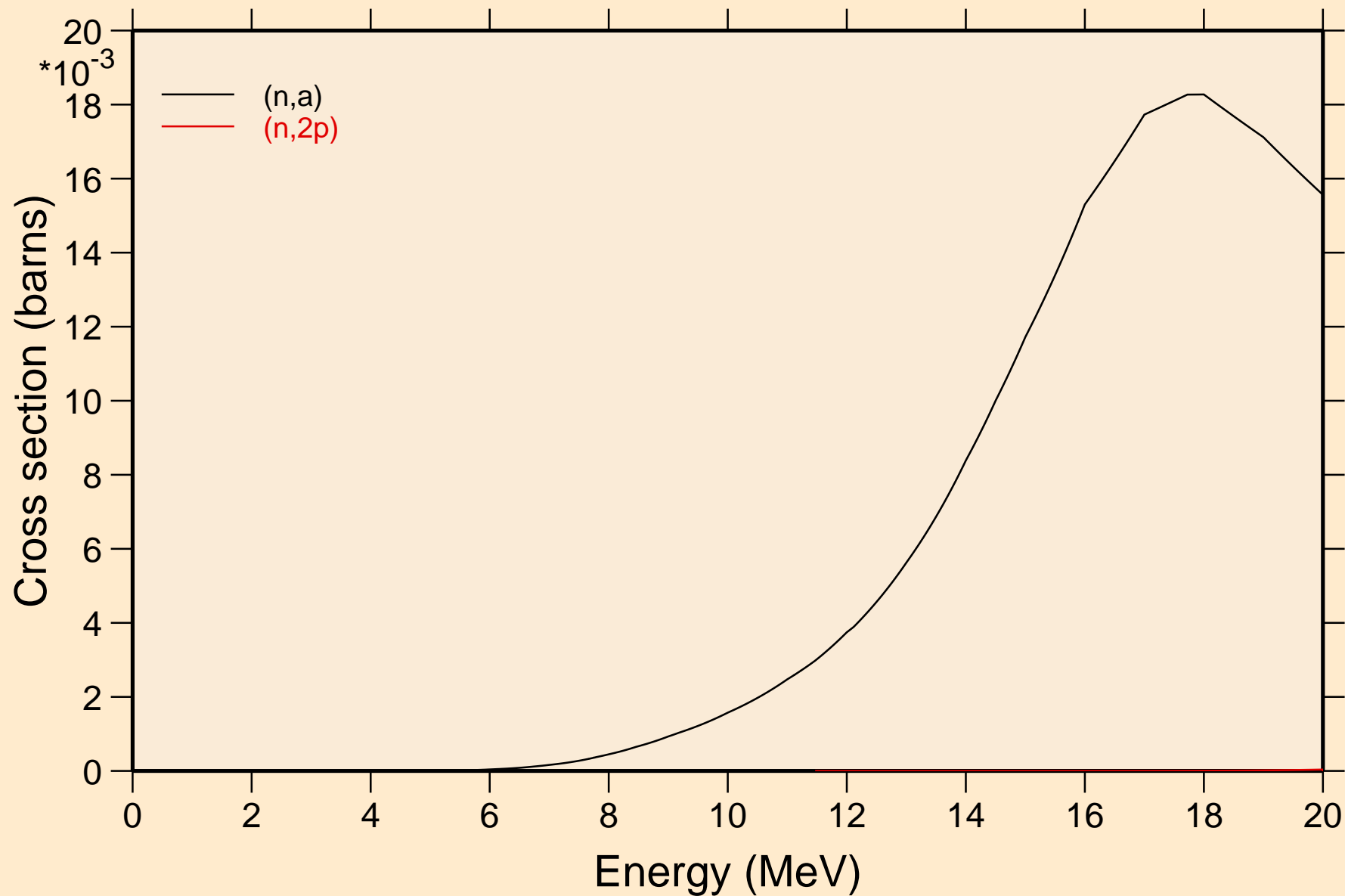

40-ZR-90 FOR FENDL-3.2 FROM FENDL-3.2 WITH NJOY2016.60+ Threshold reactions

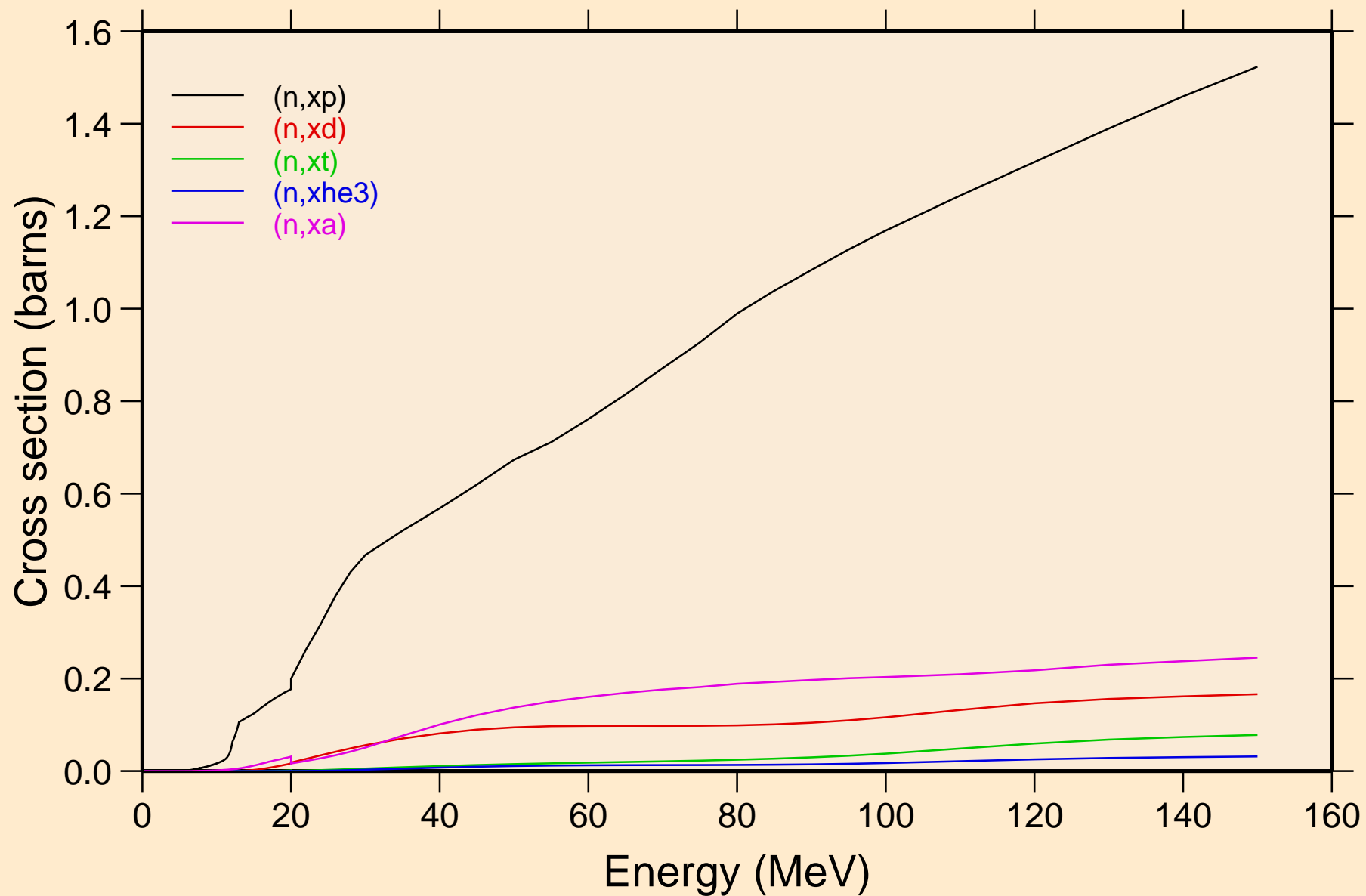

40-ZR-90 FOR FENDL-3.2 FROM FENDL-3.2 WITH NJOY2016.60+
angular distribution for elastic

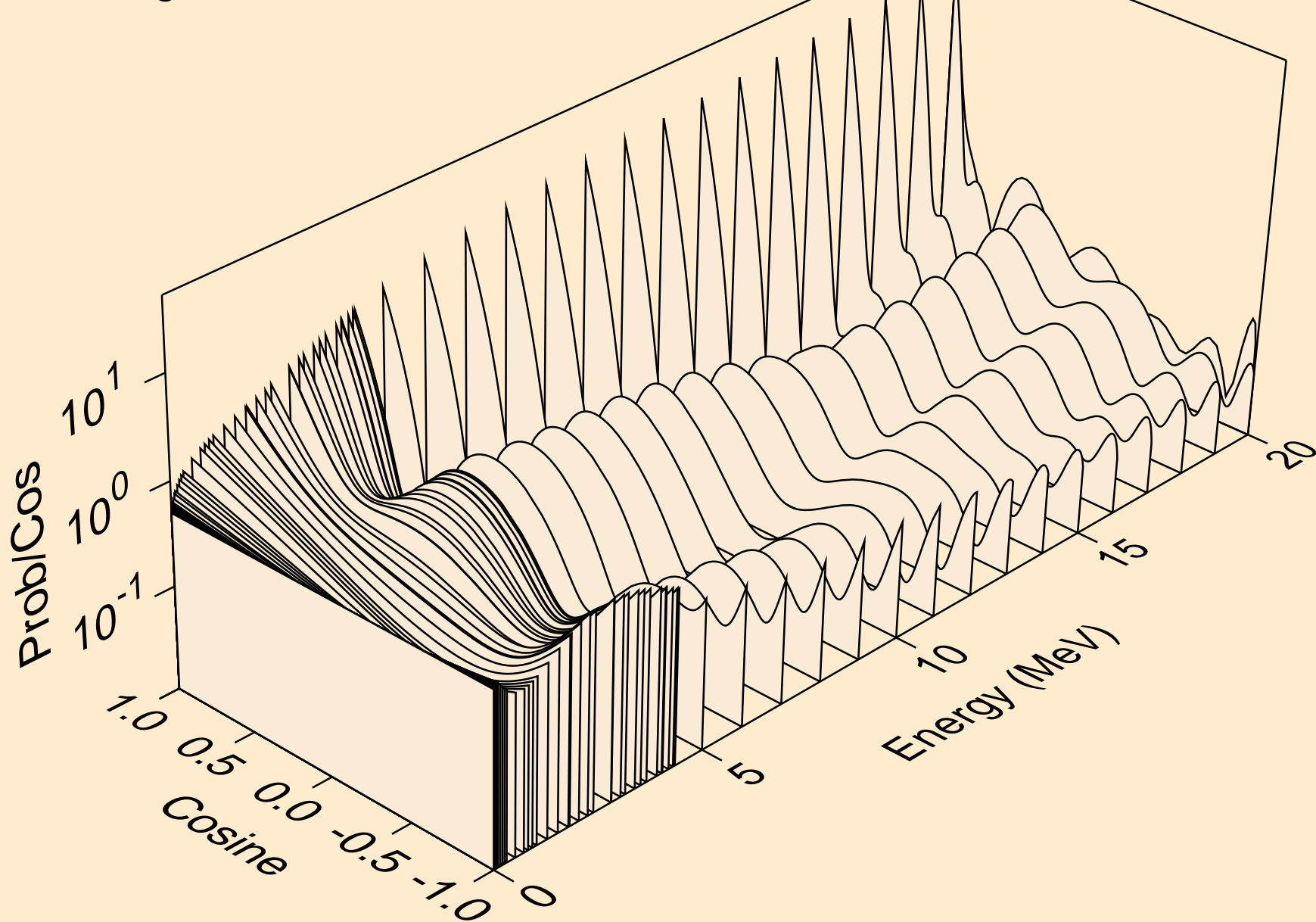

40-ZR-90 FOR FENDL-3.2 FROM FENDL-3.2 WITH NJOY2016.60+
angular distribution for elastic

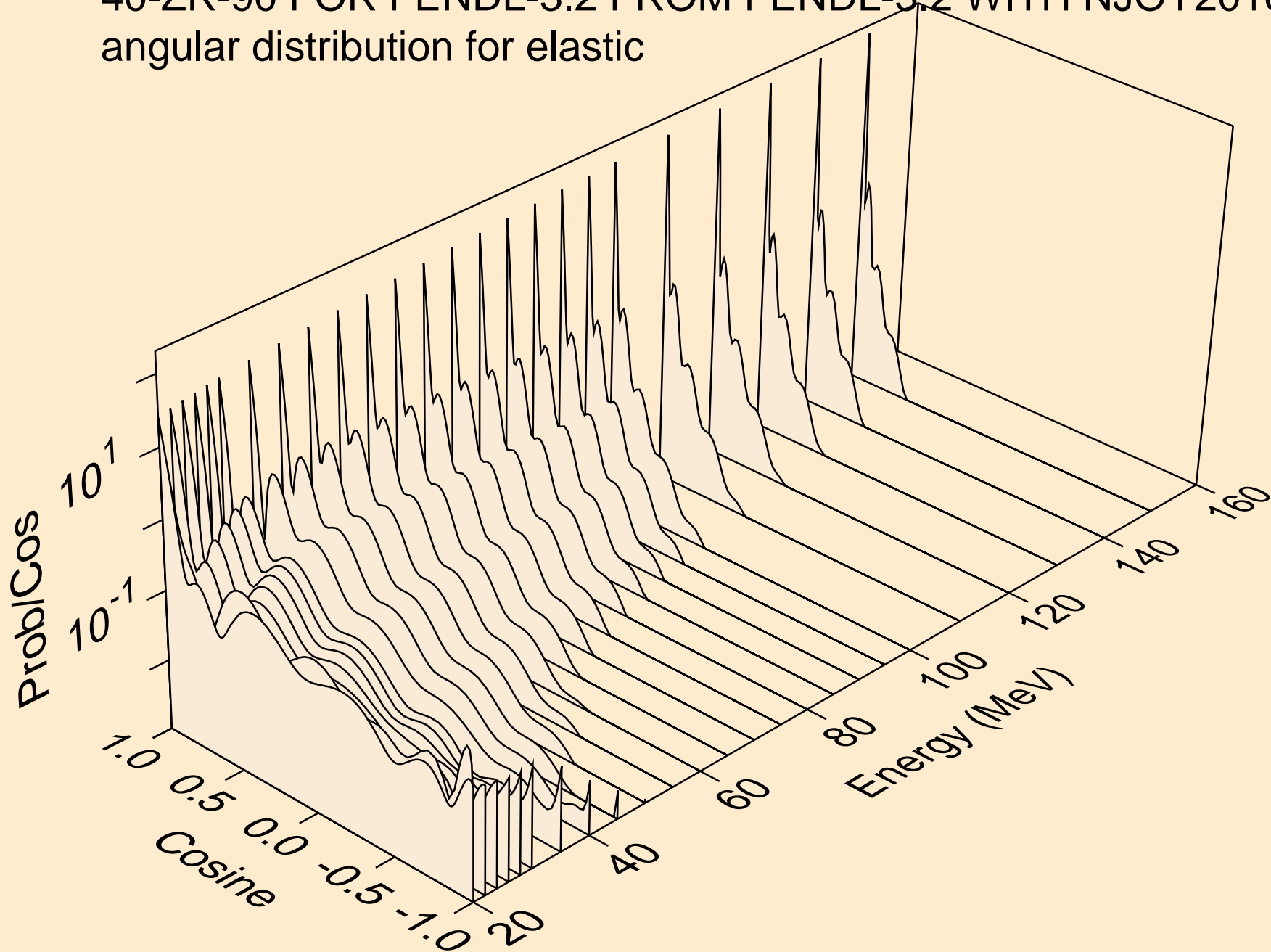

40-ZR-90 FOR FENDL-3.2 FROM FENDL-3.2 WITH NJOY2016.60+
angular distribution for (n,n*1)

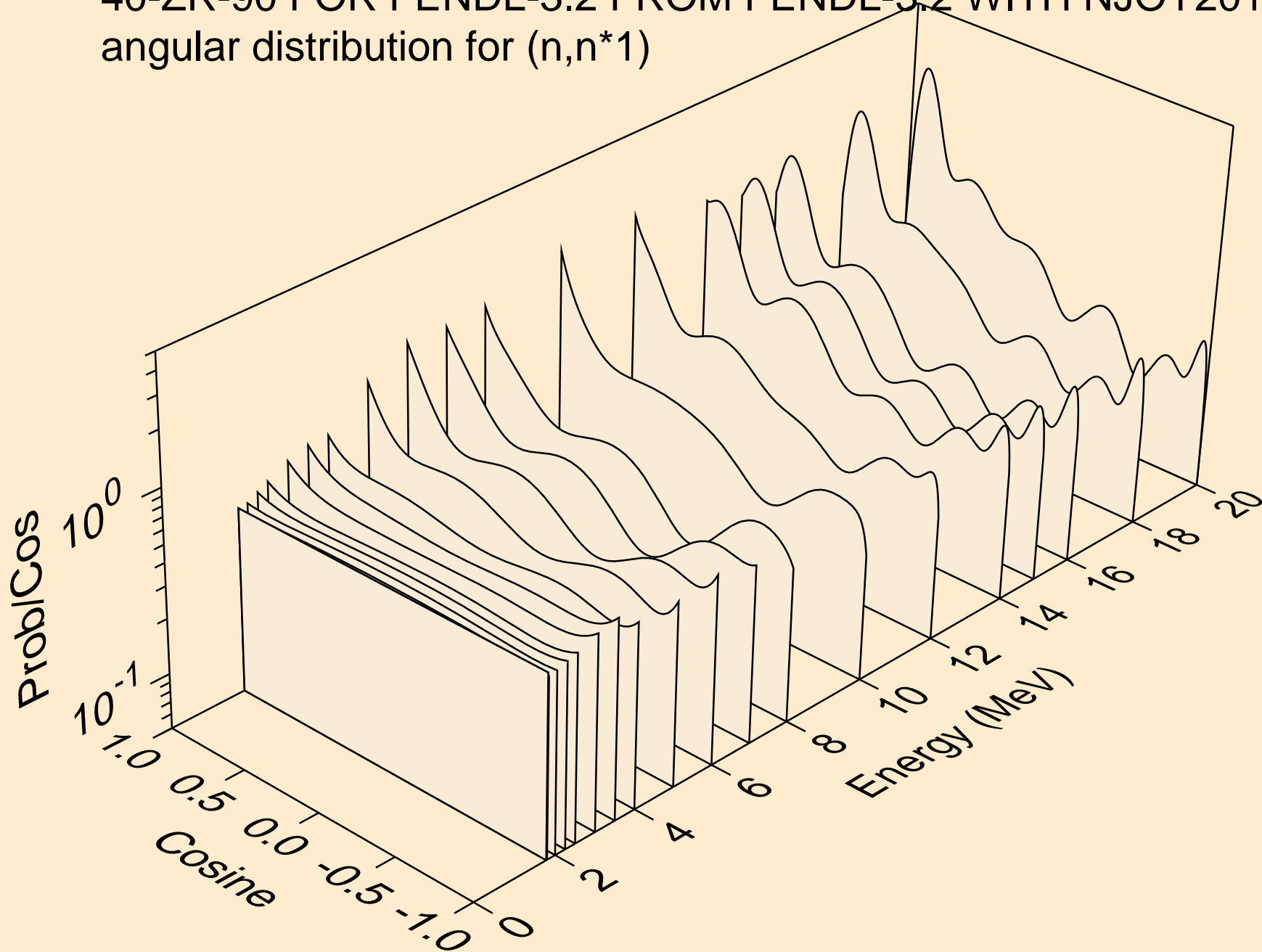

40-ZR-90 FOR FENDL-3.2 FROM FENDL-3.2 WITH NJOY2016.60+
angular distribution for (n,n*2)

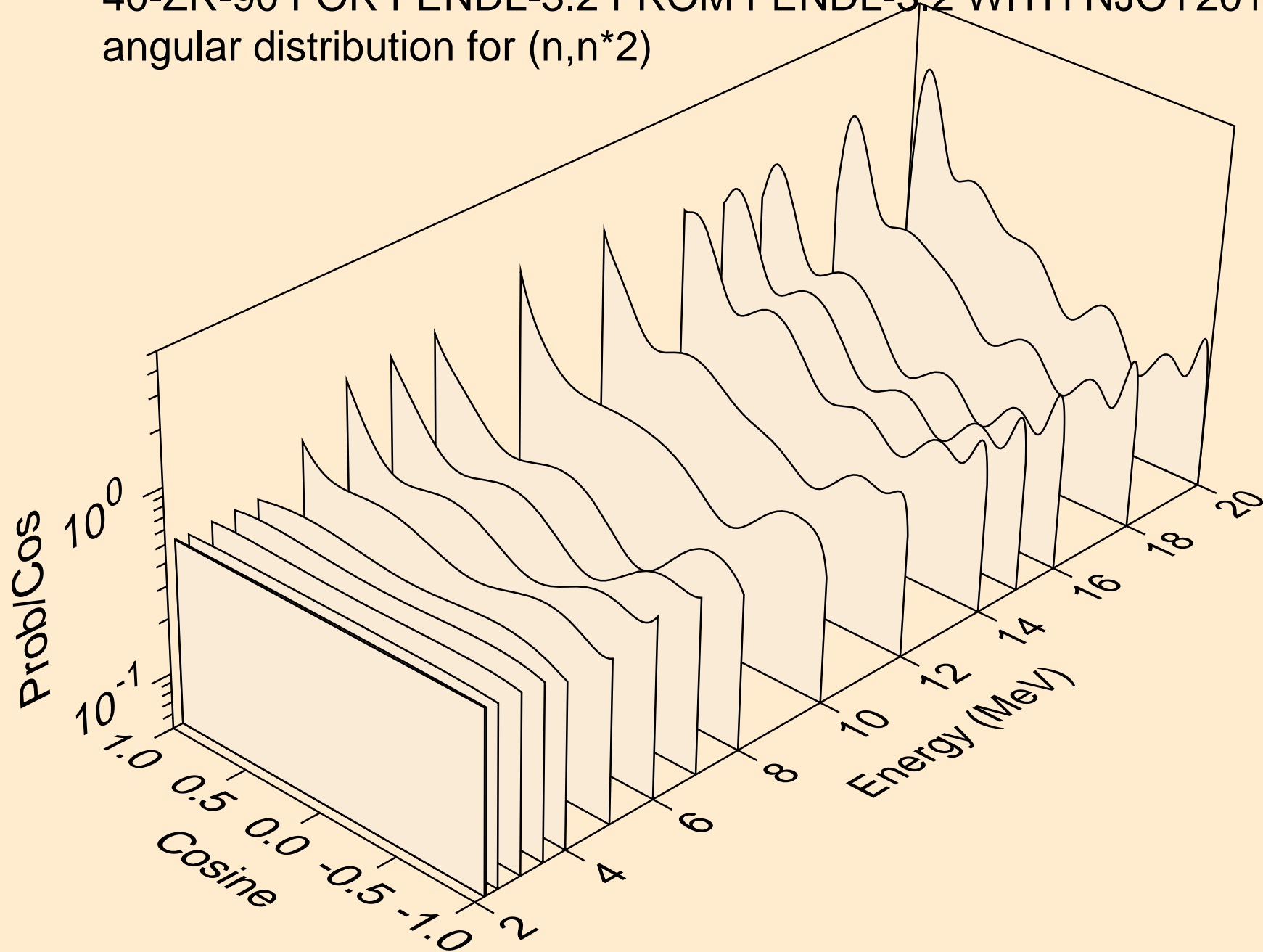

40-ZR-90 FOR FENDL-3.2 FROM FENDL-3.2 WITH NJOY2016.60+
angular distribution for (n,n*3)

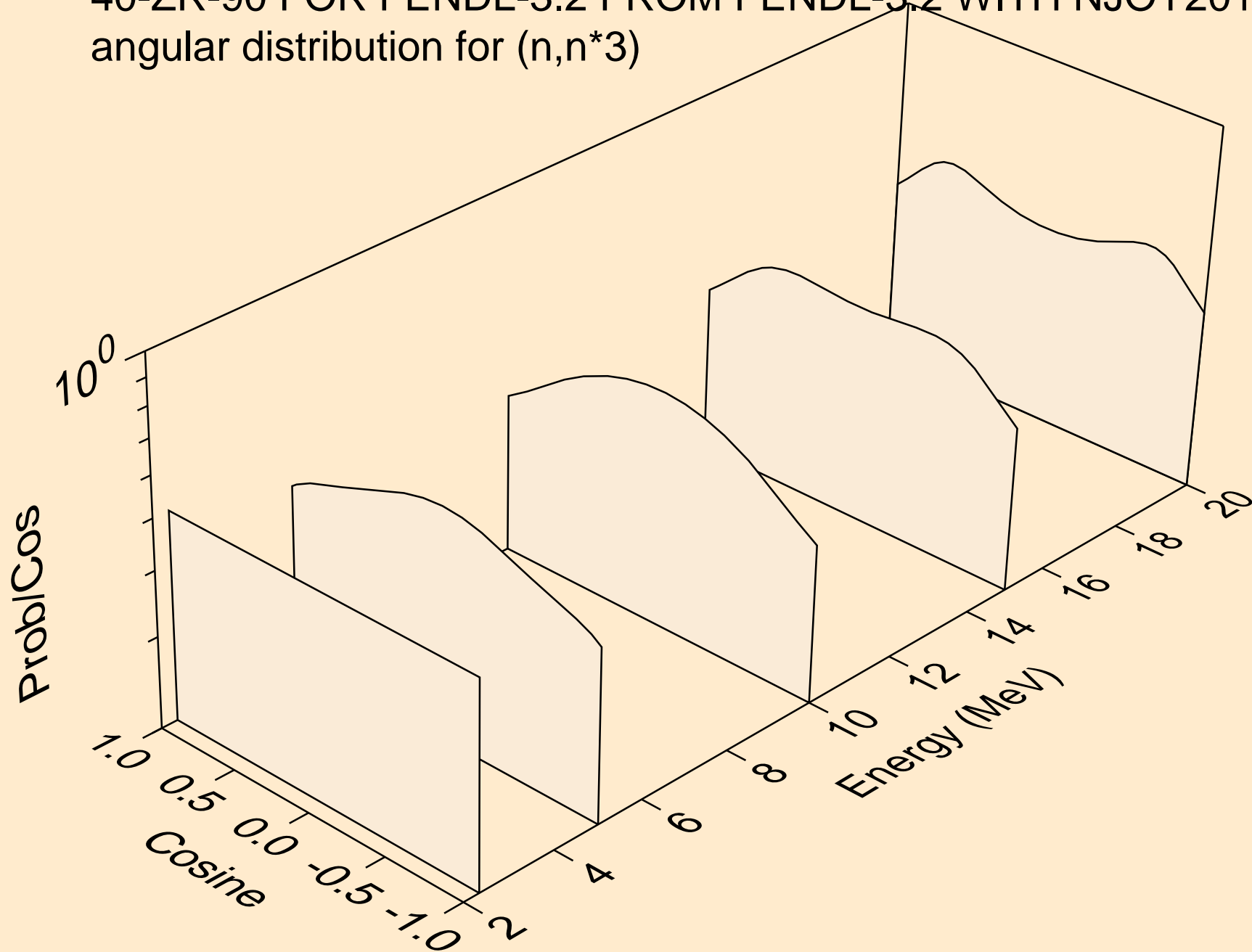

40-ZR-90 FOR FENDL-3.2 FROM FENDL-3.2 WITH NJOY2016.60+
angular distribution for (n,n*4)

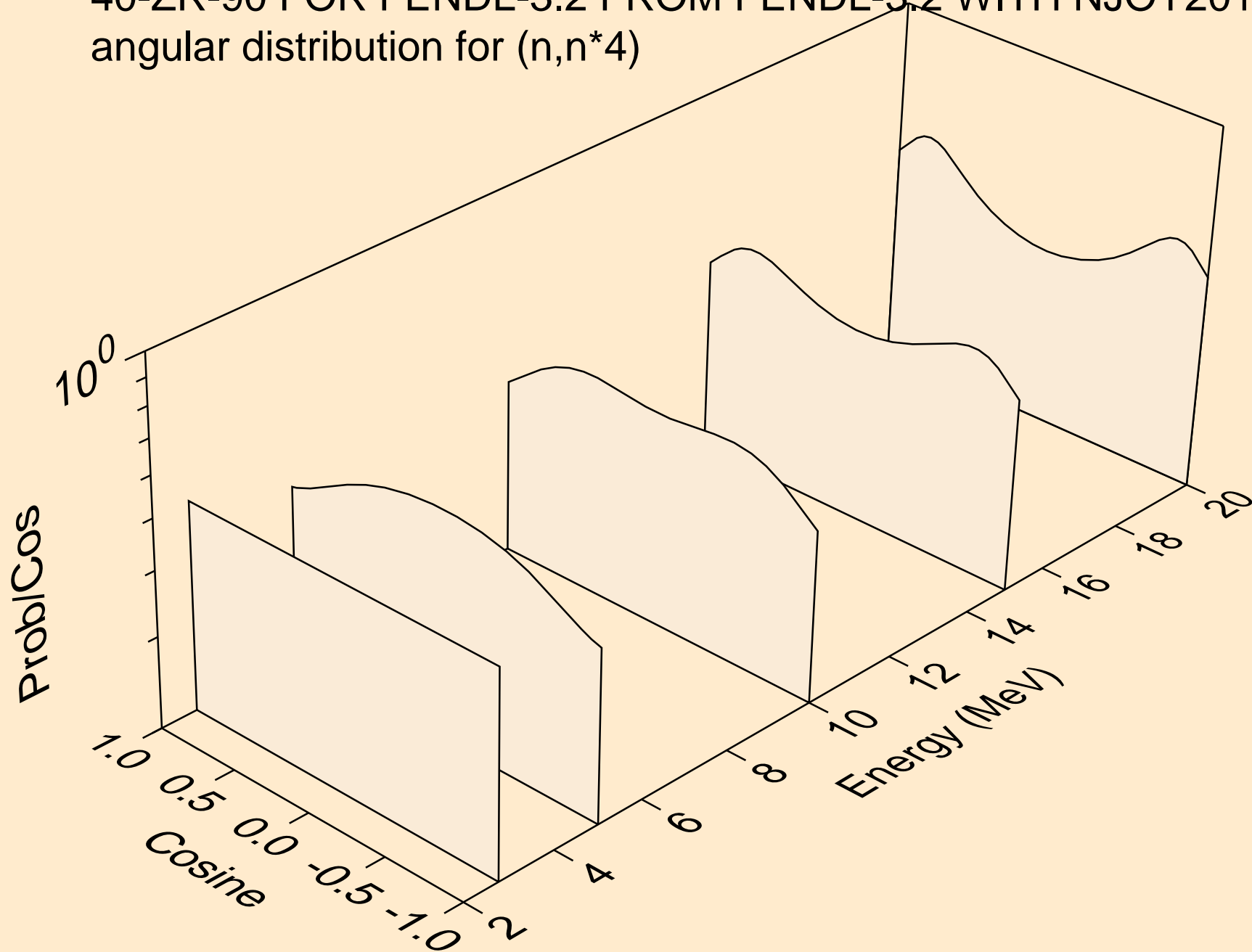

40-ZR-90 FOR FENDL-3.2 FROM FENDL-3.2 WITH NJOY2016.60+
angular distribution for (n,n*5)

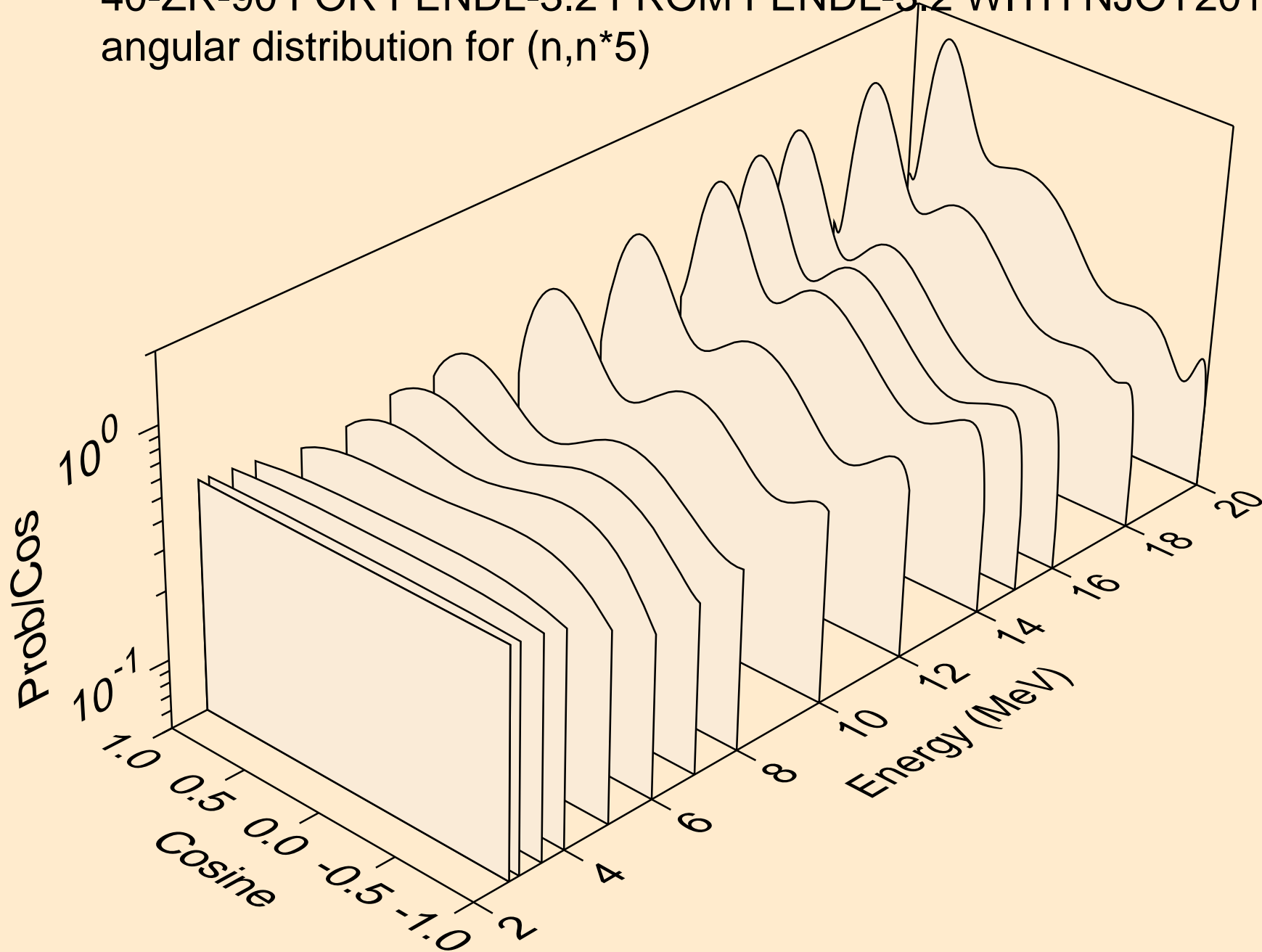

40-ZR-90 FOR FENDL-3.2 FROM FENDL-3.2 WITH NJOY2016.60+
angular distribution for (n,n*6)

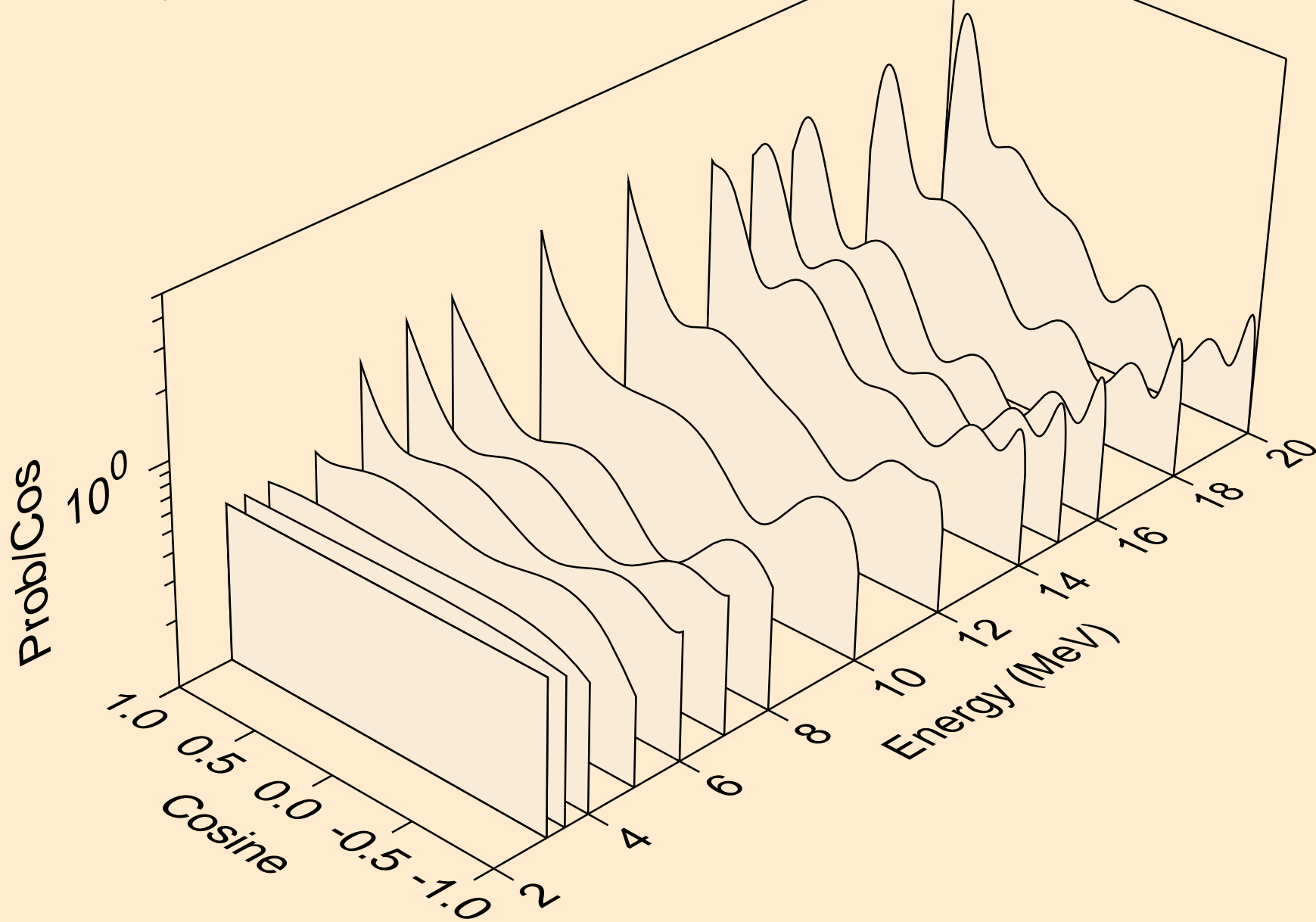

40-ZR-90 FOR FENDL-3.2 FROM FENDL-3.2 WITH NJOY2016.60+
angular distribution for (n,n*7)

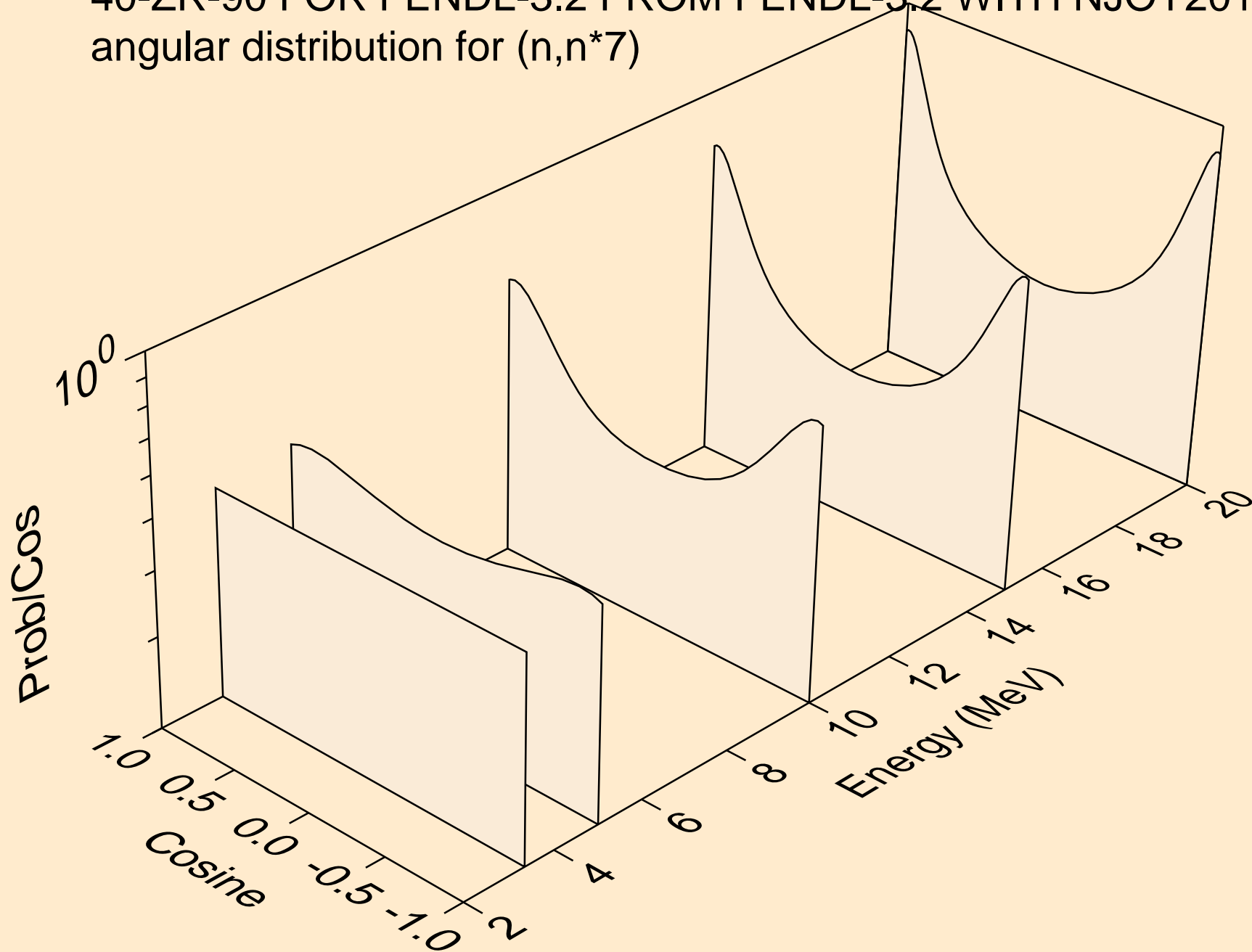

40-ZR-90 FOR FENDL-3.2 FROM FENDL-3.2 WITH NJOY2016.60+
Neutron emission for (n,x)

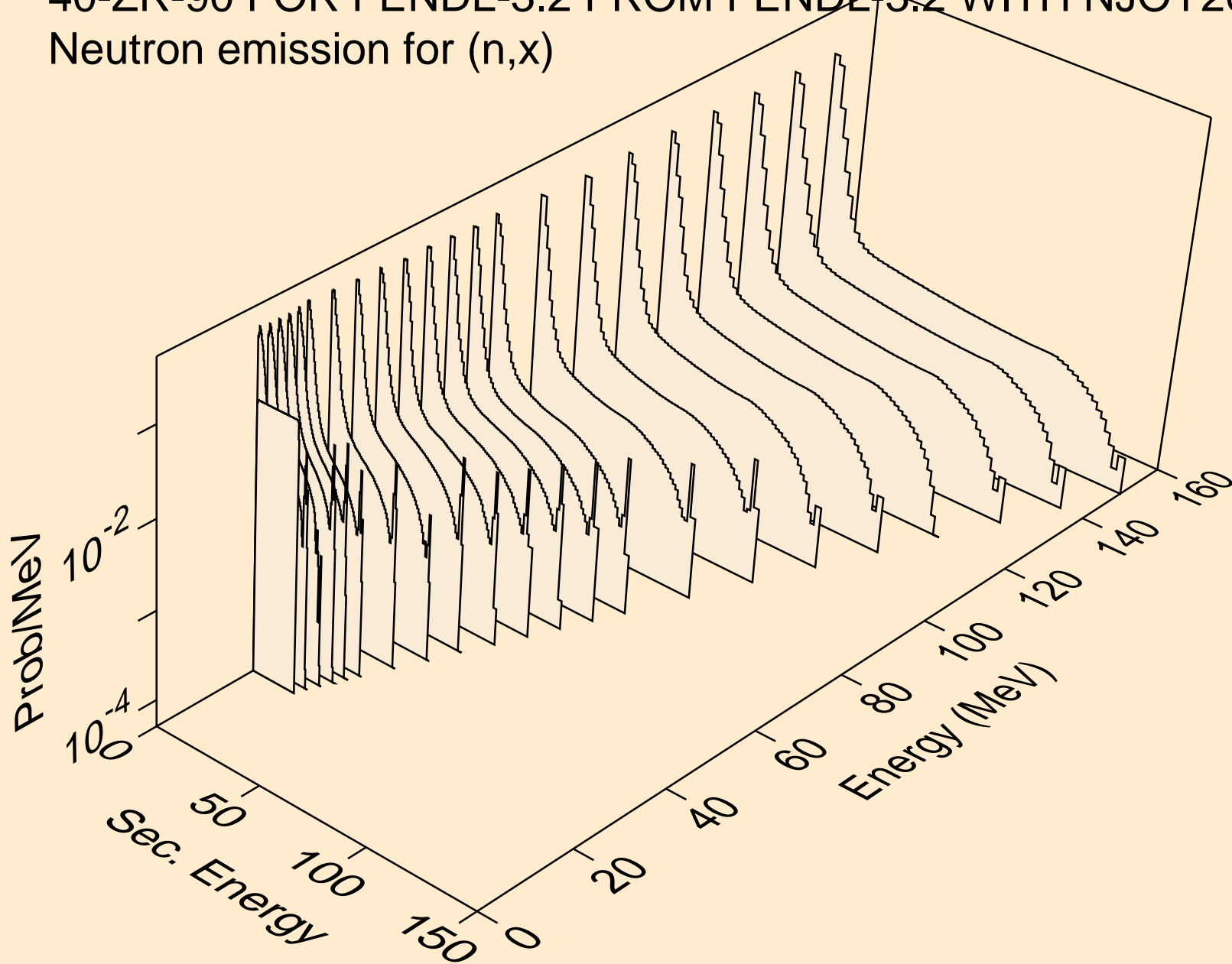

40-ZR-90 FOR FENDL-3.2 FROM FENDL-3.2 WITH NJOY2016.60+
Neutron emission for (n,2n)

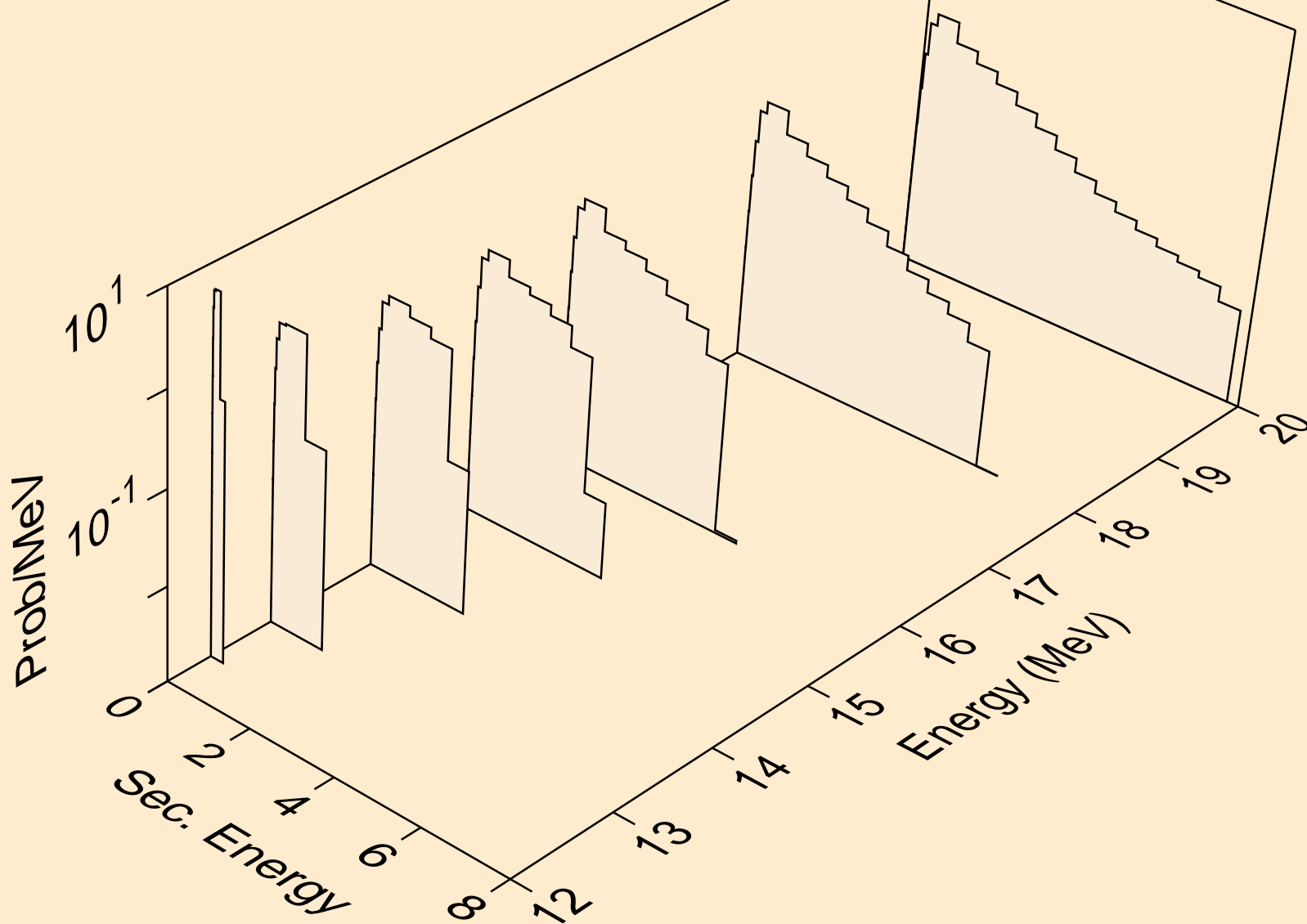

40-ZR-90 FOR FENDL-3.2 FROM FENDL-3.2 WITH NJOY2016.60+
Neutron emission for (n,n*)a

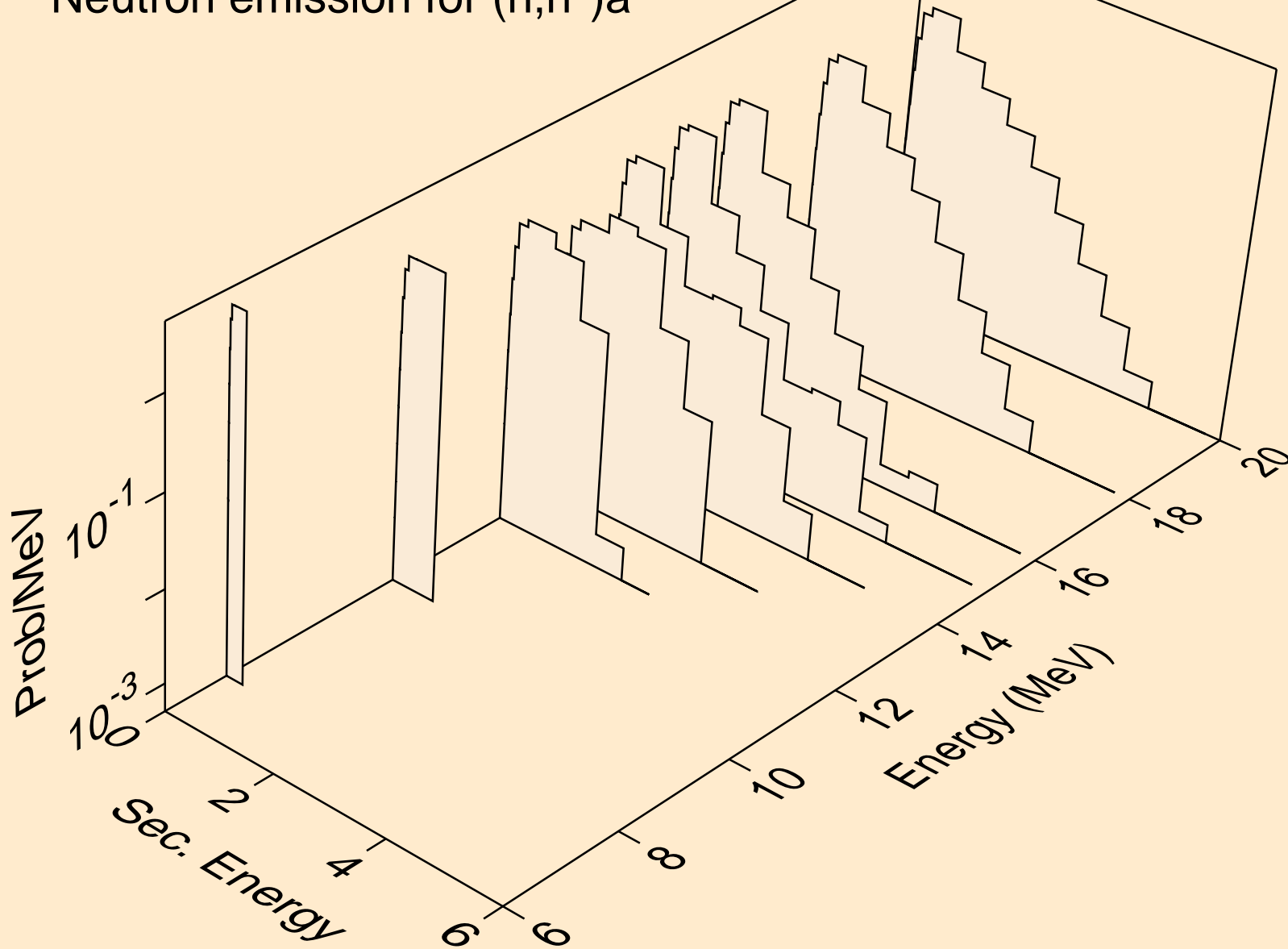

40-ZR-90 FOR FENDL-3.2 FROM FENDL-3.2 WITH NJOY2016.60+
Neutron emission for (n,n*)p

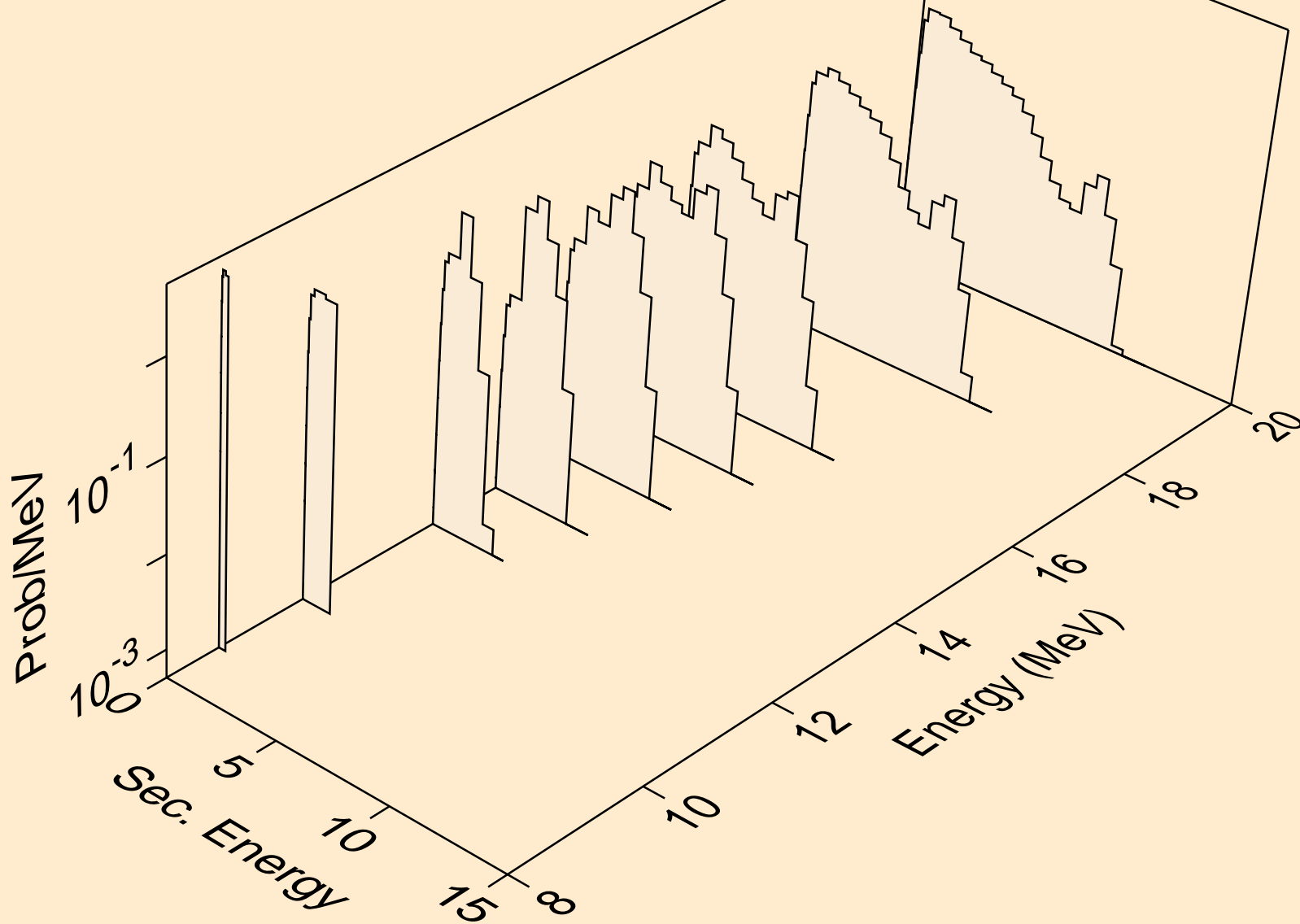

40-ZR-90 FOR FENDL-3.2 FROM FENDL-3.2 WITH NJOY2016.60+
Neutron emission for (n,n*)d

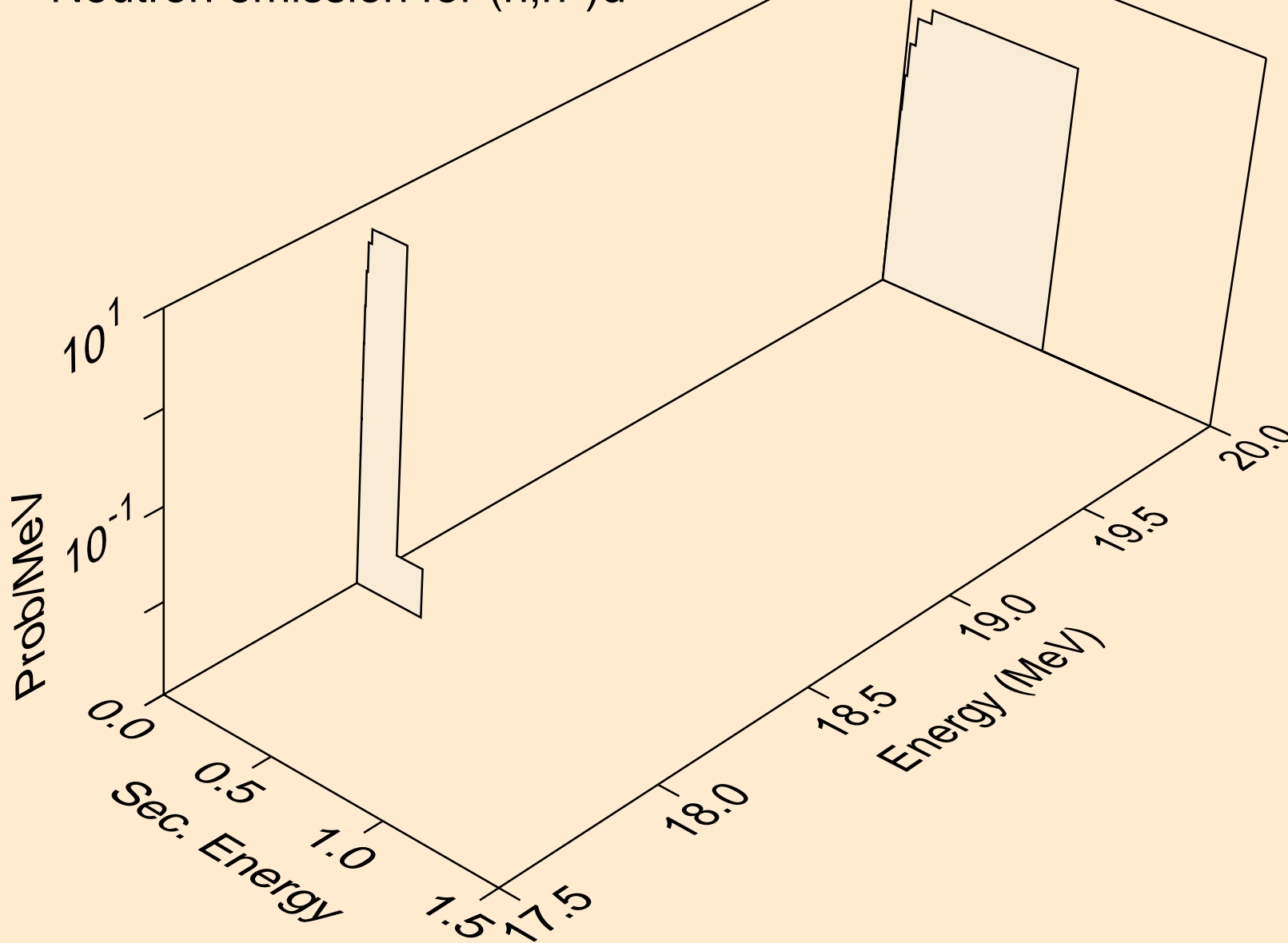

40-ZR-90 FOR FENDL-3.2 FROM FENDL-3.2 WITH NJOY2016.60+
Neutron emission for (n,n*c)

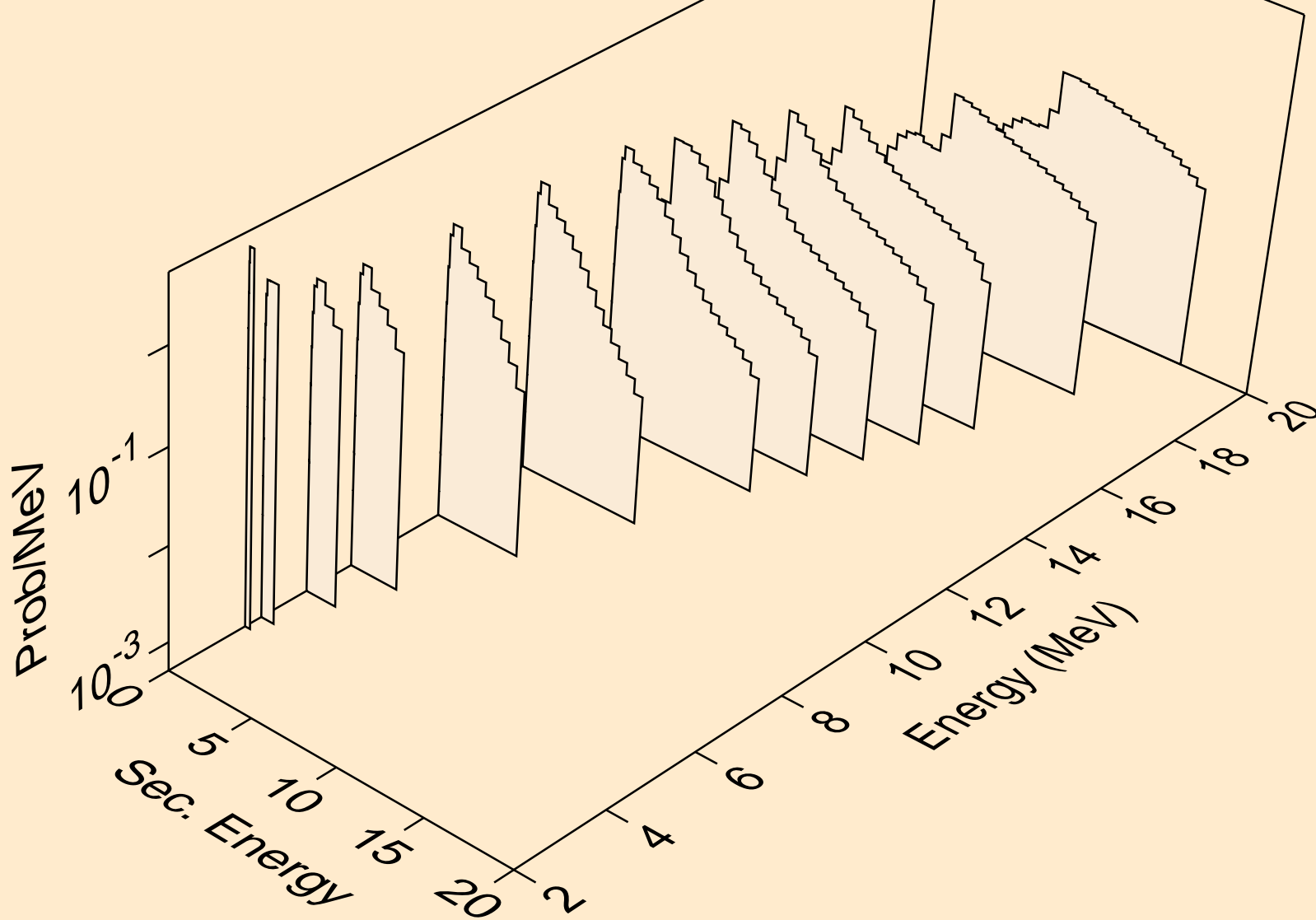

40-ZR-90 FOR FENDL-3.2 FROM FENDL-3.2 WITH NJOY2016.60+
Photon emission for (n,2n)

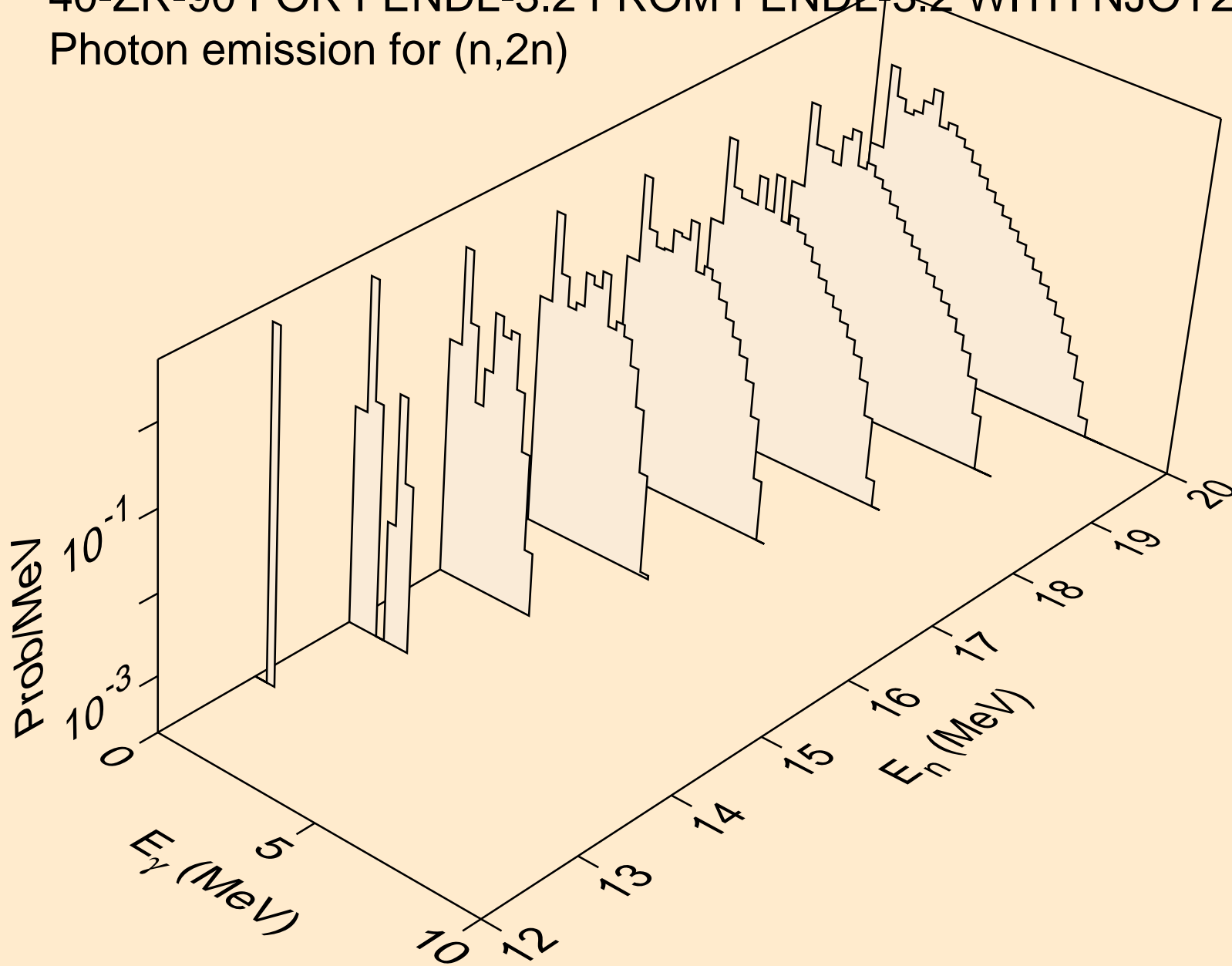

40-ZR-90 FOR FENDL-3.2 FROM FENDL-3.2 WITH NJOY2016.60+
Photon emission for (n,n*)a

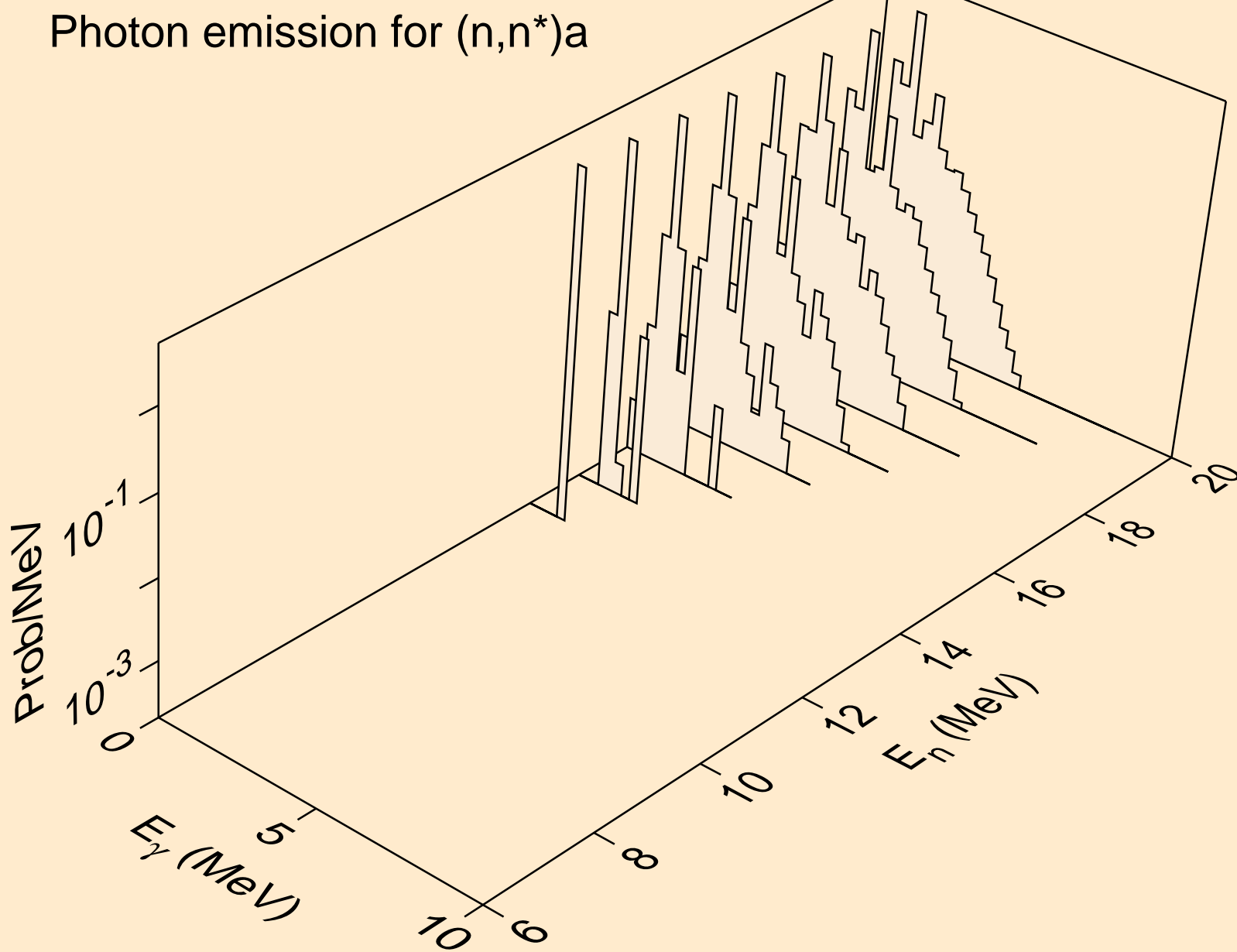

40-ZR-90 FOR FENDL-3.2 FROM FENDL-3.2 WITH NJOY2016.60+
Photon emission for (n,n*)p

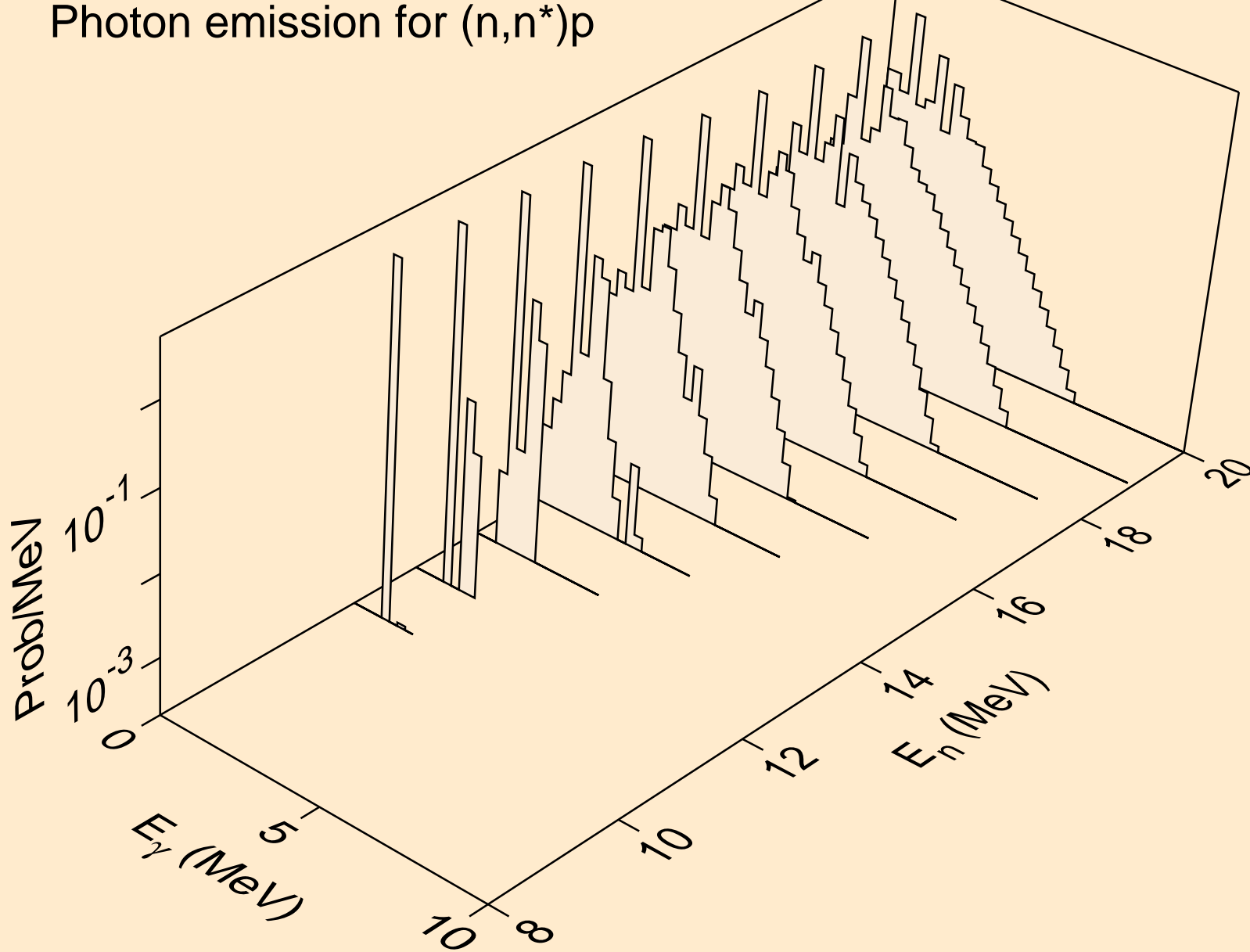

40-ZR-90 FOR FENDL-3.2 FROM FENDL-3.2 WITH NJOY2016.60+
Photon emission for (n,n*c)

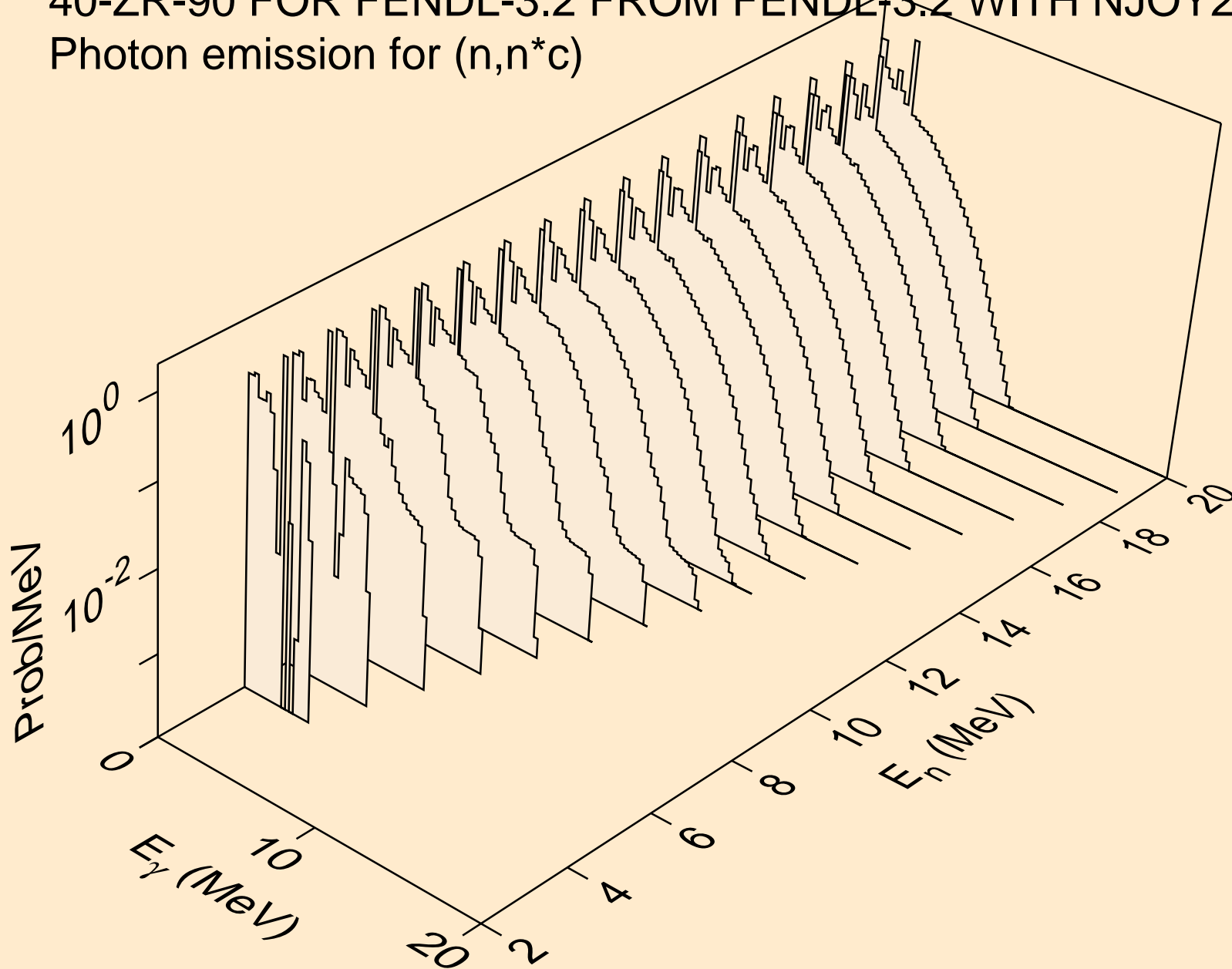

40-ZR-90 FOR FENDL-3.2 FROM FENDL-3.2 WITH NJOY2016.60+
Photon emission for (n,gma)

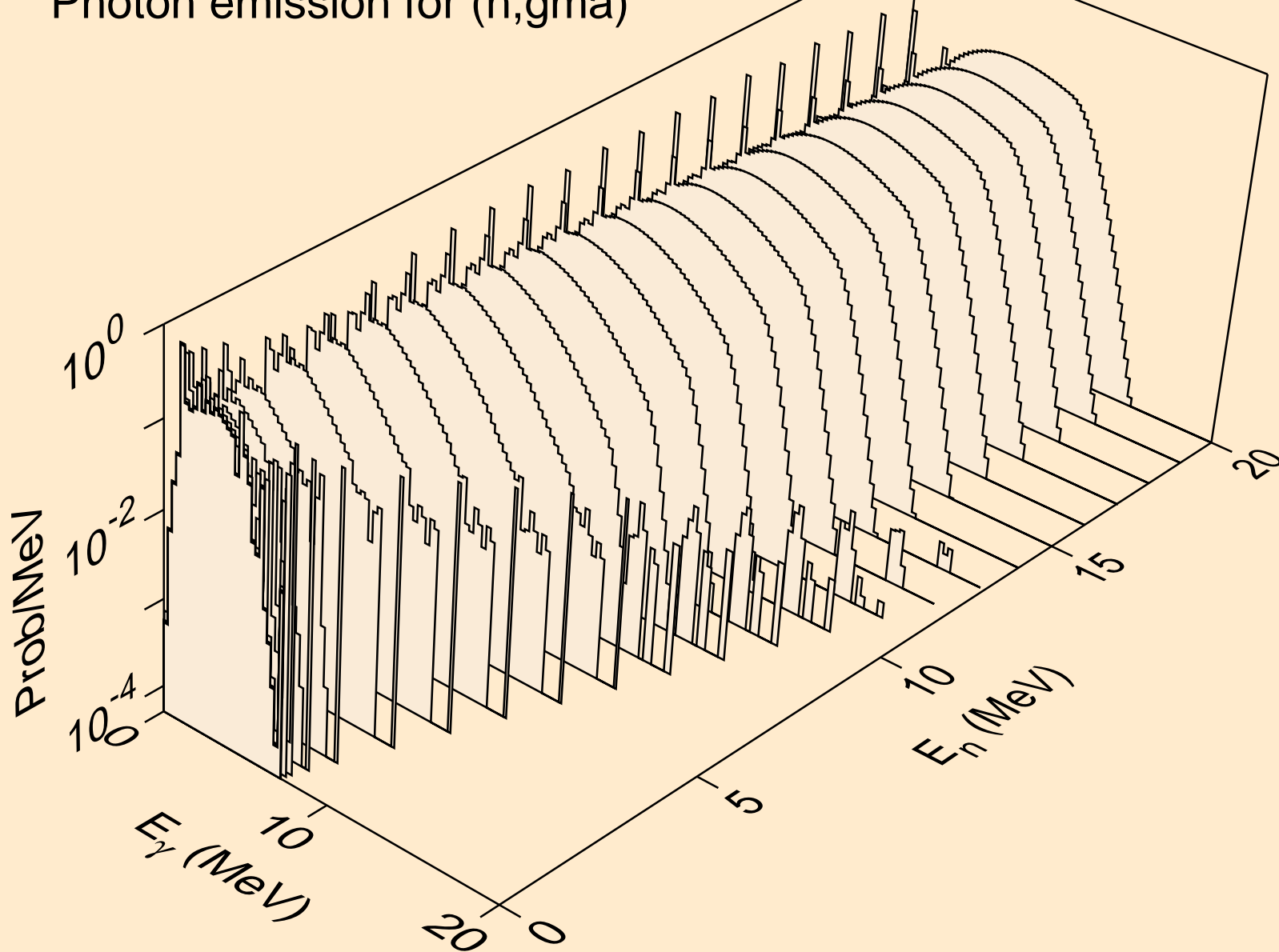

40-ZR-90 FOR FENDL-3.2 FROM FENDL-3.2 WITH NJOY2016.60+
Photon emission for (n,p)

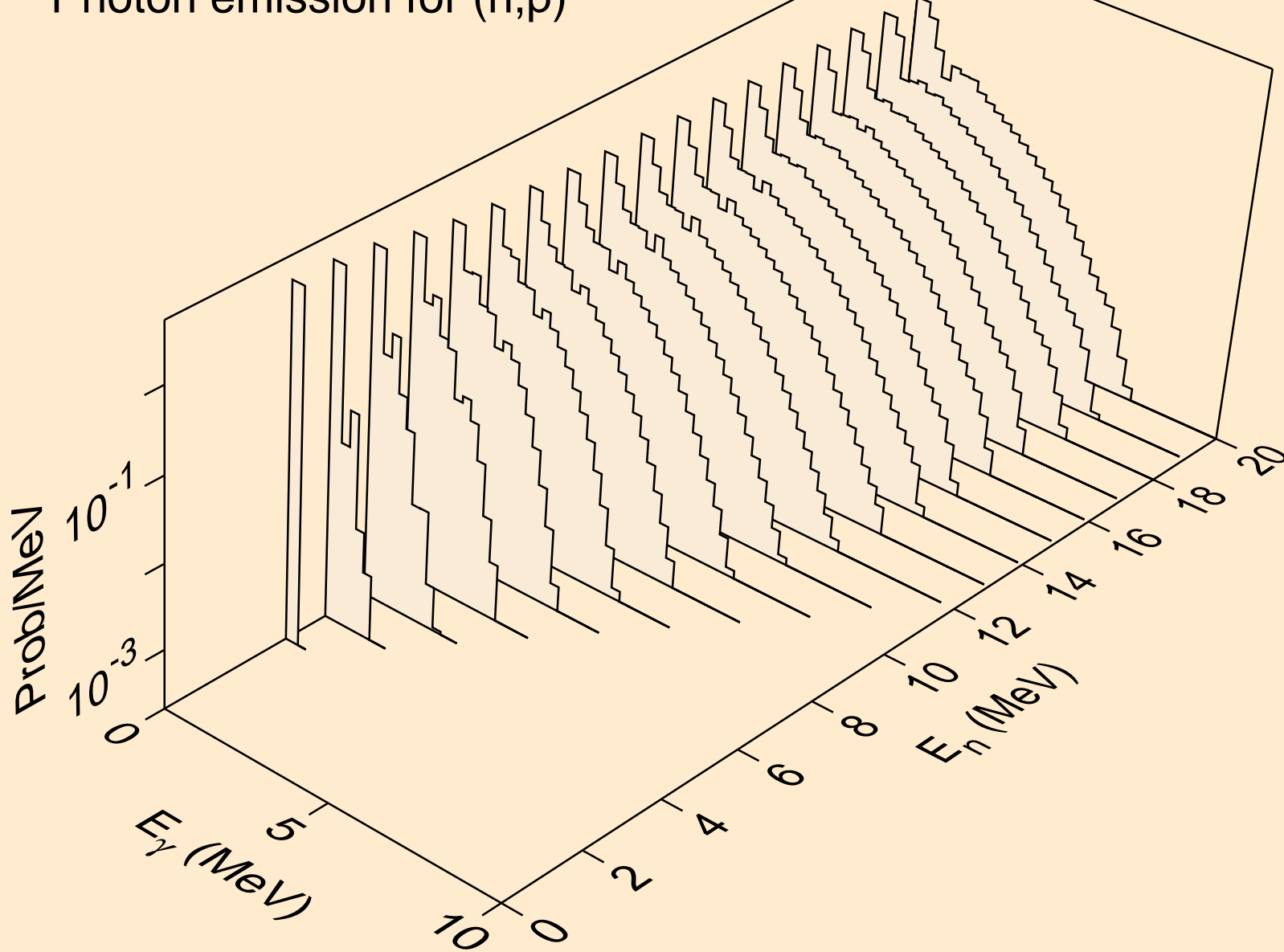

40-ZR-90 FOR FENDL-3.2 FROM FENDL-3.2 WITH NJOY2016.60+
Photon emission for (n,a)

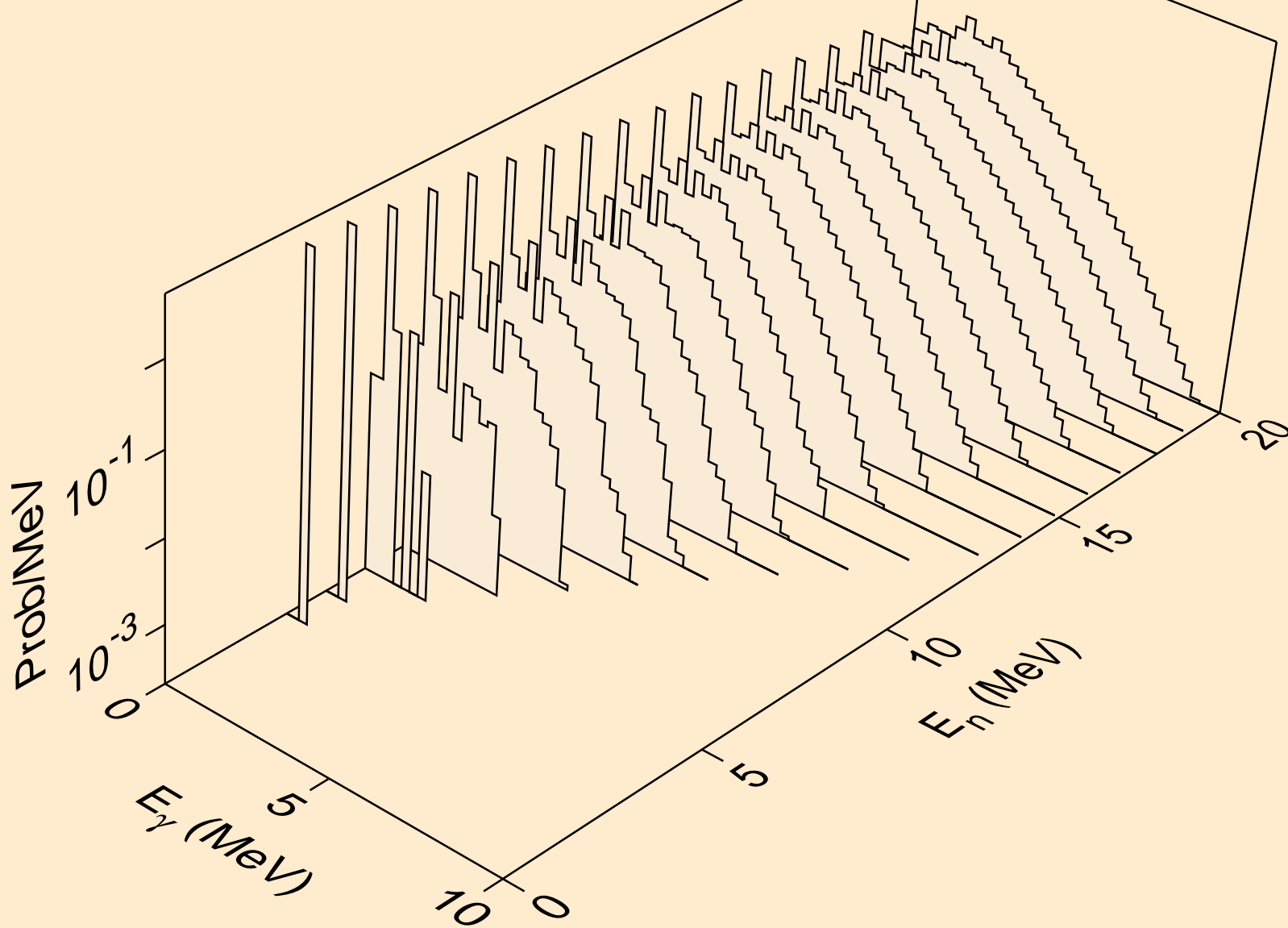

40-ZR-90 FOR FENDL-3.2 FROM FENDL-3.2 WITH NJOY2016.60+
Photon emission for (n,x)

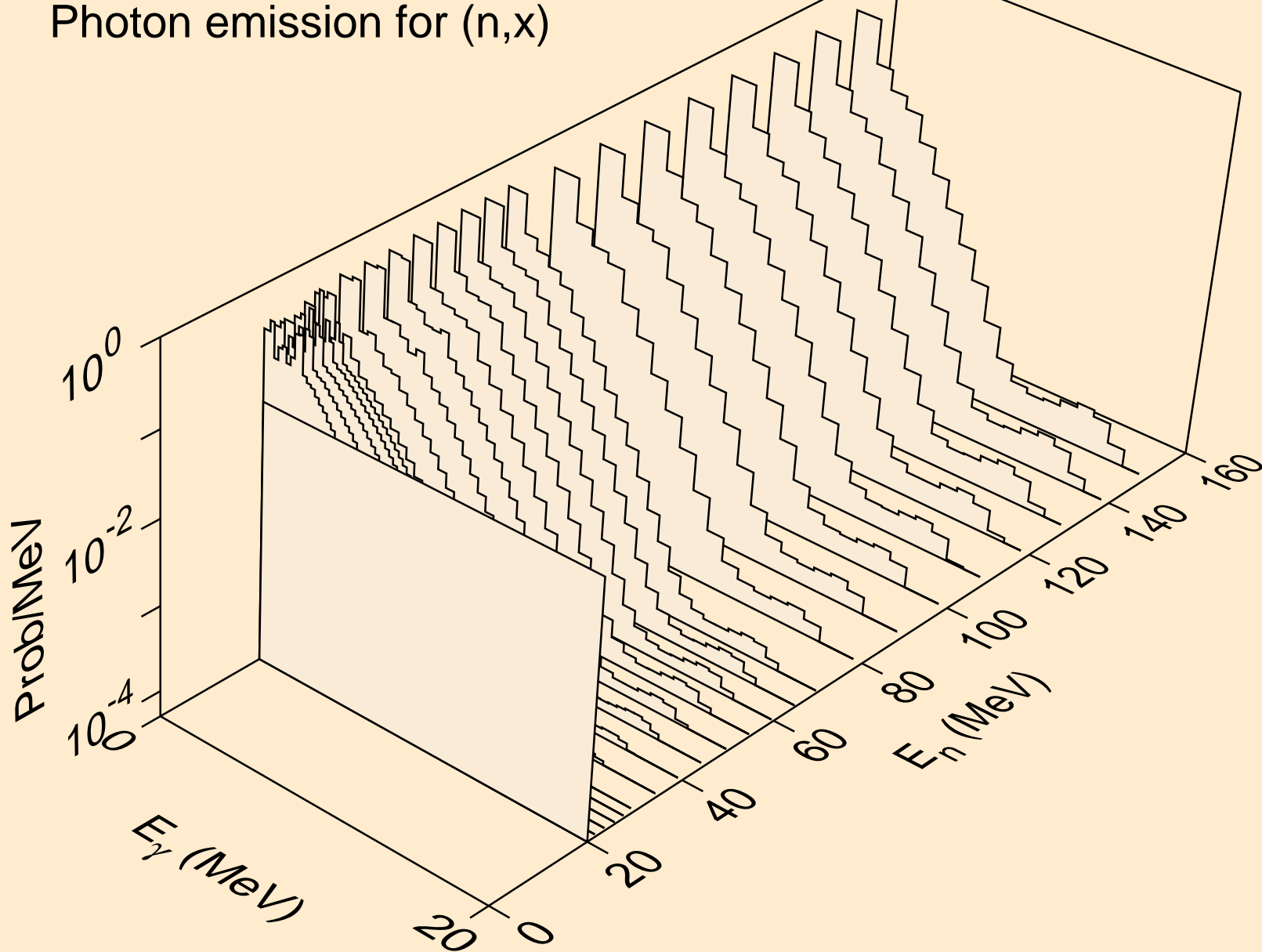

40-ZR-90 FOR FENDL-3.2 FROM FENDL-3.2 WITH NJOY2016.60+
thermal capture photon spectrum

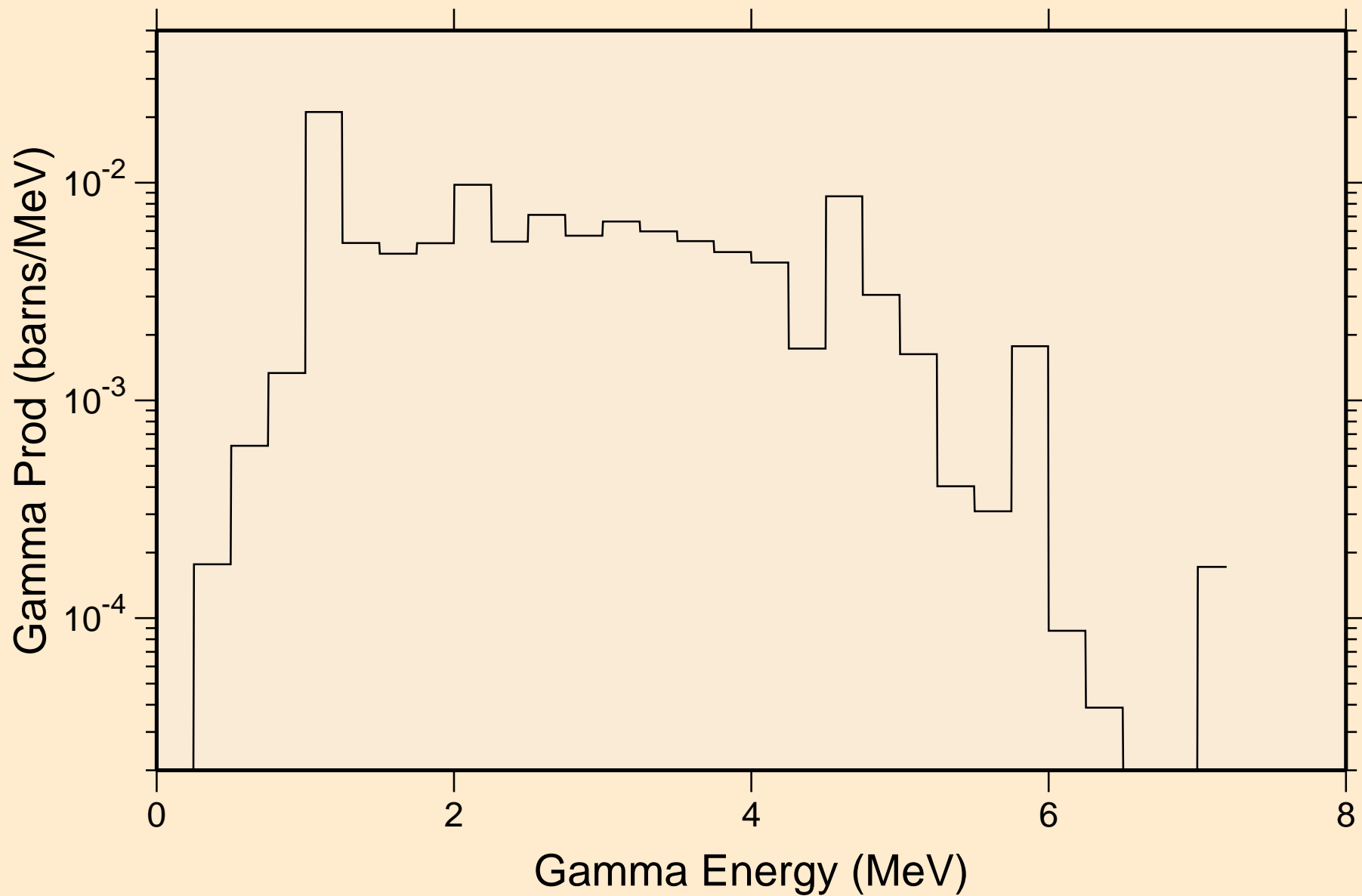

40-ZR-90 FOR FENDL-3.2 FROM FENDL-3.2 WITH NJOY2016.60+
14 MeV photon spectrum

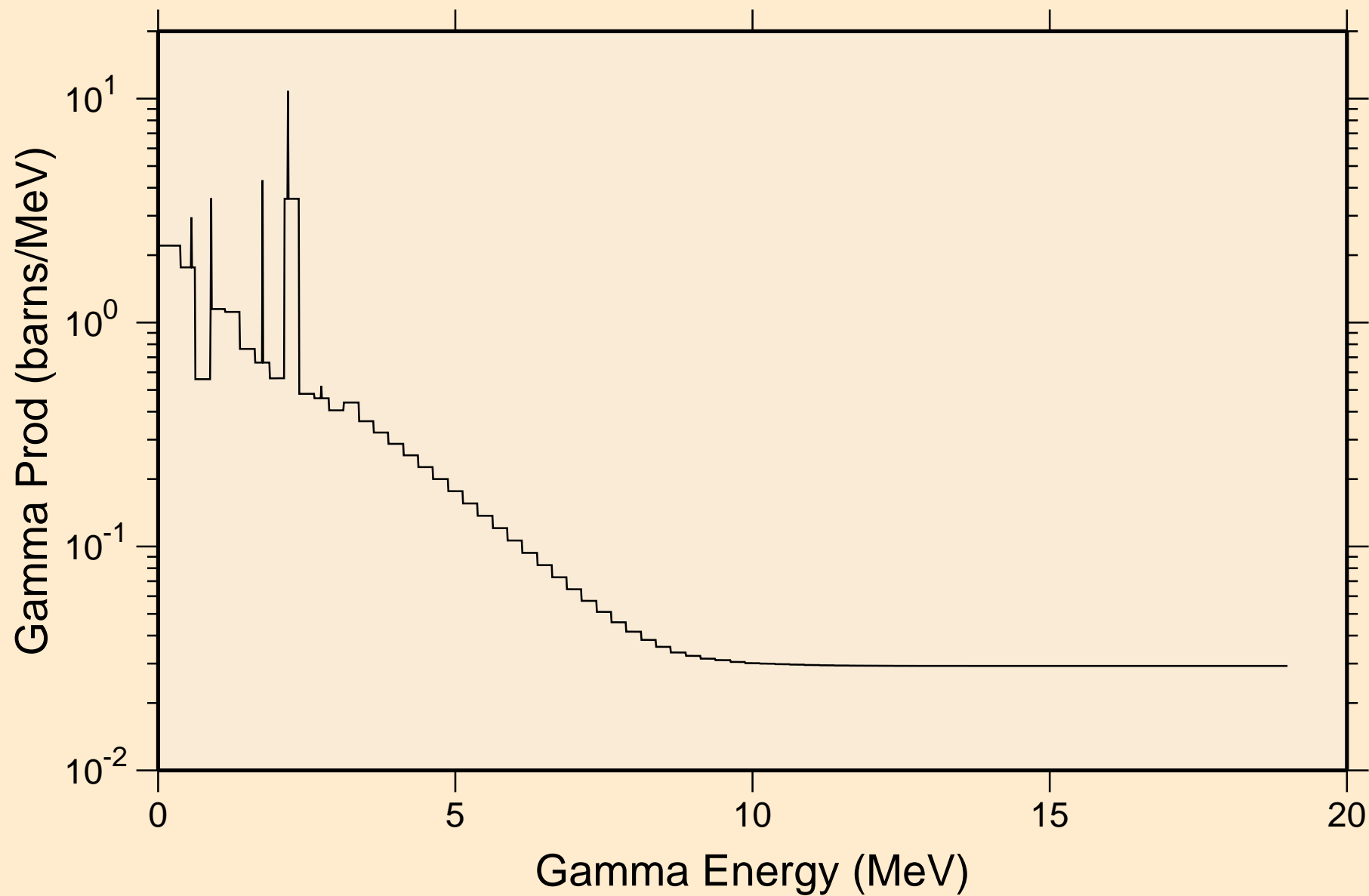

40-ZR-90 FOR FENDL-3.2 FROM FENDL-3.2 WITH NJOY2016.60+

Particle heating contributions

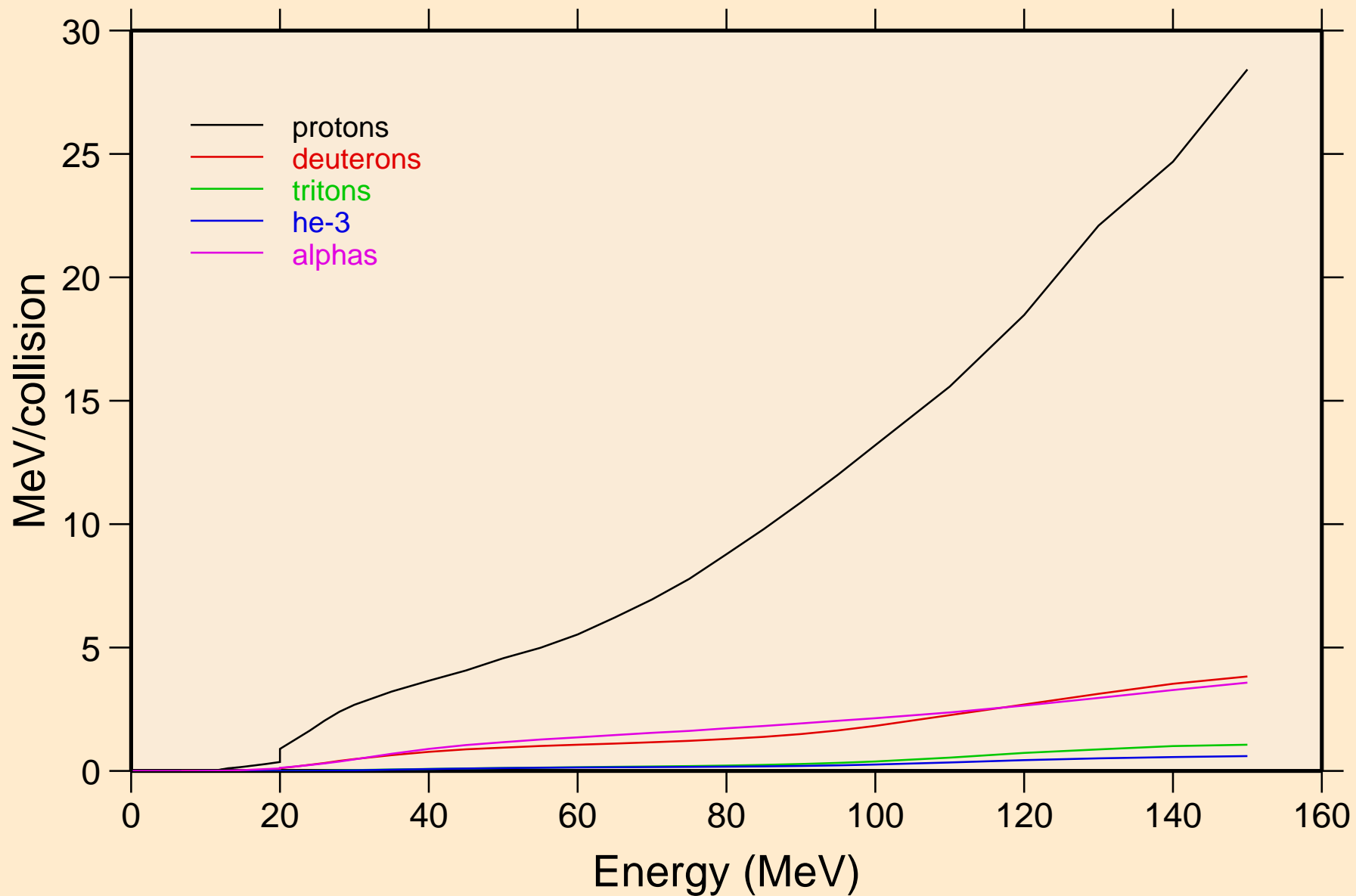

40-ZR-90 FOR FENDL-3.2 FROM FENDL-3.2 WITH NJOY2016.60+ Recoil Heating

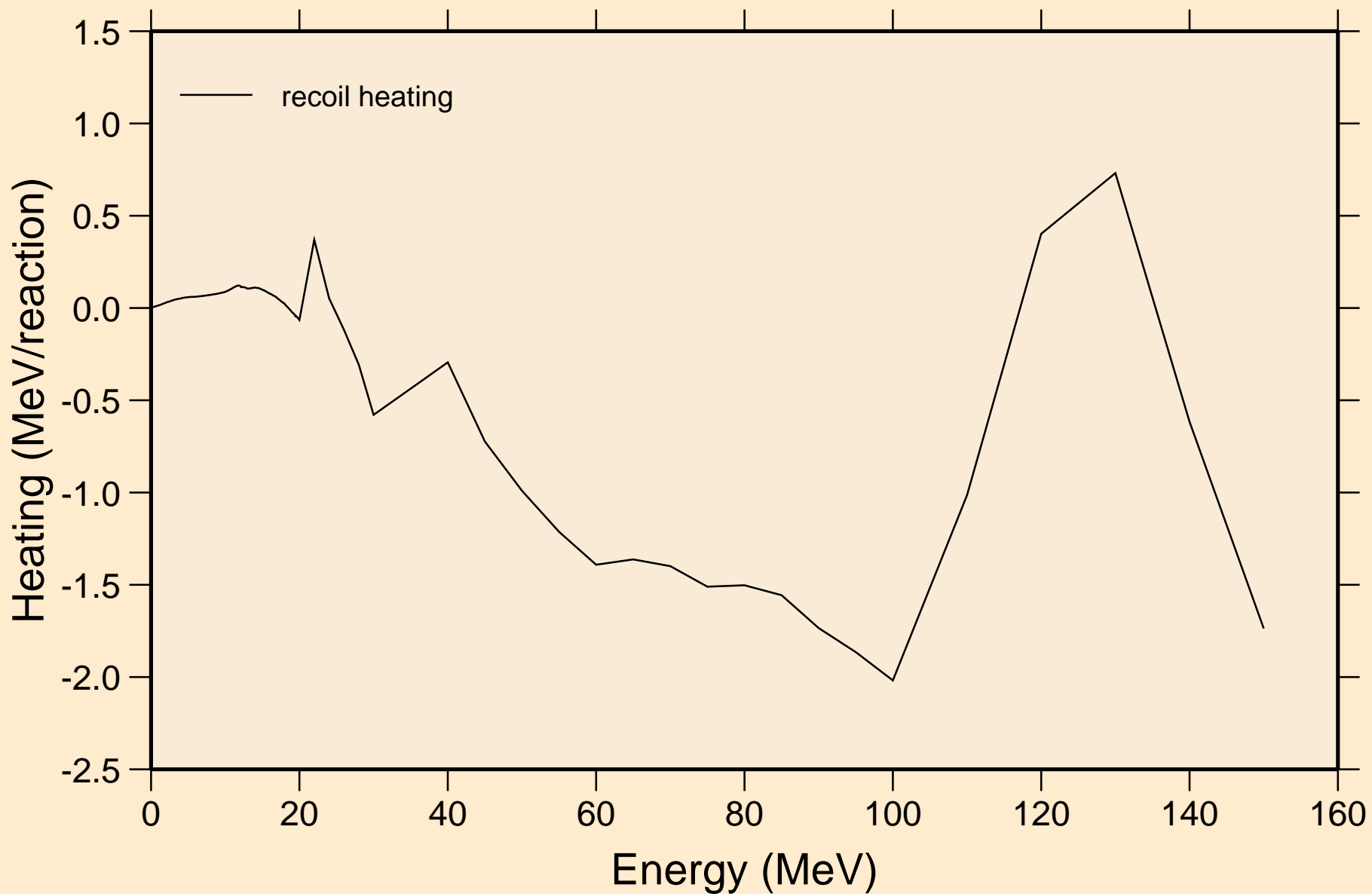

40-ZR-90 FOR FENDL-3.2 FROM FENDL-3.2 WITH NJOY2016.60+

Particle production cross sections

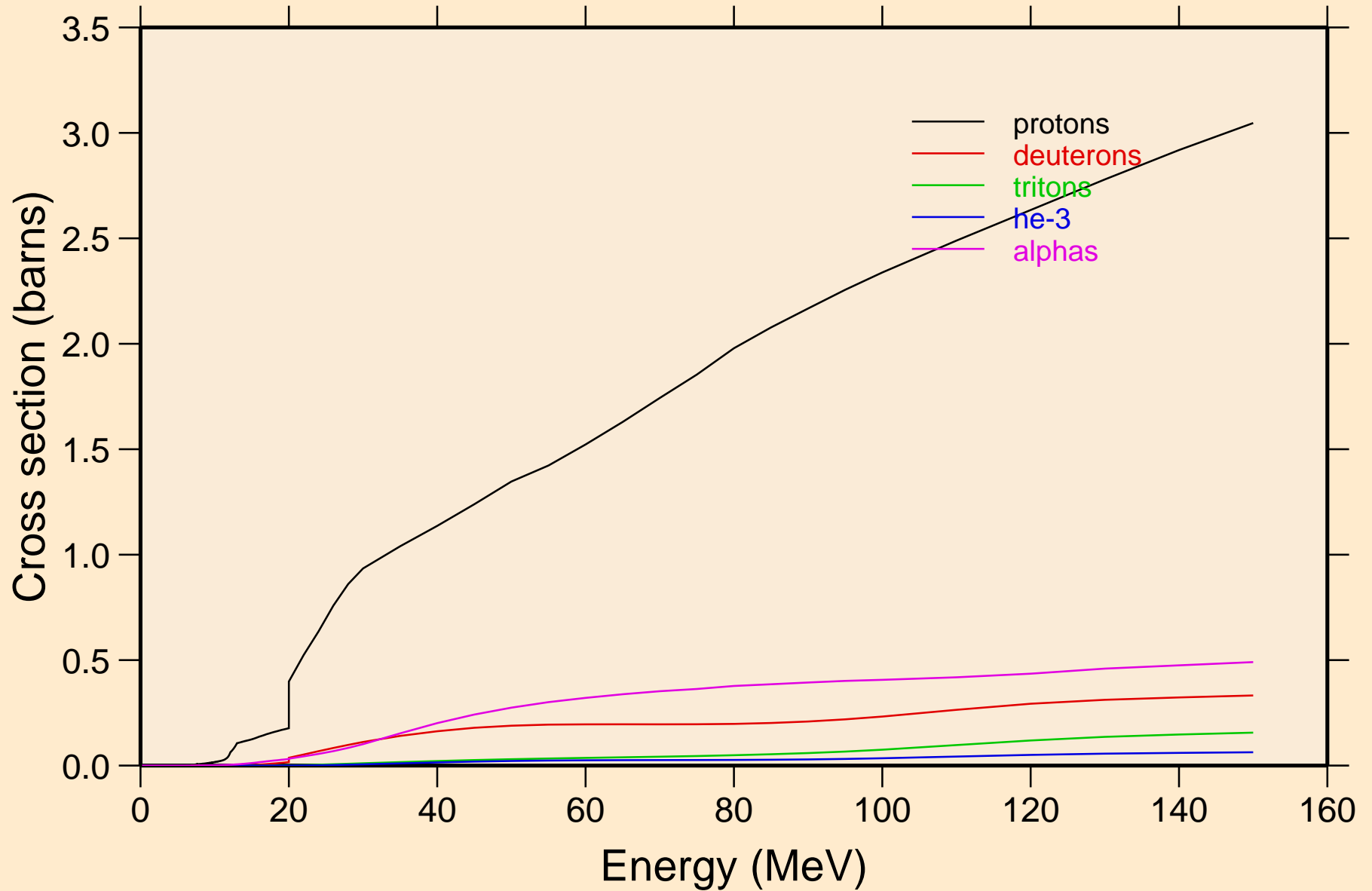

40-ZR-90 FOR FENDL-3.2 FROM FENDL-3.2 WITH NJOY2016.60+
protons from (n,x)

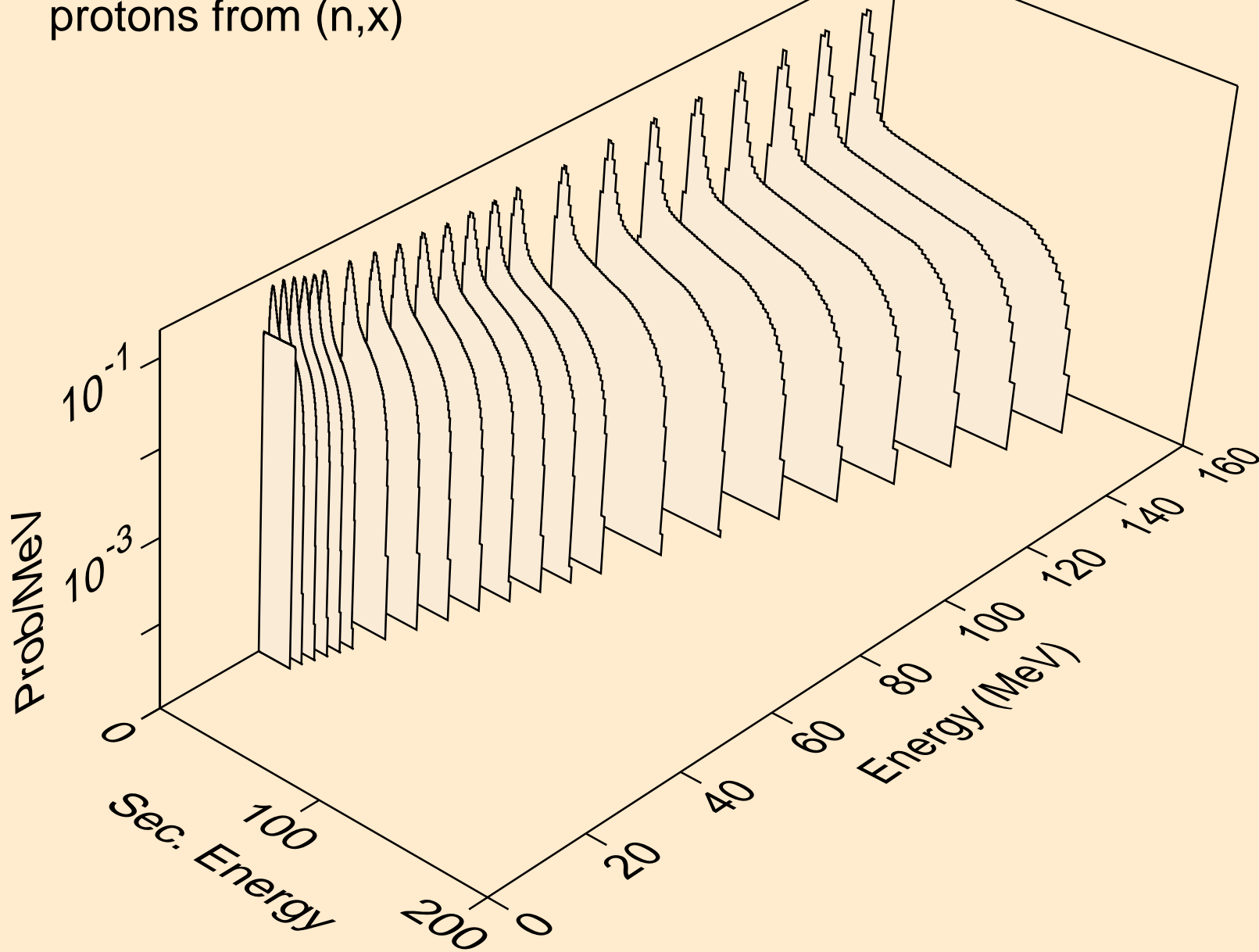

40-ZR-90 FOR FENDL-3.2 FROM FENDL-3.2 WITH NJOY2016.60+
protons from (n,xp)

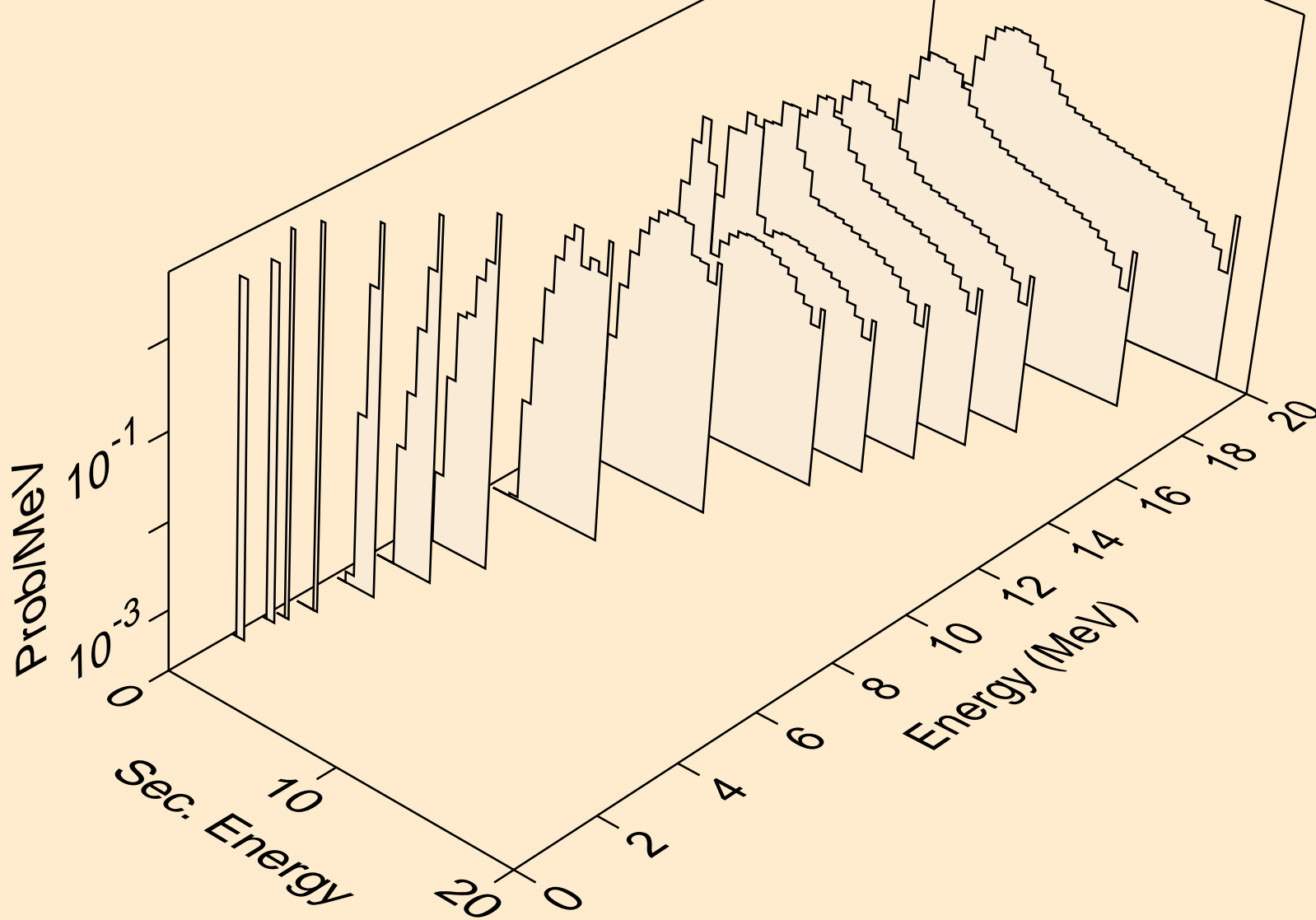

40-ZR-90 FOR FENDL-3.2 FROM FENDL-3.2 WITH NJOY2016.60+
deuterons from (n,x)

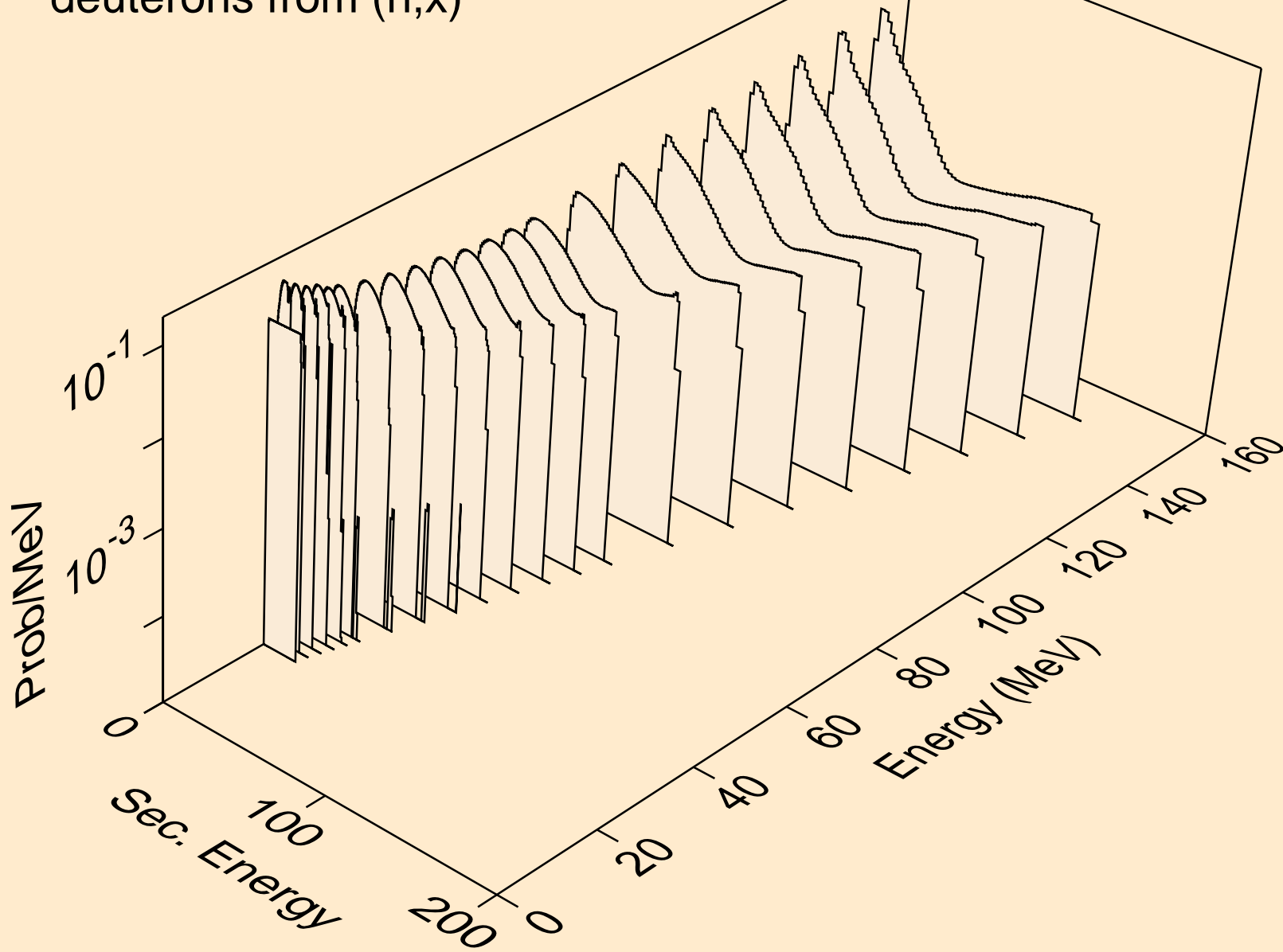

40-ZR-90 FOR FENDL-3.2 FROM FENDL-3.2 WITH NJOY2016.60+
deuterons from (n,xd)

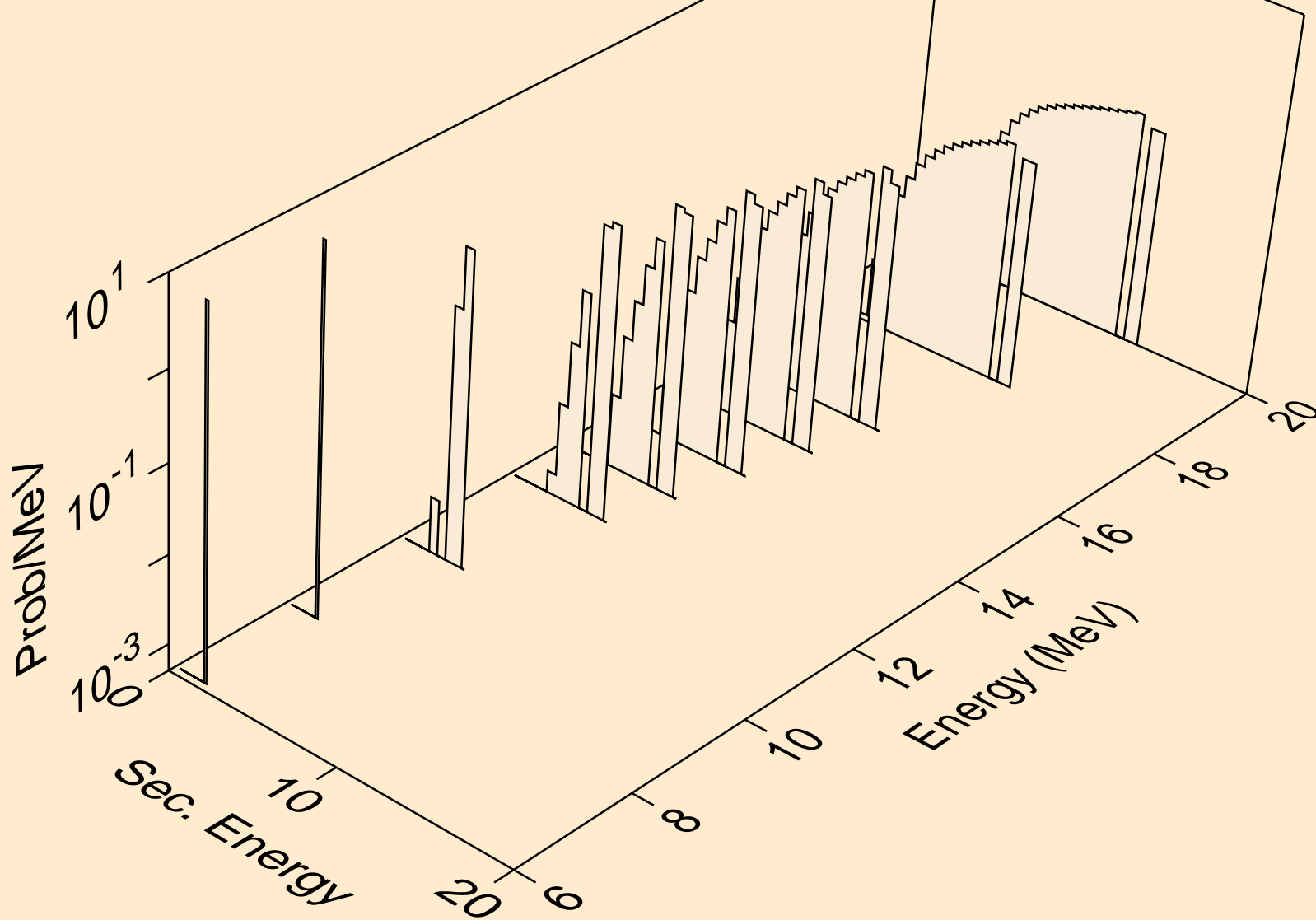

40-ZR-90 FOR FENDL-3.2 FROM FENDL-3.2 WITH NJOY2016.60+
tritons from (n,x)

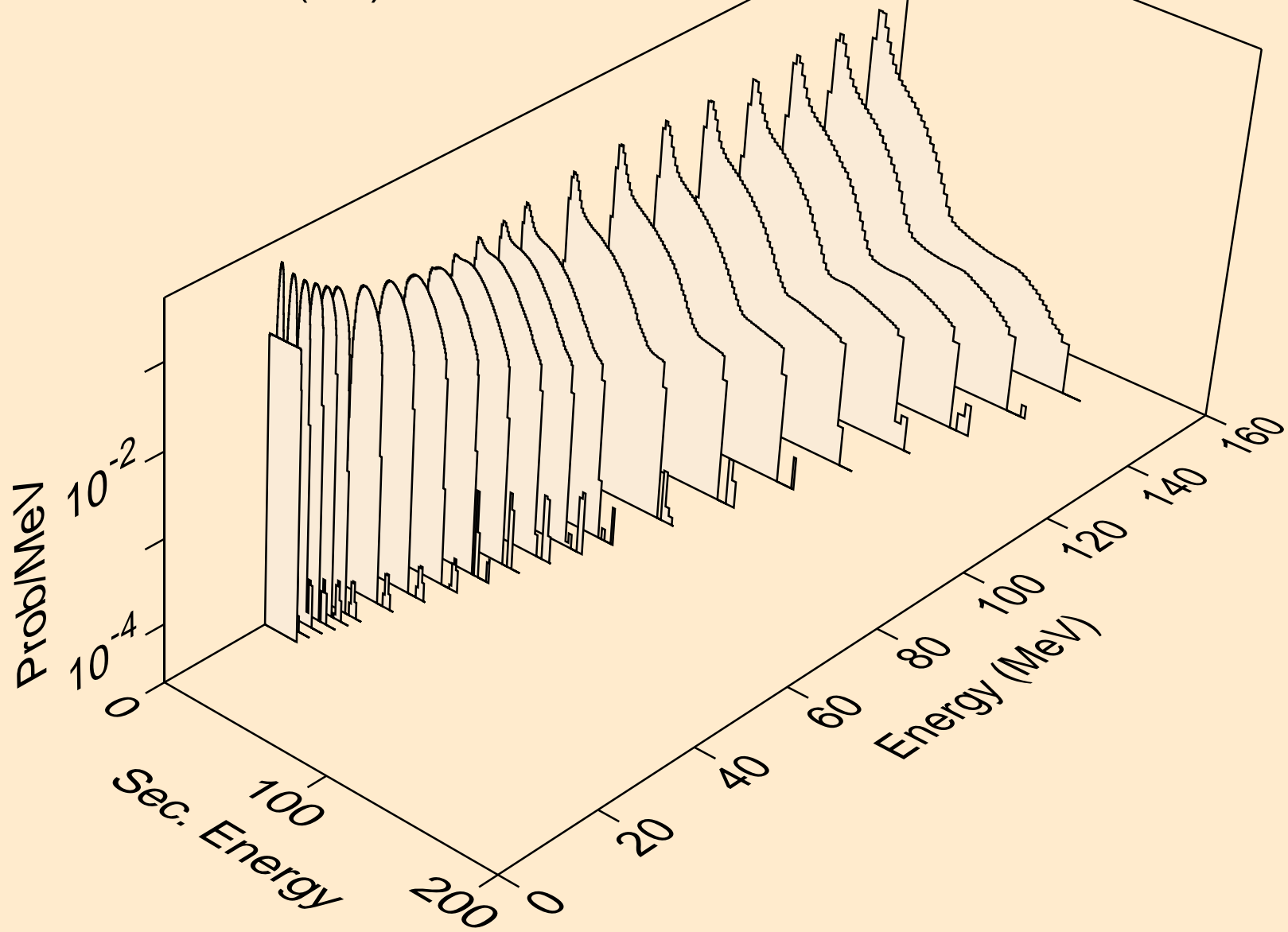

40-ZR-90 FOR FENDL-3.2 FROM FENDL-3.2 WITH NJOY2016.60+
tritons from (n,xt)

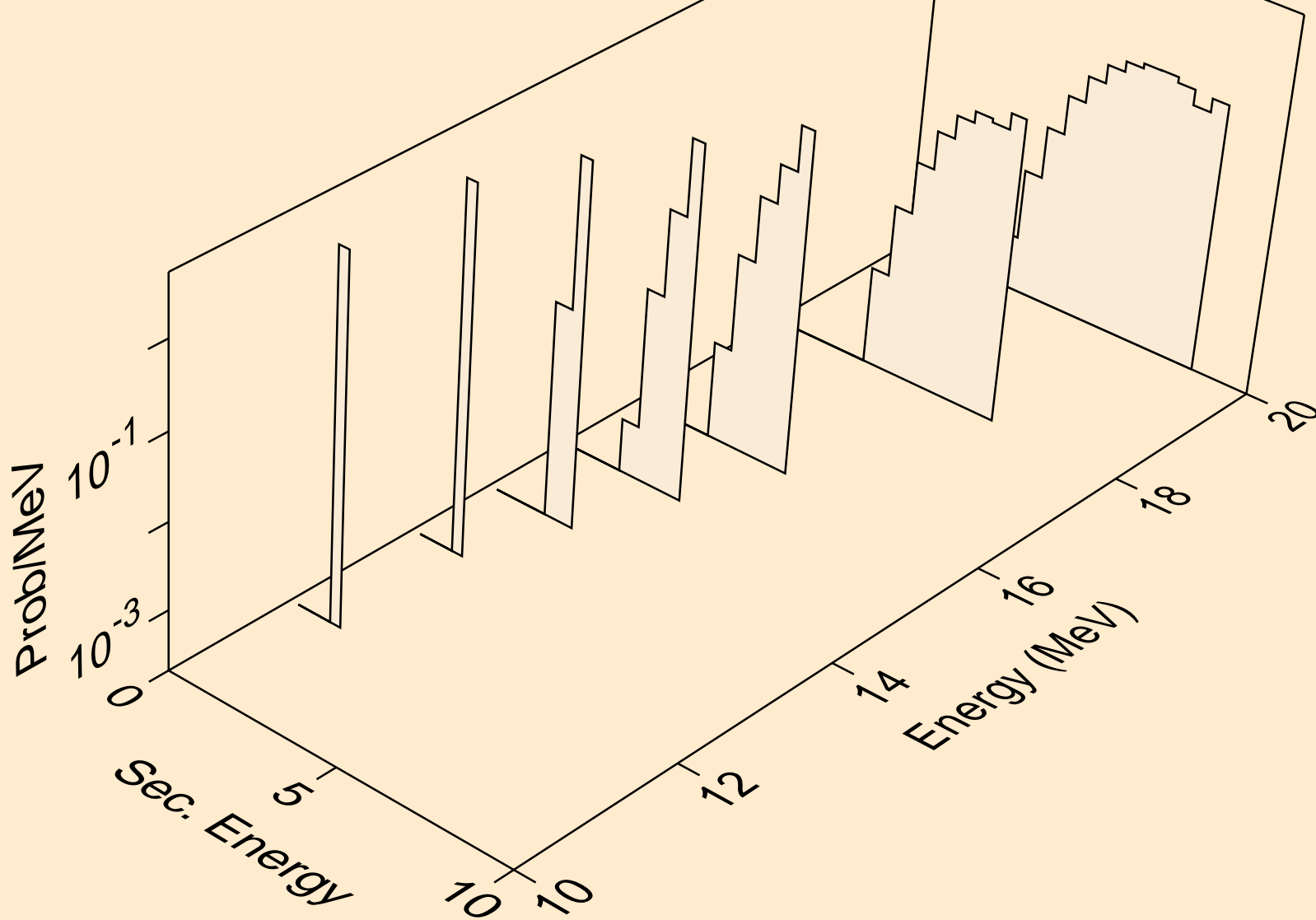

40-ZR-90 FOR FENDL-3.2 FROM FENDL-3.2 WITH NJOY2016.60+
he3s from (n,x)

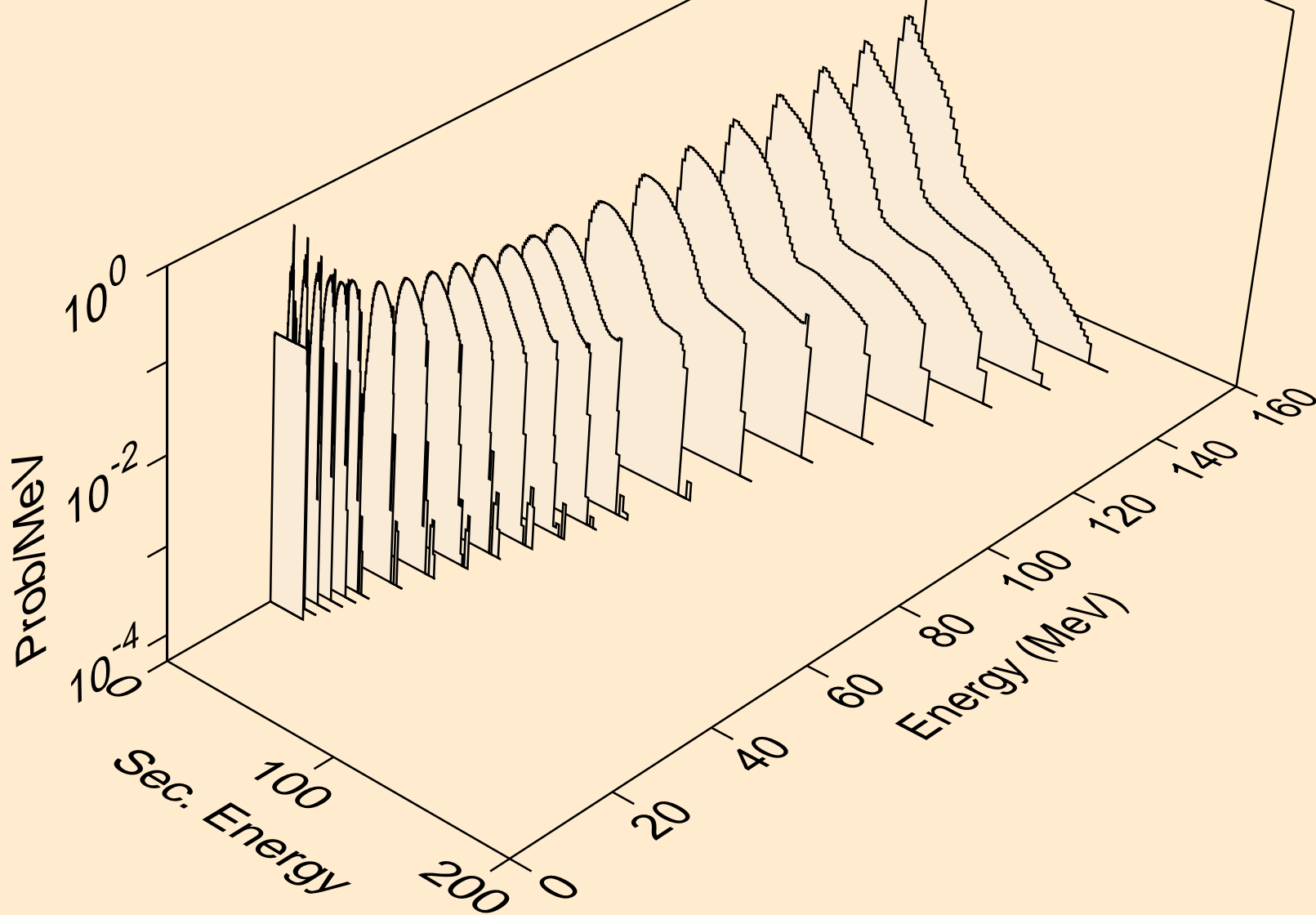

40-ZR-90 FOR FENDL-3.2 FROM FENDL-3.2 WITH NJOY2016.60+
he3s from (n,xhe3)

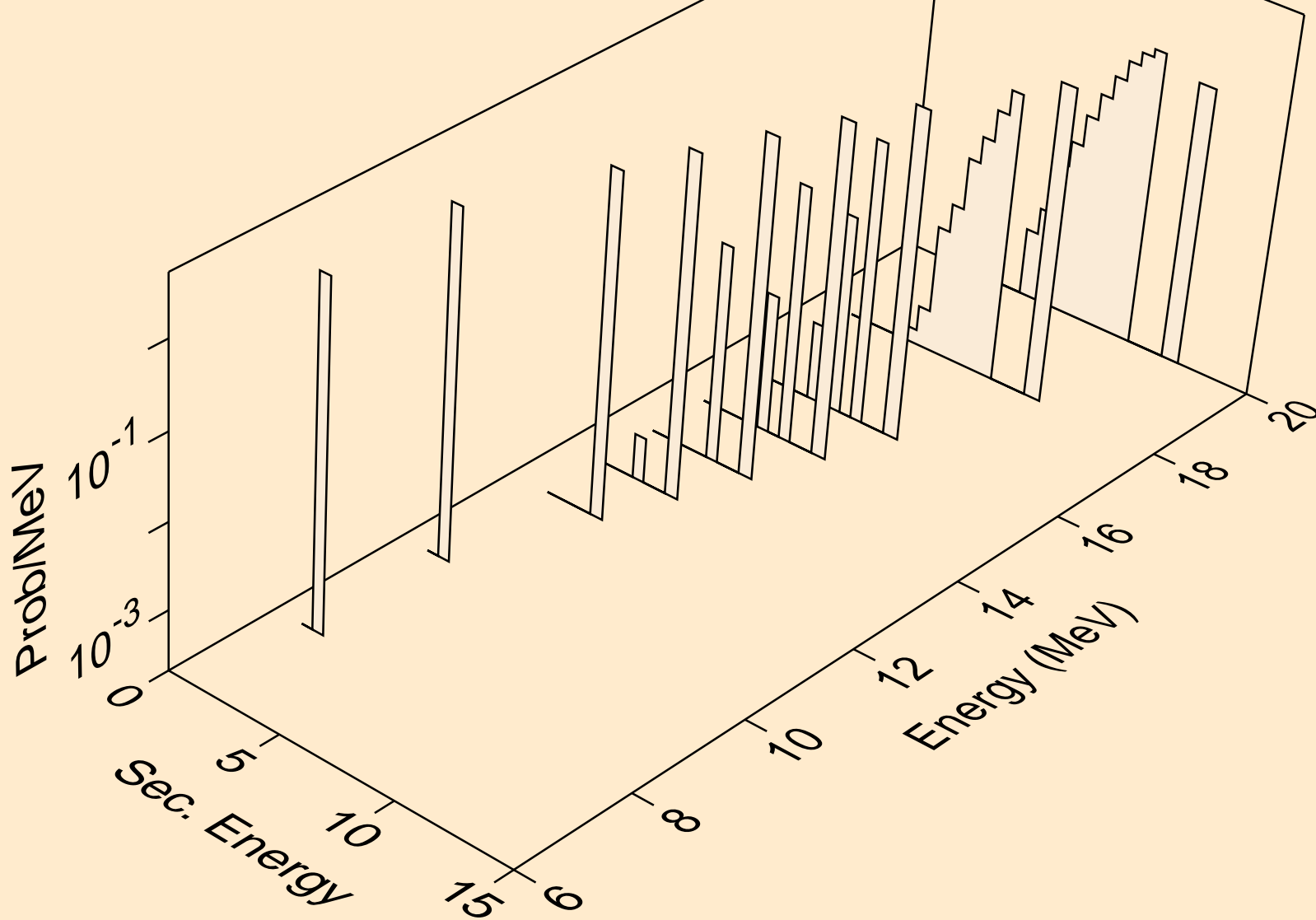

40-ZR-90 FOR FENDL-3.2 FROM FENDL-3.2 WITH NJOY2016.60+
alphas from (n,x)

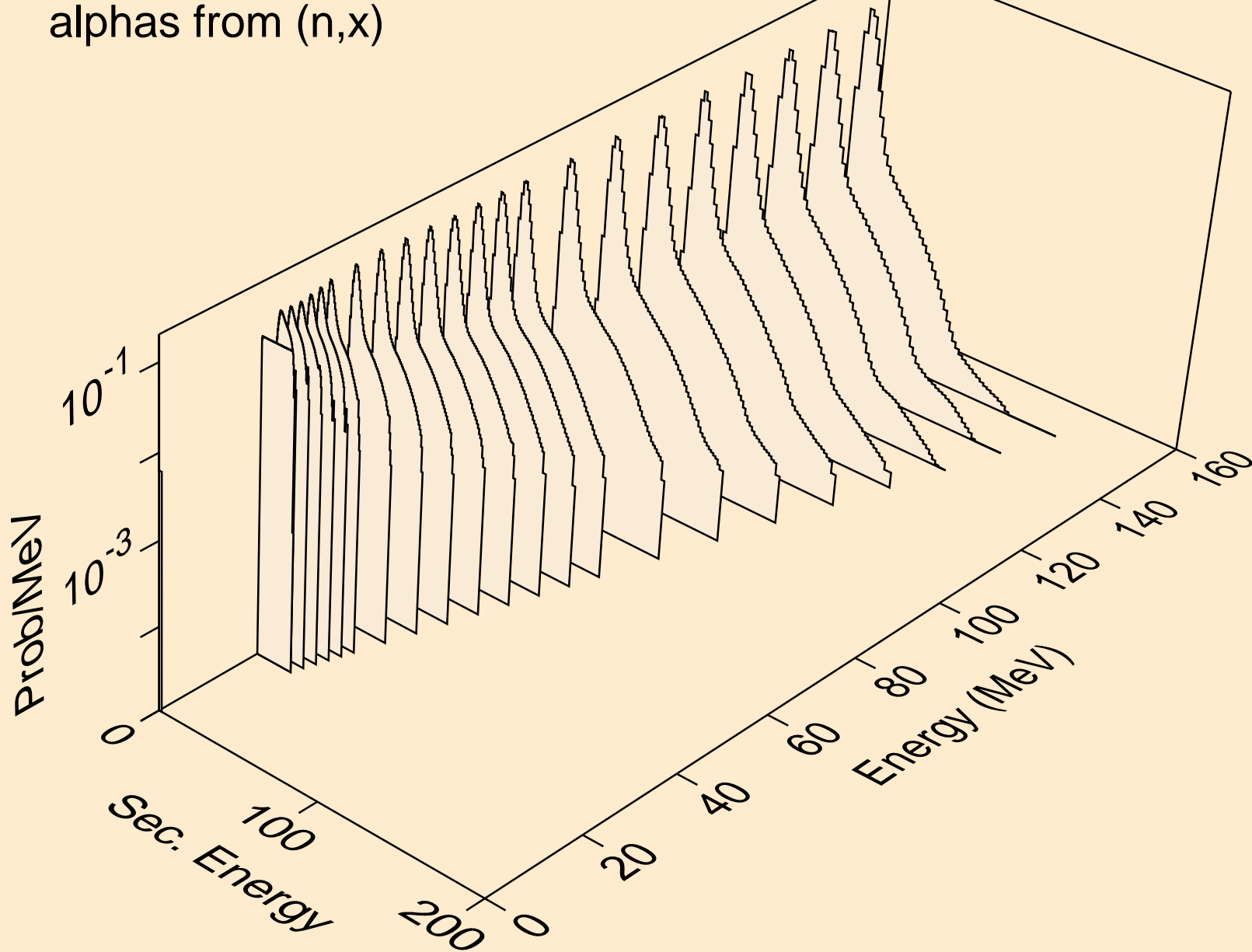

40-ZR-90 FOR FENDL-3.2 FROM FENDL-3.2 WITH NJOY2016.60+
alphas from (n,xa)

