

42-MO-98 FOR FENDL-3.2 FROM FENDL-3.2 WITH NJOY2016.60-
Principal cross sections

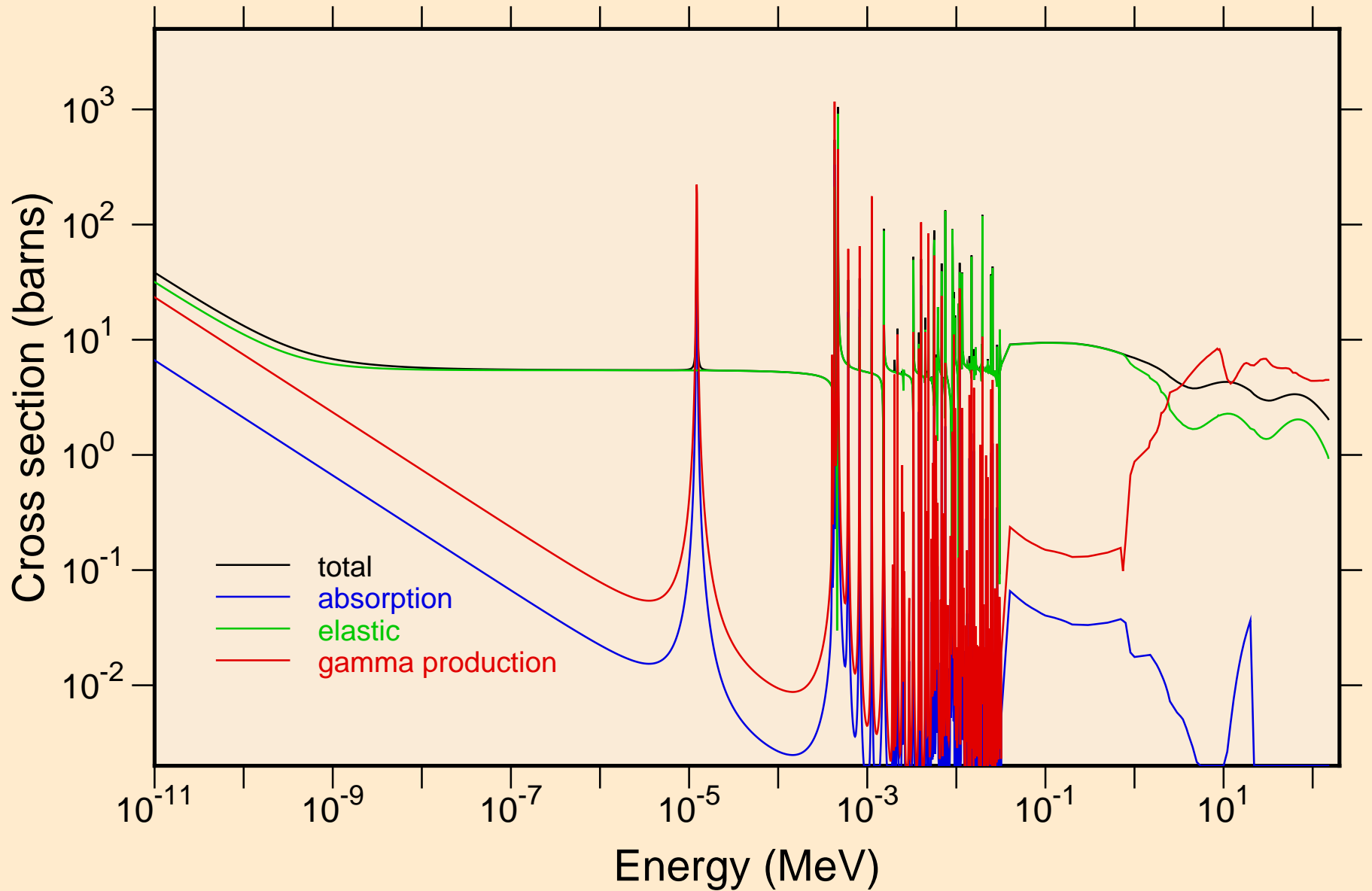

42-MO-98 FOR FENDL-3.2 FROM FENDL-3.2 WITH NJOY2016.60-
resonance total cross section

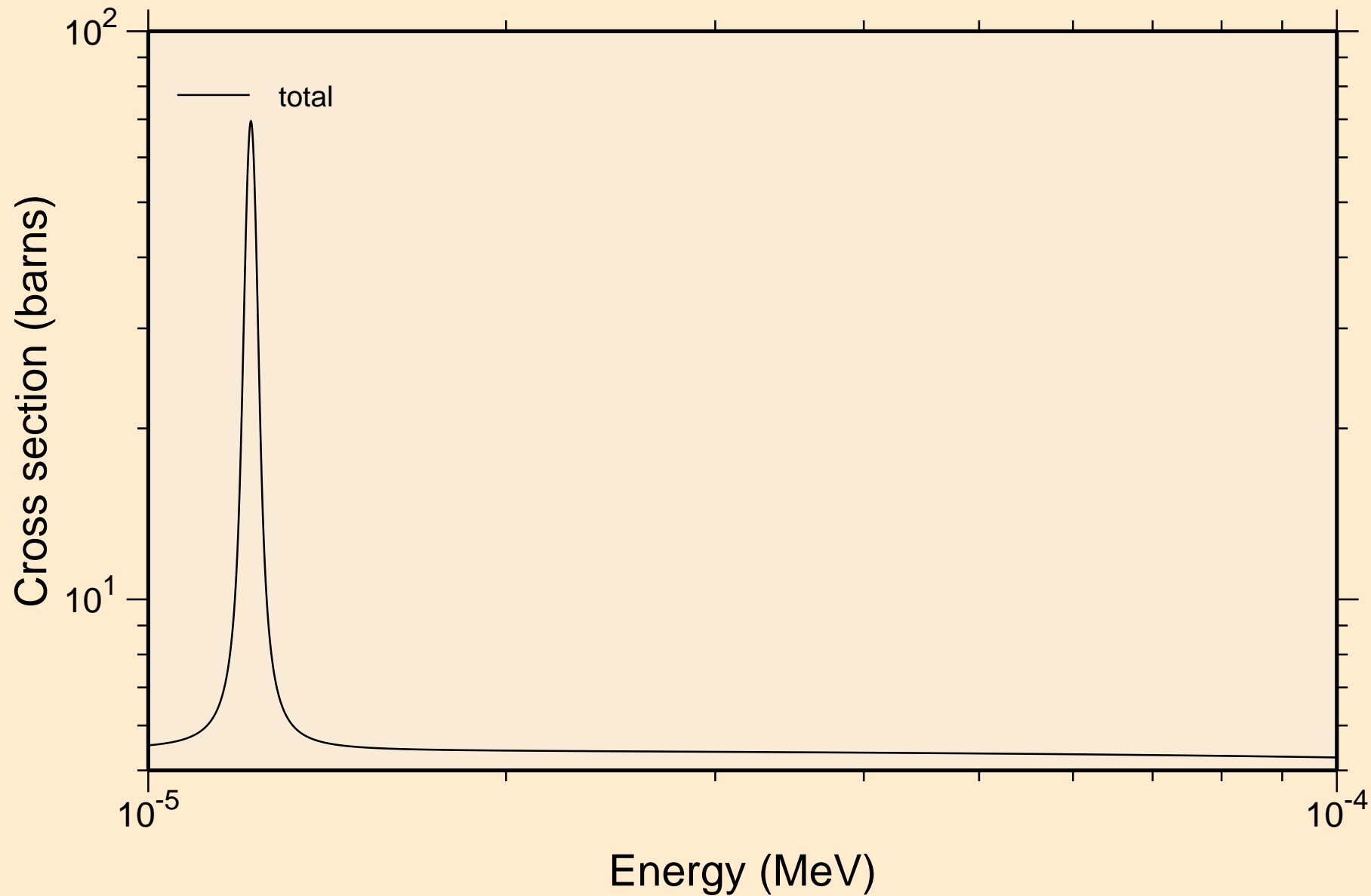

42-MO-98 FOR FENDL-3.2 FROM FENDL-3.2 WITH NJOY2016.60-
resonance total cross section

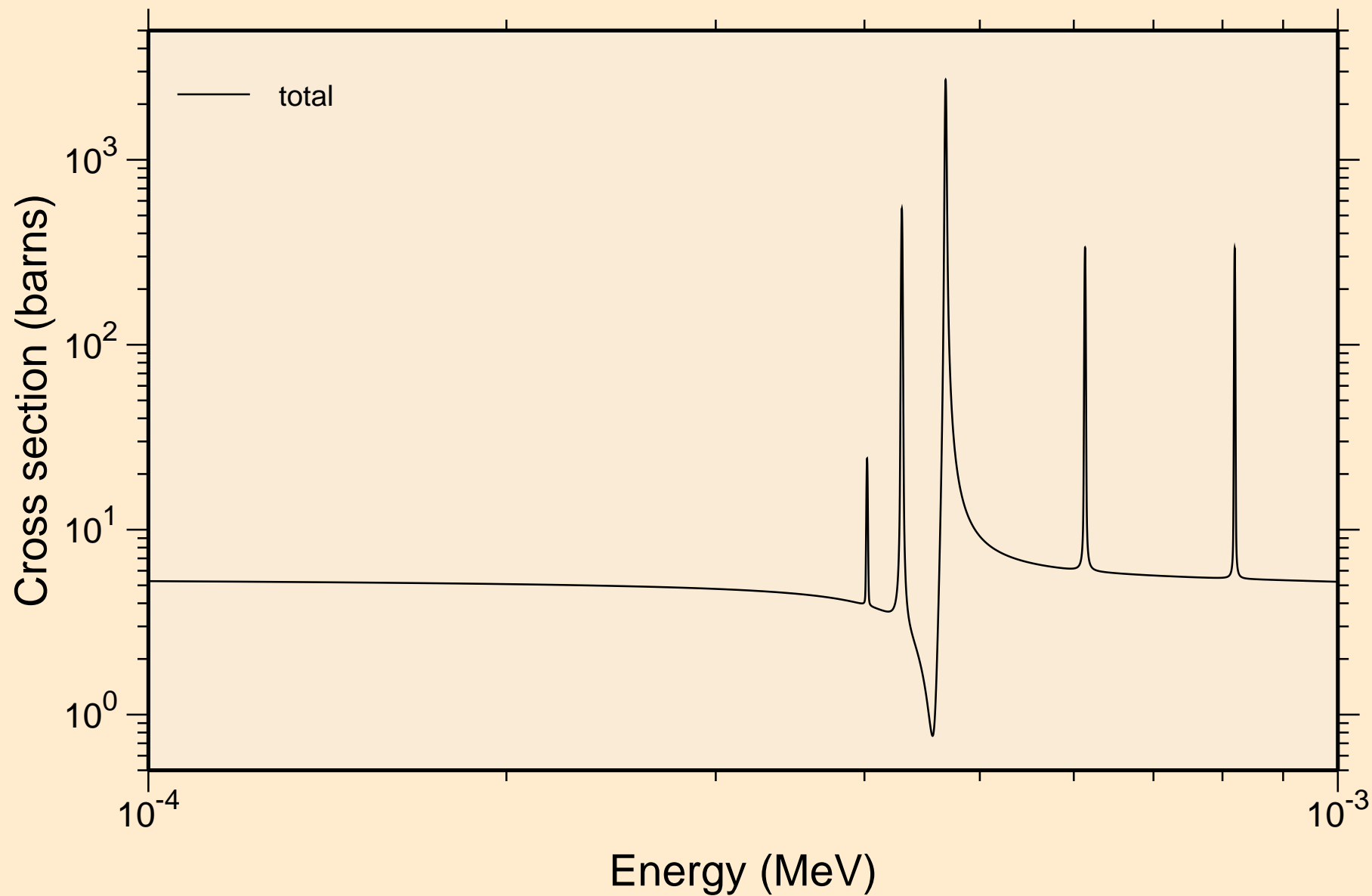

42-MO-98 FOR FENDL-3.2 FROM FENDL-3.2 WITH NJOY2016.60-
resonance total cross section

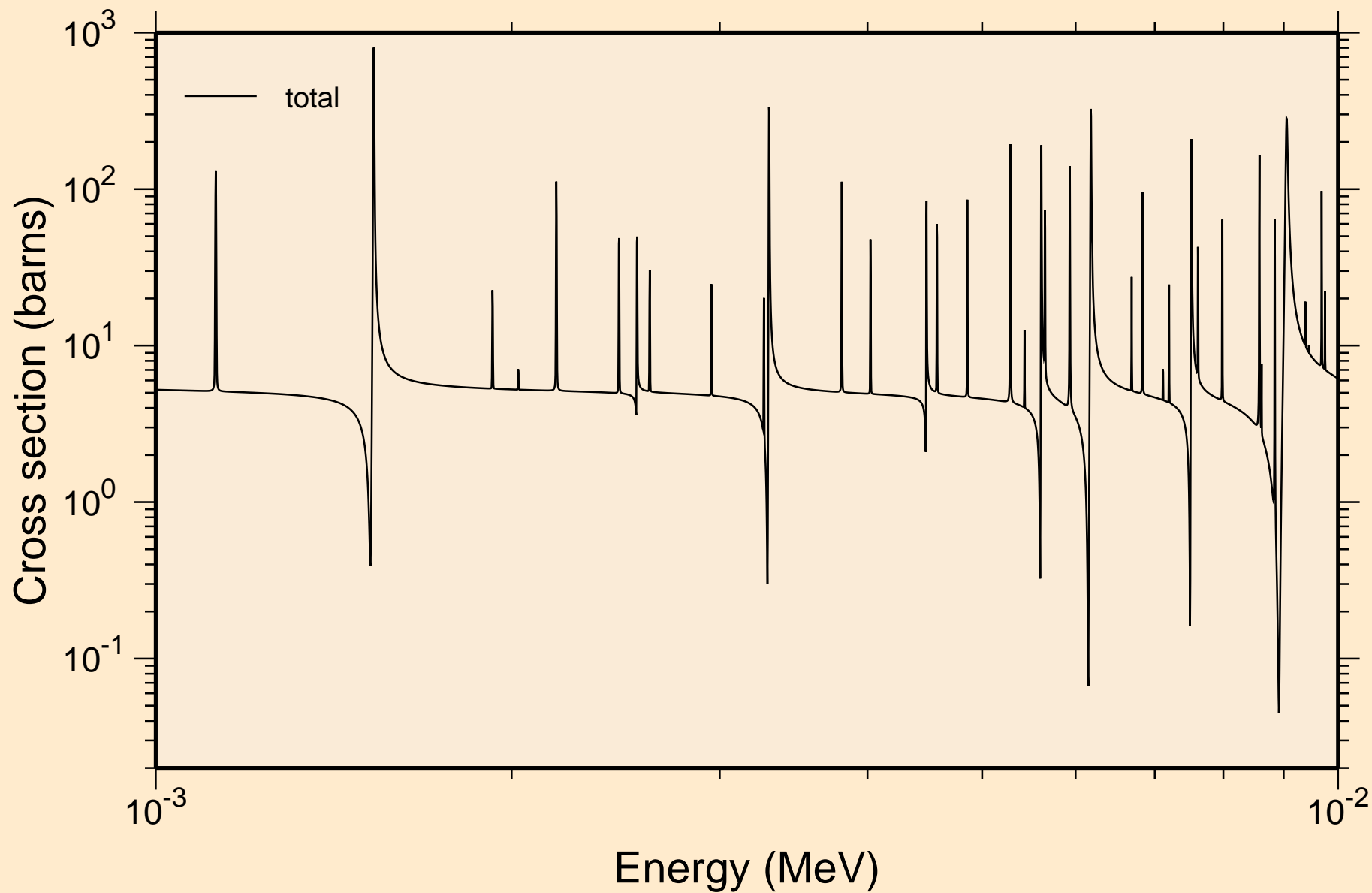

42-MO-98 FOR FENDL-3.2 FROM FENDL-3.2 WITH NJOY2016.60-
resonance total cross section

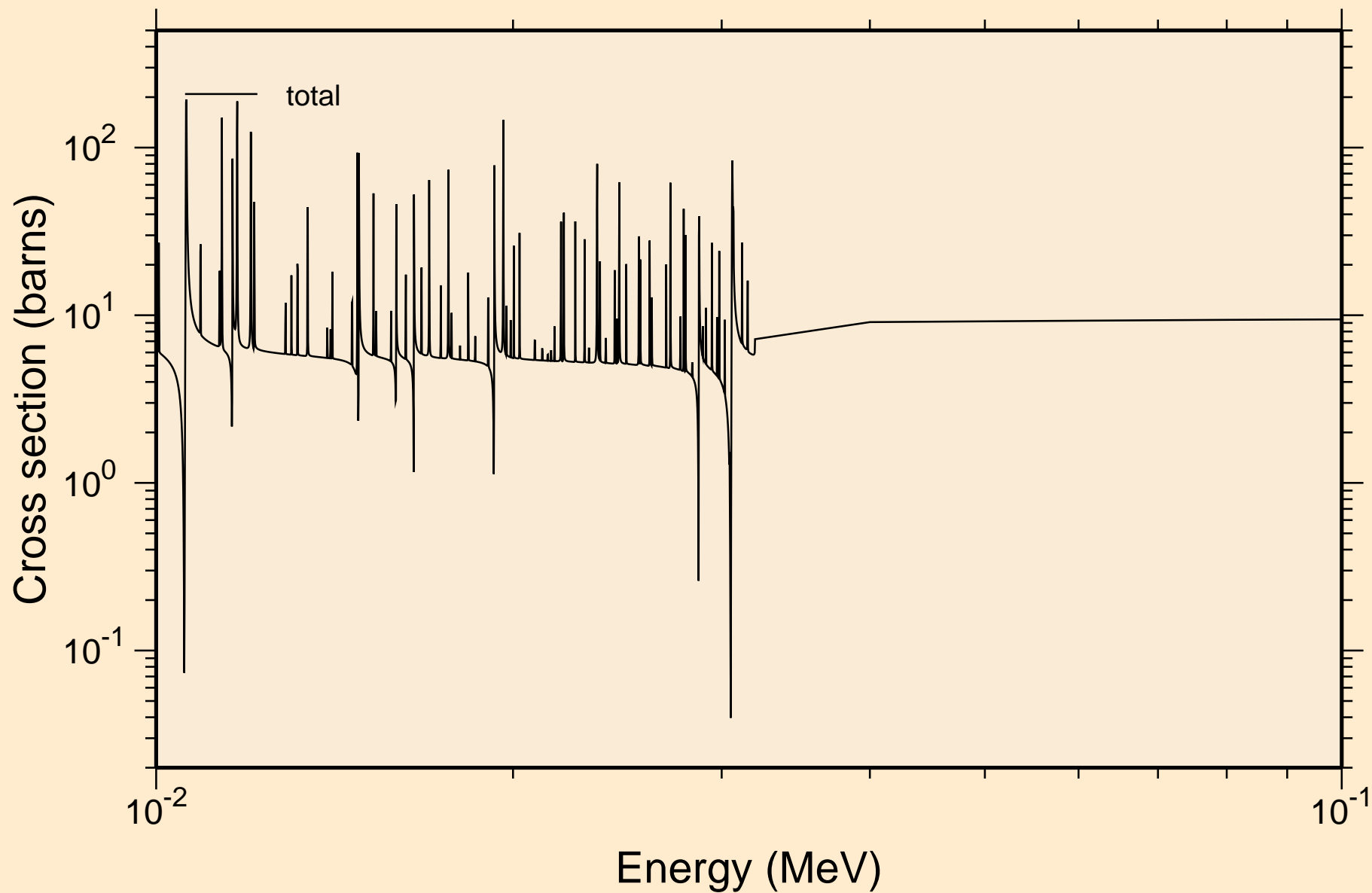

42-MO-98 FOR FENDL-3.2 FROM FENDL-3.2 WITH NJOY2016.60-
resonance absorption cross sections

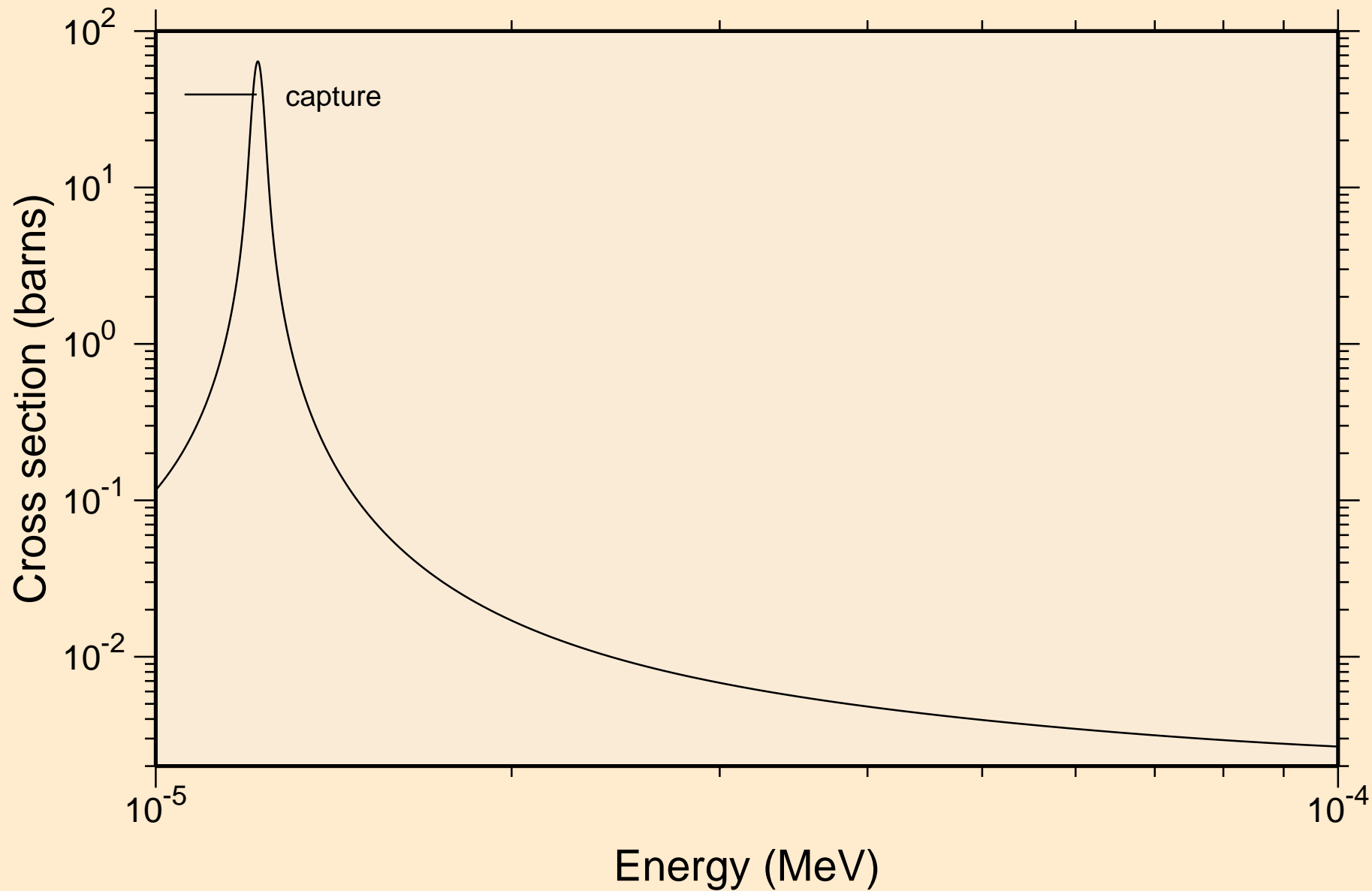

42-MO-98 FOR FENDL-3.2 FROM FENDL-3.2 WITH NJOY2016.60-
resonance absorption cross sections

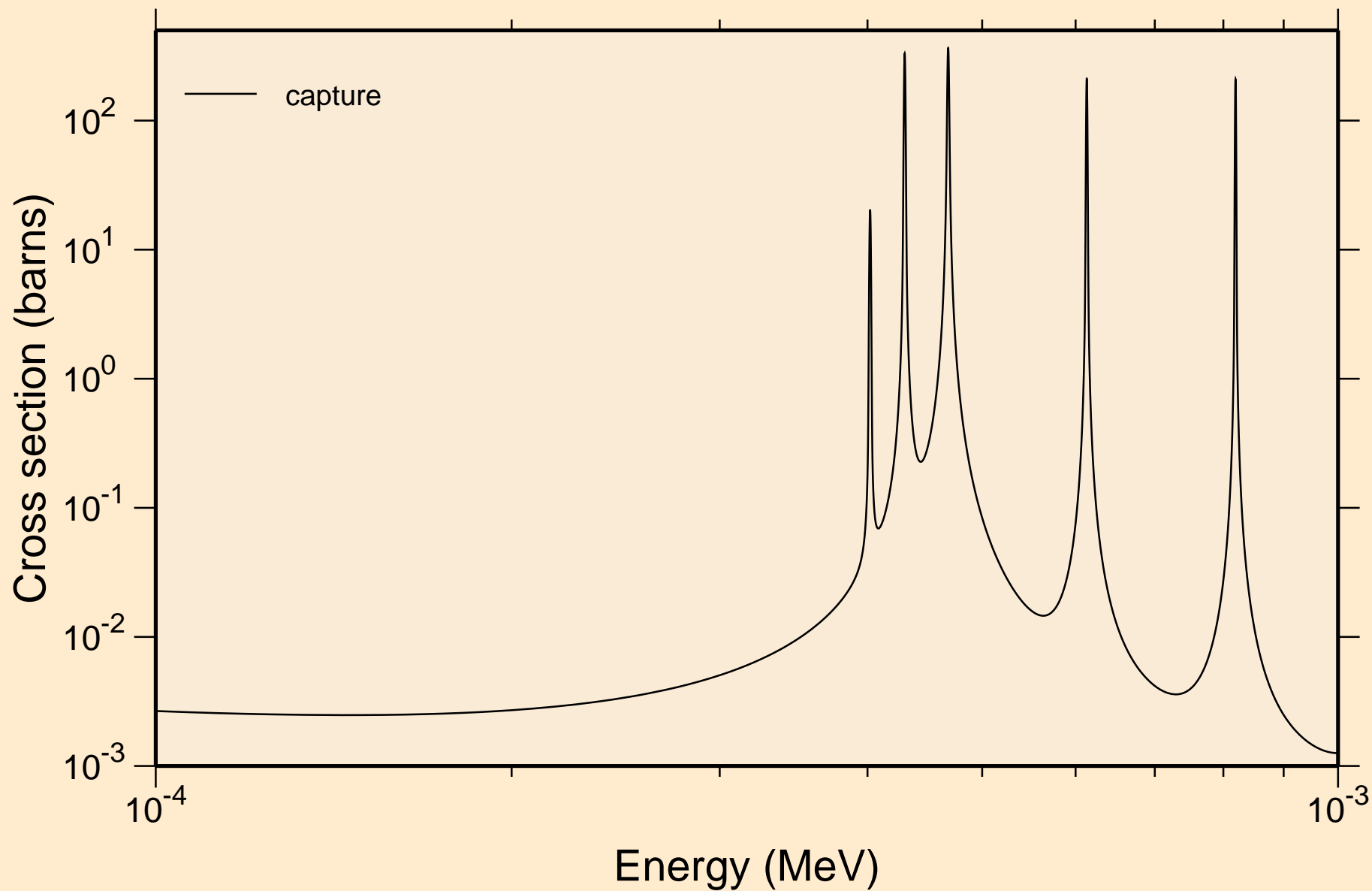

42-MO-98 FOR FENDL-3.2 FROM FENDL-3.2 WITH NJOY2016.60-
resonance absorption cross sections

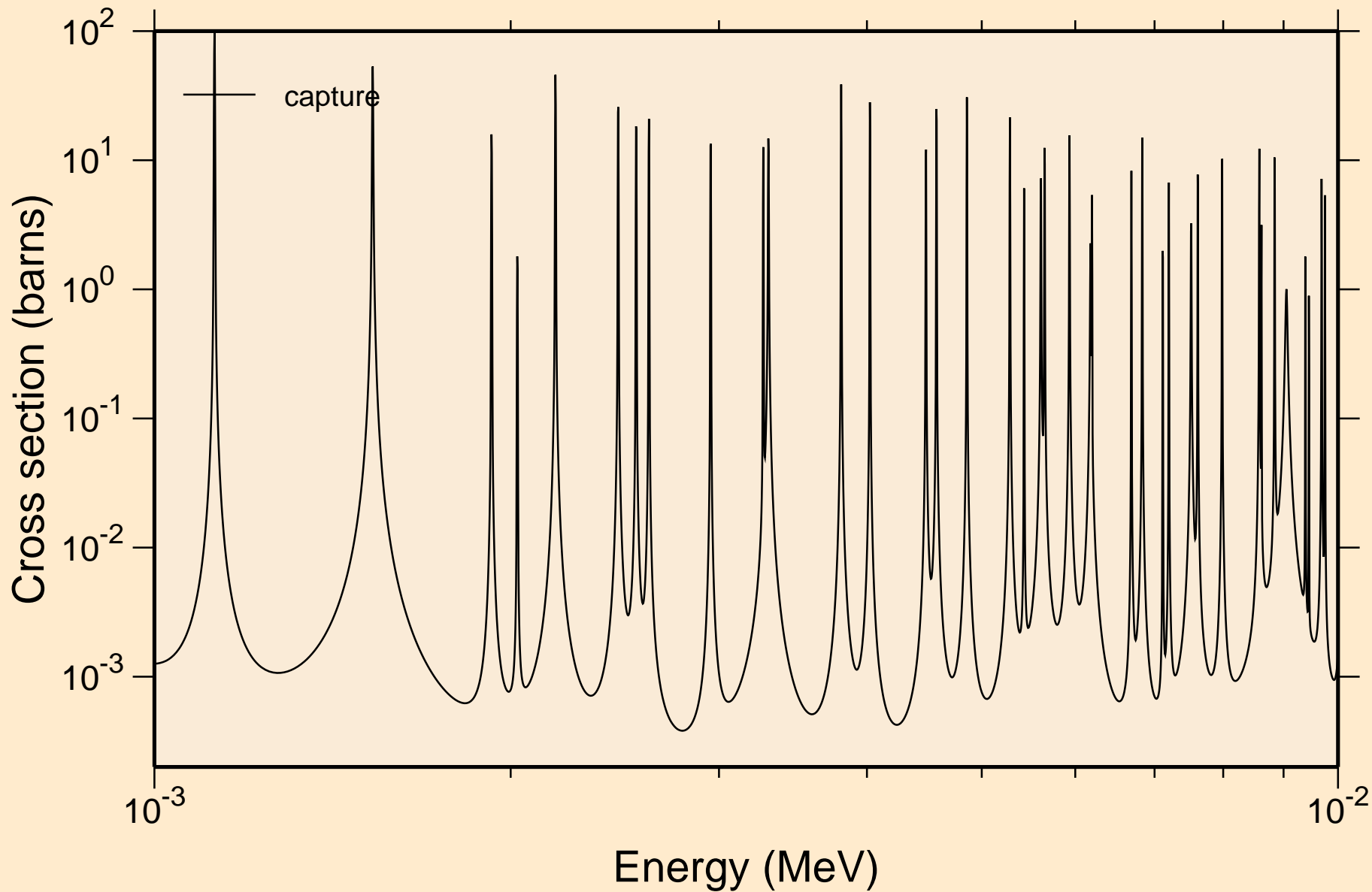

42-MO-98 FOR FENDL-3.2 FROM FENDL-3.2 WITH NJOY2016.60-
resonance absorption cross sections

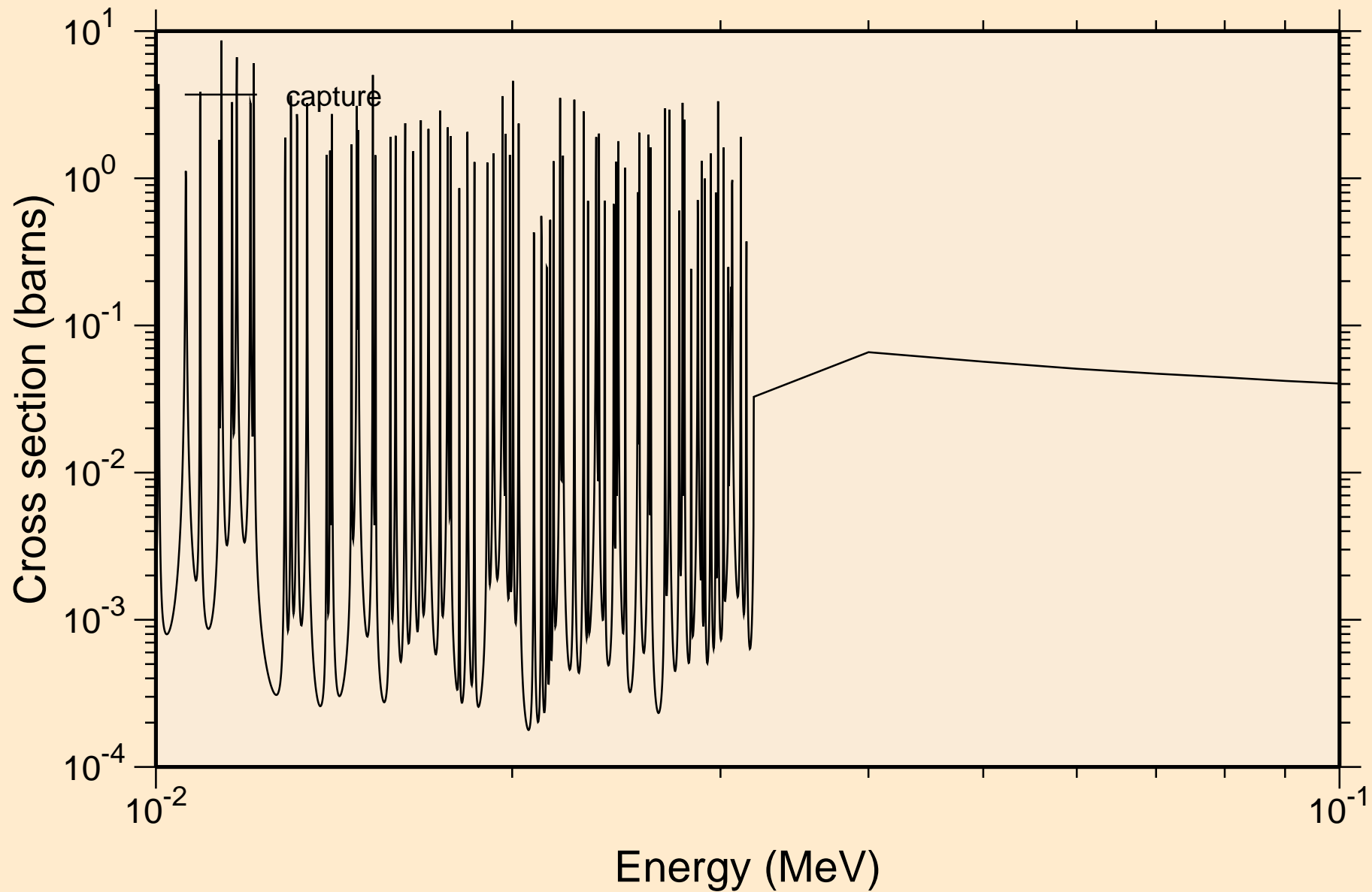

42-MO-98 FOR FENDL-3.2 FROM FENDL-3.2 WITH NJOY2016.60-
UR total cross section

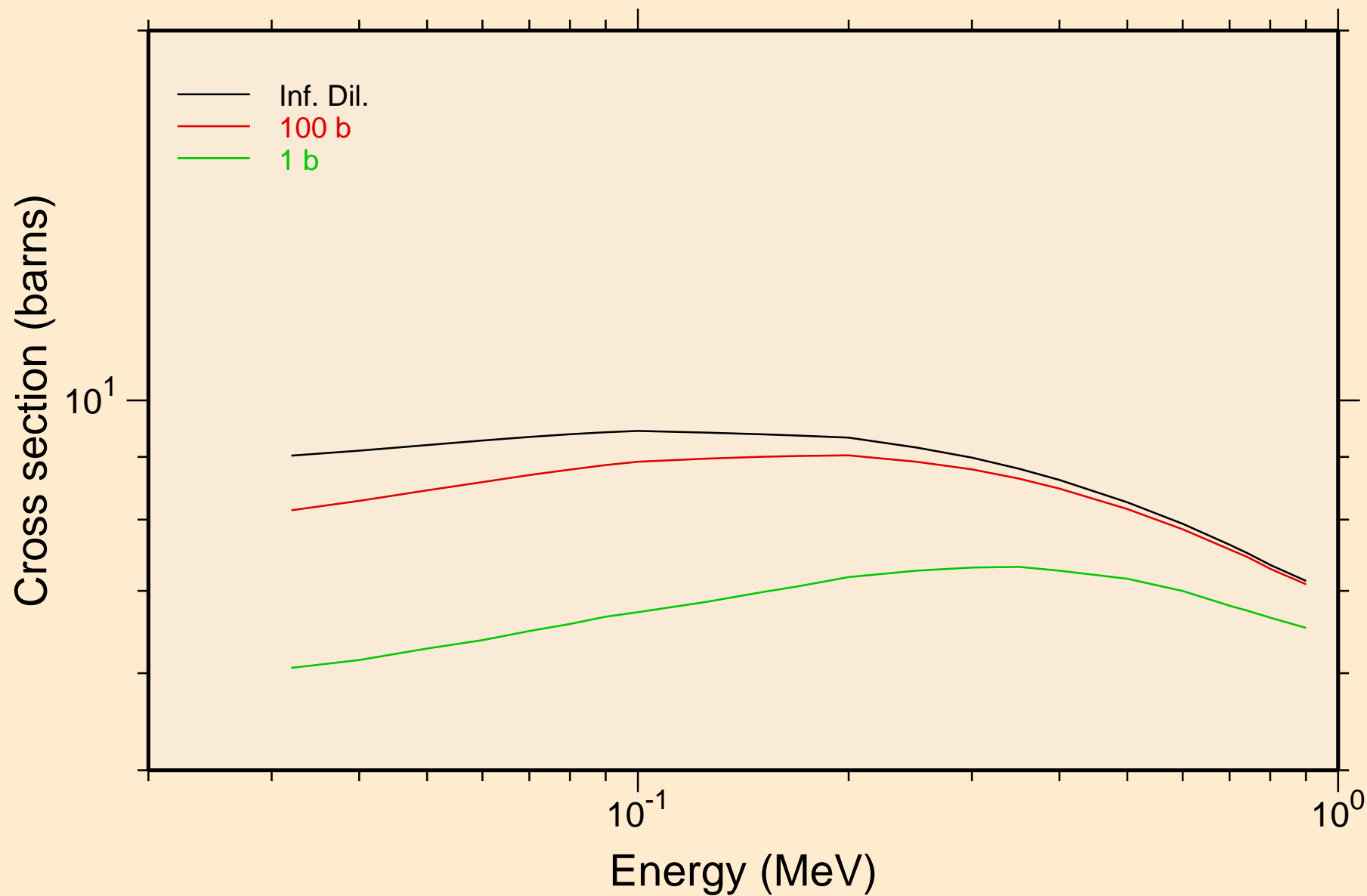

42-MO-98 FOR FENDL-3.2 FROM FENDL-3.2 WITH NJOY2016.60-
UR elastic cross section

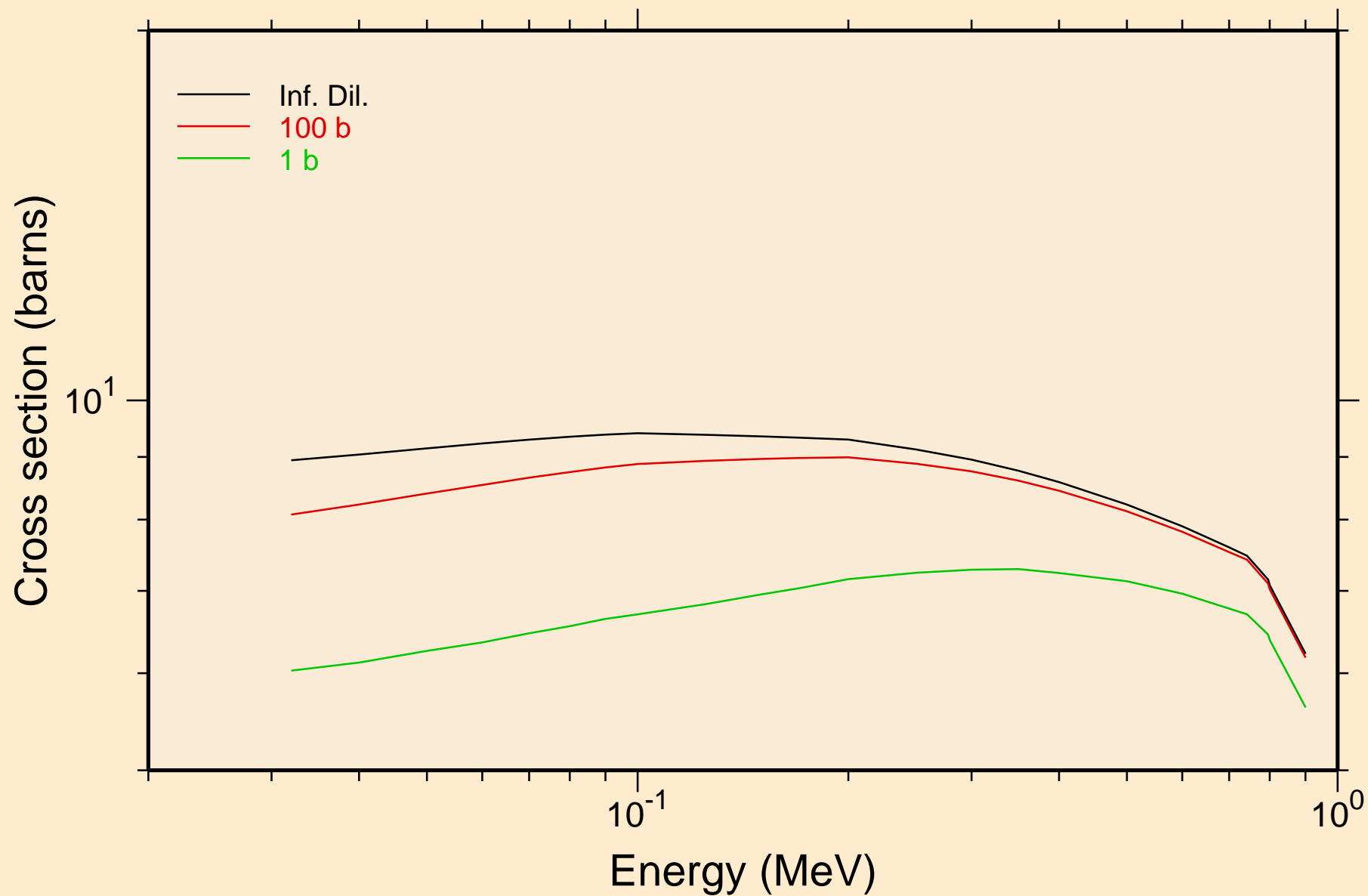

42-MO-98 FOR FENDL-3.2 FROM FENDL-3.2 WITH NJOY2016.60-
UR capture cross section

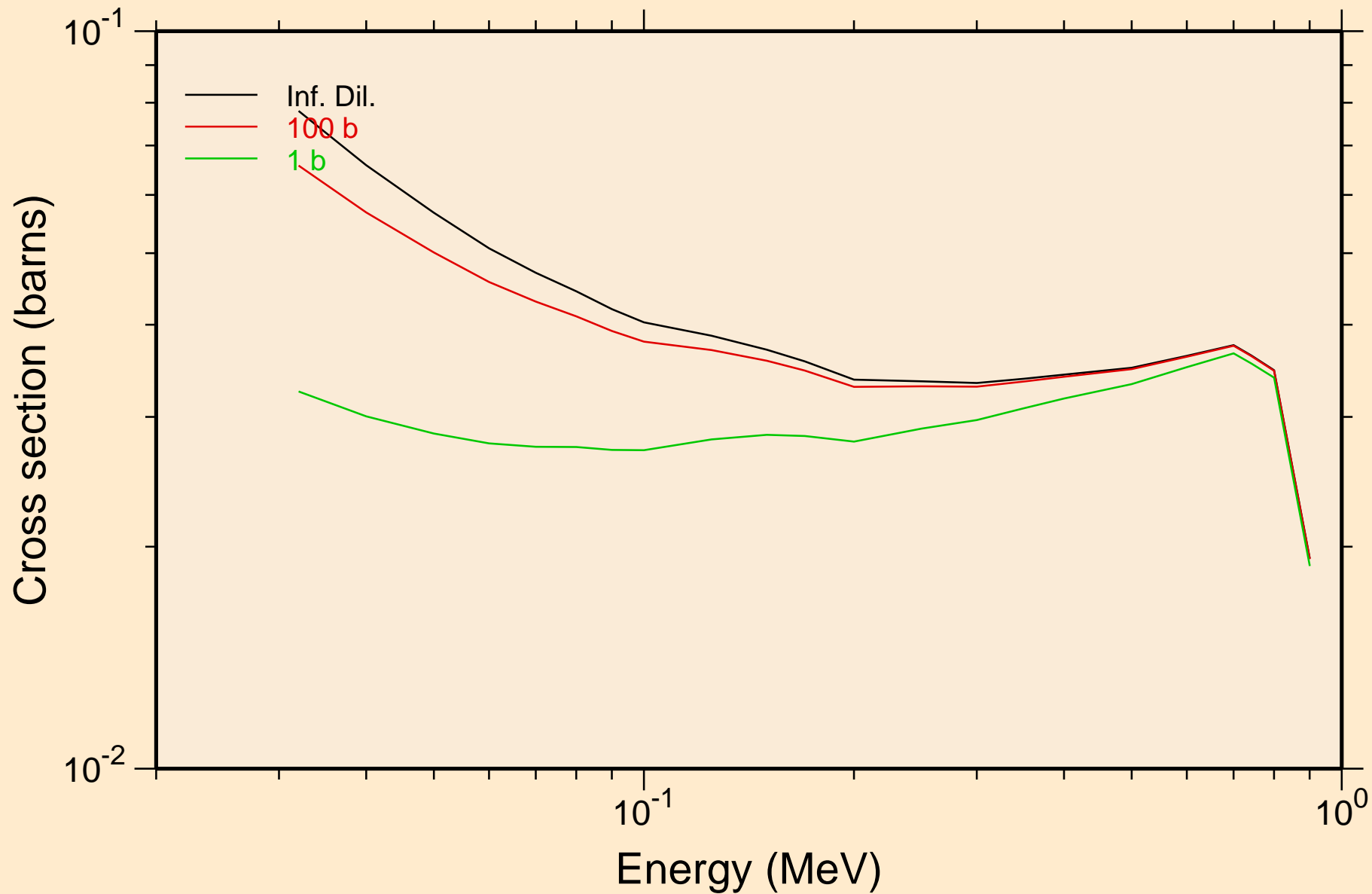

42-MO-98 FOR FENDL-3.2 FROM FENDL-3.2 WITH NJOY2016.60- Heating

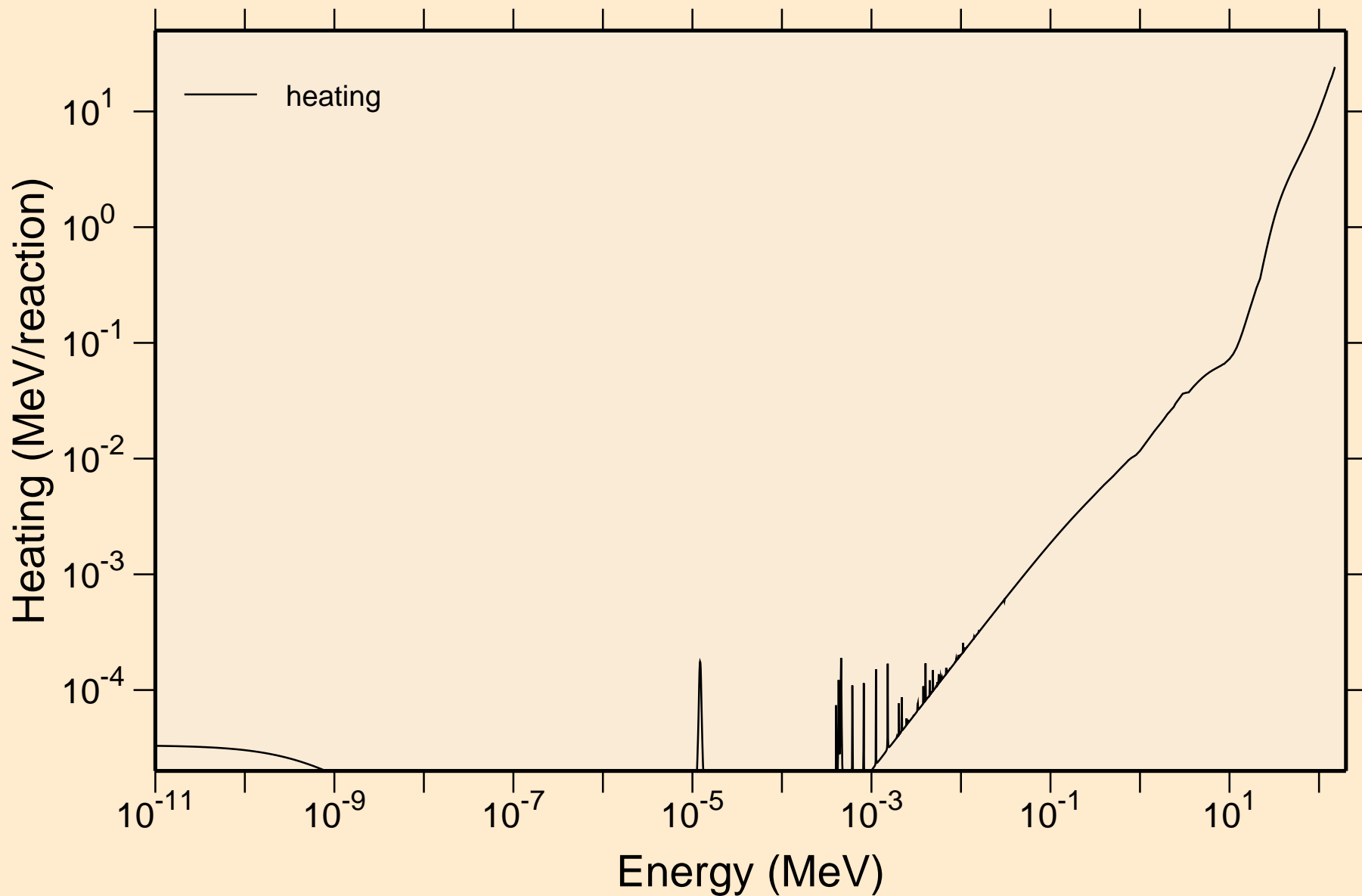

42-MO-98 FOR FENDL-3.2 FROM FENDL-3.2 WITH NJOY2016.60- Damage

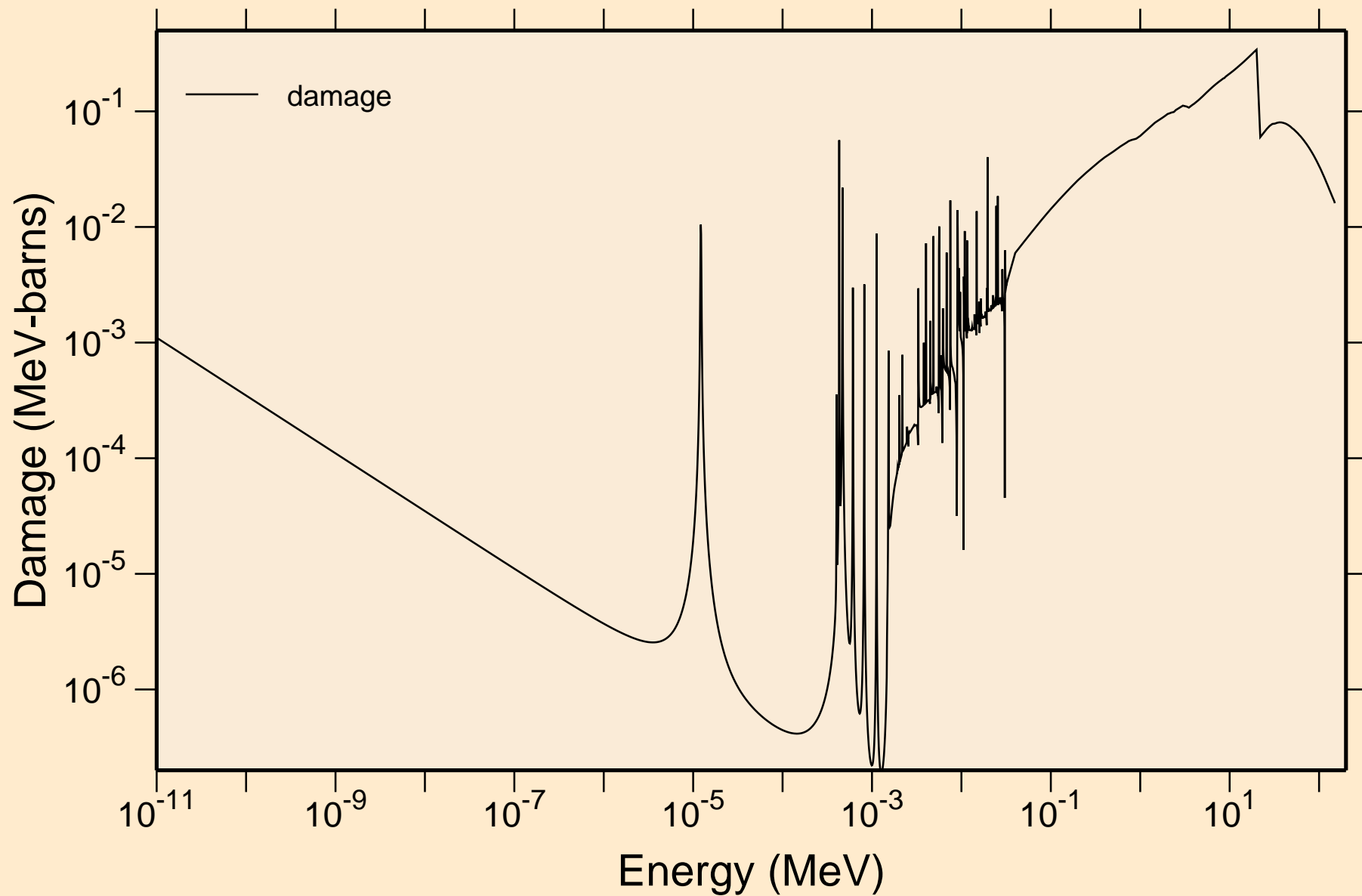

42-MO-98 FOR FENDL-3.2 FROM FENDL-3.2 WITH NJOY2016.60-
Non-threshold reactions

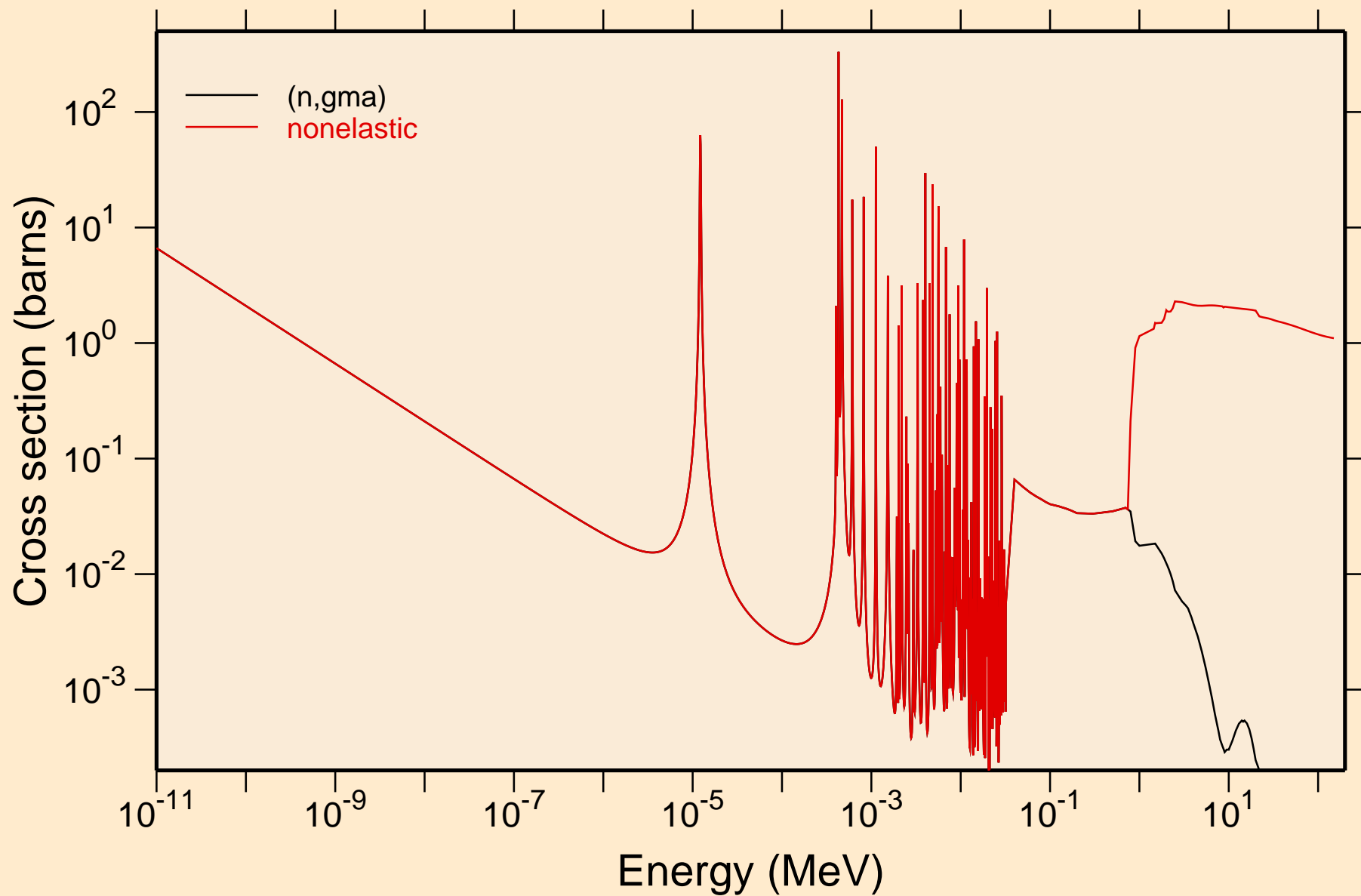

42-MO-98 FOR FENDL-3.2 FROM FENDL-3.2 WITH NJOY2016.60-
Non-threshold reactions

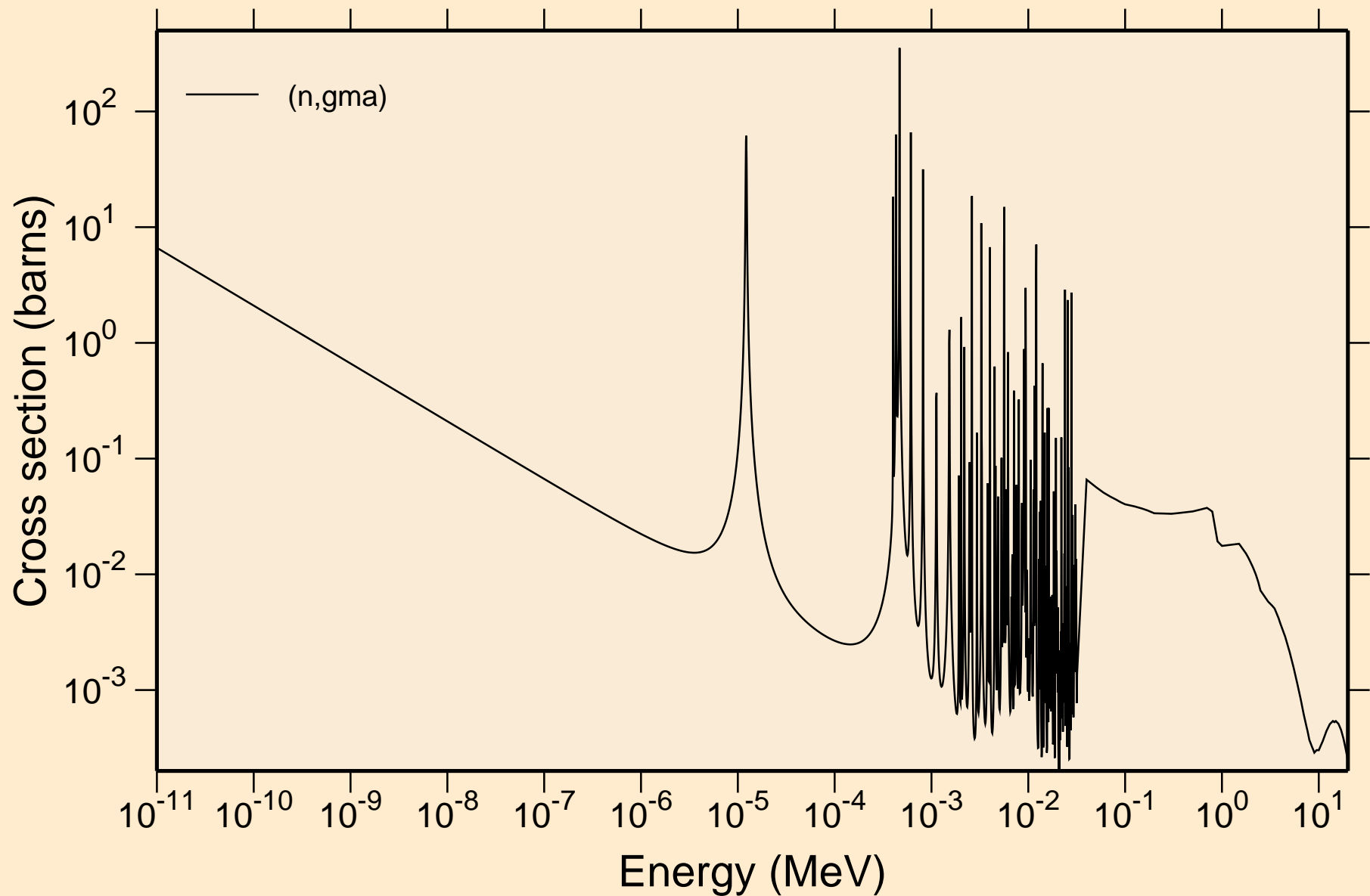

42-MO-98 FOR FENDL-3.2 FROM FENDL-3.2 WITH NJOY2016.60-
Principal cross sections

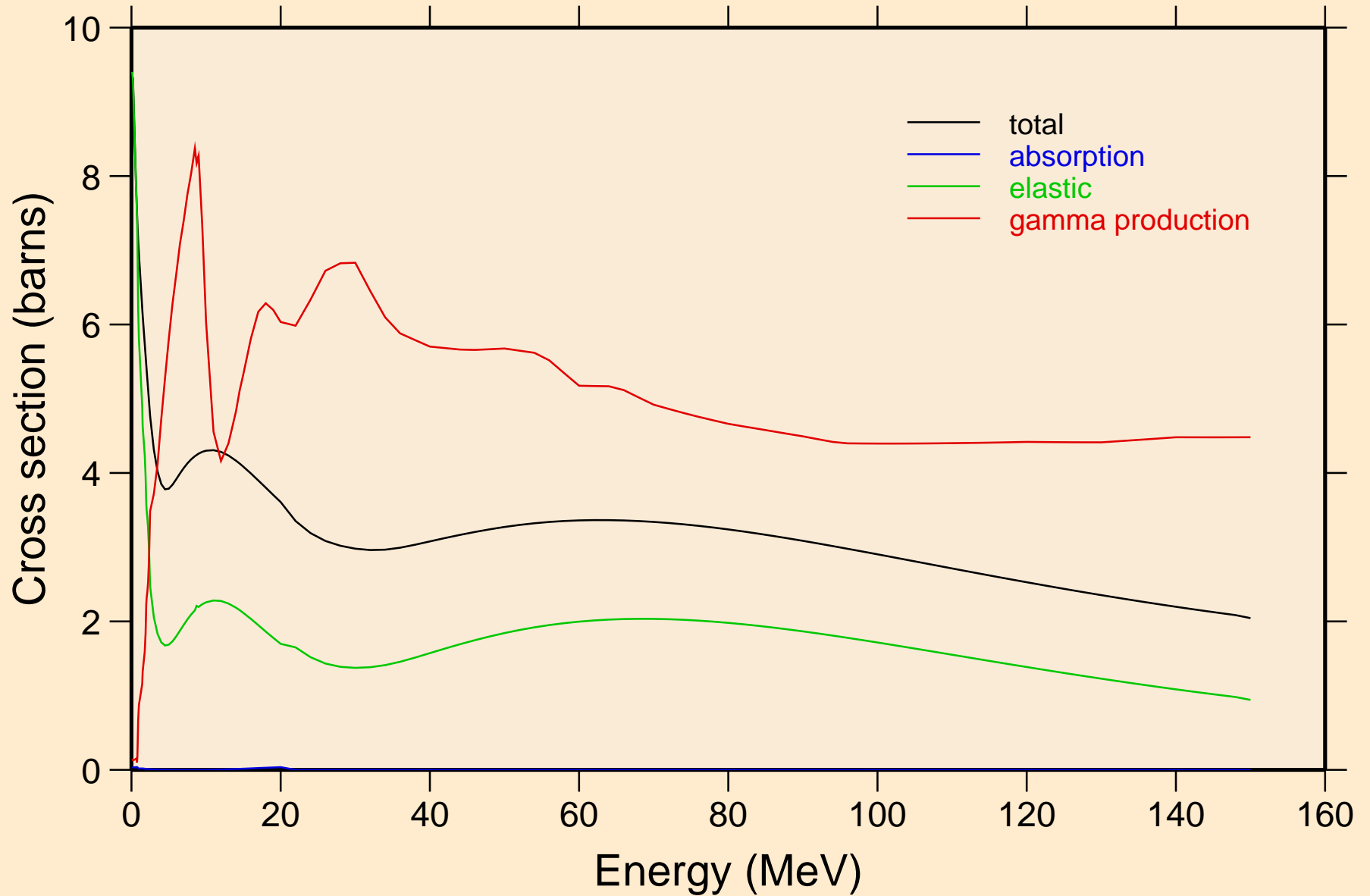

42-MO-98 FOR FENDL-3.2 FROM FENDL-3.2 WITH NJOY2016.60- Heating

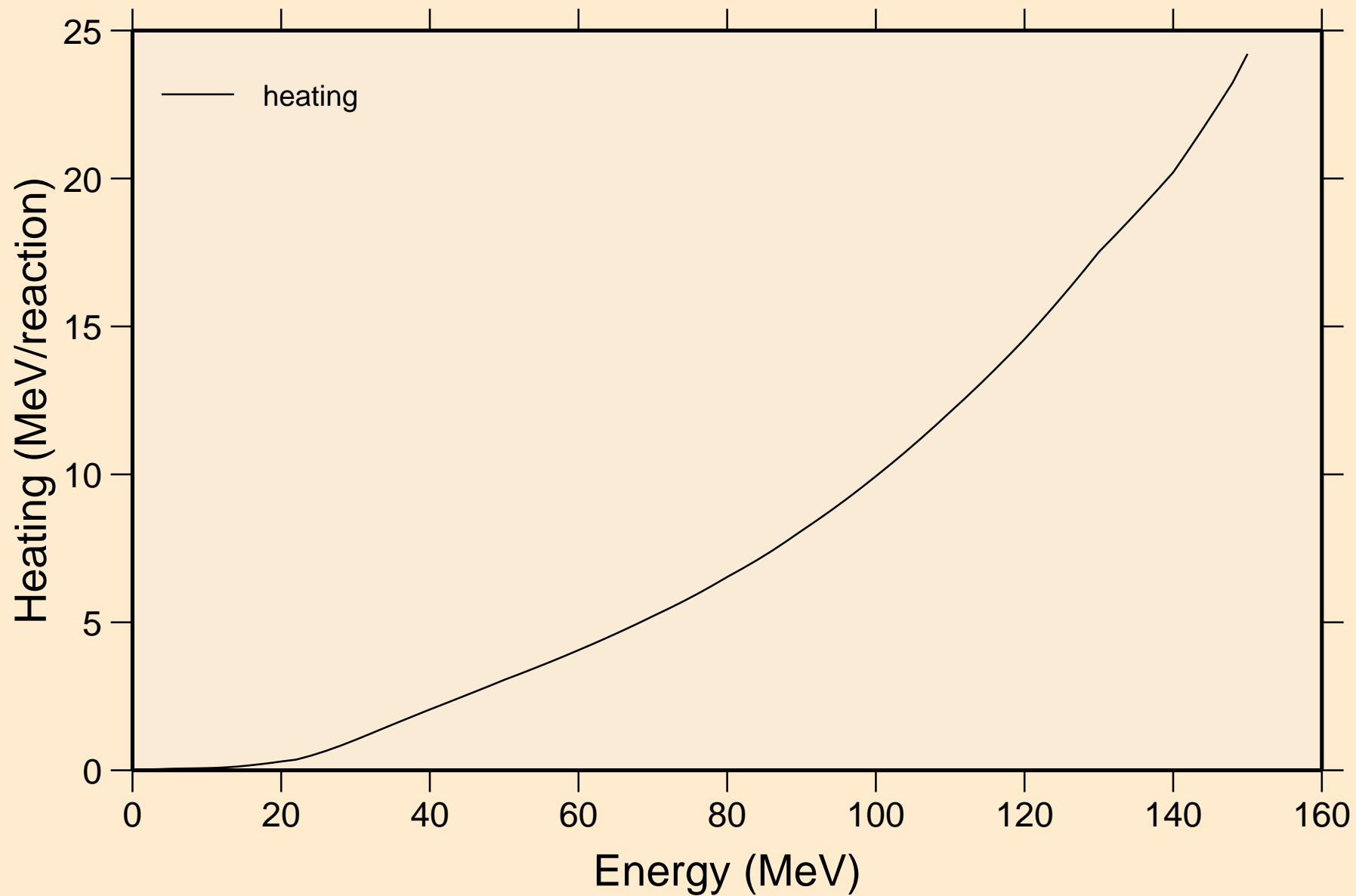

42-MO-98 FOR FENDL-3.2 FROM FENDL-3.2 WITH NJOY2016.60- Damage

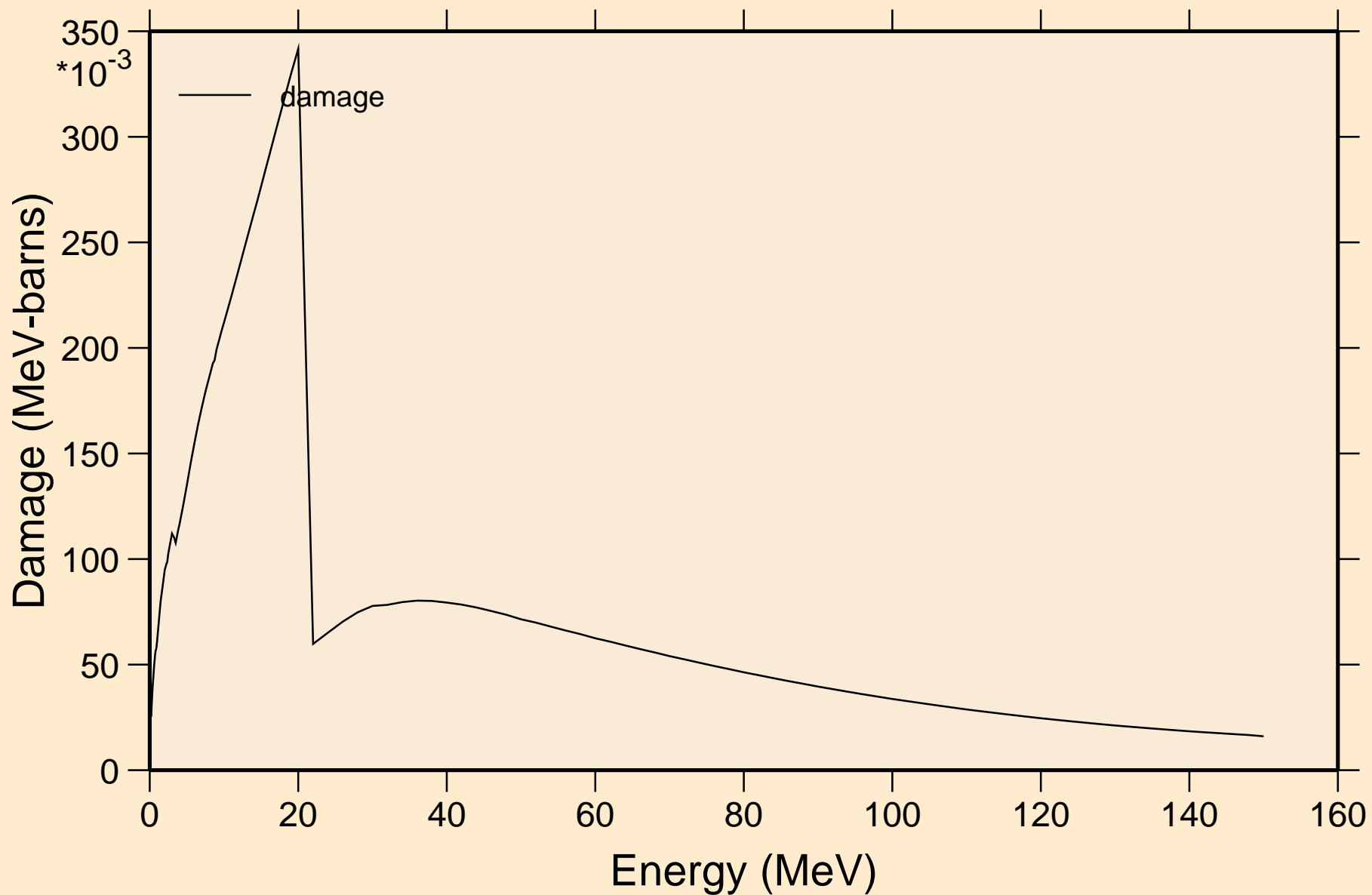

42-MO-98 FOR FENDL-3.2 FROM FENDL-3.2 WITH NJOY2016.60-
Non-threshold reactions

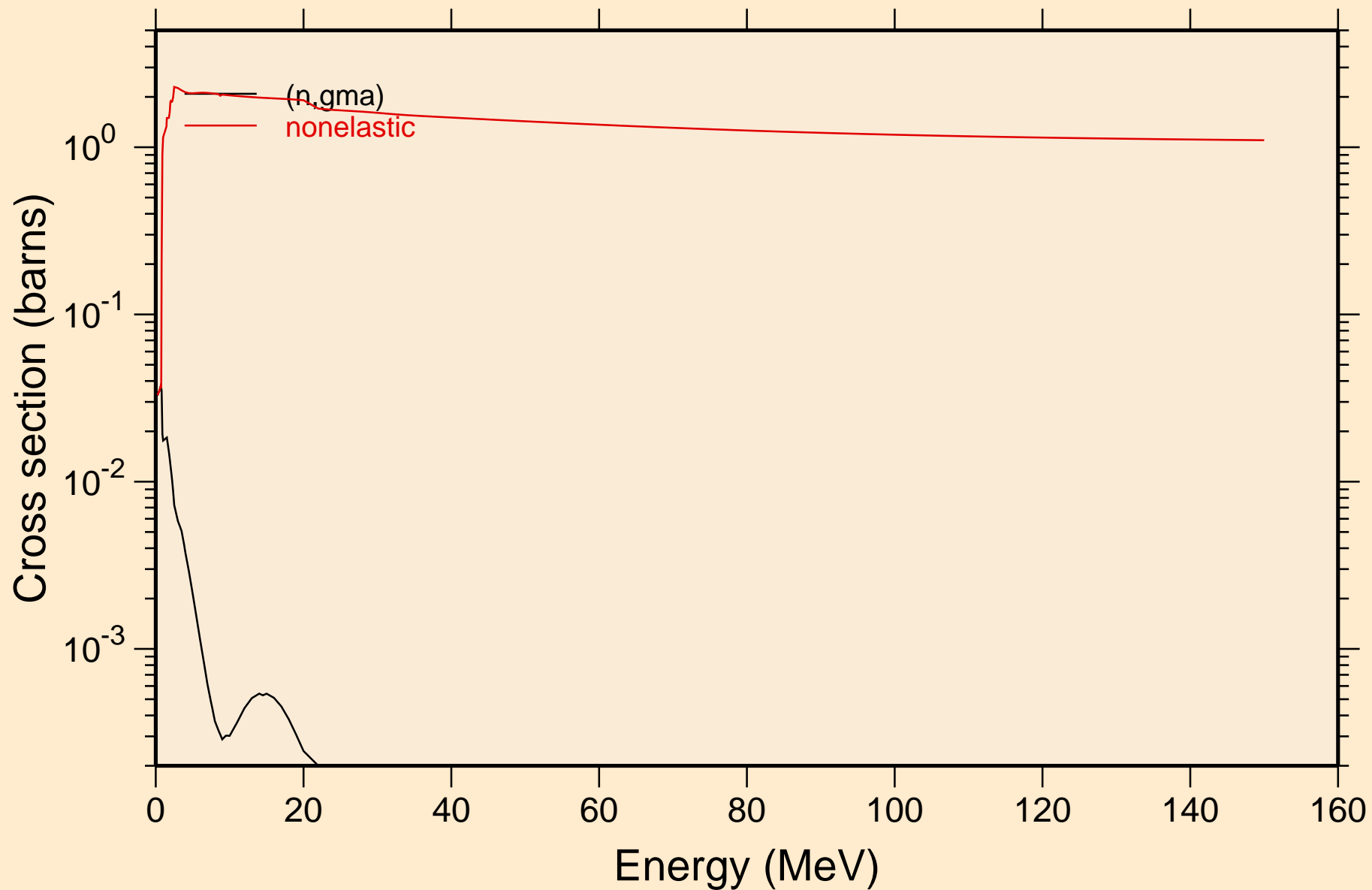

42-MO-98 FOR FENDL-3.2 FROM FENDL-3.2 WITH NJOY2016.60-
Non-threshold reactions

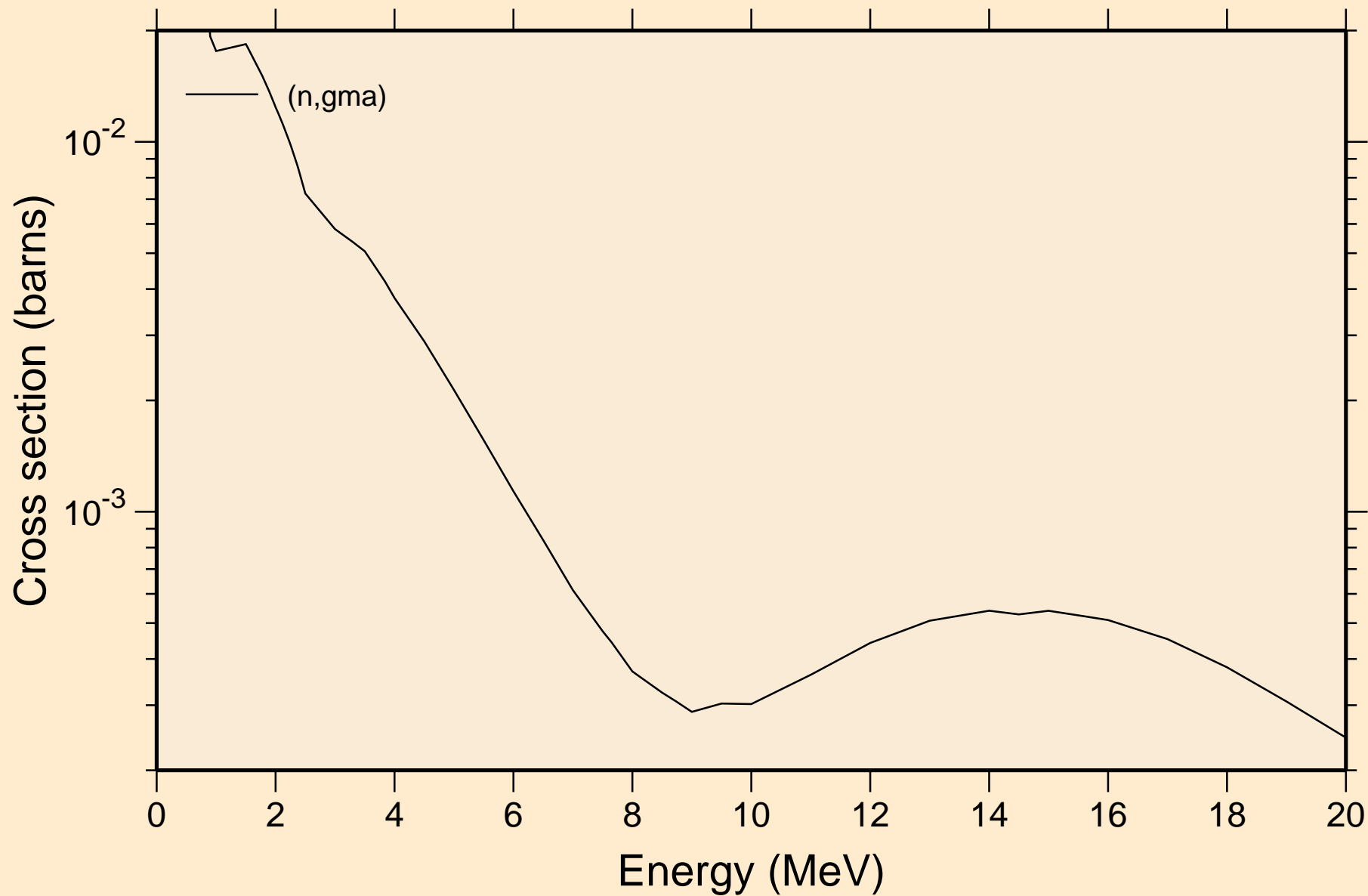

42-MO-98 FOR FENDL-3.2 FROM FENDL-3.2 WITH NJOY2016.60-
Inelastic levels

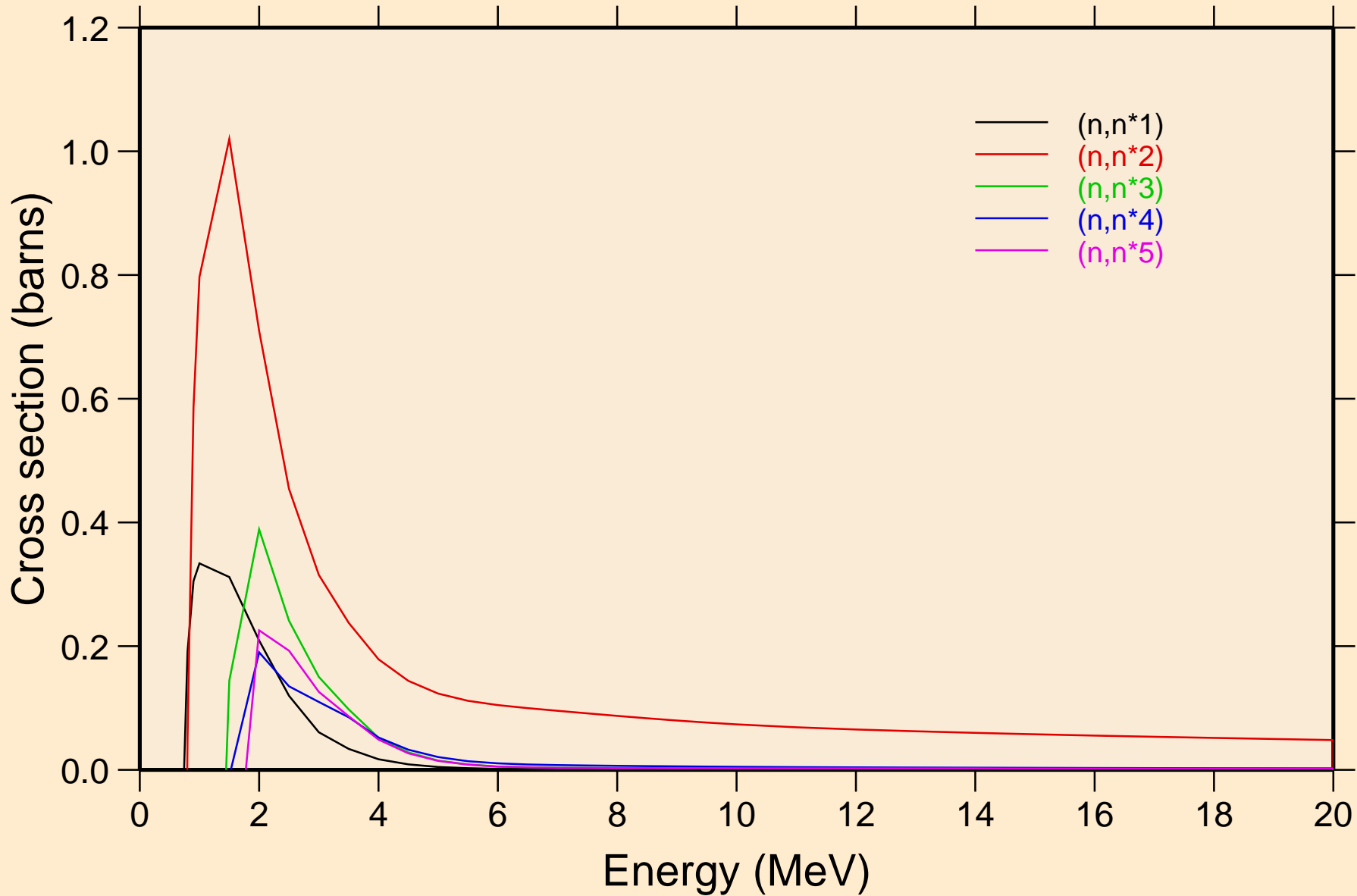

42-MO-98 FOR FENDL-3.2 FROM FENDL-3.2 WITH NJOY2016.60-
Inelastic levels

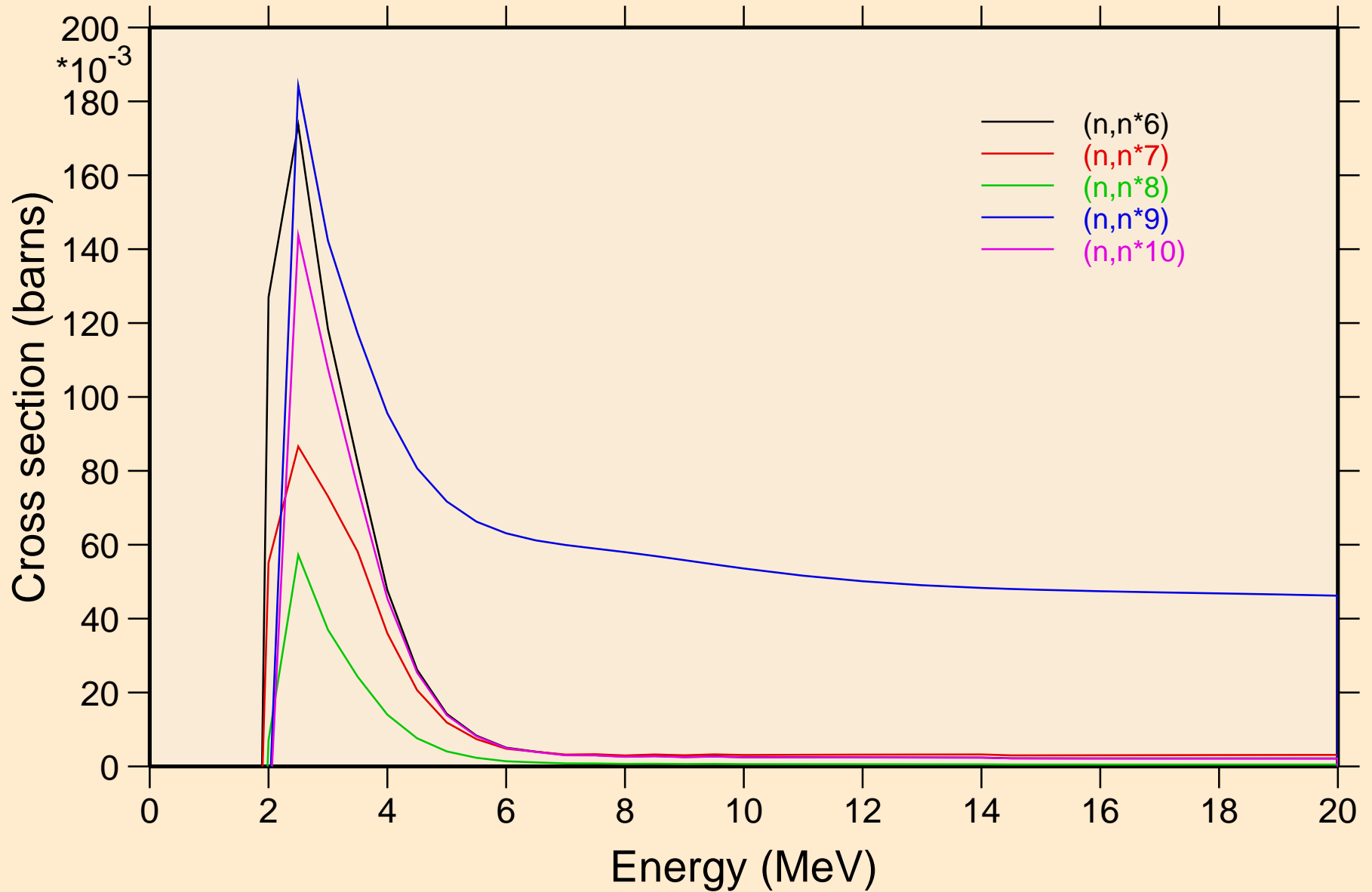

42-MO-98 FOR FENDL-3.2 FROM FENDL-3.2 WITH NJOY2016.60-
Inelastic levels

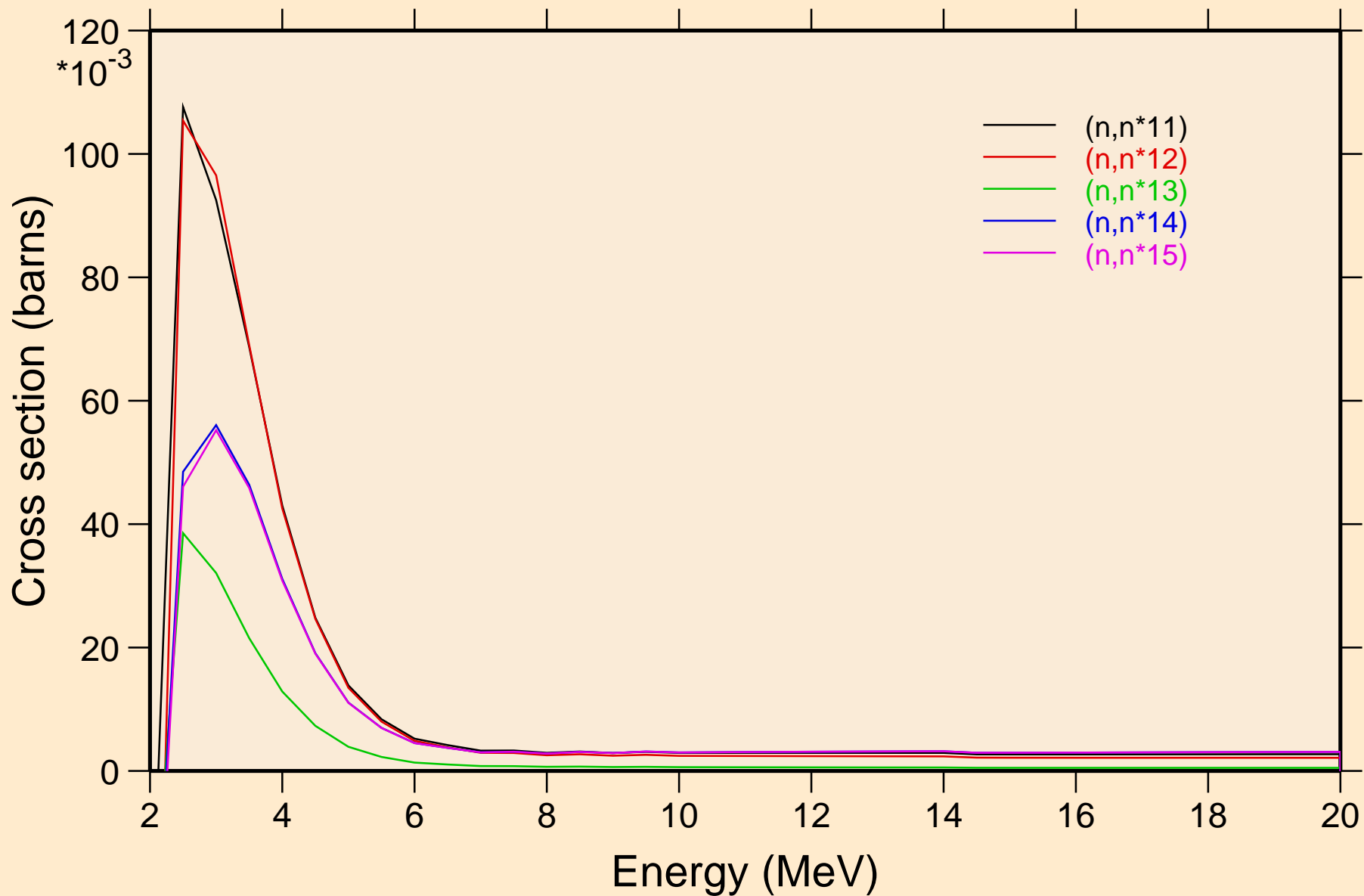

42-MO-98 FOR FENDL-3.2 FROM FENDL-3.2 WITH NJOY2016.60-
Inelastic levels

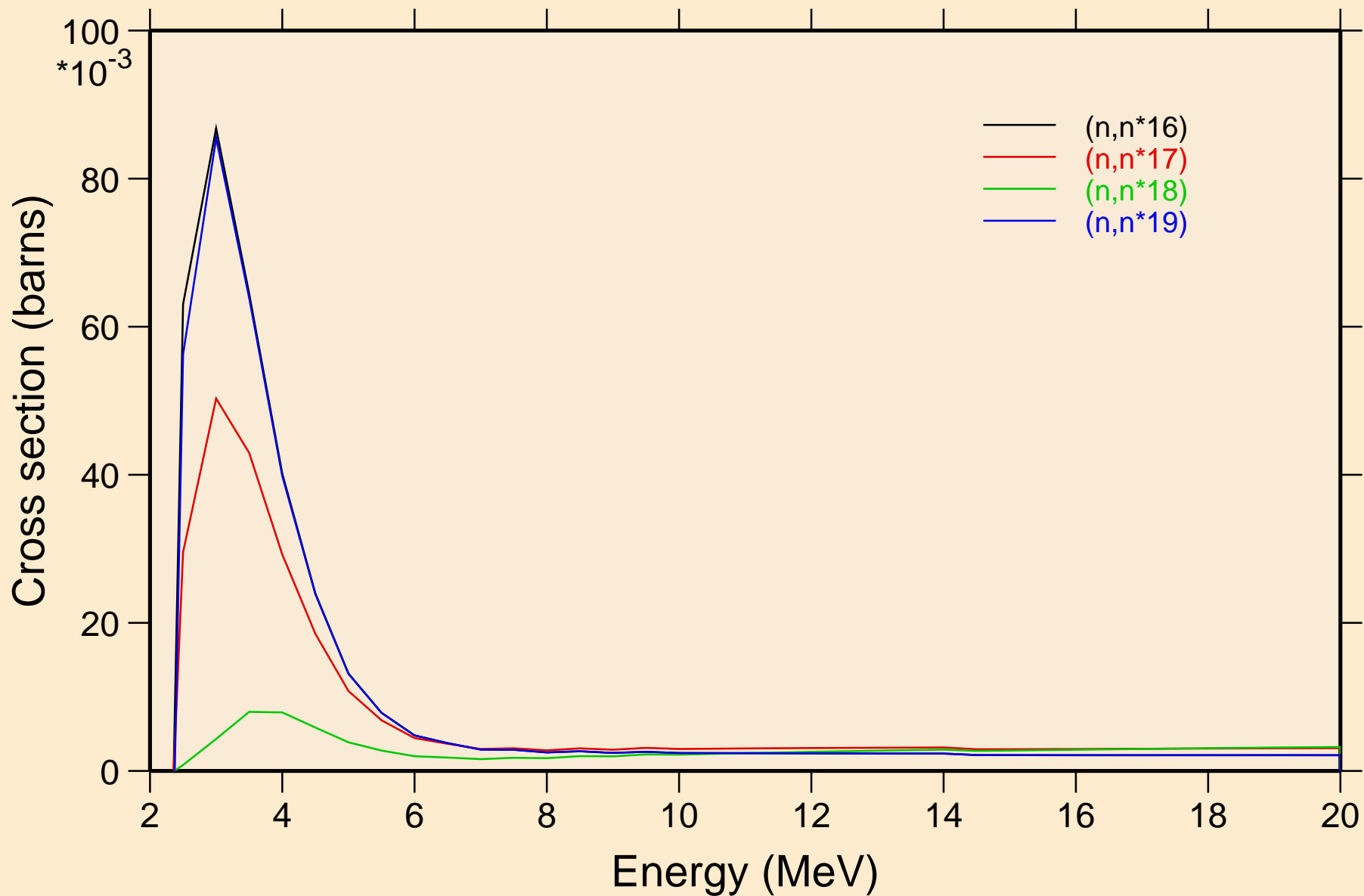

42-MO-98 FOR FENDL-3.2 FROM FENDL-3.2 WITH NJOY2016.60-
Threshold reactions

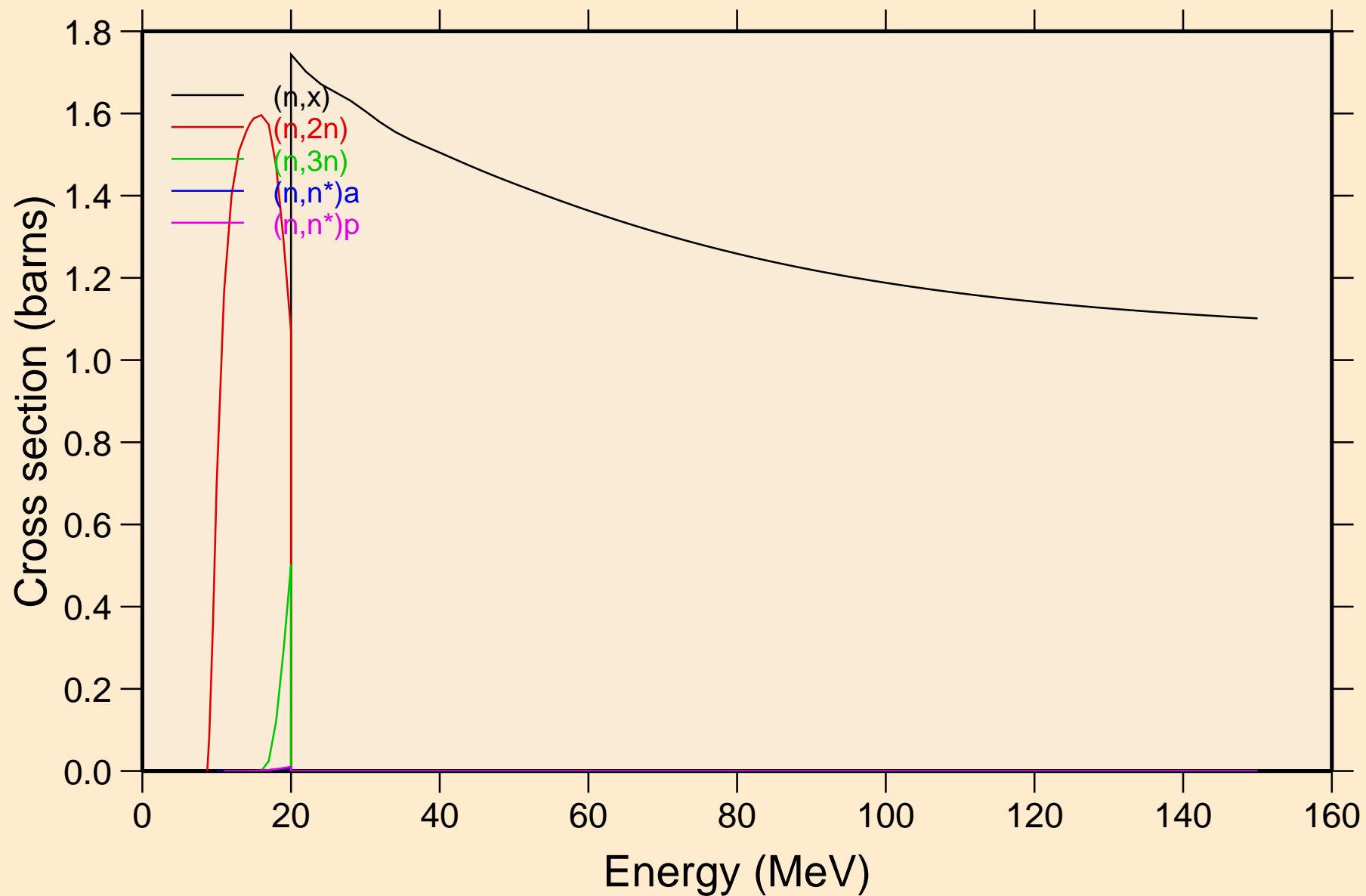

42-MO-98 FOR FENDL-3.2 FROM FENDL-3.2 WITH NJOY2016.60-
Threshold reactions

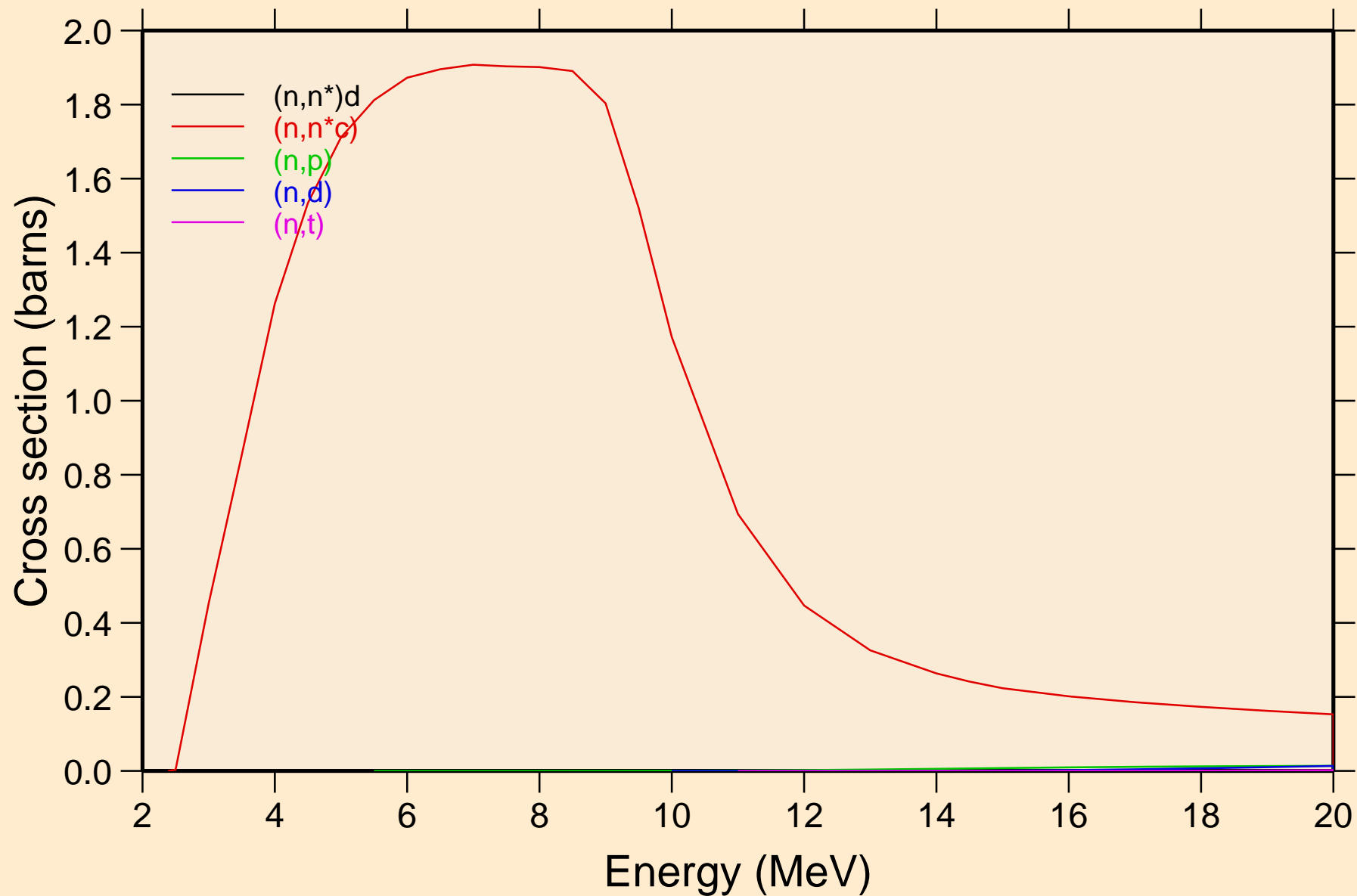

42-MO-98 FOR FENDL-3.2 FROM FENDL-3.2 WITH NJOY2016.60-
Threshold reactions

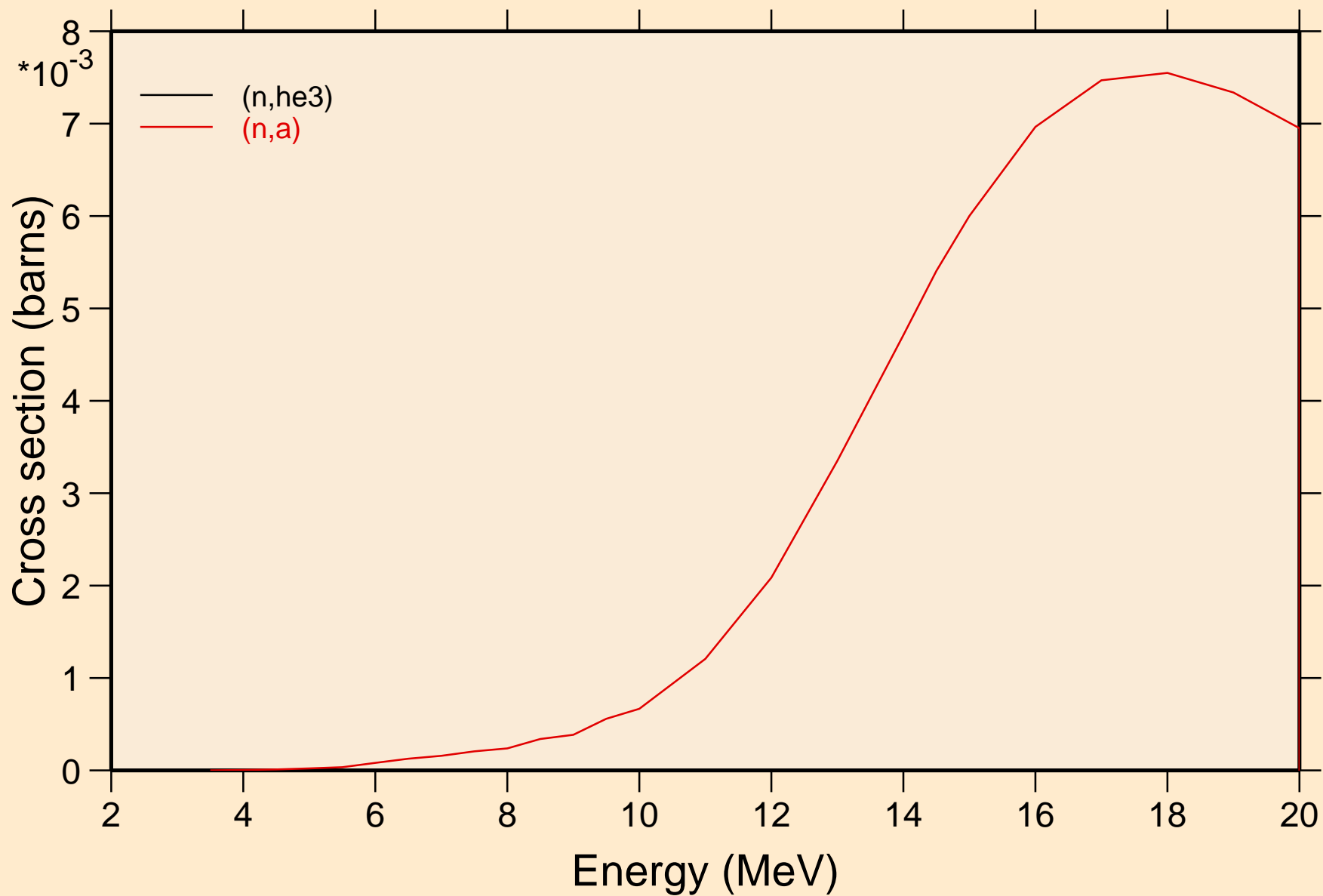

42-MO-98 FOR FENDL-3.2 FROM FENDL-3.2 WITH NJOY2016.60-
Threshold reactions

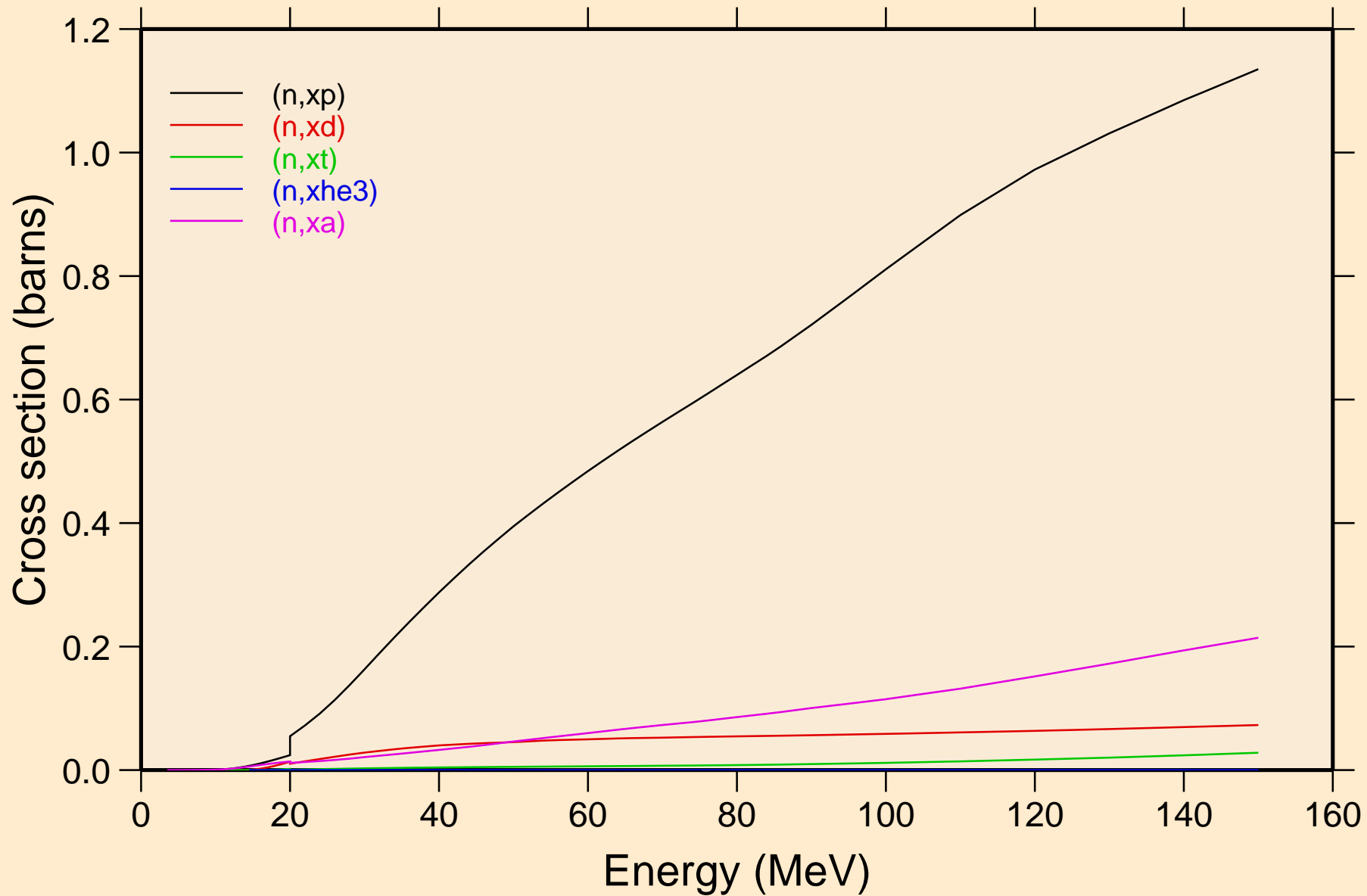

42-MO-98 FOR FENDL-3.2 FROM FENDL-3.2 WITH NJOY2016.60-
angular distribution for elastic

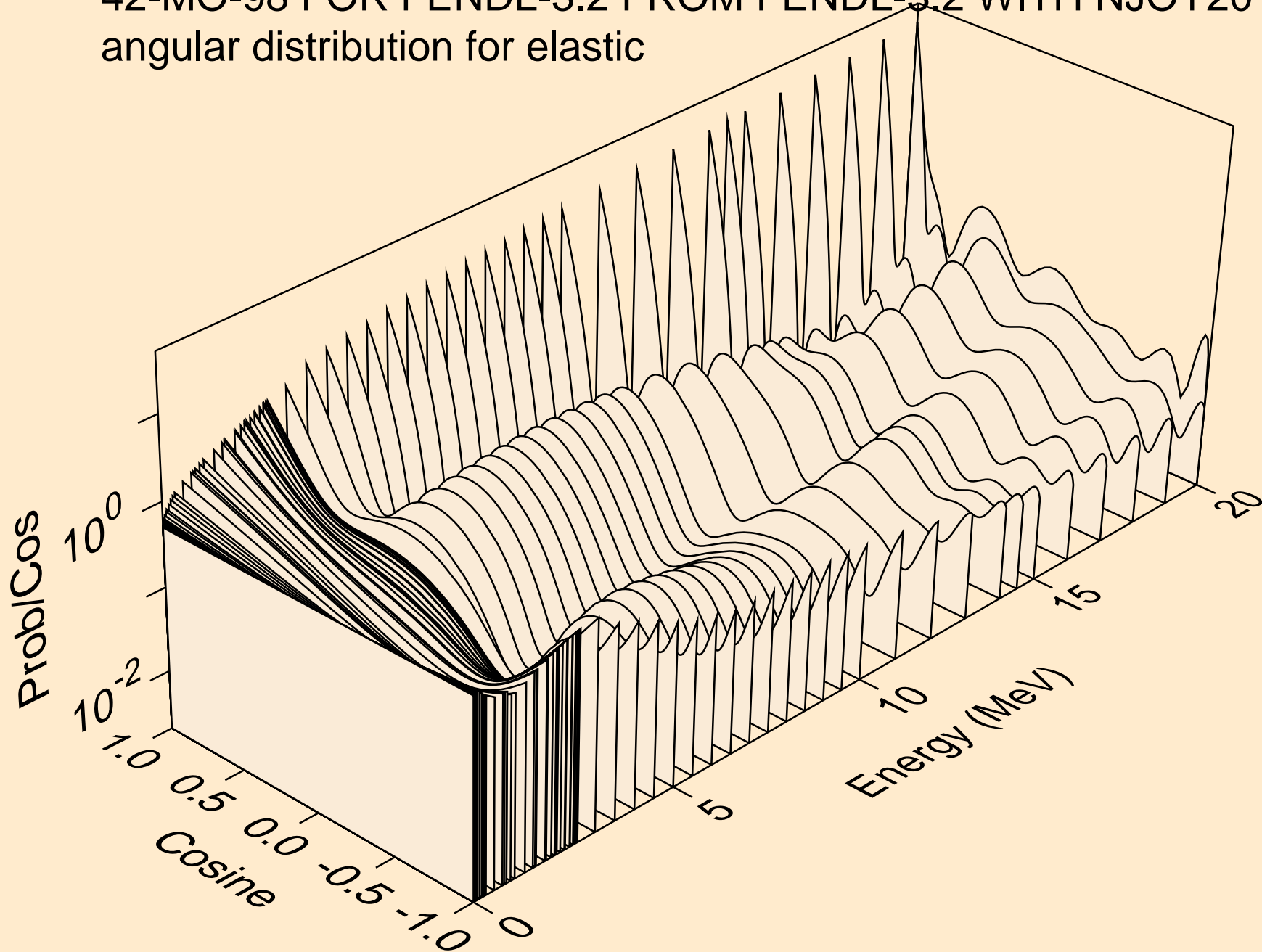

42-MO-98 FOR FENDL-3.2 FROM FENDL-3.2 WITH NJOY2016.60-
angular distribution for elastic

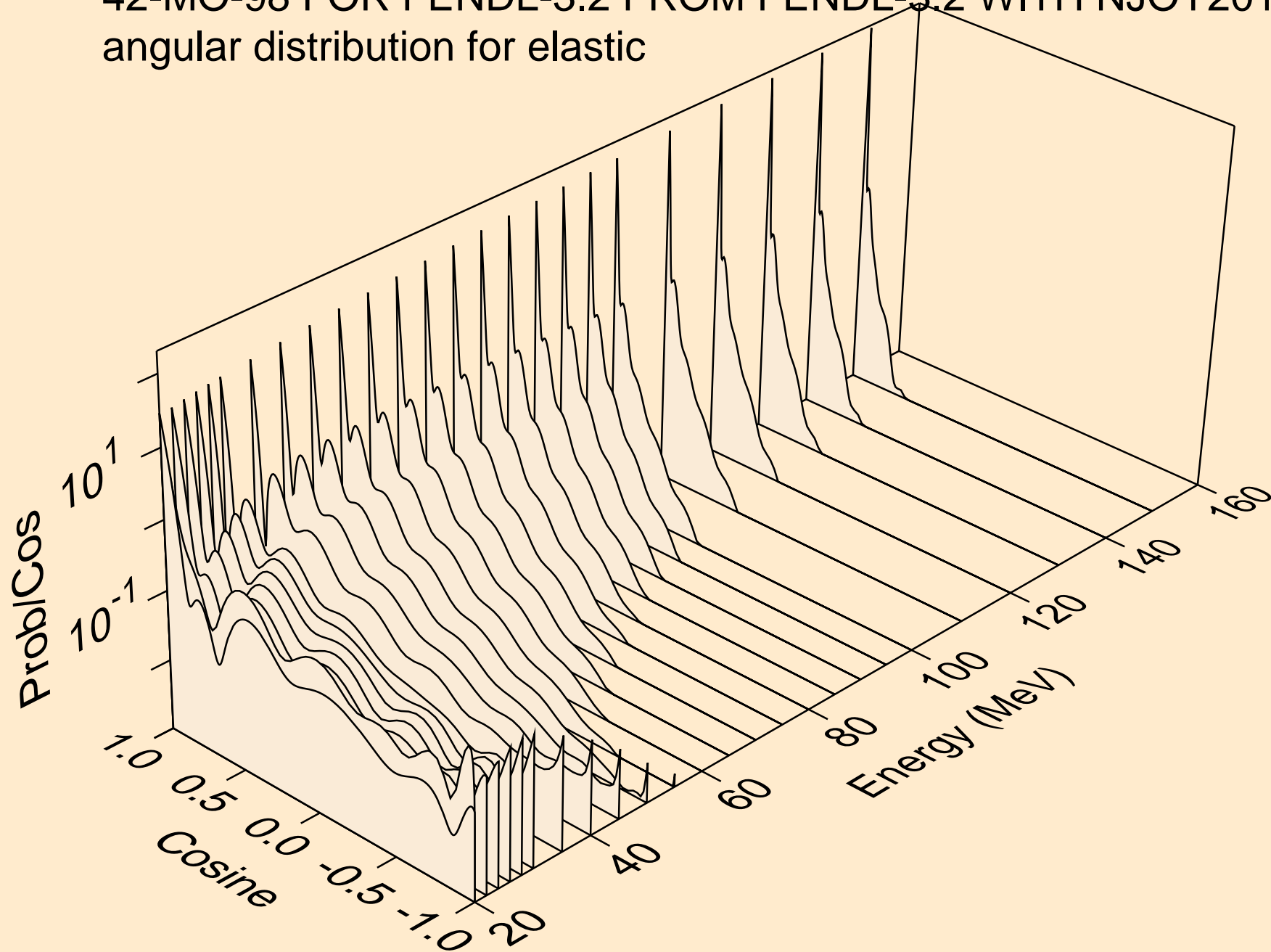

42-MO-98 FOR FENDL-3.2 FROM FENDL-3.2 WITH NJOY2016.60-
angular distribution for (n,n*1)

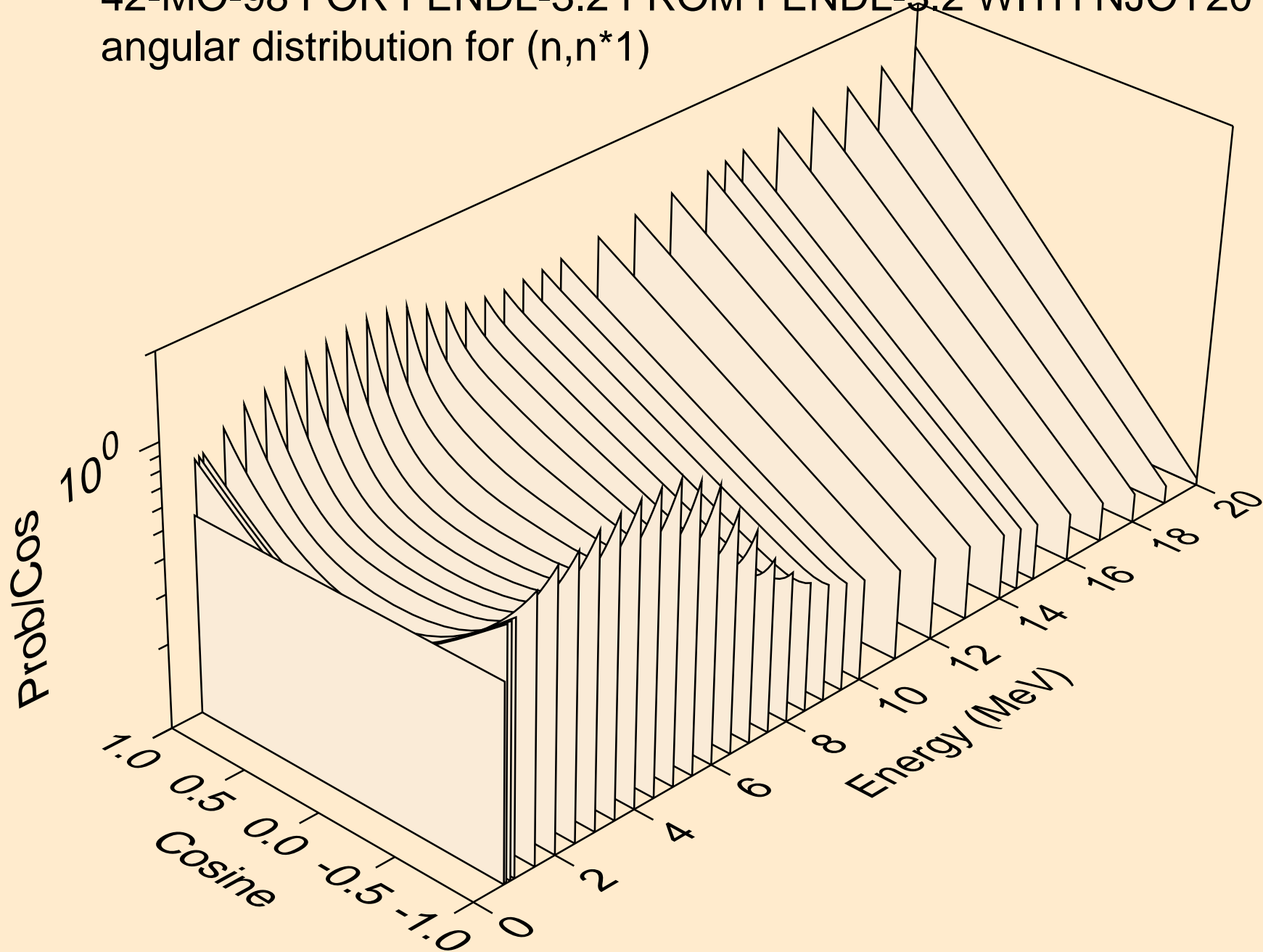

42-MO-98 FOR FENDL-3.2 FROM FENDL-3.2 WITH NJOY2016.60-
angular distribution for (n,n*2)

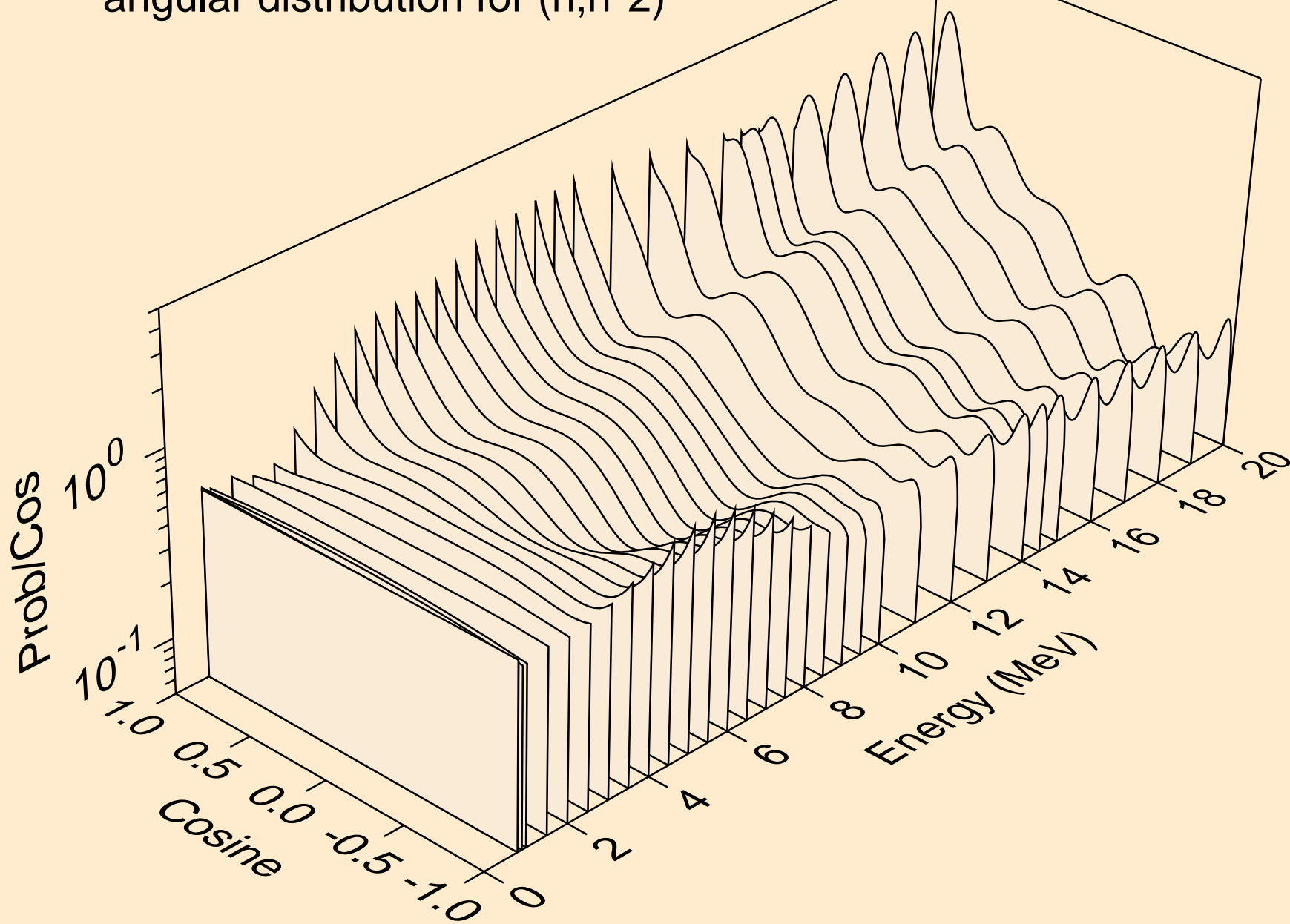

42-MO-98 FOR FENDL-3.2 FROM FENDL-3.2 WITH NJOY2016.60-
angular distribution for (n,n*3)

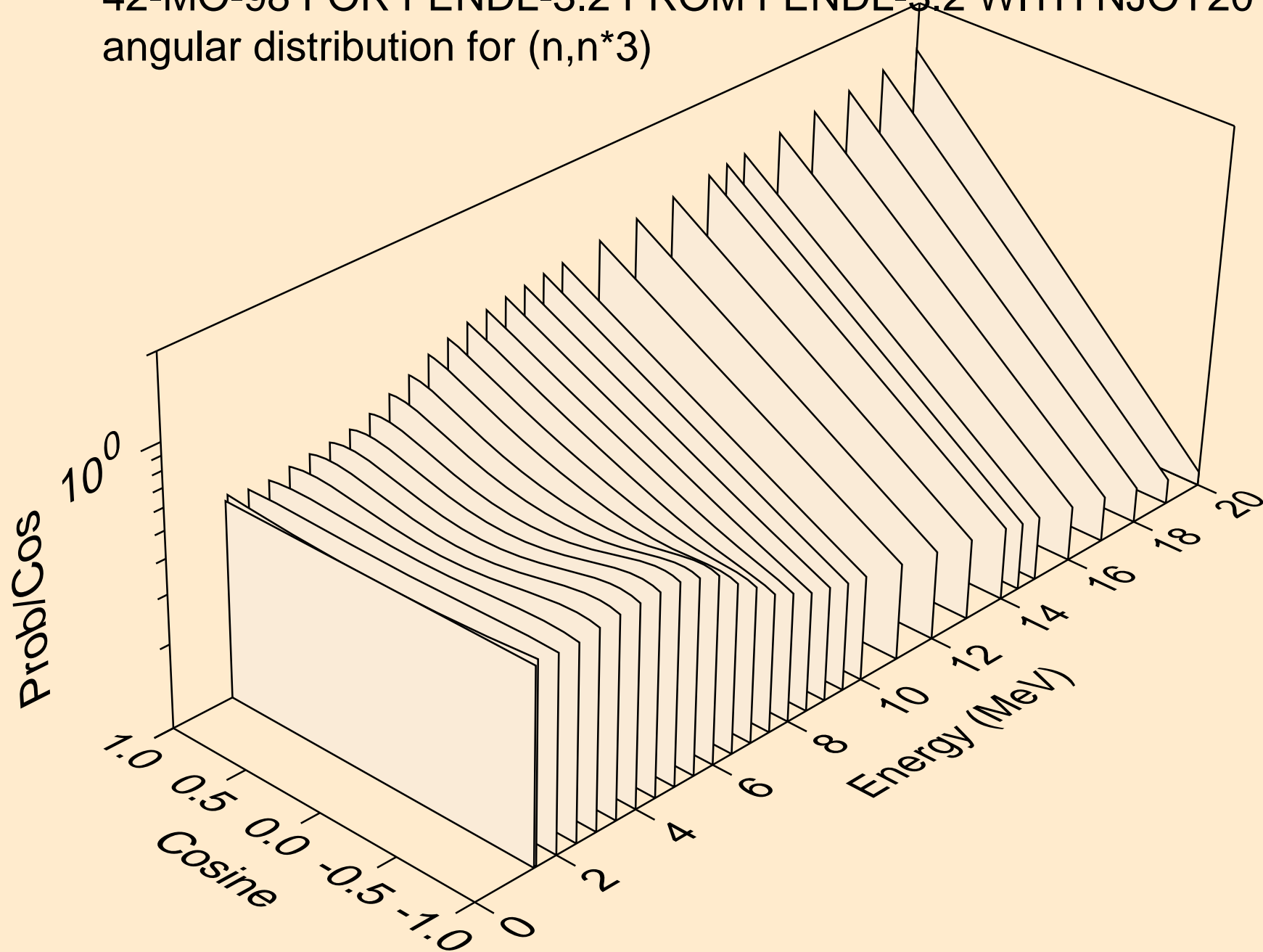

42-MO-98 FOR FENDL-3.2 FROM FENDL-3.2 WITH NJOY2016.60-
angular distribution for (n,n*4)

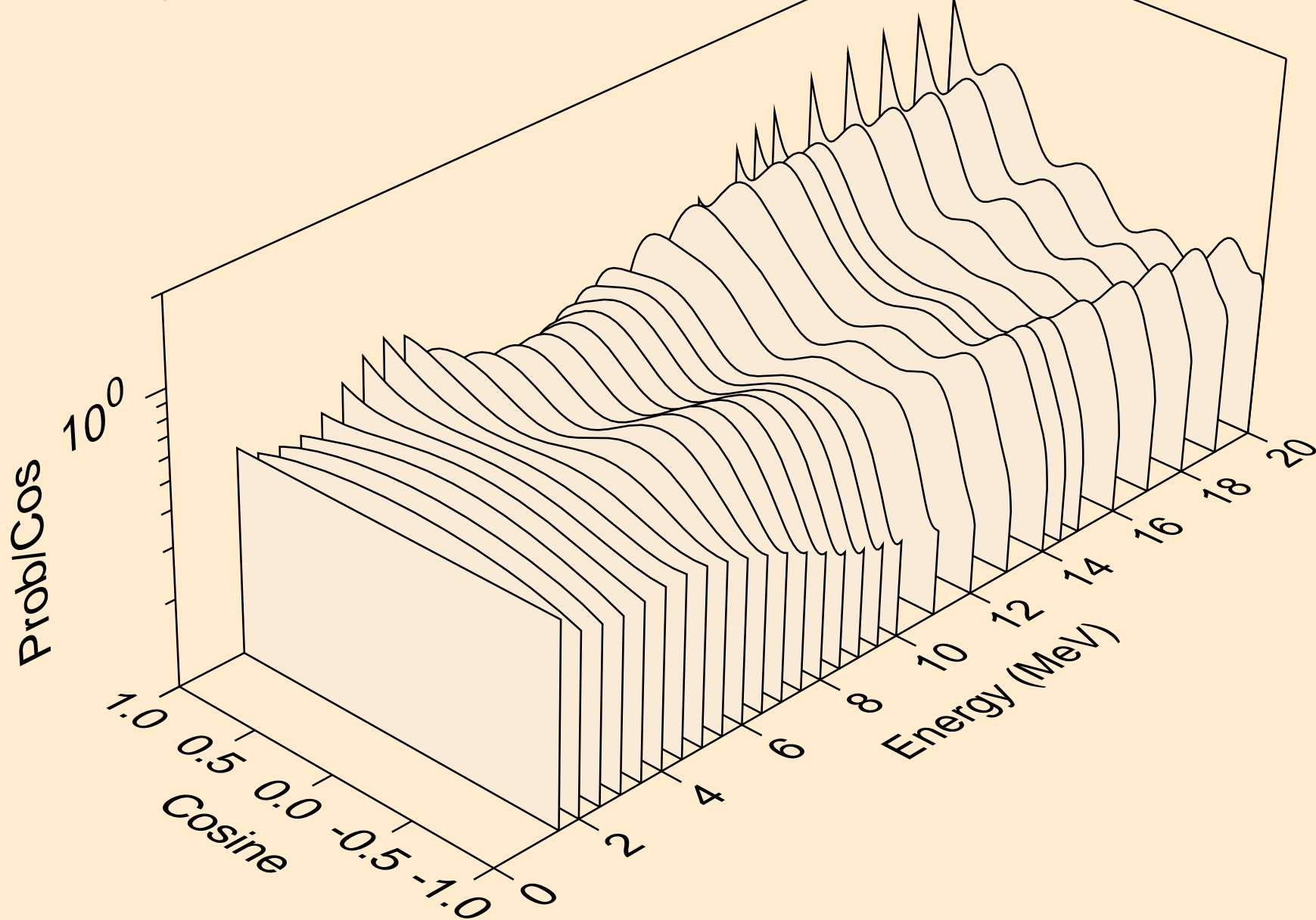

42-MO-98 FOR FENDL-3.2 FROM FENDL-3.2 WITH NJOY2016.60-
angular distribution for (n,n*5)

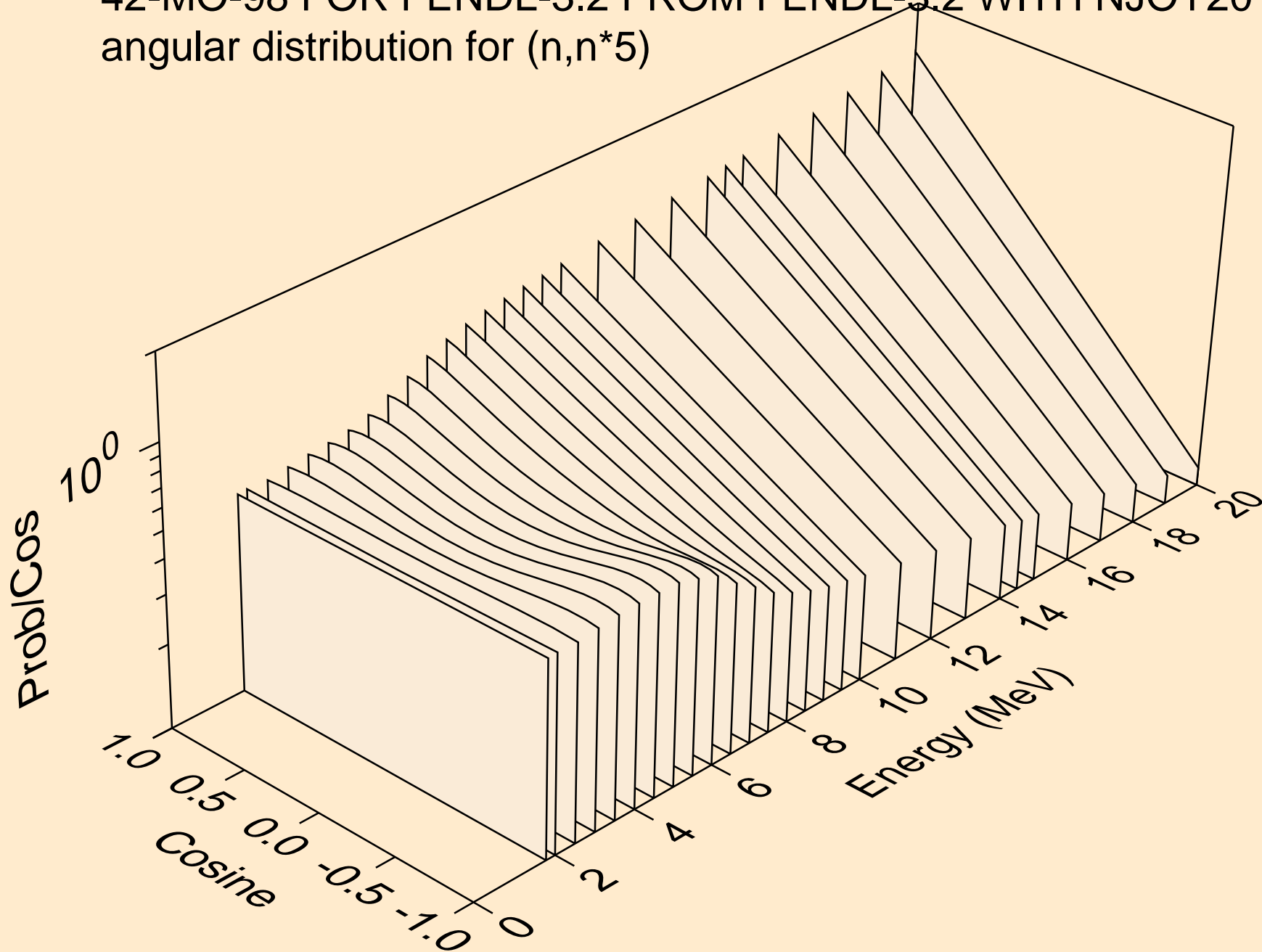

42-MO-98 FOR FENDL-3.2 FROM FENDL-3.2 WITH NJOY2016.60-
angular distribution for (n,n*6)

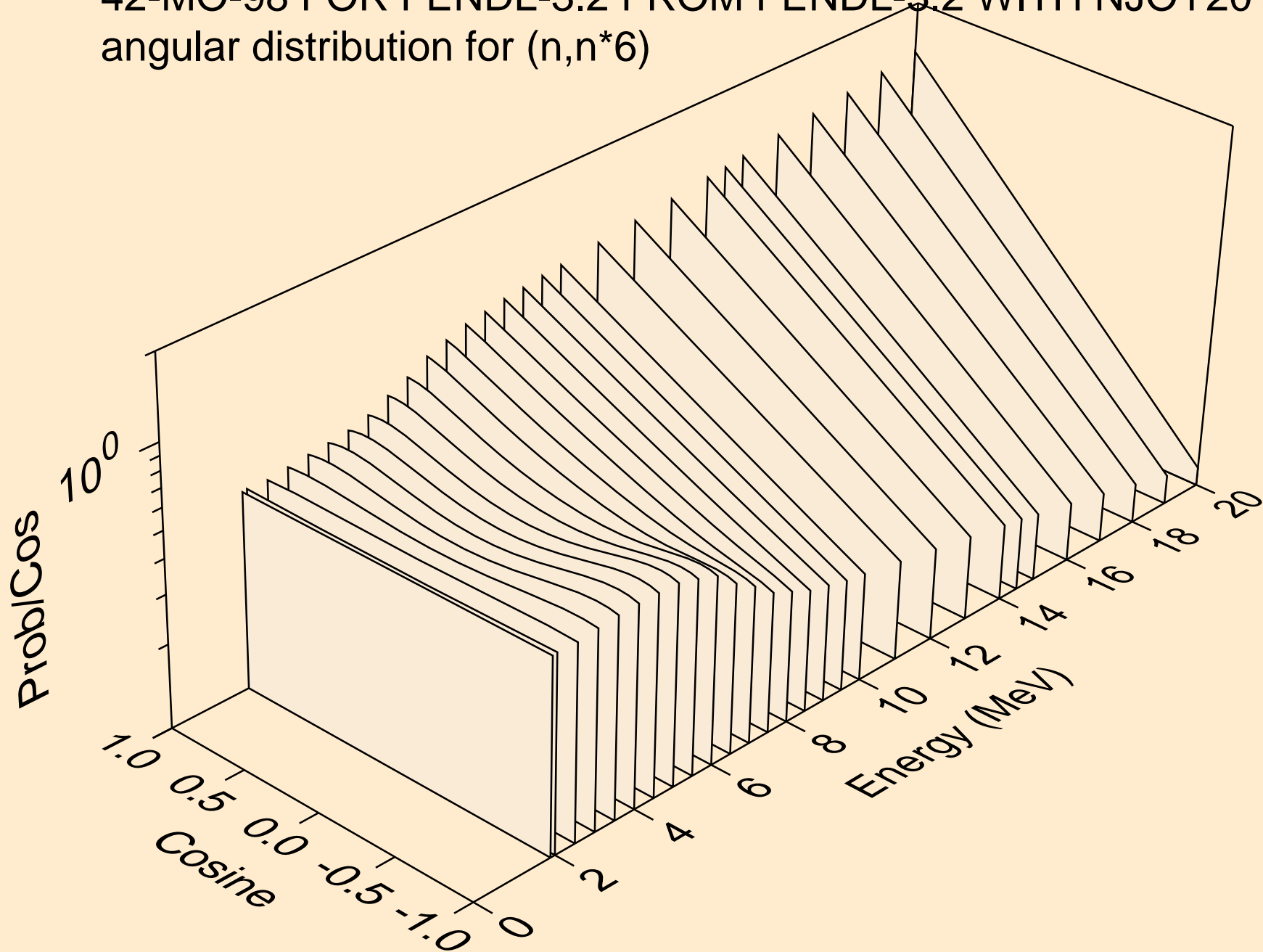

42-MO-98 FOR FENDL-3.2 FROM FENDL-3.2 WITH NJOY2016.60-
angular distribution for (n,n*7)

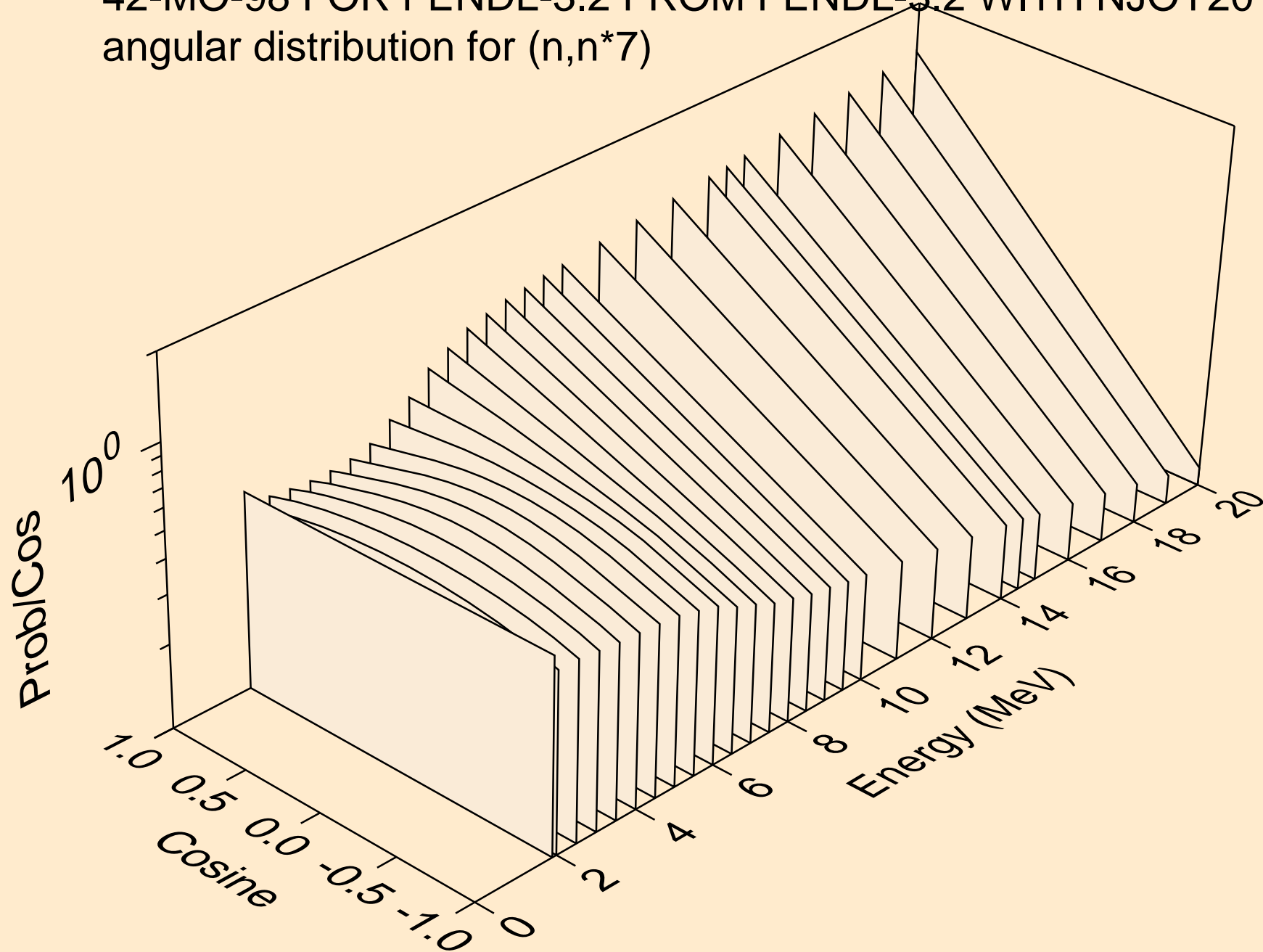

42-MO-98 FOR FENDL-3.2 FROM FENDL-3.2 WITH NJOY2016.60-
angular distribution for (n,n*8)

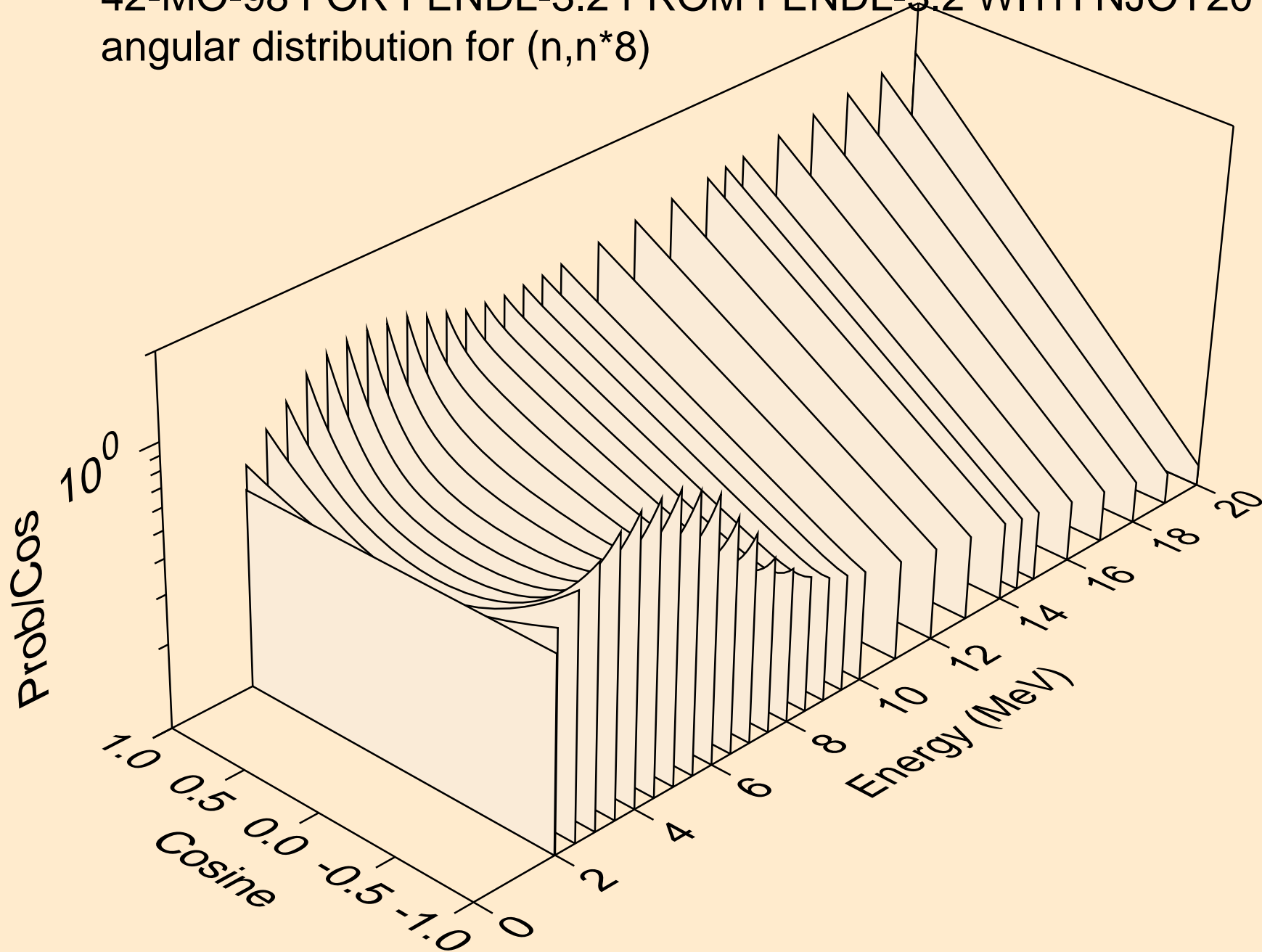

42-MO-98 FOR FENDL-3.2 FROM FENDL-3.2 WITH NJOY2016.60-
angular distribution for (n,n*9)

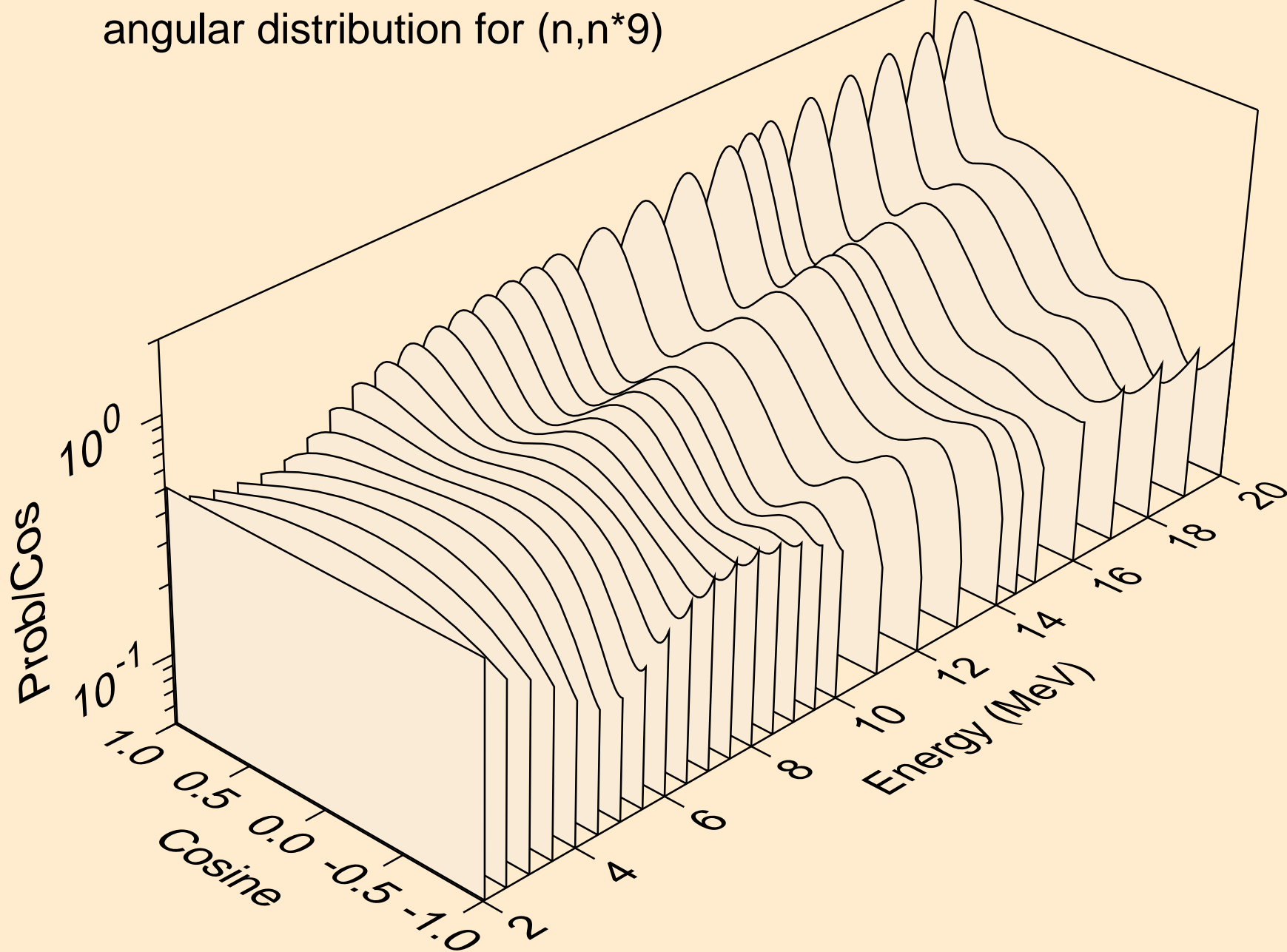

42-MO-98 FOR FENDL-3.2 FROM FENDL-3.2 WITH NJOY2016.60-
angular distribution for (n,n*10)

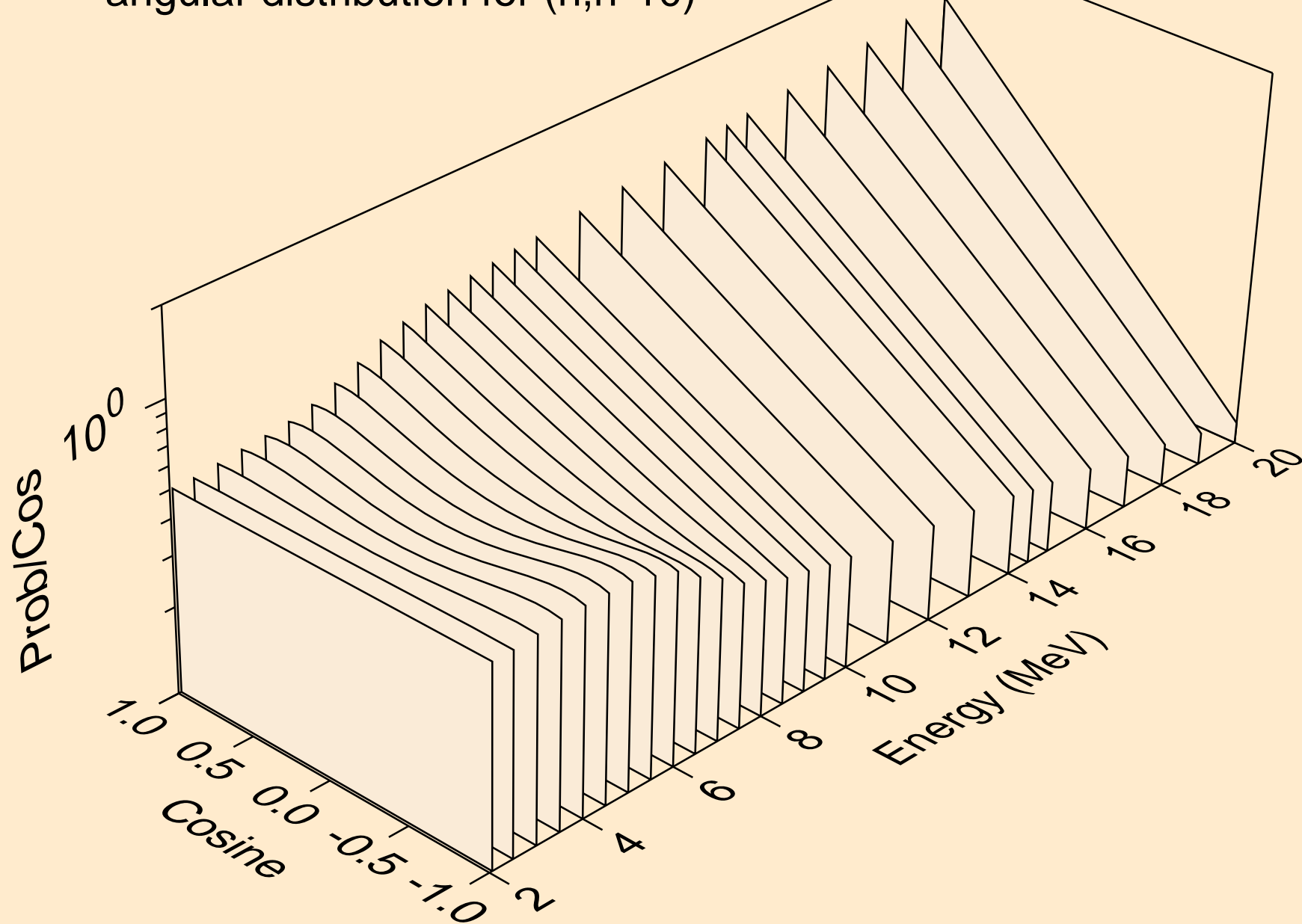

42-MO-98 FOR FENDL-3.2 FROM FENDL-3.2 WITH NJOY2016.60-
angular distribution for (n,n*11)

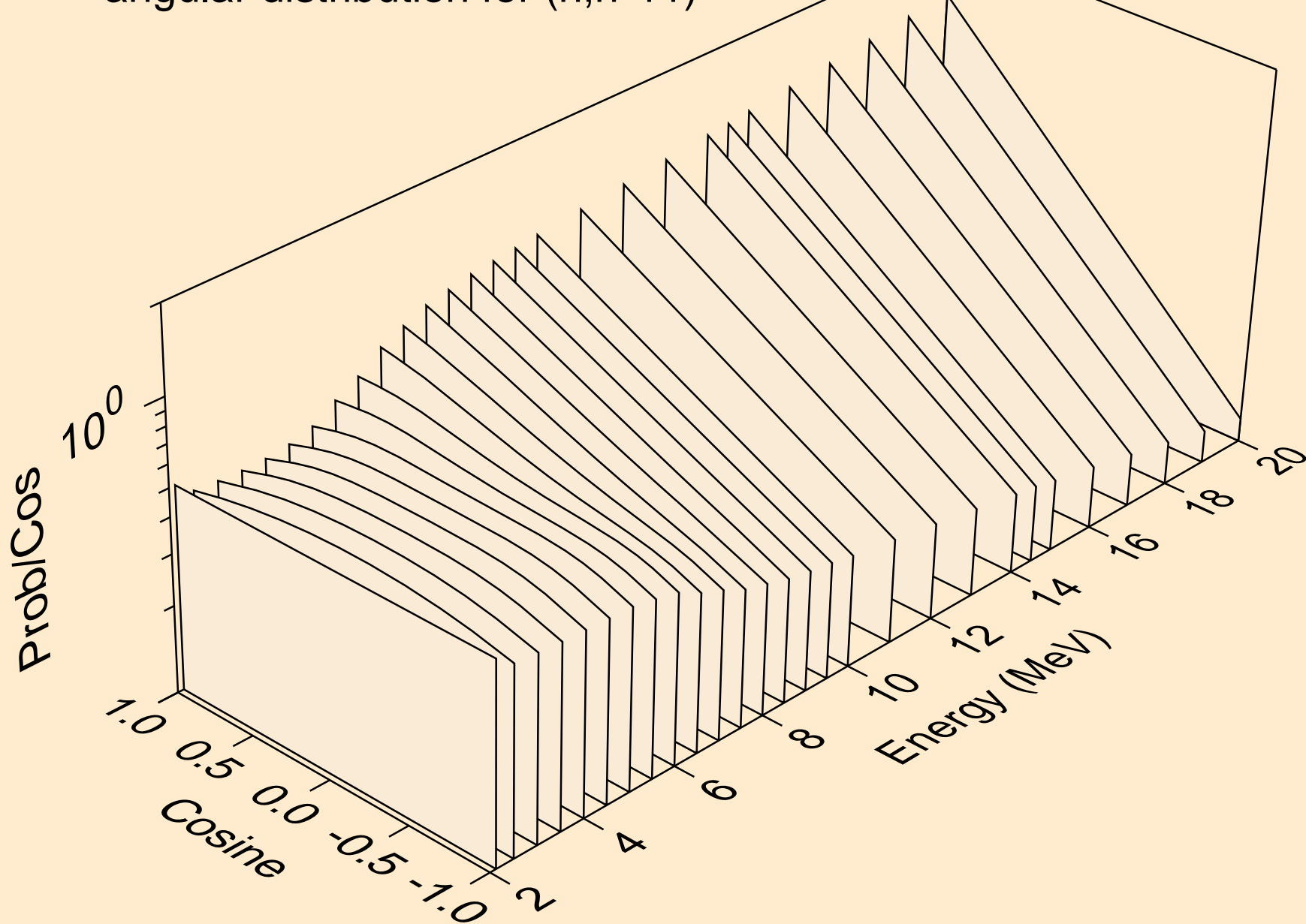

42-MO-98 FOR FENDL-3.2 FROM FENDL-3.2 WITH NJOY2016.60-
angular distribution for (n,n*12)

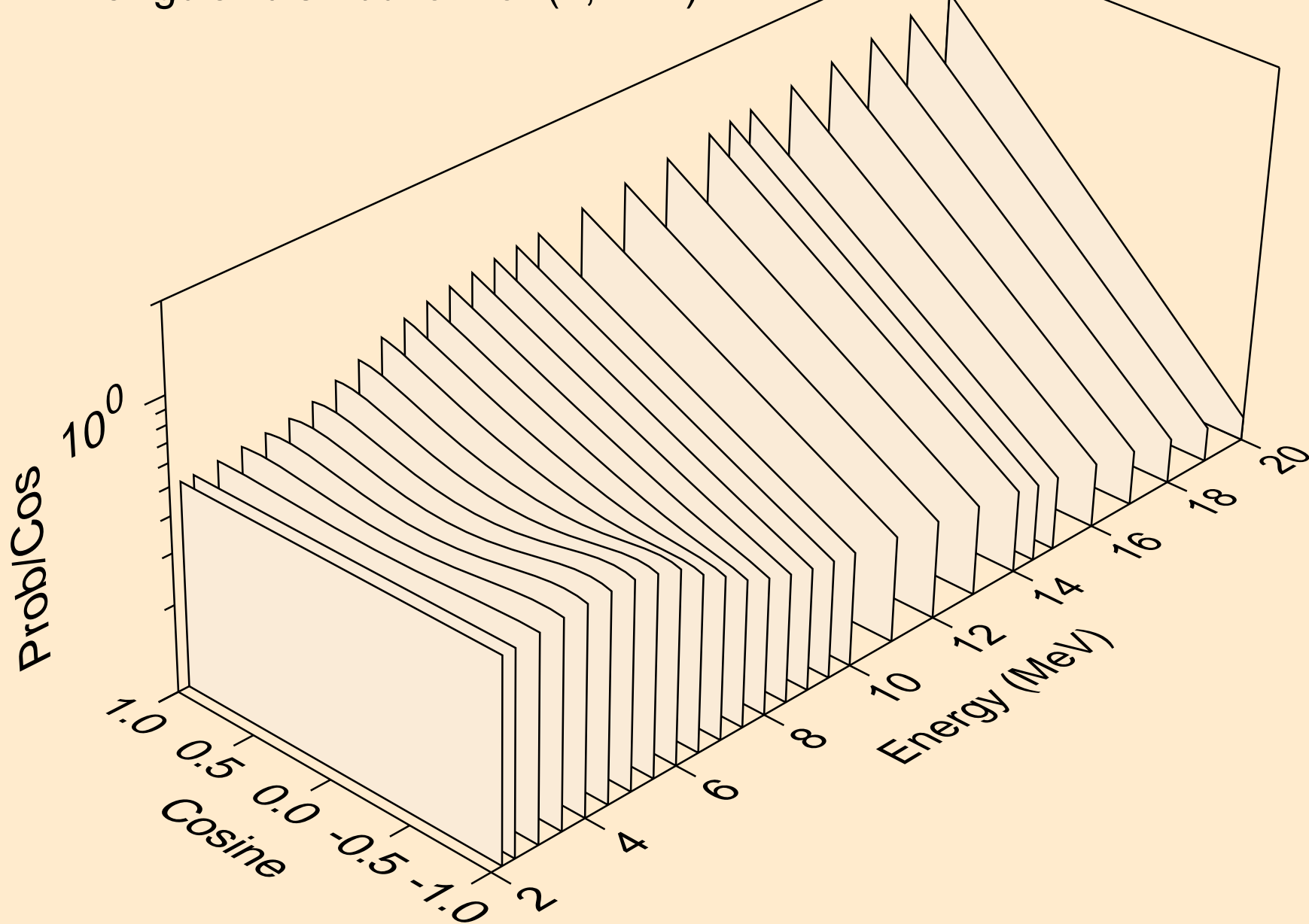

42-MO-98 FOR FENDL-3.2 FROM FENDL-3.2 WITH NJOY2016.60-
angular distribution for (n,n*13)

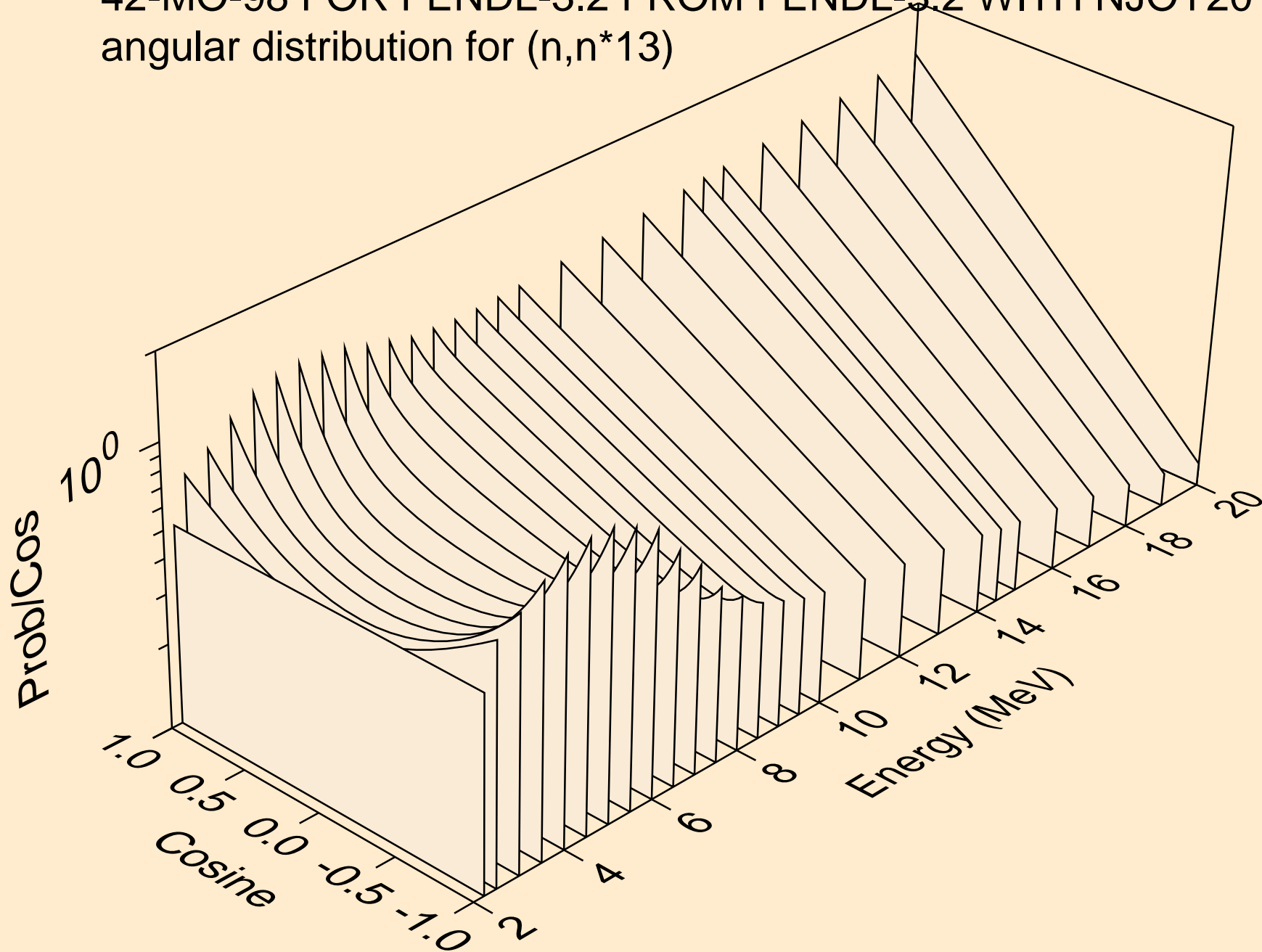

42-MO-98 FOR FENDL-3.2 FROM FENDL-3.2 WITH NJOY2016.60-
angular distribution for (n,n*14)

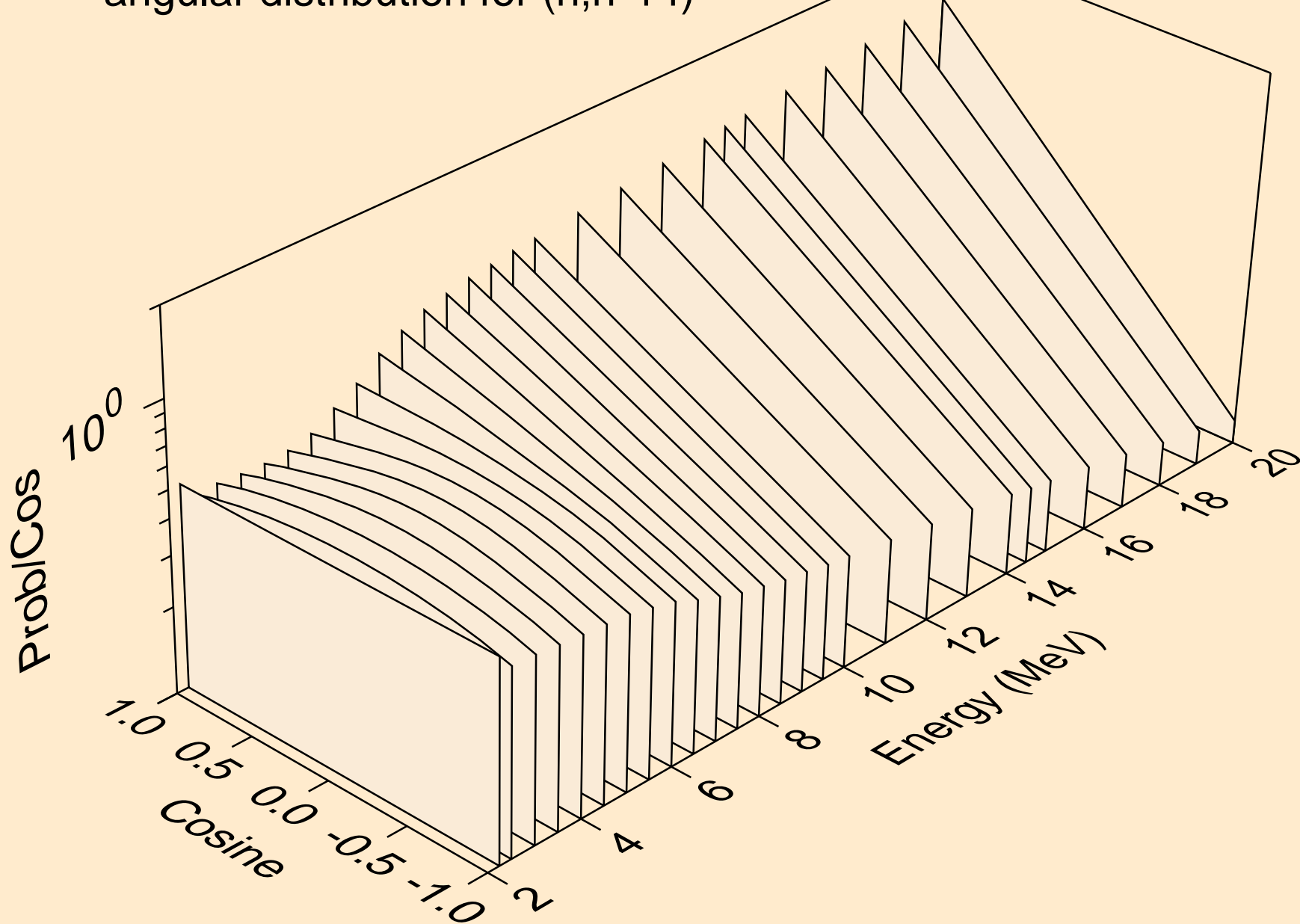

42-MO-98 FOR FENDL-3.2 FROM FENDL-3.2 WITH NJOY2016.60-
angular distribution for (n,n*15)

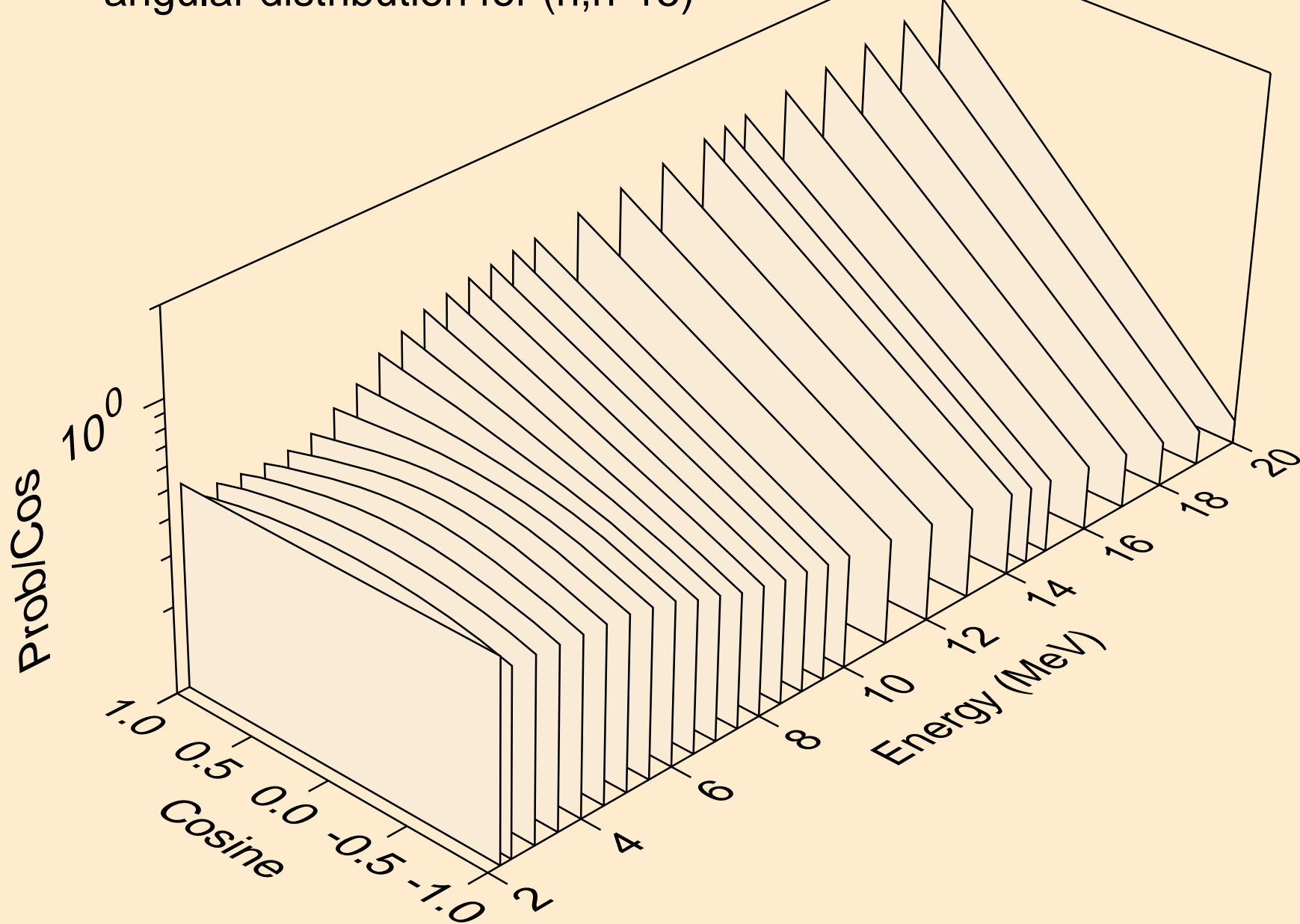

42-MO-98 FOR FENDL-3.2 FROM FENDL-3.2 WITH NJOY2016.60-
angular distribution for (n,n*16)

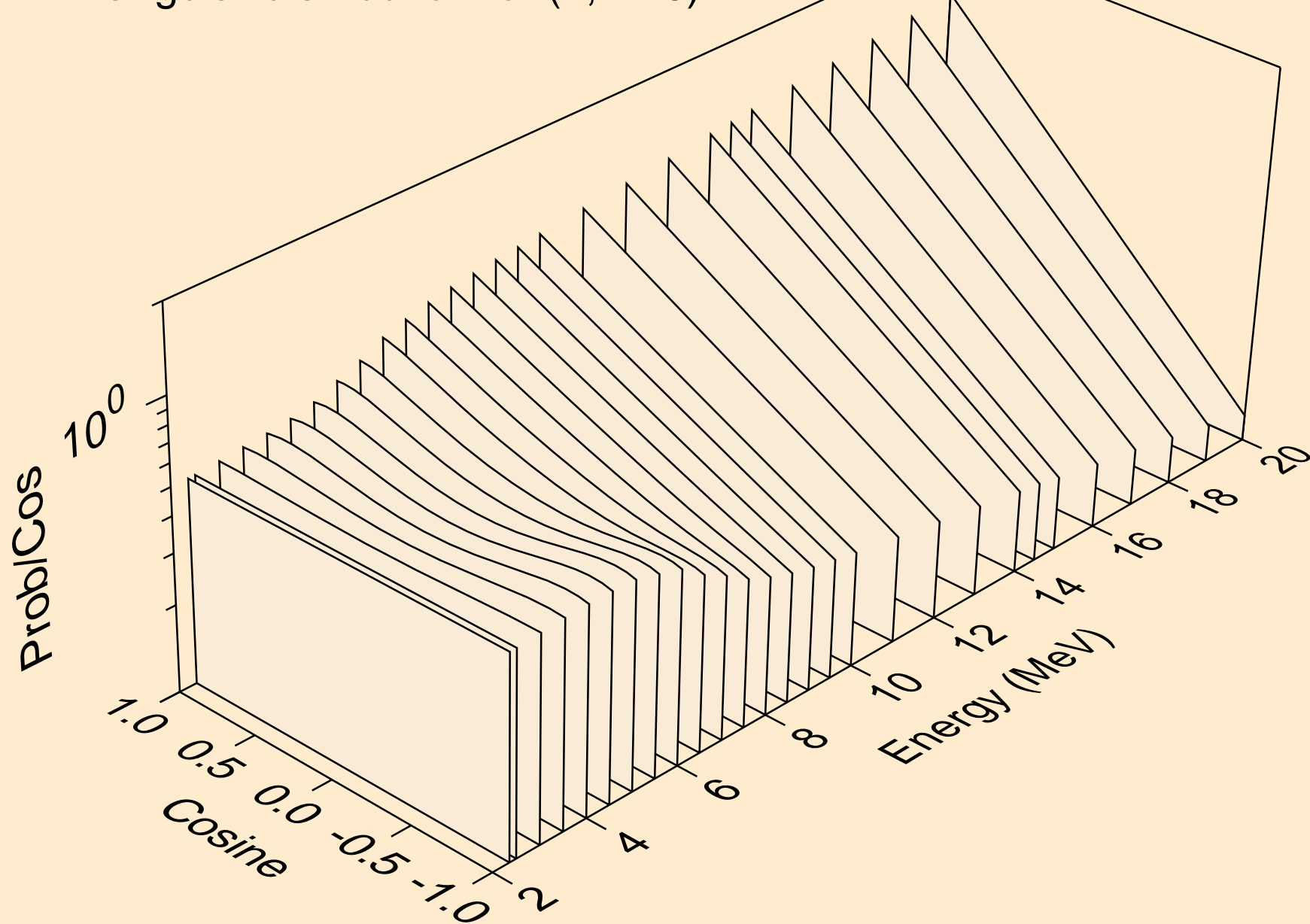

42-MO-98 FOR FENDL-3.2 FROM FENDL-3.2 WITH NJOY2016.60-
angular distribution for (n,n*17)

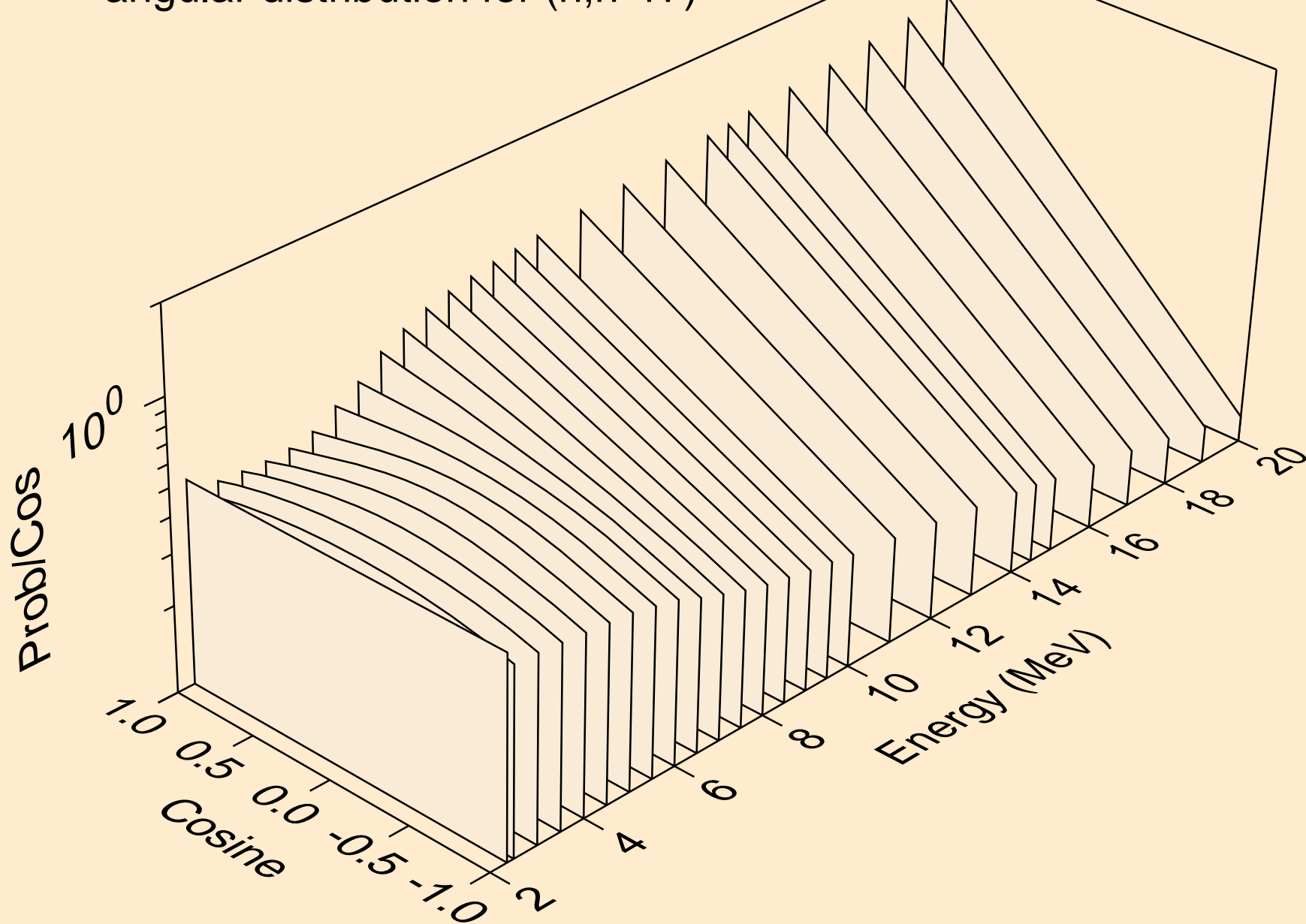

42-MO-98 FOR FENDL-3.2 FROM FENDL-3.2 WITH NJOY2016.60-
angular distribution for (n,n*18)

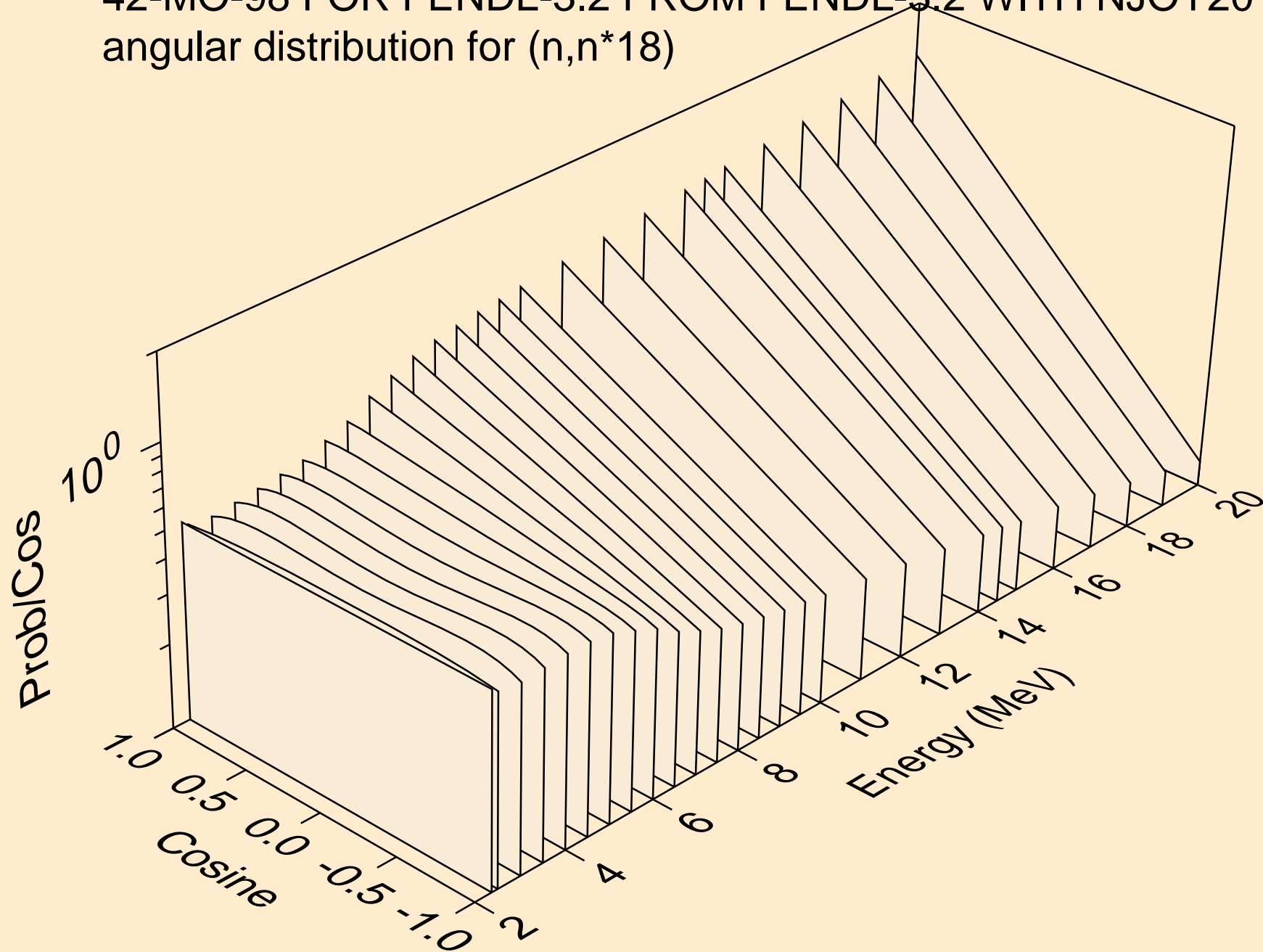

42-MO-98 FOR FENDL-3.2 FROM FENDL-3.2 WITH NJOY2016.60-
angular distribution for (n,n*19)

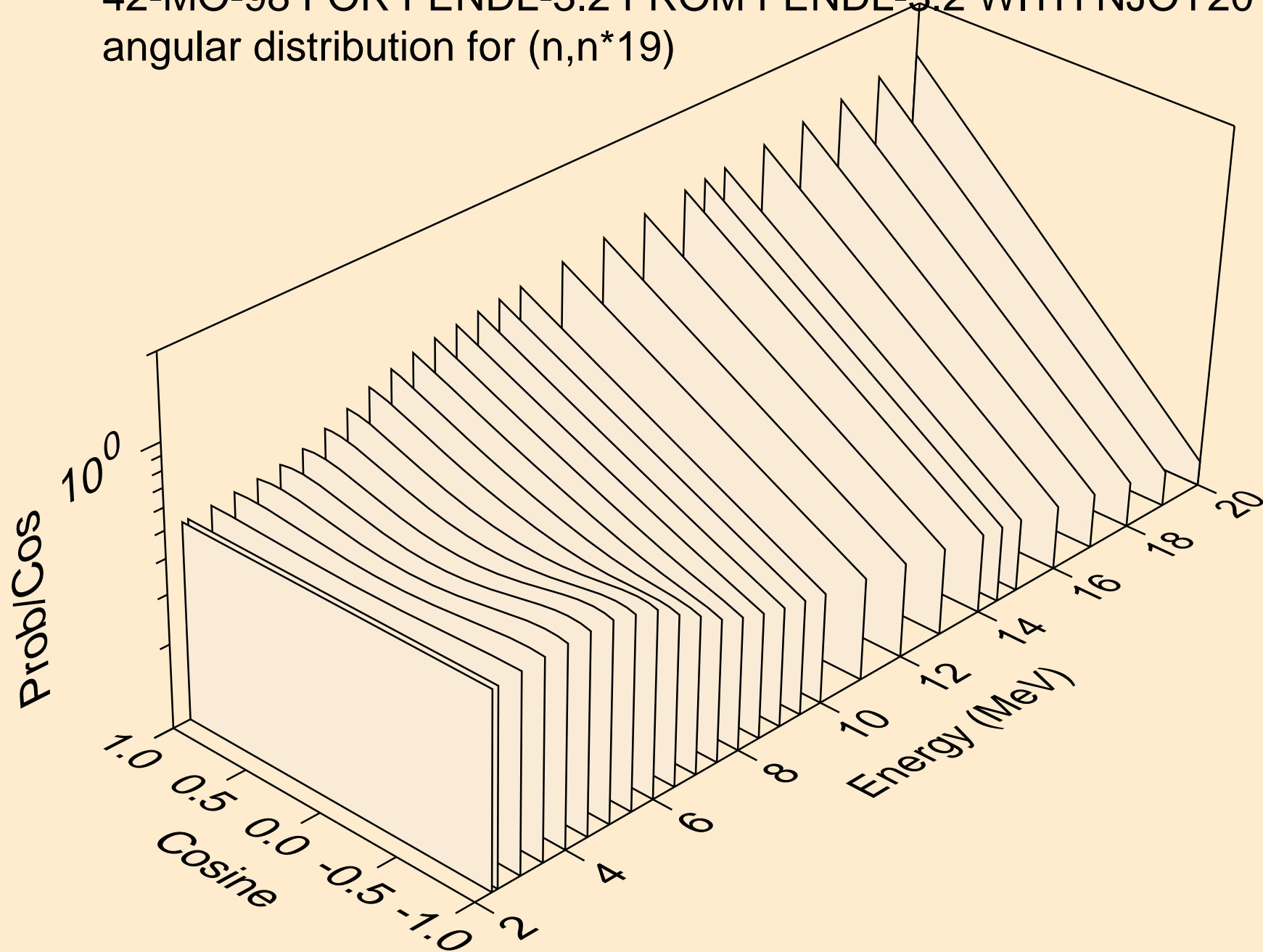

42-MO-98 FOR FENDL-3.2 FROM FENDL-3.2 WITH NJOY2016.60-
Neutron emission for (n,x)

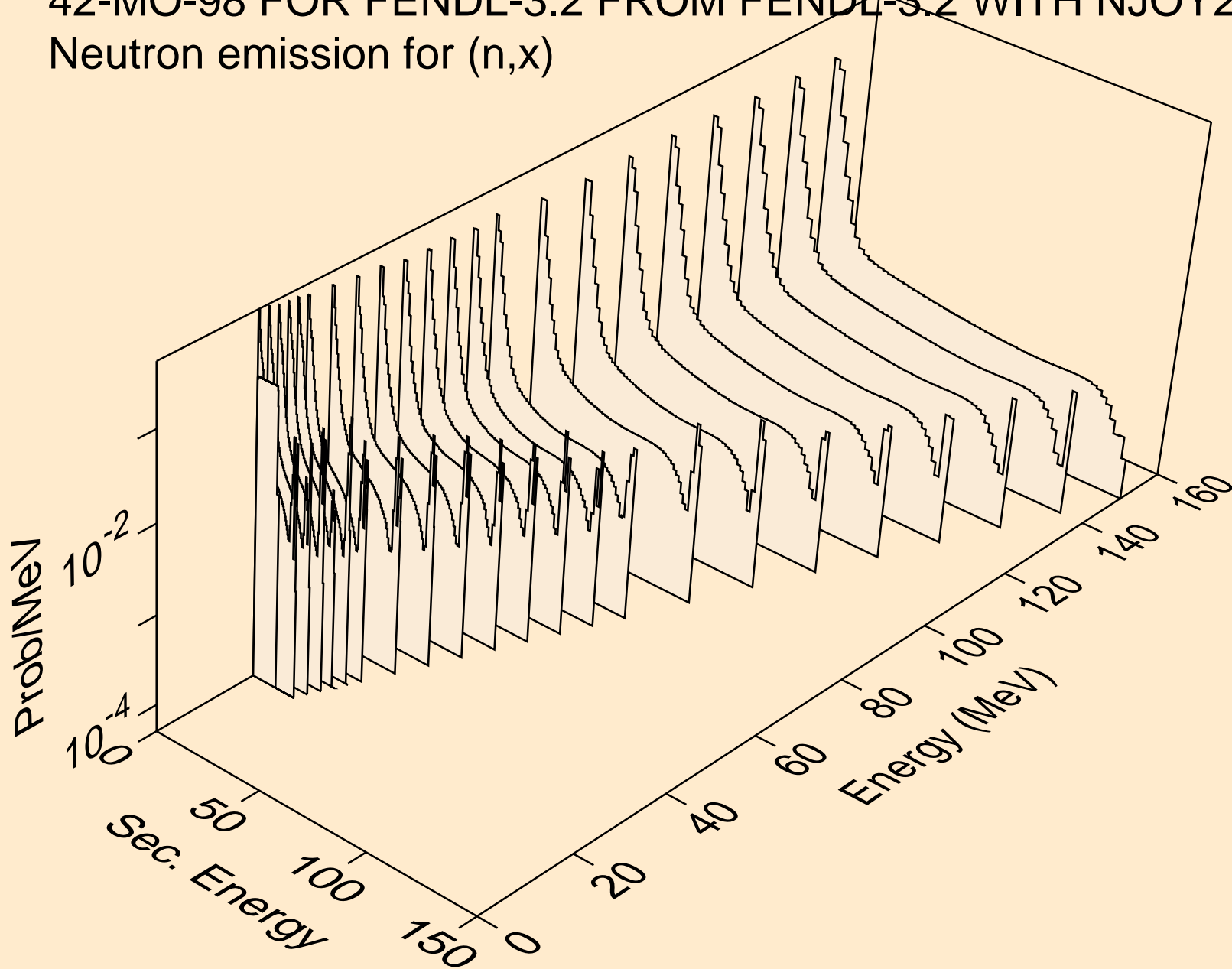

42-MO-98 FOR FENDL-3.2 FROM FENDL-3.2 WITH NJOY2016.60-
Neutron emission for (n,2n)

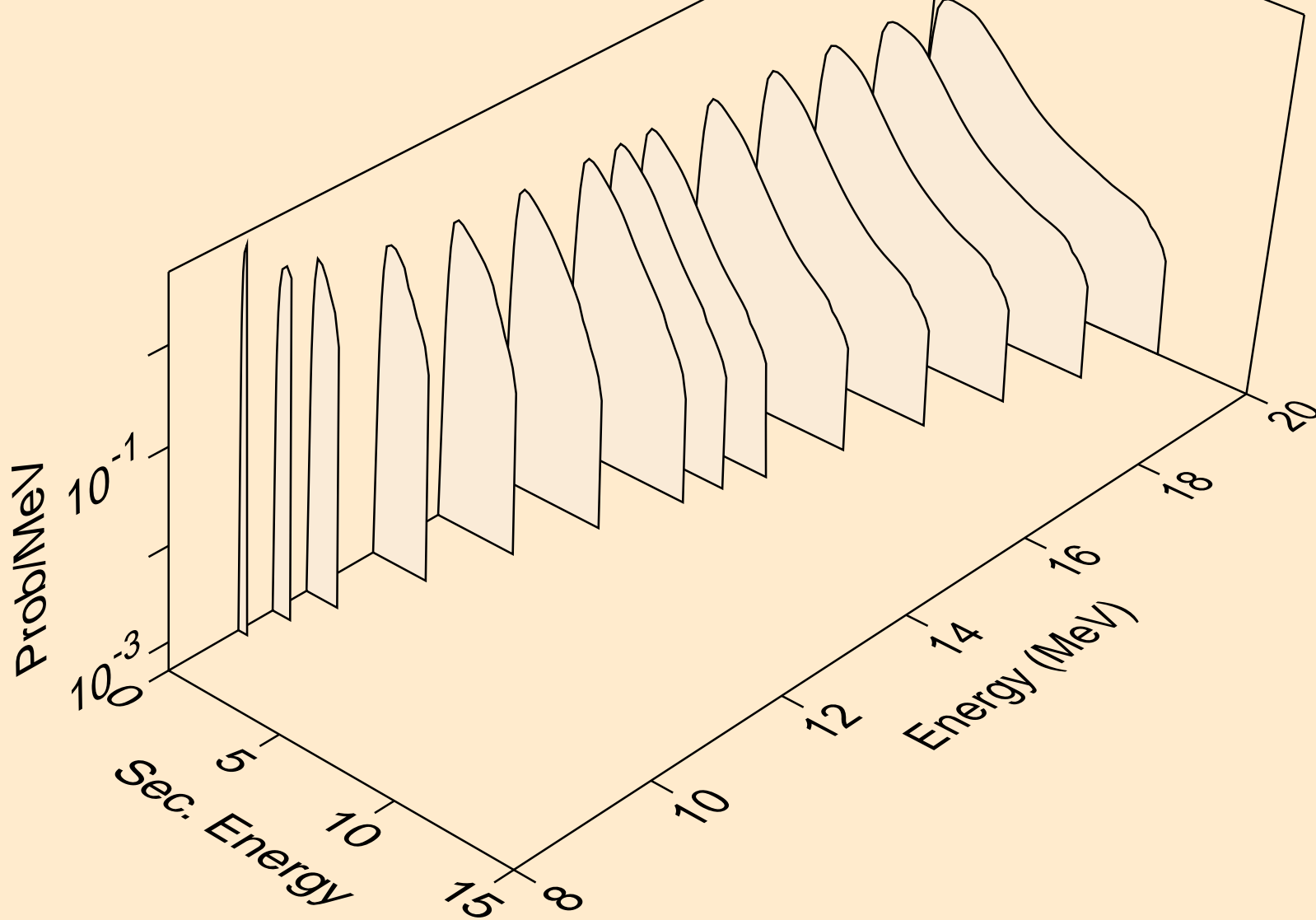

42-MO-98 FOR FENDL-3.2 FROM FENDL-3.2 WITH NJOY2016.60-
Neutron emission for (n,3n)

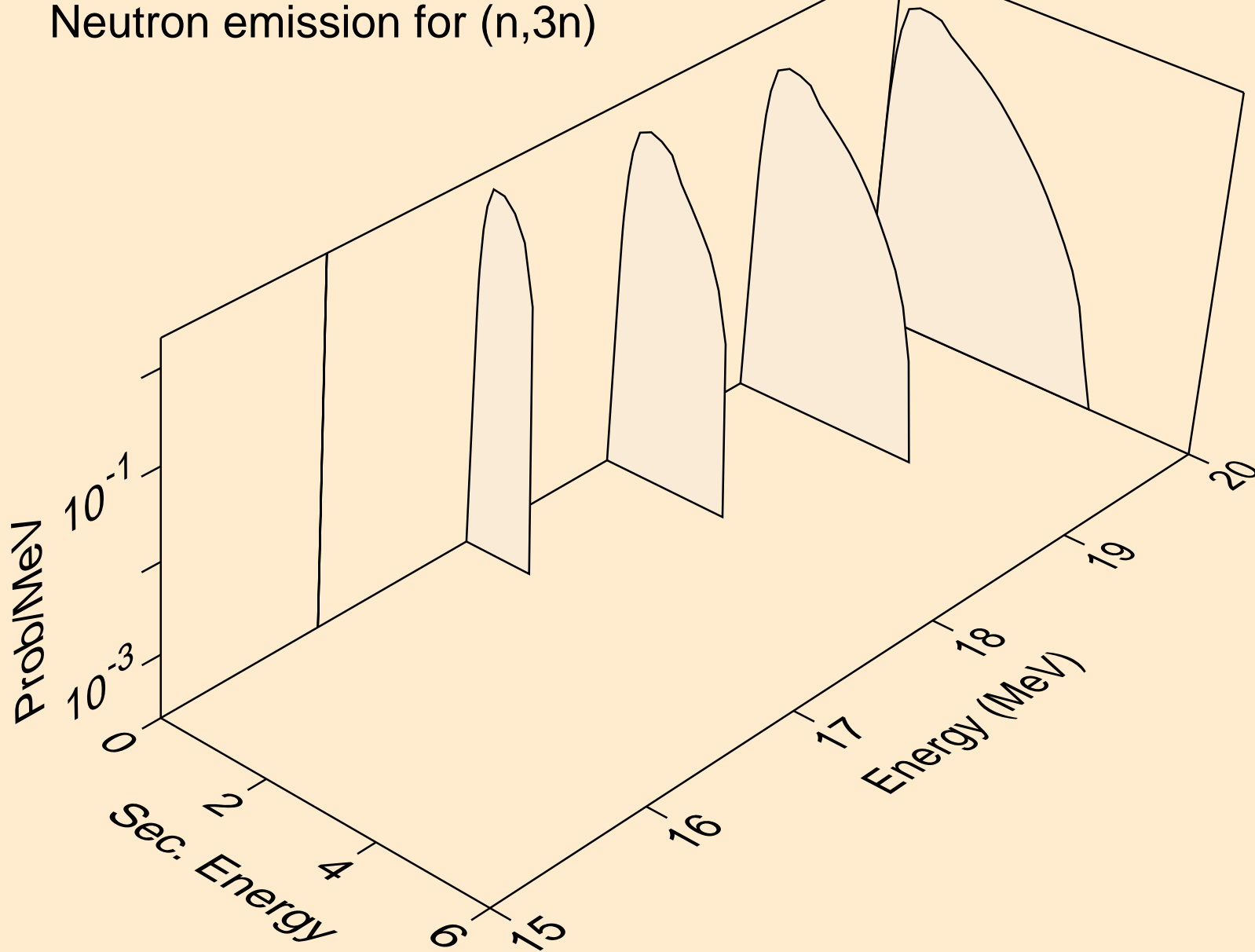

42-MO-98 FOR FENDL-3.2 FROM FENDL-3.2 WITH NJOY2016.60-
Neutron emission for (n,n*)a

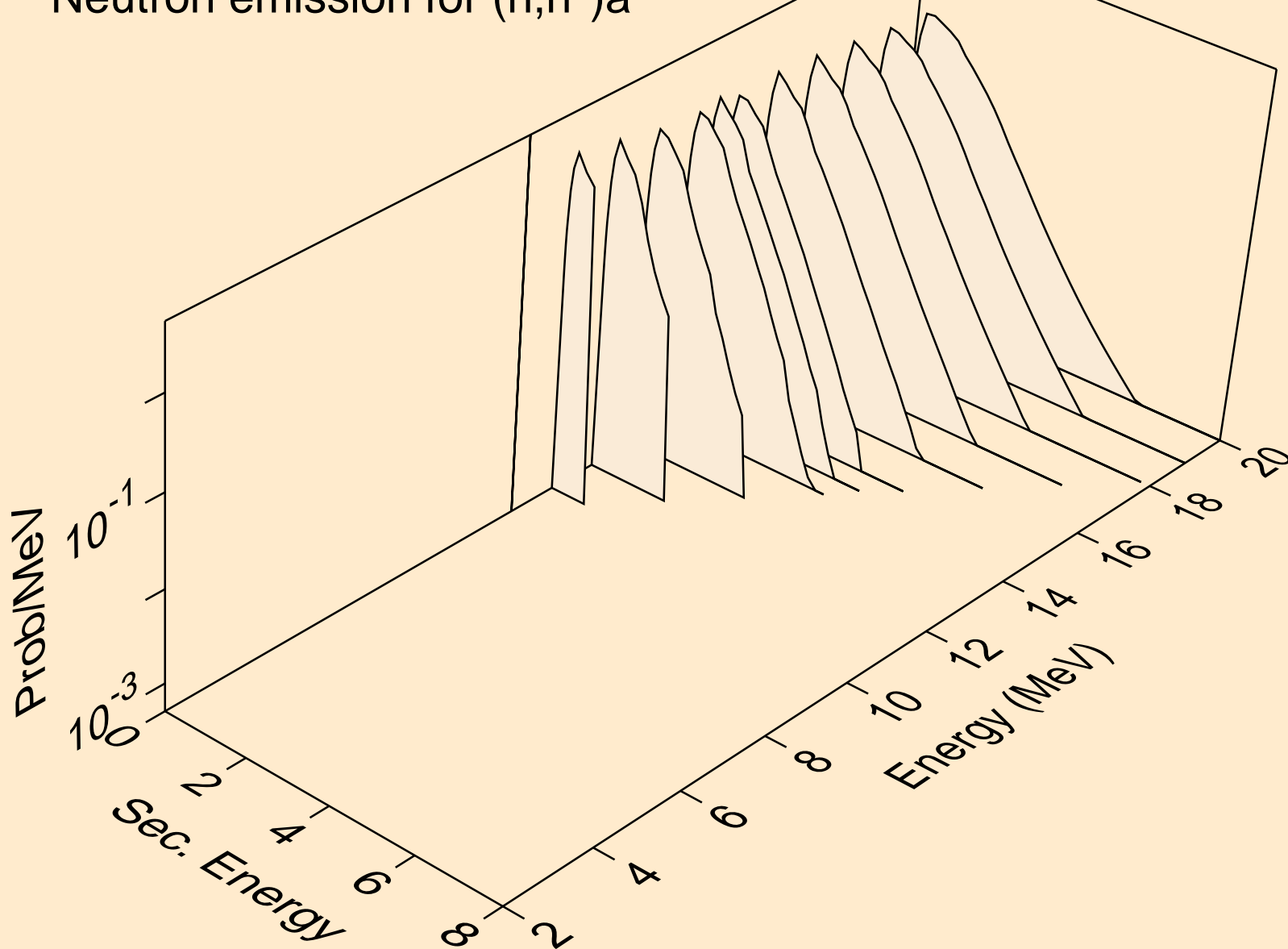

42-MO-98 FOR FENDL-3.2 FROM FENDL-3.2 WITH NJOY2016.60-
Neutron emission for (n,n*)p

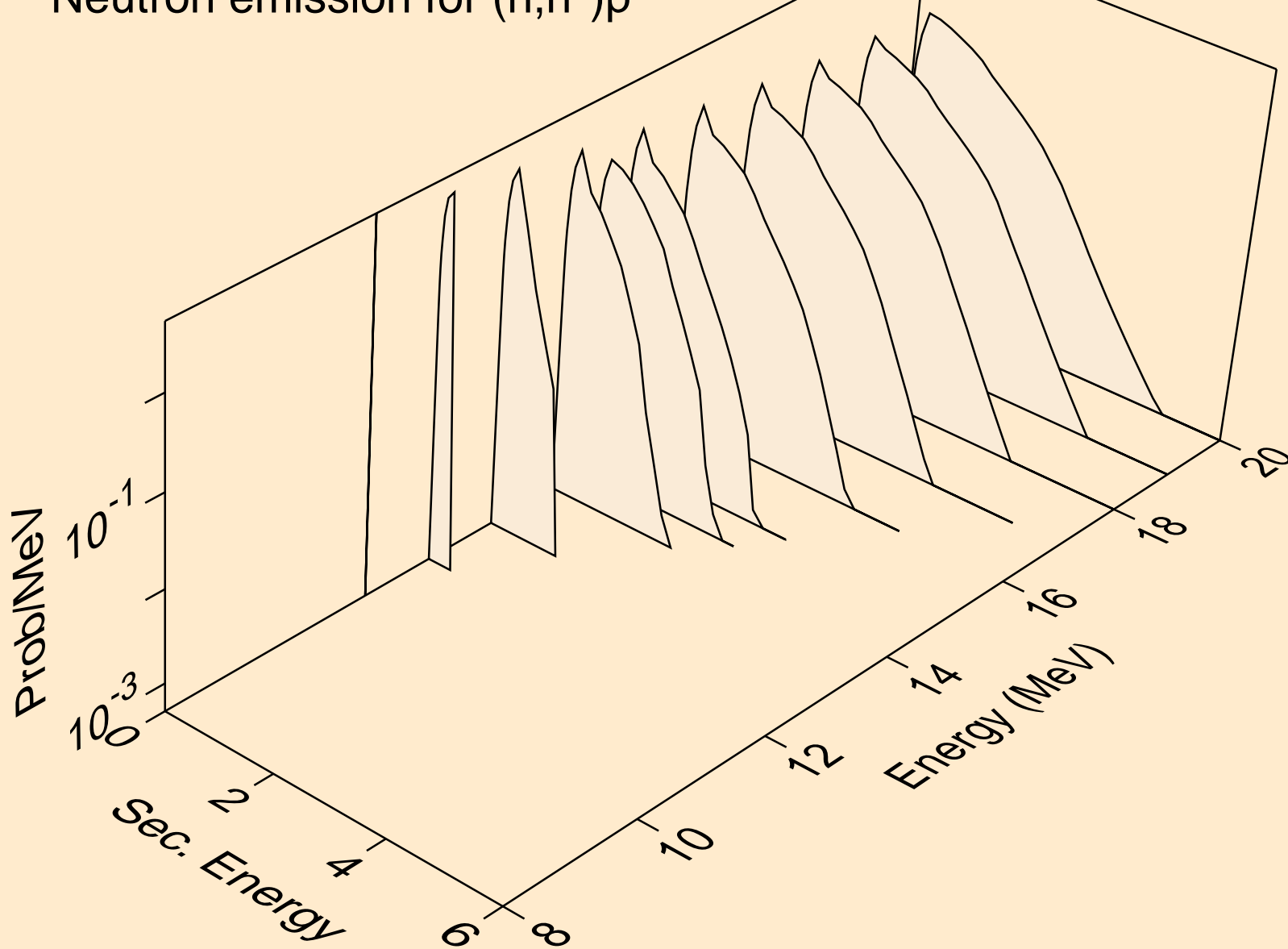

42-MO-98 FOR FENDL-3.2 FROM FENDL-3.2 WITH NJOY2016.60-
Neutron emission for (n,n*)d

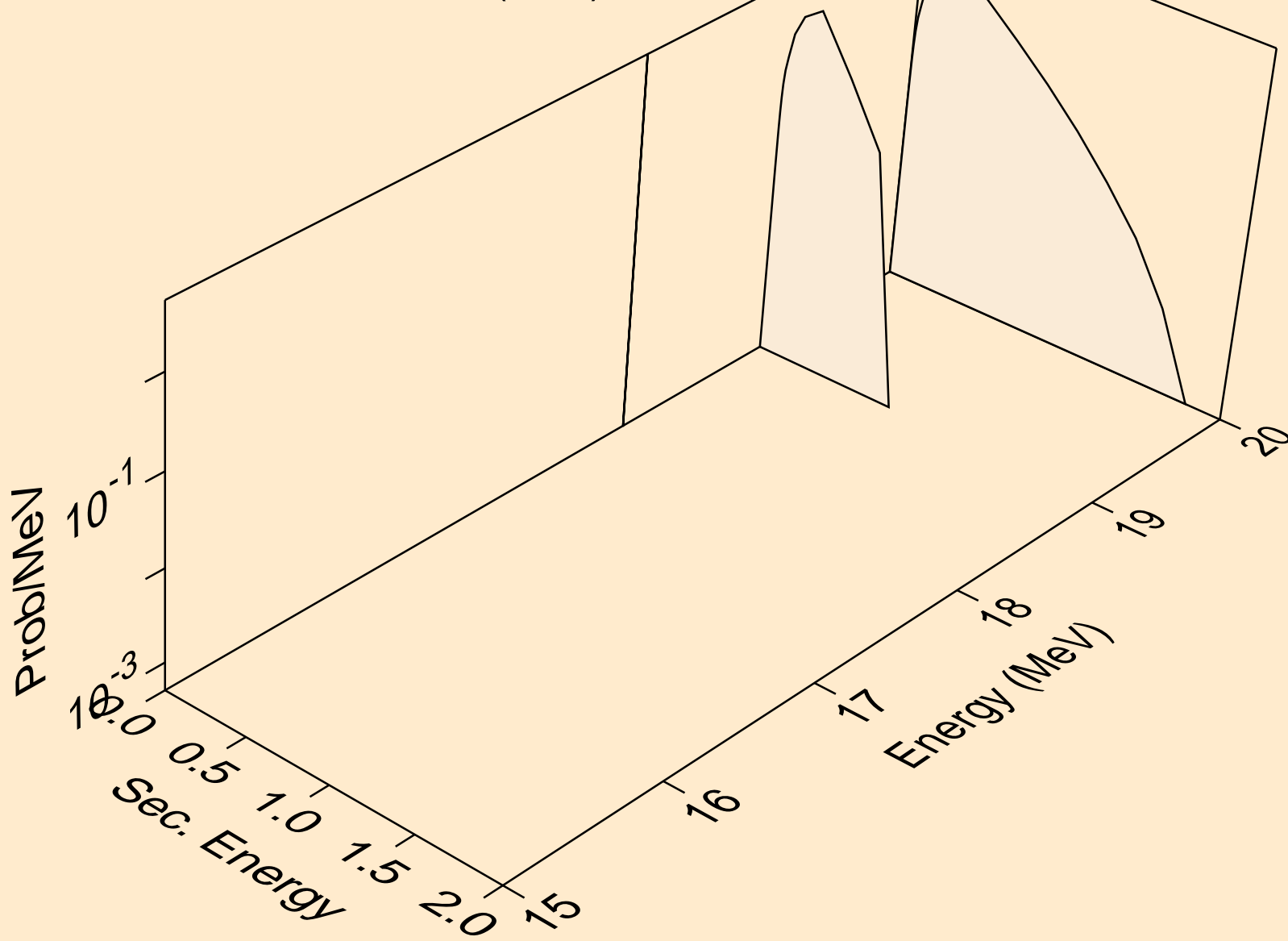

42-MO-98 FOR FENDL-3.2 FROM FENDL-3.2 WITH NJOY2016.60-
Neutron emission for (n,n*c)

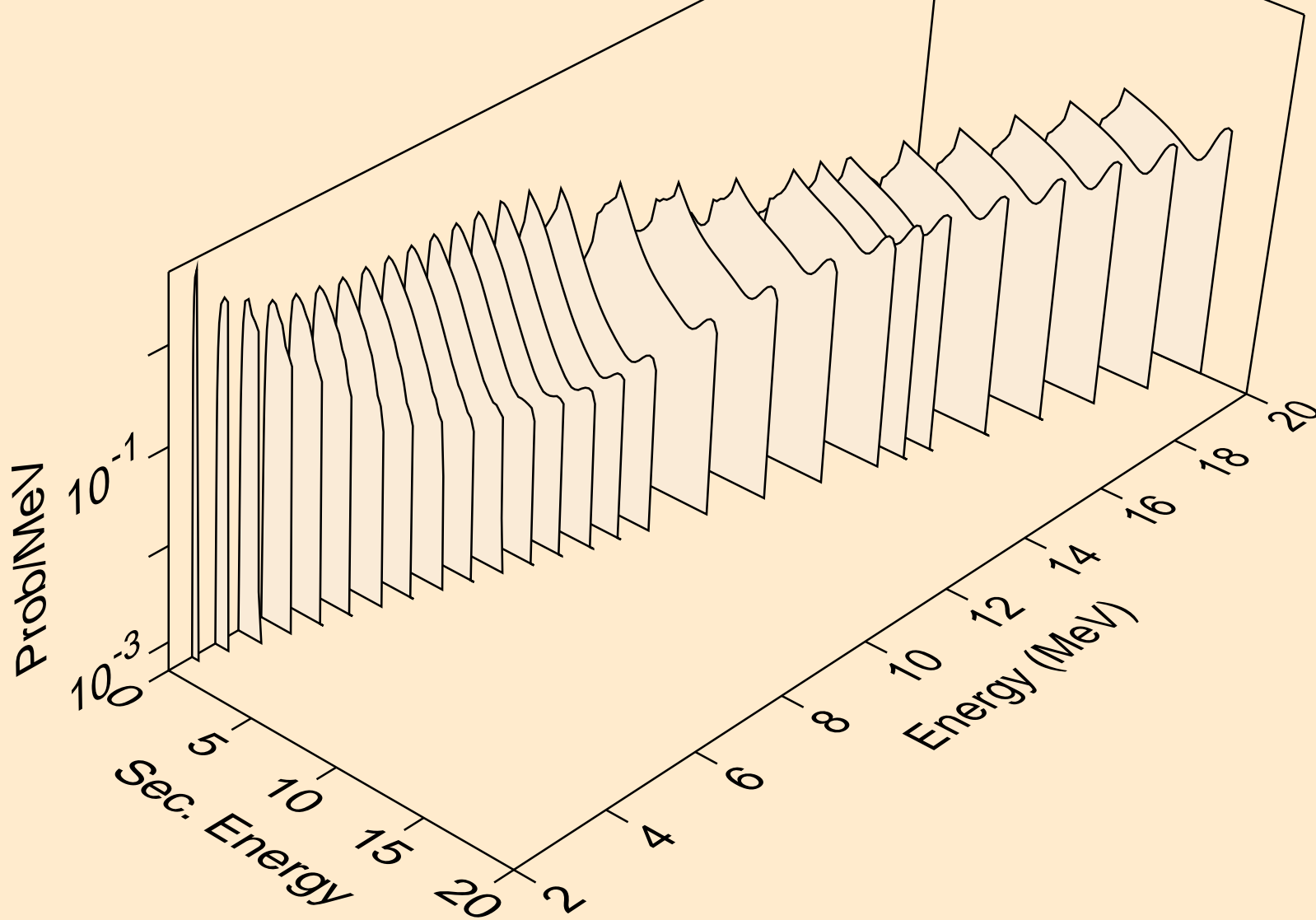

42-MO-98 FOR FENDL-3.2 FROM FENDL-3.2 WITH NJOY2016.60-
Photon emission for nonelastic

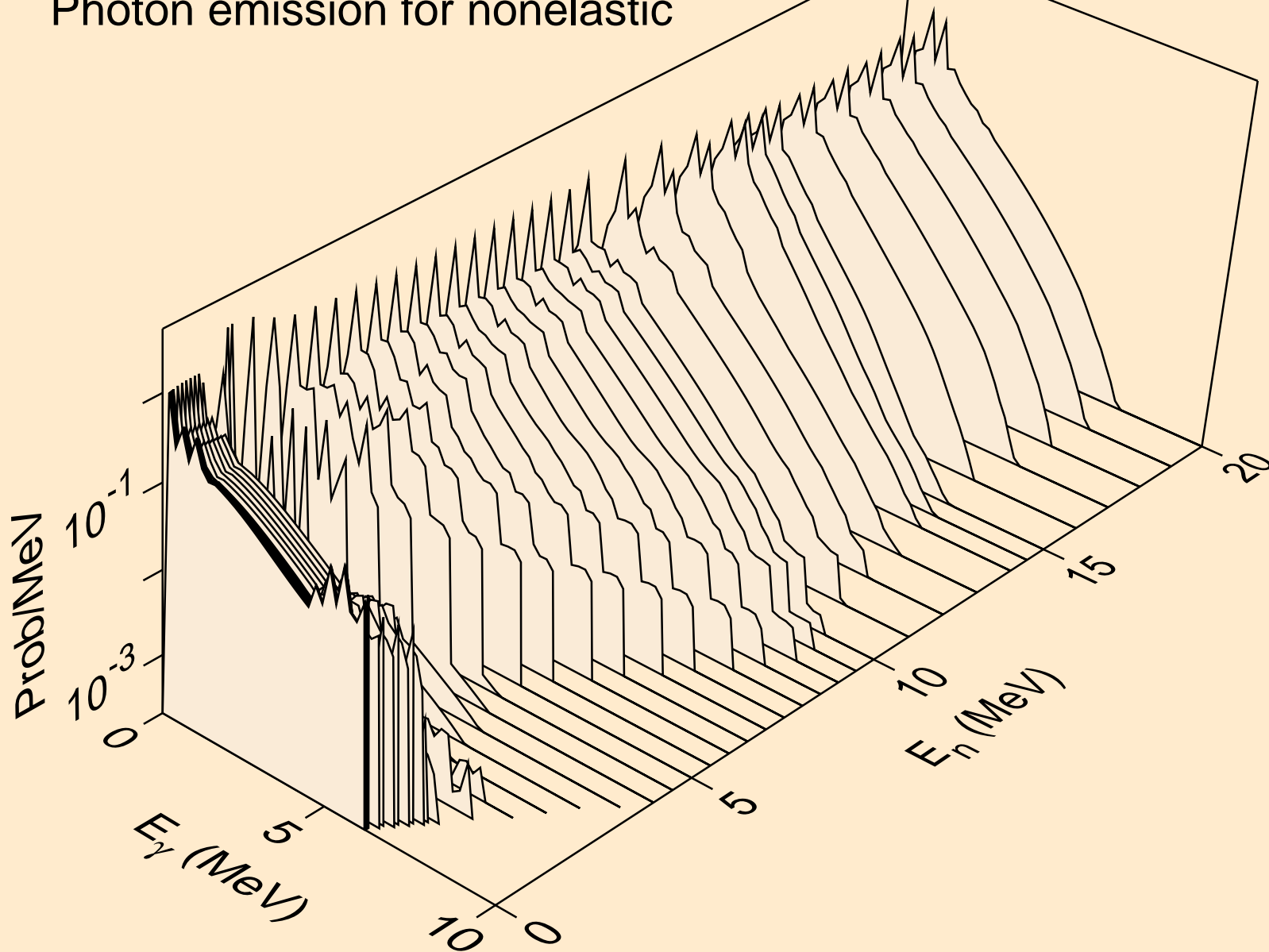

42-MO-98 FOR FENDL-3.2 FROM FENDL-3.2 WITH NJOY2016.60-
Photon emission for (n,x)

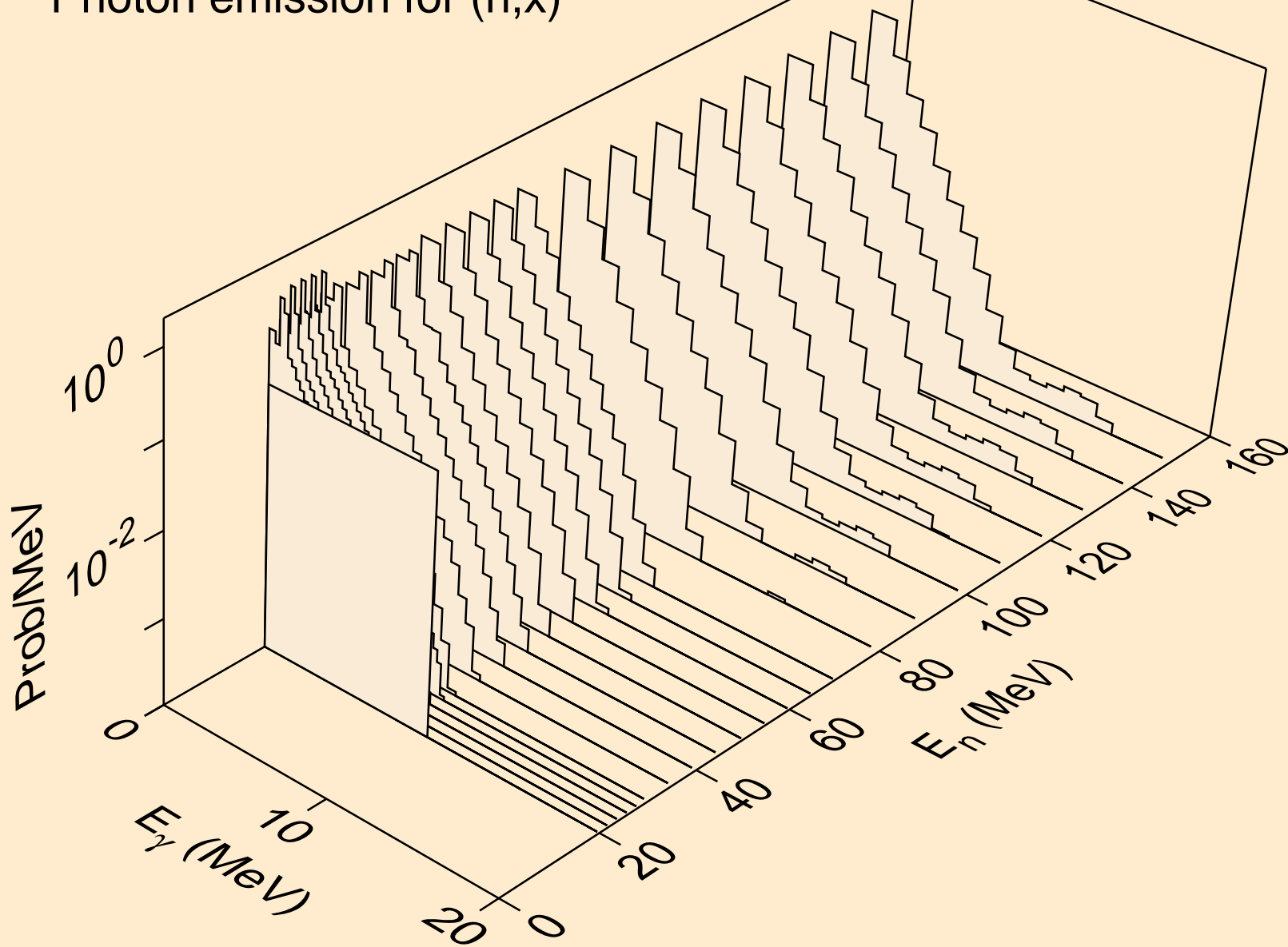

42-MO-98 FOR FENDL-3.2 FROM FENDL-3.2 WITH NJOY2016.60-
14 MeV photon spectrum

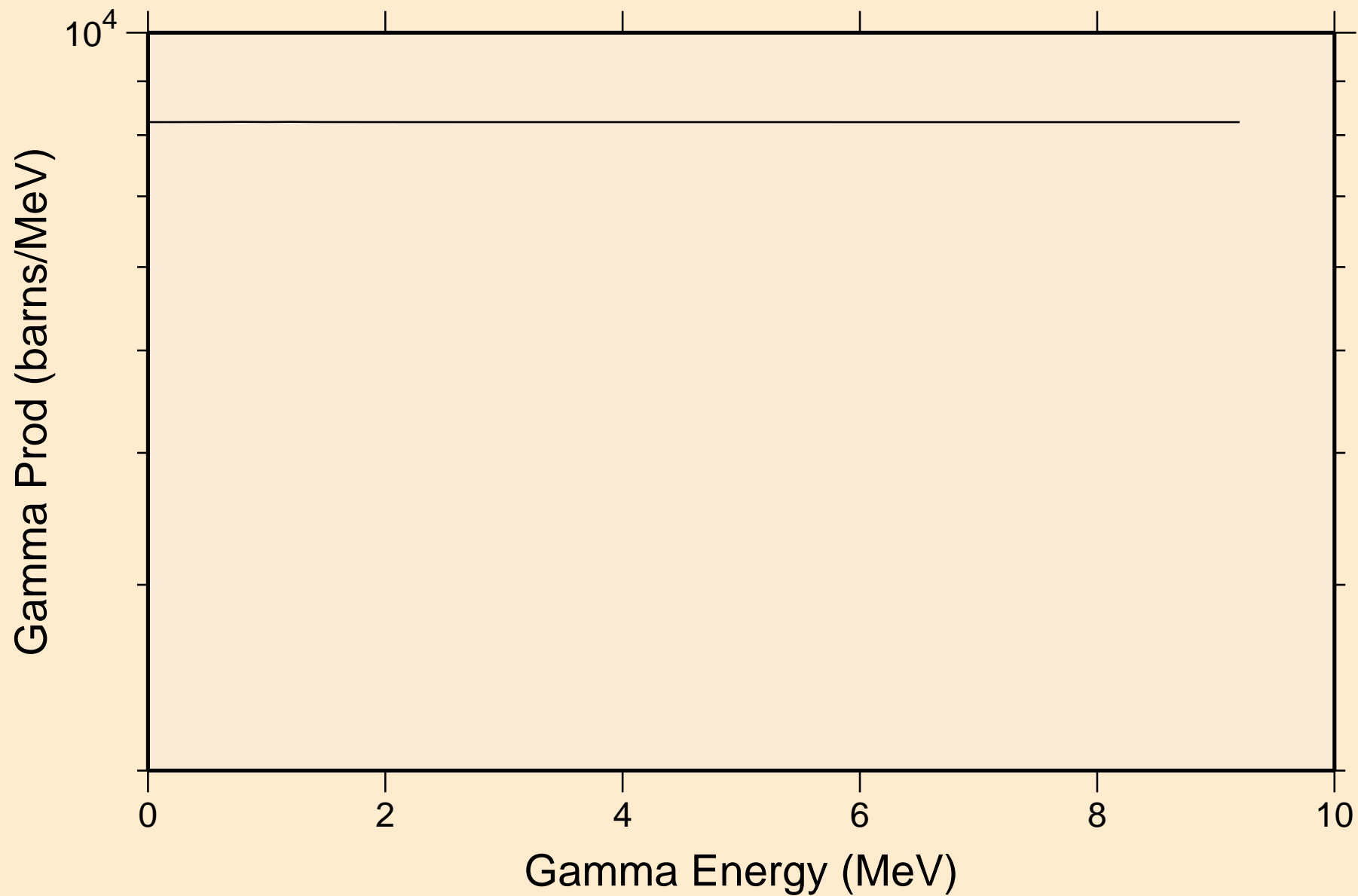

42-MO-98 FOR FENDL-3.2 FROM FENDL-3.2 WITH NJOY2016.60- Particle heating contributions

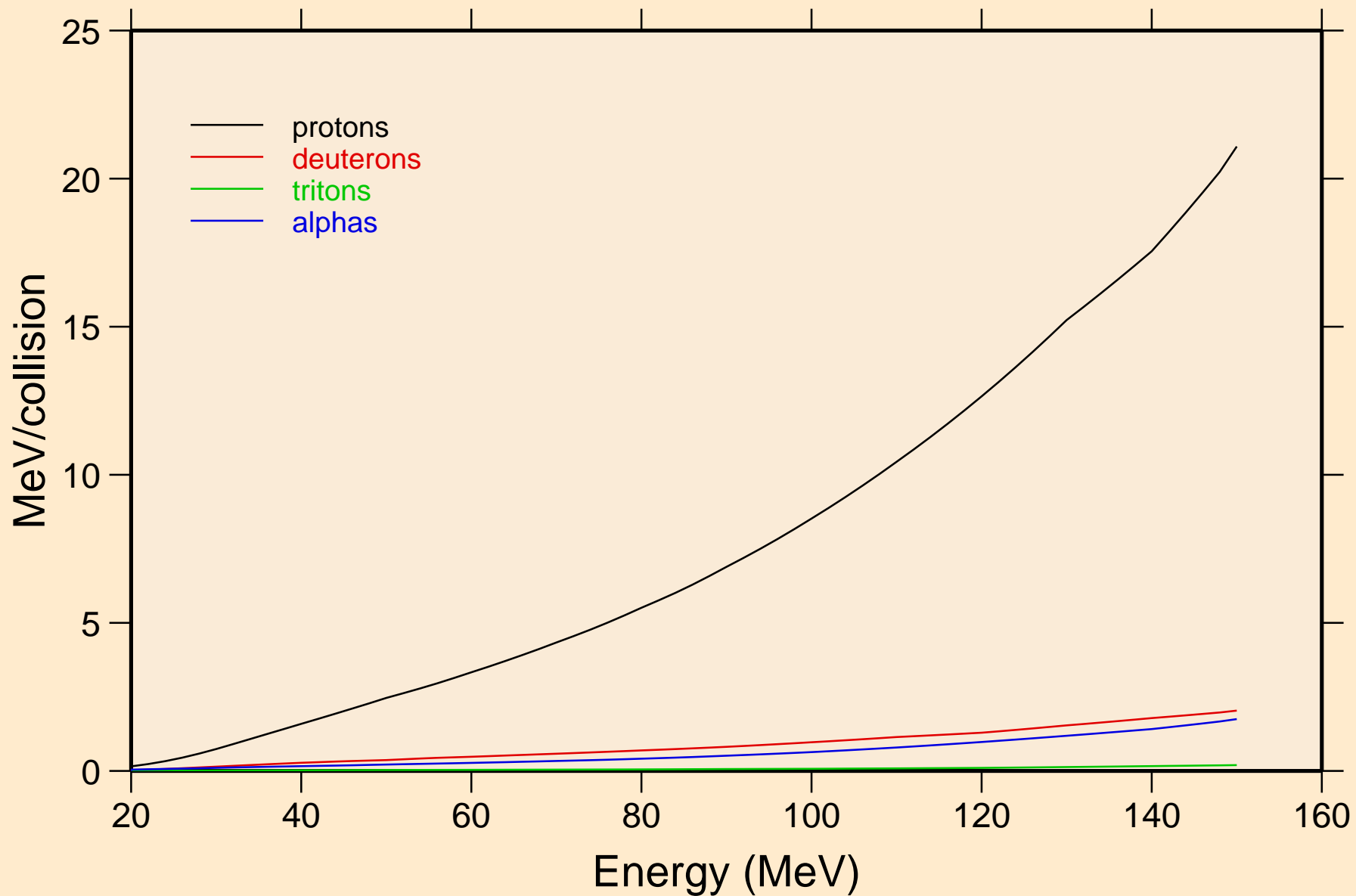

42-MO-98 FOR FENDL-3.2 FROM FENDL-3.2 WITH NJOY2016.60- Recoil Heating

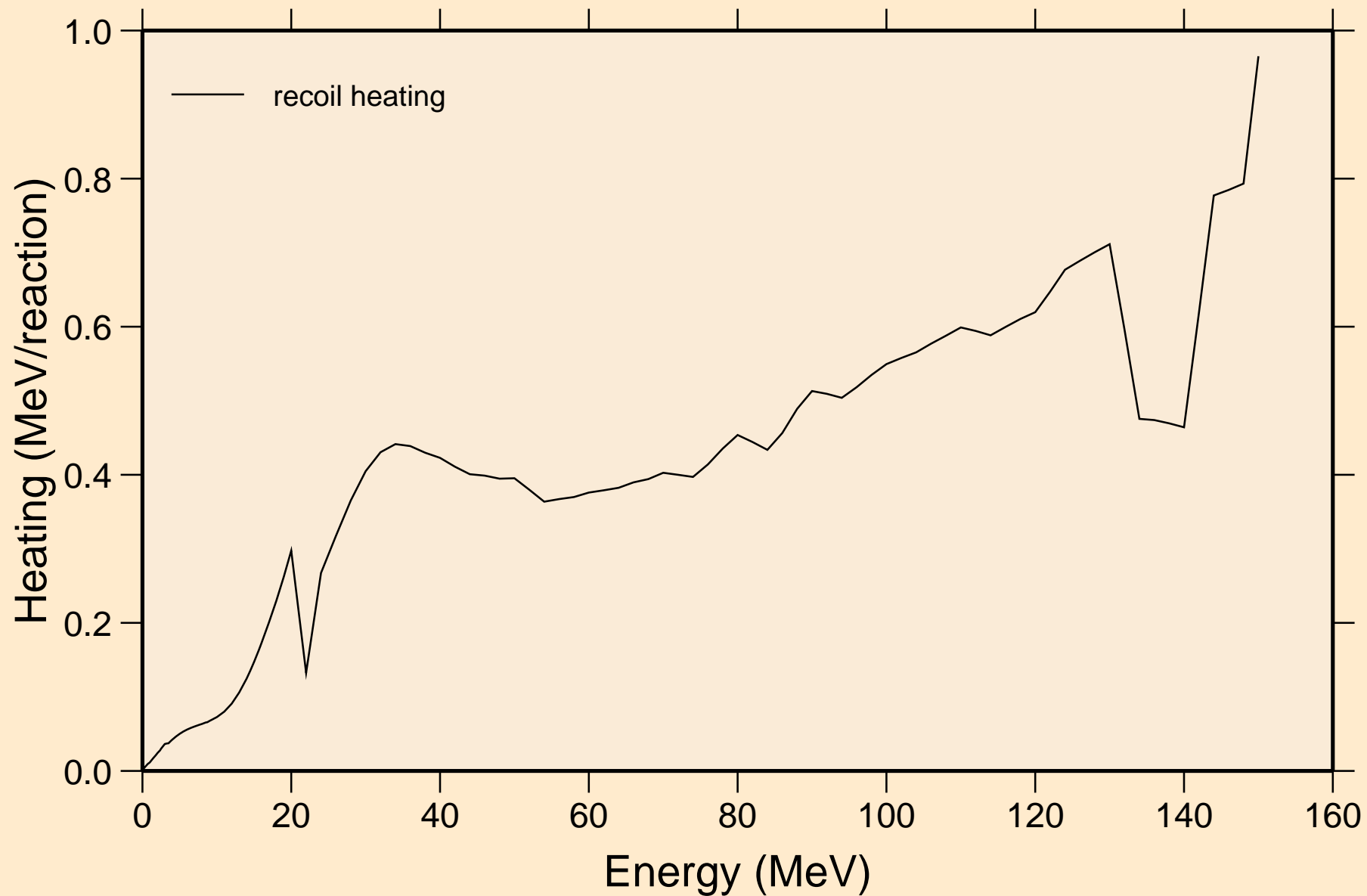

42-MO-98 FOR FENDL-3.2 FROM FENDL-3.2 WITH NJOY2016.60-
Particle production cross sections

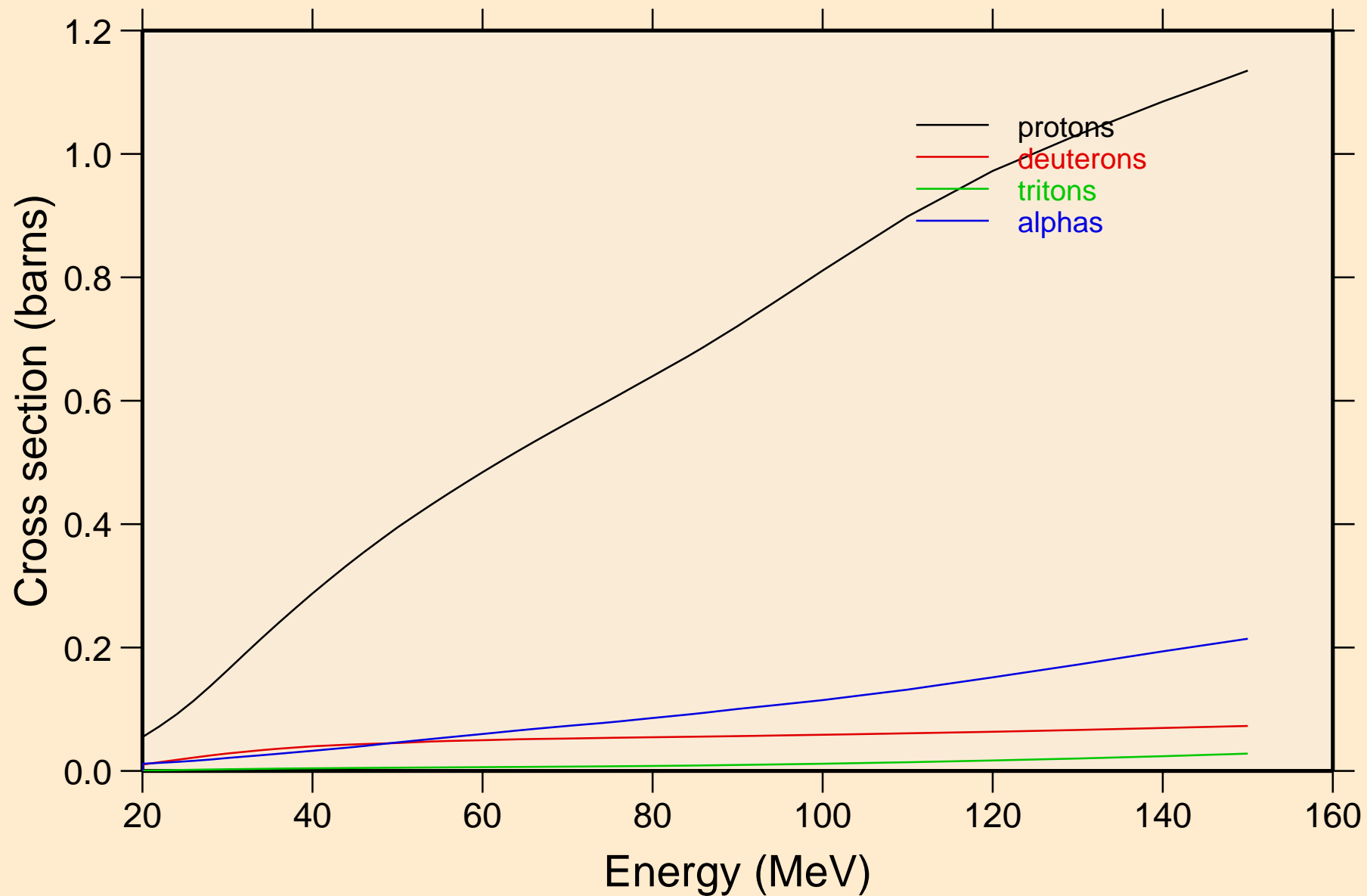

42-MO-98 FOR FENDL-3.2 FROM FENDL-3.2 WITH NJOY2016.60-
protons from (n,x)

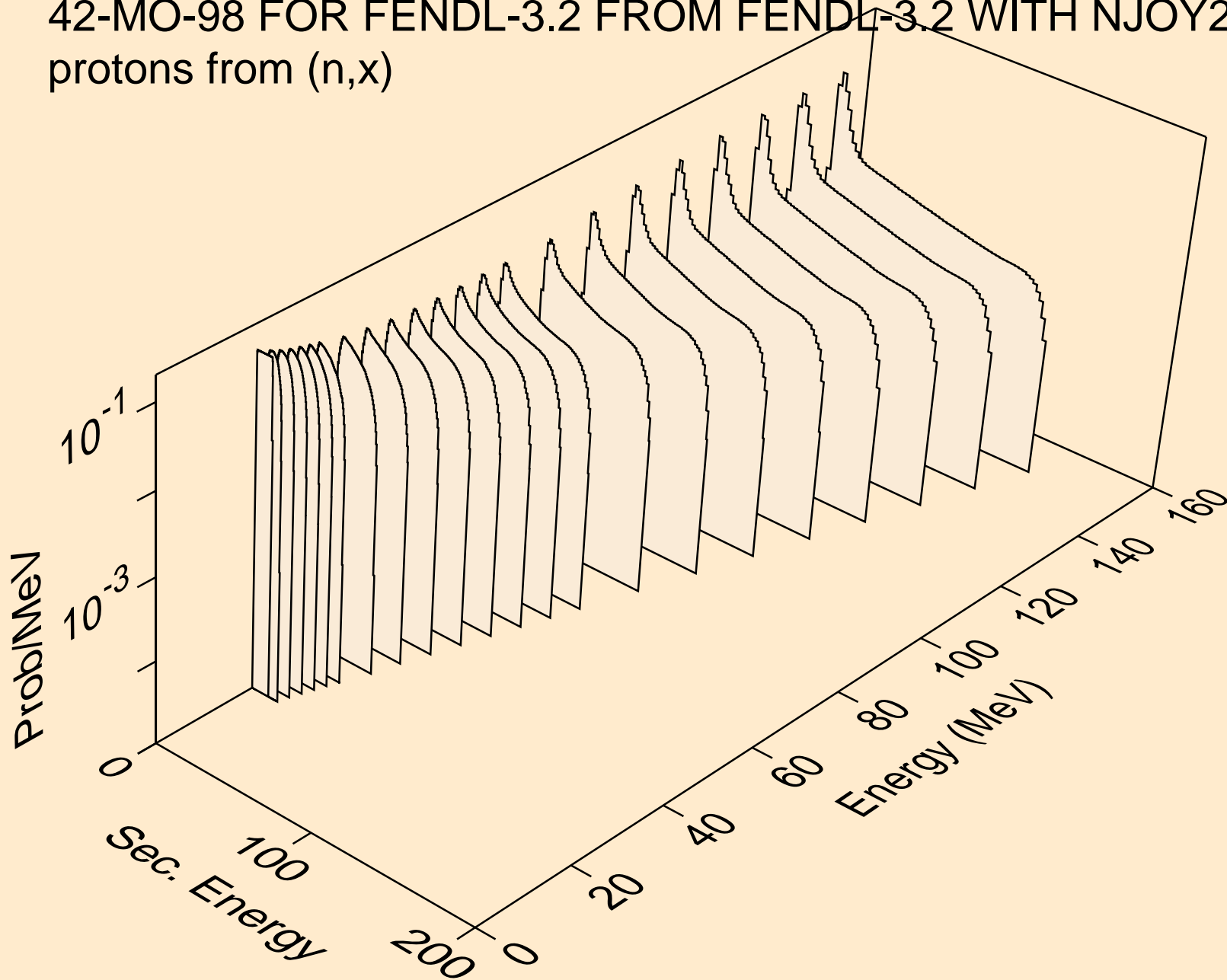

42-MO-98 FOR FENDL-3.2 FROM FENDL-3.2 WITH NJOY2016.60-
deuterons from (n,x)

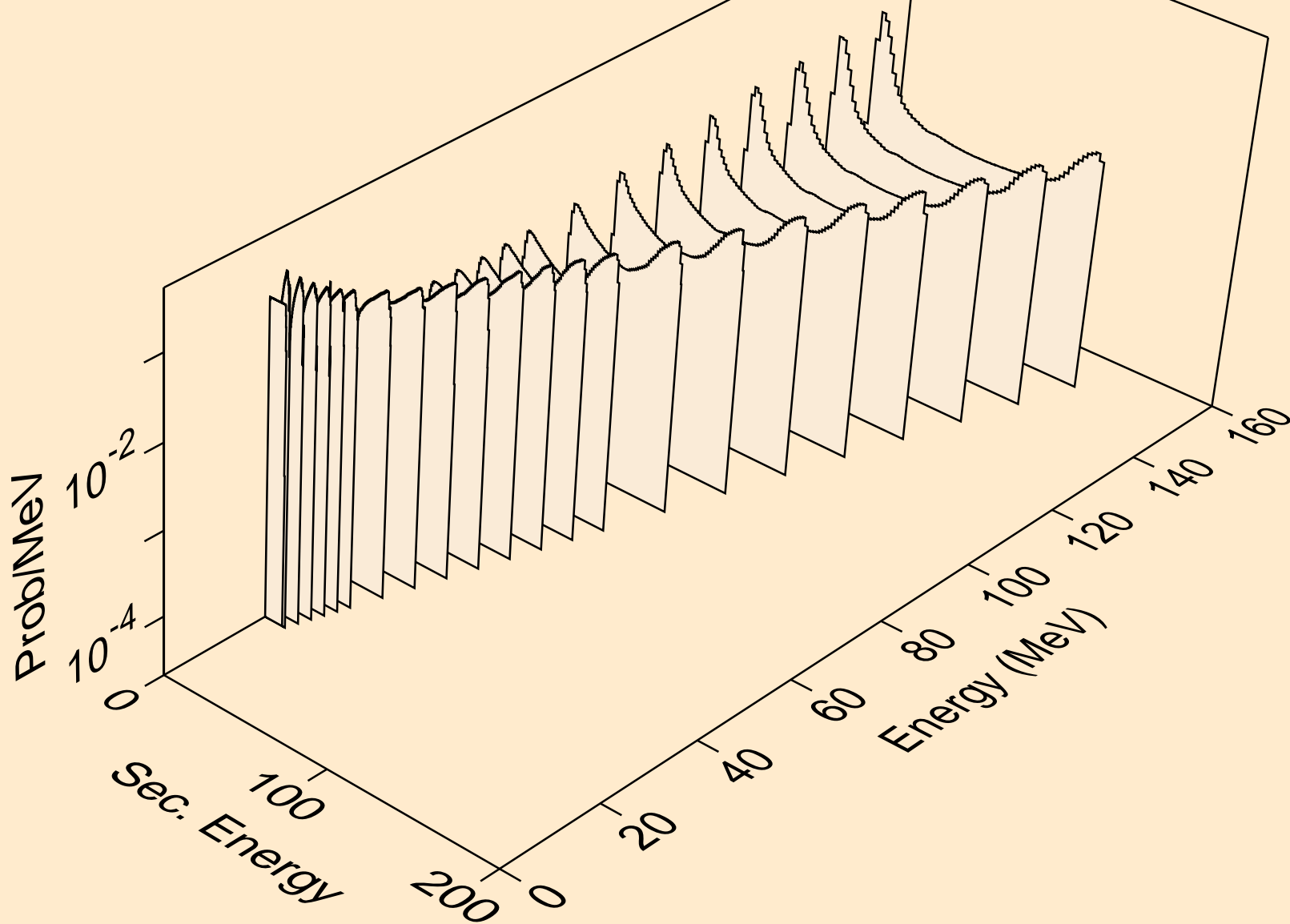

42-MO-98 FOR FENDL-3.2 FROM FENDL-3.2 WITH NJOY2016.60-
tritons from (n,x)

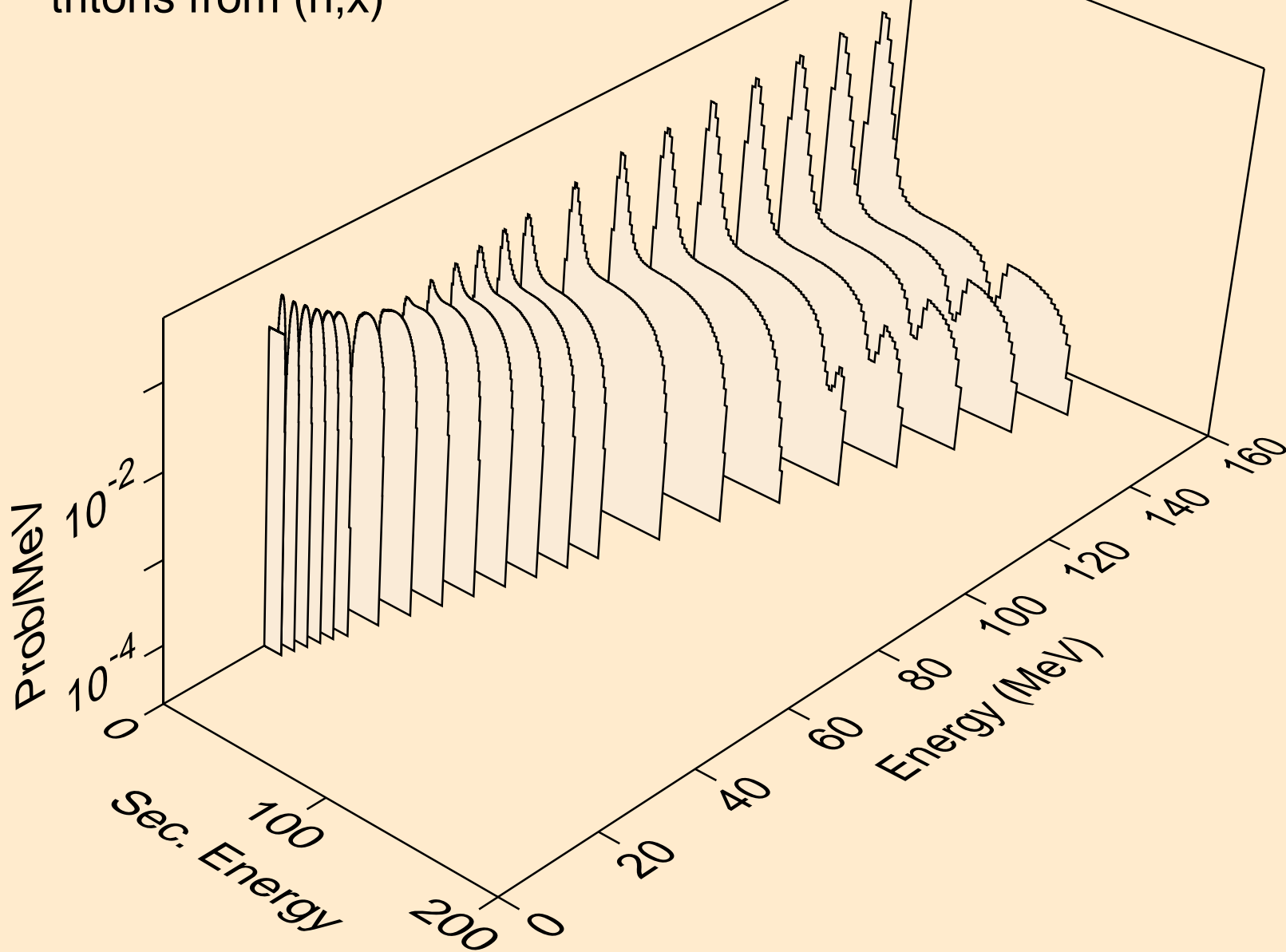

42-MO-98 FOR FENDL-3.2 FROM FENDL-3.2 WITH NJOY2016.60-
alphas from (n,x)

