

51-SB-121 FOR FENDL-3.2 FROM FENDL-3.2 WITH NJOY2016.60
Principal cross sections

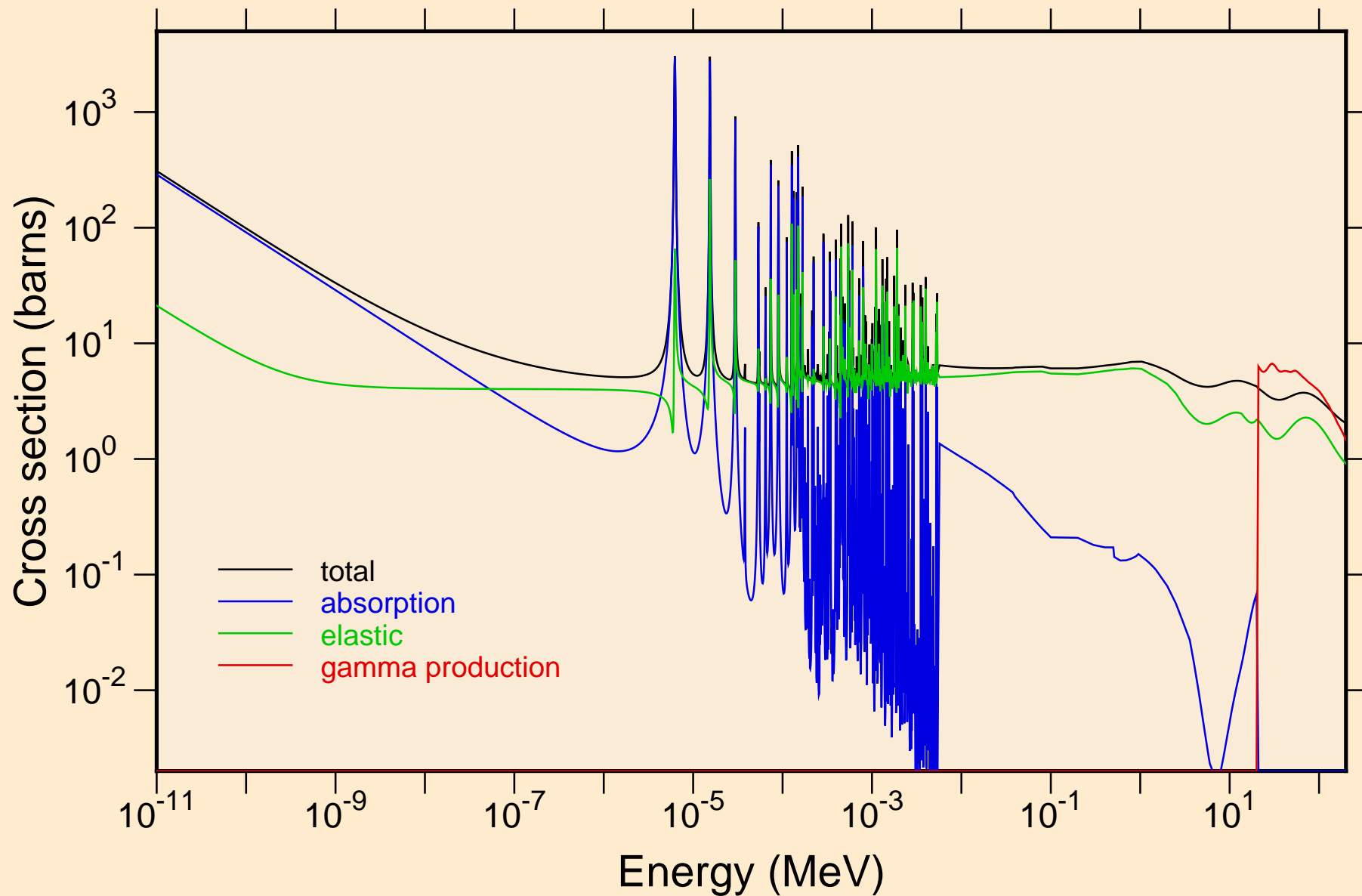

51-SB-121 FOR FENDL-3.2 FROM FENDL-3.2 WITH NJOY2016.60
resonance total cross section

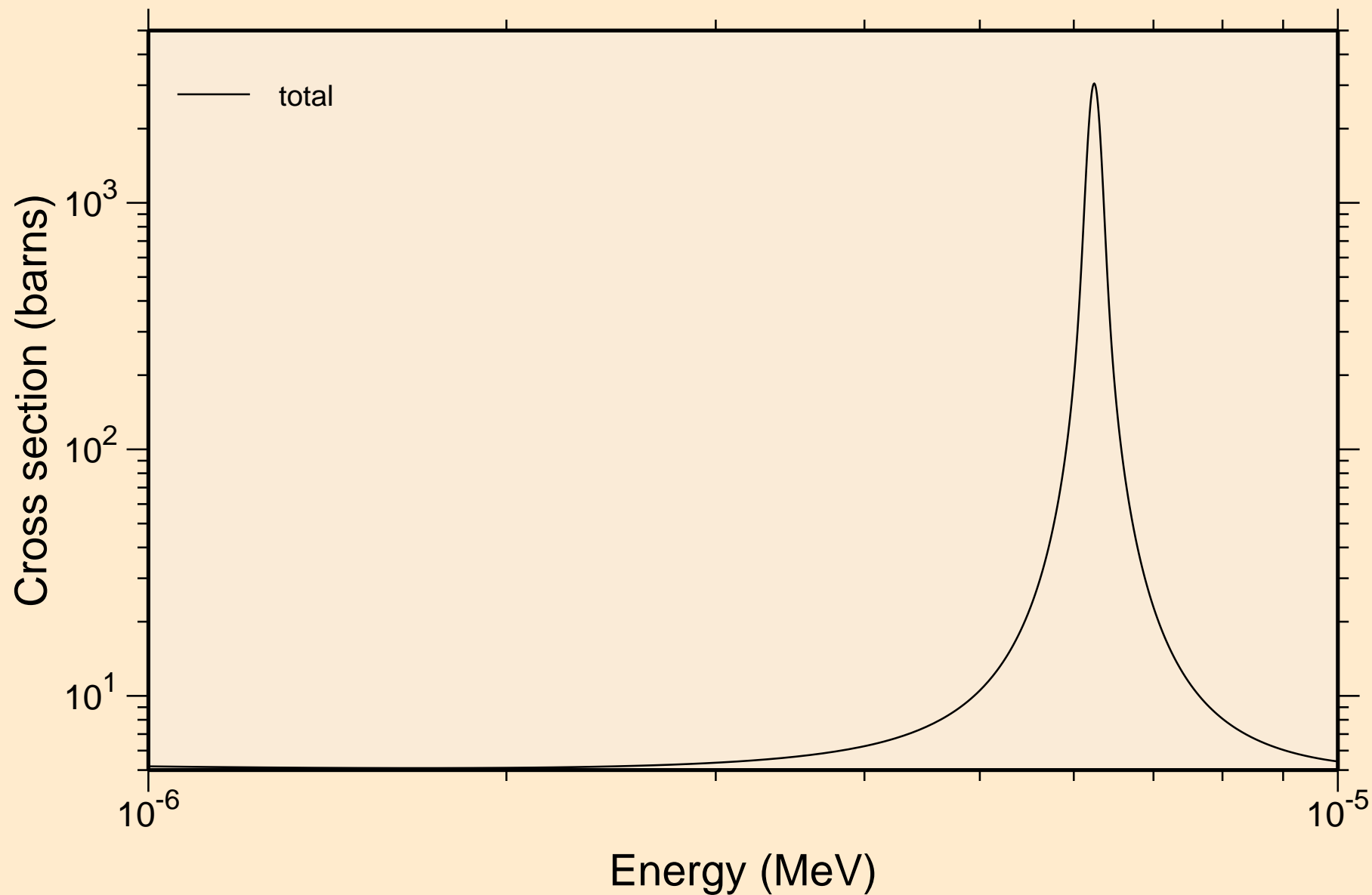

51-SB-121 FOR FENDL-3.2 FROM FENDL-3.2 WITH NJOY2016.60
resonance total cross section

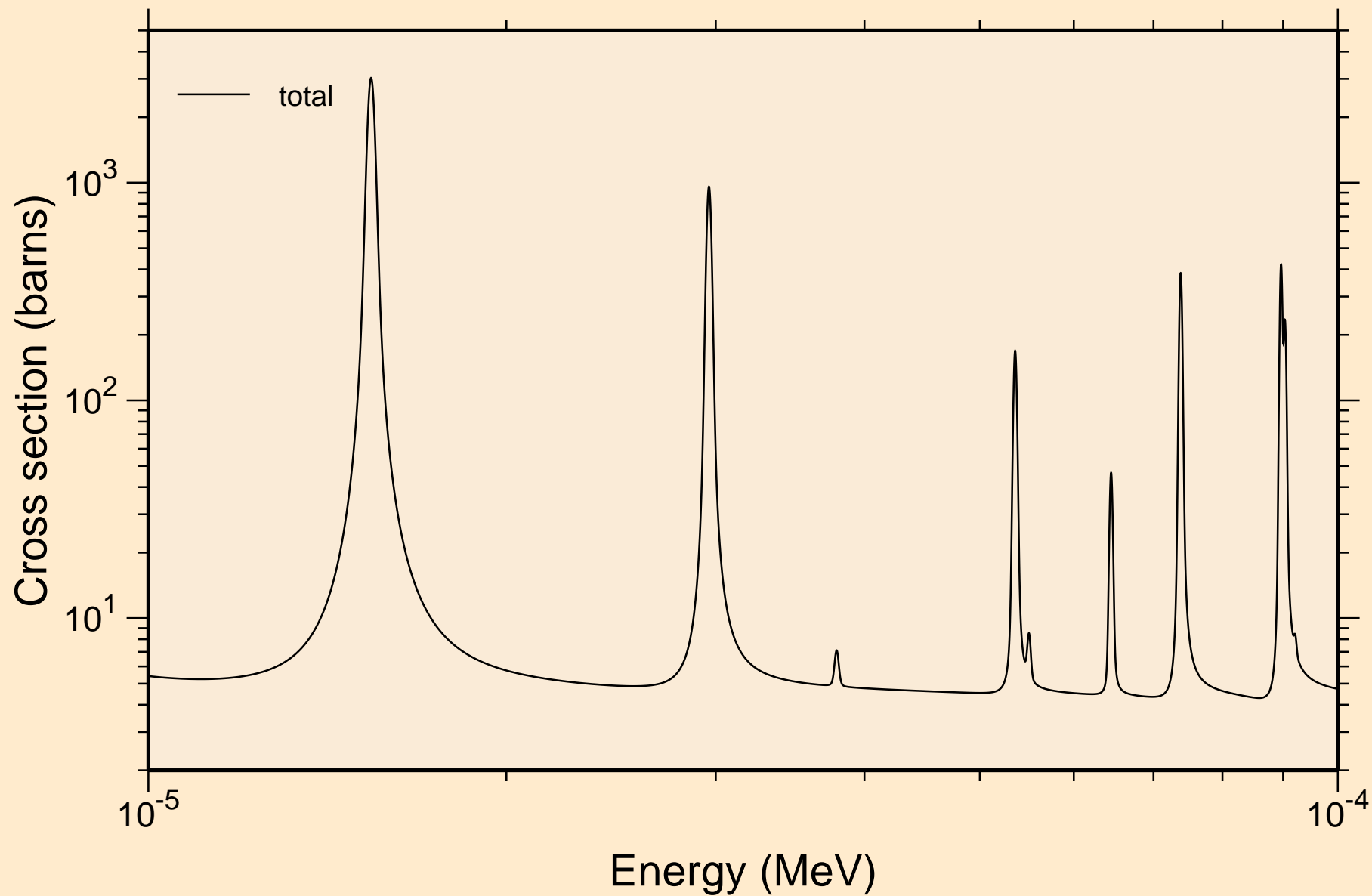

51-SB-121 FOR FENDL-3.2 FROM FENDL-3.2 WITH NJOY2016.60
resonance total cross section

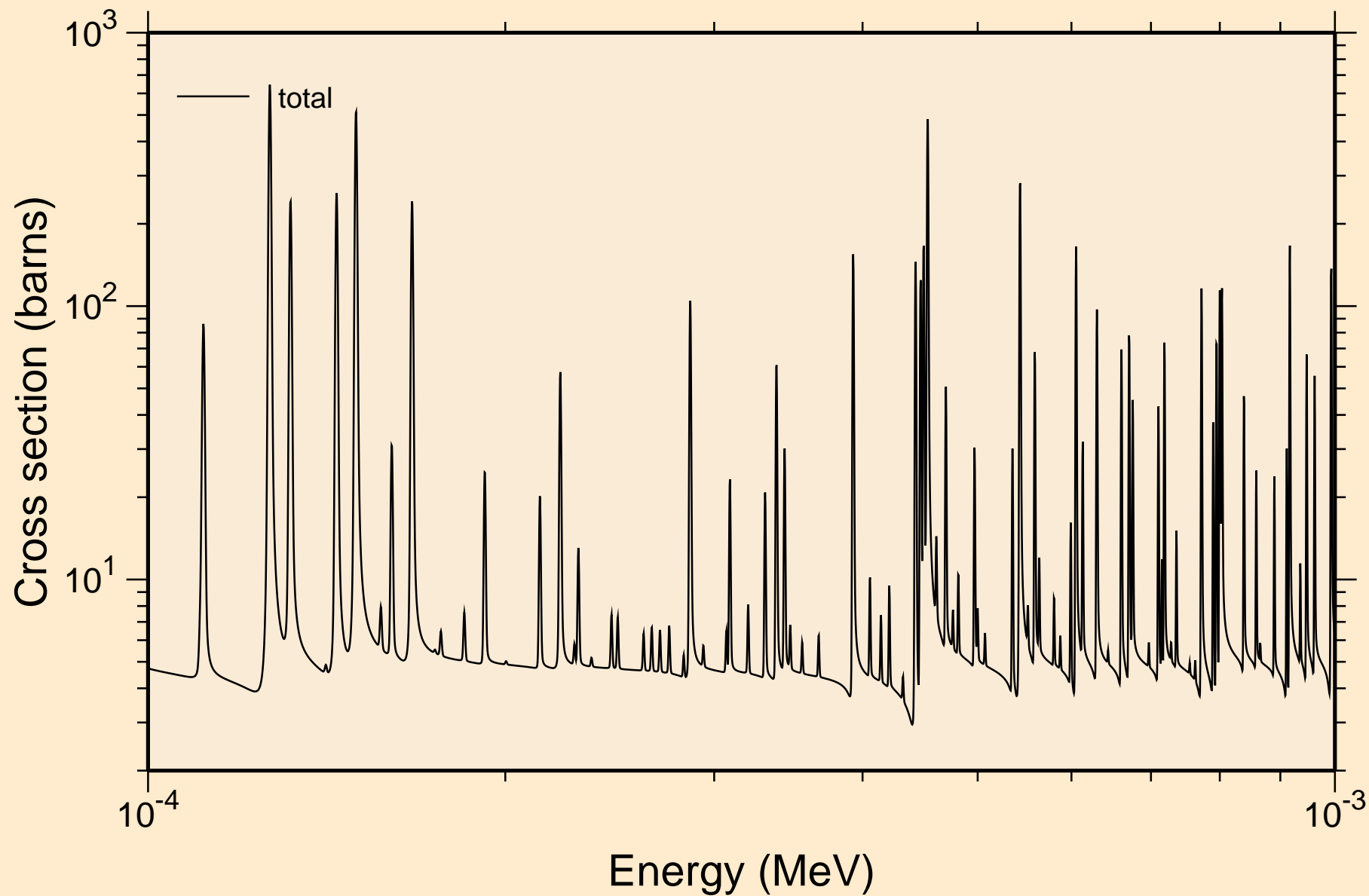

51-SB-121 FOR FENDL-3.2 FROM FENDL-3.2 WITH NJOY2016.60
resonance total cross section

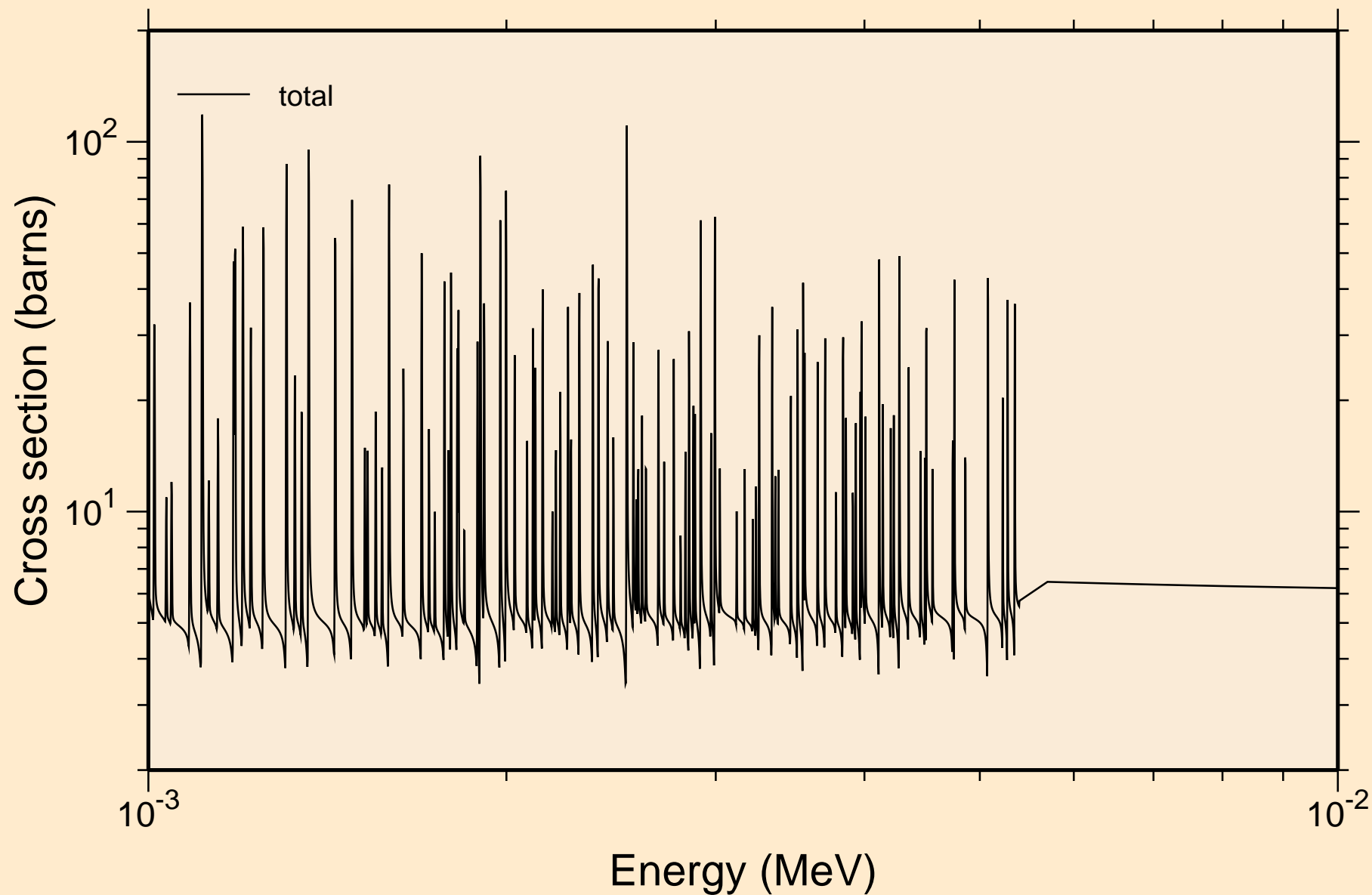

51-SB-121 FOR FENDL-3.2 FROM FENDL-3.2 WITH NJOY2016.60
resonance absorption cross sections

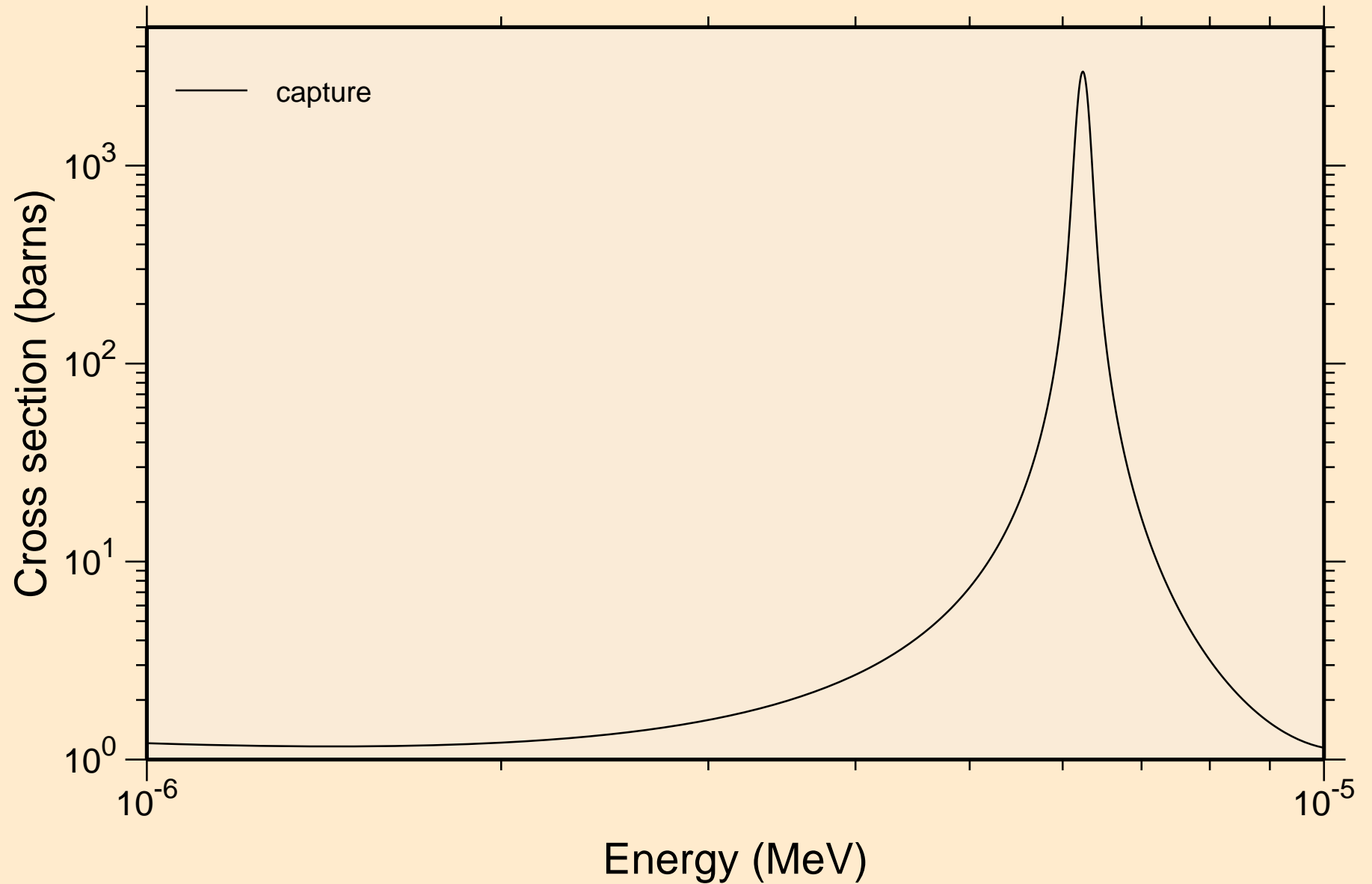

51-SB-121 FOR FENDL-3.2 FROM FENDL-3.2 WITH NJOY2016.60
resonance absorption cross sections

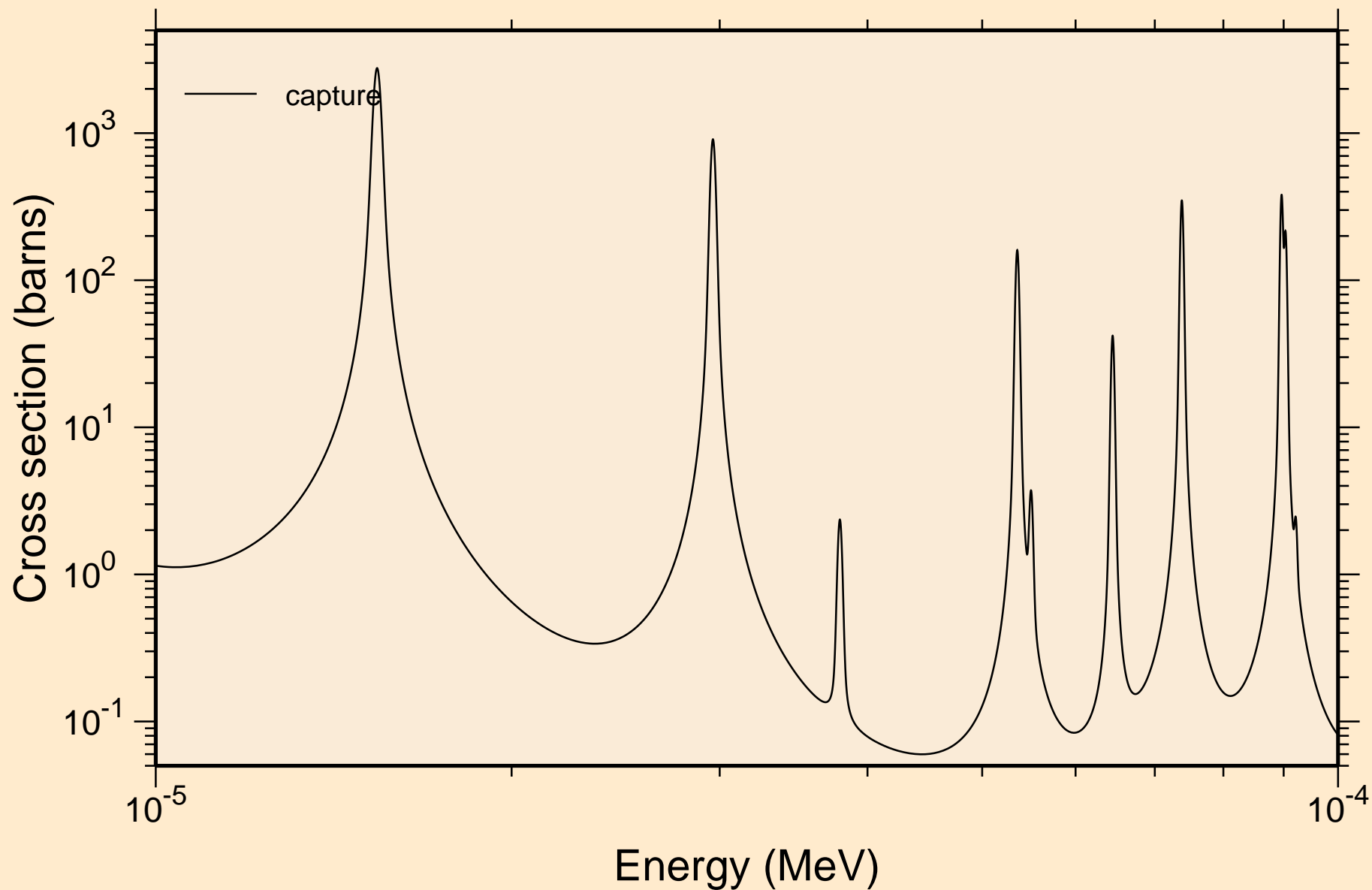

51-SB-121 FOR FENDL-3.2 FROM FENDL-3.2 WITH NJOY2016.60
resonance absorption cross sections

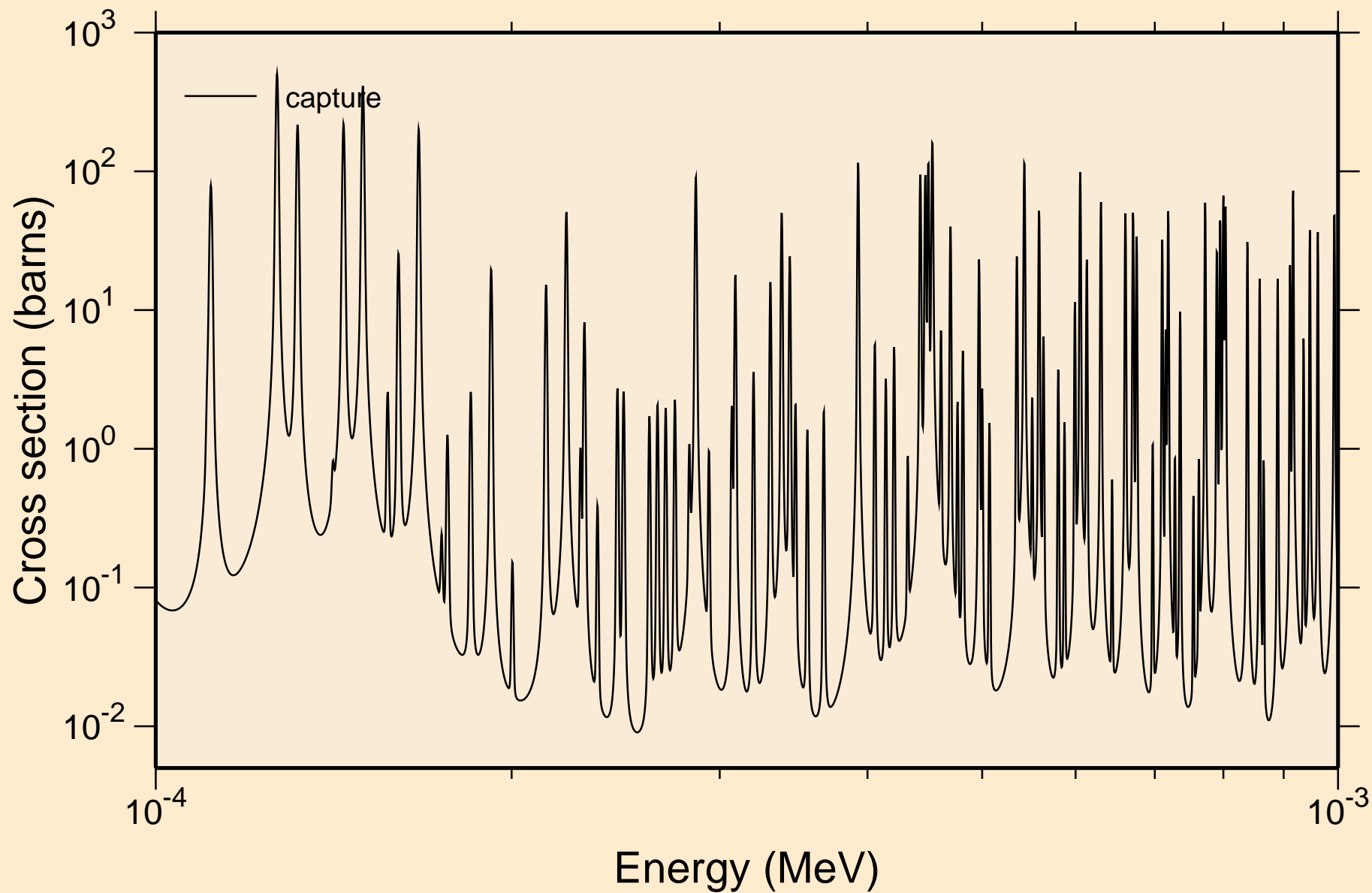

51-SB-121 FOR FENDL-3.2 FROM FENDL-3.2 WITH NJOY2016.60
resonance absorption cross sections

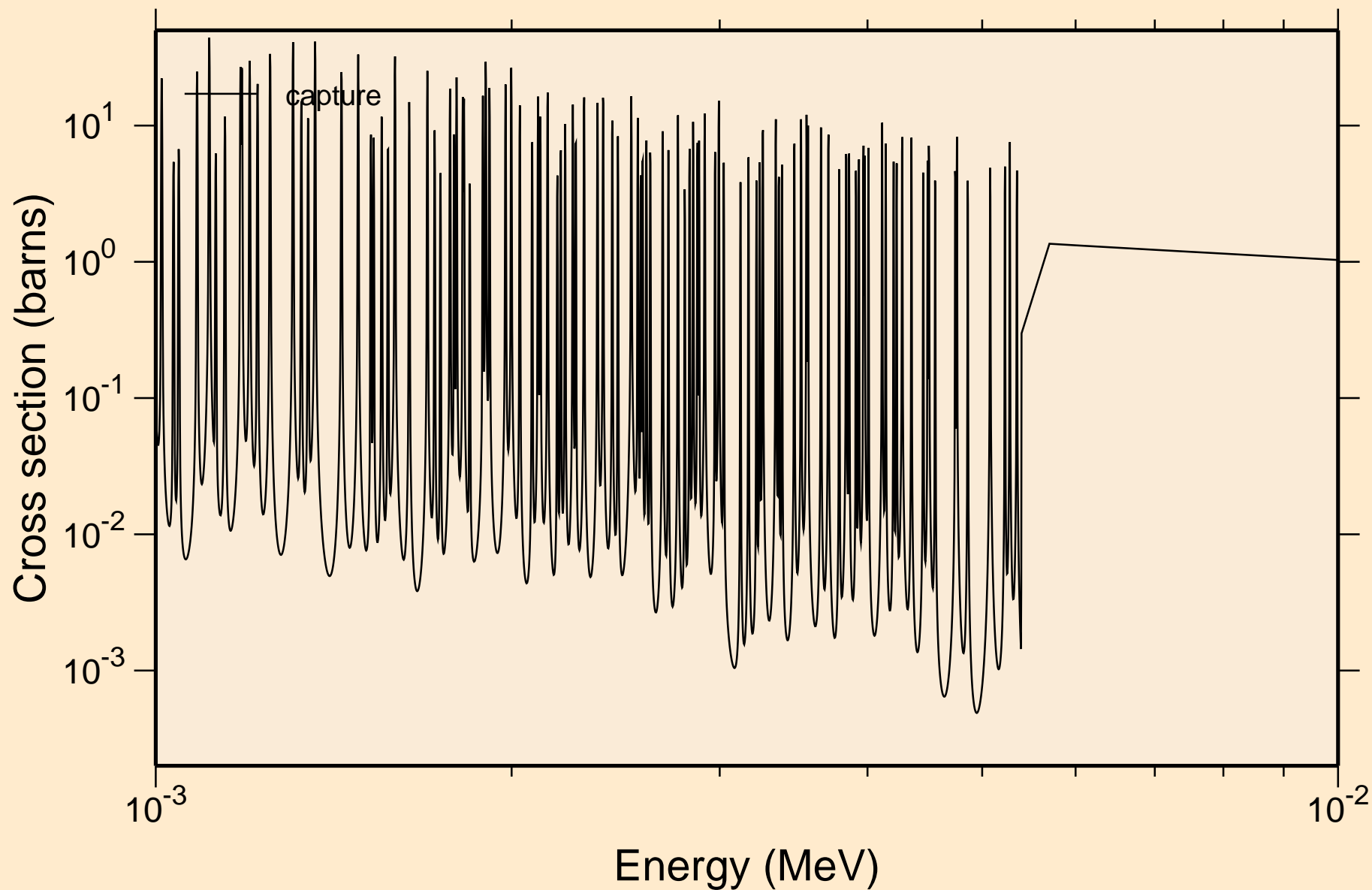

51-SB-121 FOR FENDL-3.2 FROM FENDL-3.2 WITH NJOY2016.60
resonance absorption cross sections

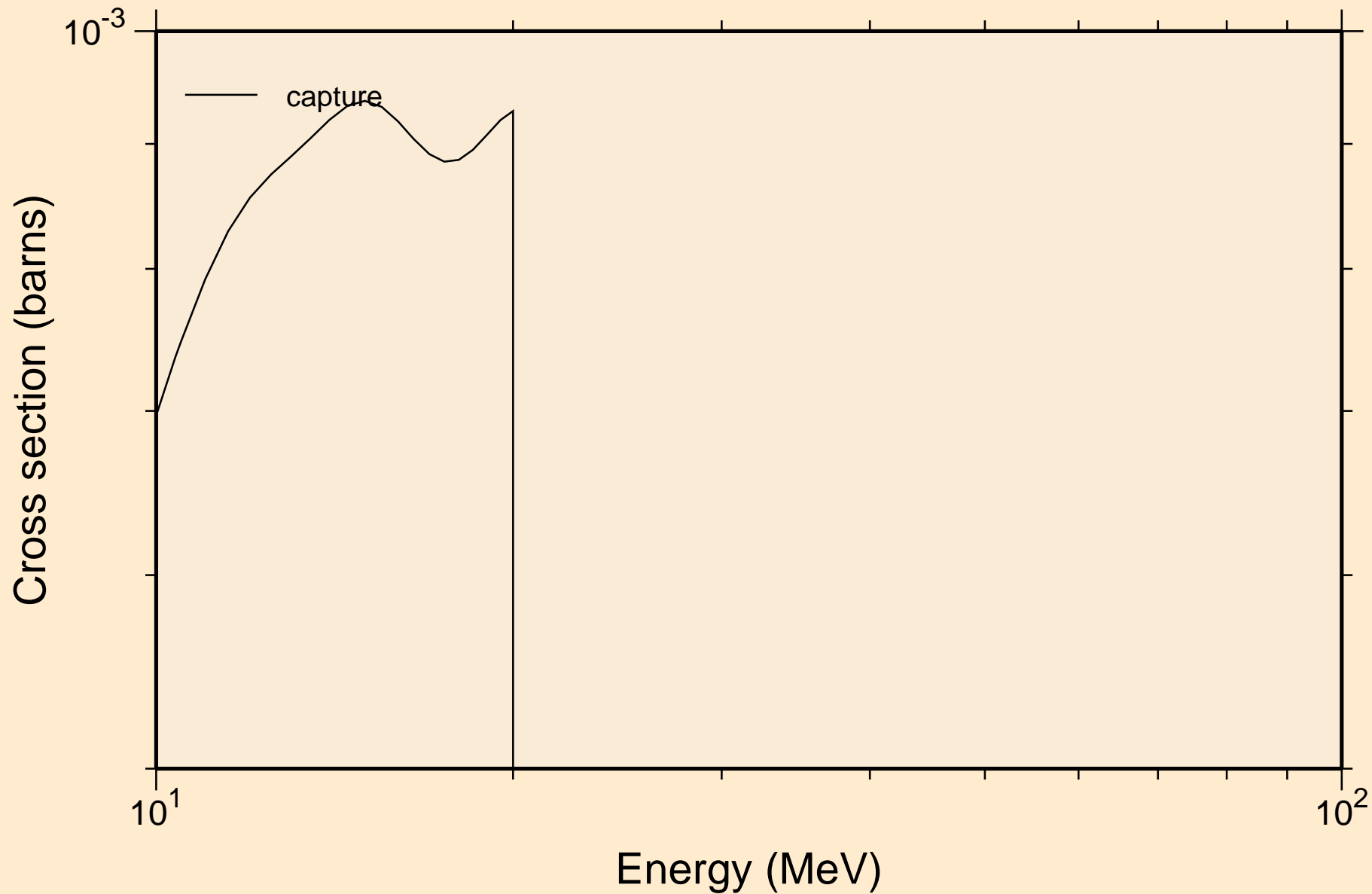

51-SB-121 FOR FENDL-3.2 FROM FENDL-3.2 WITH NJOY2016.60
UR total cross section

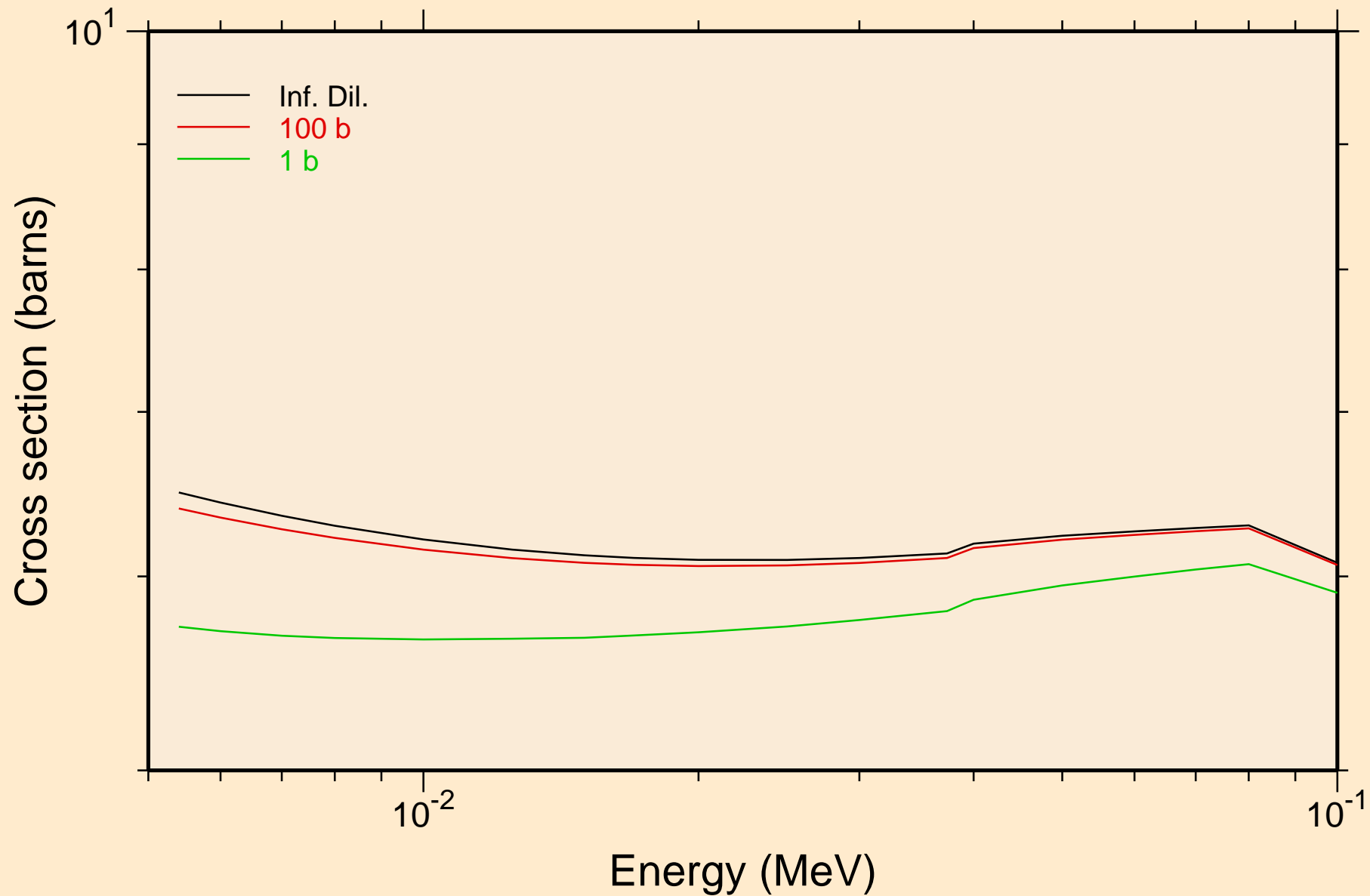

51-SB-121 FOR FENDL-3.2 FROM FENDL-3.2 WITH NJOY2016.60
UR elastic cross section

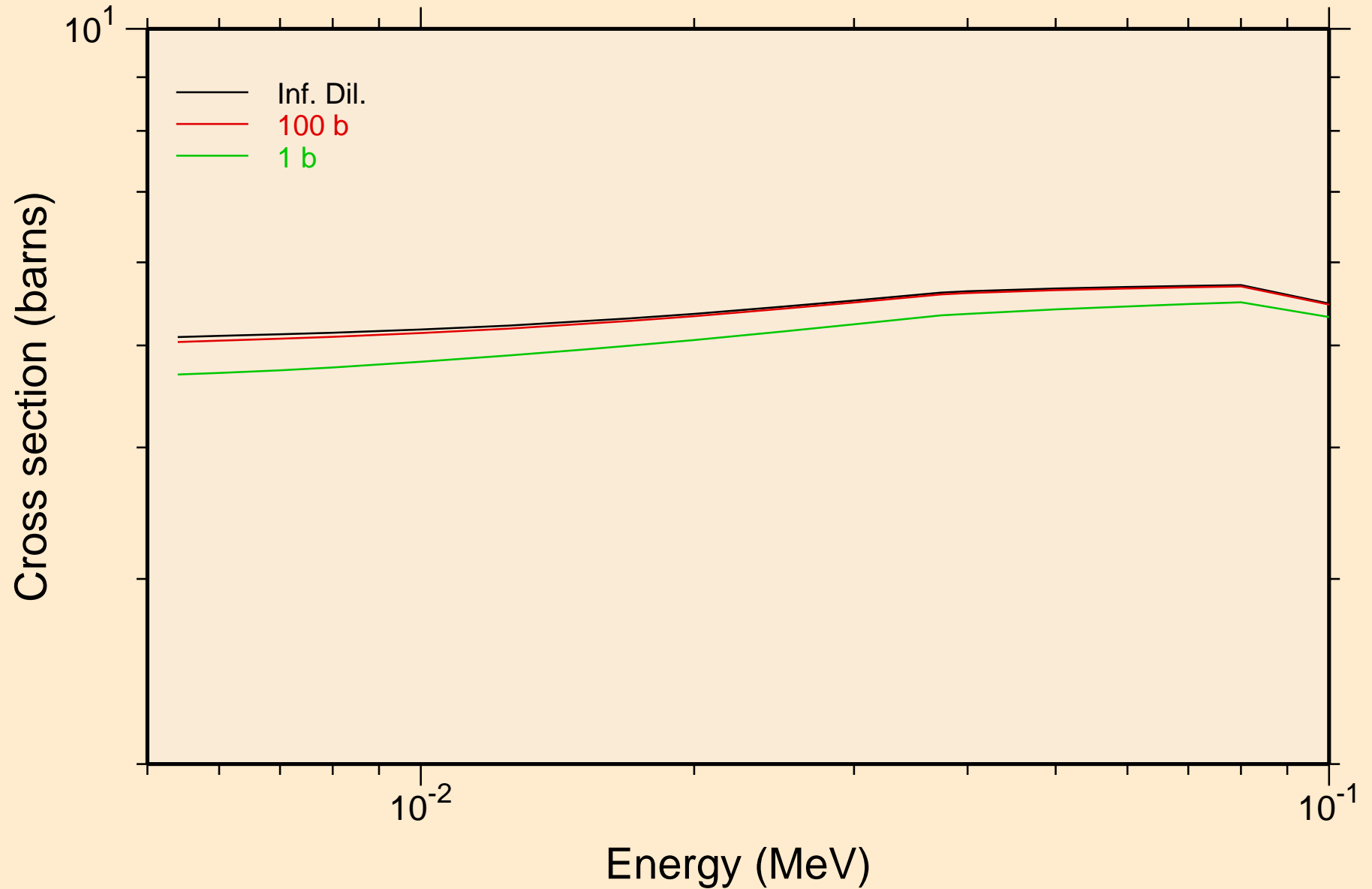

51-SB-121 FOR FENDL-3.2 FROM FENDL-3.2 WITH NJOY2016.60
UR capture cross section

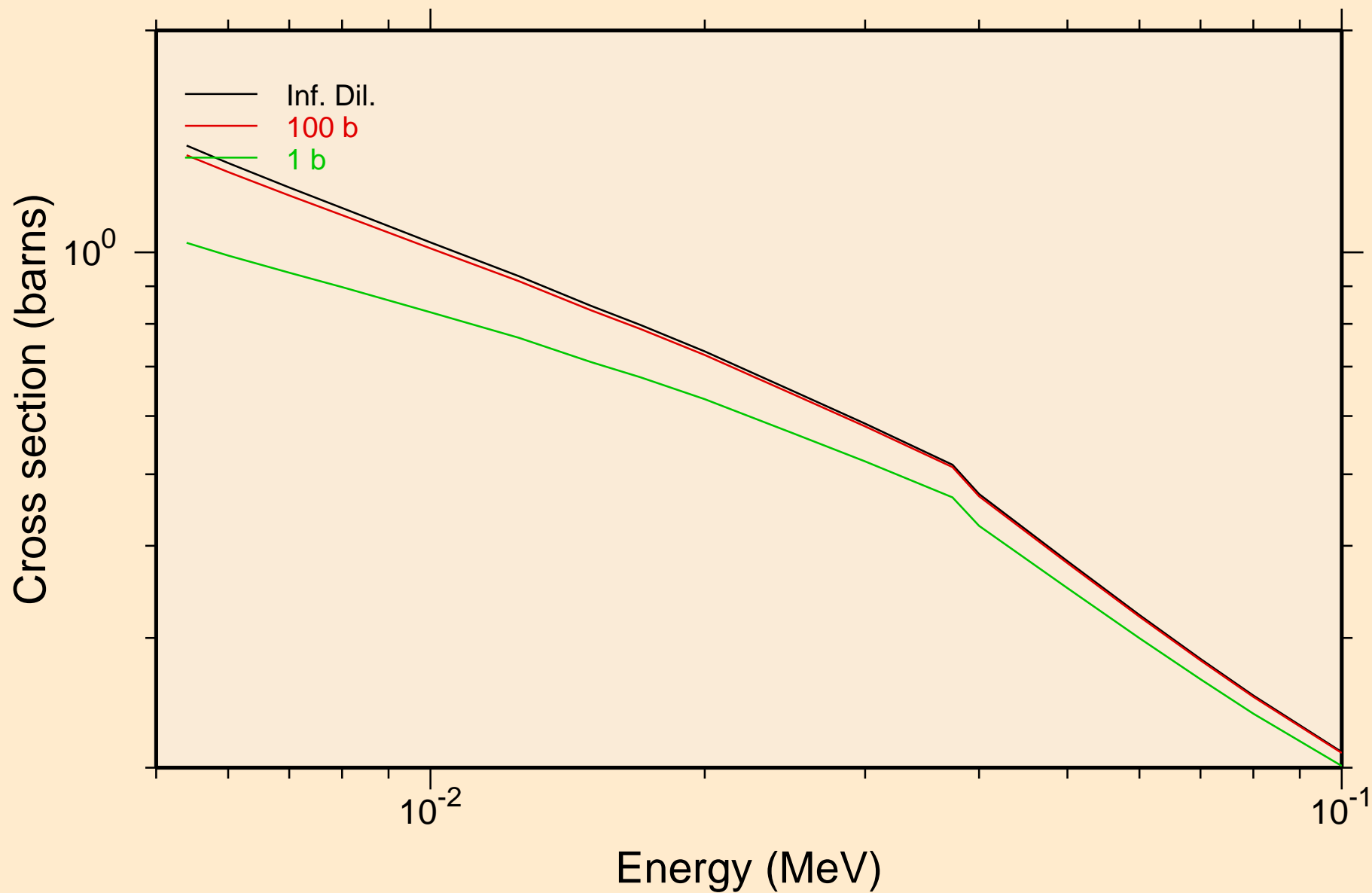

51-SB-121 FOR FENDL-3.2 FROM FENDL-3.2 WITH NJOY2016.60
Heating

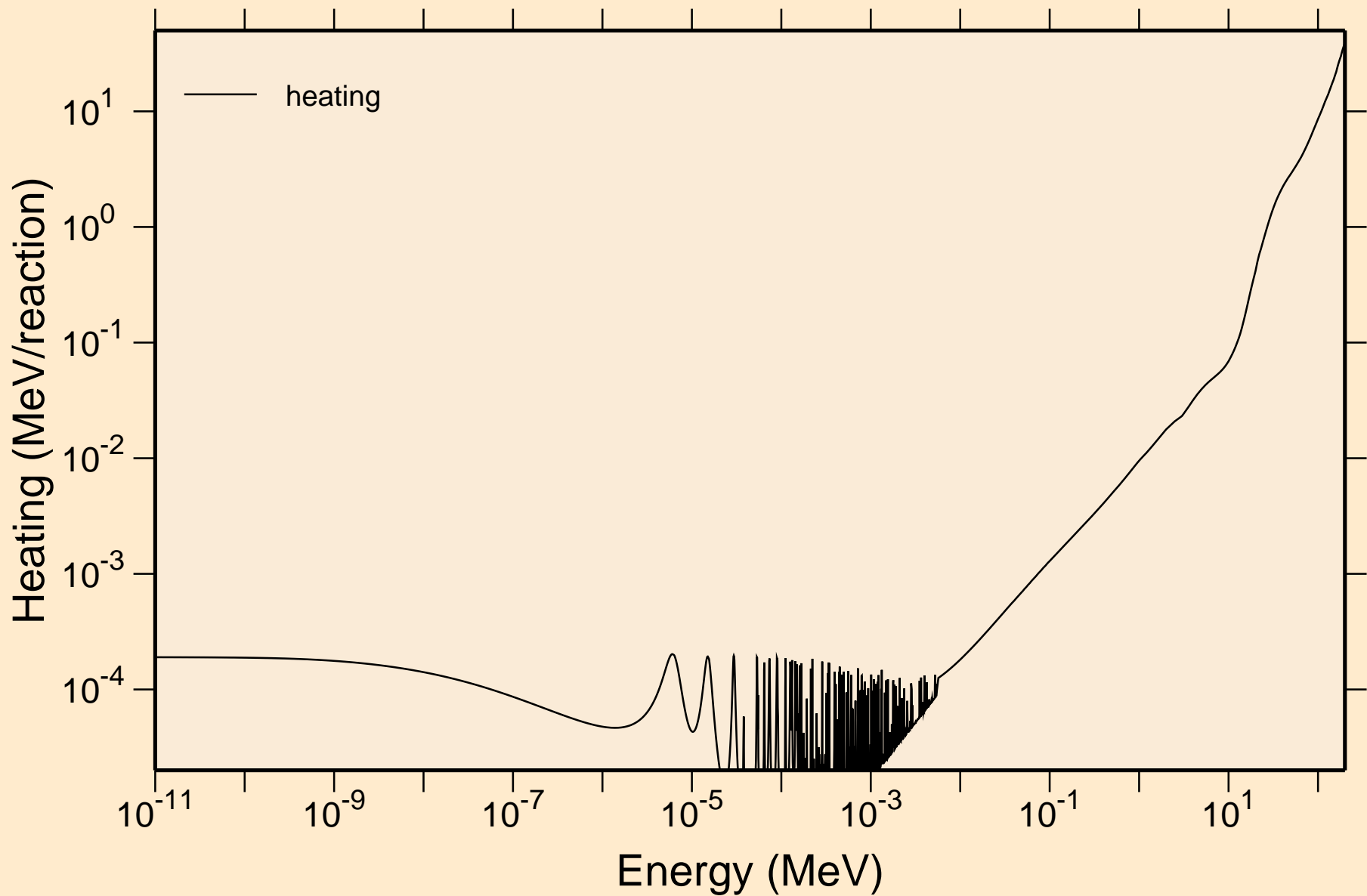

51-SB-121 FOR FENDL-3.2 FROM FENDL-3.2 WITH NJOY2016.60 Damage

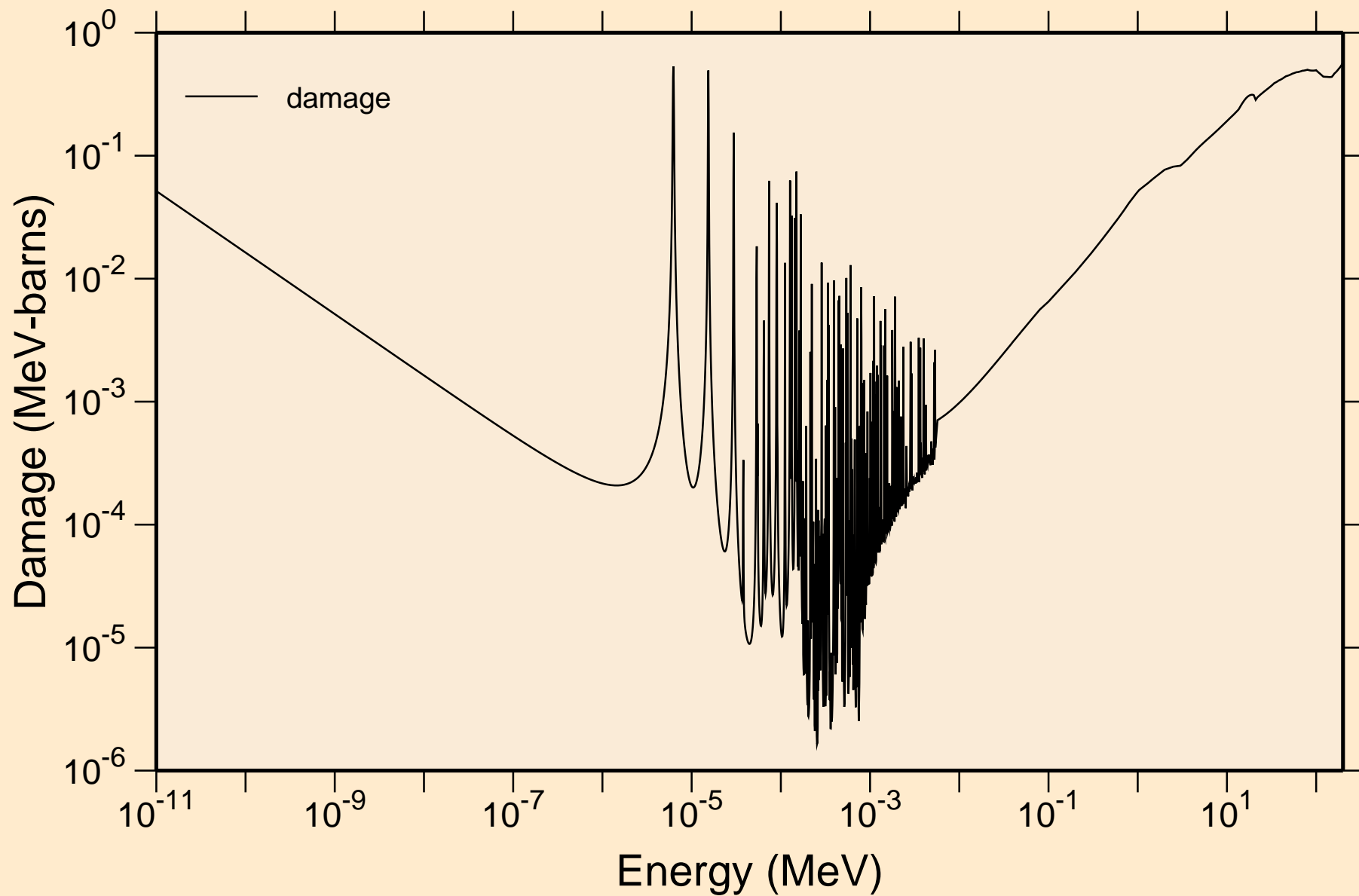

51-SB-121 FOR FENDL-3.2 FROM FENDL-3.2 WITH NJOY2016.60
Non-threshold reactions

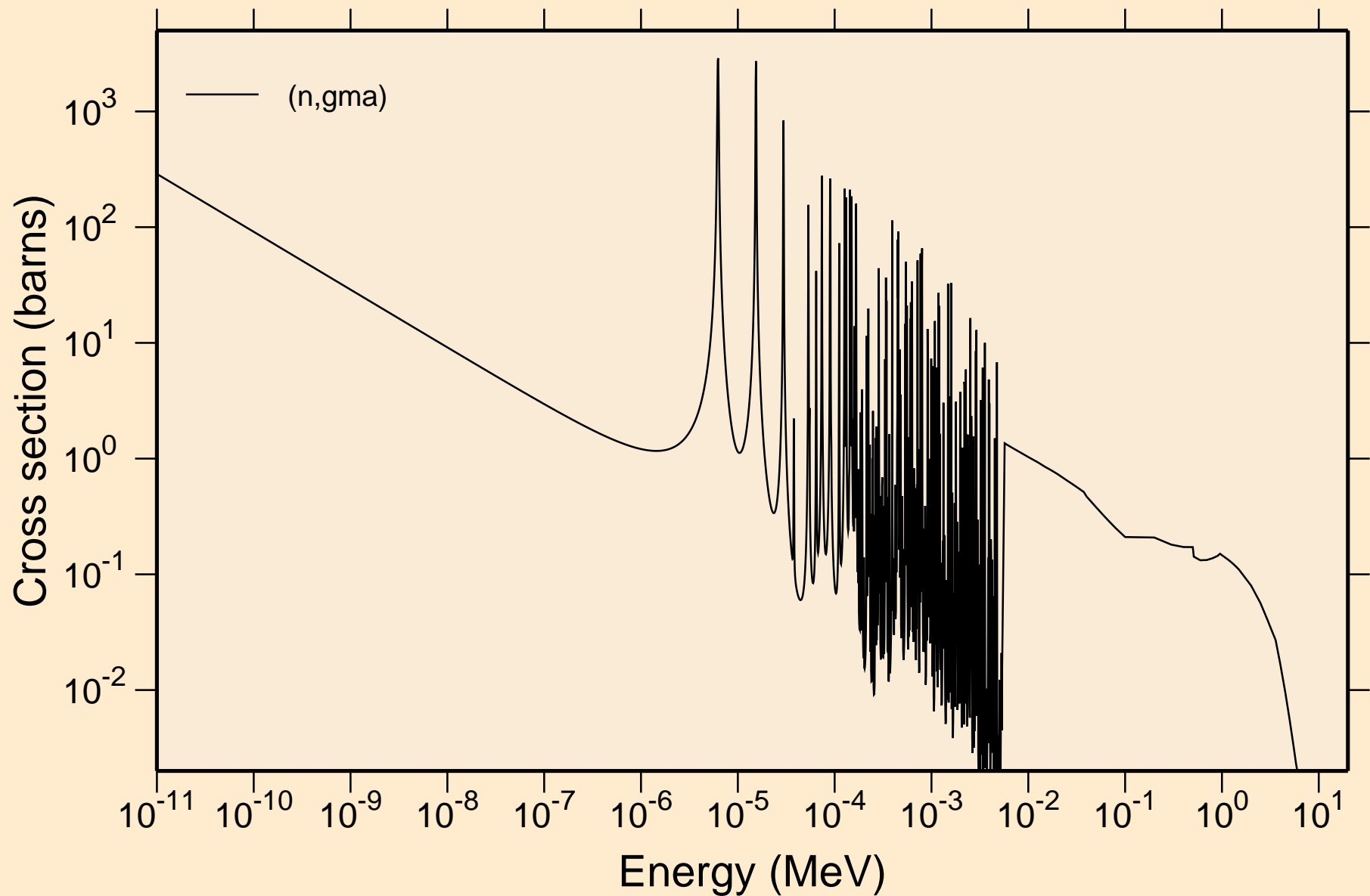

51-SB-121 FOR FENDL-3.2 FROM FENDL-3.2 WITH NJOY2016.60

Principal cross sections

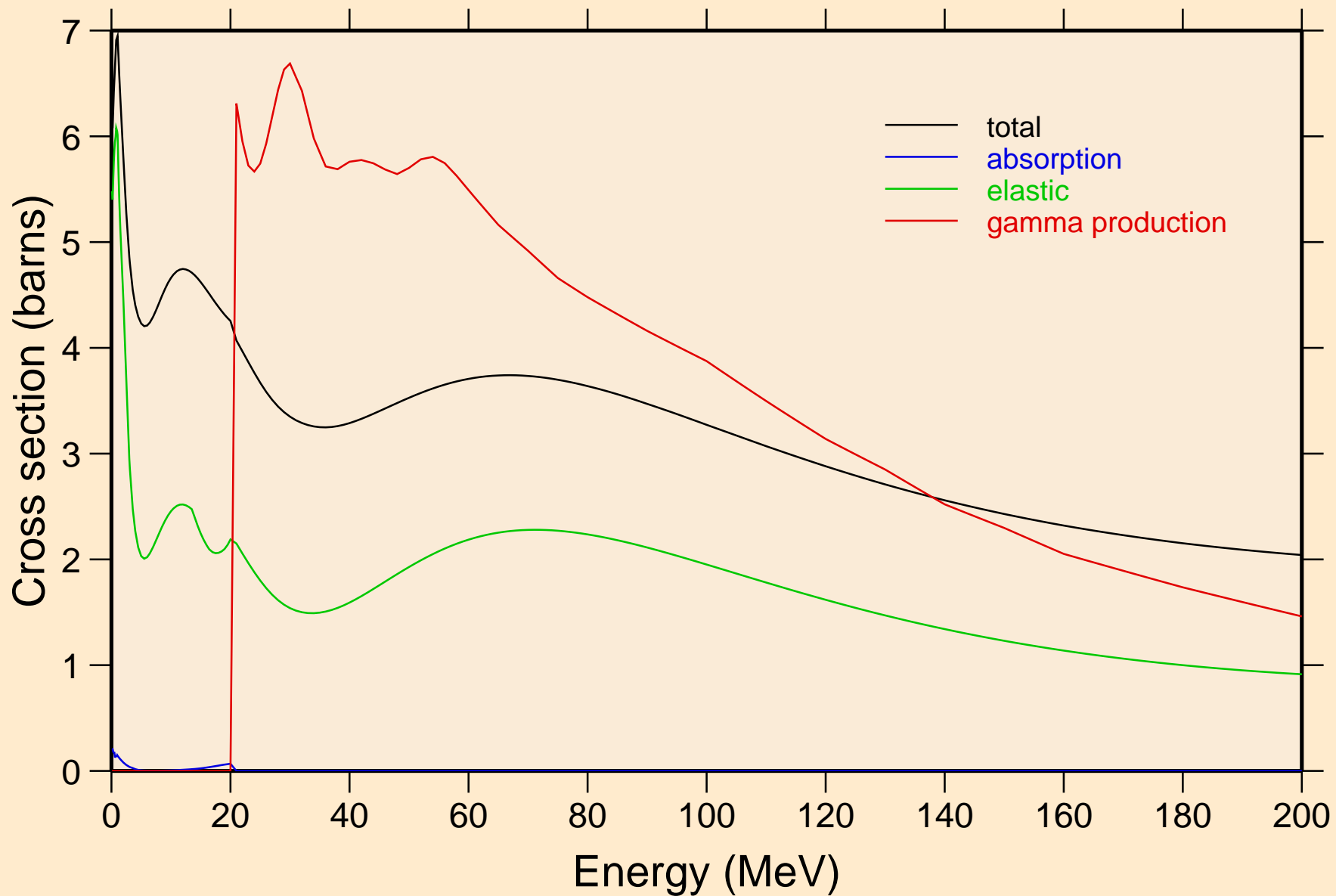

51-SB-121 FOR FENDL-3.2 FROM FENDL-3.2 WITH NJOY2016.60

Heating

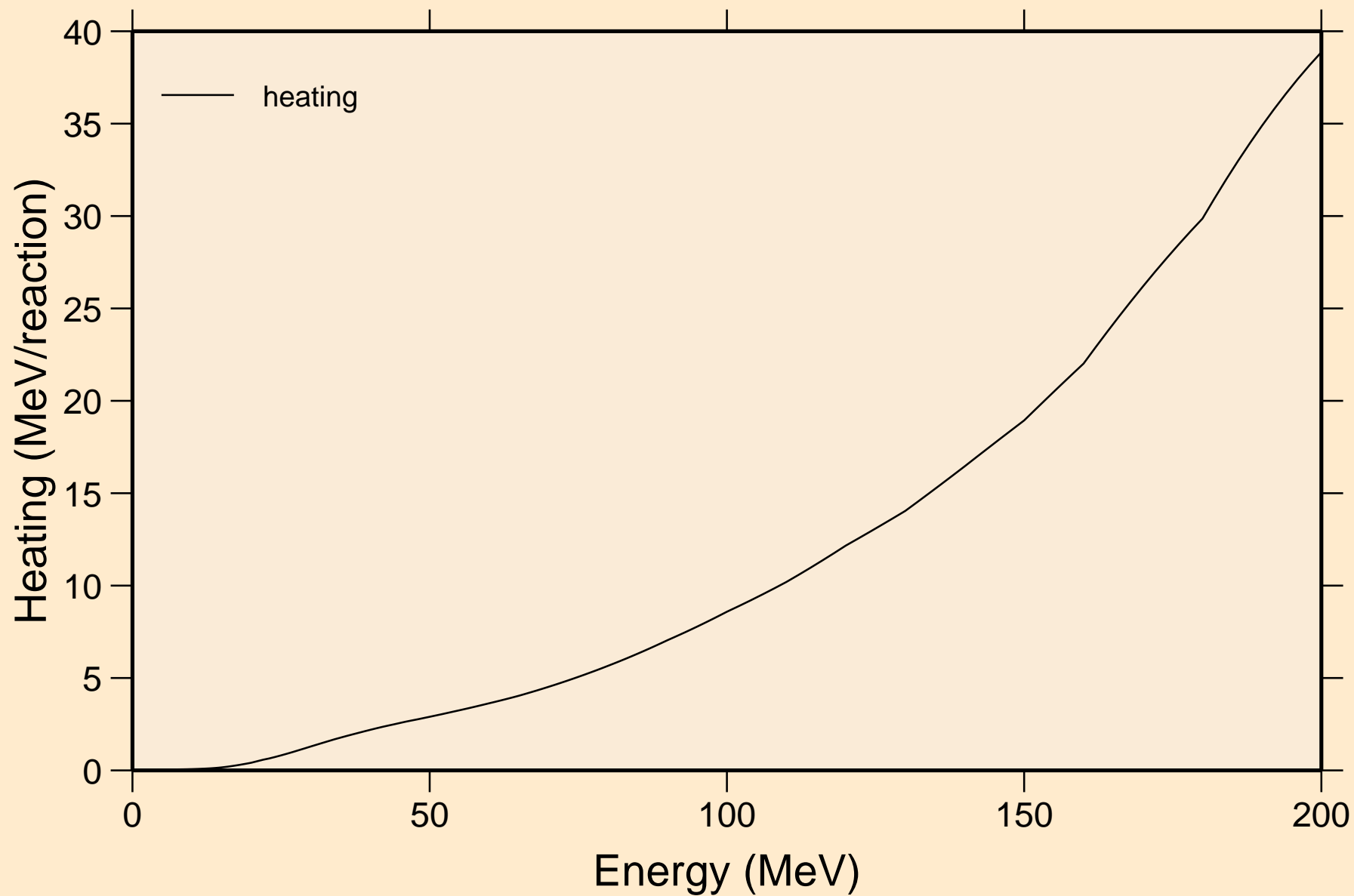

51-SB-121 FOR FENDL-3.2 FROM FENDL-3.2 WITH NJOY2016.60 Damage

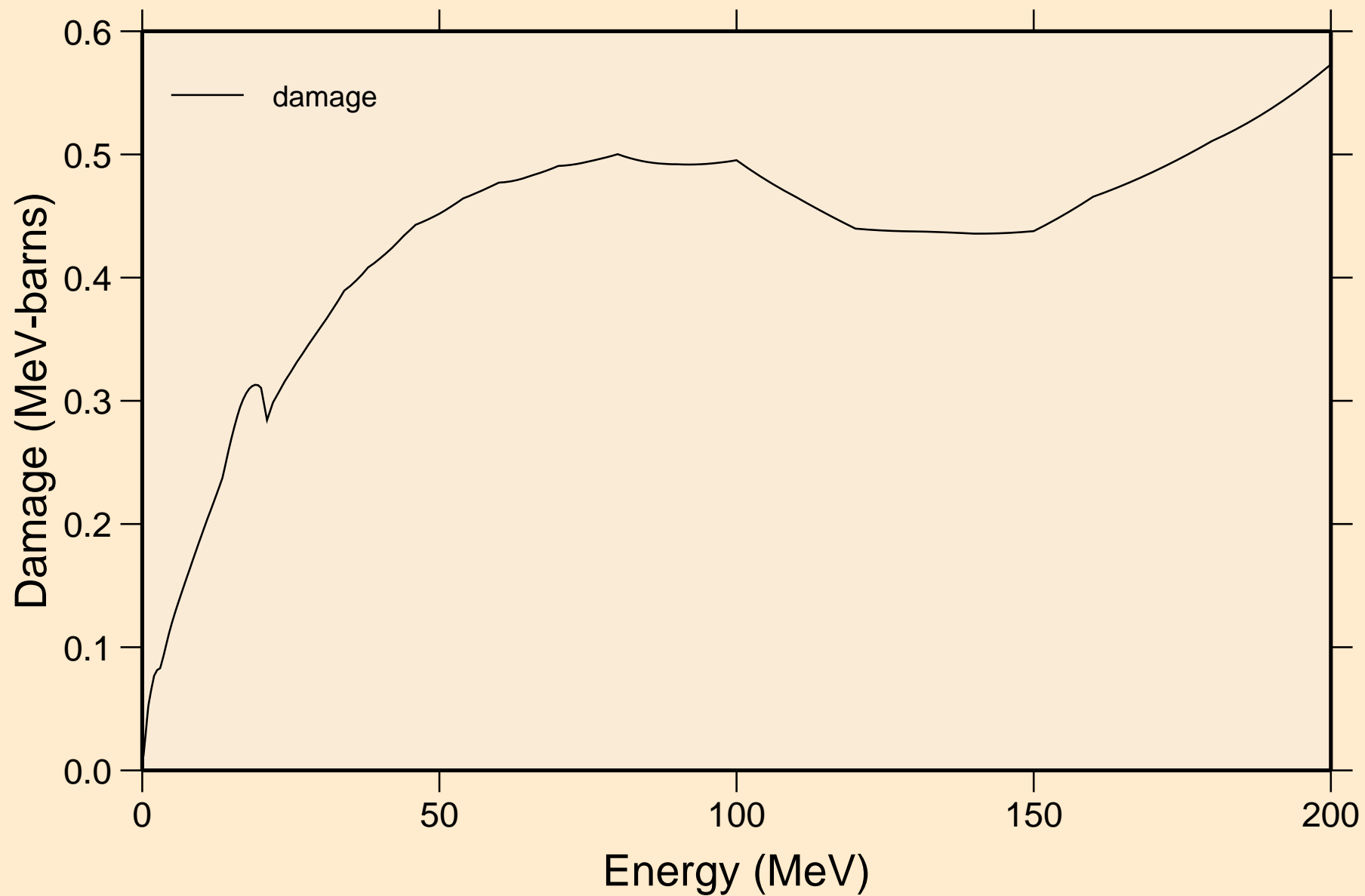

51-SB-121 FOR FENDL-3.2 FROM FENDL-3.2 WITH NJOY2016.60
Non-threshold reactions

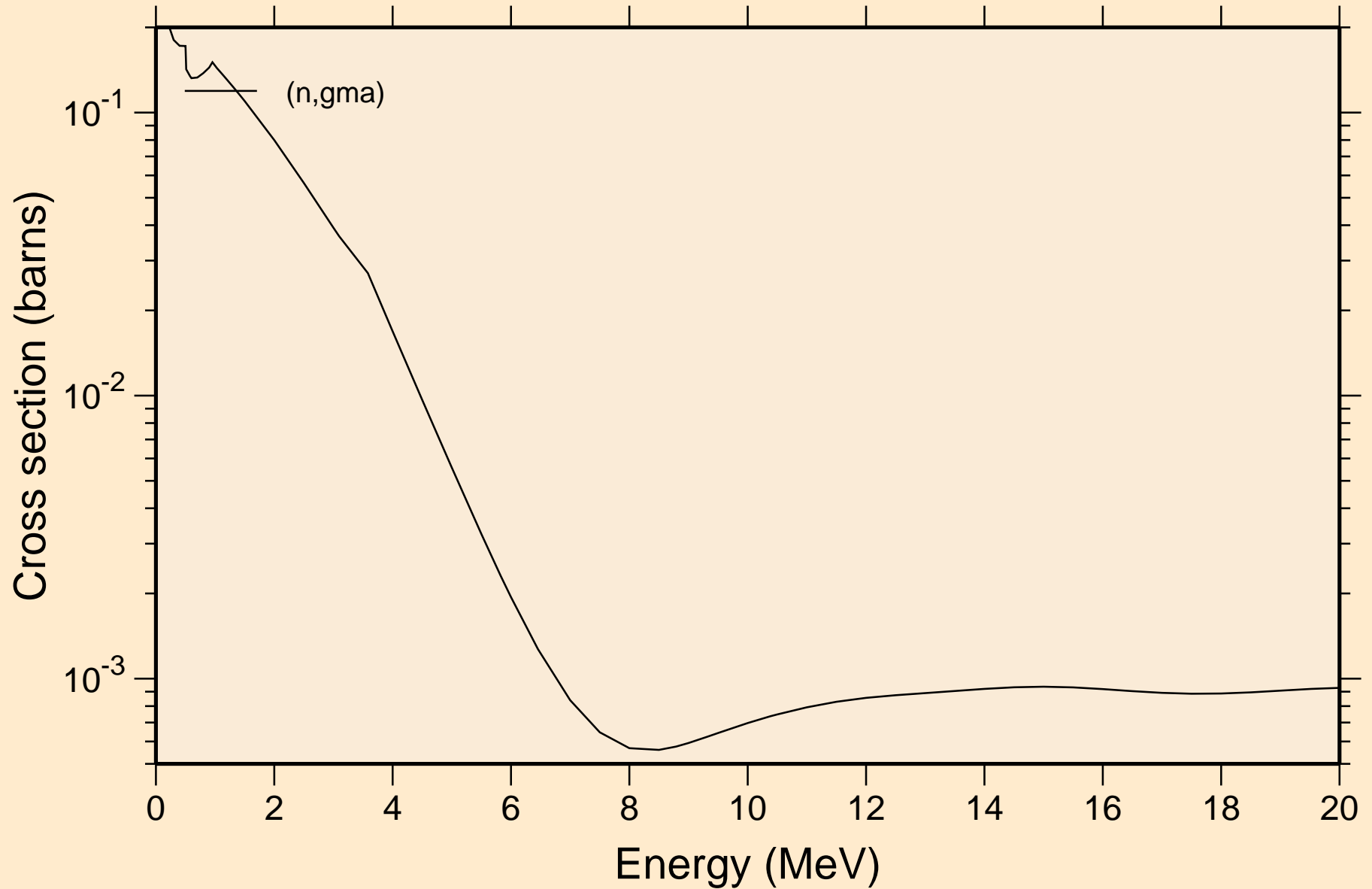

51-SB-121 FOR FENDL-3.2 FROM FENDL-3.2 WITH NJOY2016.60
Inelastic levels

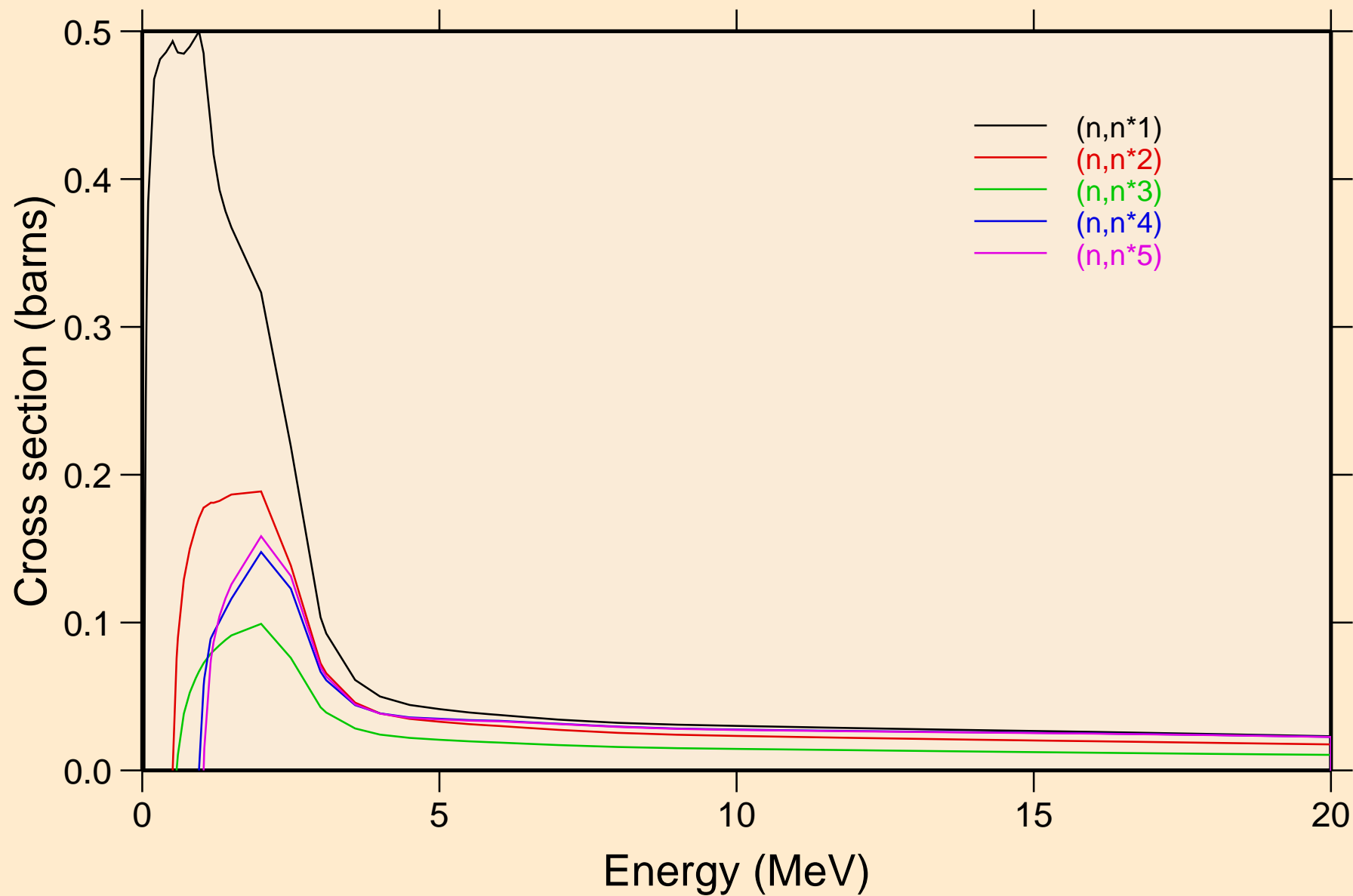

51-SB-121 FOR FENDL-3.2 FROM FENDL-3.2 WITH NJOY2016.60
Inelastic levels

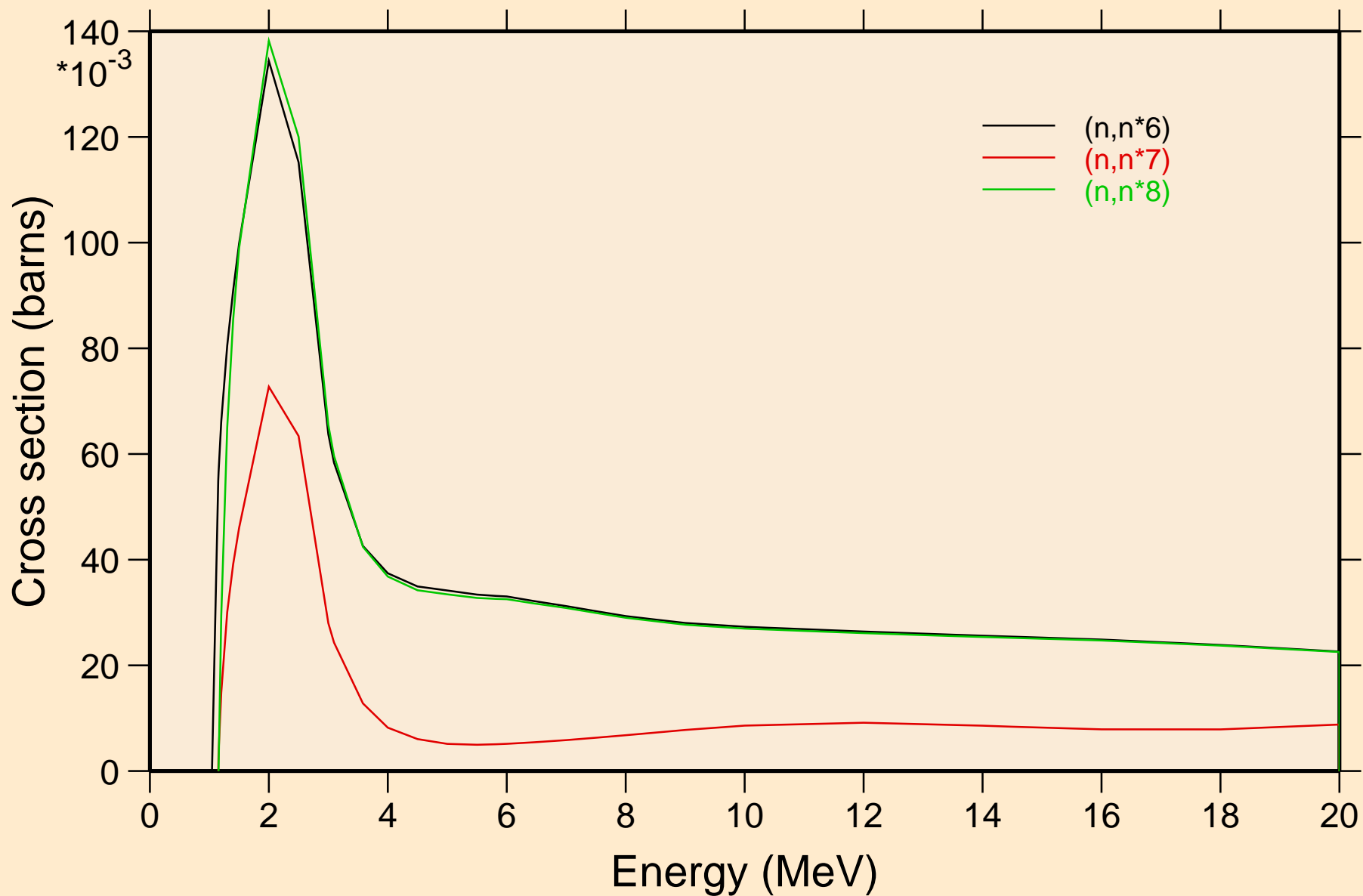

51-SB-121 FOR FENDL-3.2 FROM FENDL-3.2 WITH NJOY2016.60
Threshold reactions

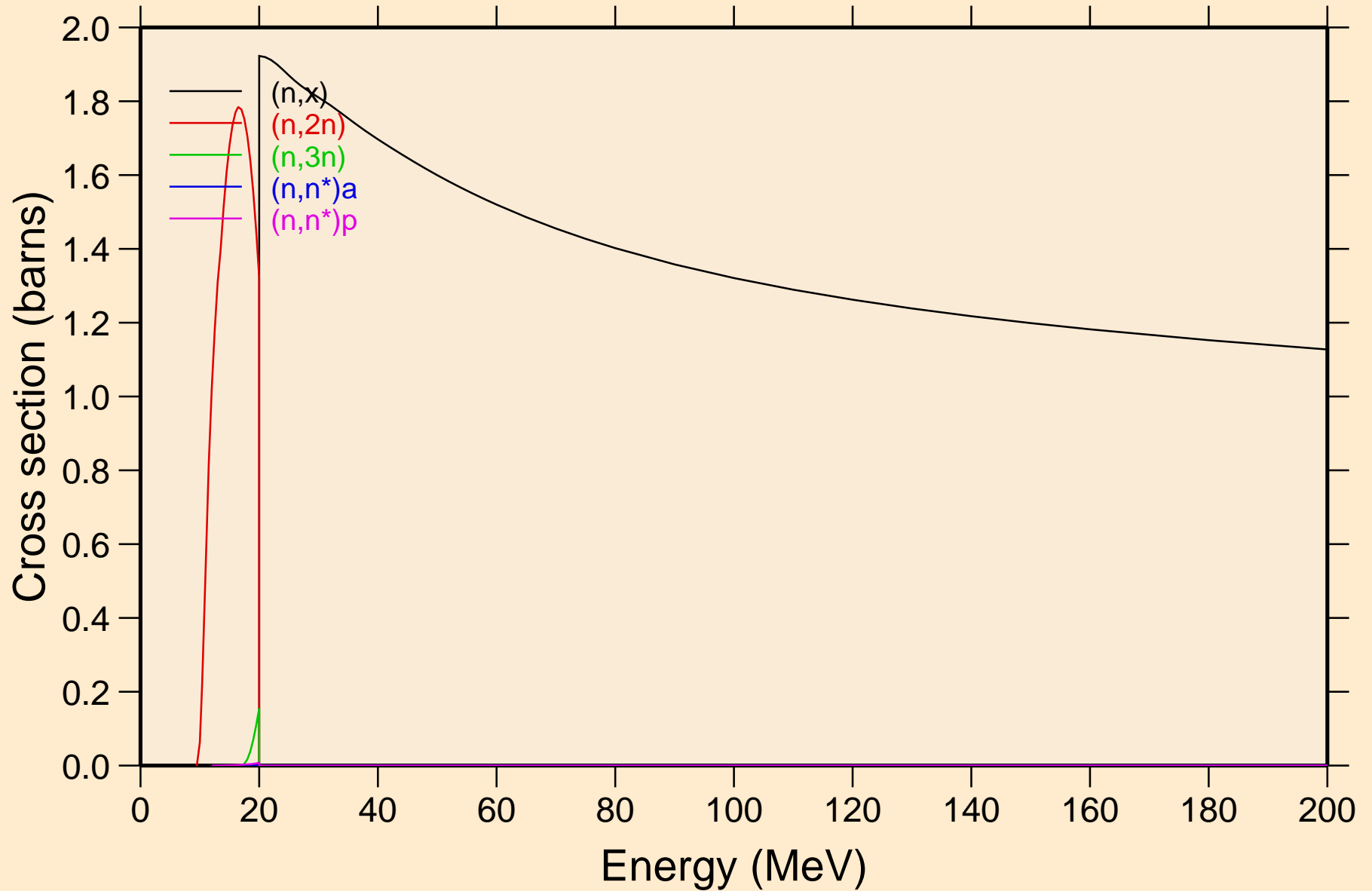

51-SB-121 FOR FENDL-3.2 FROM FENDL-3.2 WITH NJOY2016.60
Threshold reactions

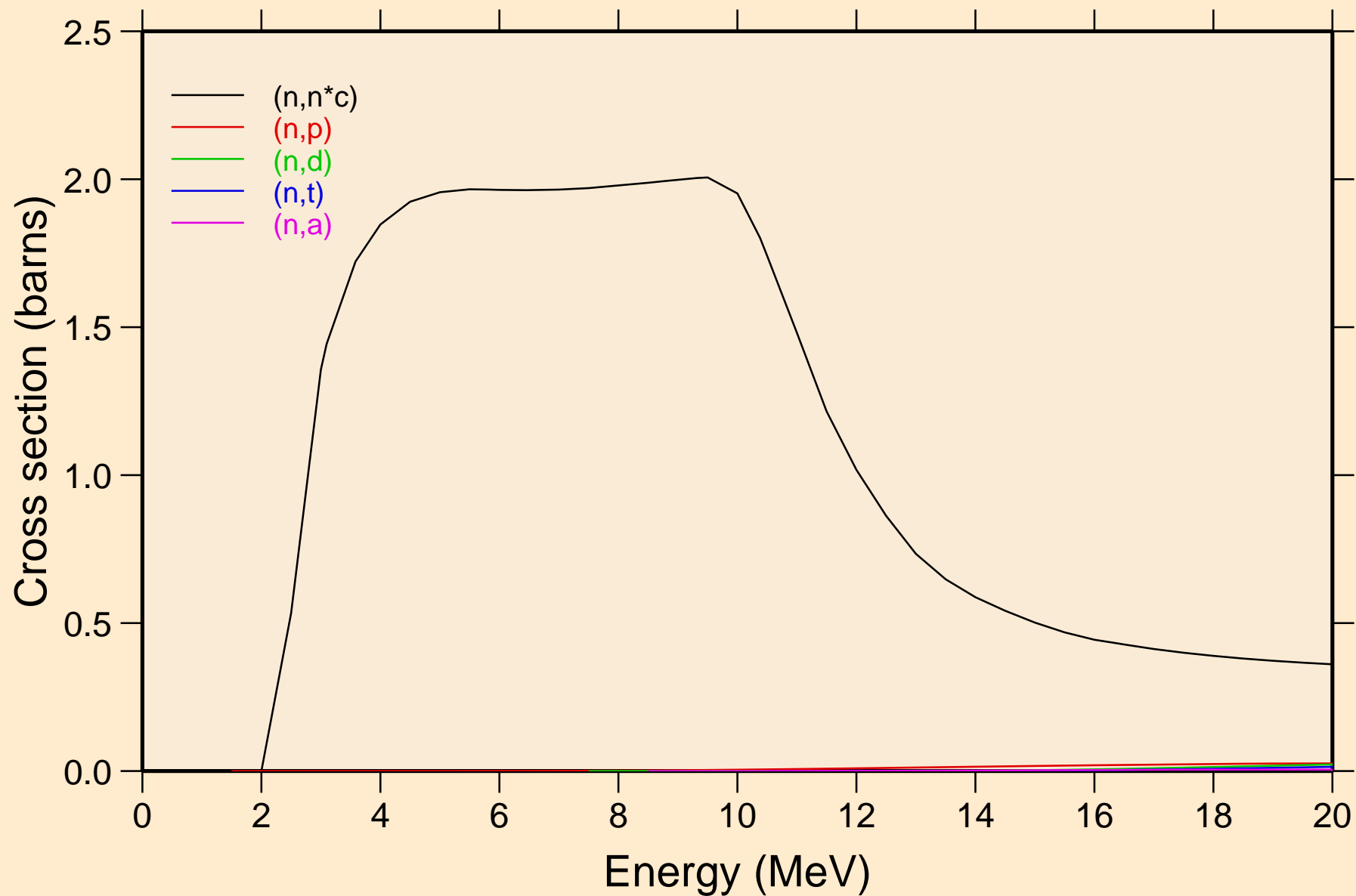

51-SB-121 FOR FENDL-3.2 FROM FENDL-3.2 WITH NJOY2016.60
Threshold reactions

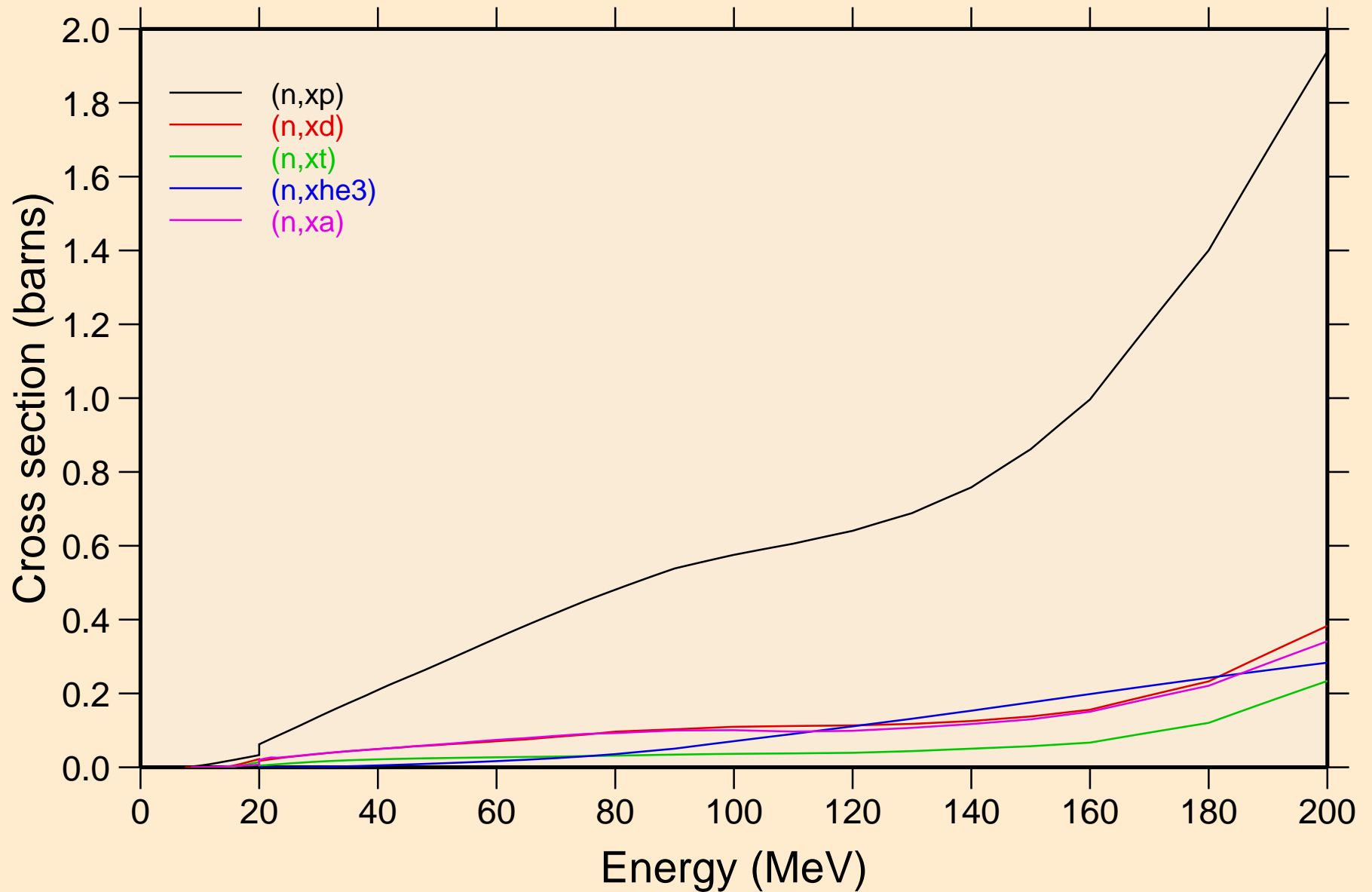

51-SB-121 FOR FENDL-3.2 FROM FENDL-3.2 WITH NJOY2016.60
angular distribution for elastic

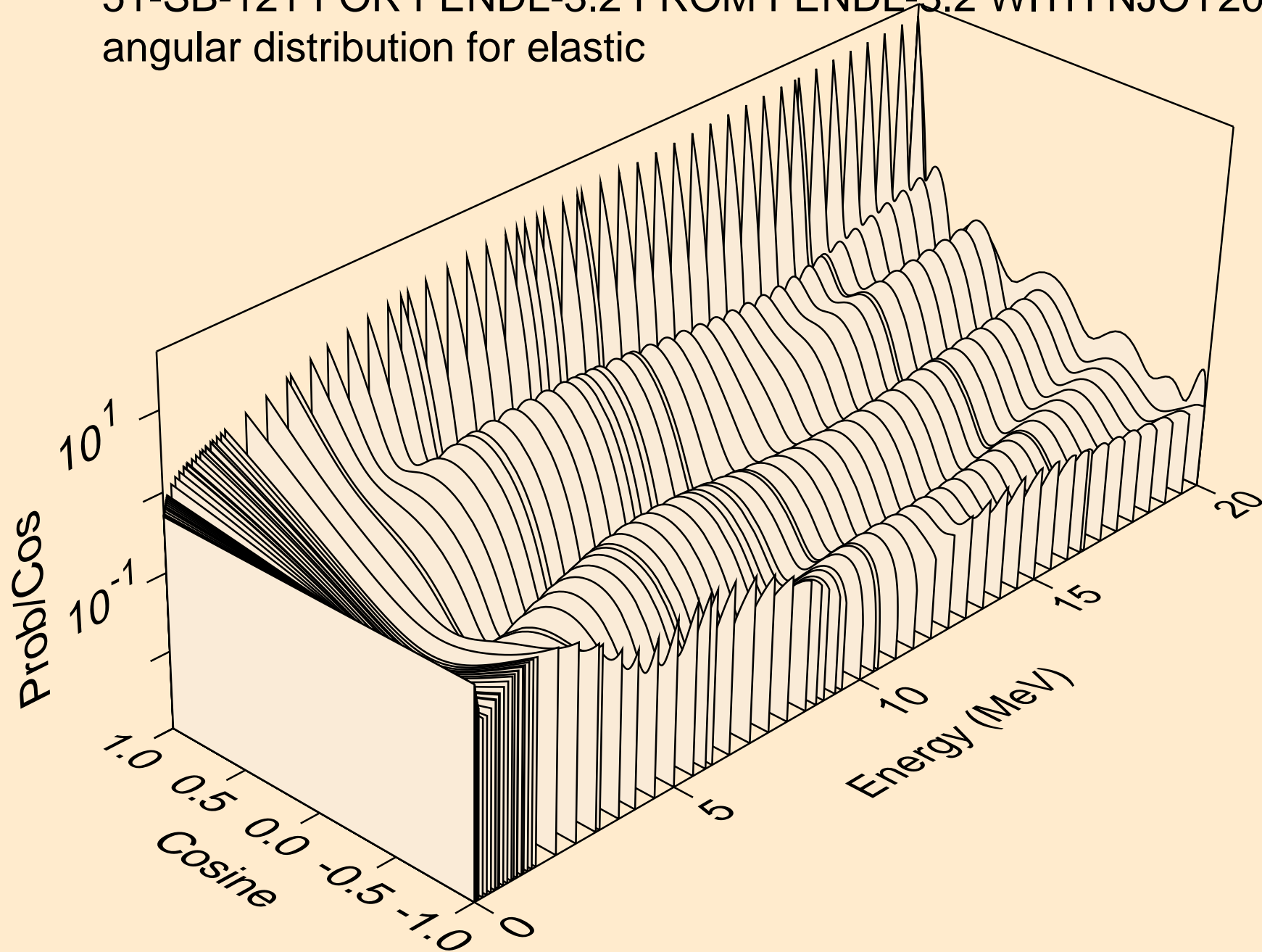

51-SB-121 FOR FENDL-3.2 FROM FENDL-3.2 WITH NJOY2016.60
angular distribution for elastic

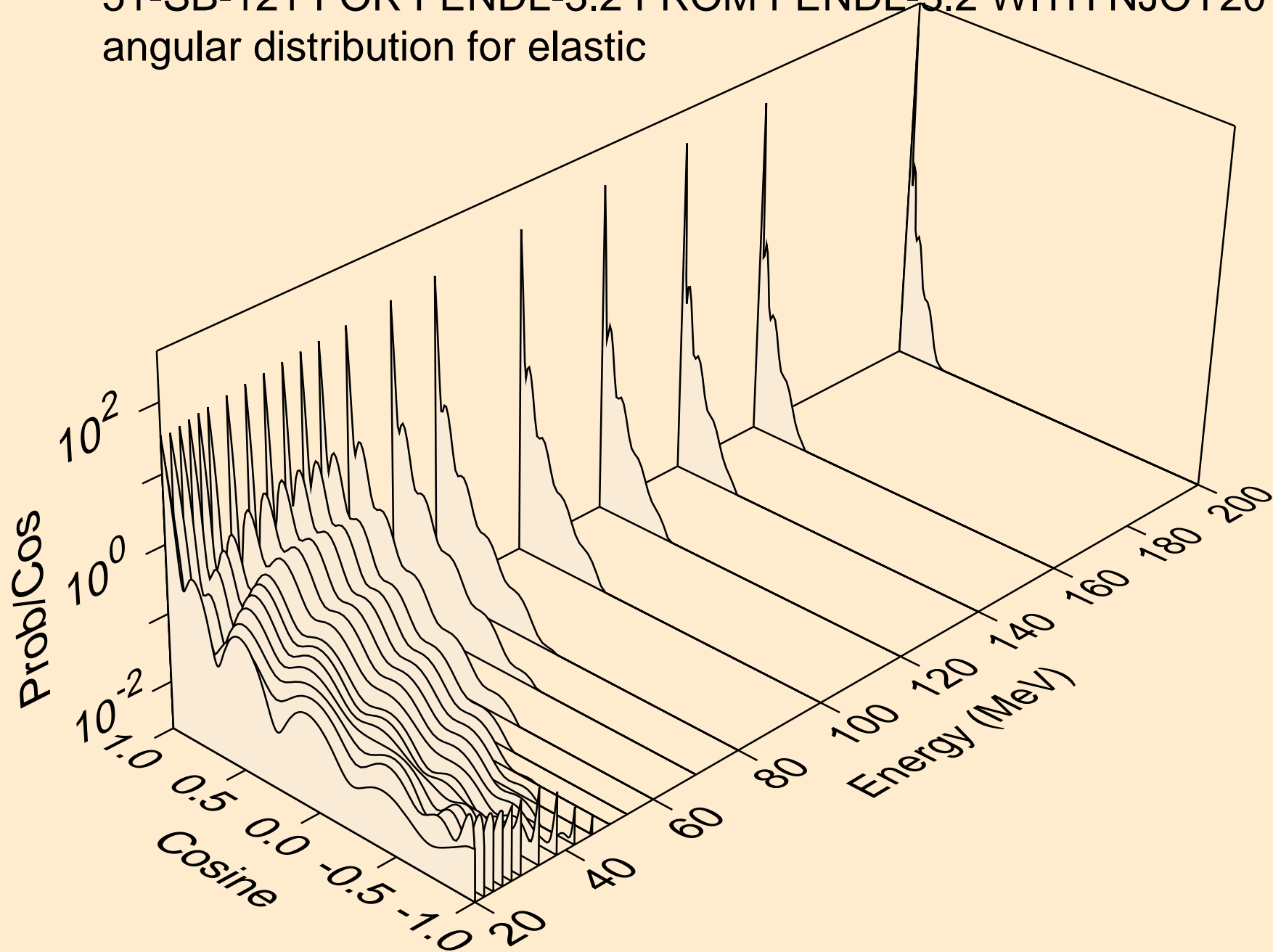

51-SB-121 FOR FENDL-3.2 FROM FENDL-3.2 WITH NJOY2016.60
angular distribution for (n,2n)

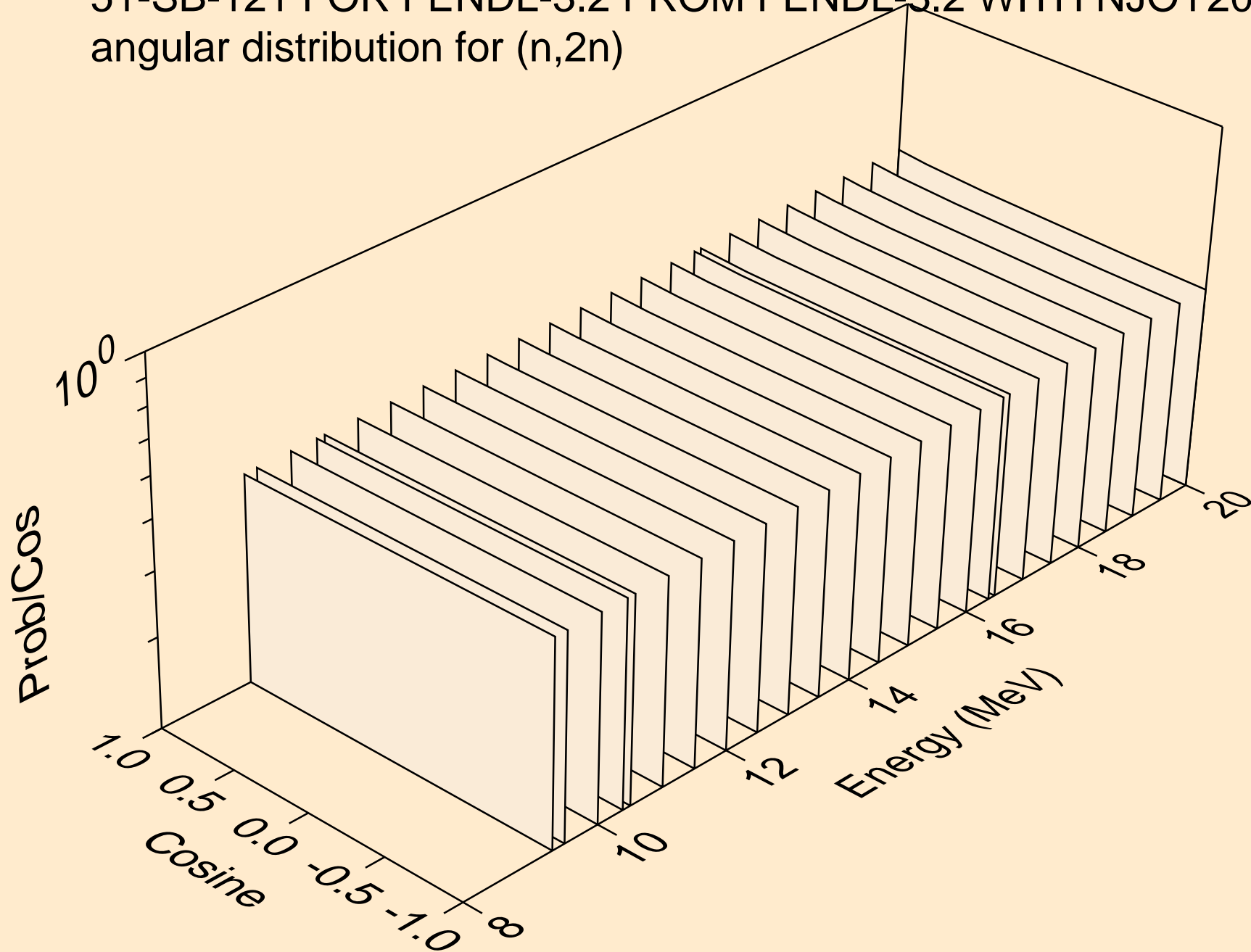

51-SB-121 FOR FENDL-3.2 FROM FENDL-3.2 WITH NJOY2016.60
angular distribution for (n,3n)

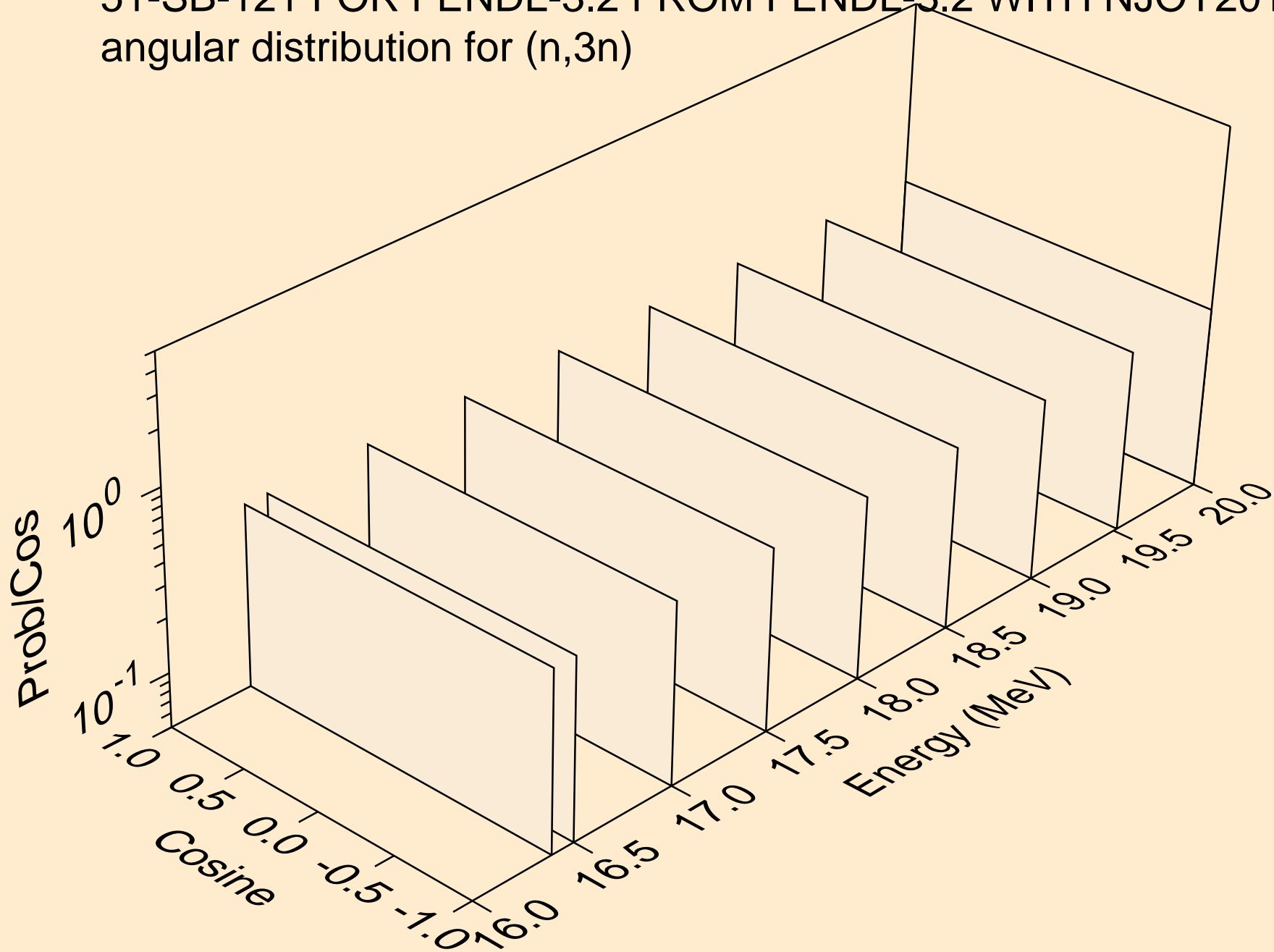

51-SB-121 FOR FENDL-3.2 FROM FENDL-3.2 WITH NJOY2016.60
angular distribution for (n,n*)a

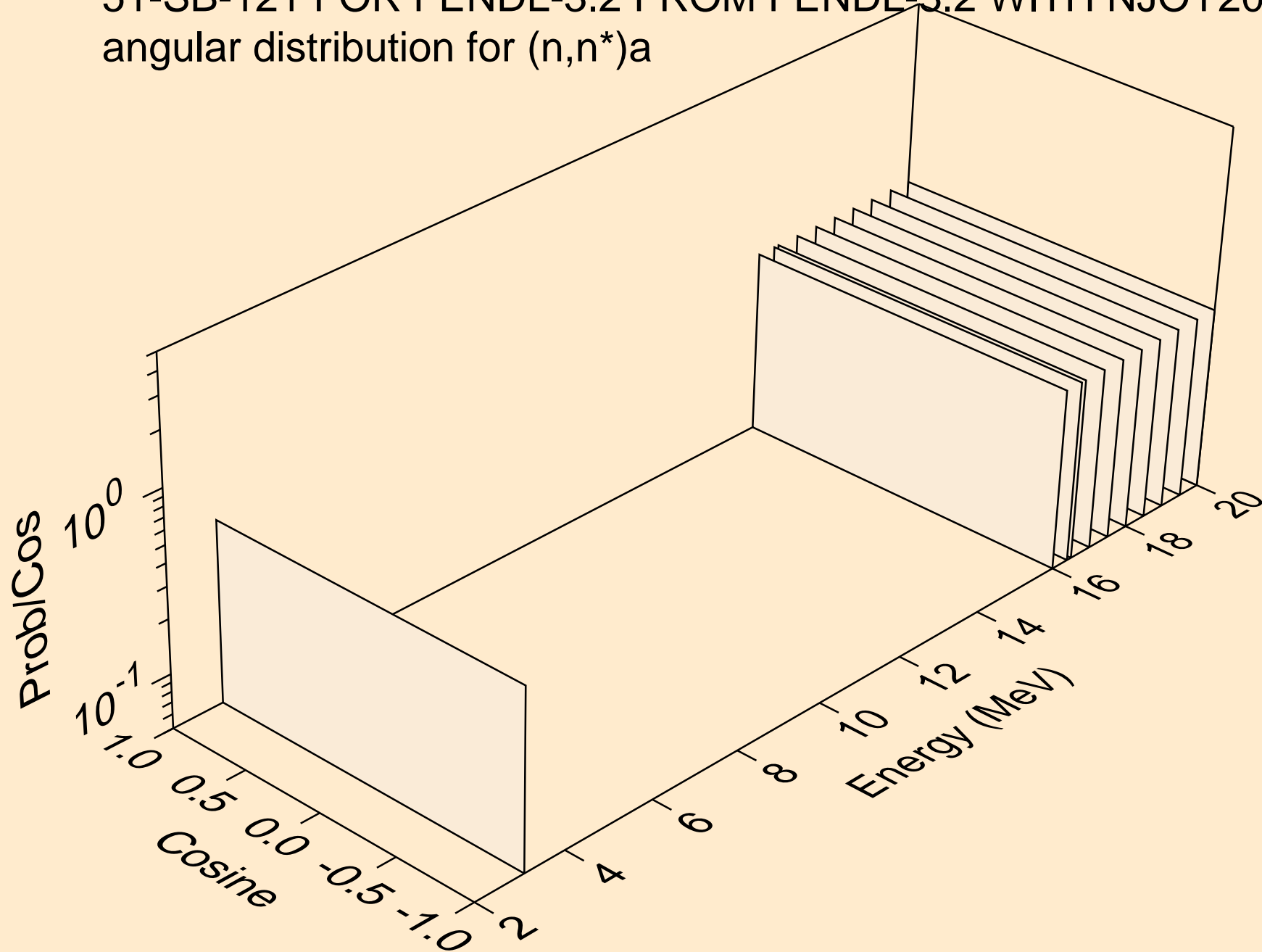

51-SB-121 FOR FENDL-3.2 FROM FENDL-3.2 WITH NJOY2016.60
angular distribution for (n,n*)p

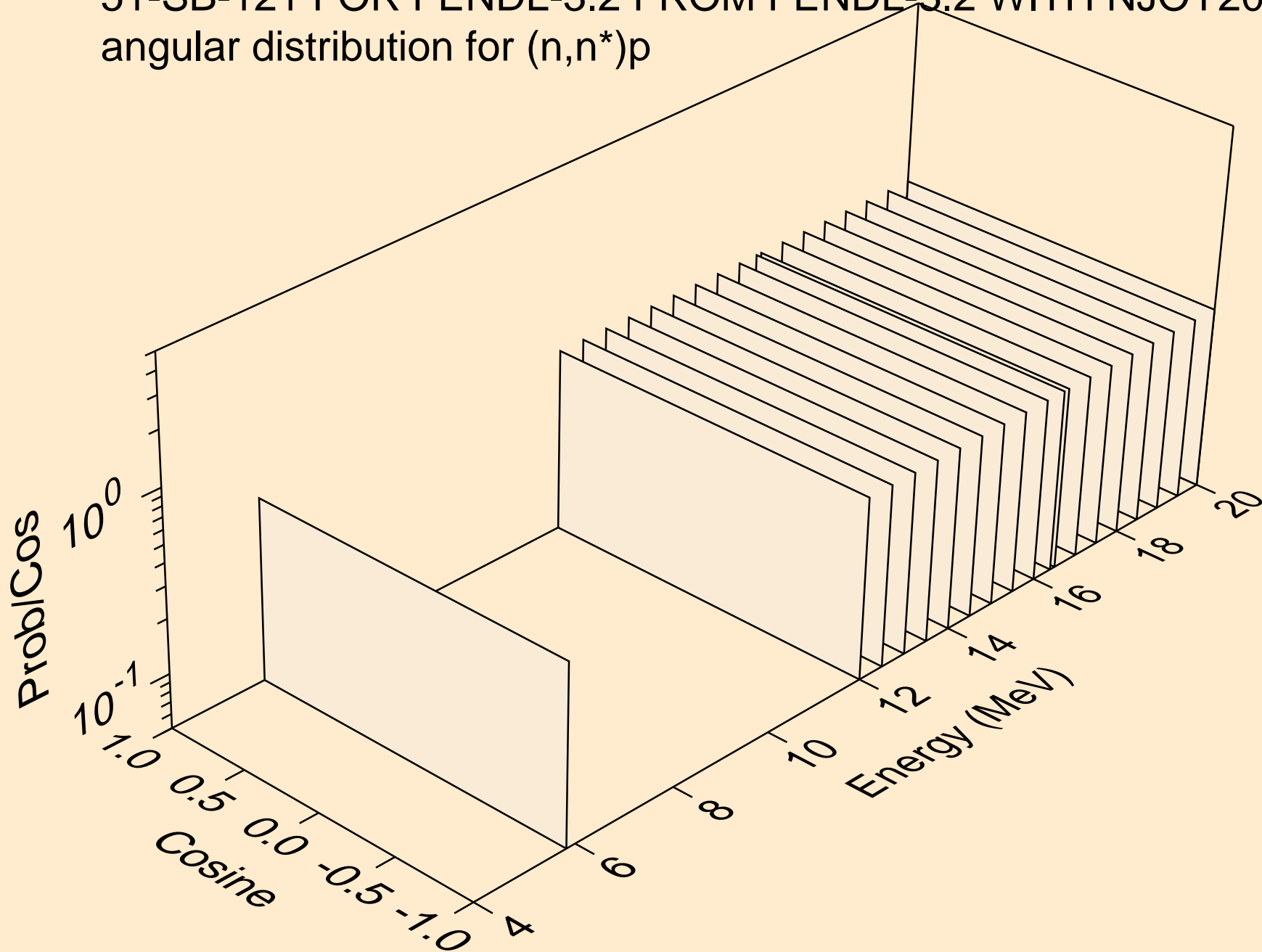

51-SB-121 FOR FENDL-3.2 FROM FENDL-3.2 WITH NJOY2016.60
angular distribution for (n,n*1)

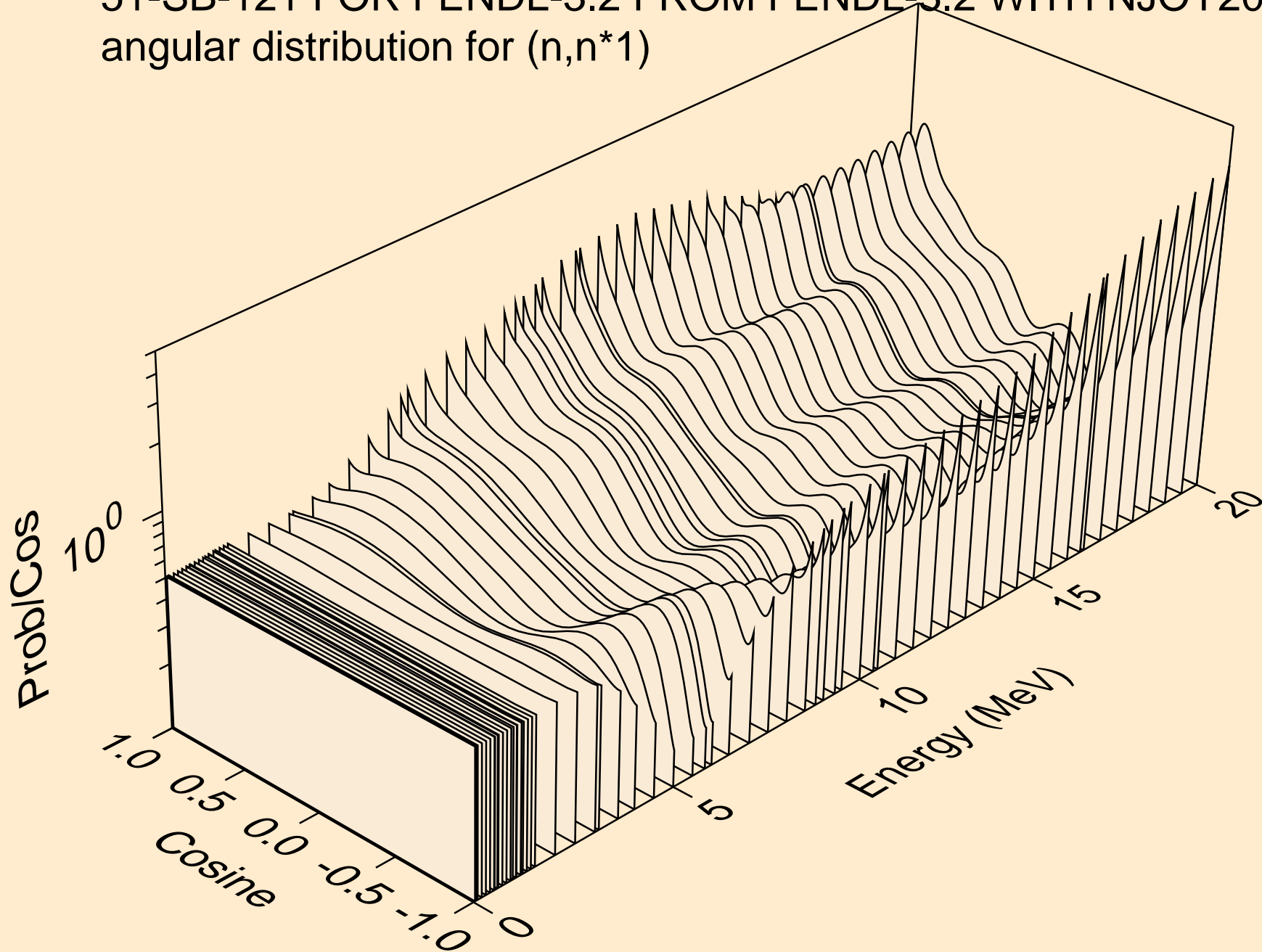

51-SB-121 FOR FENDL-3.2 FROM FENDL-3.2 WITH NJOY2016.60
angular distribution for (n,n*2)

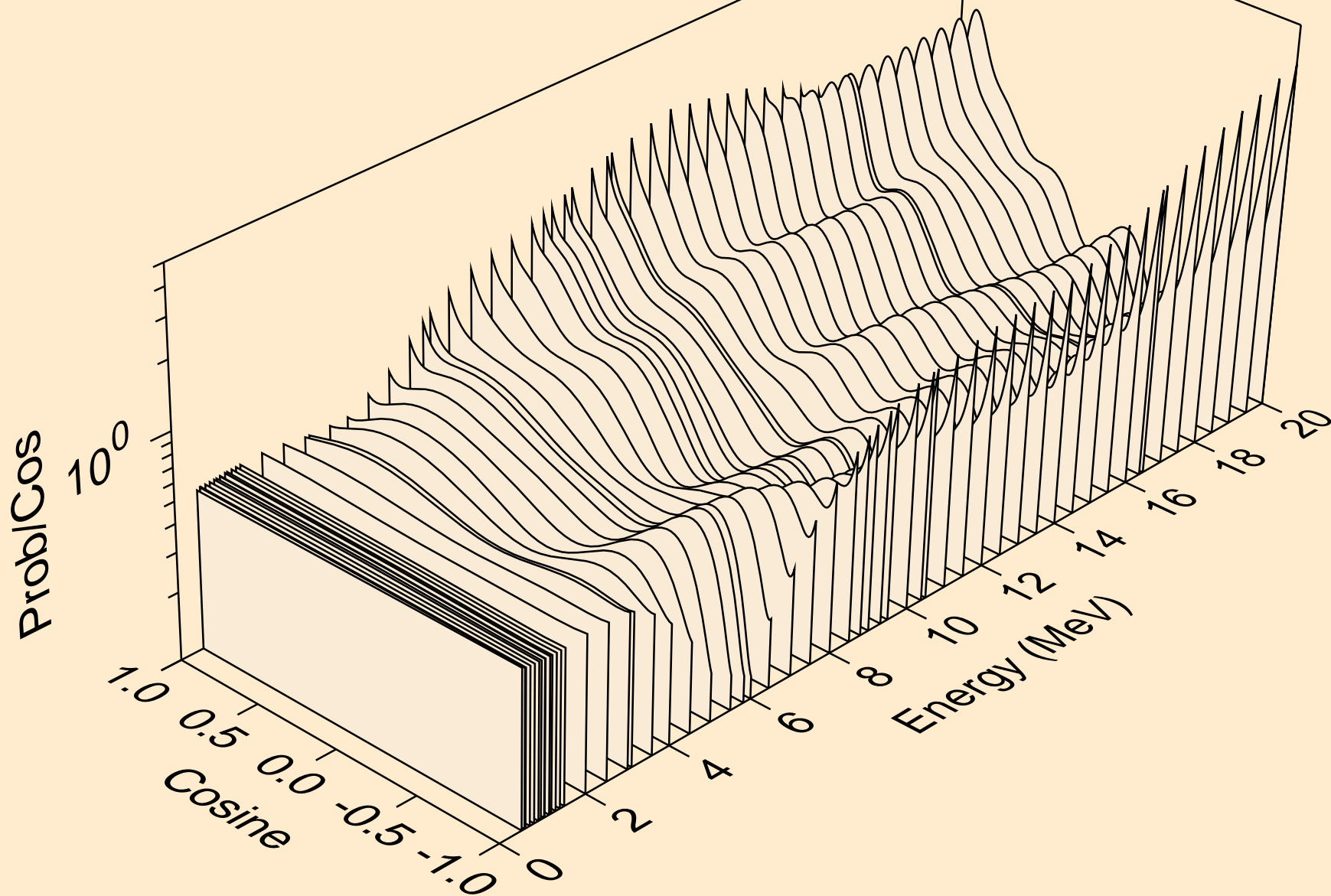

51-SB-121 FOR FENDL-3.2 FROM FENDL-3.2 WITH NJOY2016.60
angular distribution for (n,n*3)

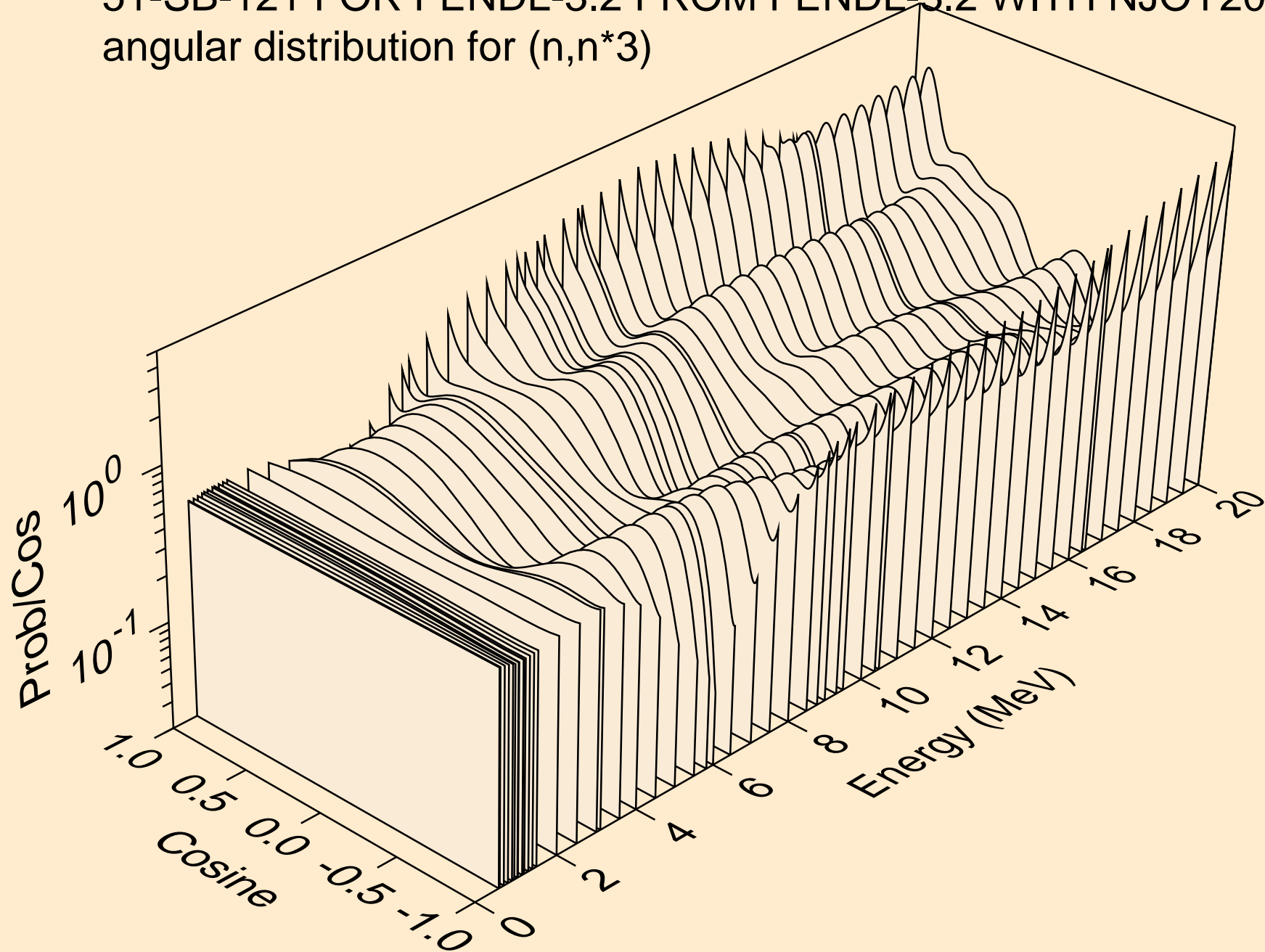

51-SB-121 FOR FENDL-3.2 FROM FENDL-3.2 WITH NJOY2016.60
angular distribution for (n,n*4)

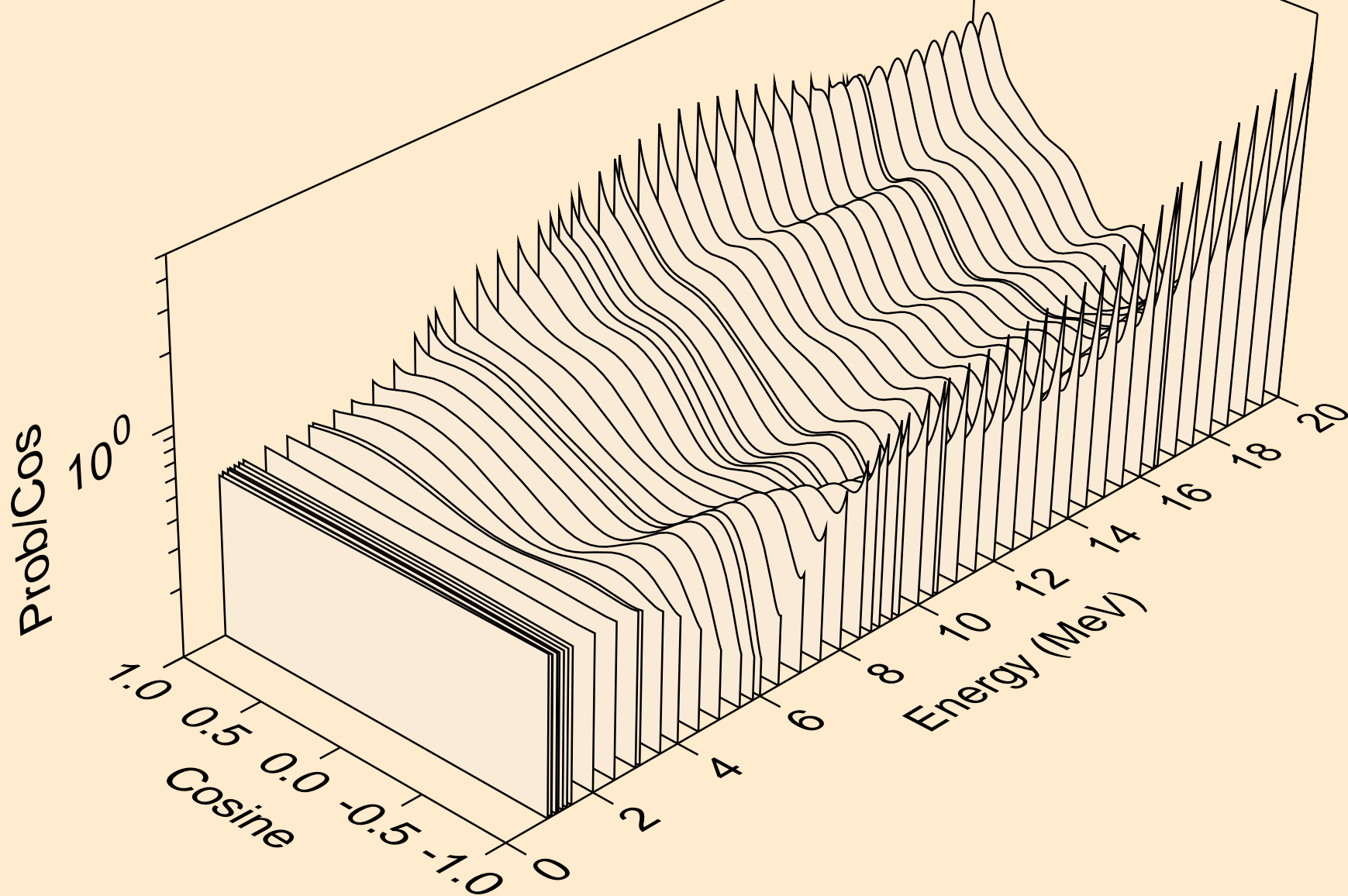

51-SB-121 FOR FENDL-3.2 FROM FENDL-3.2 WITH NJOY2016.60
angular distribution for (n,n*5)

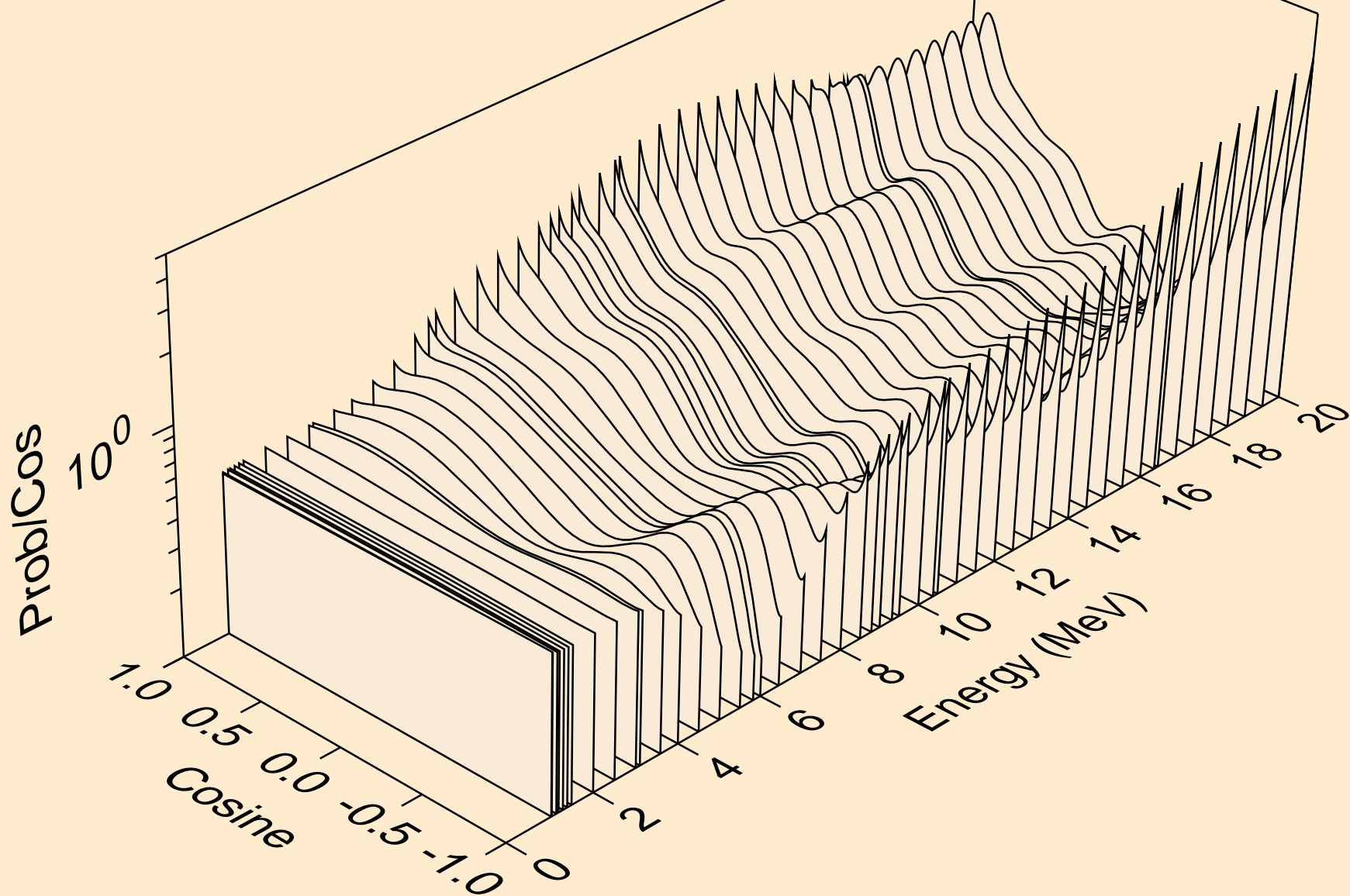

51-SB-121 FOR FENDL-3.2 FROM FENDL-3.2 WITH NJOY2016.60
angular distribution for (n,n*6)

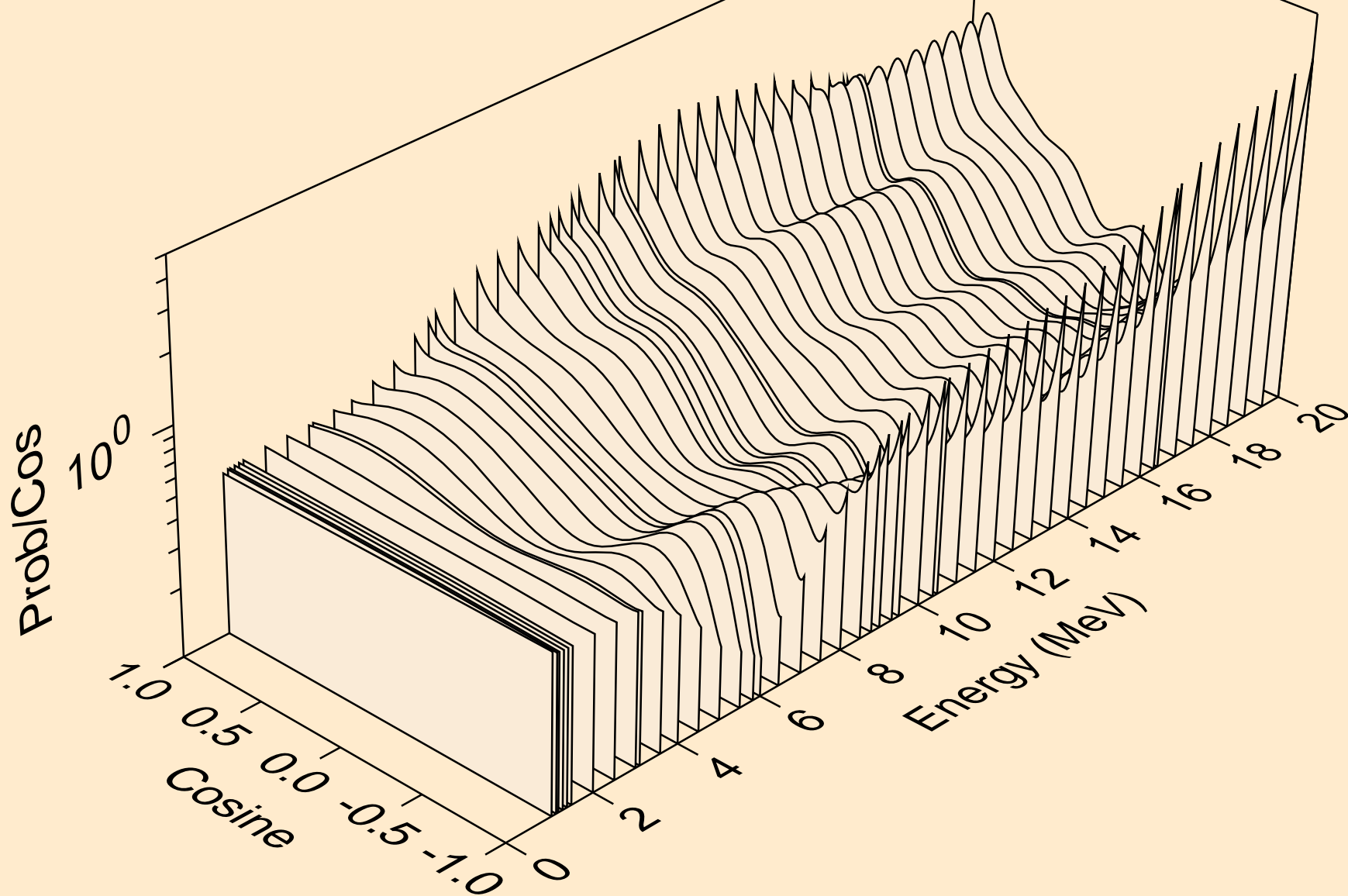

51-SB-121 FOR FENDL-3.2 FROM FENDL-3.2 WITH NJOY2016.60
angular distribution for (n,n*7)

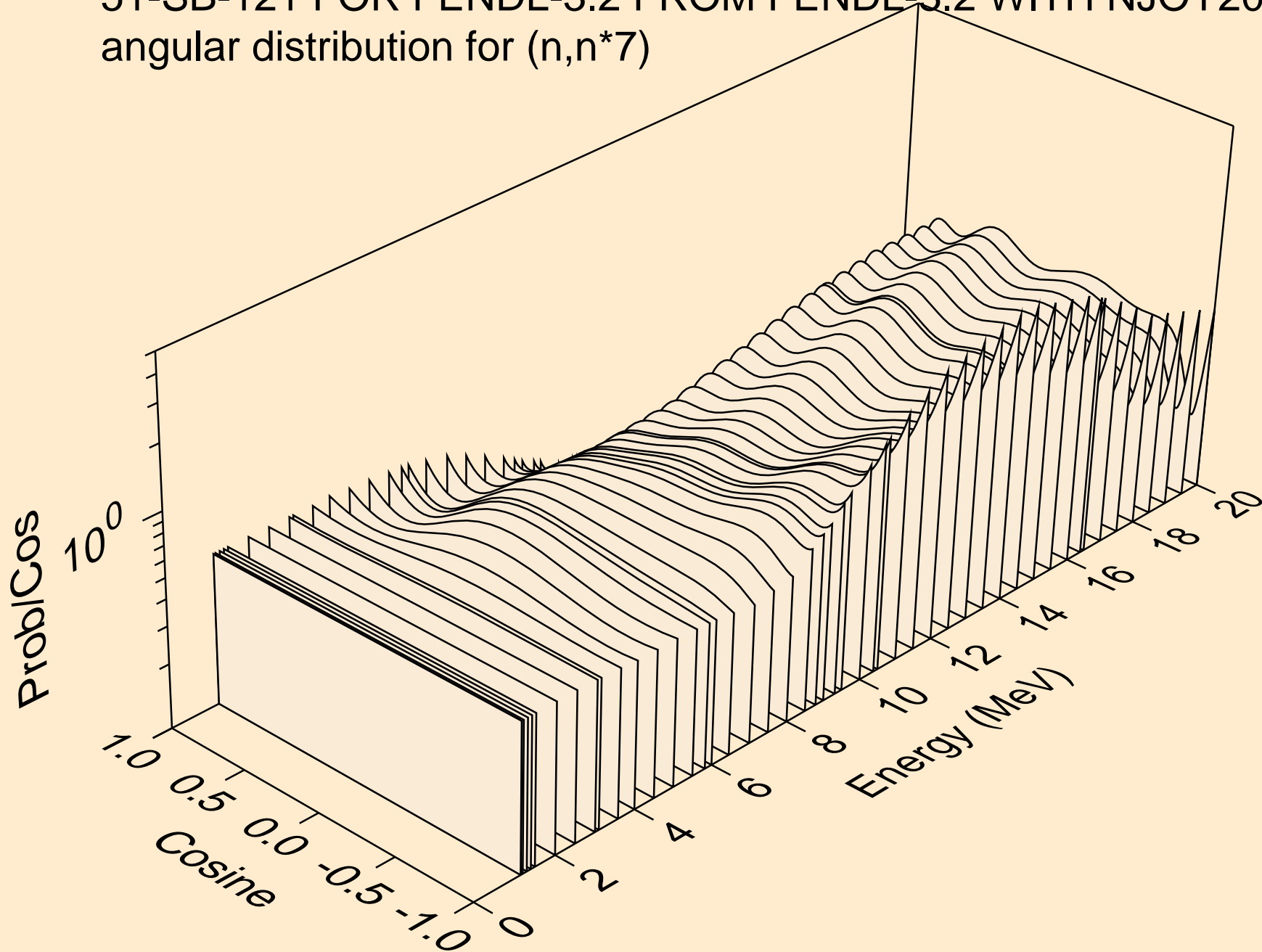

51-SB-121 FOR FENDL-3.2 FROM FENDL-3.2 WITH NJOY2016.60
angular distribution for (n,n*8)

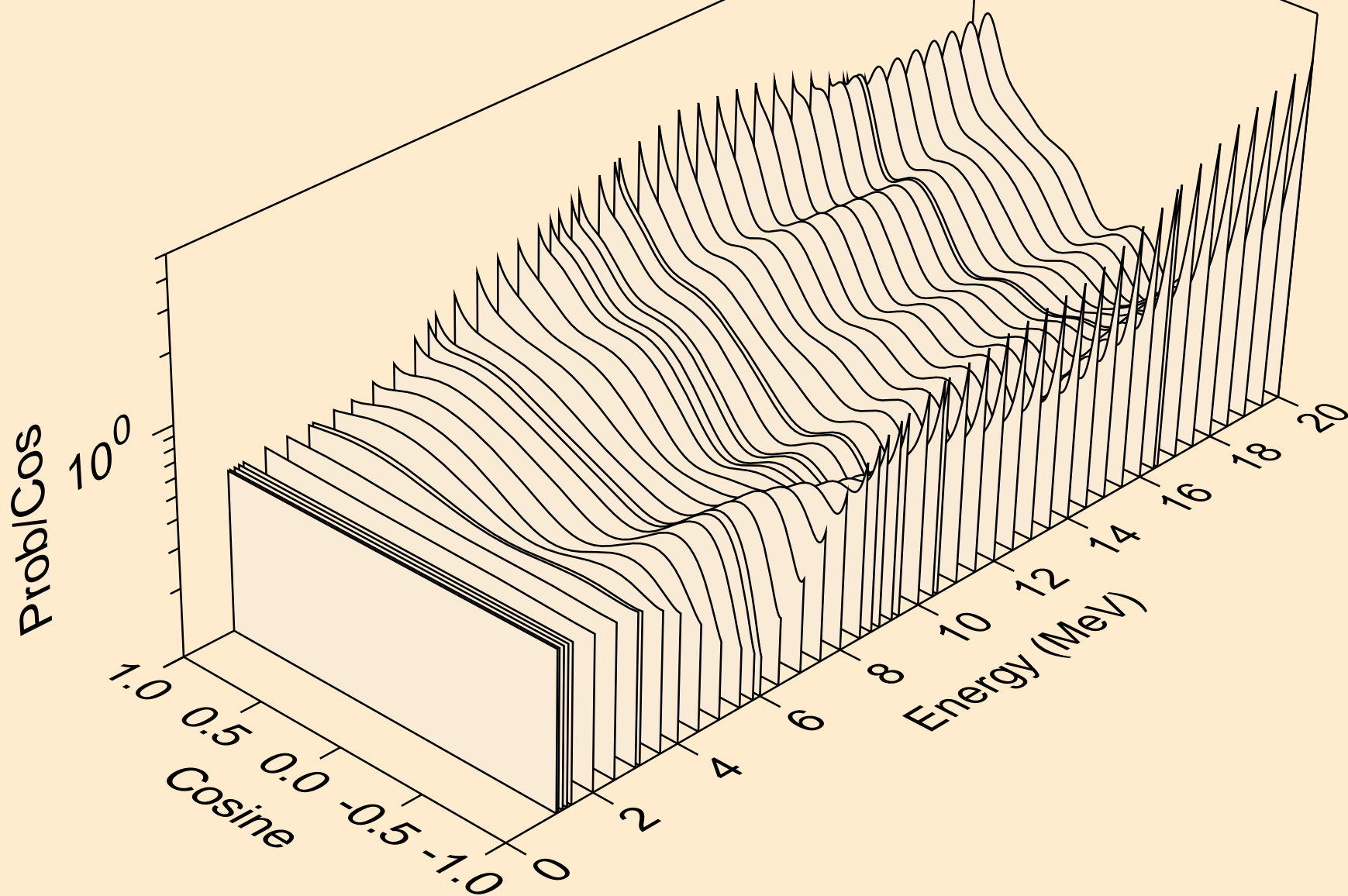

51-SB-121 FOR FENDL-3.2 FROM FENDL-3.2 WITH NJOY2016.60
angular distribution for (n,n*c)

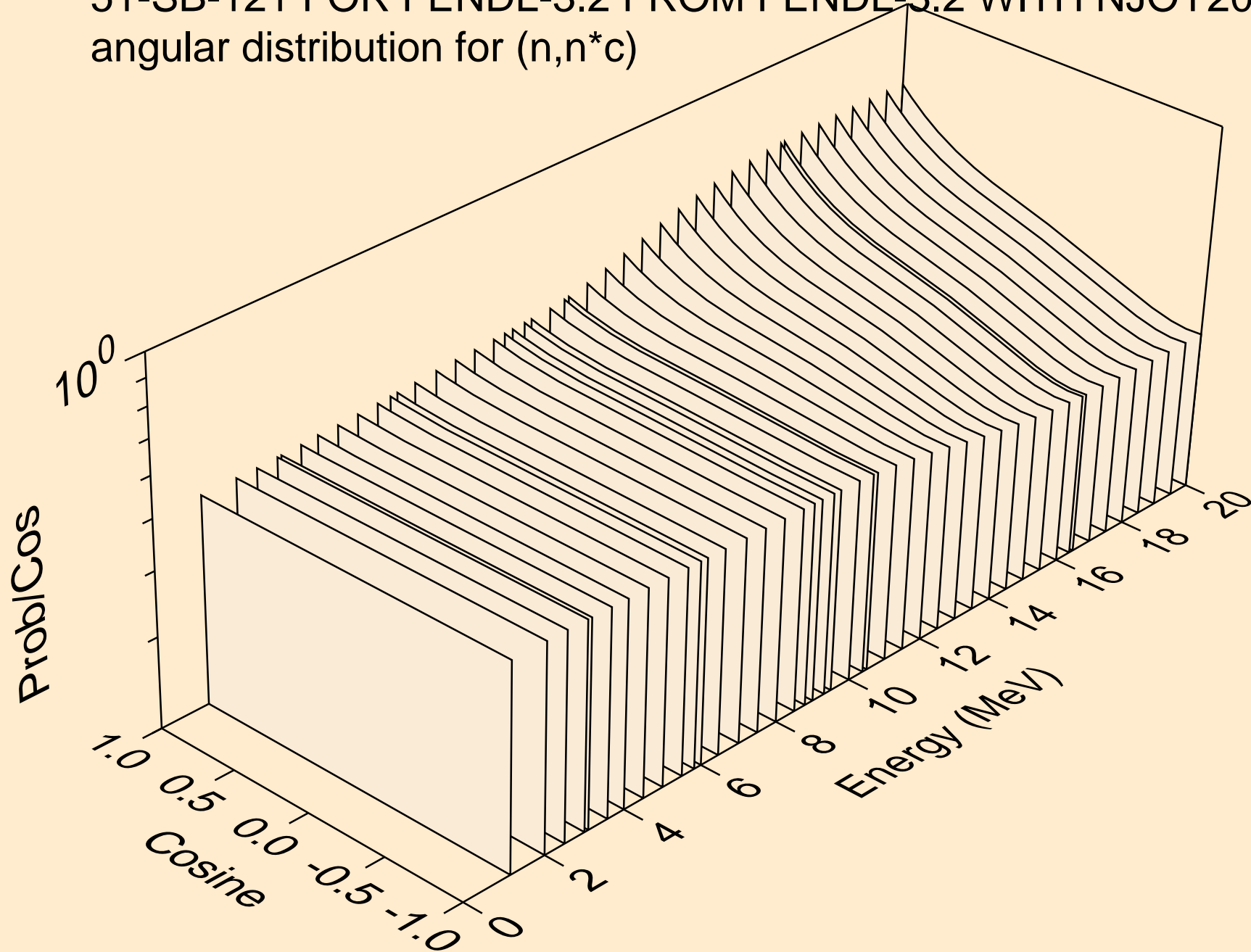

51-SB-121 FOR FENDL-3.2 FROM FENDL-3.2 WITH NJOY2016.60
Neutron emission for (n,x)

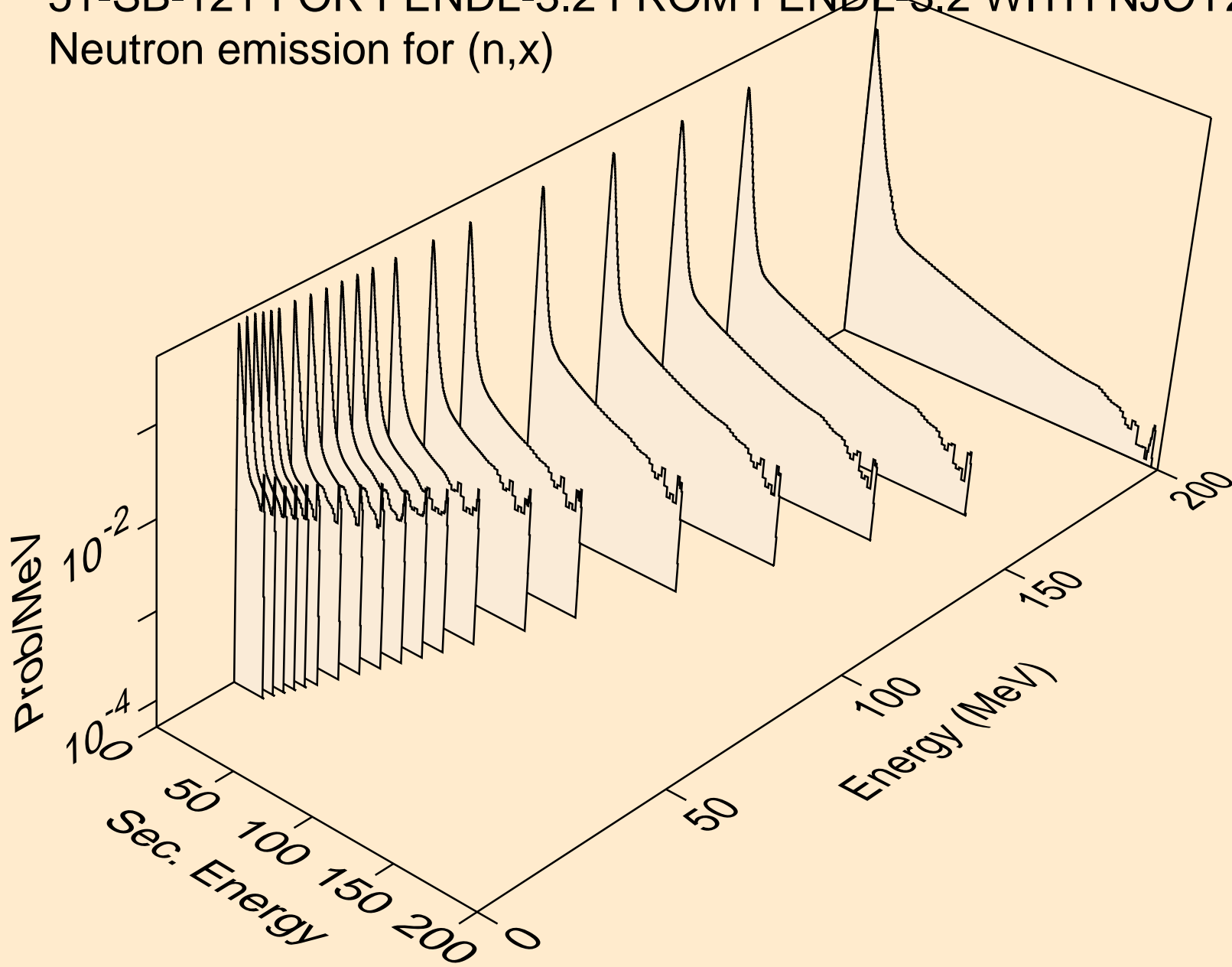

51-SB-121 FOR FENDL-3.2 FROM FENDL-3.2 WITH NJOY2016.60
Neutron emission for (n,2n)

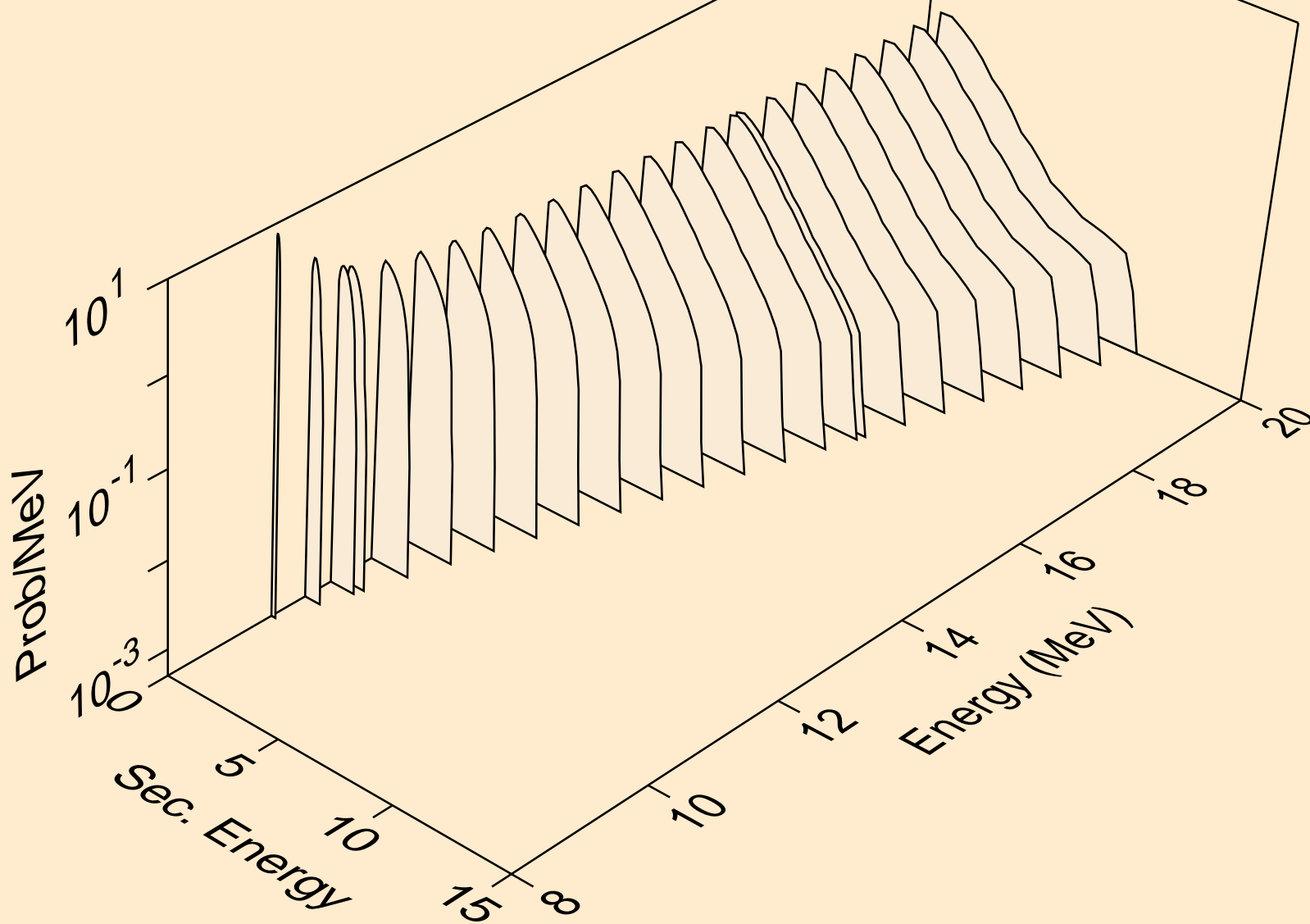

51-SB-121 FOR FENDL-3.2 FROM FENDL-3.2 WITH NJOY2016.60
Neutron emission for (n,3n)

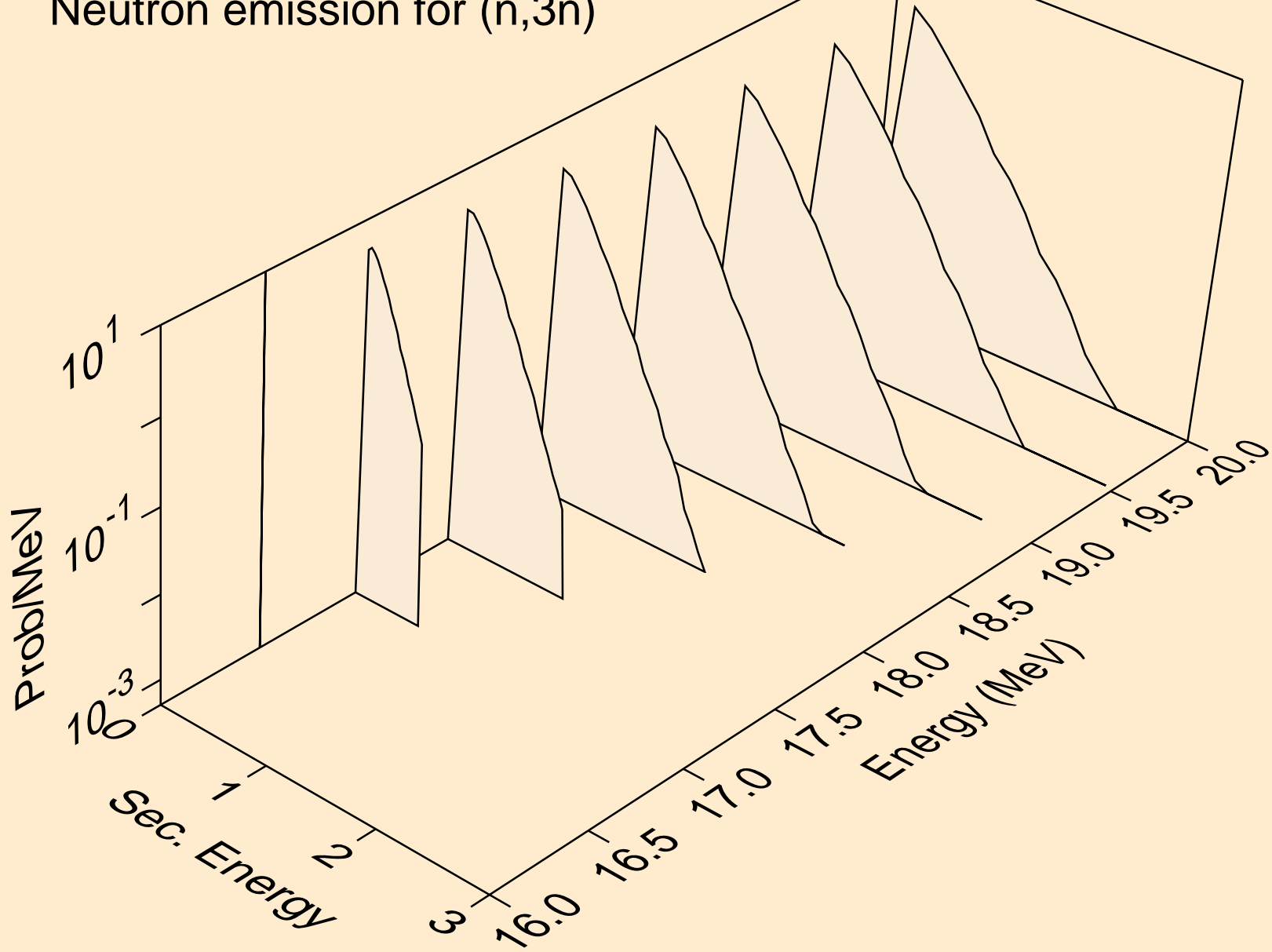

51-SB-121 FOR FENDL-3.2 FROM FENDL-3.2 WITH NJOY2016.60
Neutron emission for (n,n*)a

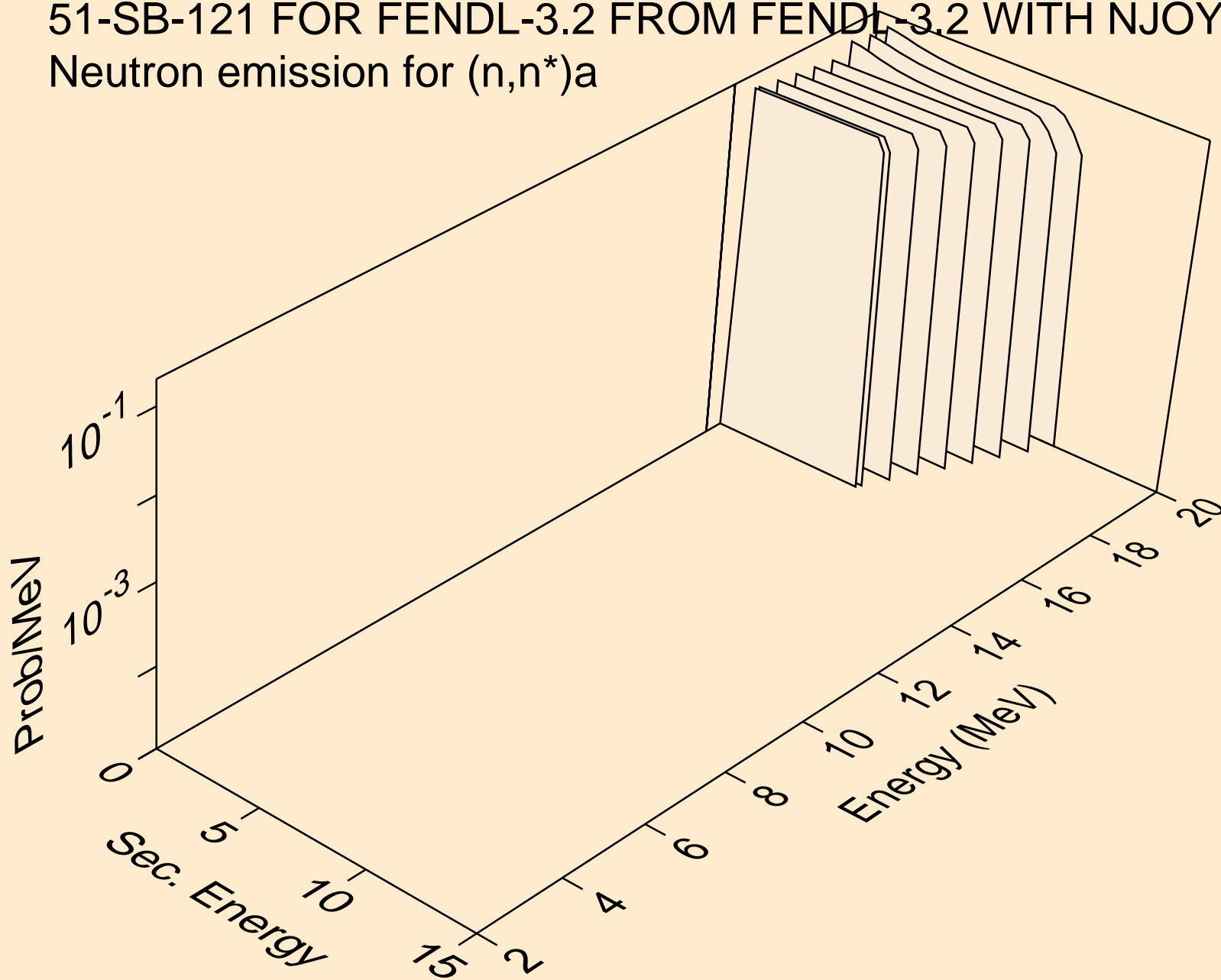

51-SB-121 FOR FENDL-3.2 FROM FENDL-3.2 WITH NJOY2016.60
Neutron emission for (n,n*)p

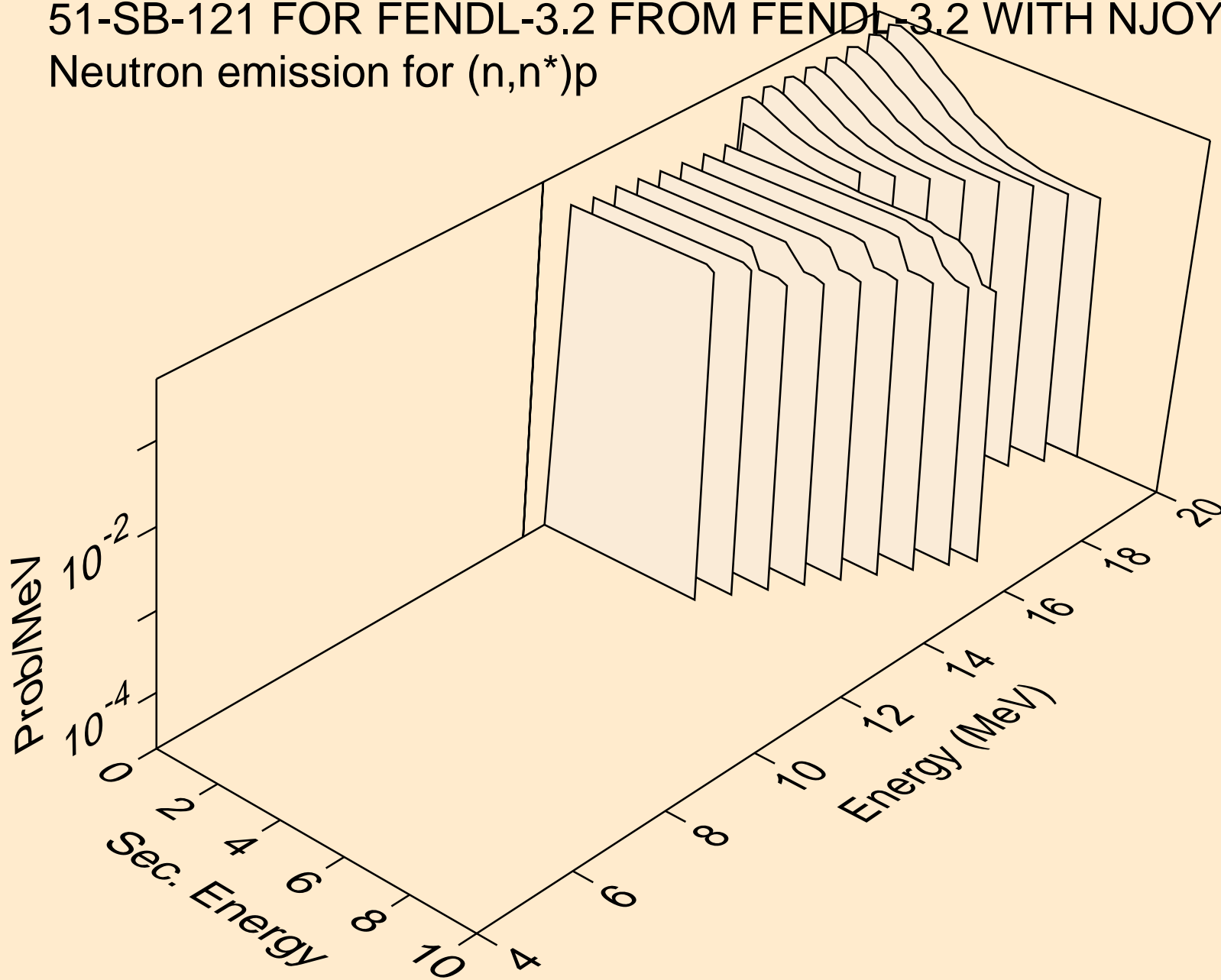

51-SB-121 FOR FENDL-3.2 FROM FENDL-3.2 WITH NJOY2016.60
Neutron emission for (n,n*c)

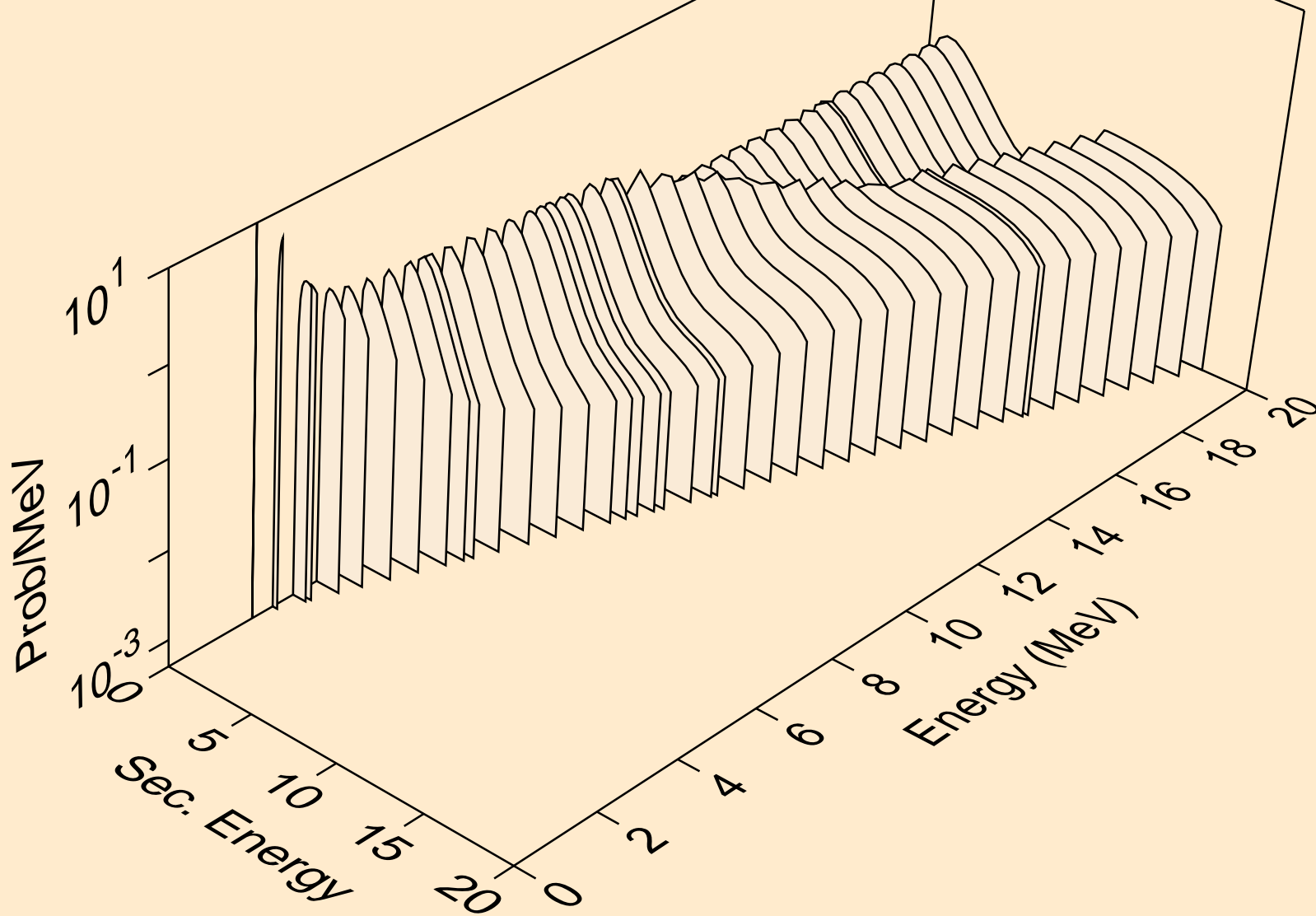

51-SB-121 FOR FENDL-3.2 FROM FENDL-3.2 WITH NJOY2016.60
Photon emission for (n,x)

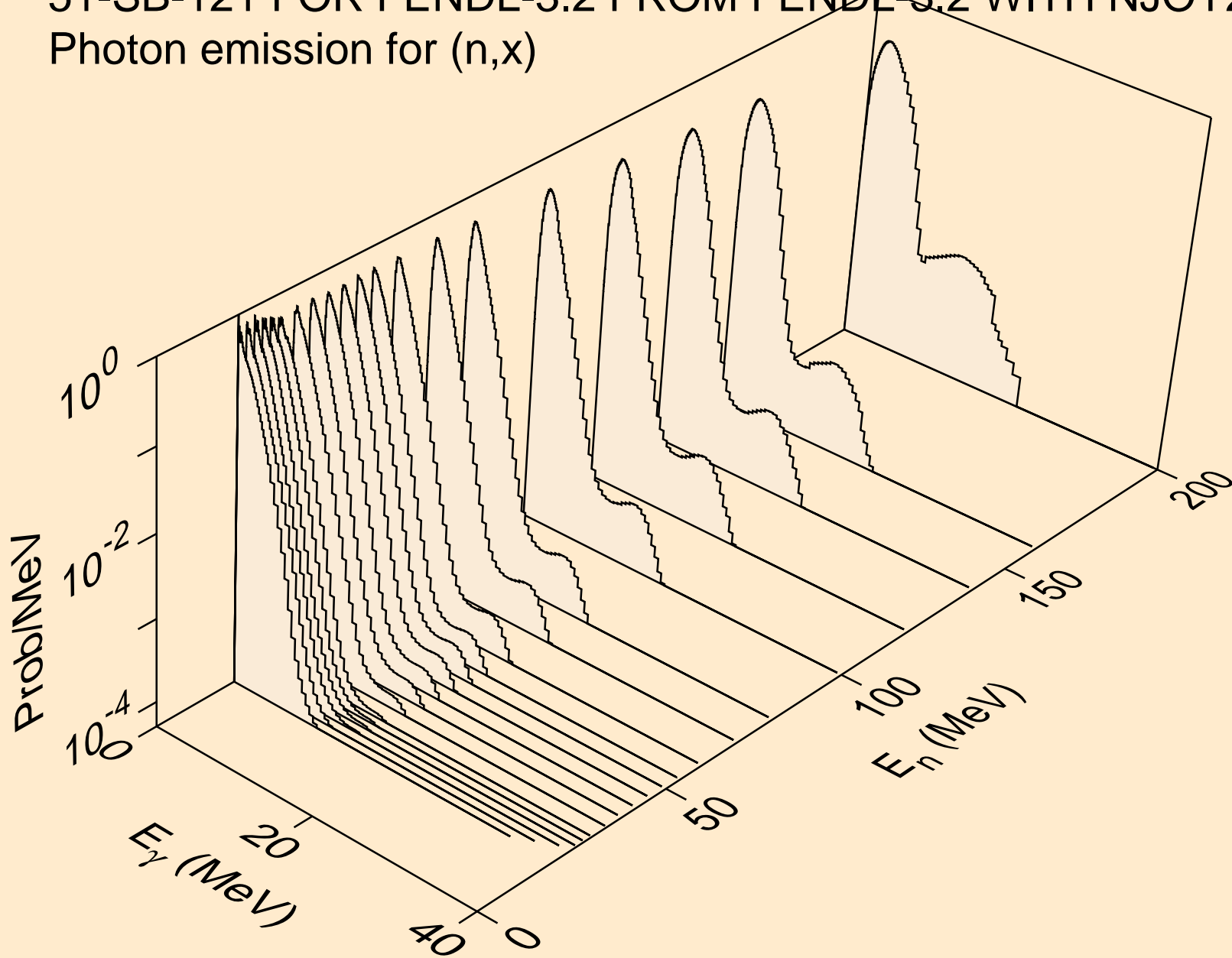

51-SB-121 FOR FENDL-3.2 FROM FENDL-3.2 WITH NJOY2016.60

Particle heating contributions

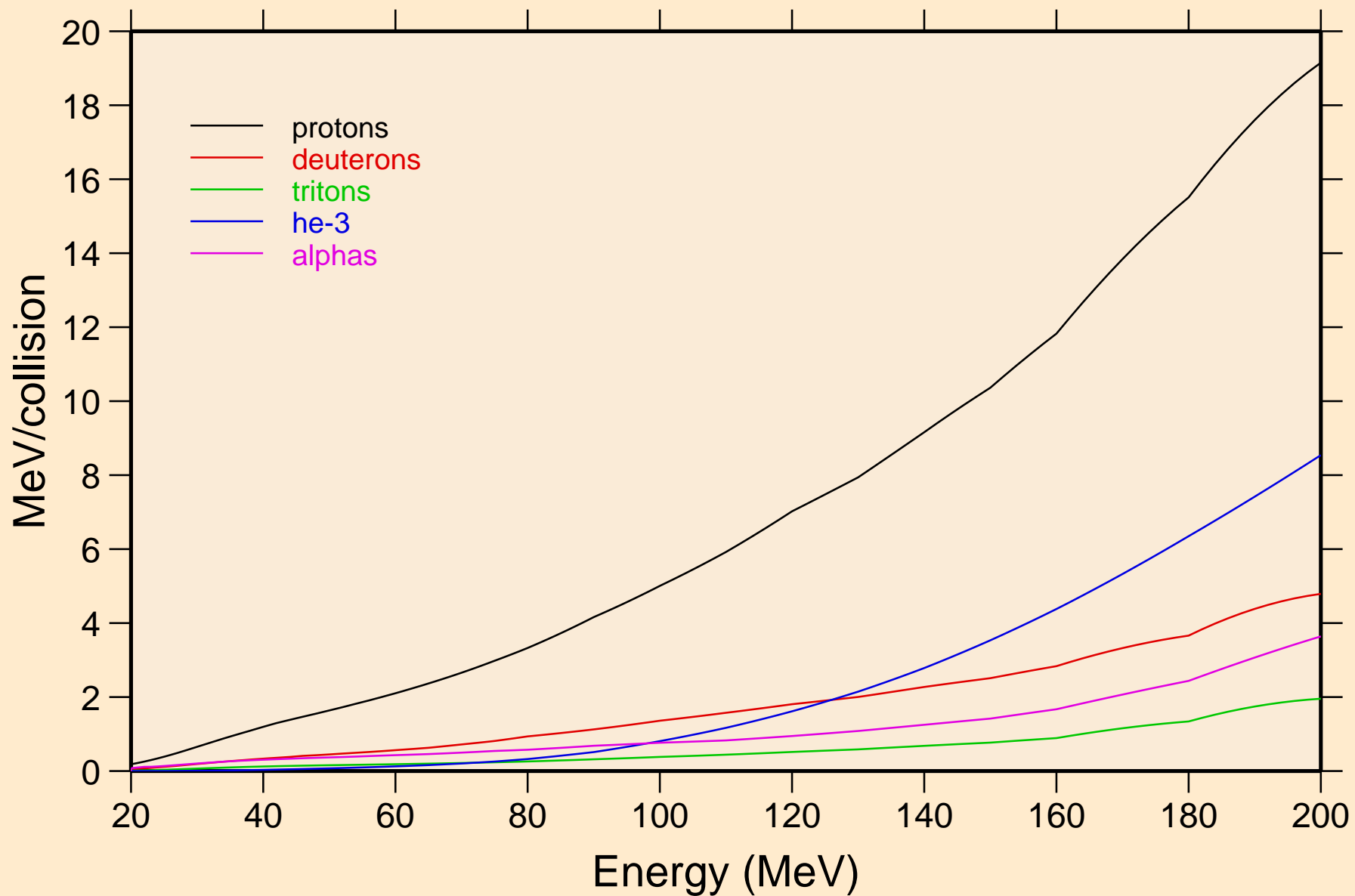

51-SB-121 FOR FENDL-3.2 FROM FENDL-3.2 WITH NJOY2016.60

Recoil Heating

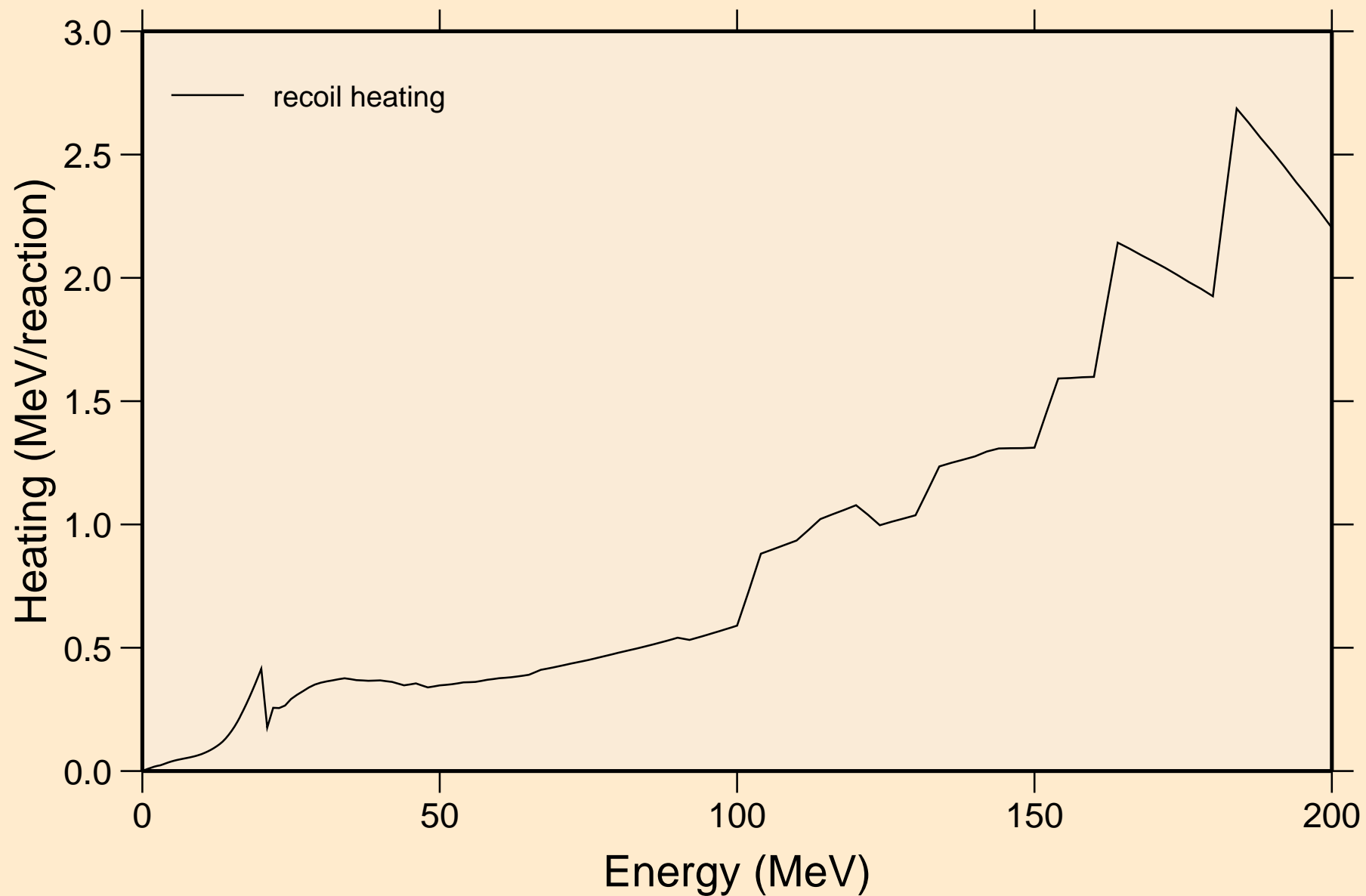

51-SB-121 FOR FENDL-3.2 FROM FENDL-3.2 WITH NJOY2016.60
Particle production cross sections

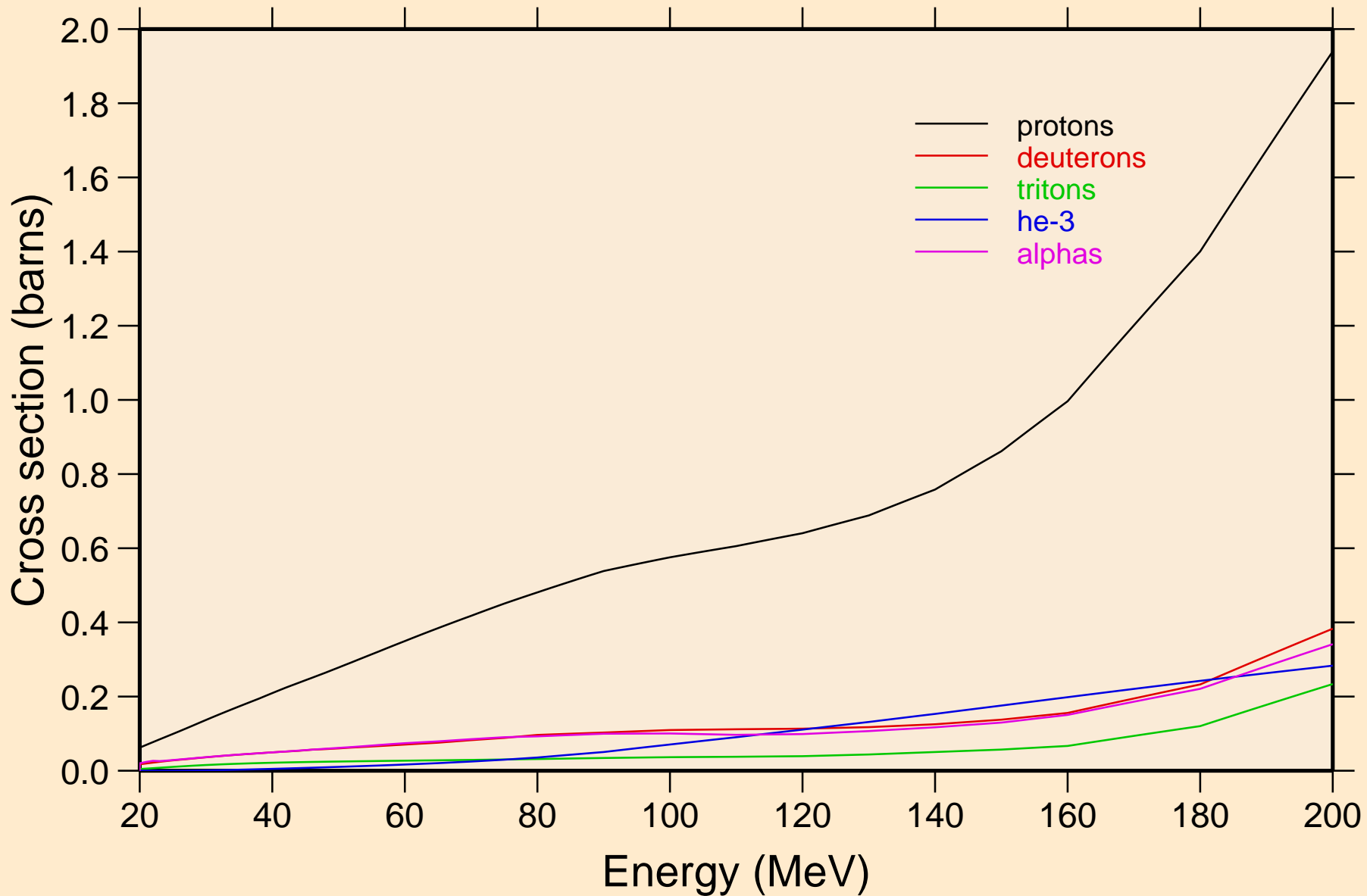

51-SB-121 FOR FENDL-3.2 FROM FENDL-3.2 WITH NJOY2016.60
protons from (n,x)

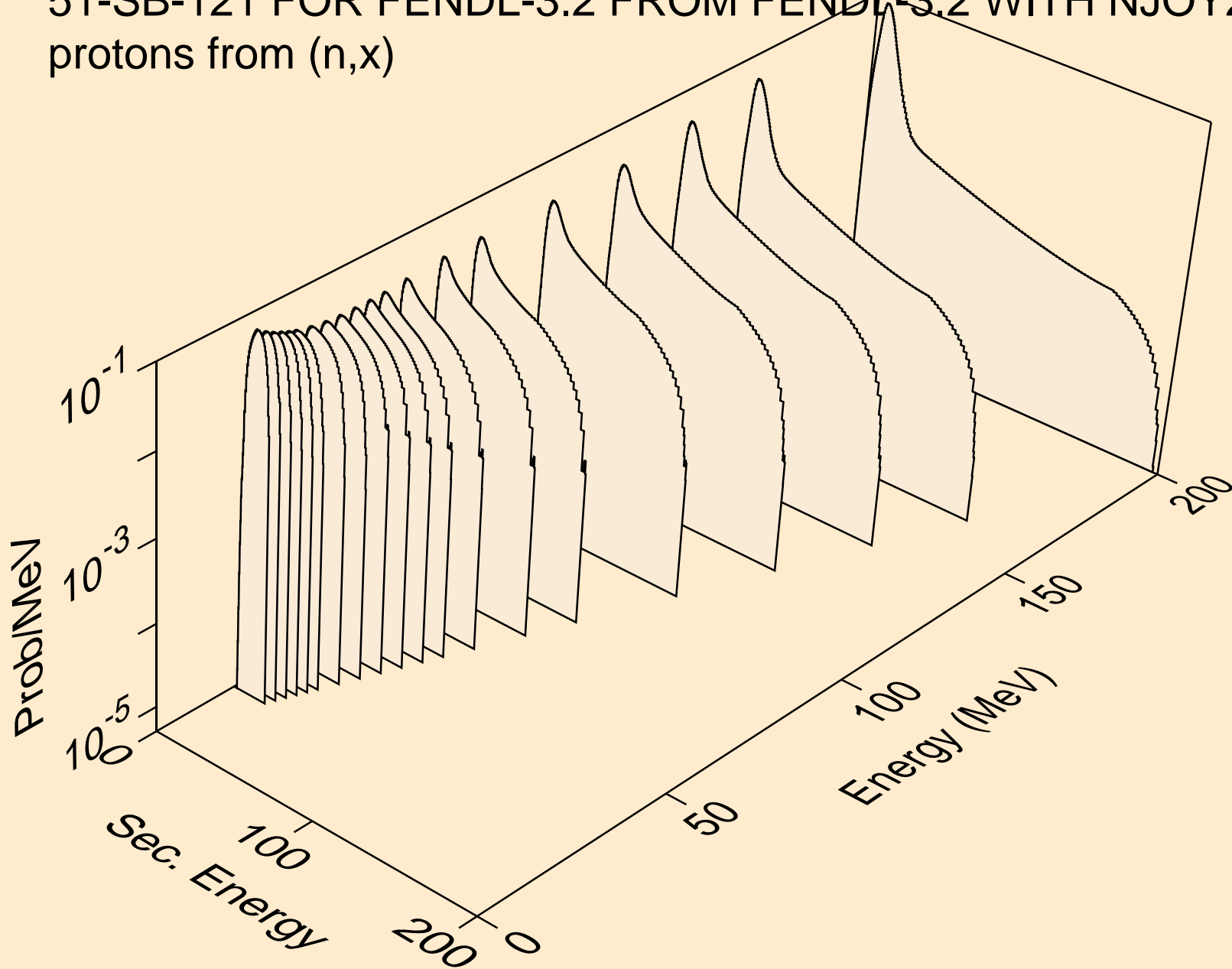

51-SB-121 FOR FENDL-3.2 FROM FENDL-3.2 WITH NJOY2016.60
deuterons from (n,x)

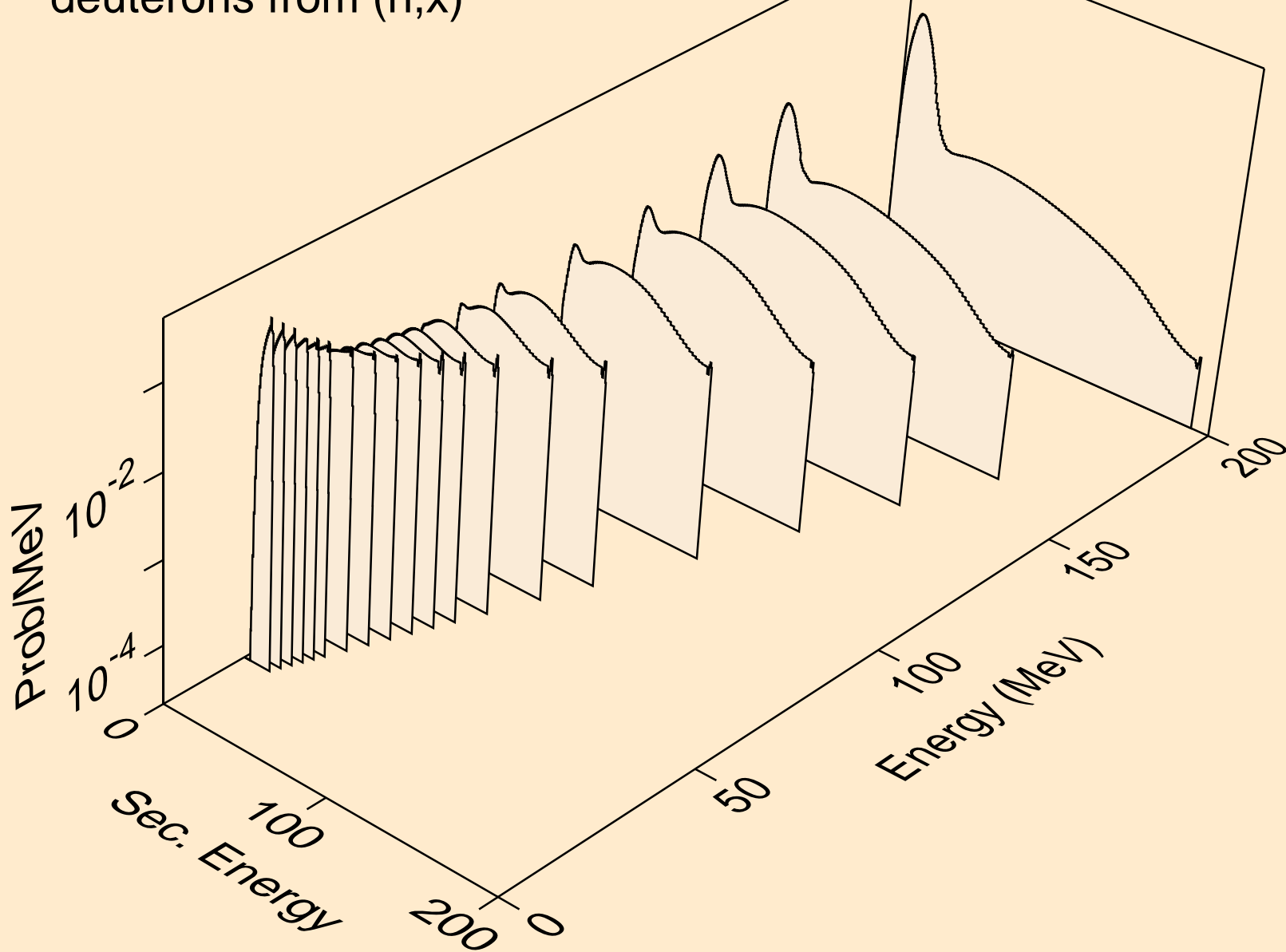

51-SB-121 FOR FENDL-3.2 FROM FENDL-3.2 WITH NJOY2016.60
tritons from (n,x)

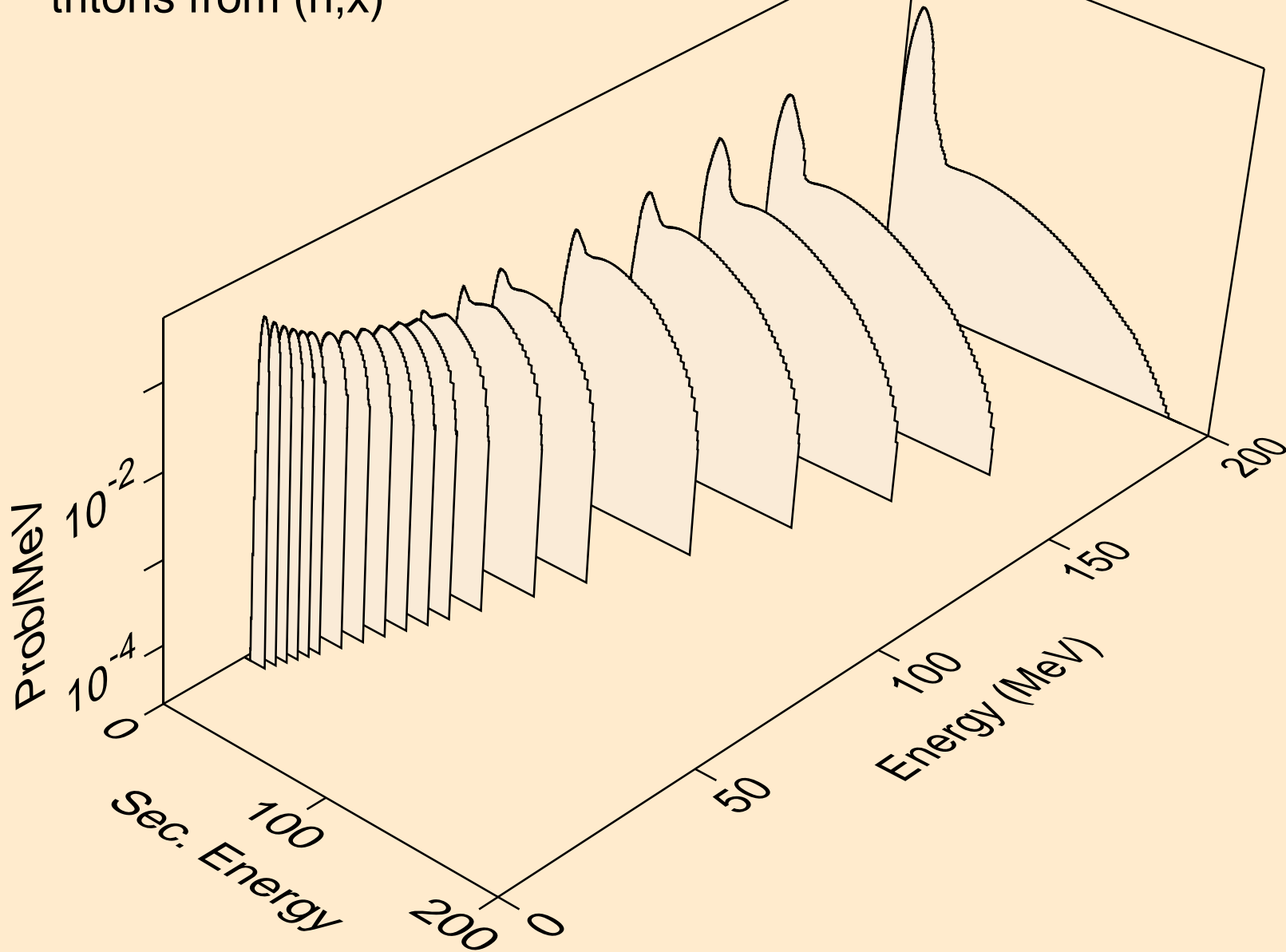

51-SB-121 FOR FENDL-3.2 FROM FENDL-3.2 WITH NJOY2016.60
he3s from (n,x)

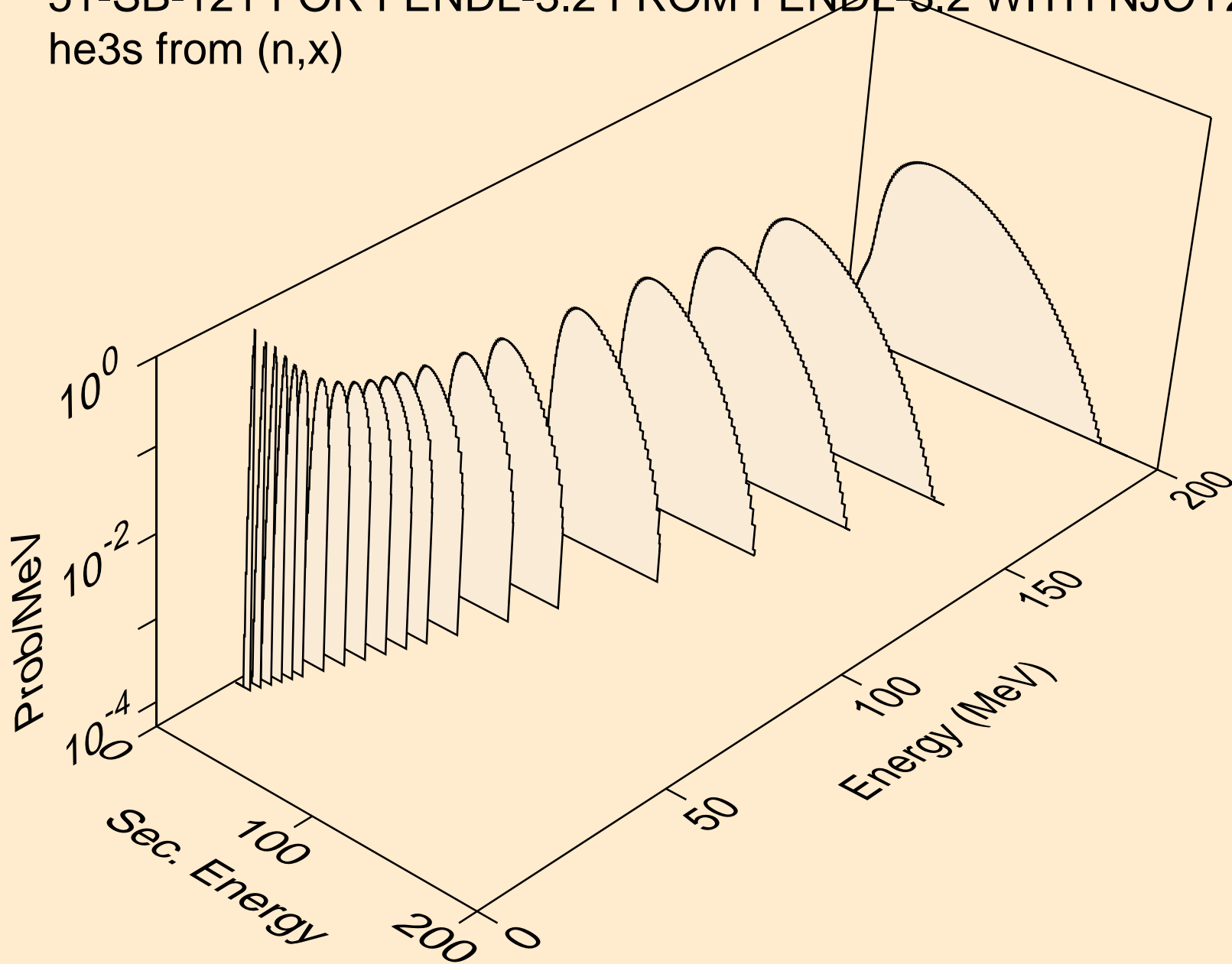

51-SB-121 FOR FENDL-3.2 FROM FENDL-3.2 WITH NJOY2016.60
alphas from (n,x)

