

56-BA-132 FOR FENDL-3.2 FROM FENDL-3.2 WITH NJOY2016.60
Principal cross sections

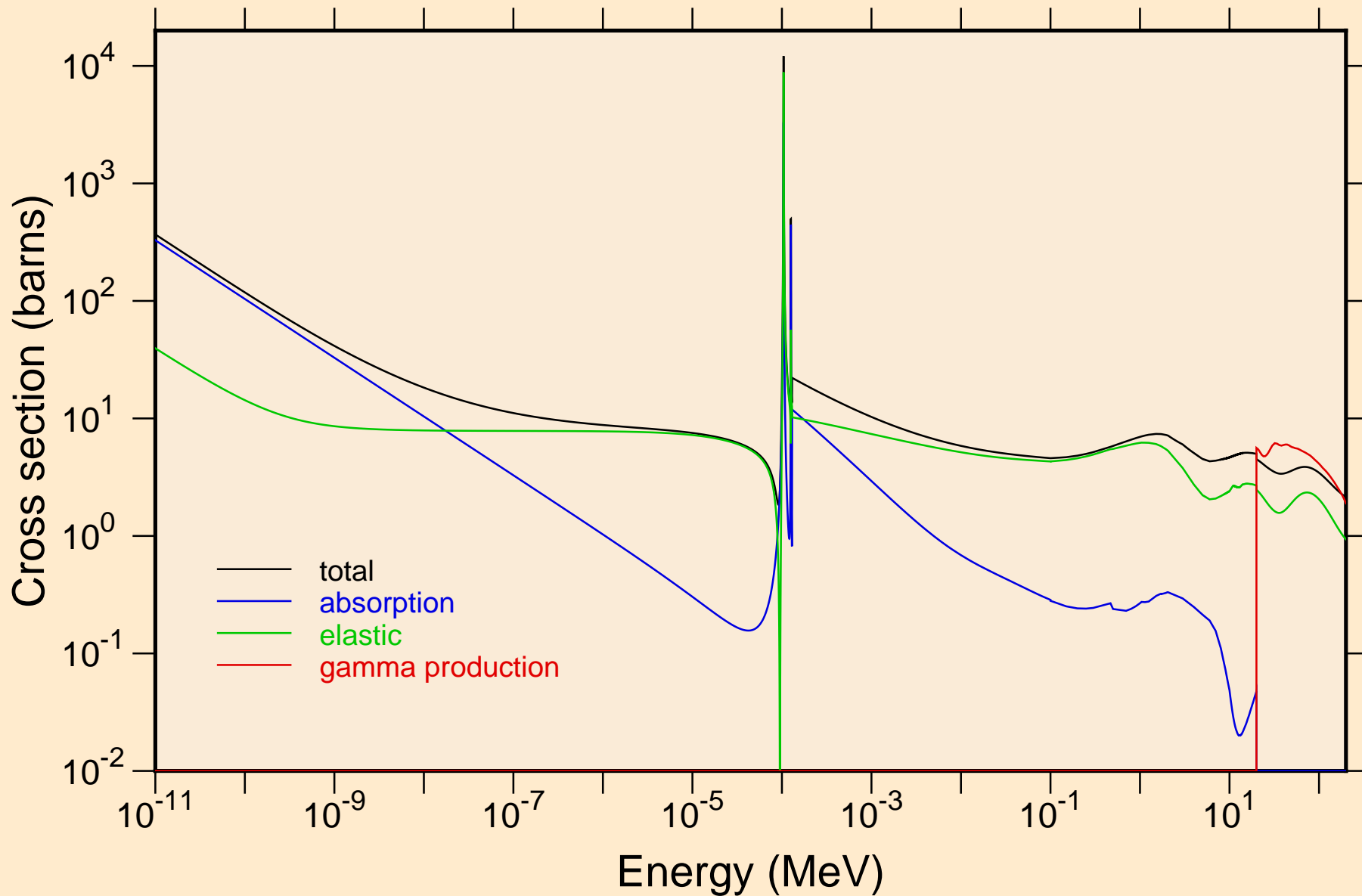

56-BA-132 FOR FENDL-3.2 FROM FENDL-3.2 WITH NJOY2016.60
resonance total cross section

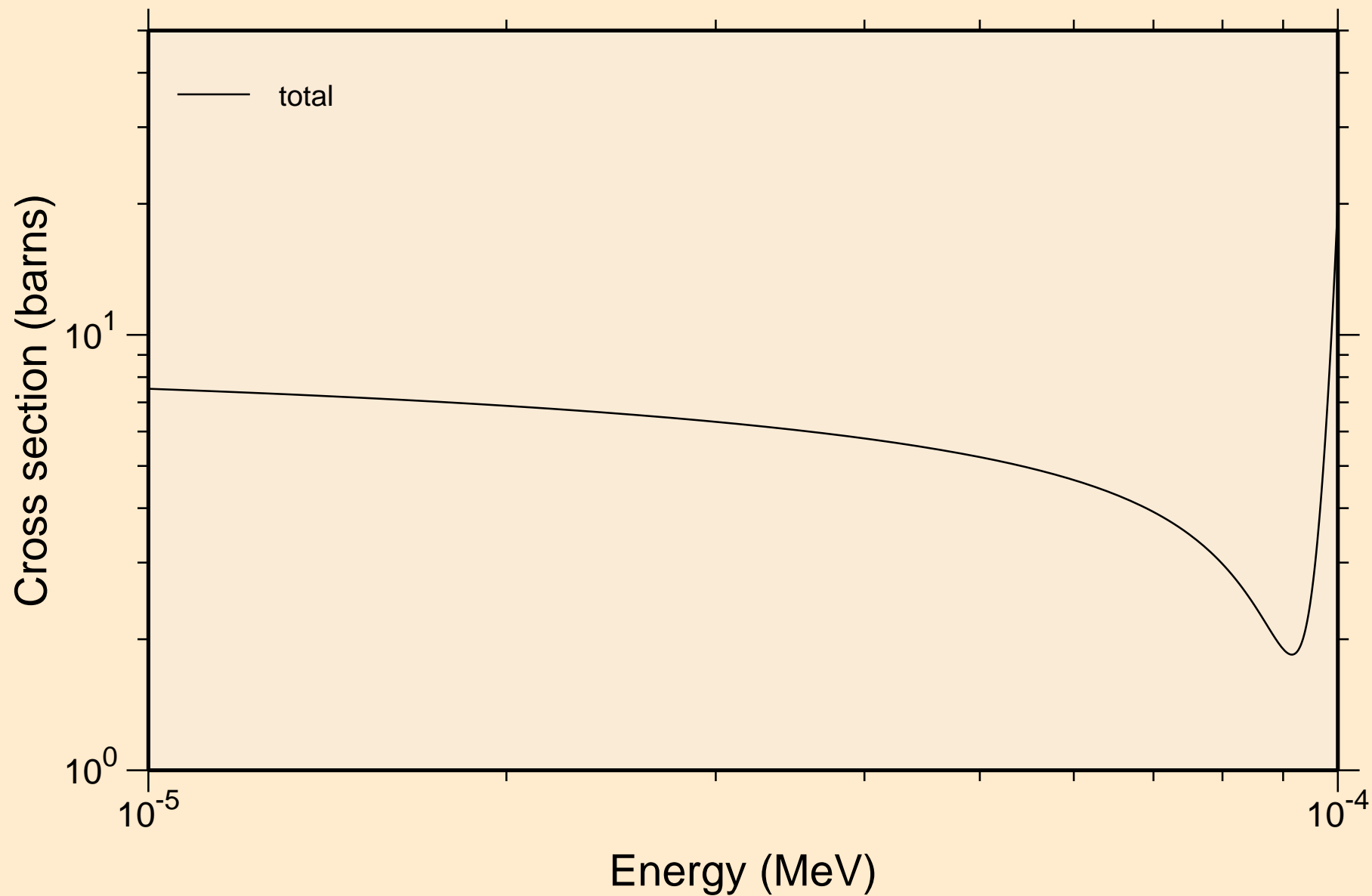

56-BA-132 FOR FENDL-3.2 FROM FENDL-3.2 WITH NJOY2016.60
resonance total cross section

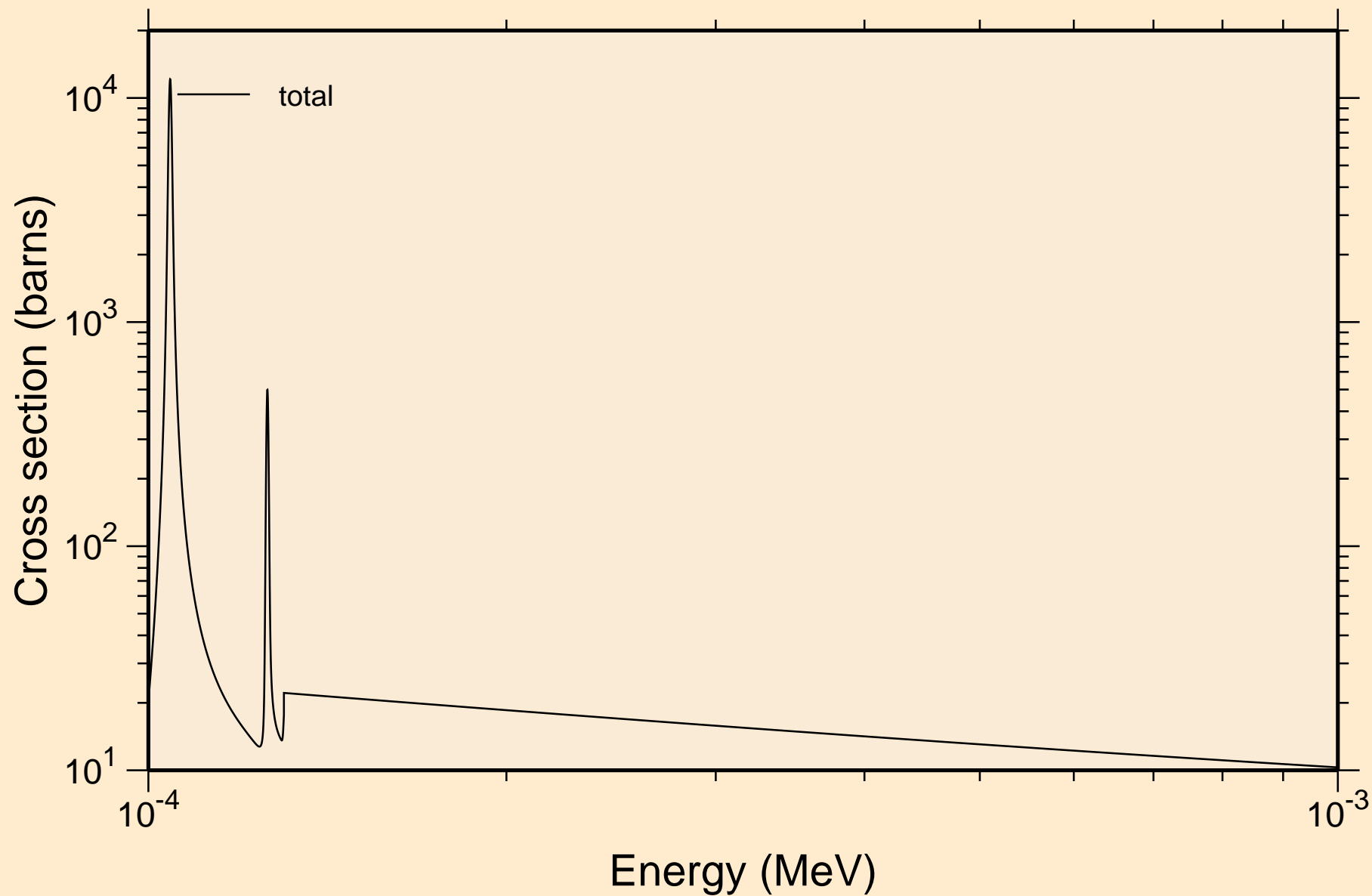

56-BA-132 FOR FENDL-3.2 FROM FENDL-3.2 WITH NJOY2016.60
resonance total cross section

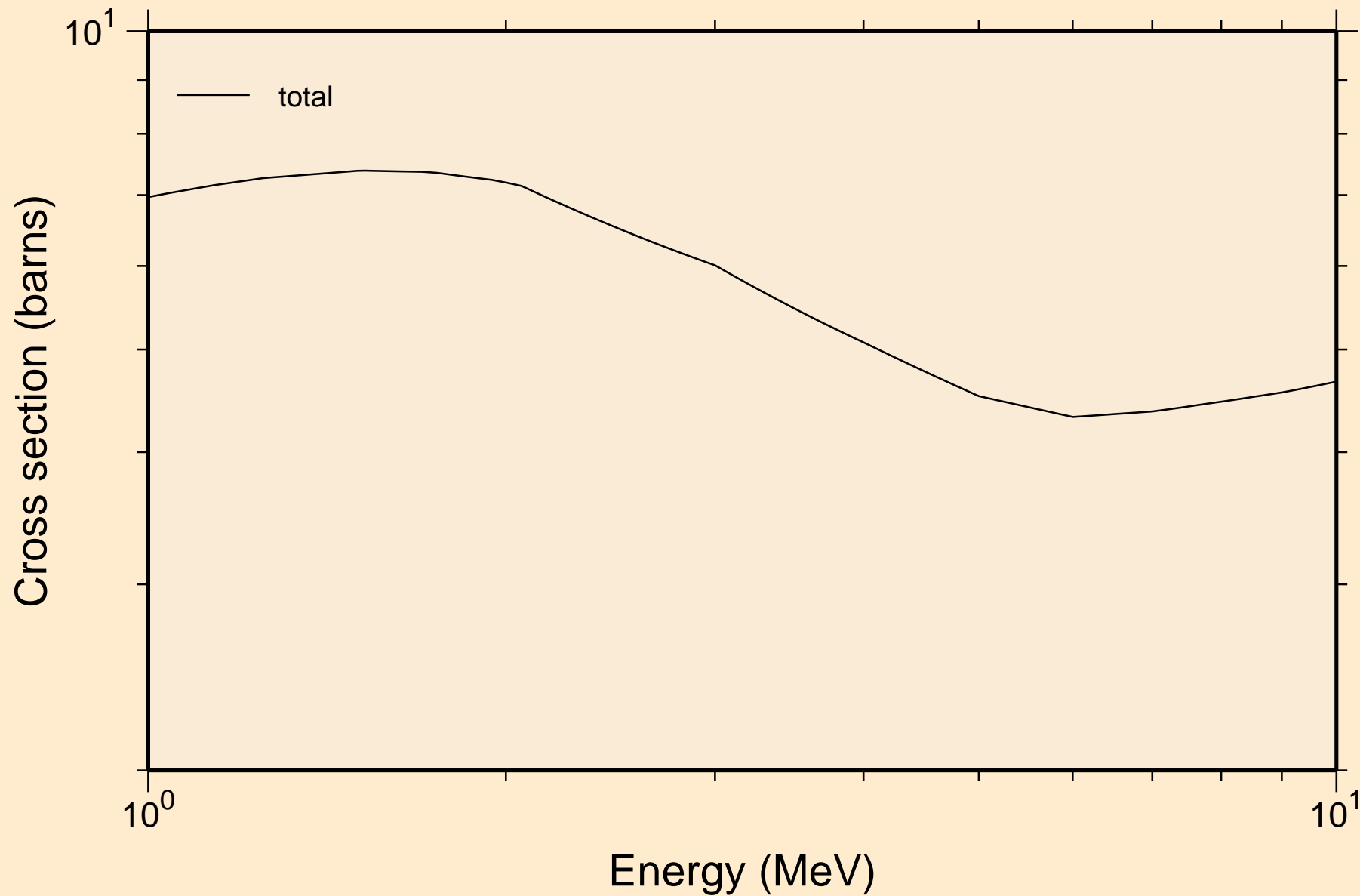

56-BA-132 FOR FENDL-3.2 FROM FENDL-3.2 WITH NJOY2016.60
resonance absorption cross sections

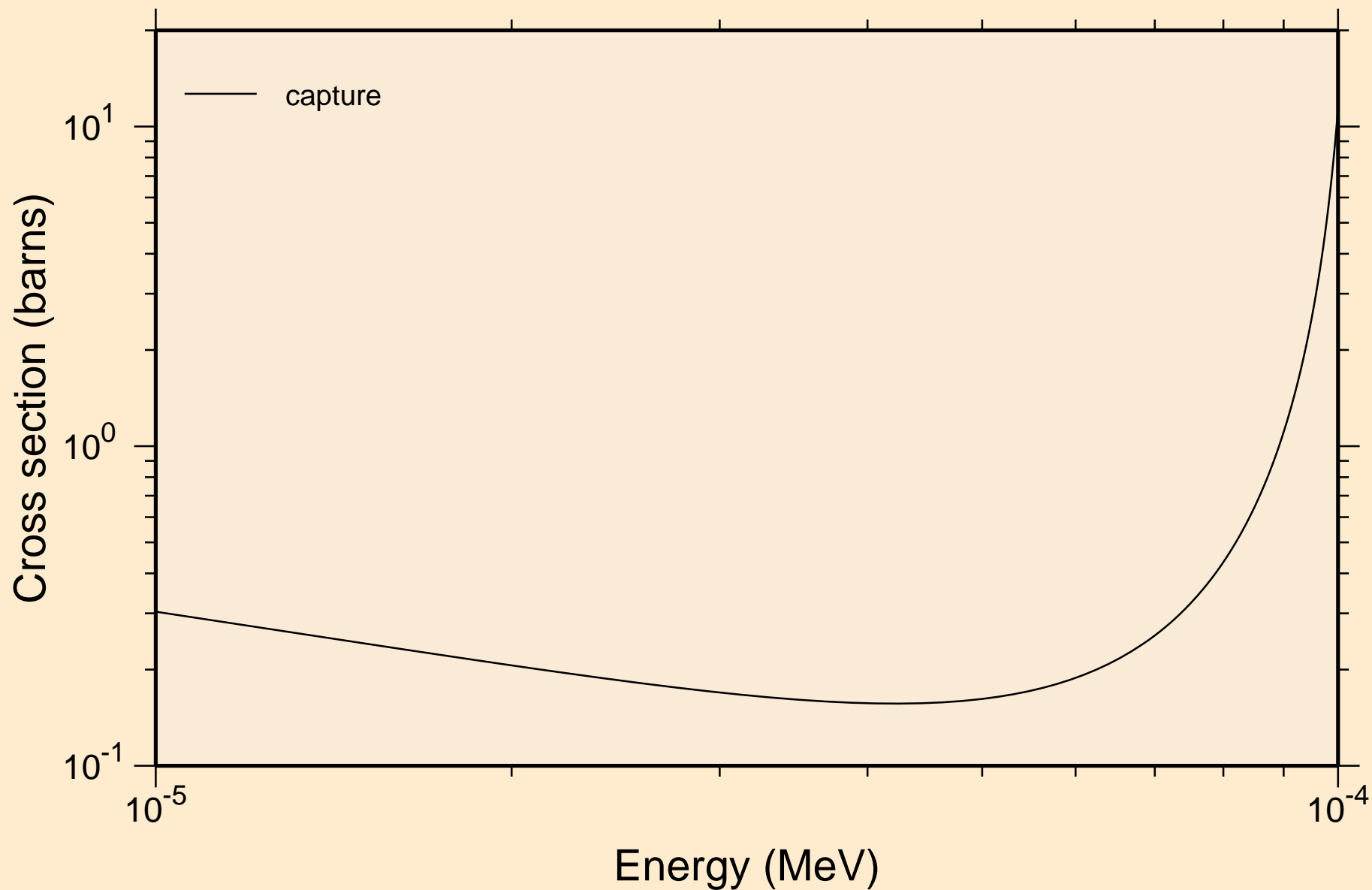

56-BA-132 FOR FENDL-3.2 FROM FENDL-3.2 WITH NJOY2016.60
resonance absorption cross sections

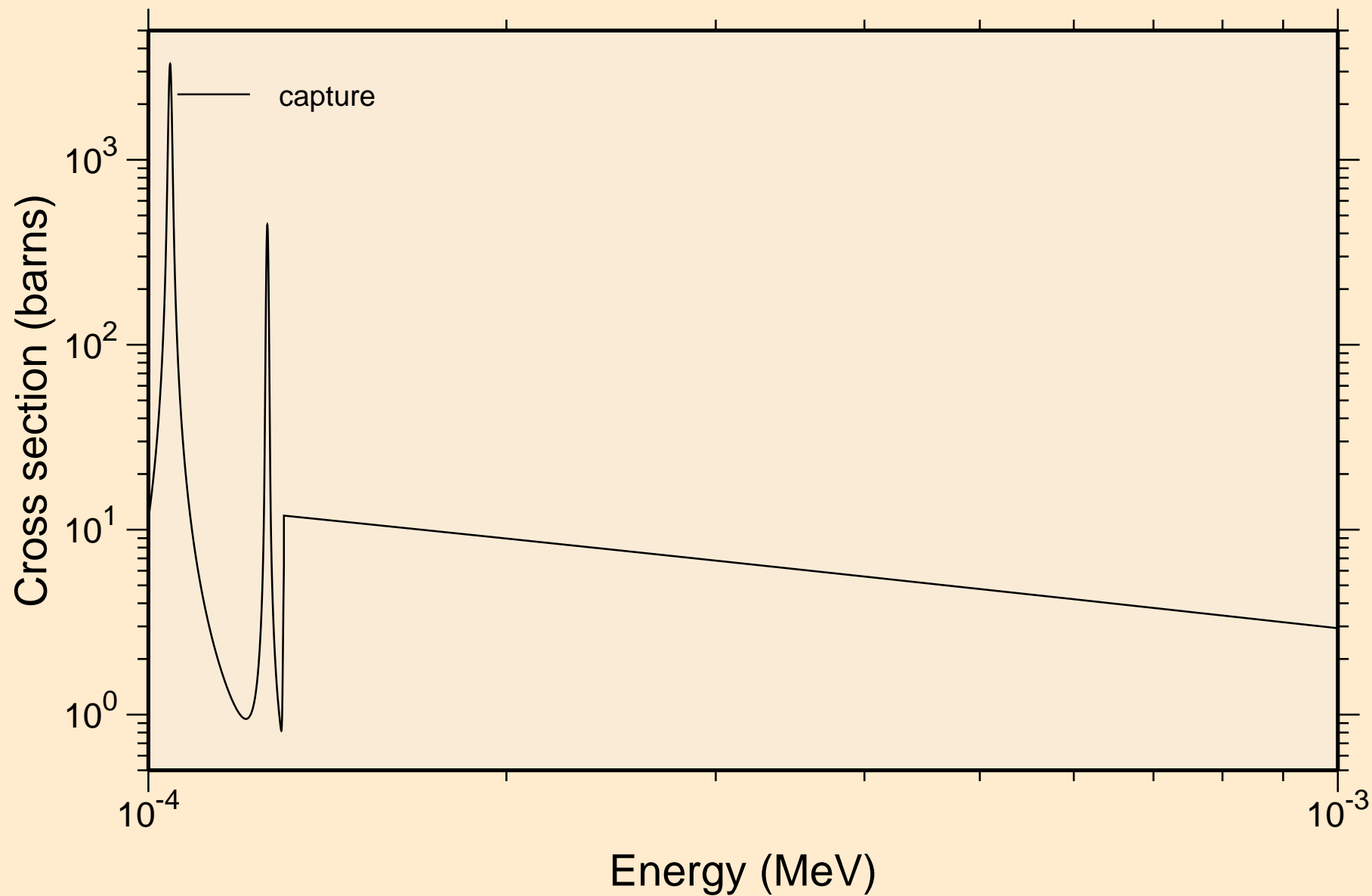

56-BA-132 FOR FENDL-3.2 FROM FENDL-3.2 WITH NJOY2016.60
resonance absorption cross sections

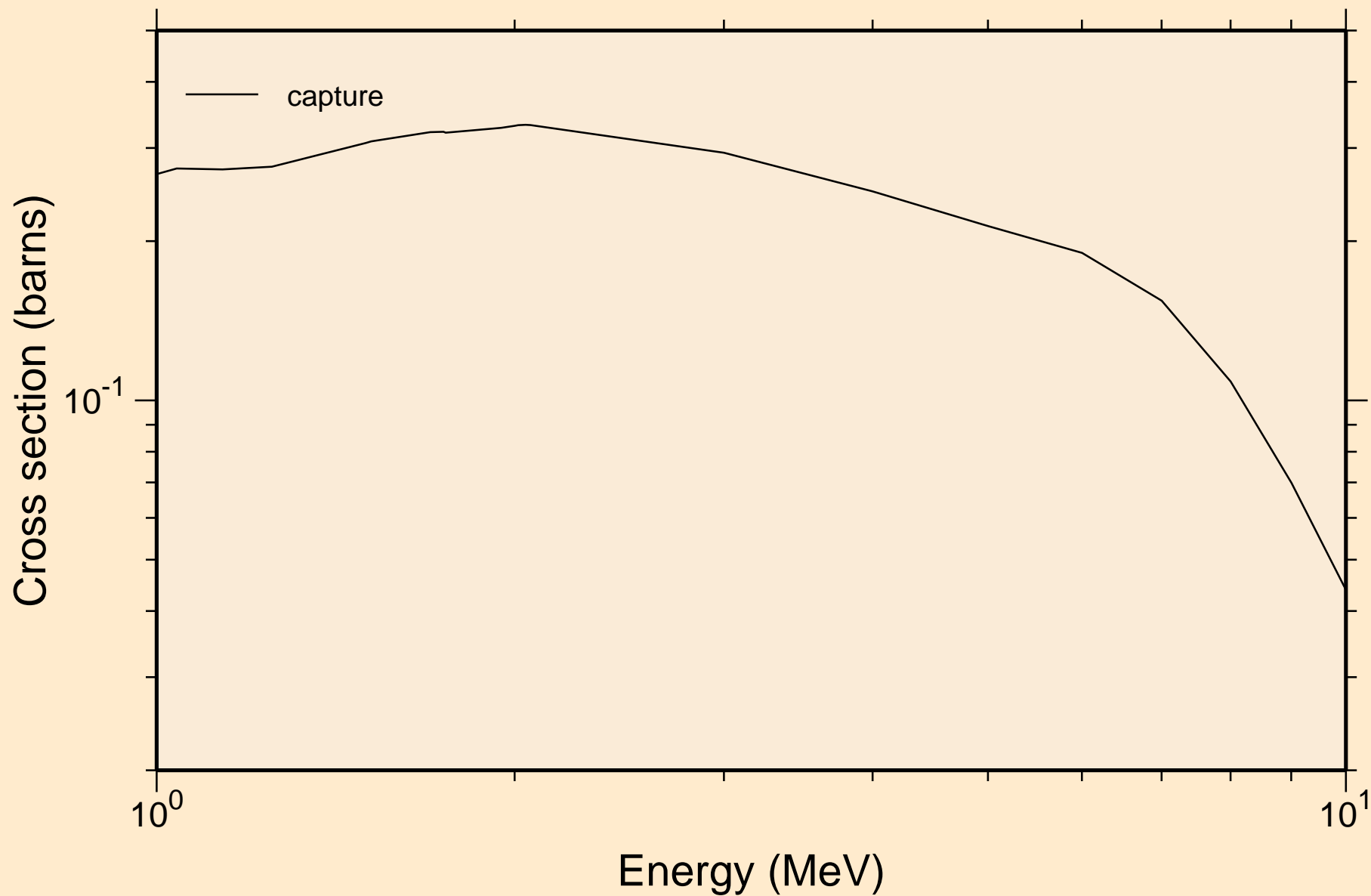

56-BA-132 FOR FENDL-3.2 FROM FENDL-3.2 WITH NJOY2016.60
UR total cross section

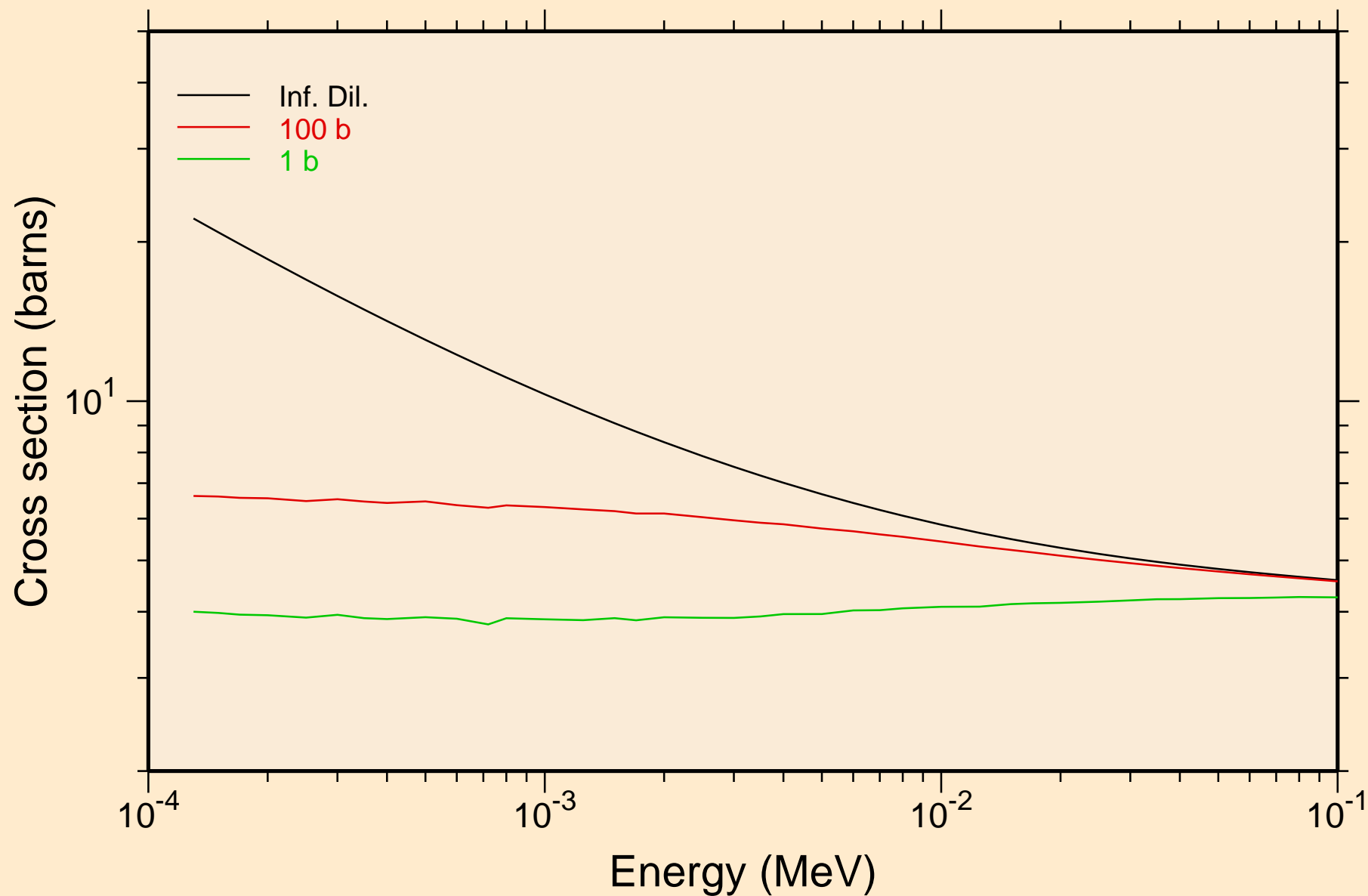

56-BA-132 FOR FENDL-3.2 FROM FENDL-3.2 WITH NJOY2016.60
UR elastic cross section

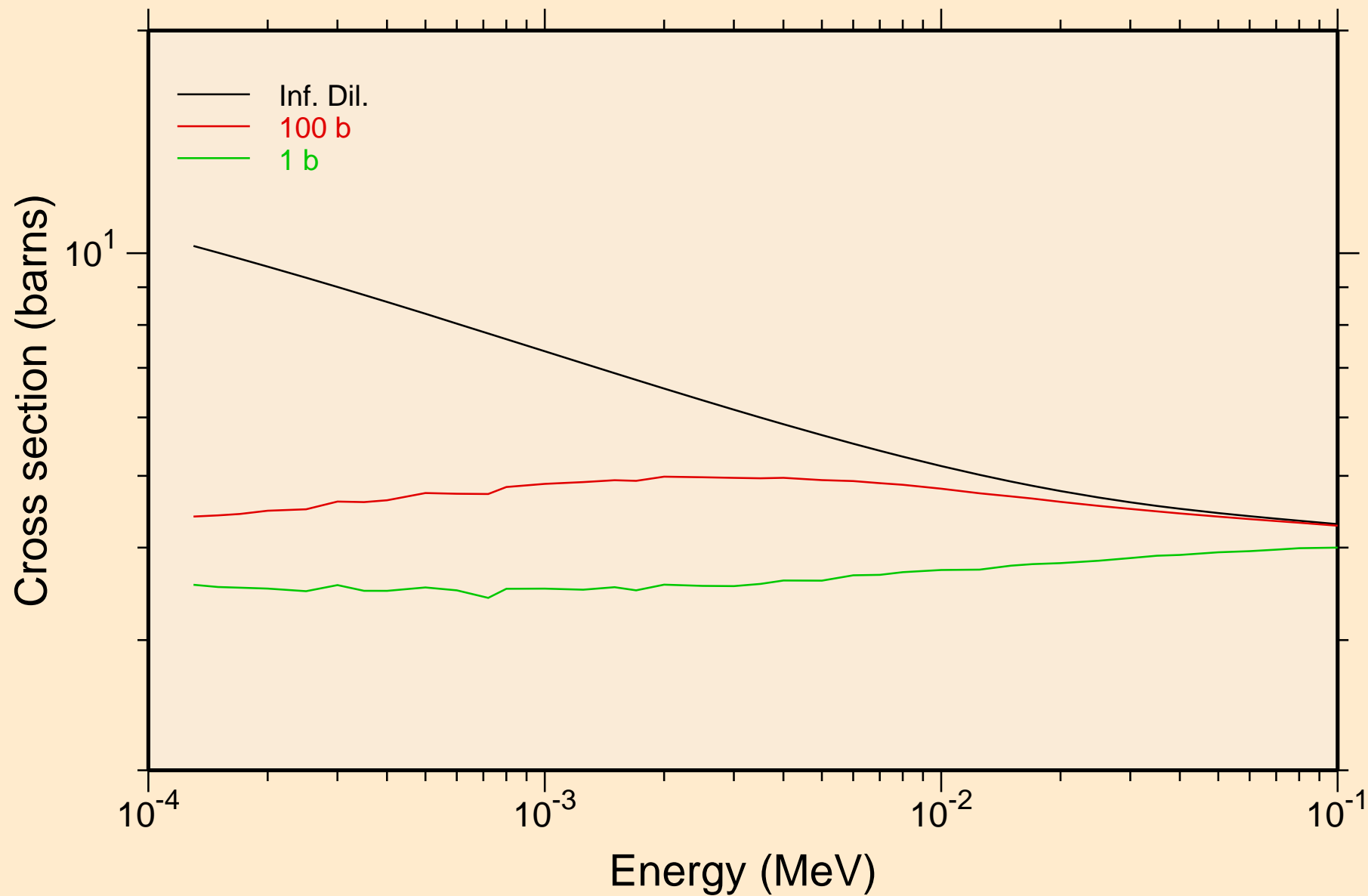

56-BA-132 FOR FENDL-3.2 FROM FENDL-3.2 WITH NJOY2016.60
UR capture cross section

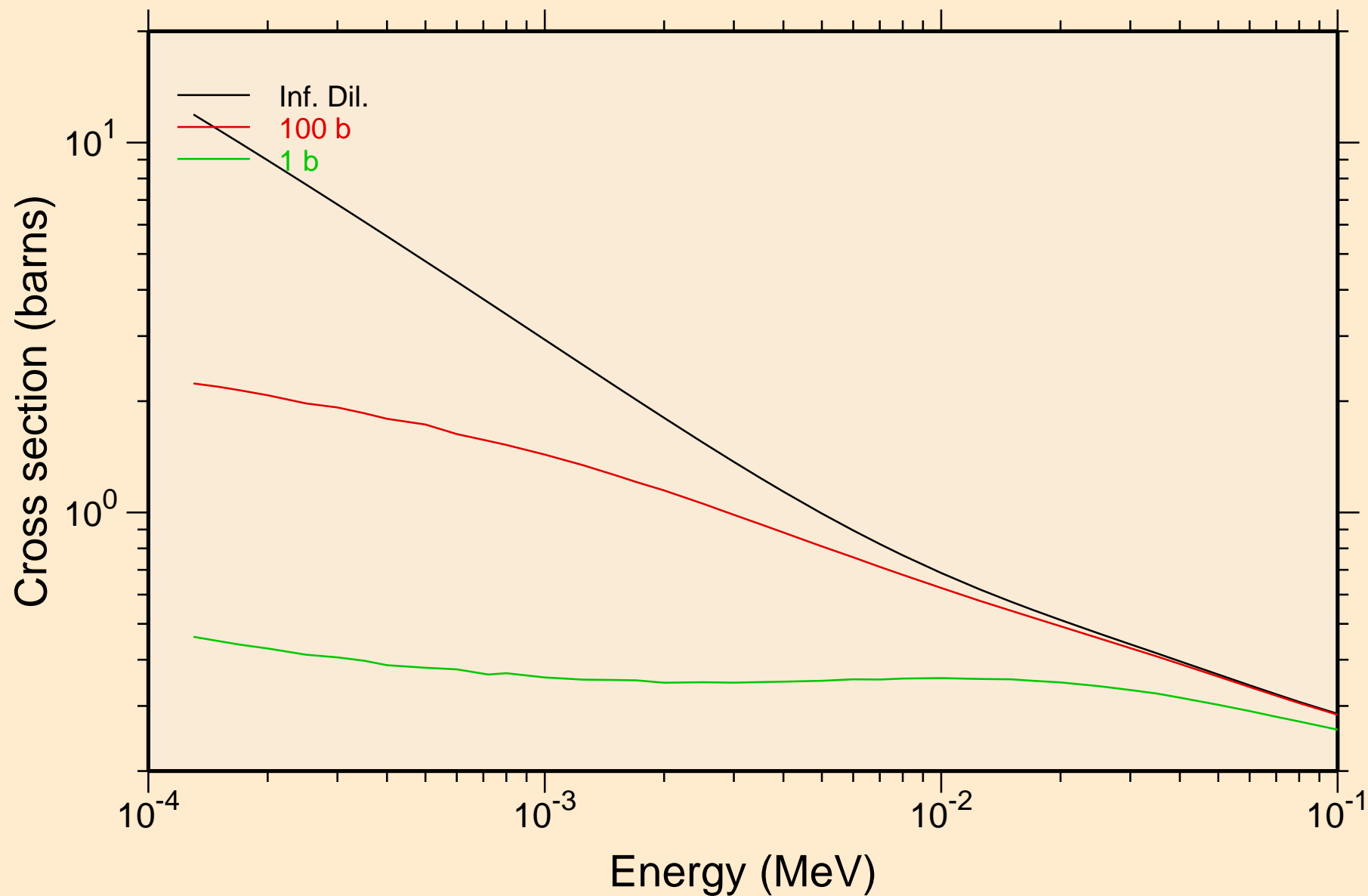

56-BA-132 FOR FENDL-3.2 FROM FENDL-3.2 WITH NJOY2016.60 Heating

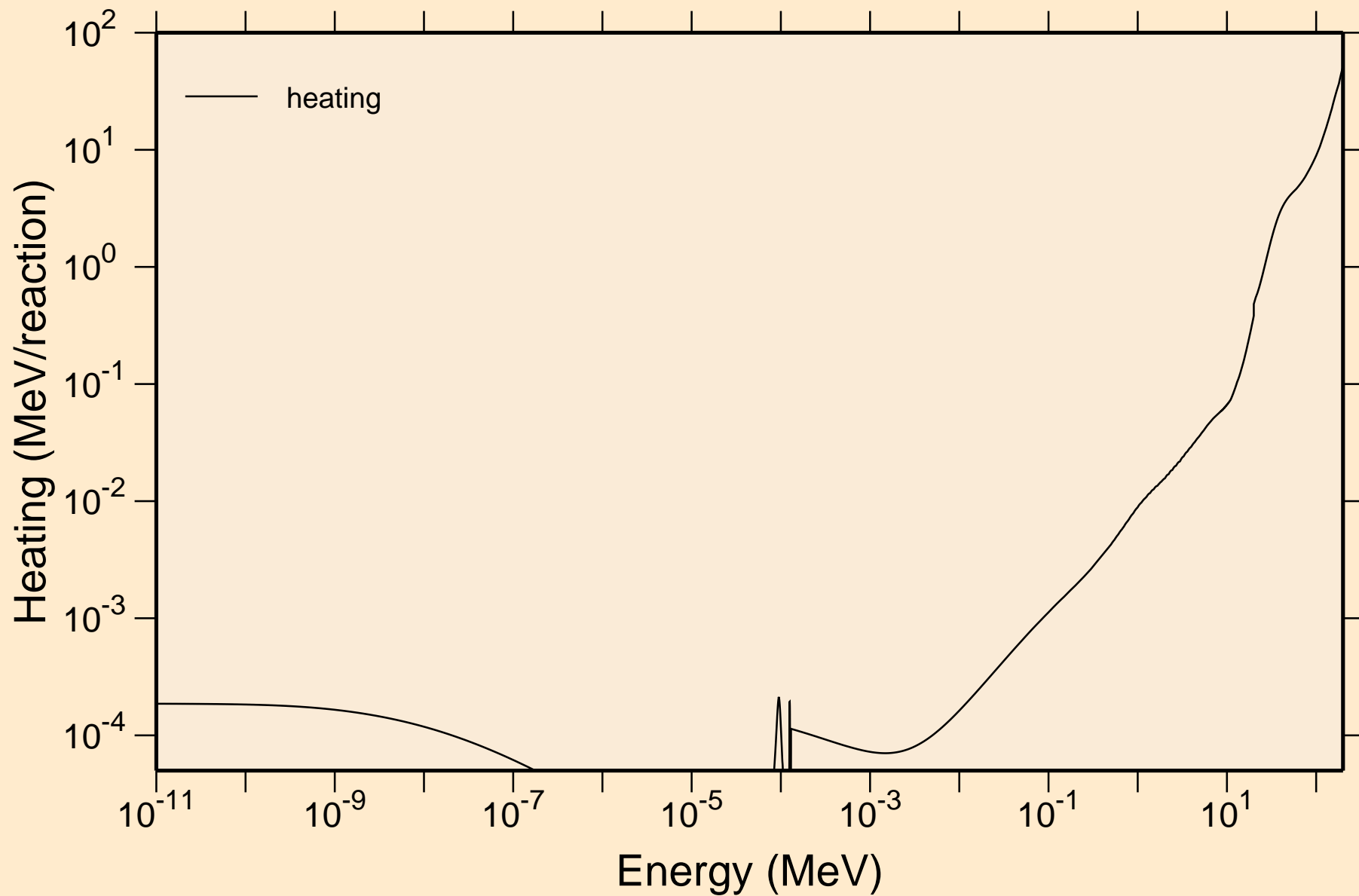

56-BA-132 FOR FENDL-3.2 FROM FENDL-3.2 WITH NJOY2016.60
Damage

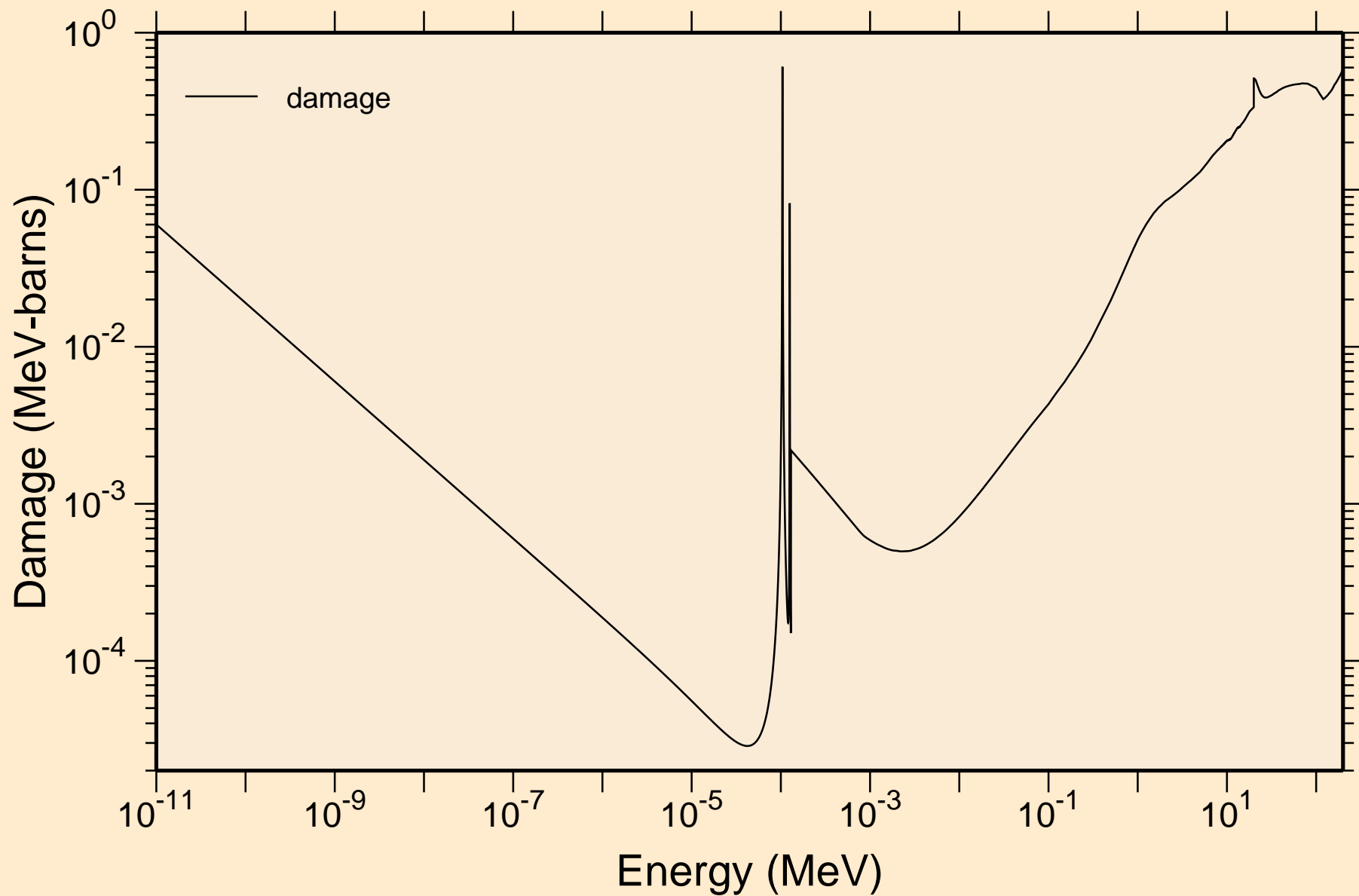

56-BA-132 FOR FENDL-3.2 FROM FENDL-3.2 WITH NJOY2016.60
Non-threshold reactions

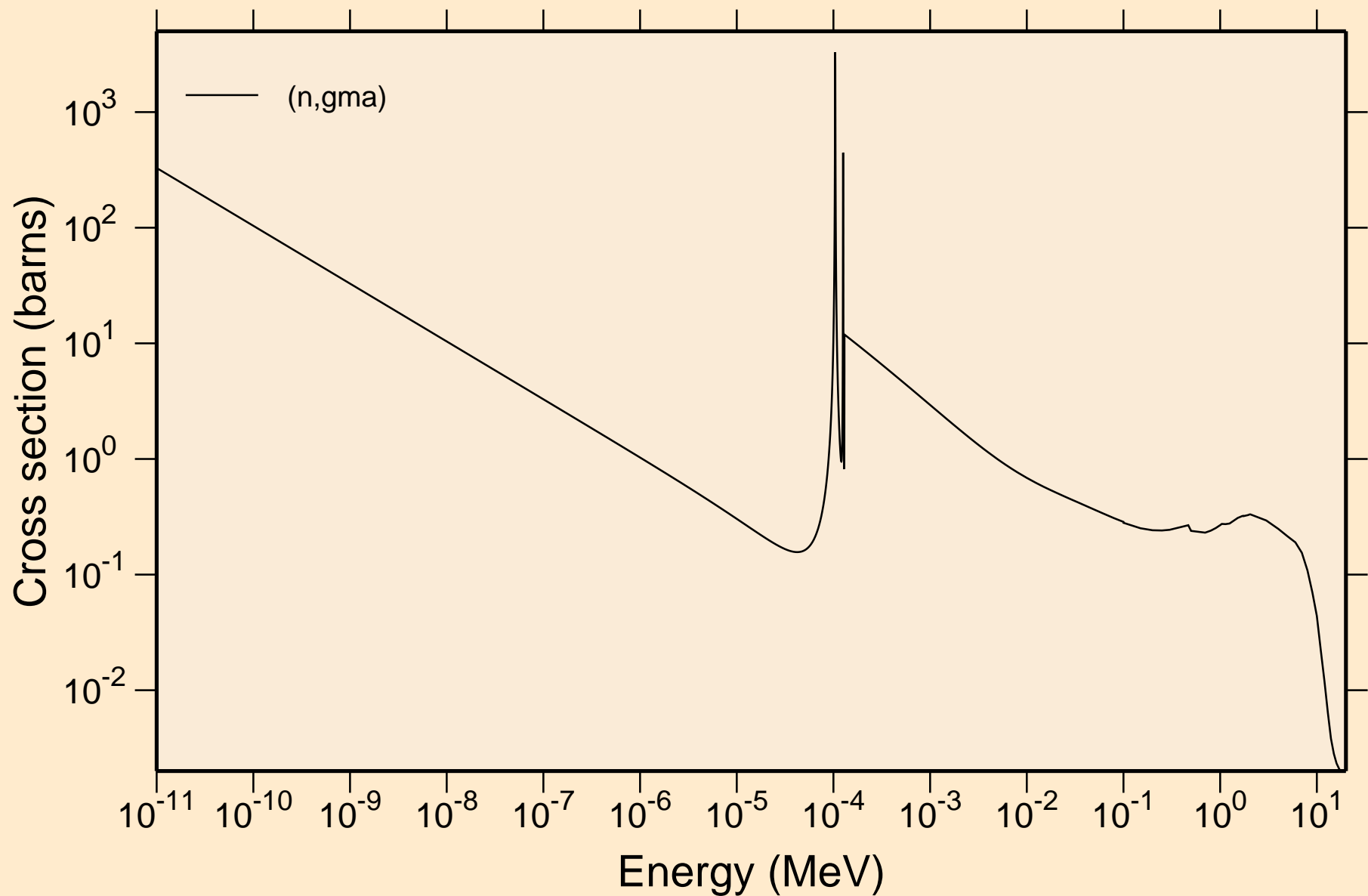

56-BA-132 FOR FENDL-3.2 FROM FENDL-3.2 WITH NJOY2016.60
Principal cross sections

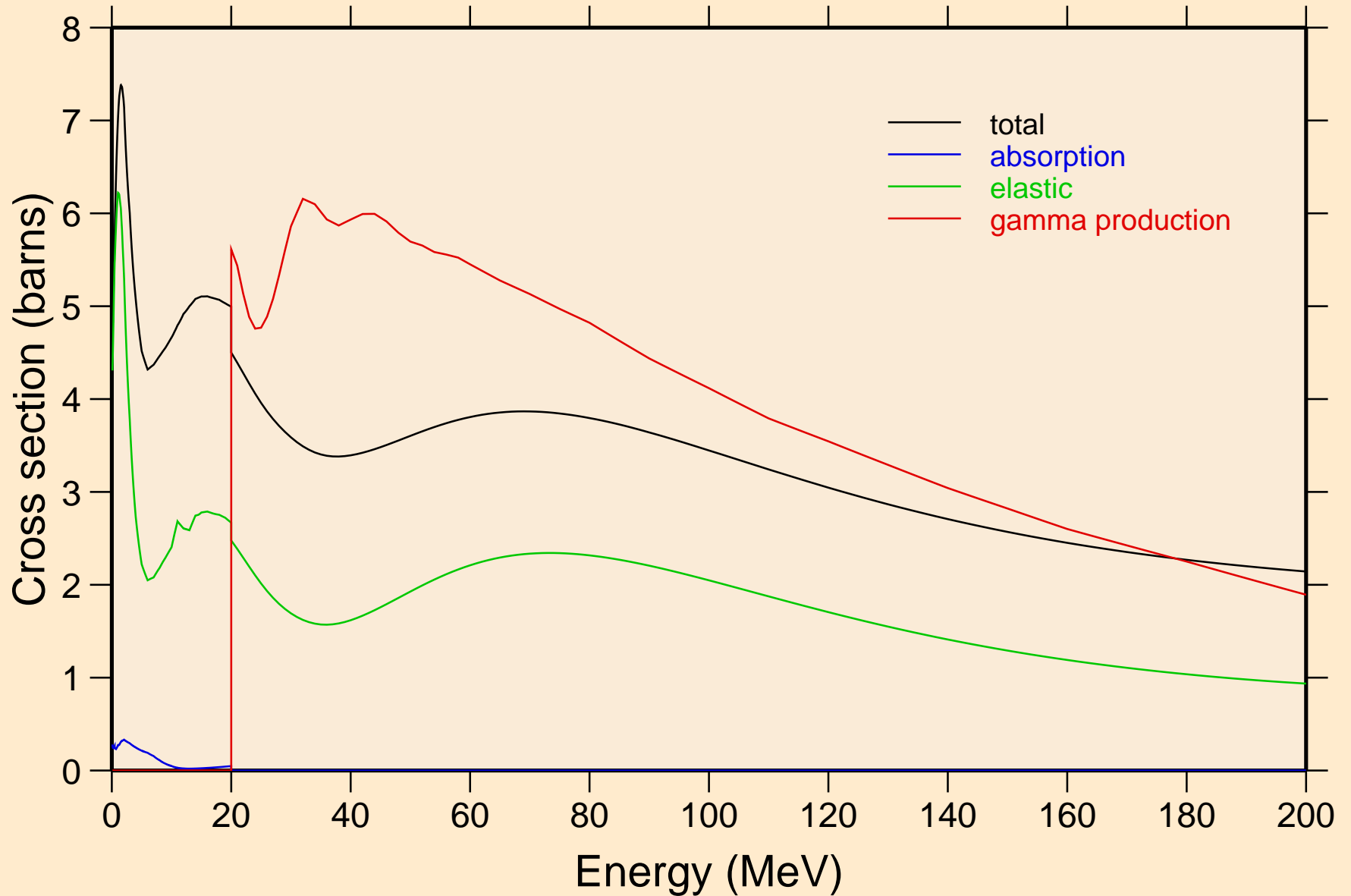

56-BA-132 FOR FENDL-3.2 FROM FENDL-3.2 WITH NJOY2016.60

Heating

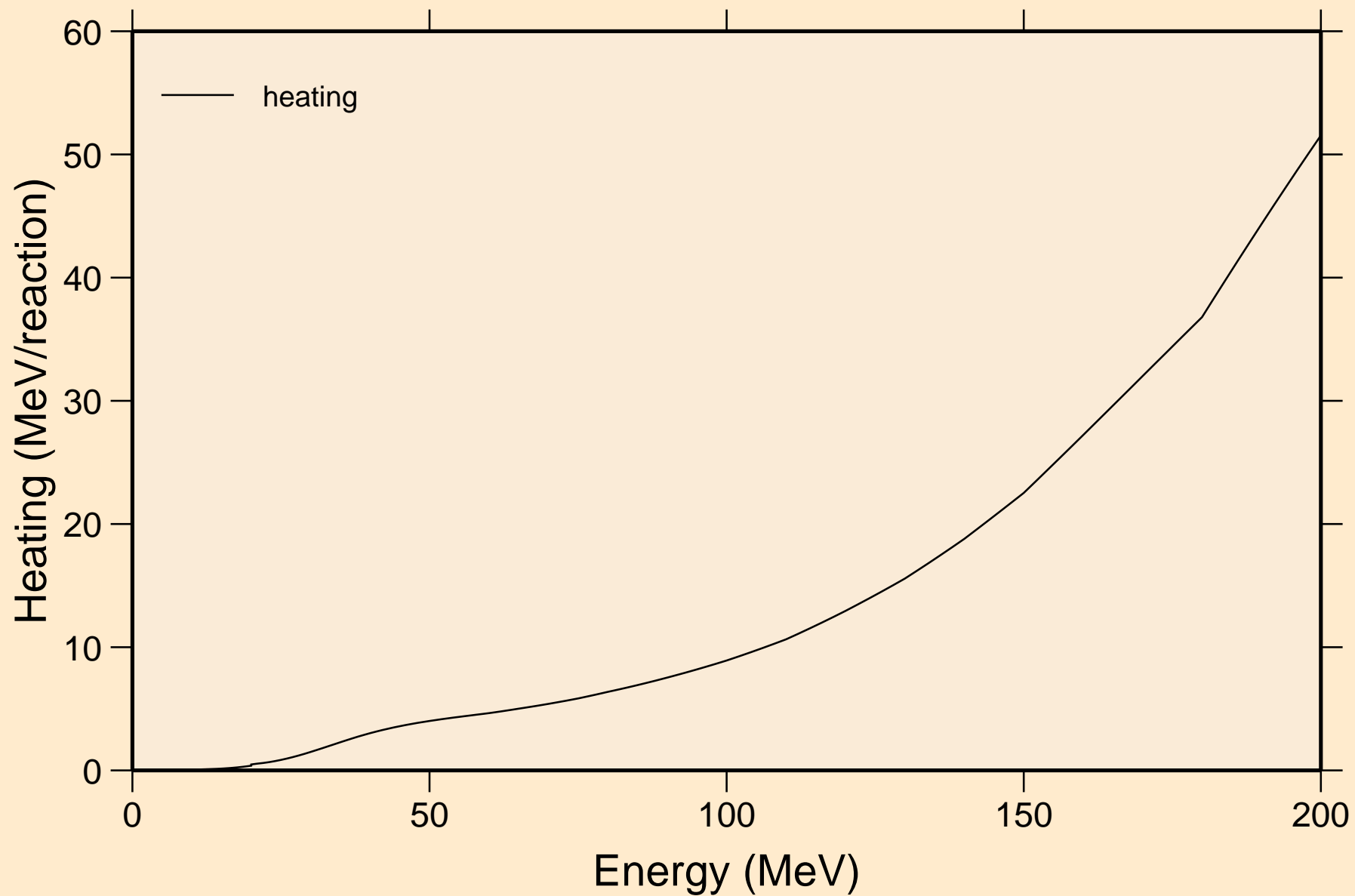

56-BA-132 FOR FENDL-3.2 FROM FENDL-3.2 WITH NJOY2016.60 Damage

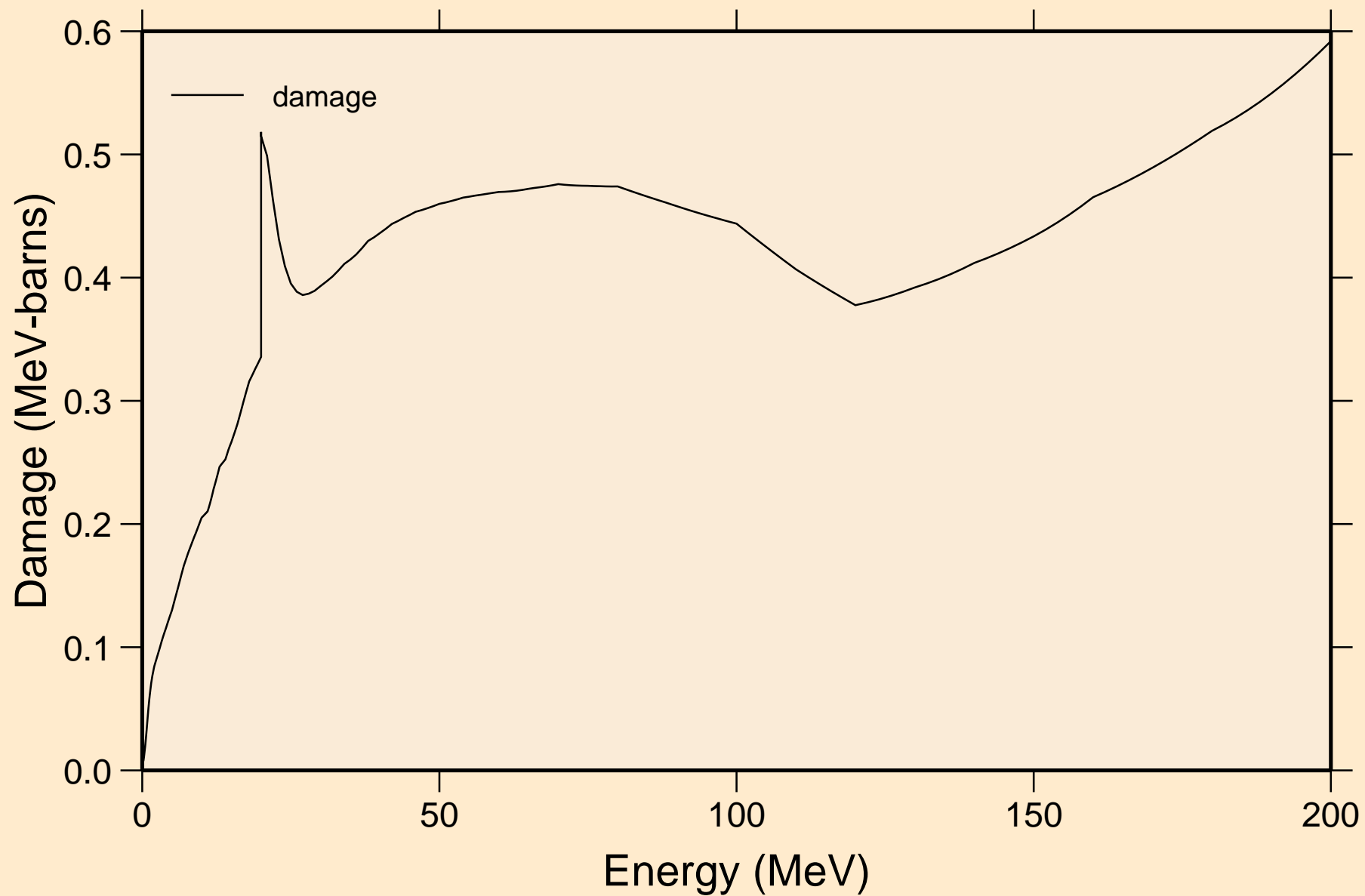

56-BA-132 FOR FENDL-3.2 FROM FENDL-3.2 WITH NJOY2016.60
Non-threshold reactions

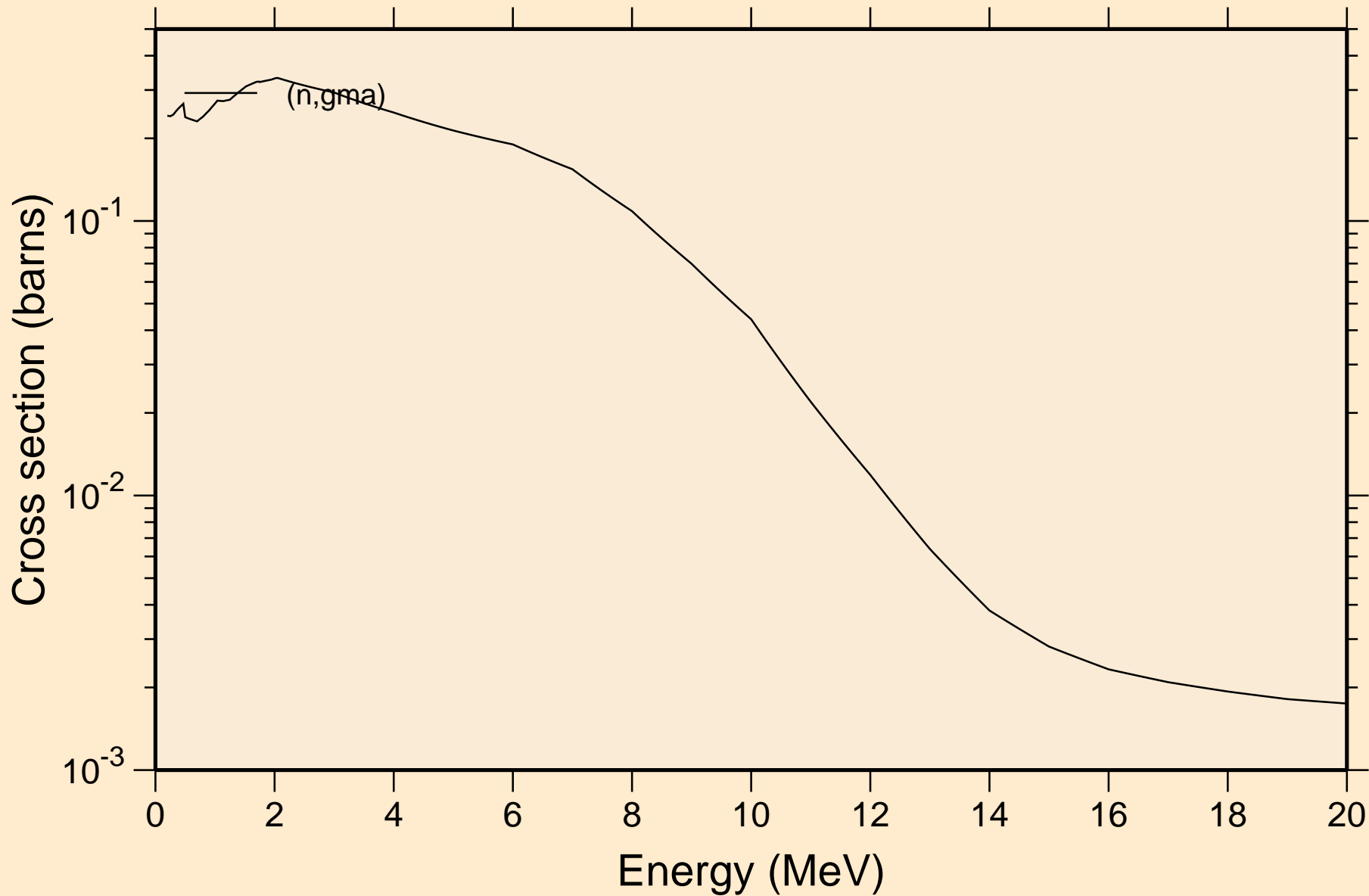

56-BA-132 FOR FENDL-3.2 FROM FENDL-3.2 WITH NJOY2016.60
Inelastic levels

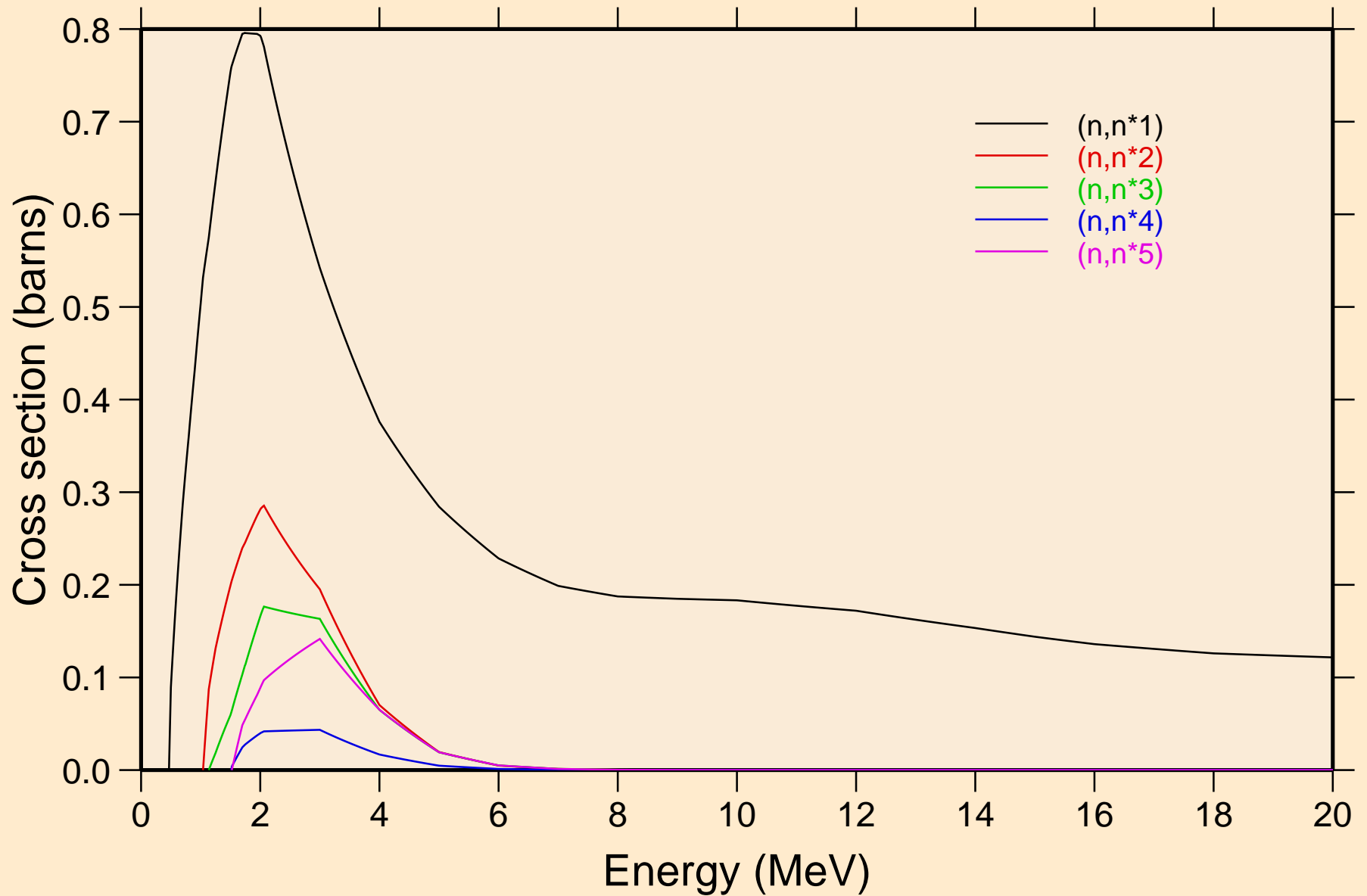

56-BA-132 FOR FENDL-3.2 FROM FENDL-3.2 WITH NJOY2016.60
Inelastic levels

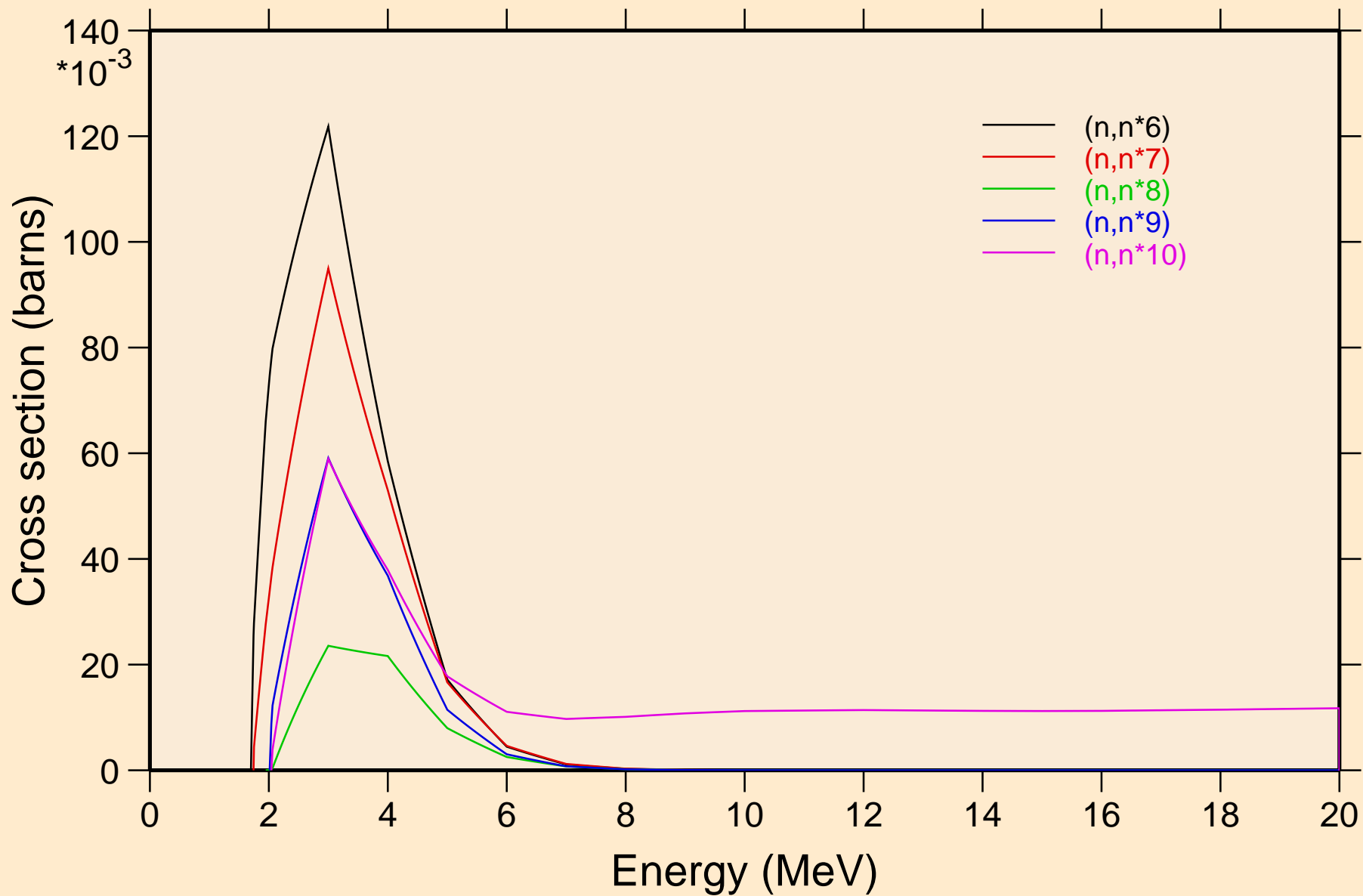

56-BA-132 FOR FENDL-3.2 FROM FENDL-3.2 WITH NJOY2016.60
Threshold reactions

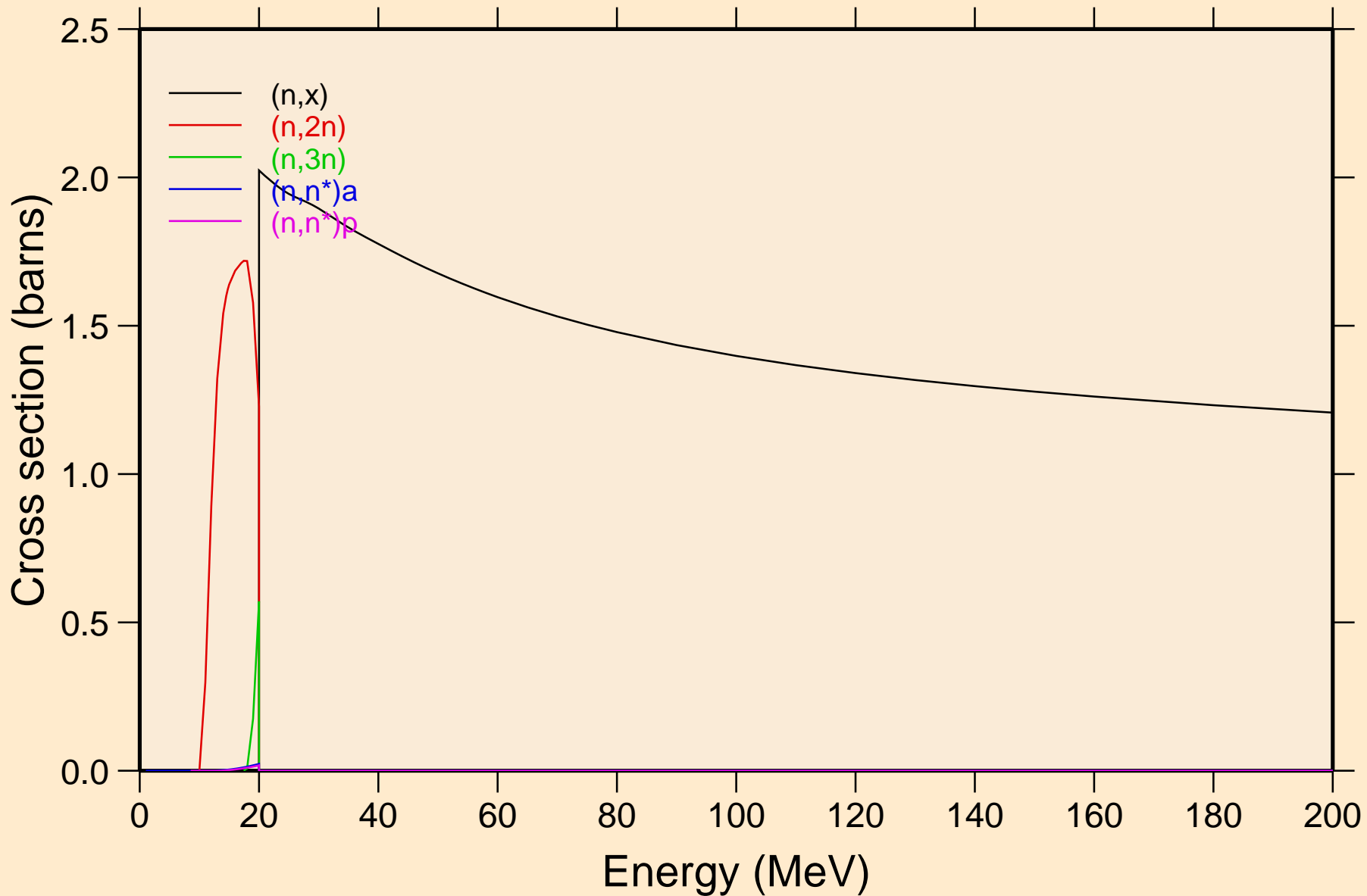

56-BA-132 FOR FENDL-3.2 FROM FENDL-3.2 WITH NJOY2016.60
Threshold reactions

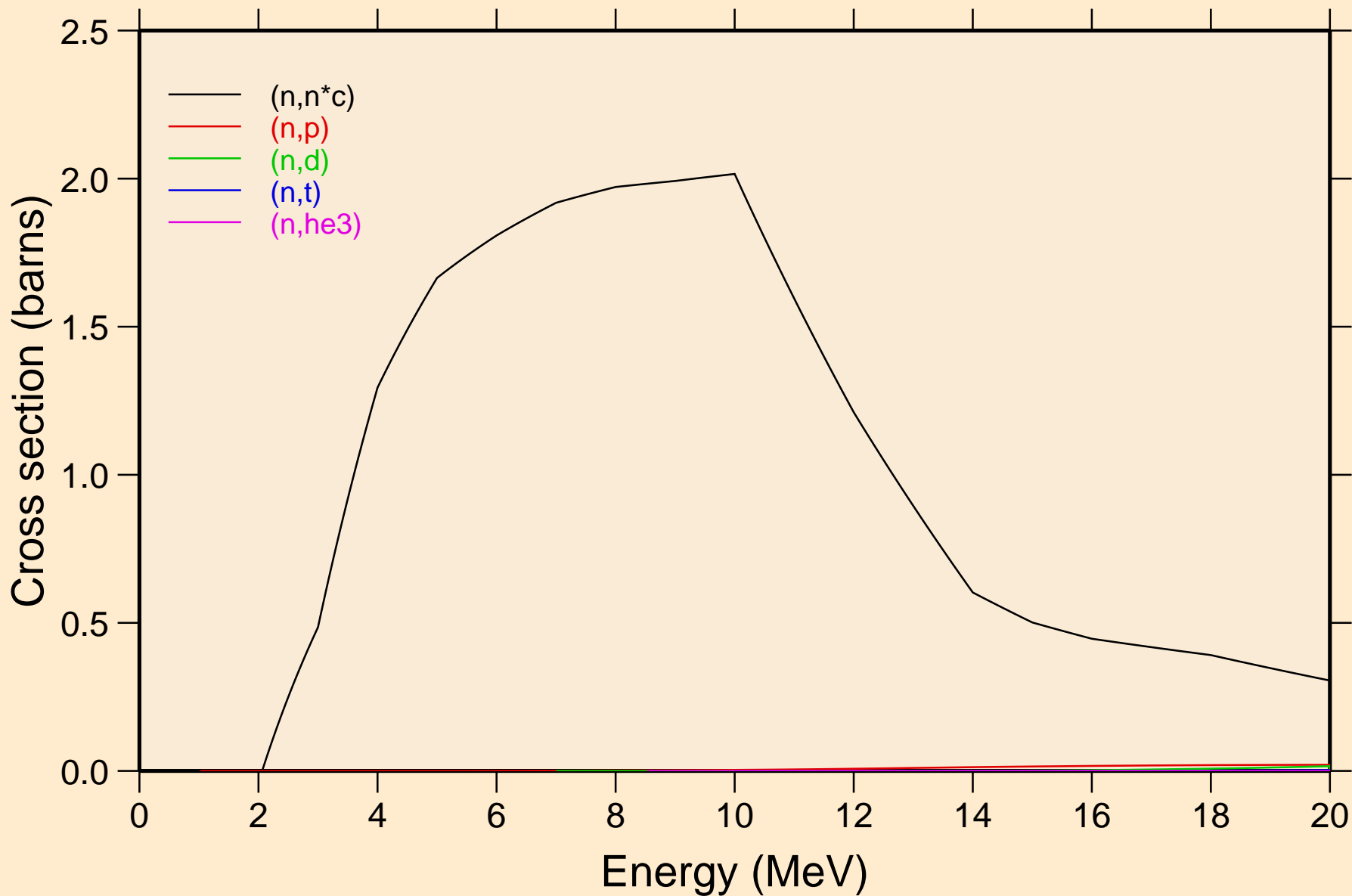

56-BA-132 FOR FENDL-3.2 FROM FENDL-3.2 WITH NJOY2016.60
Threshold reactions

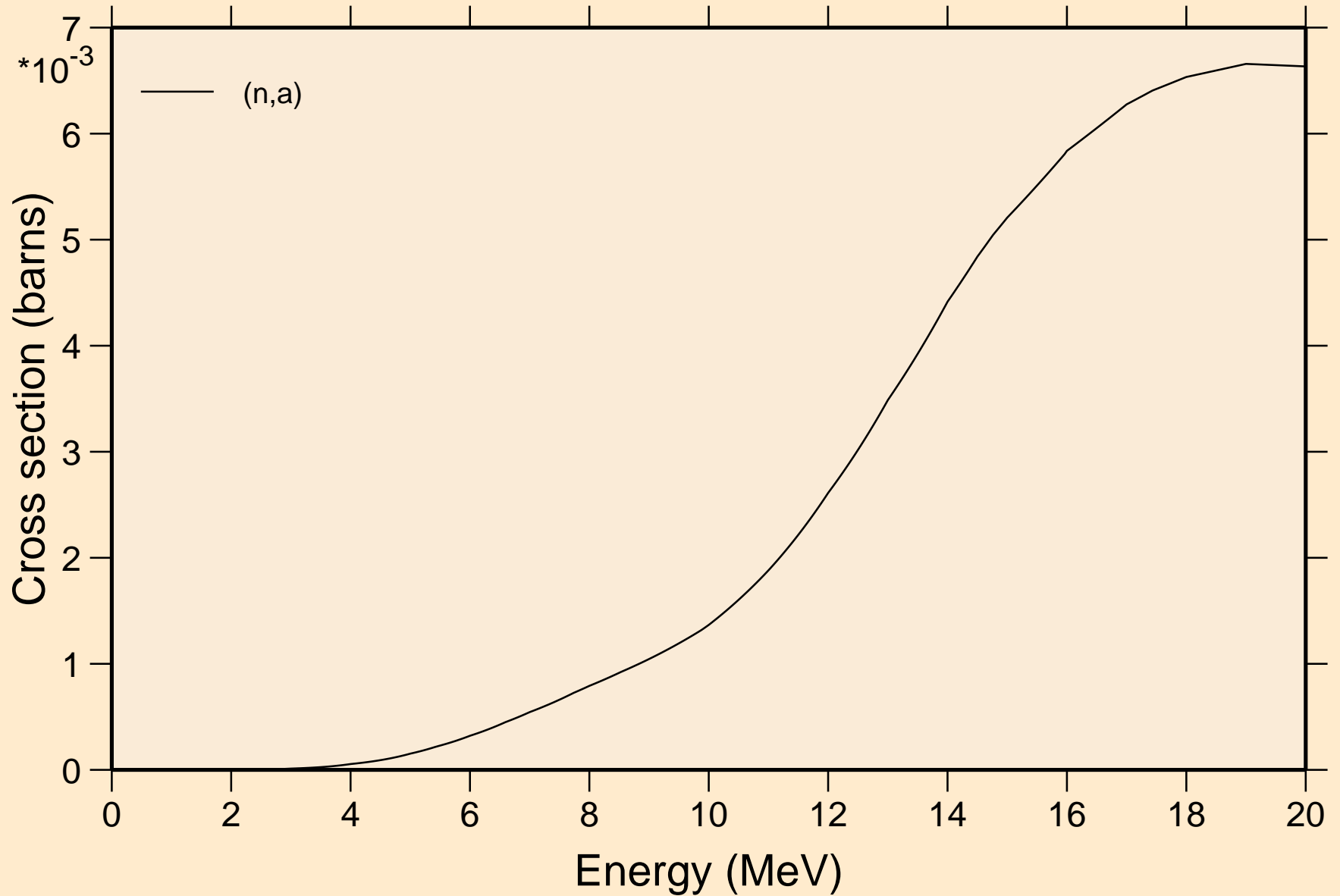

56-BA-132 FOR FENDL-3.2 FROM FENDL-3.2 WITH NJOY2016.60

Threshold reactions

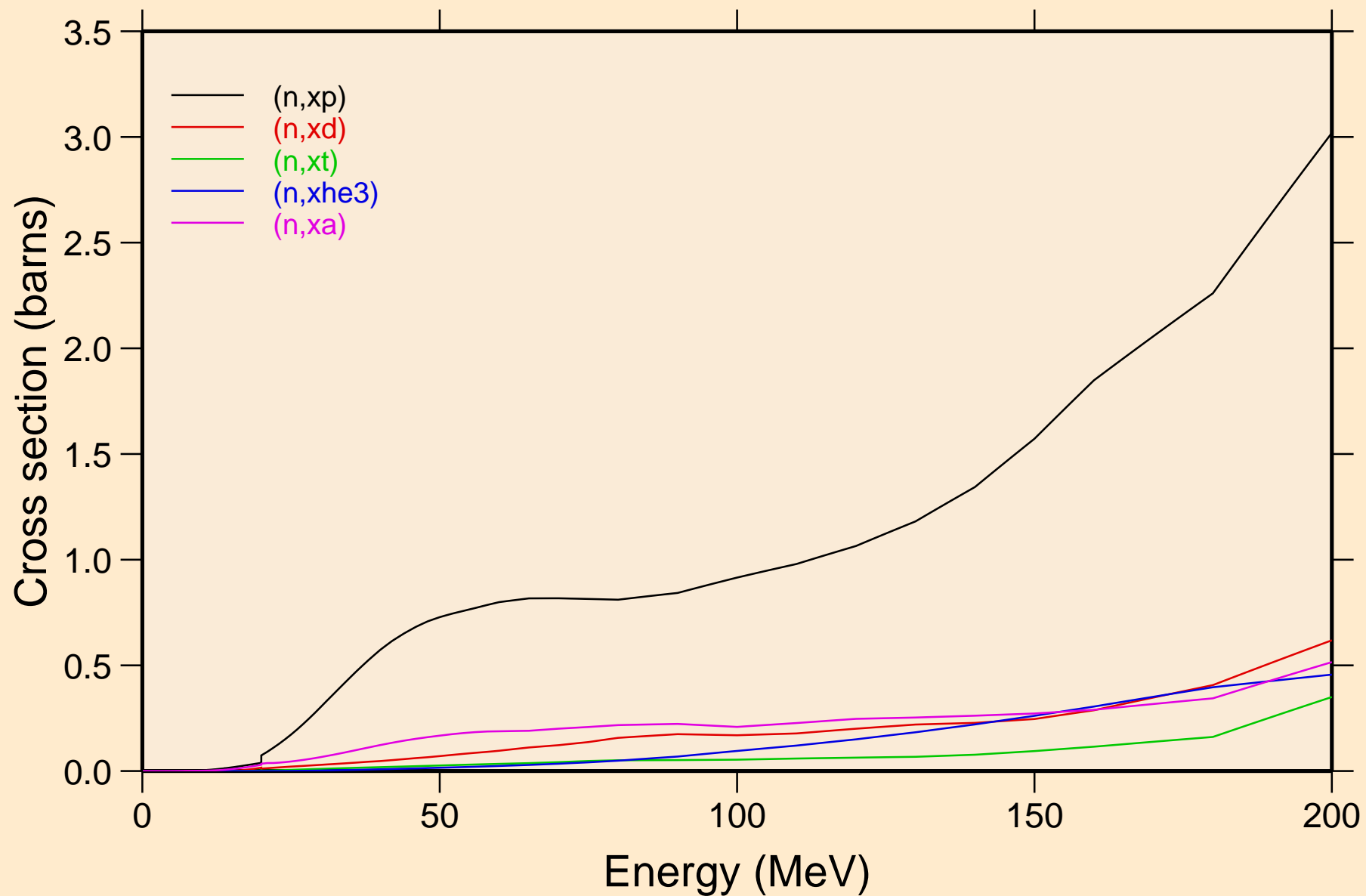

56-BA-132 FOR FENDL-3.2 FROM FENDL-3.2 WITH NJOY2016.60
angular distribution for elastic

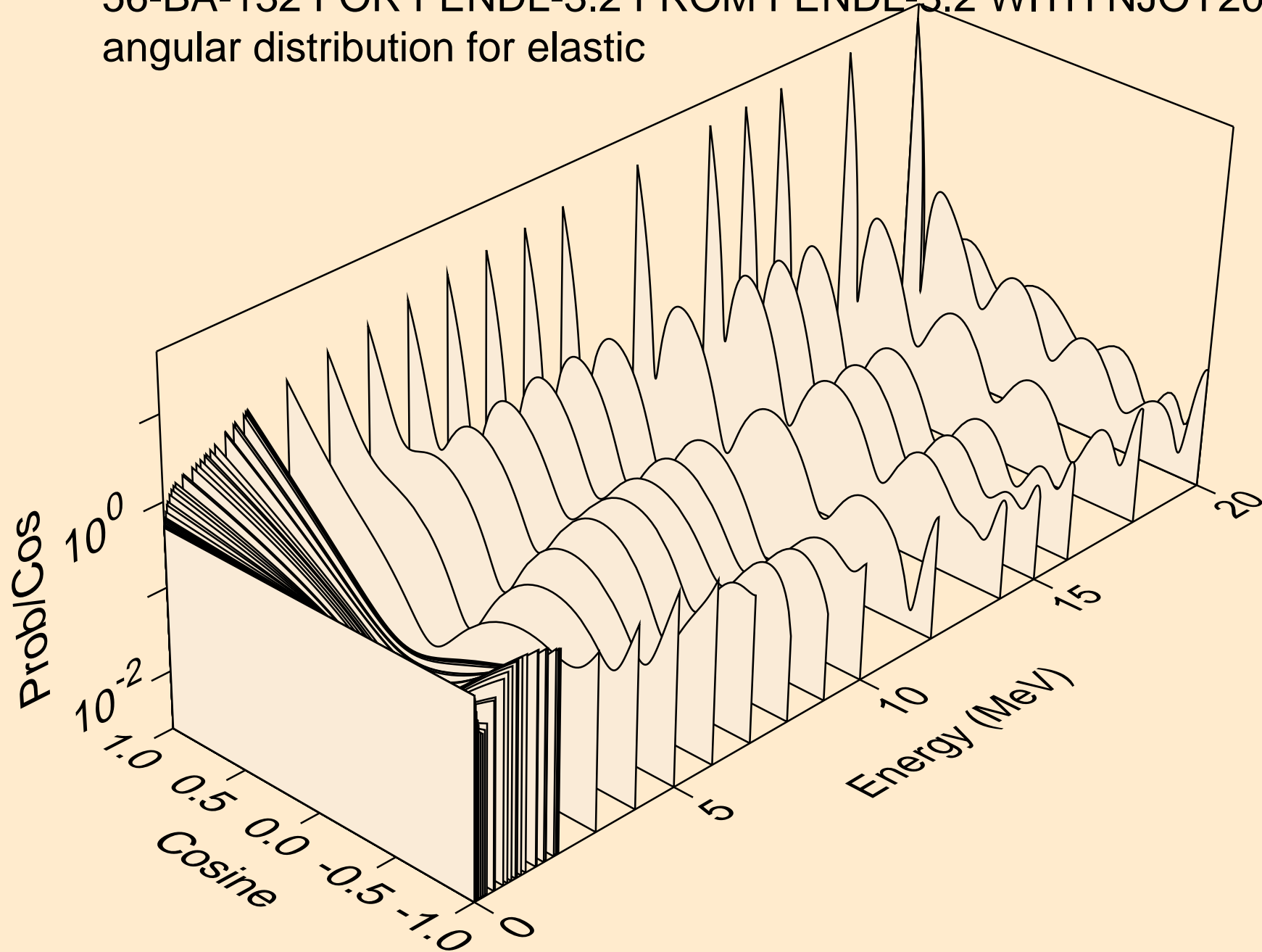

56-BA-132 FOR FENDL-3.2 FROM FENDL-3.2 WITH NJOY2016.60
angular distribution for elastic

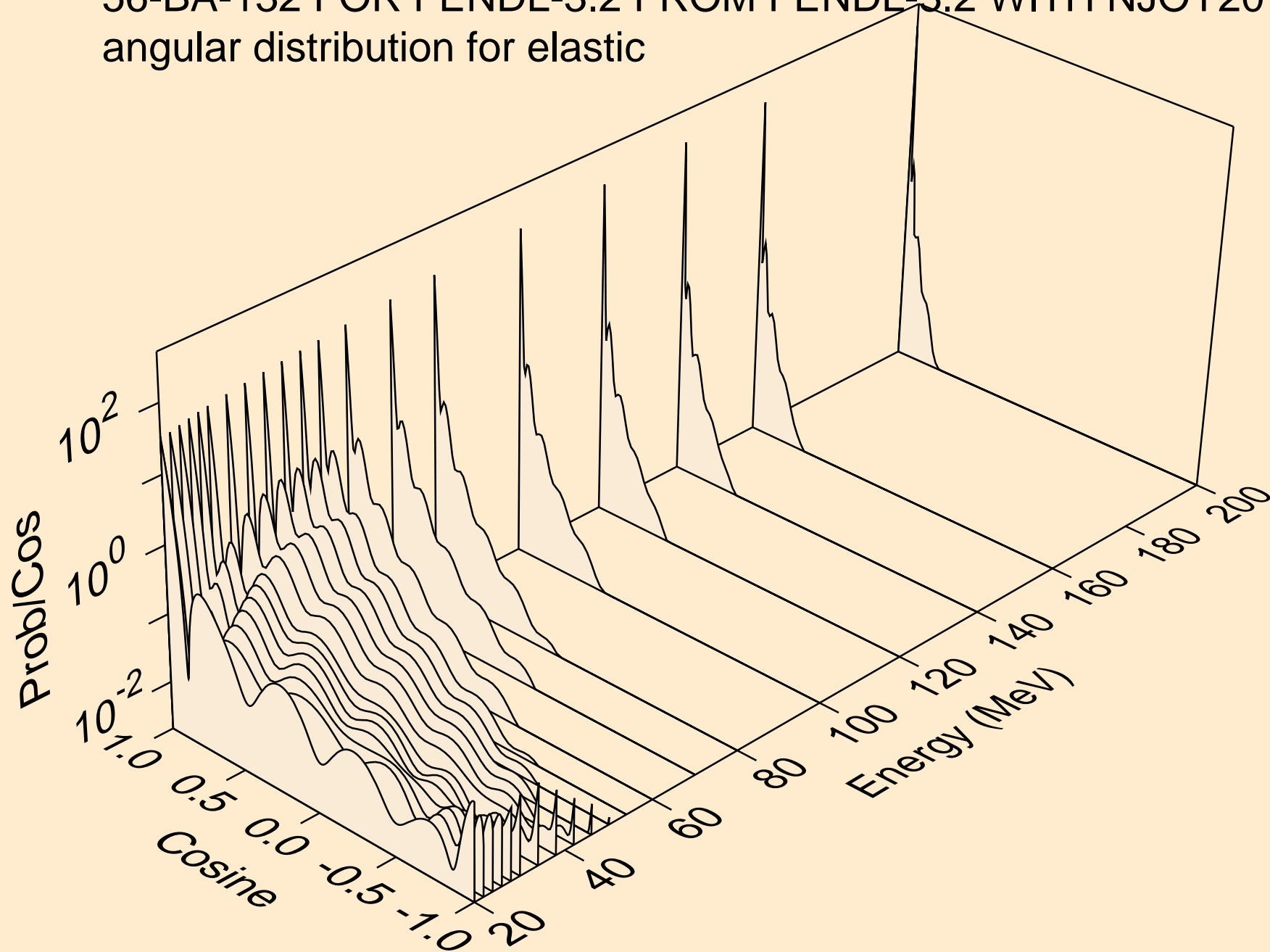

56-BA-132 FOR FENDL-3.2 FROM FENDL-3.2 WITH NJOY2016.60
angular distribution for (n,2n)

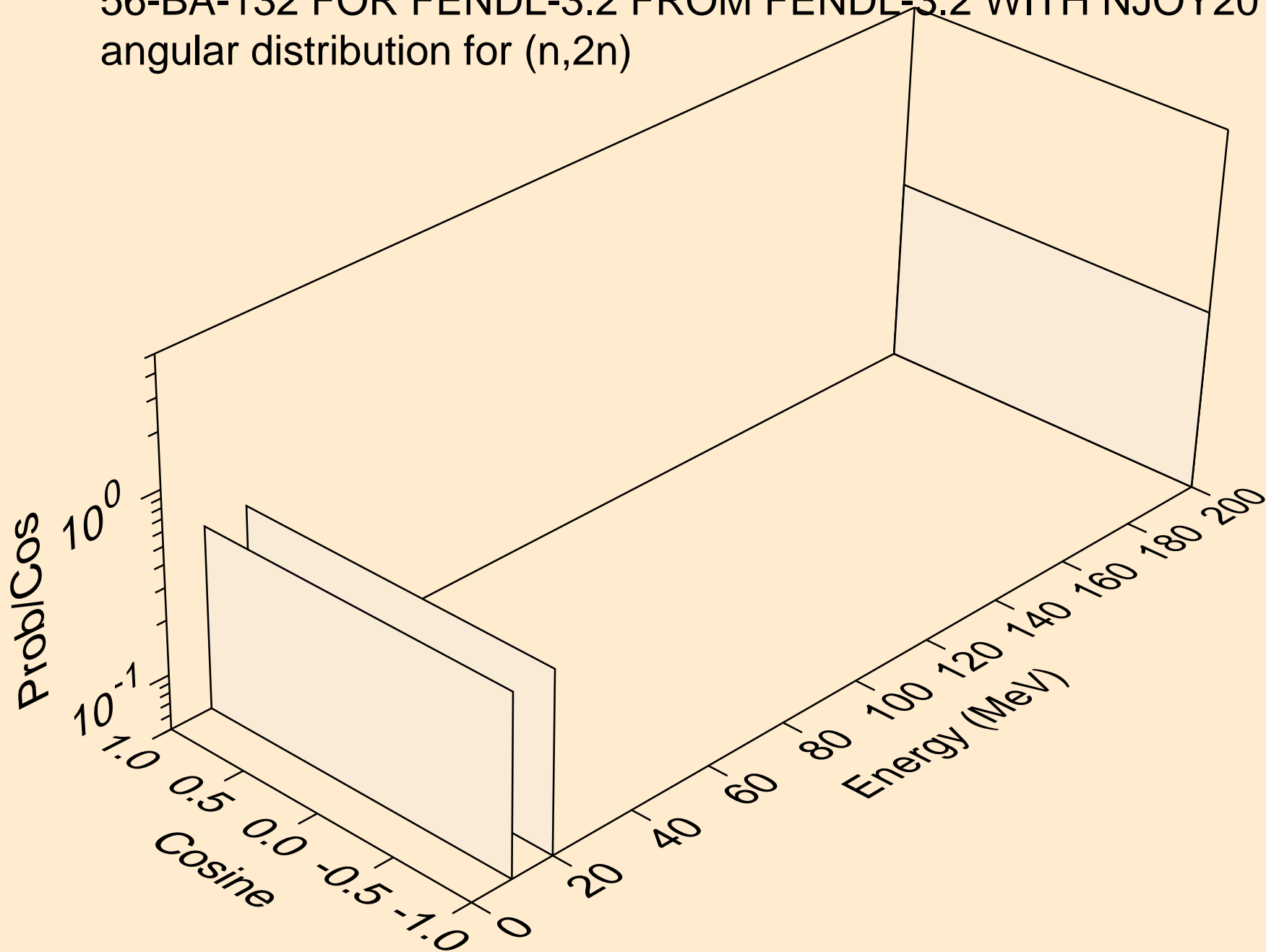

56-BA-132 FOR FENDL-3.2 FROM FENDL-3.2 WITH NJOY2016.60
angular distribution for (n,3n)

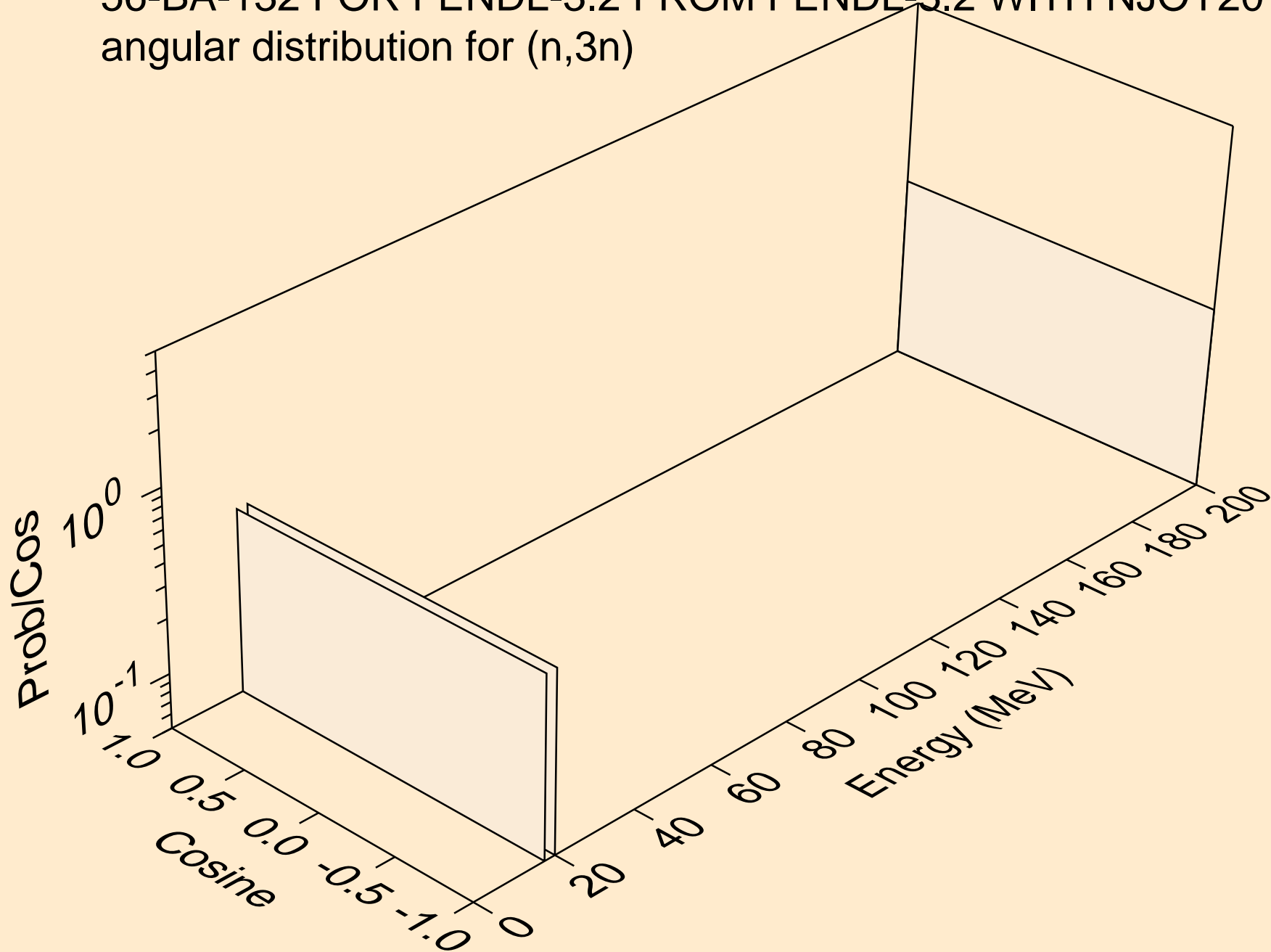

56-BA-132 FOR FENDL-3.2 FROM FENDL-3.2 WITH NJOY2016.60
angular distribution for (n,n*)a

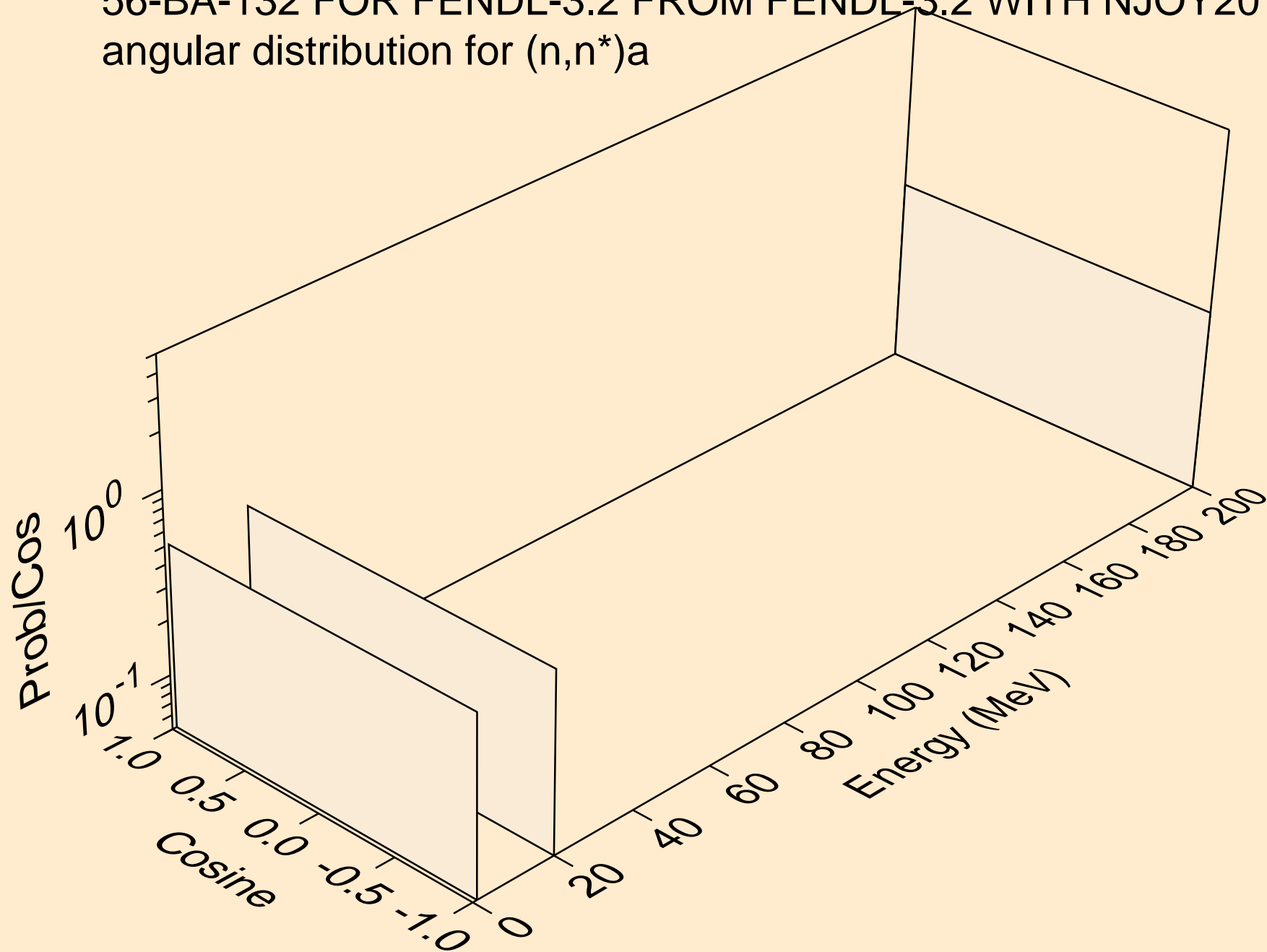

56-BA-132 FOR FENDL-3.2 FROM FENDL-3.2 WITH NJOY2016.60
angular distribution for (n,n*)p

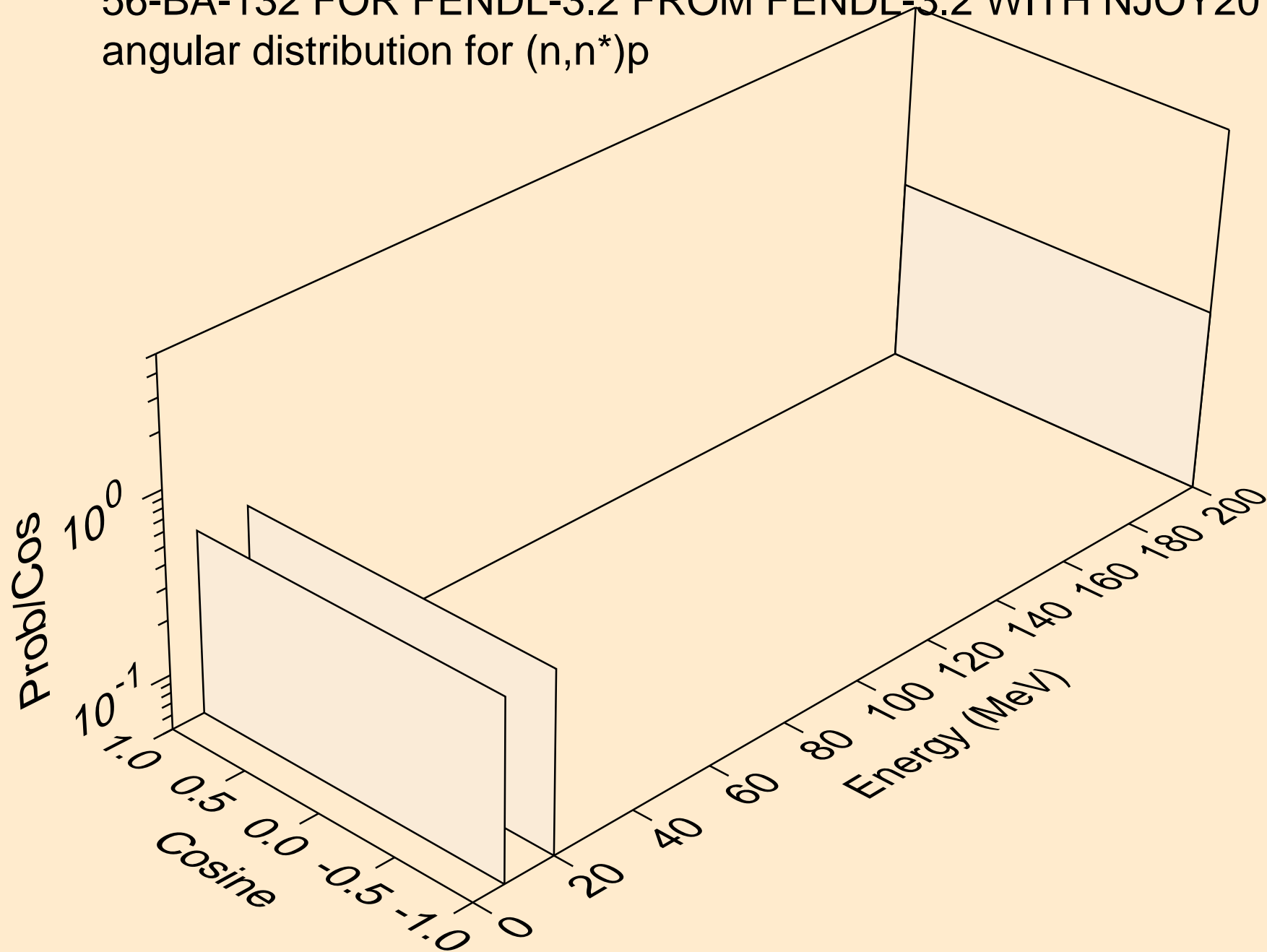

56-BA-132 FOR FENDL-3.2 FROM FENDL-3.2 WITH NJOY2016.60
angular distribution for (n,n*1)

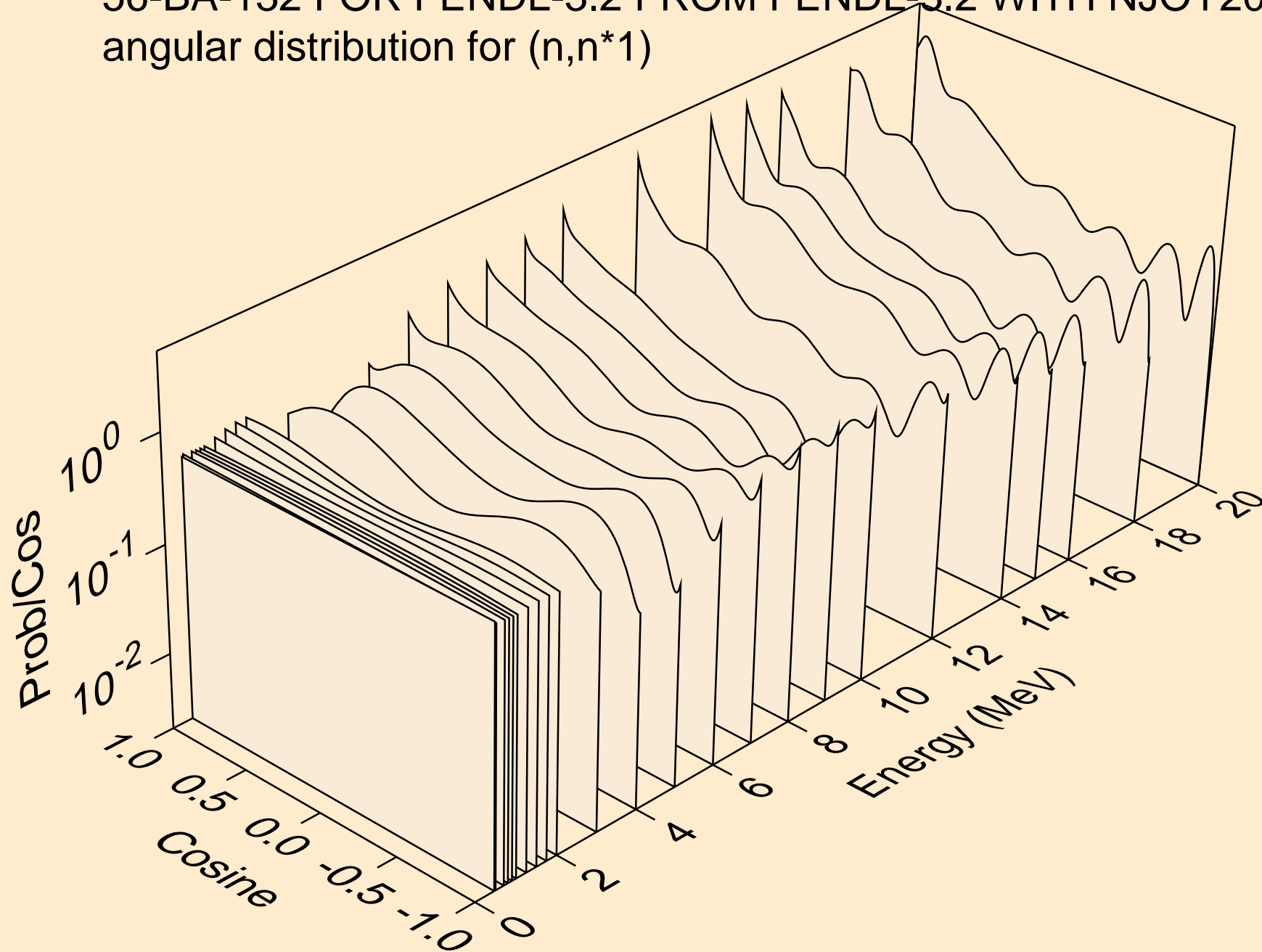

56-BA-132 FOR FENDL-3.2 FROM FENDL-3.2 WITH NJOY2016.60
angular distribution for (n,n*2)

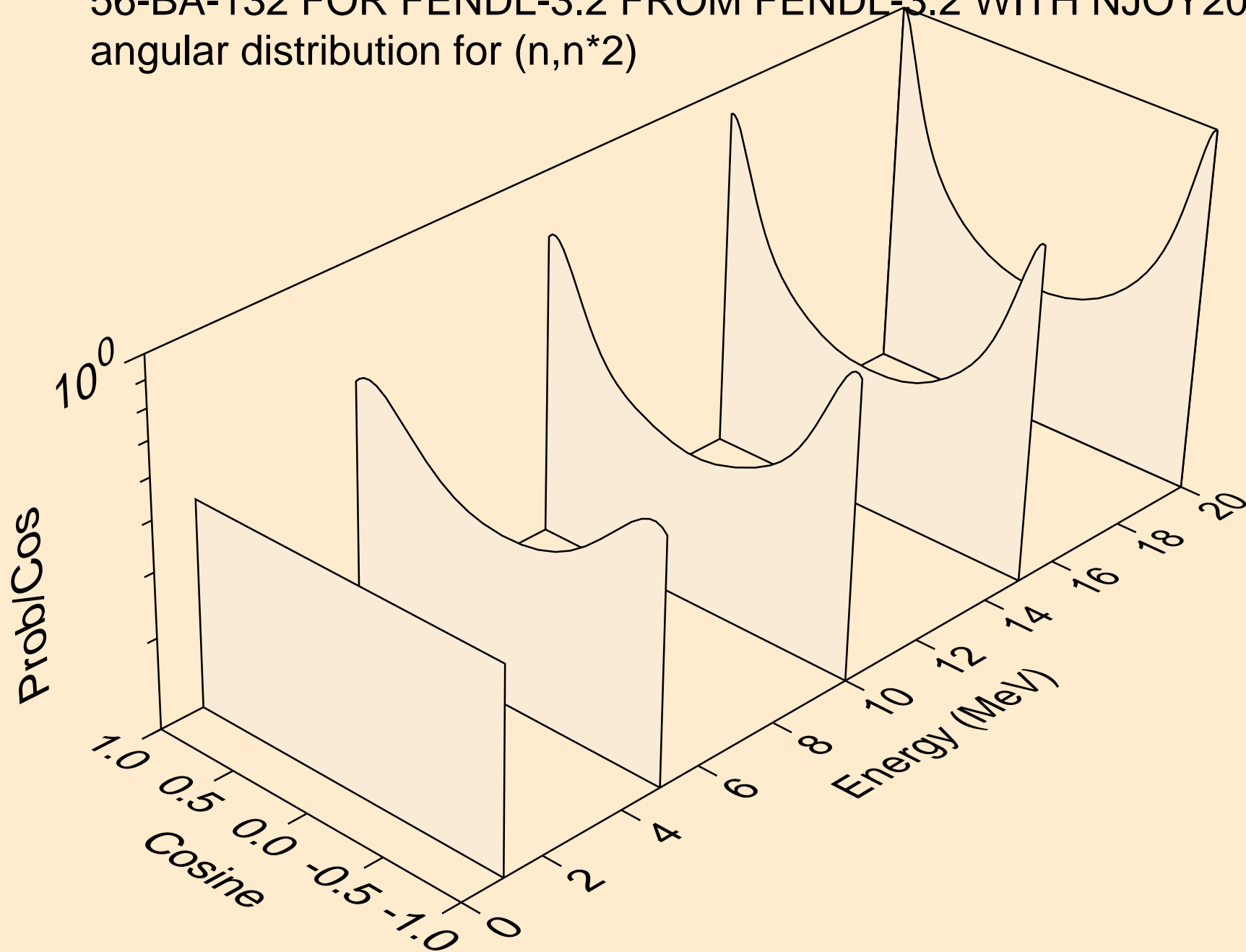

56-BA-132 FOR FENDL-3.2 FROM FENDL-3.2 WITH NJOY2016.60
angular distribution for (n,n*3)

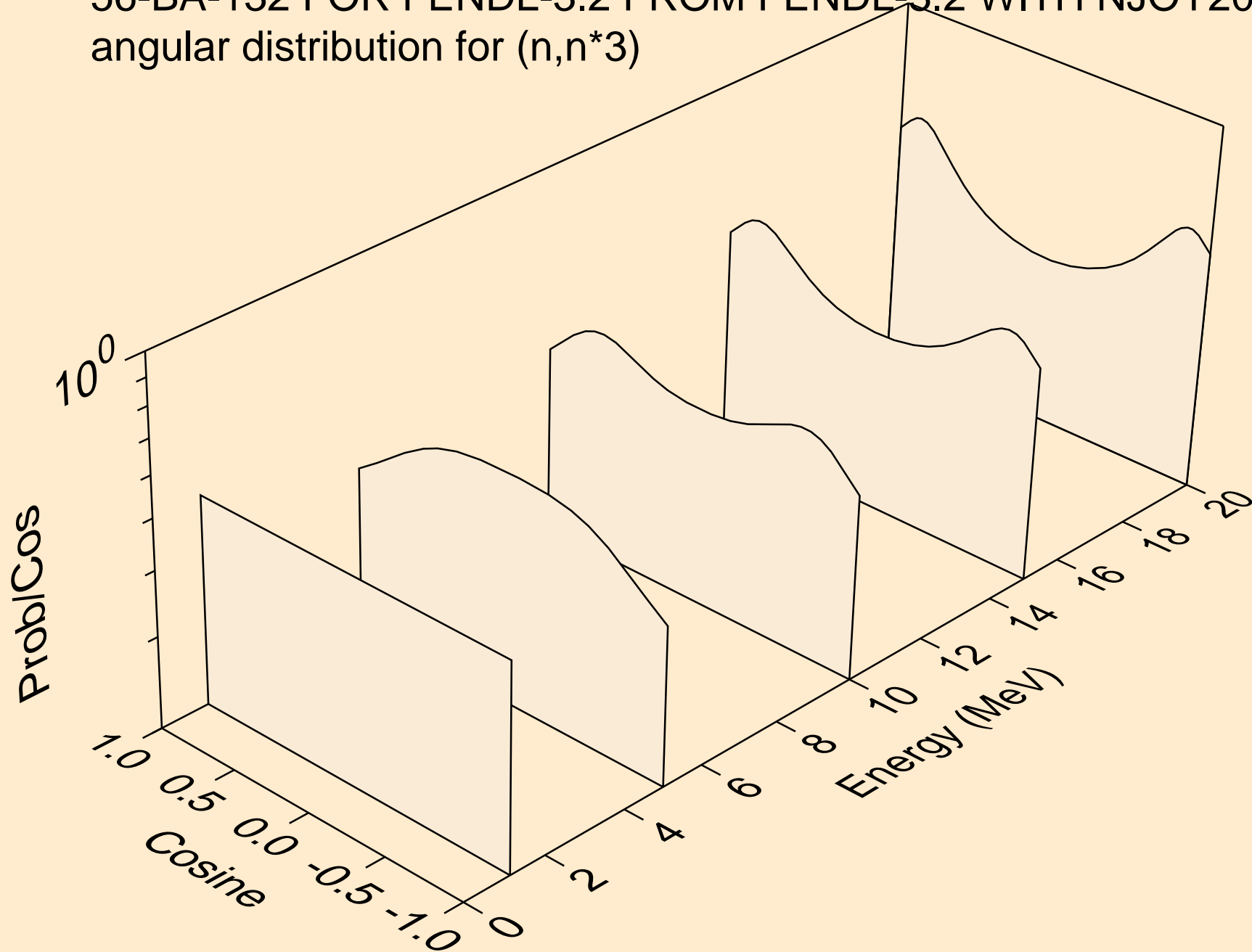

56-BA-132 FOR FENDL-3.2 FROM FENDL-3.2 WITH NJOY2016.60
angular distribution for (n,n*4)

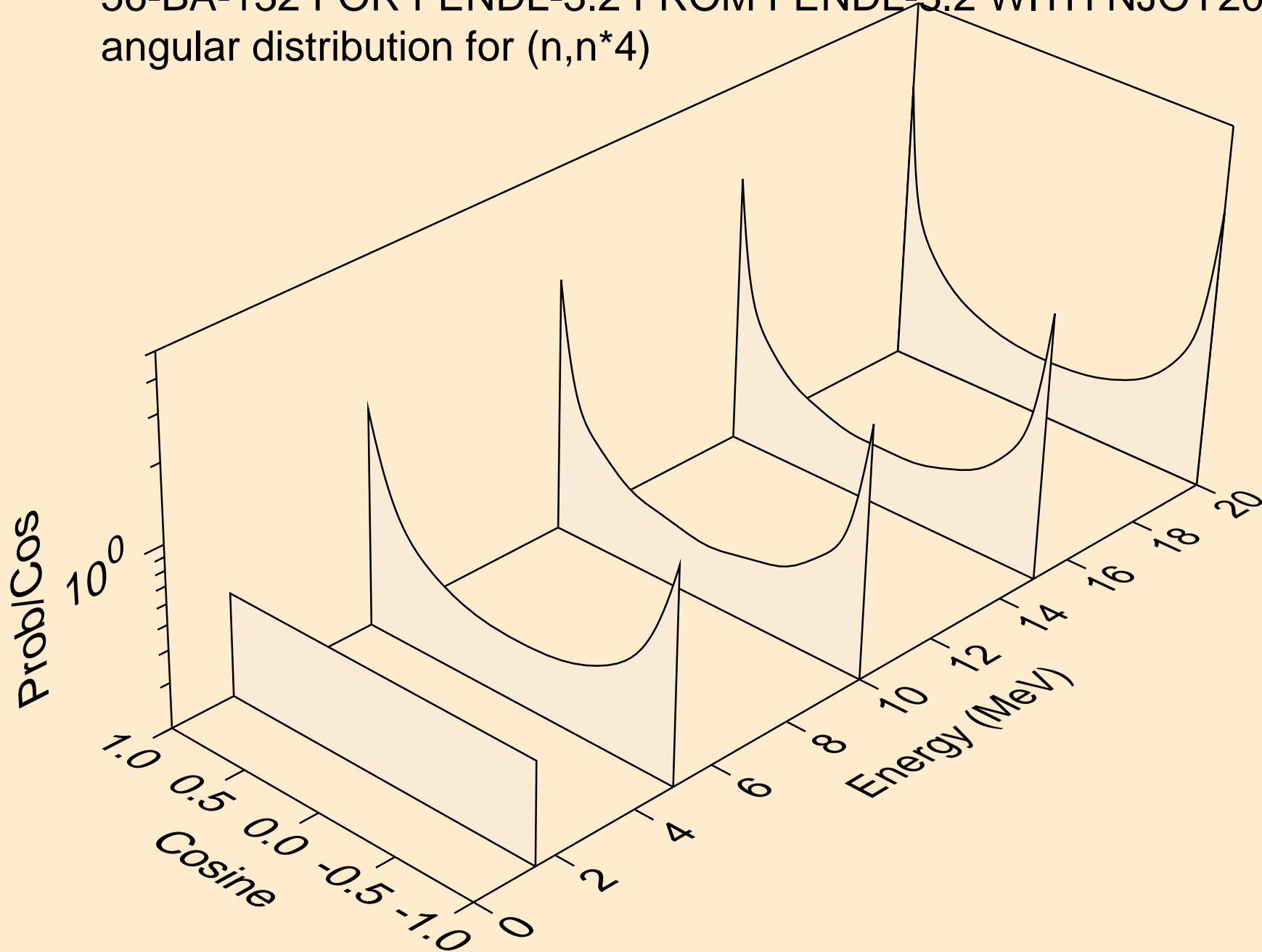

56-BA-132 FOR FENDL-3.2 FROM FENDL-3.2 WITH NJOY2016.60
angular distribution for (n,n*5)

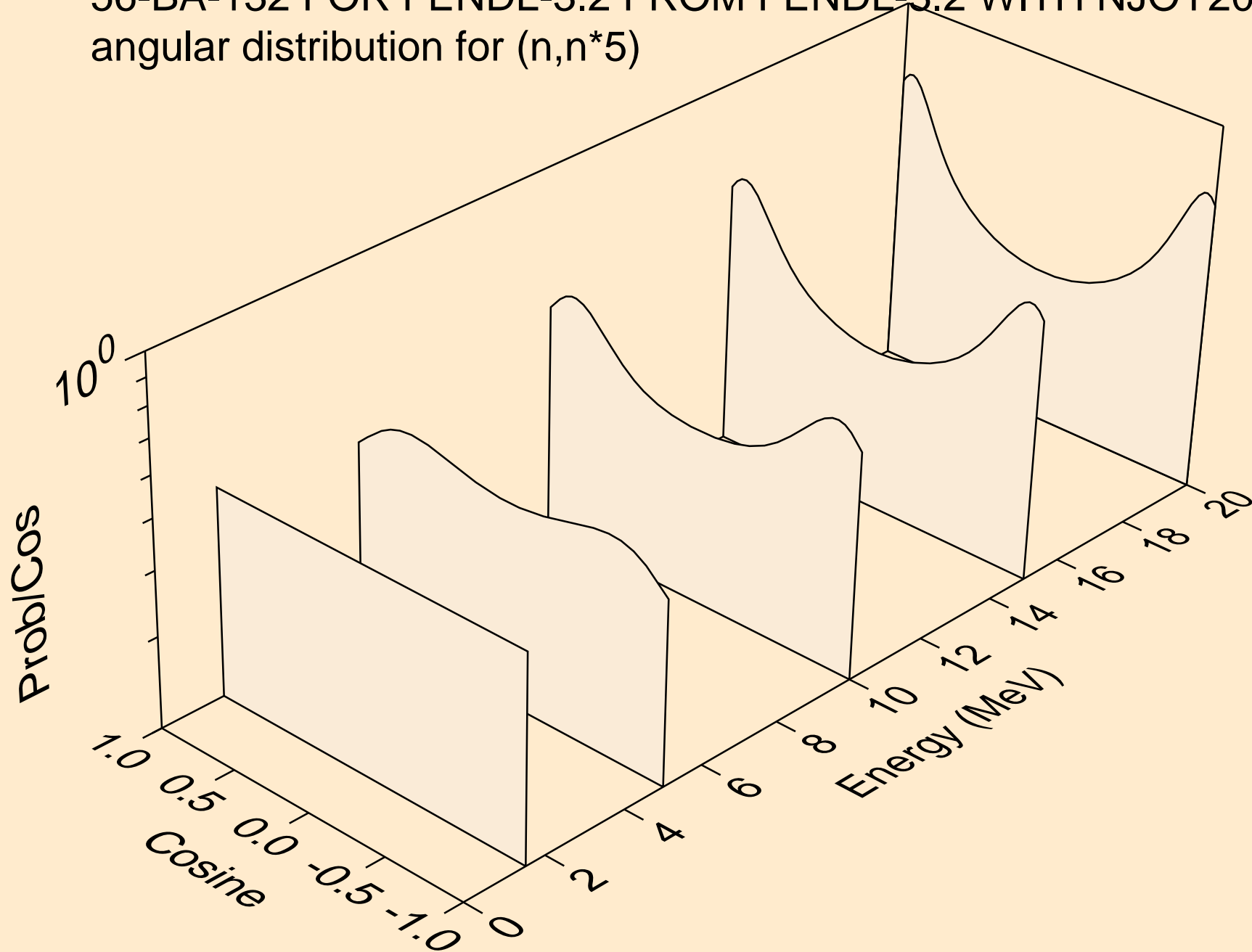

56-BA-132 FOR FENDL-3.2 FROM FENDL-3.2 WITH NJOY2016.60
angular distribution for (n,n*6)

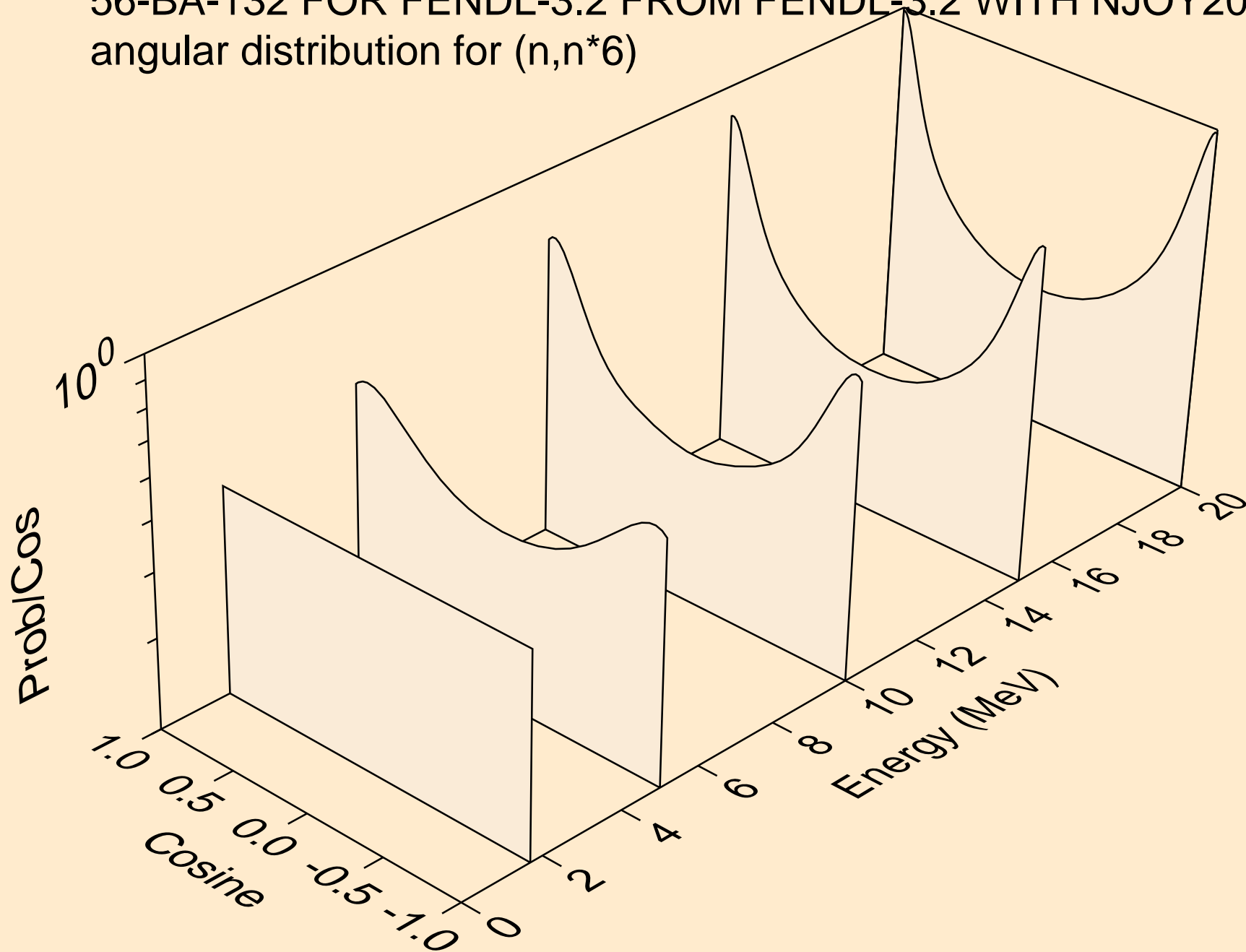

56-BA-132 FOR FENDL-3.2 FROM FENDL-3.2 WITH NJOY2016.60
angular distribution for (n,n*7)

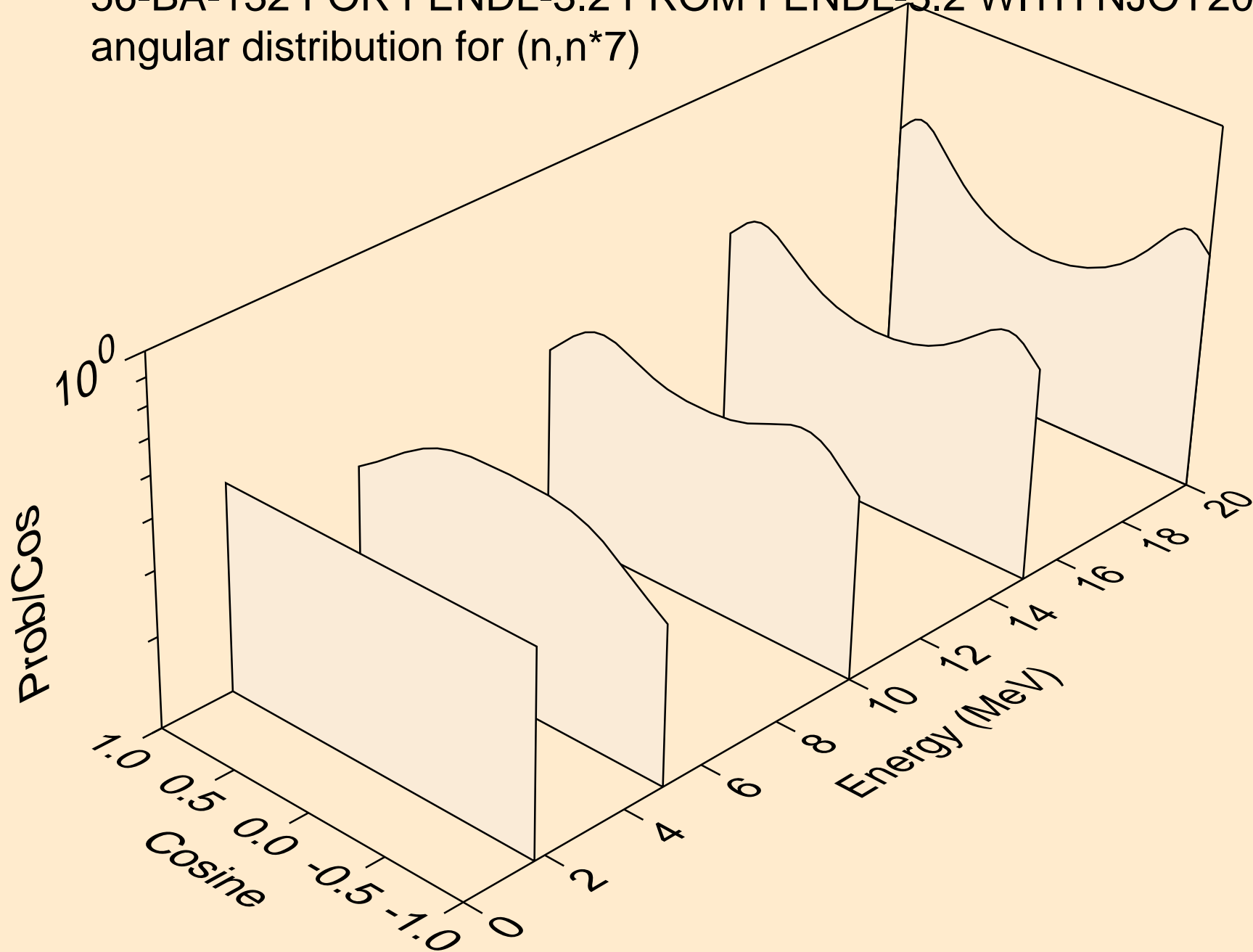

56-BA-132 FOR FENDL-3.2 FROM FENDL-3.2 WITH NJOY2016.60
angular distribution for (n,n*8)

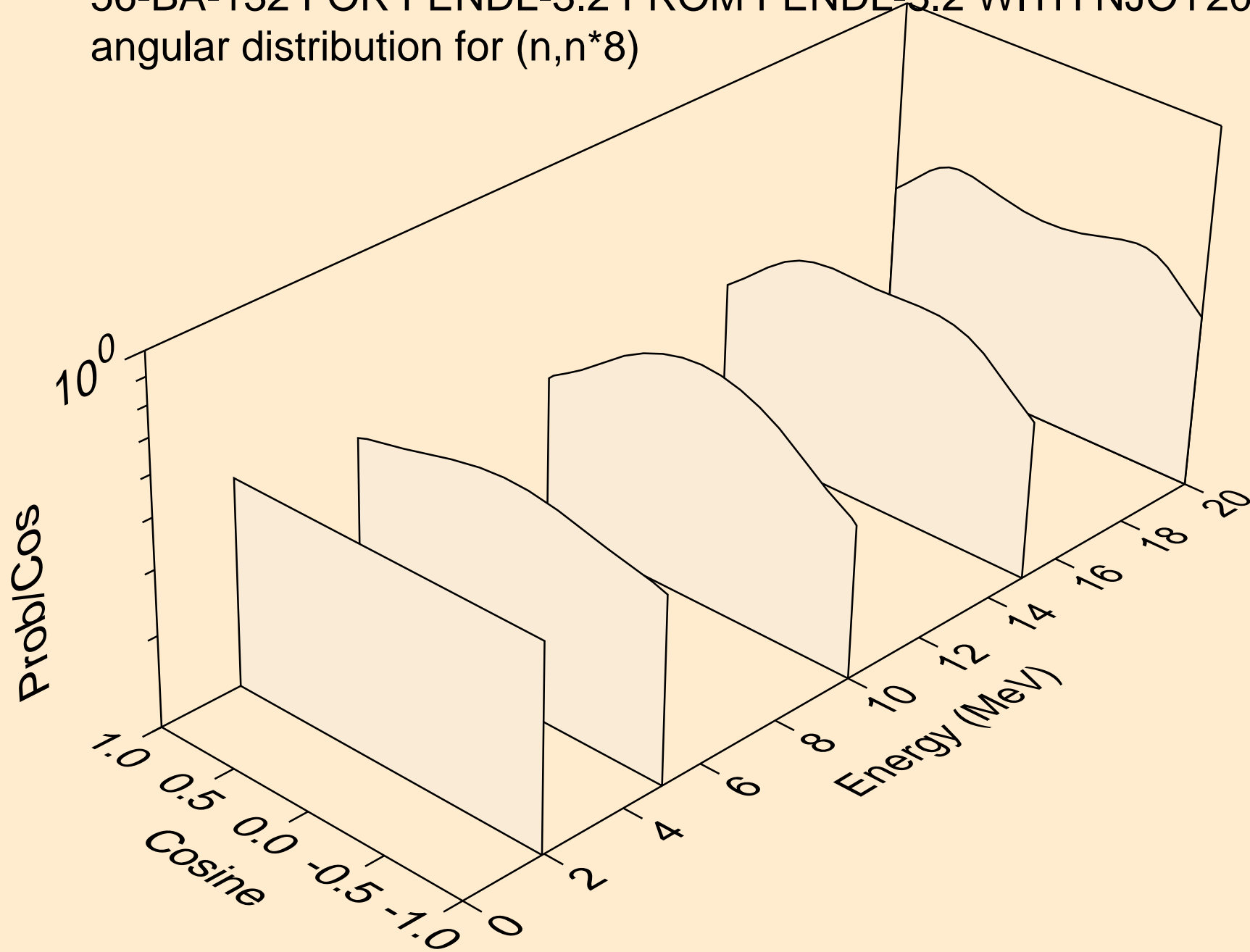

56-BA-132 FOR FENDL-3.2 FROM FENDL-3.2 WITH NJOY2016.60
angular distribution for (n,n*9)

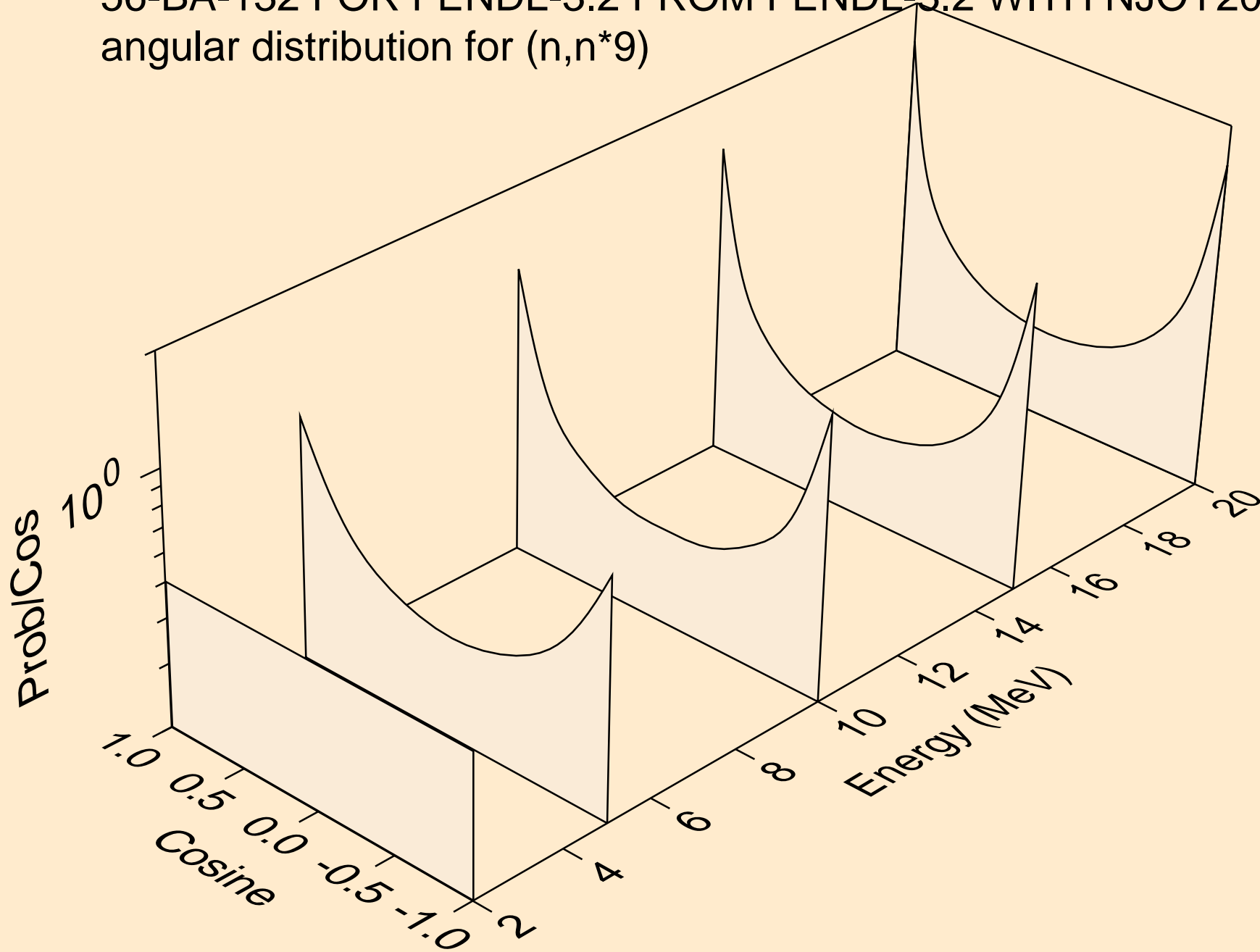

56-BA-132 FOR FENDL-3.2 FROM FENDL-3.2 WITH NJOY2016.60
angular distribution for (n,n*10)

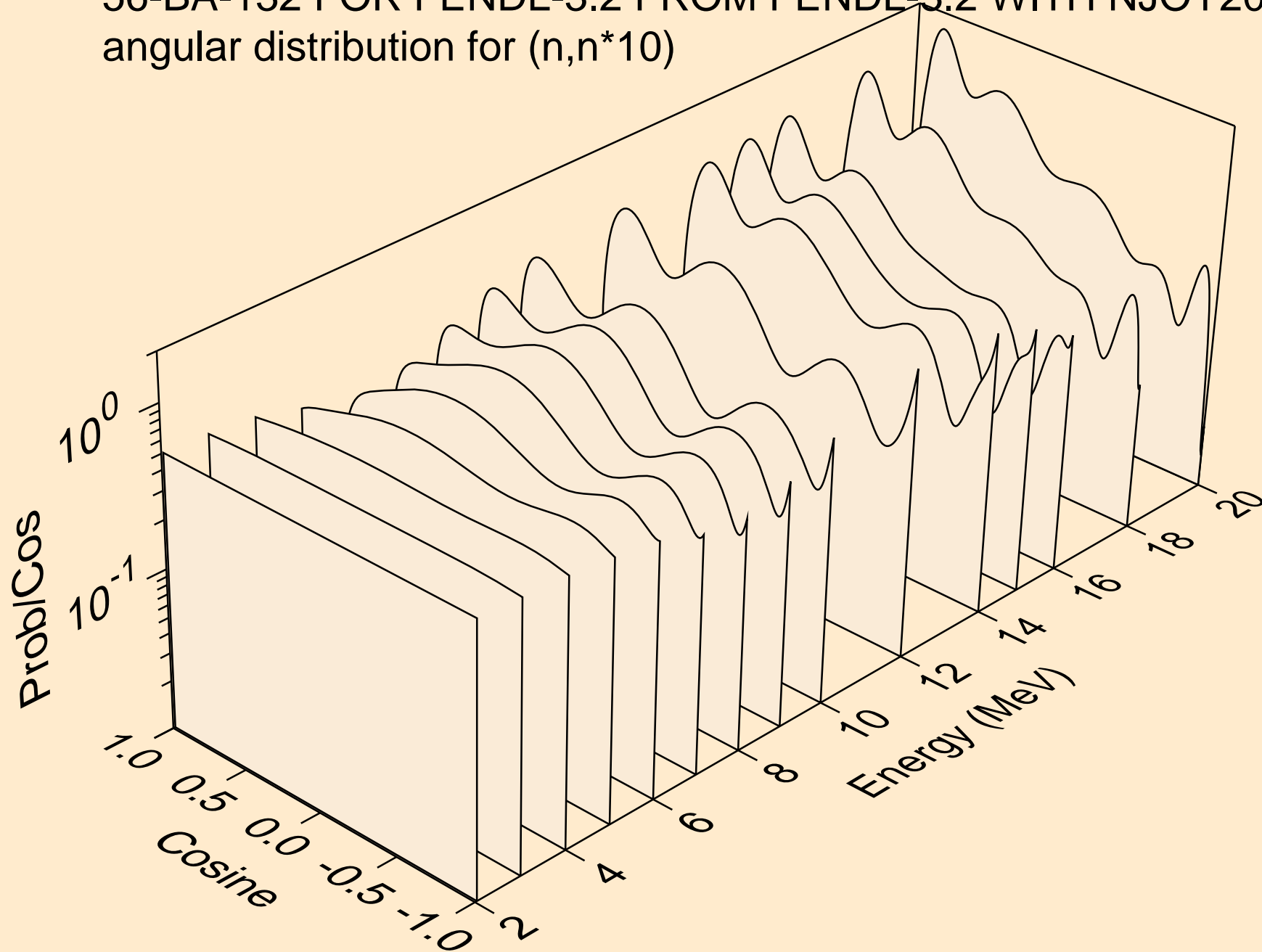

56-BA-132 FOR FENDL-3.2 FROM FENDL-3.2 WITH NJOY2016.60
angular distribution for (n,n*c)

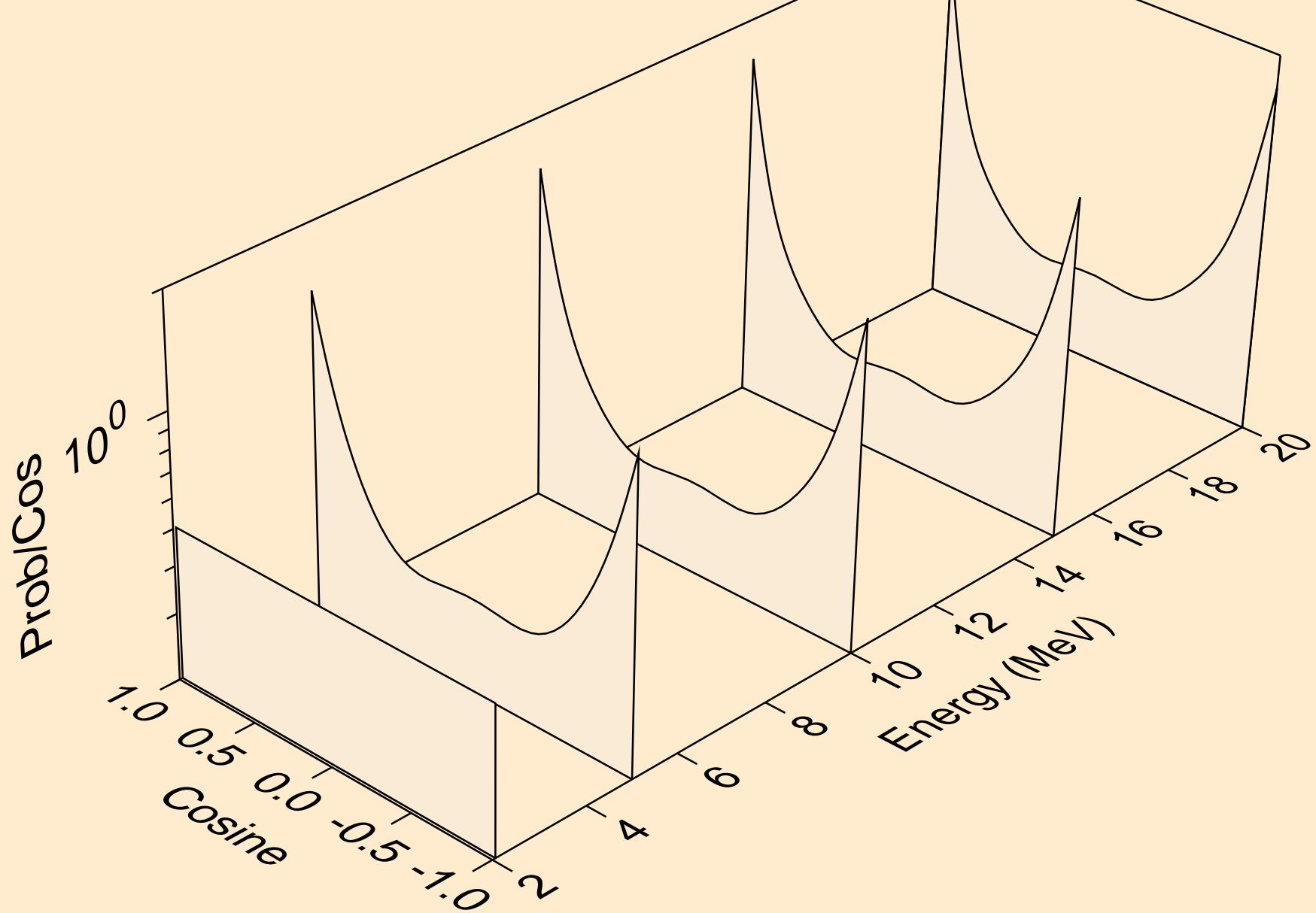

56-BA-132 FOR FENDL-3.2 FROM FENDL-3.2 WITH NJOY2016.60
Neutron emission for (n,x)

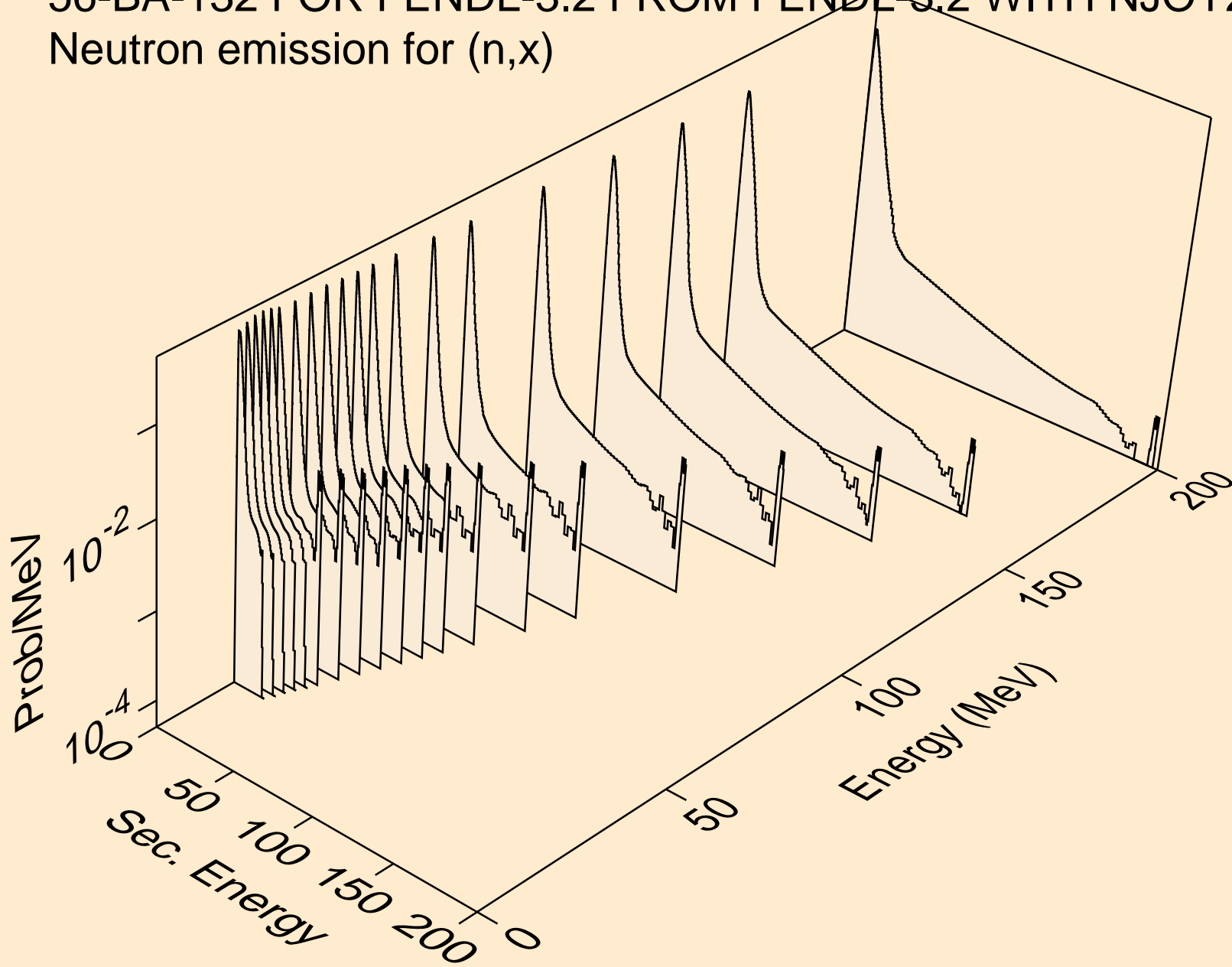

56-BA-132 FOR FENDL-3.2 FROM FENDL-3.2 WITH NJOY2016.60
Neutron emission for (n,2n)

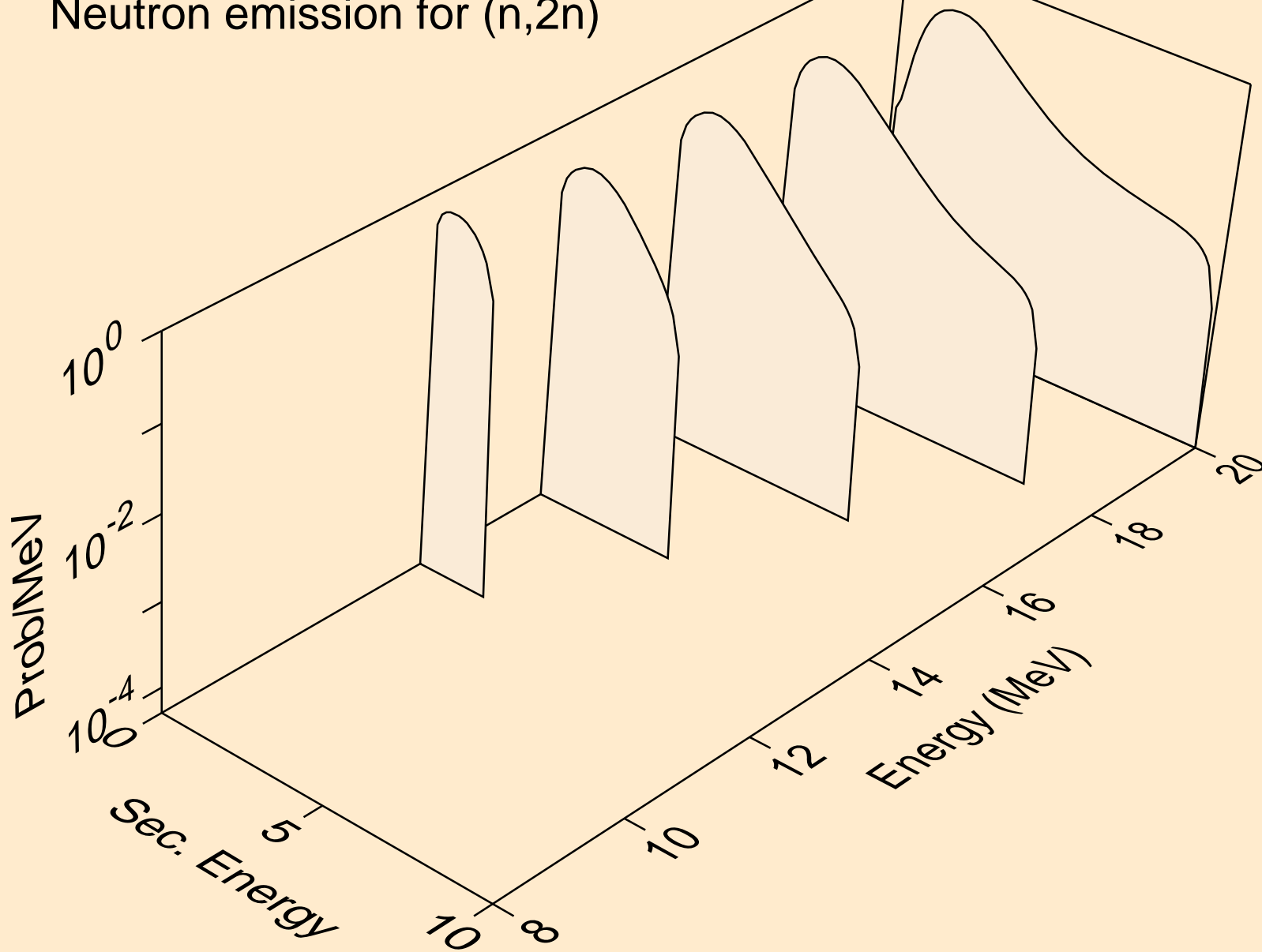

56-BA-132 FOR FENDL-3.2 FROM FENDL-3.2 WITH NJOY2016.60
Neutron emission for (n,3n)

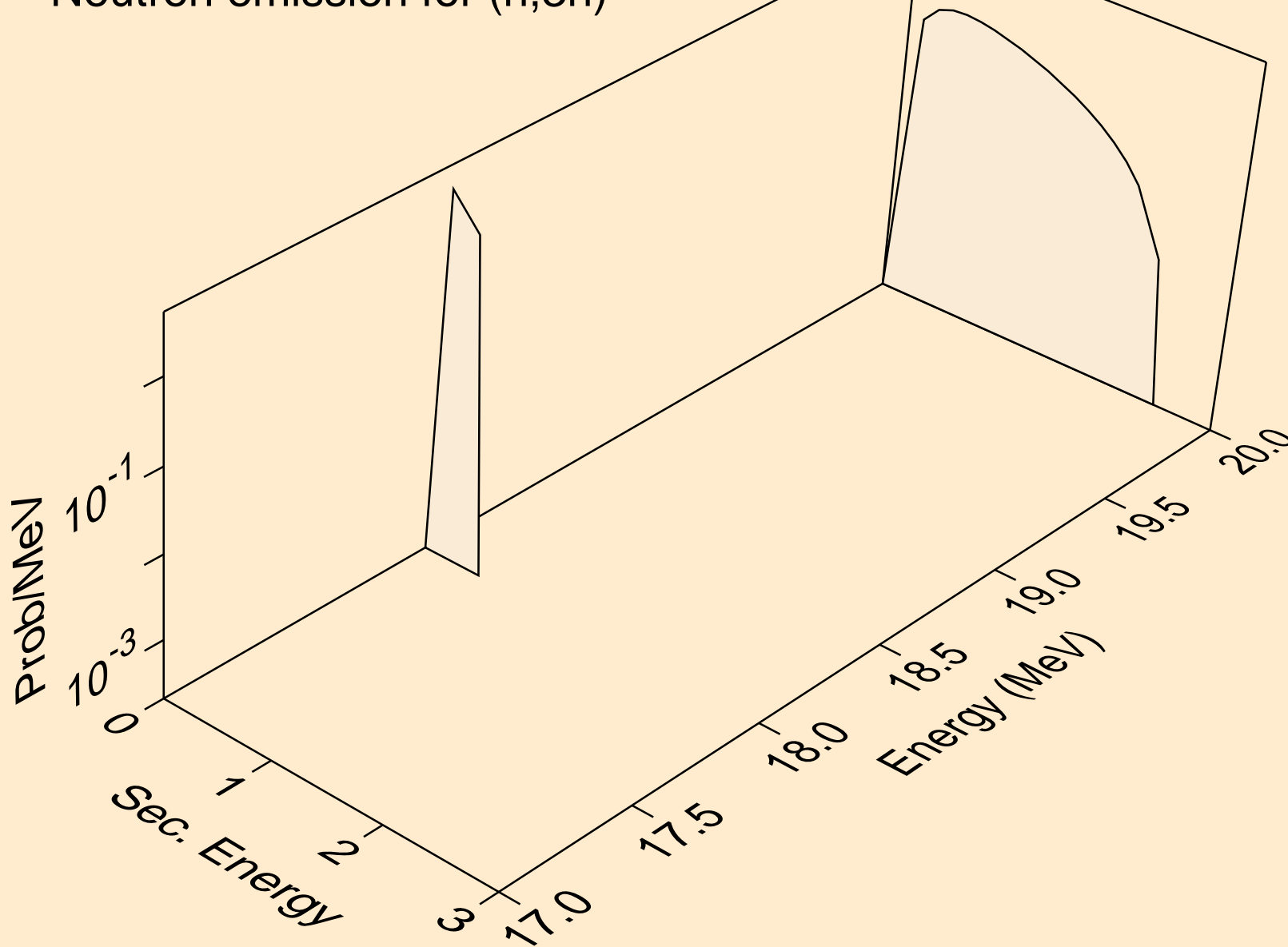

56-BA-132 FOR FENDL-3.2 FROM FENDL-3.2 WITH NJOY2016.60
Neutron emission for (n,n*)a

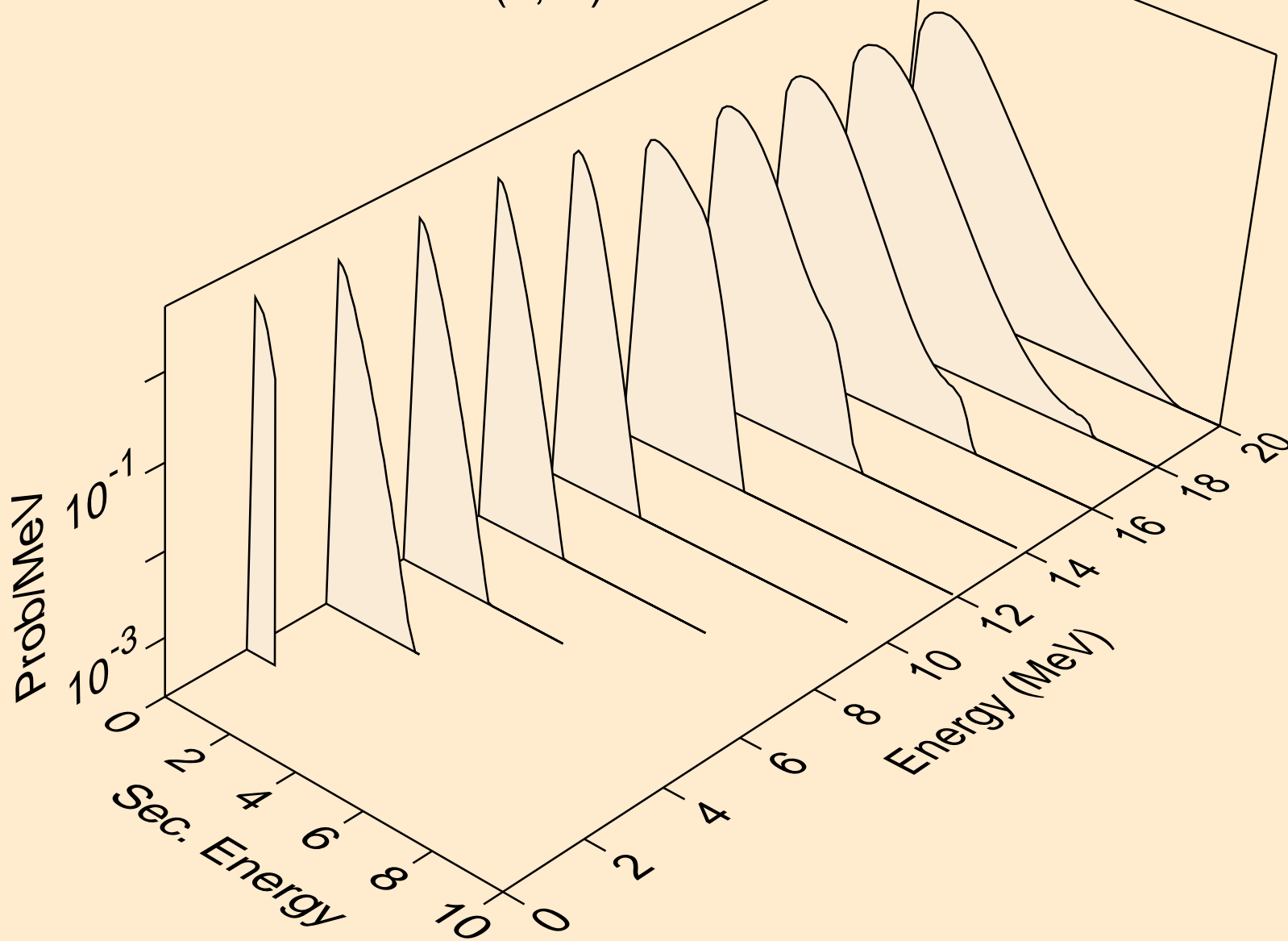

56-BA-132 FOR FENDL-3.2 FROM FENDL-3.2 WITH NJOY2016.60
Neutron emission for (n,n*)p

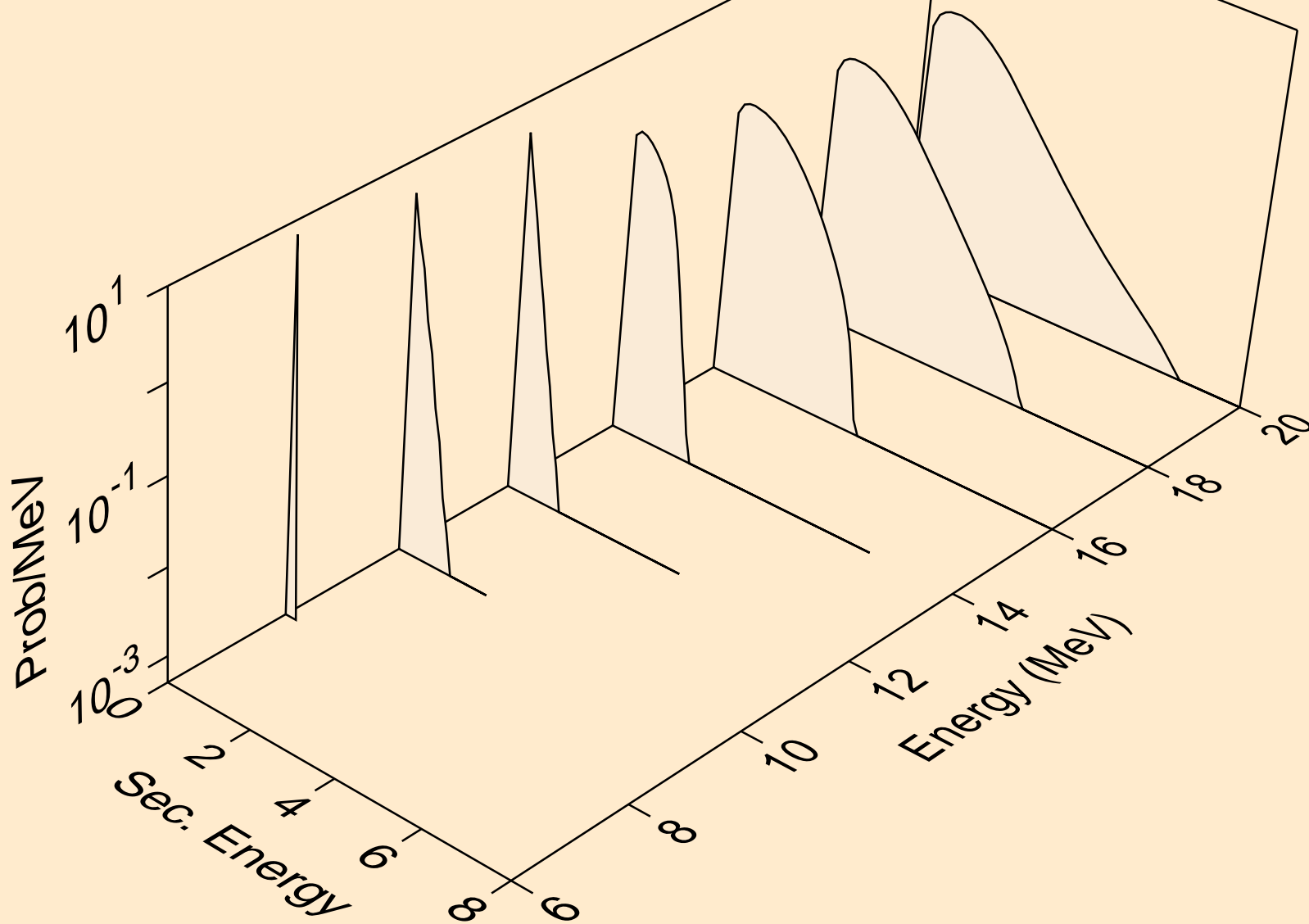

56-BA-132 FOR FENDL-3.2 FROM FENDL-3.2 WITH NJOY2016.60
Neutron emission for (n,n*c)

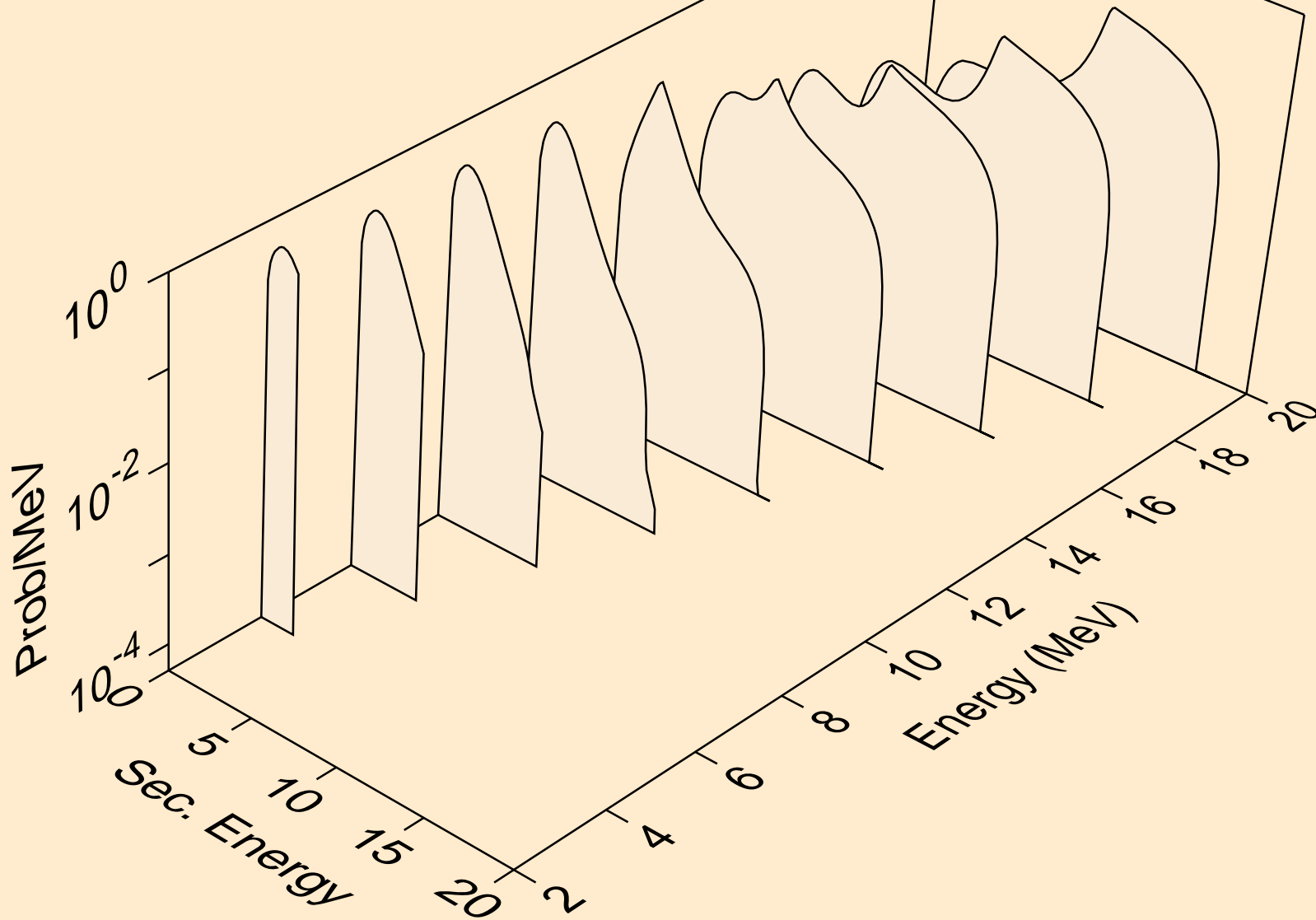

56-BA-132 FOR FENDL-3.2 FROM FENDL-3.2 WITH NJOY2016.60
Photon emission for (n,x)

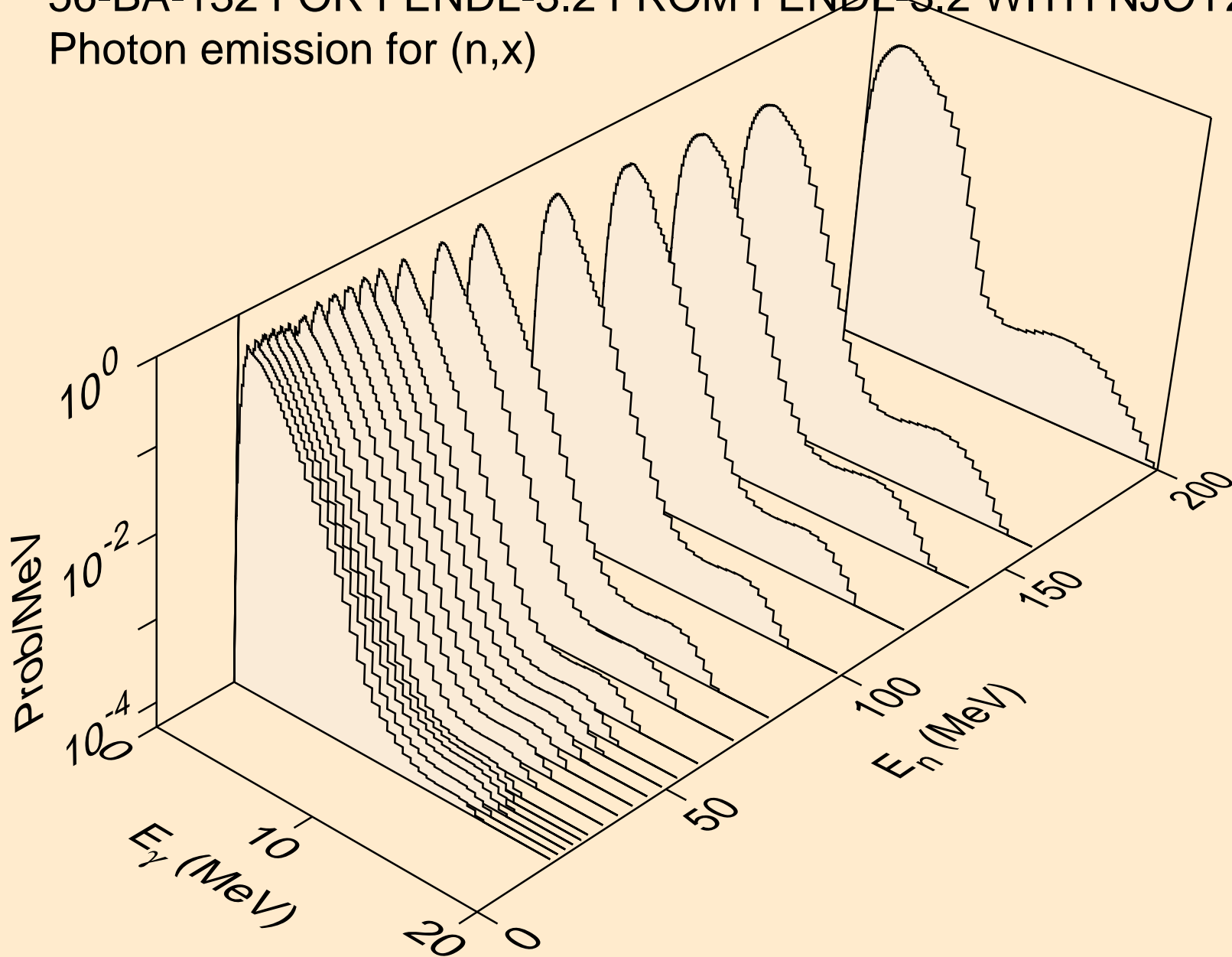

56-BA-132 FOR FENDL-3.2 FROM FENDL-3.2 WITH NJOY2016.60
Particle heating contributions

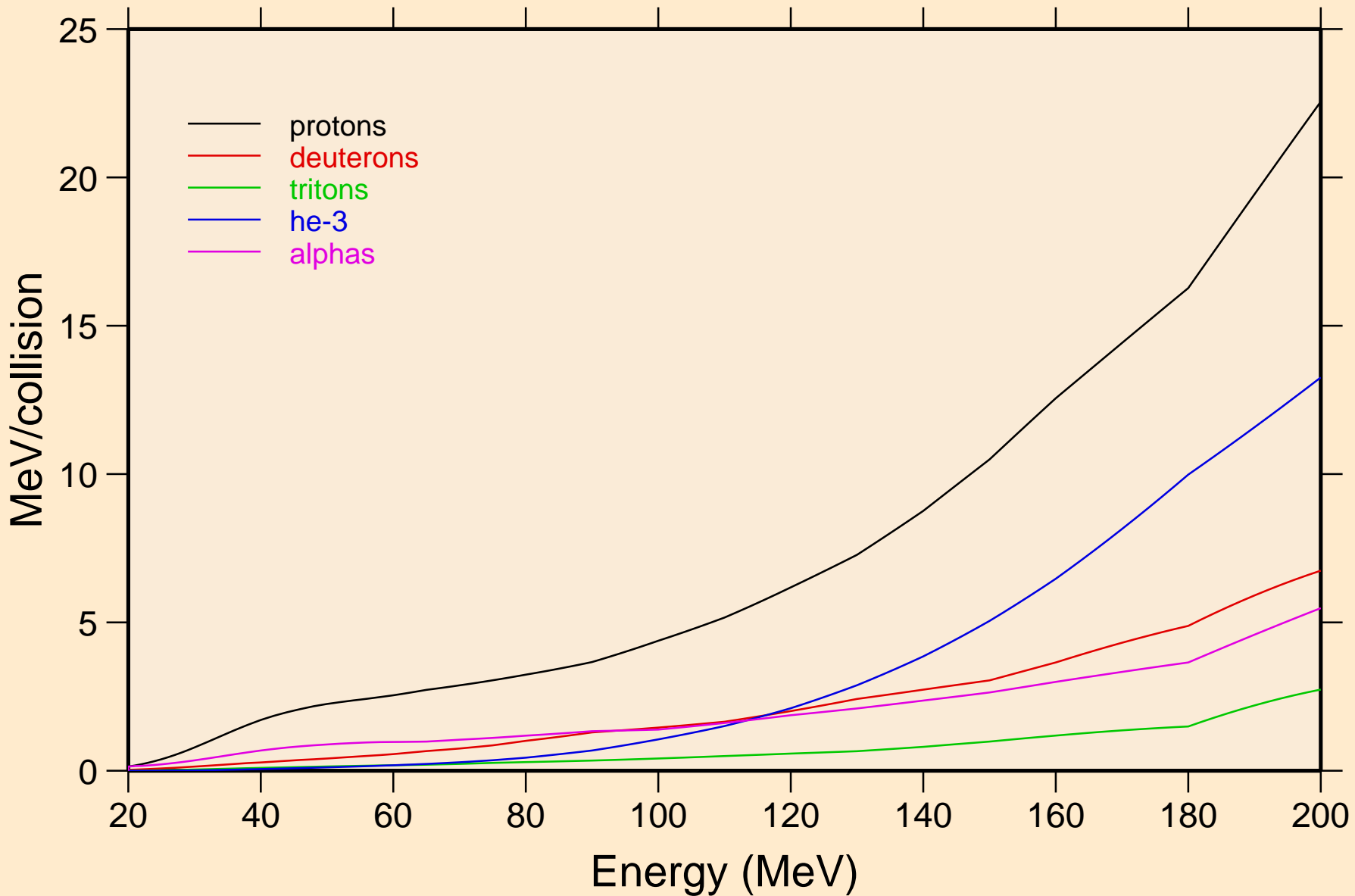

56-BA-132 FOR FENDL-3.2 FROM FENDL-3.2 WITH NJOY2016.60

Recoil Heating

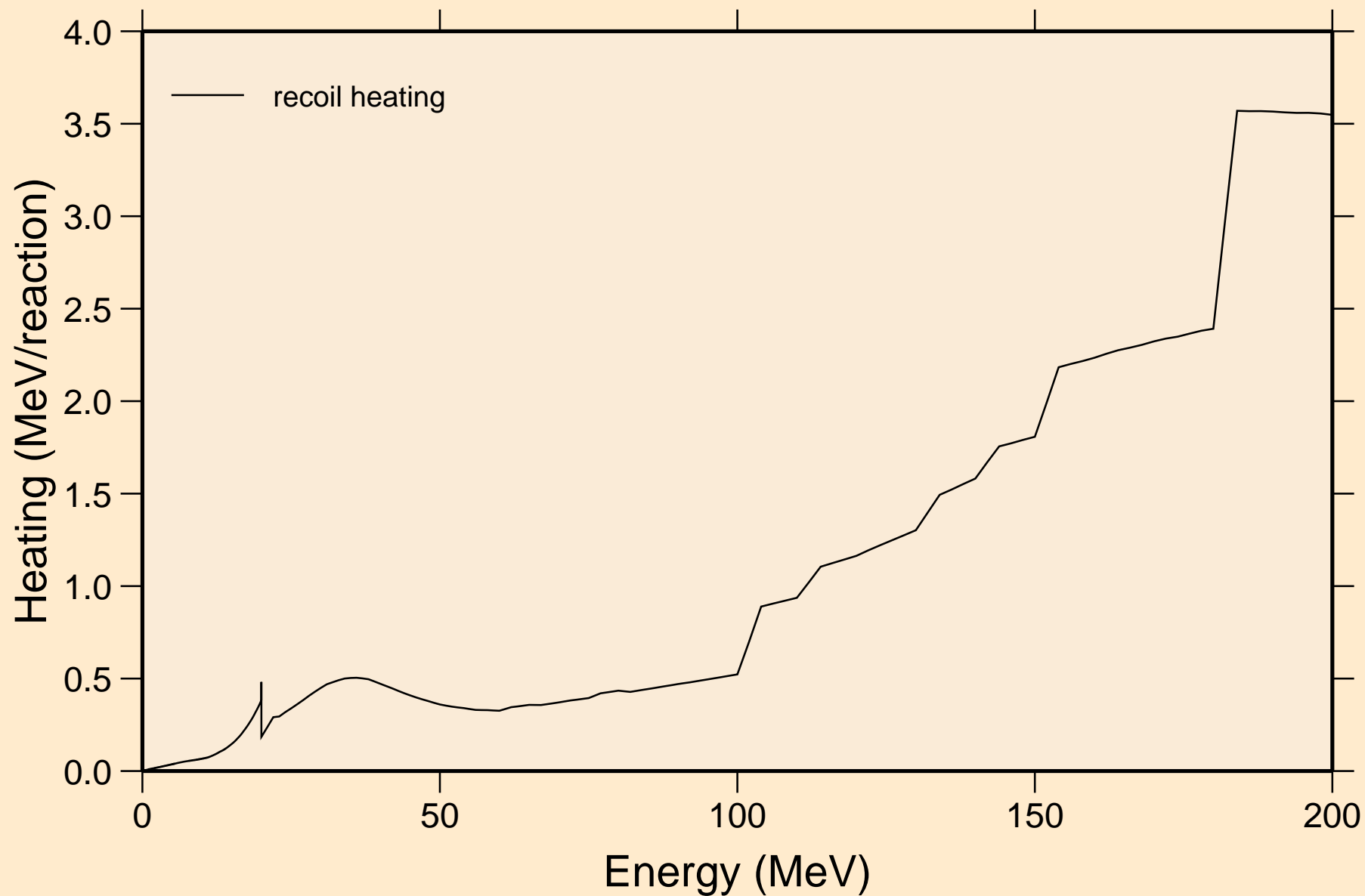

56-BA-132 FOR FENDL-3.2 FROM FENDL-3.2 WITH NJOY2016.60
Particle production cross sections

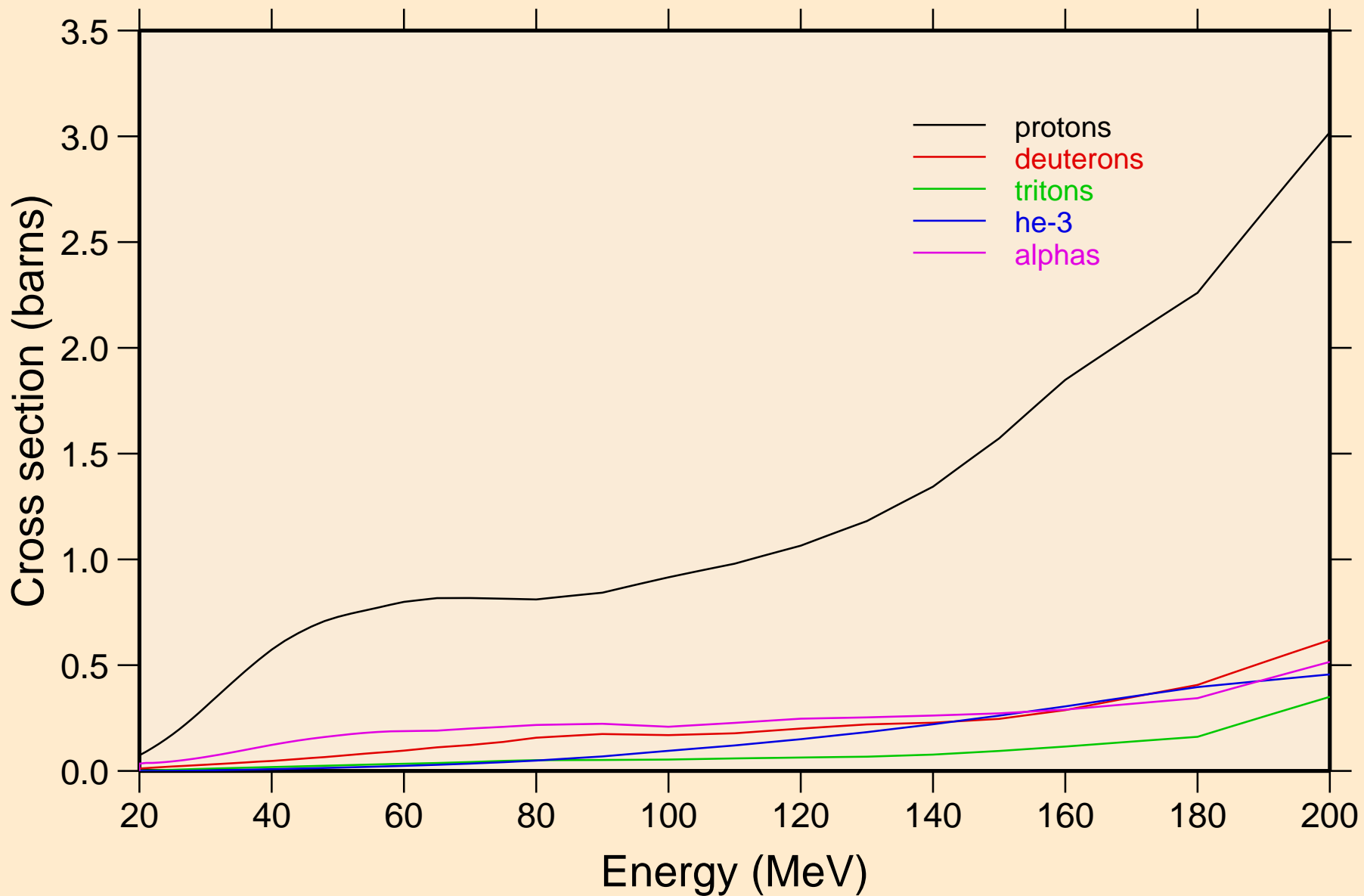

56-BA-132 FOR FENDL-3.2 FROM FENDL-3.2 WITH NJOY2016.60
protons from (n,x)

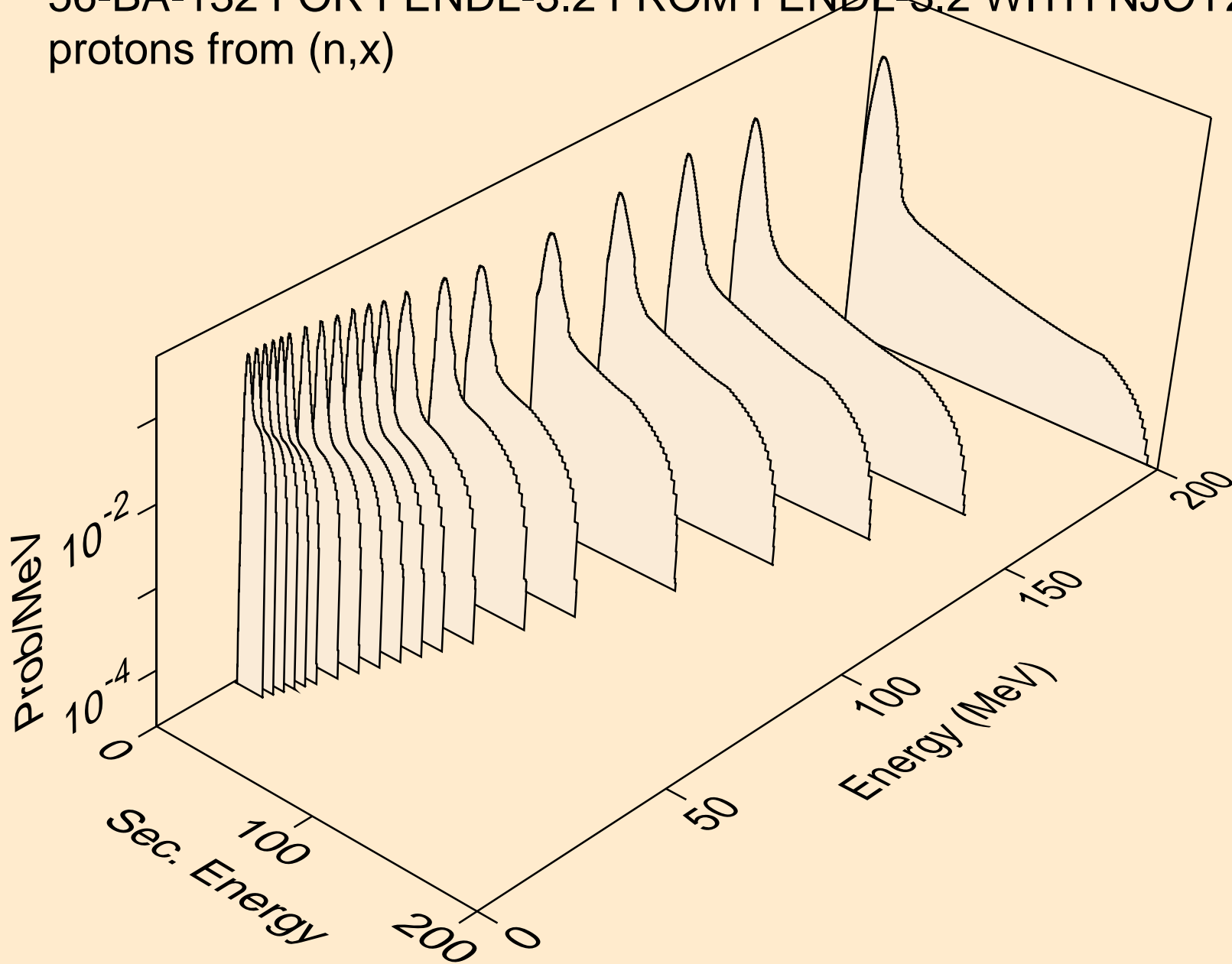

56-BA-132 FOR FENDL-3.2 FROM FENDL-3.2 WITH NJOY2016.60
deuterons from (n,x)

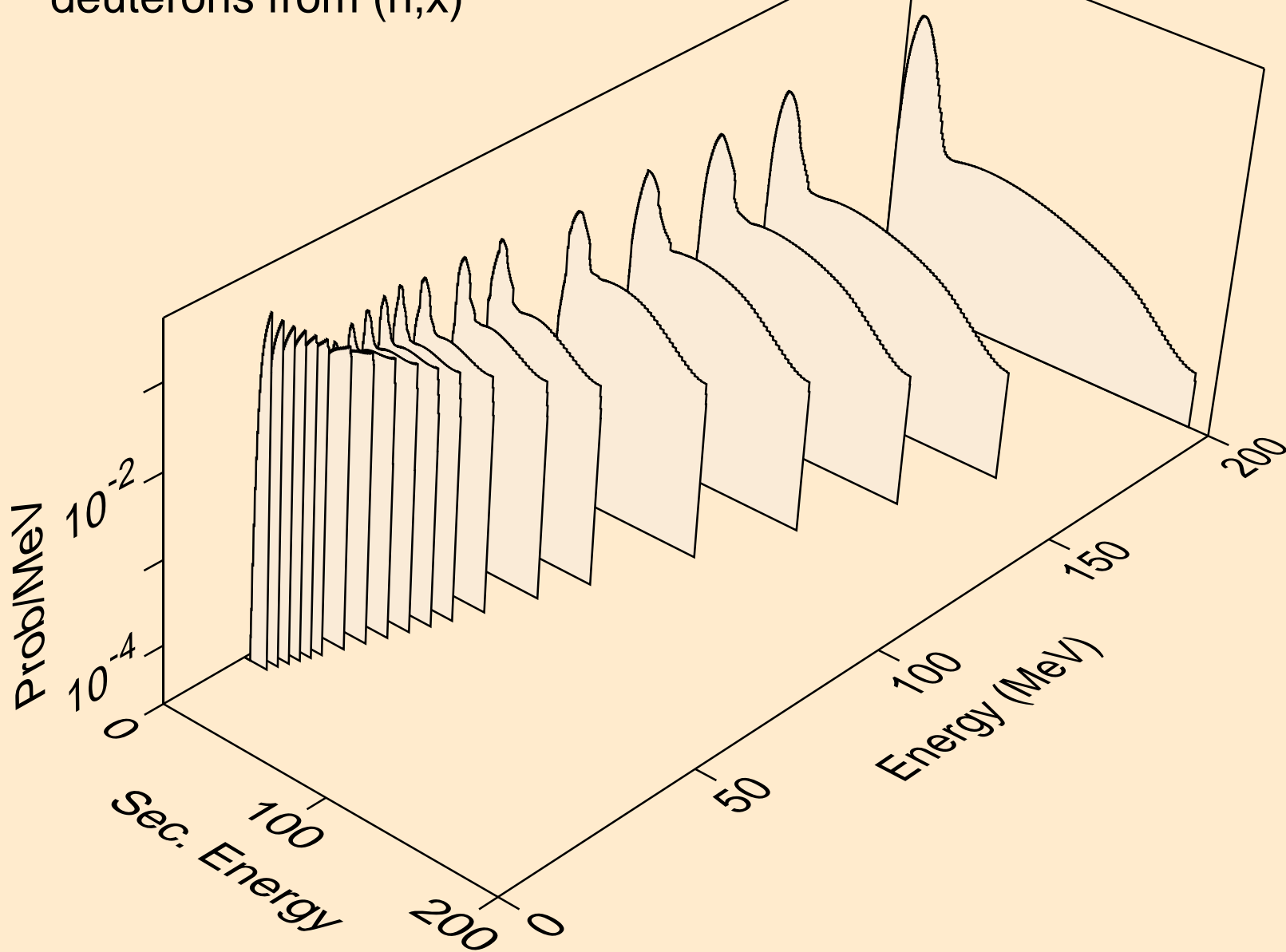

56-BA-132 FOR FENDL-3.2 FROM FENDL-3.2 WITH NJOY2016.60
tritons from (n,x)

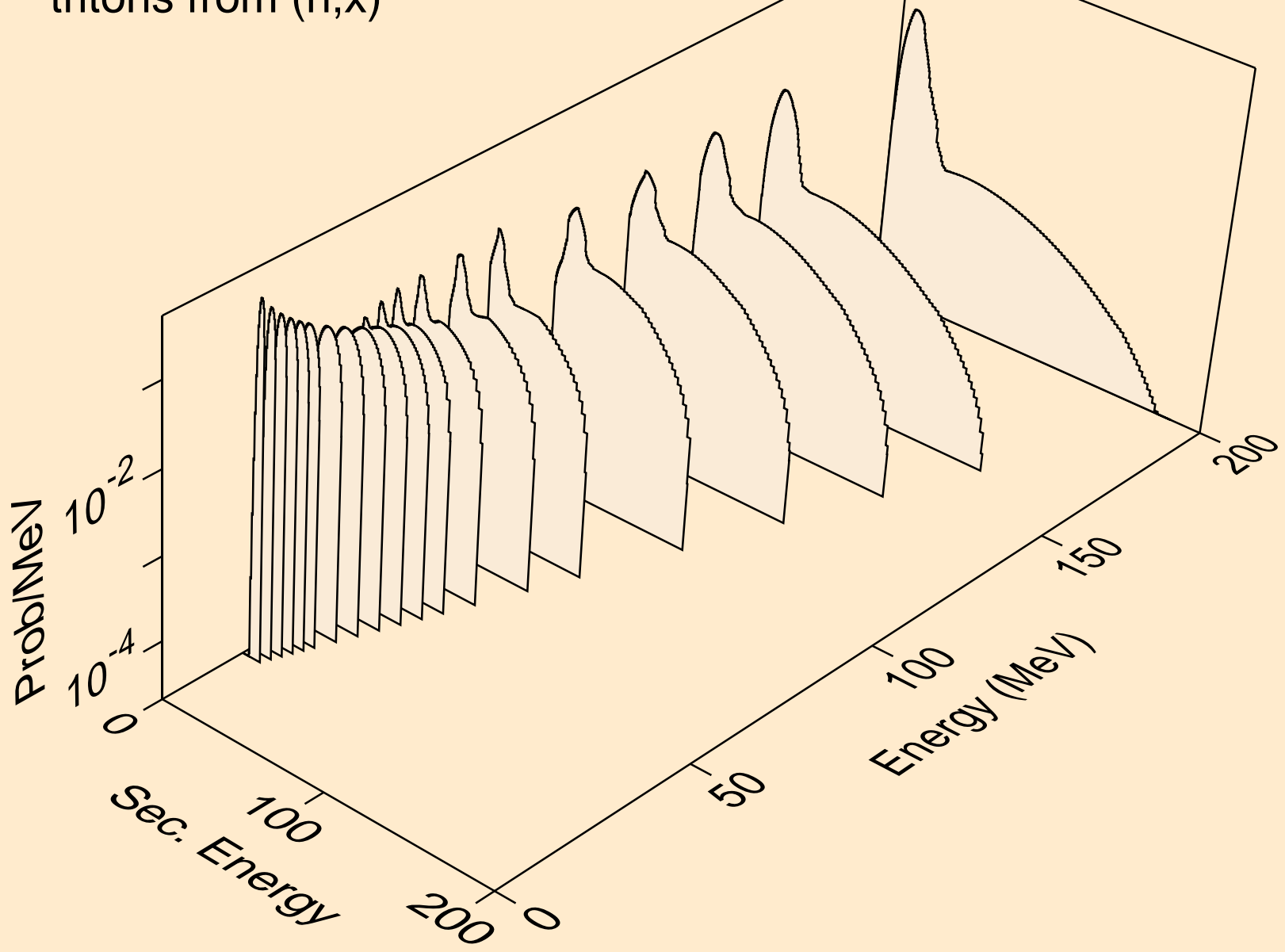

56-BA-132 FOR FENDL-3.2 FROM FENDL-3.2 WITH NJOY2016.60
he3s from (n,x)

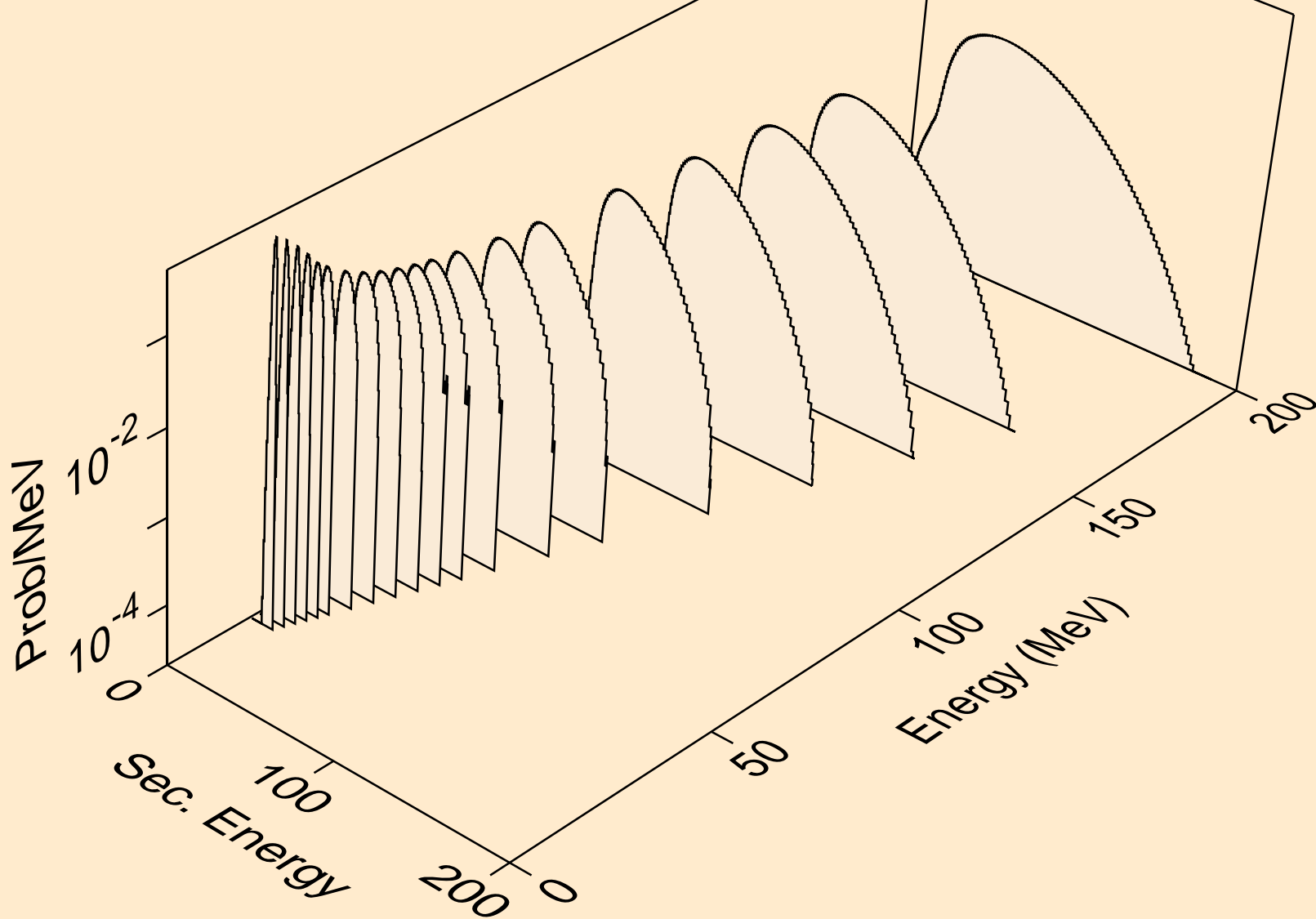

56-BA-132 FOR FENDL-3.2 FROM FENDL-3.2 WITH NJOY2016.60
alphas from (n,x)

