

68-ER-162 FOR FENDL-3.2 FROM FENDL-3.2 WITH NJOY2016.60
Principal cross sections

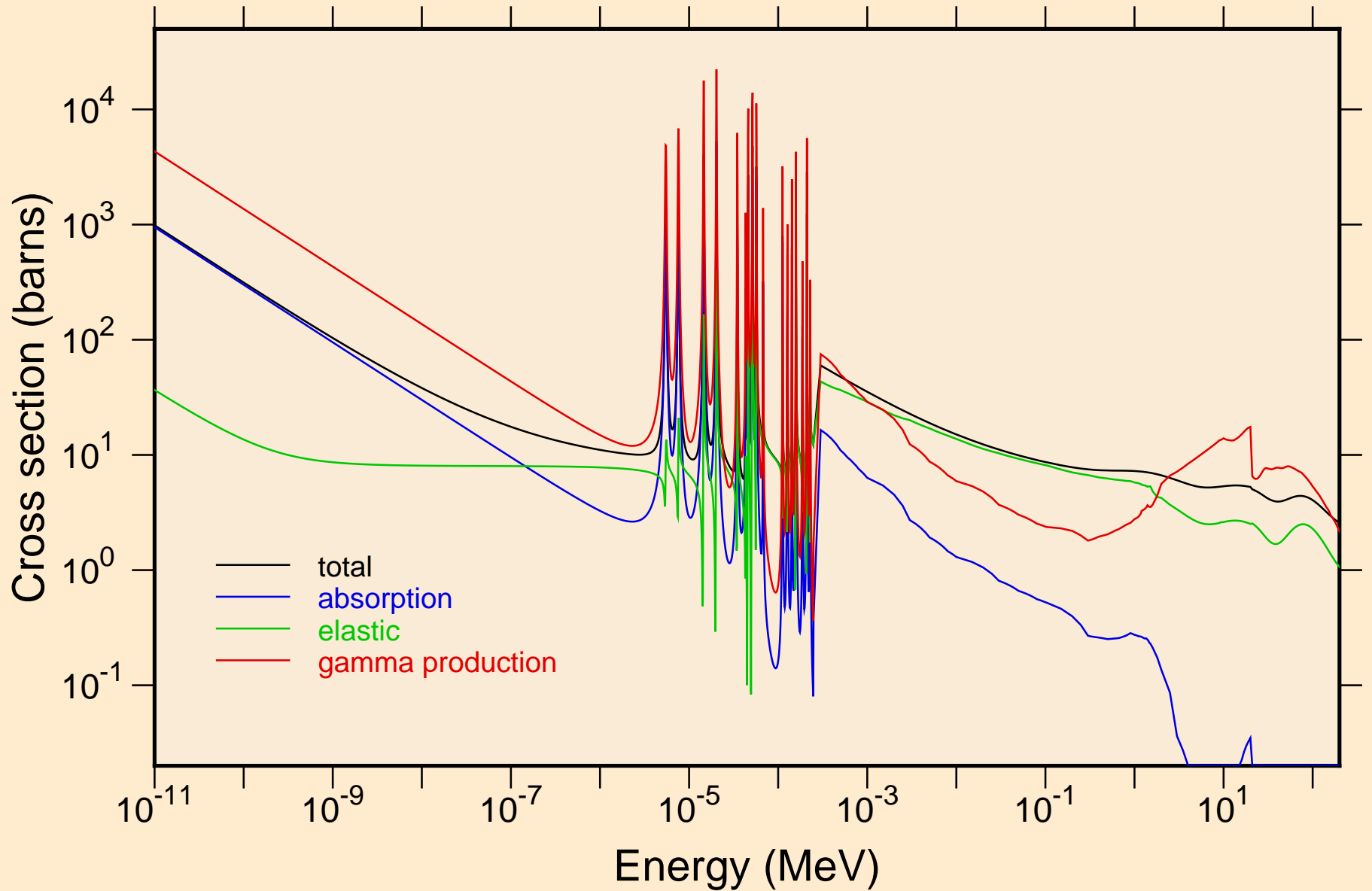

68-ER-162 FOR FENDL-3.2 FROM FENDL-3.2 WITH NJOY2016.60
resonance total cross section

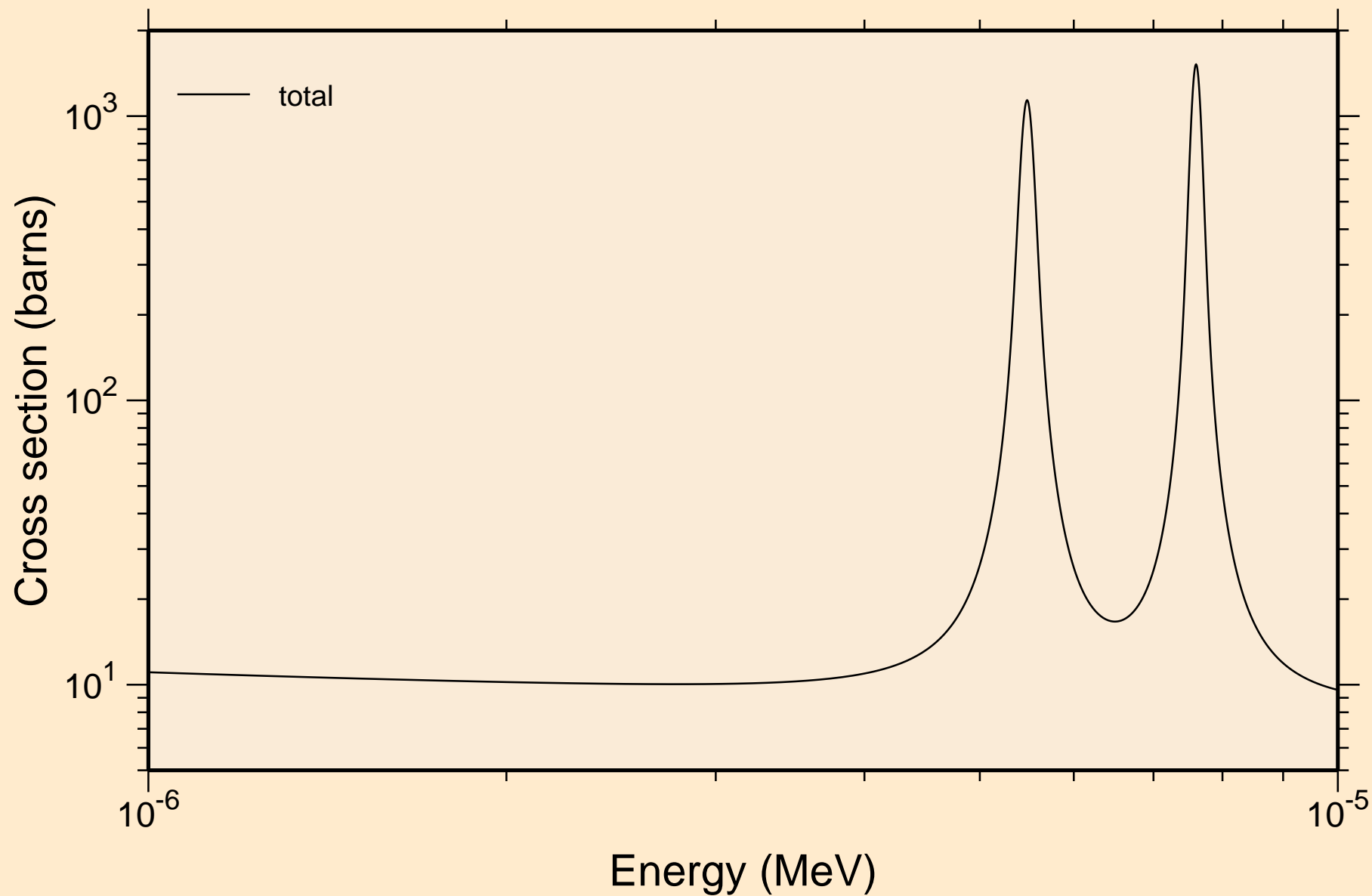

68-ER-162 FOR FENDL-3.2 FROM FENDL-3.2 WITH NJOY2016.60
resonance total cross section

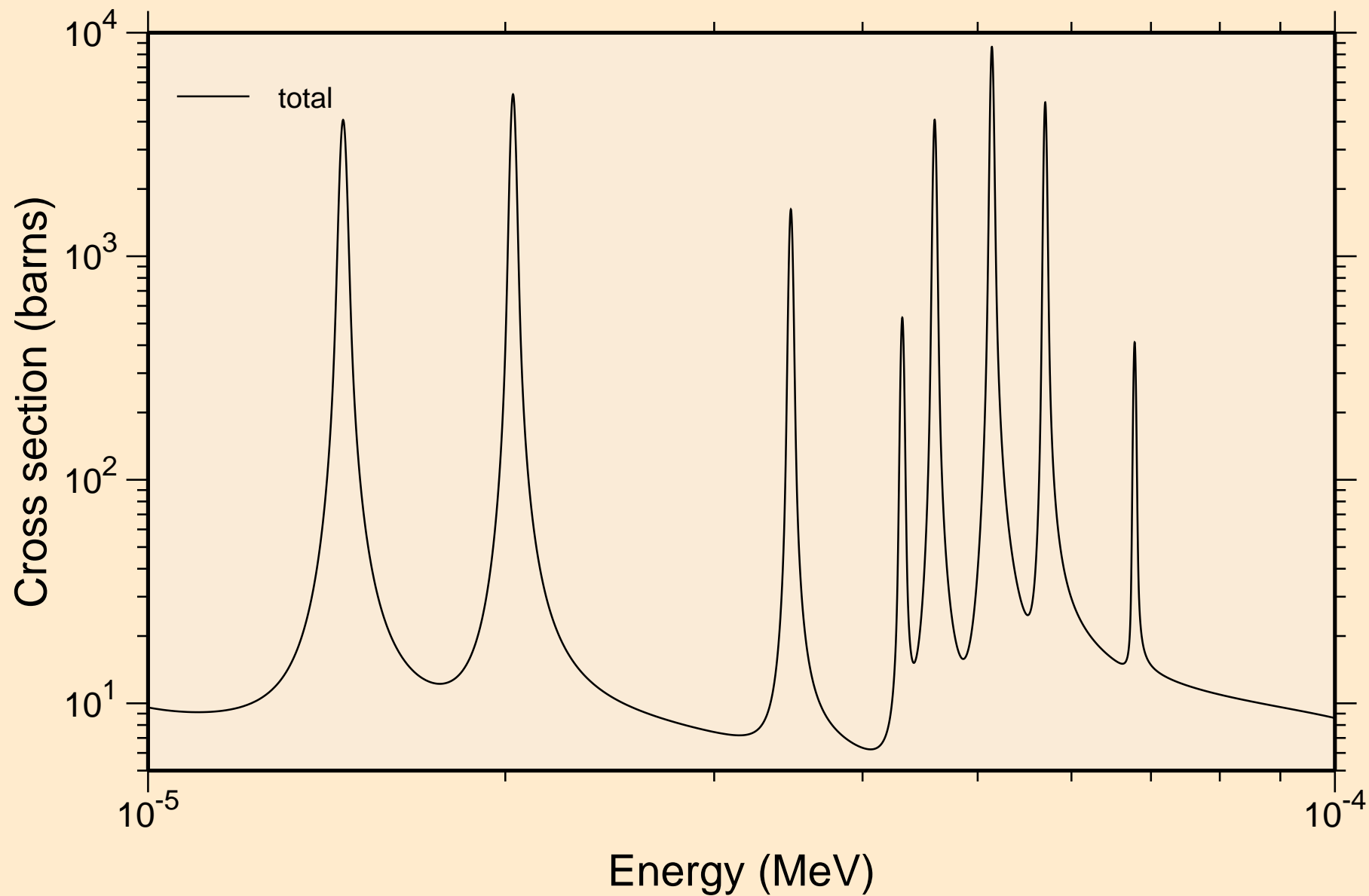

68-ER-162 FOR FENDL-3.2 FROM FENDL-3.2 WITH NJOY2016.60
resonance total cross section

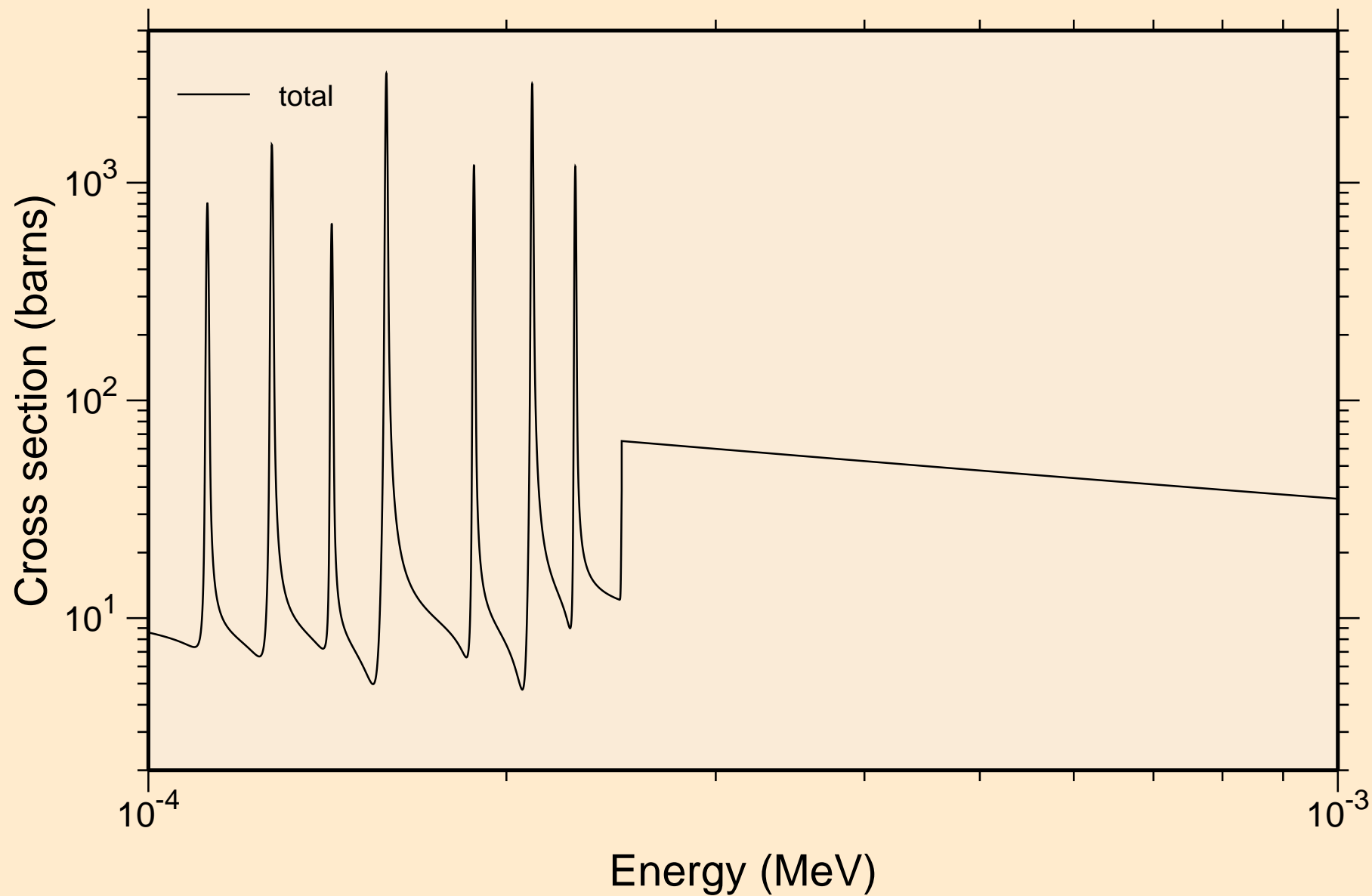

68-ER-162 FOR FENDL-3.2 FROM FENDL-3.2 WITH NJOY2016.60
resonance absorption cross sections

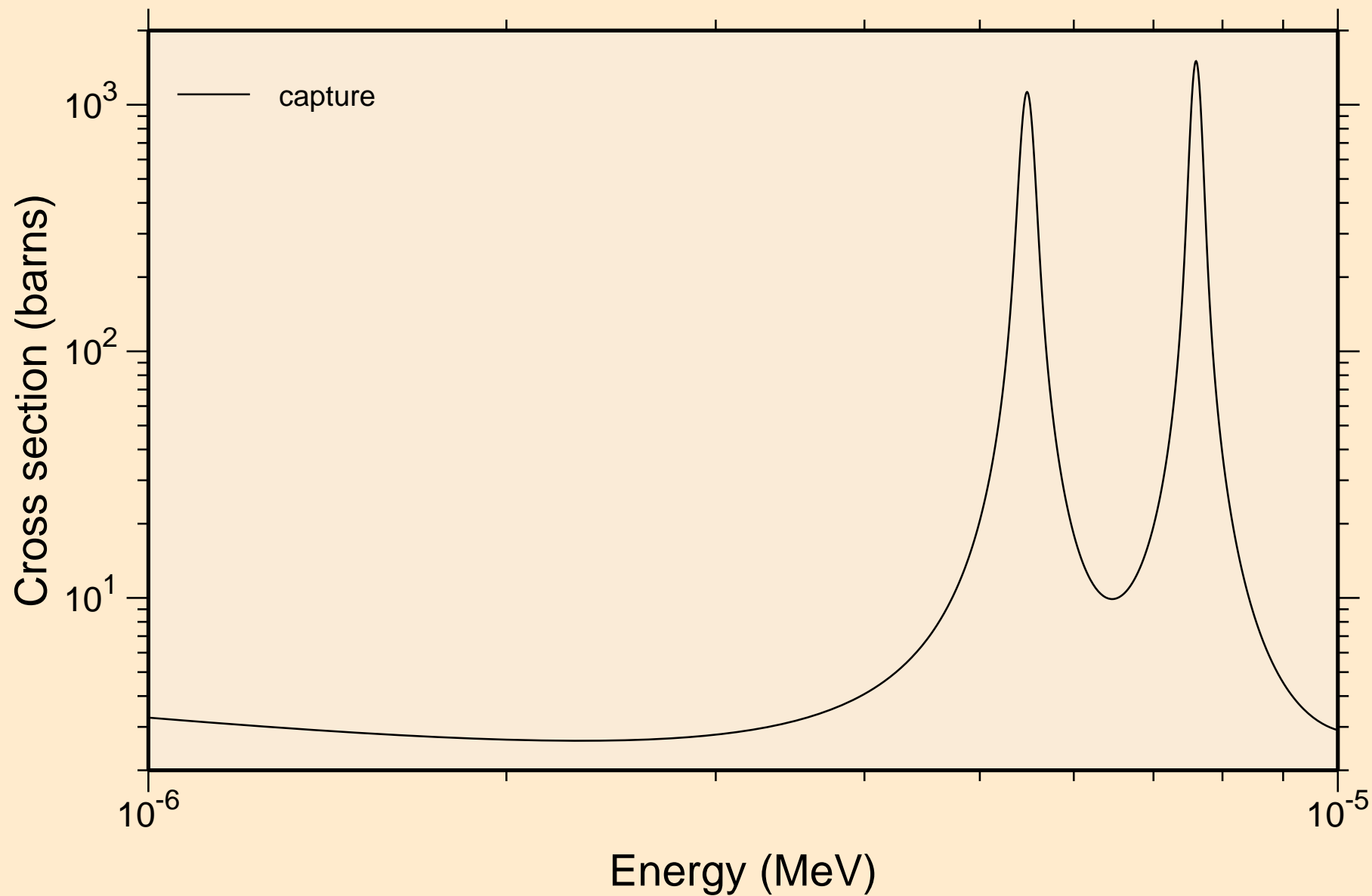

68-ER-162 FOR FENDL-3.2 FROM FENDL-3.2 WITH NJOY2016.60
resonance absorption cross sections

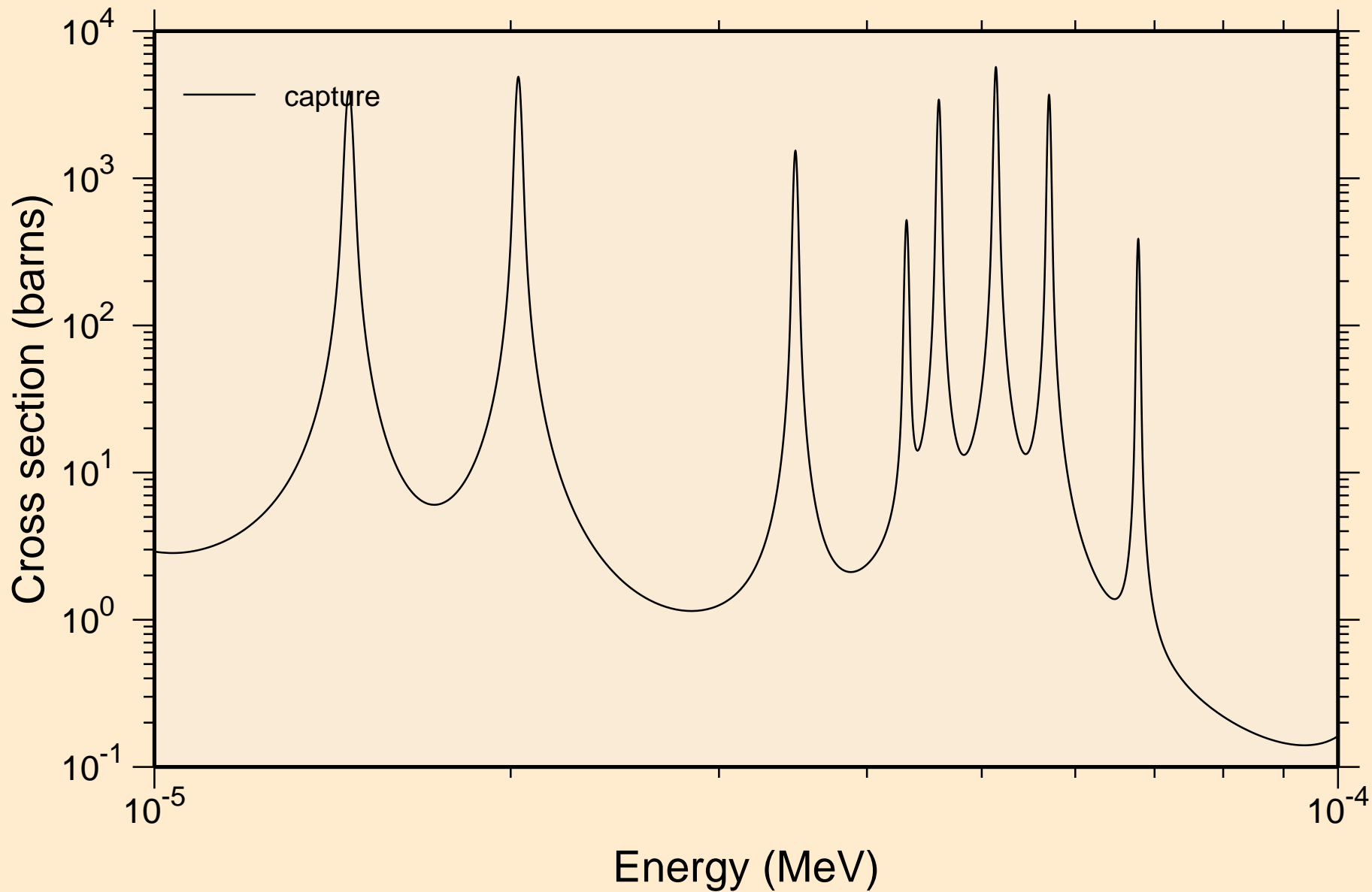

68-ER-162 FOR FENDL-3.2 FROM FENDL-3.2 WITH NJOY2016.60
resonance absorption cross sections

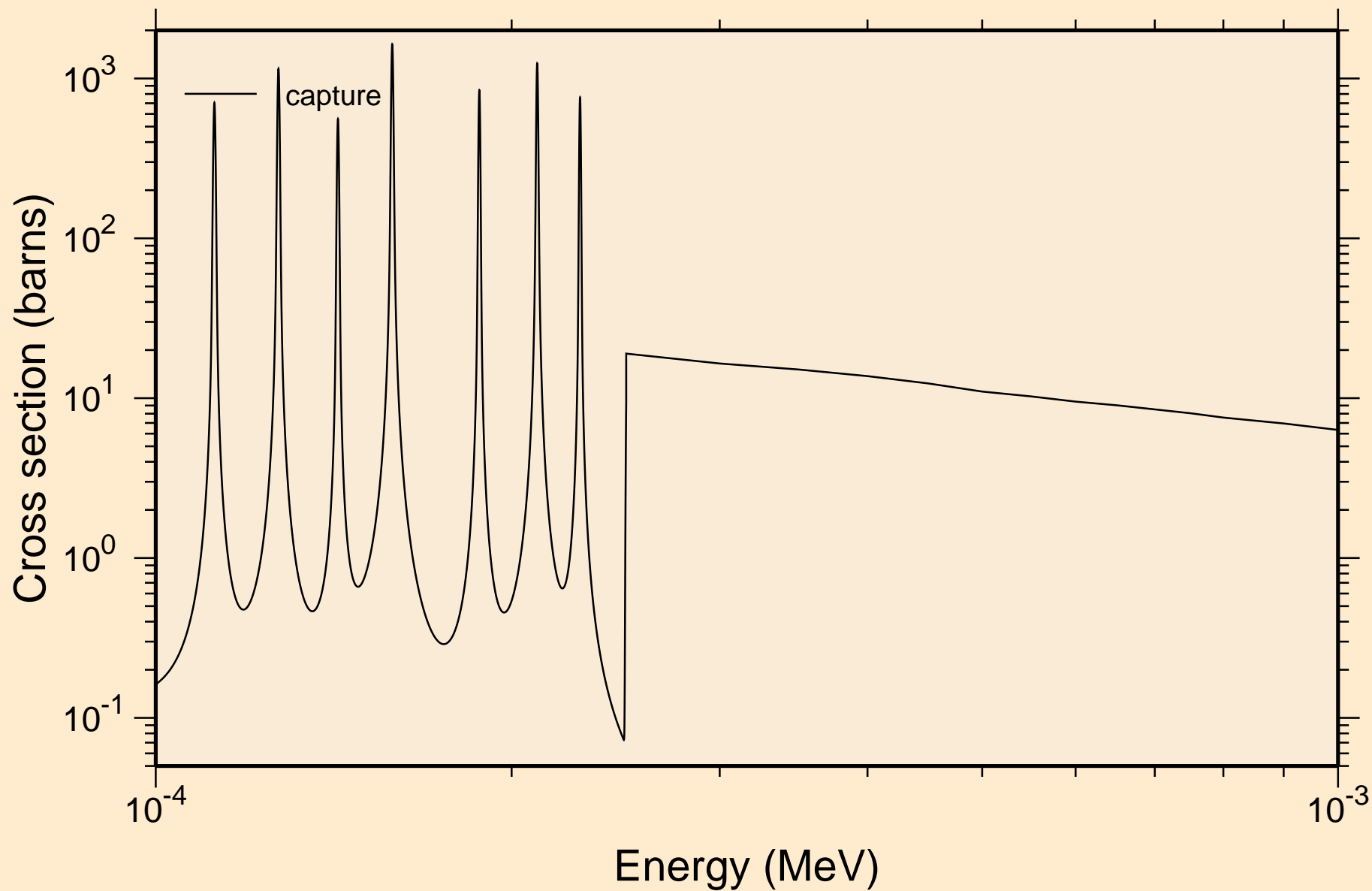

68-ER-162 FOR FENDL-3.2 FROM FENDL-3.2 WITH NJOY2016.60 Heating

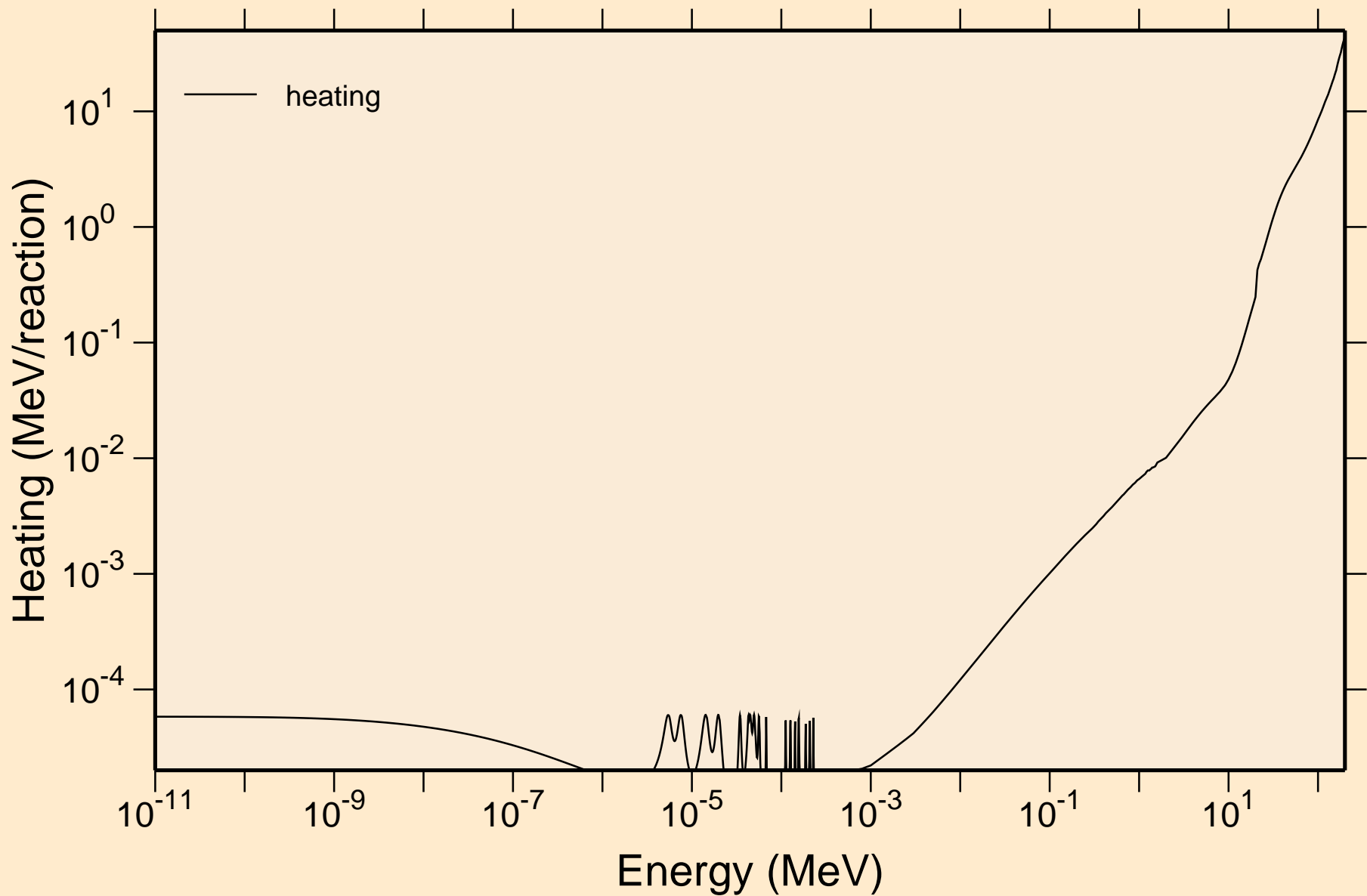

68-ER-162 FOR FENDL-3.2 FROM FENDL-3.2 WITH NJOY2016.60 Damage

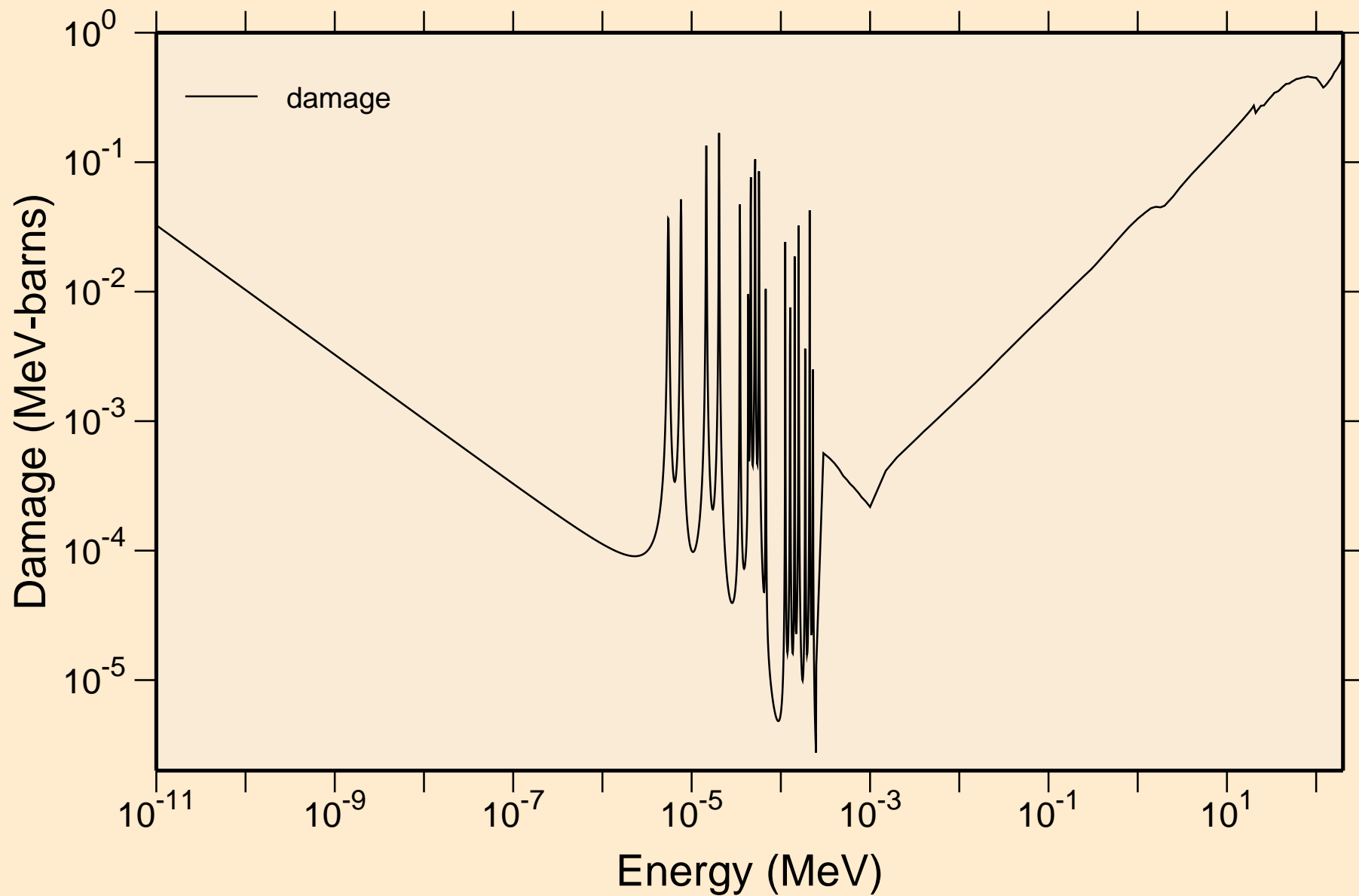

68-ER-162 FOR FENDL-3.2 FROM FENDL-3.2 WITH NJOY2016.60
Non-threshold reactions

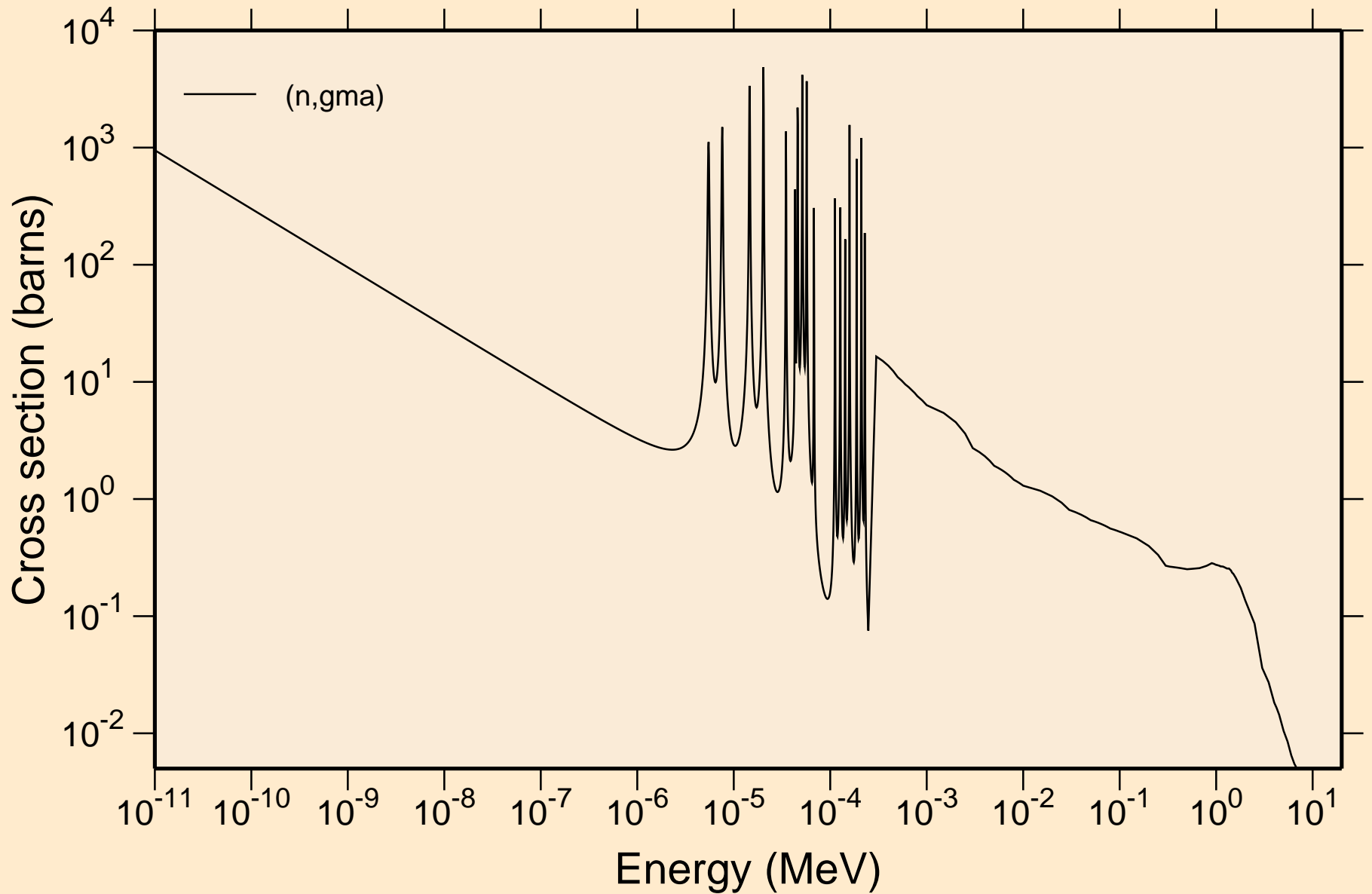

68-ER-162 FOR FENDL-3.2 FROM FENDL-3.2 WITH NJOY2016.60
Principal cross sections

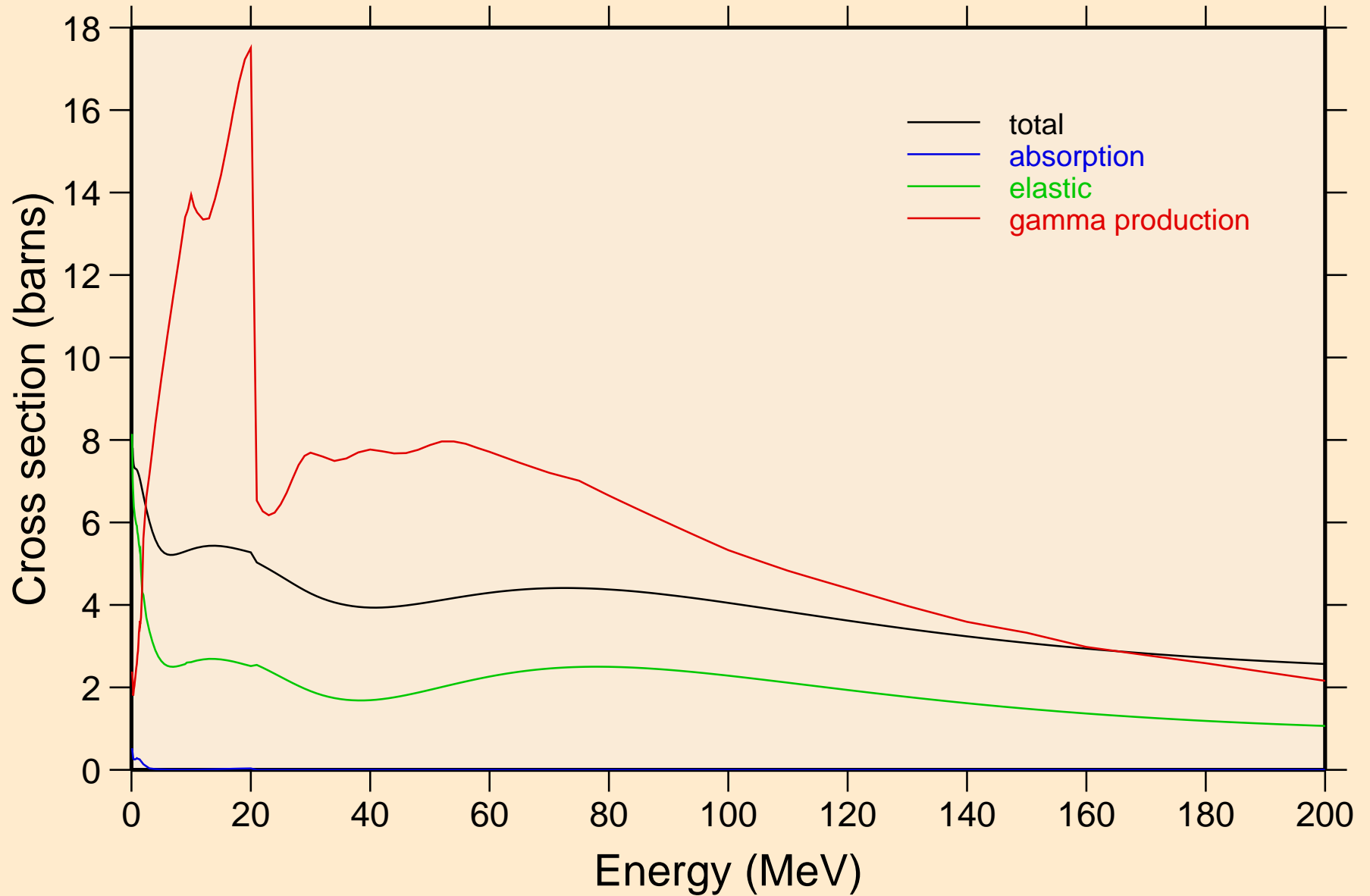

68-ER-162 FOR FENDL-3.2 FROM FENDL-3.2 WITH NJOY2016.60

Heating

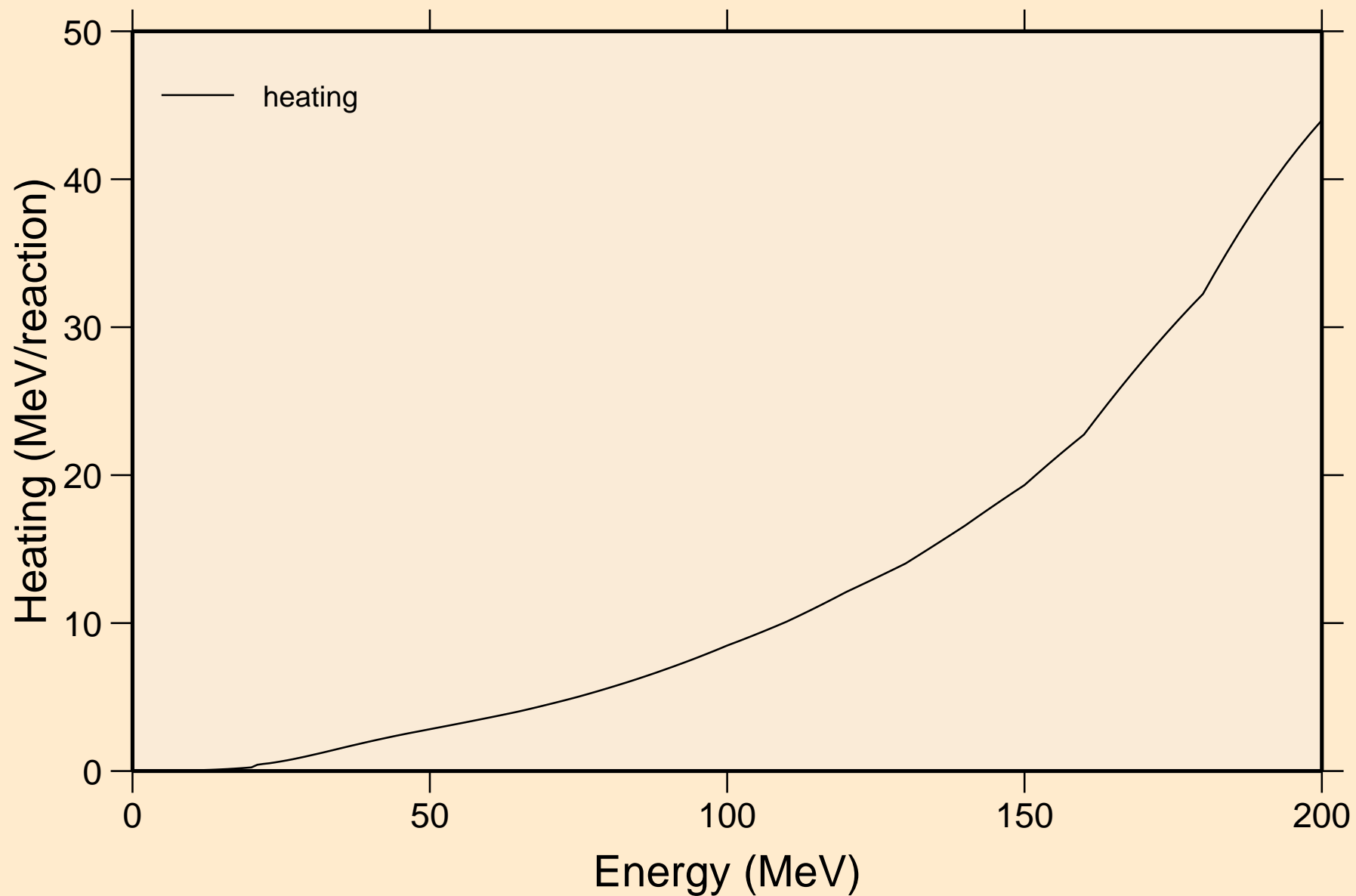

68-ER-162 FOR FENDL-3.2 FROM FENDL-3.2 WITH NJOY2016.60 Damage

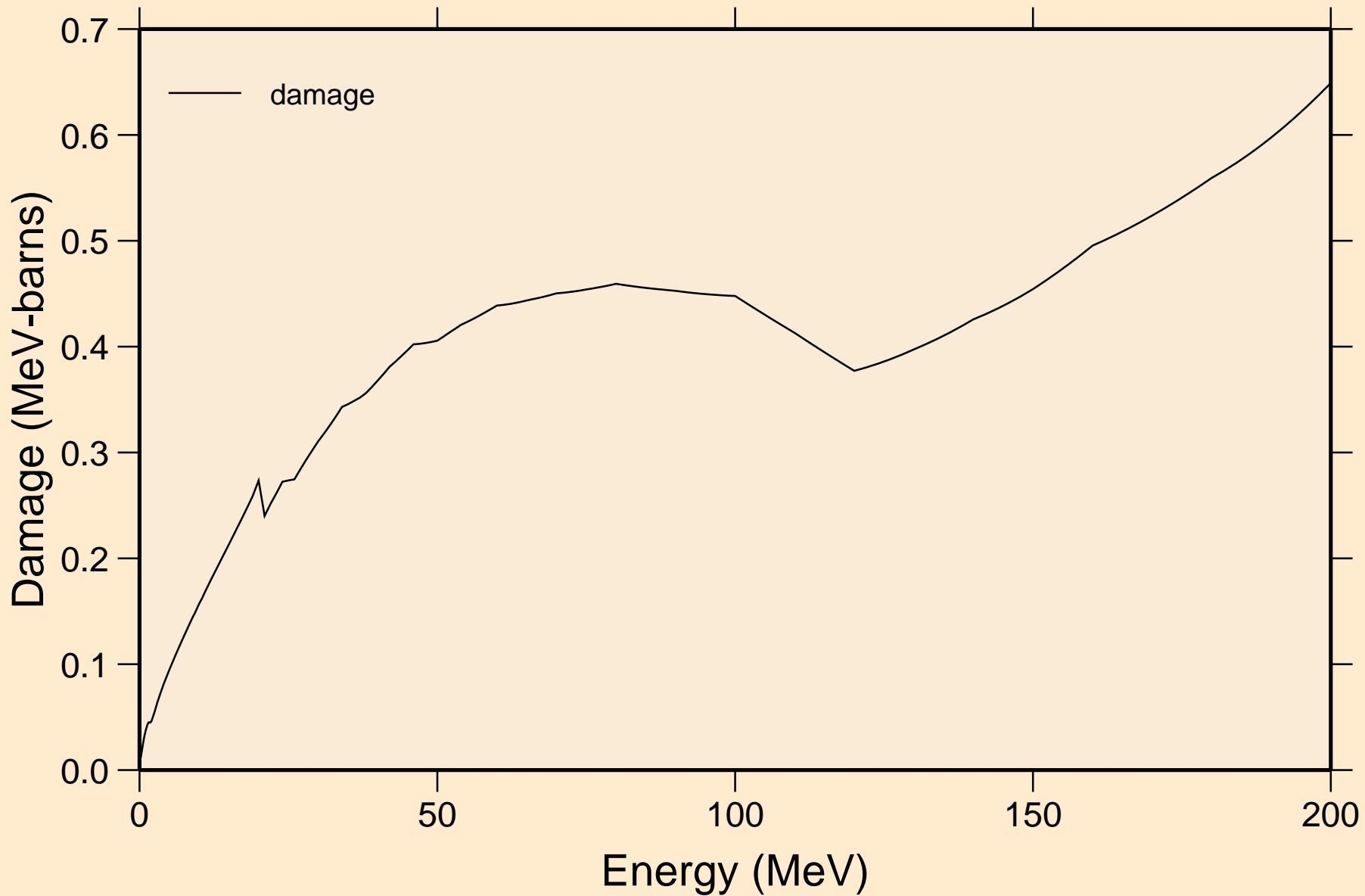

68-ER-162 FOR FENDL-3.2 FROM FENDL-3.2 WITH NJOY2016.60
Non-threshold reactions

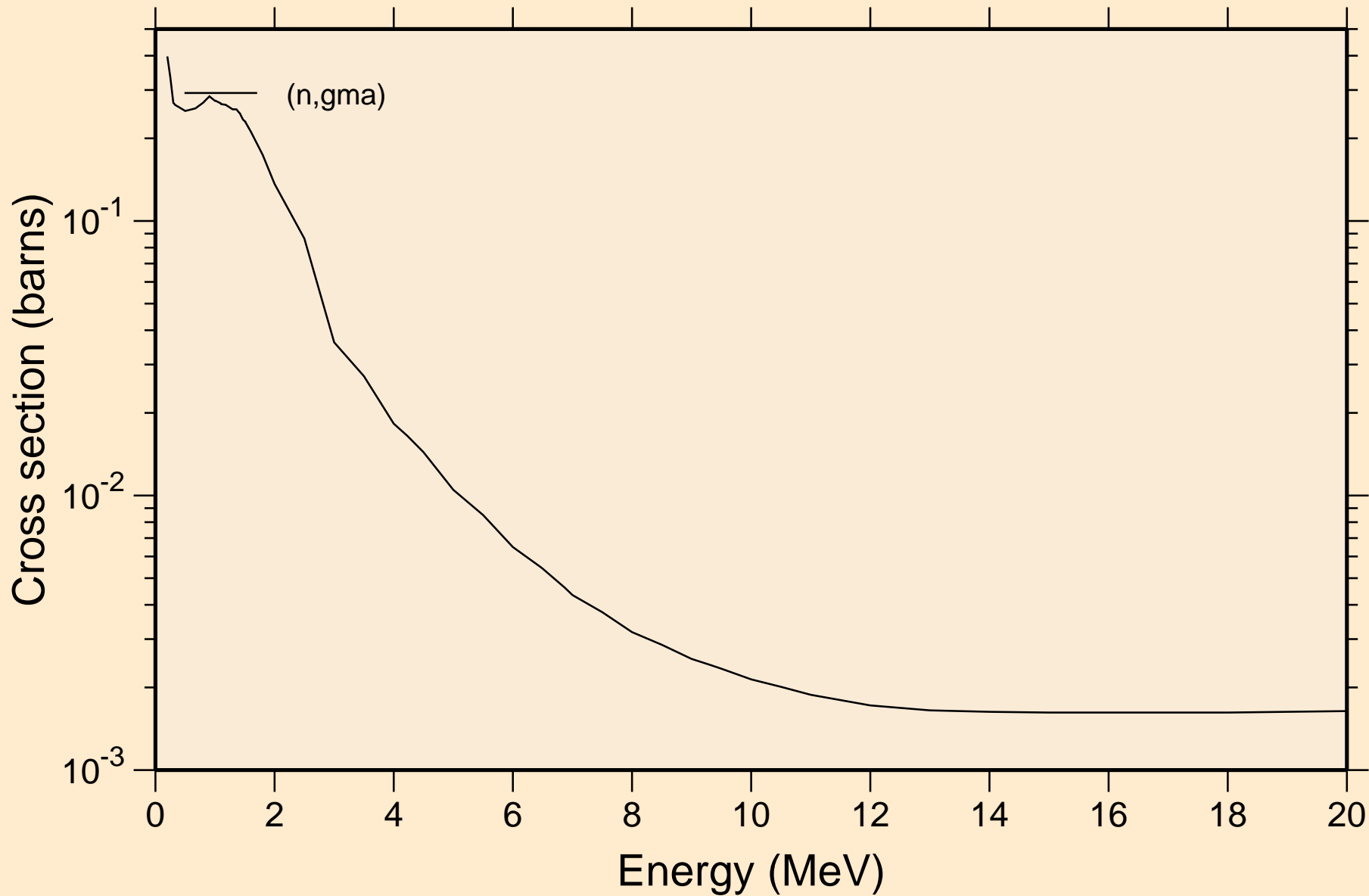

68-ER-162 FOR FENDL-3.2 FROM FENDL-3.2 WITH NJOY2016.60
Inelastic levels

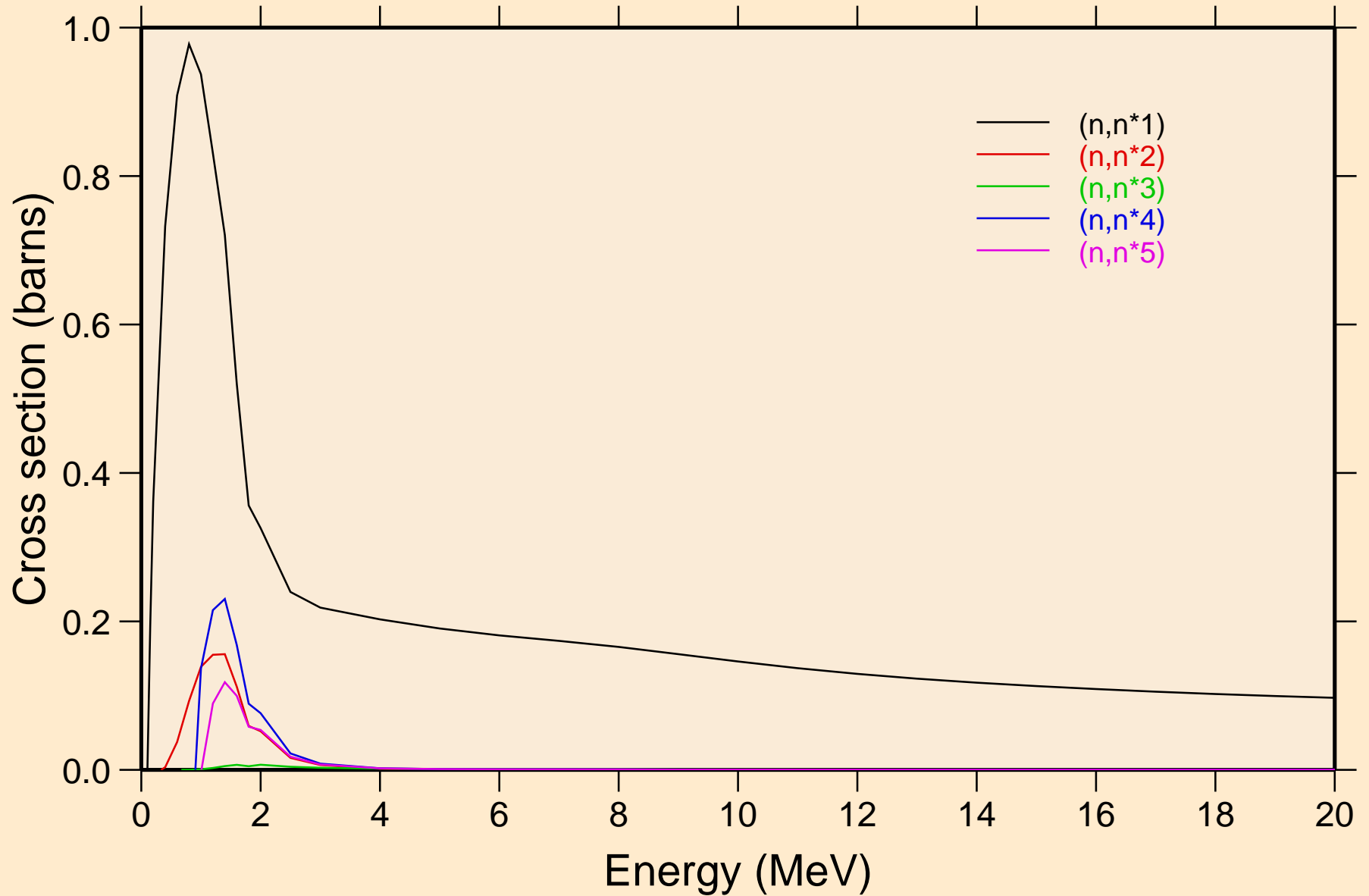

68-ER-162 FOR FENDL-3.2 FROM FENDL-3.2 WITH NJOY2016.60
Inelastic levels

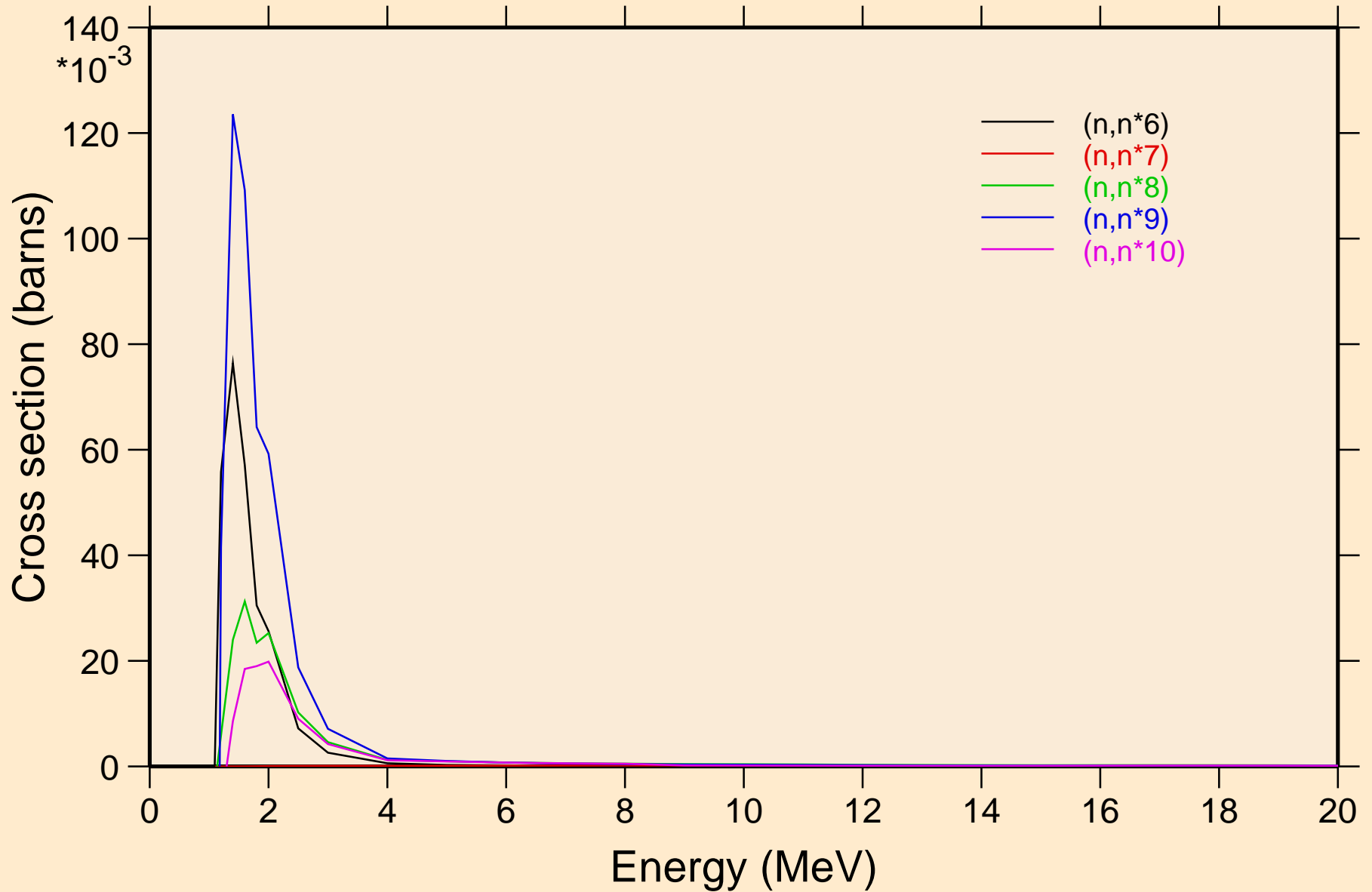

68-ER-162 FOR FENDL-3.2 FROM FENDL-3.2 WITH NJOY2016.60
Inelastic levels

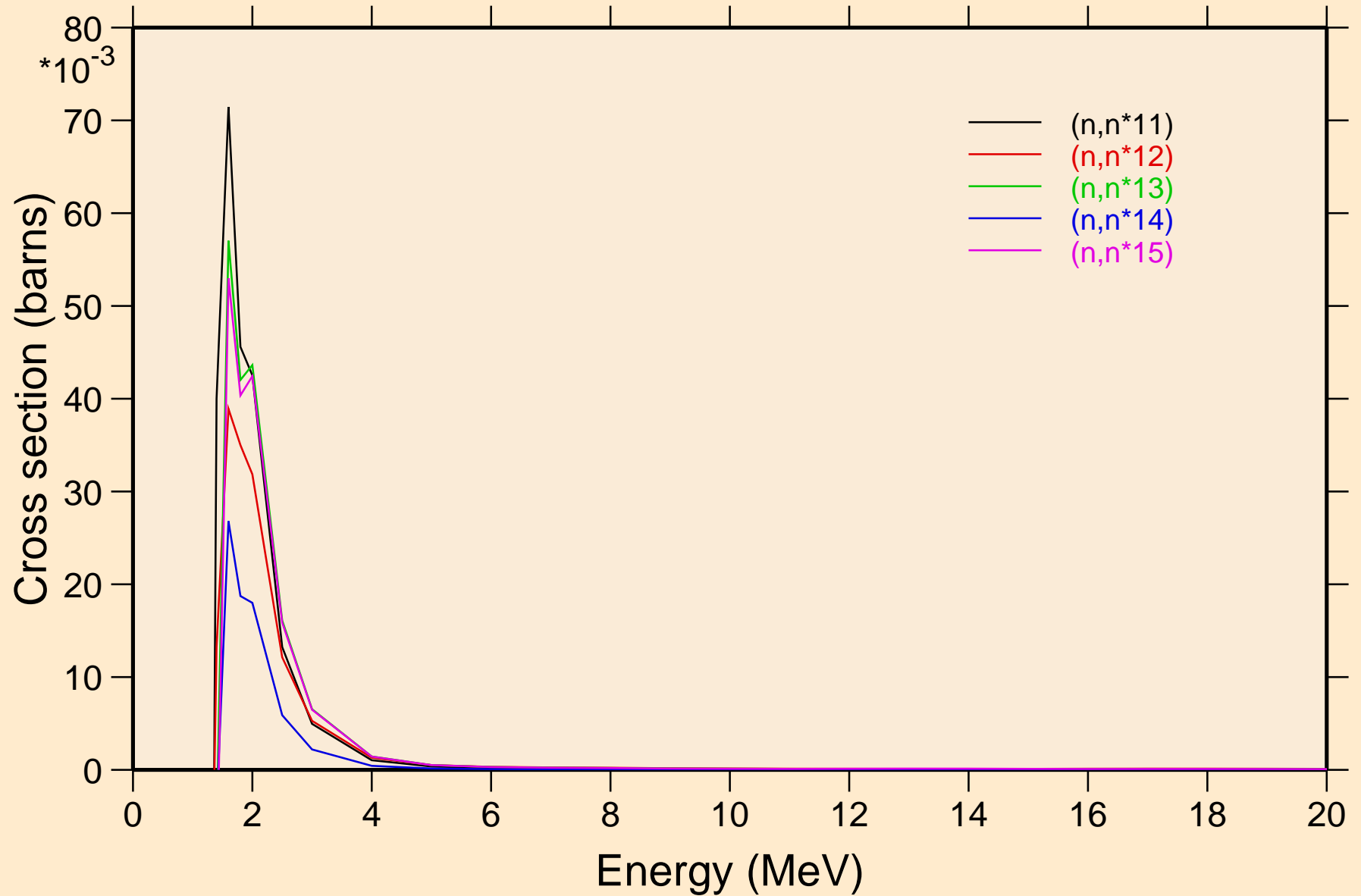

68-ER-162 FOR FENDL-3.2 FROM FENDL-3.2 WITH NJOY2016.60
Inelastic levels

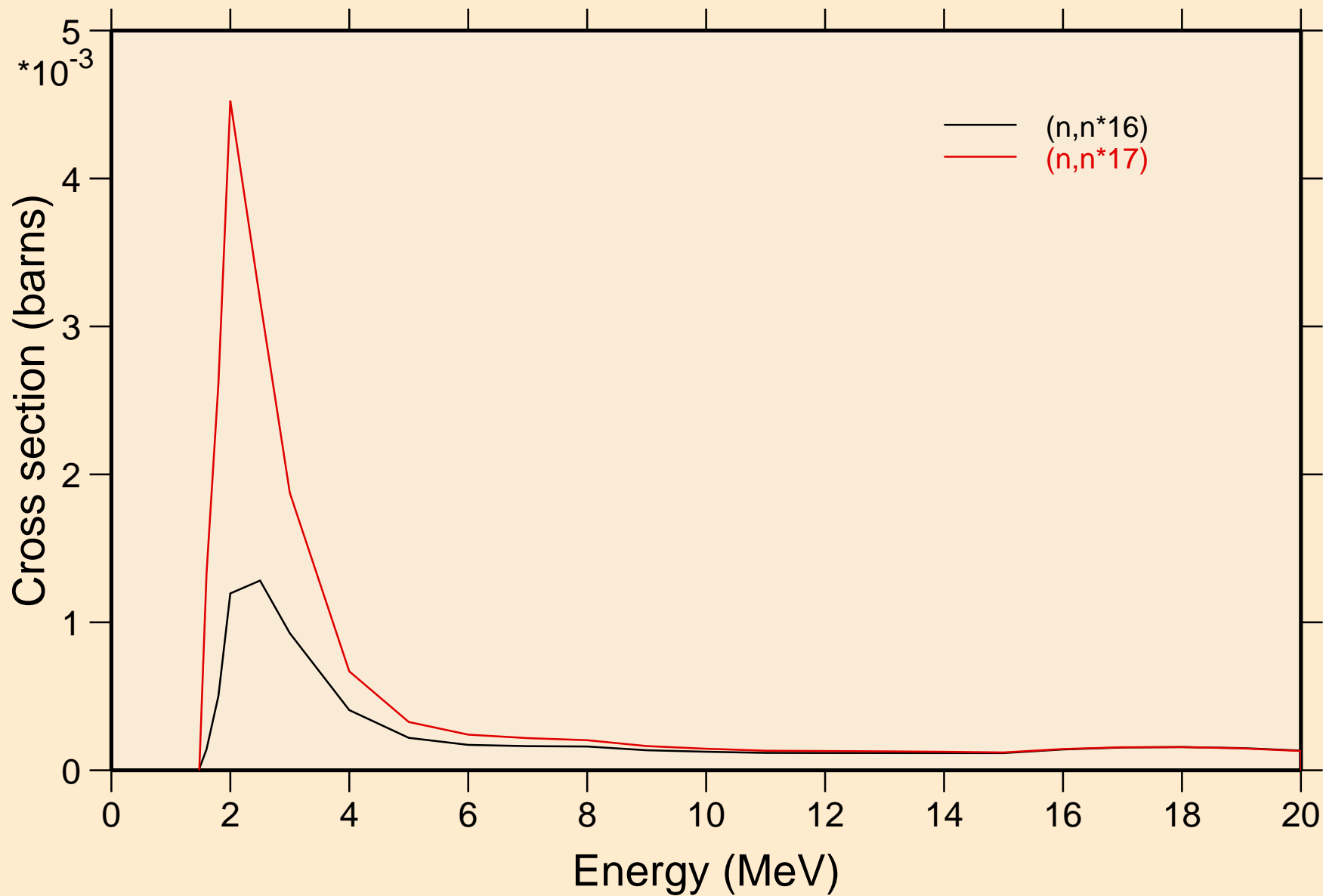

68-ER-162 FOR FENDL-3.2 FROM FENDL-3.2 WITH NJOY2016.60
Threshold reactions

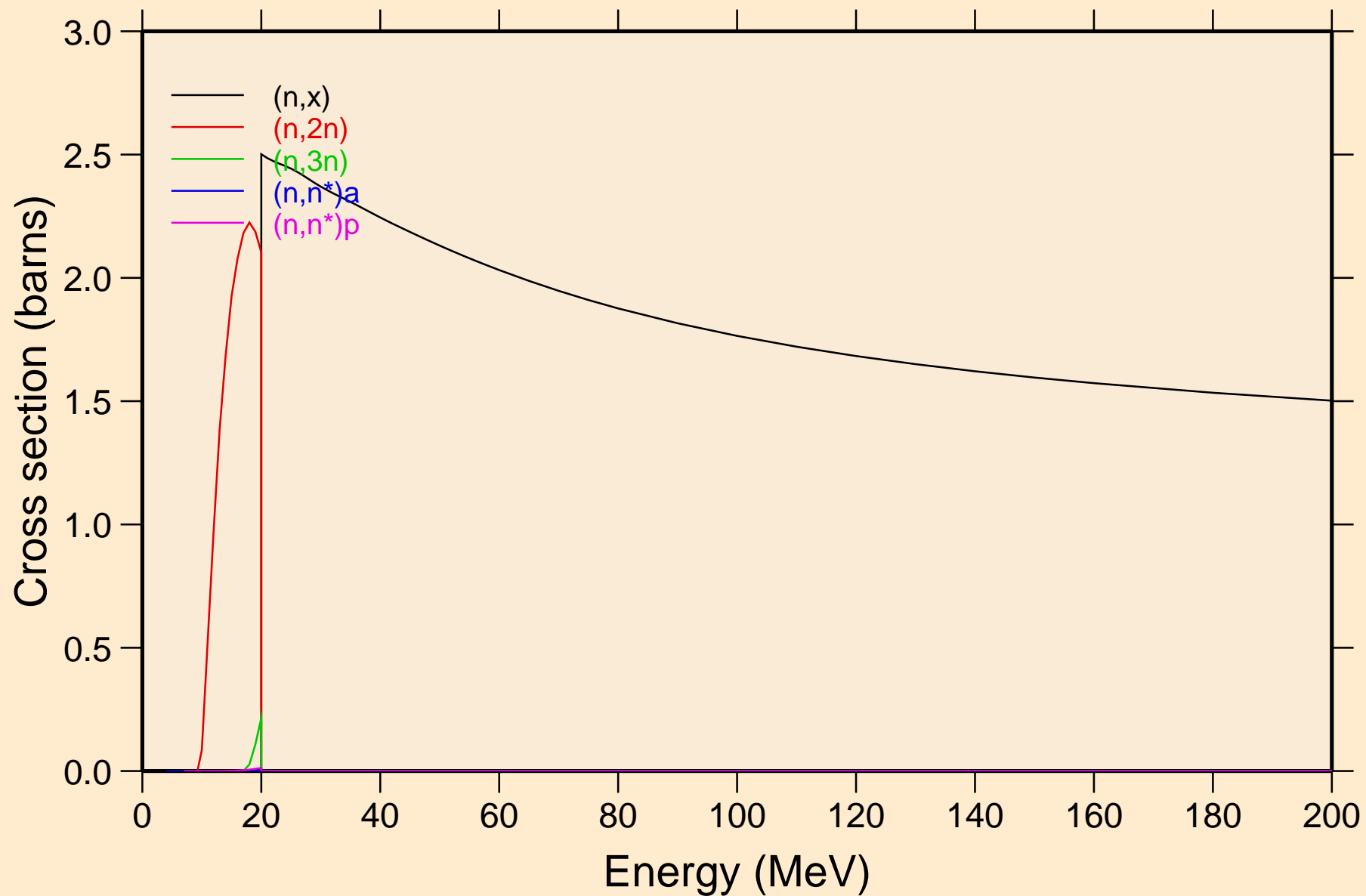

68-ER-162 FOR FENDL-3.2 FROM FENDL-3.2 WITH NJOY2016.60
Threshold reactions

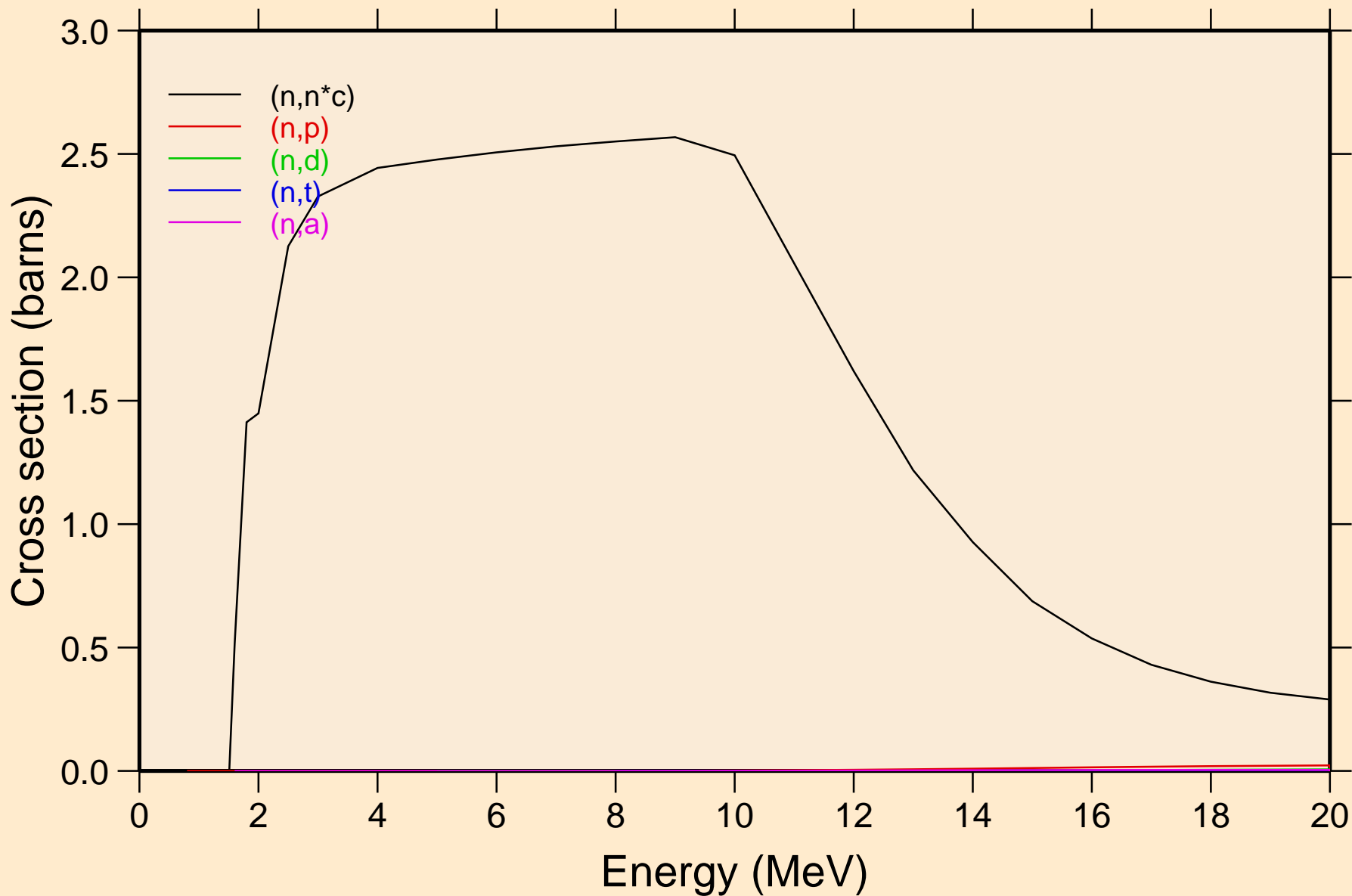

68-ER-162 FOR FENDL-3.2 FROM FENDL-3.2 WITH NJOY2016.60
Threshold reactions

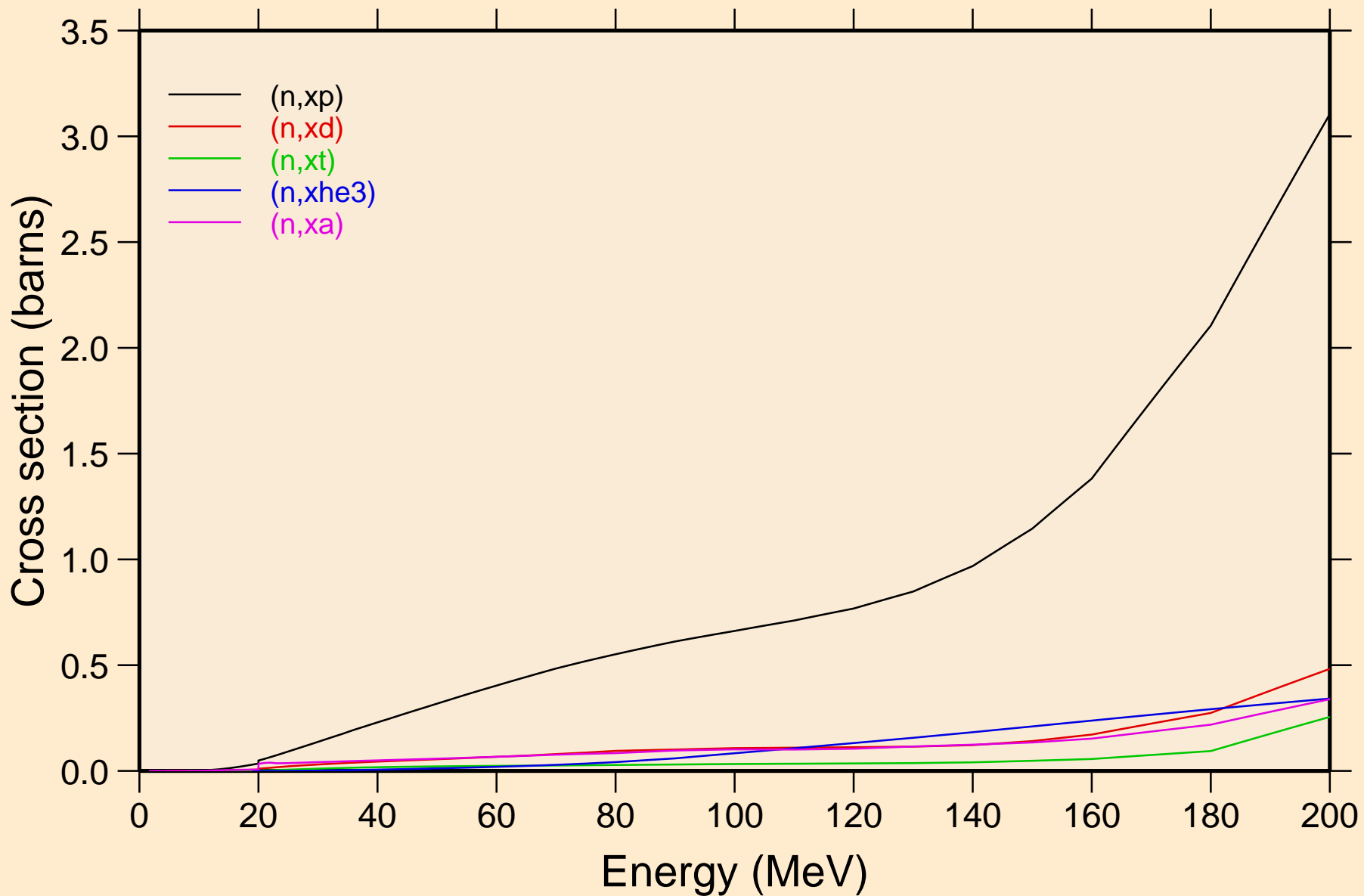

68-ER-162 FOR FENDL-3.2 FROM FENDL-3.2 WITH NJOY2016.60
angular distribution for elastic

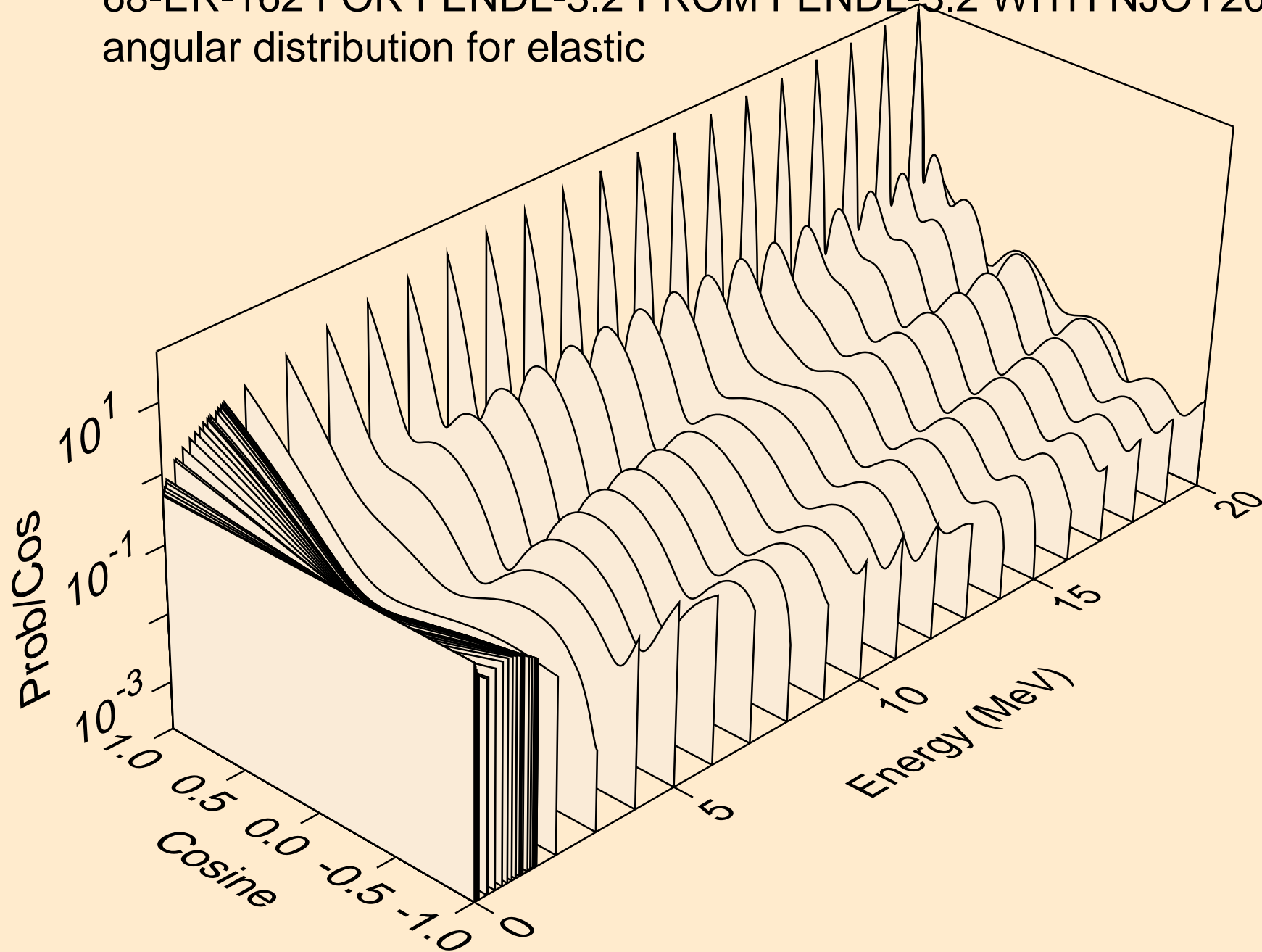

68-ER-162 FOR FENDL-3.2 FROM FENDL-3.2 WITH NJOY2016.60
angular distribution for elastic

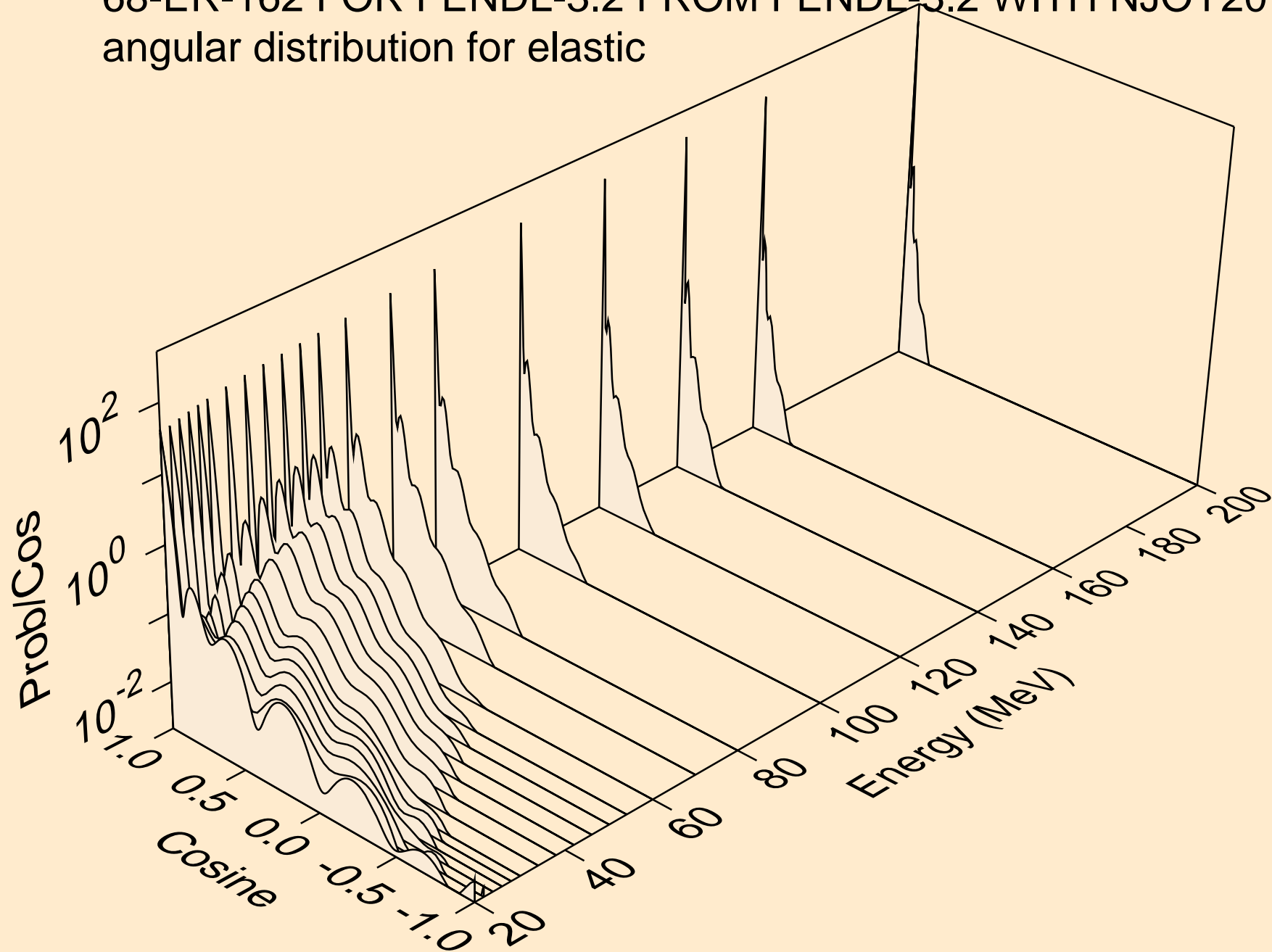

68-ER-162 FOR FENDL-3.2 FROM FENDL-3.2 WITH NJOY2016.60
angular distribution for (n,n*1)

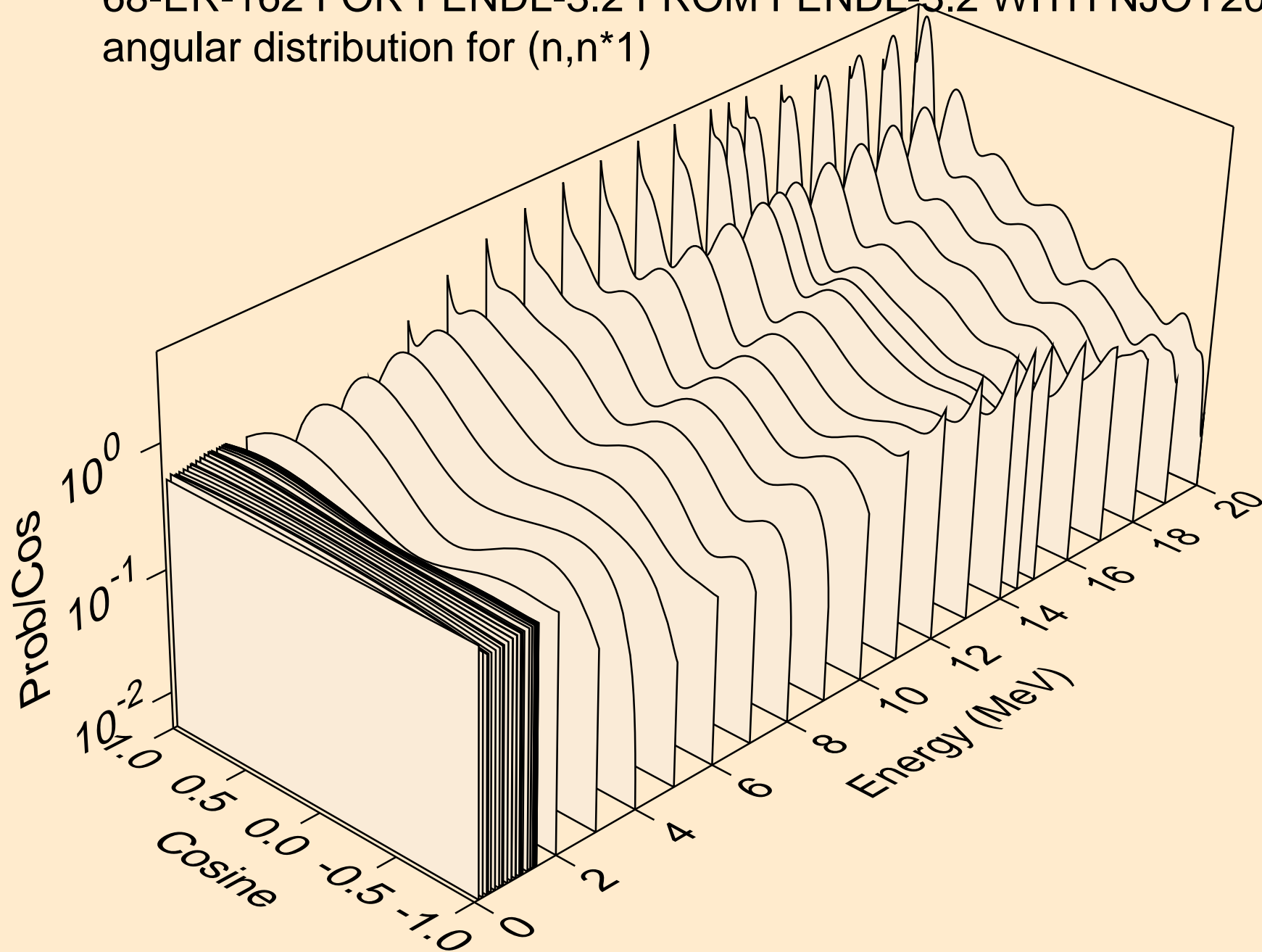

68-ER-162 FOR FENDL-3.2 FROM FENDL-3.2 WITH NJOY2016.60
angular distribution for (n,n*2)

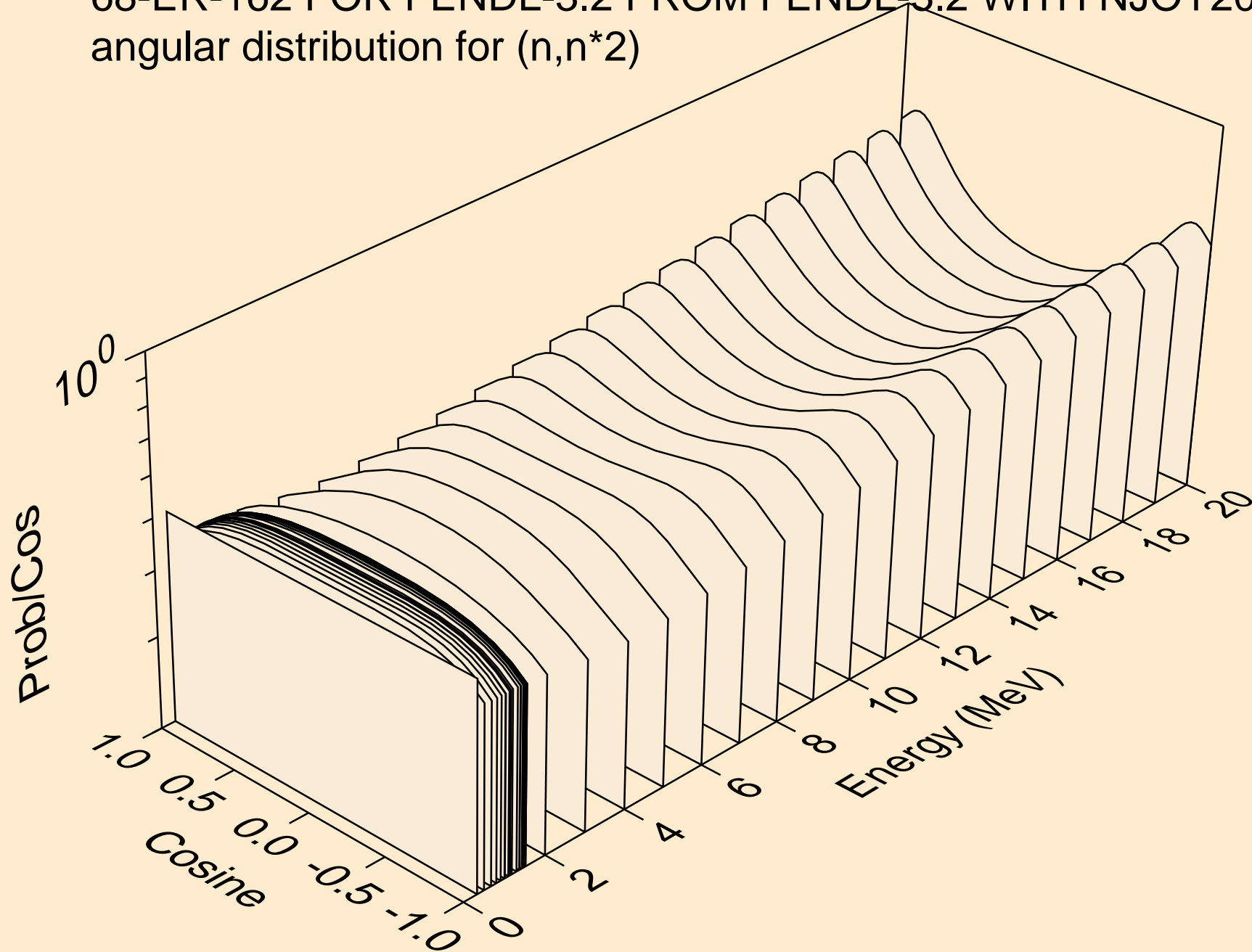

68-ER-162 FOR FENDL-3.2 FROM FENDL-3.2 WITH NJOY2016.60
angular distribution for (n,n*3)

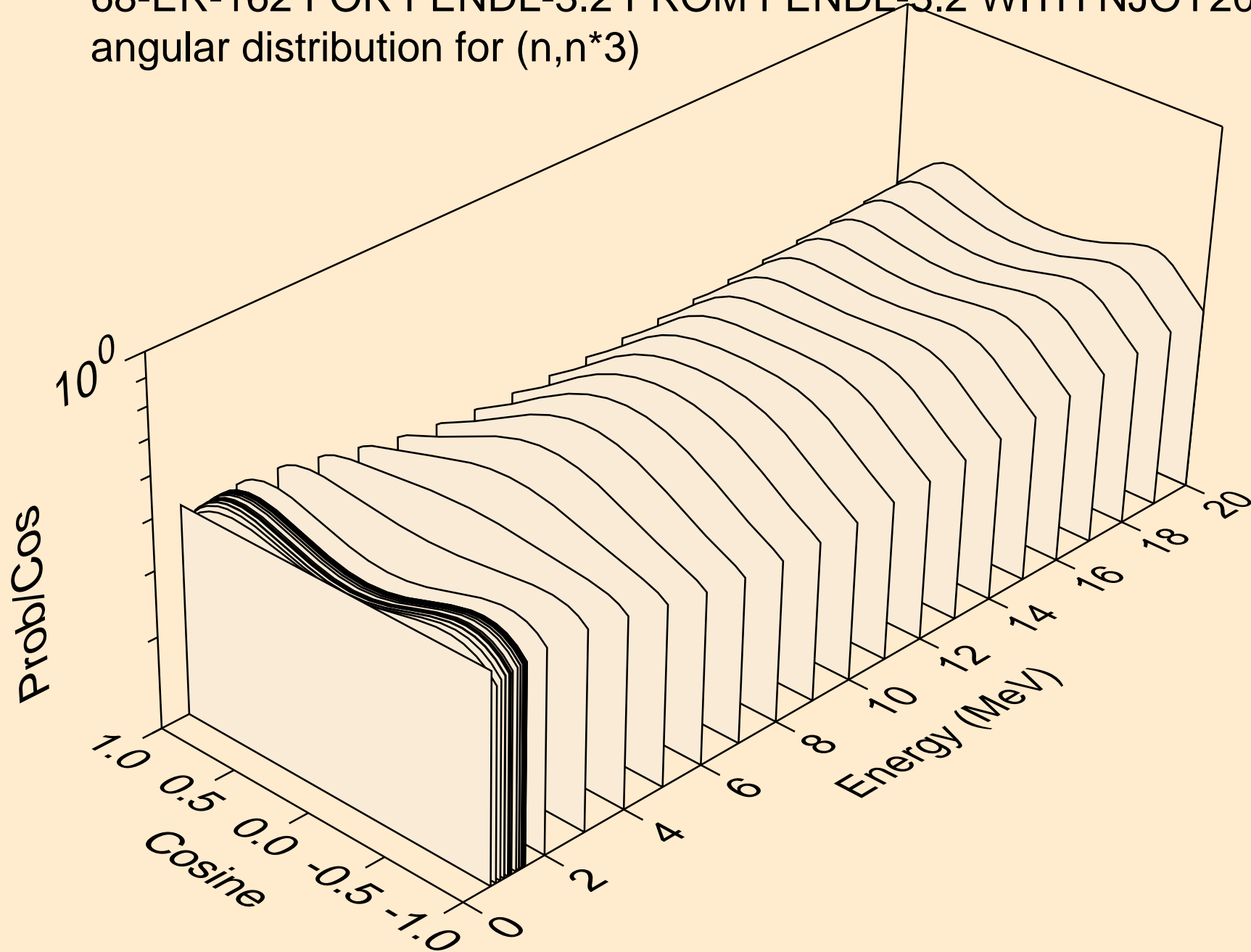

68-ER-162 FOR FENDL-3.2 FROM FENDL-3.2 WITH NJOY2016.60
angular distribution for (n,n*4)

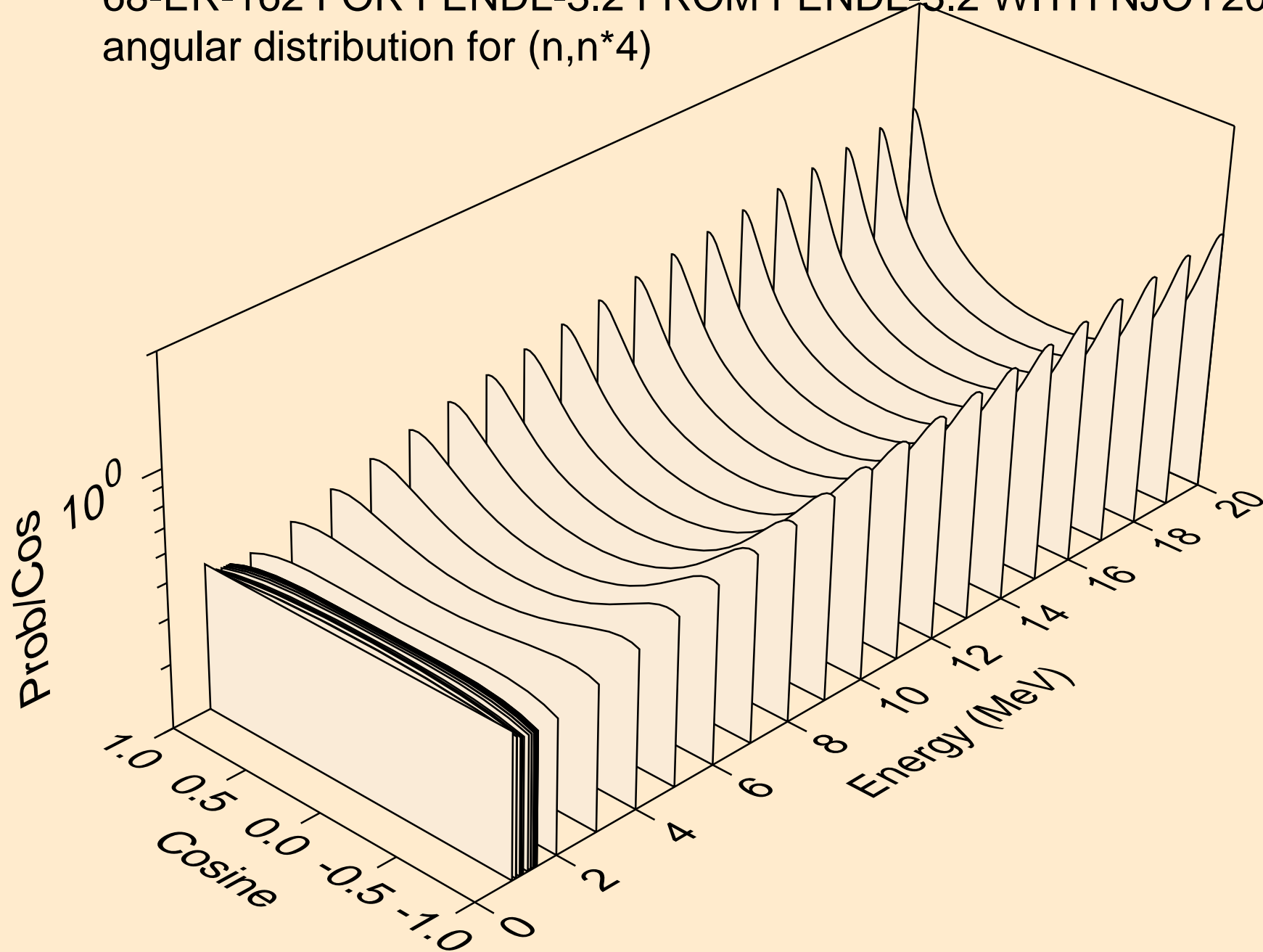

68-ER-162 FOR FENDL-3.2 FROM FENDL-3.2 WITH NJOY2016.60
angular distribution for (n,n*5)

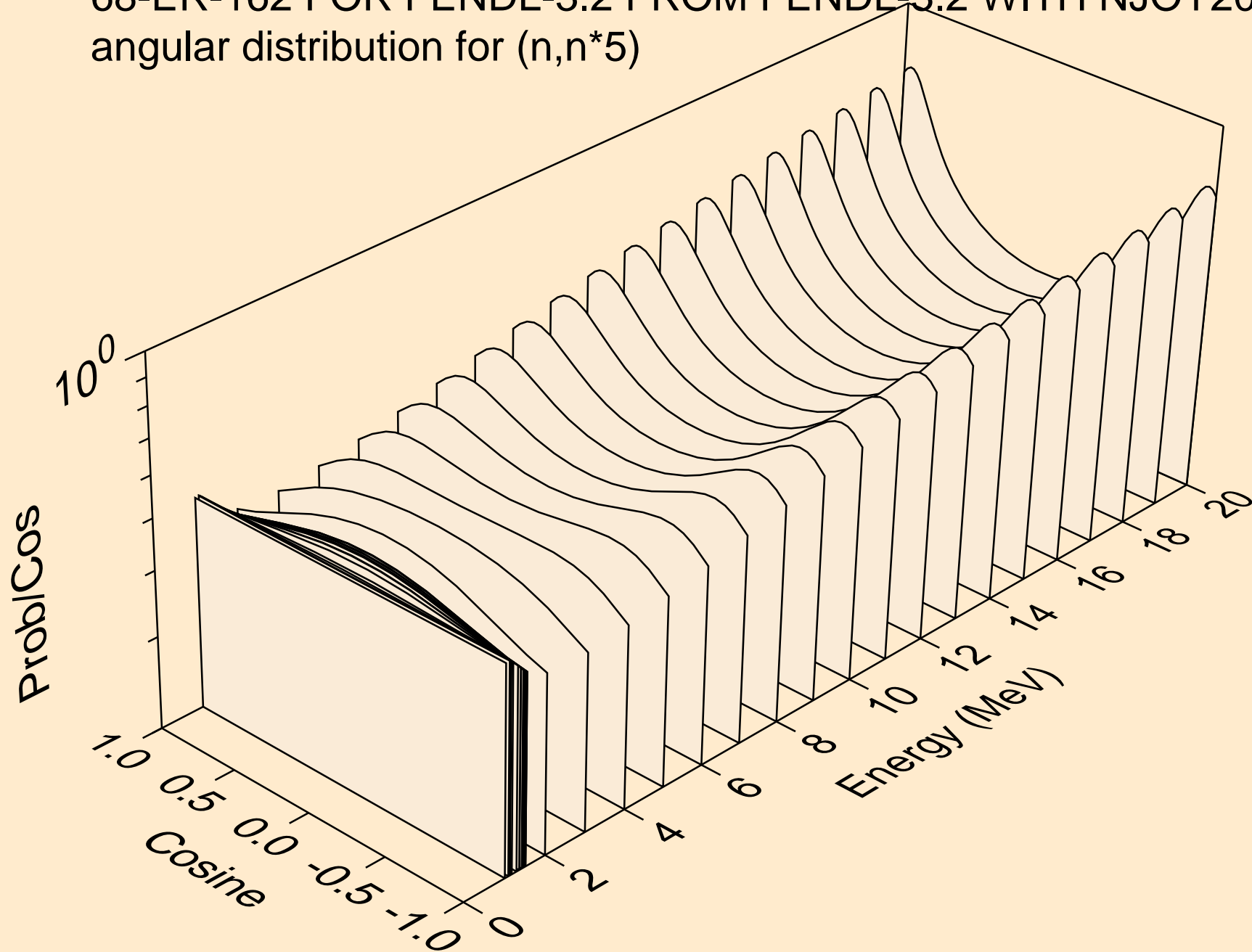

68-ER-162 FOR FENDL-3.2 FROM FENDL-3.2 WITH NJOY2016.60
angular distribution for (n,n*6)

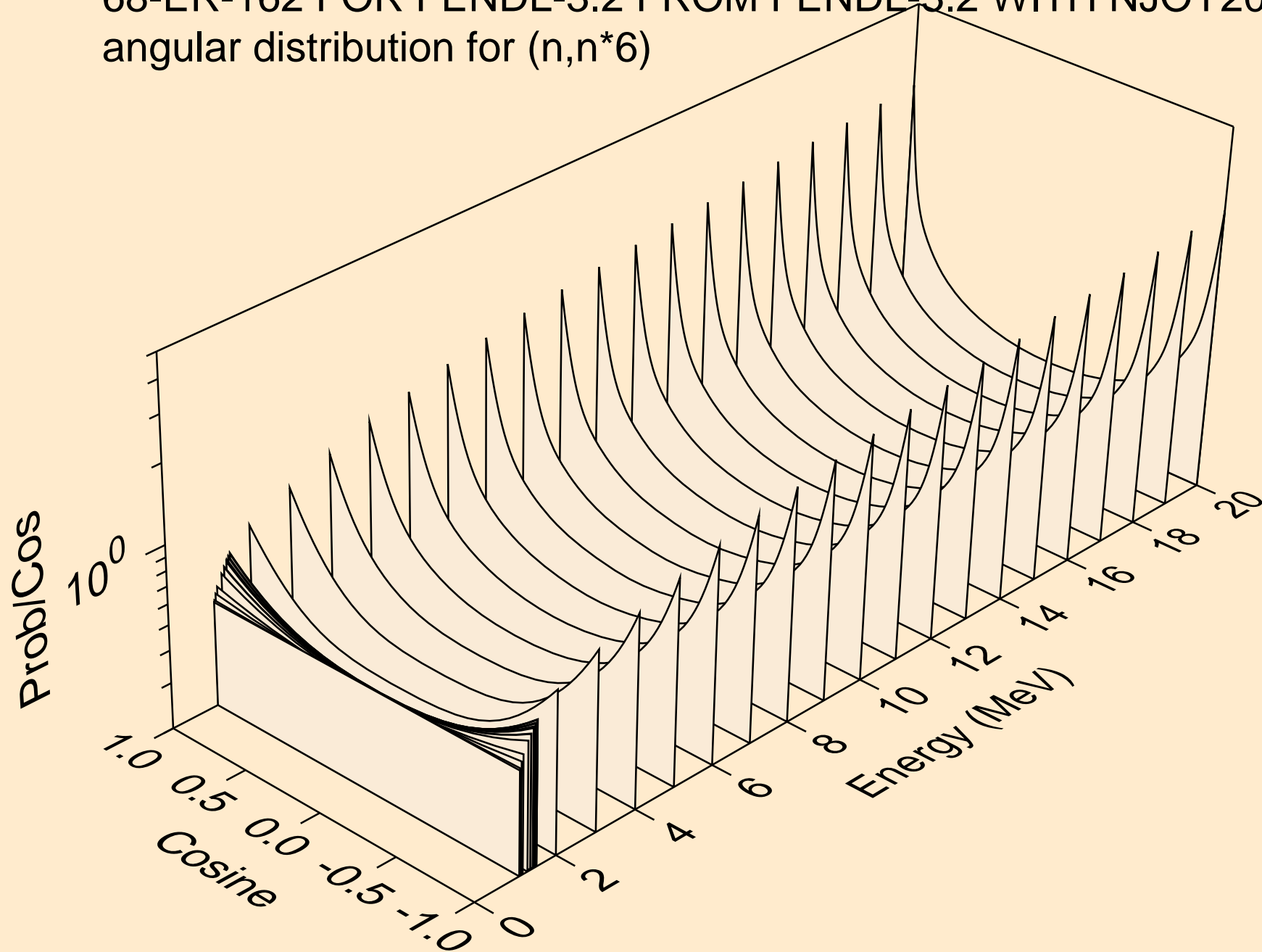

68-ER-162 FOR FENDL-3.2 FROM FENDL-3.2 WITH NJOY2016.60
angular distribution for (n,n*7)

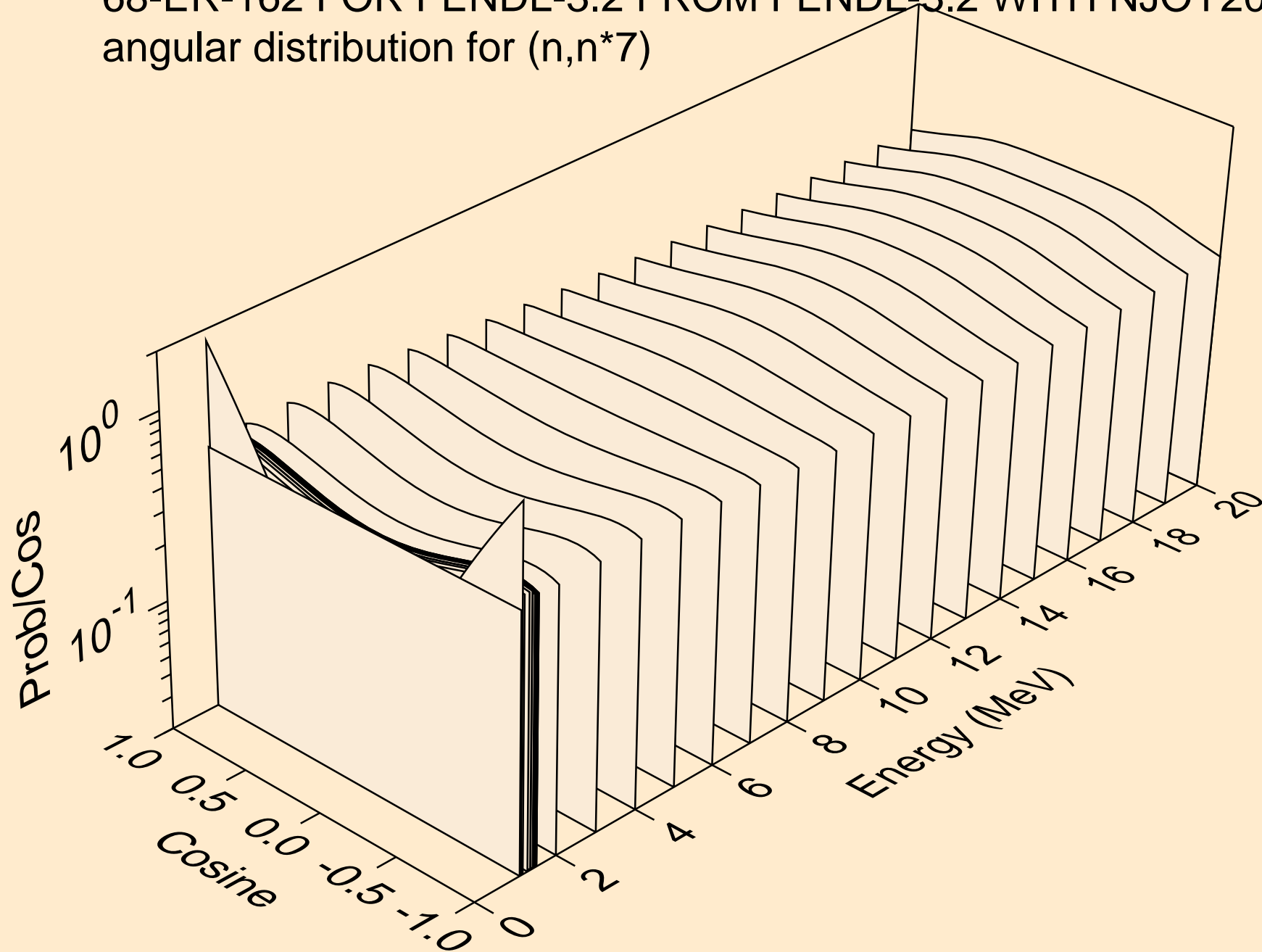

68-ER-162 FOR FENDL-3.2 FROM FENDL-3.2 WITH NJOY2016.60
angular distribution for (n,n*8)

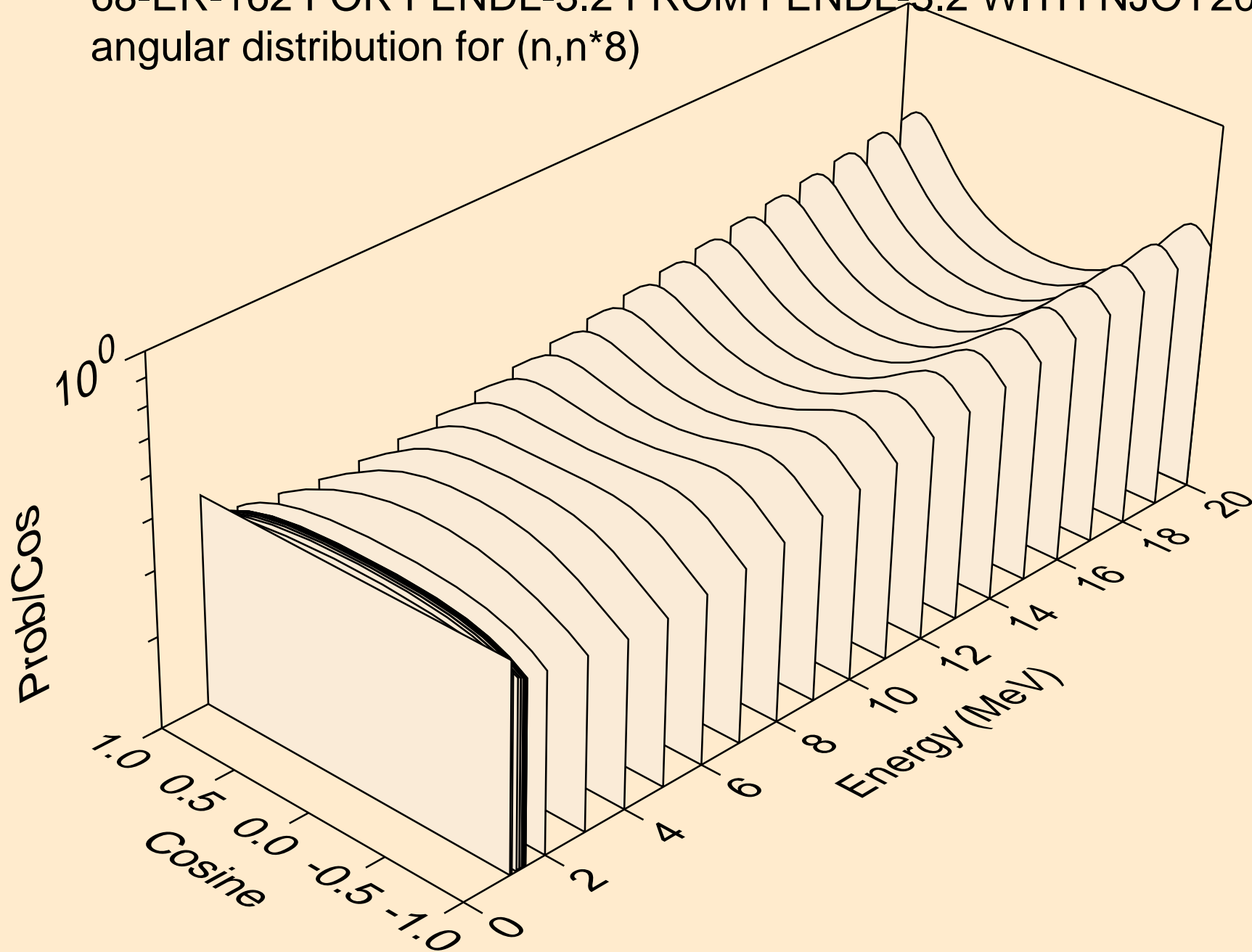

68-ER-162 FOR FENDL-3.2 FROM FENDL-3.2 WITH NJOY2016.60
angular distribution for (n,n*9)

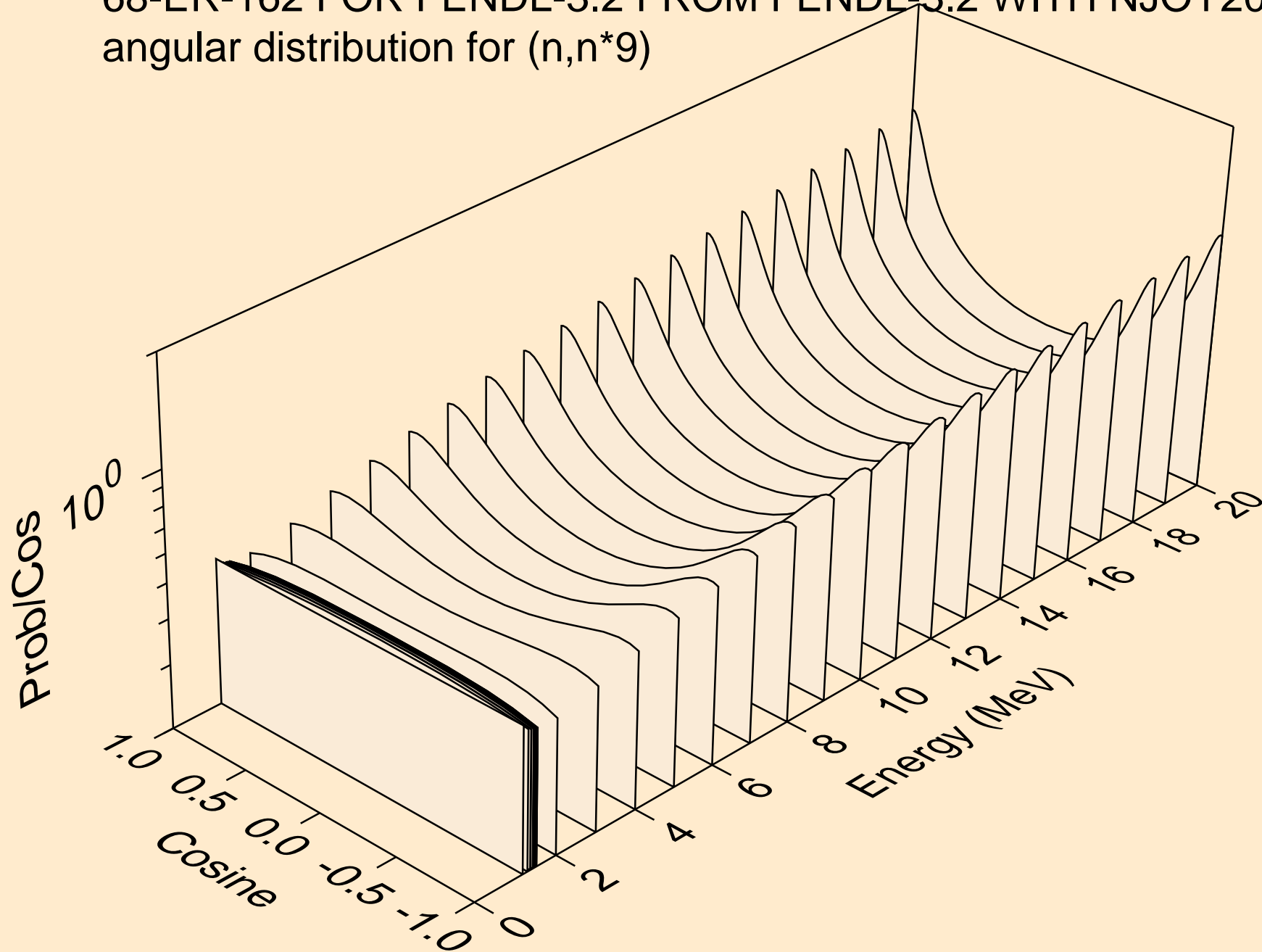

68-ER-162 FOR FENDL-3.2 FROM FENDL-3.2 WITH NJOY2016.60
angular distribution for (n,n*10)

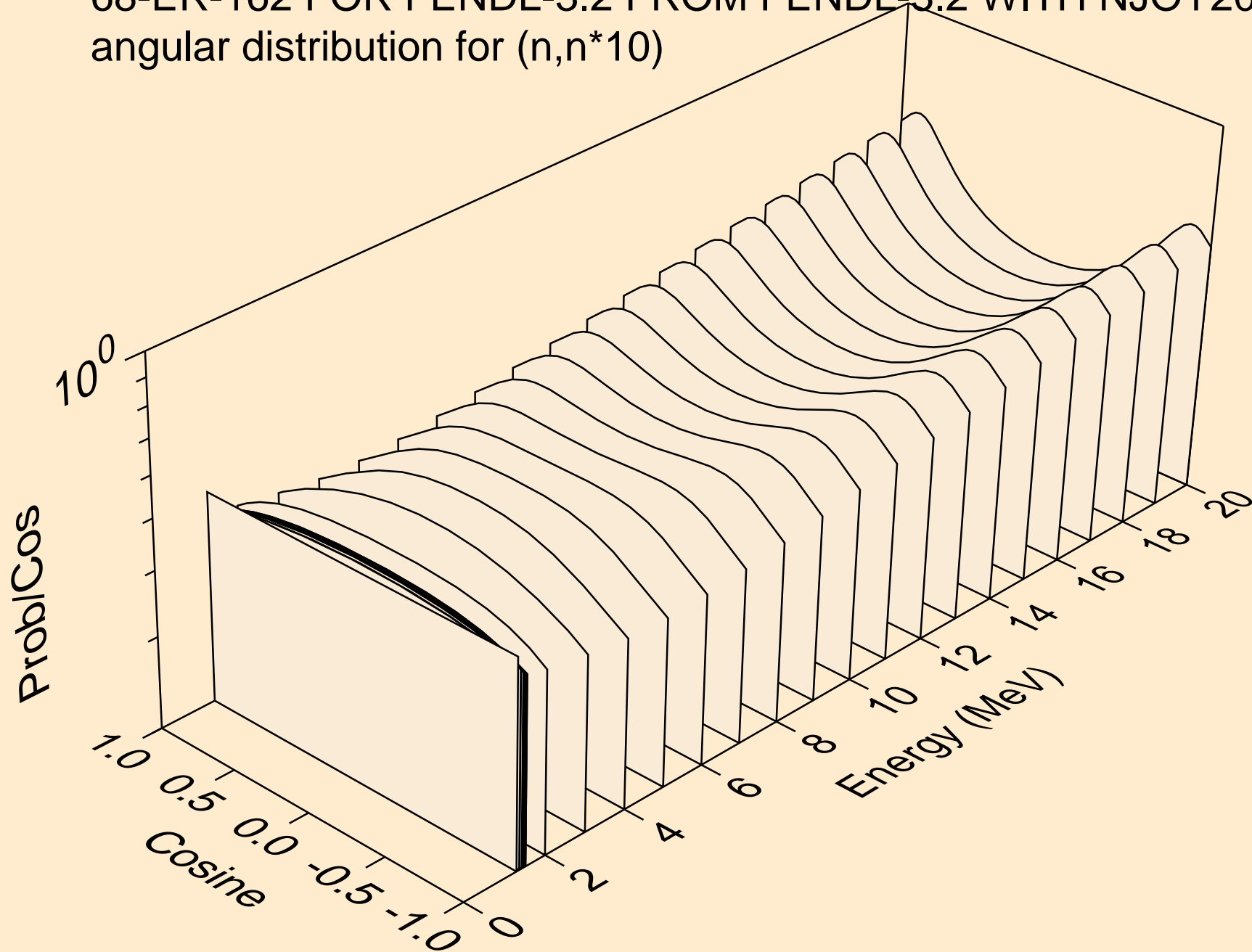

68-ER-162 FOR FENDL-3.2 FROM FENDL-3.2 WITH NJOY2016.60
angular distribution for (n,n*11)

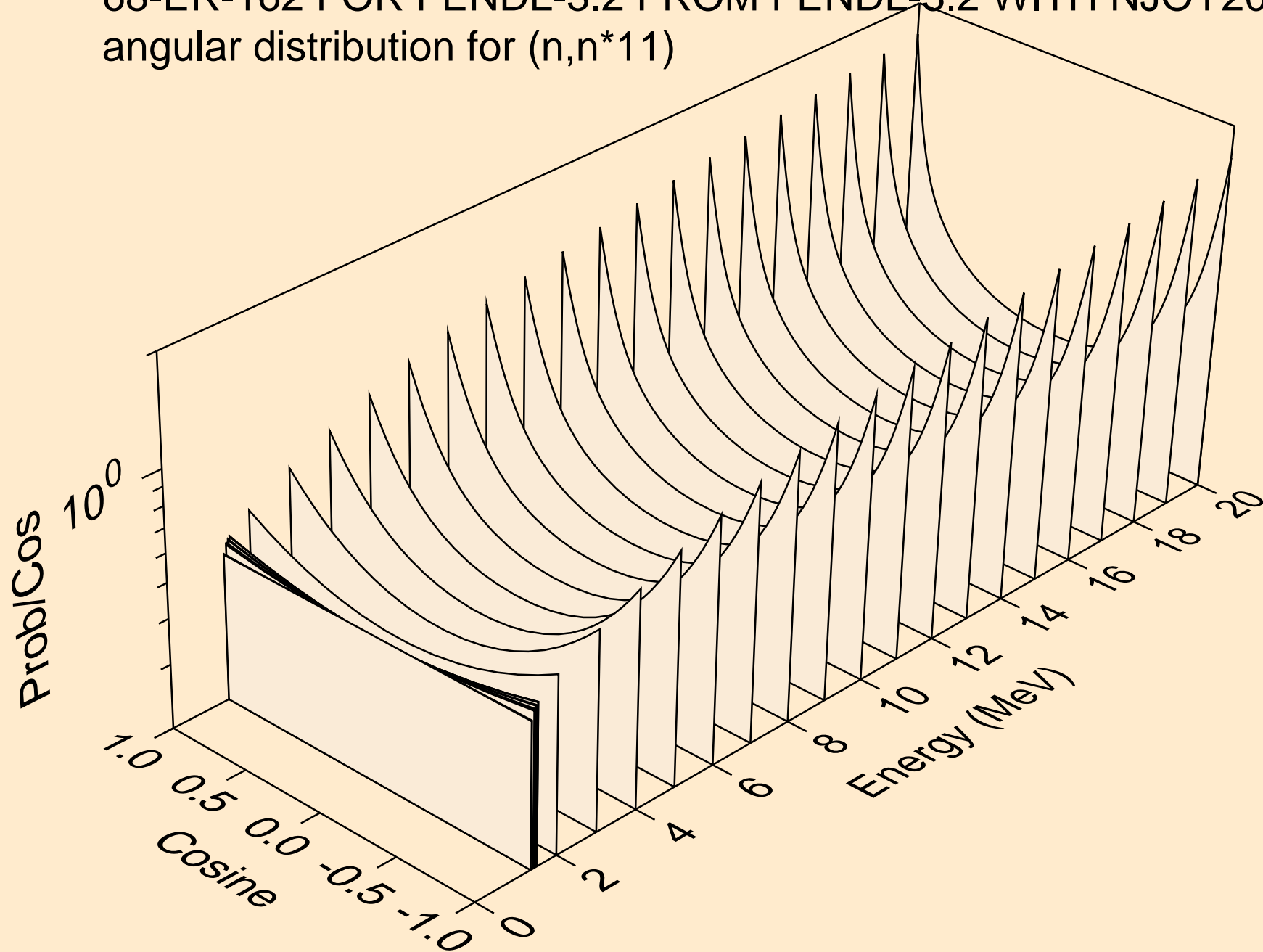

68-ER-162 FOR FENDL-3.2 FROM FENDL-3.2 WITH NJOY2016.60
angular distribution for (n,n*12)

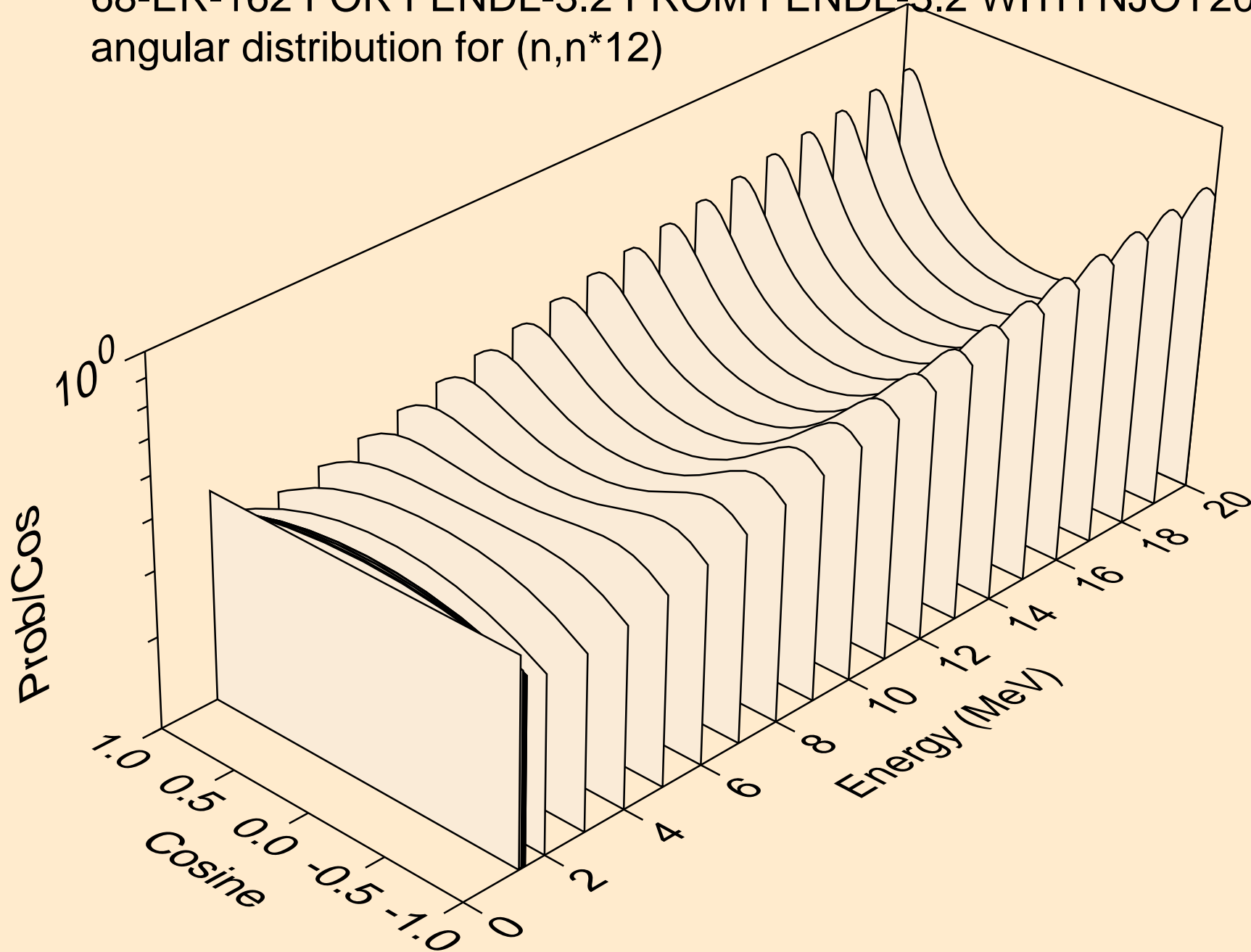

68-ER-162 FOR FENDL-3.2 FROM FENDL-3.2 WITH NJOY2016.60
angular distribution for (n,n*13)

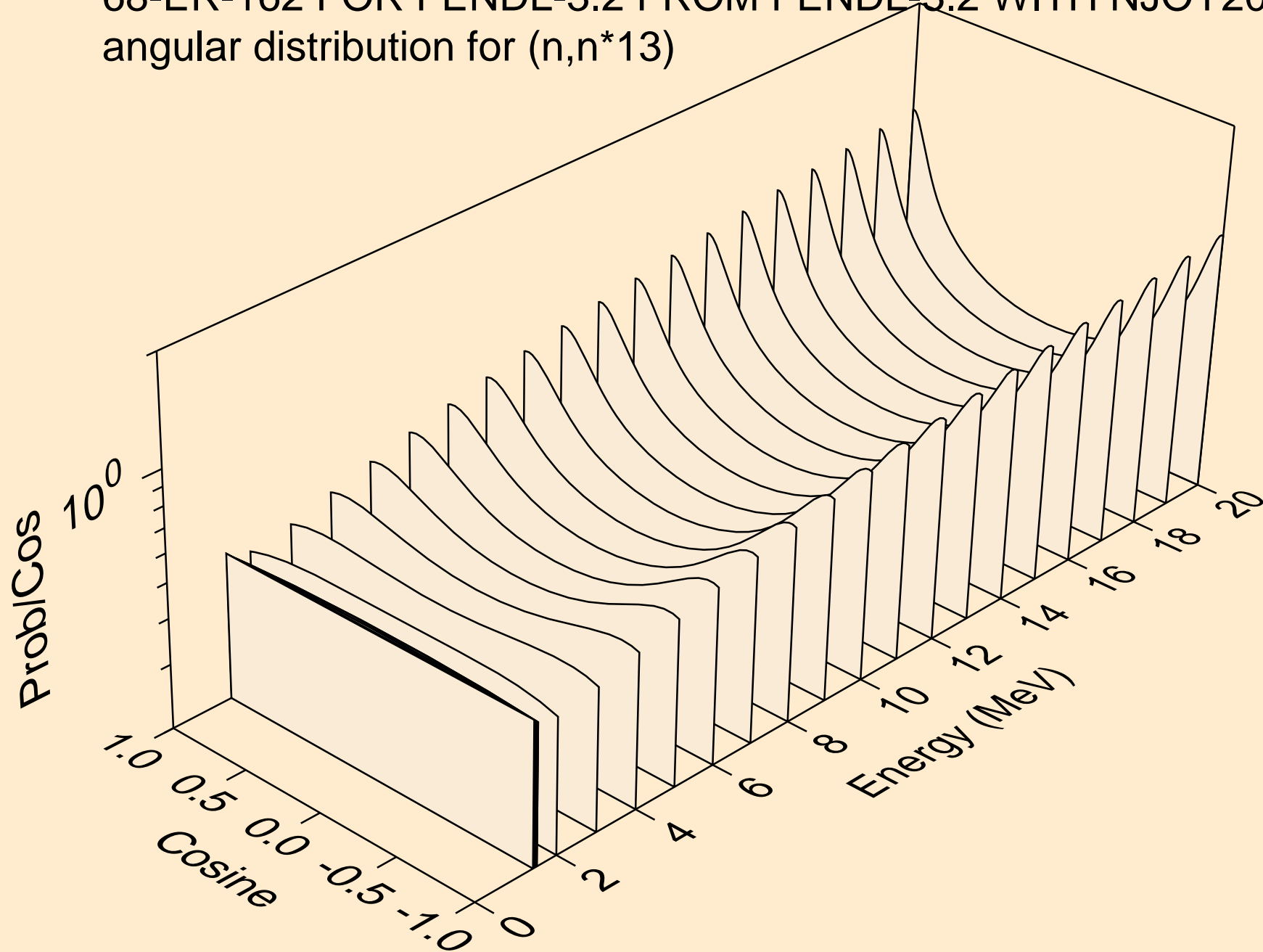

68-ER-162 FOR FENDL-3.2 FROM FENDL-3.2 WITH NJOY2016.60
angular distribution for (n,n*14)

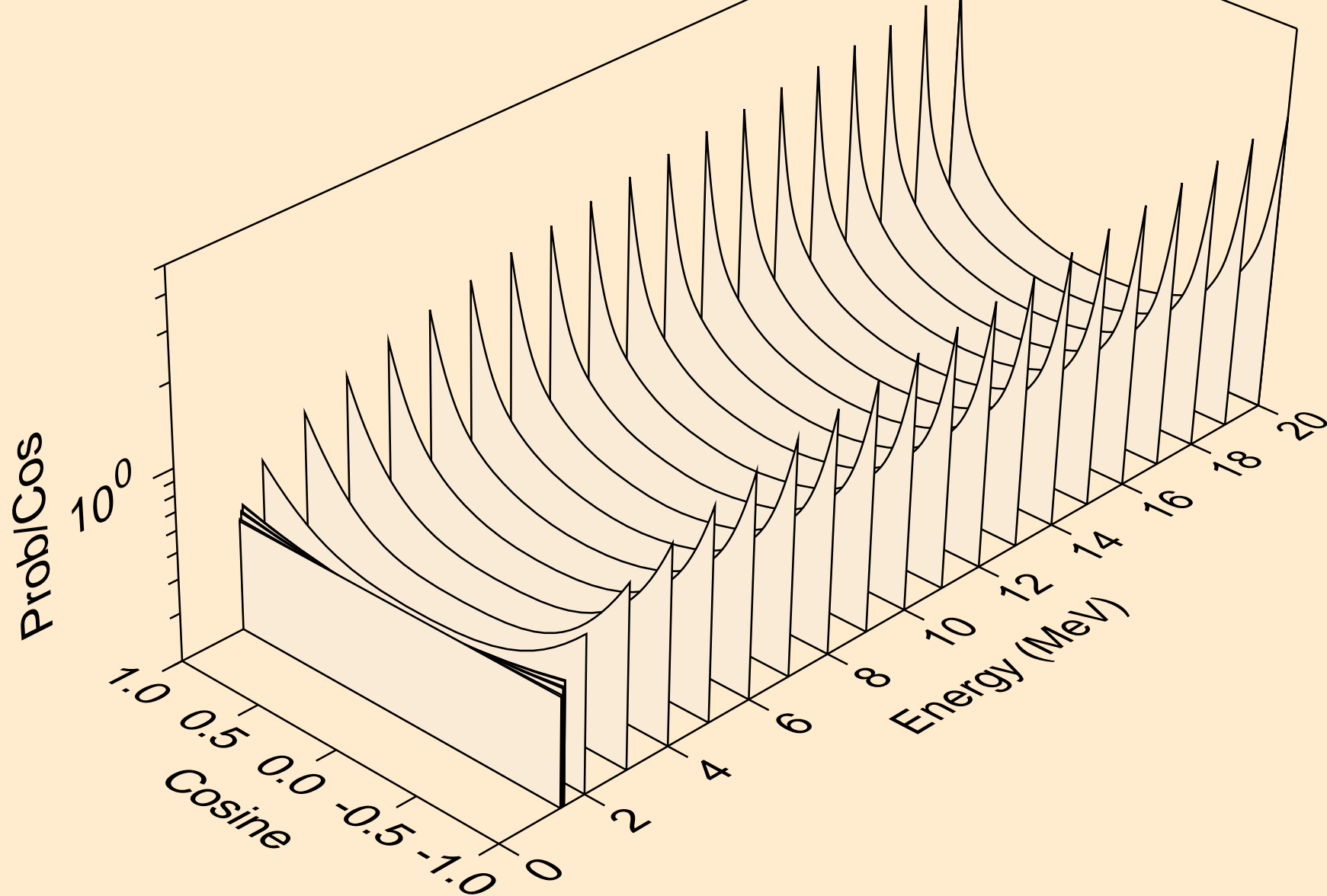

68-ER-162 FOR FENDL-3.2 FROM FENDL-3.2 WITH NJOY2016.60
angular distribution for (n,n*15)

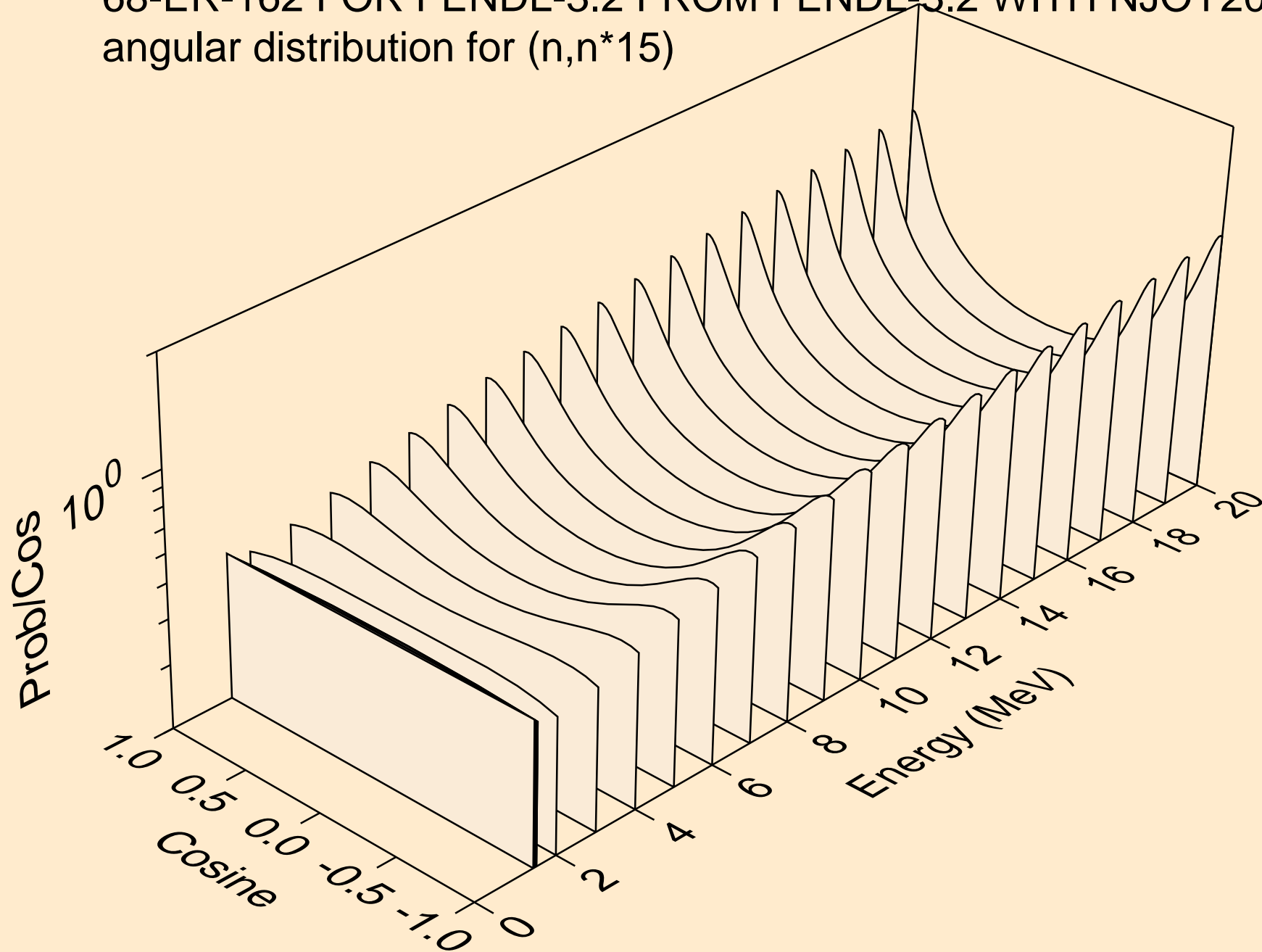

68-ER-162 FOR FENDL-3.2 FROM FENDL-3.2 WITH NJOY2016.60
angular distribution for (n,n*16)

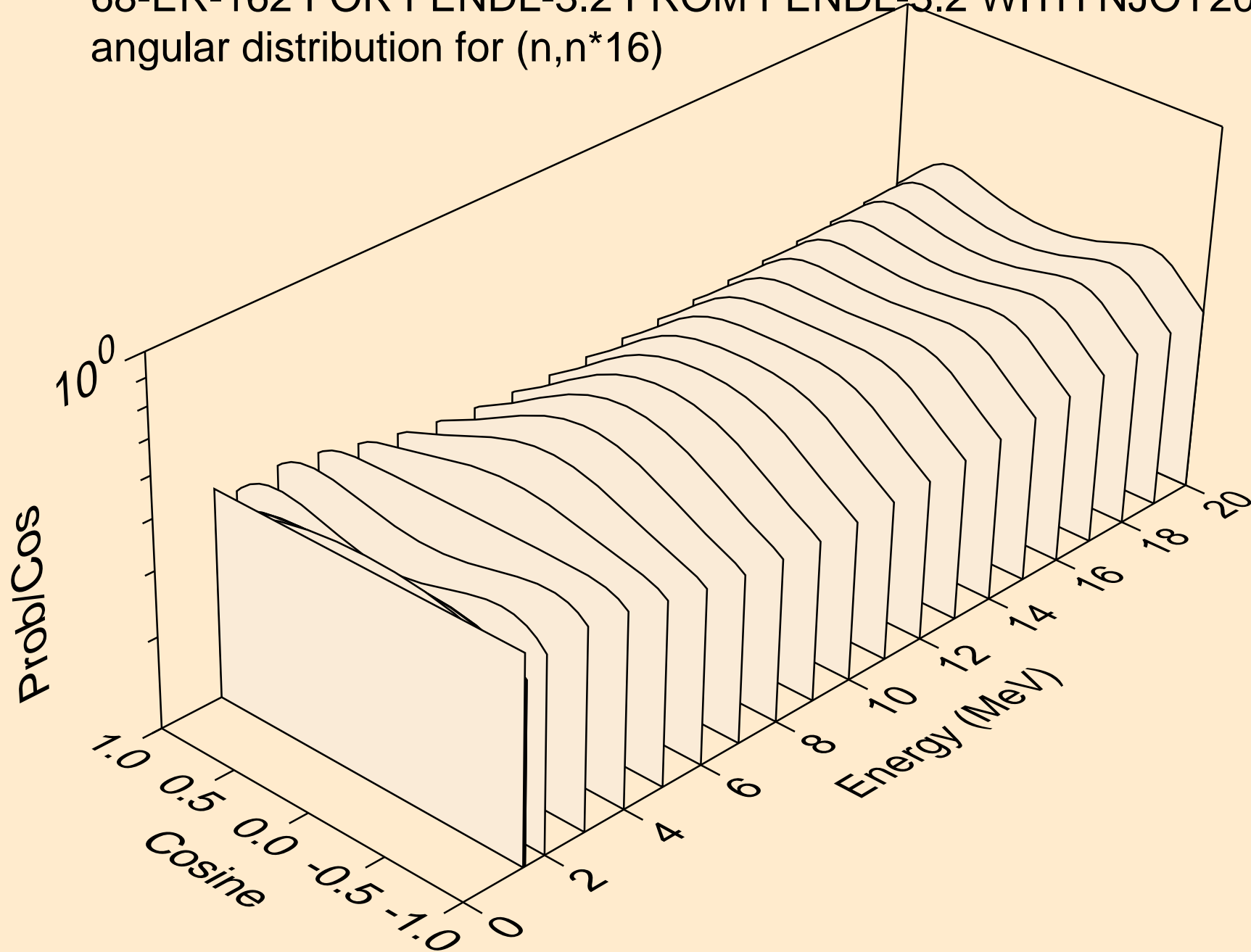

68-ER-162 FOR FENDL-3.2 FROM FENDL-3.2 WITH NJOY2016.60
angular distribution for (n,n*17)

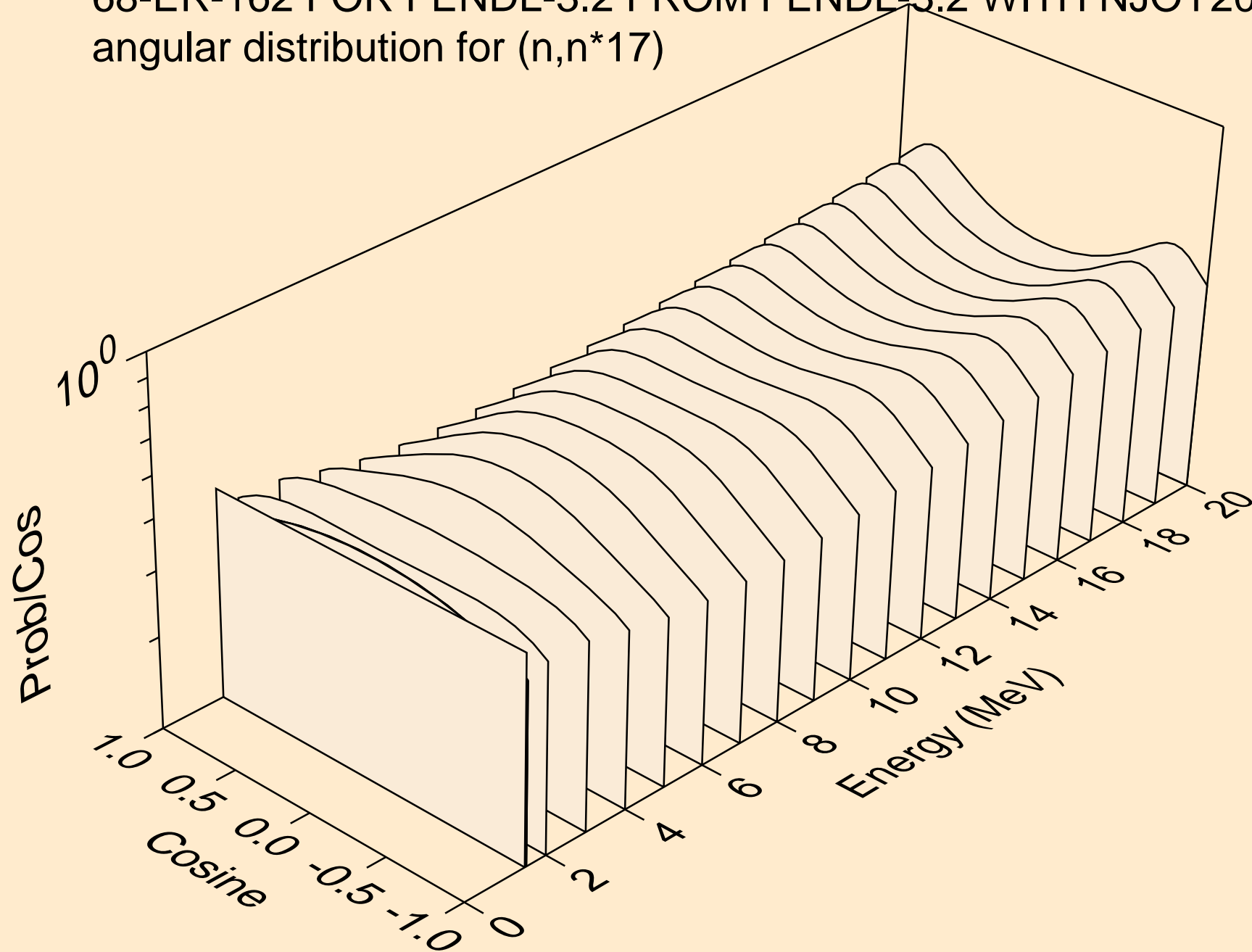

68-ER-162 FOR FENDL-3.2 FROM FENDL-3.2 WITH NJOY2016.60
angular distribution for (n,n*c)

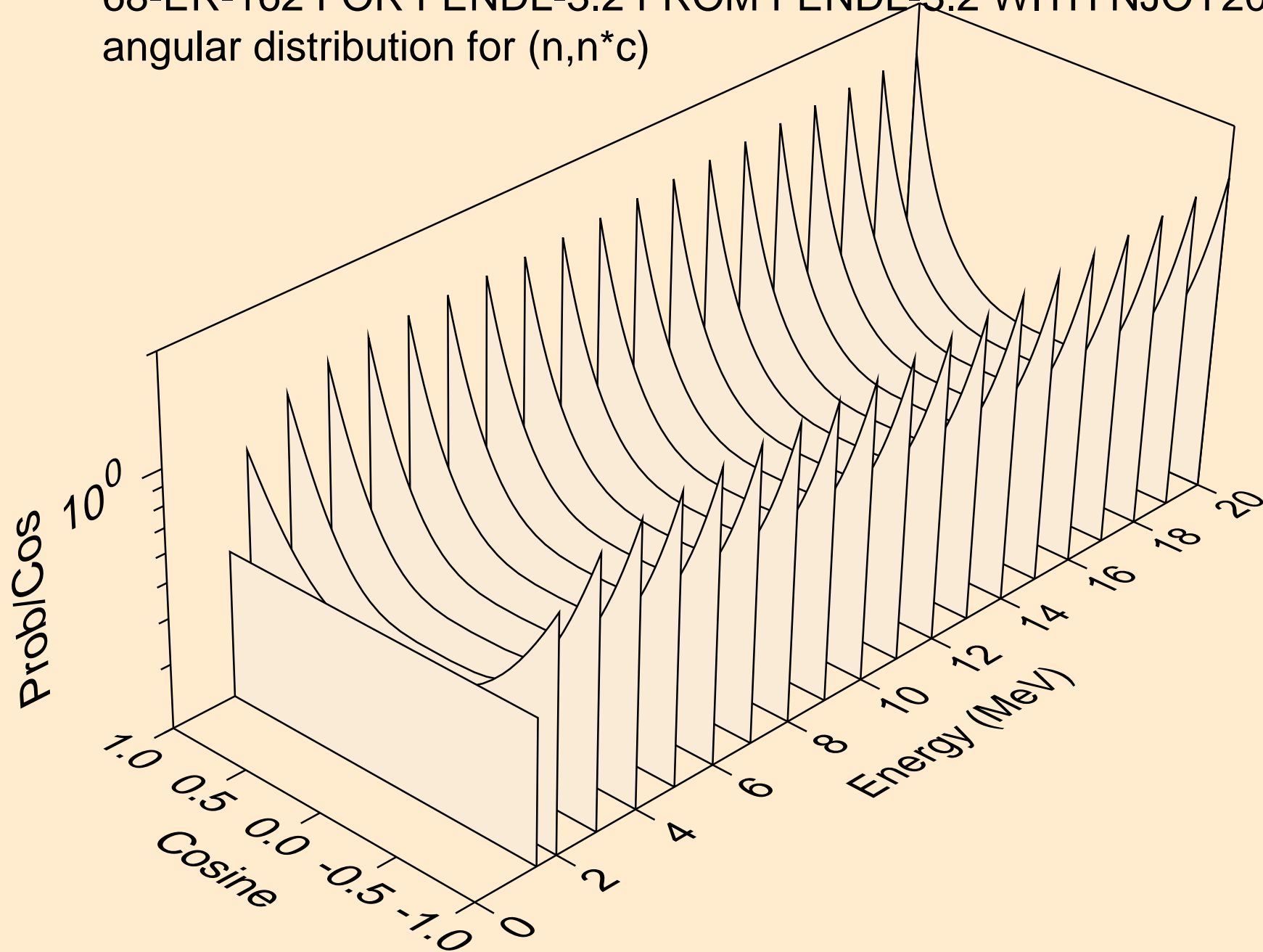

68-ER-162 FOR FENDL-3.2 FROM FENDL-3.2 WITH NJOY2016.60
Neutron emission for (n,x)

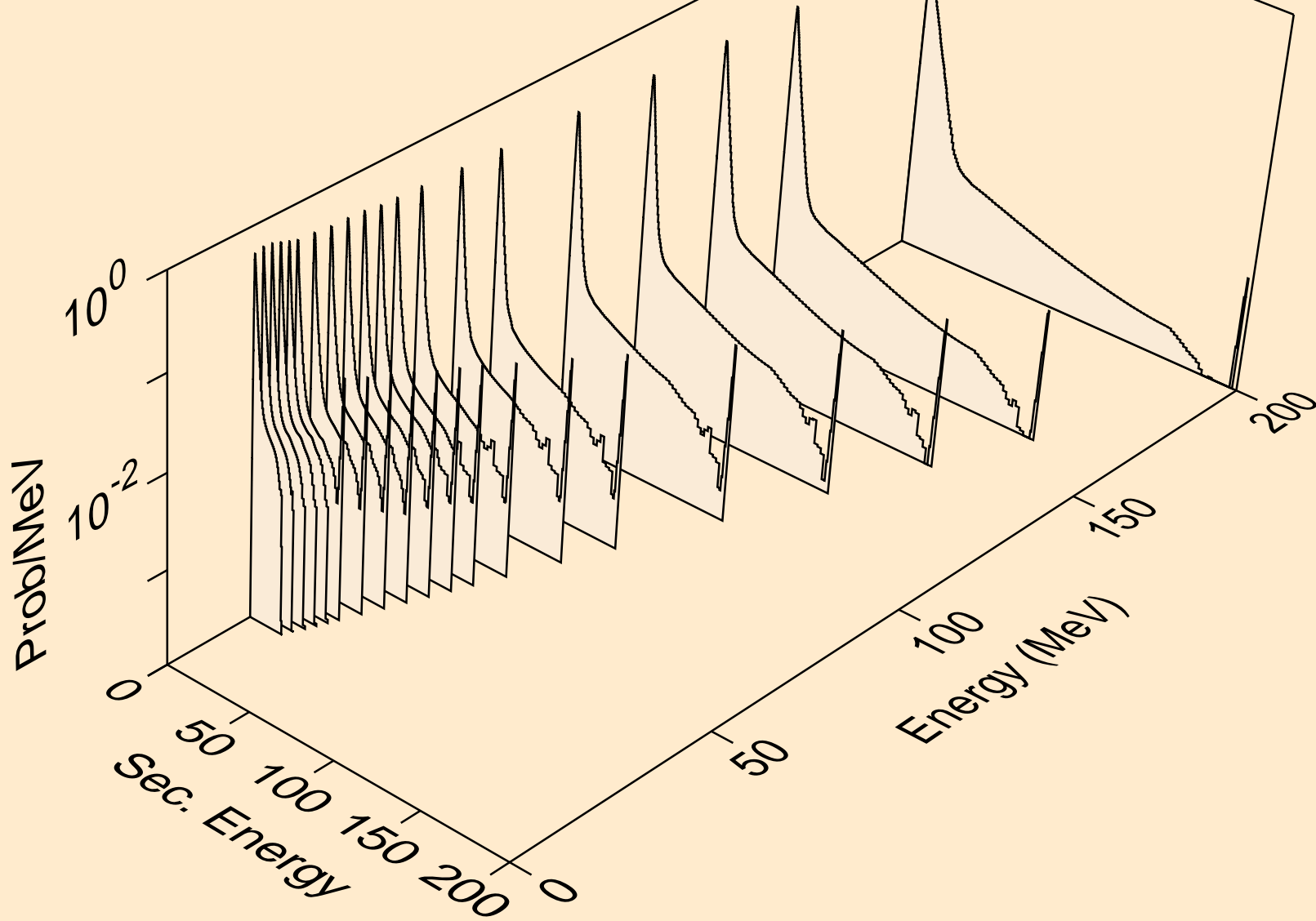

68-ER-162 FOR FENDL-3.2 FROM FENDL-3.2 WITH NJOY2016.60
Neutron emission for (n,2n)

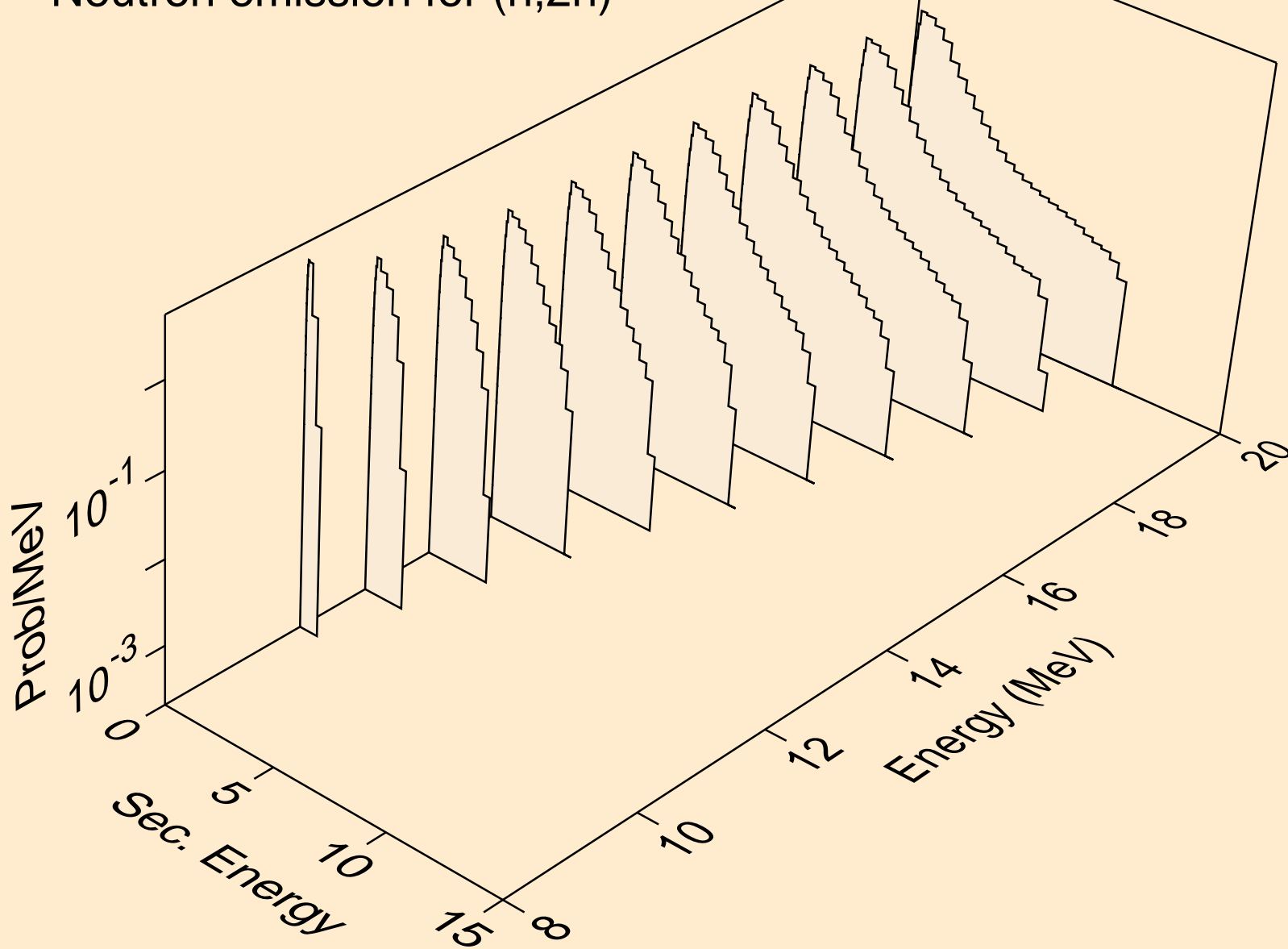

68-ER-162 FOR FENDL-3.2 FROM FENDL-3.2 WITH NJOY2016.60
Neutron emission for (n,3n)

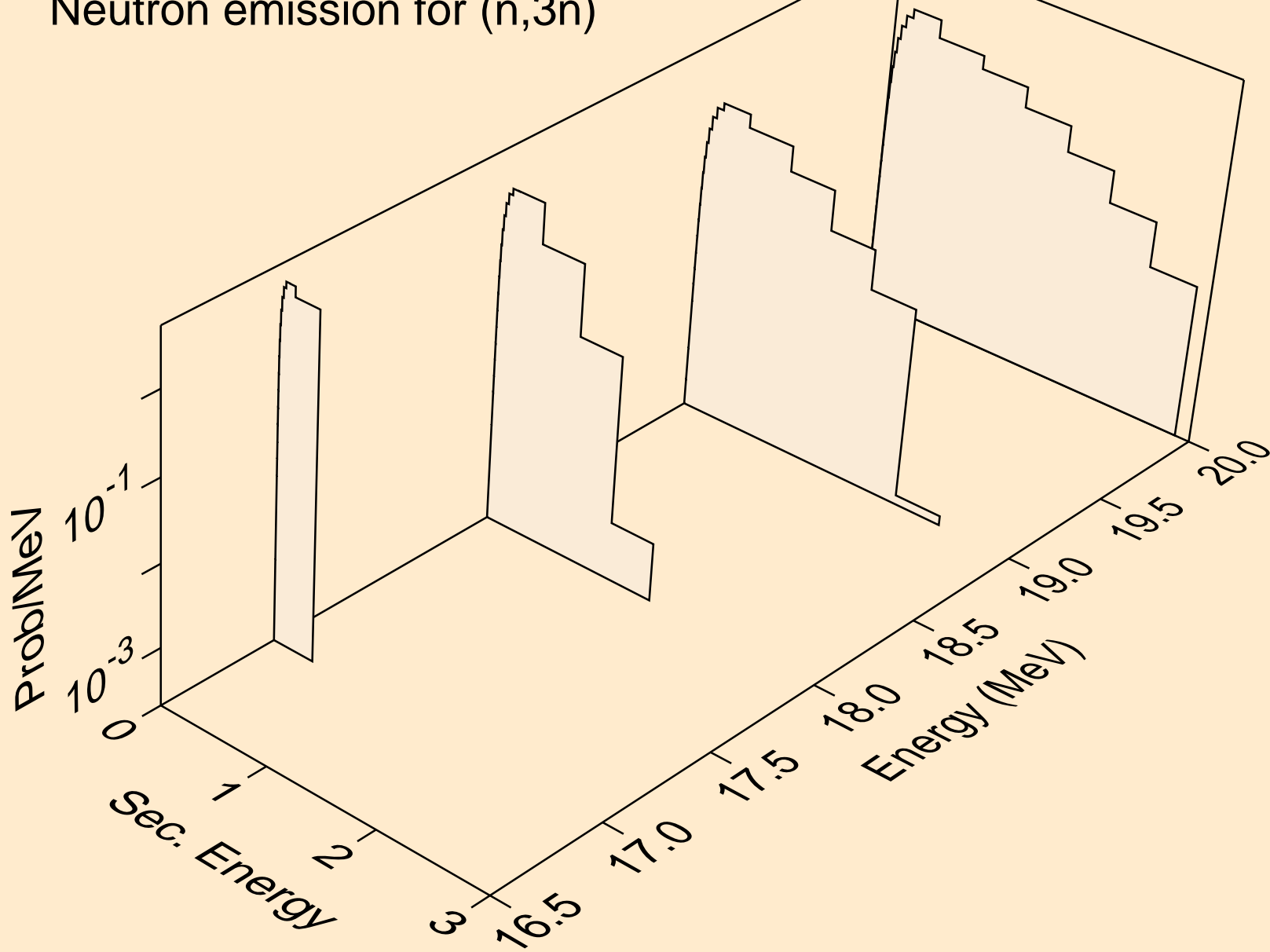

68-ER-162 FOR FENDL-3.2 FROM FENDL-3.2 WITH NJOY2016.60
Neutron emission for (n,n*)a

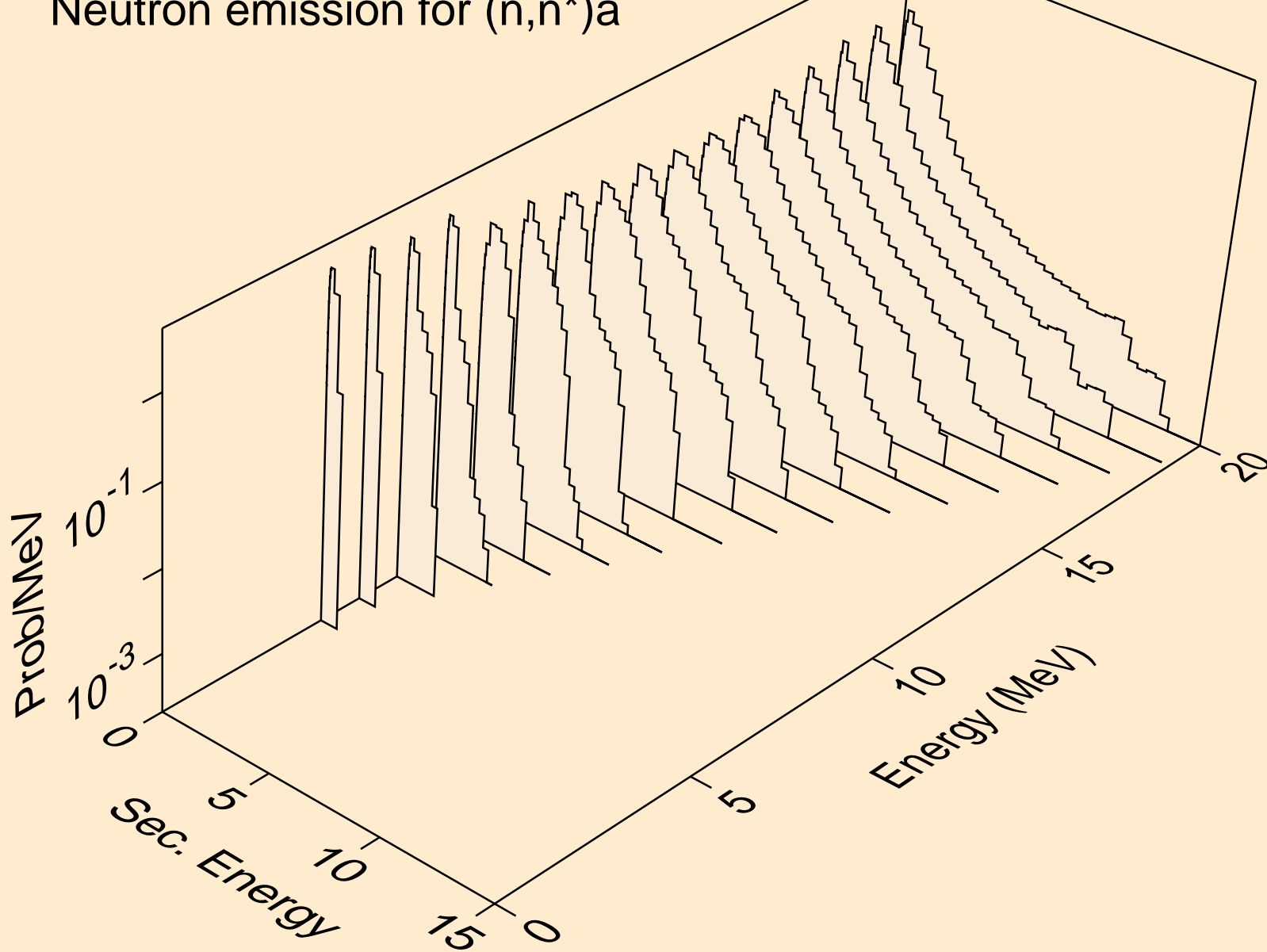

68-ER-162 FOR FENDL-3.2 FROM FENDL-3.2 WITH NJOY2016.60
Neutron emission for (n,n*)p

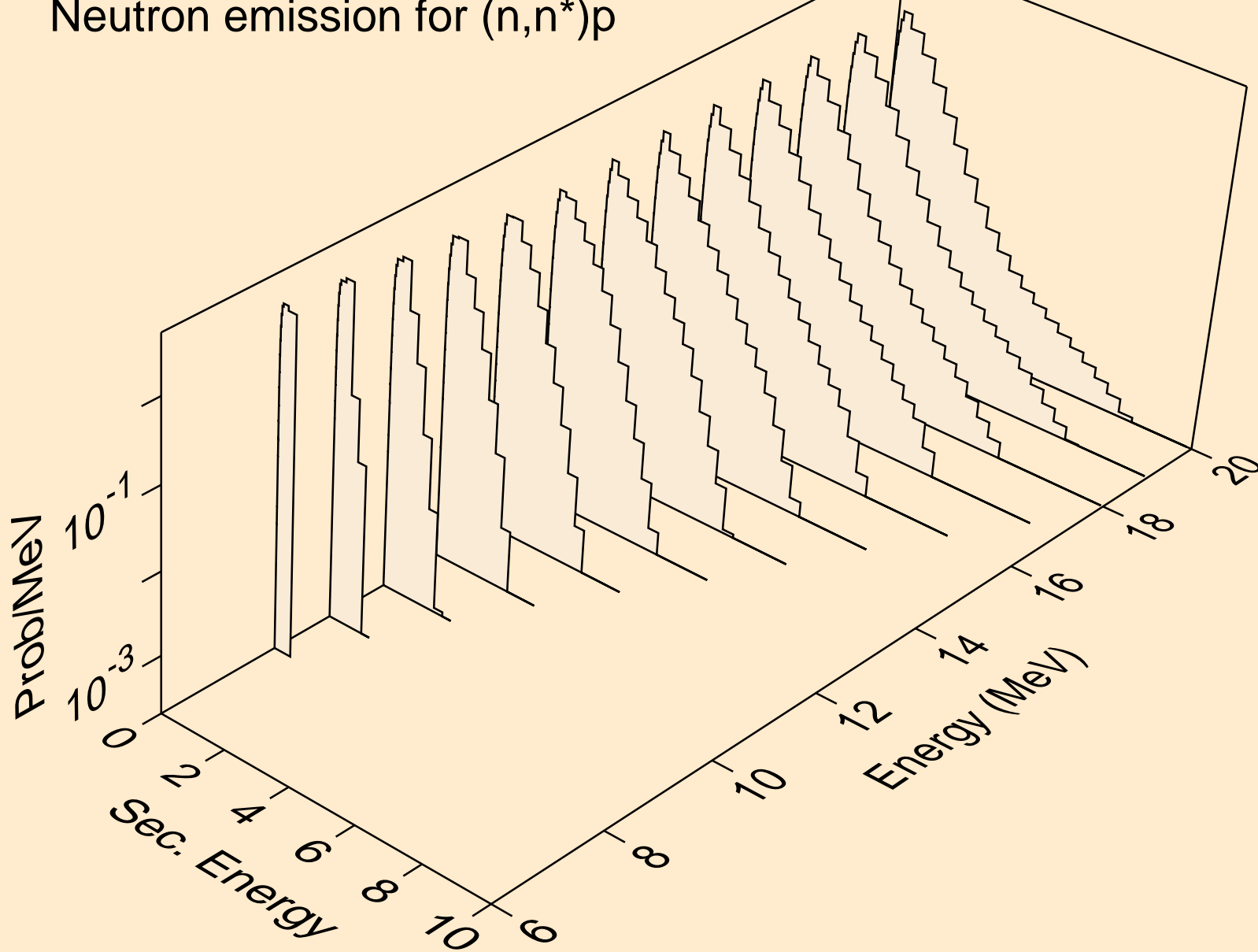

68-ER-162 FOR FENDL-3.2 FROM FENDL-3.2 WITH NJOY2016.60
Neutron emission for (n,n*c)

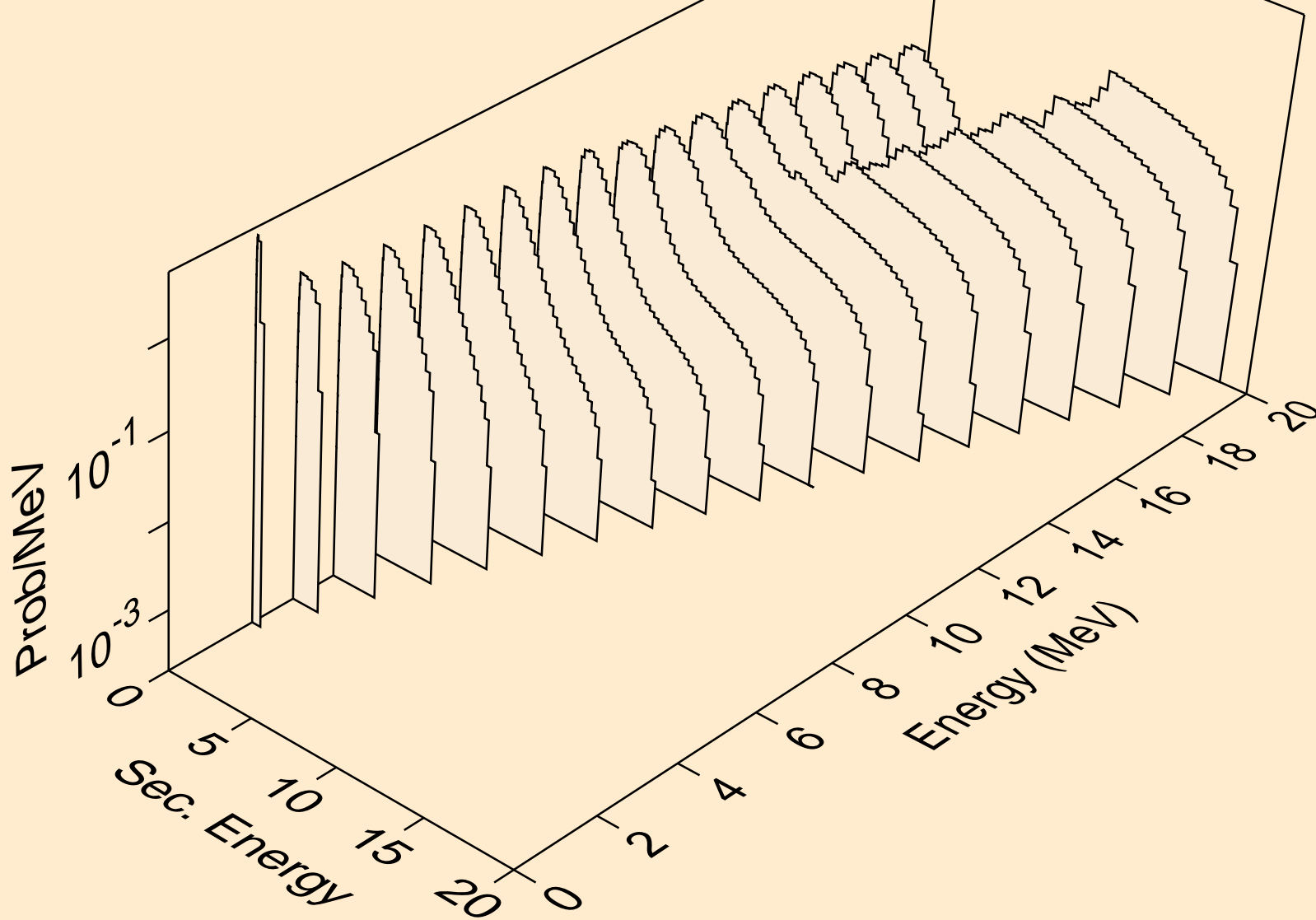

68-ER-162 FOR FENDL-3.2 FROM FENDL-3.2 WITH NJOY2016.60
Photon emission for (n,2n)

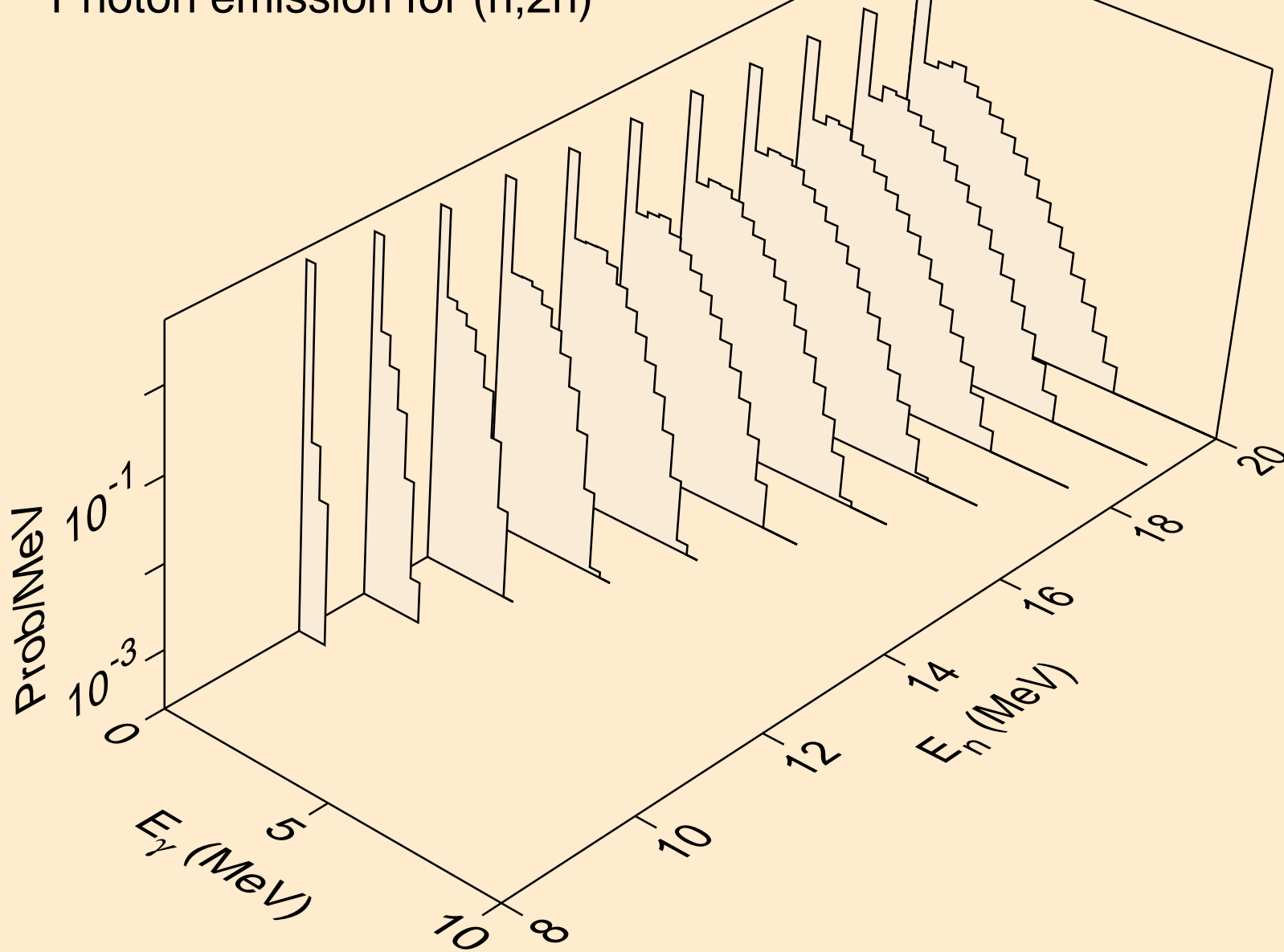

68-ER-162 FOR FENDL-3.2 FROM FENDL-3.2 WITH NJOY2016.60
Photon emission for (n,3n)

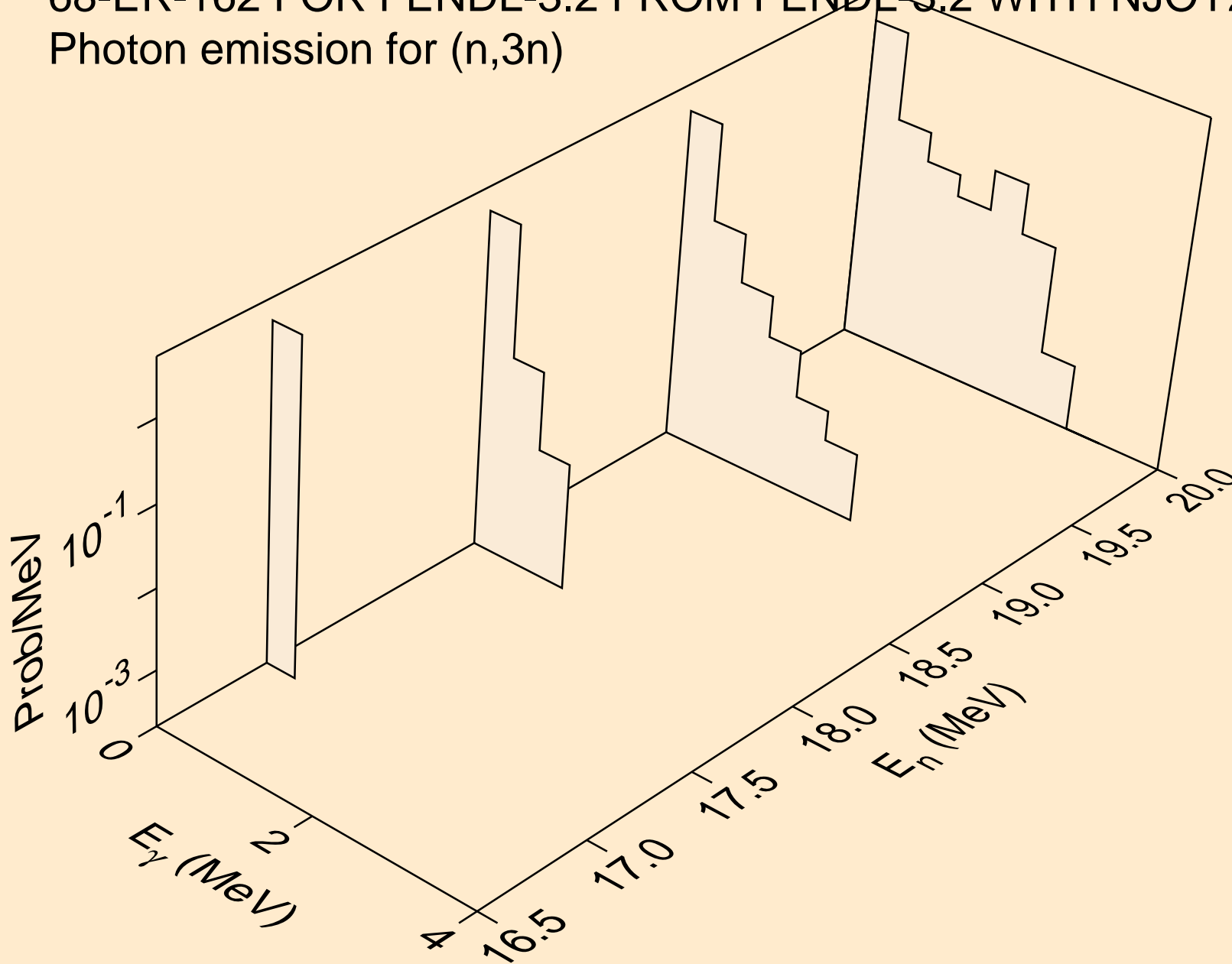

68-ER-162 FOR FENDL-3.2 FROM FENDL-3.2 WITH NJOY2016.60
Photon emission for (n,n*c)

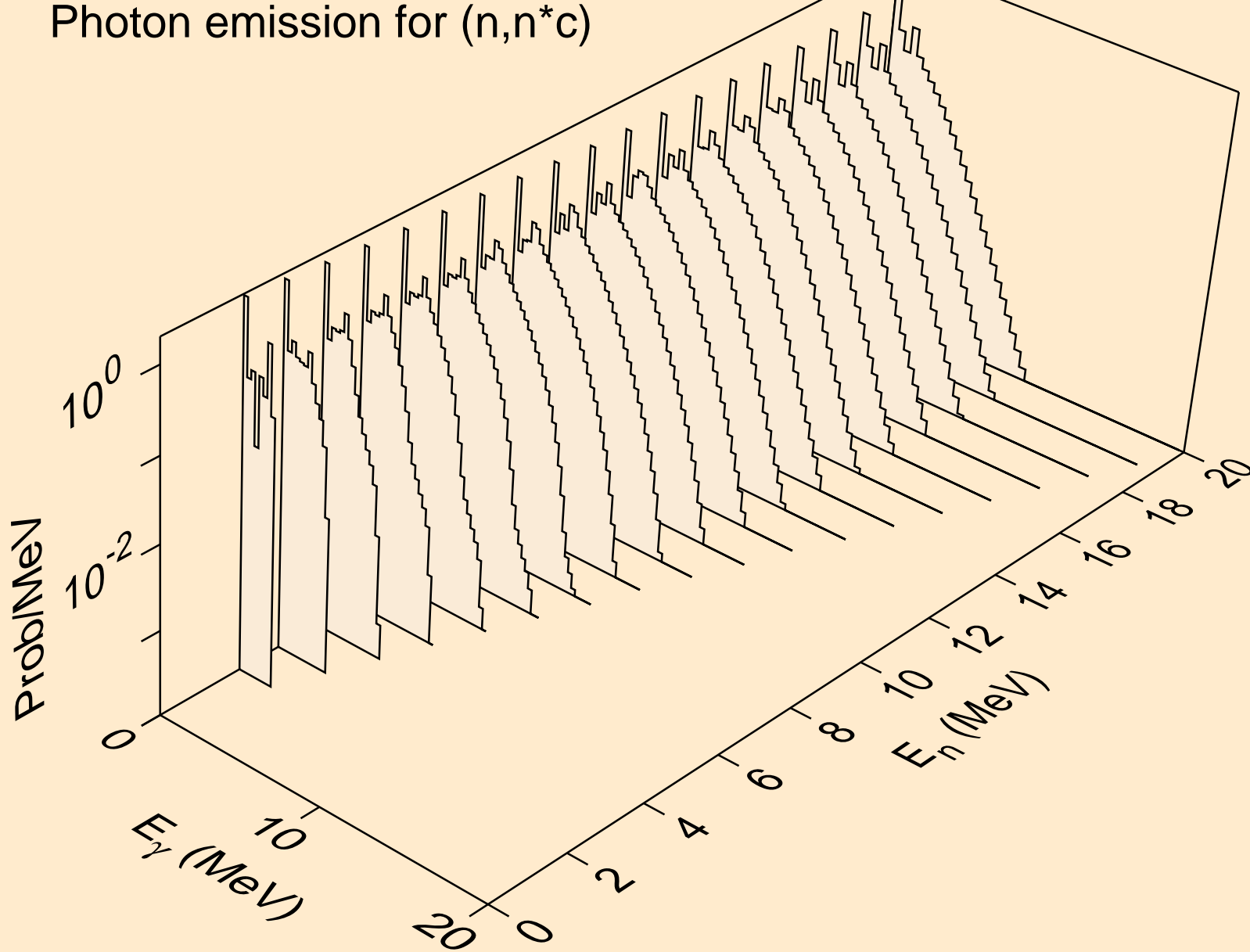

68-ER-162 FOR FENDL-3.2 FROM FENDL-3.2 WITH NJOY2016.60
Photon emission for (n,gma)

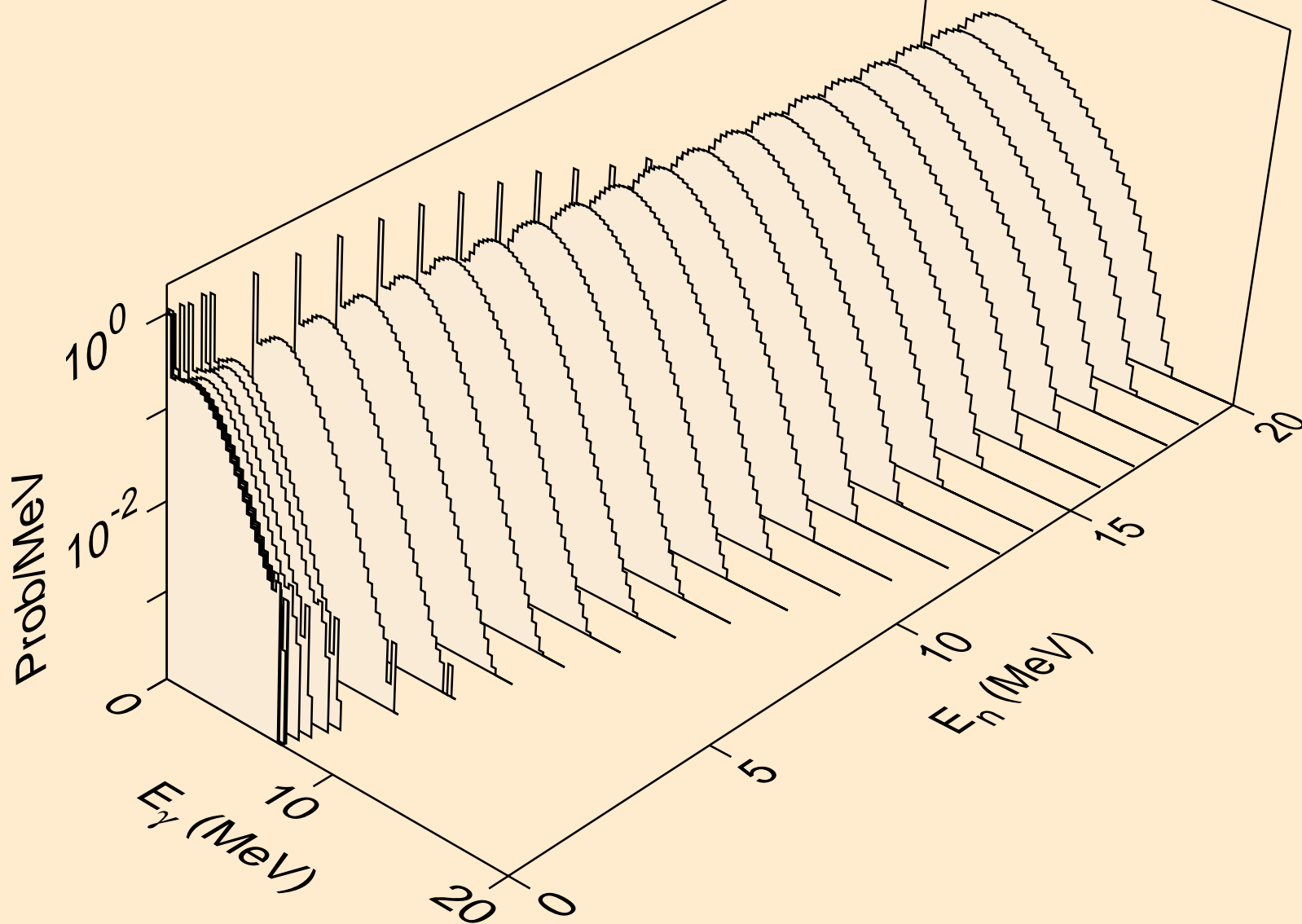

68-ER-162 FOR FENDL-3.2 FROM FENDL-3.2 WITH NJOY2016.60
Photon emission for (n,p)

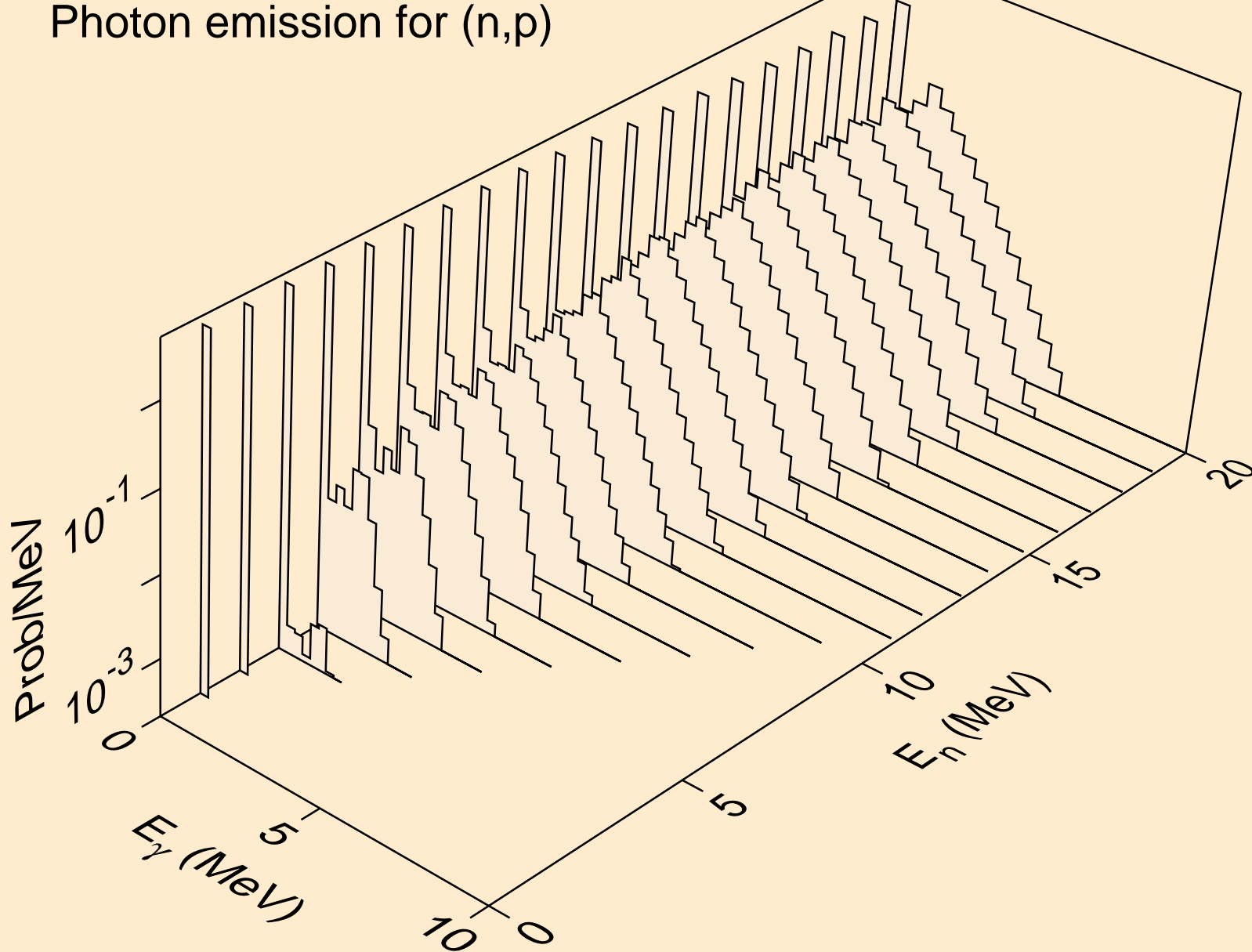

68-ER-162 FOR FENDL-3.2 FROM FENDL-3.2 WITH NJOY2016.60
Photon emission for (n,a)

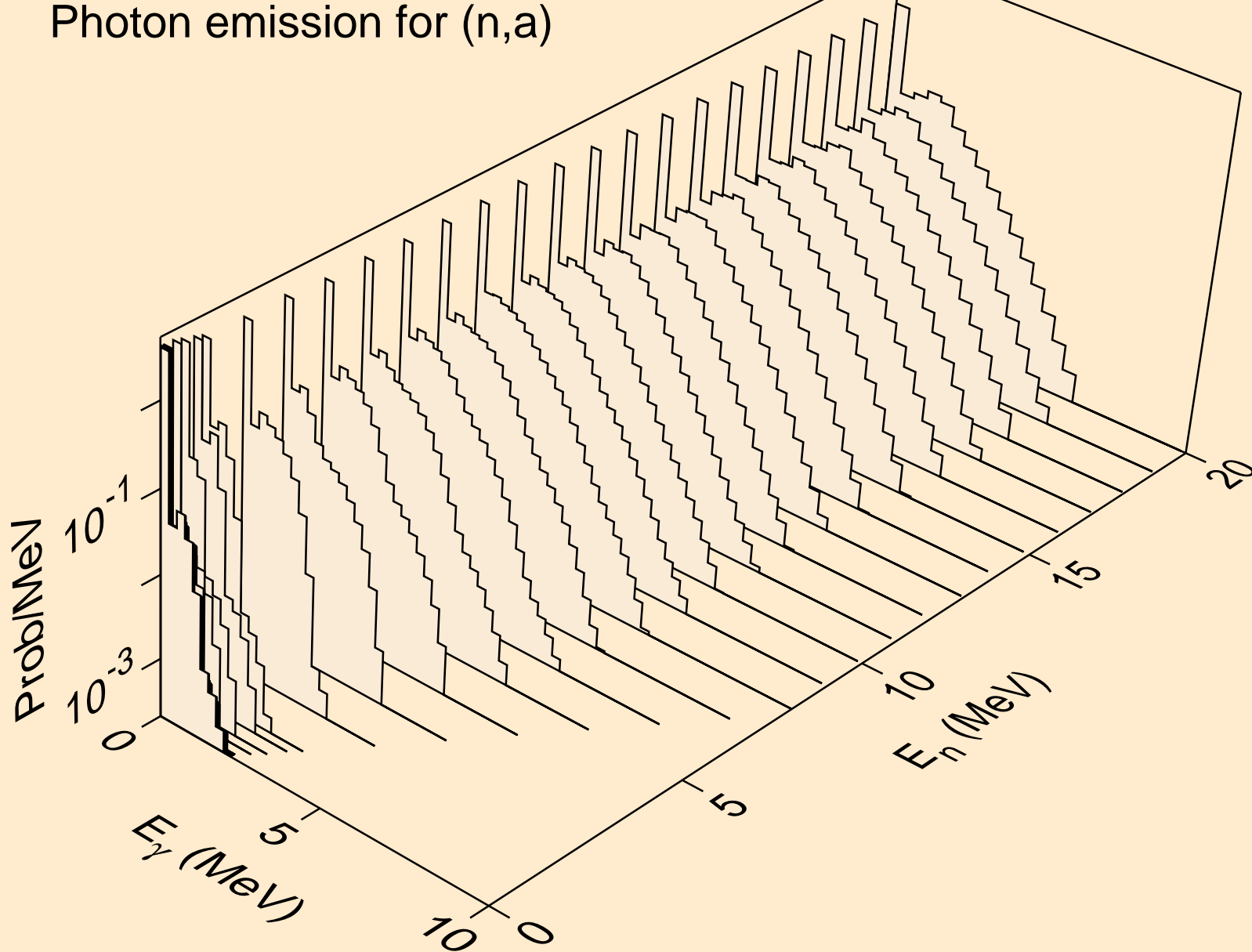

68-ER-162 FOR FENDL-3.2 FROM FENDL-3.2 WITH NJOY2016.60
Photon emission for (n,x)

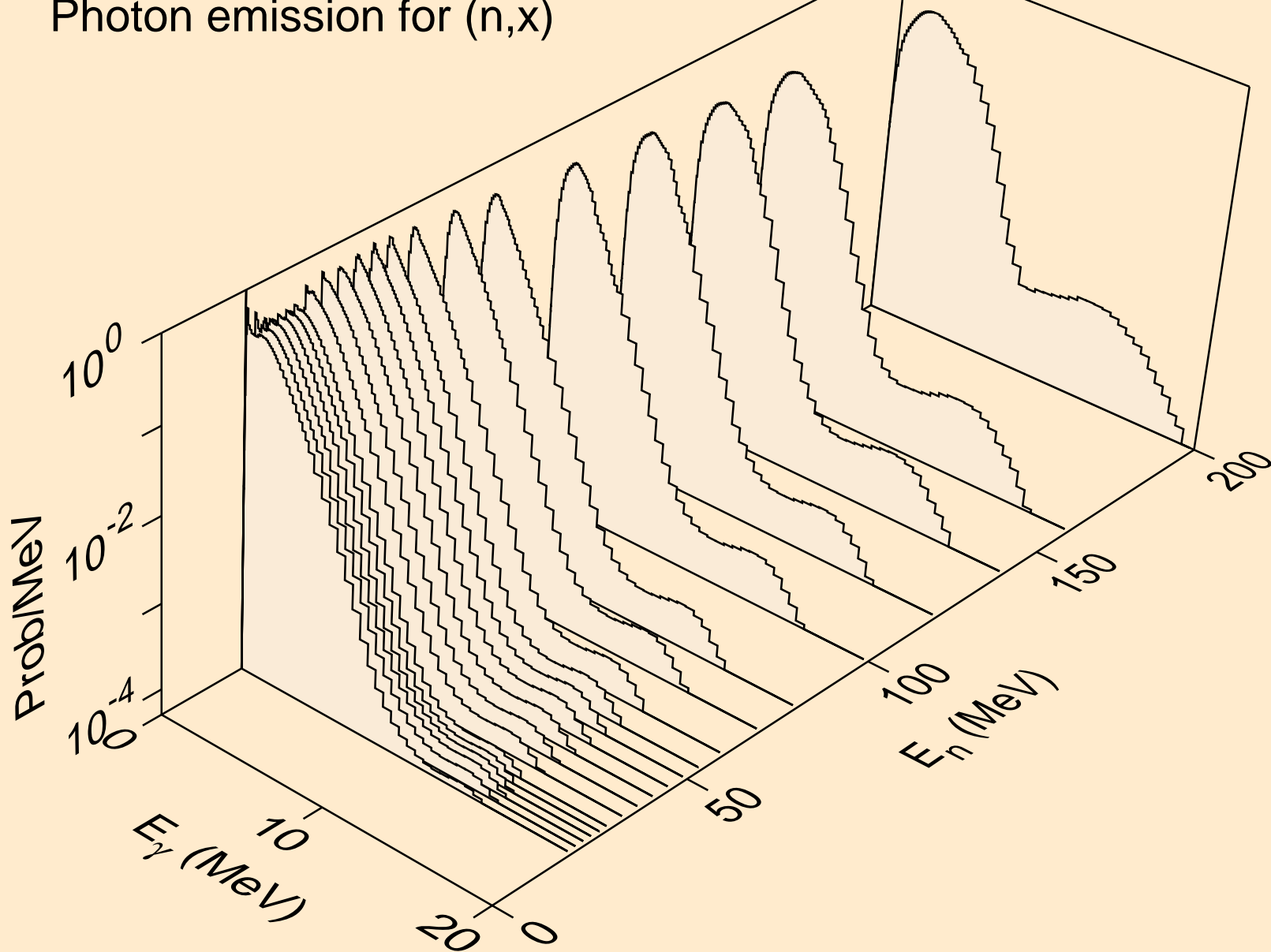

68-ER-162 FOR FENDL-3.2 FROM FENDL-3.2 WITH NJOY2016.60
thermal capture photon spectrum

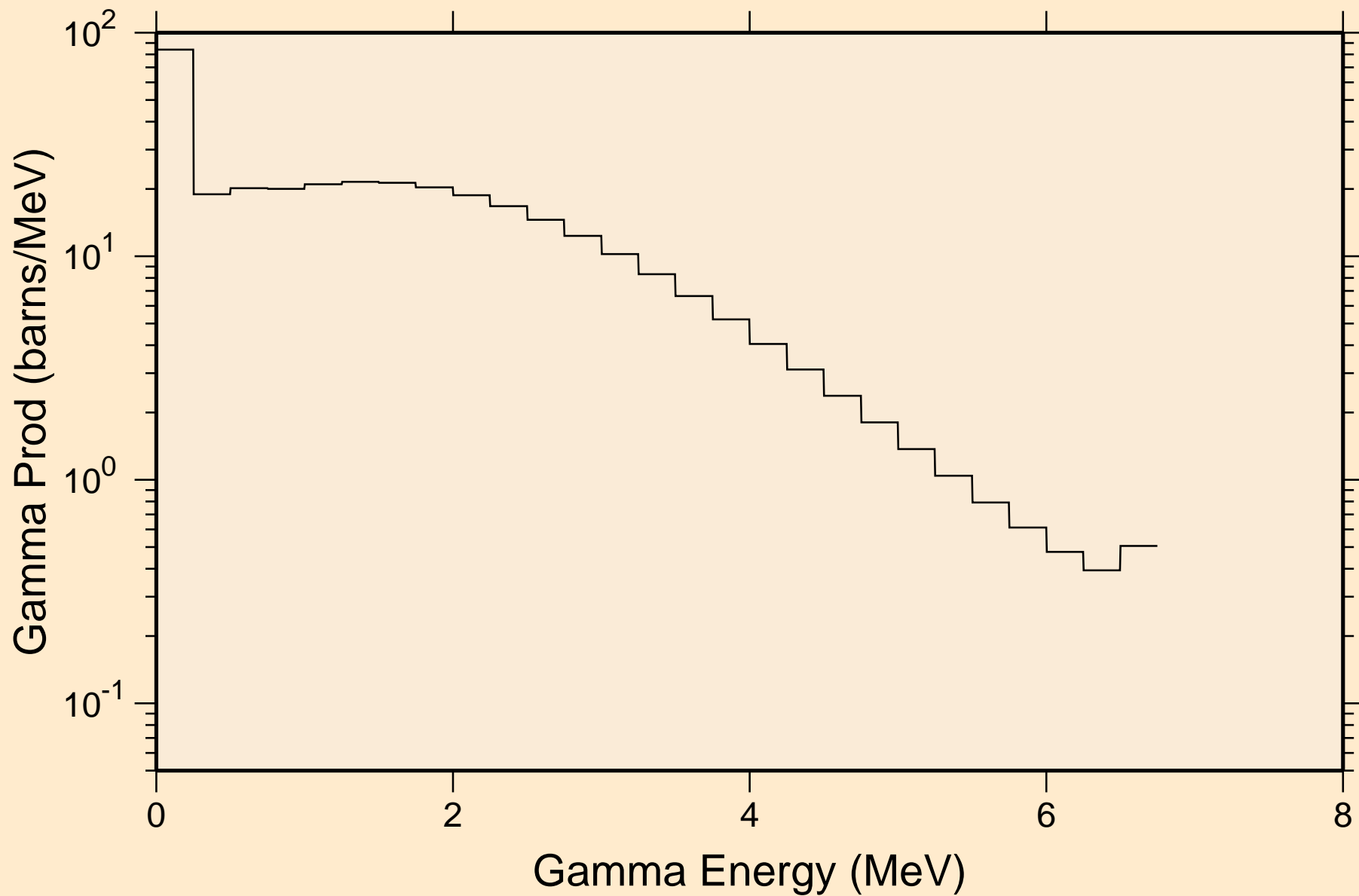

68-ER-162 FOR FENDL-3.2 FROM FENDL-3.2 WITH NJOY2016.60
14 MeV photon spectrum

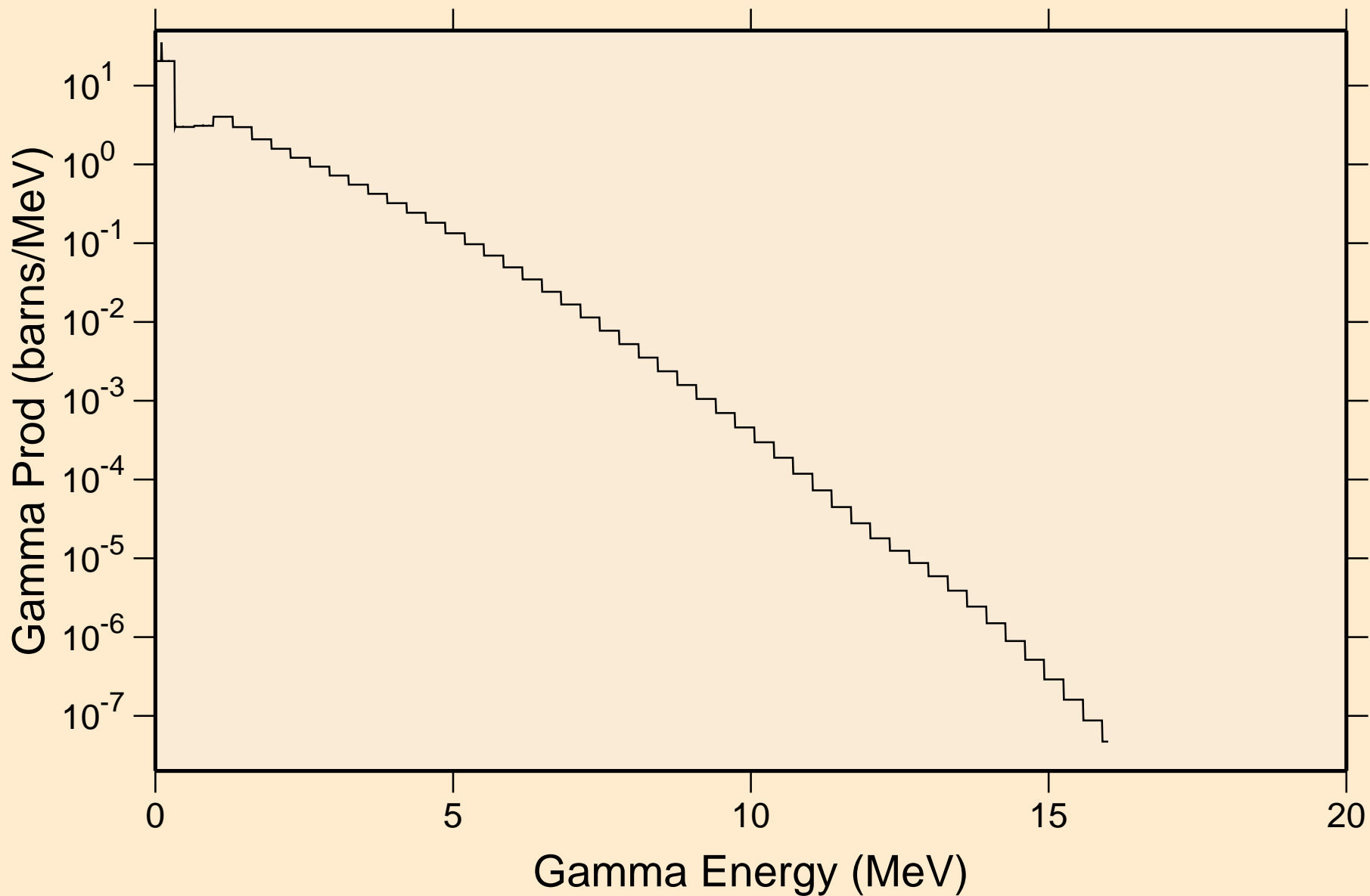

68-ER-162 FOR FENDL-3.2 FROM FENDL-3.2 WITH NJOY2016.60
Particle heating contributions

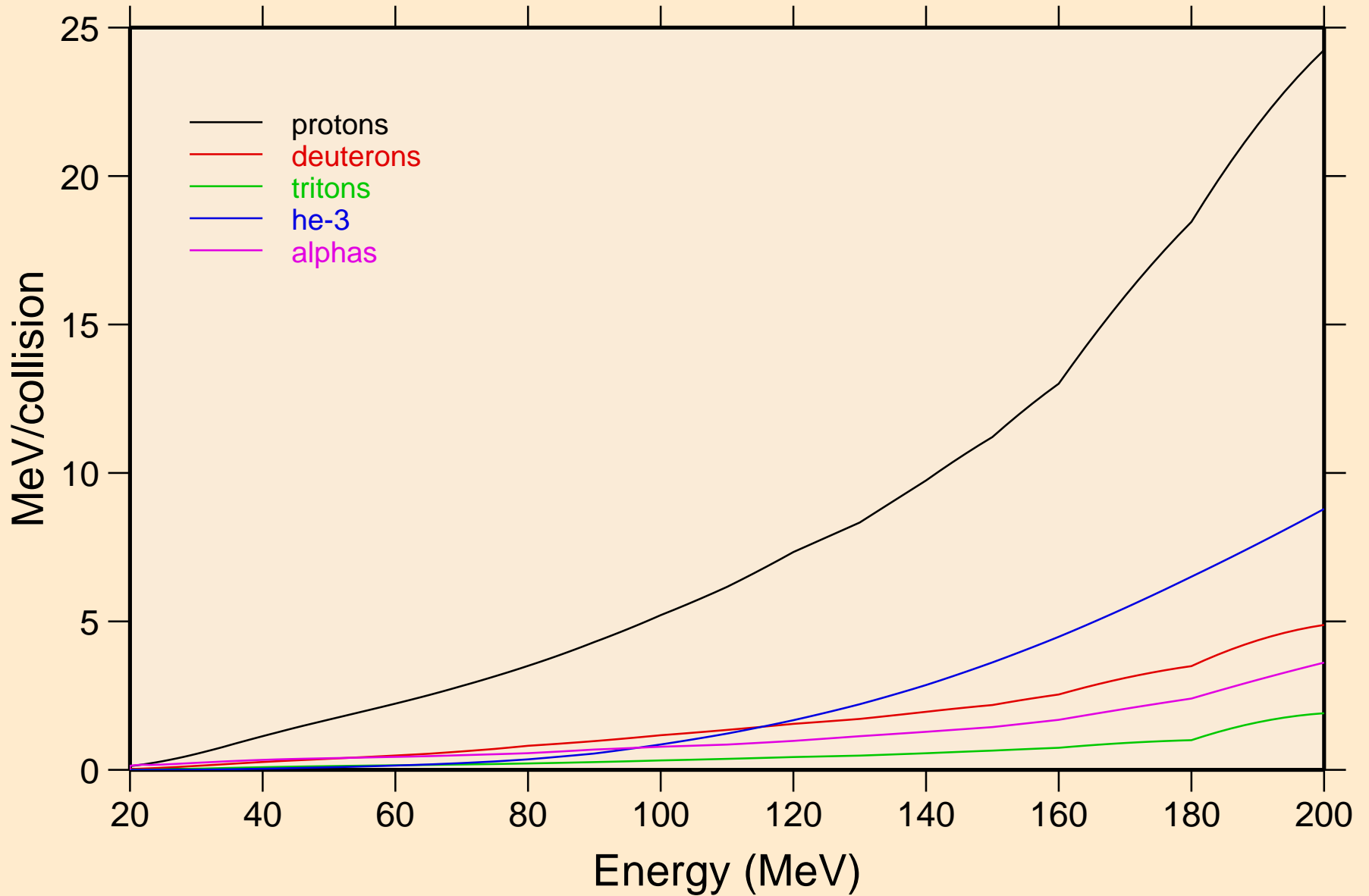

68-ER-162 FOR FENDL-3.2 FROM FENDL-3.2 WITH NJOY2016.60
Recoil Heating

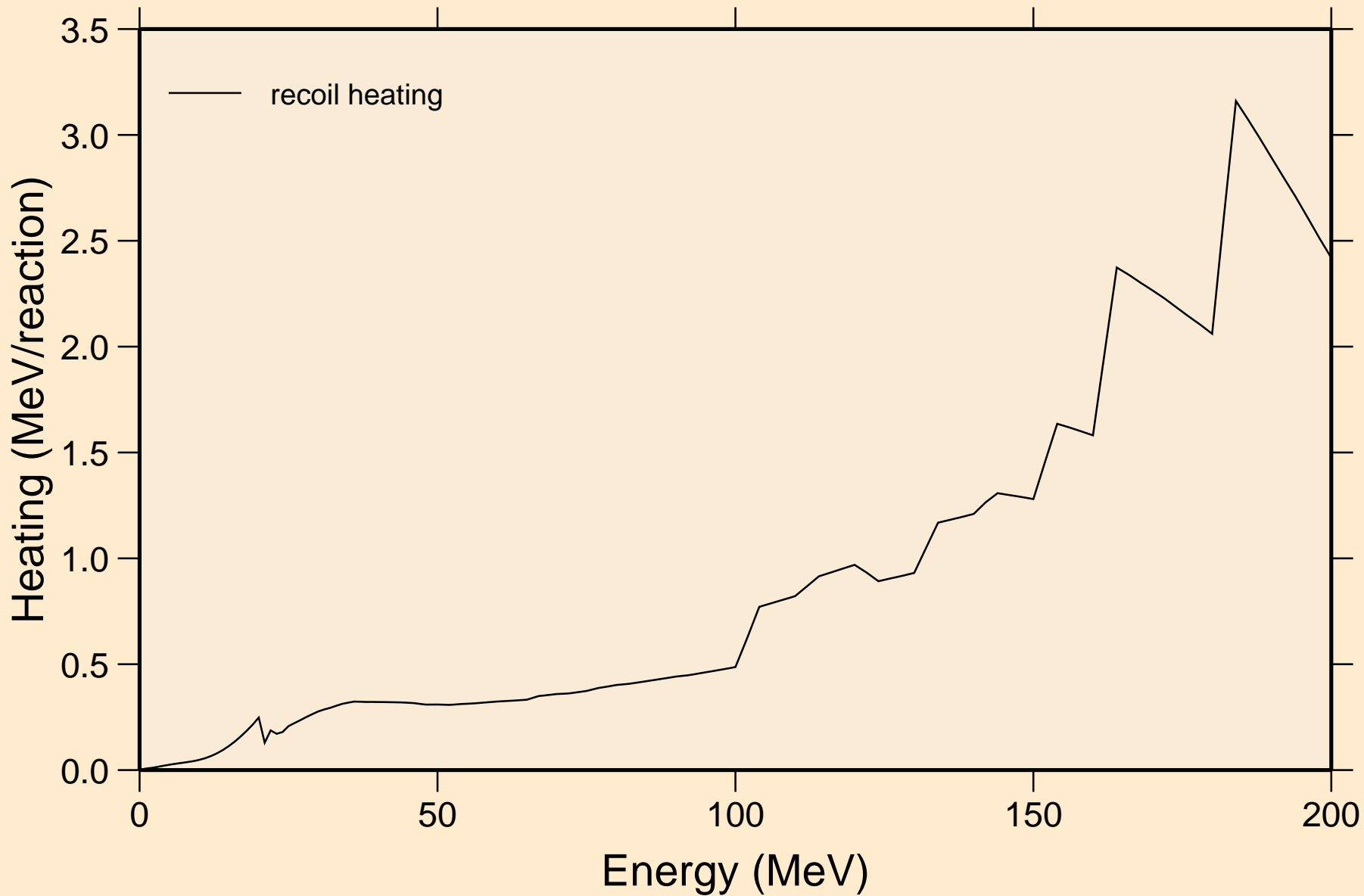

68-ER-162 FOR FENDL-3.2 FROM FENDL-3.2 WITH NJOY2016.60
Particle production cross sections

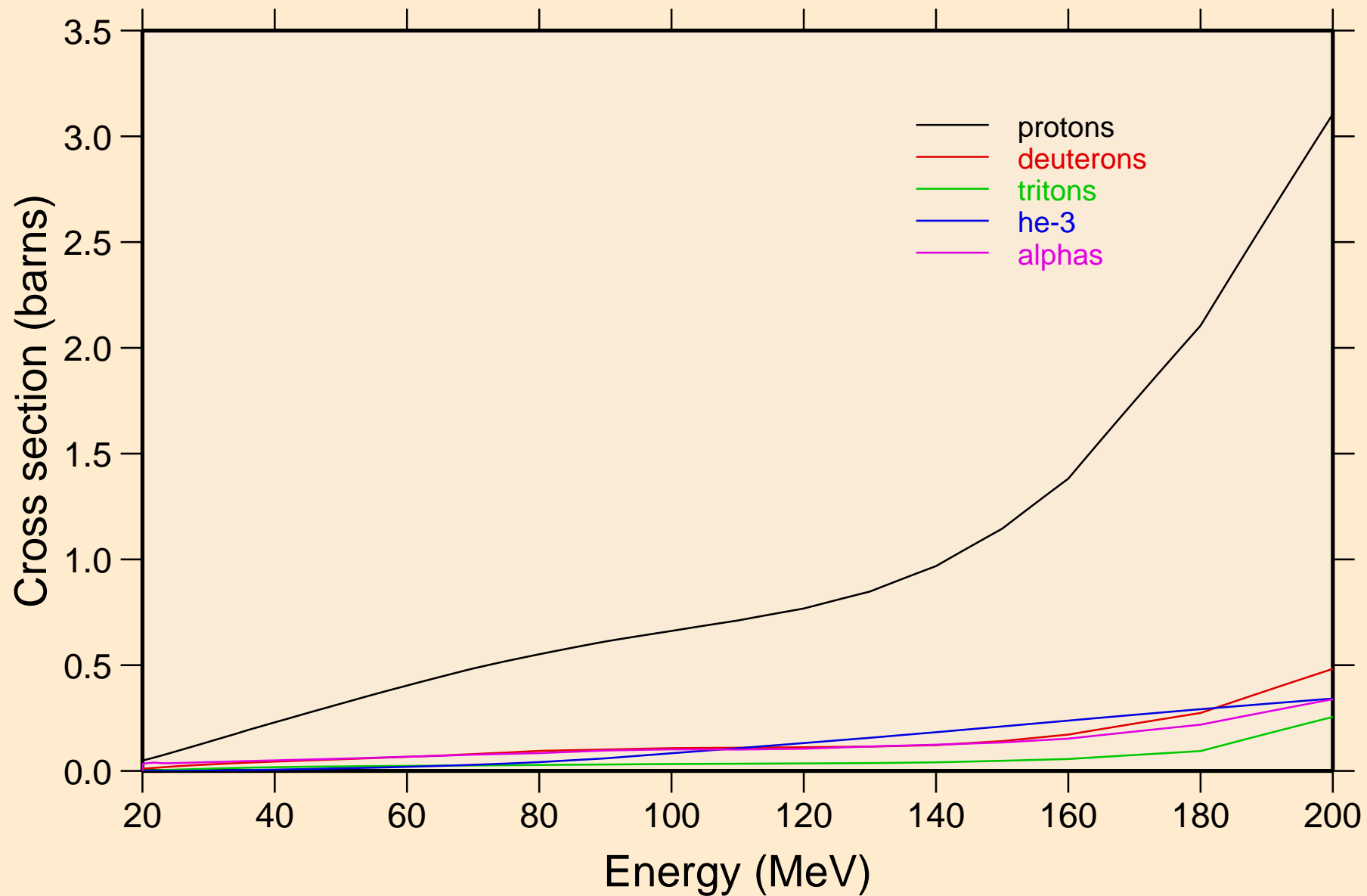

68-ER-162 FOR FENDL-3.2 FROM FENDL-3.2 WITH NJOY2016.60
protons from (n,x)

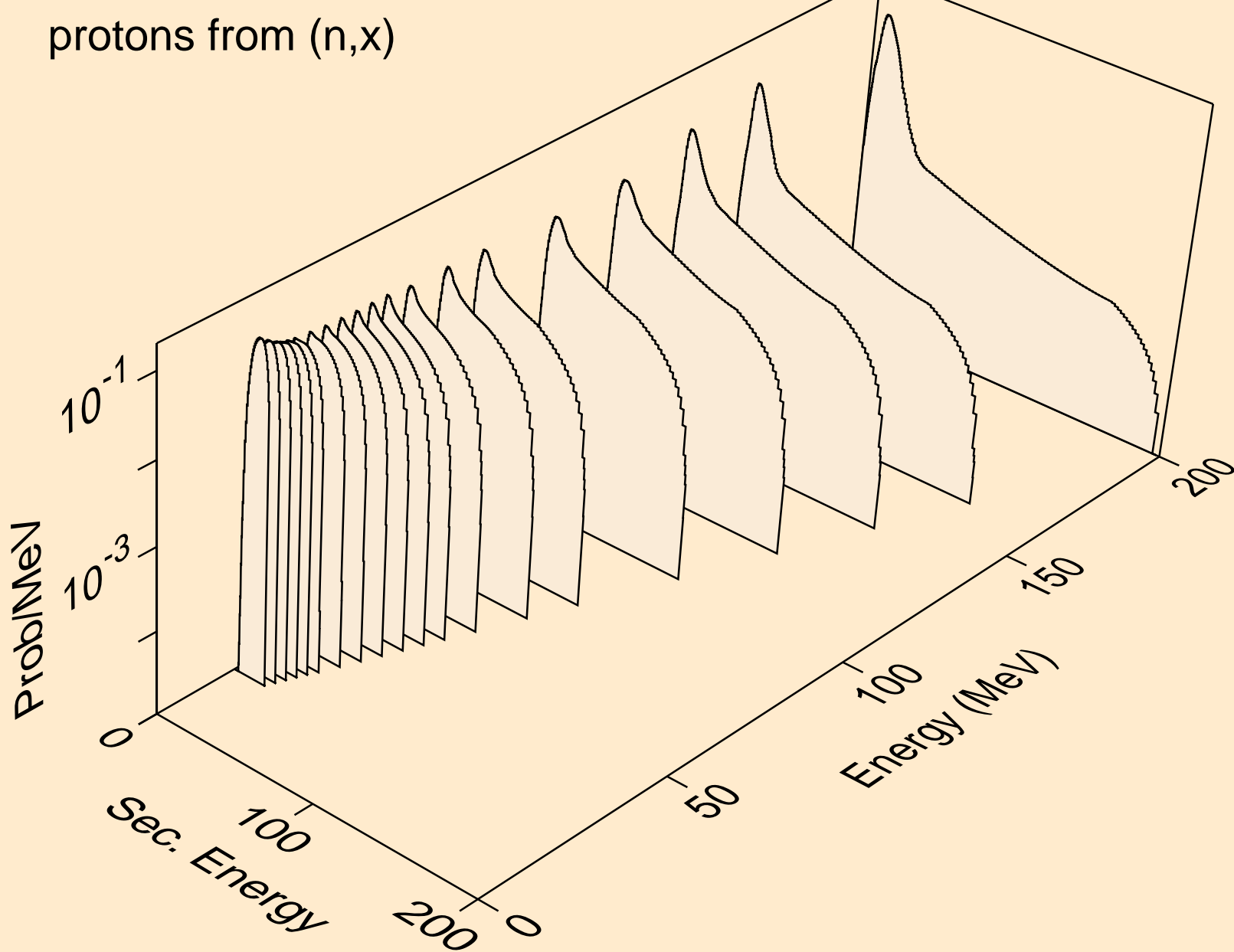

68-ER-162 FOR FENDL-3.2 FROM FENDL-3.2 WITH NJOY2016.60
deuterons from (n,x)

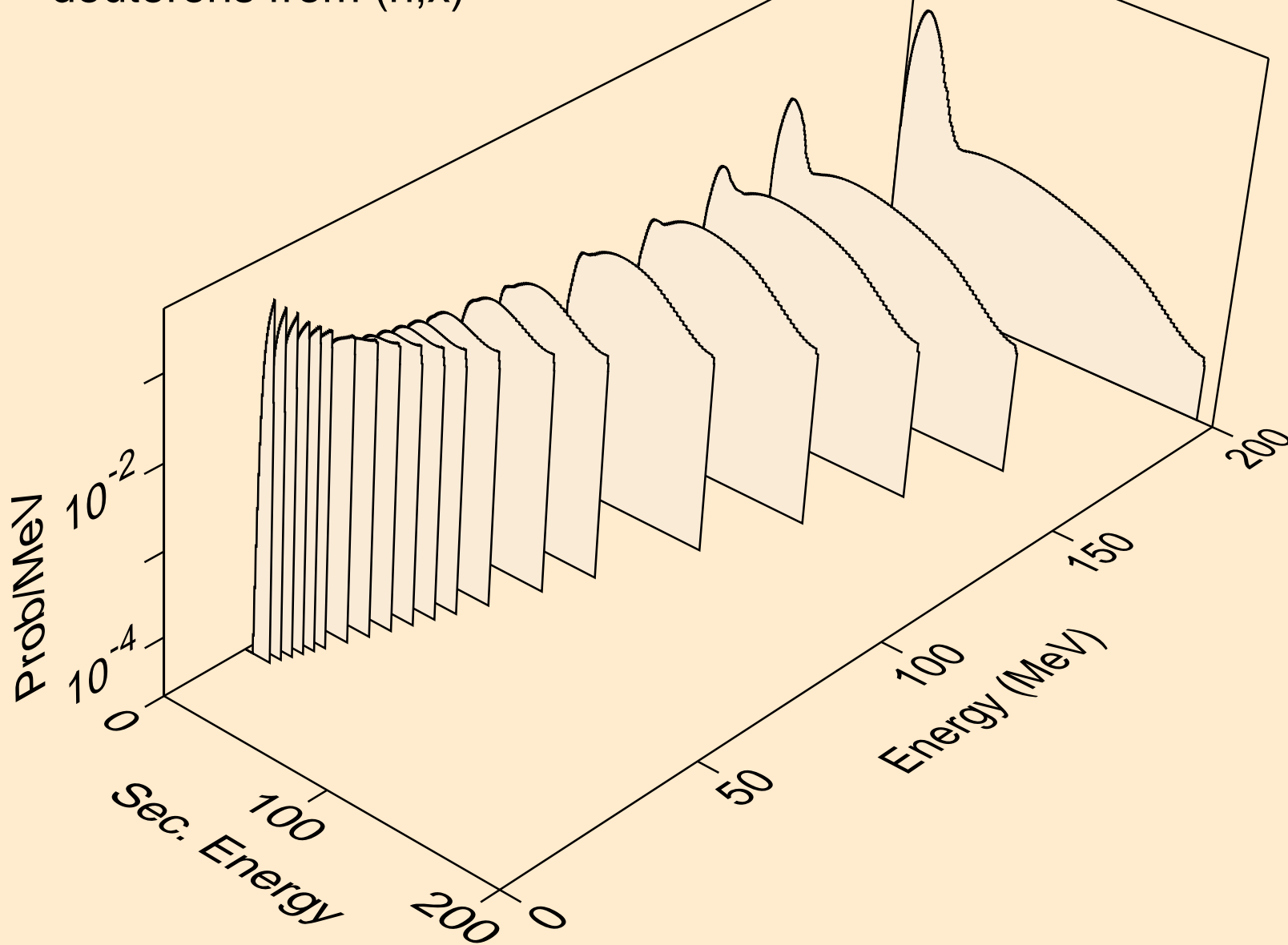

68-ER-162 FOR FENDL-3.2 FROM FENDL-3.2 WITH NJOY2016.60
tritons from (n,x)

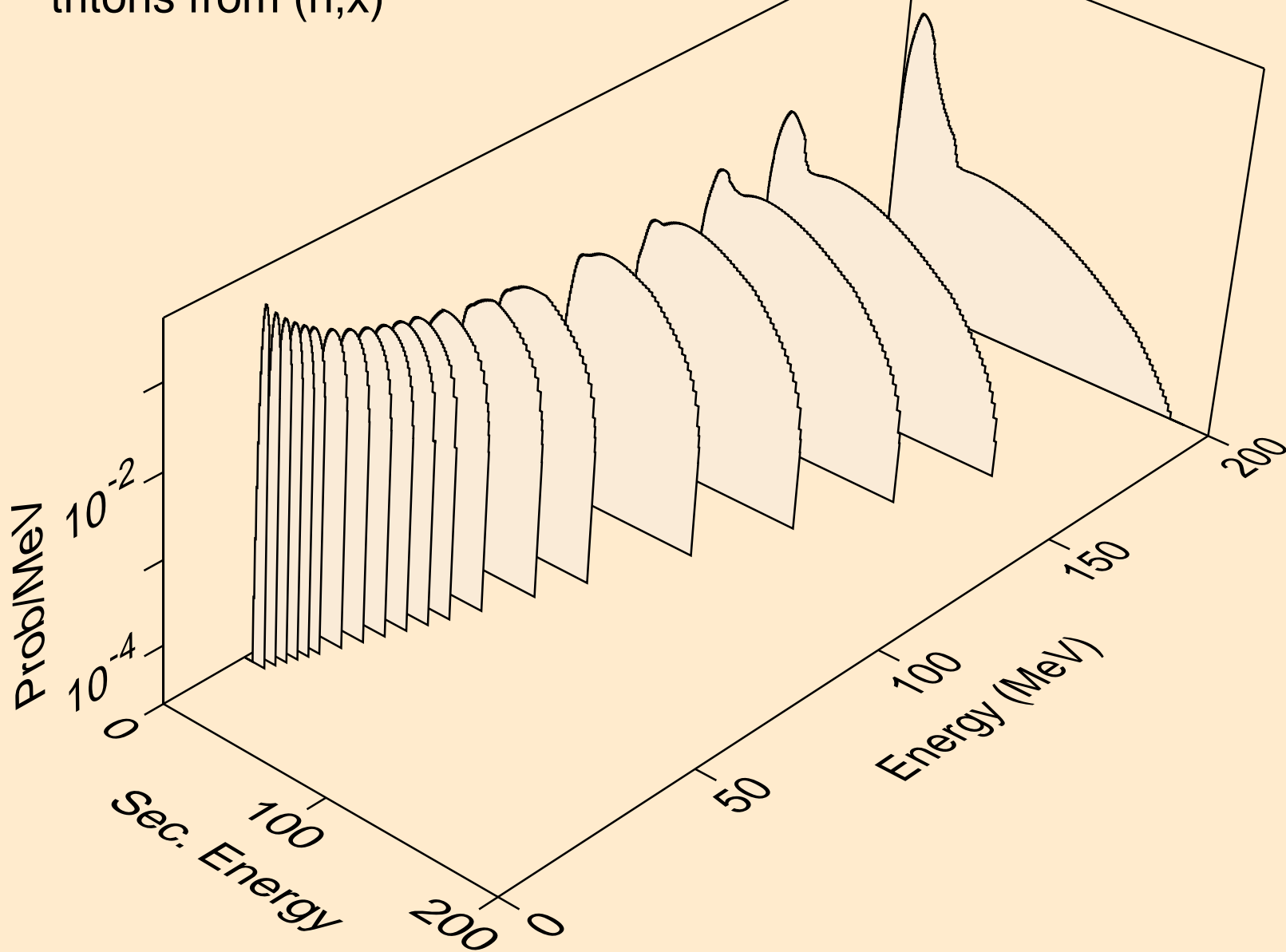

68-ER-162 FOR FENDL-3.2 FROM FENDL-3.2 WITH NJOY2016.60
he3s from (n,x)

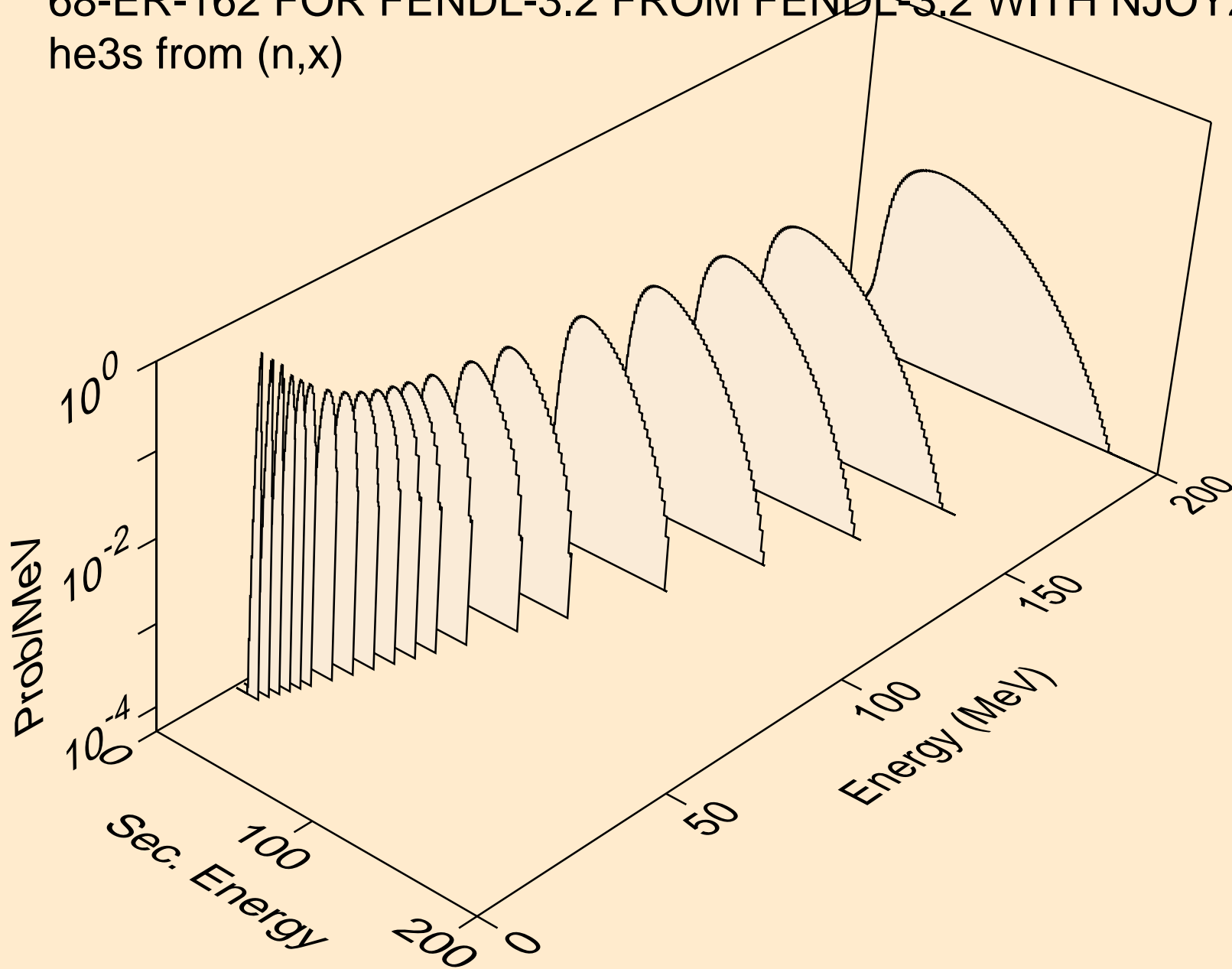

68-ER-162 FOR FENDL-3.2 FROM FENDL-3.2 WITH NJOY2016.60
alphas from (n,x)

