

72-HF-178 FOR FENDL-3.2 FROM FENDL-3.2 WITH NJOY2016.60
Principal cross sections

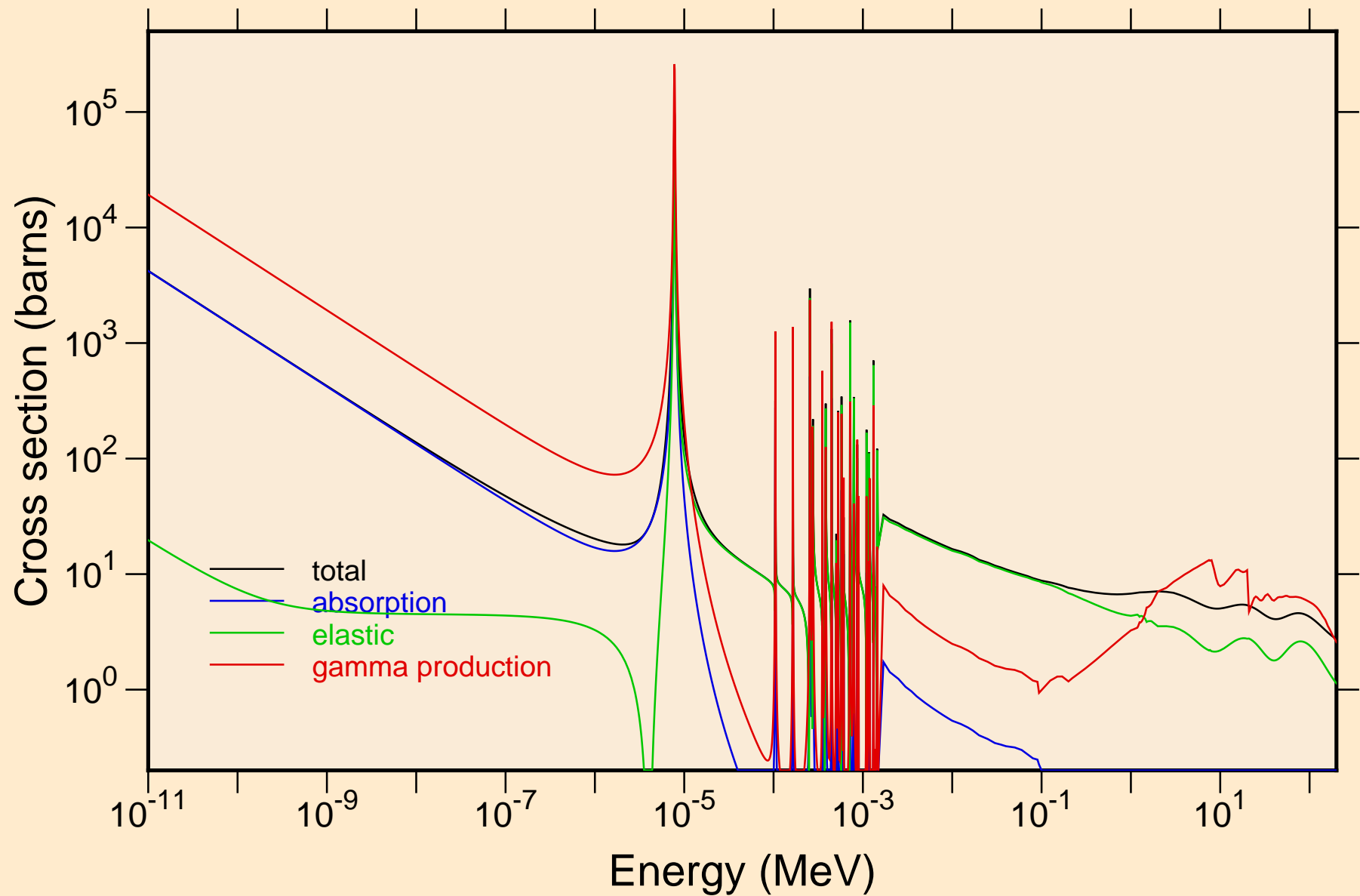

72-HF-178 FOR FENDL-3.2 FROM FENDL-3.2 WITH NJOY2016.60
resonance total cross section

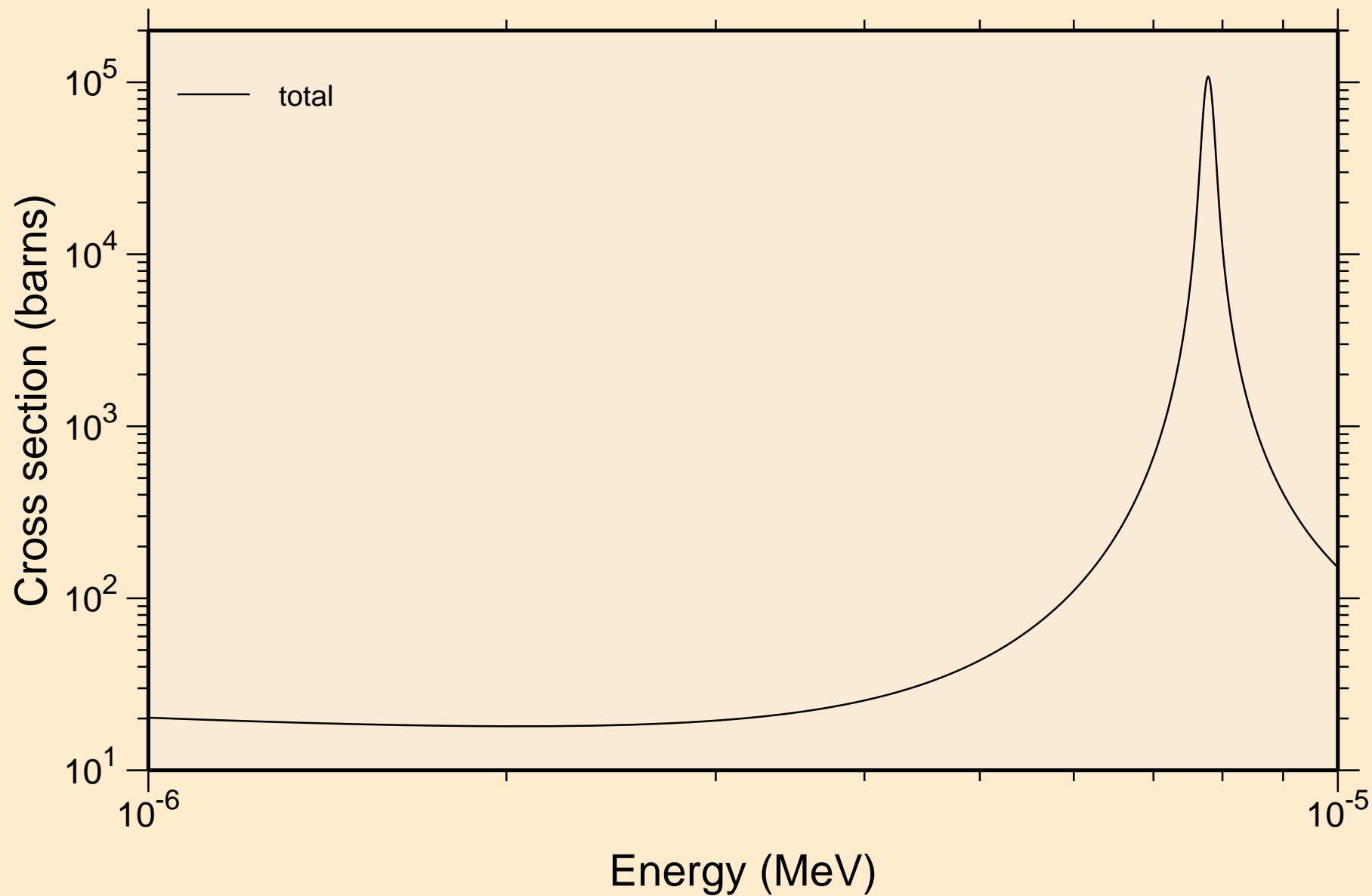

72-HF-178 FOR FENDL-3.2 FROM FENDL-3.2 WITH NJOY2016.60
resonance total cross section

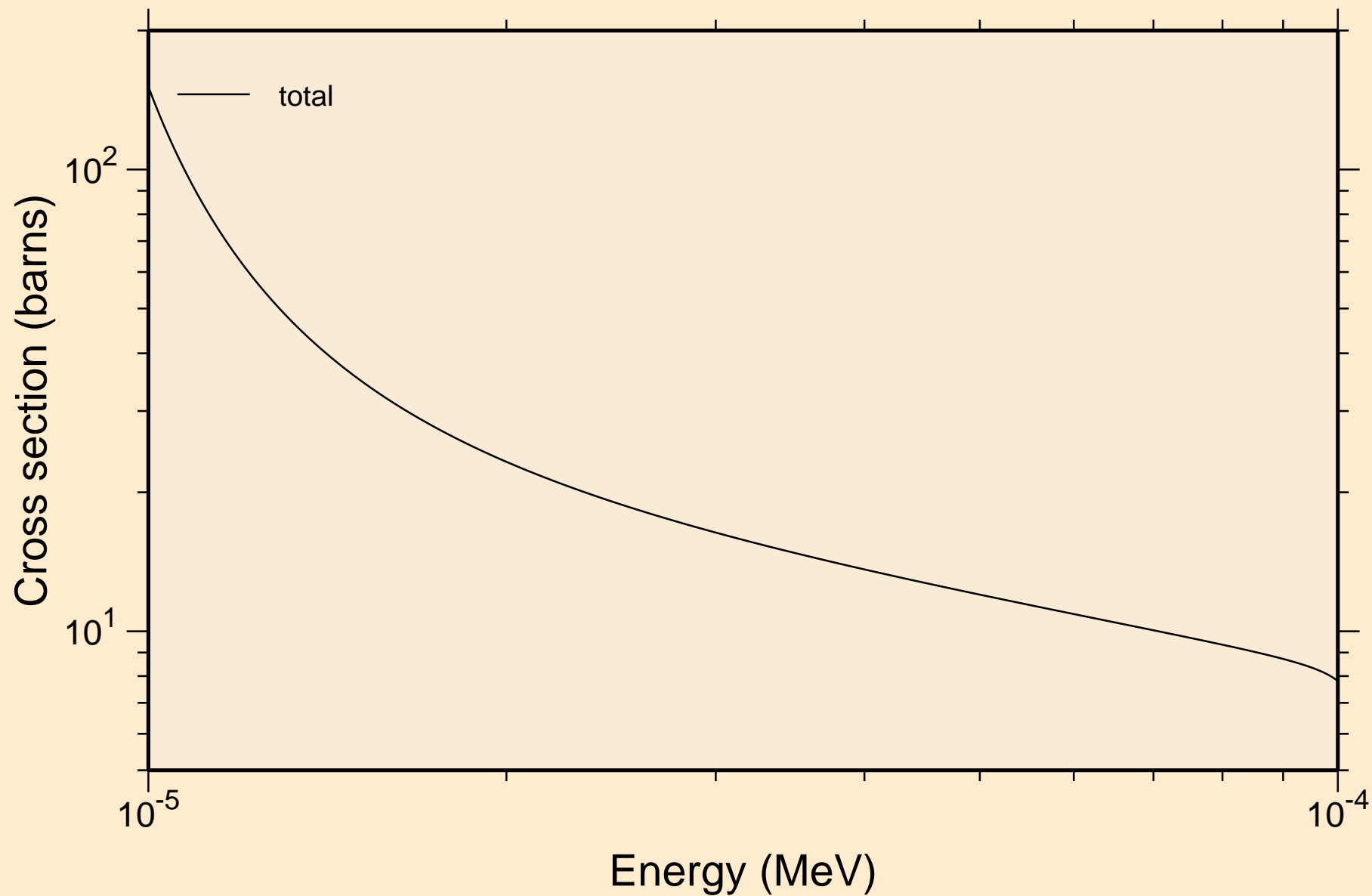

72-HF-178 FOR FENDL-3.2 FROM FENDL-3.2 WITH NJOY2016.60
resonance total cross section

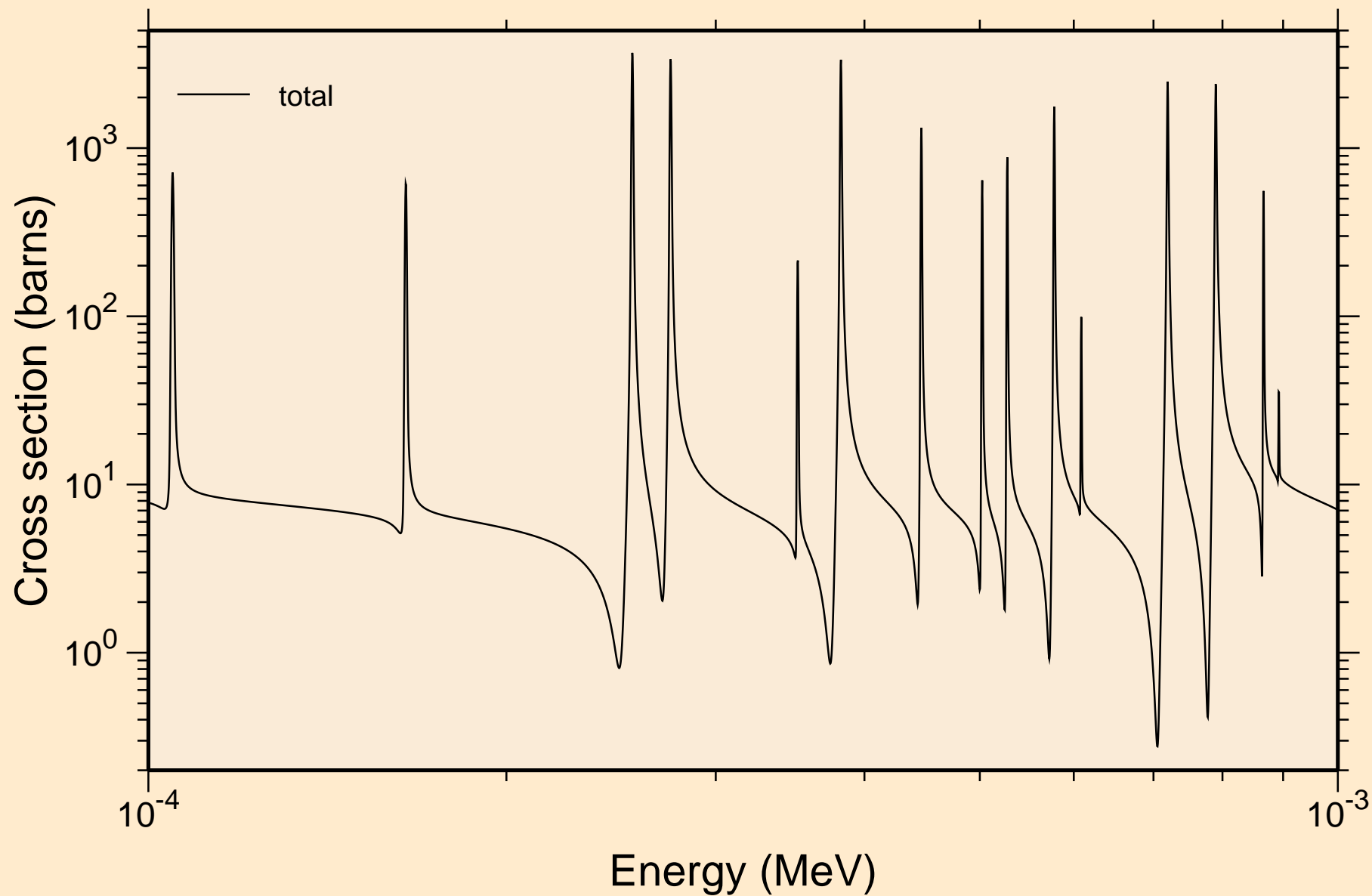

72-HF-178 FOR FENDL-3.2 FROM FENDL-3.2 WITH NJOY2016.60
resonance total cross section

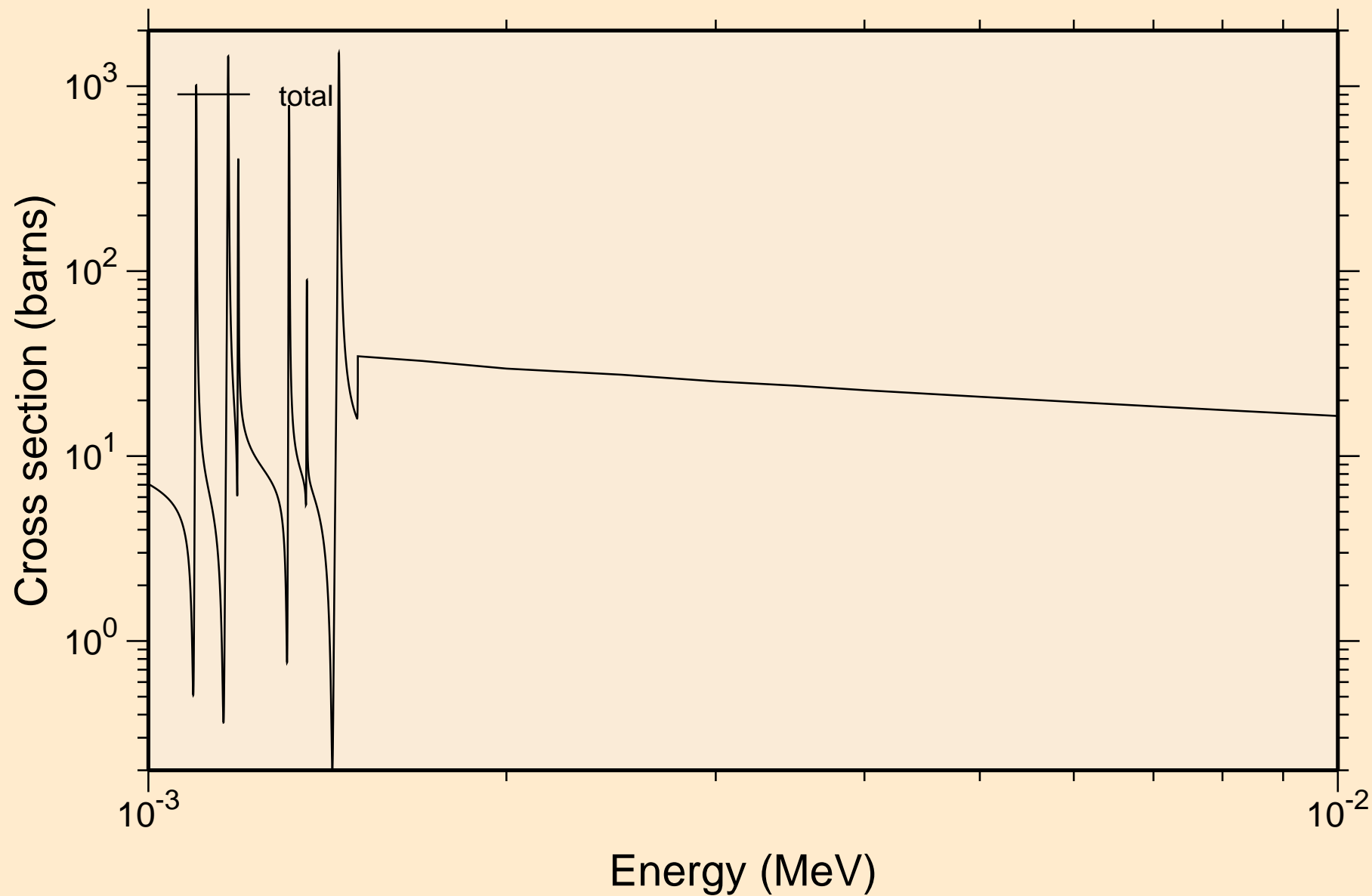

72-HF-178 FOR FENDL-3.2 FROM FENDL-3.2 WITH NJOY2016.60
resonance absorption cross sections

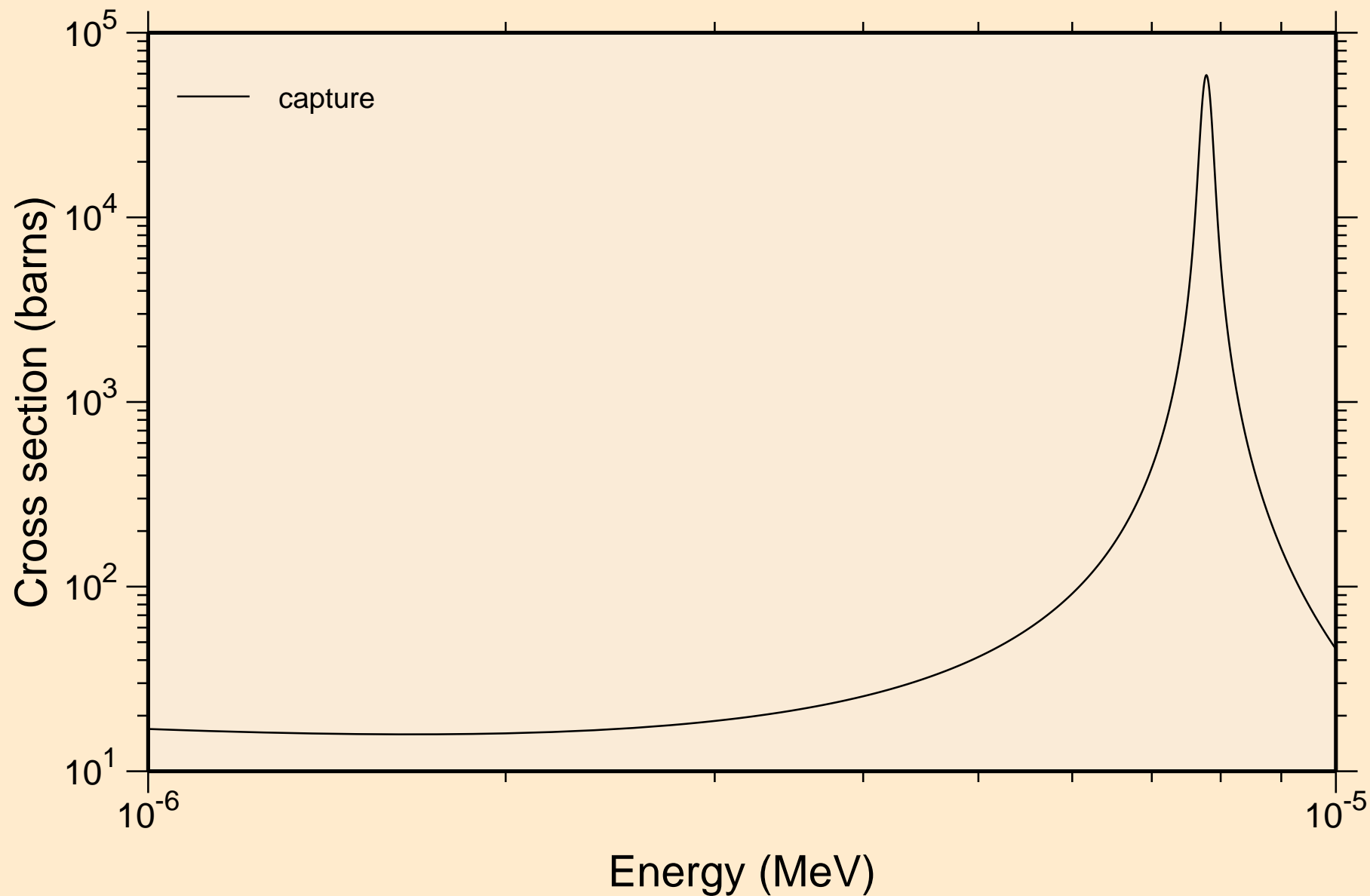

72-HF-178 FOR FENDL-3.2 FROM FENDL-3.2 WITH NJOY2016.60
resonance absorption cross sections

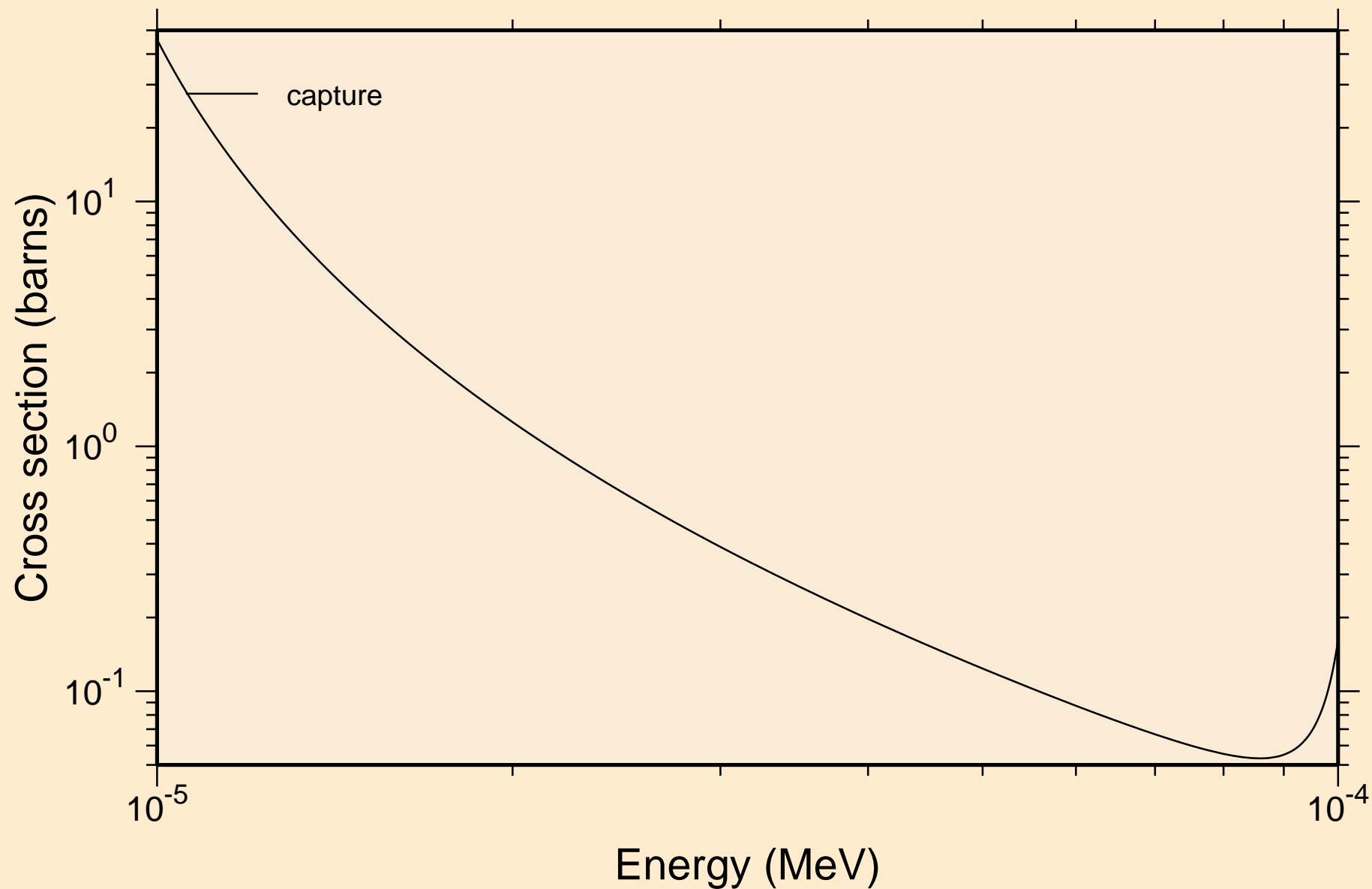

72-HF-178 FOR FENDL-3.2 FROM FENDL-3.2 WITH NJOY2016.60
resonance absorption cross sections

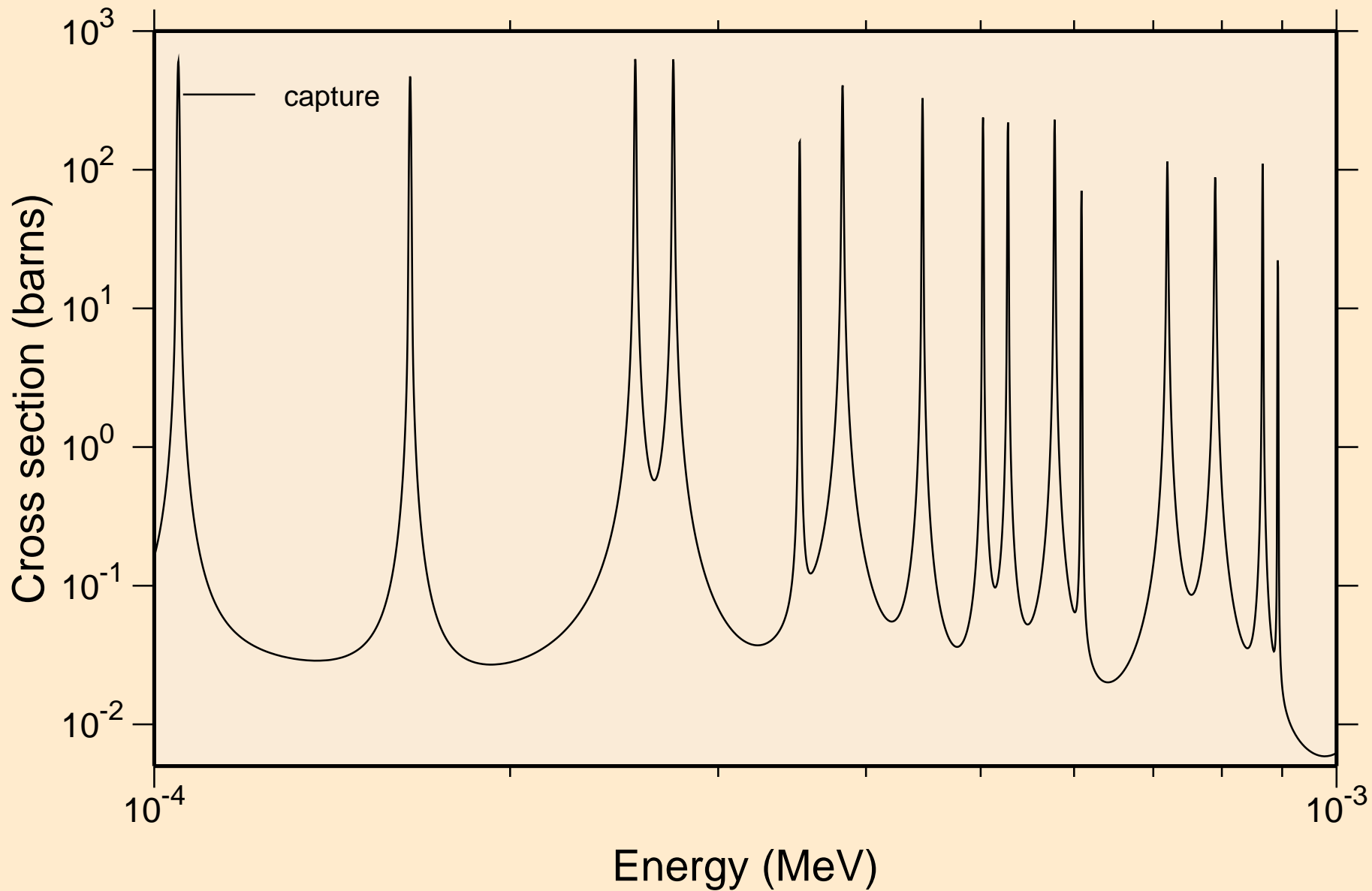

72-HF-178 FOR FENDL-3.2 FROM FENDL-3.2 WITH NJOY2016.60
resonance absorption cross sections

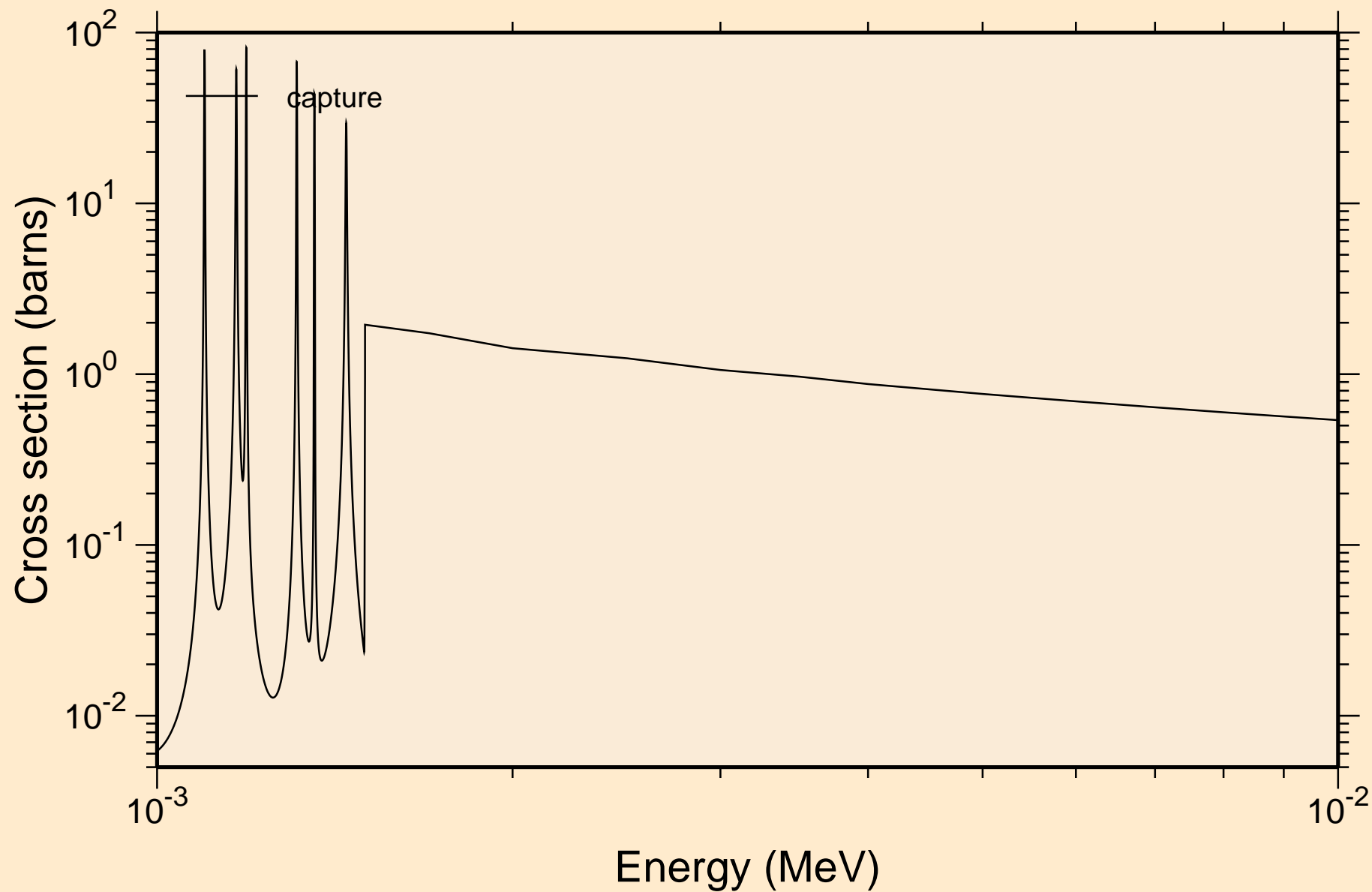

72-HF-178 FOR FENDL-3.2 FROM FENDL-3.2 WITH NJOY2016.60
resonance absorption cross sections

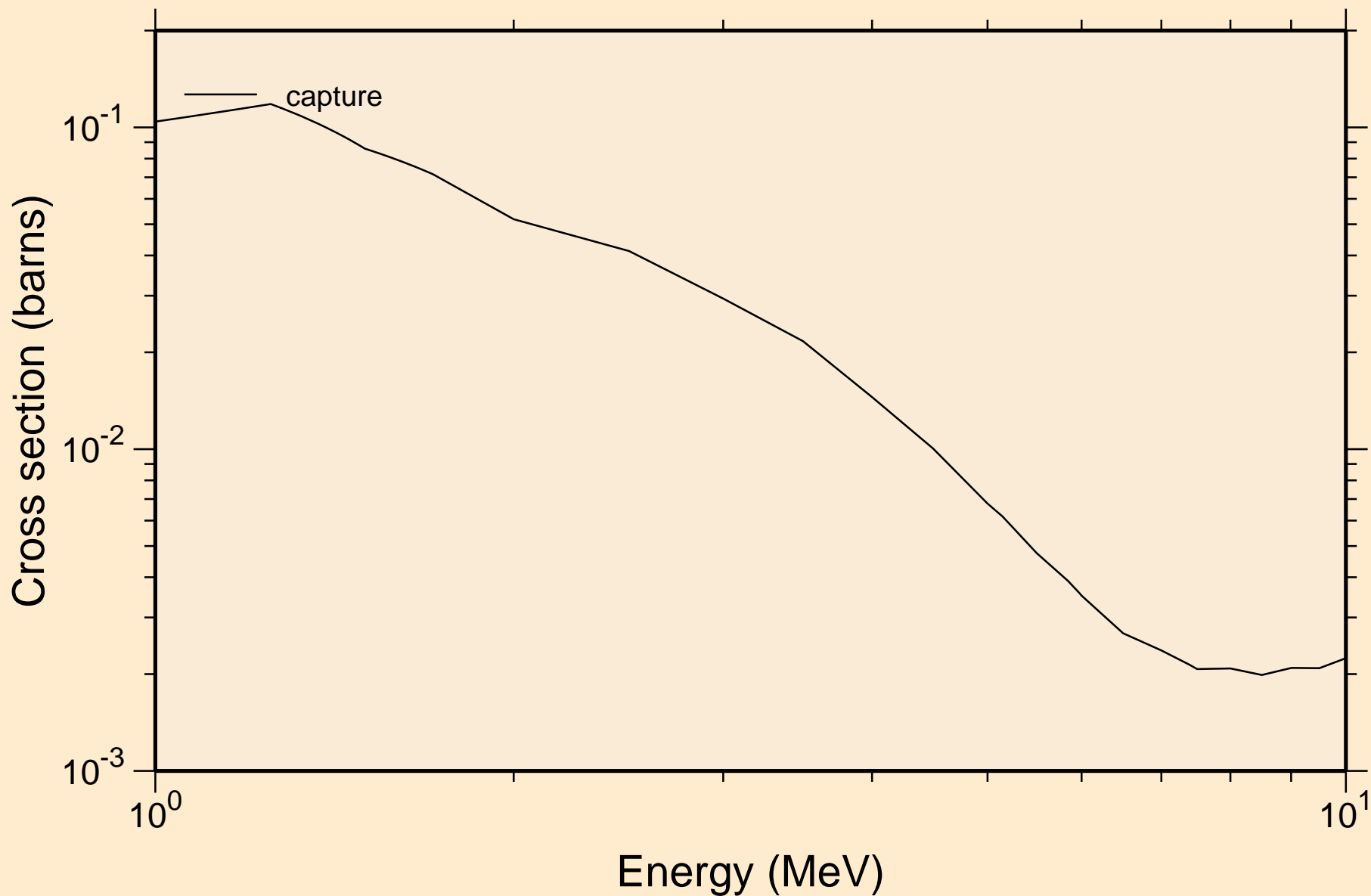

72-HF-178 FOR FENDL-3.2 FROM FENDL-3.2 WITH NJOY2016.60
UR total cross section

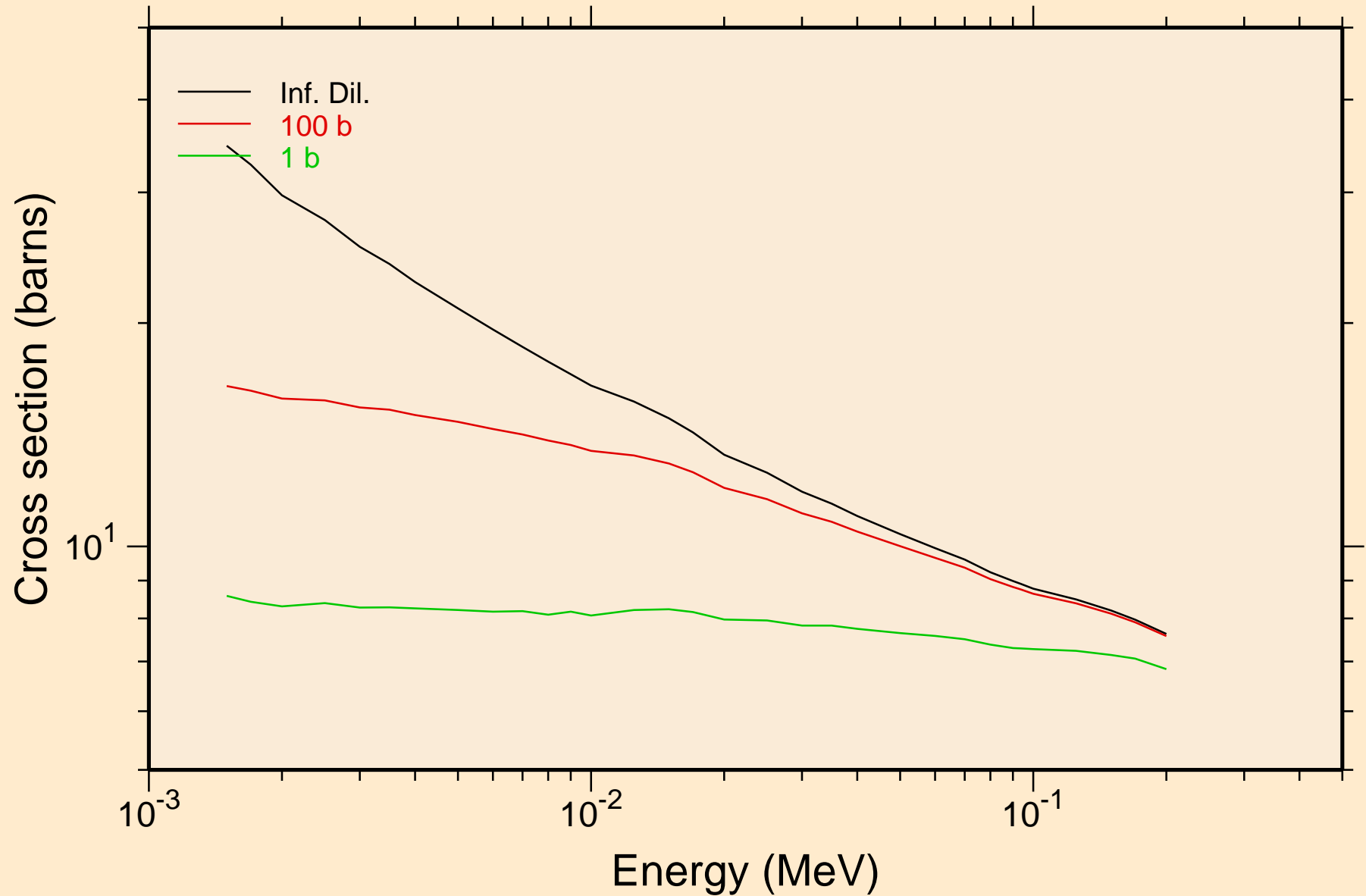

72-HF-178 FOR FENDL-3.2 FROM FENDL-3.2 WITH NJOY2016.60
UR elastic cross section

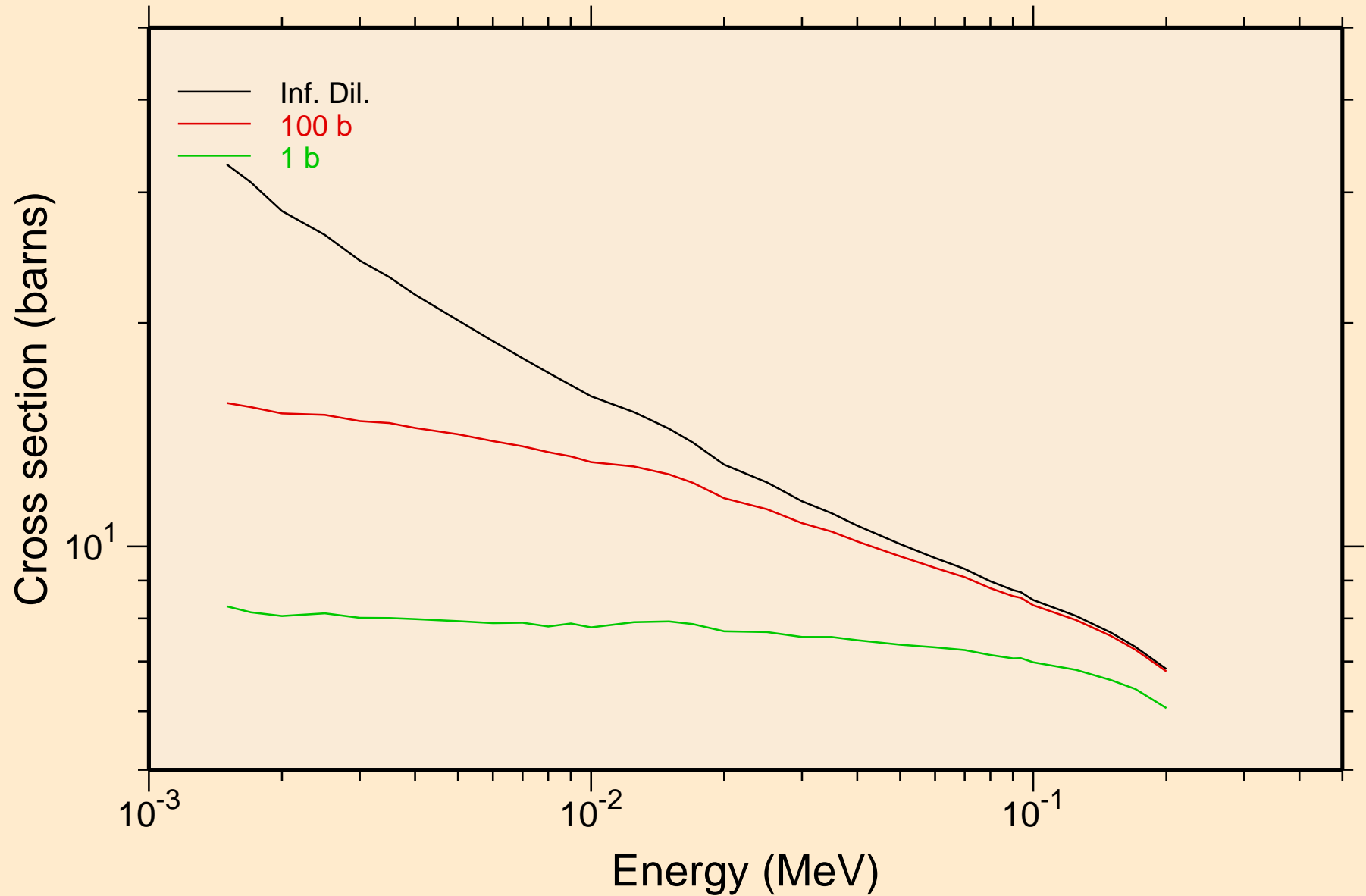

72-HF-178 FOR FENDL-3.2 FROM FENDL-3.2 WITH NJOY2016.60
UR capture cross section

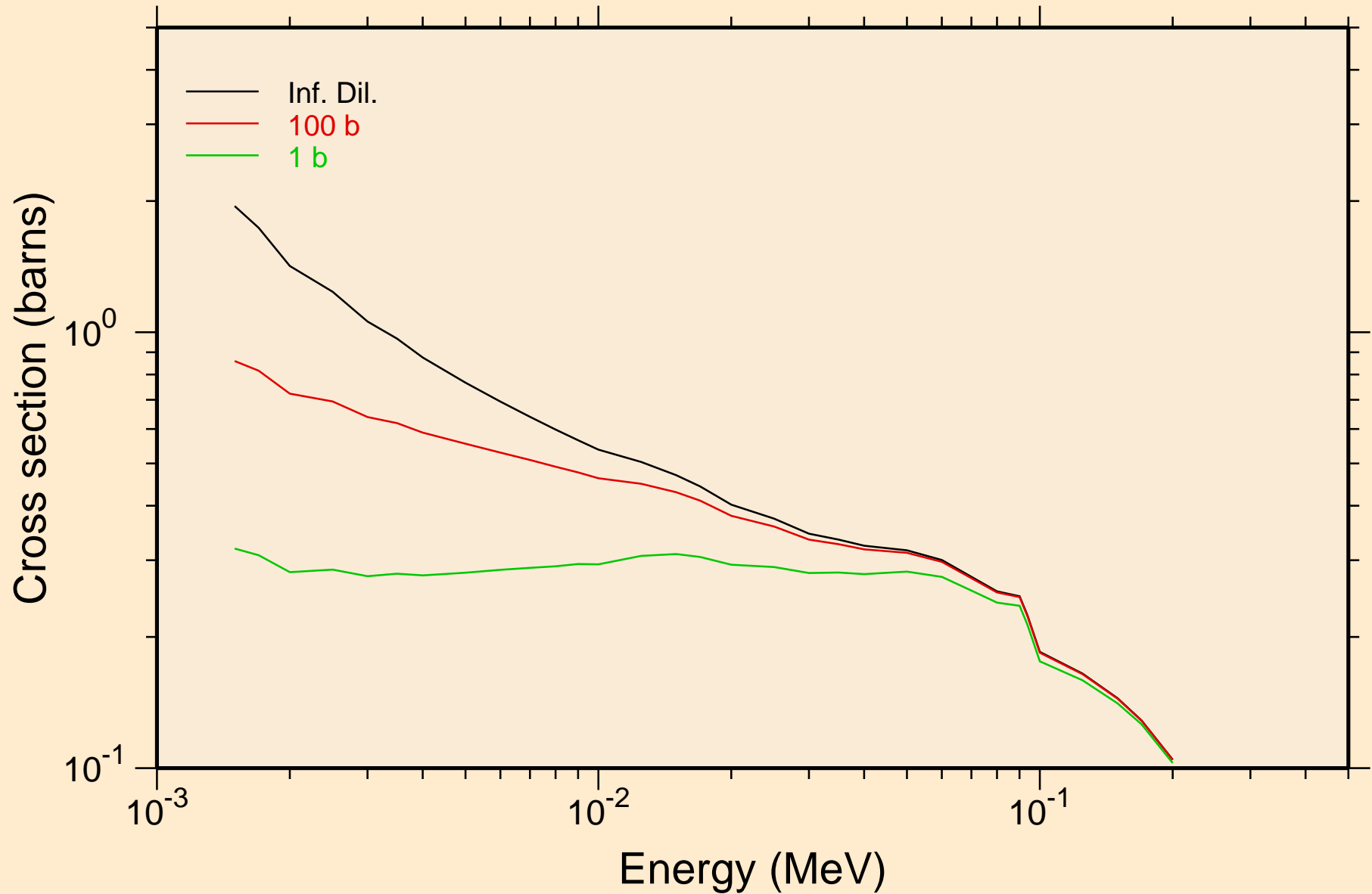

72-HF-178 FOR FENDL-3.2 FROM FENDL-3.2 WITH NJOY2016.60
Heating

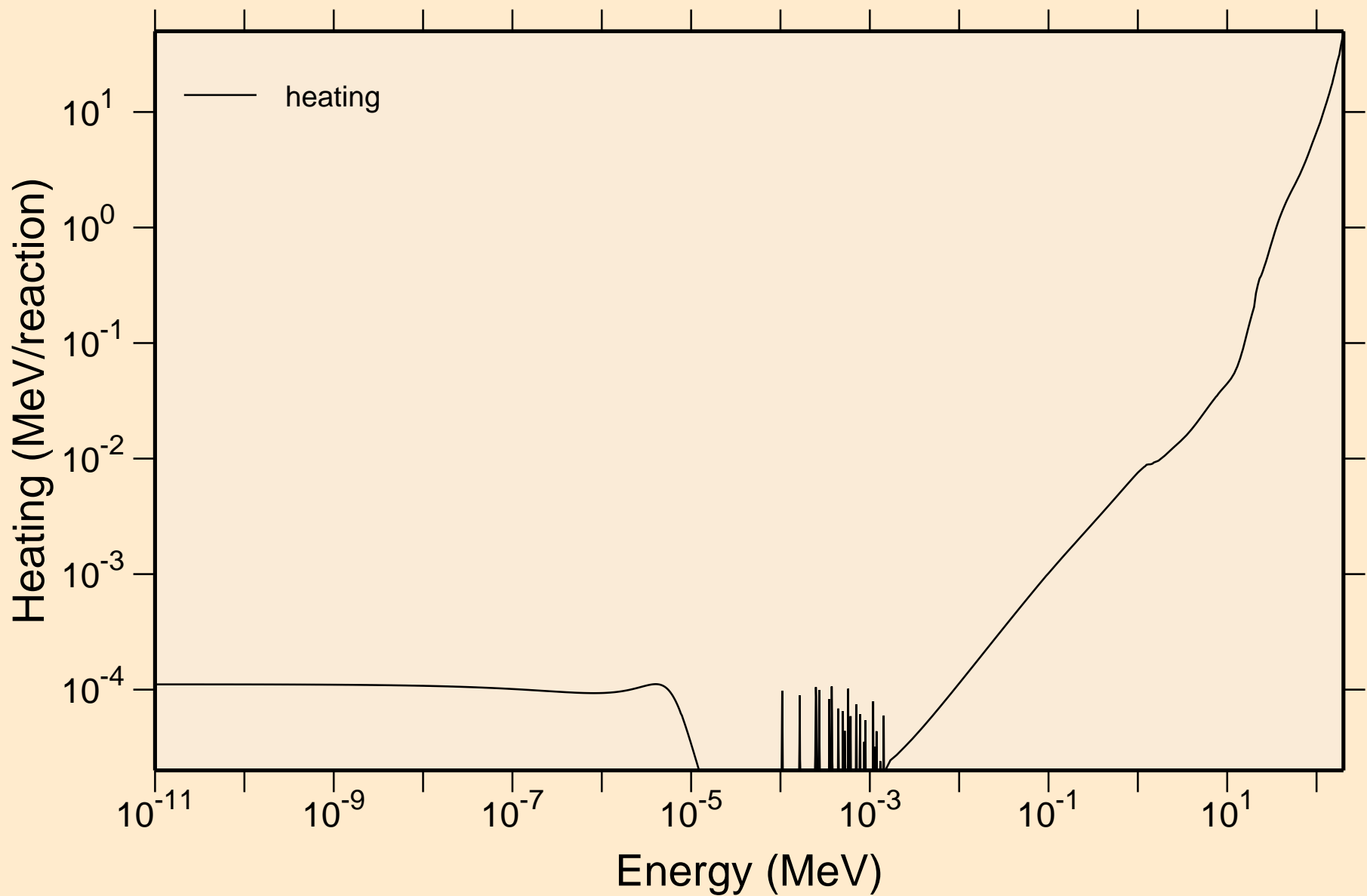

72-HF-178 FOR FENDL-3.2 FROM FENDL-3.2 WITH NJOY2016.60 Damage

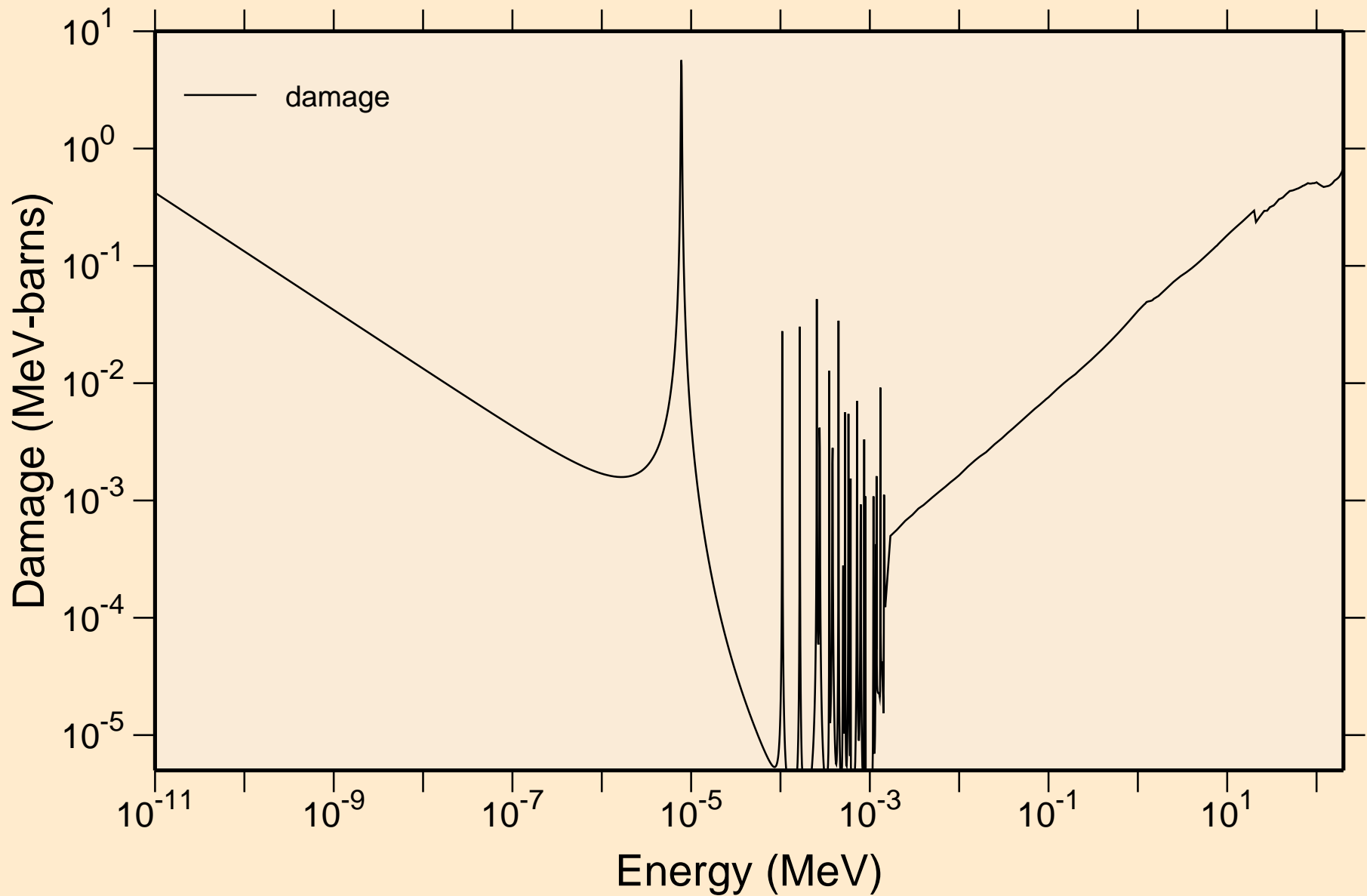

72-HF-178 FOR FENDL-3.2 FROM FENDL-3.2 WITH NJOY2016.60
Non-threshold reactions

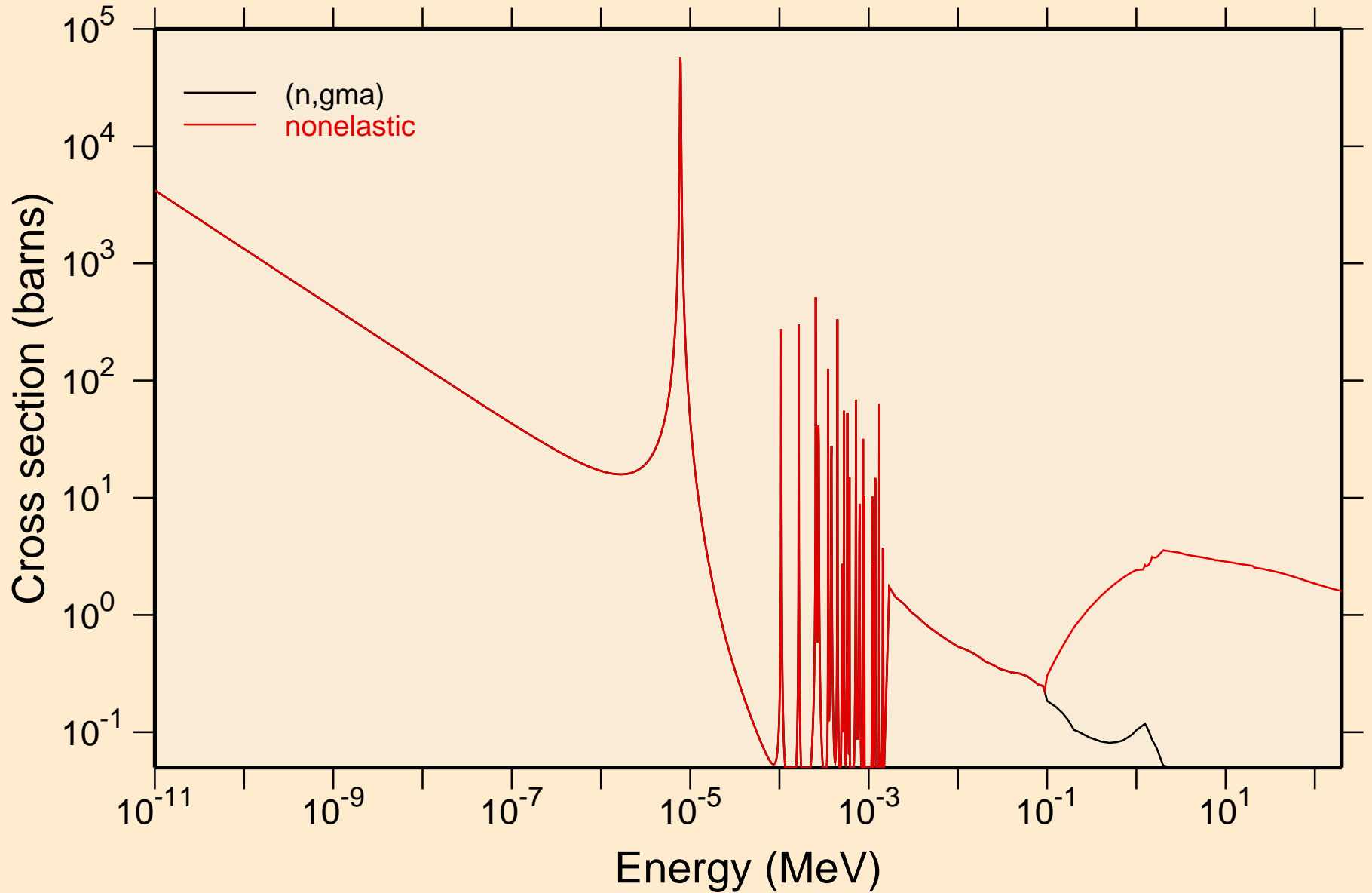

72-HF-178 FOR FENDL-3.2 FROM FENDL-3.2 WITH NJOY2016.60
Non-threshold reactions

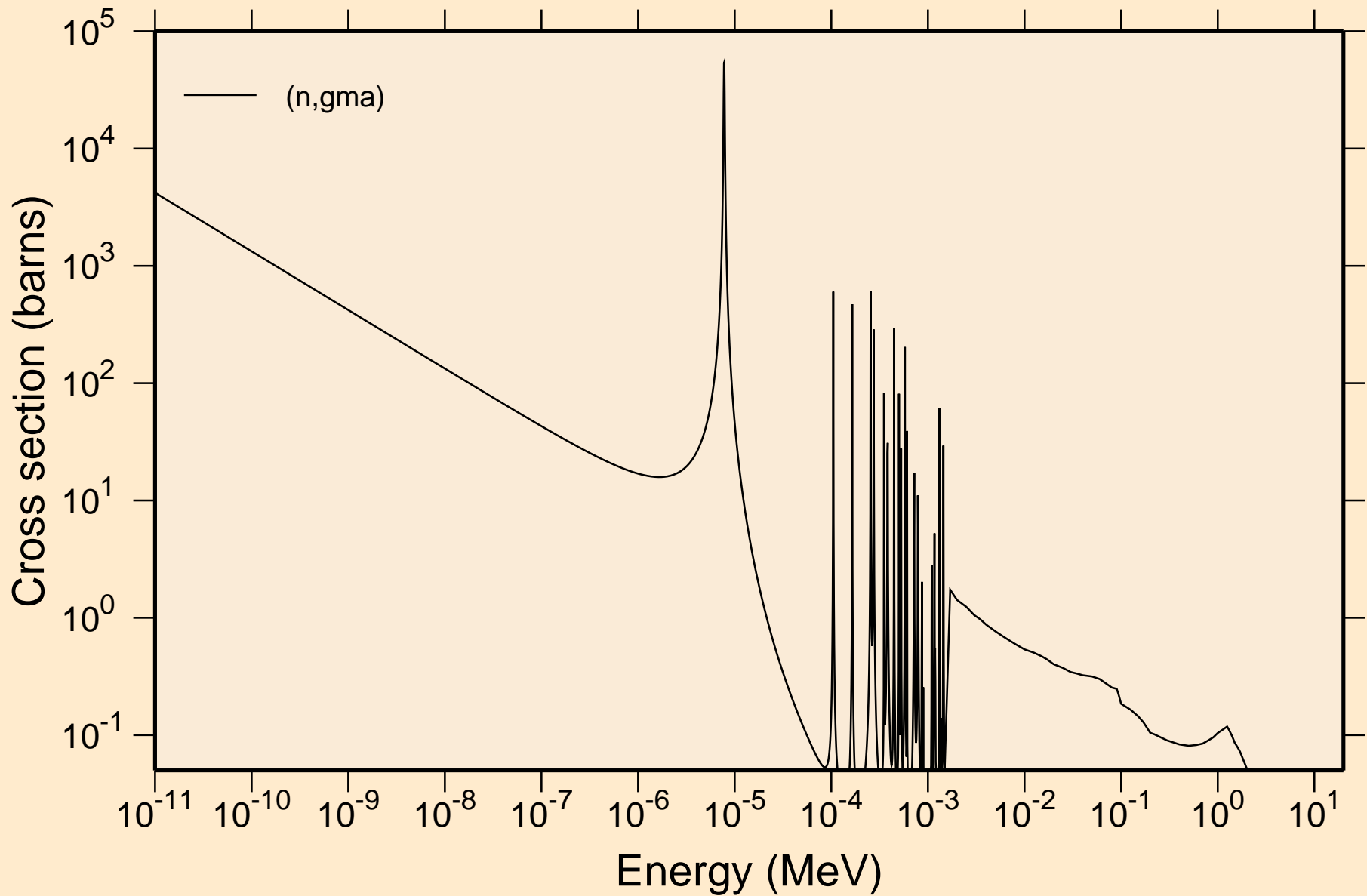

72-HF-178 FOR FENDL-3.2 FROM FENDL-3.2 WITH NJOY2016.60

Principal cross sections

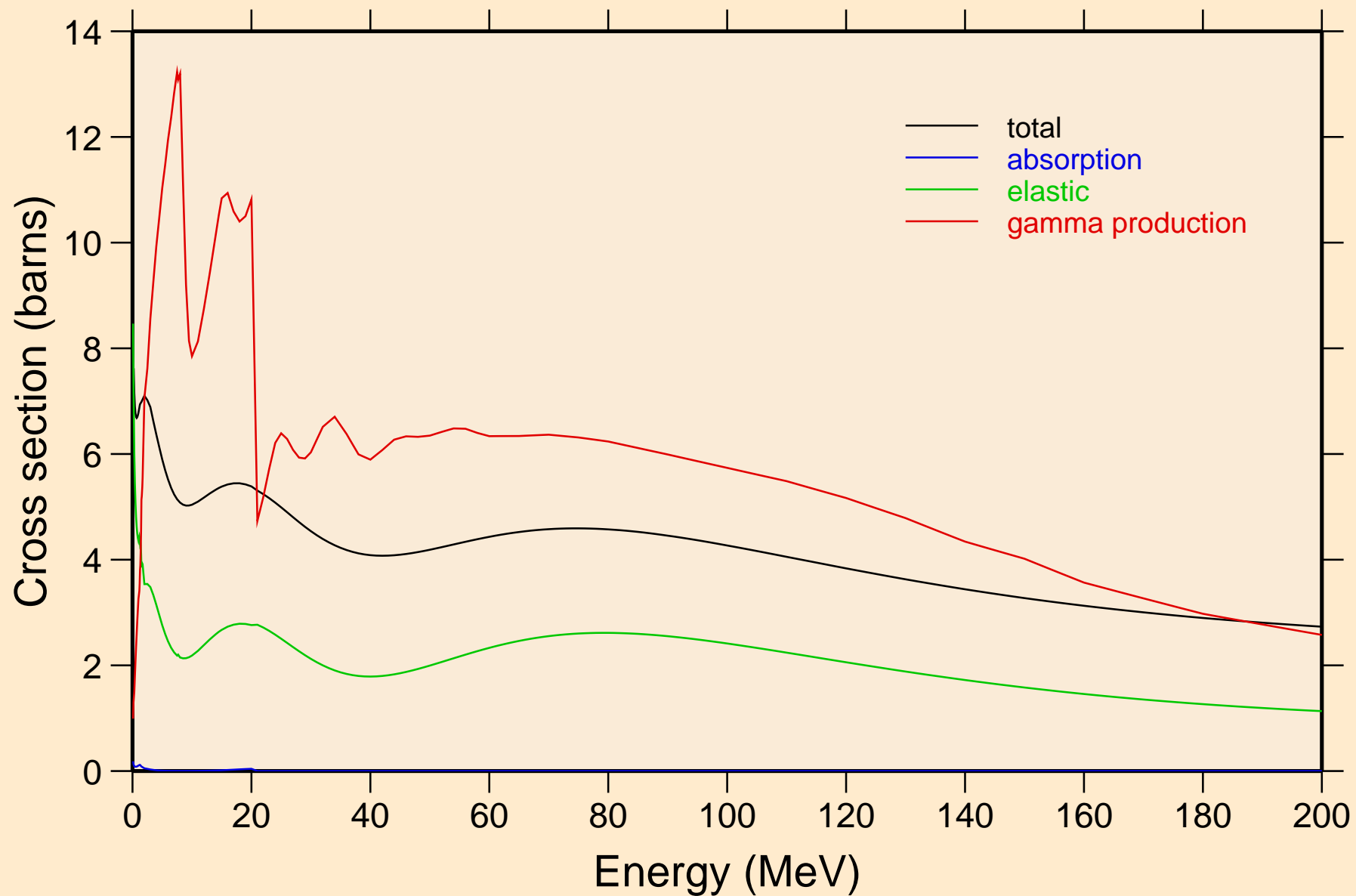

72-HF-178 FOR FENDL-3.2 FROM FENDL-3.2 WITH NJOY2016.60

Heating

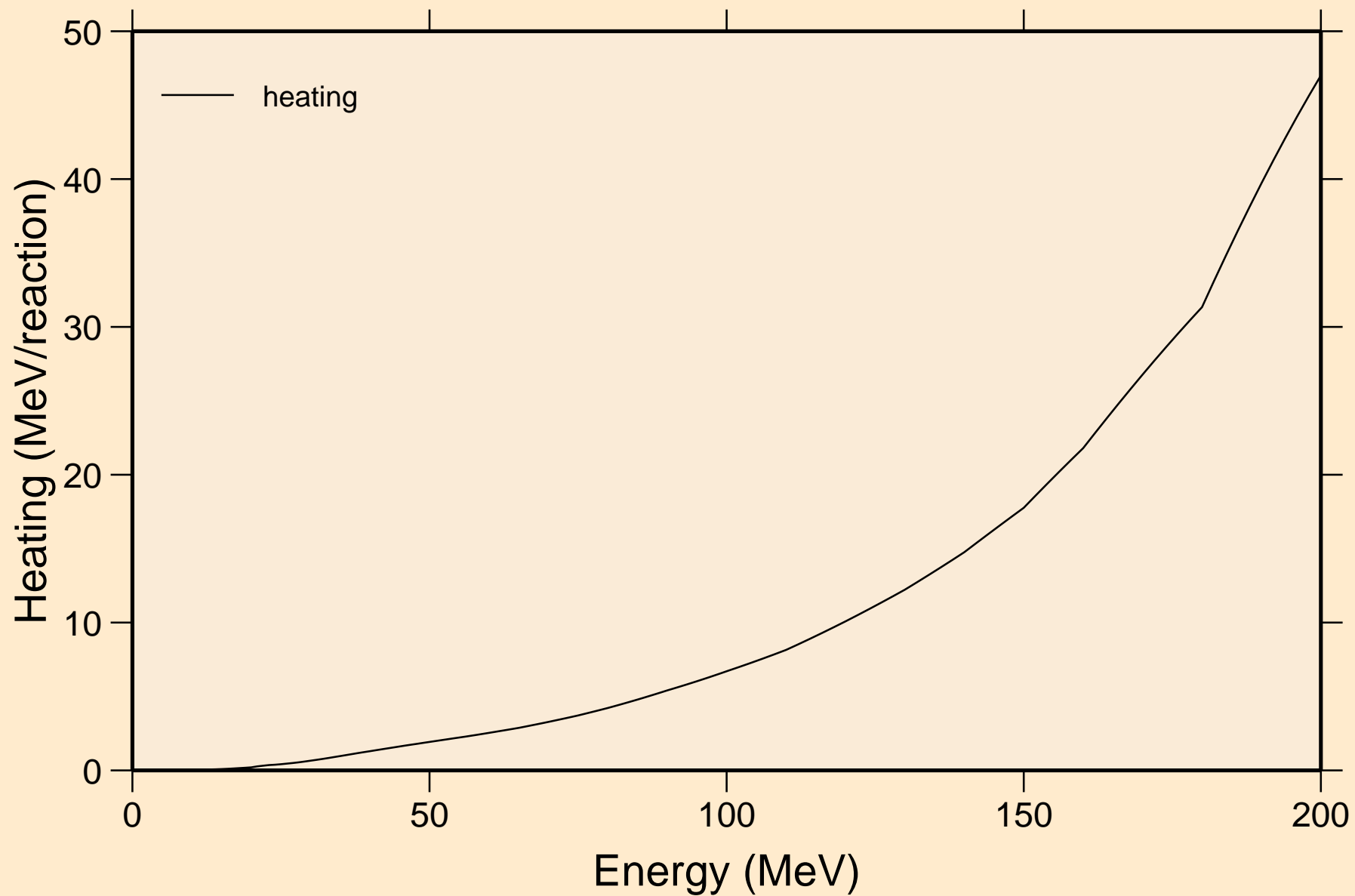

72-HF-178 FOR FENDL-3.2 FROM FENDL-3.2 WITH NJOY2016.60 Damage

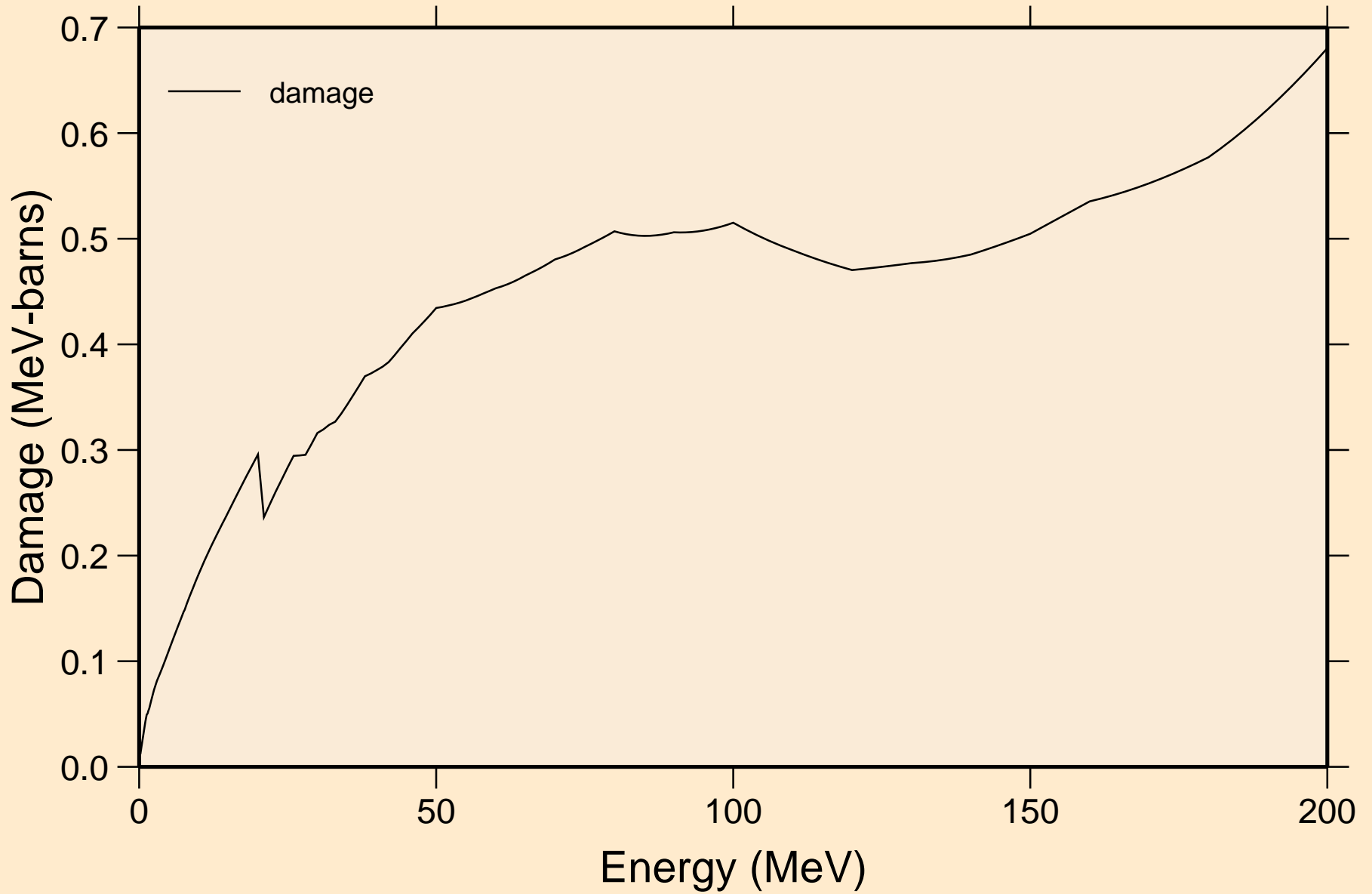

72-HF-178 FOR FENDL-3.2 FROM FENDL-3.2 WITH NJOY2016.60
Non-threshold reactions

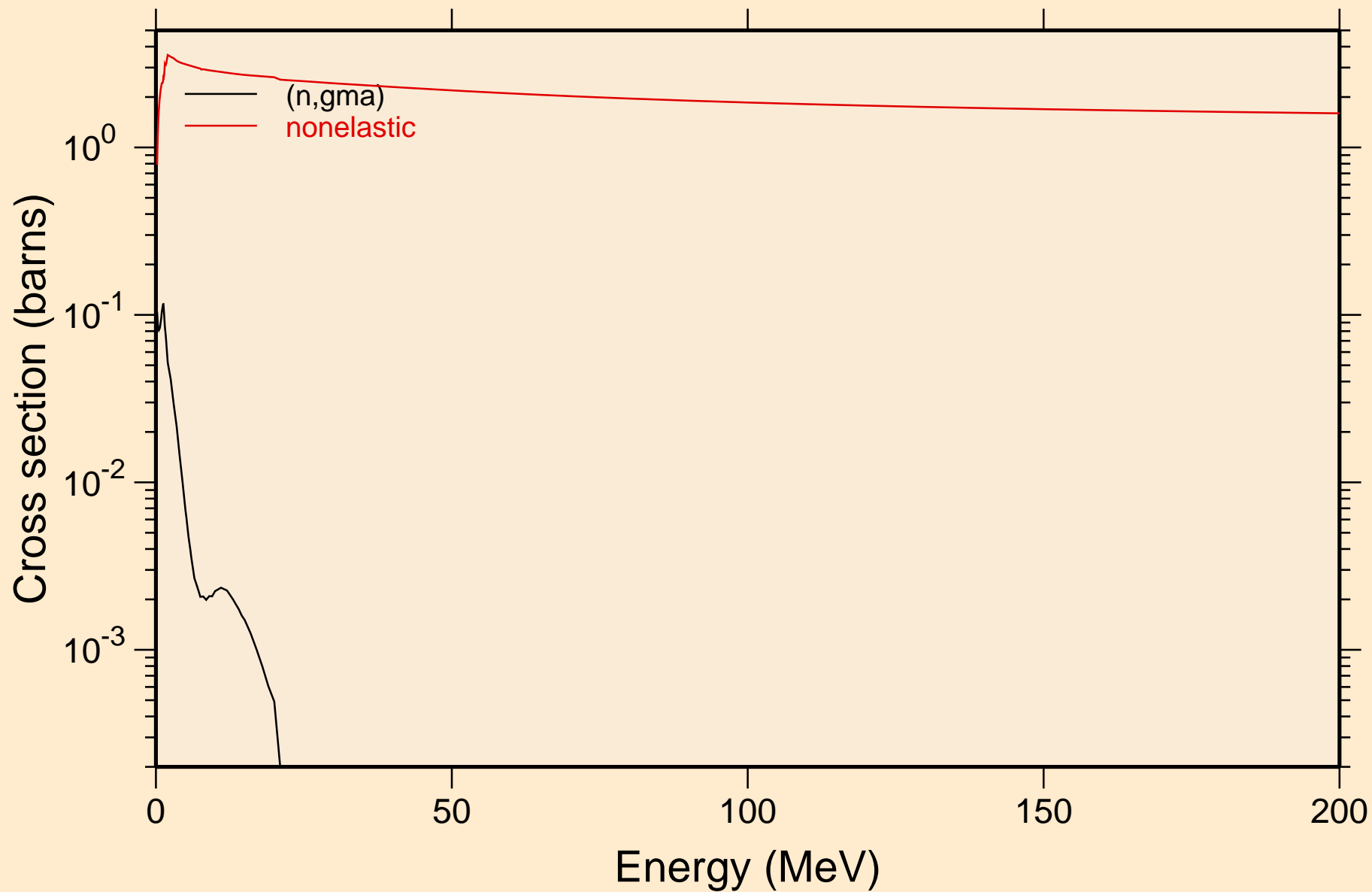

72-HF-178 FOR FENDL-3.2 FROM FENDL-3.2 WITH NJOY2016.60
Non-threshold reactions

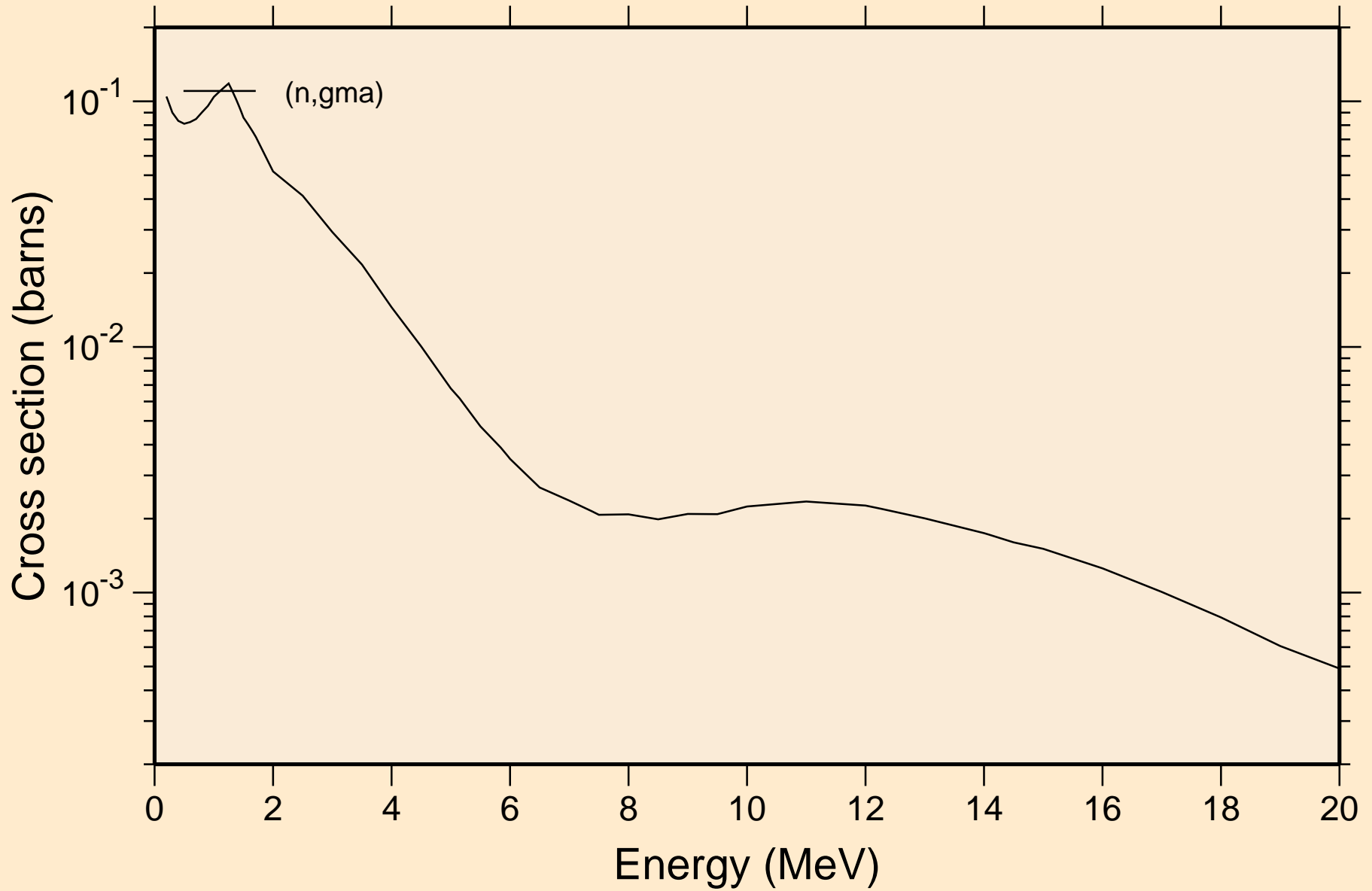

72-HF-178 FOR FENDL-3.2 FROM FENDL-3.2 WITH NJOY2016.60
Inelastic levels

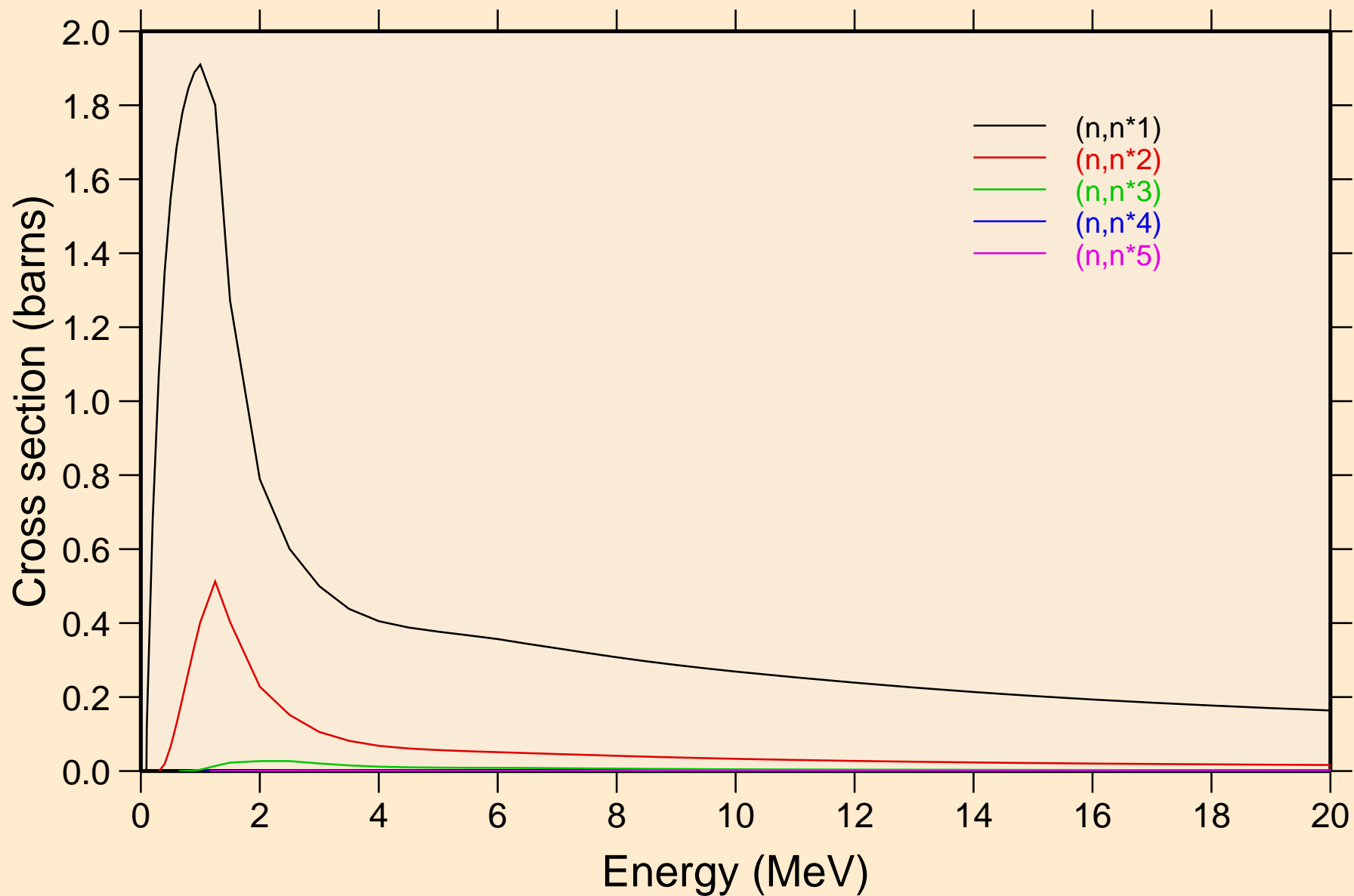

72-HF-178 FOR FENDL-3.2 FROM FENDL-3.2 WITH NJOY2016.60
Inelastic levels

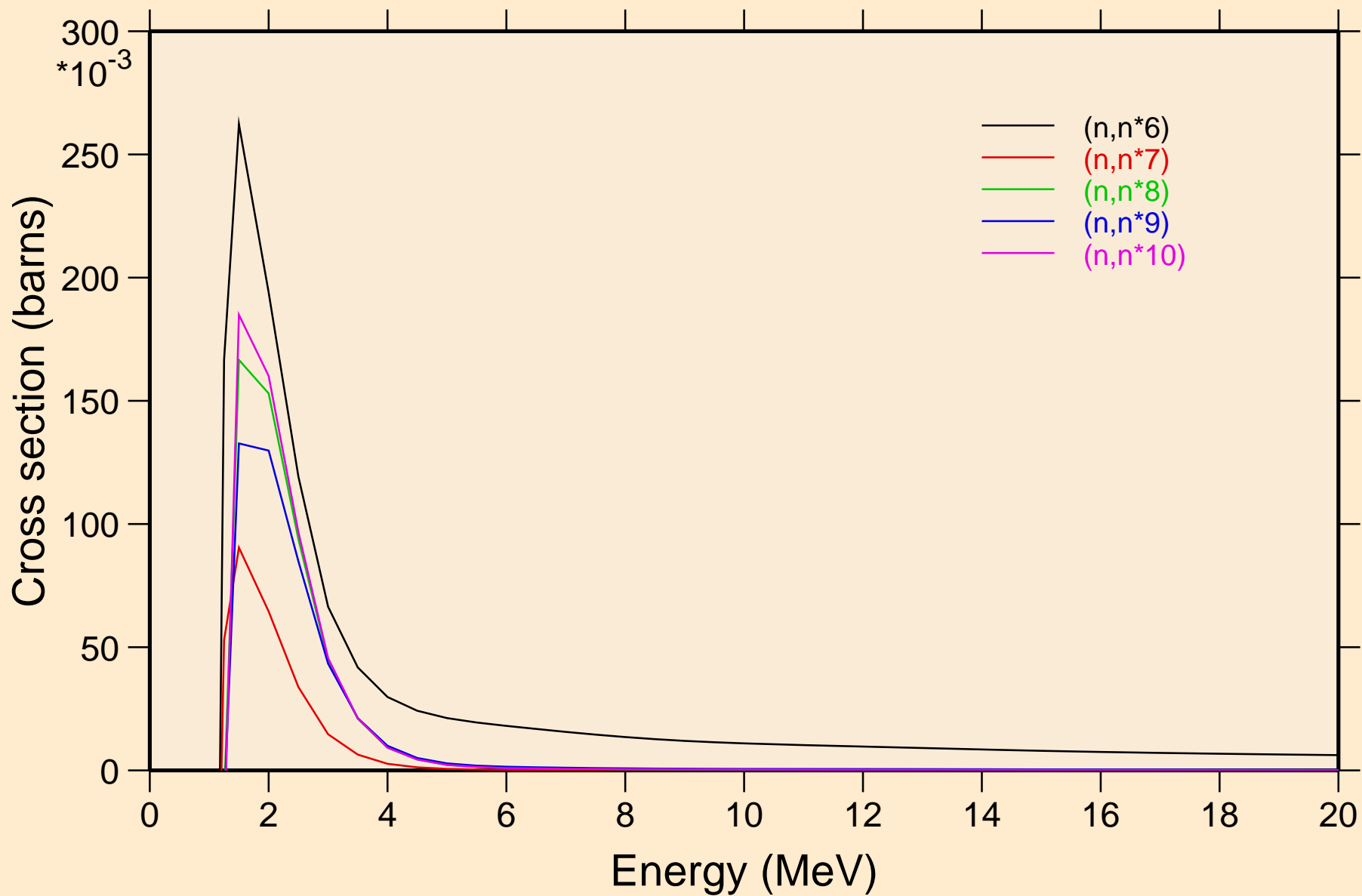

72-HF-178 FOR FENDL-3.2 FROM FENDL-3.2 WITH NJOY2016.60

Inelastic levels

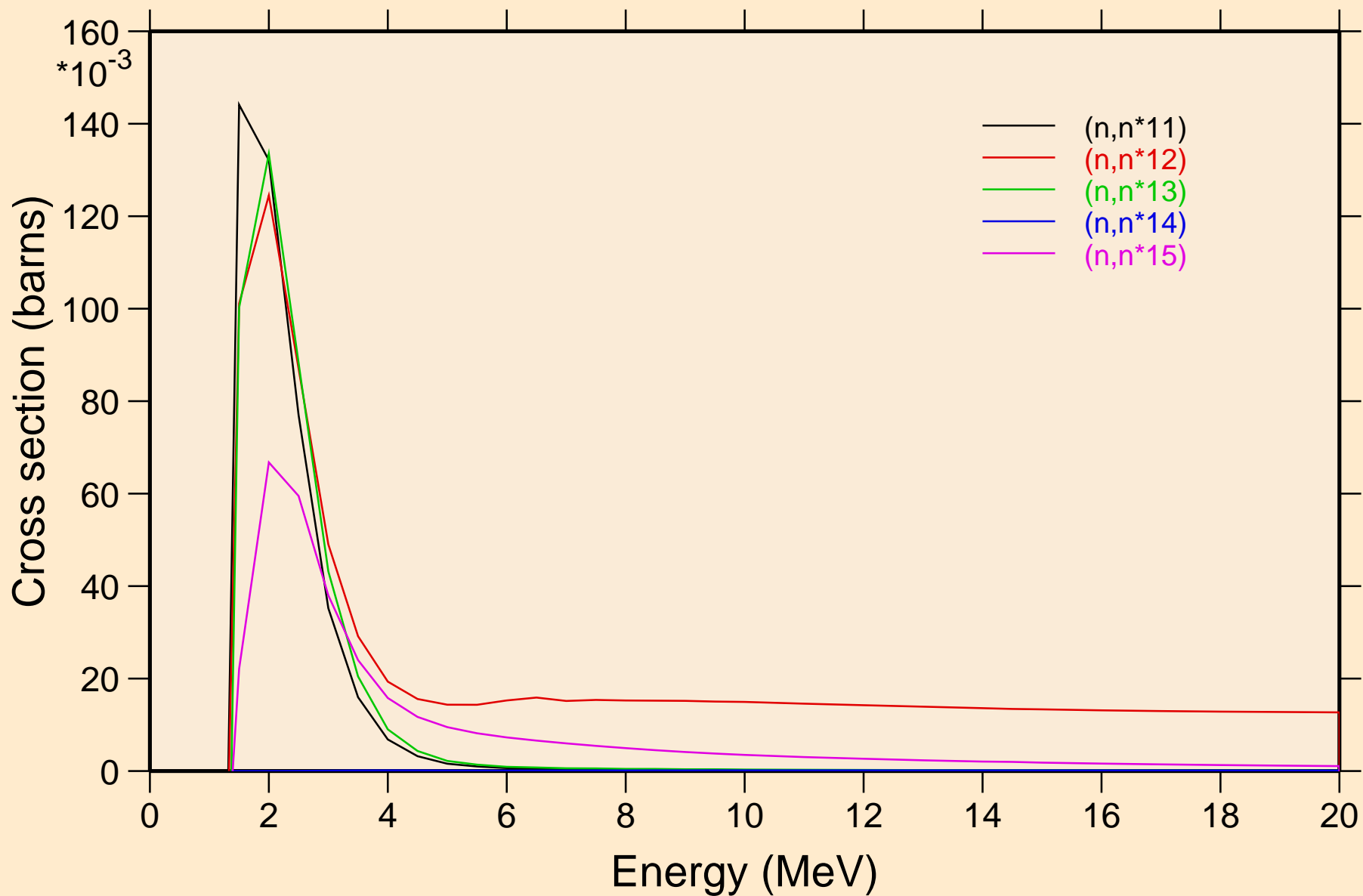

72-HF-178 FOR FENDL-3.2 FROM FENDL-3.2 WITH NJOY2016.60

Inelastic levels

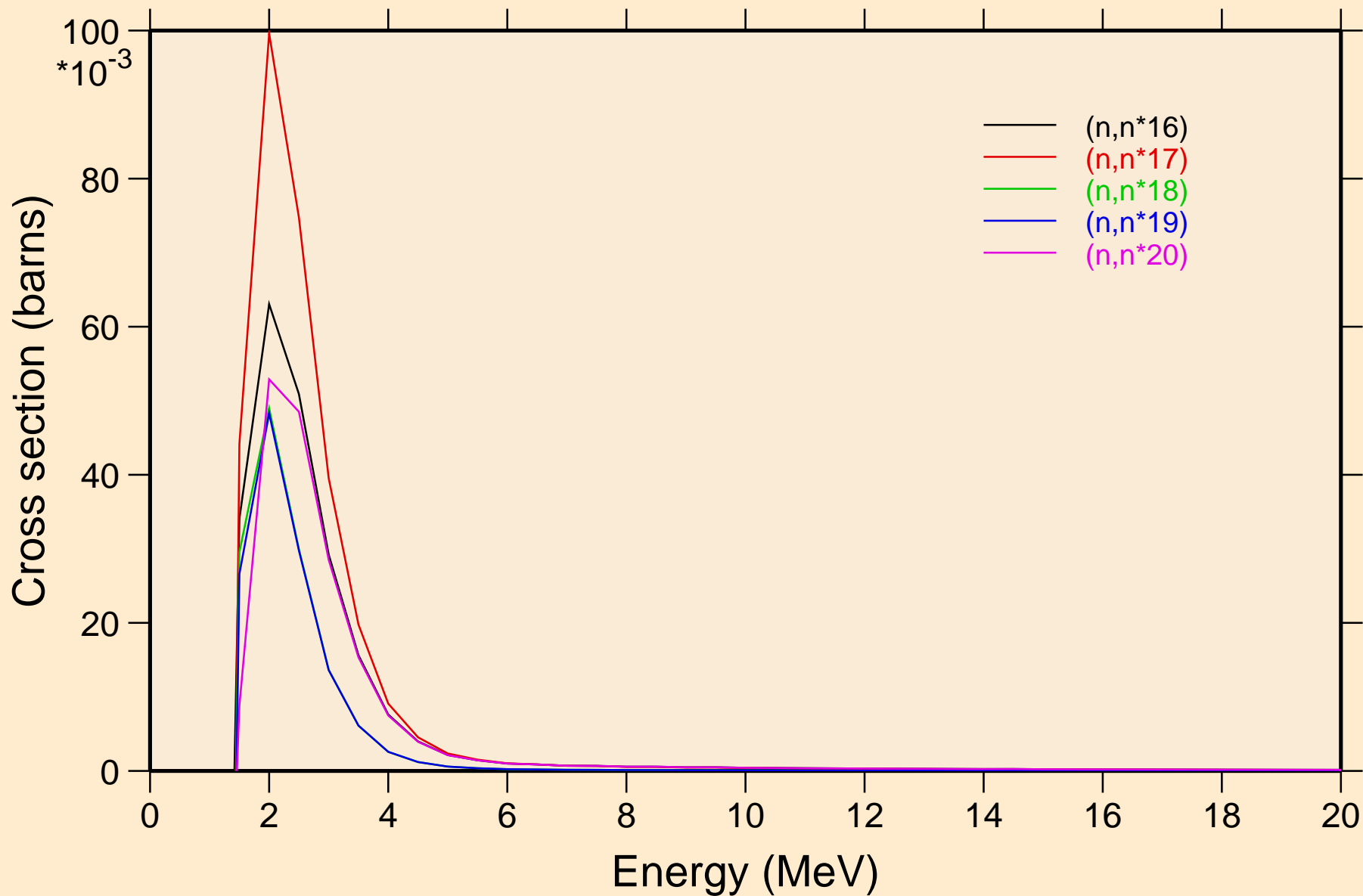

72-HF-178 FOR FENDL-3.2 FROM FENDL-3.2 WITH NJOY2016.60
Inelastic levels

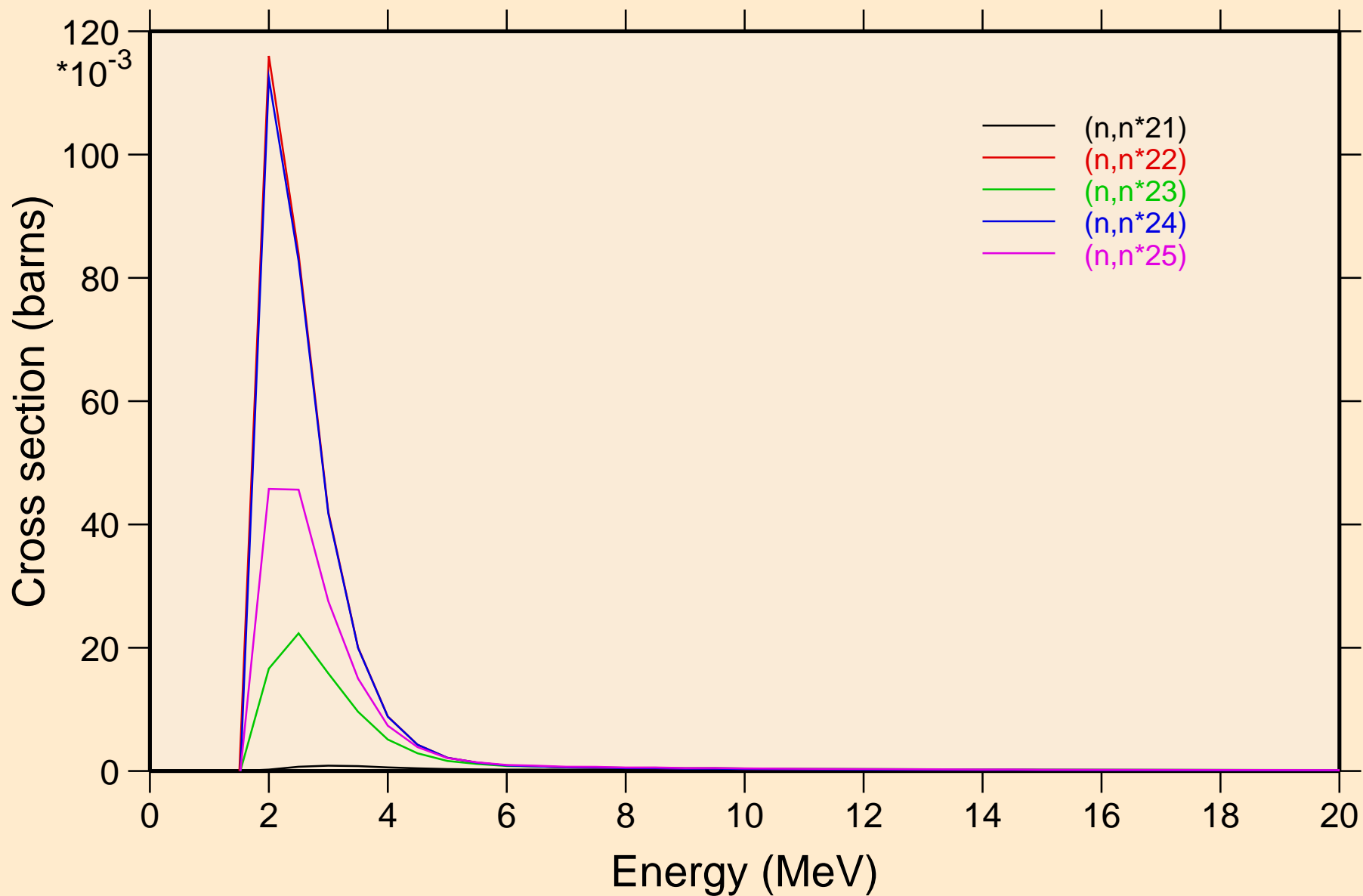

72-HF-178 FOR FENDL-3.2 FROM FENDL-3.2 WITH NJOY2016.60
Inelastic levels

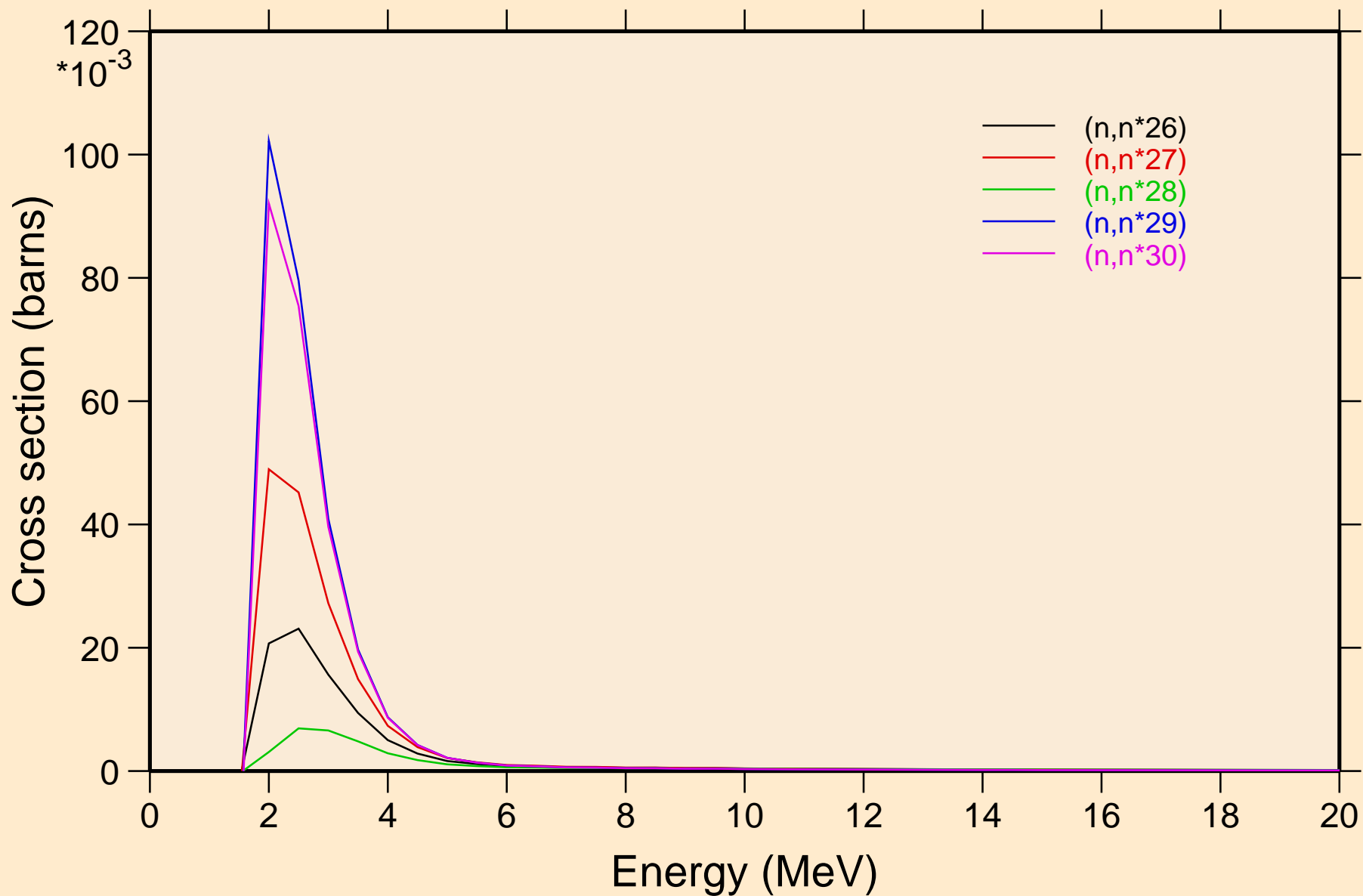

72-HF-178 FOR FENDL-3.2 FROM FENDL-3.2 WITH NJOY2016.60
Inelastic levels

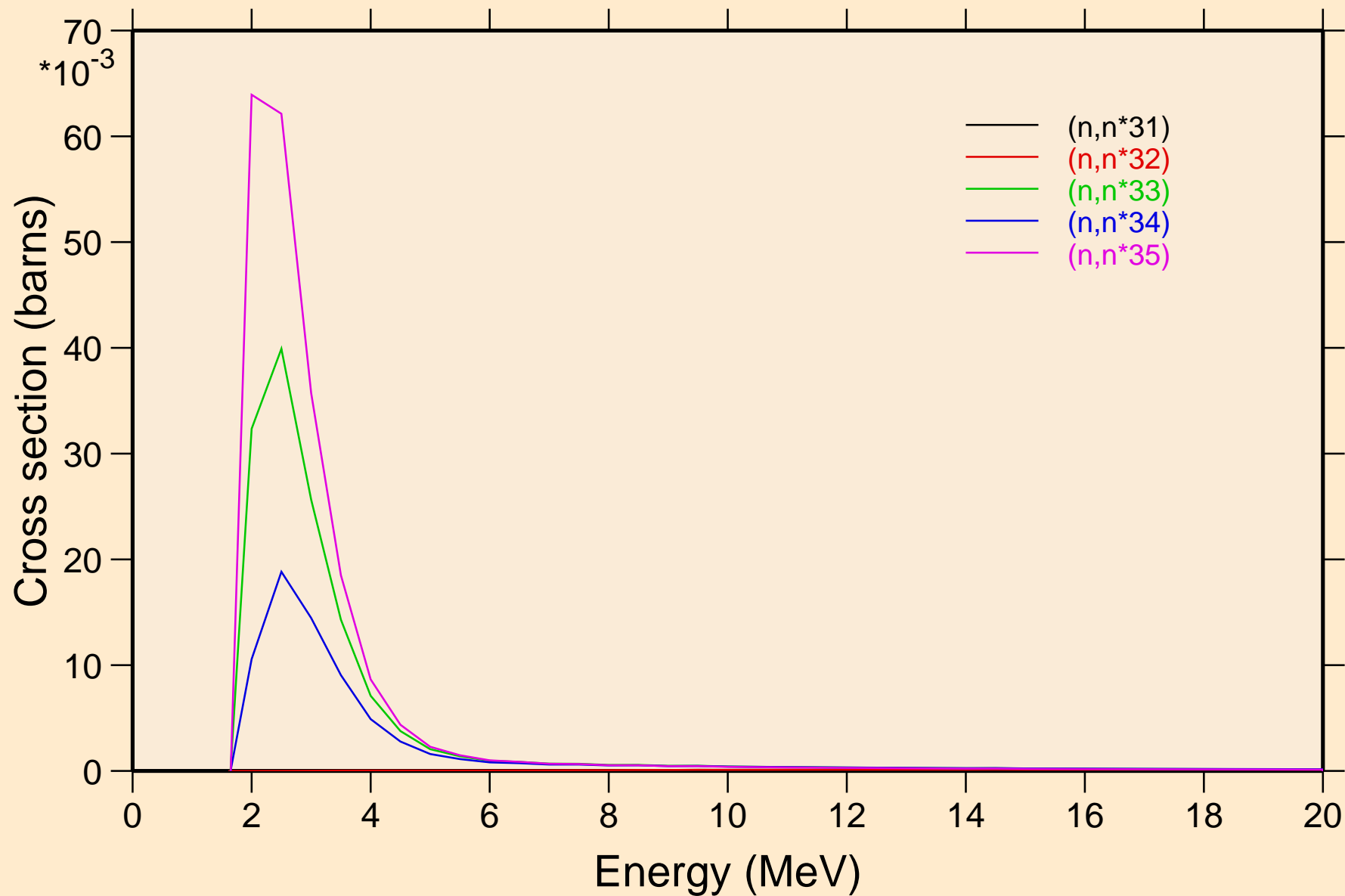

72-HF-178 FOR FENDL-3.2 FROM FENDL-3.2 WITH NJOY2016.60

Inelastic levels

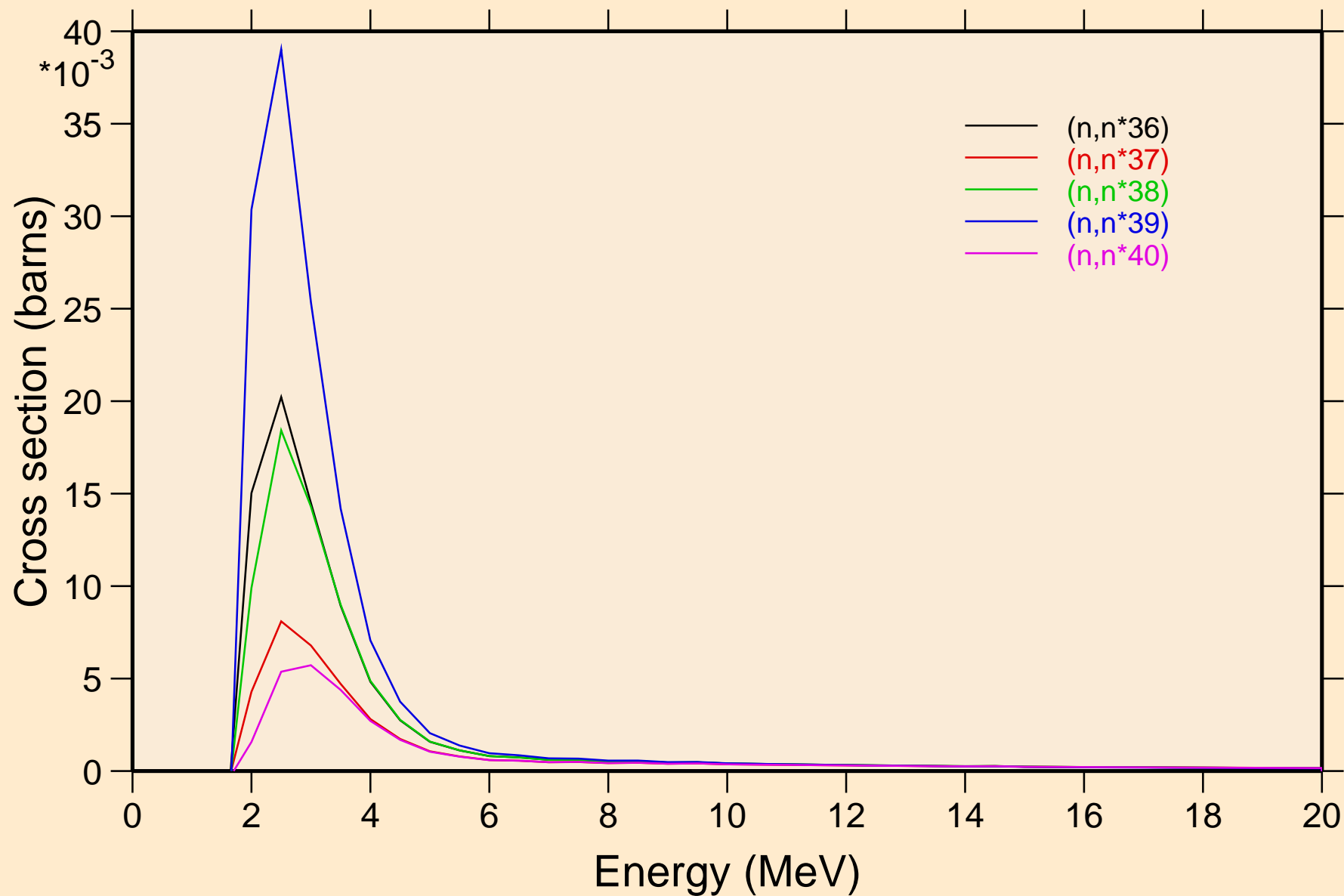

72-HF-178 FOR FENDL-3.2 FROM FENDL-3.2 WITH NJOY2016.60
Threshold reactions

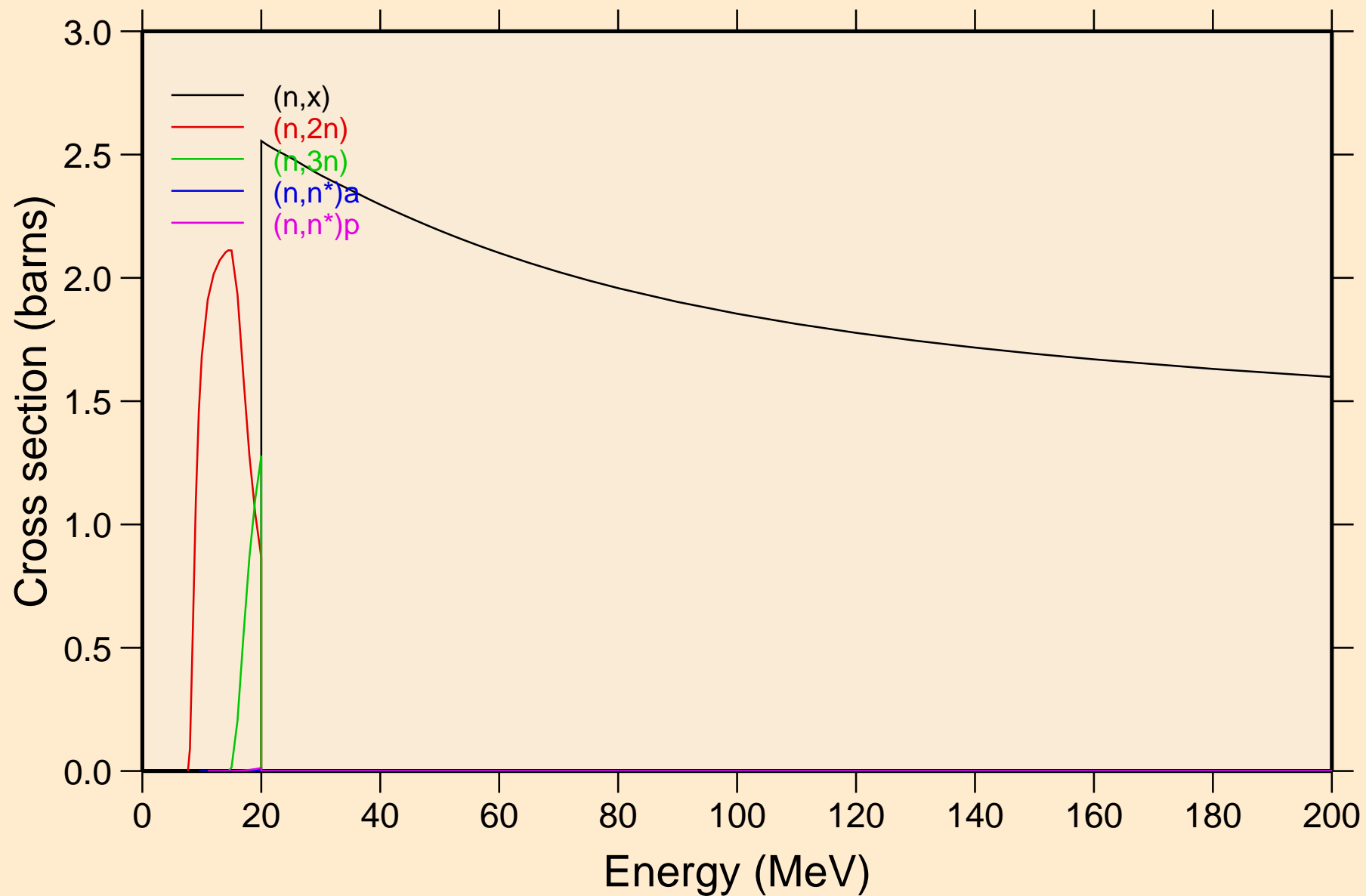

72-HF-178 FOR FENDL-3.2 FROM FENDL-3.2 WITH NJOY2016.60
Threshold reactions

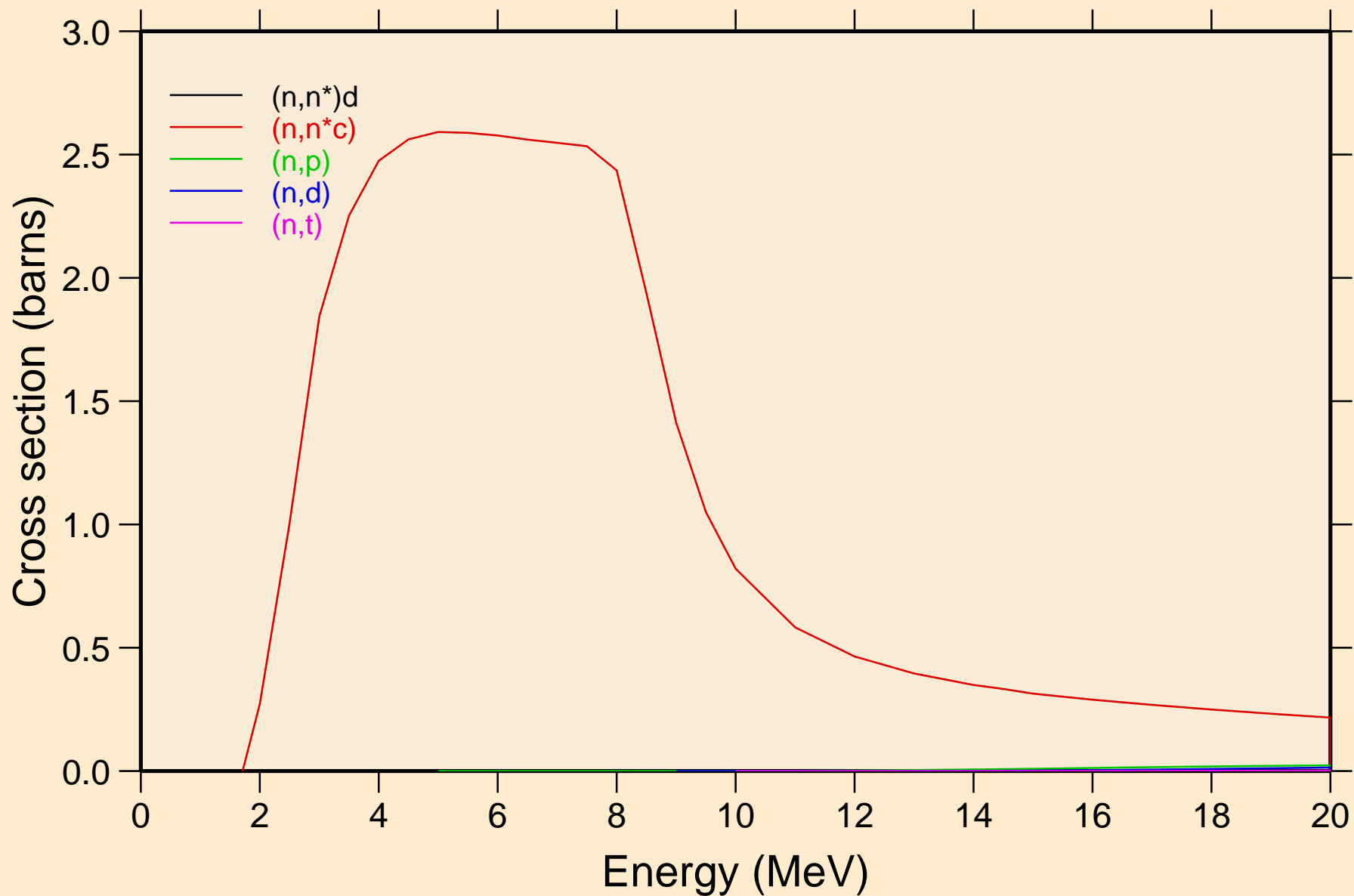

72-HF-178 FOR FENDL-3.2 FROM FENDL-3.2 WITH NJOY2016.60
Threshold reactions

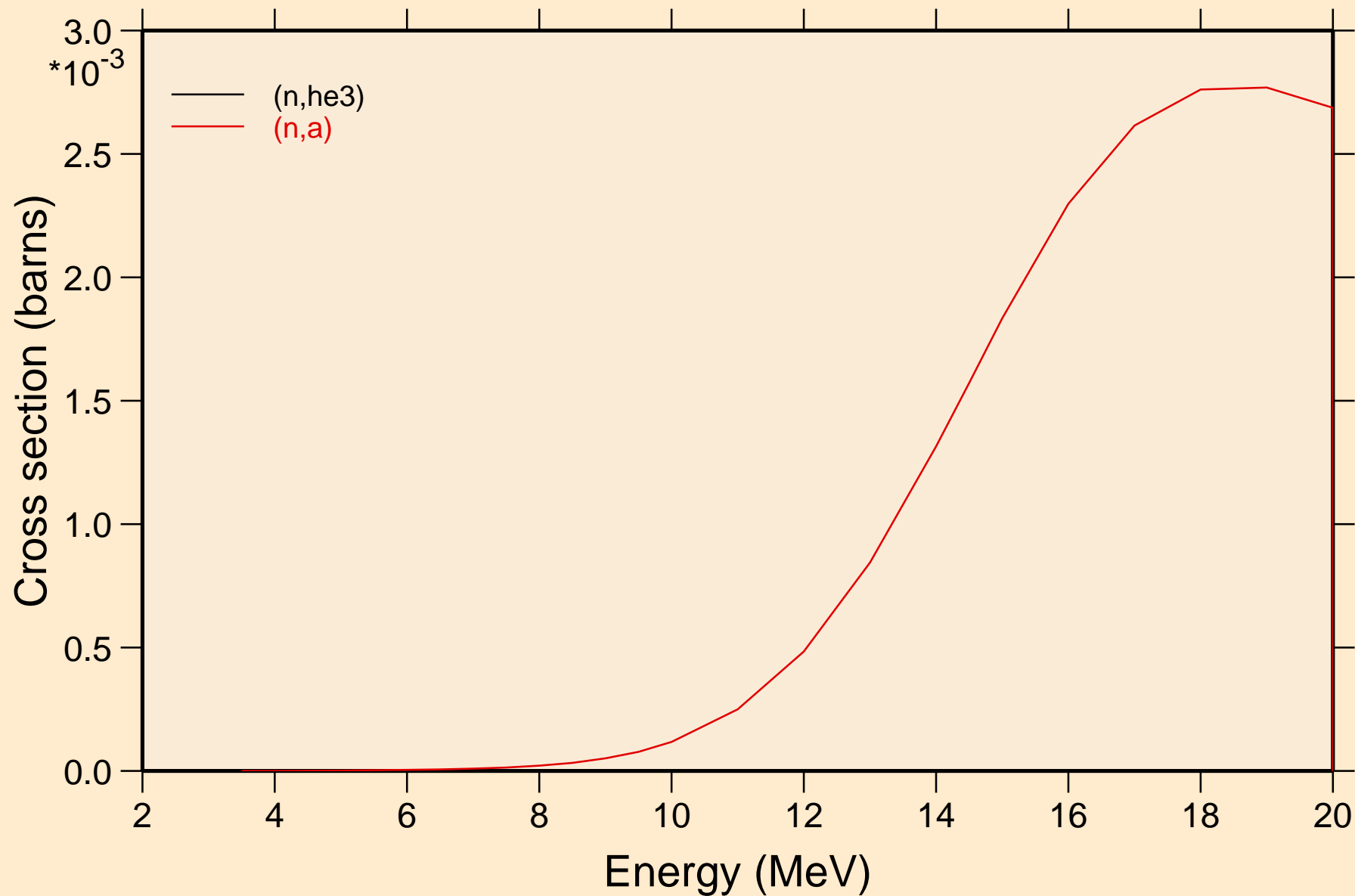

72-HF-178 FOR FENDL-3.2 FROM FENDL-3.2 WITH NJOY2016.60
Threshold reactions

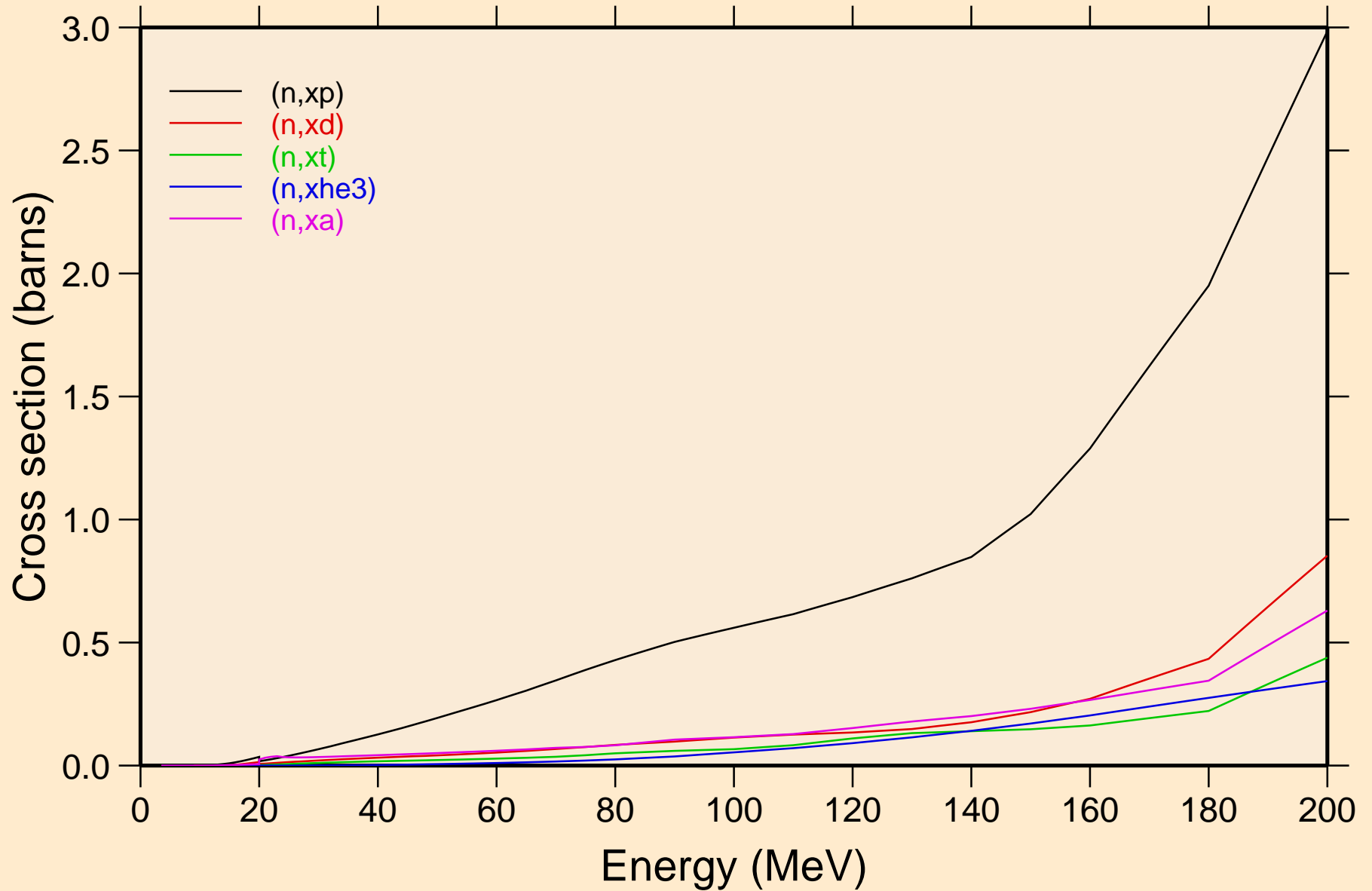

72-HF-178 FOR FENDL-3.2 FROM FENDL-3.2 WITH NJOY2016.60
angular distribution for elastic

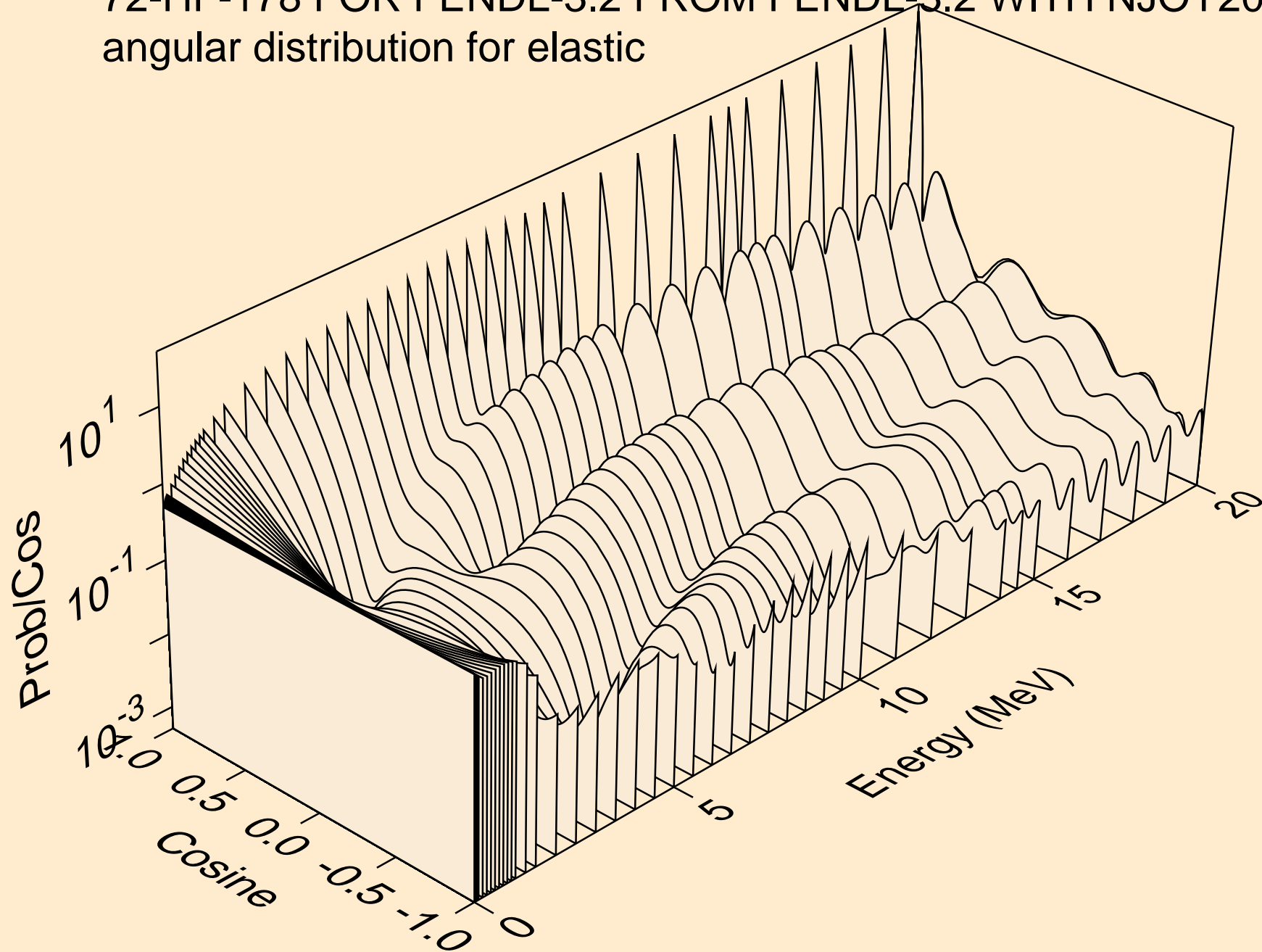

72-HF-178 FOR FENDL-3.2 FROM FENDL-3.2 WITH NJOY2016.60
angular distribution for elastic

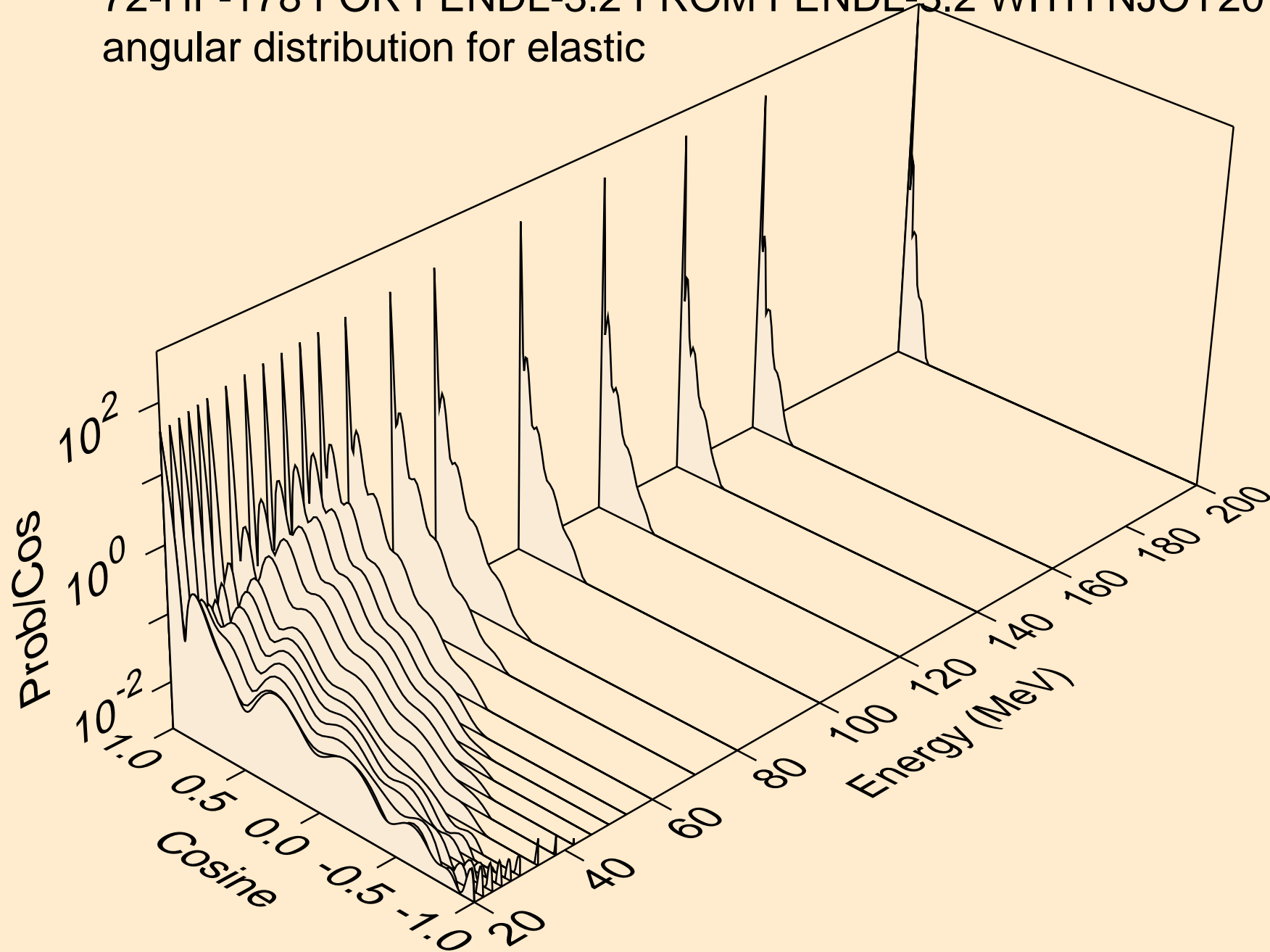

72-HF-178 FOR FENDL-3.2 FROM FENDL-3.2 WITH NJOY2016.60
angular distribution for (n,n*1)

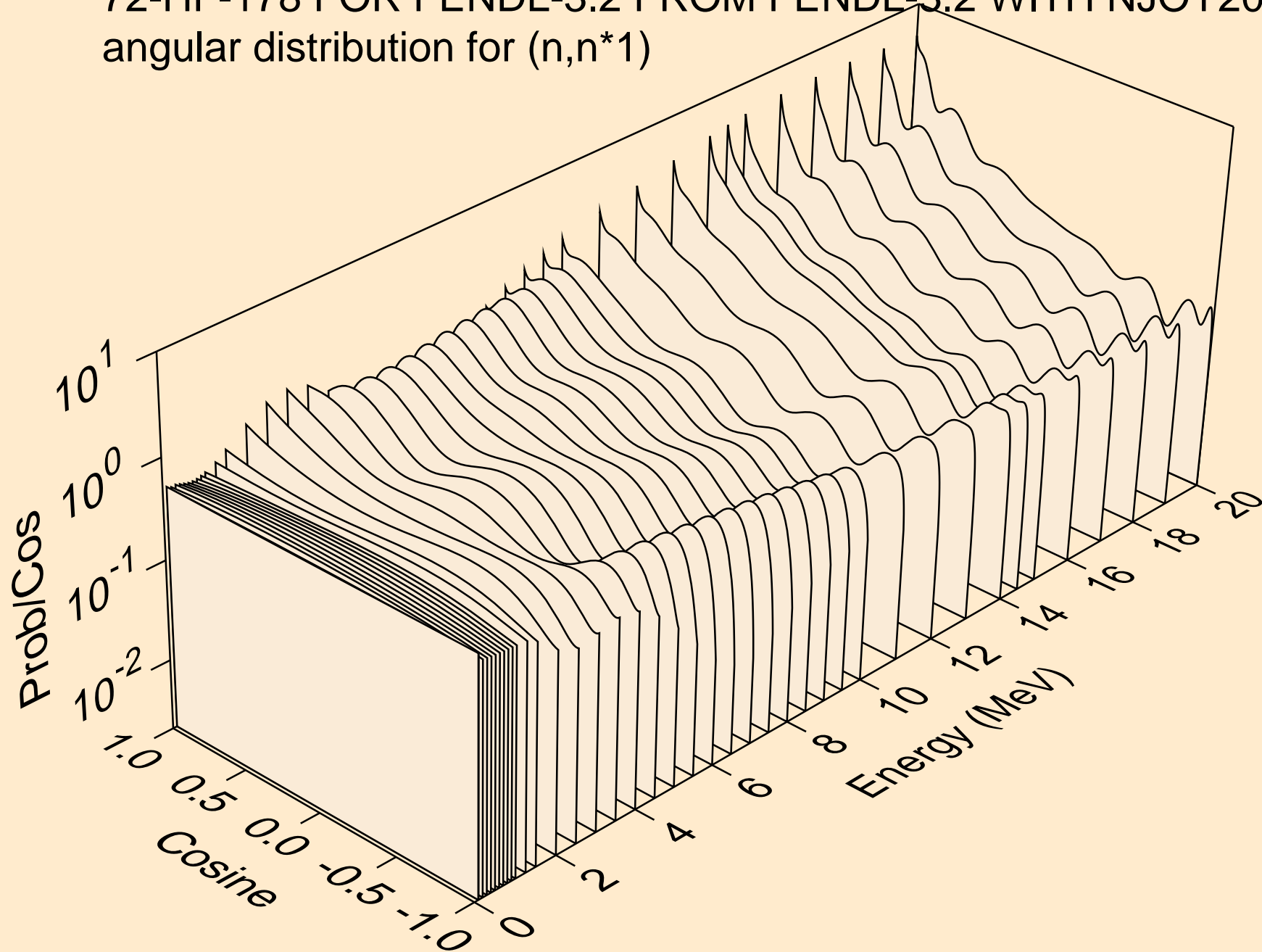

72-HF-178 FOR FENDL-3.2 FROM FENDL-3.2 WITH NJOY2016.60
angular distribution for (n,n*2)

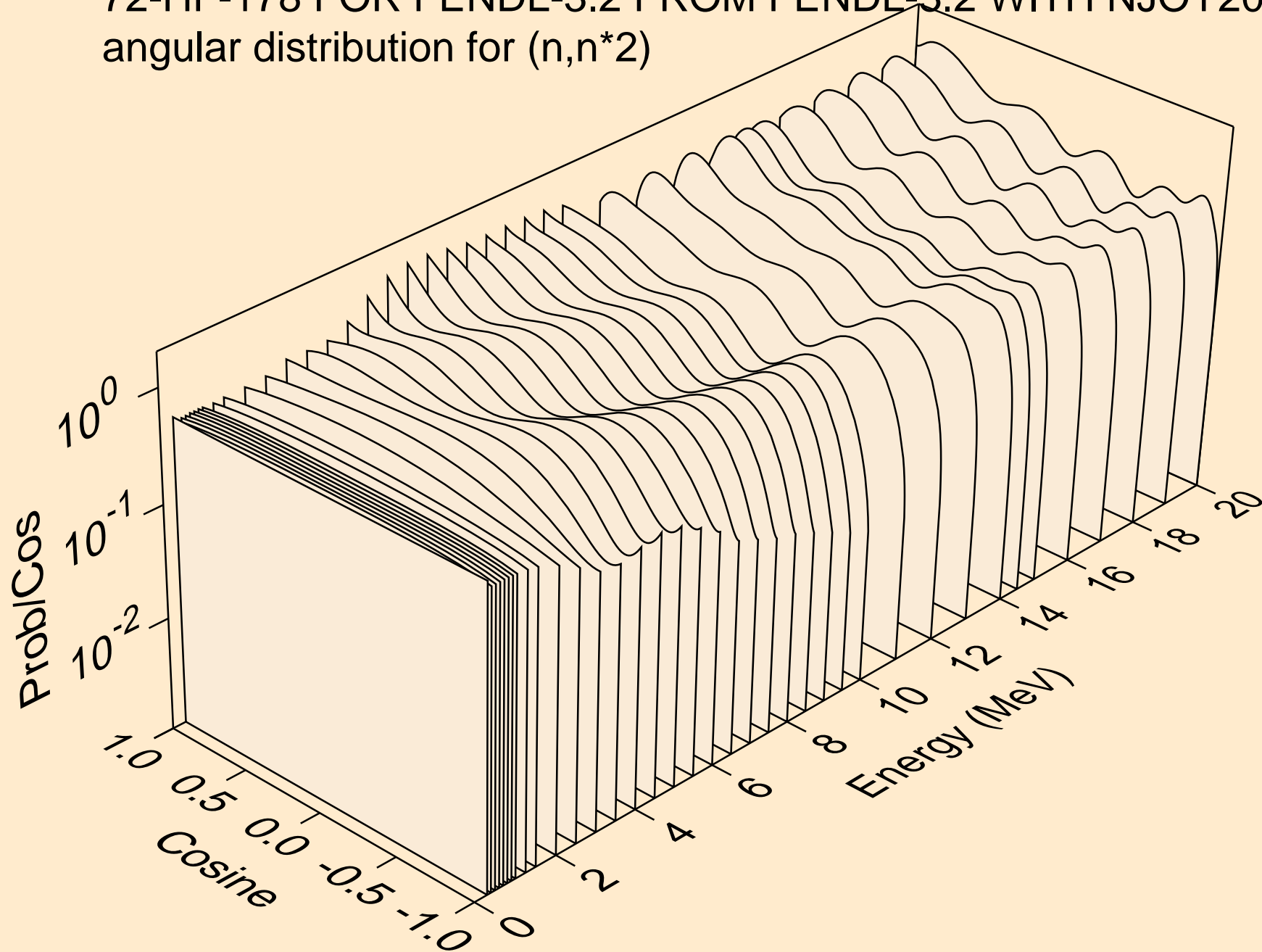

72-HF-178 FOR FENDL-3.2 FROM FENDL-3.2 WITH NJOY2016.60
angular distribution for (n,n*3)

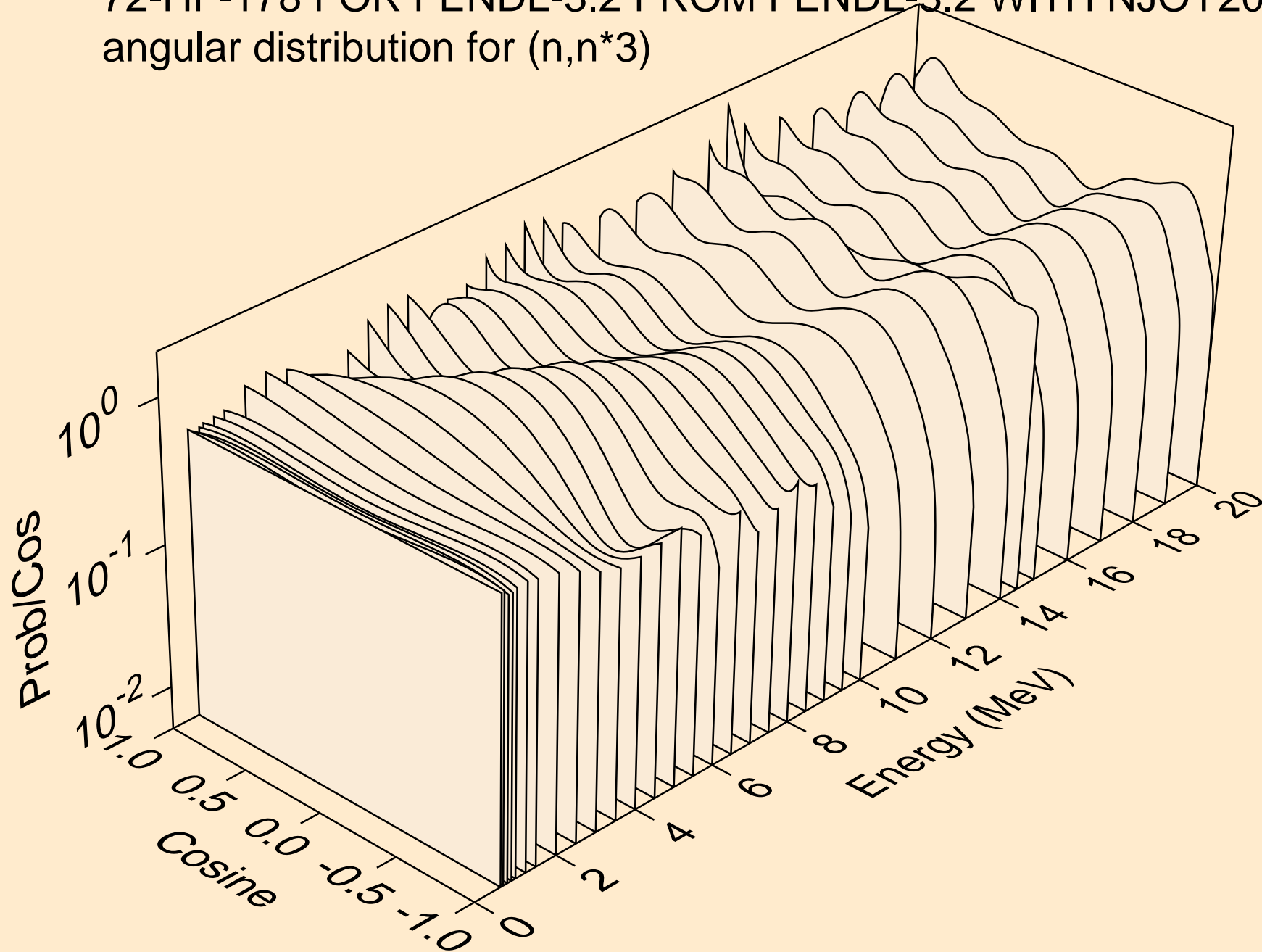

72-HF-178 FOR FENDL-3.2 FROM FENDL-3.2 WITH NJOY2016.60
angular distribution for (n,n*4)

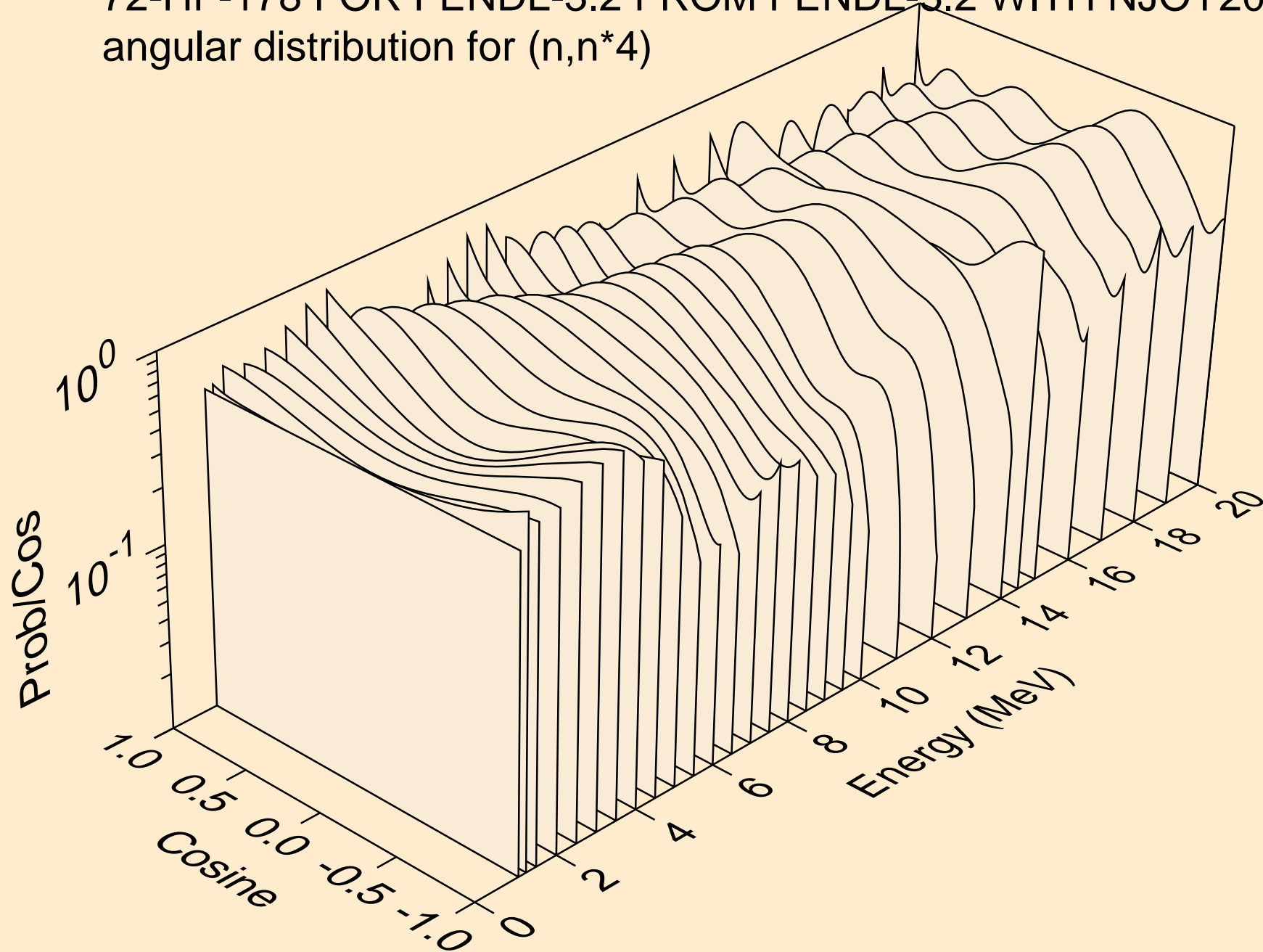

72-HF-178 FOR FENDL-3.2 FROM FENDL-3.2 WITH NJOY2016.60
angular distribution for (n,n*5)

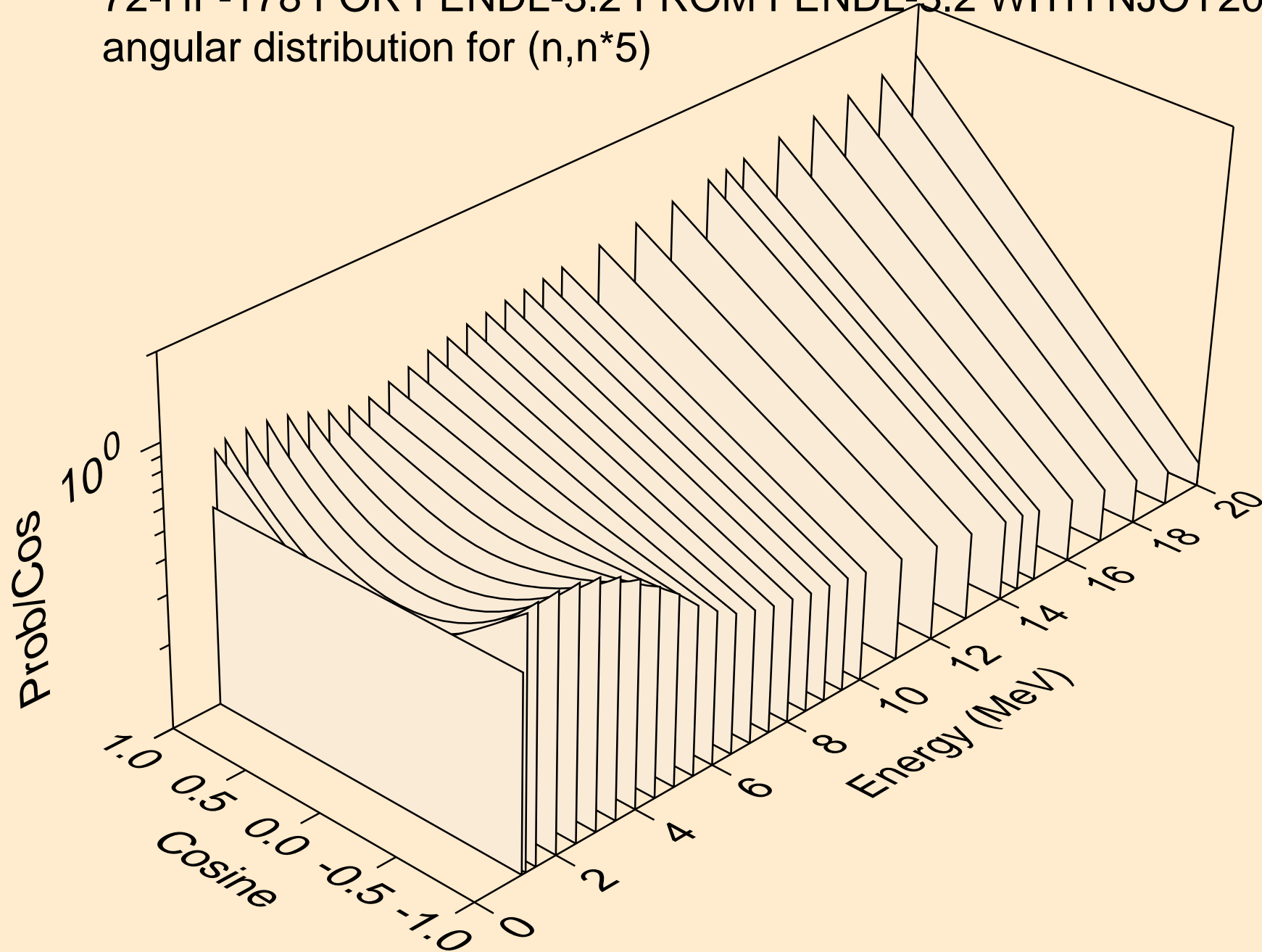

72-HF-178 FOR FENDL-3.2 FROM FENDL-3.2 WITH NJOY2016.60
angular distribution for (n,n*6)

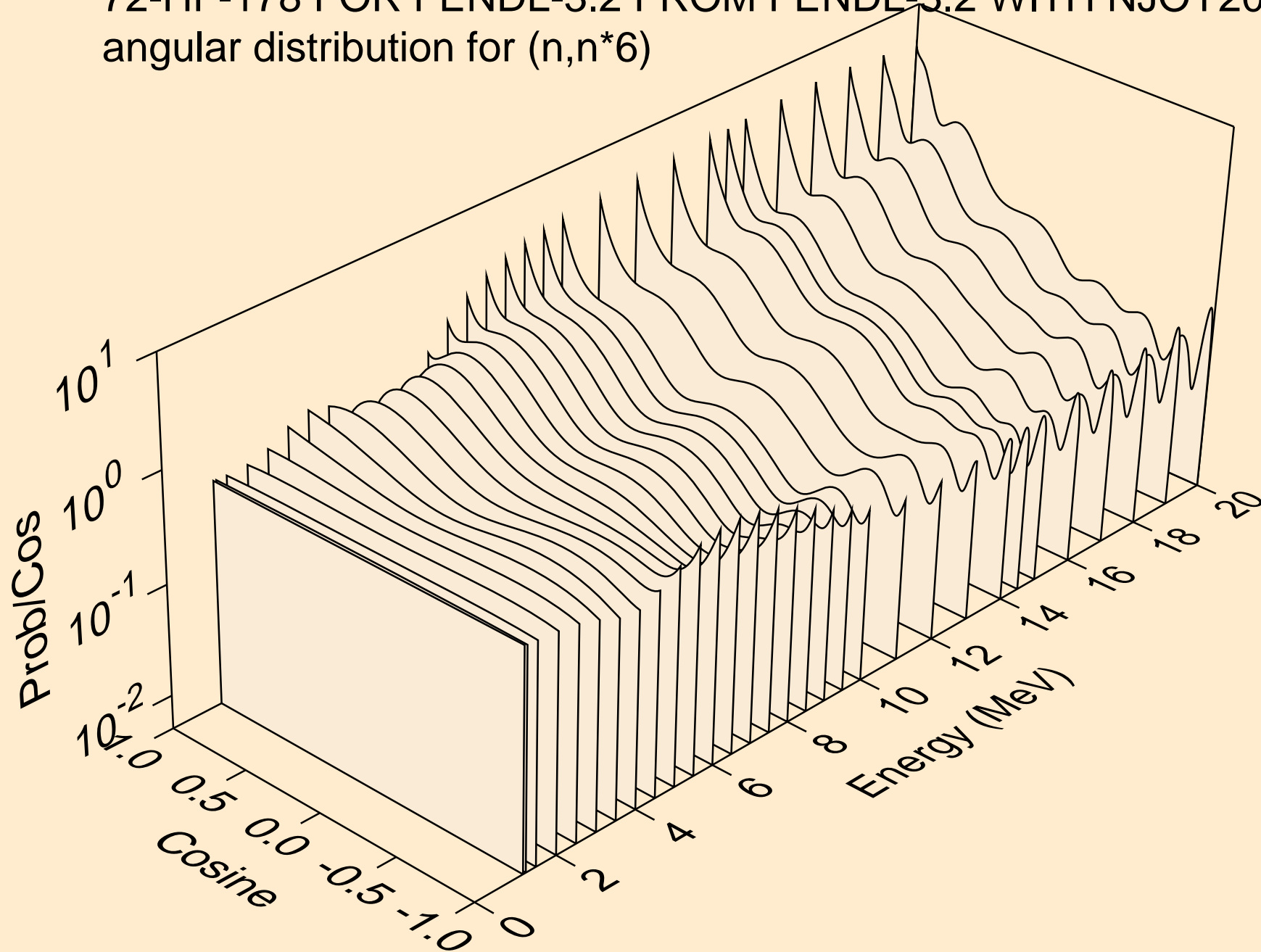

72-HF-178 FOR FENDL-3.2 FROM FENDL-3.2 WITH NJOY2016.60
angular distribution for (n,n*7)

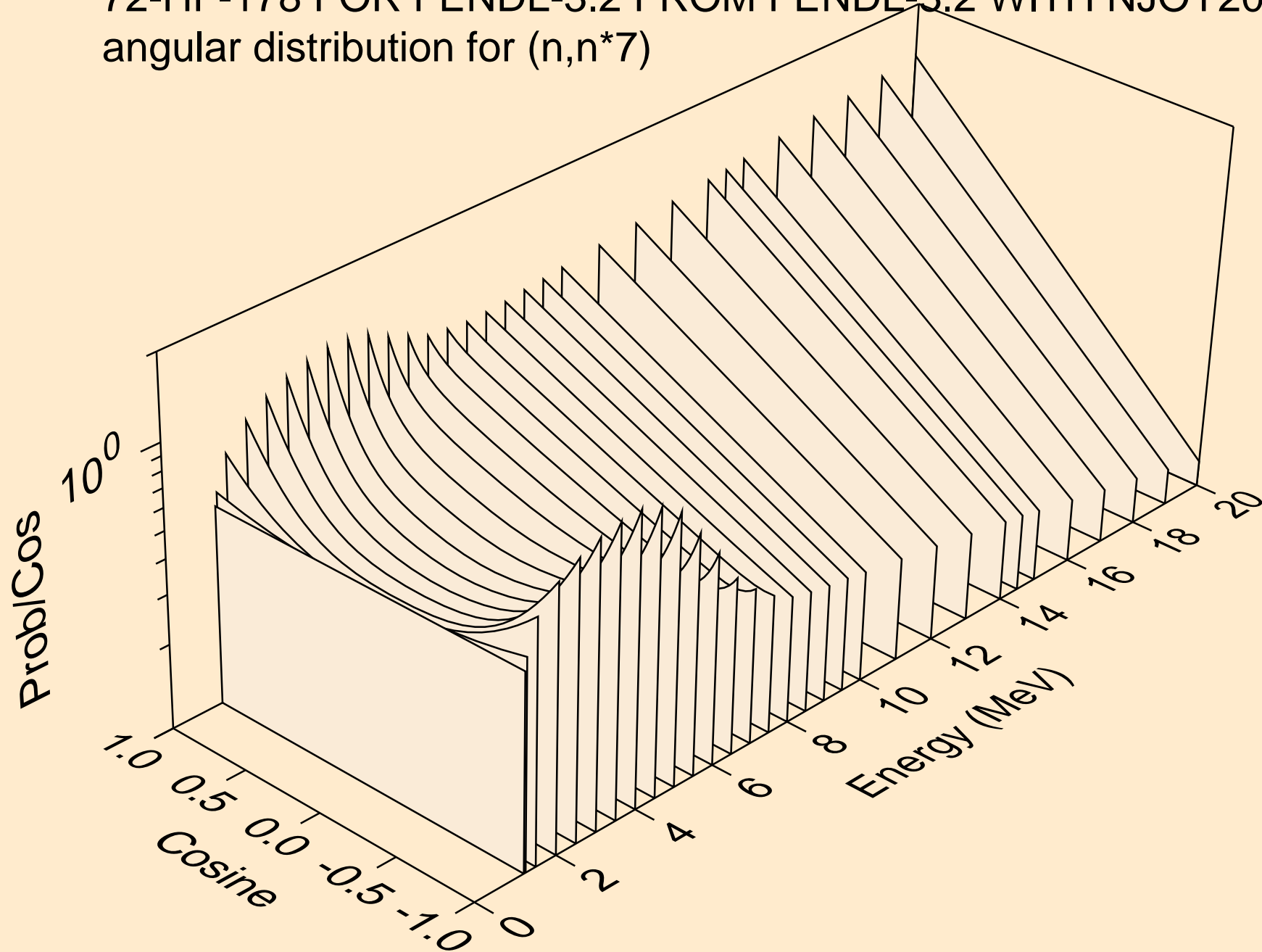

72-HF-178 FOR FENDL-3.2 FROM FENDL-3.2 WITH NJOY2016.60
angular distribution for (n,n*8)

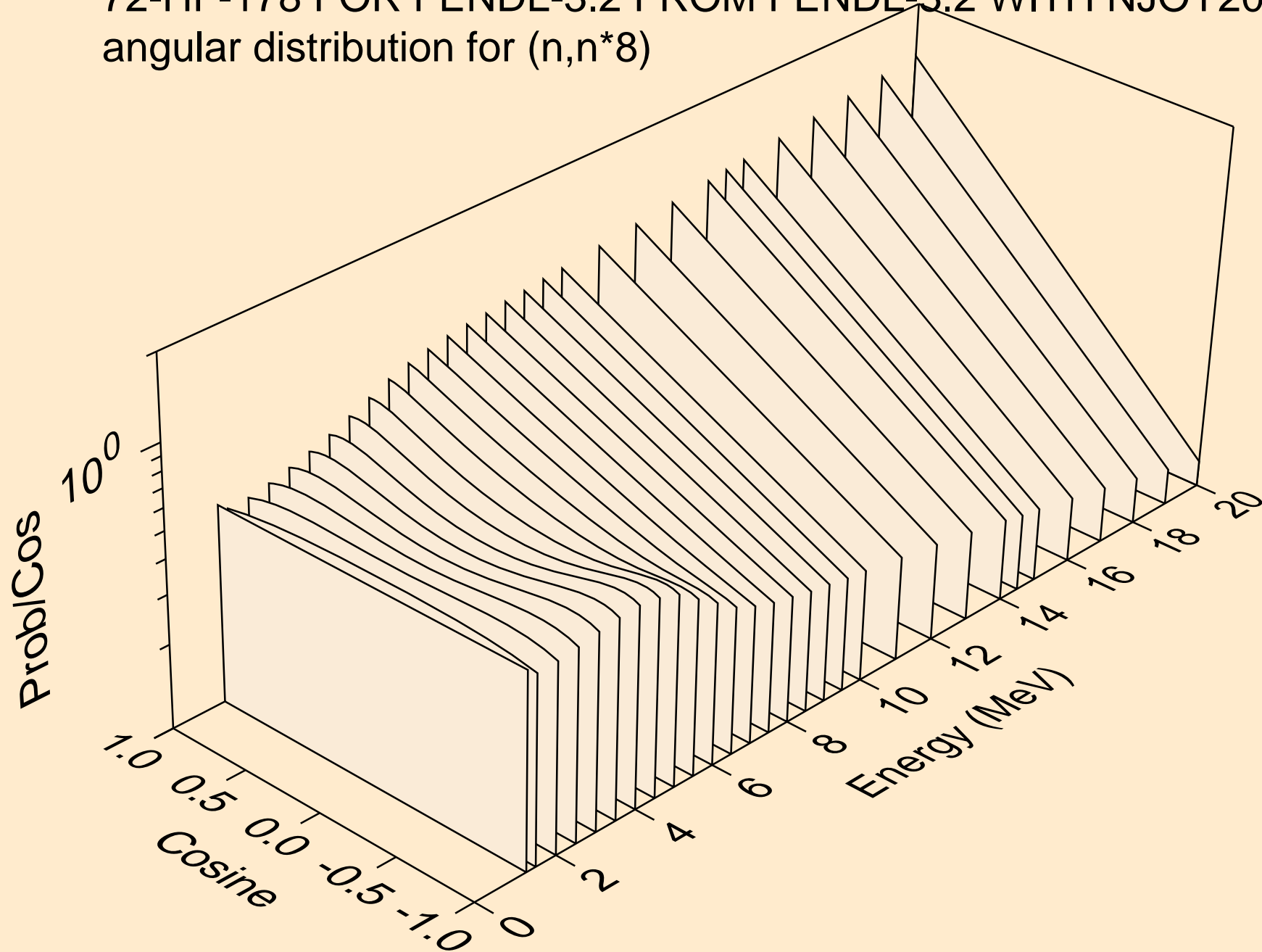

72-HF-178 FOR FENDL-3.2 FROM FENDL-3.2 WITH NJOY2016.60
angular distribution for (n,n*9)

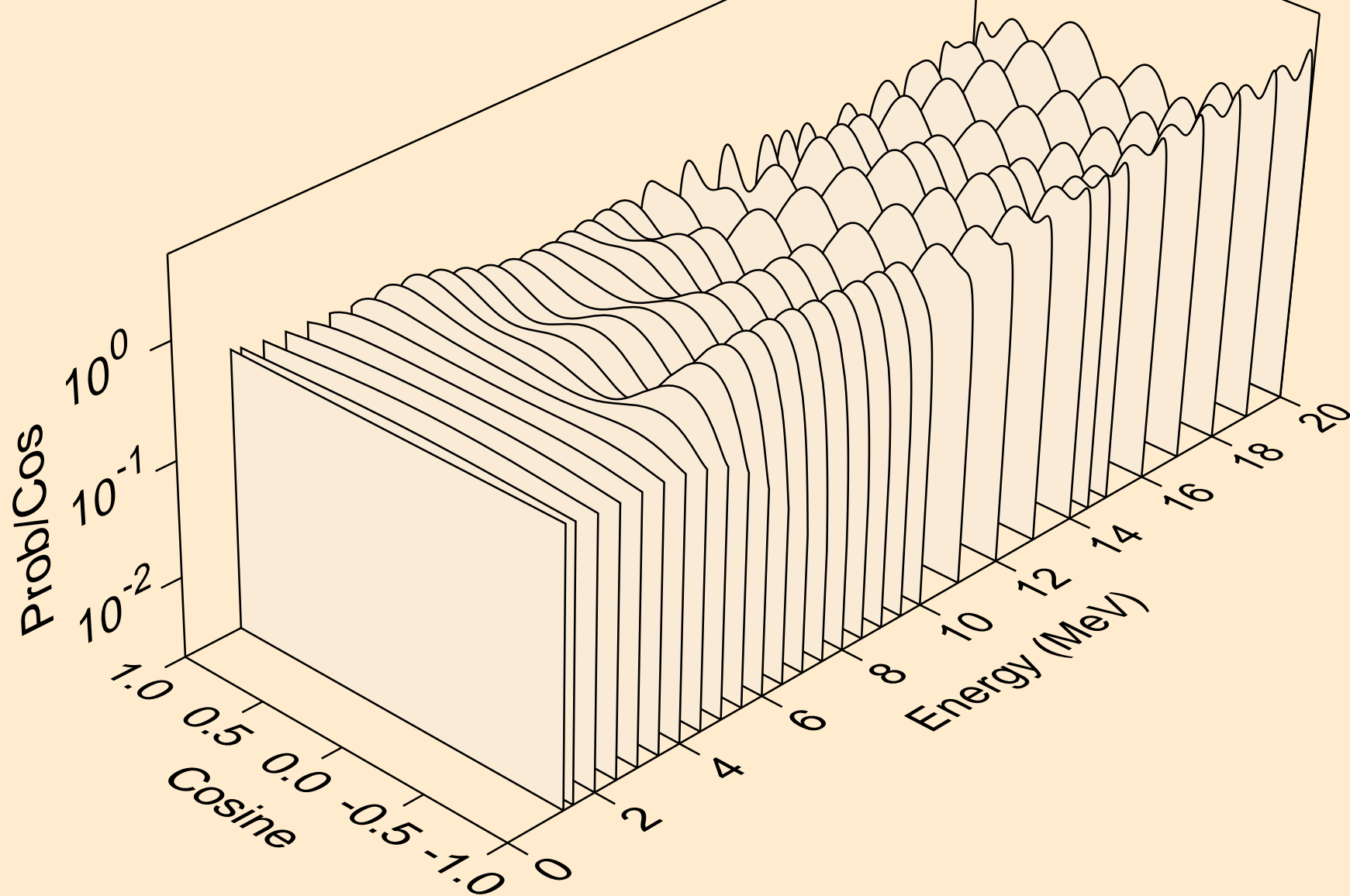

72-HF-178 FOR FENDL-3.2 FROM FENDL-3.2 WITH NJOY2016.60
angular distribution for (n,n*10)

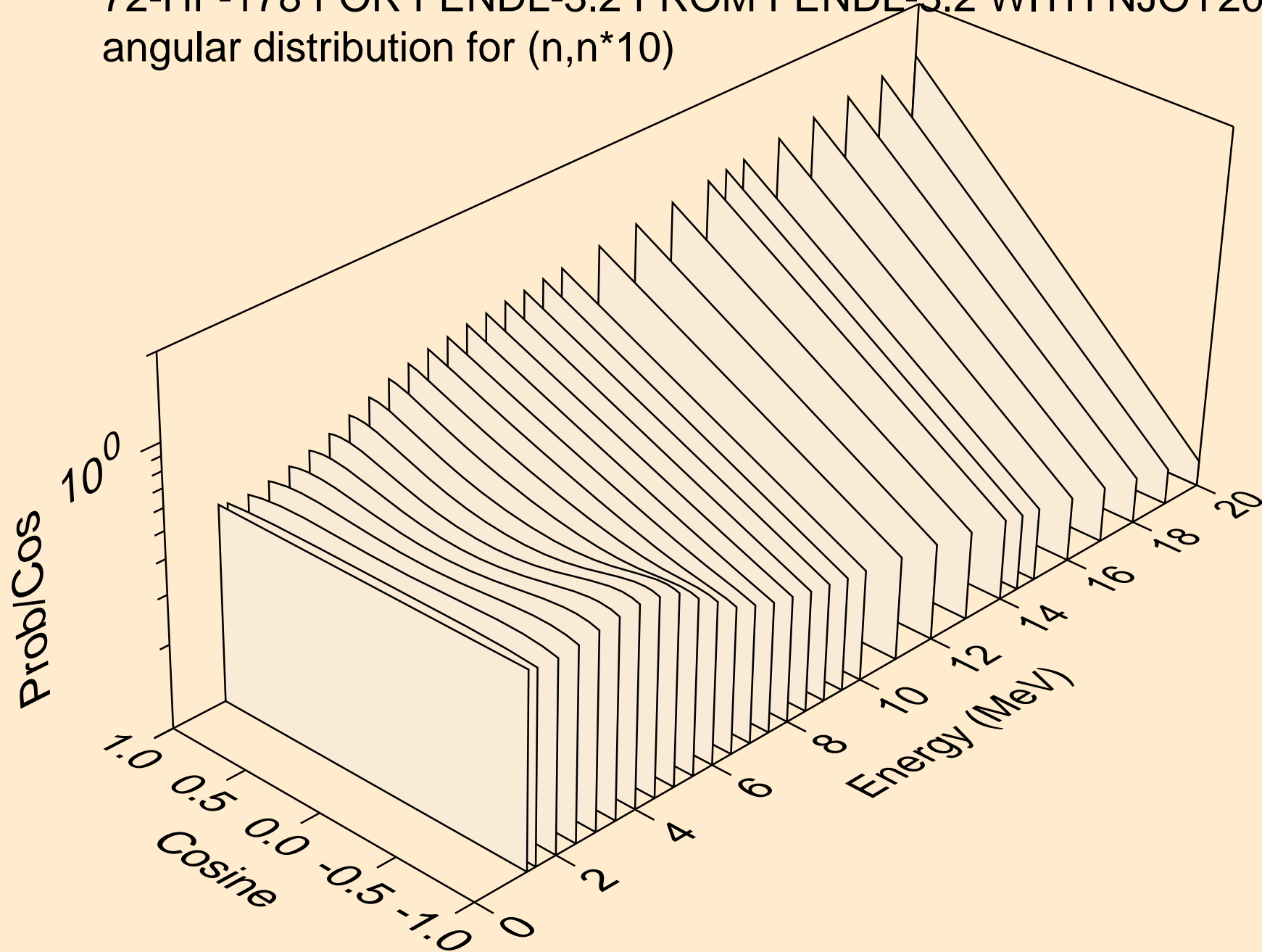

72-HF-178 FOR FENDL-3.2 FROM FENDL-3.2 WITH NJOY2016.60
angular distribution for (n,n*11)

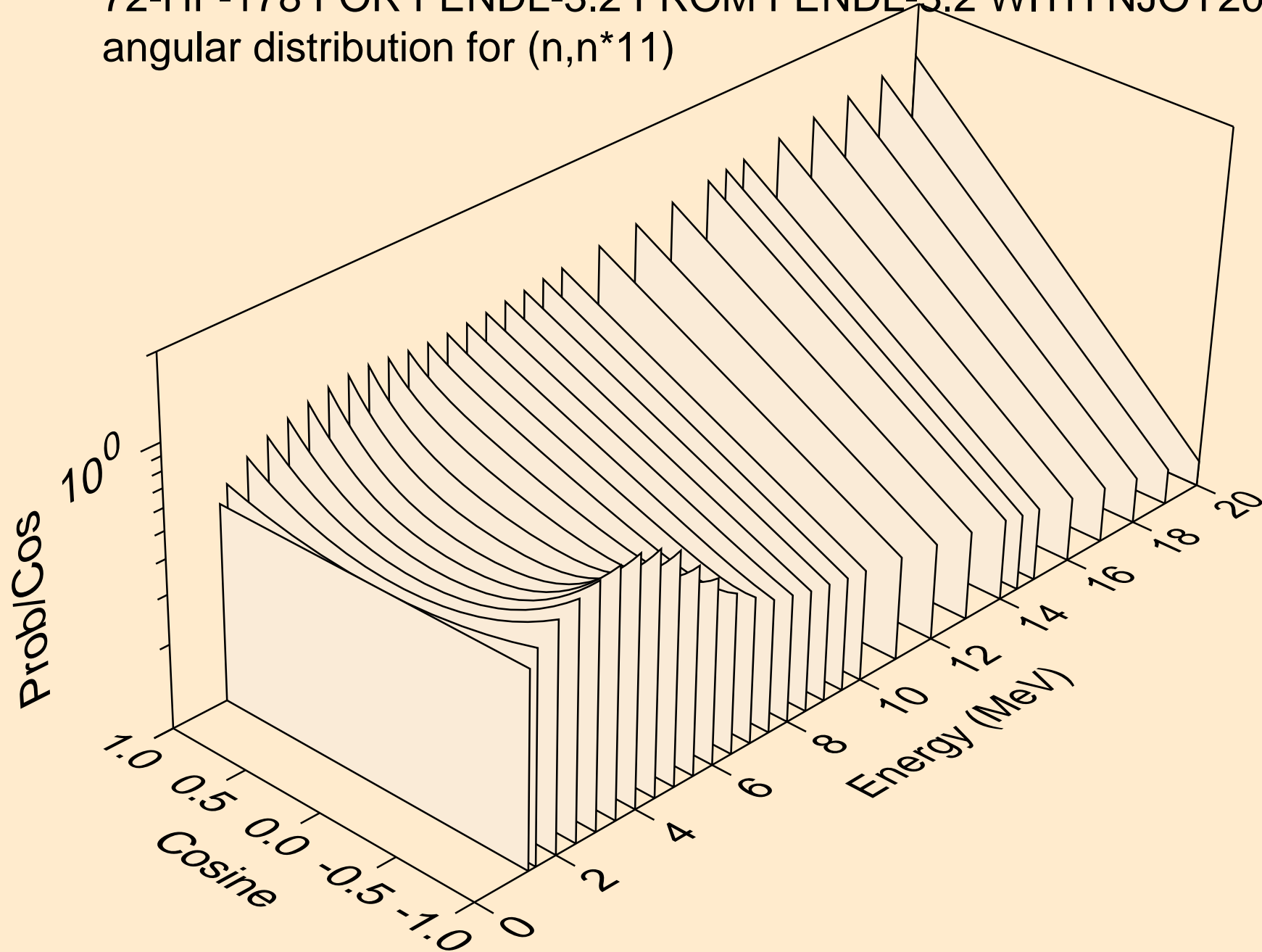

72-HF-178 FOR FENDL-3.2 FROM FENDL-3.2 WITH NJOY2016.60
angular distribution for (n,n*12)

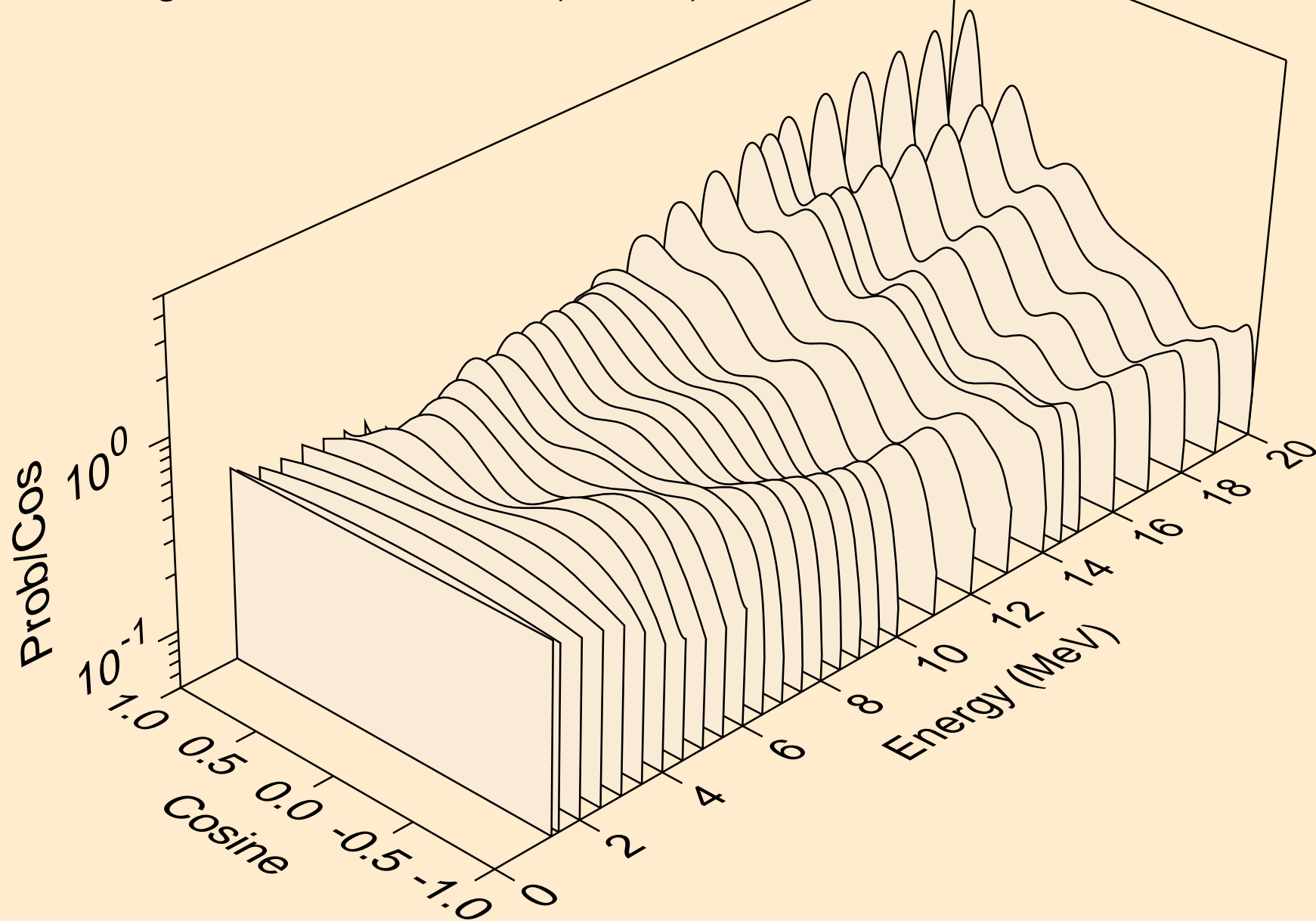

72-HF-178 FOR FENDL-3.2 FROM FENDL-3.2 WITH NJOY2016.60
angular distribution for (n,n*13)

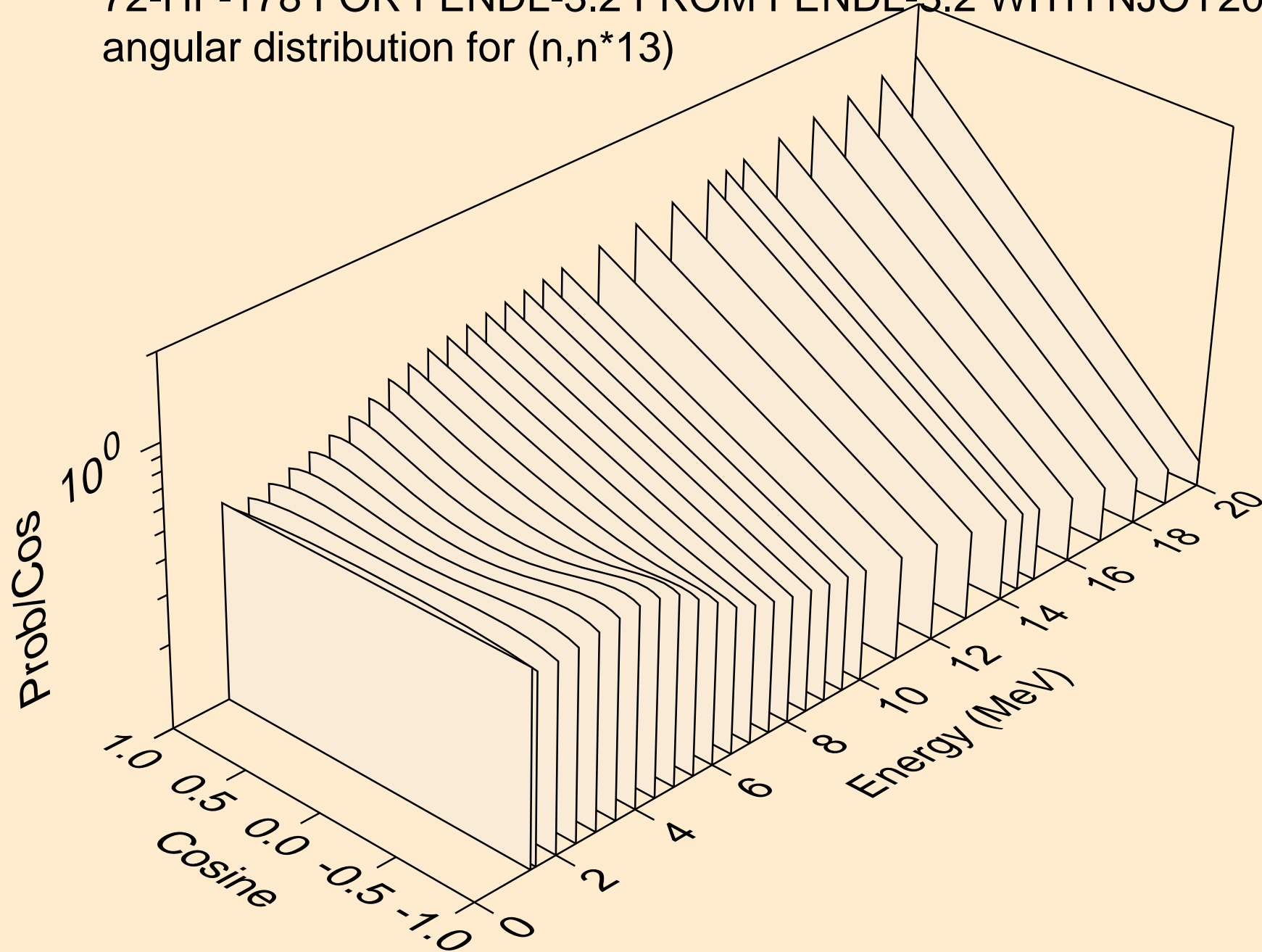

72-HF-178 FOR FENDL-3.2 FROM FENDL-3.2 WITH NJOY2016.60
angular distribution for (n,n*14)

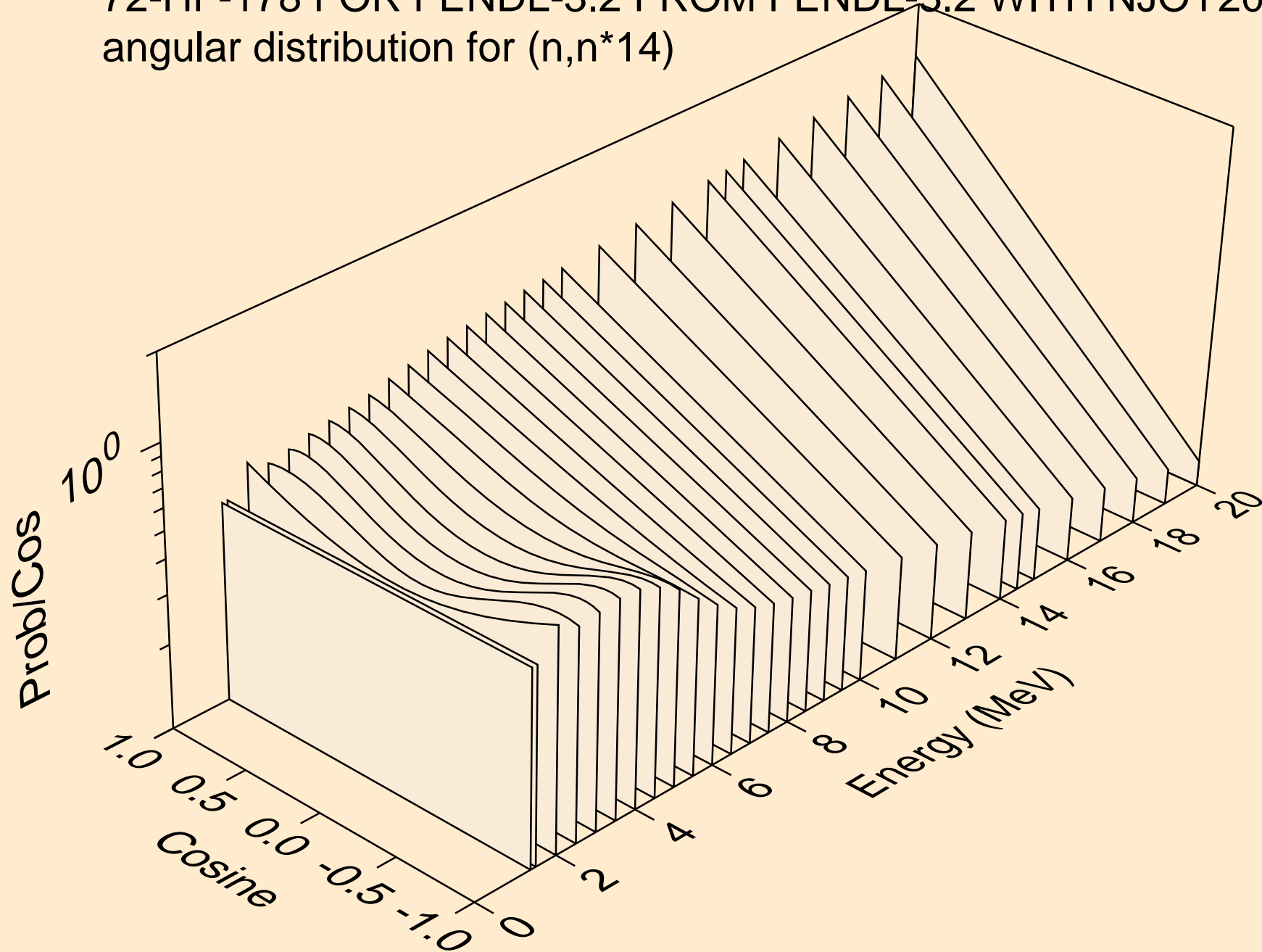

72-HF-178 FOR FENDL-3.2 FROM FENDL-3.2 WITH NJOY2016.60
angular distribution for (n,n*15)

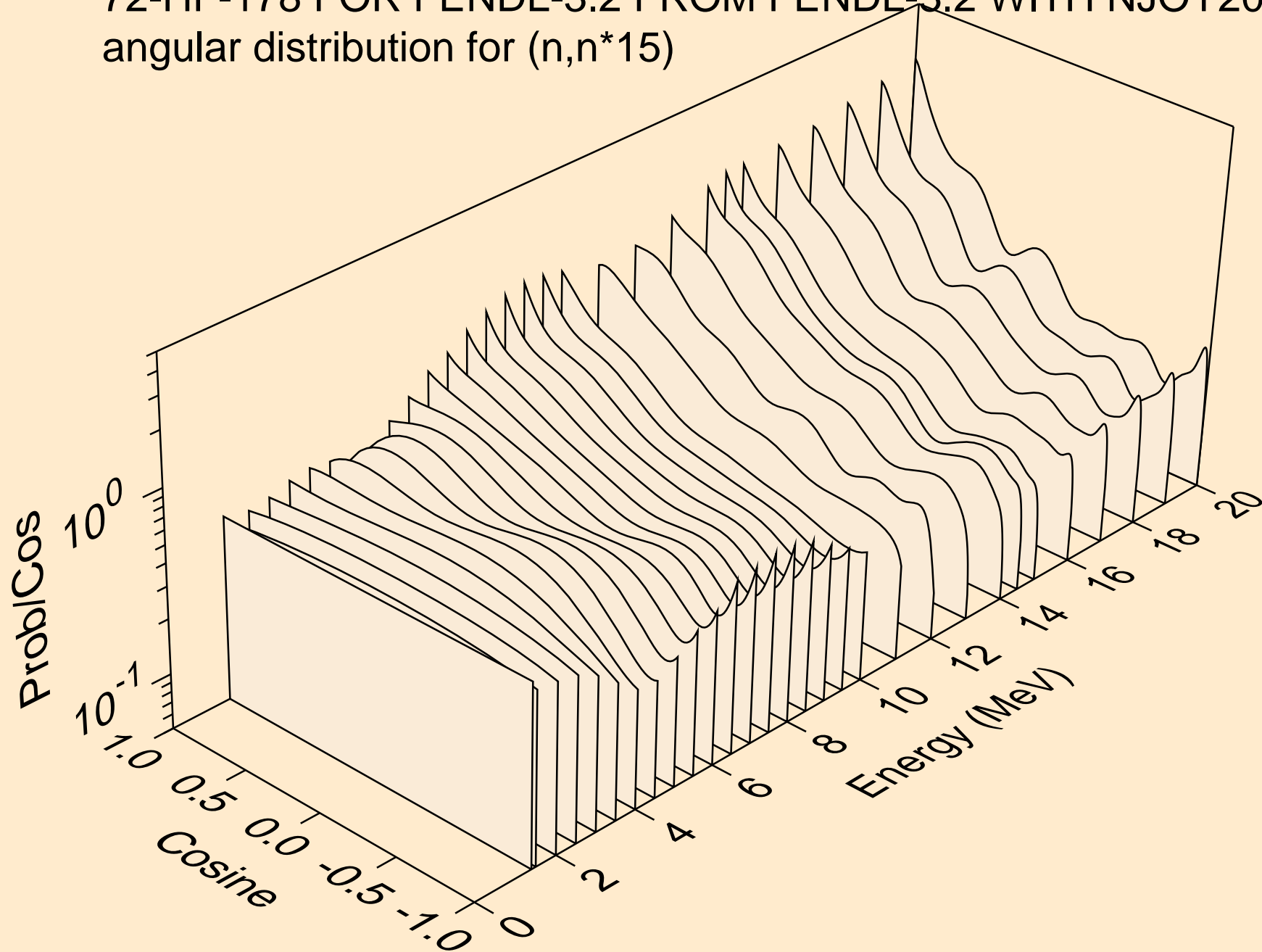

72-HF-178 FOR FENDL-3.2 FROM FENDL-3.2 WITH NJOY2016.60
angular distribution for (n,n*16)

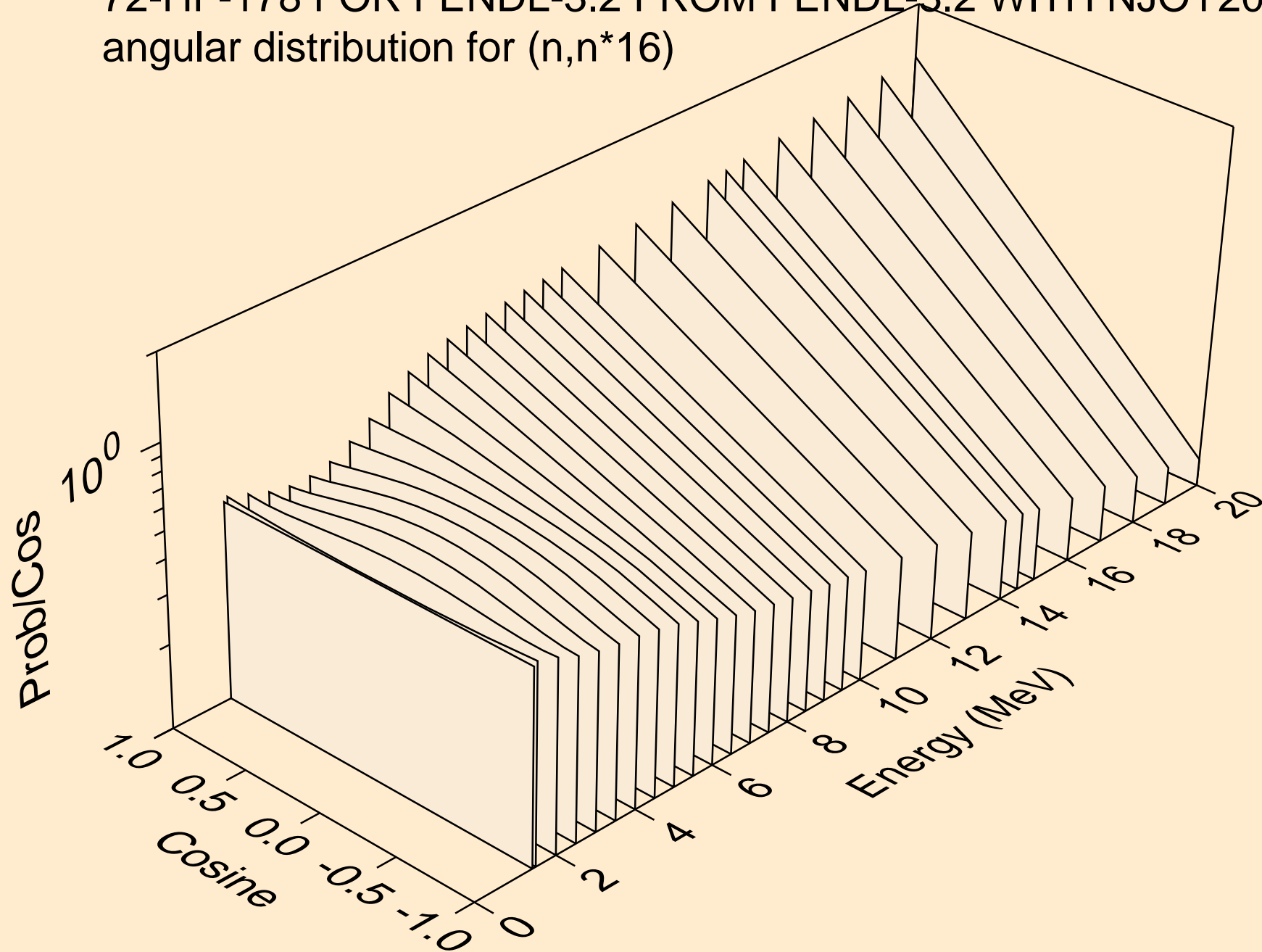

72-HF-178 FOR FENDL-3.2 FROM FENDL-3.2 WITH NJOY2016.60
angular distribution for (n,n*17)

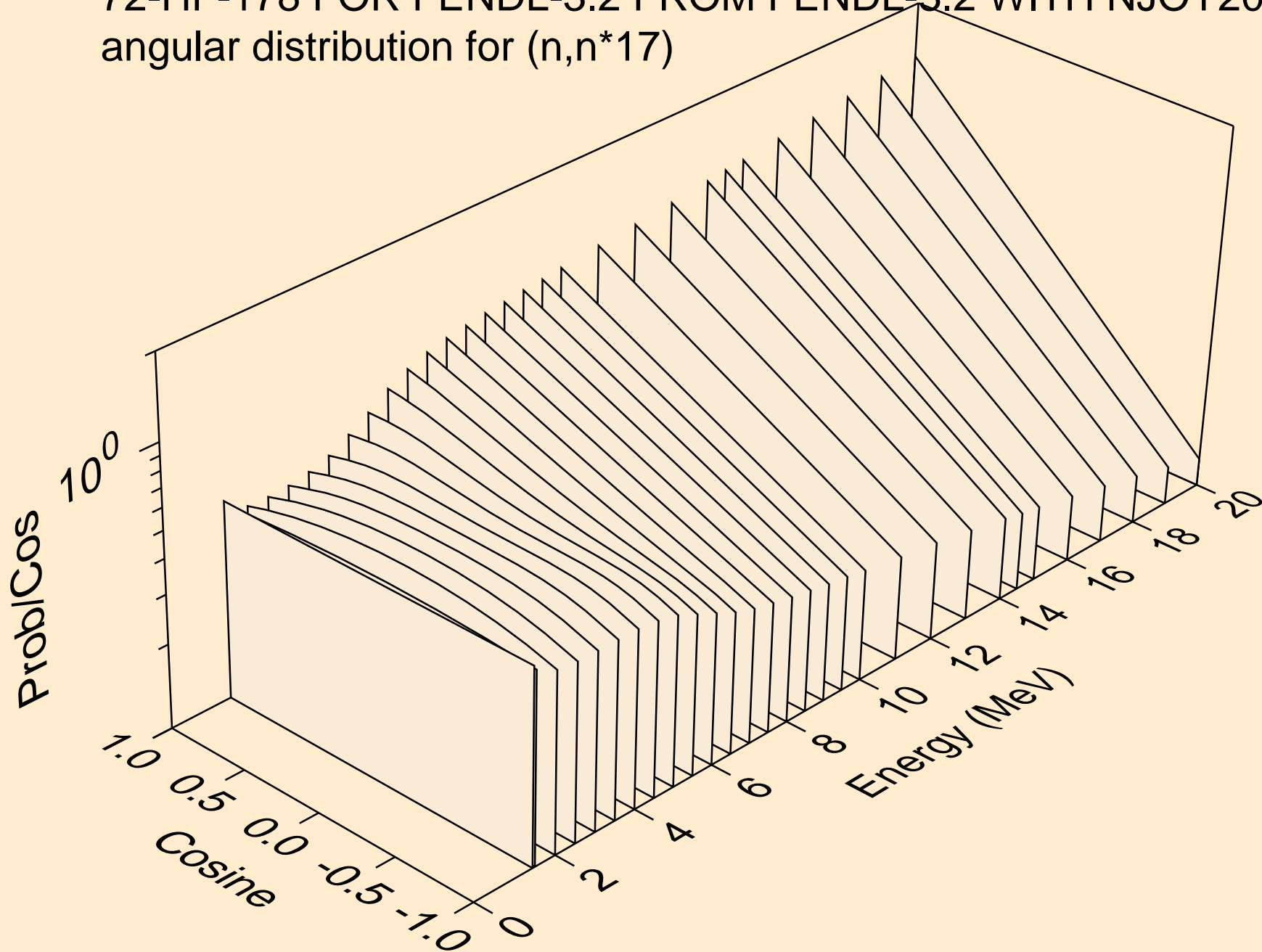

72-HF-178 FOR FENDL-3.2 FROM FENDL-3.2 WITH NJOY2016.60
angular distribution for (n,n*18)

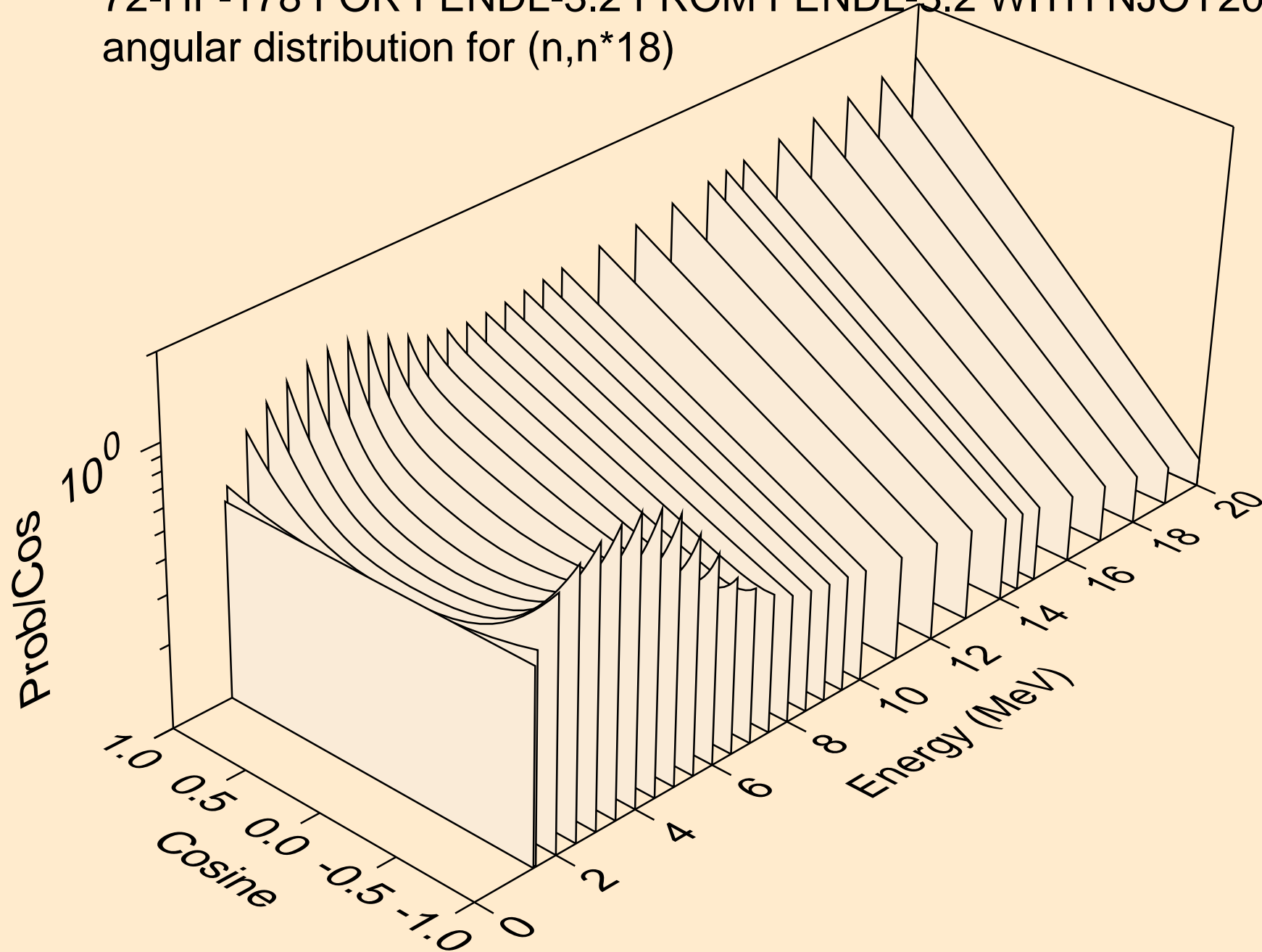

72-HF-178 FOR FENDL-3.2 FROM FENDL-3.2 WITH NJOY2016.60
angular distribution for (n,n*19)

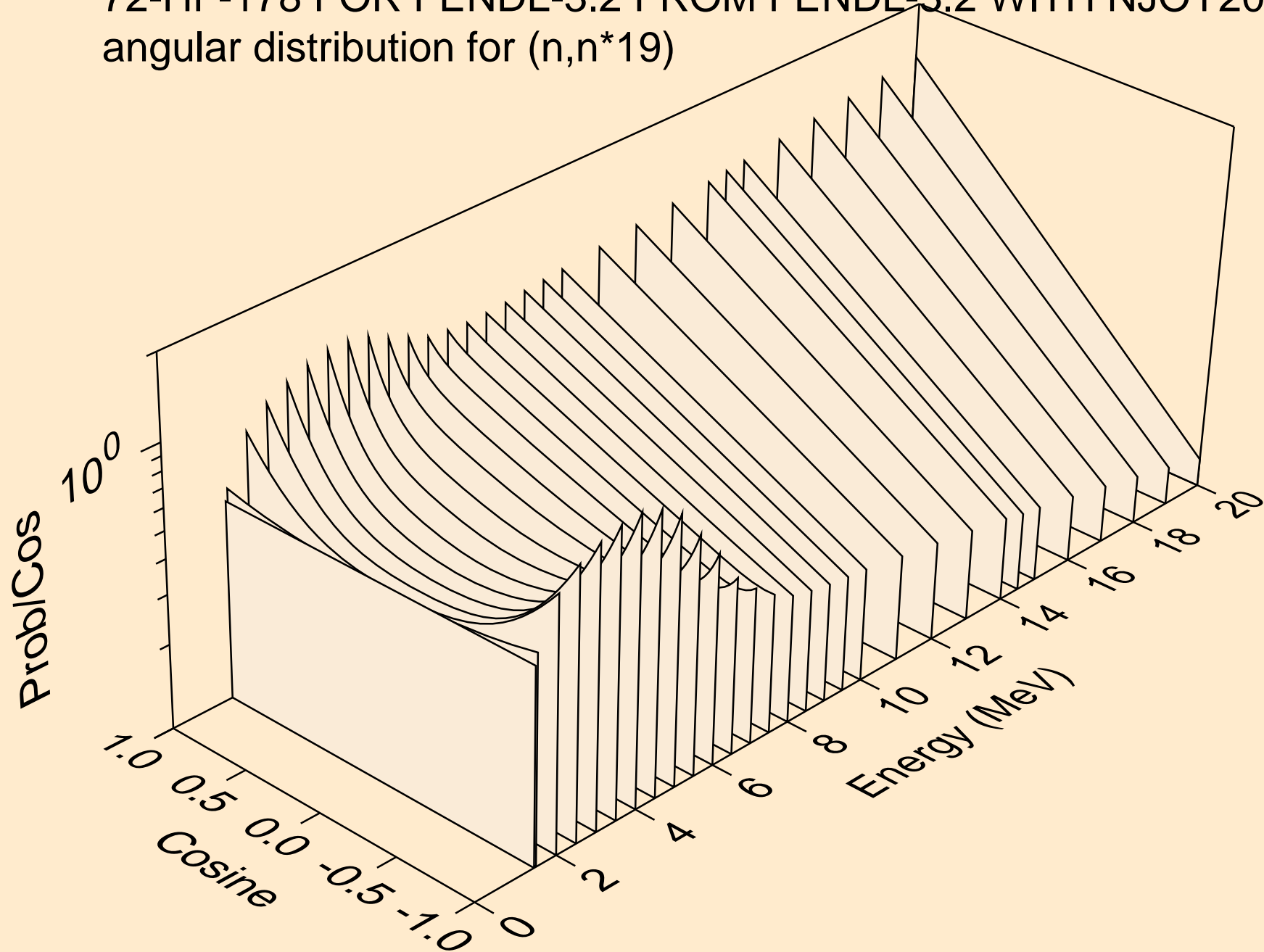

72-HF-178 FOR FENDL-3.2 FROM FENDL-3.2 WITH NJOY2016.60
angular distribution for (n,n*20)

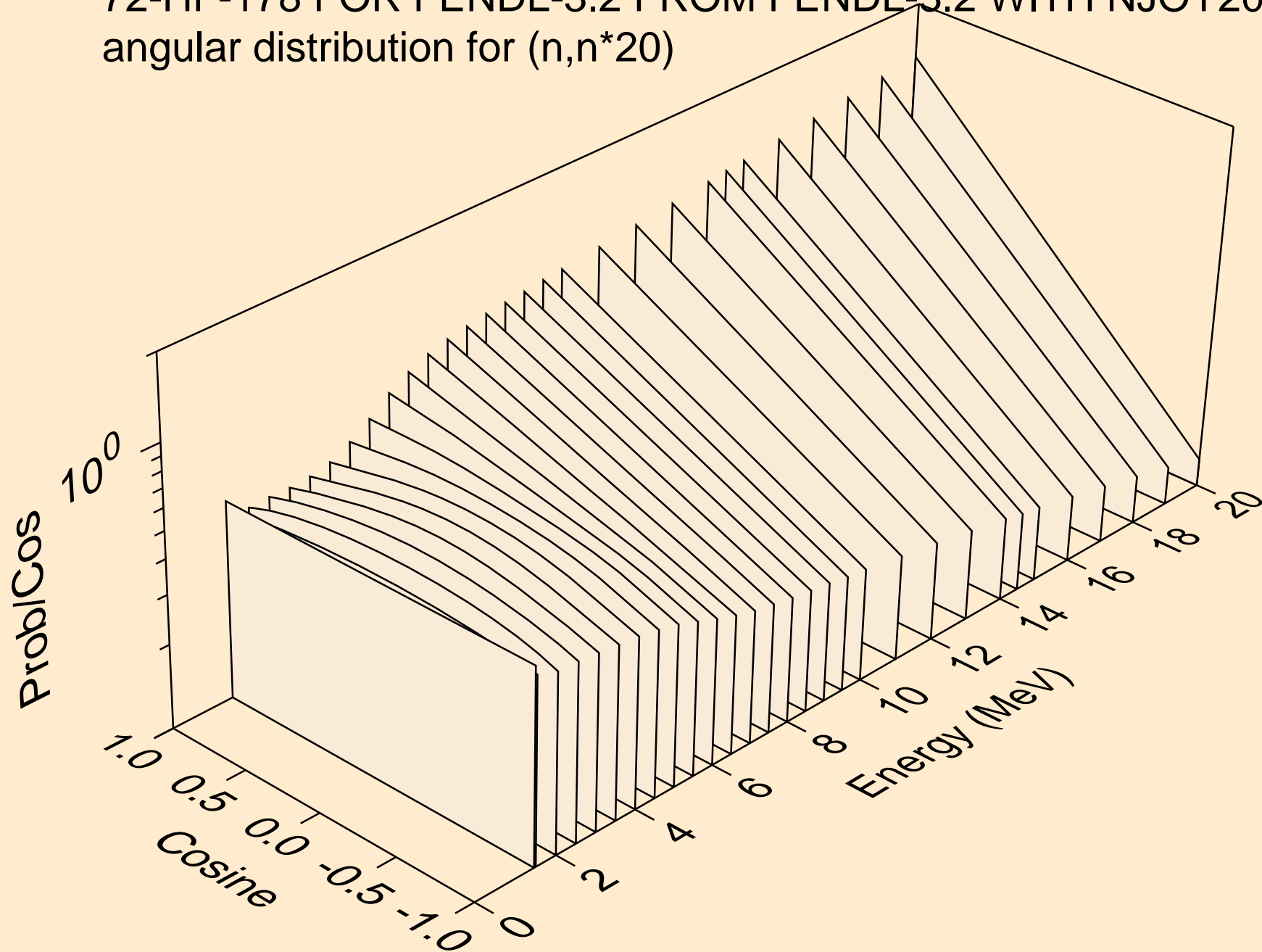

72-HF-178 FOR FENDL-3.2 FROM FENDL-3.2 WITH NJOY2016.60
angular distribution for (n,n*21)

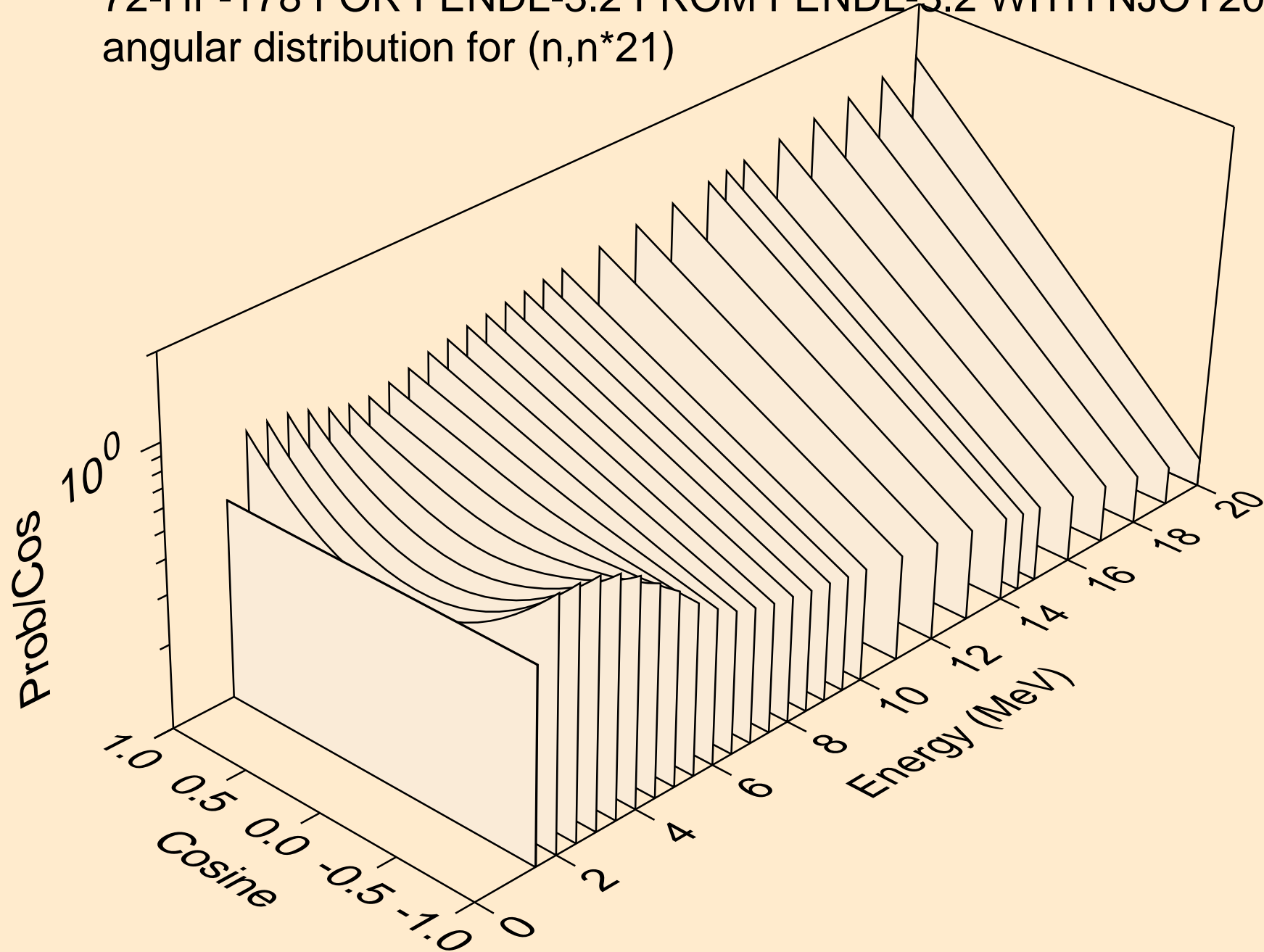

72-HF-178 FOR FENDL-3.2 FROM FENDL-3.2 WITH NJOY2016.60
angular distribution for (n,n*22)

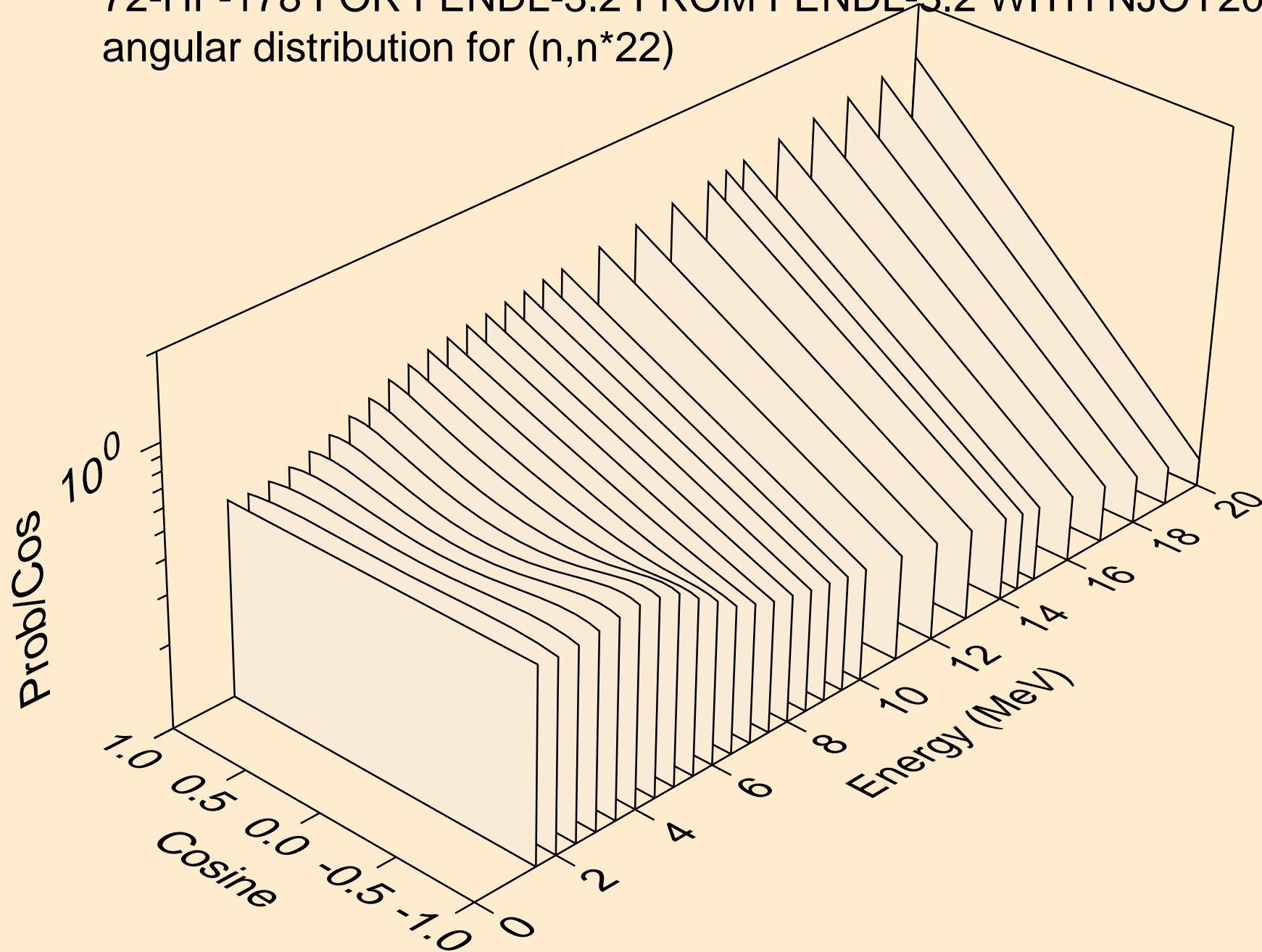

72-HF-178 FOR FENDL-3.2 FROM FENDL-3.2 WITH NJOY2016.60
angular distribution for (n,n*23)

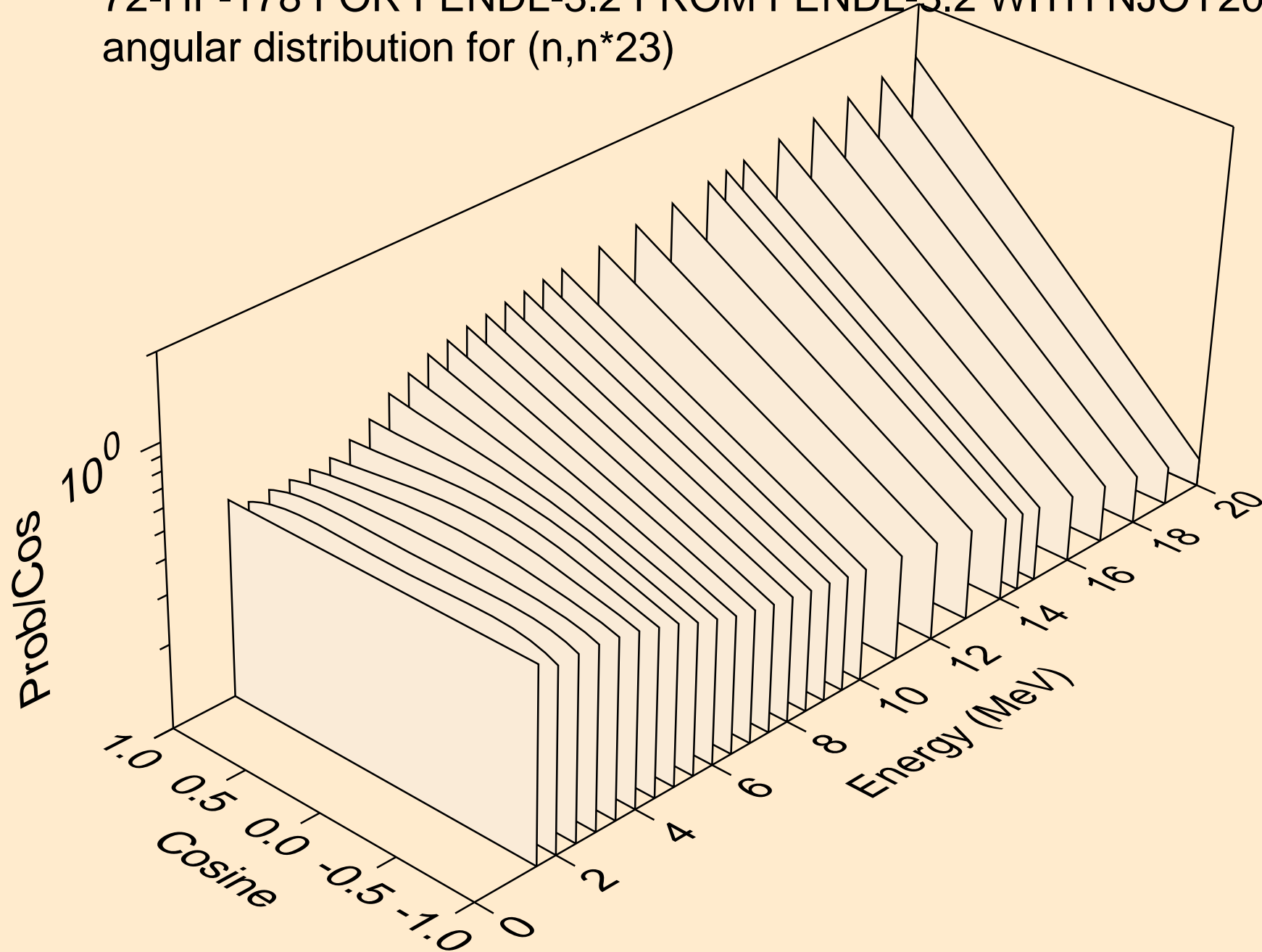

72-HF-178 FOR FENDL-3.2 FROM FENDL-3.2 WITH NJOY2016.60
angular distribution for (n,n*24)

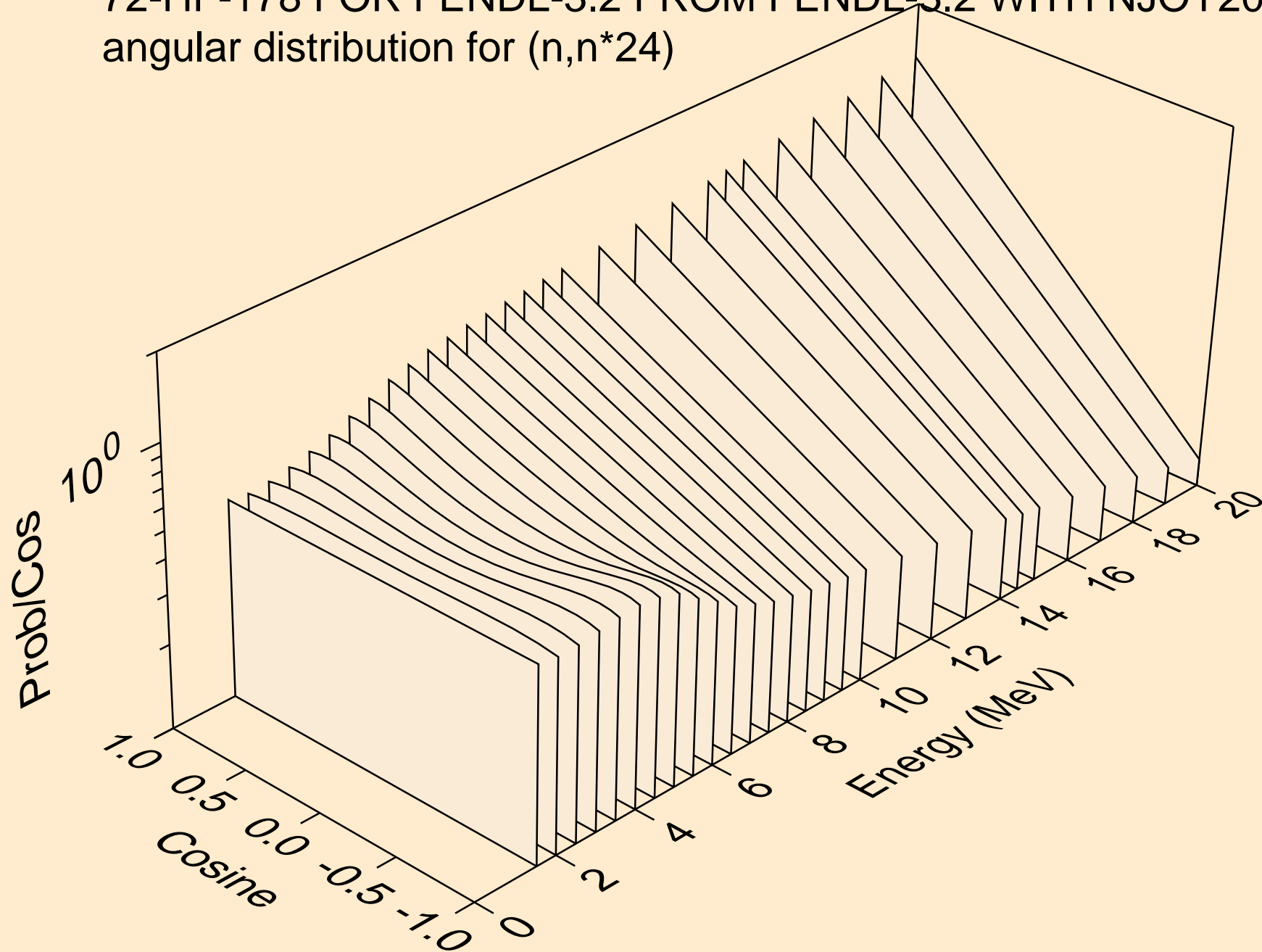

72-HF-178 FOR FENDL-3.2 FROM FENDL-3.2 WITH NJOY2016.60
angular distribution for (n,n*25)

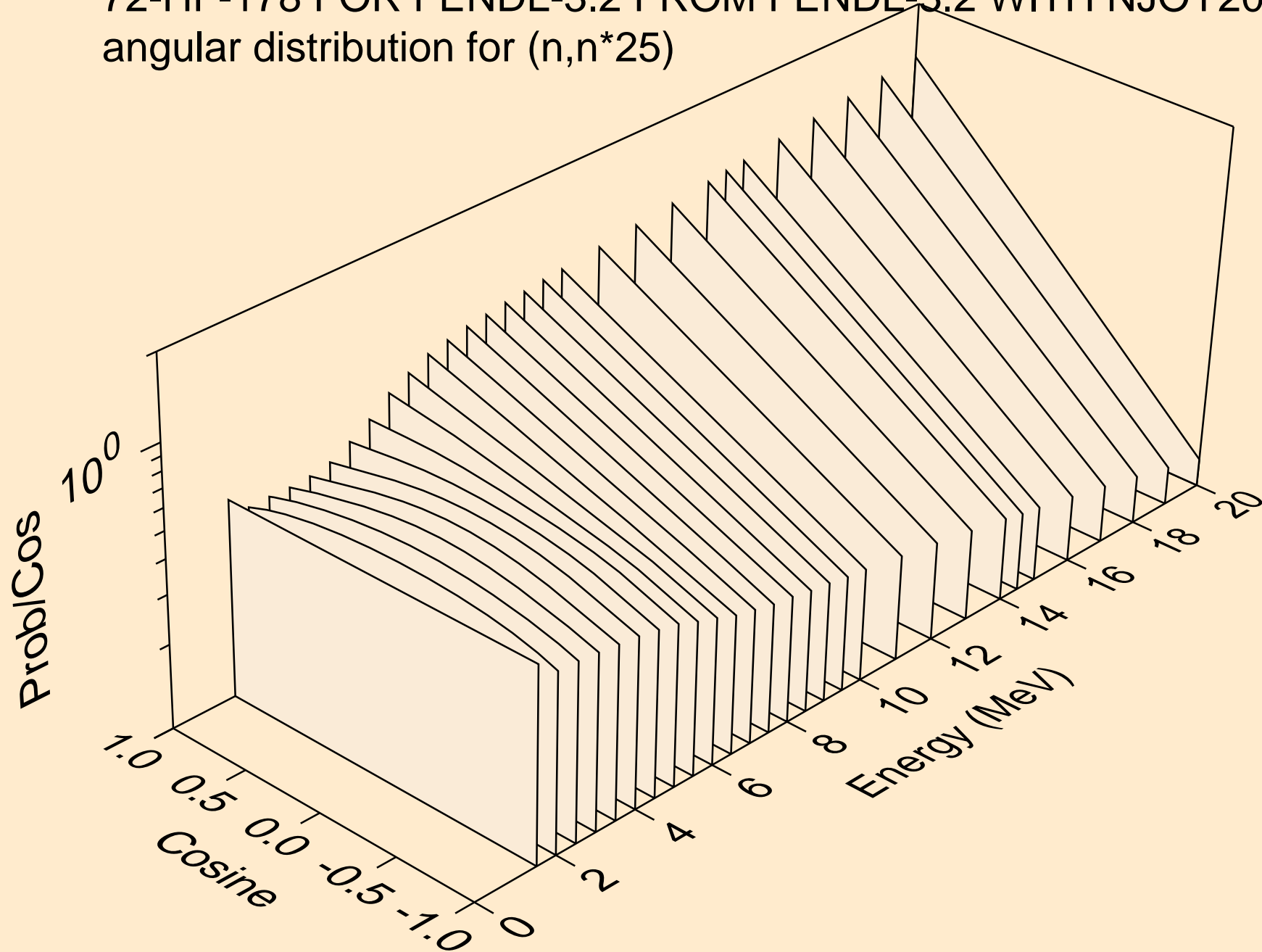

72-HF-178 FOR FENDL-3.2 FROM FENDL-3.2 WITH NJOY2016.60
angular distribution for (n,n*26)

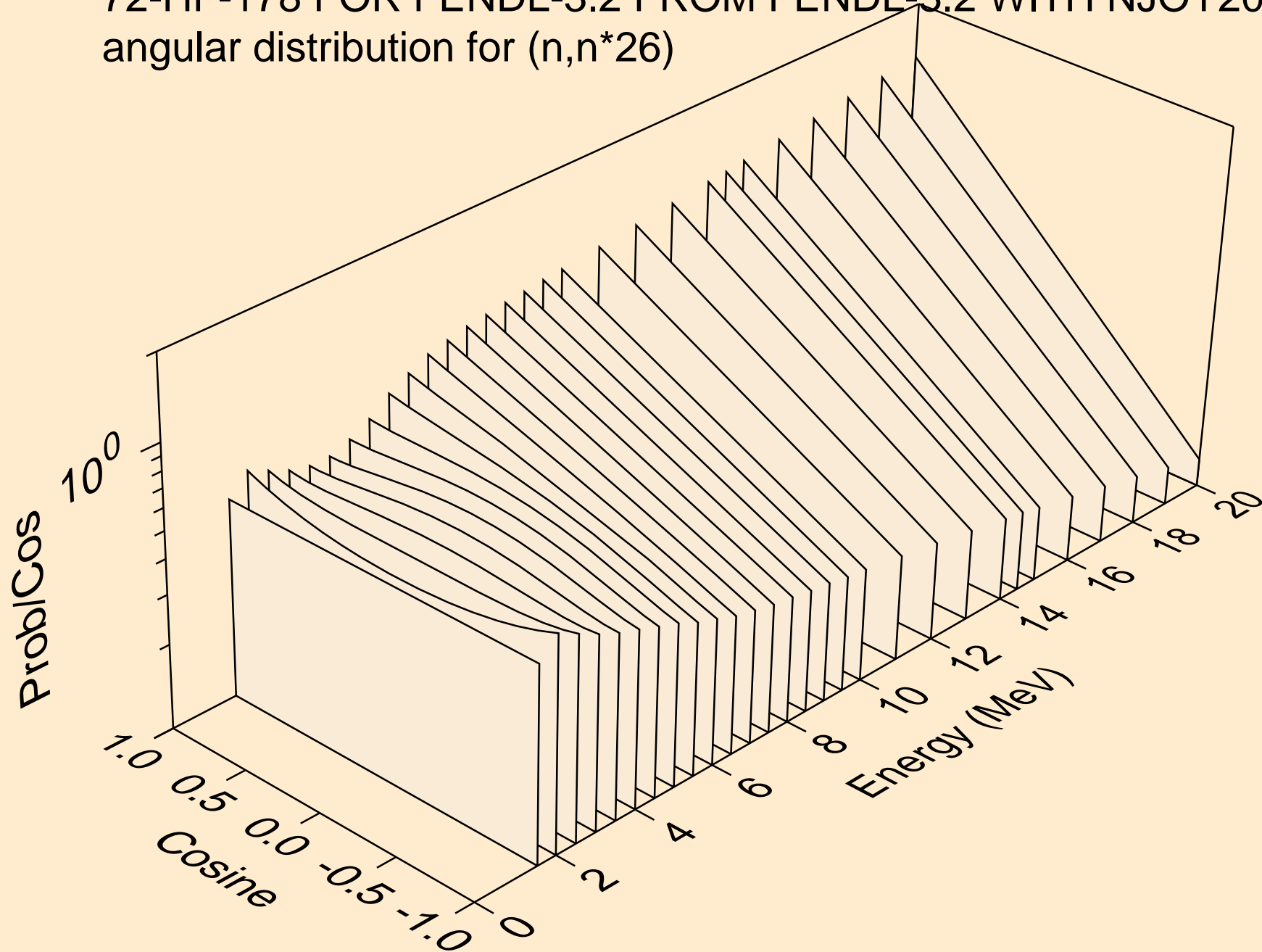

72-HF-178 FOR FENDL-3.2 FROM FENDL-3.2 WITH NJOY2016.60
angular distribution for (n,n*27)

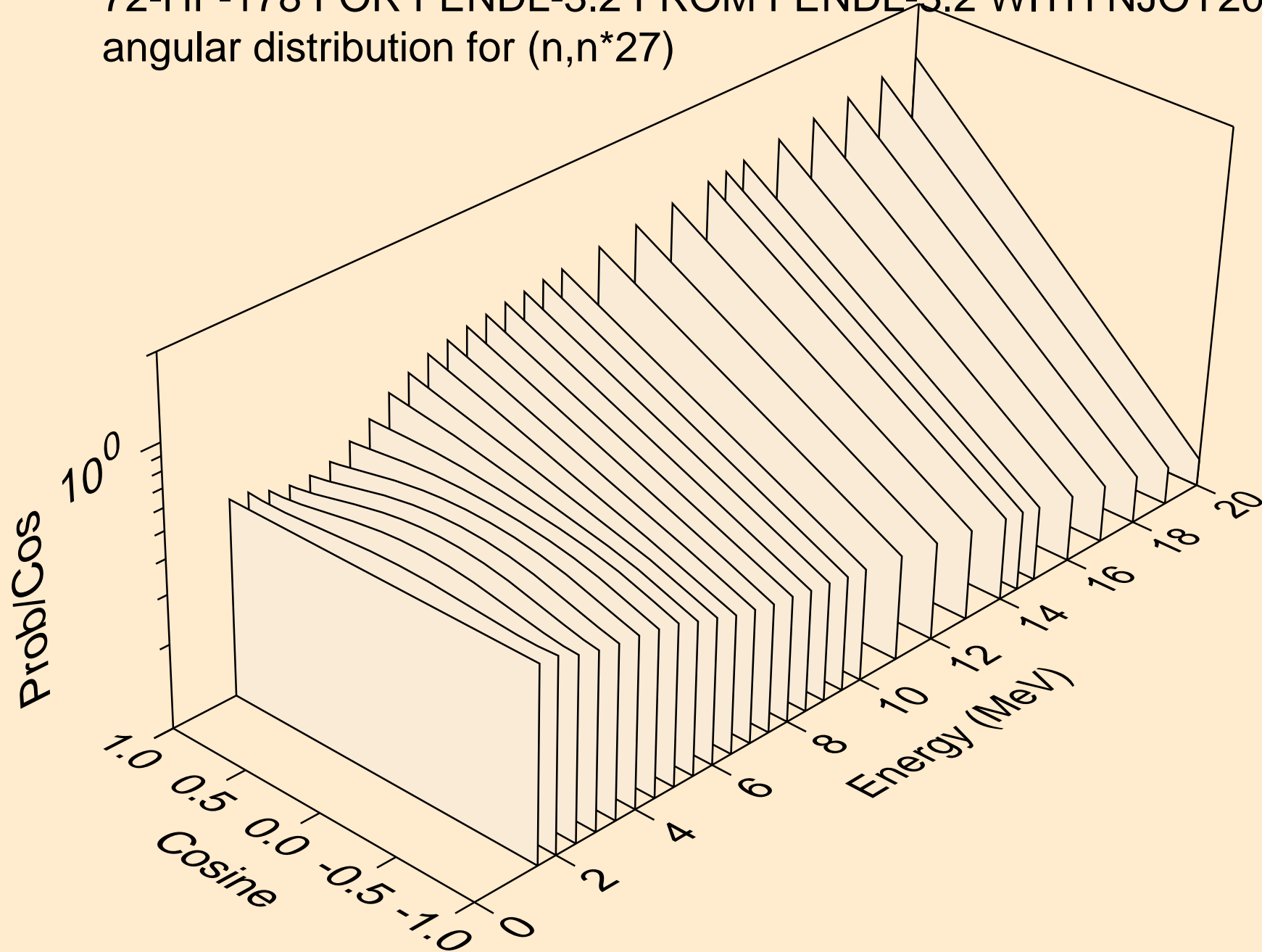

72-HF-178 FOR FENDL-3.2 FROM FENDL-3.2 WITH NJOY2016.60
angular distribution for (n,n*28)

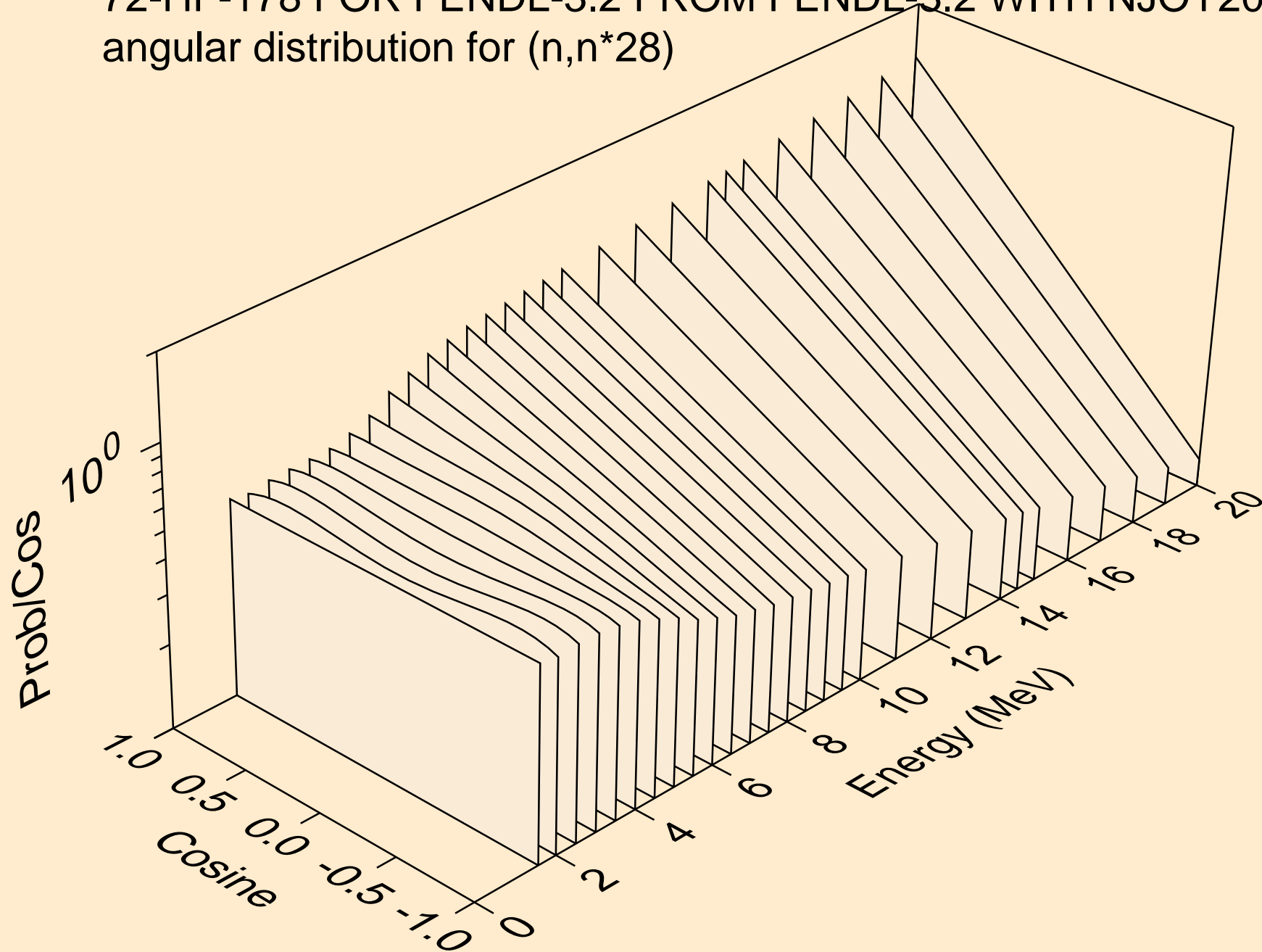

72-HF-178 FOR FENDL-3.2 FROM FENDL-3.2 WITH NJOY2016.60
angular distribution for (n,n*29)

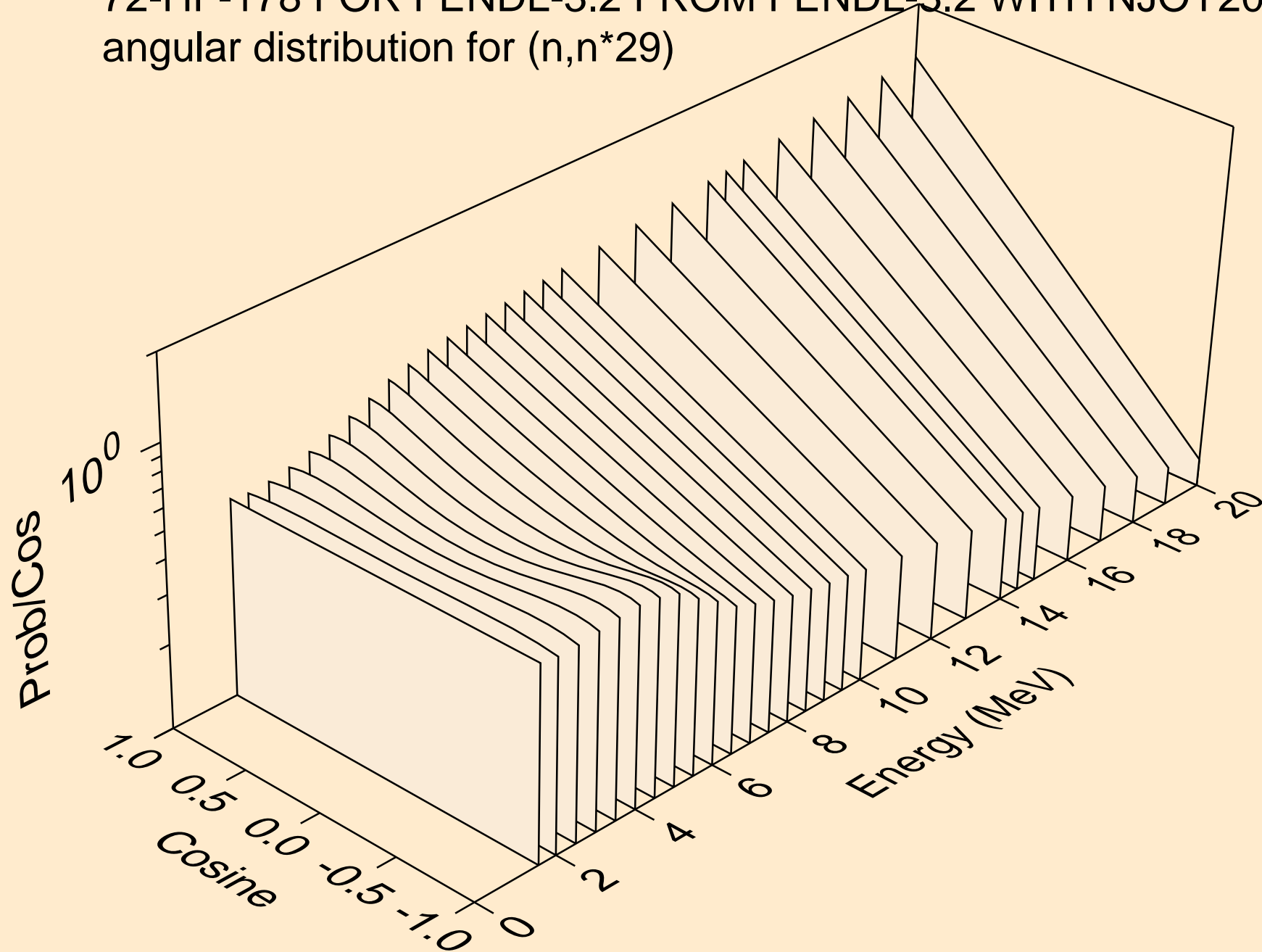

72-HF-178 FOR FENDL-3.2 FROM FENDL-3.2 WITH NJOY2016.60
angular distribution for (n,n*30)

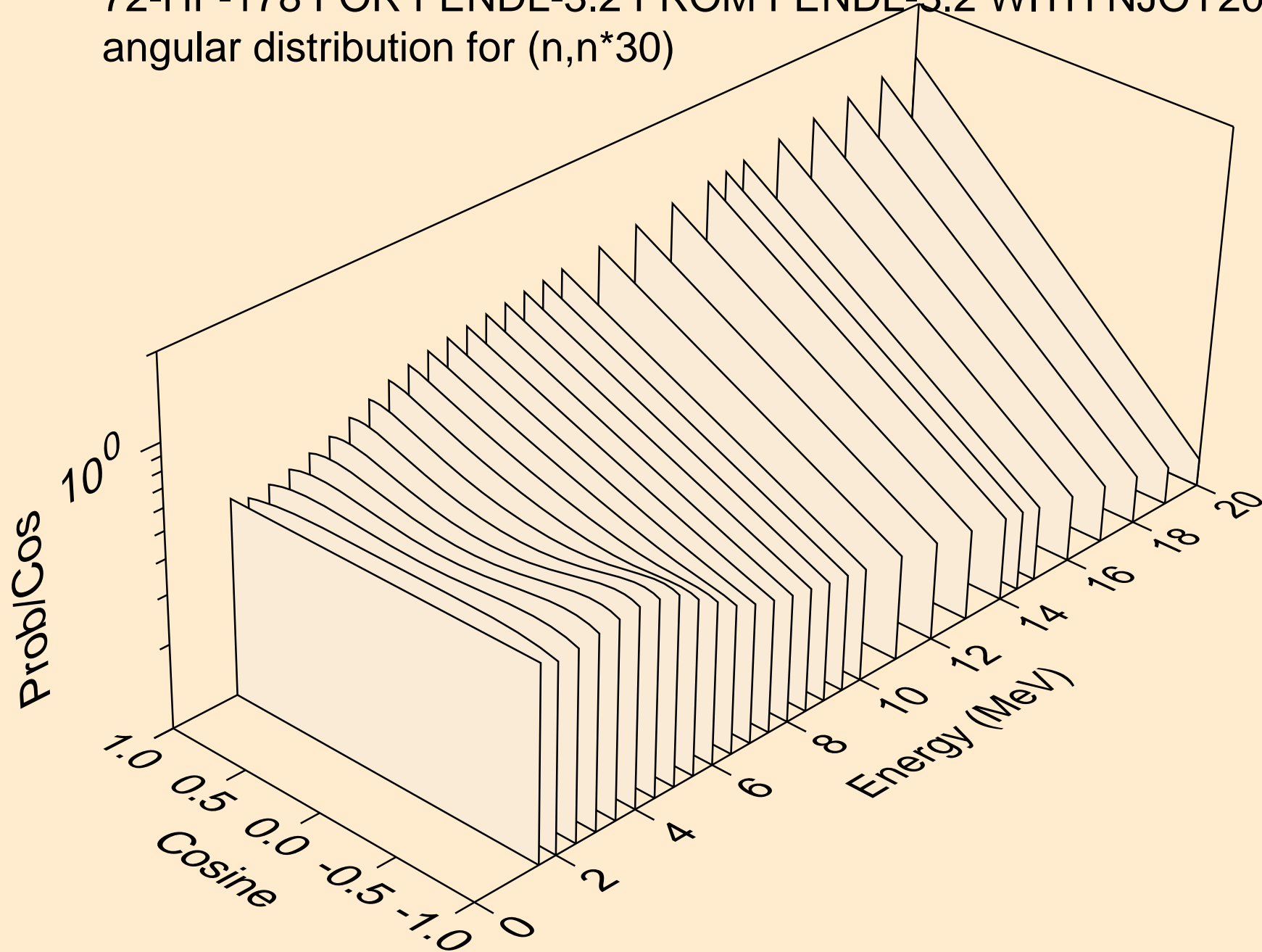

72-HF-178 FOR FENDL-3.2 FROM FENDL-3.2 WITH NJOY2016.60
angular distribution for (n,n*31)

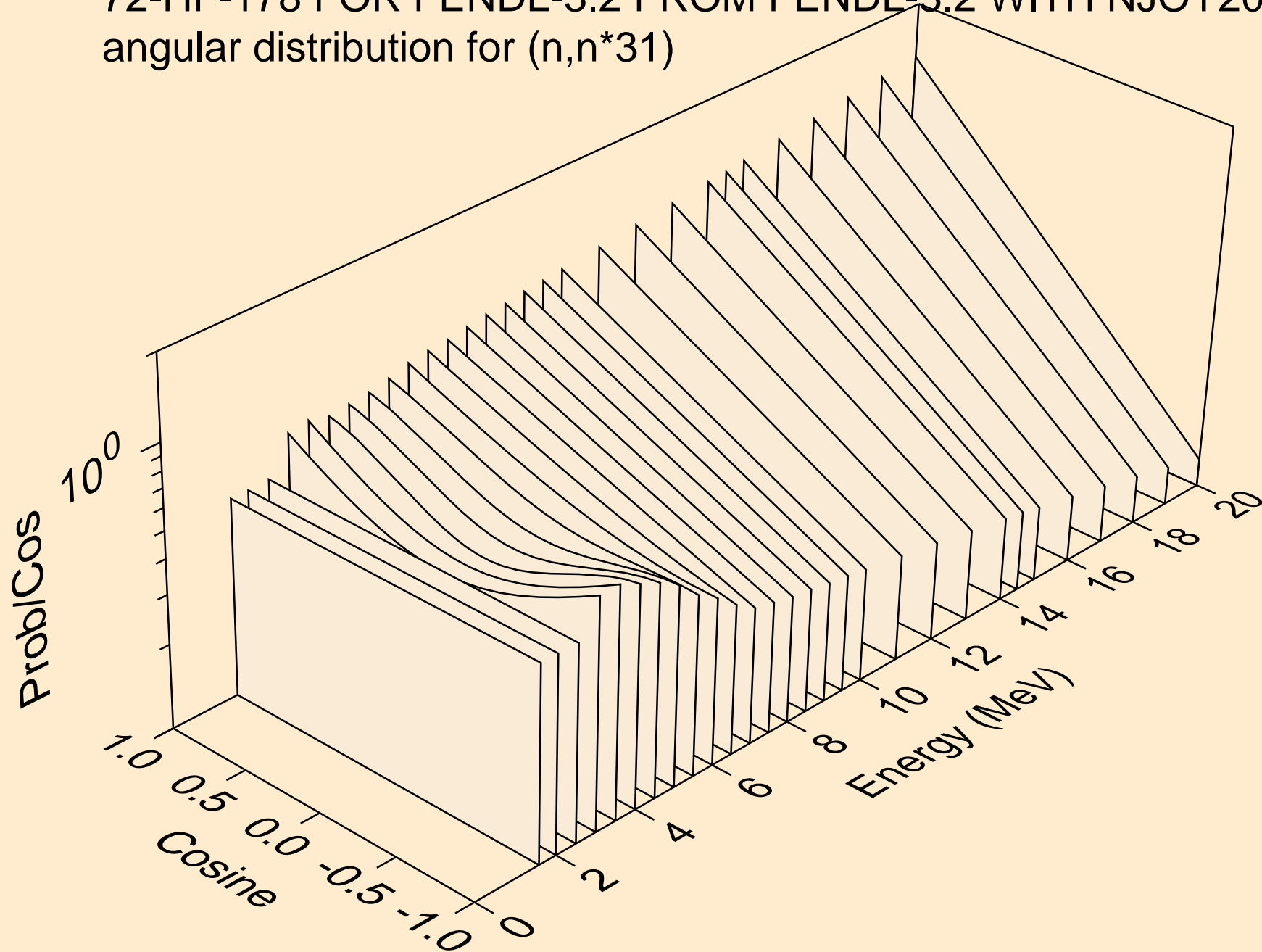

72-HF-178 FOR FENDL-3.2 FROM FENDL-3.2 WITH NJOY2016.60
angular distribution for (n,n*32)

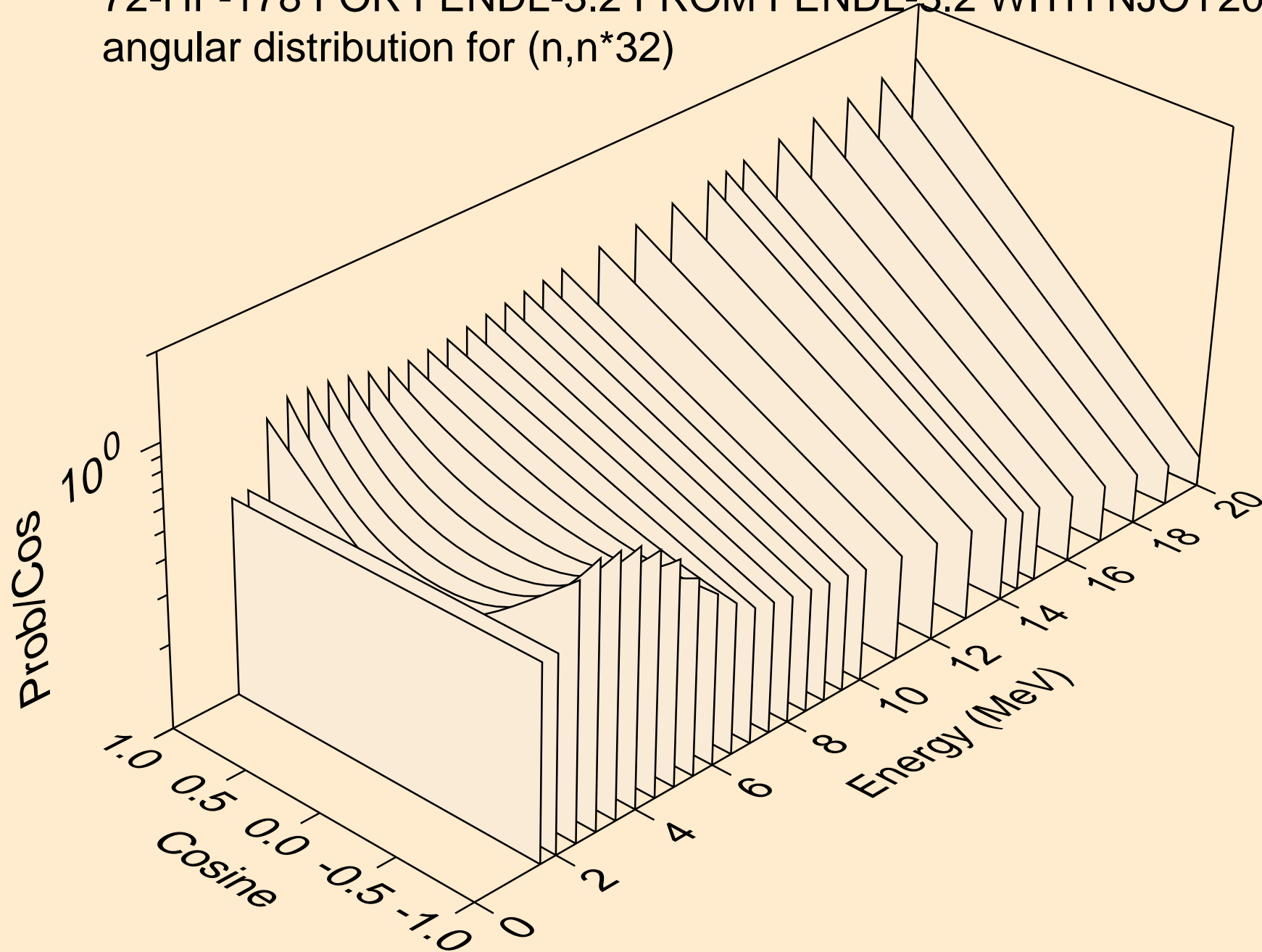

72-HF-178 FOR FENDL-3.2 FROM FENDL-3.2 WITH NJOY2016.60
angular distribution for (n,n*33)

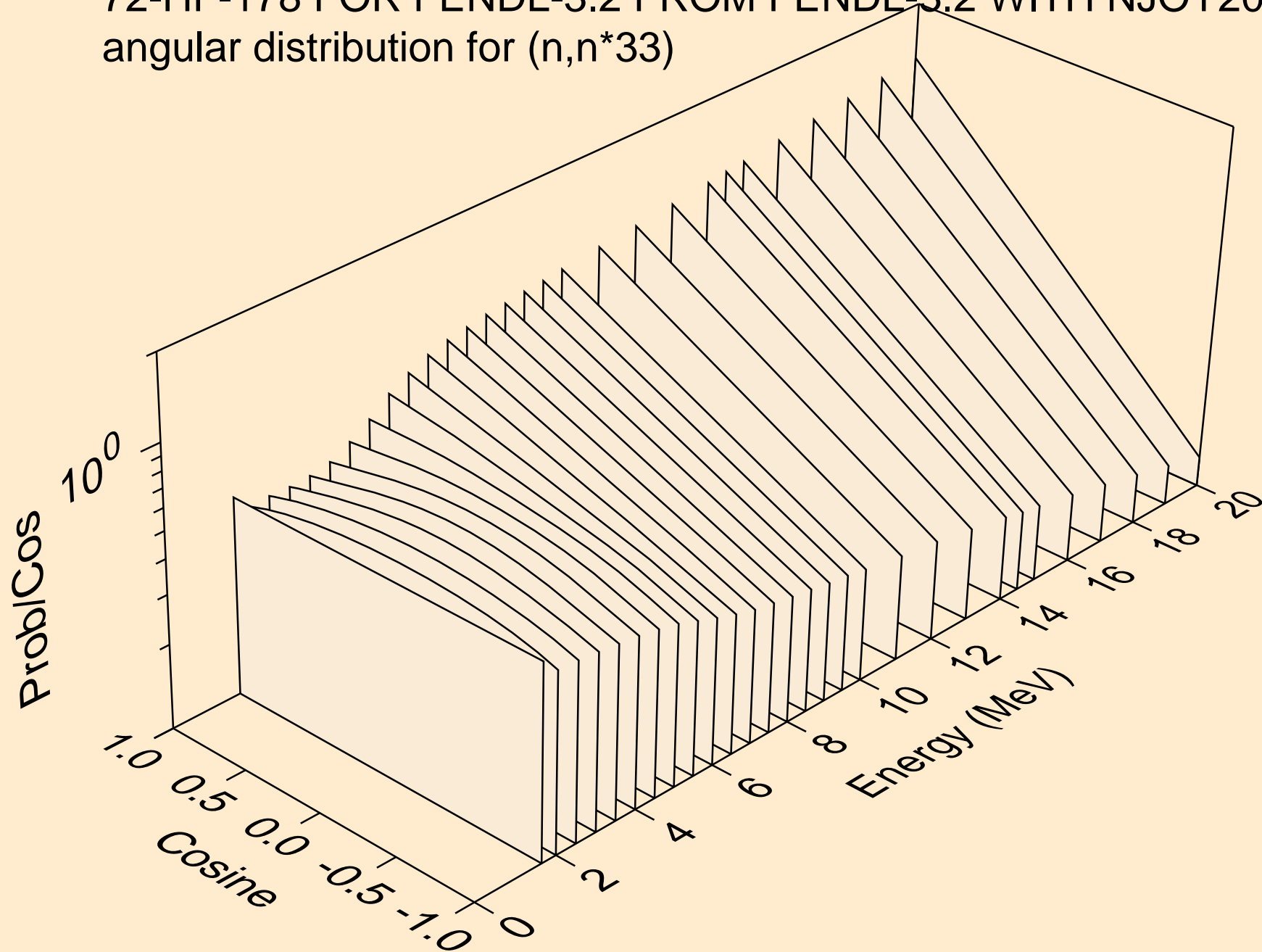

72-HF-178 FOR FENDL-3.2 FROM FENDL-3.2 WITH NJOY2016.60
angular distribution for (n,n*34)

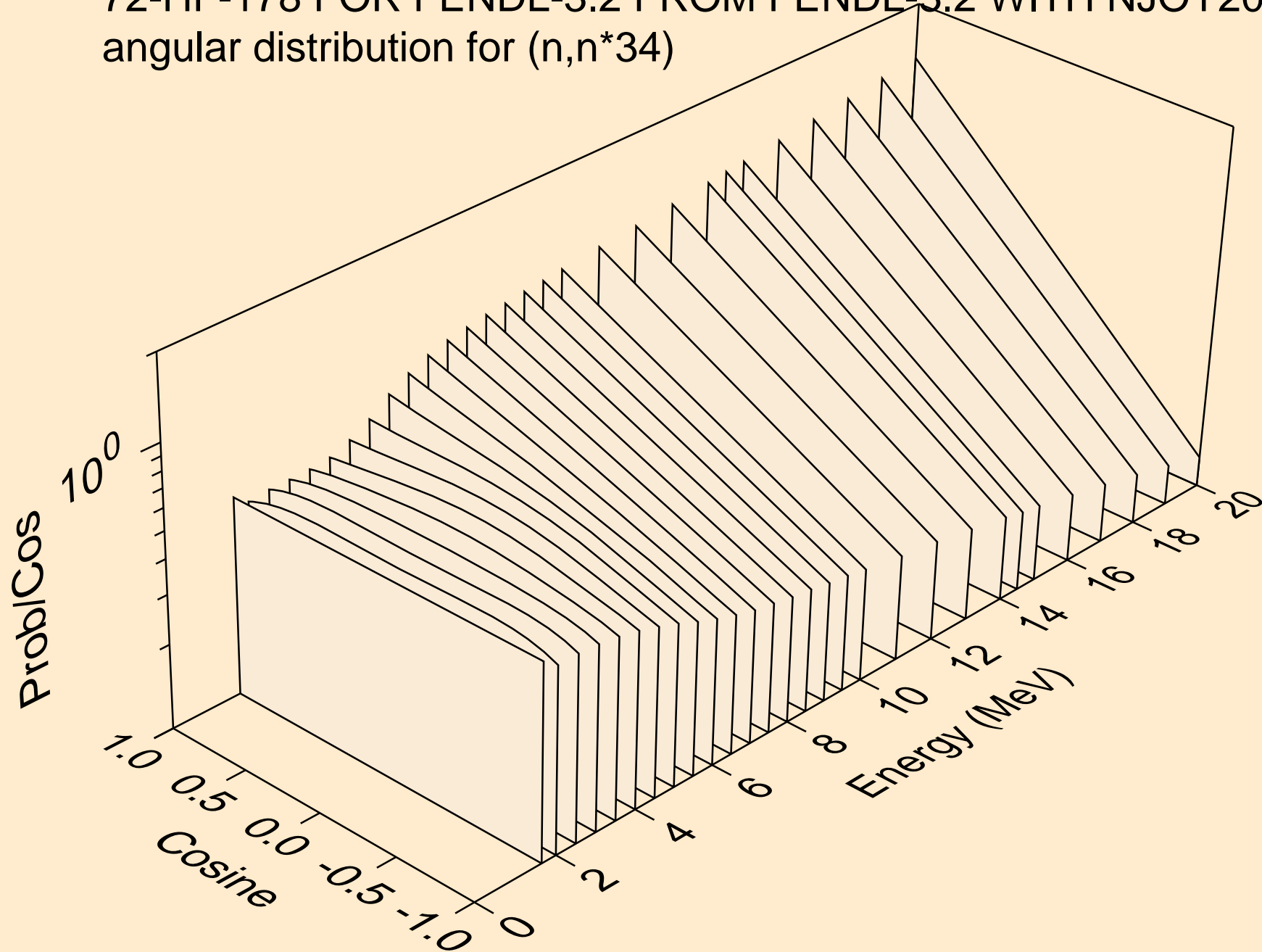

72-HF-178 FOR FENDL-3.2 FROM FENDL-3.2 WITH NJOY2016.60
angular distribution for (n,n*35)

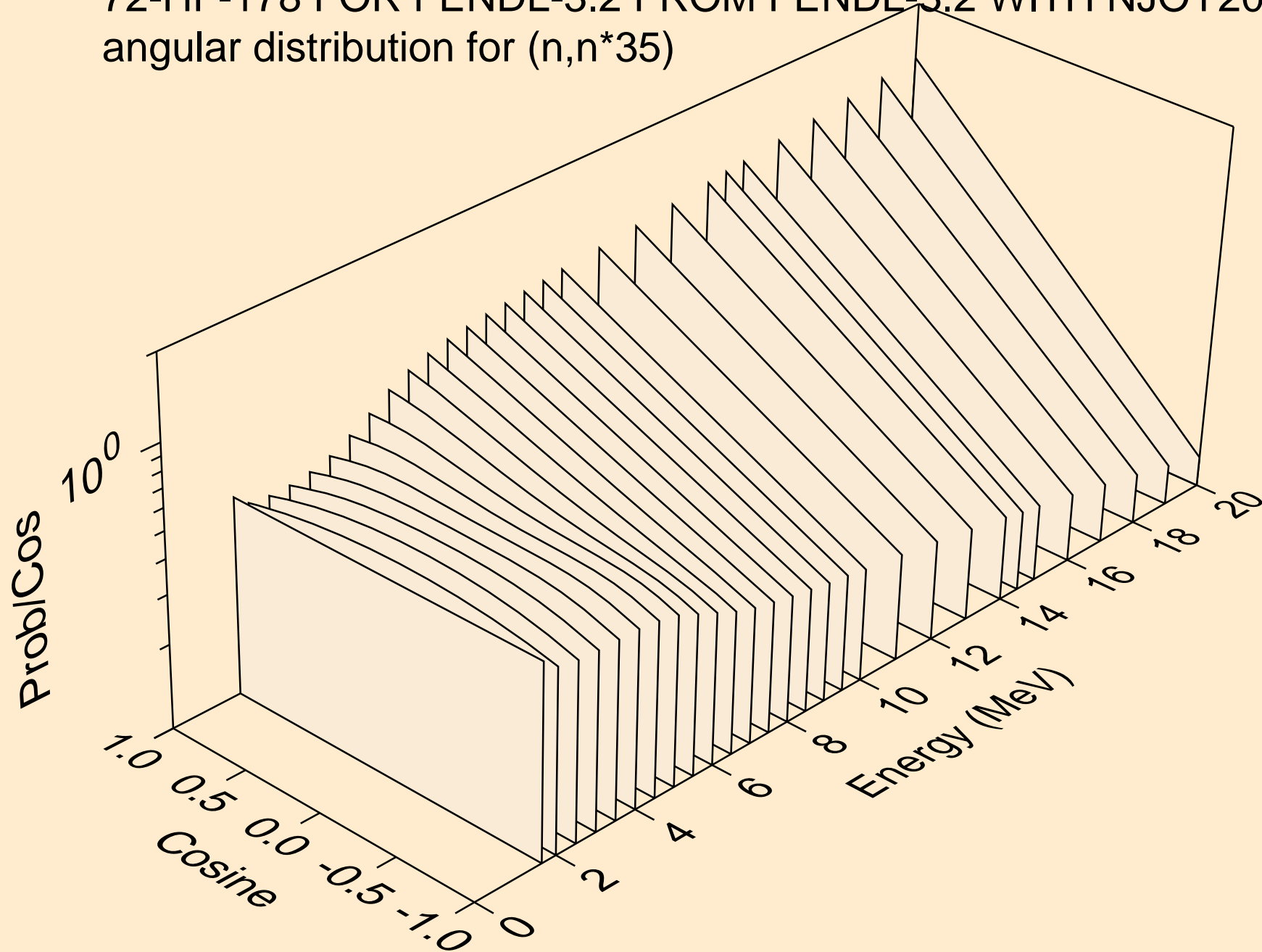

72-HF-178 FOR FENDL-3.2 FROM FENDL-3.2 WITH NJOY2016.60
angular distribution for (n,n*36)

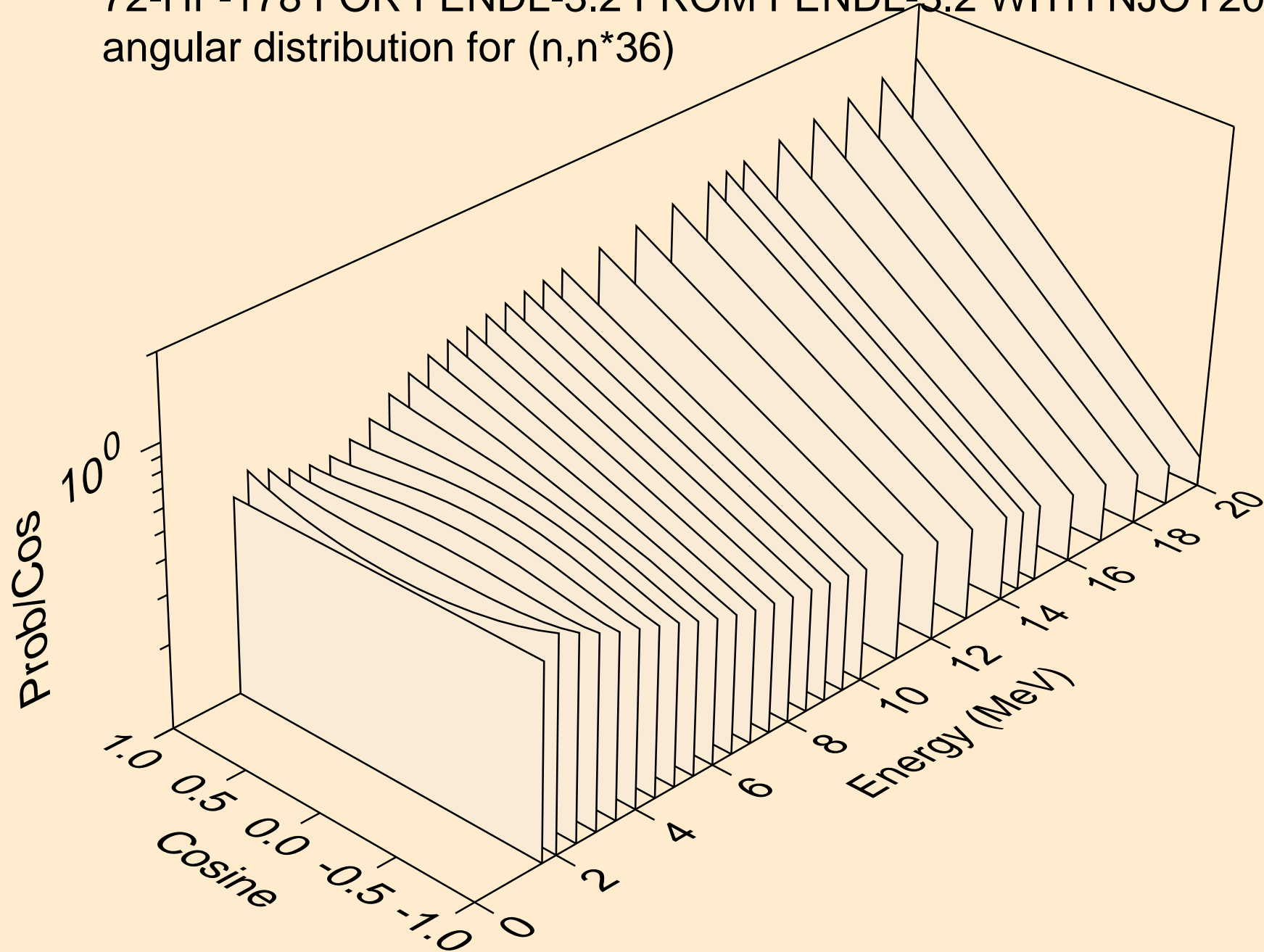

72-HF-178 FOR FENDL-3.2 FROM FENDL-3.2 WITH NJOY2016.60
angular distribution for (n,n*37)

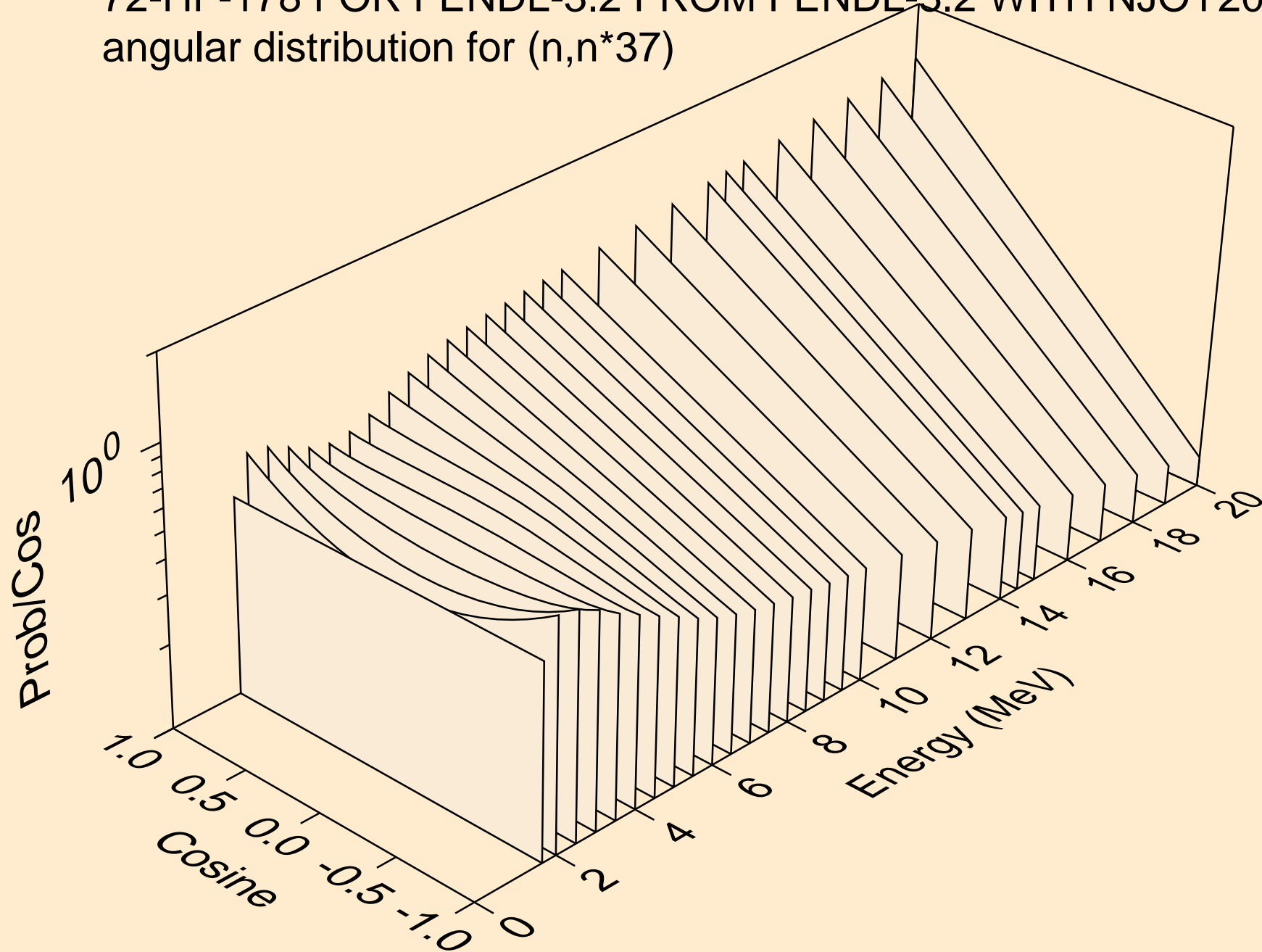

72-HF-178 FOR FENDL-3.2 FROM FENDL-3.2 WITH NJOY2016.60
angular distribution for (n,n*38)

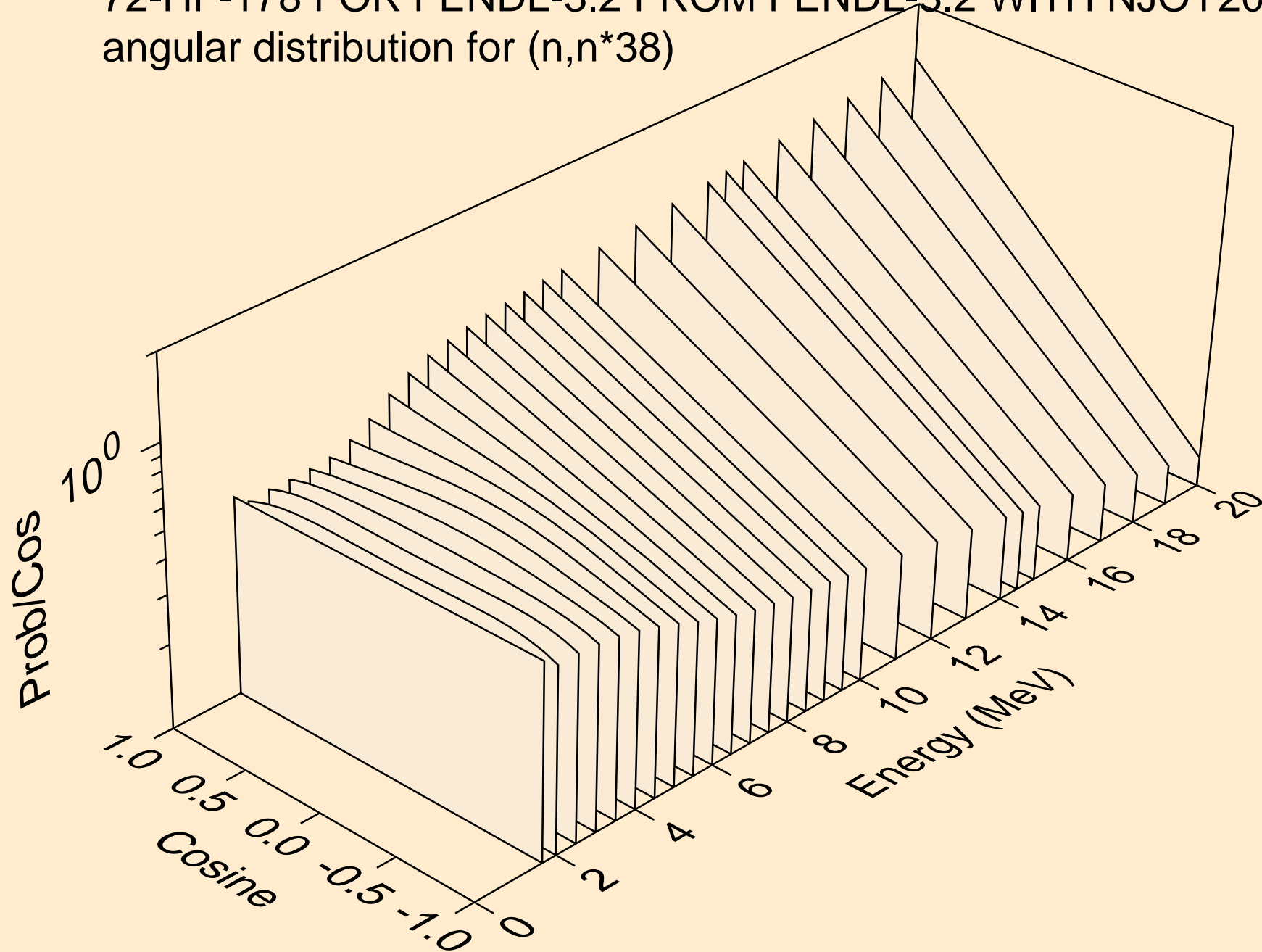

72-HF-178 FOR FENDL-3.2 FROM FENDL-3.2 WITH NJOY2016.60
angular distribution for (n,n*39)

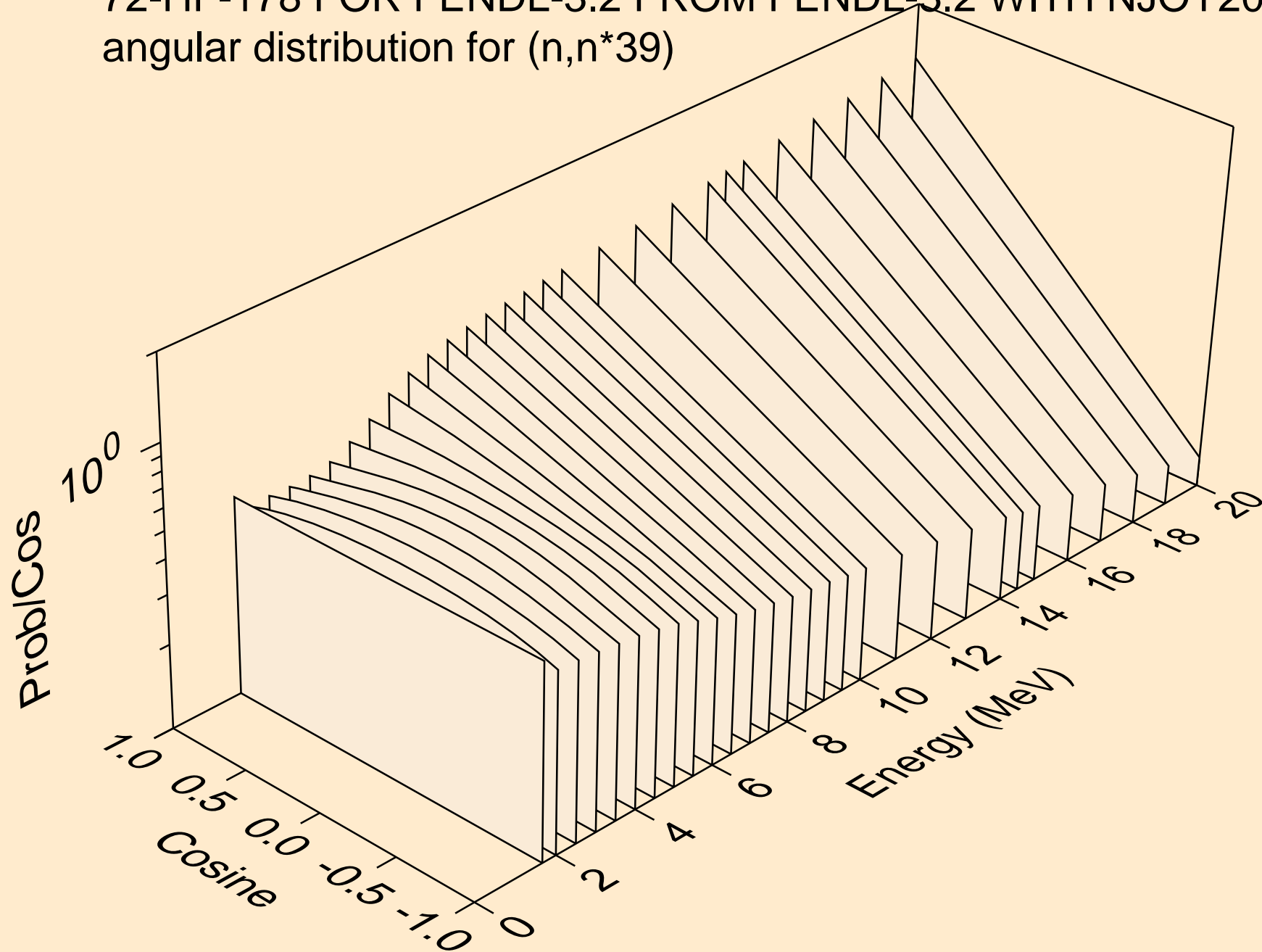

72-HF-178 FOR FENDL-3.2 FROM FENDL-3.2 WITH NJOY2016.60
angular distribution for (n,n*40)

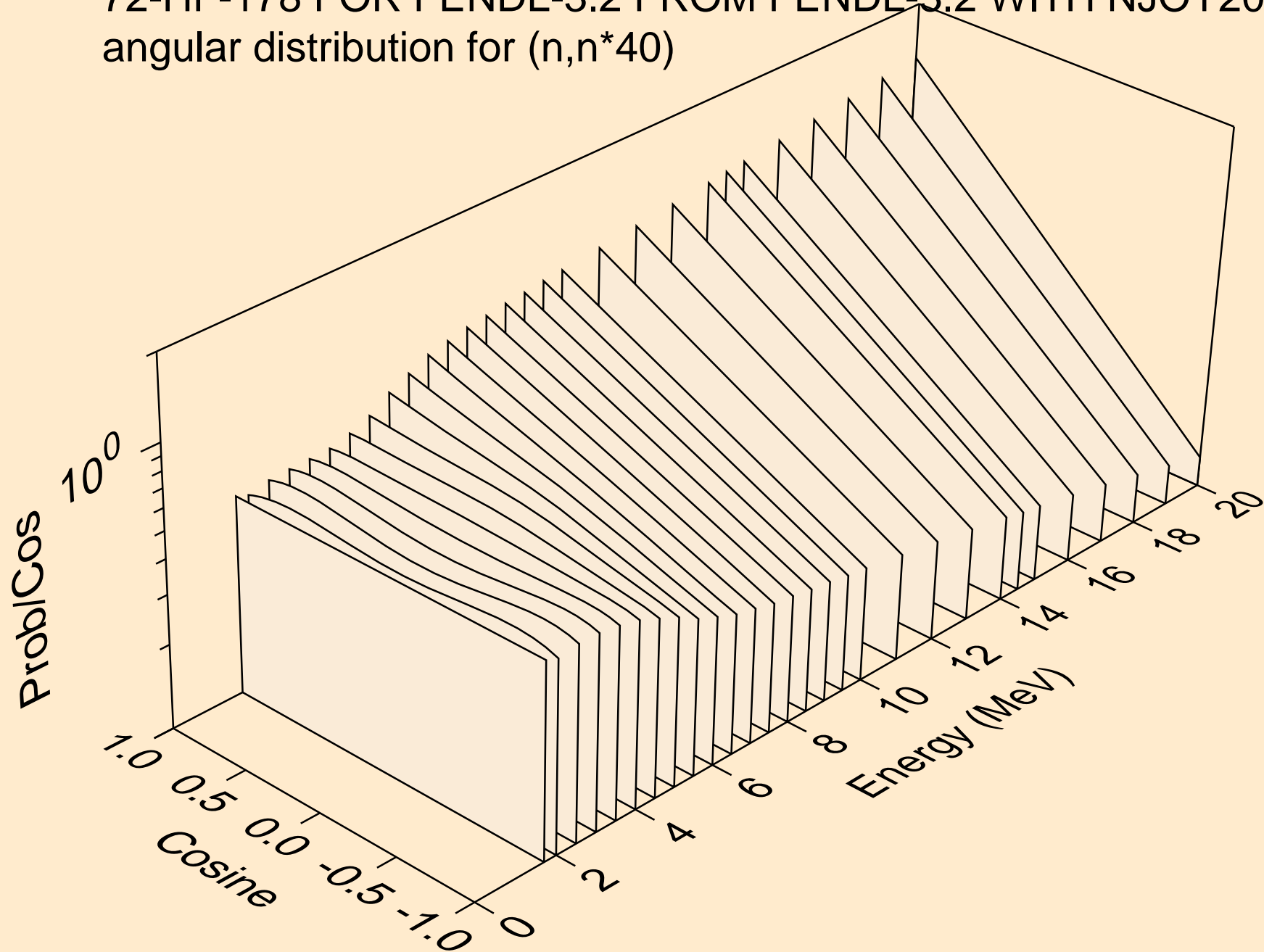

72-HF-178 FOR FENDL-3.2 FROM FENDL-3.2 WITH NJOY2016.60
Neutron emission for (n,x)

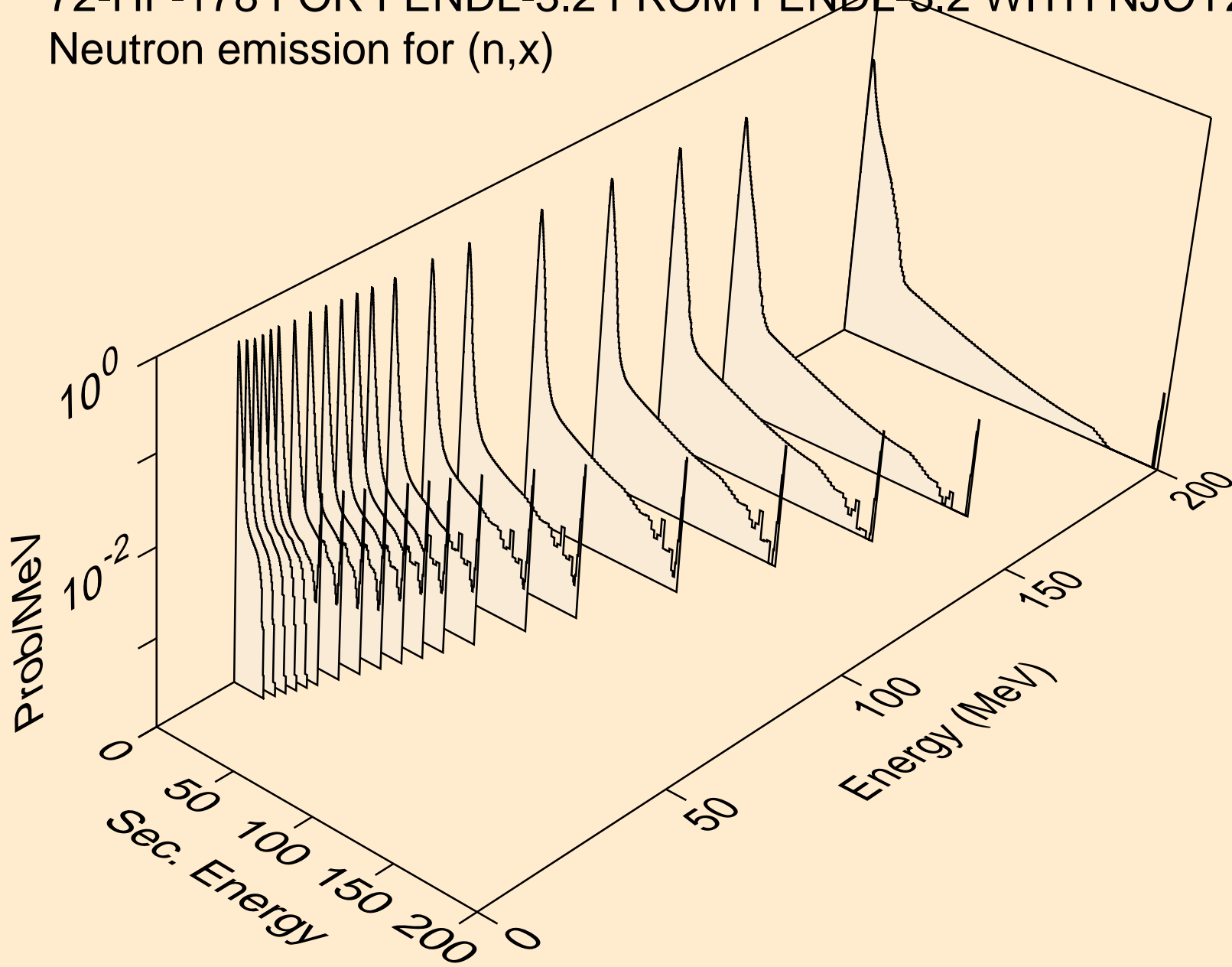

72-HF-178 FOR FENDL-3.2 FROM FENDL-3.2 WITH NJOY2016.60
Neutron emission for (n,2n)

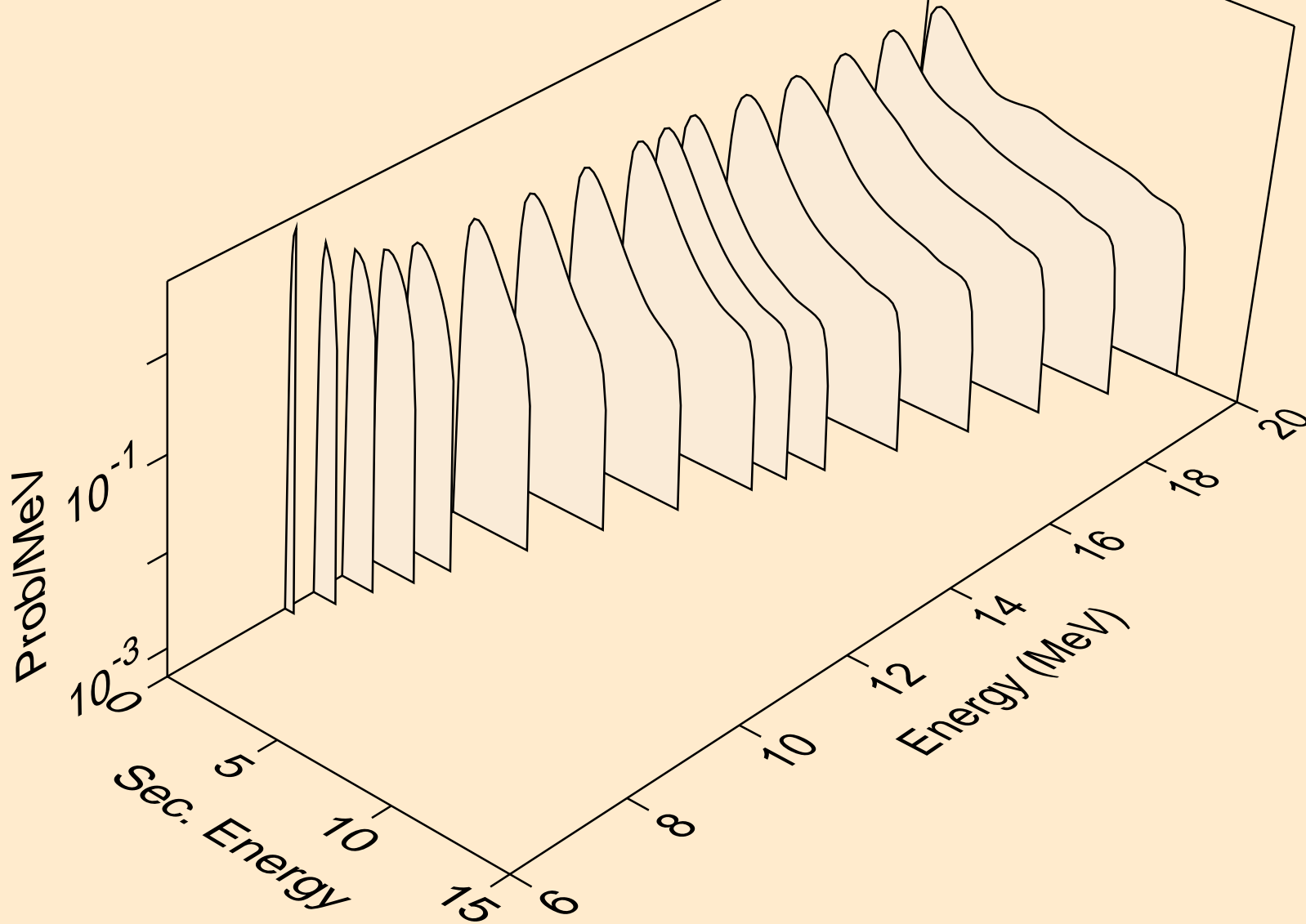

72-HF-178 FOR FENDL-3.2 FROM FENDL-3.2 WITH NJOY2016.60
Neutron emission for (n,3n)

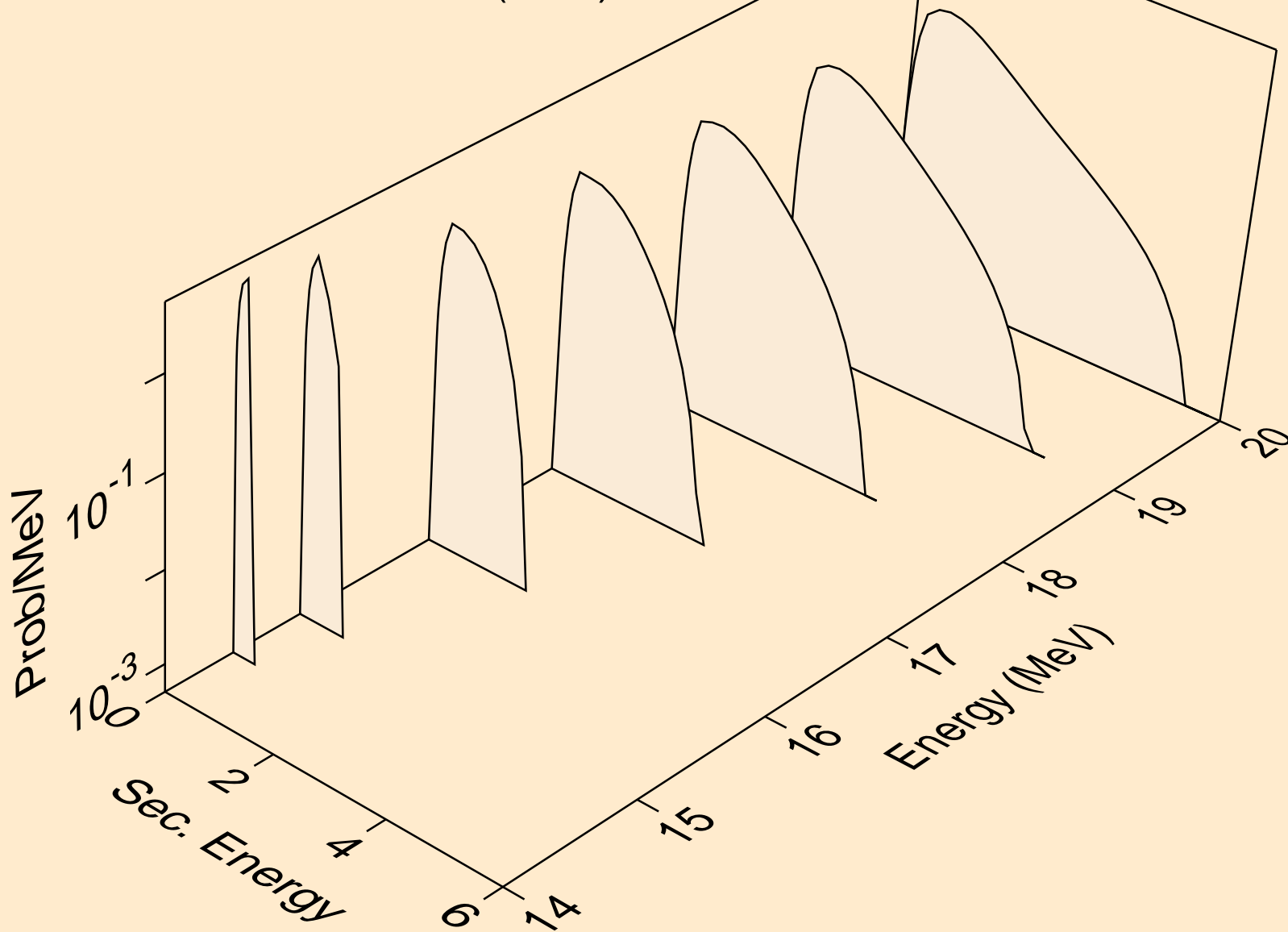

72-HF-178 FOR FENDL-3.2 FROM FENDL-3.2 WITH NJOY2016.60
Neutron emission for (n,n*)a

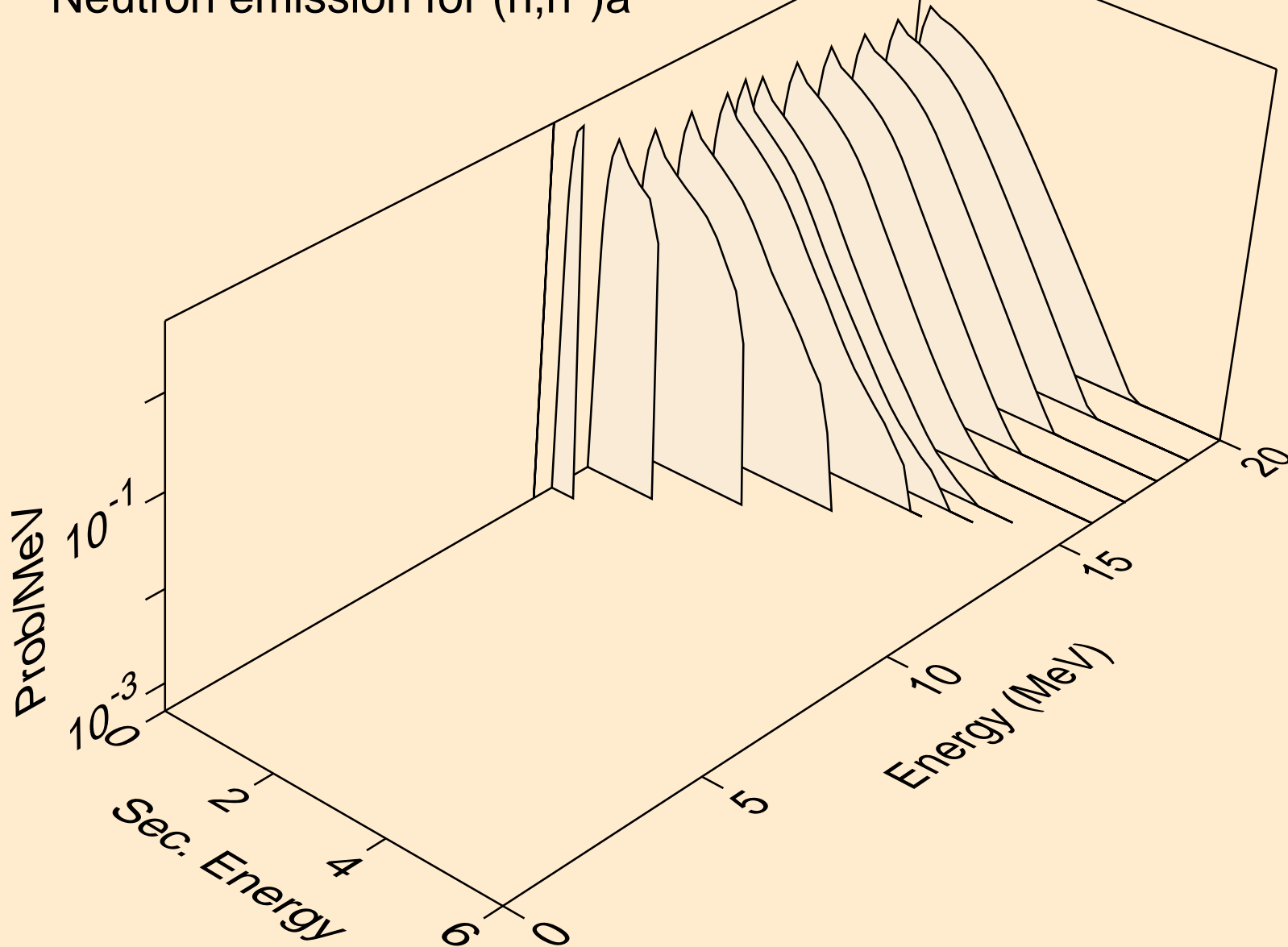

72-HF-178 FOR FENDL-3.2 FROM FENDL-3.2 WITH NJOY2016.60
Neutron emission for (n,n*)p

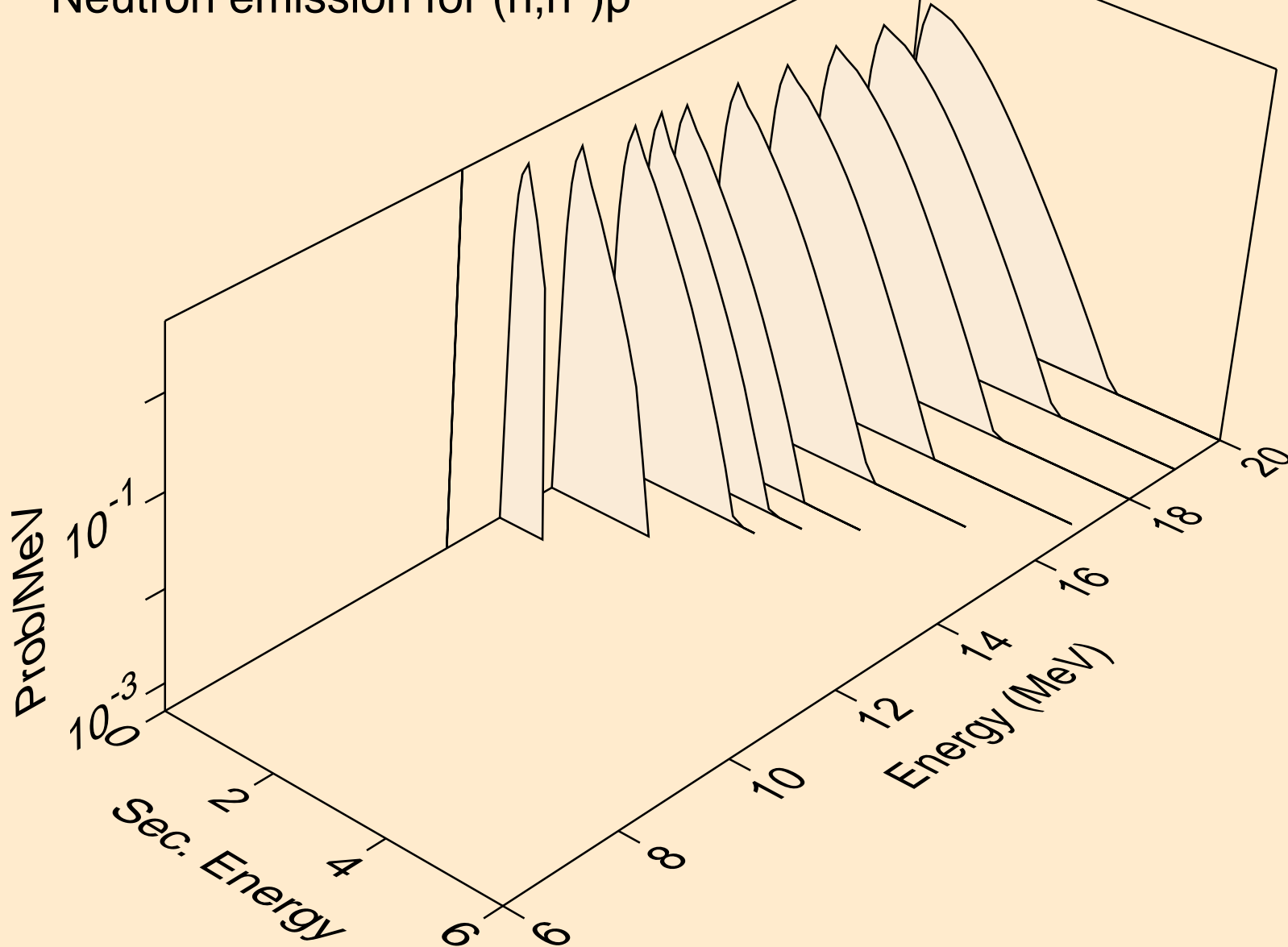

72-HF-178 FOR FENDL-3.2 FROM FENDL-3.2 WITH NJOY2016.60
Neutron emission for (n,n*)d

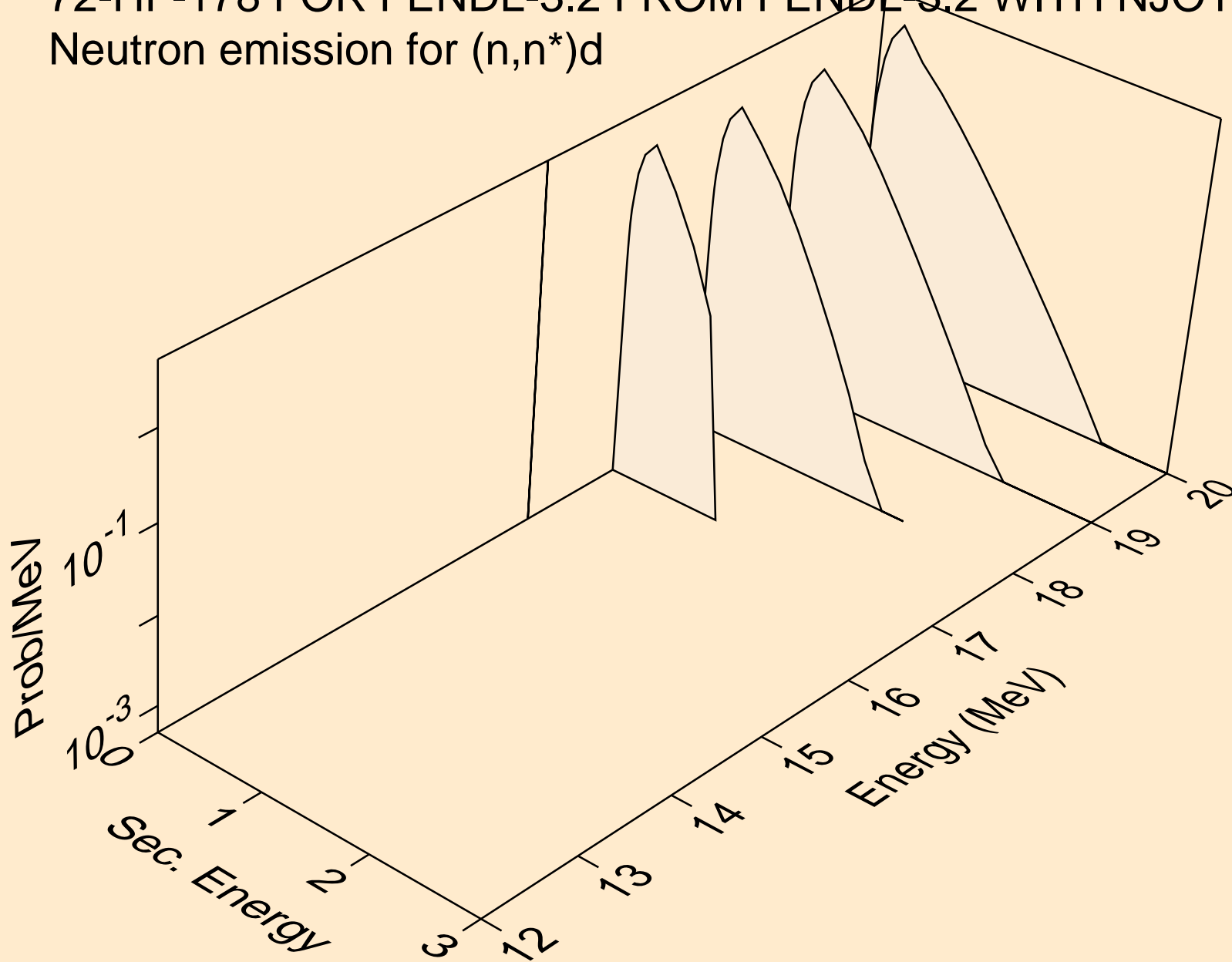

72-HF-178 FOR FENDL-3.2 FROM FENDL-3.2 WITH NJOY2016.60
Neutron emission for (n,n*c)

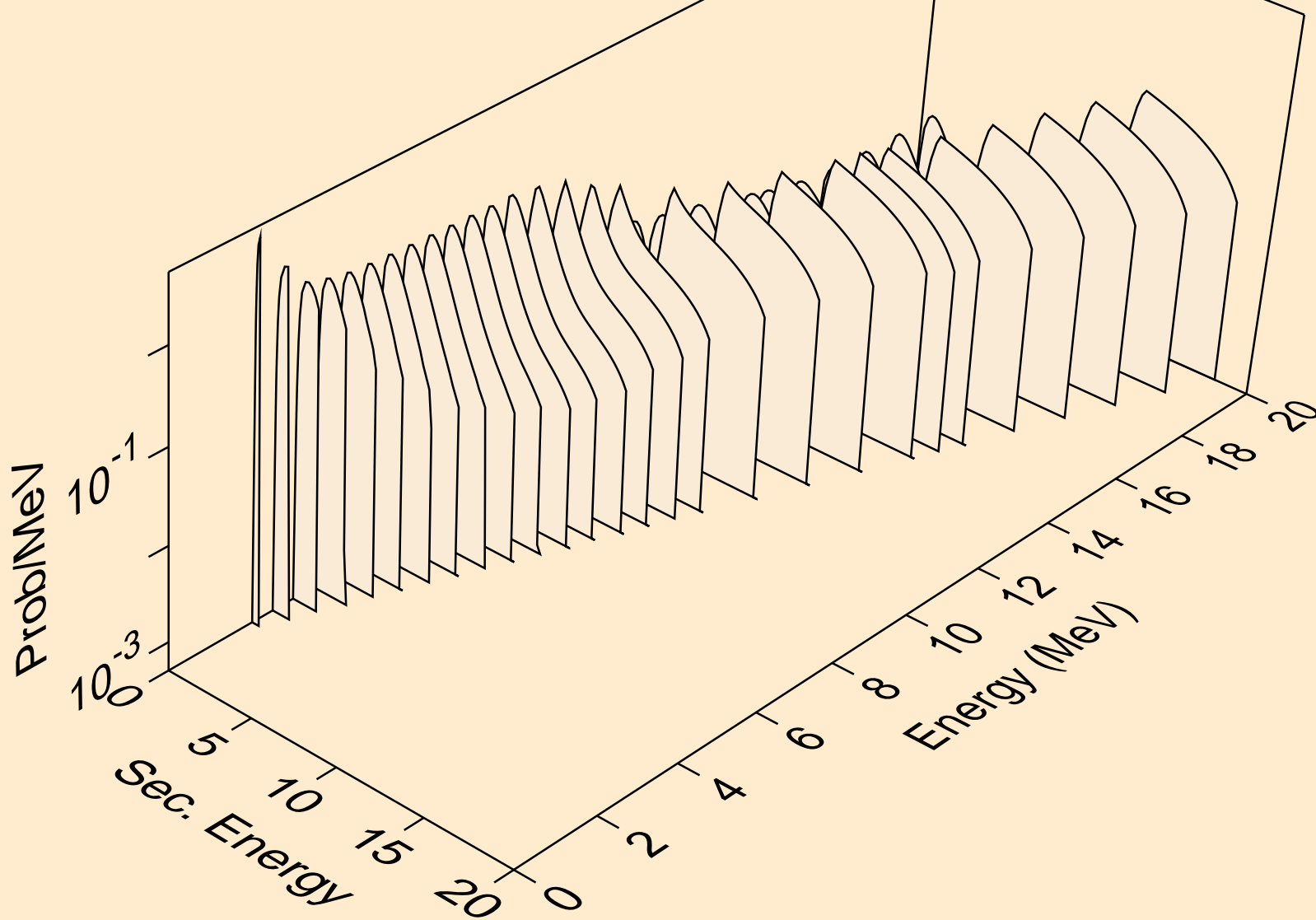

72-HF-178 FOR FENDL-3.2 FROM FENDL-3.2 WITH NJOY2016.60
Photon emission for nonelastic

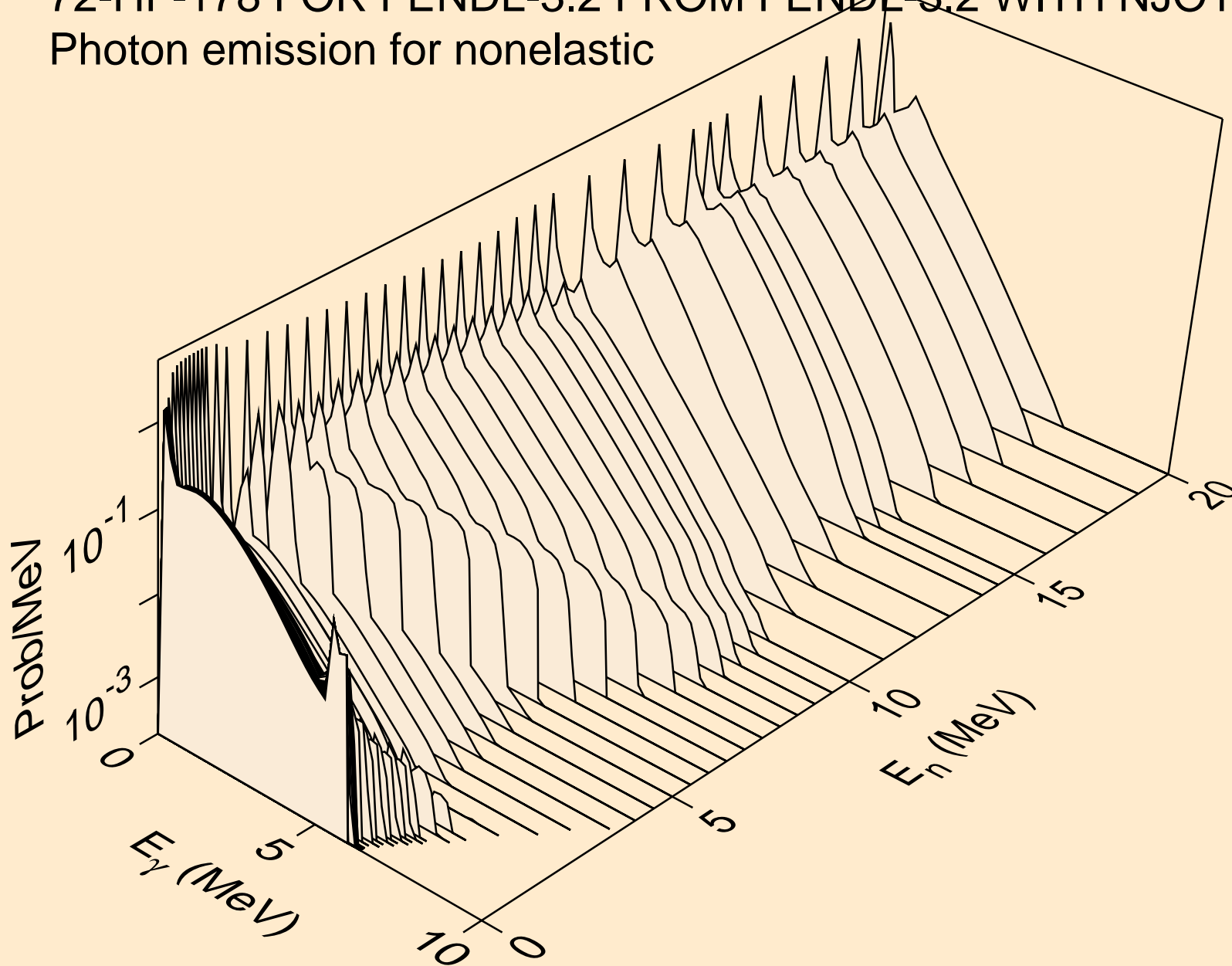

72-HF-178 FOR FENDL-3.2 FROM FENDL-3.2 WITH NJOY2016.60
Photon emission for (n,x)

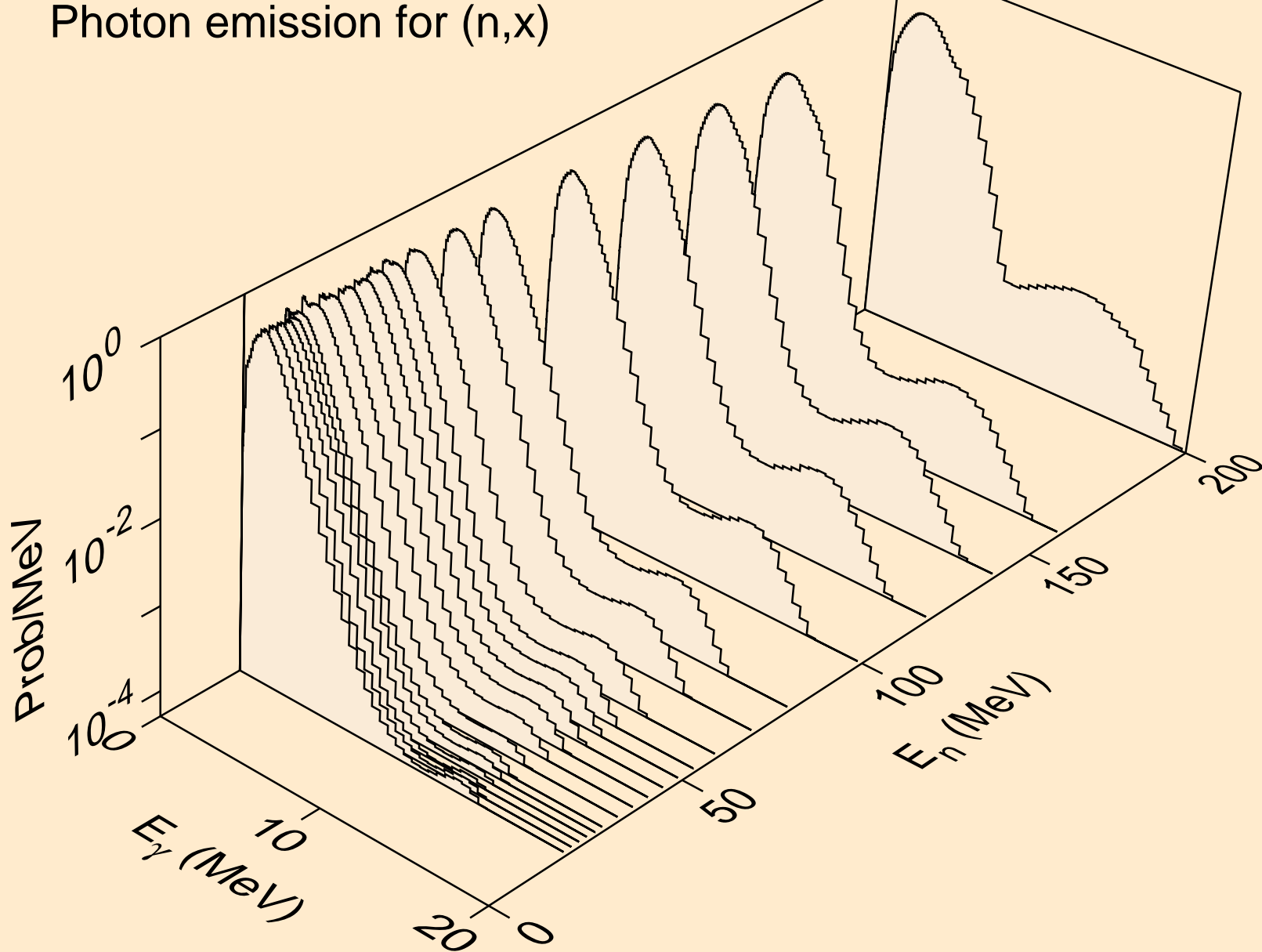

72-HF-178 FOR FENDL-3.2 FROM FENDL-3.2 WITH NJOY2016.60
14 MeV photon spectrum

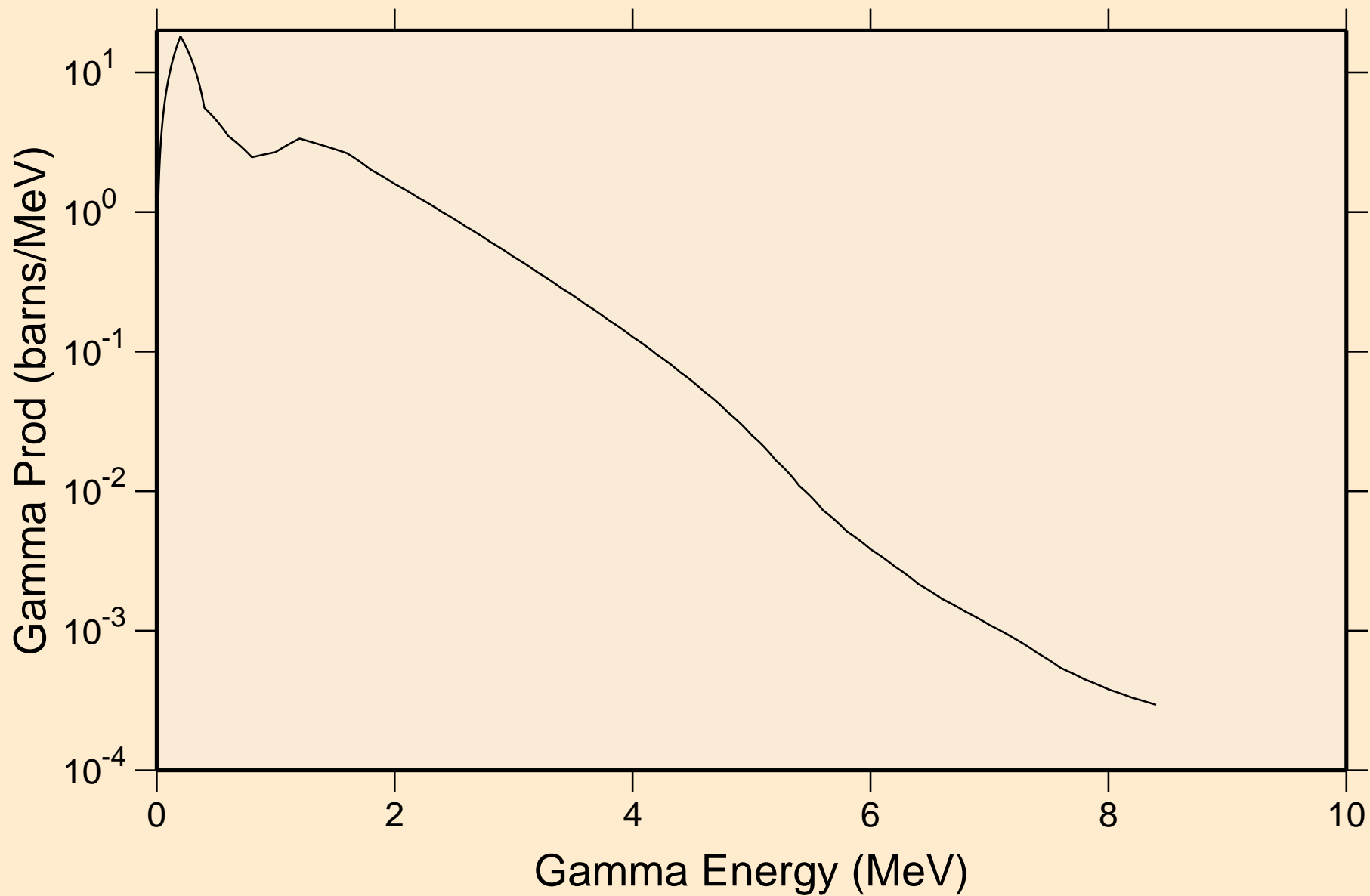

72-HF-178 FOR FENDL-3.2 FROM FENDL-3.2 WITH NJOY2016.60
Particle heating contributions

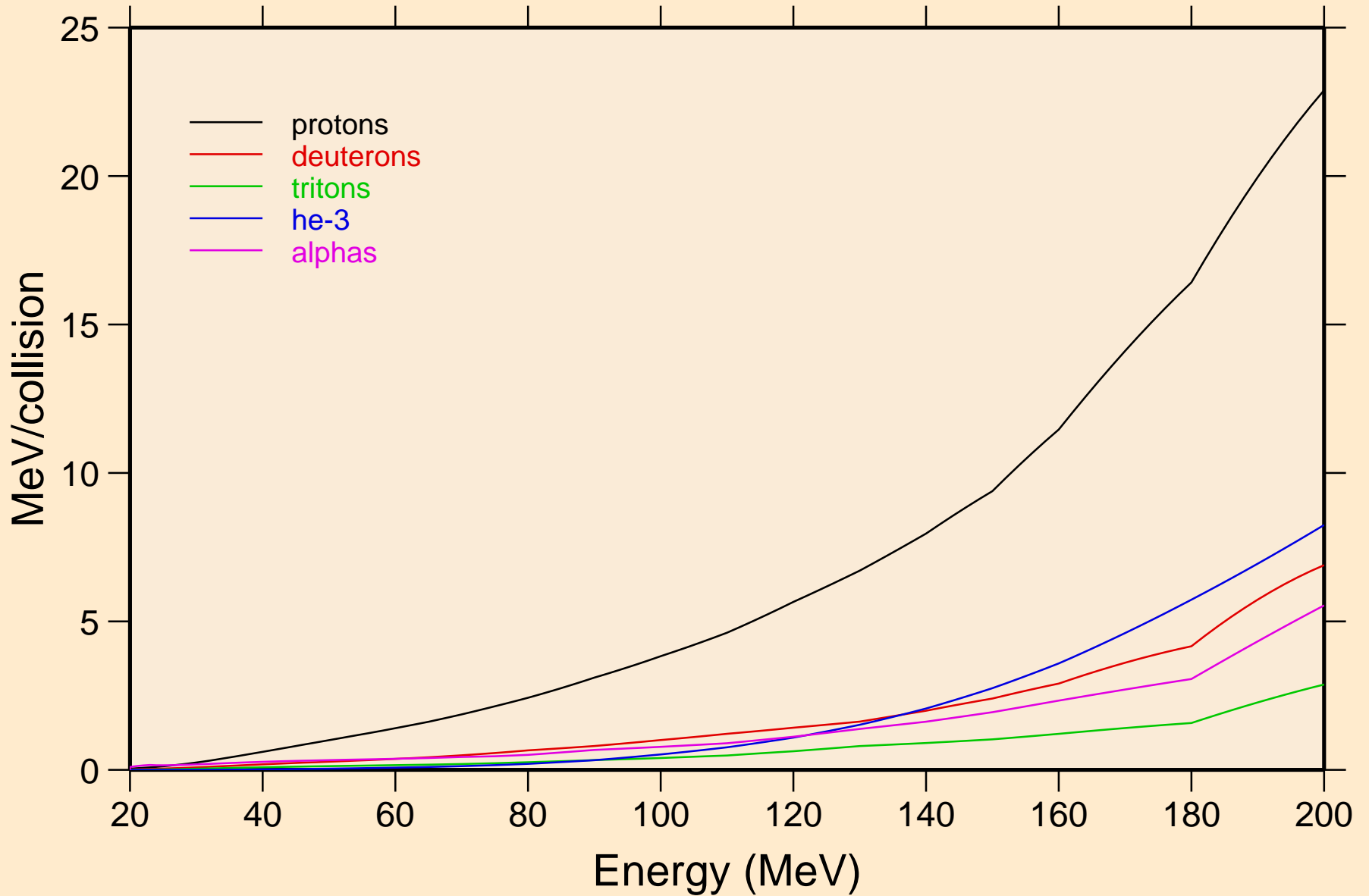

72-HF-178 FOR FENDL-3.2 FROM FENDL-3.2 WITH NJOY2016.60
Recoil Heating

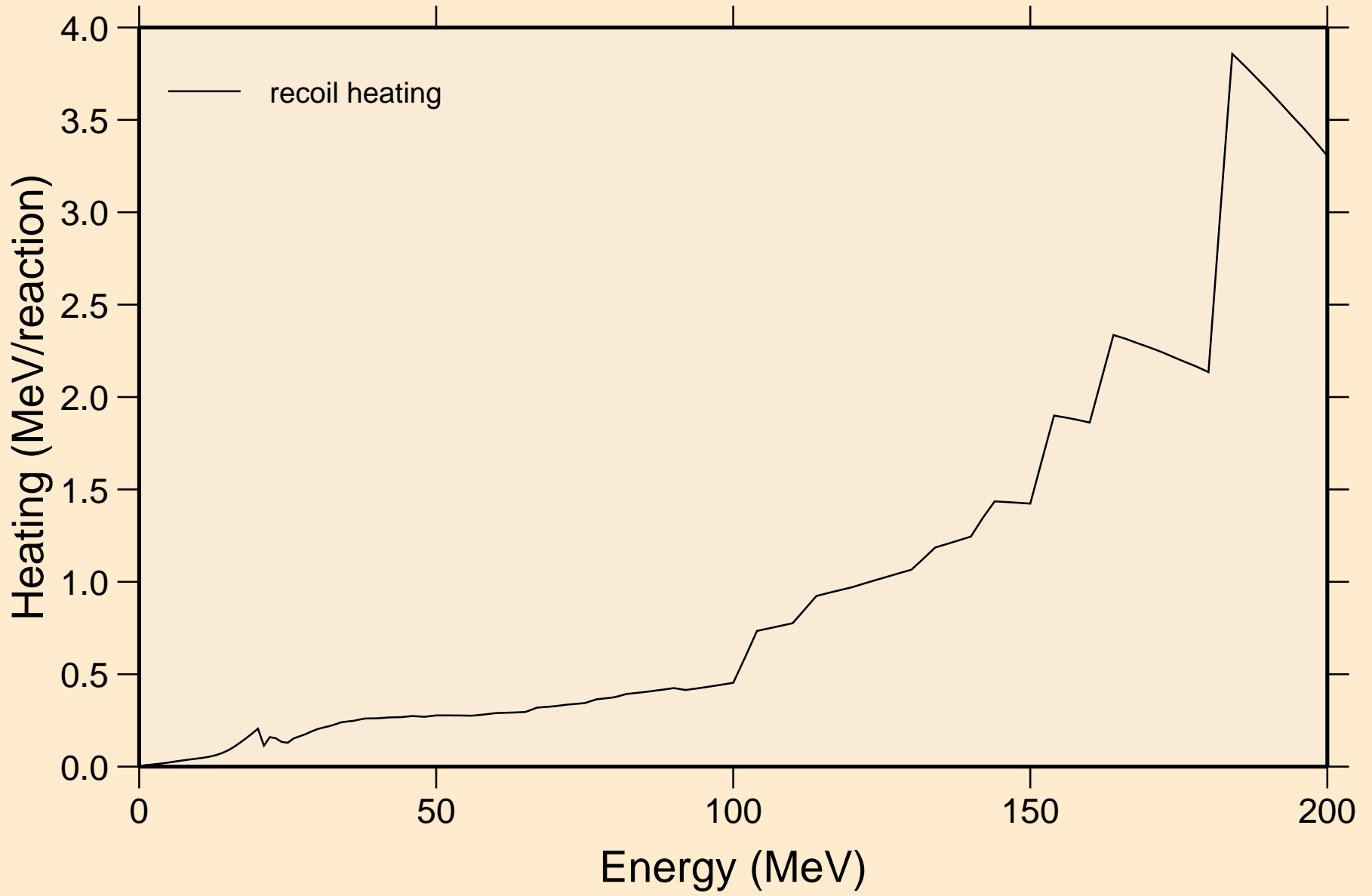

72-HF-178 FOR FENDL-3.2 FROM FENDL-3.2 WITH NJOY2016.60

Particle production cross sections

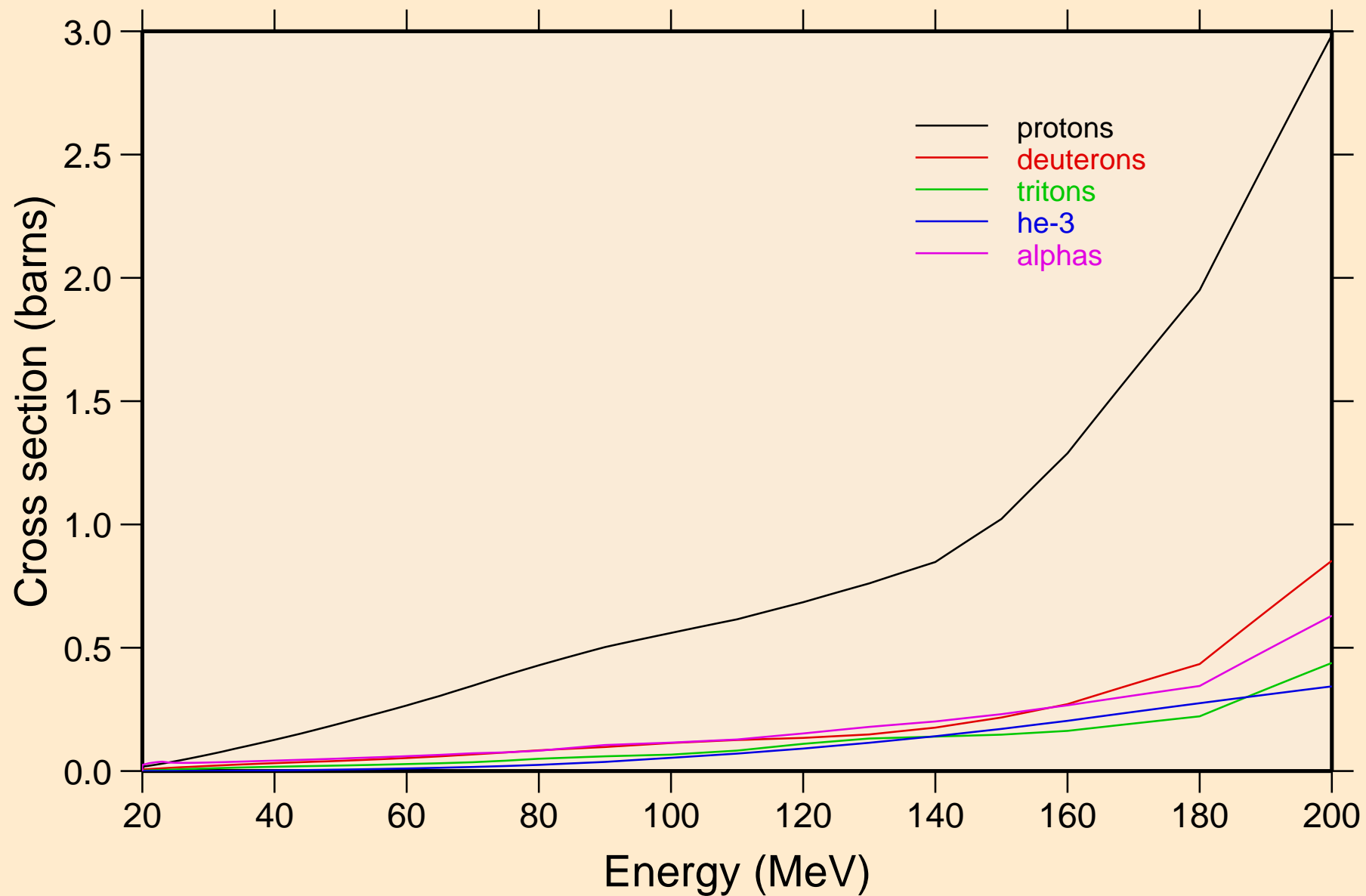

72-HF-178 FOR FENDL-3.2 FROM FENDL-3.2 WITH NJOY2016.60
protons from (n,x)

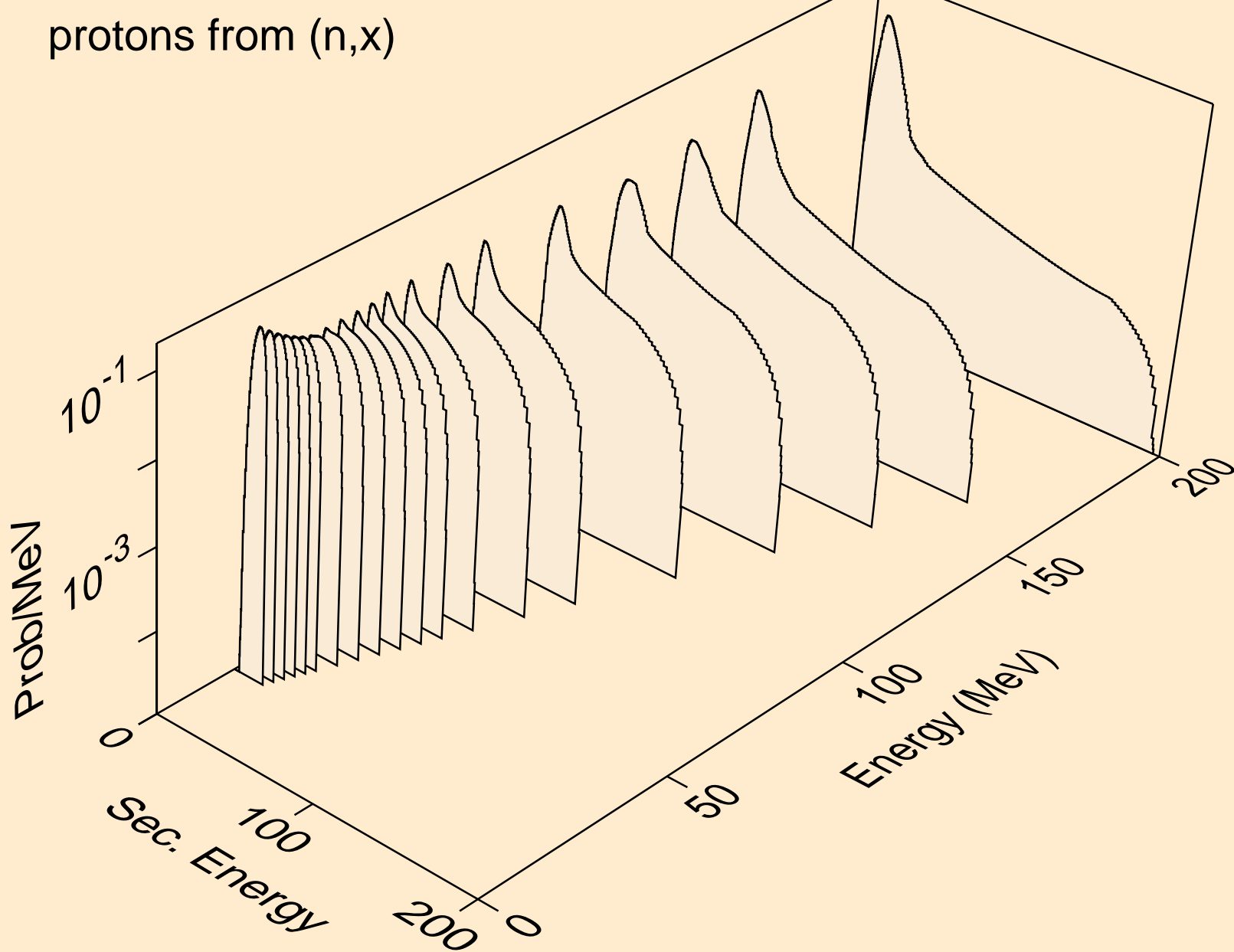

72-HF-178 FOR FENDL-3.2 FROM FENDL-3.2 WITH NJOY2016.60
deuterons from (n,x)

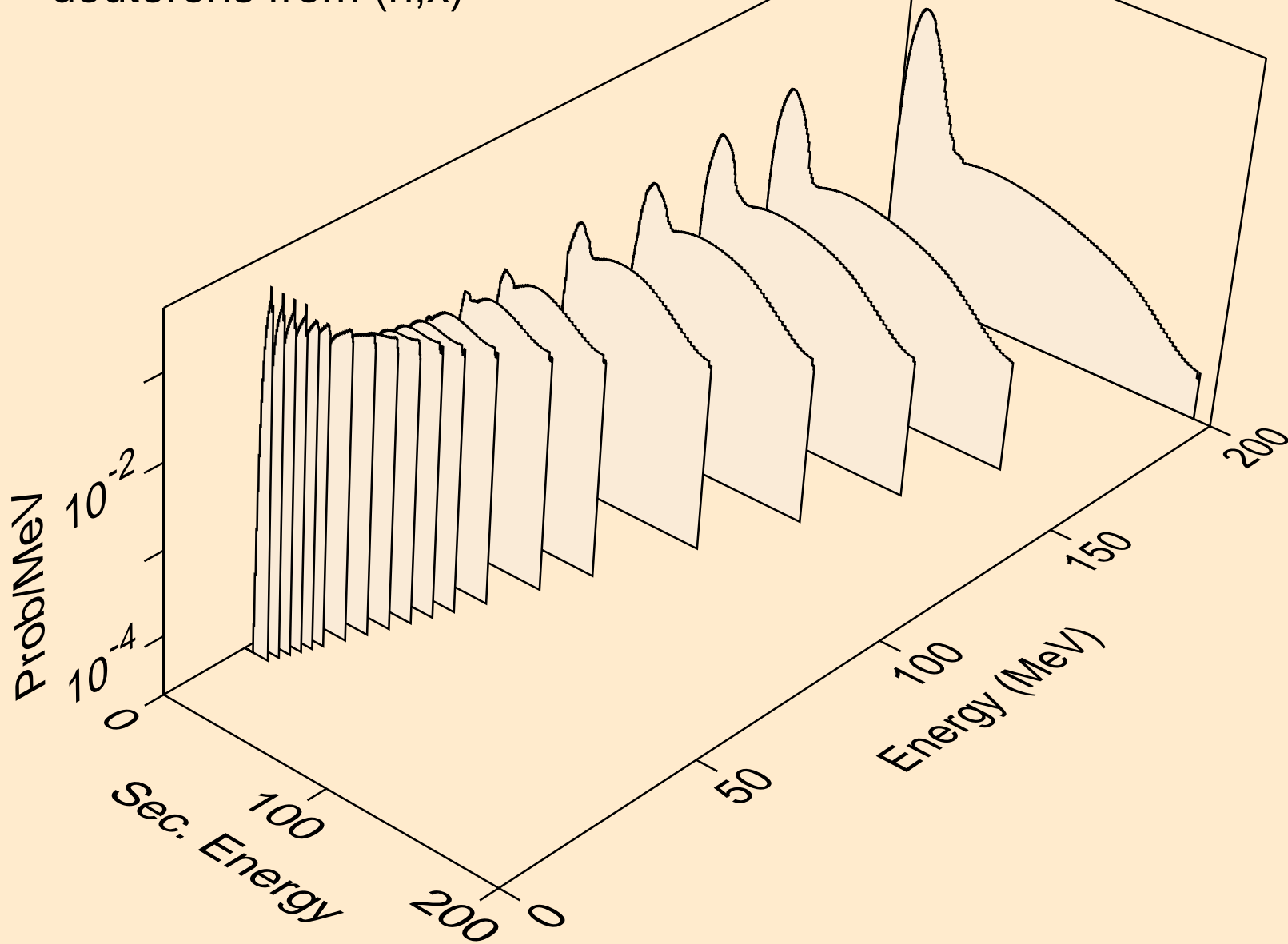

72-HF-178 FOR FENDL-3.2 FROM FENDL-3.2 WITH NJOY2016.60
tritons from (n,x)

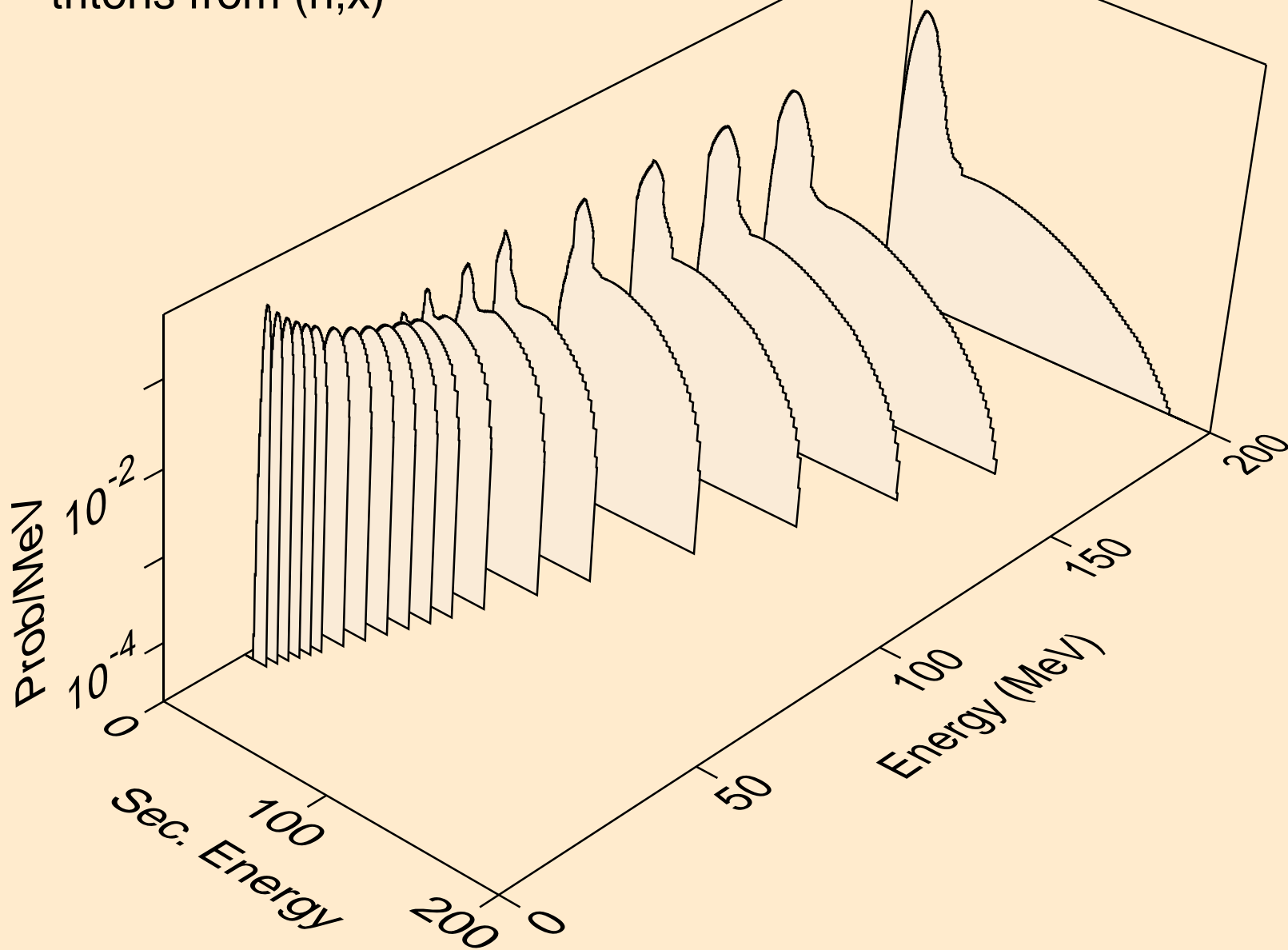

72-HF-178 FOR FENDL-3.2 FROM FENDL-3.2 WITH NJOY2016.60
he3s from (n,x)

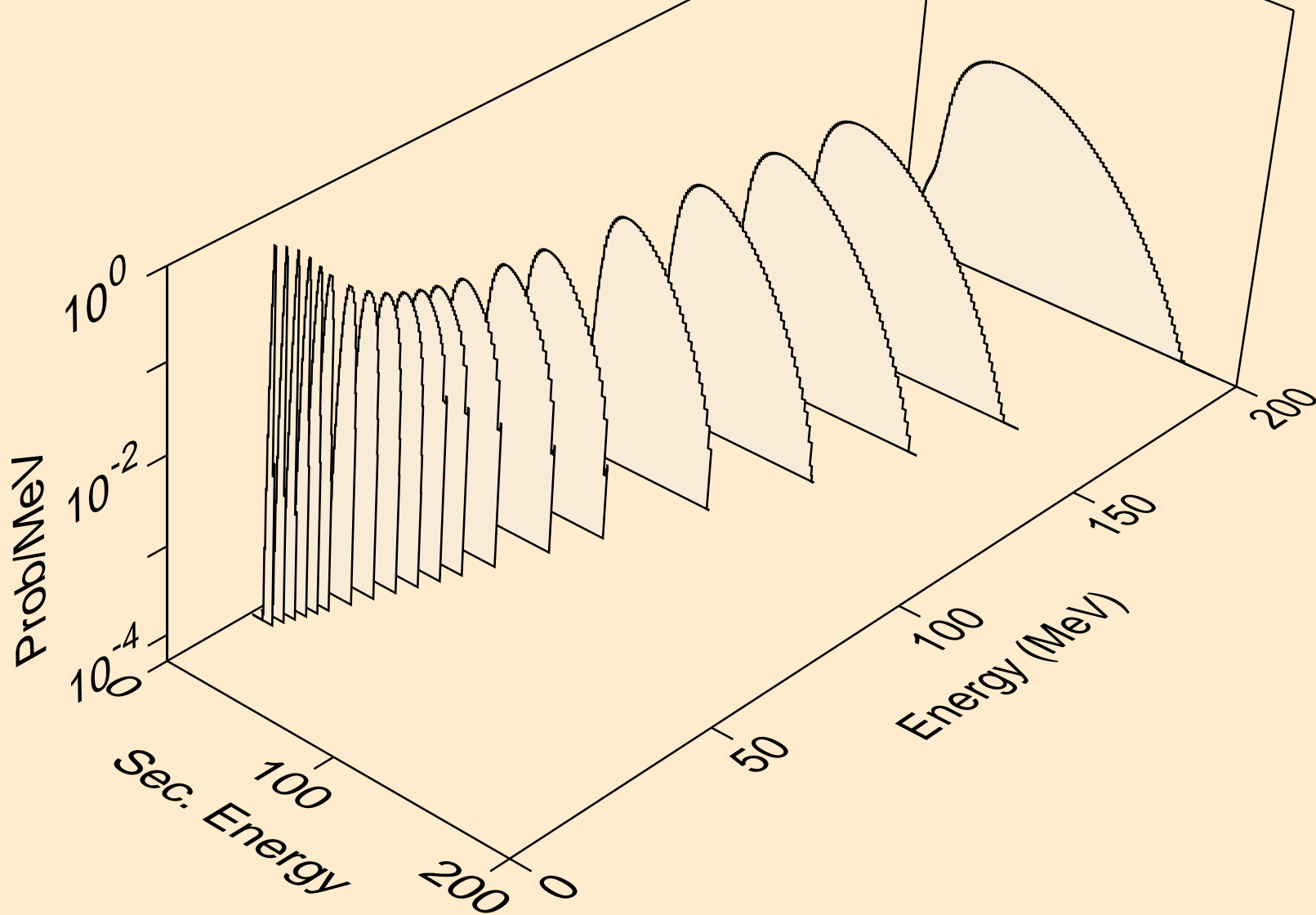

72-HF-178 FOR FENDL-3.2 FROM FENDL-3.2 WITH NJOY2016.60
alphas from (n,x)

