

8-O-16 FOR FENDL-3B2 FROM ENDF/B-VII WITH NJOY99.304+ C

Principal cross sections

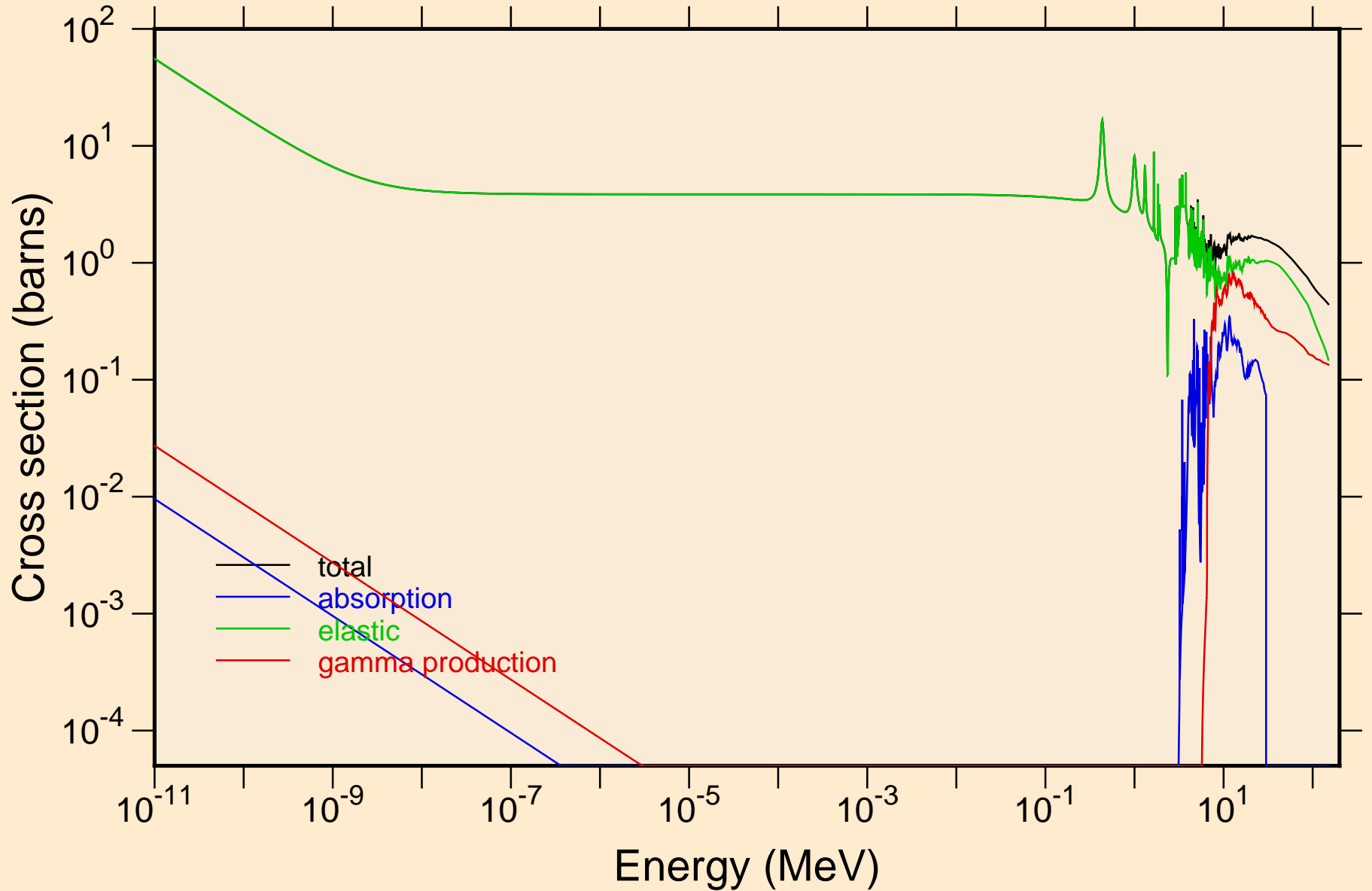

8-O-16 FOR FENDL-3B2 FROM ENDF/B-VII WITH NJOY99.304+ C
resonance total cross section

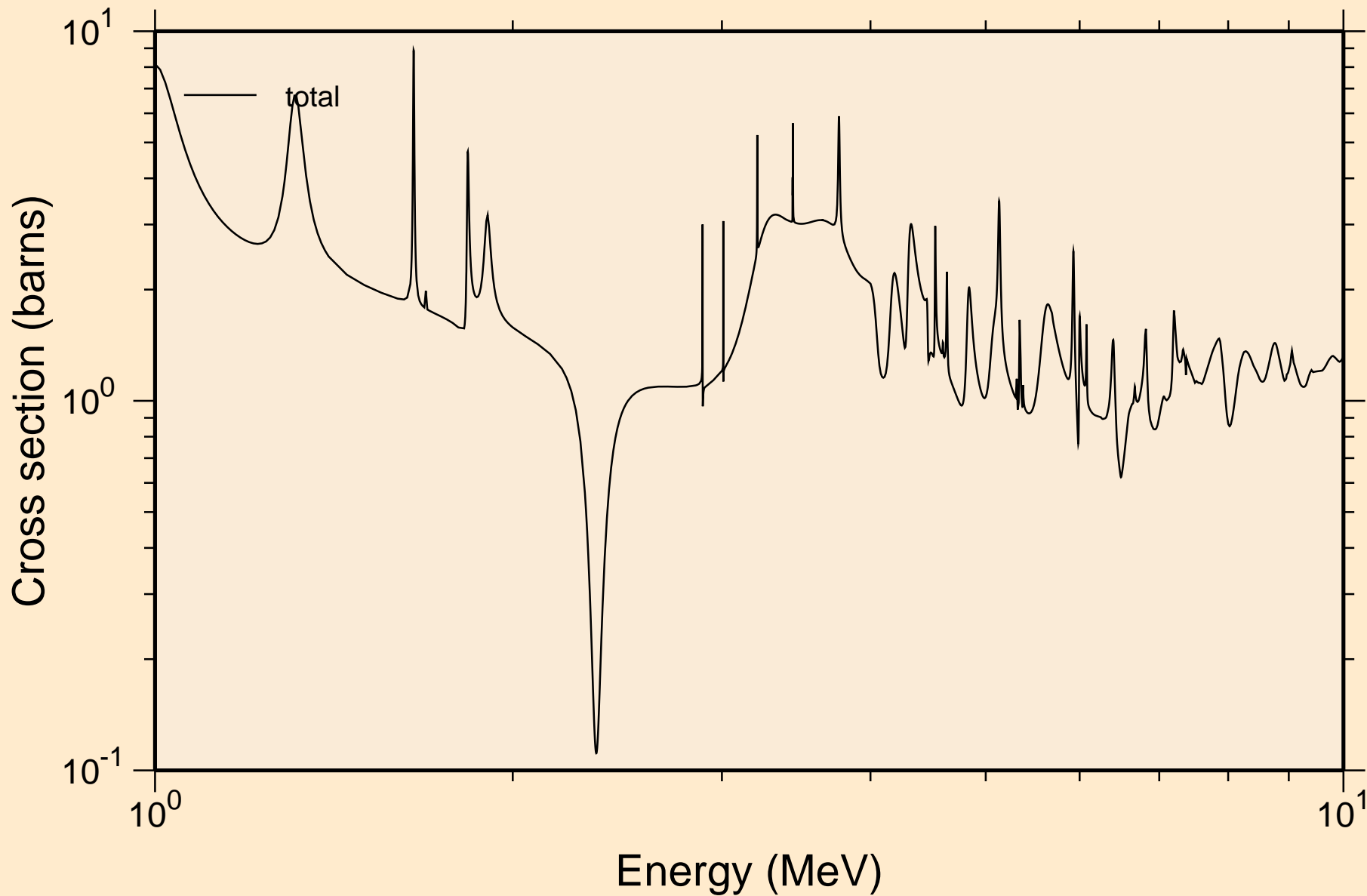

8-O-16 FOR FENDL-3B2 FROM ENDF/B-VII WITH NJOY99.304+ C
resonance absorption cross sections

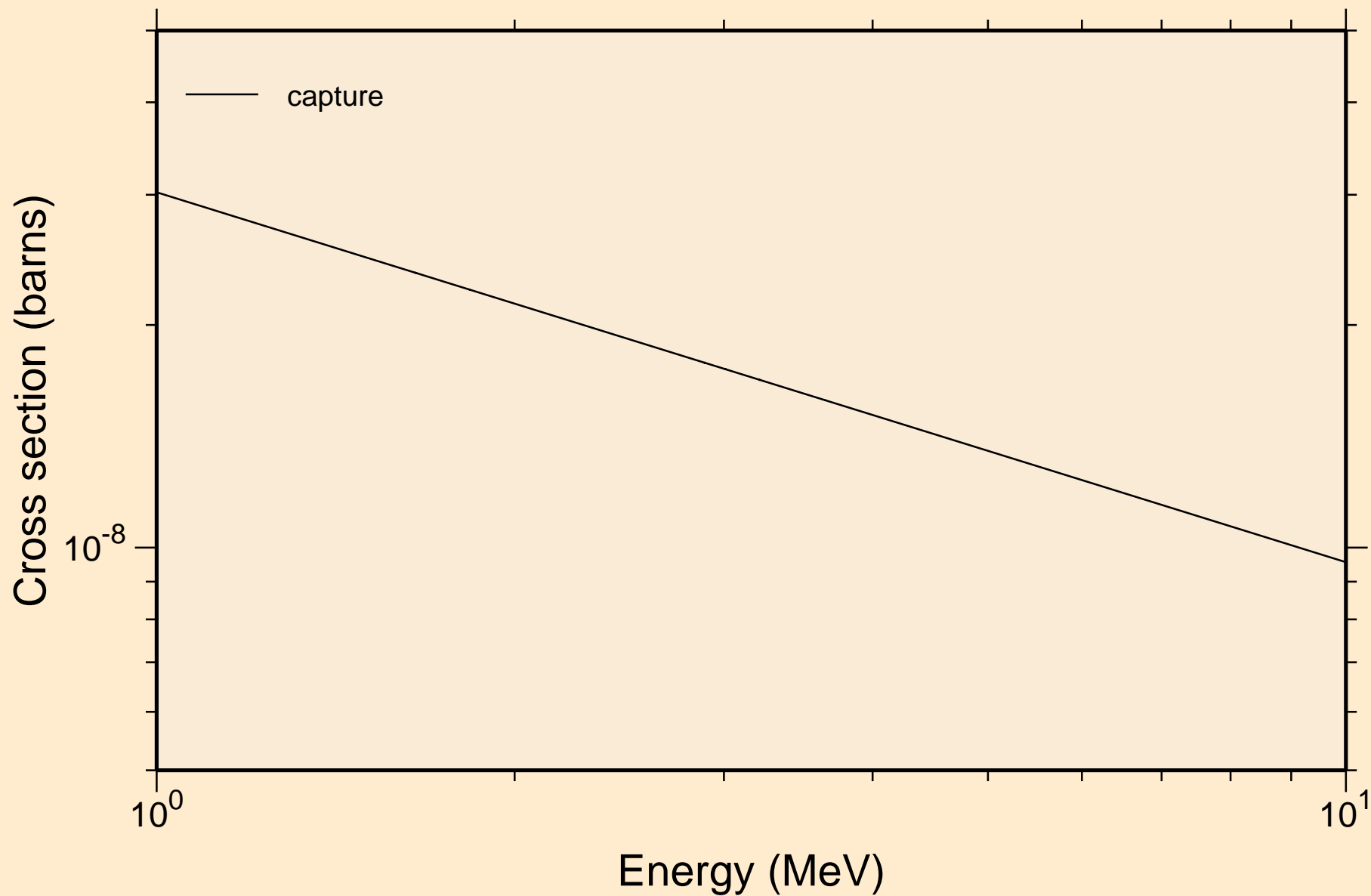

8-O-16 FOR FENDL-3B2 FROM ENDF/B-VII WITH NJOY99.304+ C
Heating

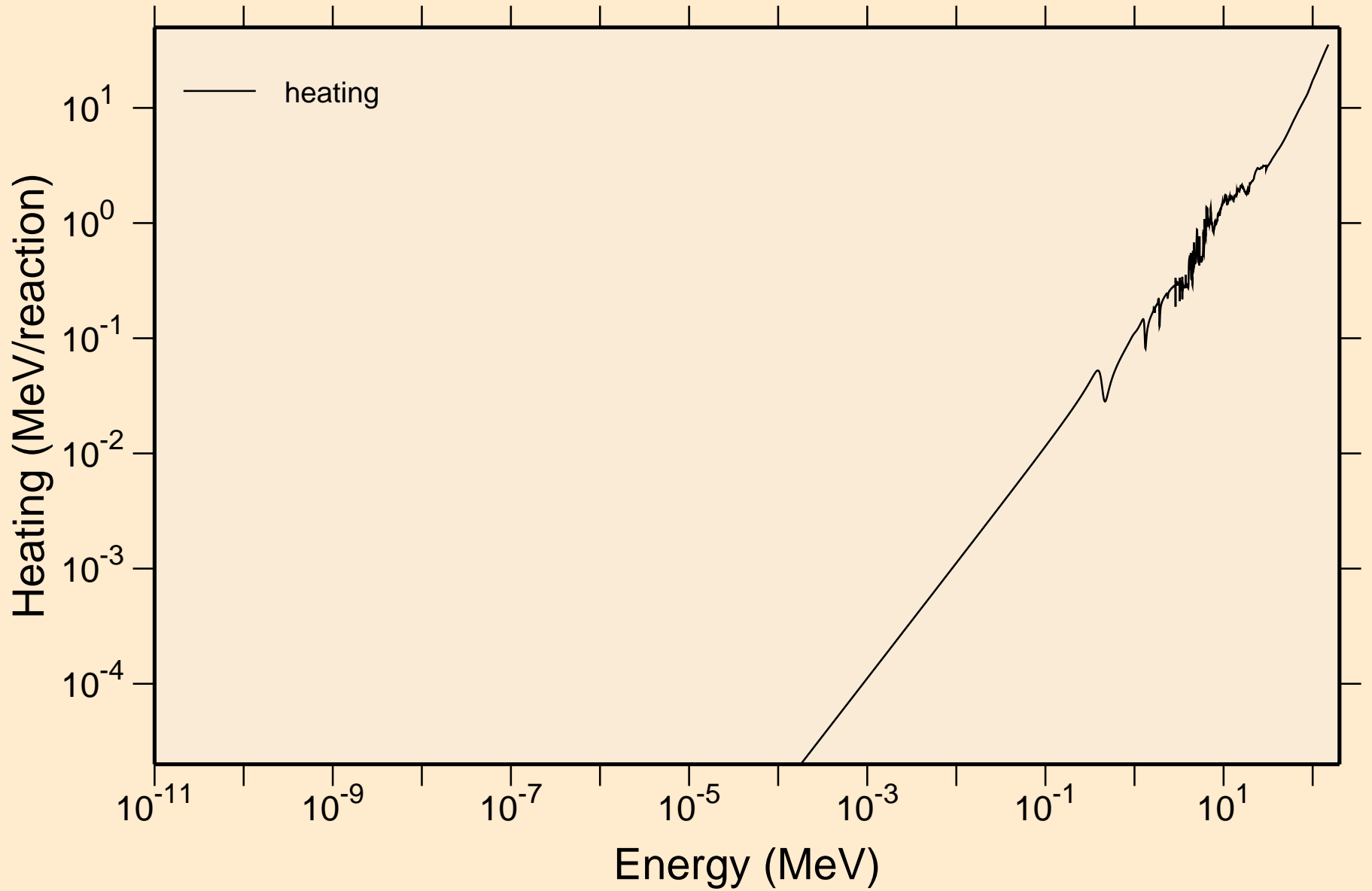

8-O-16 FOR FENDL-3B2 FROM ENDF/B-VII WITH NJOY99.304+ C Damage

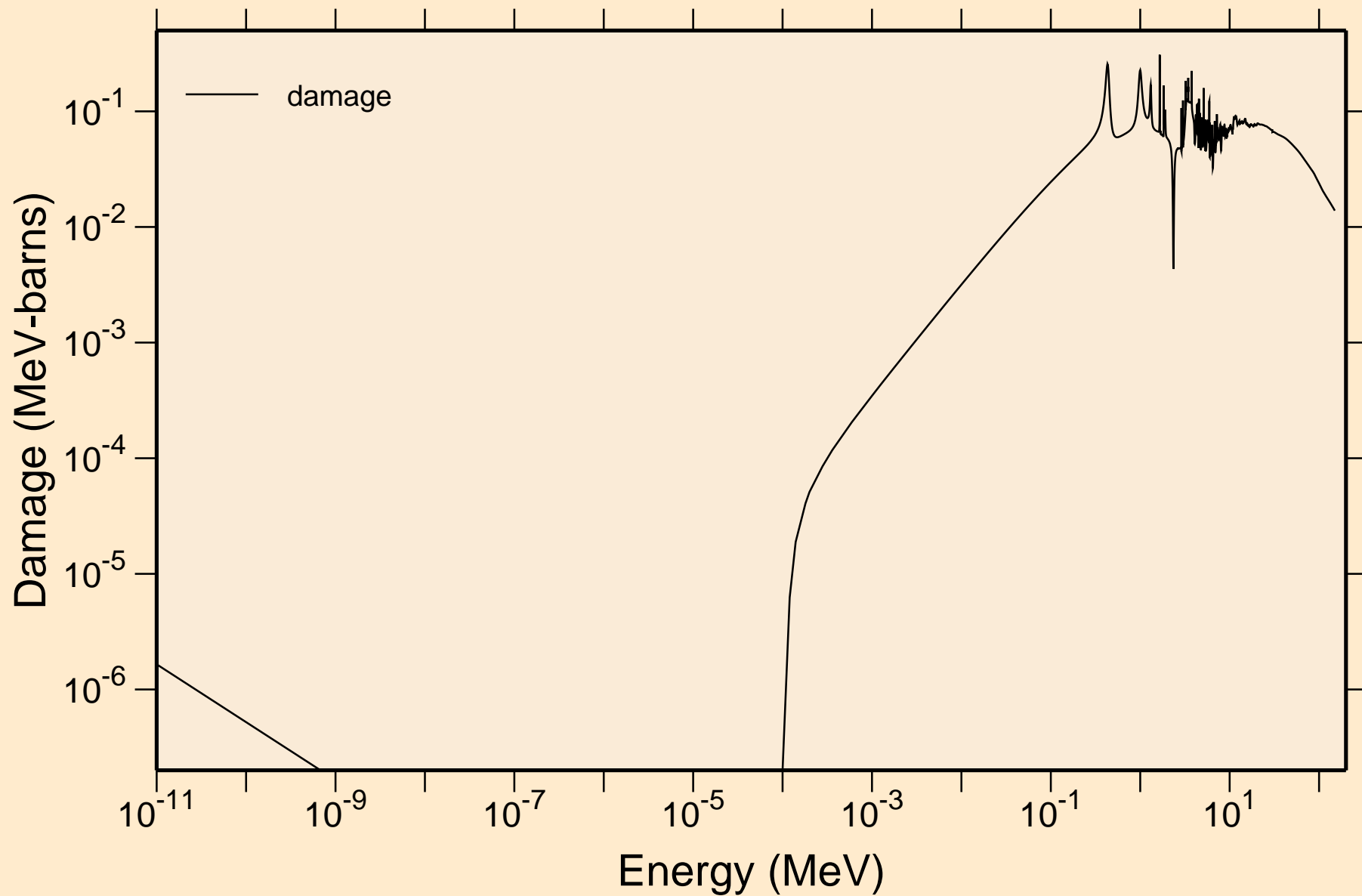

8-O-16 FOR FENDL-3B2 FROM ENDF/B-VII WITH NJOY99.304+ C
Non-threshold reactions

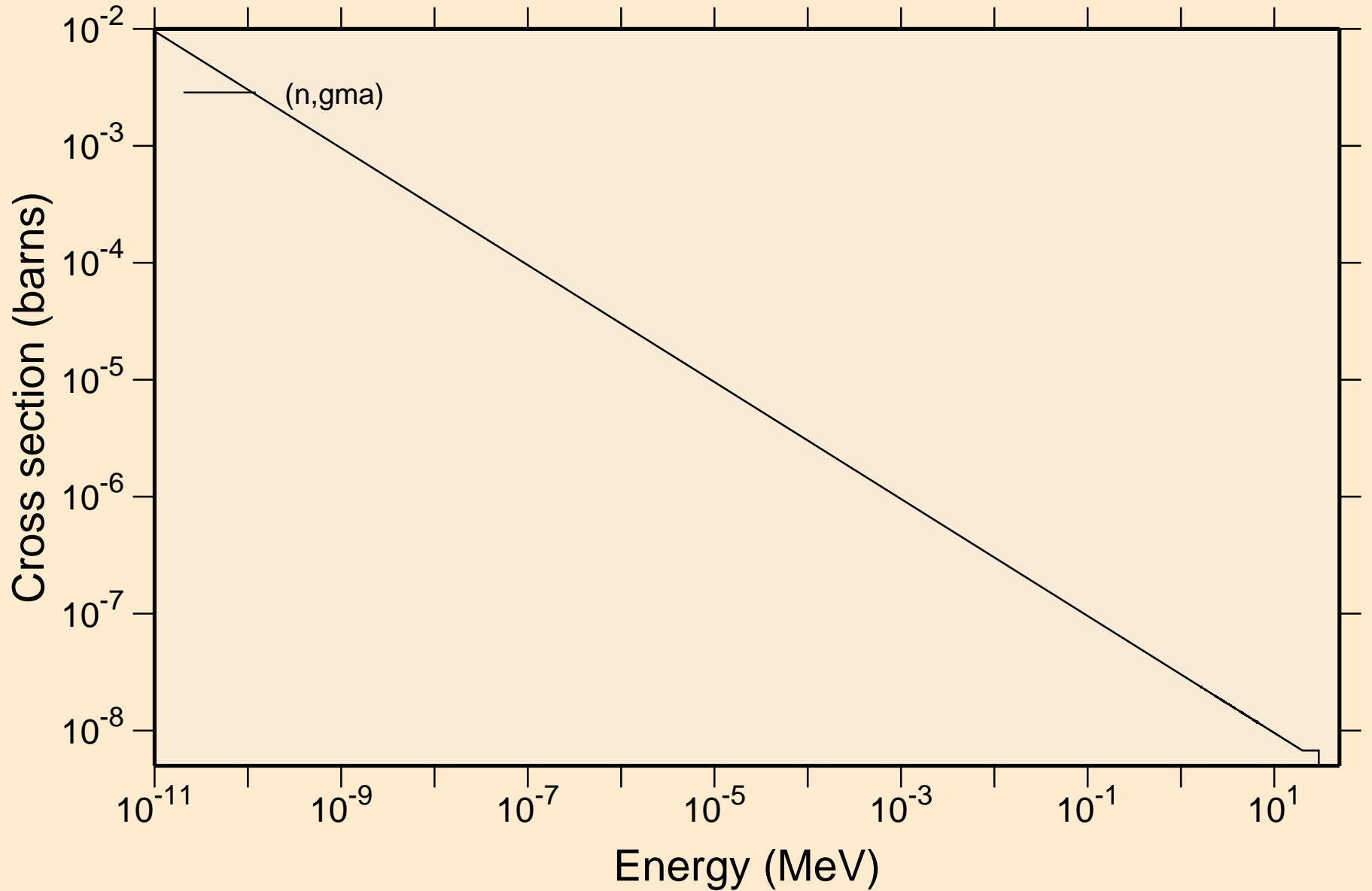

8-O-16 FOR FENDL-3B2 FROM ENDF/B-VII WITH NJOY99.304+ C
Principal cross sections

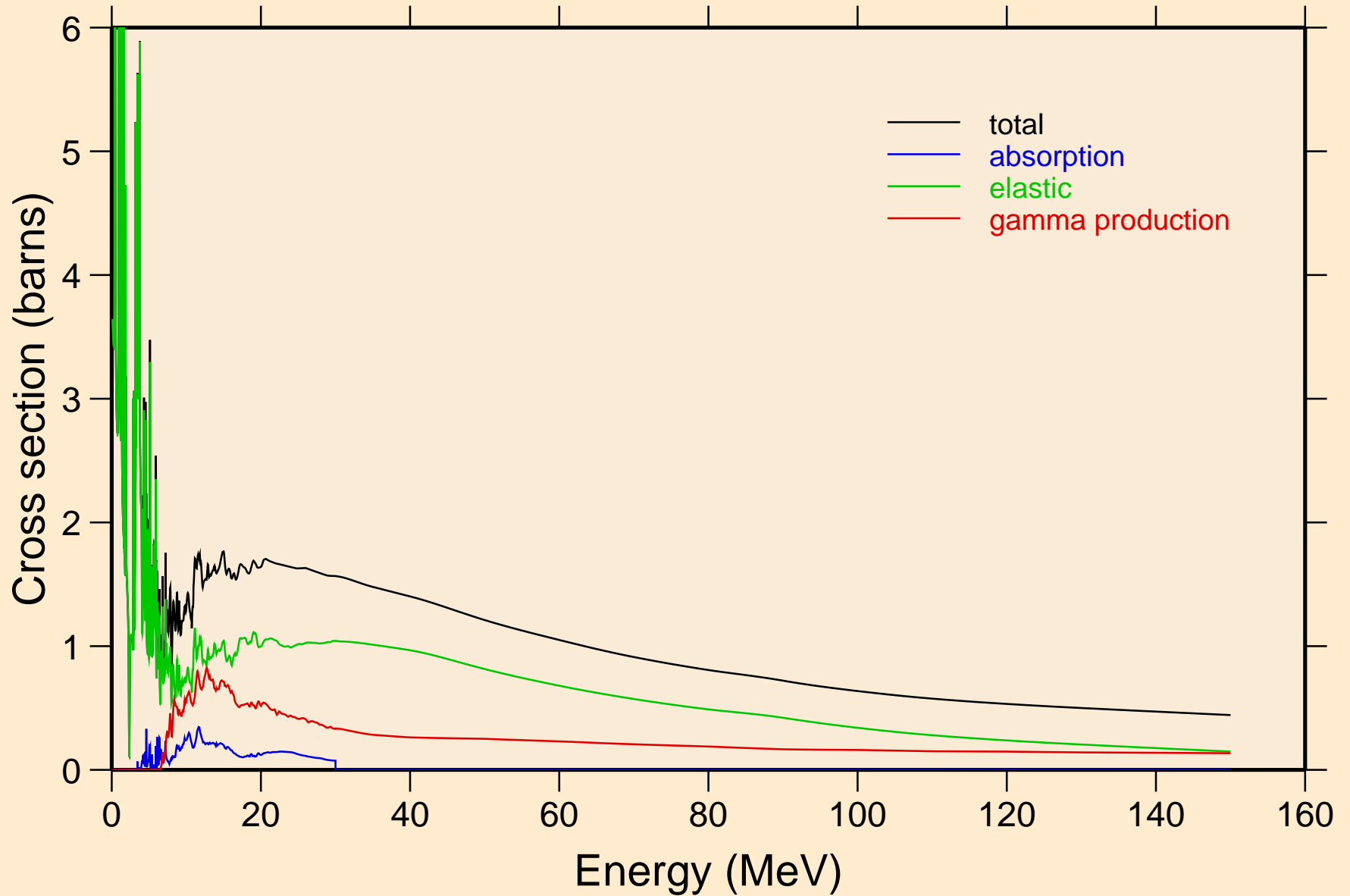

8-O-16 FOR FENDL-3B2 FROM ENDF/B-VII WITH NJOY99.304+ C Heating

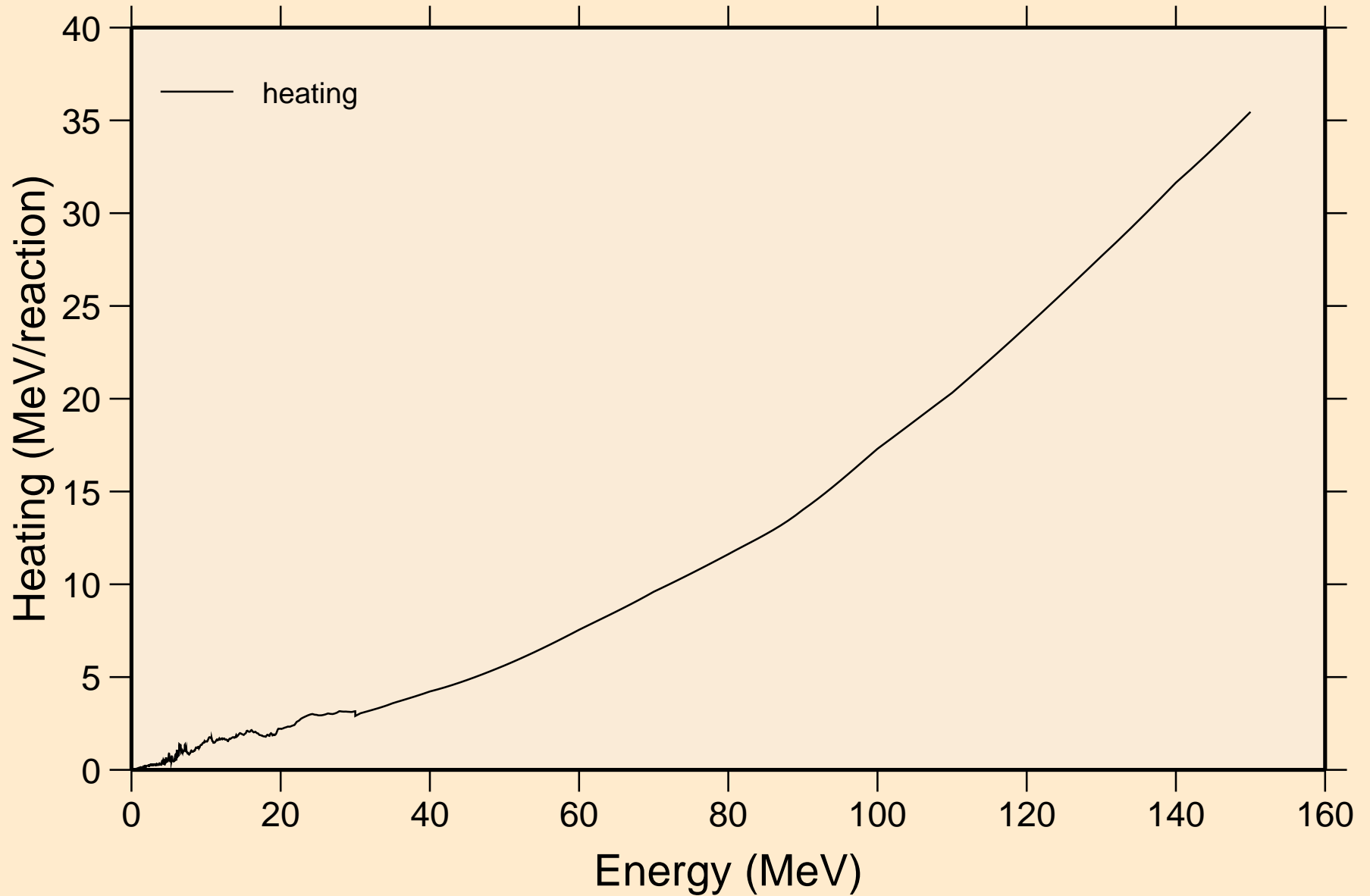

8-O-16 FOR FENDL-3B2 FROM ENDF/B-VII WITH NJOY99.304+ C Damage

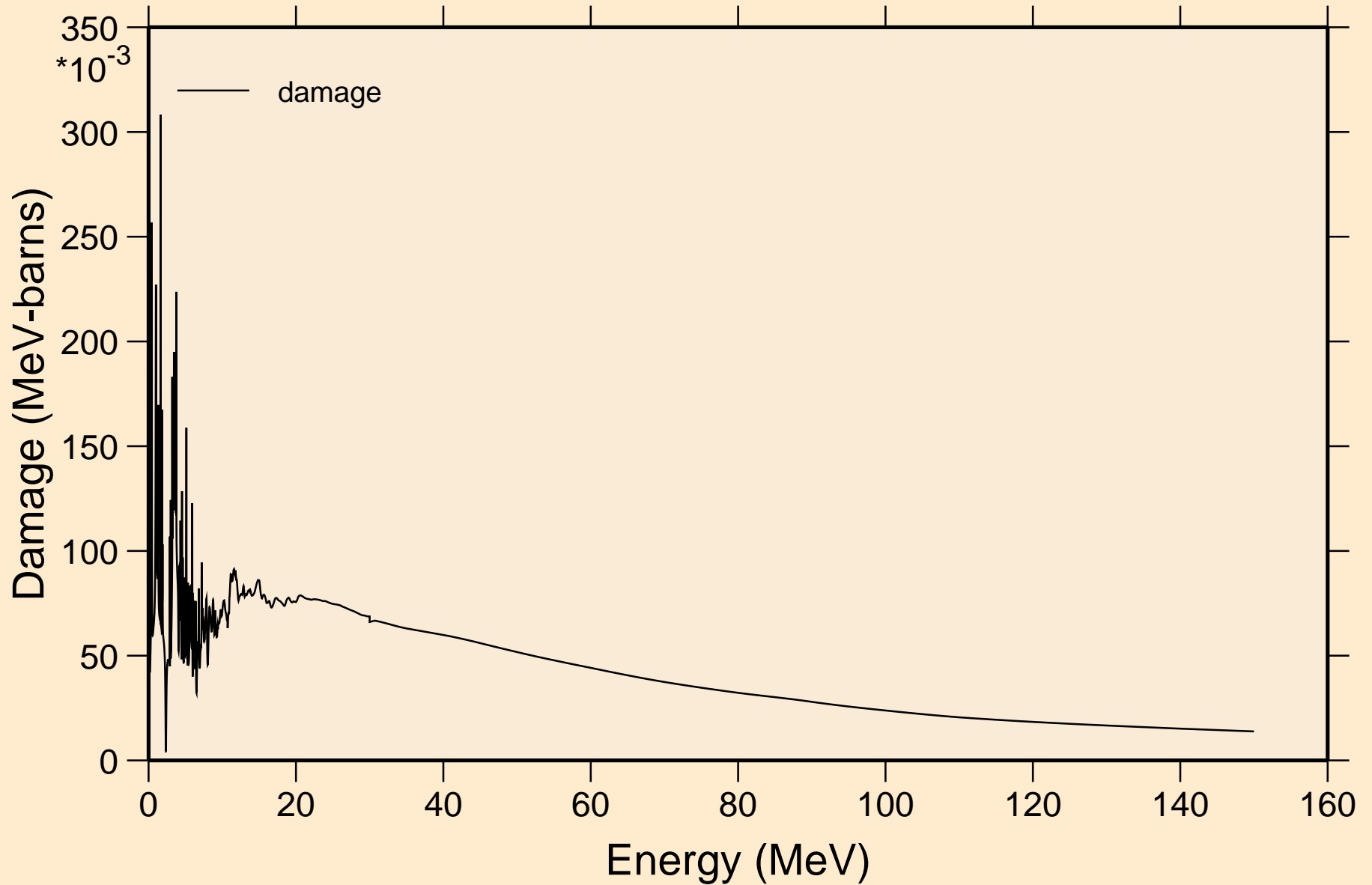

8-O-16 FOR FENDL-3B2 FROM ENDF/B-VII WITH NJOY99.304+ C
Non-threshold reactions

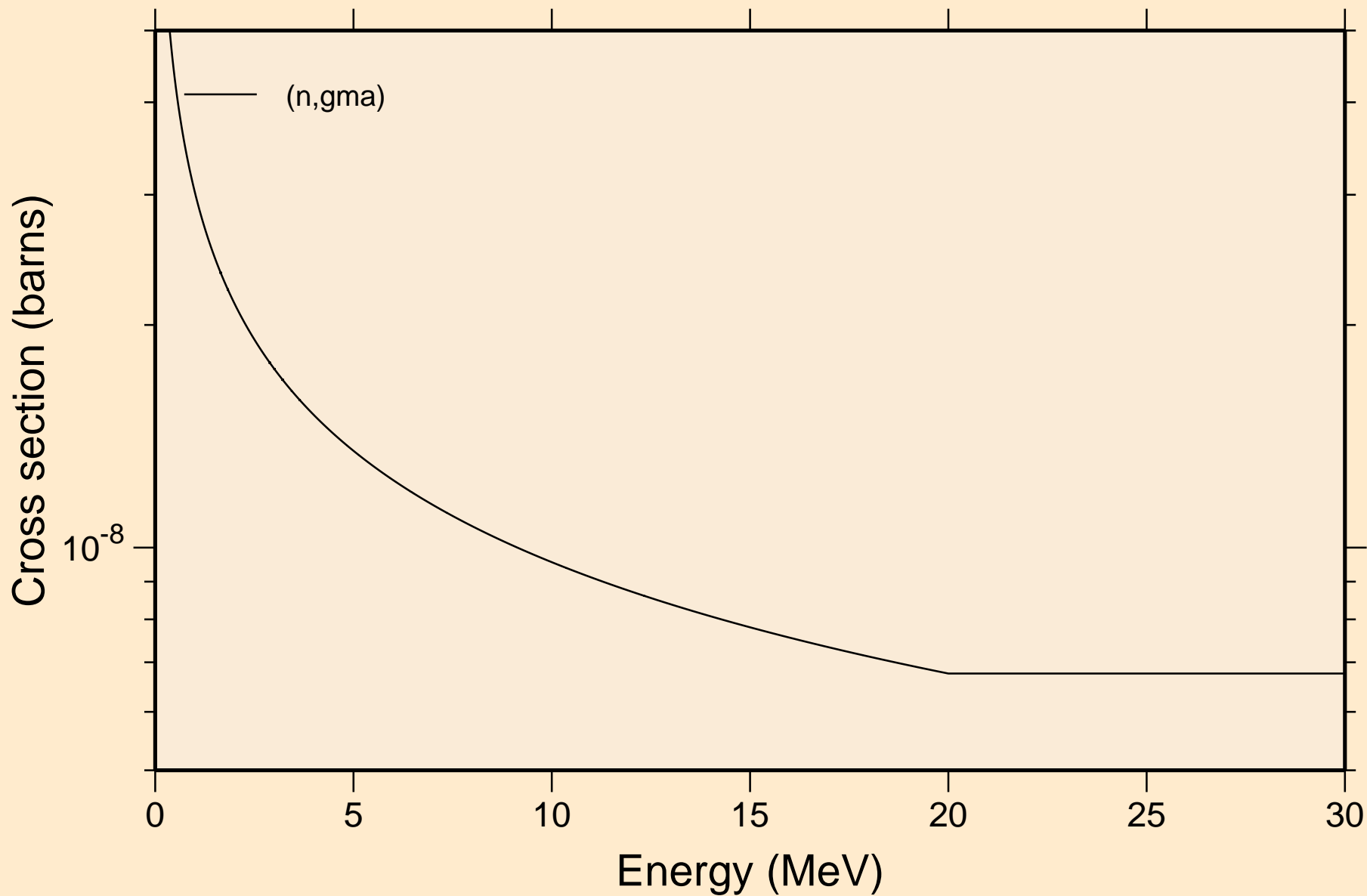

8-O-16 FOR FENDL-3B2 FROM ENDF/B-VII WITH NJOY99.304+ C

Inelastic levels

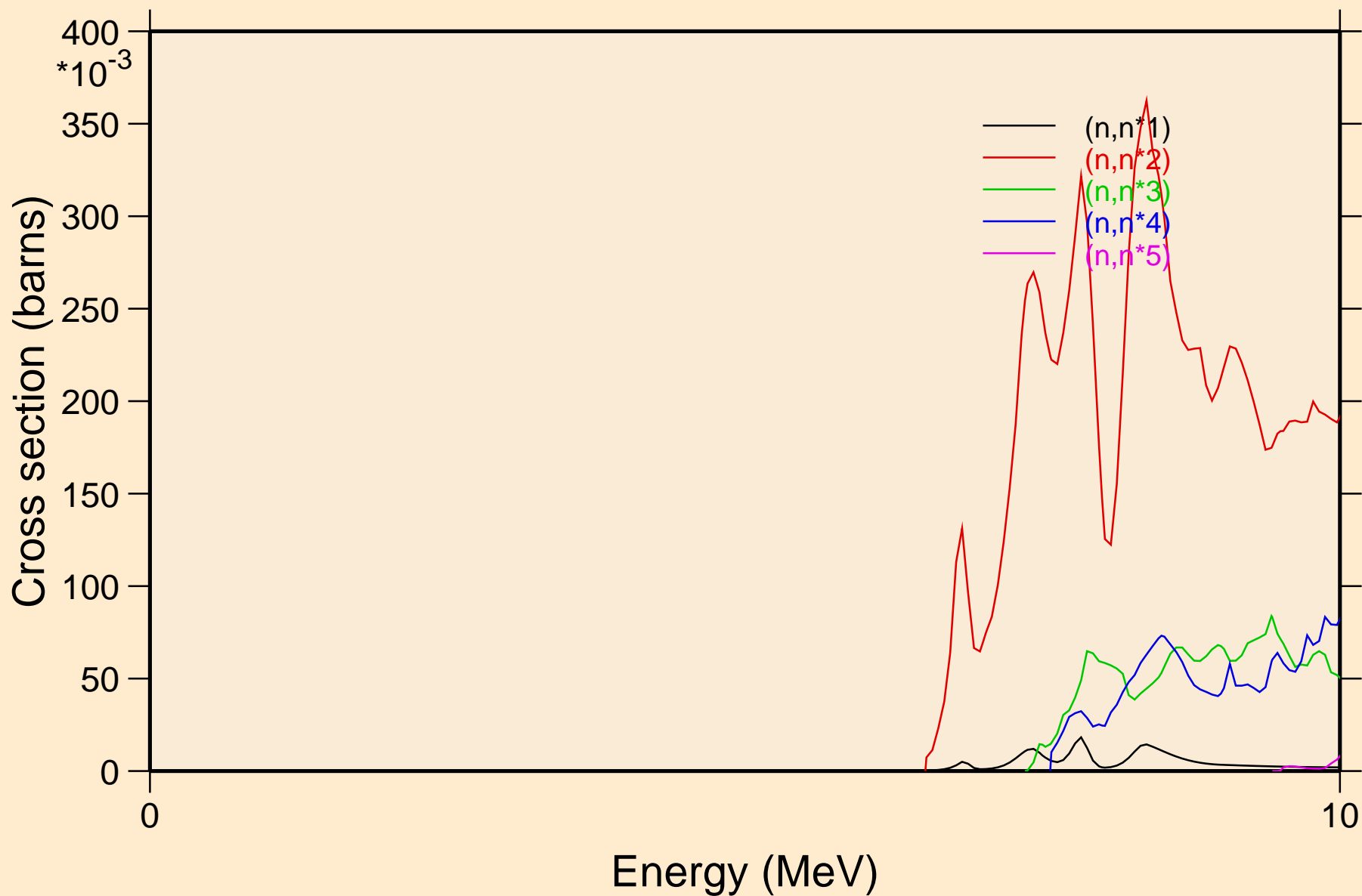

8-O-16 FOR FENDL-3B2 FROM ENDF/B-VII WITH NJOY99.304+ C
Inelastic levels

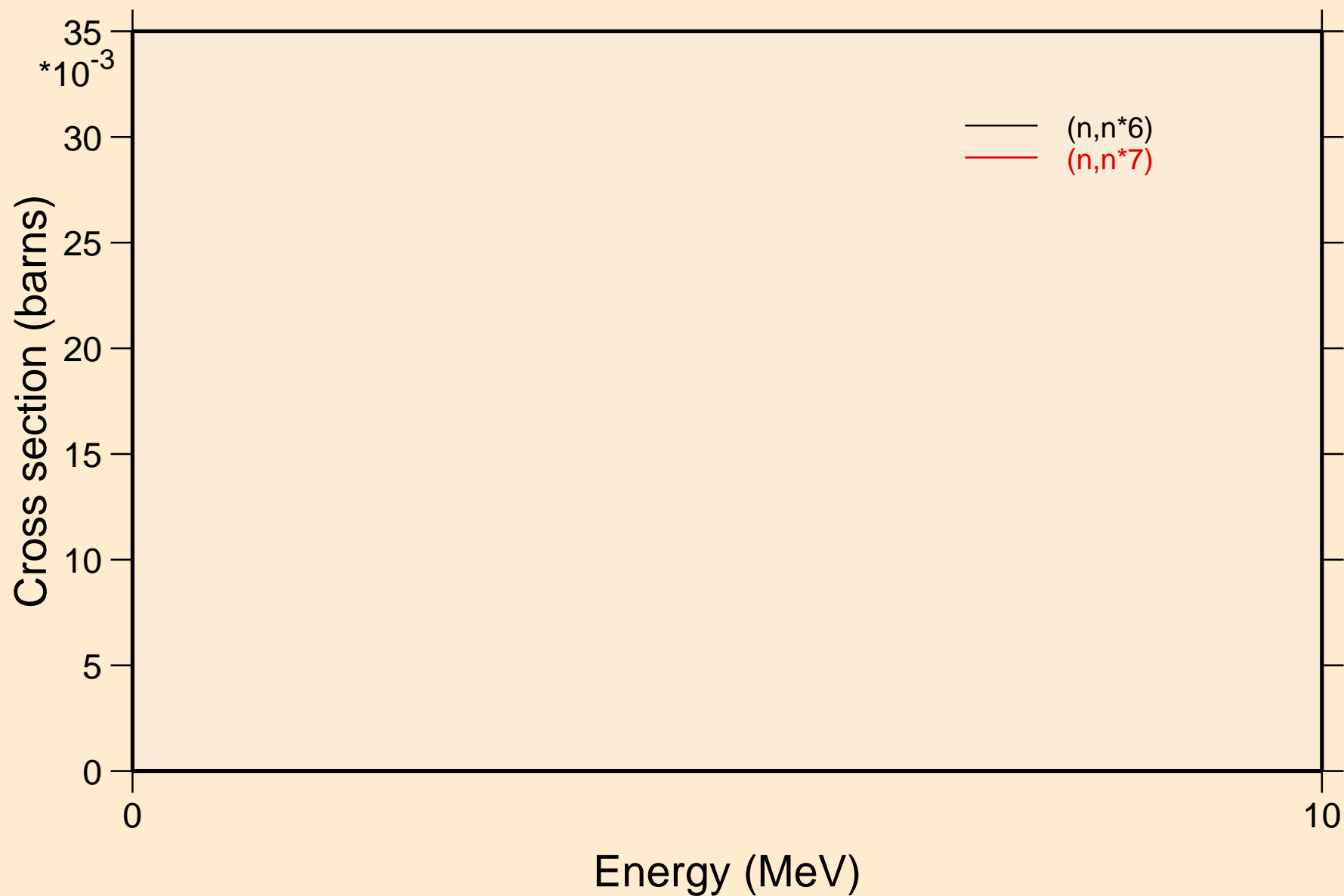

8-O-16 FOR FENDL-3B2 FROM ENDF/B-VII WITH NJOY99.304+ C
Threshold reactions

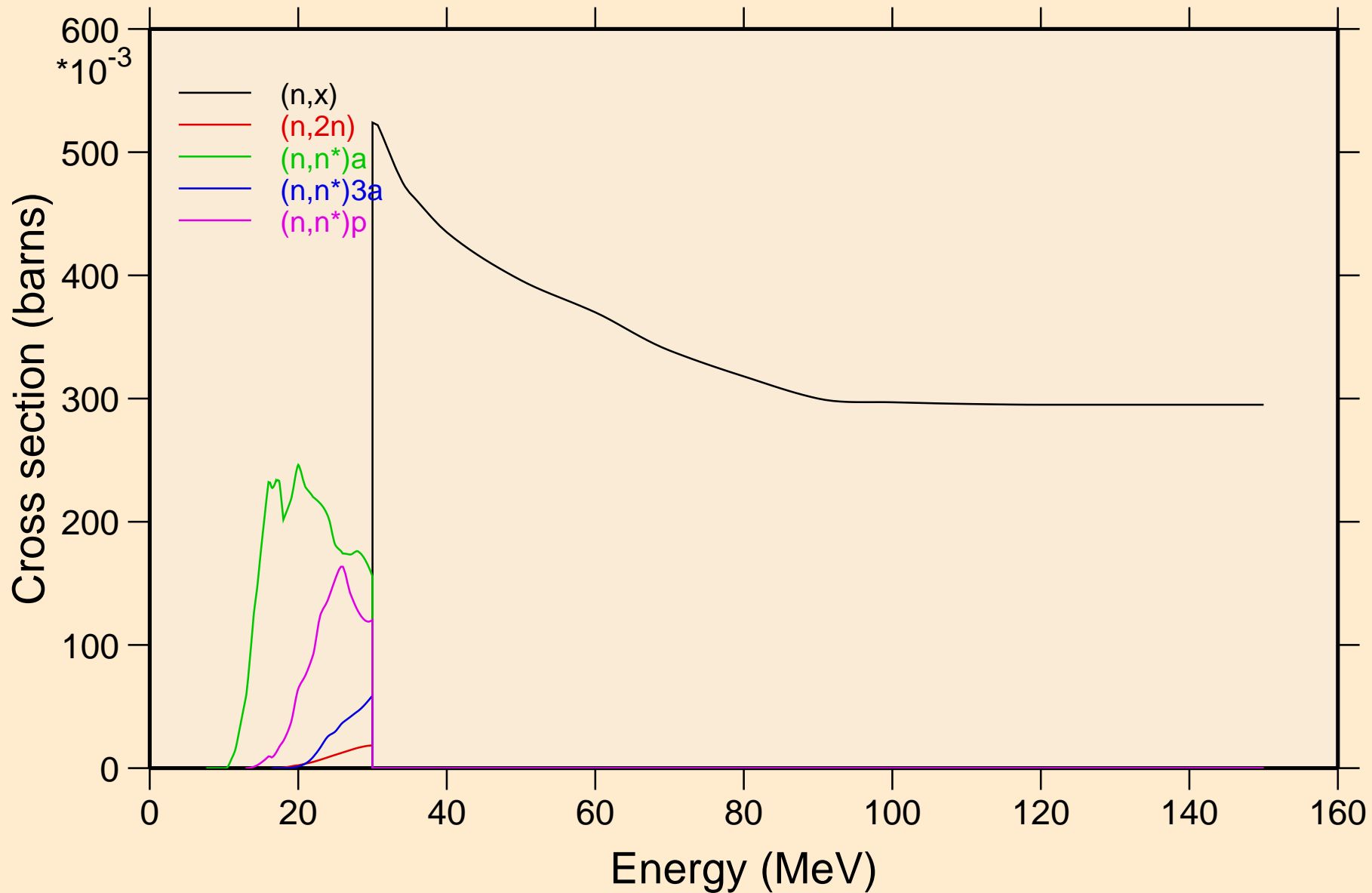

8-O-16 FOR FENDL-3B2 FROM ENDF/B-VII WITH NJOY99.304+ C

Threshold reactions

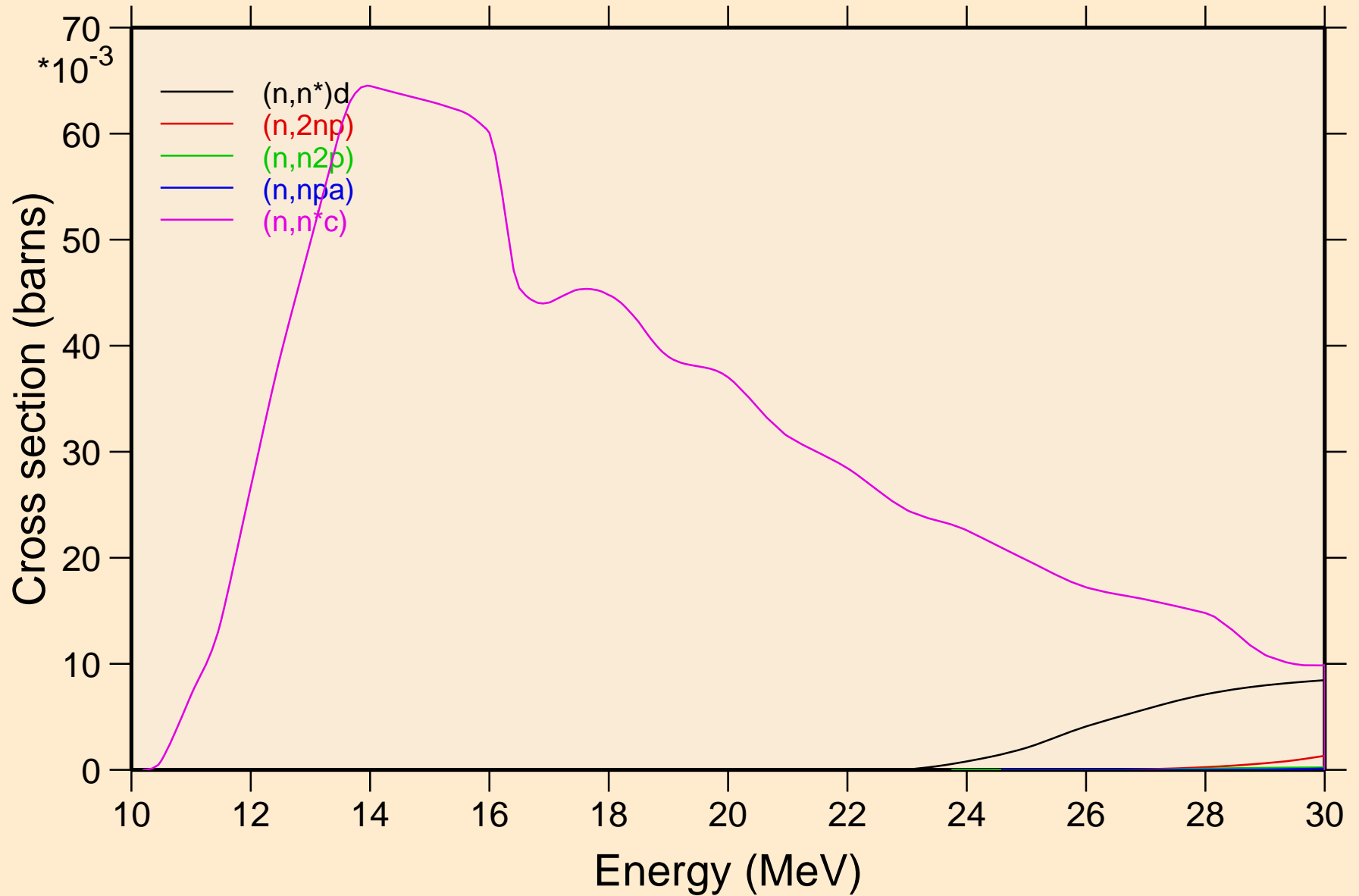

8-O-16 FOR FENDL-3B2 FROM ENDF/B-VII WITH NJOY99.304+ C

Threshold reactions

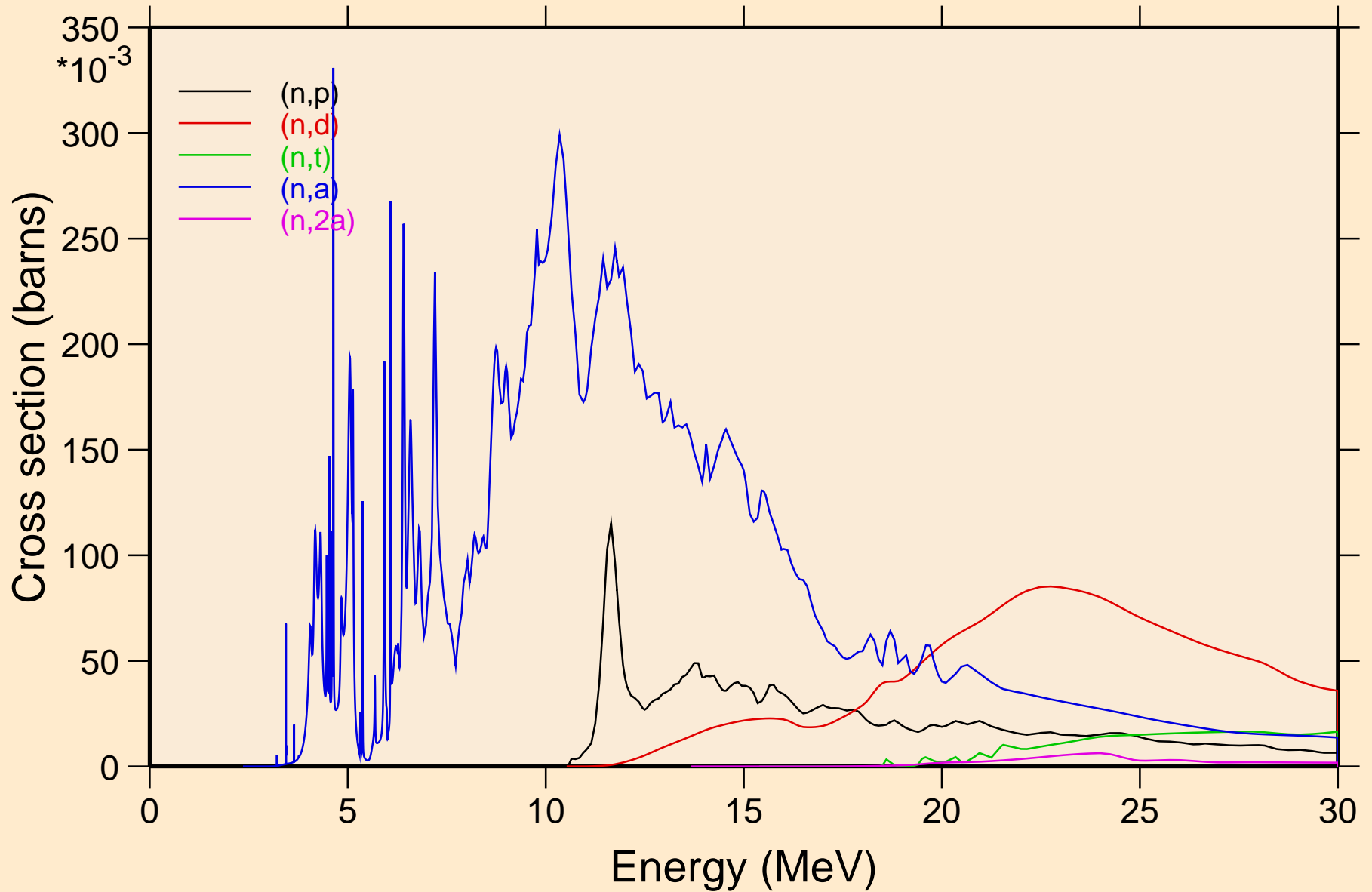

8-O-16 FOR FENDL-3B2 FROM ENDF/B-VII WITH NJOY99.304+ C
Threshold reactions

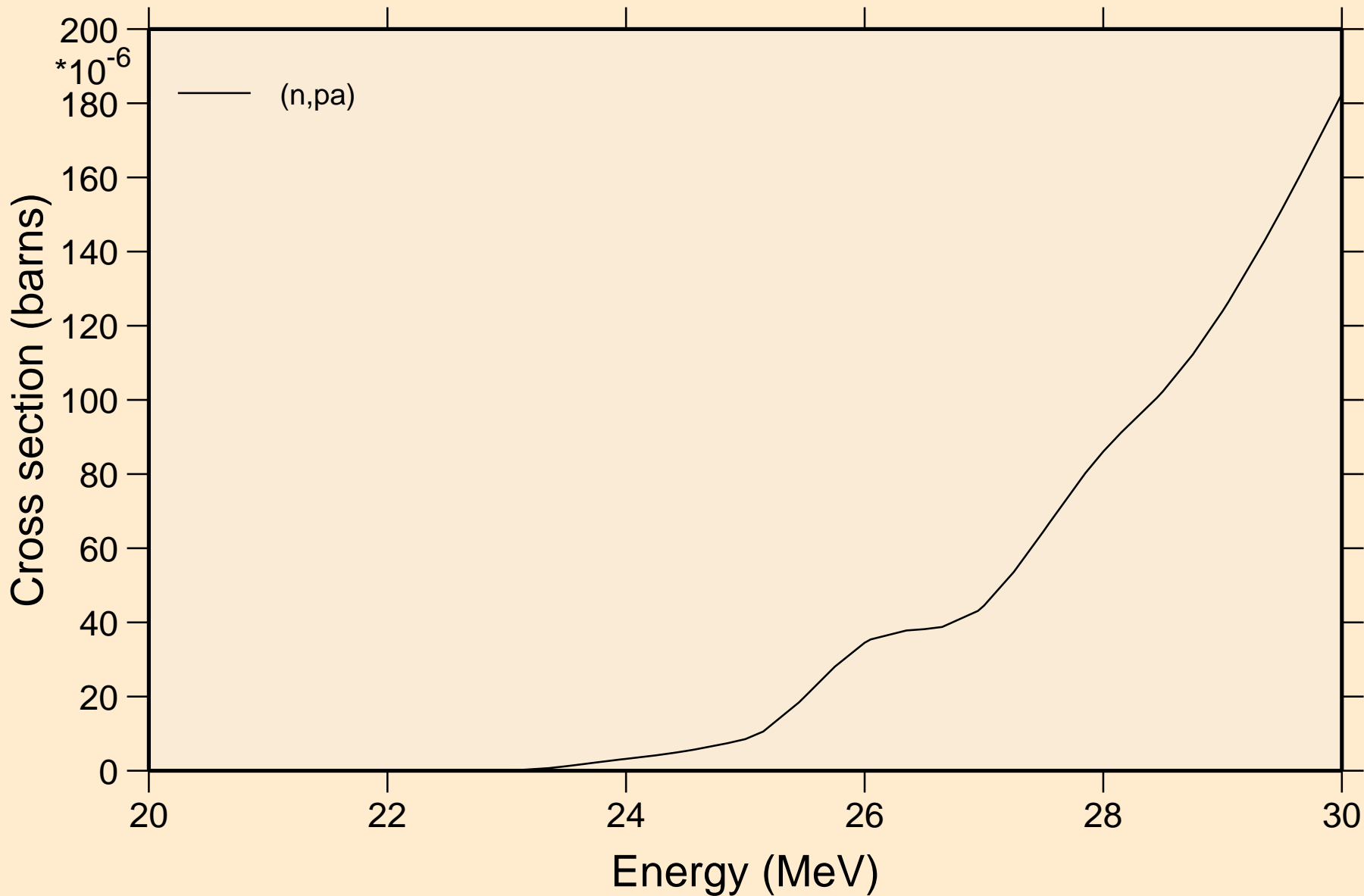

8-O-16 FOR FENDL-3B2 FROM ENDF/B-VII WITH NJOY99.304+ C

Threshold reactions

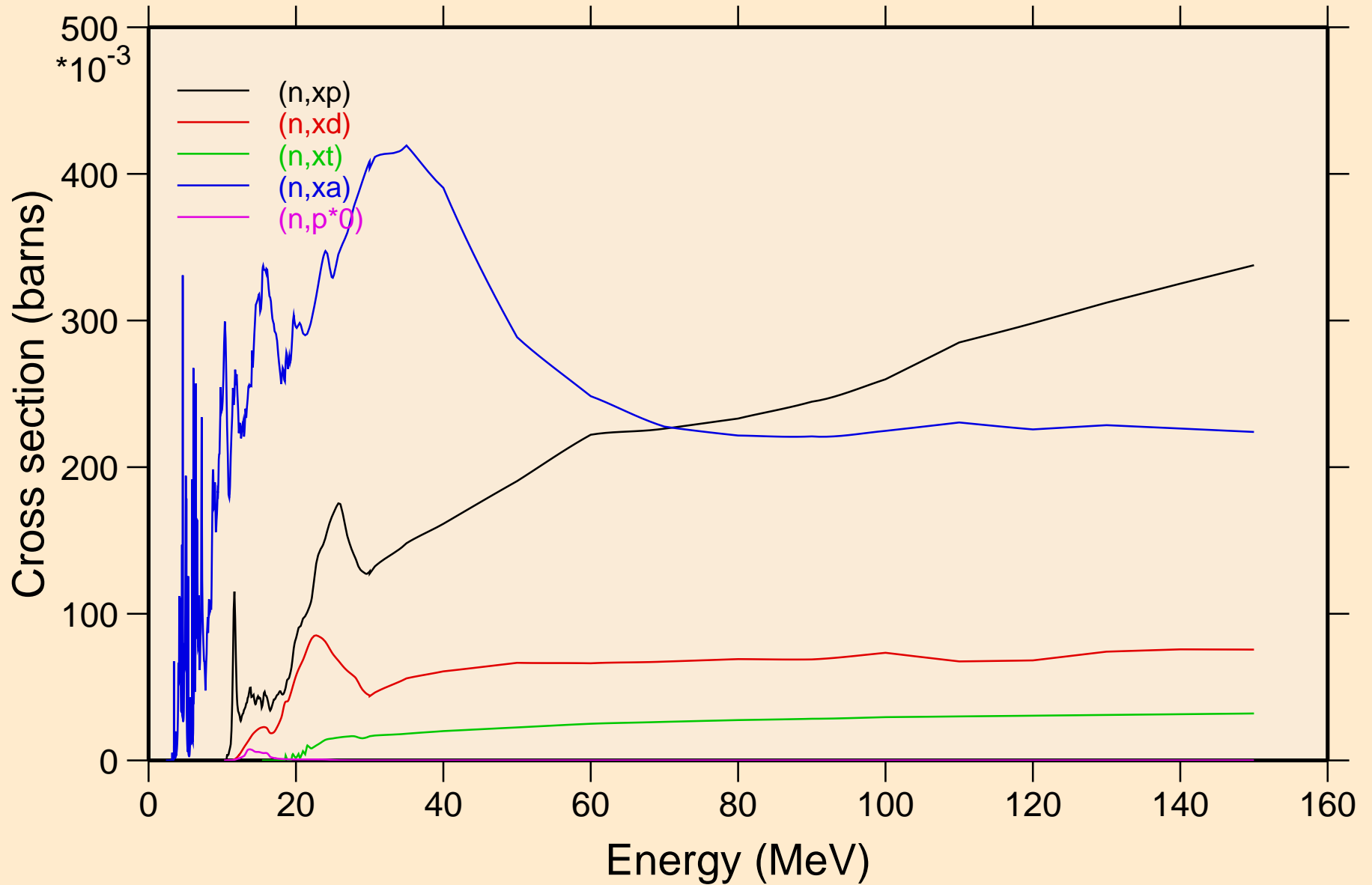

8-O-16 FOR FENDL-3B2 FROM ENDF/B-VII WITH NJOY99.304+ C

Threshold reactions

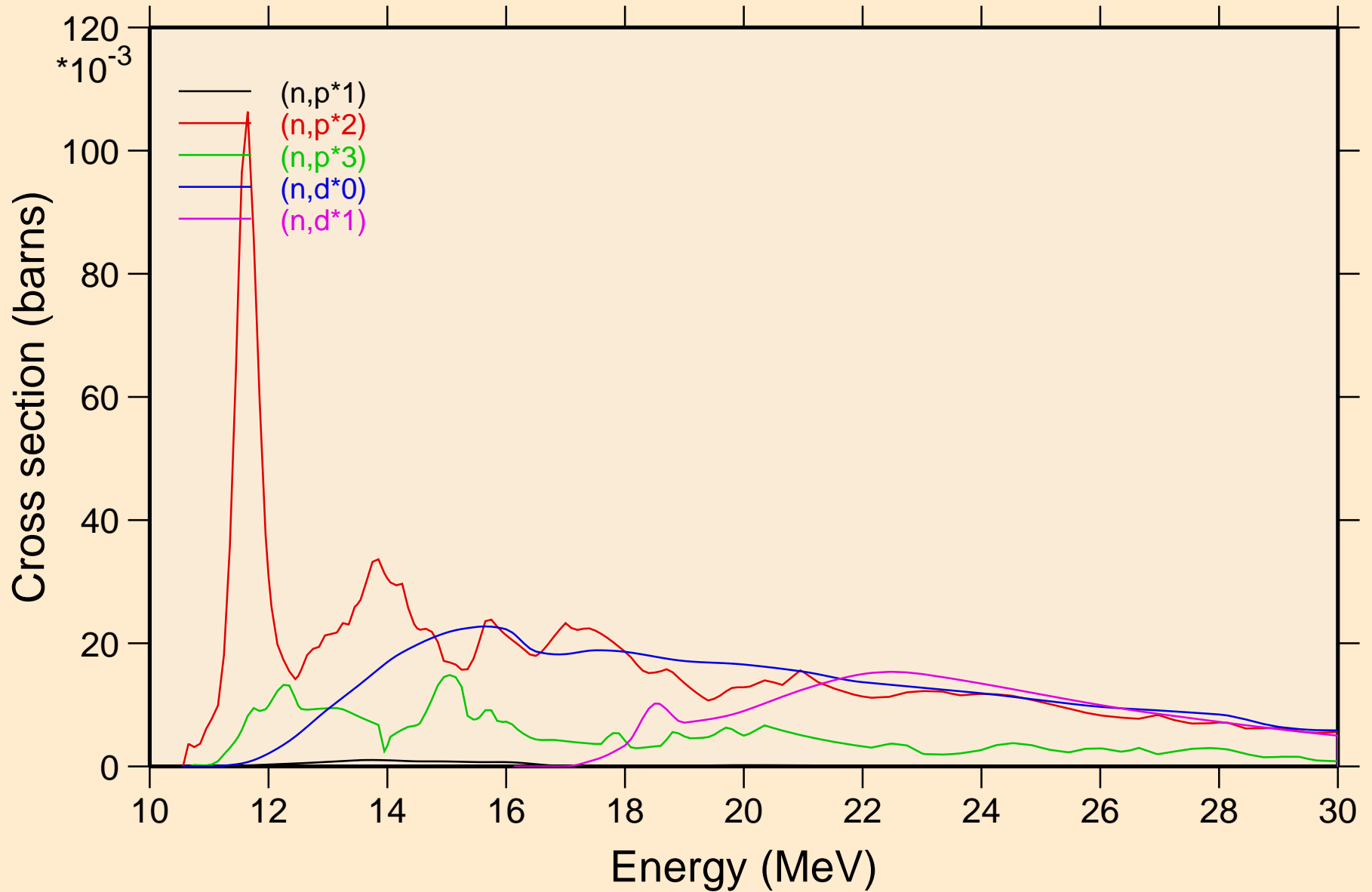

8-O-16 FOR FENDL-3B2 FROM ENDF/B-VII WITH NJOY99.304+ C
Threshold reactions

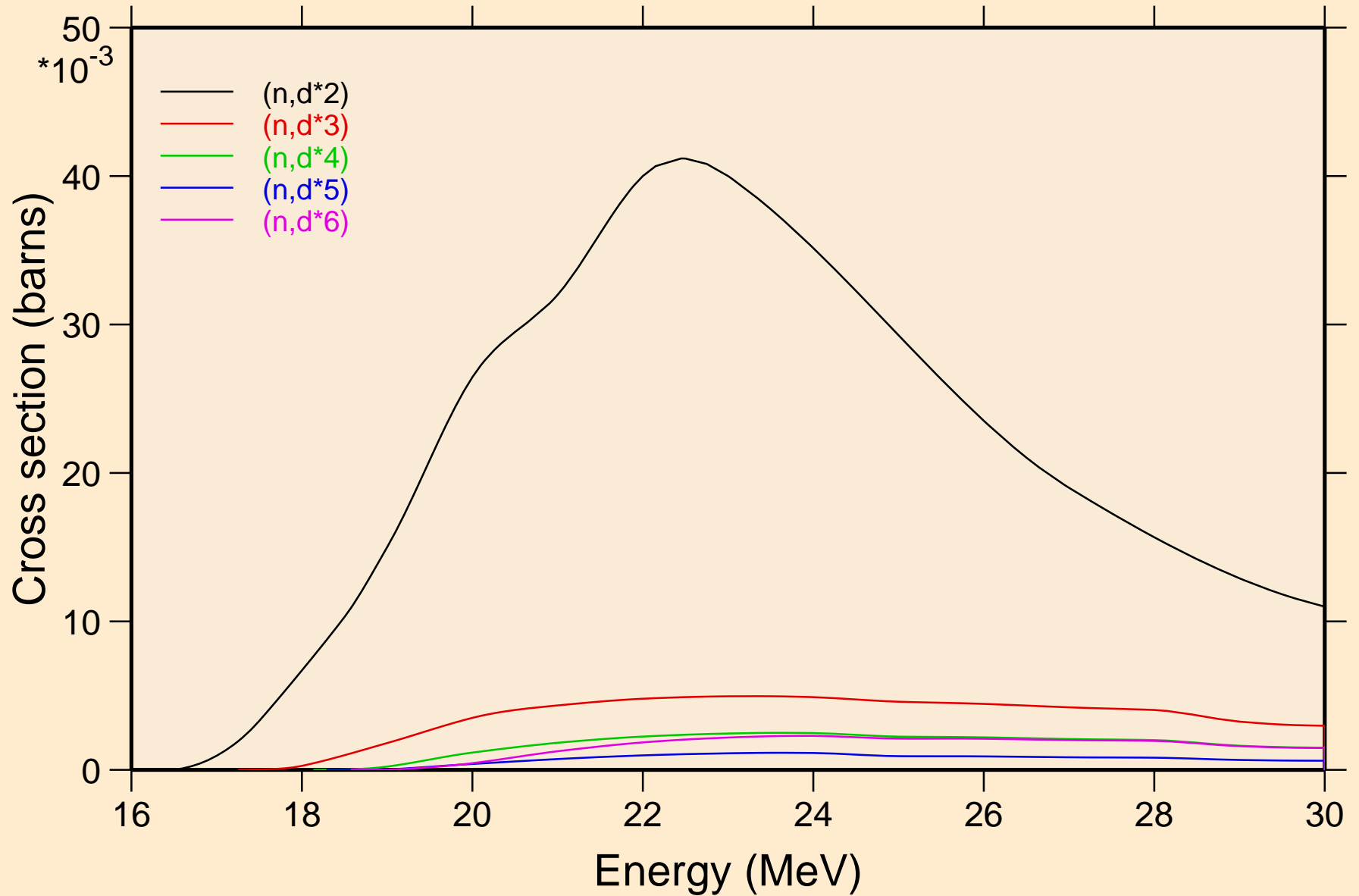

8-O-16 FOR FENDL-3B2 FROM ENDF/B-VII WITH NJOY99.304+ C

Threshold reactions

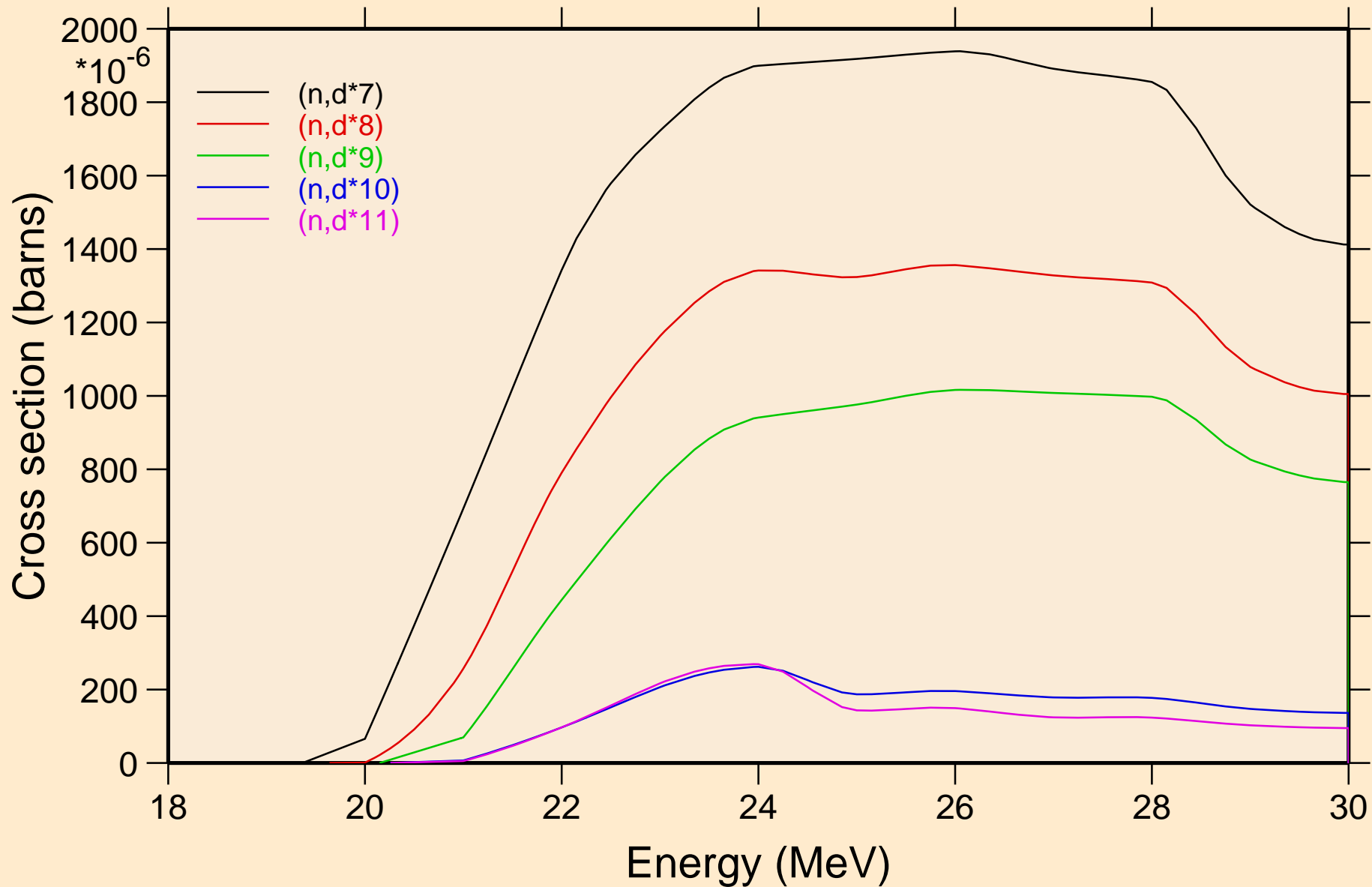

8-O-16 FOR FENDL-3B2 FROM ENDF/B-VII WITH NJOY99.304+ C

Threshold reactions

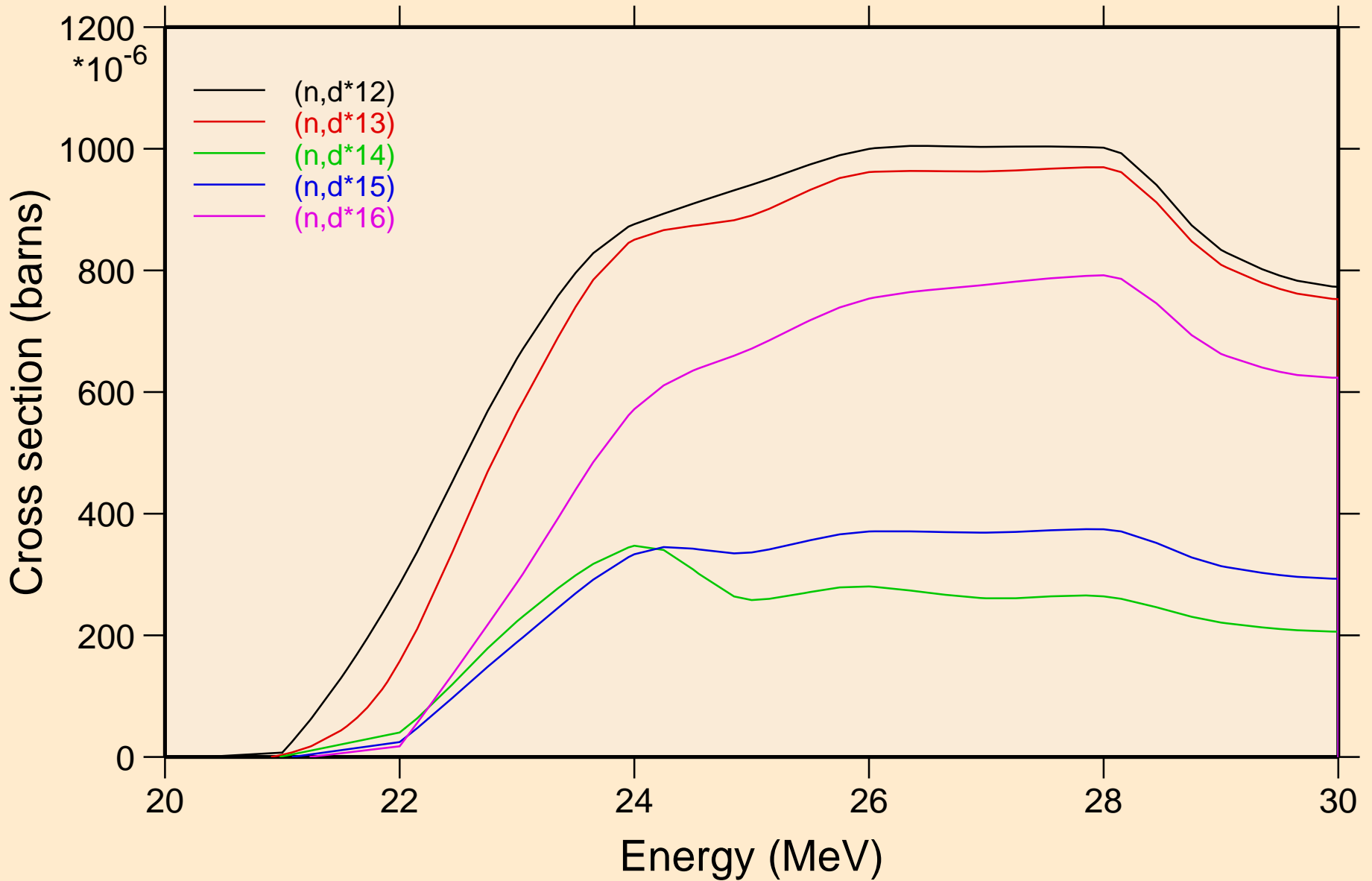

8-O-16 FOR FENDL-3B2 FROM ENDF/B-VII WITH NJOY99.304+ C

Threshold reactions

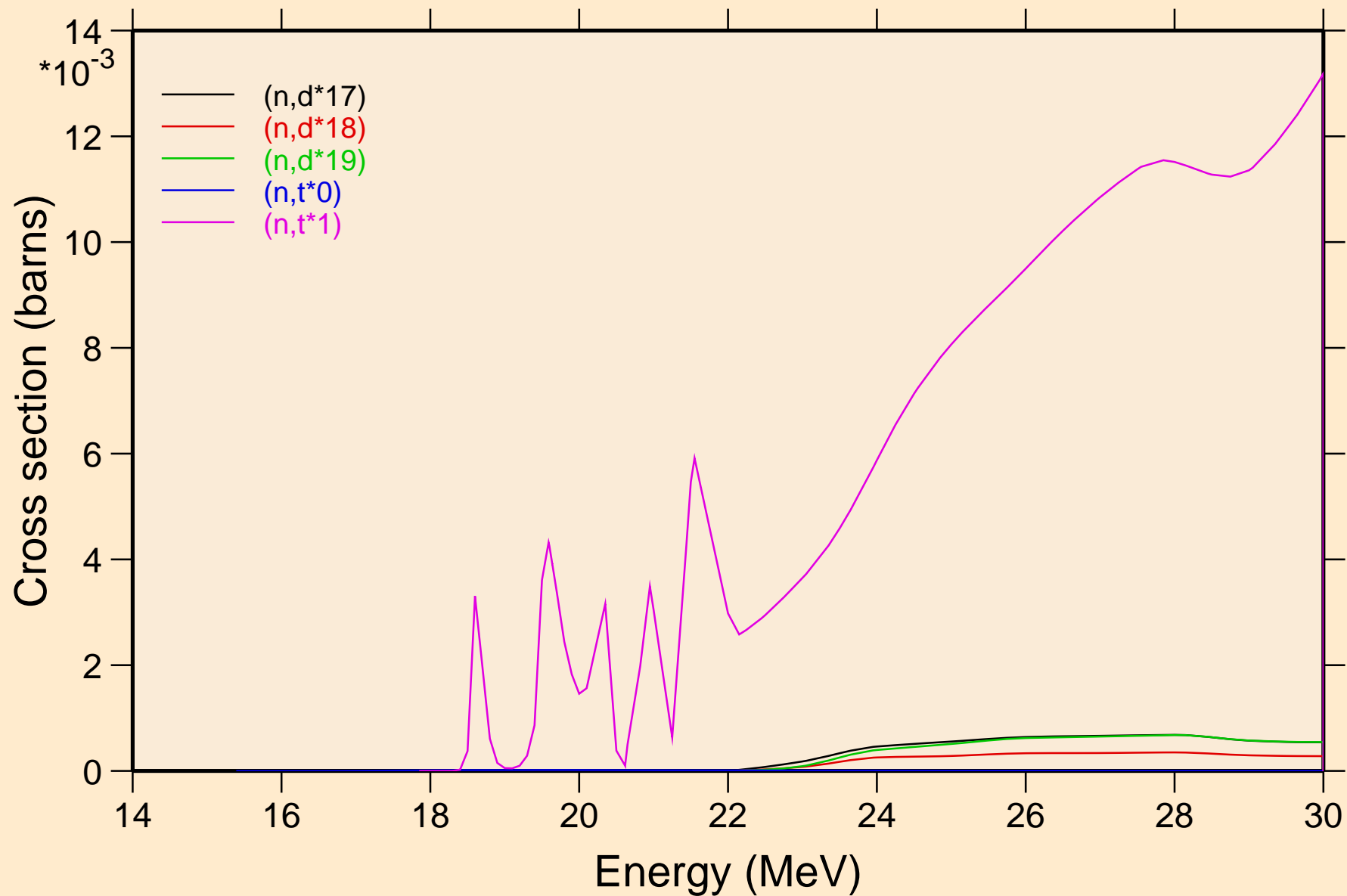

8-O-16 FOR FENDL-3B2 FROM ENDF/B-VII WITH NJOY99.304+ C
Threshold reactions

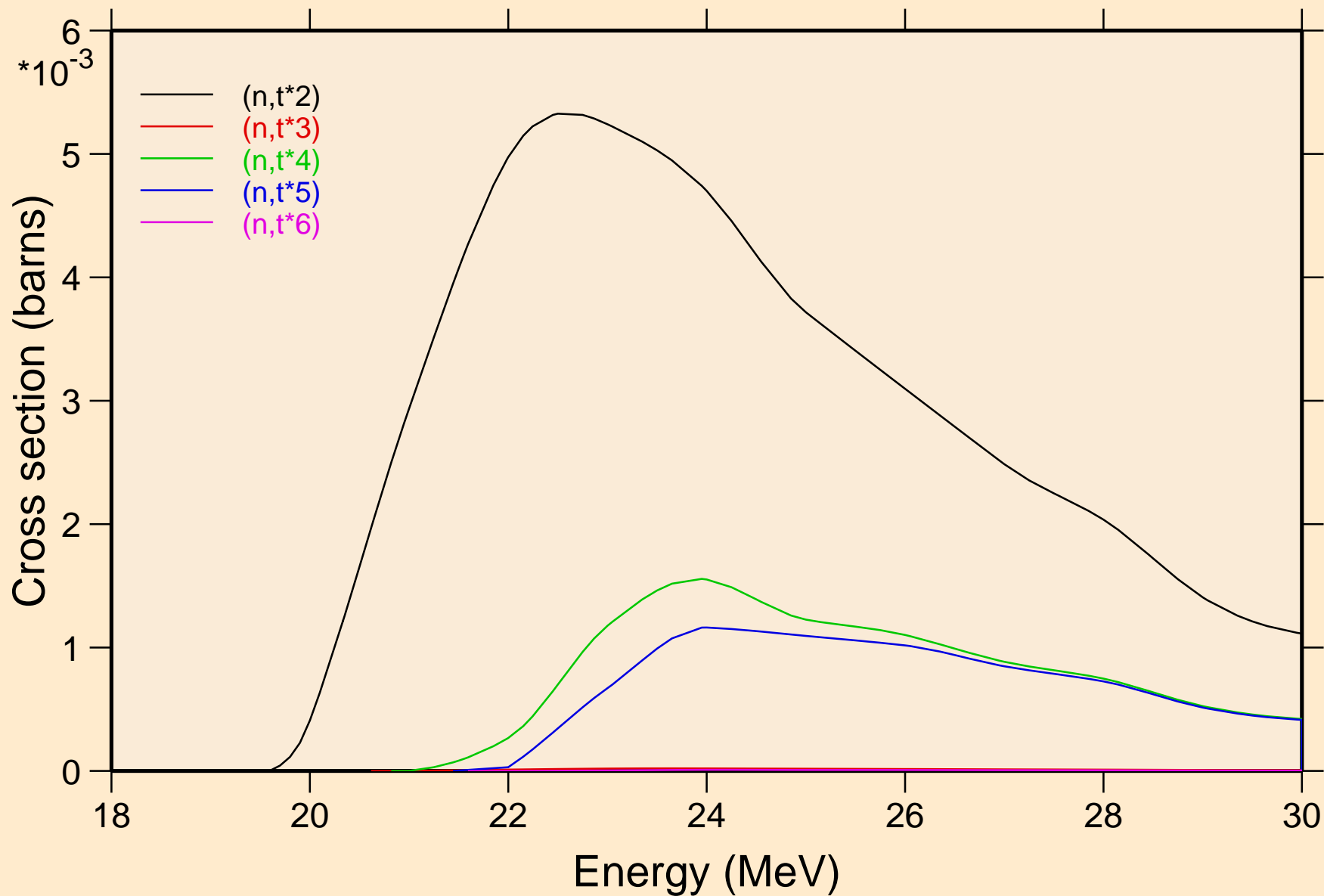

8-O-16 FOR FENDL-3B2 FROM ENDF/B-VII WITH NJOY99.304+ C
Threshold reactions

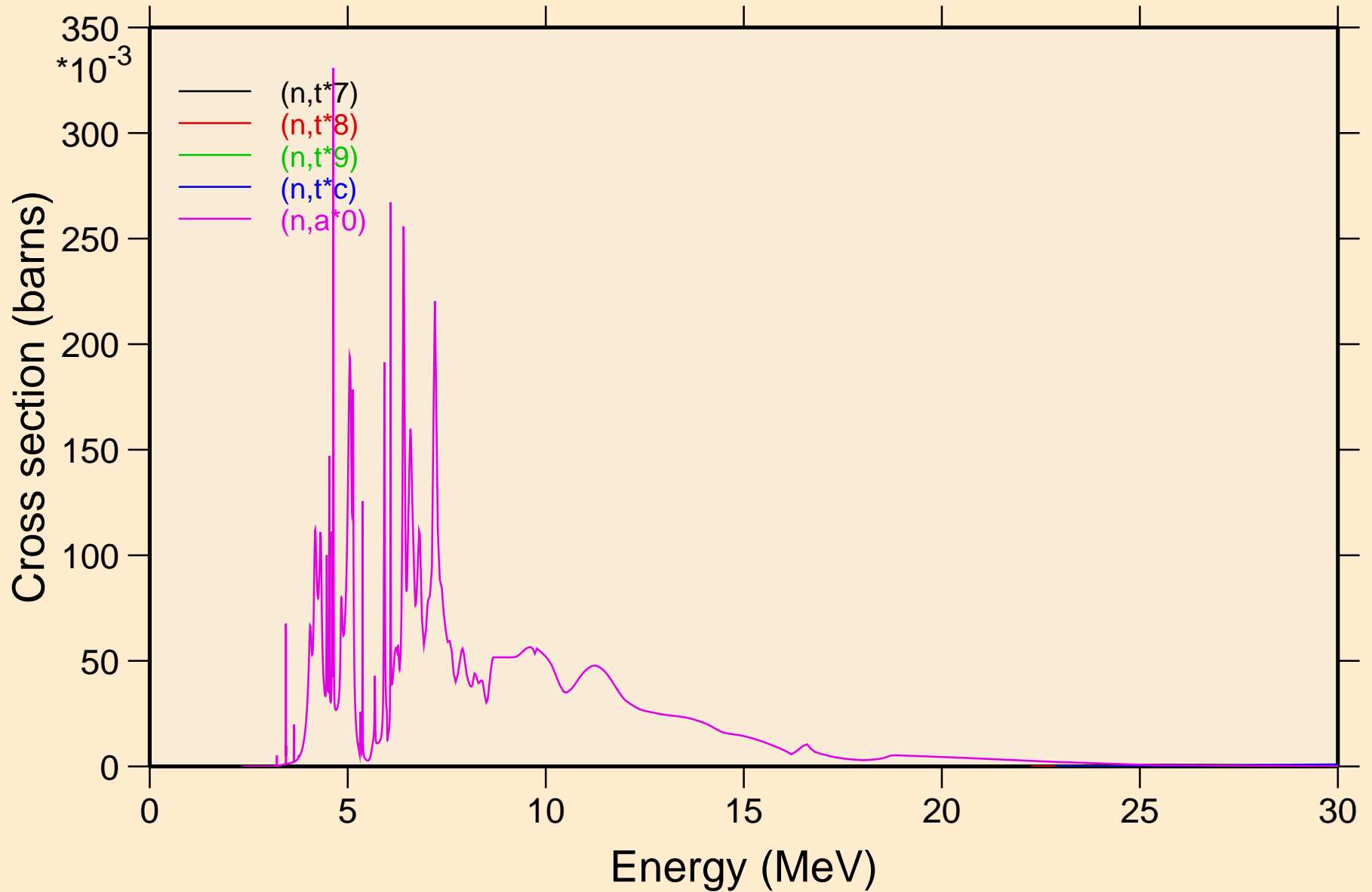

8-O-16 FOR FENDL-3B2 FROM ENDF/B-VII WITH NJOY99.304+ C

Threshold reactions

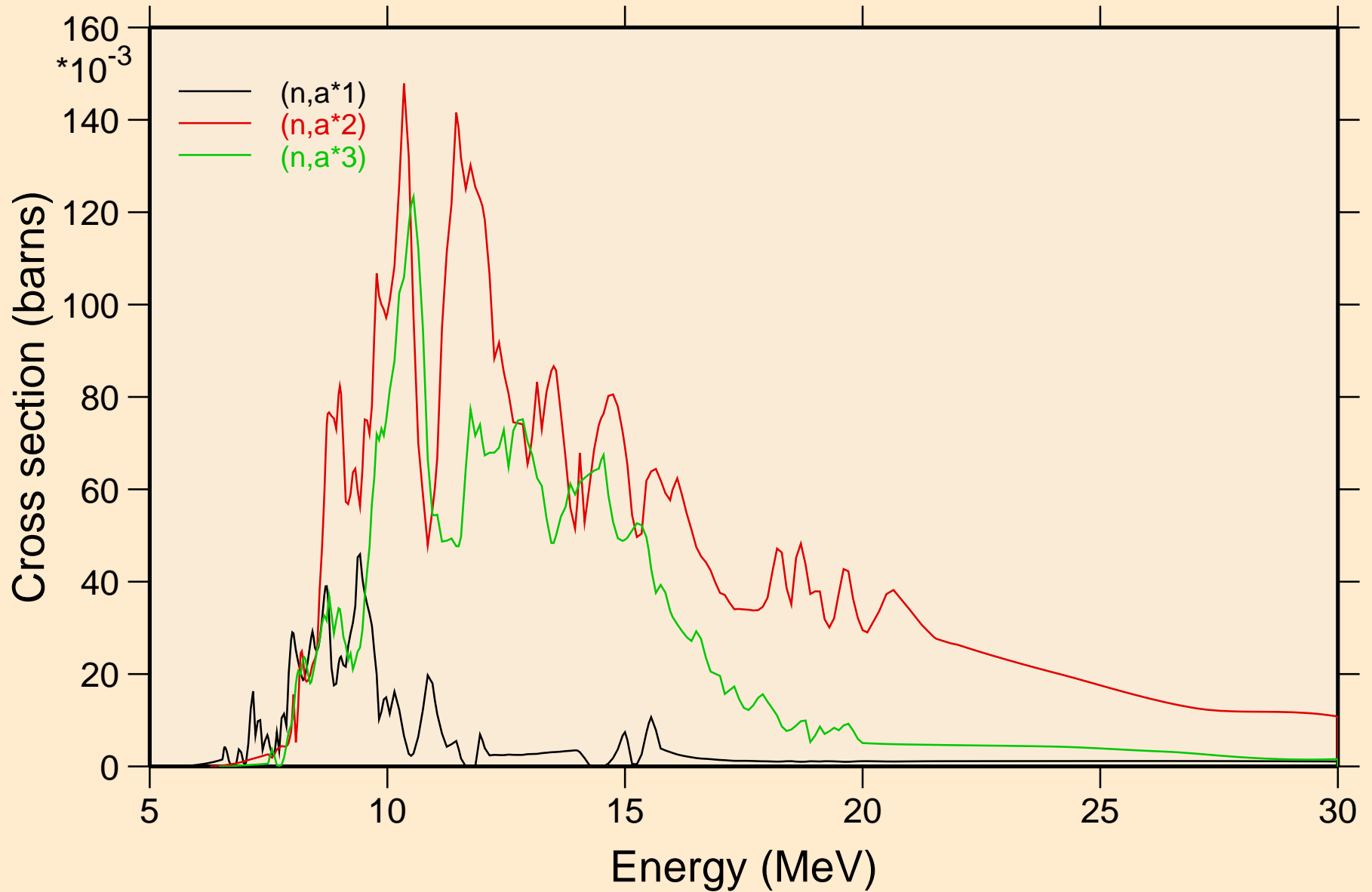

8-O-16 FOR FENDL-3B2 FROM ENDF/B-VII WITH NJOY99.304+ C
angular distribution for elastic

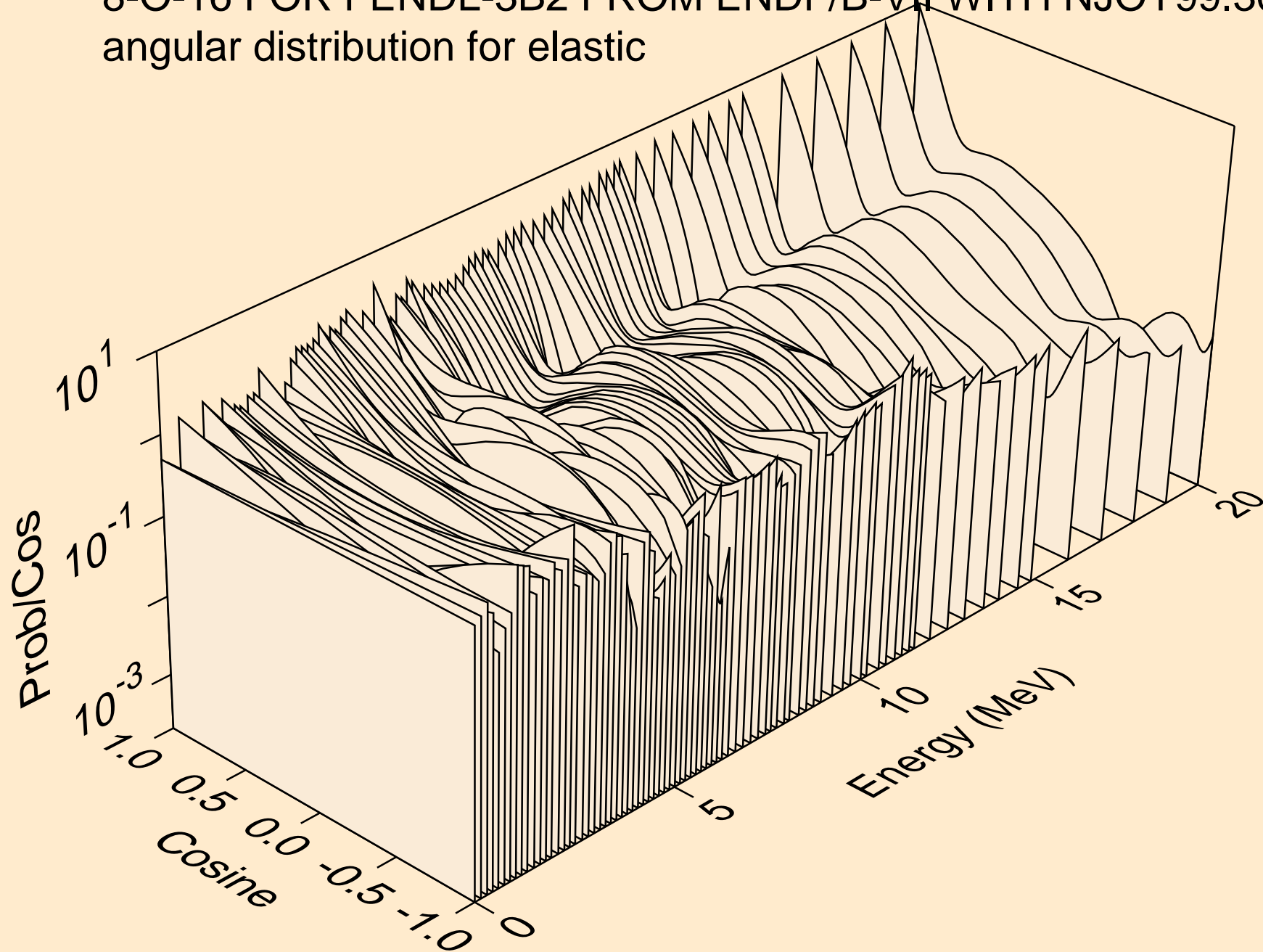

8-O-16 FOR FENDL-3B2 FROM ENDF/B-VII WITH NJOY99.304+ C
angular distribution for elastic

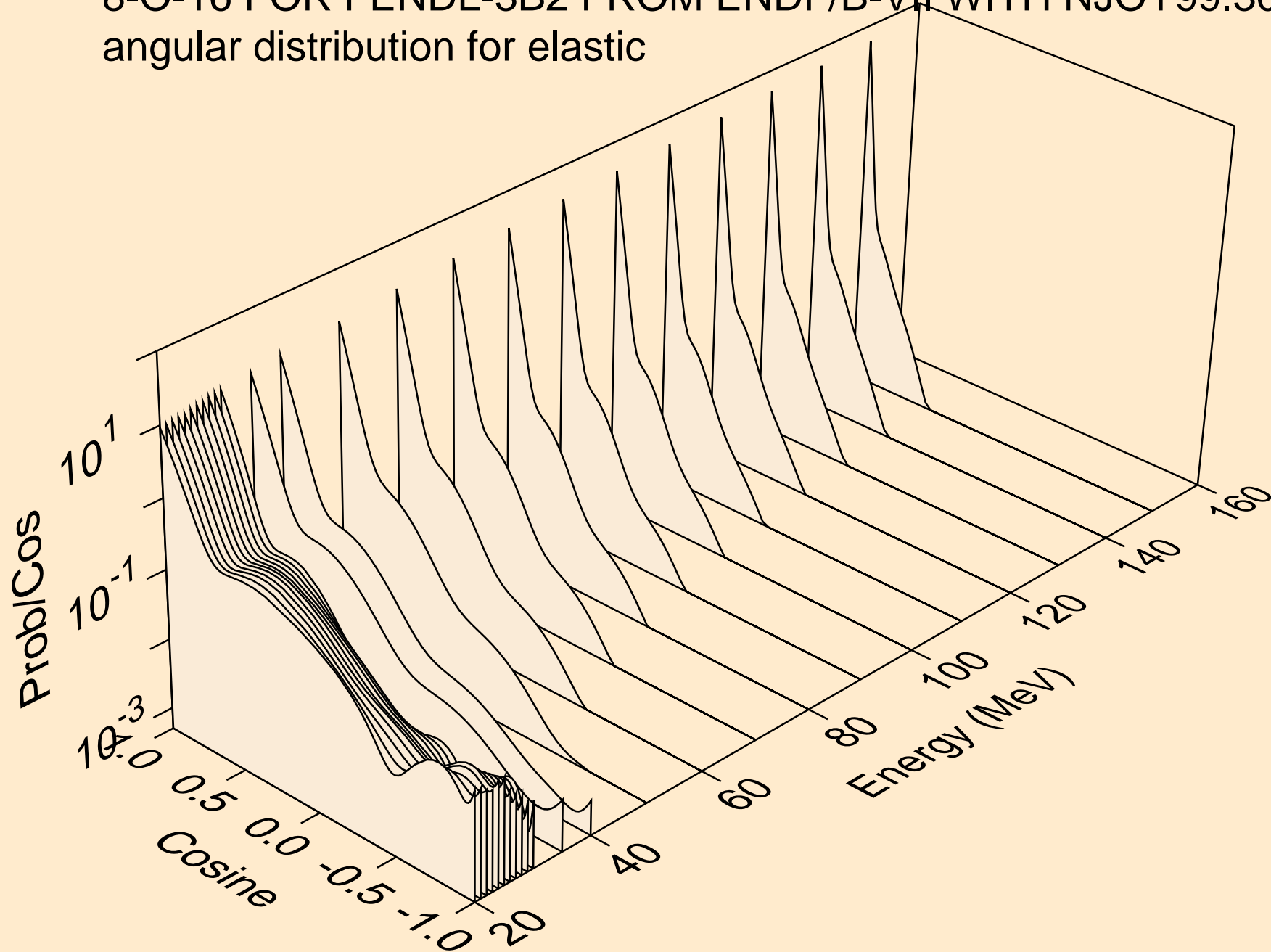

8-O-16 FOR FENDL-3B2 FROM ENDF/B-VII WITH NJOY99.304+ C
angular distribution for (n,n*1)

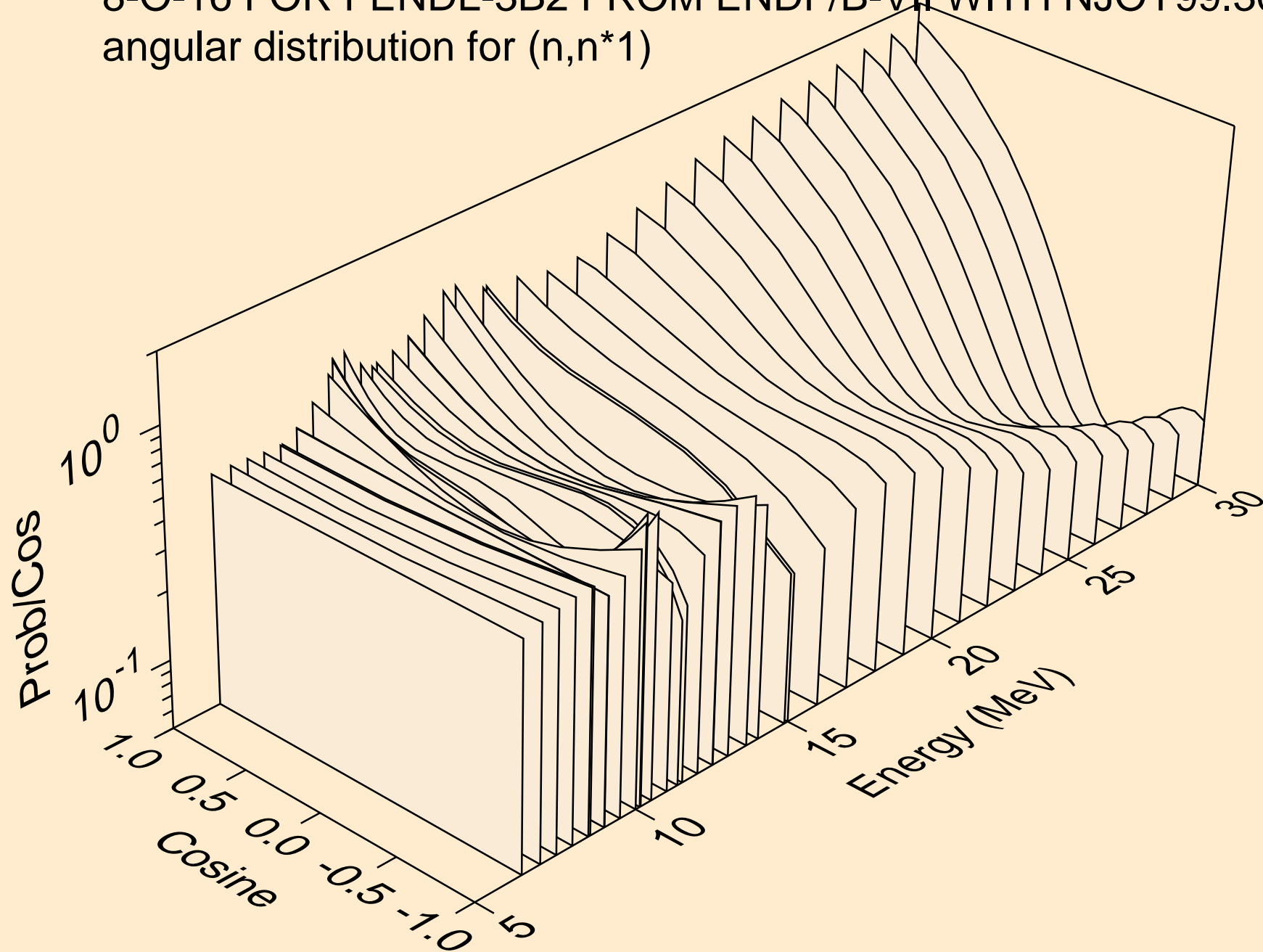

8-O-16 FOR FENDL-3B2 FROM ENDF/B-VII WITH NJOY99.304+ C
angular distribution for (n,n*2)

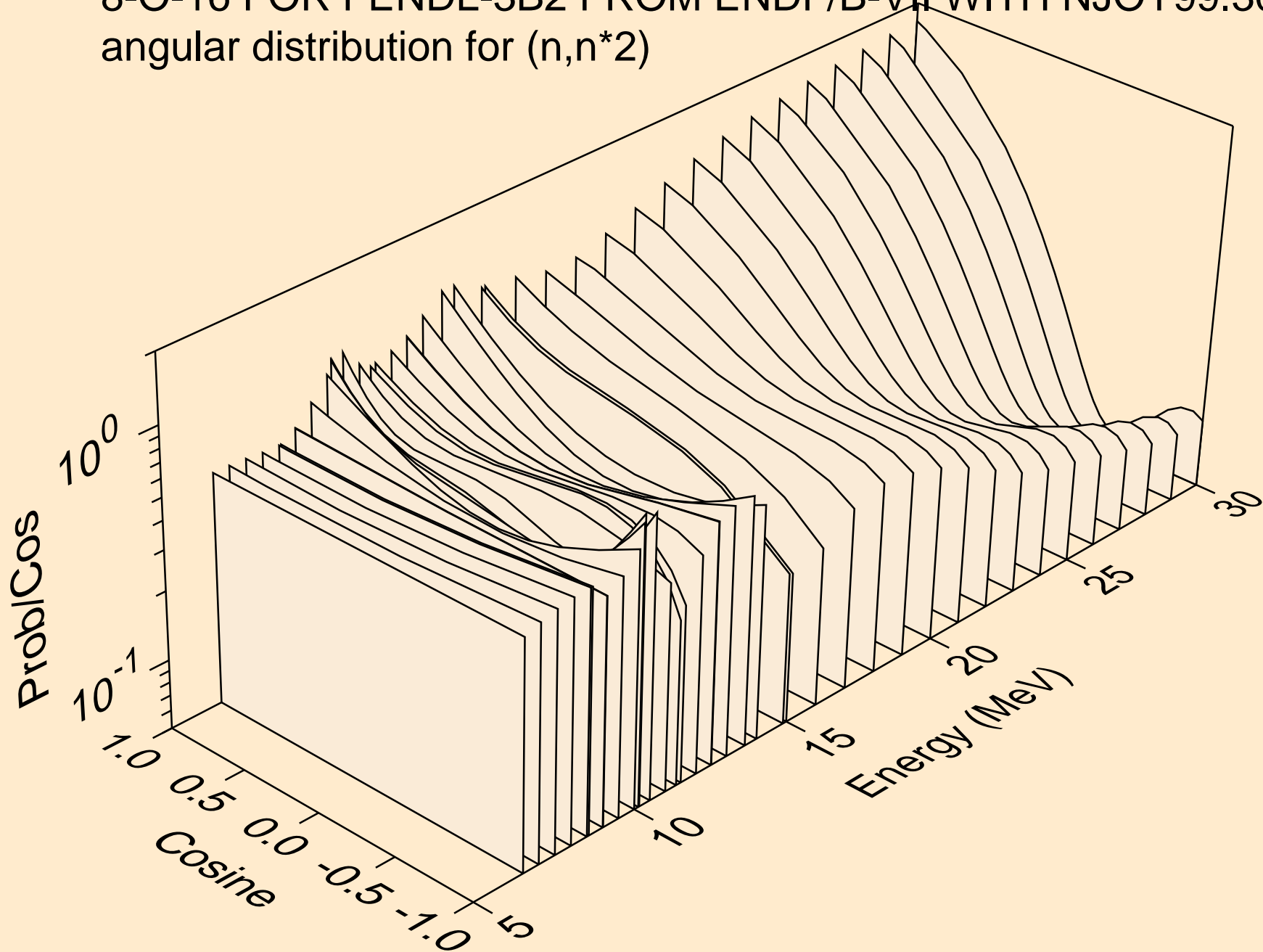

8-O-16 FOR FENDL-3B2 FROM ENDF/B-VII WITH NJOY99.304+ C
angular distribution for (n,n*3)

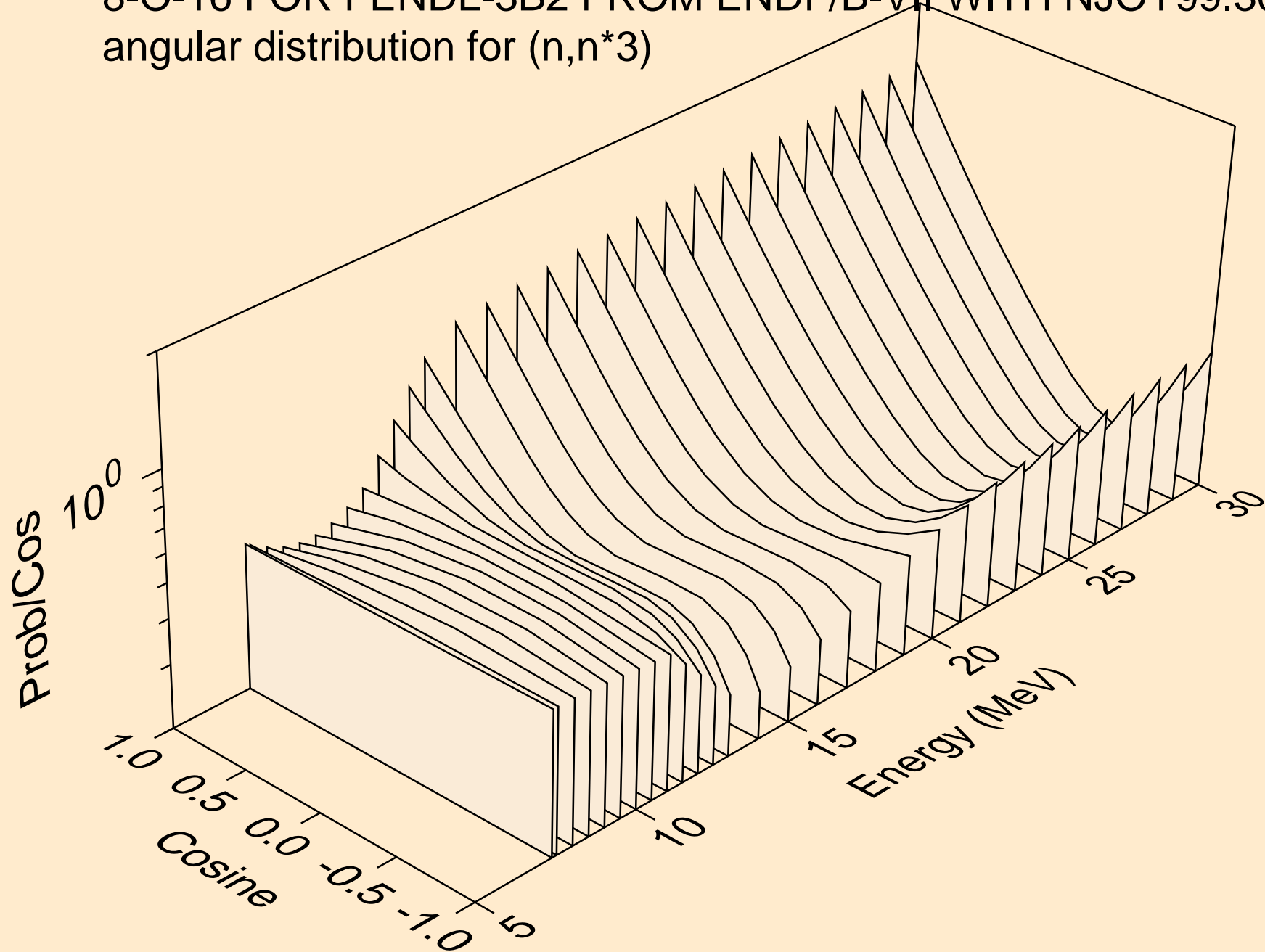

8-O-16 FOR FENDL-3B2 FROM ENDF/B-VII WITH NJOY99.304+ C
angular distribution for (n,n*4)

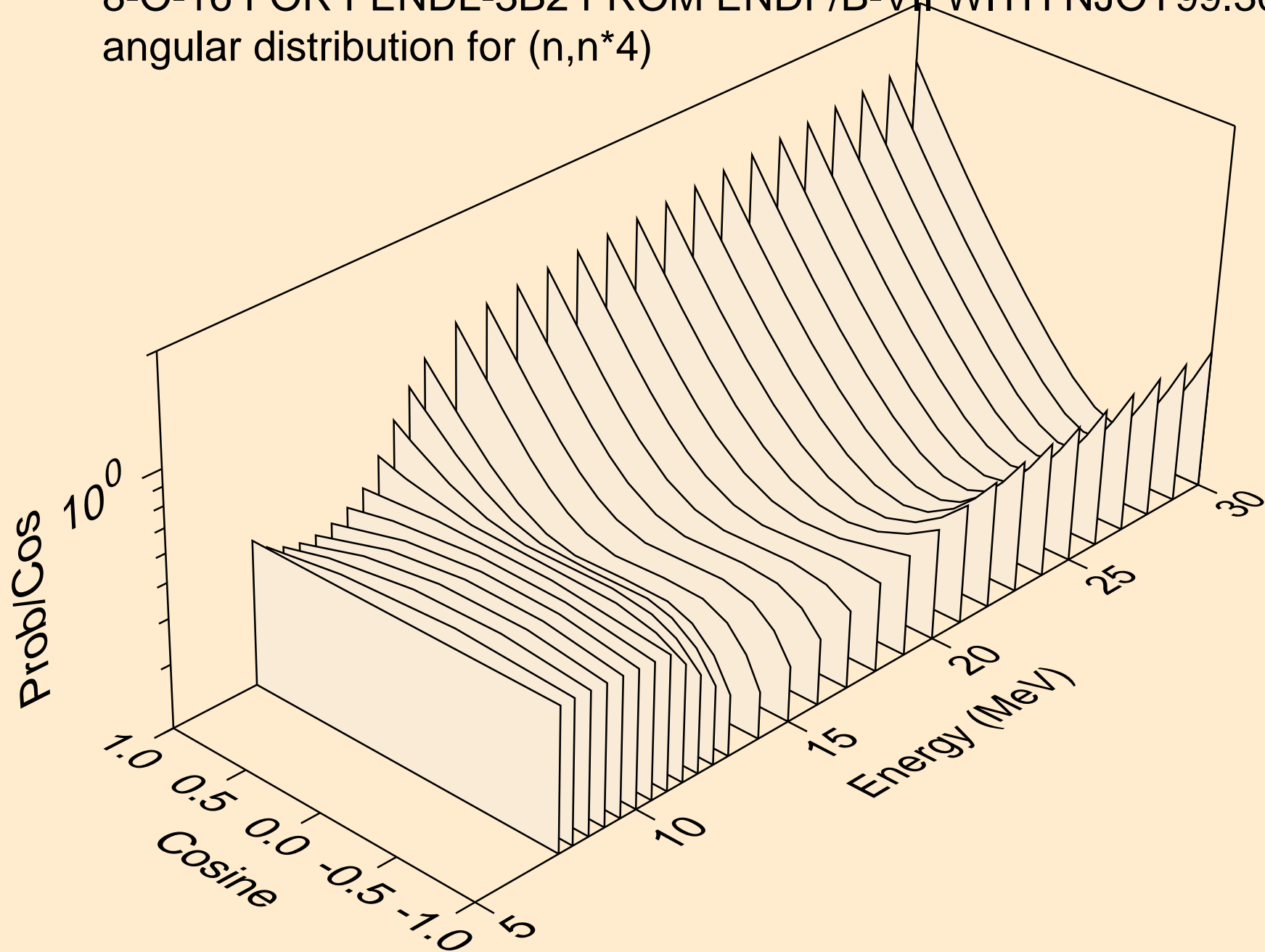

8-O-16 FOR FENDL-3B2 FROM ENDF/B-VII WITH NJOY99.304+ C
angular distribution for (n,n*5)

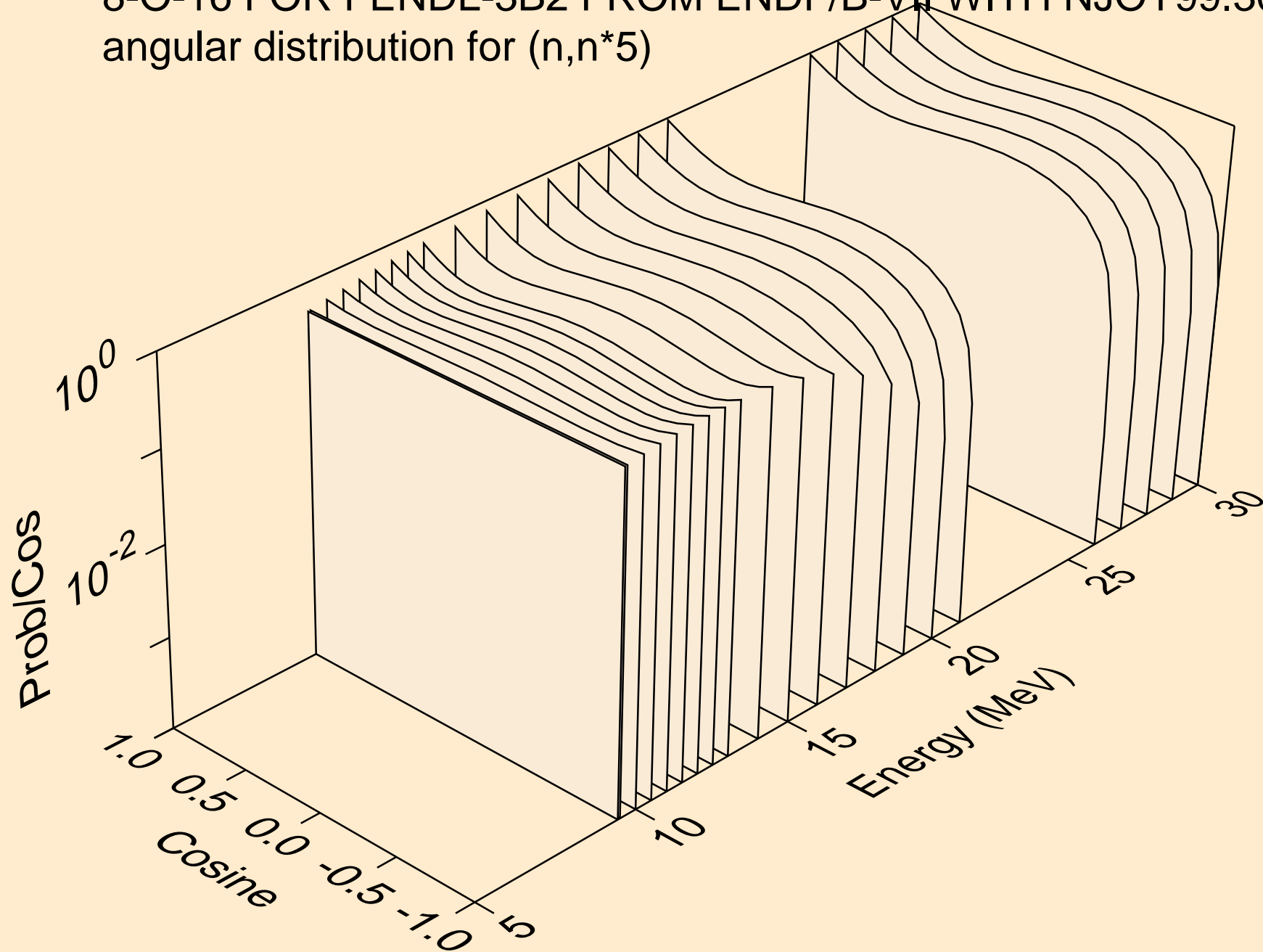

8-O-16 FOR FENDL-3B2 FROM ENDF/B-VII WITH NJOY99.304+ C
Neutron emission for (n,x)

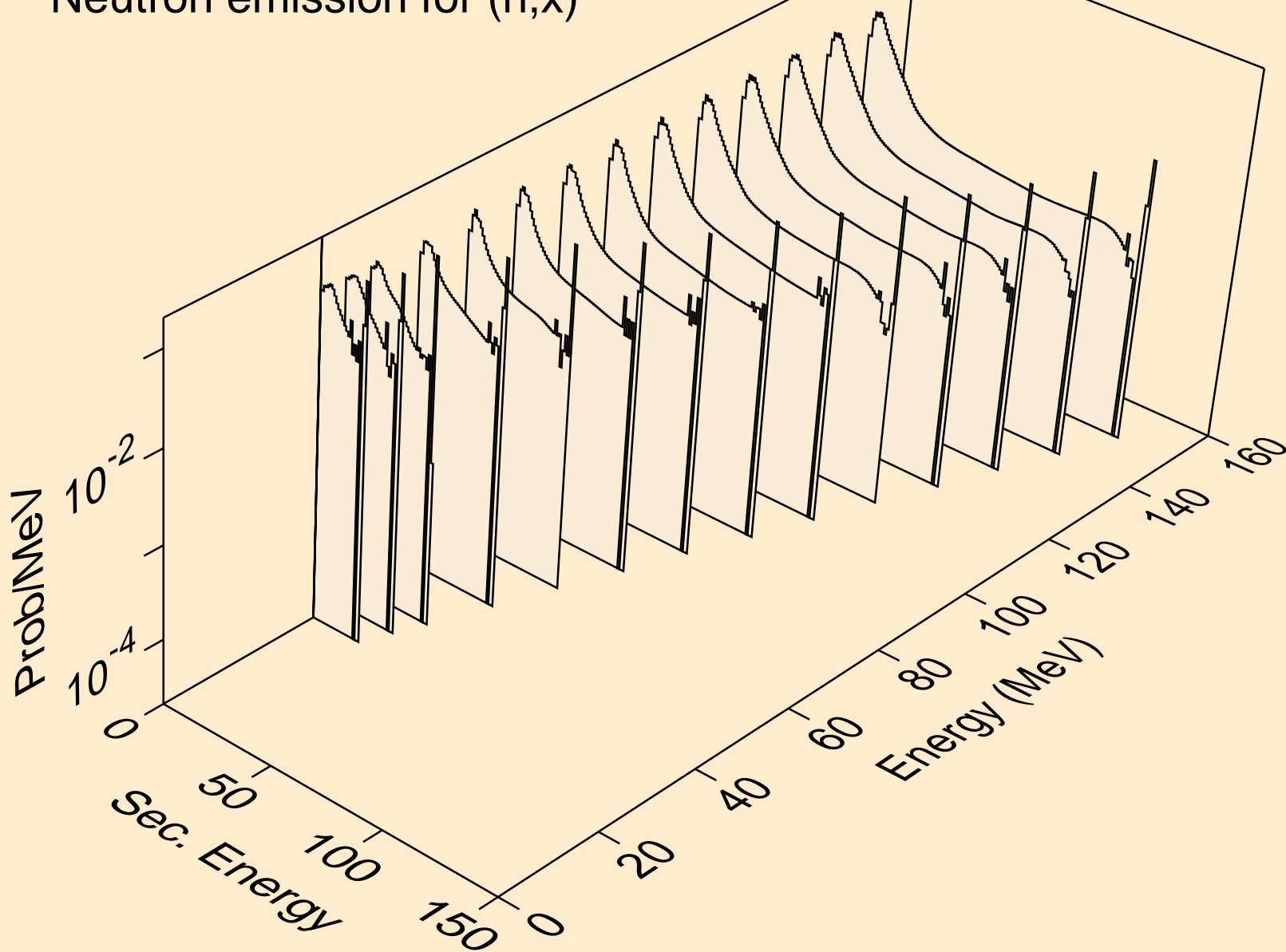

8-O-16 FOR FENDL-3B2 FROM ENDF/B-VII WITH NJOY99.304+ C
Neutron emission for (n,2n)

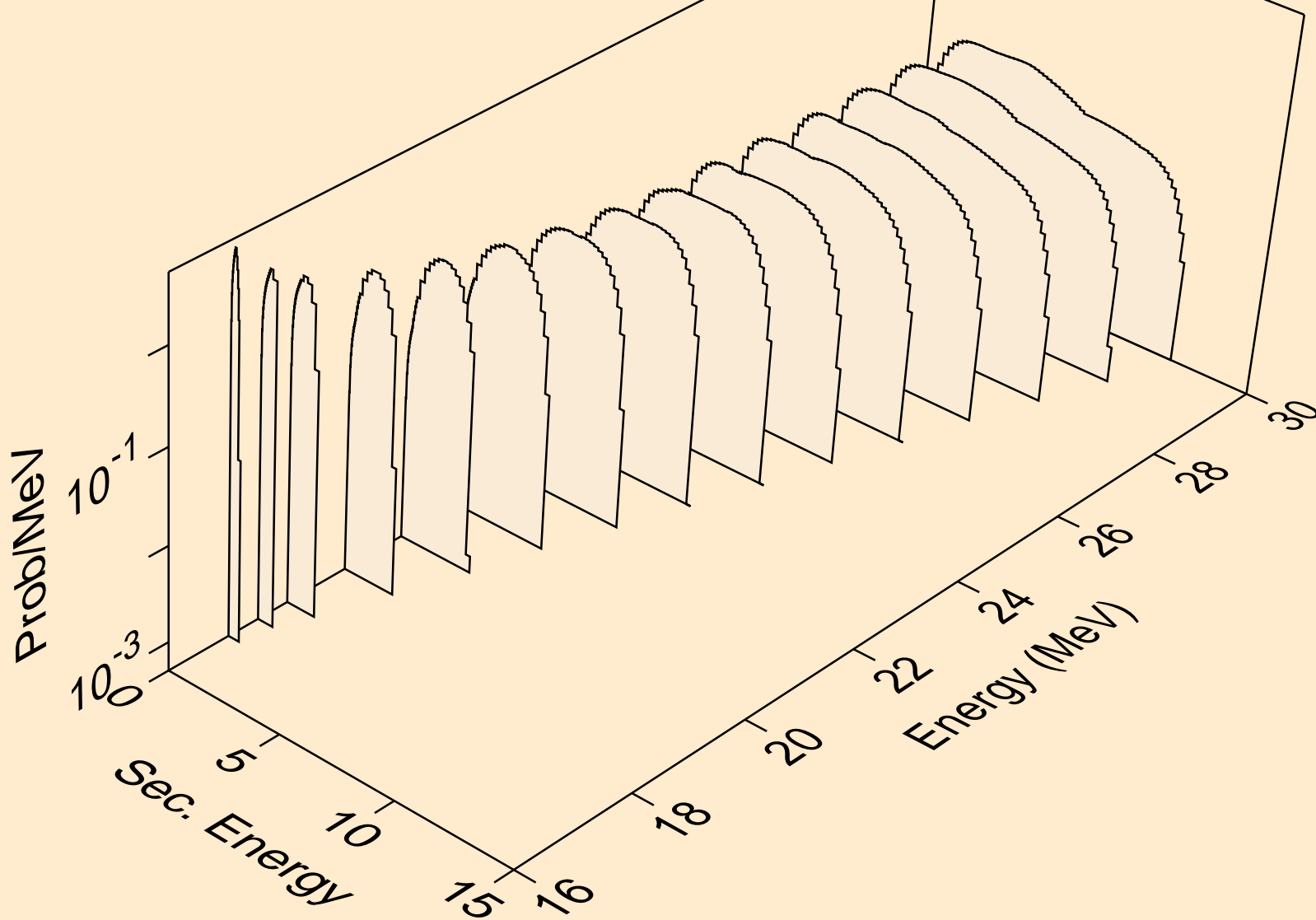

8-O-16 FOR FENDL-3B2 FROM ENDF/B-VII WITH NJOY99.304+ C
Neutron emission for (n,n*)a

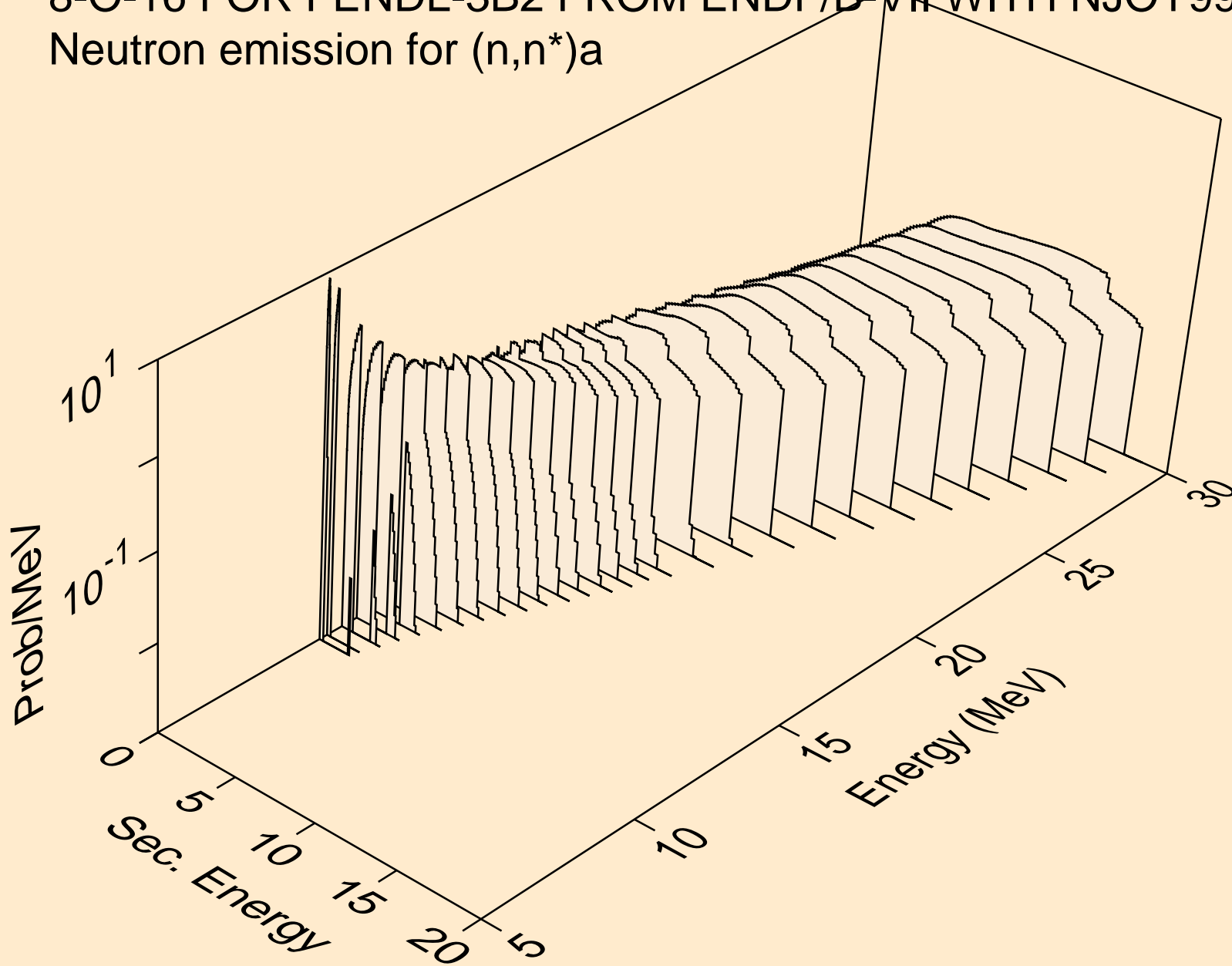

8-O-16 FOR FENDL-3B2 FROM ENDF/B-VII WITH NJOY99.304+ C
Neutron emission for (n,n*)3a

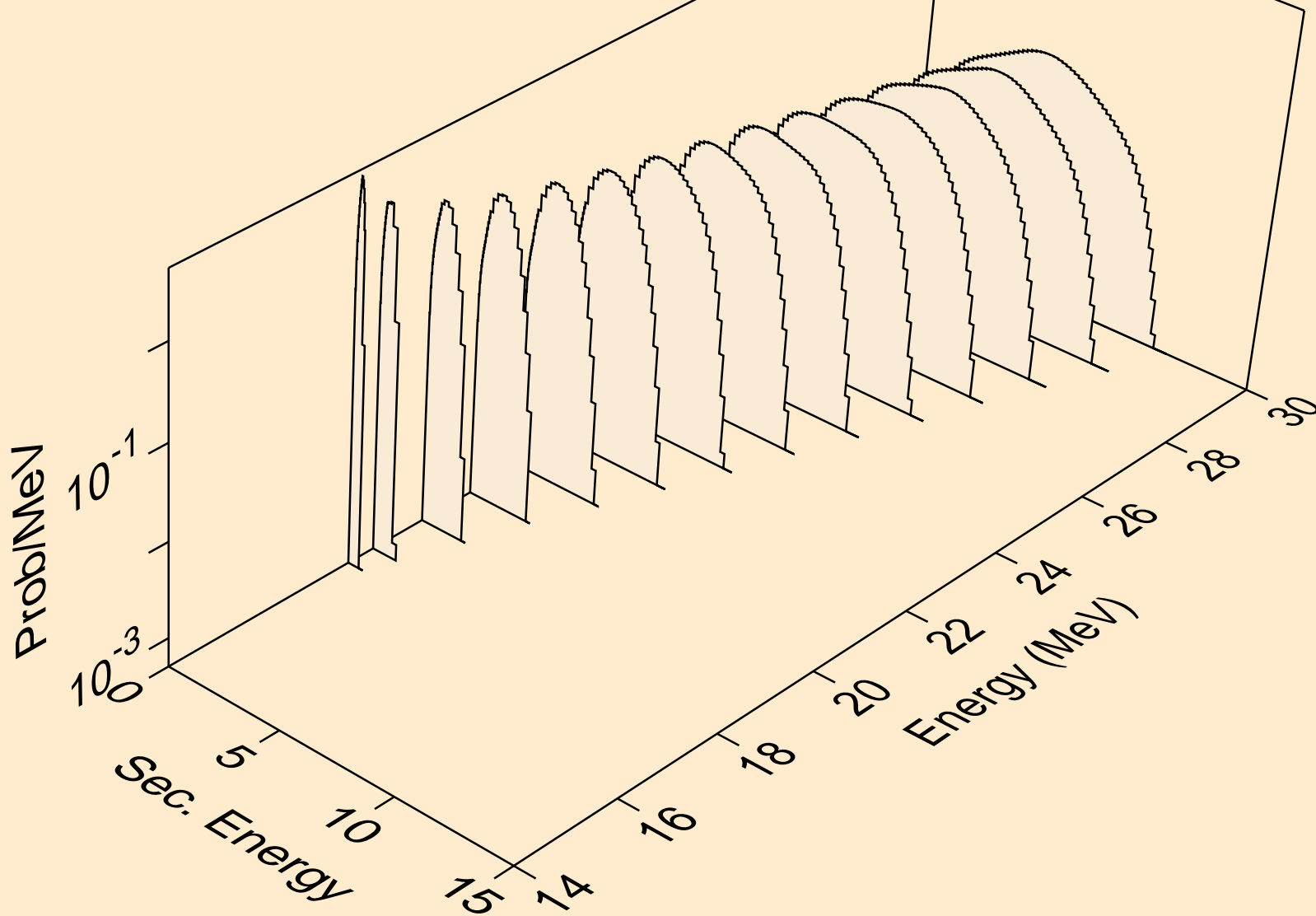

8-O-16 FOR FENDL-3B2 FROM ENDF/B-VII WITH NJOY99.304+ C
Neutron emission for (n,n*)p

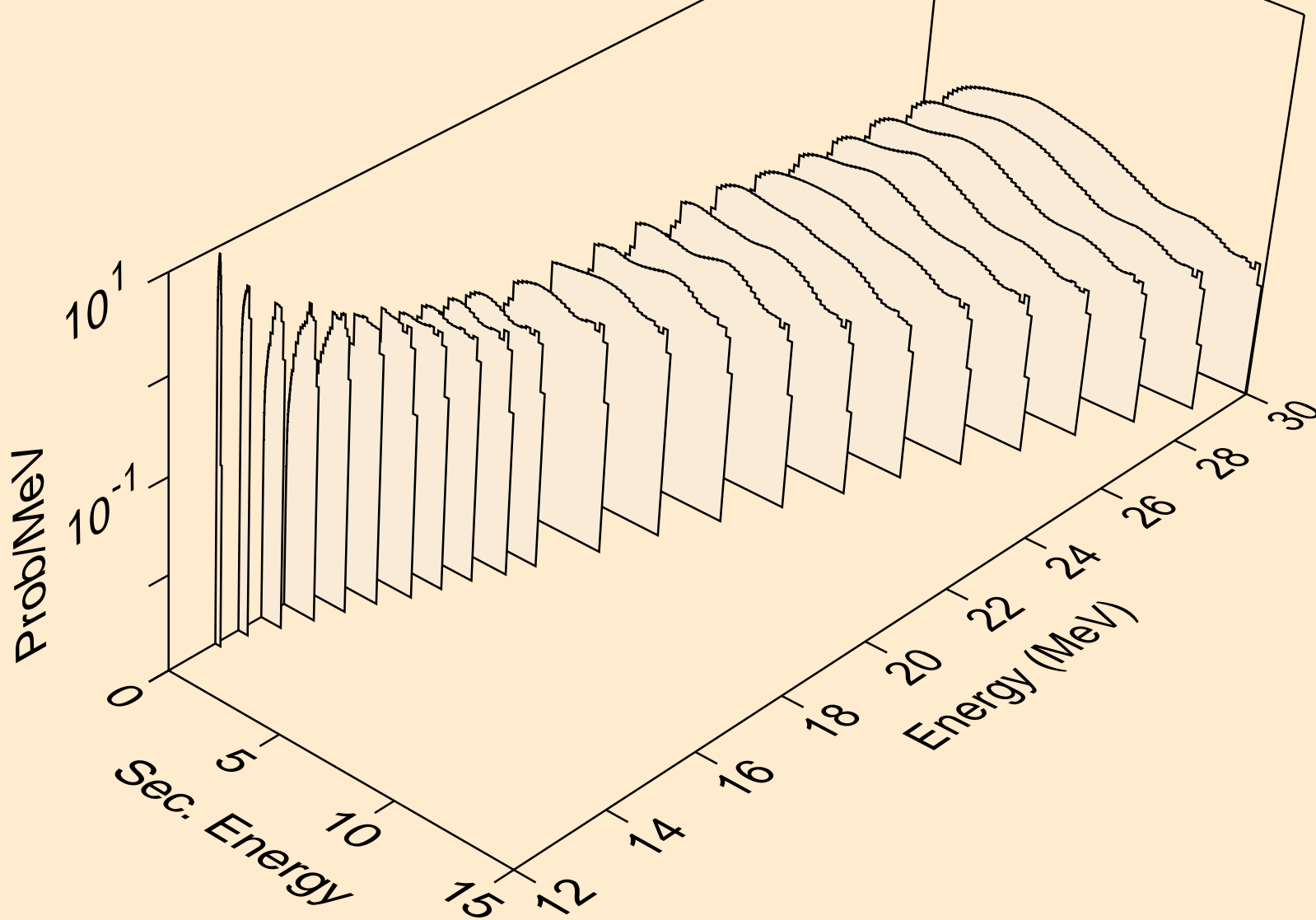

8-O-16 FOR FENDL-3B2 FROM ENDF/B-VII WITH NJOY99.304+ C
Neutron emission for (n,n*)d

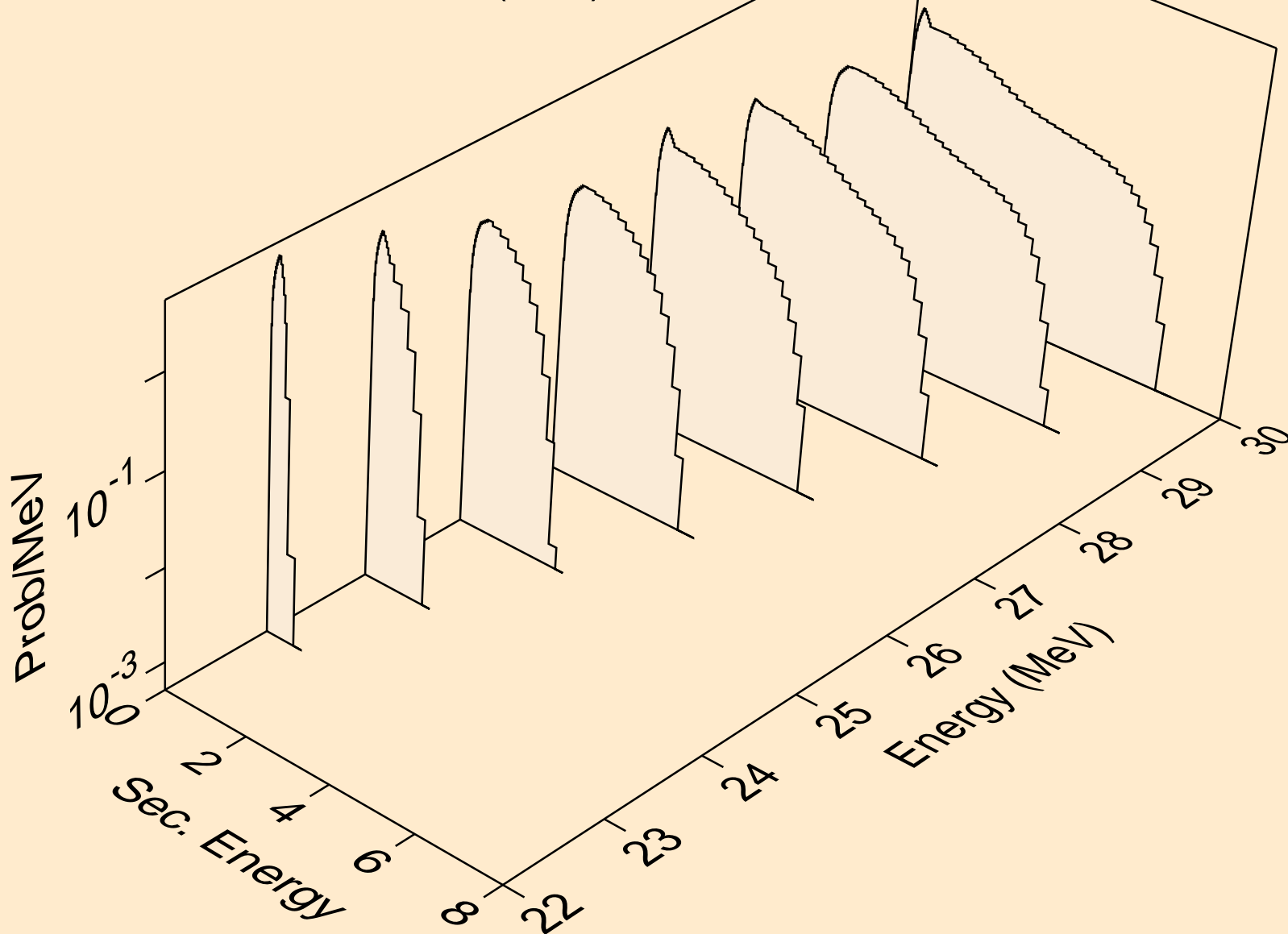

8-O-16 FOR FENDL-3B2 FROM ENDF/B-VII WITH NJOY99.304+ C
Neutron emission for (n,2np)

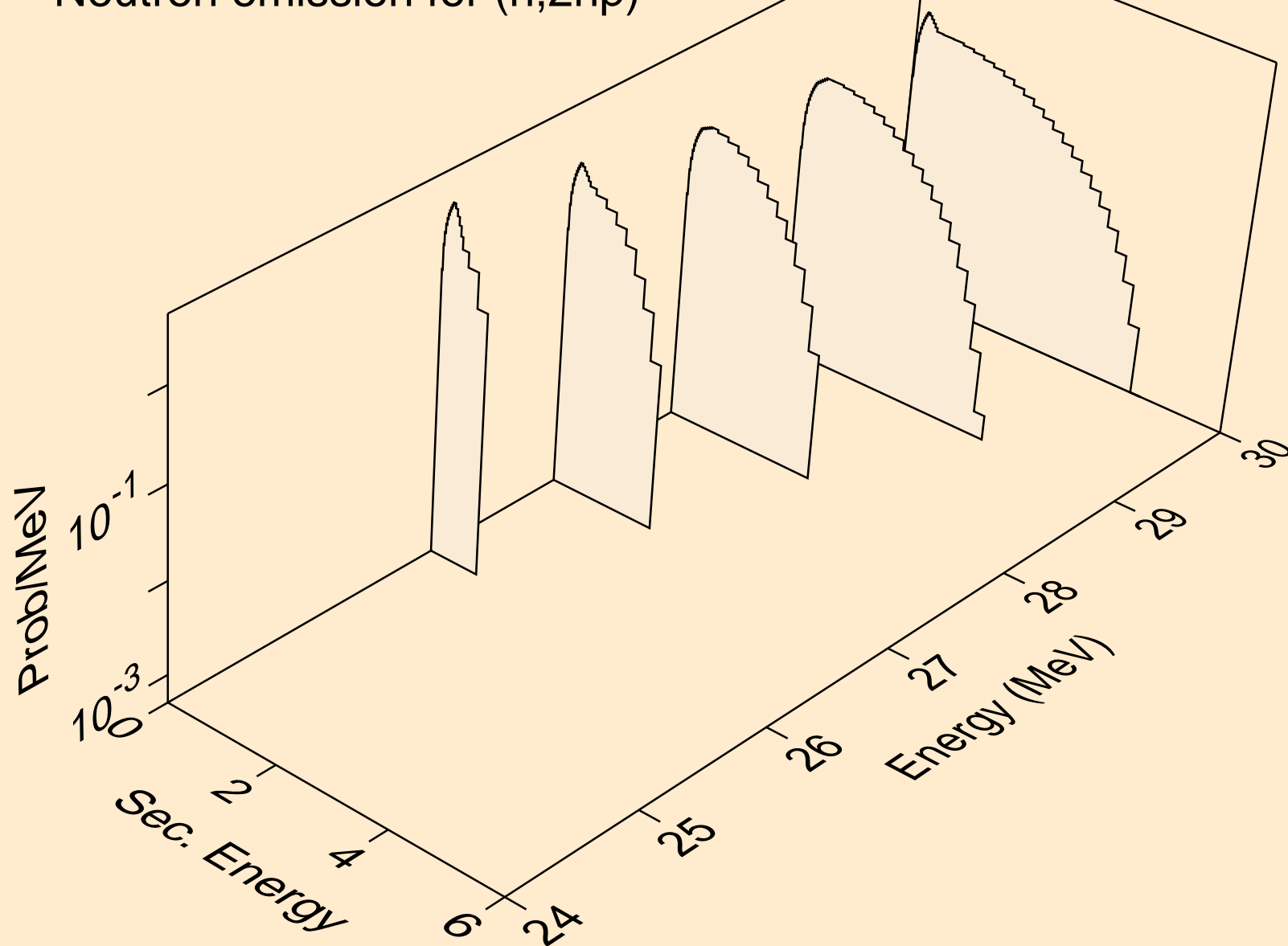

8-O-16 FOR FENDL-3B2 FROM ENDF/B-VII WITH NJOY99.304+ C
Neutron emission for (n,n2p)

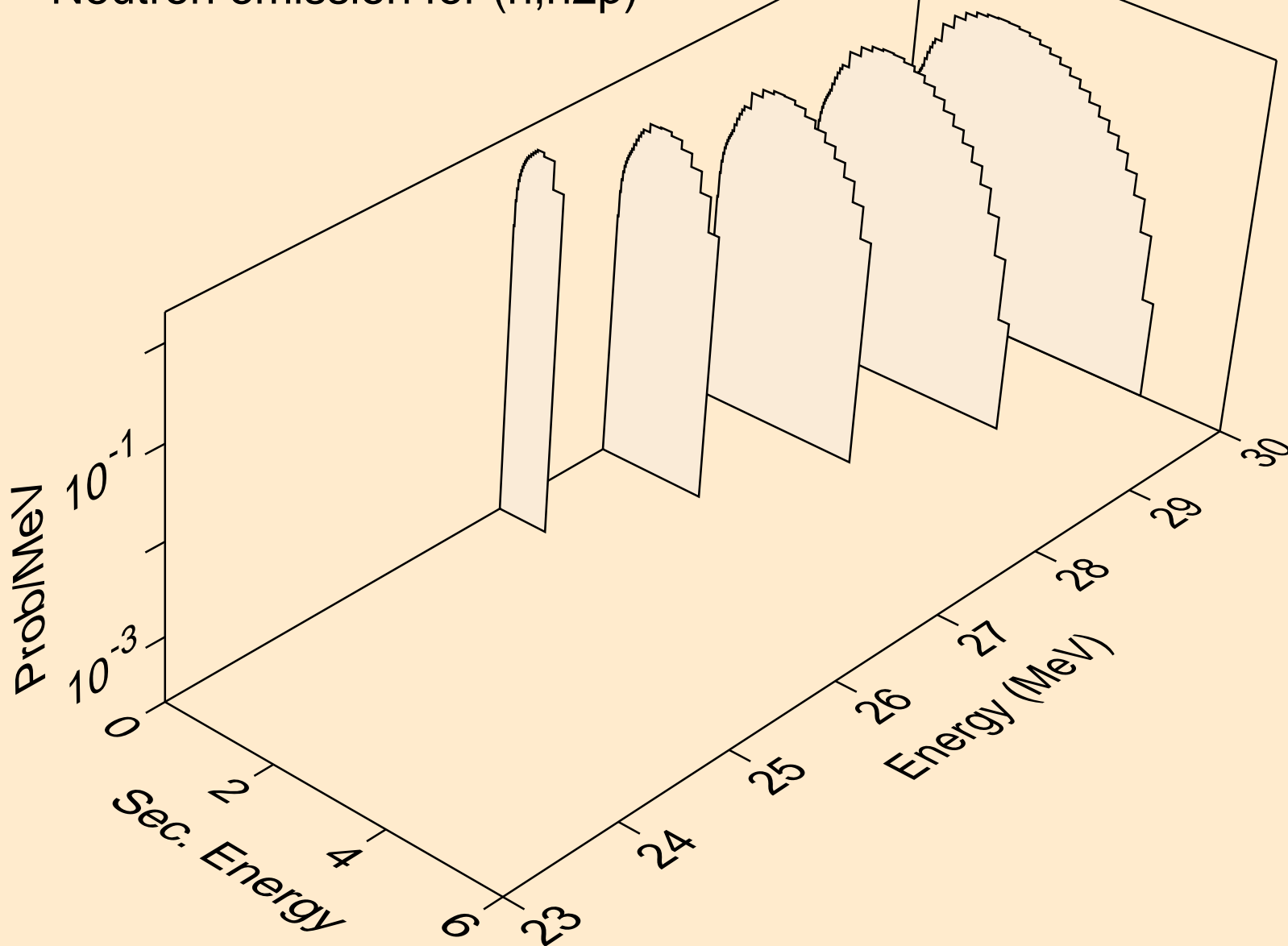

8-O-16 FOR FENDL-3B2 FROM ENDF/B-VII WITH NJOY99.304+ C
Neutron emission for (n,npa)

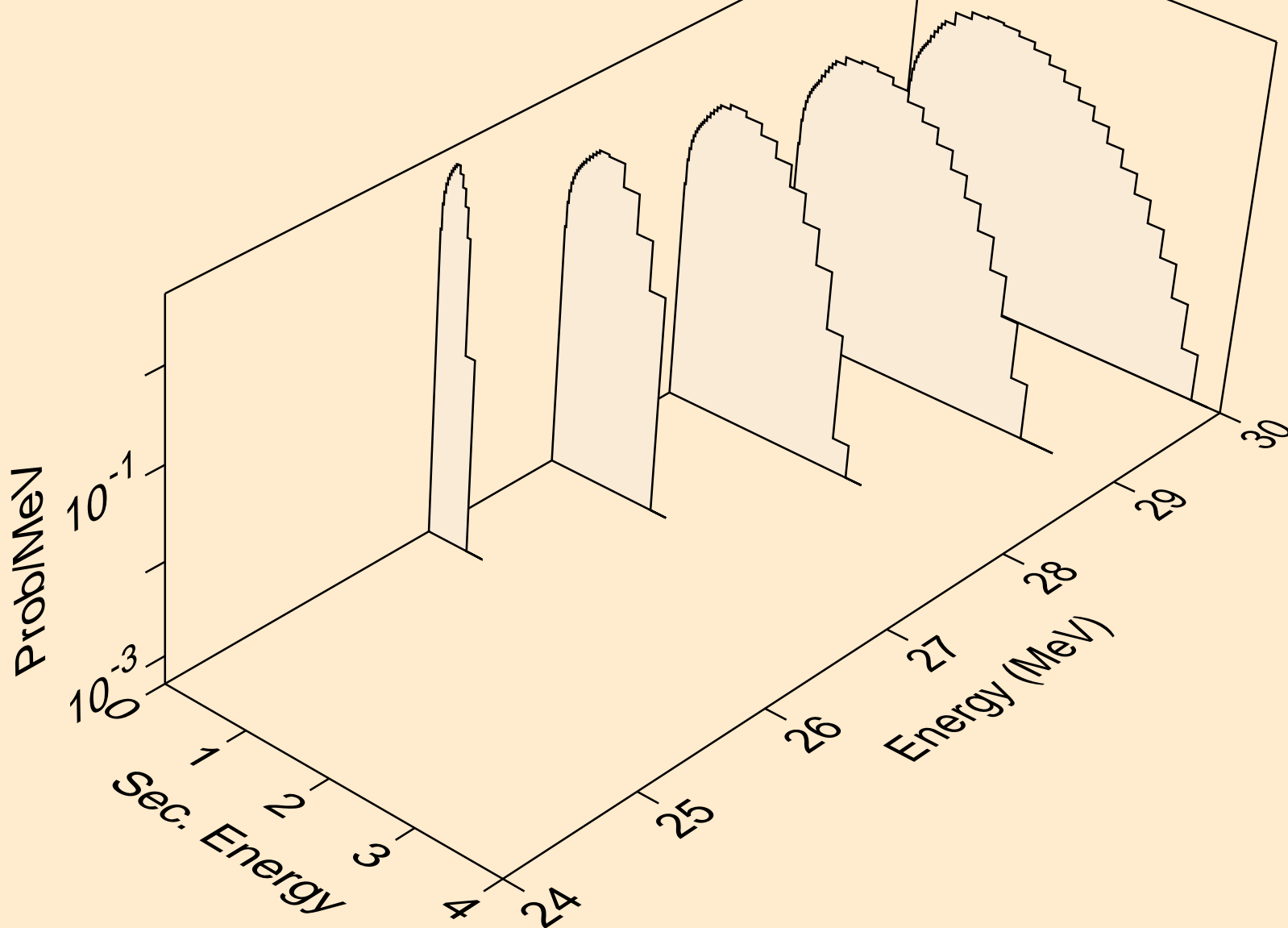

8-O-16 FOR FENDL-3B2 FROM ENDF/B-VII WITH NJOY99.304+ C
Neutron emission for (n,n*c)

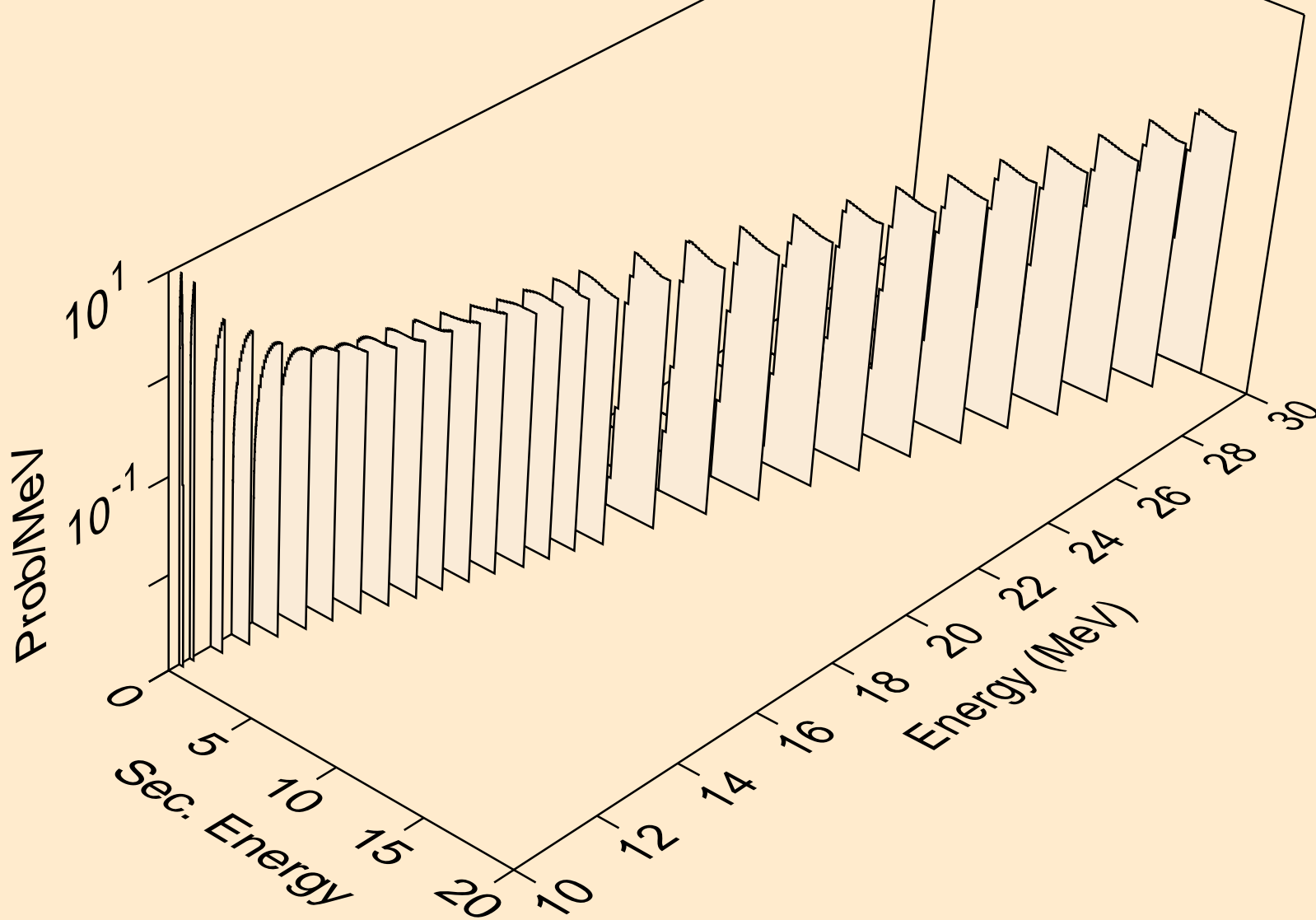

8-O-16 FOR FENDL-3B2 FROM ENDF/B-VII WITH NJOY99.304+ C
Photon emission for (n,x)

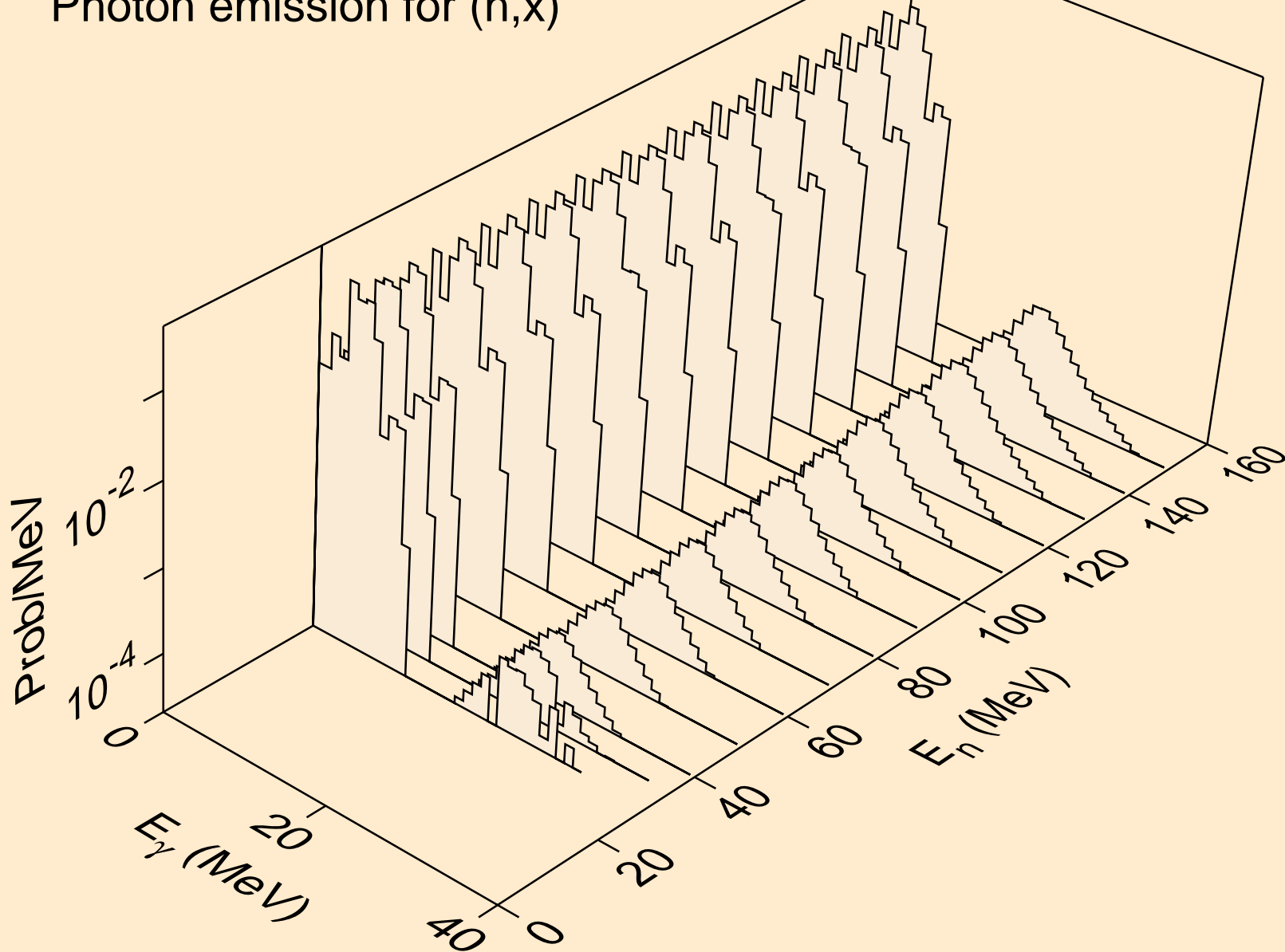

8-O-16 FOR FENDL-3B2 FROM ENDF/B-VII WITH NJOY99.304+ C
Photon emission for (n,n*)3a

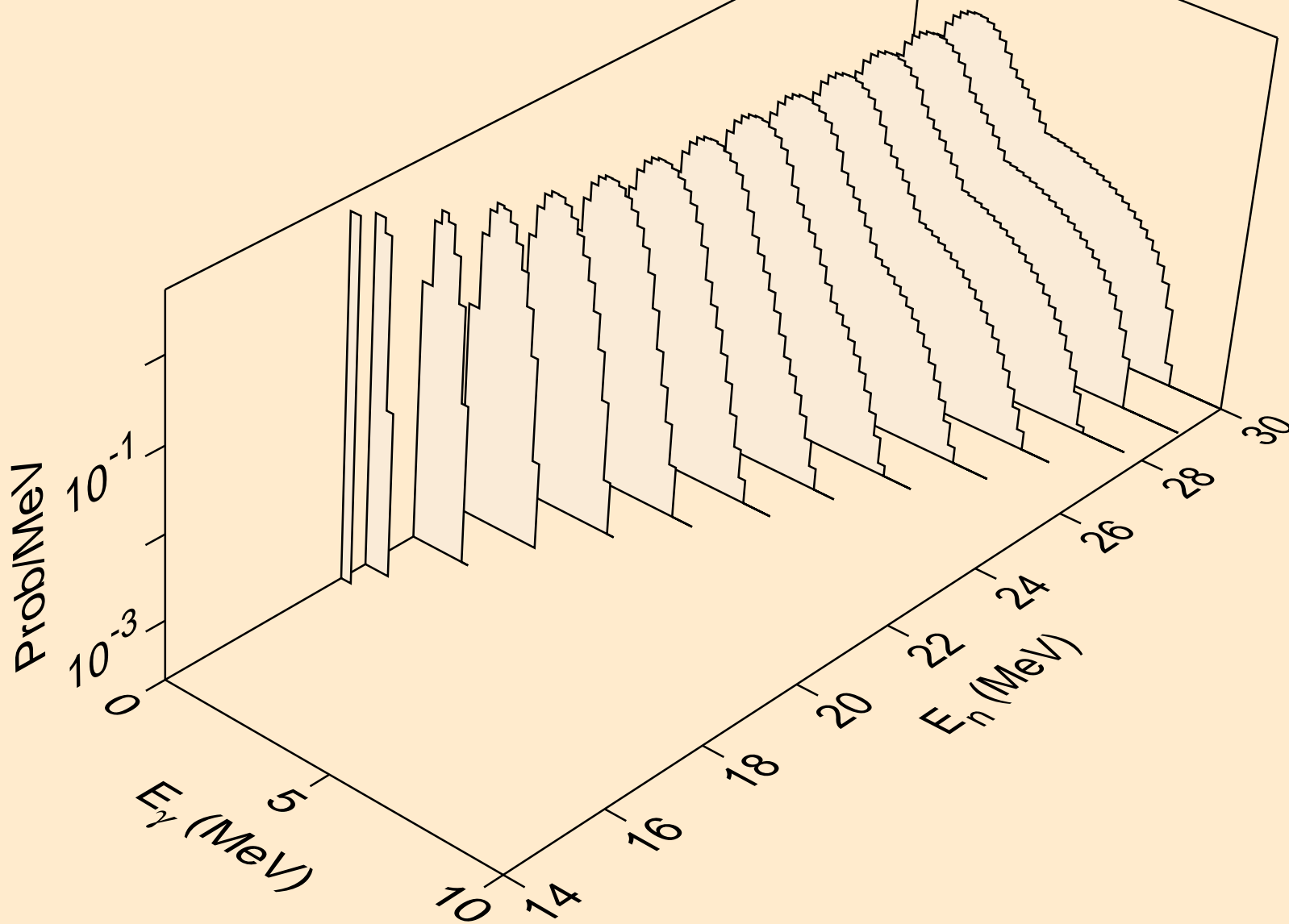

8-O-16 FOR FENDL-3B2 FROM ENDF/B-VII WITH NJOY99.304+ C
Photon emission for (n,n*)p

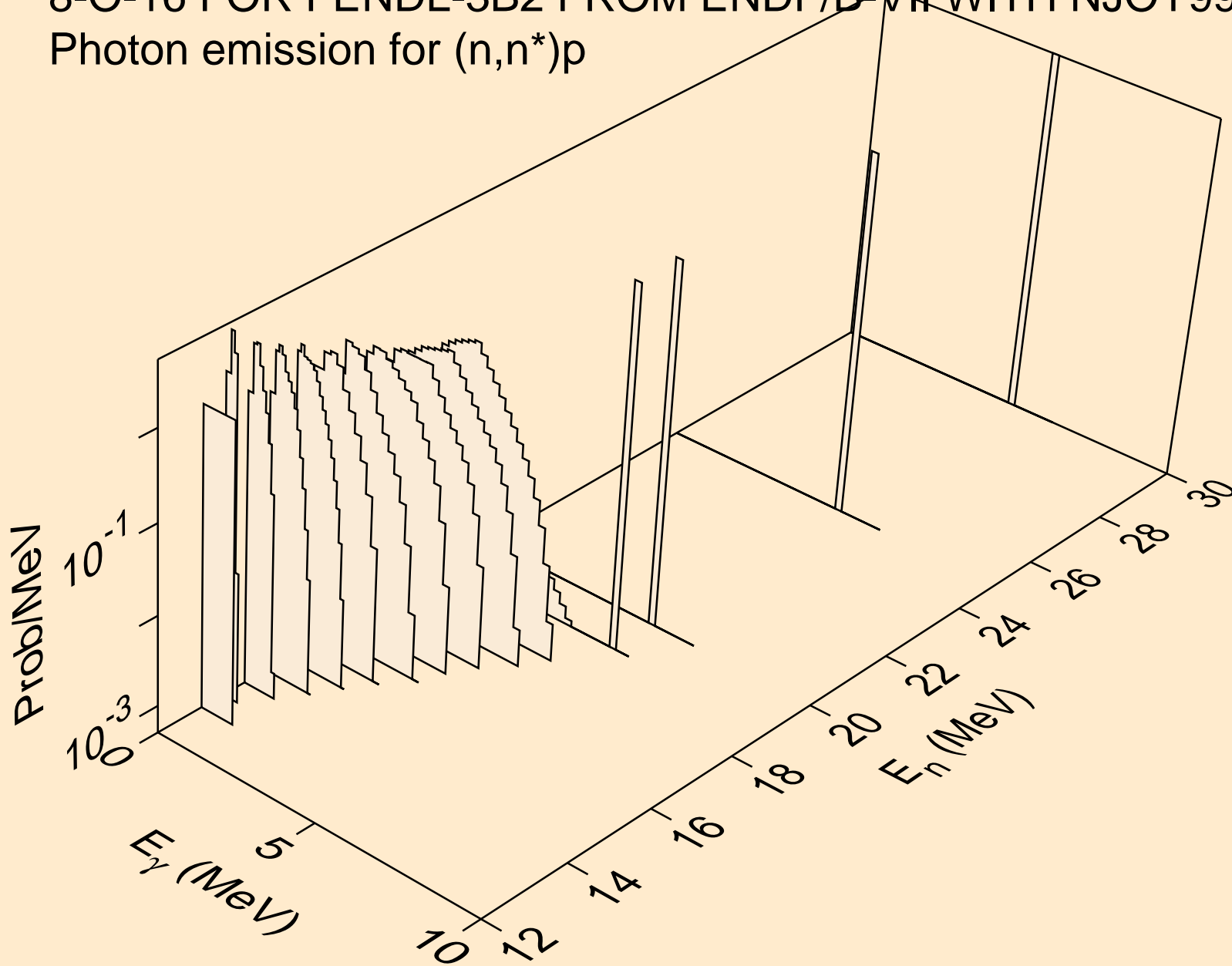

8-O-16 FOR FENDL-3B2 FROM ENDF/B-VII WITH NJOY99.304+ C
Photon emission for (n,n*)d

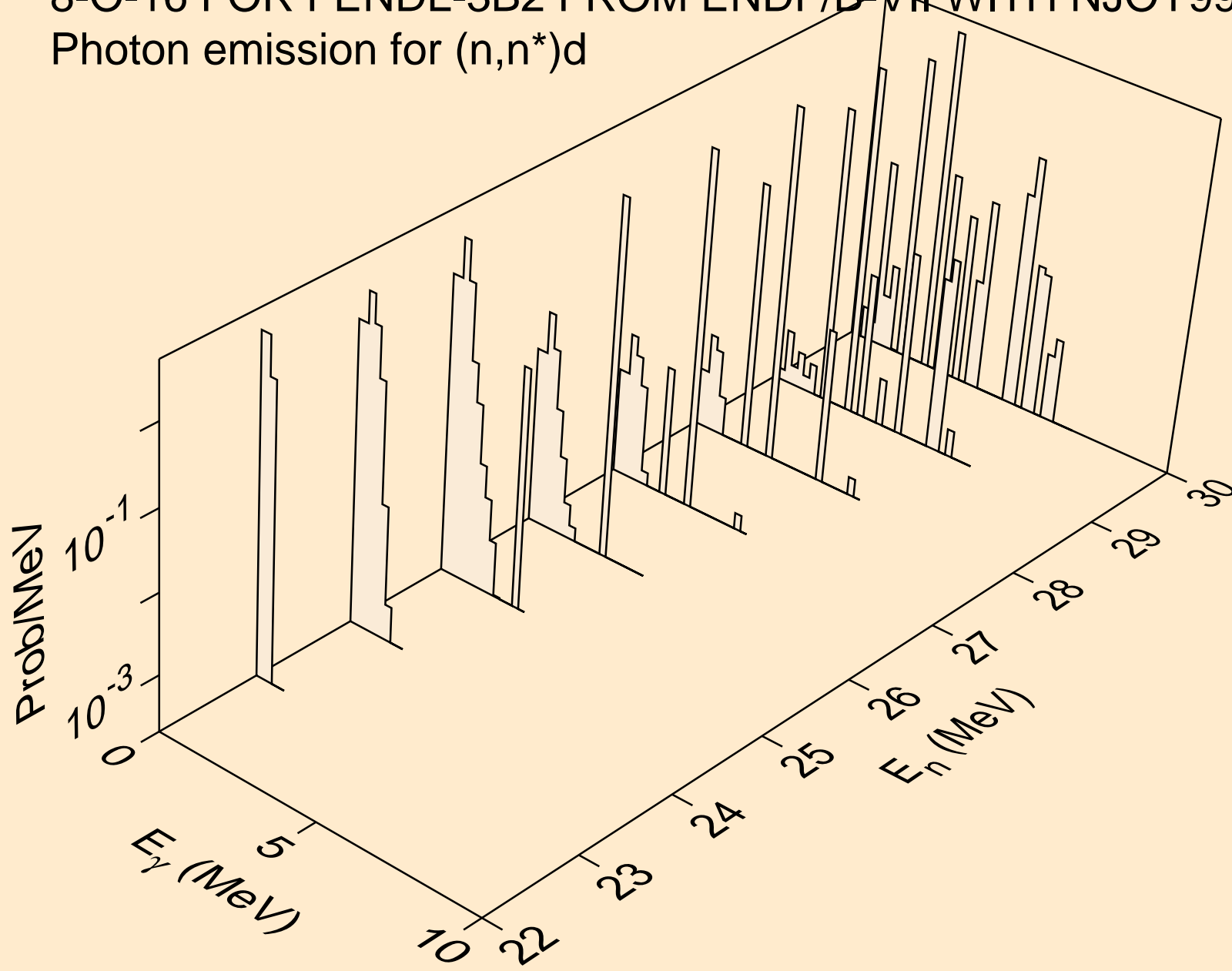

8-O-16 FOR FENDL-3B2 FROM ENDF/B-VII WITH NJOY99.304+ C
Photon emission for (n,2np)

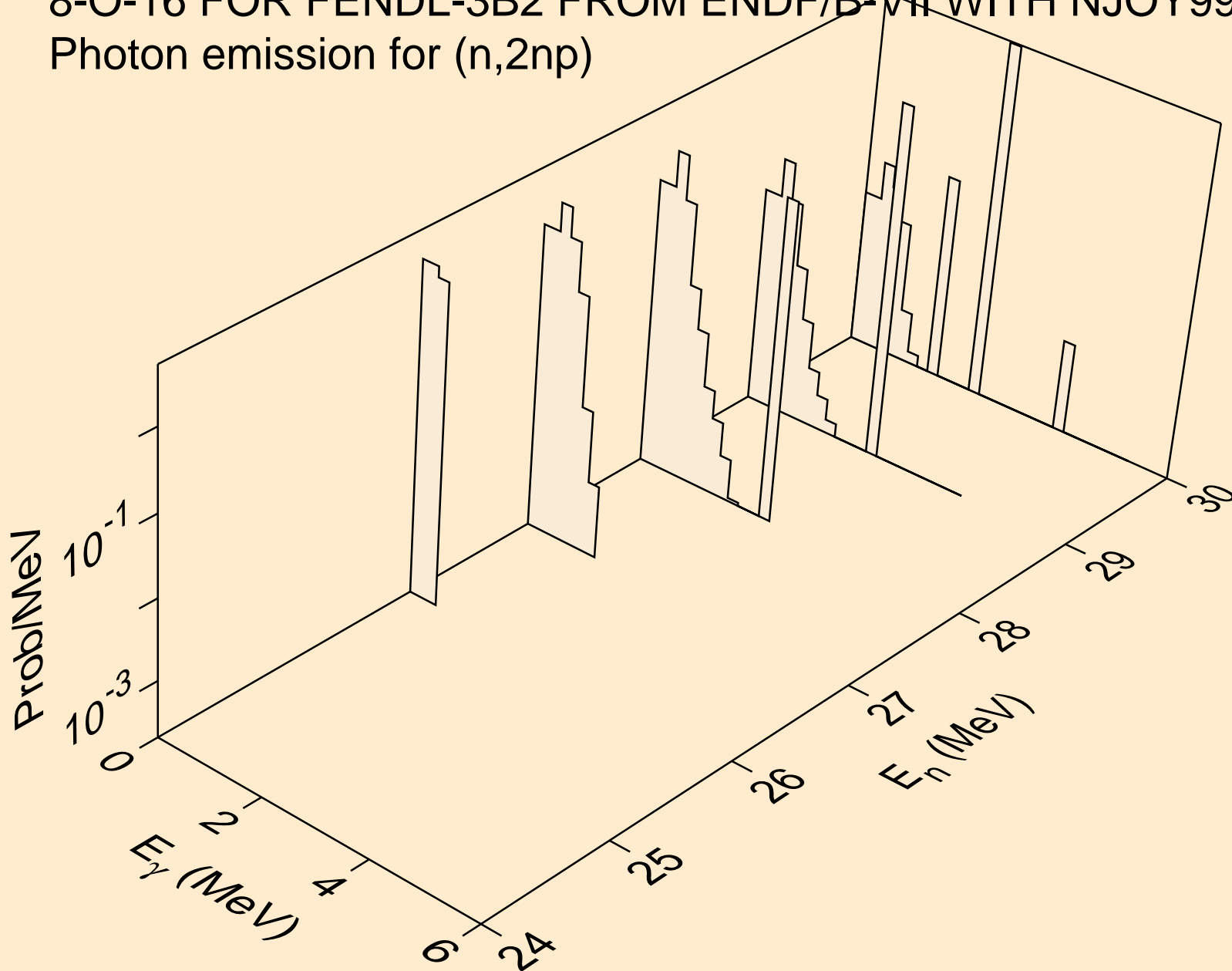

8-O-16 FOR FENDL-3B2 FROM ENDF/B-VII WITH NJOY99.304+ C
Photon emission for (n,n2p)

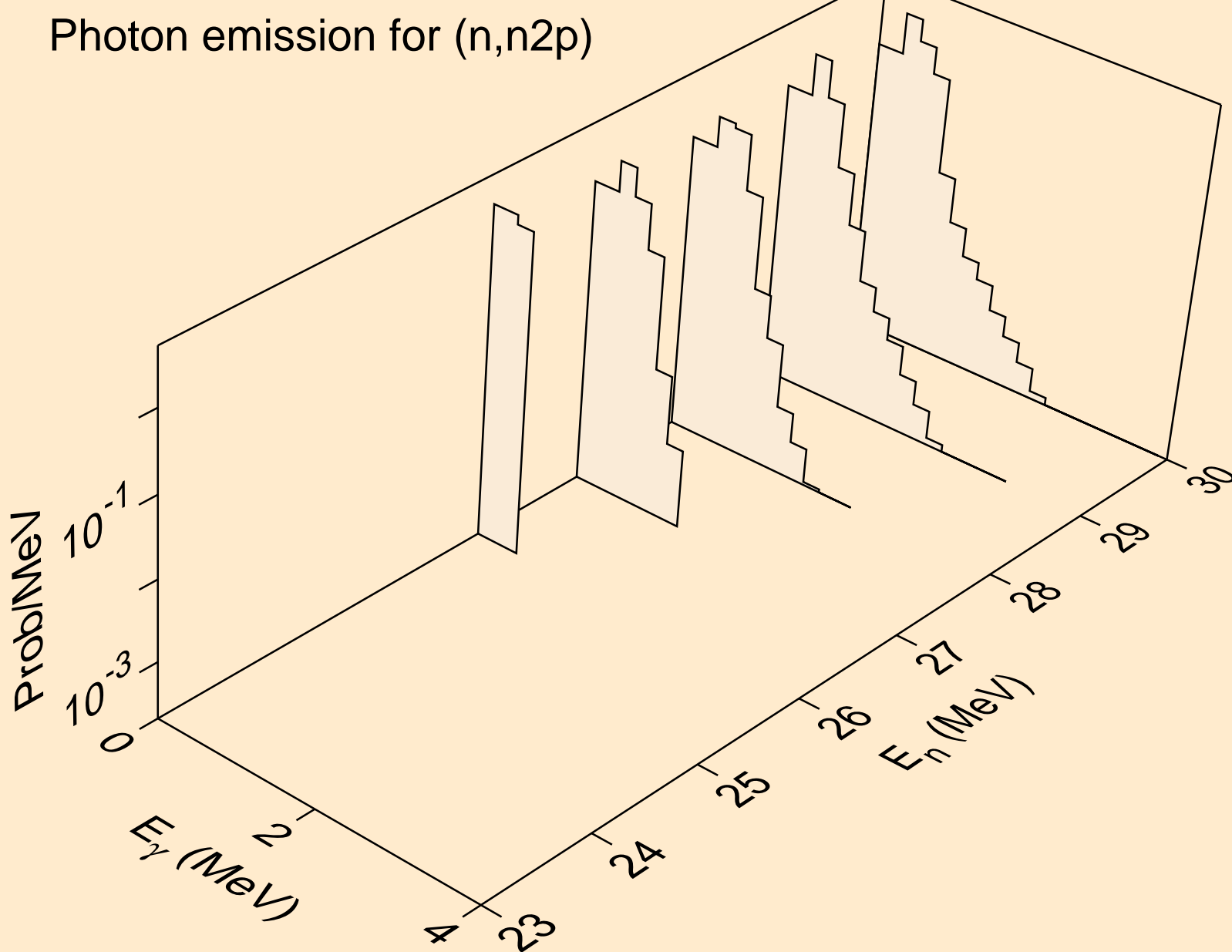

8-O-16 FOR FENDL-3B2 FROM ENDF/B-VII WITH NJOY99.304+ C
Photon emission for (n,npa)

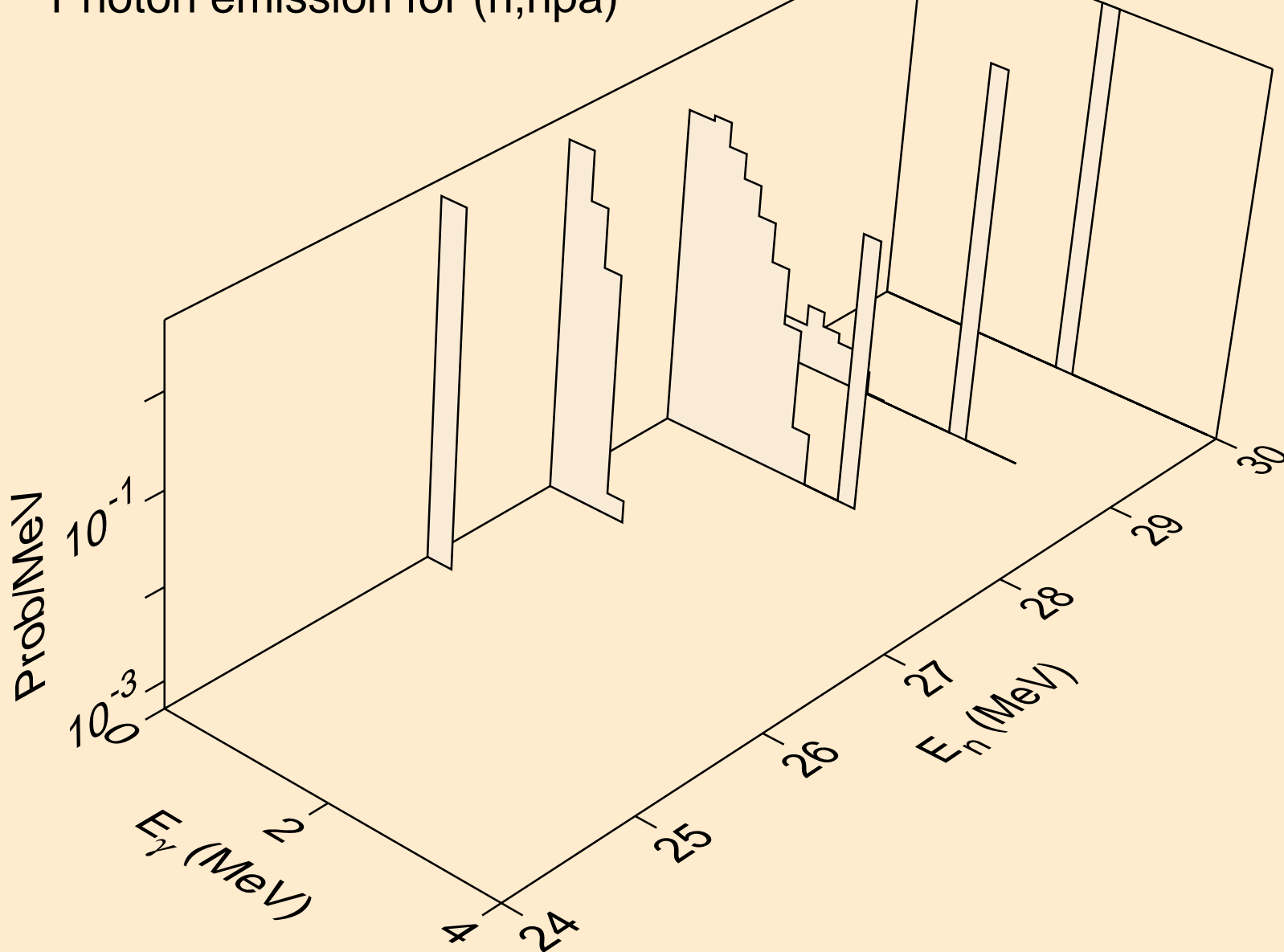

8-O-16 FOR FENDL-3B2 FROM ENDF/B-VII WITH NJOY99.304+ C
Photon emission for (n,n*c)

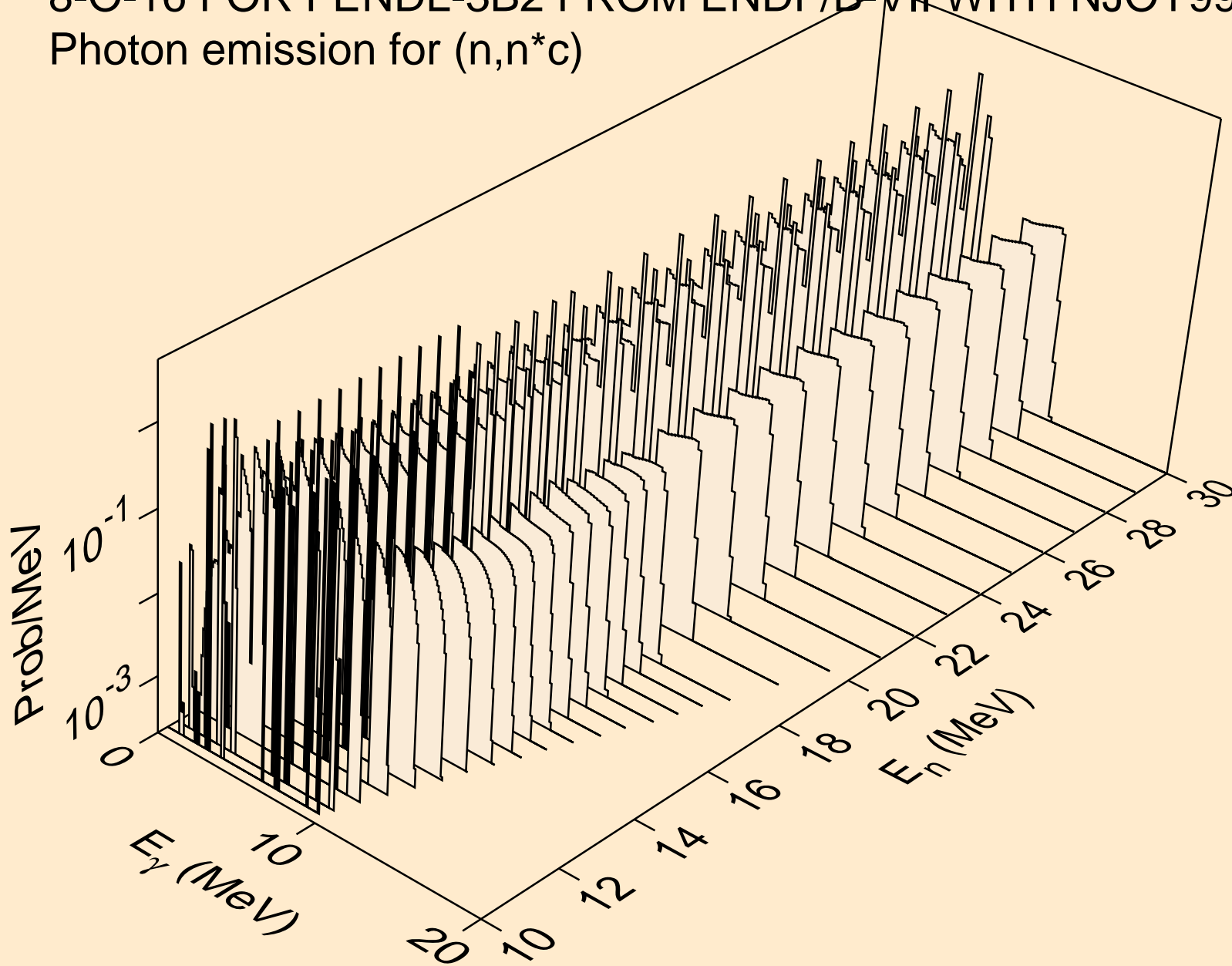

8-O-16 FOR FENDL-3B2 FROM ENDF/B-VII WITH NJOY99.304+ C
Photon emission for (n,2a)

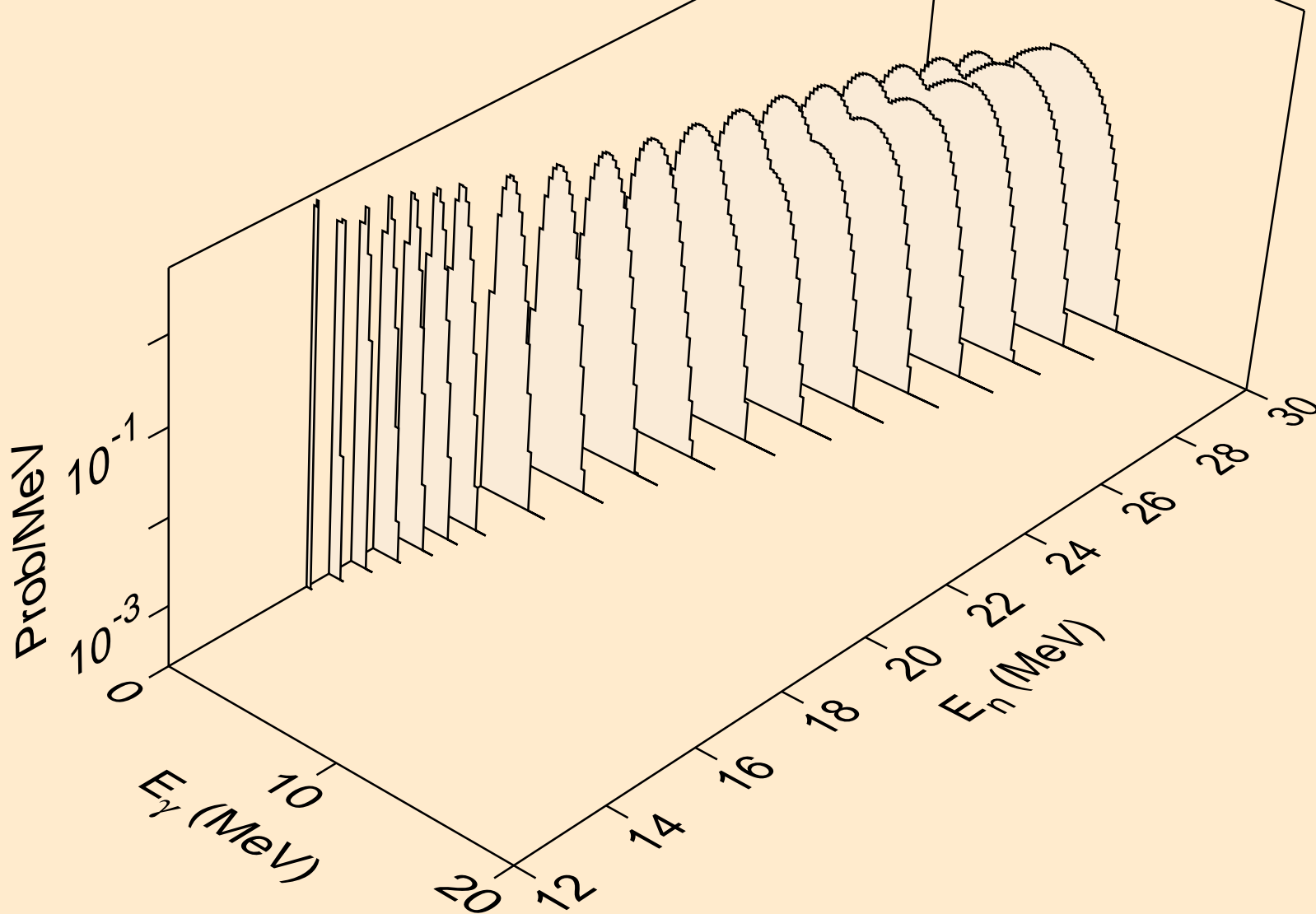

8-O-16 FOR FENDL-3B2 FROM ENDF/B-VII WITH NJOY99.304+ C
Photon emission for (n,pa)

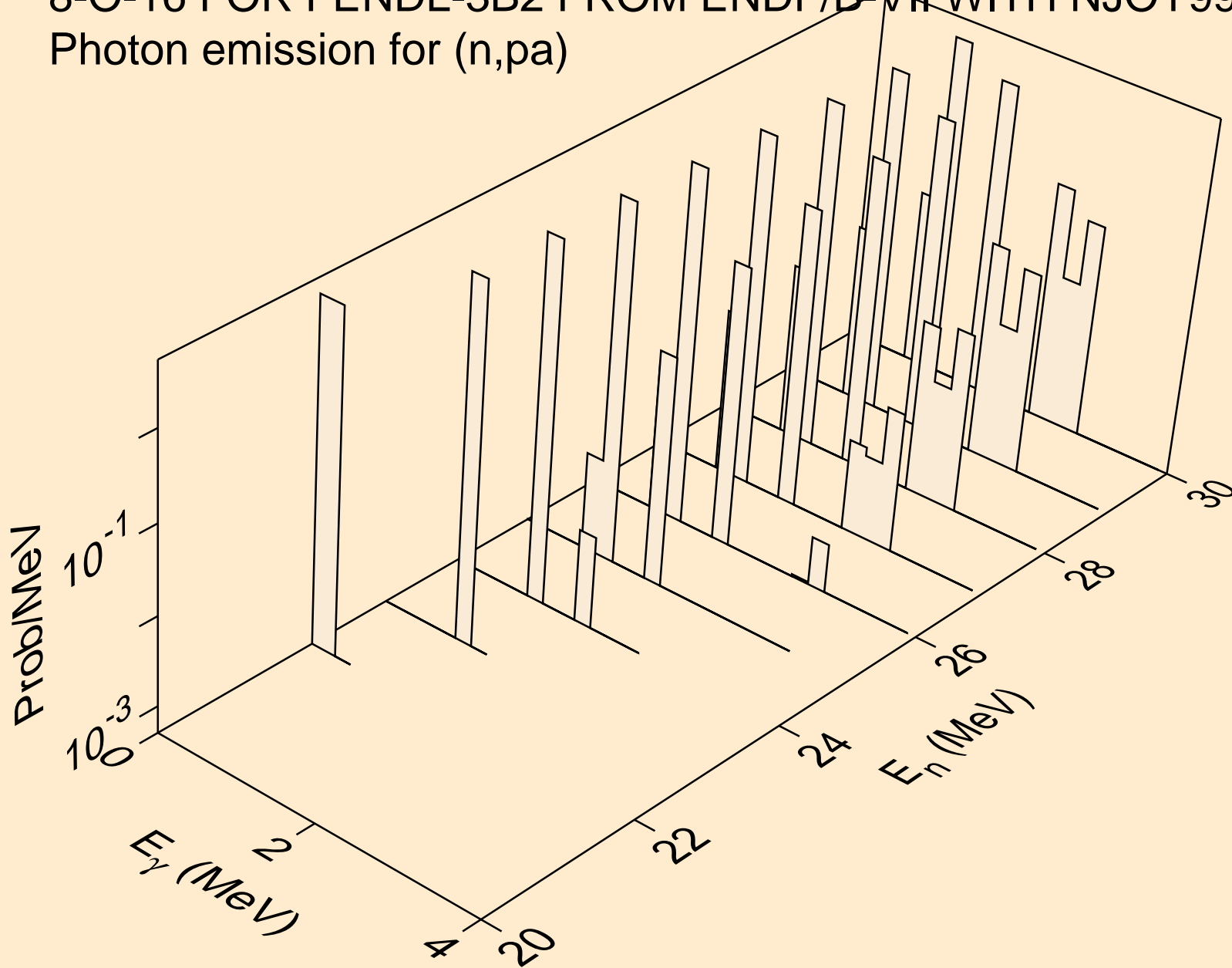

8-O-16 FOR FENDL-3B2 FROM ENDF/B-VII WITH NJOY99.304+ C
Photon emission for (n,t*c)

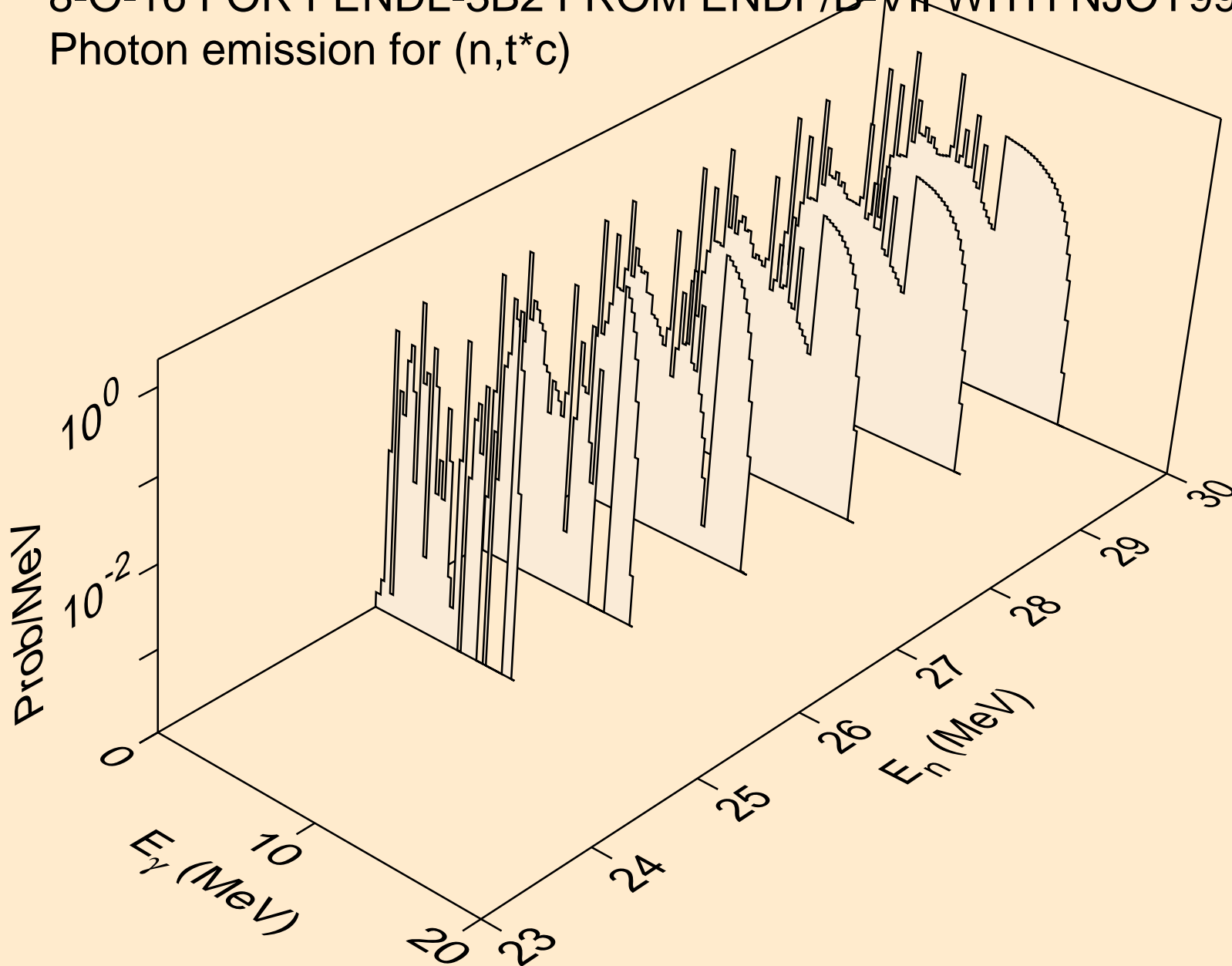

8-O-16 FOR FENDL-3B2 FROM ENDF/B-VII WITH NJOY99.304+ C
thermal capture photon spectrum

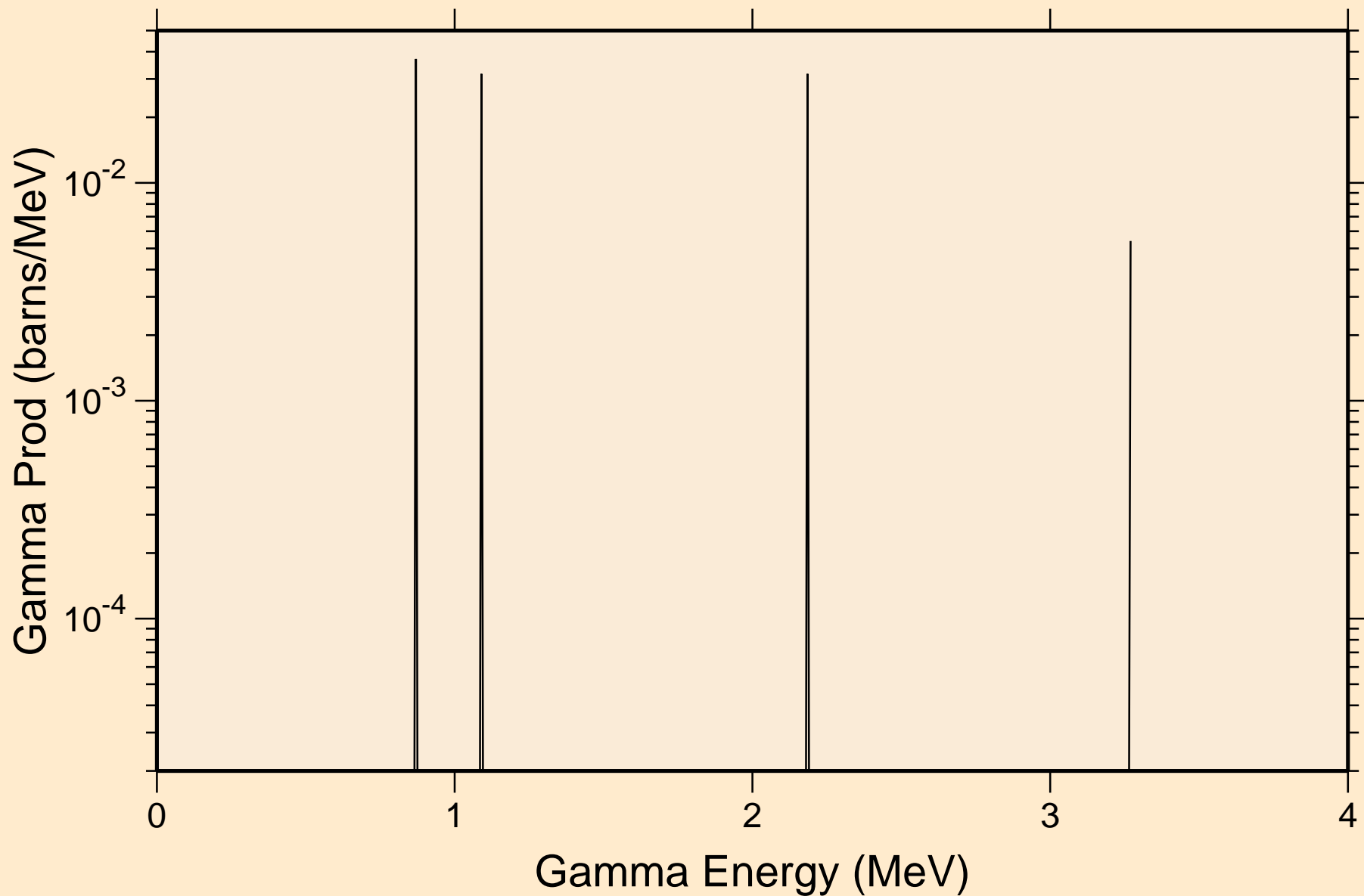

8-O-16 FOR FENDL-3B2 FROM ENDF/B-VII WITH NJOY99.304+ C
14 MeV photon spectrum

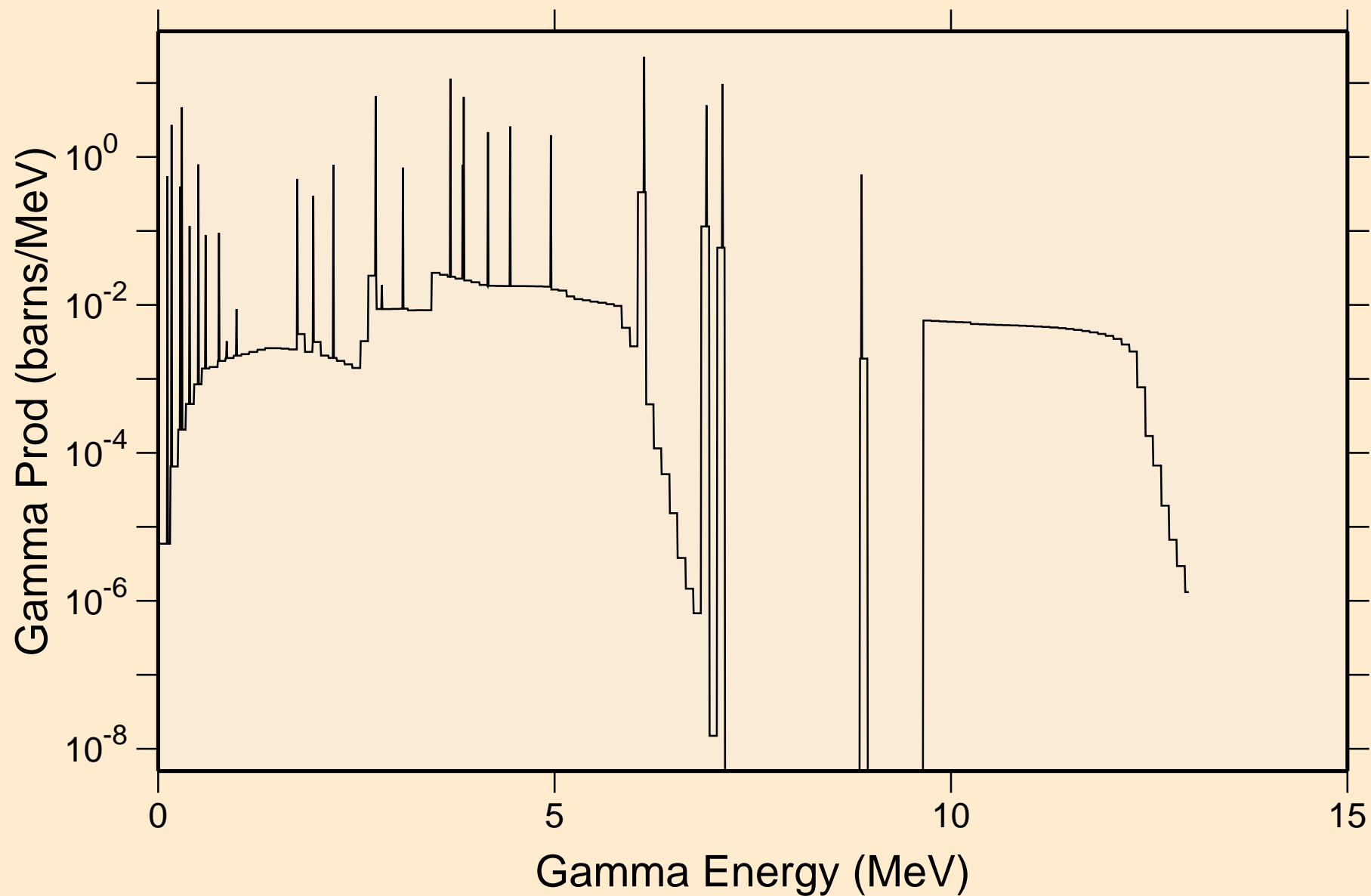

8-O-16 FOR FENDL-3B2 FROM ENDF/B-VII WITH NJOY99.304+ C

Particle heating contributions

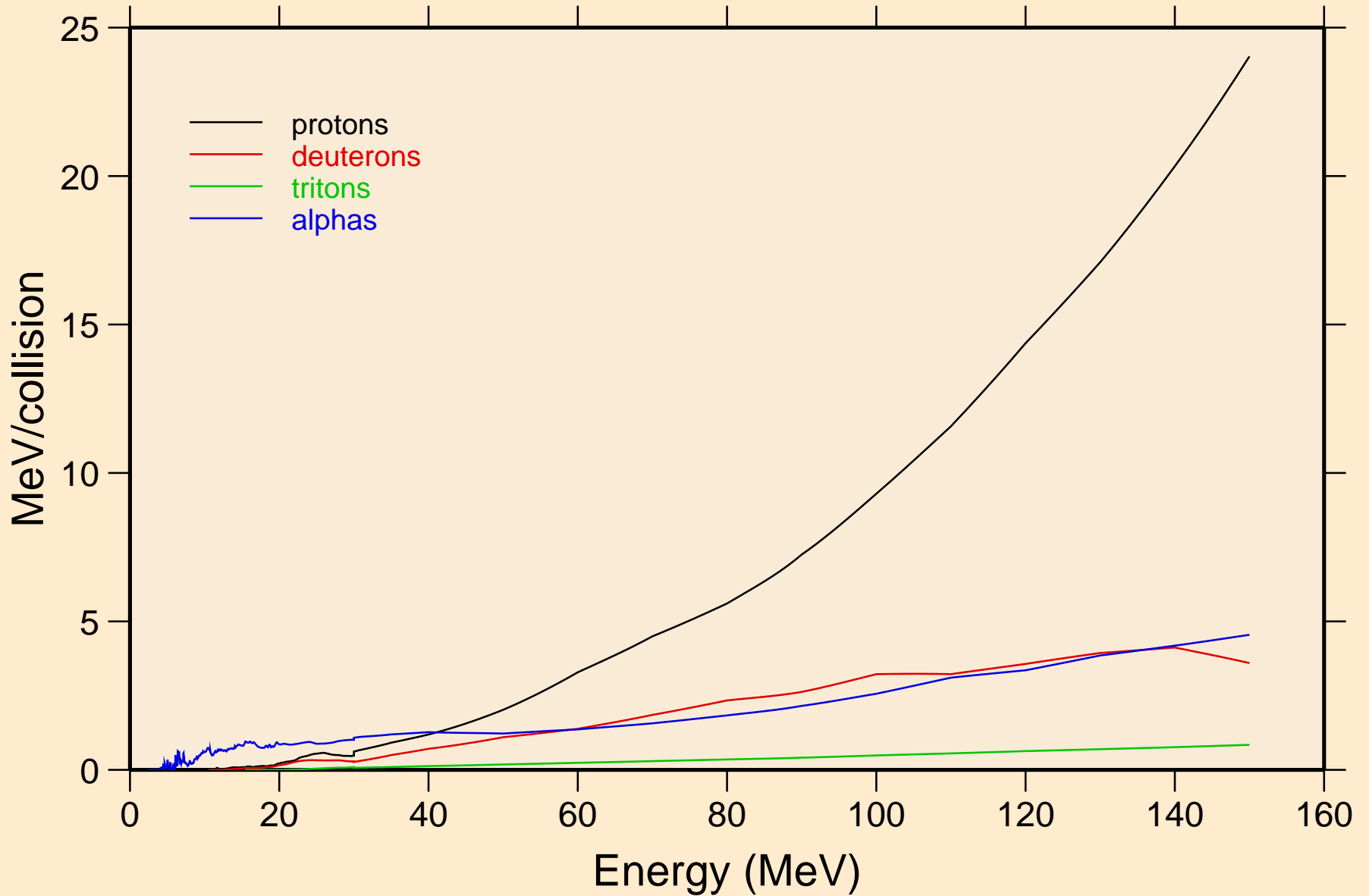

8-O-16 FOR FENDL-3B2 FROM ENDF/B-VII WITH NJOY99.304+ C Recoil Heating

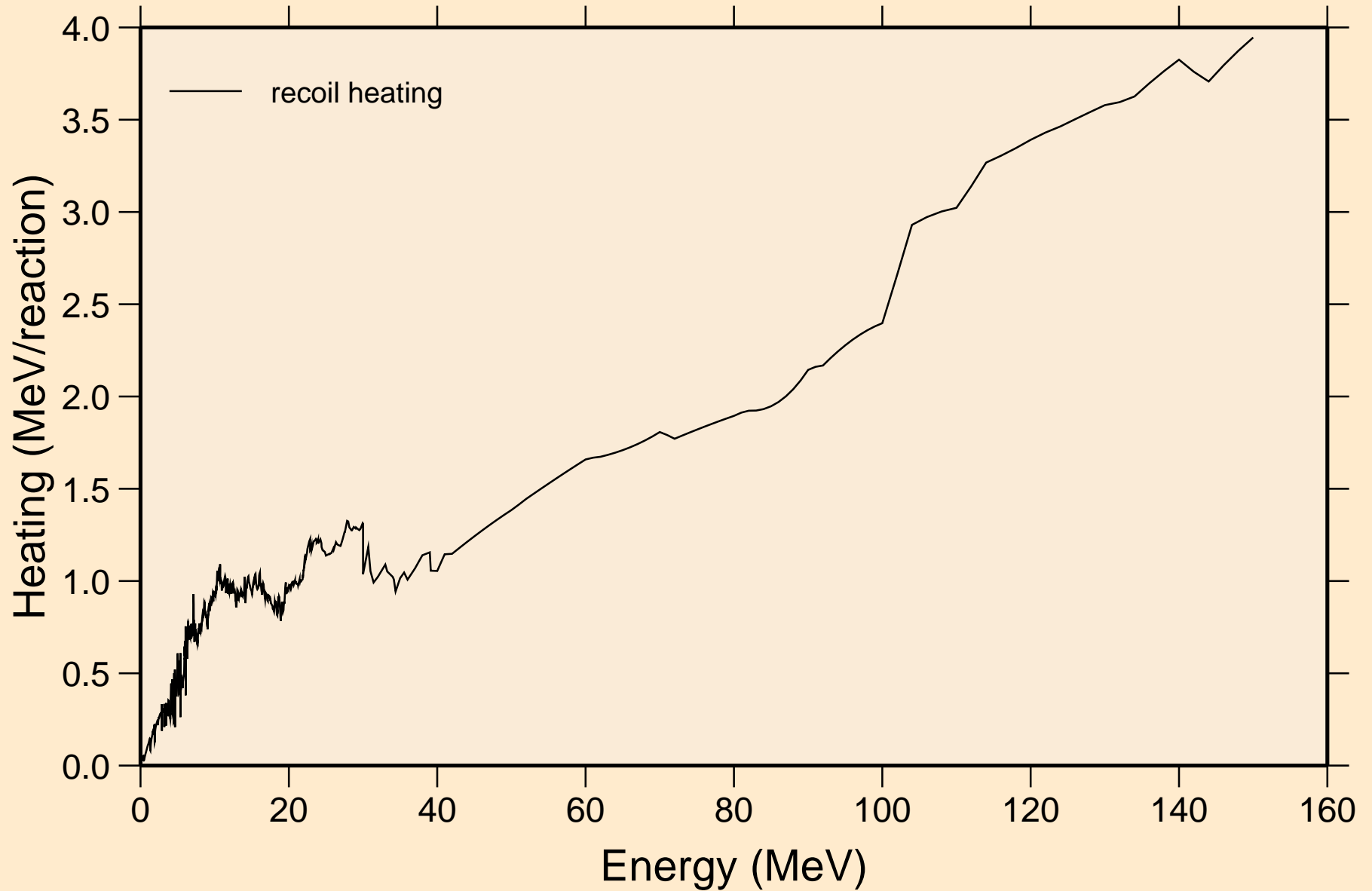

8-O-16 FOR FENDL-3B2 FROM ENDF/B-VII WITH NJOY99.304+ C

Particle production cross sections

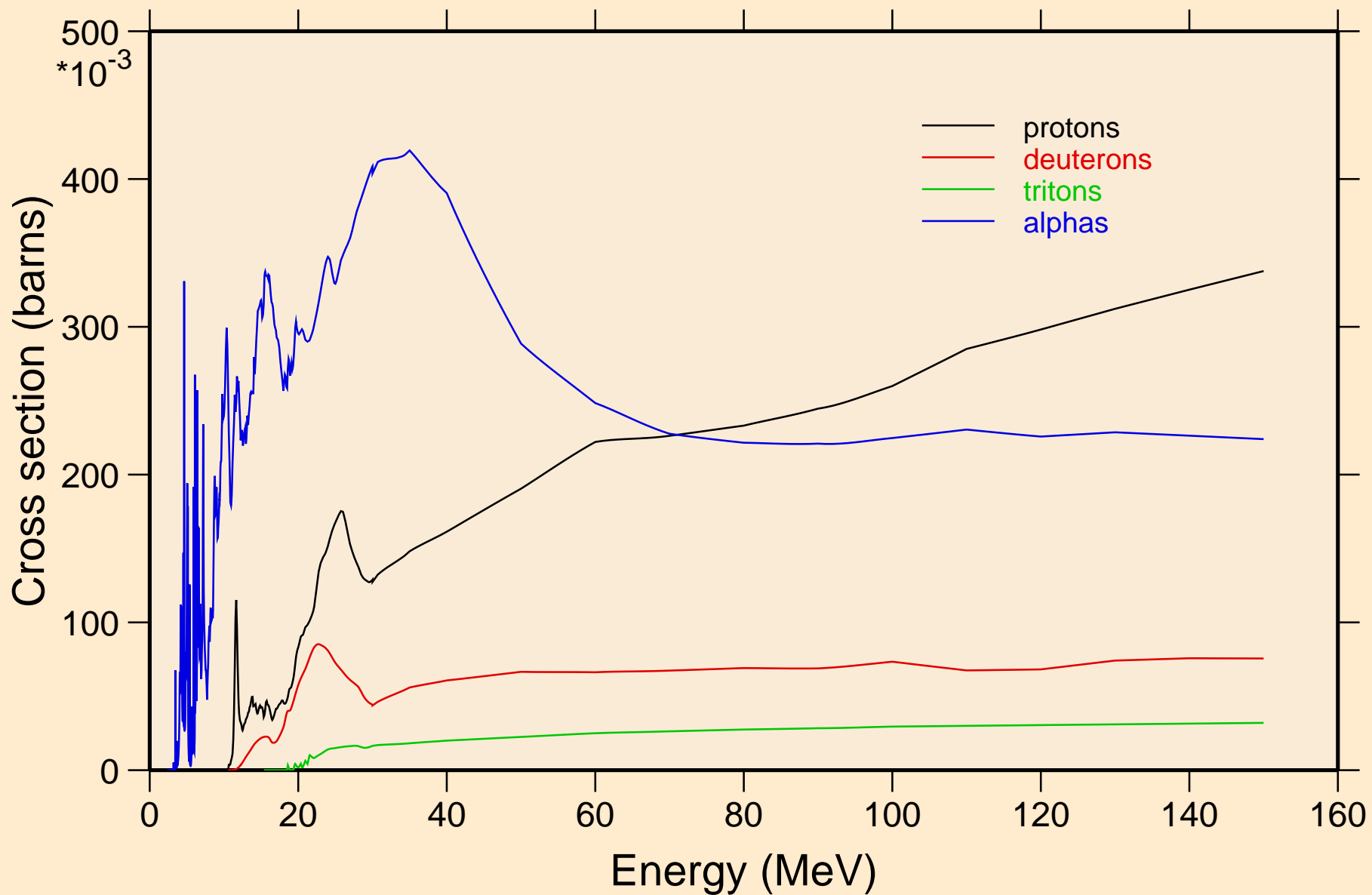

8-O-16 FOR FENDL-3B2 FROM ENDF/B-VII WITH NJOY99.304+ C
protons from (n,x)

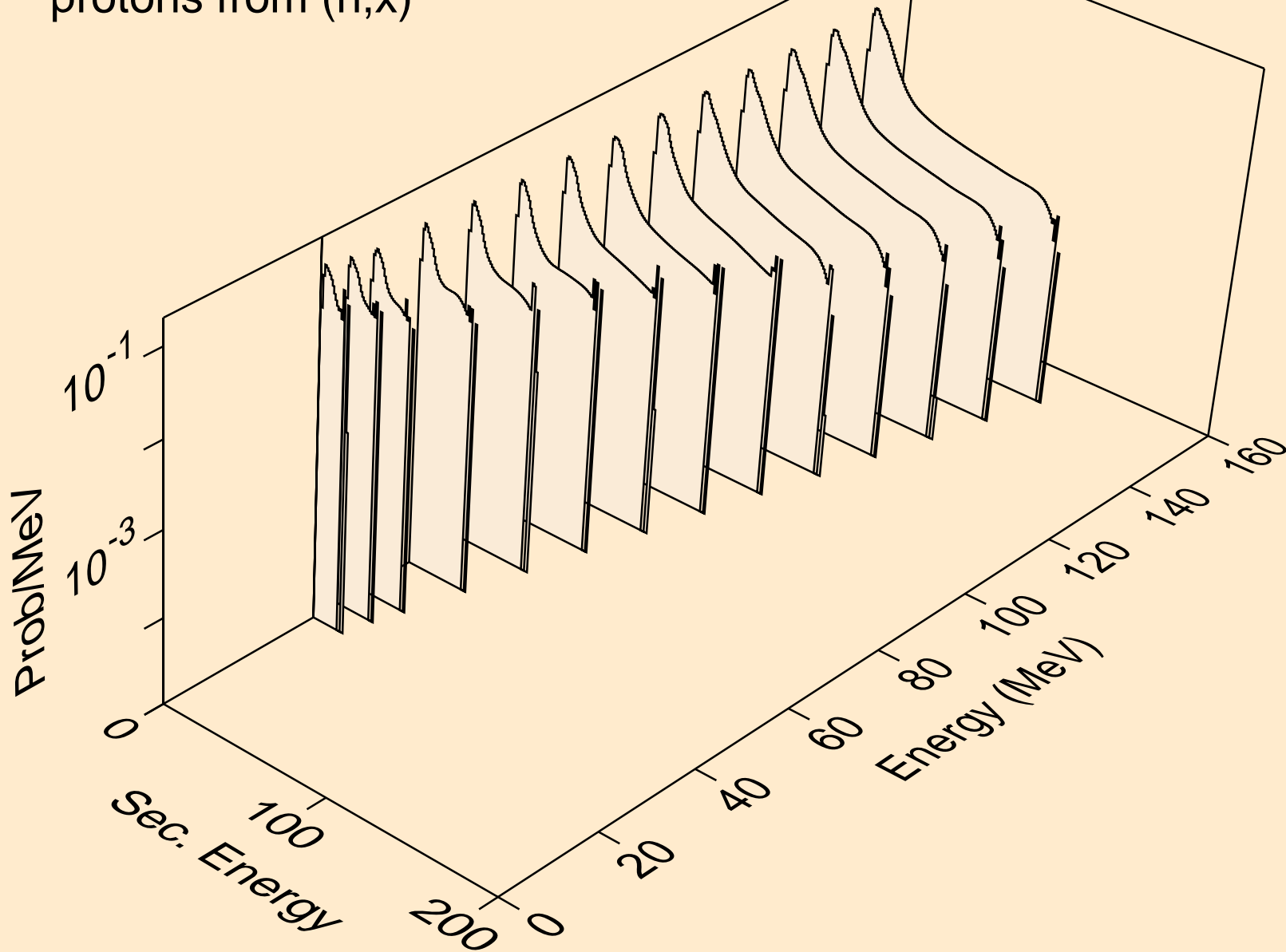

8-O-16 FOR FENDL-3B2 FROM ENDF/B-VII WITH NJOY99.304+ C
protons from (n,n*)p

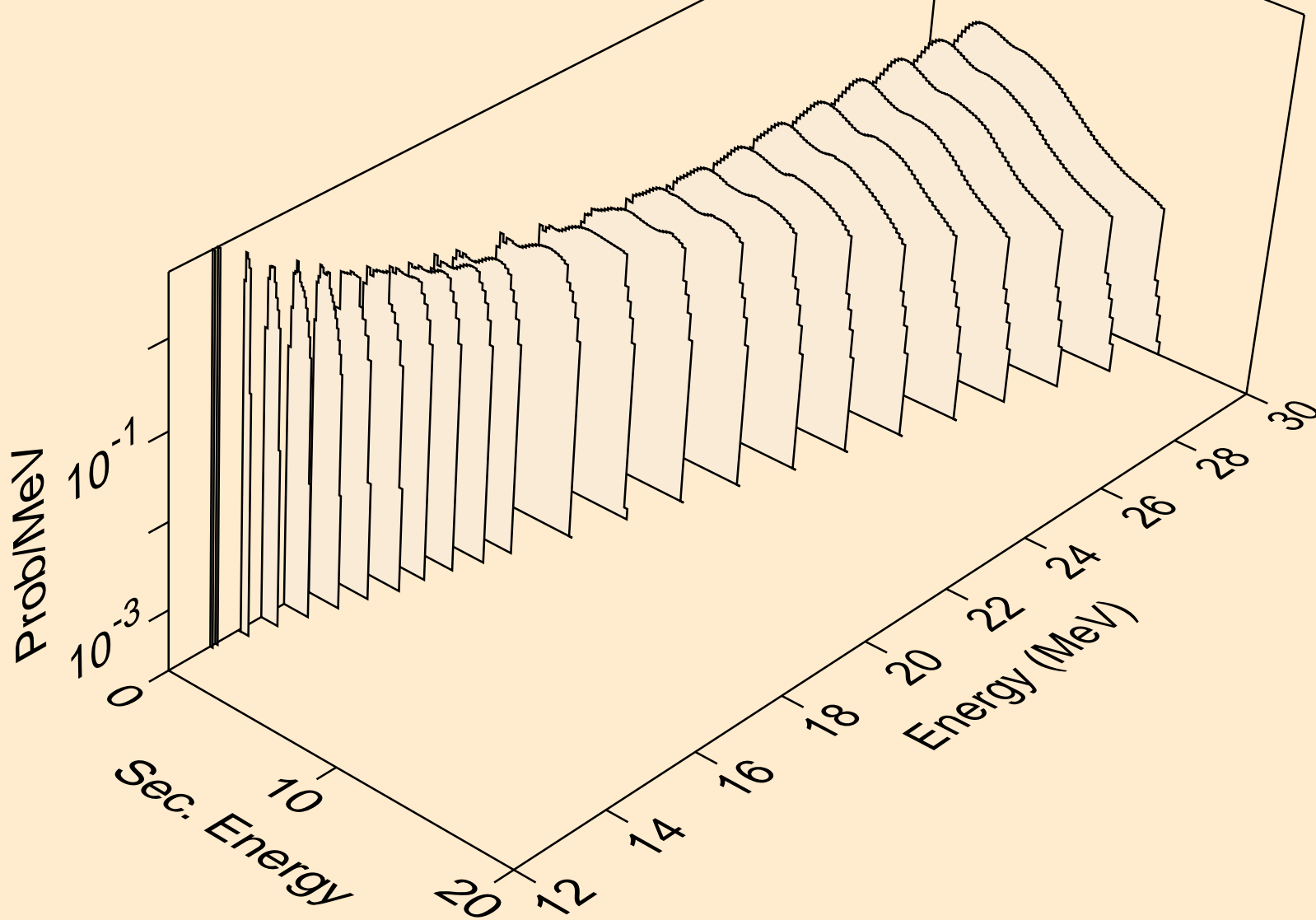

8-O-16 FOR FENDL-3B2 FROM ENDF/B-VII WITH NJOY99.304+ C
protons from (n,2np)

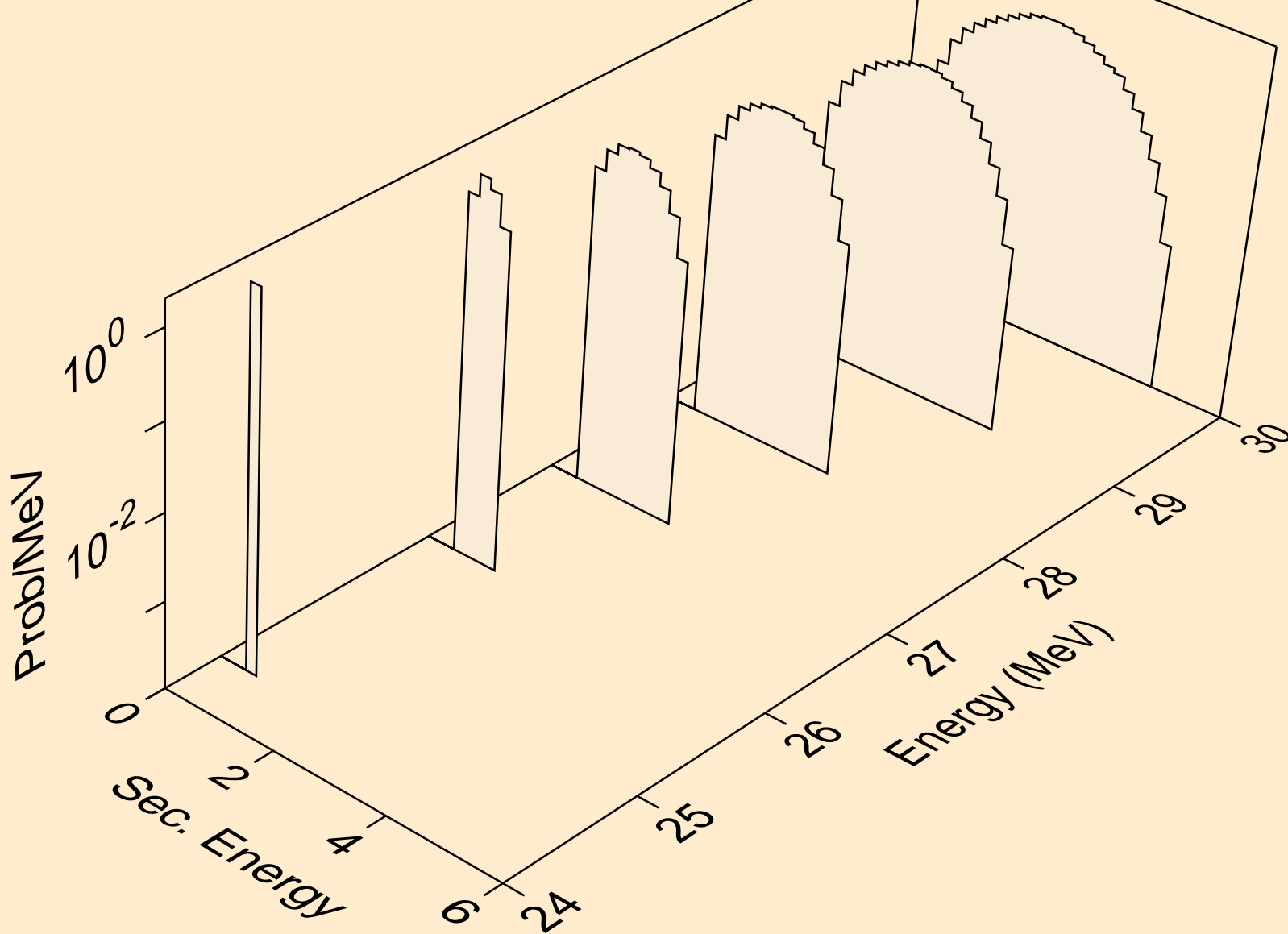

8-O-16 FOR FENDL-3B2 FROM ENDF/B-VII WITH NJOY99.304+ C
protons from (n,n2p)

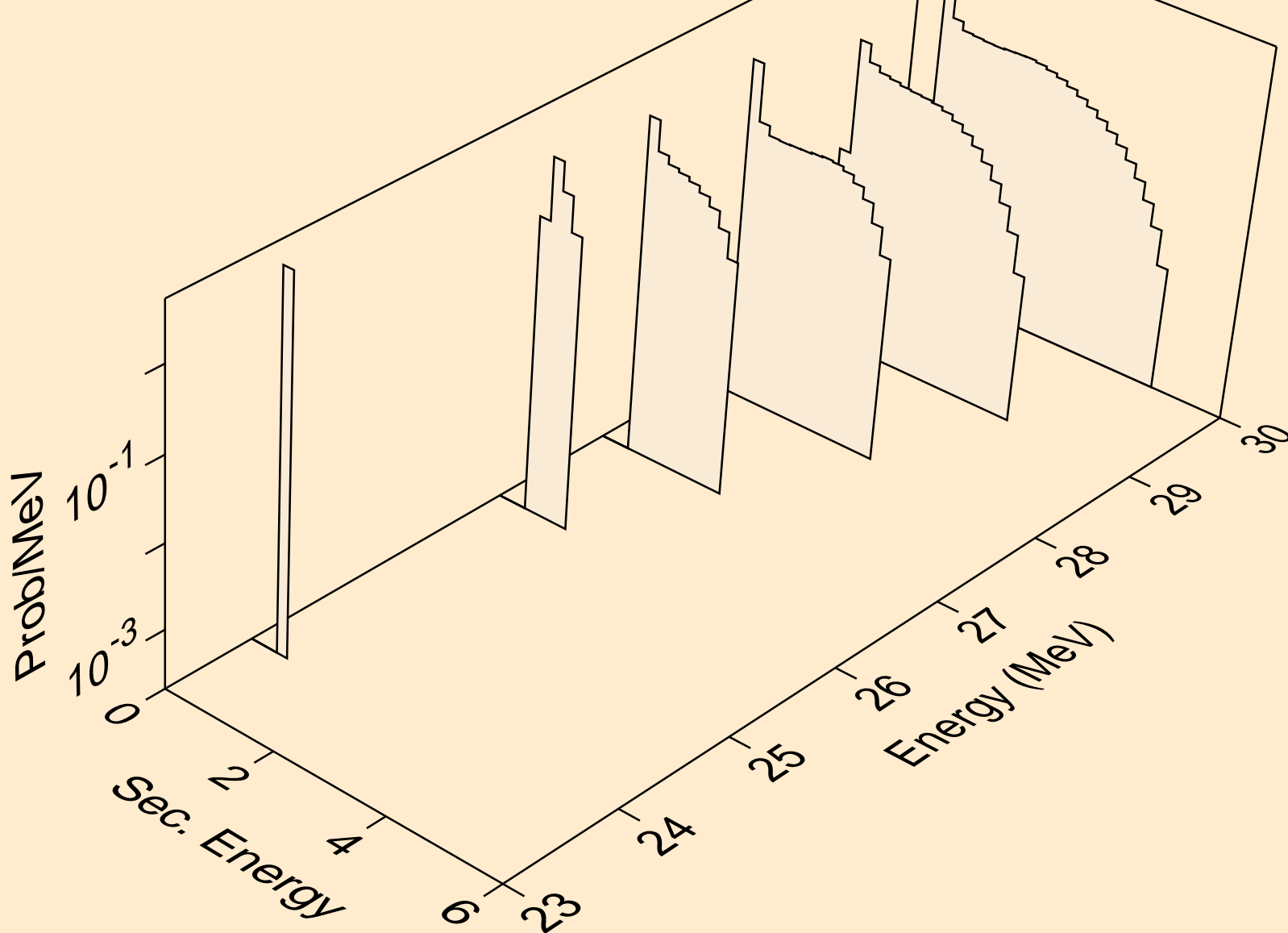

8-O-16 FOR FENDL-3B2 FROM ENDF/B-VII WITH NJOY99.304+ C
protons from (n,npa)

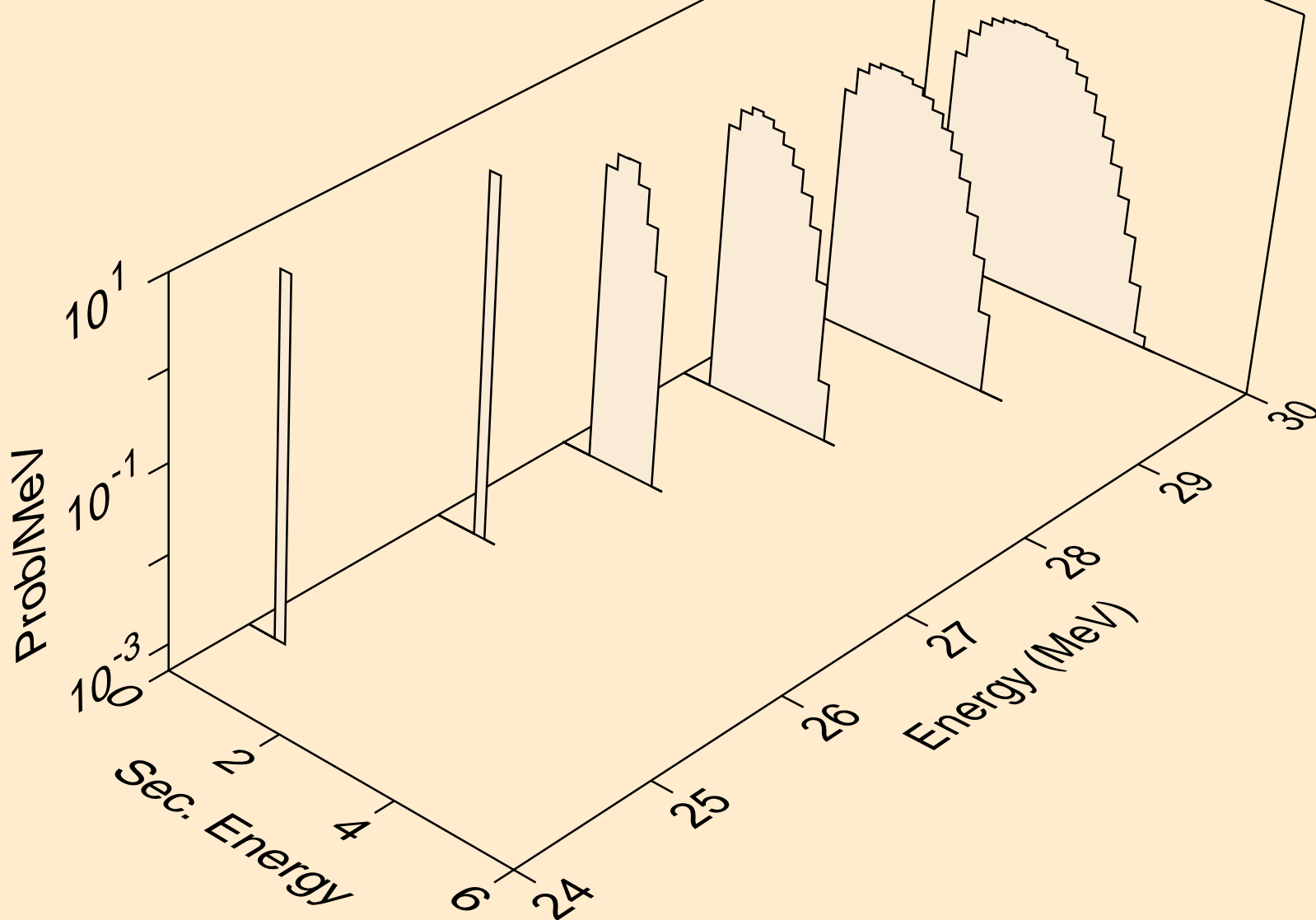

8-O-16 FOR FENDL-3B2 FROM ENDF/B-VII WITH NJOY99.304+ C
protons from (n,pa)

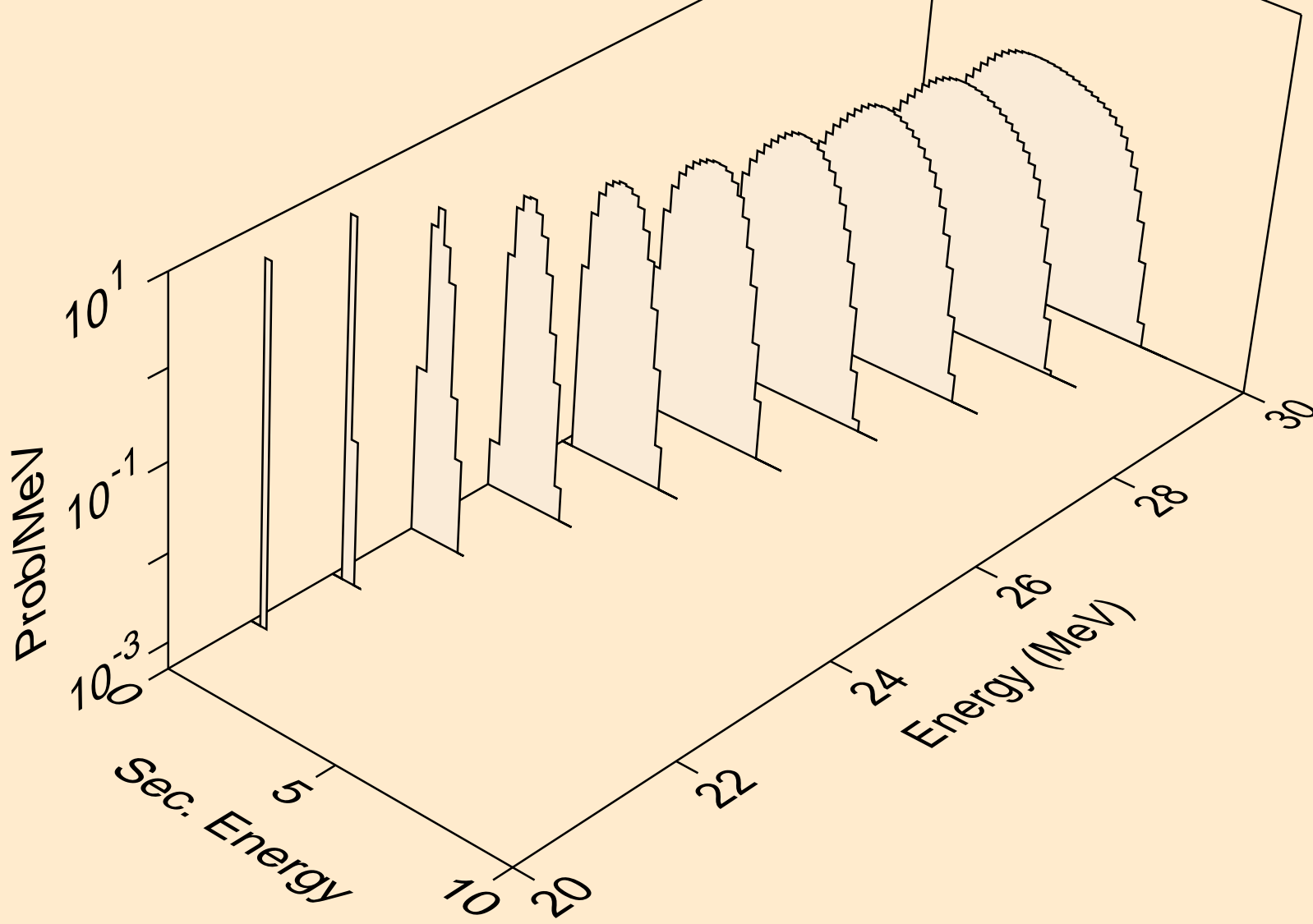

8-O-16 FOR FENDL-3B2 FROM ENDF/B-VII WITH NJOY99.304+ C
deuterons from (n,x)

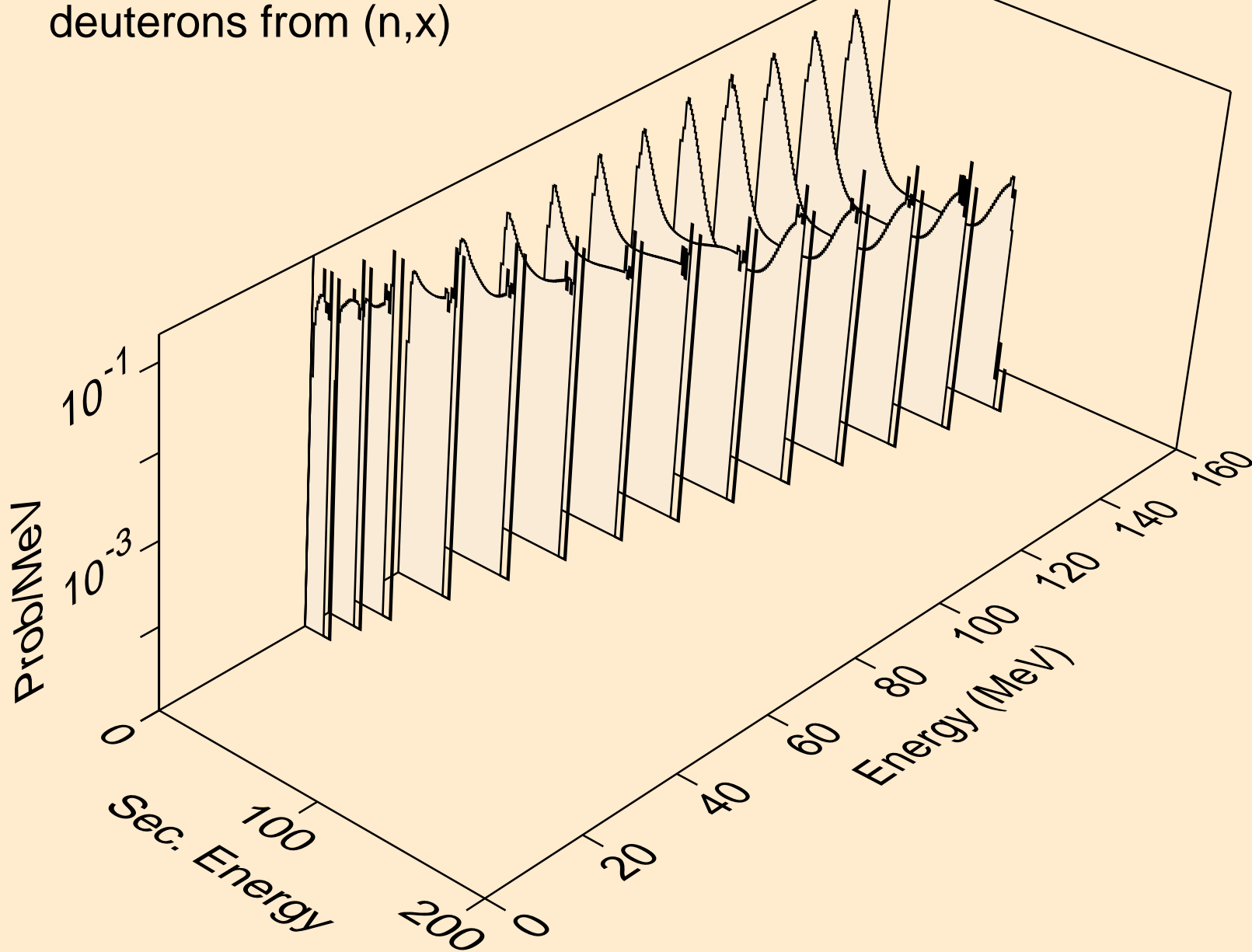

8-O-16 FOR FENDL-3B2 FROM ENDF/B-VII WITH NJOY99.304+ C
deuterons from (n,n*)d

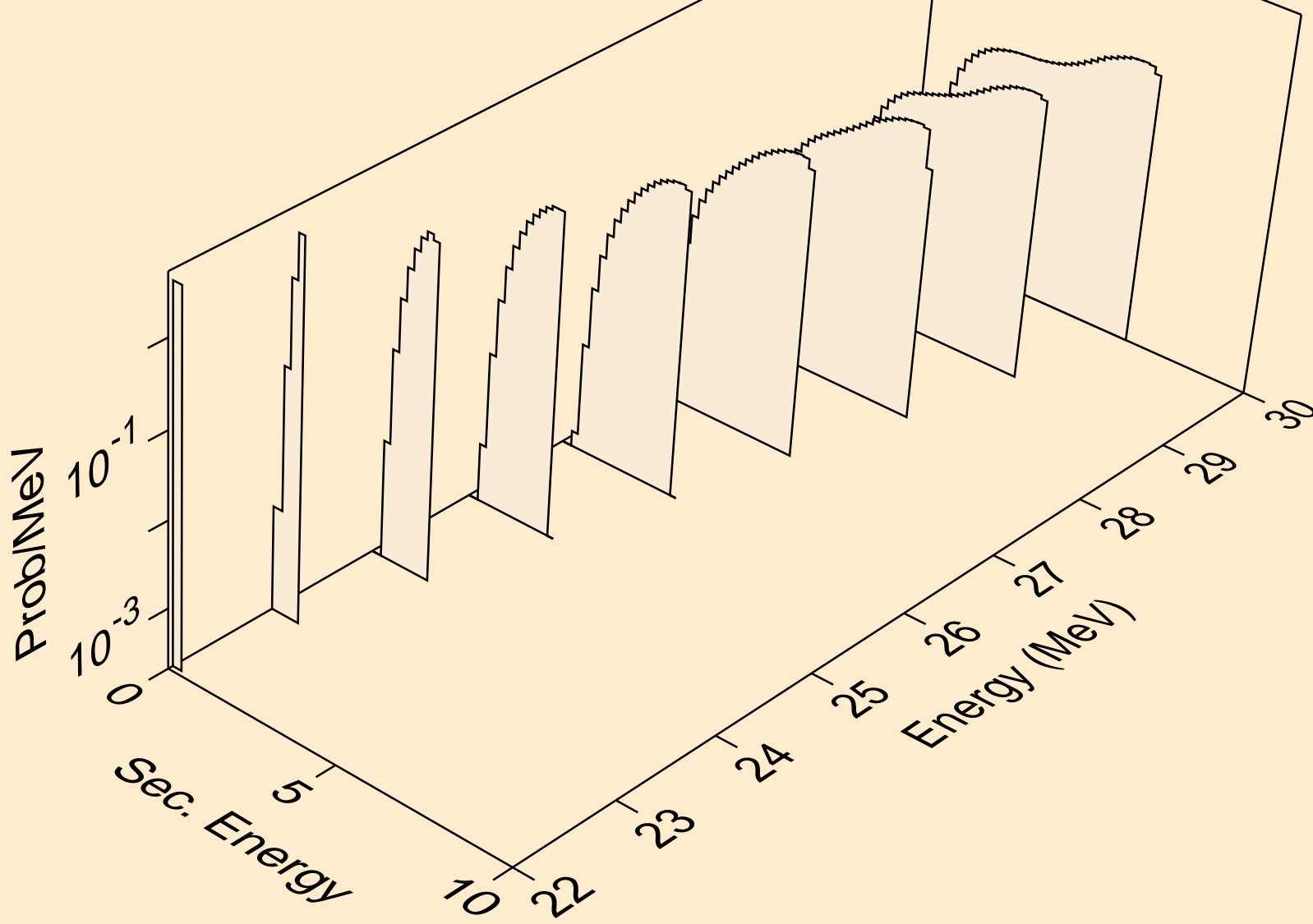

8-O-16 FOR FENDL-3B2 FROM ENDF/B-VII WITH NJOY99.304+ C
tritons from (n,x)

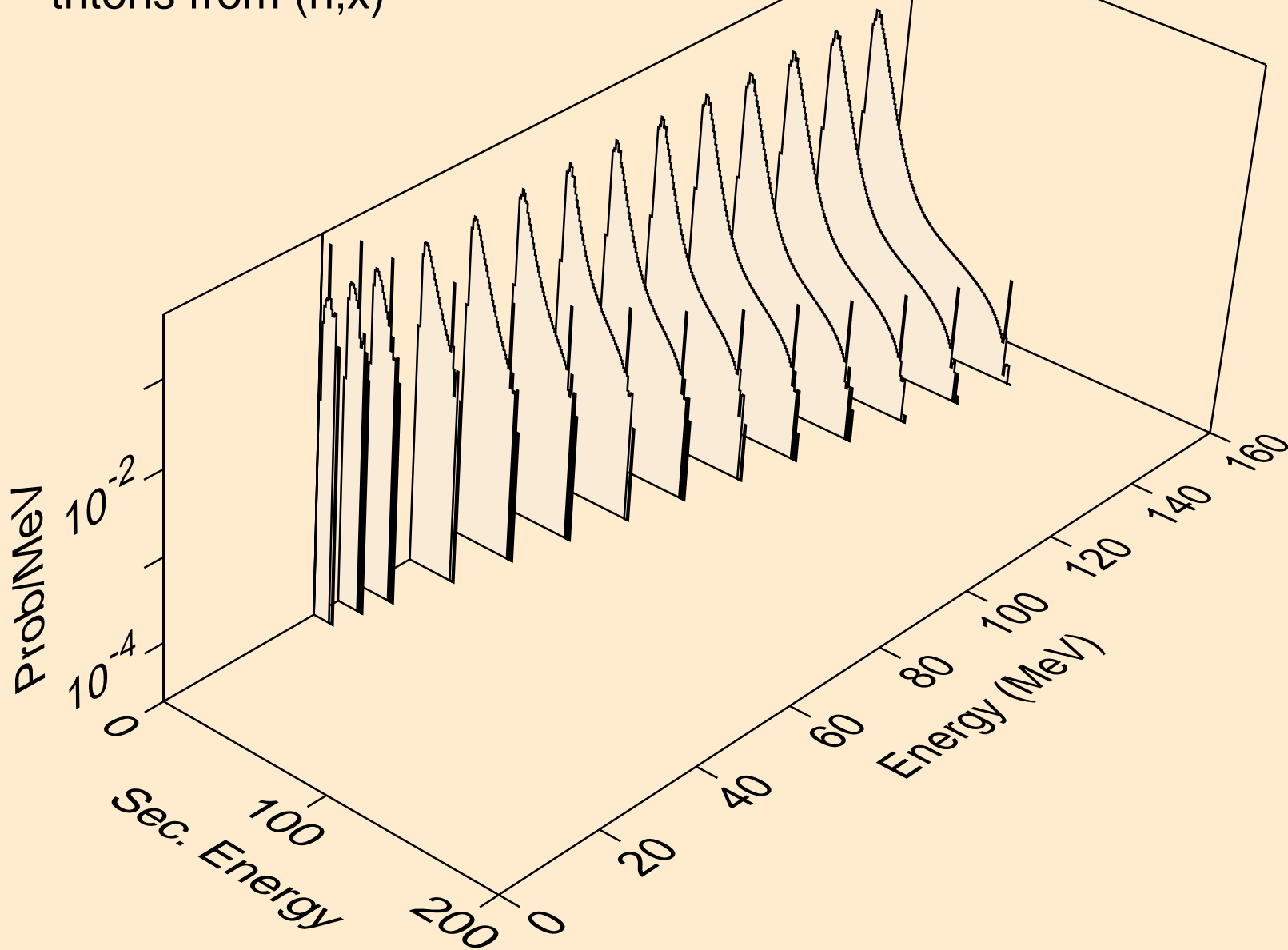

8-O-16 FOR FENDL-3B2 FROM ENDF/B-VII WITH NJOY99.304+ C
tritons from (n,t*c)

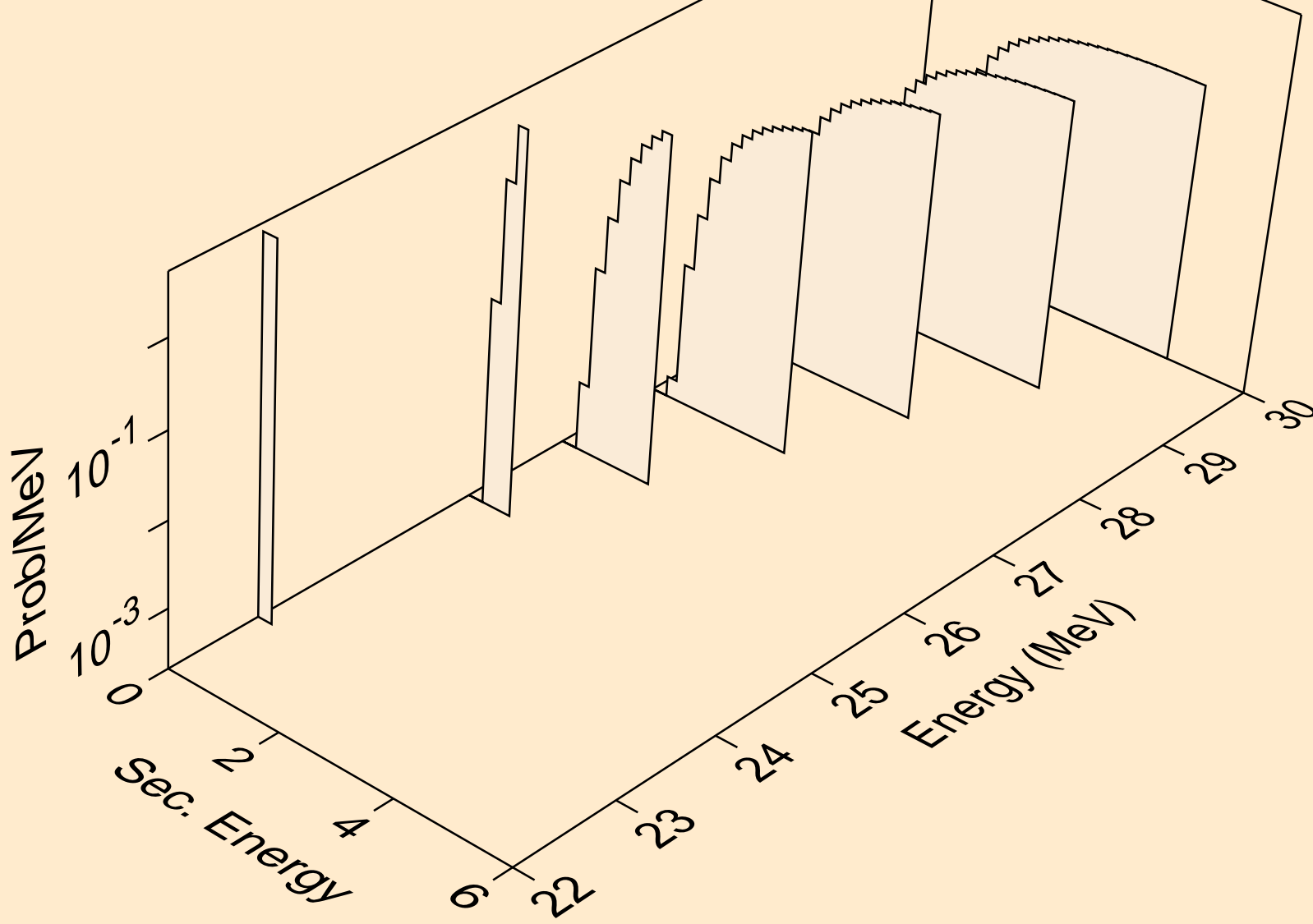

8-O-16 FOR FENDL-3B2 FROM ENDF/B-VII WITH NJOY99.304+ C
alphas from (n,x)

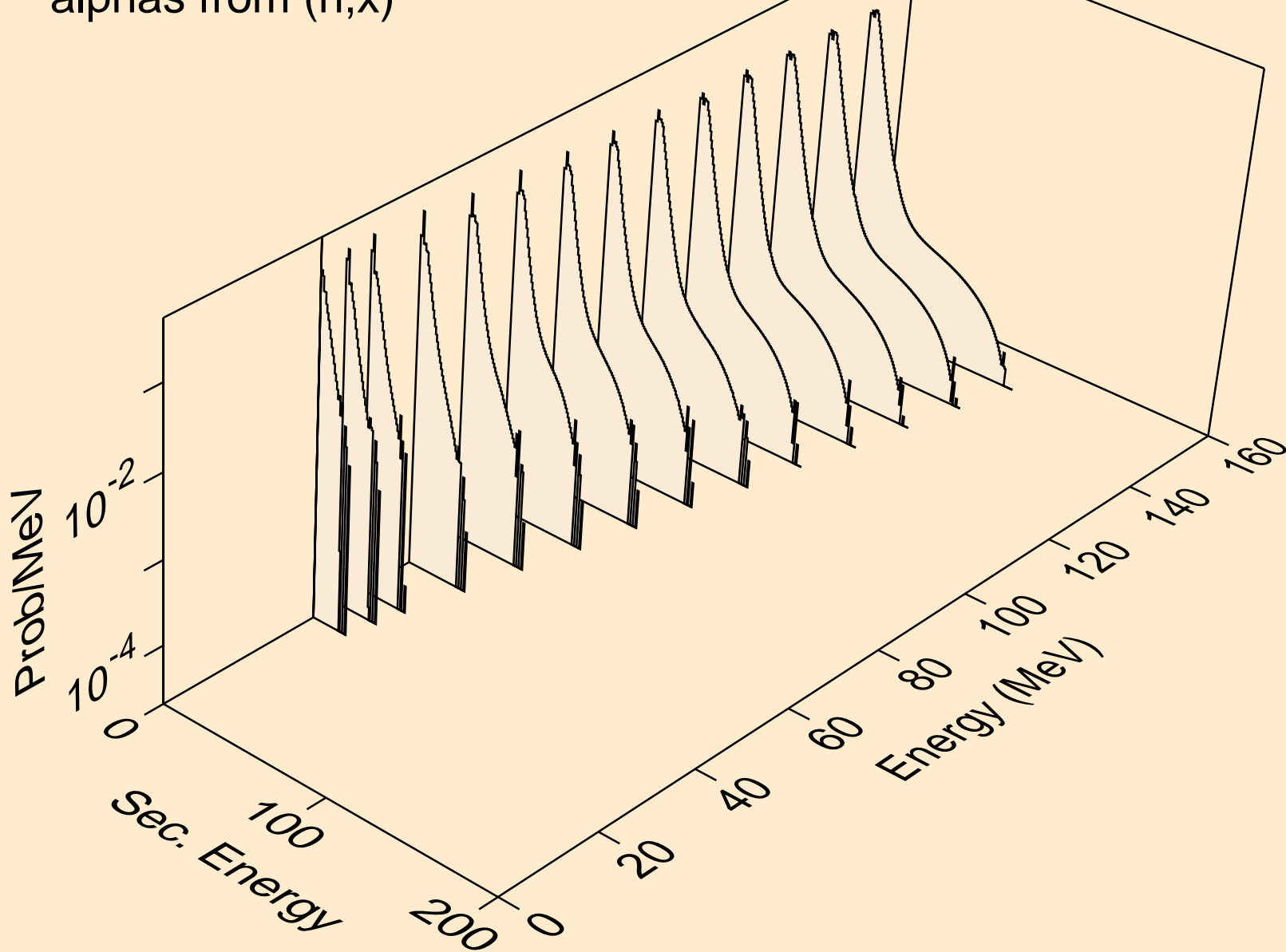

8-O-16 FOR FENDL-3B2 FROM ENDF/B-VII WITH NJOY99.304+ C
alphas from (n,n*)a

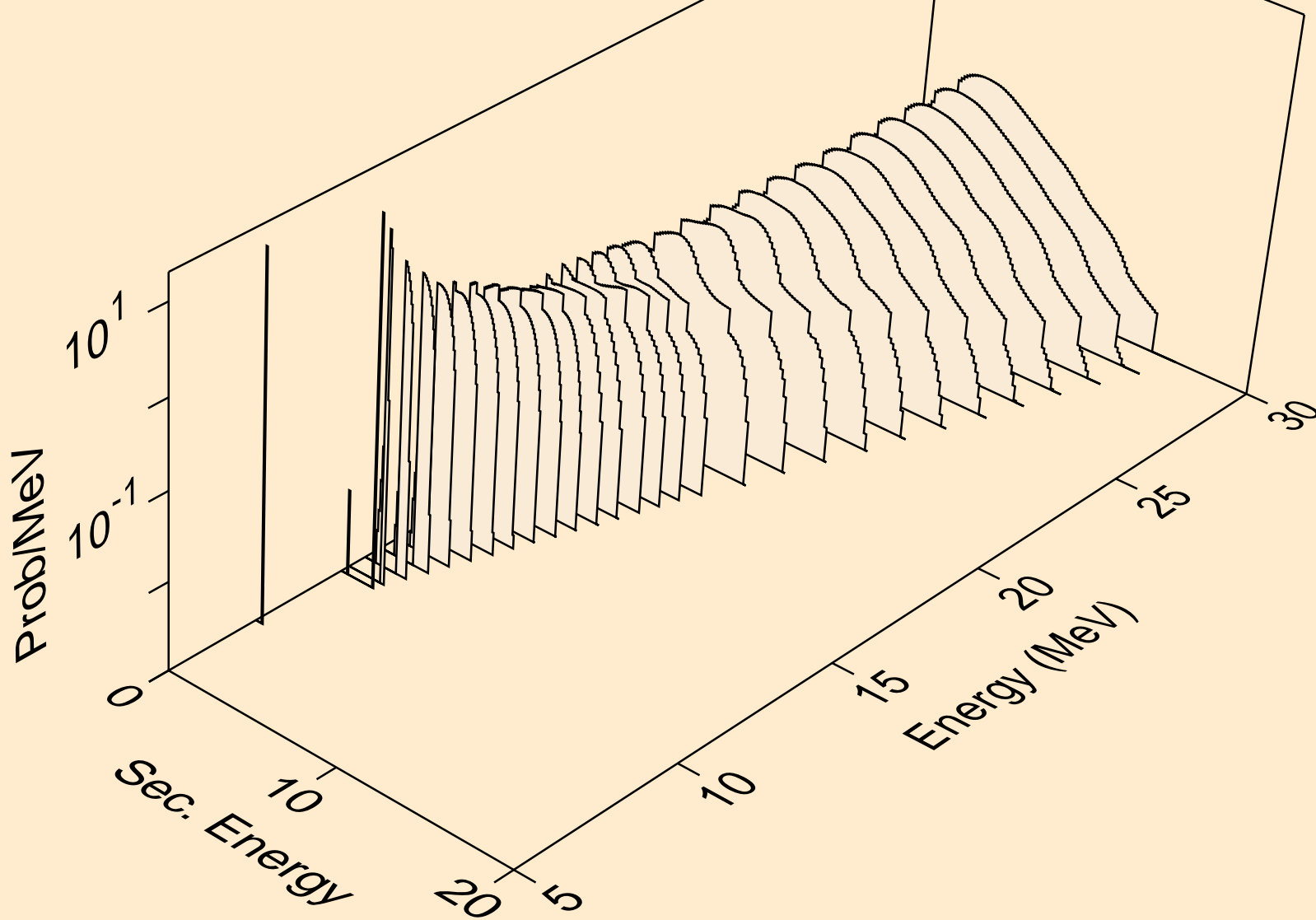

8-O-16 FOR FENDL-3B2 FROM ENDF/B-VII WITH NJOY99.304+ C
alphas from (n,n*)3a

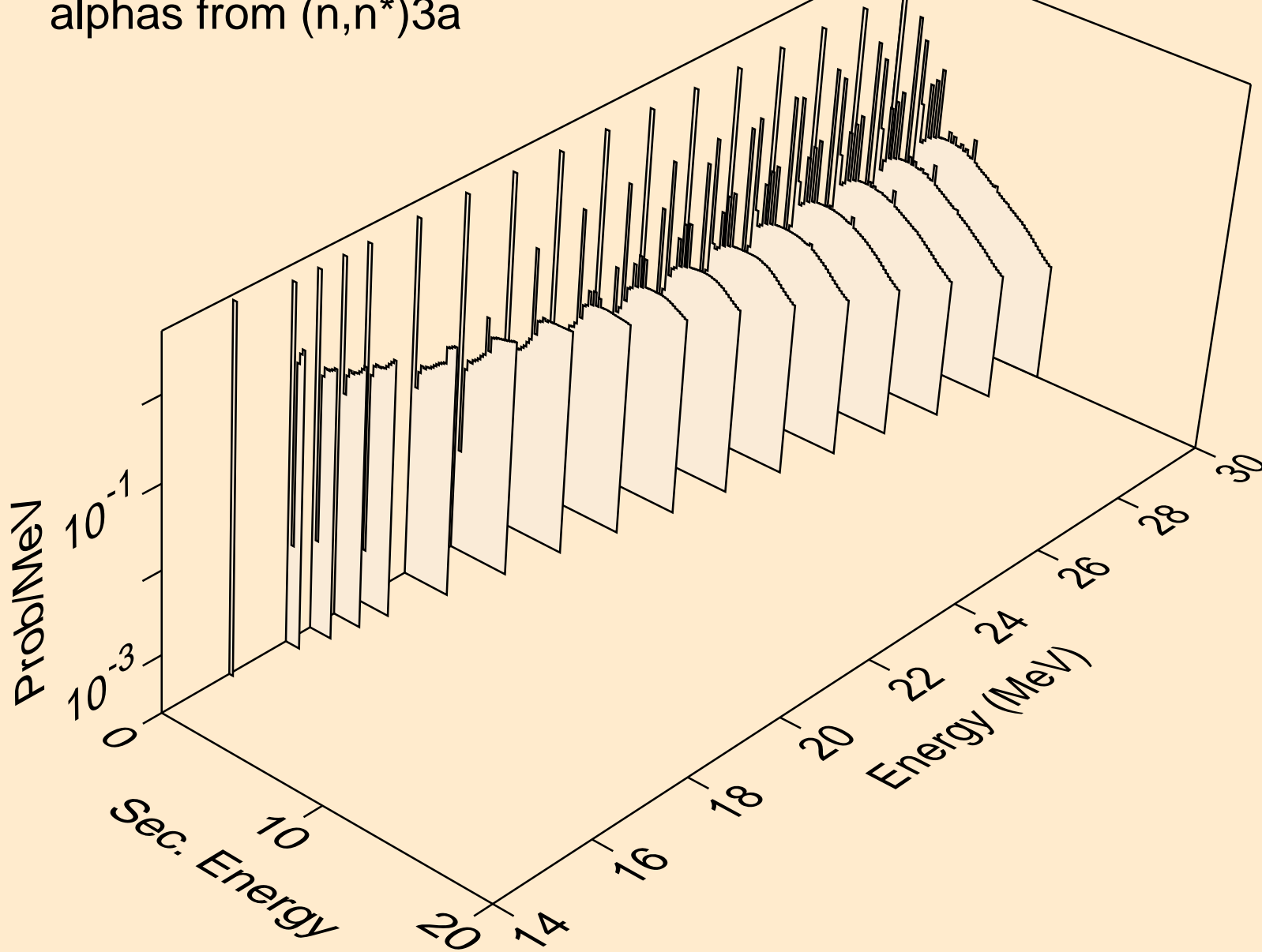

8-O-16 FOR FENDL-3B2 FROM ENDF/B-VII WITH NJOY99.304+ C
alphas from (n,npa)

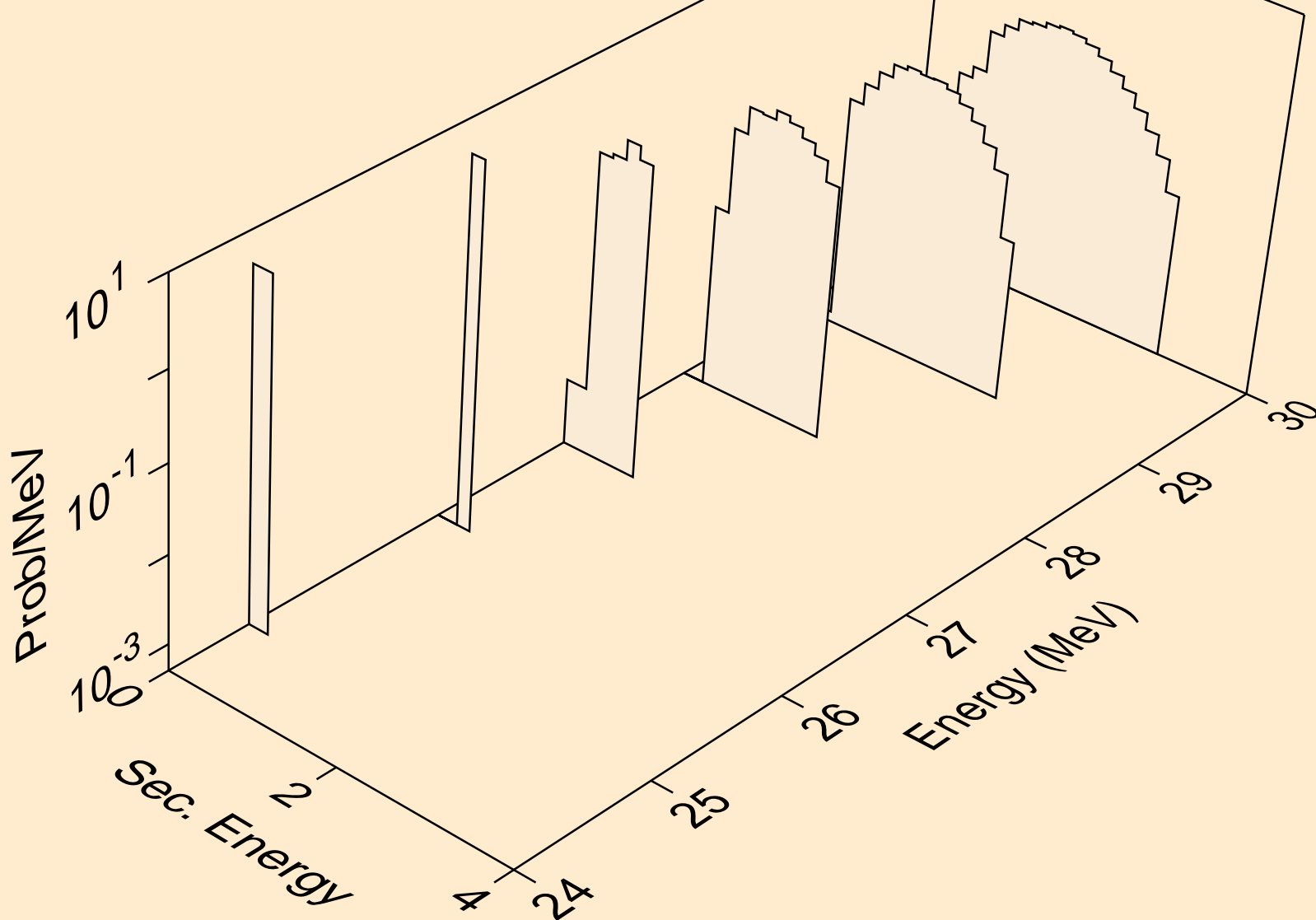

8-O-16 FOR FENDL-3B2 FROM ENDF/B-VII WITH NJOY99.304+ C
alphas from (n,2a)

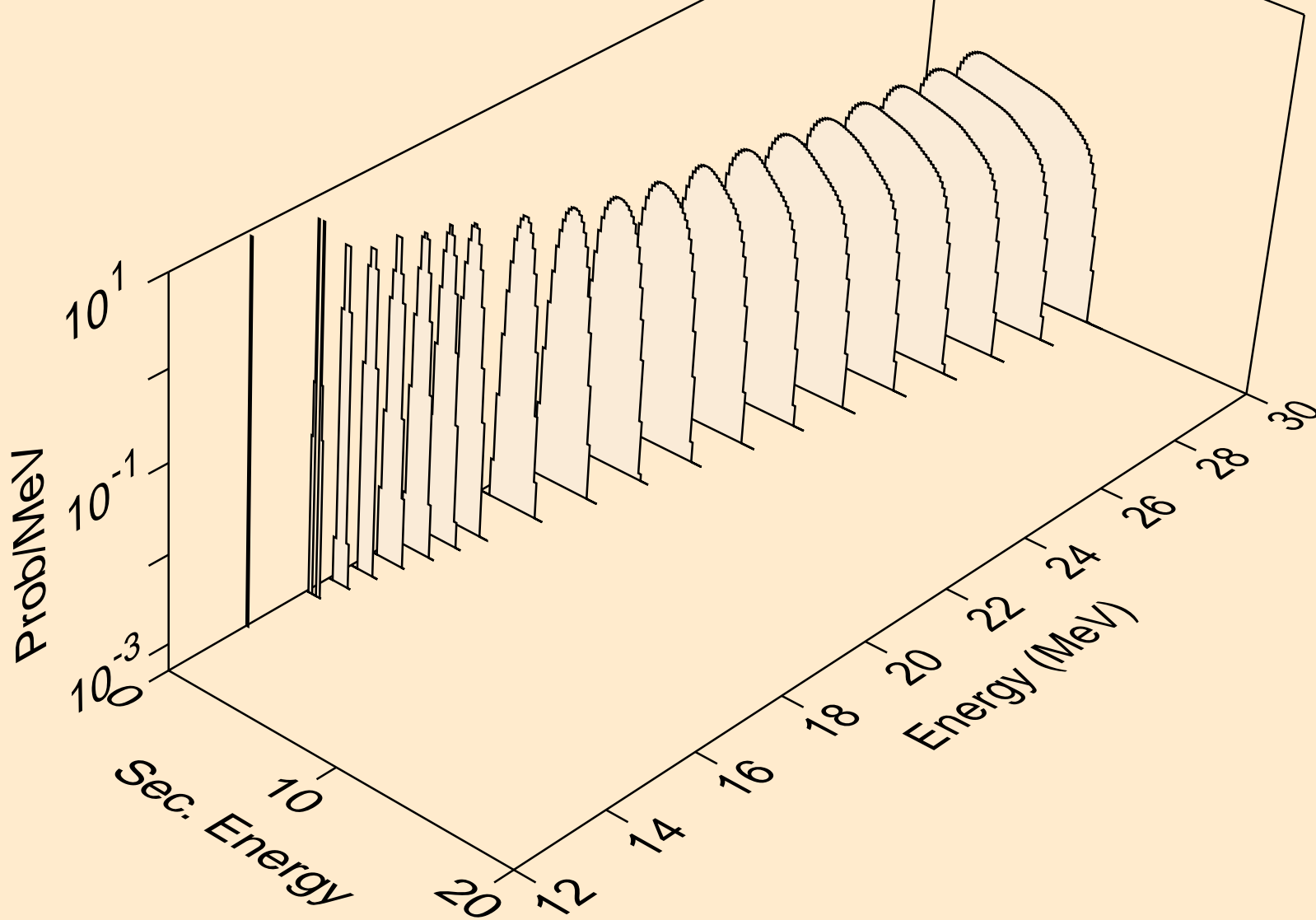

8-O-16 FOR FENDL-3B2 FROM ENDF/B-VII WITH NJOY99.304+ C
alphas from (n,pa)

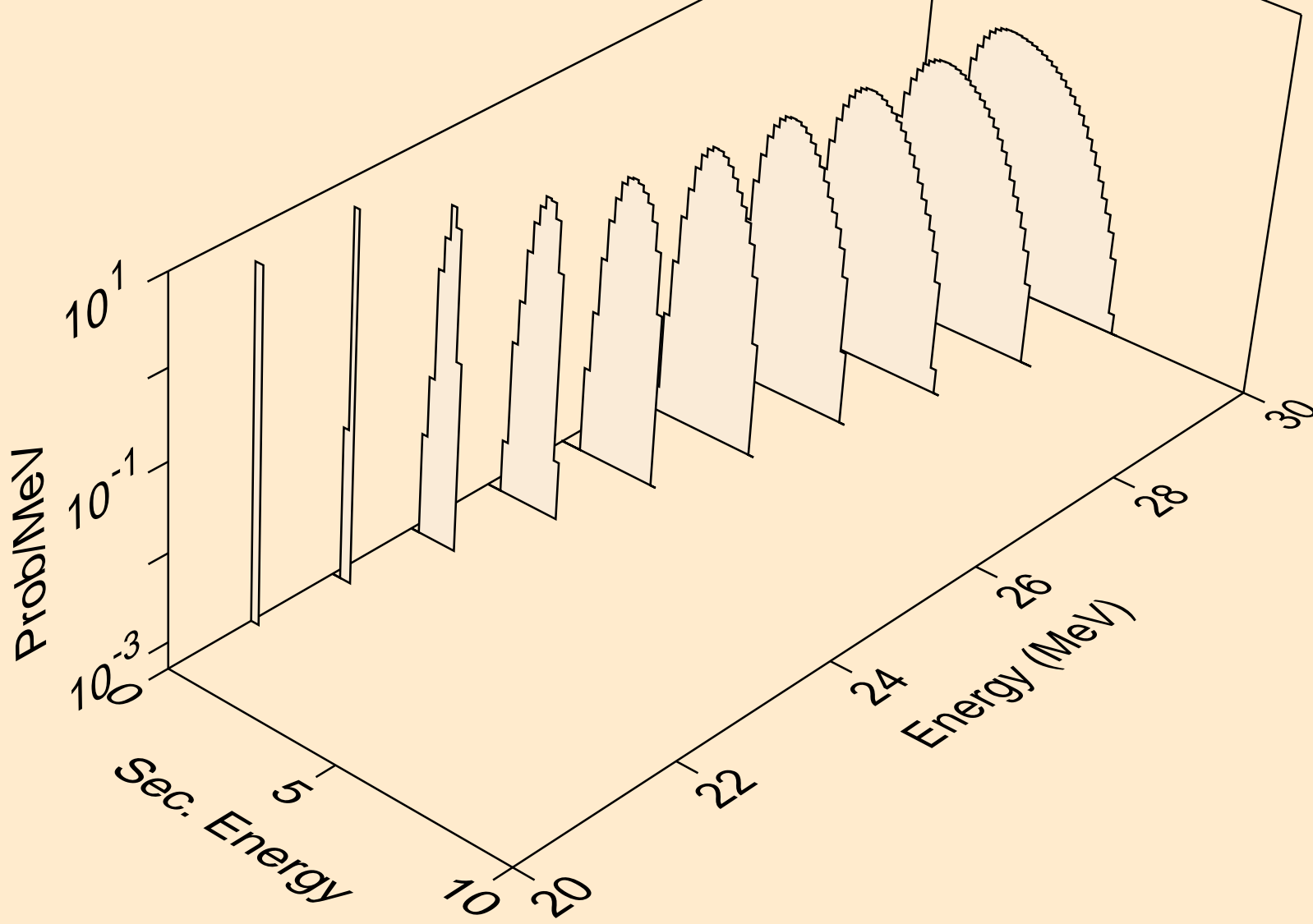

8-O-16 FOR FENDL-3B2 FROM ENDF/B-VII WITH NJOY99.304+ C
angular distribution for (n,a*0) alpha

