

13-AL-27 FOR FENDL-3B2 FROM JEFF-3.1 WITH NJOY99.304+ C  
Principal cross sections

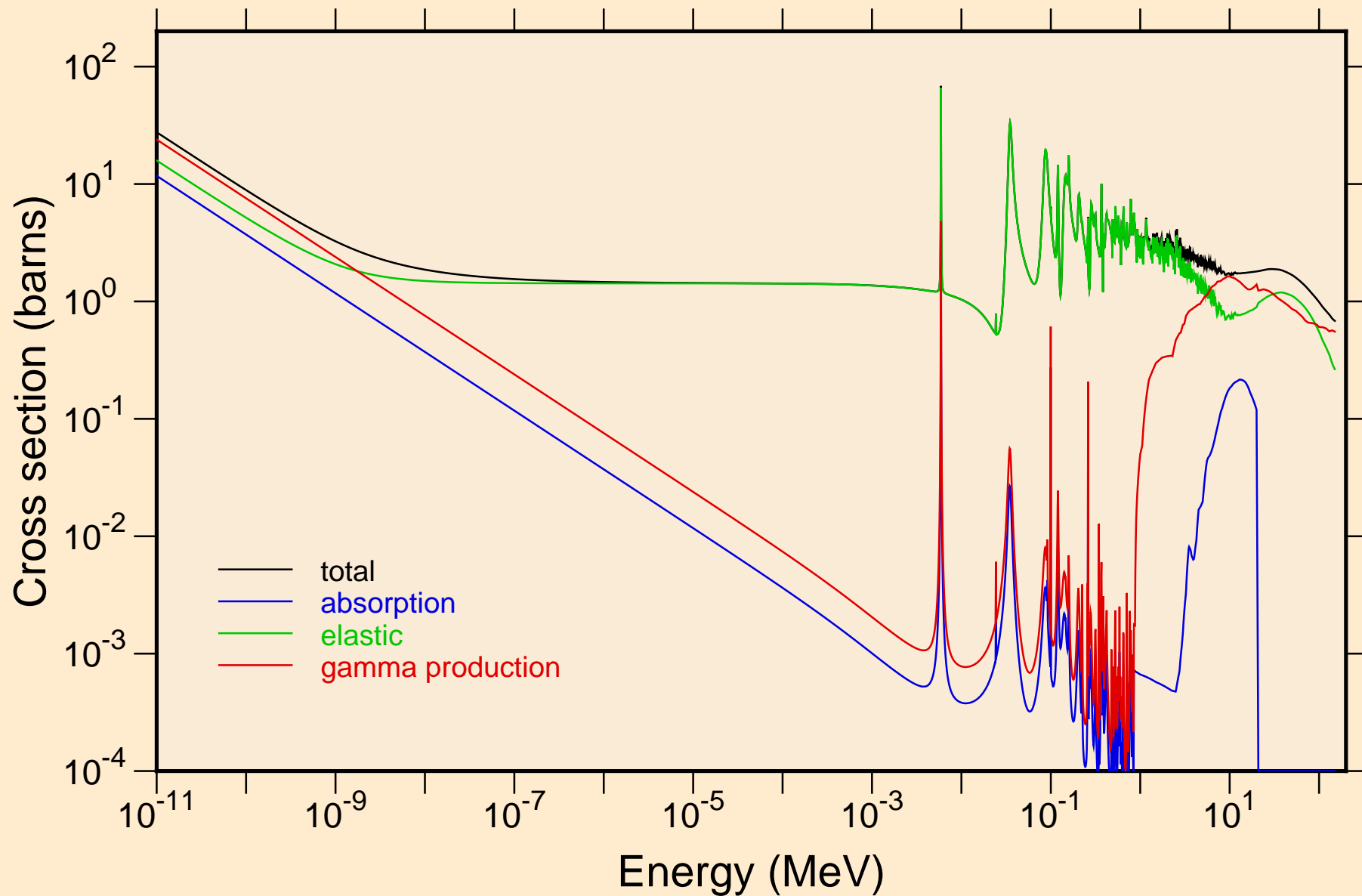

13-AL-27 FOR FENDL-3B2 FROM JEFF-3.1 WITH NJOY99.304+ C  
resonance total cross section

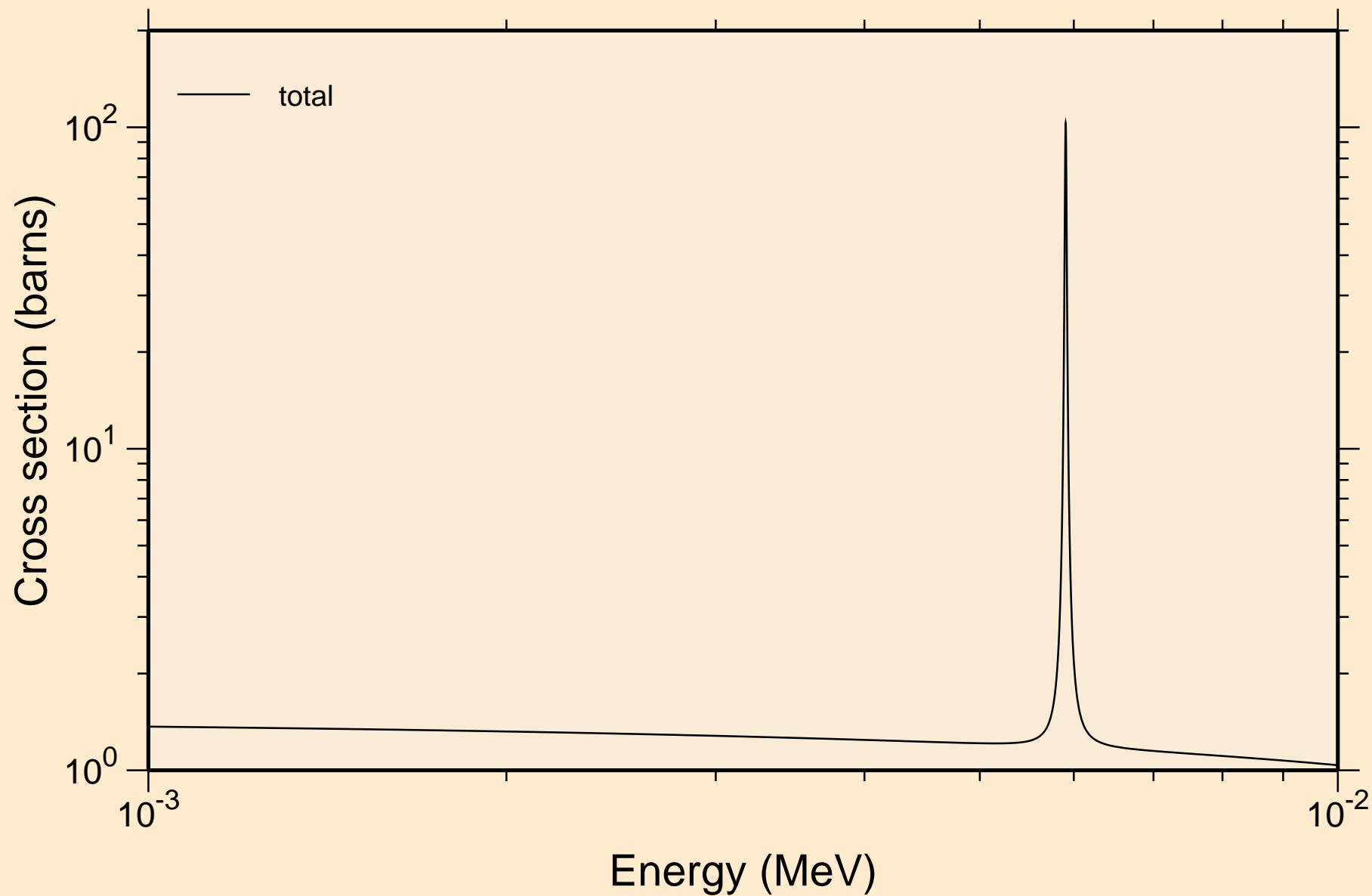

13-AL-27 FOR FENDL-3B2 FROM JEFF-3.1 WITH NJOY99.304+ C  
resonance total cross section

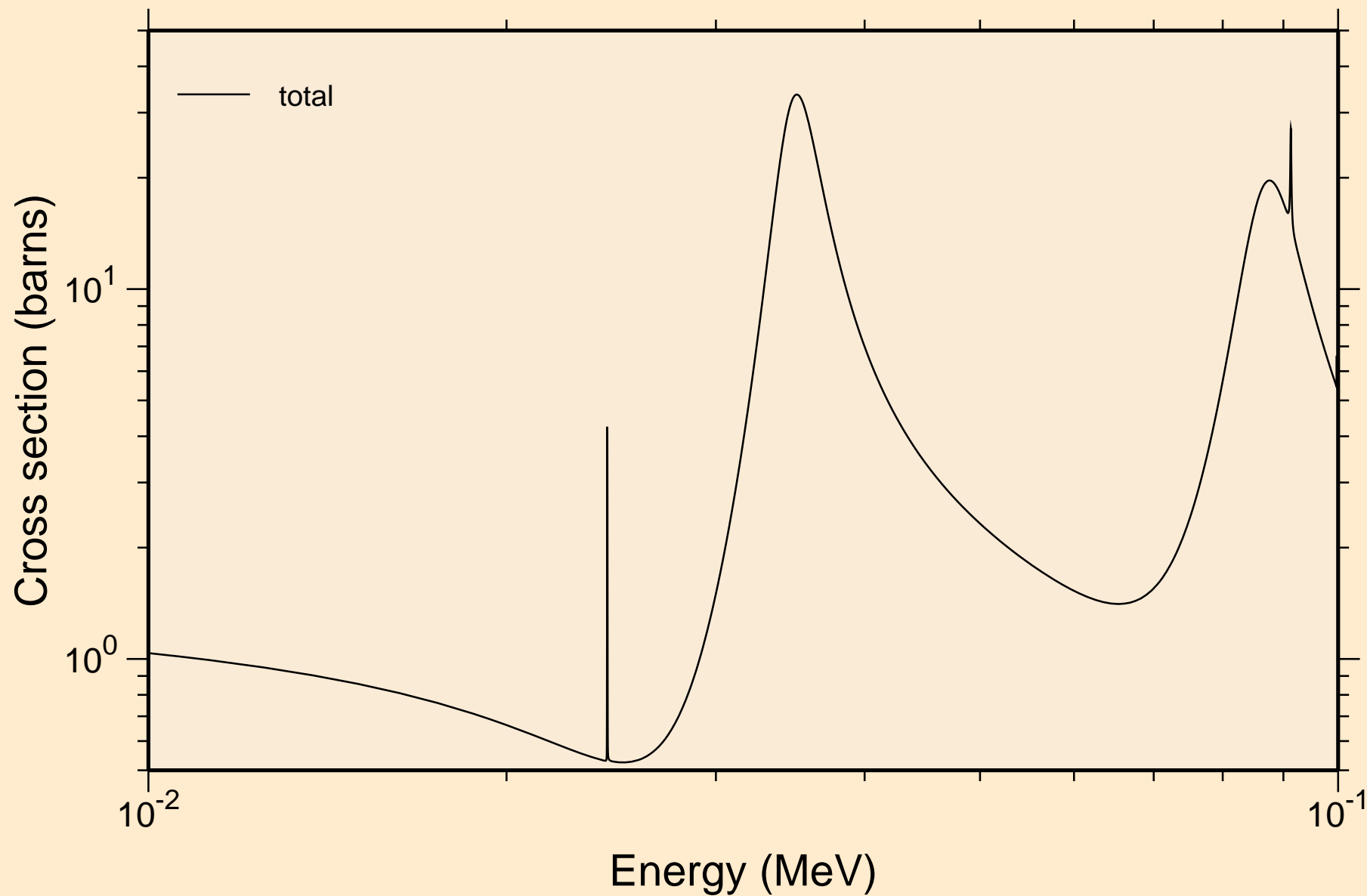

13-AL-27 FOR FENDL-3B2 FROM JEFF-3.1 WITH NJOY99.304+ C  
resonance total cross section

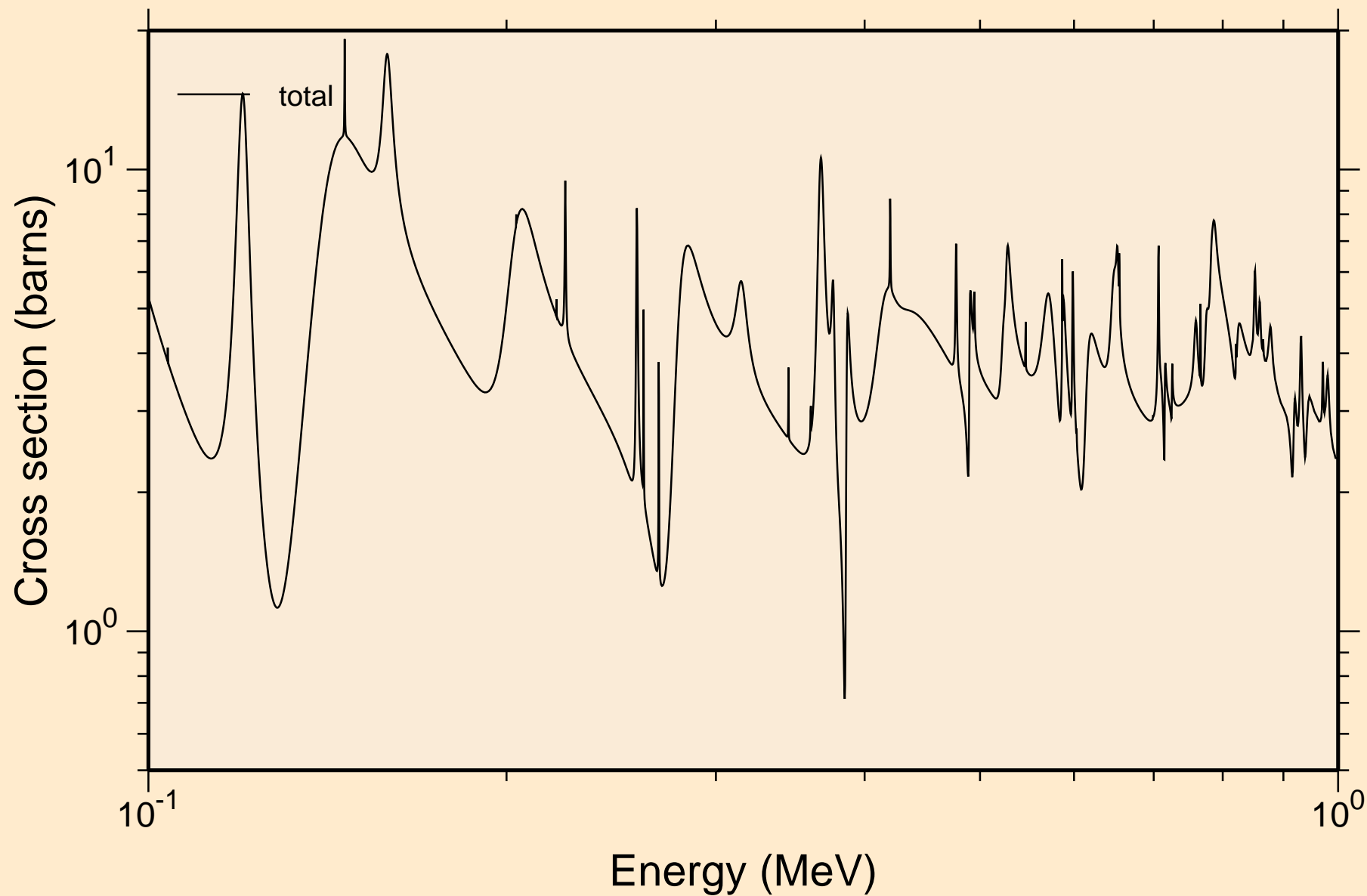

13-AL-27 FOR FENDL-3B2 FROM JEFF-3.1 WITH NJOY99.304+ C  
resonance total cross section

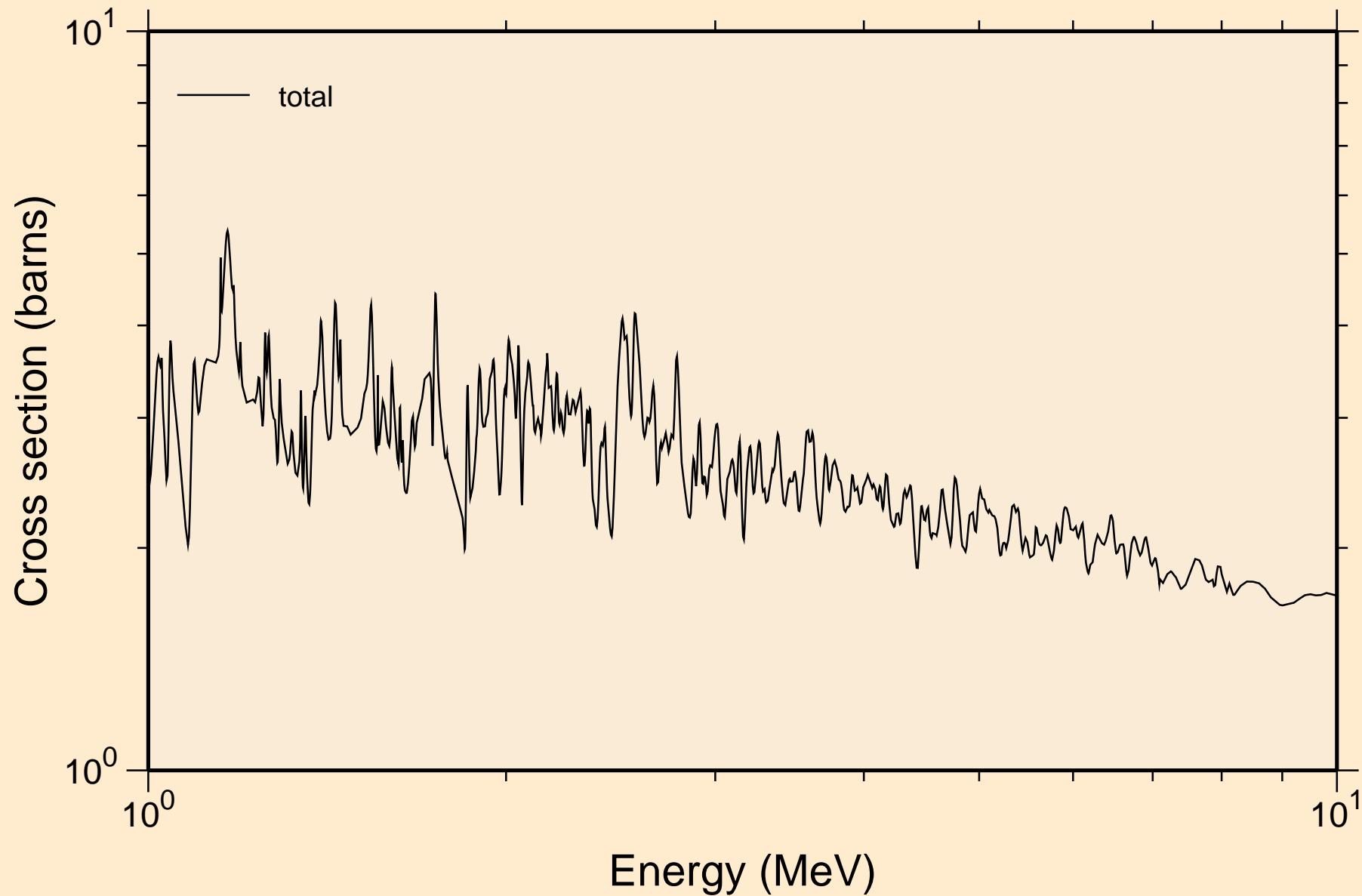

13-AL-27 FOR FENDL-3B2 FROM JEFF-3.1 WITH NJOY99.304+ C  
resonance absorption cross sections

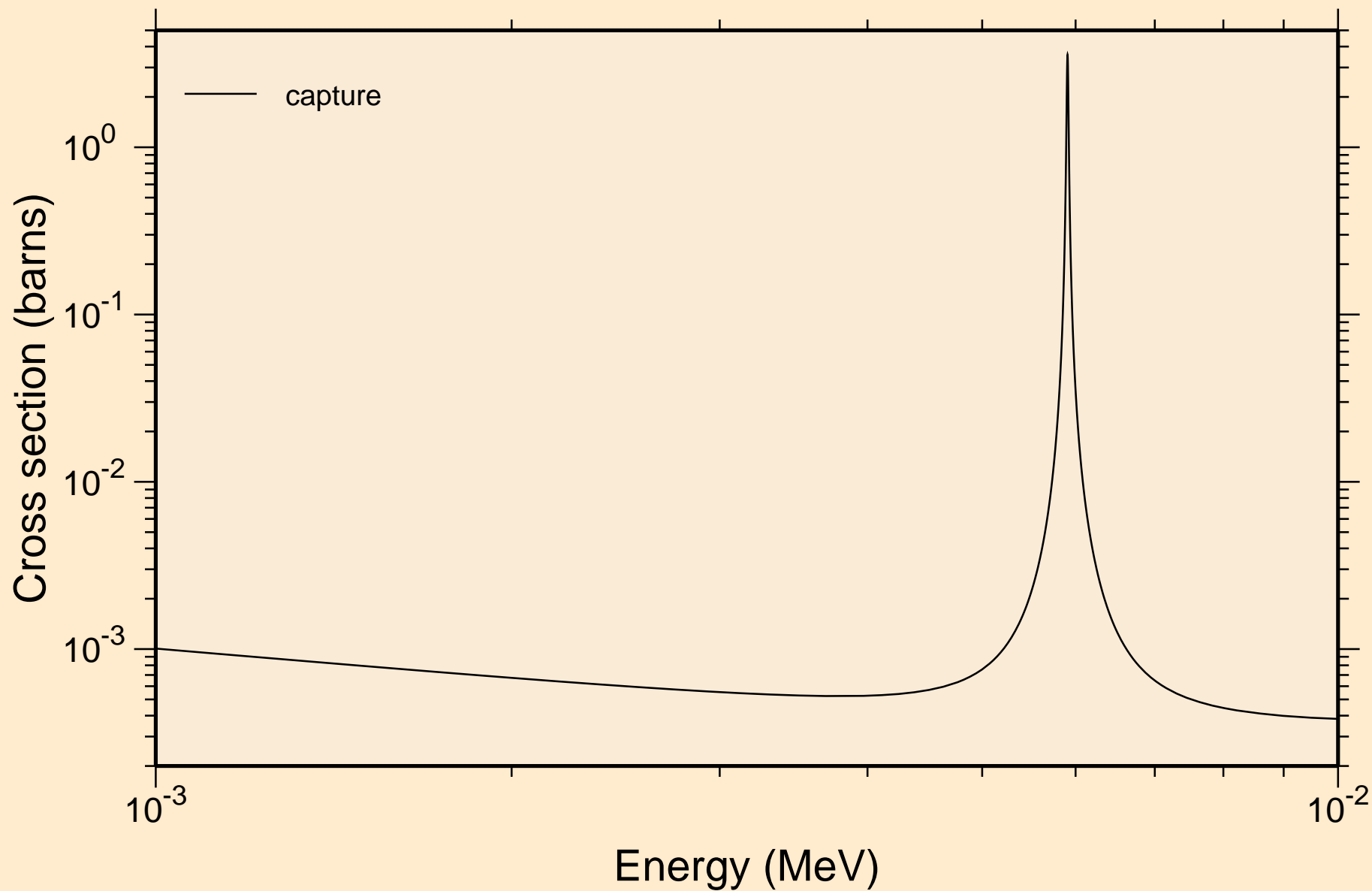

13-AL-27 FOR FENDL-3B2 FROM JEFF-3.1 WITH NJOY99.304+ C  
resonance absorption cross sections

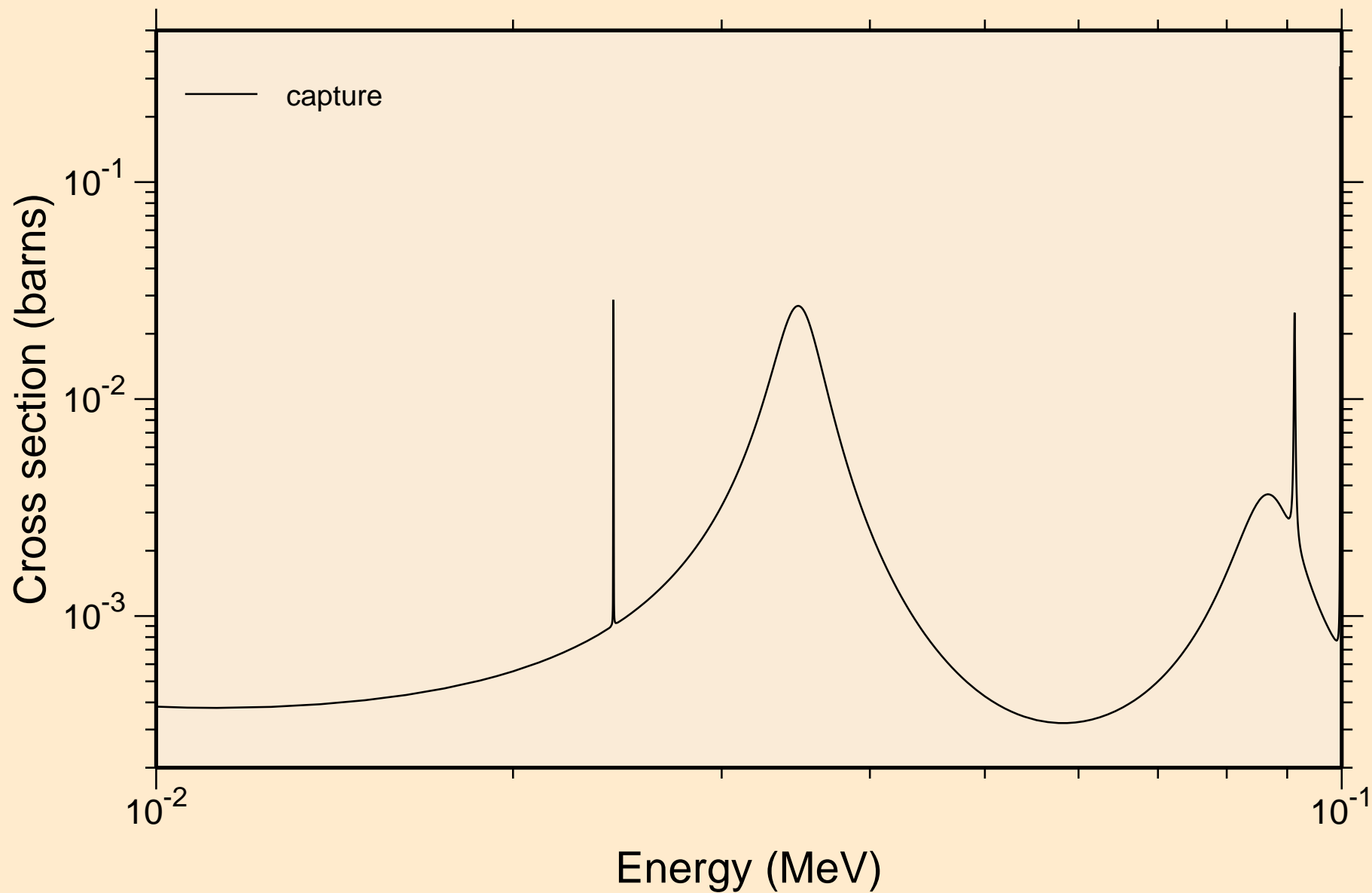

13-AL-27 FOR FENDL-3B2 FROM JEFF-3.1 WITH NJOY99.304+ C  
resonance absorption cross sections

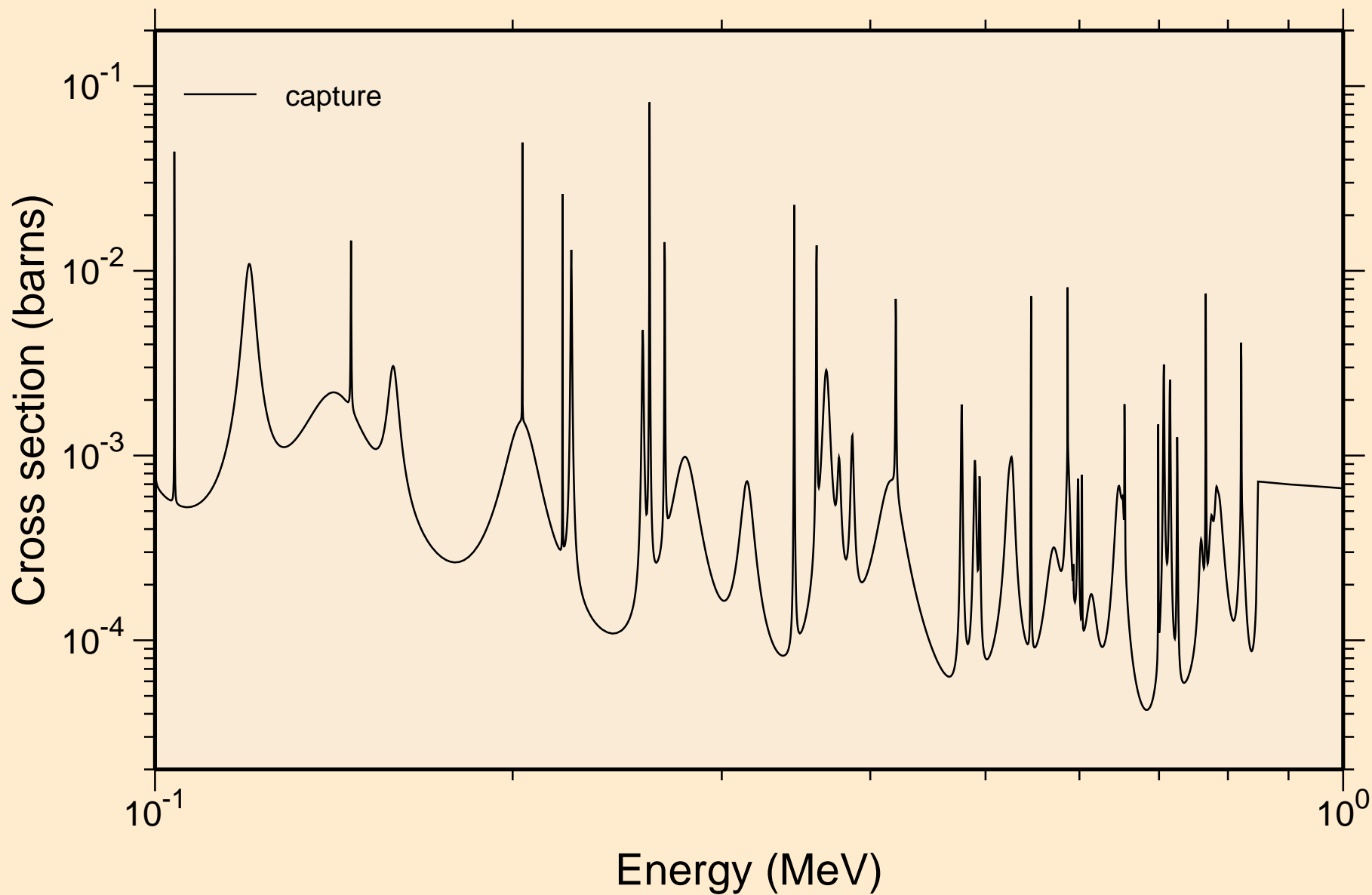



13-AL-27 FOR FENDL-3B2 FROM JEFF-3.1 WITH NJOY99.304+ C  
resonance absorption cross sections

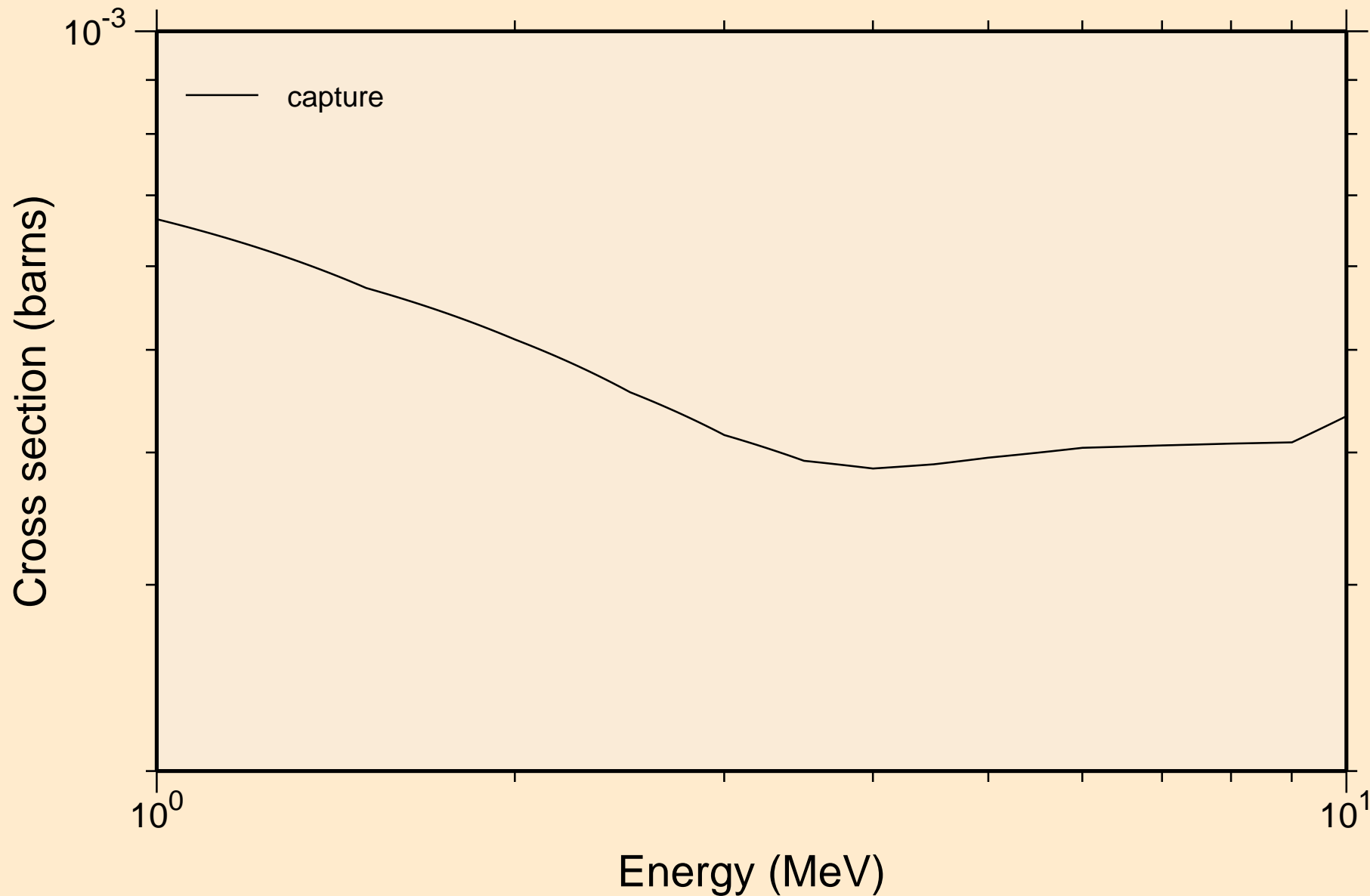

# 13-AL-27 FOR FENDL-3B2 FROM JEFF-3.1 WITH NJOY99.304+ C Heating

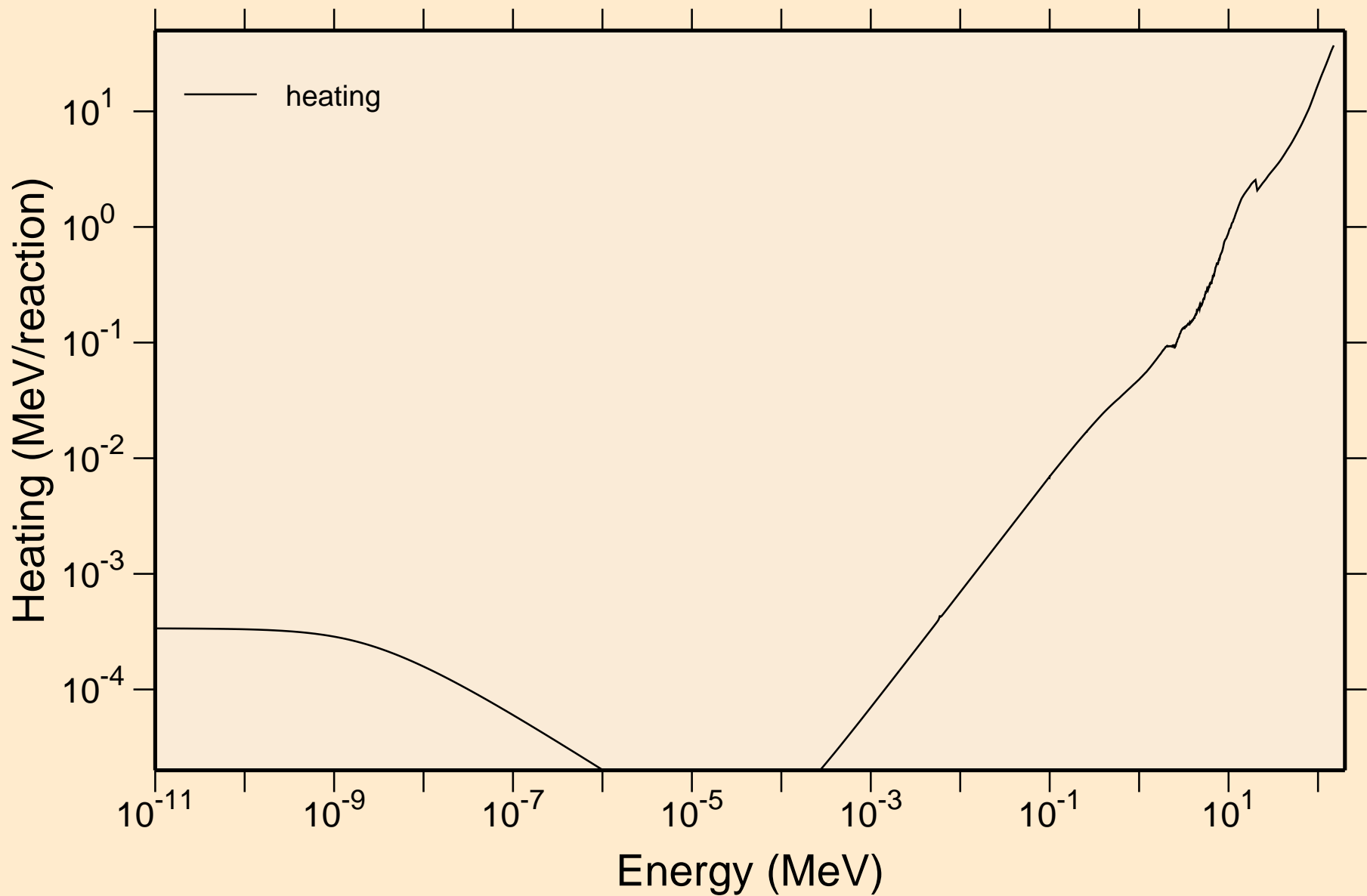

# 13-AL-27 FOR FENDL-3B2 FROM JEFF-3.1 WITH NJOY99.304+ C Damage

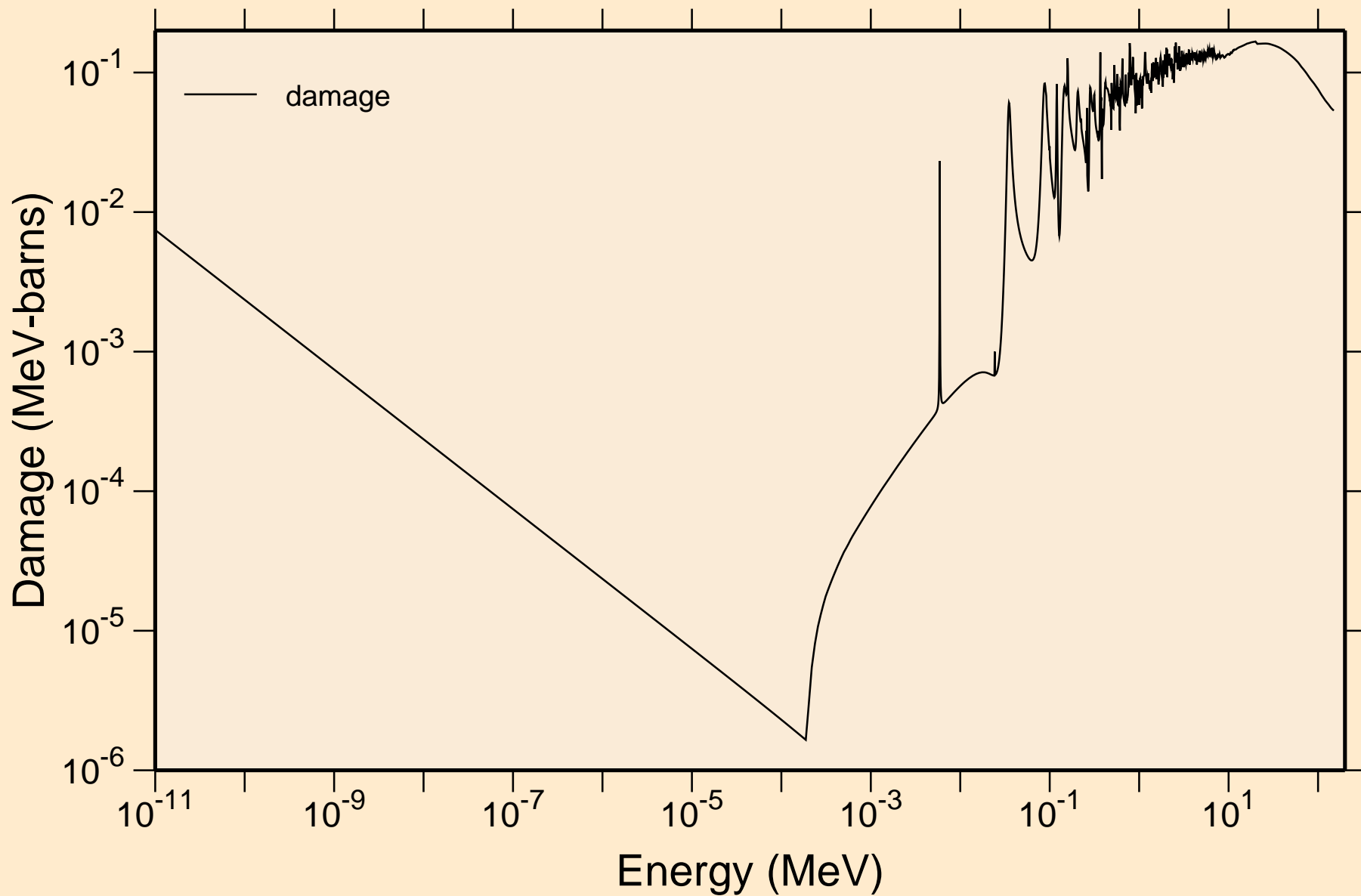

13-AL-27 FOR FENDL-3B2 FROM JEFF-3.1 WITH NJOY99.304+ C  
Non-threshold reactions

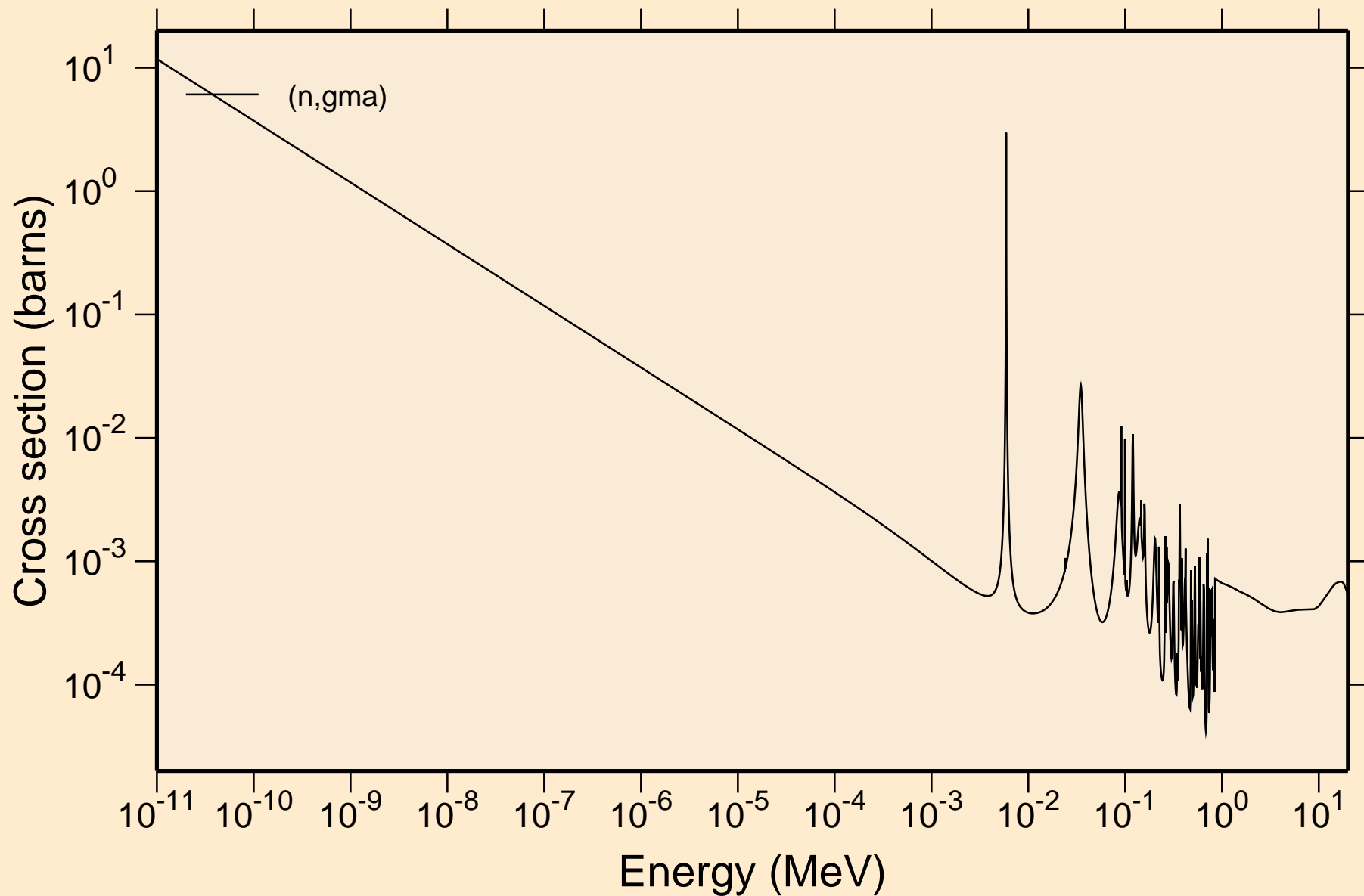

13-AL-27 FOR FENDL-3B2 FROM JEFF-3.1 WITH NJOY99.304+ C  
Principal cross sections

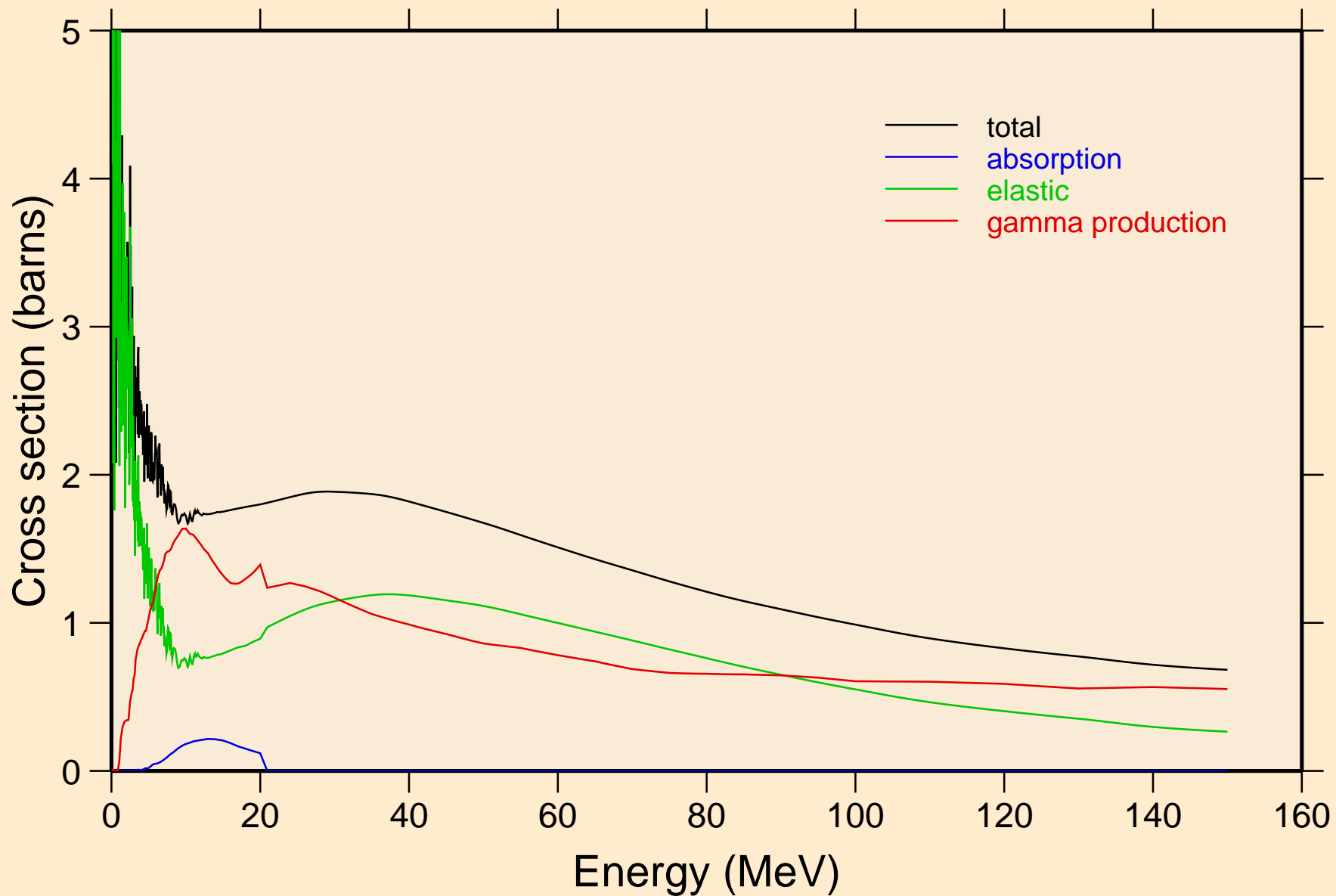

# 13-AL-27 FOR FENDL-3B2 FROM JEFF-3.1 WITH NJOY99.304+ C Heating

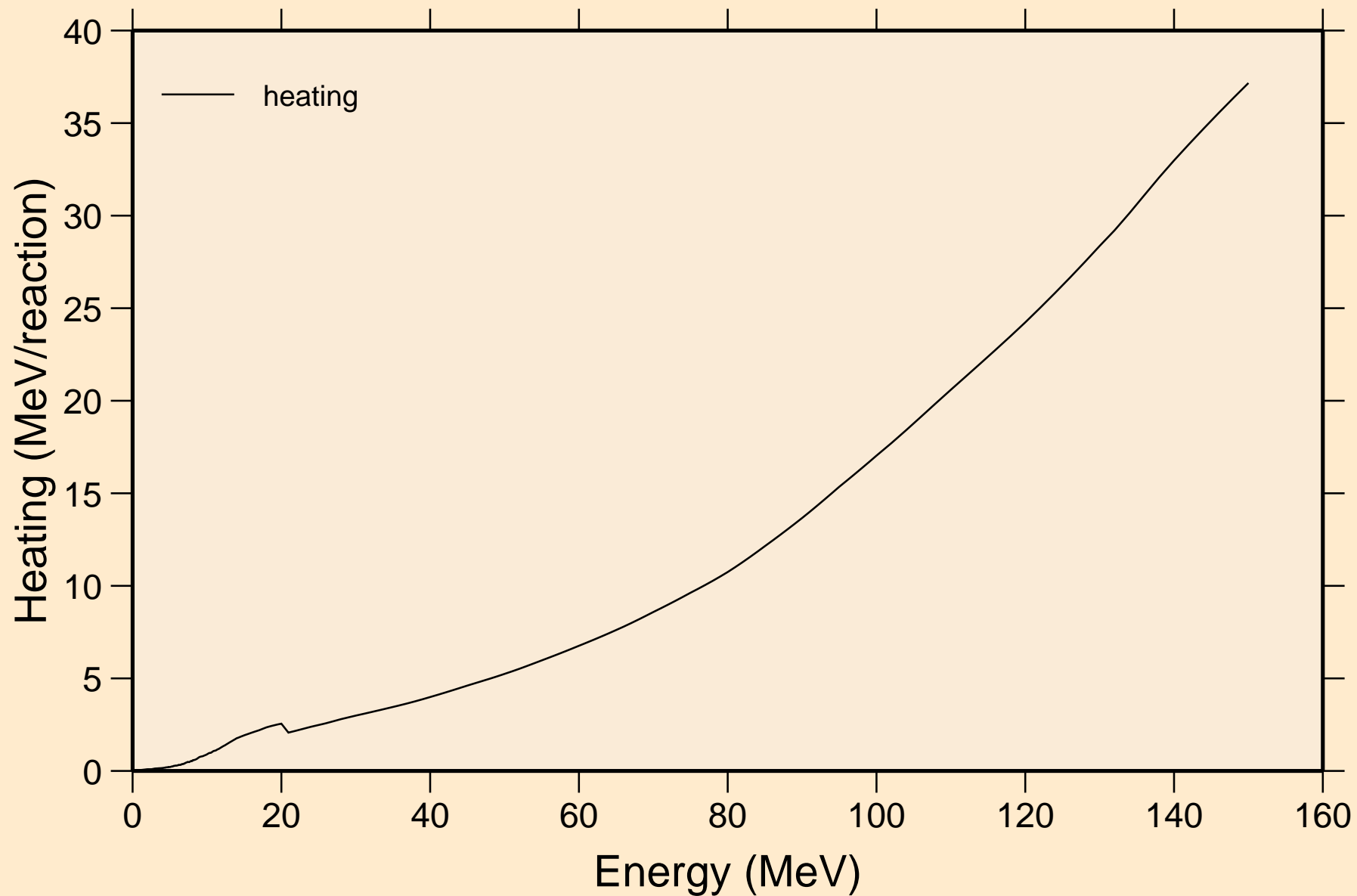

# 13-AL-27 FOR FENDL-3B2 FROM JEFF-3.1 WITH NJOY99.304+ C Damage

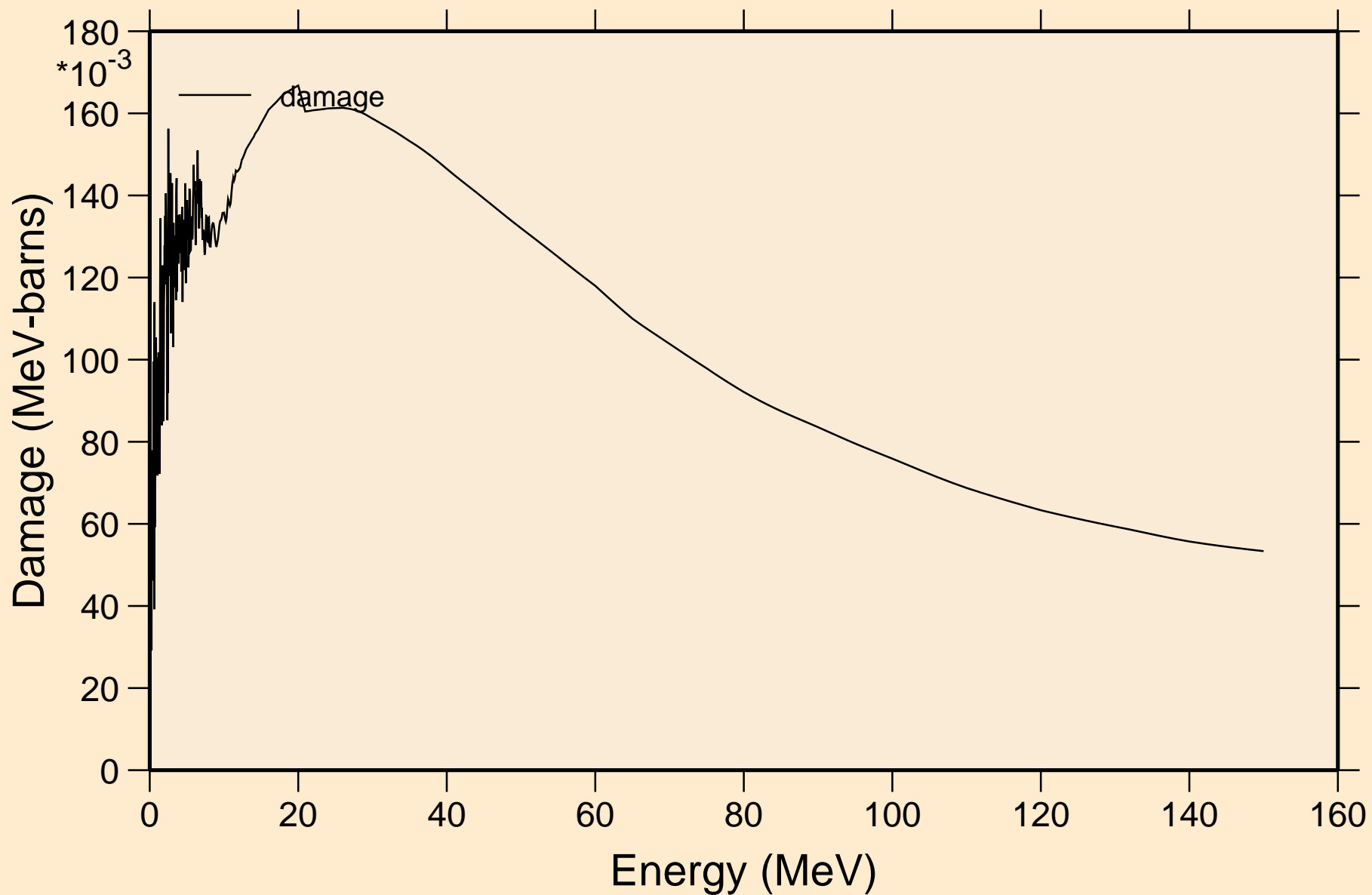

13-AL-27 FOR FENDL-3B2 FROM JEFF-3.1 WITH NJOY99.304+ C  
Non-threshold reactions

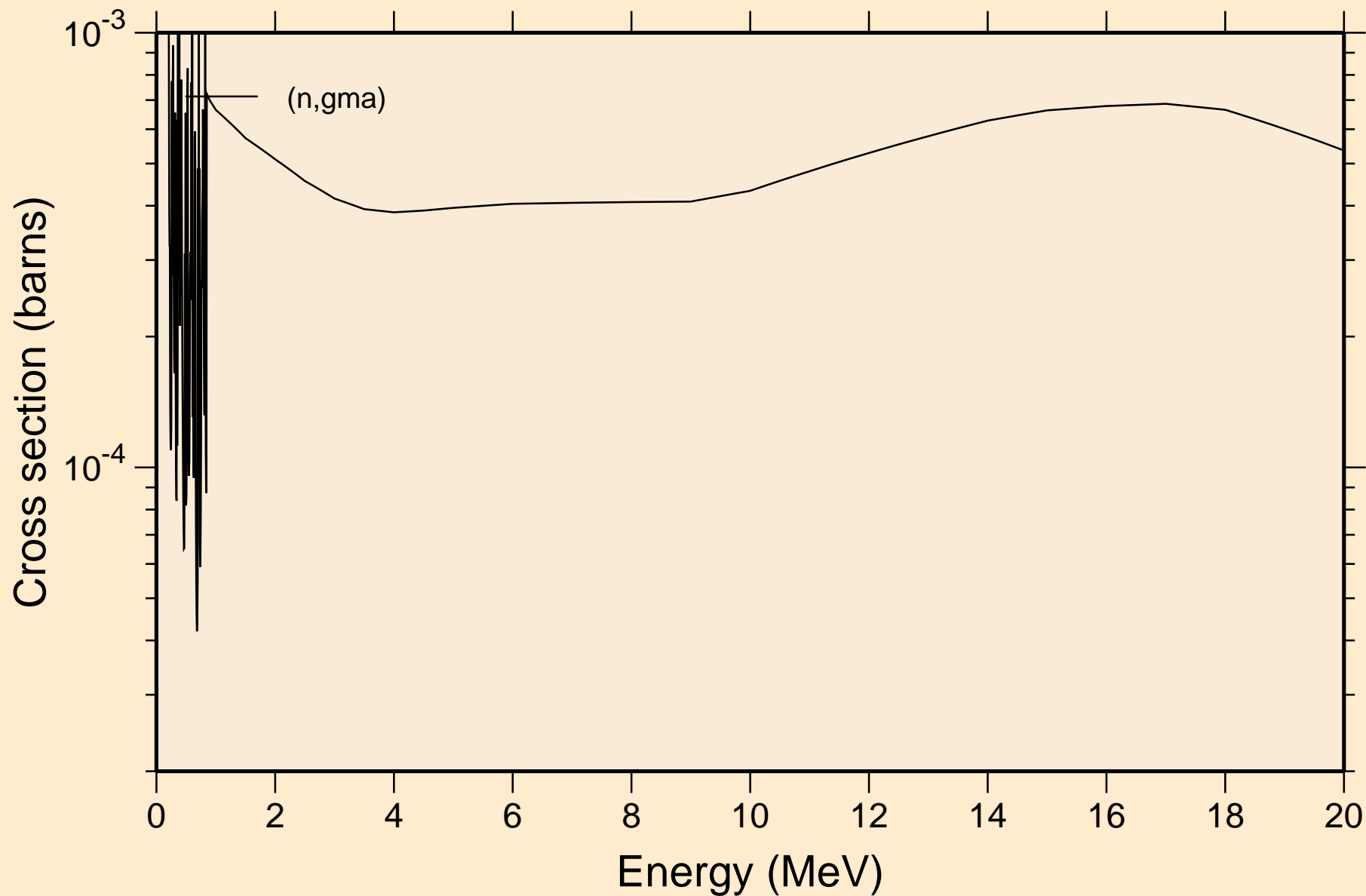



# 13-AL-27 FOR FENDL-3B2 FROM JEFF-3.1 WITH NJOY99.304+ C Inelastic levels

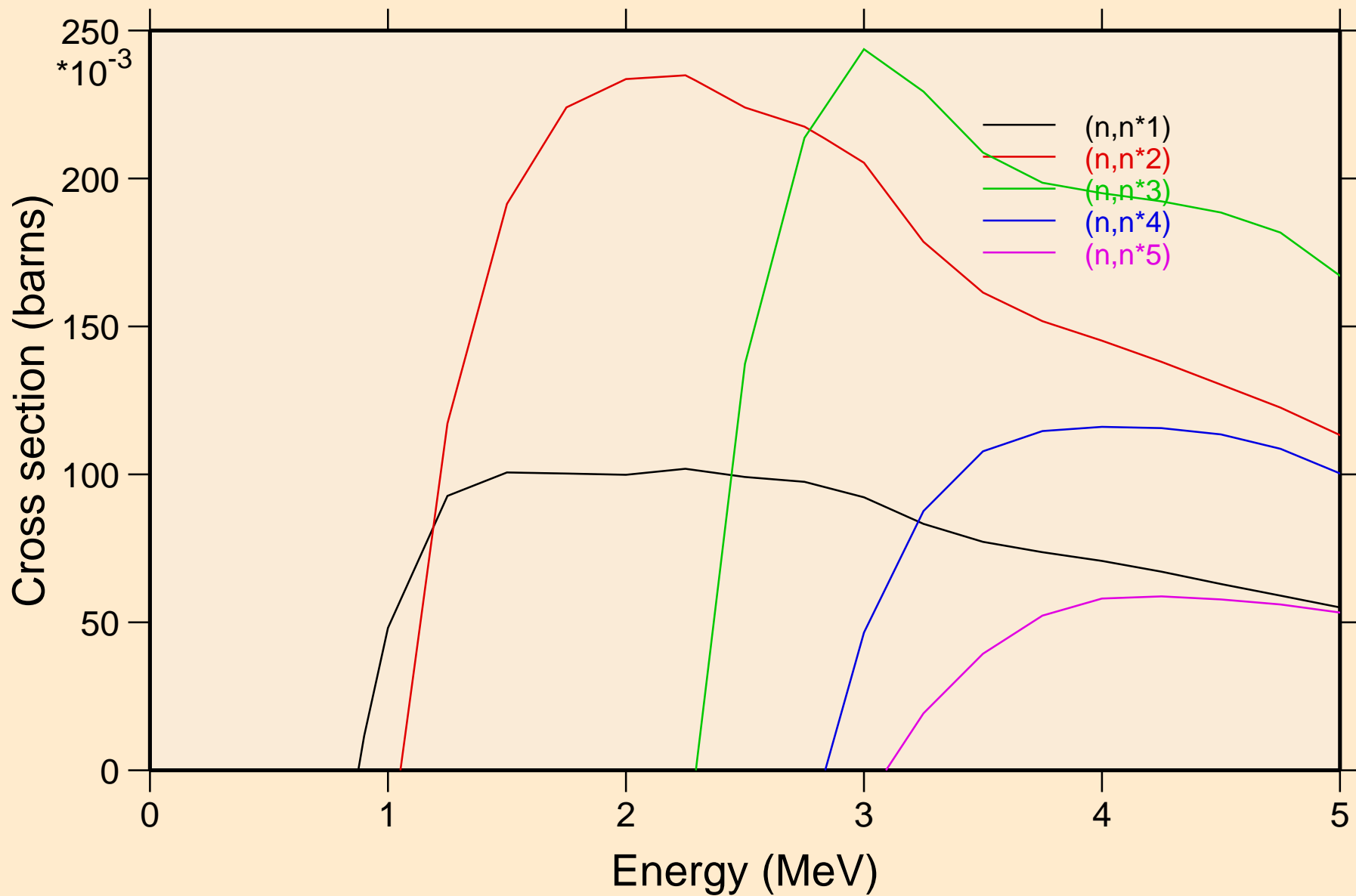

# 13-AL-27 FOR FENDL-3B2 FROM JEFF-3.1 WITH NJOY99.304+ C Inelastic levels

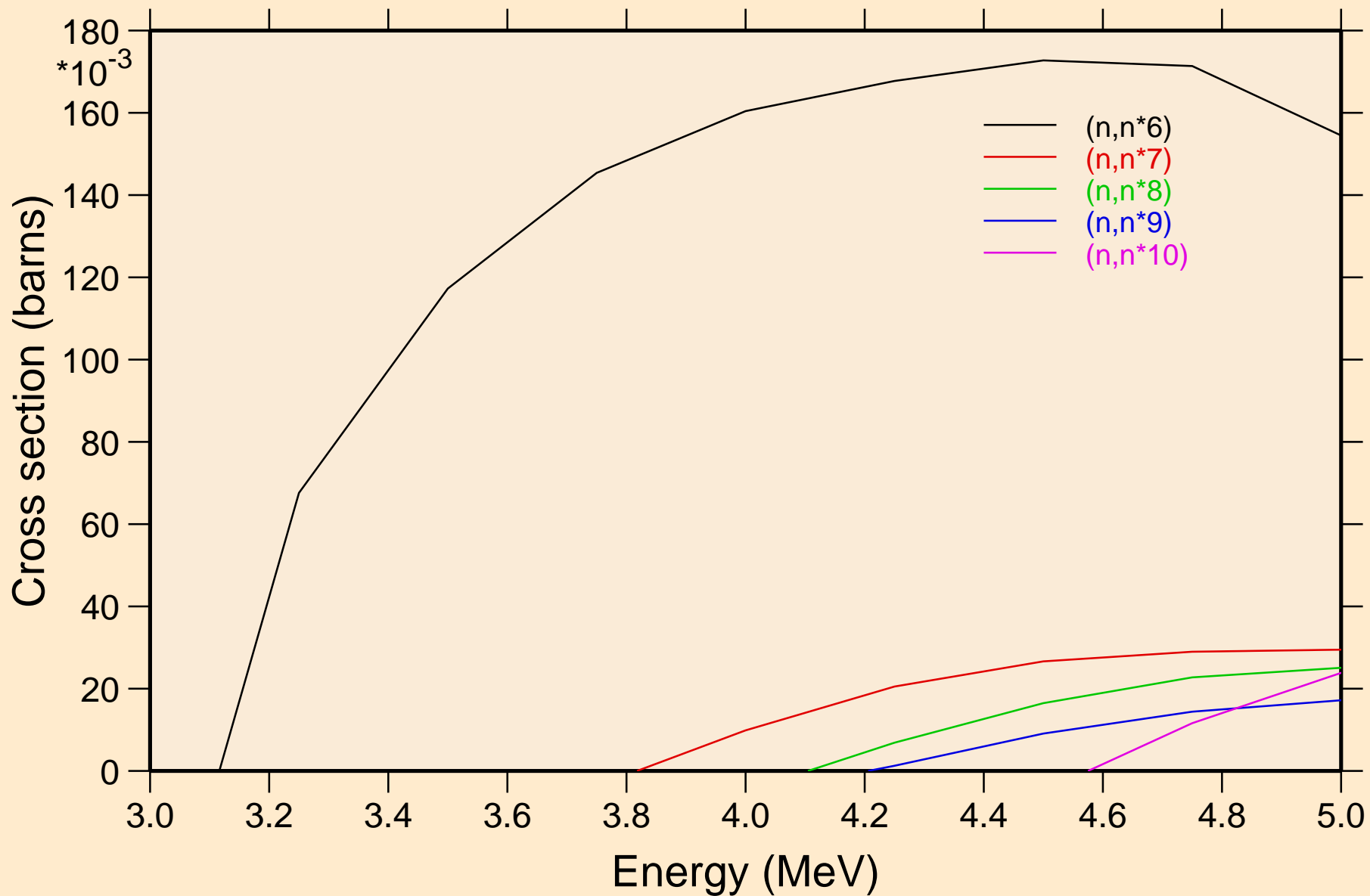

# 13-AL-27 FOR FENDL-3B2 FROM JEFF-3.1 WITH NJOY99.304+ C Inelastic levels

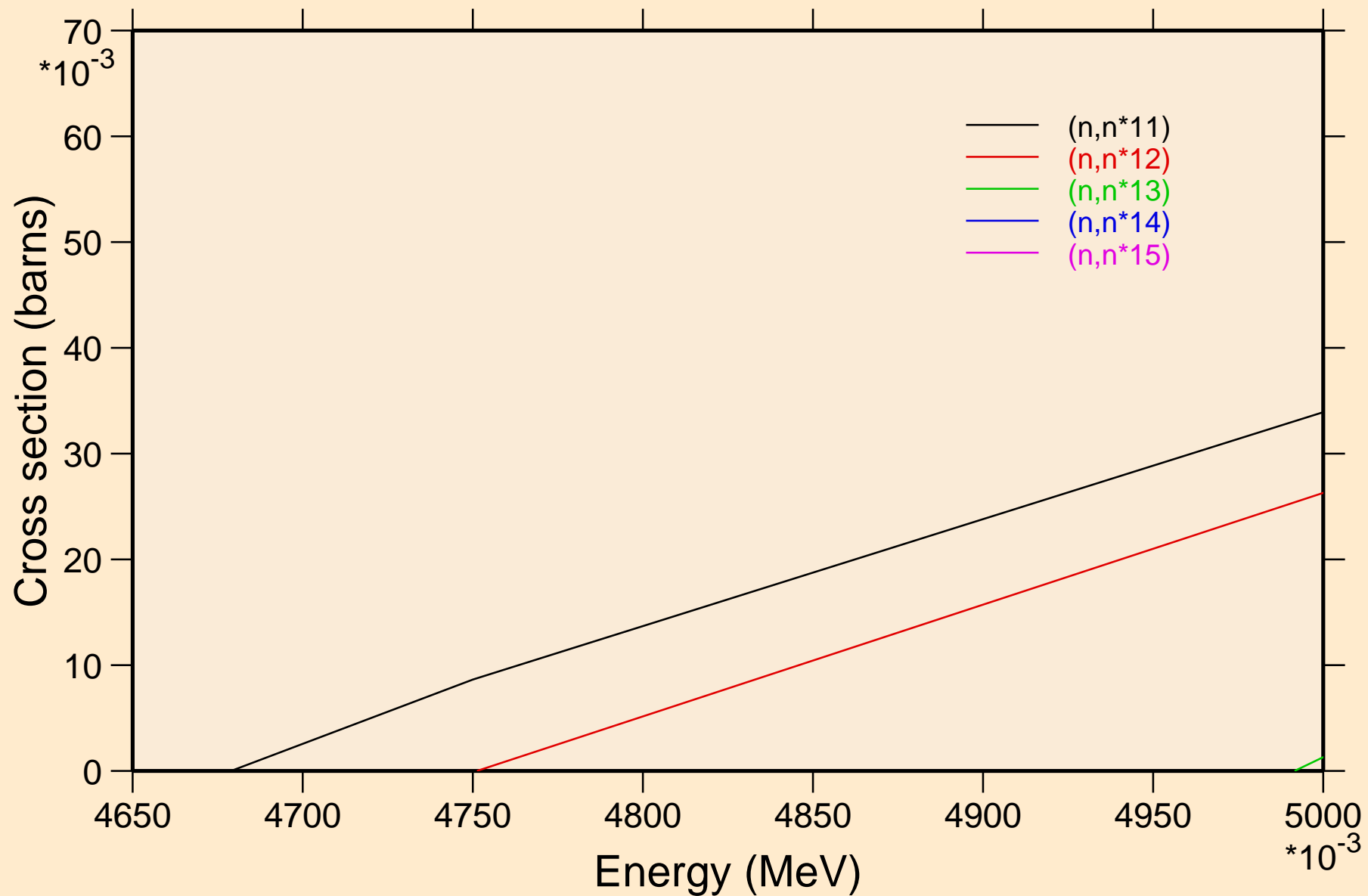

# 13-AL-27 FOR FENDL-3B2 FROM JEFF-3.1 WITH NJOY99.304+ C Inelastic levels

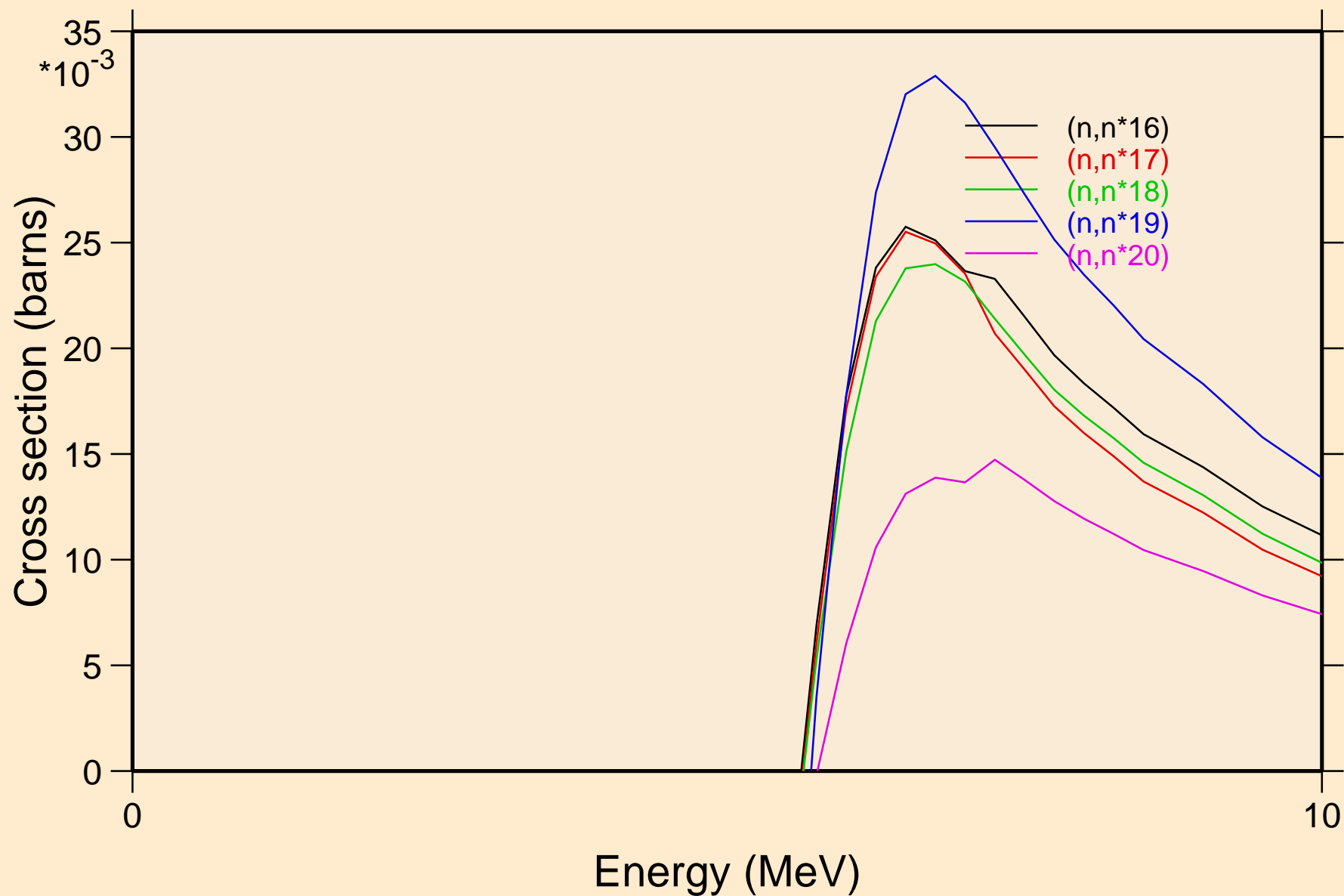

# 13-AL-27 FOR FENDL-3B2 FROM JEFF-3.1 WITH NJOY99.304+ C Inelastic levels

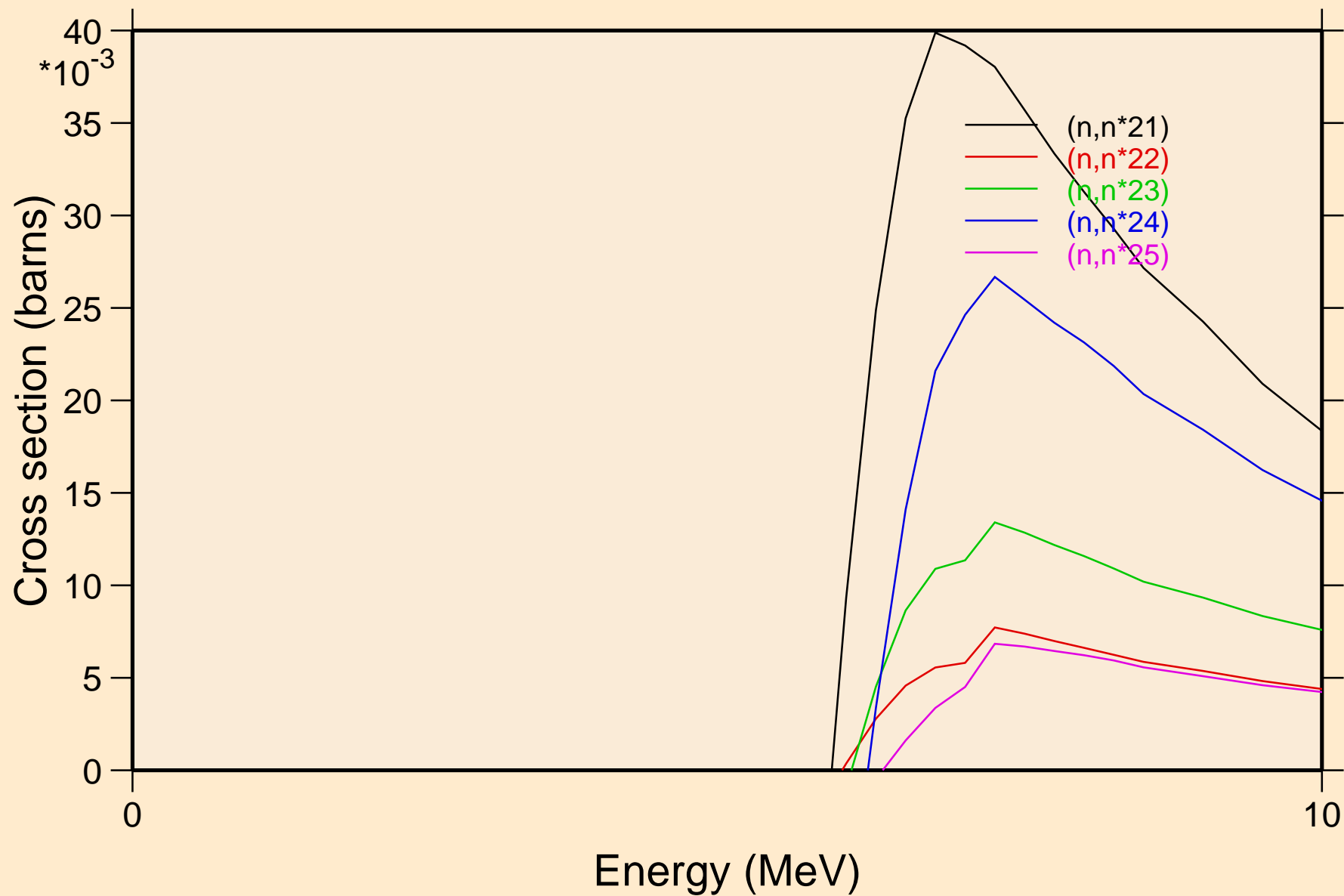

# 13-AL-27 FOR FENDL-3B2 FROM JEFF-3.1 WITH NJOY99.304+ C Inelastic levels

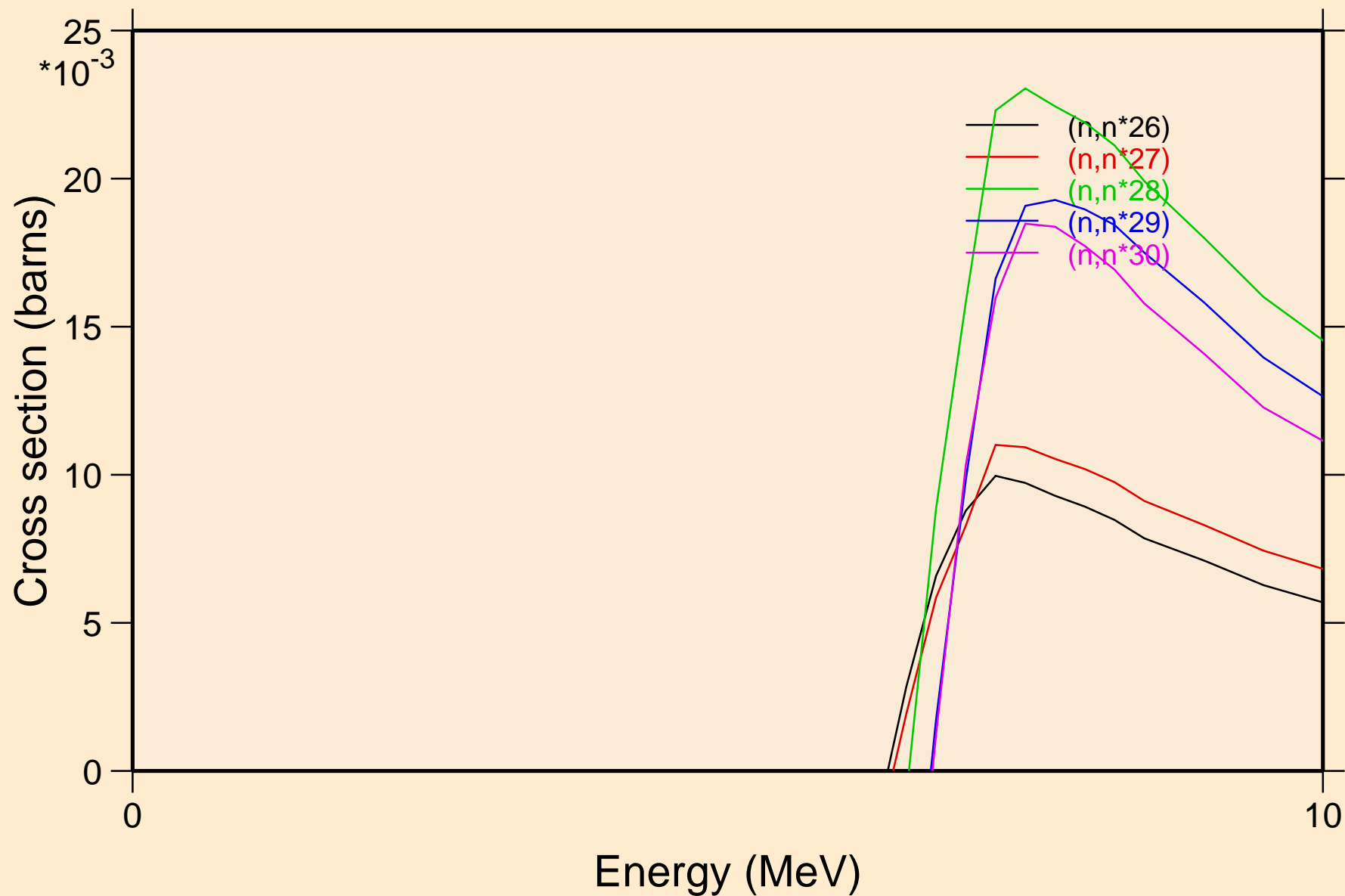

13-AL-27 FOR FENDL-3B2 FROM JEFF-3.1 WITH NJOY99.304+ C  
Inelastic levels

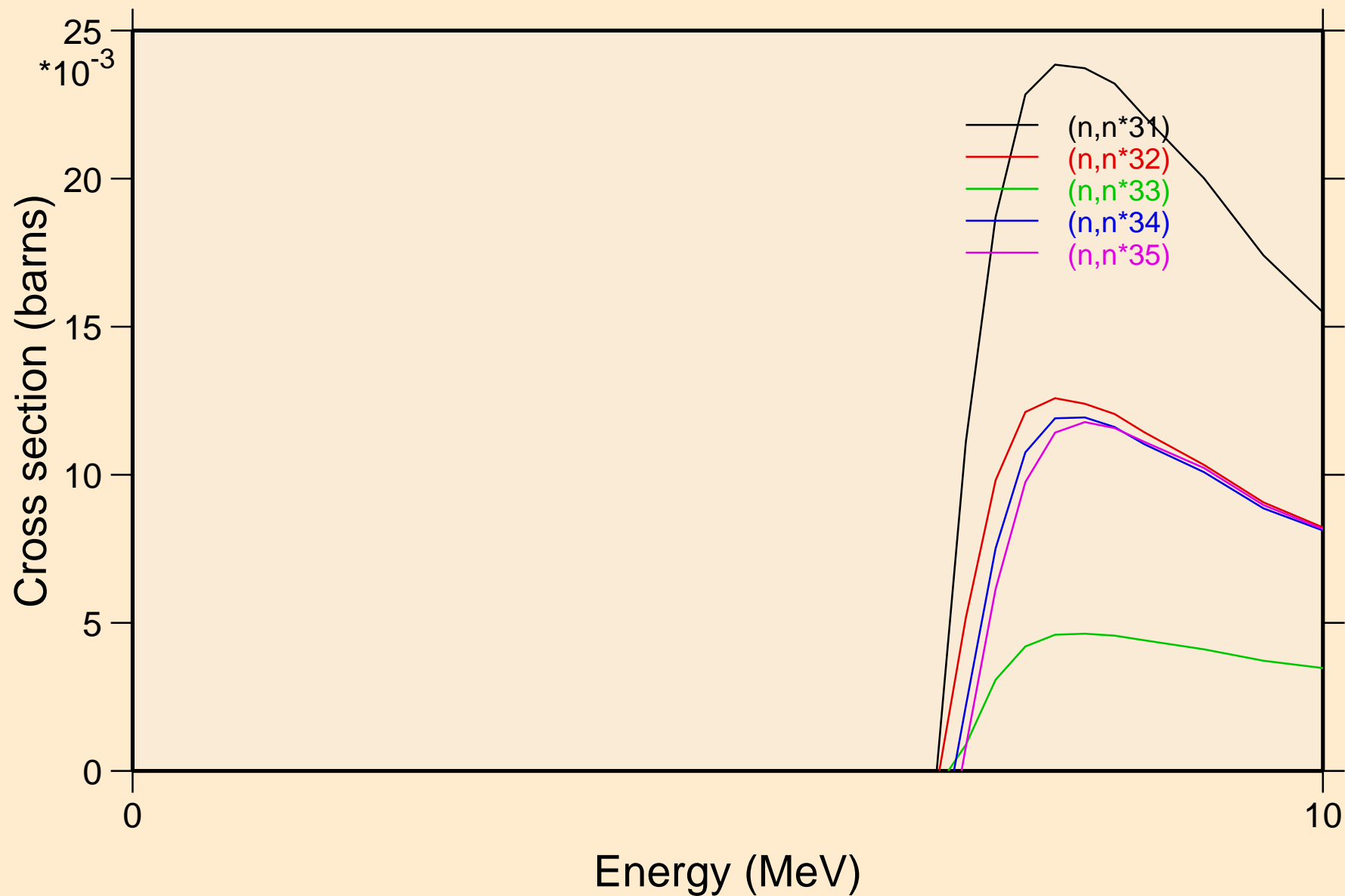

13-AL-27 FOR FENDL-3B2 FROM JEFF-3.1 WITH NJOY99.304+ C  
Inelastic levels

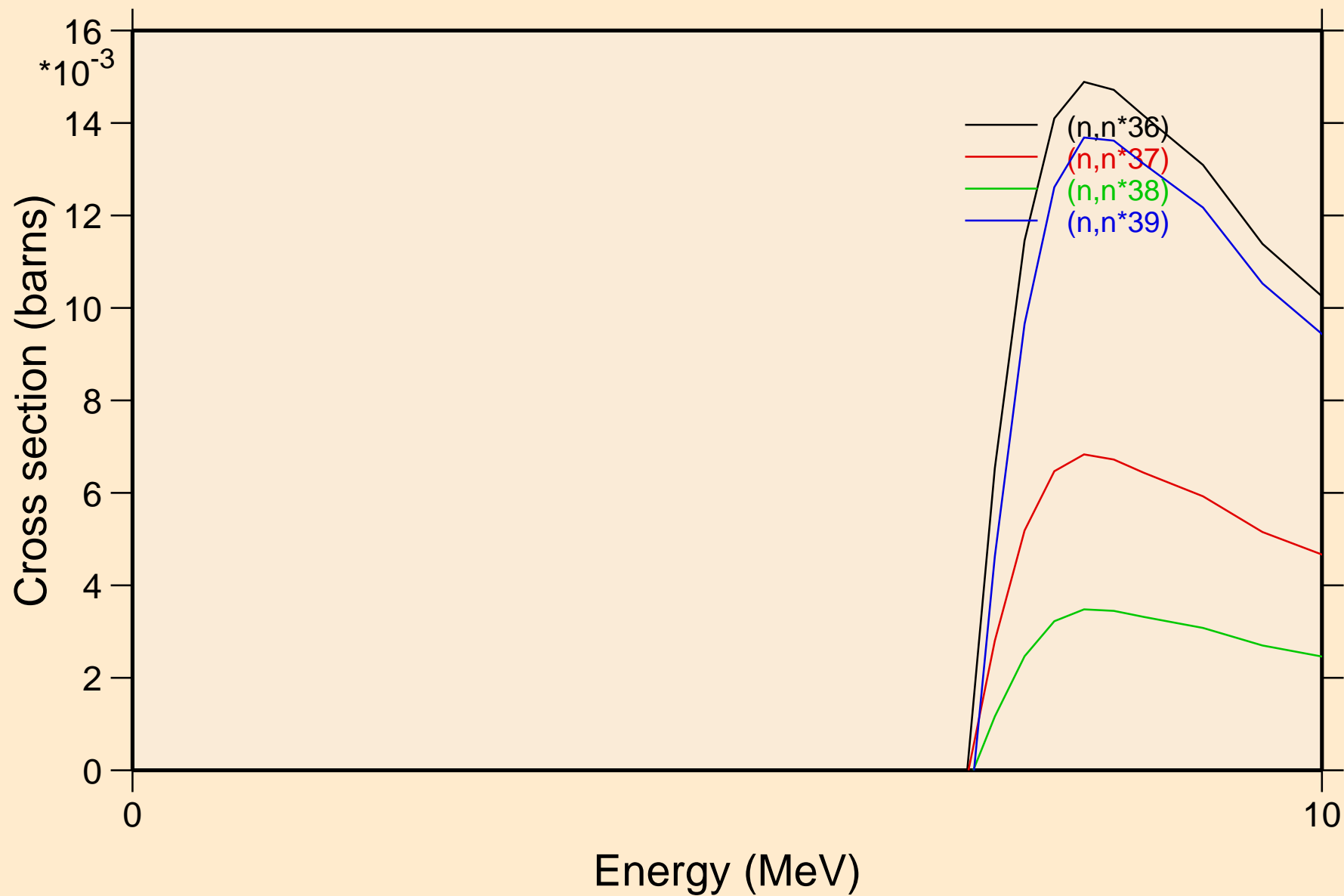



13-AL-27 FOR FENDL-3B2 FROM JEFF-3.1 WITH NJOY99.304+ C  
Threshold reactions

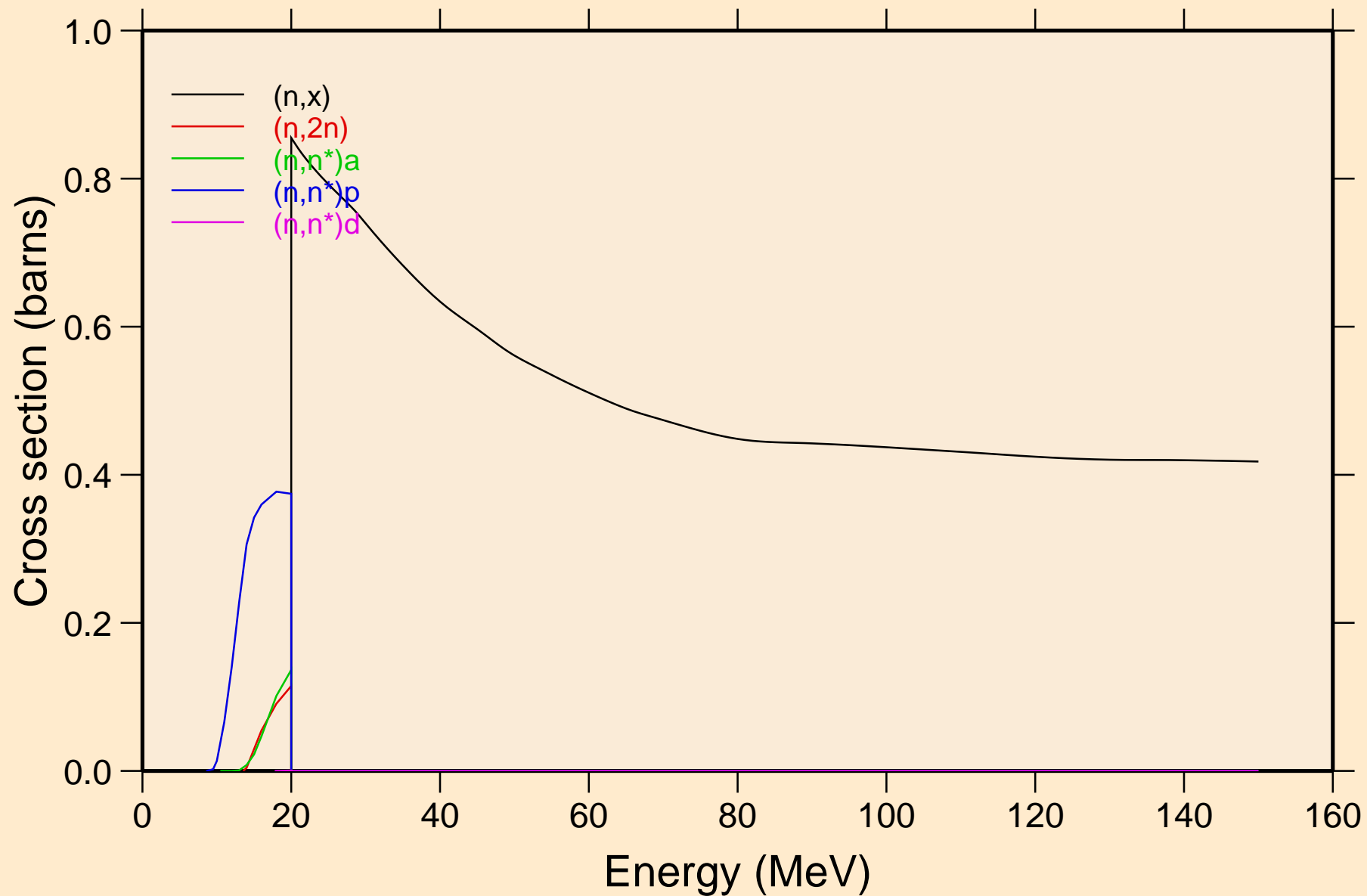

13-AL-27 FOR FENDL-3B2 FROM JEFF-3.1 WITH NJOY99.304+ C  
Threshold reactions

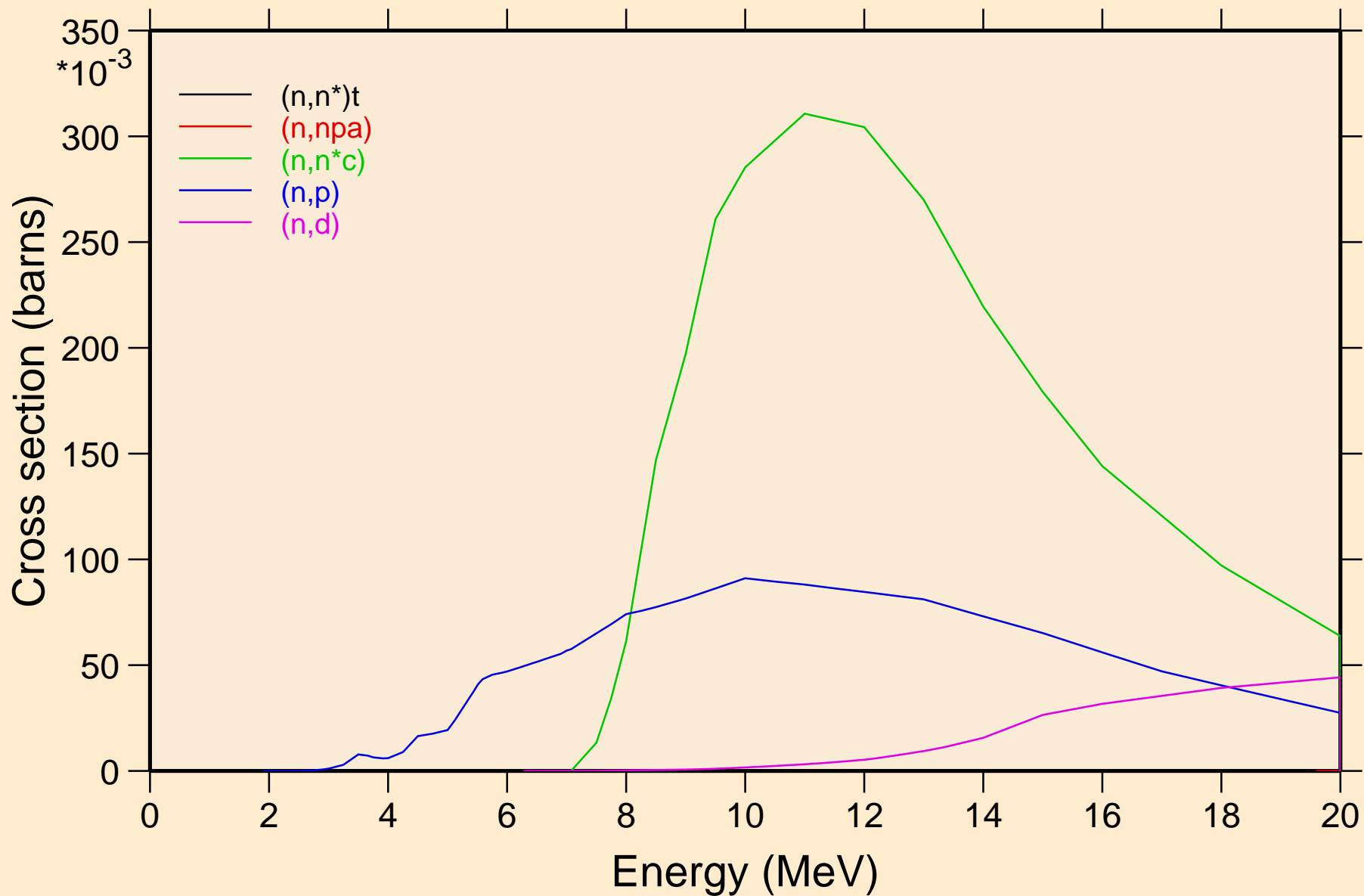

13-AL-27 FOR FENDL-3B2 FROM JEFF-3.1 WITH NJOY99.304+ C  
Threshold reactions

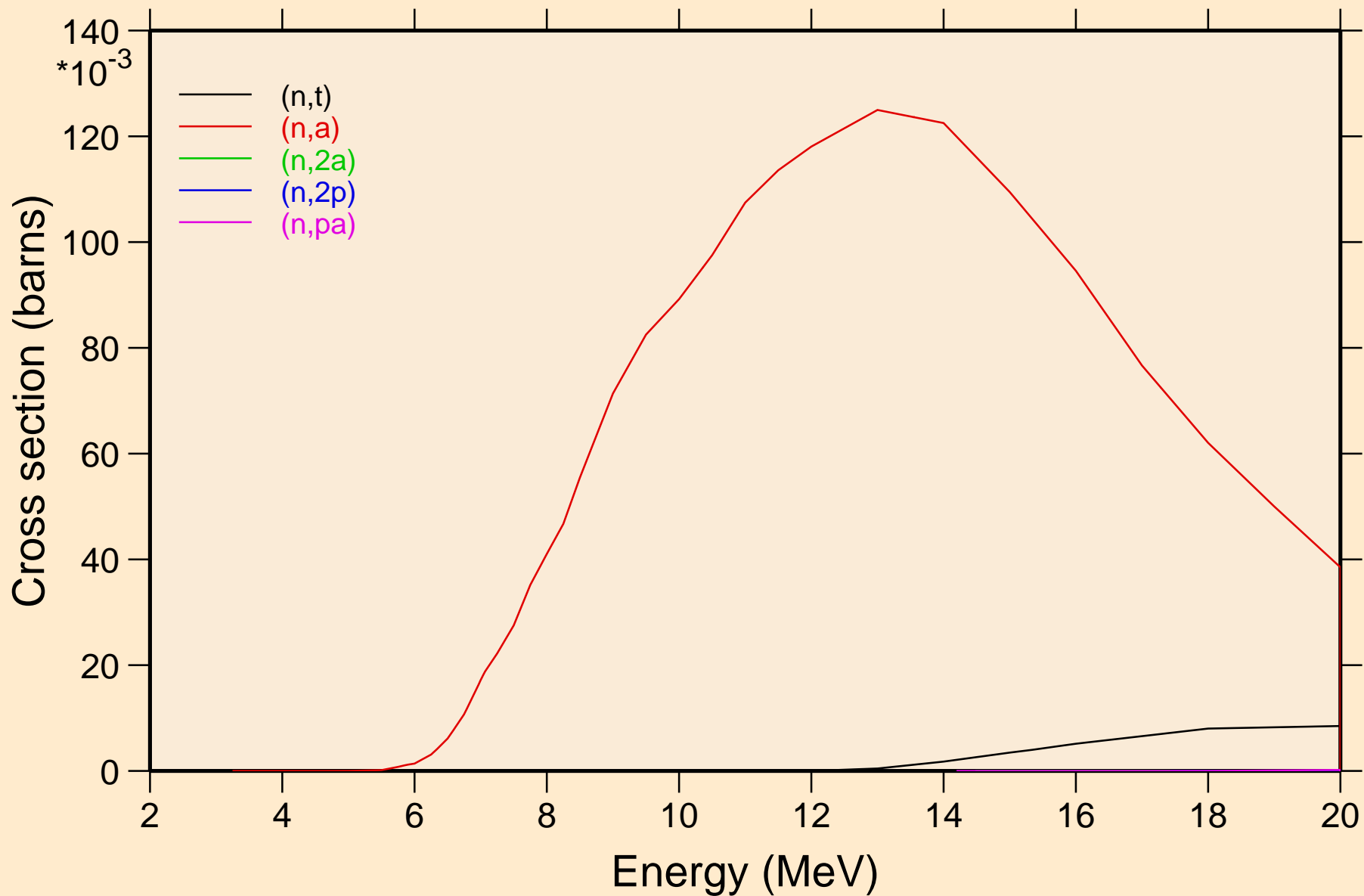

13-AL-27 FOR FENDL-3B2 FROM JEFF-3.1 WITH NJOY99.304+ C  
Threshold reactions

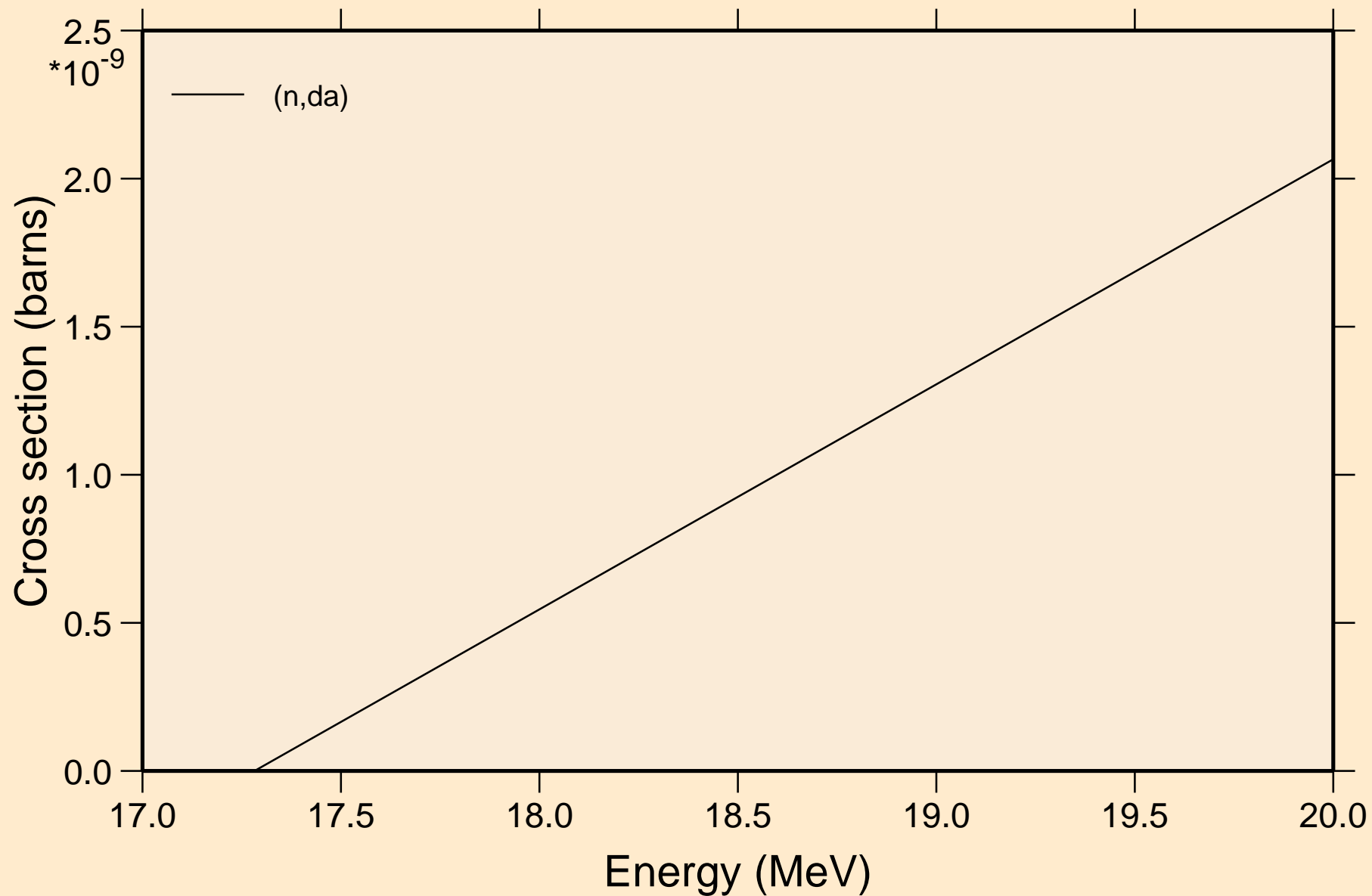

# 13-AL-27 FOR FENDL-3B2 FROM JEFF-3.1 WITH NJOY99.304+ C

## Threshold reactions

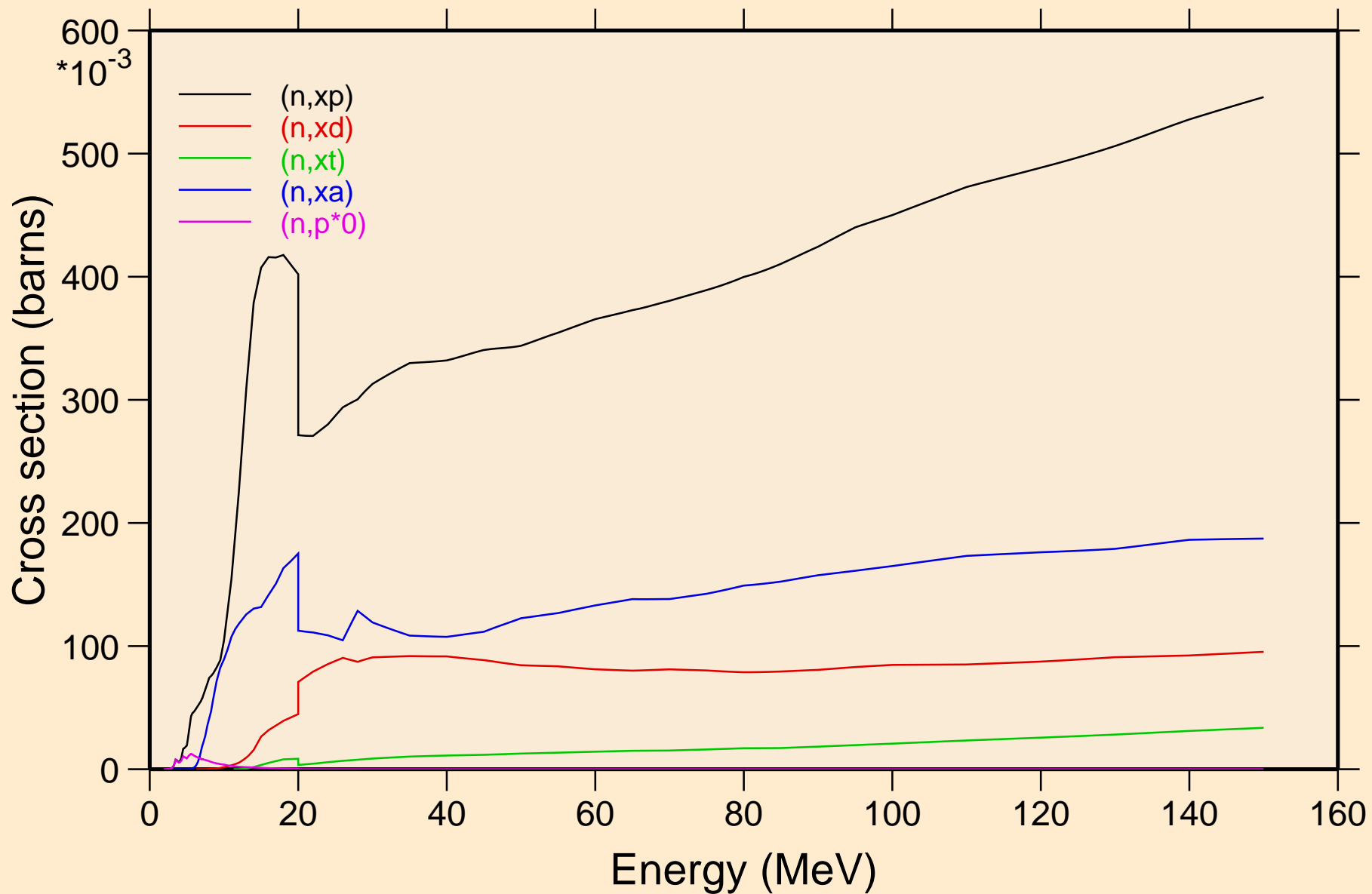

13-AL-27 FOR FENDL-3B2 FROM JEFF-3.1 WITH NJOY99.304+ C  
Threshold reactions

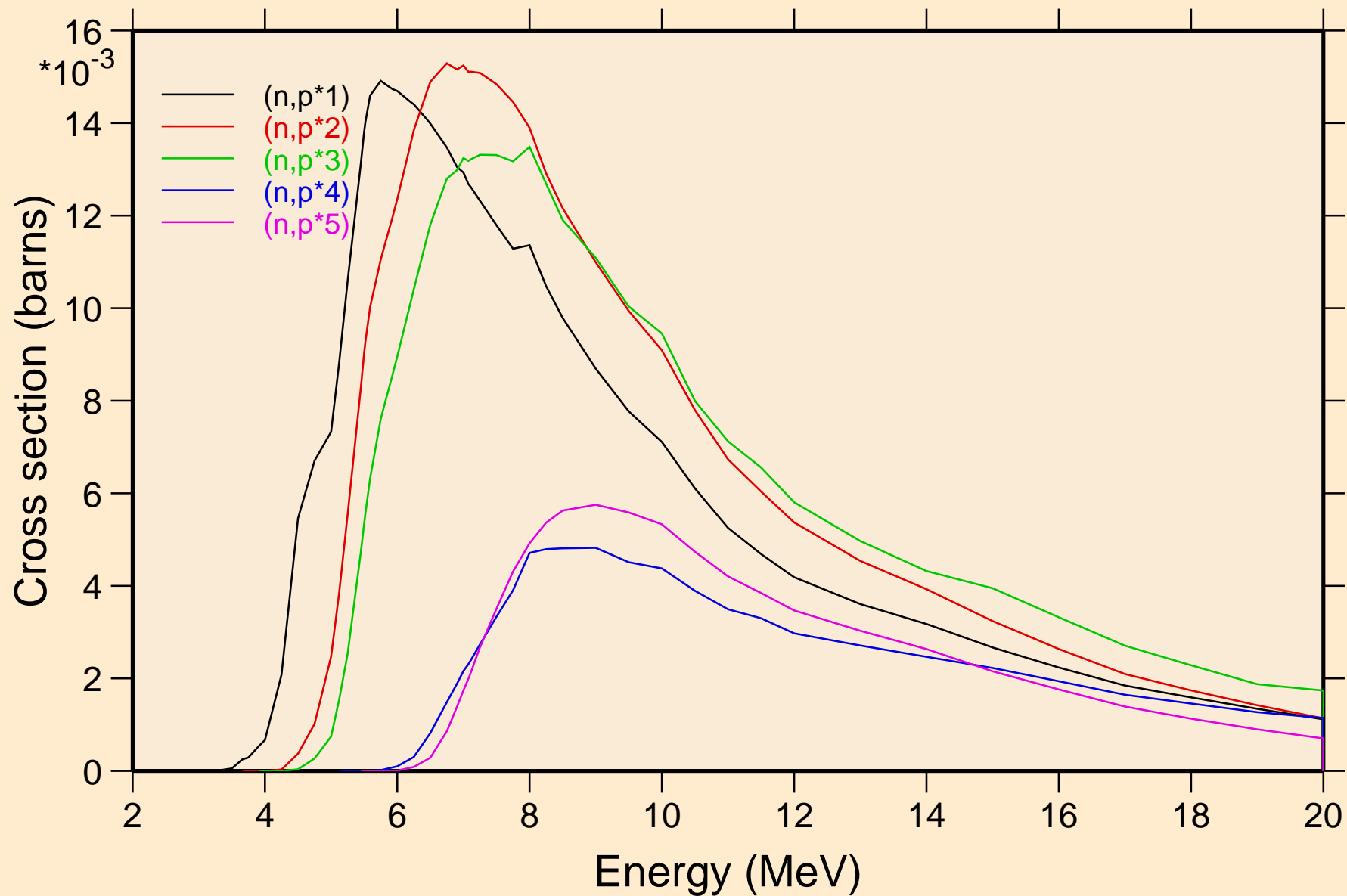

# 13-AL-27 FOR FENDL-3B2 FROM JEFF-3.1 WITH NJOY99.304+ C

## Threshold reactions

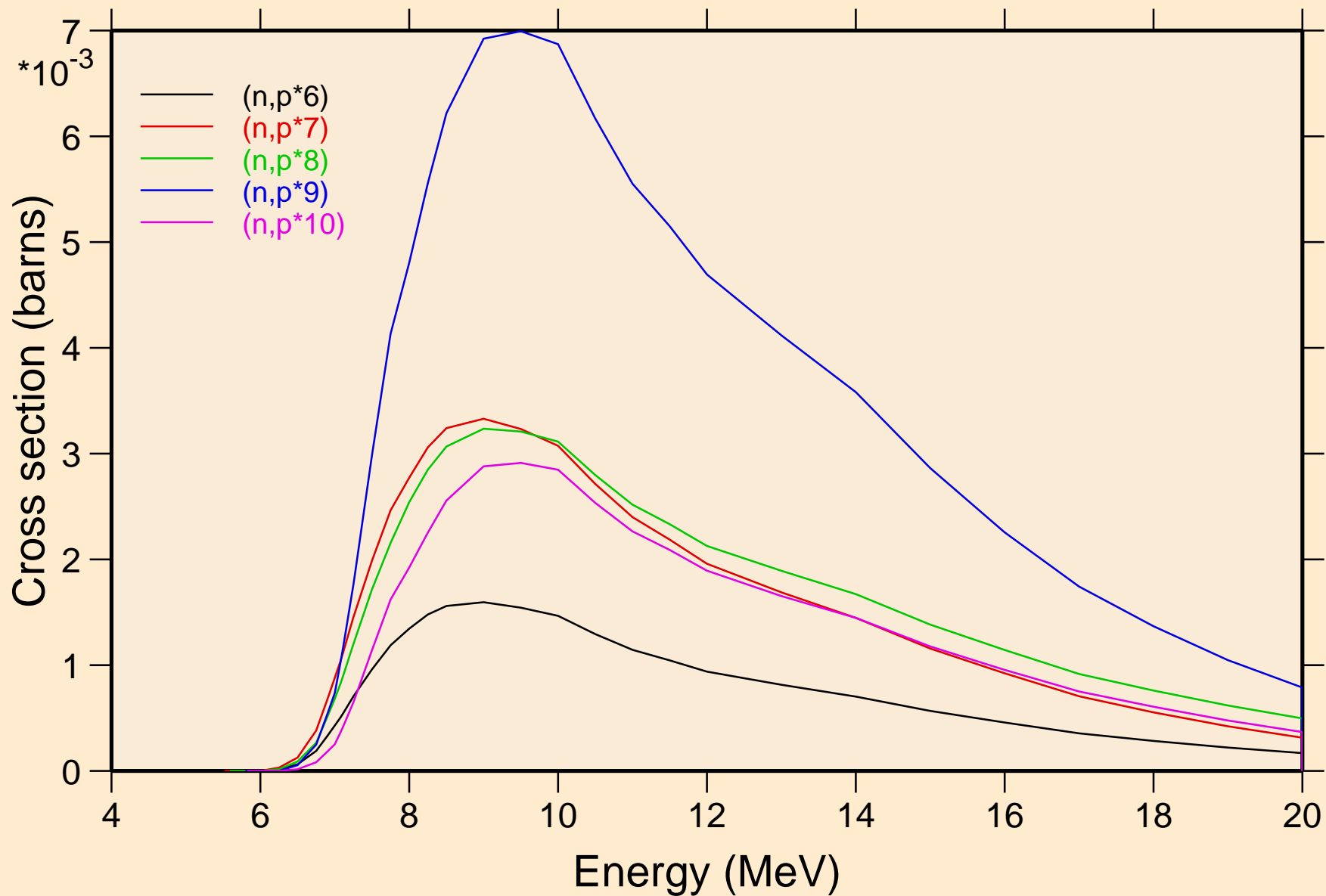

13-AL-27 FOR FENDL-3B2 FROM JEFF-3.1 WITH NJOY99.304+ C  
Threshold reactions

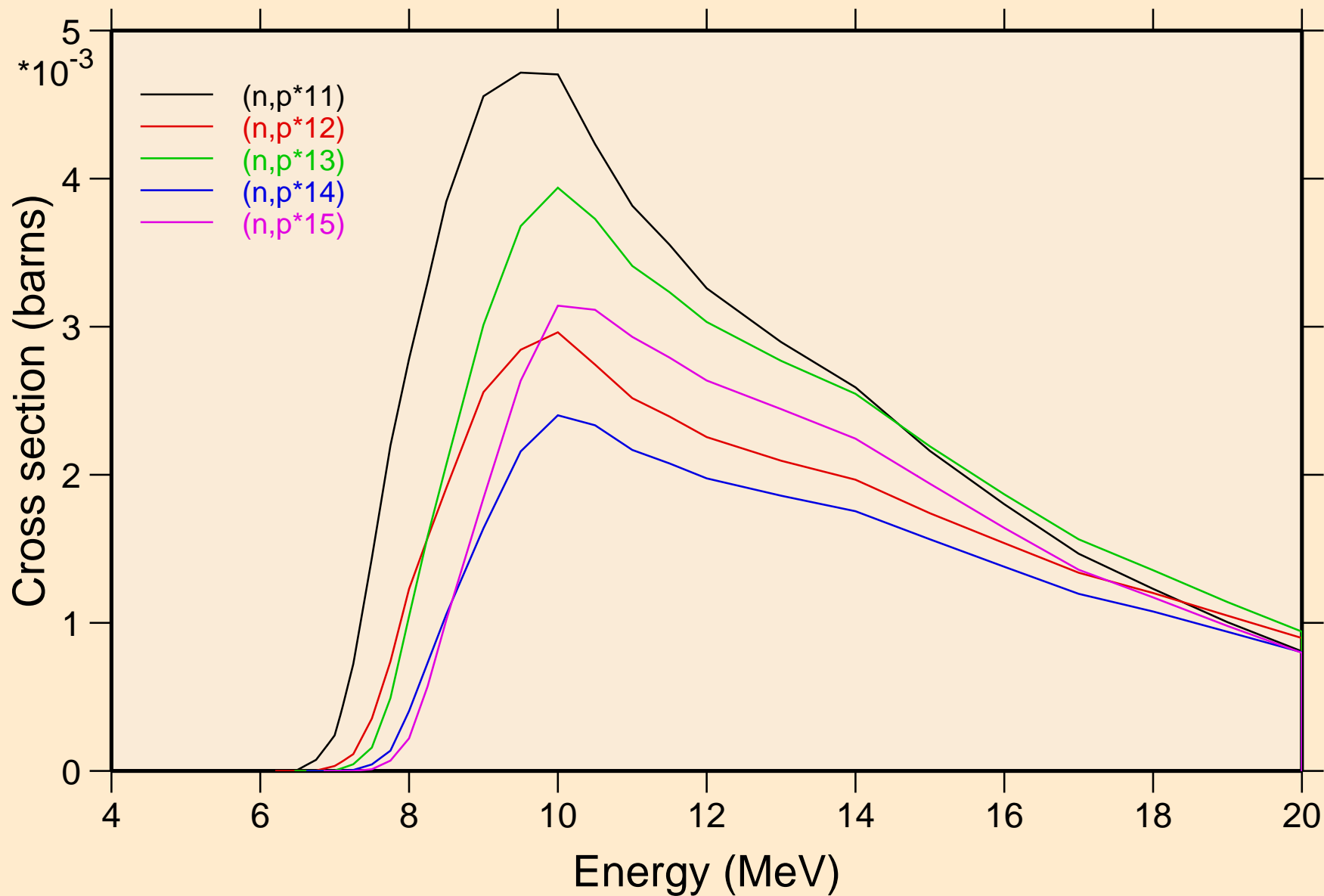



# 13-AL-27 FOR FENDL-3B2 FROM JEFF-3.1 WITH NJOY99.304+ C

## Threshold reactions

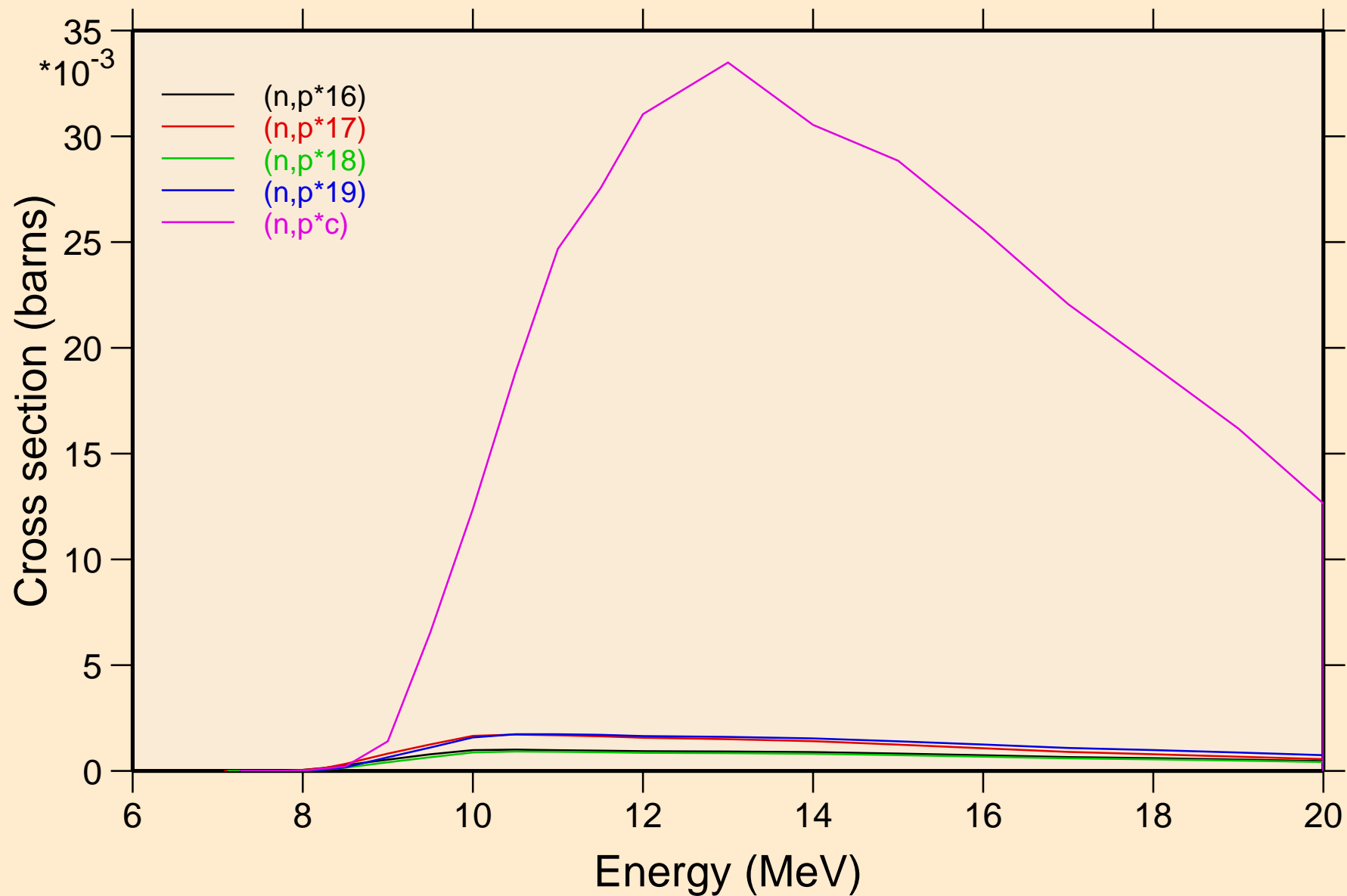

13-AL-27 FOR FENDL-3B2 FROM JEFF-3.1 WITH NJOY99.304+ C  
Threshold reactions

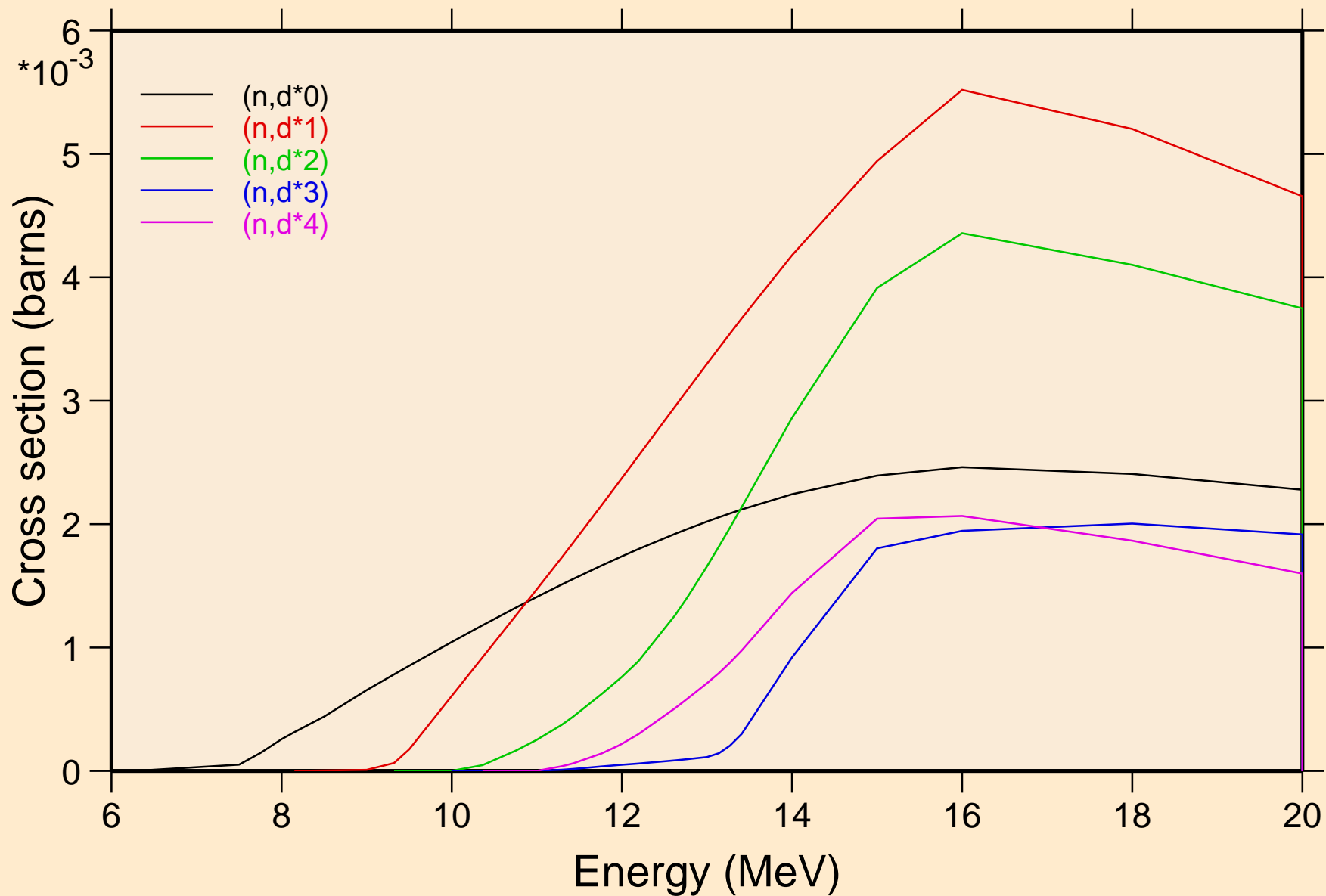

# 13-AL-27 FOR FENDL-3B2 FROM JEFF-3.1 WITH NJOY99.304+ C

## Threshold reactions

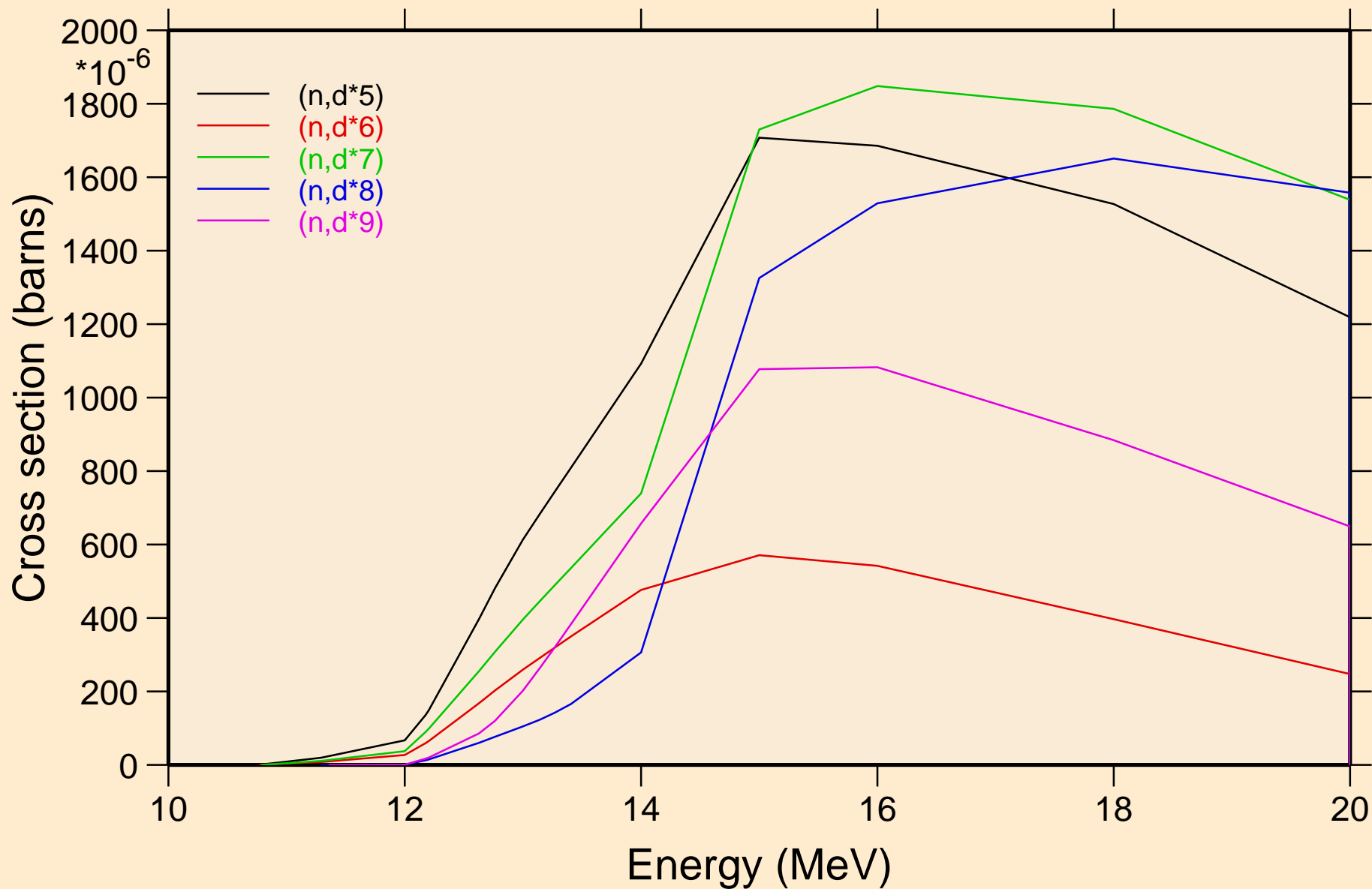

13-AL-27 FOR FENDL-3B2 FROM JEFF-3.1 WITH NJOY99.304+ C  
Threshold reactions

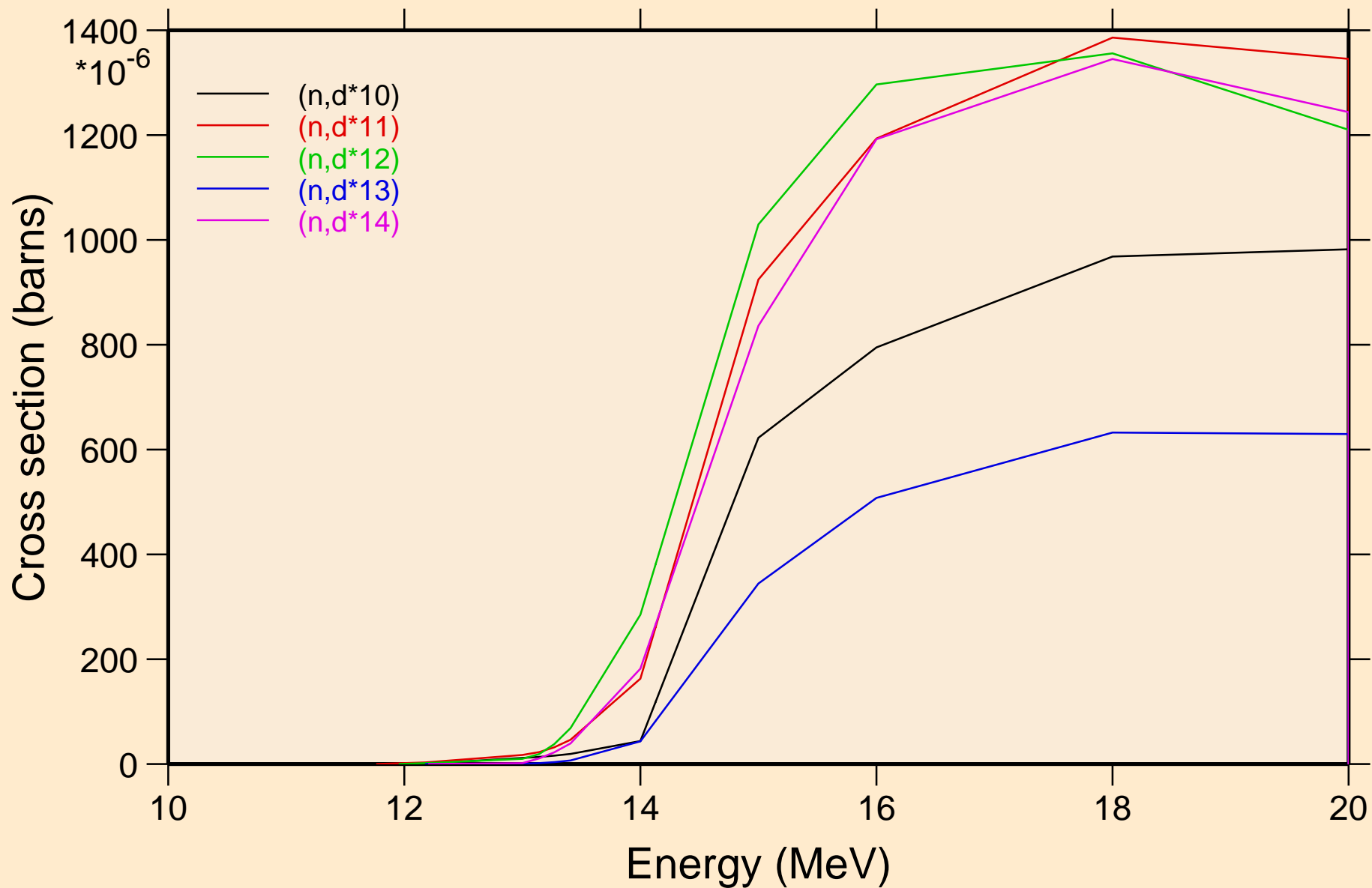

13-AL-27 FOR FENDL-3B2 FROM JEFF-3.1 WITH NJOY99.304+ C  
Threshold reactions

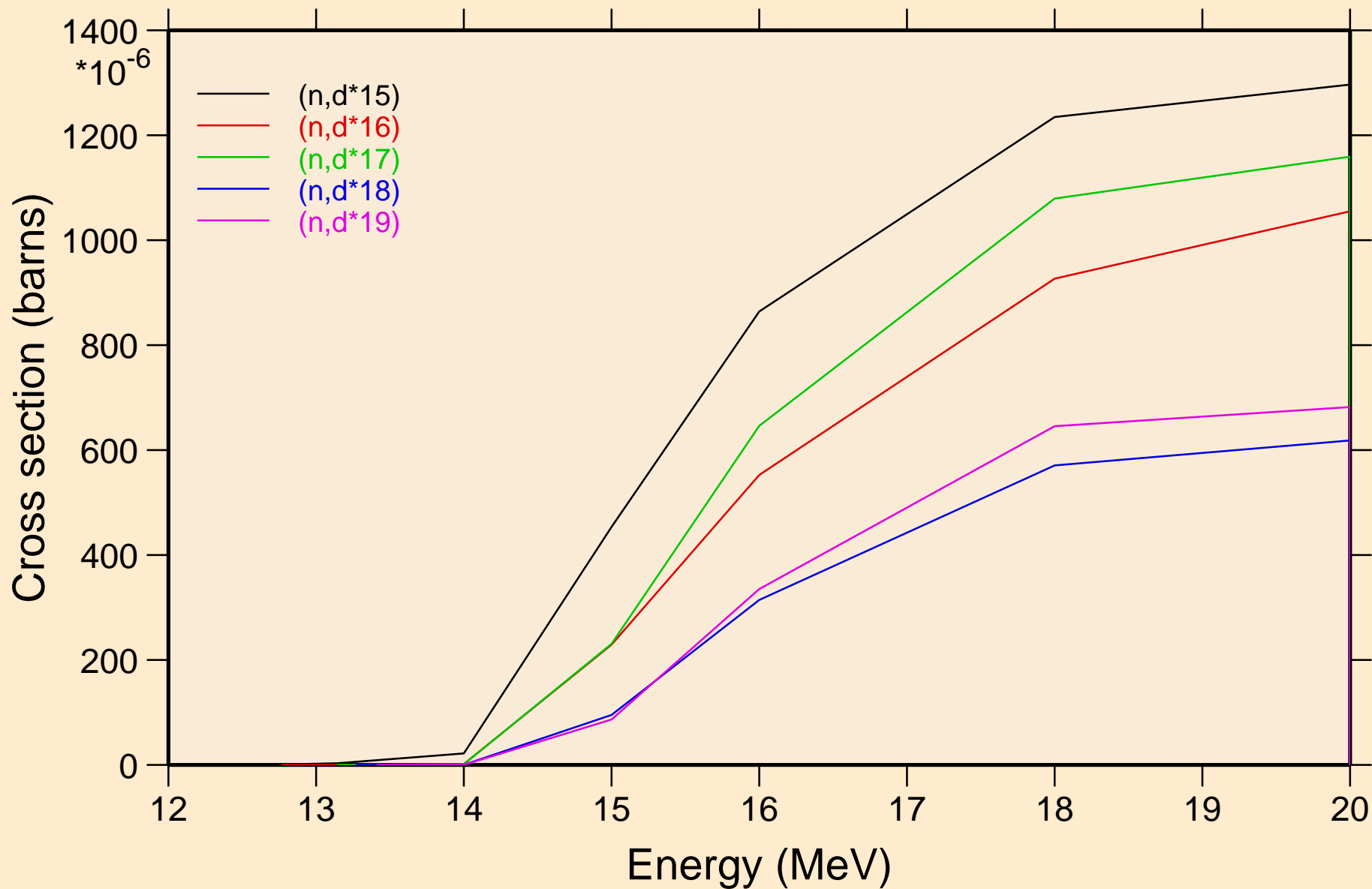

13-AL-27 FOR FENDL-3B2 FROM JEFF-3.1 WITH NJOY99.304+ C  
Threshold reactions

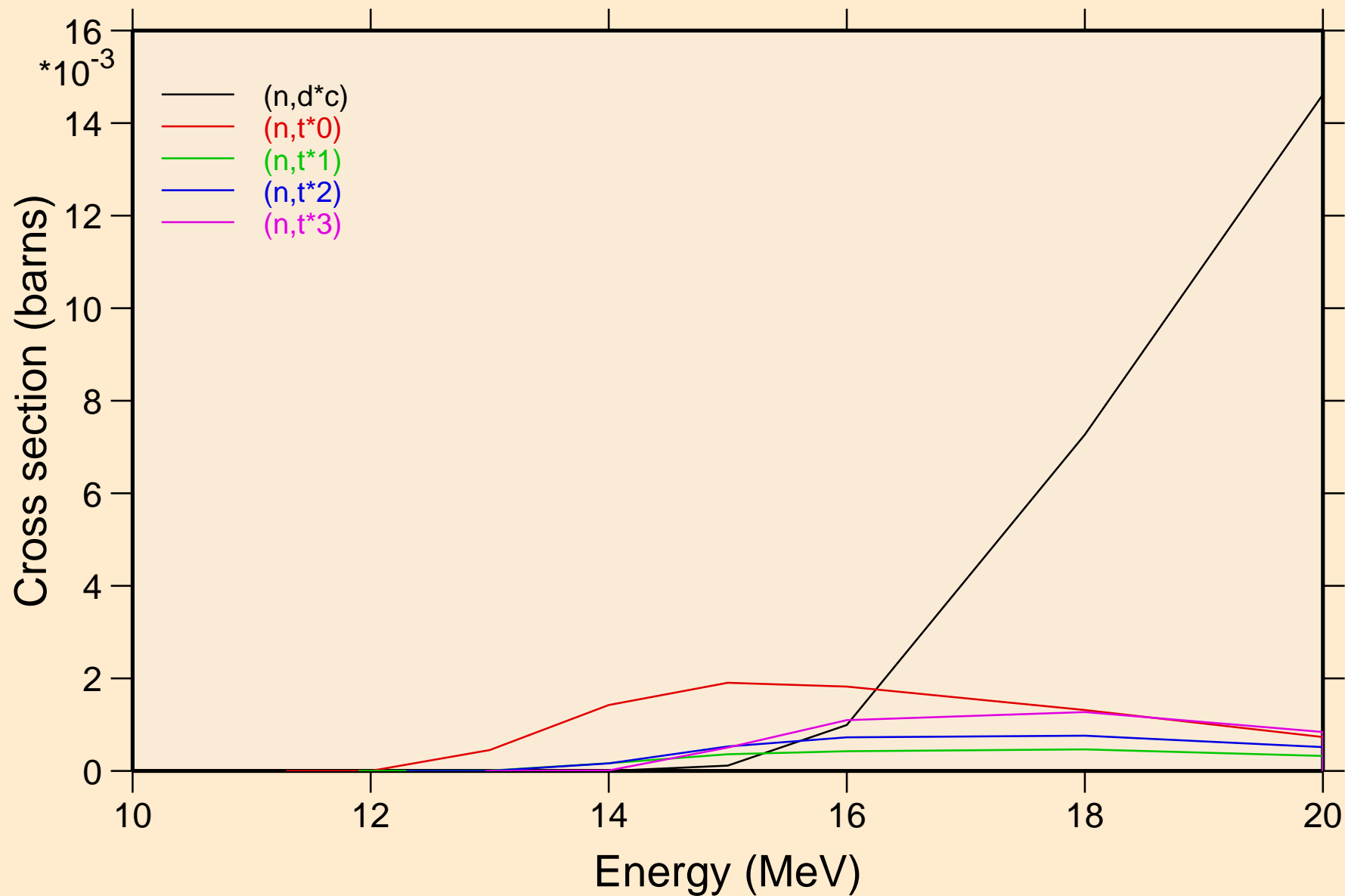

13-AL-27 FOR FENDL-3B2 FROM JEFF-3.1 WITH NJOY99.304+ C  
Threshold reactions

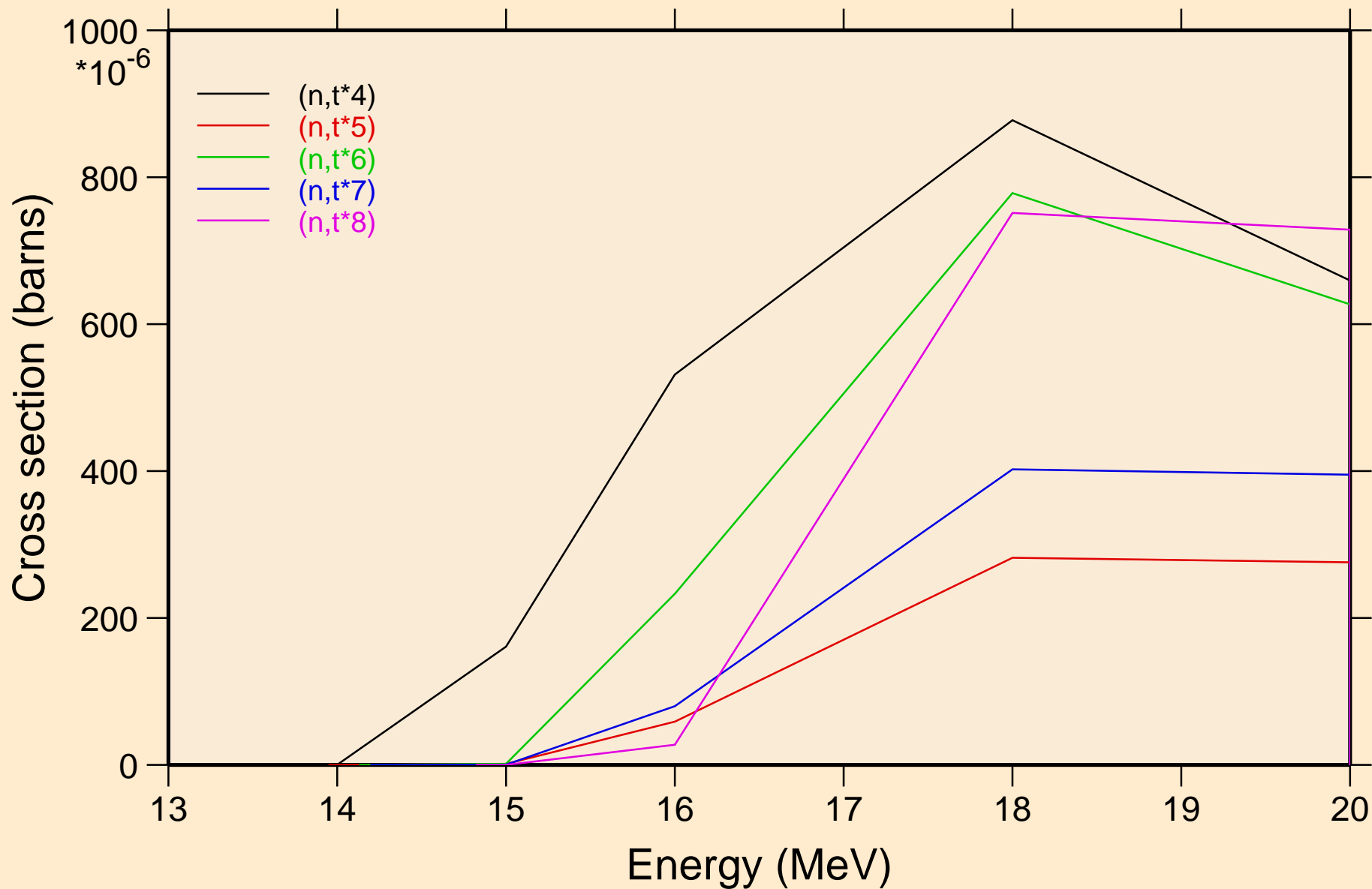

13-AL-27 FOR FENDL-3B2 FROM JEFF-3.1 WITH NJOY99.304+ C  
Threshold reactions

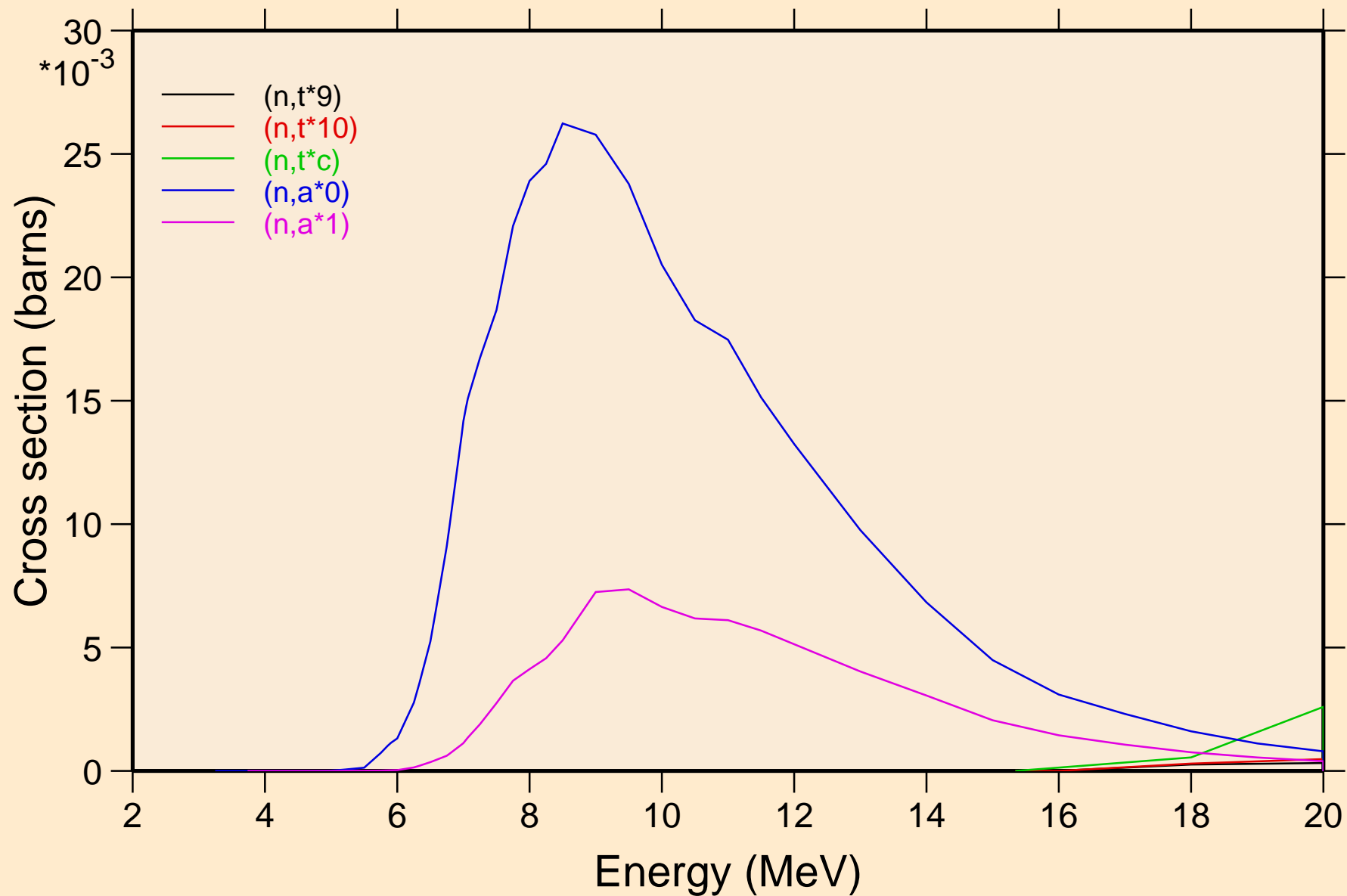



13-AL-27 FOR FENDL-3B2 FROM JEFF-3.1 WITH NJOY99.304+ C  
Threshold reactions

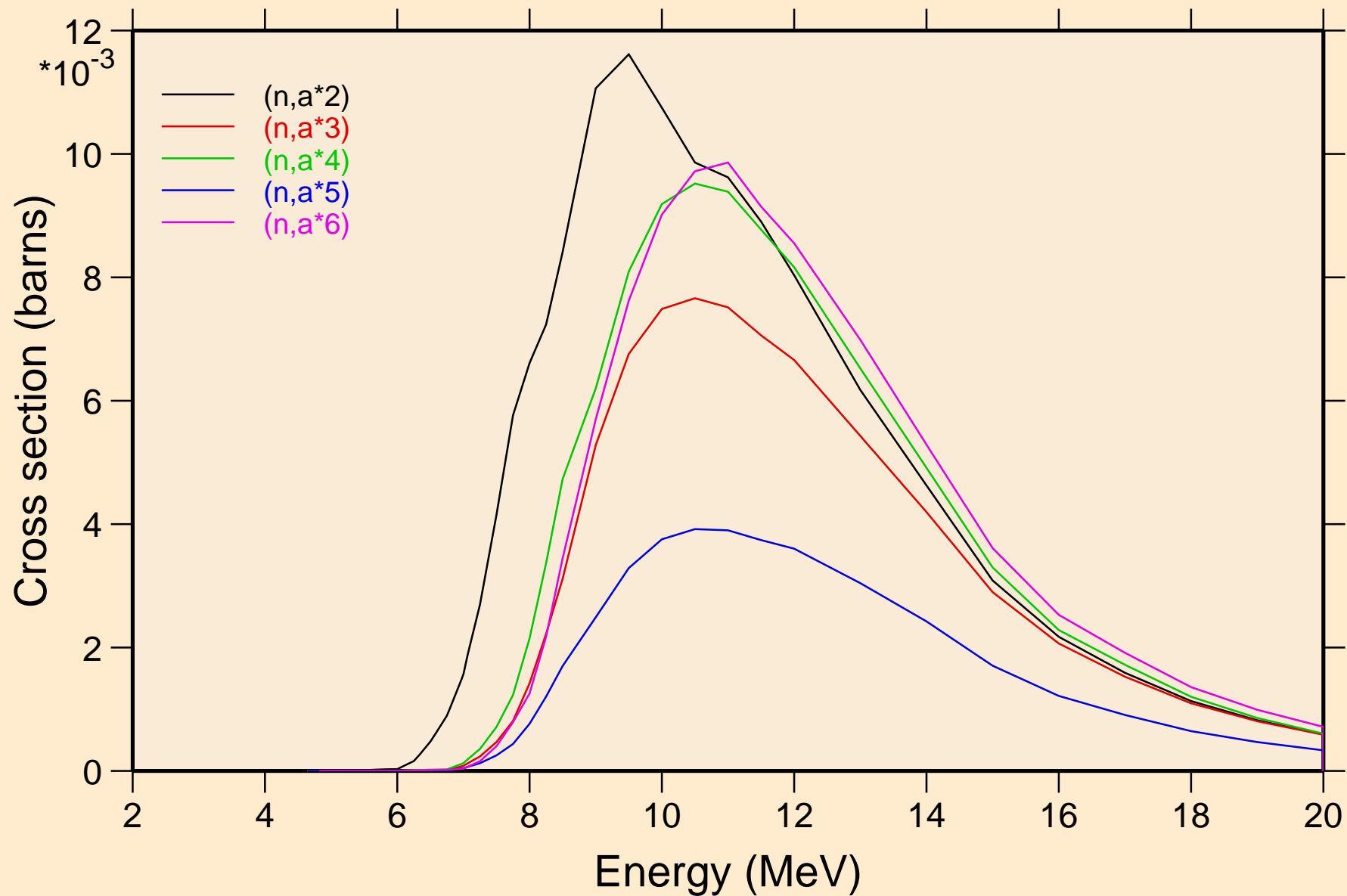

13-AL-27 FOR FENDL-3B2 FROM JEFF-3.1 WITH NJOY99.304+ C  
Threshold reactions

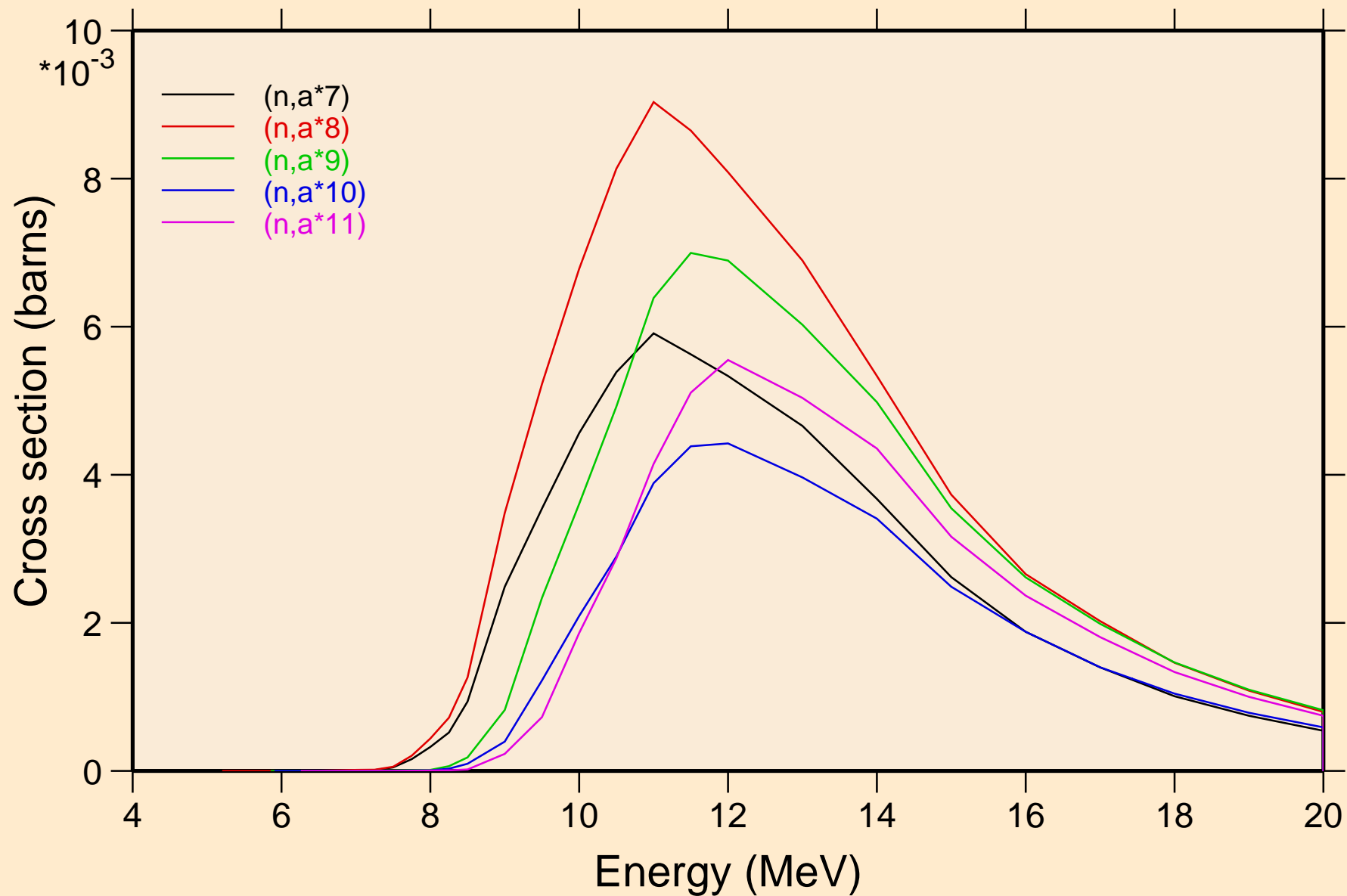

13-AL-27 FOR FENDL-3B2 FROM JEFF-3.1 WITH NJOY99.304+ C  
Threshold reactions

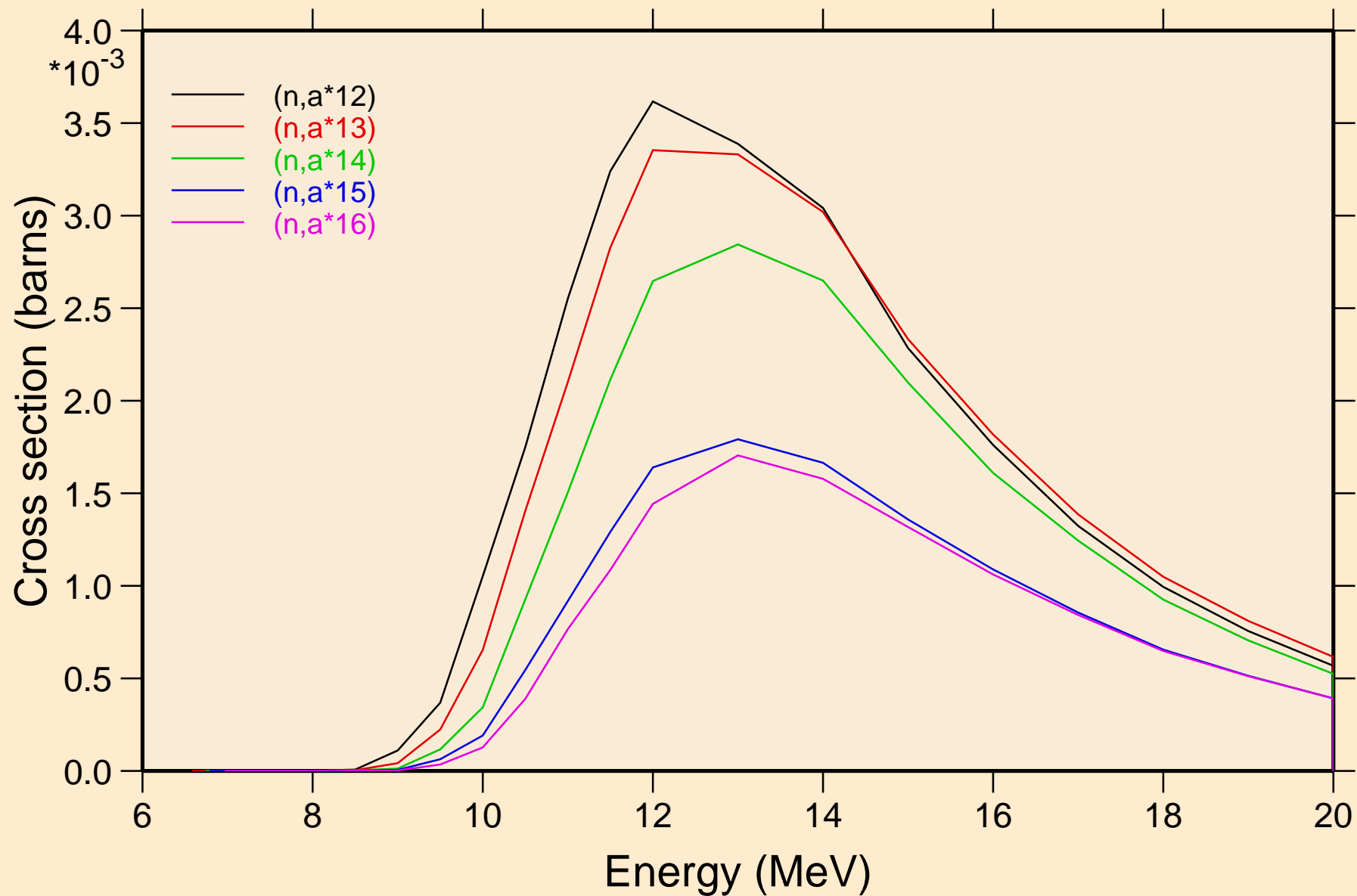

# 13-AL-27 FOR FENDL-3B2 FROM JEFF-3.1 WITH NJOY99.304+ C

## Threshold reactions

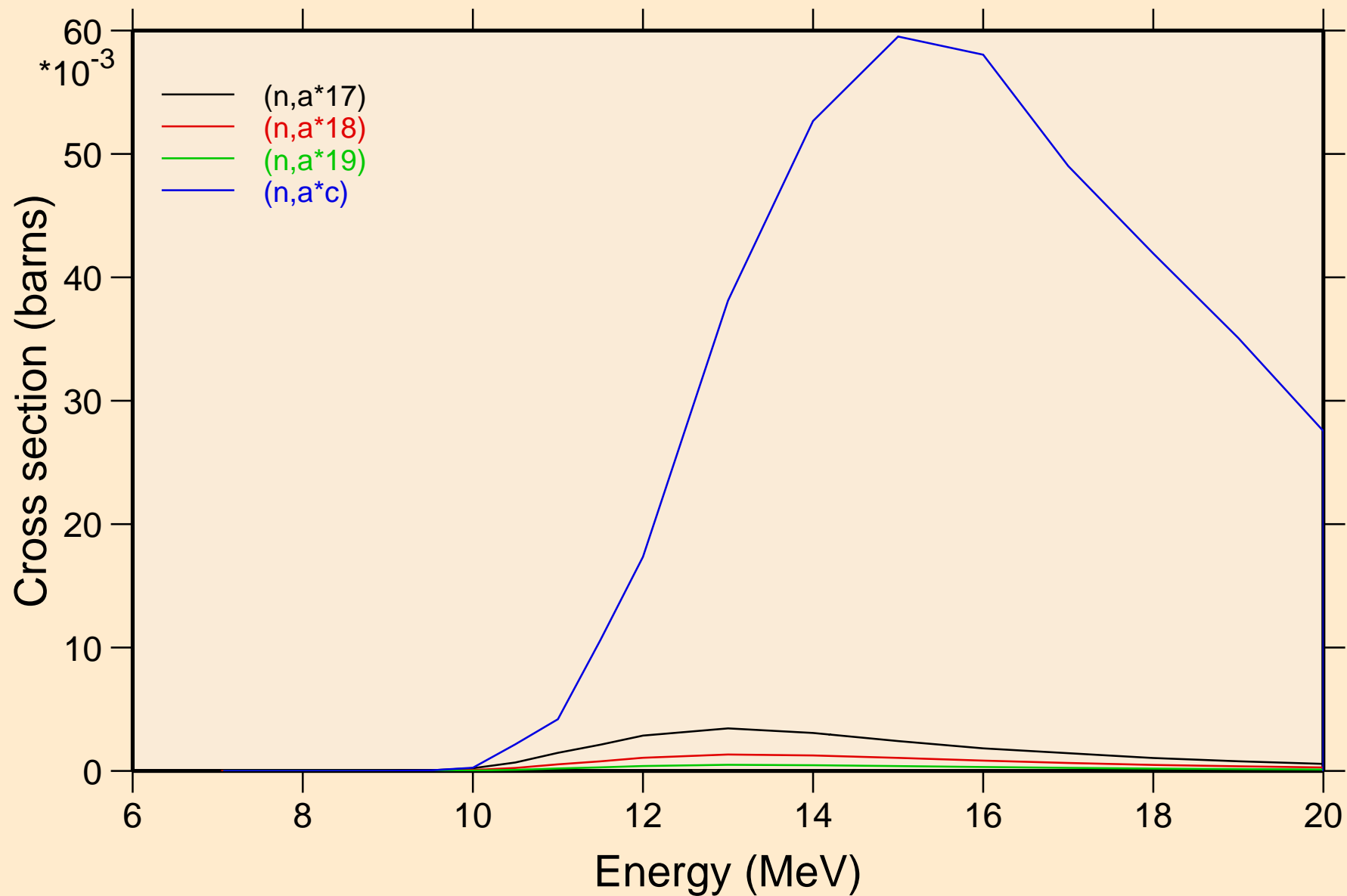

13-AL-27 FOR FENDL-3B2 FROM JEFF-3.1 WITH NJOY99.304+ C  
angular distribution for elastic

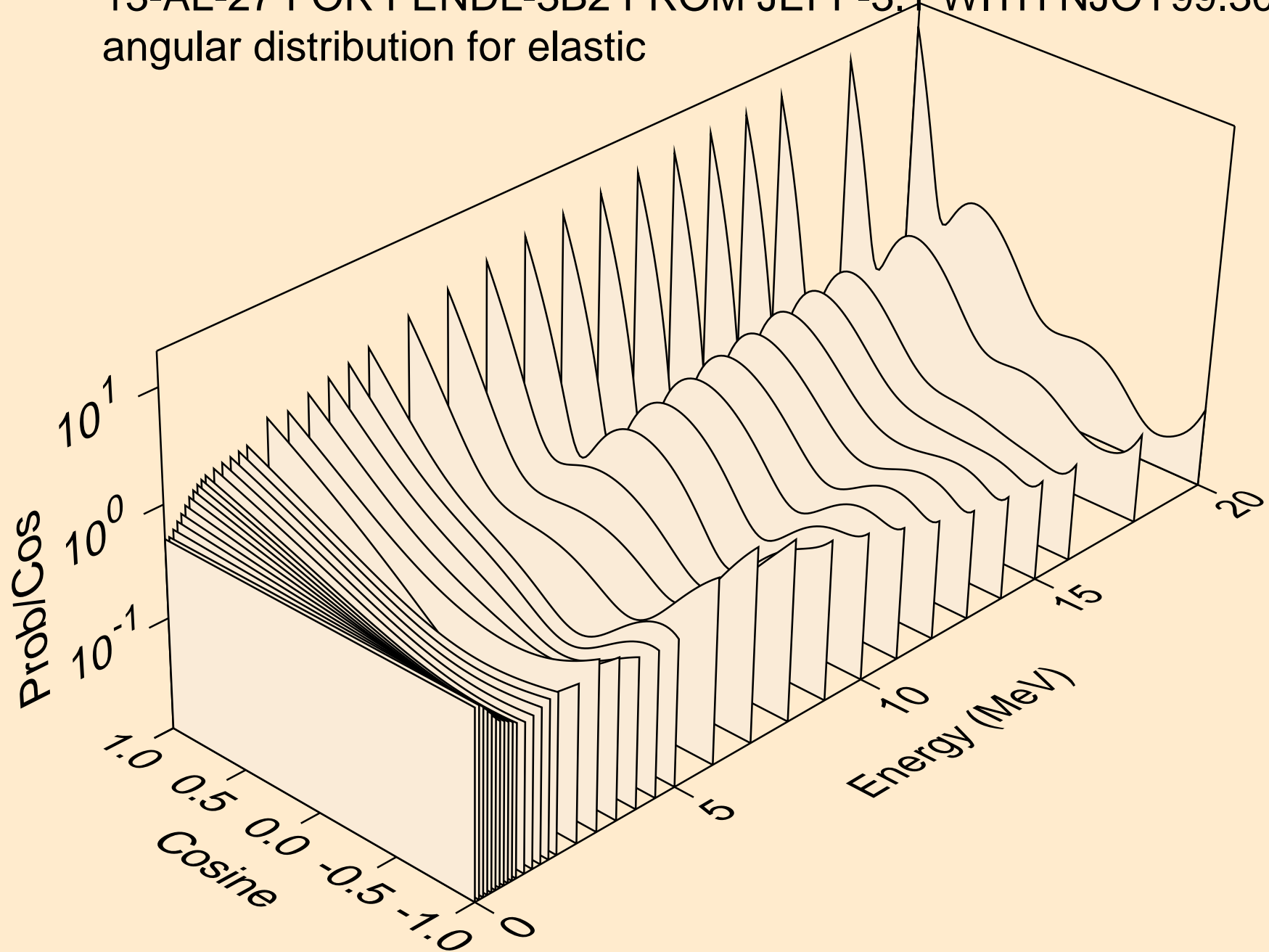

13-AL-27 FOR FENDL-3B2 FROM JEFF-3.1 WITH NJOY99.304+ C  
angular distribution for elastic

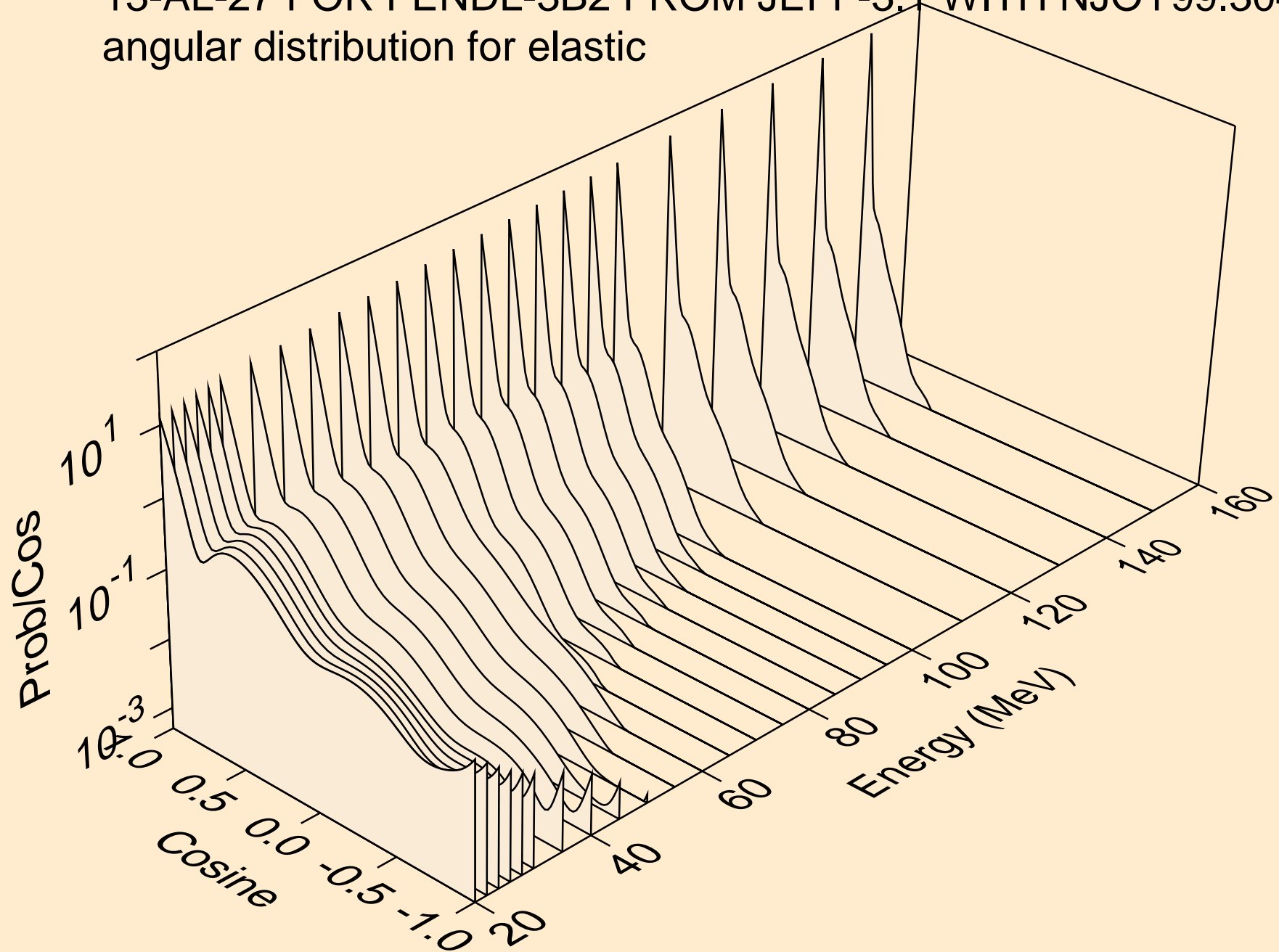

13-AL-27 FOR FENDL-3B2 FROM JEFF-3.1 WITH NJOY99.304+ C  
angular distribution for (n,n\*1)

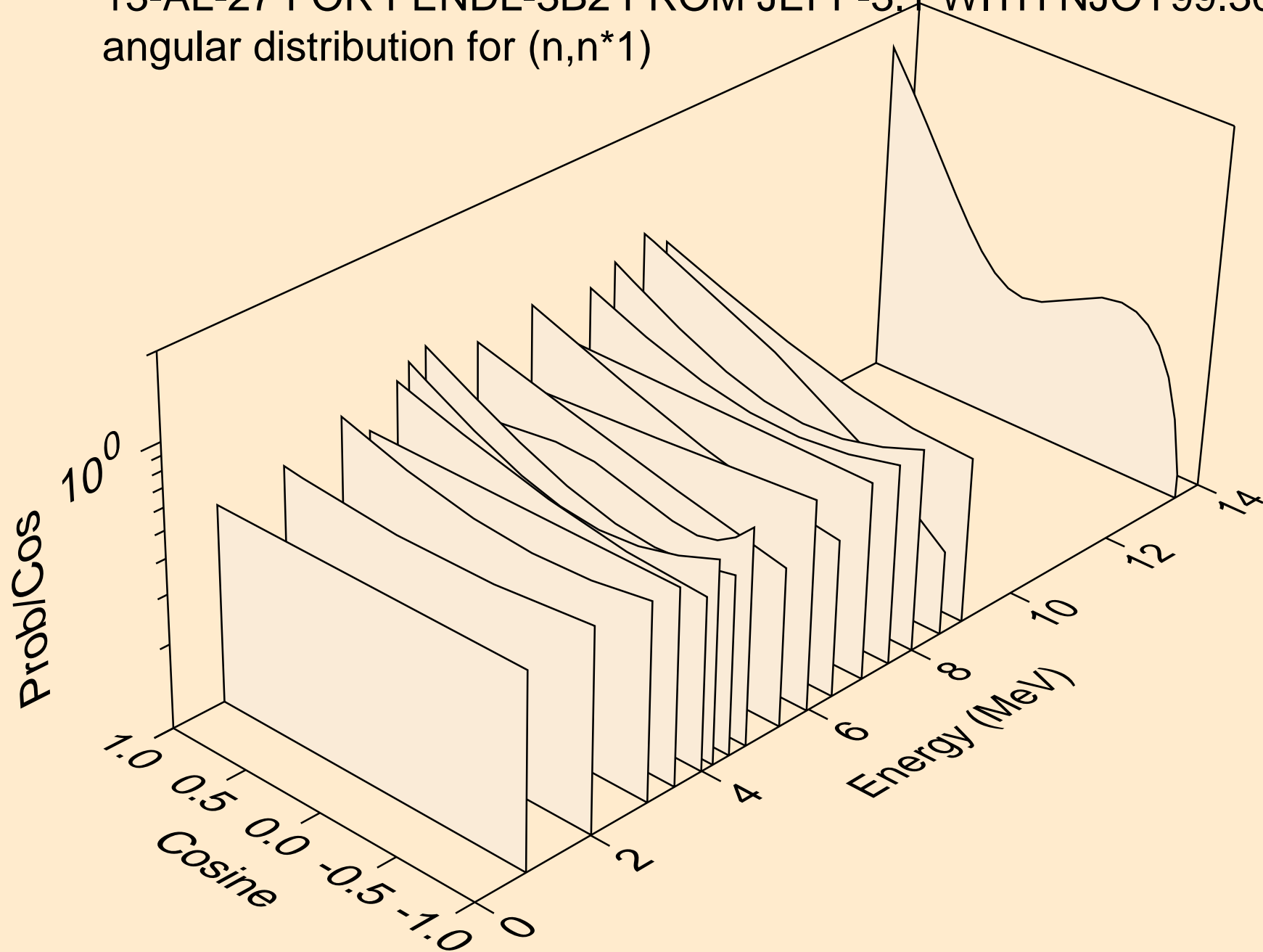

13-AL-27 FOR FENDL-3B2 FROM JEFF-3.1 WITH NJOY99.304+ C  
angular distribution for (n,n\*2)

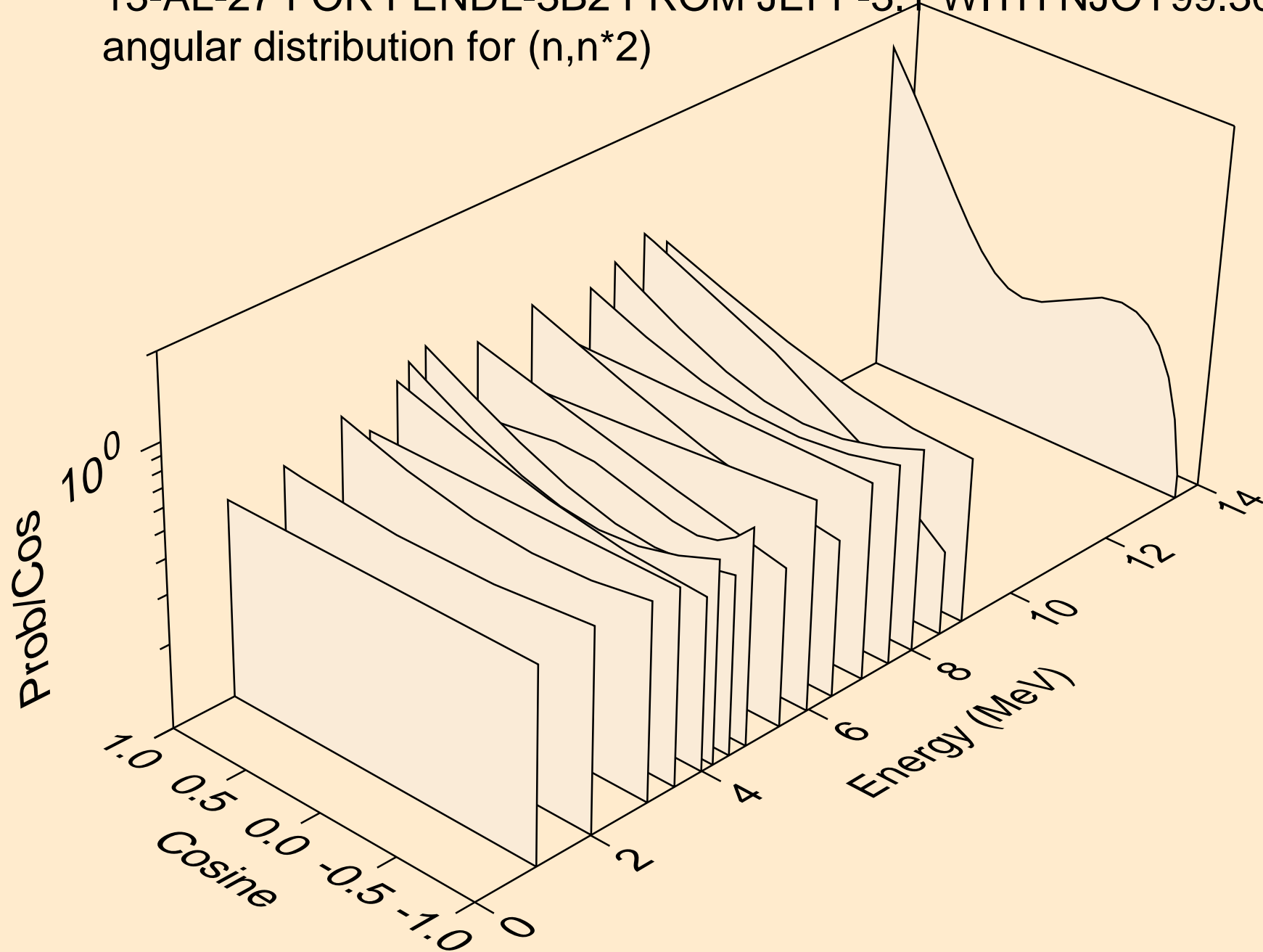



13-AL-27 FOR FENDL-3B2 FROM JEFF-3.1 WITH NJOY99.304+ C  
angular distribution for (n,n\*3)

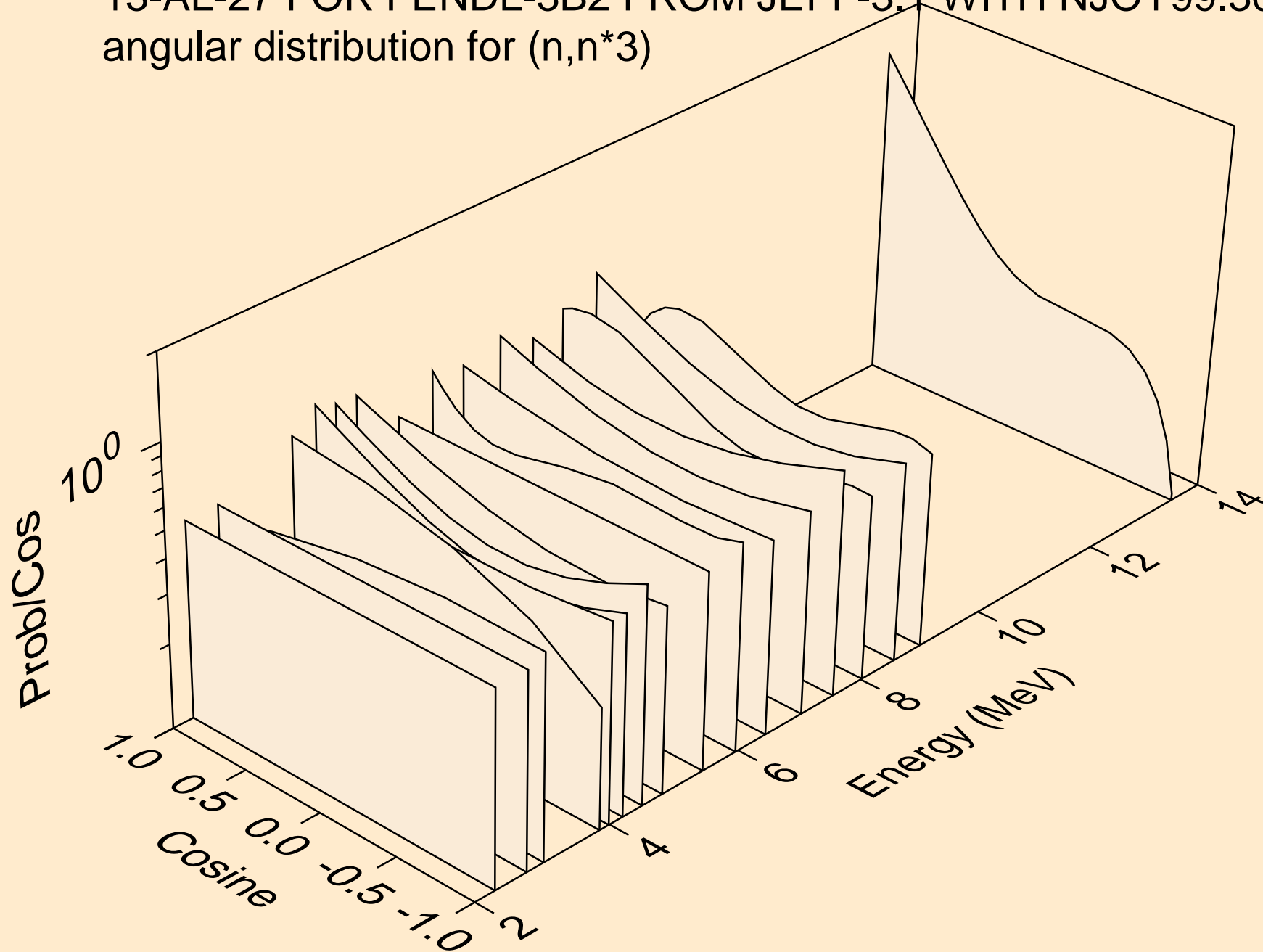

13-AL-27 FOR FENDL-3B2 FROM JEFF-3.1 WITH NJOY99.304+ C  
angular distribution for (n,n\*4)

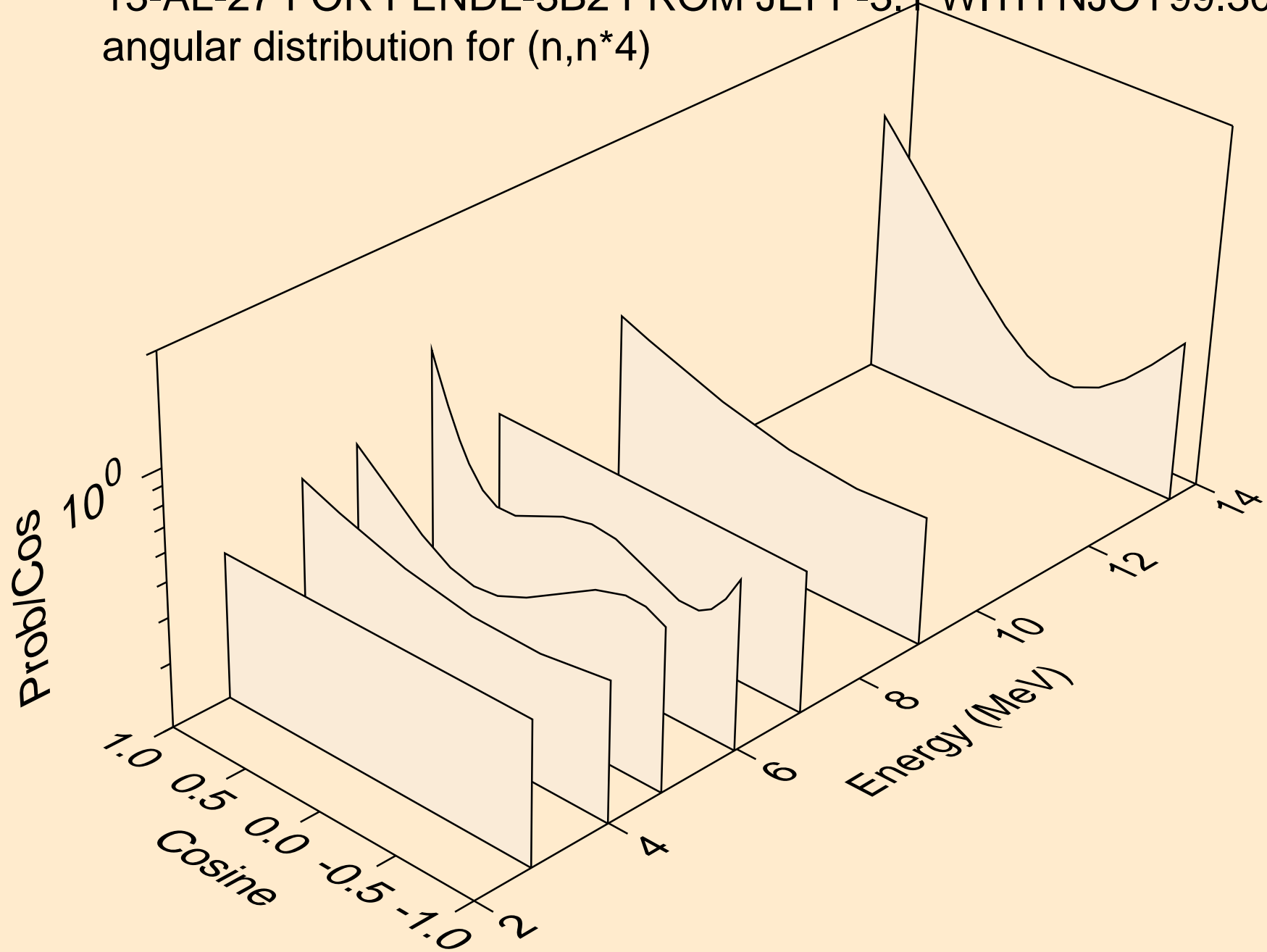

13-AL-27 FOR FENDL-3B2 FROM JEFF-3.1 WITH NJOY99.304+ C  
angular distribution for (n,n\*5)

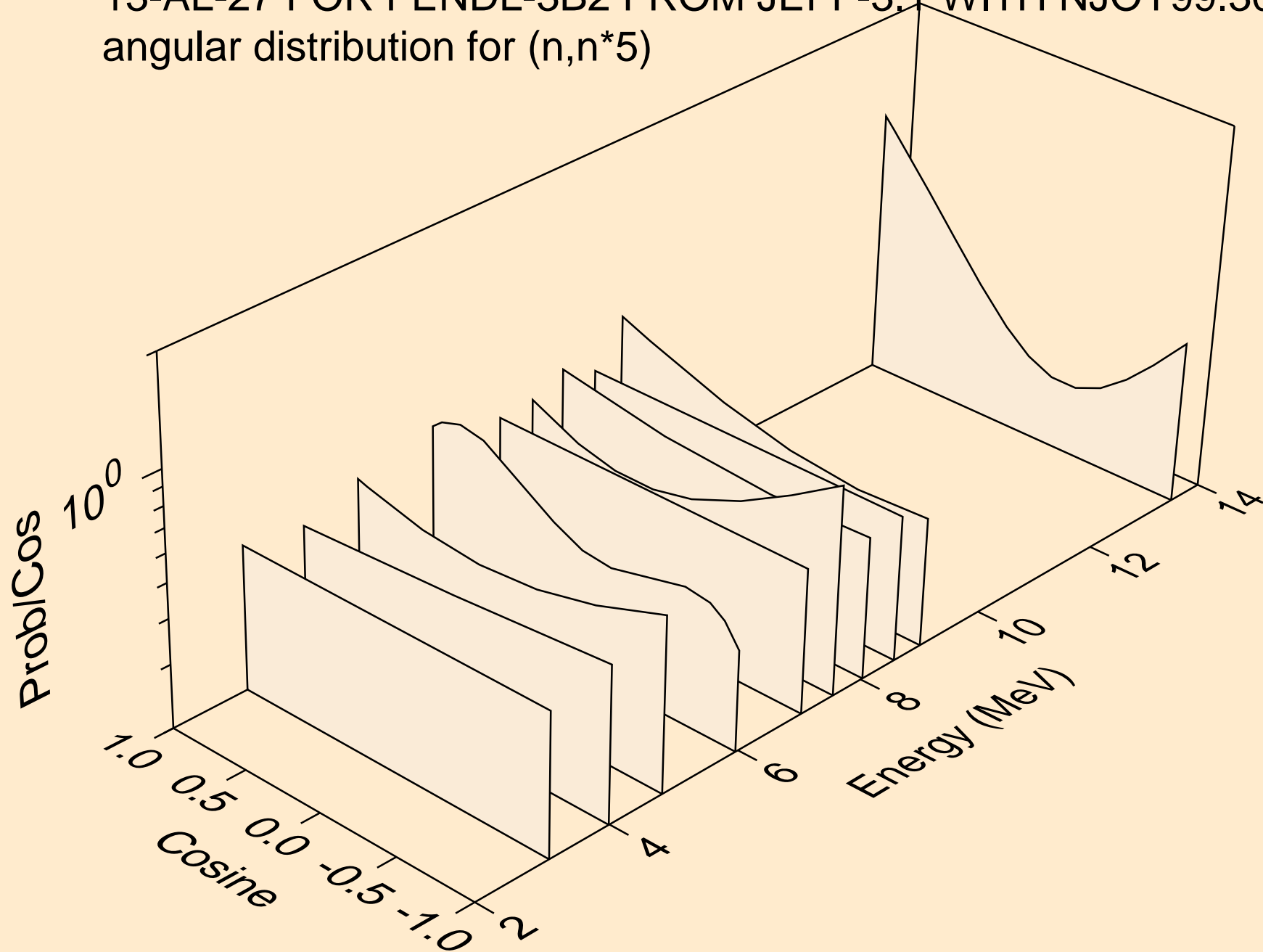

13-AL-27 FOR FENDL-3B2 FROM JEFF-3.1 WITH NJOY99.304+ C  
angular distribution for (n,n\*6)

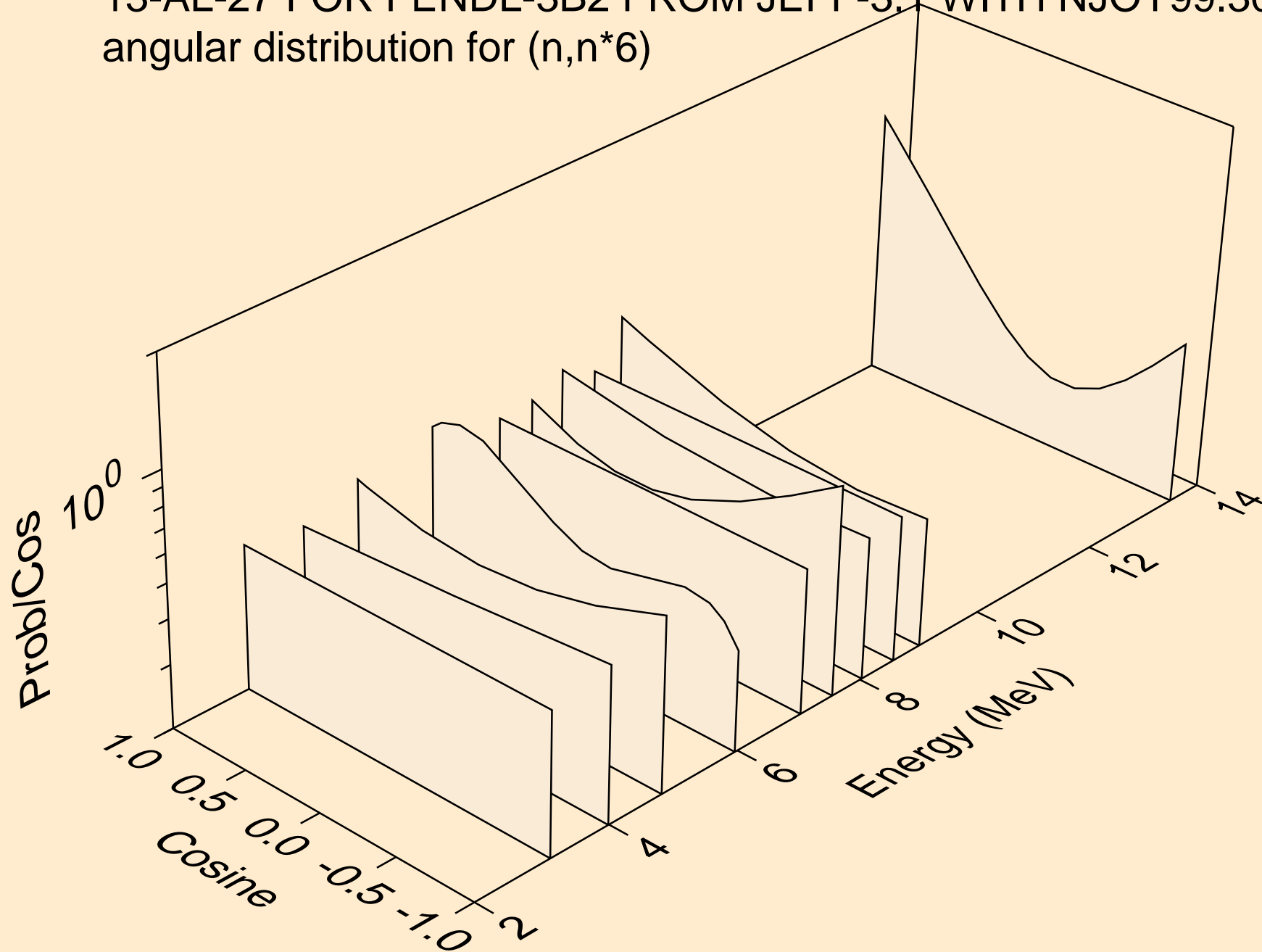

13-AL-27 FOR FENDL-3B2 FROM JEFF-3.1 WITH NJOY99.304+ C  
angular distribution for (n,n\*7)

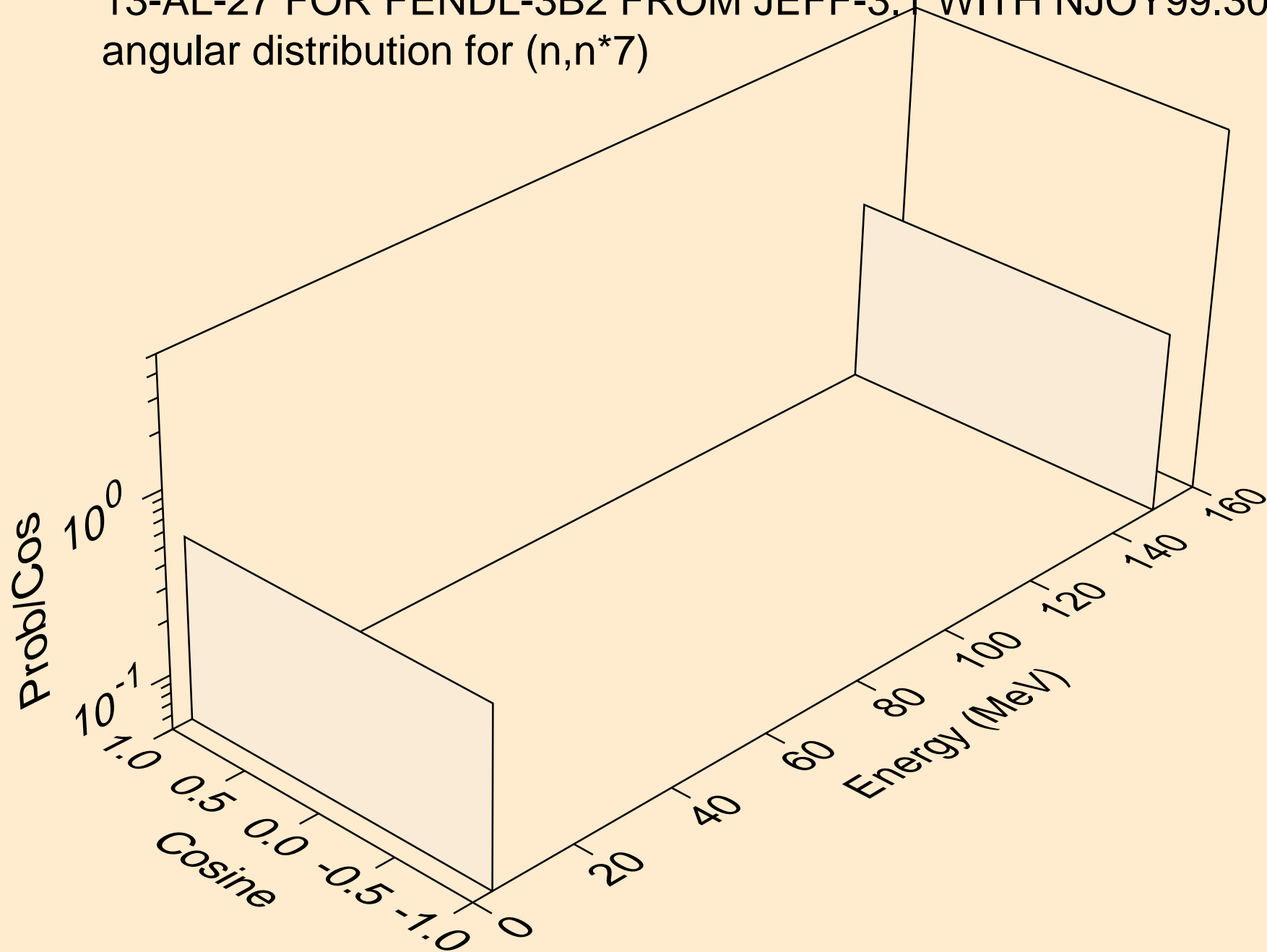

13-AL-27 FOR FENDL-3B2 FROM JEFF-3.1 WITH NJOY99.304+ C  
angular distribution for (n,n\*8)

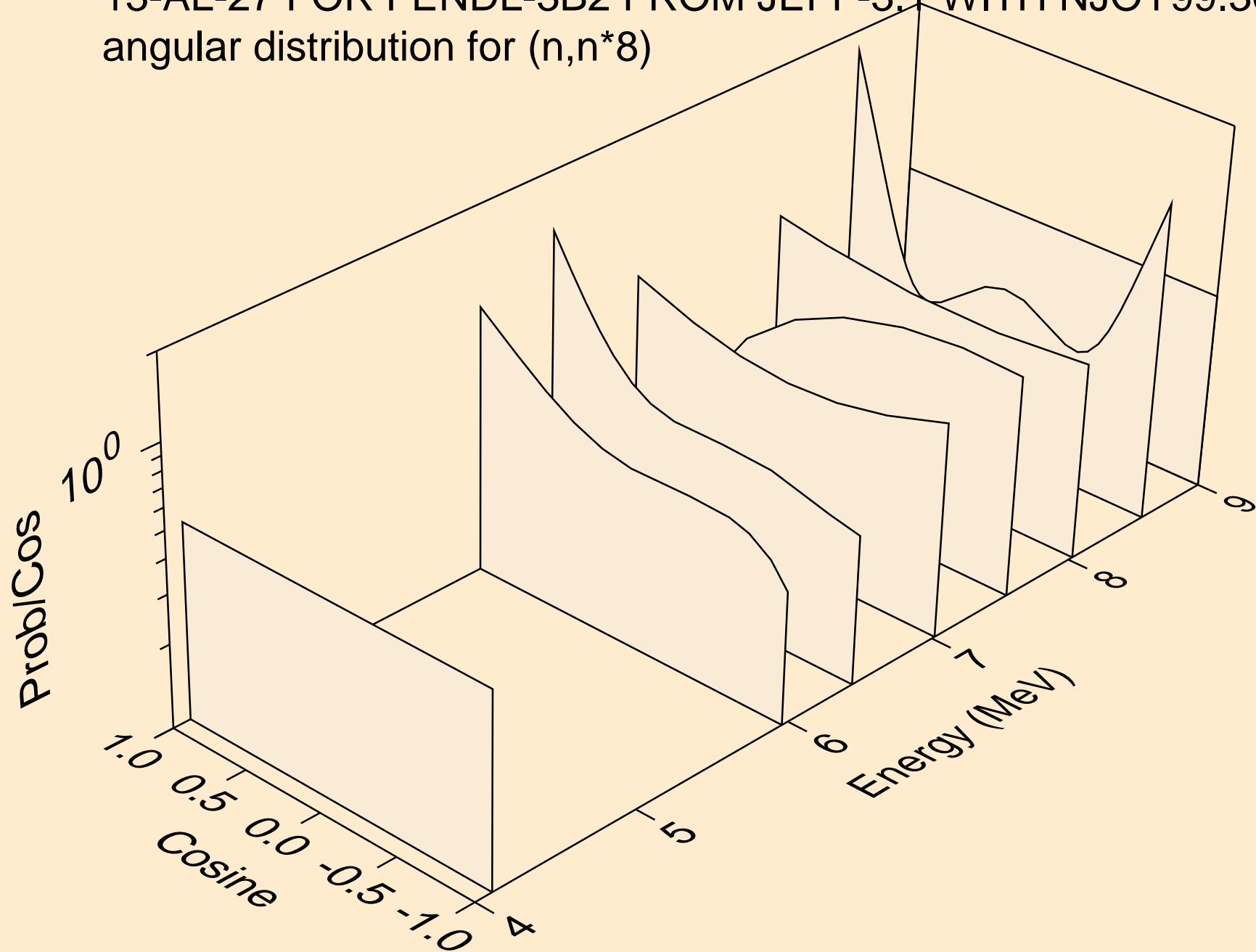

13-AL-27 FOR FENDL-3B2 FROM JEFF-3.1 WITH NJOY99.304+ C  
angular distribution for (n,n\*9)

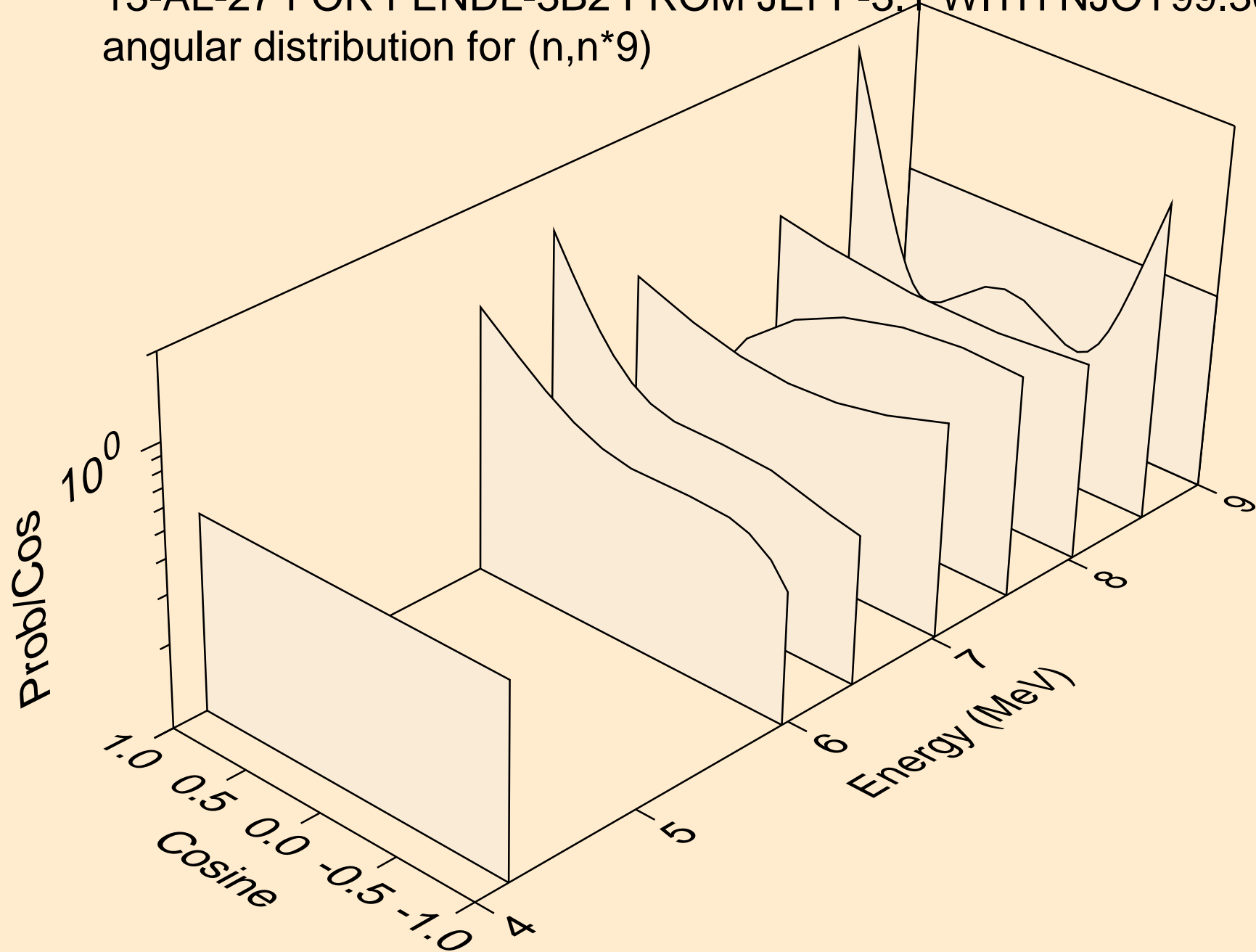

13-AL-27 FOR FENDL-3B2 FROM JEFF-3.1 WITH NJOY99.304+ C  
angular distribution for (n,n\*10)

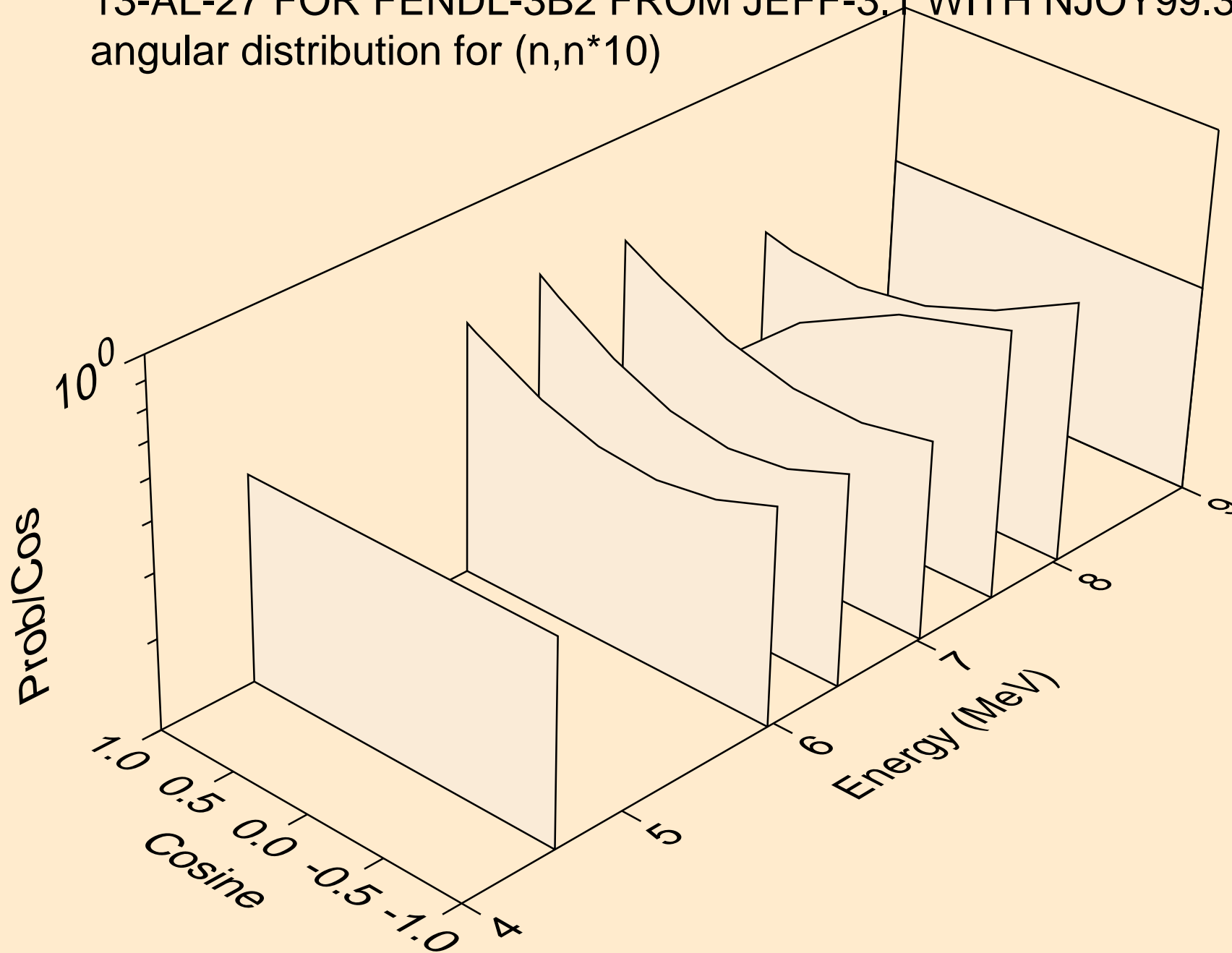



13-AL-27 FOR FENDL-3B2 FROM JEFF-3.1 WITH NJOY99.304+ C  
angular distribution for (n,n\*11)

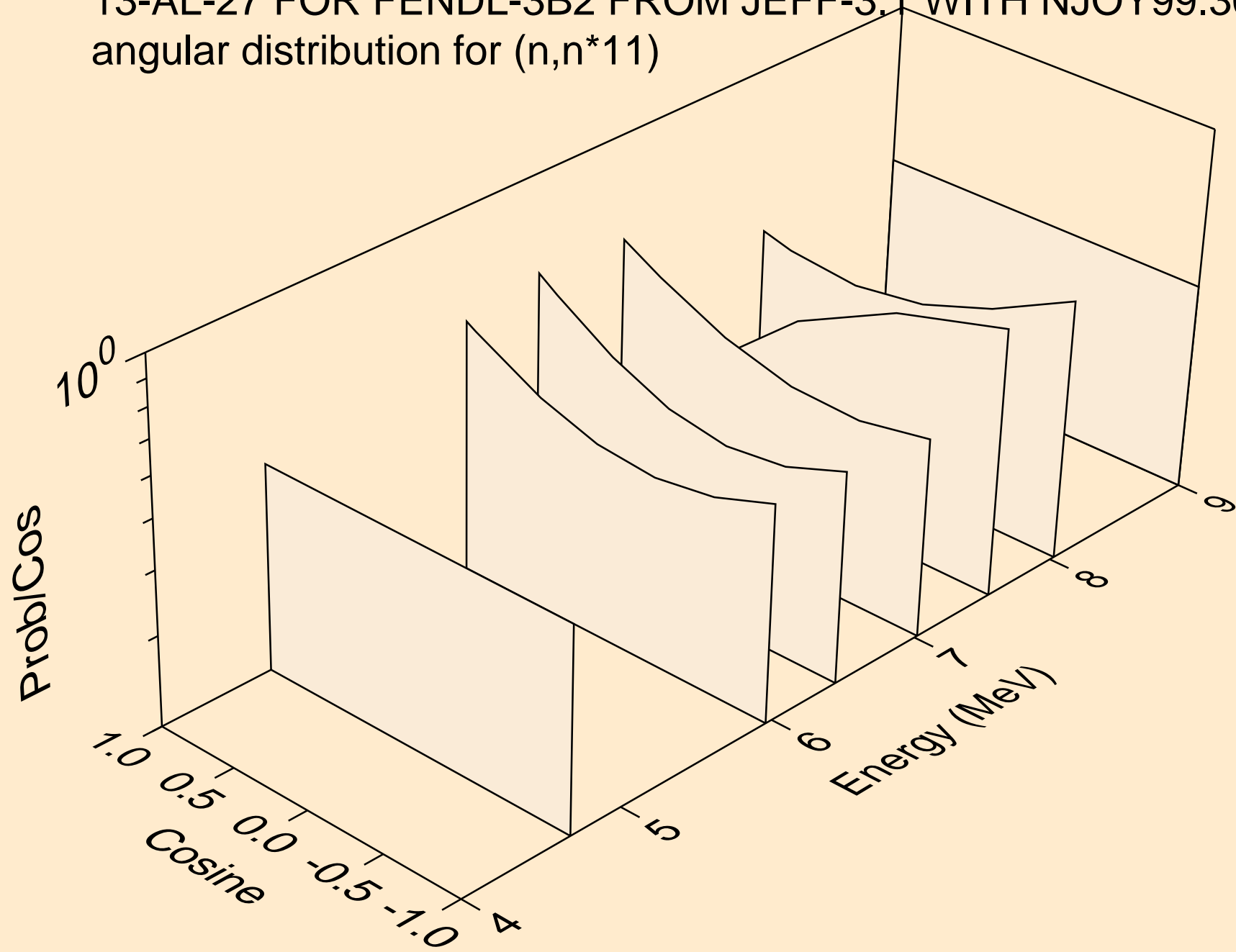

13-AL-27 FOR FENDL-3B2 FROM JEFF-3.1 WITH NJOY99.304+ C  
angular distribution for (n,n\*12)

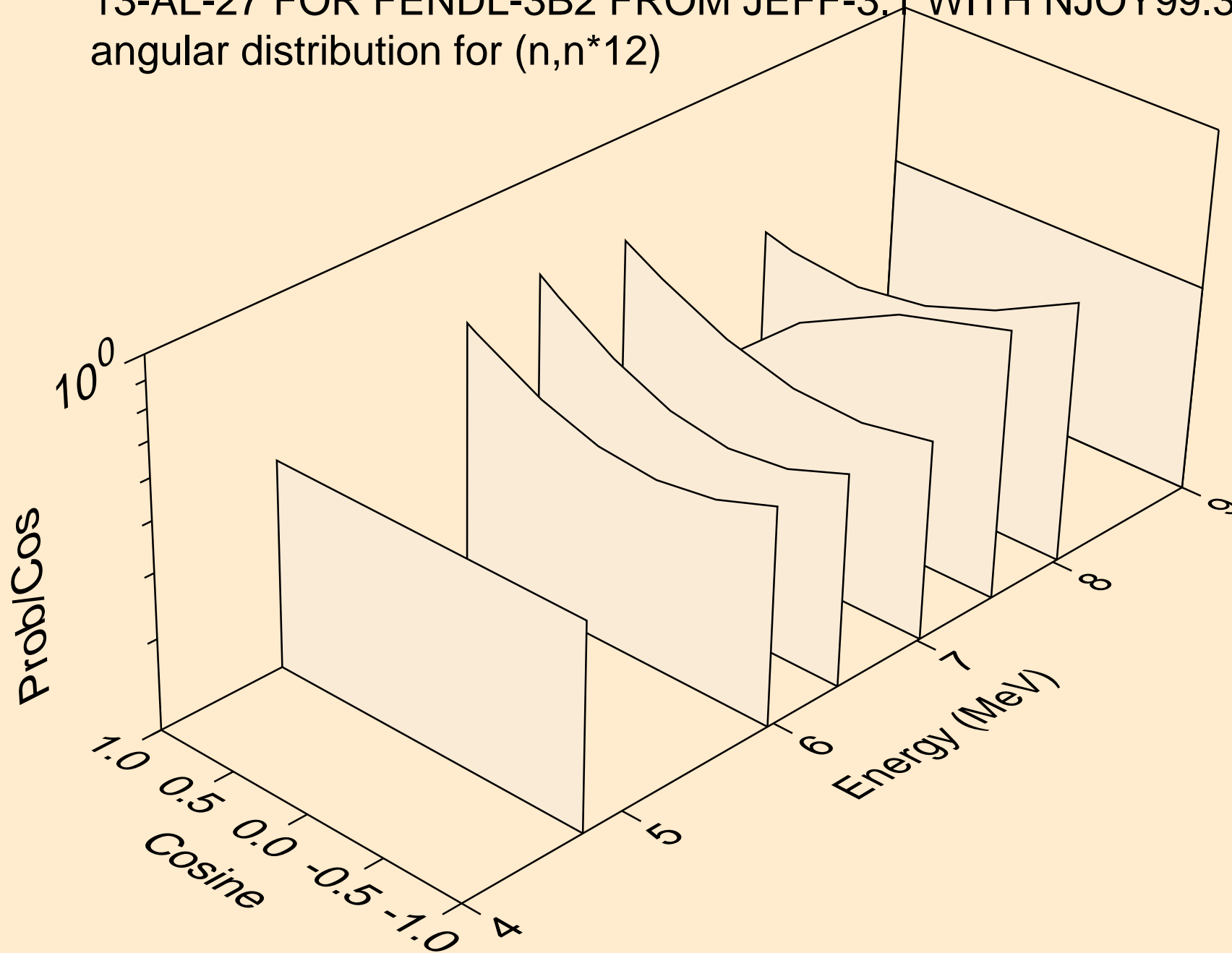

13-AL-27 FOR FENDL-3B2 FROM JEFF-3.1 WITH NJOY99.304+ C  
angular distribution for (n,n\*13)

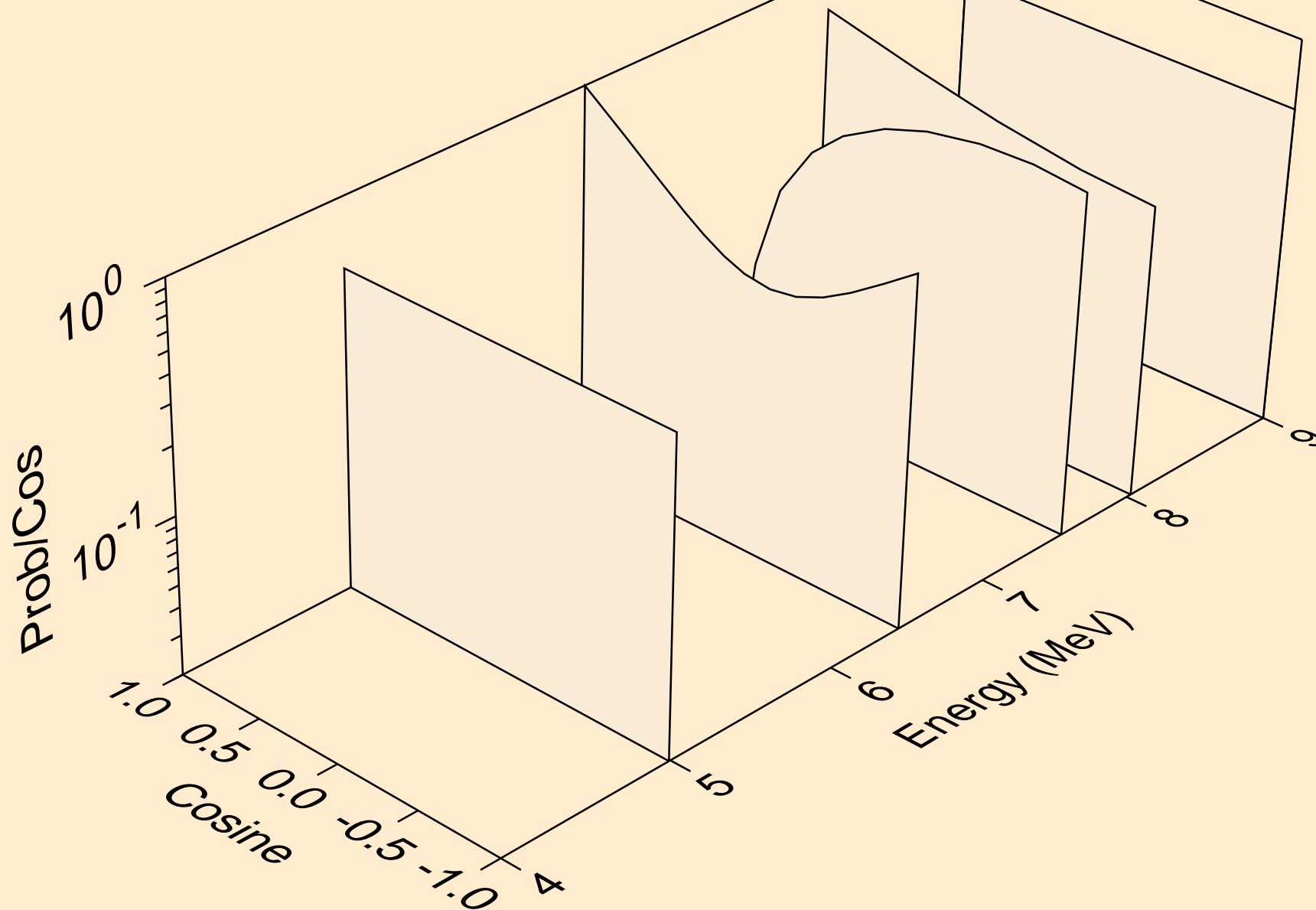

13-AL-27 FOR FENDL-3B2 FROM JEFF-3.1 WITH NJOY99.304+ C  
angular distribution for (n,n\*14)

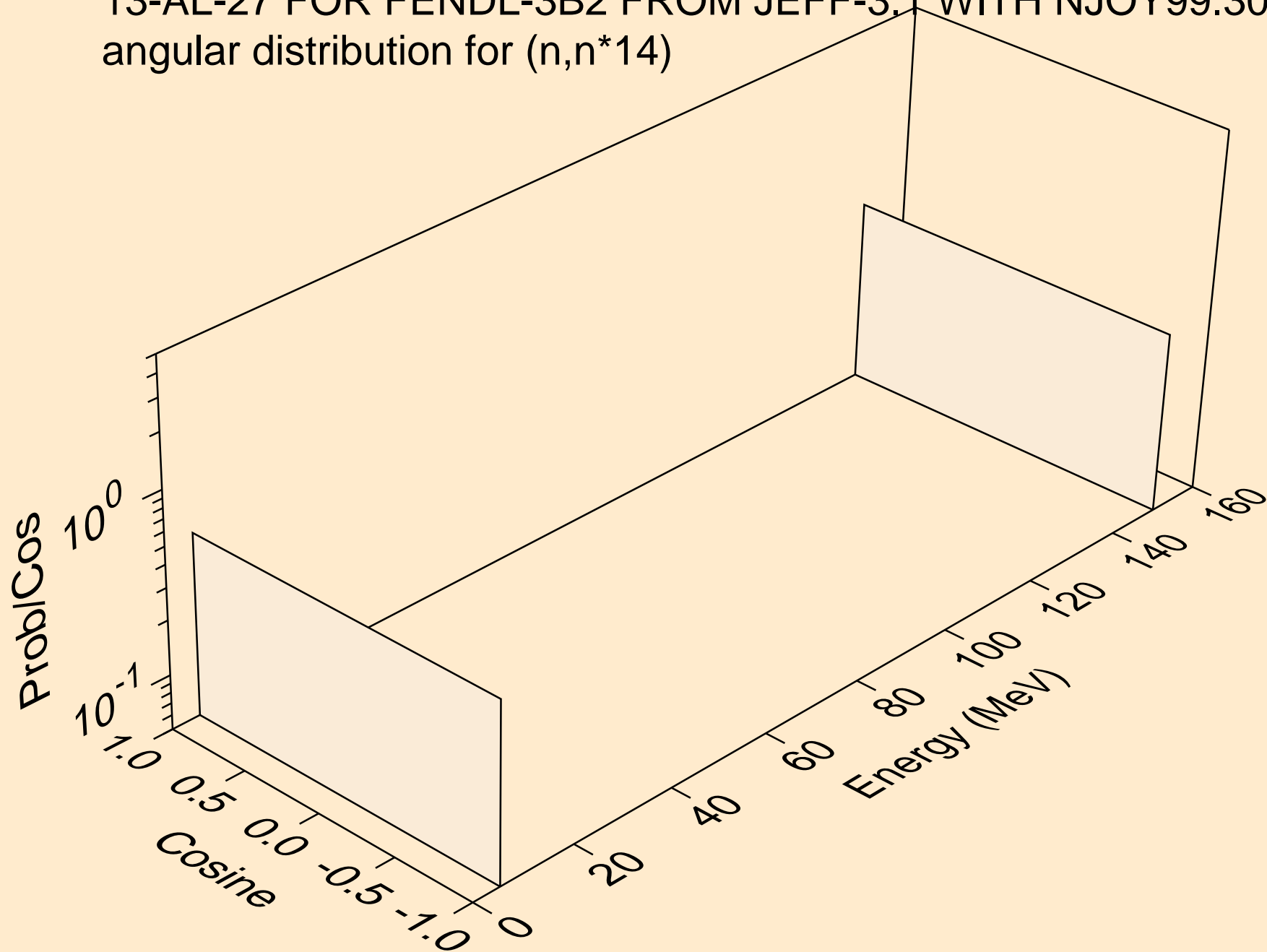

13-AL-27 FOR FENDL-3B2 FROM JEFF-3.1 WITH NJOY99.304+ C  
angular distribution for (n,n\*15)

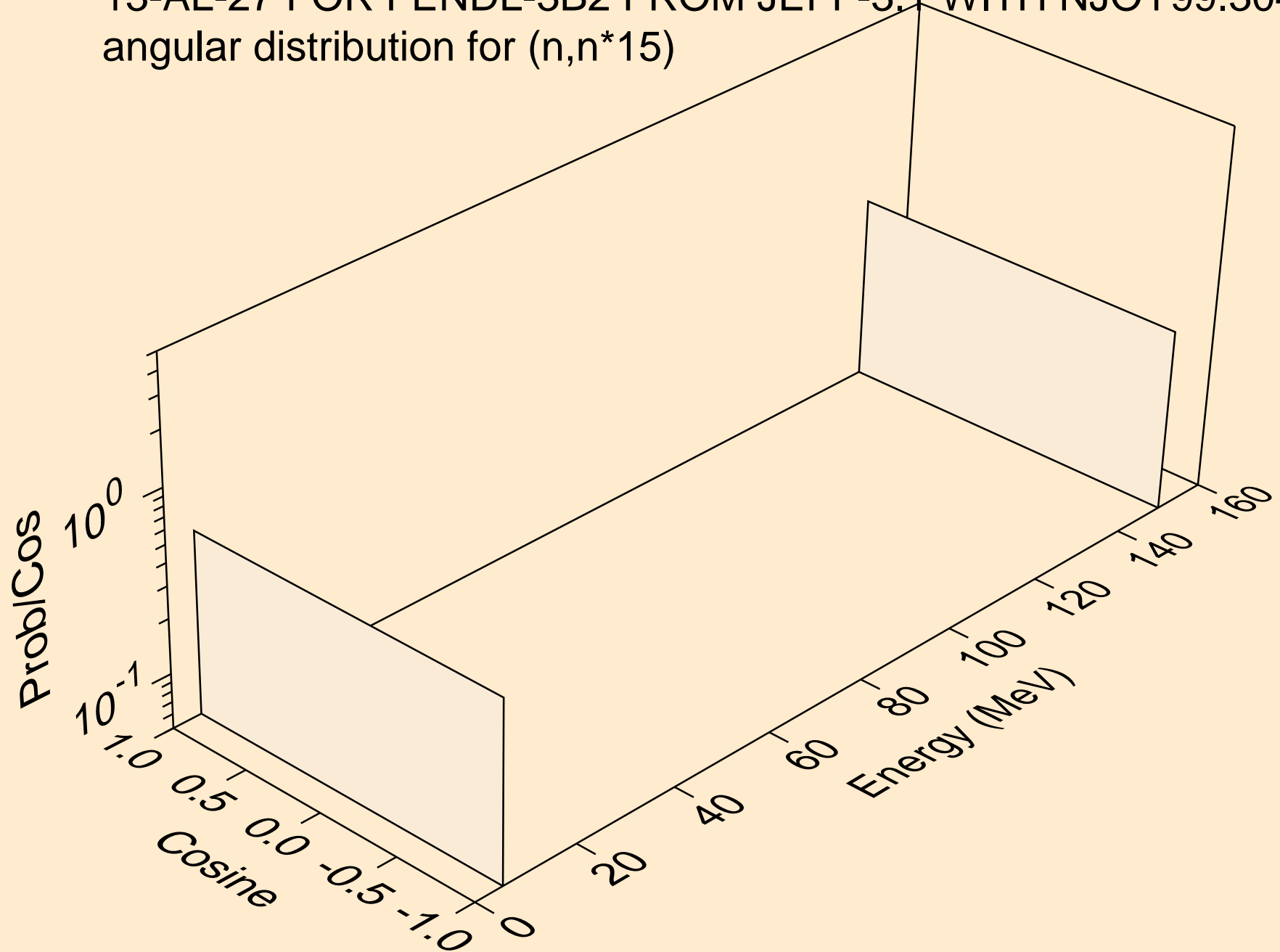

13-AL-27 FOR FENDL-3B2 FROM JEFF-3.1 WITH NJOY99.304+ C  
angular distribution for (n,n\*16)

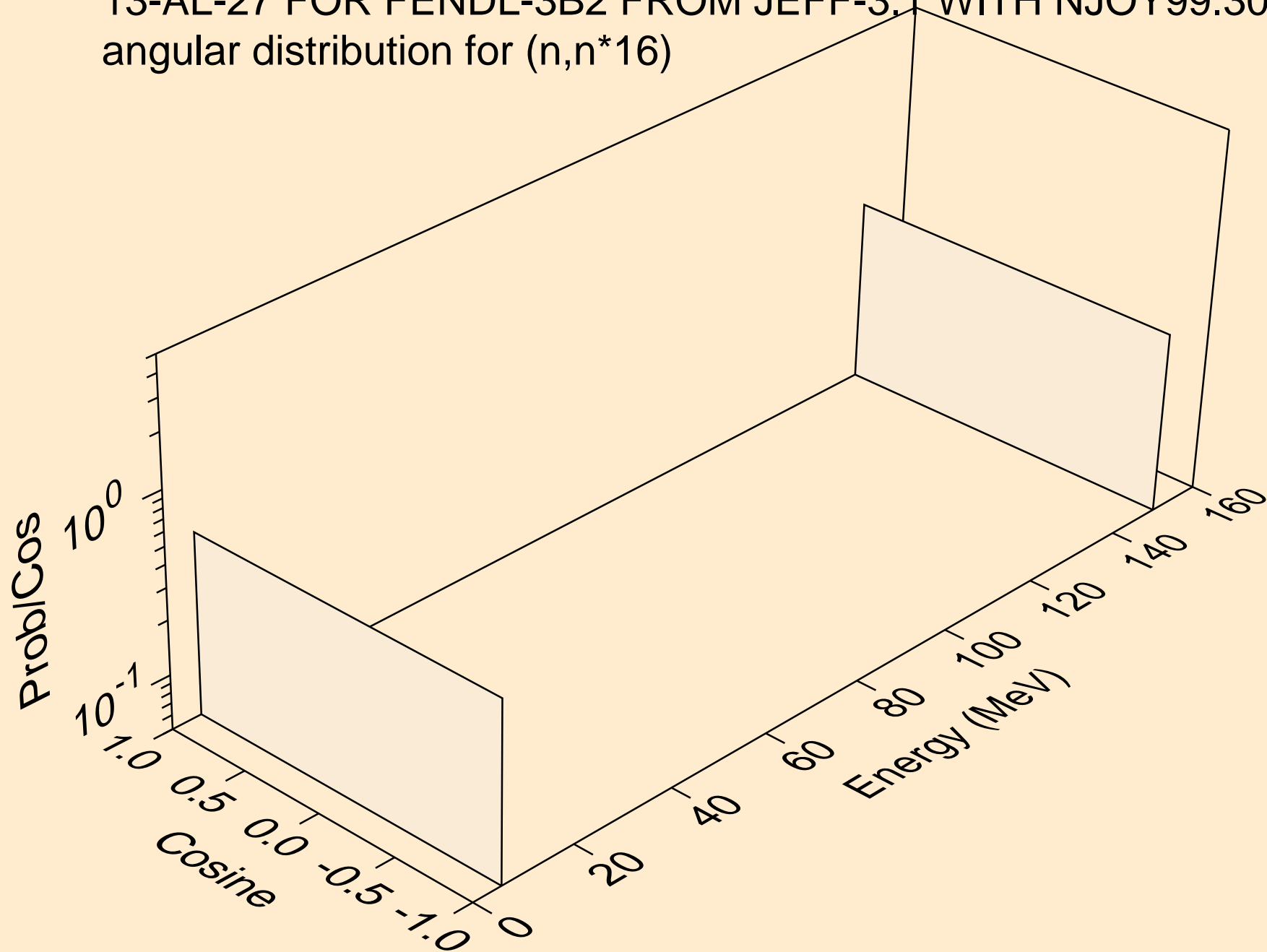

13-AL-27 FOR FENDL-3B2 FROM JEFF-3.1 WITH NJOY99.304+ C  
angular distribution for (n,n\*17)

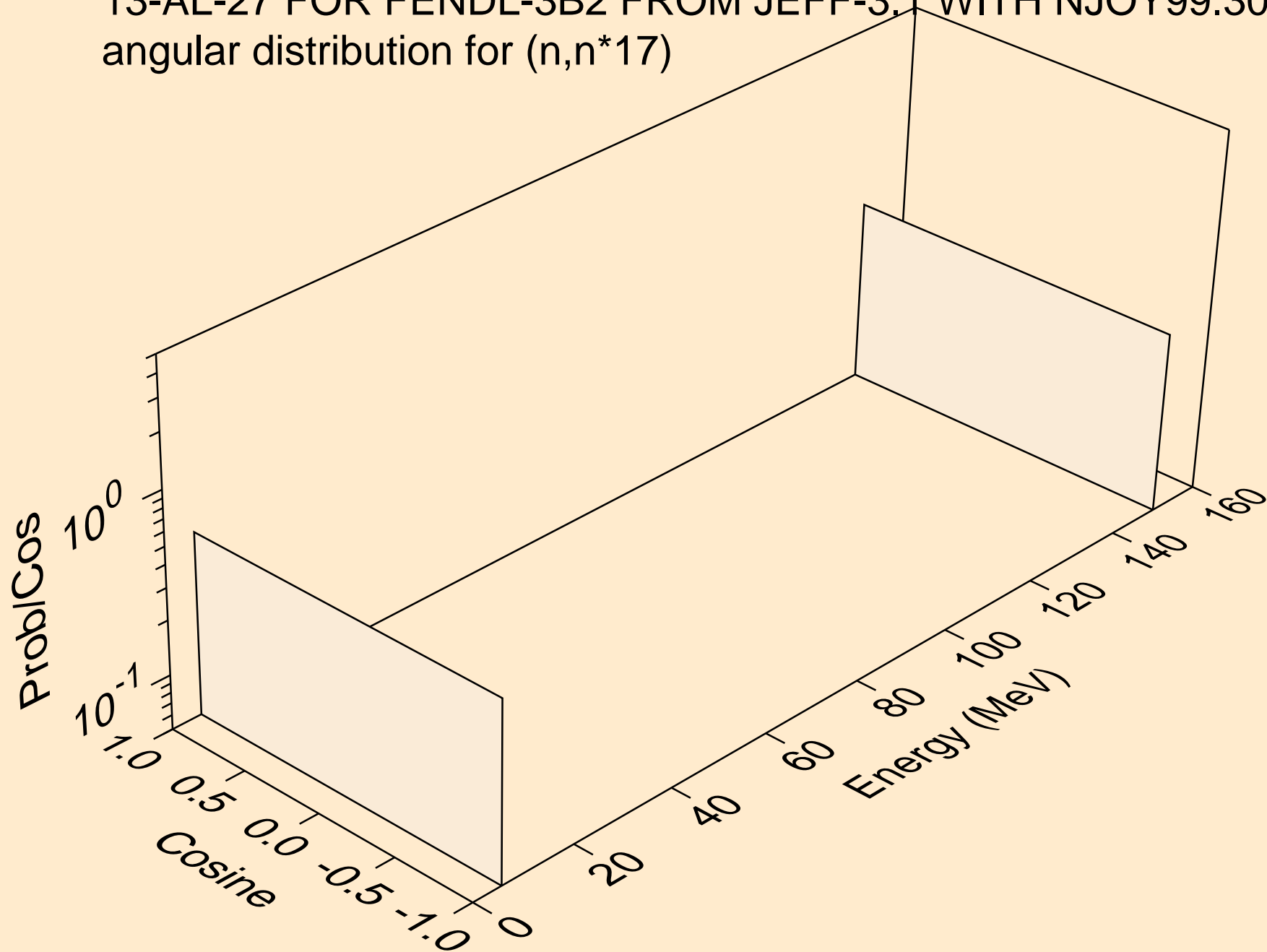

13-AL-27 FOR FENDL-3B2 FROM JEFF-3.1 WITH NJOY99.304+ C  
angular distribution for (n,n\*18)

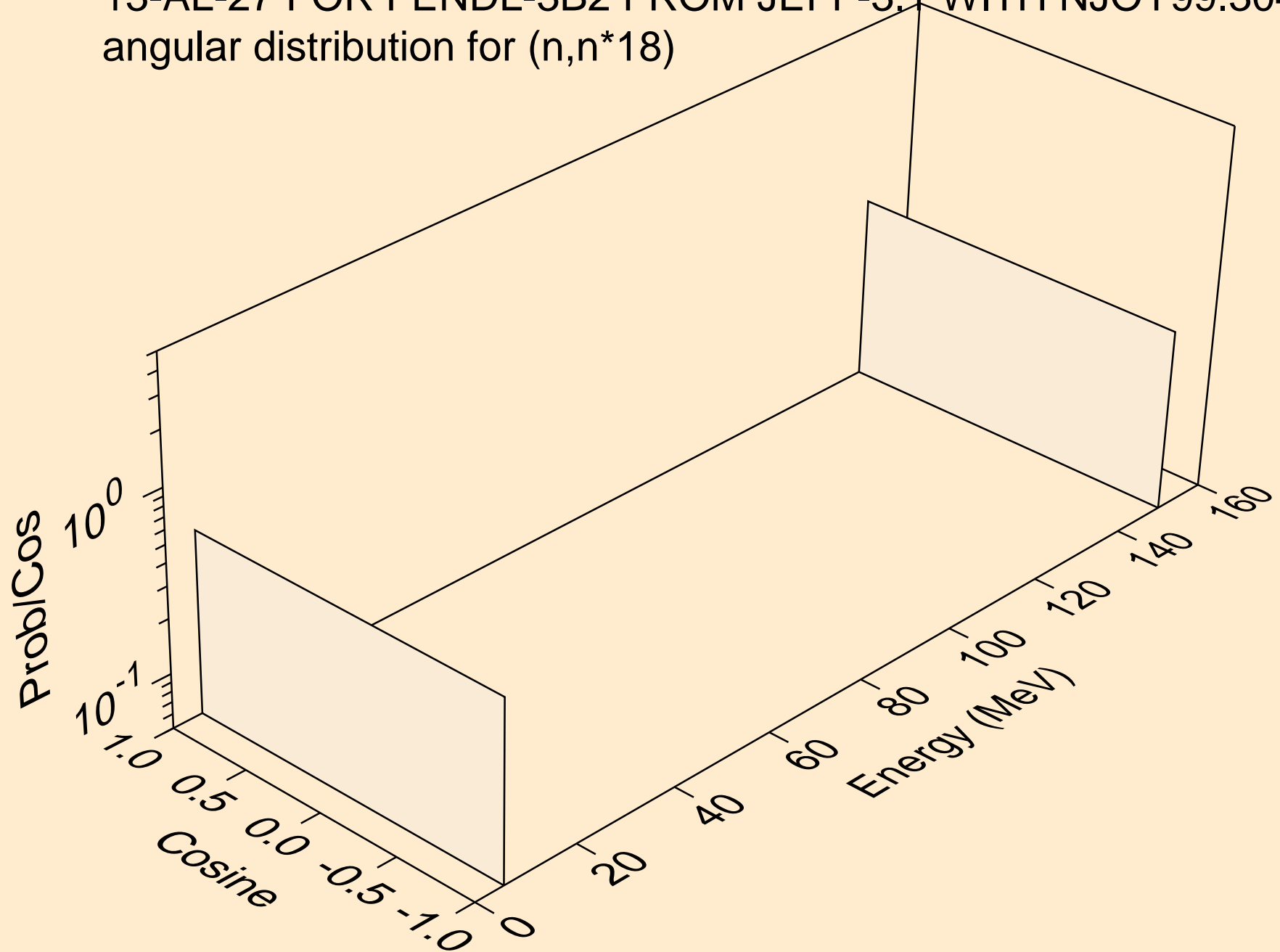



13-AL-27 FOR FENDL-3B2 FROM JEFF-3.1 WITH NJOY99.304+ C  
angular distribution for (n,n\*19)

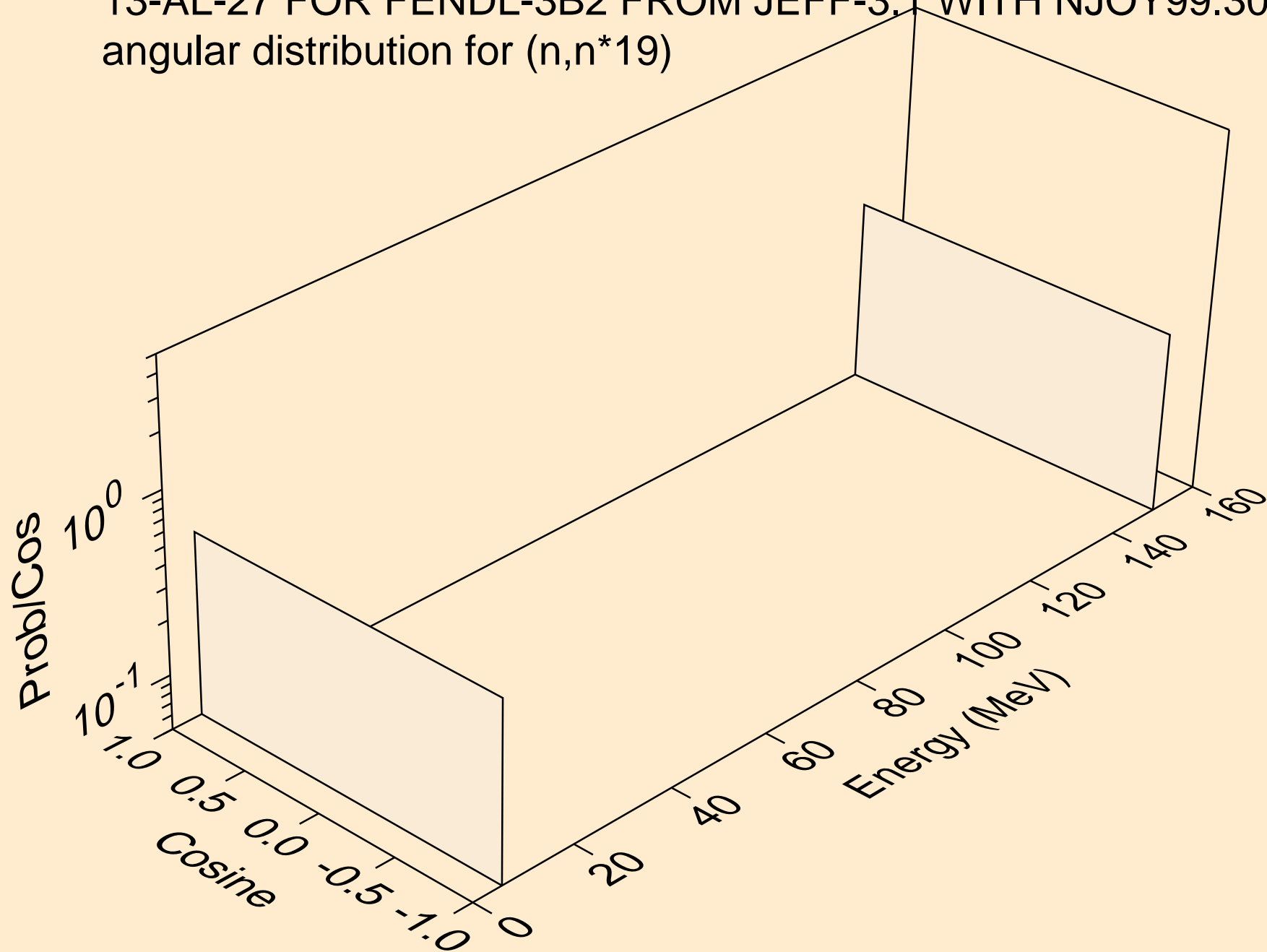

13-AL-27 FOR FENDL-3B2 FROM JEFF-3.1 WITH NJOY99.304+ C  
angular distribution for (n,n\*20)

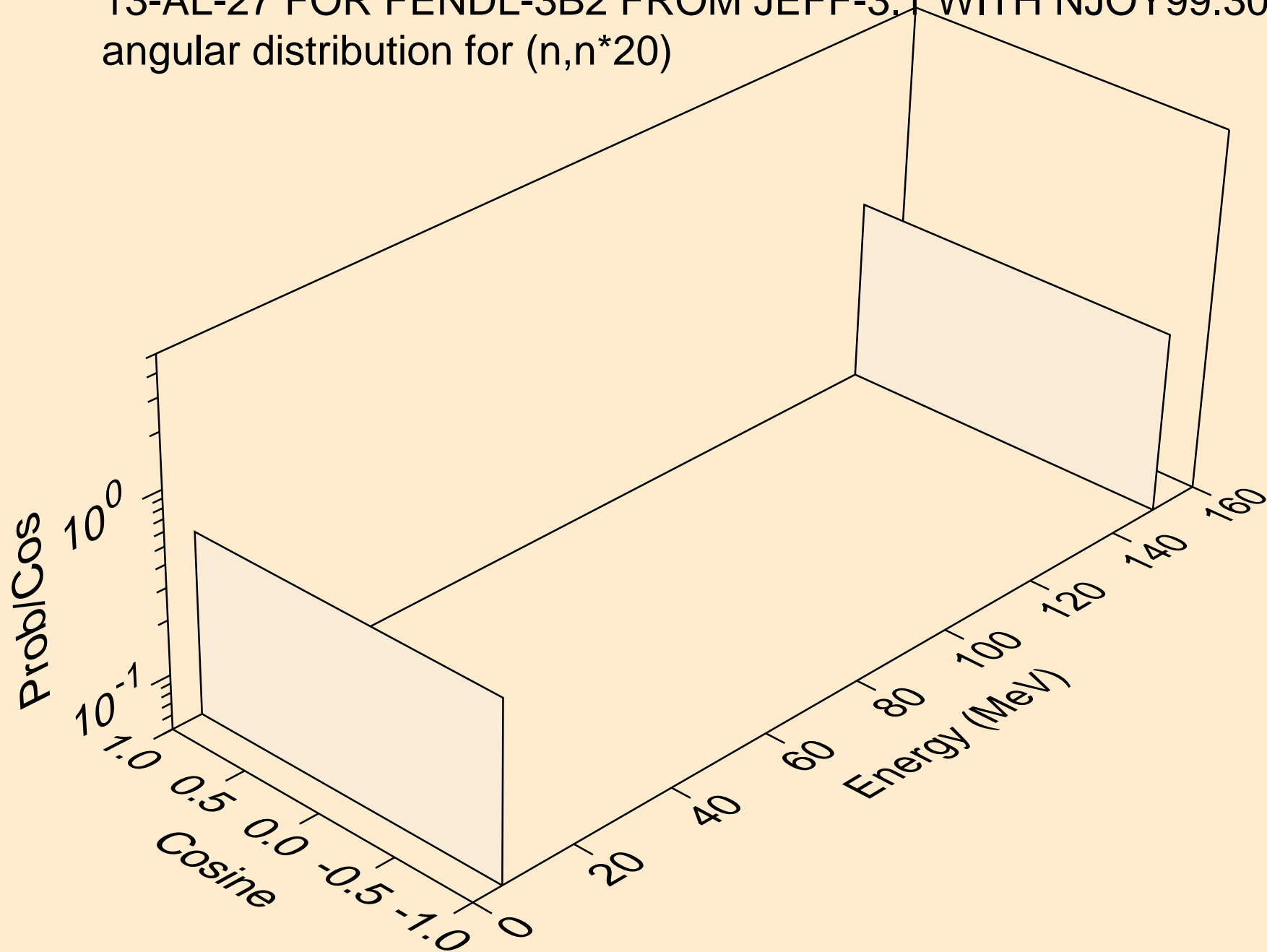

13-AL-27 FOR FENDL-3B2 FROM JEFF-3.1 WITH NJOY99.304+ C  
angular distribution for (n,n\*21)

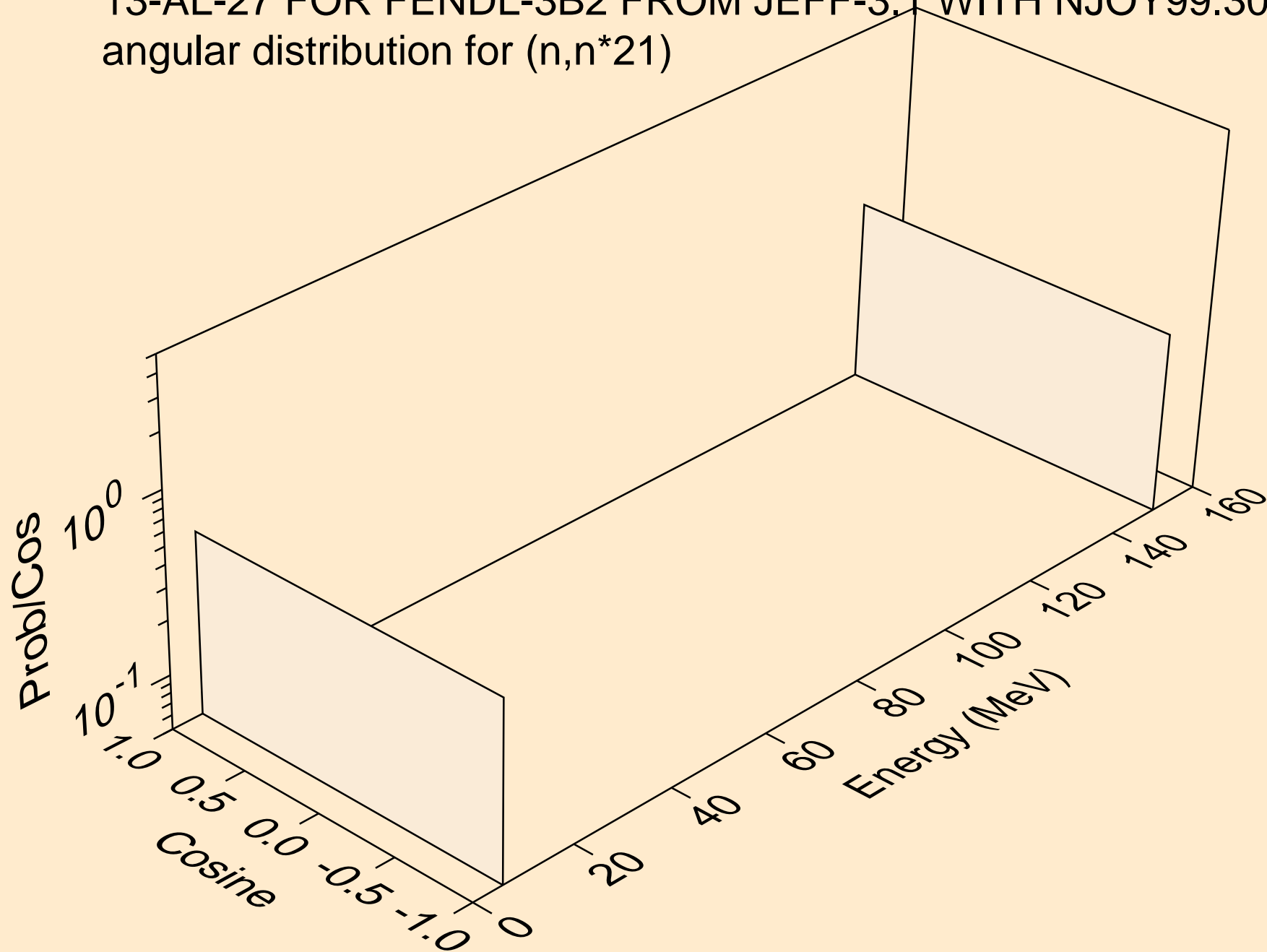

13-AL-27 FOR FENDL-3B2 FROM JEFF-3.1 WITH NJOY99.304+ C  
angular distribution for (n,n\*22)

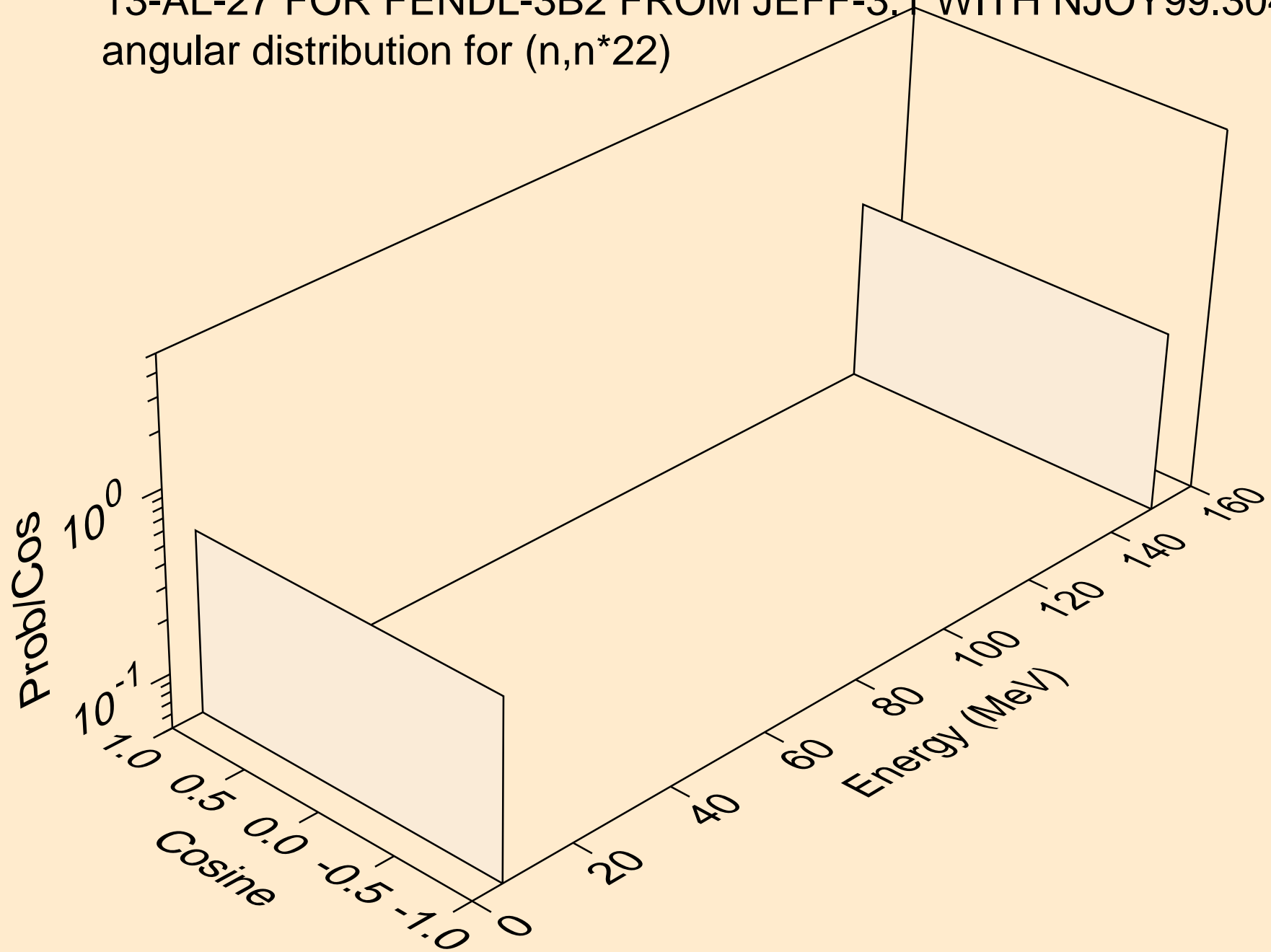

13-AL-27 FOR FENDL-3B2 FROM JEFF-3.1 WITH NJOY99.304+ C  
angular distribution for (n,n\*23)

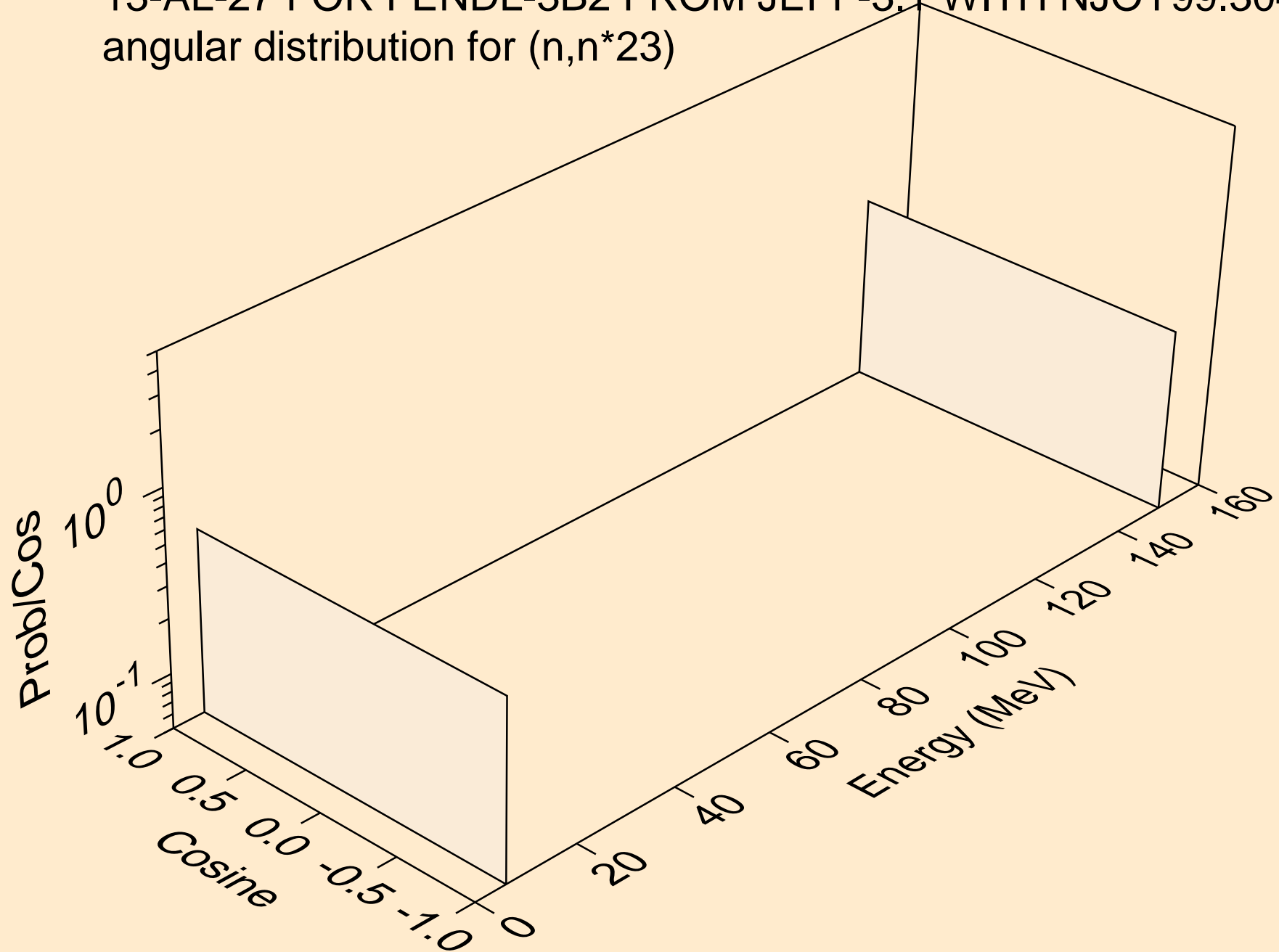

13-AL-27 FOR FENDL-3B2 FROM JEFF-3.1 WITH NJOY99.304+ C  
angular distribution for (n,n\*24)

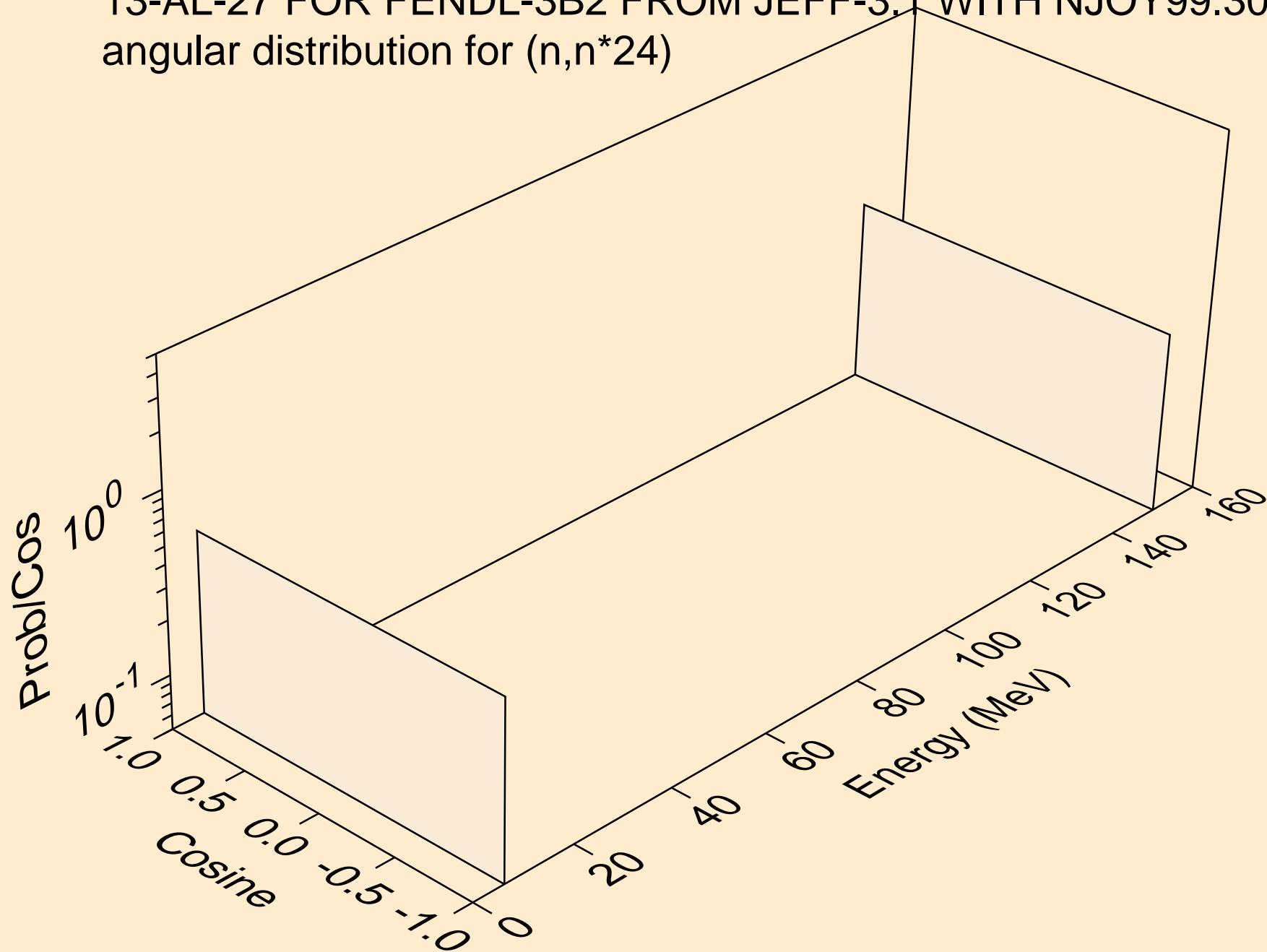

13-AL-27 FOR FENDL-3B2 FROM JEFF-3.1 WITH NJOY99.304+ C  
angular distribution for (n,n\*25)

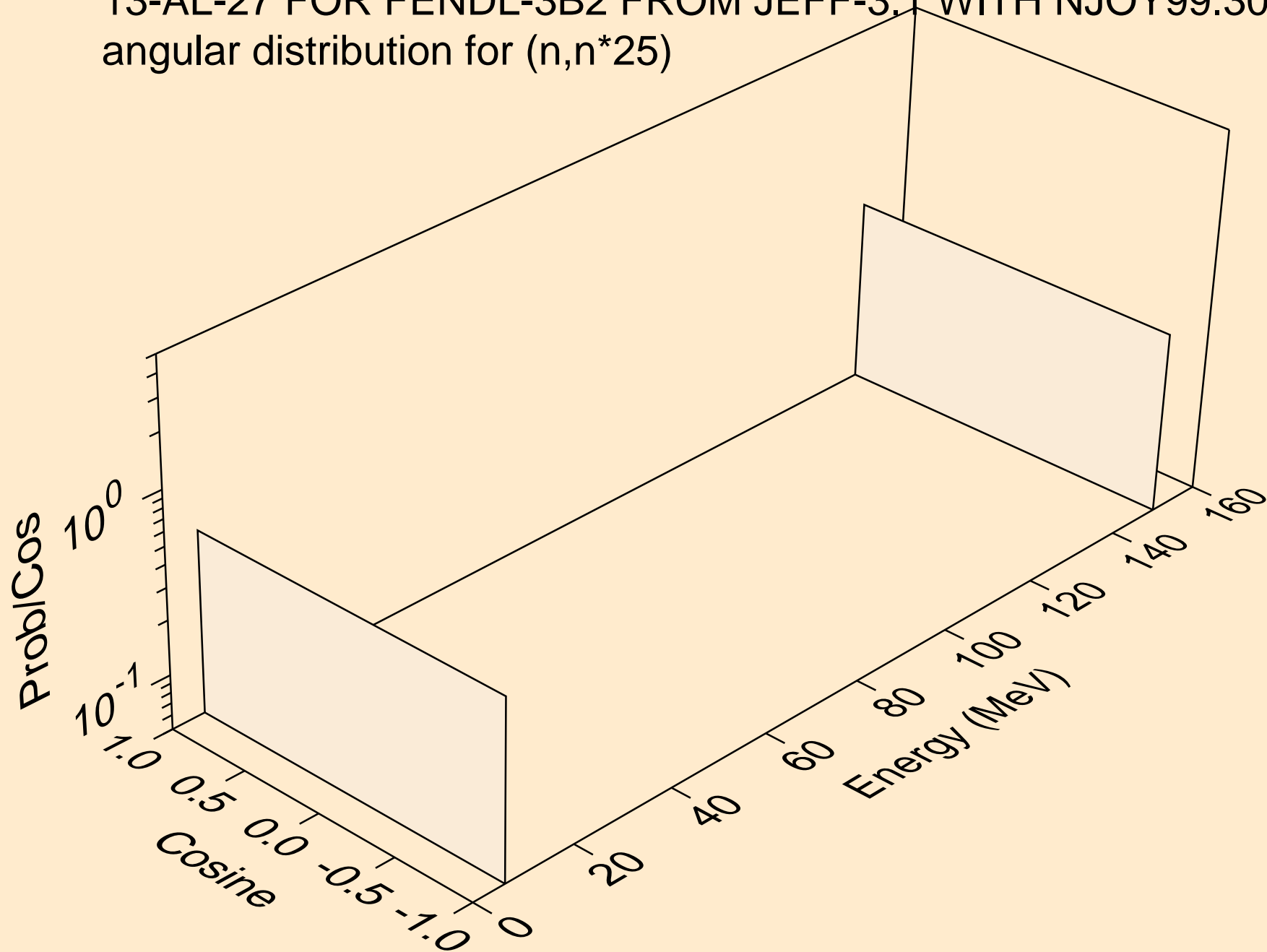

13-AL-27 FOR FENDL-3B2 FROM JEFF-3.1 WITH NJOY99.304+ C  
angular distribution for (n,n\*26)

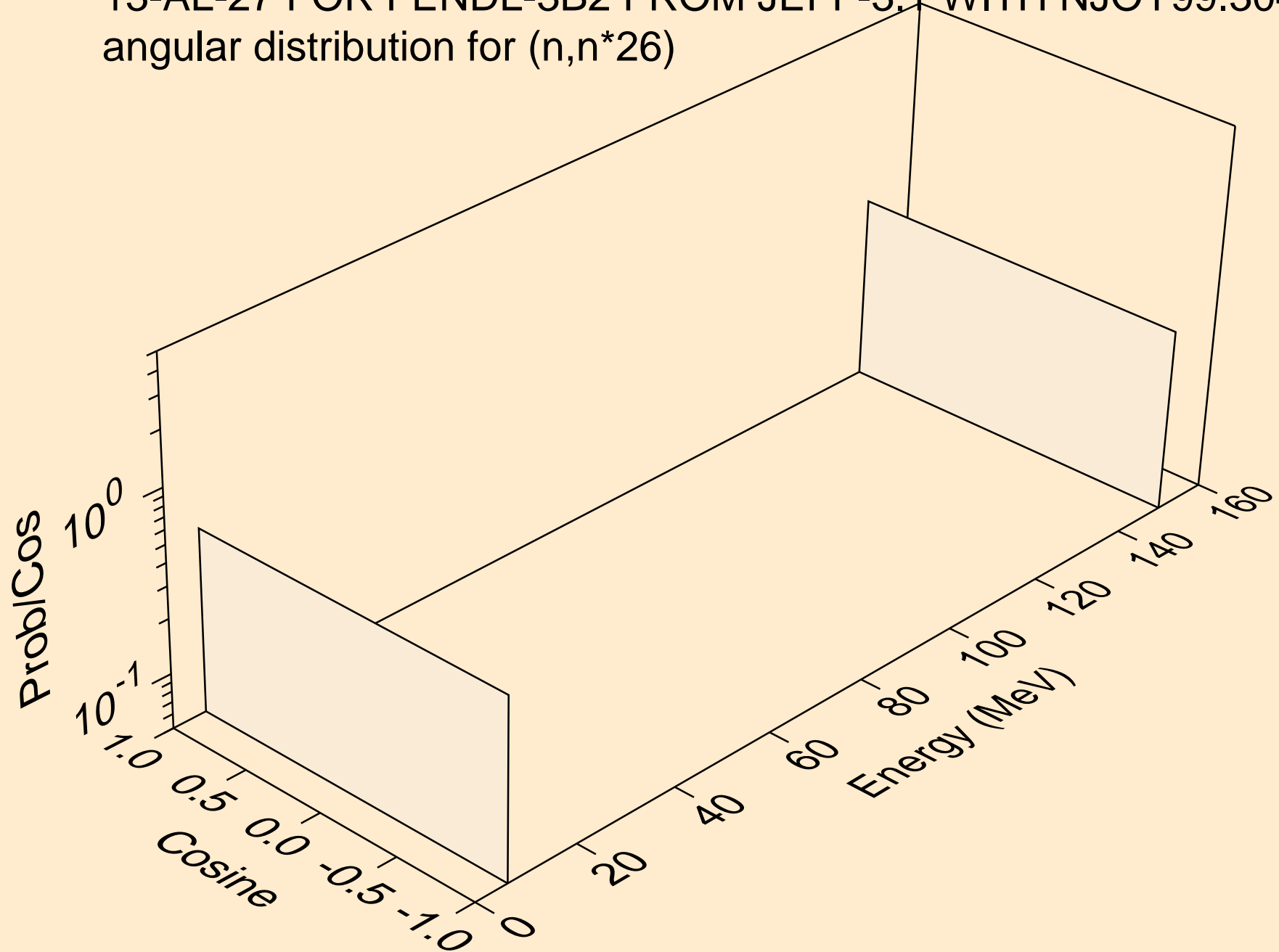



13-AL-27 FOR FENDL-3B2 FROM JEFF-3.1 WITH NJOY99.304+ C  
angular distribution for (n,n\*27)

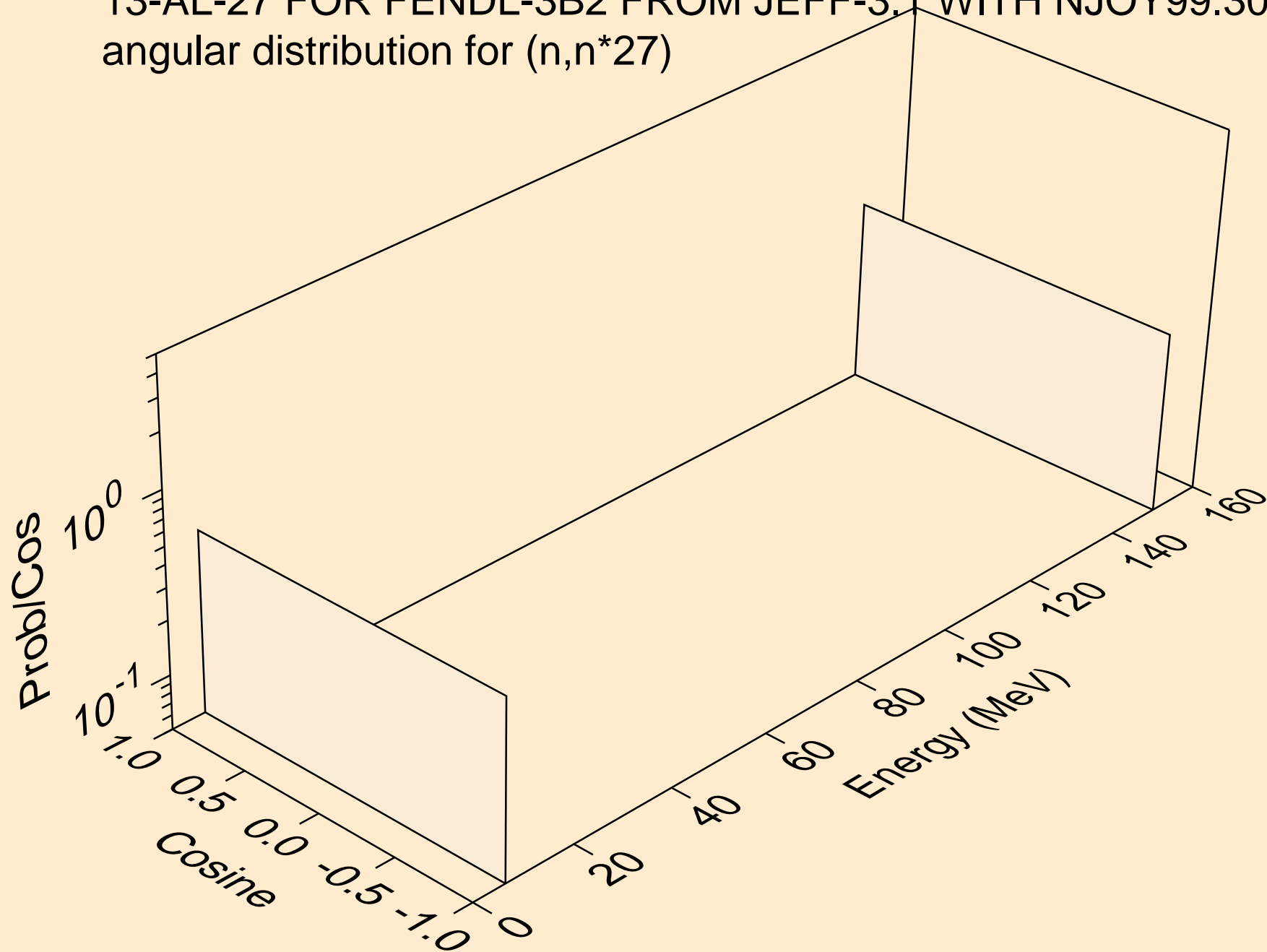

13-AL-27 FOR FENDL-3B2 FROM JEFF-3.1 WITH NJOY99.304+ C  
angular distribution for (n,n\*28)

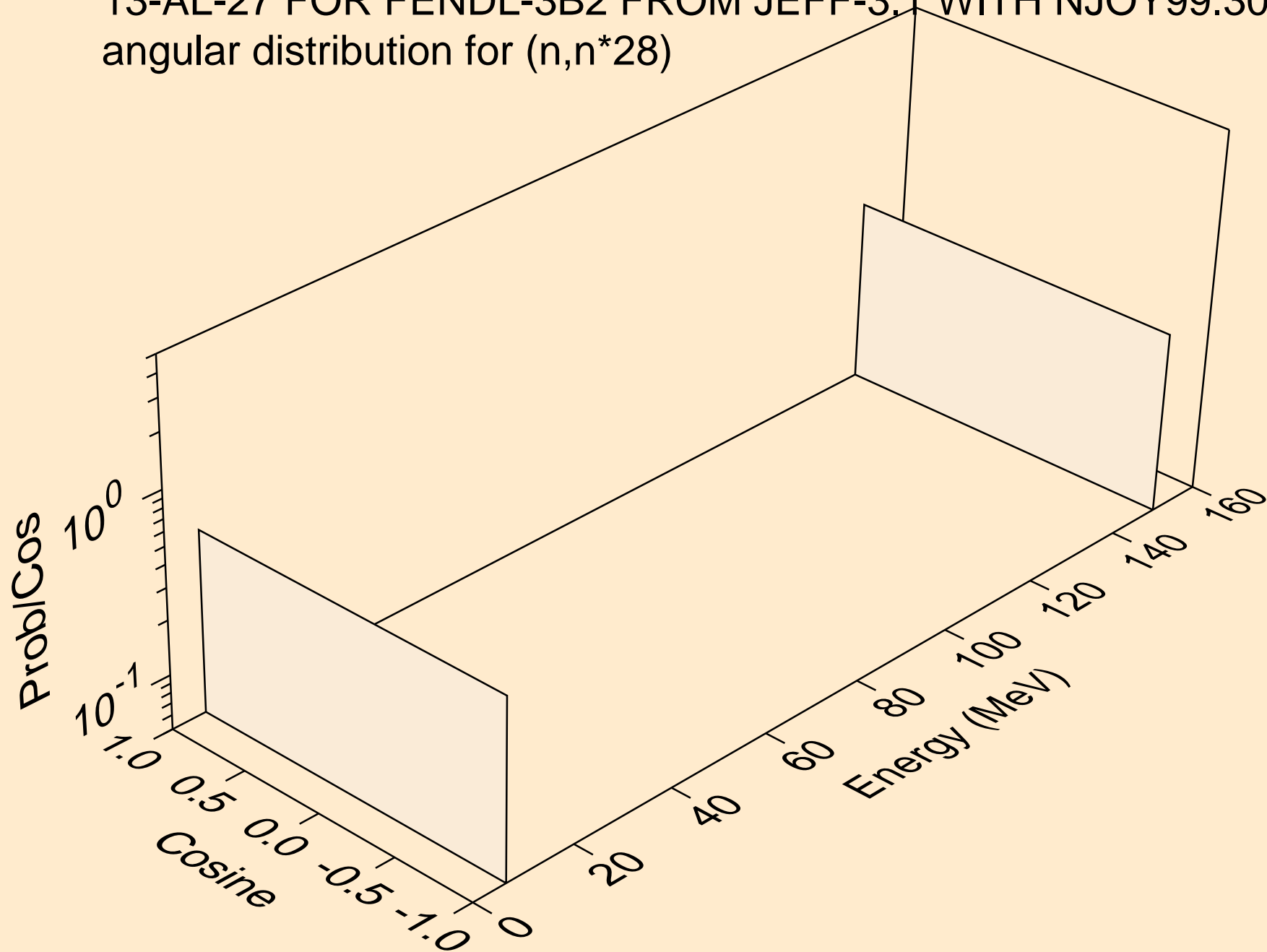

13-AL-27 FOR FENDL-3B2 FROM JEFF-3.1 WITH NJOY99.304+ C  
angular distribution for (n,n\*29)

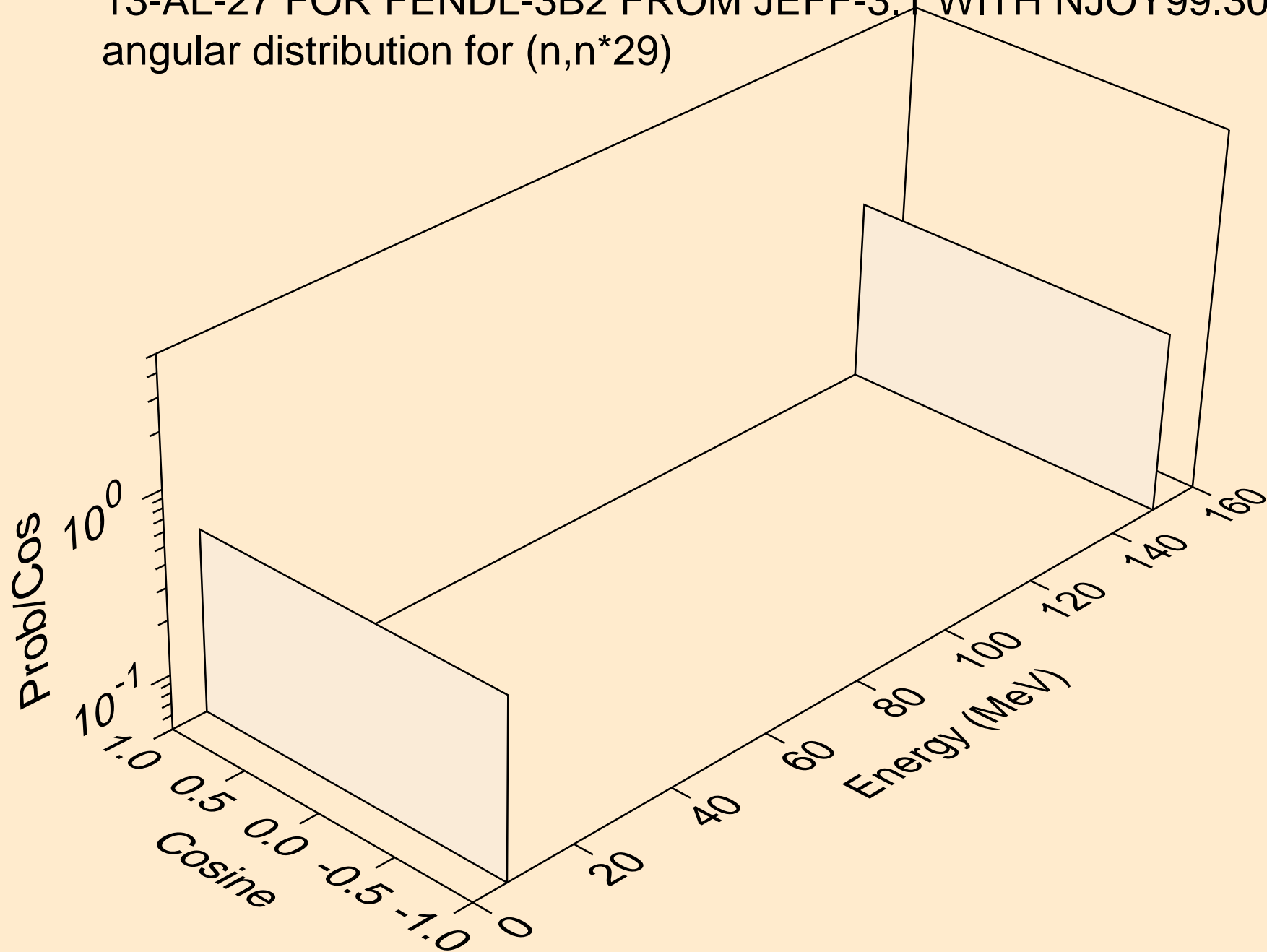

13-AL-27 FOR FENDL-3B2 FROM JEFF-3.1 WITH NJOY99.304+ C  
angular distribution for (n,n\*30)

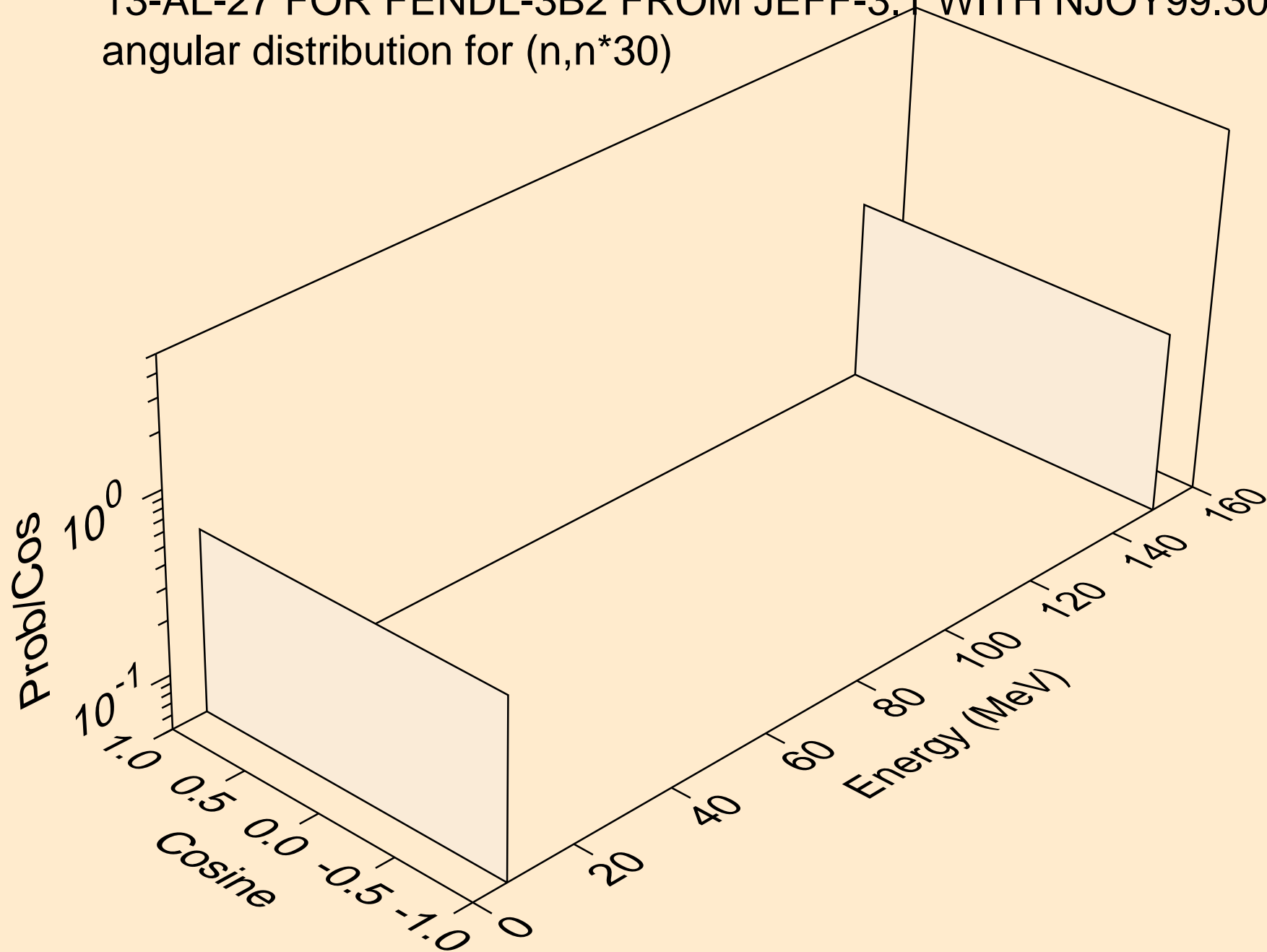

13-AL-27 FOR FENDL-3B2 FROM JEFF-3.1 WITH NJOY99.304+ C  
angular distribution for (n,n\*31)

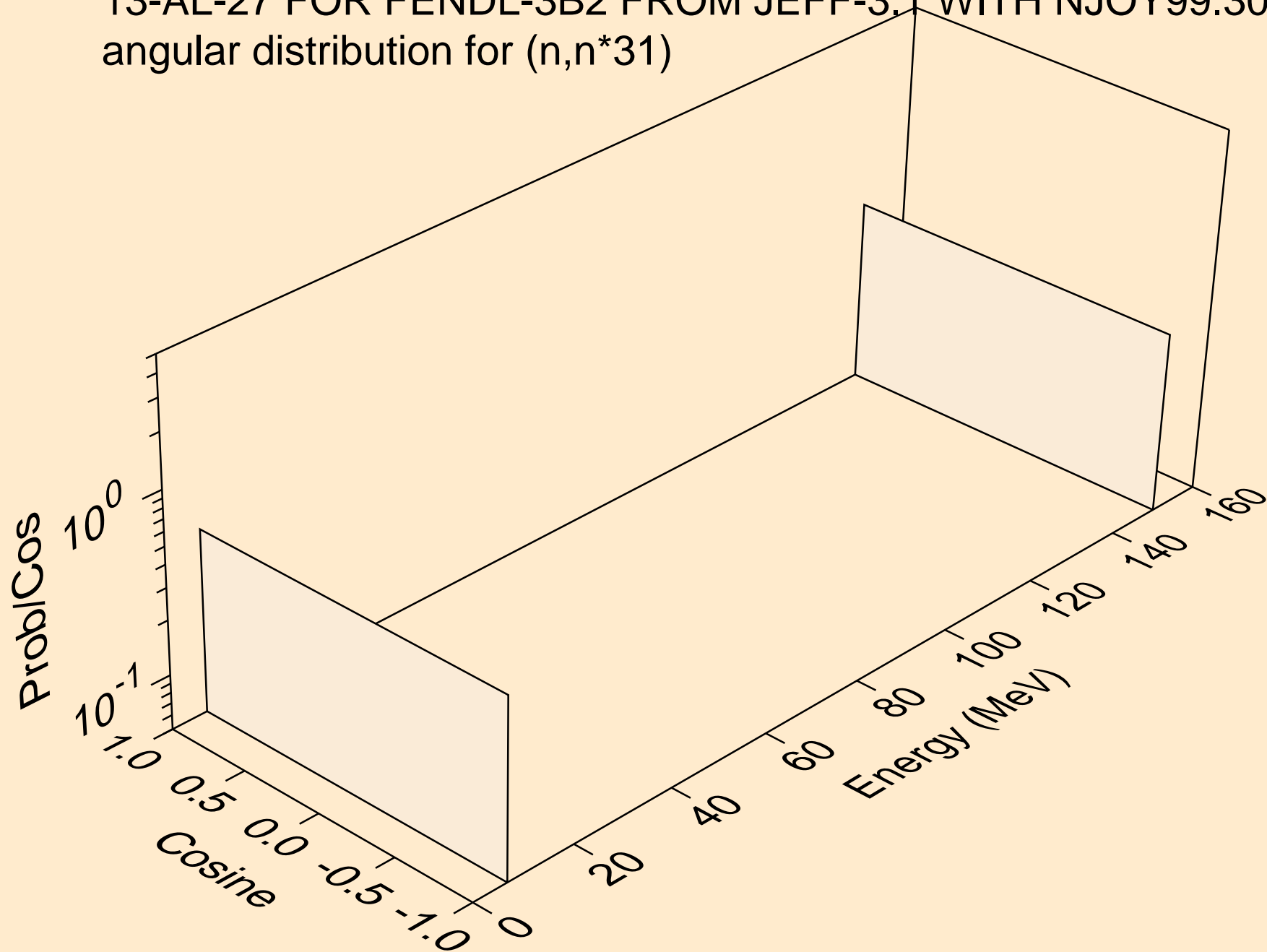

13-AL-27 FOR FENDL-3B2 FROM JEFF-3.1 WITH NJOY99.304+ C  
angular distribution for (n,n\*32)

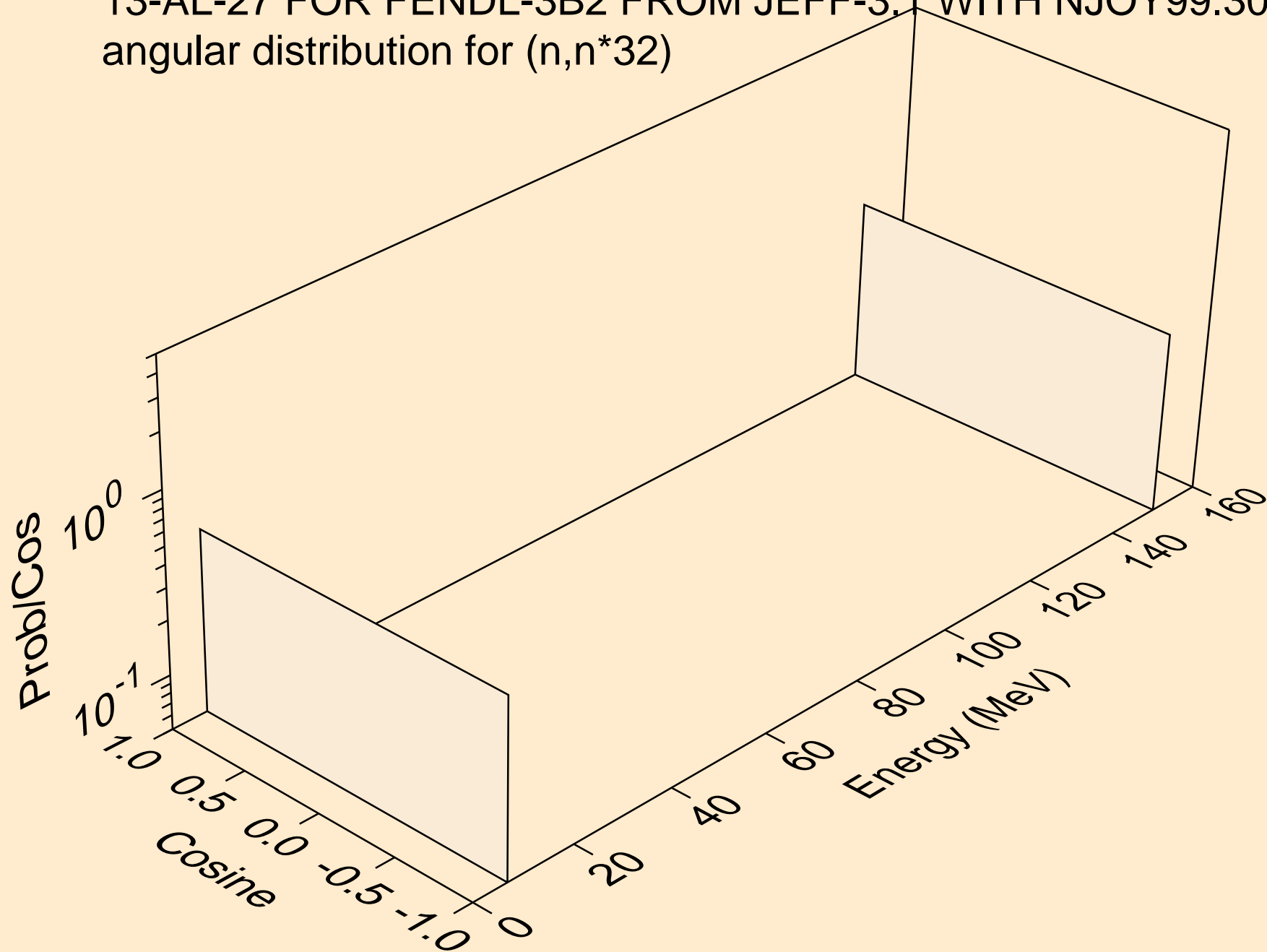

13-AL-27 FOR FENDL-3B2 FROM JEFF-3.1 WITH NJOY99.304+ C  
angular distribution for (n,n\*33)

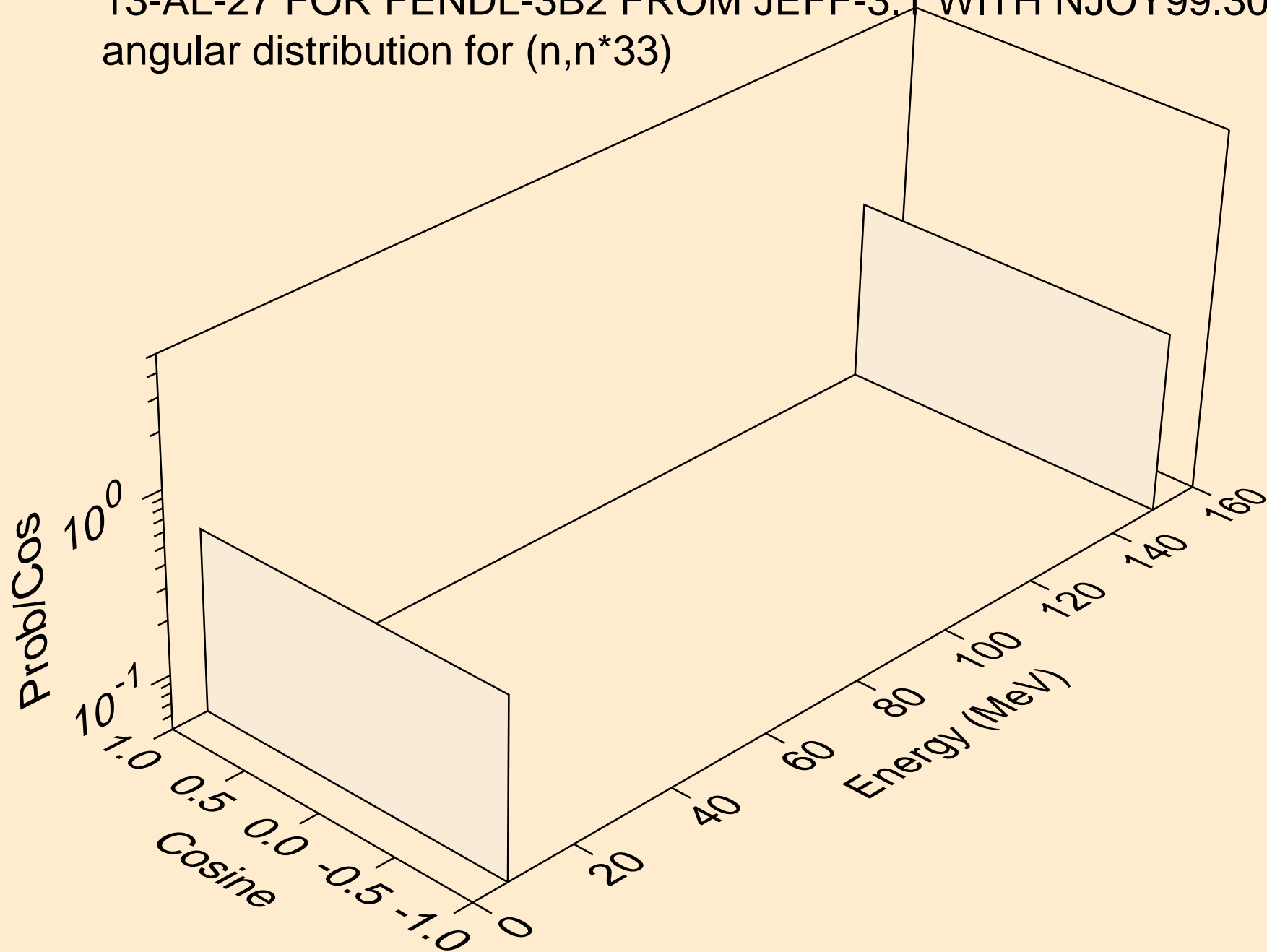

13-AL-27 FOR FENDL-3B2 FROM JEFF-3.1 WITH NJOY99.304+ C  
angular distribution for (n,n\*34)

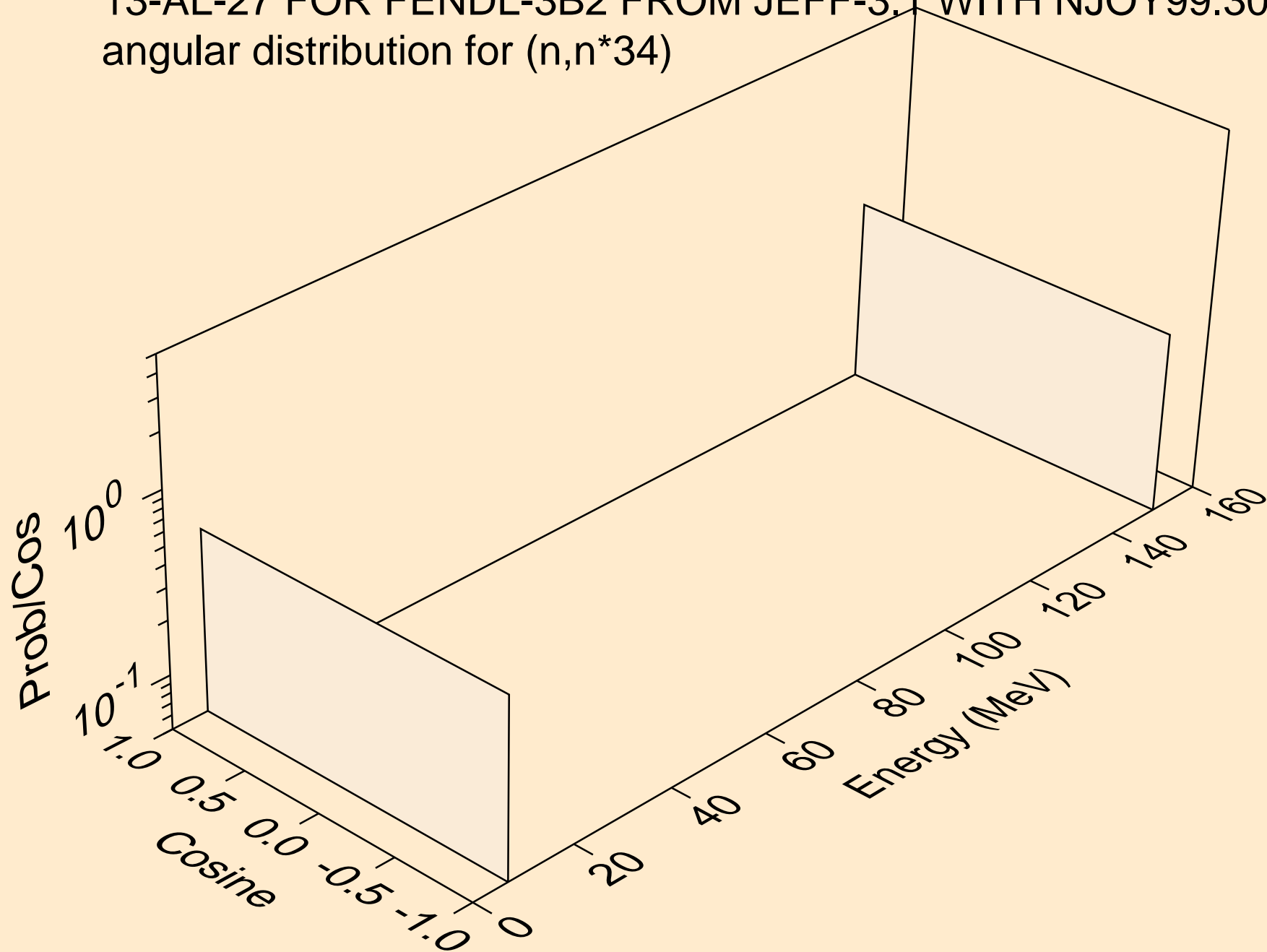



13-AL-27 FOR FENDL-3B2 FROM JEFF-3.1 WITH NJOY99.304+ C  
angular distribution for (n,n\*35)

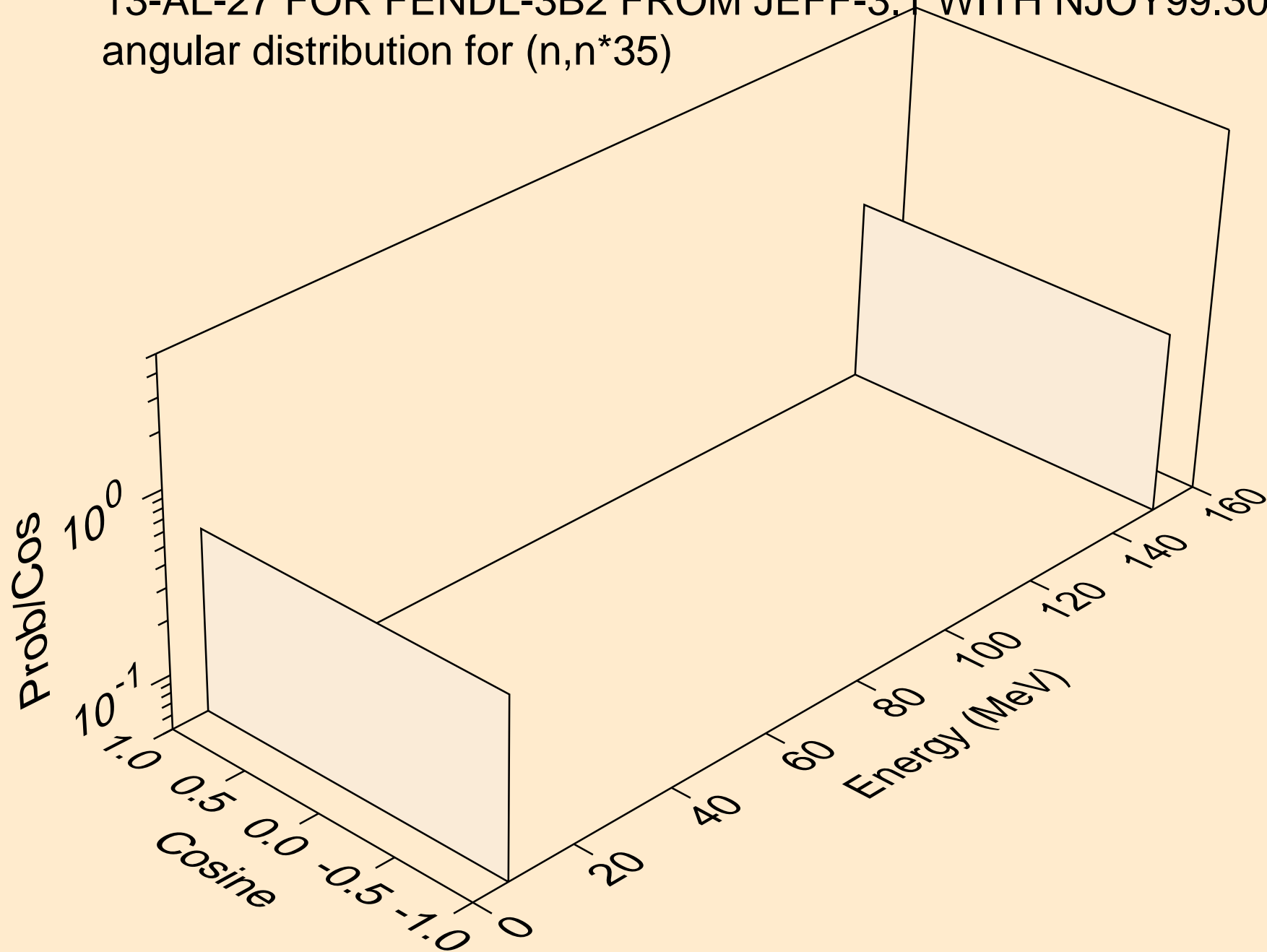

13-AL-27 FOR FENDL-3B2 FROM JEFF-3.1 WITH NJOY99.304+ C  
angular distribution for (n,n\*36)

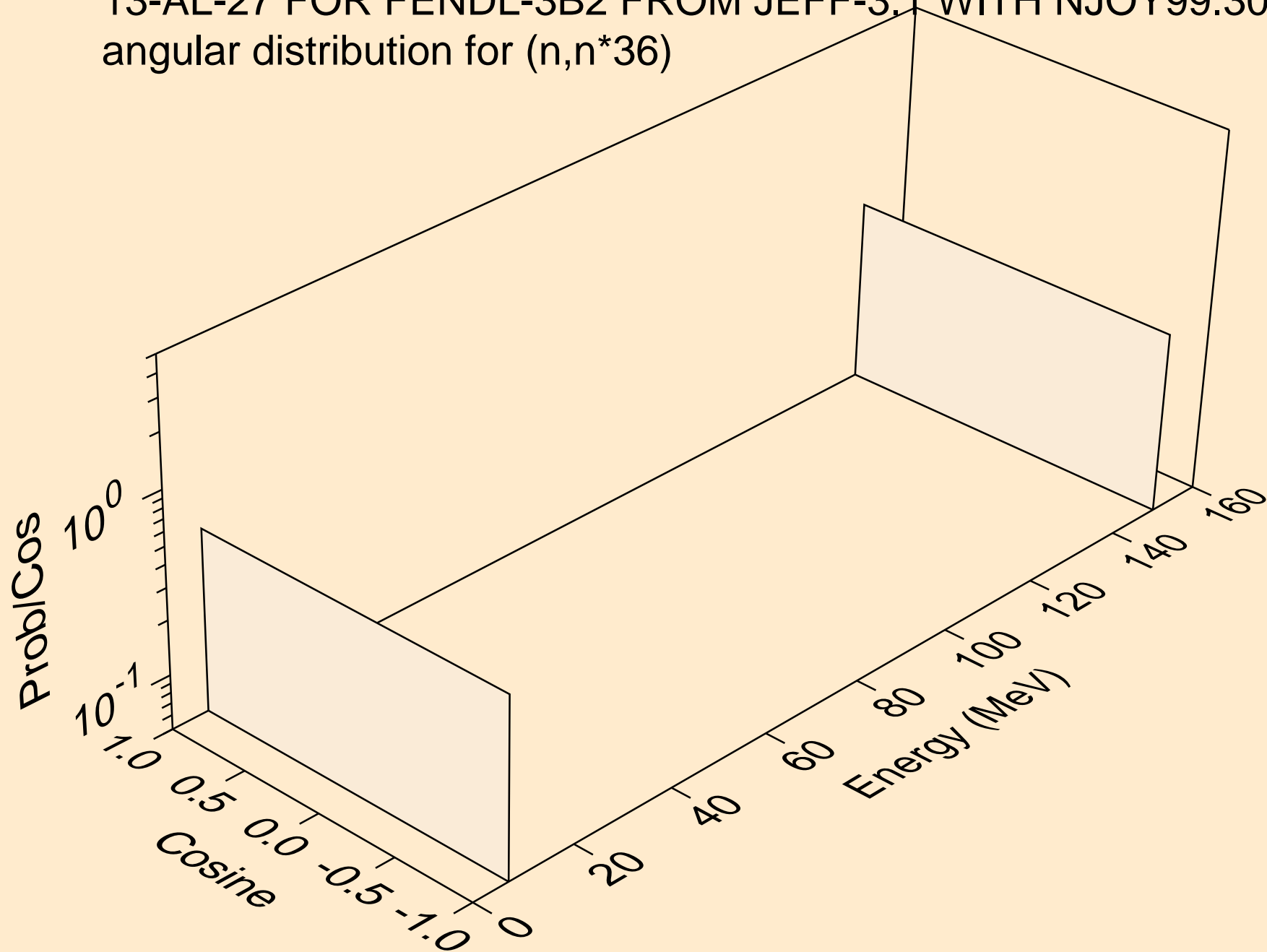

13-AL-27 FOR FENDL-3B2 FROM JEFF-3.1 WITH NJOY99.304+ C  
angular distribution for (n,n\*37)

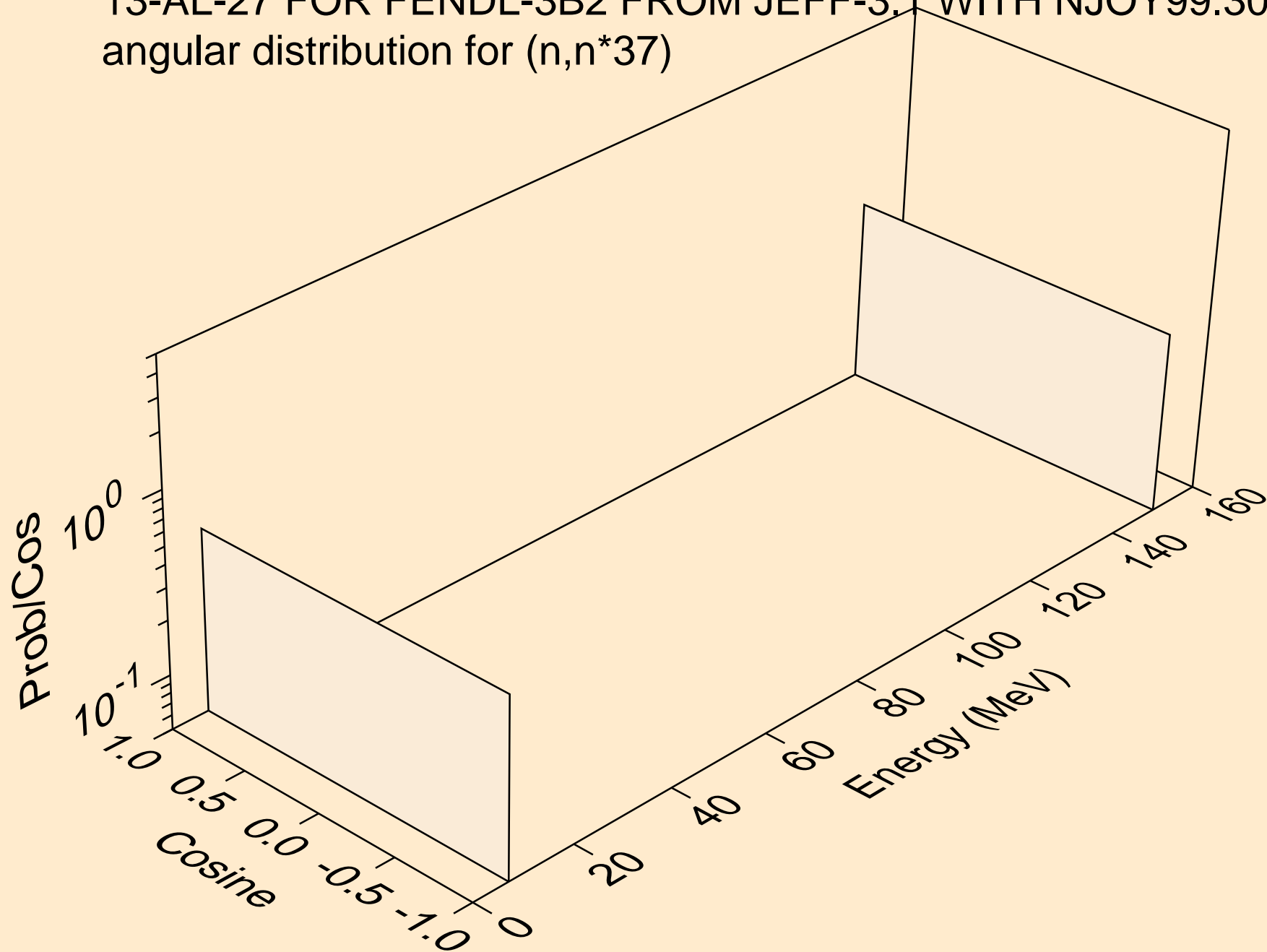

13-AL-27 FOR FENDL-3B2 FROM JEFF-3.1 WITH NJOY99.304+ C  
angular distribution for (n,n\*38)

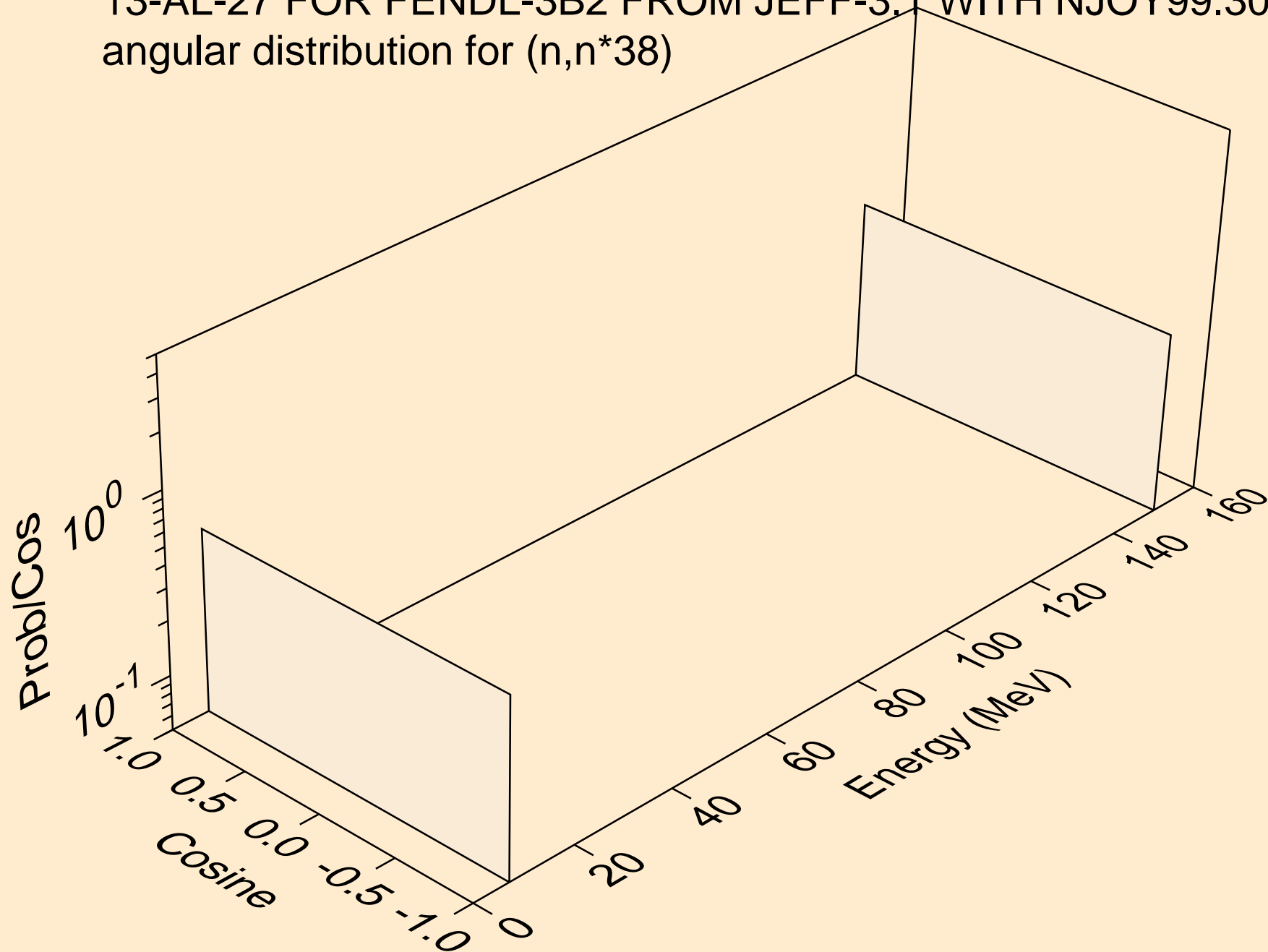

13-AL-27 FOR FENDL-3B2 FROM JEFF-3.1 WITH NJOY99.304+ C  
angular distribution for (n,n\*39)

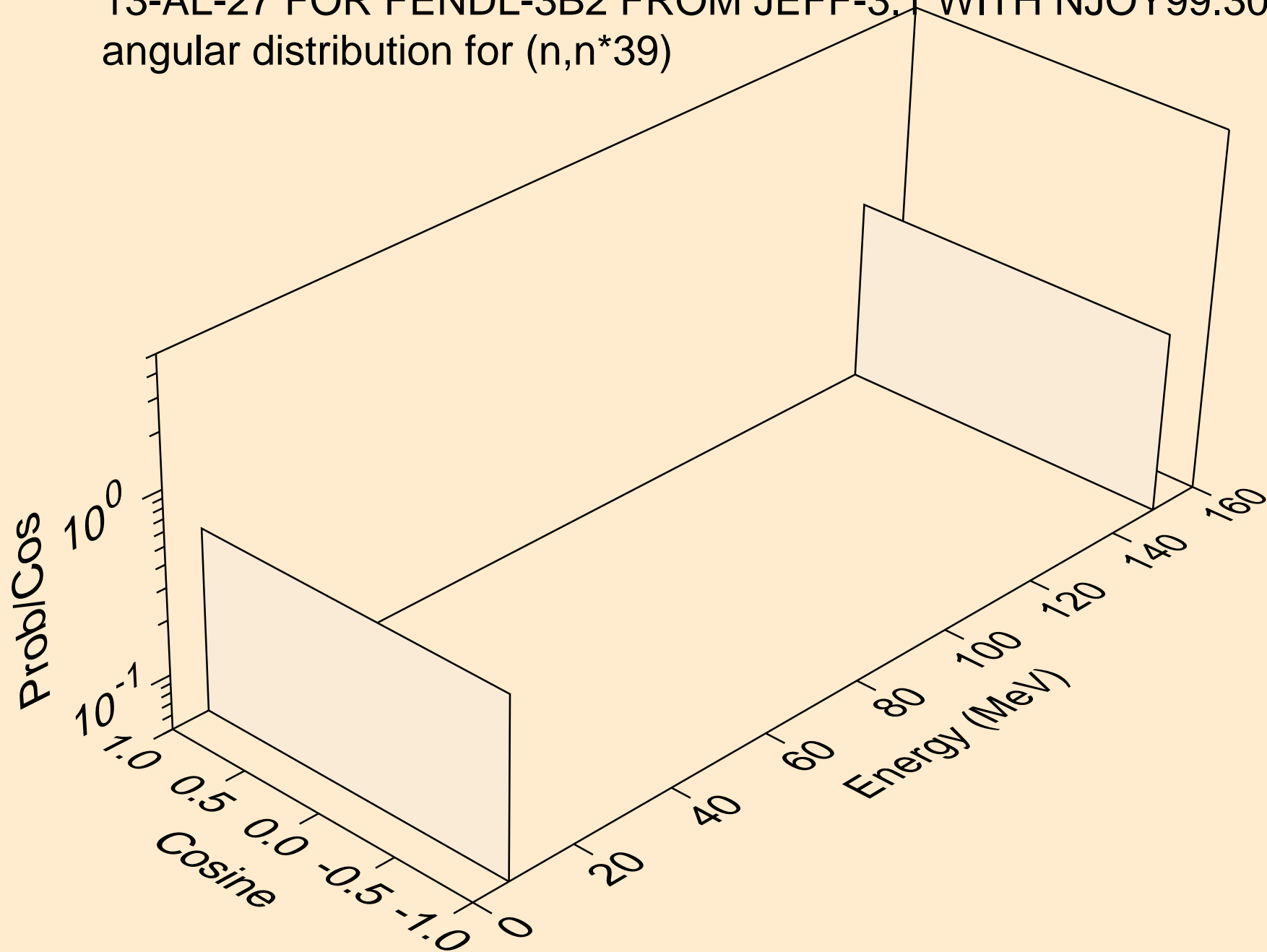

13-AL-27 FOR FENDL-3B2 FROM JEFF-3.1 WITH NJOY99.304+ C  
Neutron emission for (n,x)

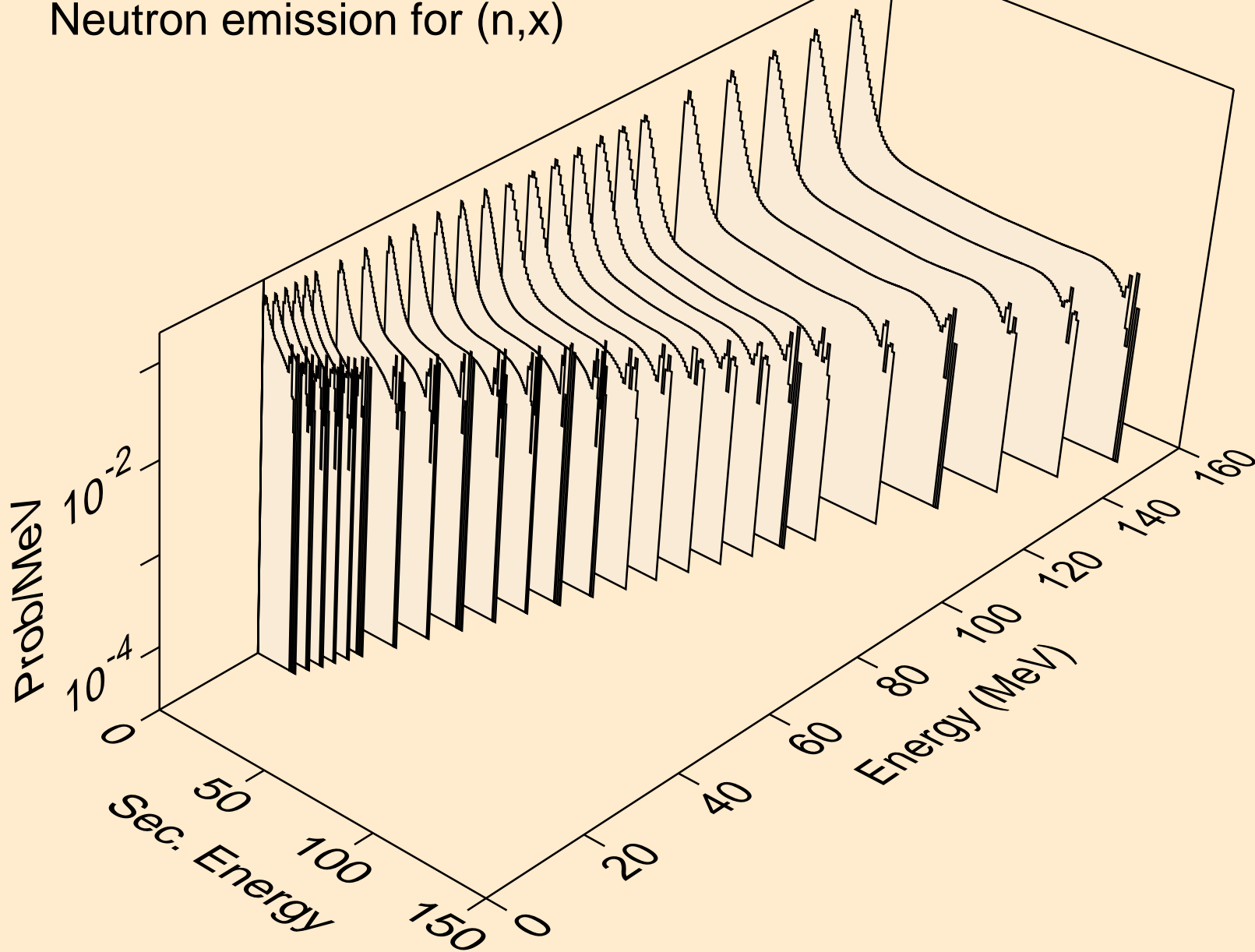

13-AL-27 FOR FENDL-3B2 FROM JEFF-3.1 WITH NJOY99.304+ C  
Neutron emission for (n,2n)

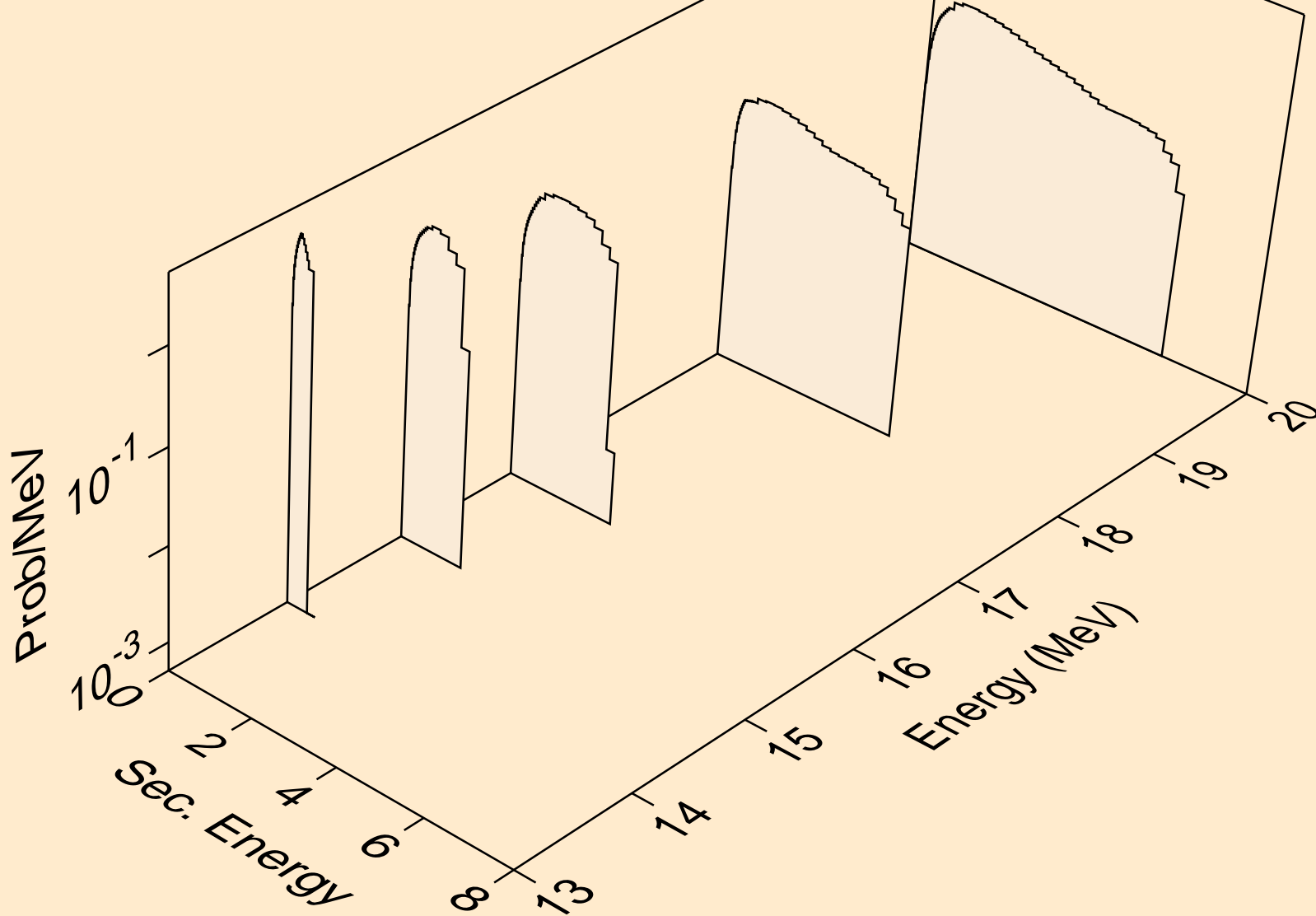

13-AL-27 FOR FENDL-3B2 FROM JEFF-3.1 WITH NJOY99.304+ C  
Neutron emission for (n,n\*)a

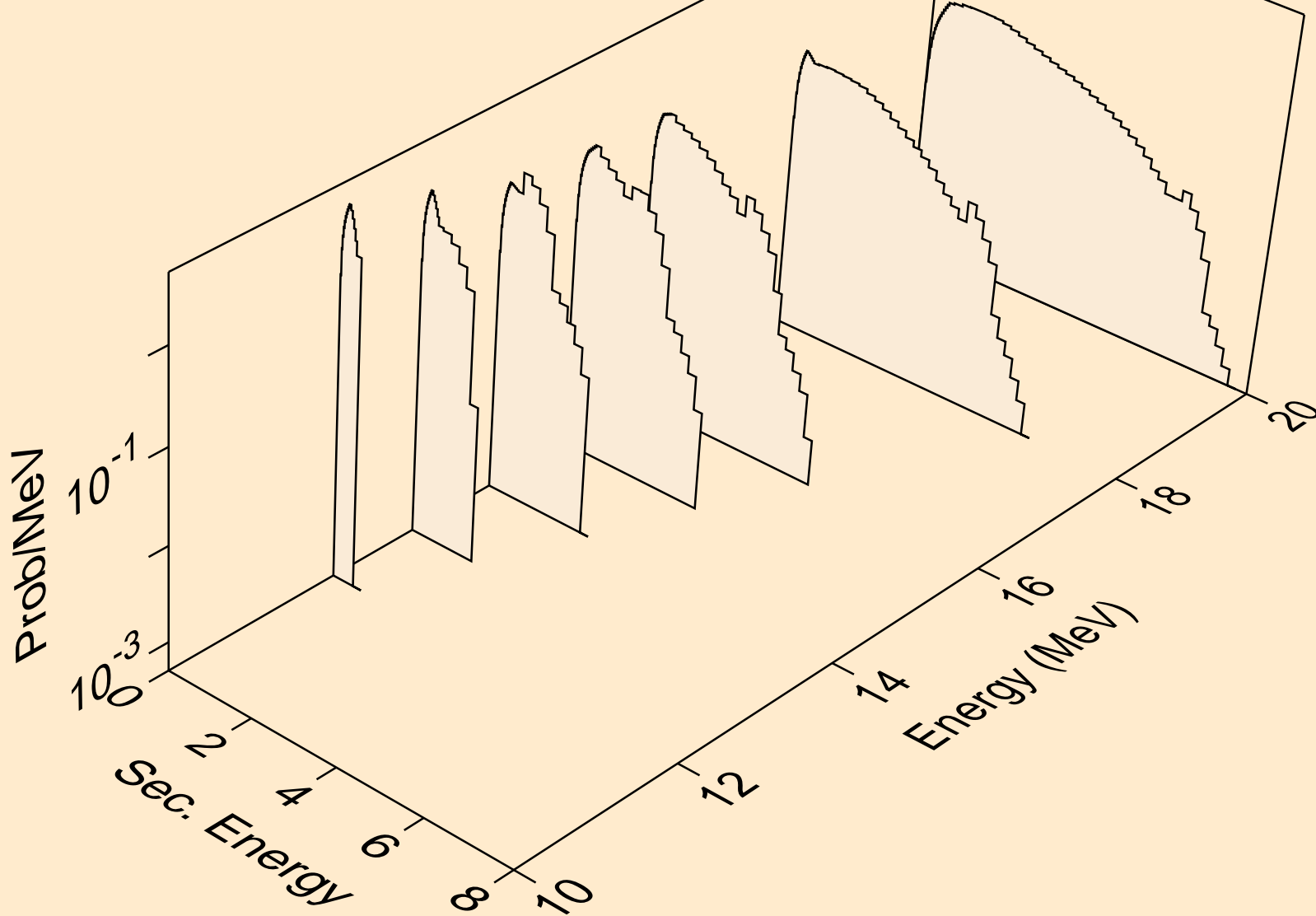



13-AL-27 FOR FENDL-3B2 FROM JEFF-3.1 WITH NJOY99.304+ C  
Neutron emission for (n,n\*)p

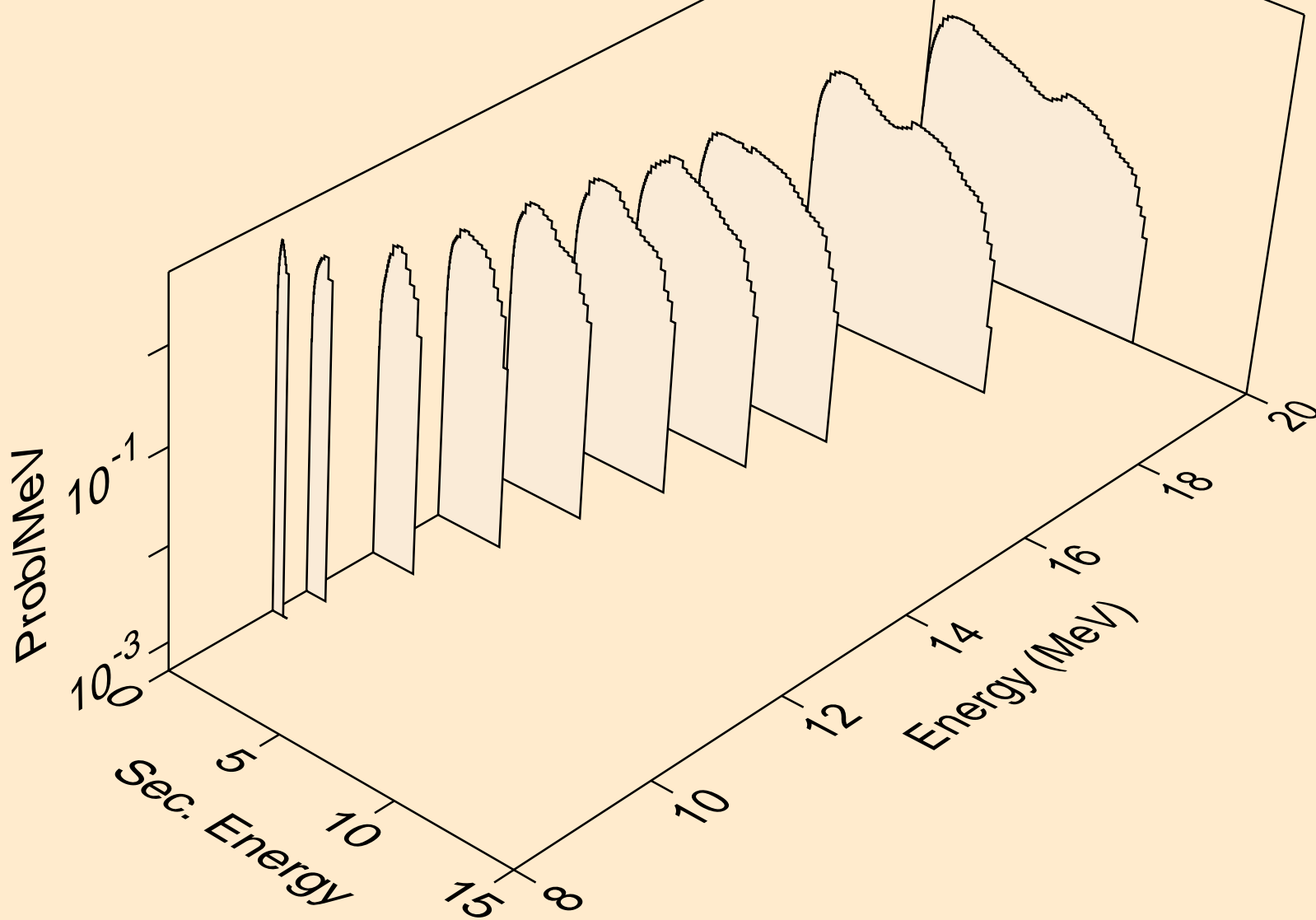

13-AL-27 FOR FENDL-3B2 FROM JEFF-3.1 WITH NJOY99.304+ C  
Neutron emission for (n,n\*)d

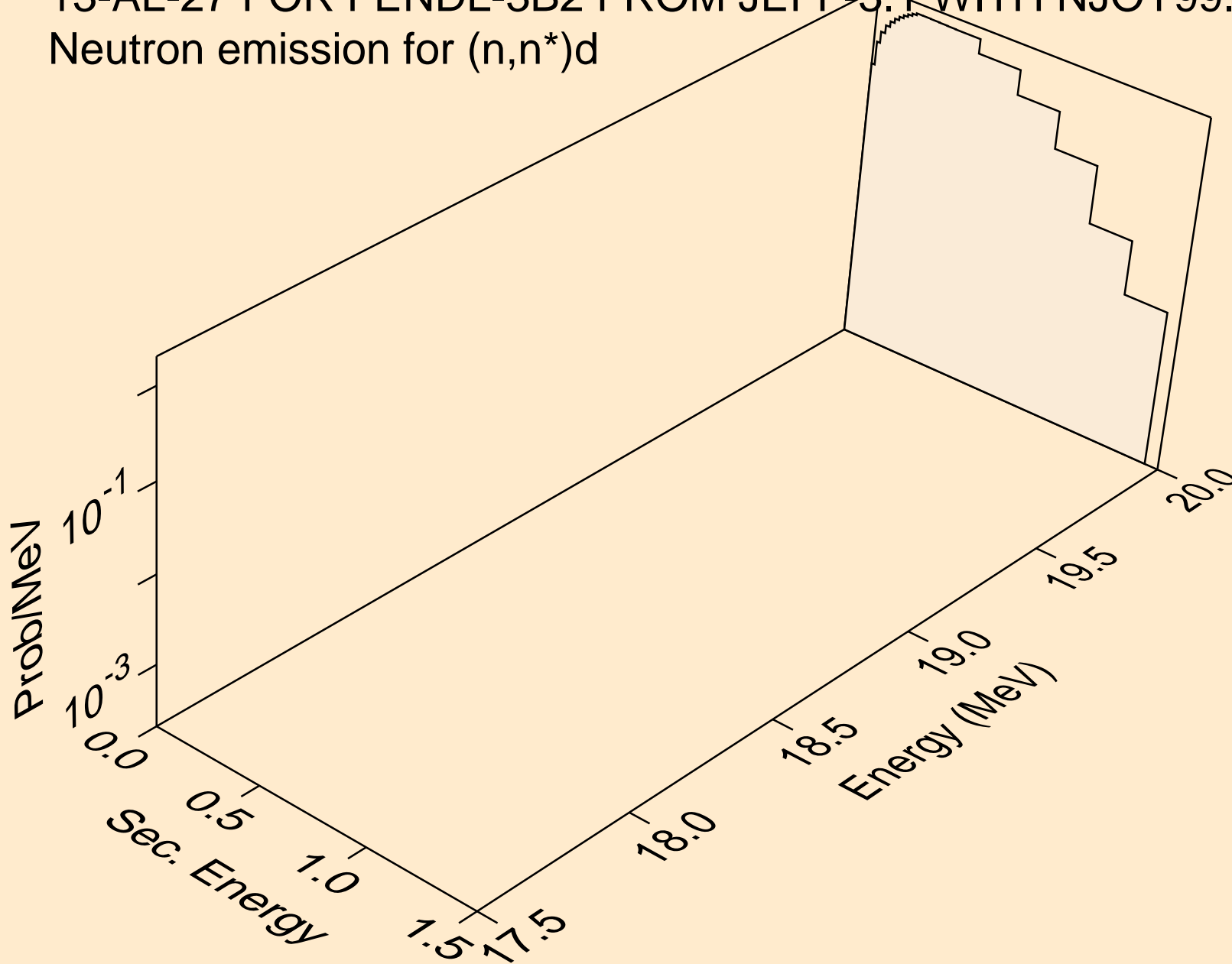

13-AL-27 FOR FENDL-3B2 FROM JEFF-3.1 WITH NJOY99.304+ C  
Neutron emission for (n,n\*)t

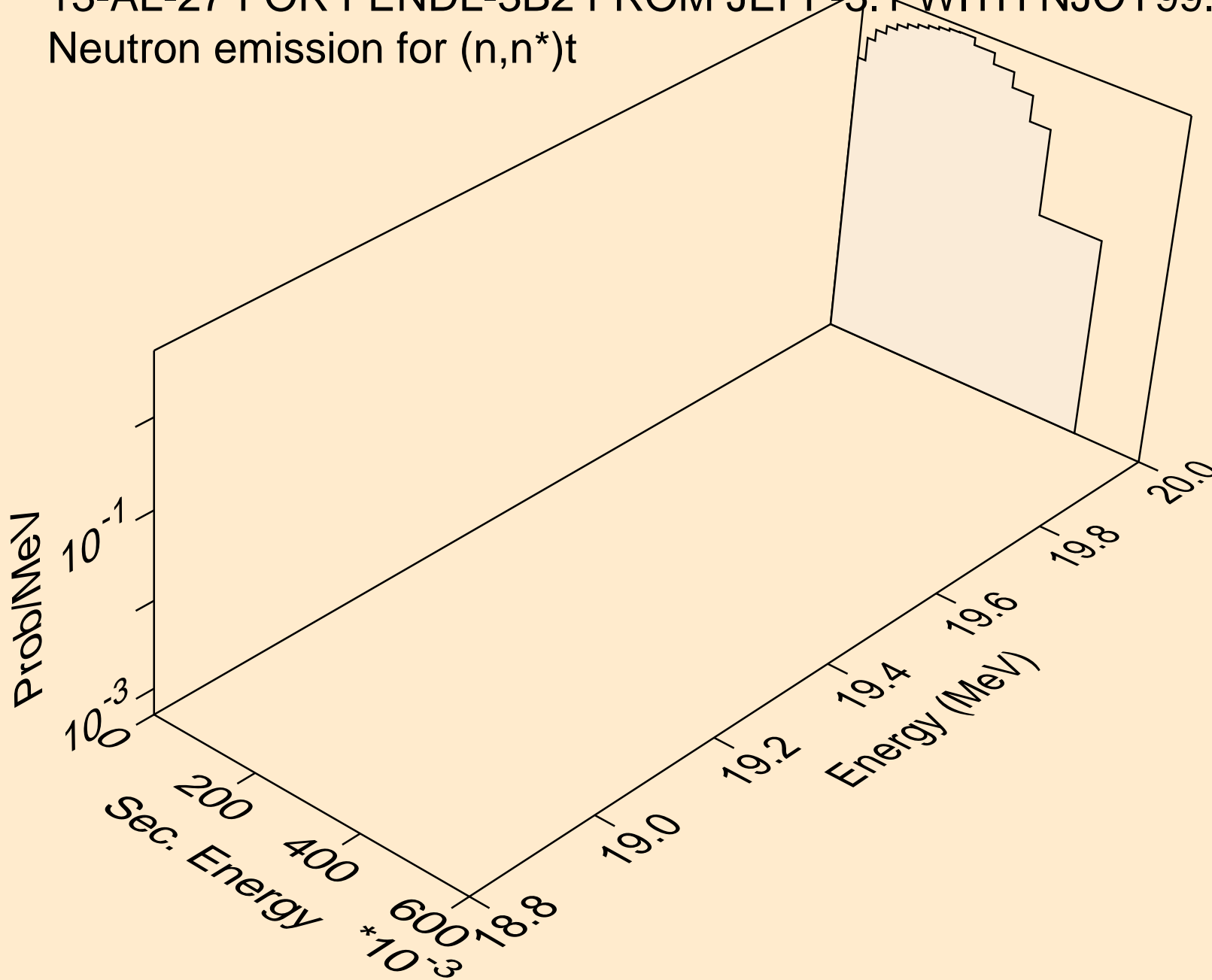

13-AL-27 FOR FENDL-3B2 FROM JEFF-3.1 WITH NJOY99.304+ C  
Neutron emission for (n,n\*c)

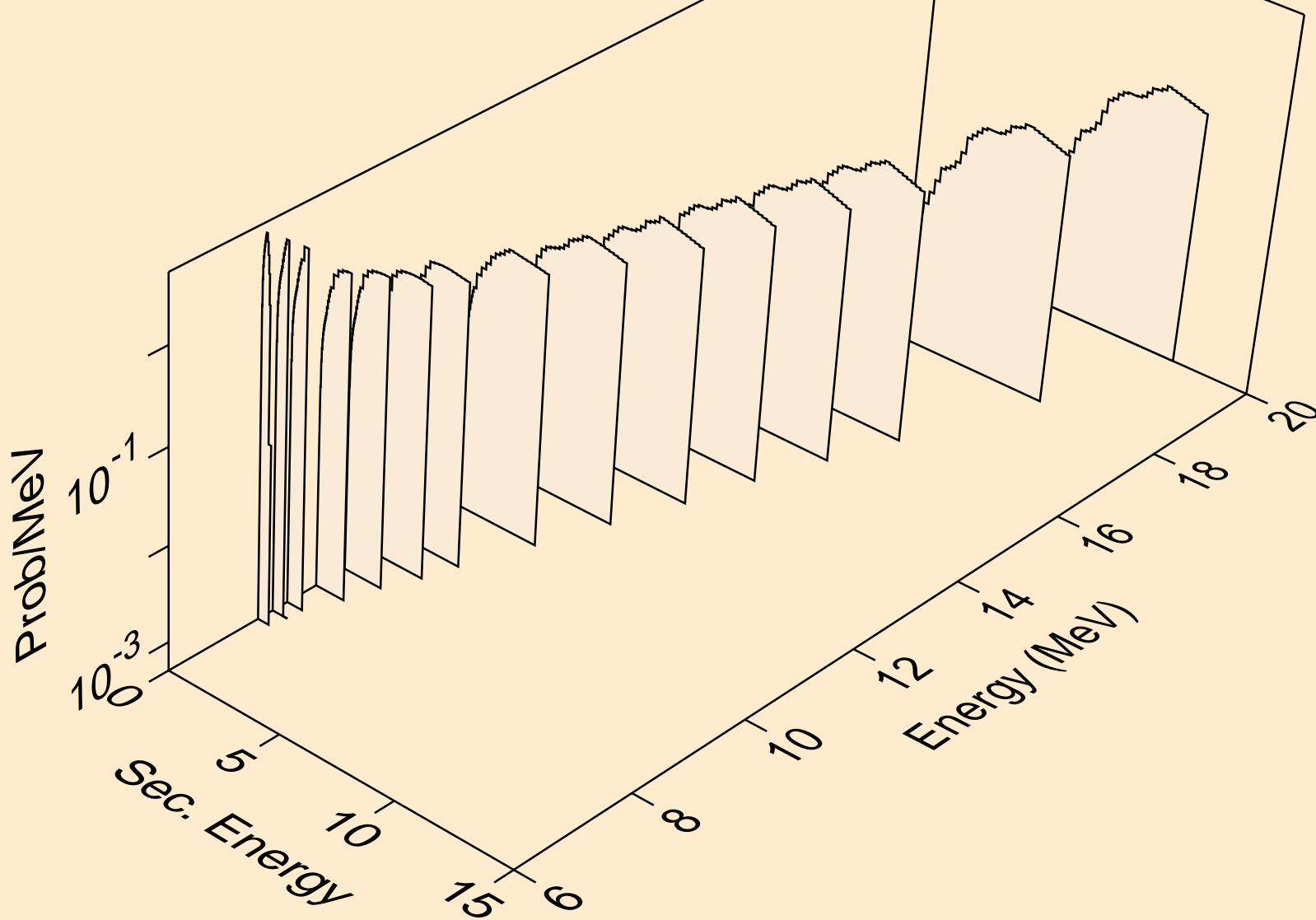

13-AL-27 FOR FENDL-3B2 FROM JEFF-3.1 WITH NJOY99.304+ C  
Photon emission for (n,gma)

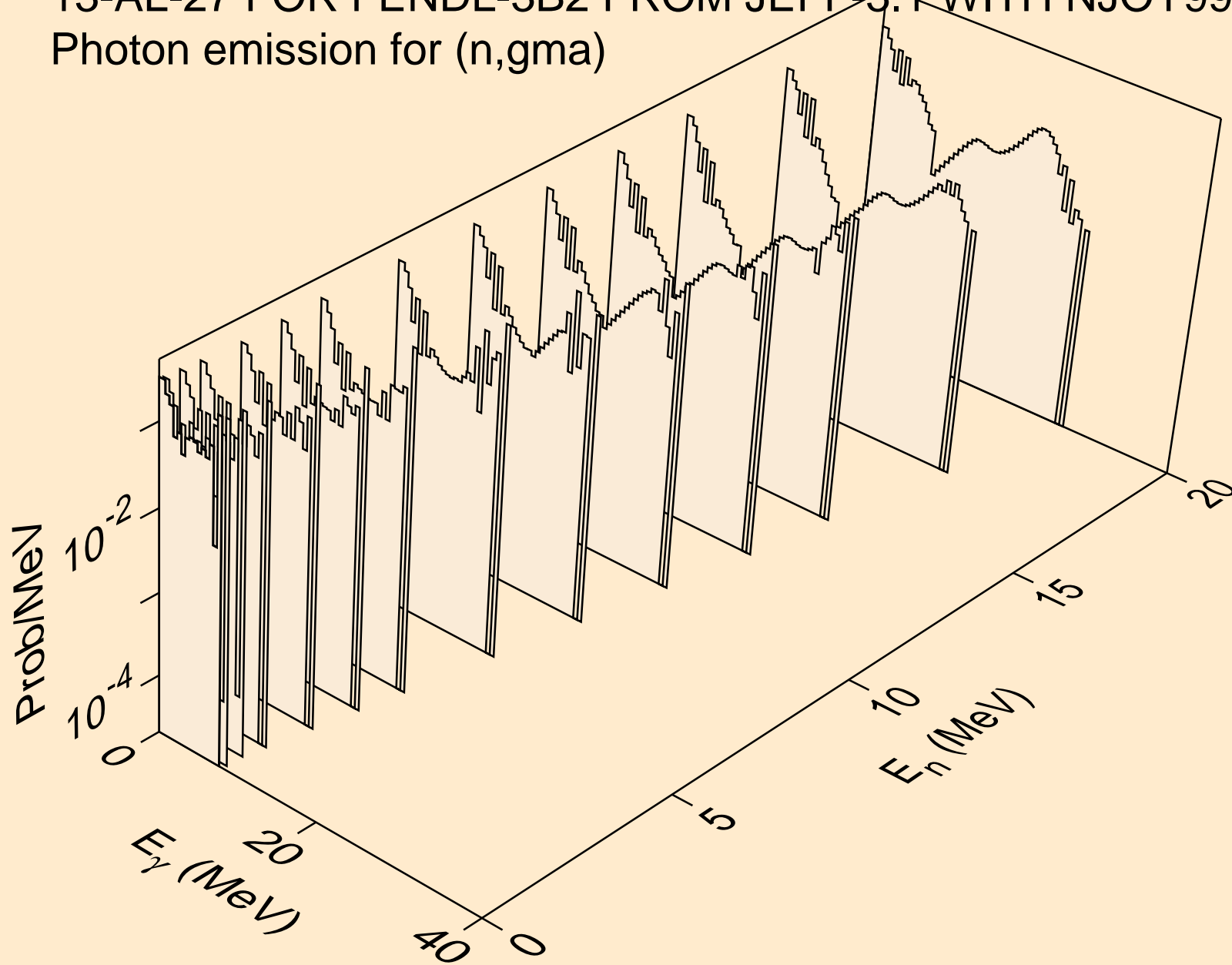

13-AL-27 FOR FENDL-3B2 FROM JEFF-3.1 WITH NJOY99.304+ C  
Photon emission for (n,x)

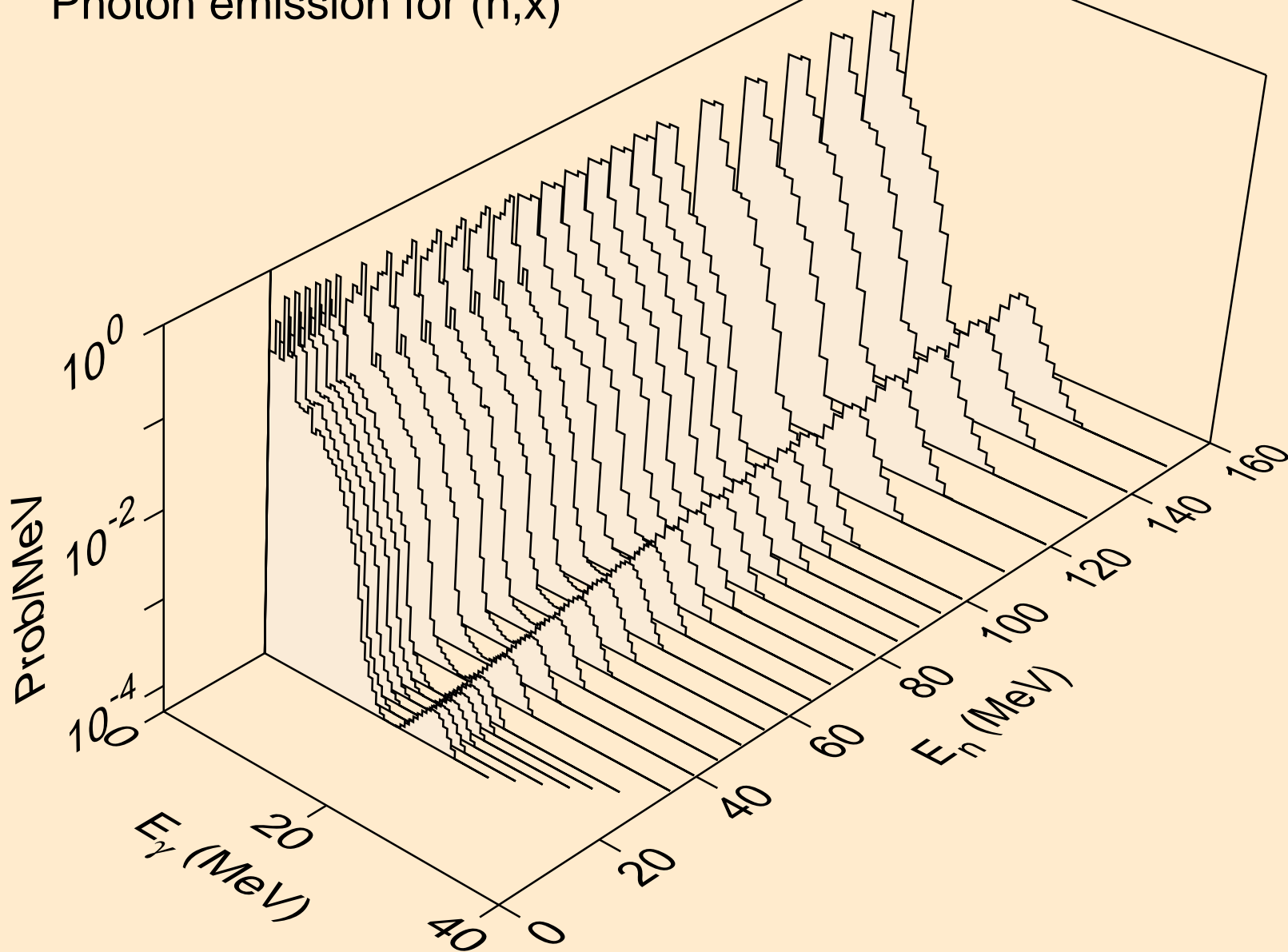

13-AL-27 FOR FENDL-3B2 FROM JEFF-3.1 WITH NJOY99.304+ C  
Photon emission for (n,2n)

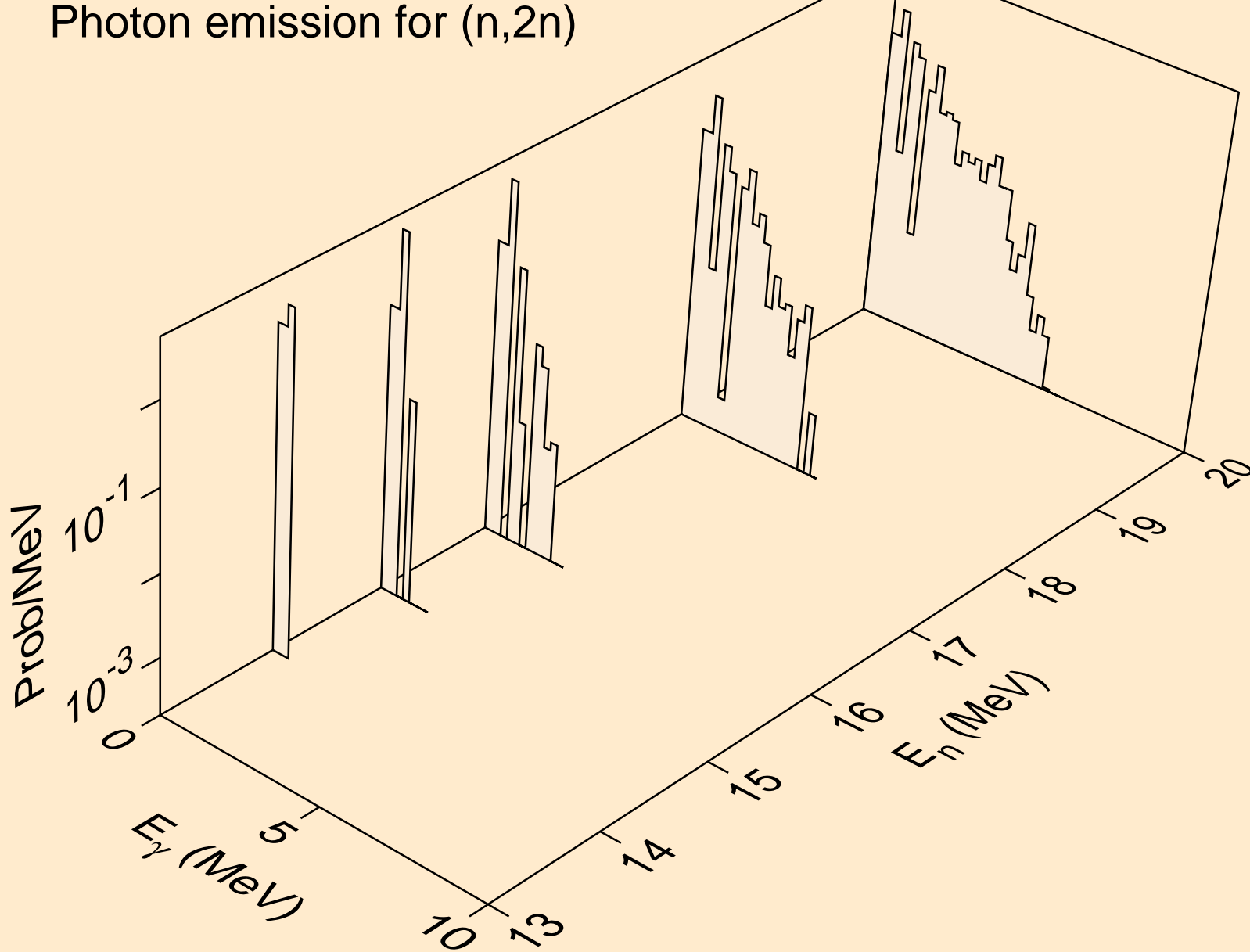

13-AL-27 FOR FENDL-3B2 FROM JEFF-3.1 WITH NJOY99.304+ C  
Photon emission for (n,n\*)a

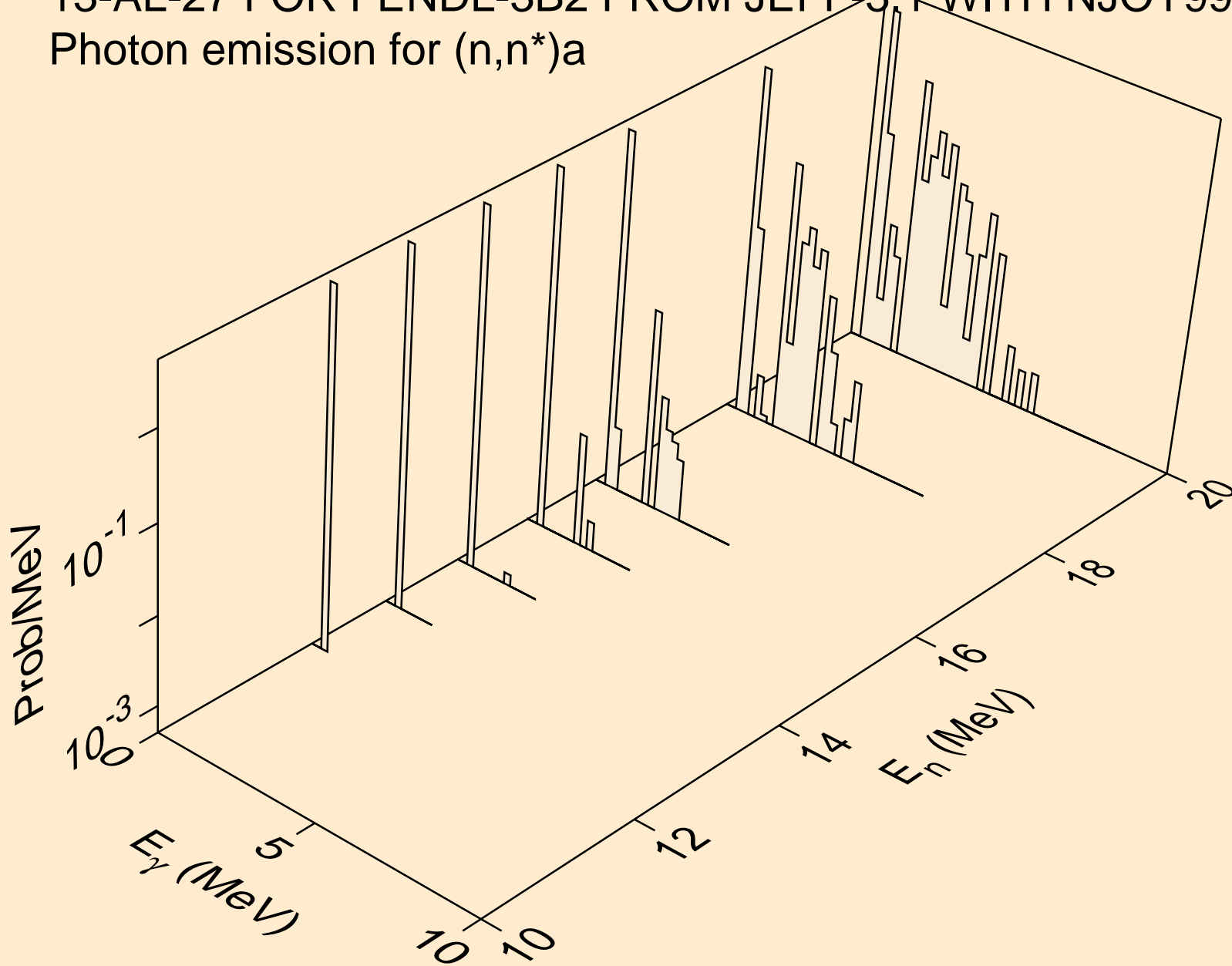



13-AL-27 FOR FENDL-3B2 FROM JEFF-3.1 WITH NJOY99.304+ C  
Photon emission for (n,n\*)p

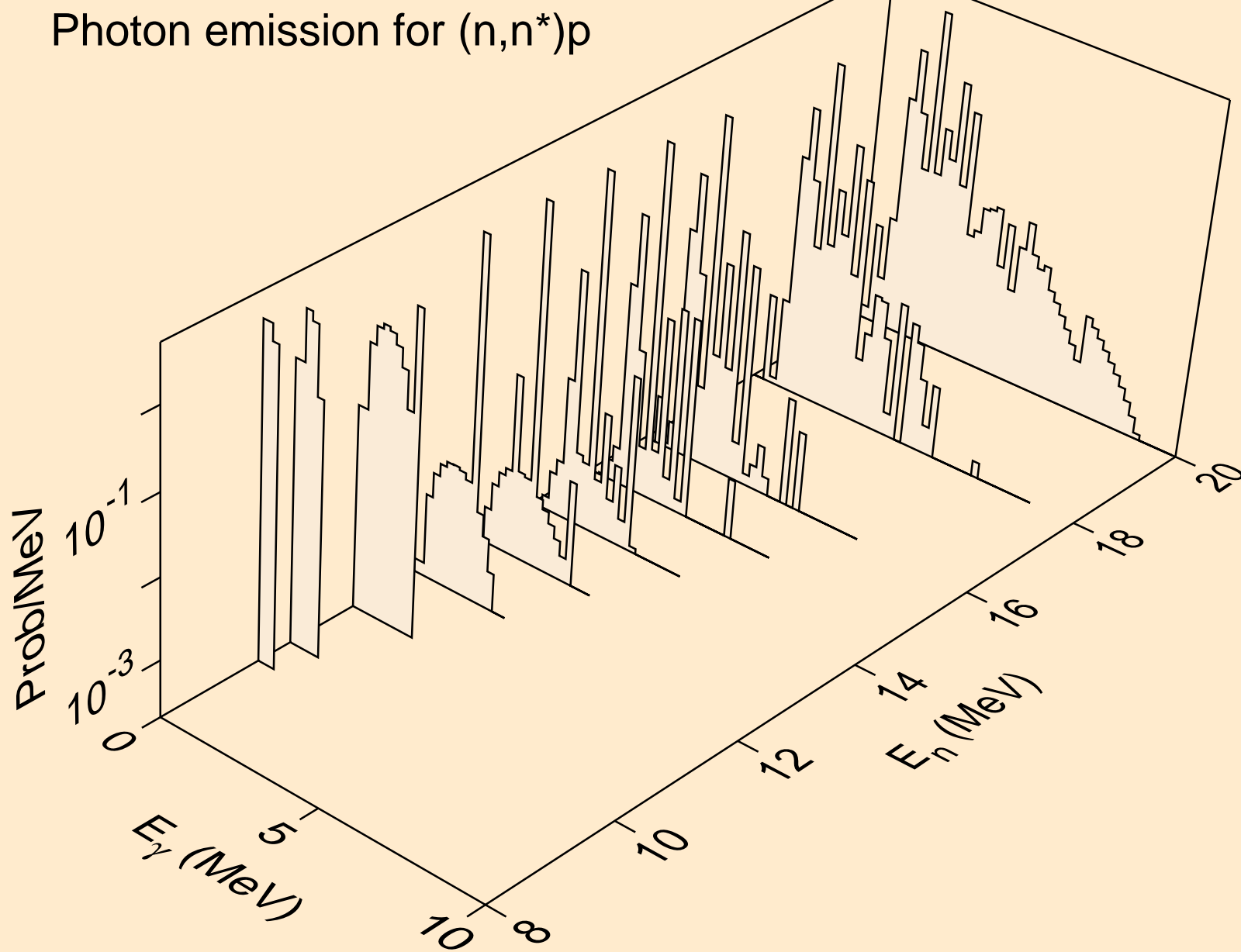

13-AL-27 FOR FENDL-3B2 FROM JEFF-3.1 WITH NJOY99.304+ C  
Photon emission for (n,n\*)d

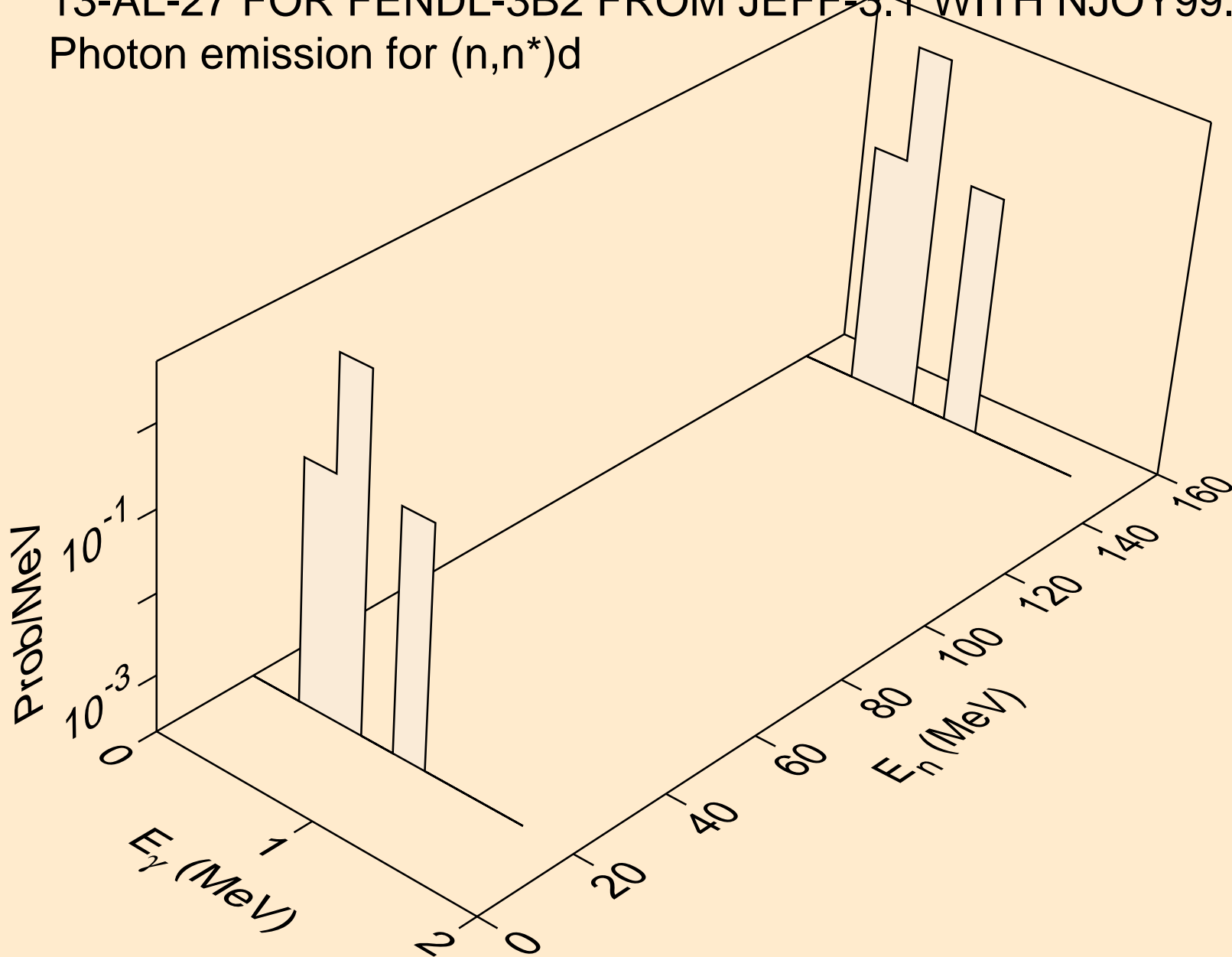

13-AL-27 FOR FENDL-3B2 FROM JEFF-3.1 WITH NJOY99.304+ C  
Photon emission for (n,n\*)t

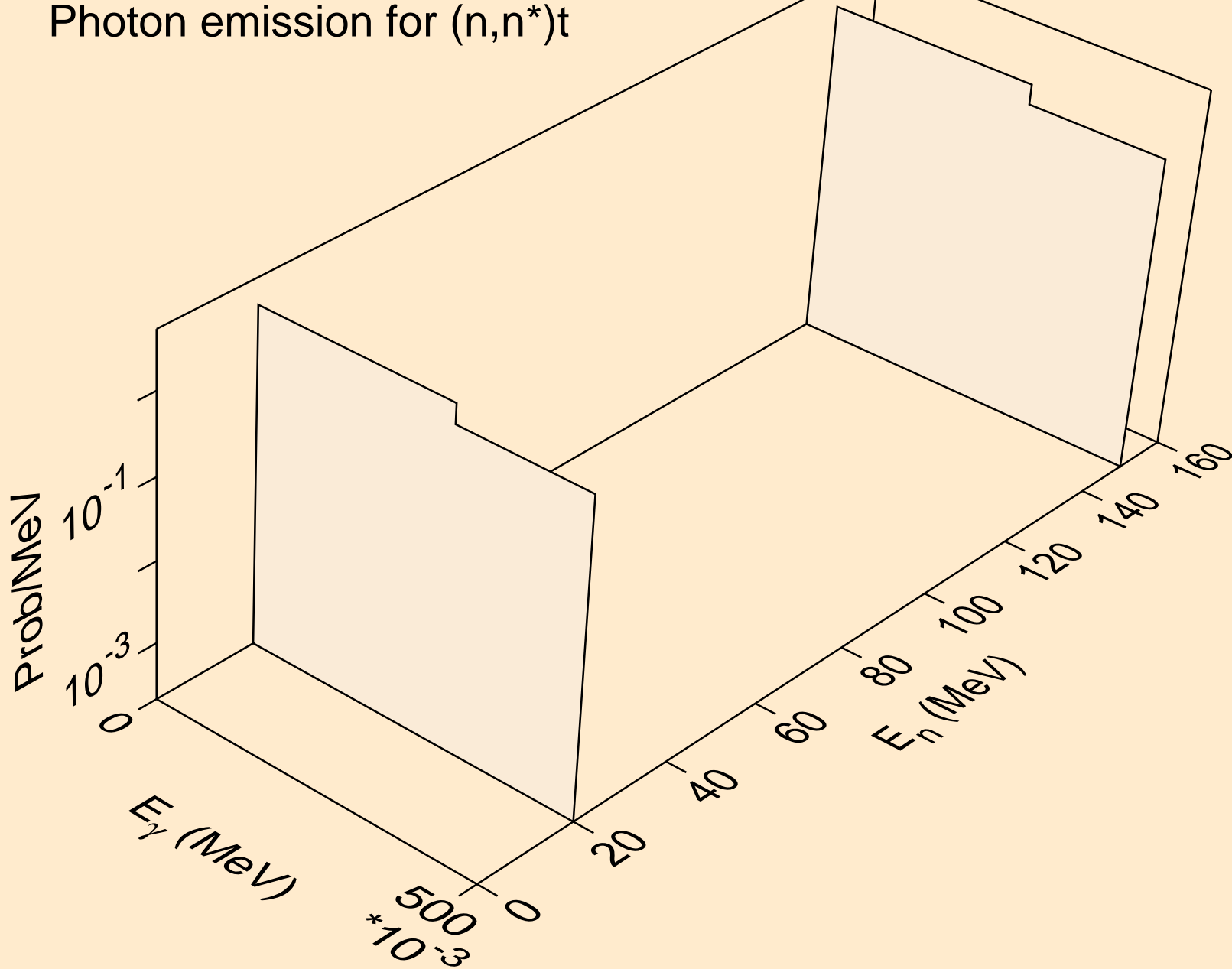

13-AL-27 FOR FENDL-3B2 FROM JEFF-3.1 WITH NJOY99.304+ C  
Photon emission for (n,n\*1)

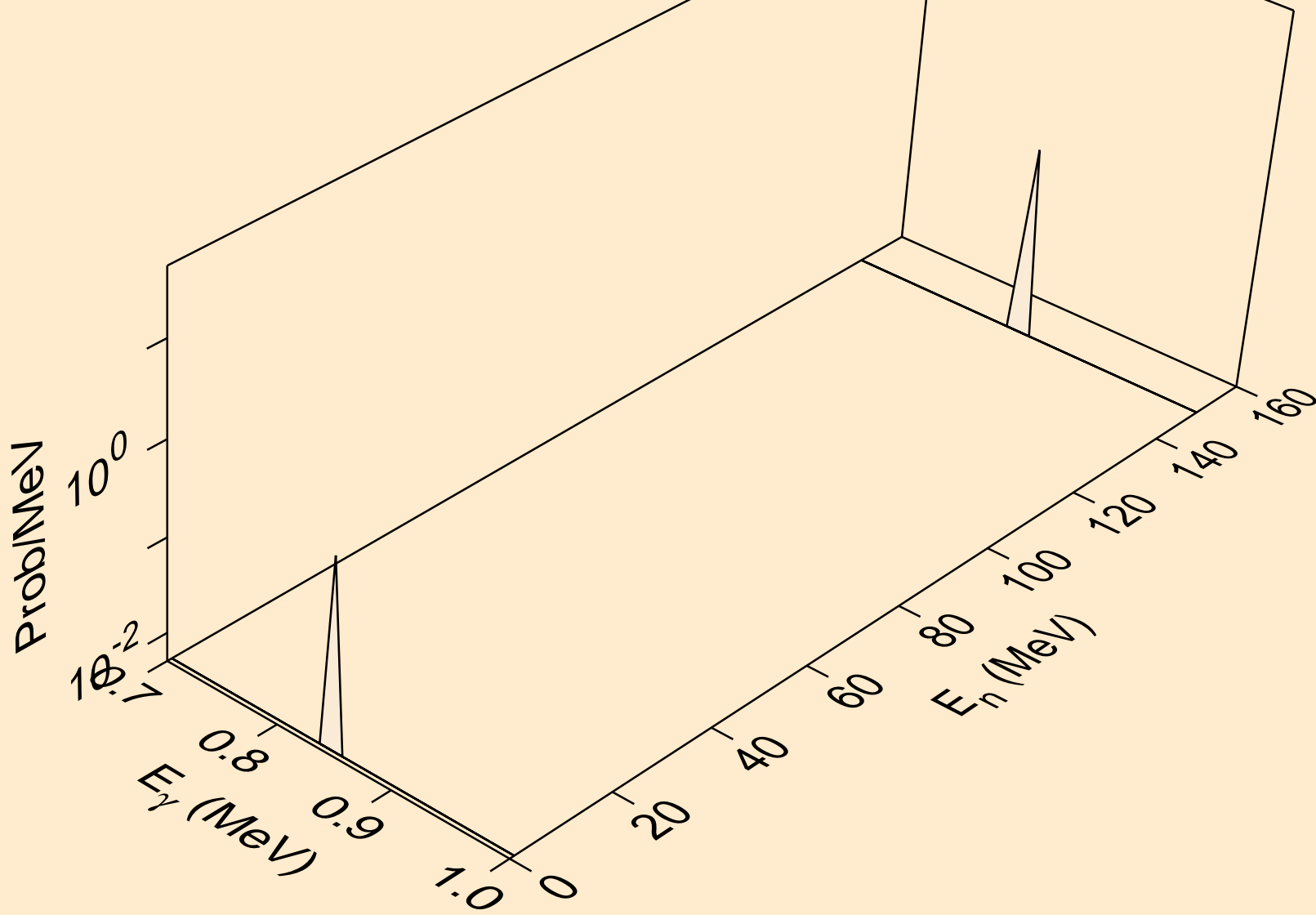

13-AL-27 FOR FENDL-3B2 FROM JEFF-3.1 WITH NJOY99.304+ C  
Photon emission for (n,n\*2)

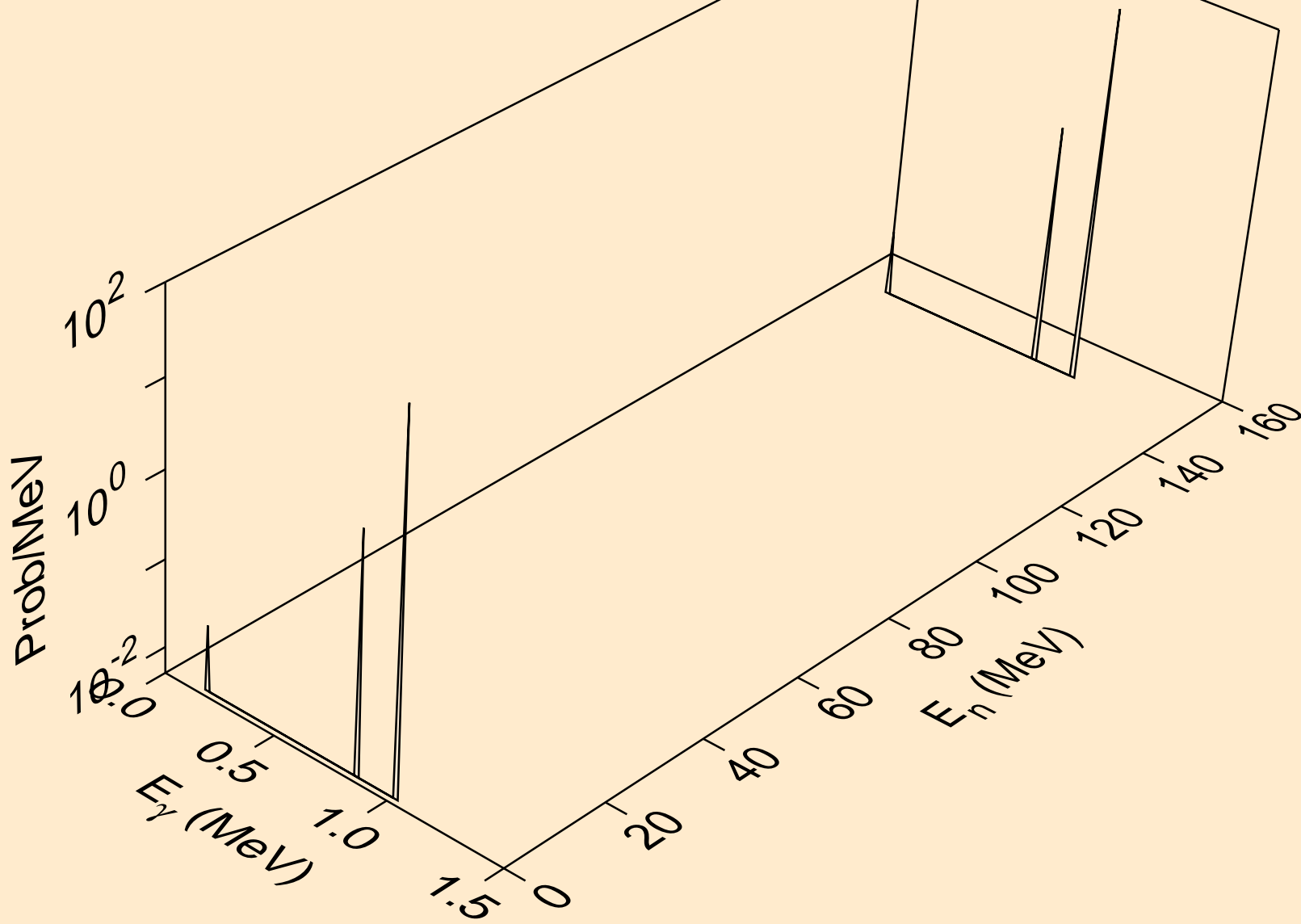

13-AL-27 FOR FENDL-3B2 FROM JEFF-3.1 WITH NJOY99.304+ C  
Photon emission for (n,n\*3)

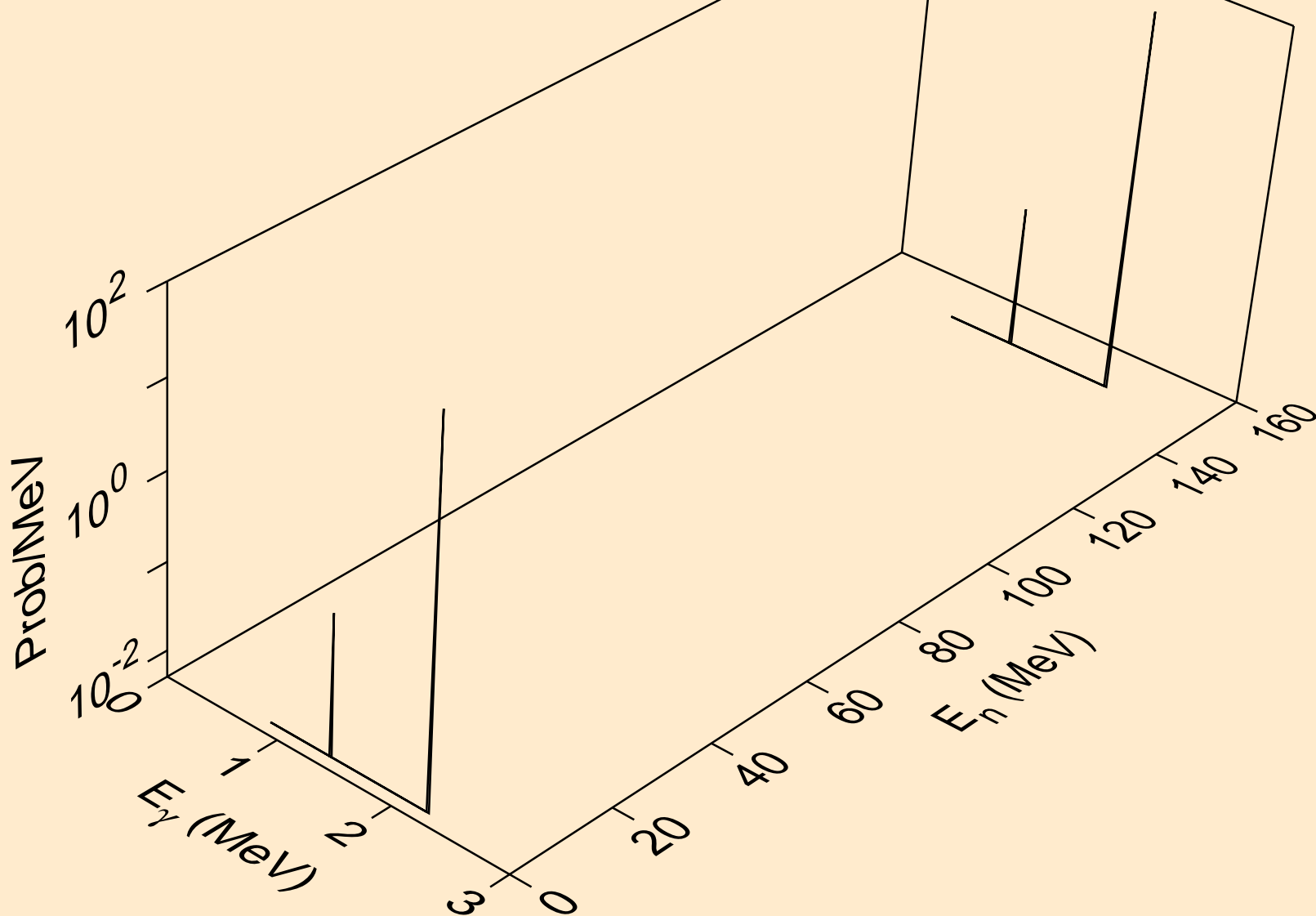

13-AL-27 FOR FENDL-3B2 FROM JEFF-3.1 WITH NJOY99.304+ C  
Photon emission for (n,n\*4)

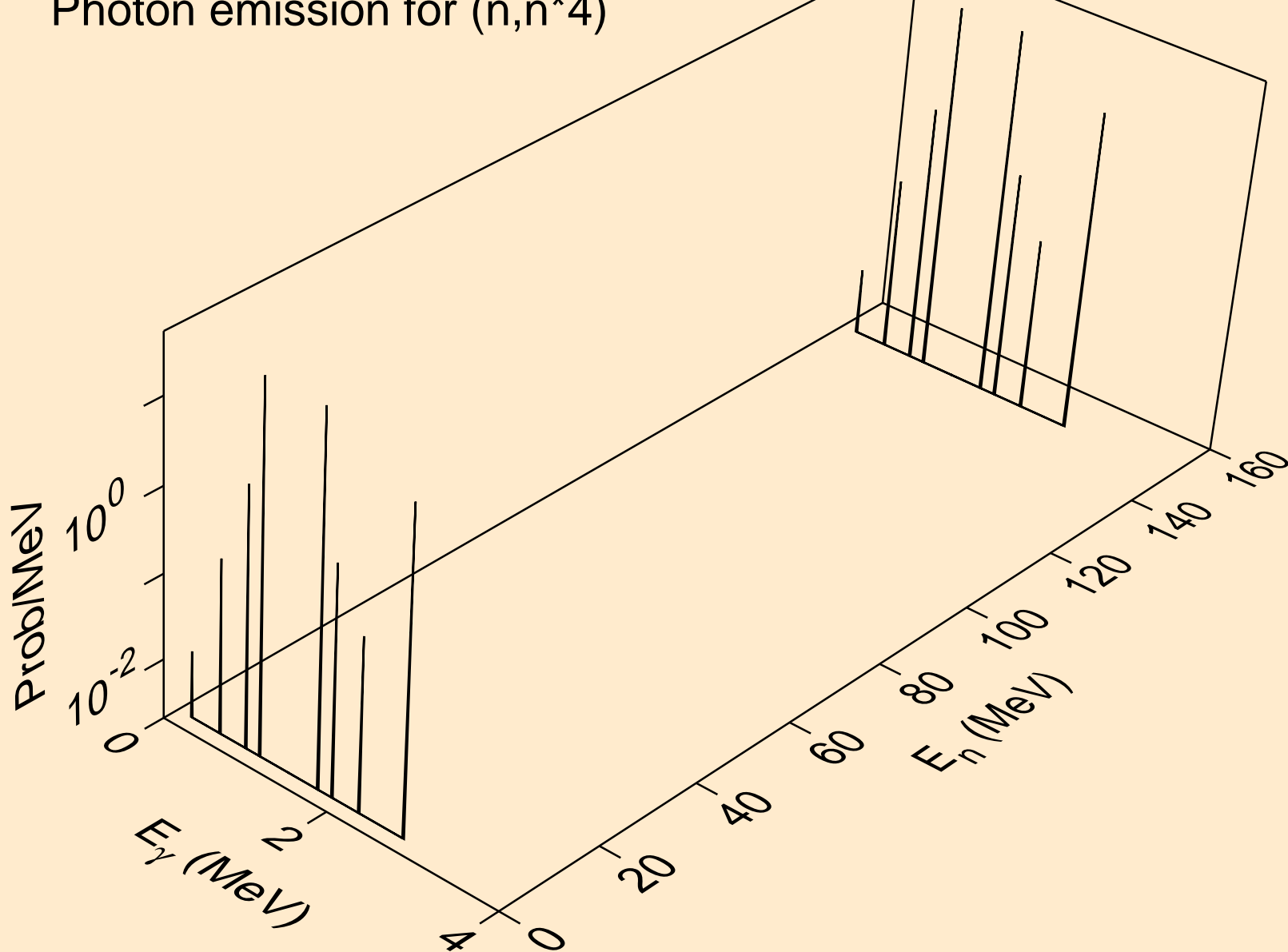

13-AL-27 FOR FENDL-3B2 FROM JEFF-3.1 WITH NJOY99.304+ C  
Photon emission for (n,n\*5)

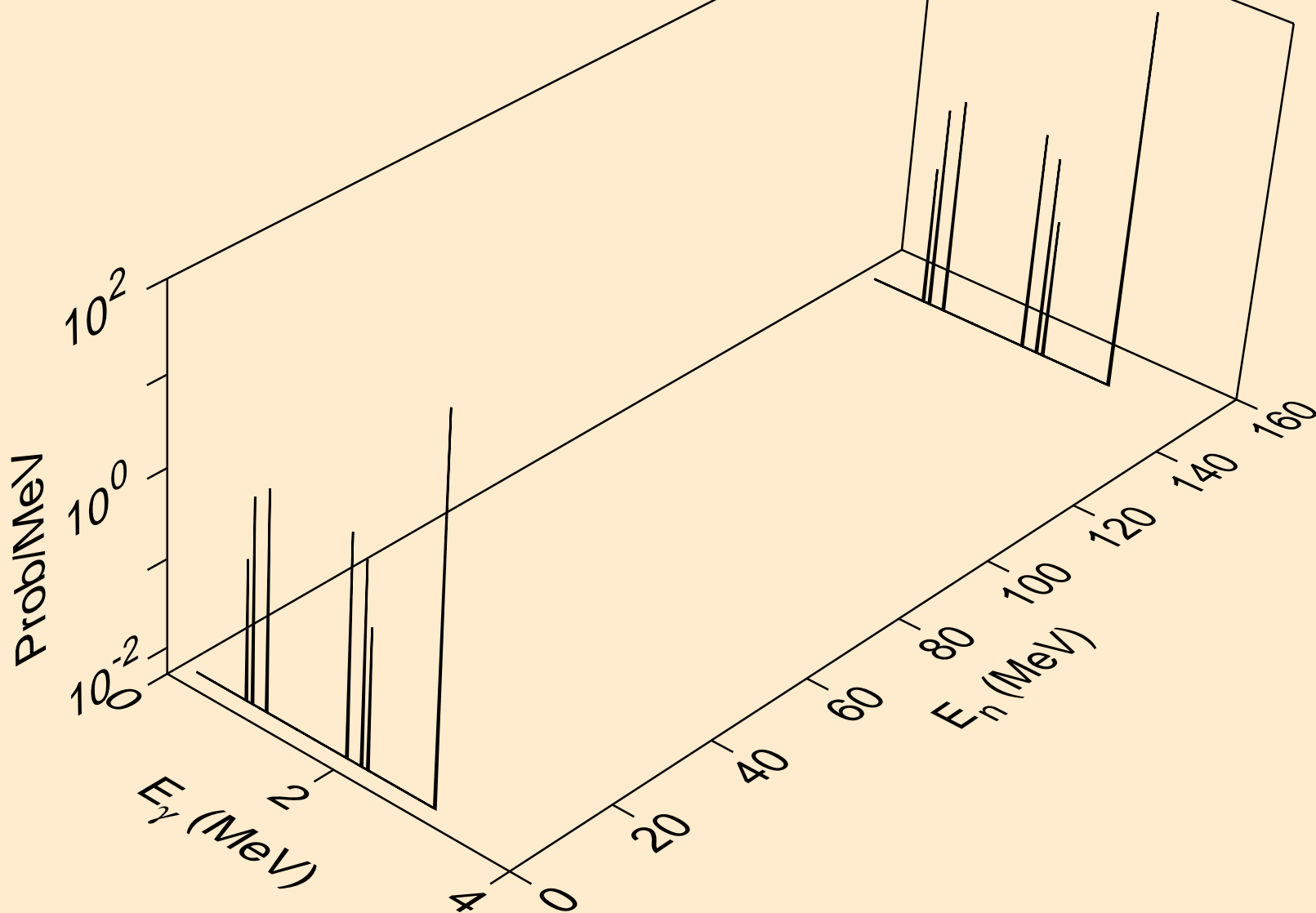



13-AL-27 FOR FENDL-3B2 FROM JEFF-3.1 WITH NJOY99.304+ C  
Photon emission for (n,n\*6)

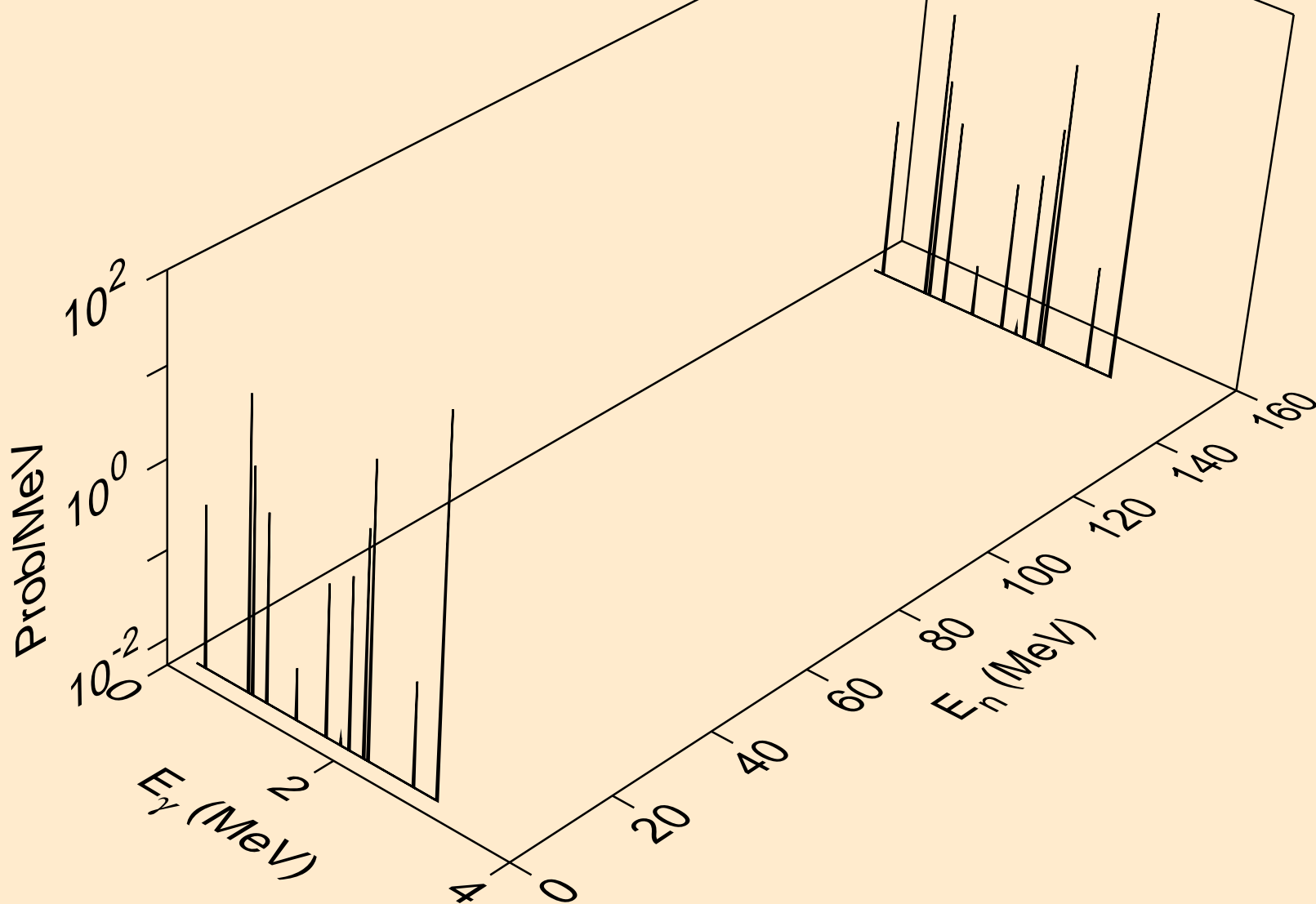

13-AL-27 FOR FENDL-3B2 FROM JEFF-3.1 WITH NJOY99.304+ C  
Photon emission for (n,n\*7)

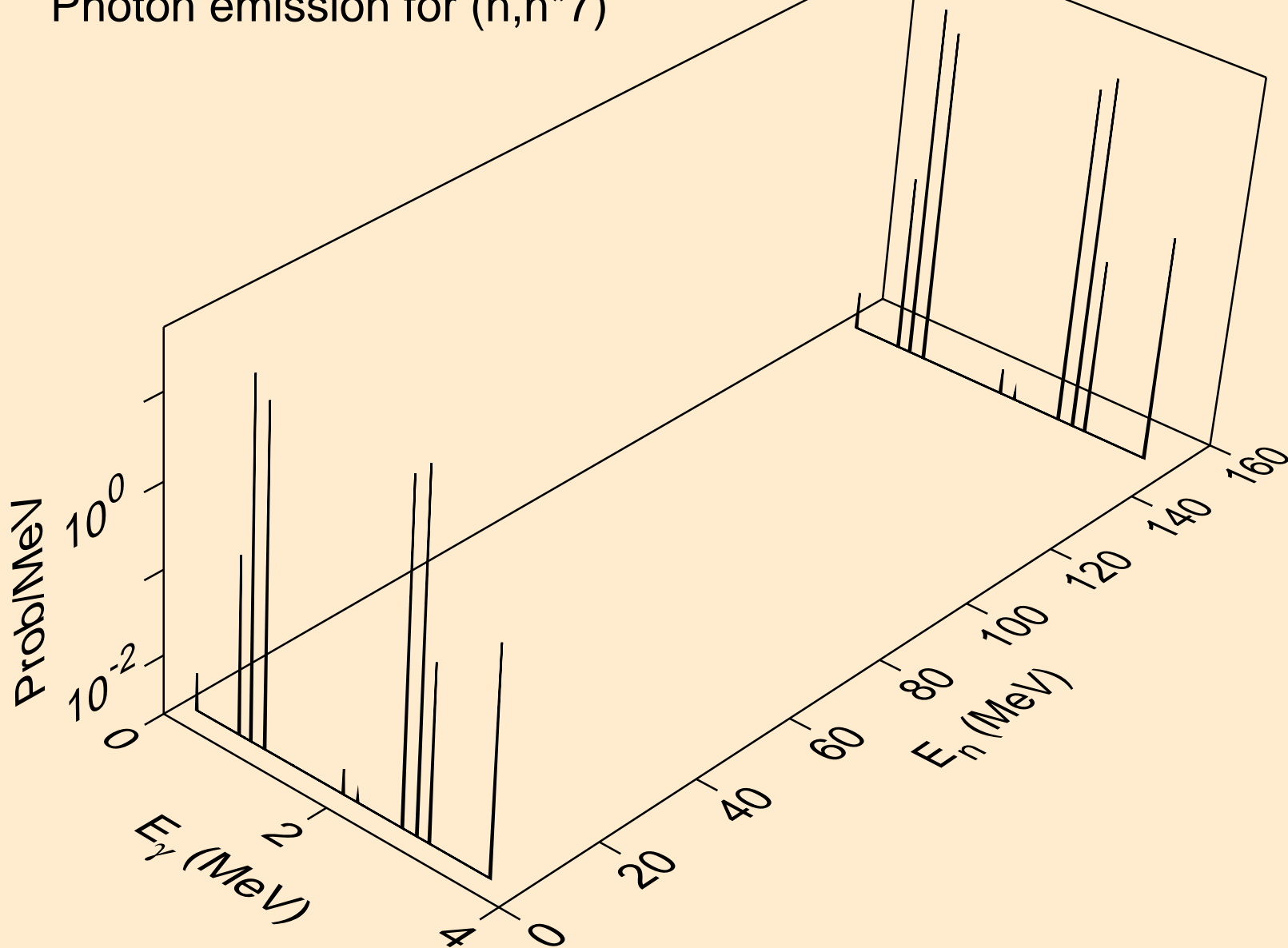

13-AL-27 FOR FENDL-3B2 FROM JEFF-3.1 WITH NJOY99.304+ C  
Photon emission for (n,n\*8)

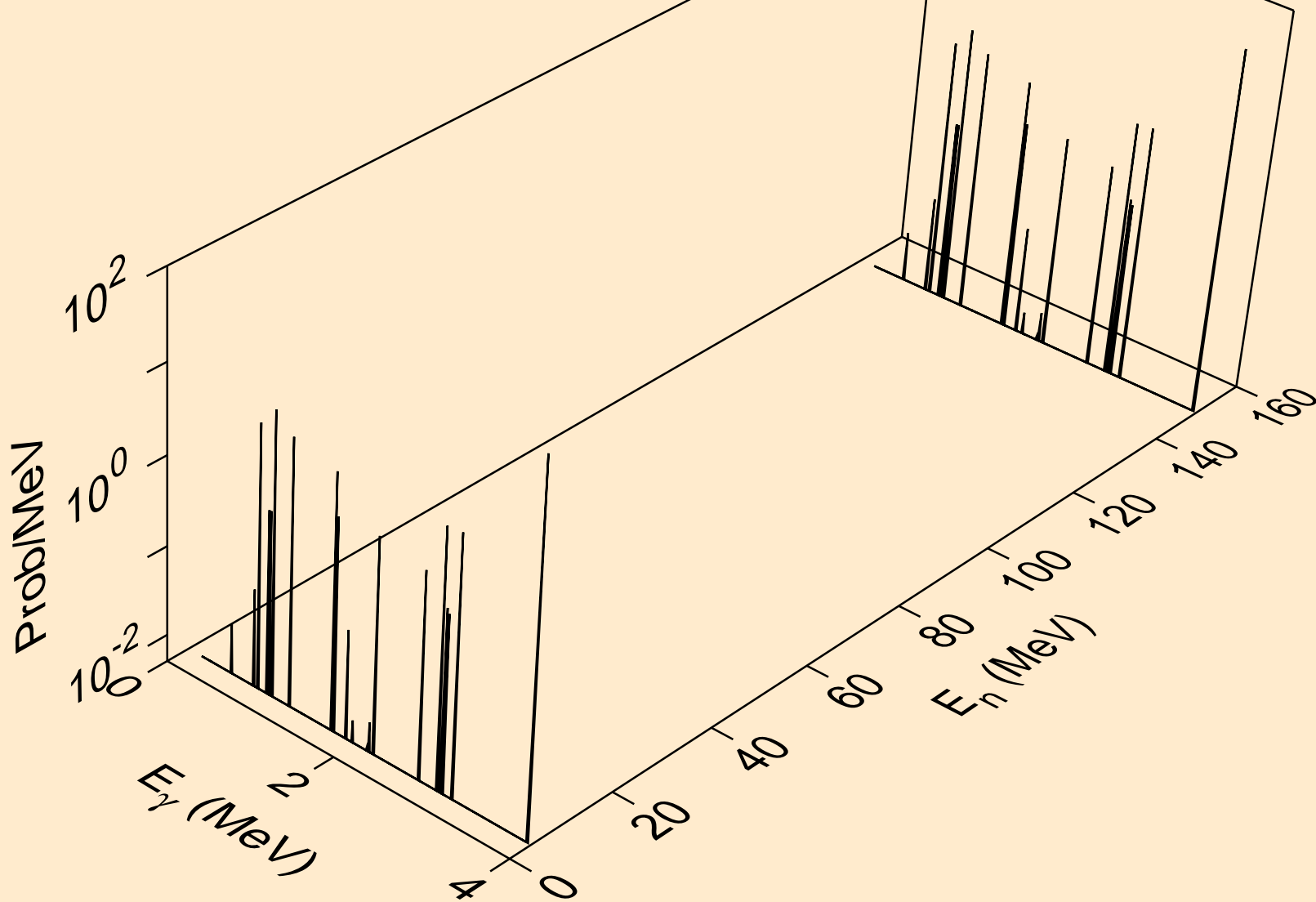

13-AL-27 FOR FENDL-3B2 FROM JEFF-3.1 WITH NJOY99.304+ C  
Photon emission for (n,n\*9)

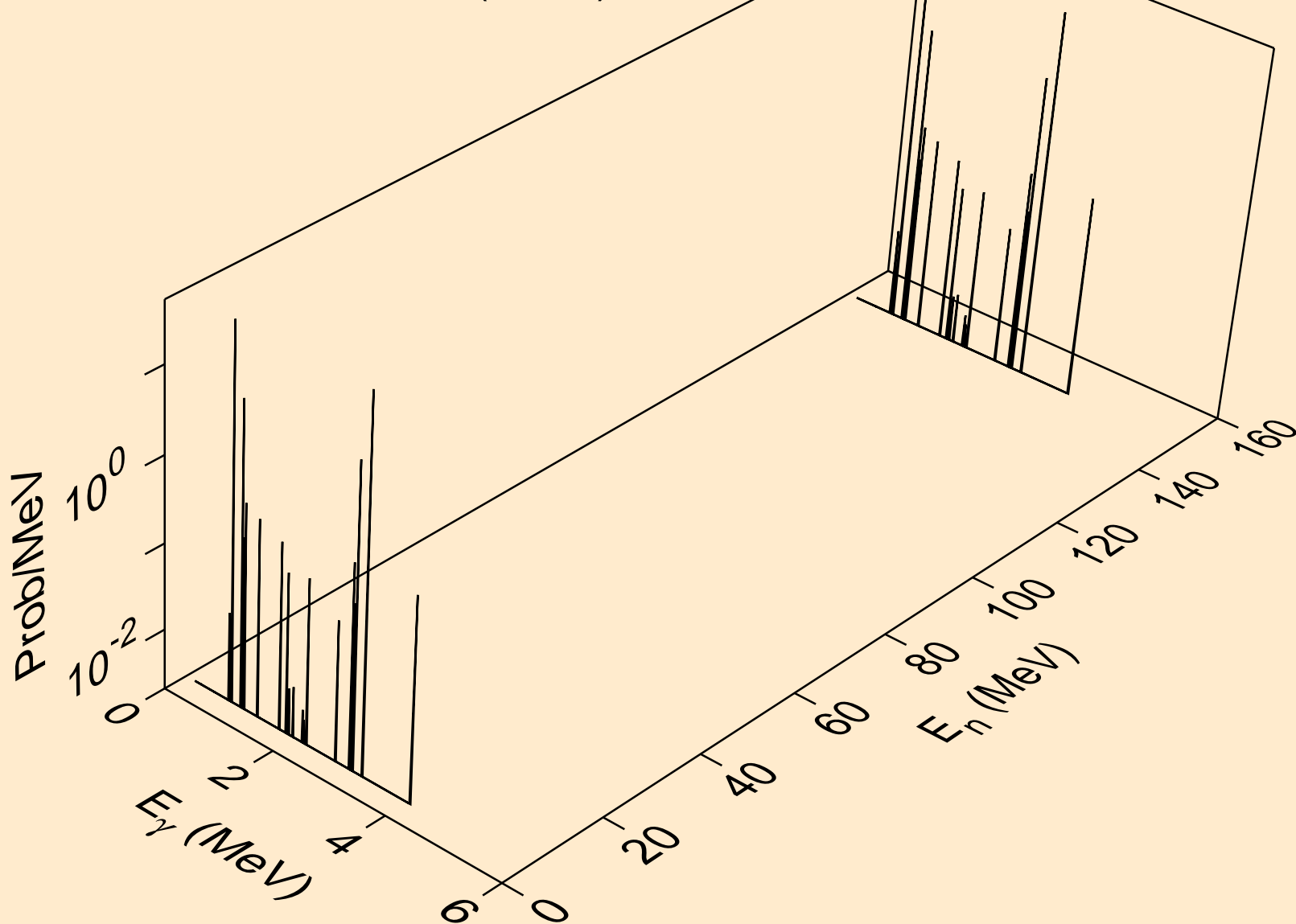

13-AL-27 FOR FENDL-3B2 FROM JEFF-3.1 WITH NJOY99.304+ C  
Photon emission for (n,n\*10)

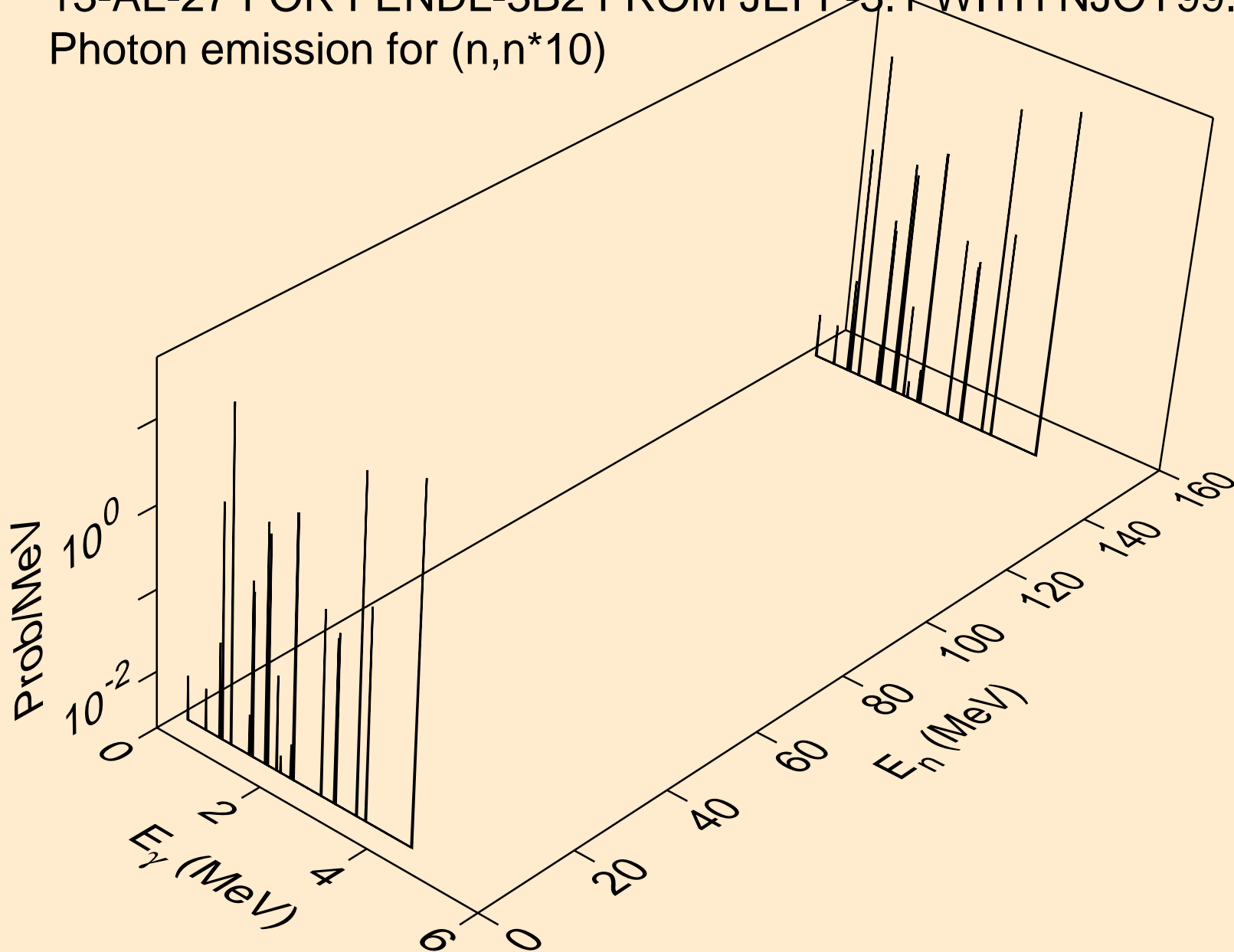

13-AL-27 FOR FENDL-3B2 FROM JEFF-3.1 WITH NJOY99.304+ C  
Photon emission for (n,n\*11)

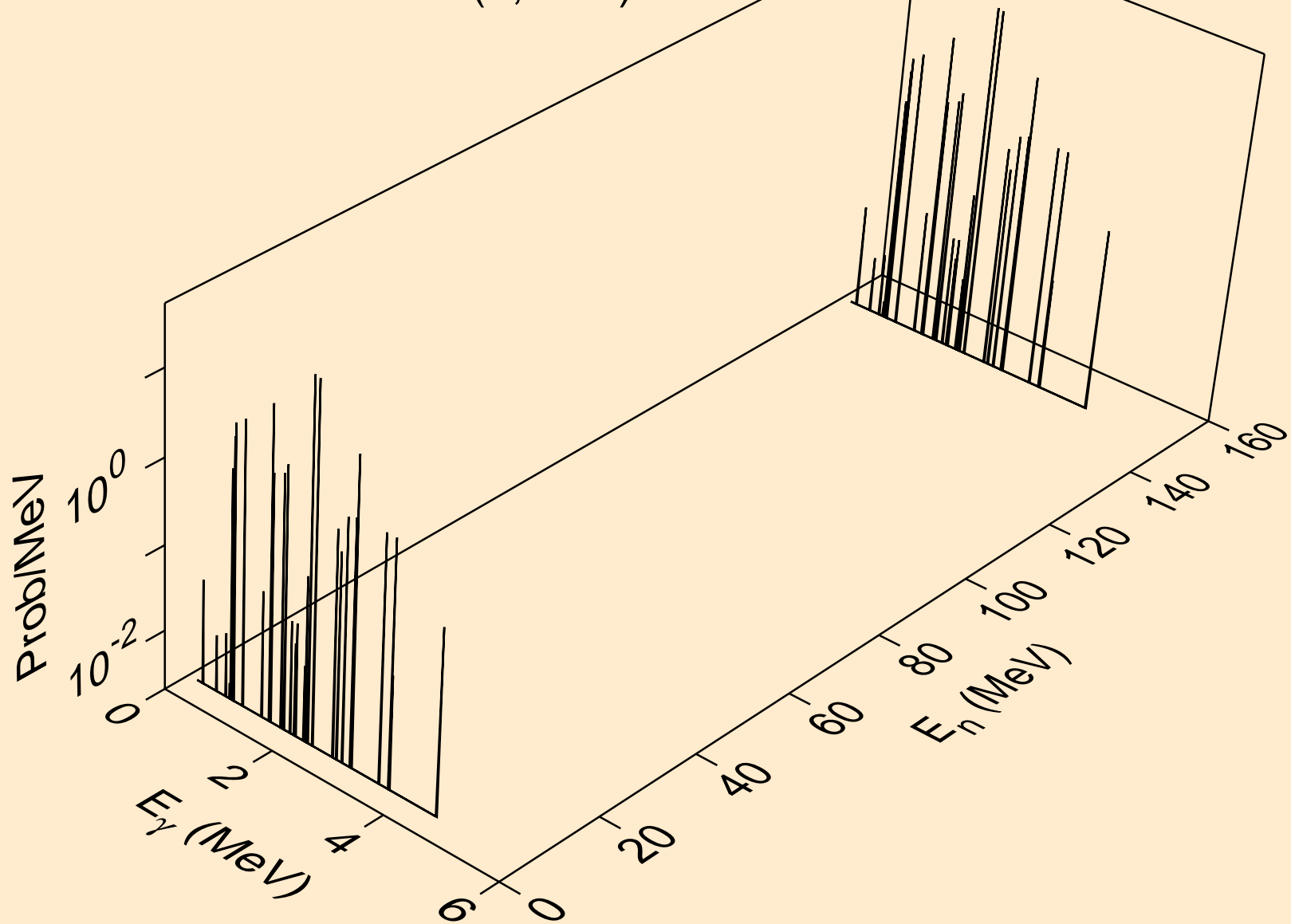

13-AL-27 FOR FENDL-3B2 FROM JEFF-3.1 WITH NJOY99.304+ C  
Photon emission for (n,n\*12)

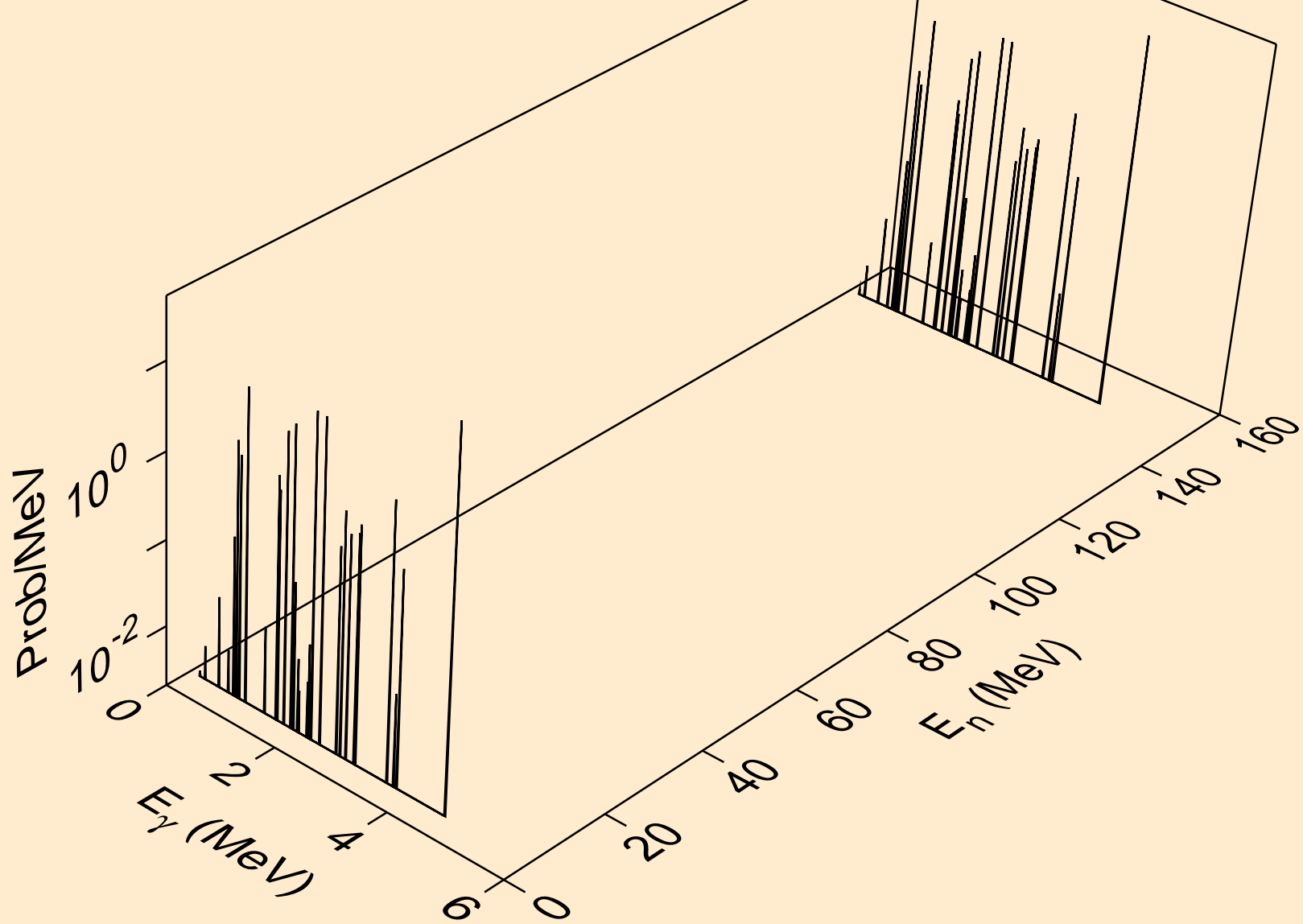

13-AL-27 FOR FENDL-3B2 FROM JEFF-3.1 WITH NJOY99.304+ C  
Photon emission for (n,n\*13)

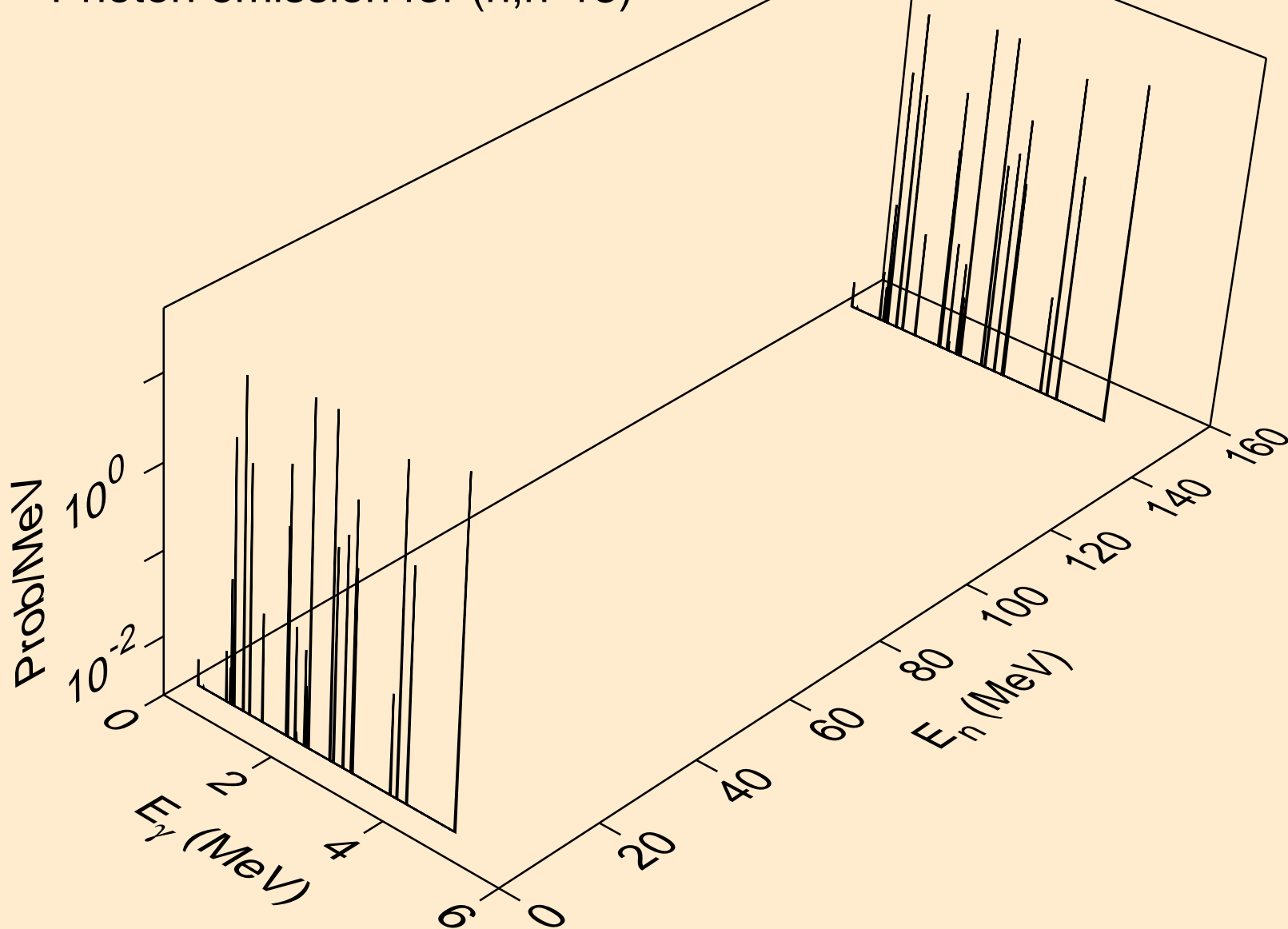



13-AL-27 FOR FENDL-3B2 FROM JEFF-3.1 WITH NJOY99.304+ C  
Photon emission for (n,n\*14)

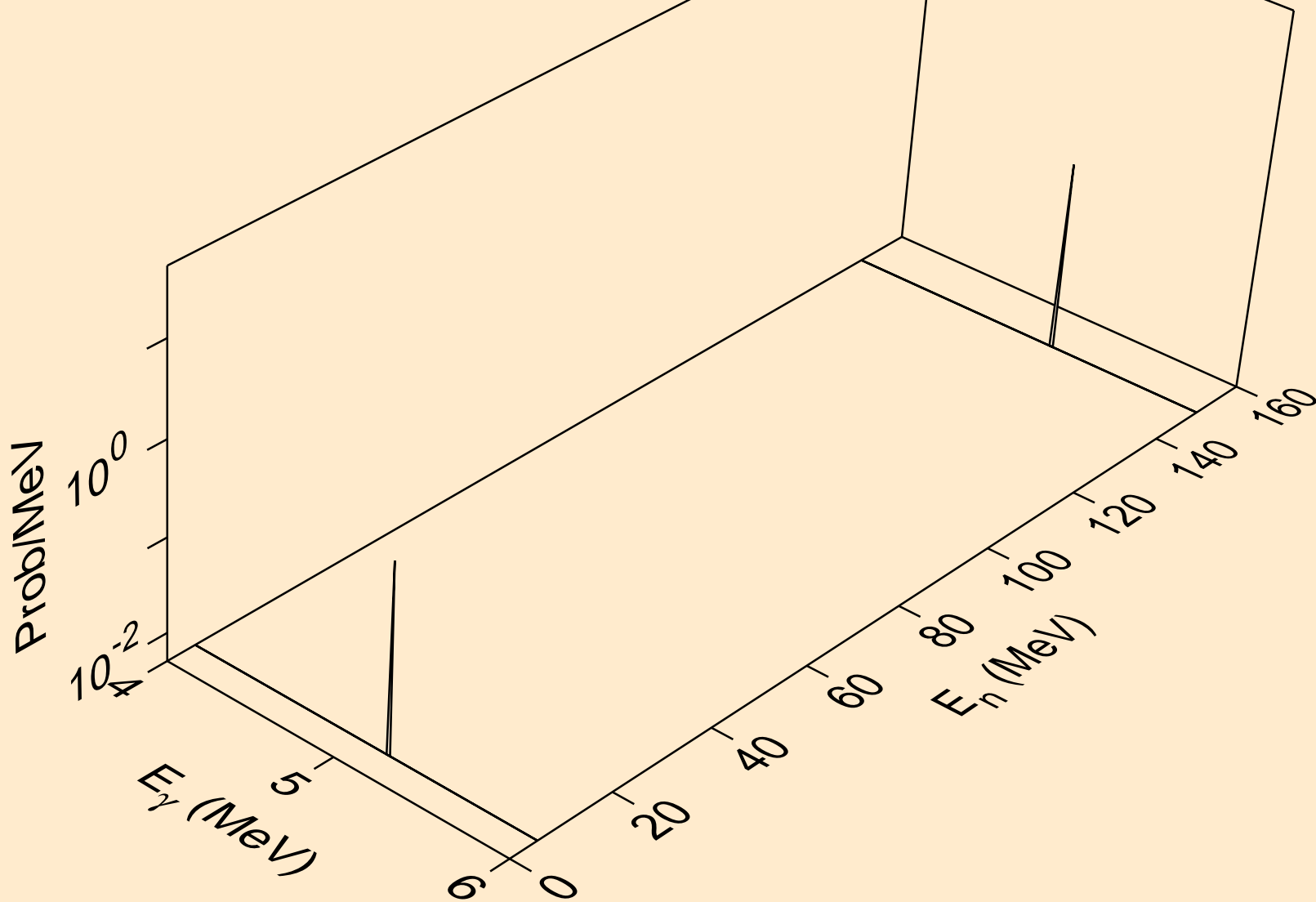

13-AL-27 FOR FENDL-3B2 FROM JEFF-3.1 WITH NJOY99.304+ C  
Photon emission for (n,n\*15)

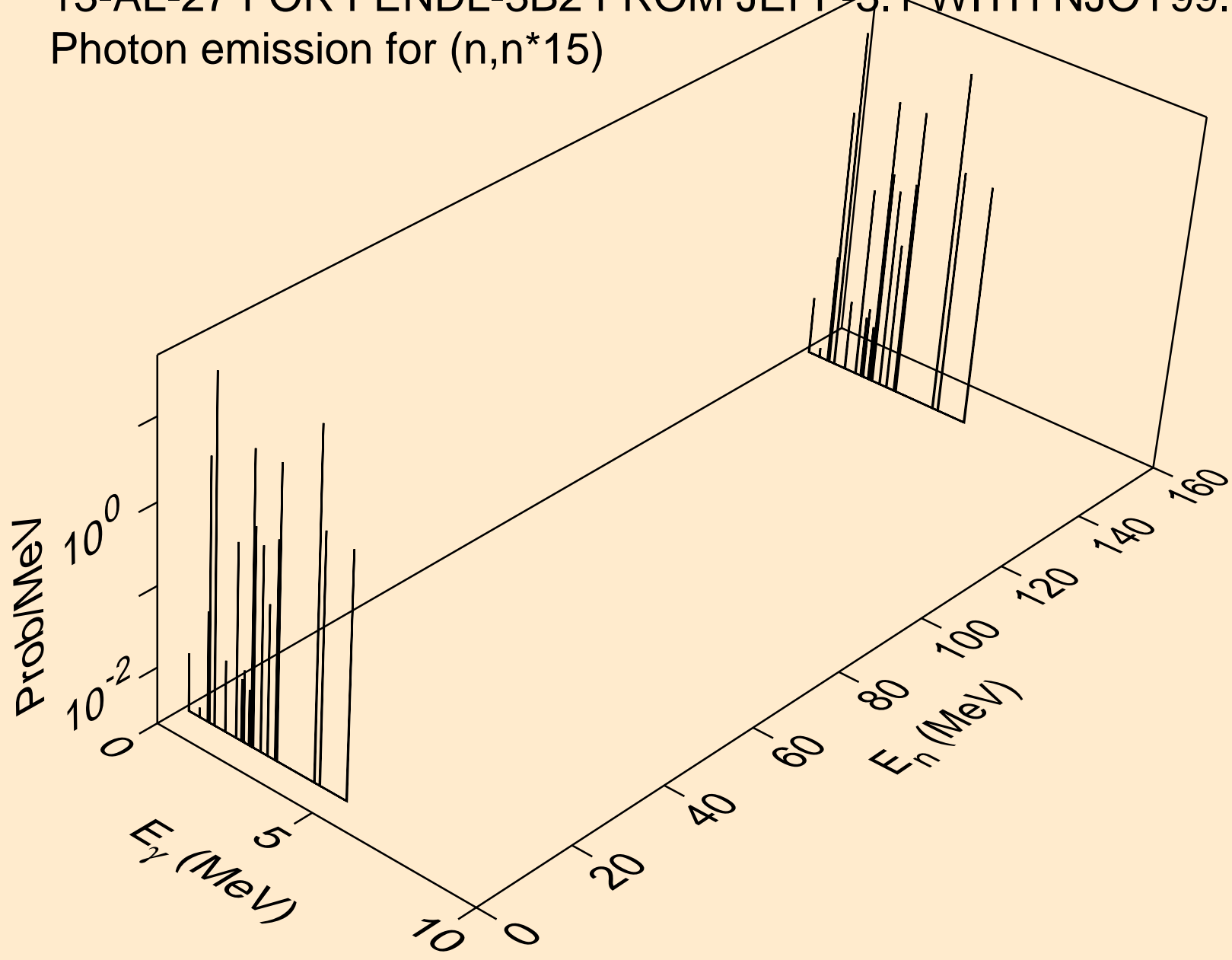

13-AL-27 FOR FENDL-3B2 FROM JEFF-3.1 WITH NJOY99.304+ C  
Photon emission for (n,n\*16)

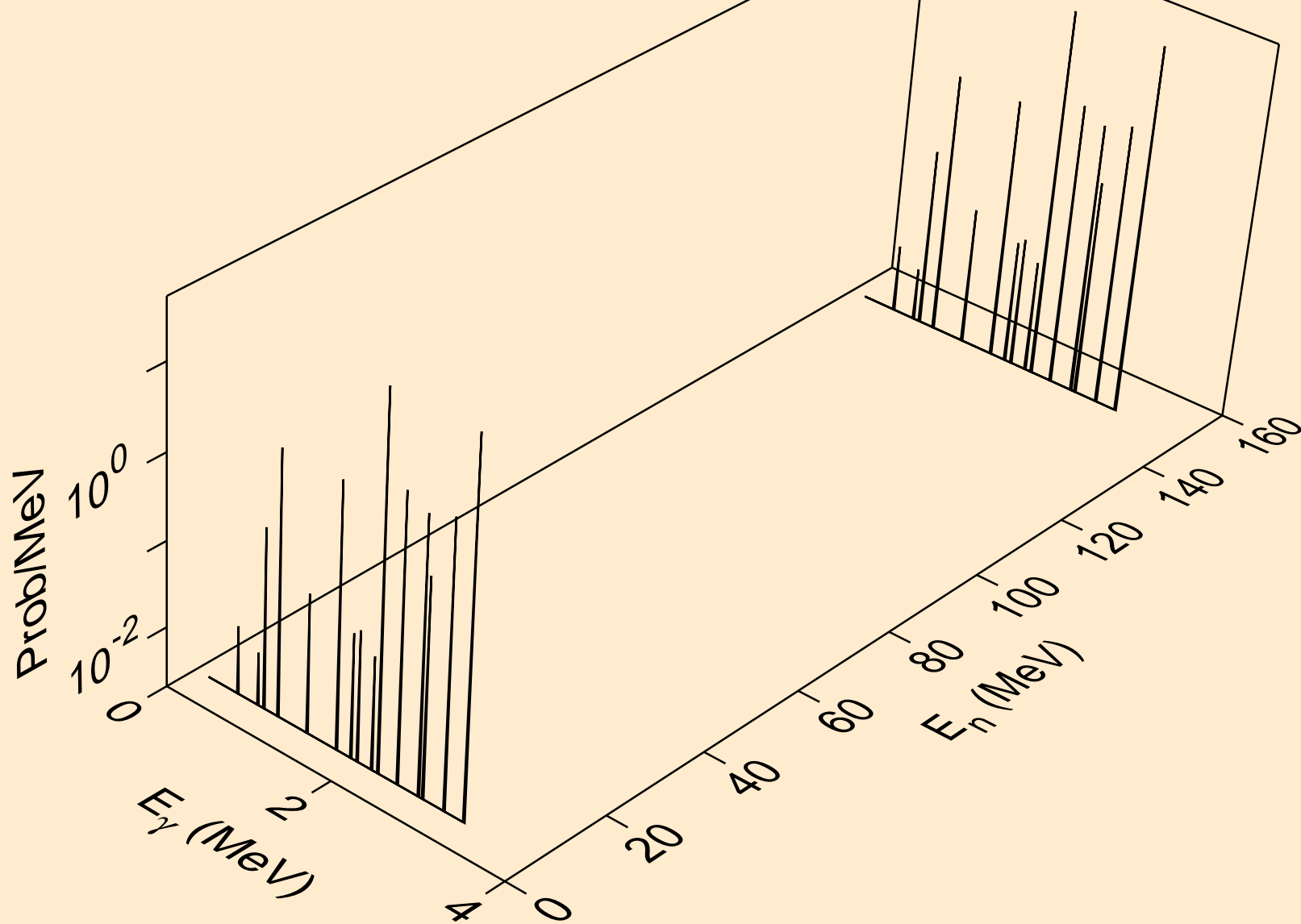

13-AL-27 FOR FENDL-3B2 FROM JEFF-3.1 WITH NJOY99.304+ C  
Photon emission for (n,n\*17)

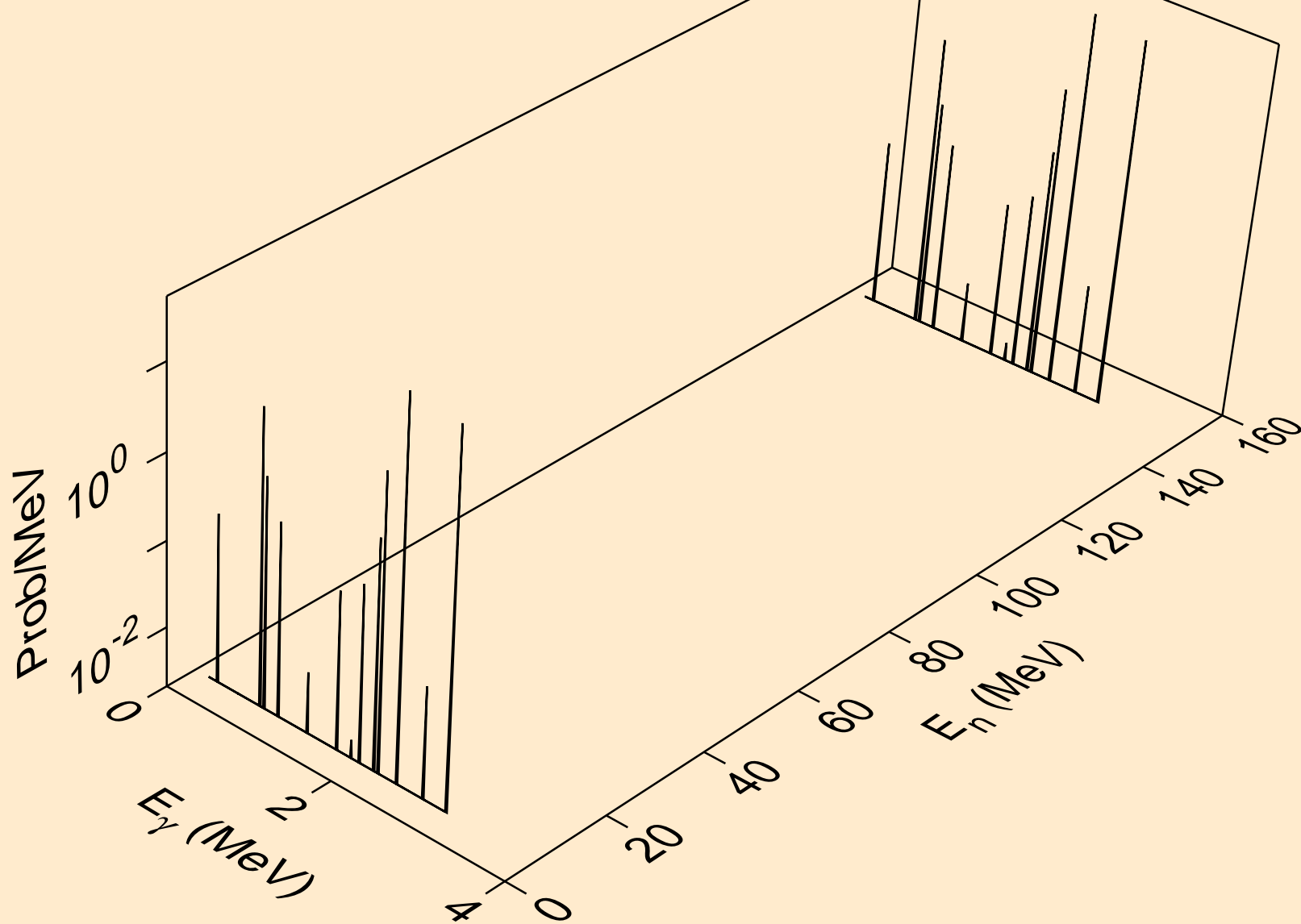

13-AL-27 FOR FENDL-3B2 FROM JEFF-3.1 WITH NJOY99.304+ C  
Photon emission for (n,n\*18)

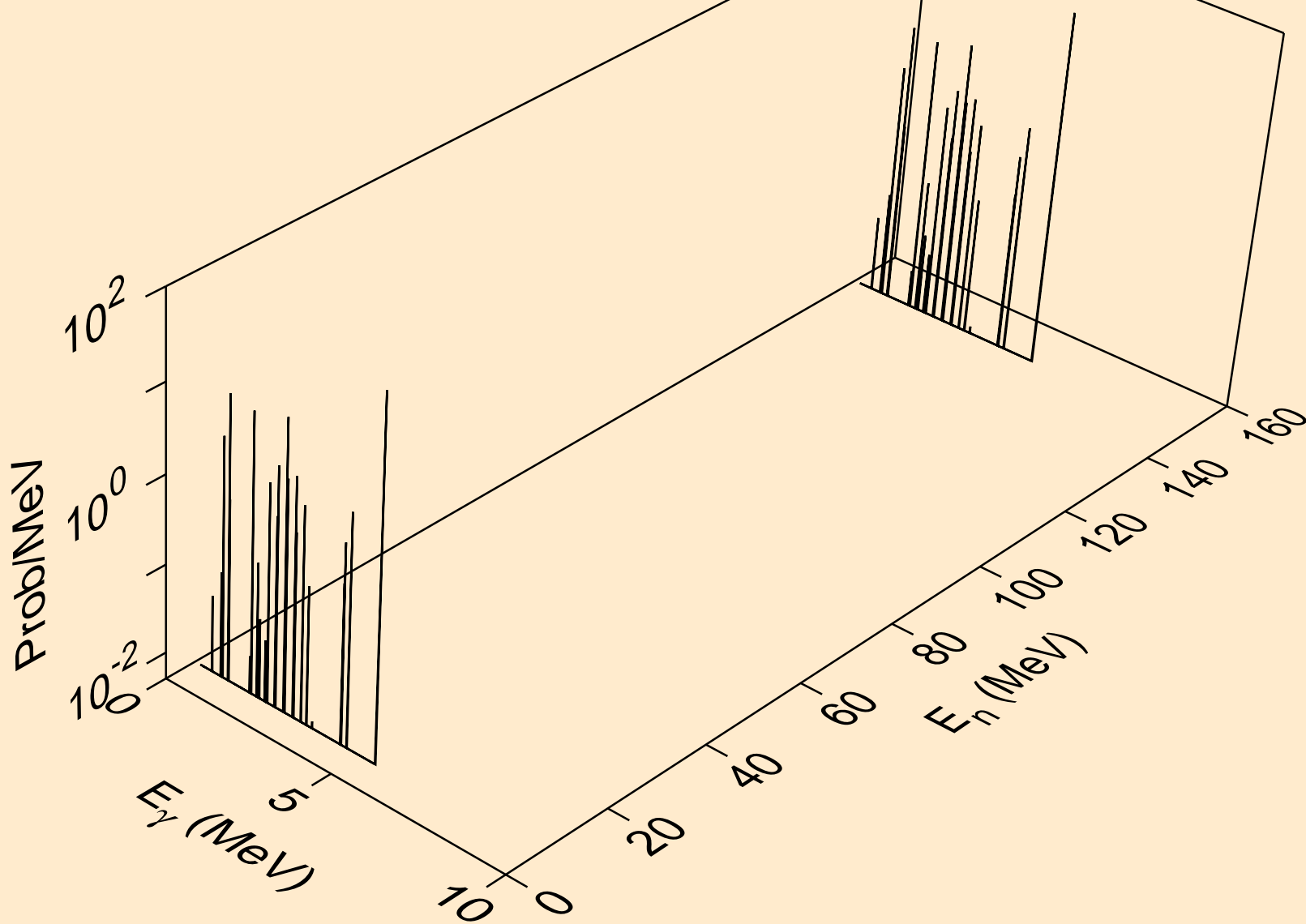

13-AL-27 FOR FENDL-3B2 FROM JEFF-3.1 WITH NJOY99.304+ C  
Photon emission for (n,n\*19)

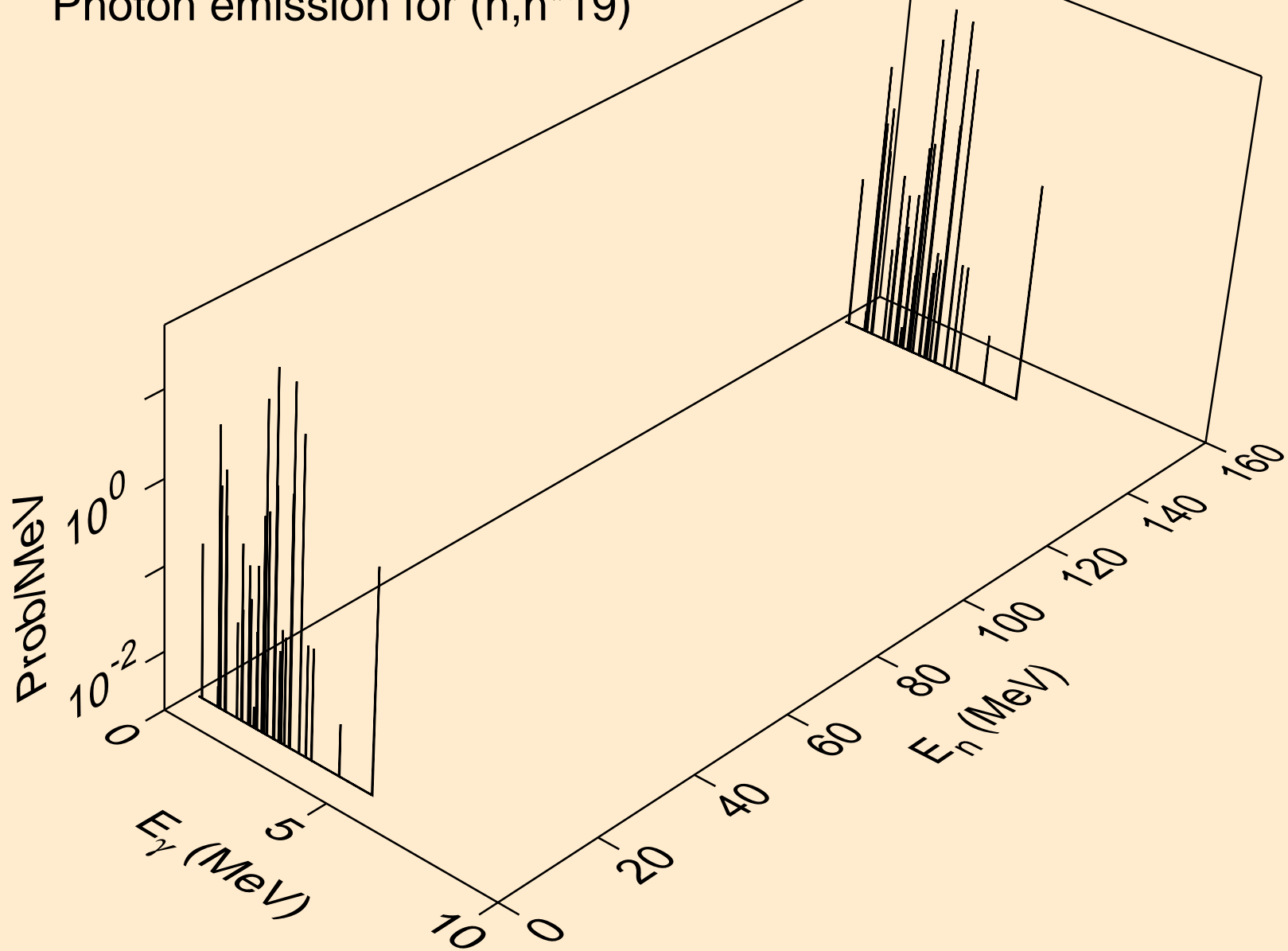

13-AL-27 FOR FENDL-3B2 FROM JEFF-3.1 WITH NJOY99.304+ C  
Photon emission for (n,n\*20)

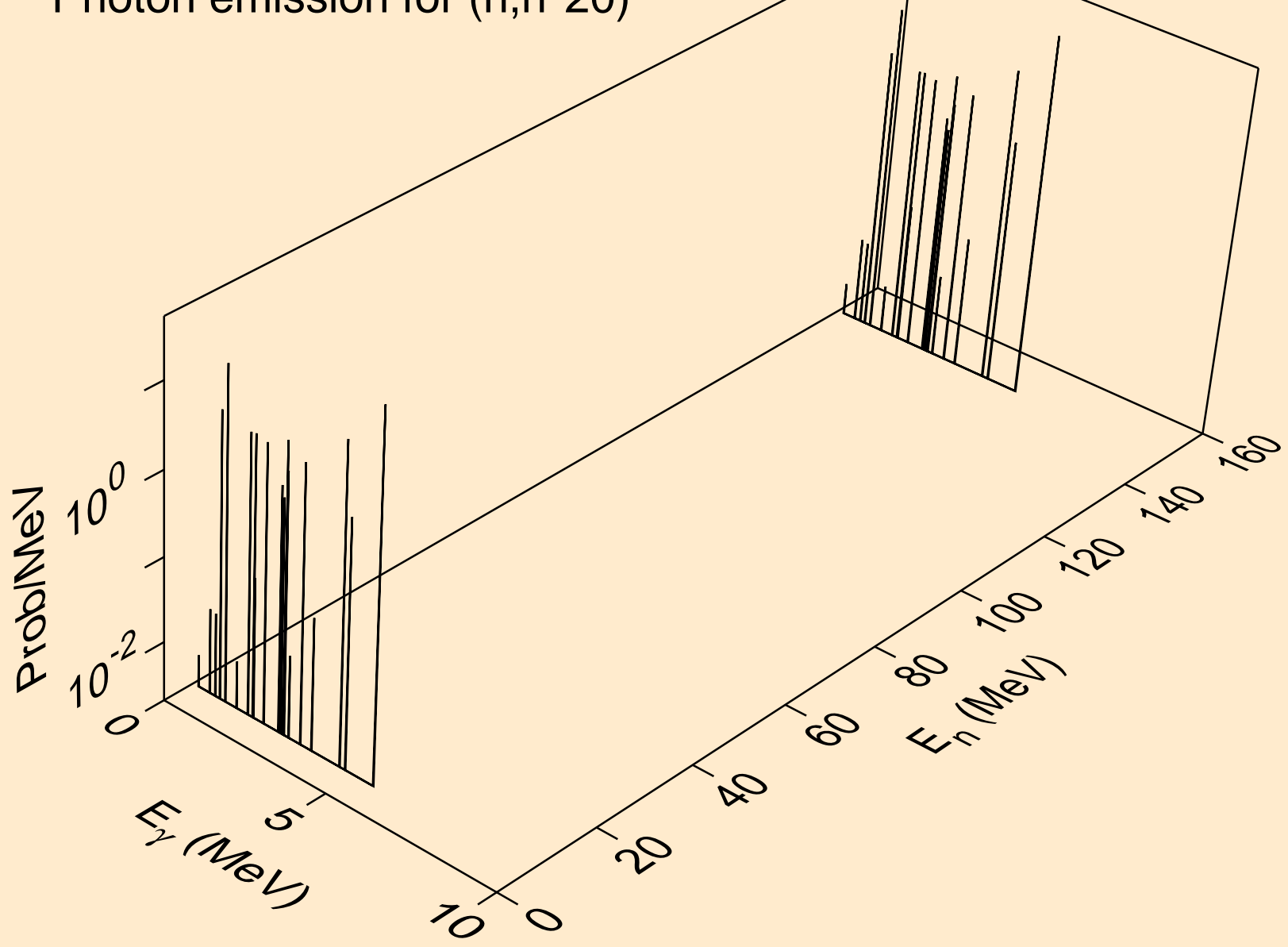

13-AL-27 FOR FENDL-3B2 FROM JEFF-3.1 WITH NJOY99.304+ C  
Photon emission for (n,n\*21)

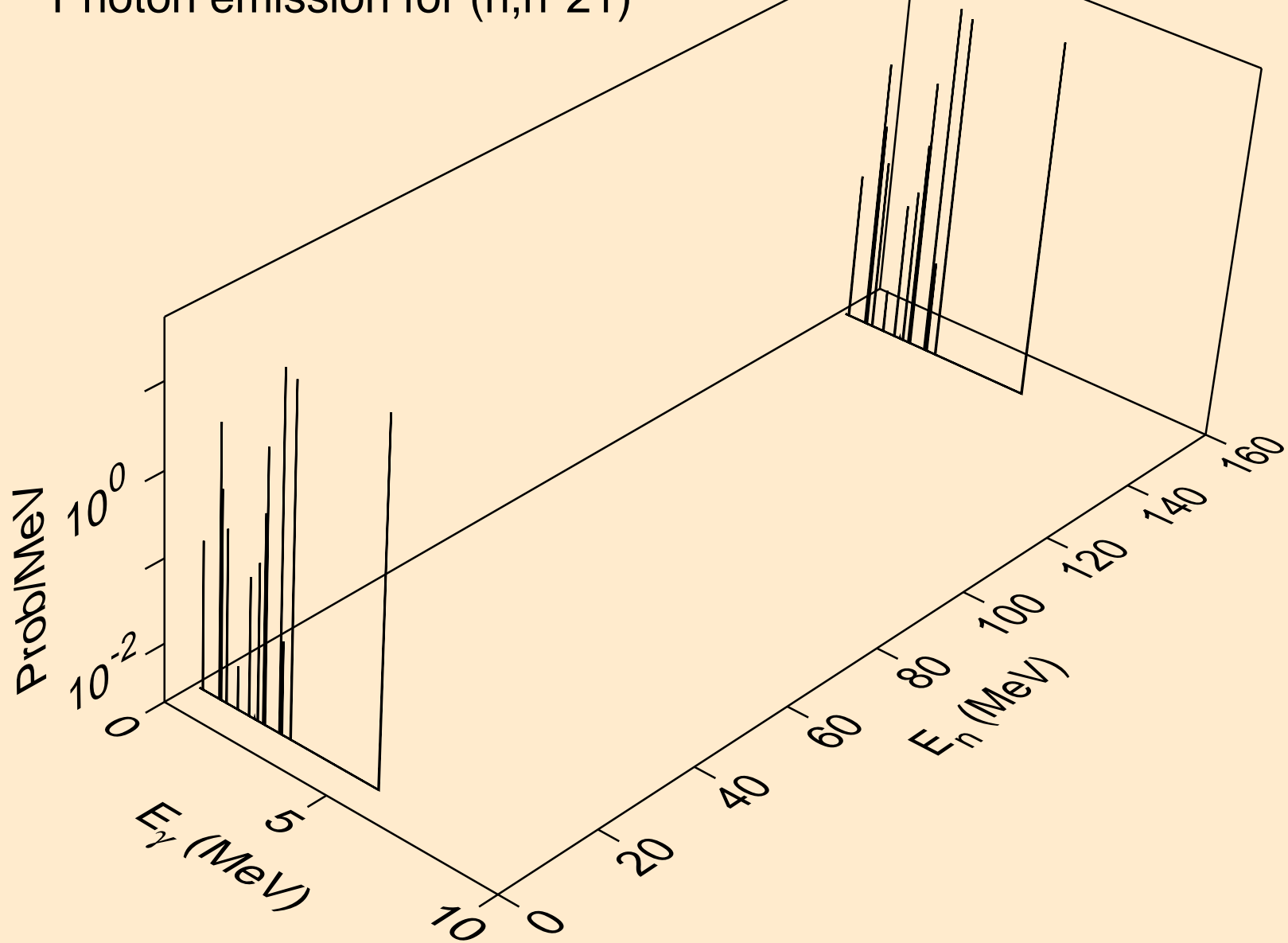



13-AL-27 FOR FENDL-3B2 FROM JEFF-3.1 WITH NJOY99.304+ C  
Photon emission for (n,n\*22)

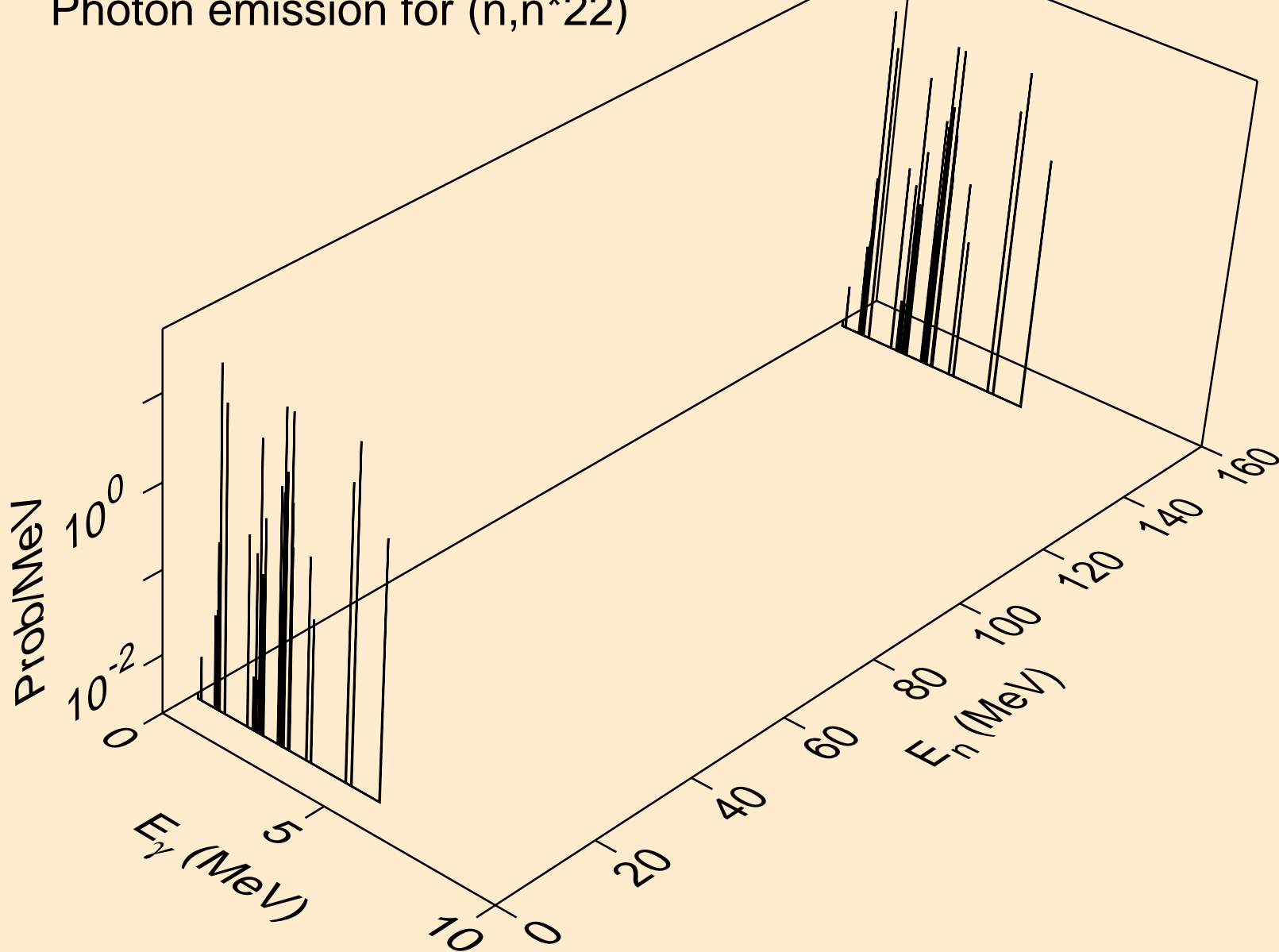

13-AL-27 FOR FENDL-3B2 FROM JEFF-3.1 WITH NJOY99.304+ C  
Photon emission for (n,n\*23)

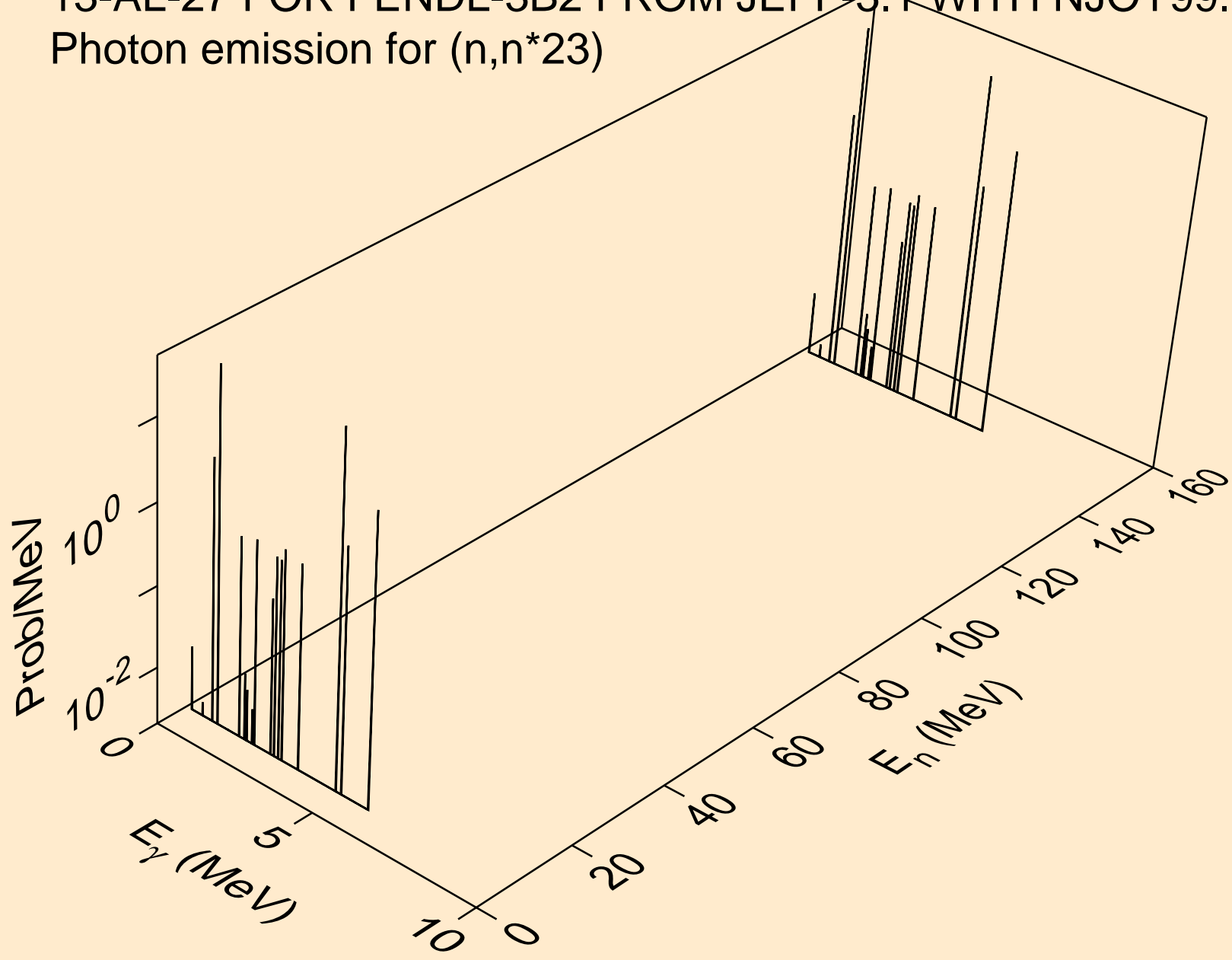

13-AL-27 FOR FENDL-3B2 FROM JEFF-3.1 WITH NJOY99.304+ C  
Photon emission for (n,n\*24)

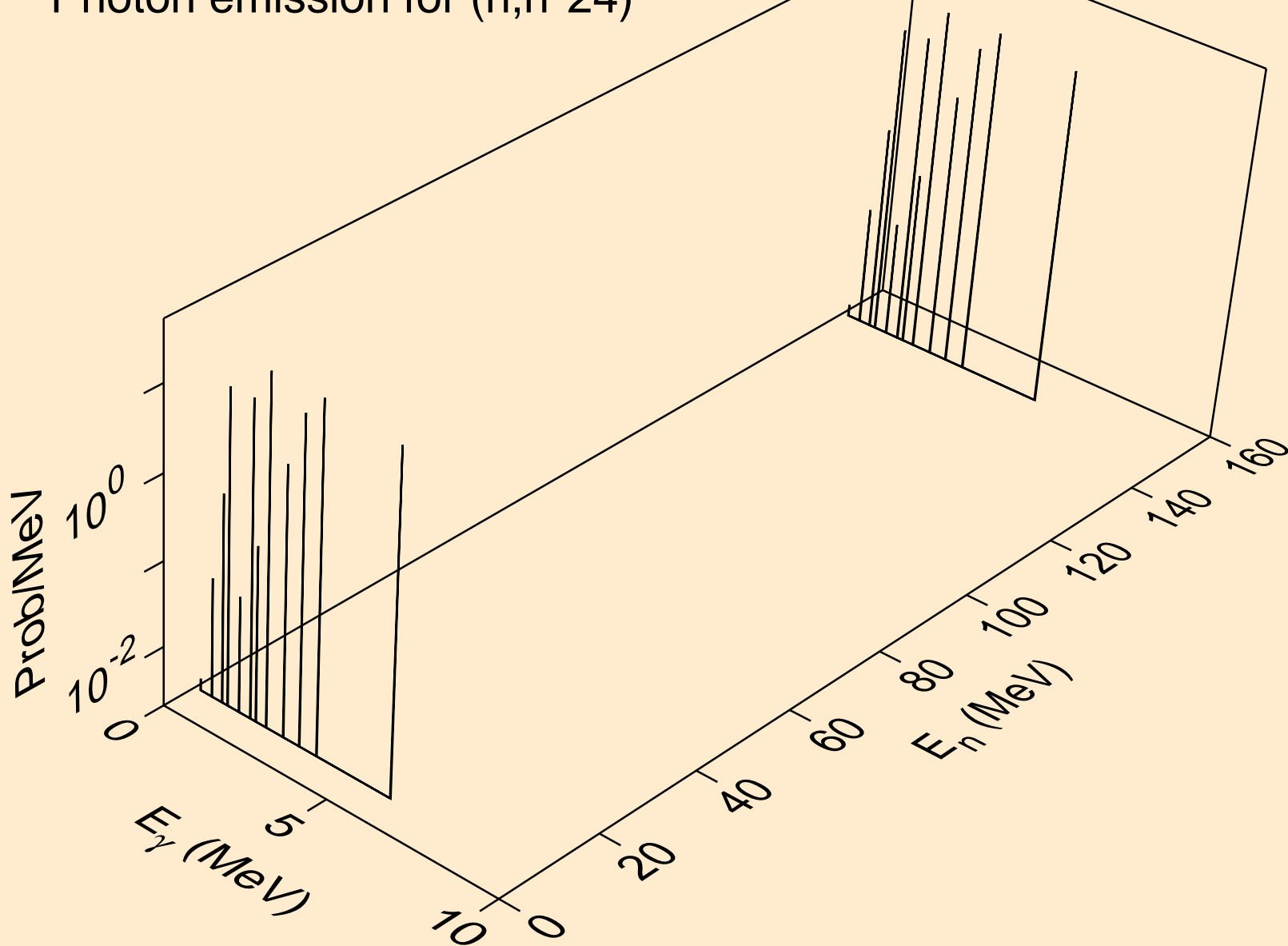

13-AL-27 FOR FENDL-3B2 FROM JEFF-3.1 WITH NJOY99.304+ C  
Photon emission for (n,n\*25)

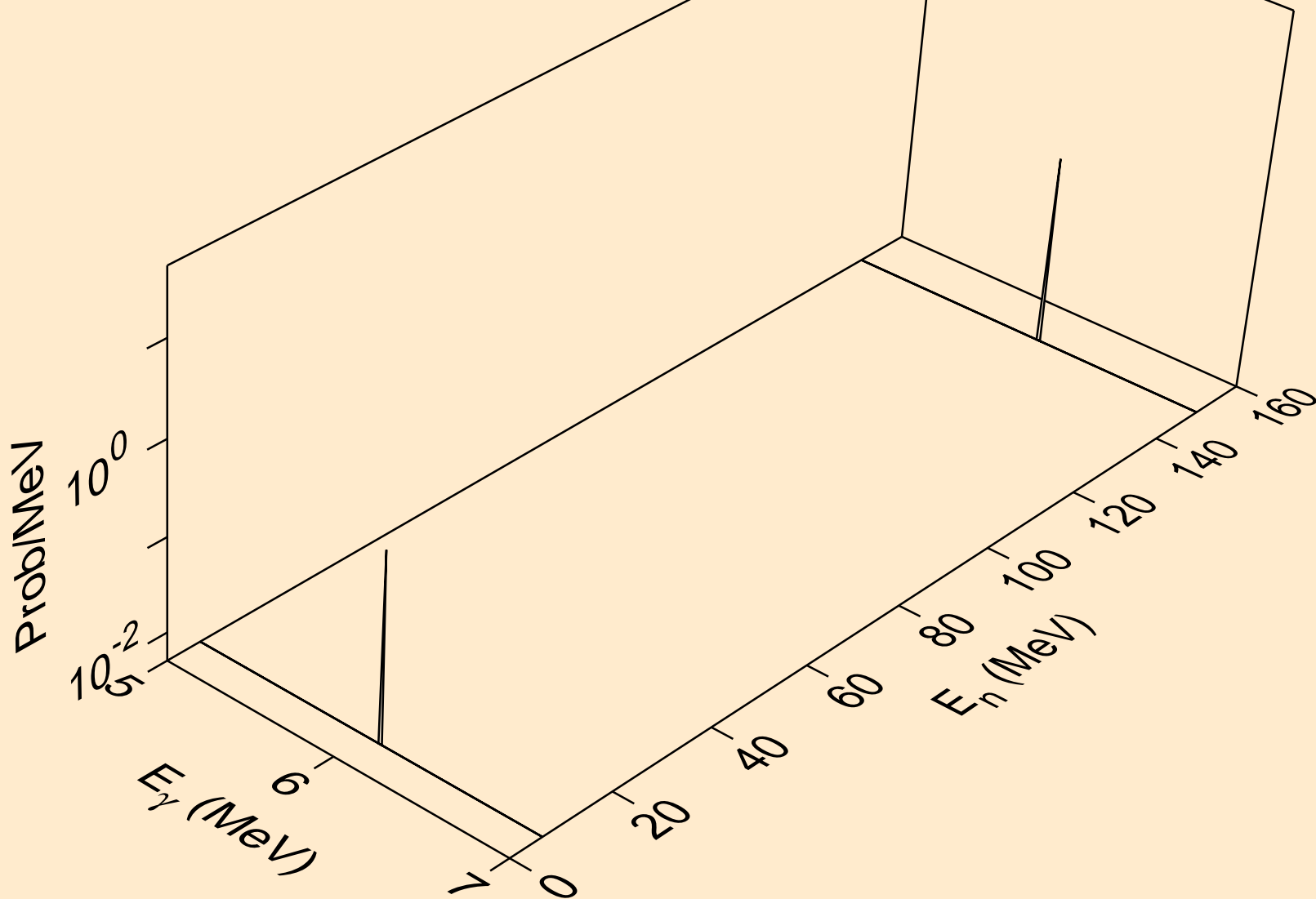

13-AL-27 FOR FENDL-3B2 FROM JEFF-3.1 WITH NJOY99.304+ C  
Photon emission for (n,n\*26)

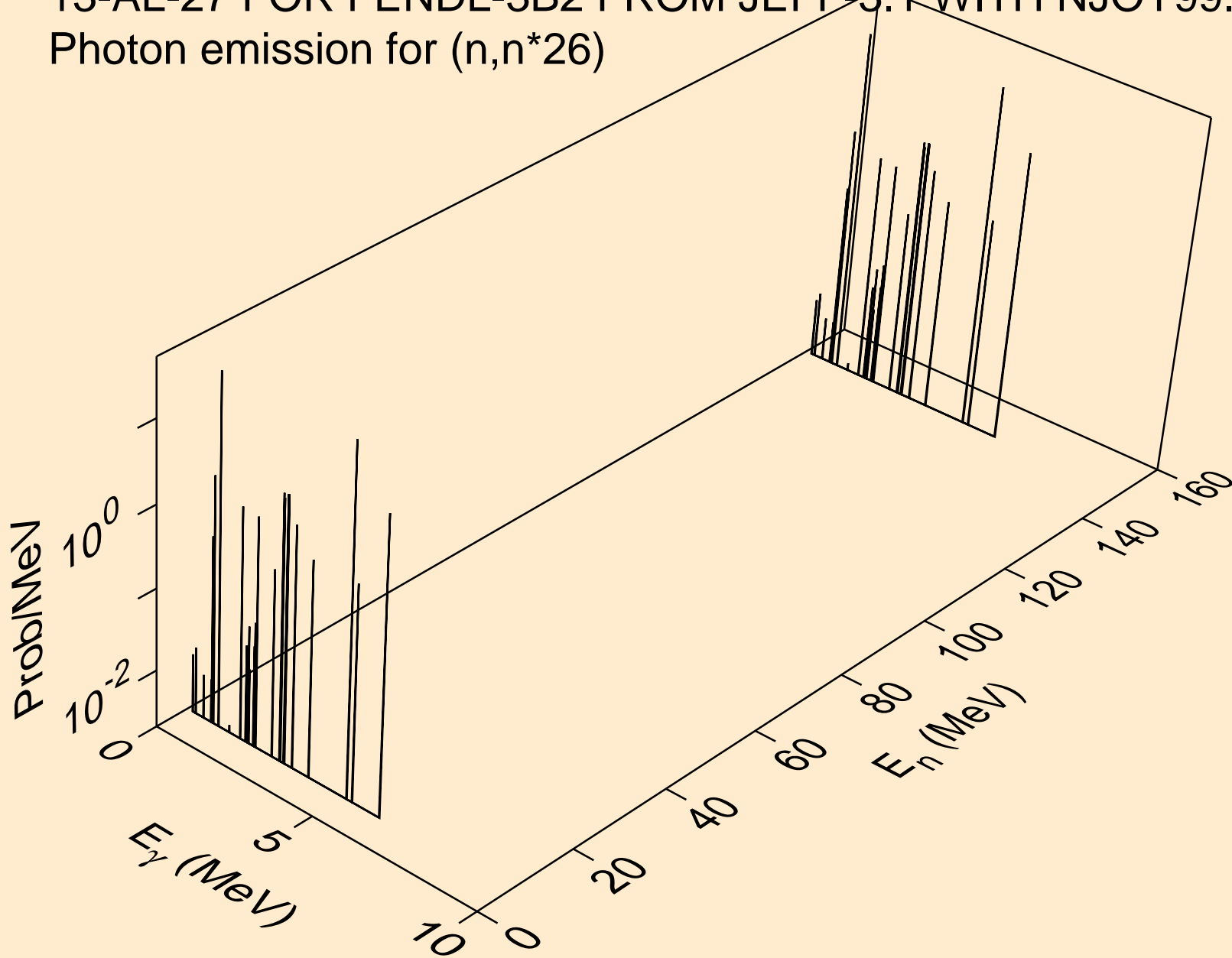

13-AL-27 FOR FENDL-3B2 FROM JEFF-3.1 WITH NJOY99.304+ C  
Photon emission for (n,n\*27)

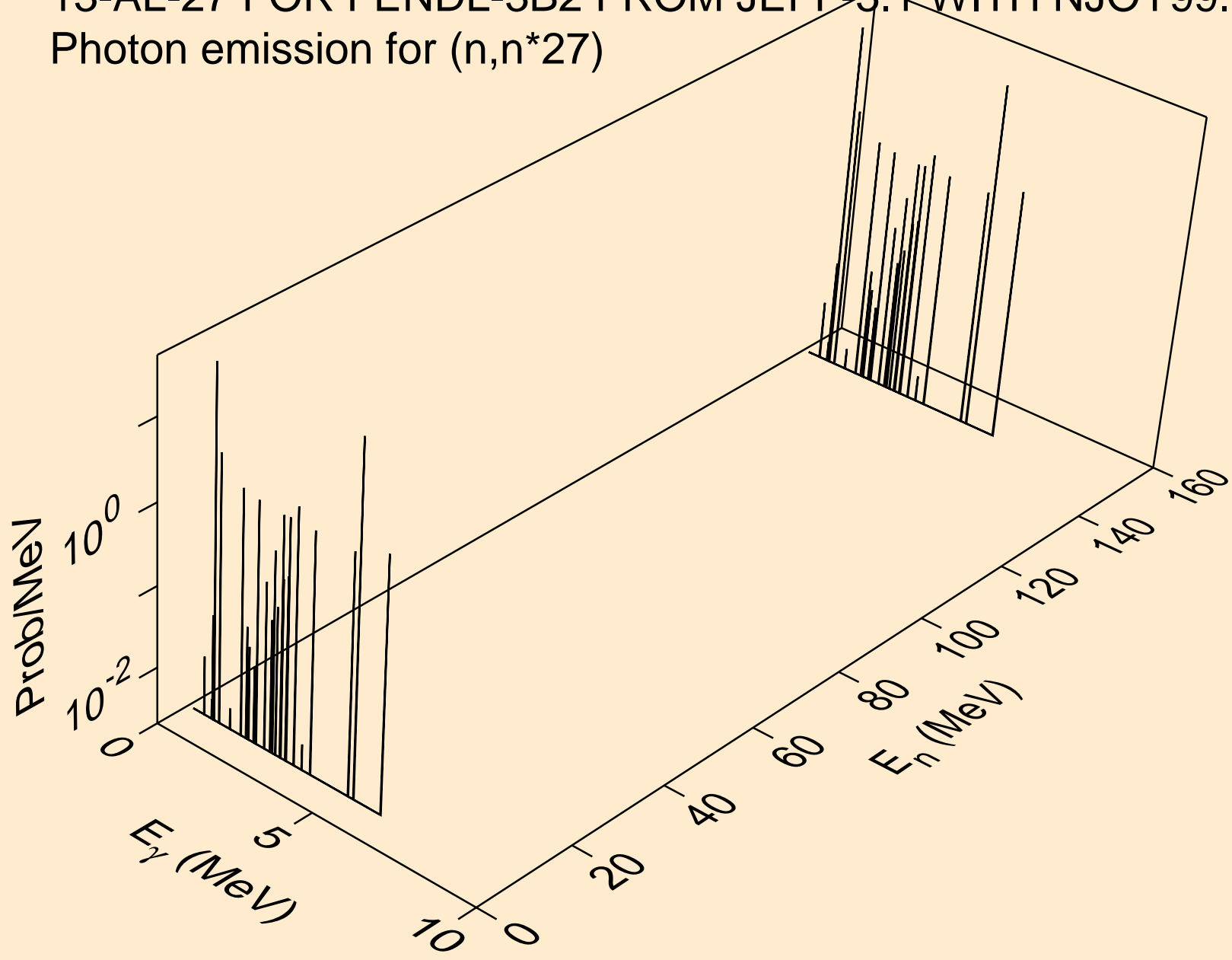

13-AL-27 FOR FENDL-3B2 FROM JEFF-3.1 WITH NJOY99.304+ C  
Photon emission for (n,n\*28)

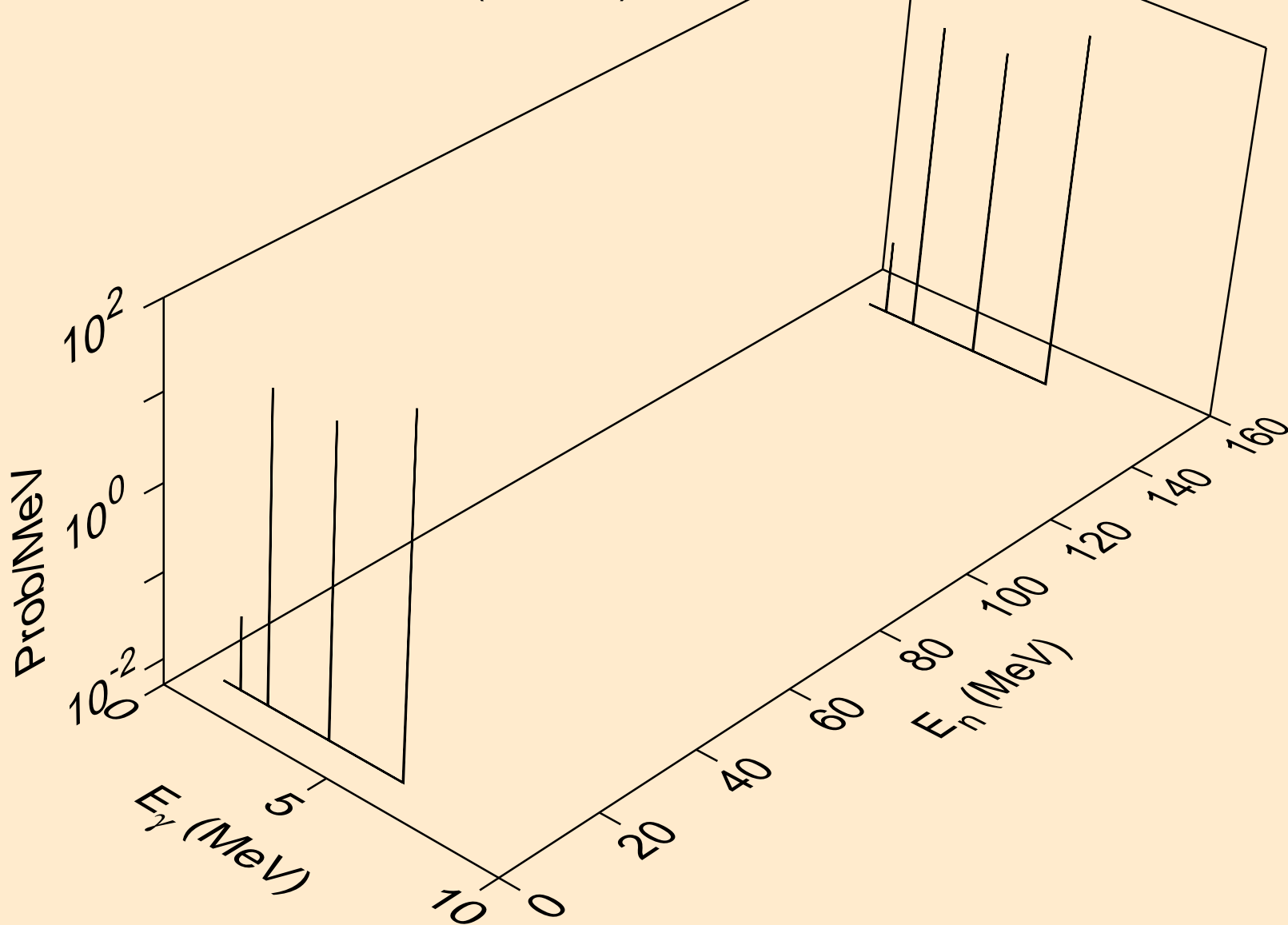

13-AL-27 FOR FENDL-3B2 FROM JEFF-3.1 WITH NJOY99.304+ C  
Photon emission for (n,n\*29)

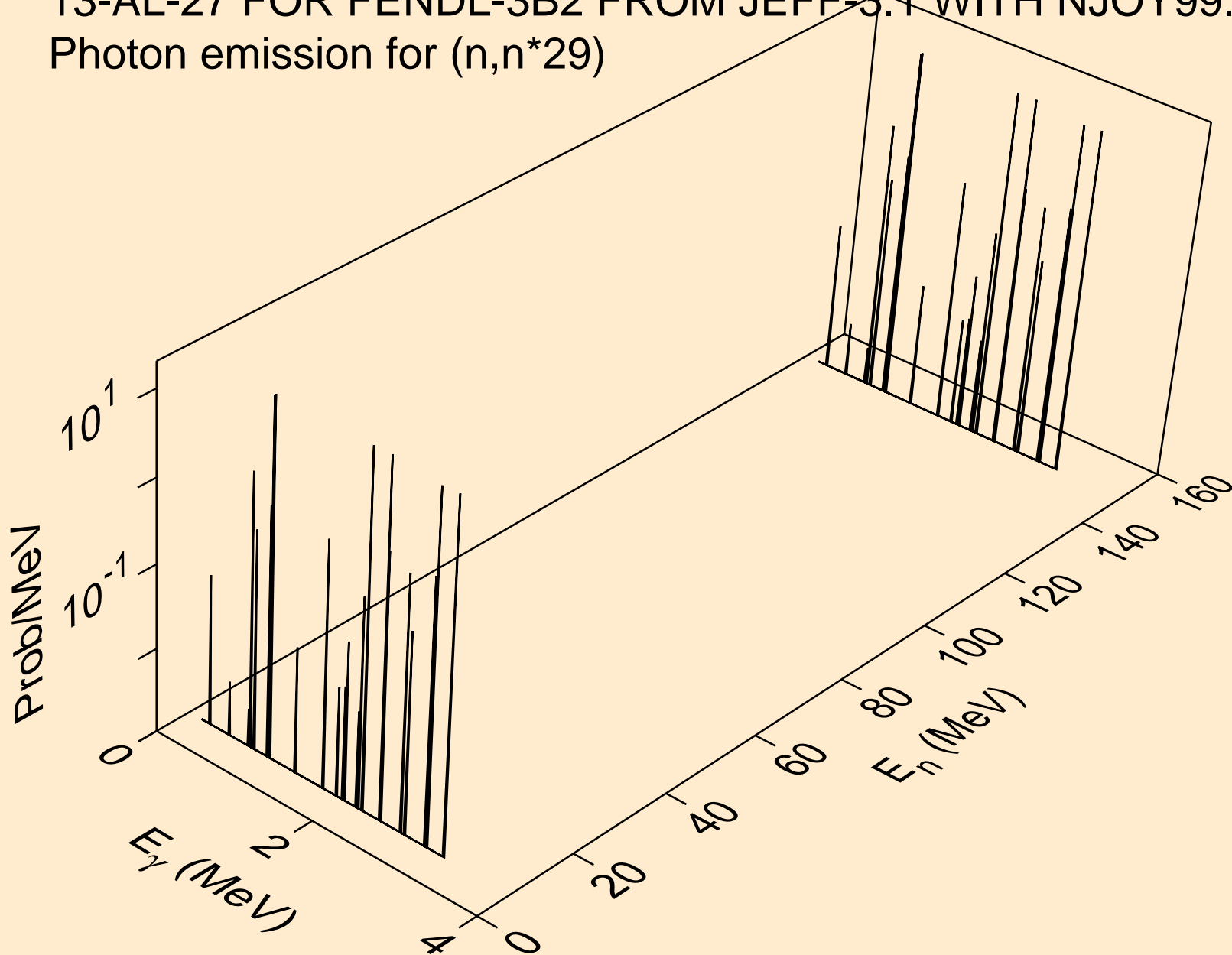



13-AL-27 FOR FENDL-3B2 FROM JEFF-3.1 WITH NJOY99.304+ C  
Photon emission for (n,n\*30)

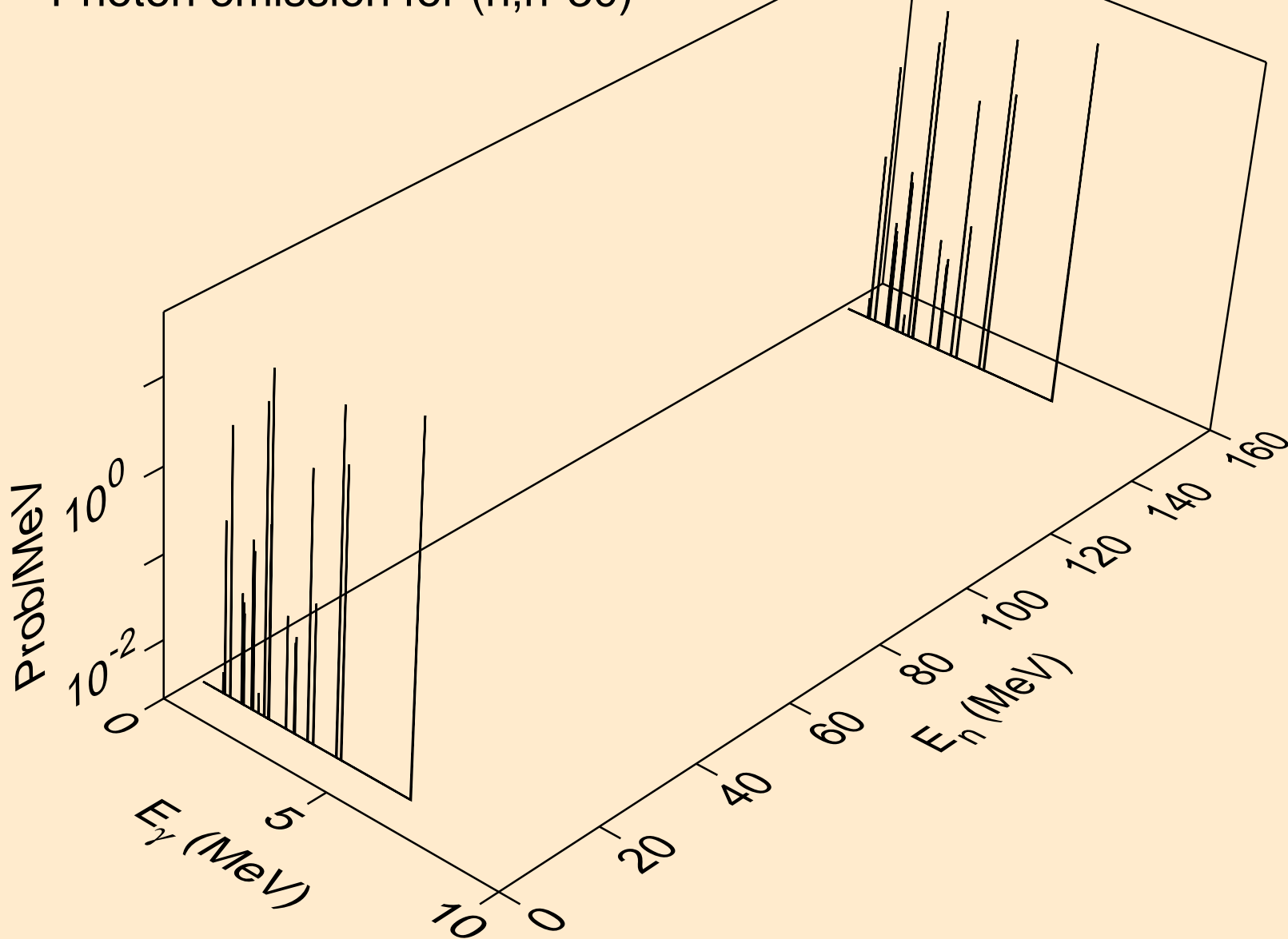

13-AL-27 FOR FENDL-3B2 FROM JEFF-3.1 WITH NJOY99.304+ C  
Photon emission for (n,n\*31)

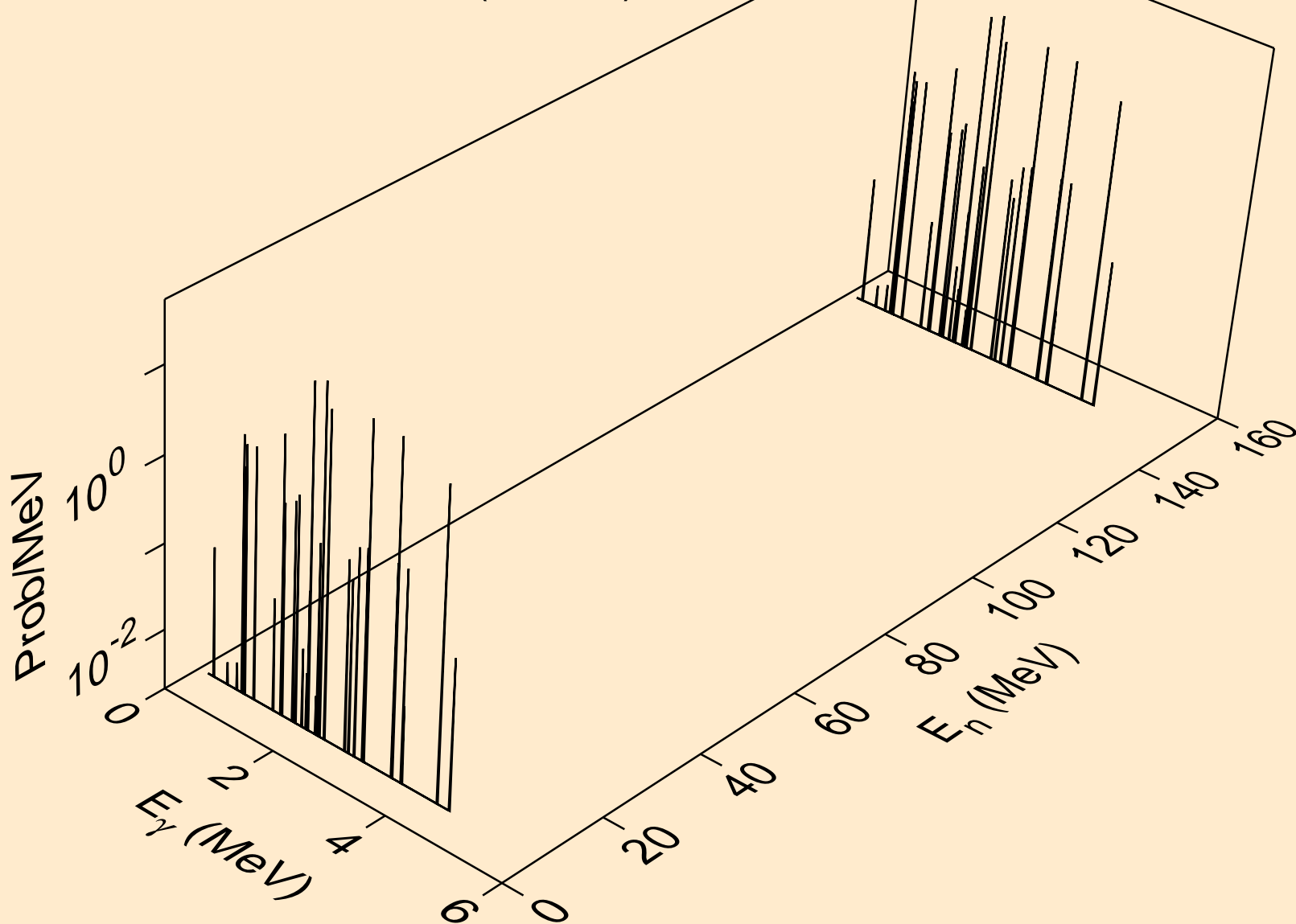

13-AL-27 FOR FENDL-3B2 FROM JEFF-3.1 WITH NJOY99.304+ C  
Photon emission for (n,n\*32)

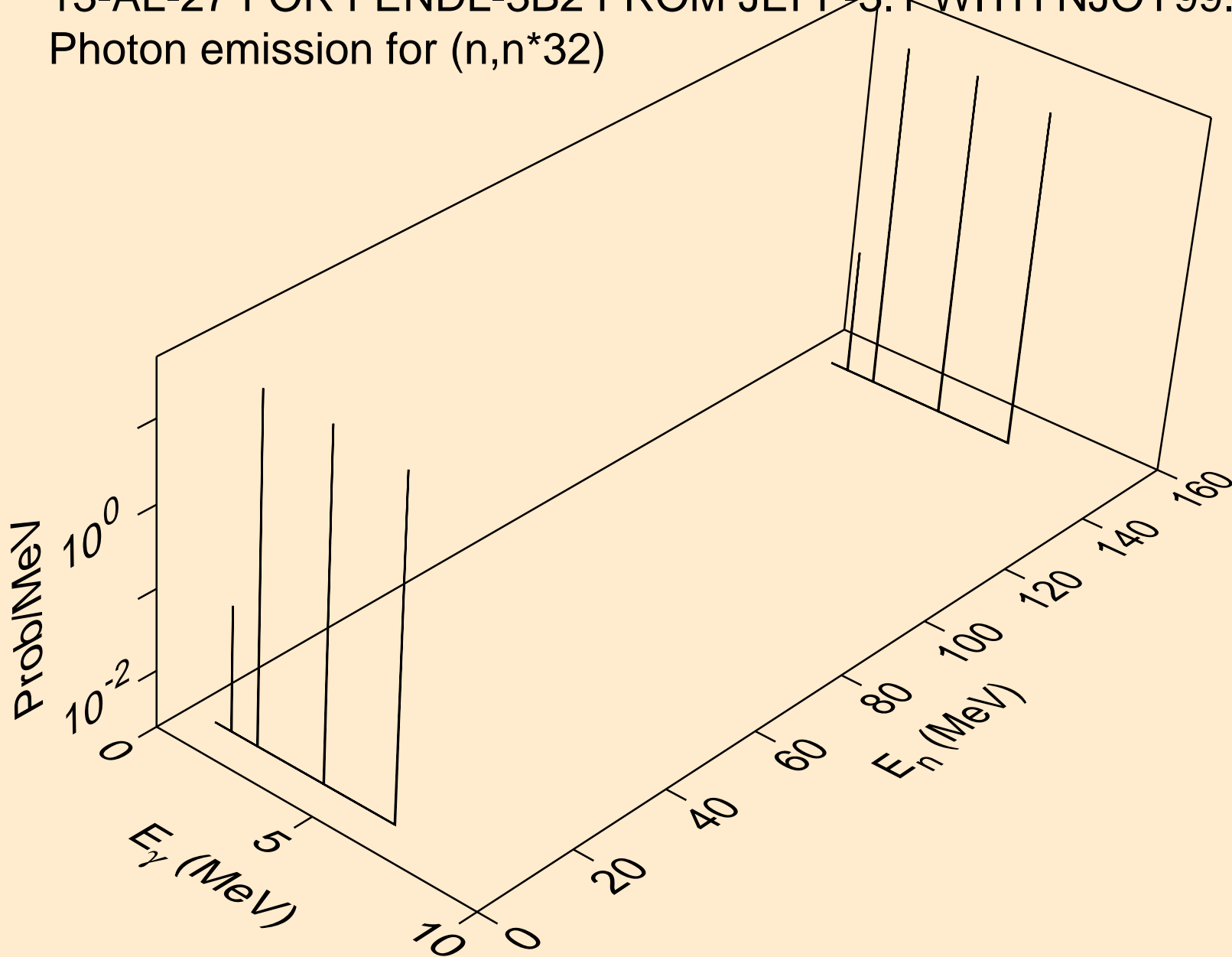

13-AL-27 FOR FENDL-3B2 FROM JEFF-3.1 WITH NJOY99.304+ C  
Photon emission for (n,n\*33)

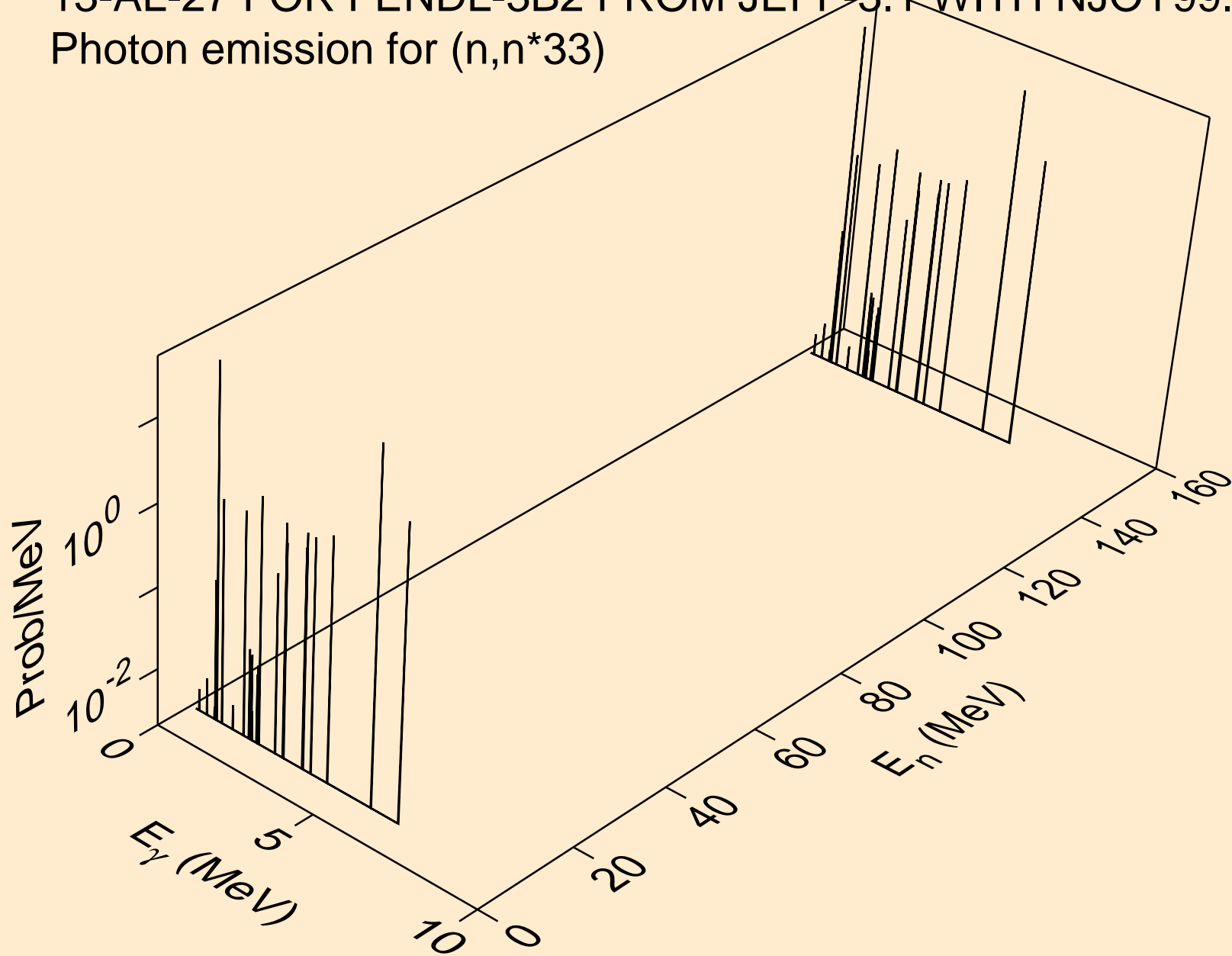

13-AL-27 FOR FENDL-3B2 FROM JEFF-3.1 WITH NJOY99.304+ C  
Photon emission for (n,n\*34)

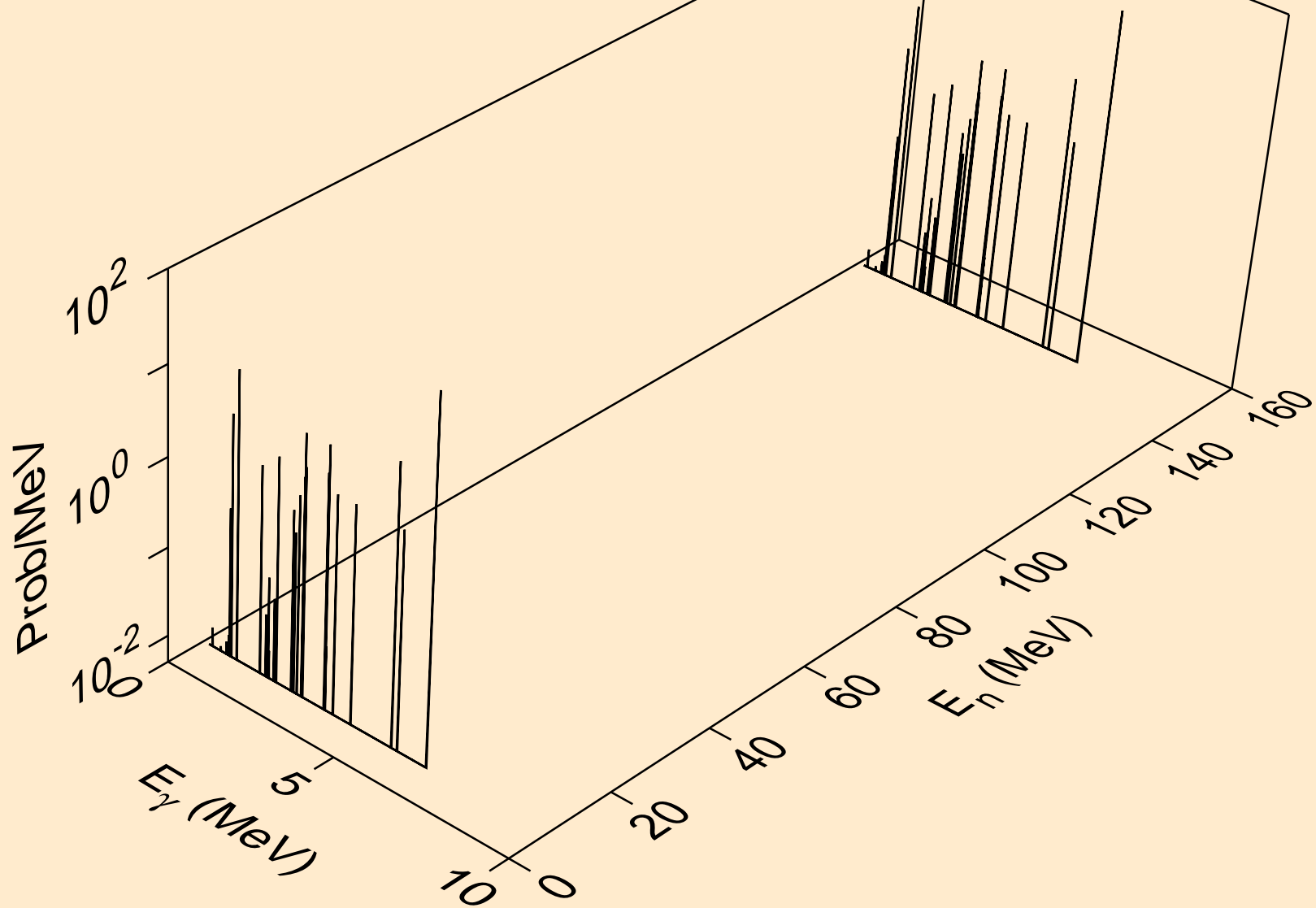

13-AL-27 FOR FENDL-3B2 FROM JEFF-3.1 WITH NJOY99.304+ C  
Photon emission for (n,n\*35)

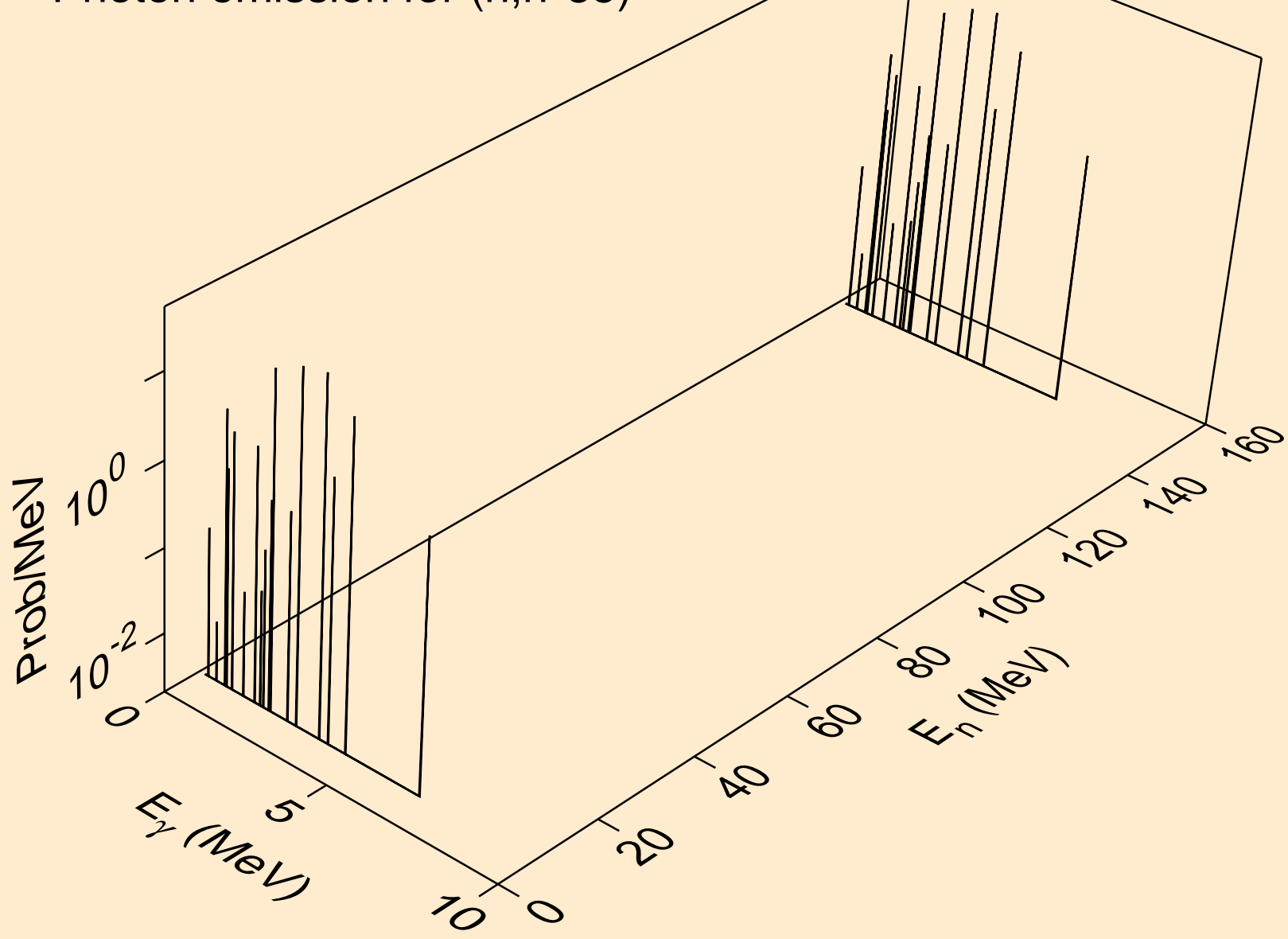

13-AL-27 FOR FENDL-3B2 FROM JEFF-3.1 WITH NJOY99.304+ C  
Photon emission for (n,n\*36)

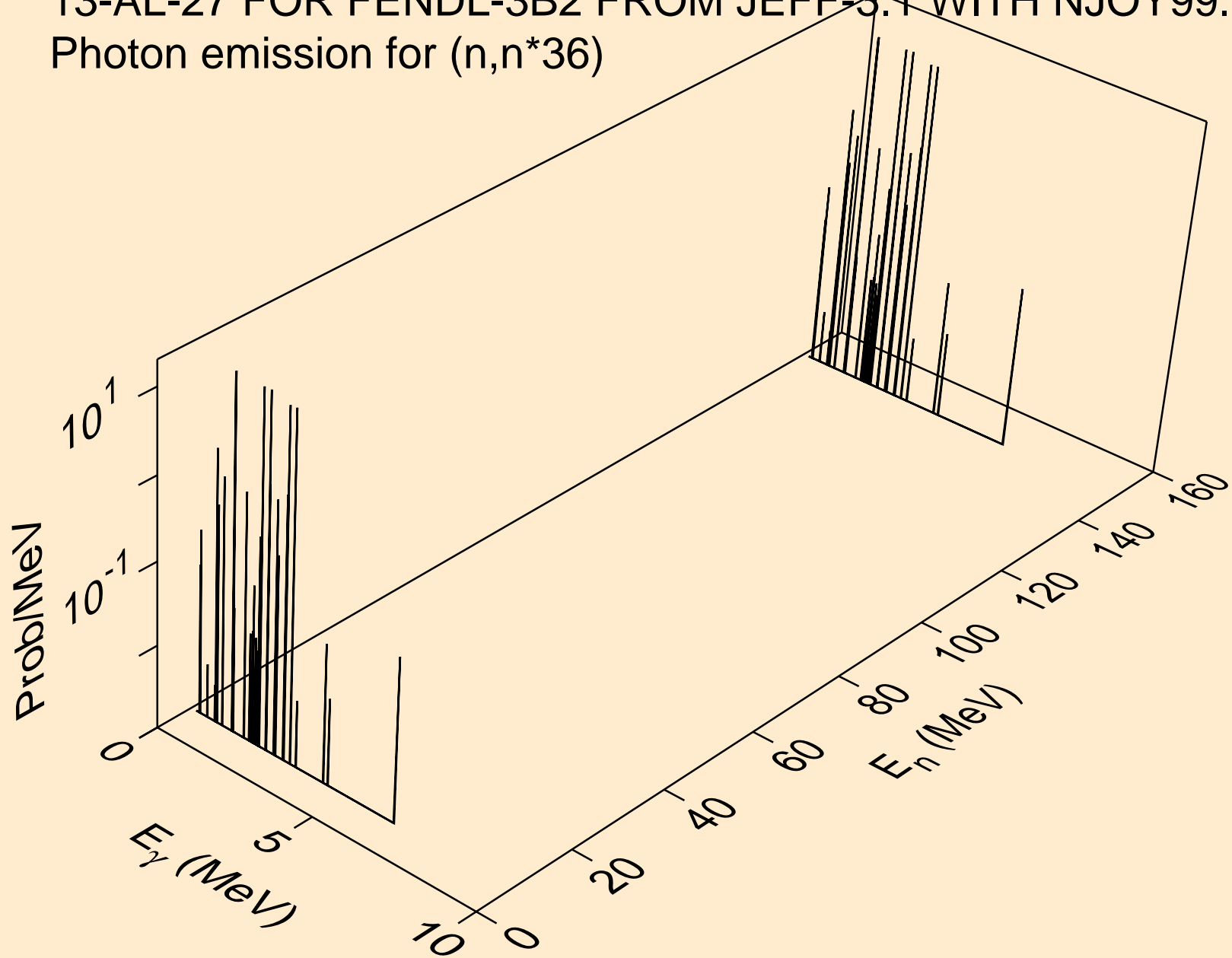

13-AL-27 FOR FENDL-3B2 FROM JEFF-3.1 WITH NJOY99.304+ C  
Photon emission for (n,n\*37)

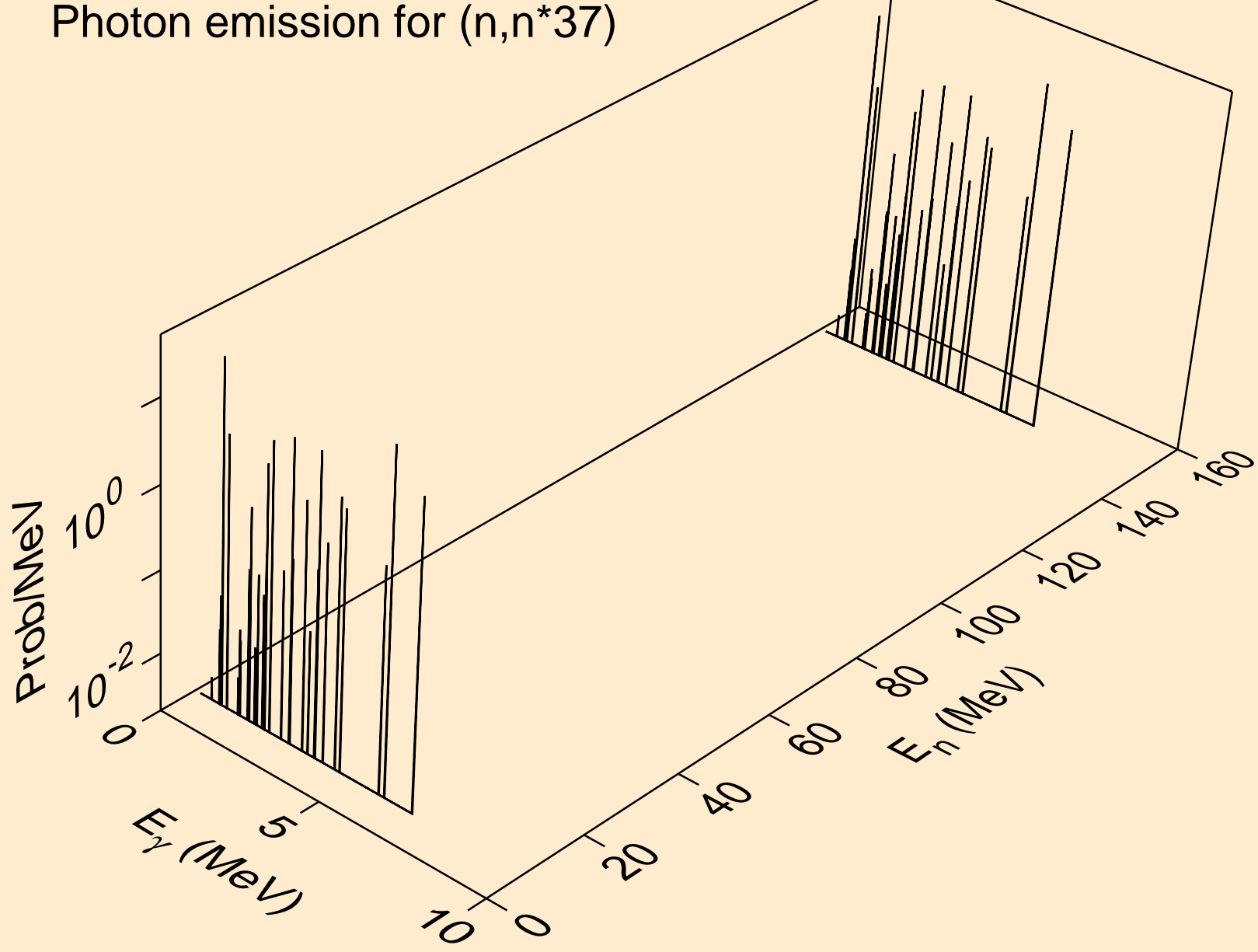



13-AL-27 FOR FENDL-3B2 FROM JEFF-3.1 WITH NJOY99.304+ C  
Photon emission for (n,n\*38)

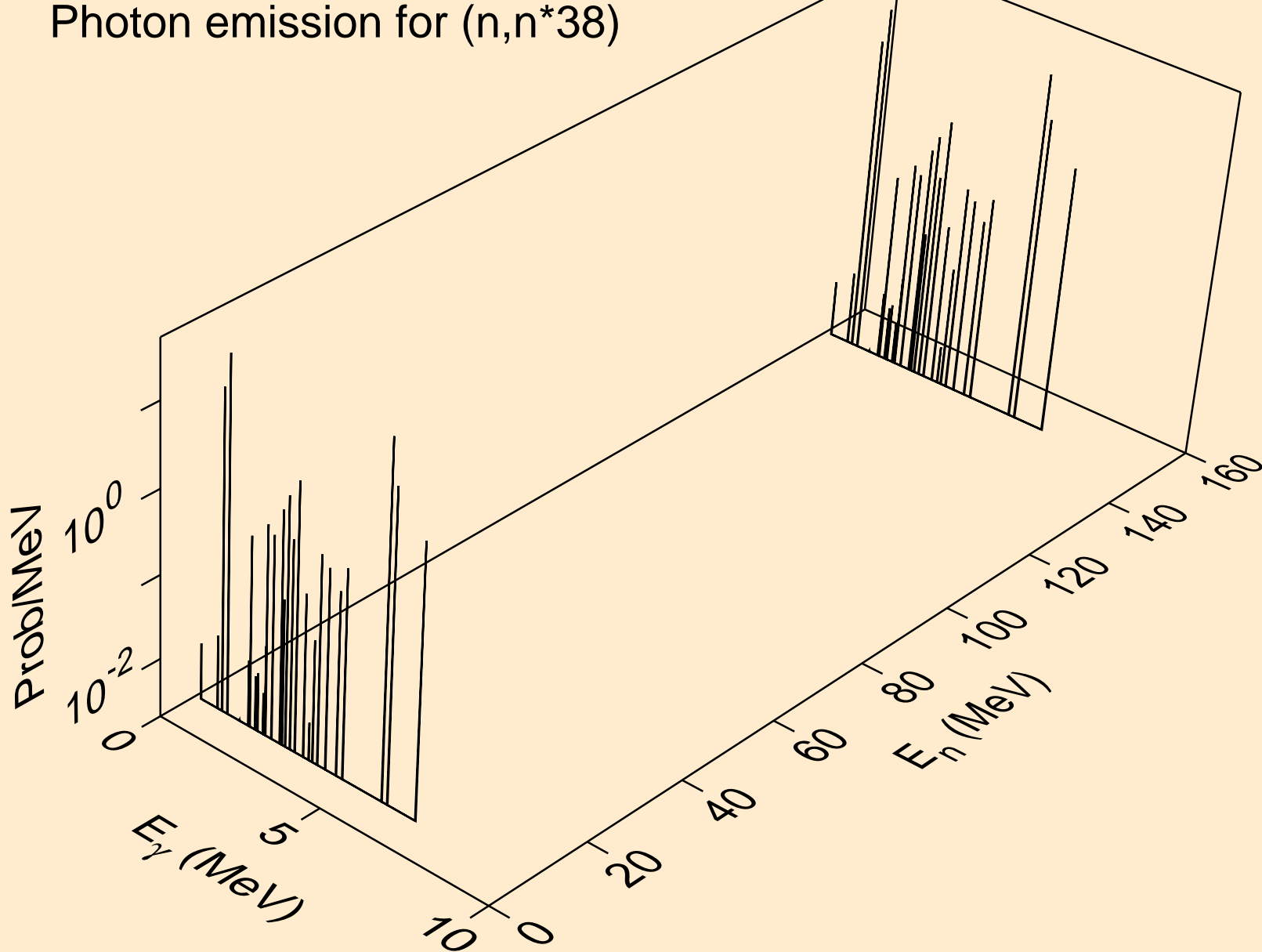

13-AL-27 FOR FENDL-3B2 FROM JEFF-3.1 WITH NJOY99.304+ C  
Photon emission for (n,n\*39)

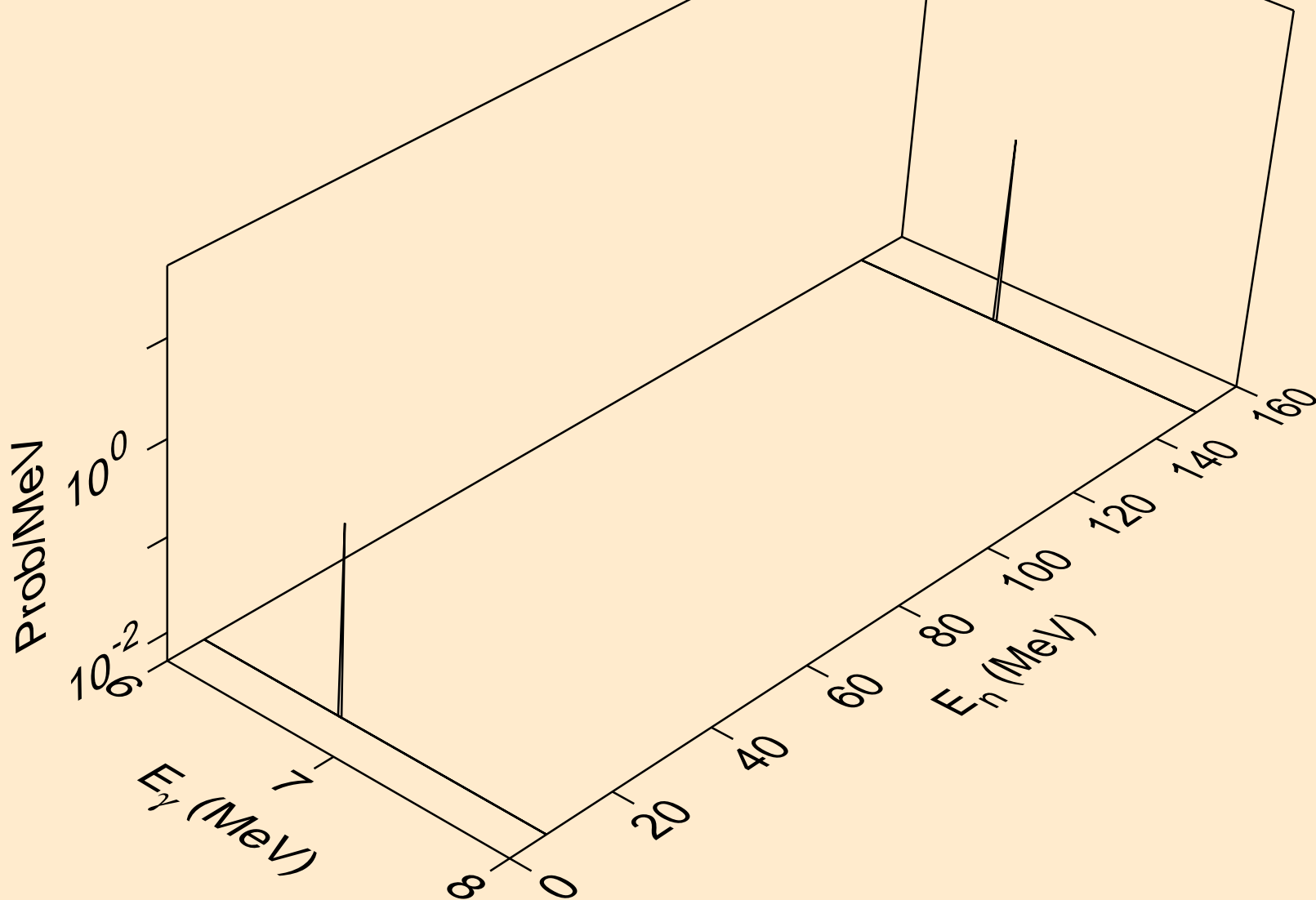

13-AL-27 FOR FENDL-3B2 FROM JEFF-3.1 WITH NJOY99.304+ C  
Photon emission for (n,n\*c)

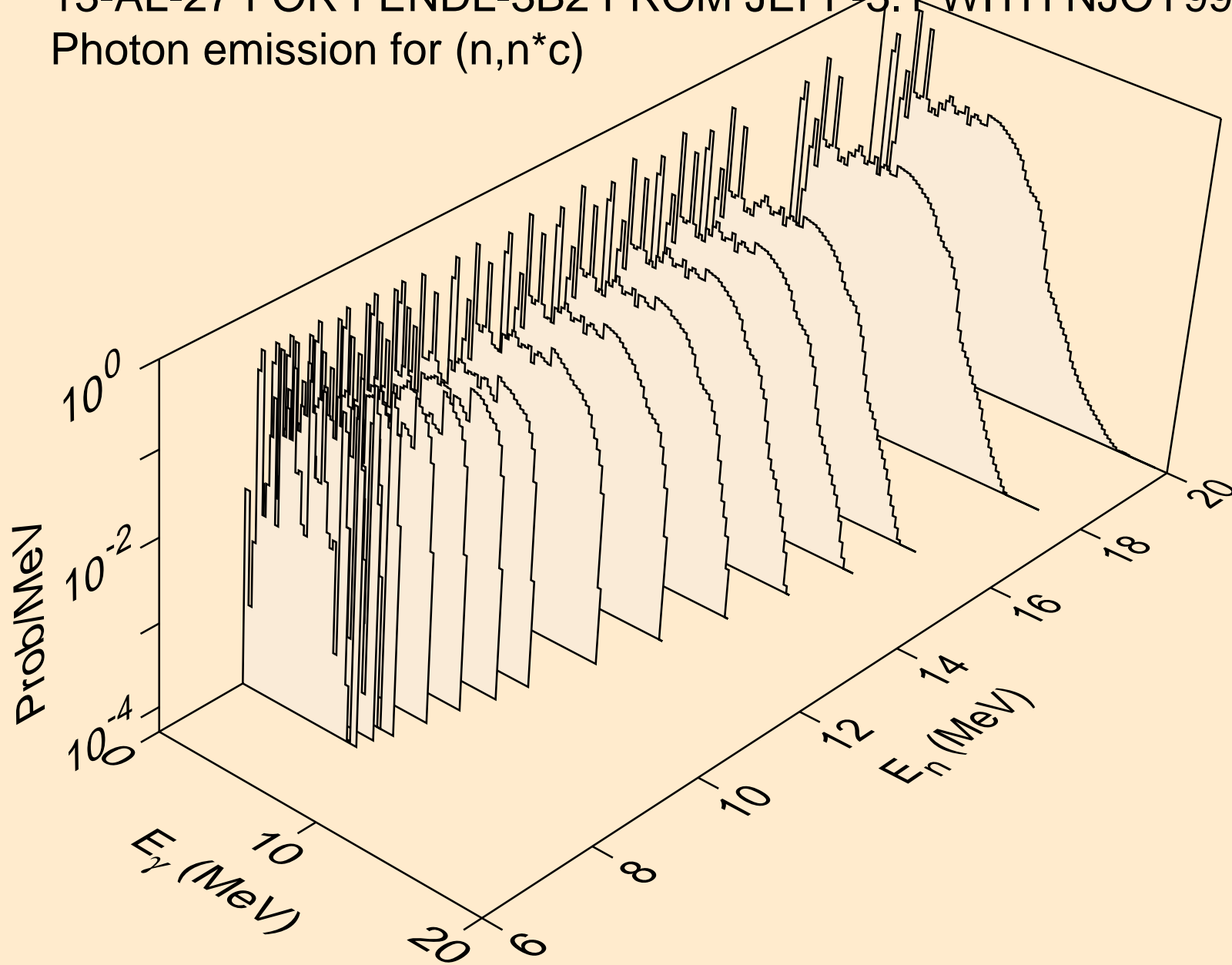

13-AL-27 FOR FENDL-3B2 FROM JEFF-3.1 WITH NJOY99.304+ C  
Photon emission for (n,2a)

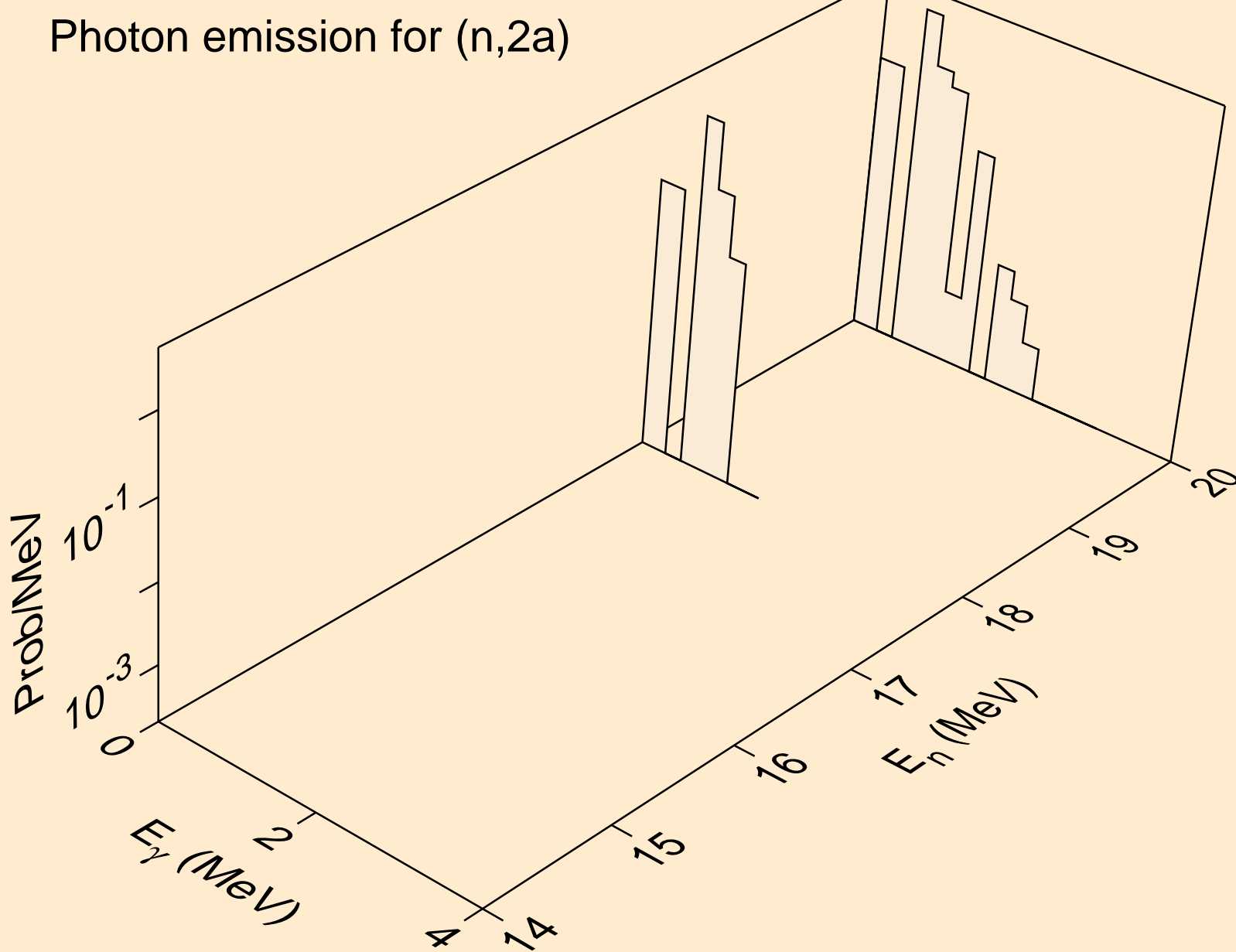

13-AL-27 FOR FENDL-3B2 FROM JEFF-3.1 WITH NJOY99.304+ C  
Photon emission for (n,2p)

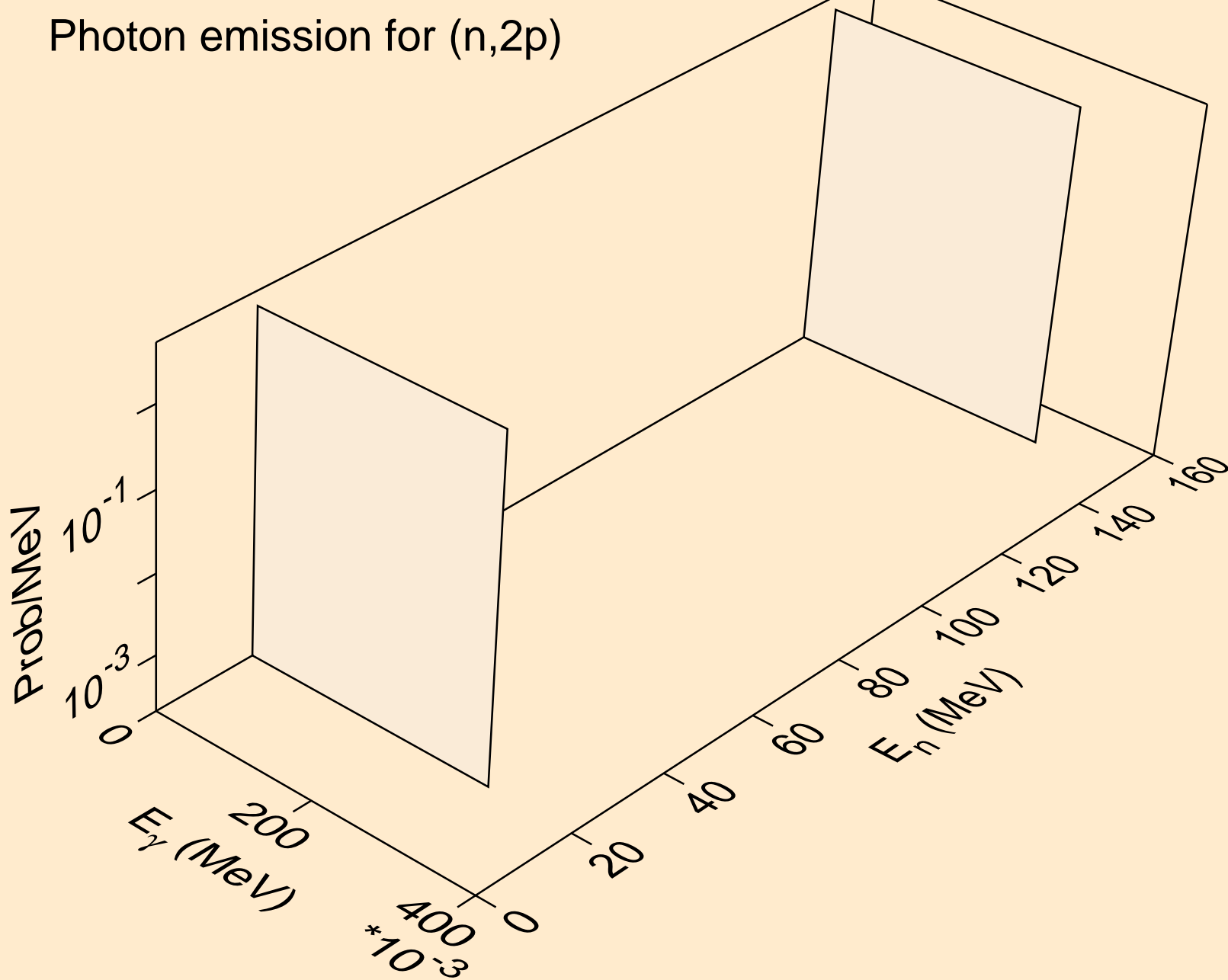

13-AL-27 FOR FENDL-3B2 FROM JEFF-3.1 WITH NJOY99.304+ C  
Photon emission for (n,pa)

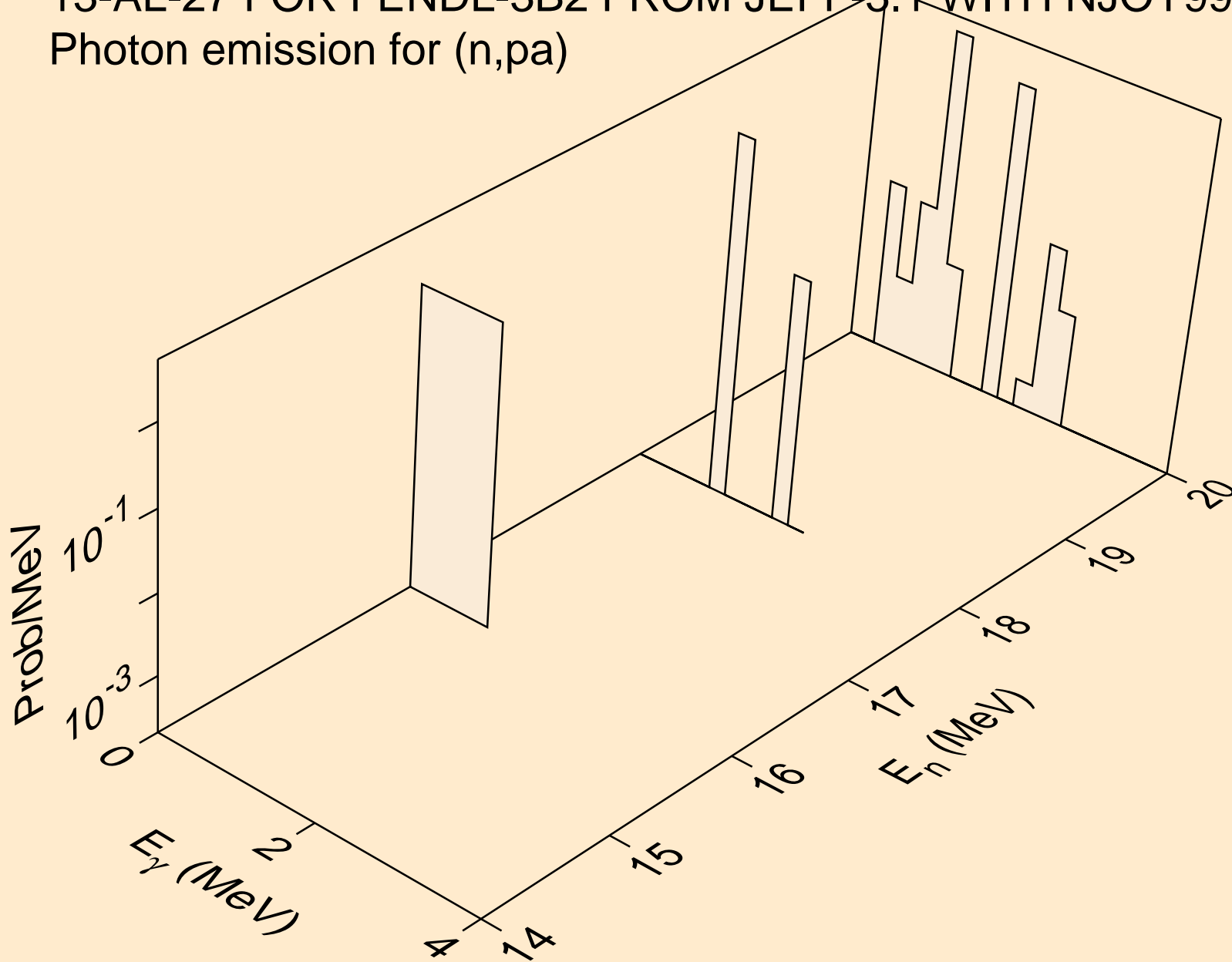

13-AL-27 FOR FENDL-3B2 FROM JEFF-3.1 WITH NJOY99.304+ C  
Photon emission for (n,da)

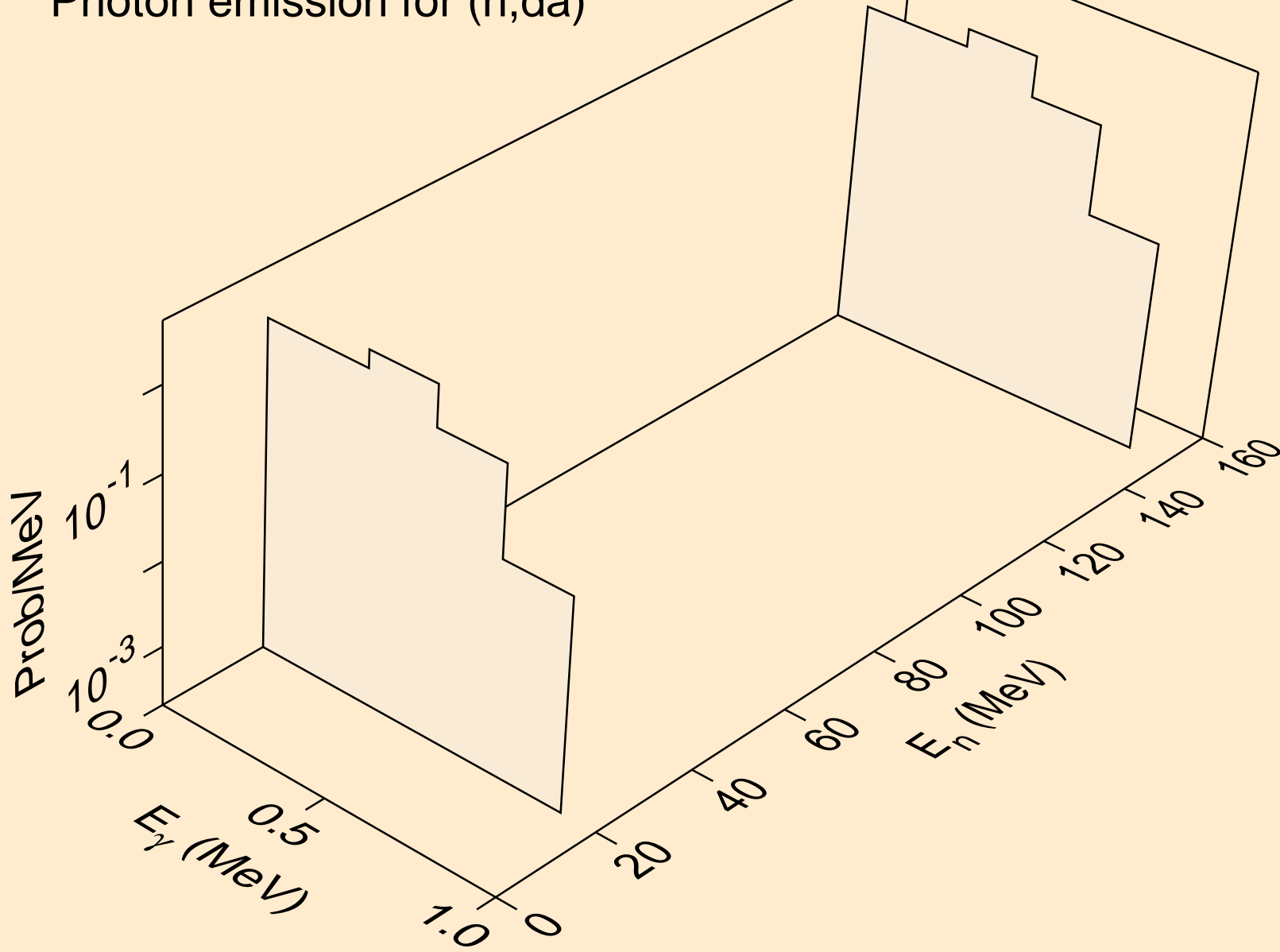

13-AL-27 FOR FENDL-3B2 FROM JEFF-3.1 WITH NJOY99.304+ C  
Photon emission for (n,p\*1)

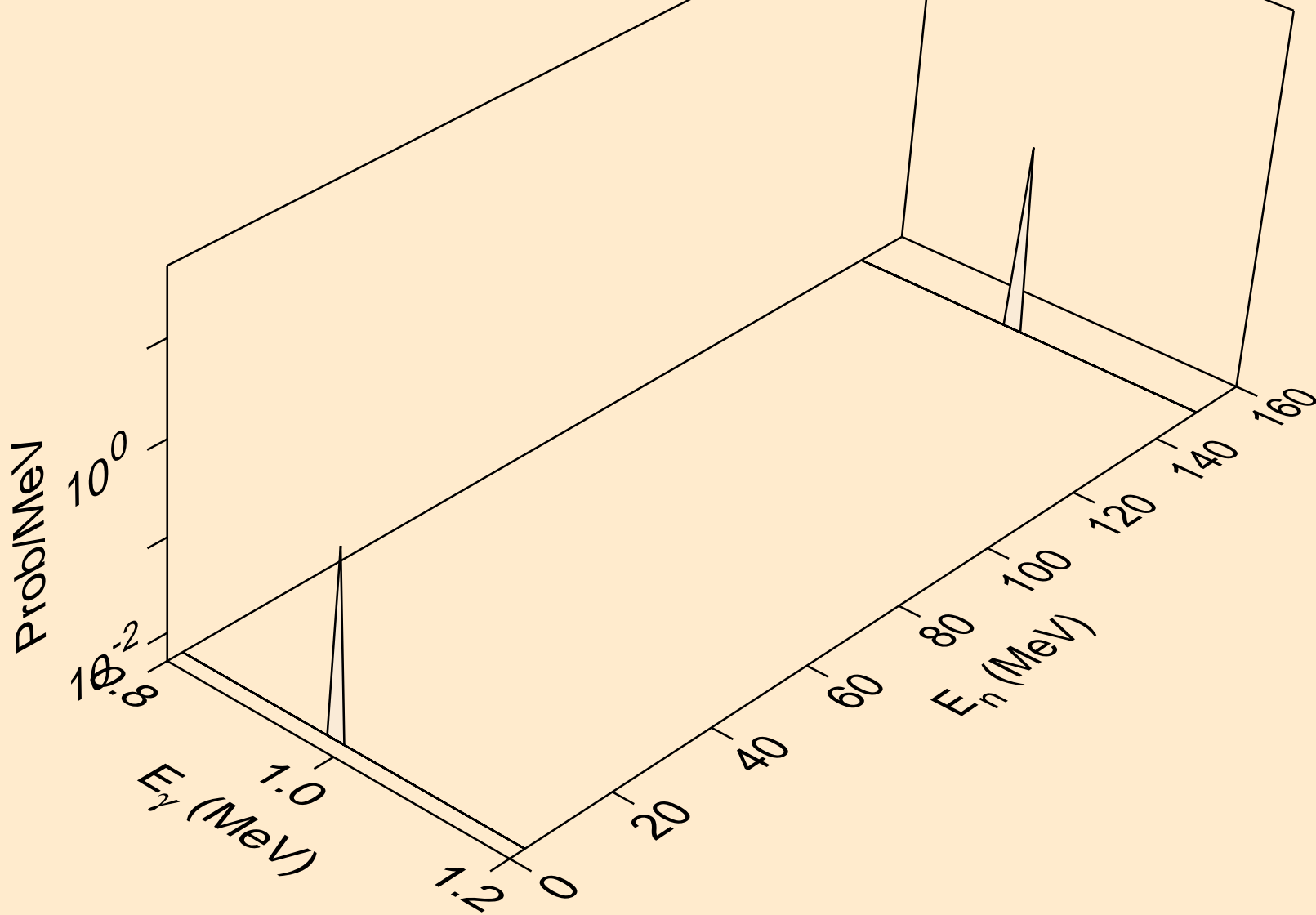



13-AL-27 FOR FENDL-3B2 FROM JEFF-3.1 WITH NJOY99.304+ C  
Photon emission for (n,p\*2)

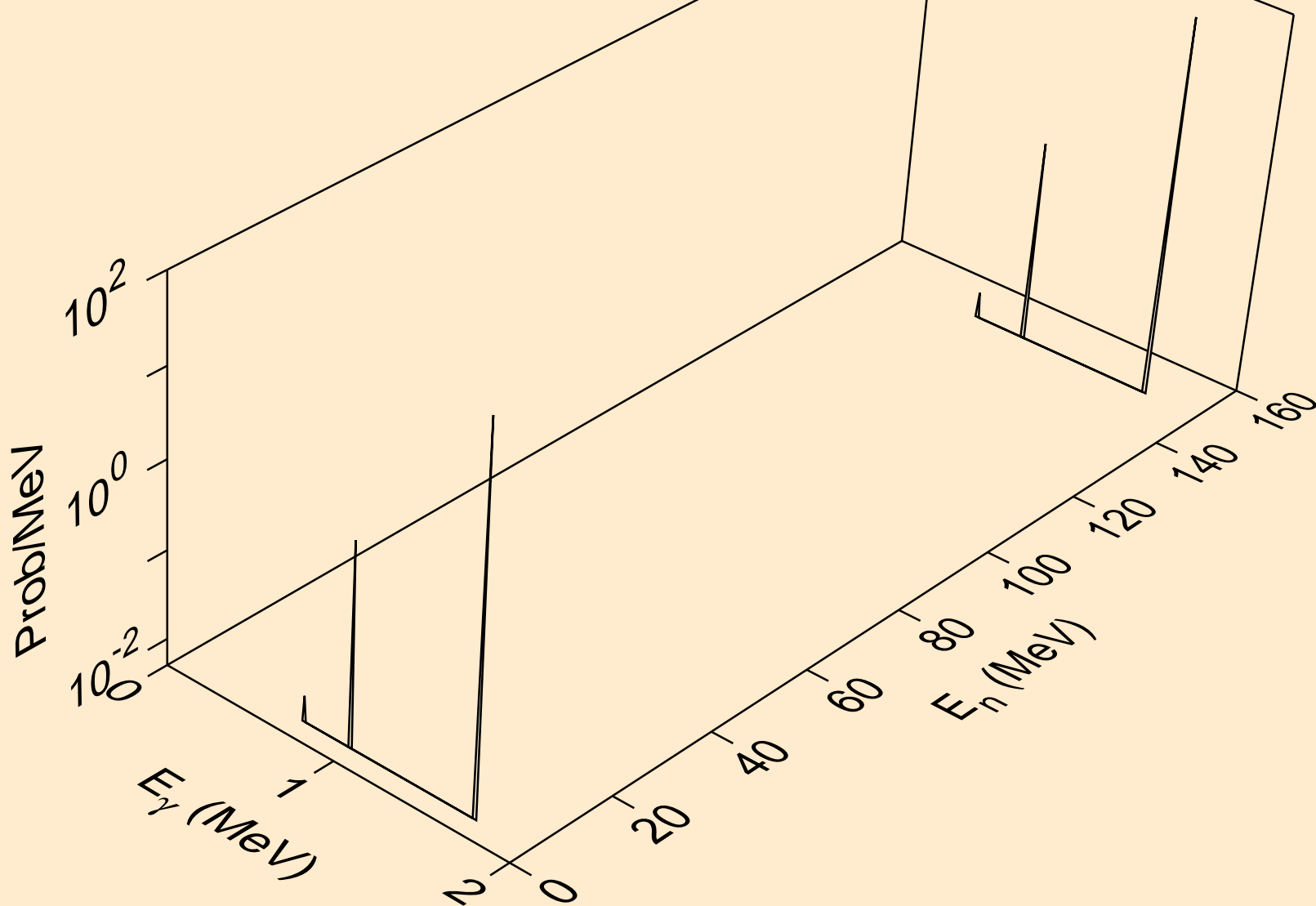

13-AL-27 FOR FENDL-3B2 FROM JEFF-3.1 WITH NJOY99.304+ C  
Photon emission for (n,p\*3)

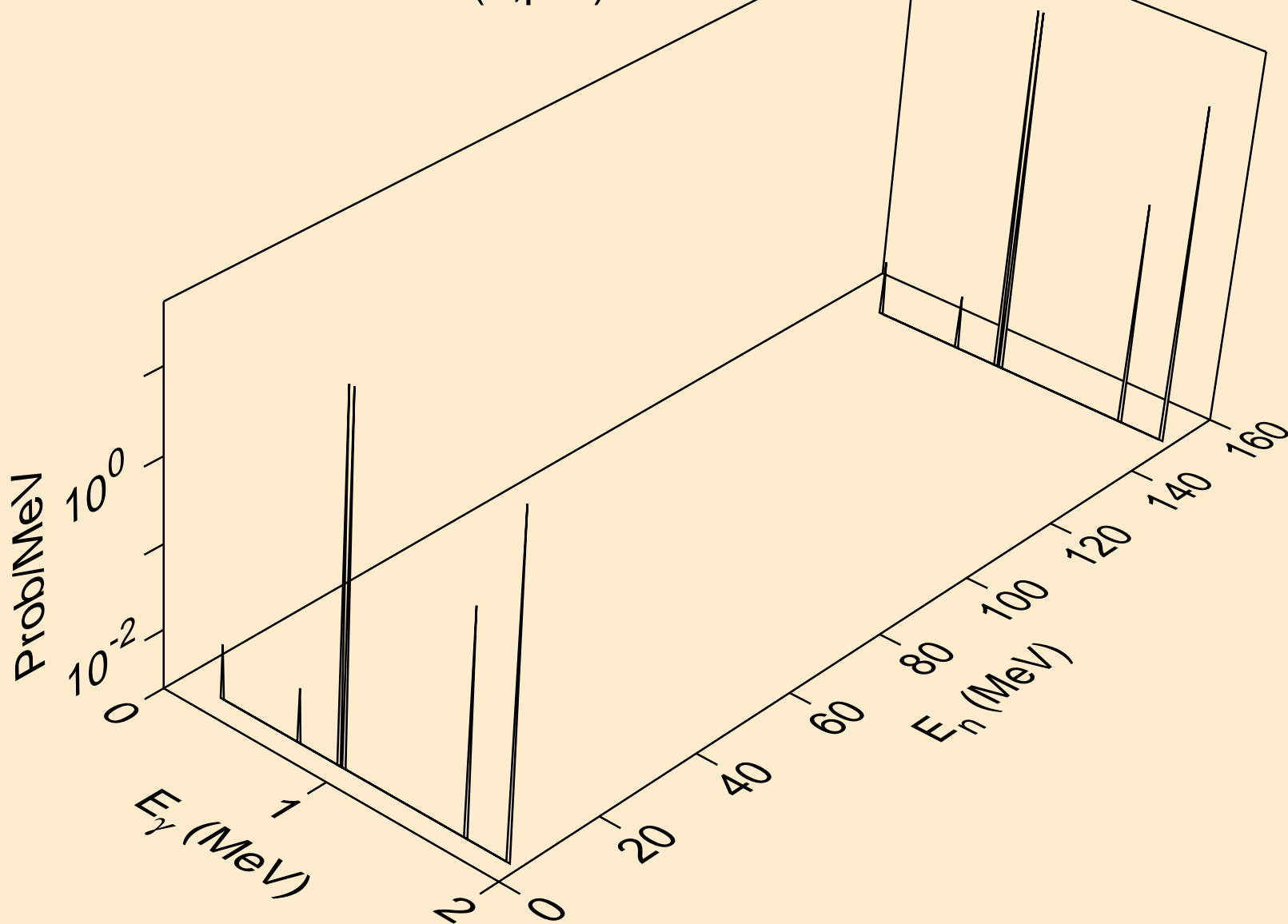

13-AL-27 FOR FENDL-3B2 FROM JEFF-3.1 WITH NJOY99.304+ C  
Photon emission for (n,p\*4)

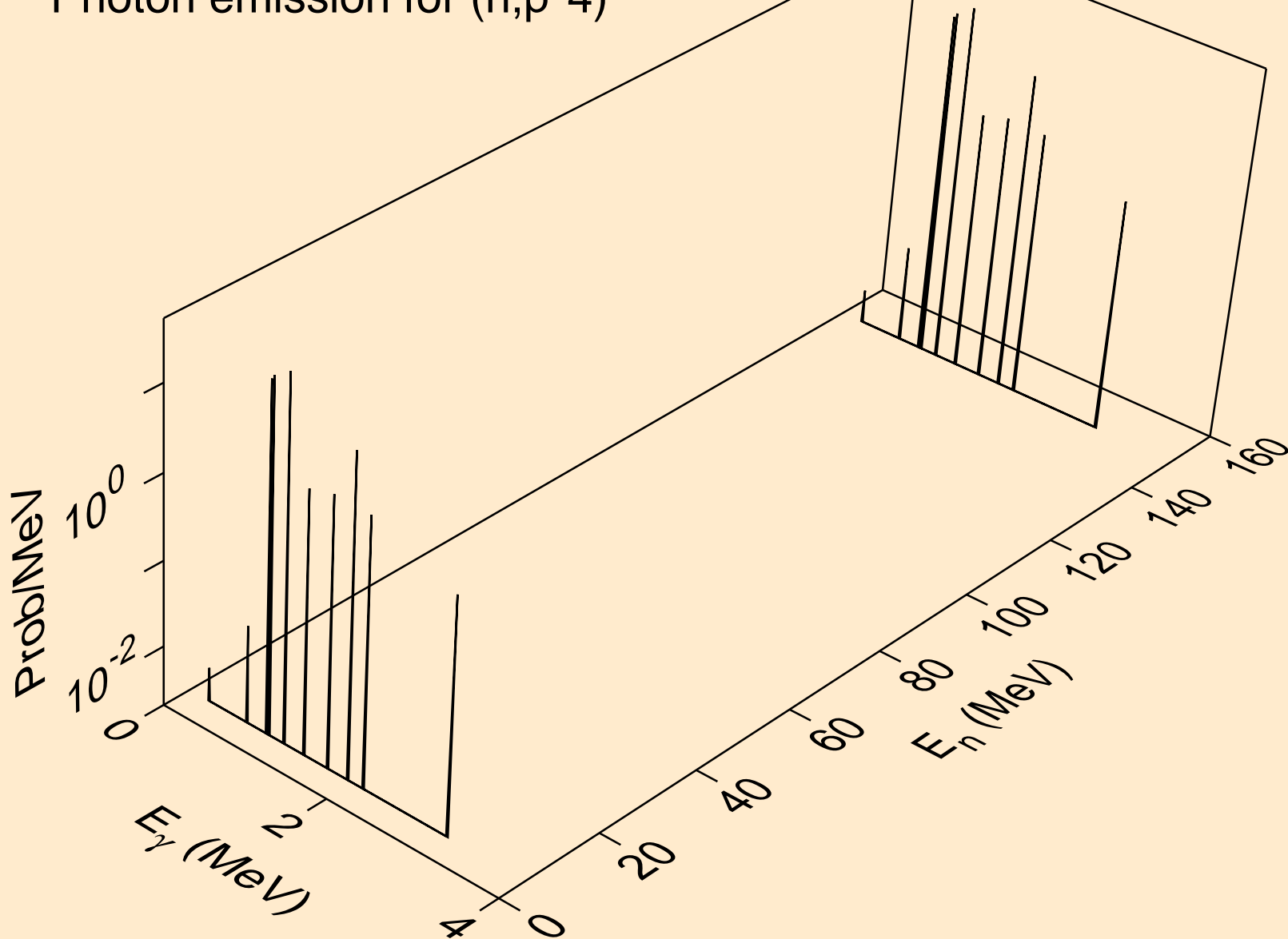

13-AL-27 FOR FENDL-3B2 FROM JEFF-3.1 WITH NJOY99.304+ C  
Photon emission for (n,p\*5)

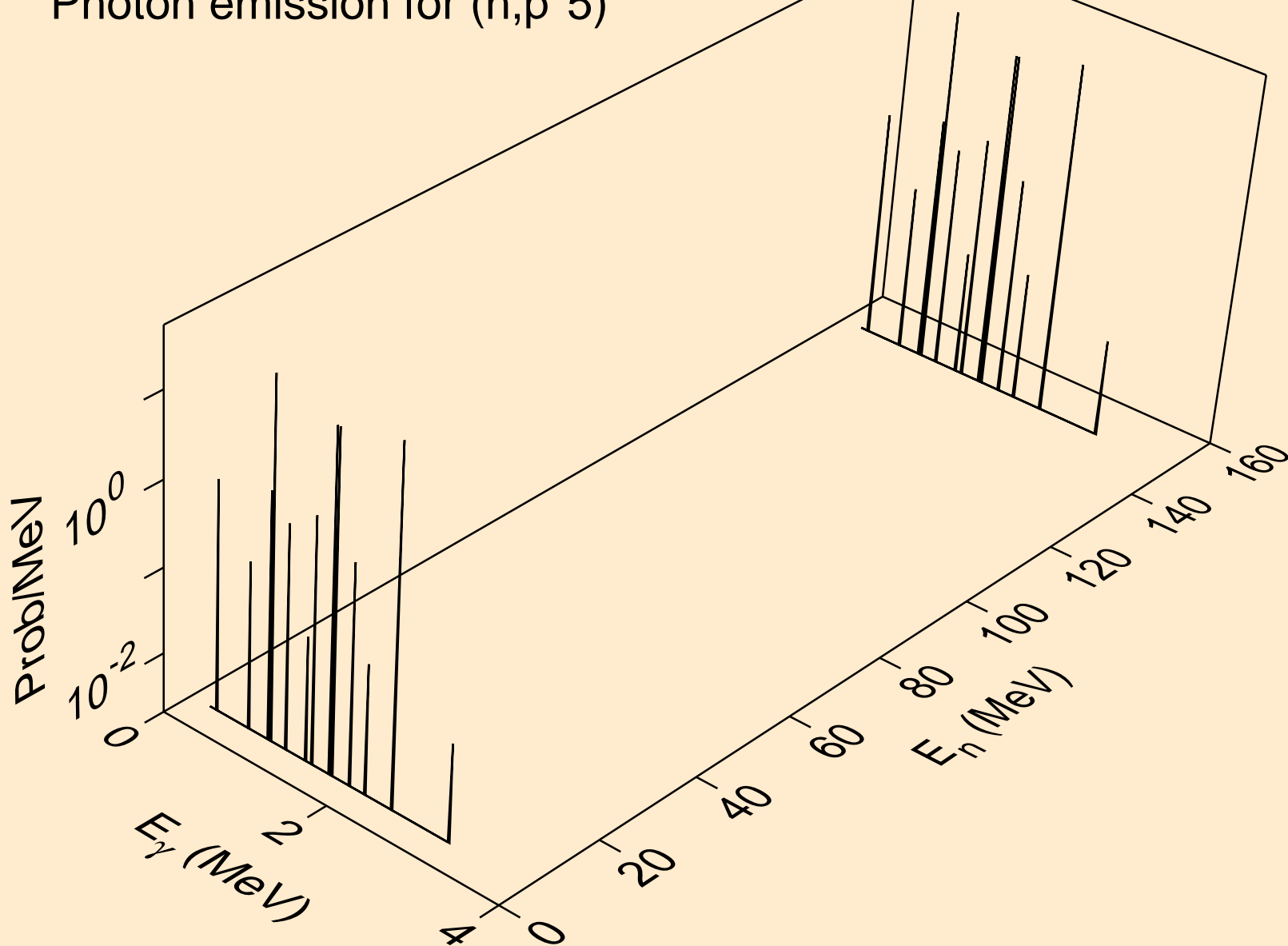

13-AL-27 FOR FENDL-3B2 FROM JEFF-3.1 WITH NJOY99.304+ C  
Photon emission for (n,p\*6)

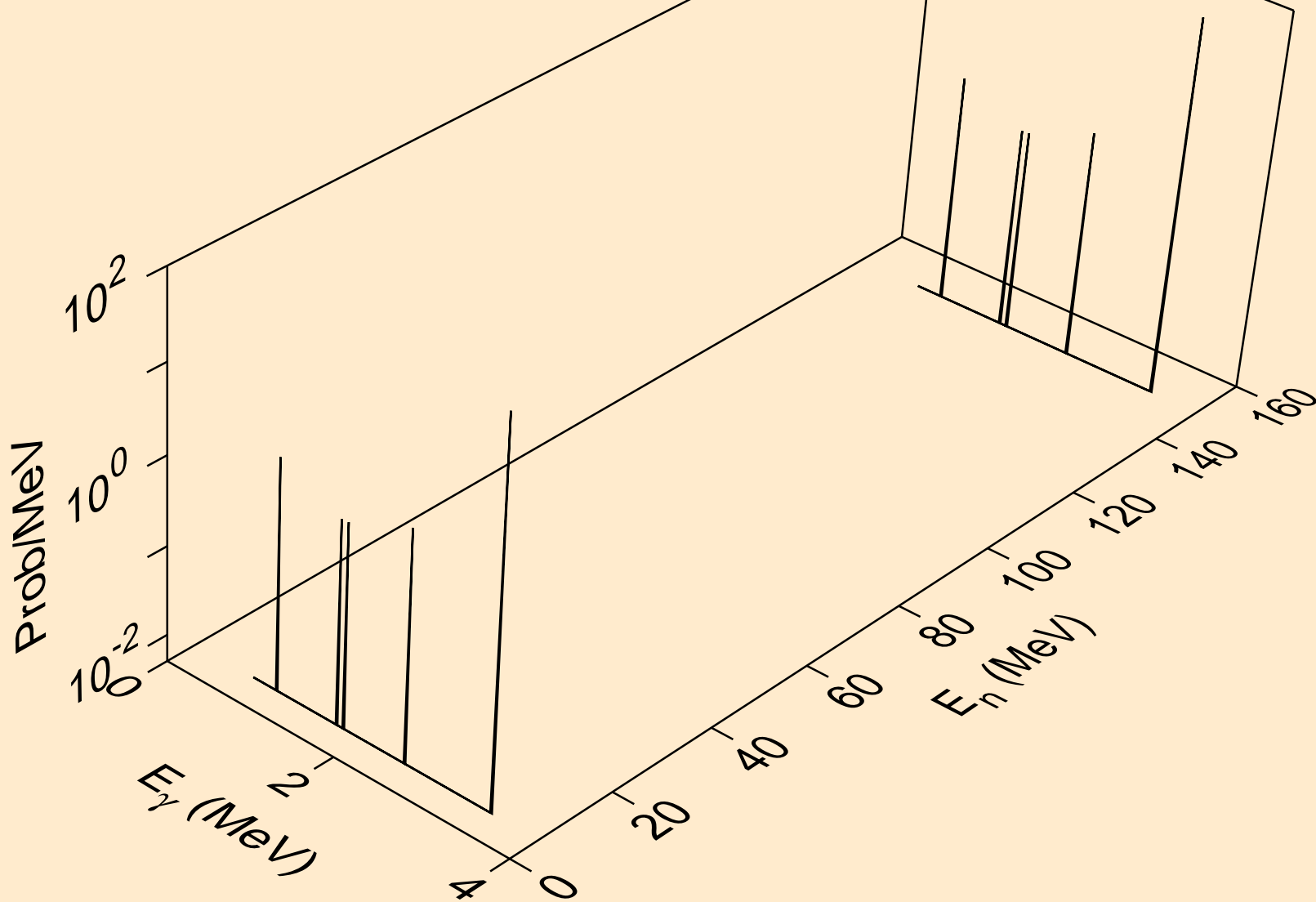

13-AL-27 FOR FENDL-3B2 FROM JEFF-3.1 WITH NJOY99.304+ C  
Photon emission for (n,p\*7)

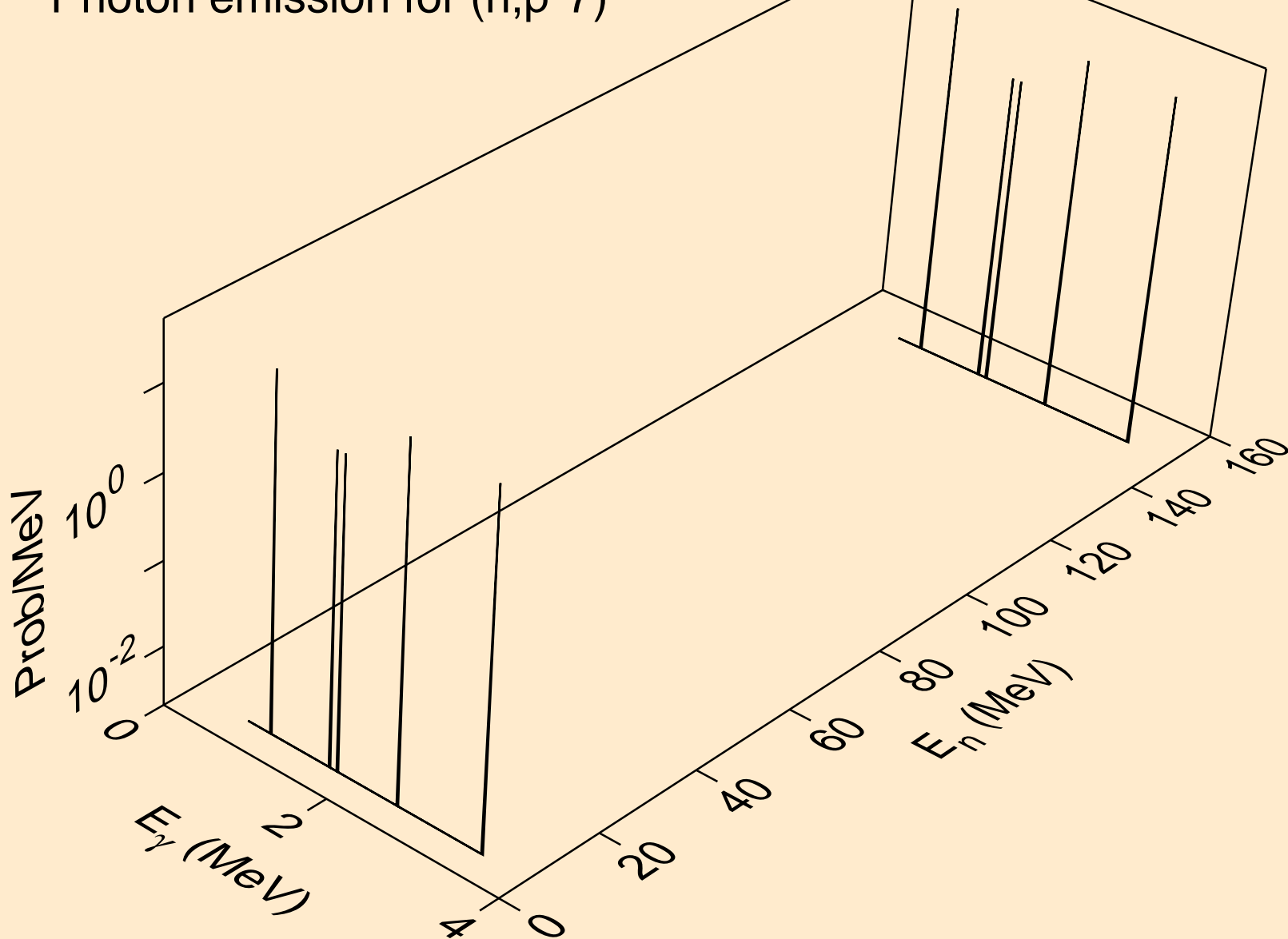

13-AL-27 FOR FENDL-3B2 FROM JEFF-3.1 WITH NJOY99.304+ C  
Photon emission for (n,p\*8)

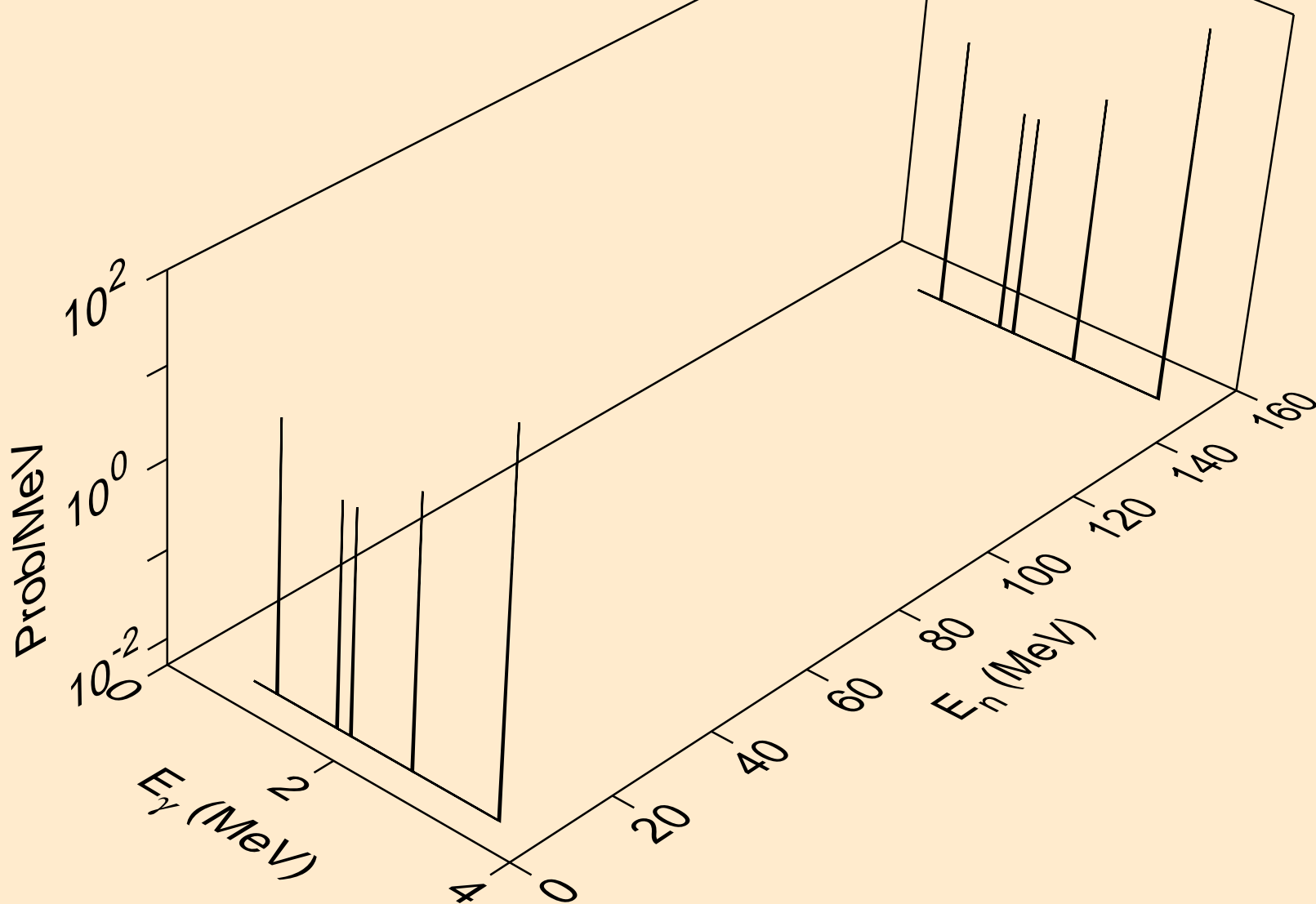

13-AL-27 FOR FENDL-3B2 FROM JEFF-3.1 WITH NJOY99.304+ C  
Photon emission for (n,p\*9)

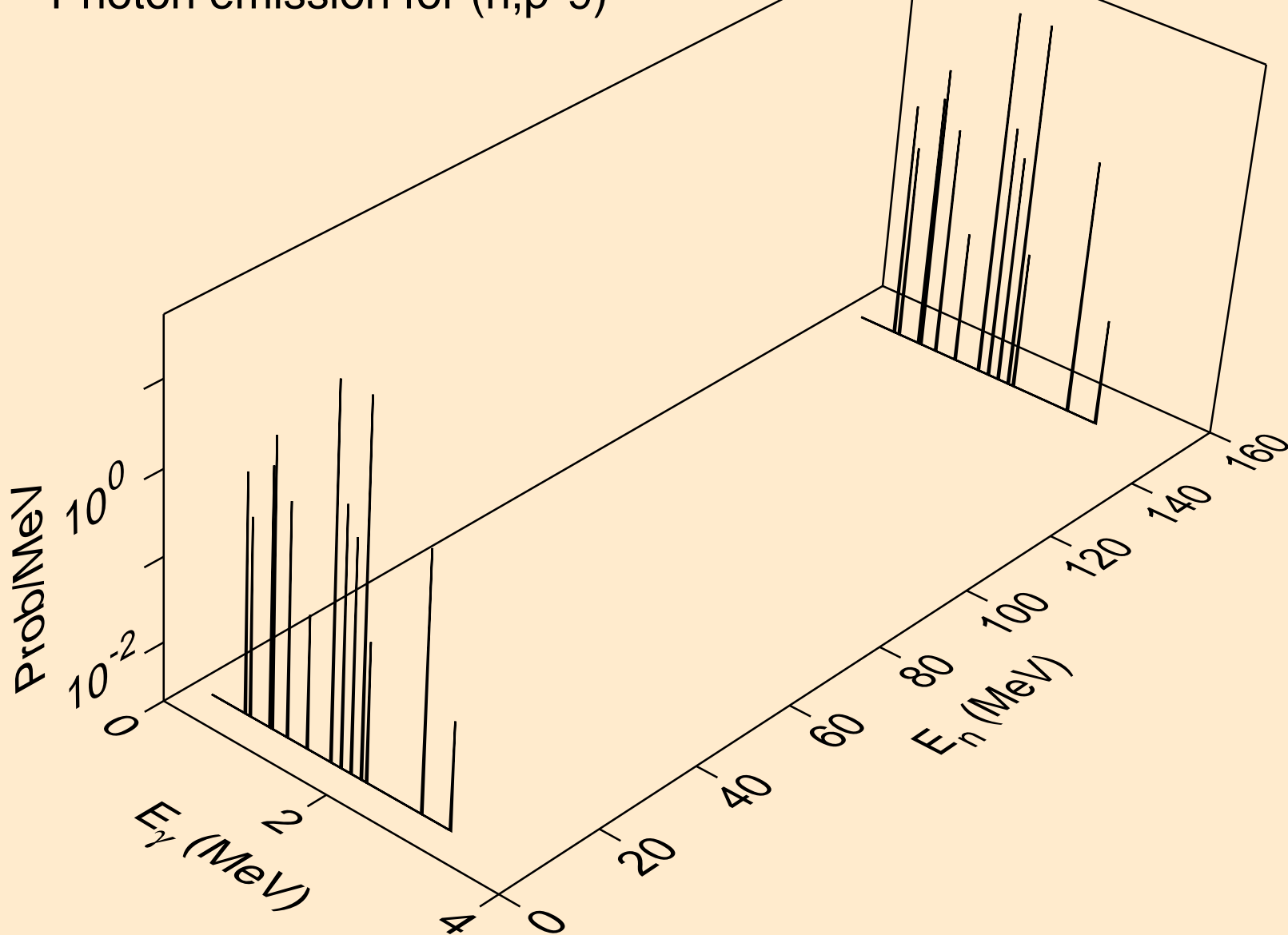



13-AL-27 FOR FENDL-3B2 FROM JEFF-3.1 WITH NJOY99.304+ C  
Photon emission for (n,p\*10)

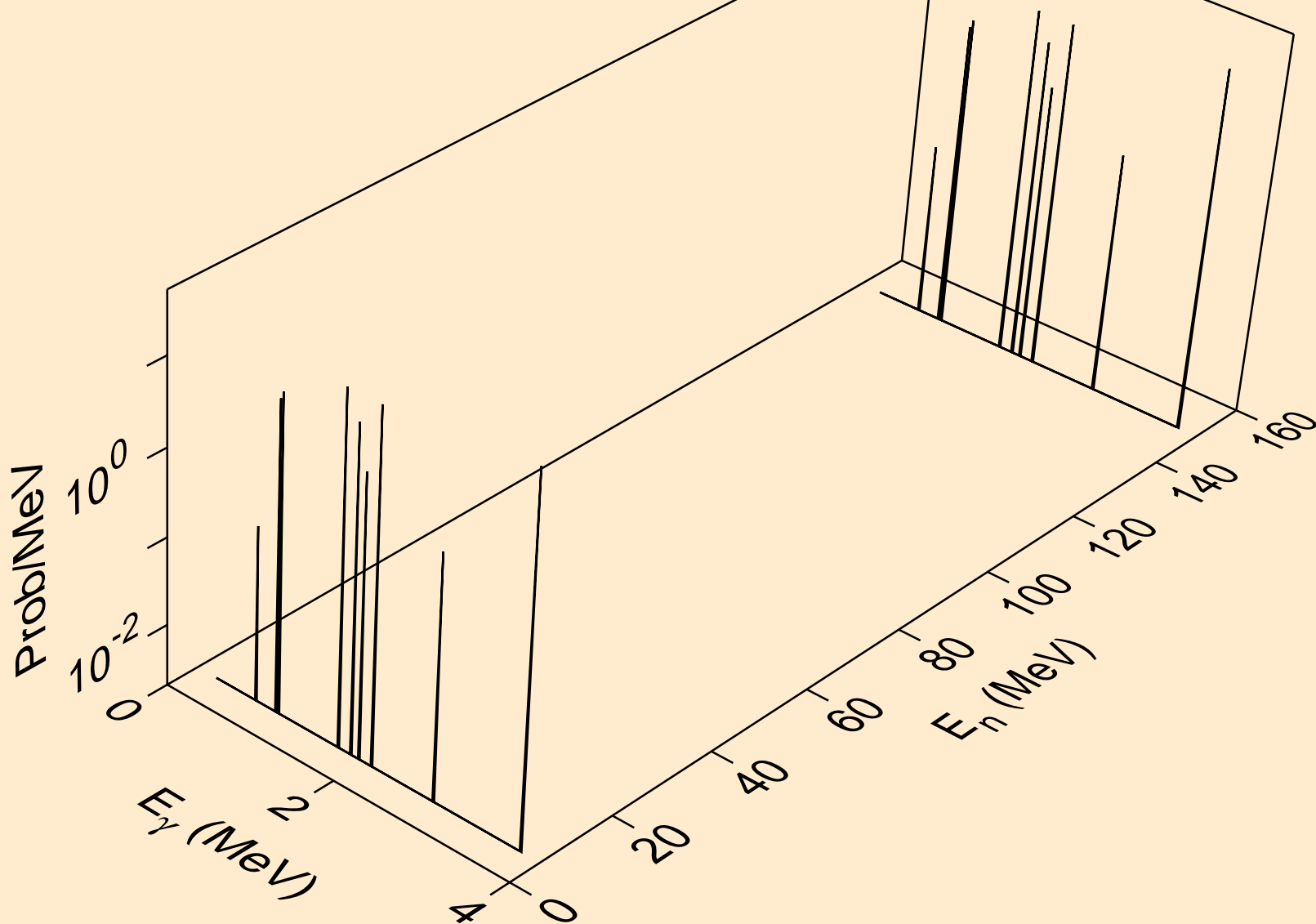

13-AL-27 FOR FENDL-3B2 FROM JEFF-3.1 WITH NJOY99.304+ C  
Photon emission for (n,p\*11)

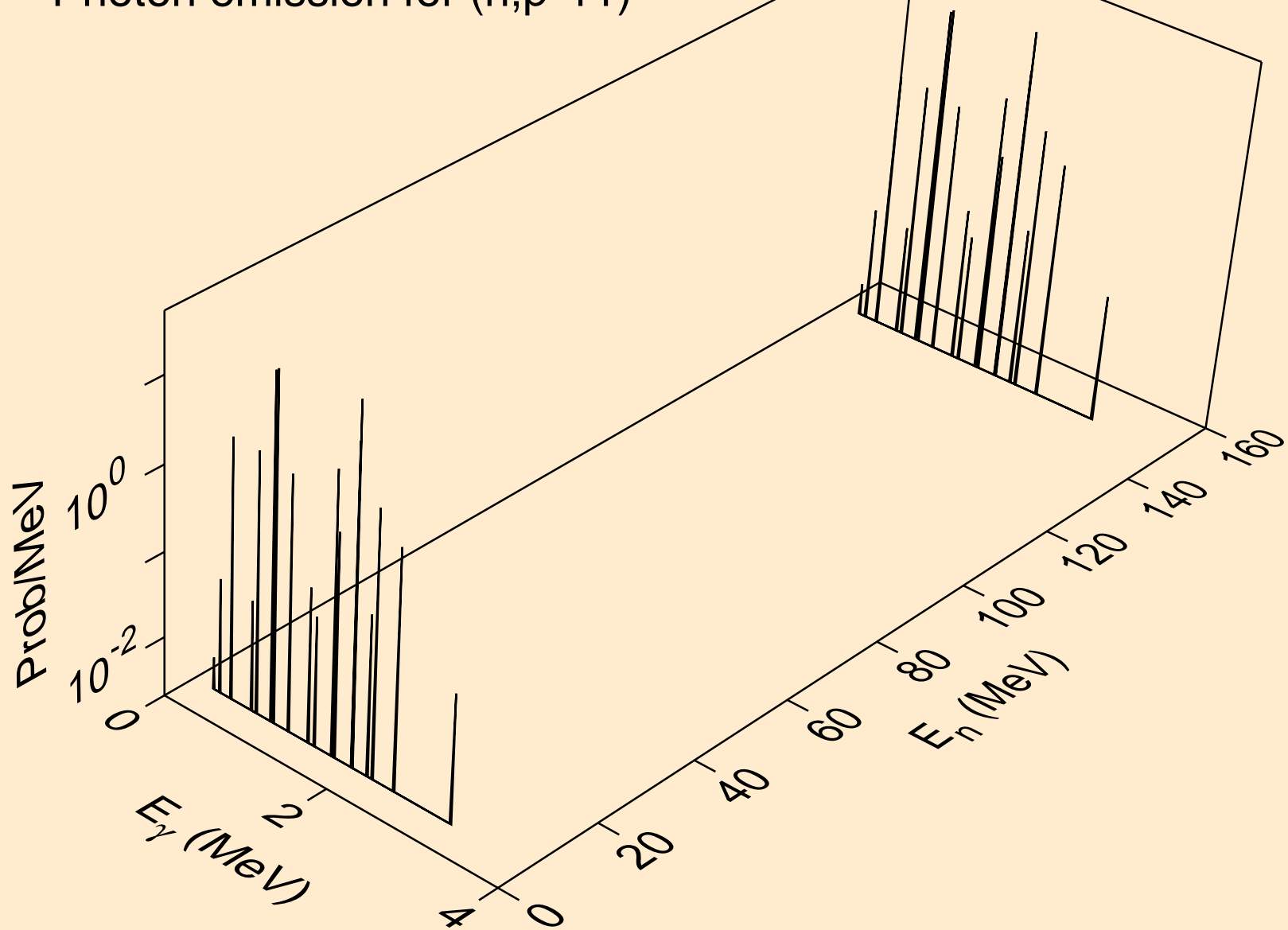

13-AL-27 FOR FENDL-3B2 FROM JEFF-3.1 WITH NJOY99.304+ C  
Photon emission for (n,p\*12)

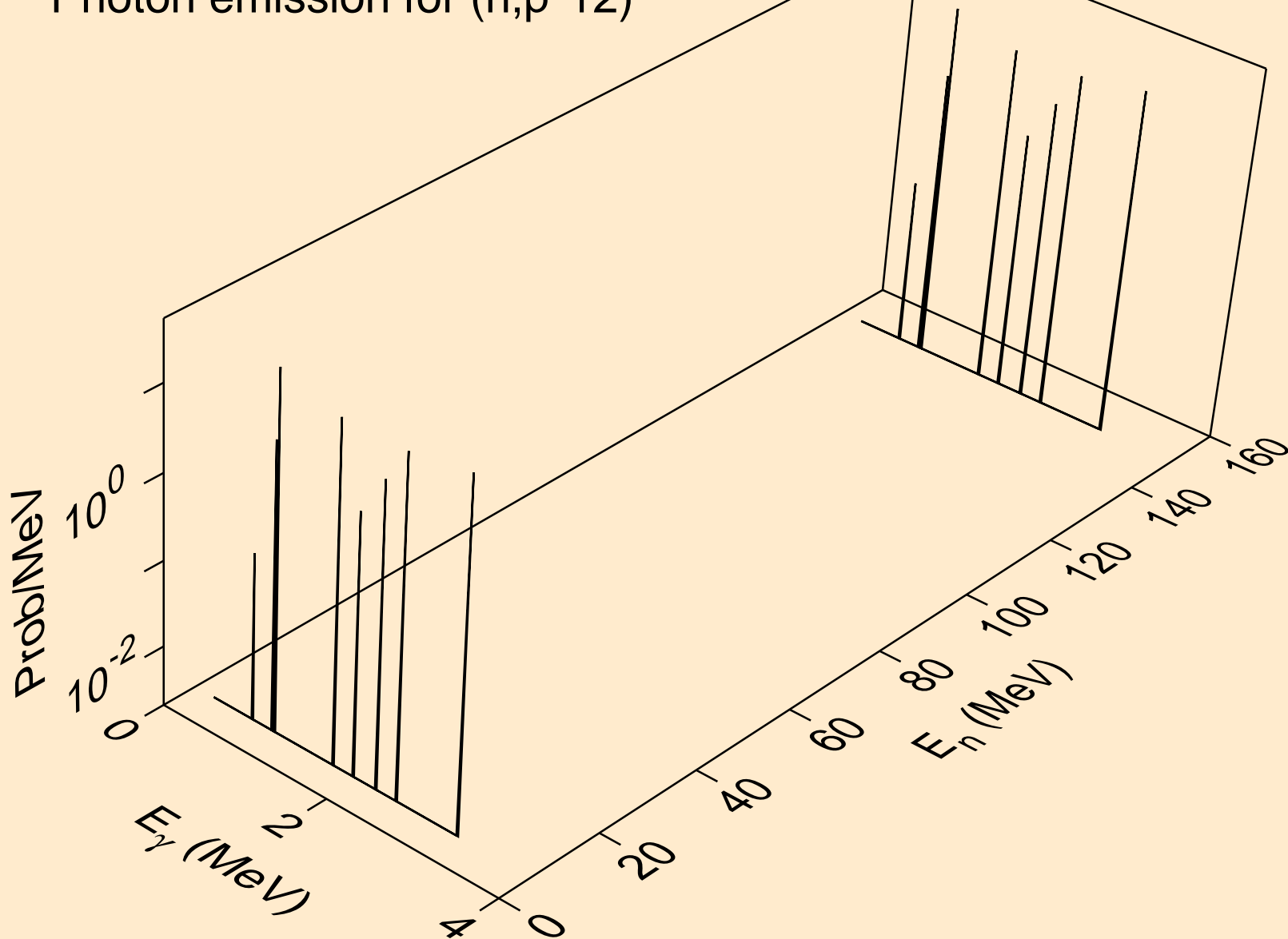

13-AL-27 FOR FENDL-3B2 FROM JEFF-3.1 WITH NJOY99.304+ C  
Photon emission for (n,p\*13)

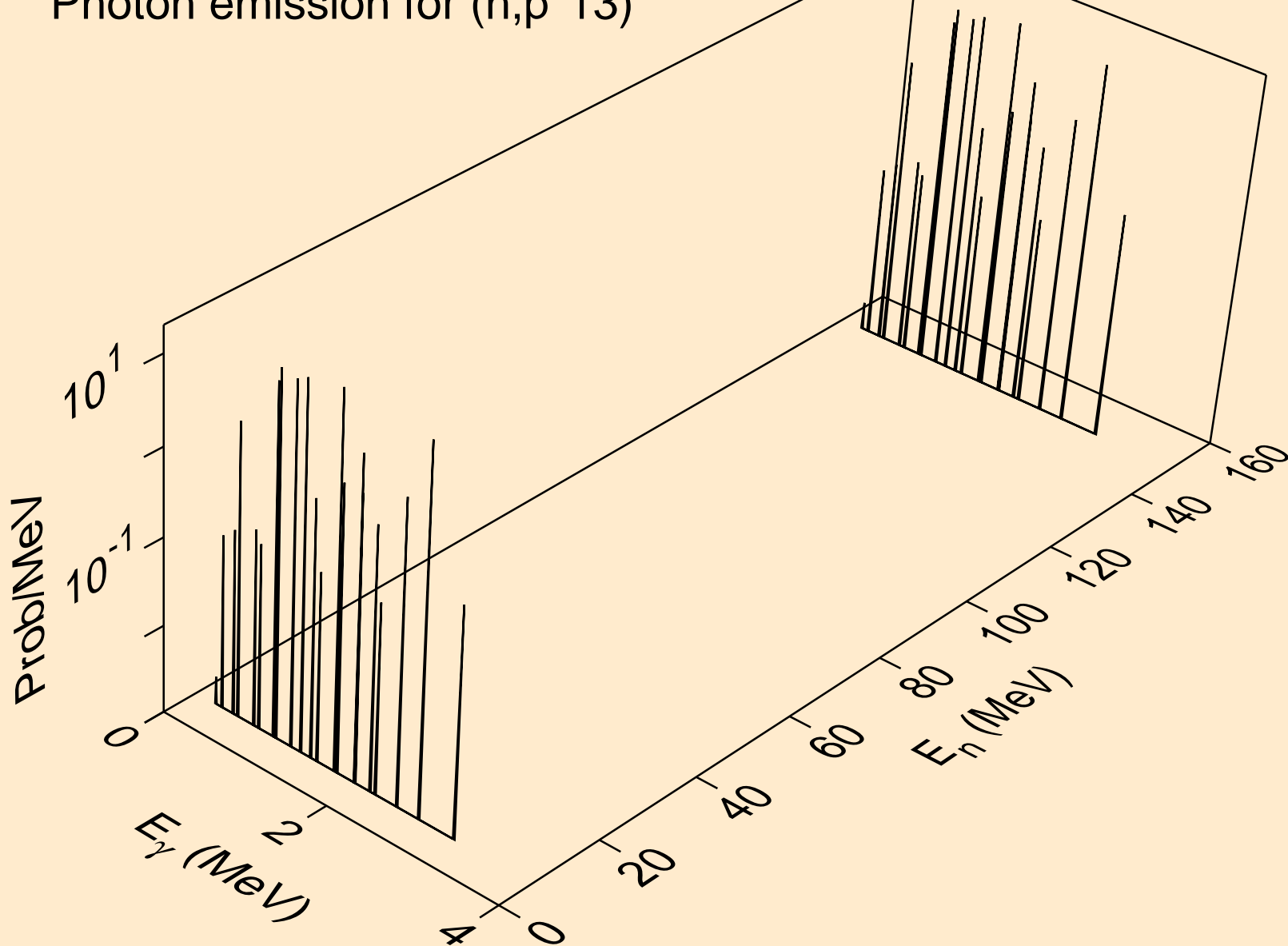

13-AL-27 FOR FENDL-3B2 FROM JEFF-3.1 WITH NJOY99.304+ C  
Photon emission for (n,p\*14)

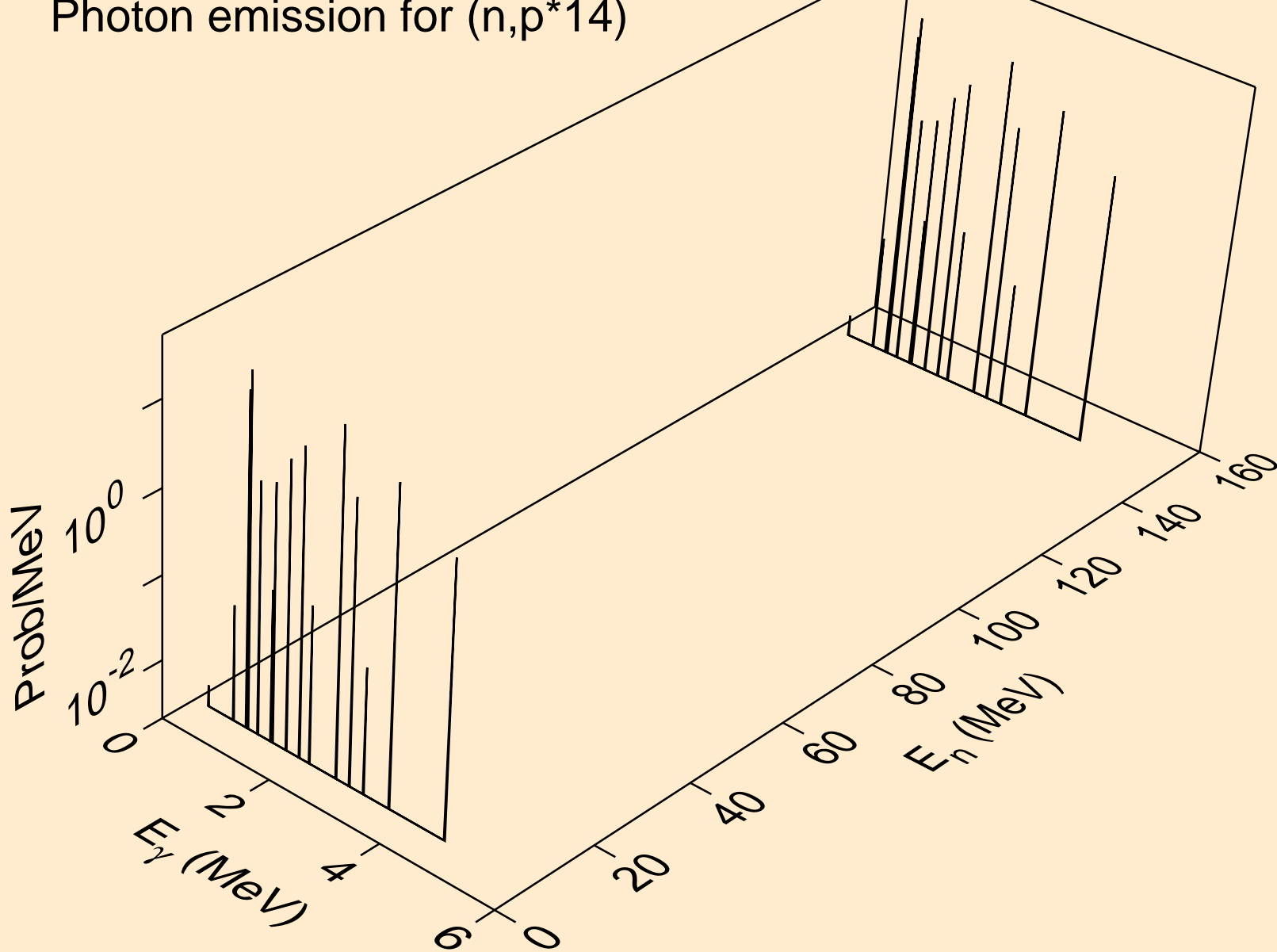

13-AL-27 FOR FENDL-3B2 FROM JEFF-3.1 WITH NJOY99.304+ C  
Photon emission for (n,p\*15)

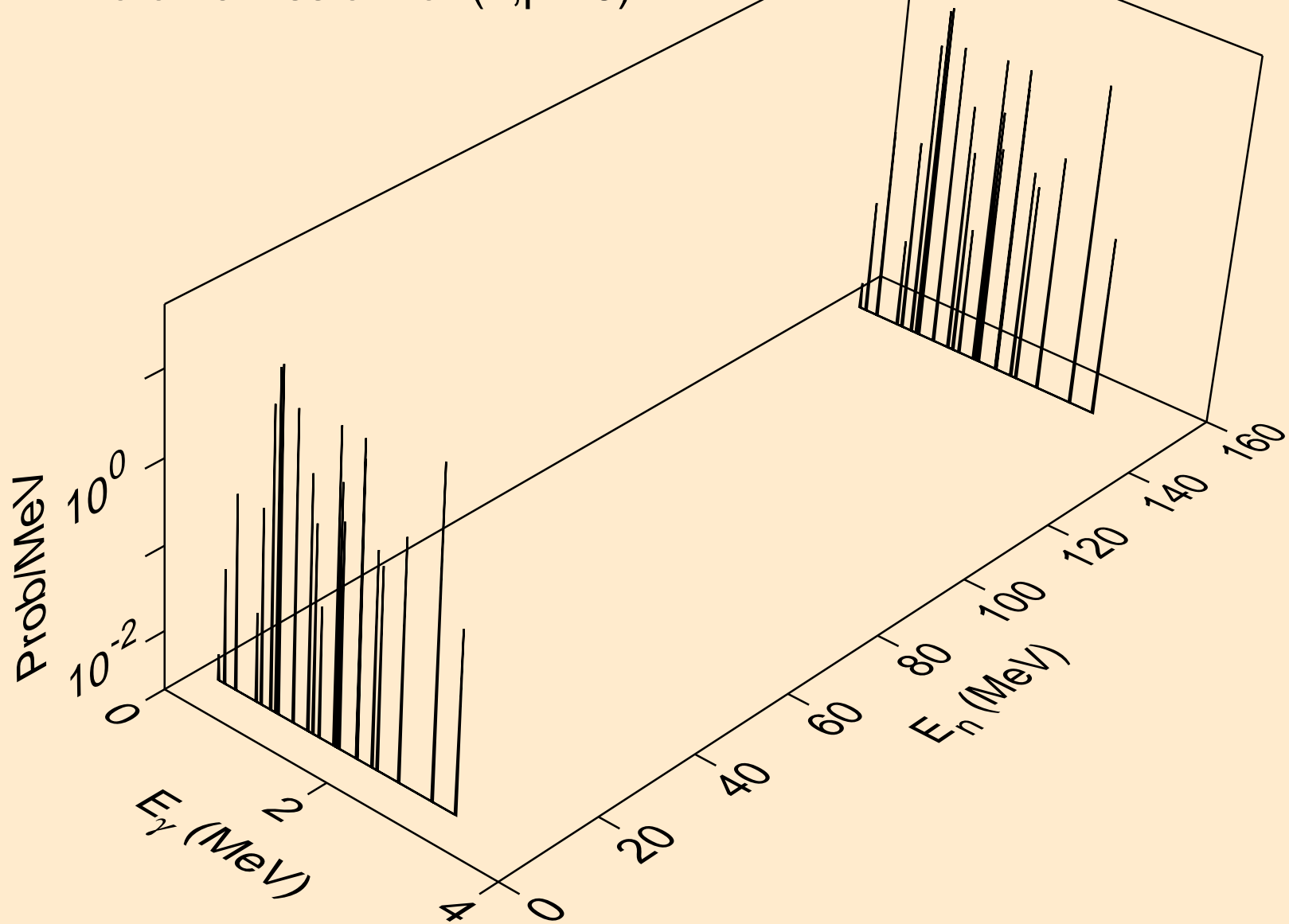

13-AL-27 FOR FENDL-3B2 FROM JEFF-3.1 WITH NJOY99.304+ C  
Photon emission for (n,p\*16)

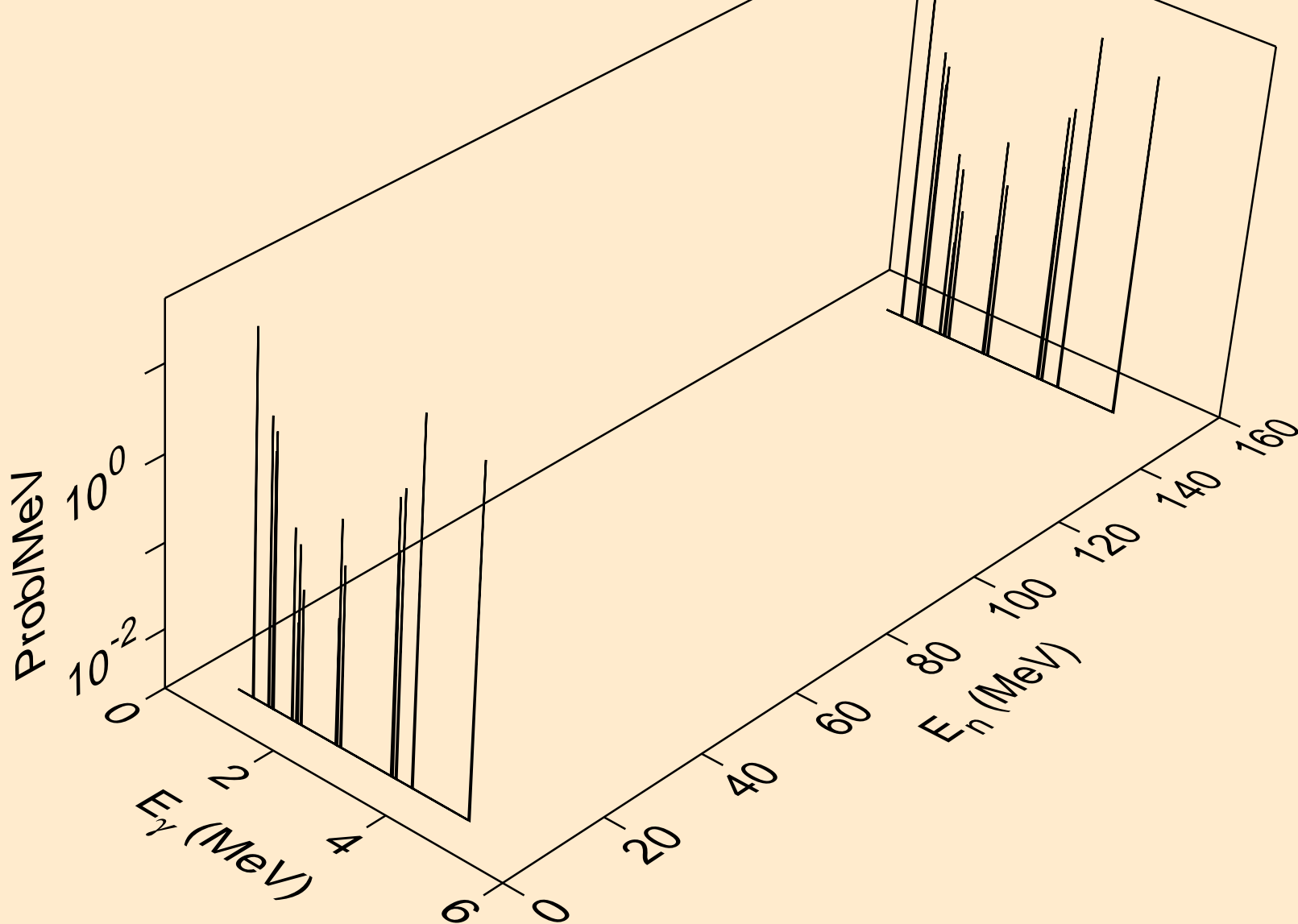

13-AL-27 FOR FENDL-3B2 FROM JEFF-3.1 WITH NJOY99.304+ C  
Photon emission for (n,p\*17)

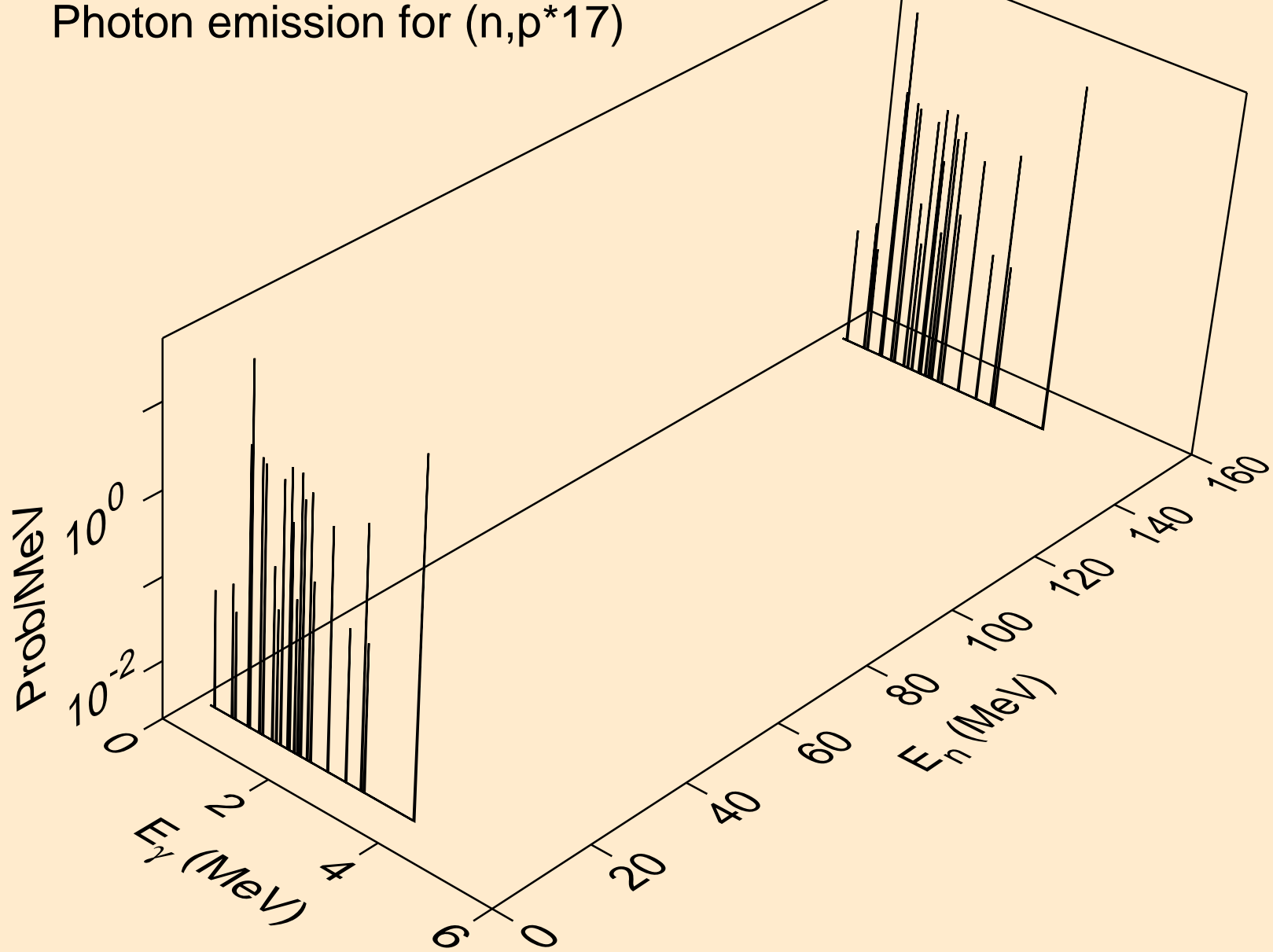



13-AL-27 FOR FENDL-3B2 FROM JEFF-3.1 WITH NJOY99.304+ C  
Photon emission for (n,p\*18)

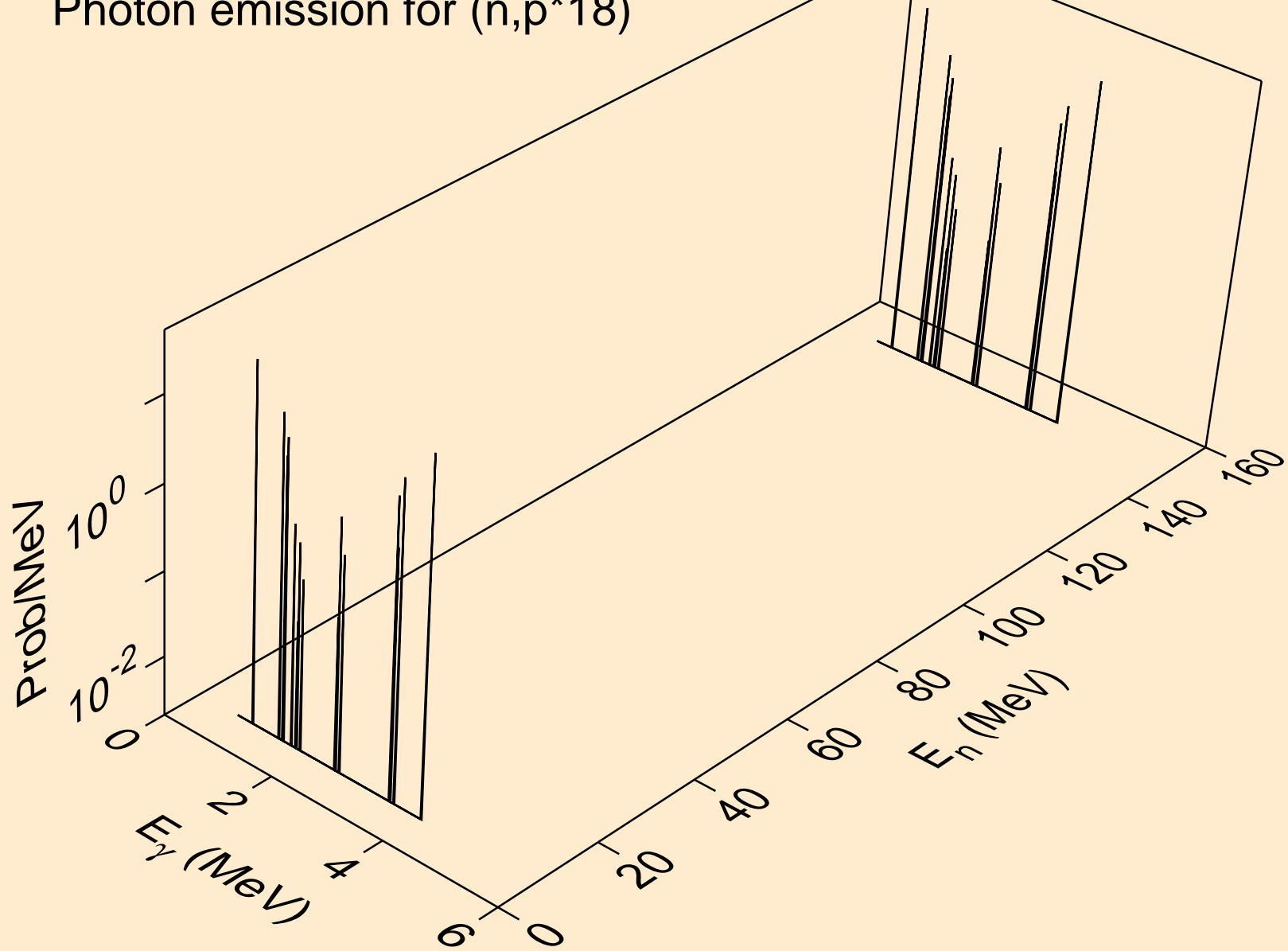

13-AL-27 FOR FENDL-3B2 FROM JEFF-3.1 WITH NJOY99.304+ C  
Photon emission for (n,p\*19)

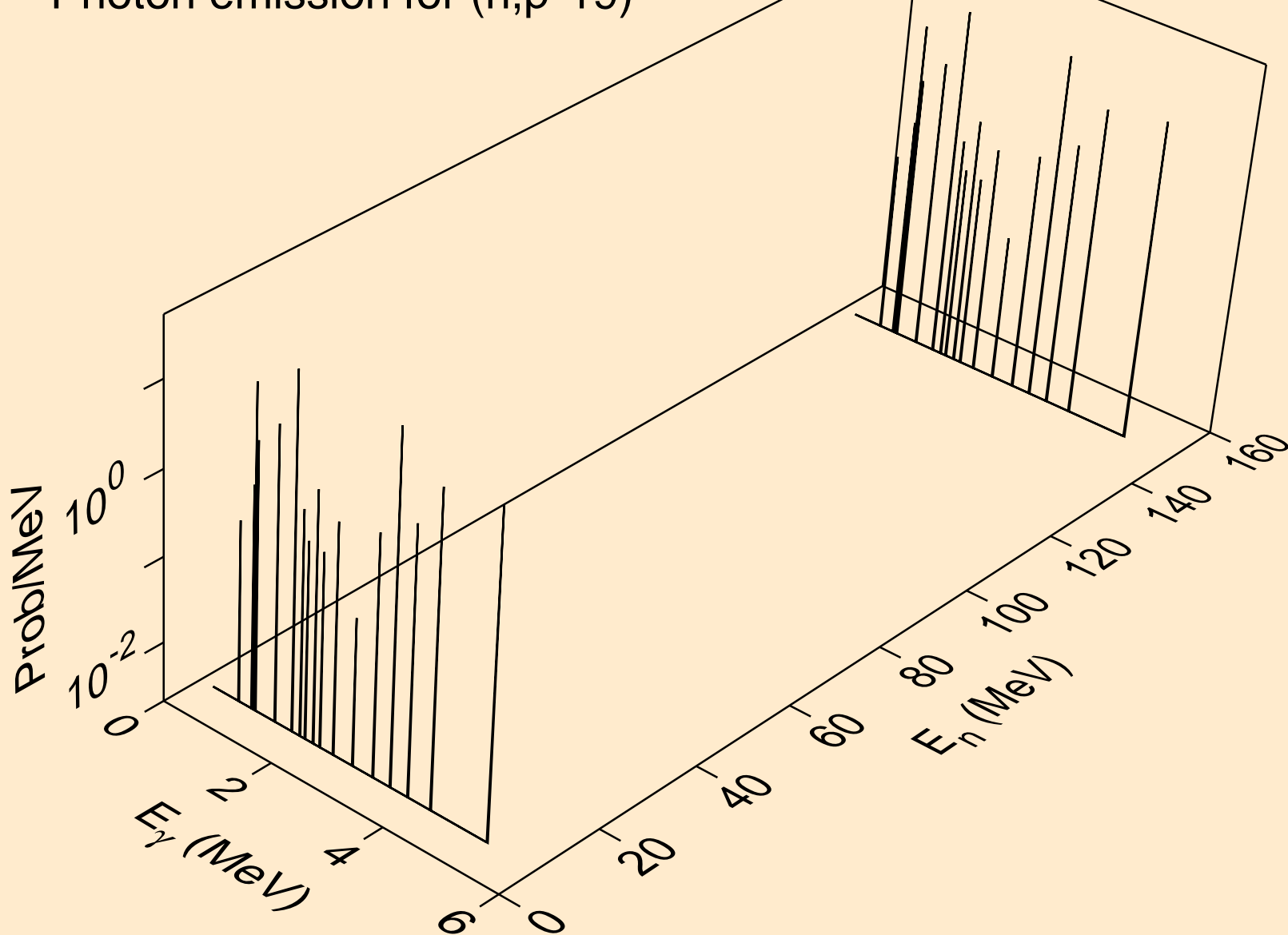

13-AL-27 FOR FENDL-3B2 FROM JEFF-3.1 WITH NJOY99.304+ C  
Photon emission for (n,p\*c)

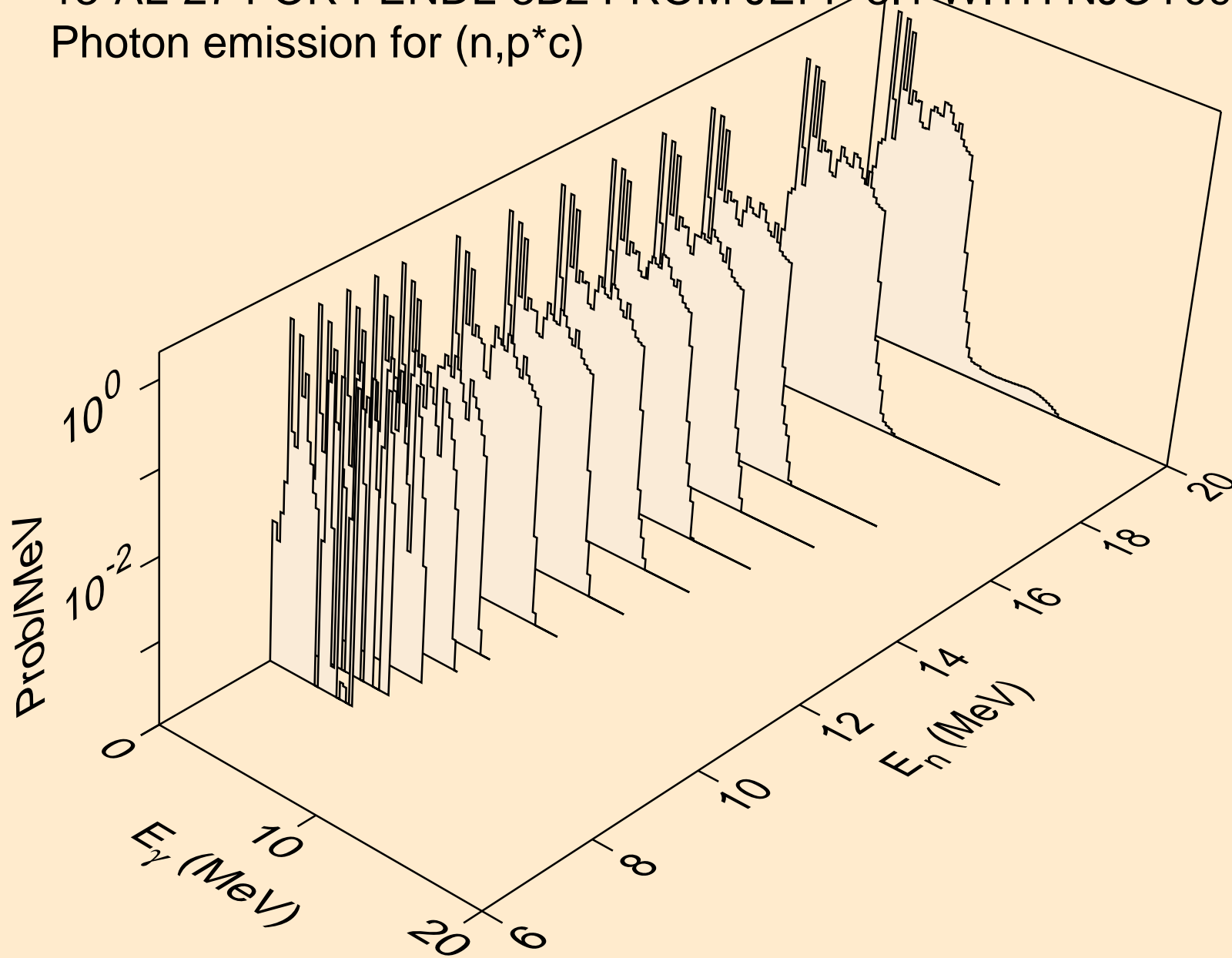

13-AL-27 FOR FENDL-3B2 FROM JEFF-3.1 WITH NJOY99.304+ C  
Photon emission for (n,d\*1)

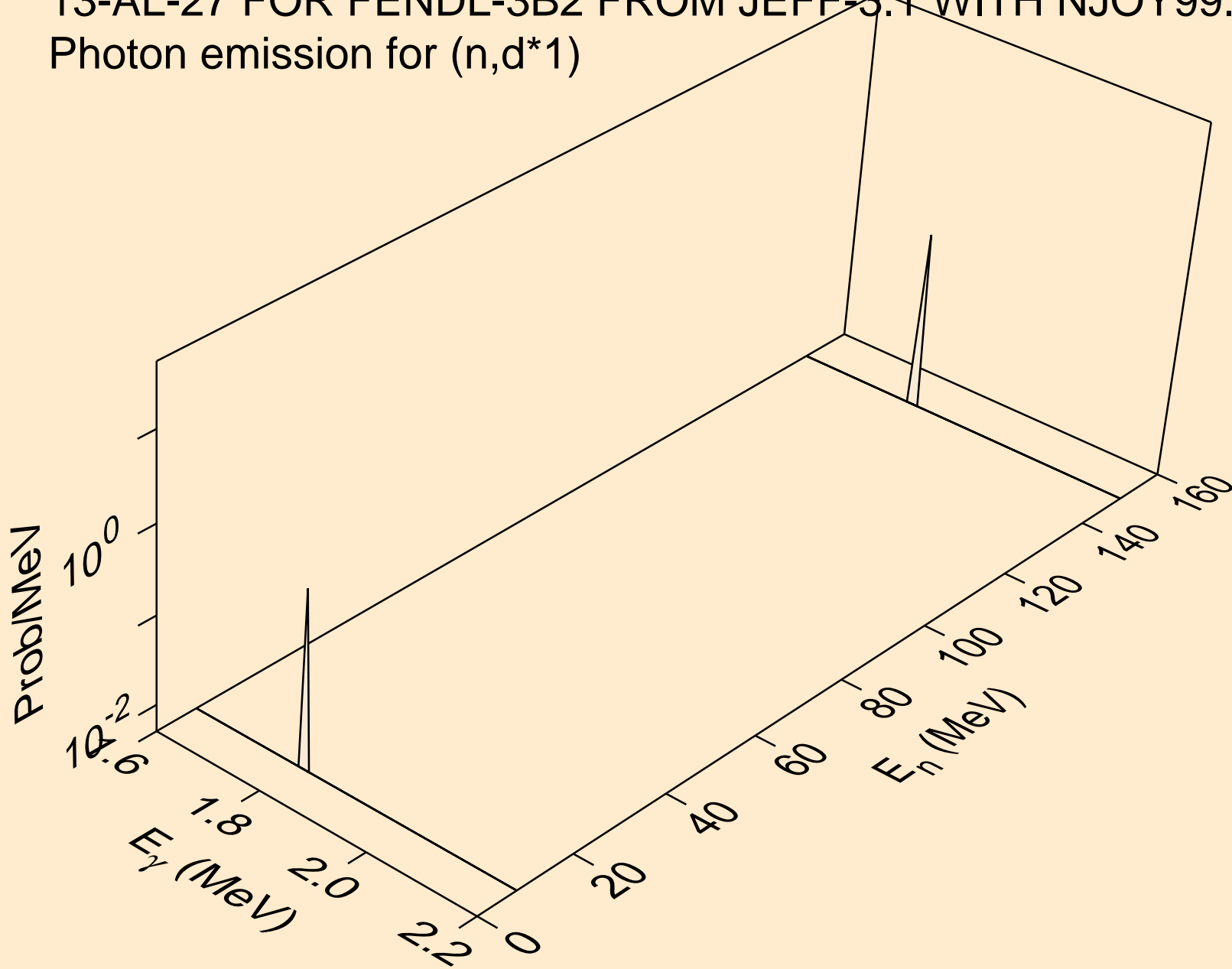

13-AL-27 FOR FENDL-3B2 FROM JEFF-3.1 WITH NJOY99.304+ C  
Photon emission for (n,d\*2)

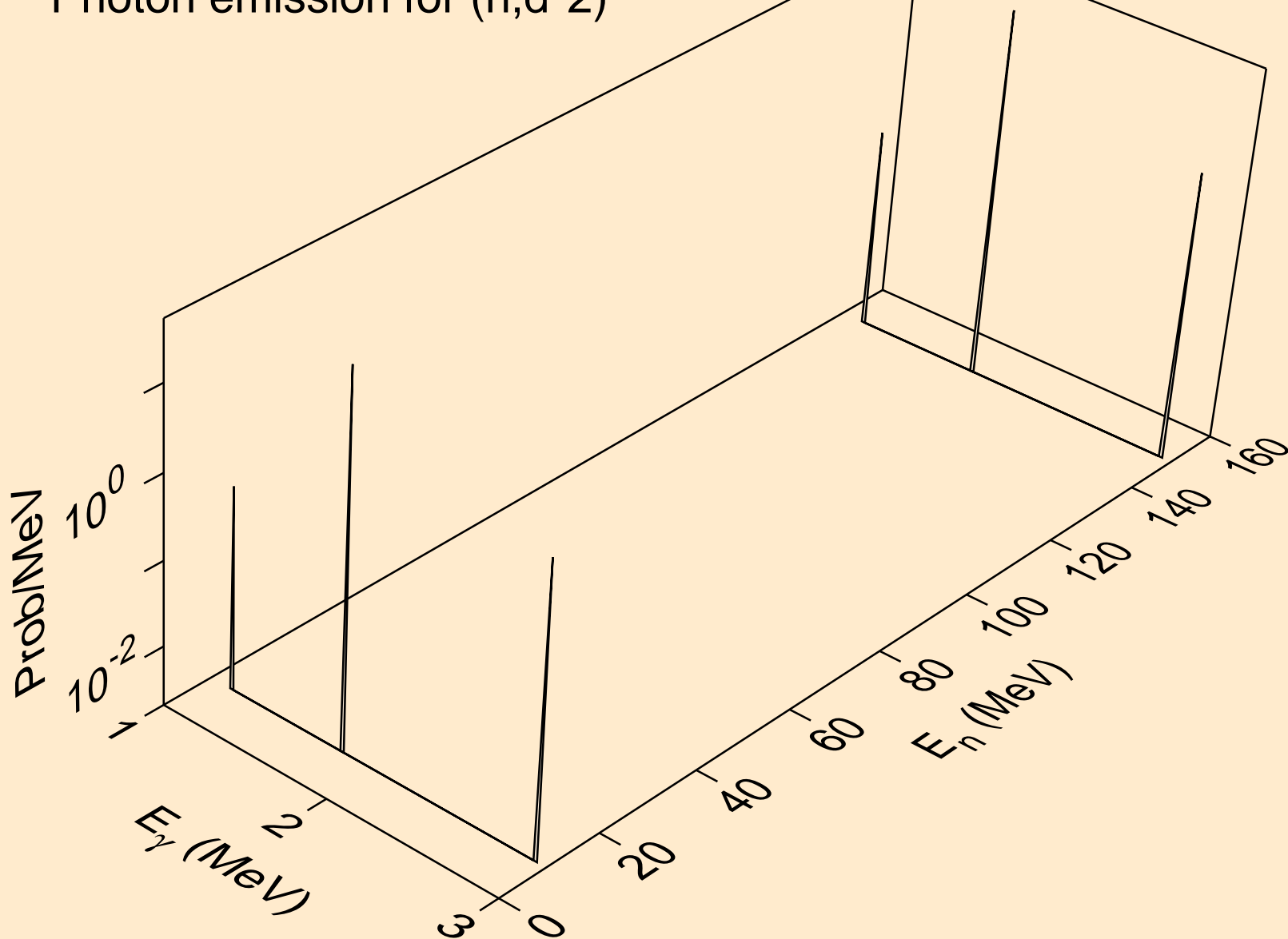

13-AL-27 FOR FENDL-3B2 FROM JEFF-3.1 WITH NJOY99.304+ C  
Photon emission for (n,d\*3)

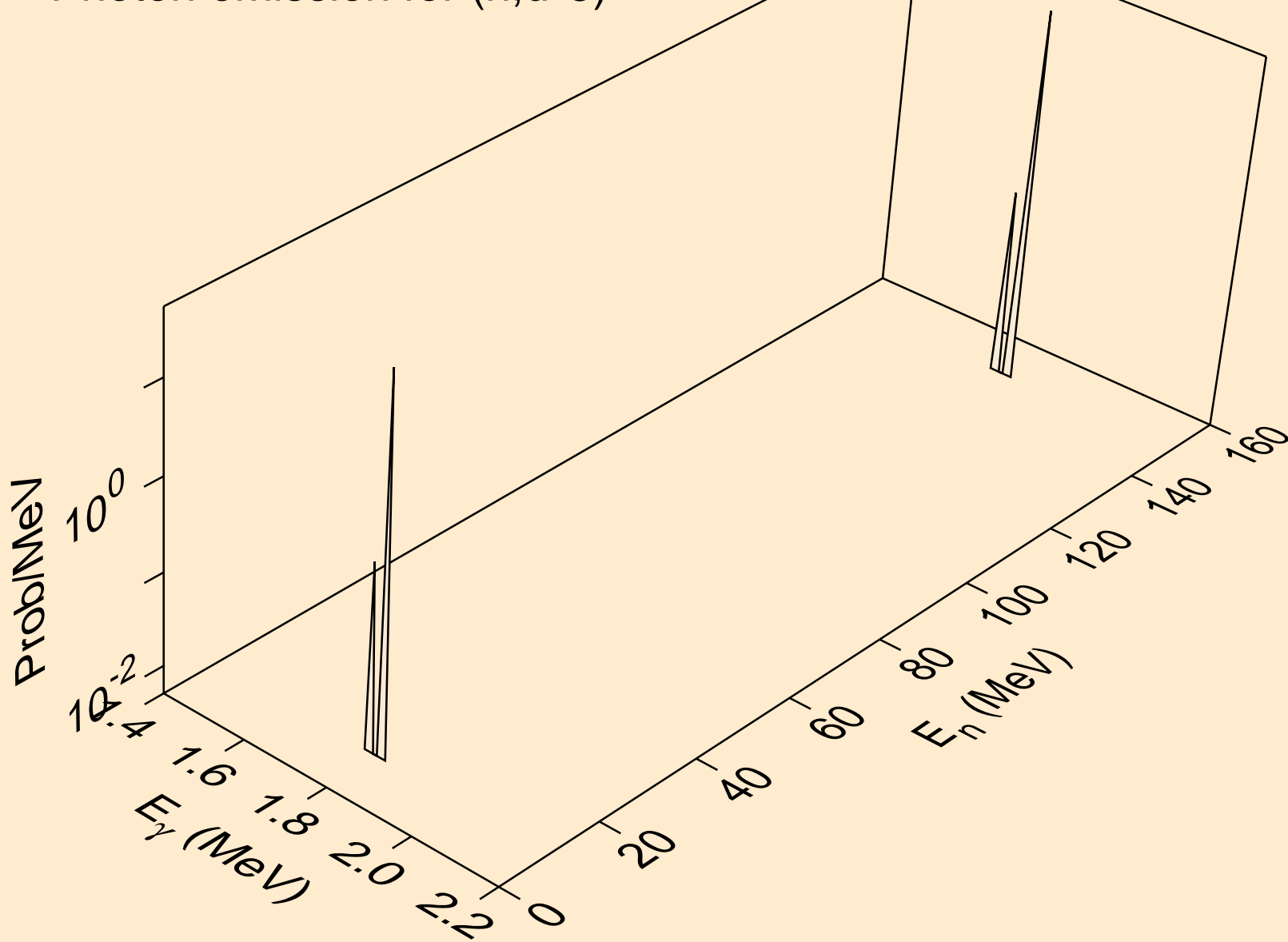

13-AL-27 FOR FENDL-3B2 FROM JEFF-3.1 WITH NJOY99.304+ C  
Photon emission for (n,d\*4)

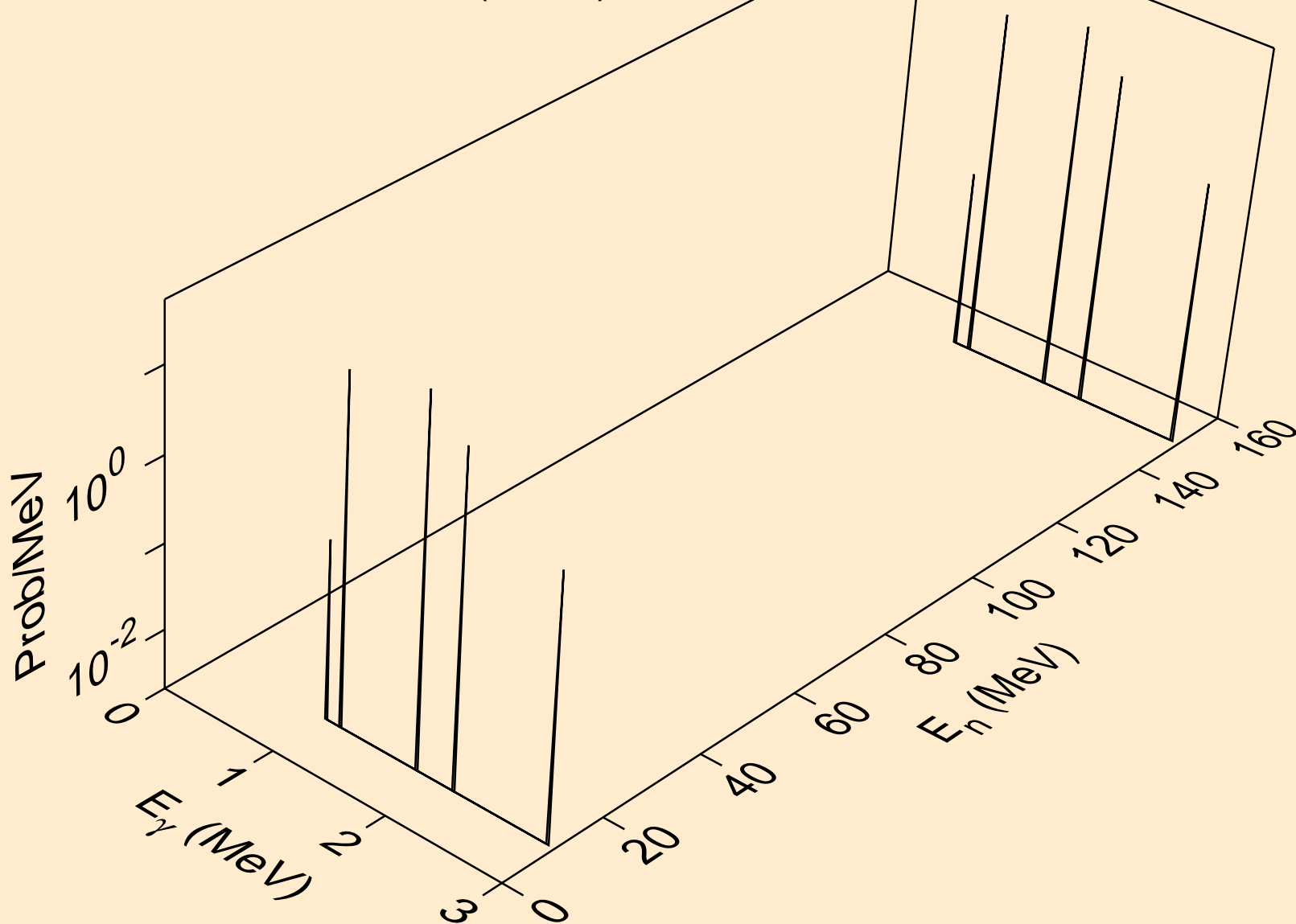

13-AL-27 FOR FENDL-3B2 FROM JEFF-3.1 WITH NJOY99.304+ C  
Photon emission for (n,d\*5)

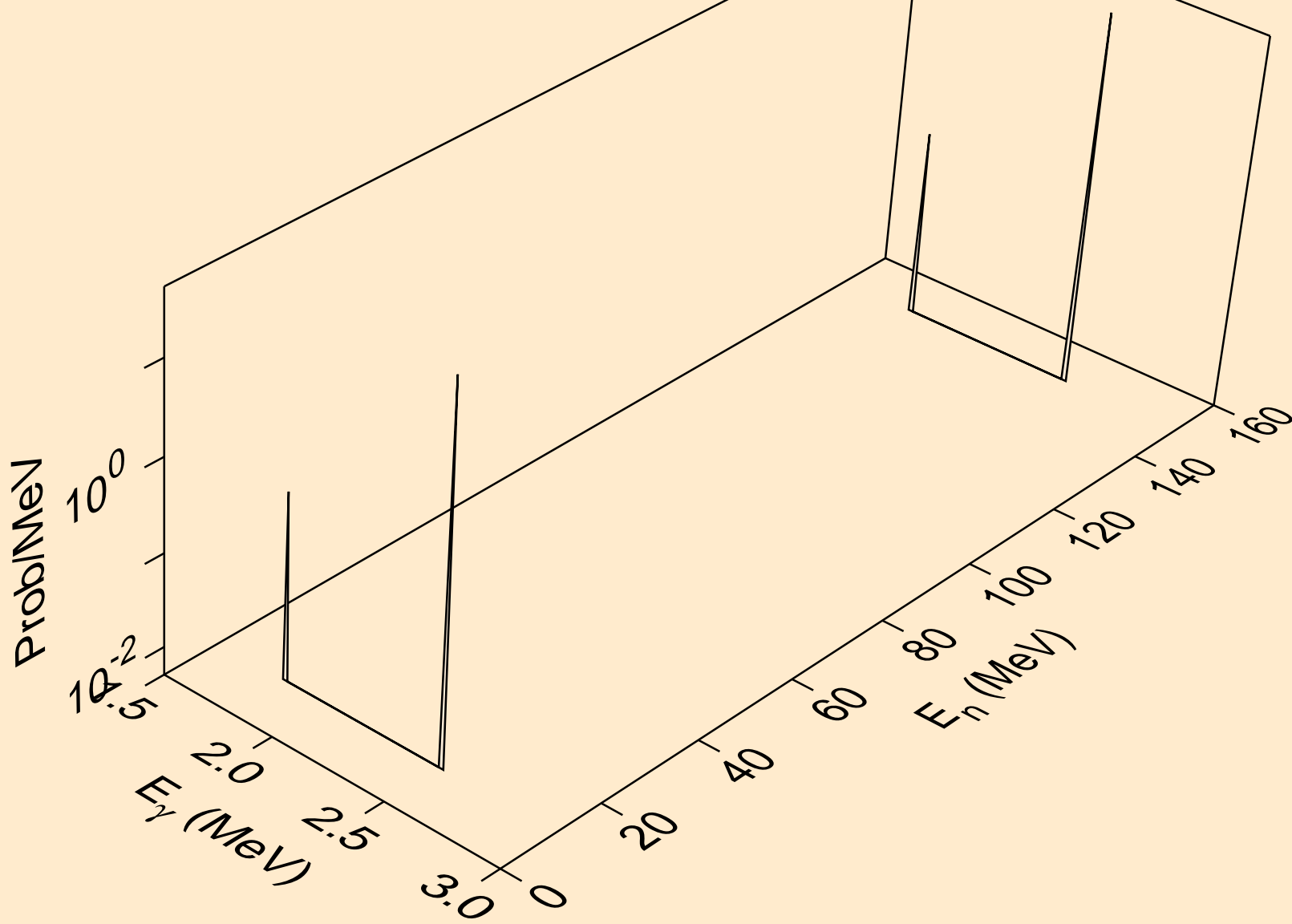



13-AL-27 FOR FENDL-3B2 FROM JEFF-3.1 WITH NJOY99.304+ C  
Photon emission for (n,d\*6)

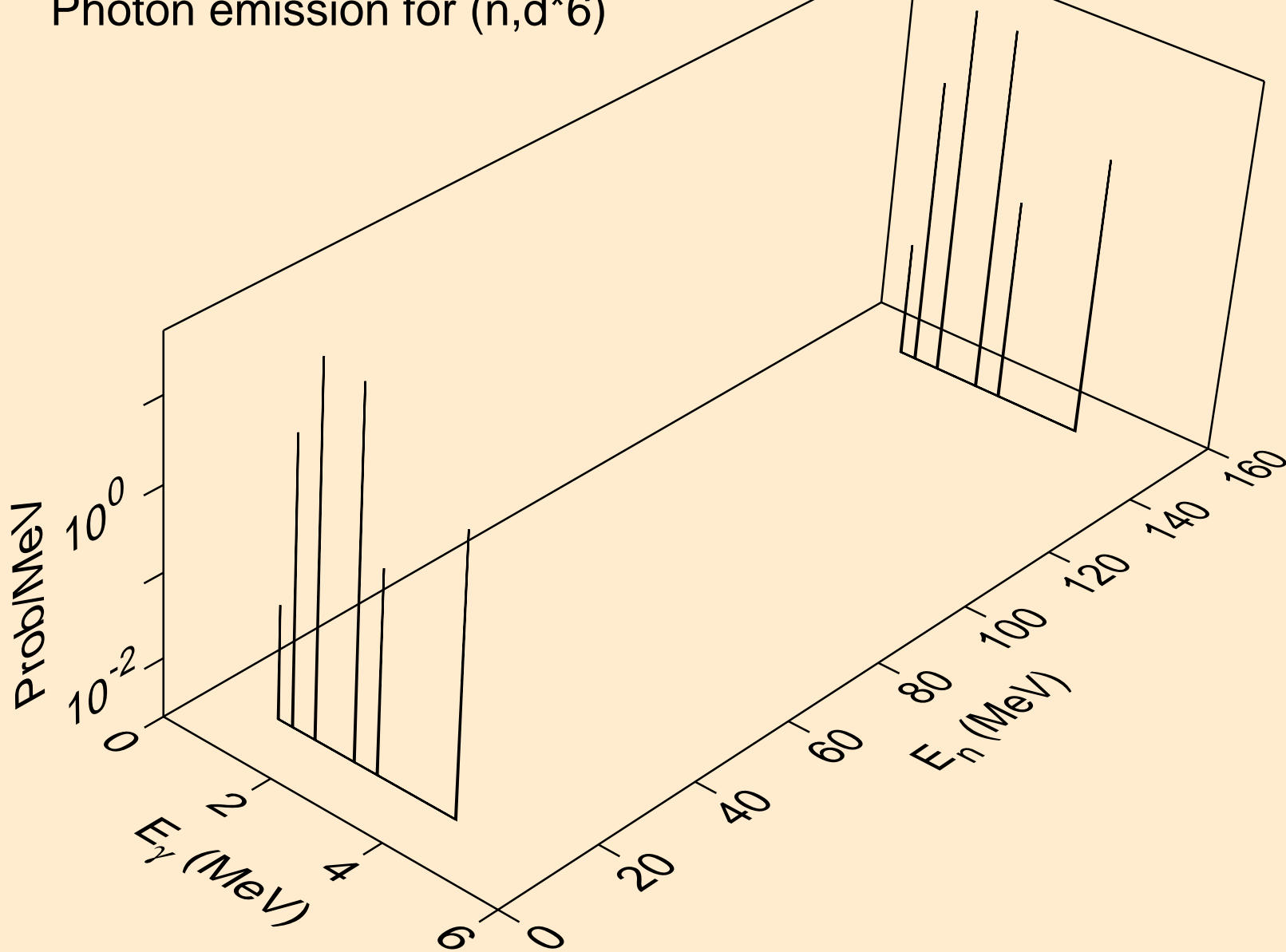

13-AL-27 FOR FENDL-3B2 FROM JEFF-3.1 WITH NJOY99.304+ C  
Photon emission for (n,d\*7)

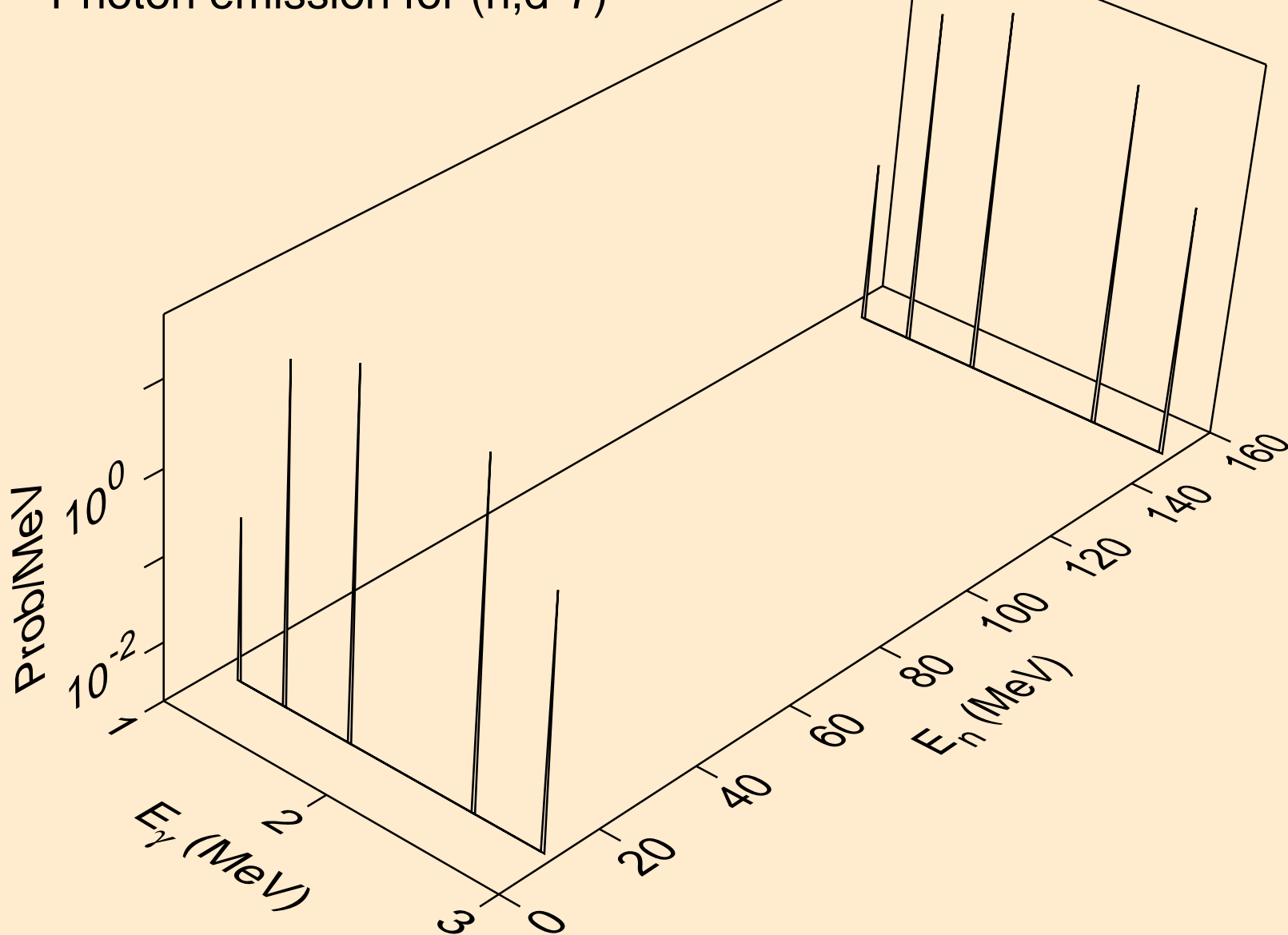

13-AL-27 FOR FENDL-3B2 FROM JEFF-3.1 WITH NJOY99.304+ C  
Photon emission for (n,d\*8)

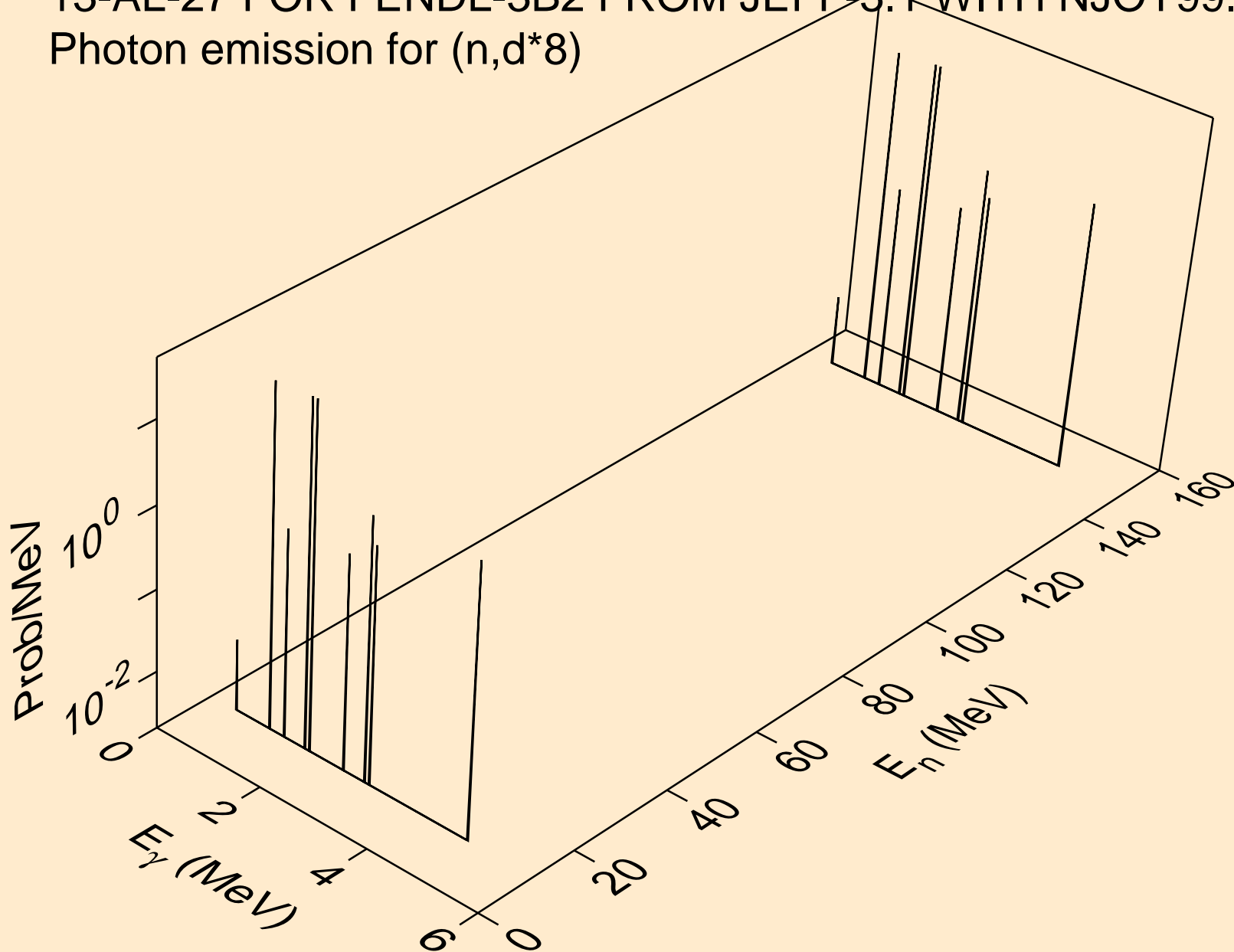

13-AL-27 FOR FENDL-3B2 FROM JEFF-3.1 WITH NJOY99.304+ C  
Photon emission for (n,d\*9)

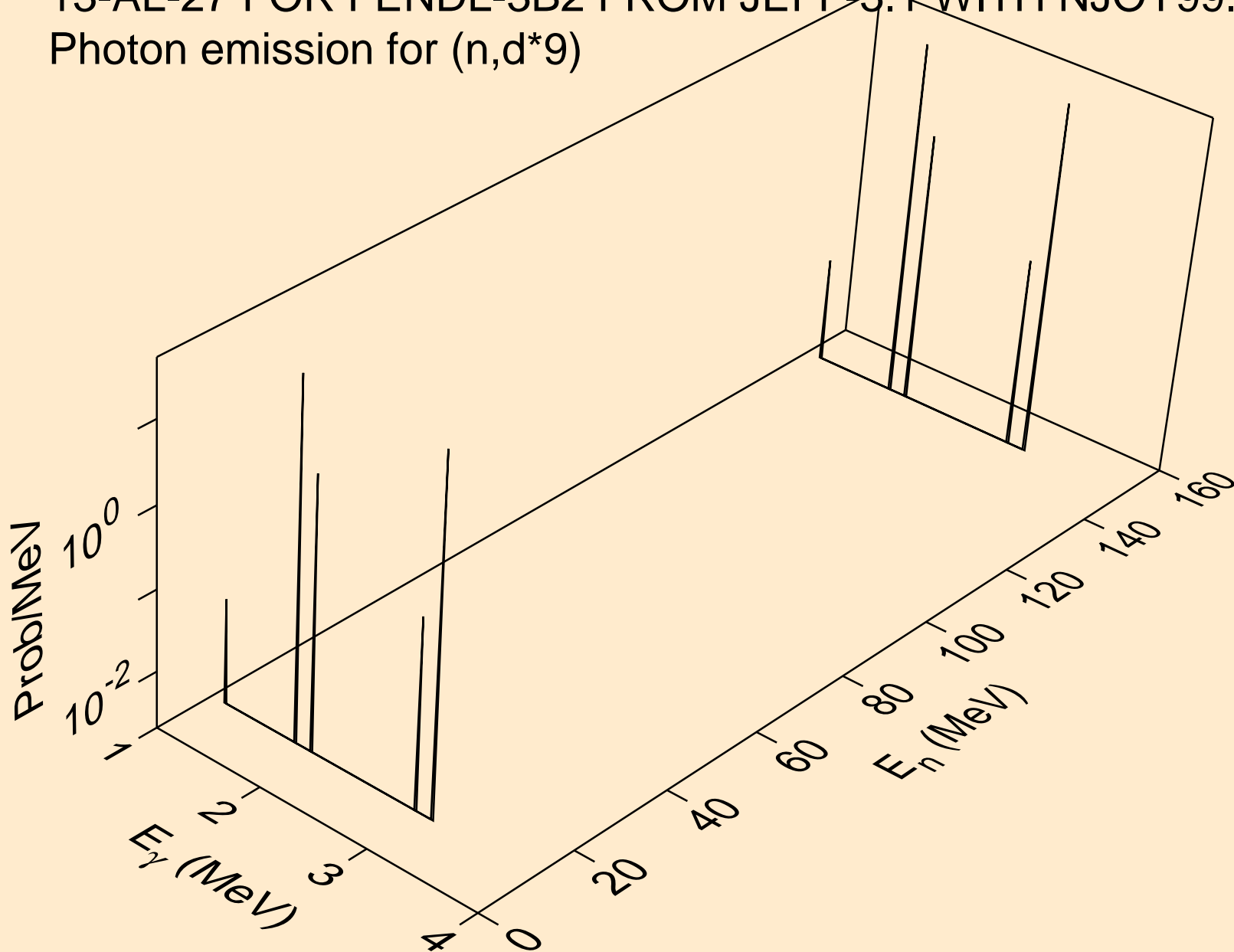

13-AL-27 FOR FENDL-3B2 FROM JEFF-3.1 WITH NJOY99.304+ C  
Photon emission for (n,d\*10)

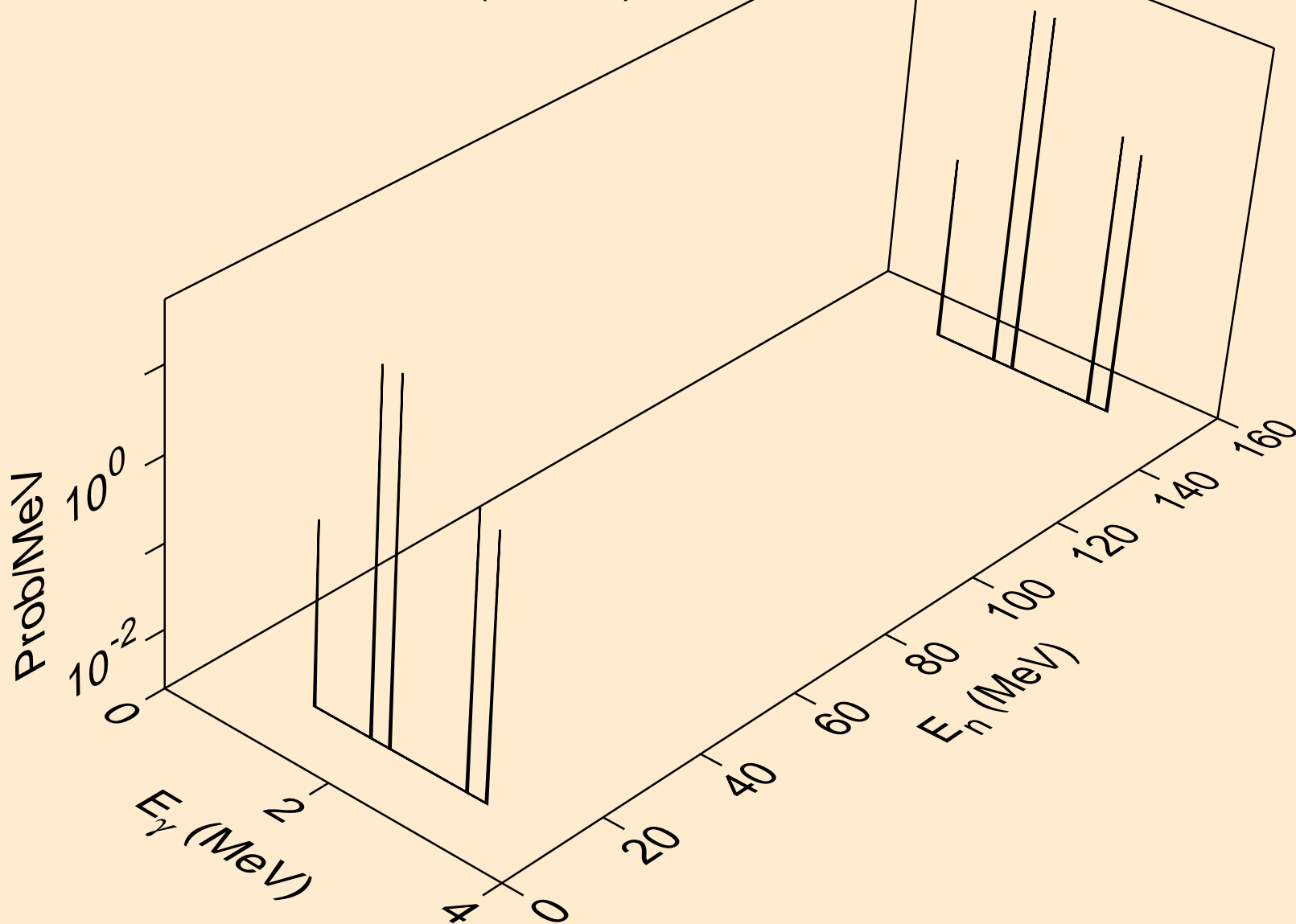

13-AL-27 FOR FENDL-3B2 FROM JEFF-3.1 WITH NJOY99.304+ C  
Photon emission for (n,d\*11)

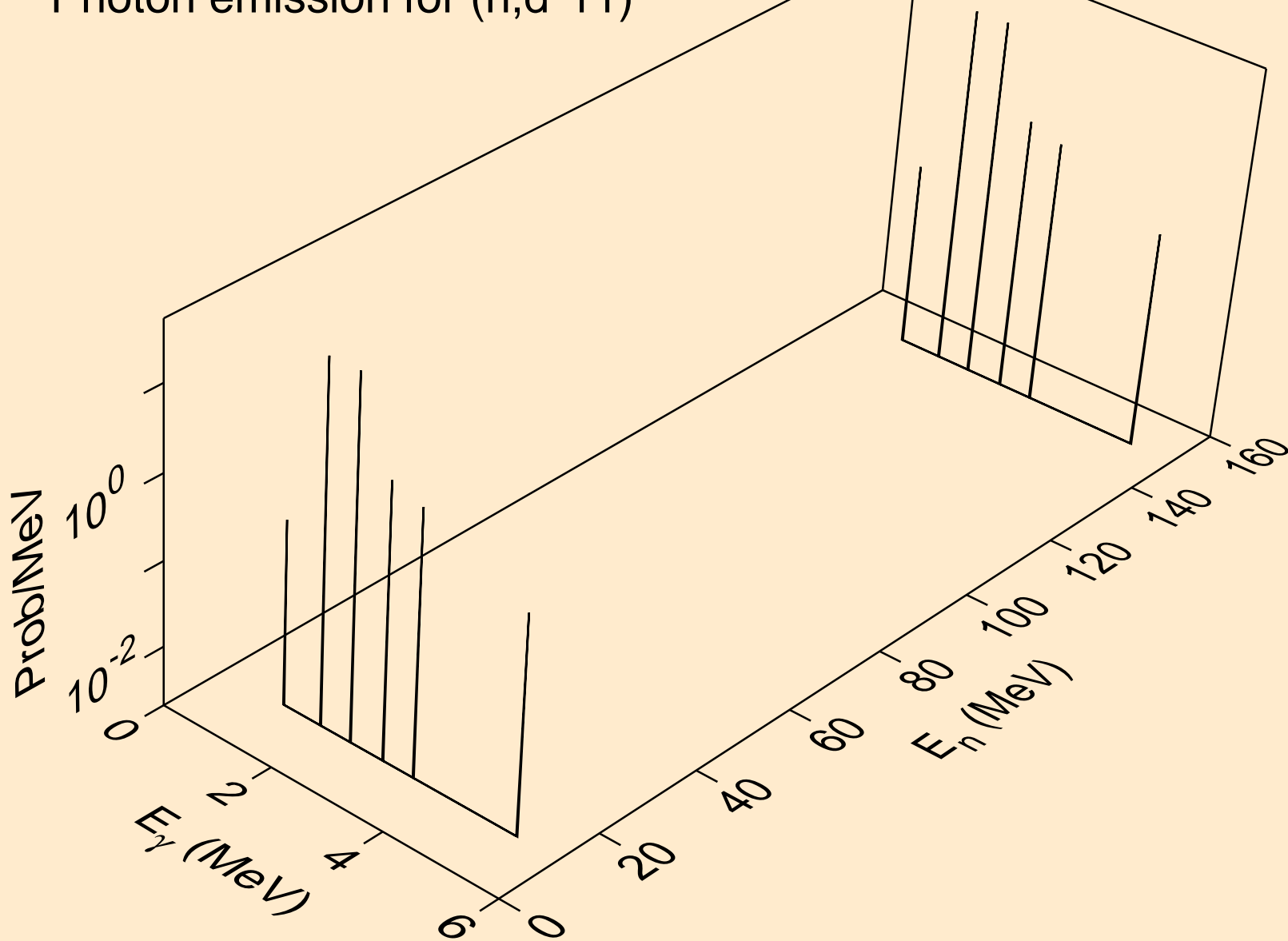

13-AL-27 FOR FENDL-3B2 FROM JEFF-3.1 WITH NJOY99.304+ C  
Photon emission for (n,d\*12)

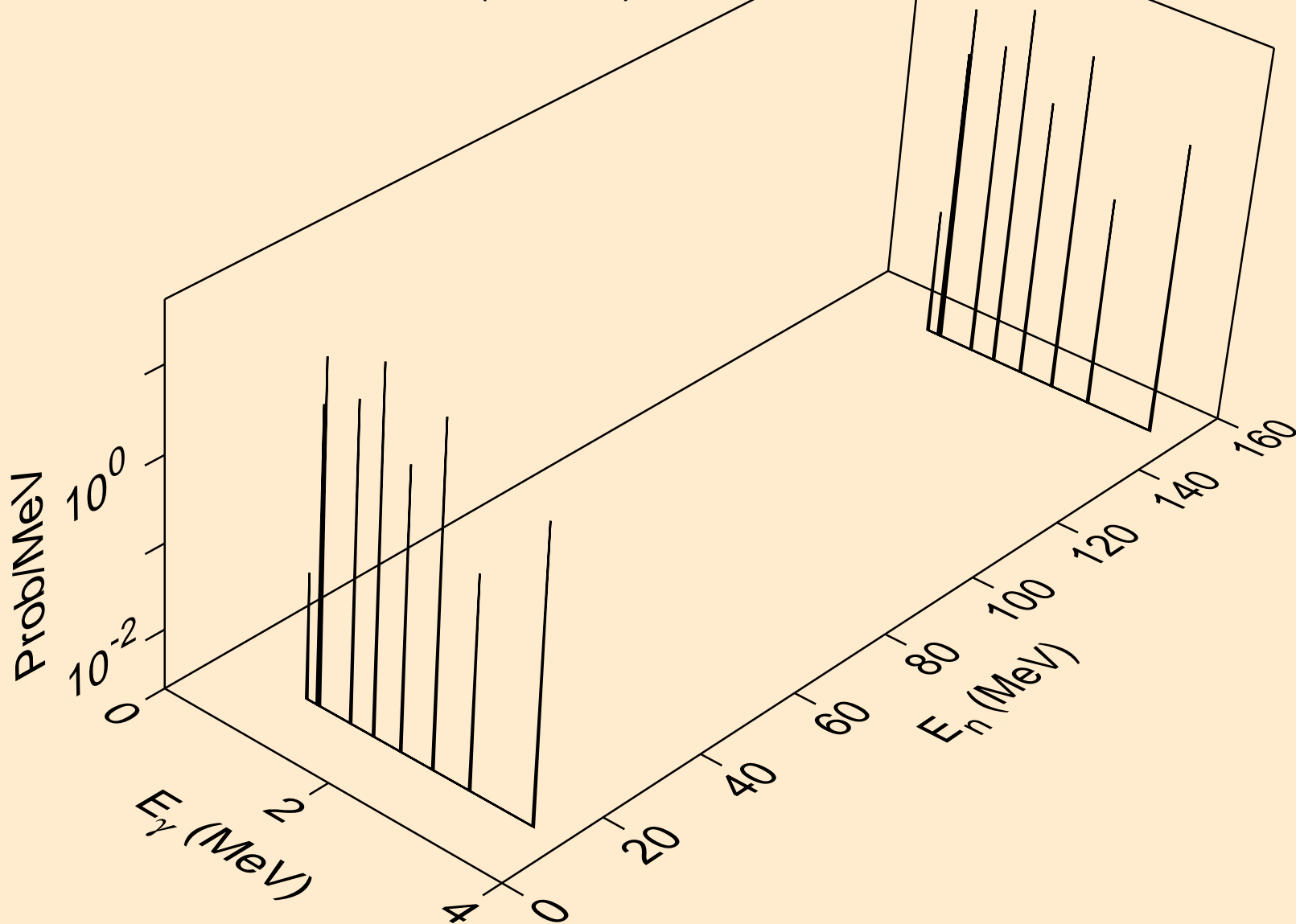

13-AL-27 FOR FENDL-3B2 FROM JEFF-3.1 WITH NJOY99.304+ C  
Photon emission for (n,d\*13)

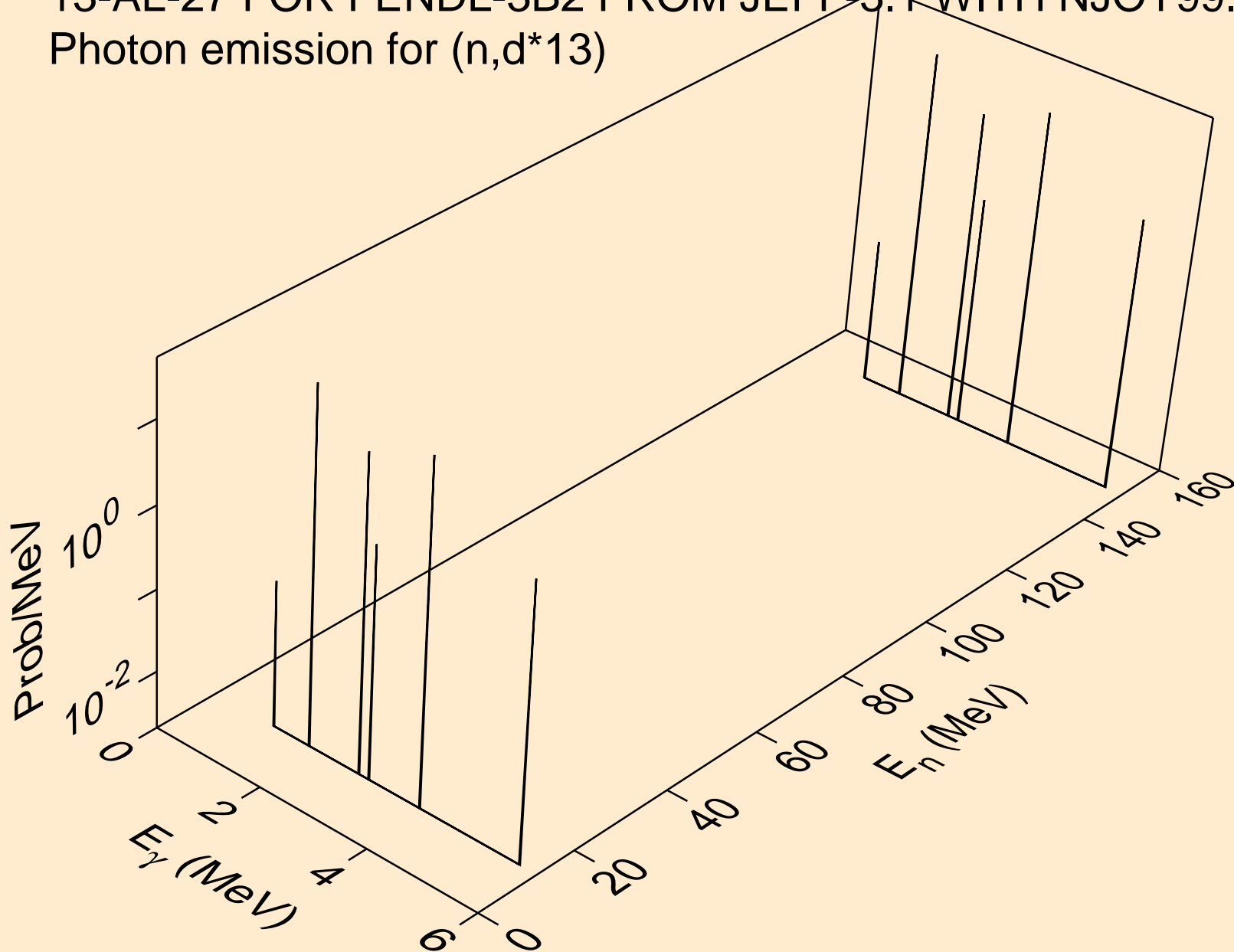



13-AL-27 FOR FENDL-3B2 FROM JEFF-3.1 WITH NJOY99.304+ C  
Photon emission for (n,d\*14)

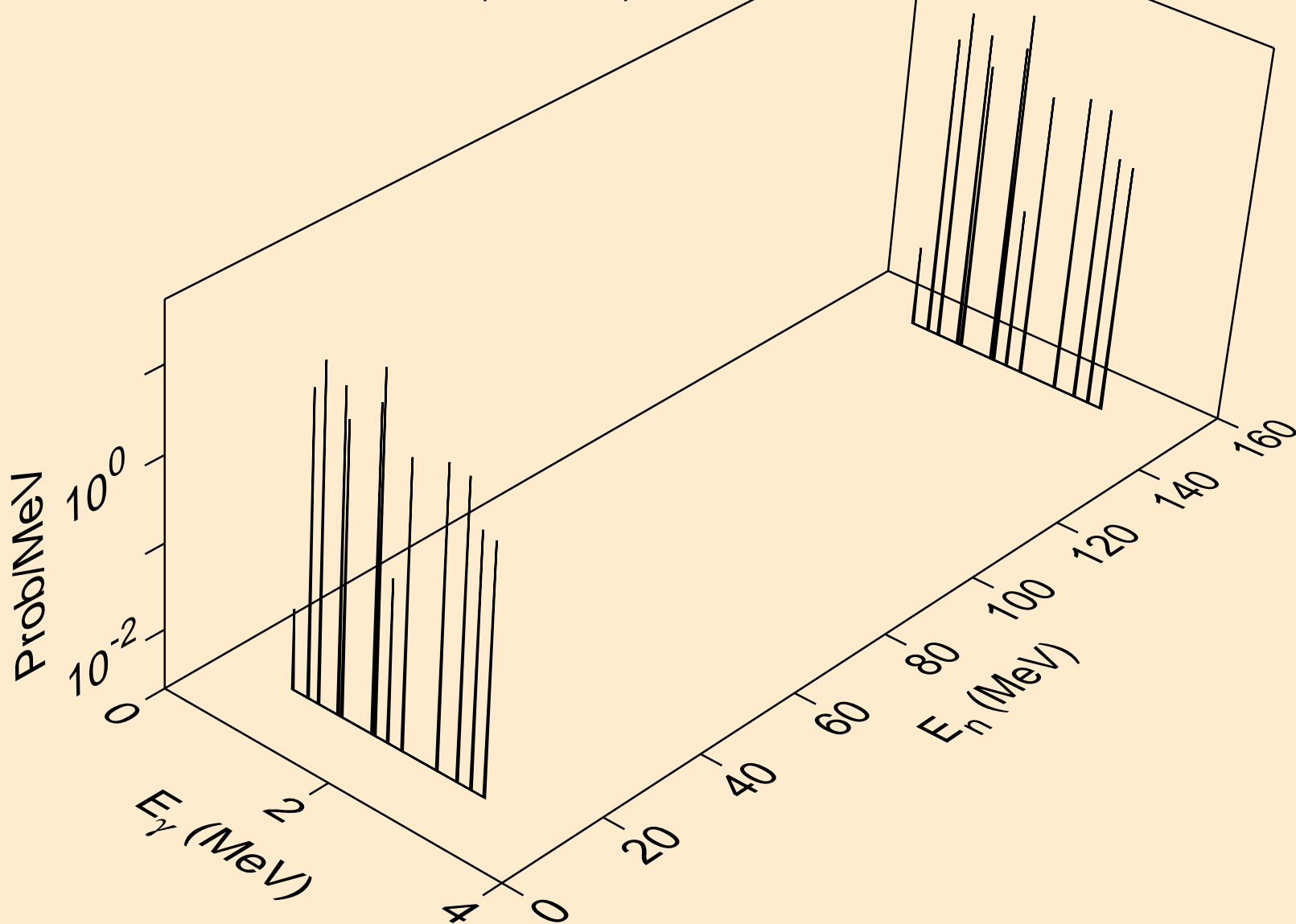

13-AL-27 FOR FENDL-3B2 FROM JEFF-3.1 WITH NJOY99.304+ C  
Photon emission for (n,d\*15)

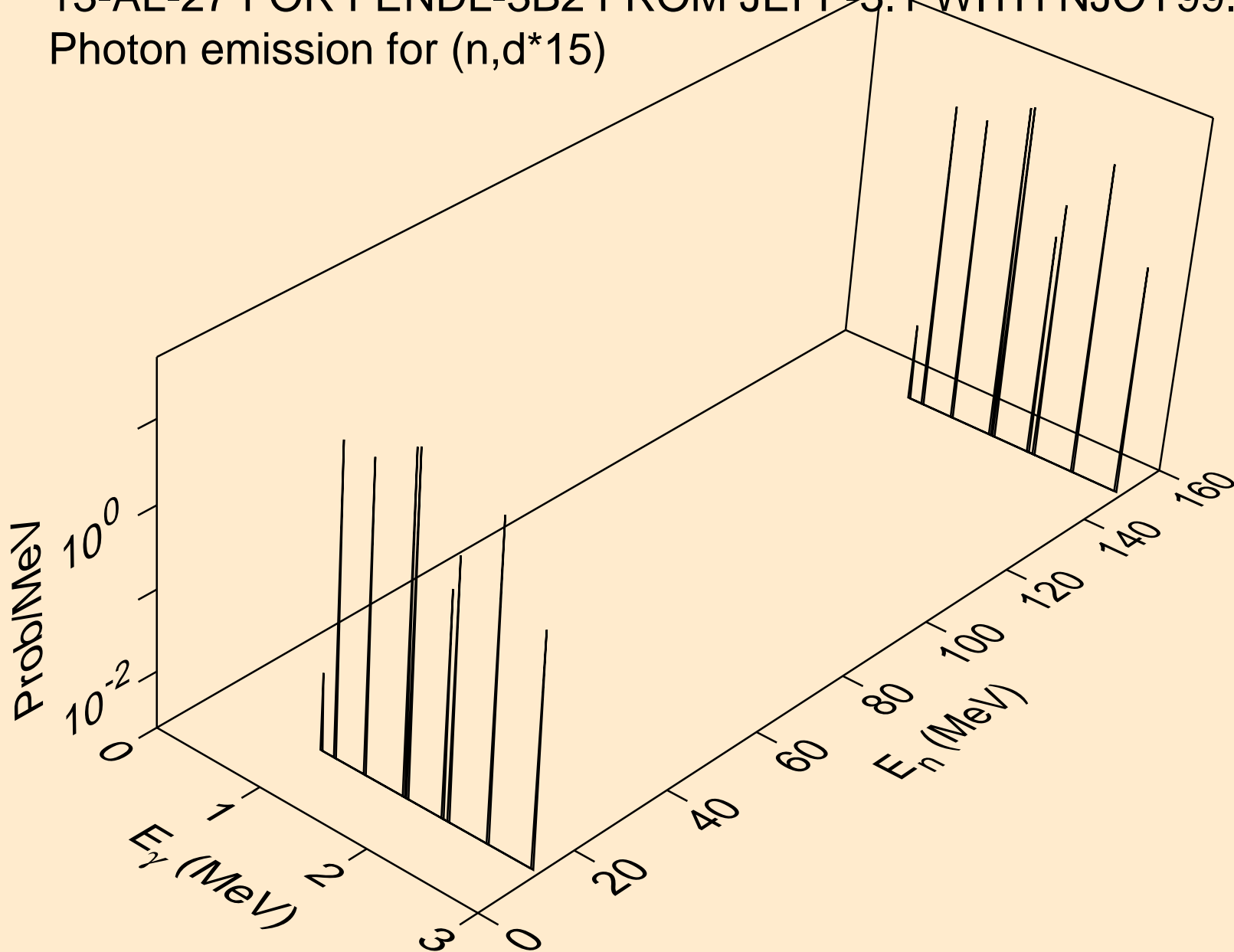

13-AL-27 FOR FENDL-3B2 FROM JEFF-3.1 WITH NJOY99.304+ C  
Photon emission for (n,d\*16)

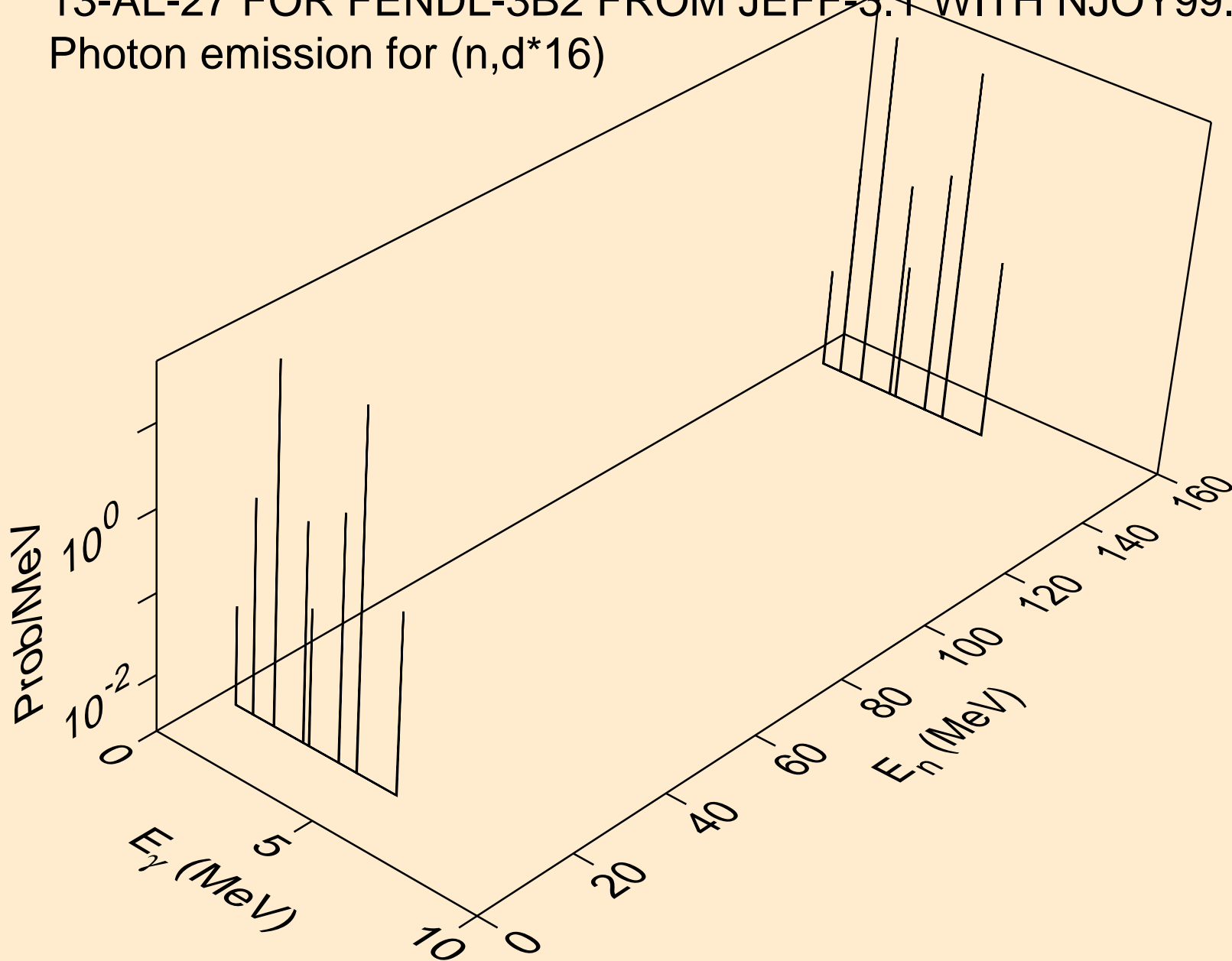

13-AL-27 FOR FENDL-3B2 FROM JEFF-3.1 WITH NJOY99.304+ C  
Photon emission for (n,d\*17)

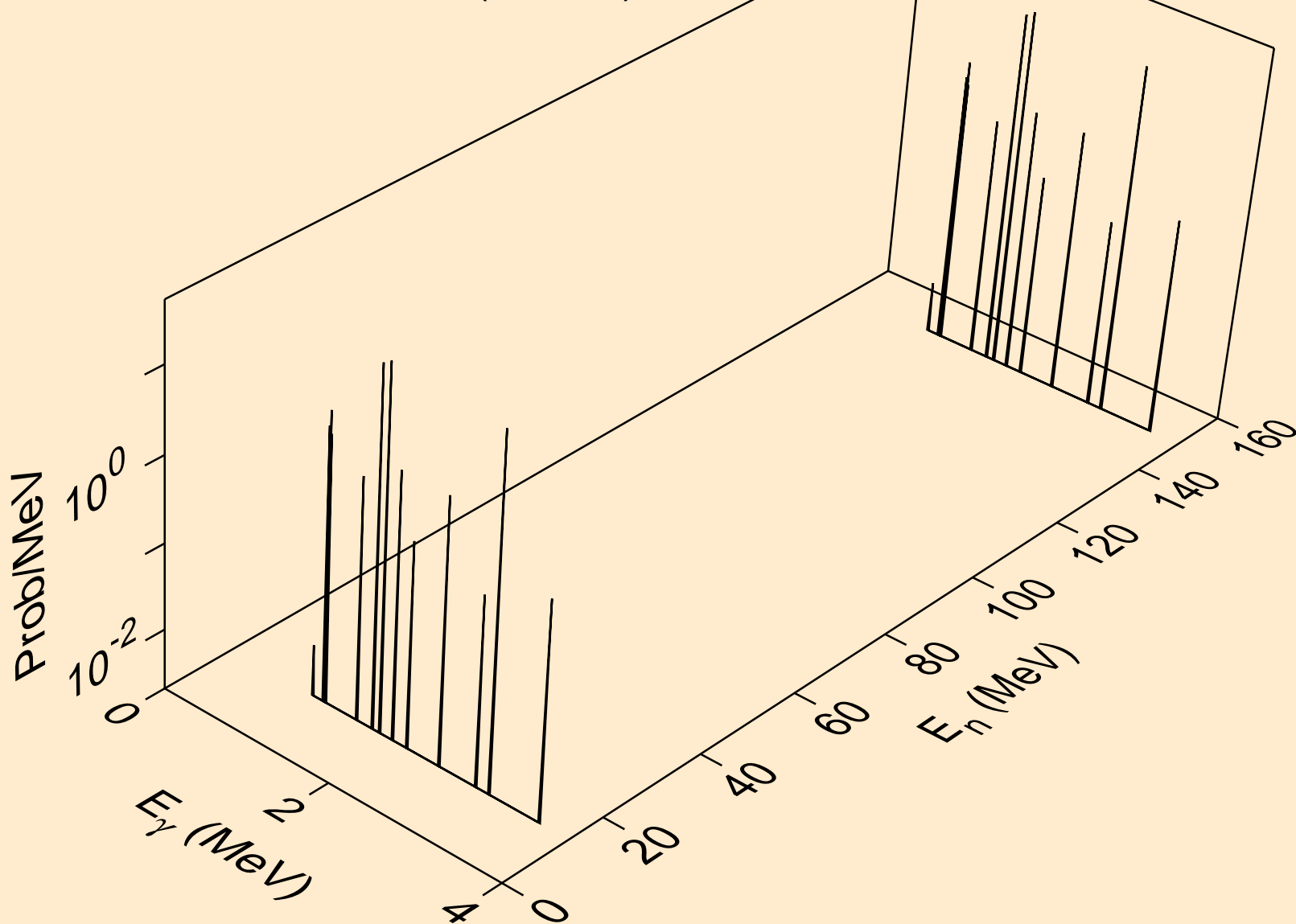

13-AL-27 FOR FENDL-3B2 FROM JEFF-3.1 WITH NJOY99.304+ C  
Photon emission for (n,d\*18)

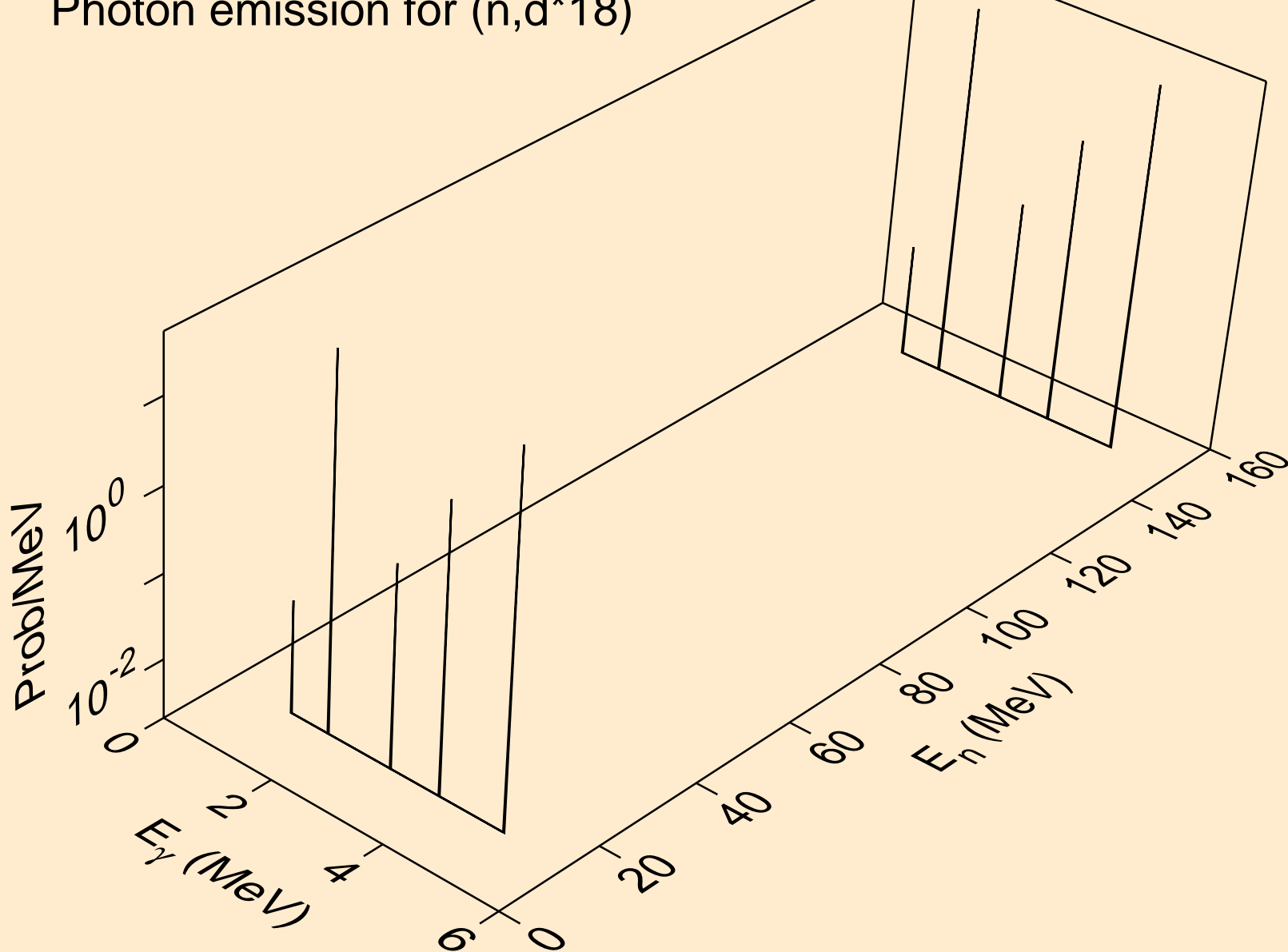

13-AL-27 FOR FENDL-3B2 FROM JEFF-3.1 WITH NJOY99.304+ C  
Photon emission for (n,d\*19)

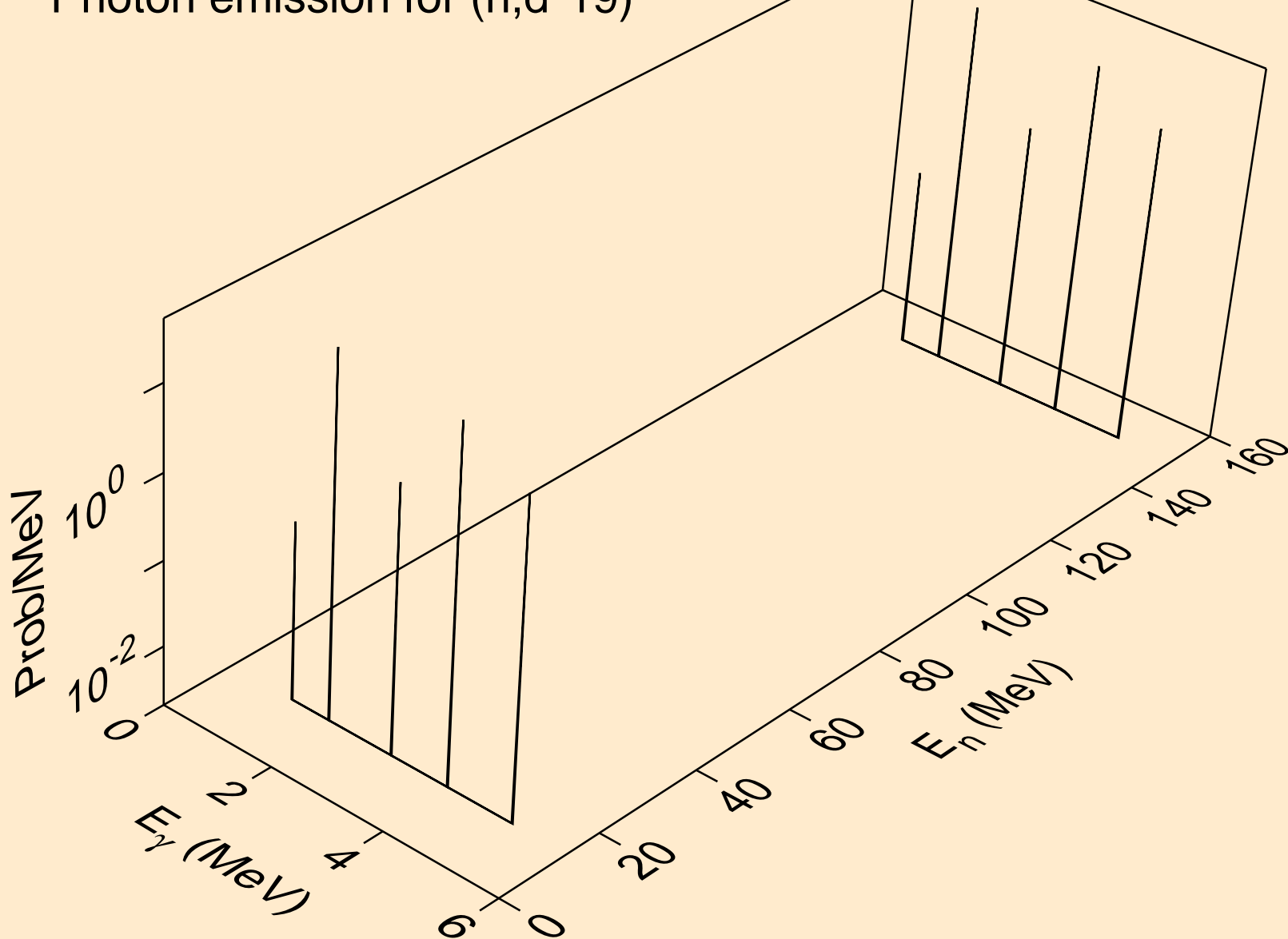

13-AL-27 FOR FENDL-3B2 FROM JEFF-3.1 WITH NJOY99.304+ C  
Photon emission for (n,d\*c)

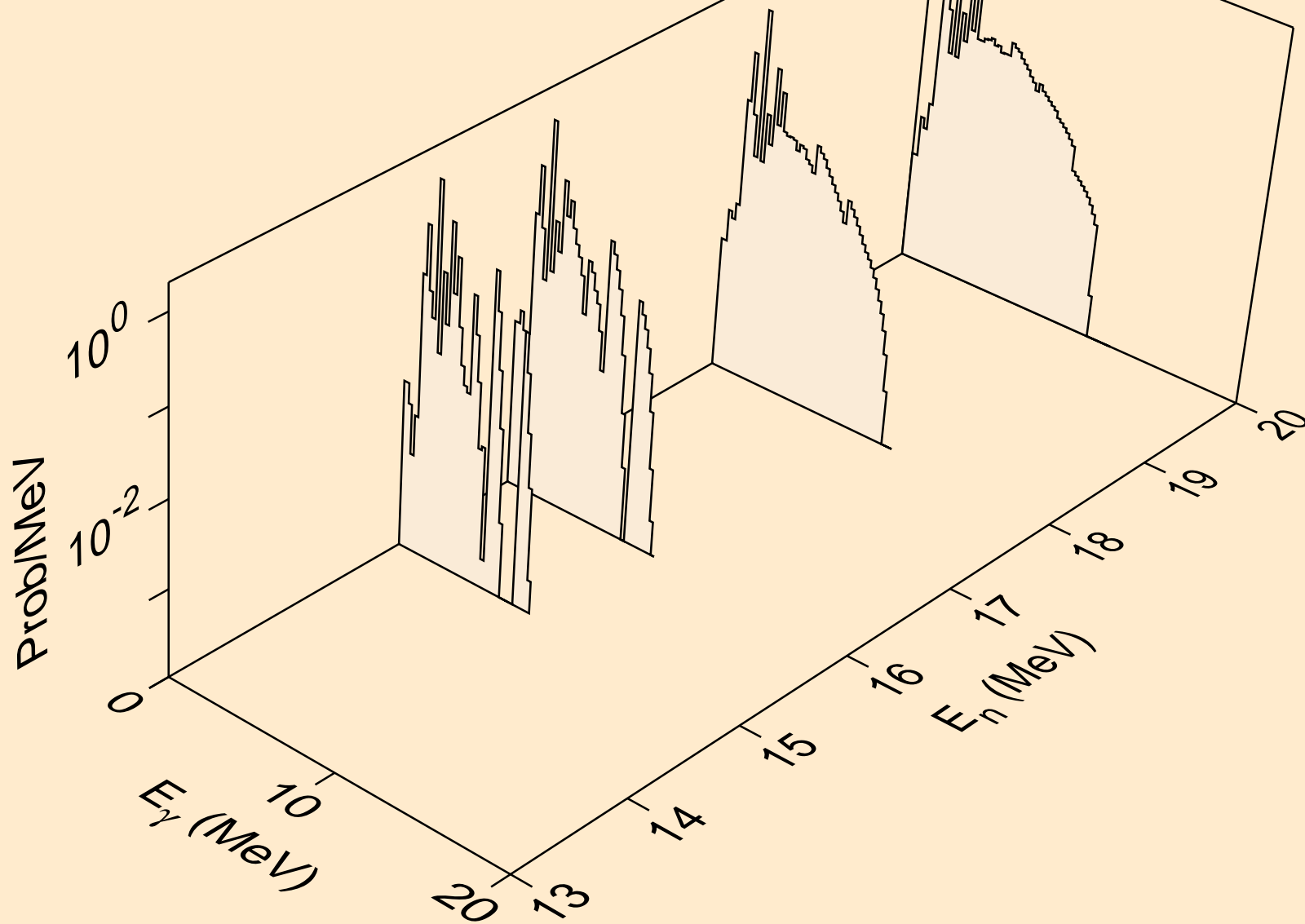

13-AL-27 FOR FENDL-3B2 FROM JEFF-3.1 WITH NJOY99.304+ C  
Photon emission for (n,t\*1)

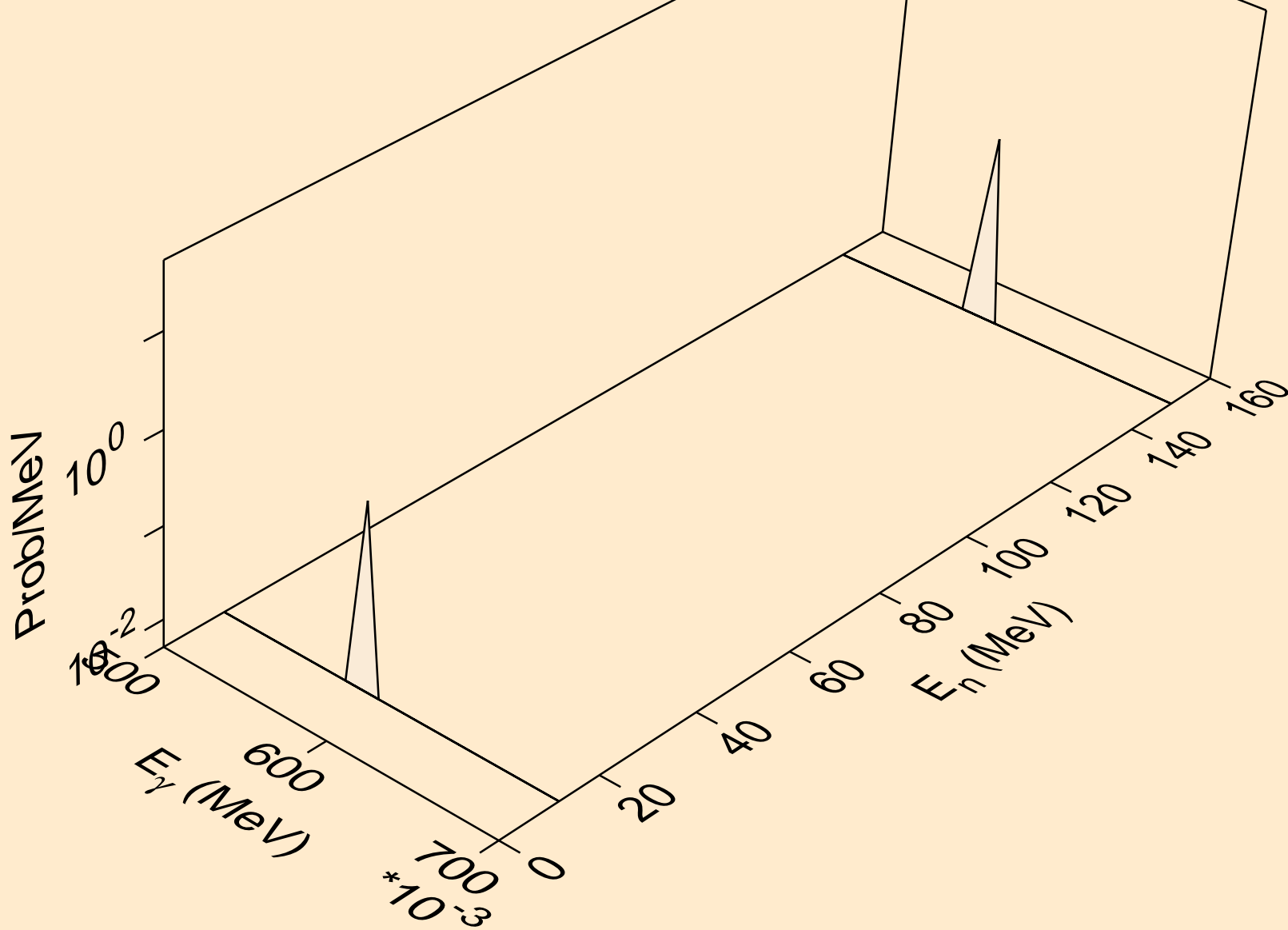



13-AL-27 FOR FENDL-3B2 FROM JEFF-3.1 WITH NJOY99.304+ C  
Photon emission for (n,t\*2)

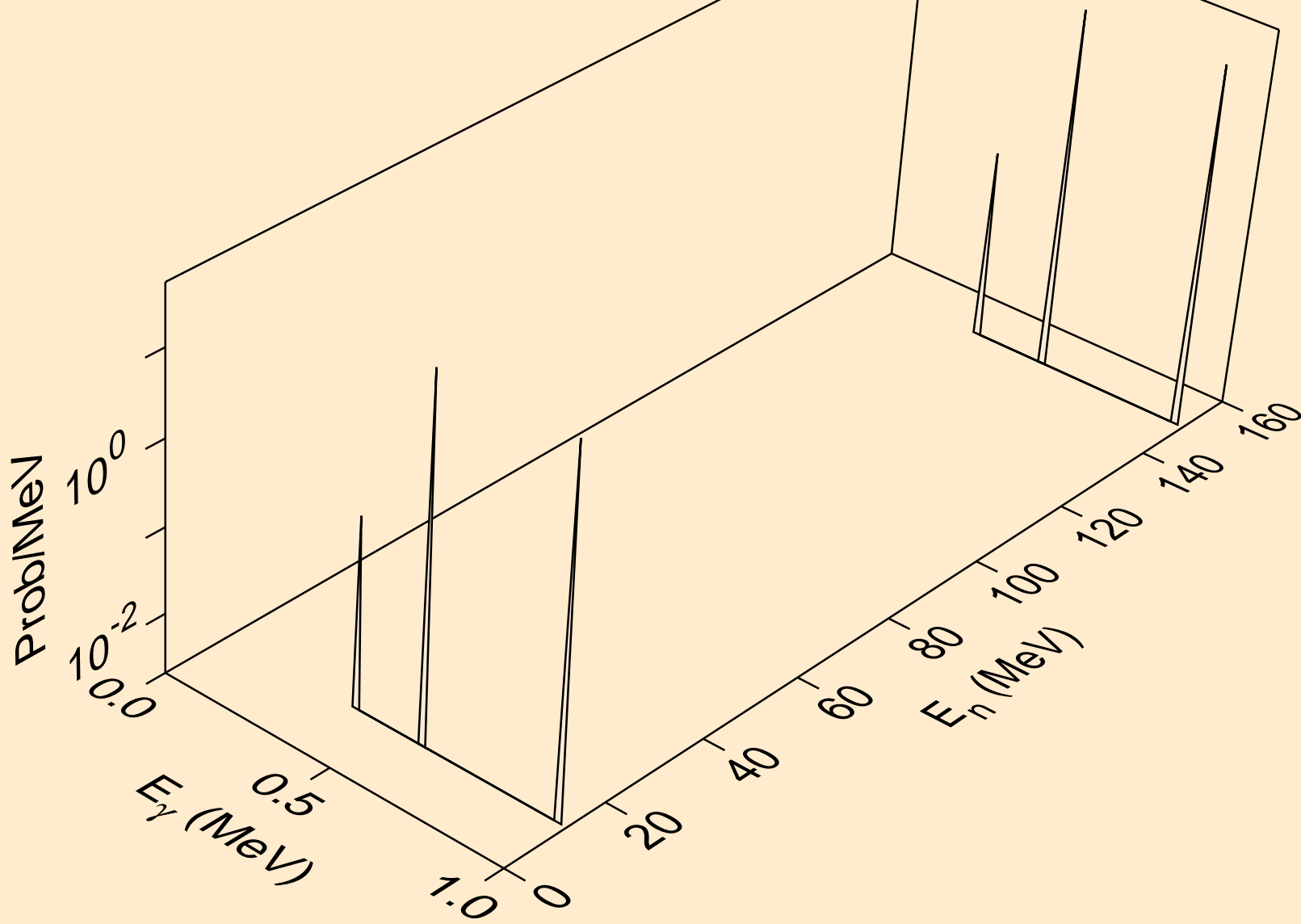

13-AL-27 FOR FENDL-3B2 FROM JEFF-3.1 WITH NJOY99.304+ C  
Photon emission for (n,t\*3)

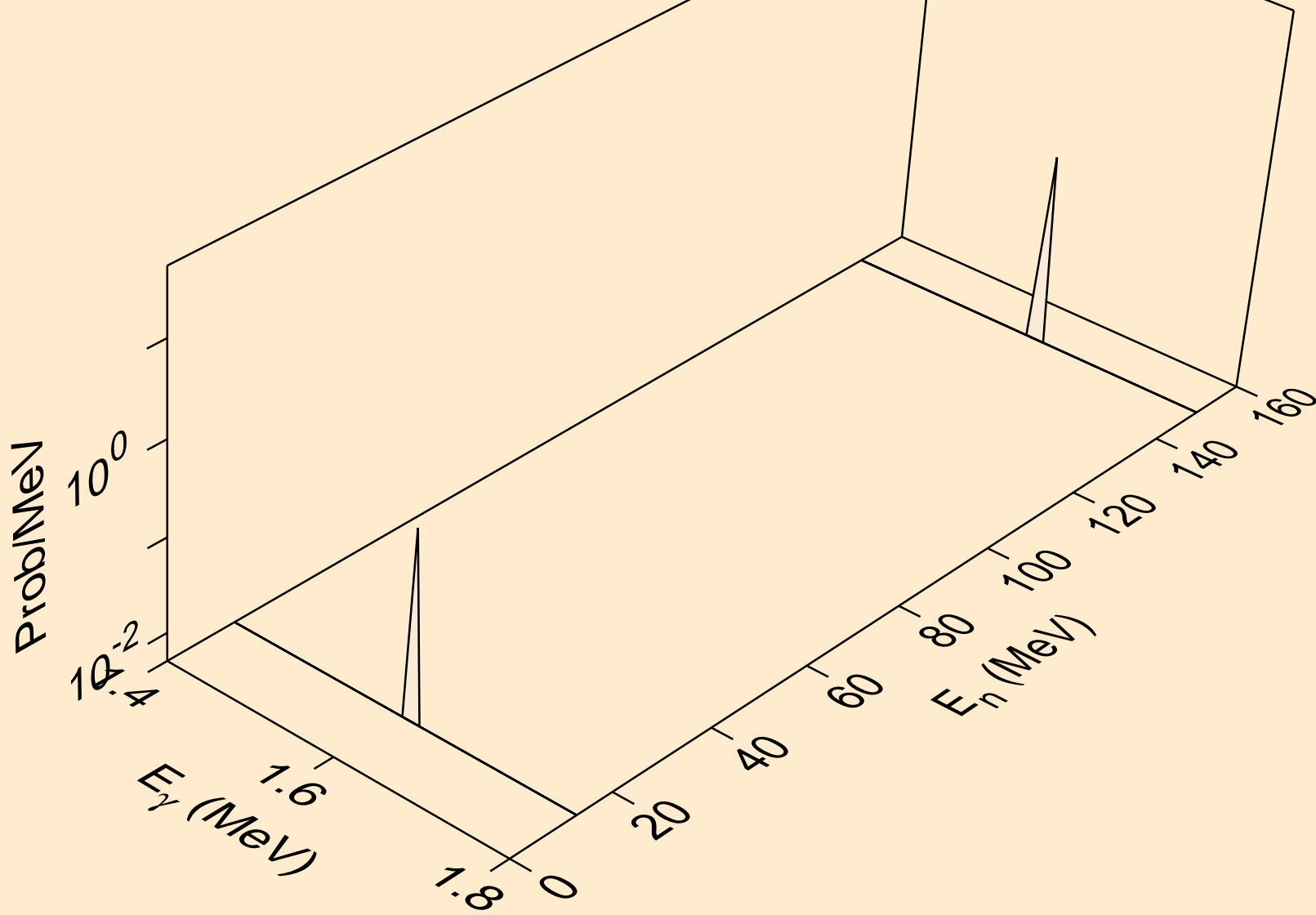

13-AL-27 FOR FENDL-3B2 FROM JEFF-3.1 WITH NJOY99.304+ C  
Photon emission for (n,t\*4)

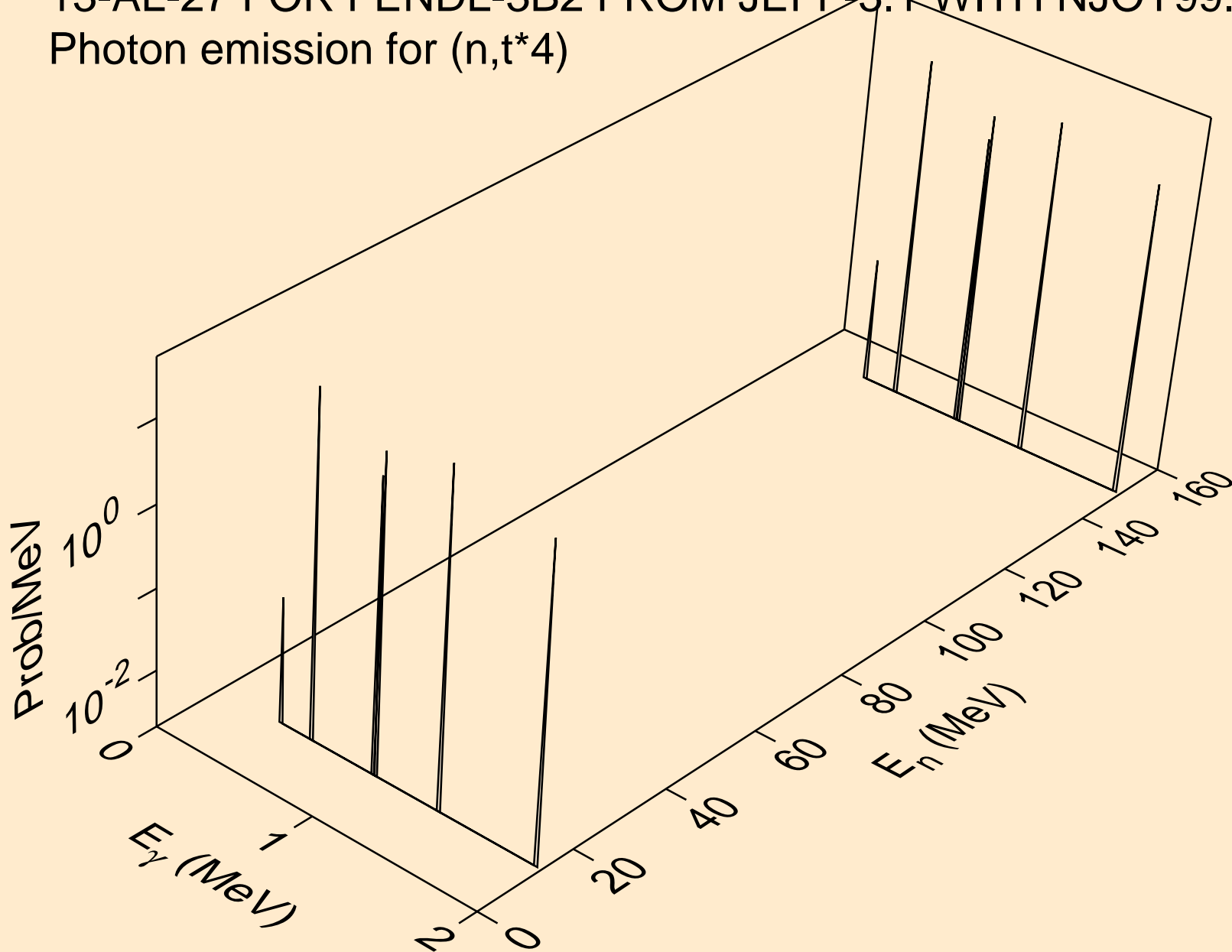

13-AL-27 FOR FENDL-3B2 FROM JEFF-3.1 WITH NJOY99.304+ C  
Photon emission for (n,t\*5)

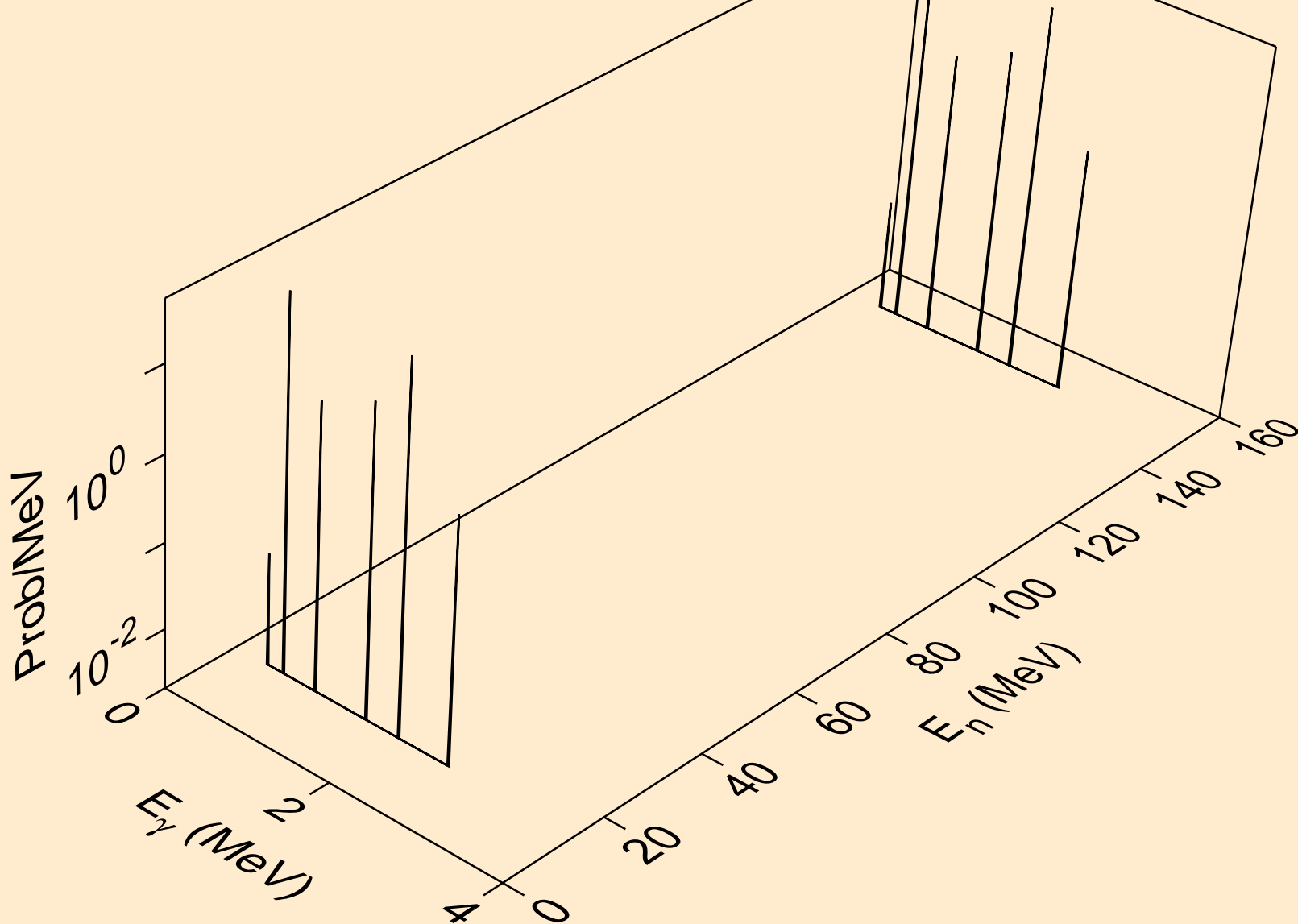

13-AL-27 FOR FENDL-3B2 FROM JEFF-3.1 WITH NJOY99.304+ C  
Photon emission for (n,t\*6)

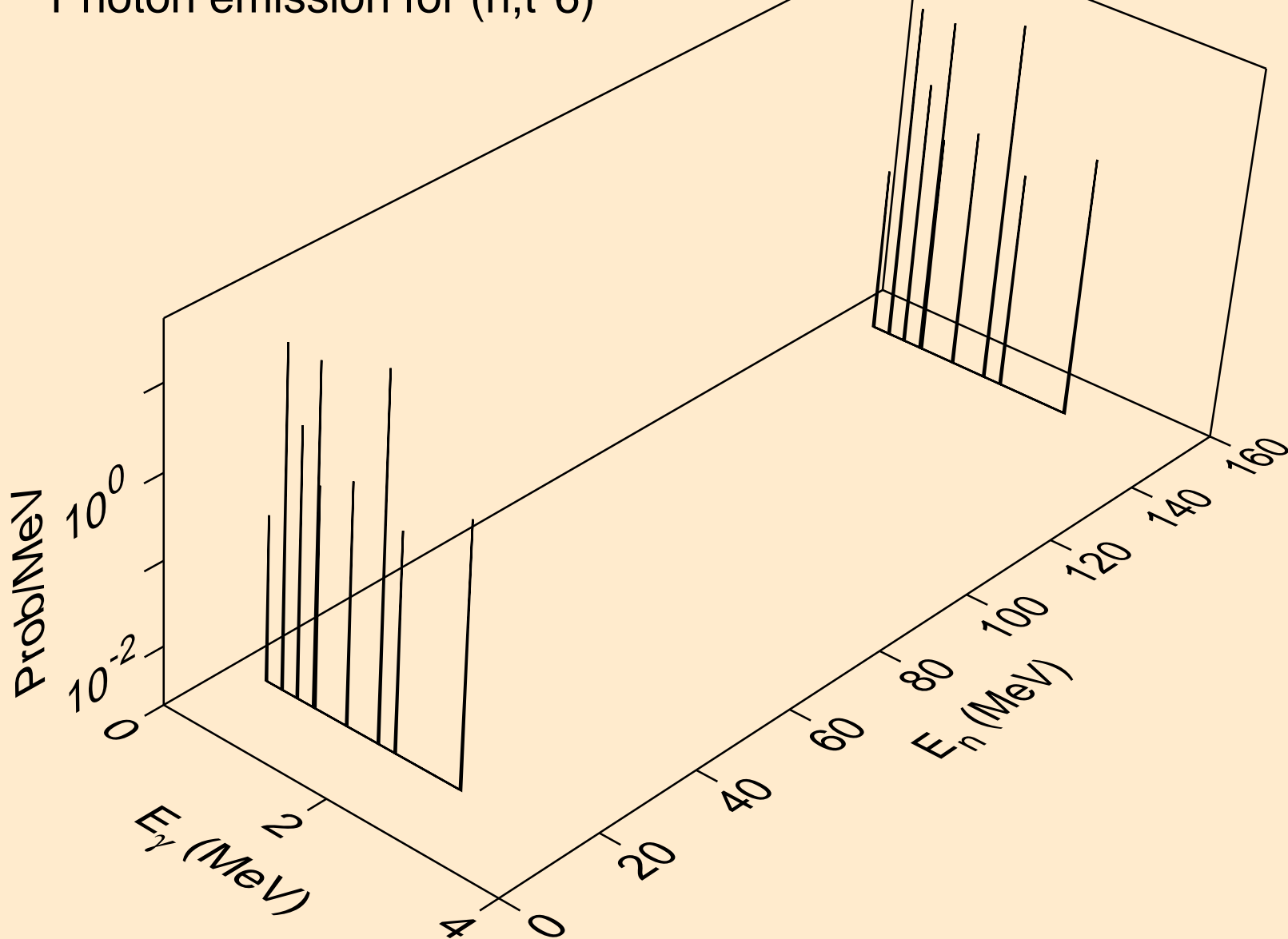

13-AL-27 FOR FENDL-3B2 FROM JEFF-3.1 WITH NJOY99.304+ C  
Photon emission for (n,t\*7)

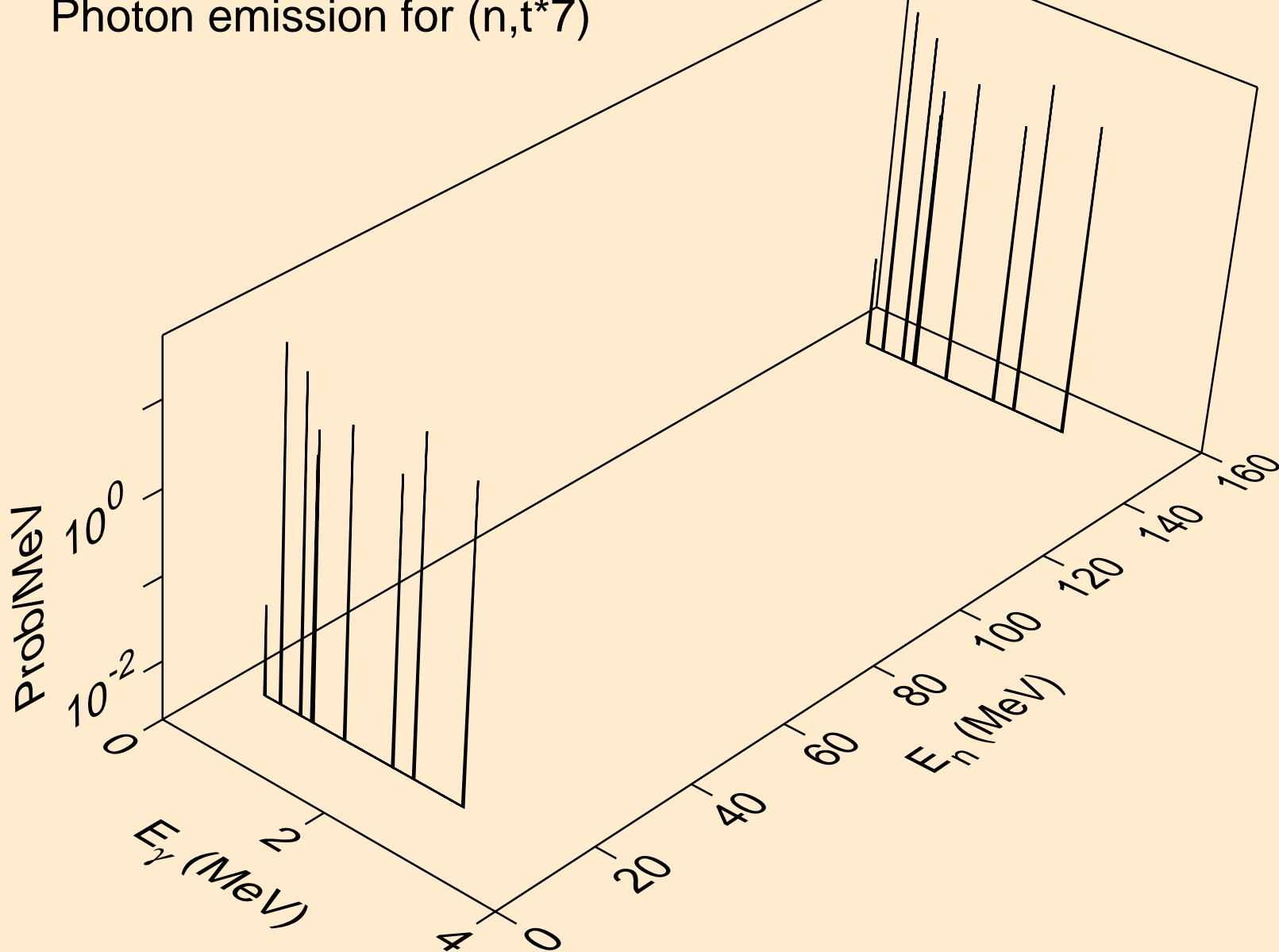

13-AL-27 FOR FENDL-3B2 FROM JEFF-3.1 WITH NJOY99.304+ C  
Photon emission for (n,t\*8)

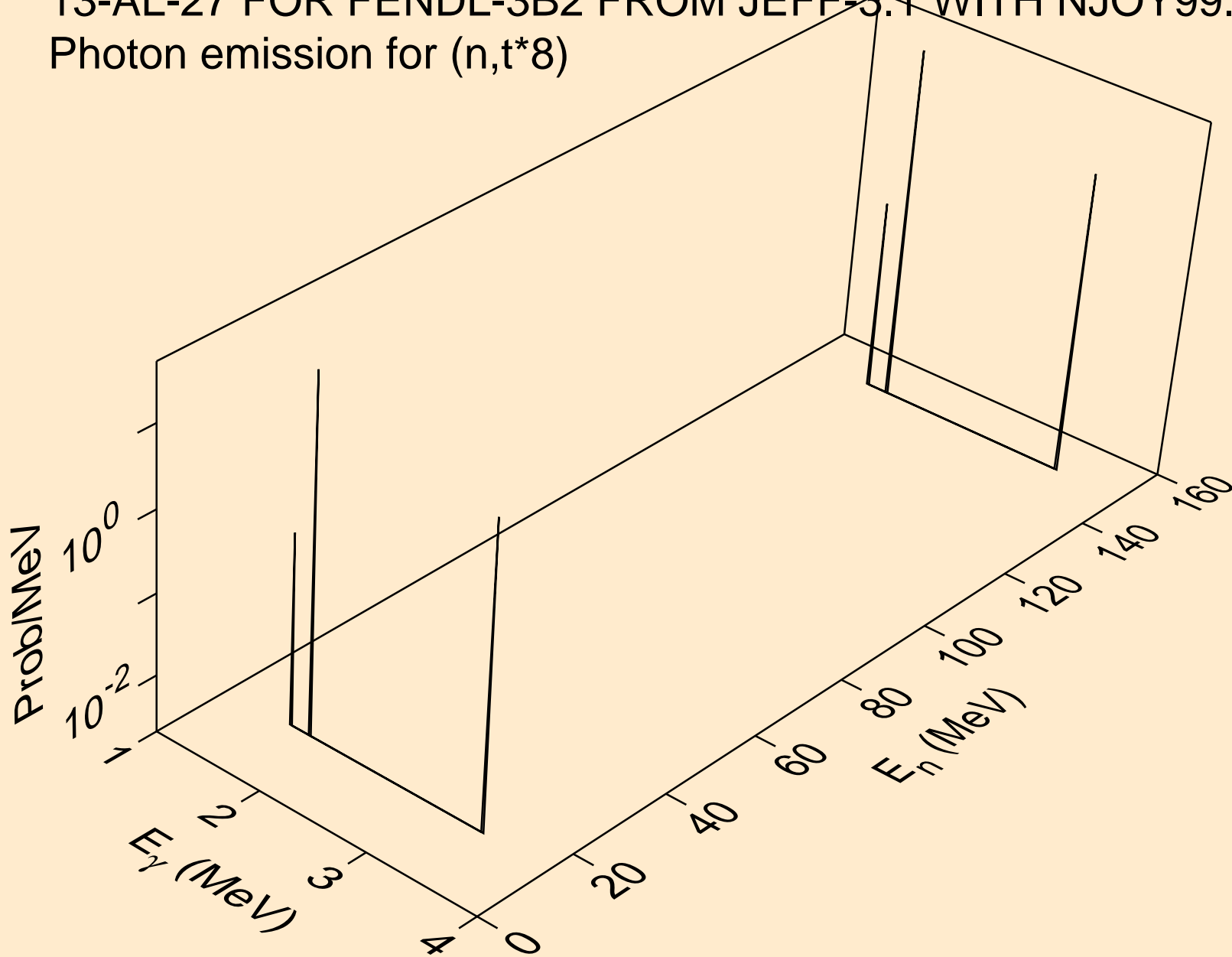

13-AL-27 FOR FENDL-3B2 FROM JEFF-3.1 WITH NJOY99.304+ C  
Photon emission for (n,t\*9)

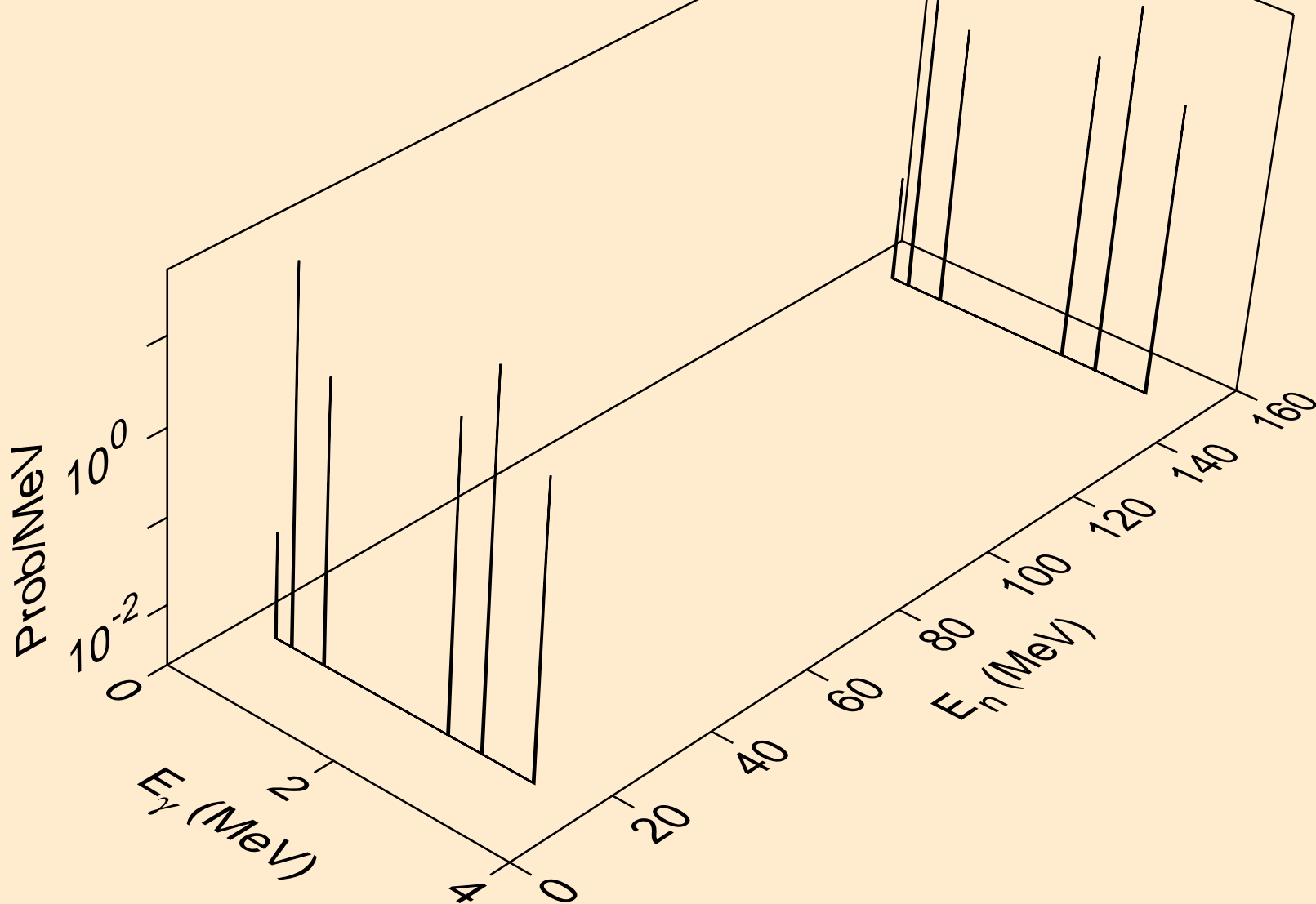



13-AL-27 FOR FENDL-3B2 FROM JEFF-3.1 WITH NJOY99.304+ C  
Photon emission for (n,t\*10)

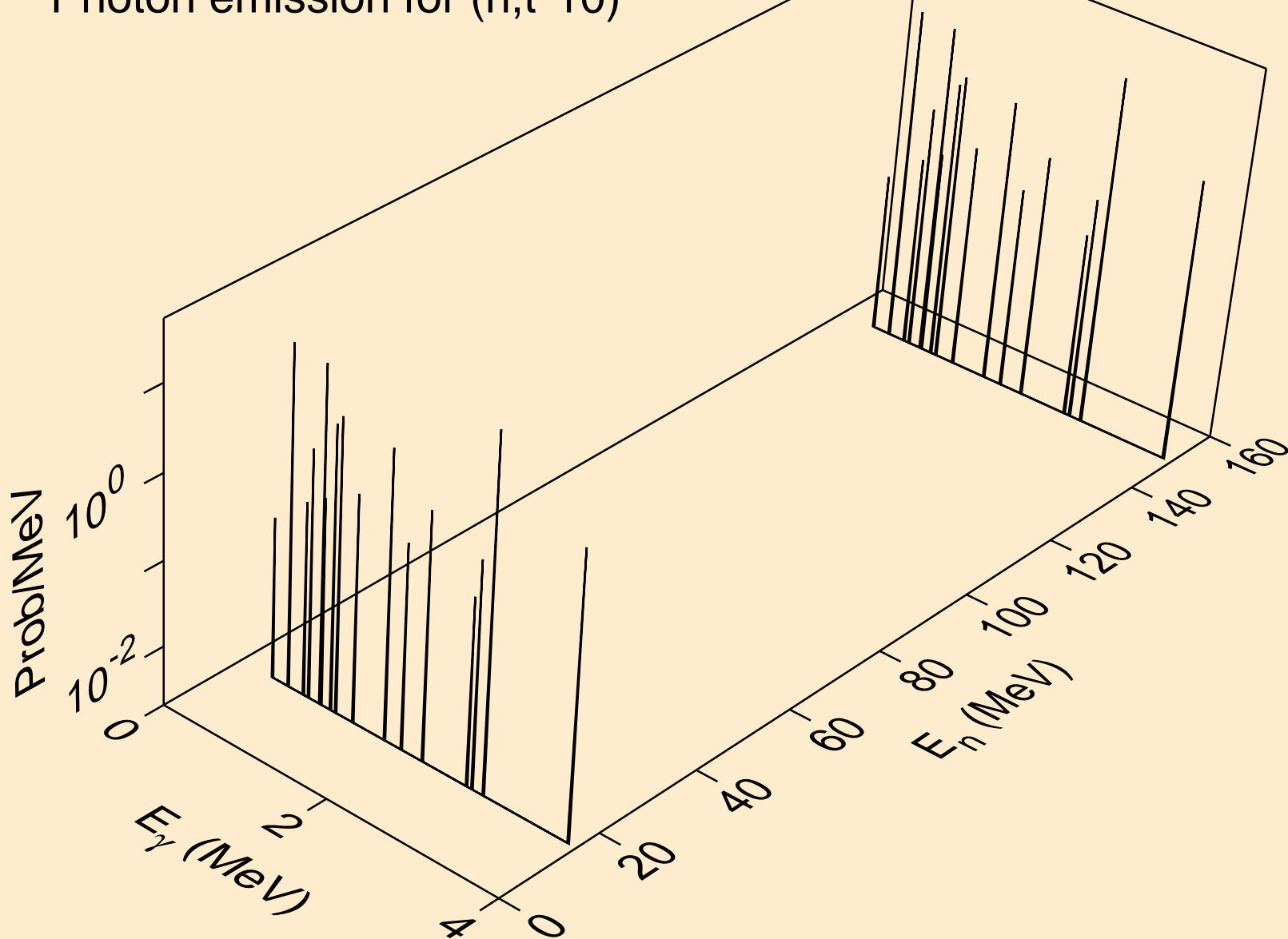

13-AL-27 FOR FENDL-3B2 FROM JEFF-3.1 WITH NJOY99.304+ C  
Photon emission for (n,t\*c)

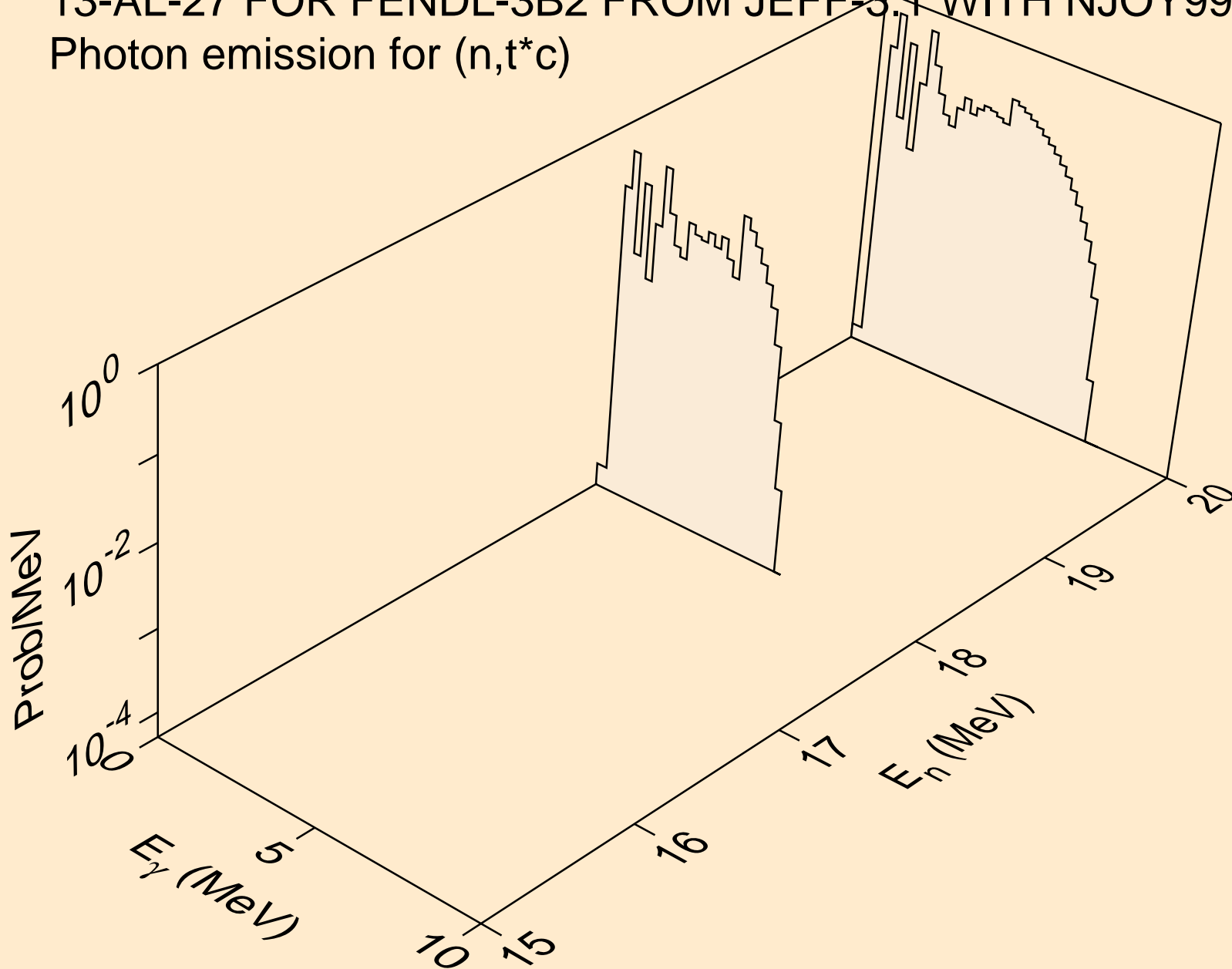

13-AL-27 FOR FENDL-3B2 FROM JEFF-3.1 WITH NJOY99.304+ C  
Photon emission for (n,a\*1)

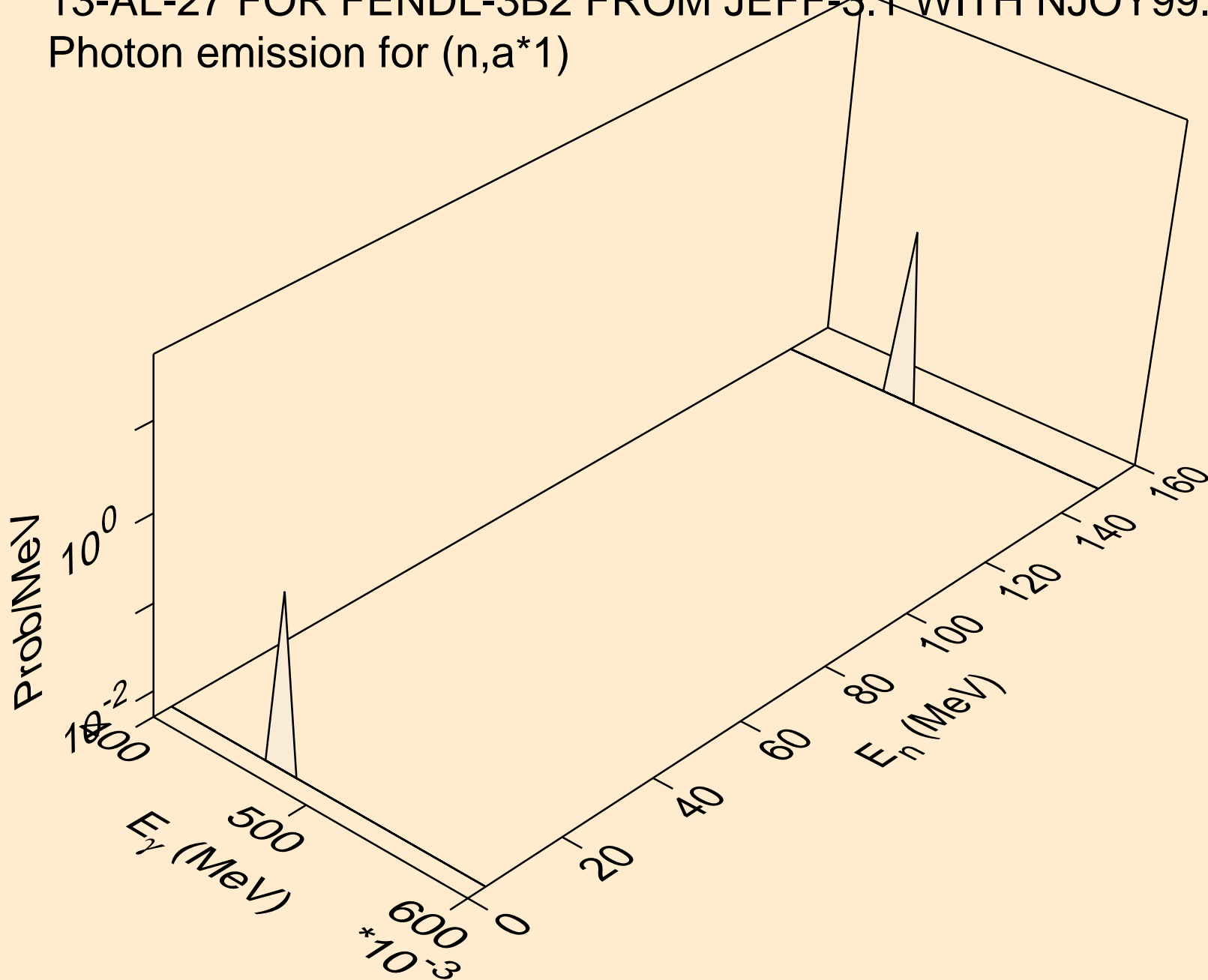

13-AL-27 FOR FENDL-3B2 FROM JEFF-3.1 WITH NJOY99.304+ C  
Photon emission for (n,a\*2)

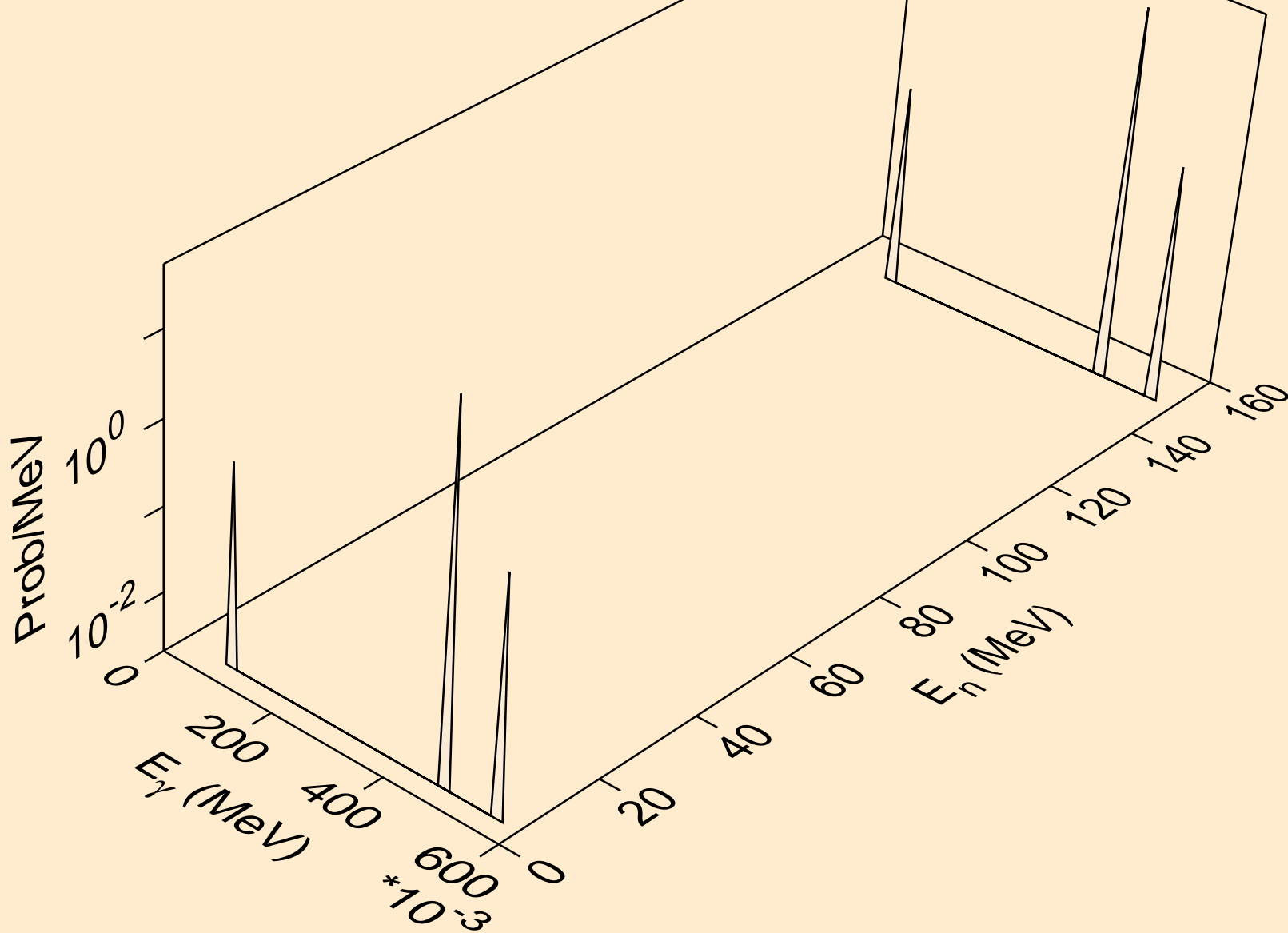

13-AL-27 FOR FENDL-3B2 FROM JEFF-3.1 WITH NJOY99.304+ C  
Photon emission for (n,a\*3)

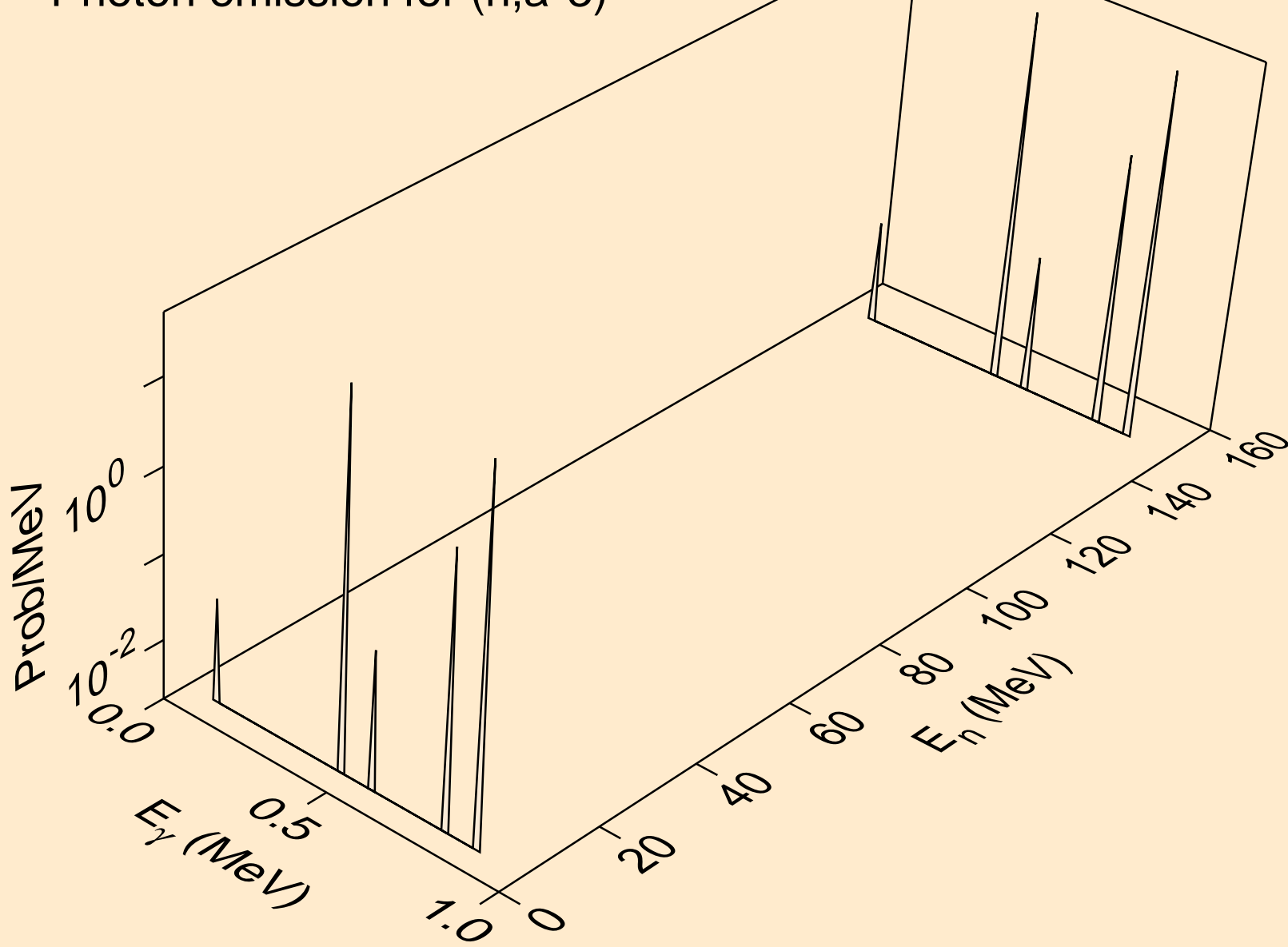

13-AL-27 FOR FENDL-3B2 FROM JEFF-3.1 WITH NJOY99.304+ C  
Photon emission for (n,a\*4)

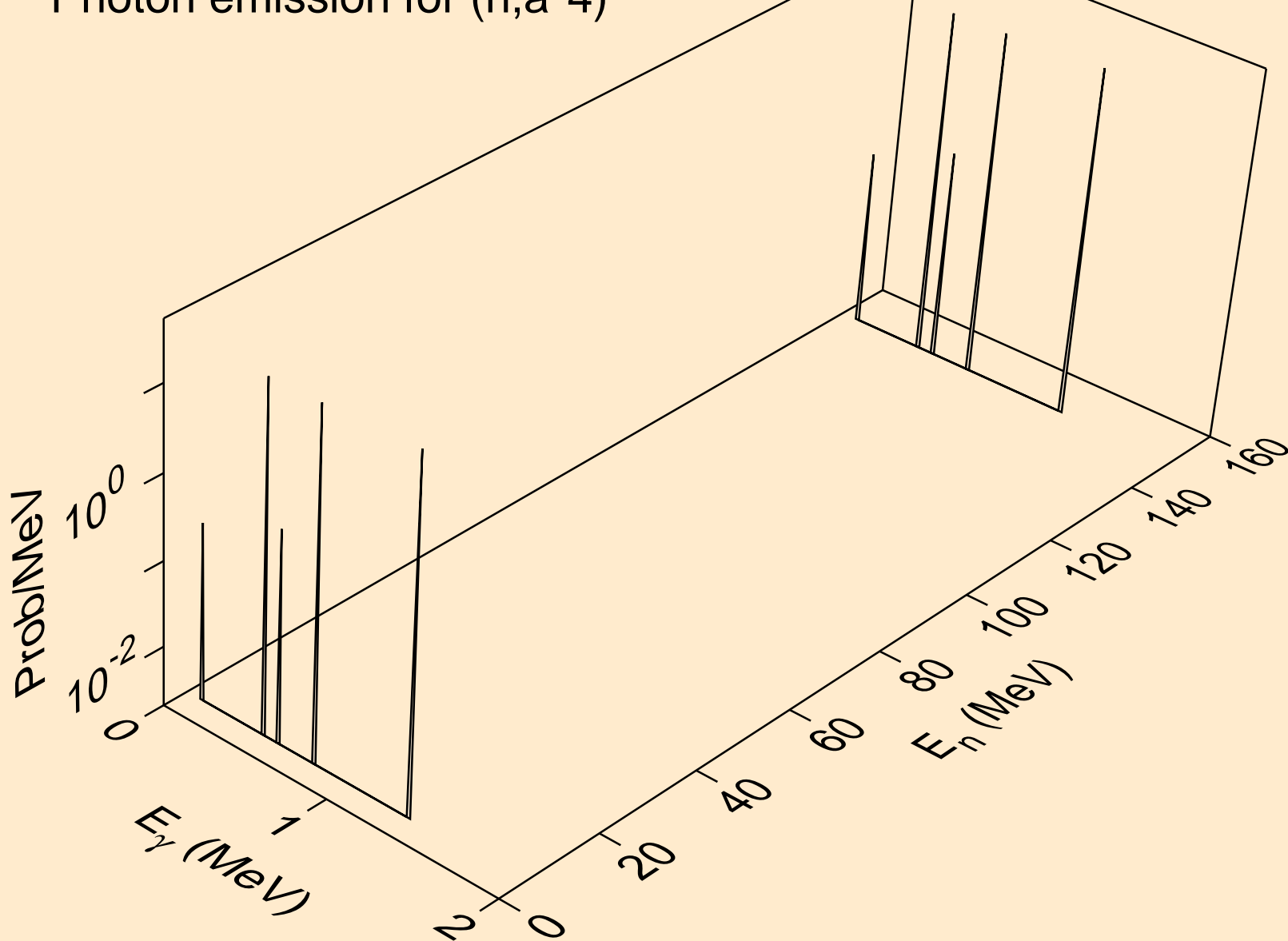

13-AL-27 FOR FENDL-3B2 FROM JEFF-3.1 WITH NJOY99.304+ C  
Photon emission for (n,a\*5)

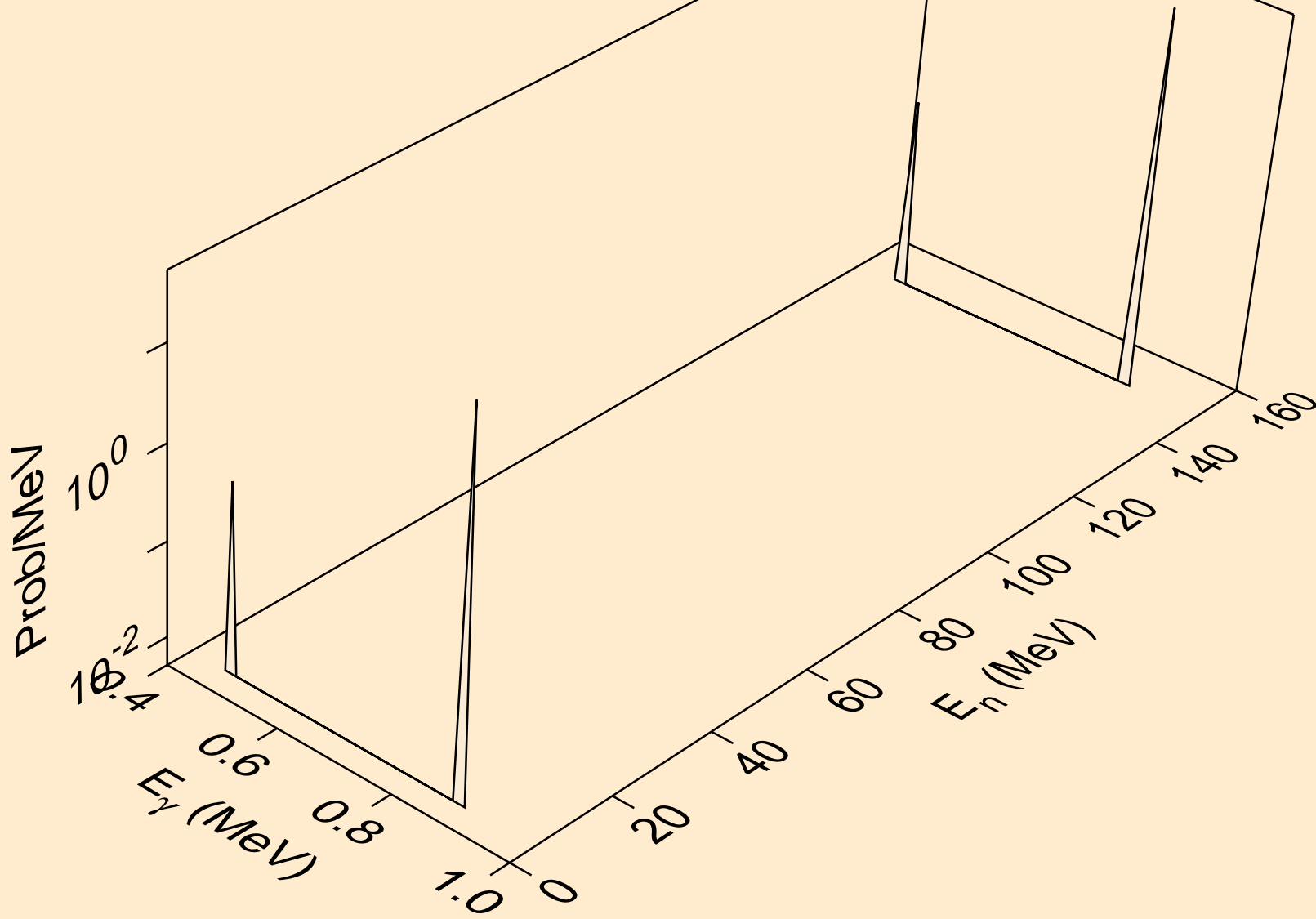

13-AL-27 FOR FENDL-3B2 FROM JEFF-3.1 WITH NJOY99.304+ C  
Photon emission for (n,a\*6)

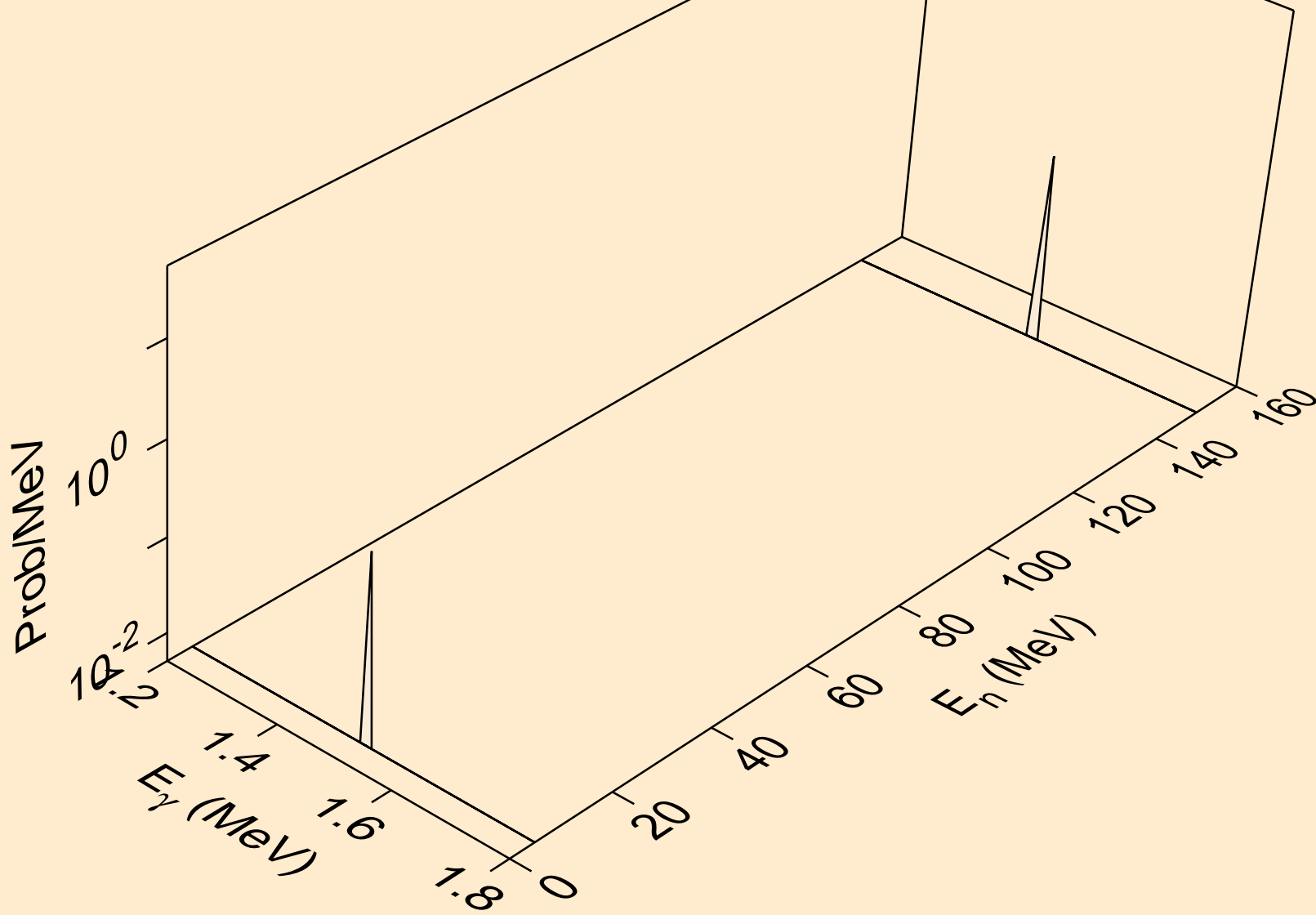



13-AL-27 FOR FENDL-3B2 FROM JEFF-3.1 WITH NJOY99.304+ C  
Photon emission for (n,a\*7)

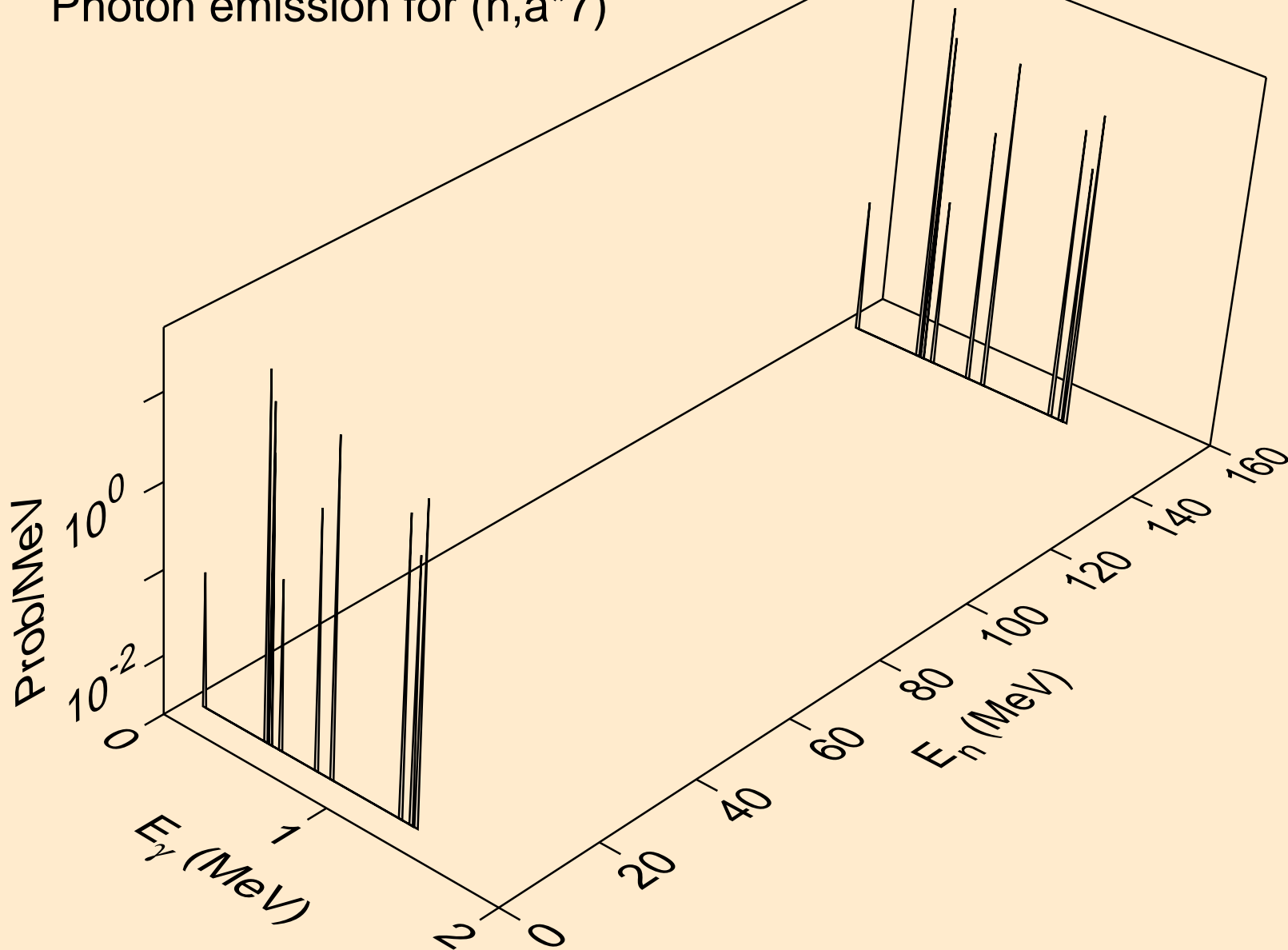

13-AL-27 FOR FENDL-3B2 FROM JEFF-3.1 WITH NJOY99.304+ C  
Photon emission for (n,a\*8)

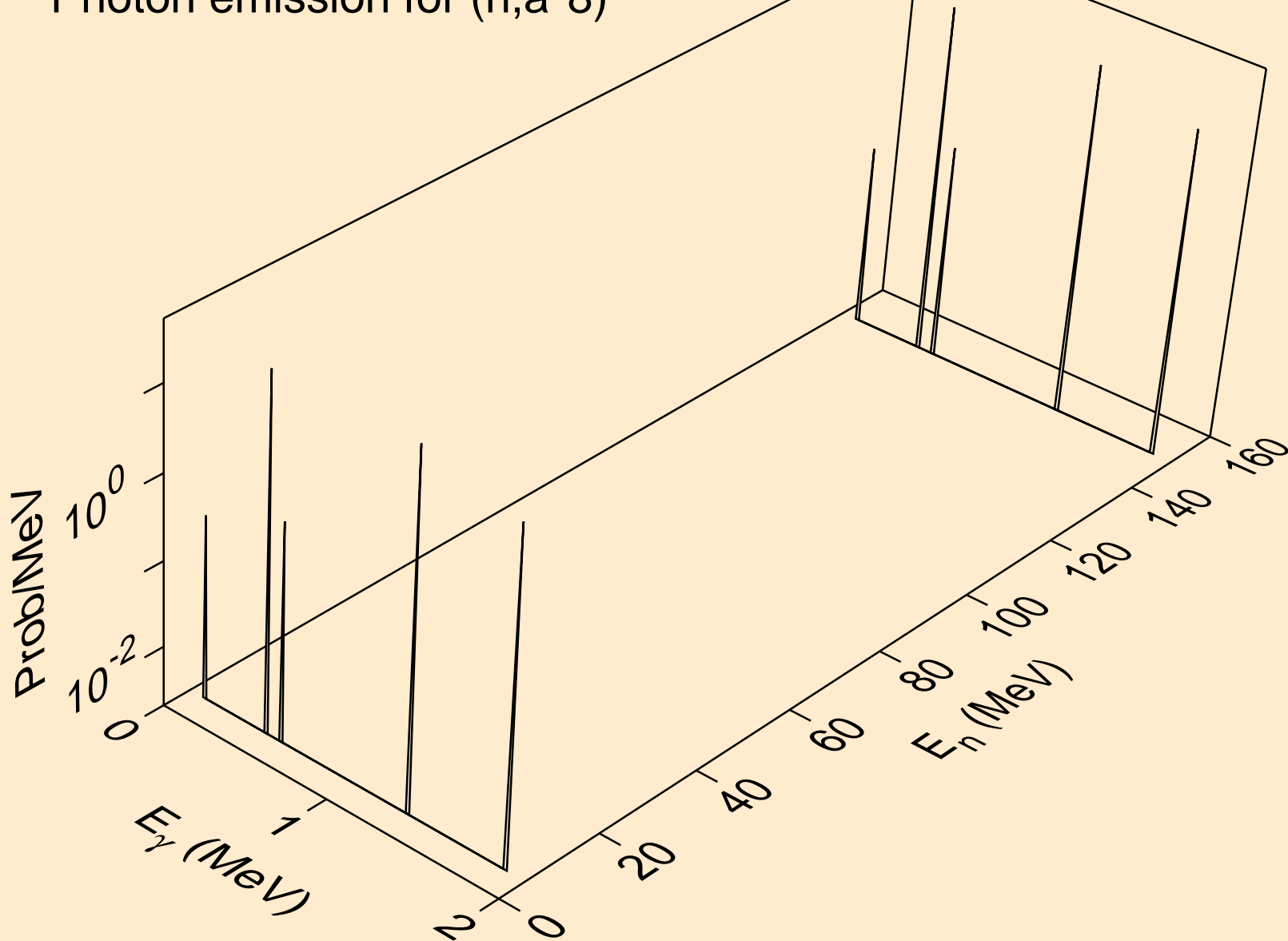

13-AL-27 FOR FENDL-3B2 FROM JEFF-3.1 WITH NJOY99.304+ C  
Photon emission for (n,a\*9)

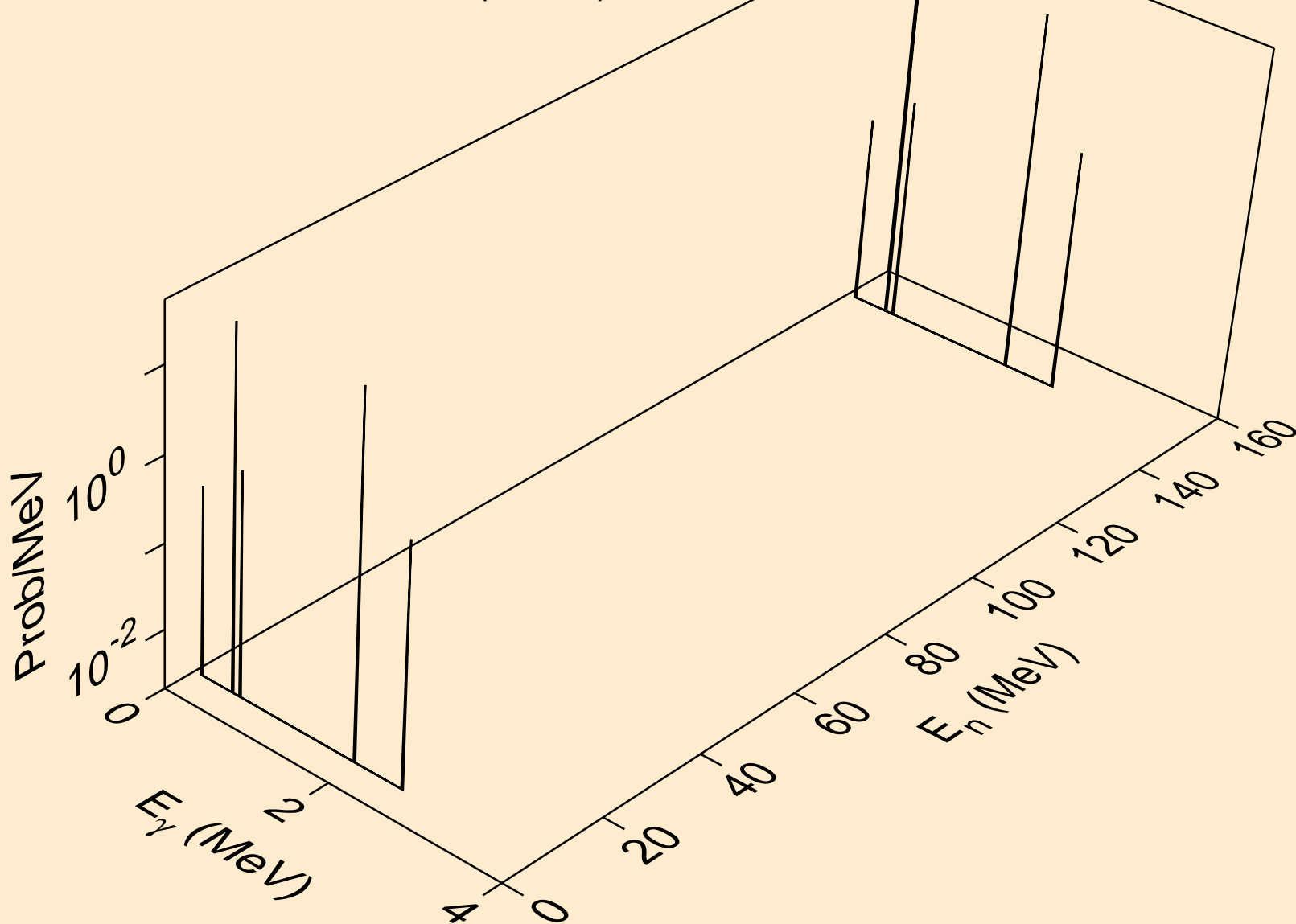

13-AL-27 FOR FENDL-3B2 FROM JEFF-3.1 WITH NJOY99.304+ C  
Photon emission for (n,a\*10)

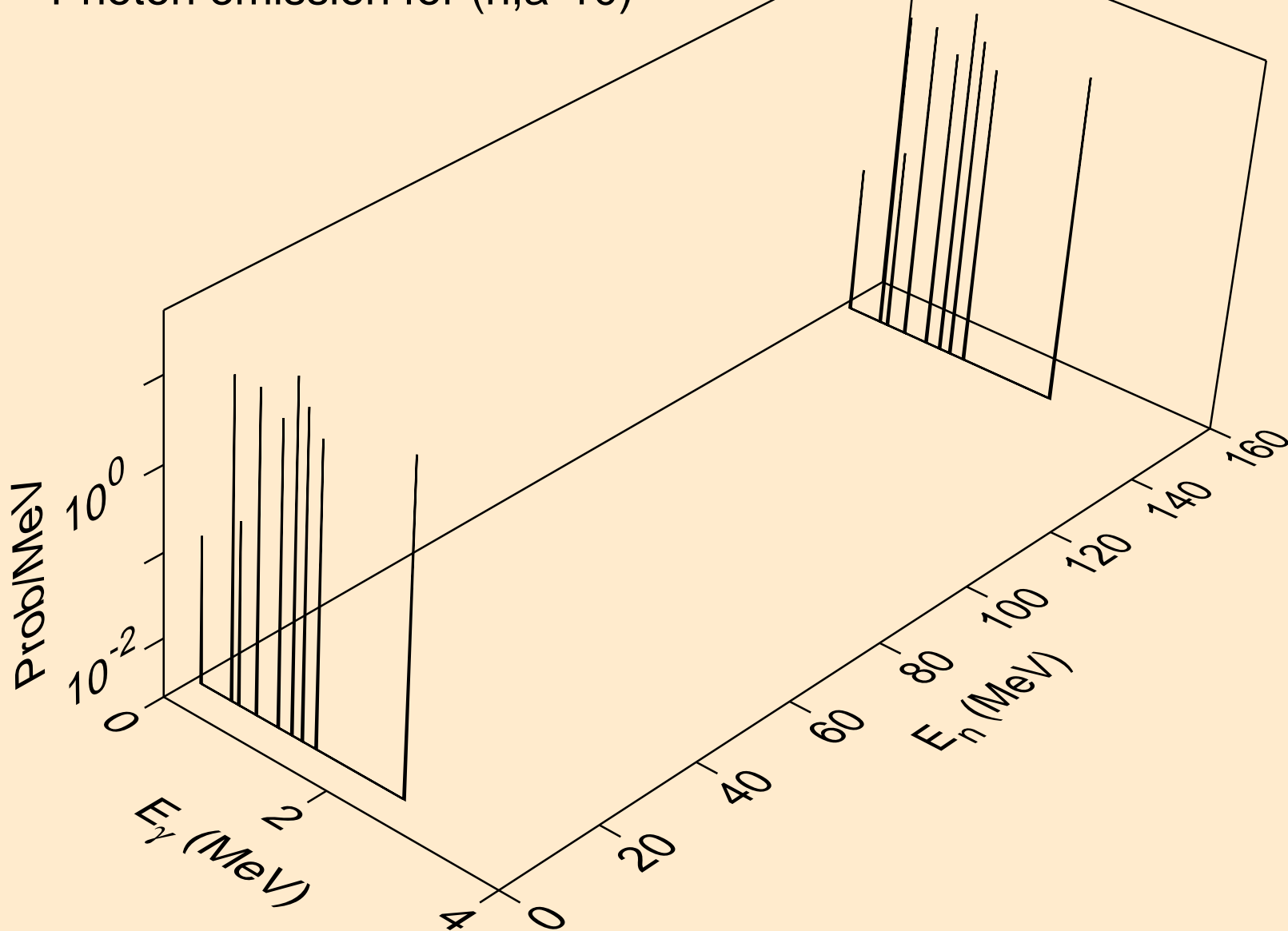

13-AL-27 FOR FENDL-3B2 FROM JEFF-3.1 WITH NJOY99.304+ C  
Photon emission for (n,a\*11)

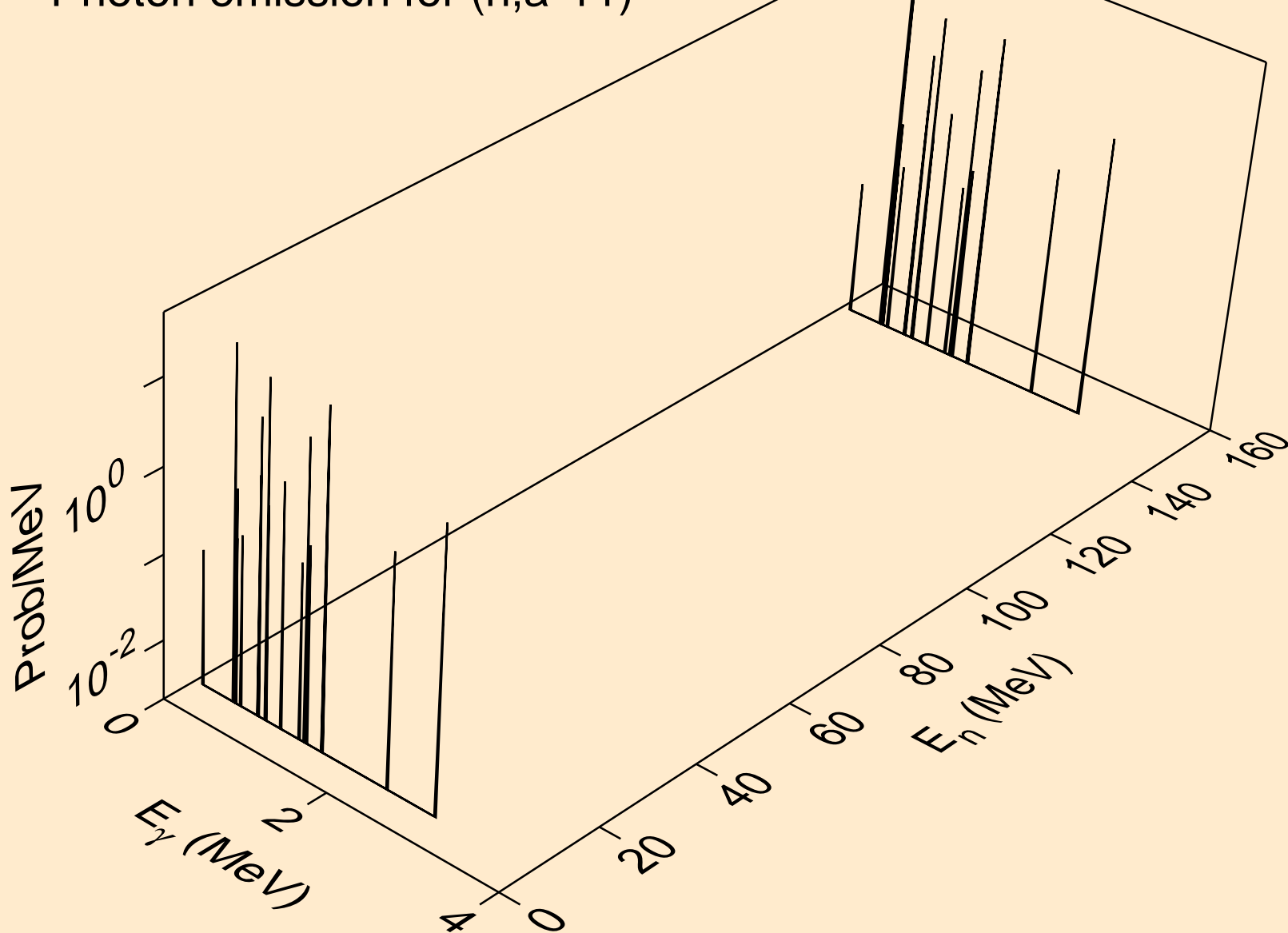

13-AL-27 FOR FENDL-3B2 FROM JEFF-3.1 WITH NJOY99.304+ C  
Photon emission for (n,a\*12)

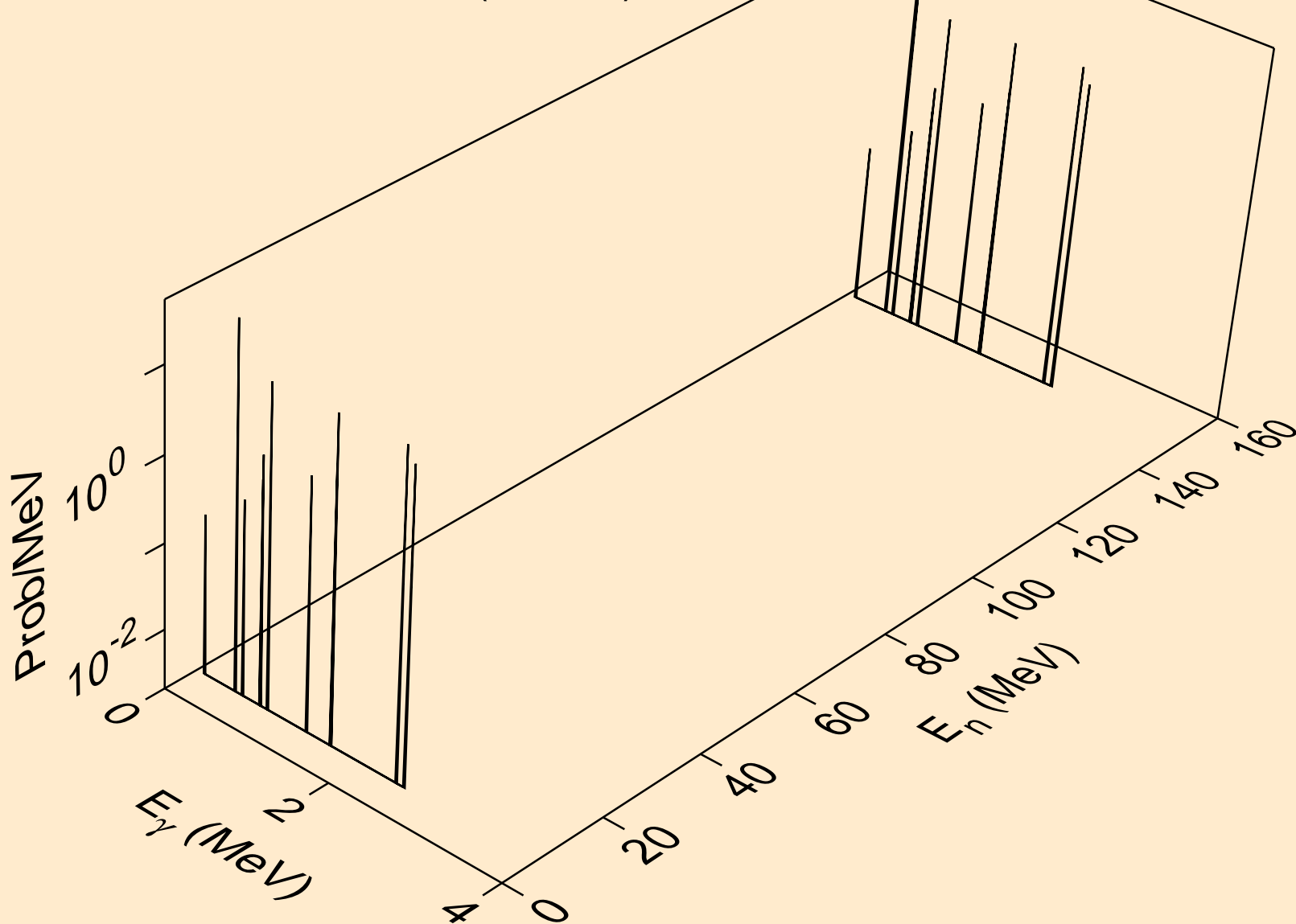

13-AL-27 FOR FENDL-3B2 FROM JEFF-3.1 WITH NJOY99.304+ C  
Photon emission for (n,a\*13)

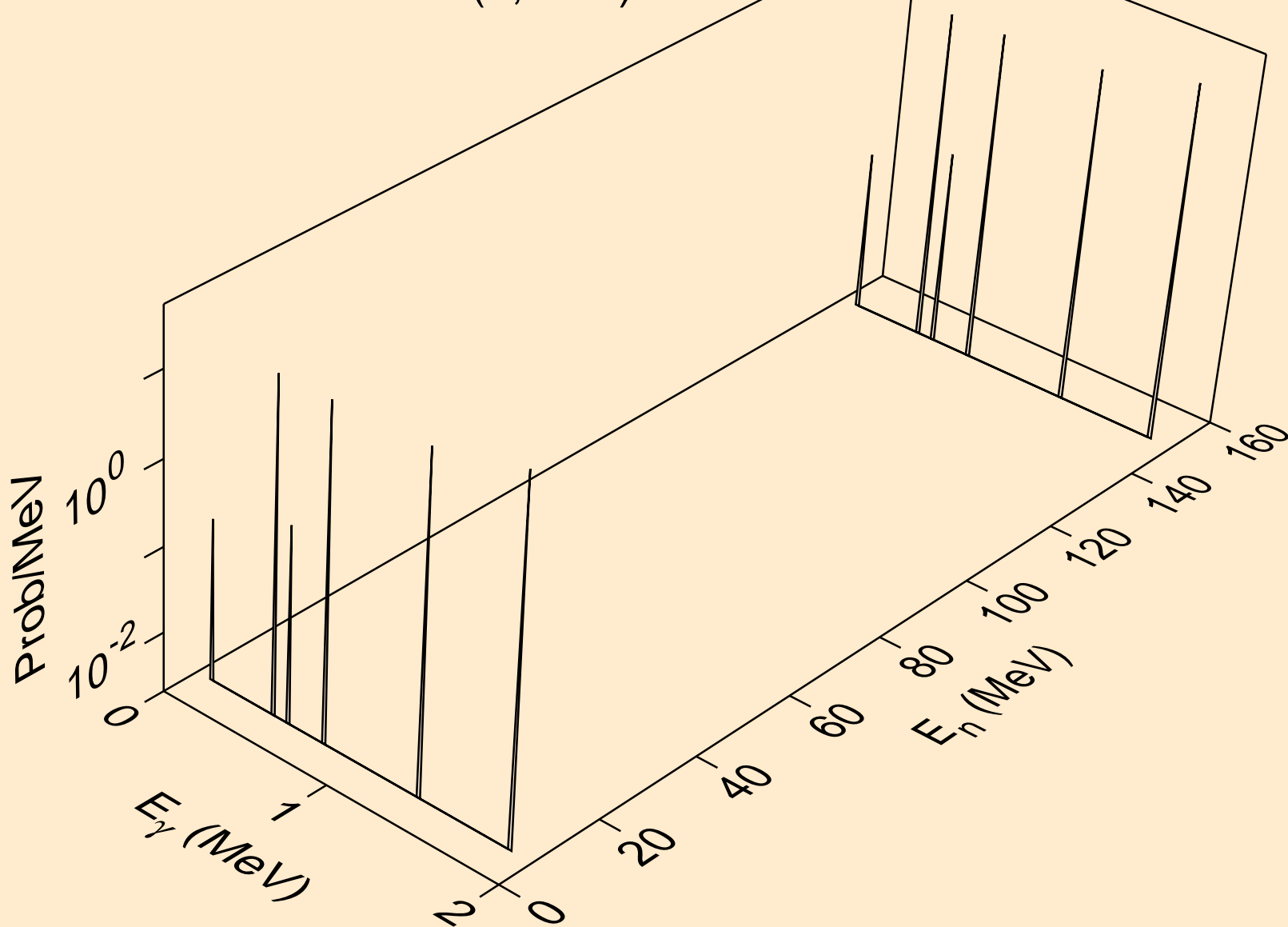

13-AL-27 FOR FENDL-3B2 FROM JEFF-3.1 WITH NJOY99.304+ C  
Photon emission for (n,a\*14)

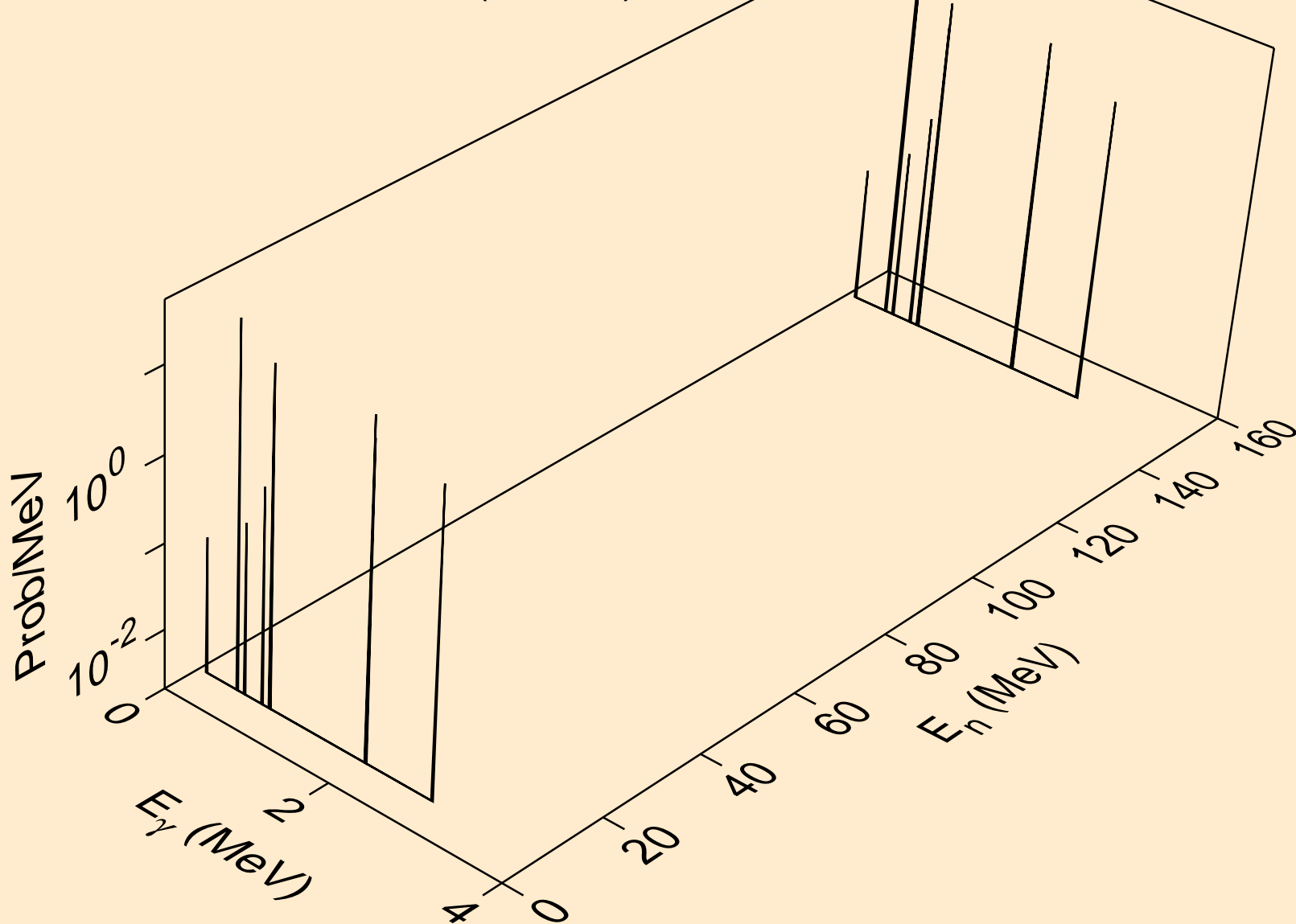



13-AL-27 FOR FENDL-3B2 FROM JEFF-3.1 WITH NJOY99.304+ C  
Photon emission for (n,a\*15)

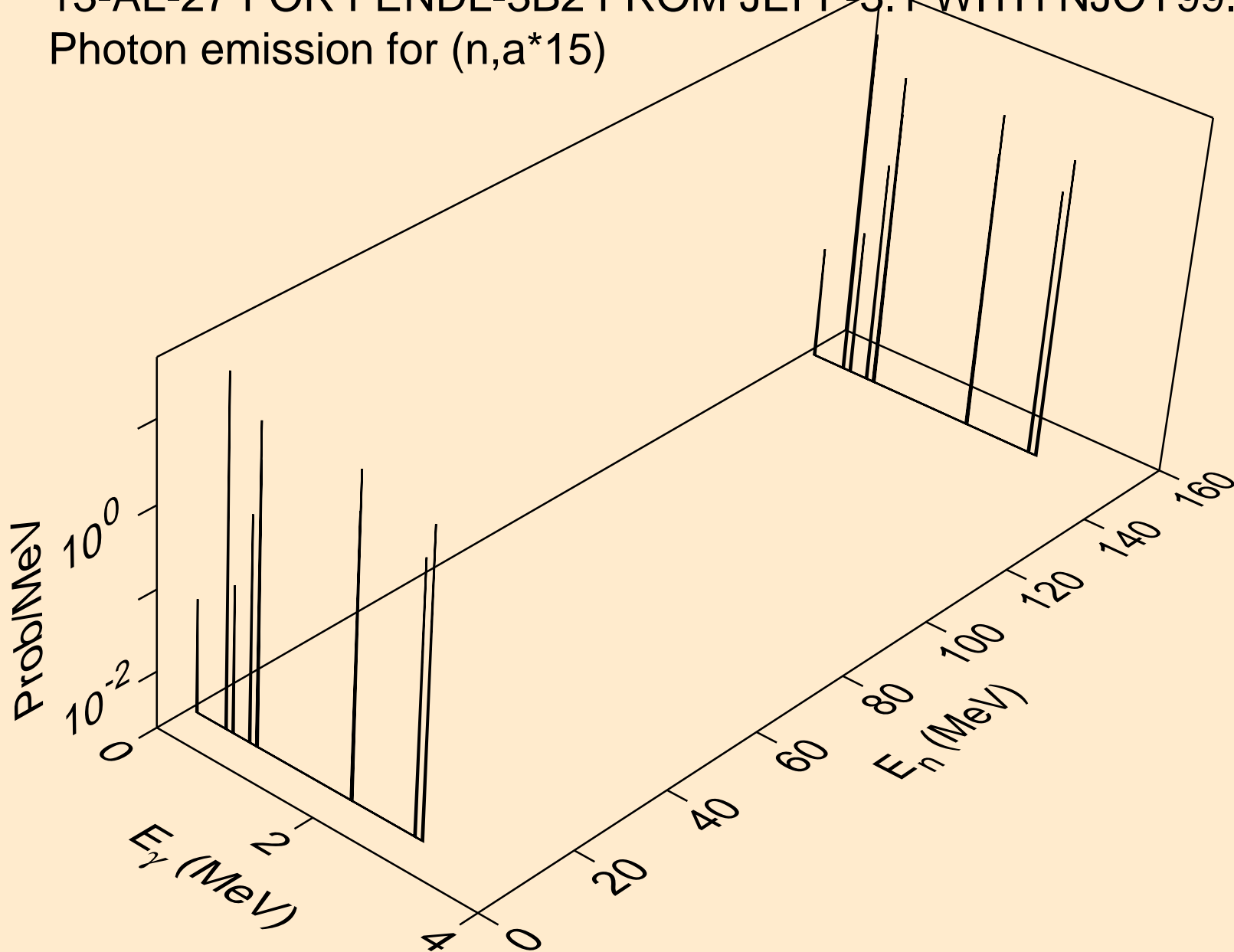

13-AL-27 FOR FENDL-3B2 FROM JEFF-3.1 WITH NJOY99.304+ C  
Photon emission for (n,a\*16)

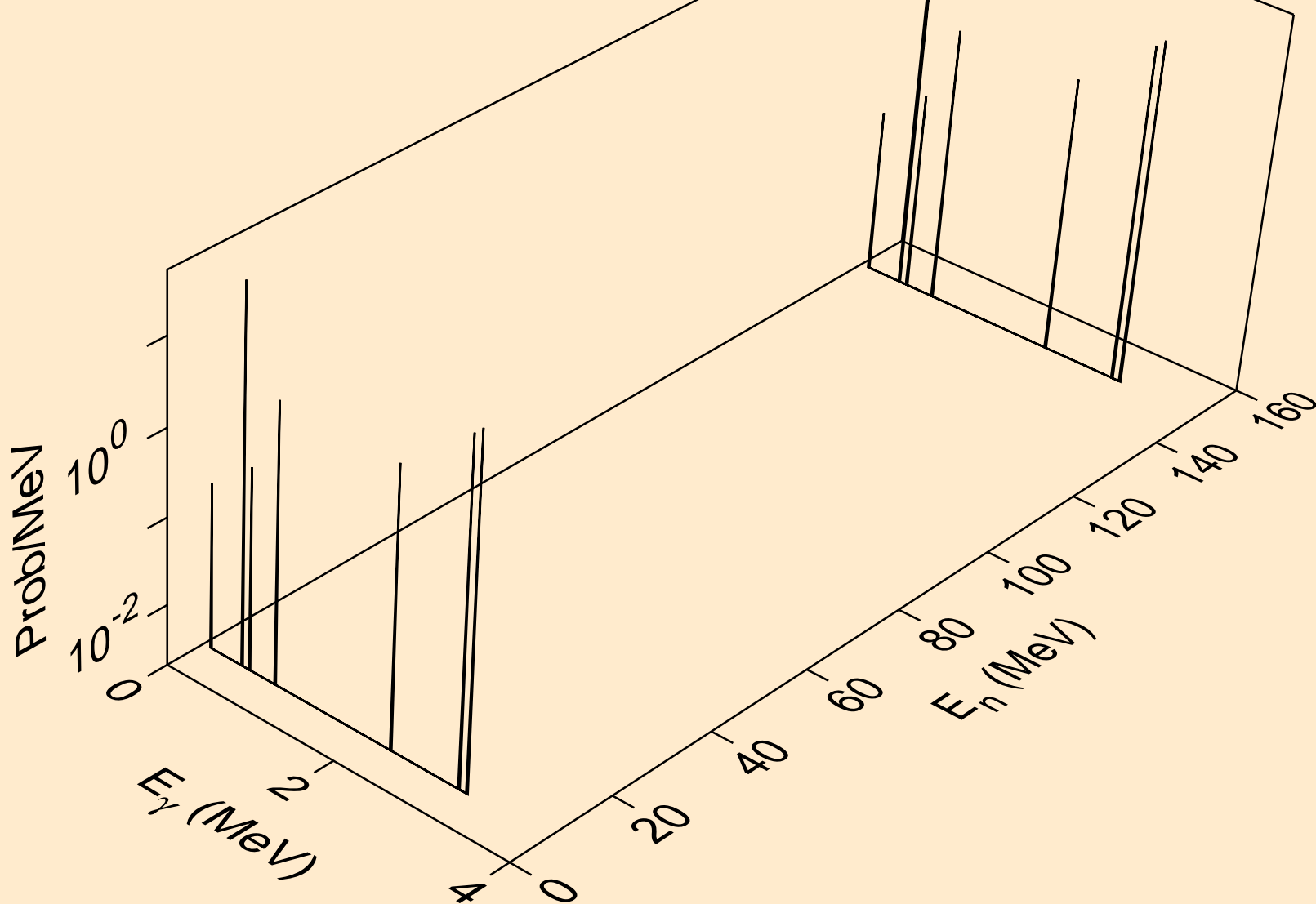

13-AL-27 FOR FENDL-3B2 FROM JEFF-3.1 WITH NJOY99.304+ C  
Photon emission for (n,a\*17)

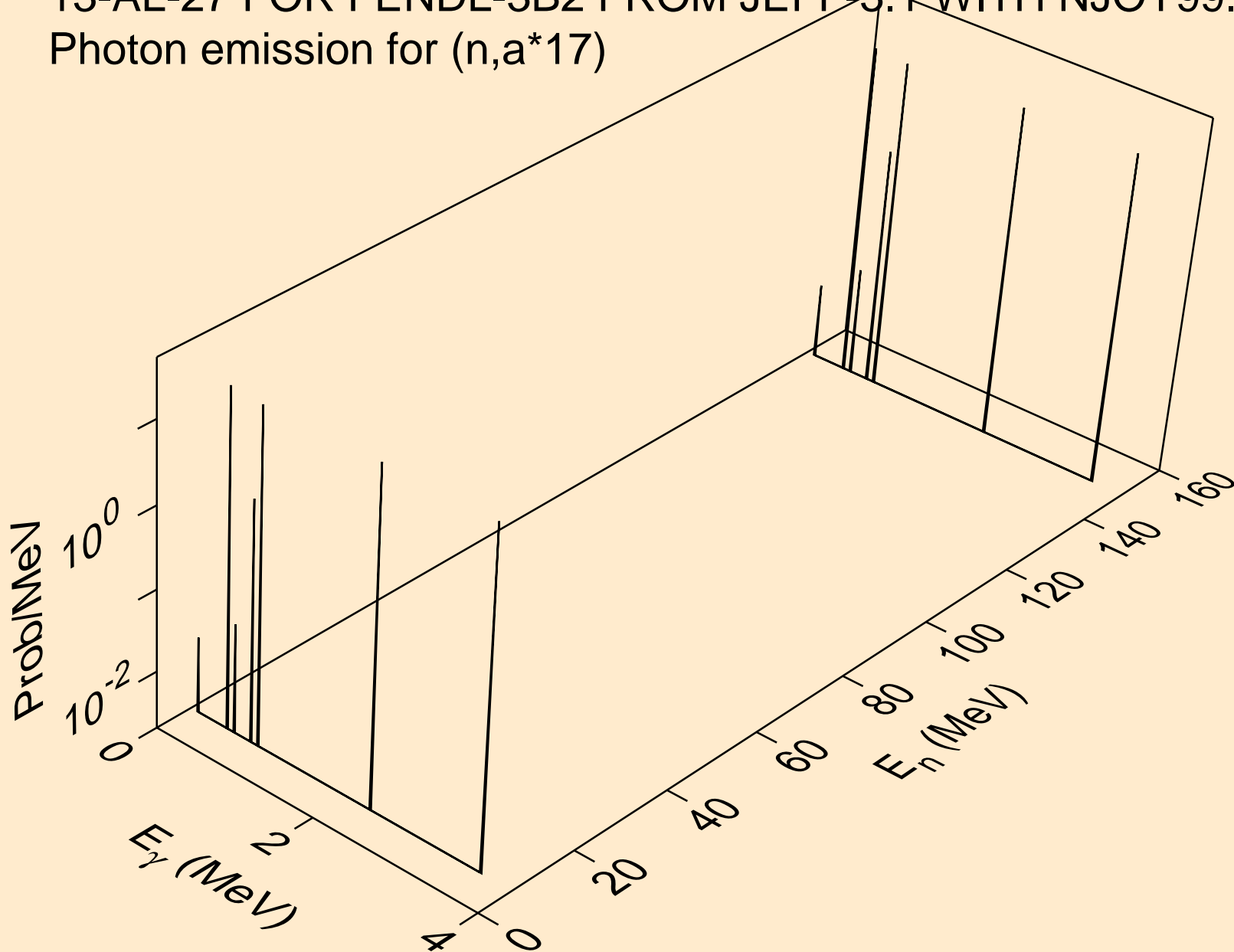

13-AL-27 FOR FENDL-3B2 FROM JEFF-3.1 WITH NJOY99.304+ C  
Photon emission for (n,a\*18)

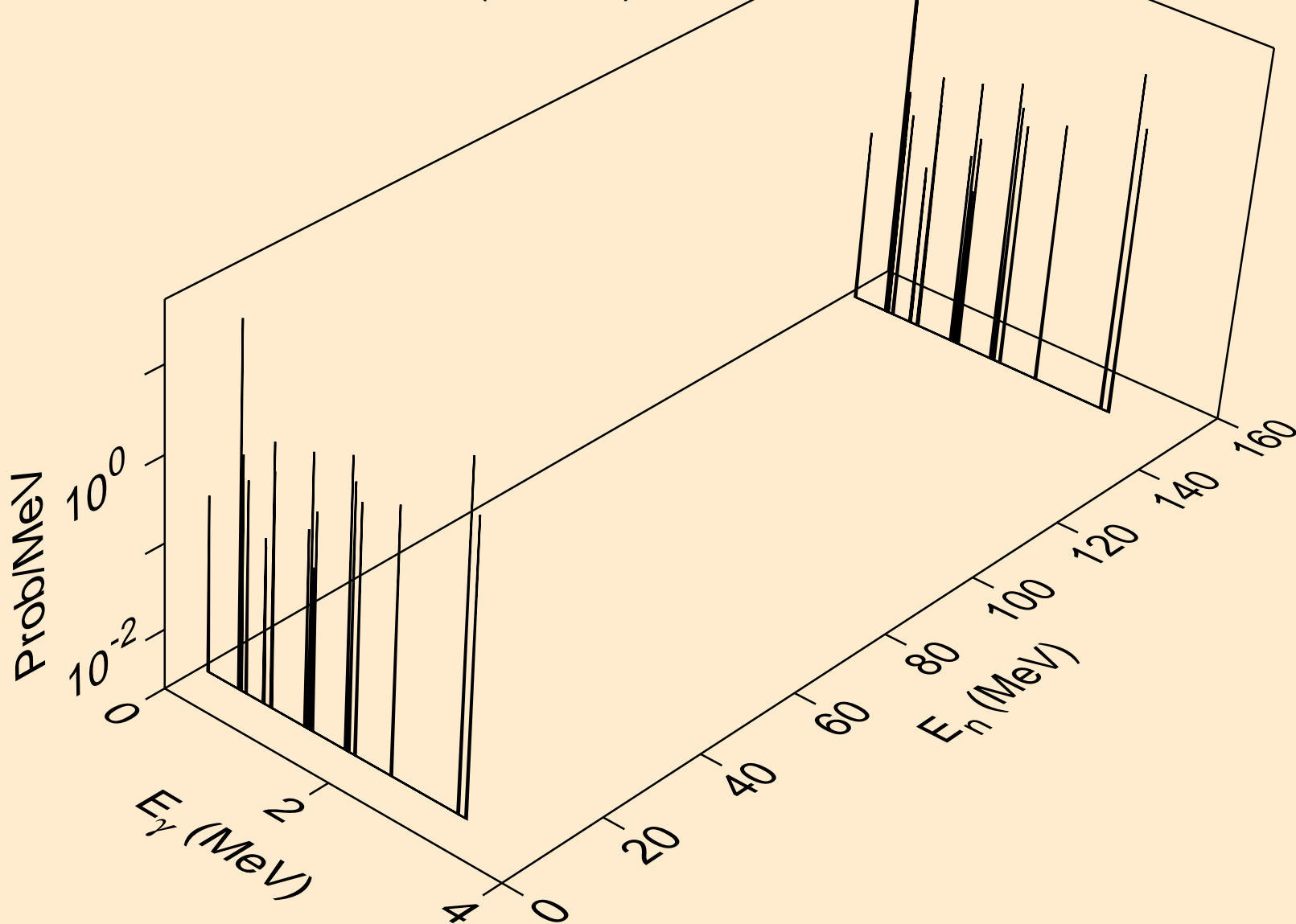

13-AL-27 FOR FENDL-3B2 FROM JEFF-3.1 WITH NJOY99.304+ C  
Photon emission for (n,a\*19)

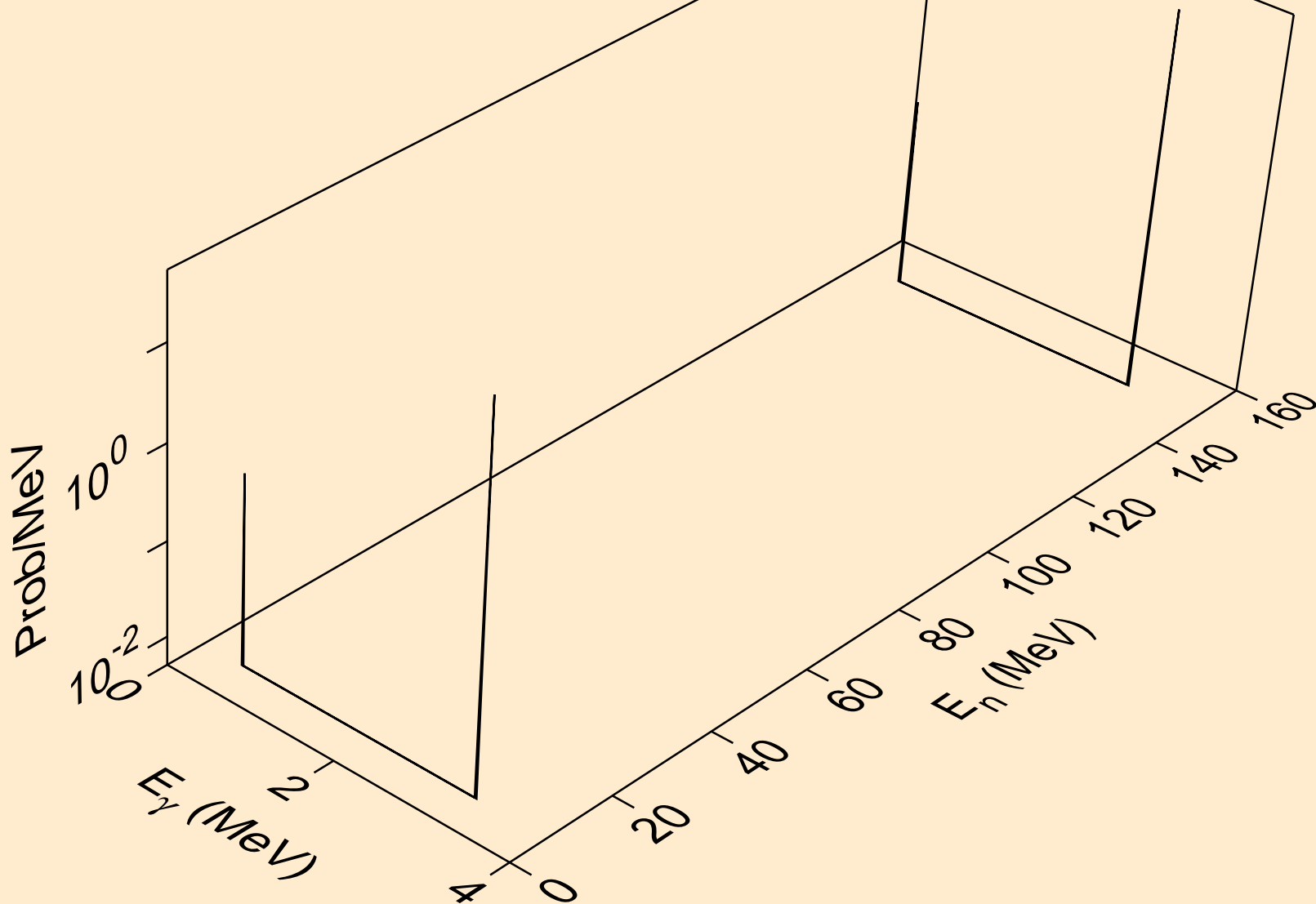

13-AL-27 FOR FENDL-3B2 FROM JEFF-3.1 WITH NJOY99.304+ C  
Photon emission for (n,a\*c)

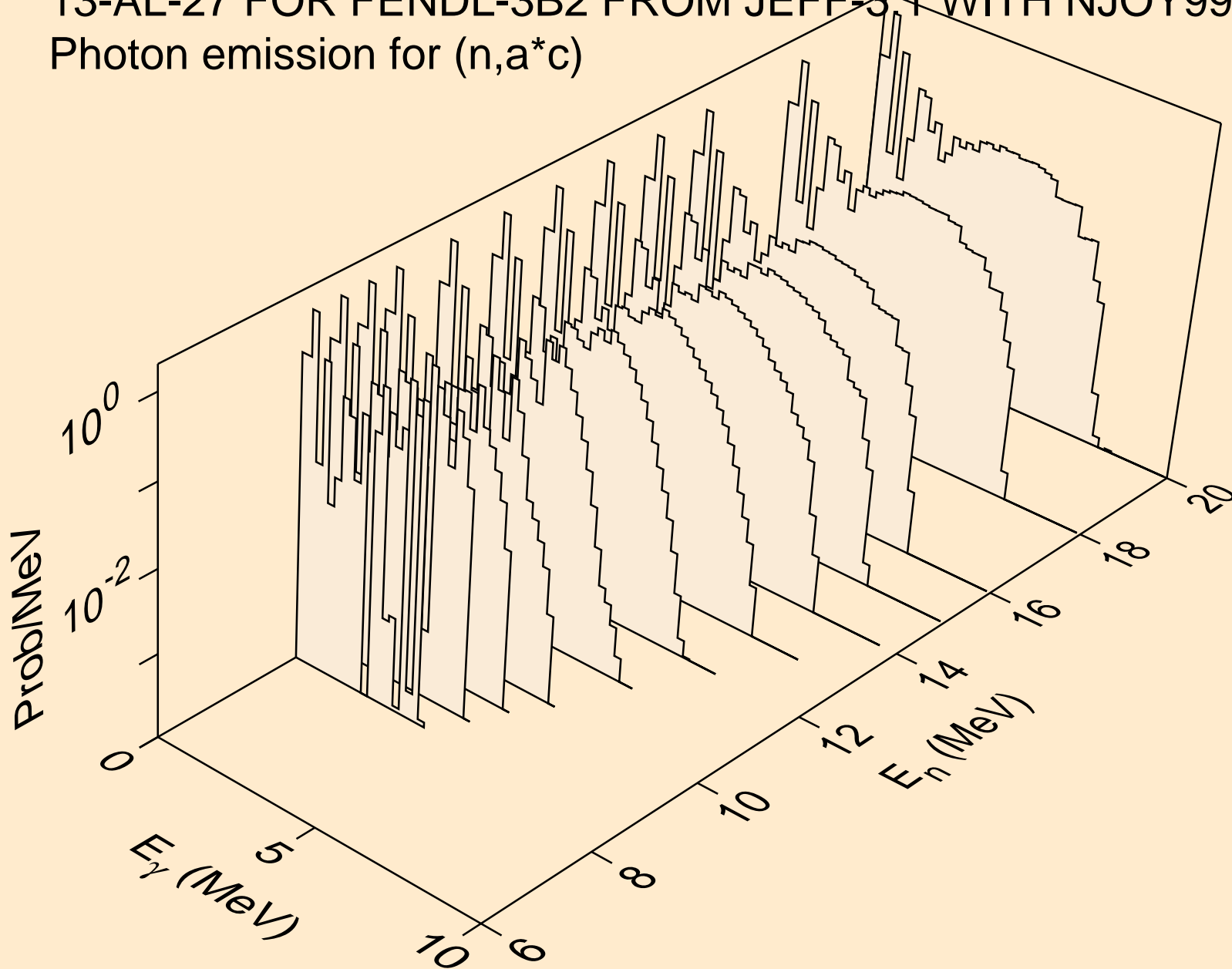

13-AL-27 FOR FENDL-3B2 FROM JEFF-3.1 WITH NJOY99.304+ C  
thermal capture photon spectrum

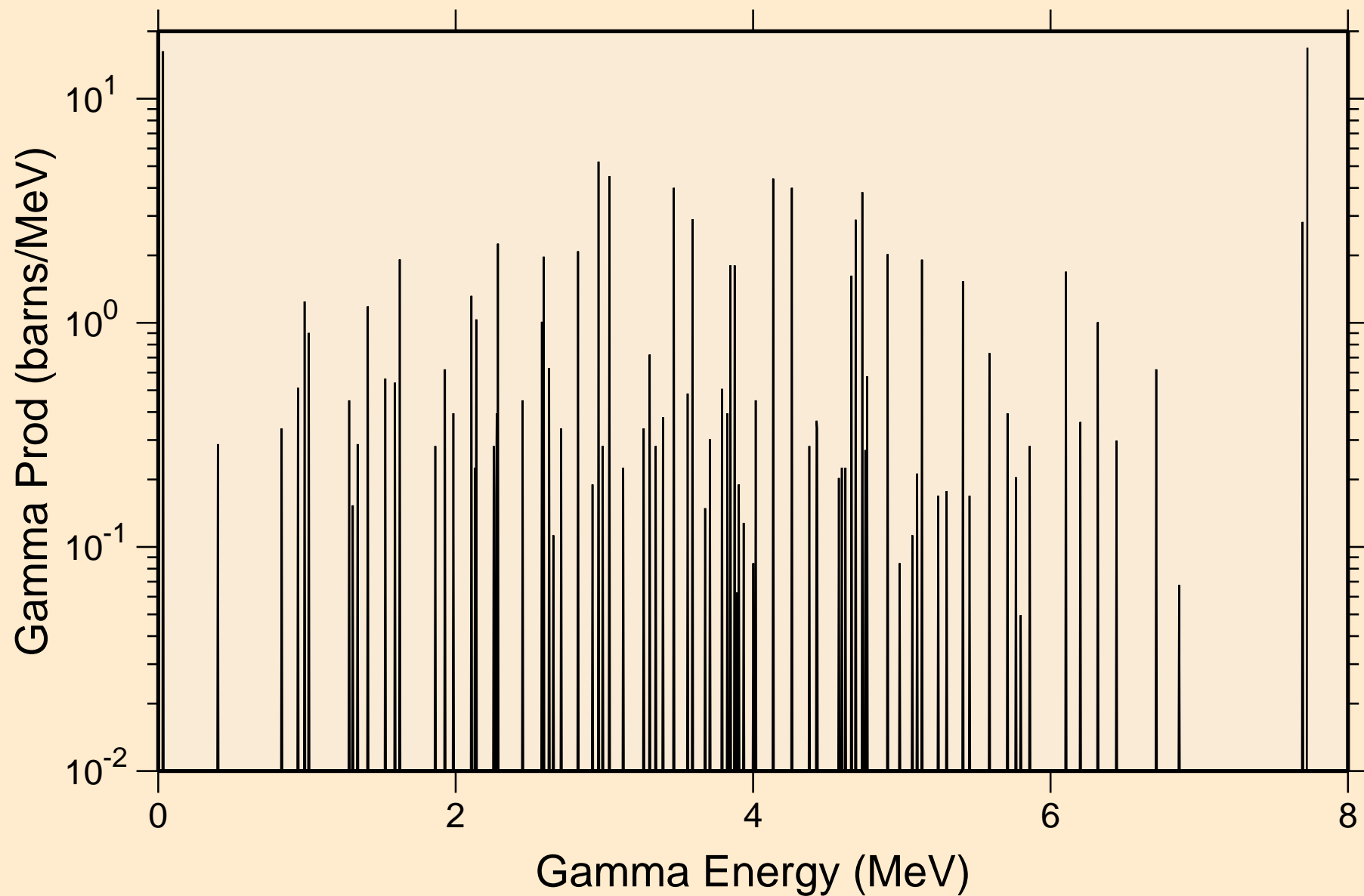

13-AL-27 FOR FENDL-3B2 FROM JEFF-3.1 WITH NJOY99.304+ C  
14 MeV photon spectrum

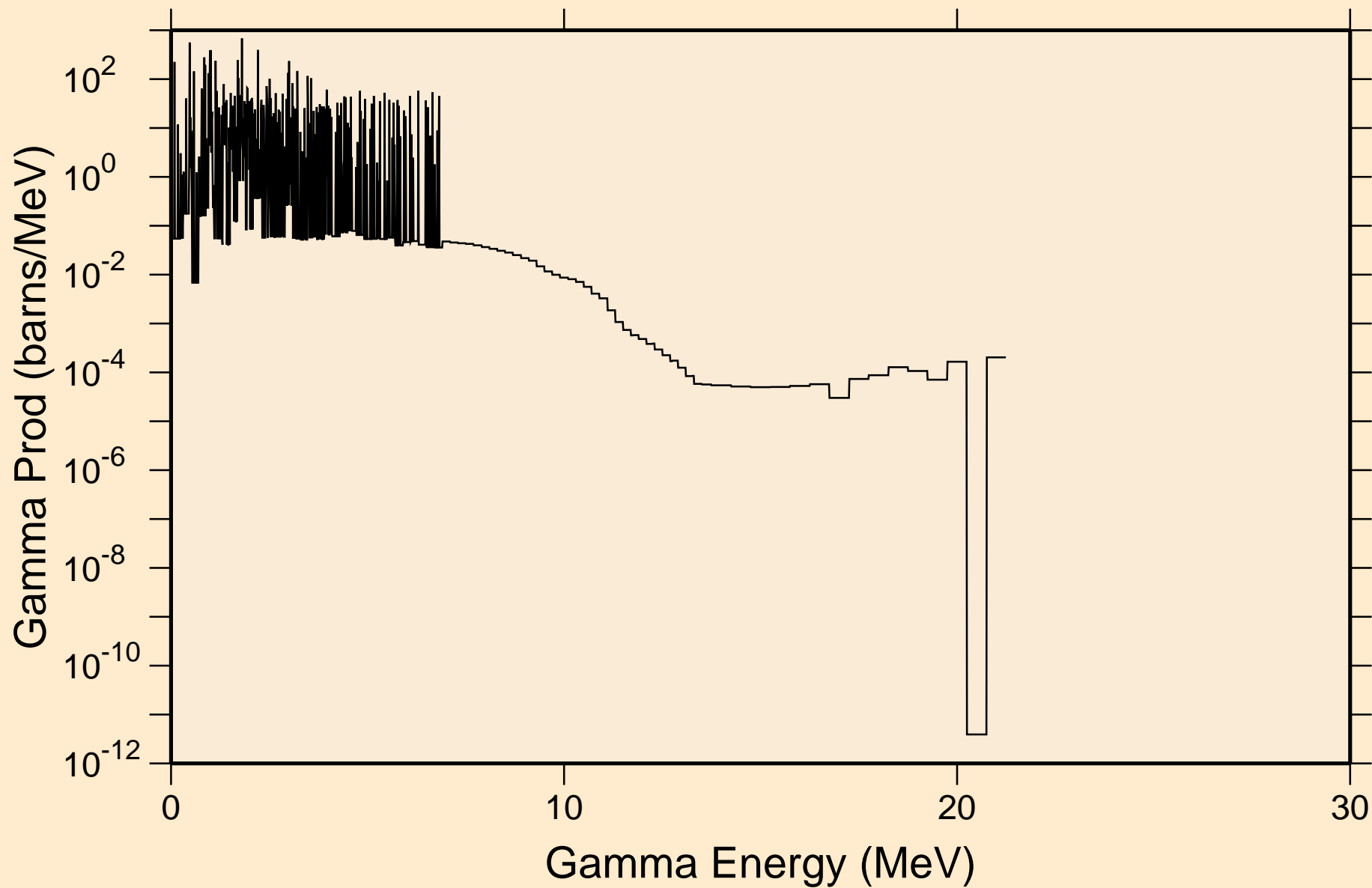



# 13-AL-27 FOR FENDL-3B2 FROM JEFF-3.1 WITH NJOY99.304+ C

## Particle heating contributions

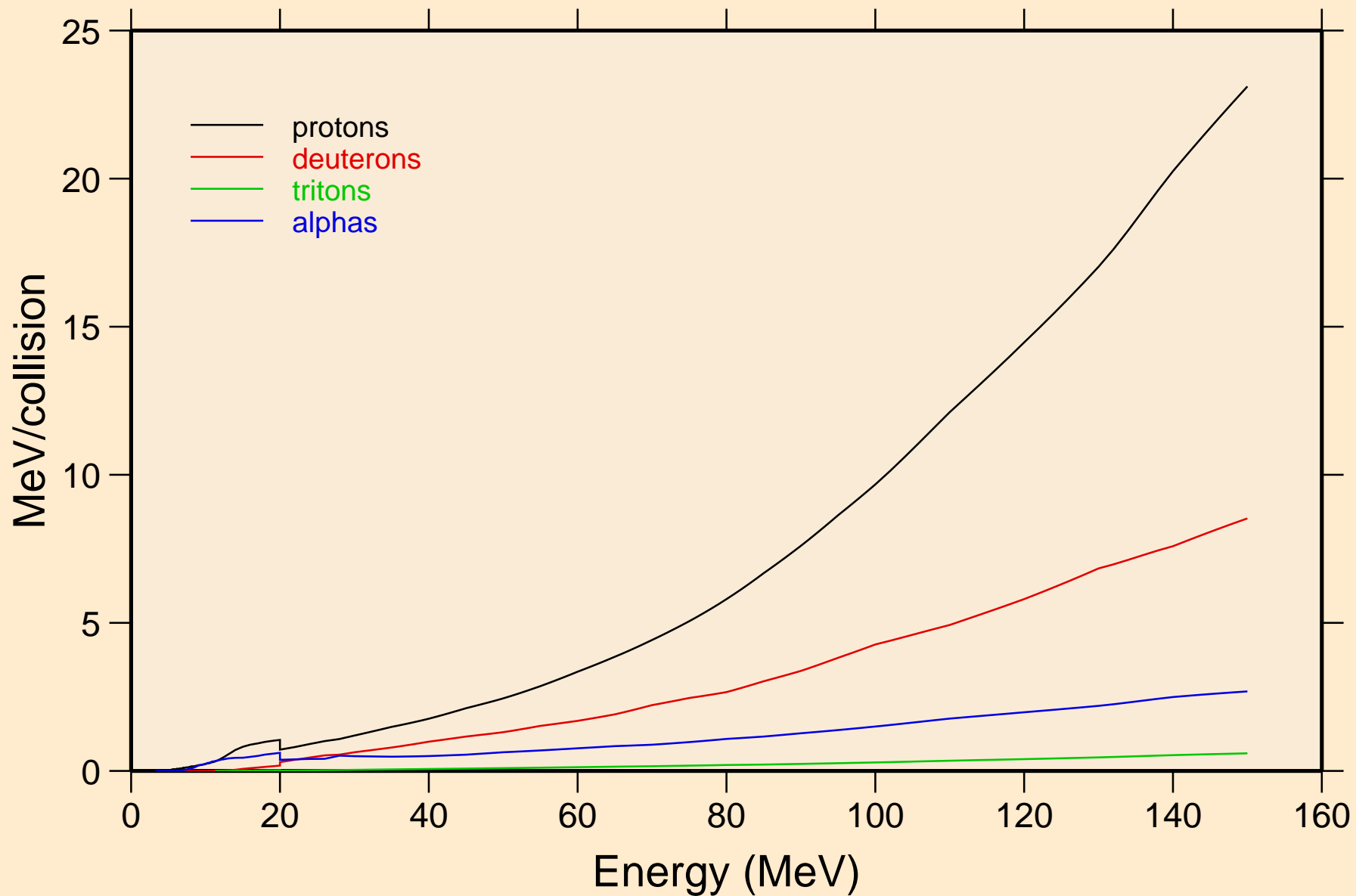

# 13-AL-27 FOR FENDL-3B2 FROM JEFF-3.1 WITH NJOY99.304+ C Recoil Heating

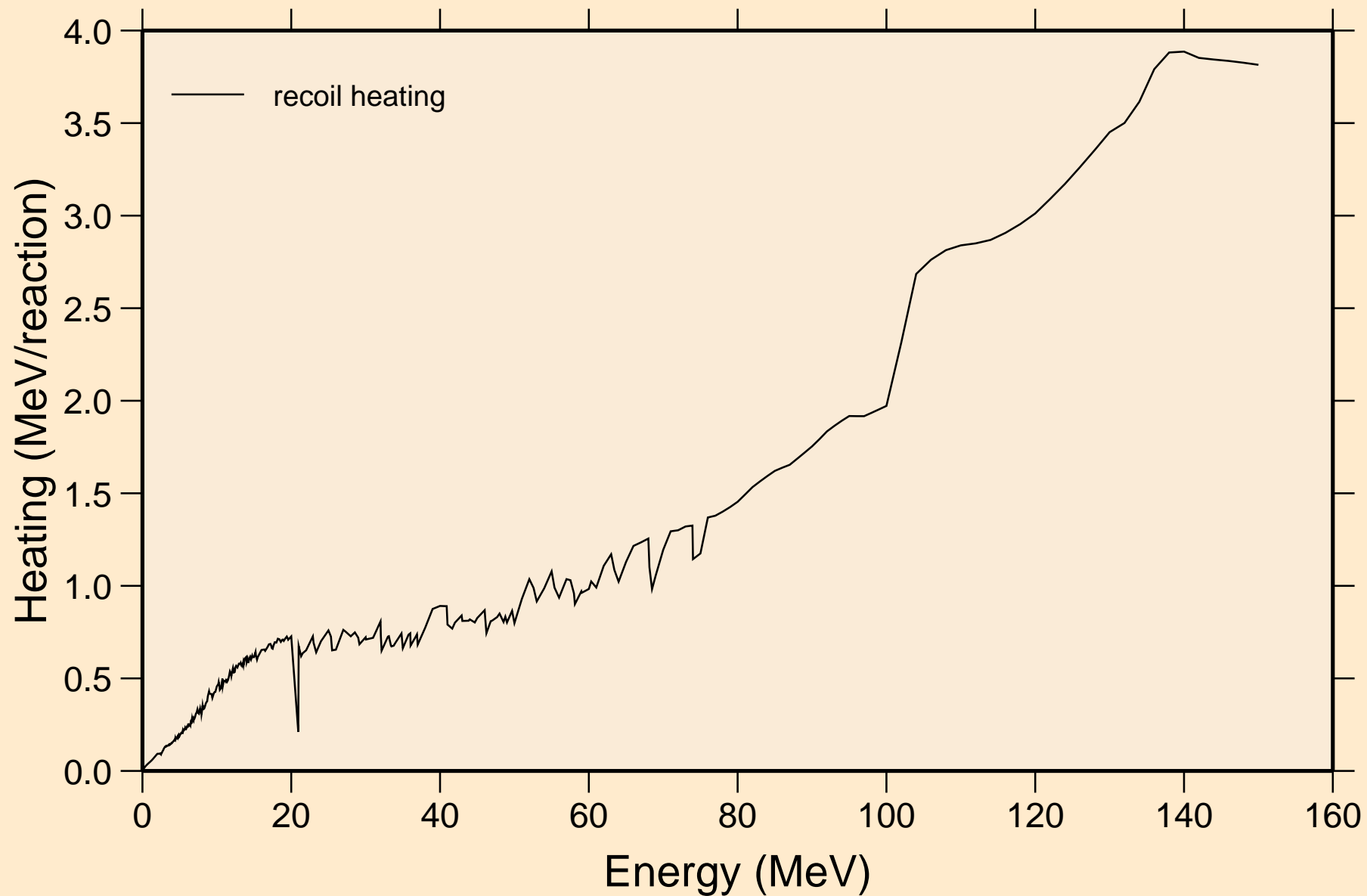

13-AL-27 FOR FENDL-3B2 FROM JEFF-3.1 WITH NJOY99.304+ C  
Particle production cross sections

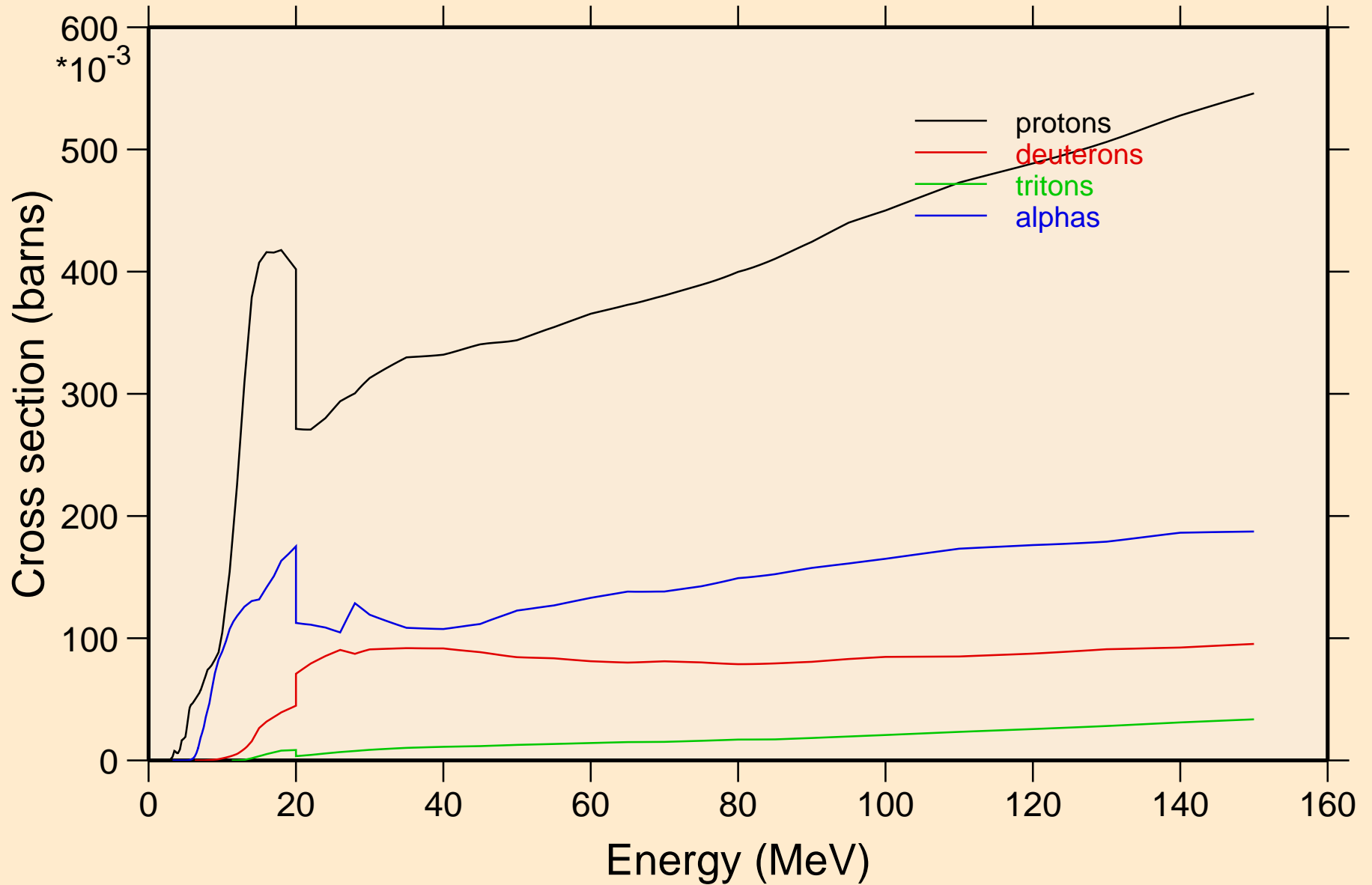

13-AL-27 FOR FENDL-3B2 FROM JEFF-3.1 WITH NJOY99.304+ C  
protons from (n,x)

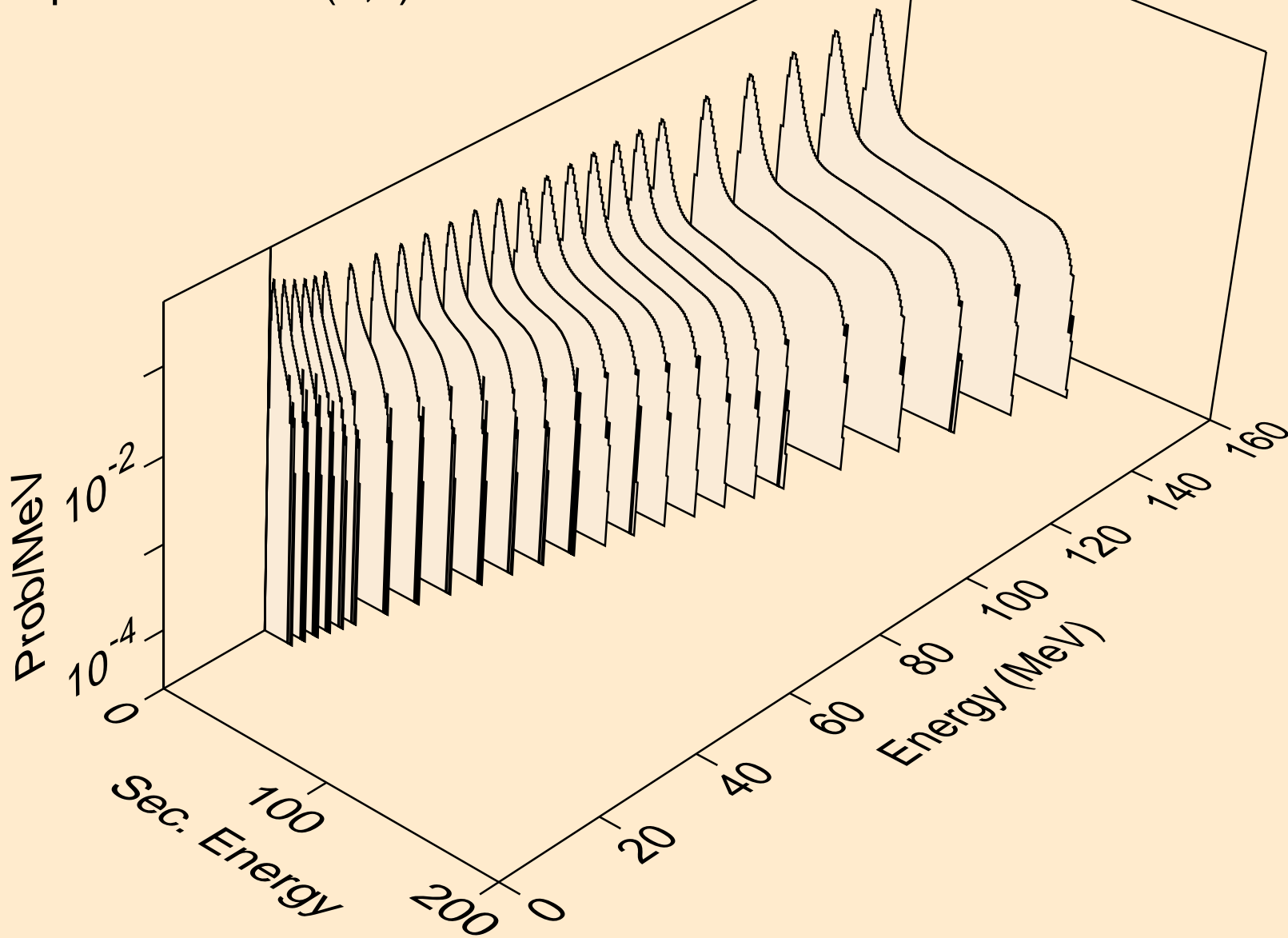

13-AL-27 FOR FENDL-3B2 FROM JEFF-3.1 WITH NJOY99.304+ C  
protons from (n,n\*)p

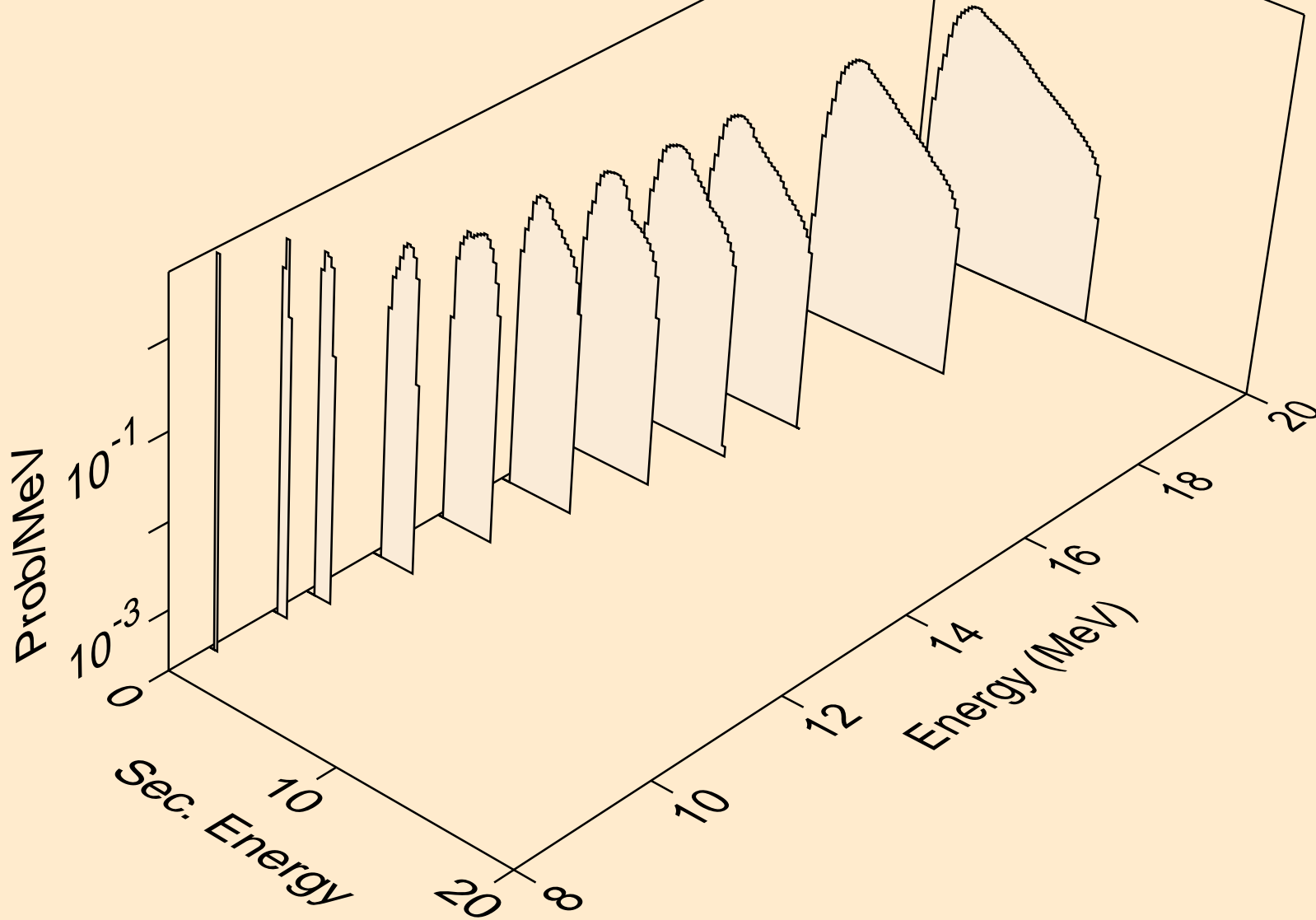

13-AL-27 FOR FENDL-3B2 FROM JEFF-3.1 WITH NJOY99.304+ C  
protons from (n,npa)

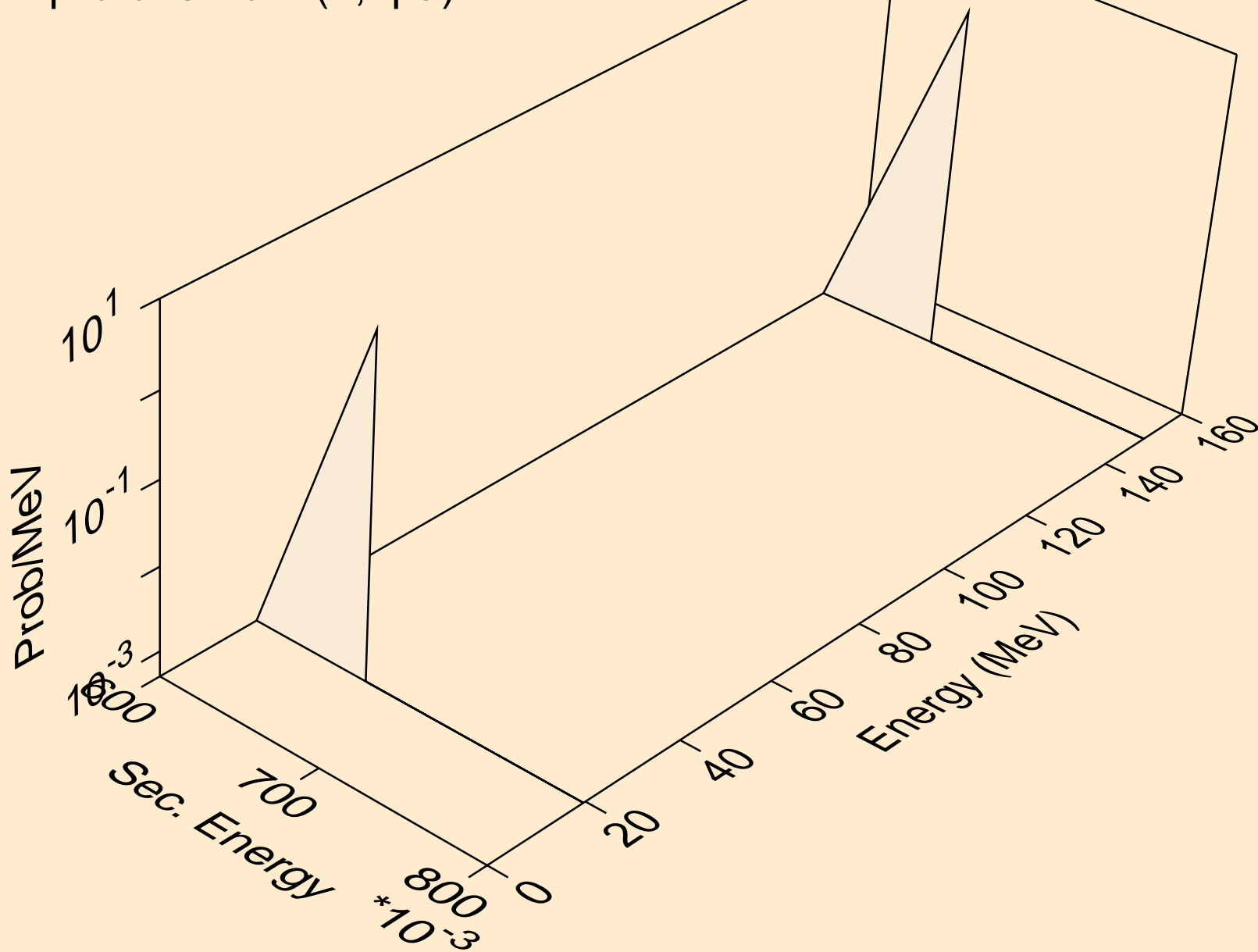

13-AL-27 FOR FENDL-3B2 FROM JEFF-3.1 WITH NJOY99.304+ C  
protons from (n,2p)

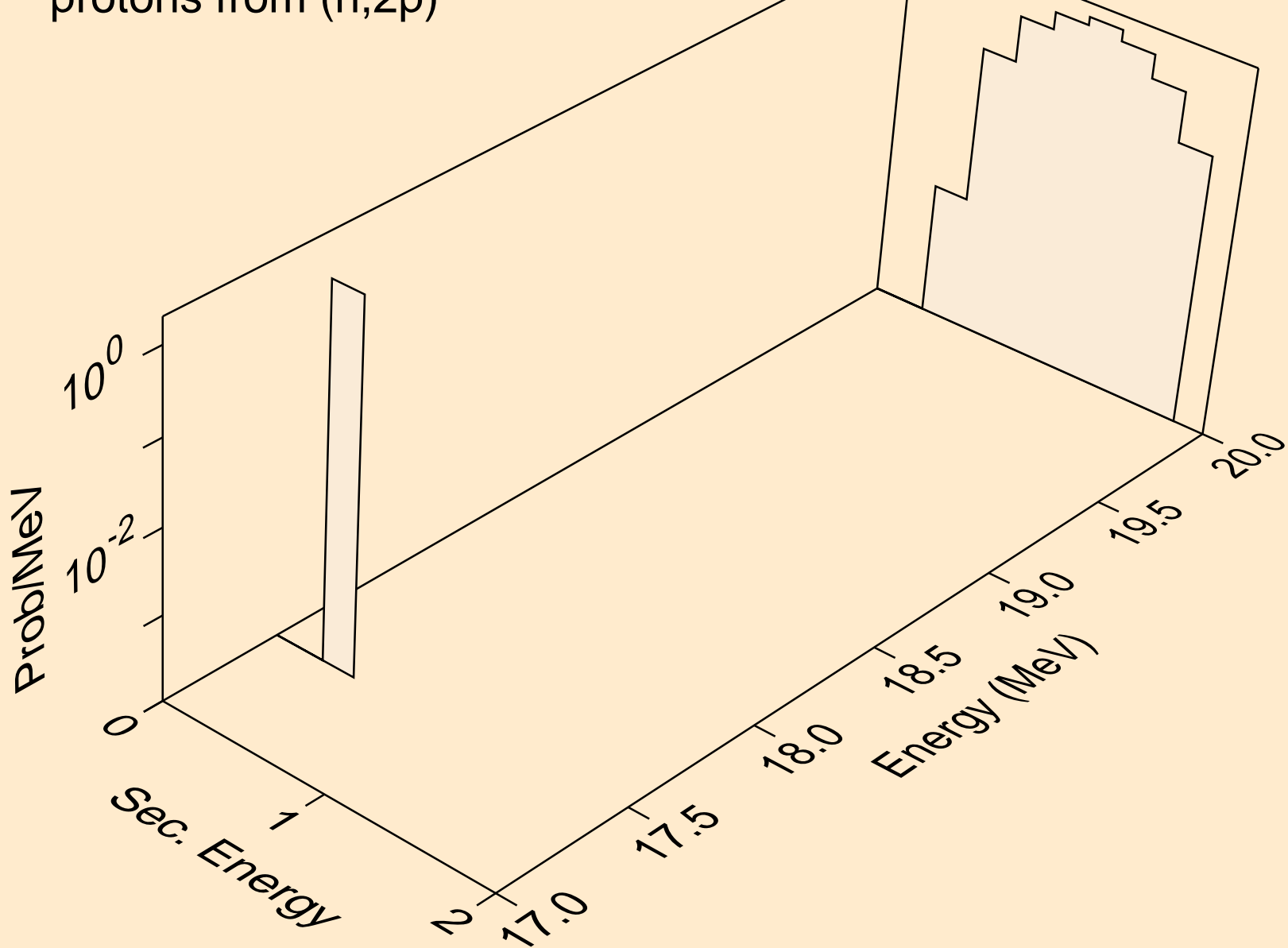

13-AL-27 FOR FENDL-3B2 FROM JEFF-3.1 WITH NJOY99.304+ C  
protons from (n,pa)

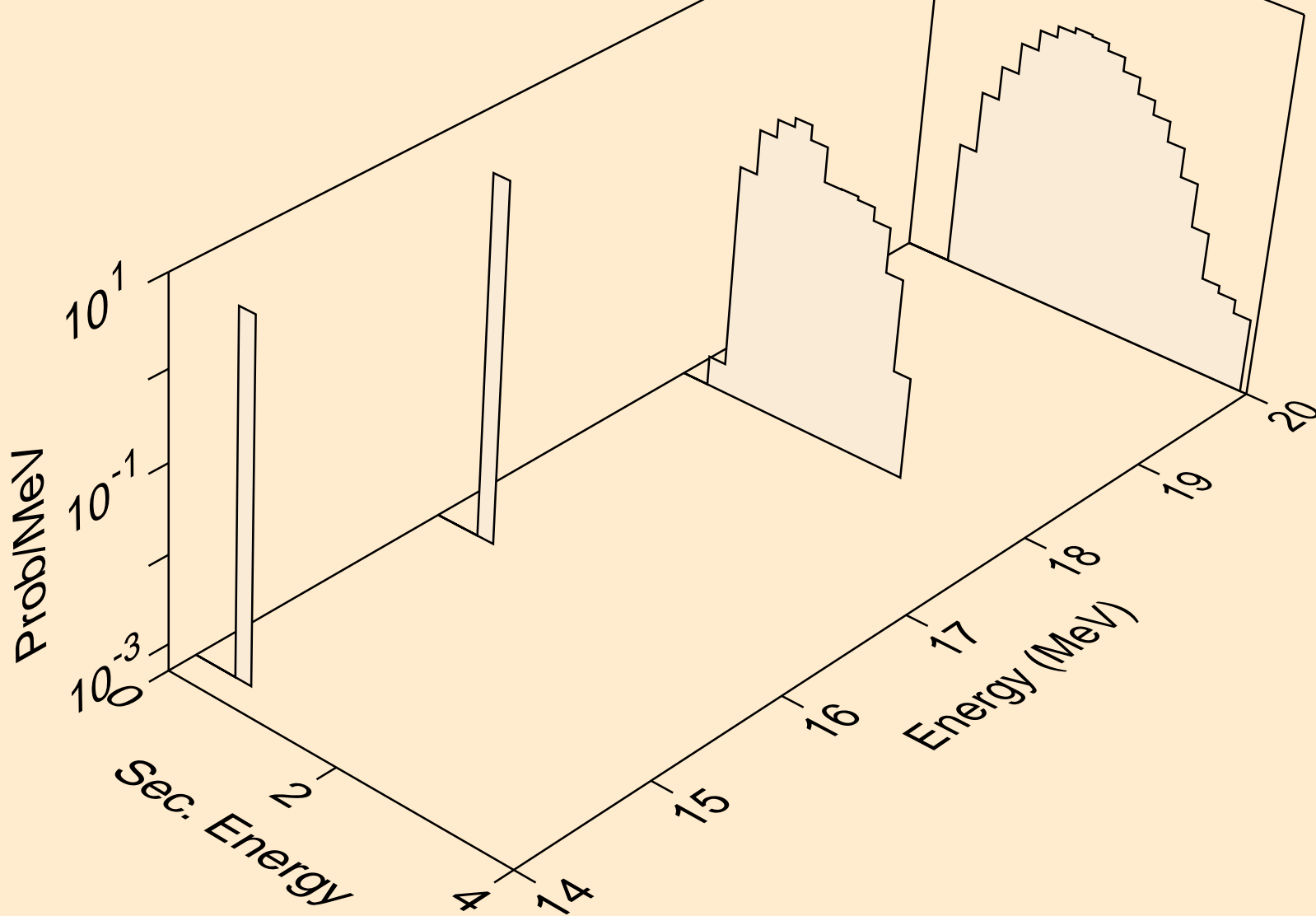



13-AL-27 FOR FENDL-3B2 FROM JEFF-3.1 WITH NJOY99.304+ C  
angular distribution for (n,p\*0) proton

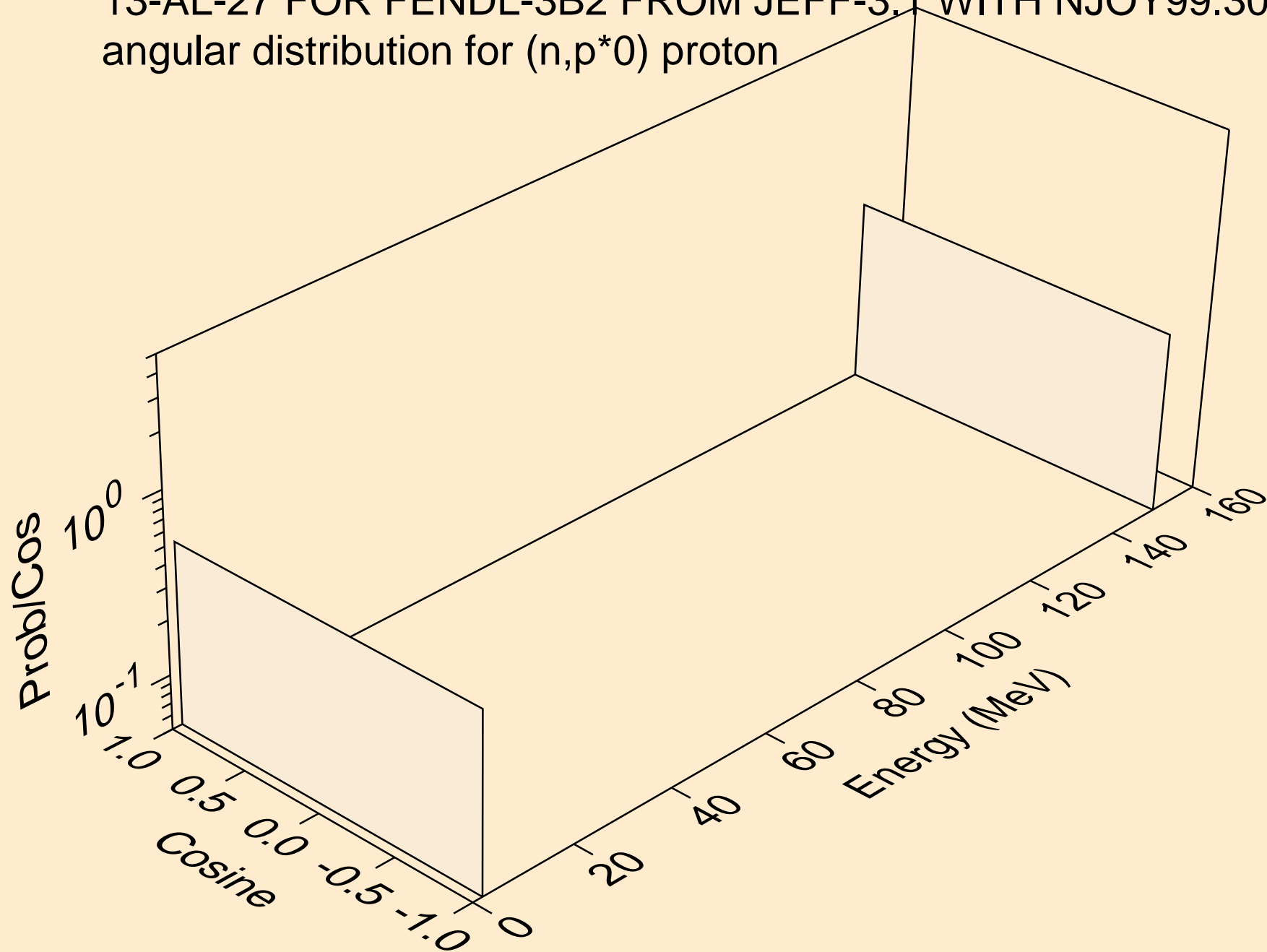

13-AL-27 FOR FENDL-3B2 FROM JEFF-3.1 WITH NJOY99.304+ C  
angular distribution for (n,p\*1) proton

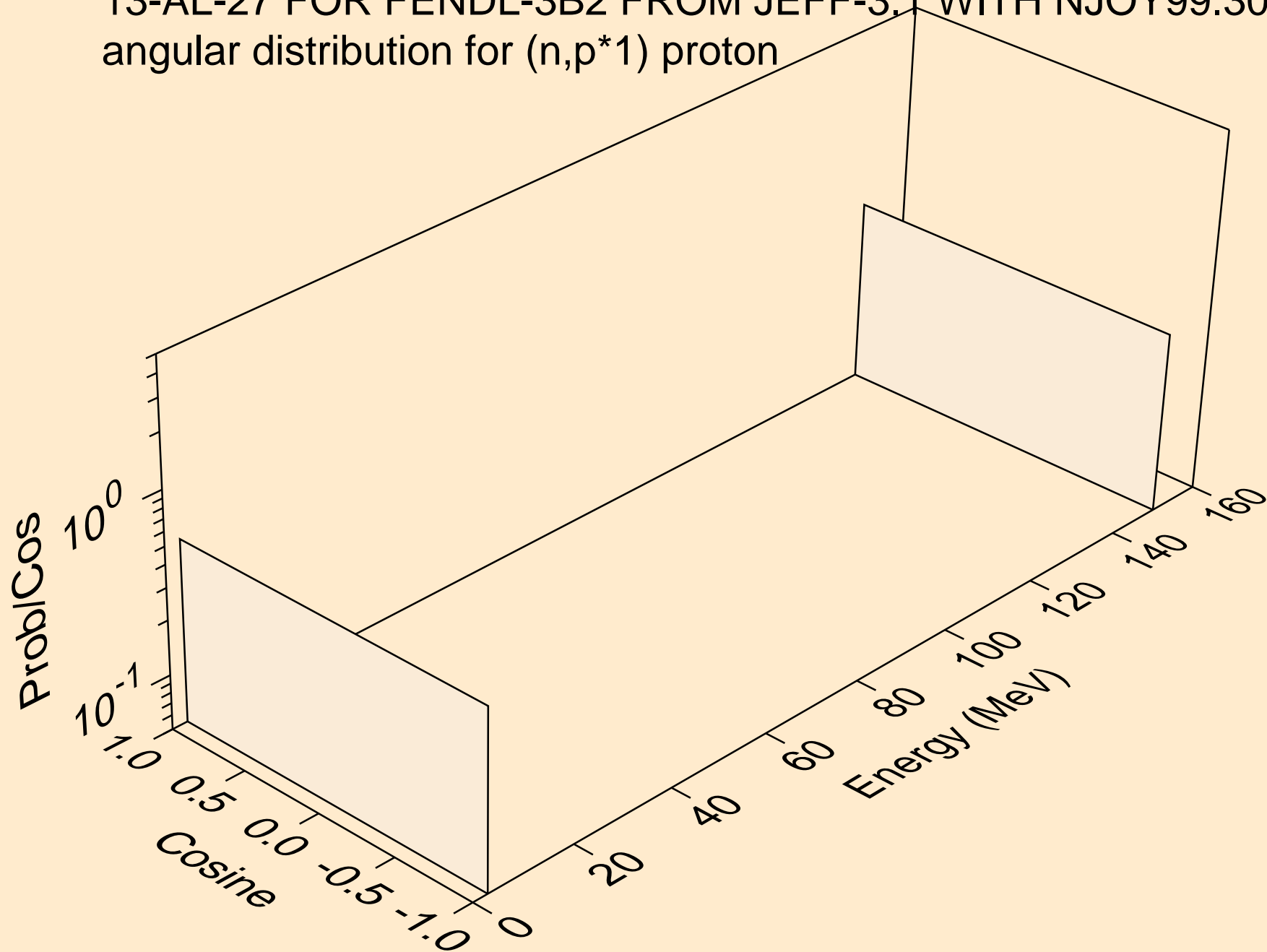

13-AL-27 FOR FENDL-3B2 FROM JEFF-3.1 WITH NJOY99.304+ C  
angular distribution for (n,p\*2) proton

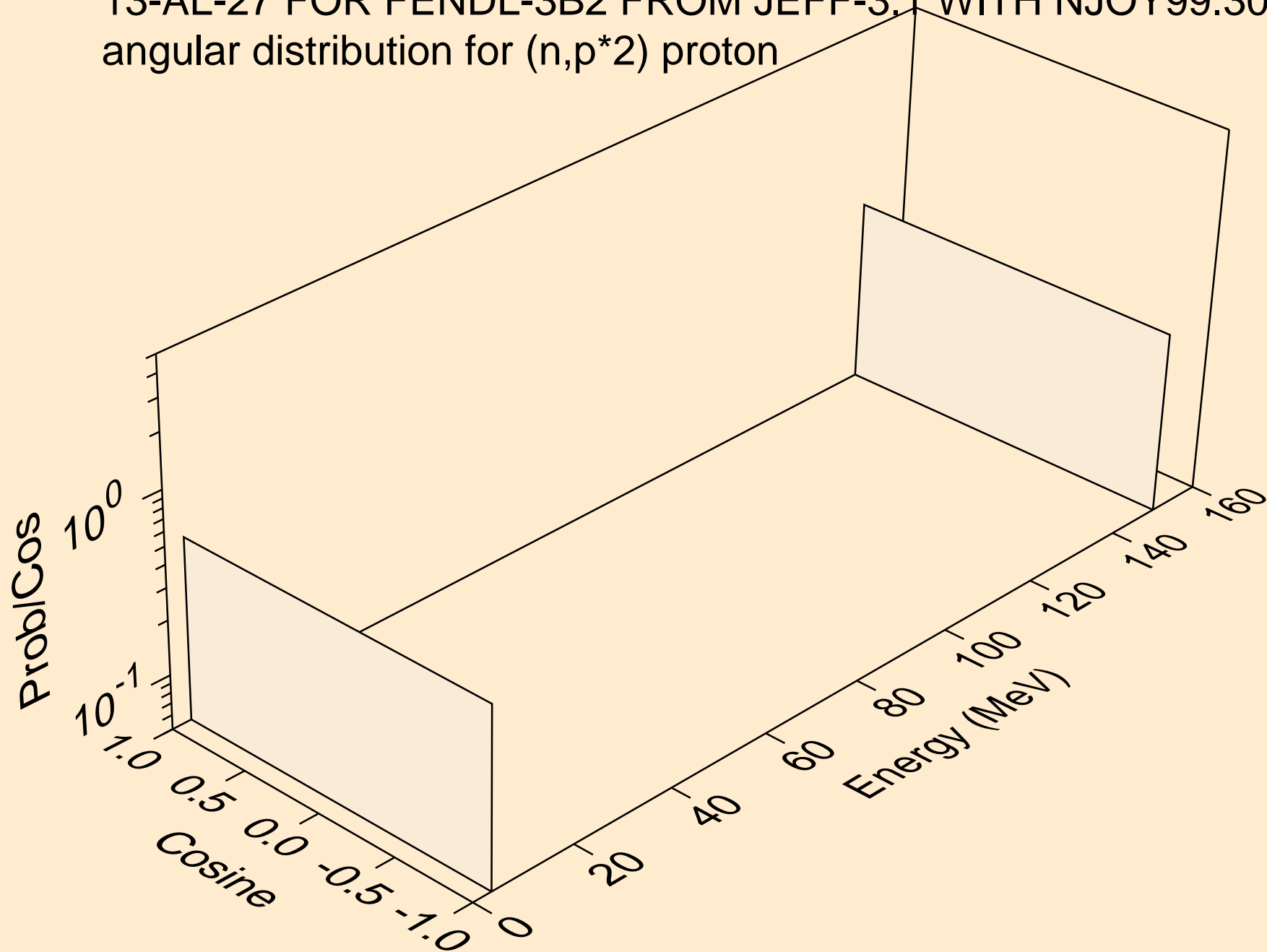

13-AL-27 FOR FENDL-3B2 FROM JEFF-3.1 WITH NJOY99.304+ C  
angular distribution for (n,p\*3) proton

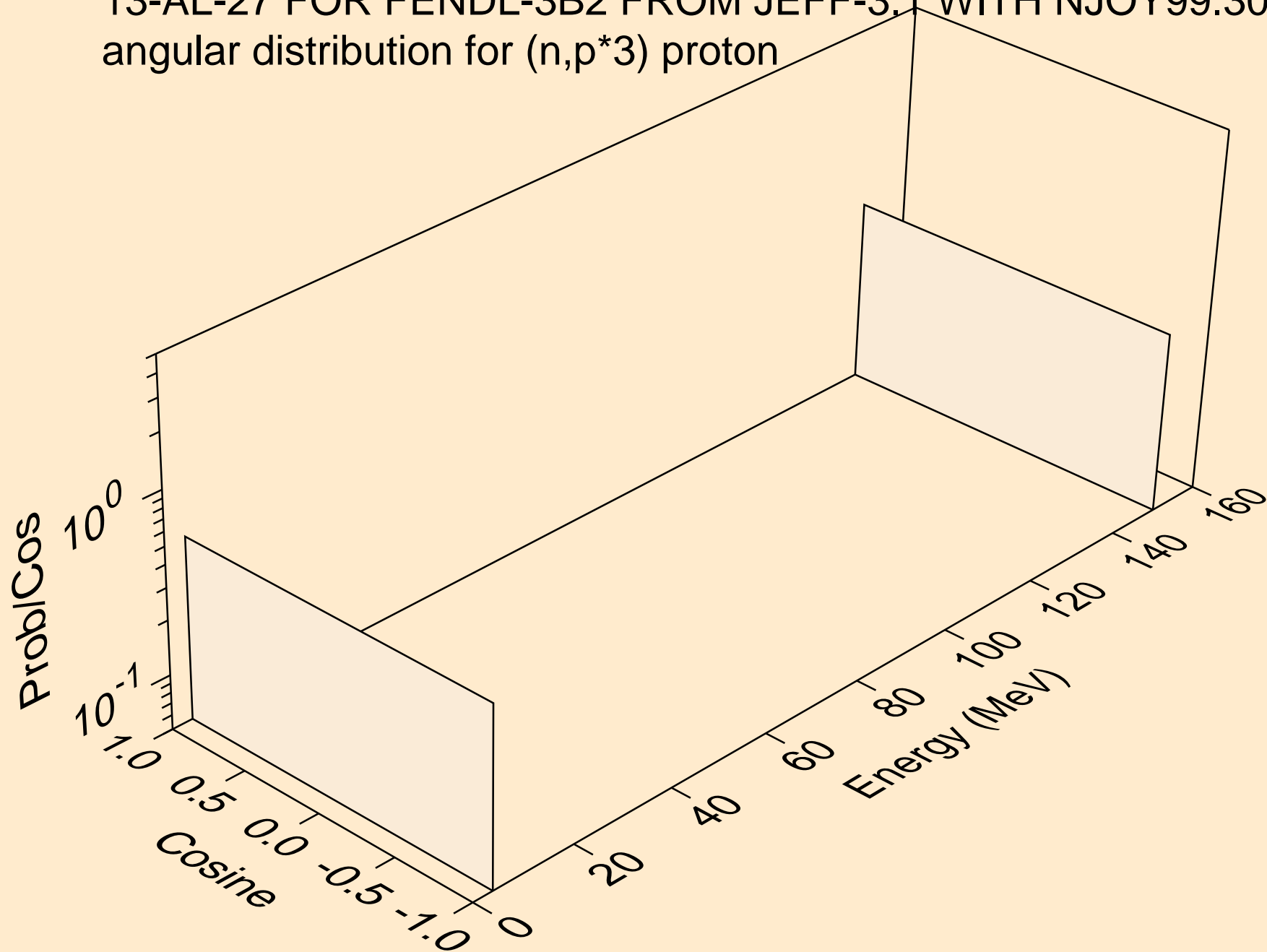

13-AL-27 FOR FENDL-3B2 FROM JEFF-3.1 WITH NJOY99.304+ C  
angular distribution for (n,p\*4) proton

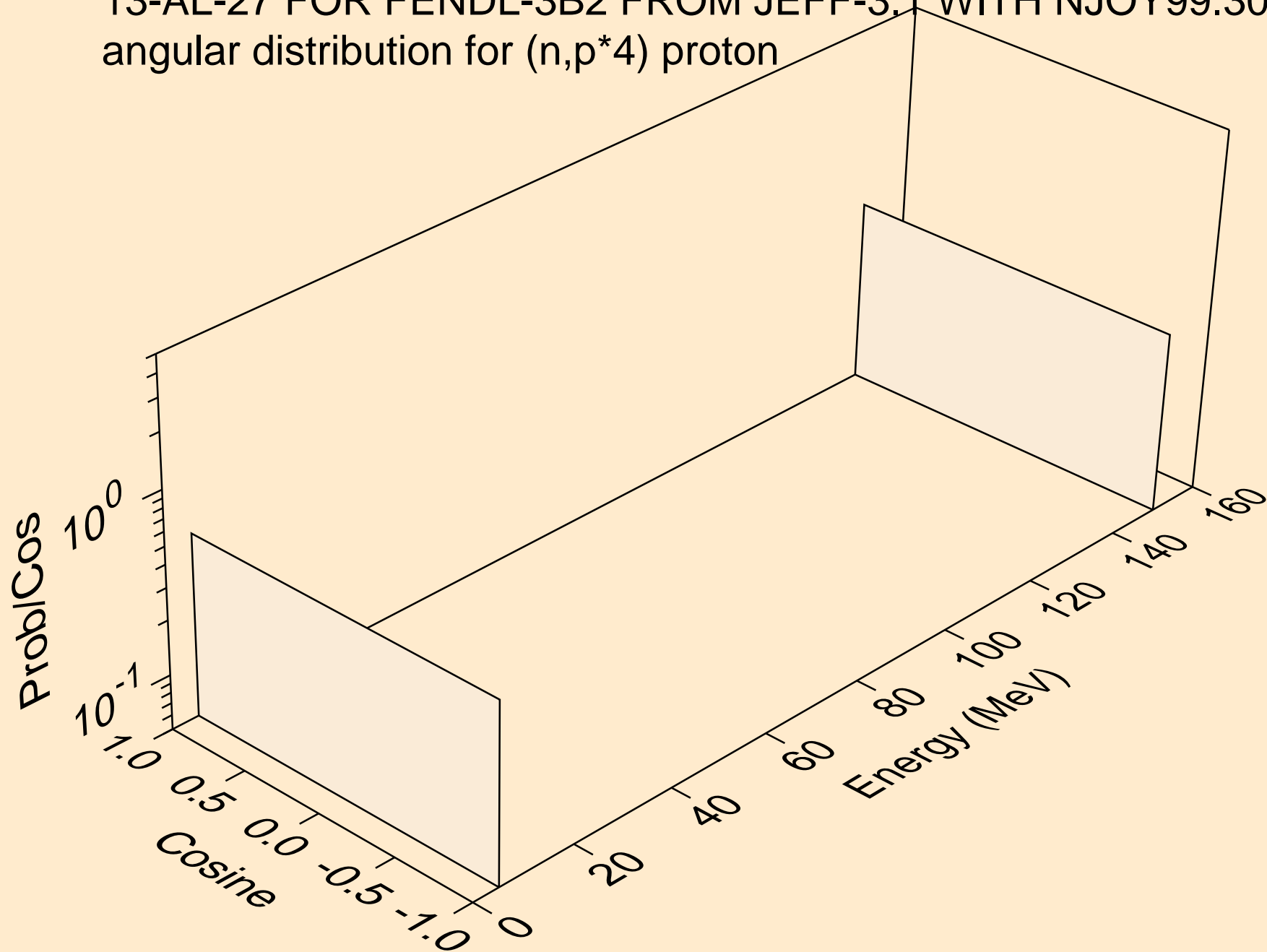

13-AL-27 FOR FENDL-3B2 FROM JEFF-3.1 WITH NJOY99.304+ C  
angular distribution for (n,p\*5) proton

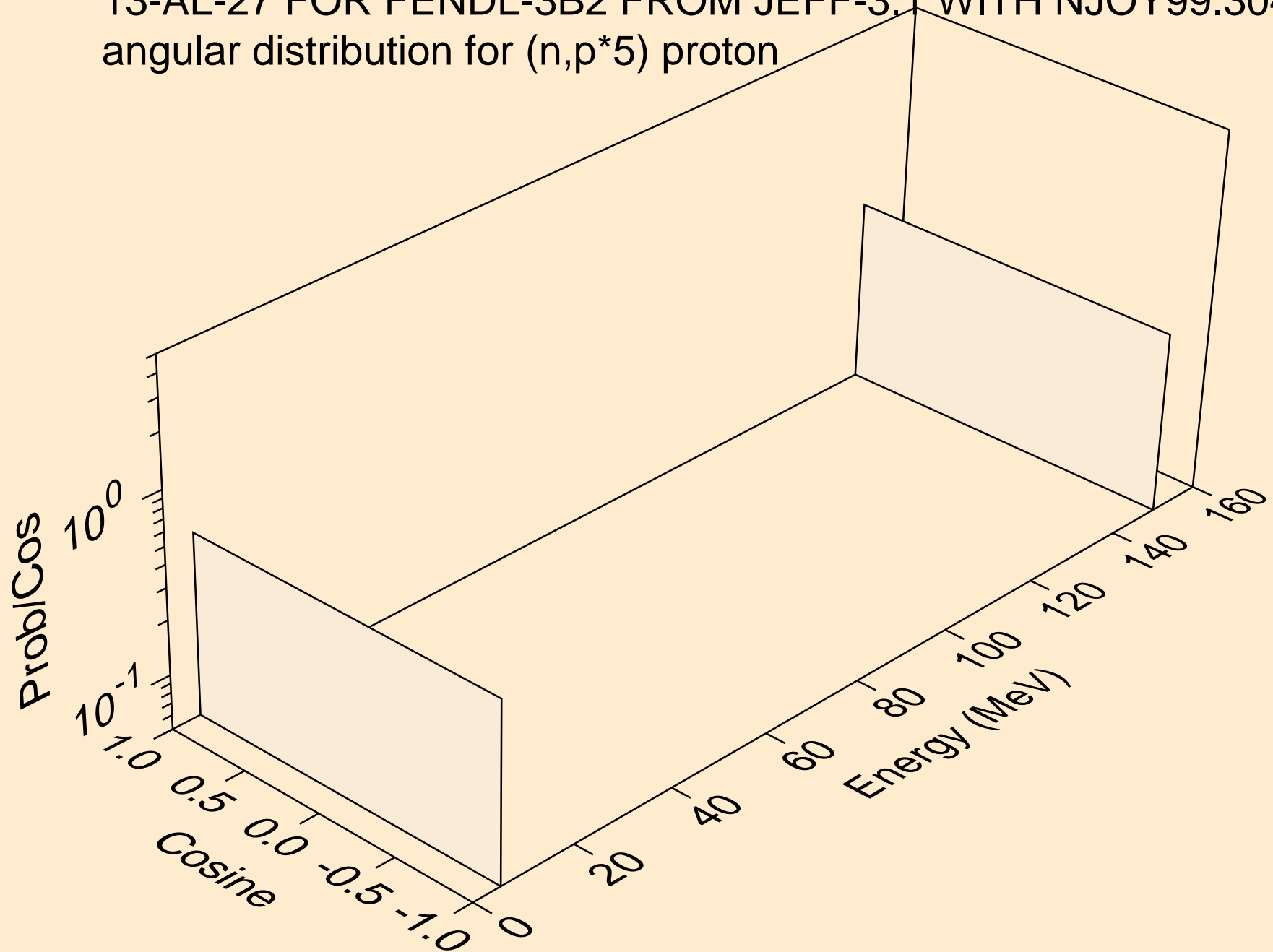

13-AL-27 FOR FENDL-3B2 FROM JEFF-3.1 WITH NJOY99.304+ C  
angular distribution for (n,p\*6) proton

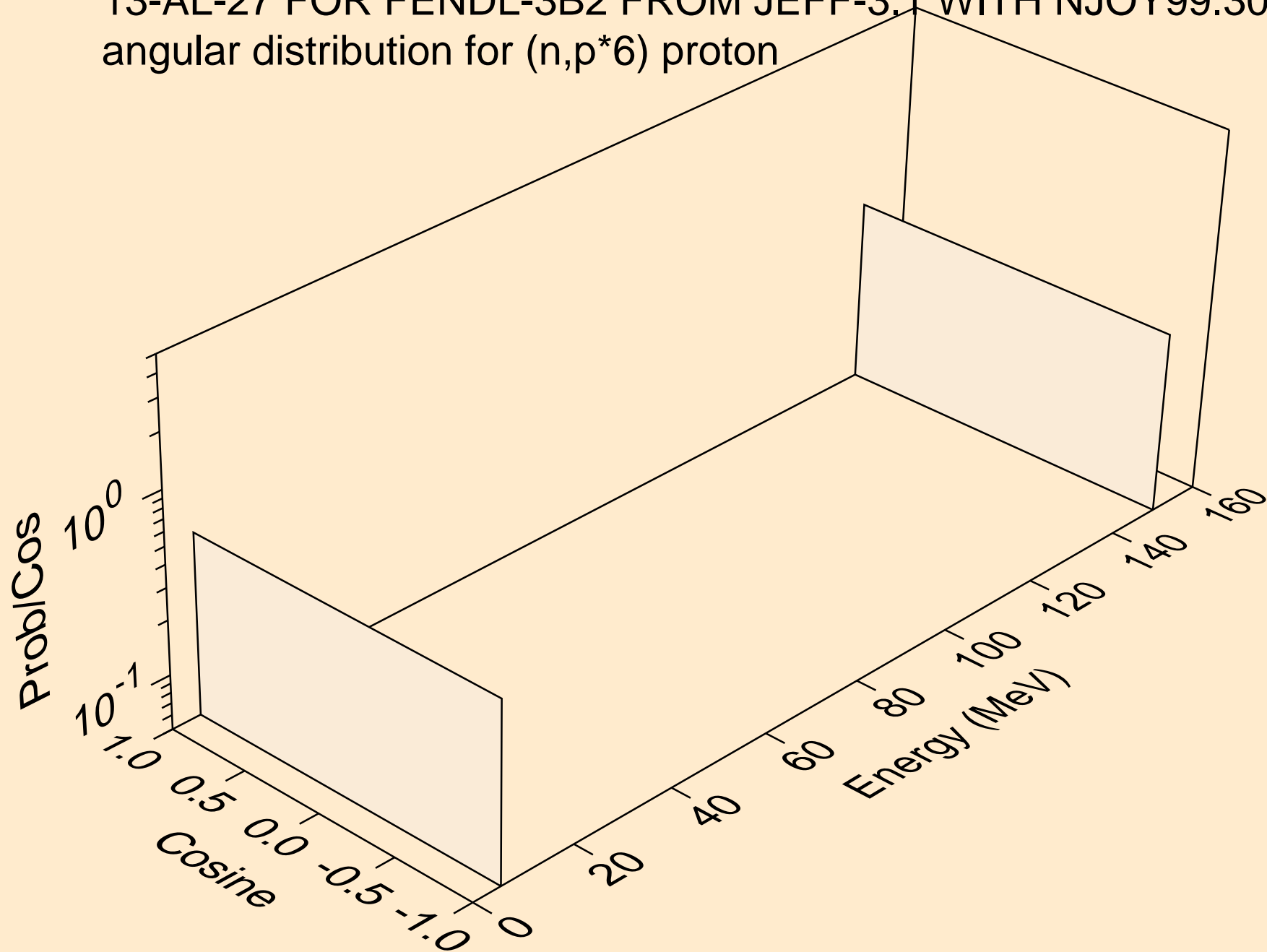

13-AL-27 FOR FENDL-3B2 FROM JEFF-3.1 WITH NJOY99.304+ C  
angular distribution for (n,p\*7) proton

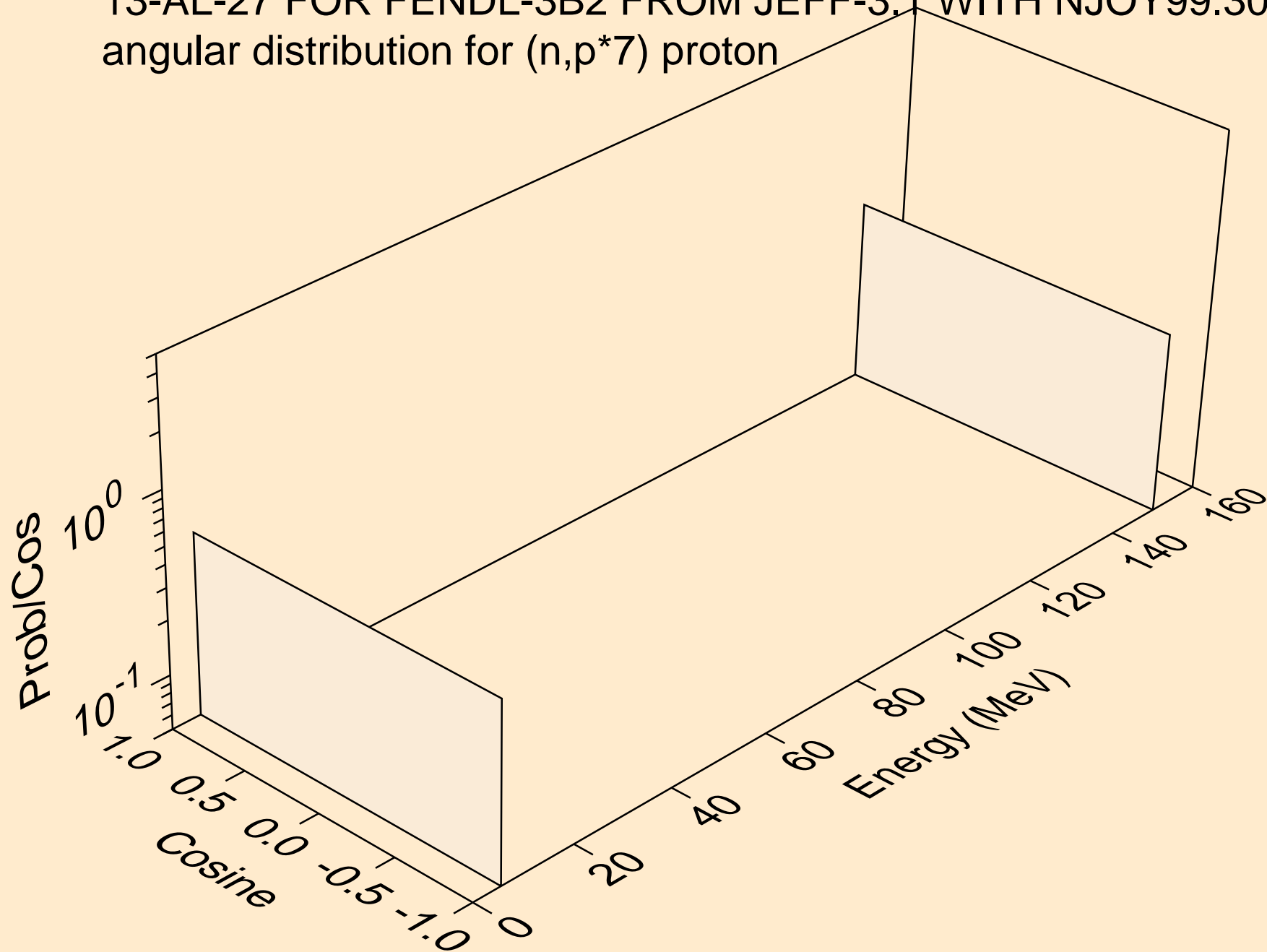



13-AL-27 FOR FENDL-3B2 FROM JEFF-3.1 WITH NJOY99.304+ C  
angular distribution for (n,p\*8) proton

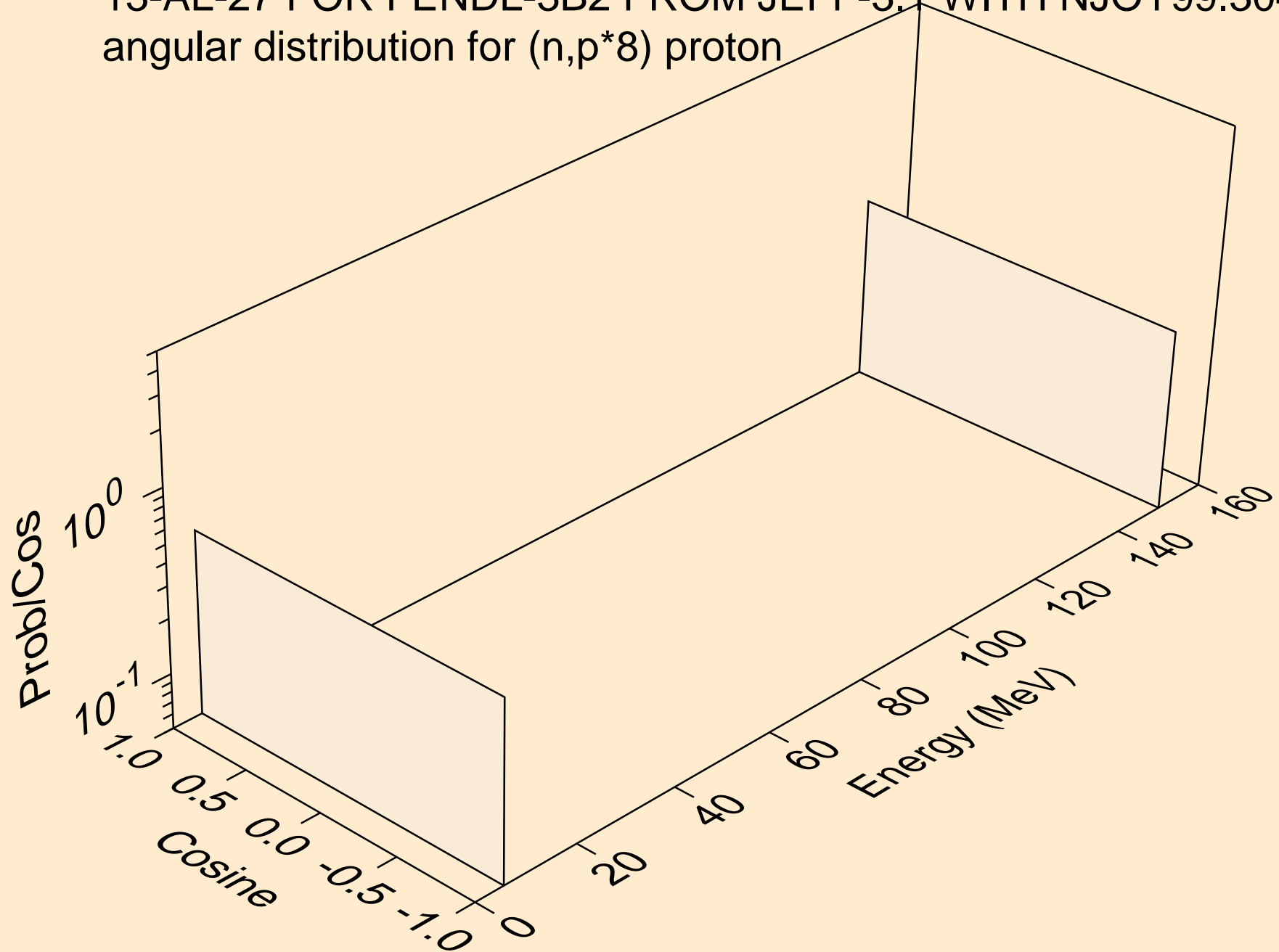

13-AL-27 FOR FENDL-3B2 FROM JEFF-3.1 WITH NJOY99.304+ C  
angular distribution for (n,p\*9) proton

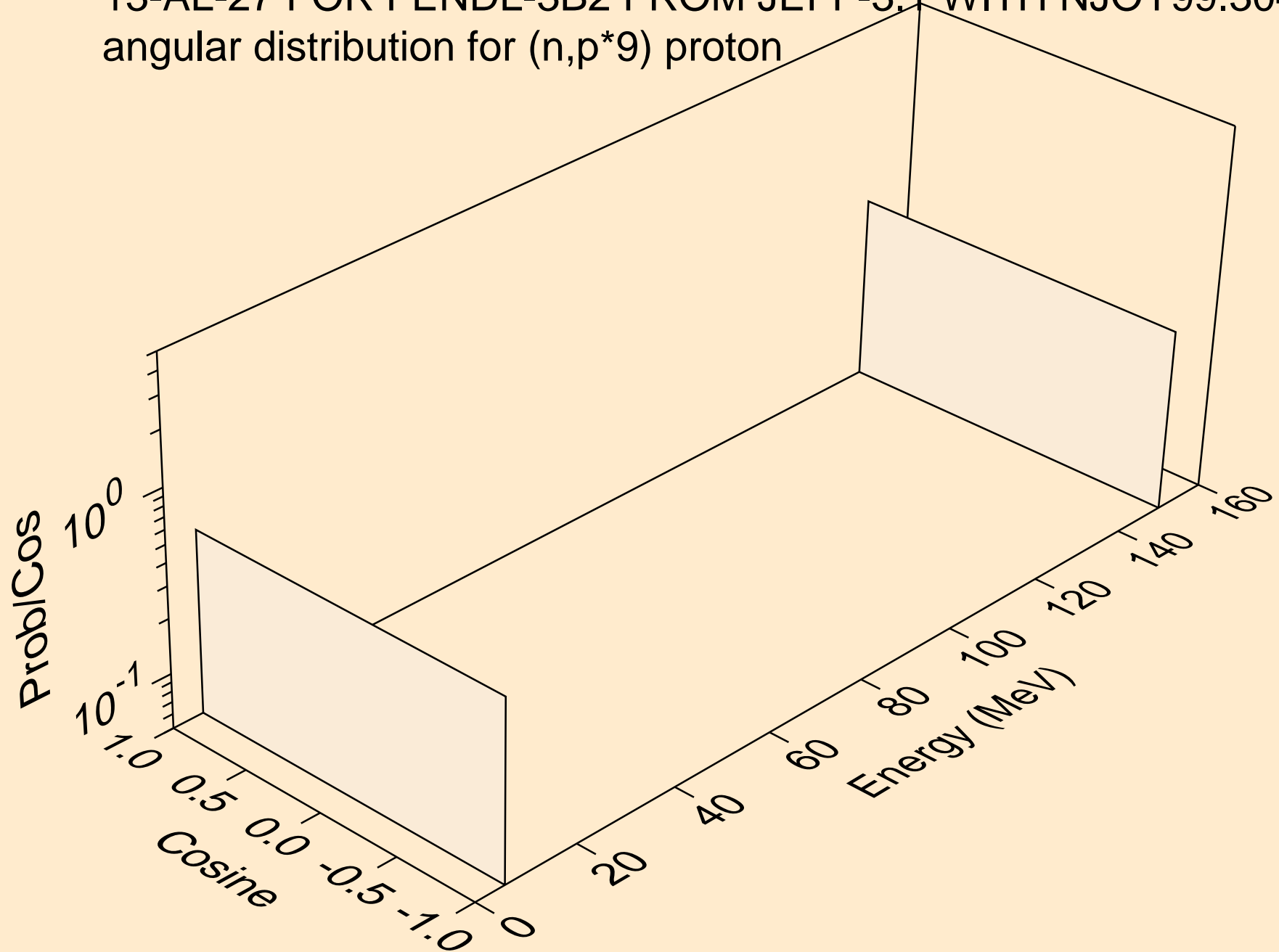

13-AL-27 FOR FENDL-3B2 FROM JEFF-3.1 WITH NJOY99.304+ C  
angular distribution for (n,p\*10) proton

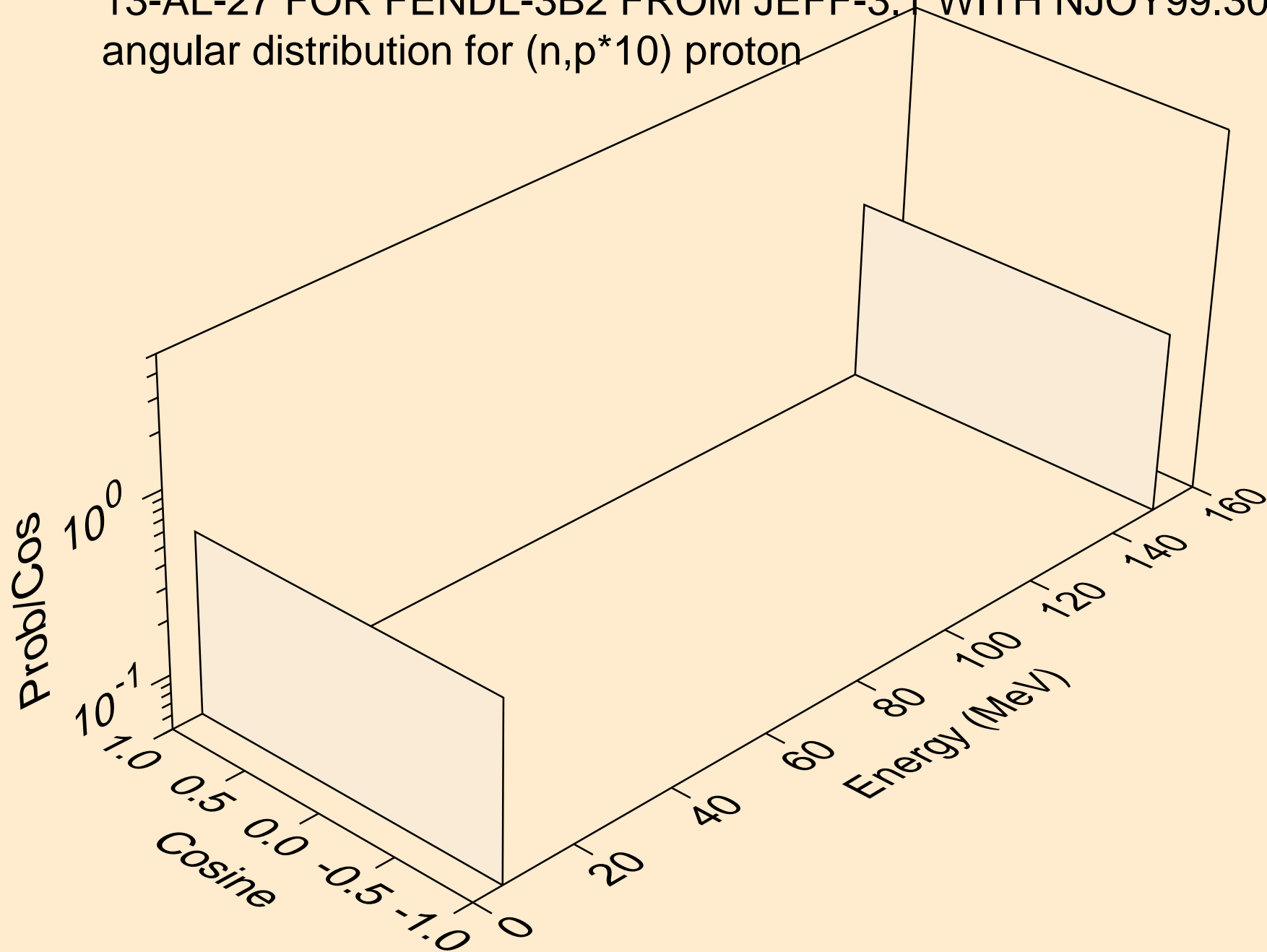

13-AL-27 FOR FENDL-3B2 FROM JEFF-3.1 WITH NJOY99.304+ C  
angular distribution for (n,p\*11) proton

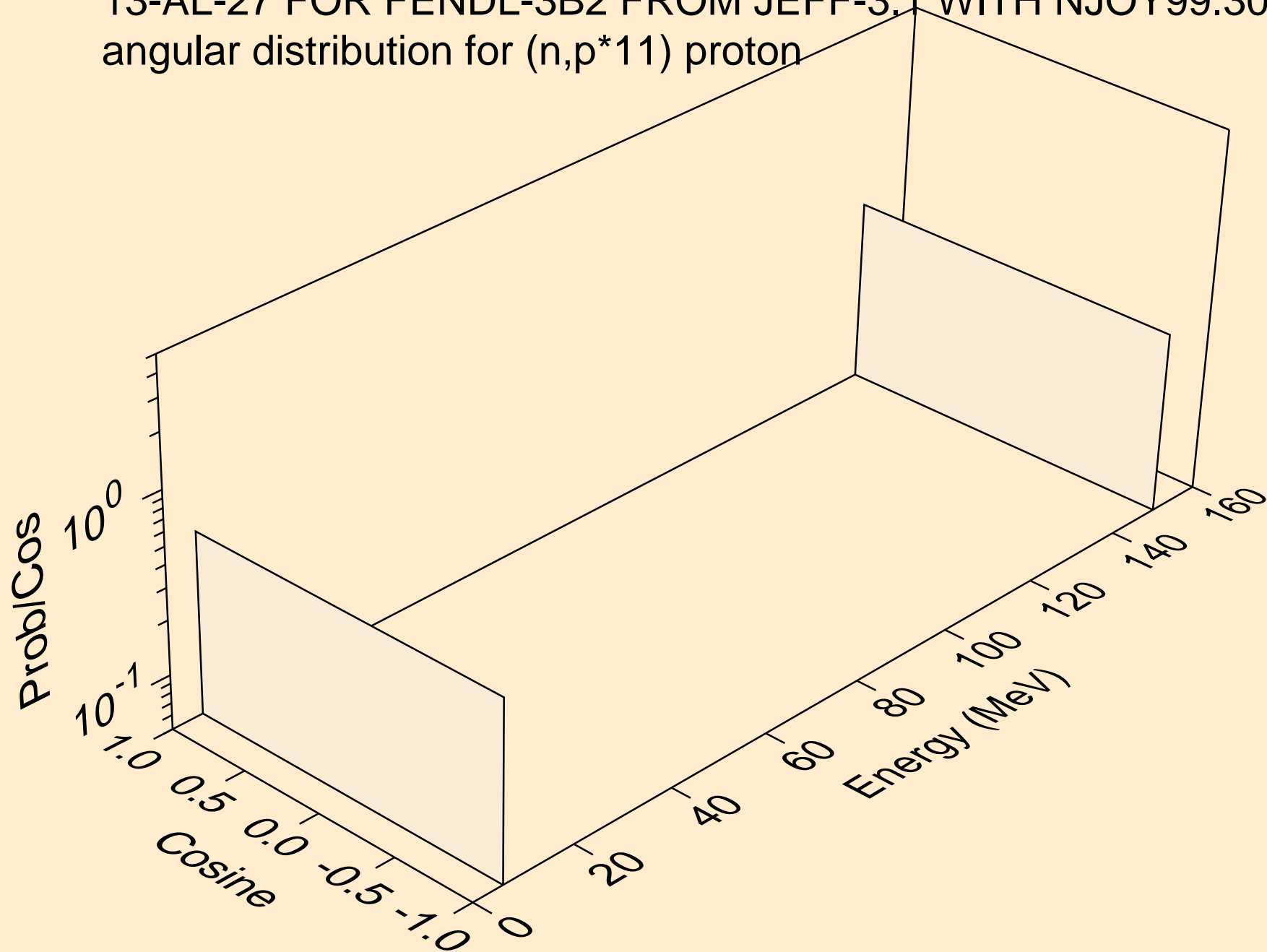

13-AL-27 FOR FENDL-3B2 FROM JEFF-3.1 WITH NJOY99.304+ C  
angular distribution for (n,p\*12) proton

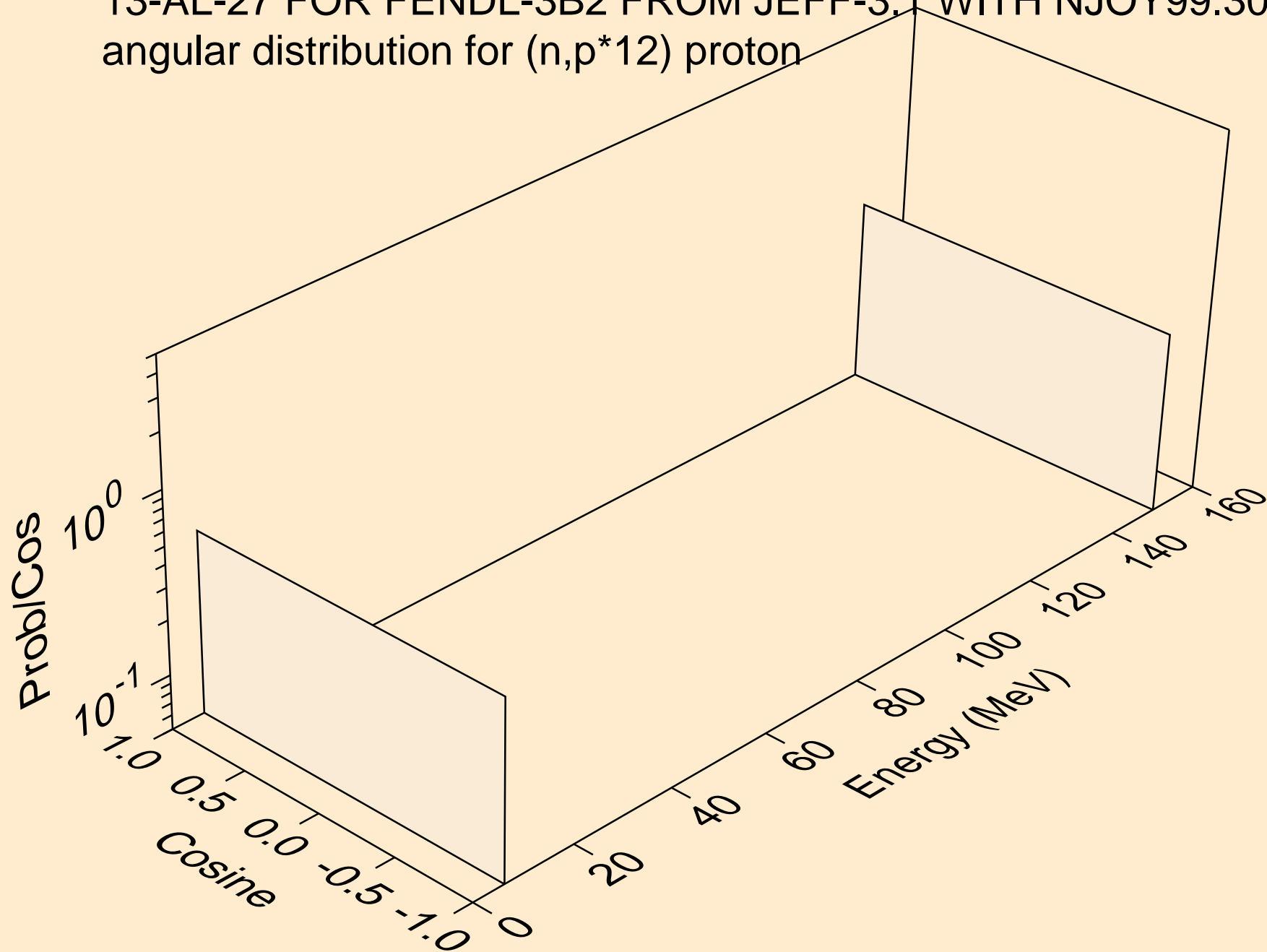

13-AL-27 FOR FENDL-3B2 FROM JEFF-3.1 WITH NJOY99.304+ C  
angular distribution for (n,p\*13) proton

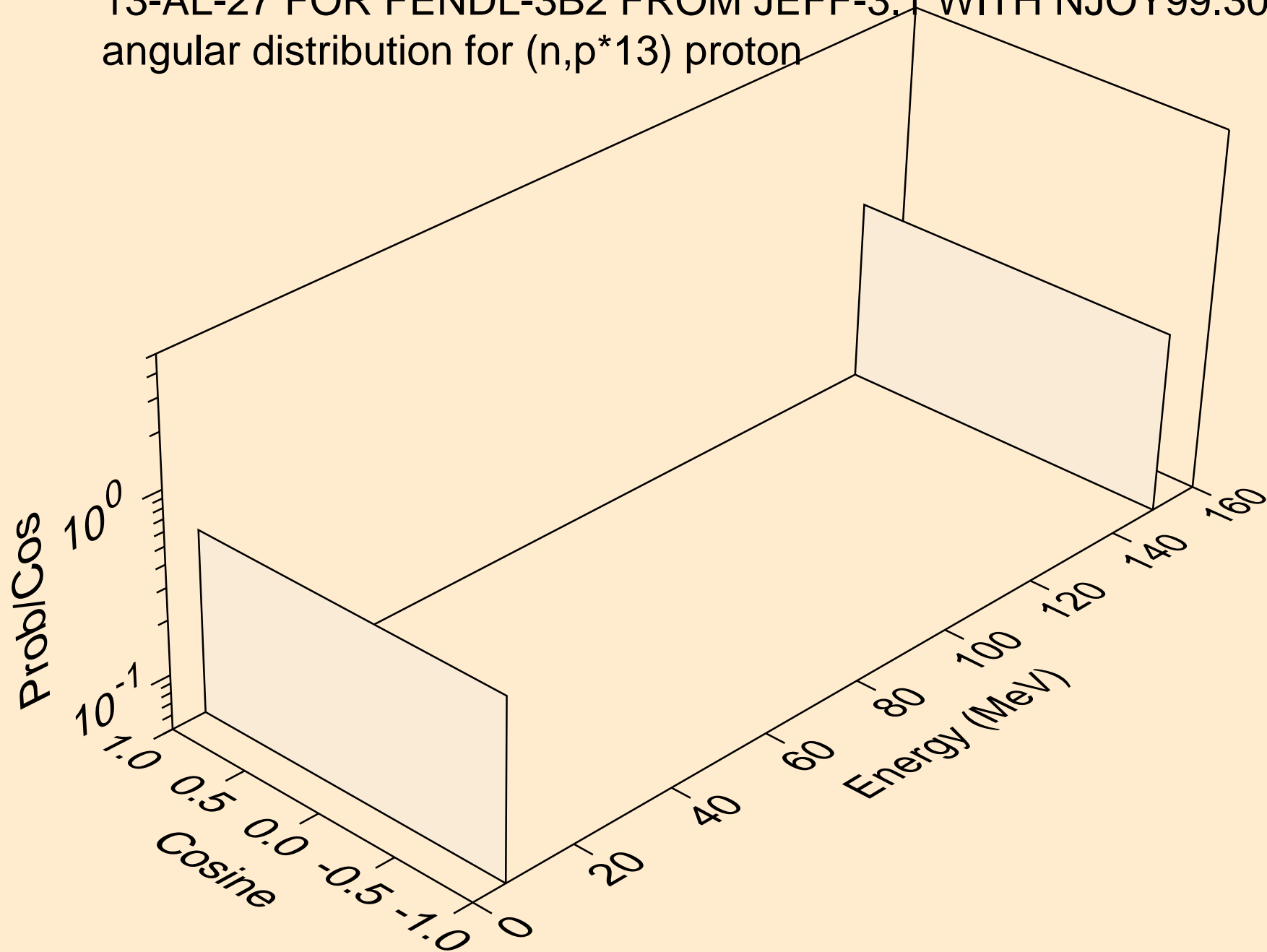

13-AL-27 FOR FENDL-3B2 FROM JEFF-3.1 WITH NJOY99.304+ C  
angular distribution for (n,p\*14) proton

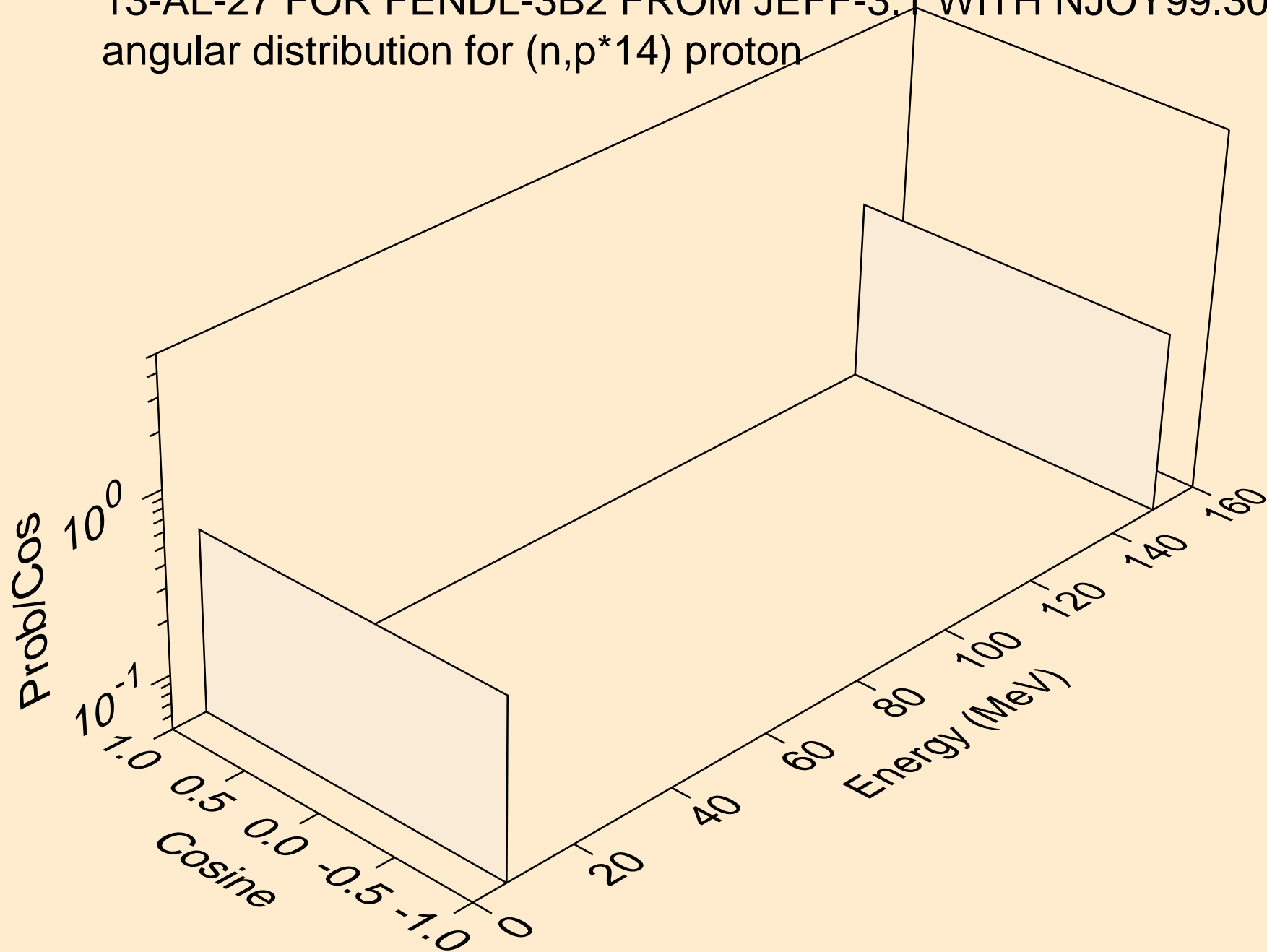

13-AL-27 FOR FENDL-3B2 FROM JEFF-3.1 WITH NJOY99.304+ C  
angular distribution for (n,p\*15) proton

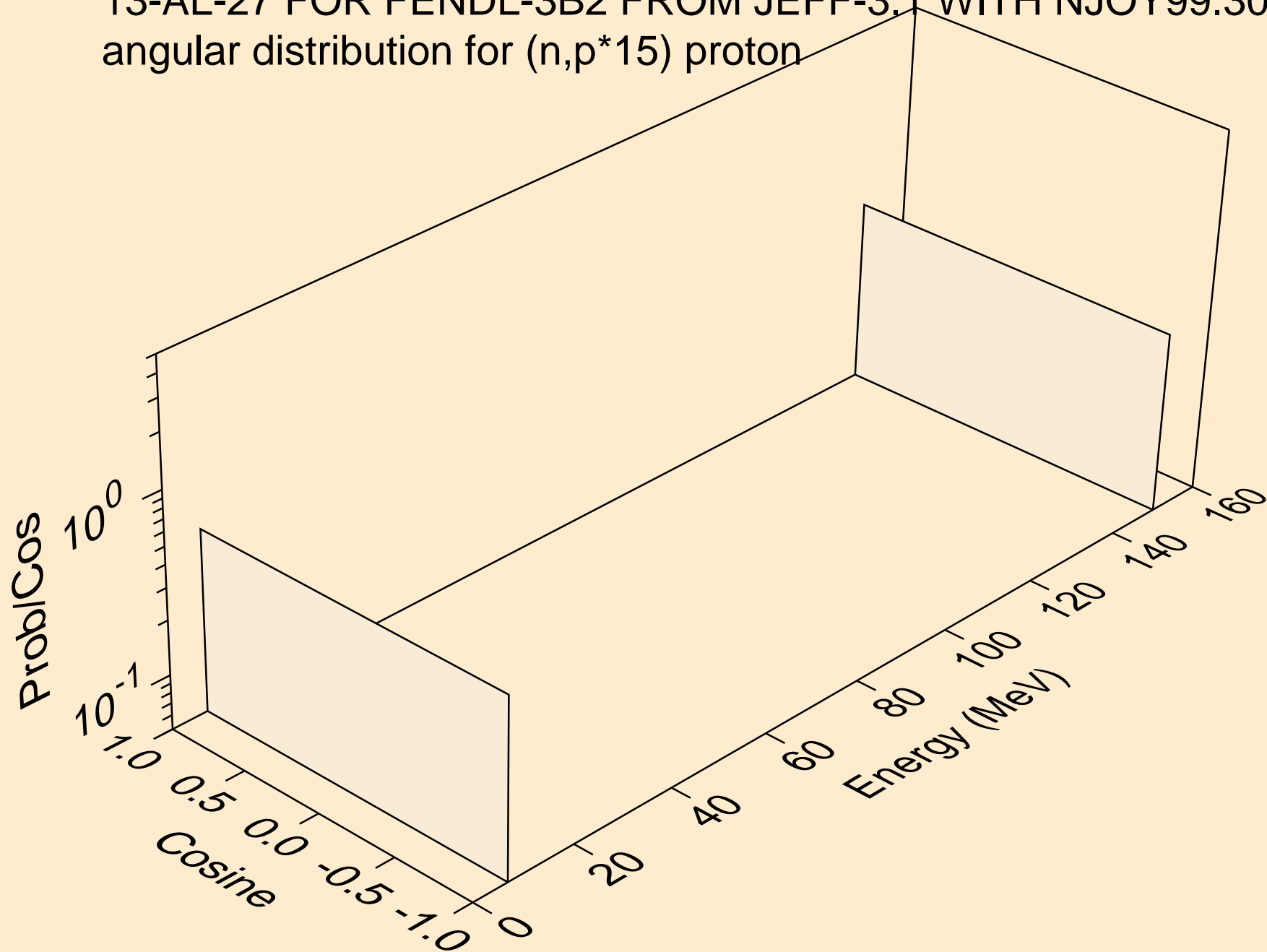



13-AL-27 FOR FENDL-3B2 FROM JEFF-3.1 WITH NJOY99.304+ C  
angular distribution for (n,p\*16) proton

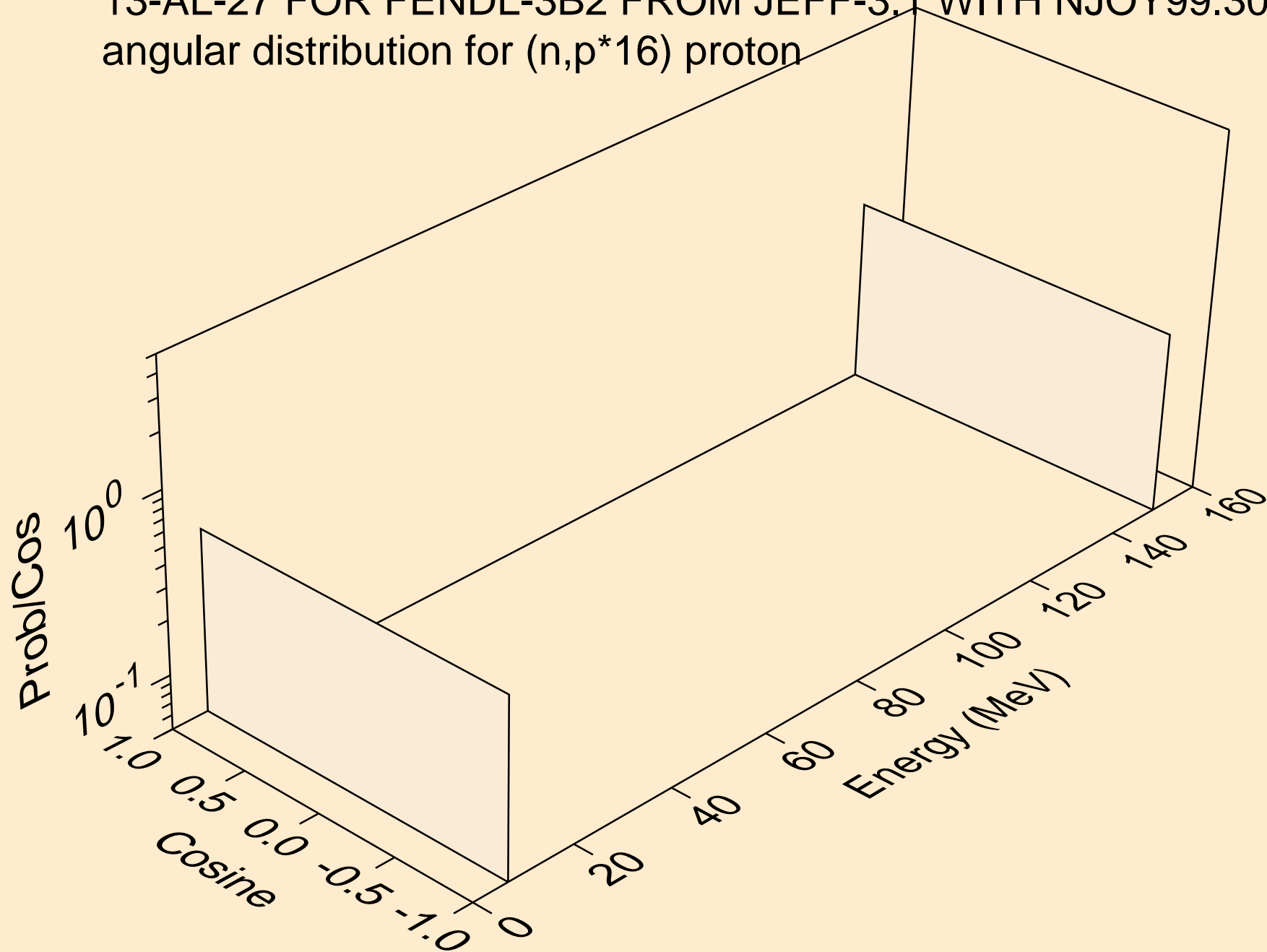

13-AL-27 FOR FENDL-3B2 FROM JEFF-3.1 WITH NJOY99.304+ C  
angular distribution for (n,p\*17) proton

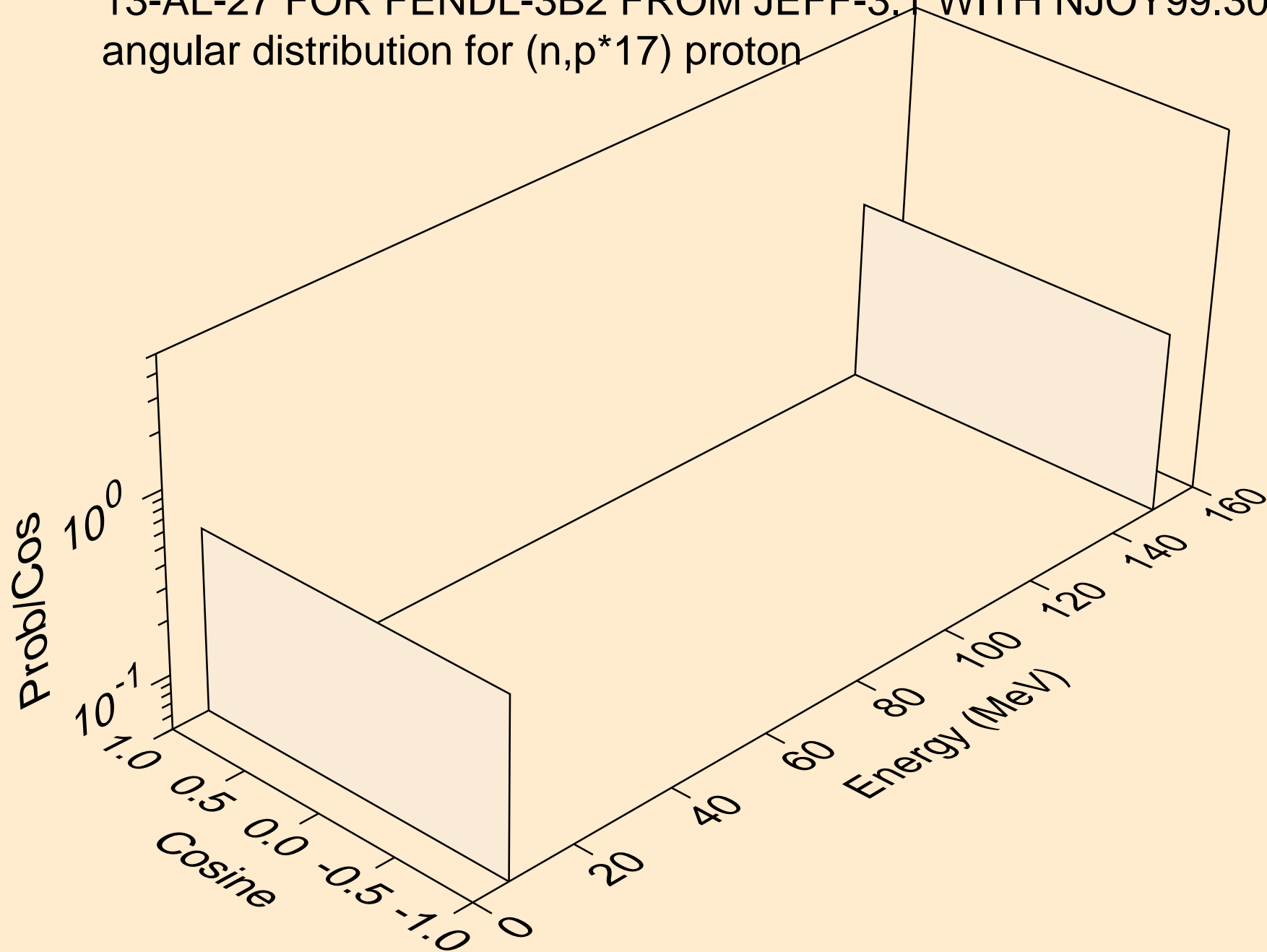

13-AL-27 FOR FENDL-3B2 FROM JEFF-3.1 WITH NJOY99.304+ C  
angular distribution for (n,p\*18) proton

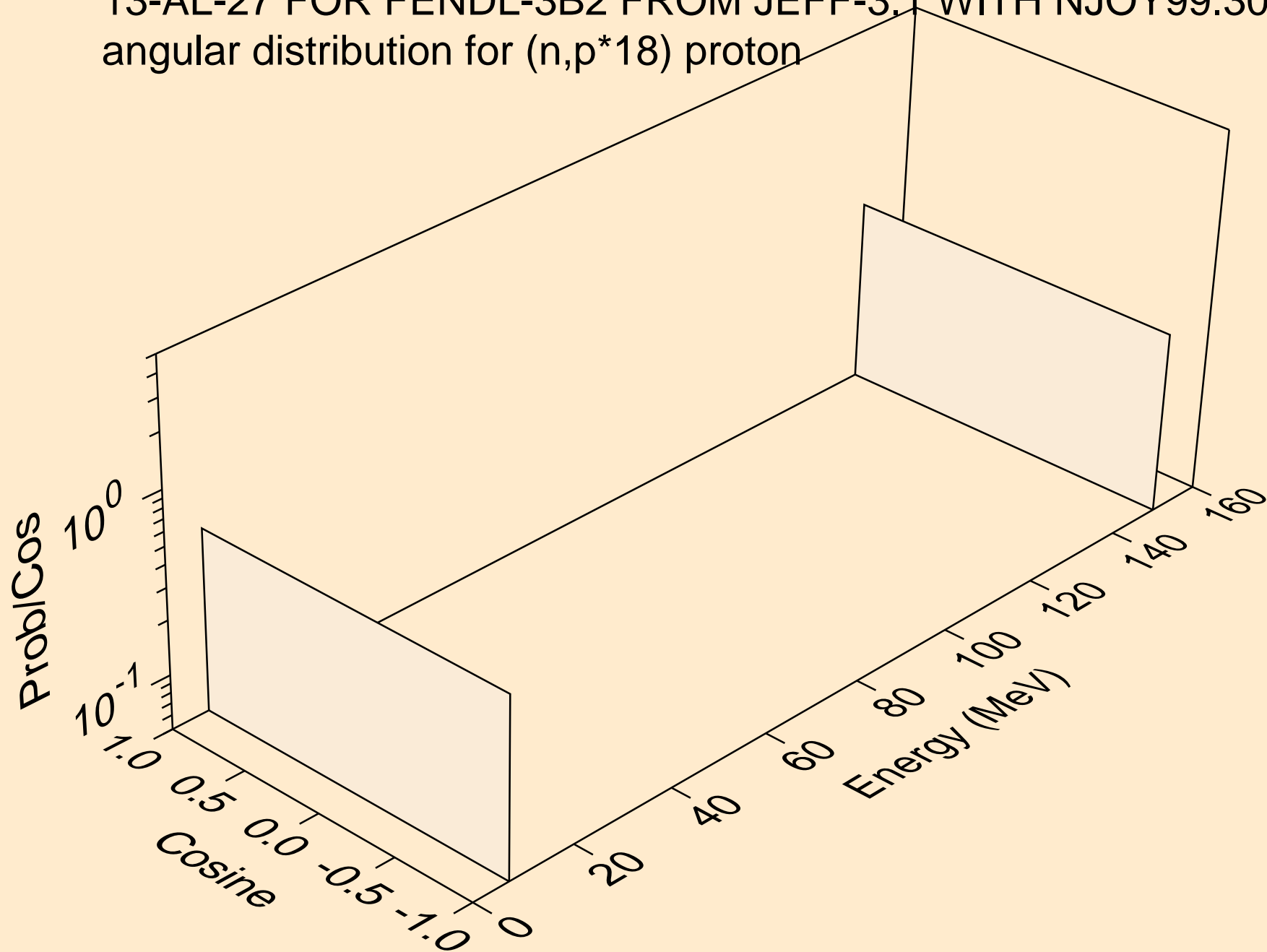

13-AL-27 FOR FENDL-3B2 FROM JEFF-3.1 WITH NJOY99.304+ C  
angular distribution for (n,p\*19) proton

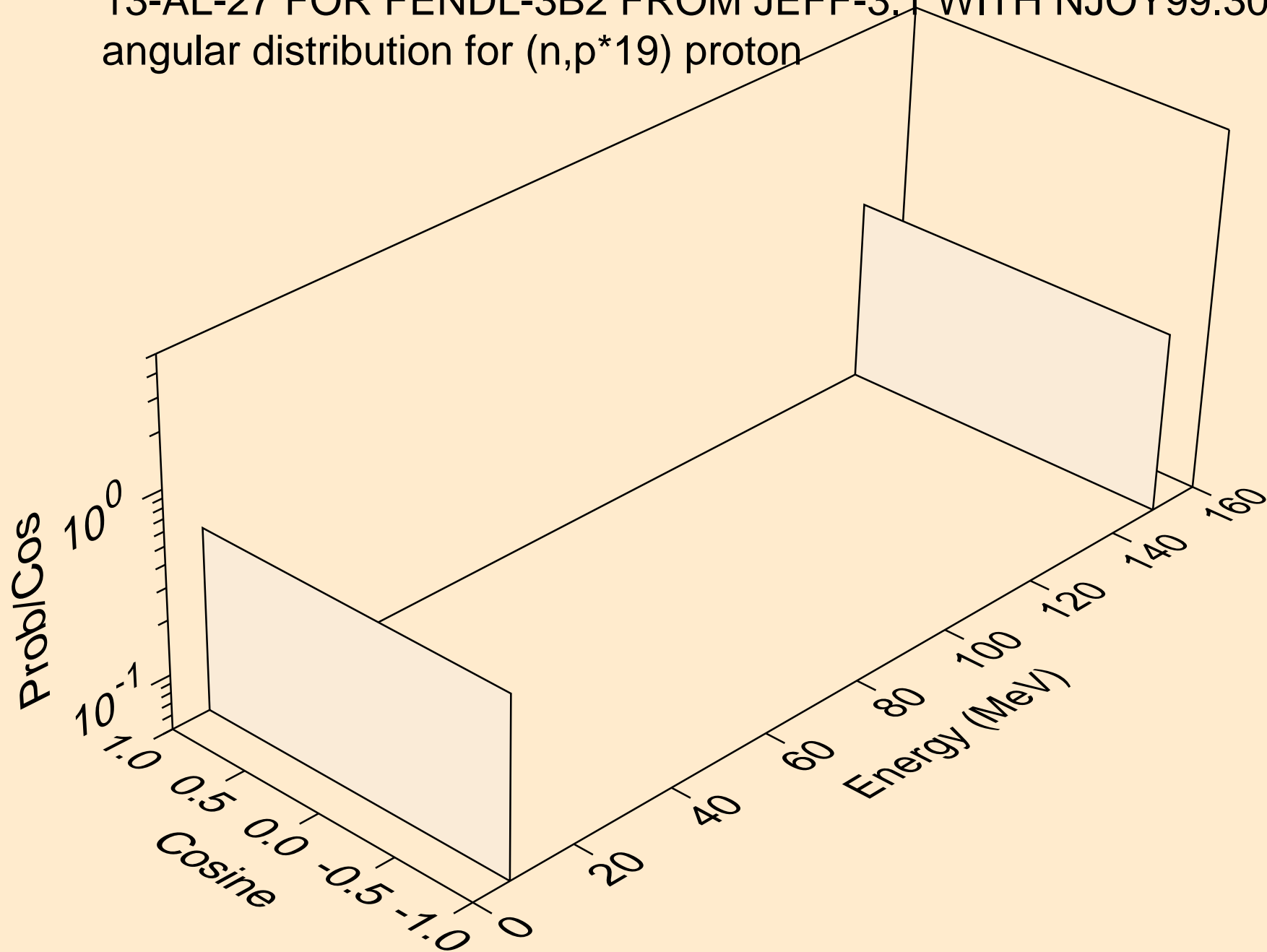

13-AL-27 FOR FENDL-3B2 FROM JEFF-3.1 WITH NJOY99.304+ C  
protons from (n,p\*c)

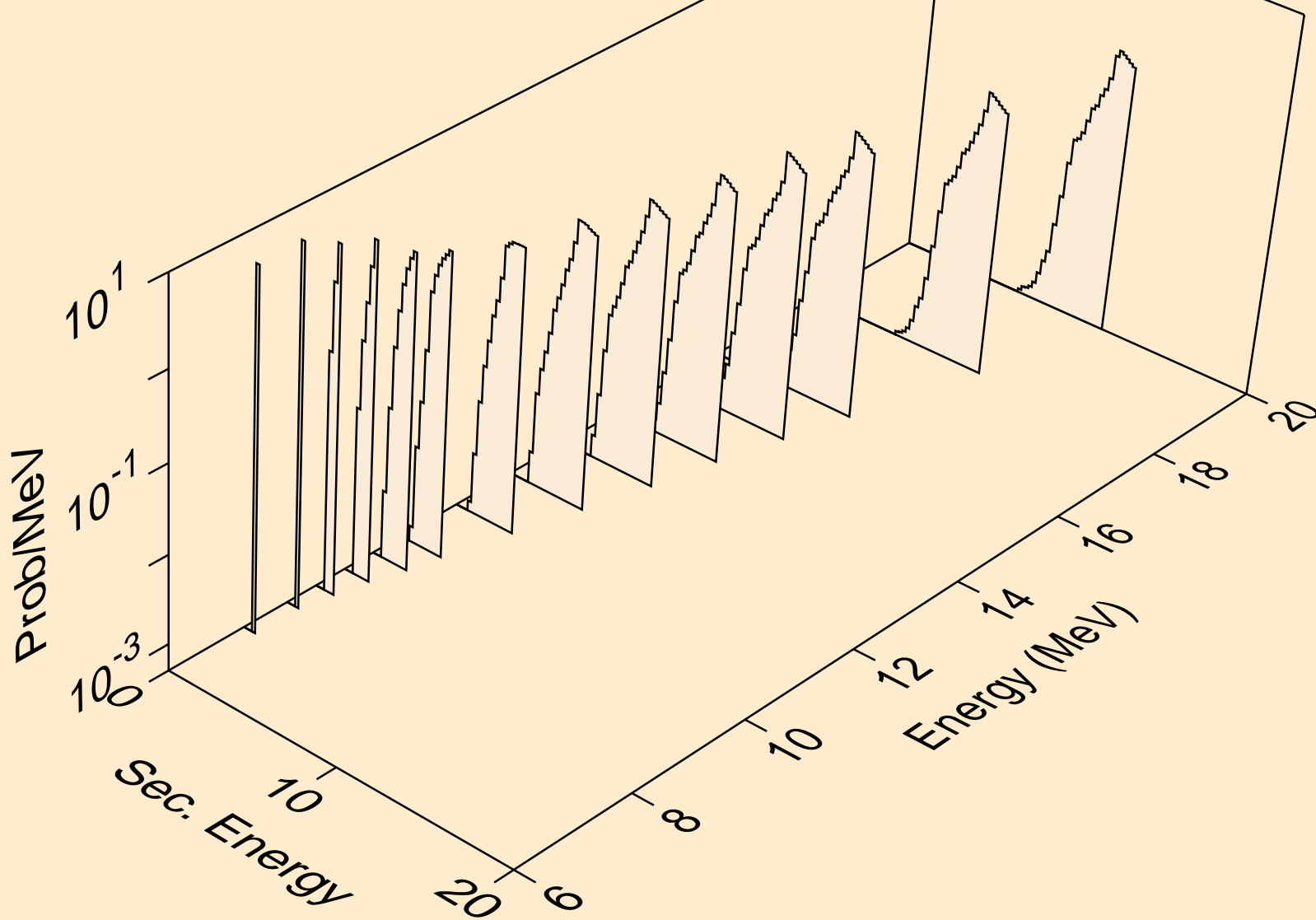

13-AL-27 FOR FENDL-3B2 FROM JEFF-3.1 WITH NJOY99.304+ C  
deuterons from (n,x)

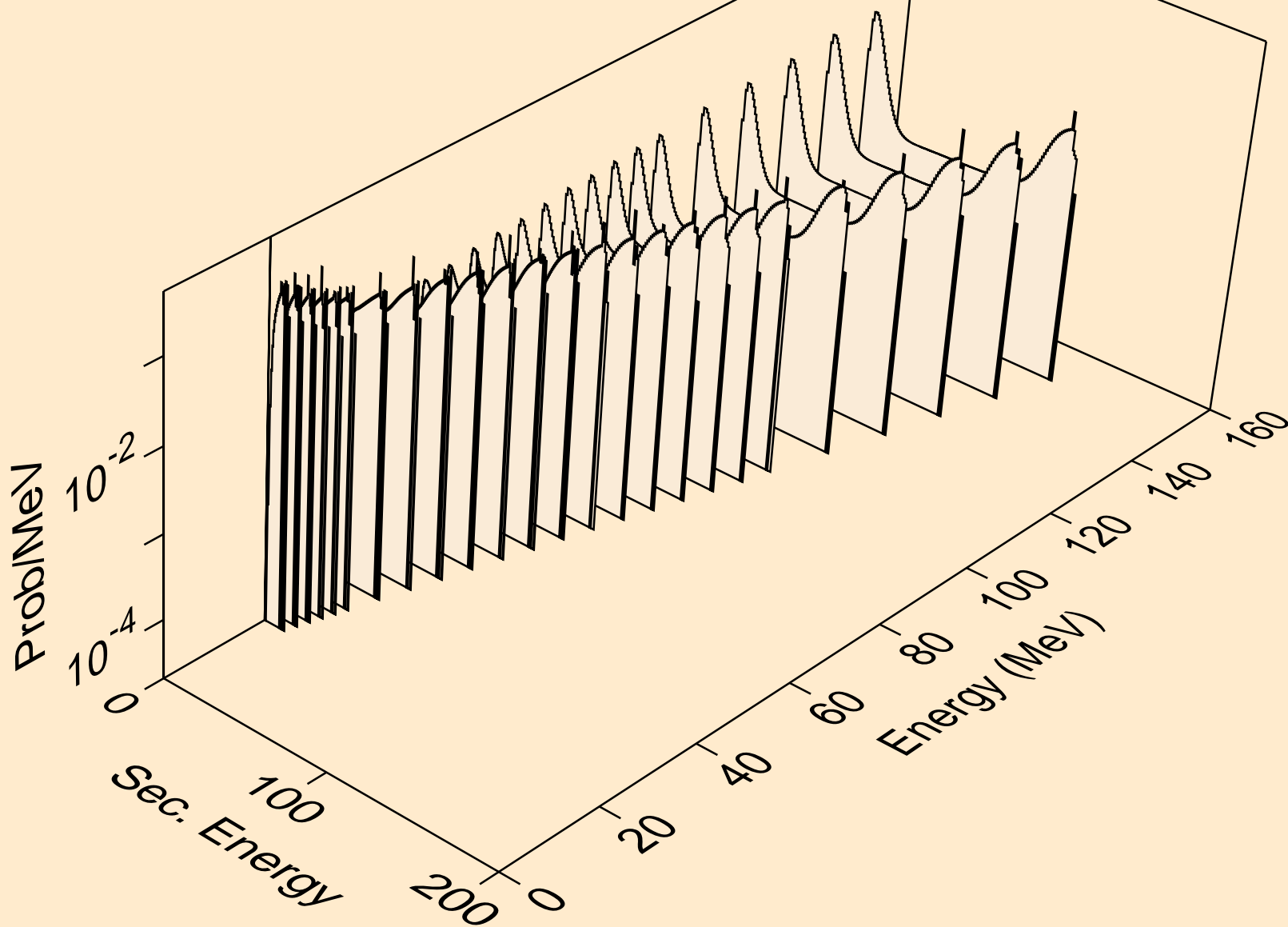

13-AL-27 FOR FENDL-3B2 FROM JEFF-3.1 WITH NJOY99.304+ C  
deuterons from (n,n\*)d

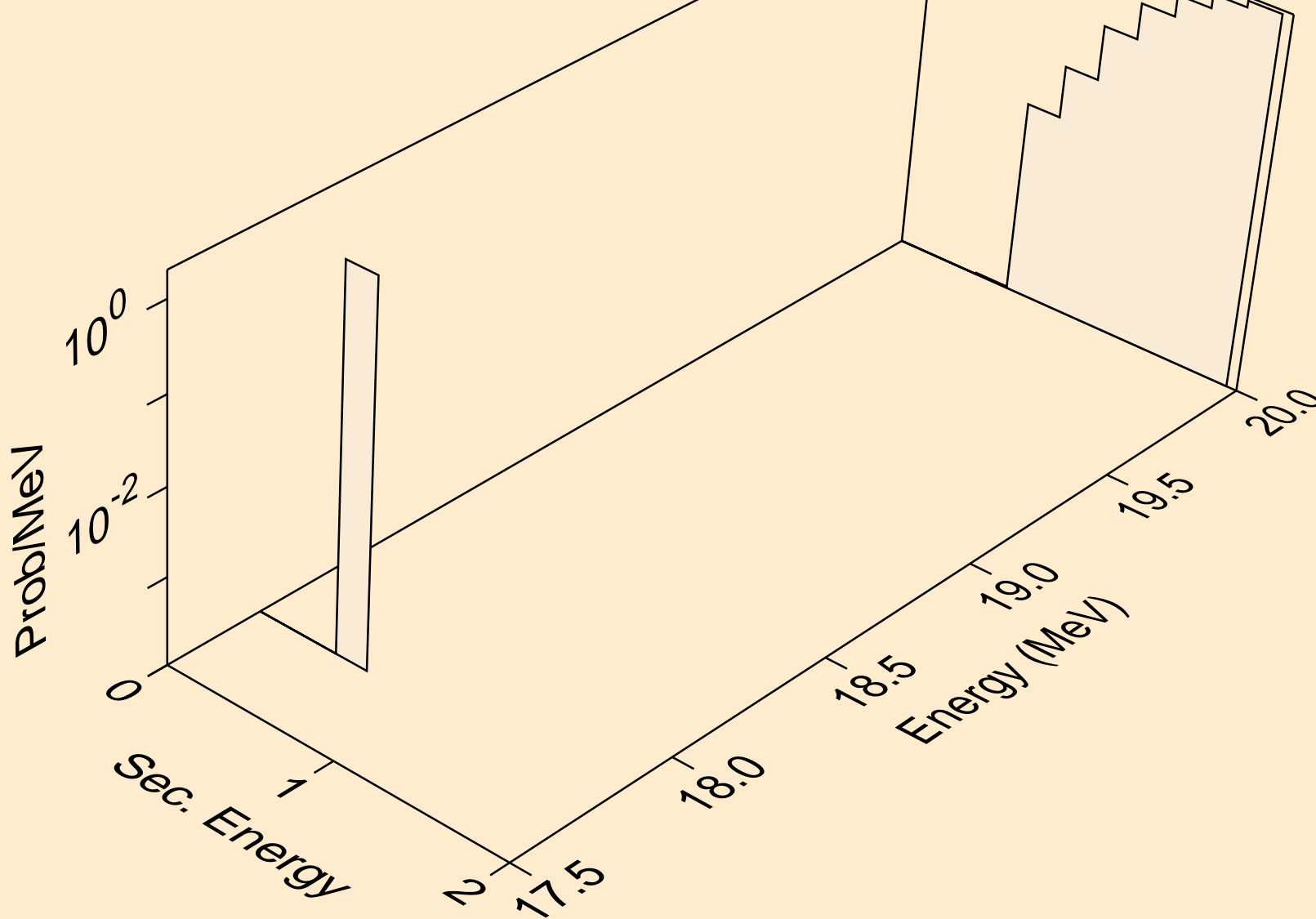

13-AL-27 FOR FENDL-3B2 FROM JEFF-3.1 WITH NJOY99.304+ C  
deuterons from (n,da)

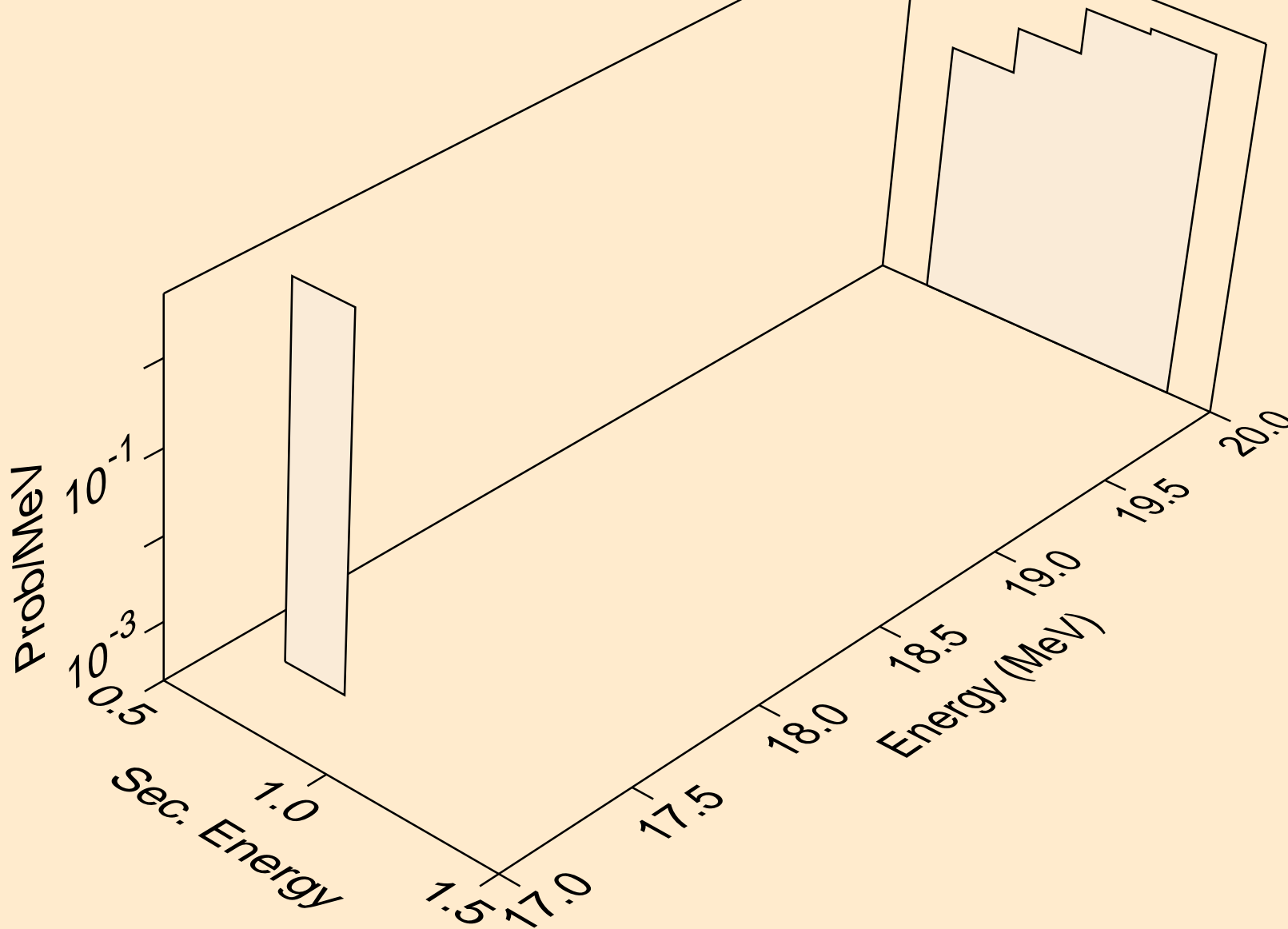



13-AL-27 FOR FENDL-3B2 FROM JEFF-3.1 WITH NJOY99.304+ C  
angular distribution for (n,d\*0) deuteron

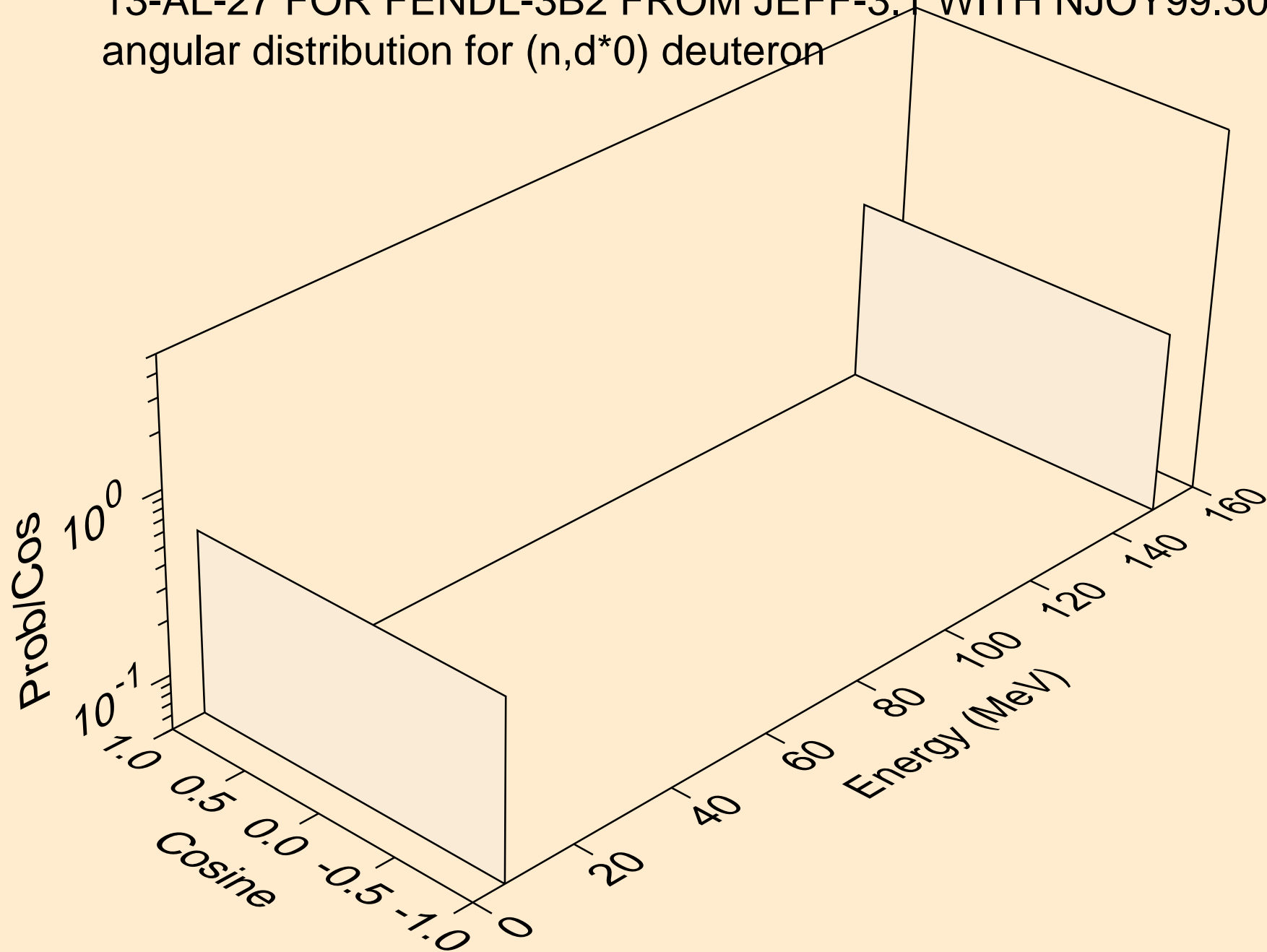

13-AL-27 FOR FENDL-3B2 FROM JEFF-3.1 WITH NJOY99.304+ C  
angular distribution for (n,d\*1) deuteron

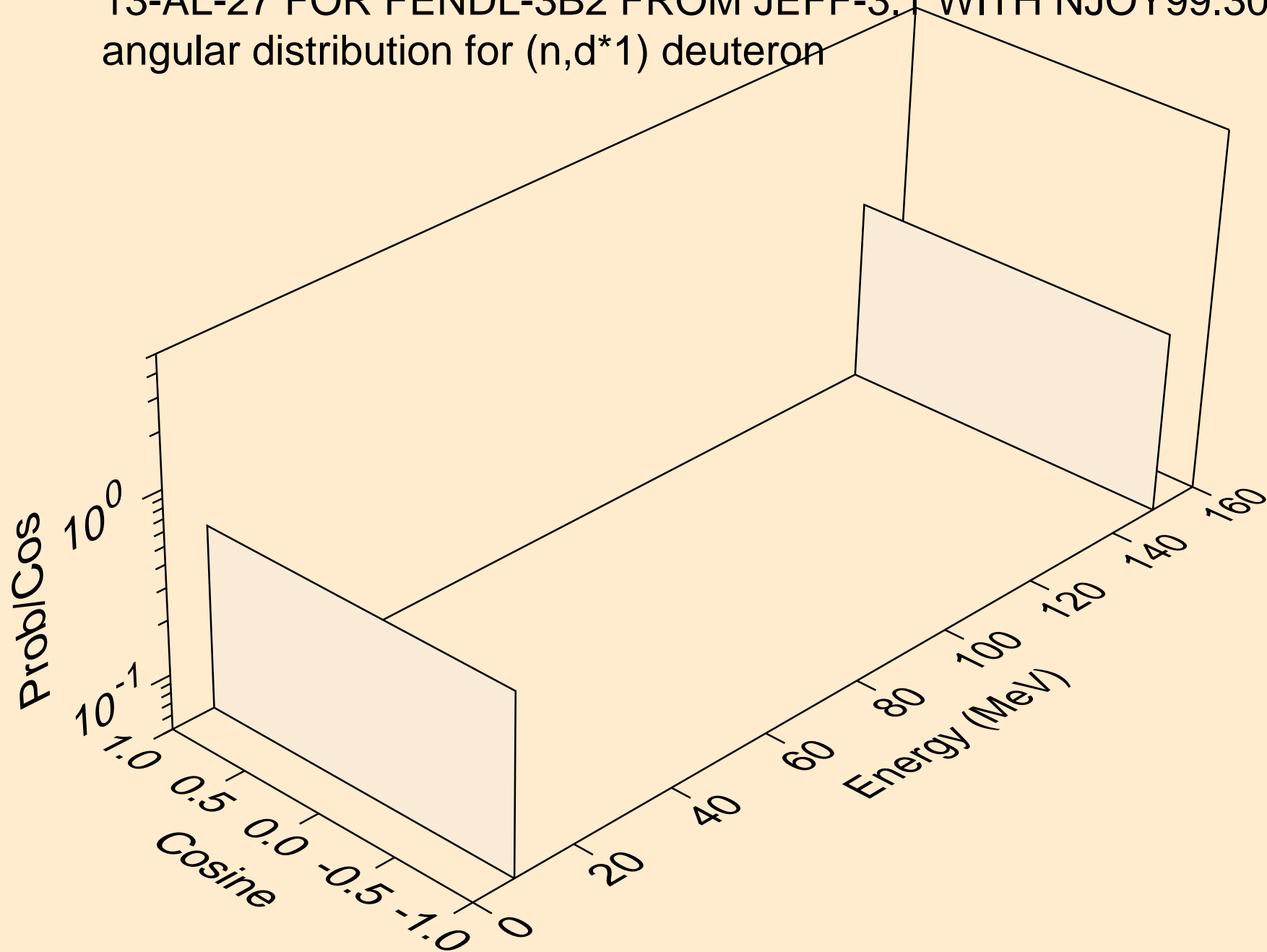

13-AL-27 FOR FENDL-3B2 FROM JEFF-3.1 WITH NJOY99.304+ C  
angular distribution for (n,d\*2) deuteron

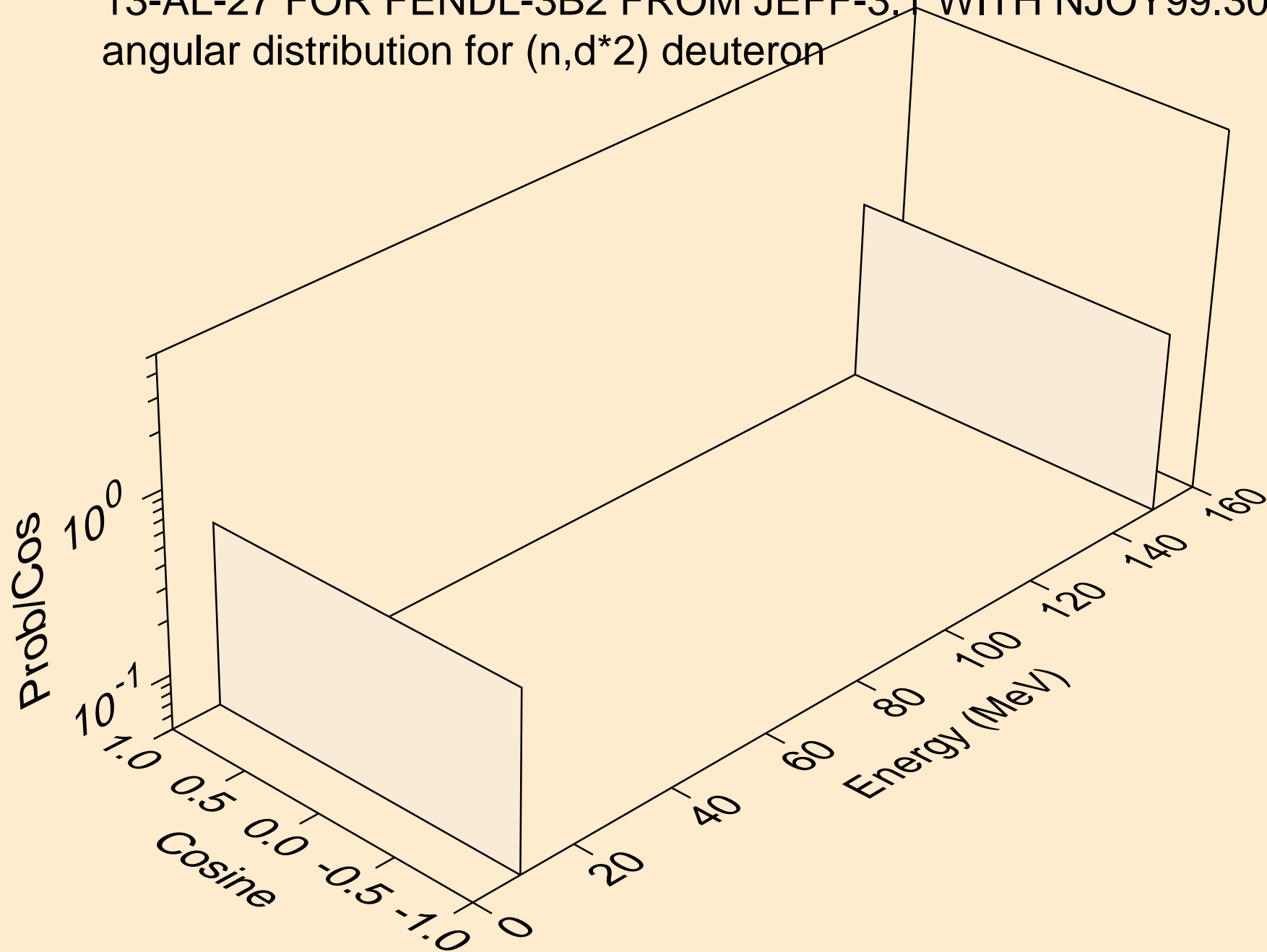

13-AL-27 FOR FENDL-3B2 FROM JEFF-3.1 WITH NJOY99.304+ C  
angular distribution for (n,d\*3) deuteron

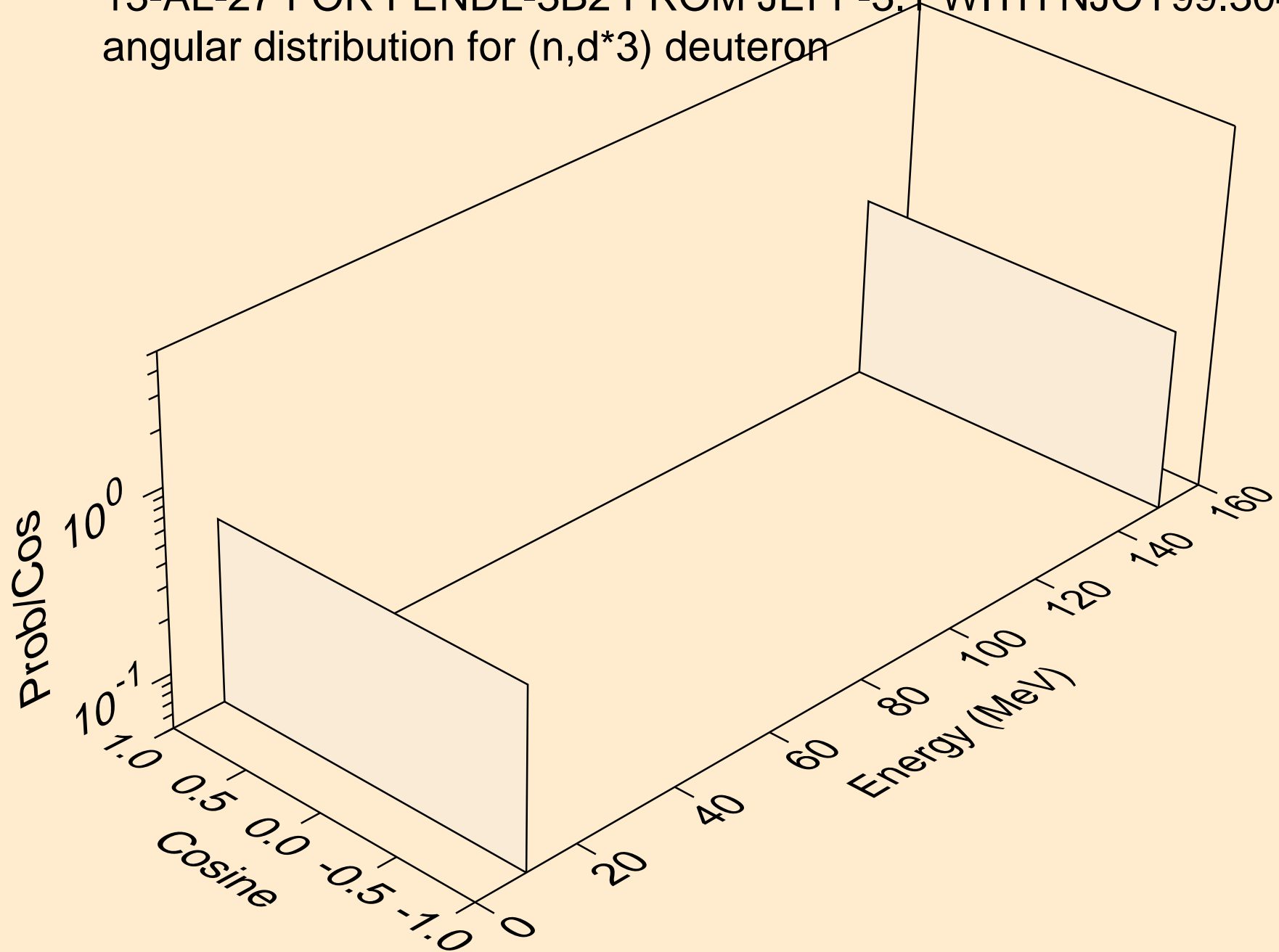

13-AL-27 FOR FENDL-3B2 FROM JEFF-3.1 WITH NJOY99.304+ C  
angular distribution for (n,d\*4) deuteron

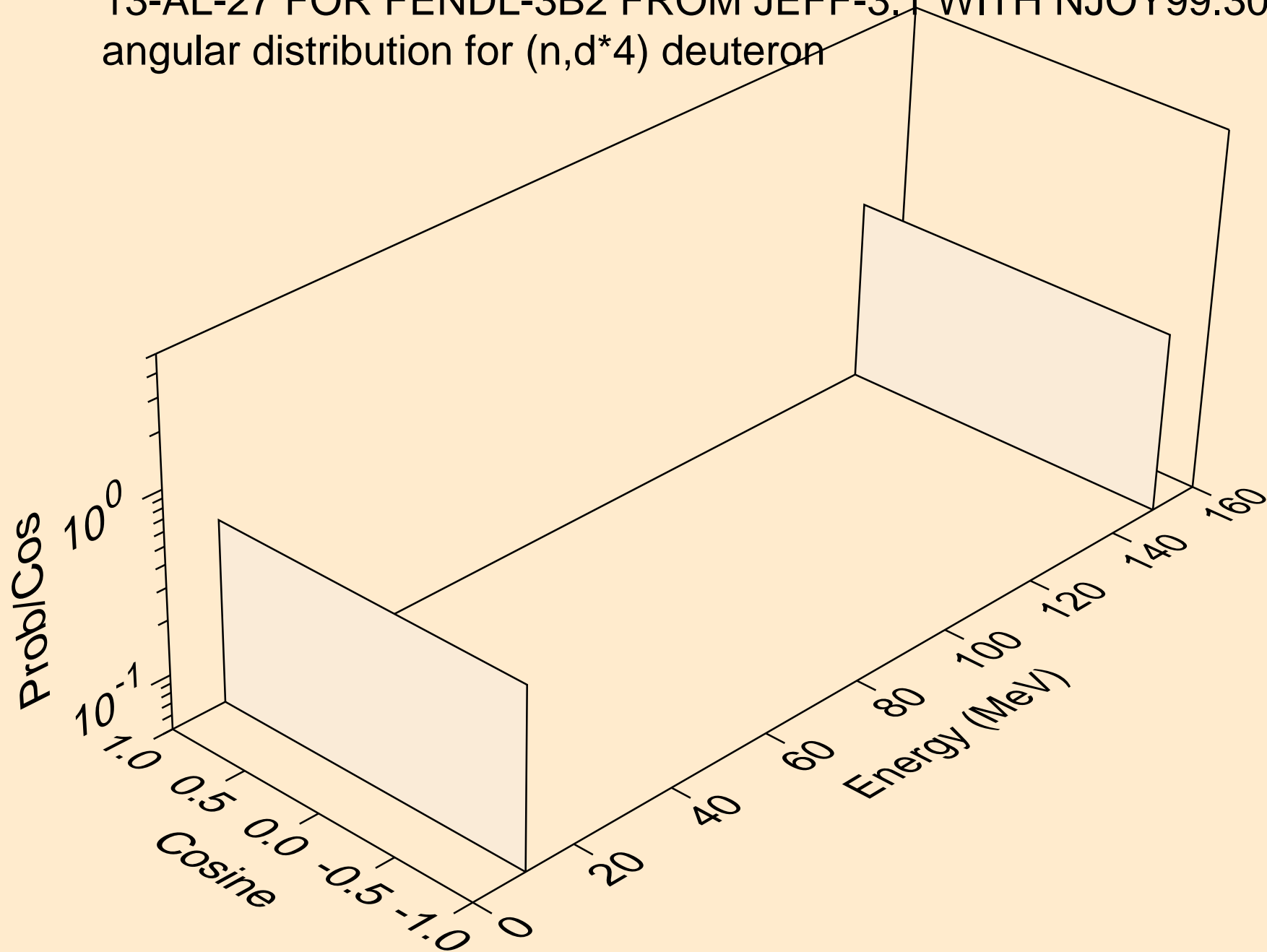

13-AL-27 FOR FENDL-3B2 FROM JEFF-3.1 WITH NJOY99.304+ C  
angular distribution for (n,d\*5) deuteron

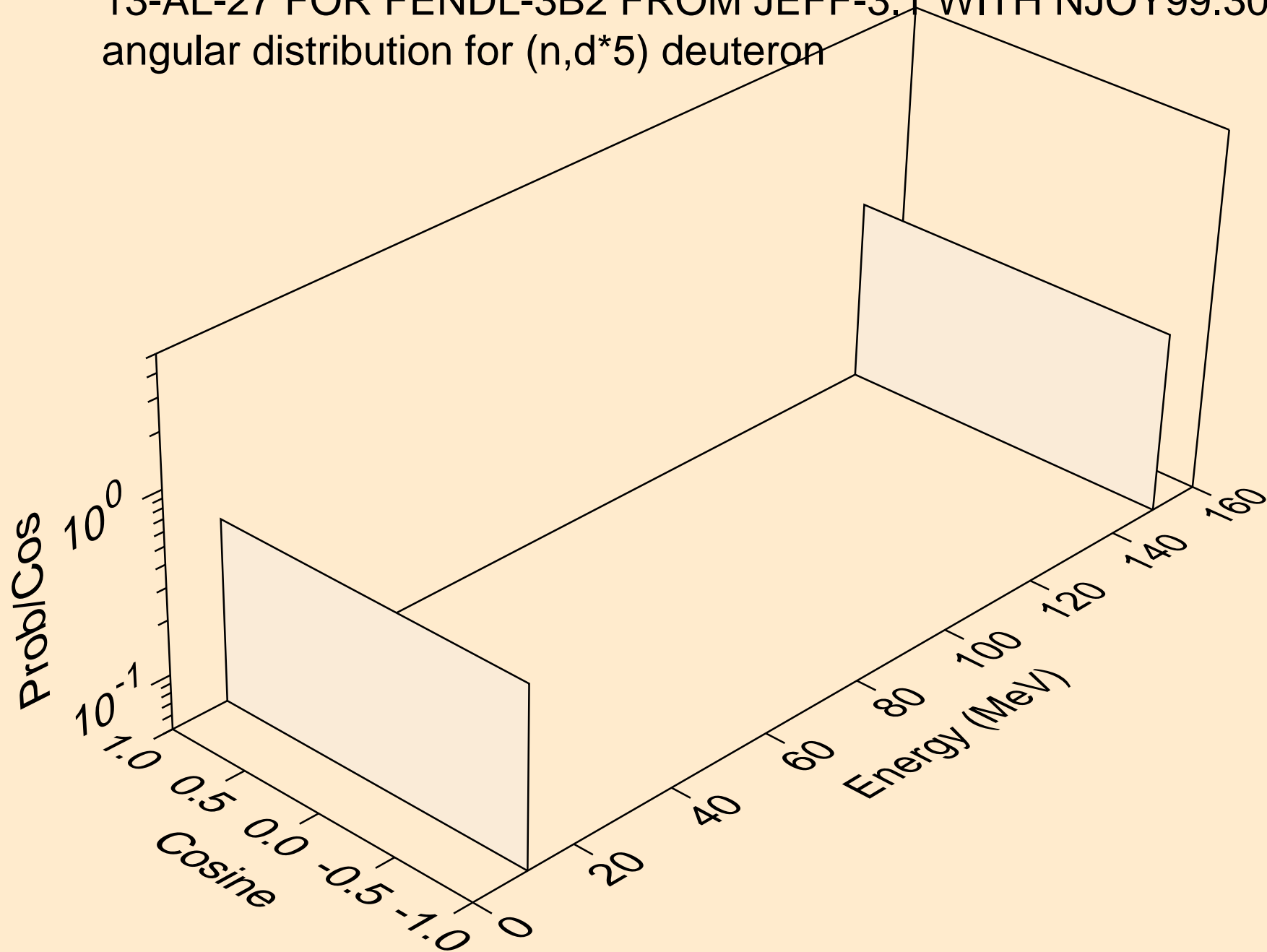

13-AL-27 FOR FENDL-3B2 FROM JEFF-3.1 WITH NJOY99.304+ C  
angular distribution for (n,d\*6) deuteron

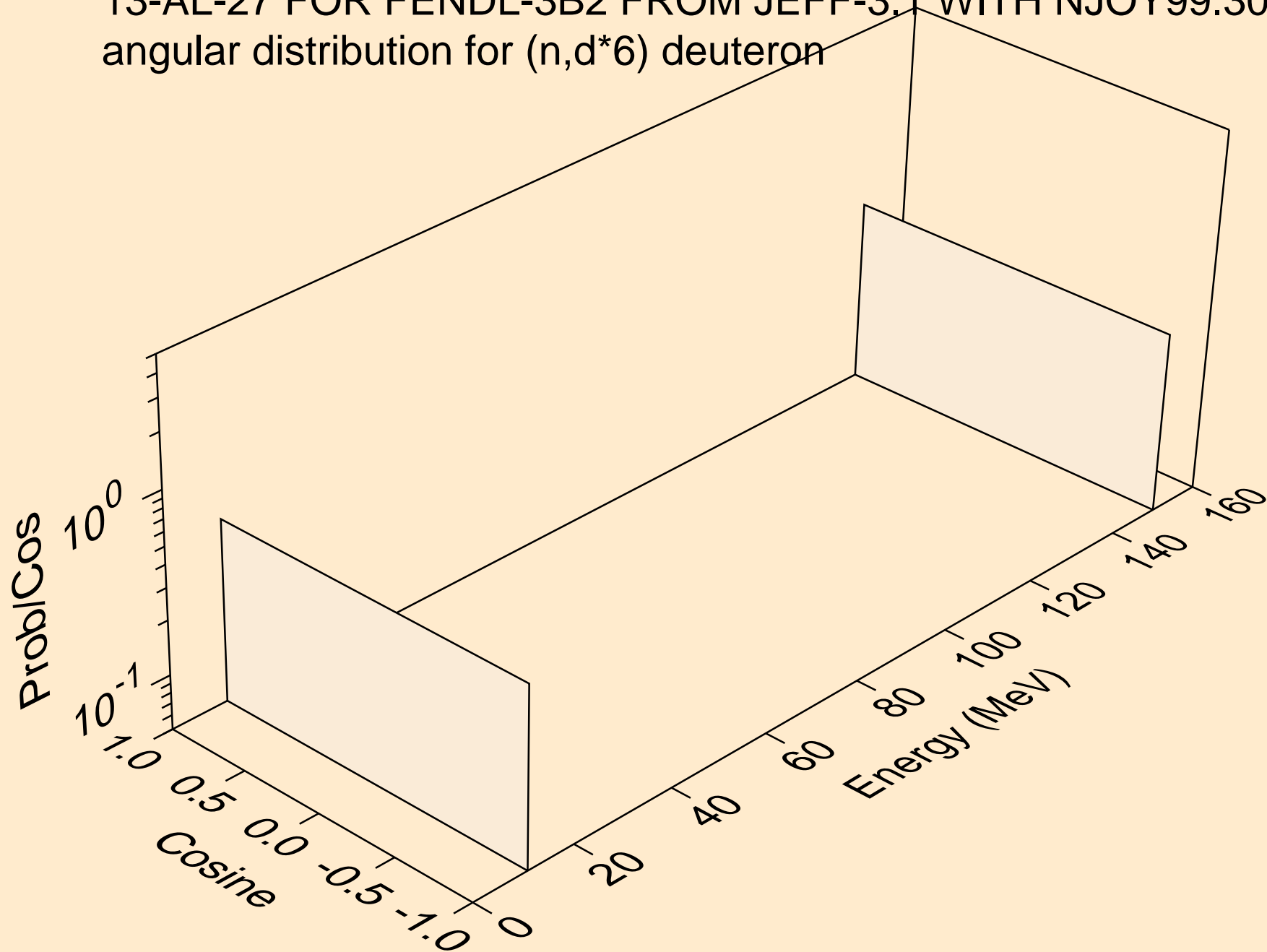

13-AL-27 FOR FENDL-3B2 FROM JEFF-3.1 WITH NJOY99.304+ C  
angular distribution for (n,d\*7) deuteron

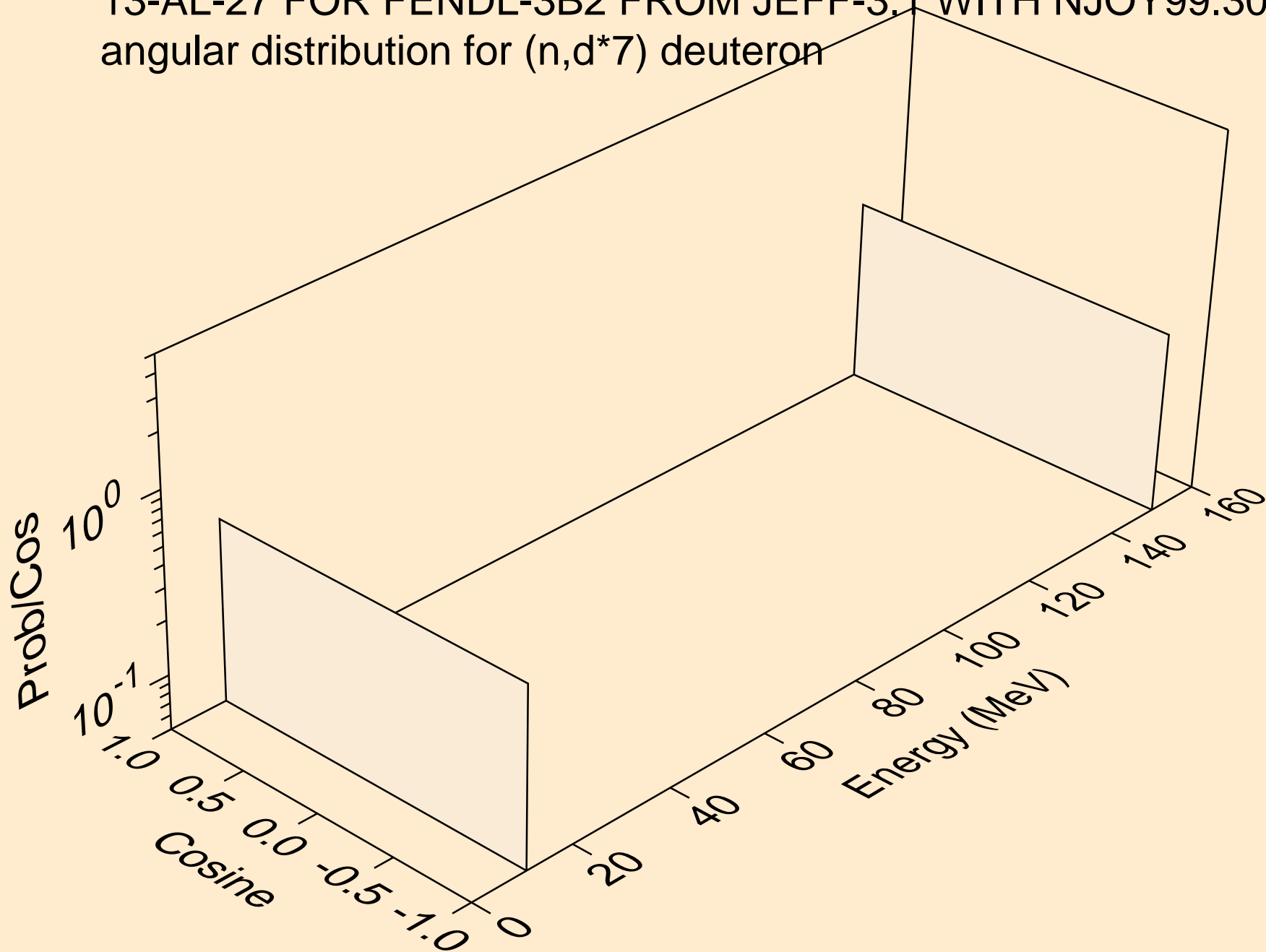



13-AL-27 FOR FENDL-3B2 FROM JEFF-3.1 WITH NJOY99.304+ C  
angular distribution for (n,d\*8) deuteron

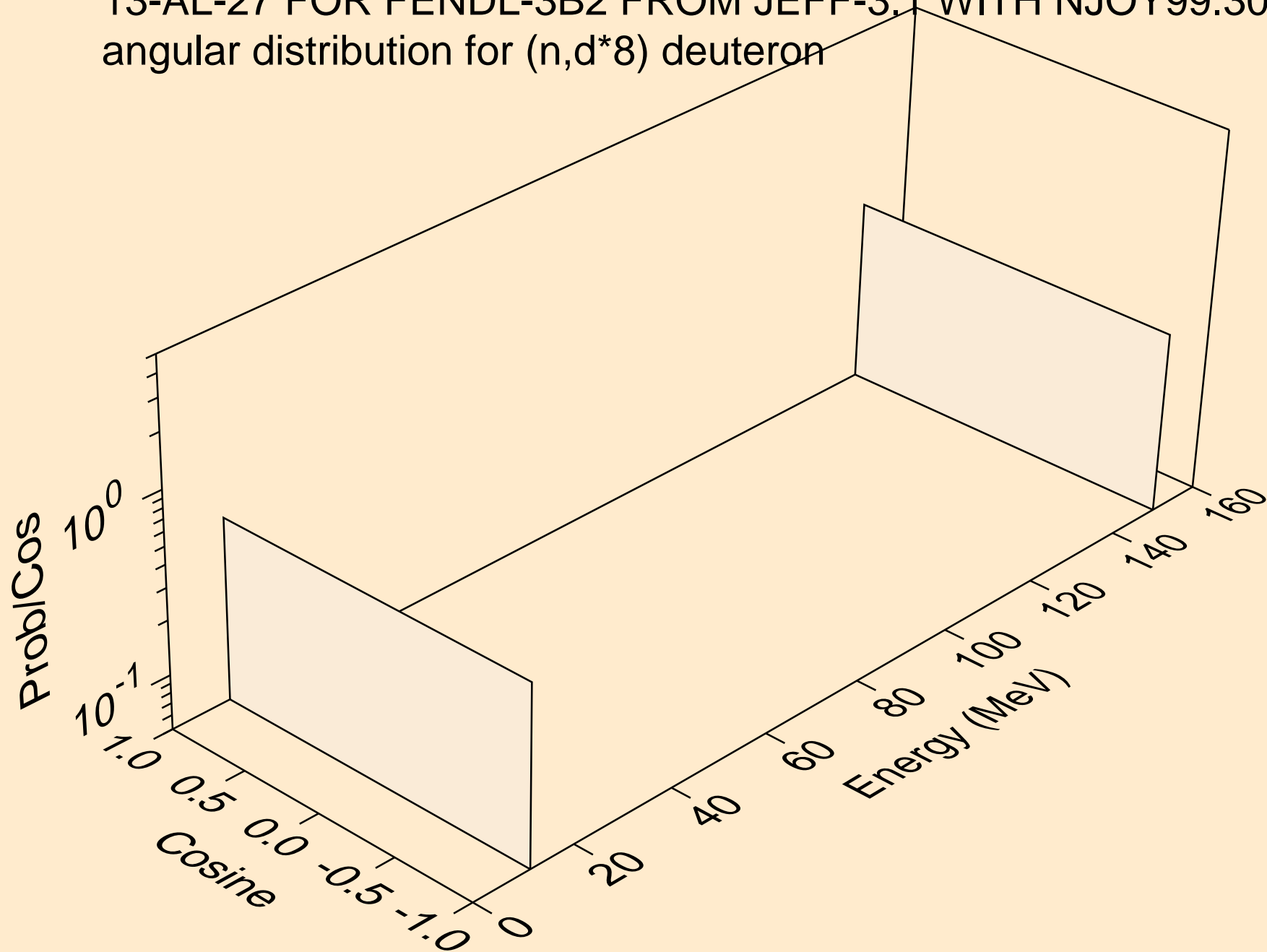

13-AL-27 FOR FENDL-3B2 FROM JEFF-3.1 WITH NJOY99.304+ C  
angular distribution for (n,d\*9) deuteron

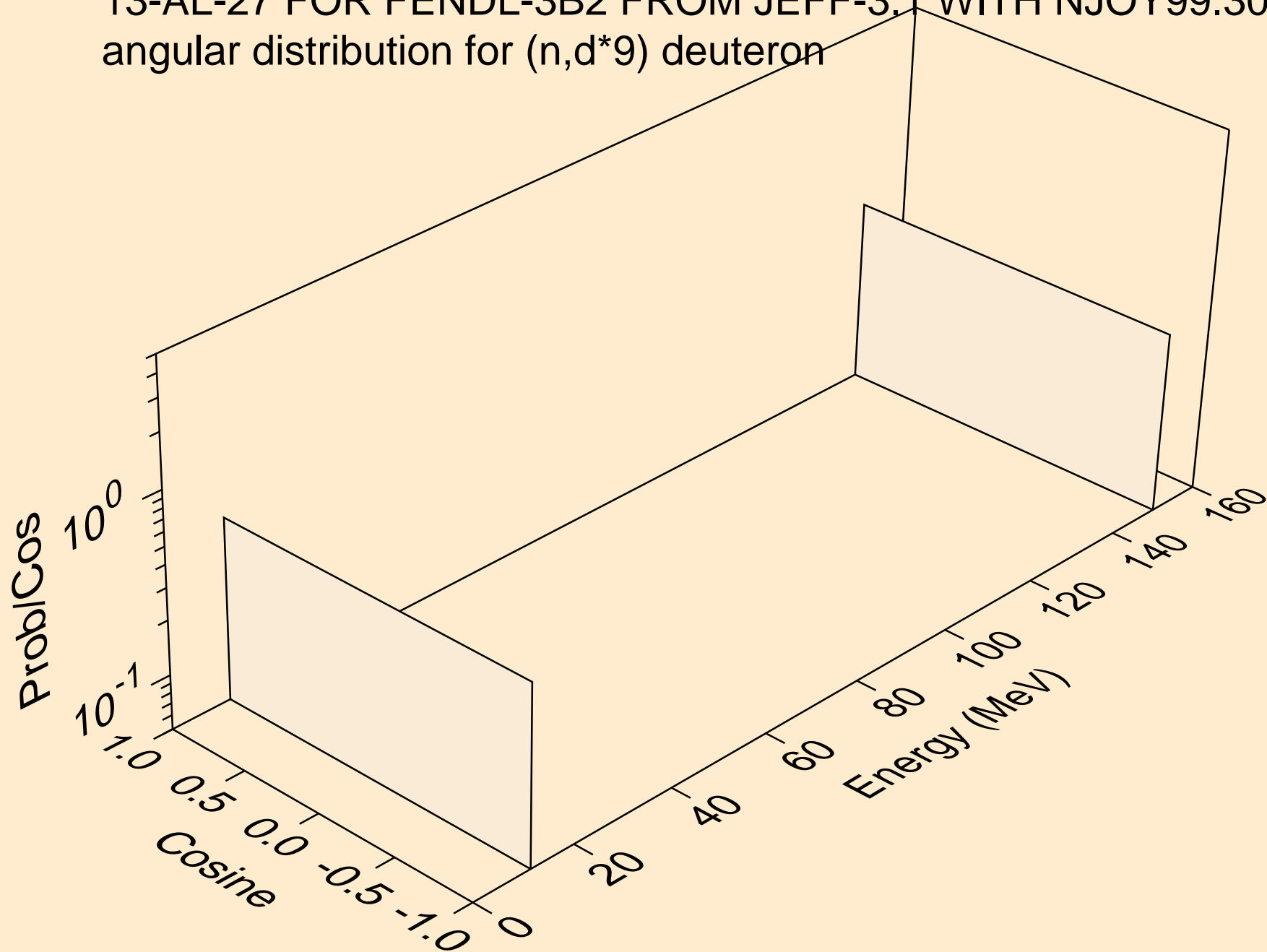

13-AL-27 FOR FENDL-3B2 FROM JEFF-3.1 WITH NJOY99.304+ C  
angular distribution for (n,d\*10) deuteron

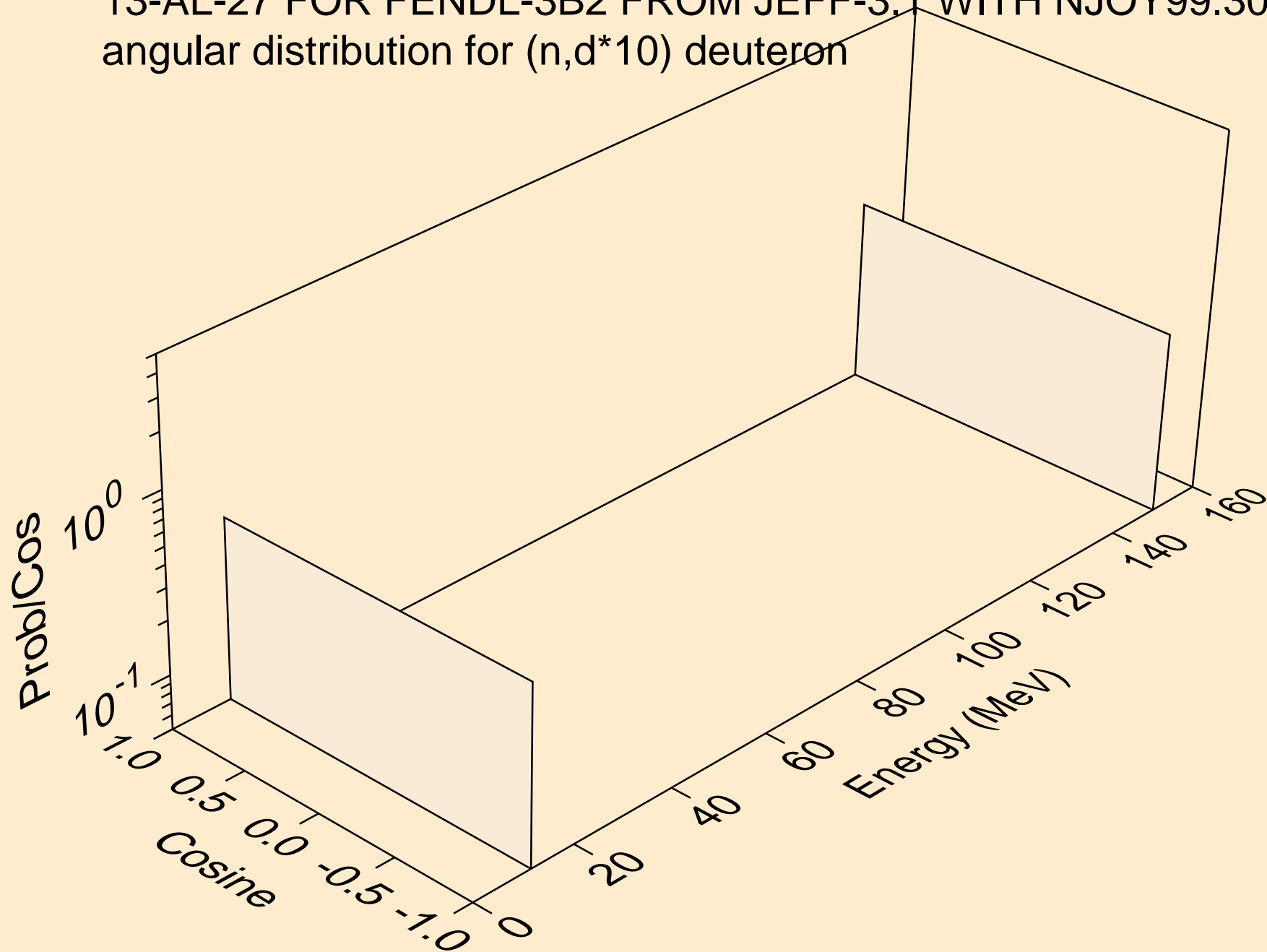

13-AL-27 FOR FENDL-3B2 FROM JEFF-3.1 WITH NJOY99.304+ C  
angular distribution for (n,d\*11) deuteron

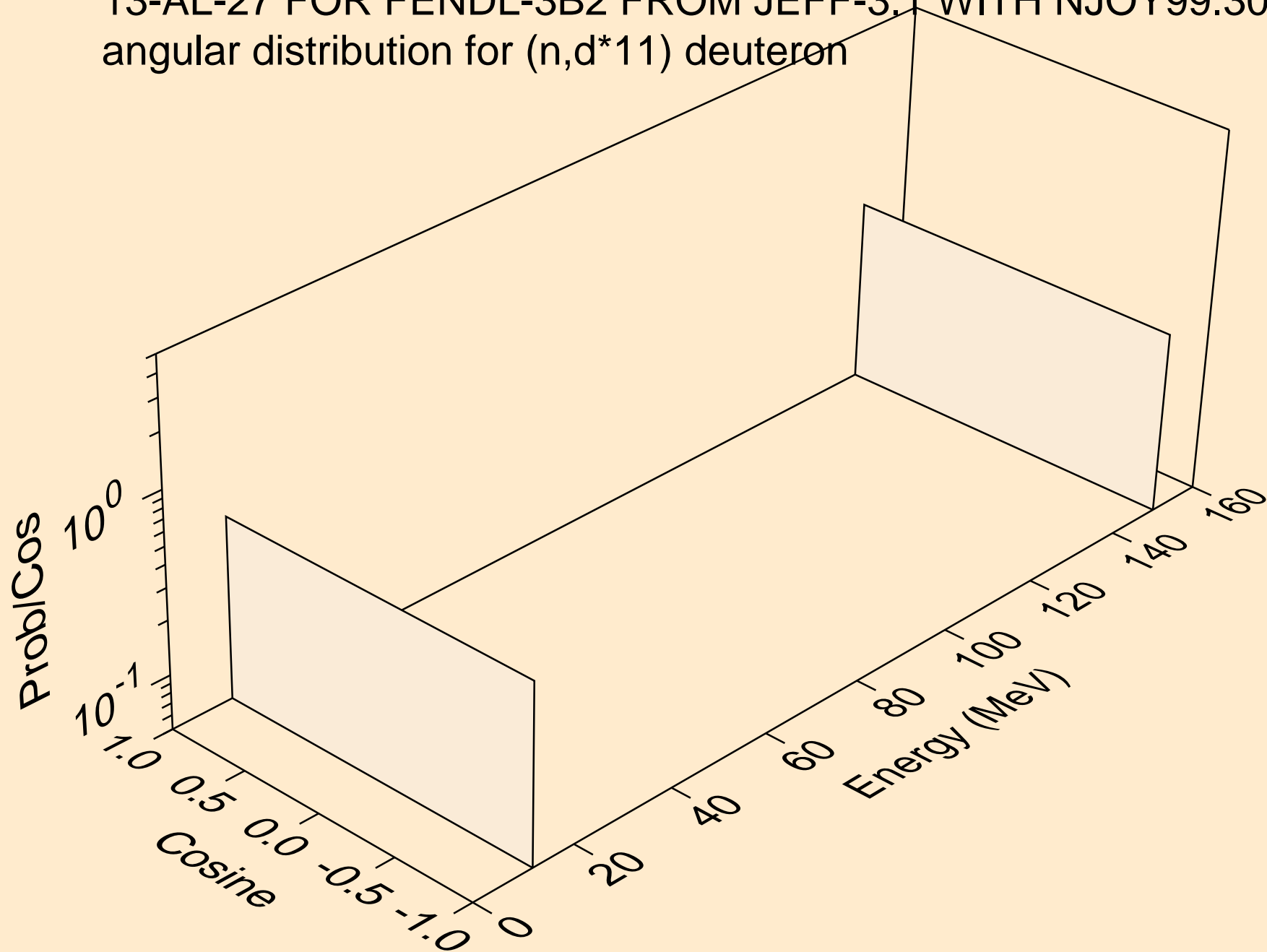

13-AL-27 FOR FENDL-3B2 FROM JEFF-3.1 WITH NJOY99.304+ C  
angular distribution for (n,d\*12) deuteron

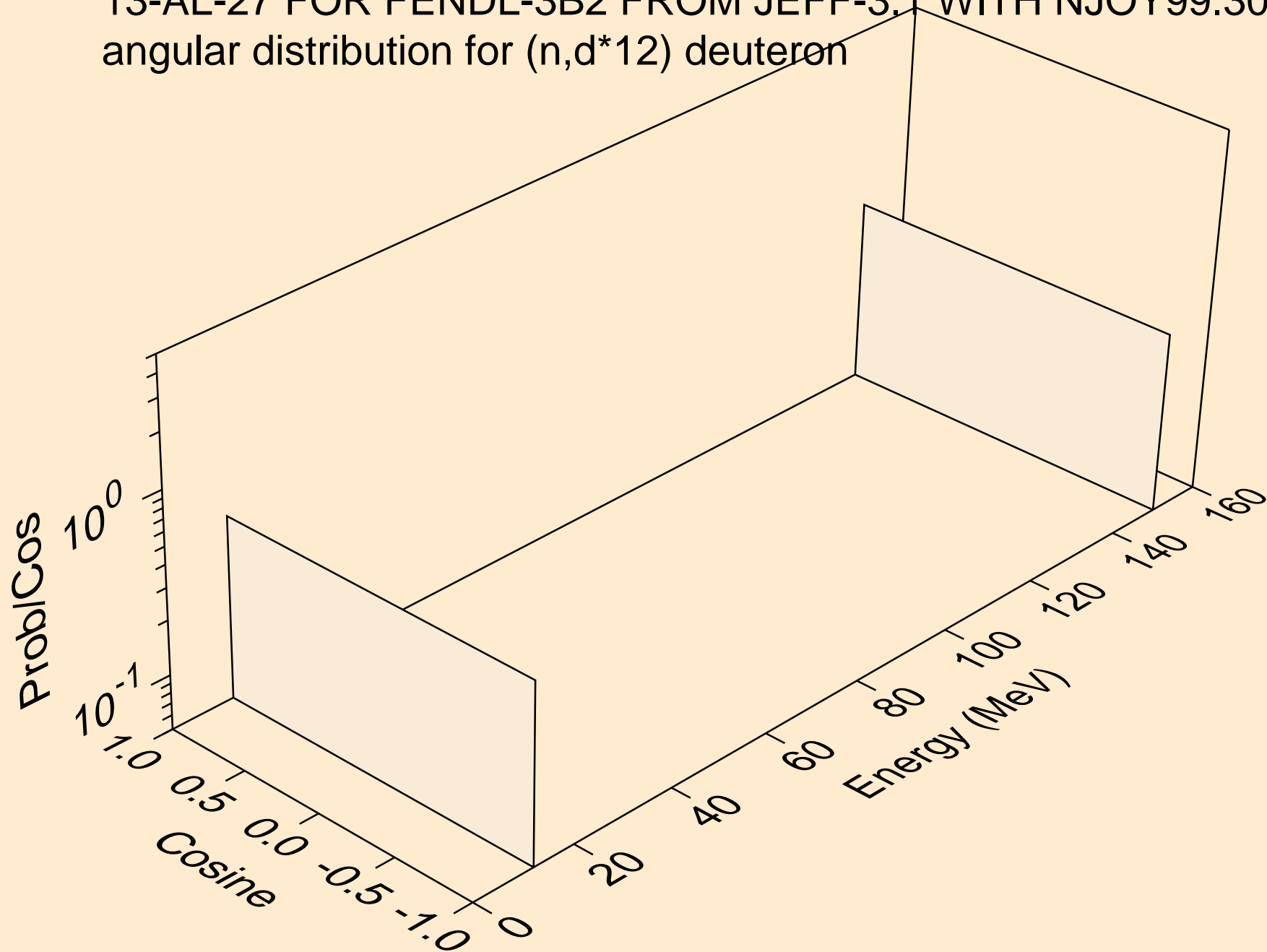

13-AL-27 FOR FENDL-3B2 FROM JEFF-3.1 WITH NJOY99.304+ C  
angular distribution for (n,d\*13) deuteron

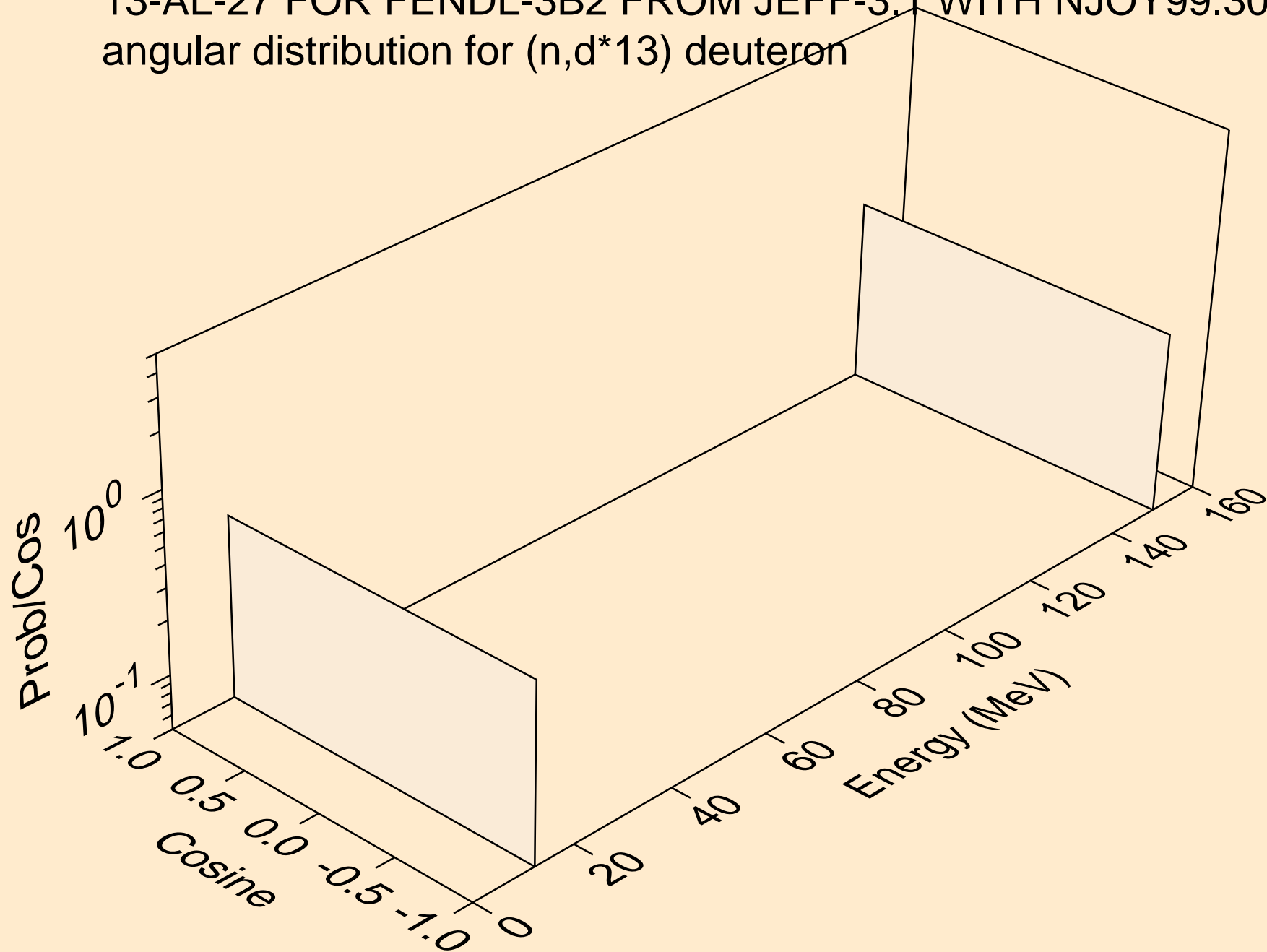

13-AL-27 FOR FENDL-3B2 FROM JEFF-3.1 WITH NJOY99.304+ C  
angular distribution for (n,d\*14) deuteron

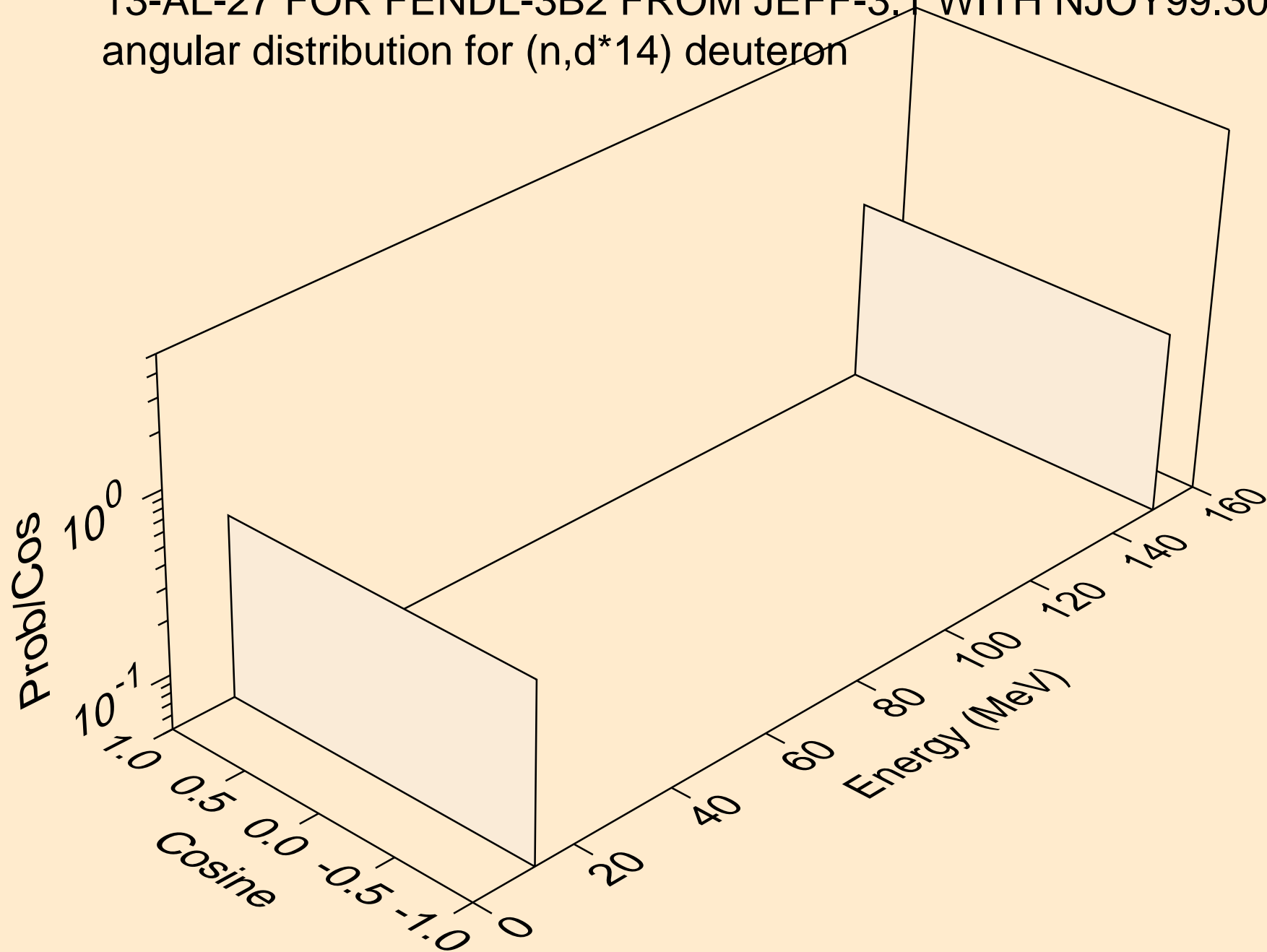

13-AL-27 FOR FENDL-3B2 FROM JEFF-3.1 WITH NJOY99.304+ C  
angular distribution for (n,d\*15) deuteron

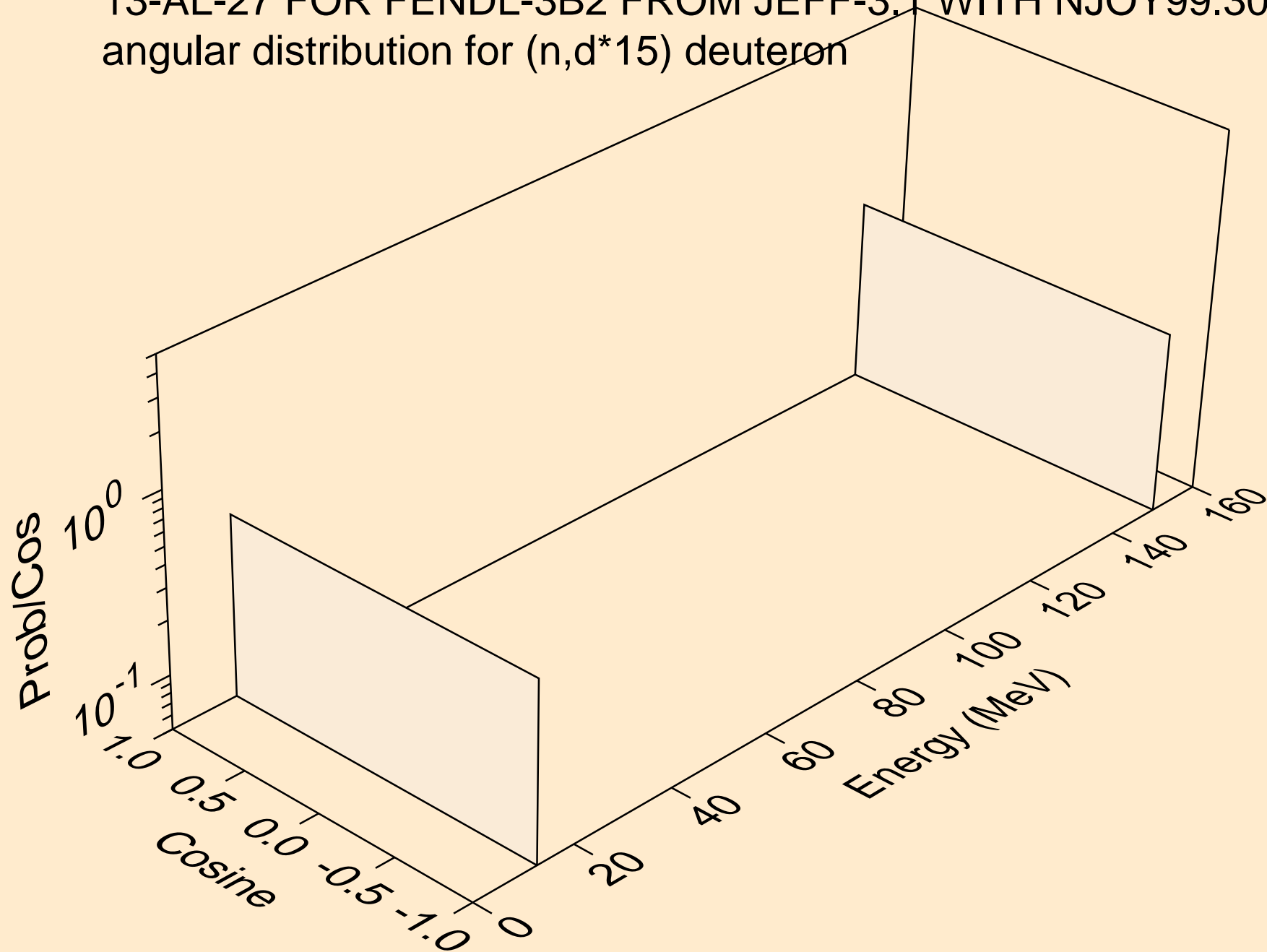



13-AL-27 FOR FENDL-3B2 FROM JEFF-3.1 WITH NJOY99.304+ C  
angular distribution for (n,d\*16) deuteron

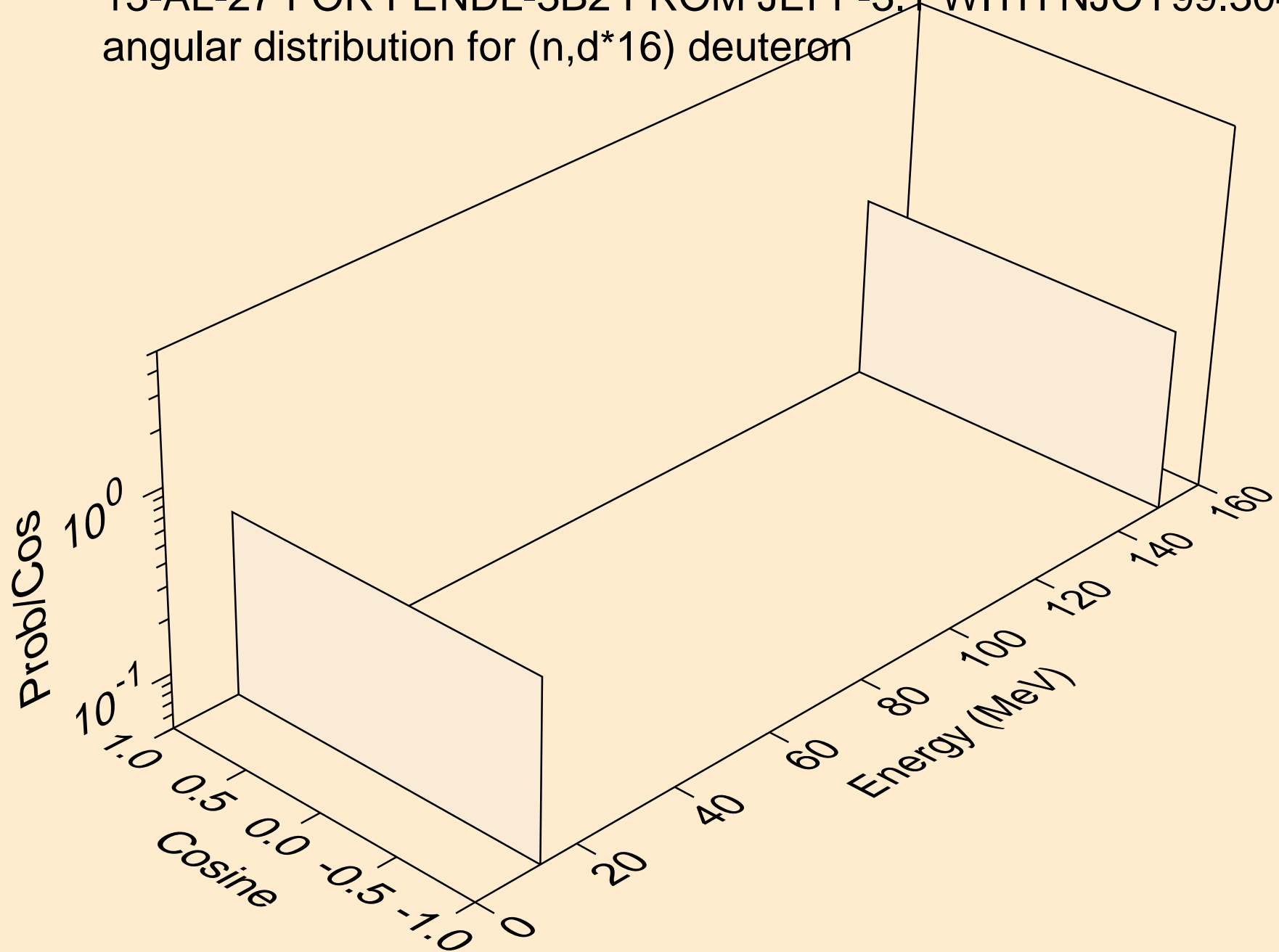

13-AL-27 FOR FENDL-3B2 FROM JEFF-3.1 WITH NJOY99.304+ C  
angular distribution for (n,d\*17) deuteron

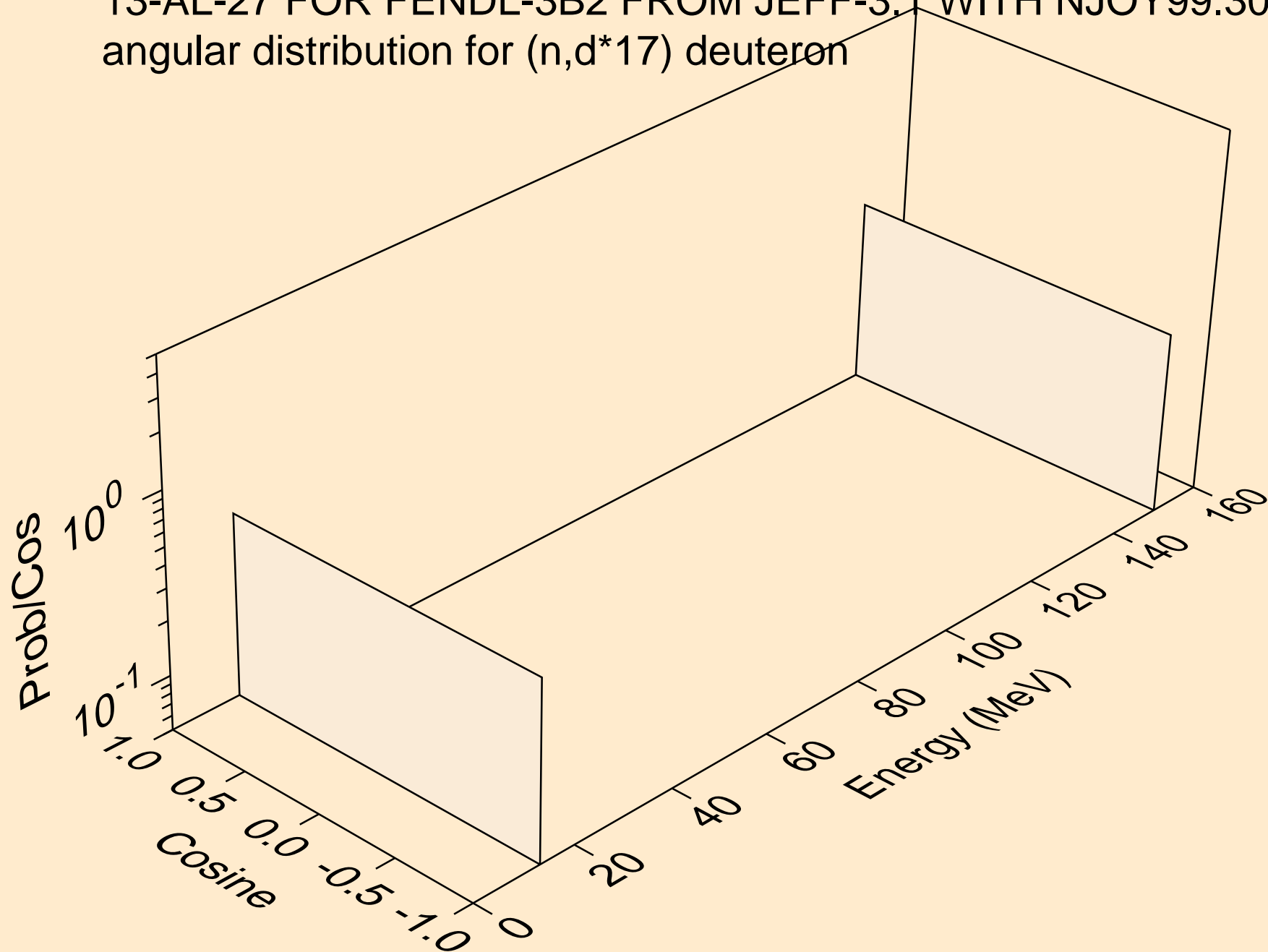

13-AL-27 FOR FENDL-3B2 FROM JEFF-3.1 WITH NJOY99.304+ C  
angular distribution for (n,d\*18) deuteron

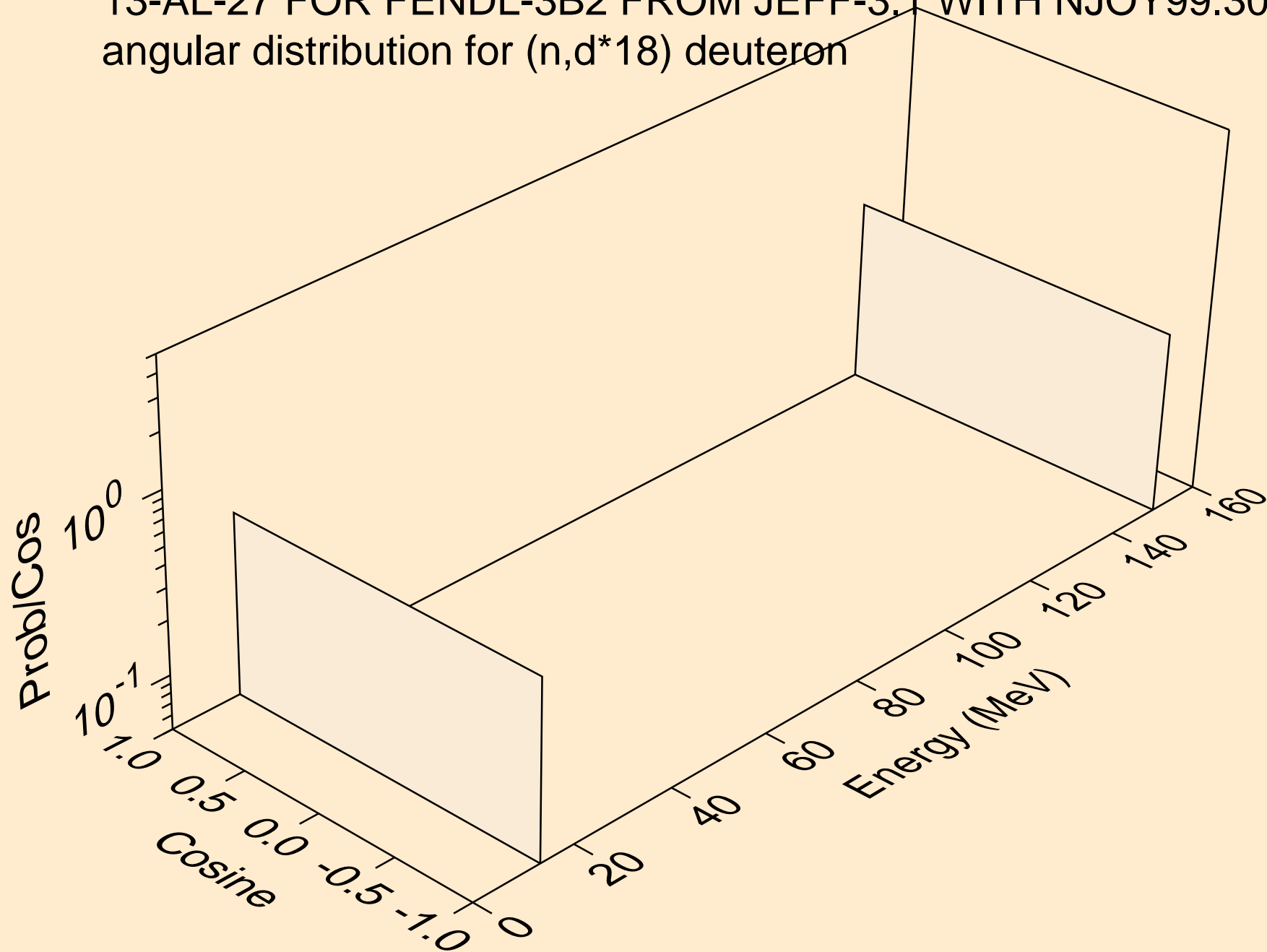

13-AL-27 FOR FENDL-3B2 FROM JEFF-3.1 WITH NJOY99.304+ C  
angular distribution for (n,d\*19) deuteron

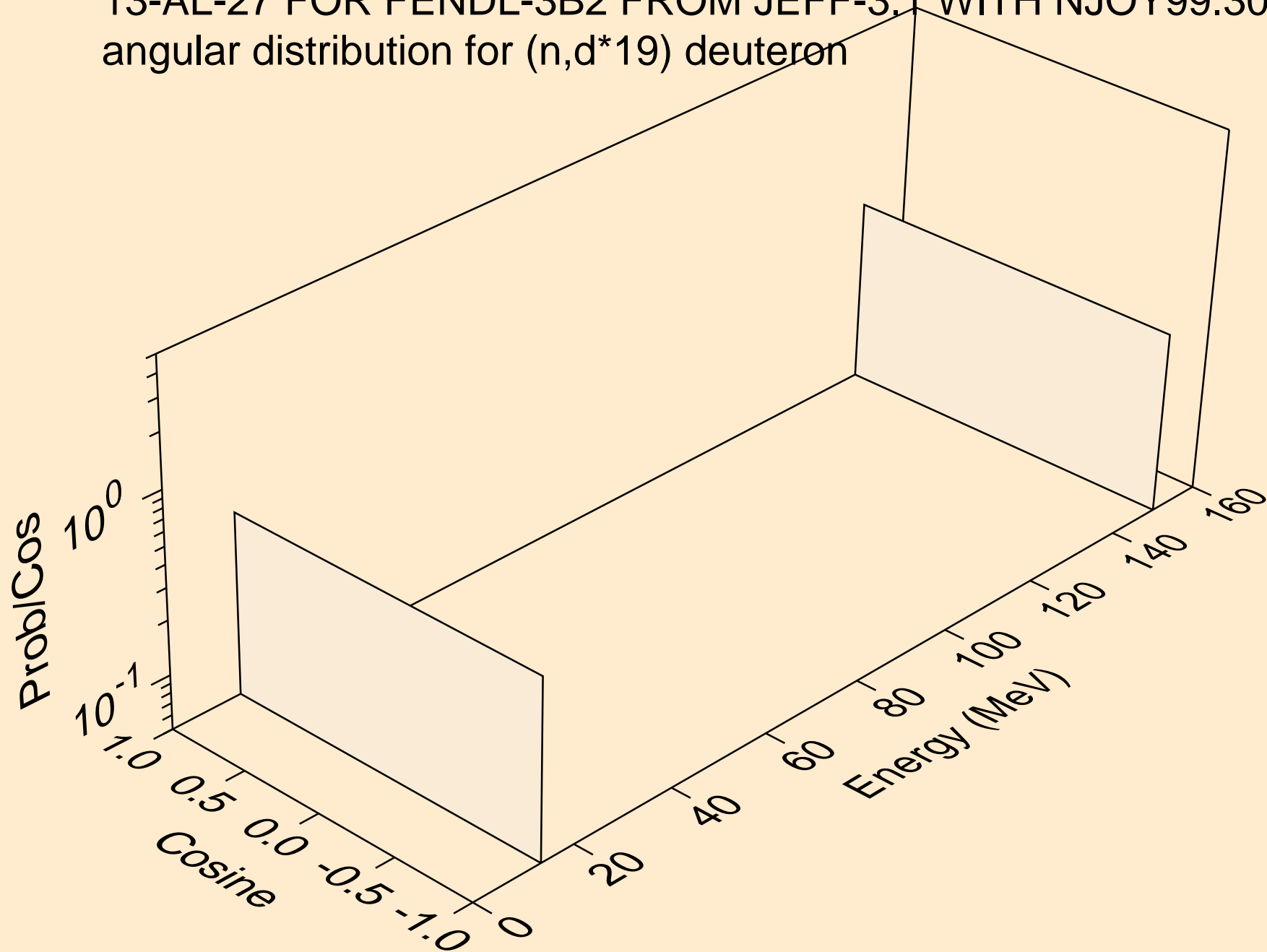

13-AL-27 FOR FENDL-3B2 FROM JEFF-3.1 WITH NJOY99.304+ C  
deuterons from (n,d\*c)

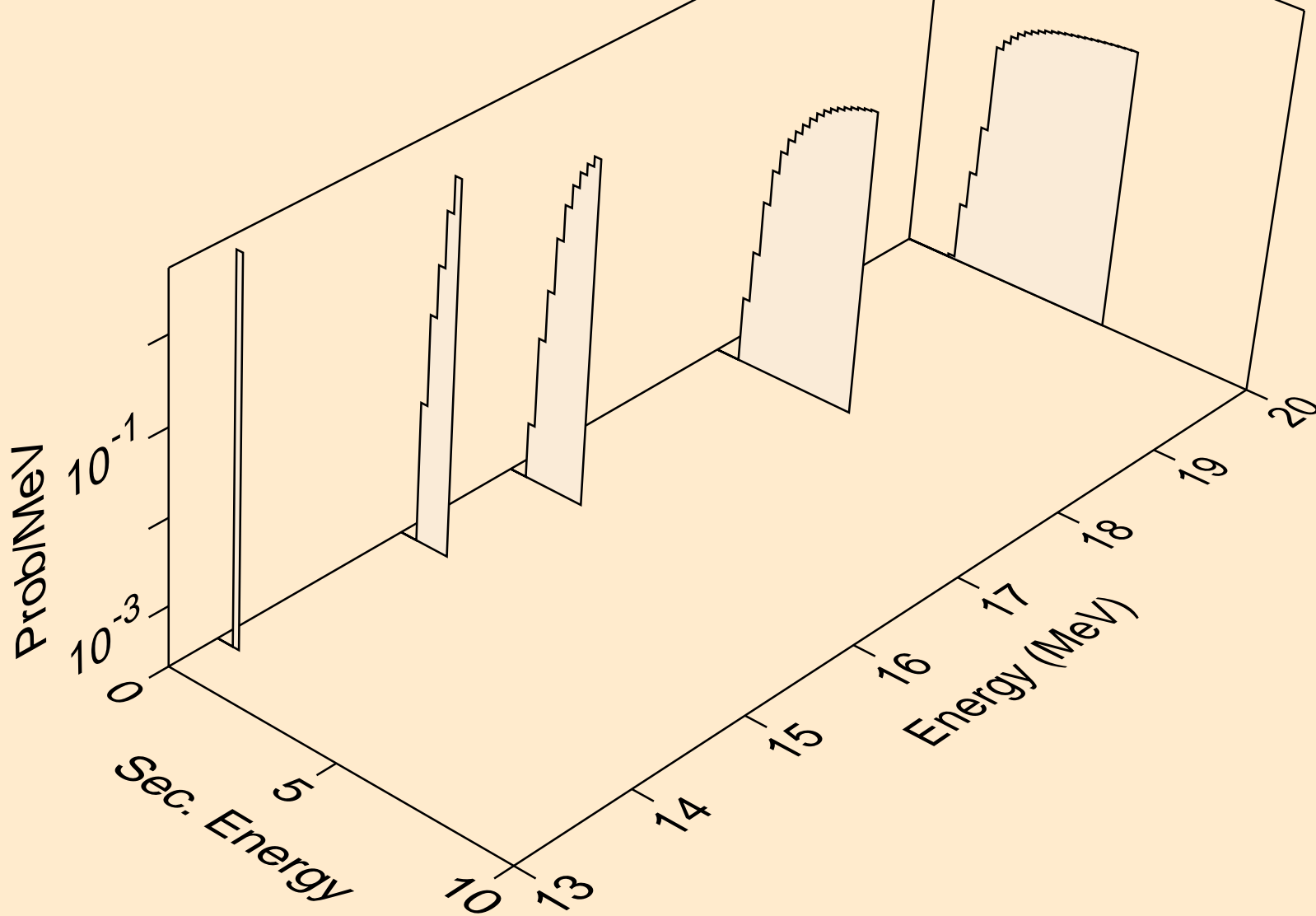

13-AL-27 FOR FENDL-3B2 FROM JEFF-3.1 WITH NJOY99.304+ C  
tritons from (n,x)

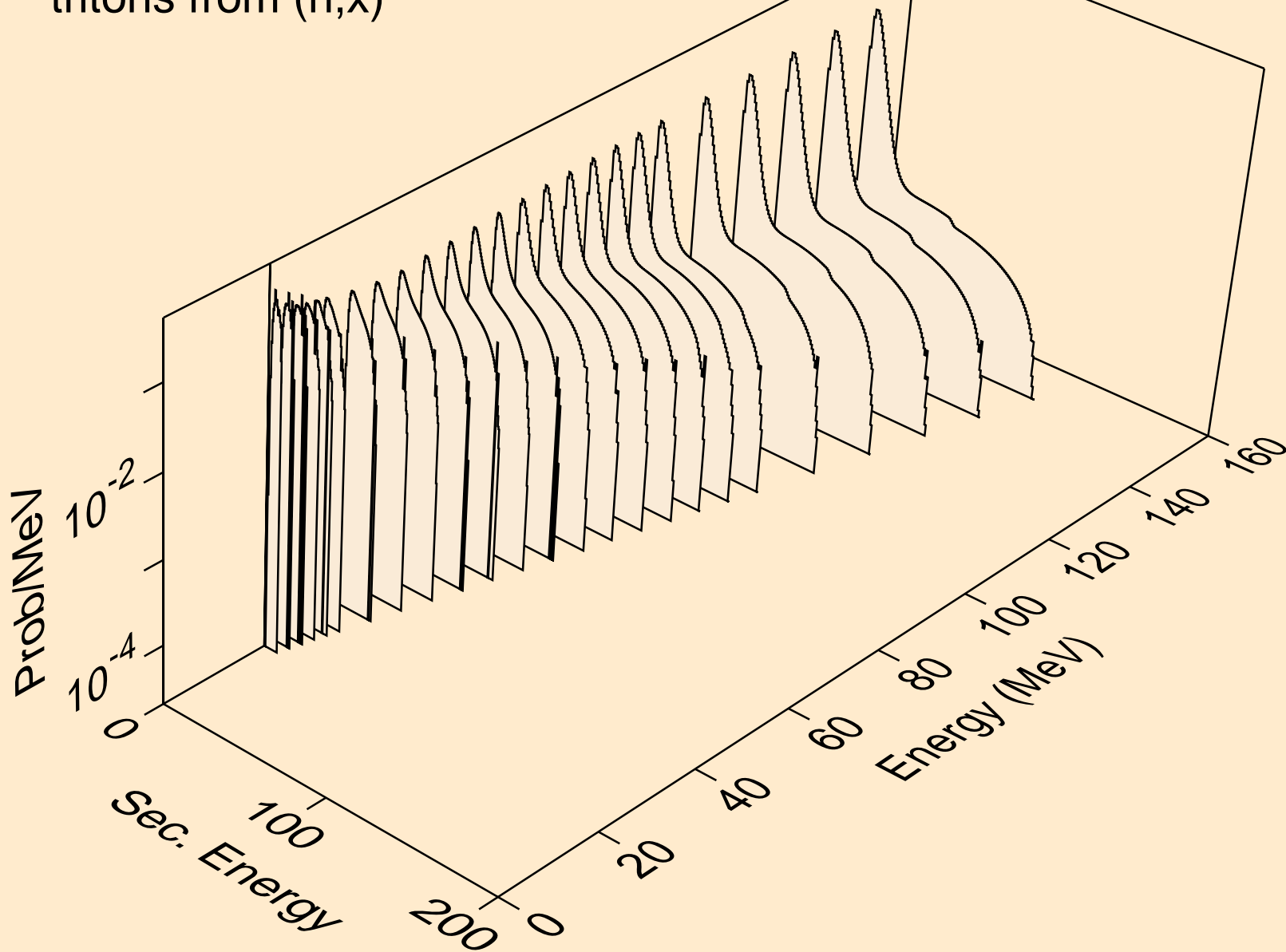

13-AL-27 FOR FENDL-3B2 FROM JEFF-3.1 WITH NJOY99.304+ C  
tritons from (n,n\*)t

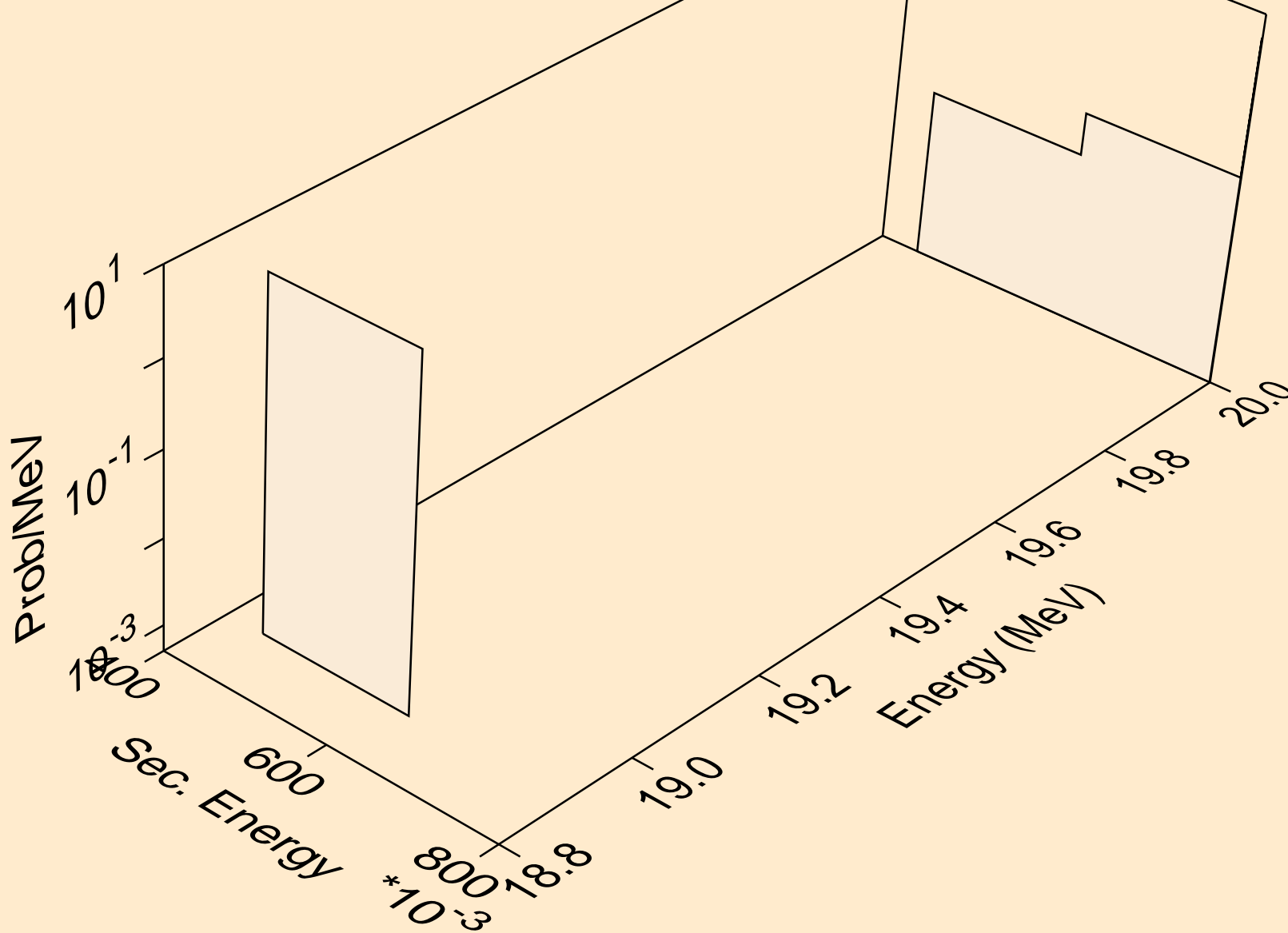

13-AL-27 FOR FENDL-3B2 FROM JEFF-3.1 WITH NJOY99.304+ C  
angular distribution for (n,t\*0) triton

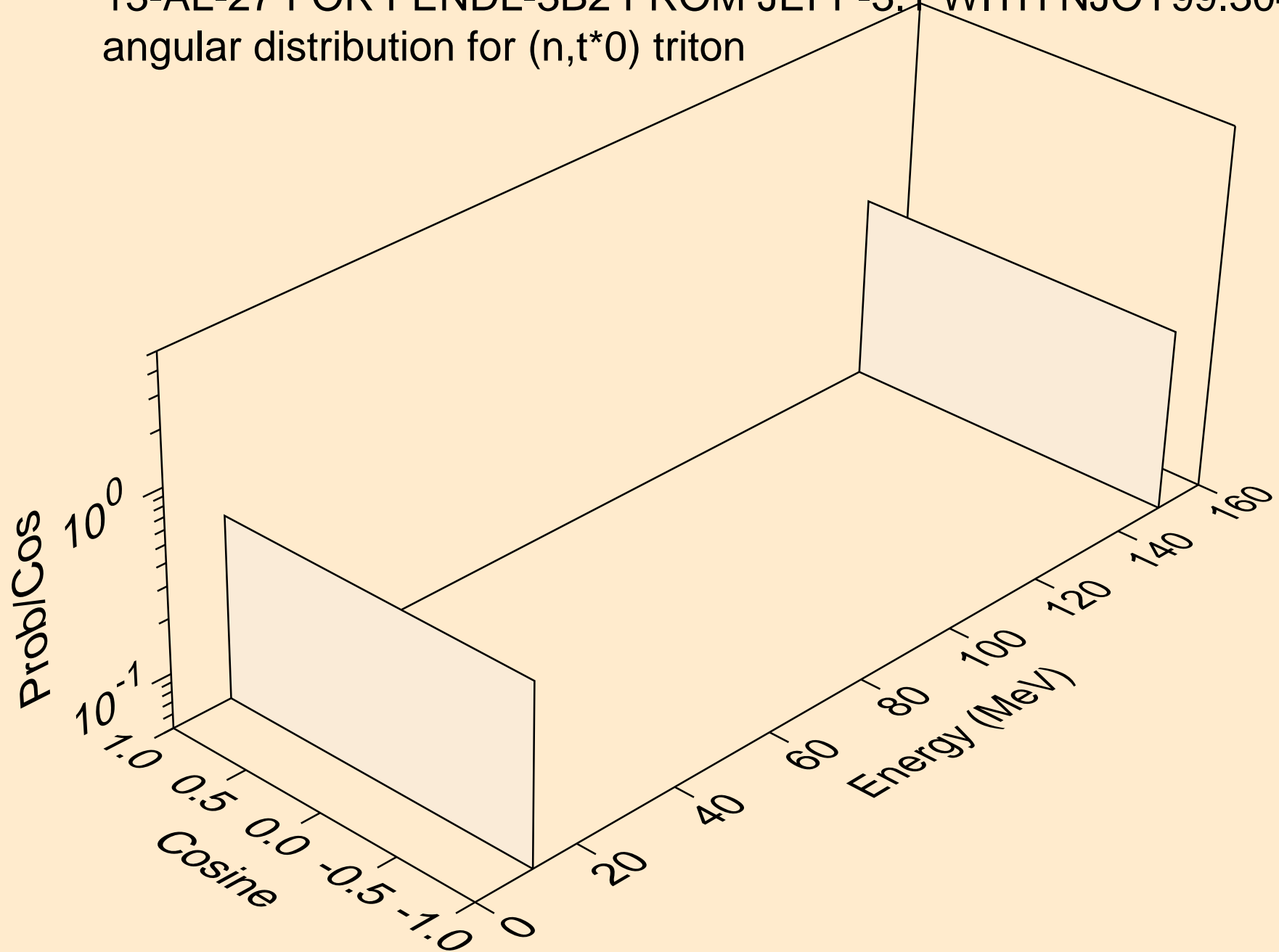



13-AL-27 FOR FENDL-3B2 FROM JEFF-3.1 WITH NJOY99.304+ C  
angular distribution for (n,t\*1) triton

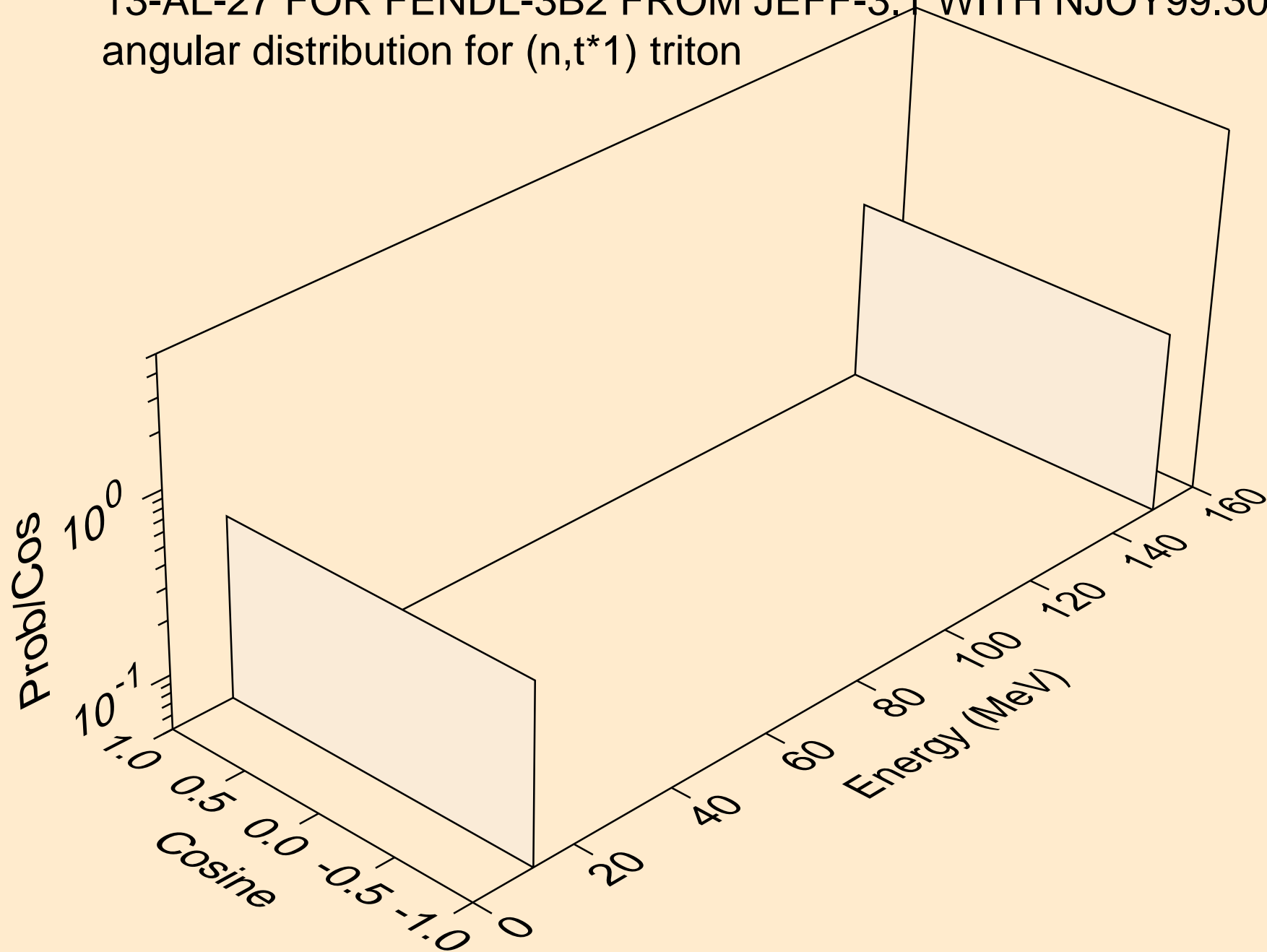

13-AL-27 FOR FENDL-3B2 FROM JEFF-3.1 WITH NJOY99.304+ C  
angular distribution for (n,t\*2) triton

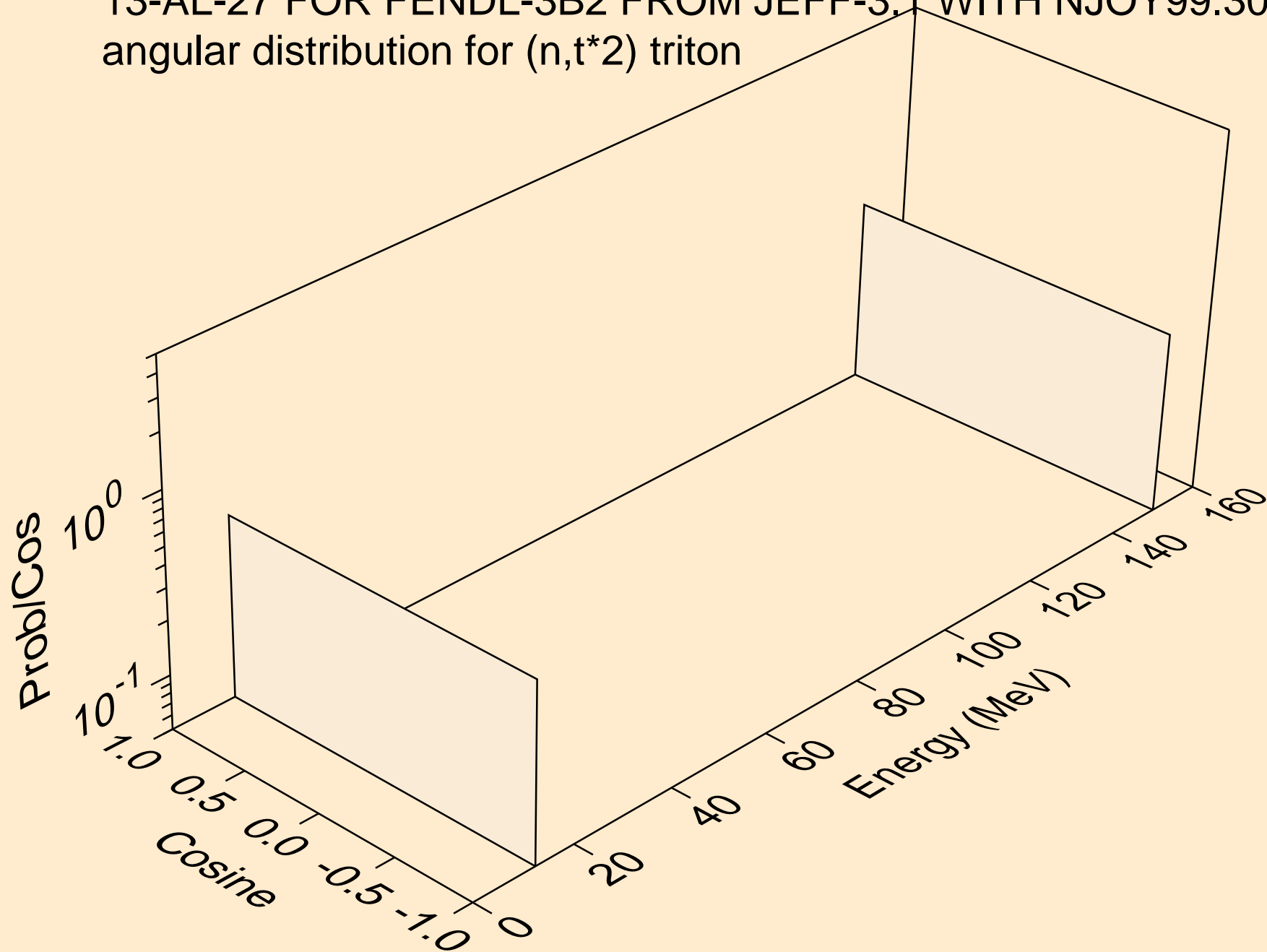

13-AL-27 FOR FENDL-3B2 FROM JEFF-3.1 WITH NJOY99.304+ C  
angular distribution for (n,t\*3) triton

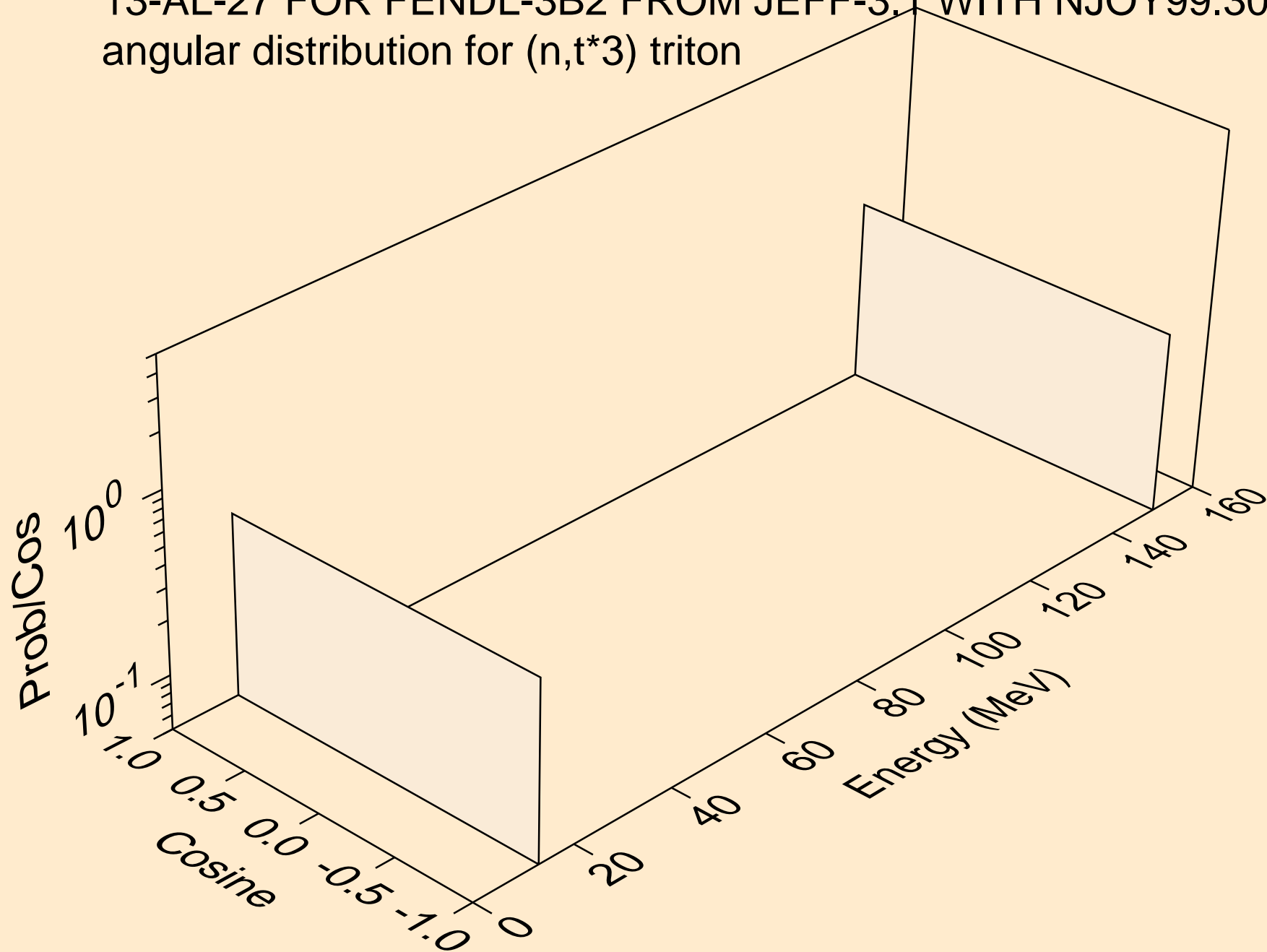

13-AL-27 FOR FENDL-3B2 FROM JEFF-3.1 WITH NJOY99.304+ C  
angular distribution for (n,t\*4) triton

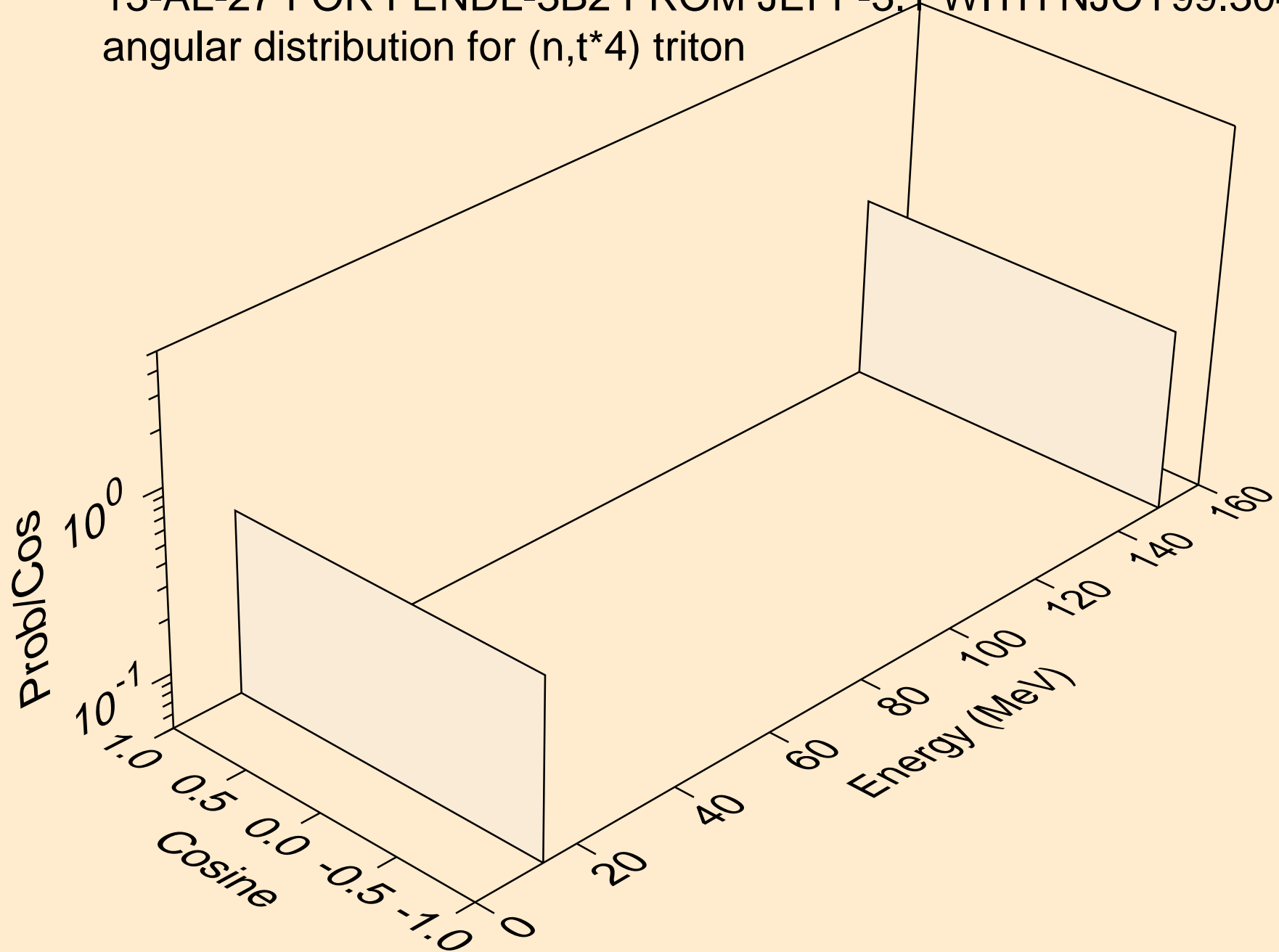

13-AL-27 FOR FENDL-3B2 FROM JEFF-3.1 WITH NJOY99.304+ C  
angular distribution for (n,t\*5) triton

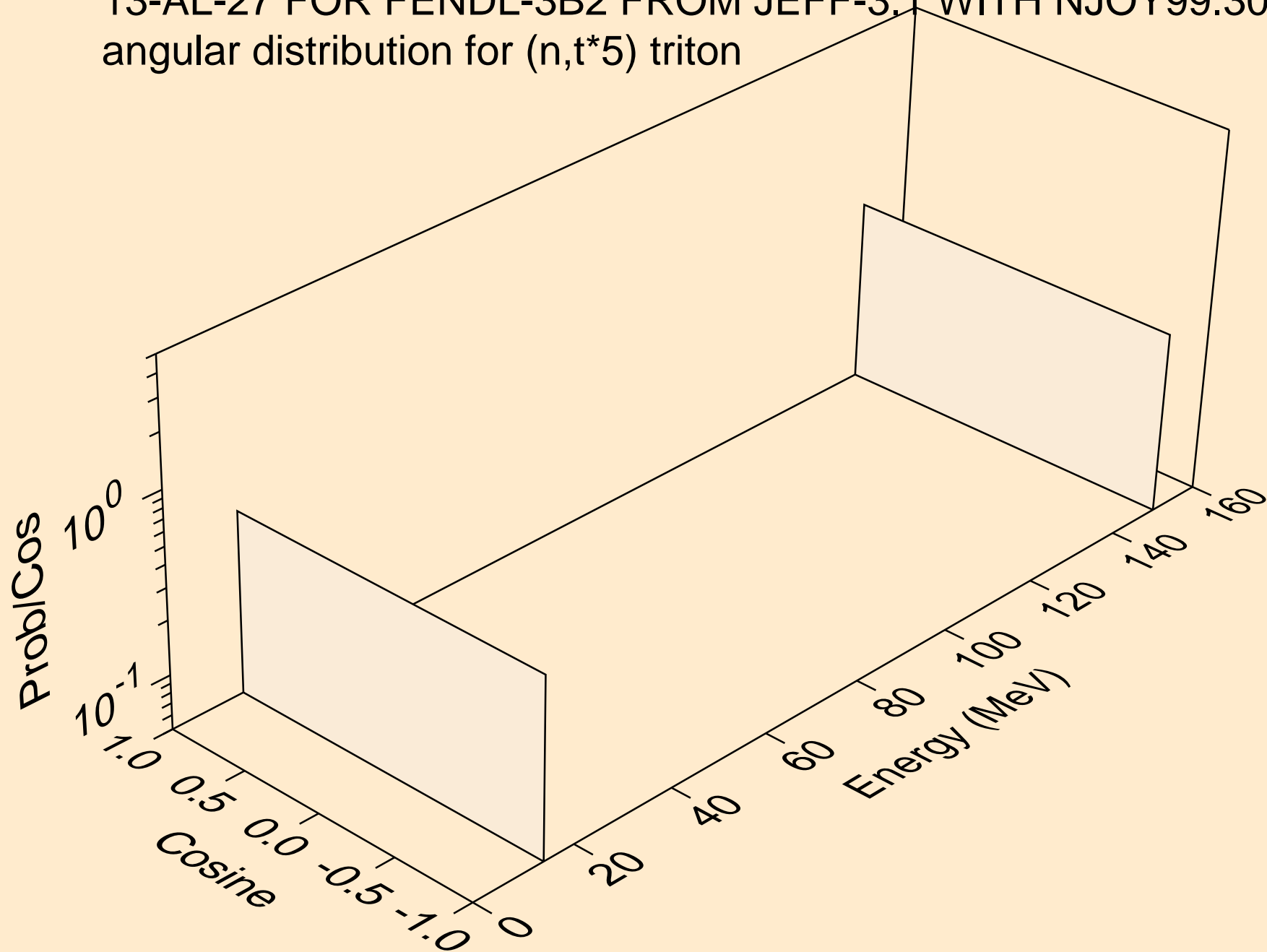

13-AL-27 FOR FENDL-3B2 FROM JEFF-3.1 WITH NJOY99.304+ C  
angular distribution for (n,t\*6) triton

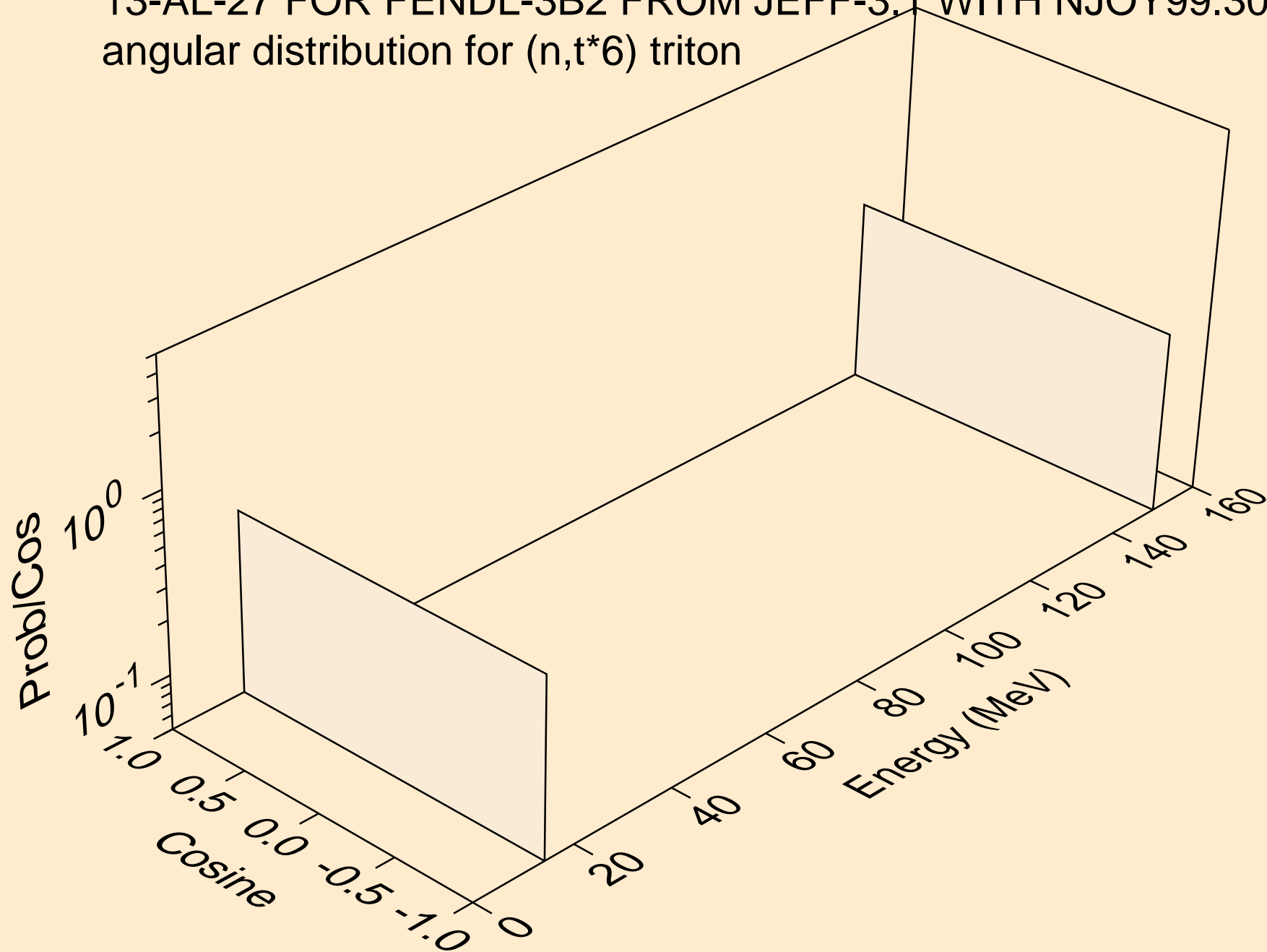

13-AL-27 FOR FENDL-3B2 FROM JEFF-3.1 WITH NJOY99.304+ C  
angular distribution for (n,t\*7) triton

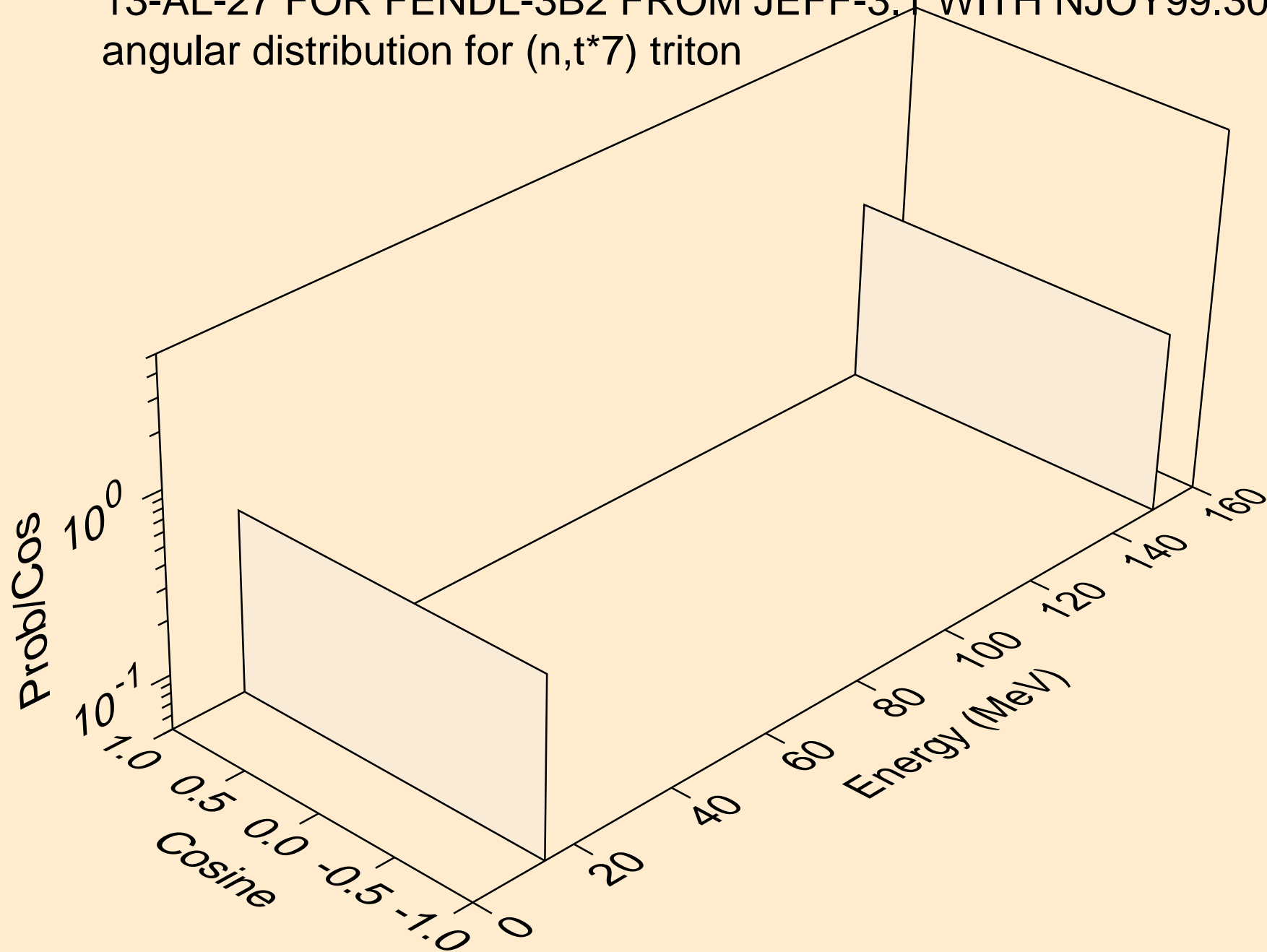

13-AL-27 FOR FENDL-3B2 FROM JEFF-3.1 WITH NJOY99.304+ C  
angular distribution for (n,t\*8) triton

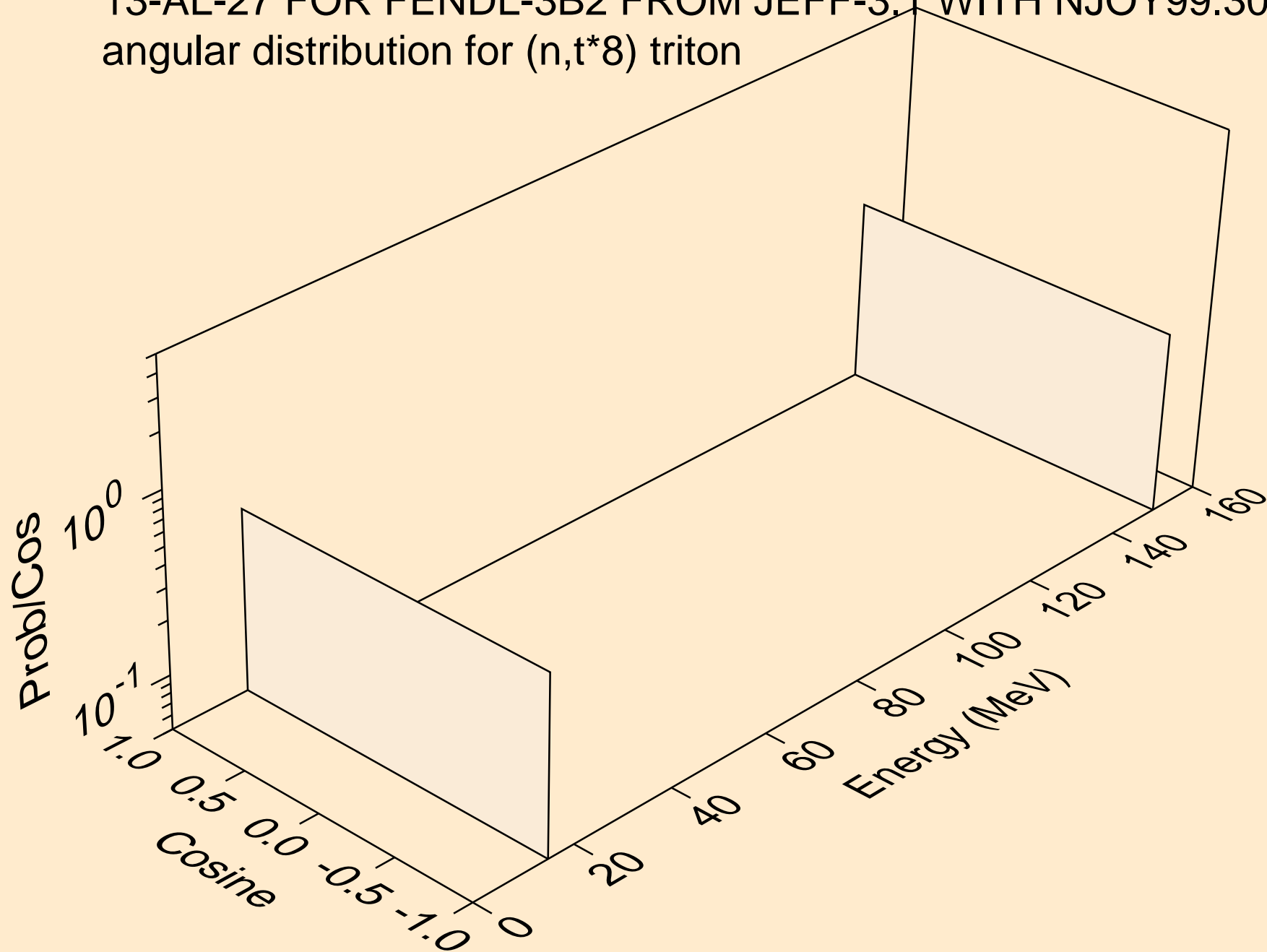



13-AL-27 FOR FENDL-3B2 FROM JEFF-3.1 WITH NJOY99.304+ C  
angular distribution for (n,t\*9) triton

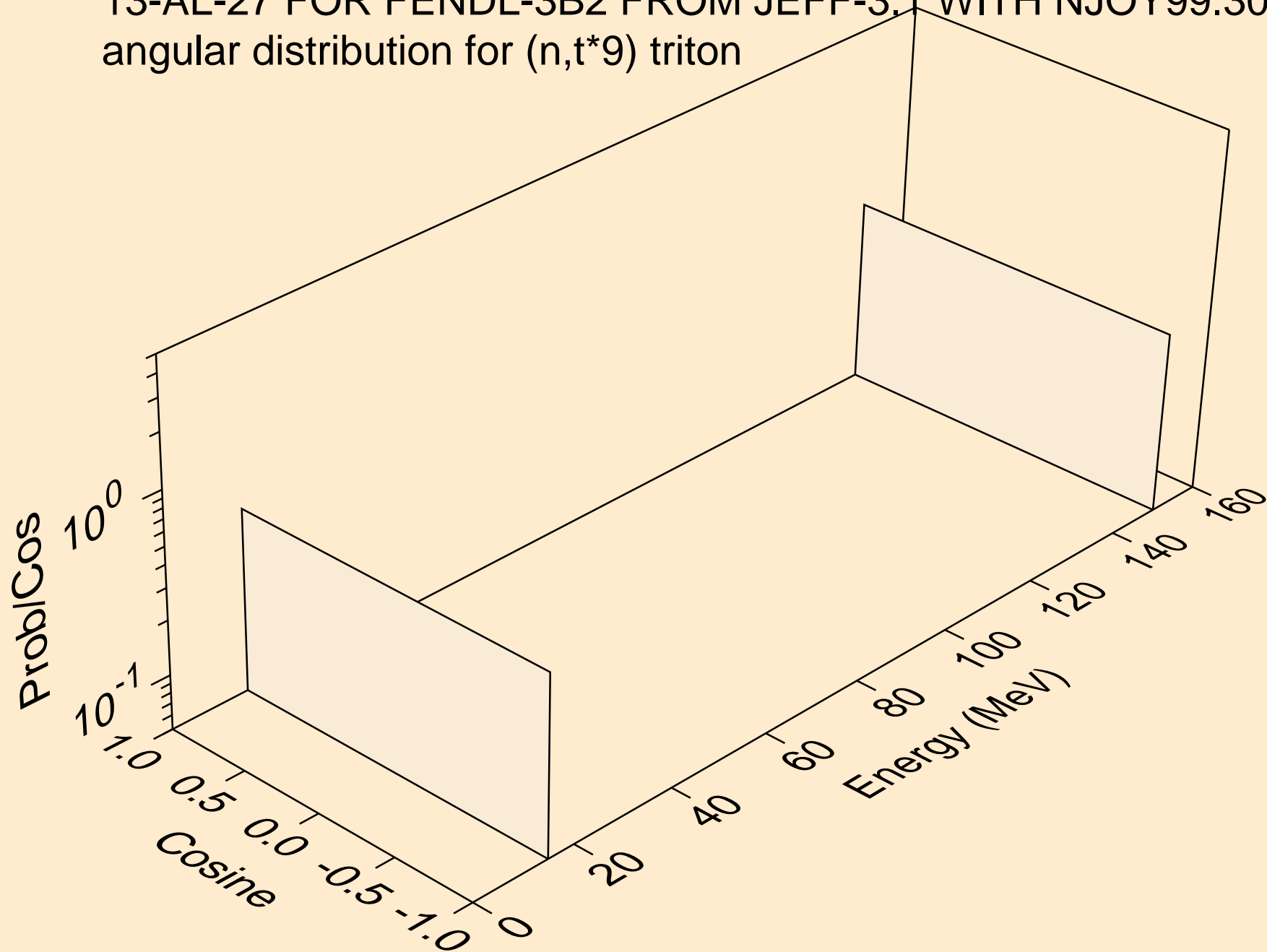

13-AL-27 FOR FENDL-3B2 FROM JEFF-3.1 WITH NJOY99.304+ C  
angular distribution for (n,t\*10) triton

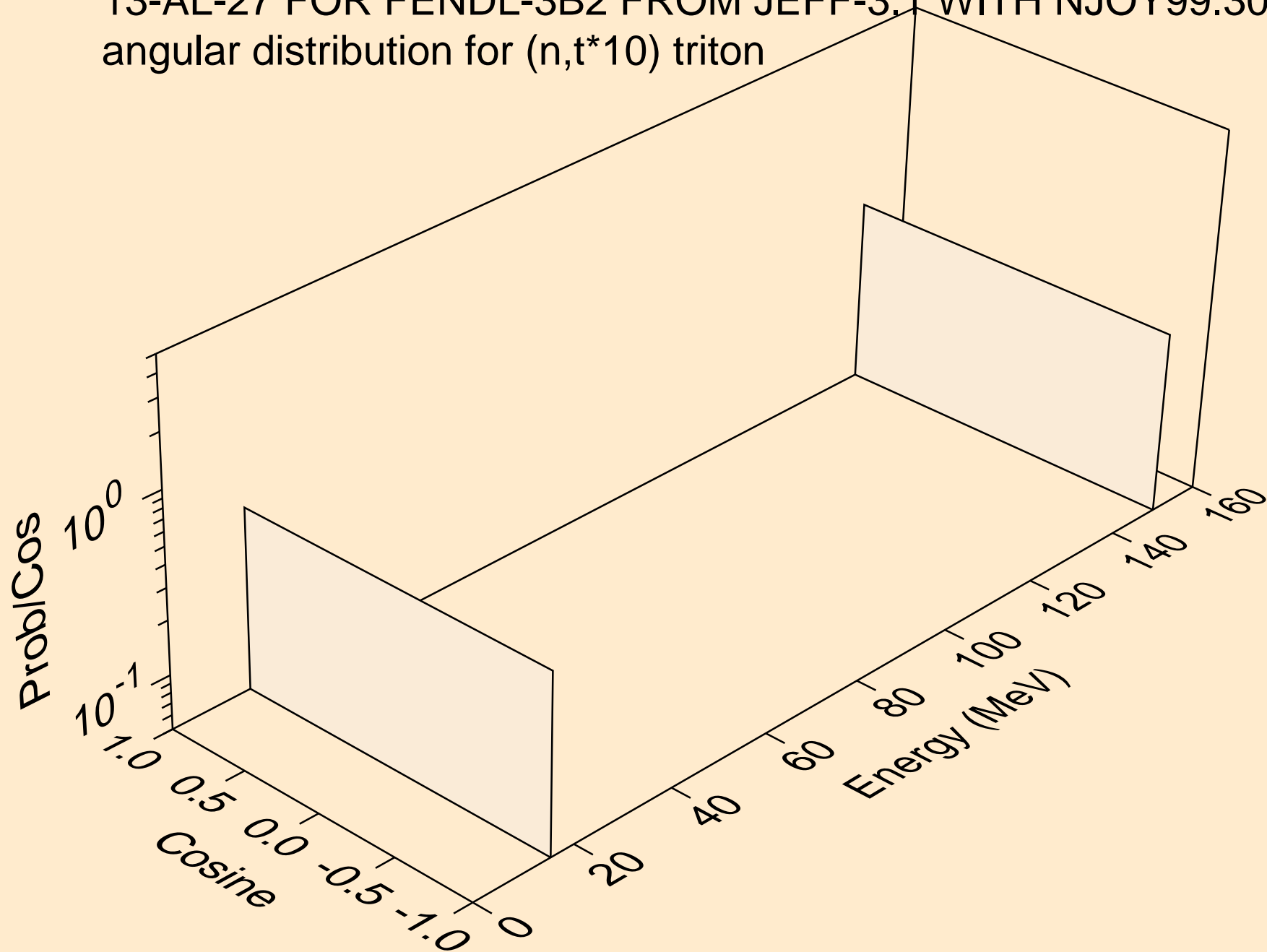

13-AL-27 FOR FENDL-3B2 FROM JEFF-3.1 WITH NJOY99.304+ C  
tritons from (n,t\*c)

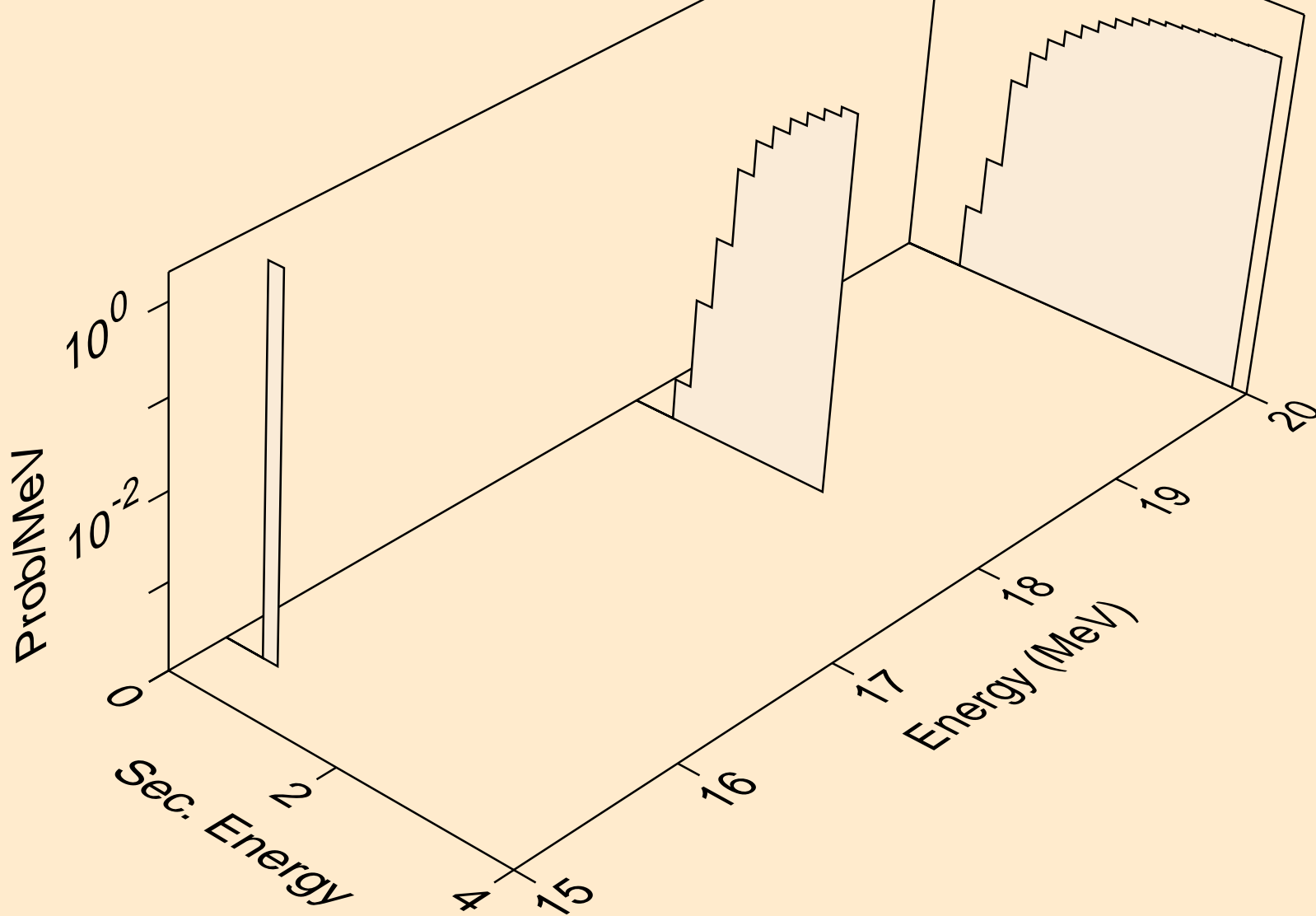

13-AL-27 FOR FENDL-3B2 FROM JEFF-3.1 WITH NJOY99.304+ C  
alphas from (n,x)

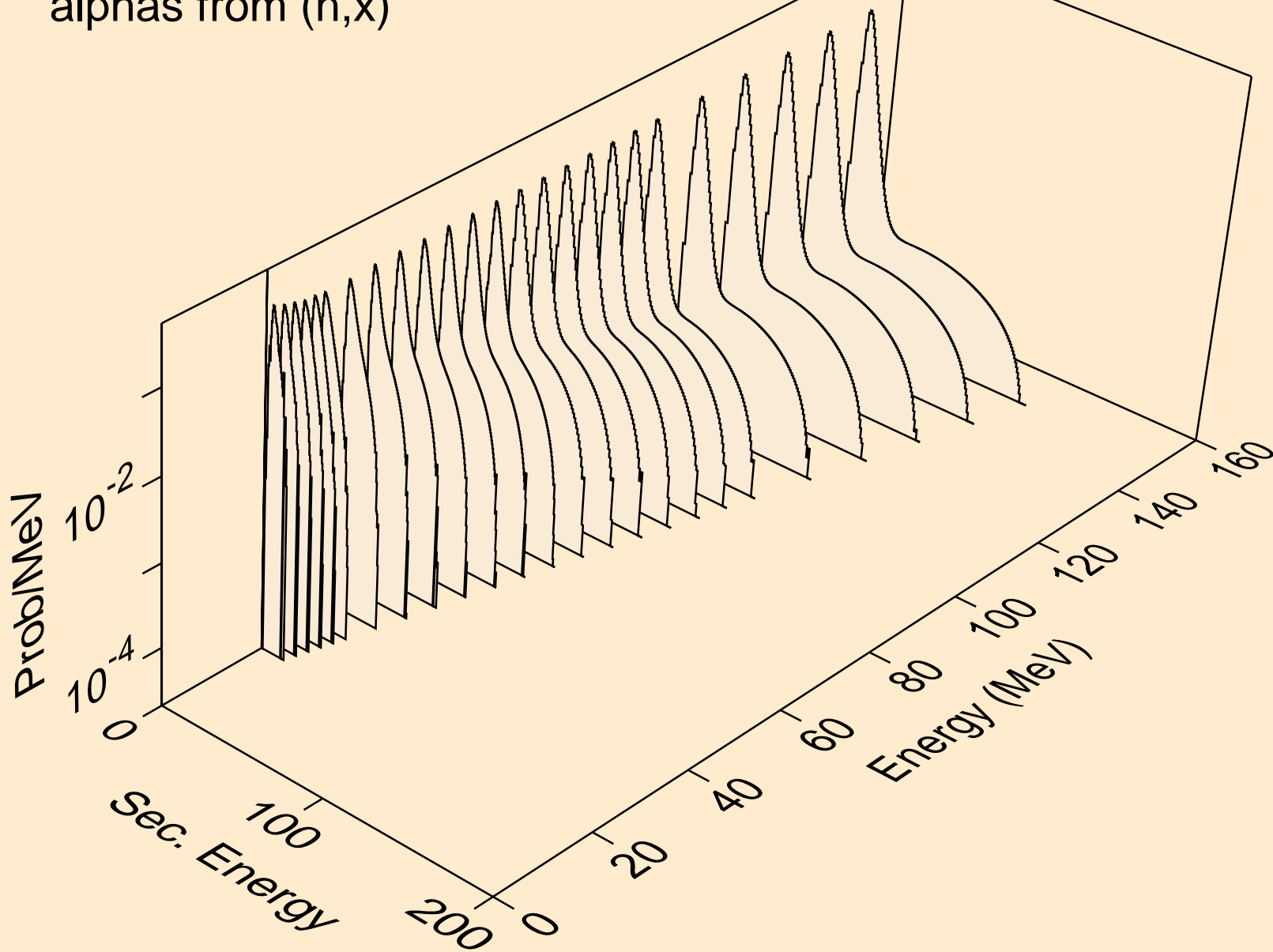

13-AL-27 FOR FENDL-3B2 FROM JEFF-3.1 WITH NJOY99.304+ C  
alphas from (n,n\*)a

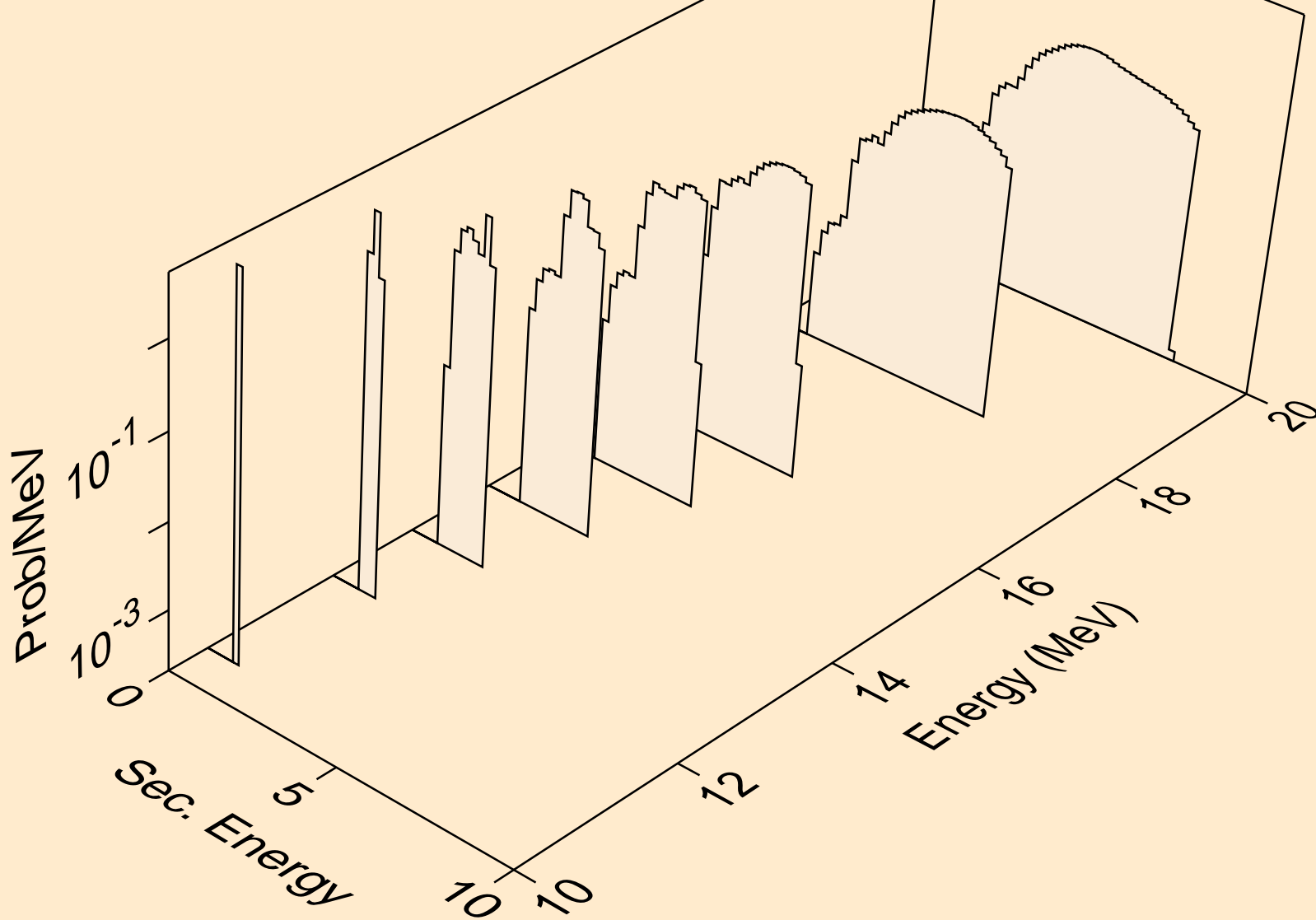

13-AL-27 FOR FENDL-3B2 FROM JEFF-3.1 WITH NJOY99.304+ C  
alphas from (n,npa)

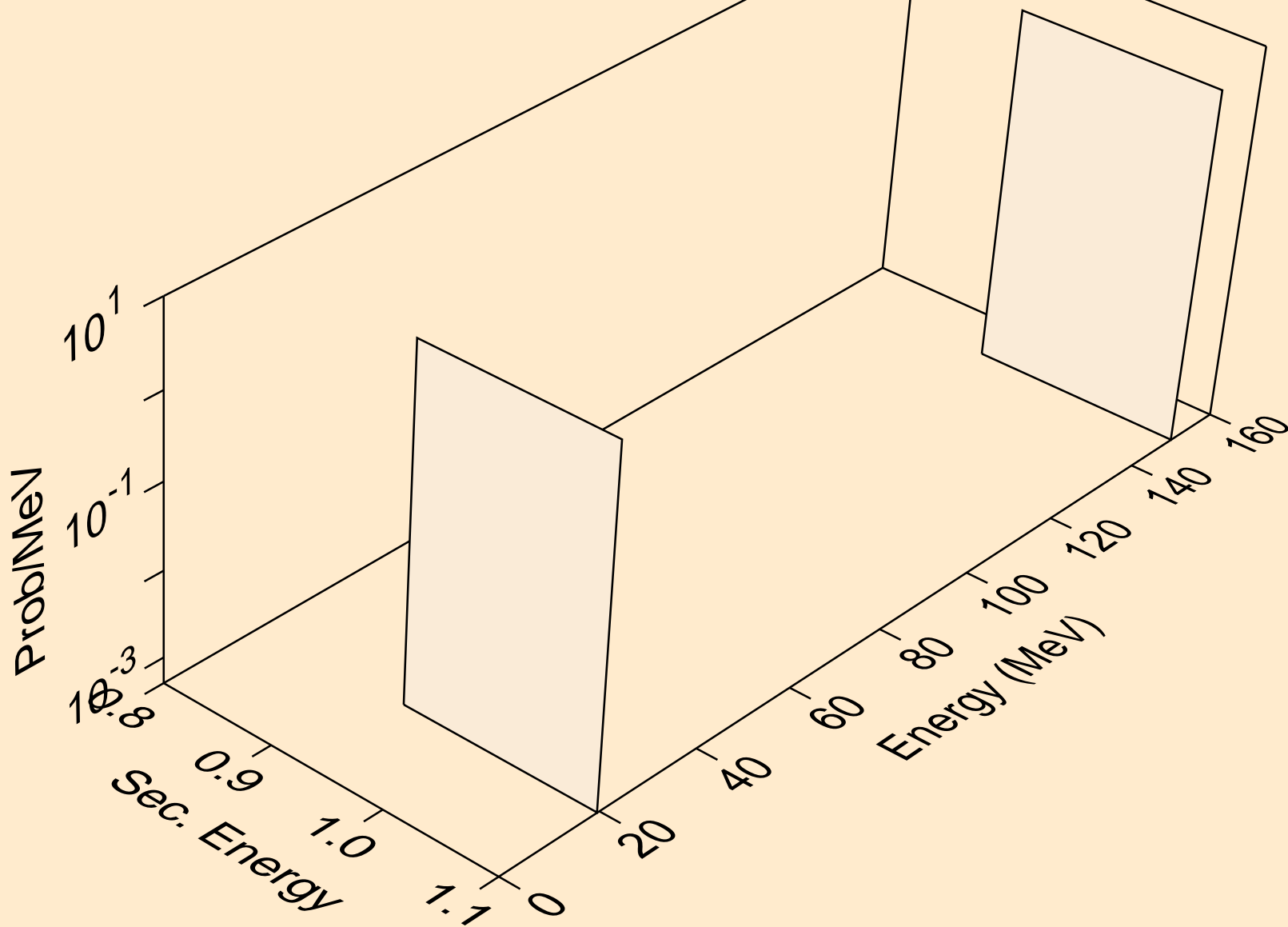

13-AL-27 FOR FENDL-3B2 FROM JEFF-3.1 WITH NJOY99.304+ C  
alphas from (n,2a)

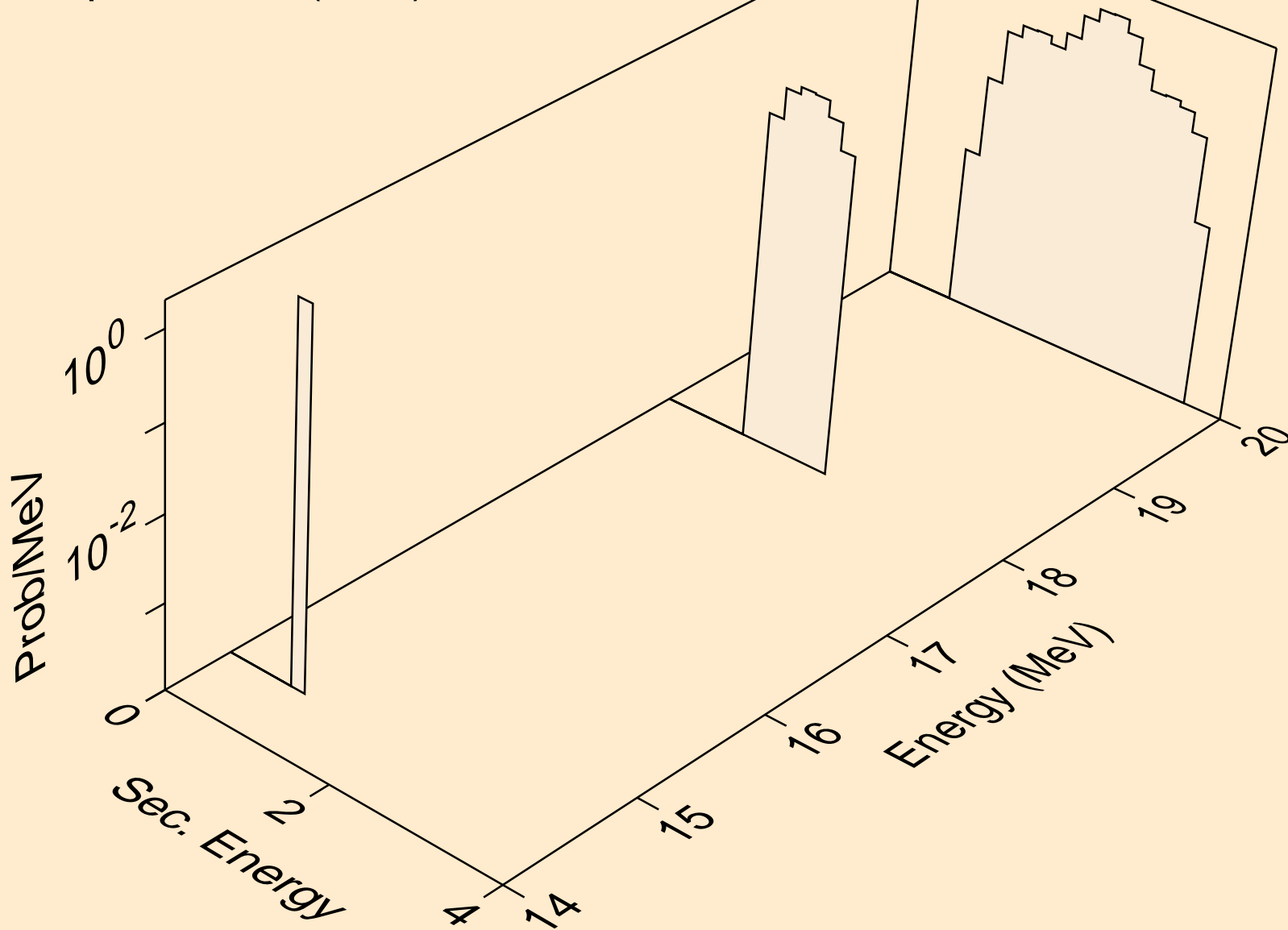

13-AL-27 FOR FENDL-3B2 FROM JEFF-3.1 WITH NJOY99.304+ C  
alphas from (n,pa)

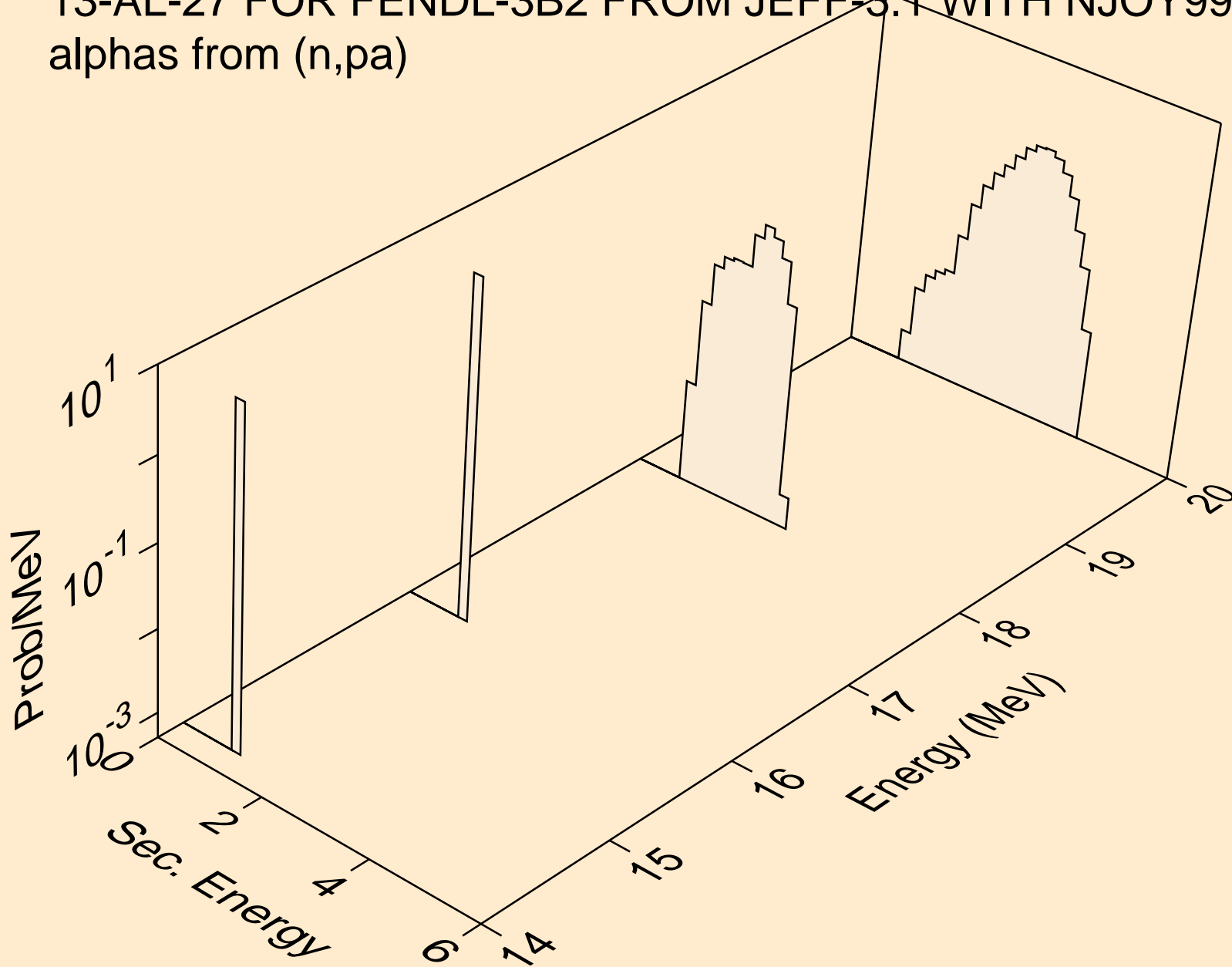



13-AL-27 FOR FENDL-3B2 FROM JEFF-3.1 WITH NJOY99.304+ C  
alphas from (n,da)

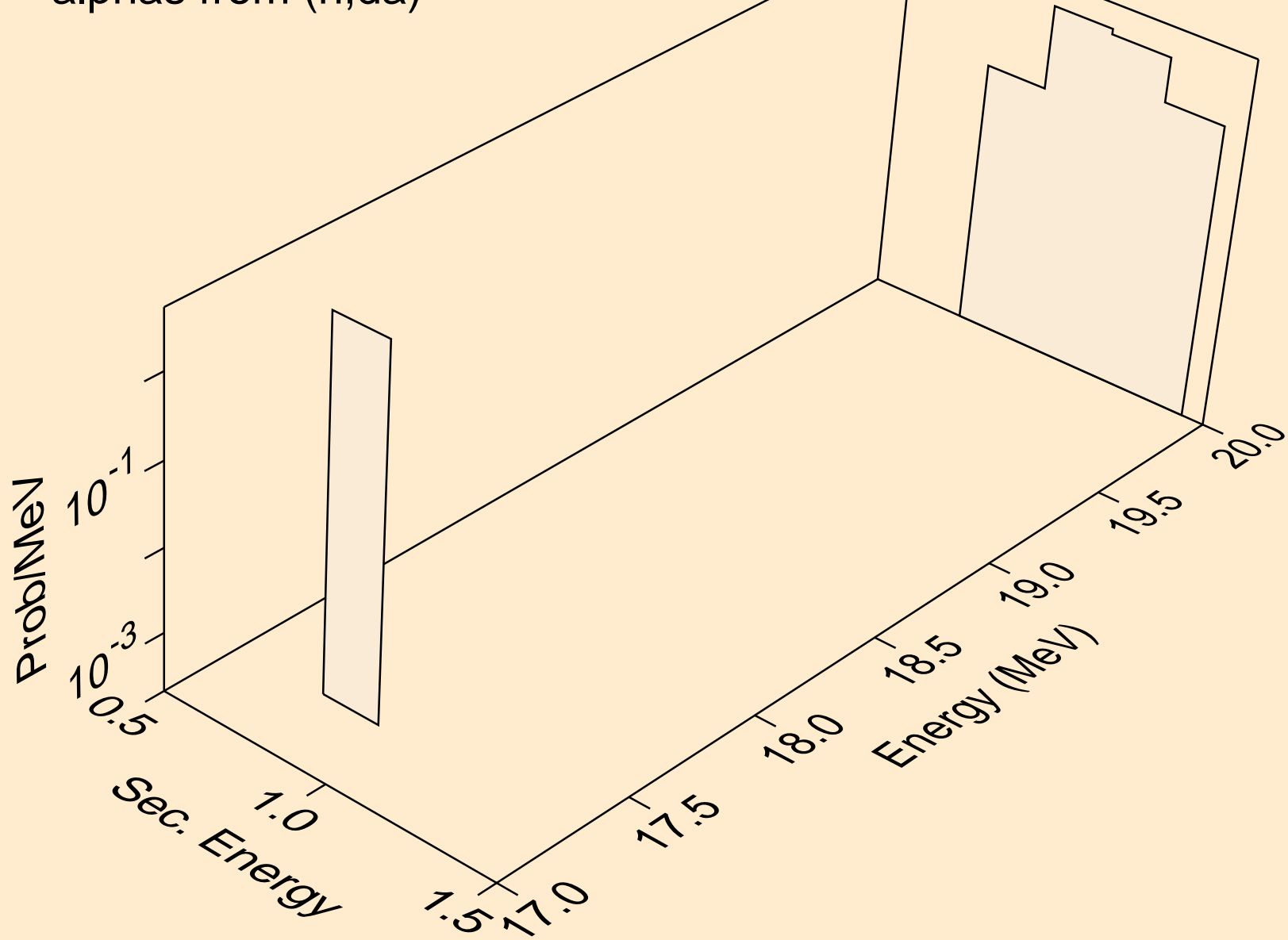

13-AL-27 FOR FENDL-3B2 FROM JEFF-3.1 WITH NJOY99.304+ C  
angular distribution for (n,a\*0) alpha

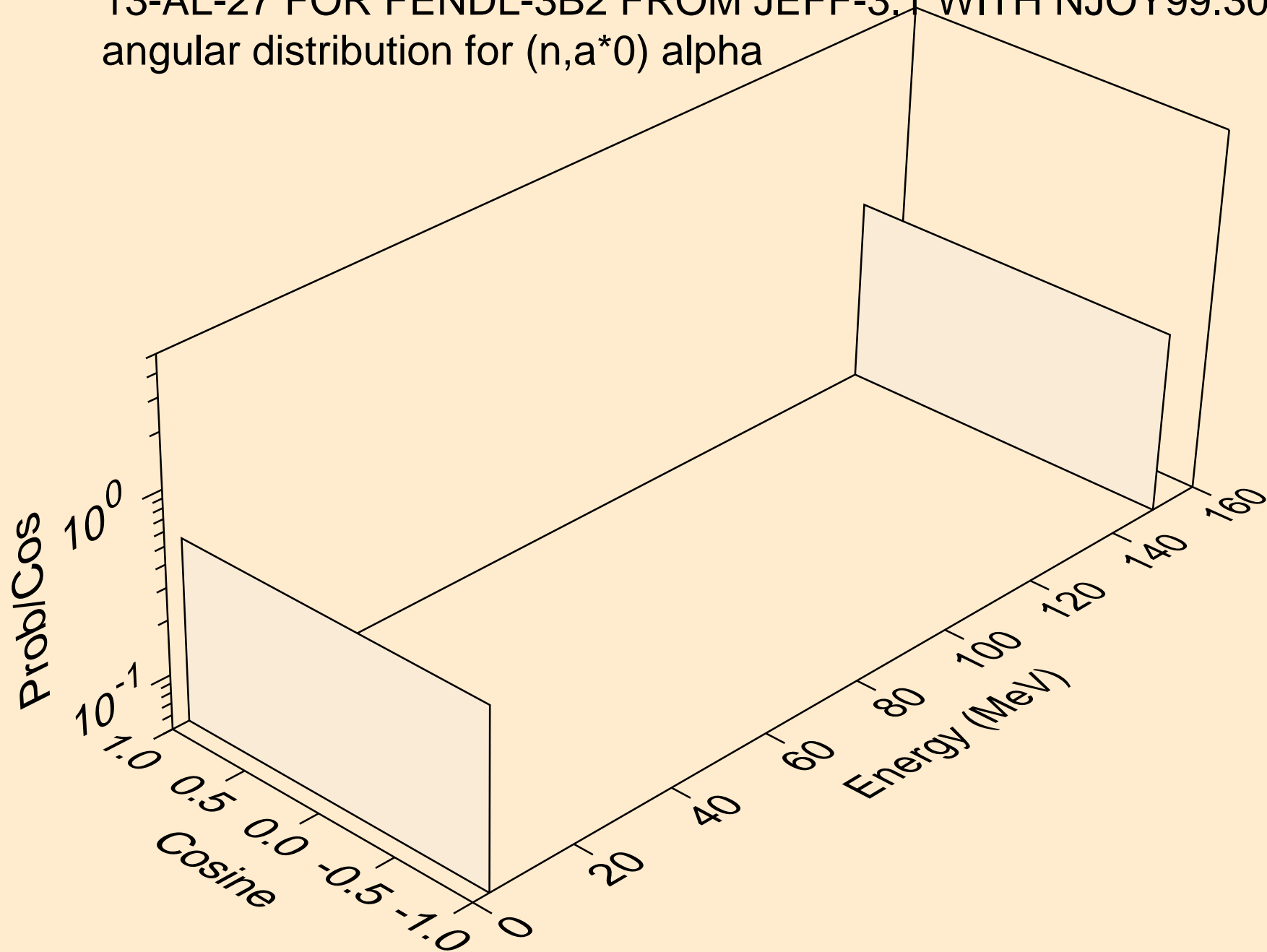

13-AL-27 FOR FENDL-3B2 FROM JEFF-3.1 WITH NJOY99.304+ C  
angular distribution for (n,a\*1) alpha

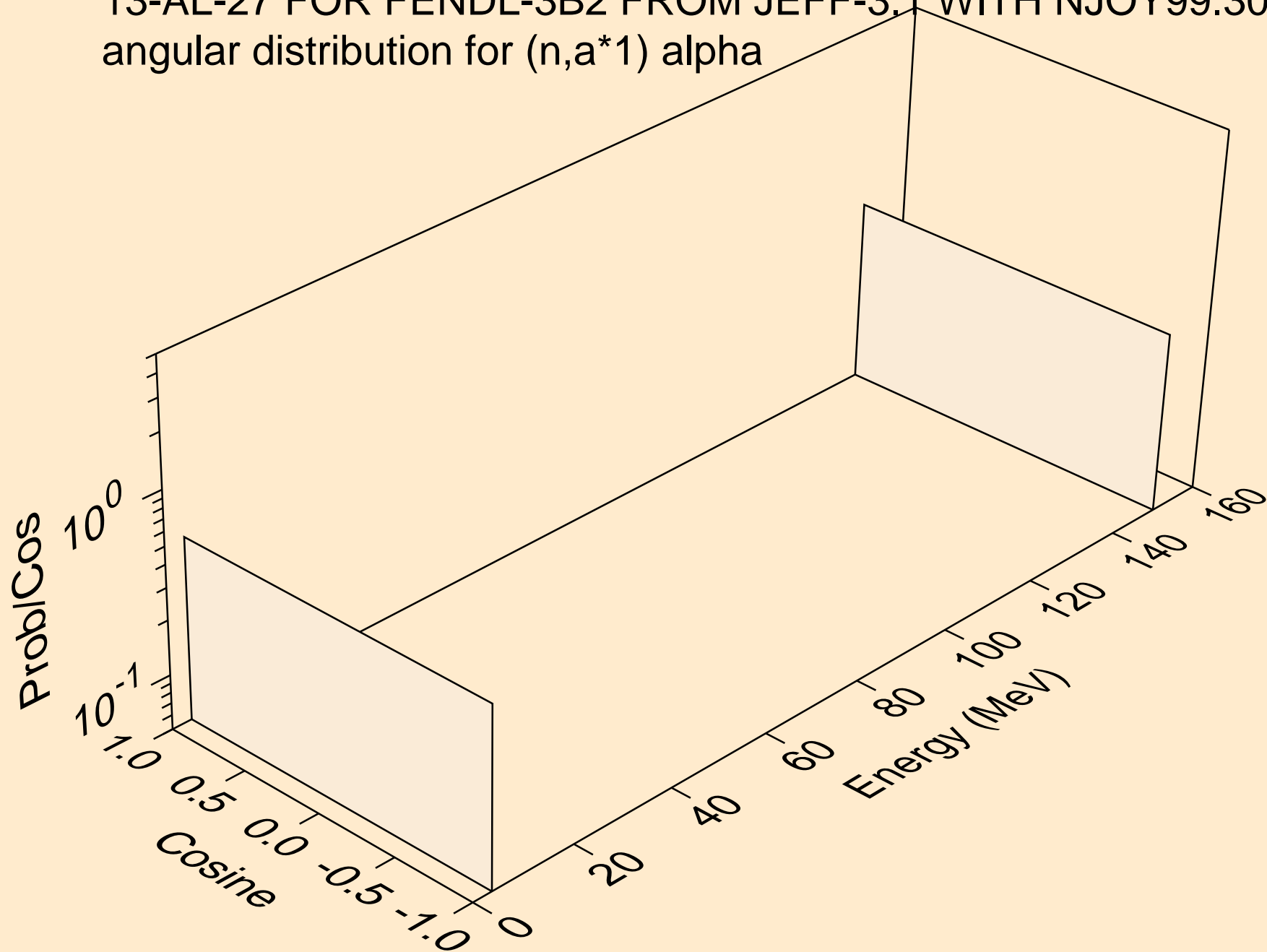

13-AL-27 FOR FENDL-3B2 FROM JEFF-3.1 WITH NJOY99.304+ C  
angular distribution for (n,a\*2) alpha

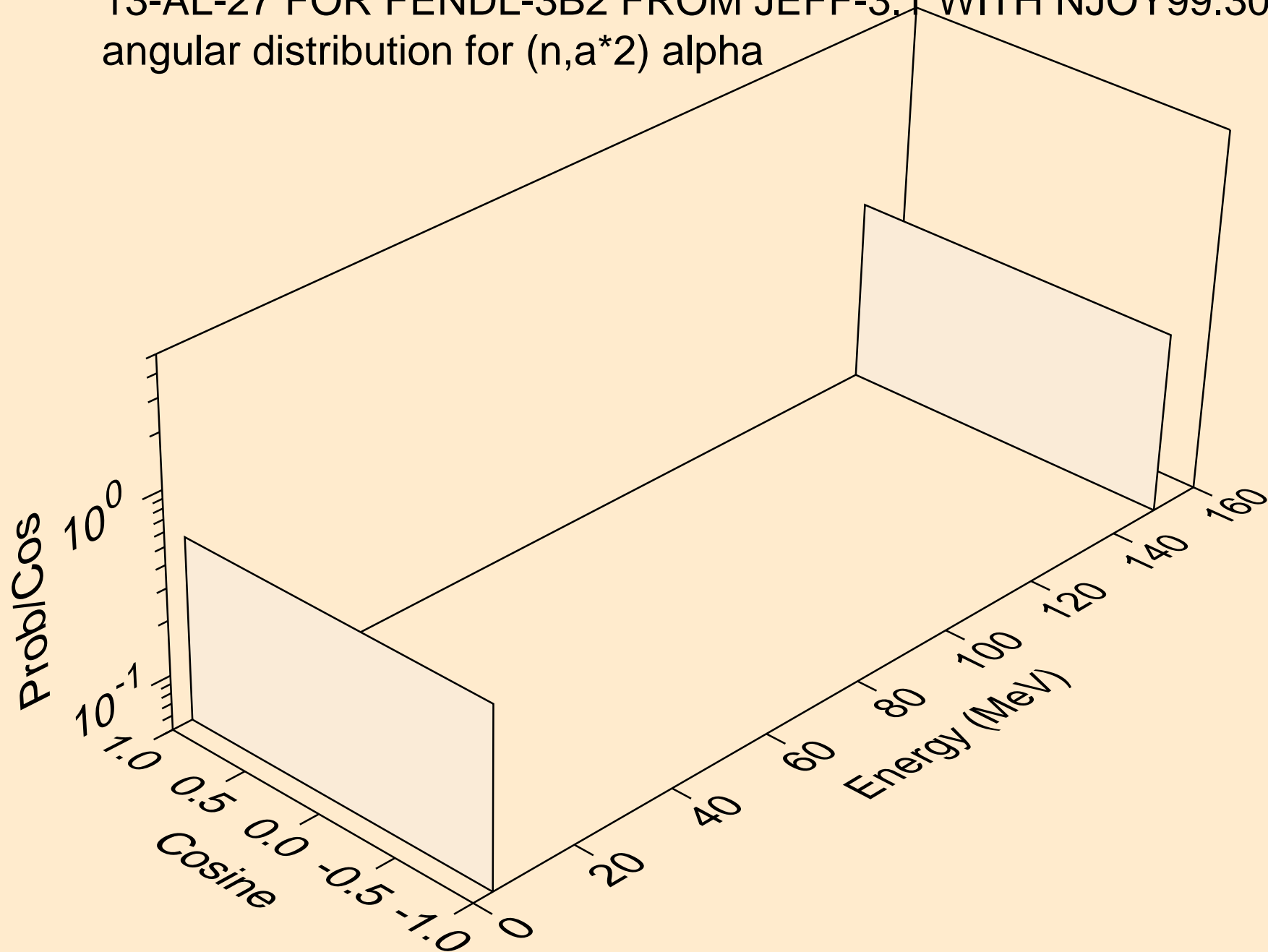

13-AL-27 FOR FENDL-3B2 FROM JEFF-3.1 WITH NJOY99.304+ C  
angular distribution for (n,a\*3) alpha

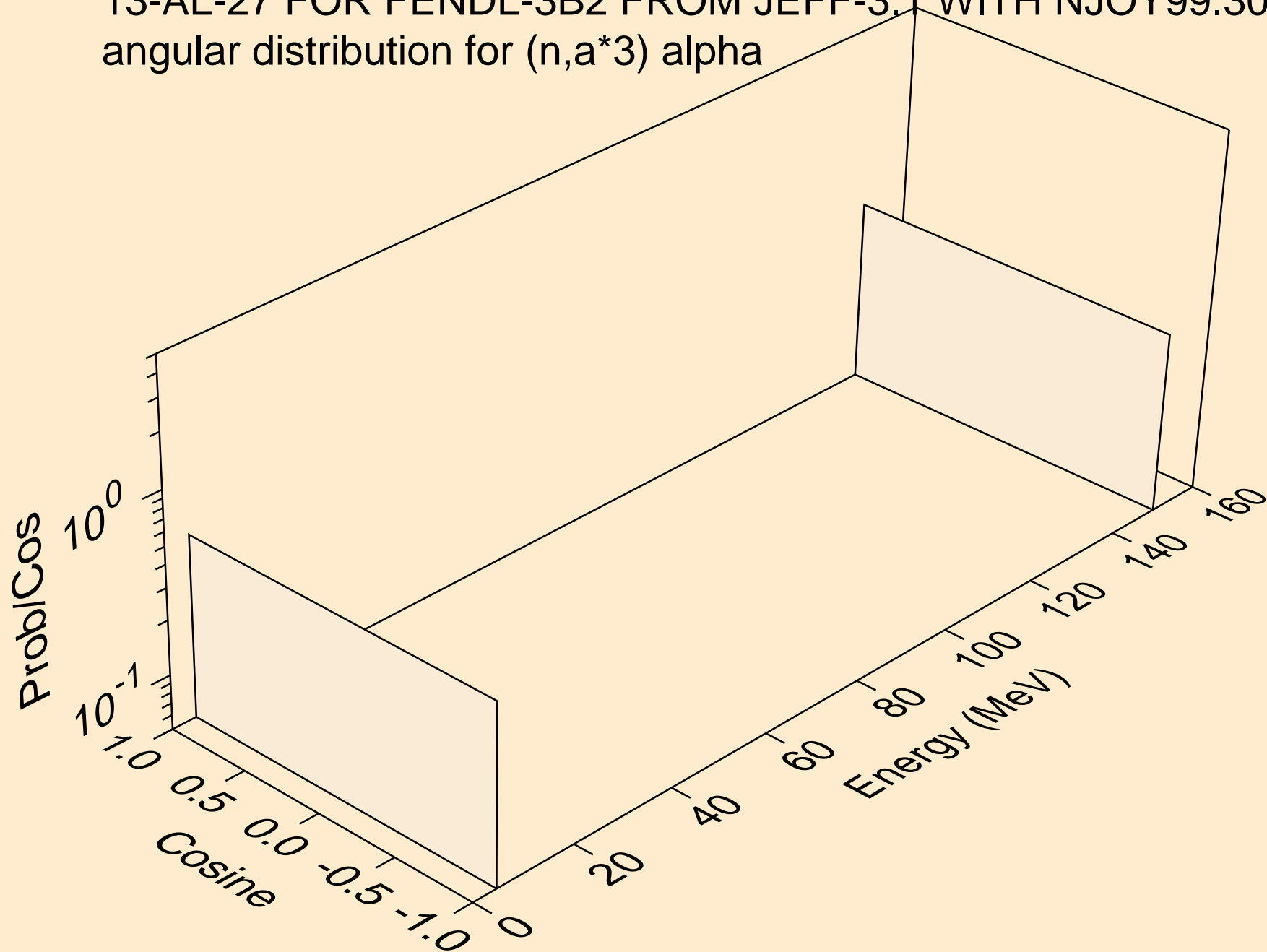

13-AL-27 FOR FENDL-3B2 FROM JEFF-3.1 WITH NJOY99.304+ C  
angular distribution for (n,a\*4) alpha

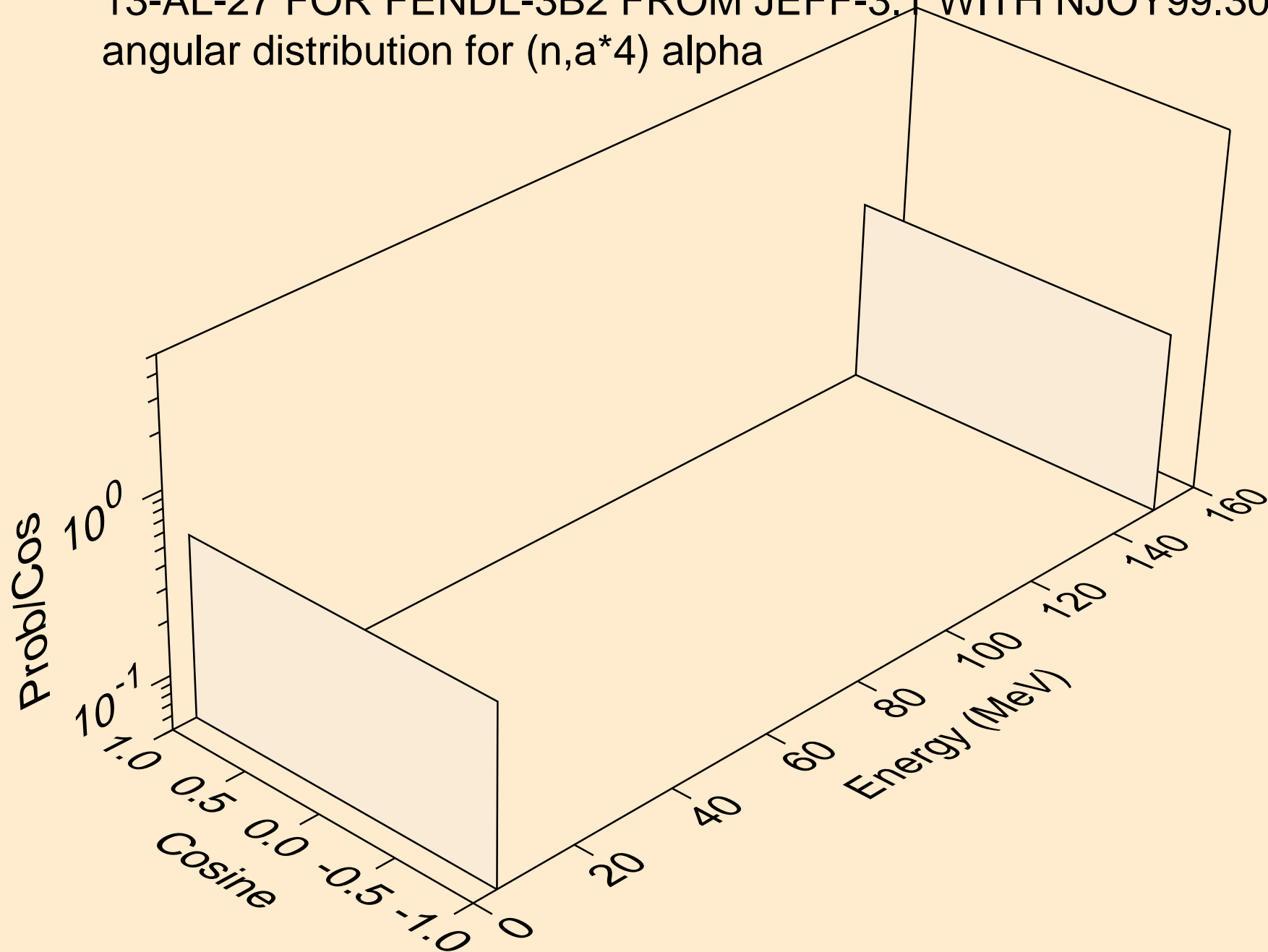

13-AL-27 FOR FENDL-3B2 FROM JEFF-3.1 WITH NJOY99.304+ C  
angular distribution for (n,a\*5) alpha

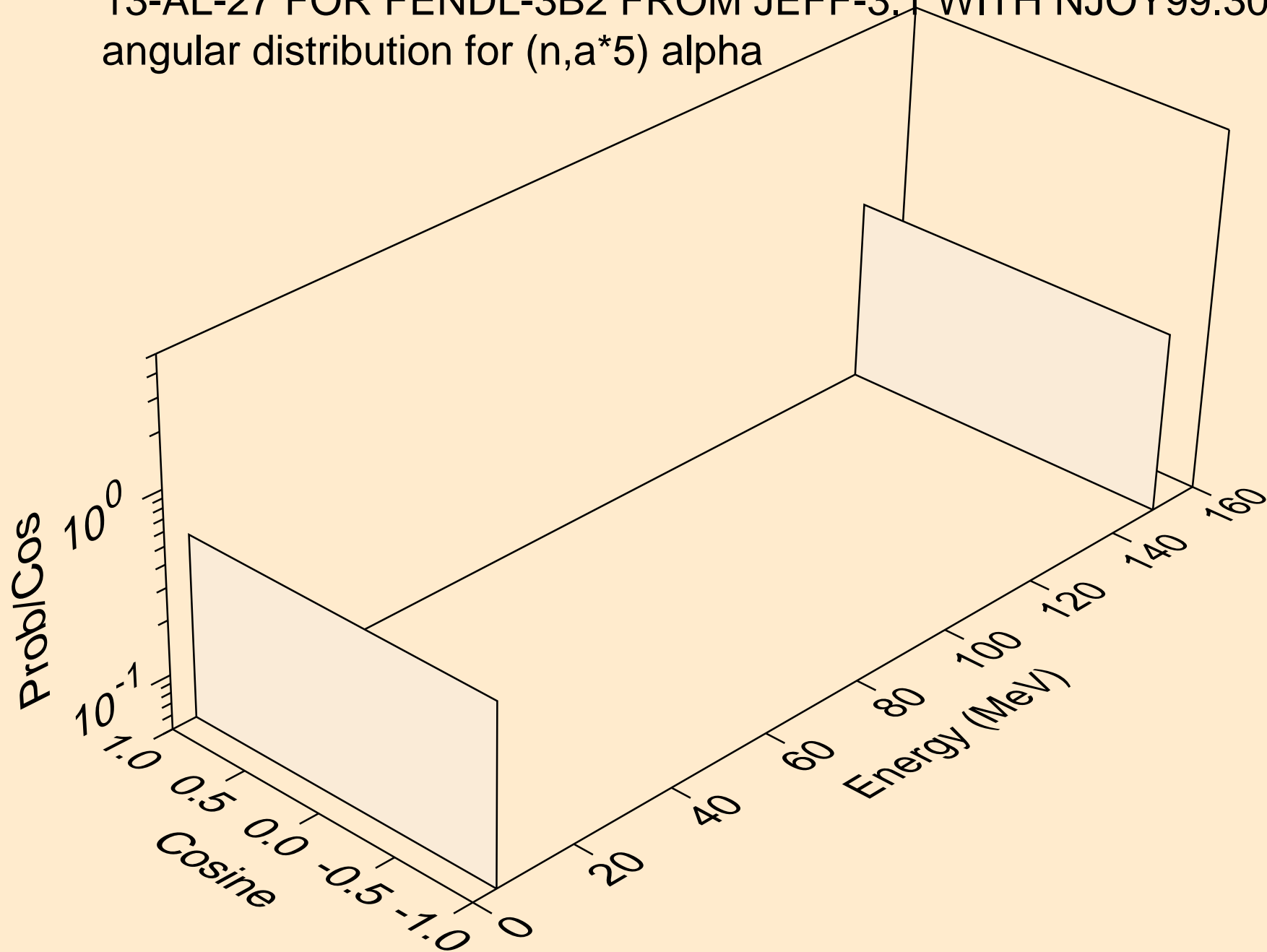

13-AL-27 FOR FENDL-3B2 FROM JEFF-3.1 WITH NJOY99.304+ C  
angular distribution for (n,a\*6) alpha

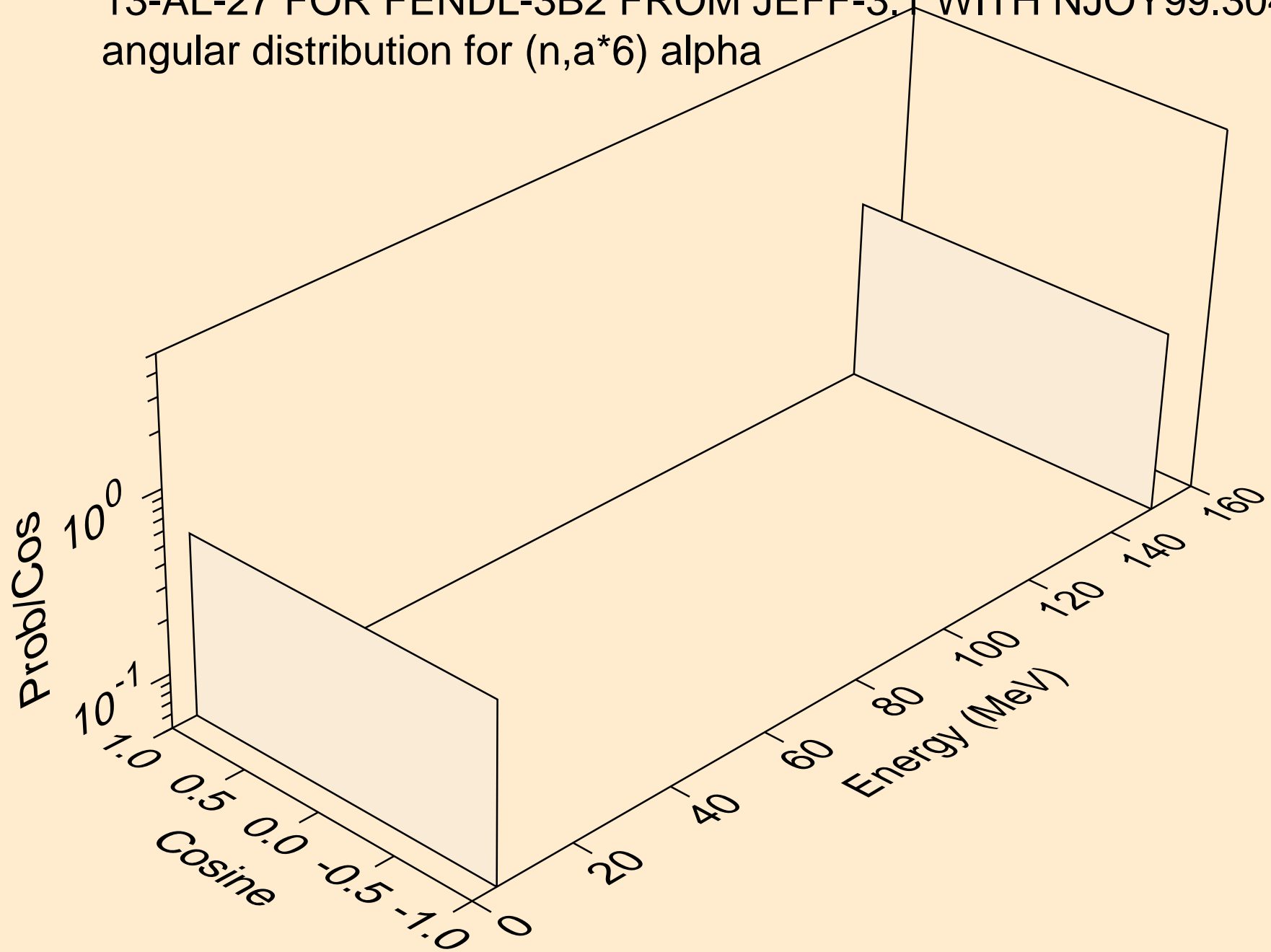



13-AL-27 FOR FENDL-3B2 FROM JEFF-3.1 WITH NJOY99.304+ C  
angular distribution for (n,a\*7) alpha

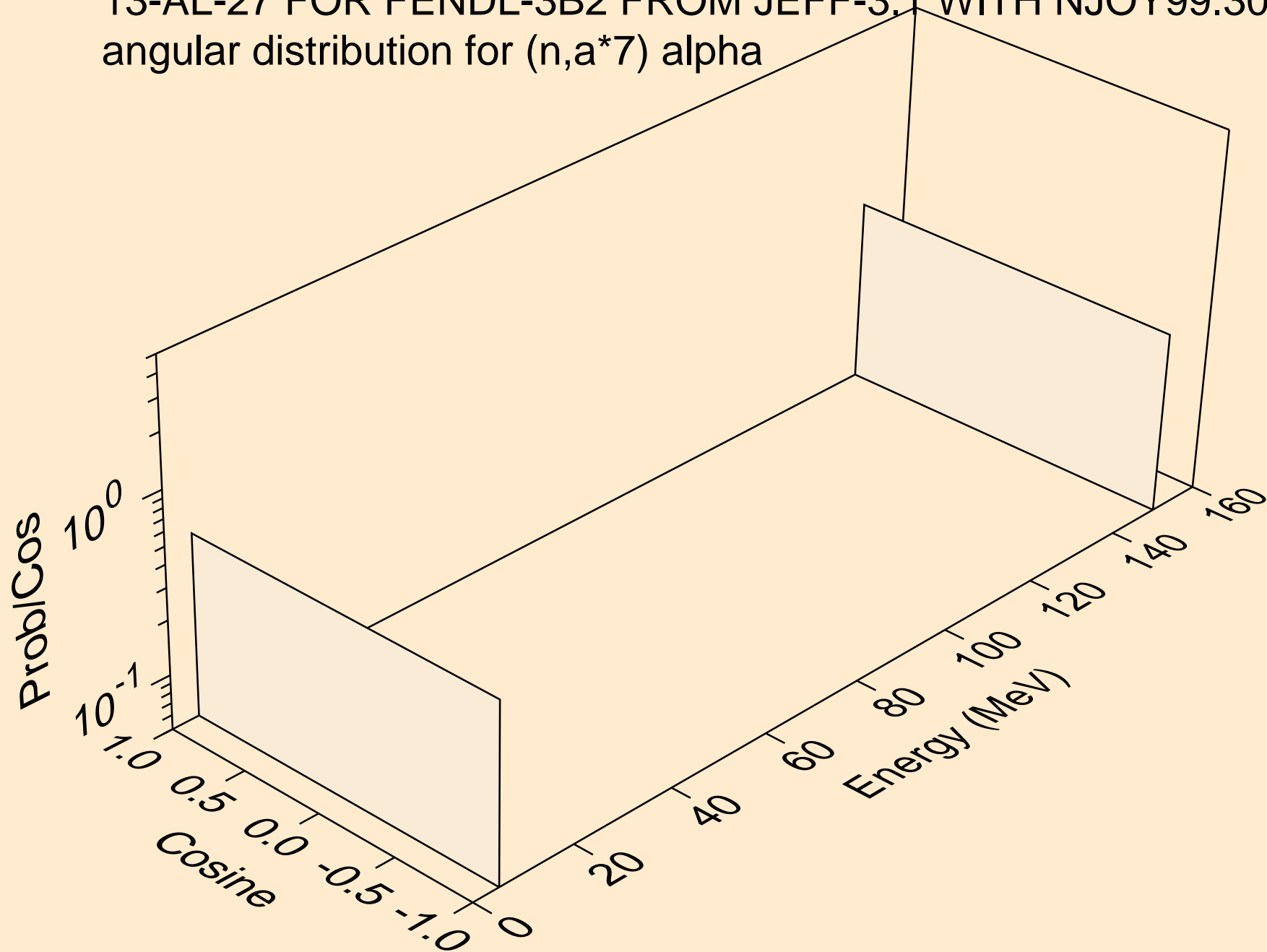

13-AL-27 FOR FENDL-3B2 FROM JEFF-3.1 WITH NJOY99.304+ C  
angular distribution for (n,a\*8) alpha

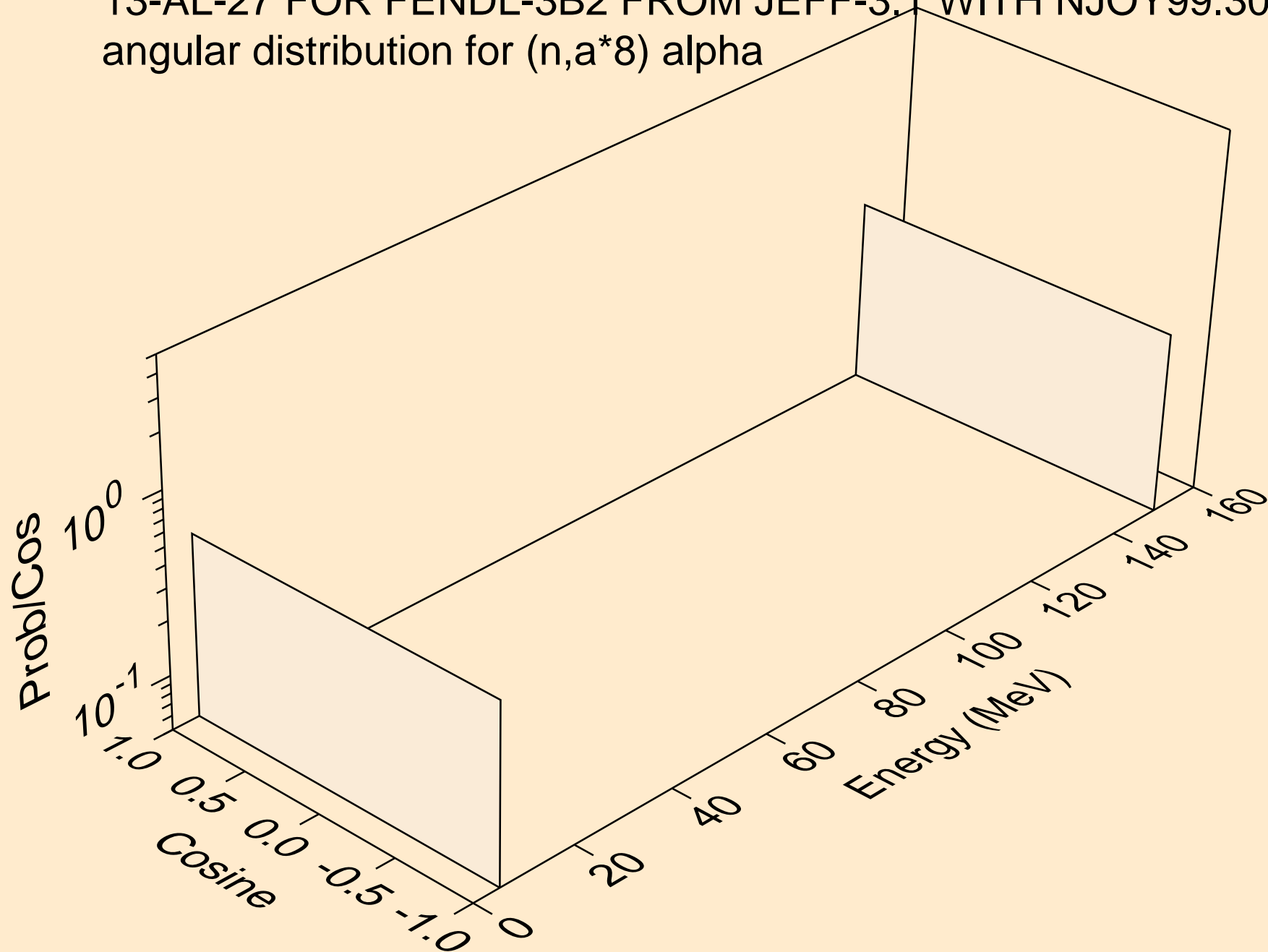

13-AL-27 FOR FENDL-3B2 FROM JEFF-3.1 WITH NJOY99.304+ C  
angular distribution for (n,a\*9) alpha

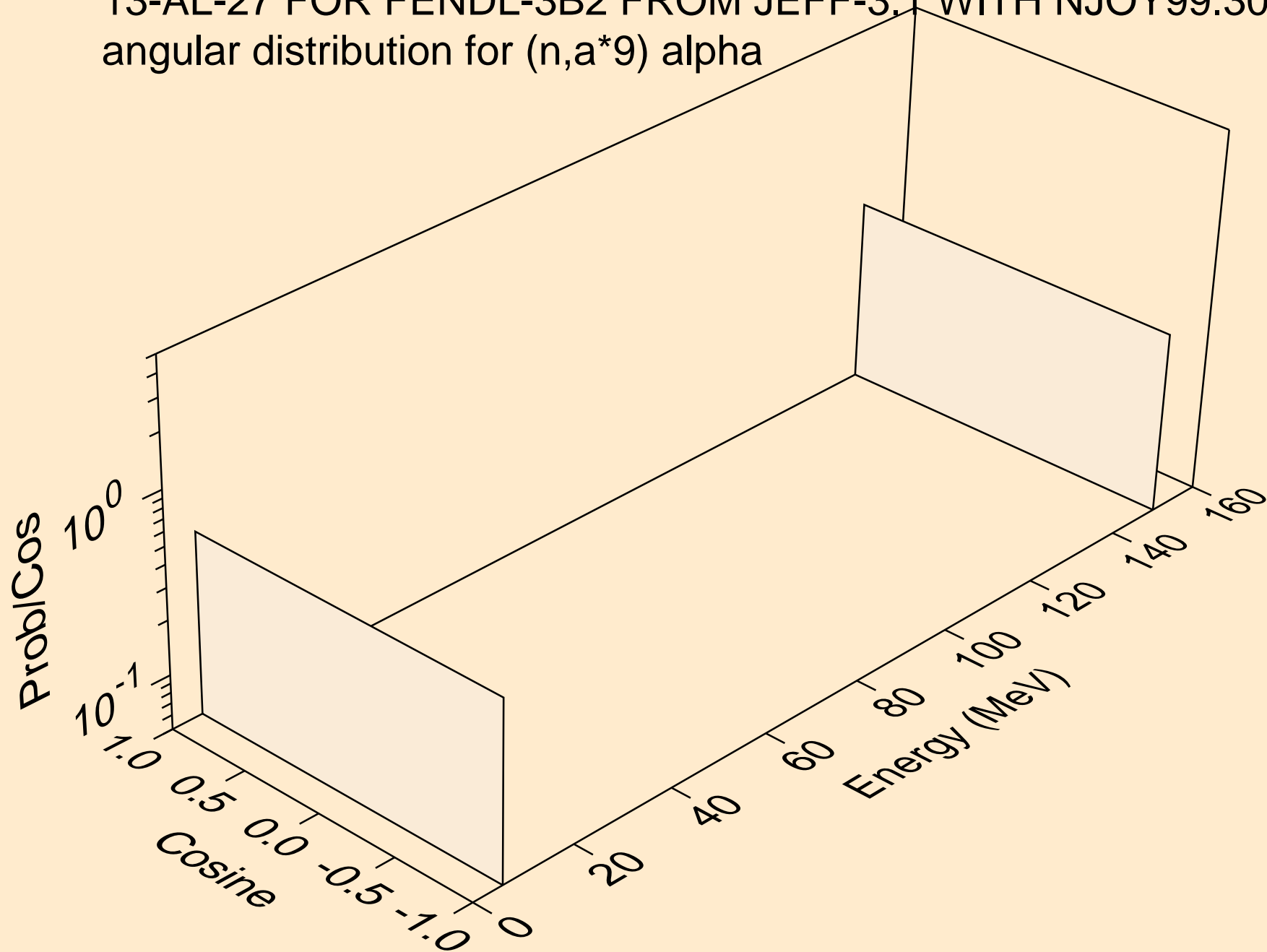

13-AL-27 FOR FENDL-3B2 FROM JEFF-3.1 WITH NJOY99.304+ C  
angular distribution for (n,a\*10) alpha

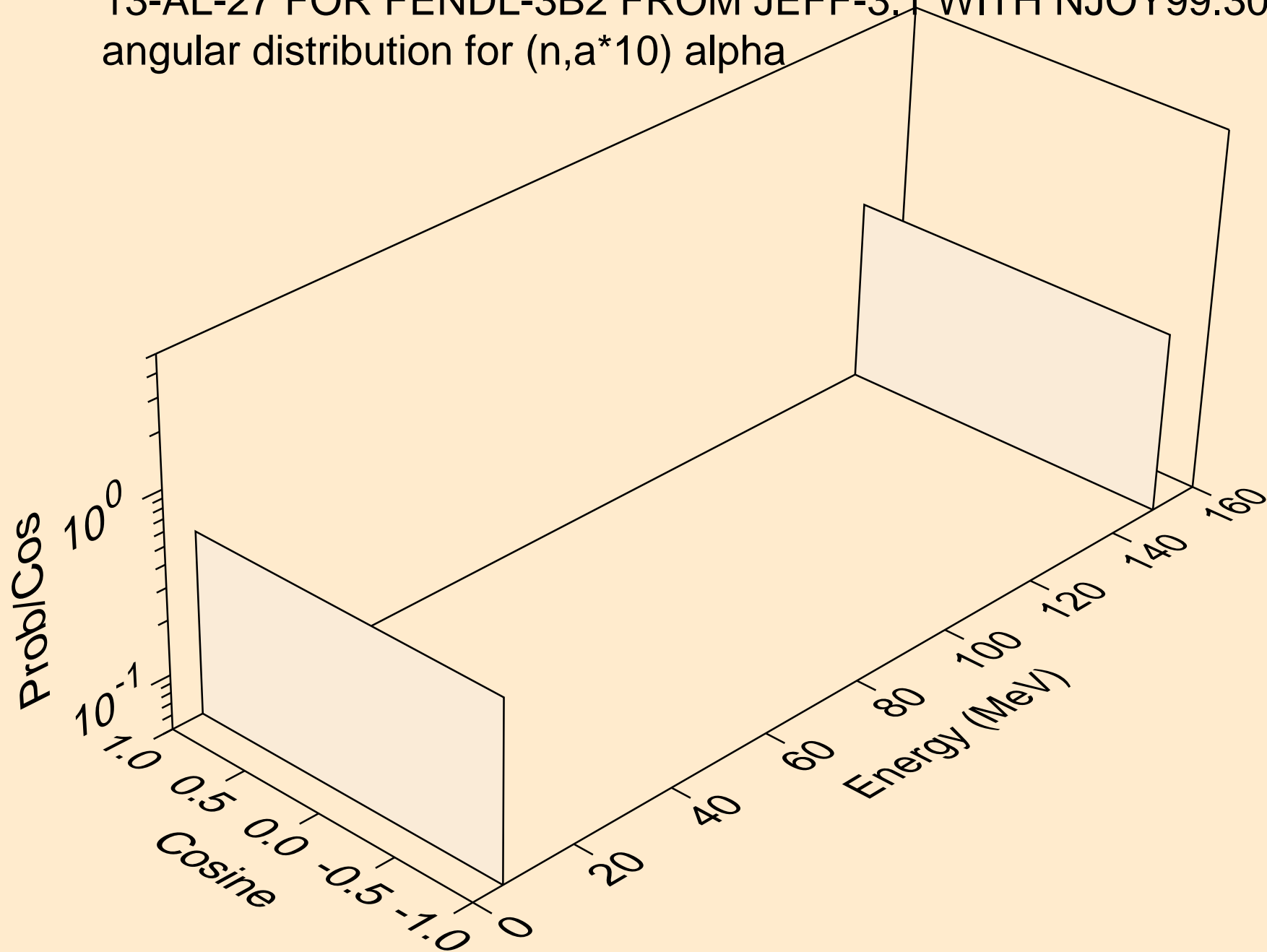

13-AL-27 FOR FENDL-3B2 FROM JEFF-3.1 WITH NJOY99.304+ C  
angular distribution for (n,a\*11) alpha

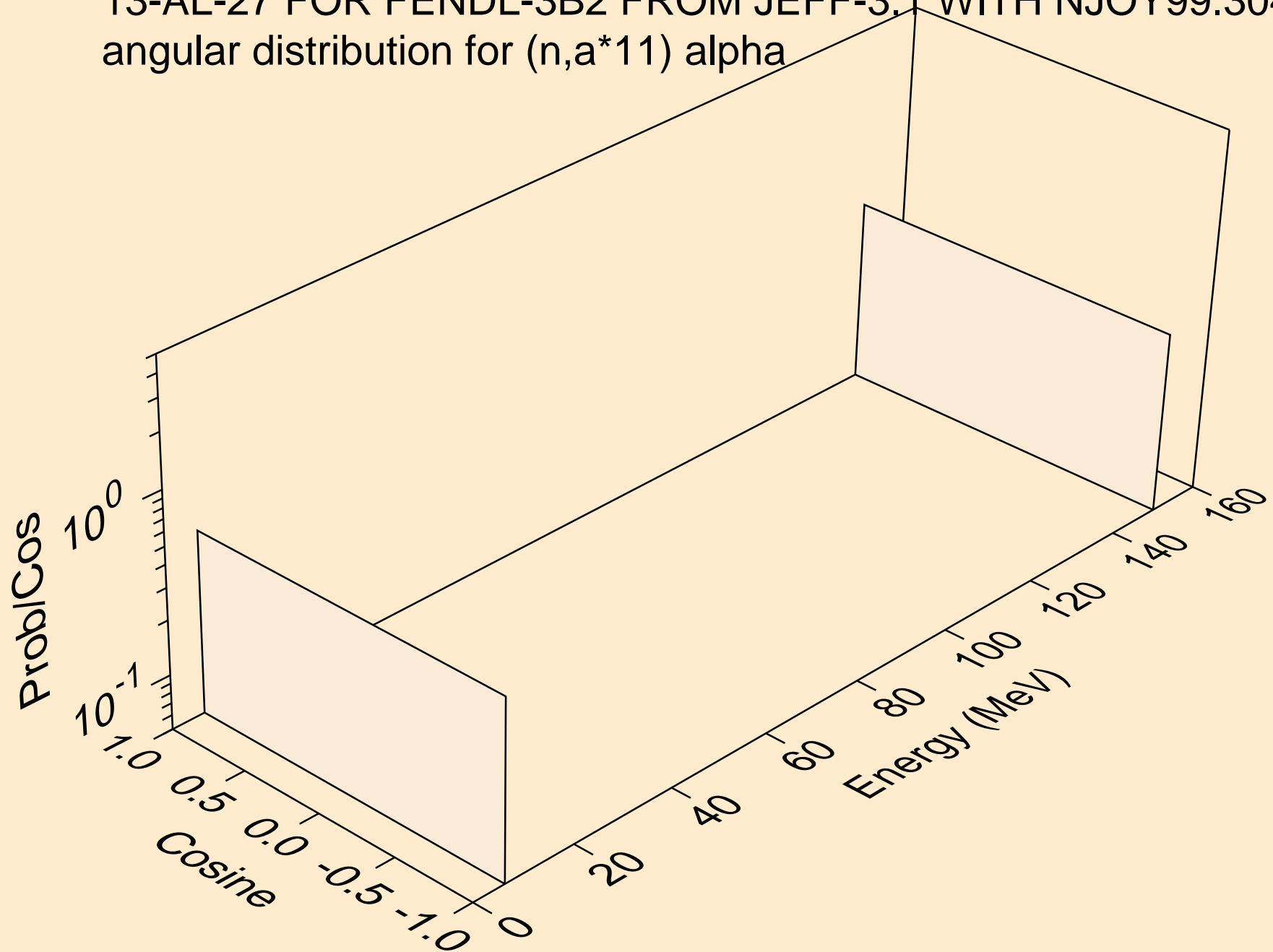

13-AL-27 FOR FENDL-3B2 FROM JEFF-3.1 WITH NJOY99.304+ C  
angular distribution for (n,a\*12) alpha

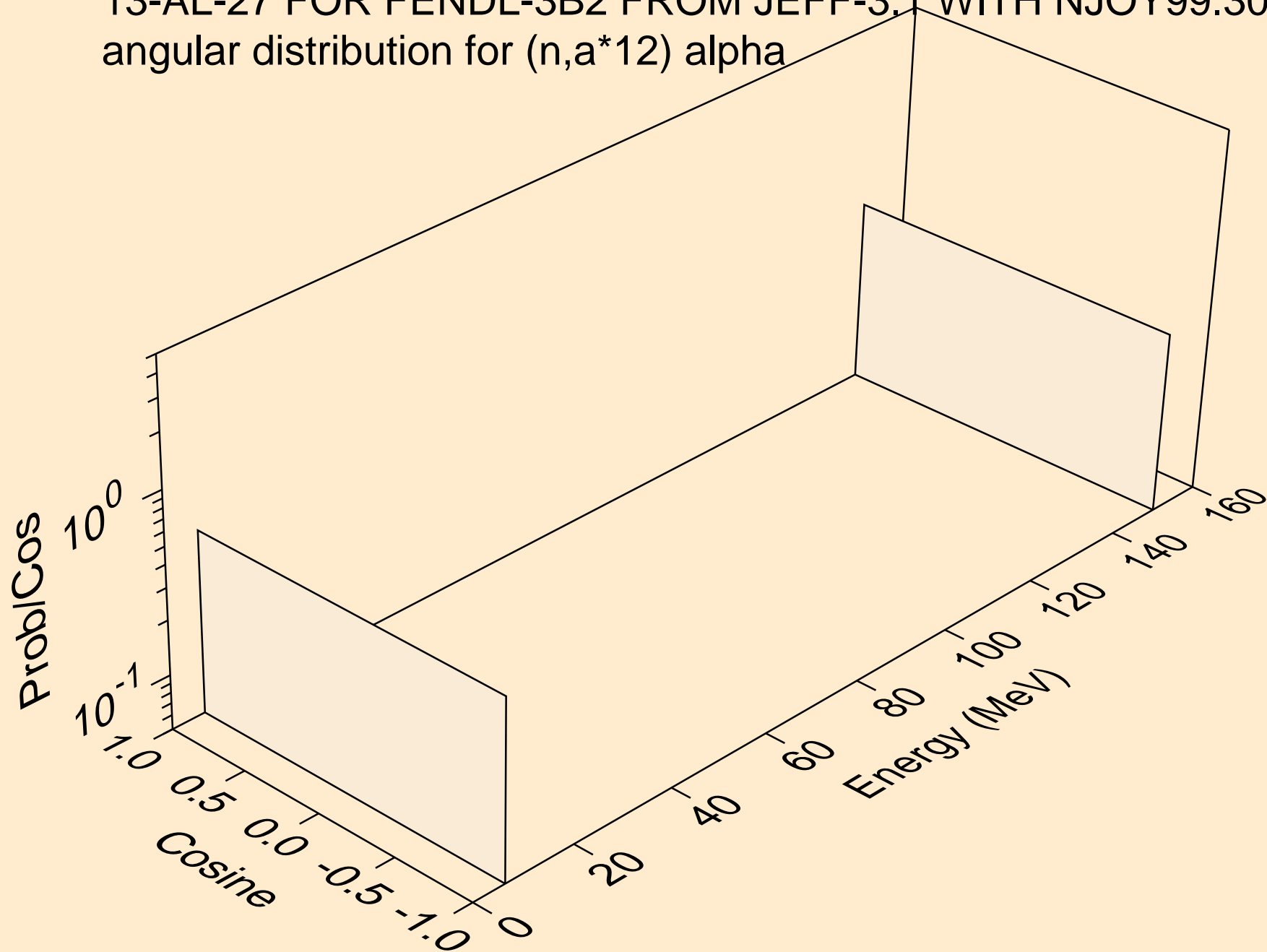

13-AL-27 FOR FENDL-3B2 FROM JEFF-3.1 WITH NJOY99.304+ C  
angular distribution for (n,a\*13) alpha

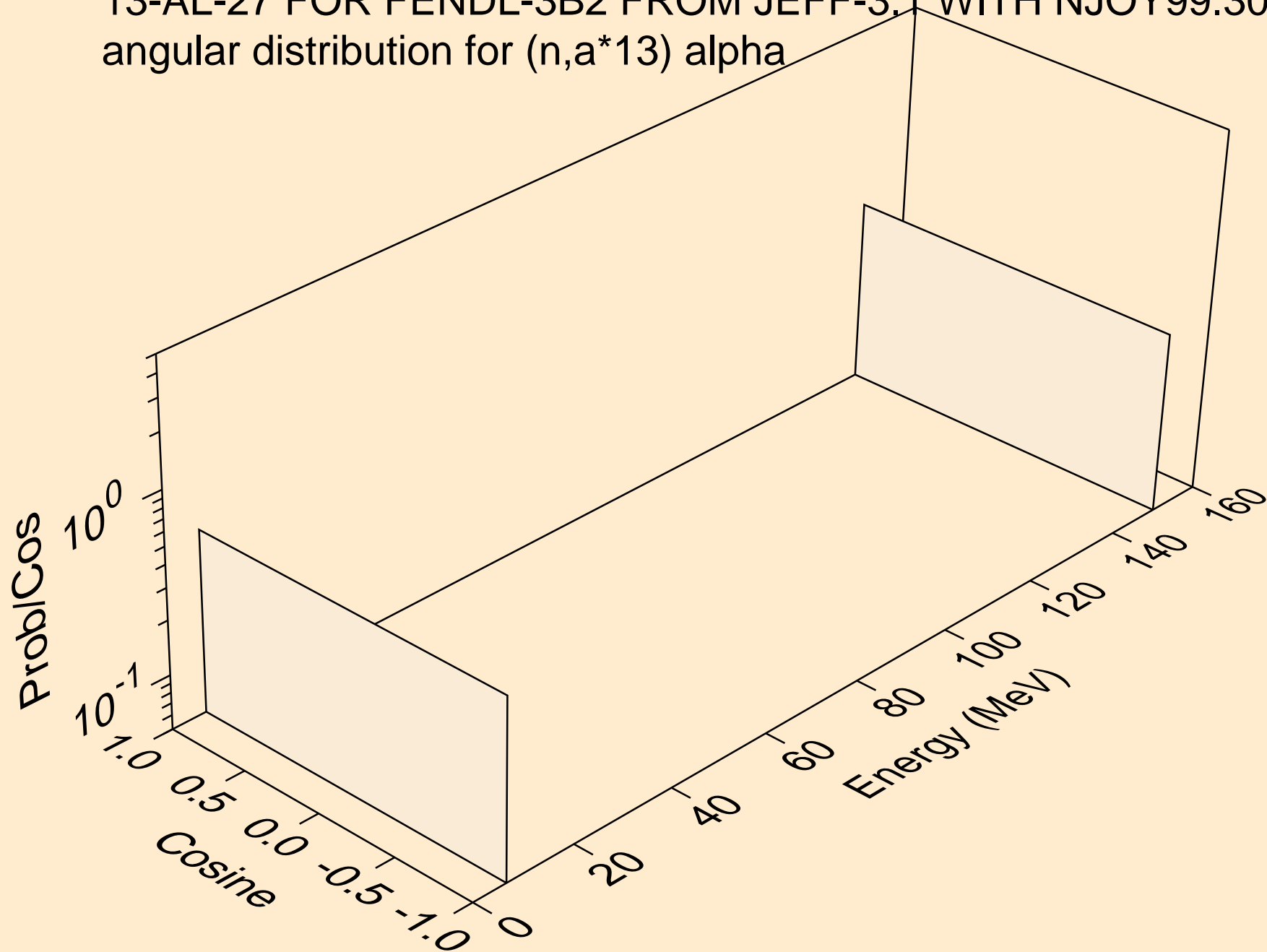

13-AL-27 FOR FENDL-3B2 FROM JEFF-3.1 WITH NJOY99.304+ C  
angular distribution for (n,a\*14) alpha

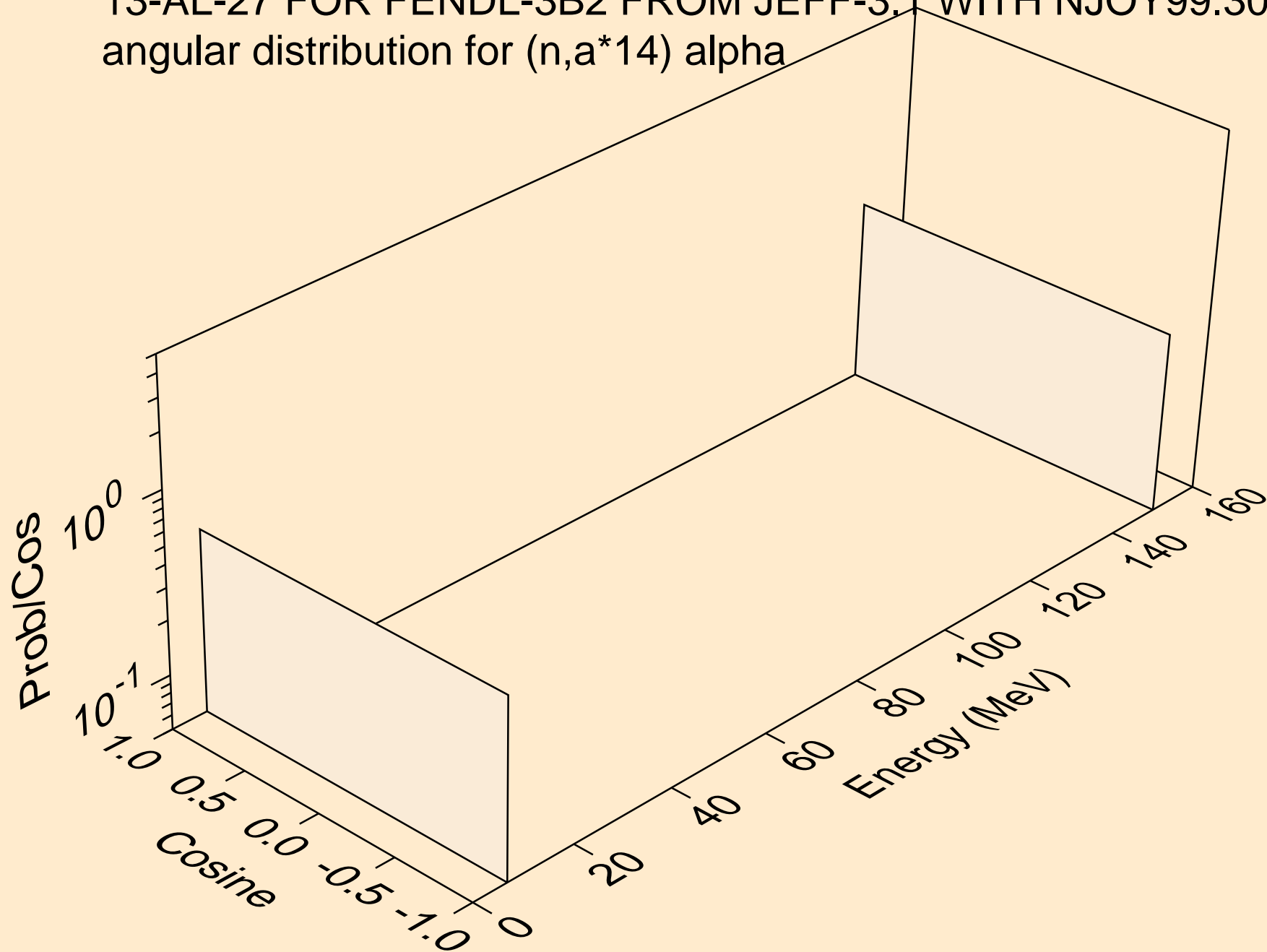



13-AL-27 FOR FENDL-3B2 FROM JEFF-3.1 WITH NJOY99.304+ C  
angular distribution for (n,a\*15) alpha

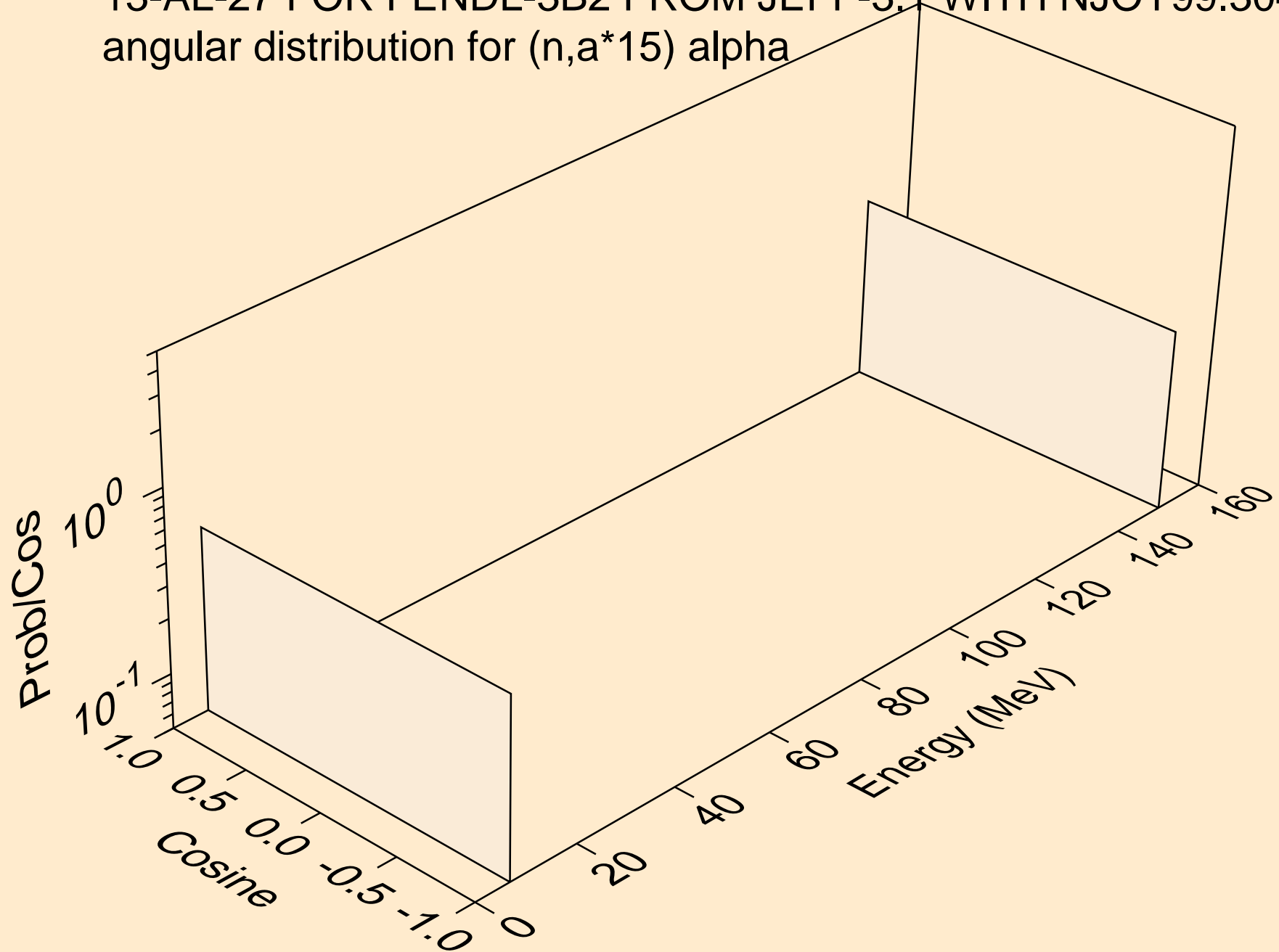

13-AL-27 FOR FENDL-3B2 FROM JEFF-3.1 WITH NJOY99.304+ C  
angular distribution for (n,a\*16) alpha

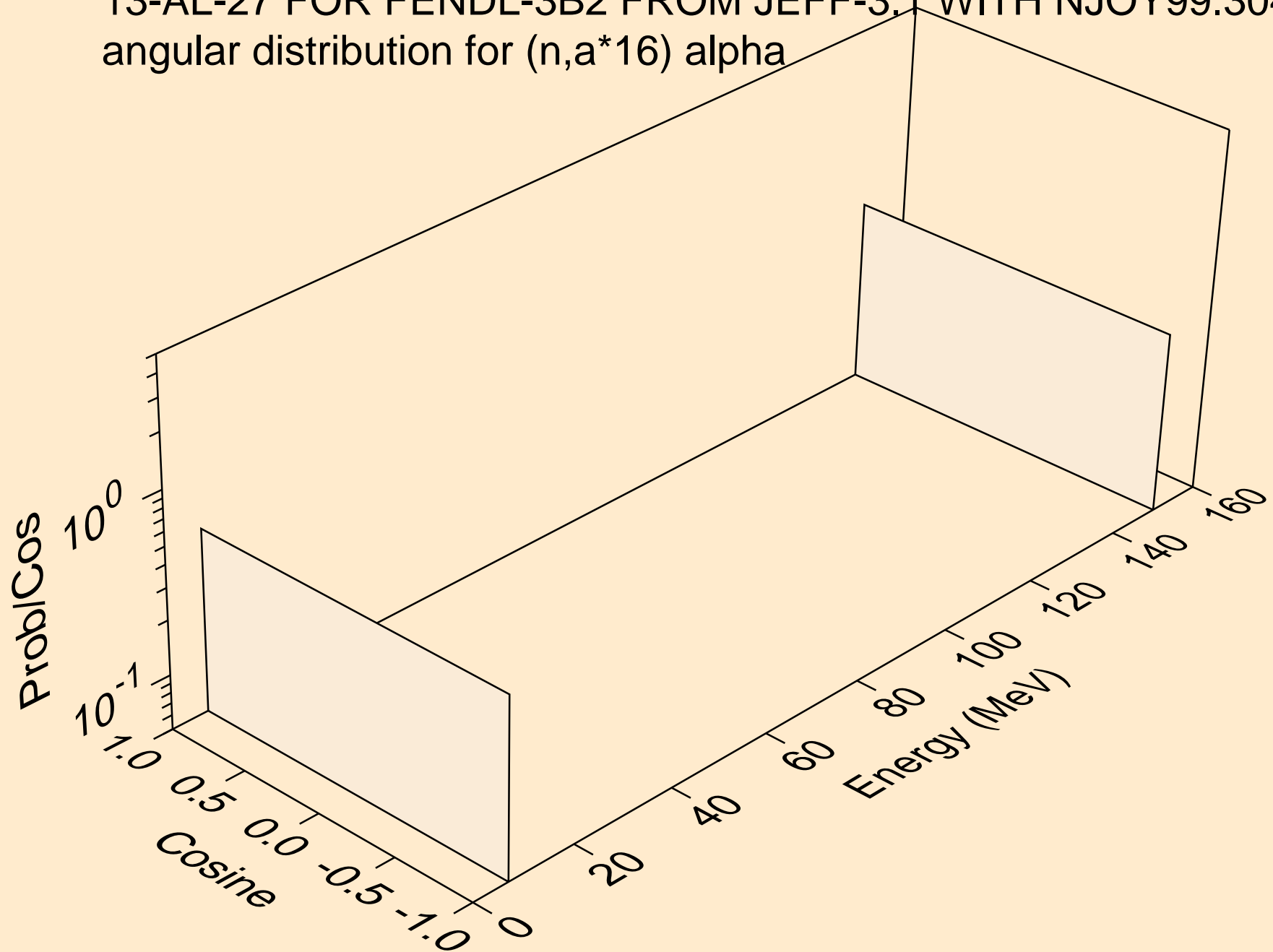

13-AL-27 FOR FENDL-3B2 FROM JEFF-3.1 WITH NJOY99.304+ C  
angular distribution for (n,a\*17) alpha

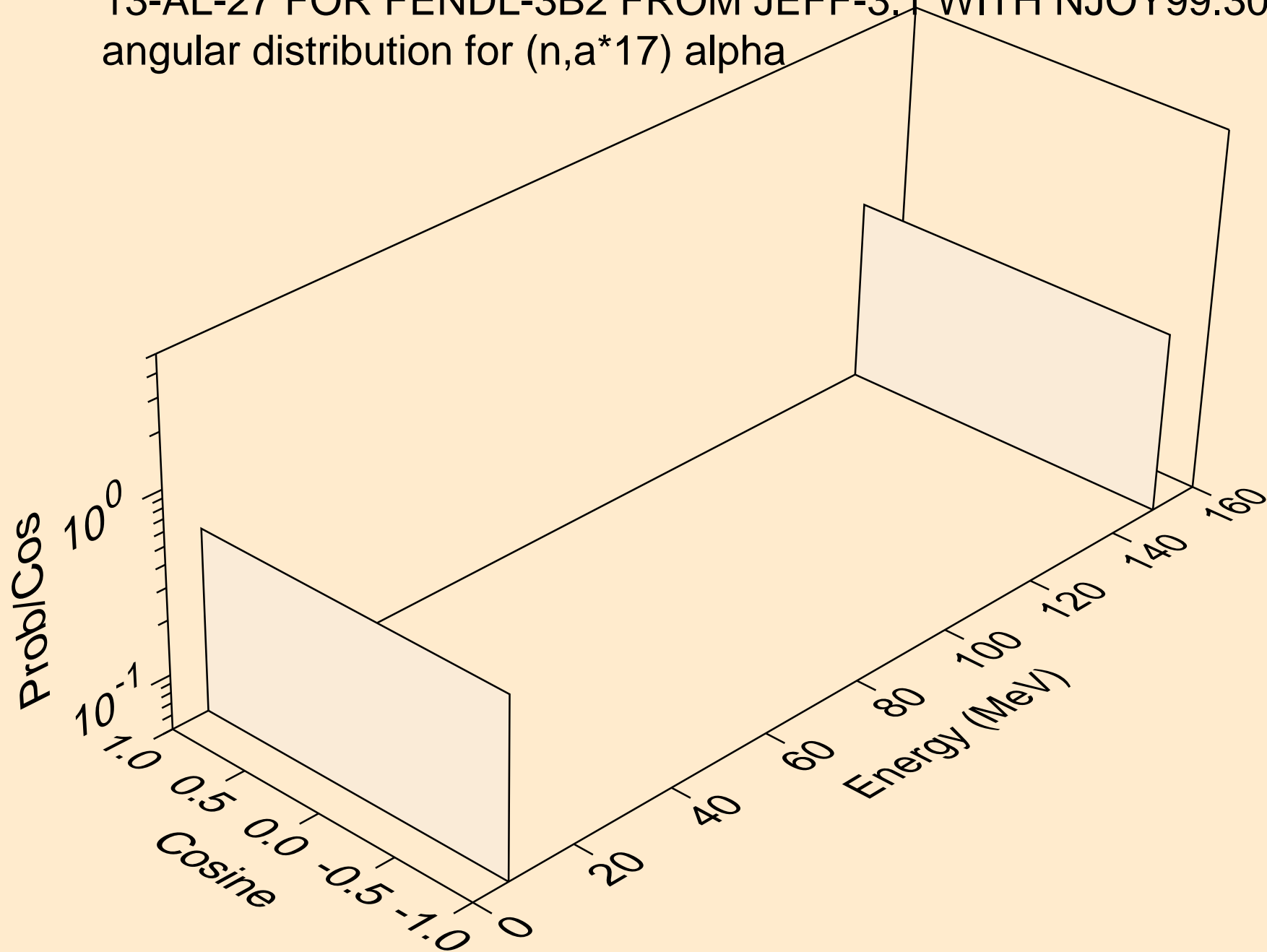

13-AL-27 FOR FENDL-3B2 FROM JEFF-3.1 WITH NJOY99.304+ C  
angular distribution for (n,a\*18) alpha

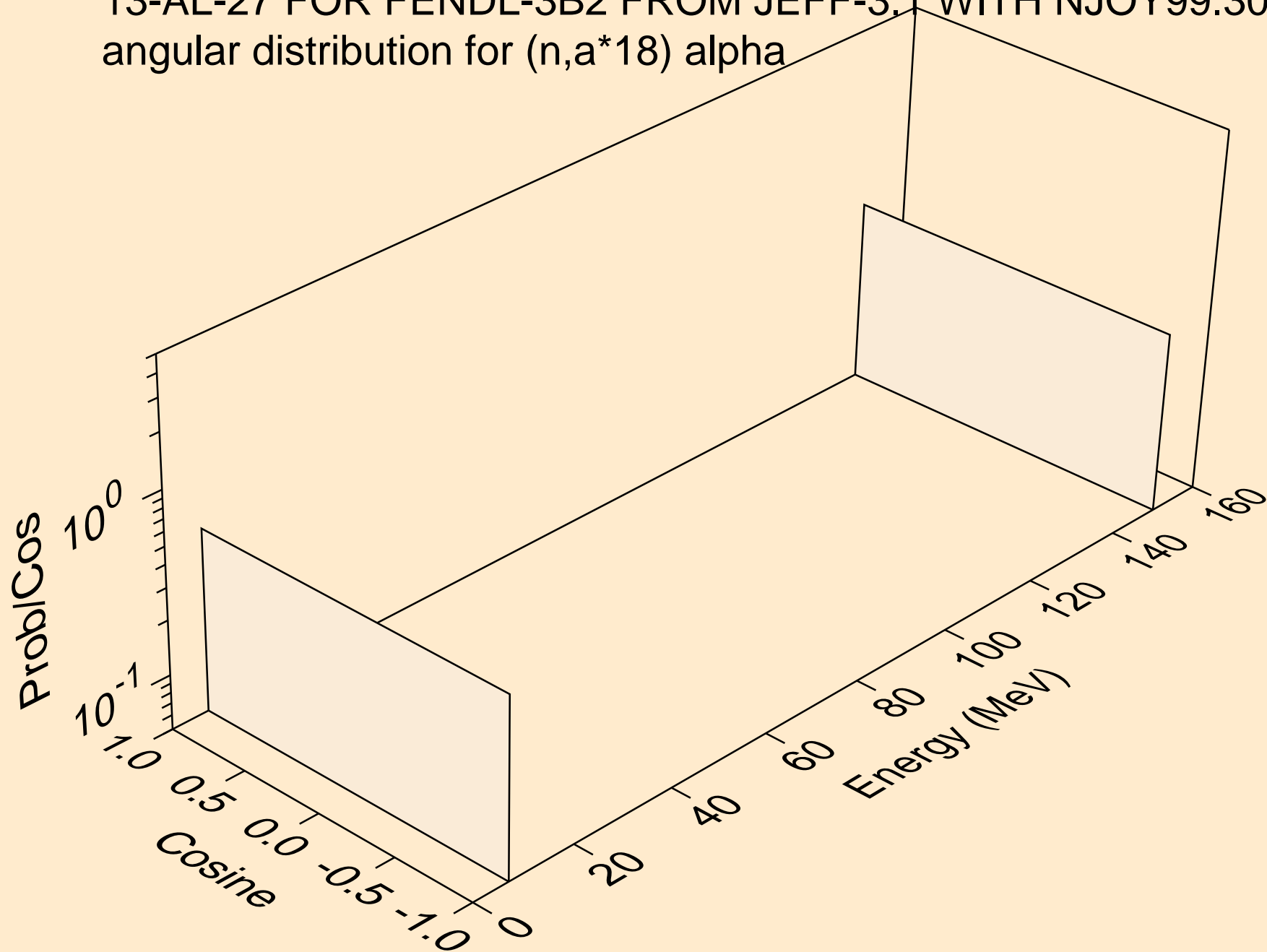

13-AL-27 FOR FENDL-3B2 FROM JEFF-3.1 WITH NJOY99.304+ C  
angular distribution for (n,a\*19) alpha

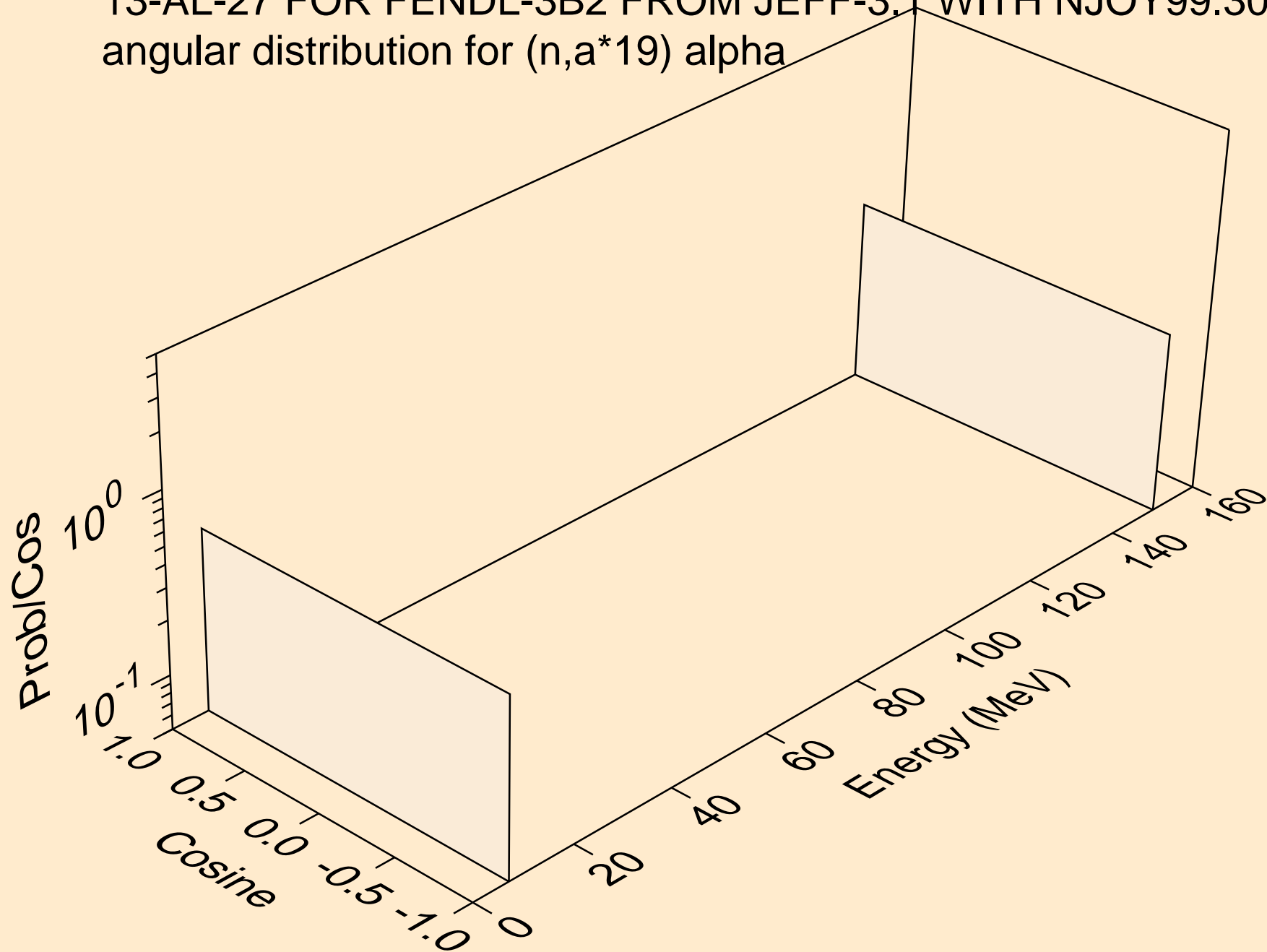

13-AL-27 FOR FENDL-3B2 FROM JEFF-3.1 WITH NJOY99.304+ C  
alphas from (n,a\*c)

