

28-NI-61 FOR FENDL-3B2 FROM ENDF/B-VII WITH NJOY99.304+

Principal cross sections

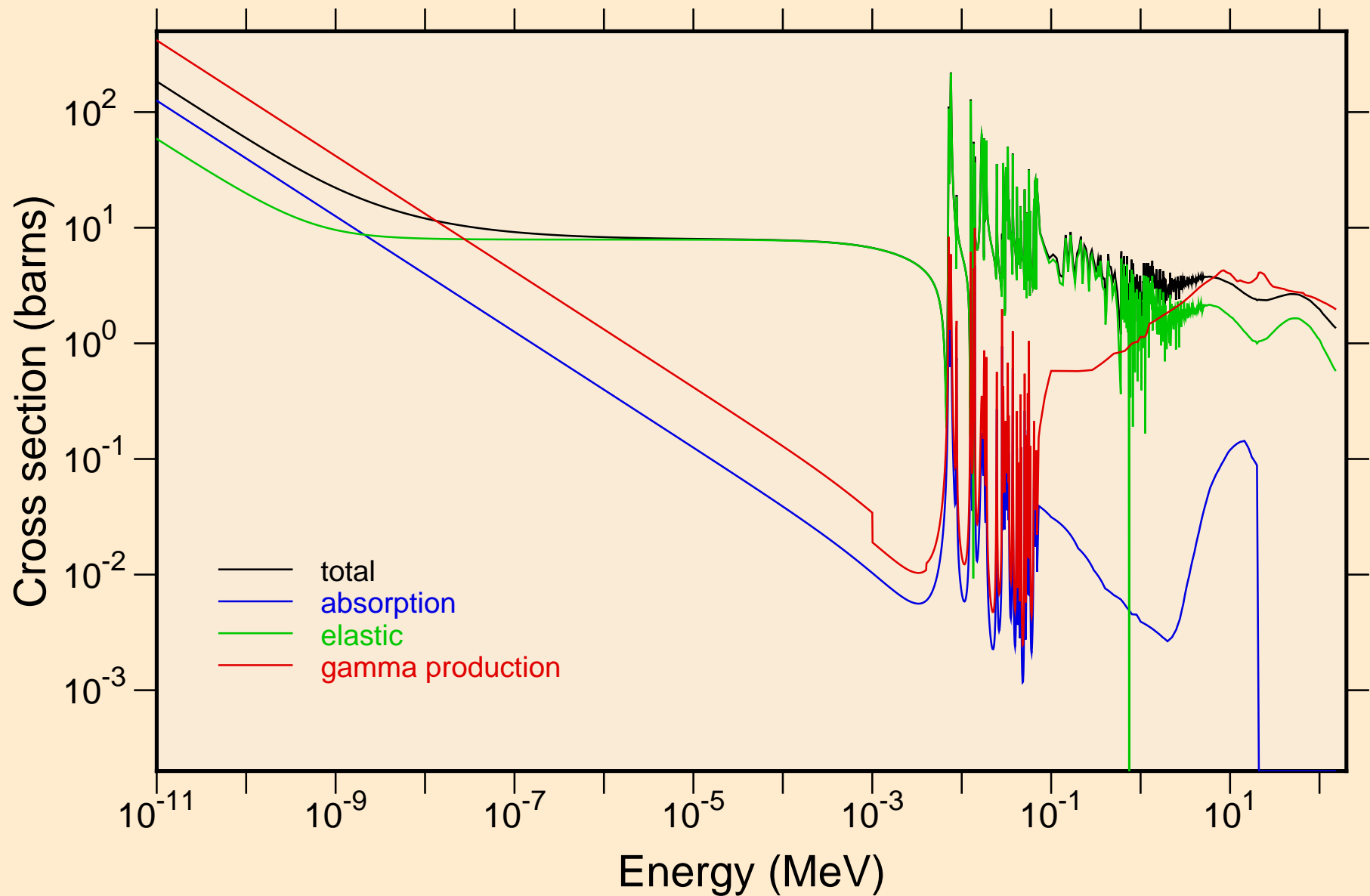

28-NI-61 FOR FENDL-3B2 FROM ENDF/B-VII WITH NJOY99.304+
resonance total cross section

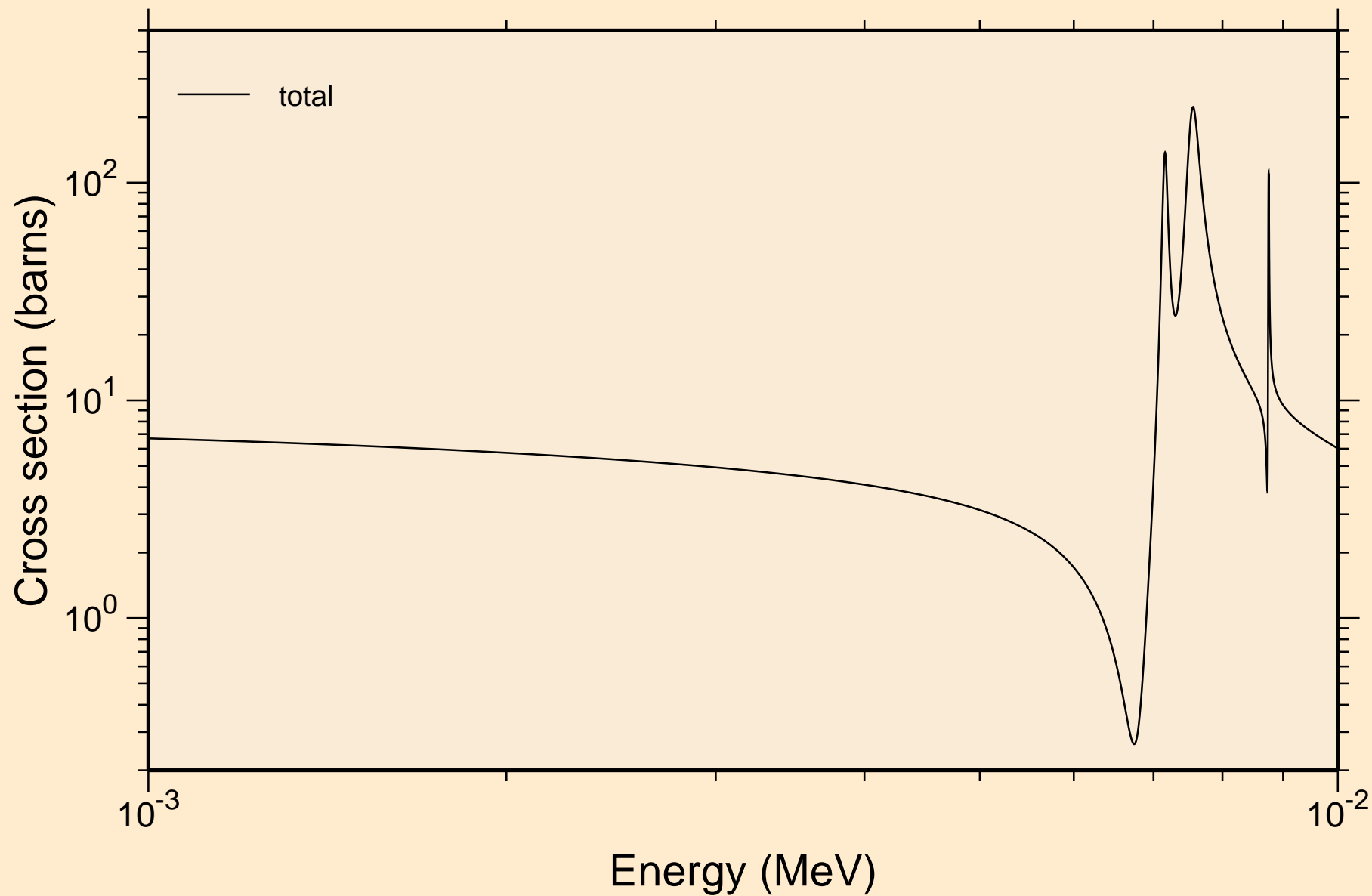

28-NI-61 FOR FENDL-3B2 FROM ENDF/B-VII WITH NJOY99.304+
resonance total cross section

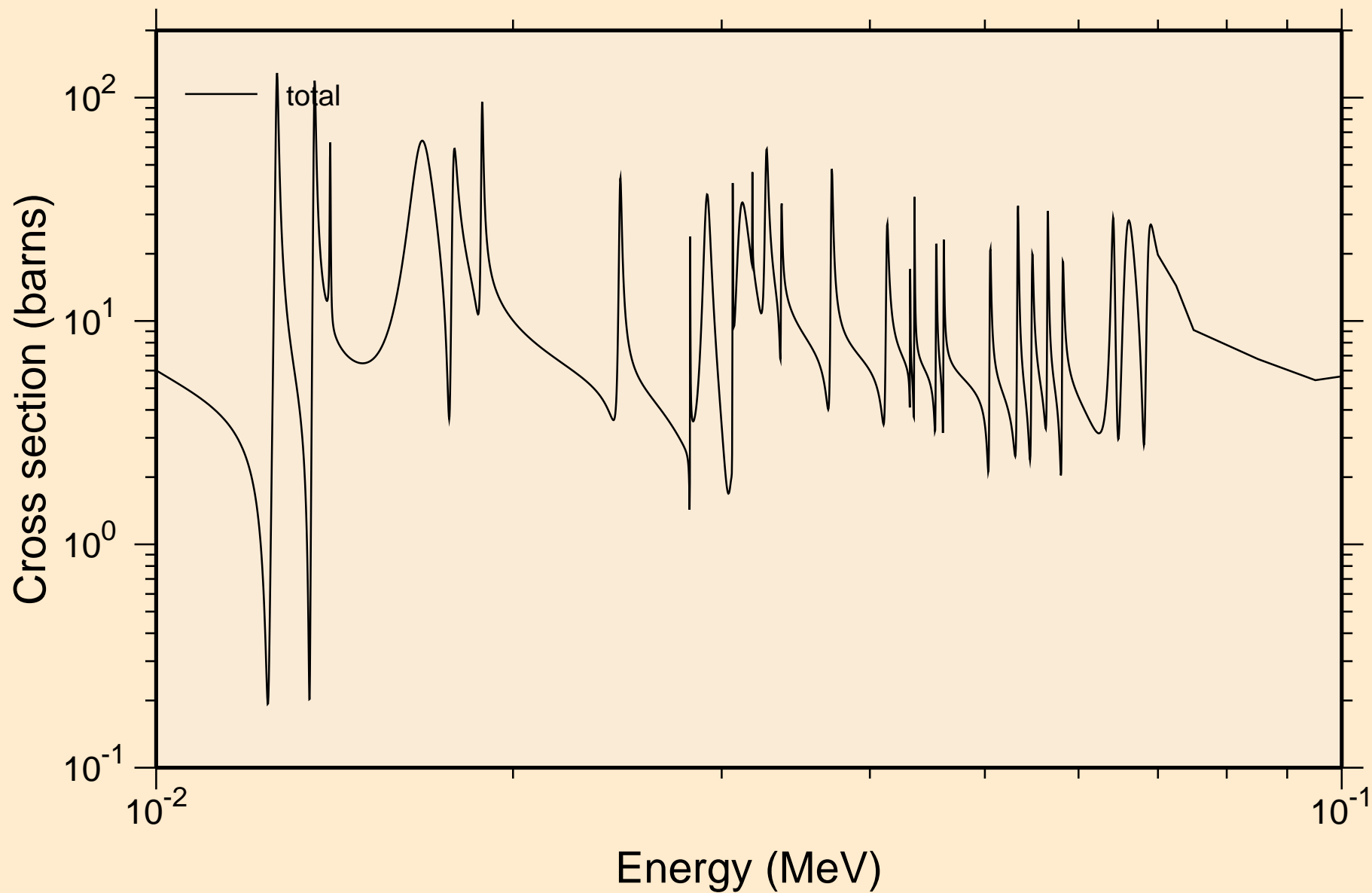

28-NI-61 FOR FENDL-3B2 FROM ENDF/B-VII WITH NJOY99.304+
resonance total cross section

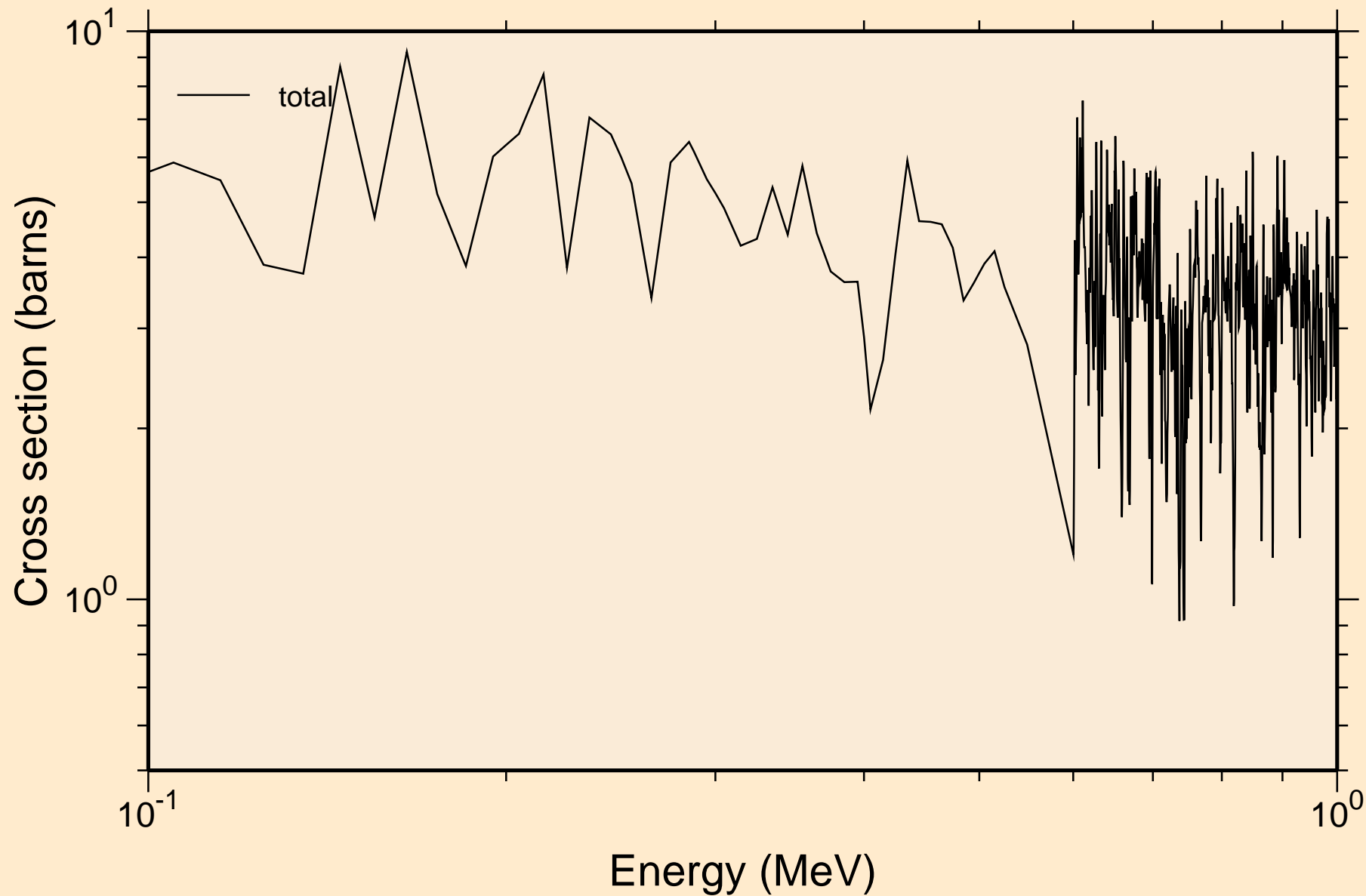

28-NI-61 FOR FENDL-3B2 FROM ENDF/B-VII WITH NJOY99.304+
resonance total cross section

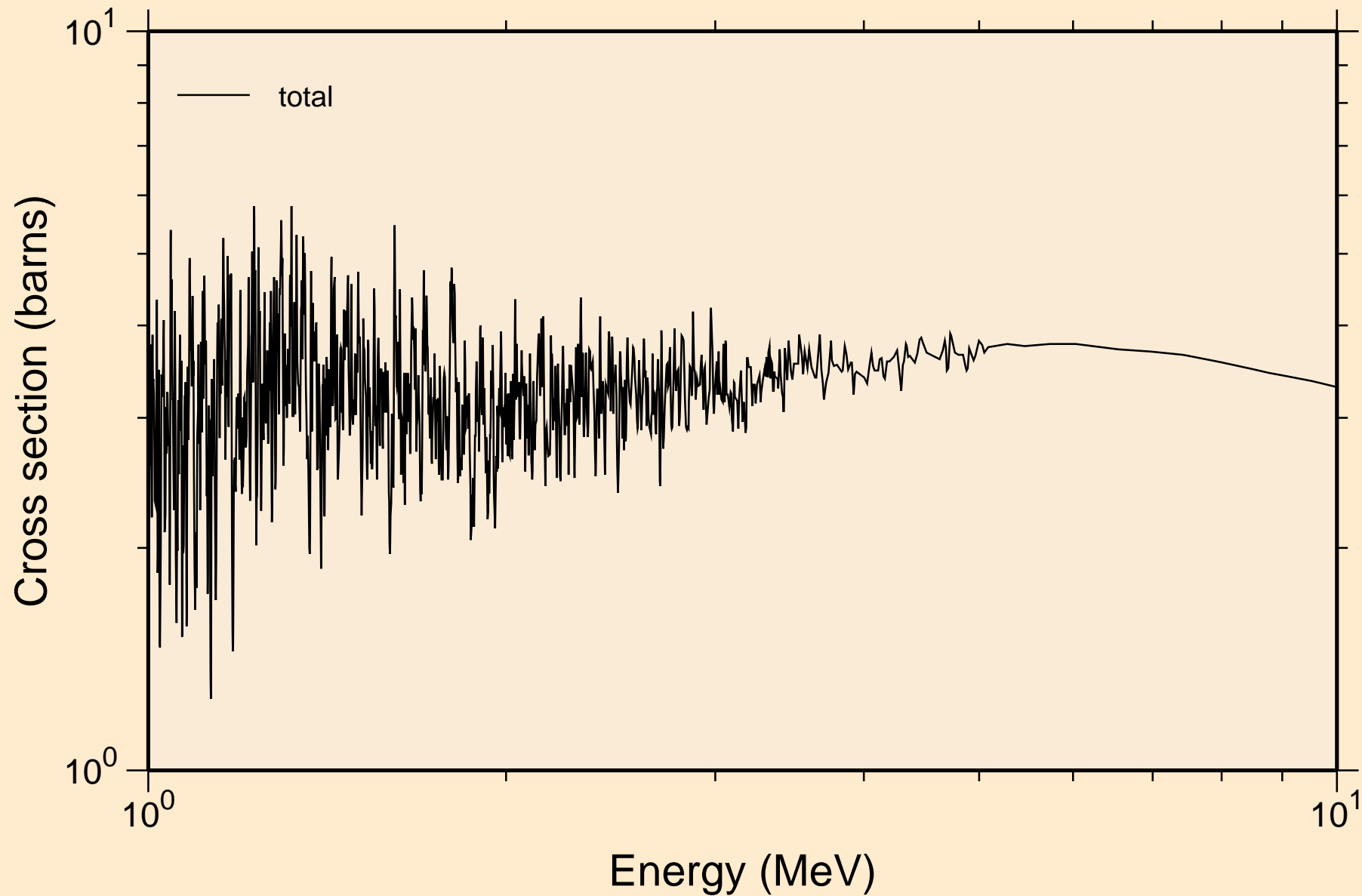

28-NI-61 FOR FENDL-3B2 FROM ENDF/B-VII WITH NJOY99.304+
resonance absorption cross sections

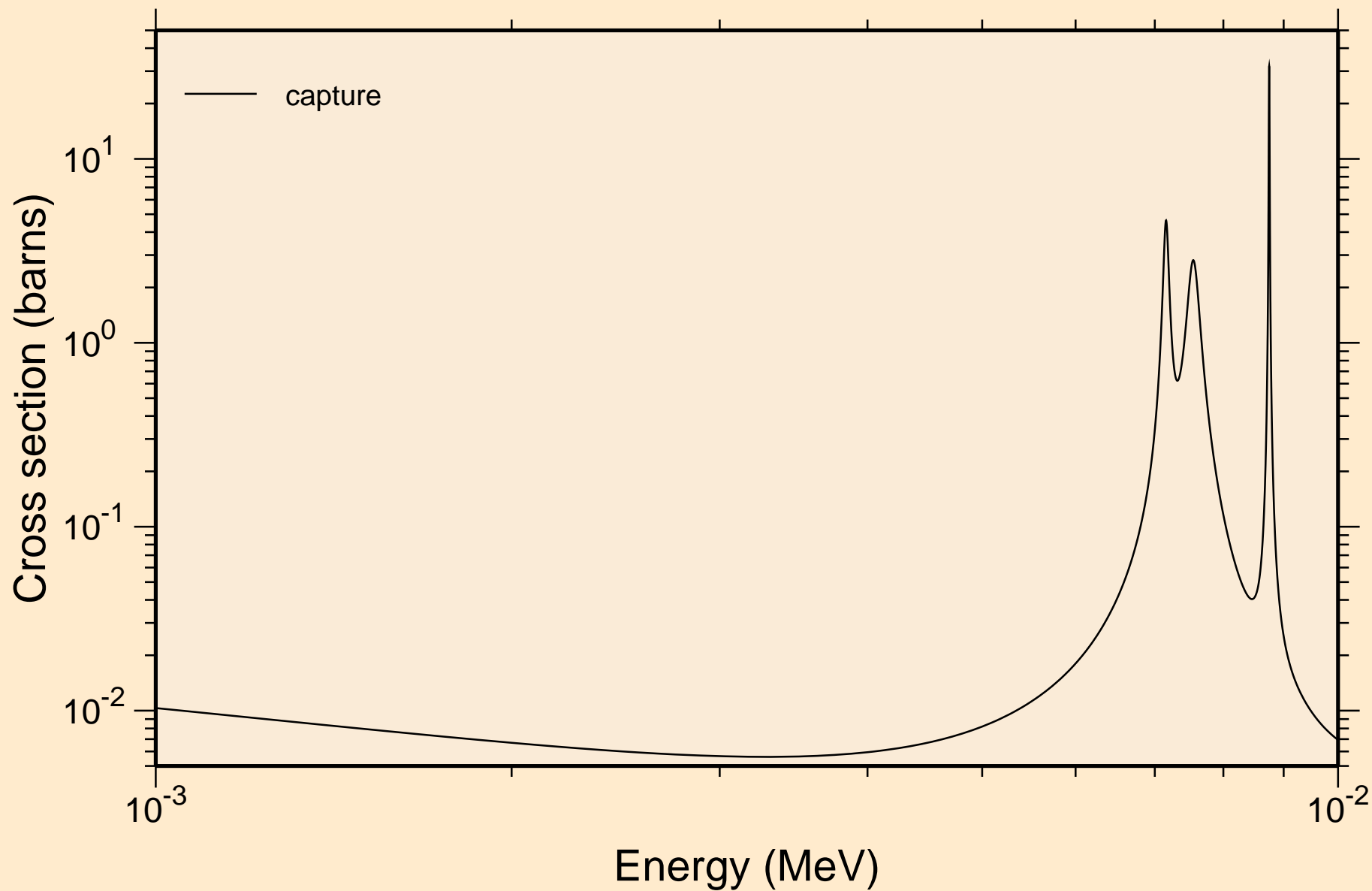

28-NI-61 FOR FENDL-3B2 FROM ENDF/B-VII WITH NJOY99.304+
resonance absorption cross sections

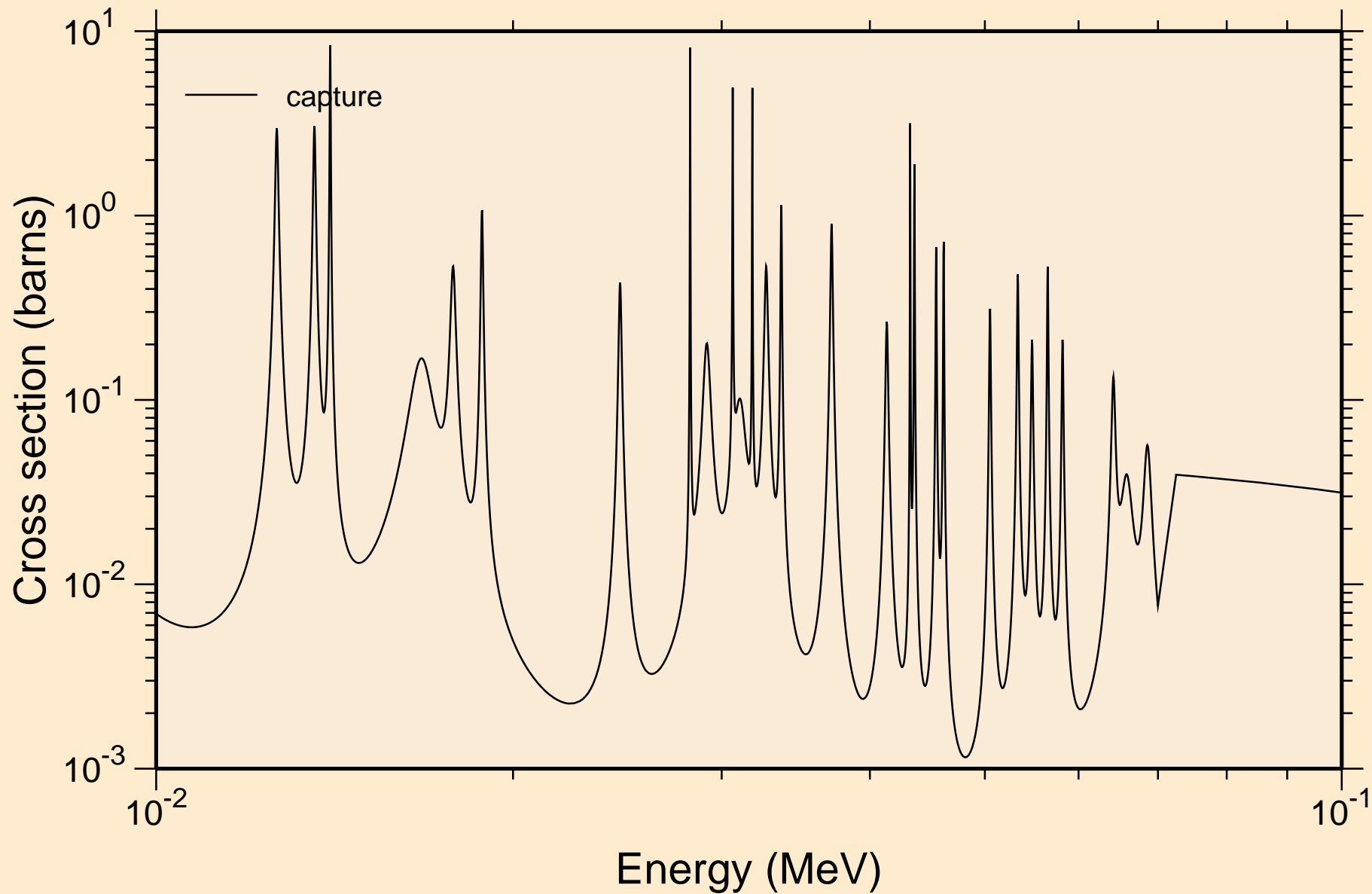

28-NI-61 FOR FENDL-3B2 FROM ENDF/B-VII WITH NJOY99.304+
resonance absorption cross sections

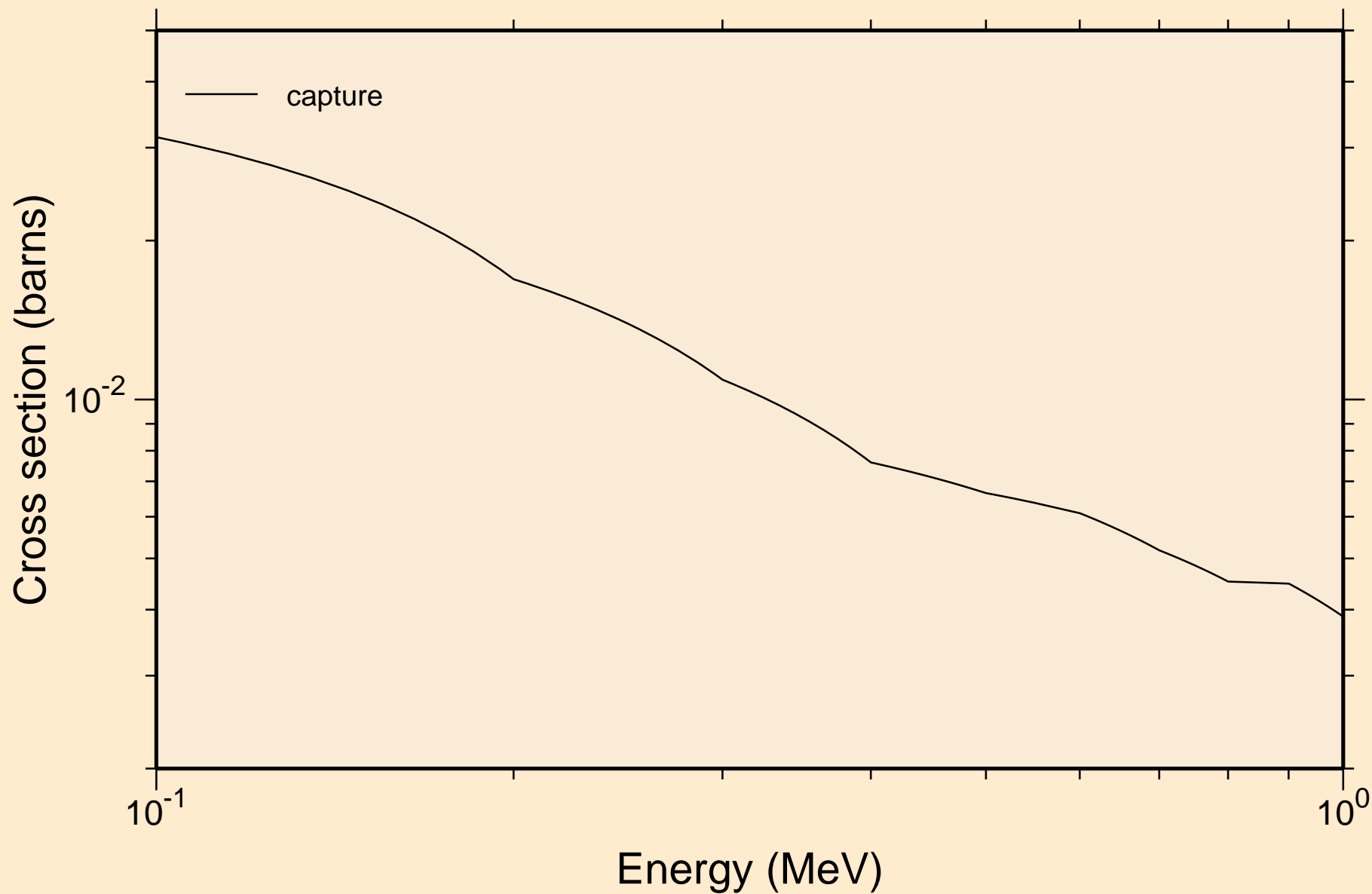

28-NI-61 FOR FENDL-3B2 FROM ENDF/B-VII WITH NJOY99.304+
resonance absorption cross sections

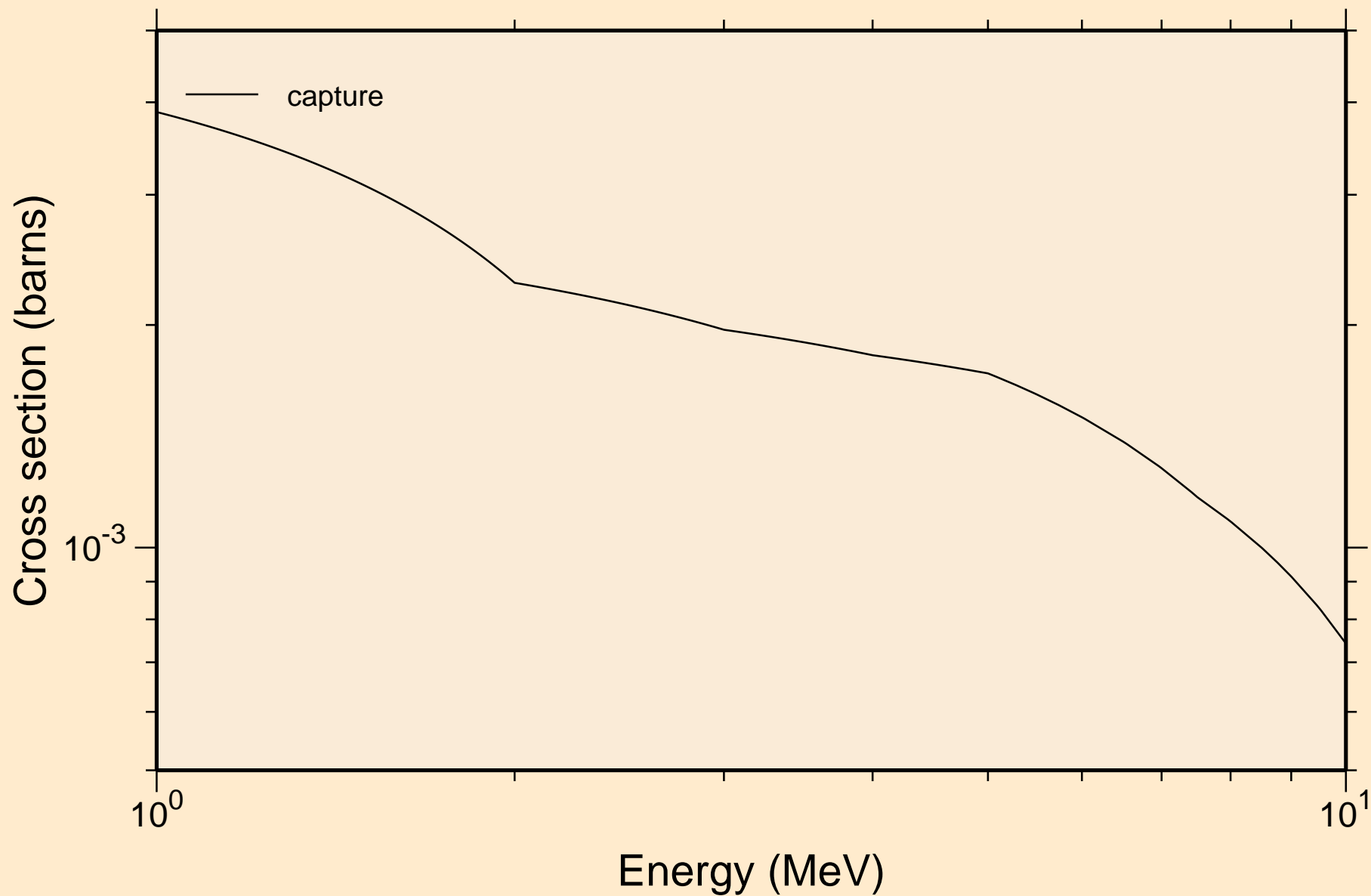

28-NI-61 FOR FENDL-3B2 FROM ENDF/B-VII WITH NJOY99.304+ Heating

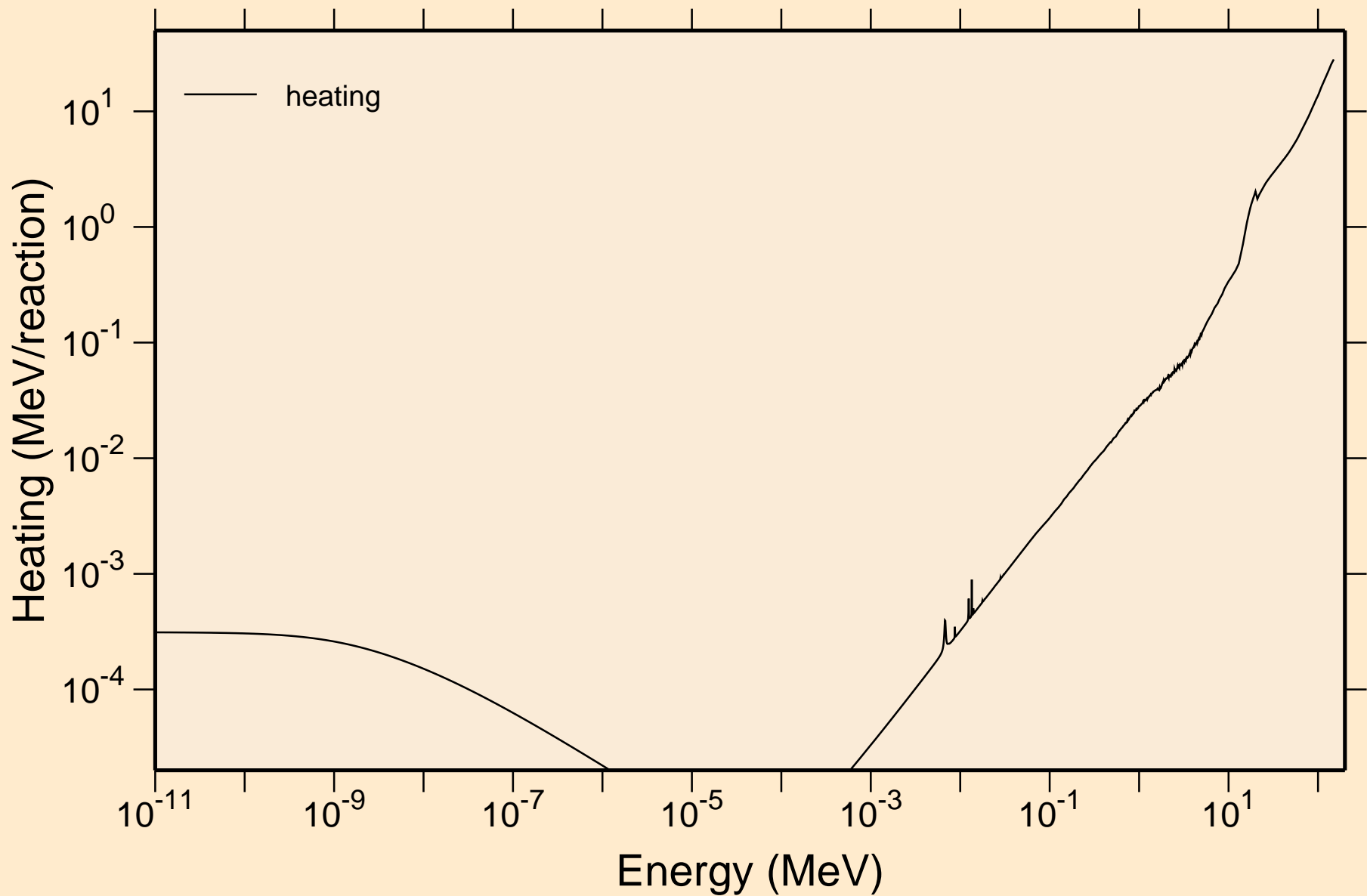

28-NI-61 FOR FENDL-3B2 FROM ENDF/B-VII WITH NJOY99.304+ Damage

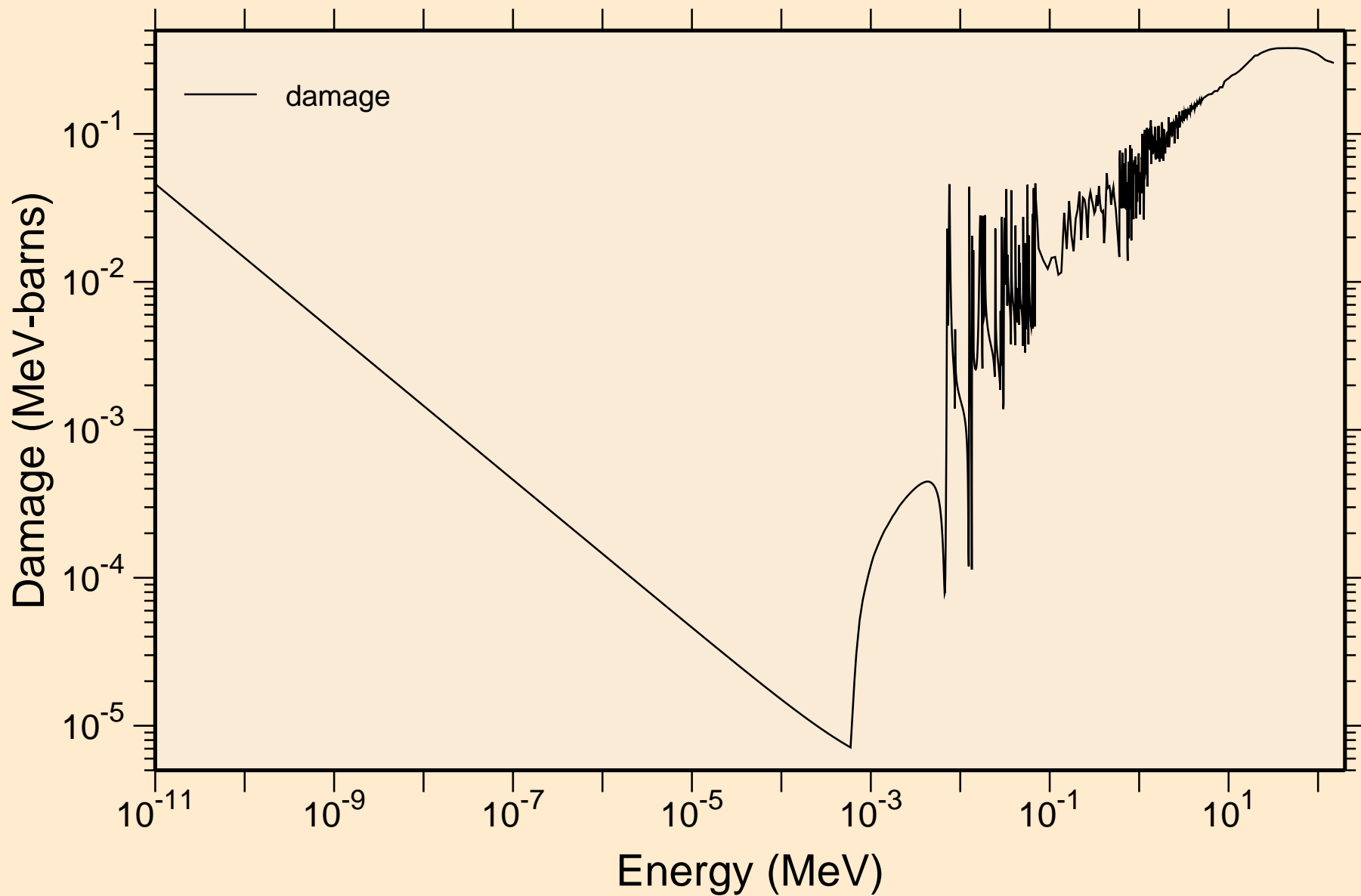

28-NI-61 FOR FENDL-3B2 FROM ENDF/B-VII WITH NJOY99.304+
Non-threshold reactions

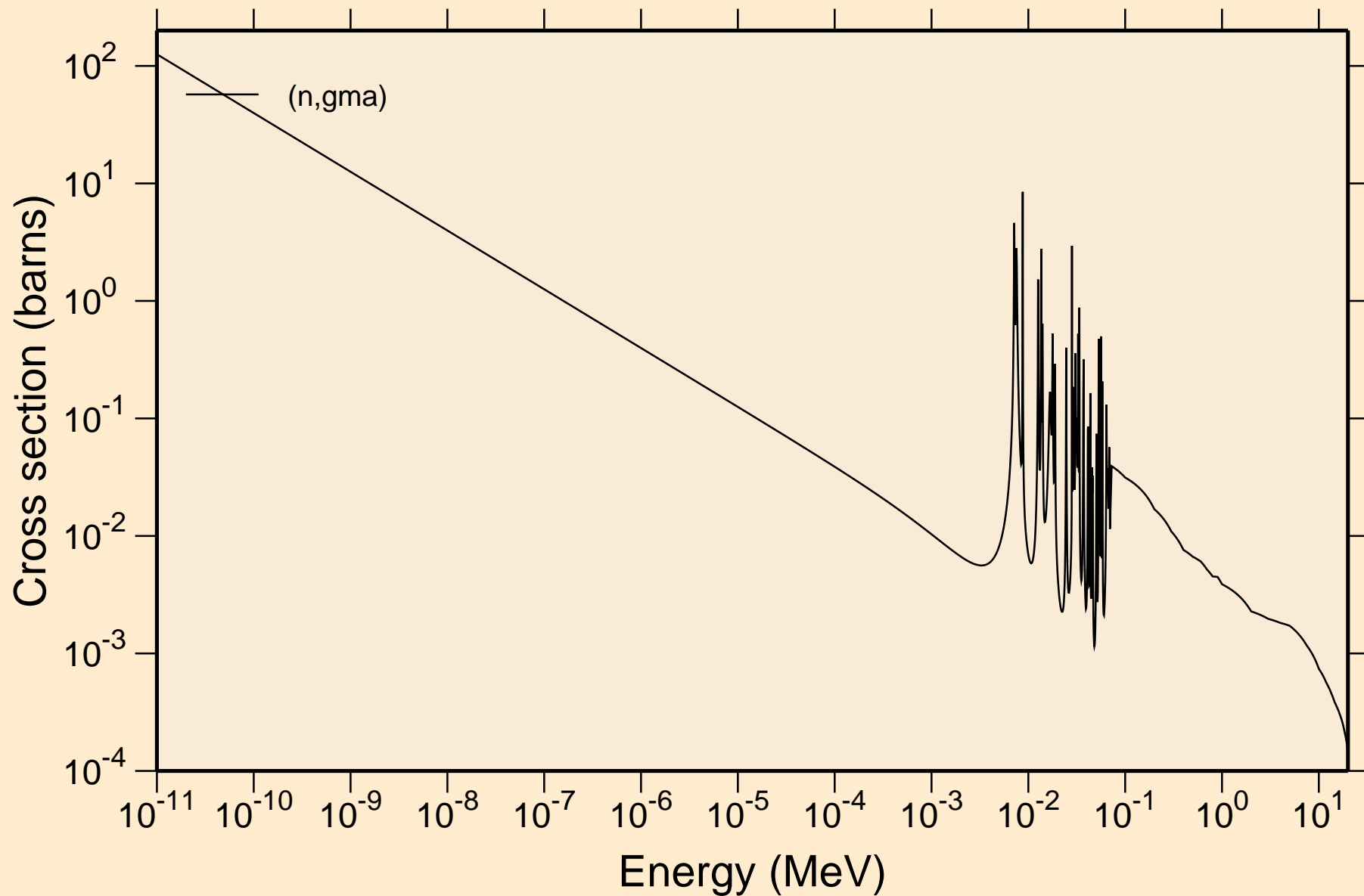

28-NI-61 FOR FENDL-3B2 FROM ENDF/B-VII WITH NJOY99.304+

Principal cross sections

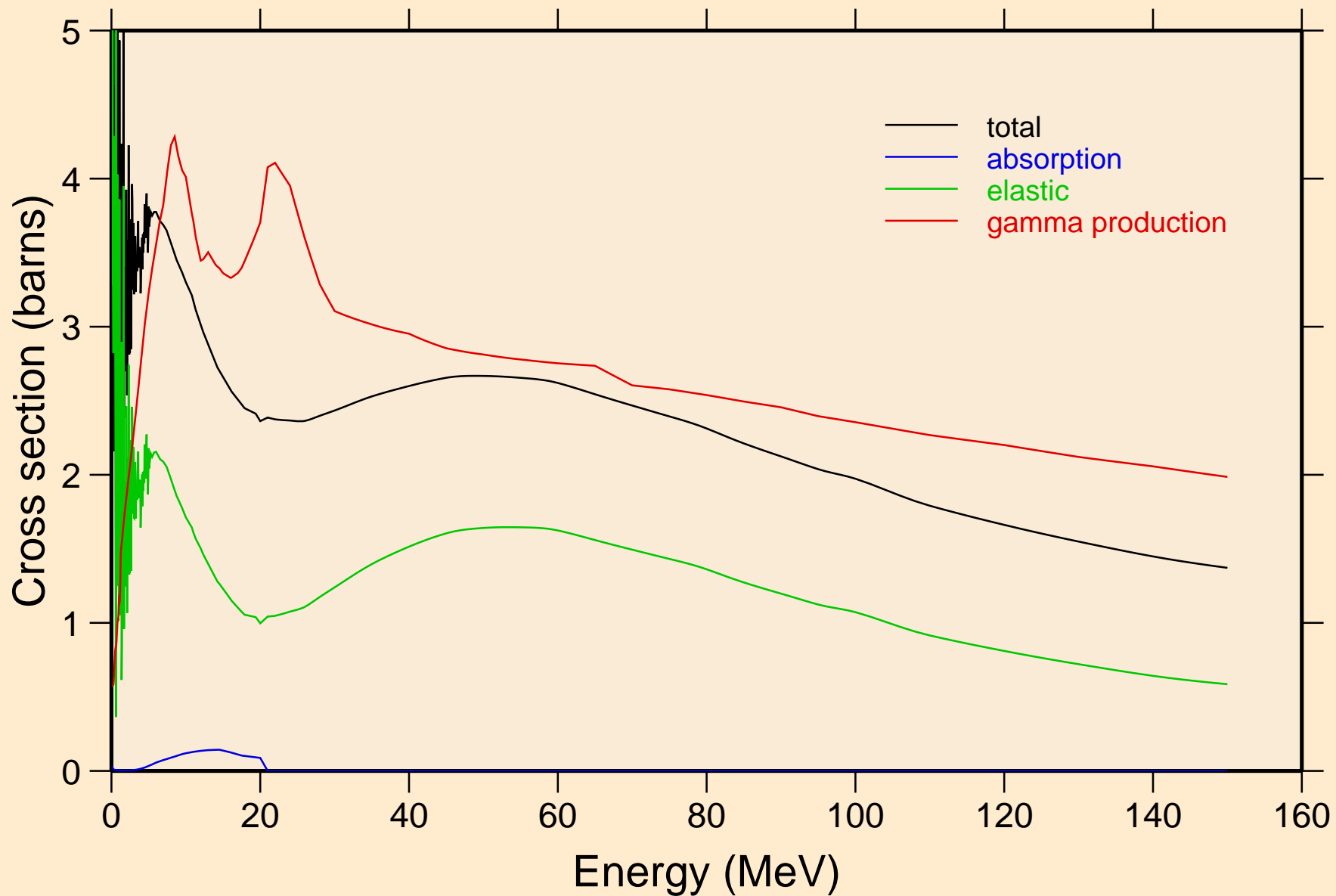

28-NI-61 FOR FENDL-3B2 FROM ENDF/B-VII WITH NJOY99.304+ Heating

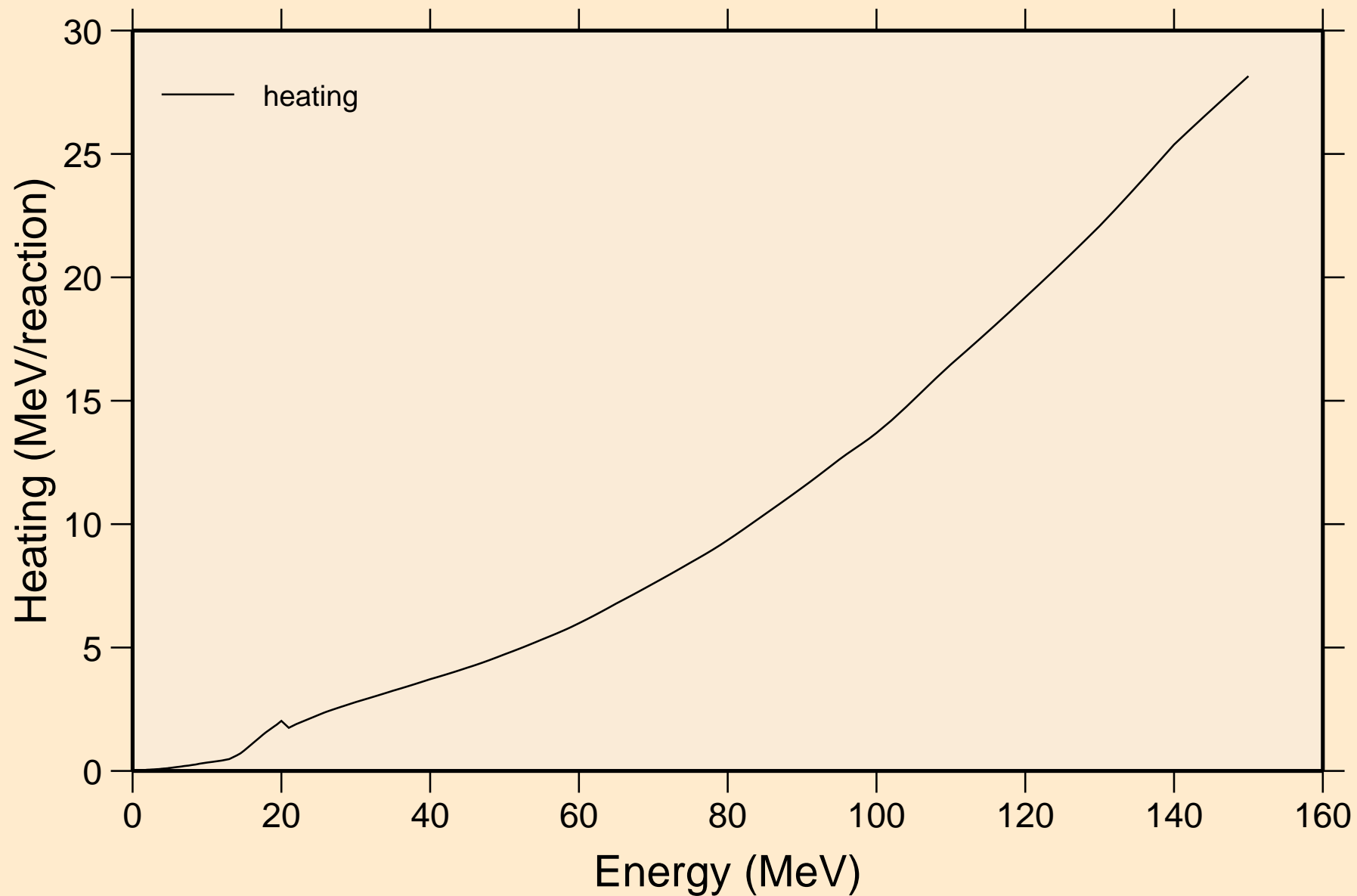

28-NI-61 FOR FENDL-3B2 FROM ENDF/B-VII WITH NJOY99.304+ Damage

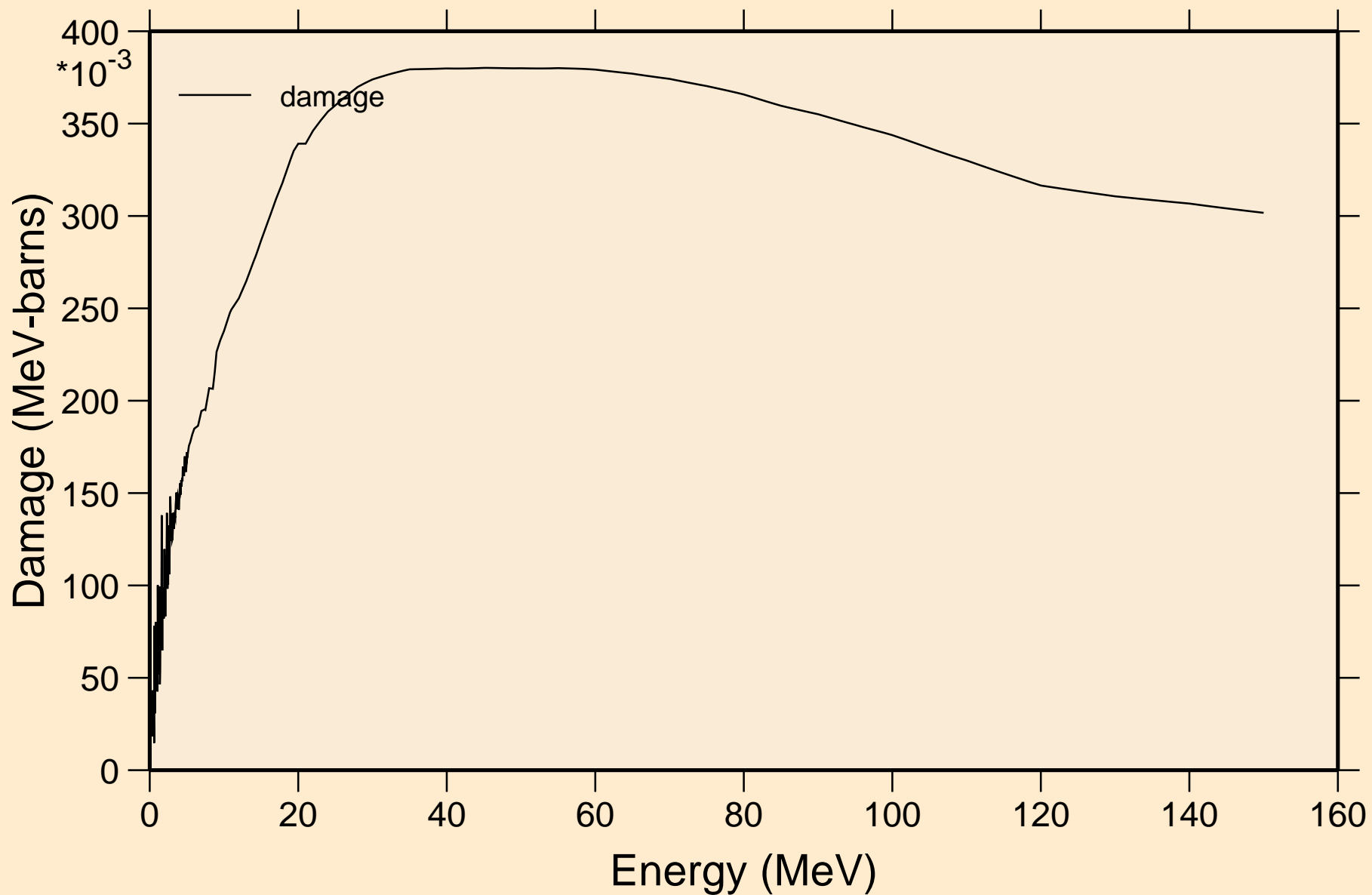

28-NI-61 FOR FENDL-3B2 FROM ENDF/B-VII WITH NJOY99.304+
Non-threshold reactions

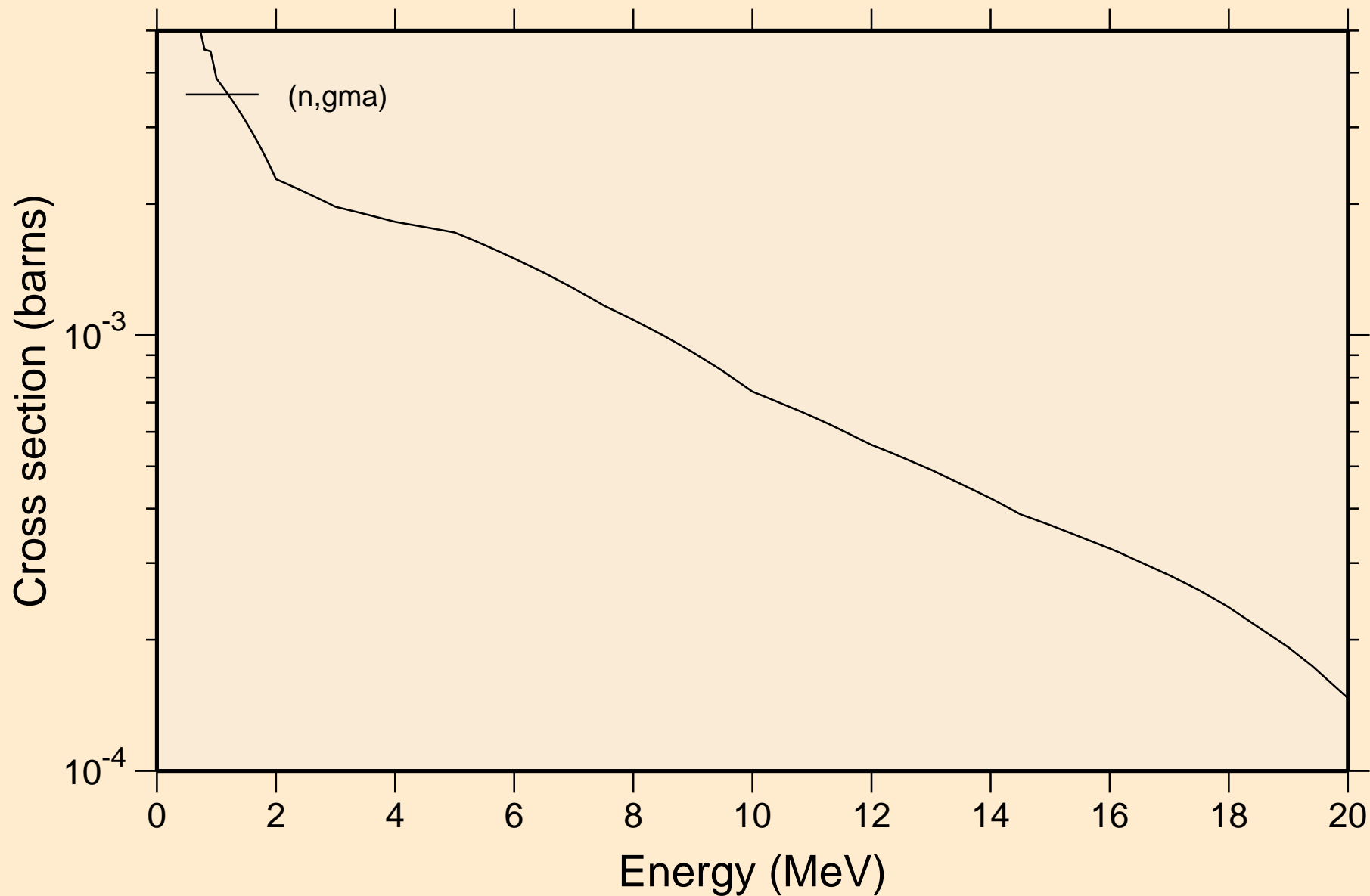

28-NI-61 FOR FENDL-3B2 FROM ENDF/B-VII WITH NJOY99.304+ Inelastic levels

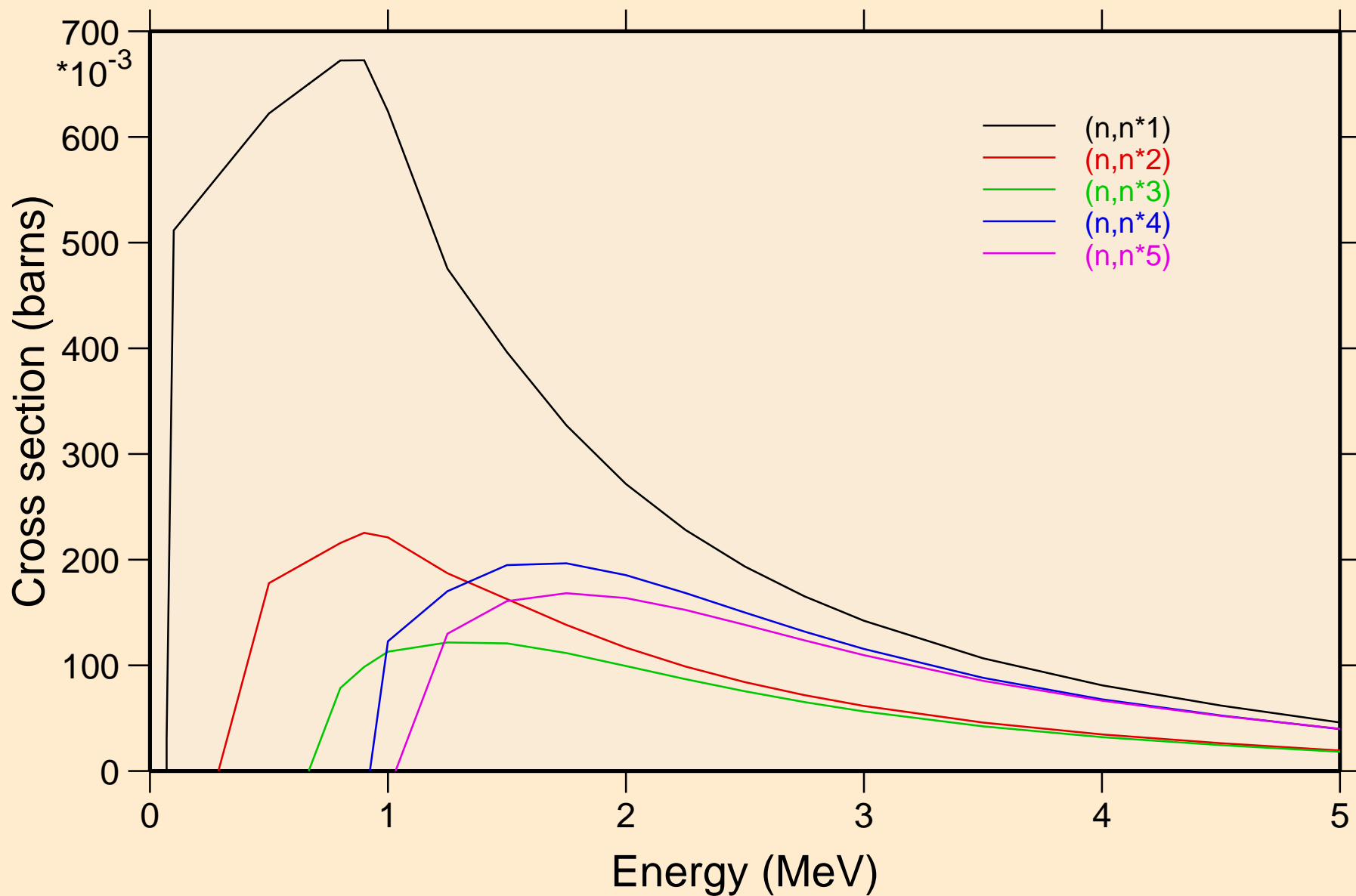

28-NI-61 FOR FENDL-3B2 FROM ENDF/B-VII WITH NJOY99.304+
Inelastic levels

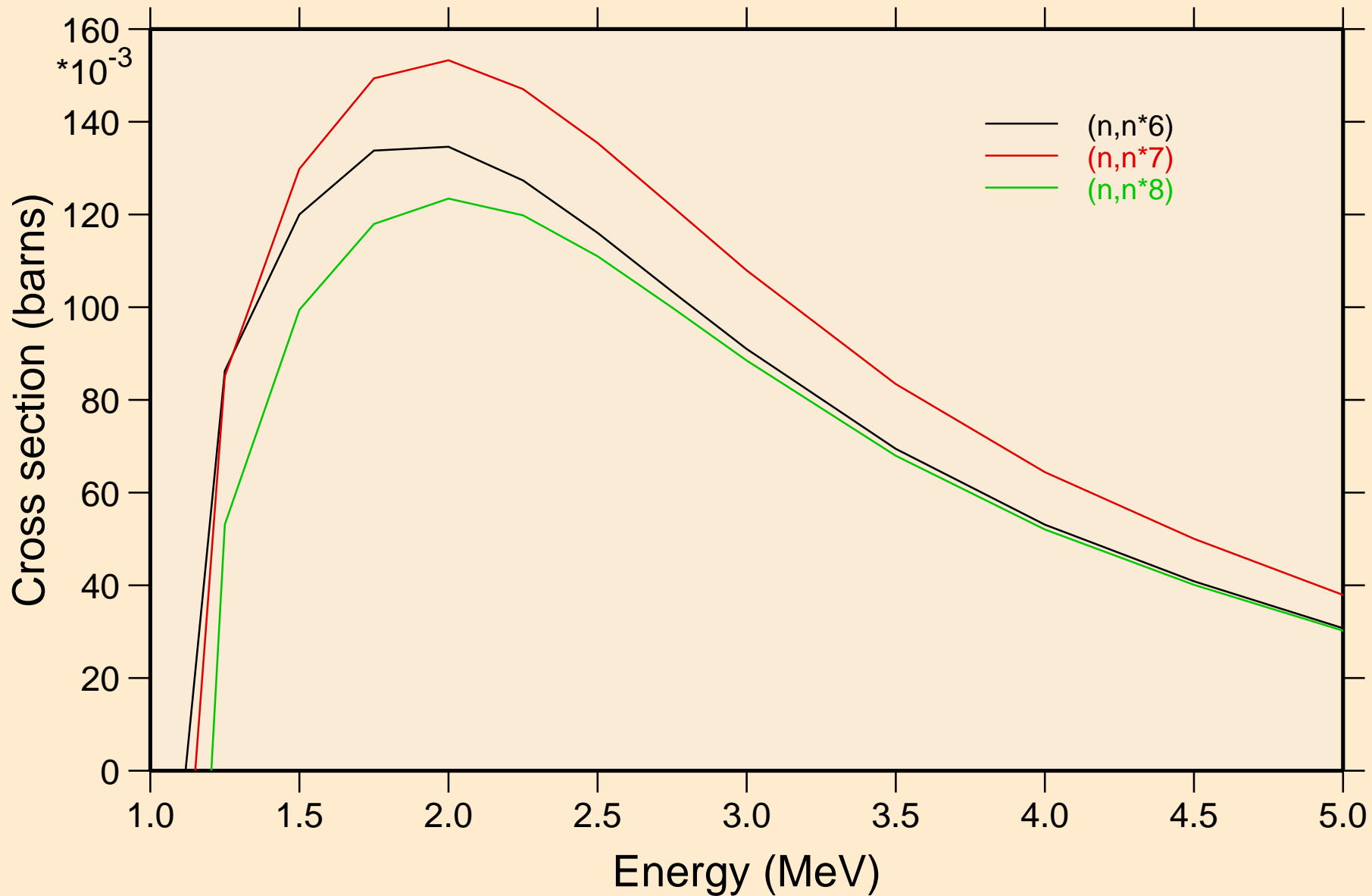

28-NI-61 FOR FENDL-3B2 FROM ENDF/B-VII WITH NJOY99.304+

Threshold reactions

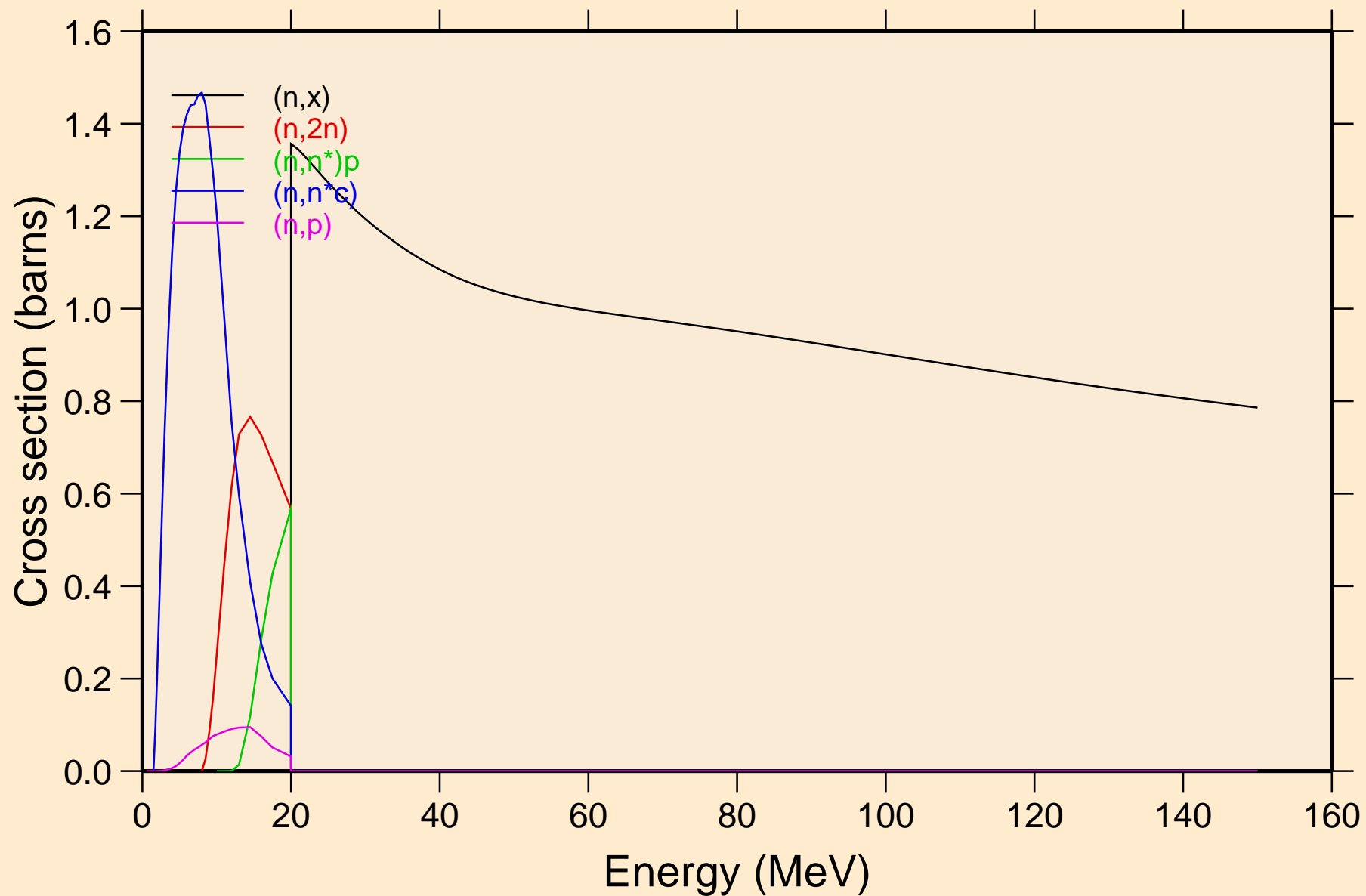

28-NI-61 FOR FENDL-3B2 FROM ENDF/B-VII WITH NJOY99.304+

Threshold reactions

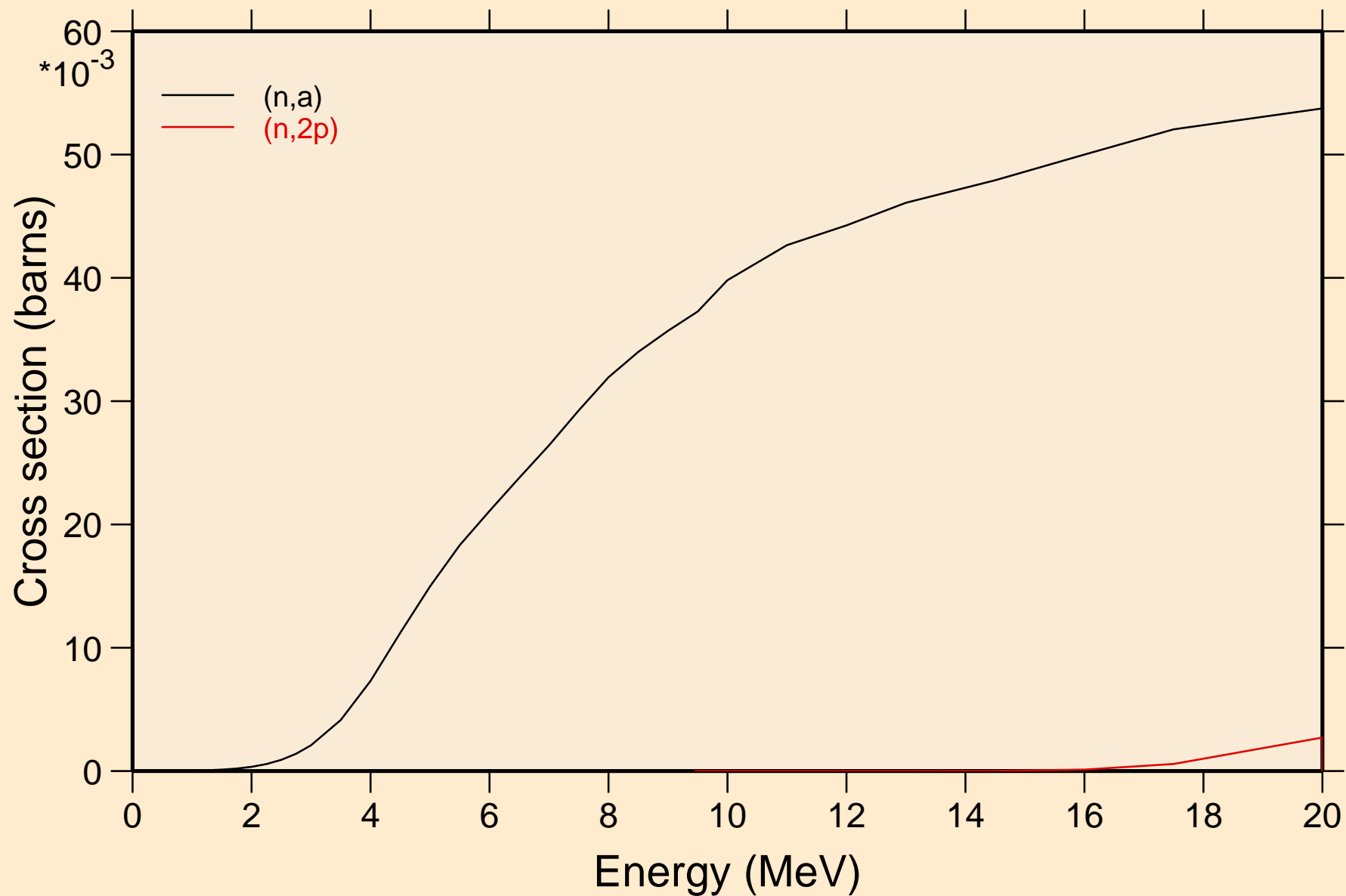

28-NI-61 FOR FENDL-3B2 FROM ENDF/B-VII WITH NJOY99.304+

Threshold reactions

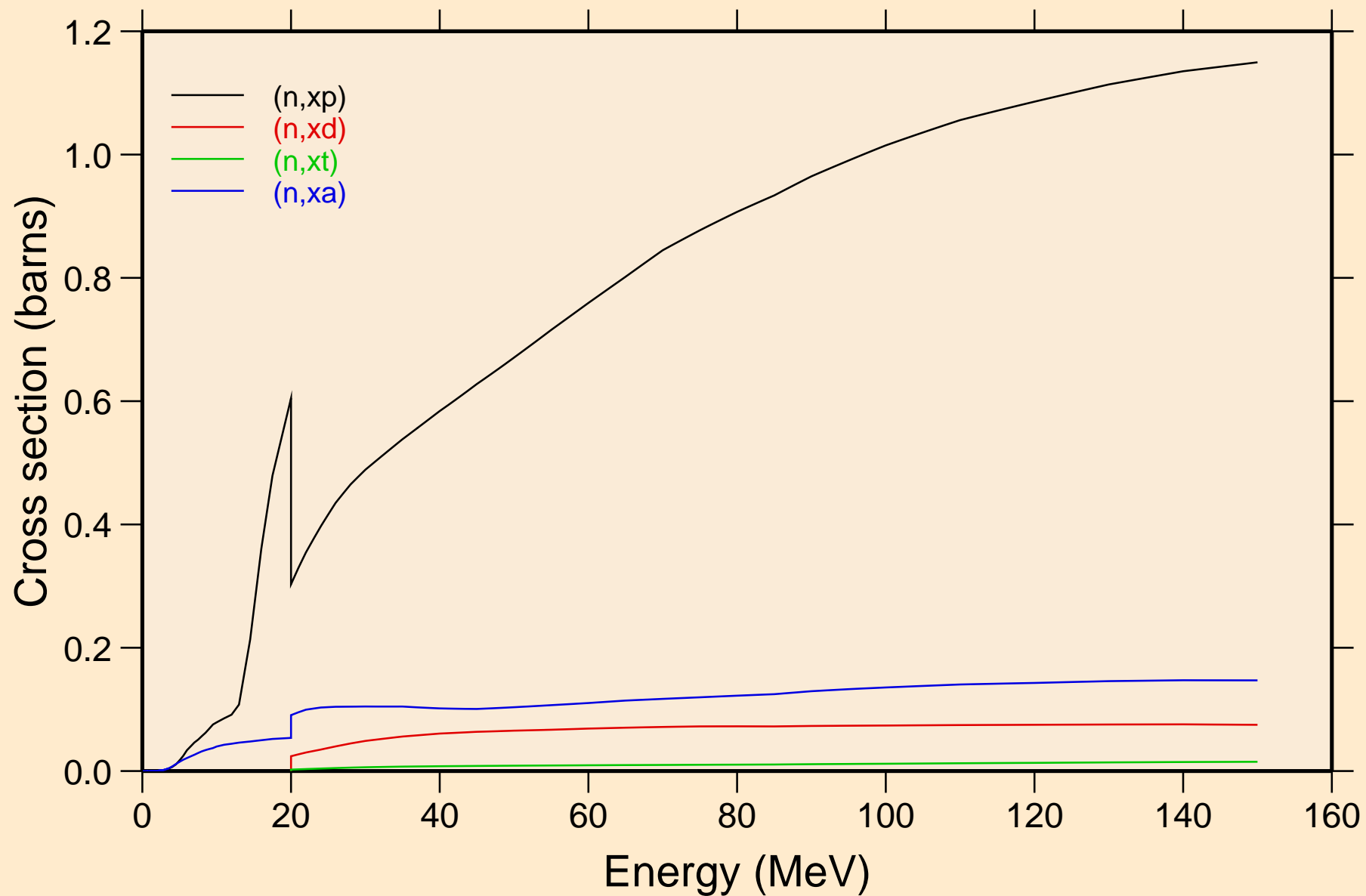

28-NI-61 FOR FENDL-3B2 FROM ENDF/B-VII WITH NJOY99.304+
angular distribution for elastic

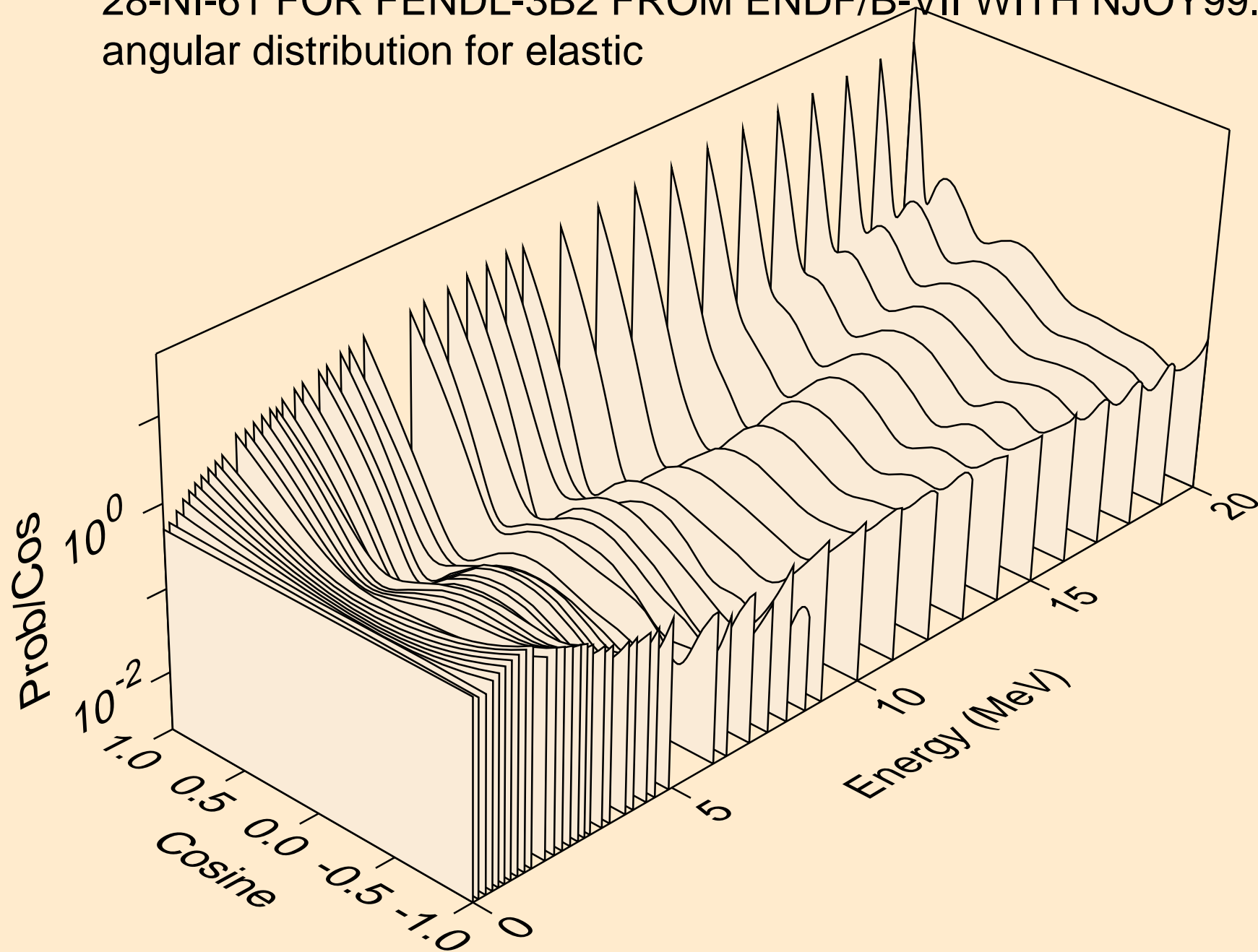

28-NI-61 FOR FENDL-3B2 FROM ENDF/B-VII WITH NJOY99.304+
angular distribution for elastic

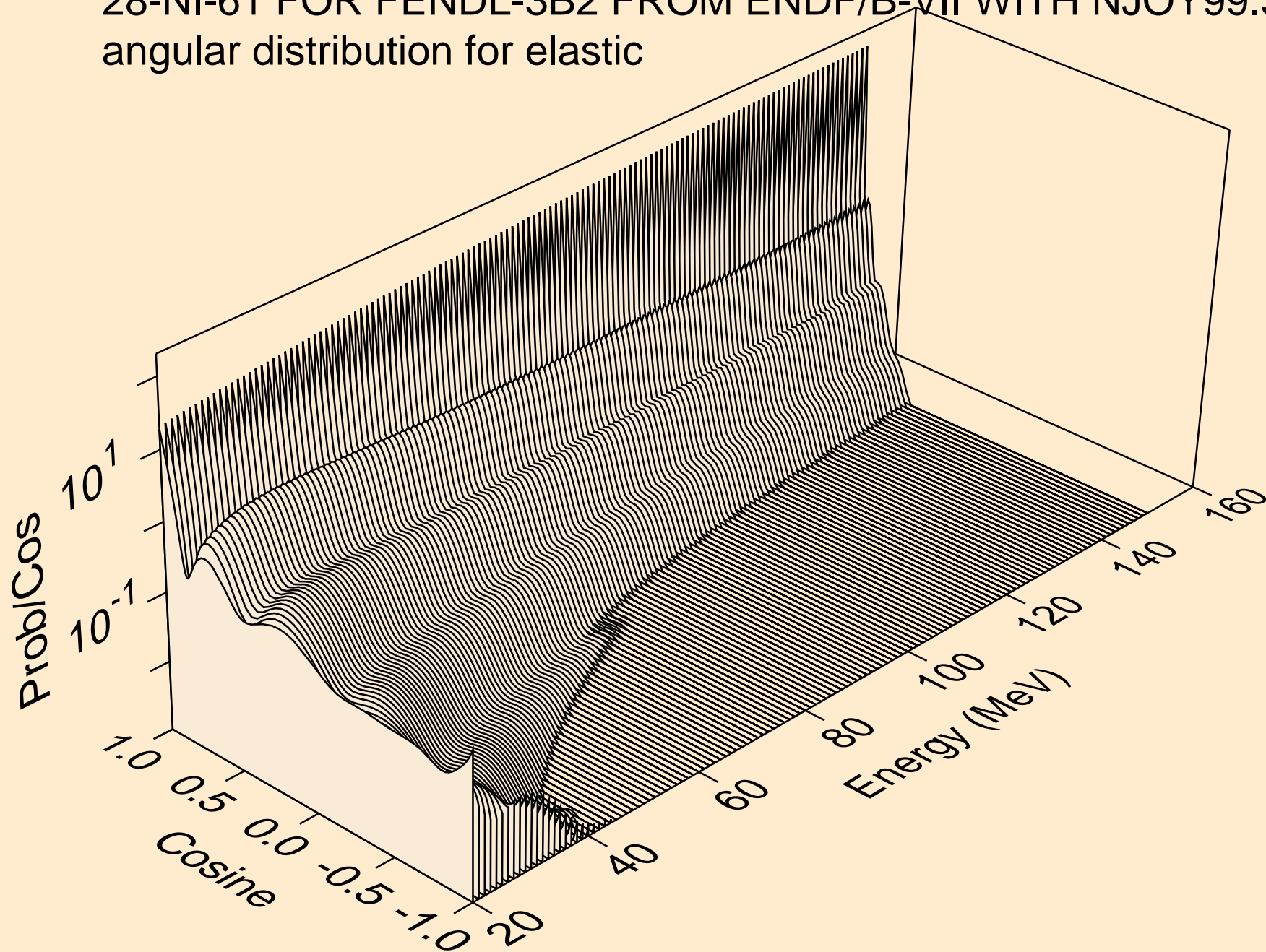

28-NI-61 FOR FENDL-3B2 FROM ENDF/B-VII WITH NJOY99.304+
Neutron emission for (n,x)

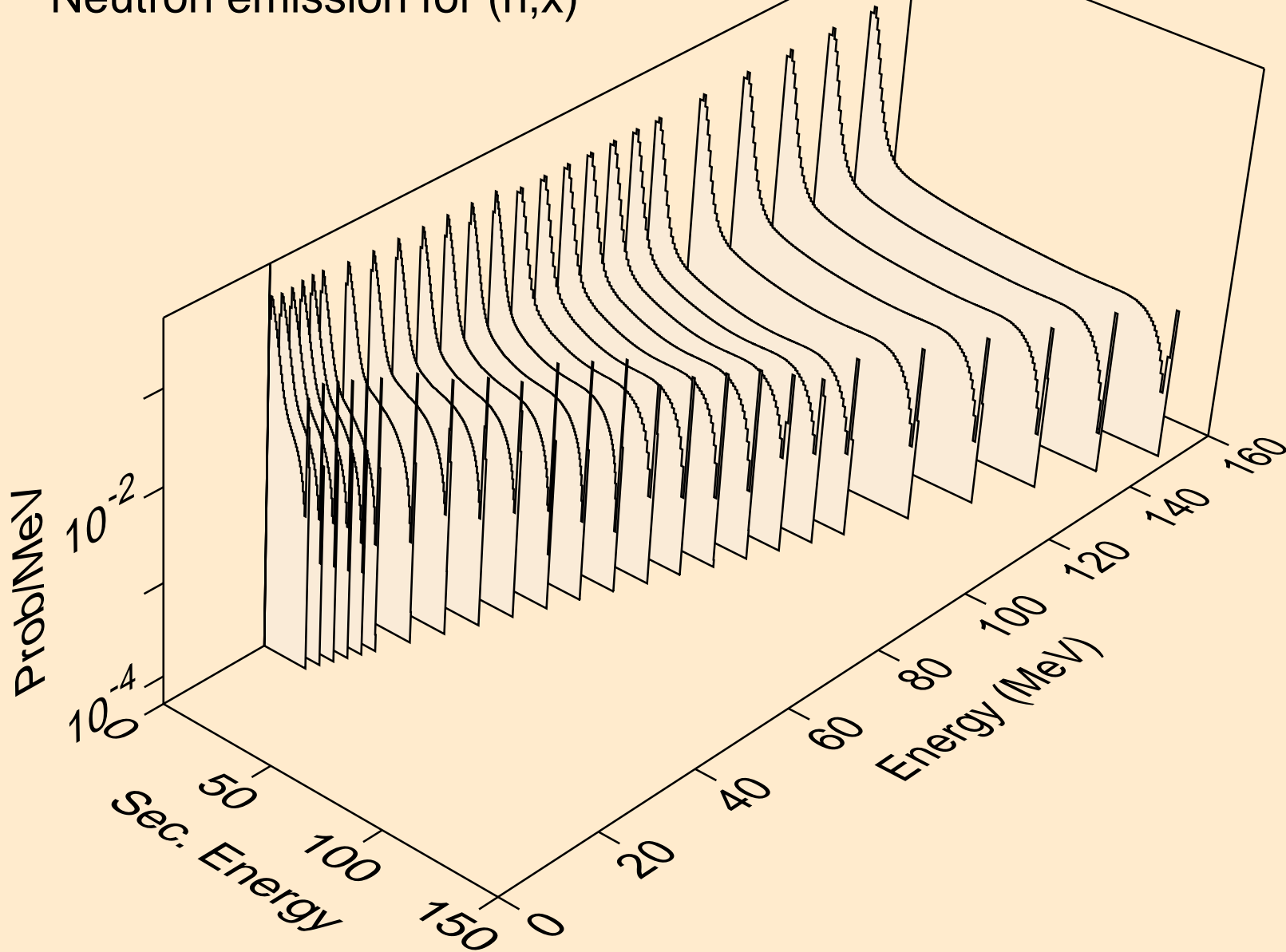

28-NI-61 FOR FENDL-3B2 FROM ENDF/B-VII WITH NJOY99.304+
Neutron emission for (n,2n)

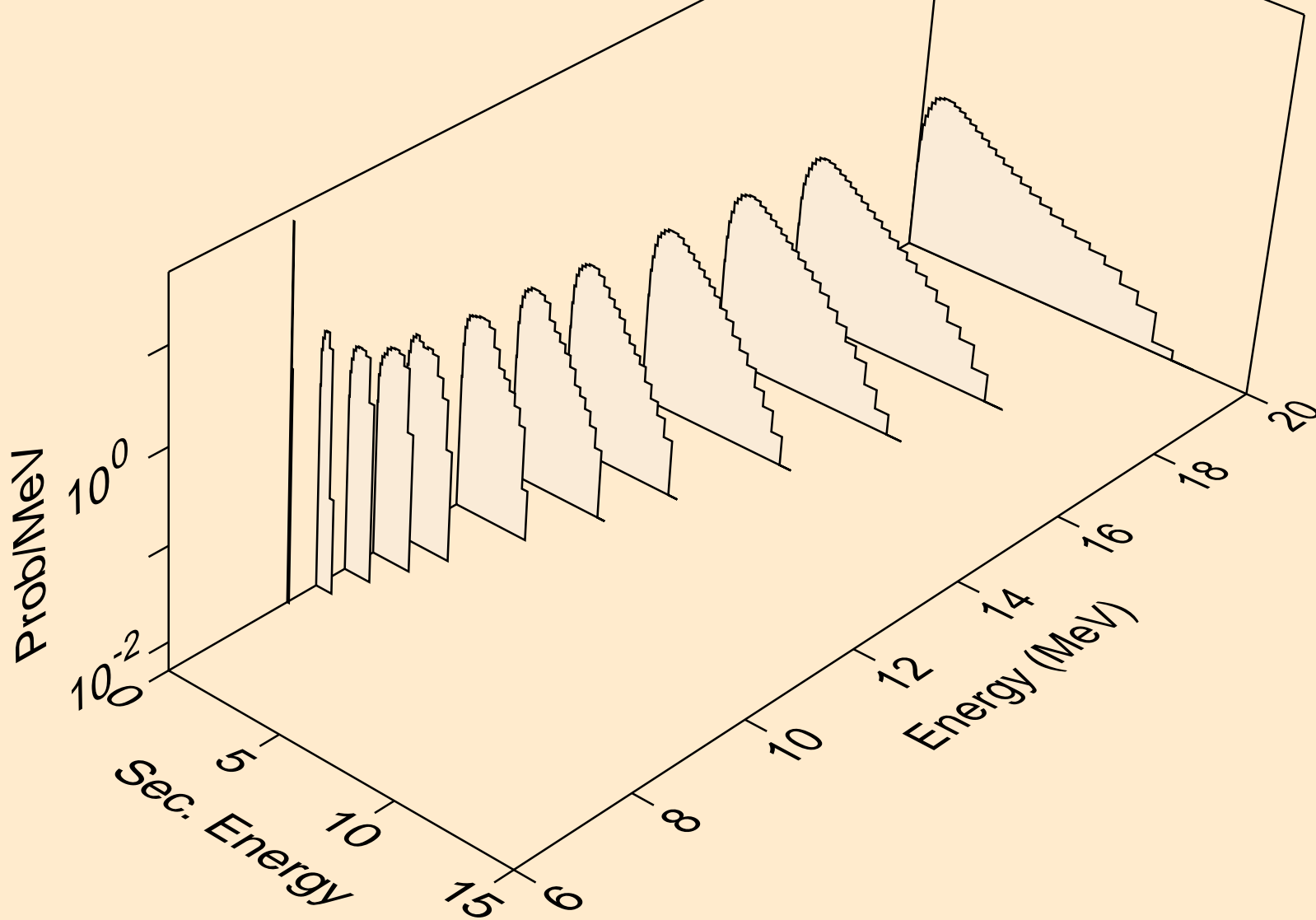

28-NI-61 FOR FENDL-3B2 FROM ENDF/B-VII WITH NJOY99.304+
Neutron emission for (n,n*)p

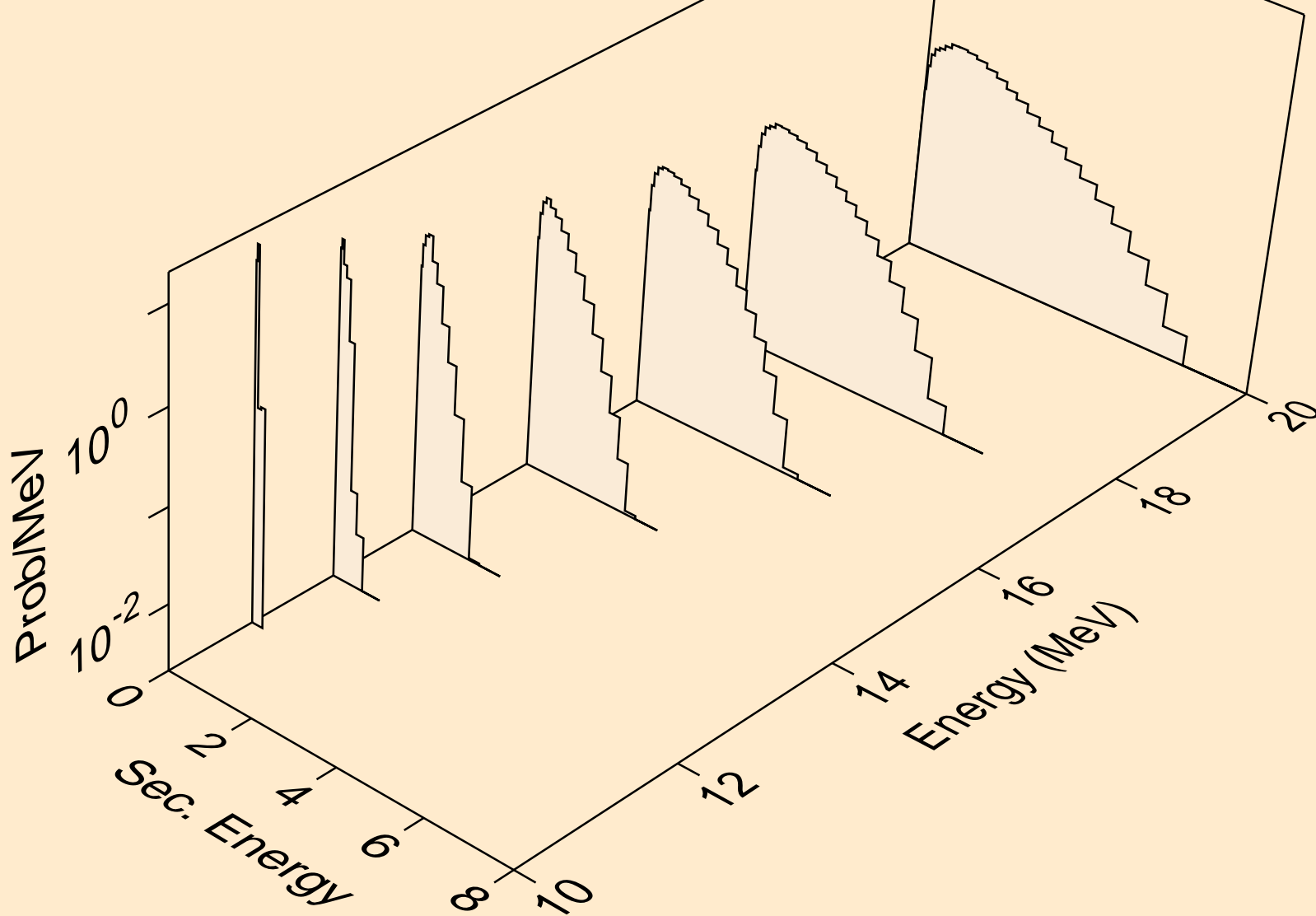

28-NI-61 FOR FENDL-3B2 FROM ENDF/B-VII WITH NJOY99.304+
Neutron emission for (n,n*c)

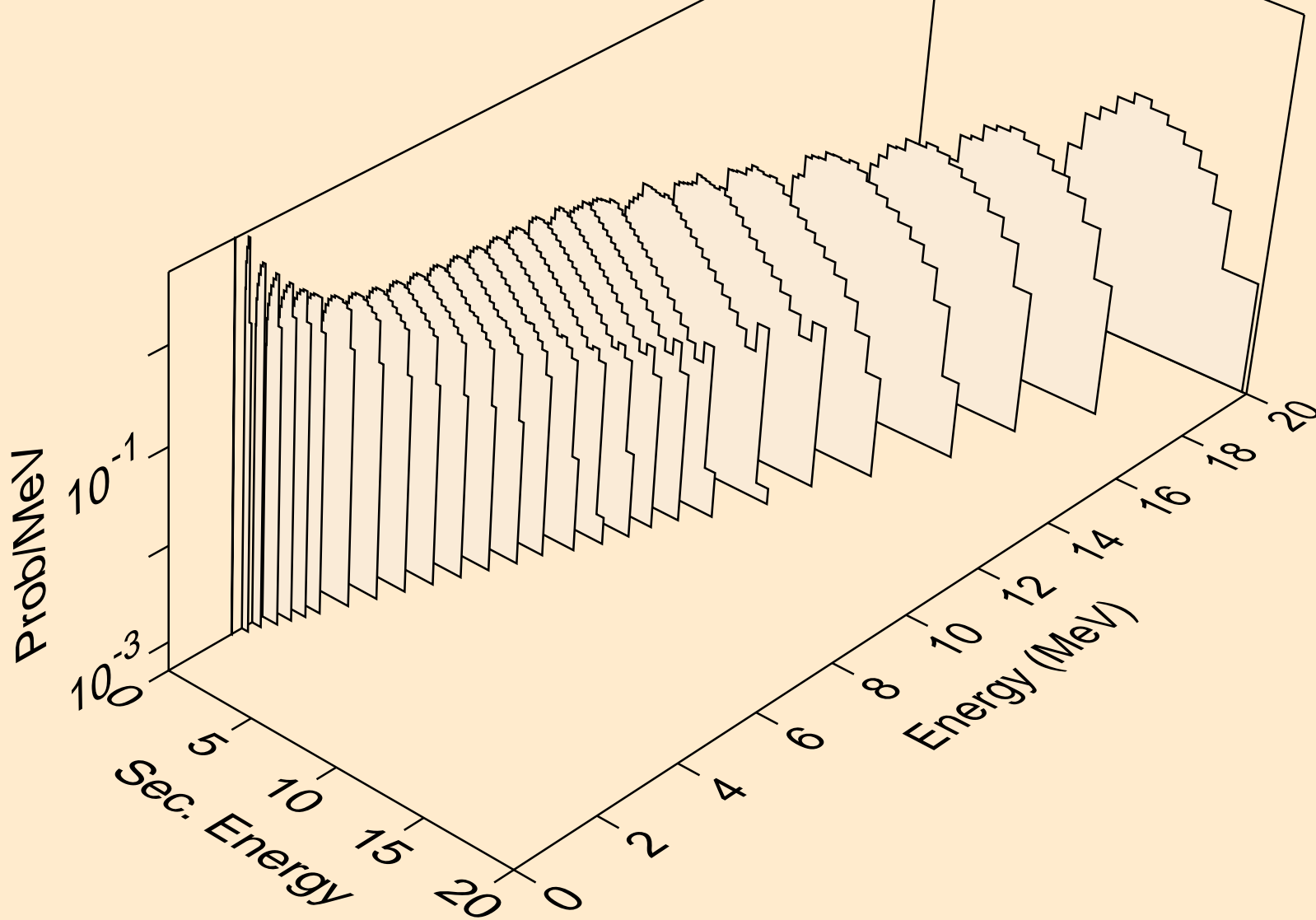

28-NI-61 FOR FENDL-3B2 FROM ENDF/B-VII WITH NJOY99.304+
Photon emission for (n,gma)

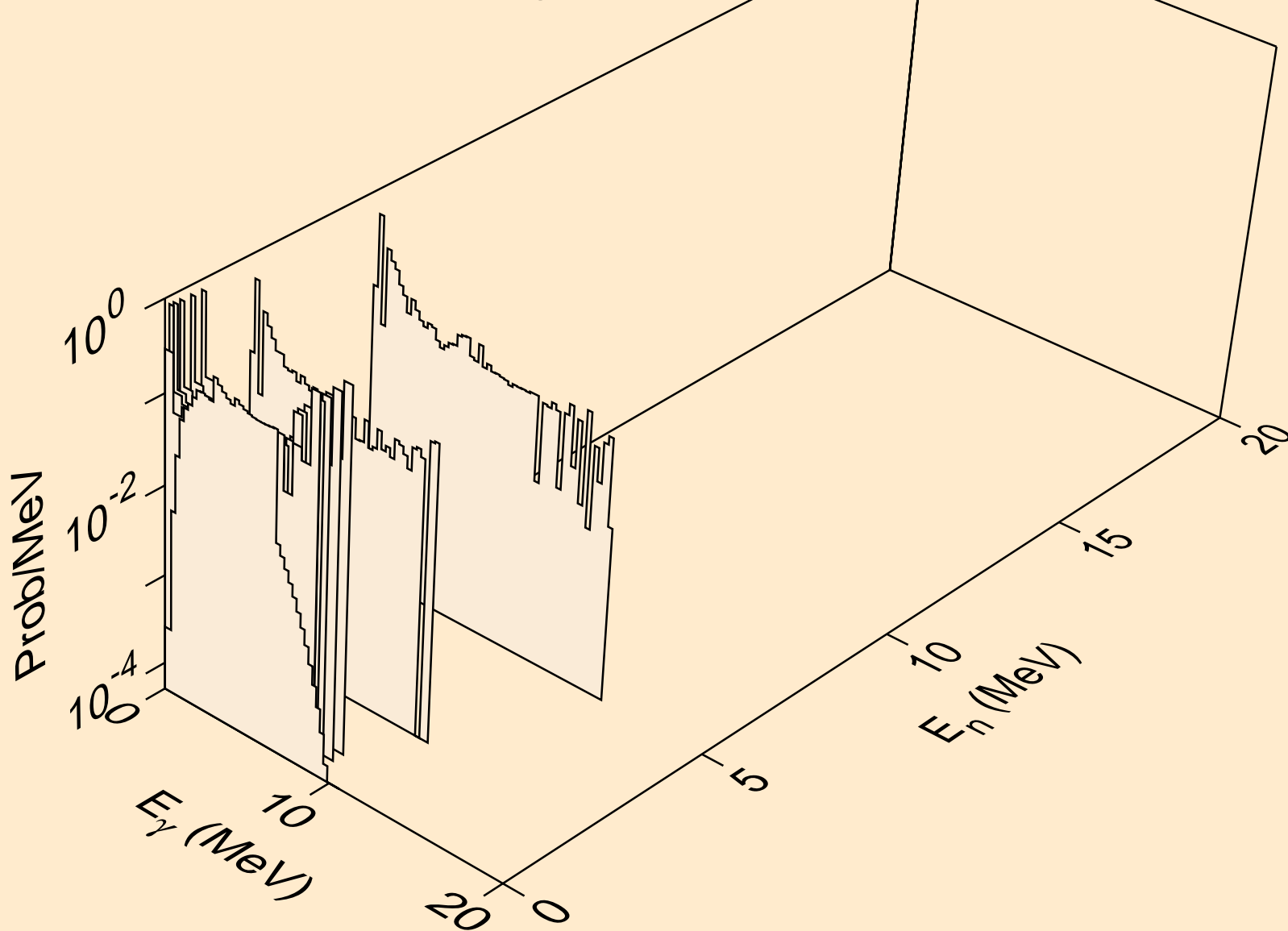

28-NI-61 FOR FENDL-3B2 FROM ENDF/B-VII WITH NJOY99.304+
Photon emission for (n,x)

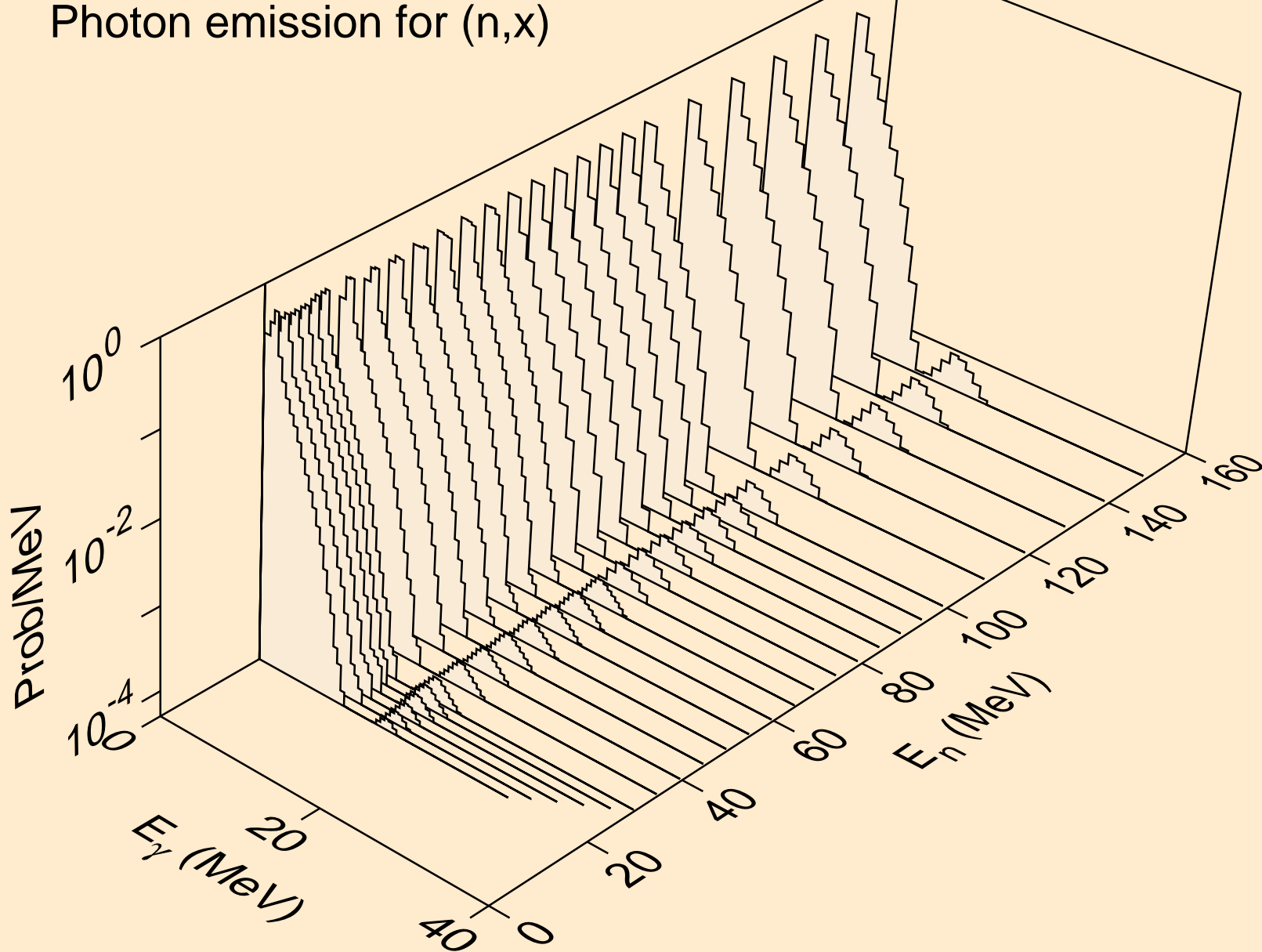

28-NI-61 FOR FENDL-3B2 FROM ENDF/B-VII WITH NJOY99.304+
Photon emission for (n,2n)

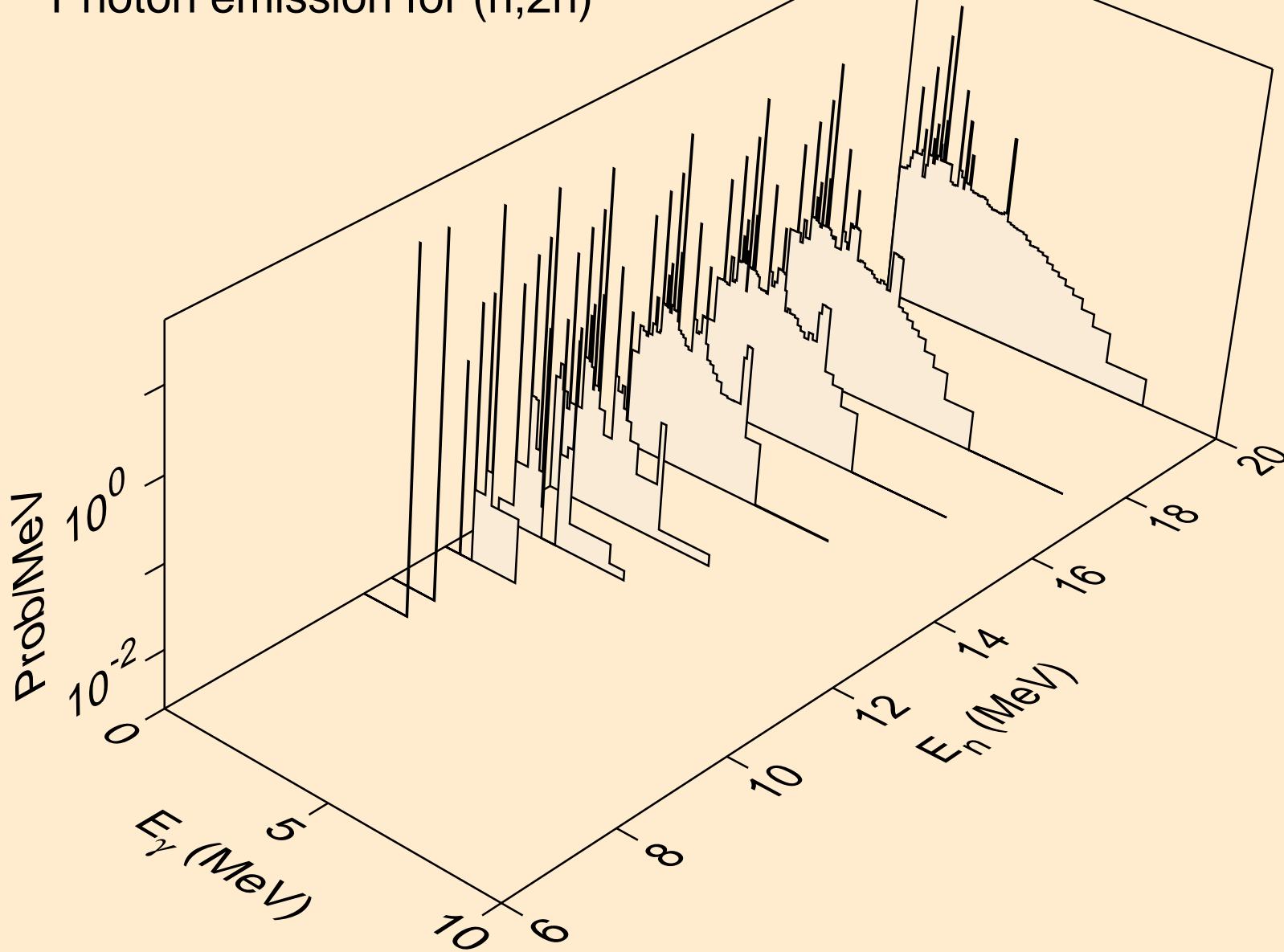

28-NI-61 FOR FENDL-3B2 FROM ENDF/B-VII WITH NJOY99.304+
Photon emission for (n,n*)p

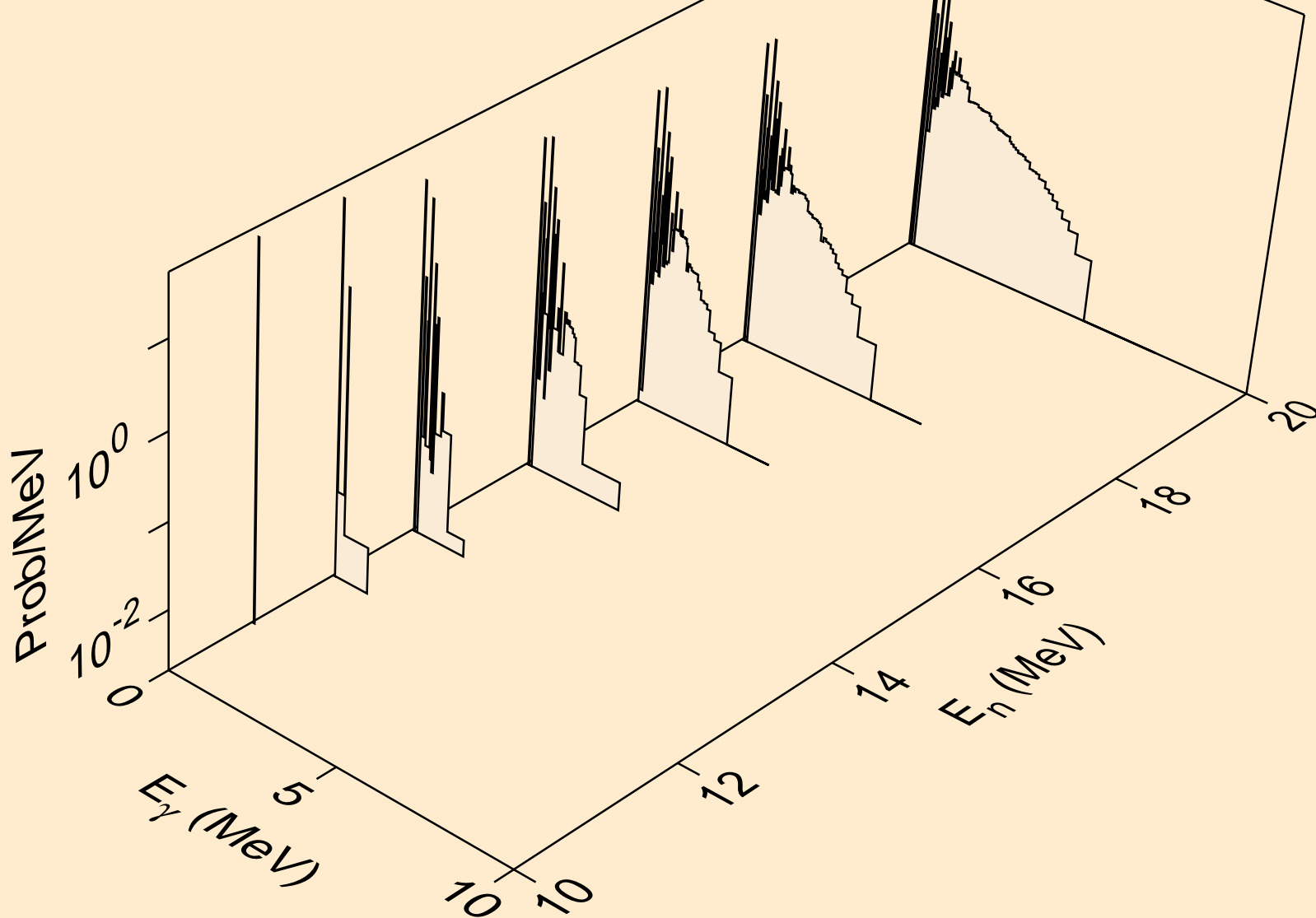

28-NI-61 FOR FENDL-3B2 FROM ENDF/B-VII WITH NJOY99.304+
Photon emission for (n,n*c)

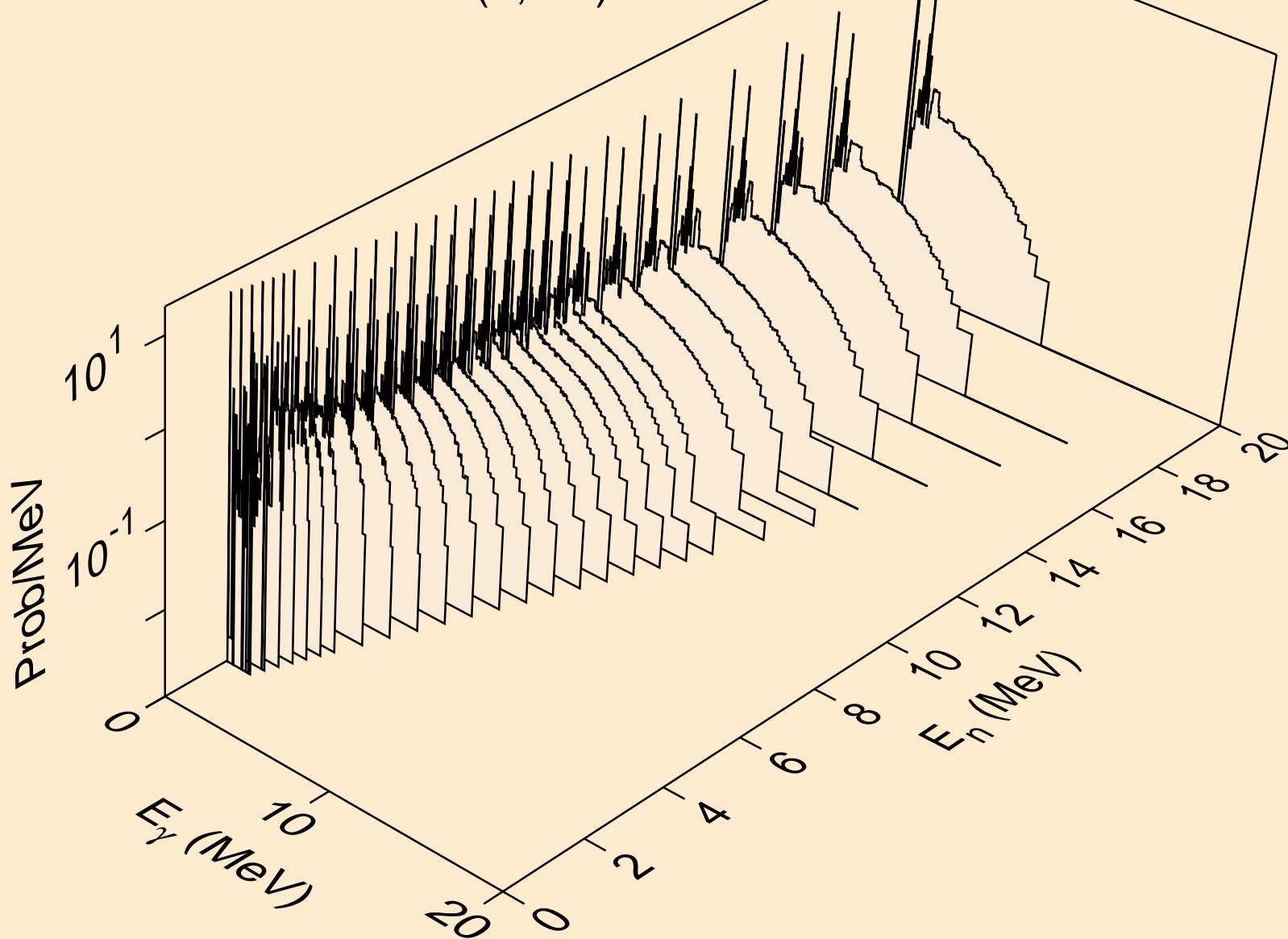

28-NI-61 FOR FENDL-3B2 FROM ENDF/B-VII WITH NJOY99.304+
Photon emission for (n,p)

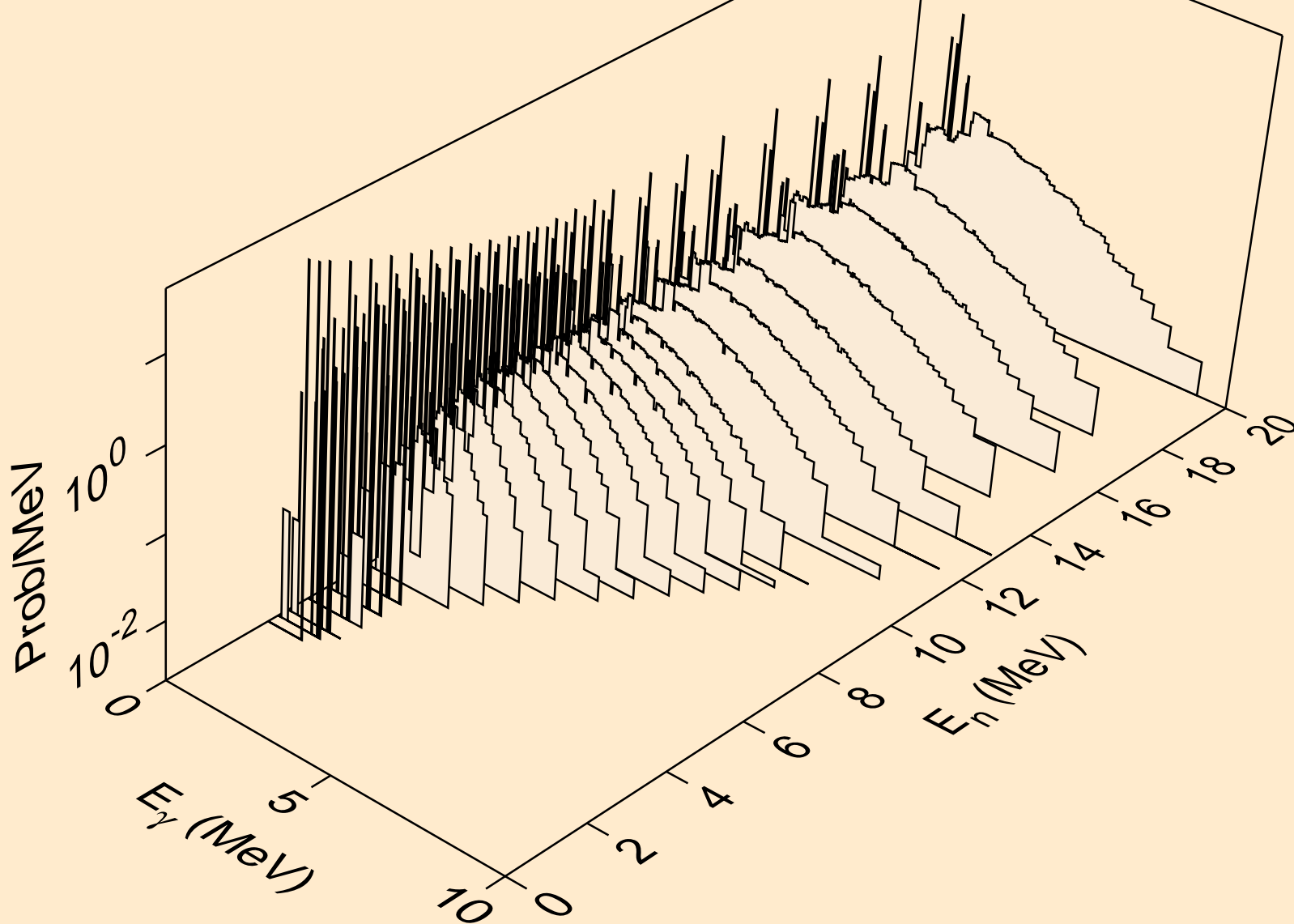

28-NI-61 FOR FENDL-3B2 FROM ENDF/B-VII WITH NJOY99.304+
Photon emission for (n,a)

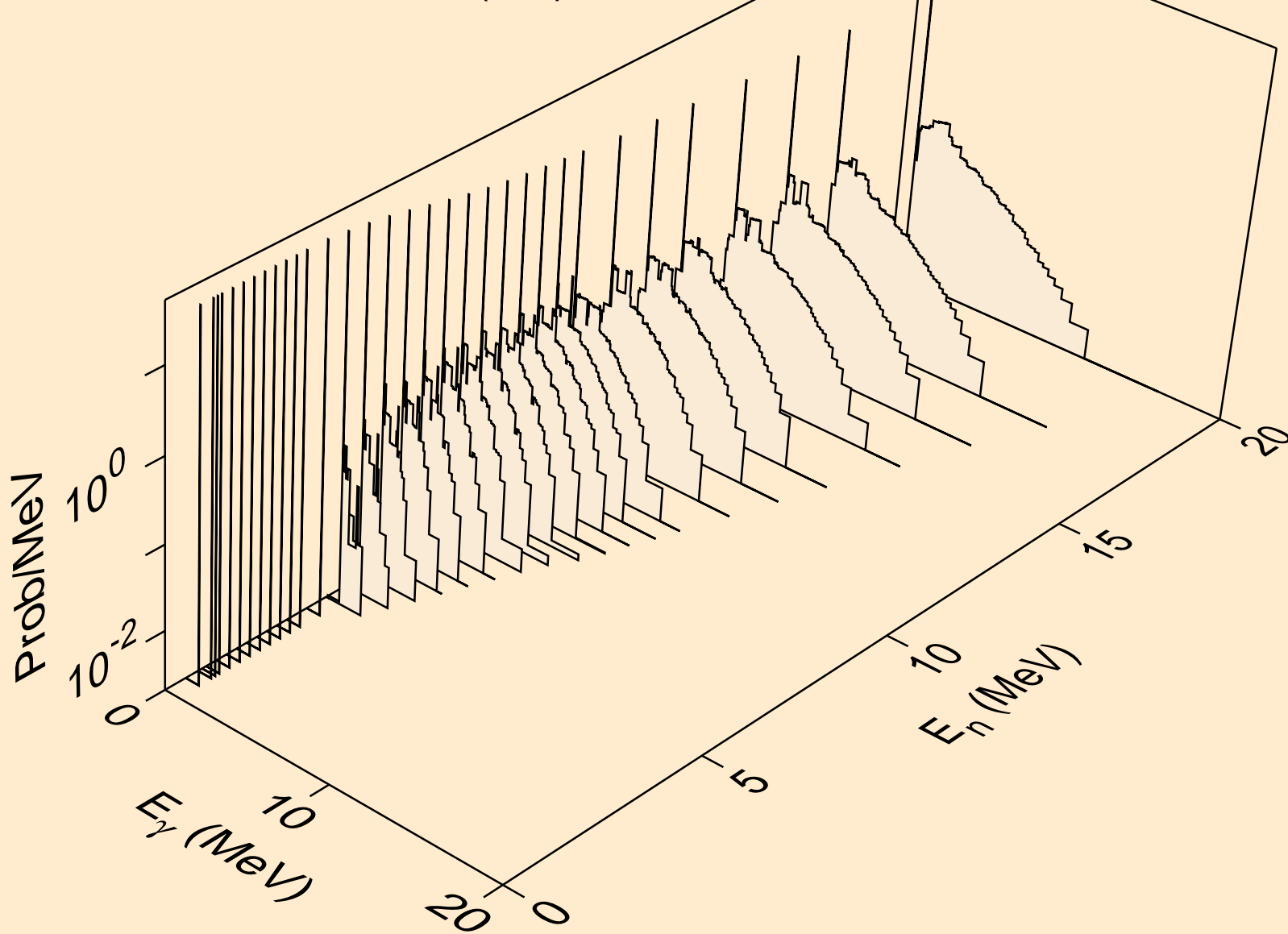

28-NI-61 FOR FENDL-3B2 FROM ENDF/B-VII WITH NJOY99.304+
thermal capture photon spectrum

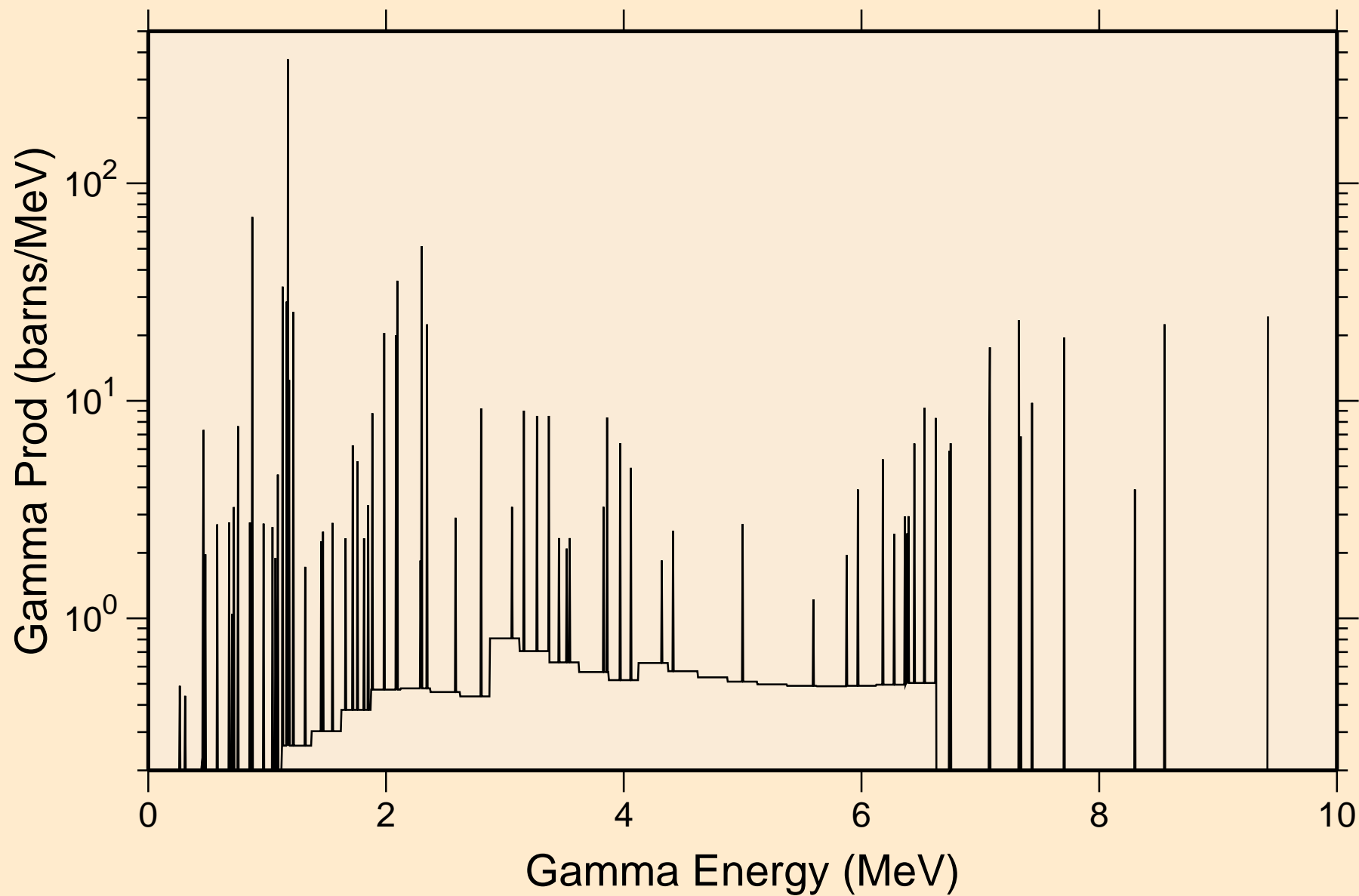

28-NI-61 FOR FENDL-3B2 FROM ENDF/B-VII WITH NJOY99.304+
14 MeV photon spectrum

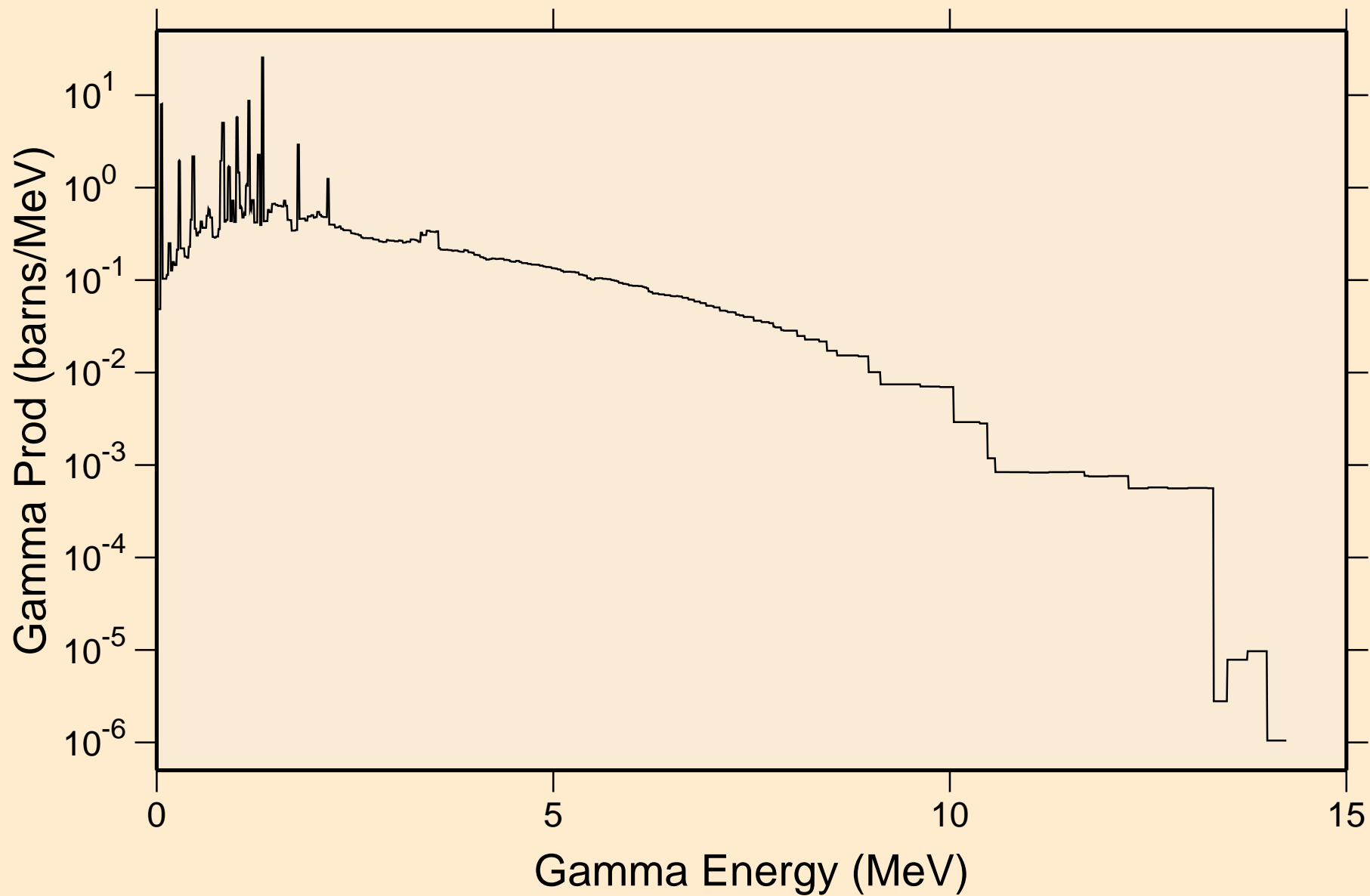

28-NI-61 FOR FENDL-3B2 FROM ENDF/B-VII WITH NJOY99.304+

Particle heating contributions

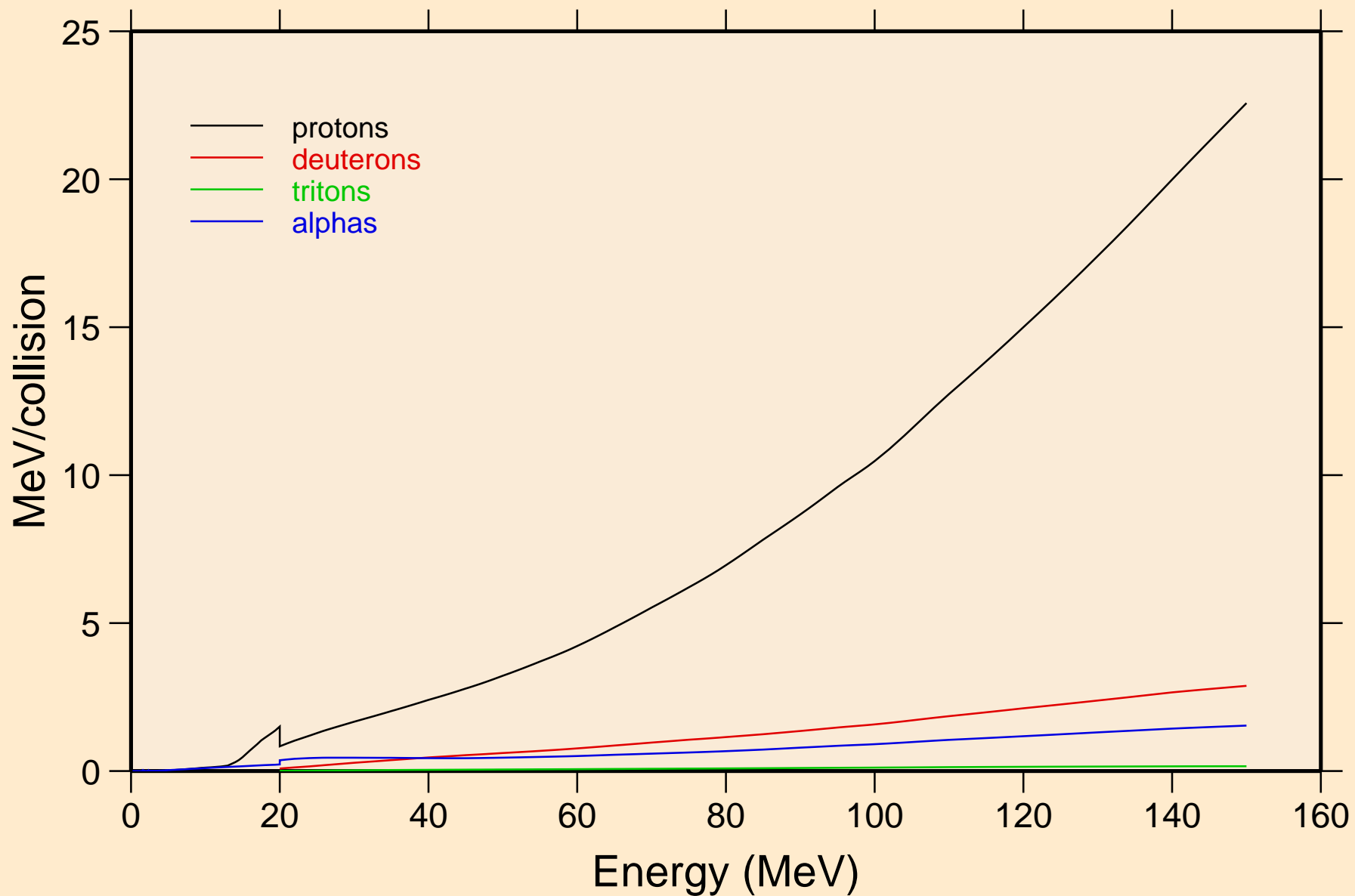

28-NI-61 FOR FENDL-3B2 FROM ENDF/B-VII WITH NJOY99.304+ Recoil Heating

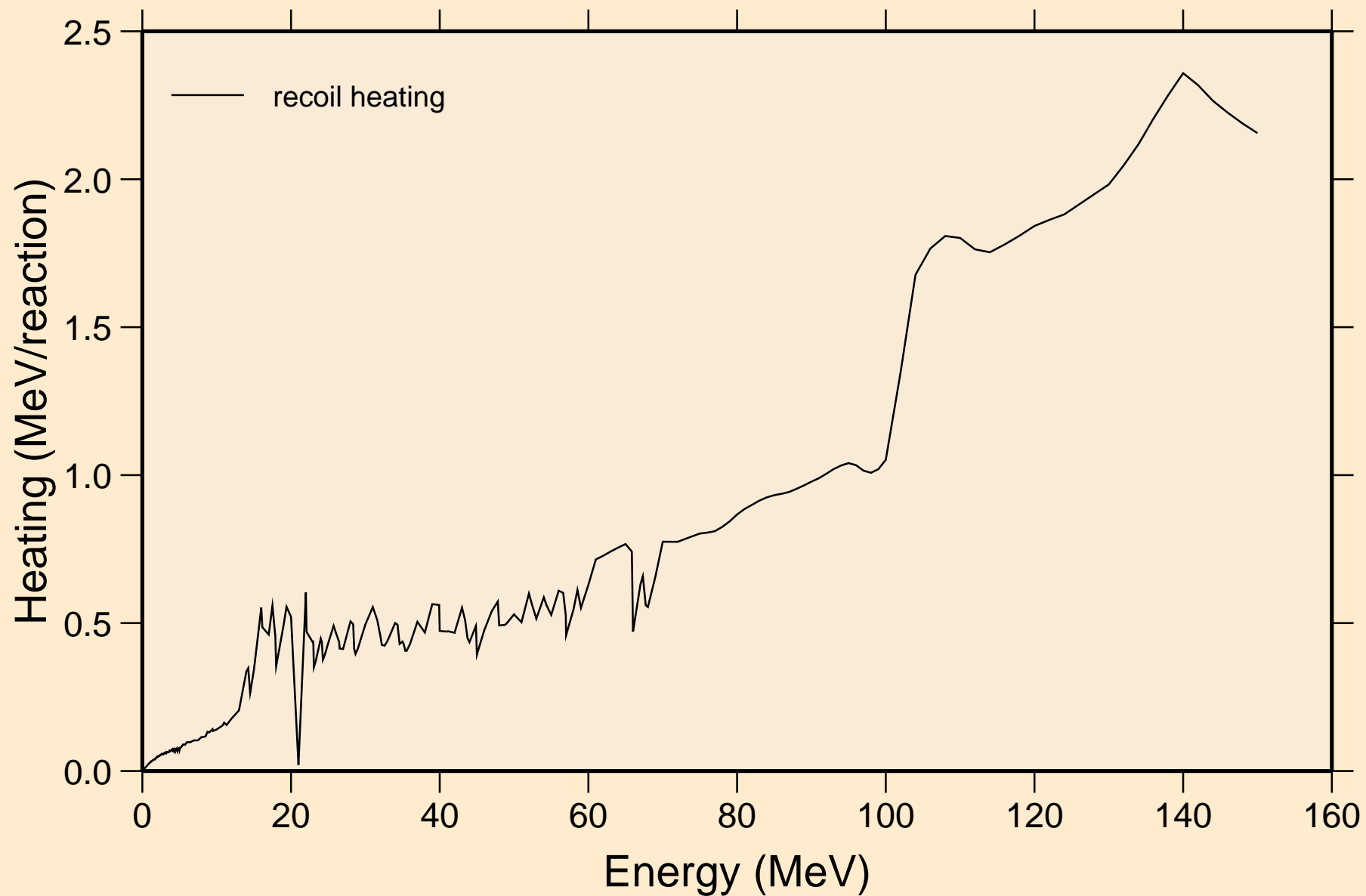

28-NI-61 FOR FENDL-3B2 FROM ENDF/B-VII WITH NJOY99.304+

Particle production cross sections

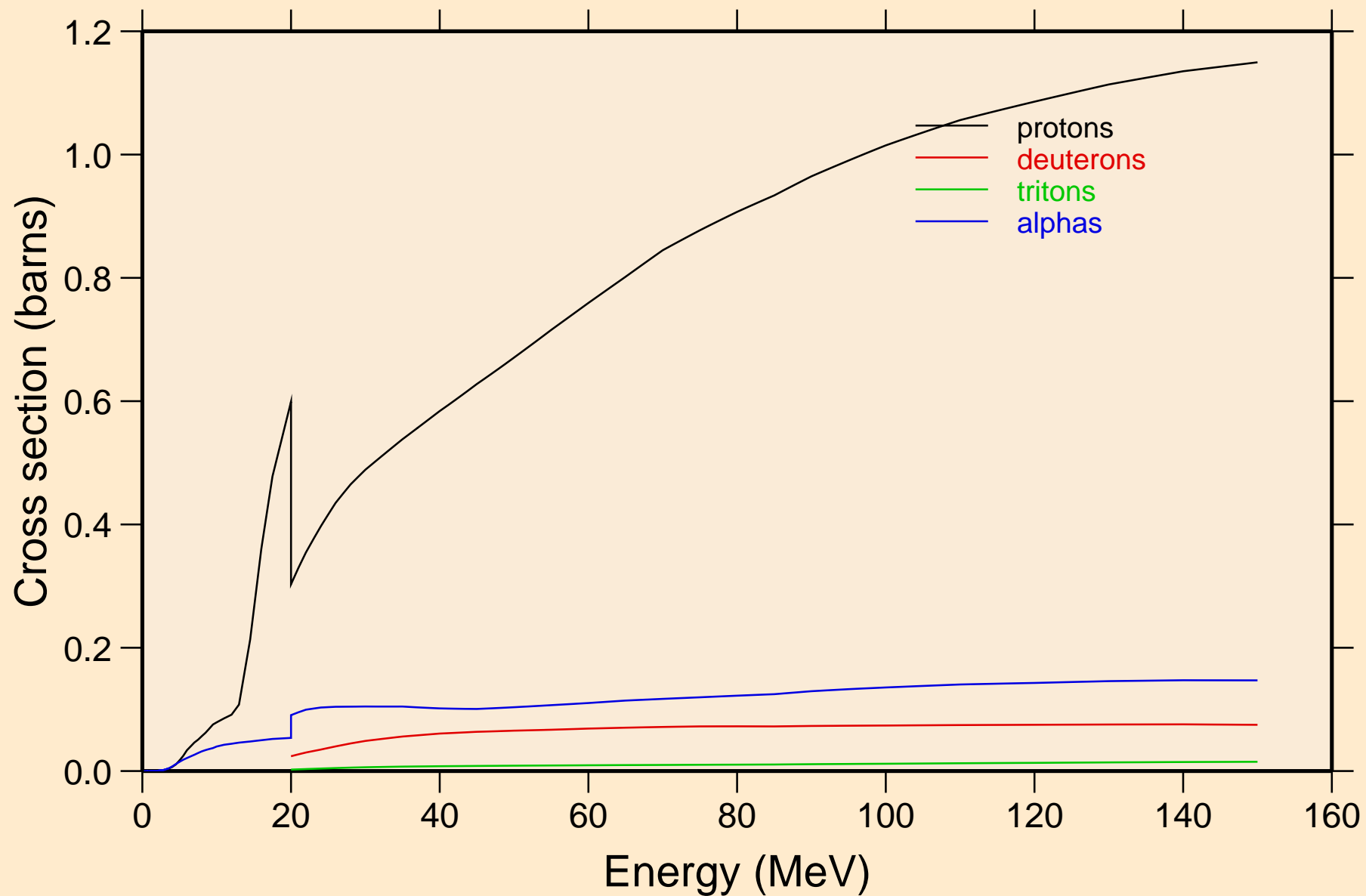

28-NI-61 FOR FENDL-3B2 FROM ENDF/B-VII WITH NJOY99.304+
protons from (n,x)

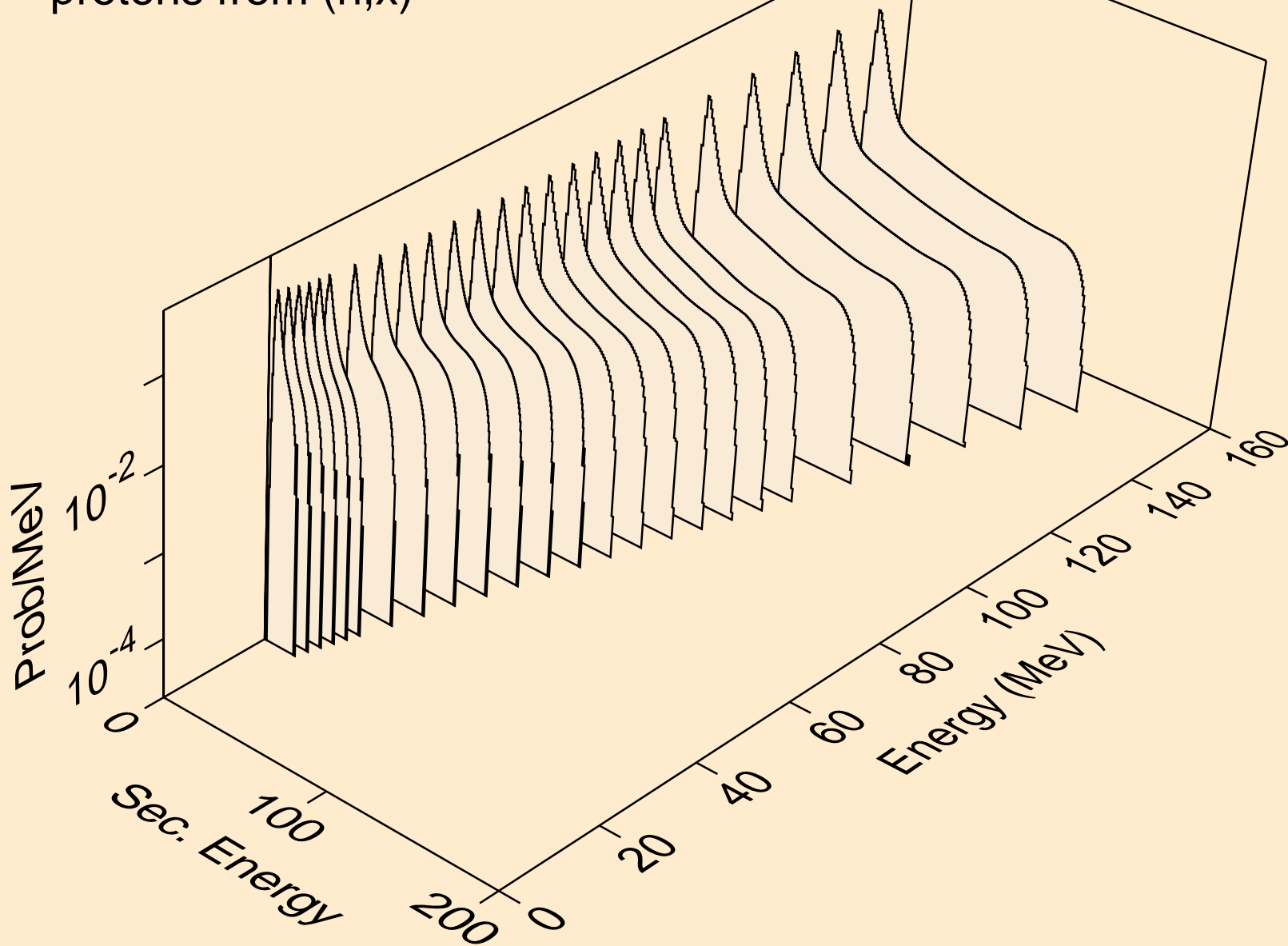

28-NI-61 FOR FENDL-3B2 FROM ENDF/B-VII WITH NJOY99.304+
protons from (n,n*)p

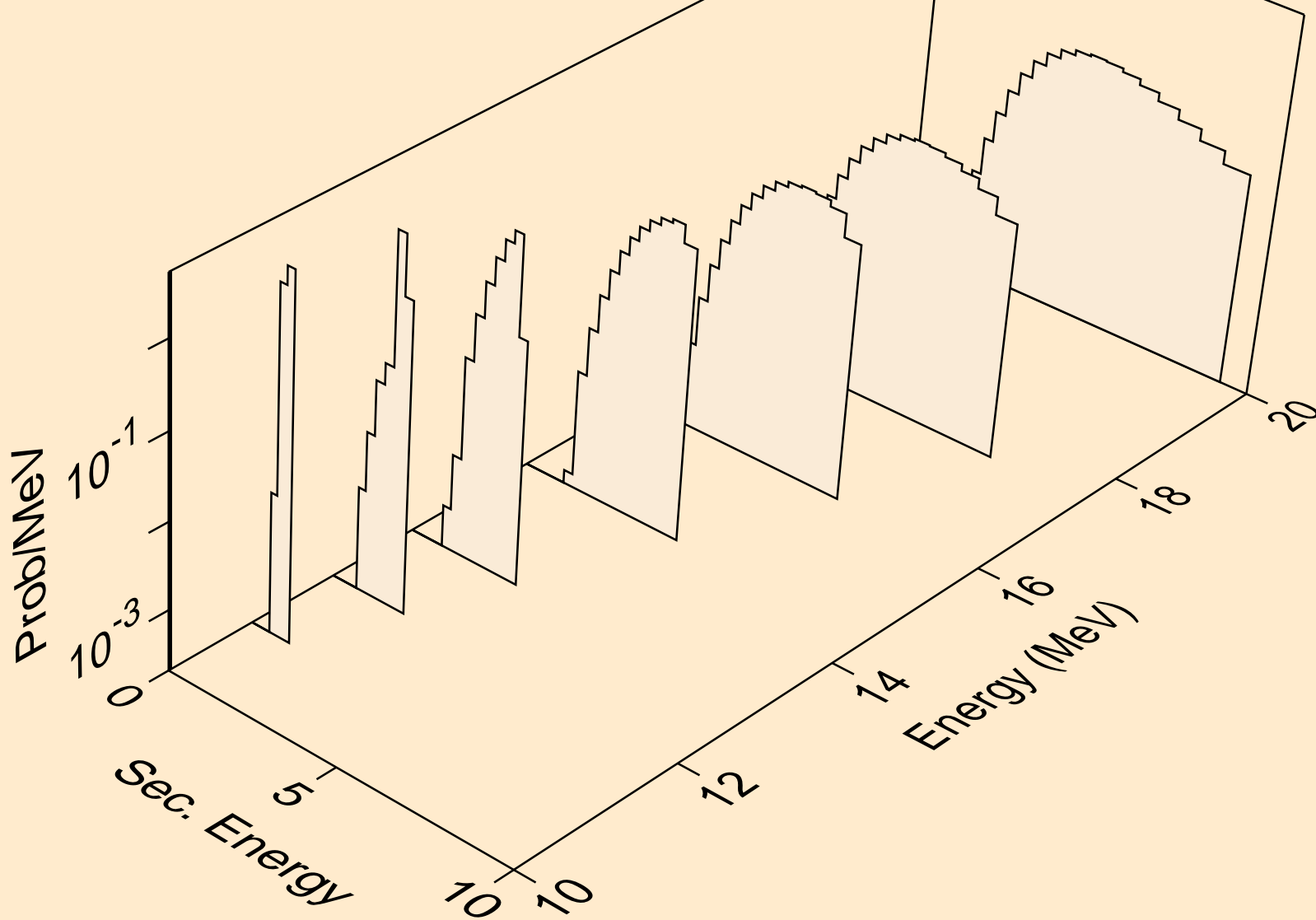

28-NI-61 FOR FENDL-3B2 FROM ENDF/B-VII WITH NJOY99.304+
protons from (n,p)

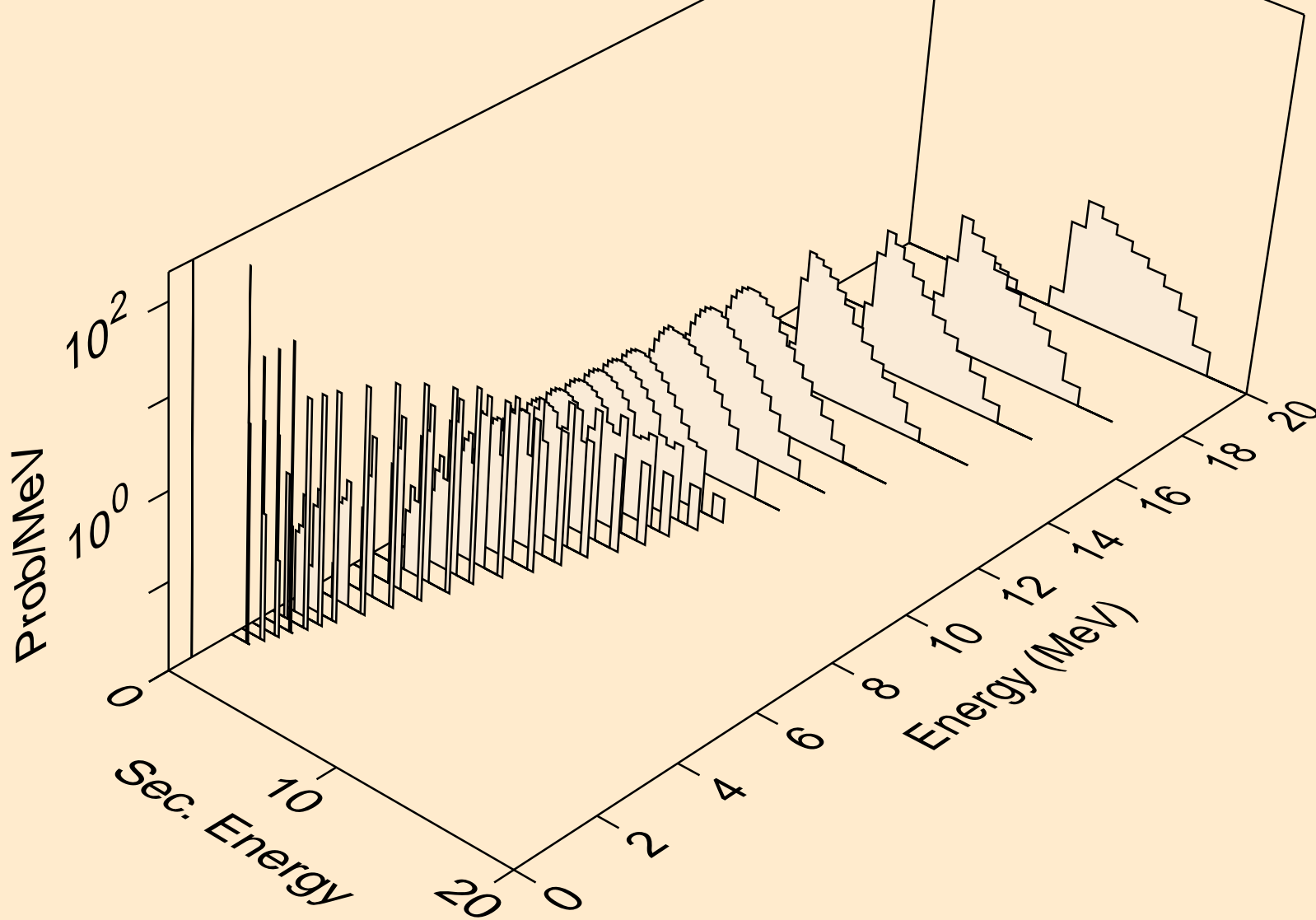

28-NI-61 FOR FENDL-3B2 FROM ENDF/B-VII WITH NJOY99.304+
deuterons from (n,x)

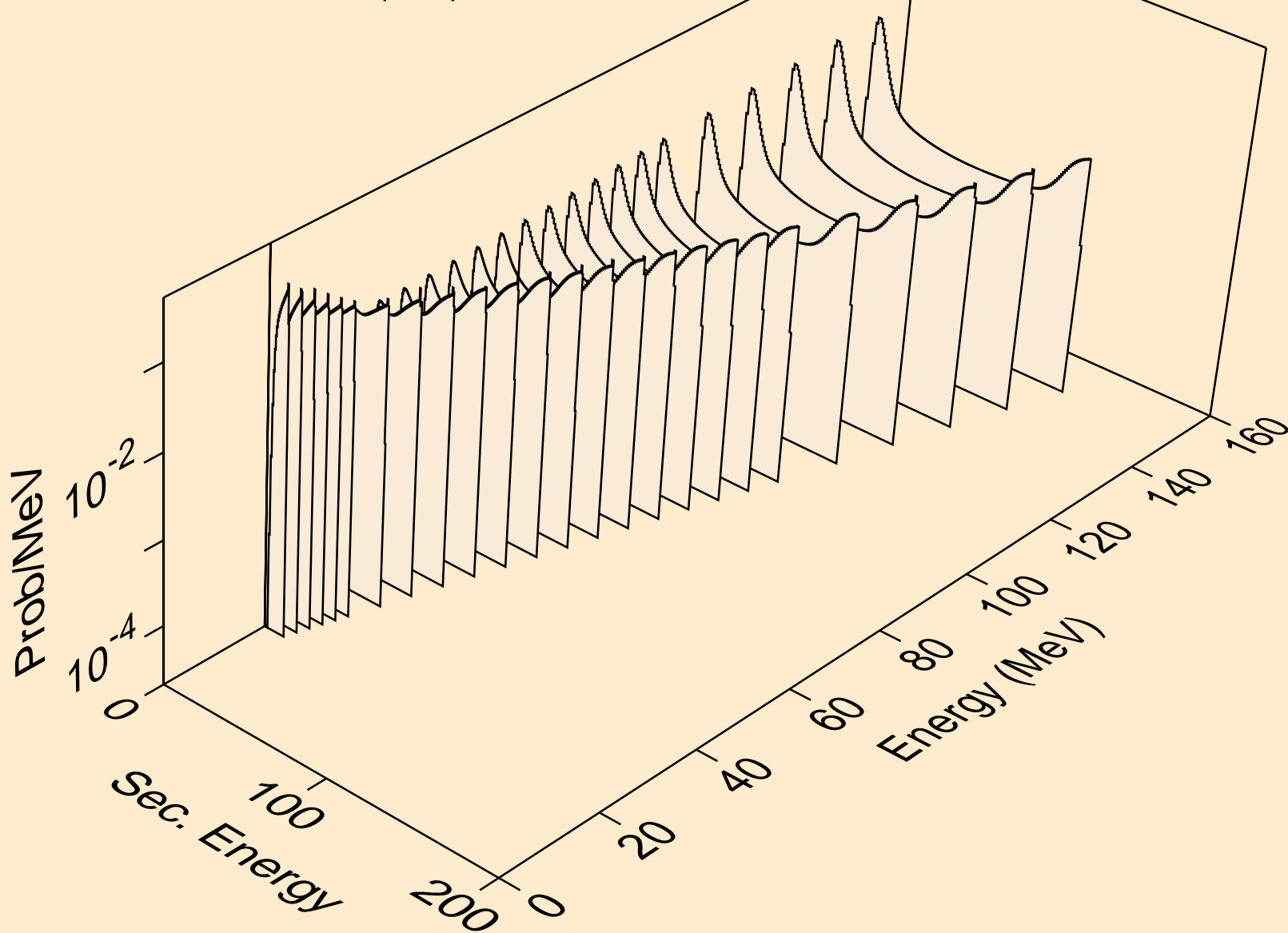

28-NI-61 FOR FENDL-3B2 FROM ENDF/B-VII WITH NJOY99.304+
tritons from (n,x)

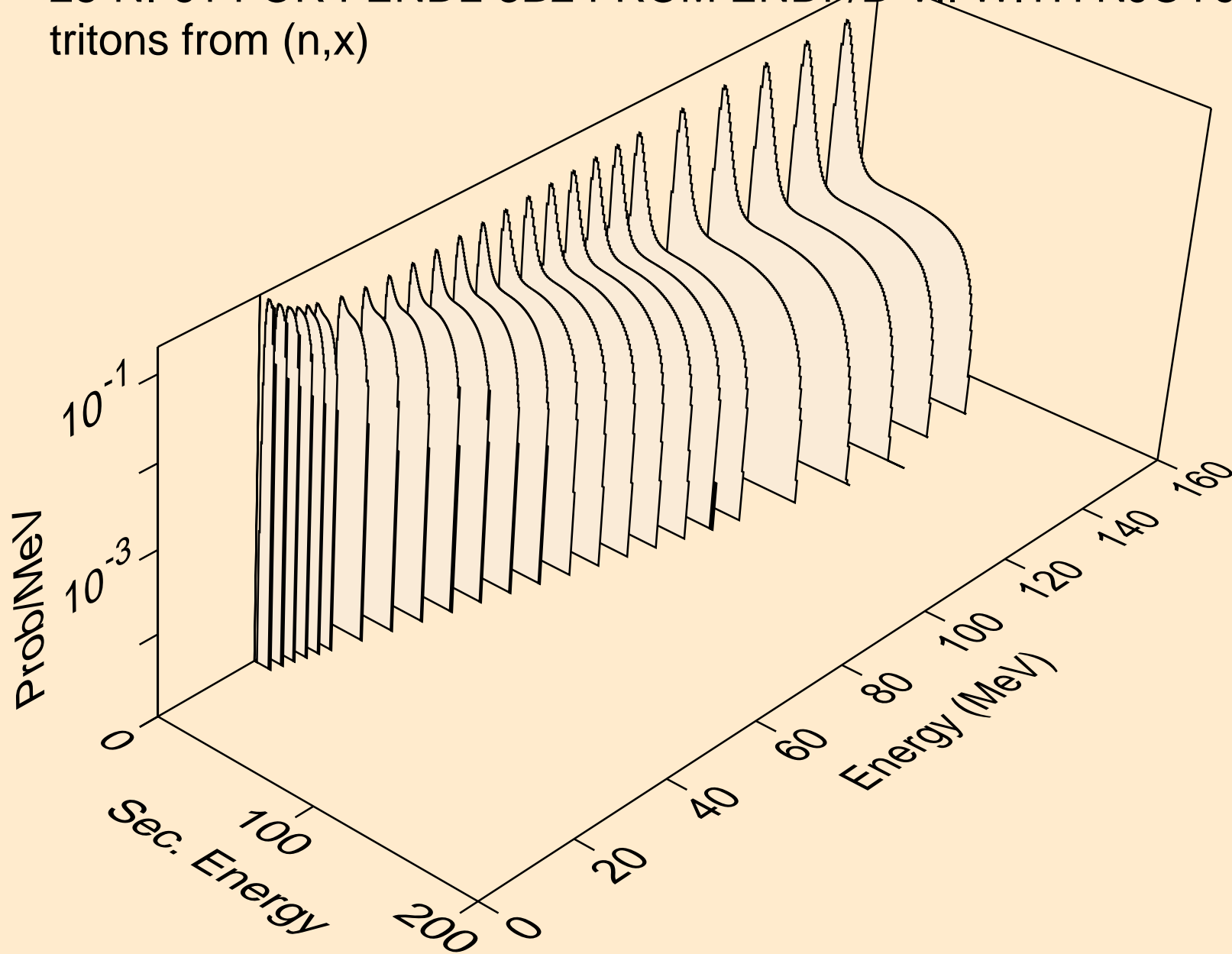

28-NI-61 FOR FENDL-3B2 FROM ENDF/B-VII WITH NJOY99.304+
alphas from (n,x)

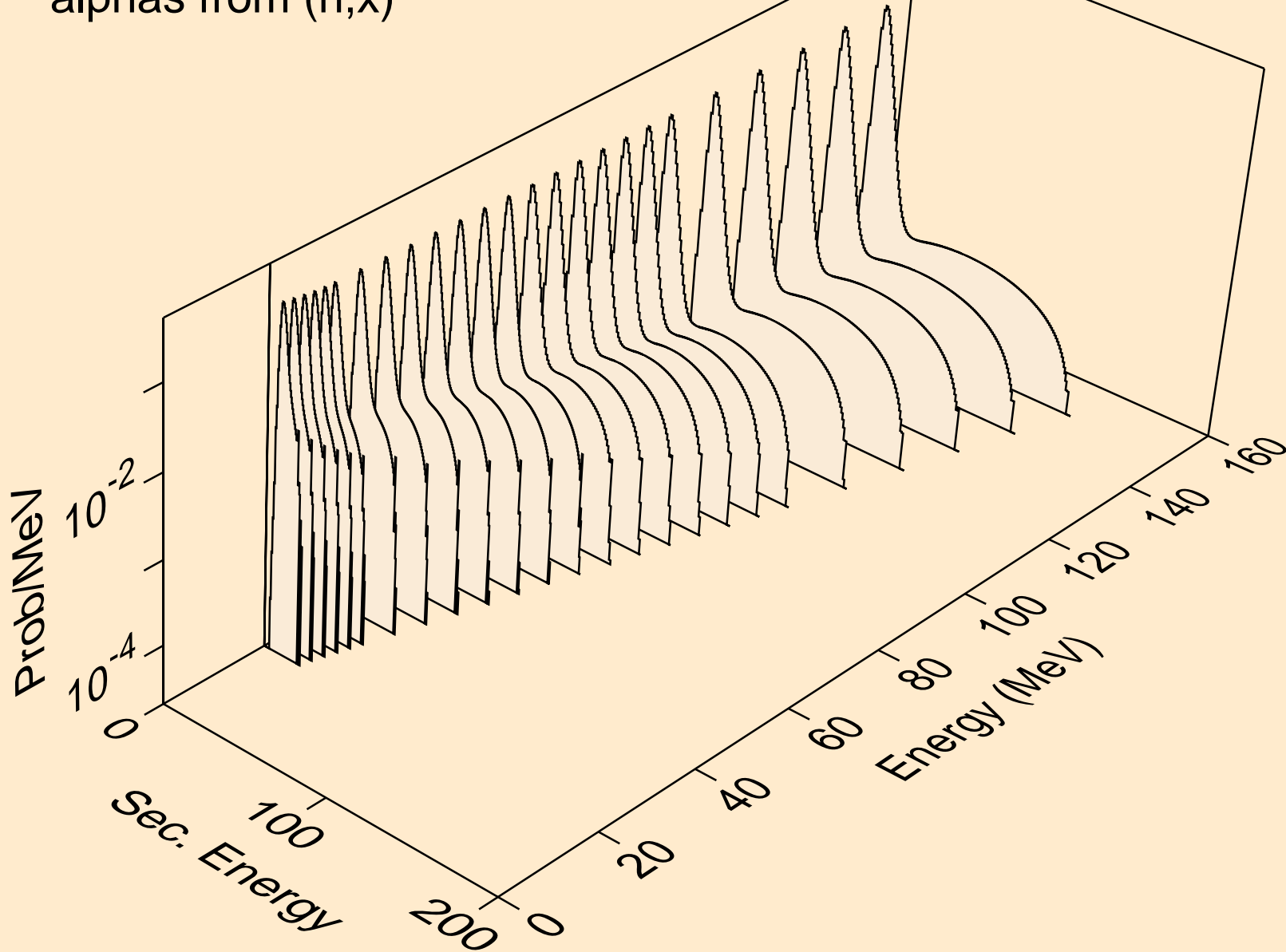

28-NI-61 FOR FENDL-3B2 FROM ENDF/B-VII WITH NJOY99.304+
alphas from (n,a)

