

31-GA-69 FOR FENDL-3B2 FROM JENDL-HE WITH NJOY99.304+

Principal cross sections

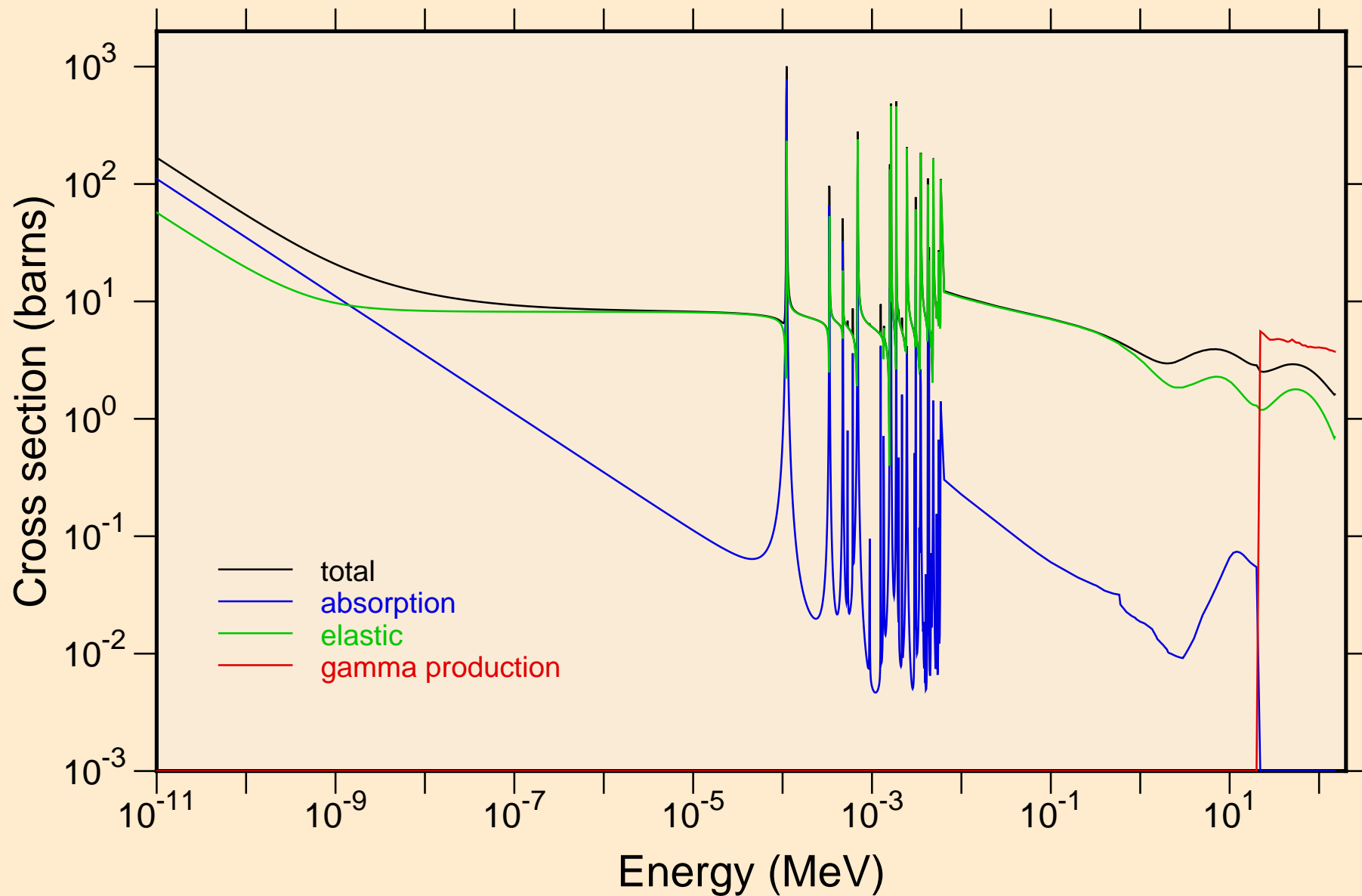

31-GA-69 FOR FENDL-3B2 FROM JENDL-HE WITH NJOY99.304+
resonance total cross section

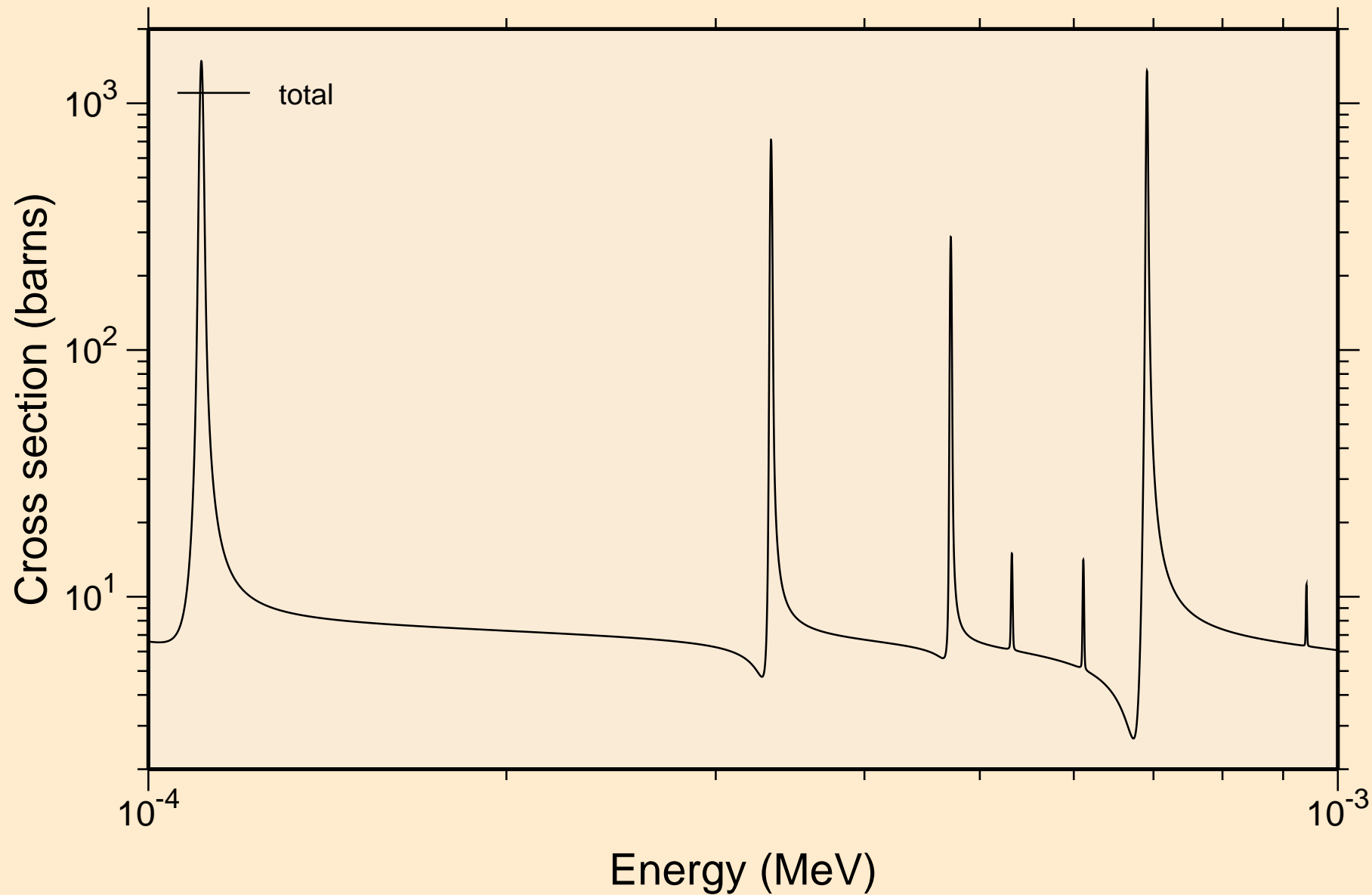

31-GA-69 FOR FENDL-3B2 FROM JENDL-HE WITH NJOY99.304+
resonance total cross section

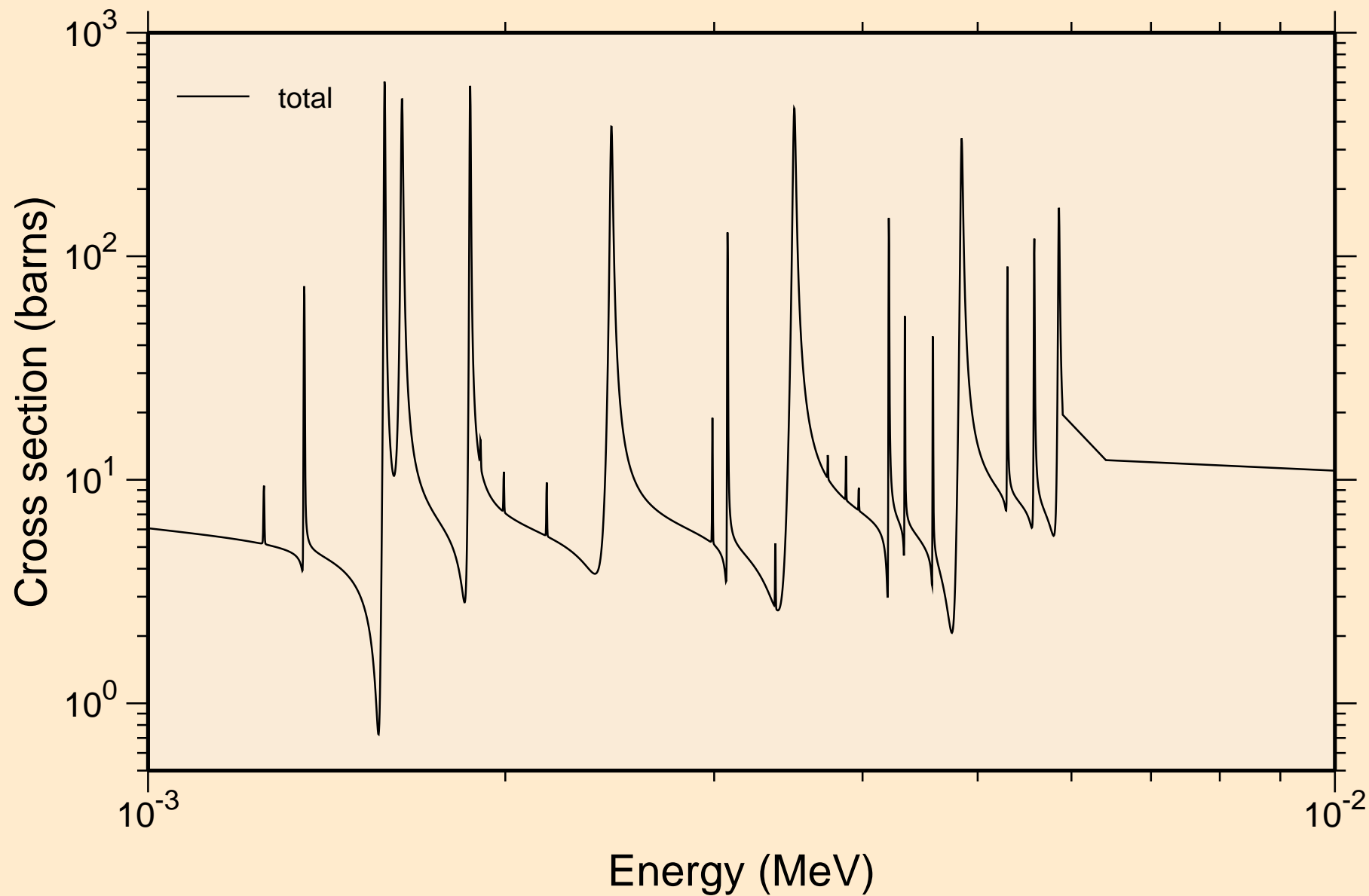

31-GA-69 FOR FENDL-3B2 FROM JENDL-HE WITH NJOY99.304+
resonance total cross section

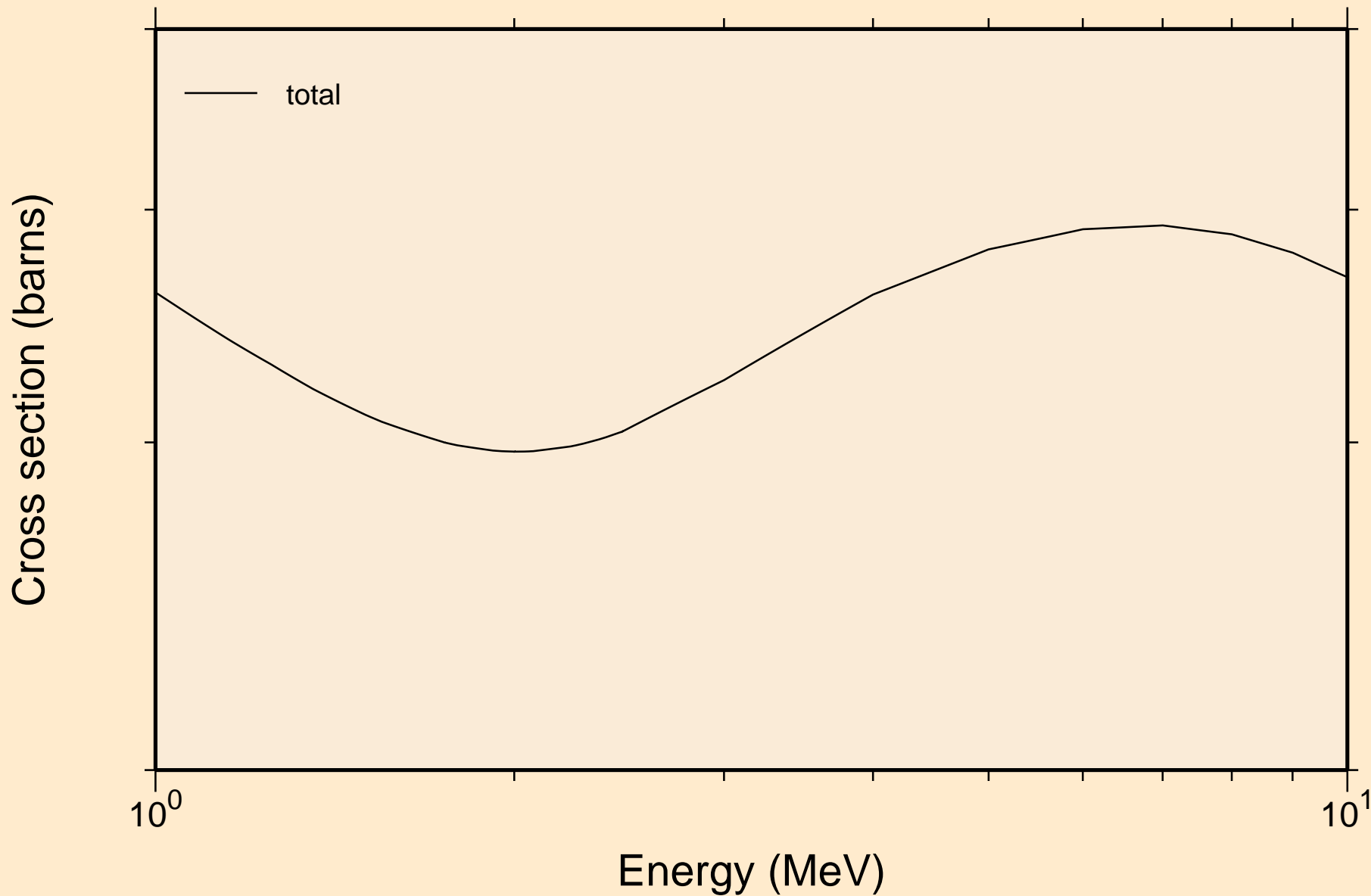

31-GA-69 FOR FENDL-3B2 FROM JENDL-HE WITH NJOY99.304+
resonance absorption cross sections

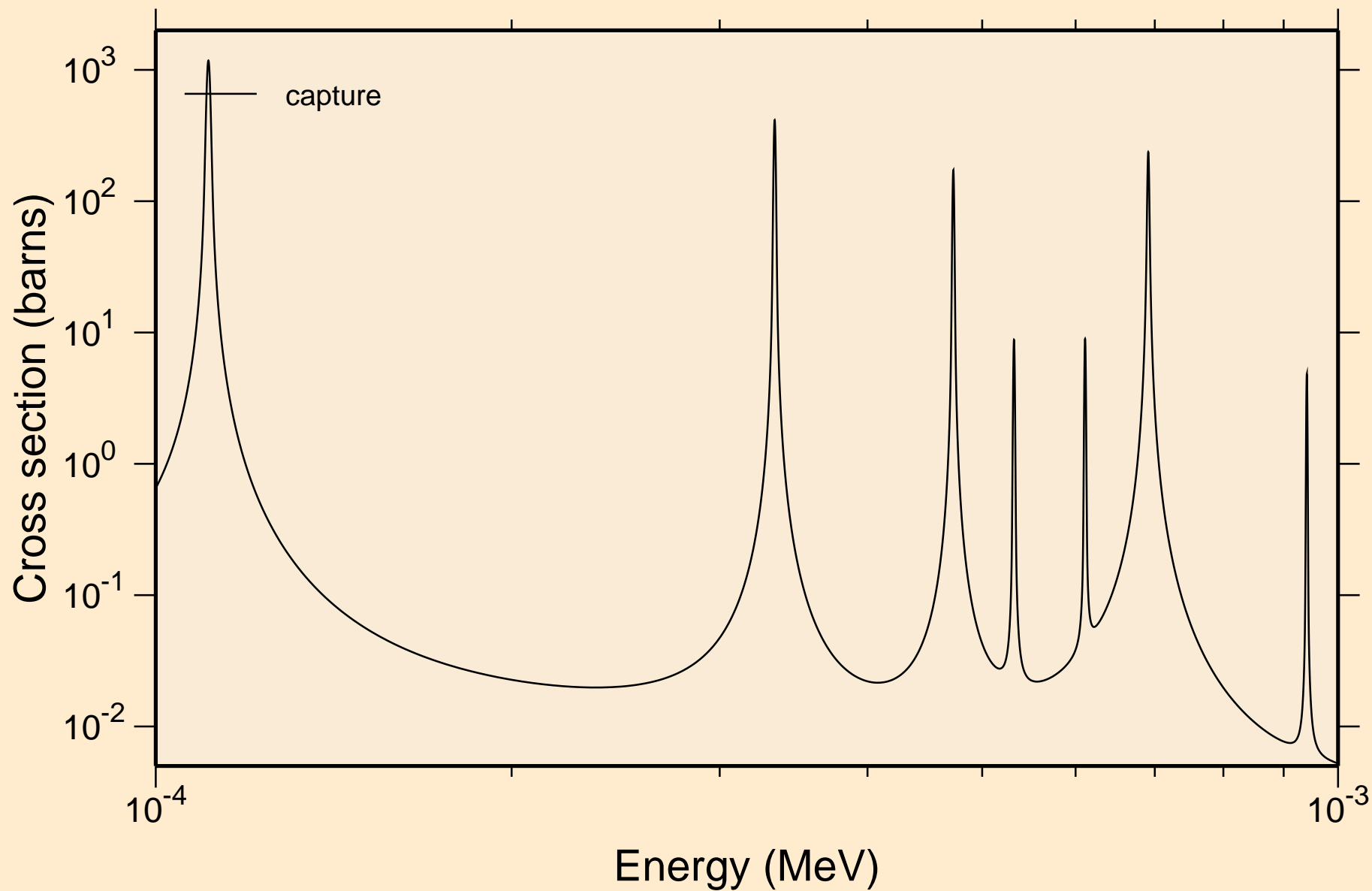

31-GA-69 FOR FENDL-3B2 FROM JENDL-HE WITH NJOY99.304+
resonance absorption cross sections

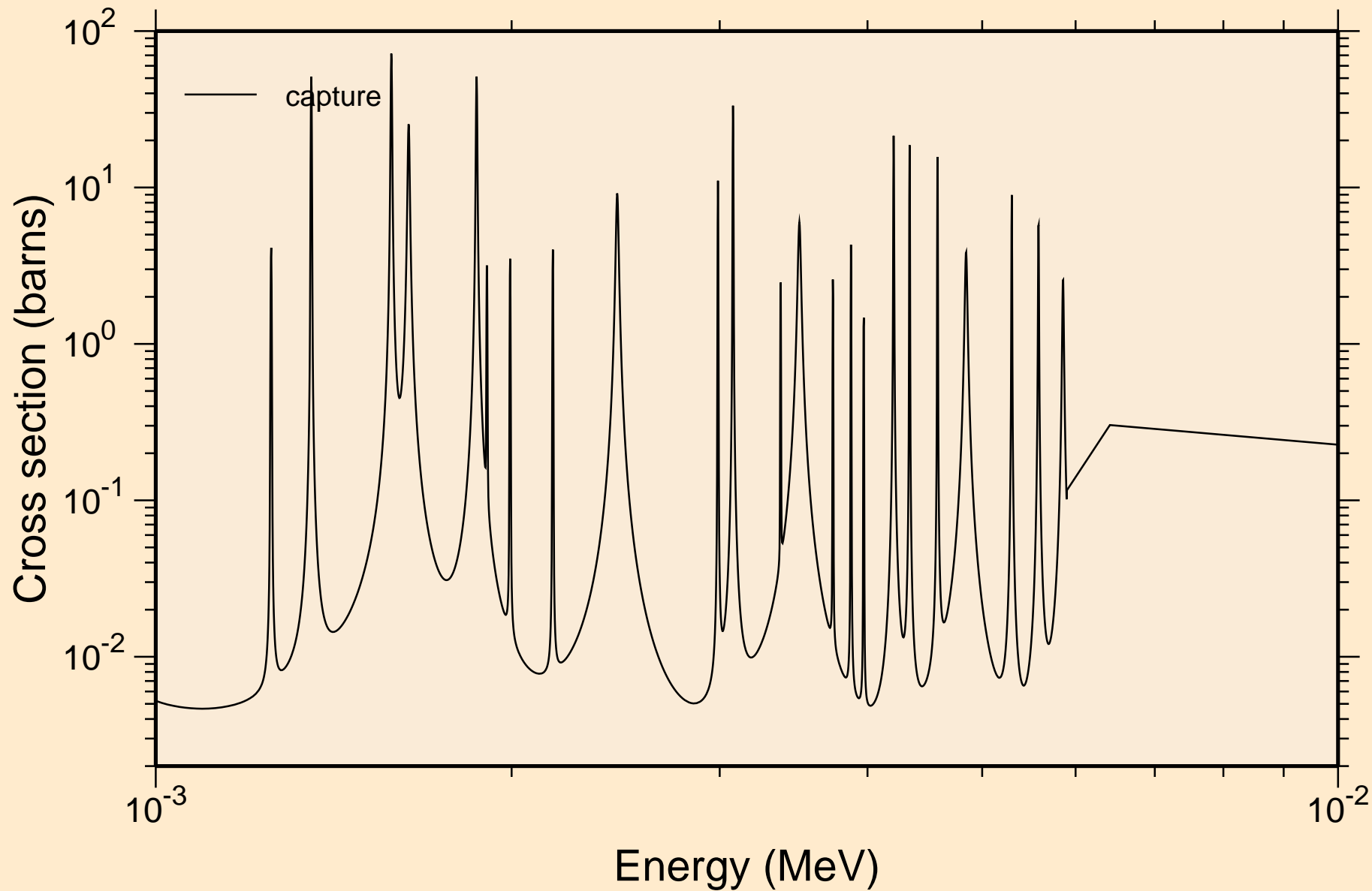

31-GA-69 FOR FENDL-3B2 FROM JENDL-HE WITH NJOY99.304+
resonance absorption cross sections

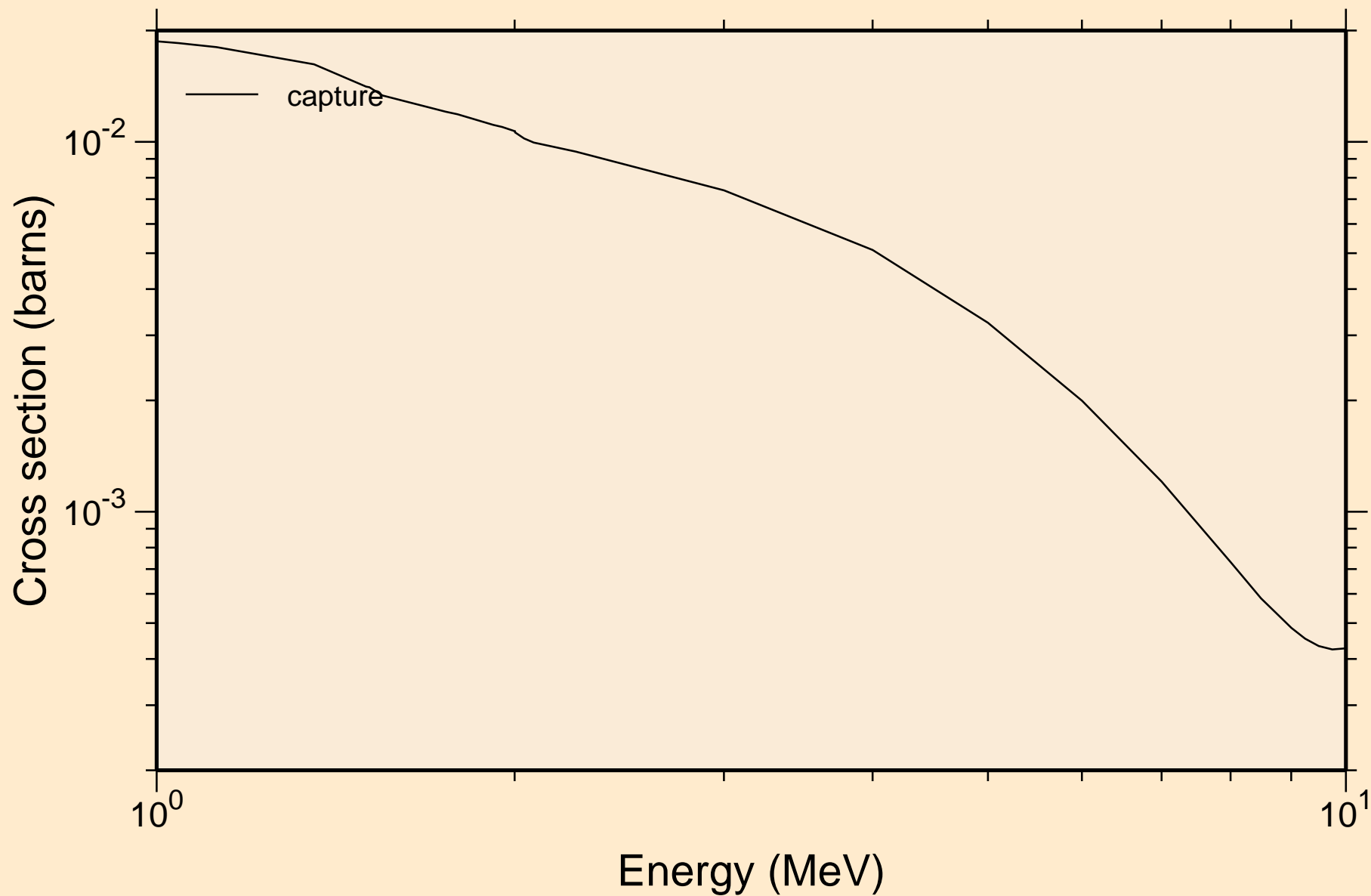

31-GA-69 FOR FENDL-3B2 FROM JENDL-HE WITH NJOY99.304+ Heating

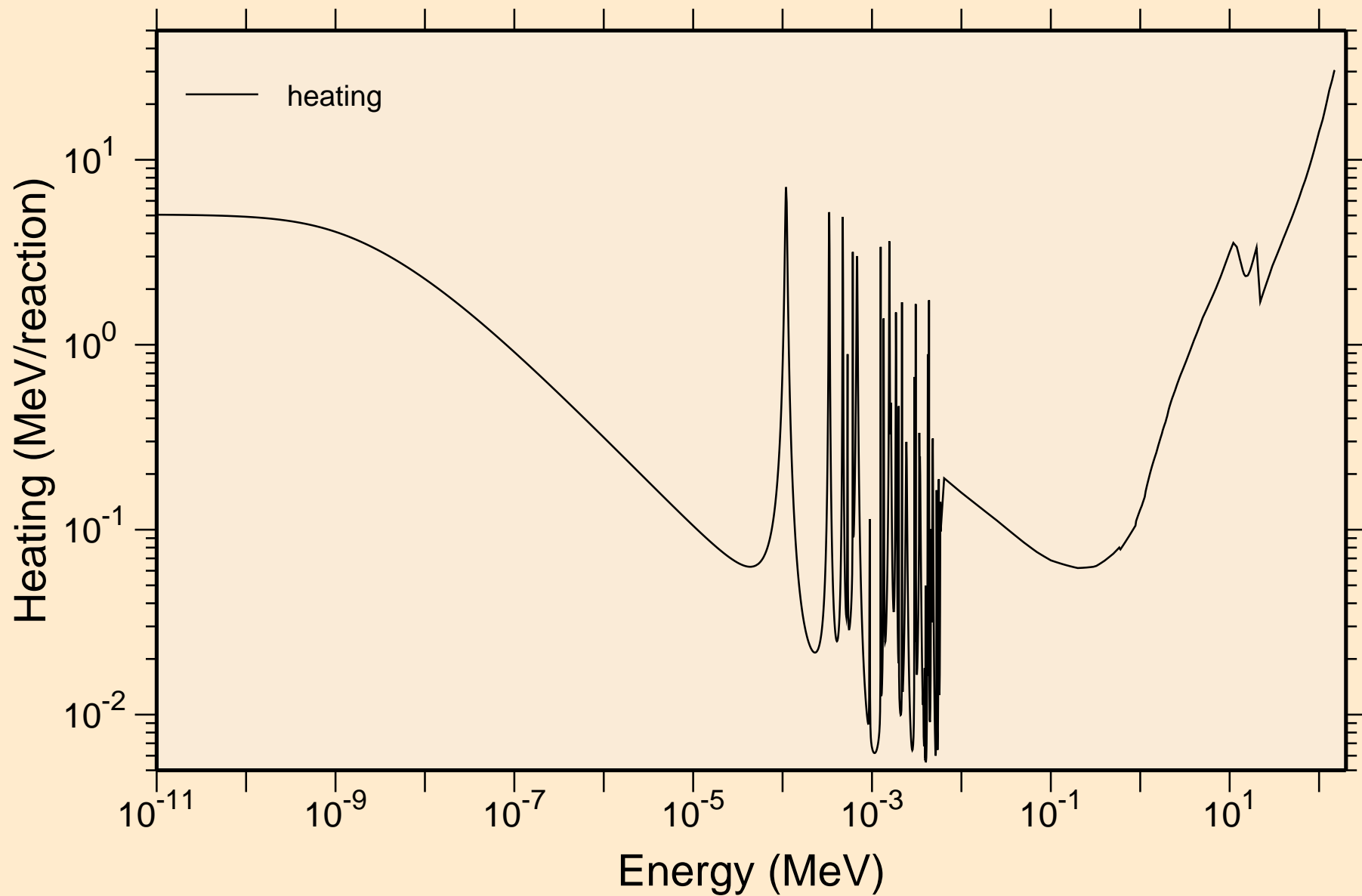

31-GA-69 FOR FENDL-3B2 FROM JENDL-HE WITH NJOY99.304+ Damage

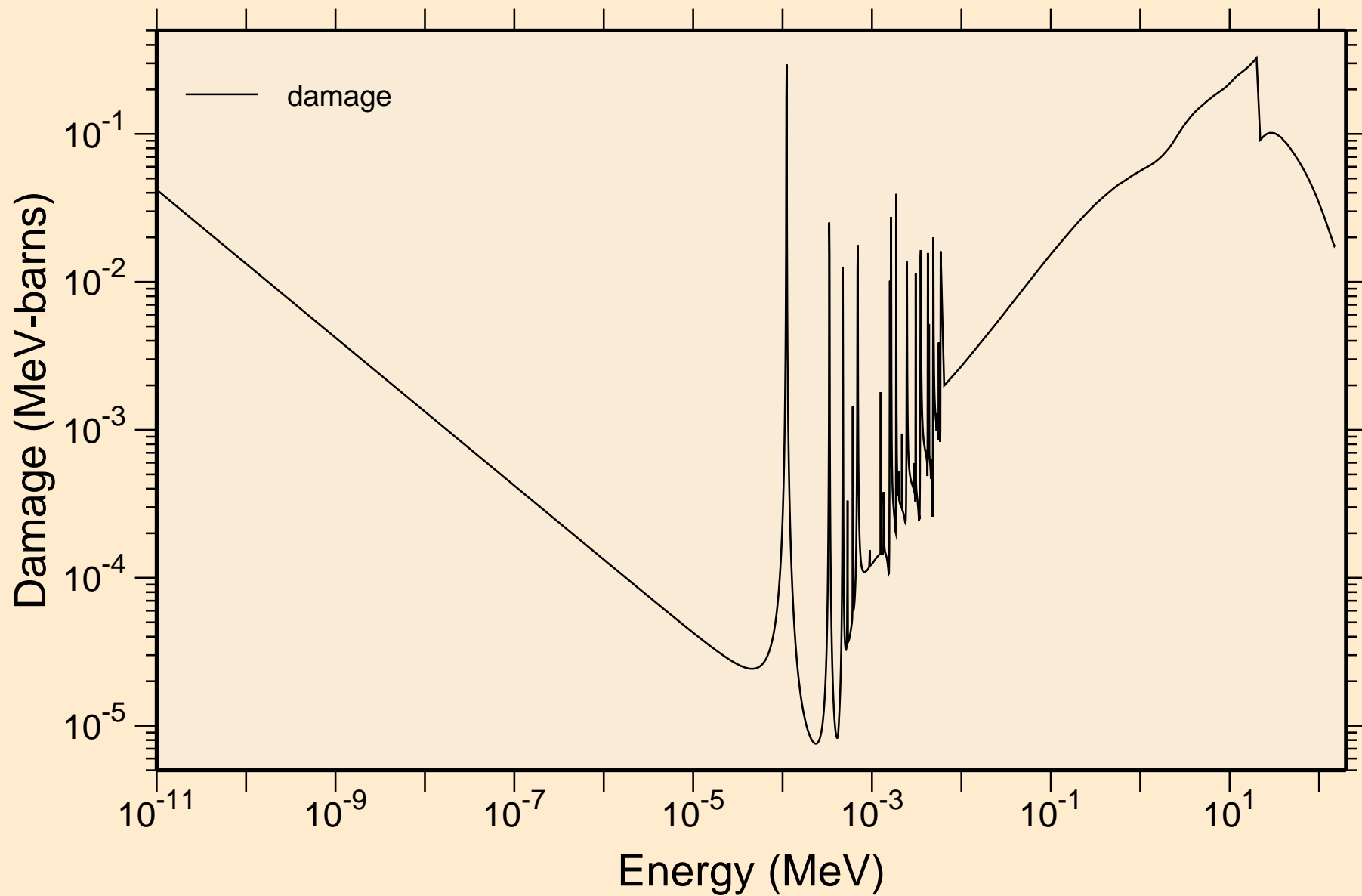

31-GA-69 FOR FENDL-3B2 FROM JENDL-HE WITH NJOY99.304+
Non-threshold reactions

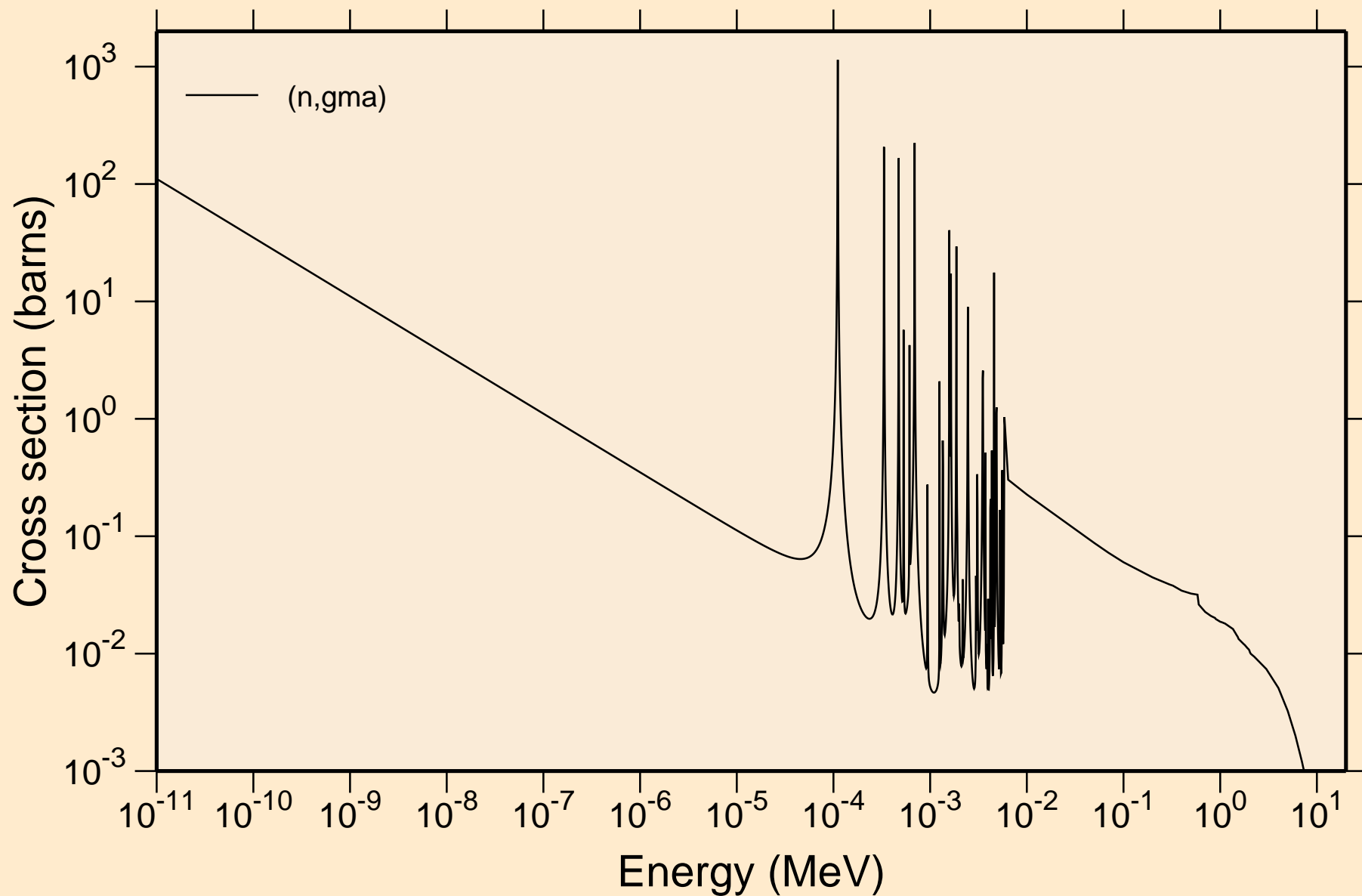

31-GA-69 FOR FENDL-3B2 FROM JENDL-HE WITH NJOY99.304+
Principal cross sections

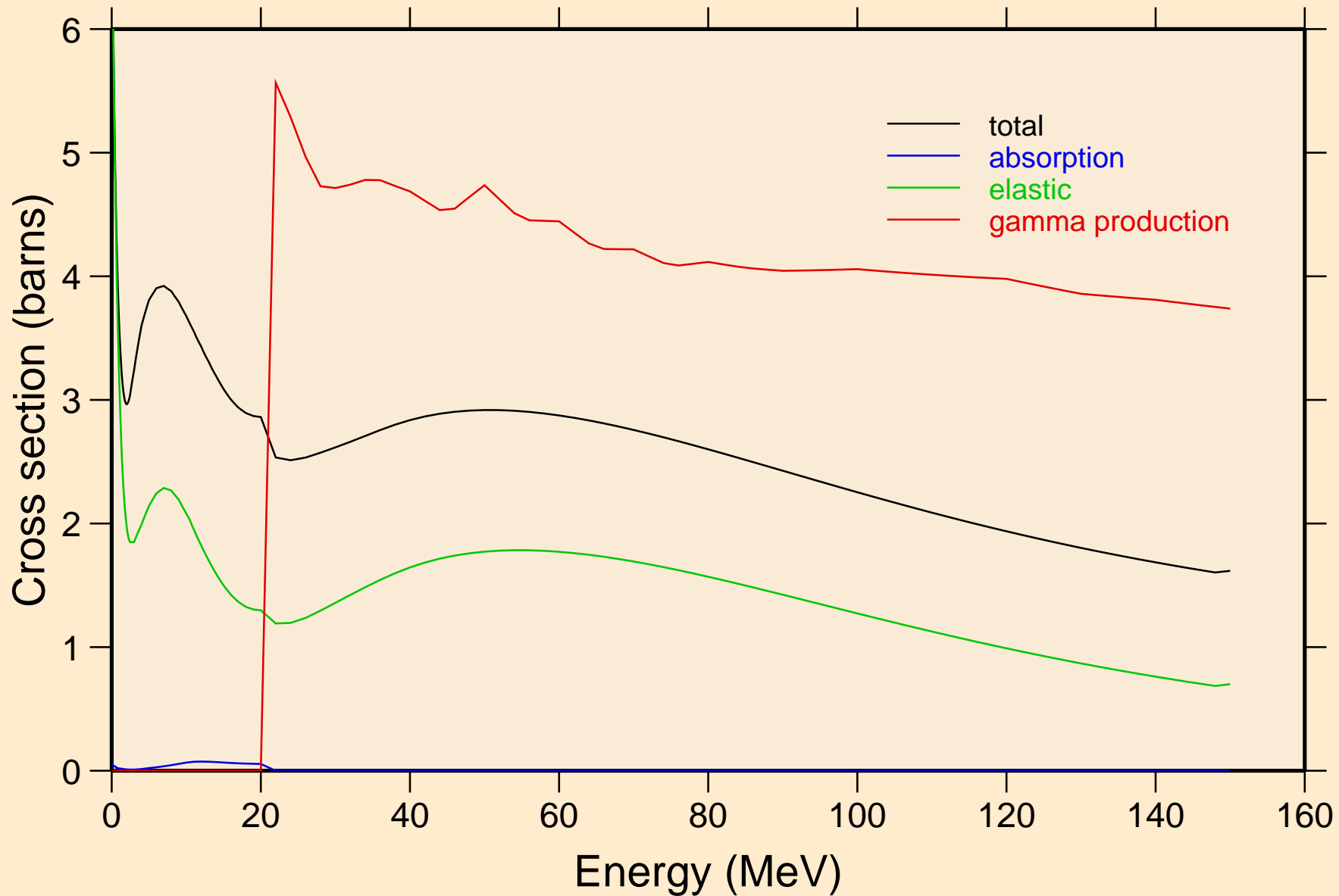

31-GA-69 FOR FENDL-3B2 FROM JENDL-HE WITH NJOY99.304+ Heating

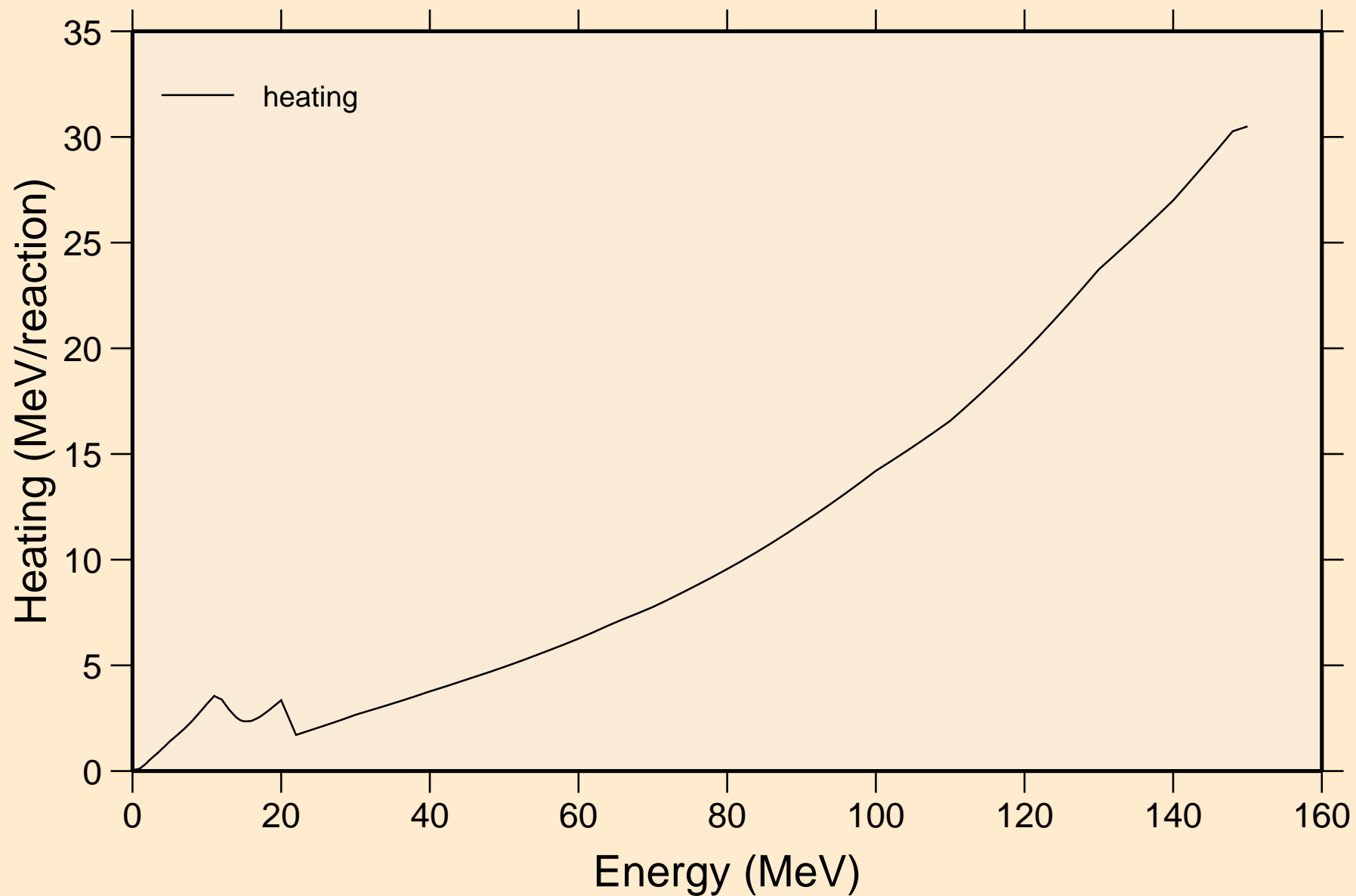

31-GA-69 FOR FENDL-3B2 FROM JENDL-HE WITH NJOY99.304+ Damage

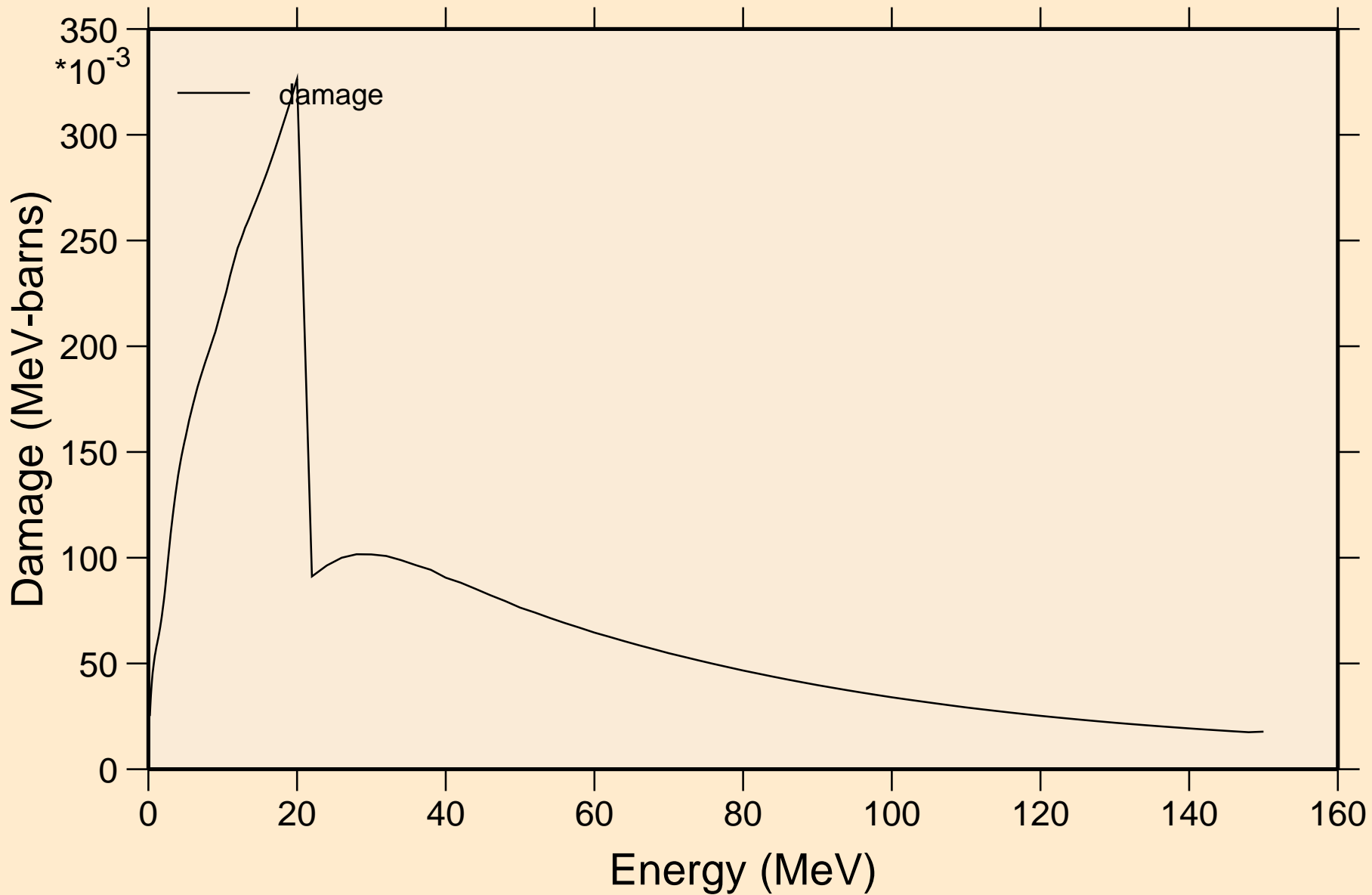

31-GA-69 FOR FENDL-3B2 FROM JENDL-HE WITH NJOY99.304+
Non-threshold reactions

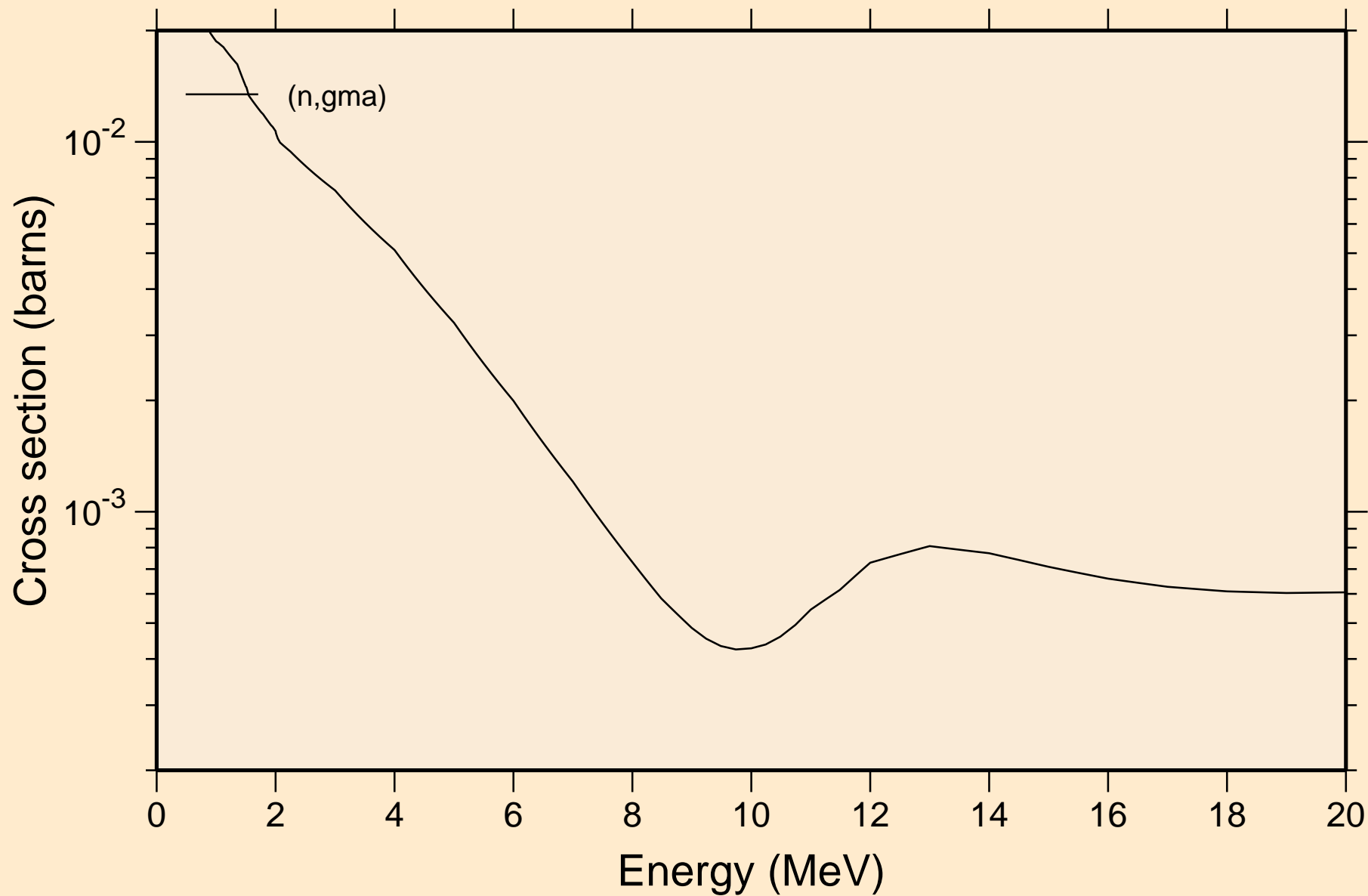

31-GA-69 FOR FENDL-3B2 FROM JENDL-HE WITH NJOY99.304+ Inelastic levels

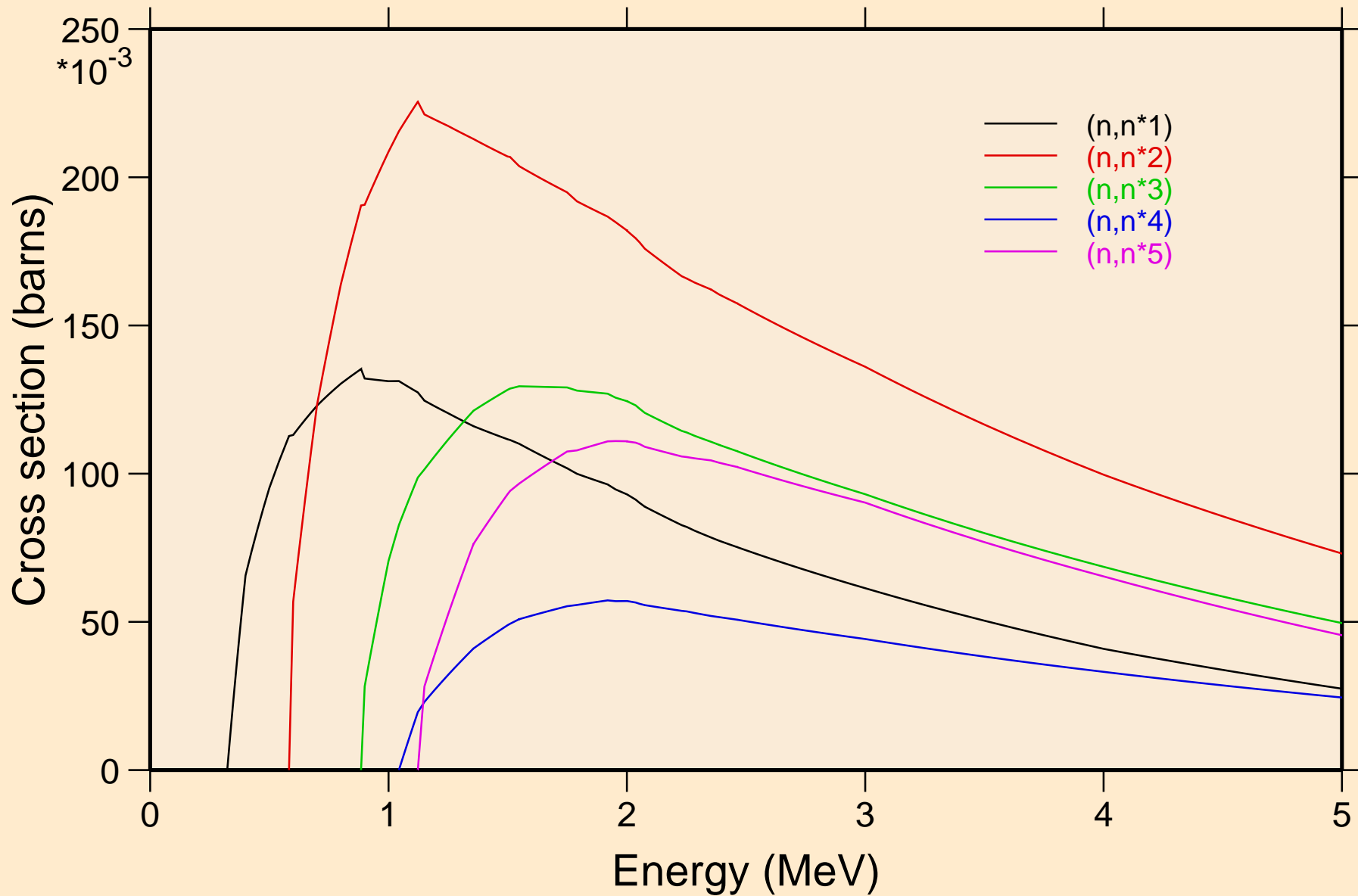

31-GA-69 FOR FENDL-3B2 FROM JENDL-HE WITH NJOY99.304+ Inelastic levels

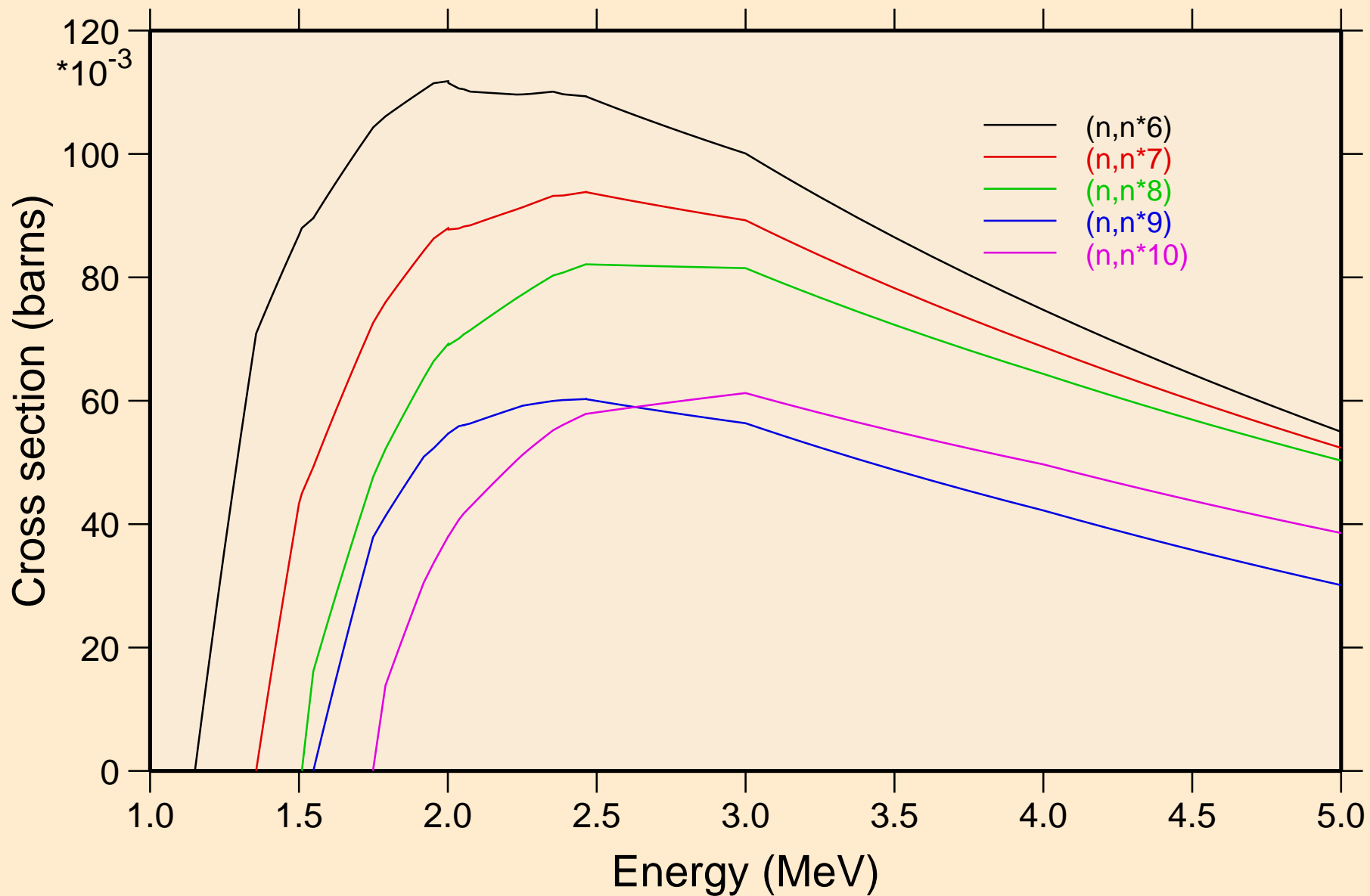

31-GA-69 FOR FENDL-3B2 FROM JENDL-HE WITH NJOY99.304+ Inelastic levels

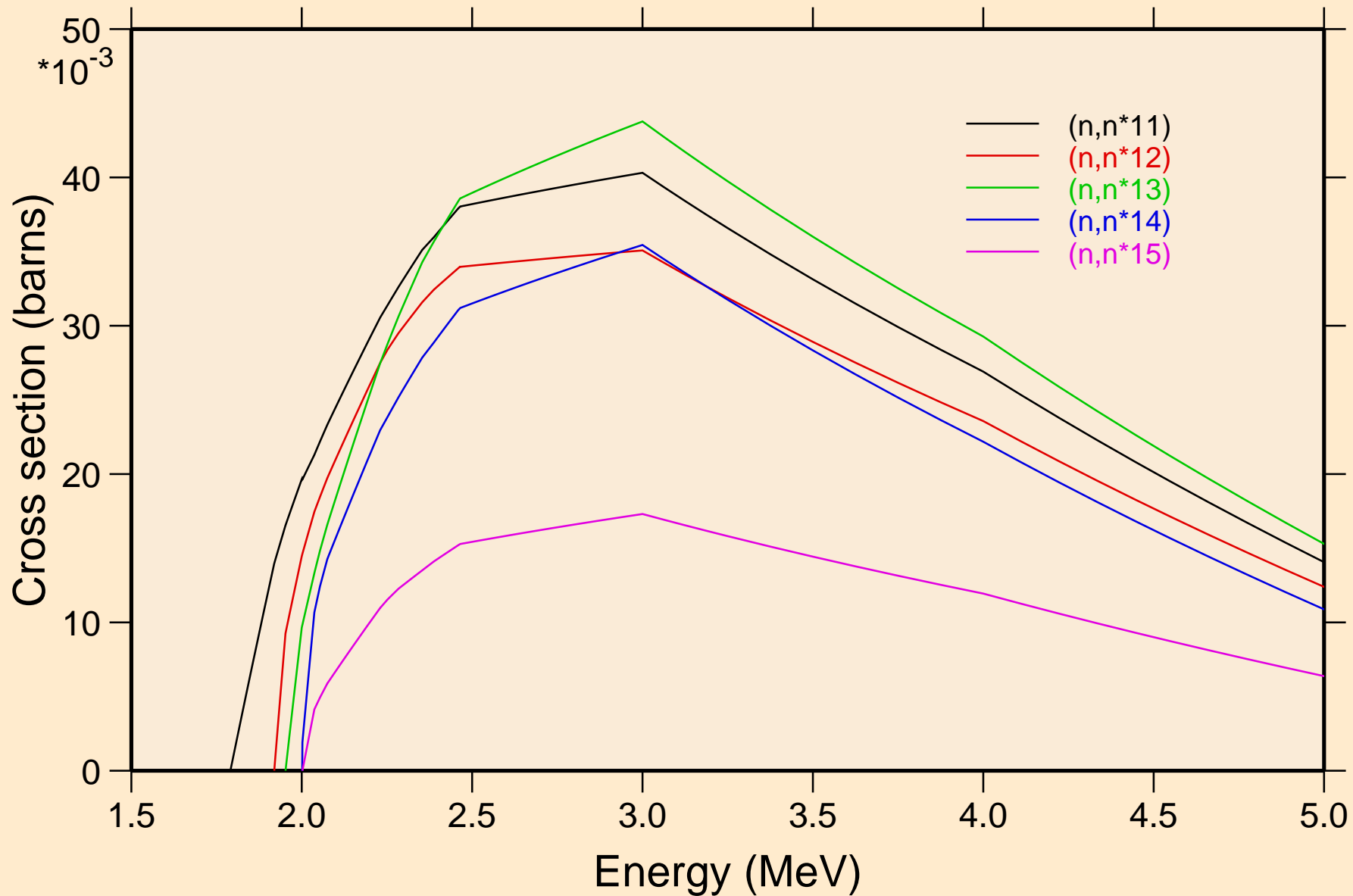

31-GA-69 FOR FENDL-3B2 FROM JENDL-HE WITH NJOY99.304+ Inelastic levels

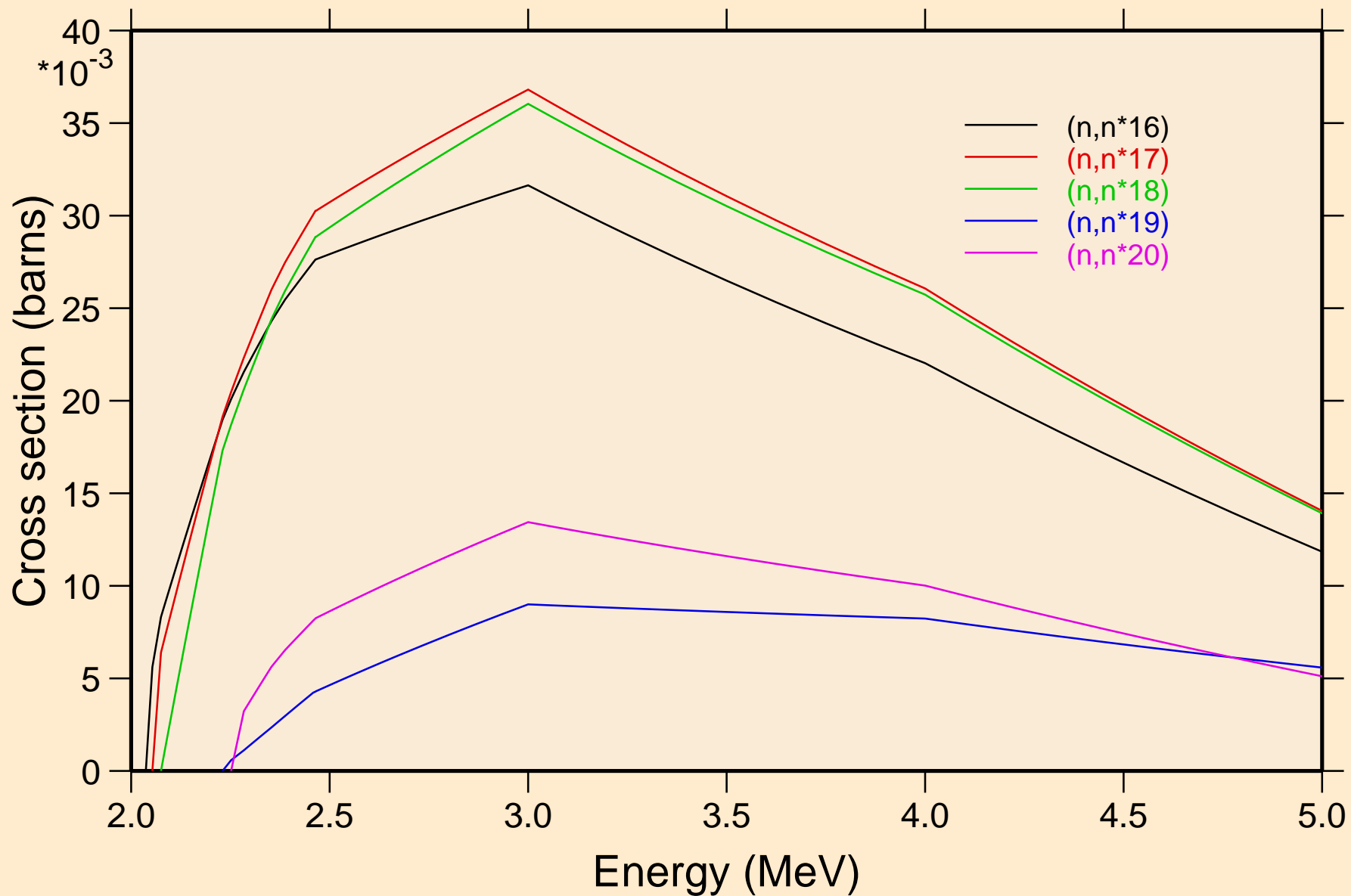

31-GA-69 FOR FENDL-3B2 FROM JENDL-HE WITH NJOY99.304+ Inelastic levels

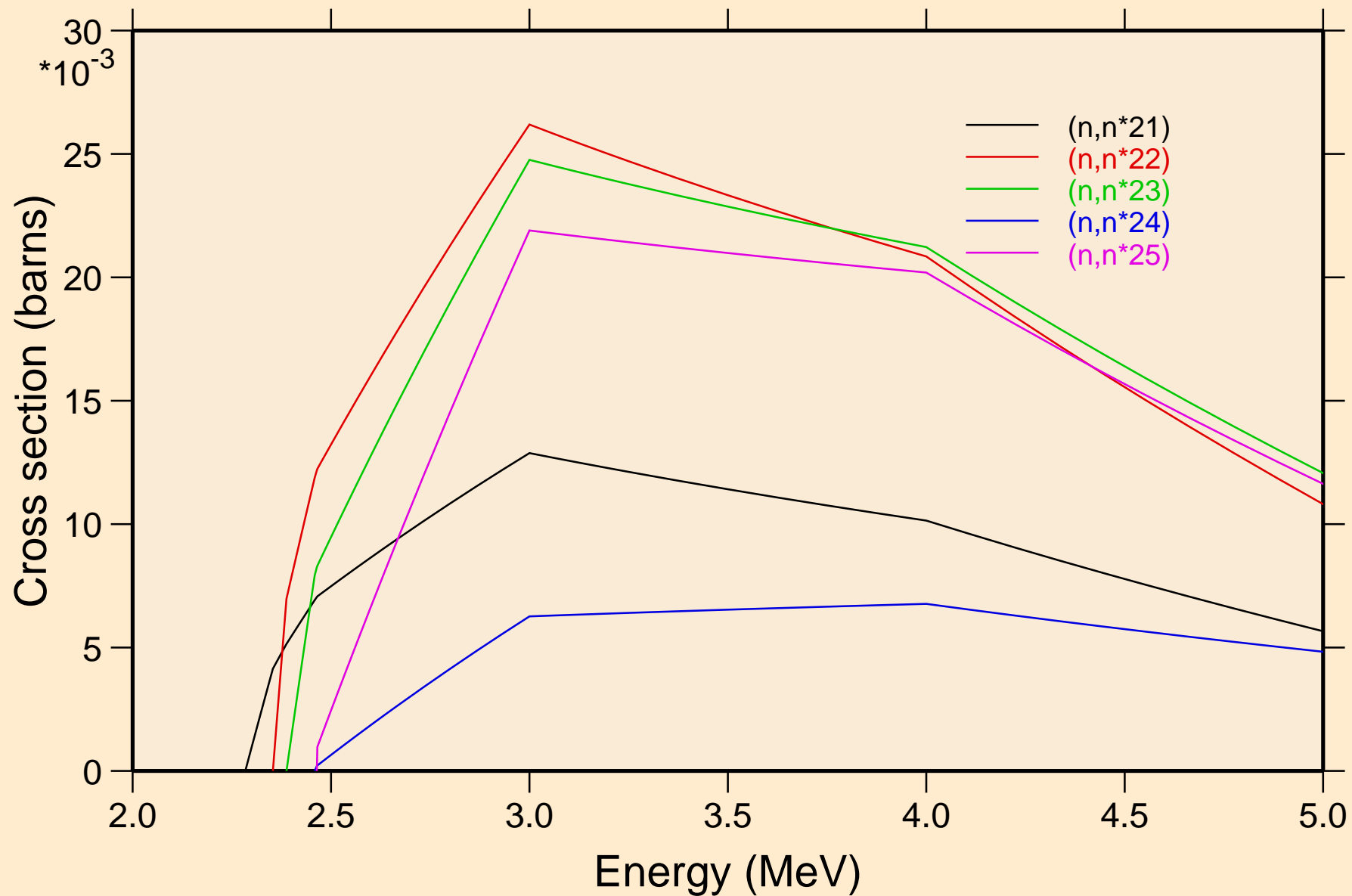

31-GA-69 FOR FENDL-3B2 FROM JENDL-HE WITH NJOY99.304+ Threshold reactions

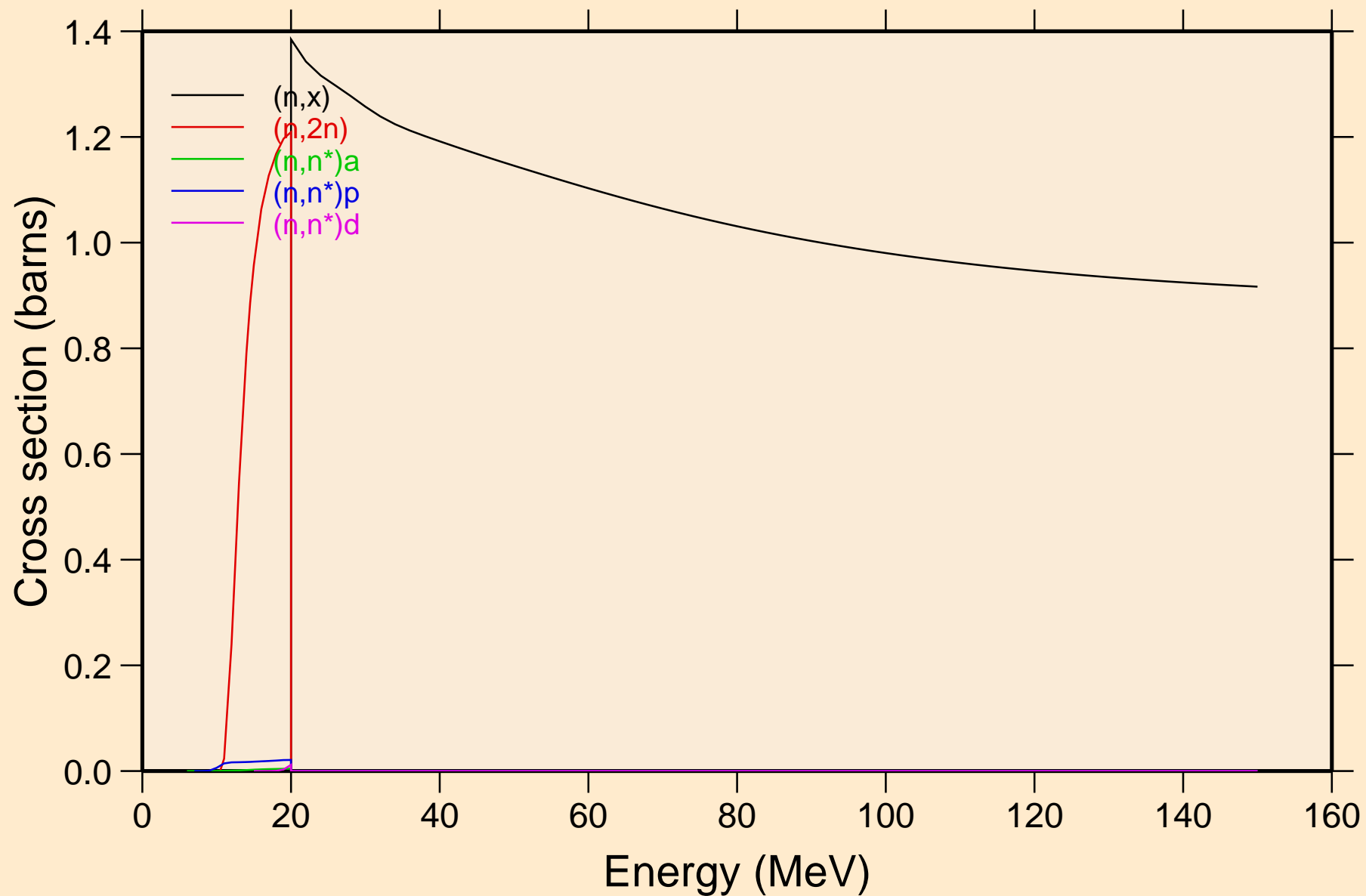

31-GA-69 FOR FENDL-3B2 FROM JENDL-HE WITH NJOY99.304+ Threshold reactions

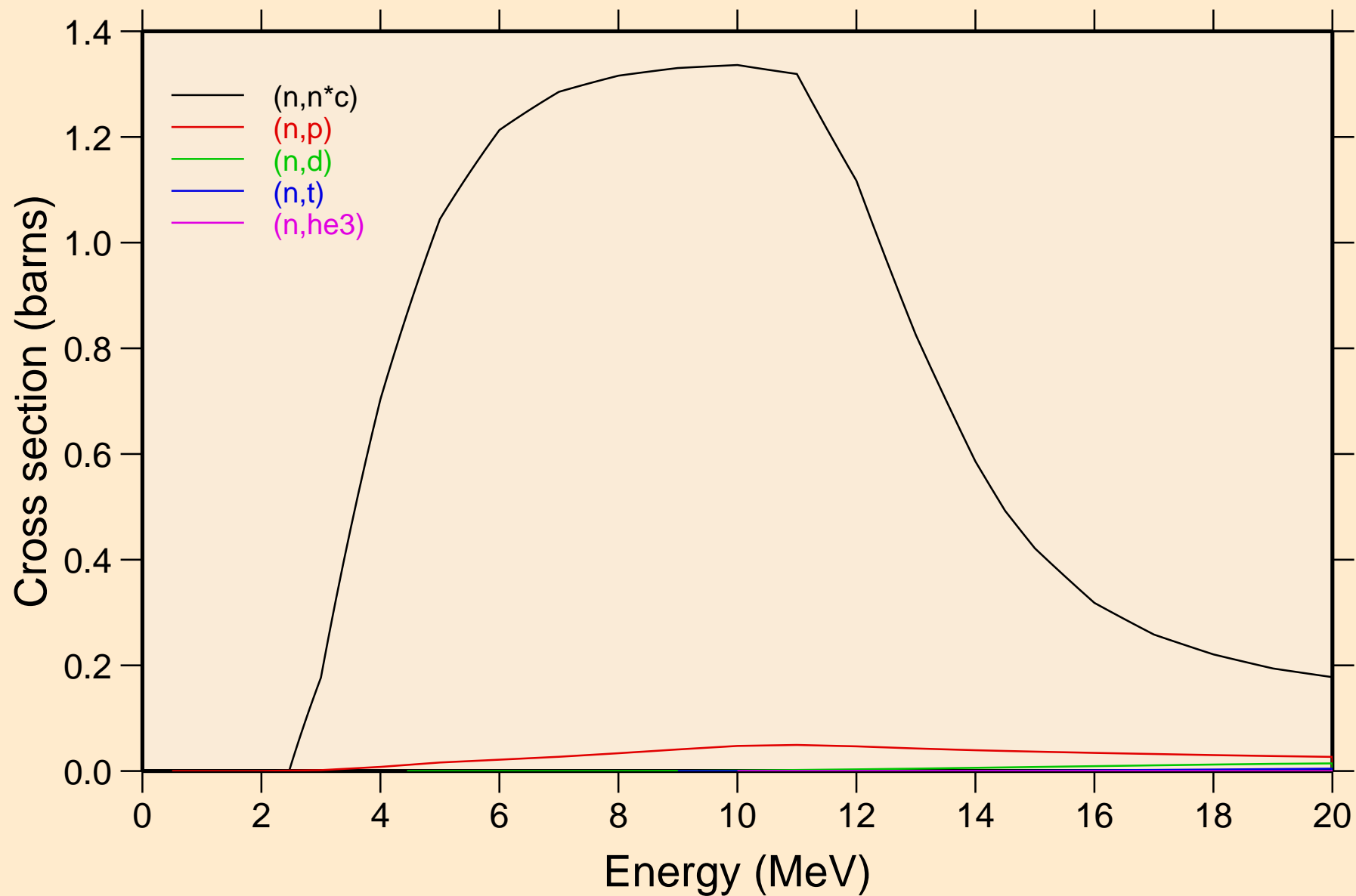

31-GA-69 FOR FENDL-3B2 FROM JENDL-HE WITH NJOY99.304+ Threshold reactions

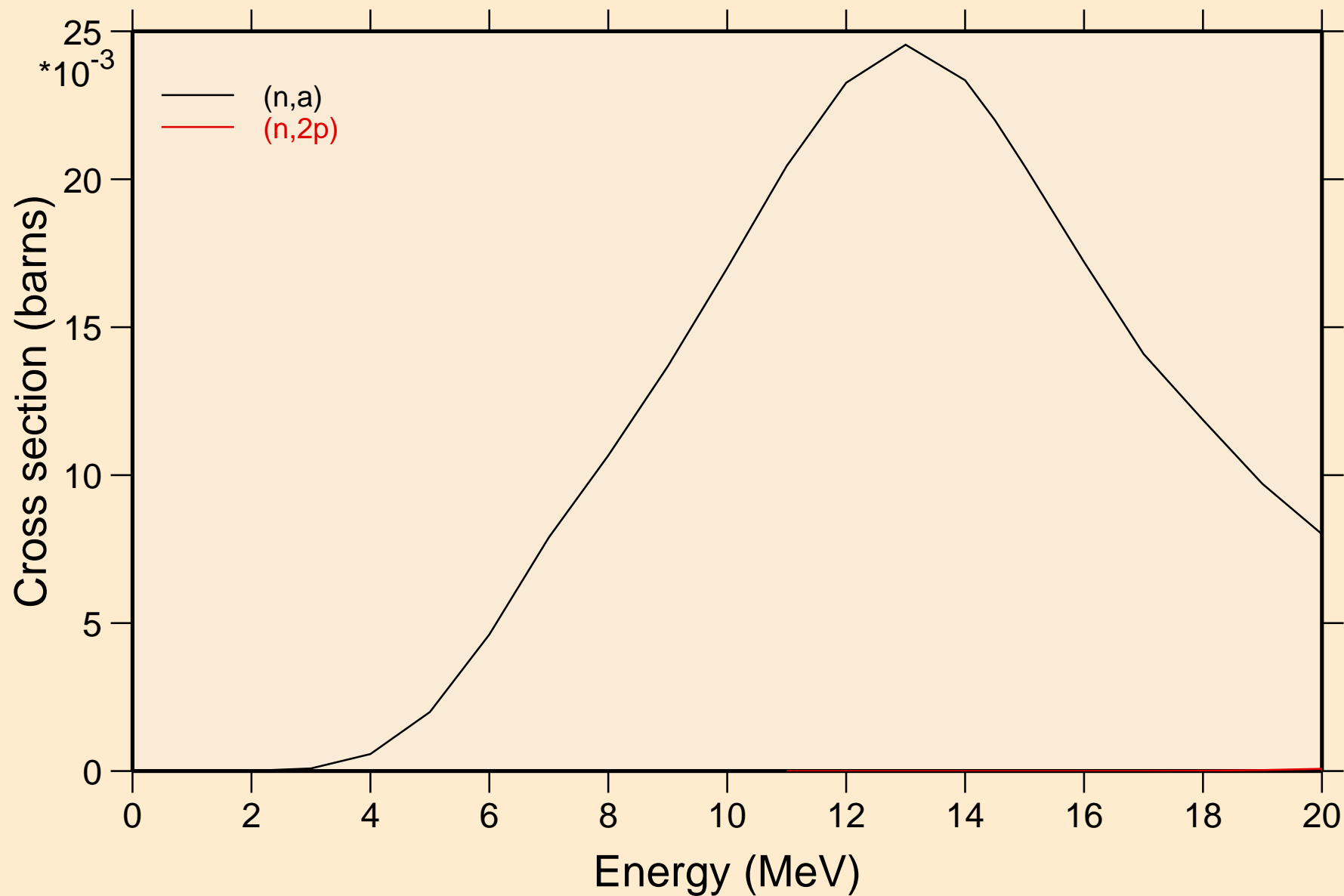

31-GA-69 FOR FENDL-3B2 FROM JENDL-HE WITH NJOY99.304+ Threshold reactions

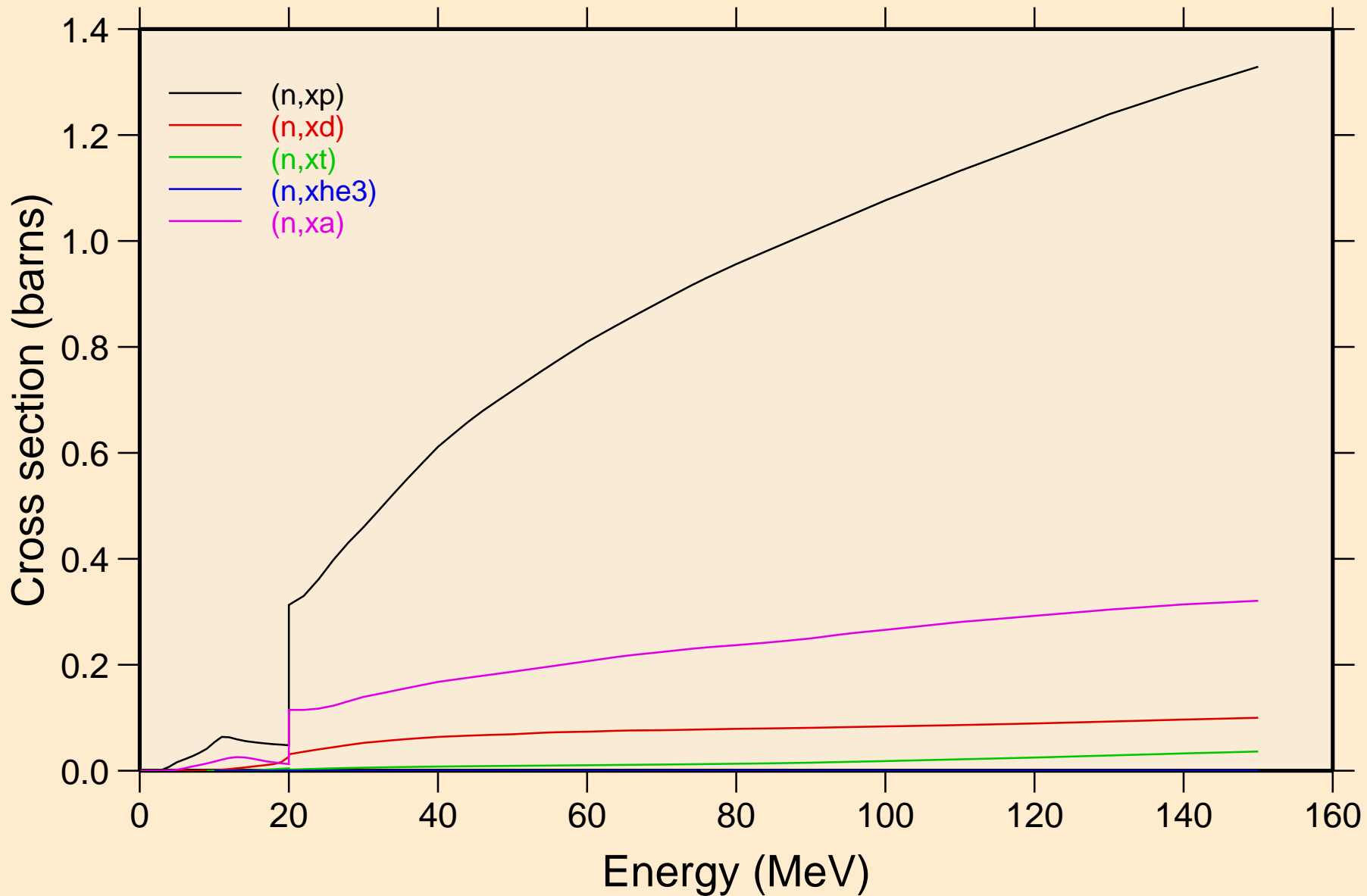

31-GA-69 FOR FENDL-3B2 FROM JENDL-HE WITH NJOY99.304+
angular distribution for elastic

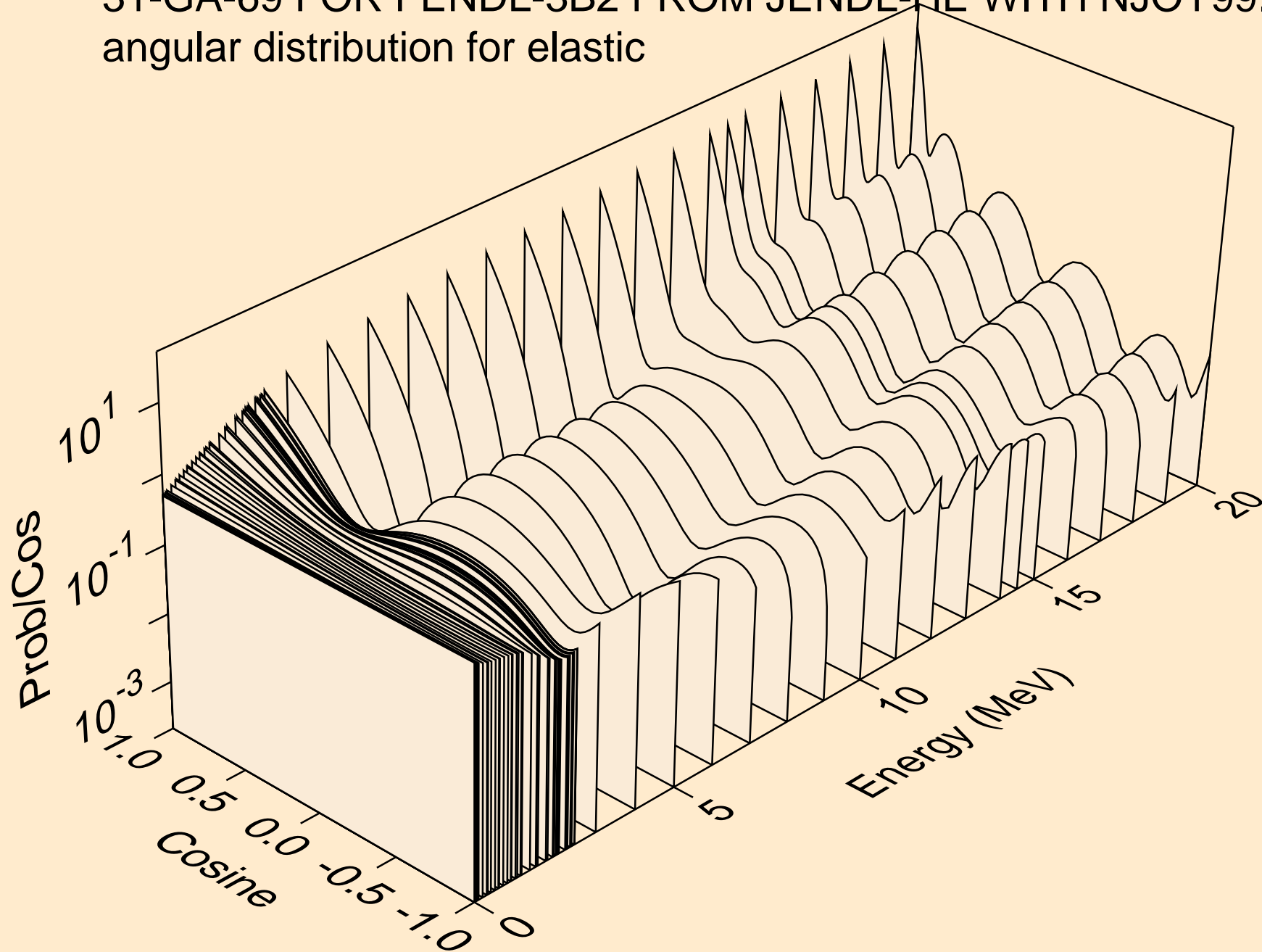

31-GA-69 FOR FENDL-3B2 FROM JENDL-HE WITH NJOY99.304+
angular distribution for elastic

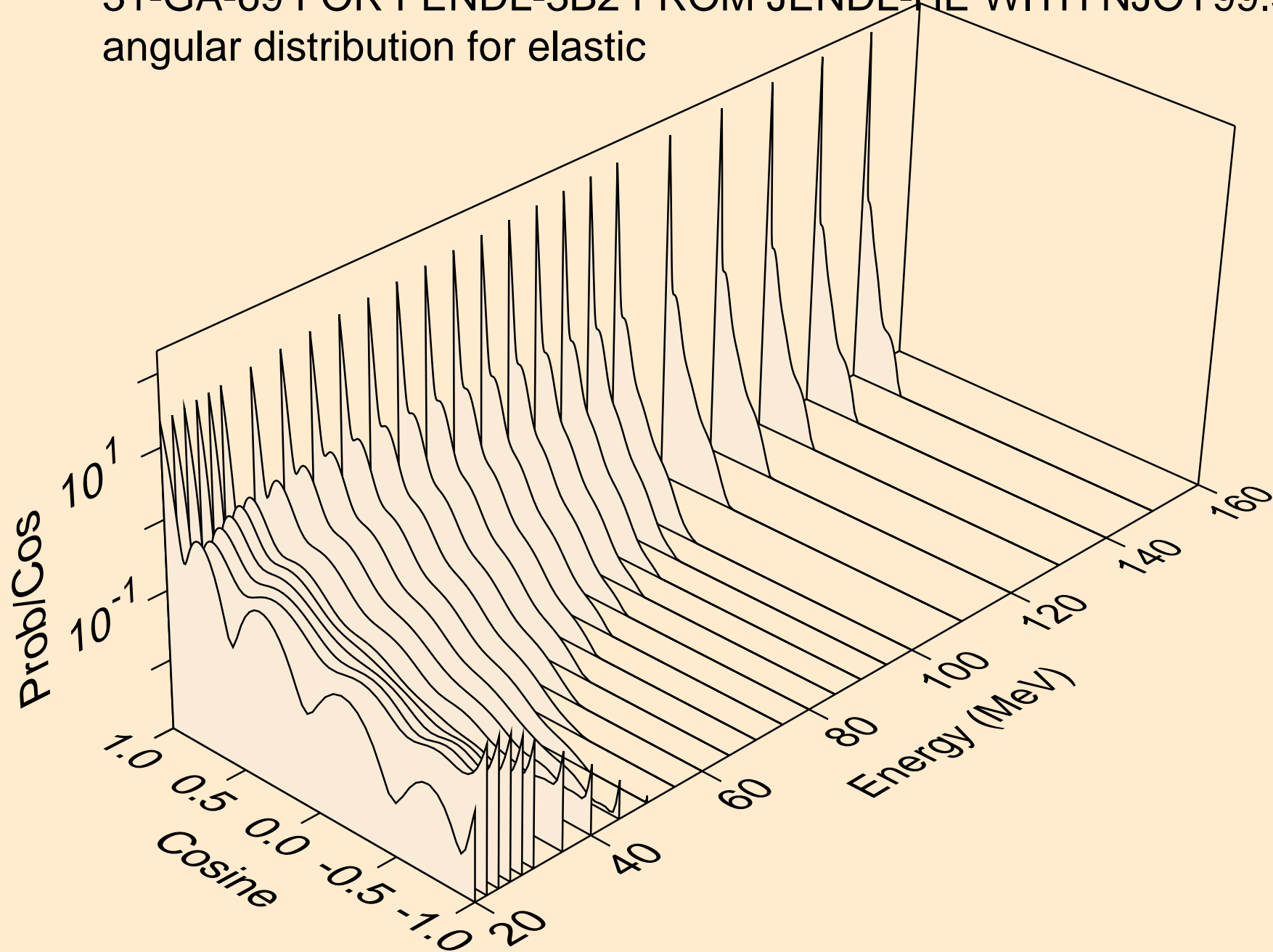

31-GA-69 FOR FENDL-3B2 FROM JENDL-HE WITH NJOY99.304+
angular distribution for (n,2n)

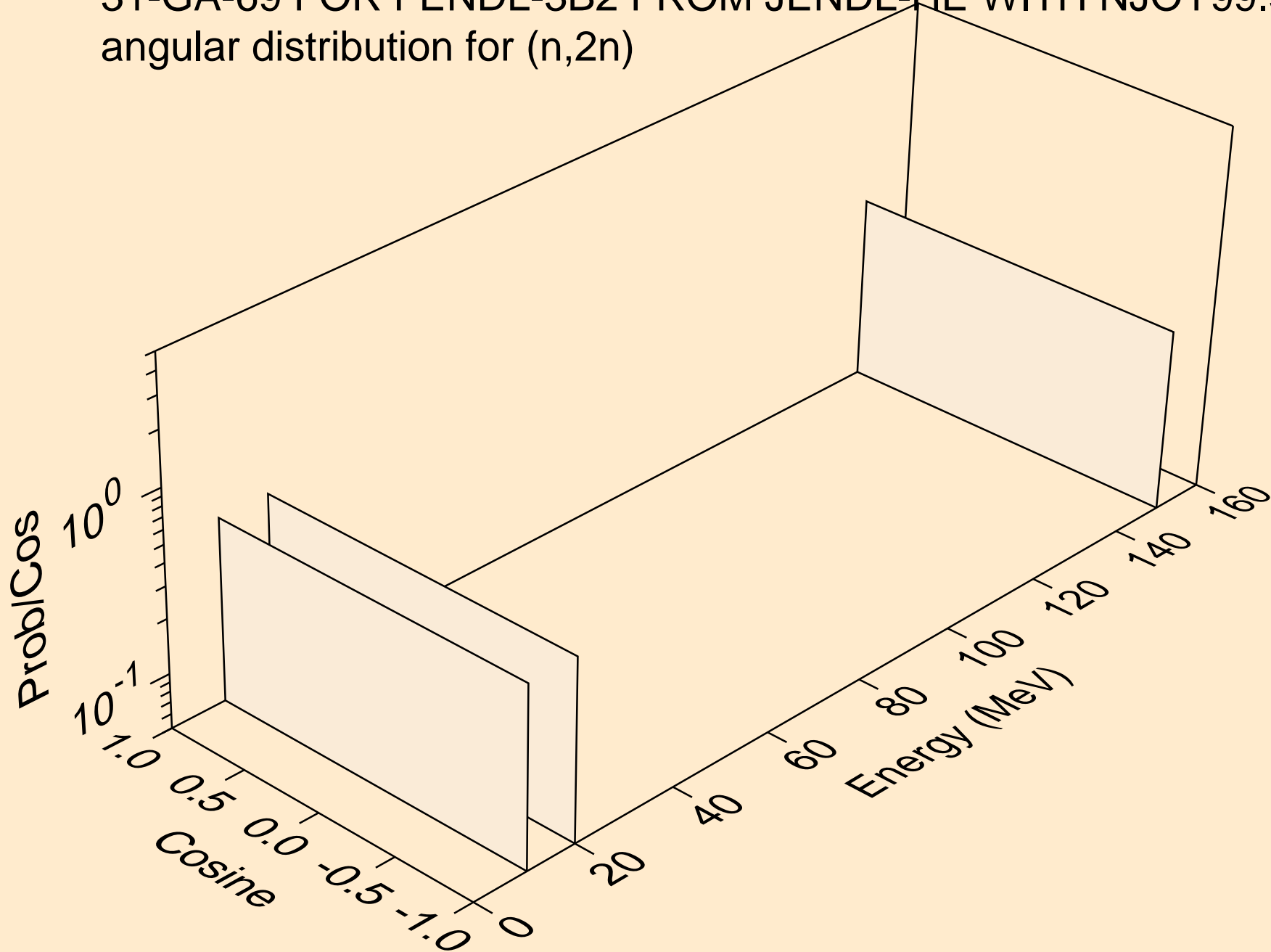

31-GA-69 FOR FENDL-3B2 FROM JENDL-HE WITH NJOY99.304+
angular distribution for (n,n*)a

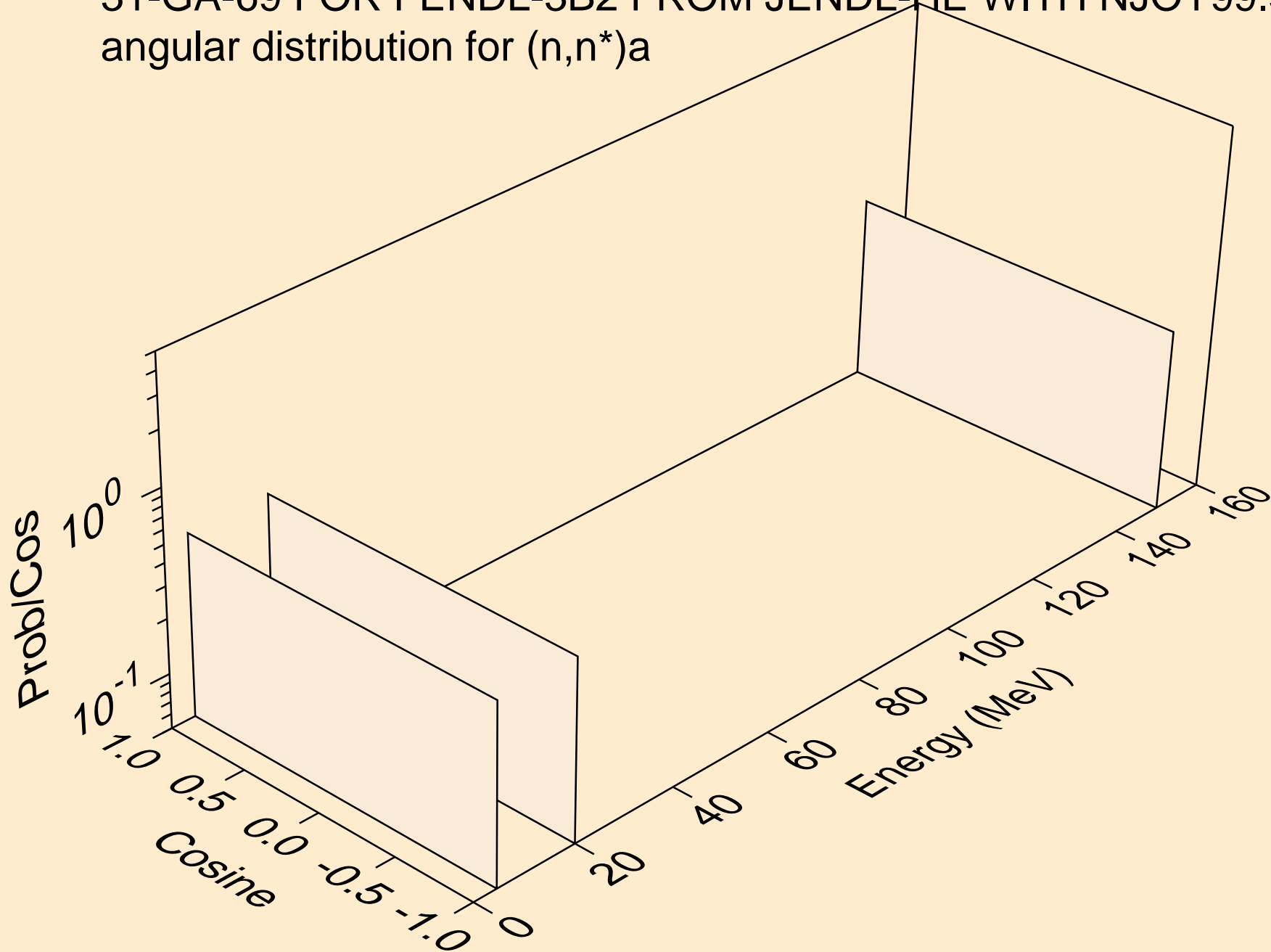

31-GA-69 FOR FENDL-3B2 FROM JENDL-HE WITH NJOY99.304+
angular distribution for (n,n*)p

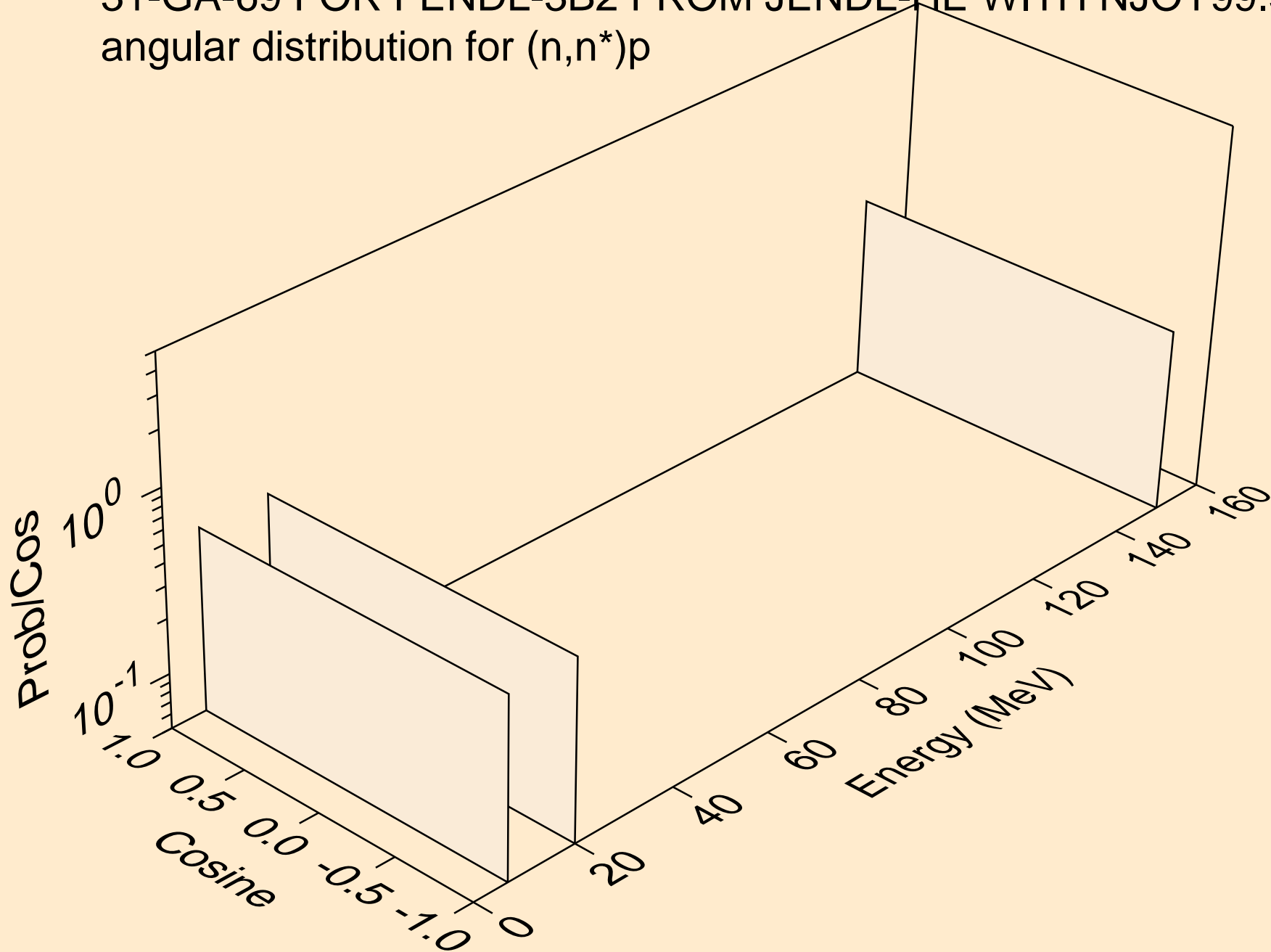

31-GA-69 FOR FENDL-3B2 FROM JENDL-HE WITH NJOY99.304+
angular distribution for (n,n*)d

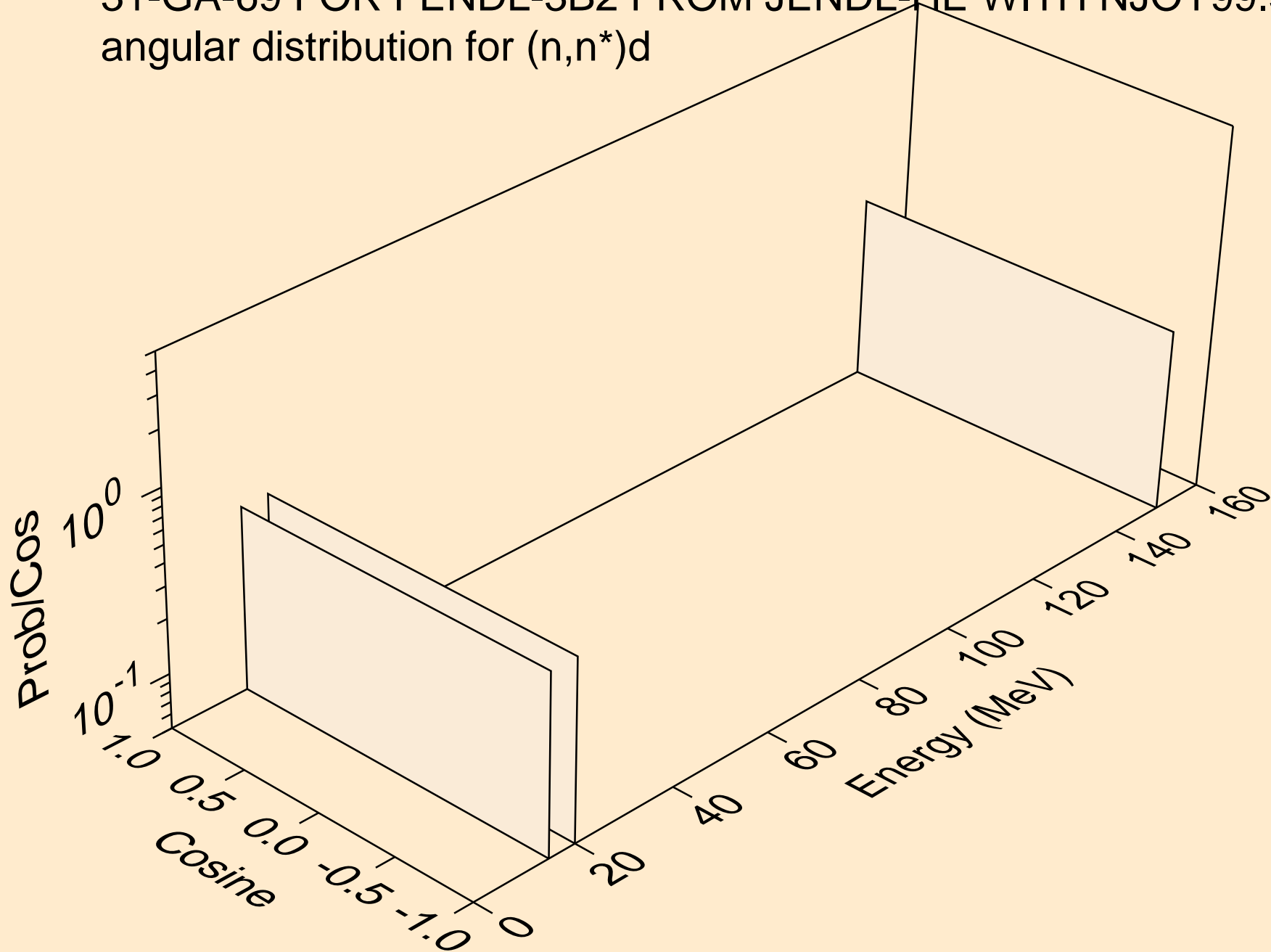

31-GA-69 FOR FENDL-3B2 FROM JENDL-HE WITH NJOY99.304+
angular distribution for (n,n*1)

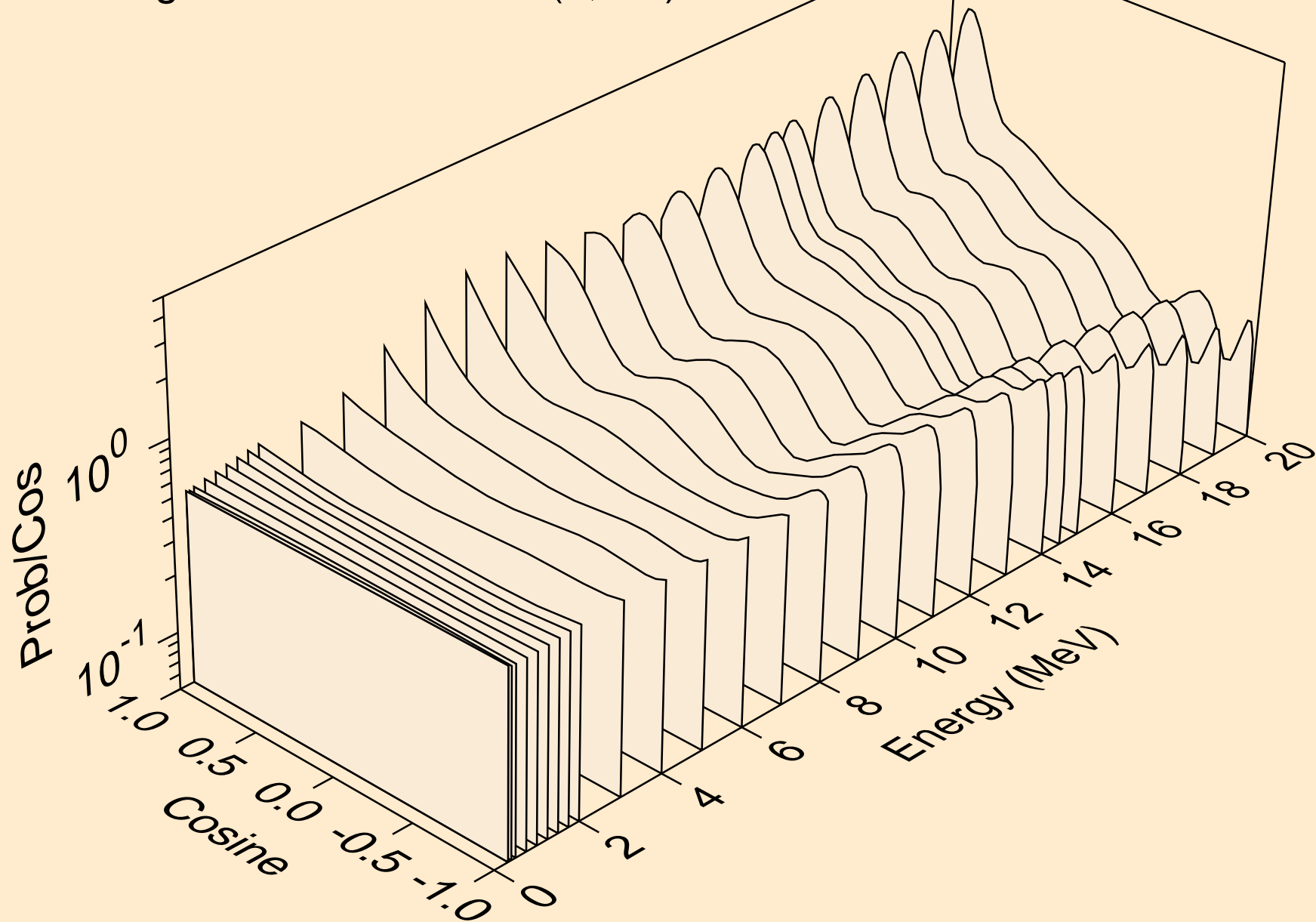

31-GA-69 FOR FENDL-3B2 FROM JENDL-HE WITH NJOY99.304+
angular distribution for (n,n*2)

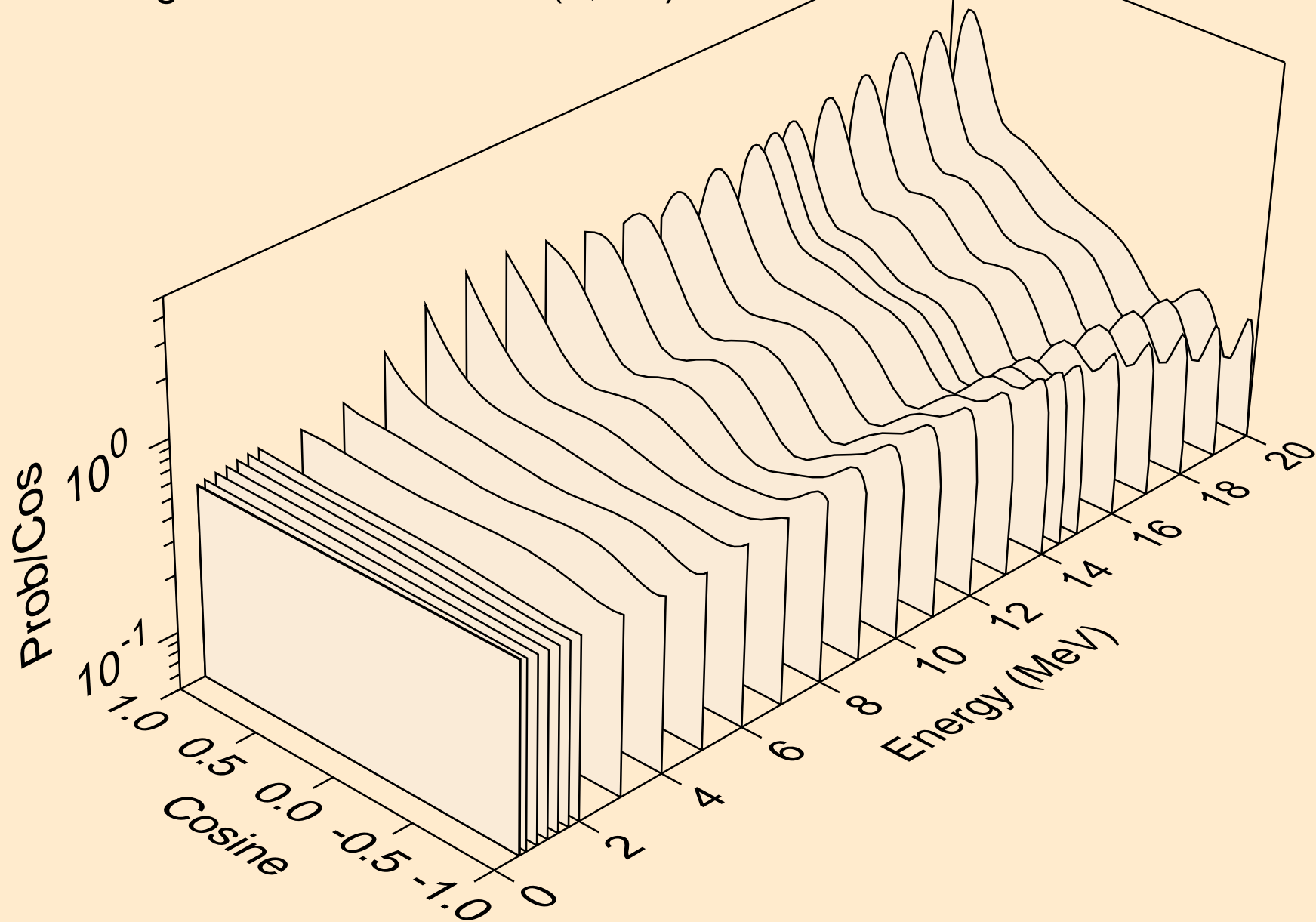

31-GA-69 FOR FENDL-3B2 FROM JENDL-HE WITH NJOY99.304+
angular distribution for (n,n*3)

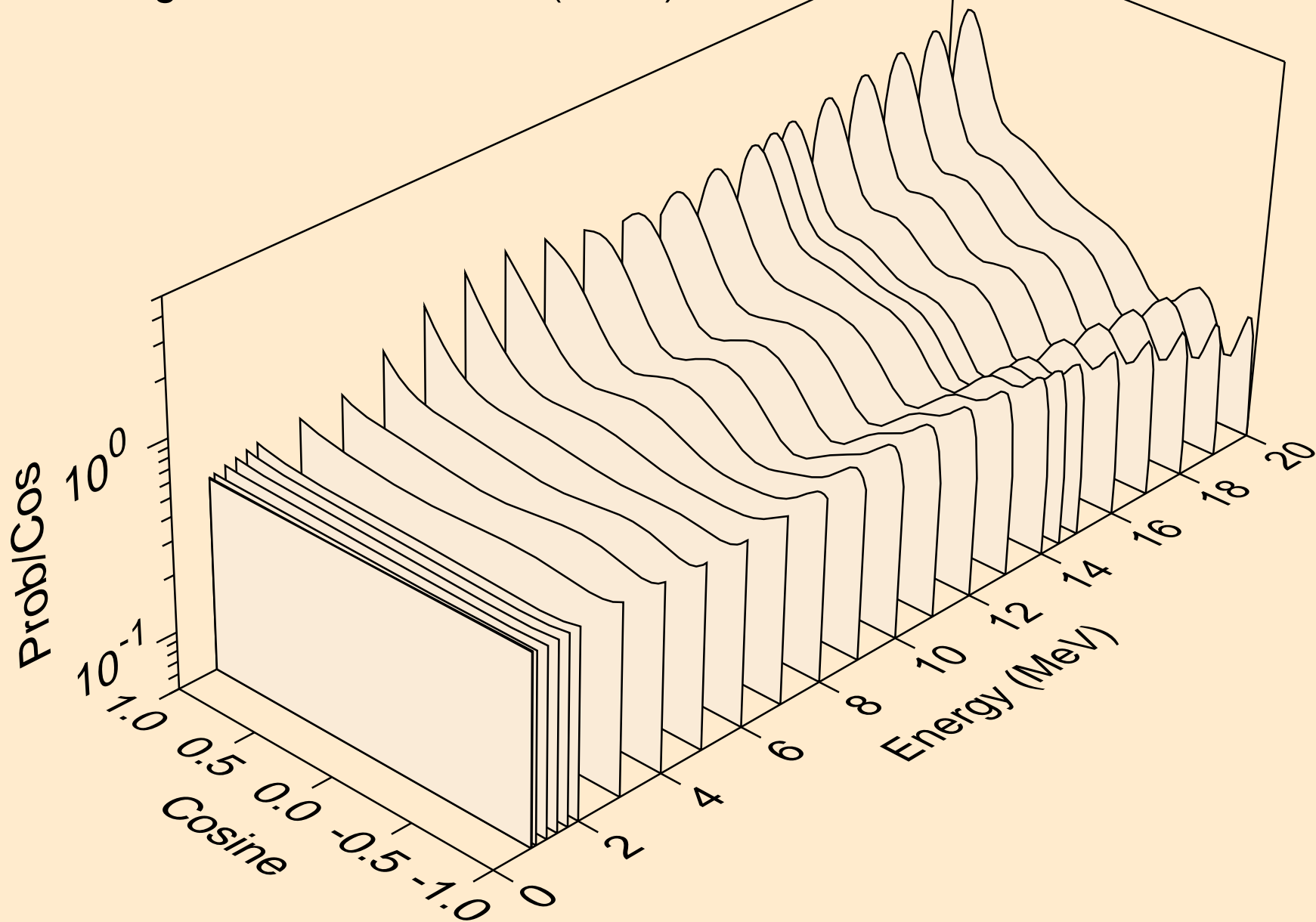

31-GA-69 FOR FENDL-3B2 FROM JENDL-HE WITH NJOY99.304+
angular distribution for (n,n*4)

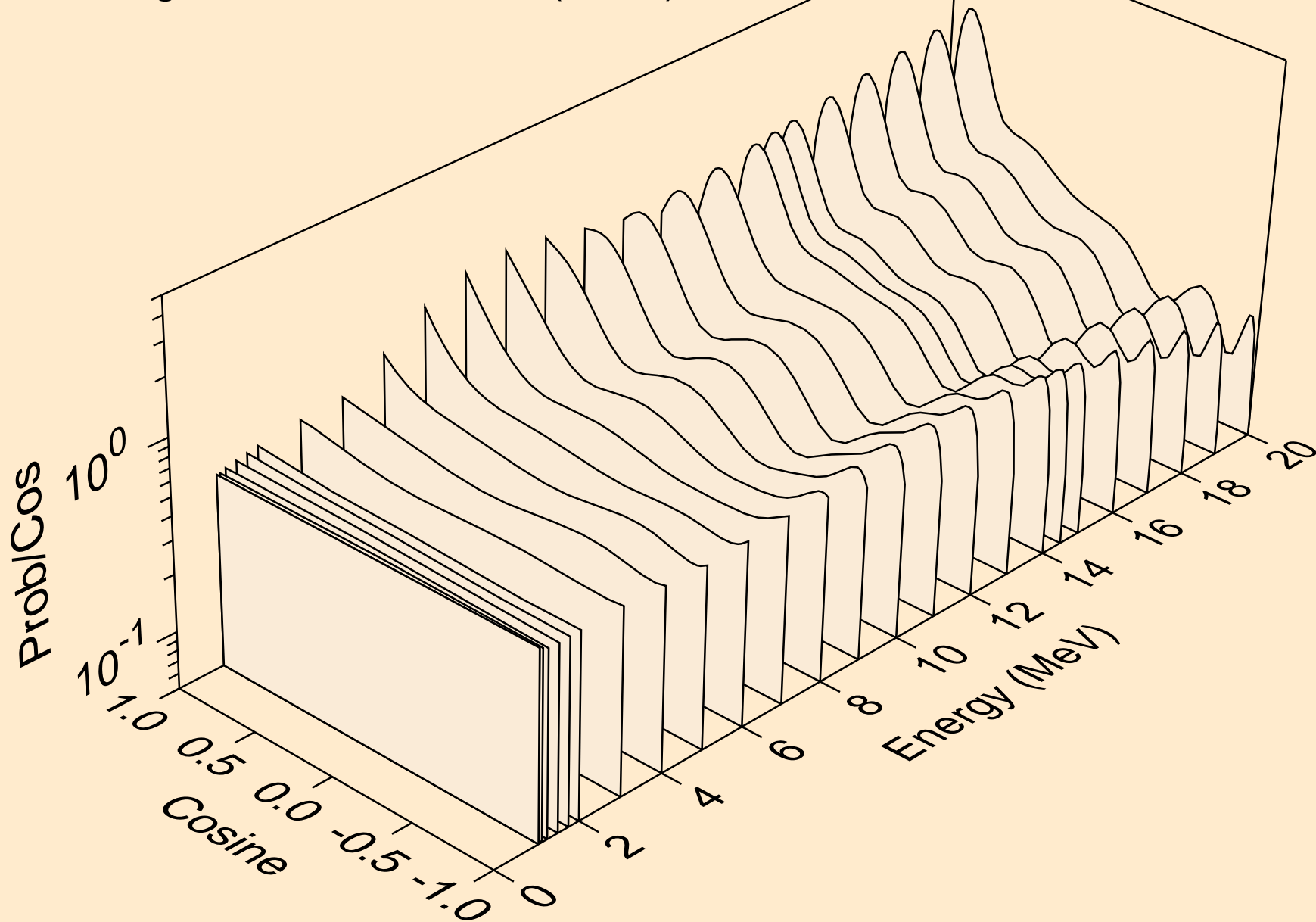

31-GA-69 FOR FENDL-3B2 FROM JENDL-HE WITH NJOY99.304+
angular distribution for (n,n*5)

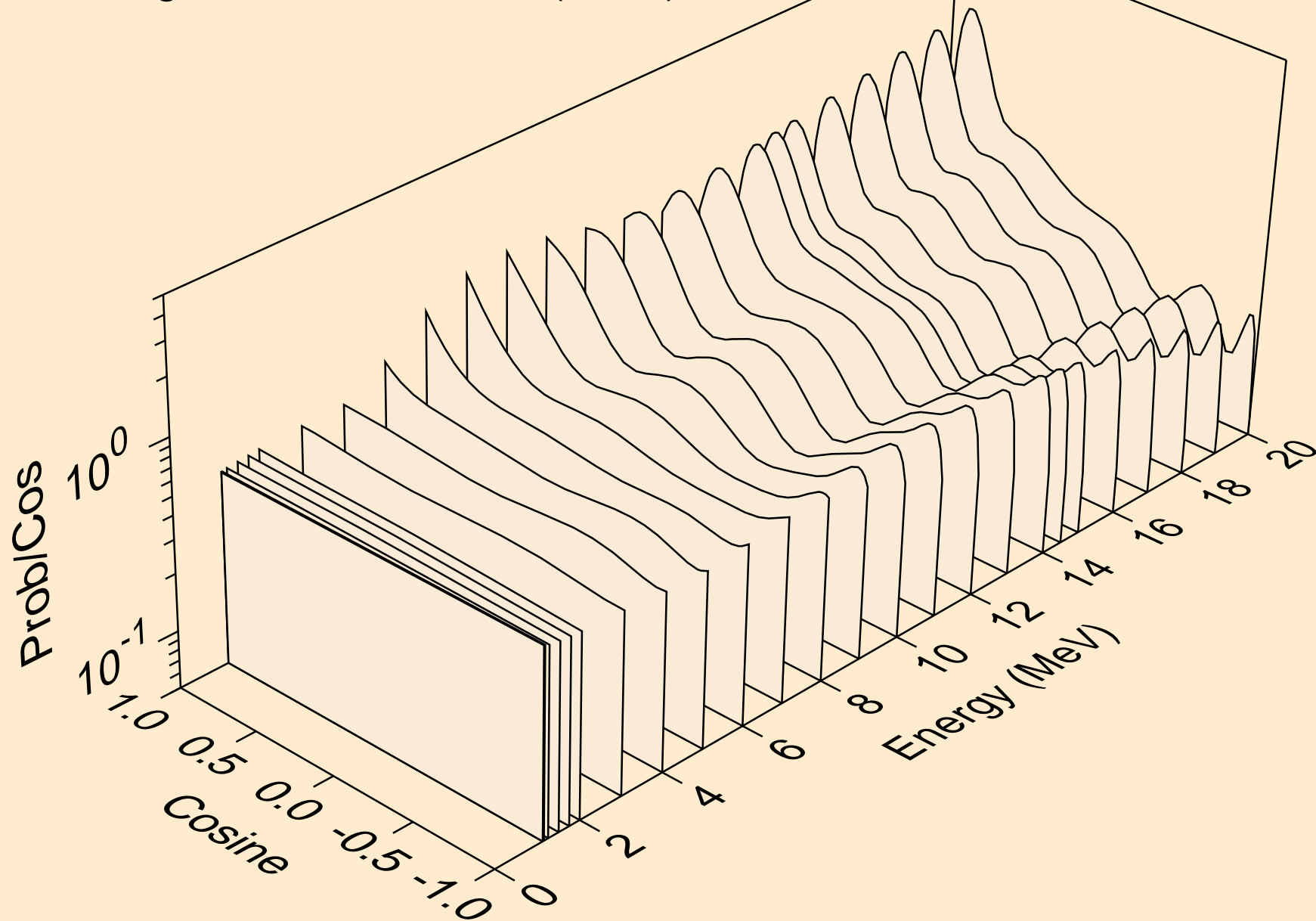

31-GA-69 FOR FENDL-3B2 FROM JENDL-HE WITH NJOY99.304+
angular distribution for (n,n*6)

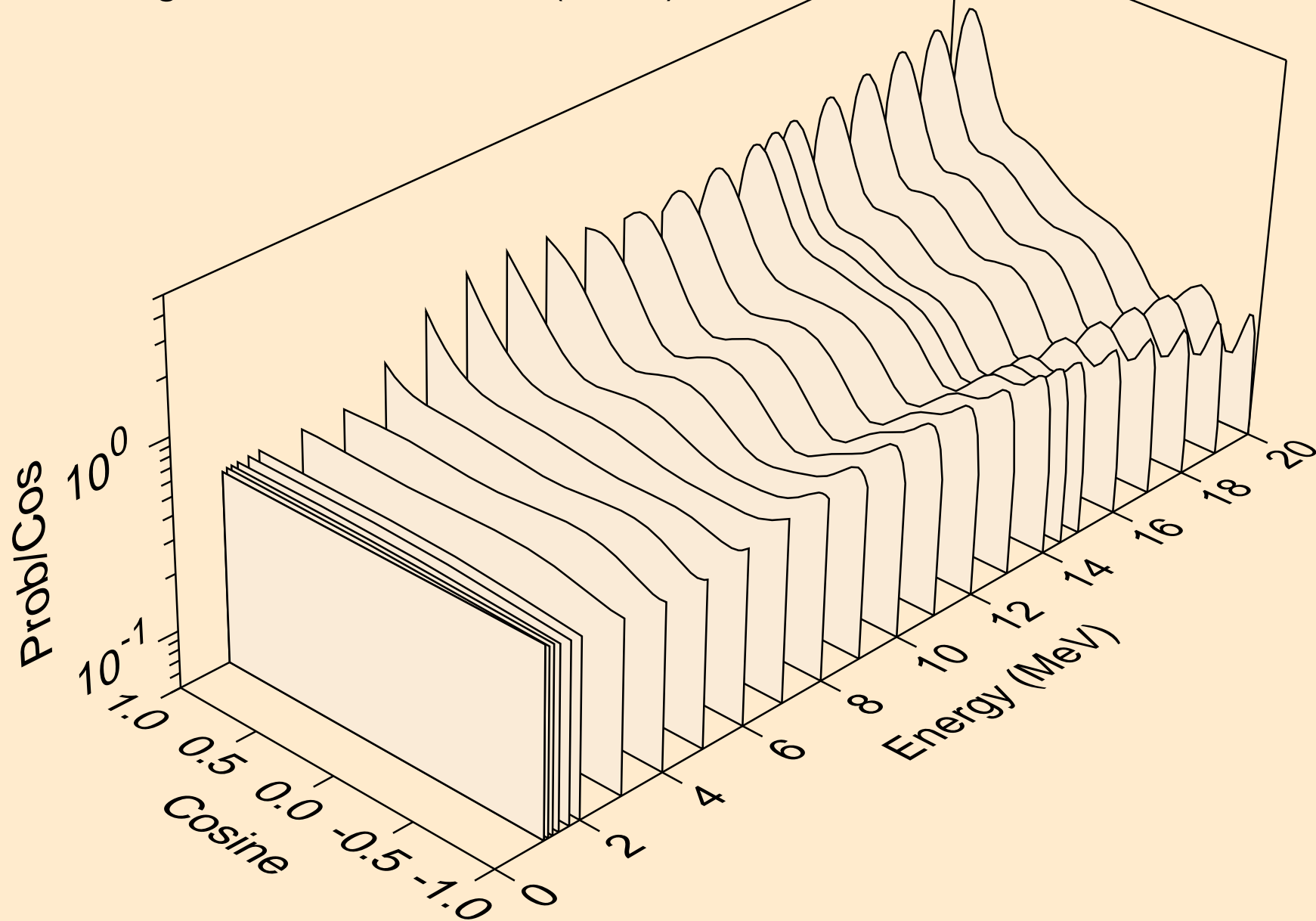

31-GA-69 FOR FENDL-3B2 FROM JENDL-HE WITH NJOY99.304+
angular distribution for (n,n*7)

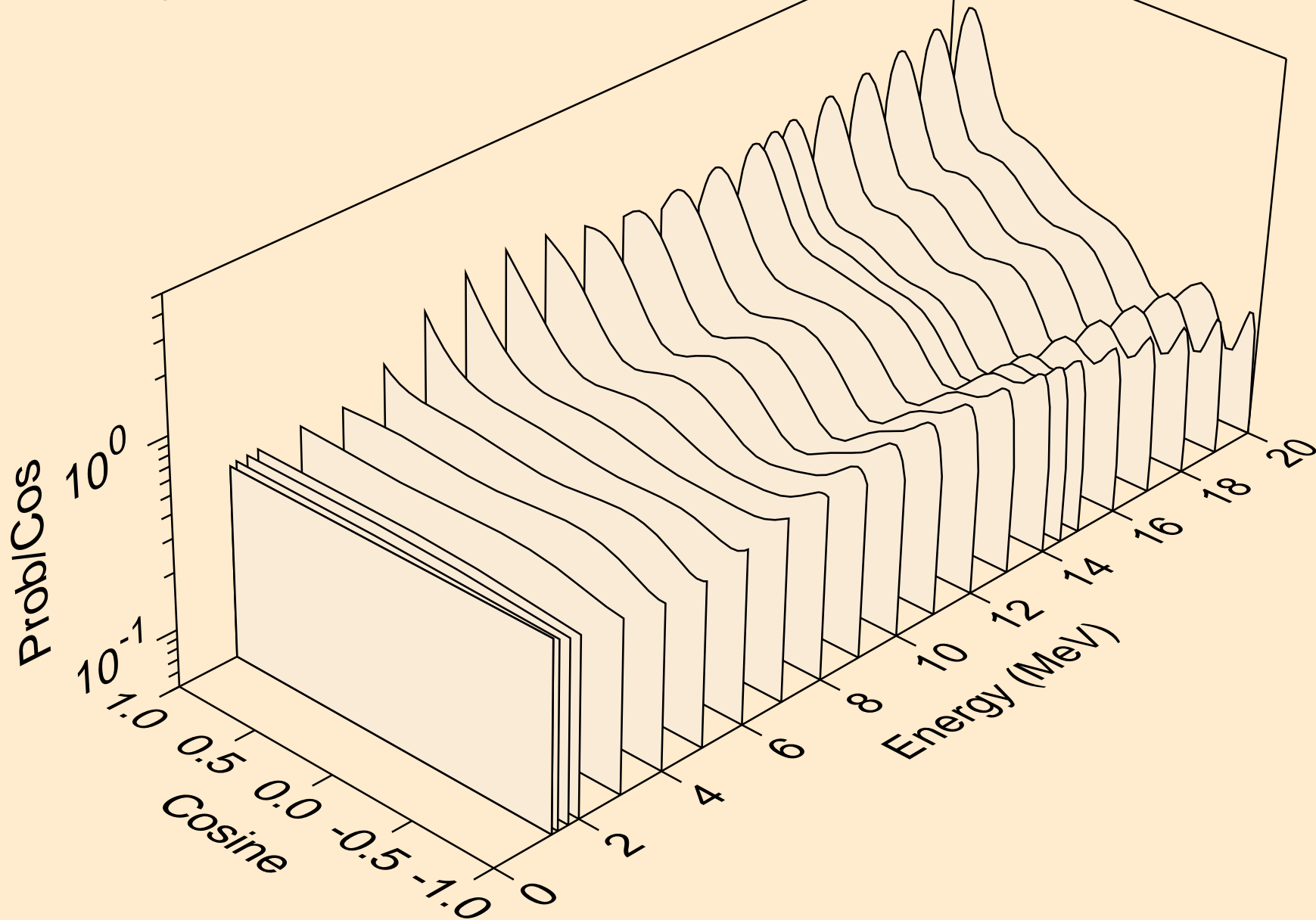

31-GA-69 FOR FENDL-3B2 FROM JENDL-HE WITH NJOY99.304+
angular distribution for (n,n*8)

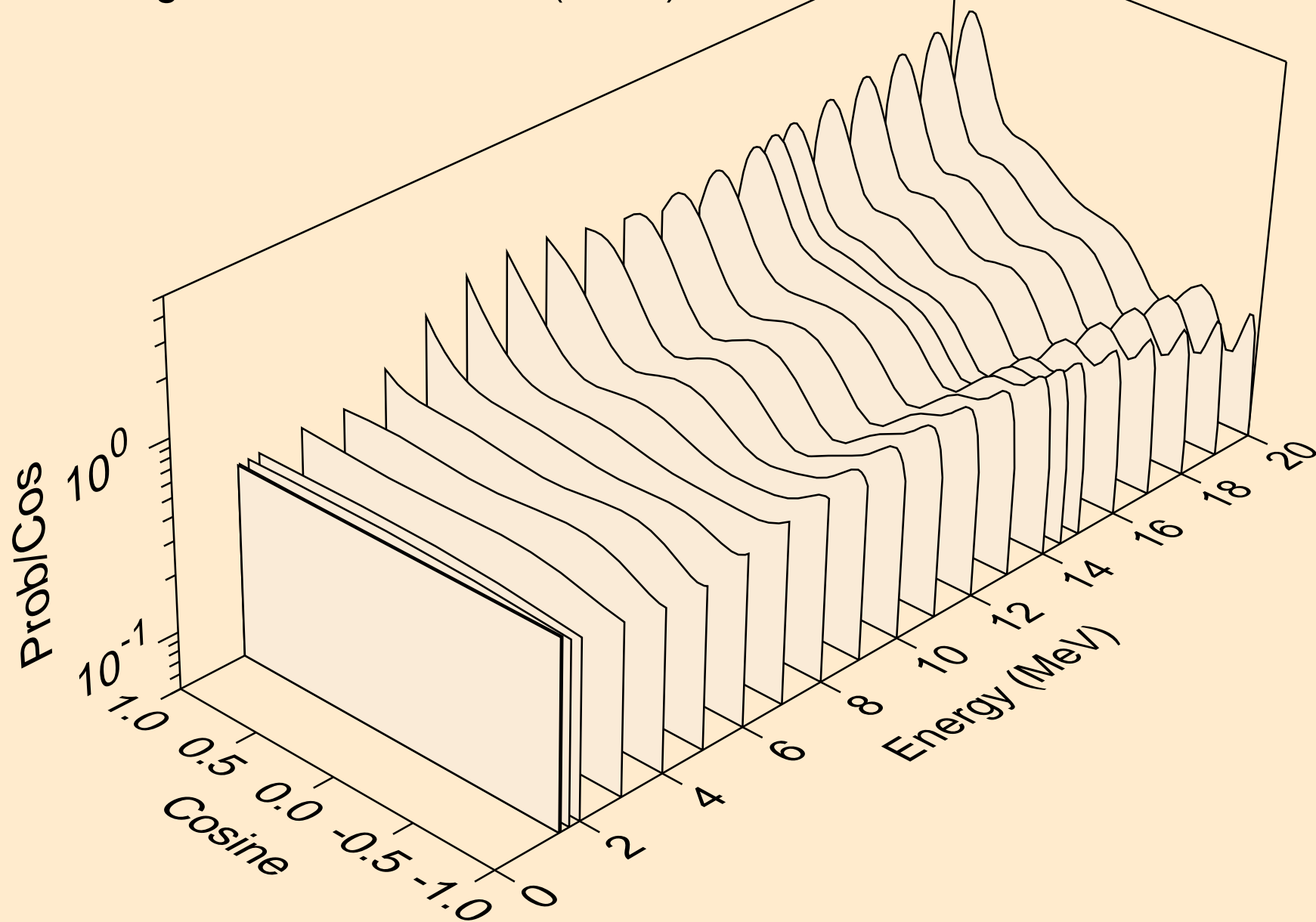

31-GA-69 FOR FENDL-3B2 FROM JENDL-HE WITH NJOY99.304+
angular distribution for (n,n*9)

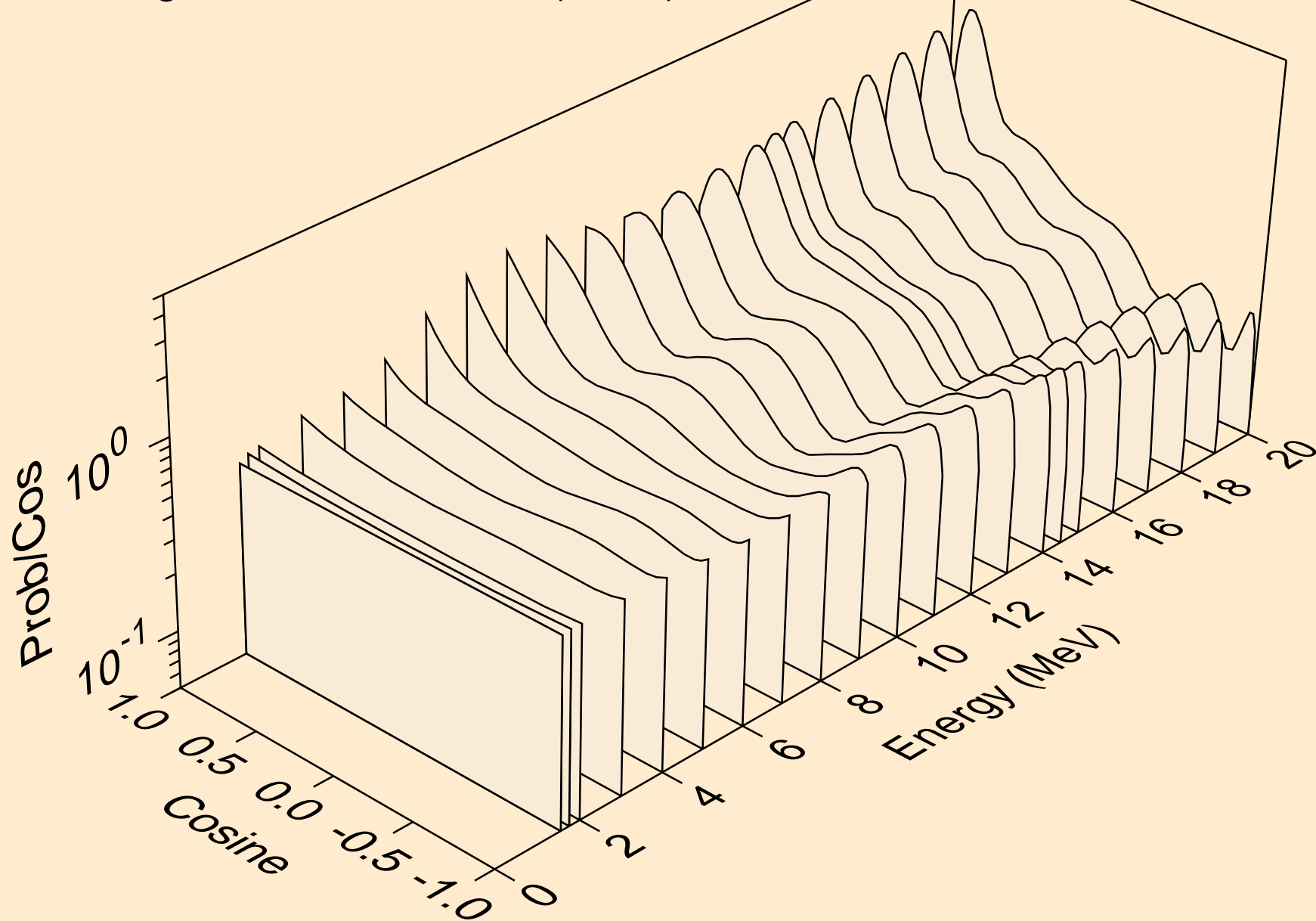

31-GA-69 FOR FENDL-3B2 FROM JENDL-HE WITH NJOY99.304+
angular distribution for (n,n*10)

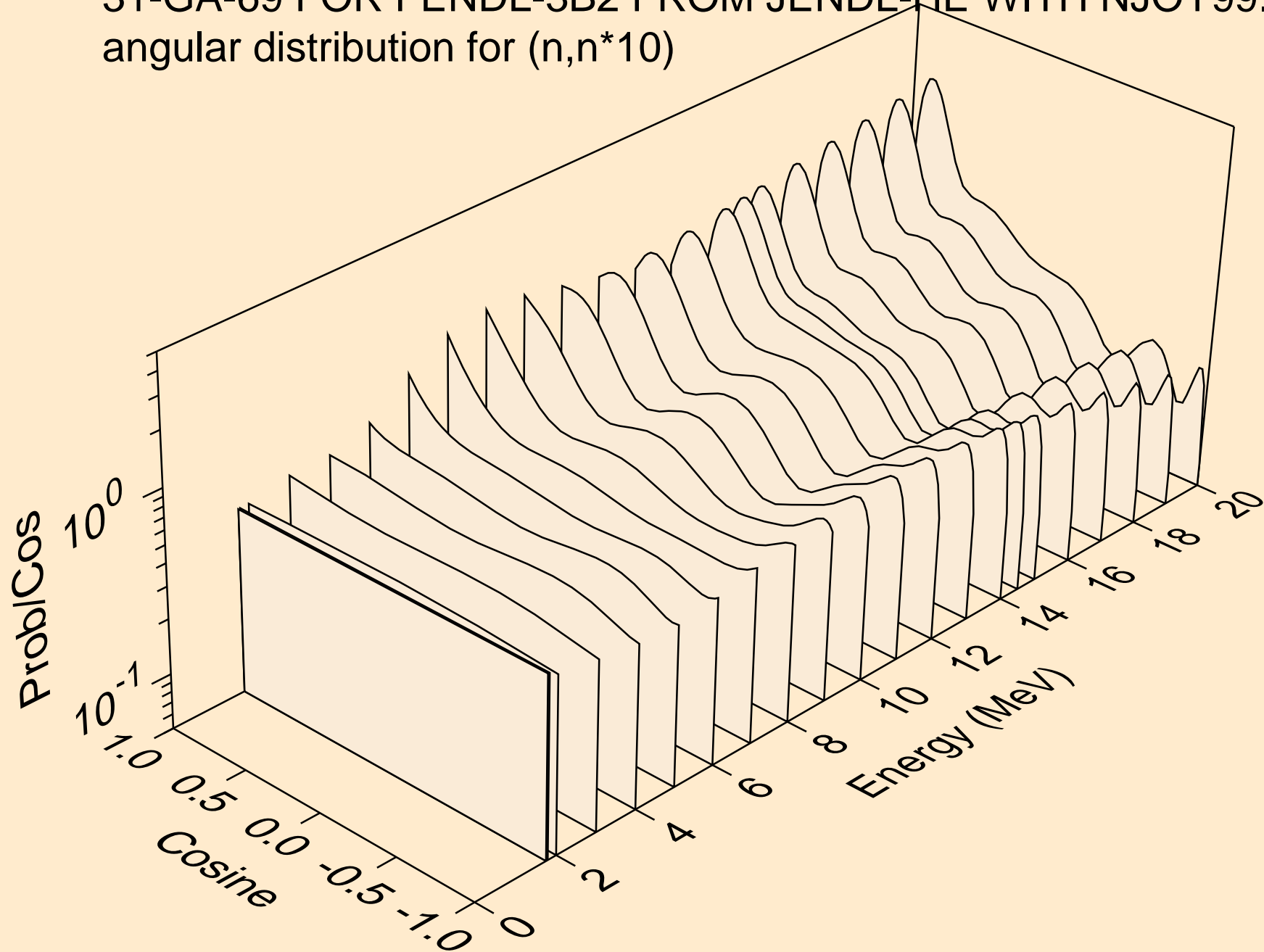

31-GA-69 FOR FENDL-3B2 FROM JENDL-HE WITH NJOY99.304+
angular distribution for (n,n*11)

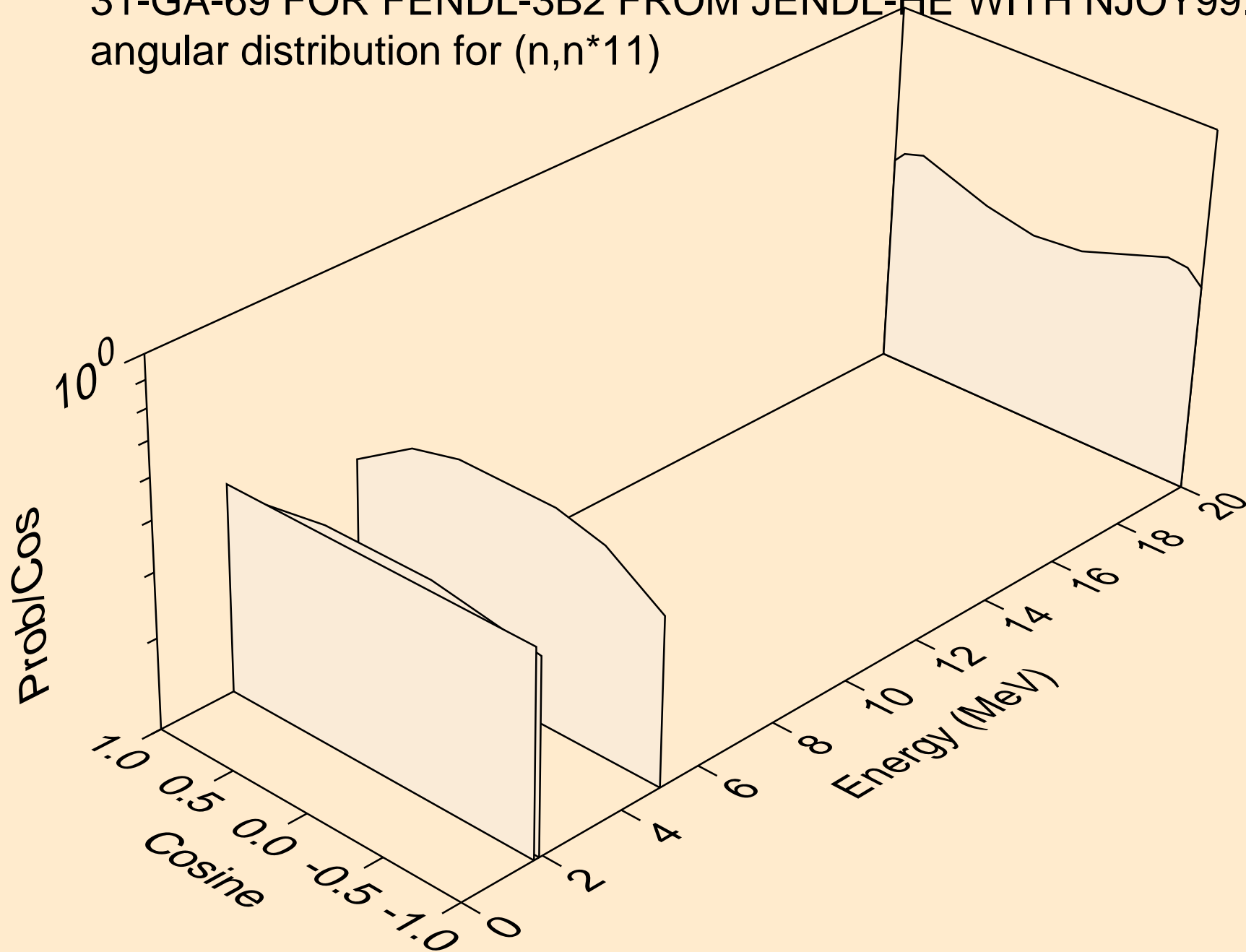

31-GA-69 FOR FENDL-3B2 FROM JENDL-HE WITH NJOY99.304+
angular distribution for (n,n*12)

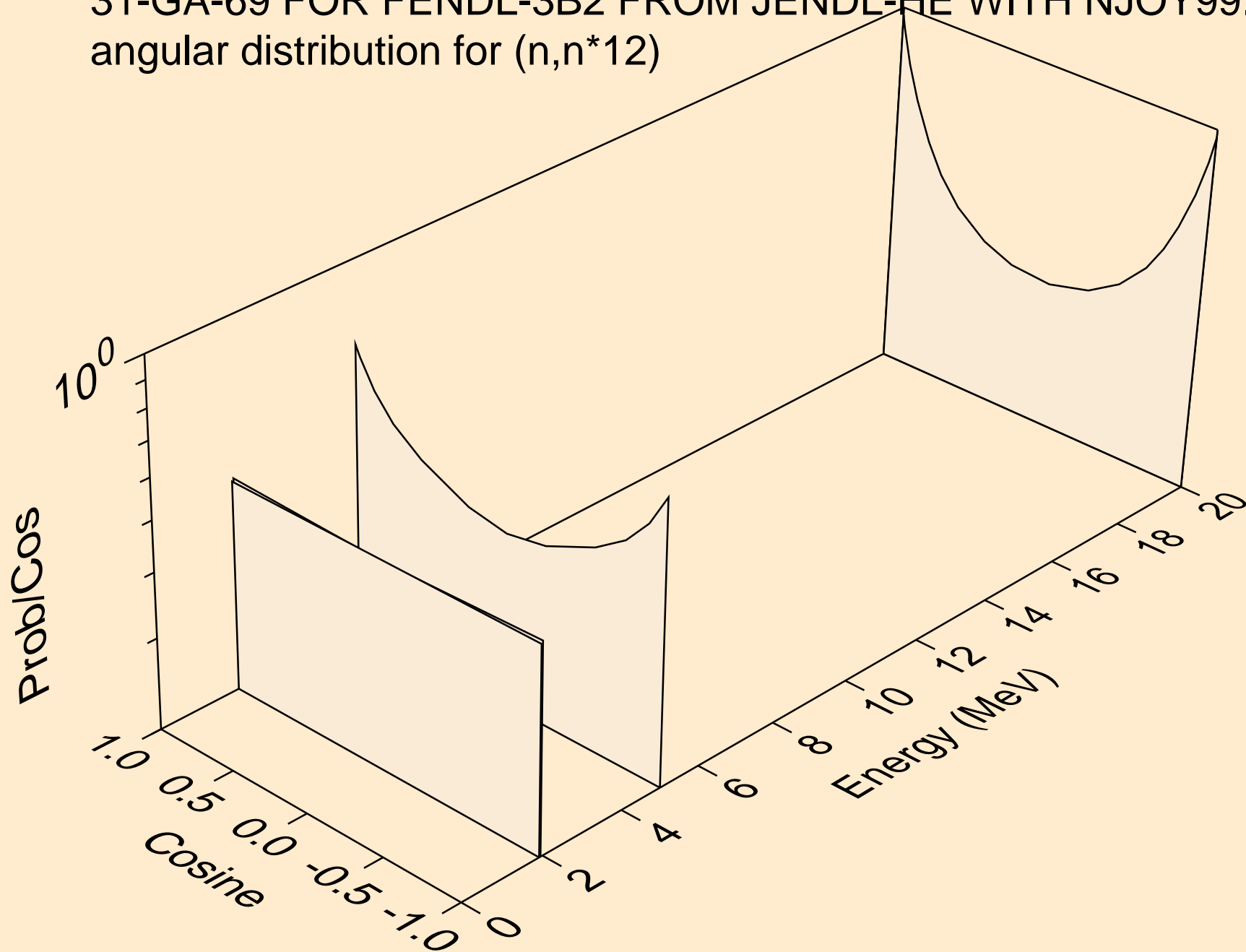

31-GA-69 FOR FENDL-3B2 FROM JENDL-HE WITH NJOY99.304+
angular distribution for (n,n*13)

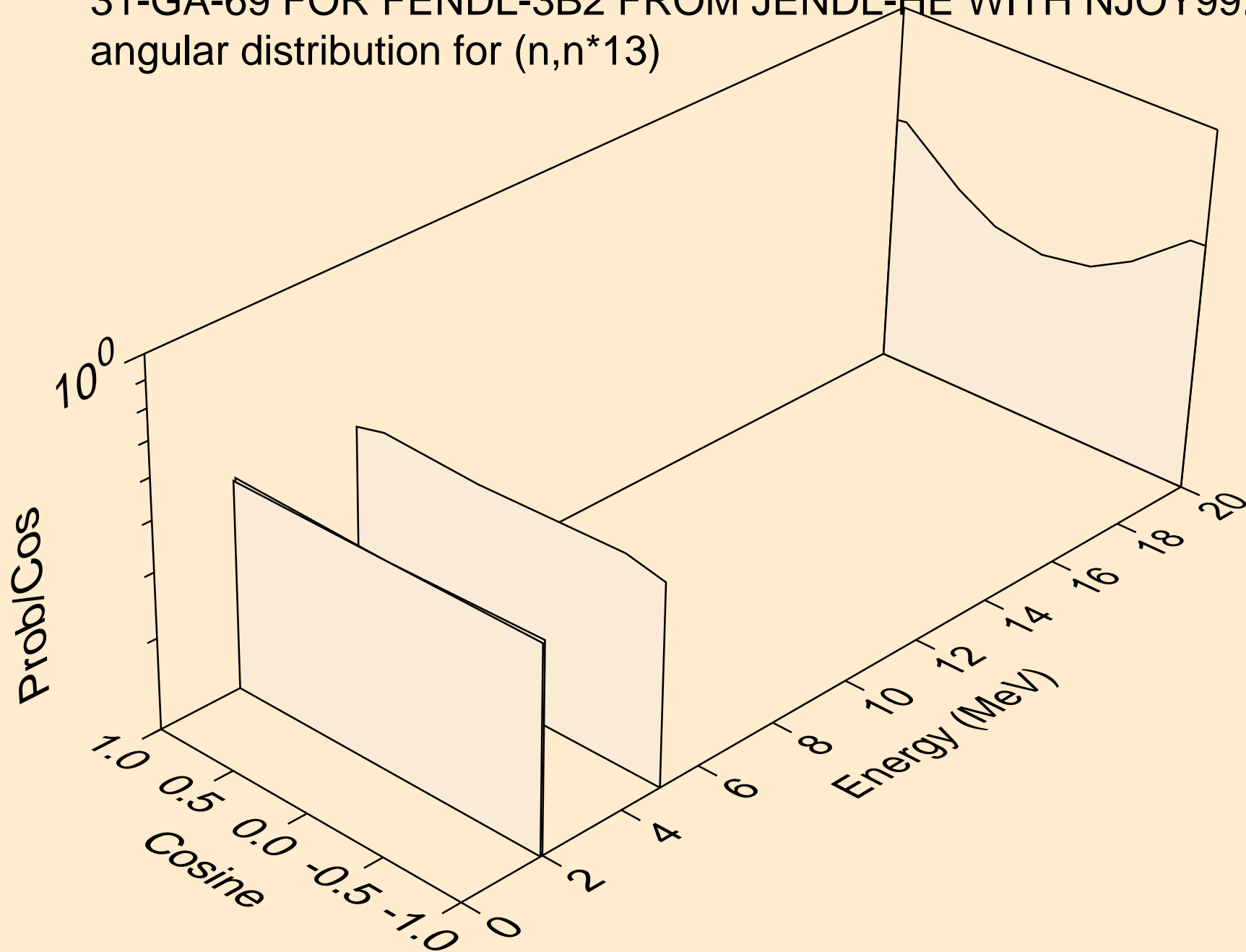

31-GA-69 FOR FENDL-3B2 FROM JENDL-HE WITH NJOY99.304+
angular distribution for (n,n*14)

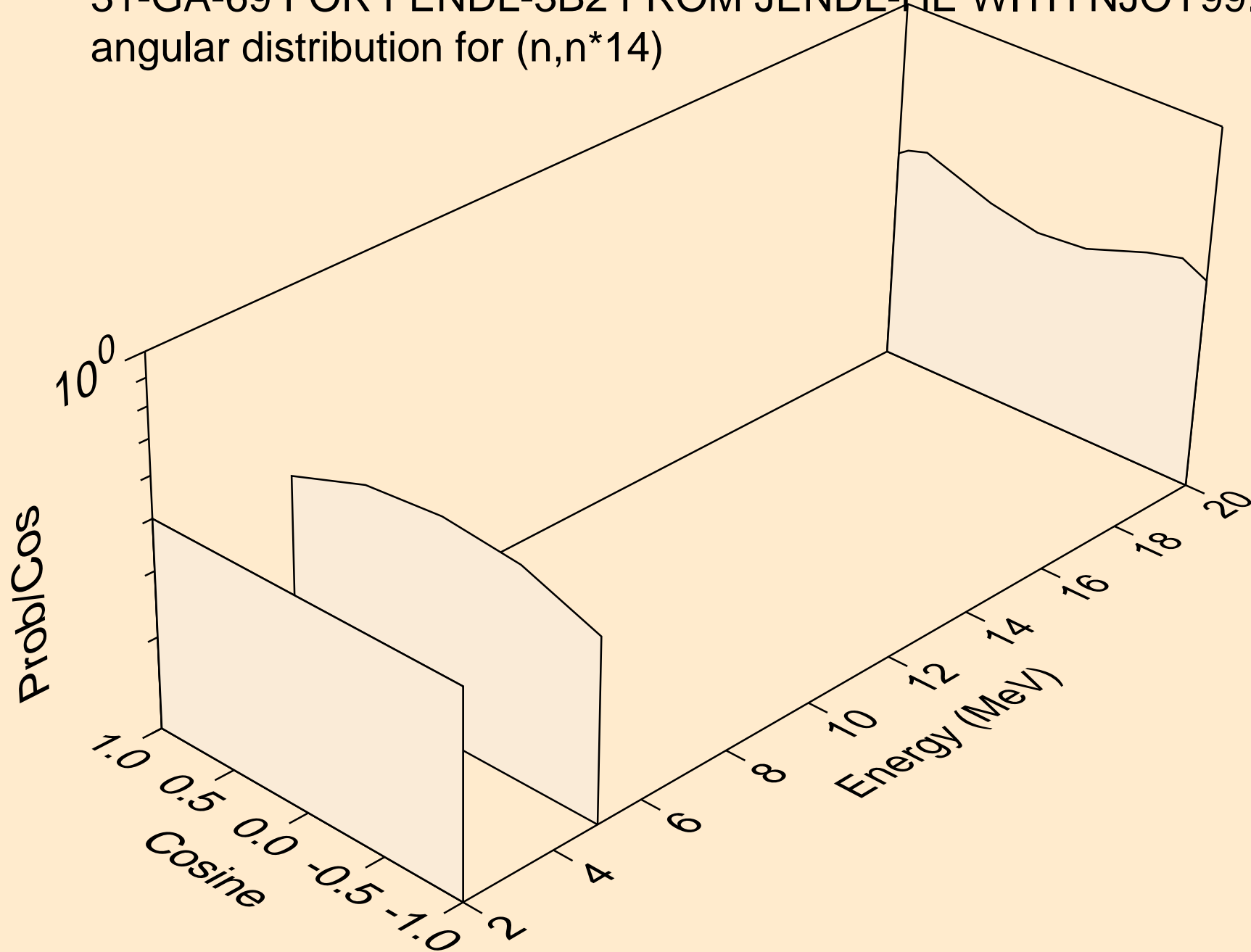

31-GA-69 FOR FENDL-3B2 FROM JENDL-HE WITH NJOY99.304+
angular distribution for (n,n*15)

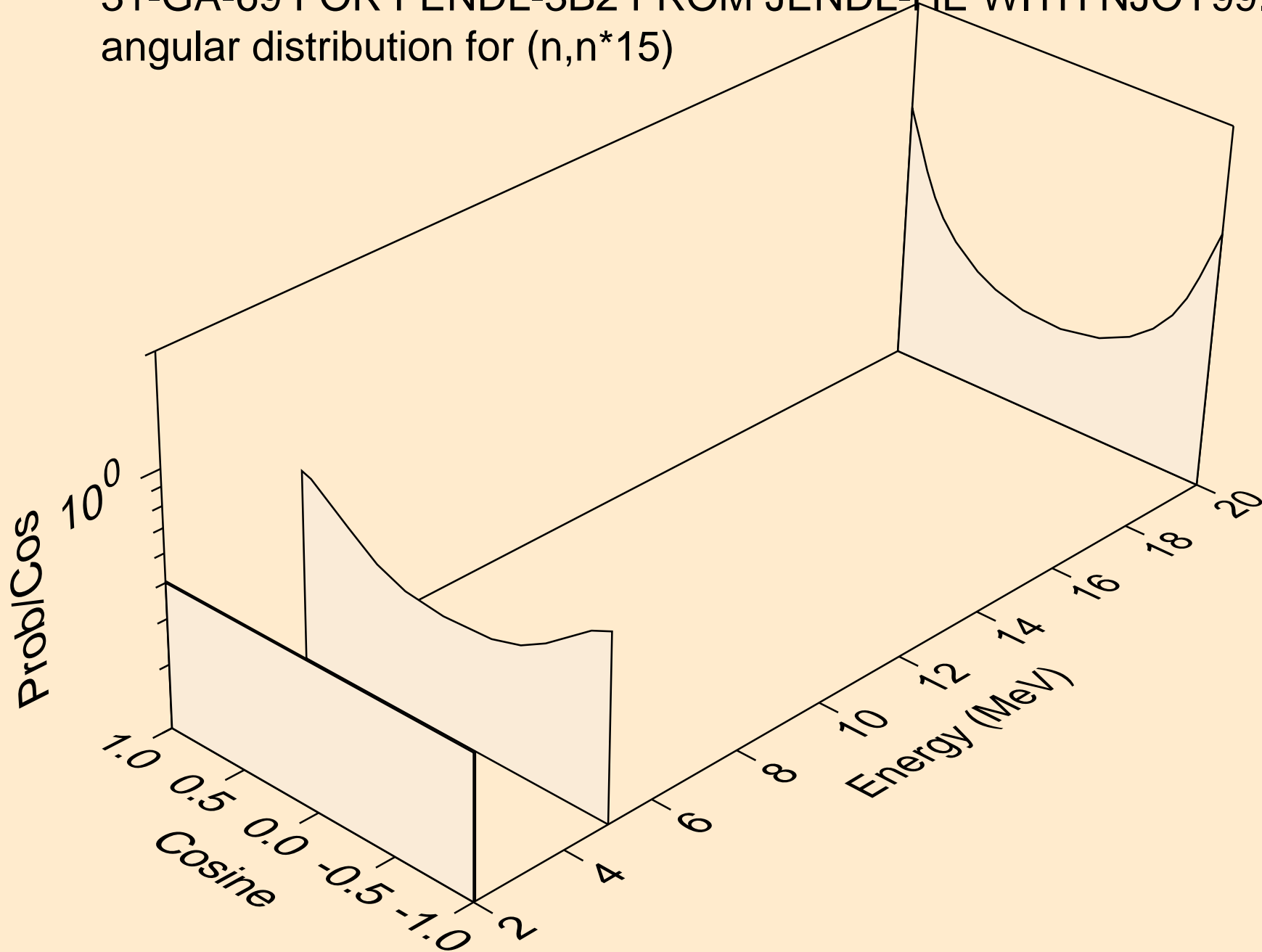

31-GA-69 FOR FENDL-3B2 FROM JENDL-HE WITH NJOY99.304+
angular distribution for (n,n*16)

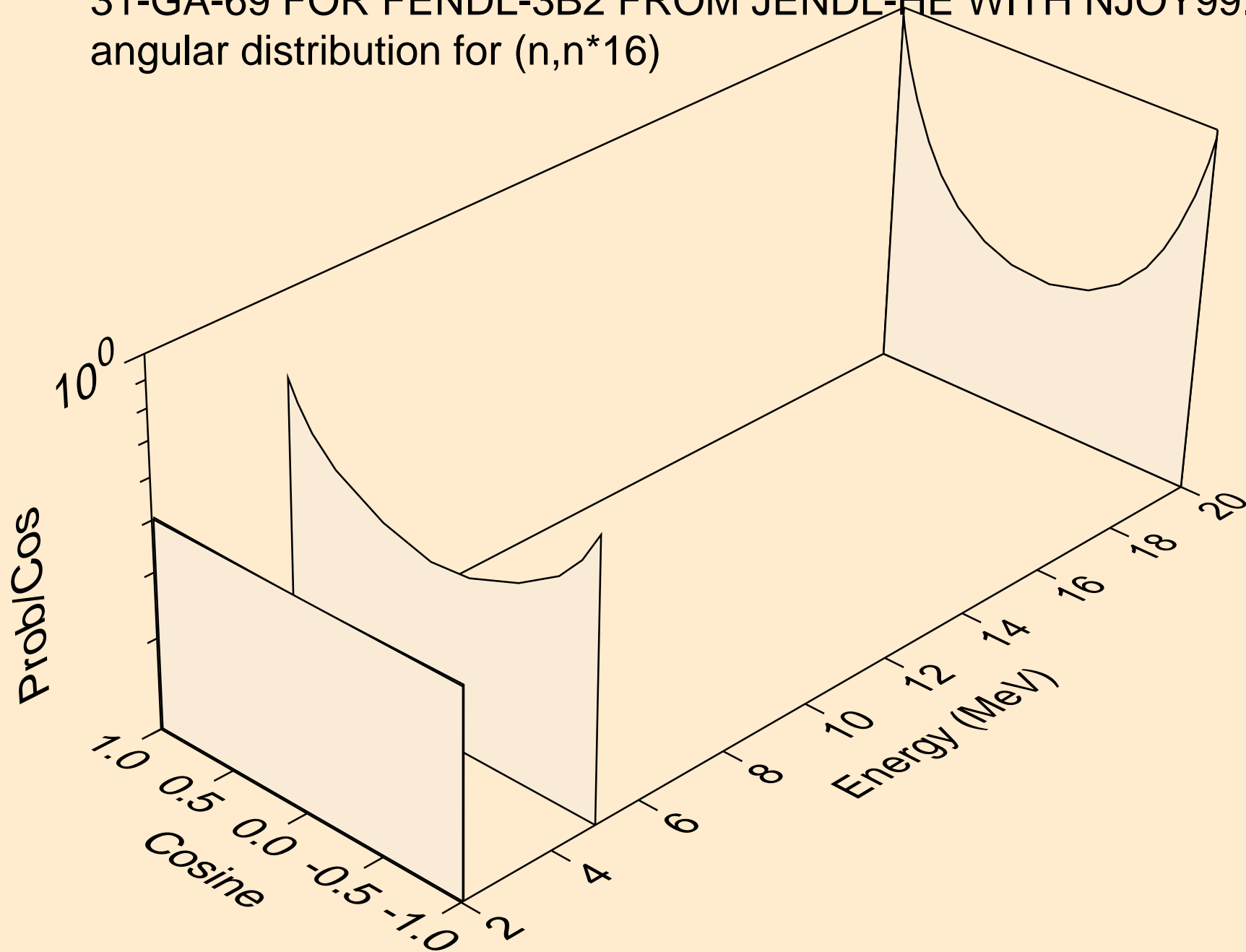

31-GA-69 FOR FENDL-3B2 FROM JENDL-HE WITH NJOY99.304+
angular distribution for (n,n*17)

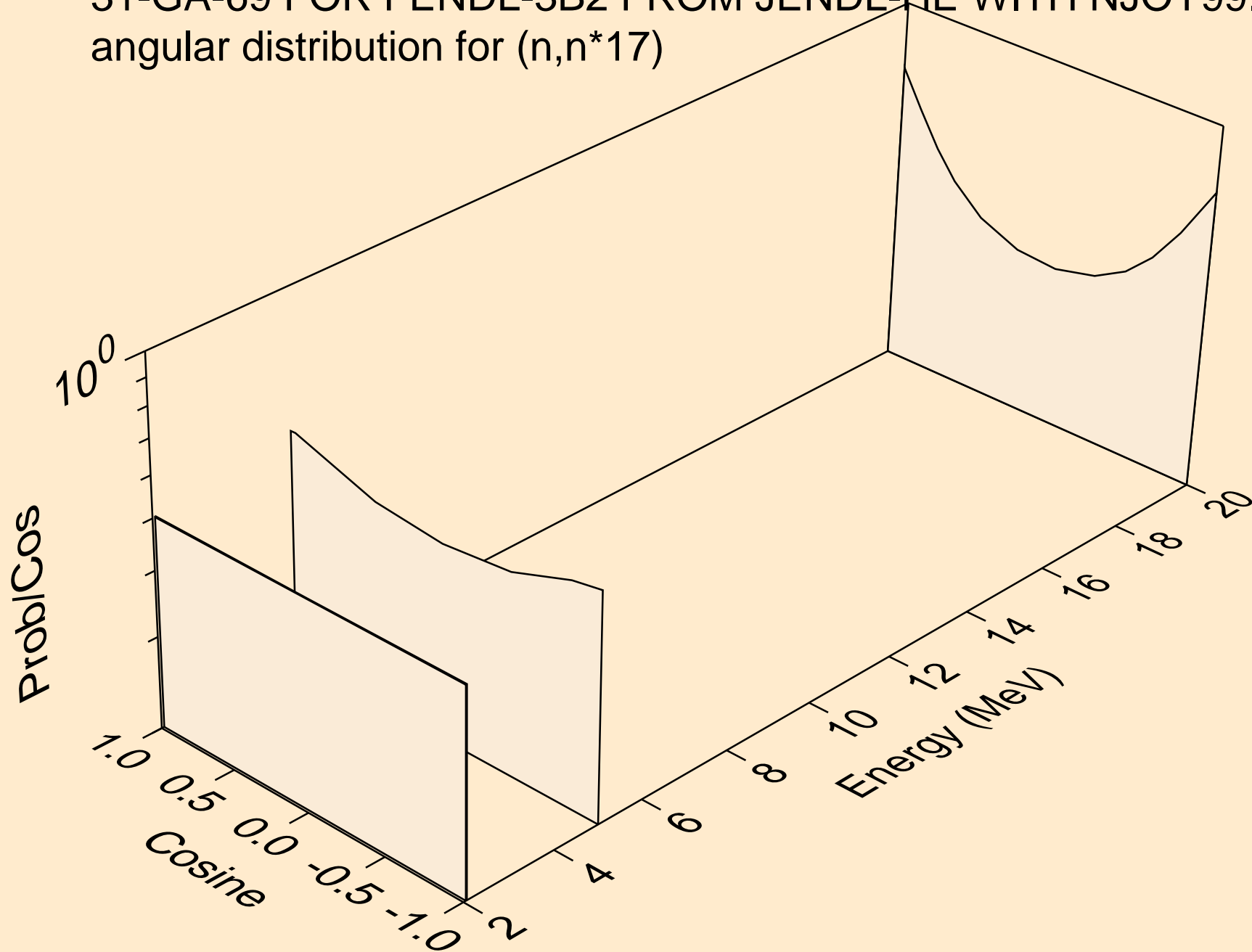

31-GA-69 FOR FENDL-3B2 FROM JENDL-HE WITH NJOY99.304+
angular distribution for (n,n*18)

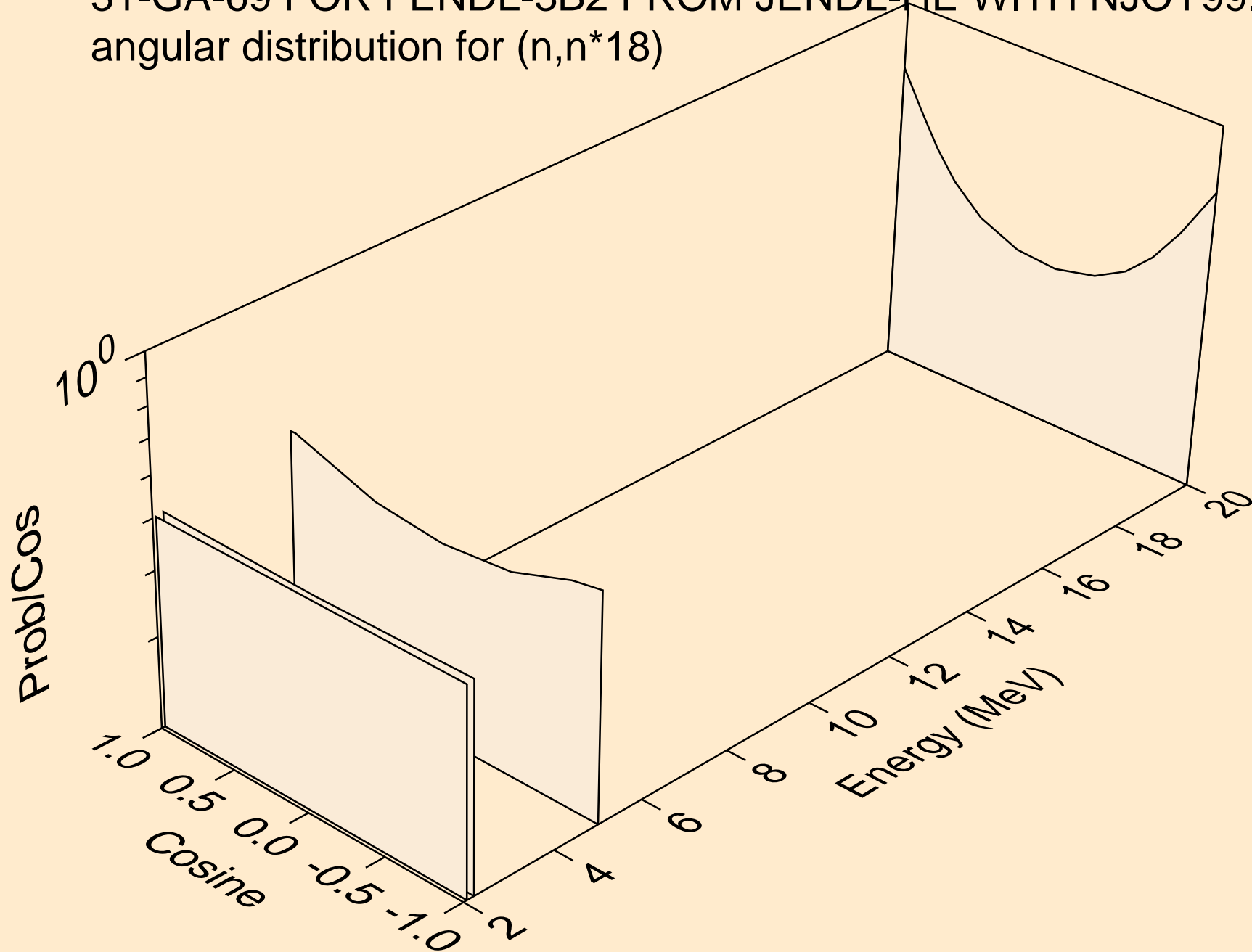

31-GA-69 FOR FENDL-3B2 FROM JENDL-HE WITH NJOY99.304+
angular distribution for (n,n*19)

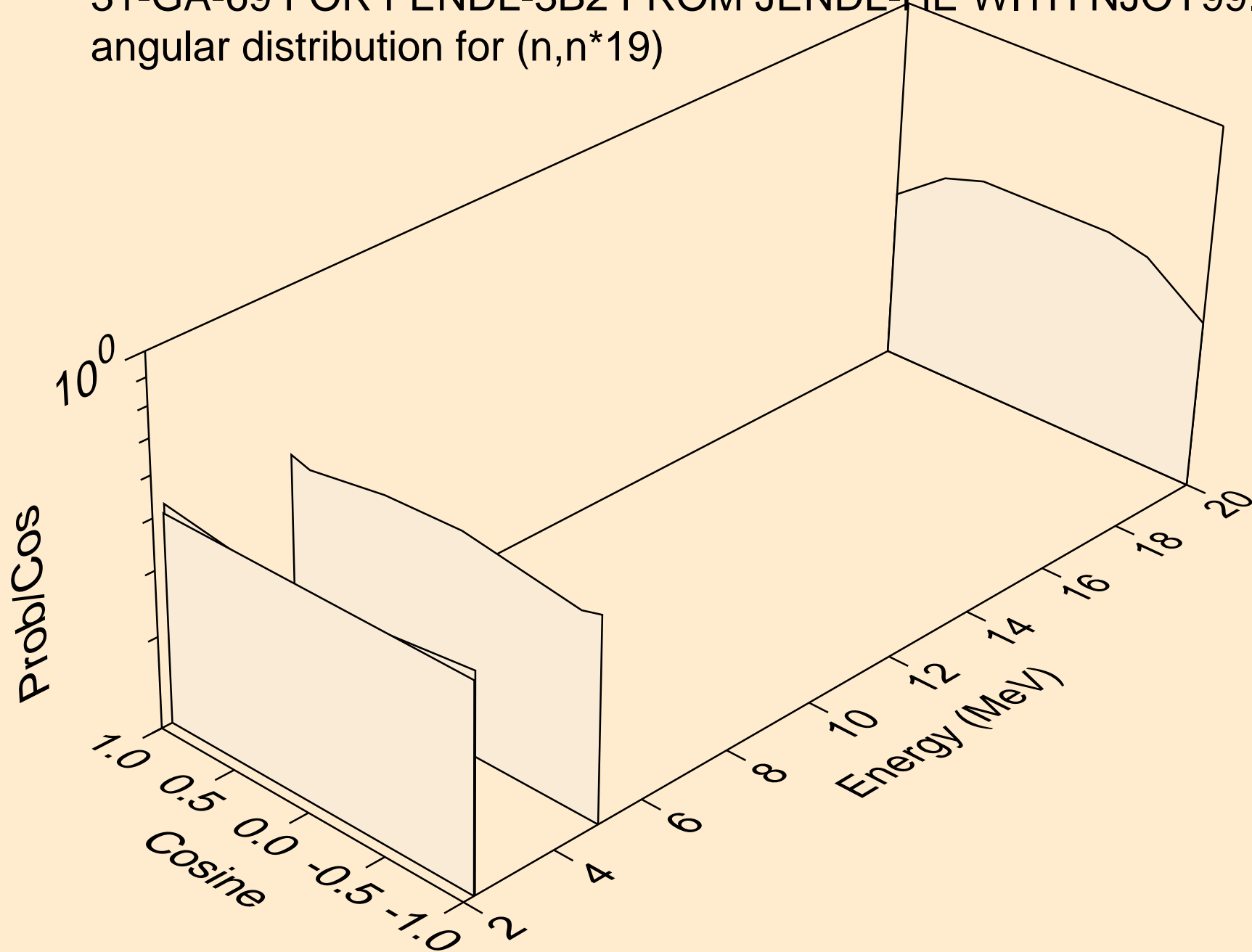

31-GA-69 FOR FENDL-3B2 FROM JENDL-HE WITH NJOY99.304+
angular distribution for (n,n*20)

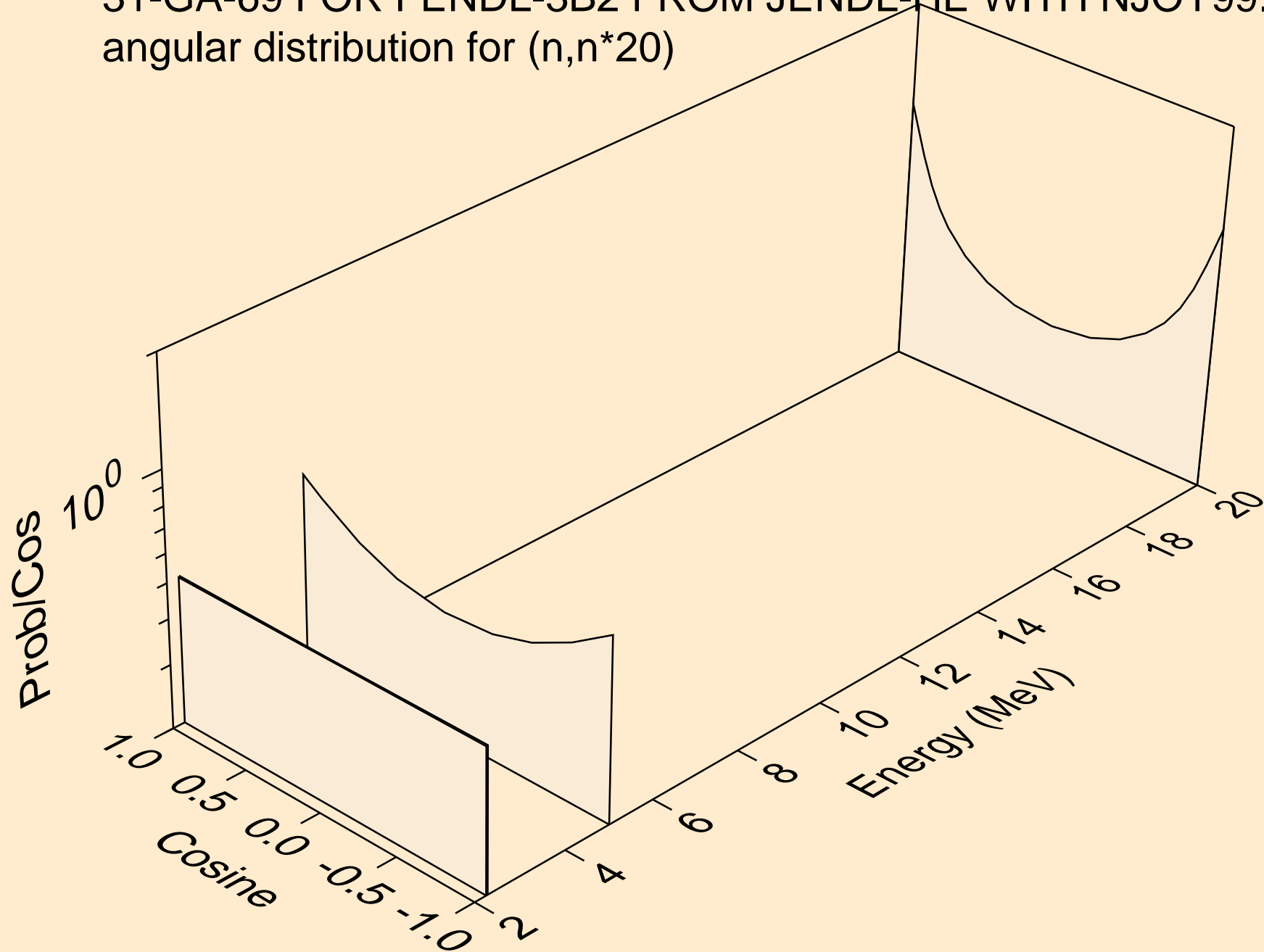

31-GA-69 FOR FENDL-3B2 FROM JENDL-HE WITH NJOY99.304+
angular distribution for (n,n*21)

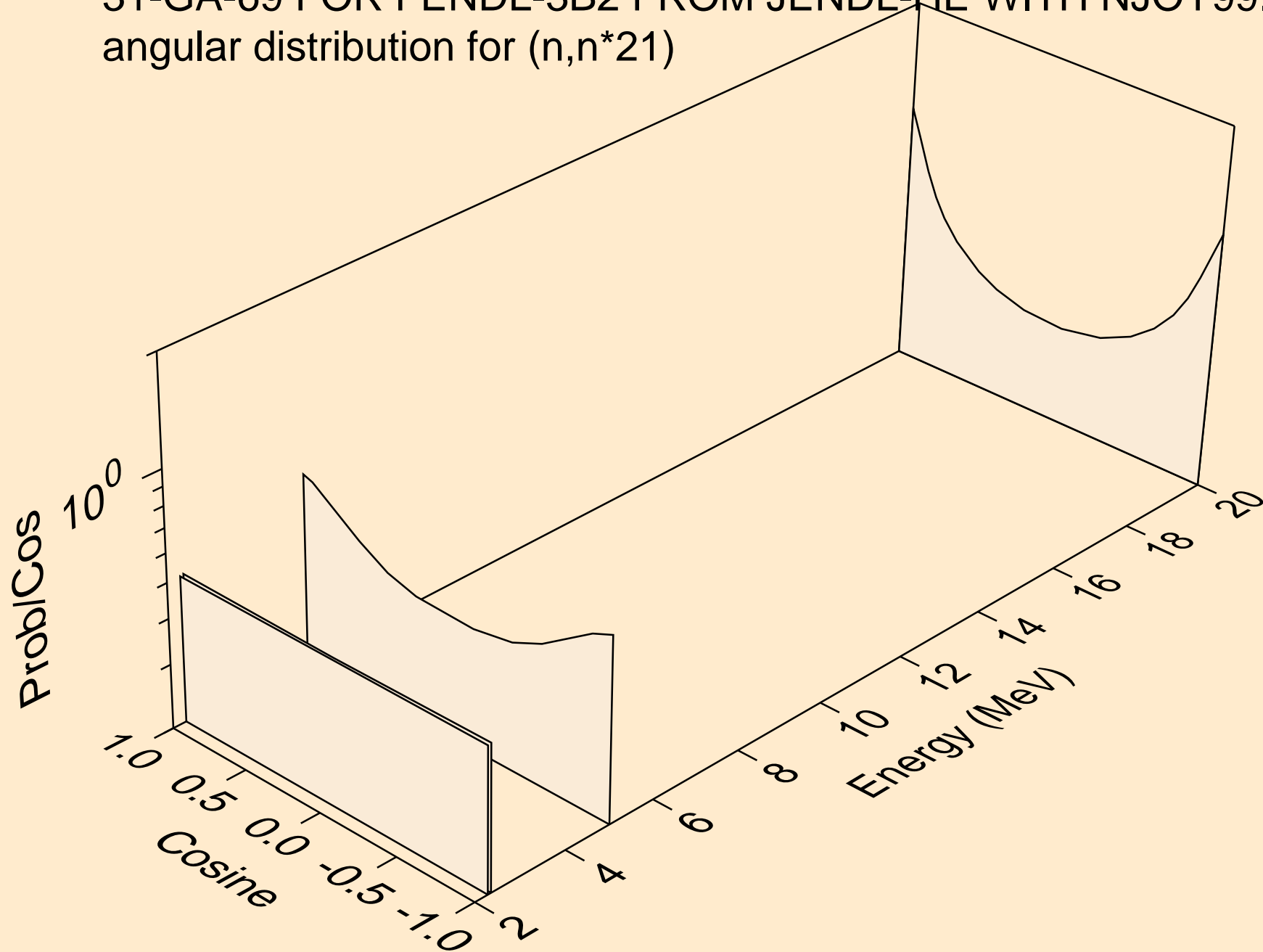

31-GA-69 FOR FENDL-3B2 FROM JENDL-HE WITH NJOY99.304+
angular distribution for (n,n*22)

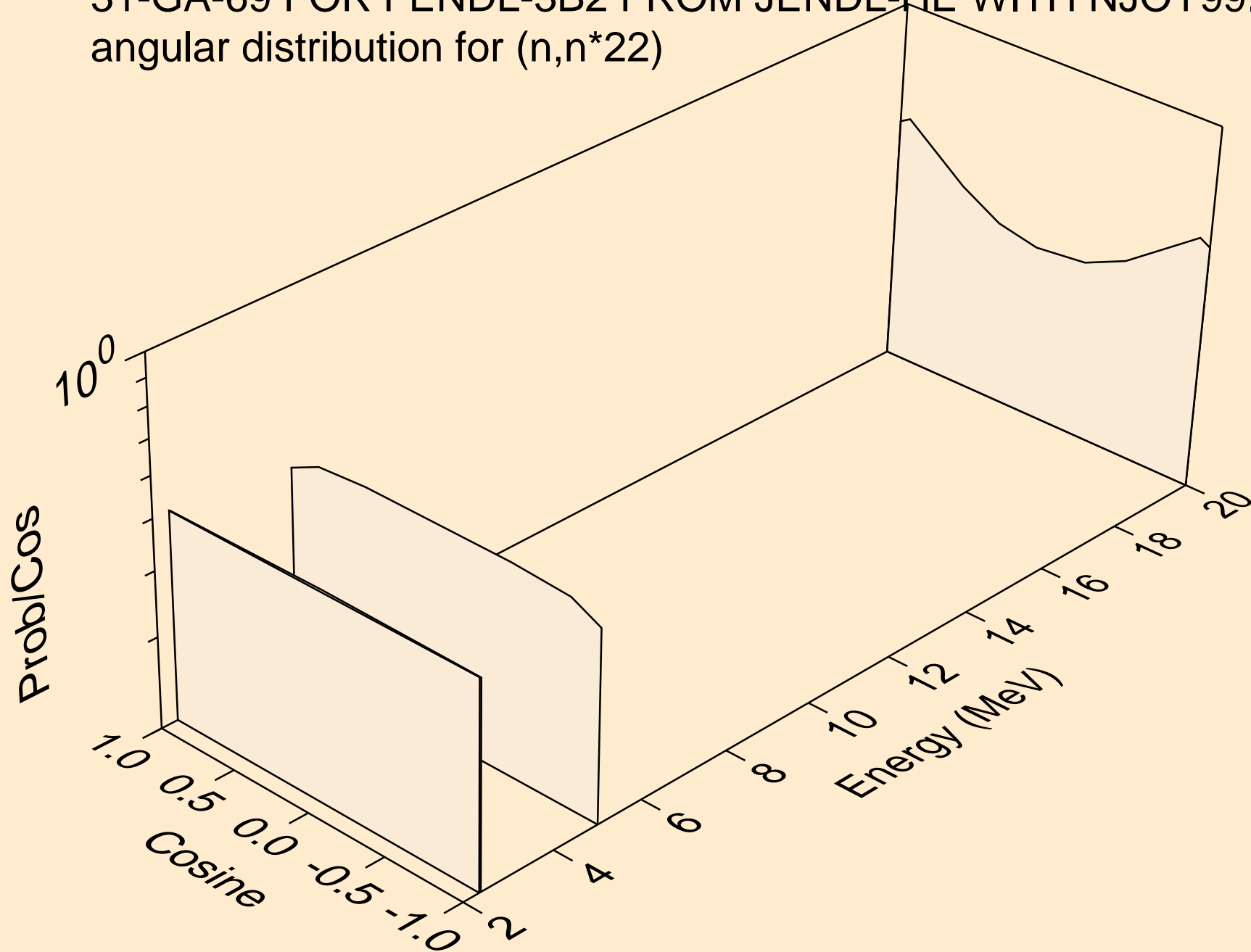

31-GA-69 FOR FENDL-3B2 FROM JENDL-HE WITH NJOY99.304+
angular distribution for (n,n*23)

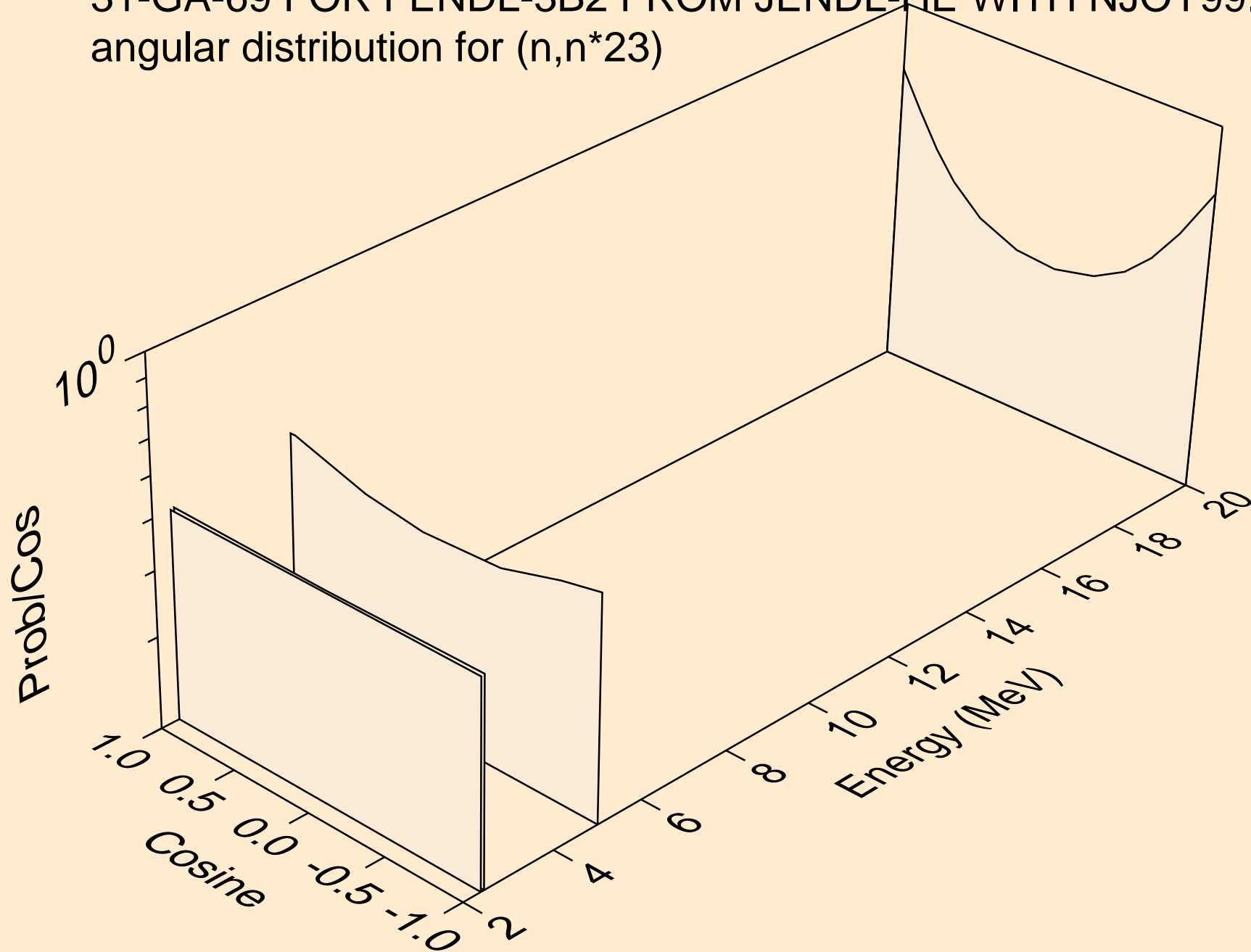

31-GA-69 FOR FENDL-3B2 FROM JENDL-HE WITH NJOY99.304+
angular distribution for (n,n*24)

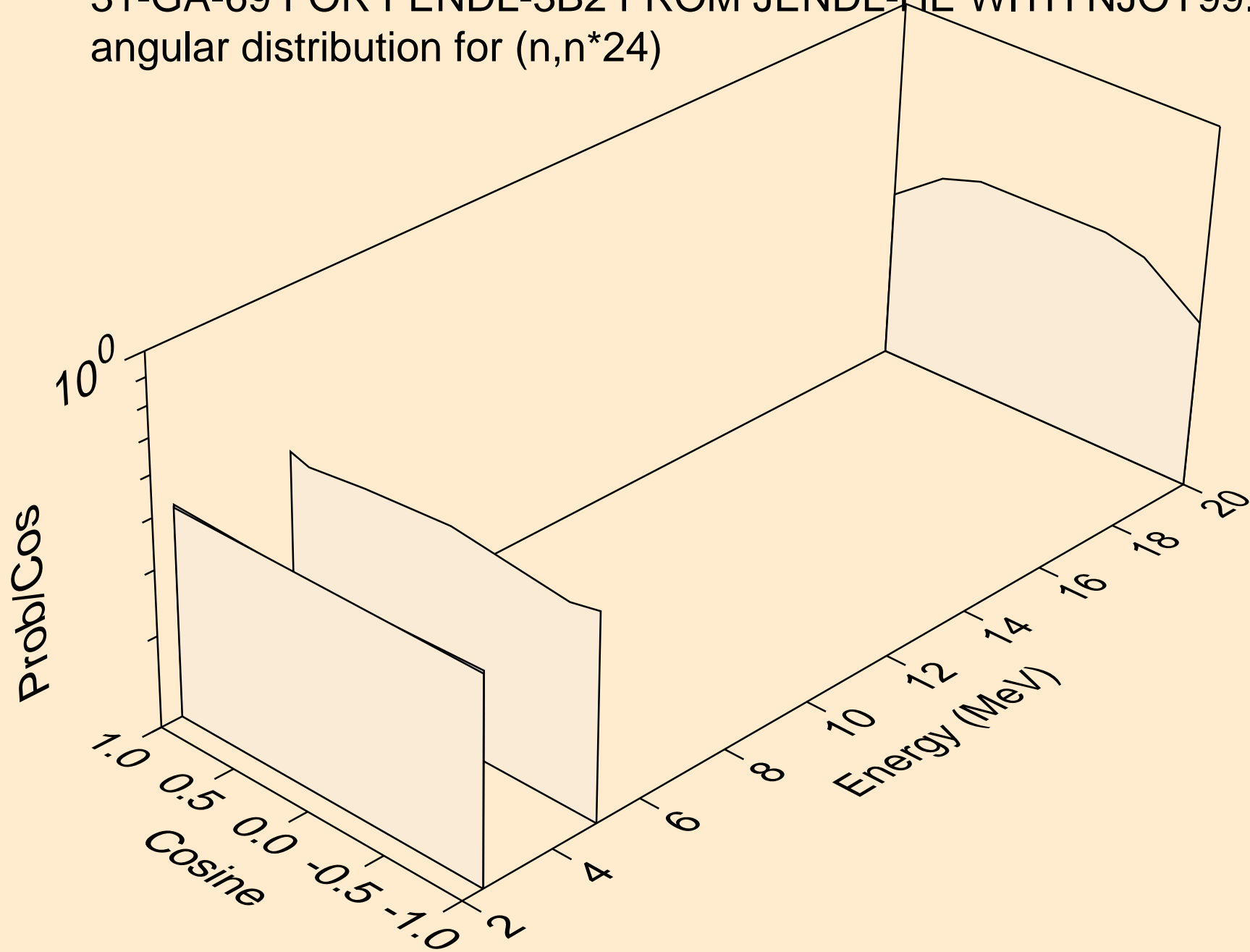

31-GA-69 FOR FENDL-3B2 FROM JENDL-HE WITH NJOY99.304+
angular distribution for (n,n*25)

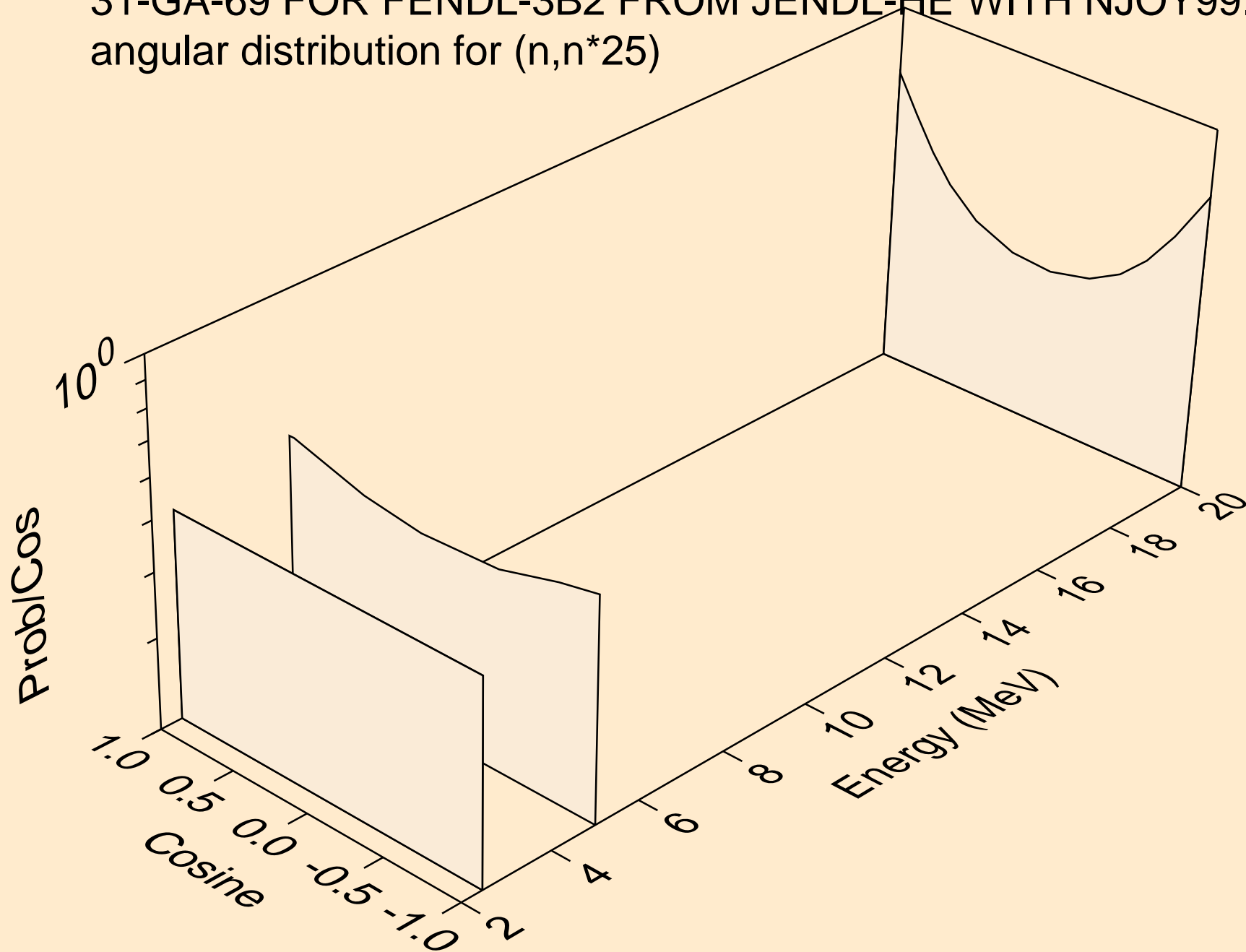

31-GA-69 FOR FENDL-3B2 FROM JENDL-HE WITH NJOY99.304+
angular distribution for (n,n*c)

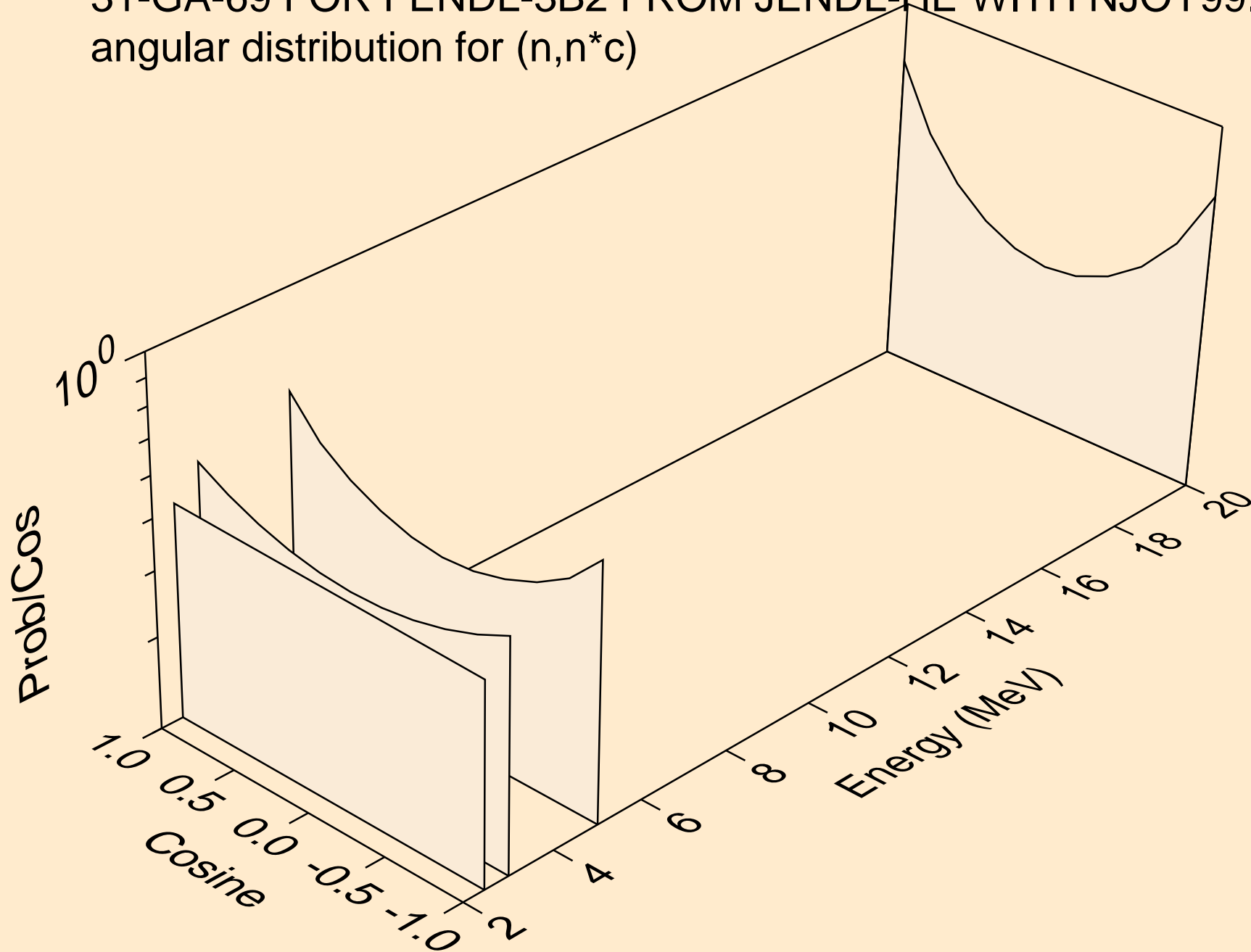

31-GA-69 FOR FENDL-3B2 FROM JENDL-HE WITH NJOY99.304+
Neutron emission for (n,x)

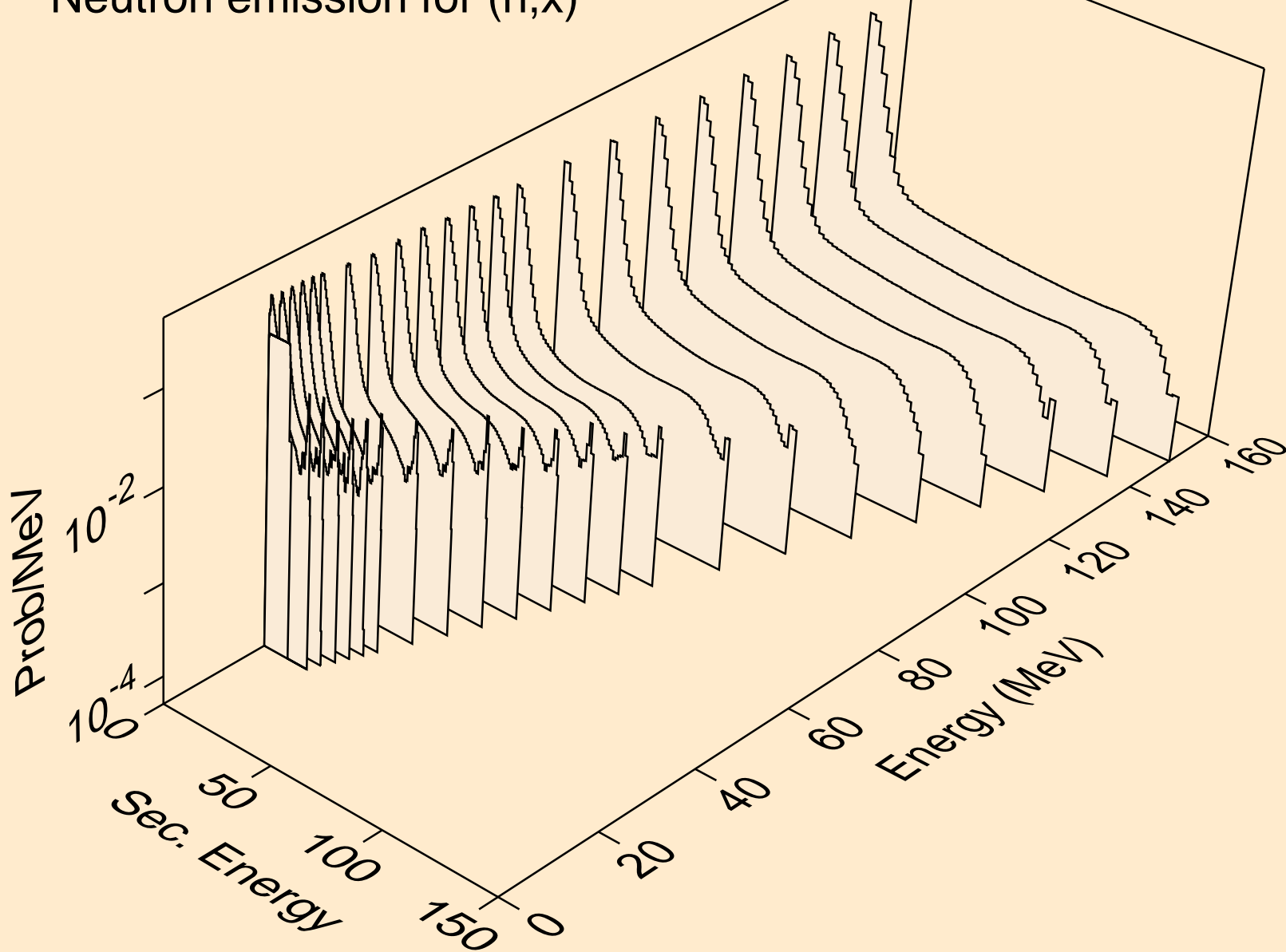

31-GA-69 FOR FENDL-3B2 FROM JENDL-HE WITH NJOY99.304+
Neutron emission for (n,2n)

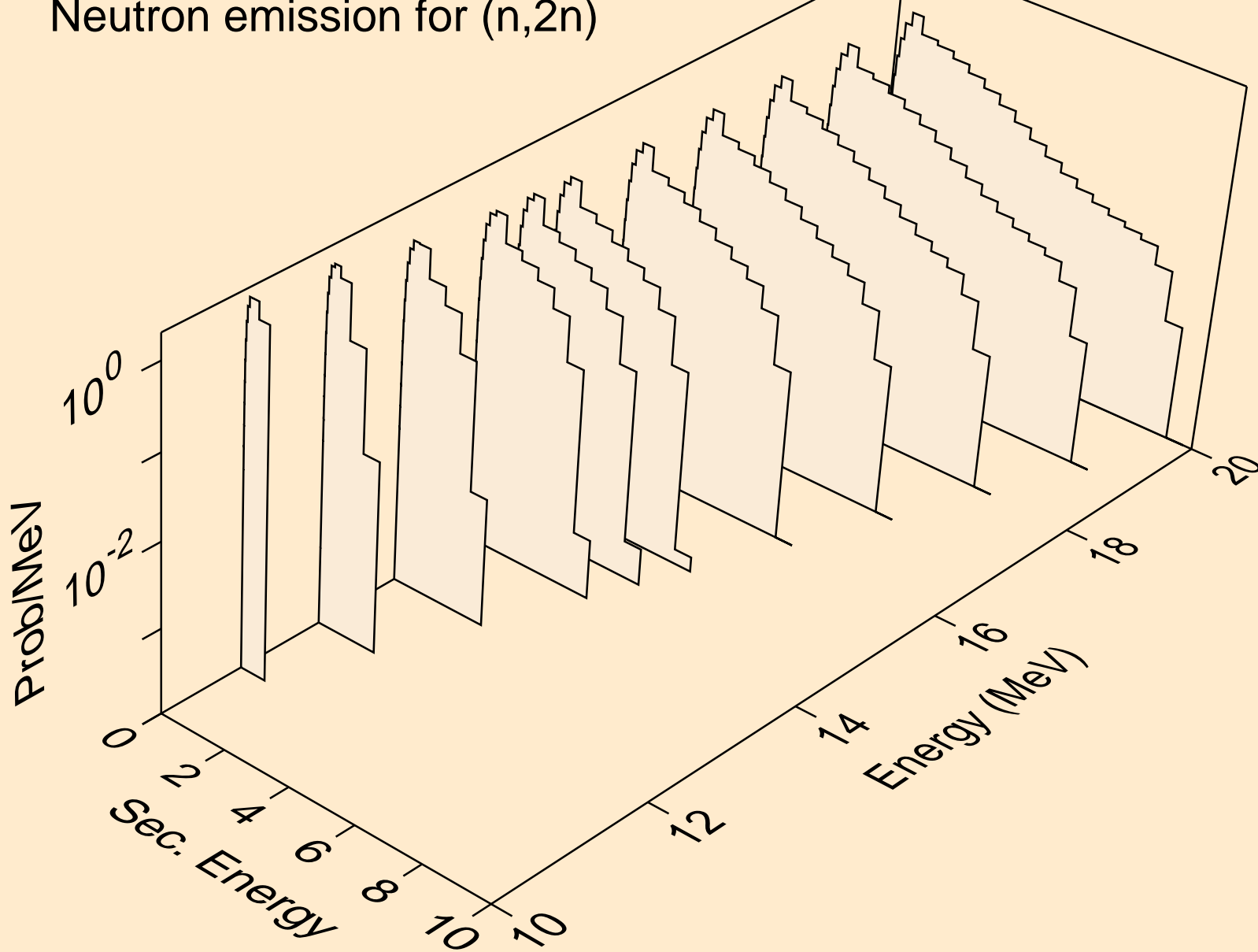

31-GA-69 FOR FENDL-3B2 FROM JENDL-HE WITH NJOY99.304+
Neutron emission for (n,n*)a

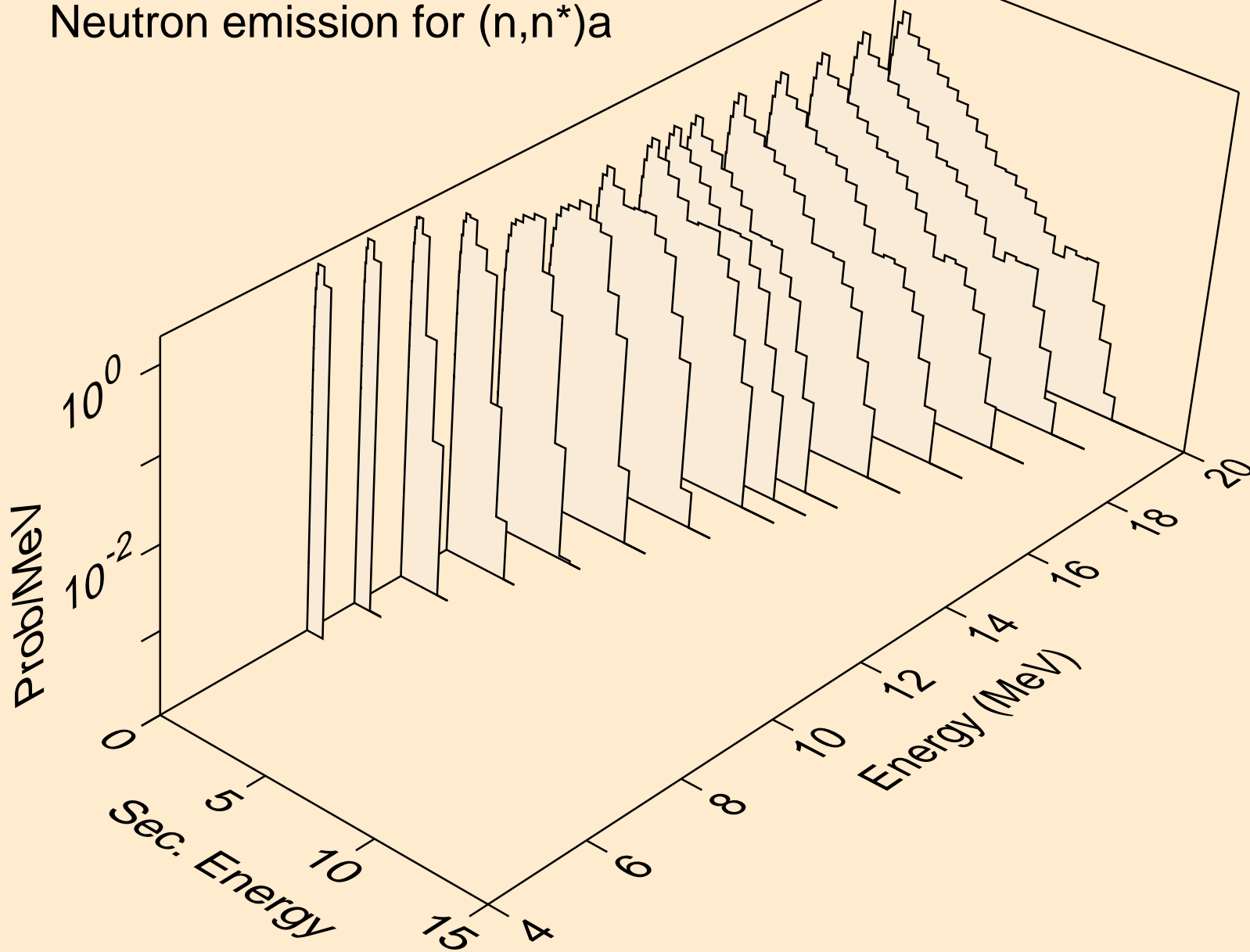

31-GA-69 FOR FENDL-3B2 FROM JENDL-HE WITH NJOY99.304+
Neutron emission for (n,n*)p

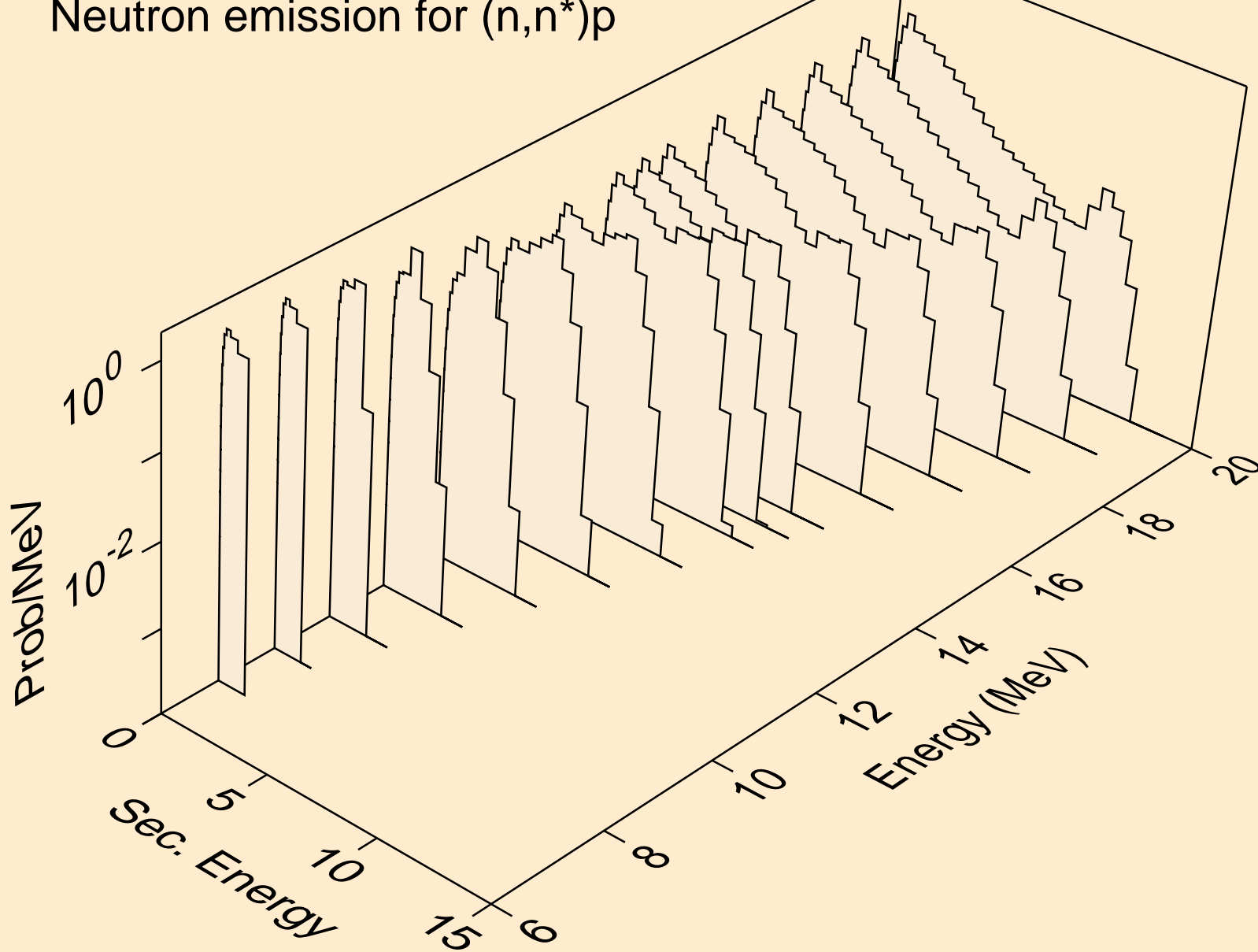

31-GA-69 FOR FENDL-3B2 FROM JENDL-HE WITH NJOY99.304+
Neutron emission for (n,n*)d

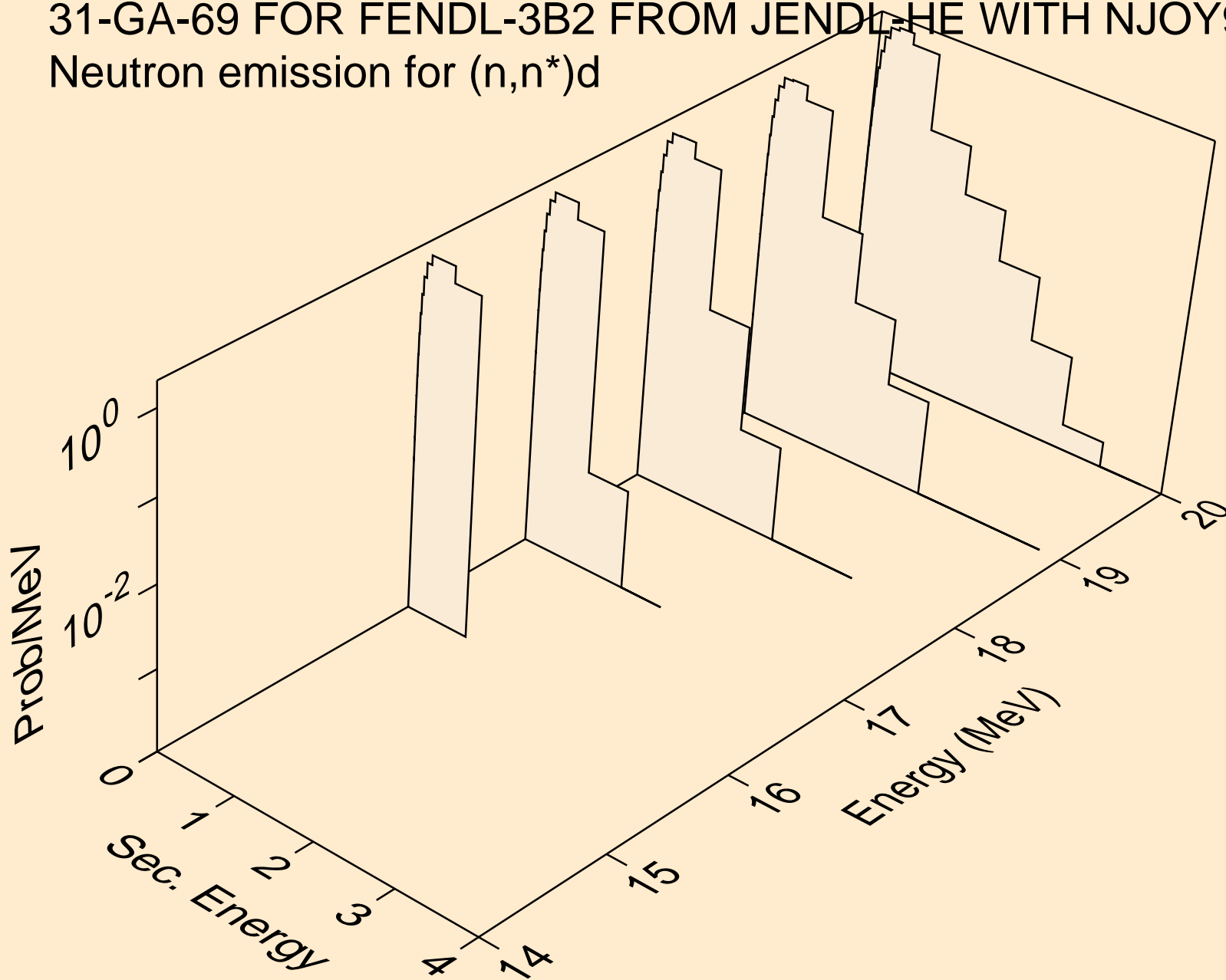

31-GA-69 FOR FENDL-3B2 FROM JENDL-HE WITH NJOY99.304+
Neutron emission for (n,n*c)

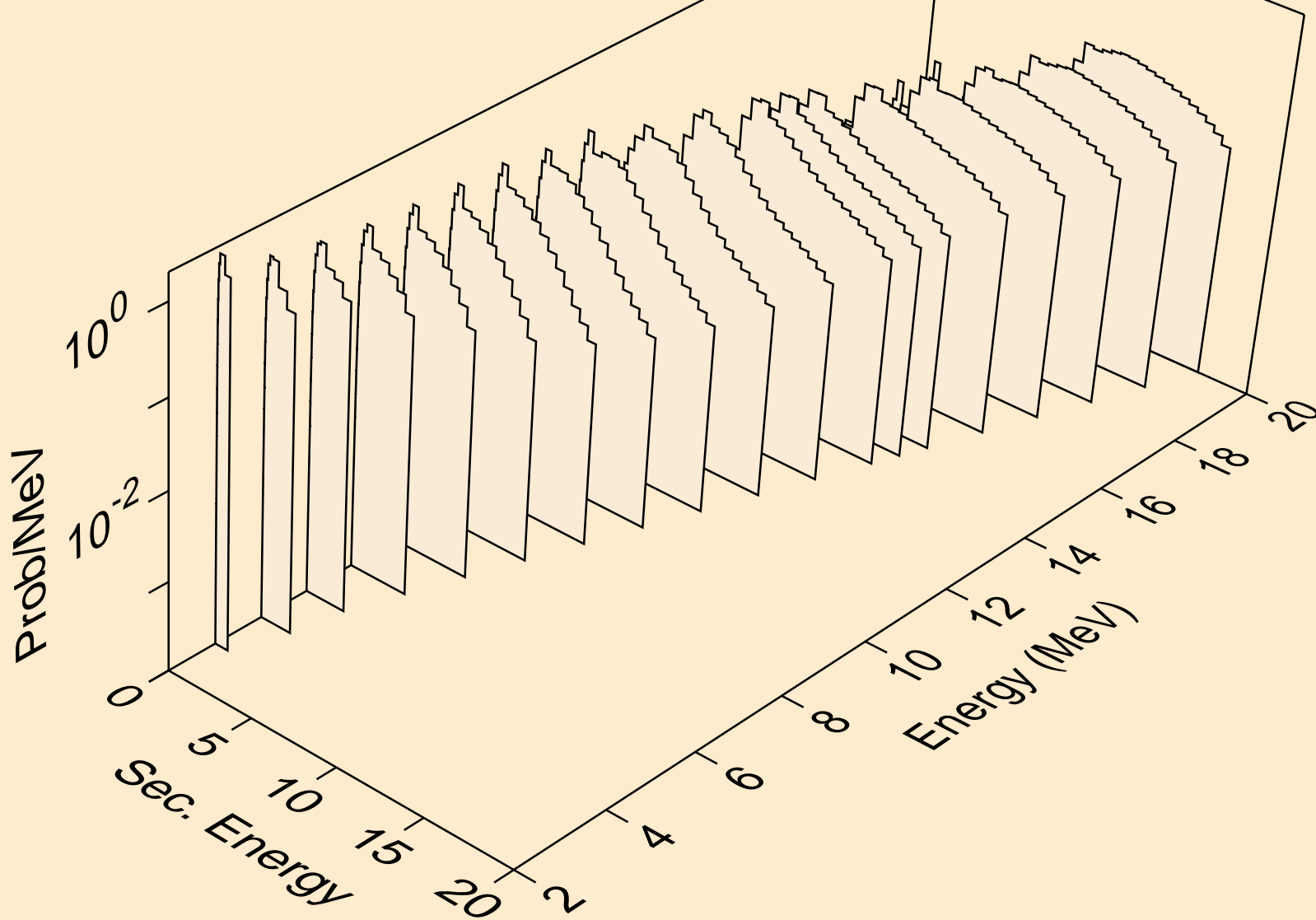

31-GA-69 FOR FENDL-3B2 FROM JENDL-HE WITH NJOY99.304+
Photon emission for (n,x)

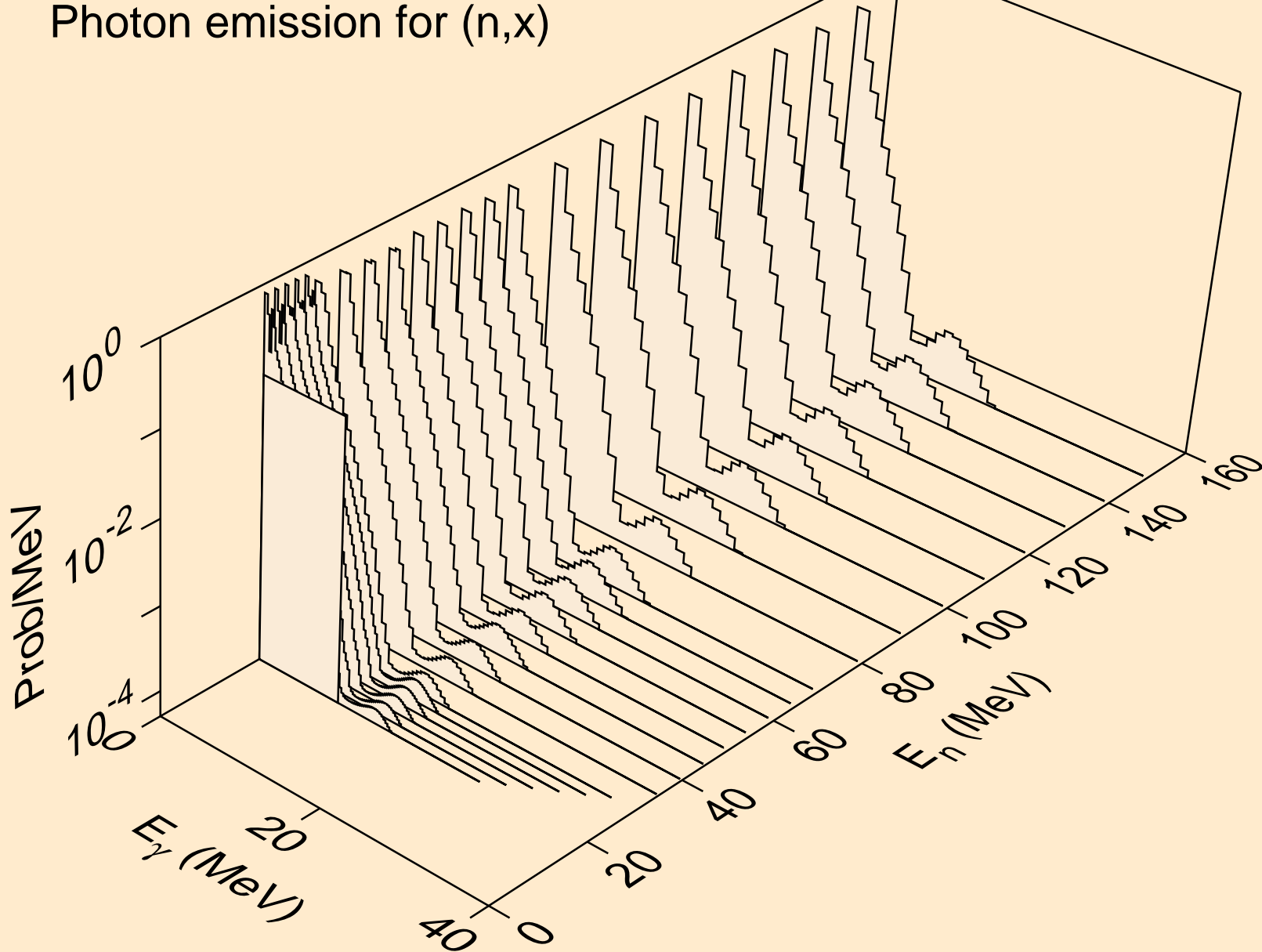

31-GA-69 FOR FENDL-3B2 FROM JENDL-HE WITH NJOY99.304+
14 MeV photon spectrum

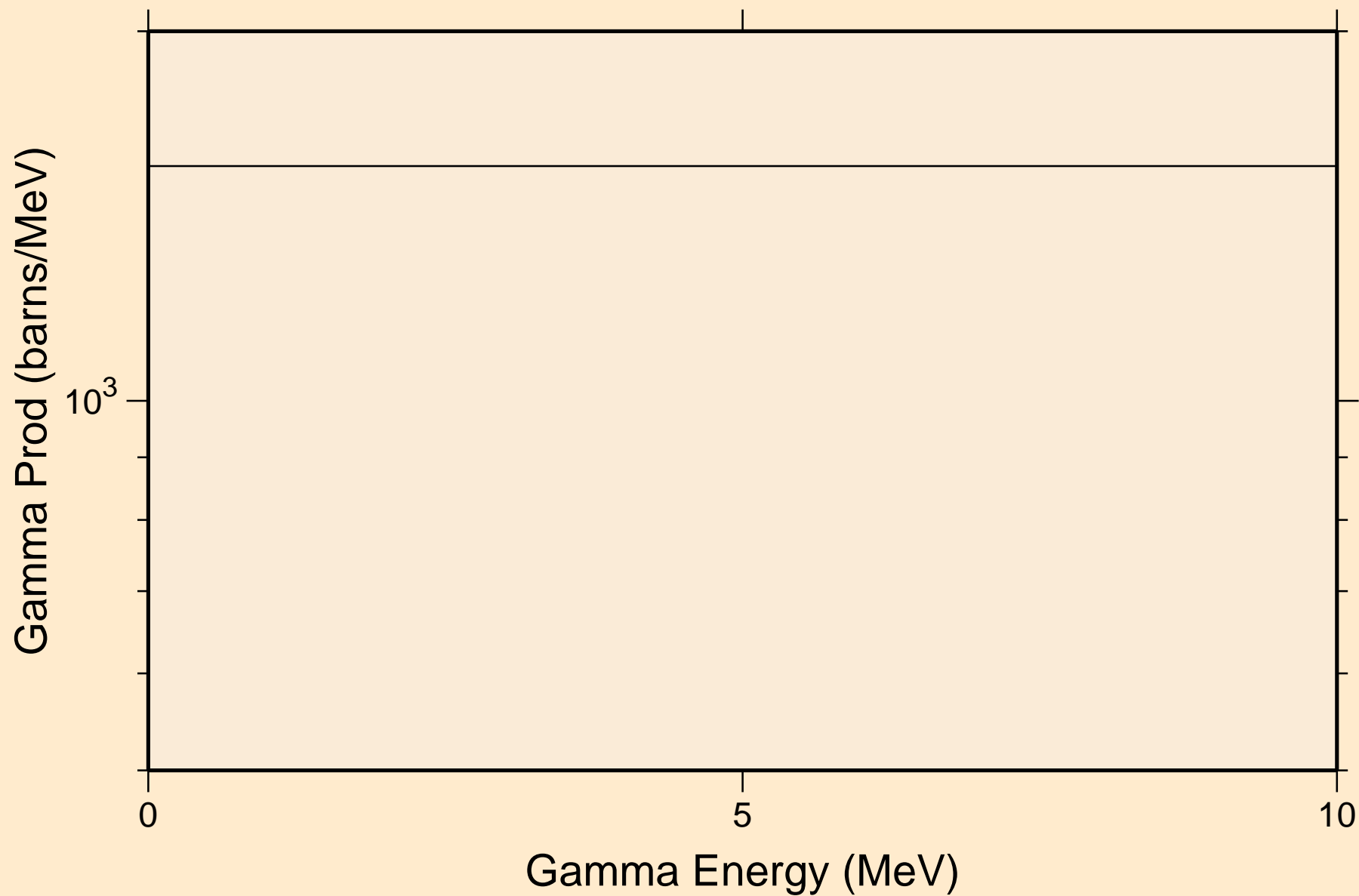

31-GA-69 FOR FENDL-3B2 FROM JENDL-HE WITH NJOY99.304+

Particle heating contributions

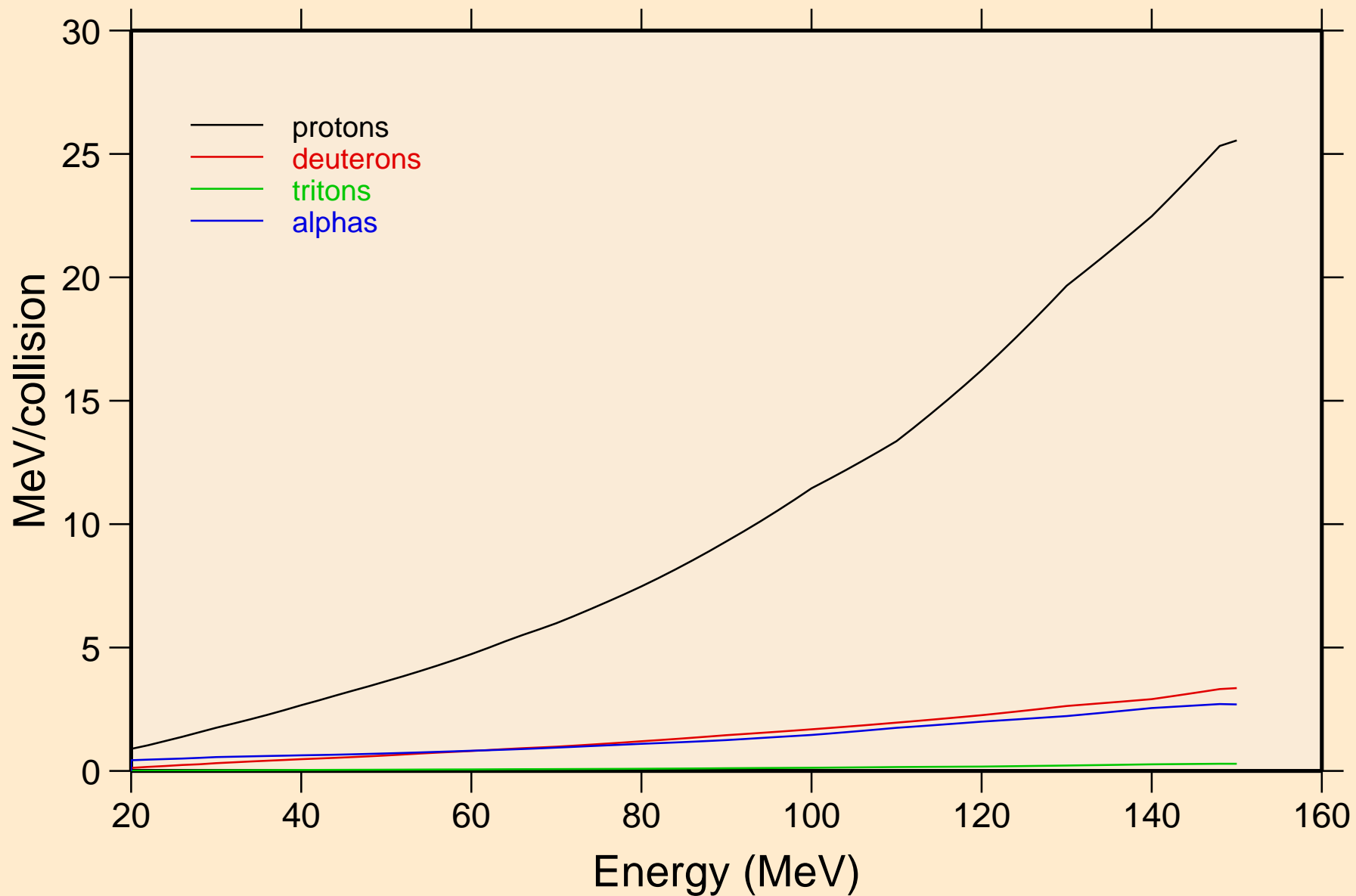

31-GA-69 FOR FENDL-3B2 FROM JENDL-HE WITH NJOY99.304+ Recoil Heating

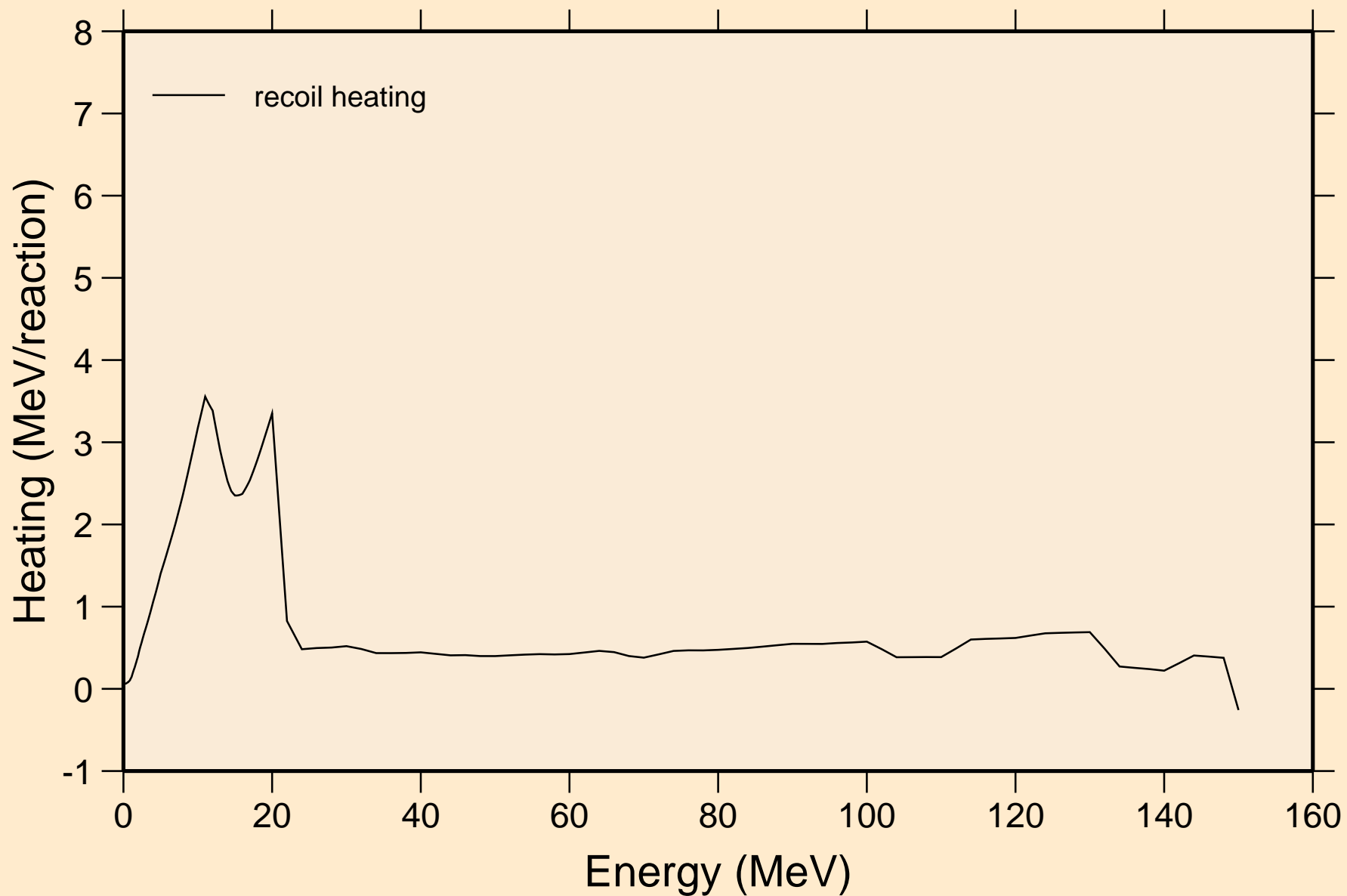

31-GA-69 FOR FENDL-3B2 FROM JENDL-HE WITH NJOY99.304+

Particle production cross sections

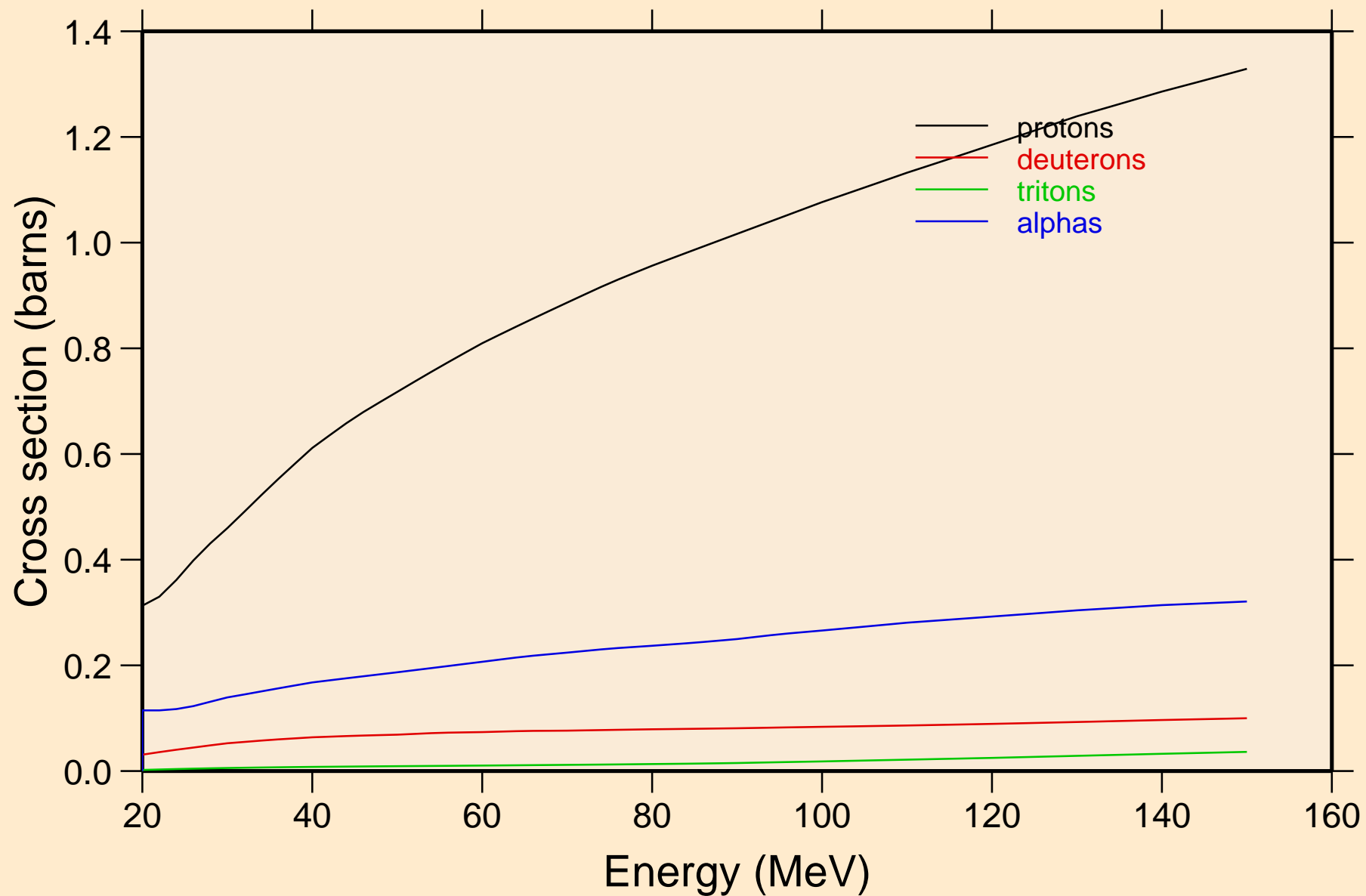

31-GA-69 FOR FENDL-3B2 FROM JENDL-HE WITH NJOY99.304+
protons from (n,x)

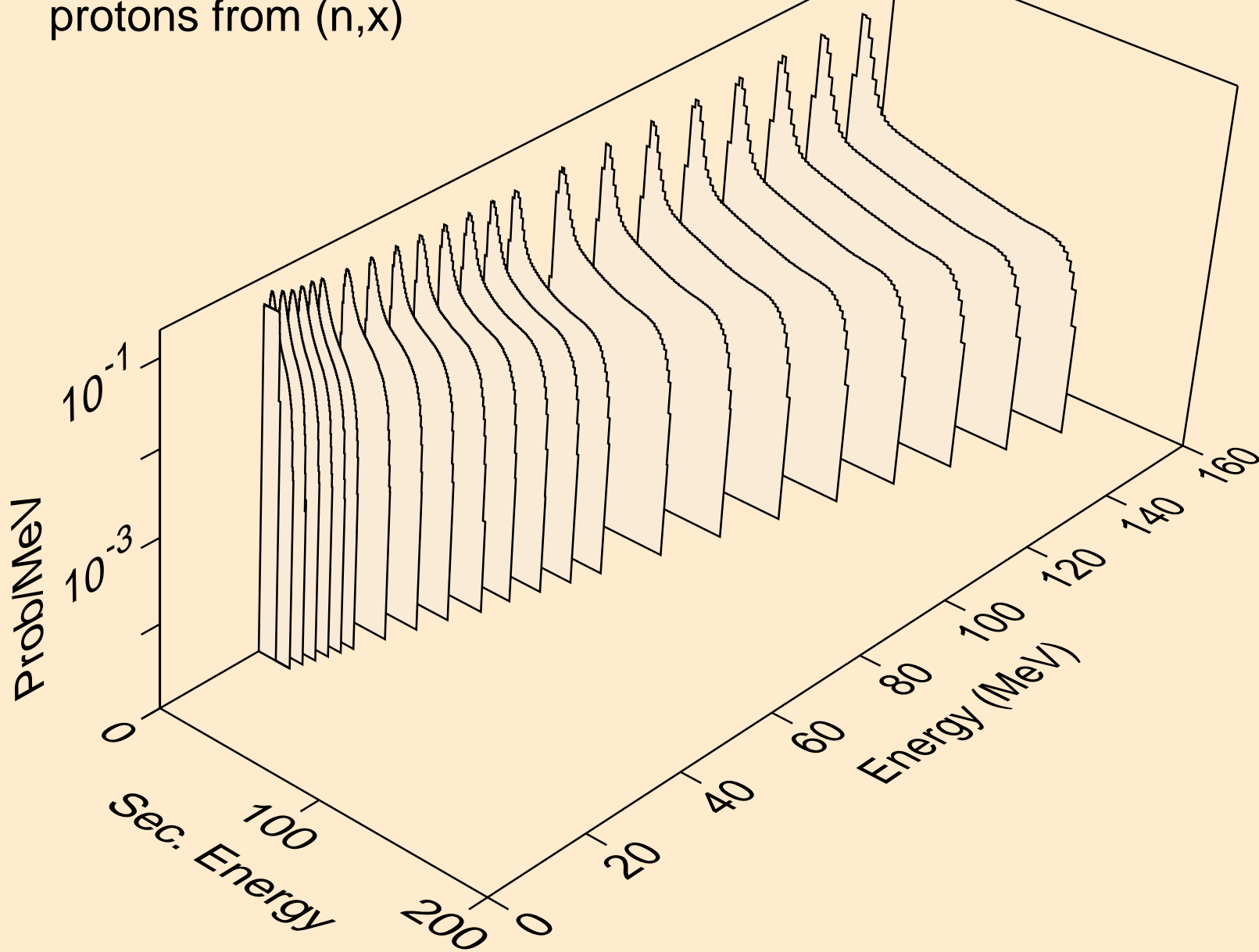

31-GA-69 FOR FENDL-3B2 FROM JENDL-HE WITH NJOY99.304+
deuterons from (n,x)

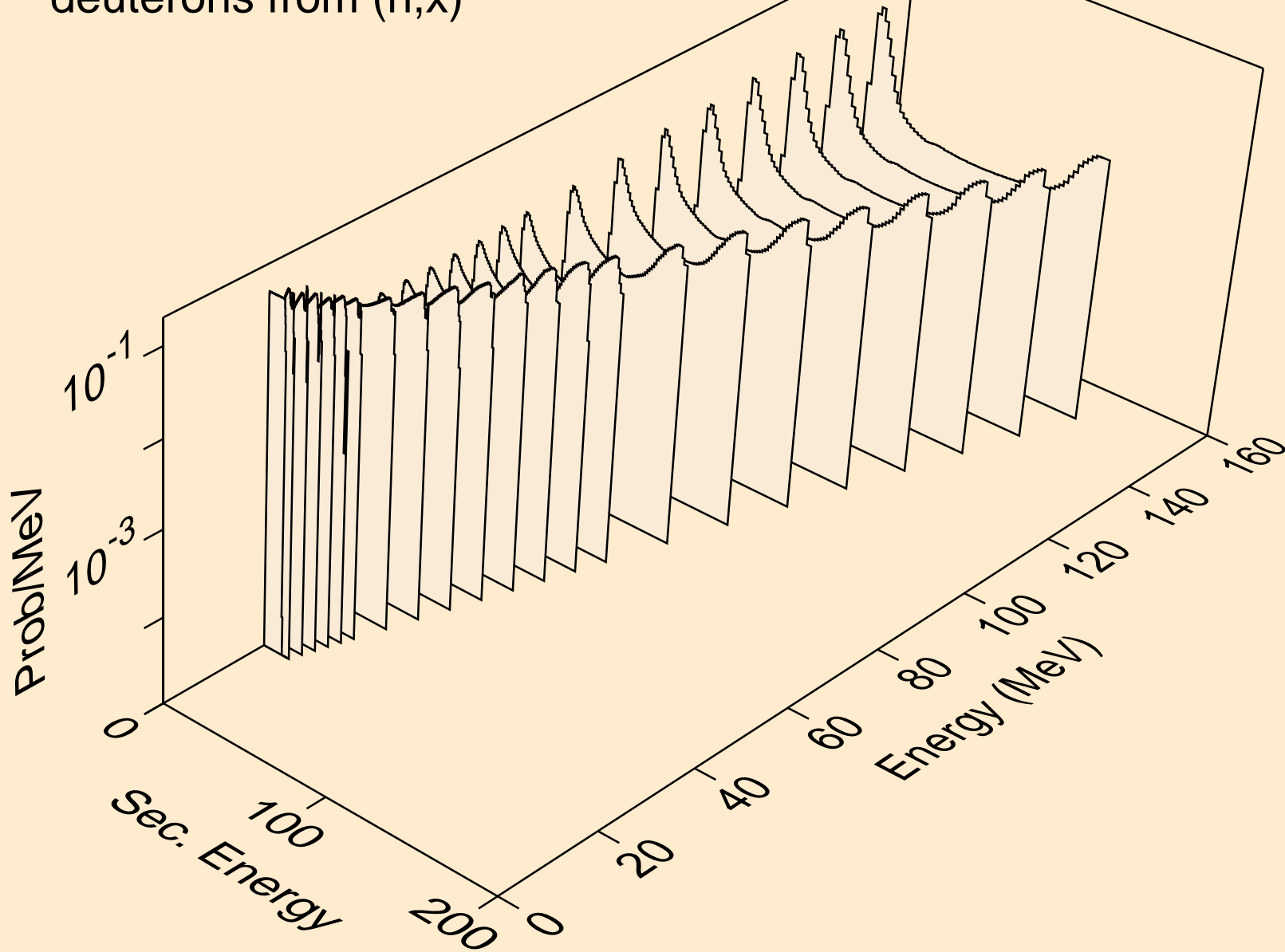

31-GA-69 FOR FENDL-3B2 FROM JENDL-HE WITH NJOY99.304+
tritons from (n,x)

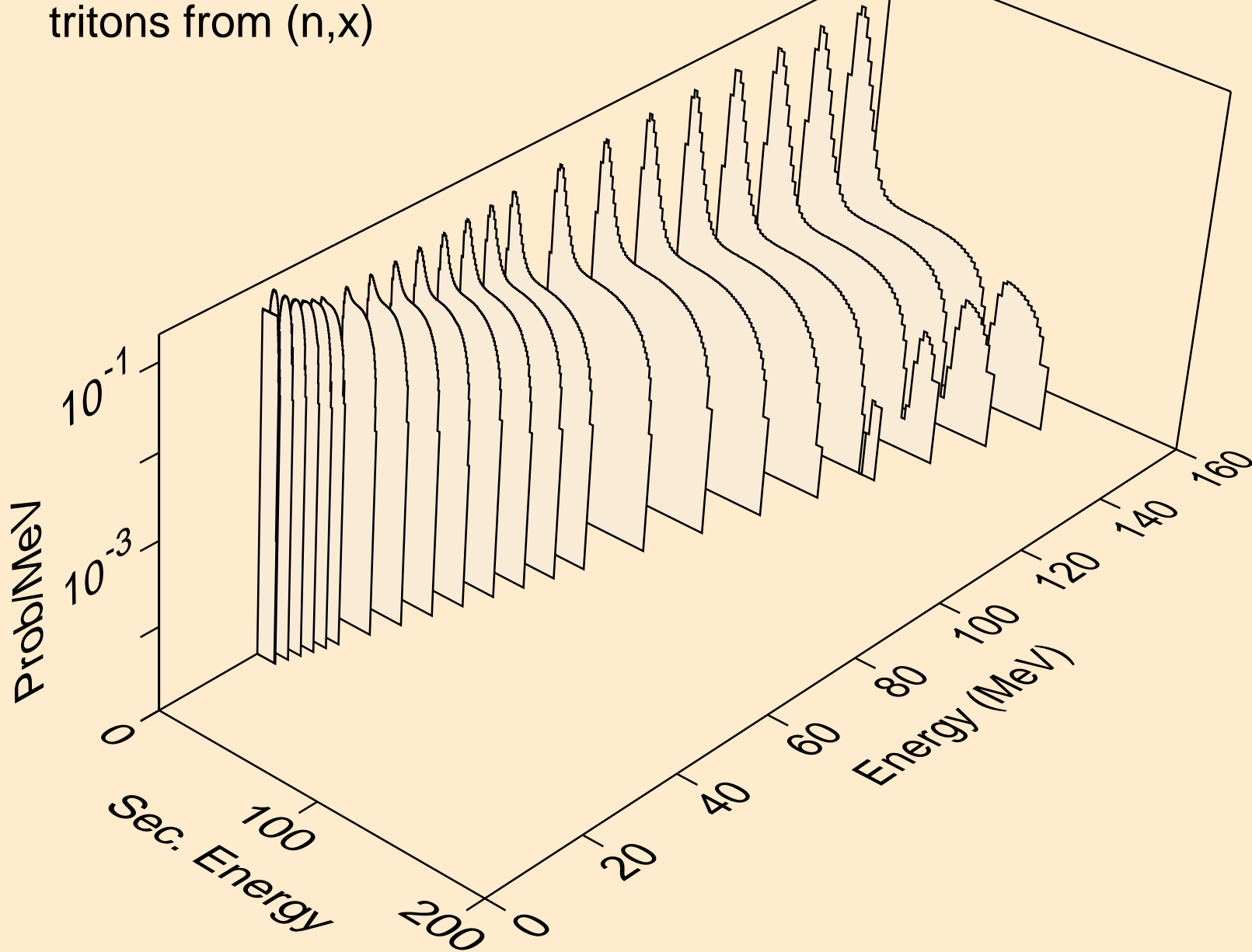

31-GA-69 FOR FENDL-3B2 FROM JENDL-HE WITH NJOY99.304+
alphas from (n,x)

