

42-MO-97 FOR FENDL-3B2 FROM JENDL-HE WITH NJOY99.304+

Principal cross sections

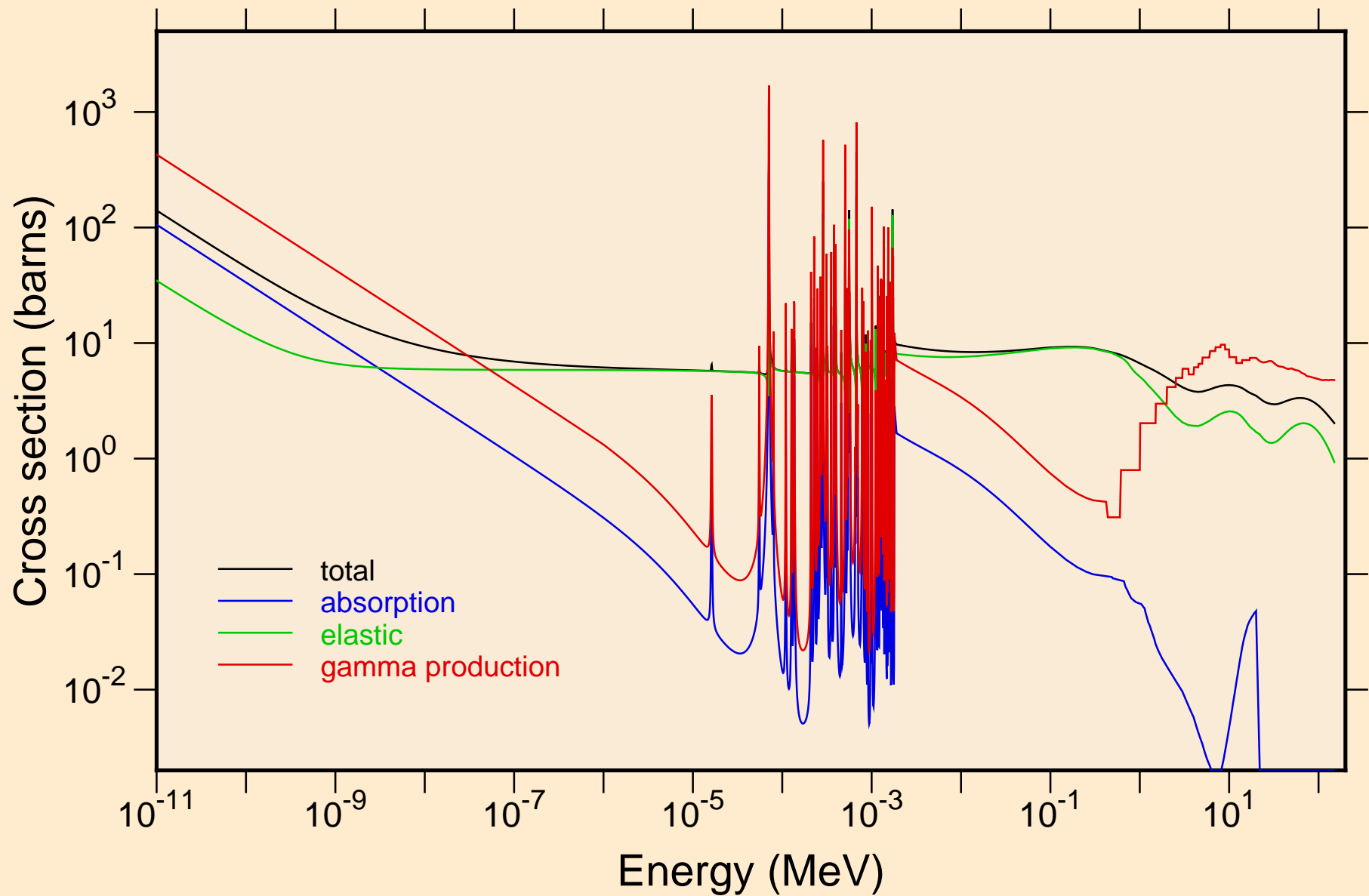

42-MO-97 FOR FENDL-3B2 FROM JENDL-HE WITH NJOY99.304+
resonance total cross section

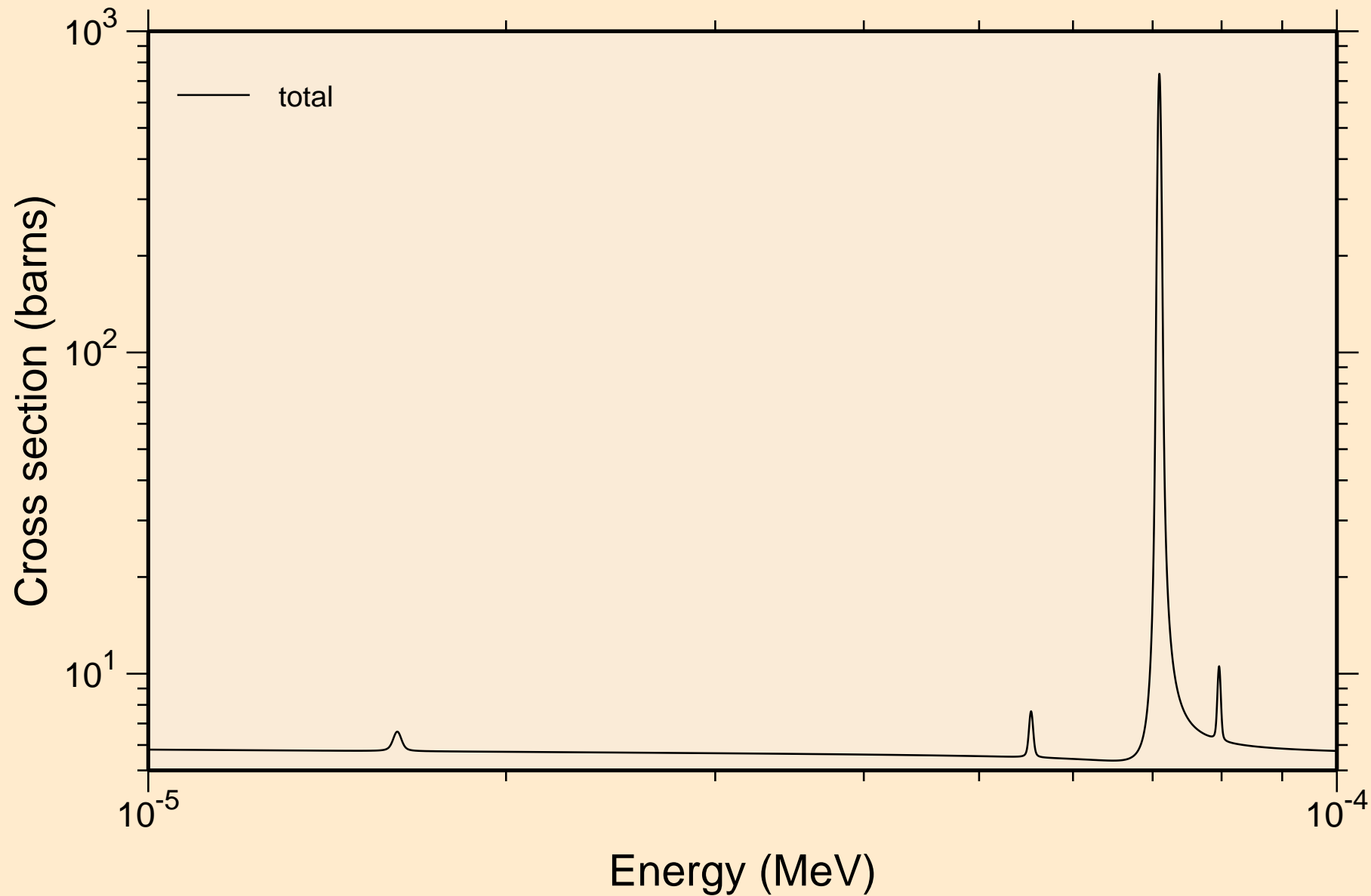

42-MO-97 FOR FENDL-3B2 FROM JENDL-HE WITH NJOY99.304+
resonance total cross section

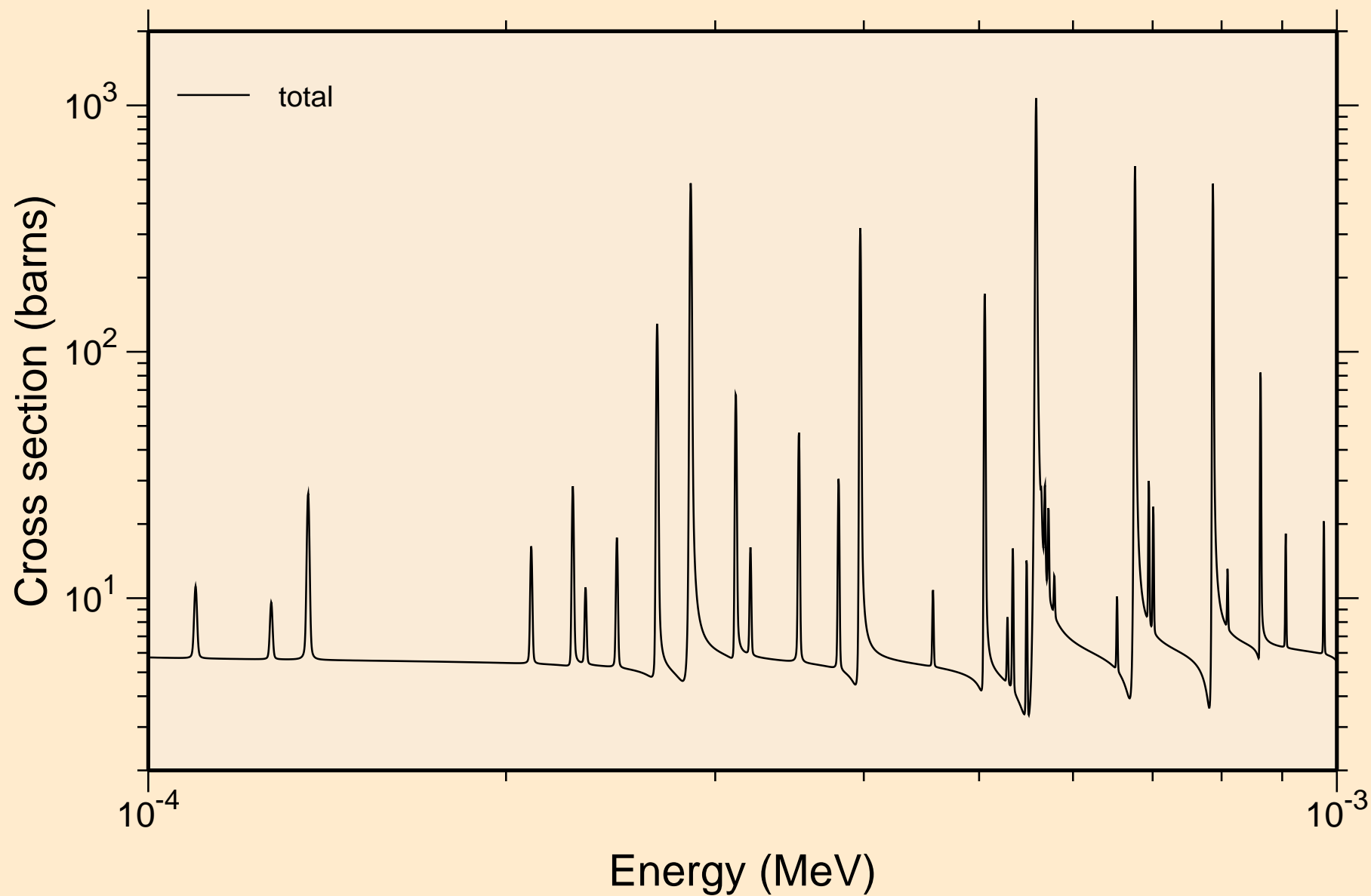

42-MO-97 FOR FENDL-3B2 FROM JENDL-HE WITH NJOY99.304+
resonance total cross section

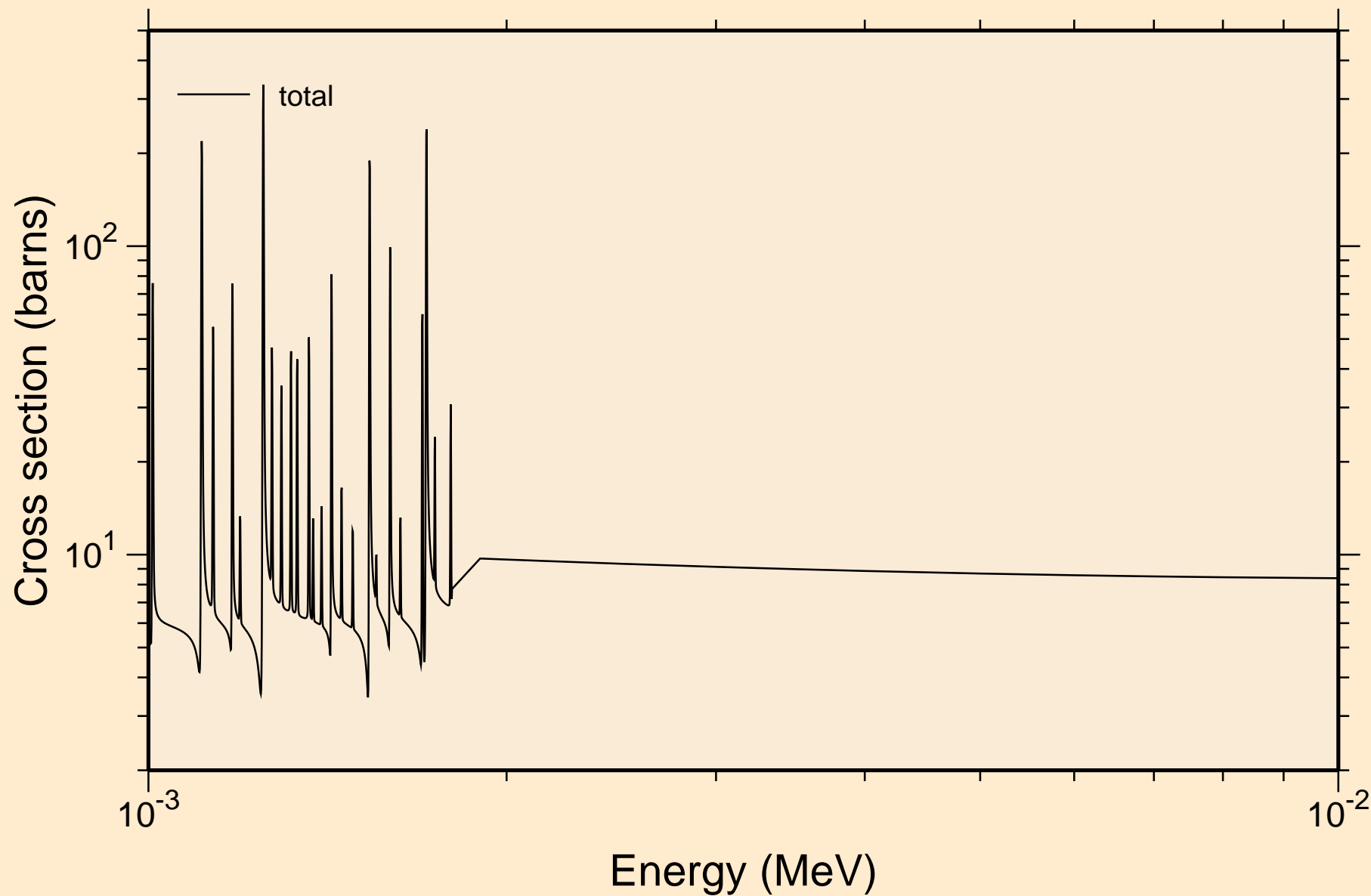

42-MO-97 FOR FENDL-3B2 FROM JENDL-HE WITH NJOY99.304+
resonance total cross section

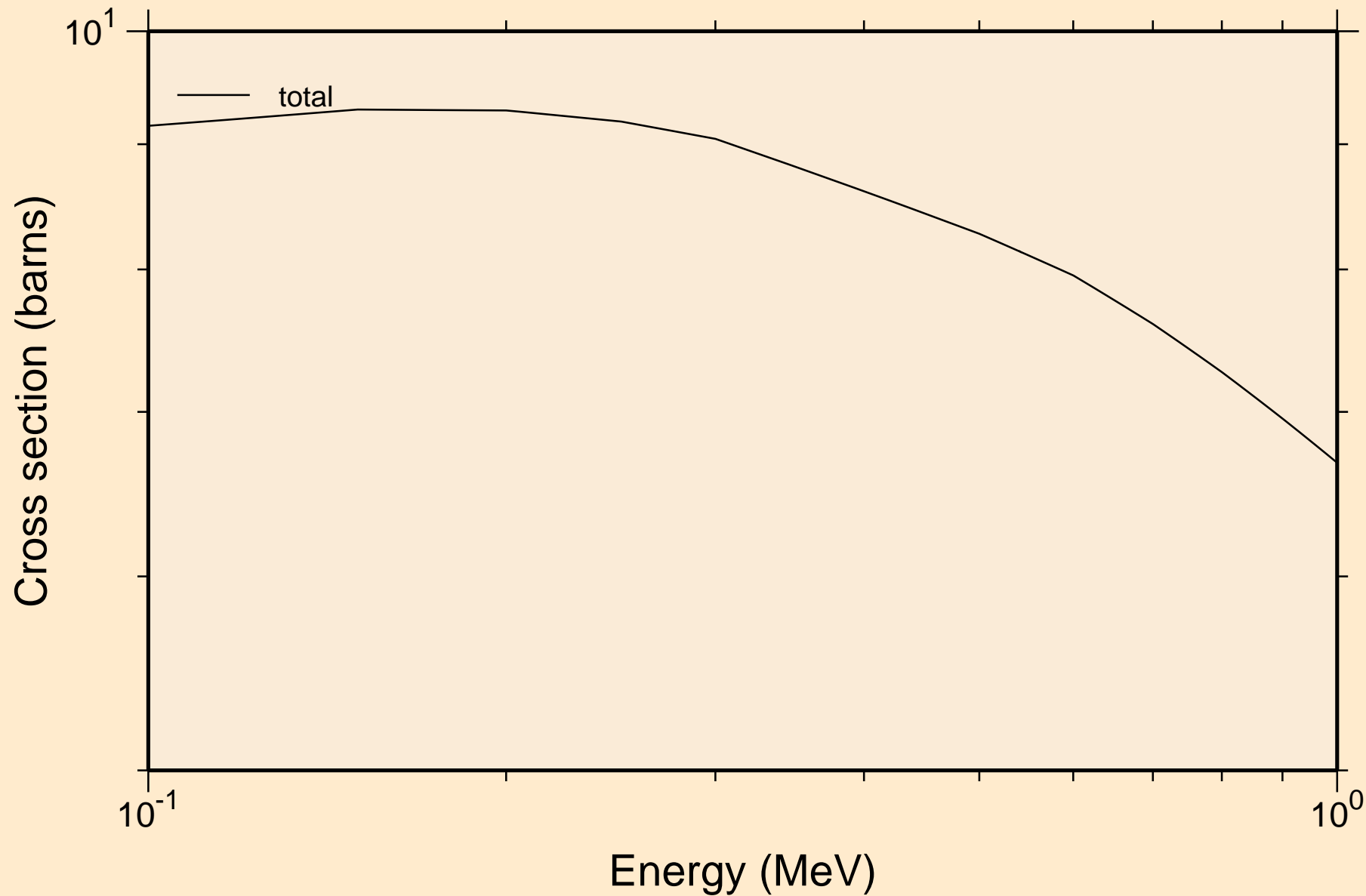

42-MO-97 FOR FENDL-3B2 FROM JENDL-HE WITH NJOY99.304+
resonance total cross section

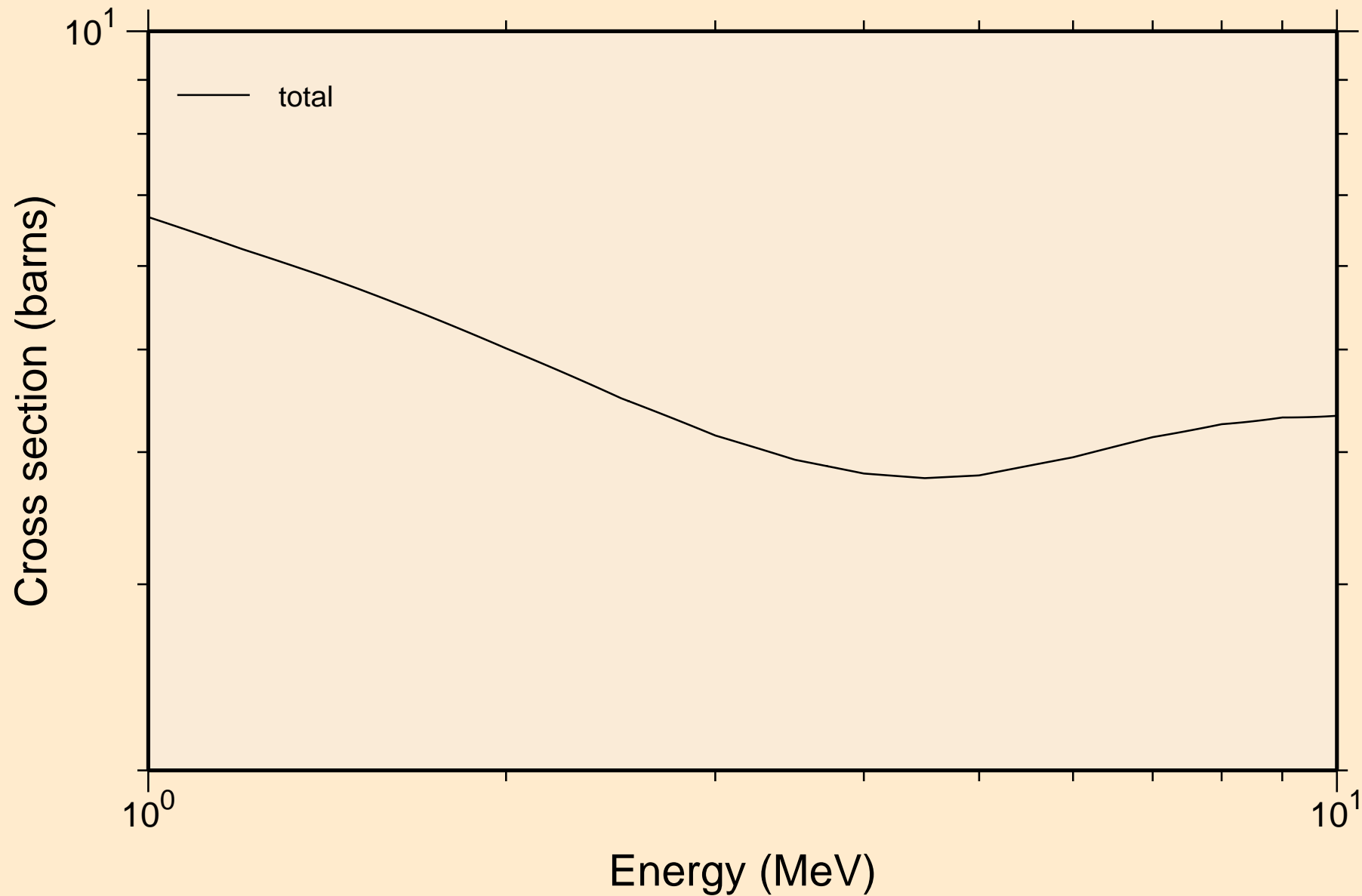

42-MO-97 FOR FENDL-3B2 FROM JENDL-HE WITH NJOY99.304+
resonance absorption cross sections

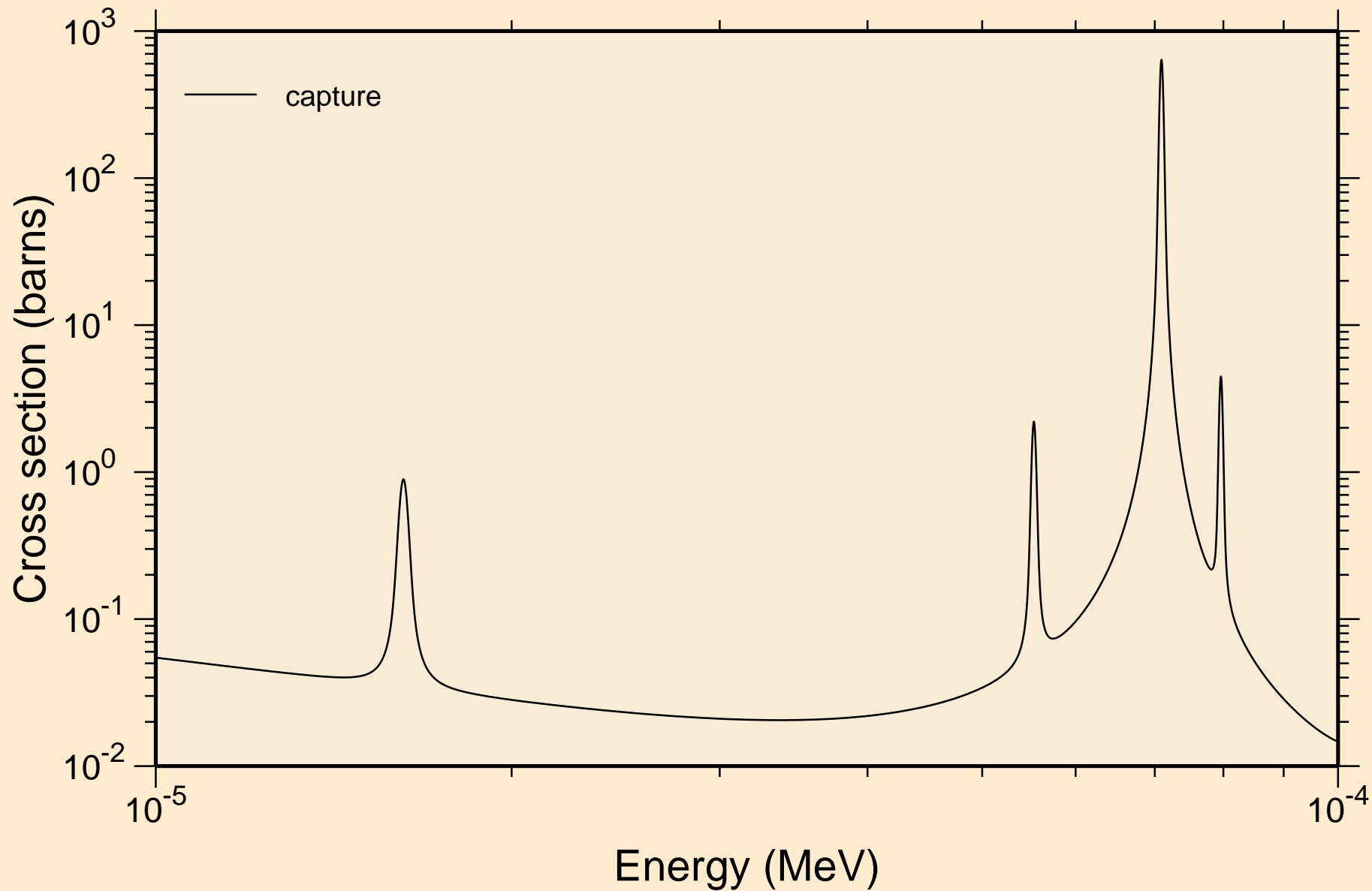

42-MO-97 FOR FENDL-3B2 FROM JENDL-HE WITH NJOY99.304+ resonance absorption cross sections

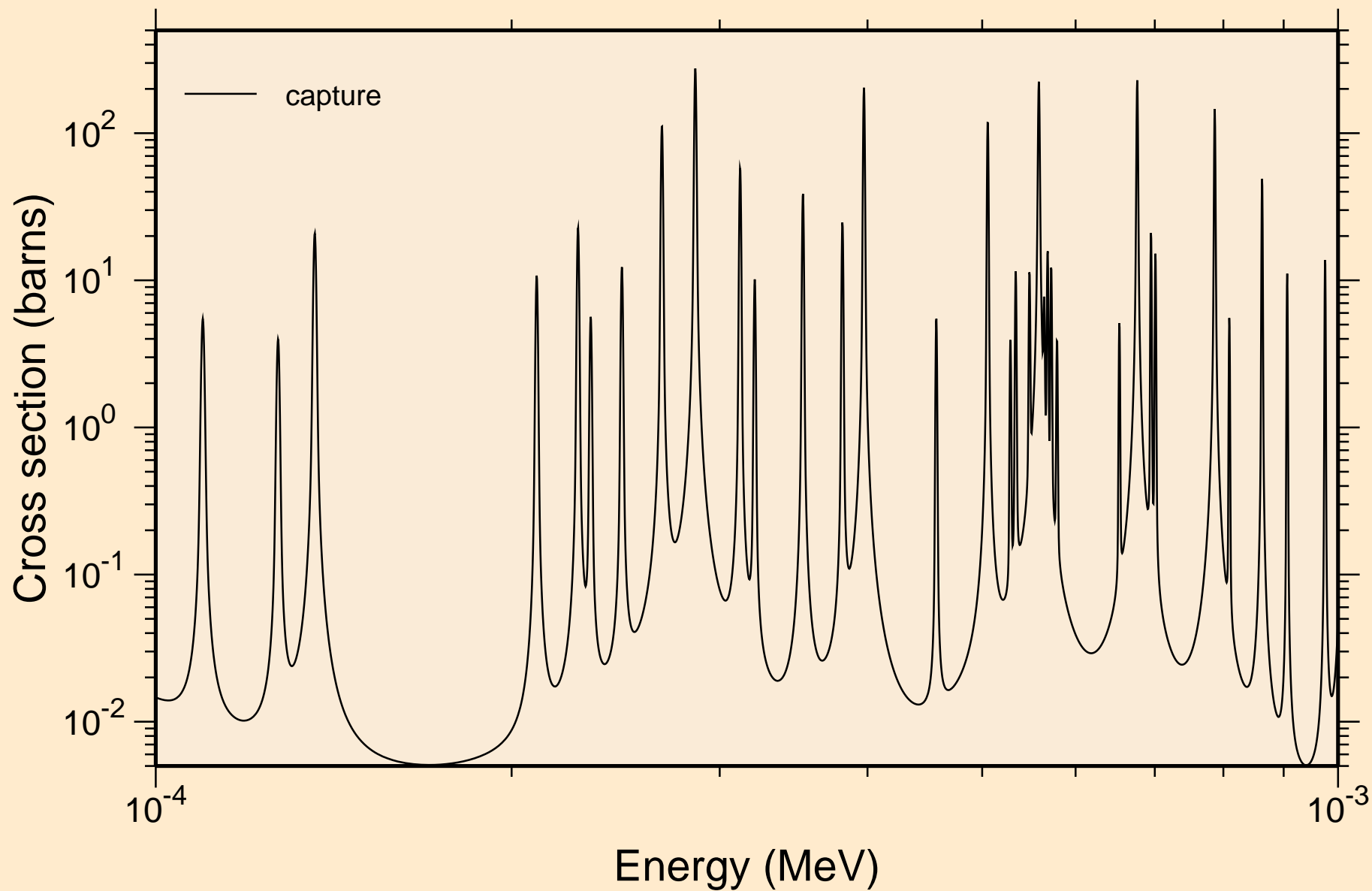

42-MO-97 FOR FENDL-3B2 FROM JENDL-HE WITH NJOY99.304+
resonance absorption cross sections

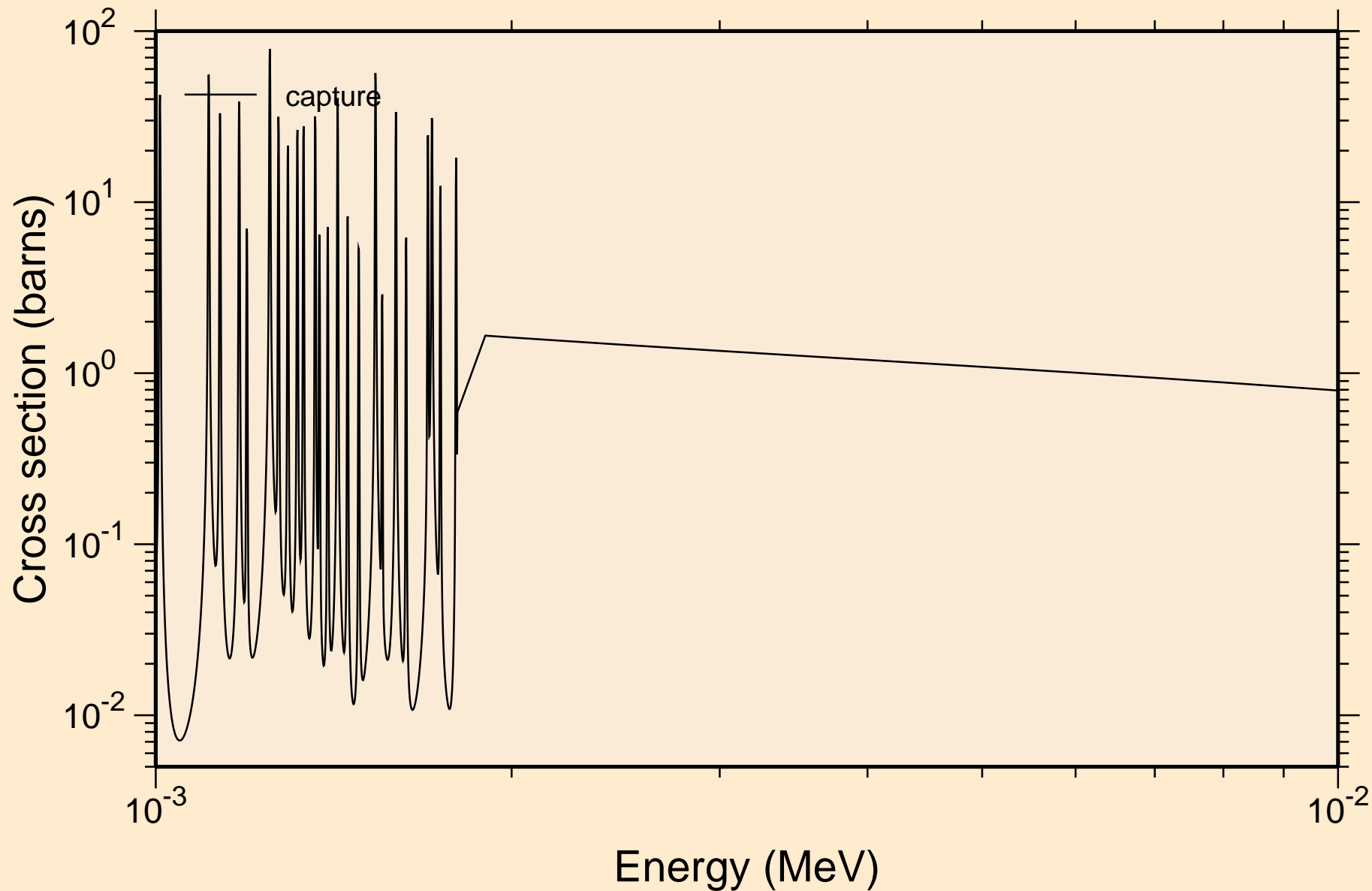

42-MO-97 FOR FENDL-3B2 FROM JENDL-HE WITH NJOY99.304+
resonance absorption cross sections

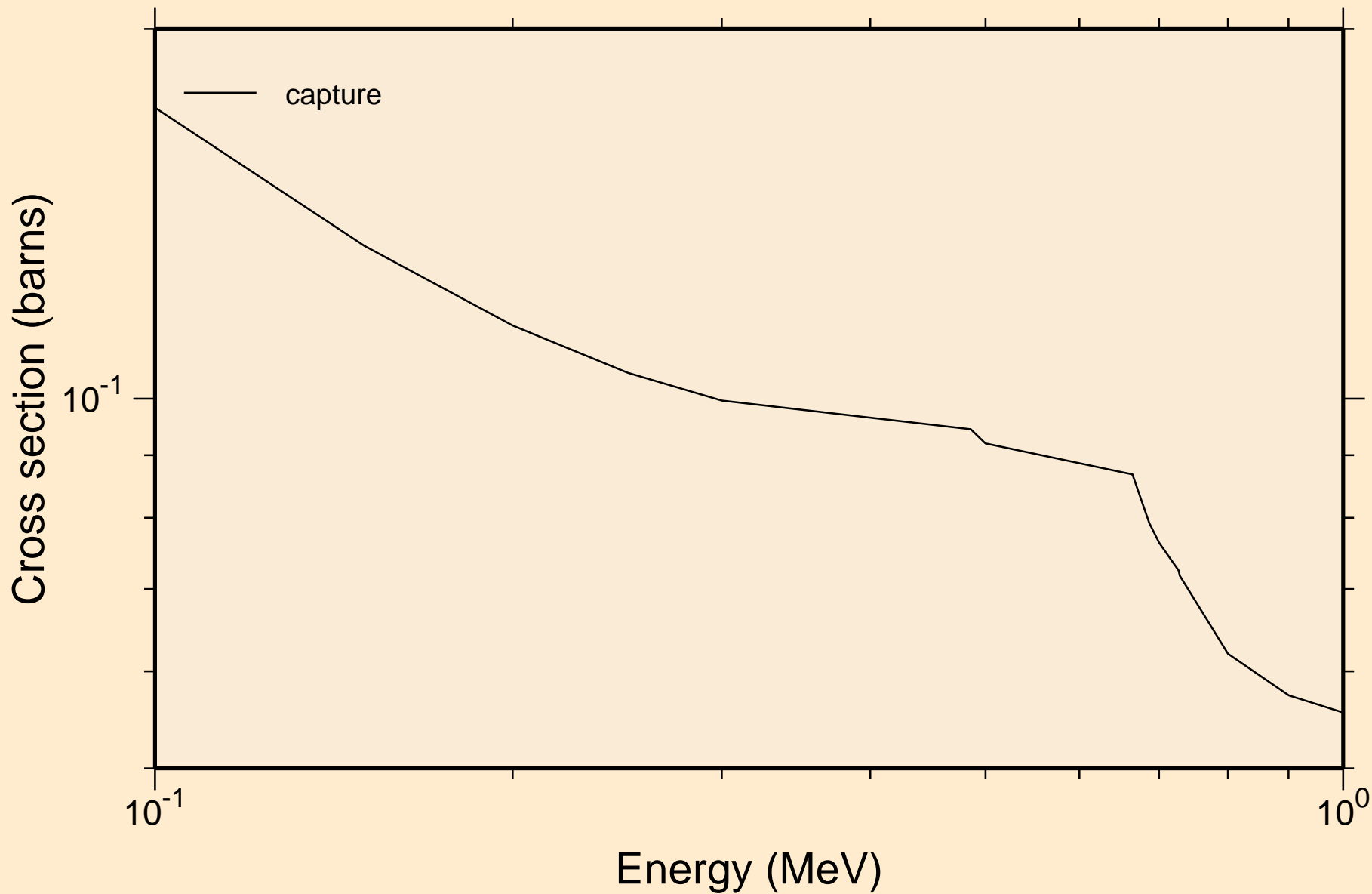

42-MO-97 FOR FENDL-3B2 FROM JENDL-HE WITH NJOY99.304+
resonance absorption cross sections

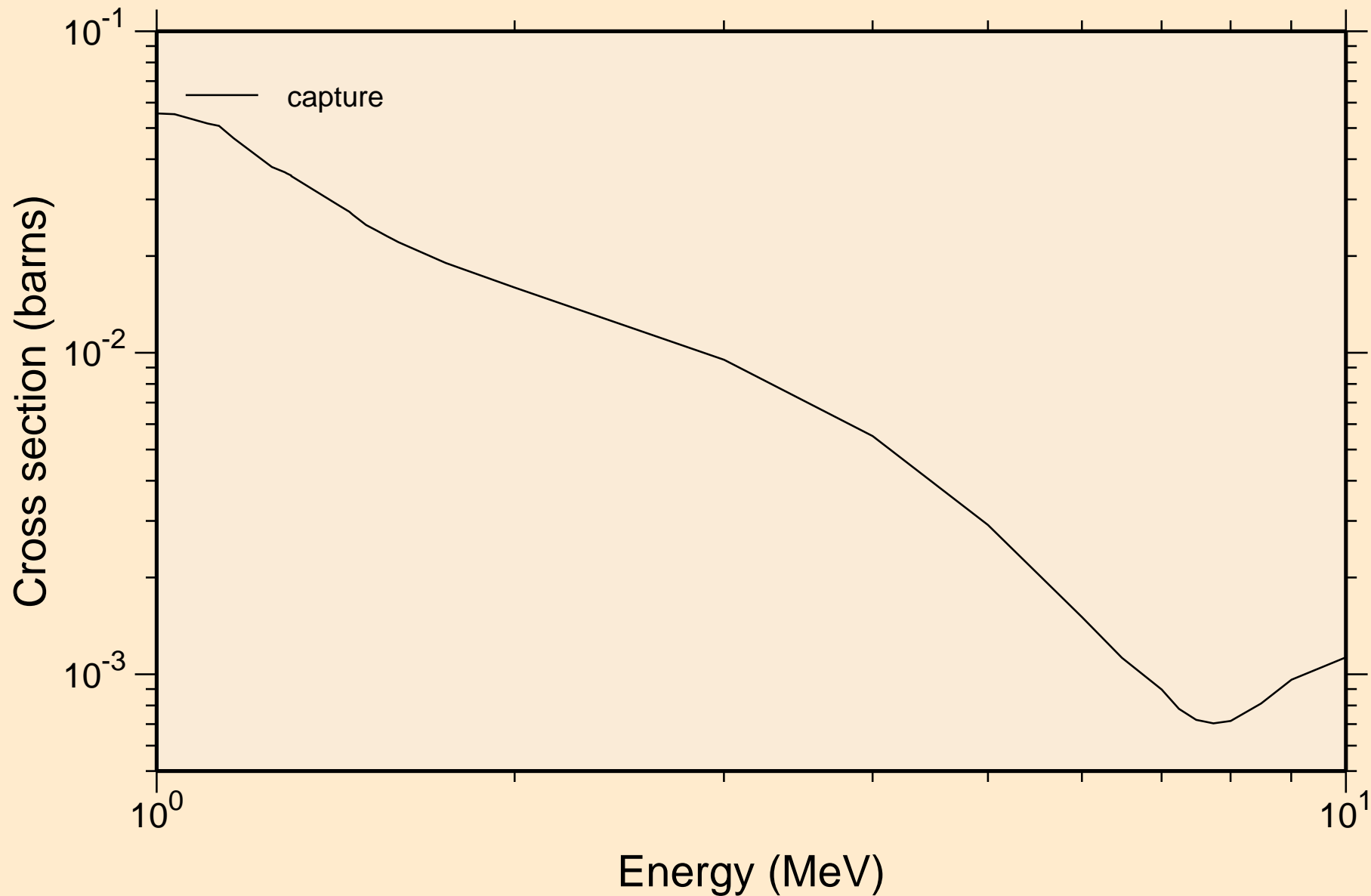

42-MO-97 FOR FENDL-3B2 FROM JENDL-HE WITH NJOY99.304+
UR total cross section

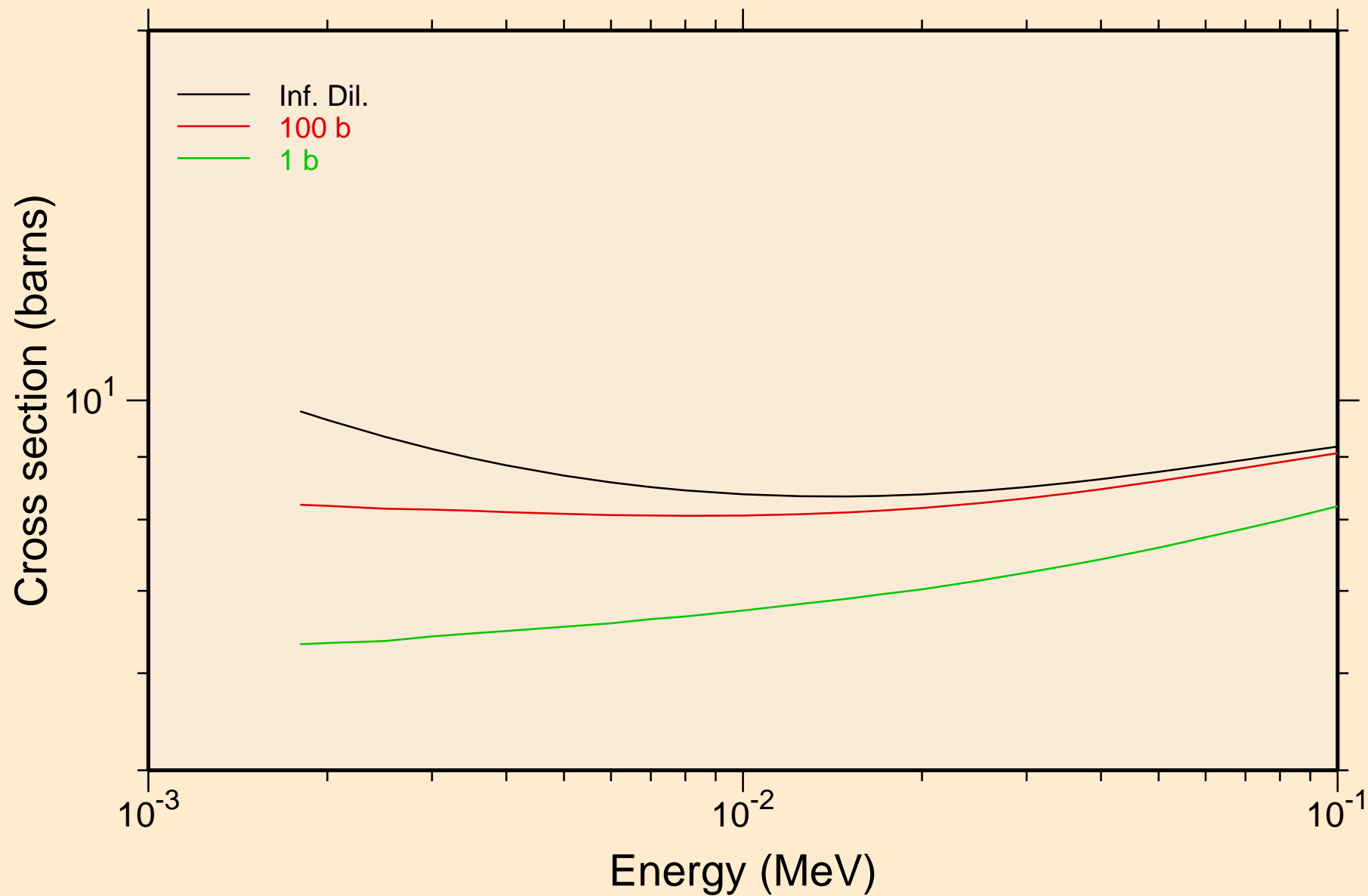

42-MO-97 FOR FENDL-3B2 FROM JENDL-HE WITH NJOY99.304+
UR elastic cross section

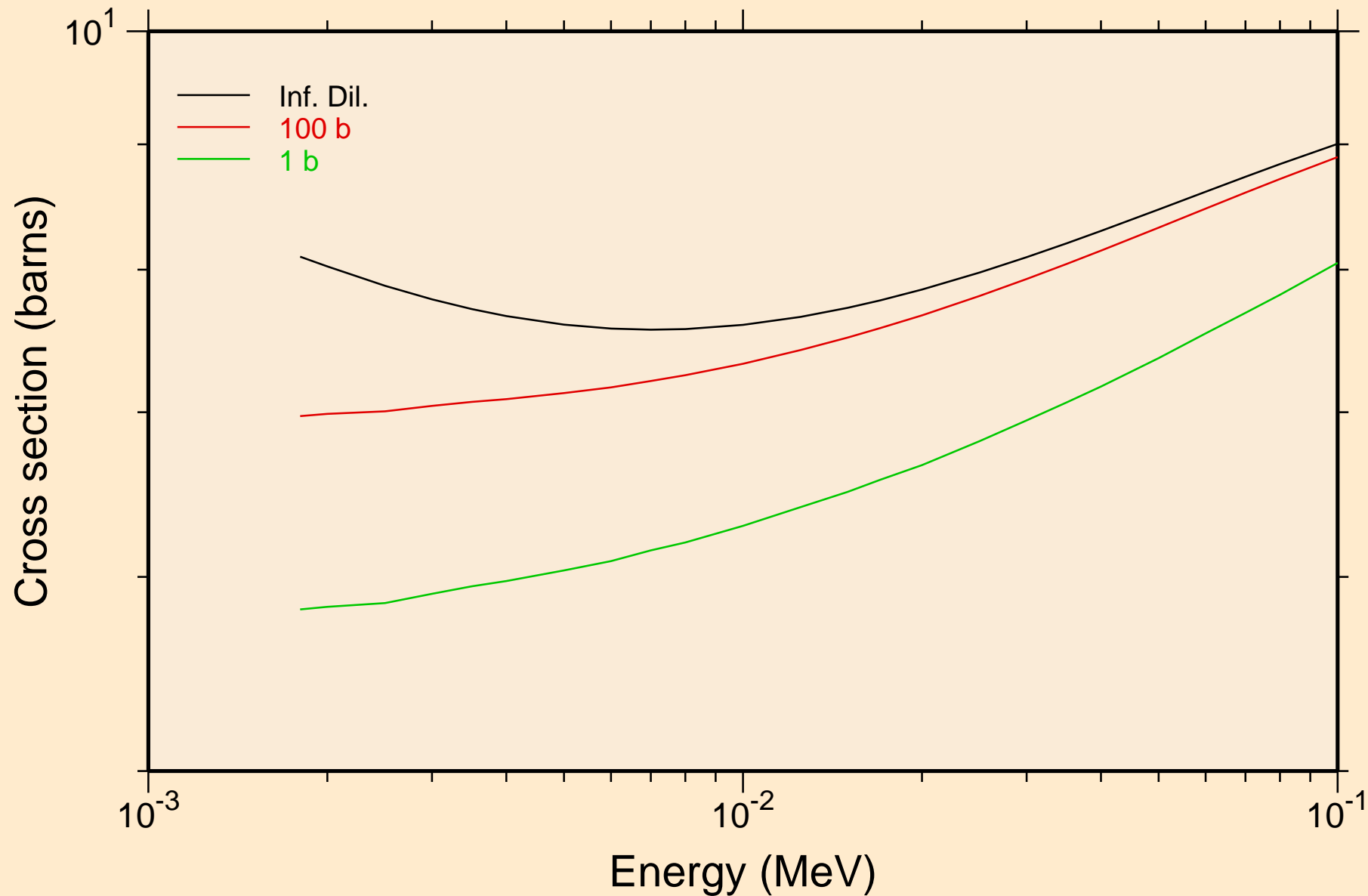

42-MO-97 FOR FENDL-3B2 FROM JENDL-HE WITH NJOY99.304+
UR capture cross section

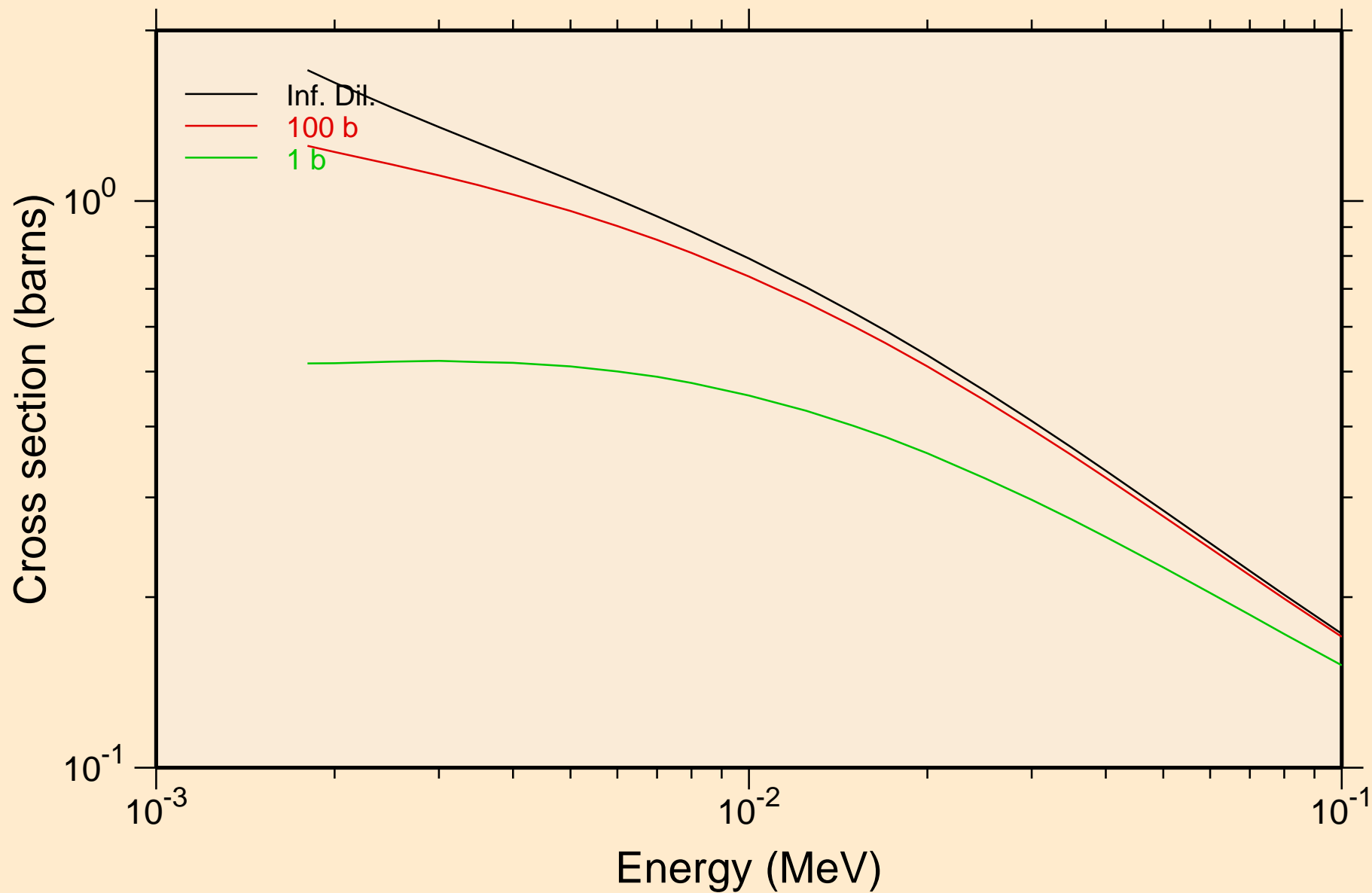

42-MO-97 FOR FENDL-3B2 FROM JENDL-HE WITH NJOY99.304+ Heating

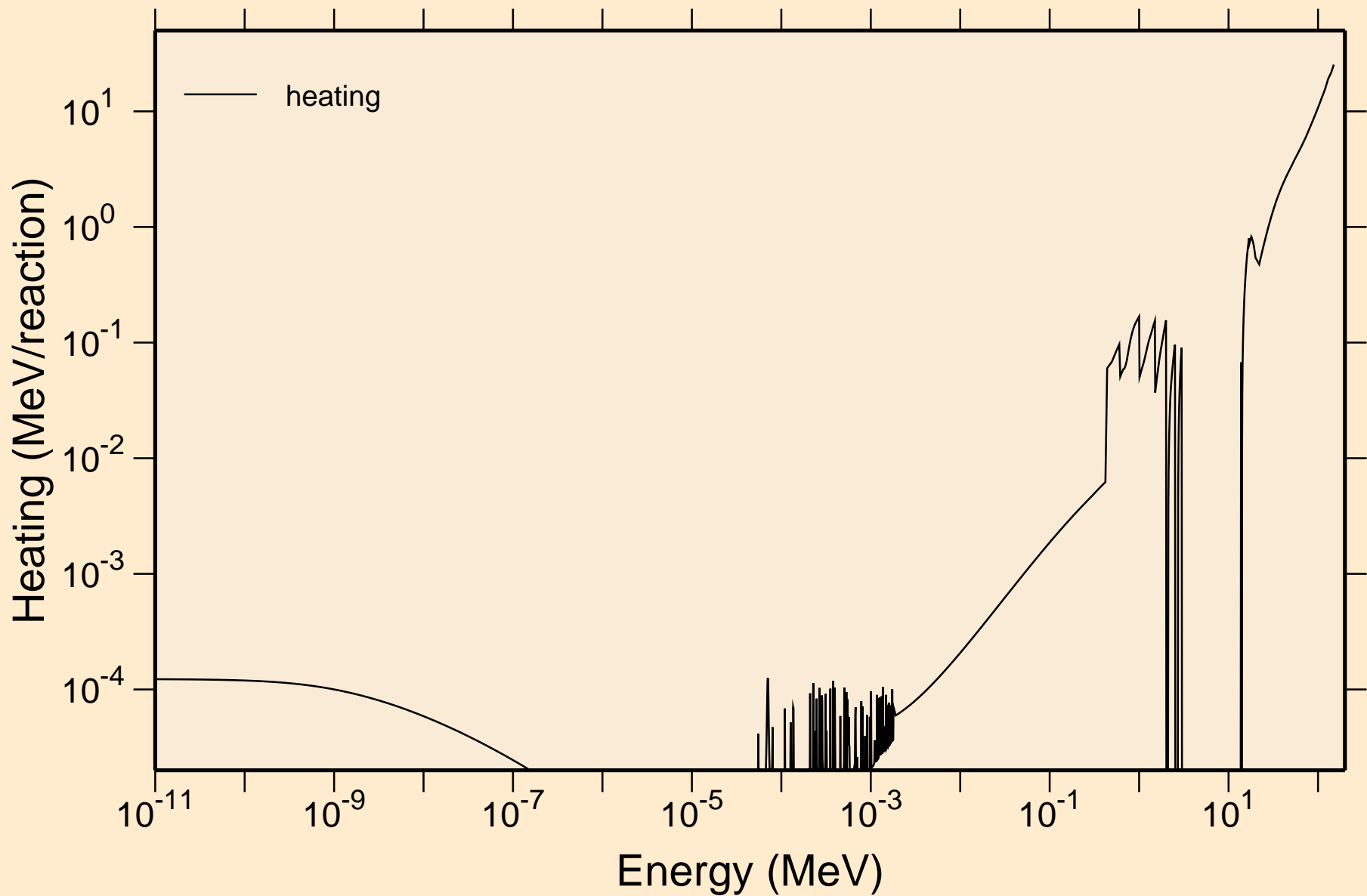

42-MO-97 FOR FENDL-3B2 FROM JENDL-HE WITH NJOY99.304+ Damage

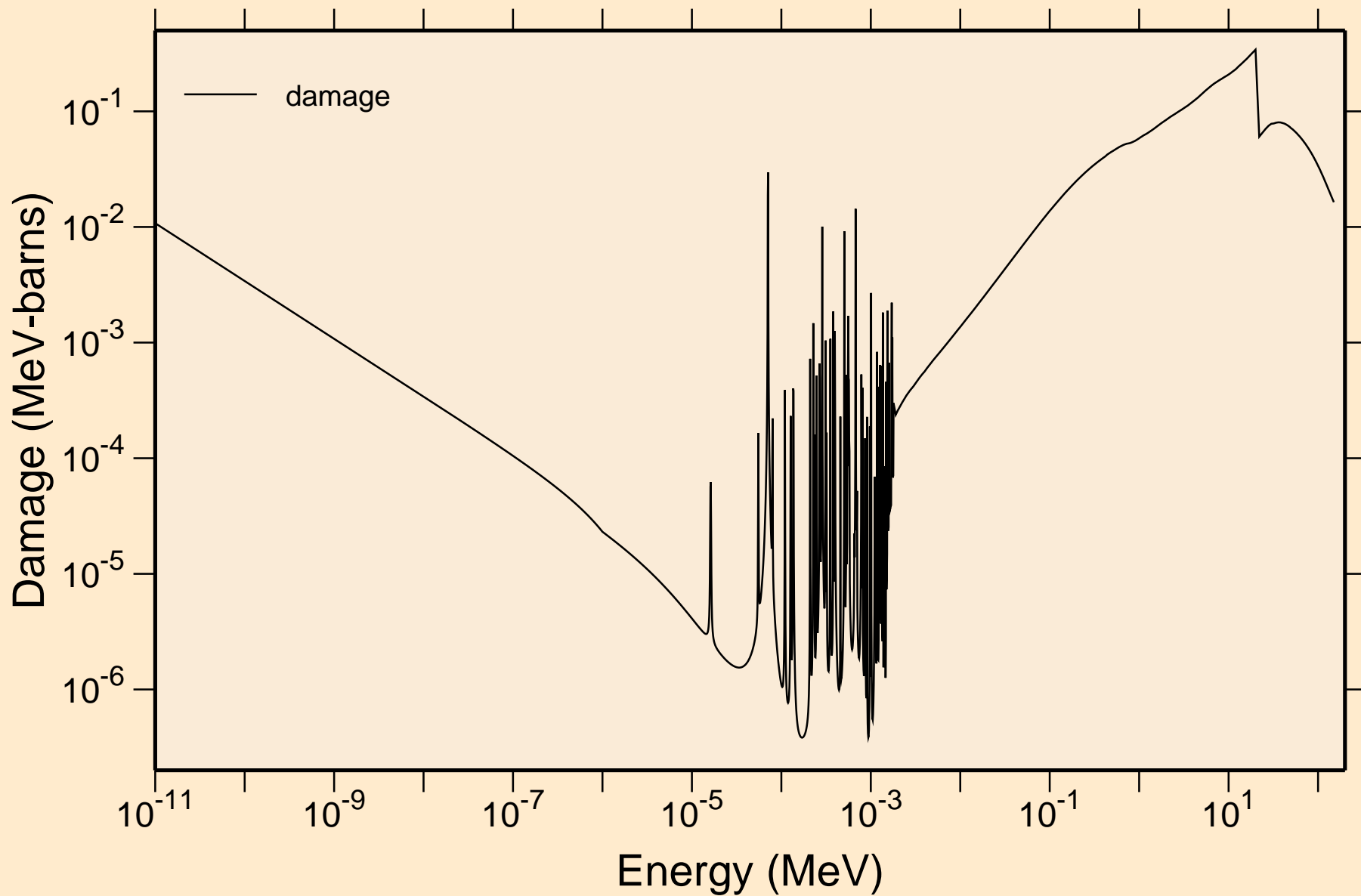

42-MO-97 FOR FENDL-3B2 FROM JENDL-HE WITH NJOY99.304+
Non-threshold reactions

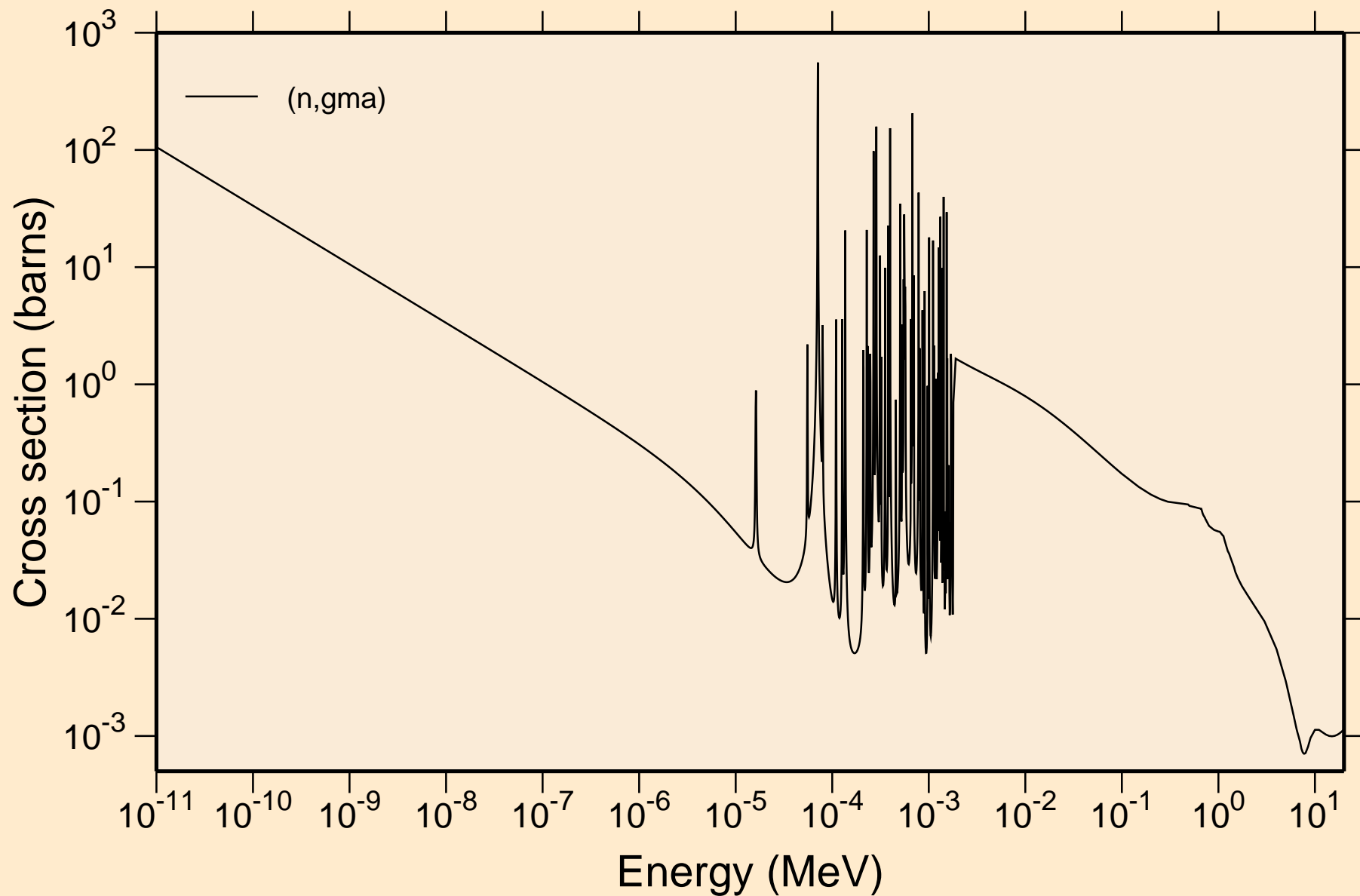

42-MO-97 FOR FENDL-3B2 FROM JENDL-HE WITH NJOY99.304+

Principal cross sections

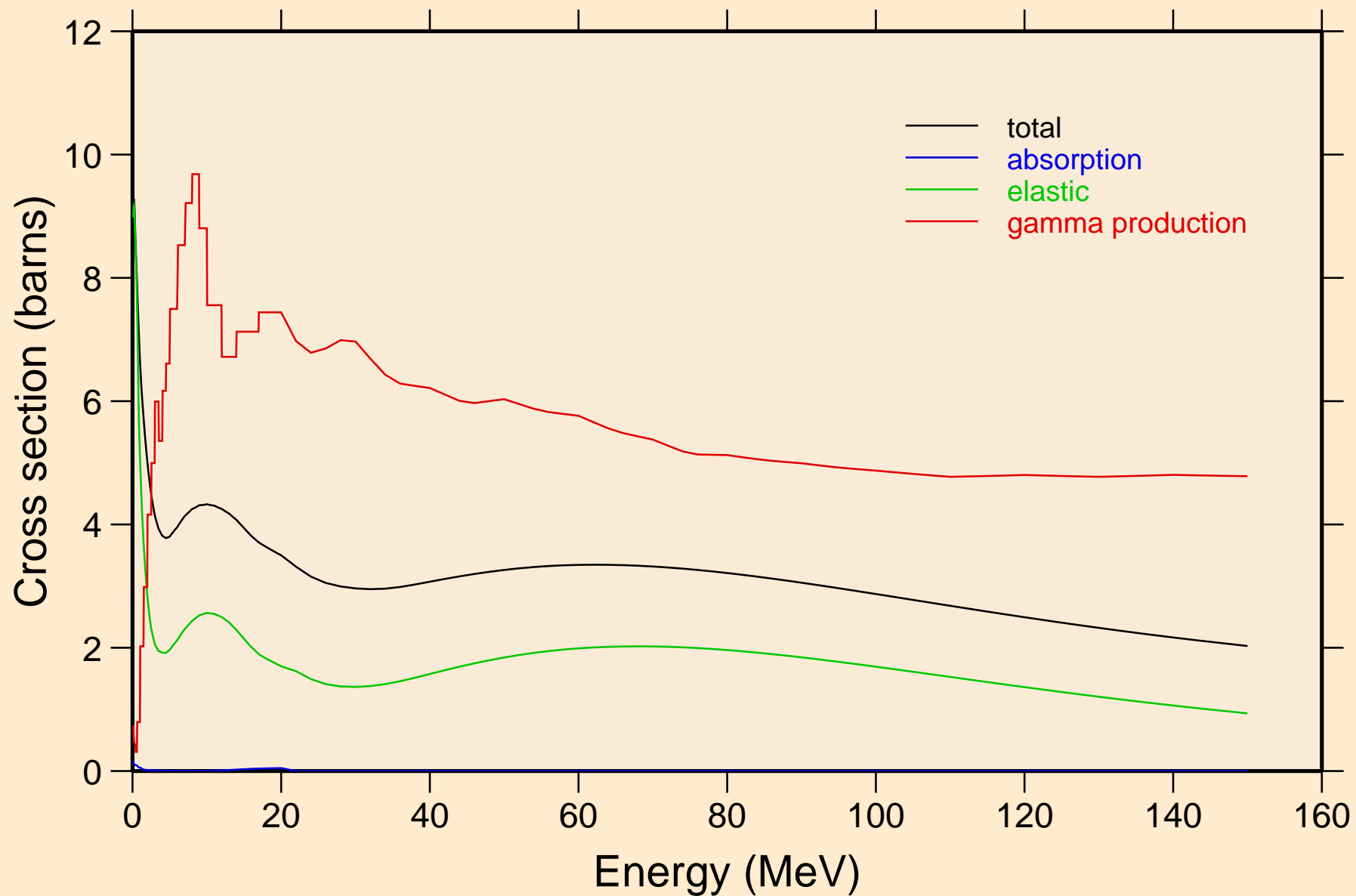

42-MO-97 FOR FENDL-3B2 FROM JENDL-HE WITH NJOY99.304+ Heating

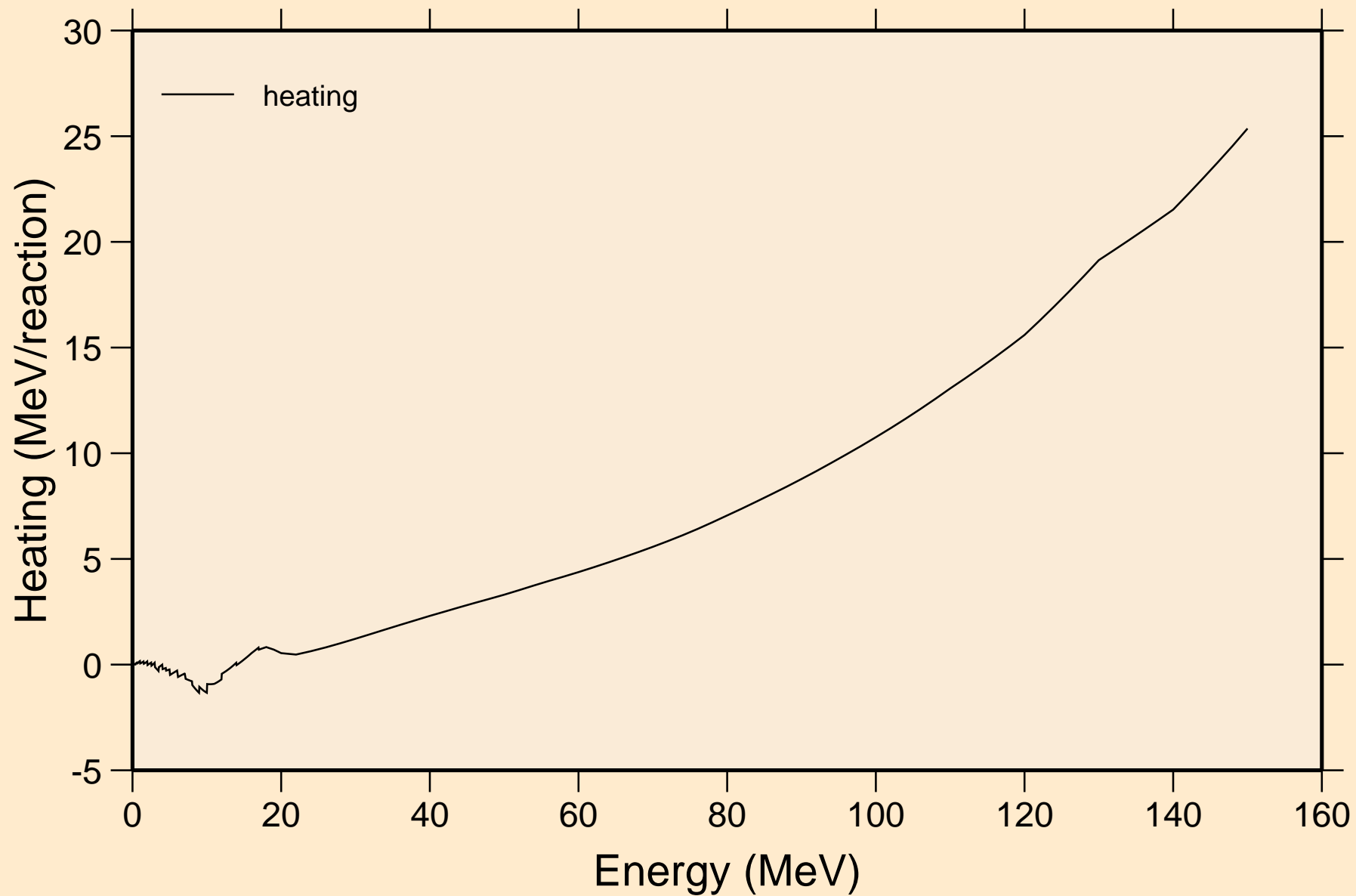

42-MO-97 FOR FENDL-3B2 FROM JENDL-HE WITH NJOY99.304+ Damage

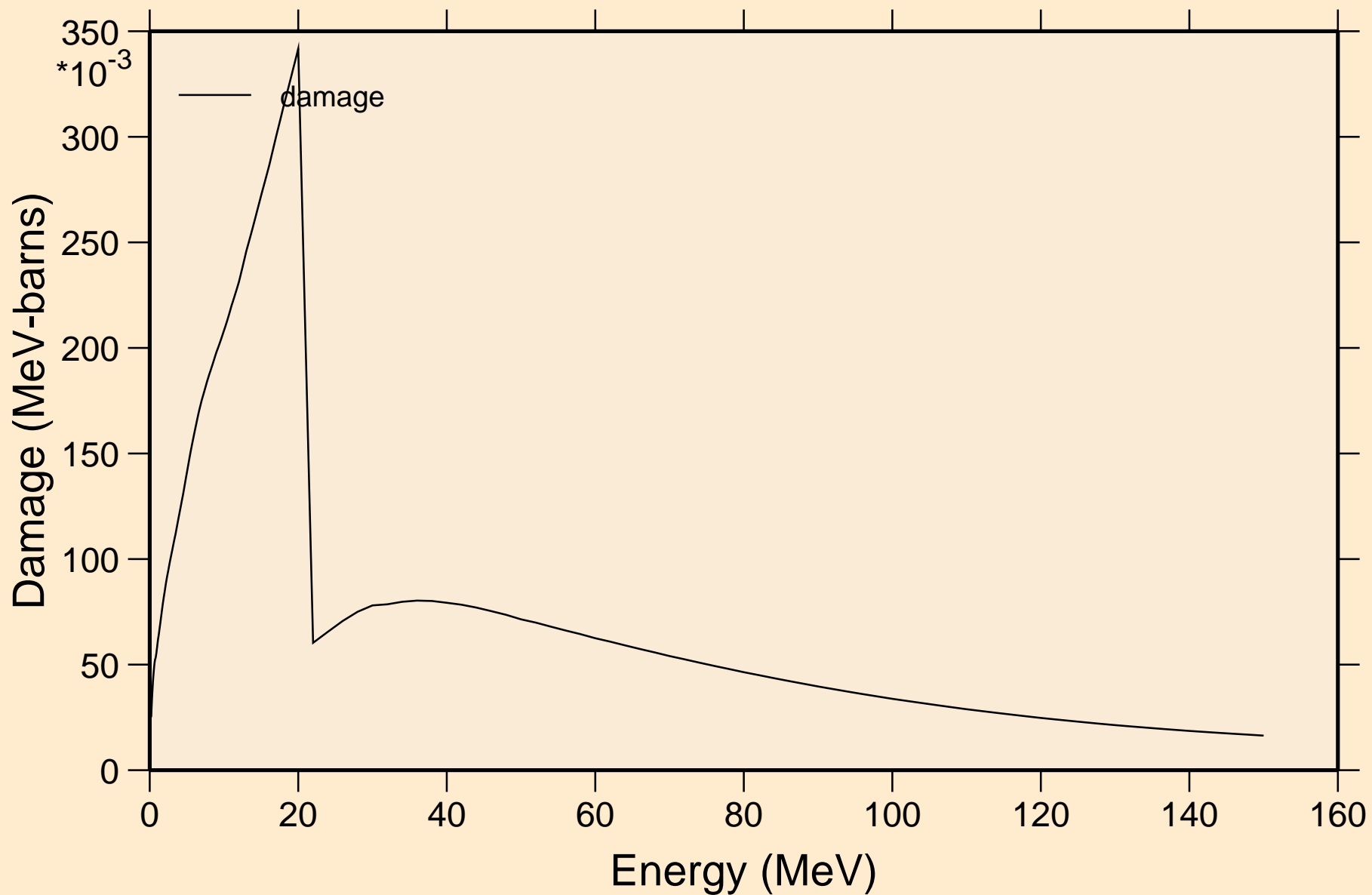

42-MO-97 FOR FENDL-3B2 FROM JENDL-HE WITH NJOY99.304+
Non-threshold reactions

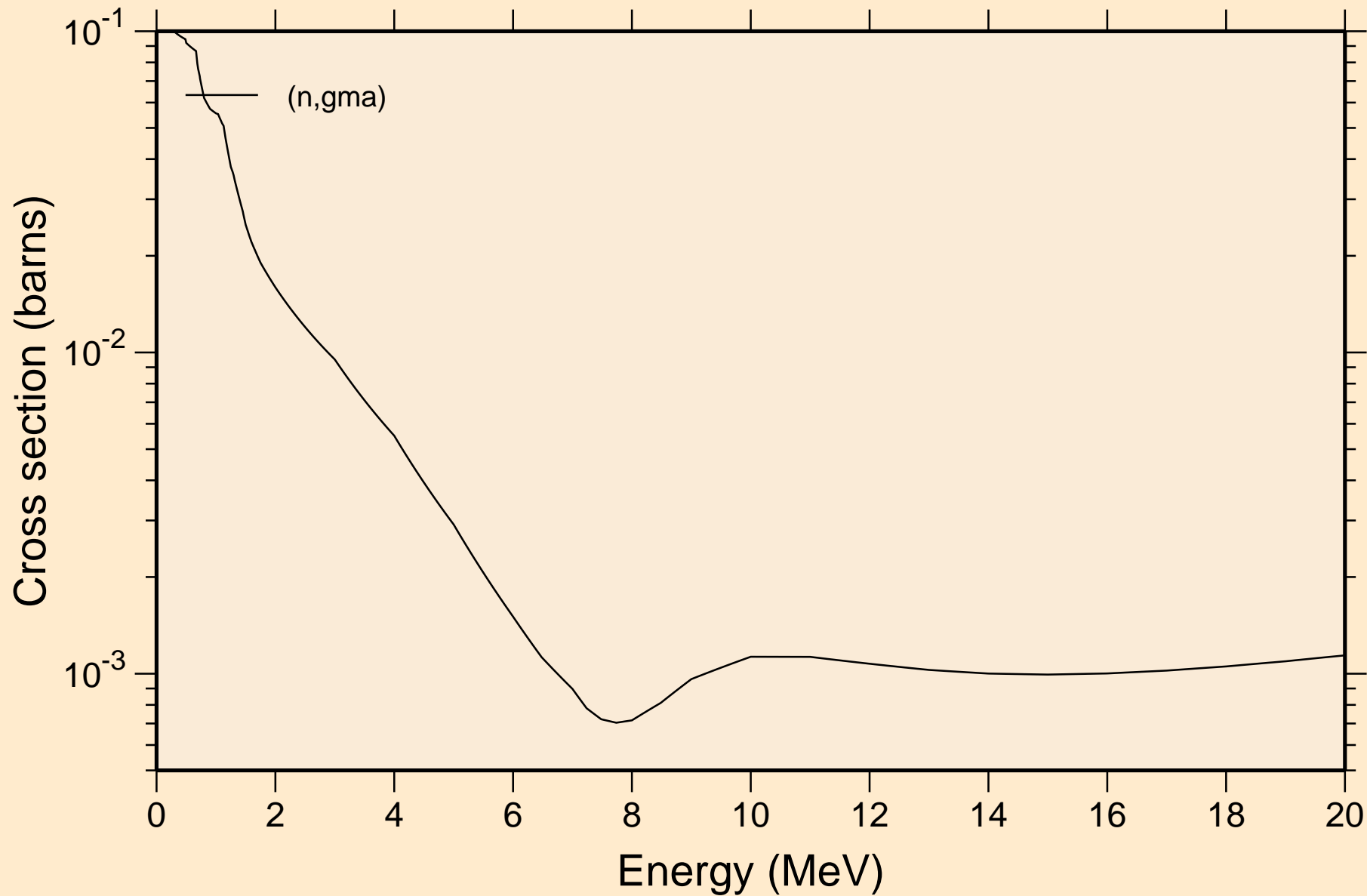

42-MO-97 FOR FENDL-3B2 FROM JENDL-HE WITH NJOY99.304+
Inelastic levels

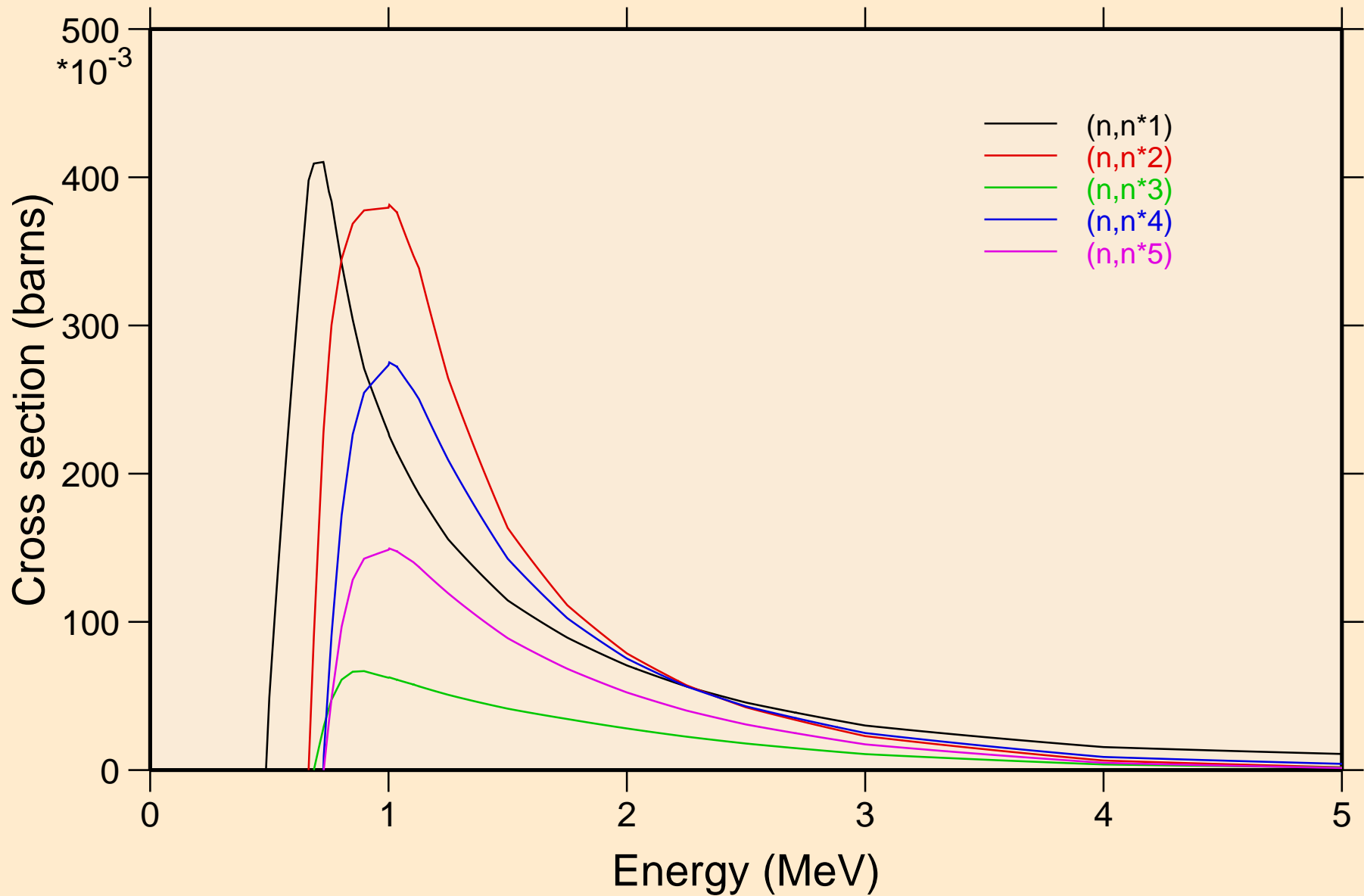

42-MO-97 FOR FENDL-3B2 FROM JENDL-HE WITH NJOY99.304+ Inelastic levels

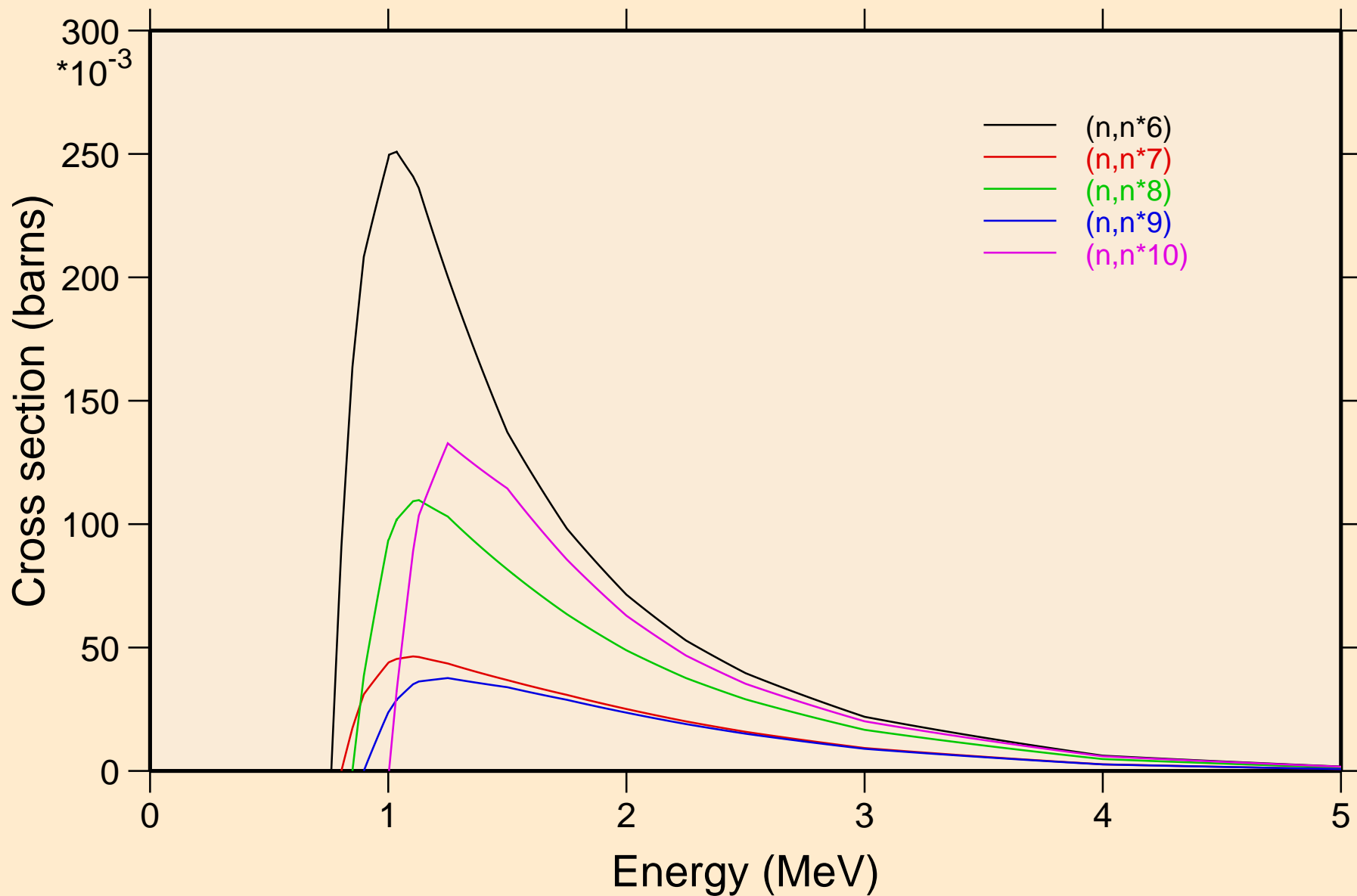

42-MO-97 FOR FENDL-3B2 FROM JENDL-HE WITH NJOY99.304+
Inelastic levels

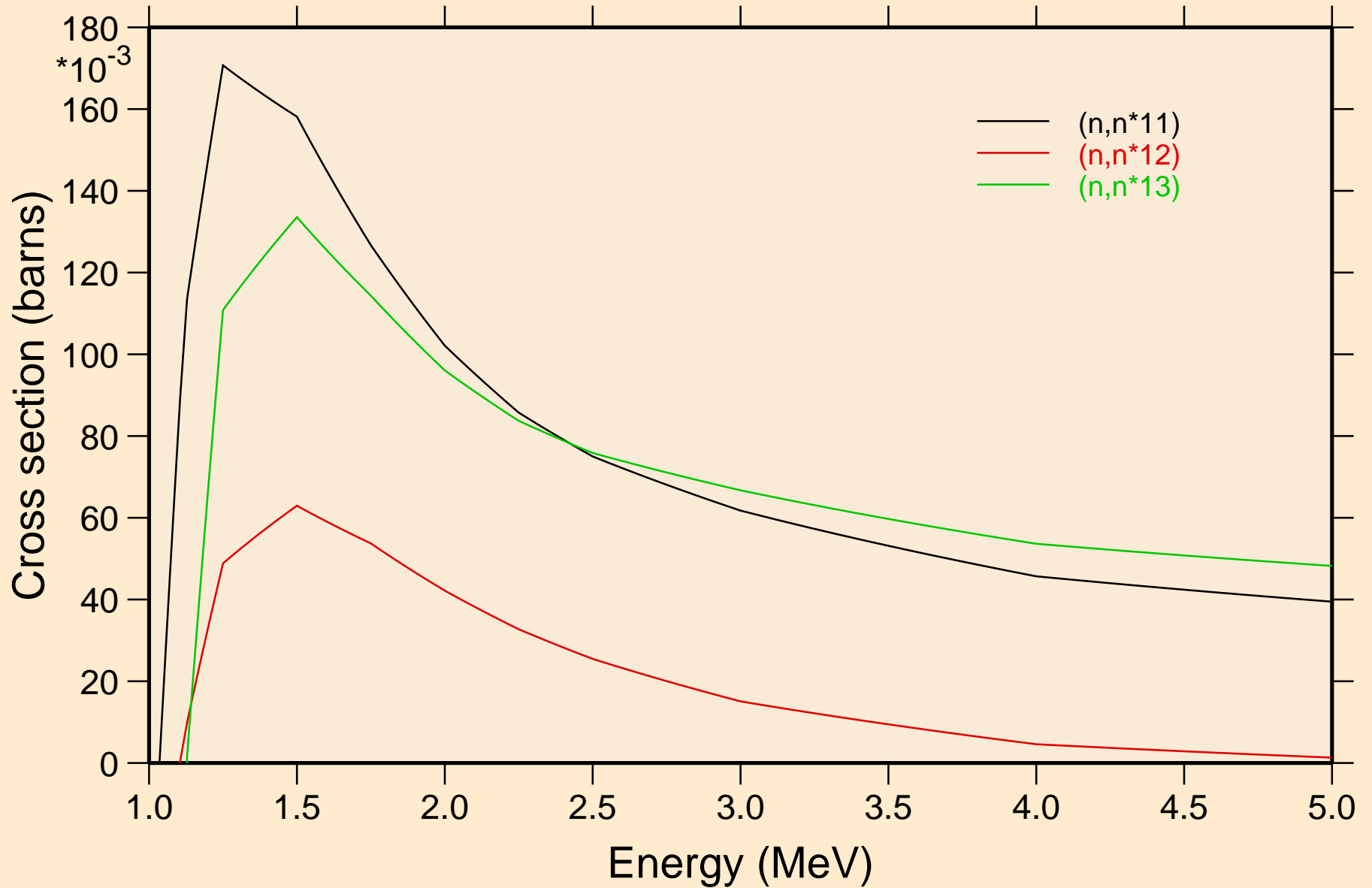

42-MO-97 FOR FENDL-3B2 FROM JENDL-HE WITH NJOY99.304+
Threshold reactions

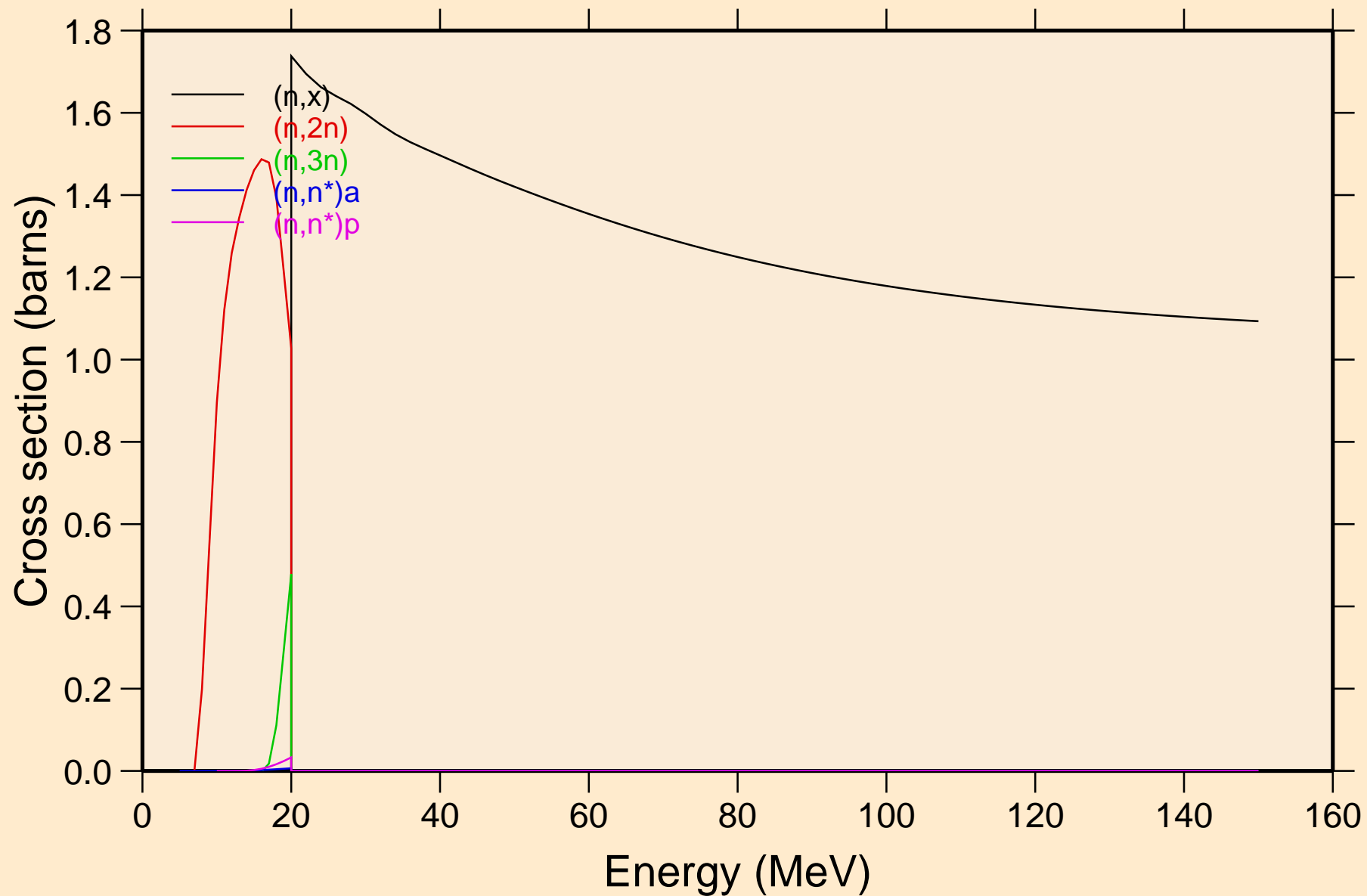

42-MO-97 FOR FENDL-3B2 FROM JENDL-HE WITH NJOY99.304+ Threshold reactions

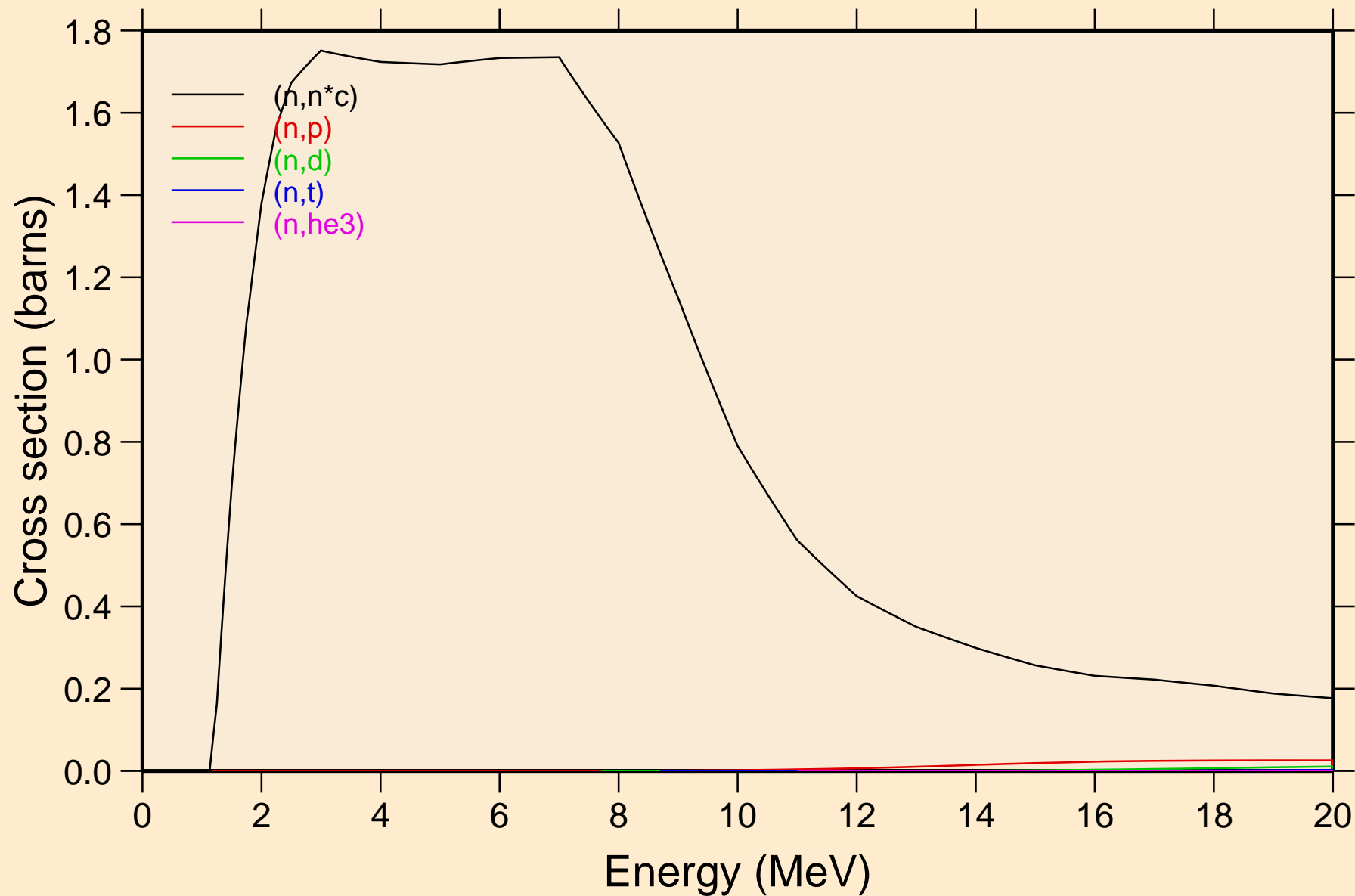

42-MO-97 FOR FENDL-3B2 FROM JENDL-HE WITH NJOY99.304+
Threshold reactions

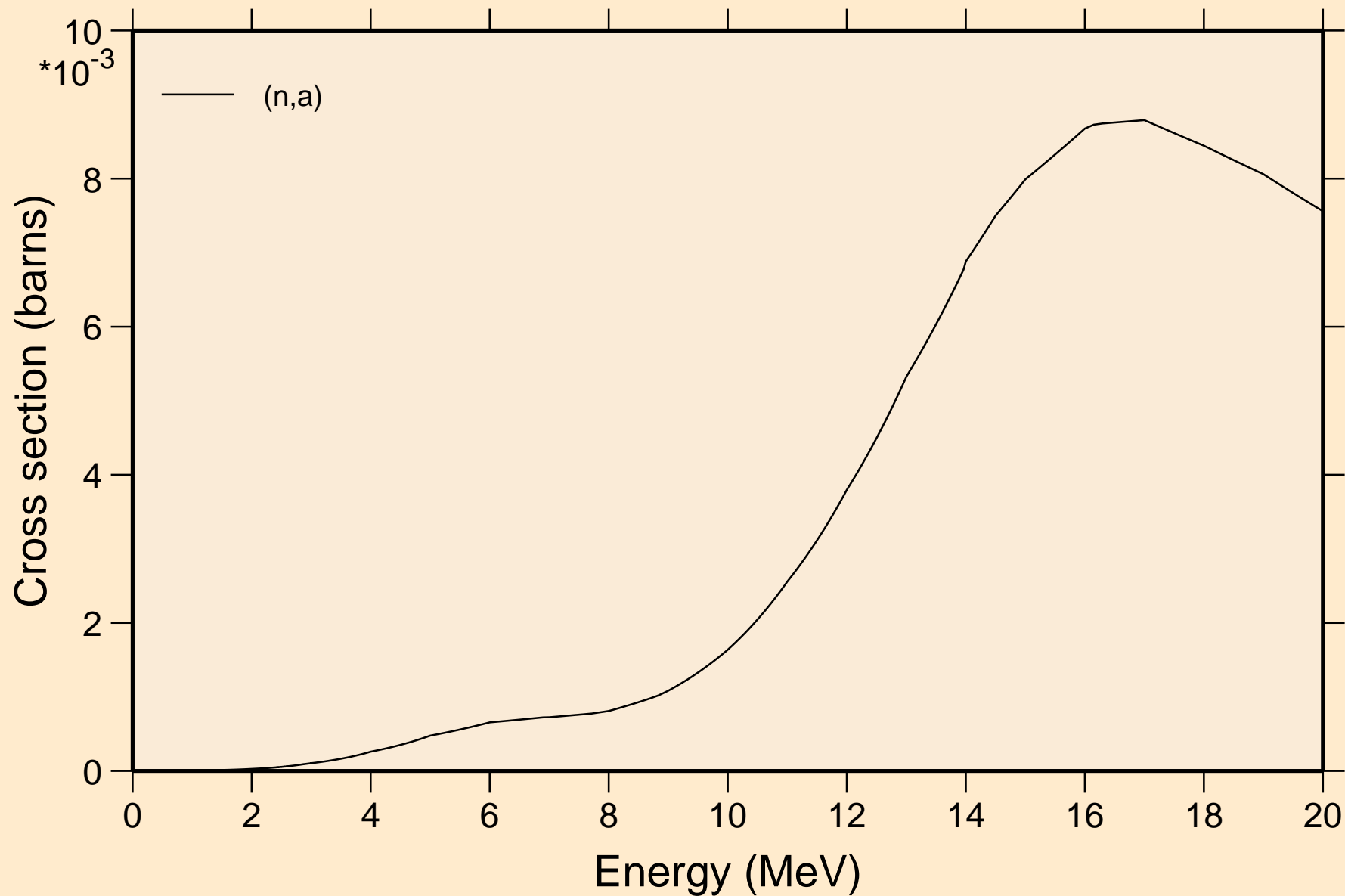

42-MO-97 FOR FENDL-3B2 FROM JENDL-HE WITH NJOY99.304+

Threshold reactions

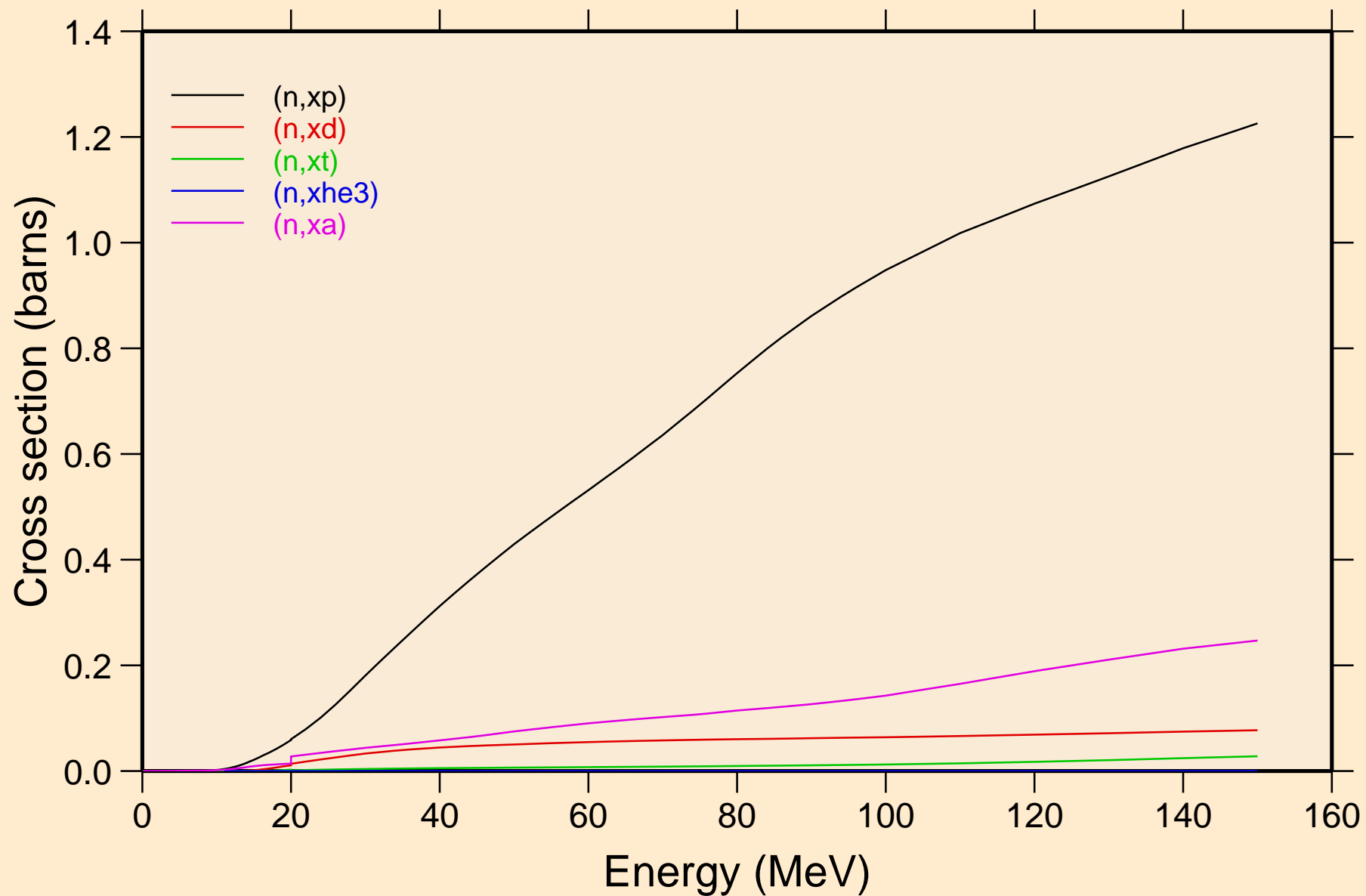

42-MO-97 FOR FENDL-3B2 FROM JENDL-HE WITH NJOY99.304+
angular distribution for elastic

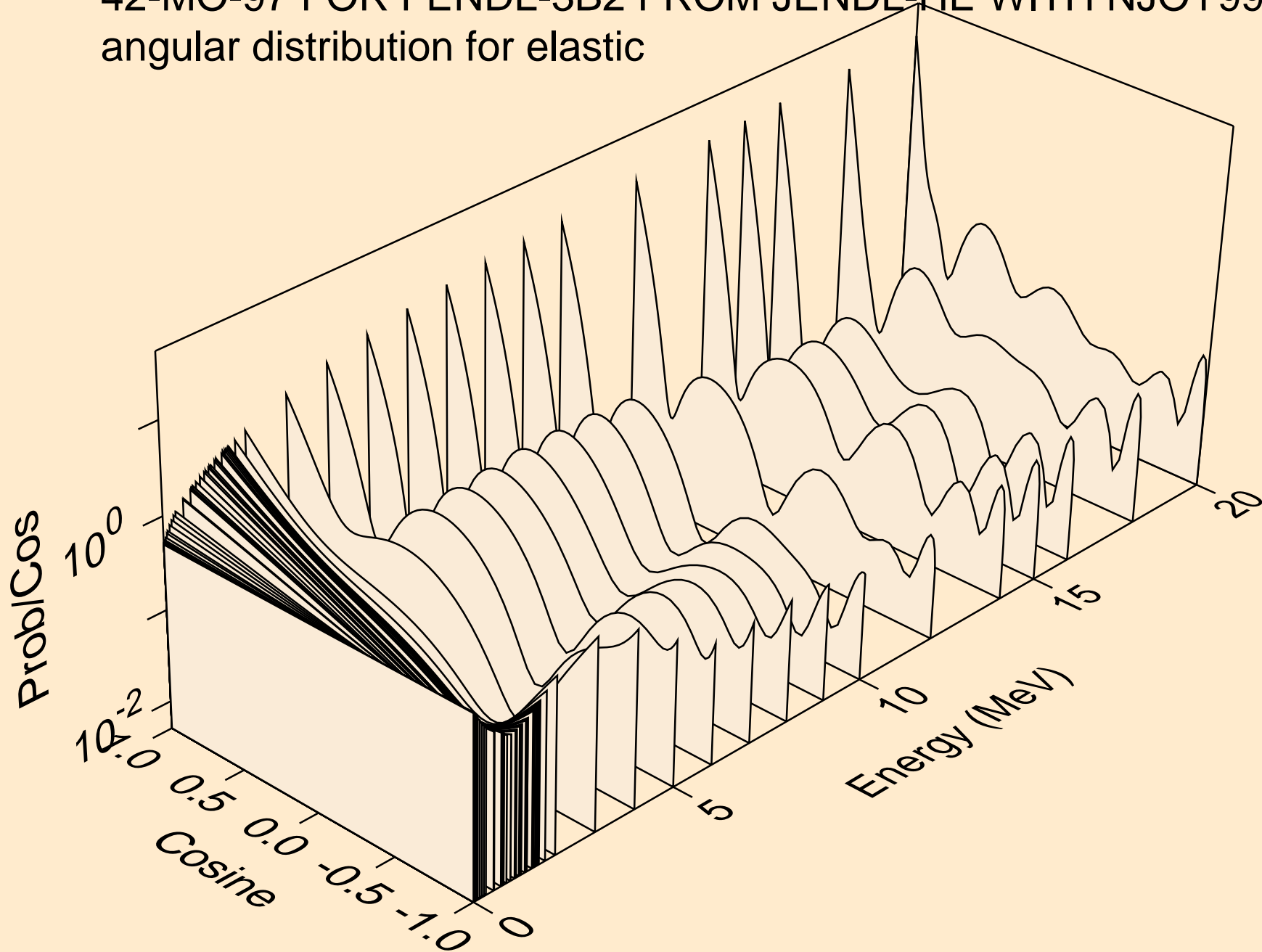

42-MO-97 FOR FENDL-3B2 FROM JENDL-HE WITH NJOY99.304+
angular distribution for elastic

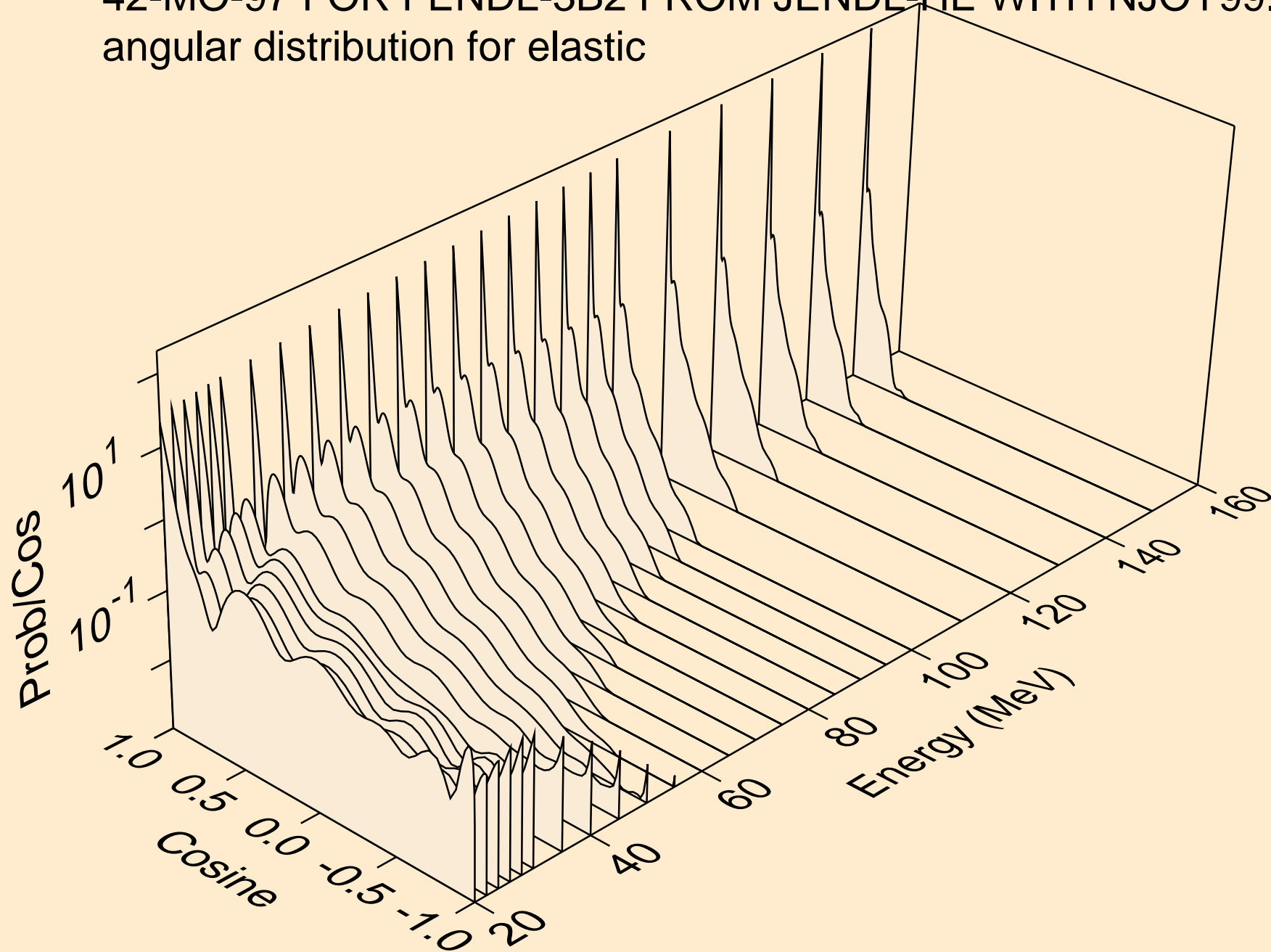

42-MO-97 FOR FENDL-3B2 FROM JENDL-HE WITH NJOY99.304+
angular distribution for (n,n*1)

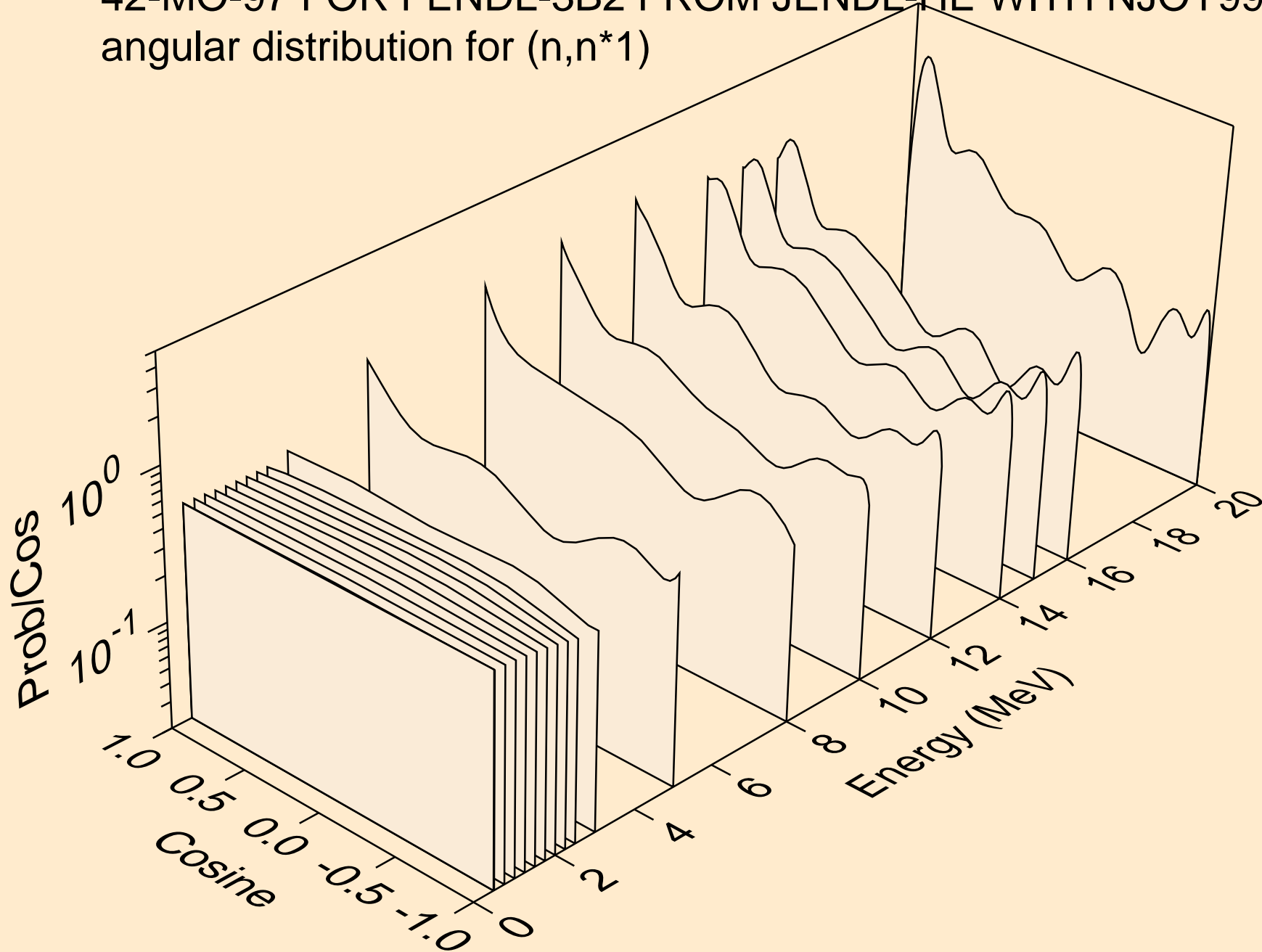

42-MO-97 FOR FENDL-3B2 FROM JENDL-HE WITH NJOY99.304+
angular distribution for (n,n*2)

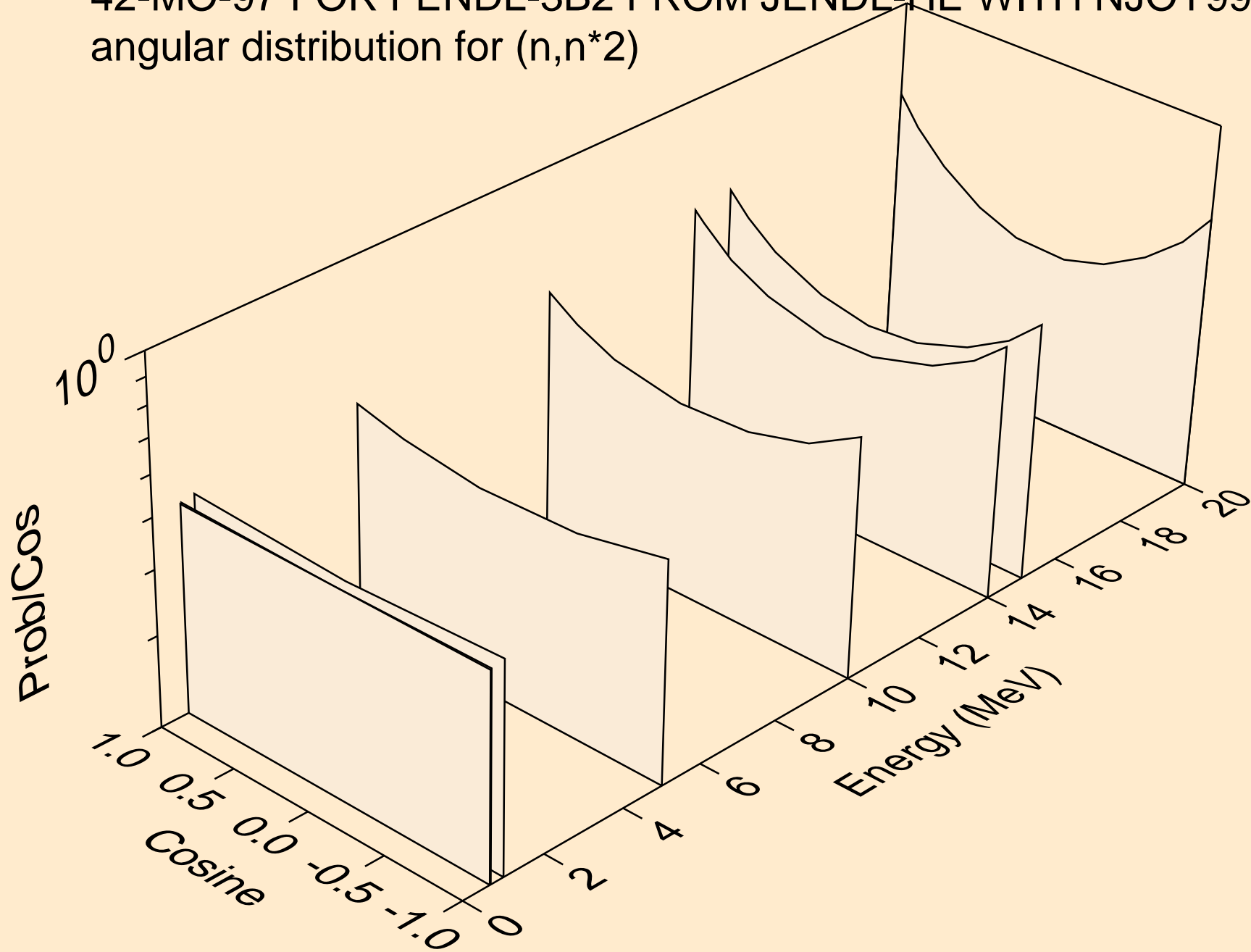

42-MO-97 FOR FENDL-3B2 FROM JENDL-HE WITH NJOY99.304+
angular distribution for (n,n*3)

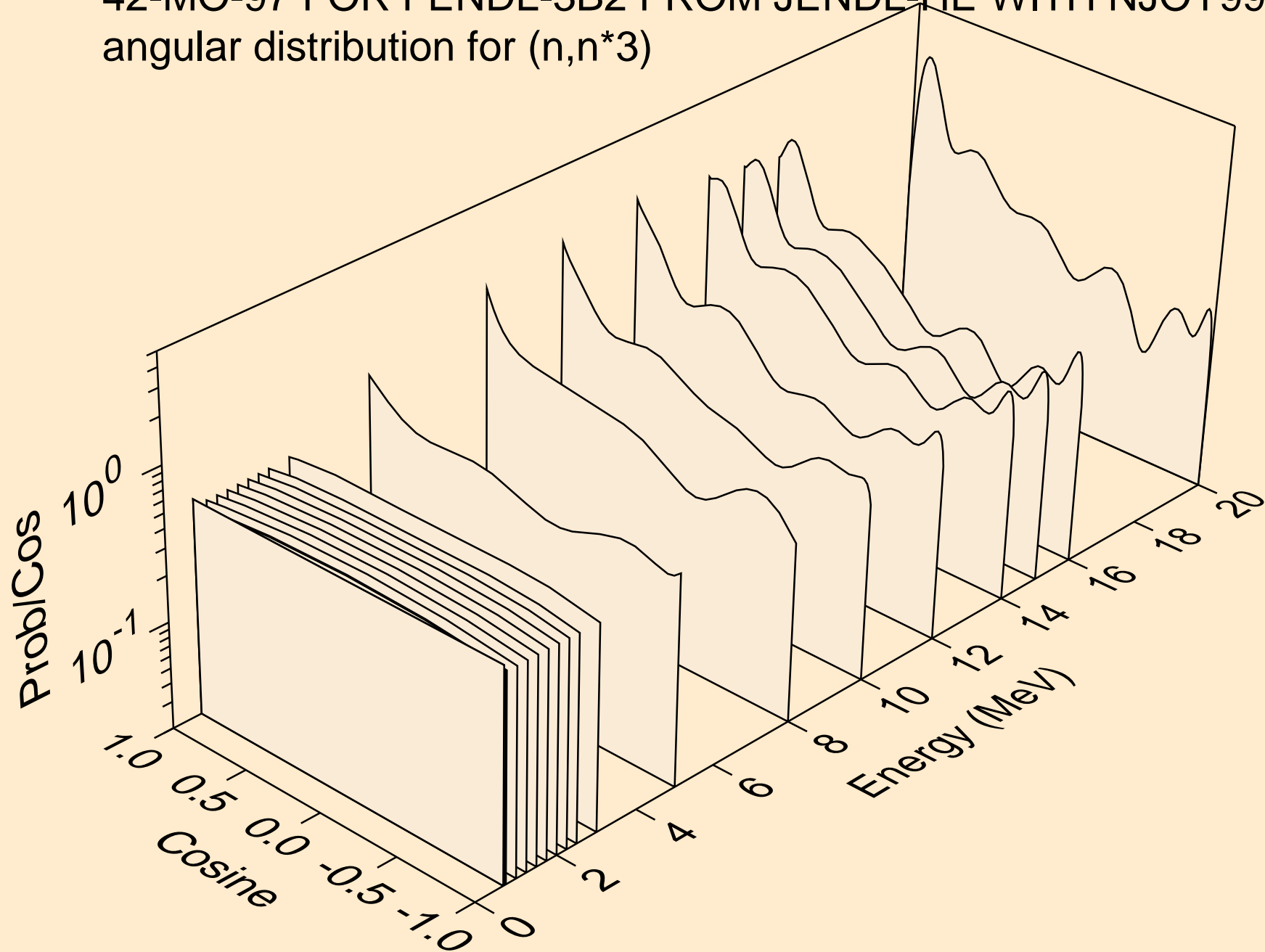

42-MO-97 FOR FENDL-3B2 FROM JENDL-HE WITH NJOY99.304+
angular distribution for (n,n*4)

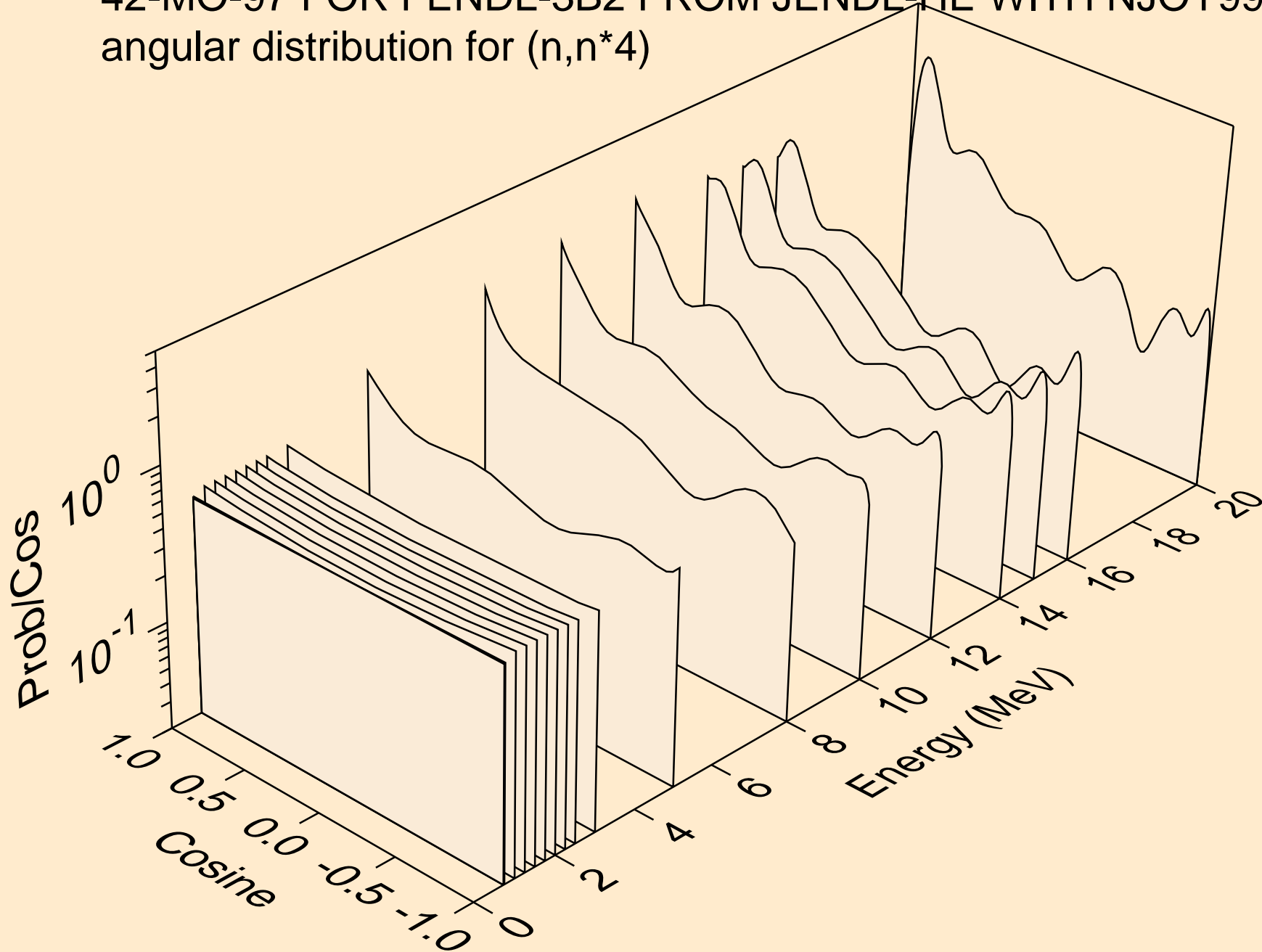

42-MO-97 FOR FENDL-3B2 FROM JENDL-HE WITH NJOY99.304+
angular distribution for (n,n*5)

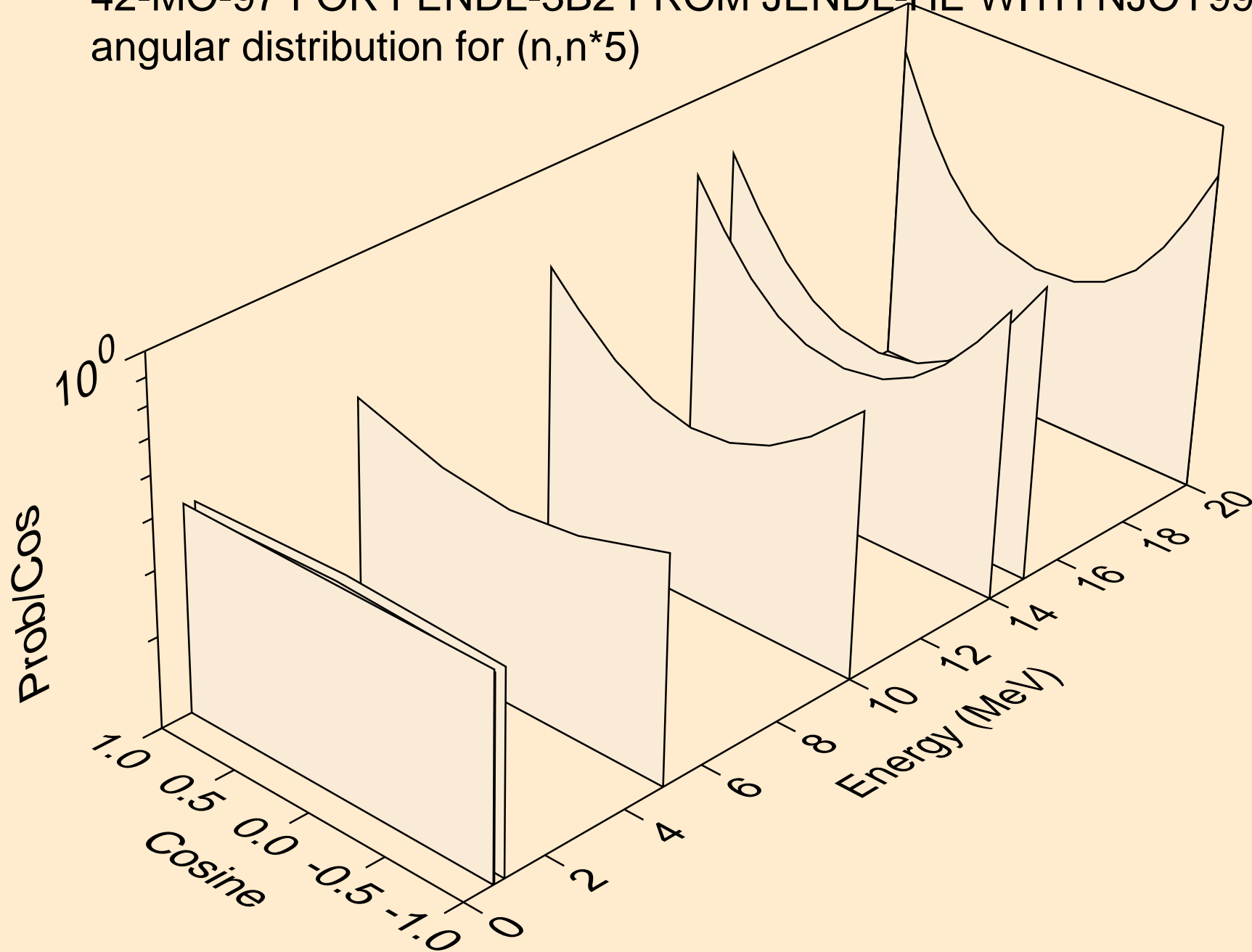

42-MO-97 FOR FENDL-3B2 FROM JENDL-HE WITH NJOY99.304+
angular distribution for (n,n*6)

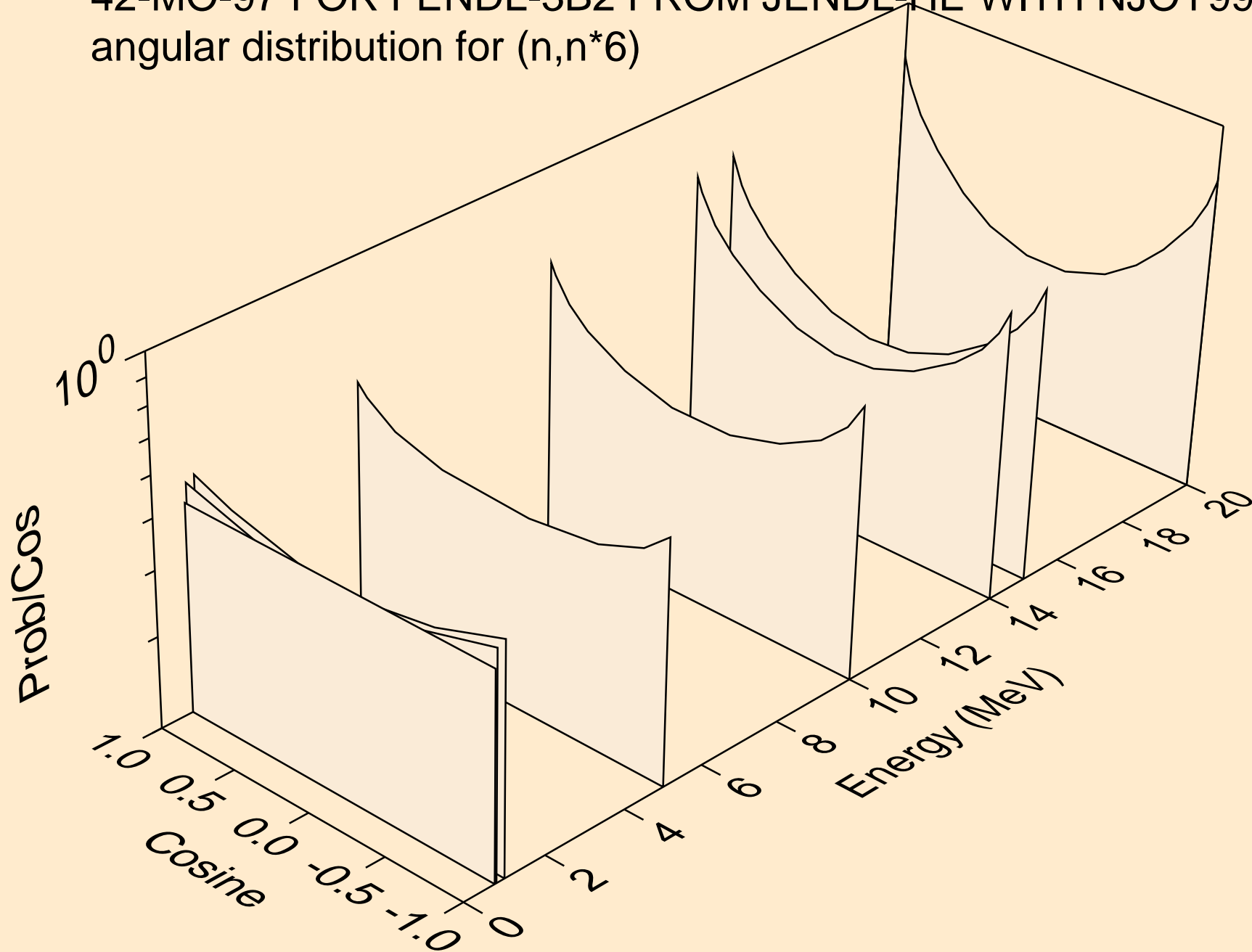

42-MO-97 FOR FENDL-3B2 FROM JENDL-HE WITH NJOY99.304+
angular distribution for (n,n*7)

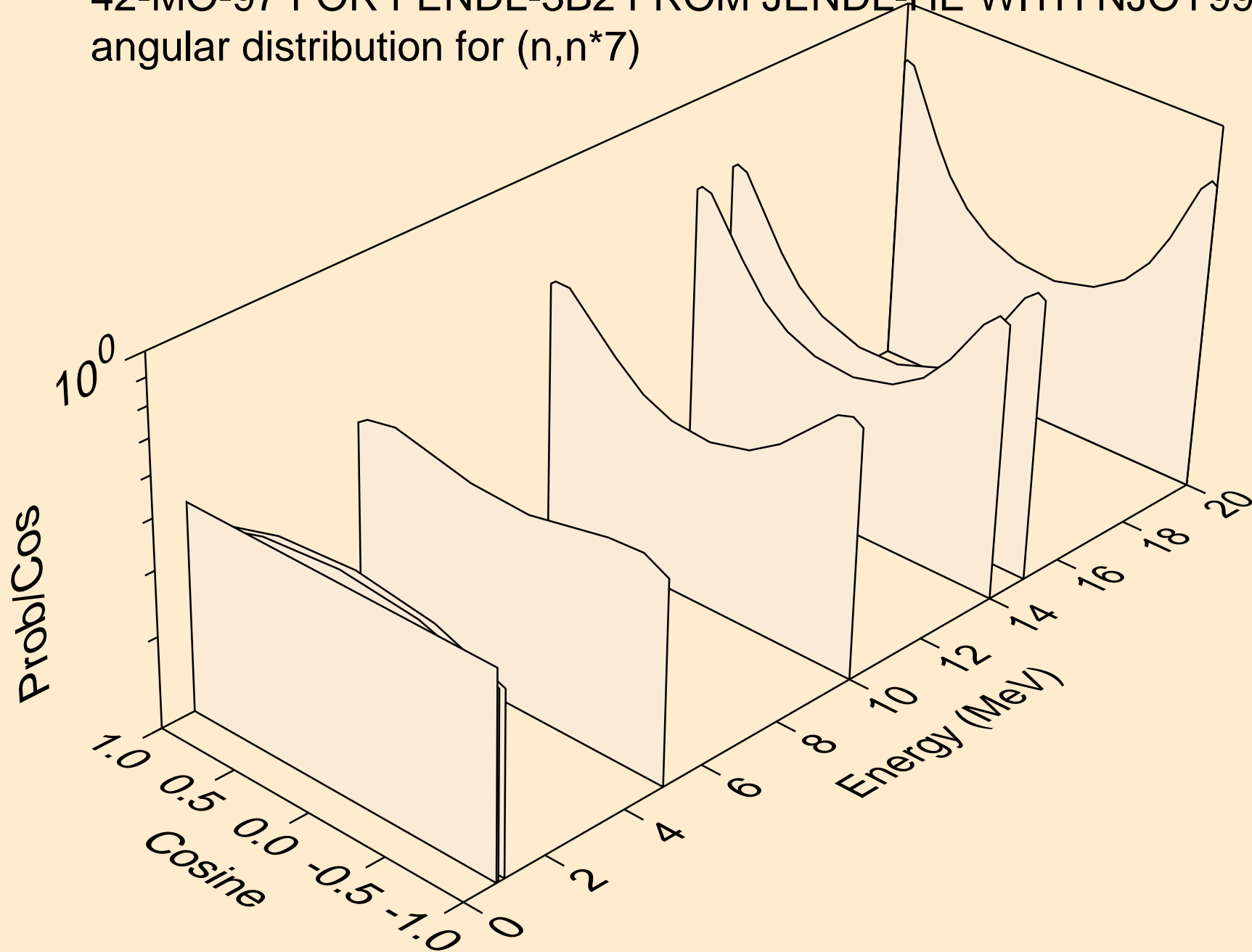

42-MO-97 FOR FENDL-3B2 FROM JENDL-HE WITH NJOY99.304+
angular distribution for (n,n*8)

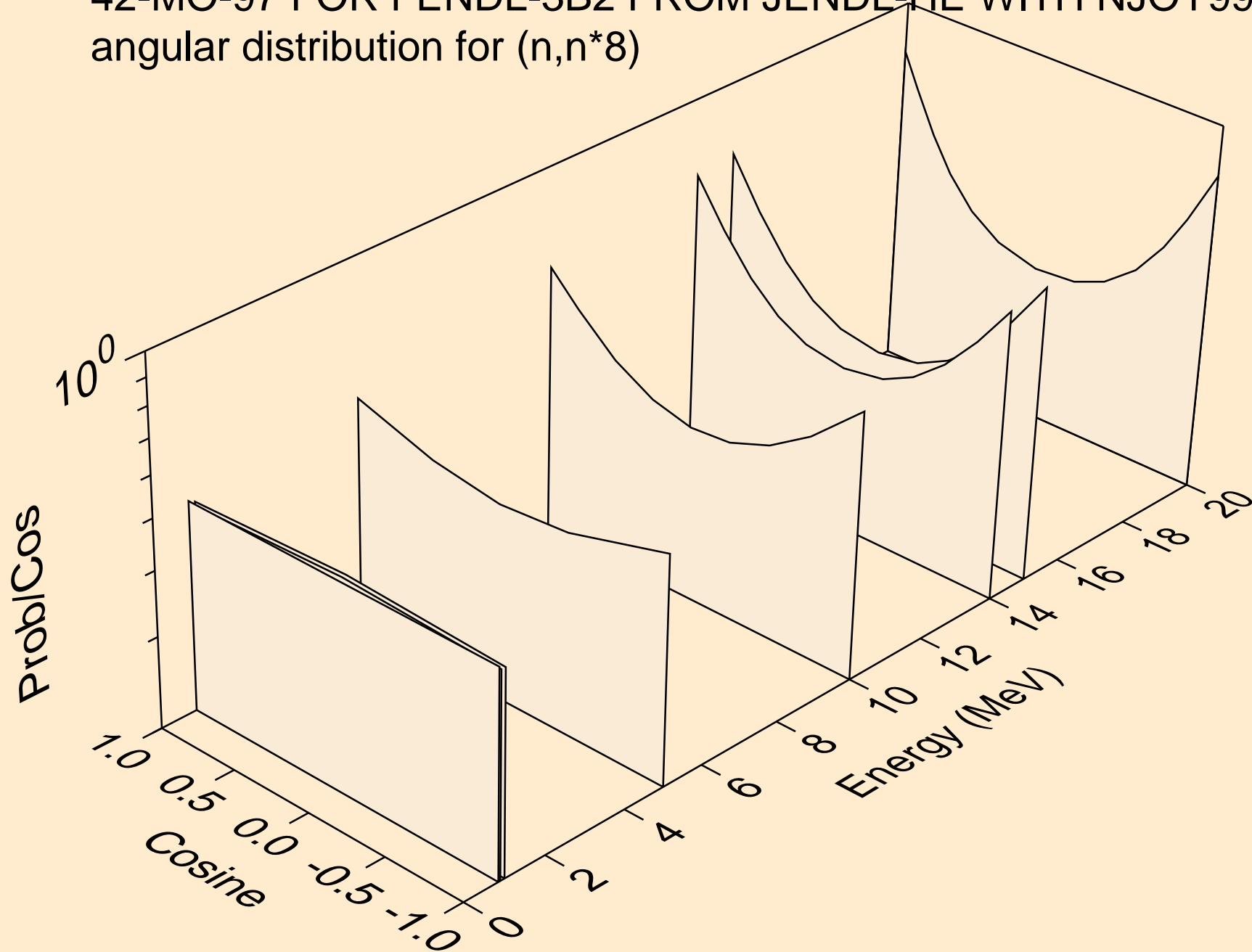

42-MO-97 FOR FENDL-3B2 FROM JENDL-HE WITH NJOY99.304+
angular distribution for (n,n*9)

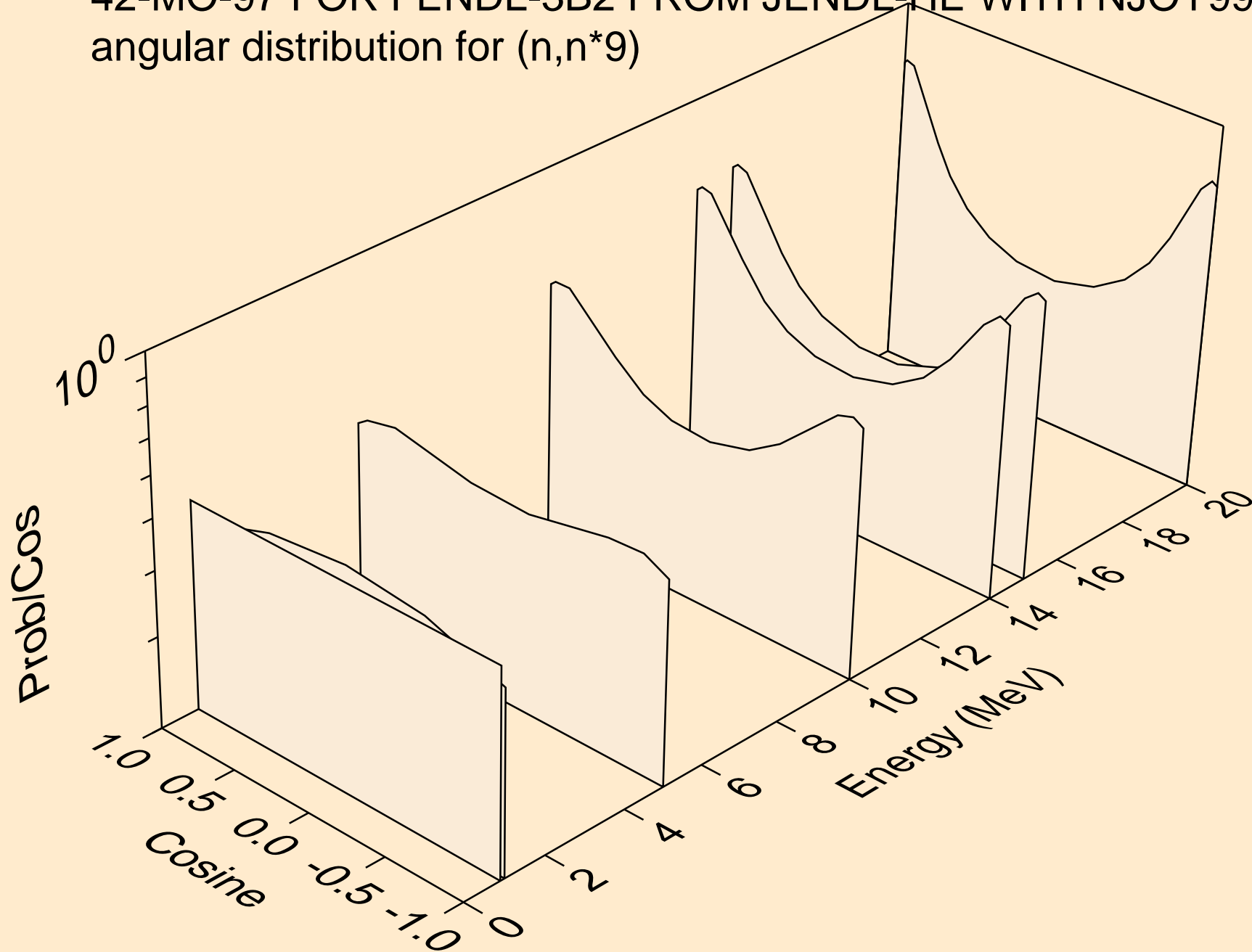

42-MO-97 FOR FENDL-3B2 FROM JENDL-HE WITH NJOY99.304+
angular distribution for (n,n*10)

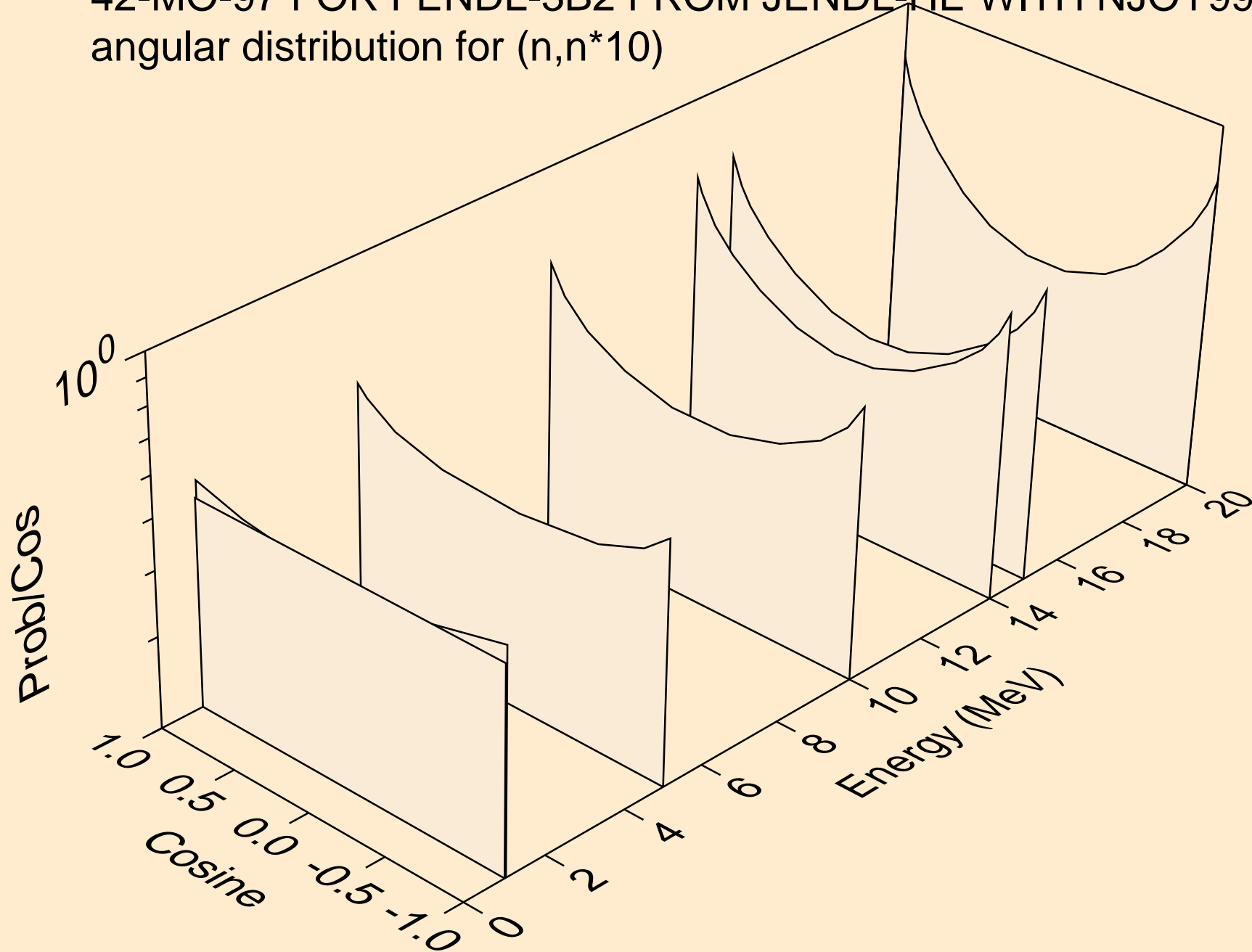

42-MO-97 FOR FENDL-3B2 FROM JENDL-HE WITH NJOY99.304+
angular distribution for (n,n*11)

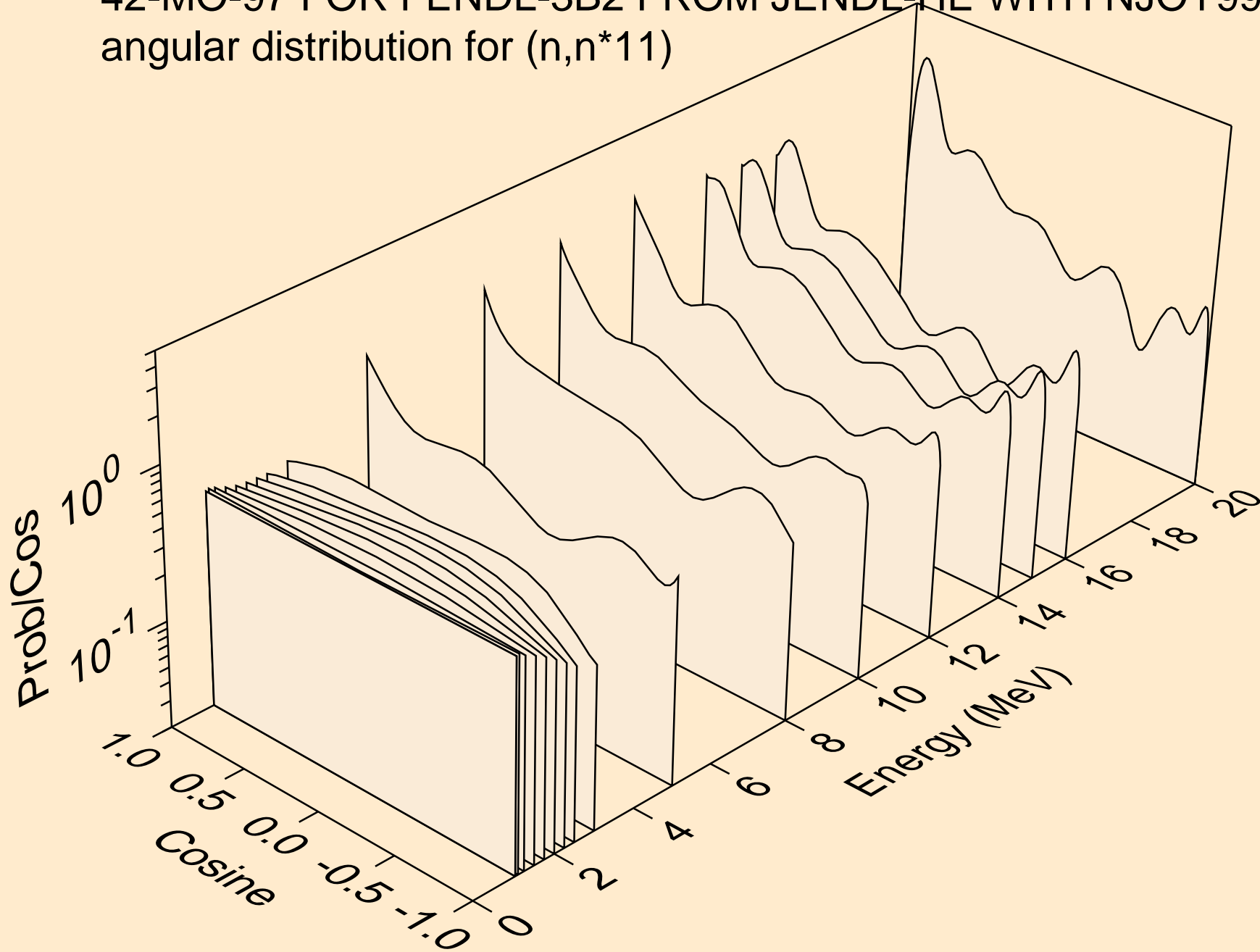

42-MO-97 FOR FENDL-3B2 FROM JENDL-HE WITH NJOY99.304+
angular distribution for (n,n*12)

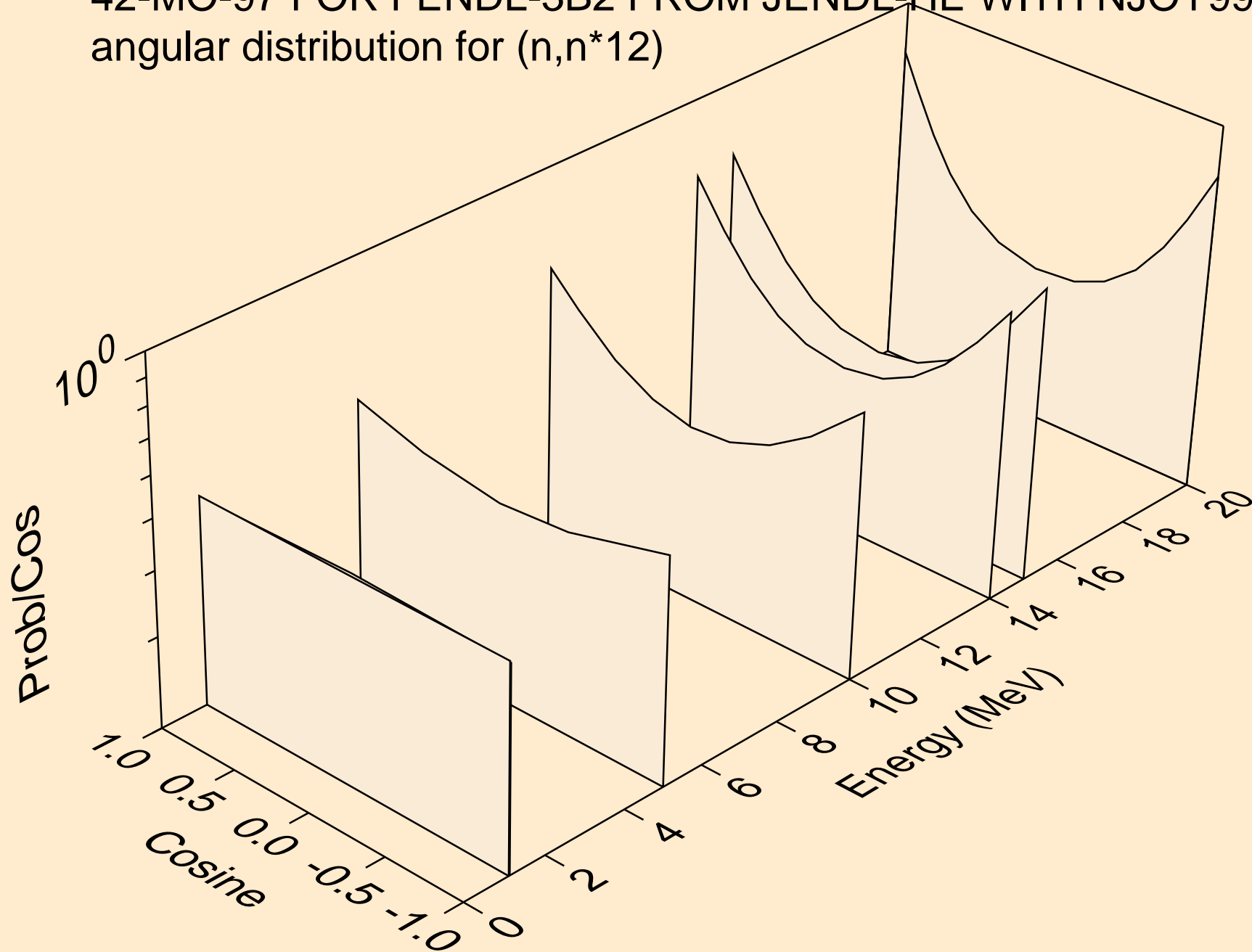

42-MO-97 FOR FENDL-3B2 FROM JENDL-HE WITH NJOY99.304+
angular distribution for (n,n*13)

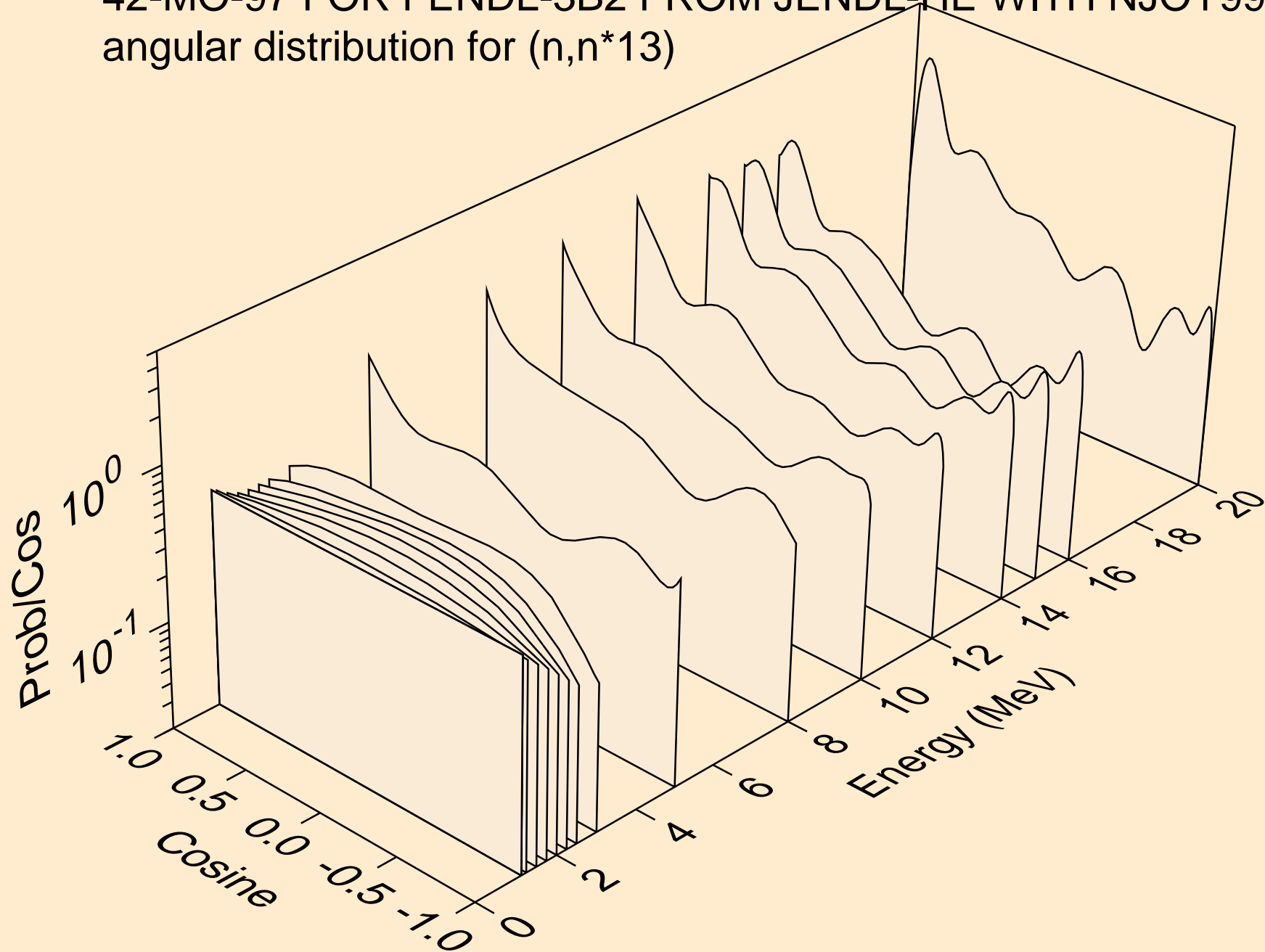

42-MO-97 FOR FENDL-3B2 FROM JENDL-HE WITH NJOY99.304+
Neutron emission for (n,x)

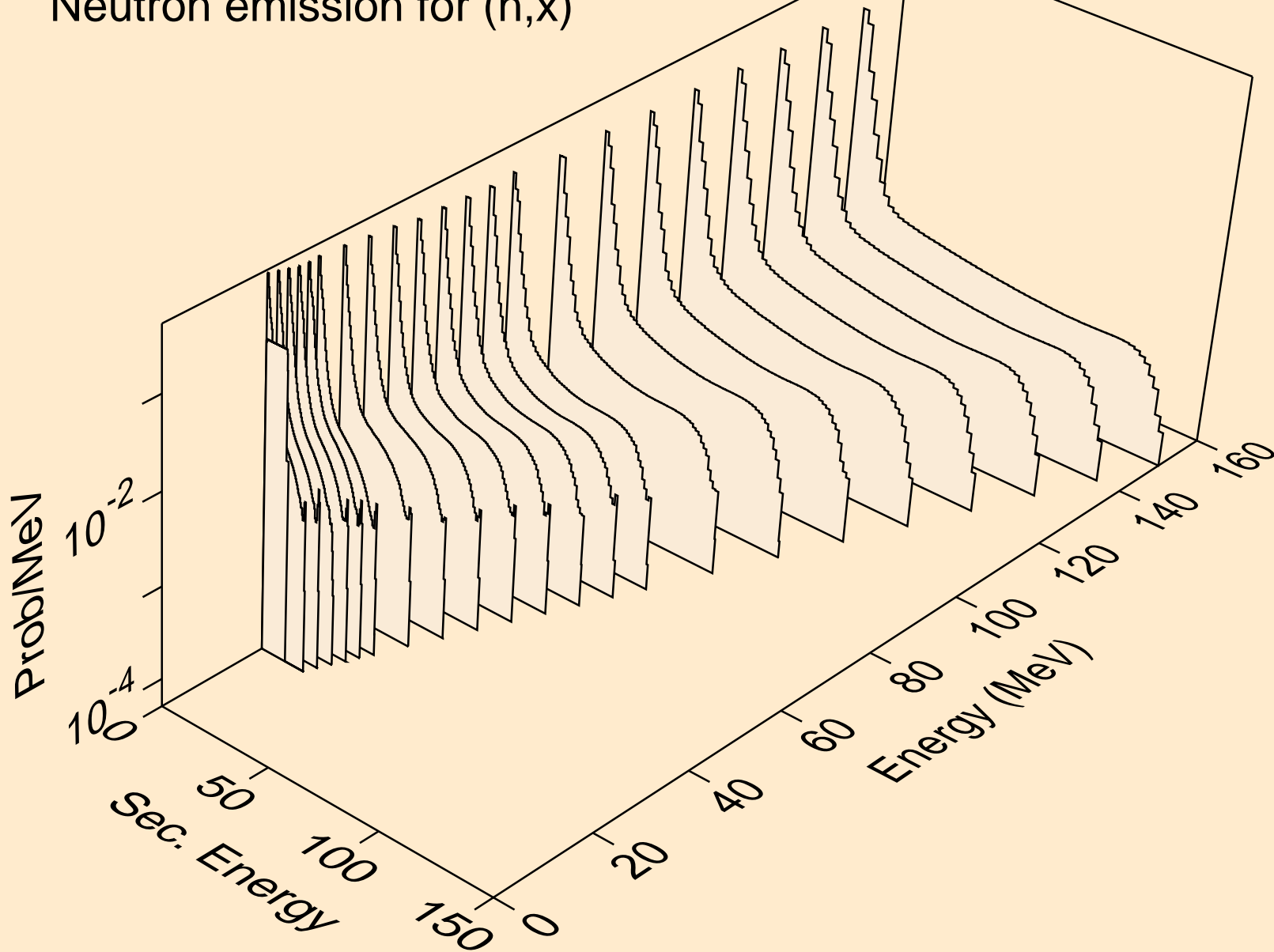

42-MO-97 FOR FENDL-3B2 FROM JENDL-HE WITH NJOY99.304+
Neutron emission for (n,2n)

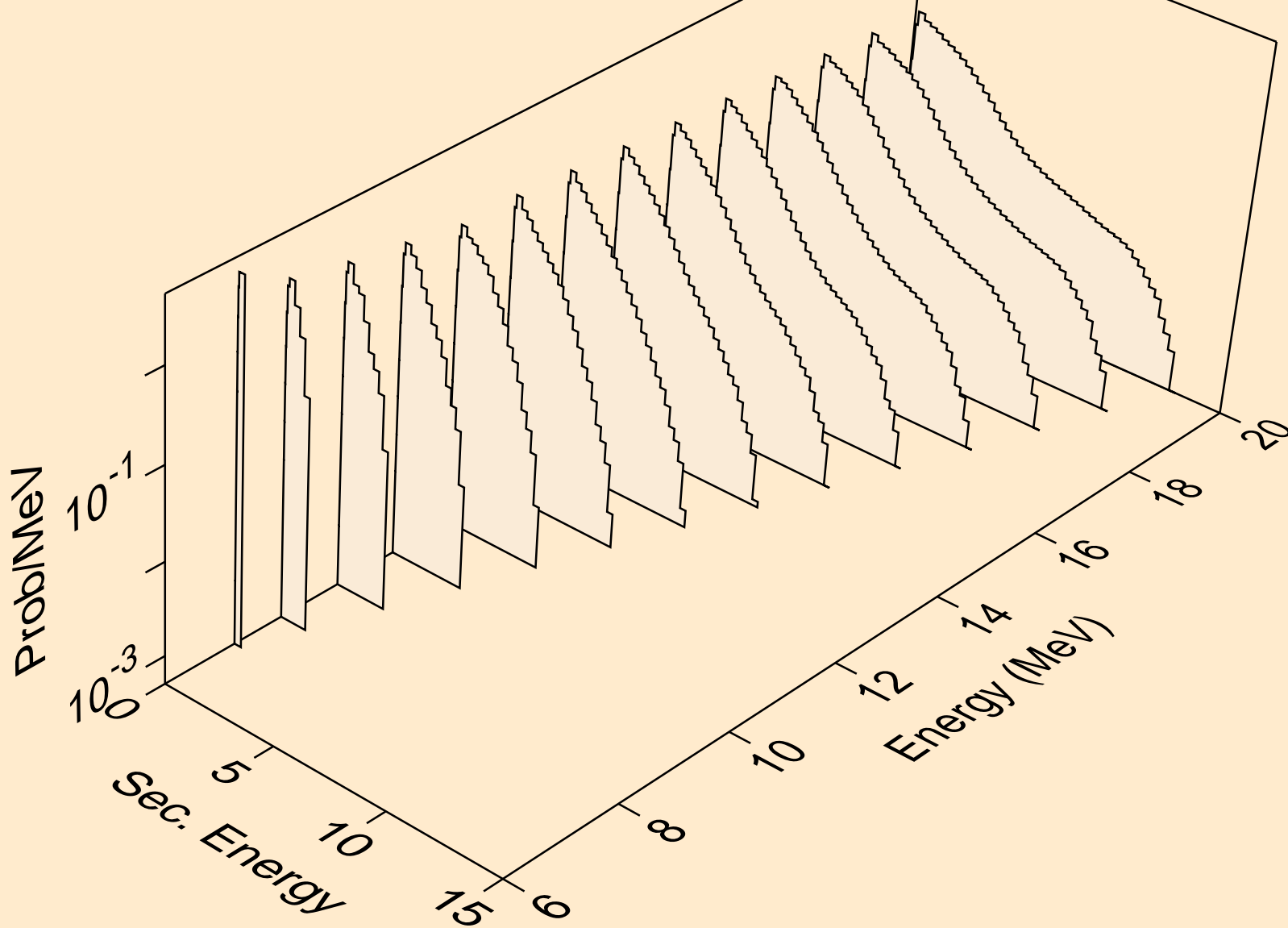

42-MO-97 FOR FENDL-3B2 FROM JENDL-HE WITH NJOY99.304+
Neutron emission for (n,3n)

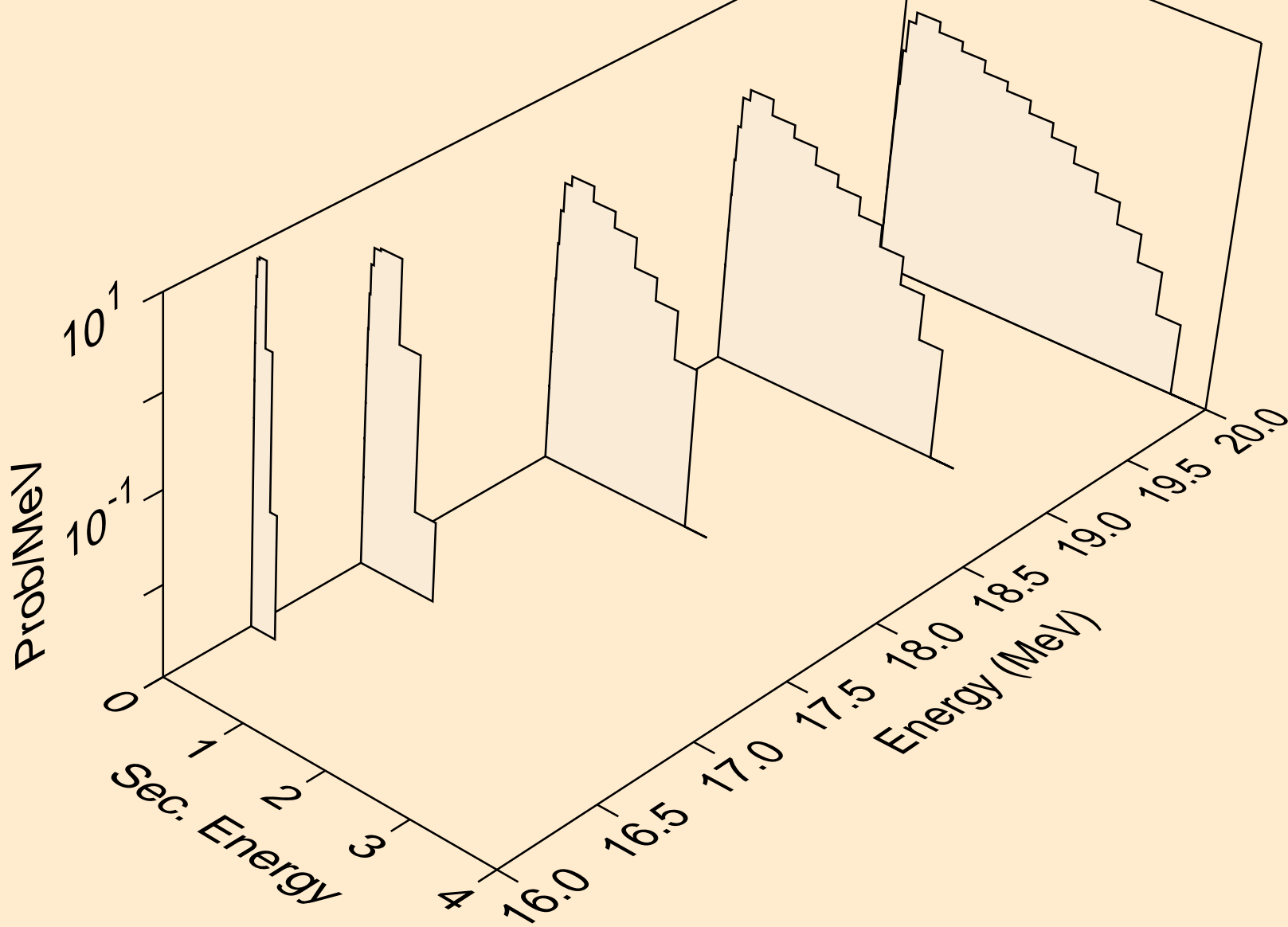

42-MO-97 FOR FENDL-3B2 FROM JENDL-HE WITH NJOY99.304+
Neutron emission for (n,n*)a

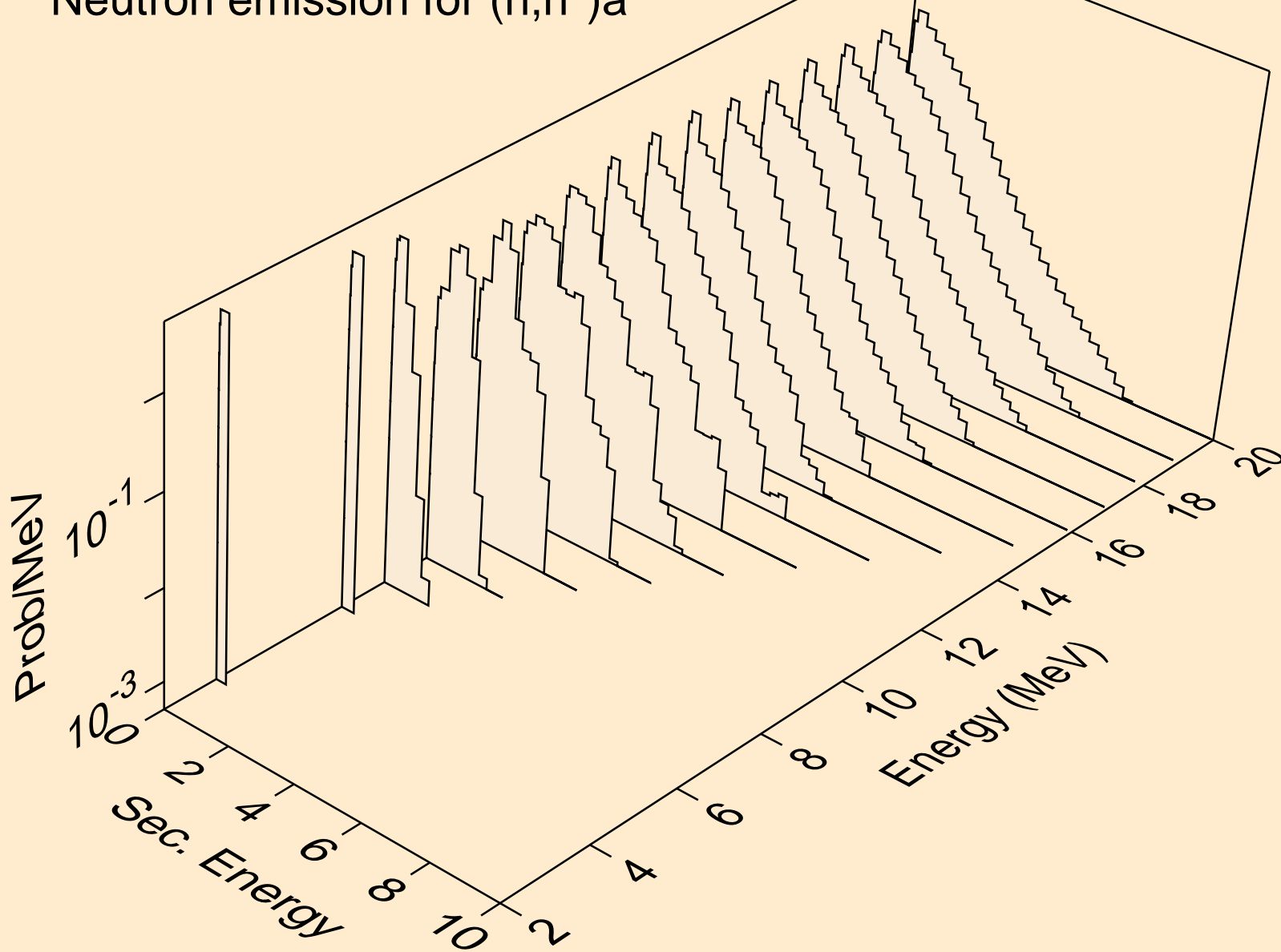

42-MO-97 FOR FENDL-3B2 FROM JENDL-HE WITH NJOY99.304+
Neutron emission for (n,n*)p

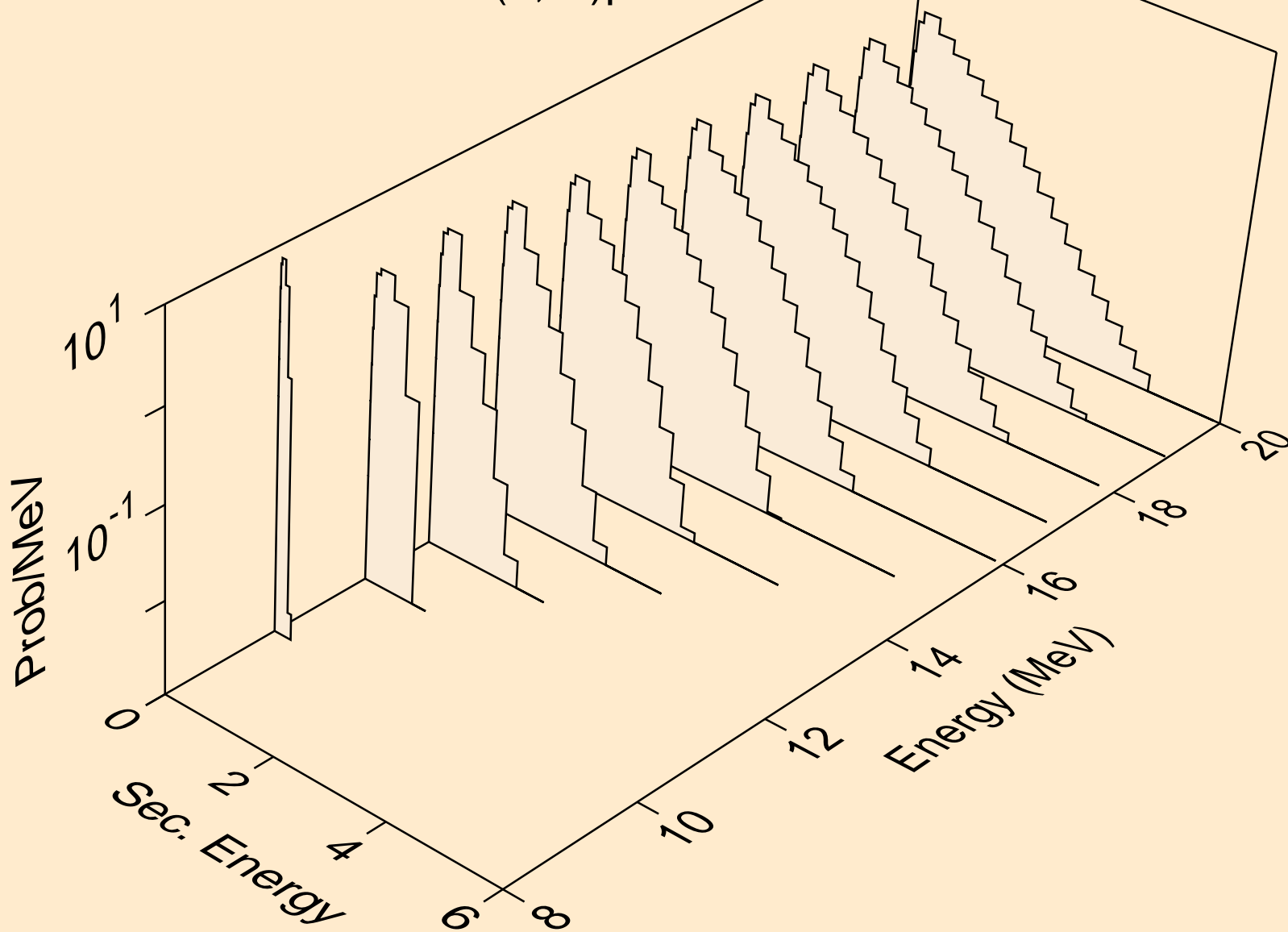

42-MO-97 FOR FENDL-3B2 FROM JENDL-HE WITH NJOY99.304+
Neutron emission for (n,n*c)

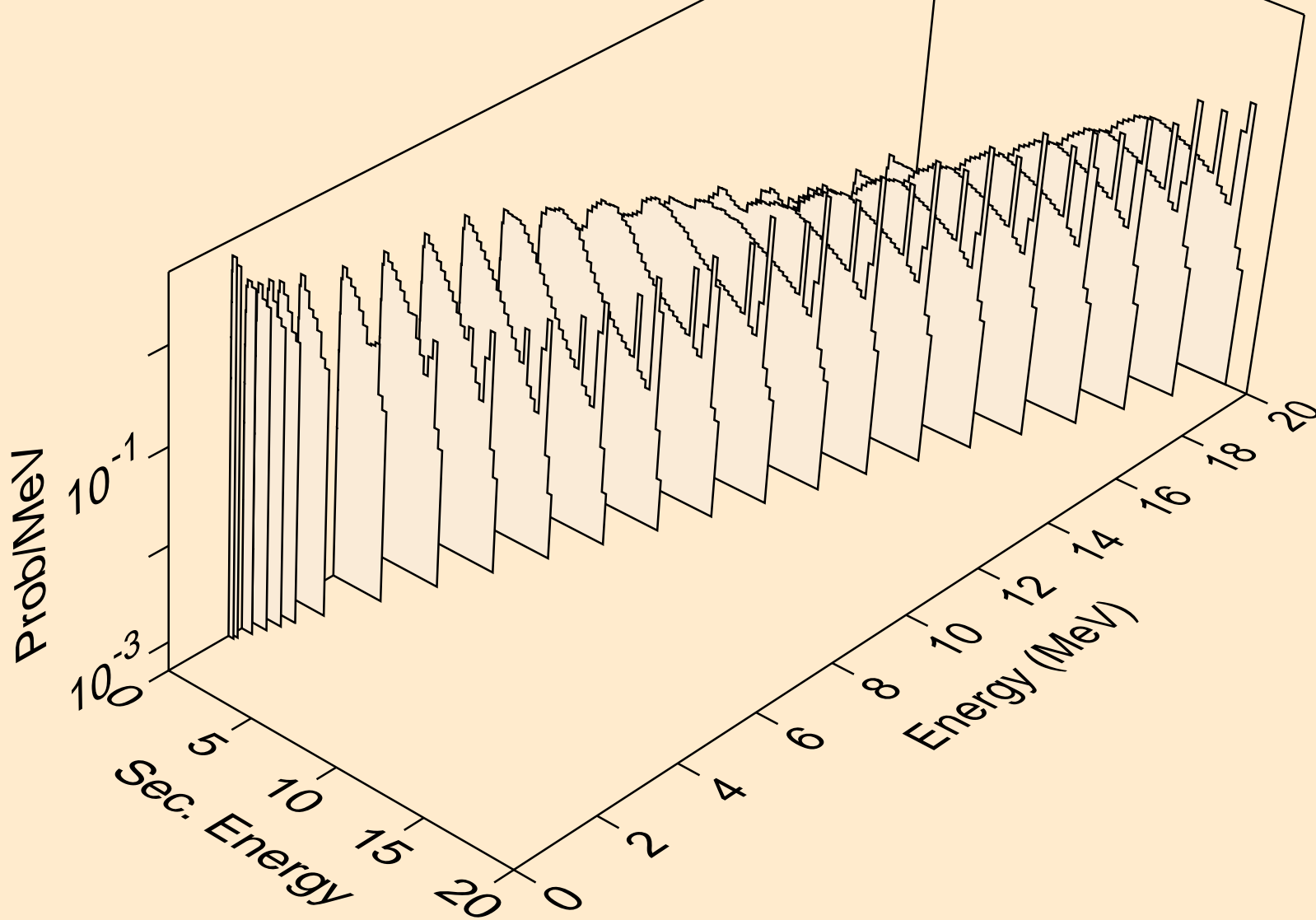

42-MO-97 FOR FENDL-3B2 FROM JENDL HE WITH NJOY99.304+
Photon emission for (n,gma)

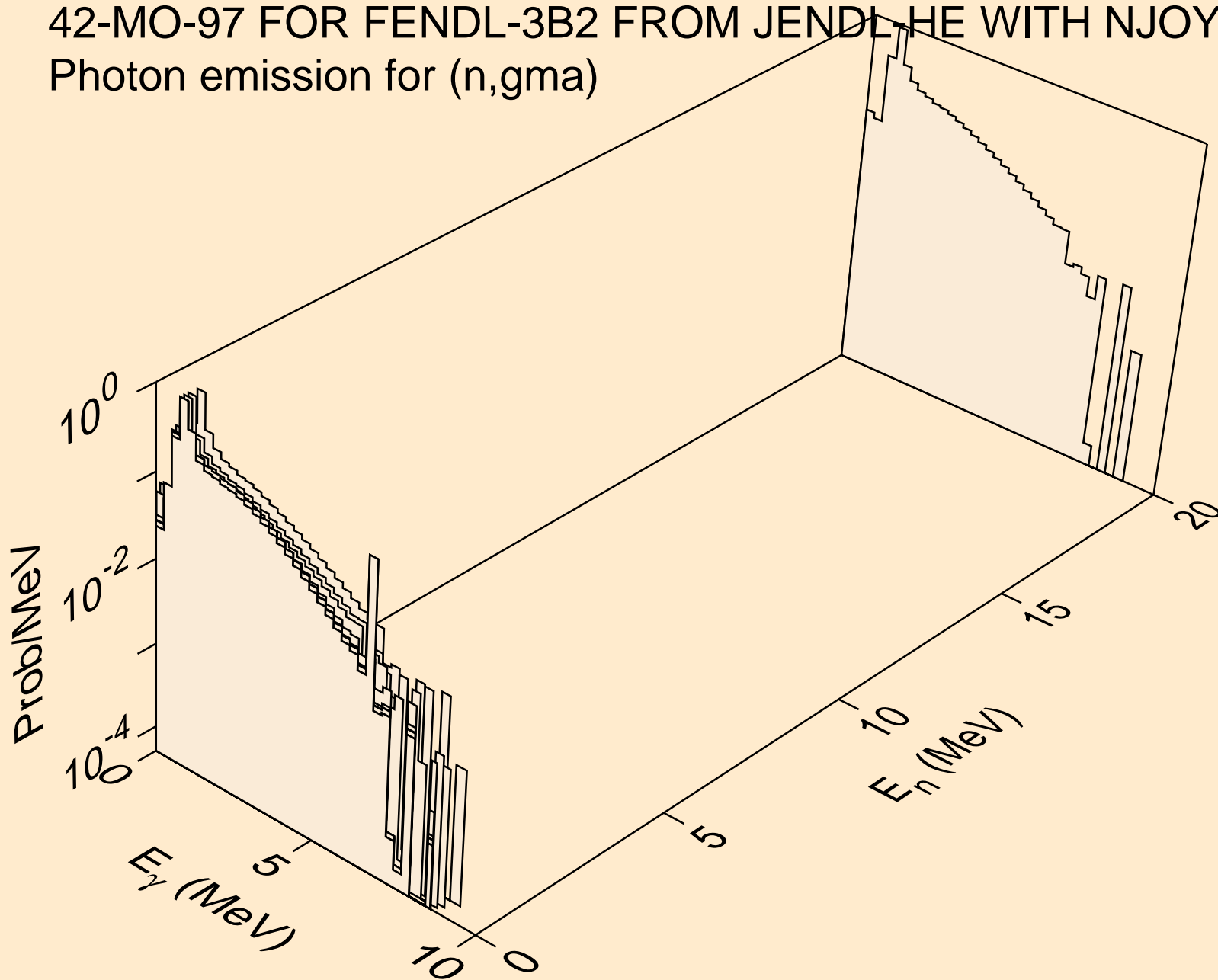

42-MO-97 FOR FENDL-3B2 FROM JENDL-HE WITH NJOY99.304+
Photon emission for nonelastic

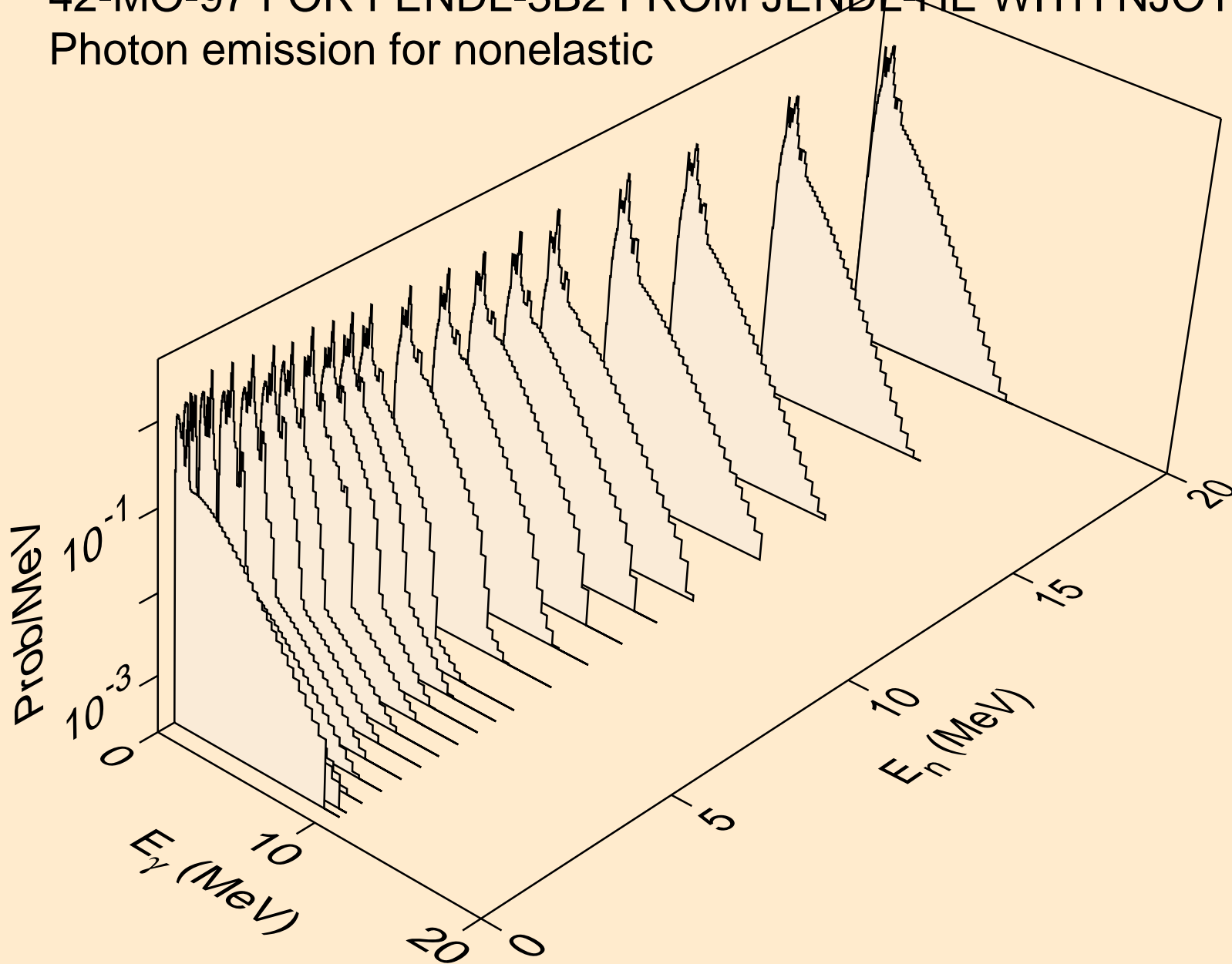

42-MO-97 FOR FENDL-3B2 FROM JENDL-HE WITH NJOY99.304+
Photon emission for (n,x)

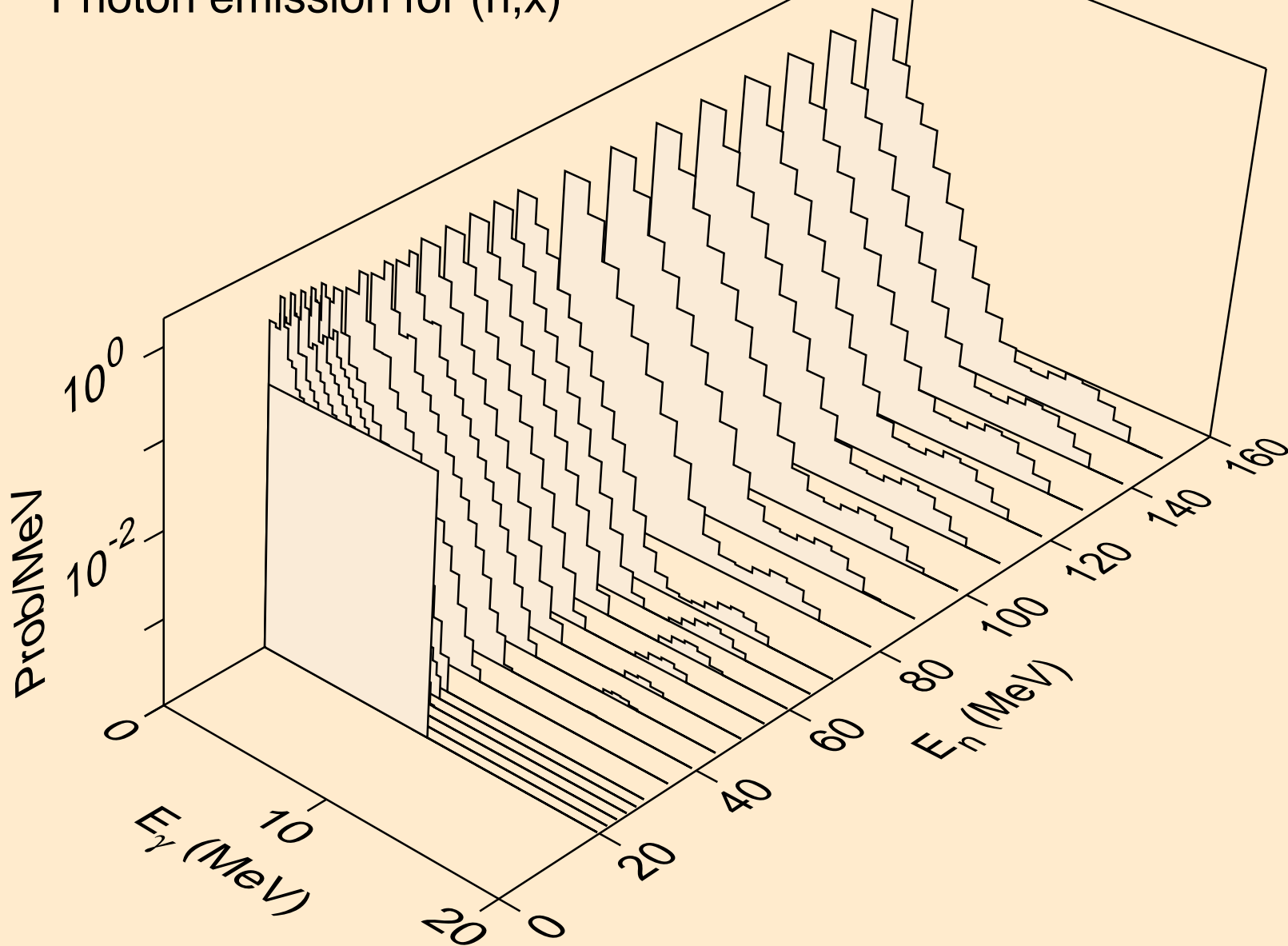

42-MO-97 FOR FENDL-3B2 FROM JENDL-HE WITH NJOY99.304+
thermal capture photon spectrum

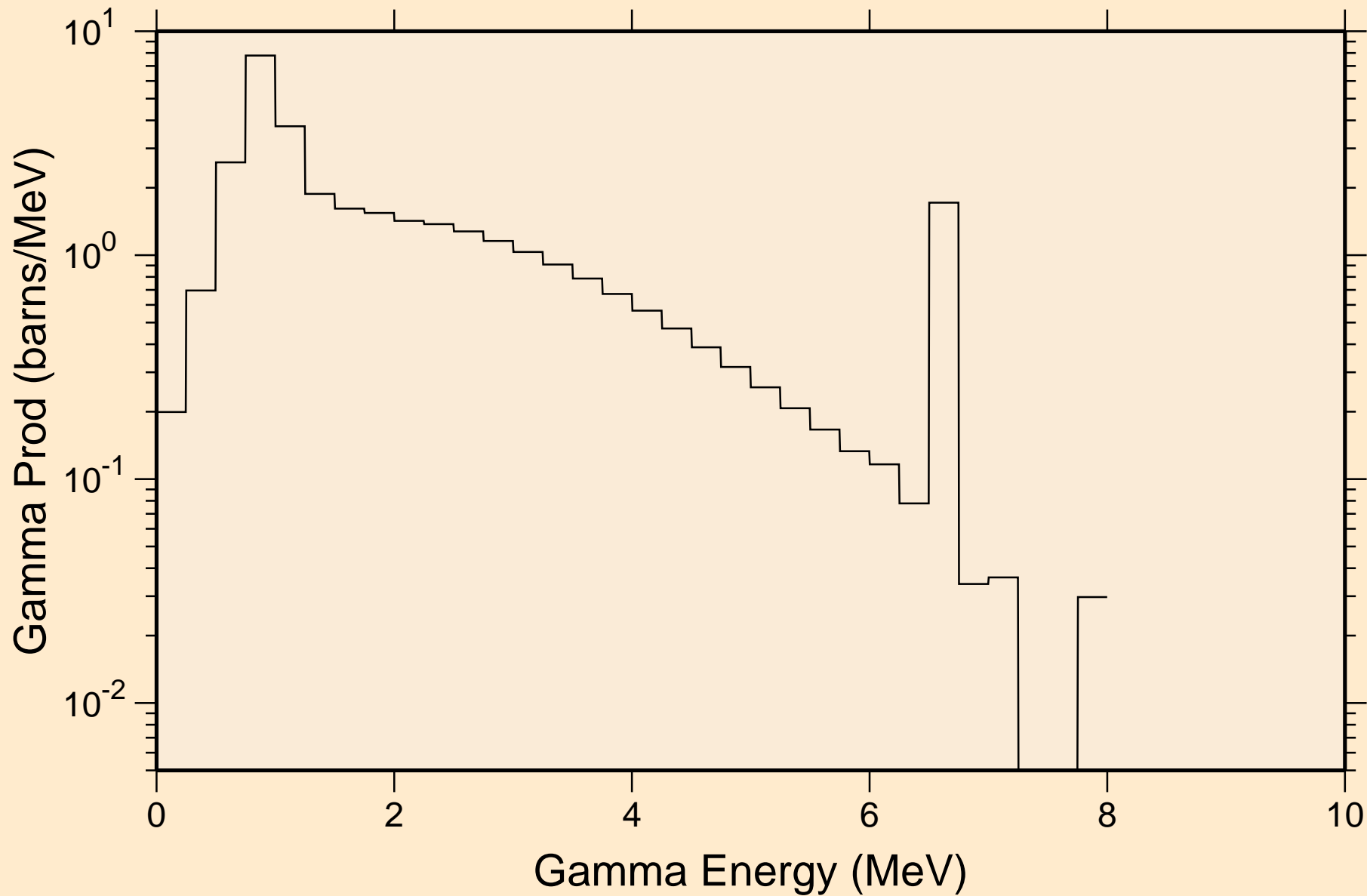

42-MO-97 FOR FENDL-3B2 FROM JENDL-HE WITH NJOY99.304+
14 MeV photon spectrum

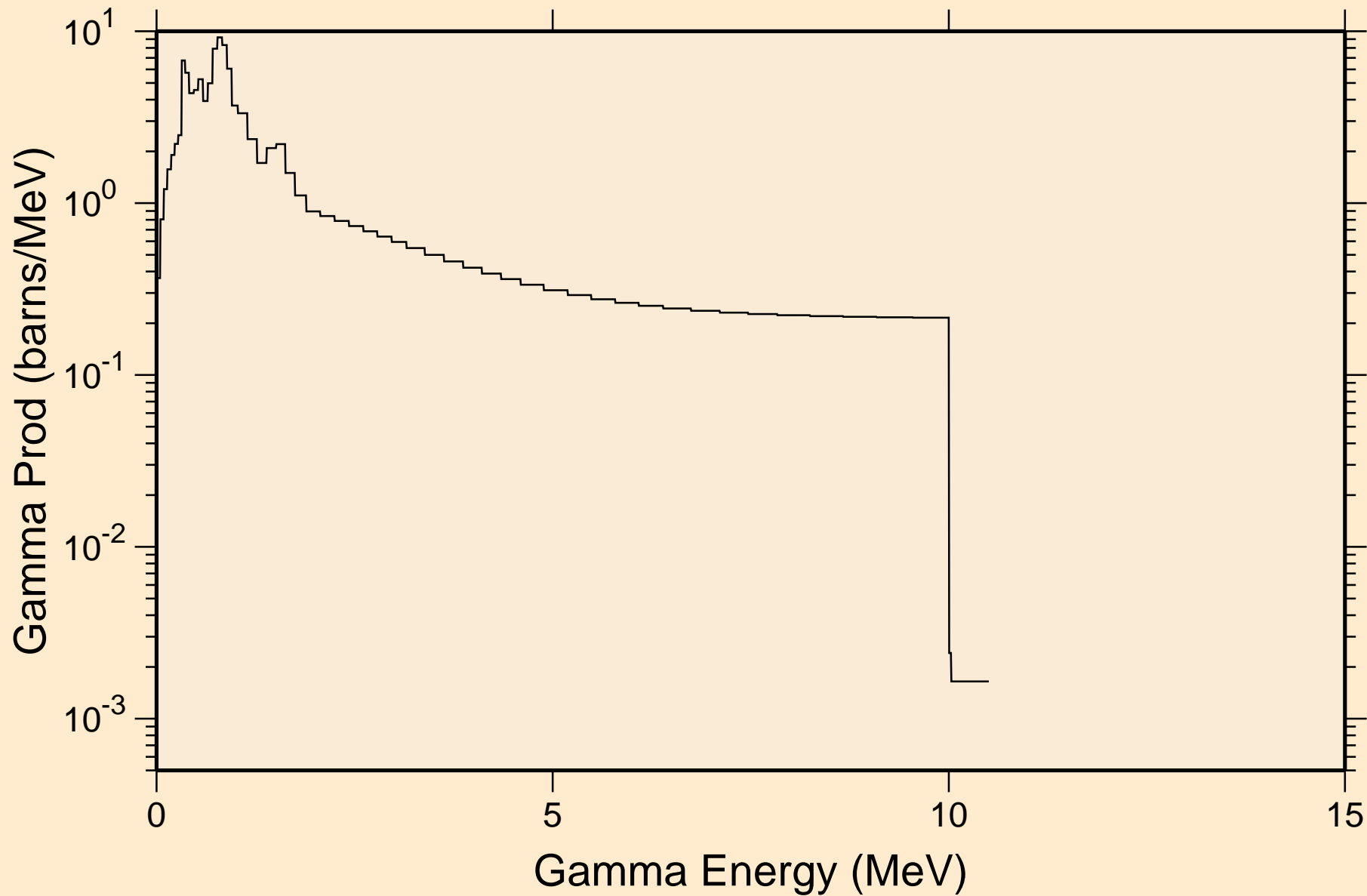

42-MO-97 FOR FENDL-3B2 FROM JENDL-HE WITH NJOY99.304+

Particle heating contributions

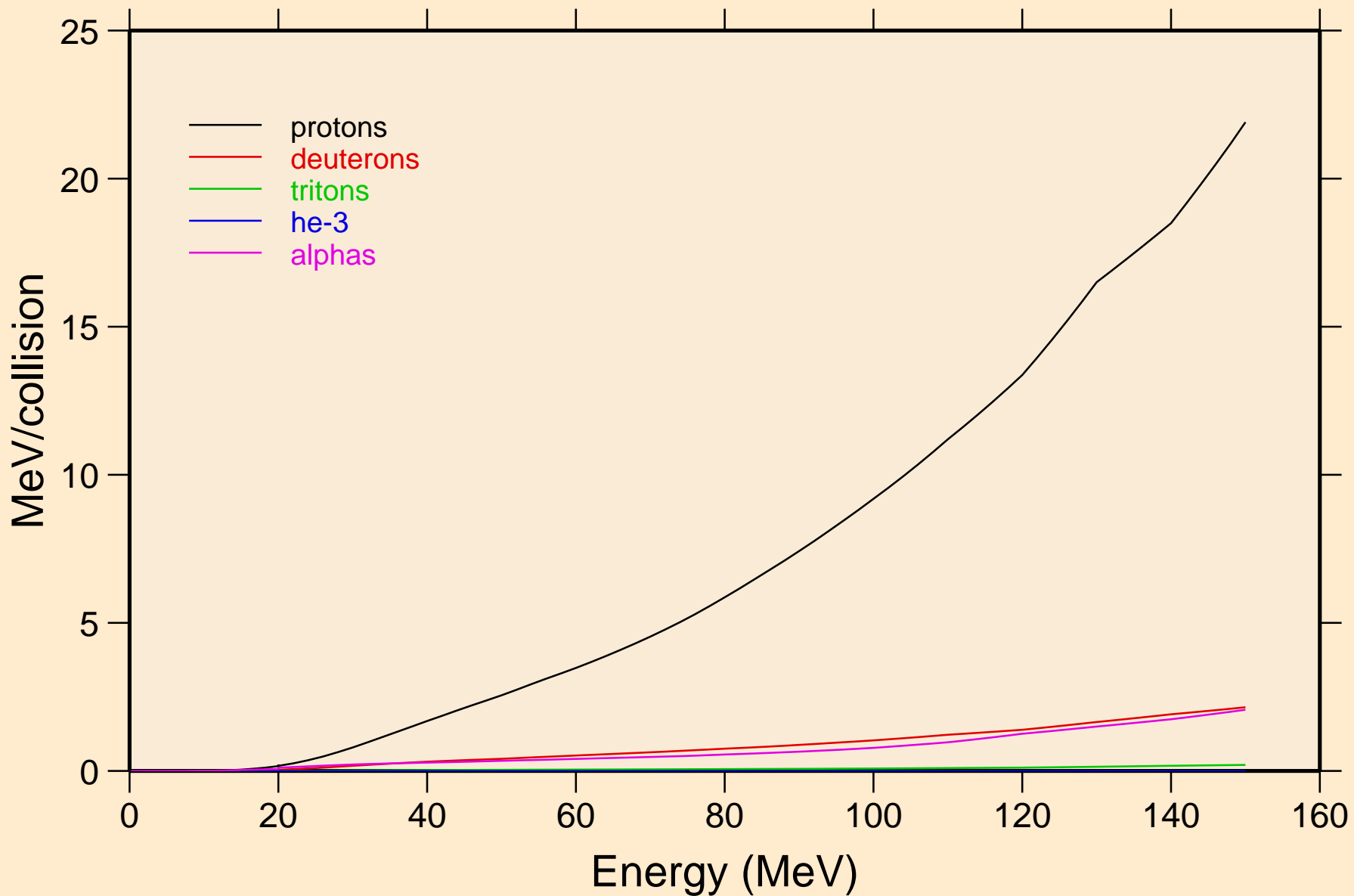

42-MO-97 FOR FENDL-3B2 FROM JENDL-HE WITH NJOY99.304+
Recoil Heating

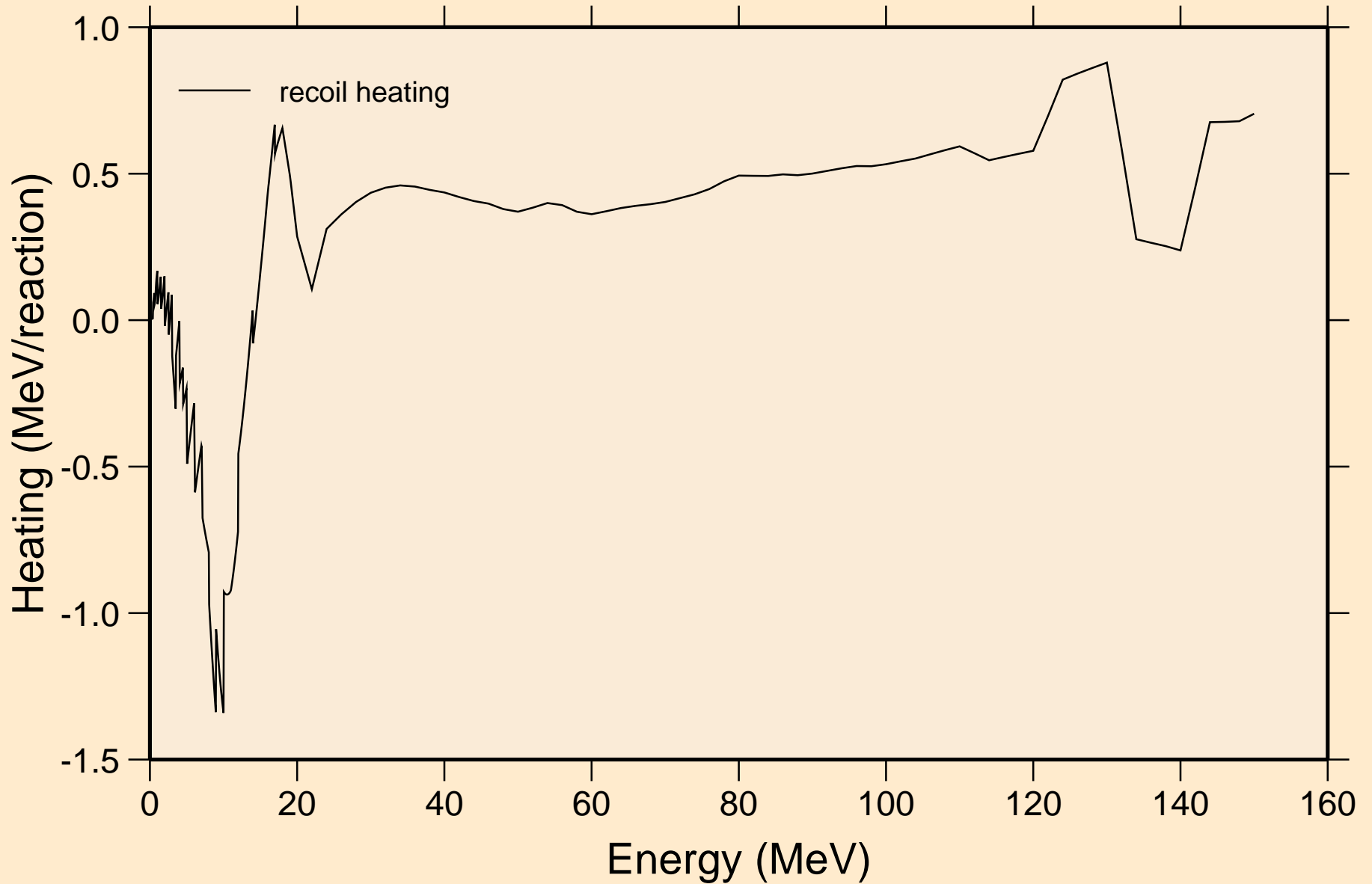

42-MO-97 FOR FENDL-3B2 FROM JENDL-HE WITH NJOY99.304+
Particle production cross sections

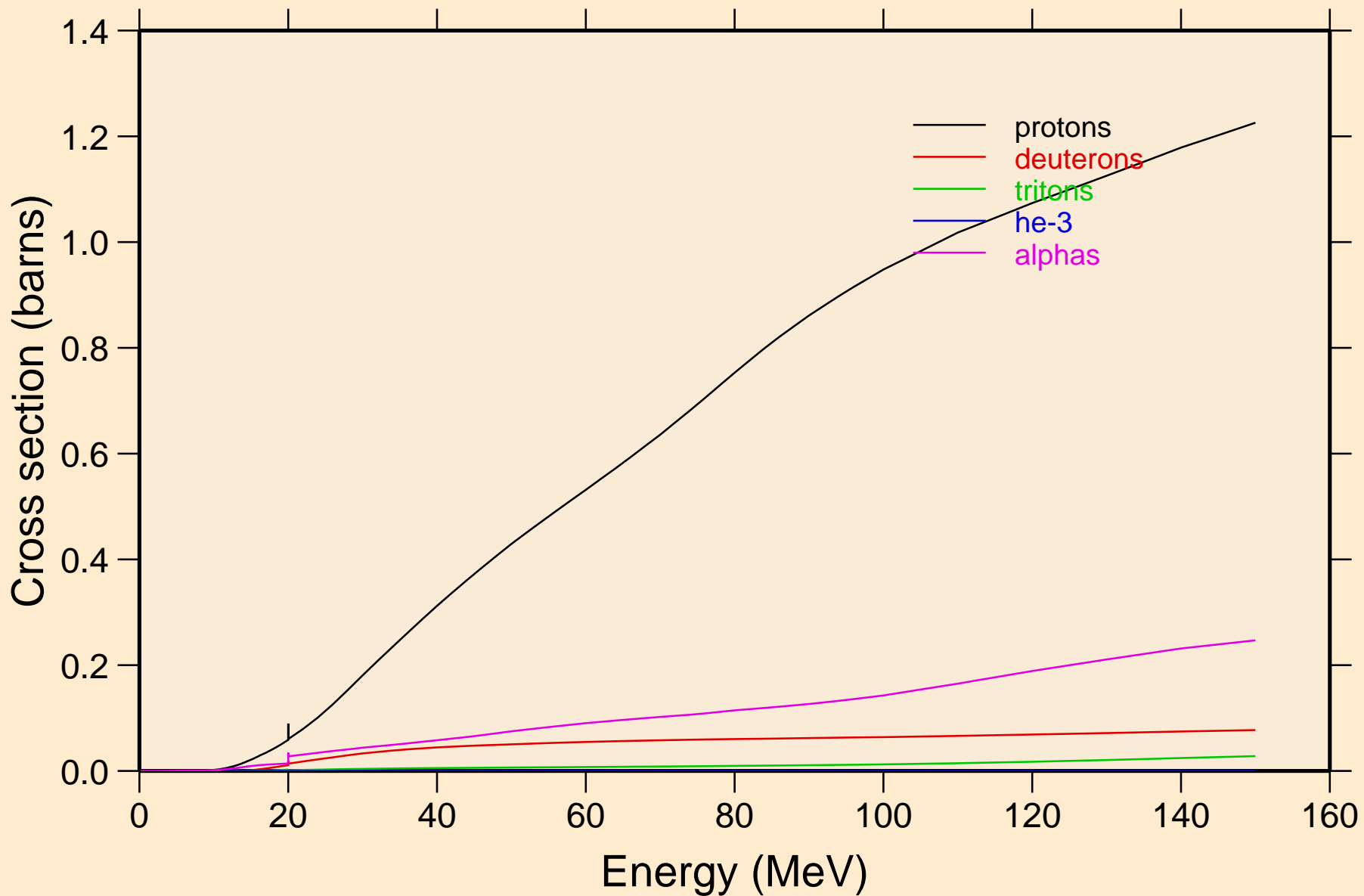

42-MO-97 FOR FENDL-3B2 FROM JENDL-HE WITH NJOY99.304+
protons from (n,x)

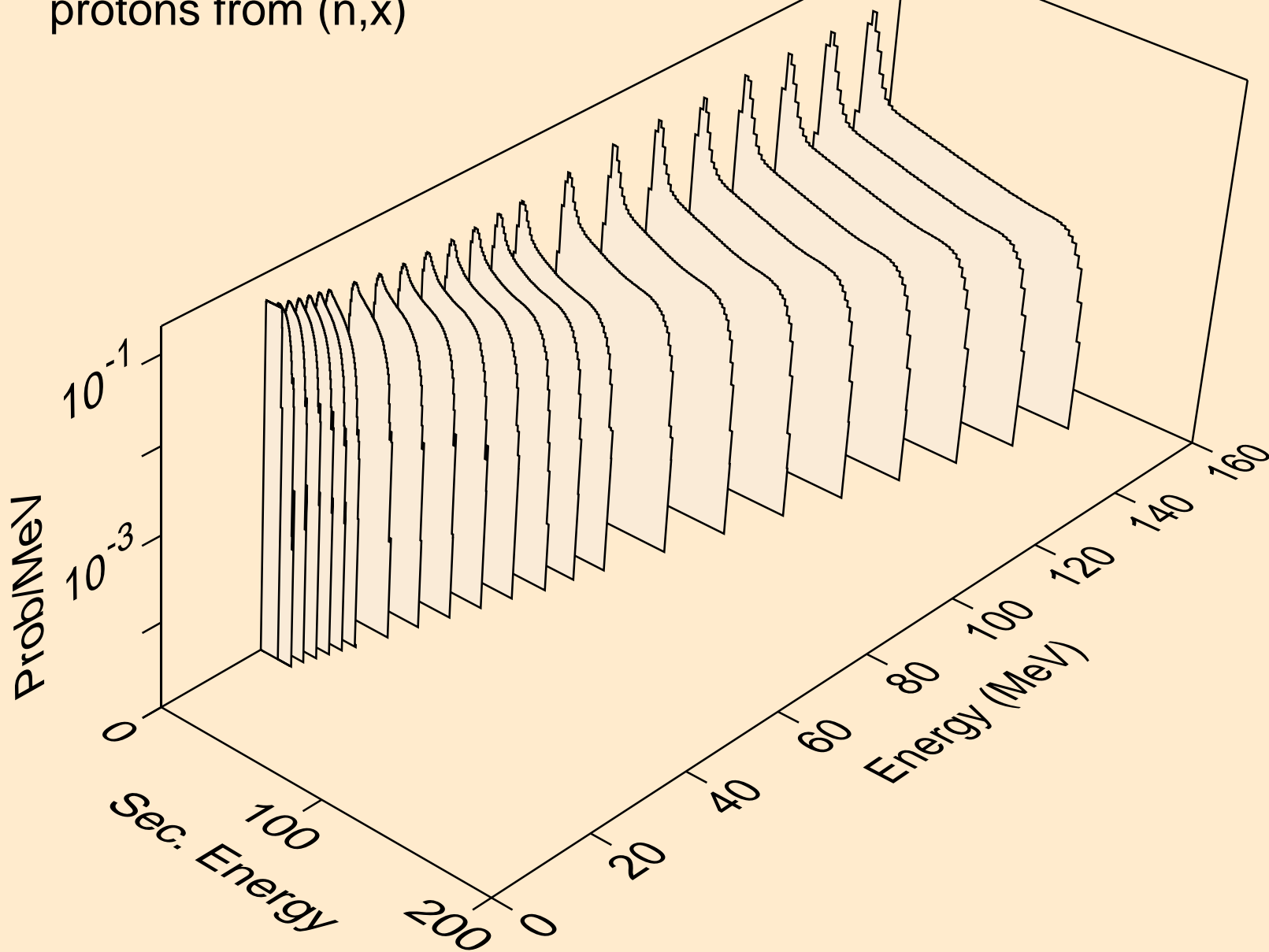

42-MO-97 FOR FENDL-3B2 FROM JENDL-HE WITH NJOY99.304+
protons from (n,xp)

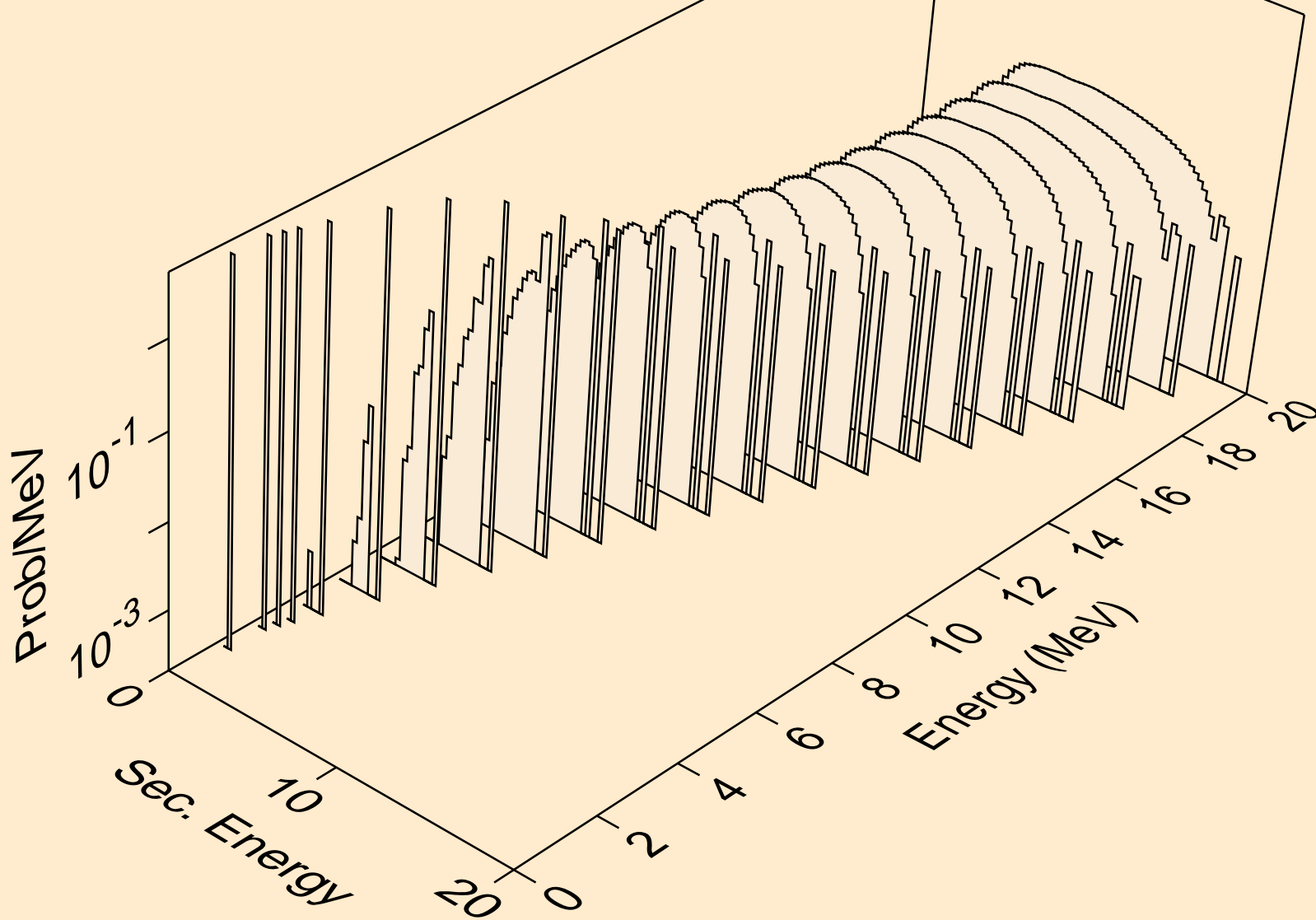

42-MO-97 FOR FENDL-3B2 FROM JENDL-HE WITH NJOY99.304+
deuterons from (n,x)

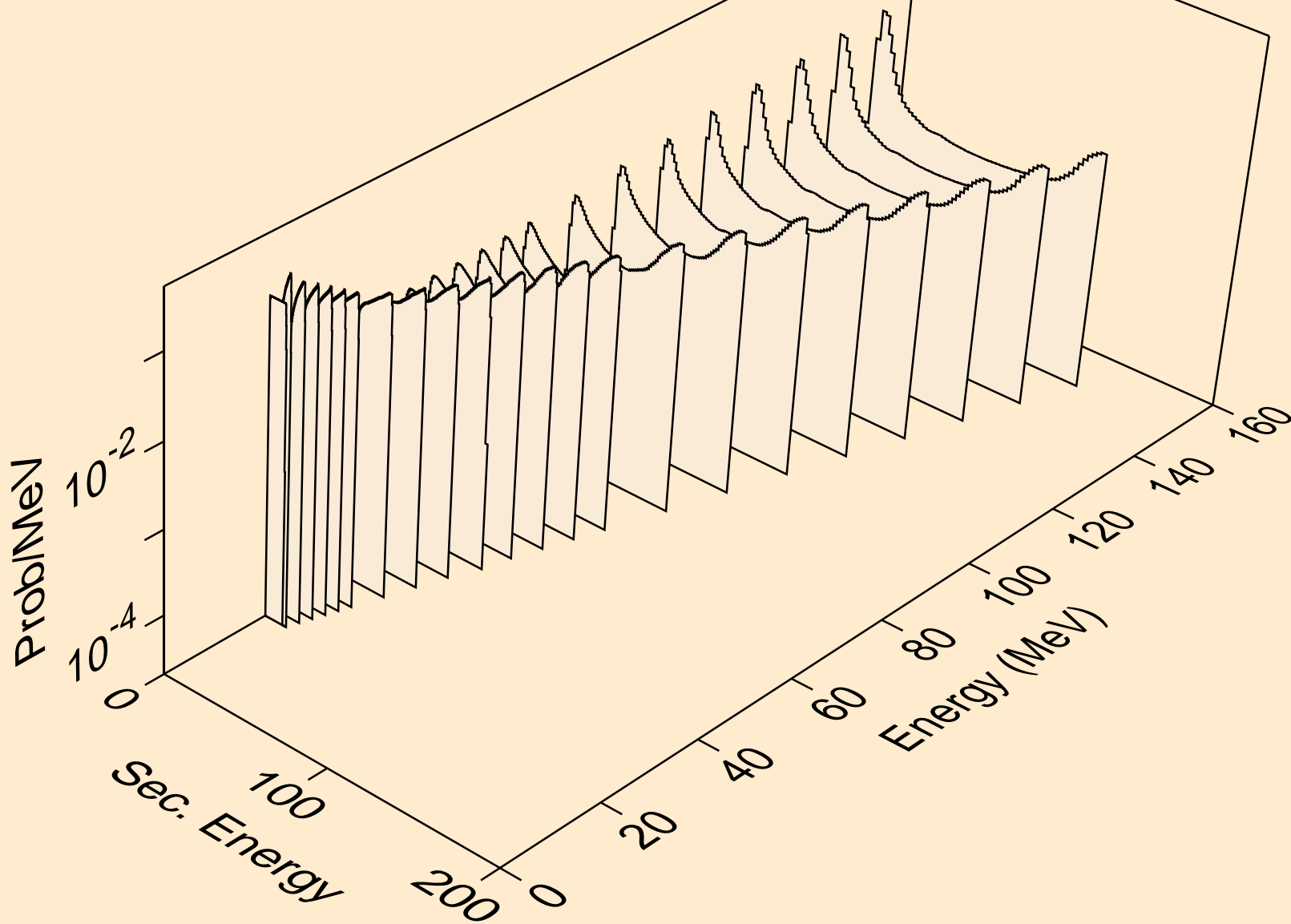

42-MO-97 FOR FENDL-3B2 FROM JENDL-HE WITH NJOY99.304+
deuterons from (n,xd)

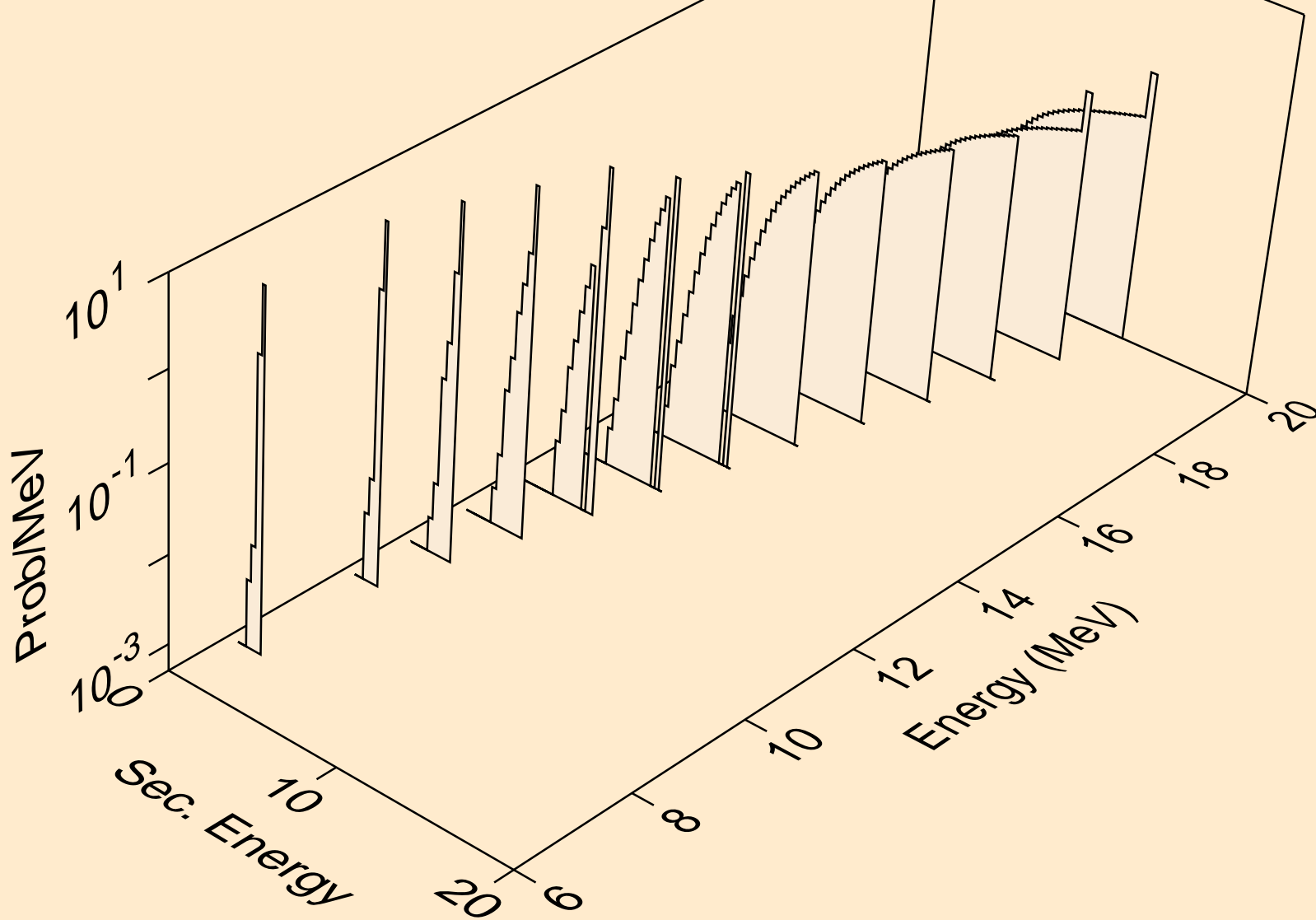

42-MO-97 FOR FENDL-3B2 FROM JENDL-HE WITH NJOY99.304+
tritons from (n,x)

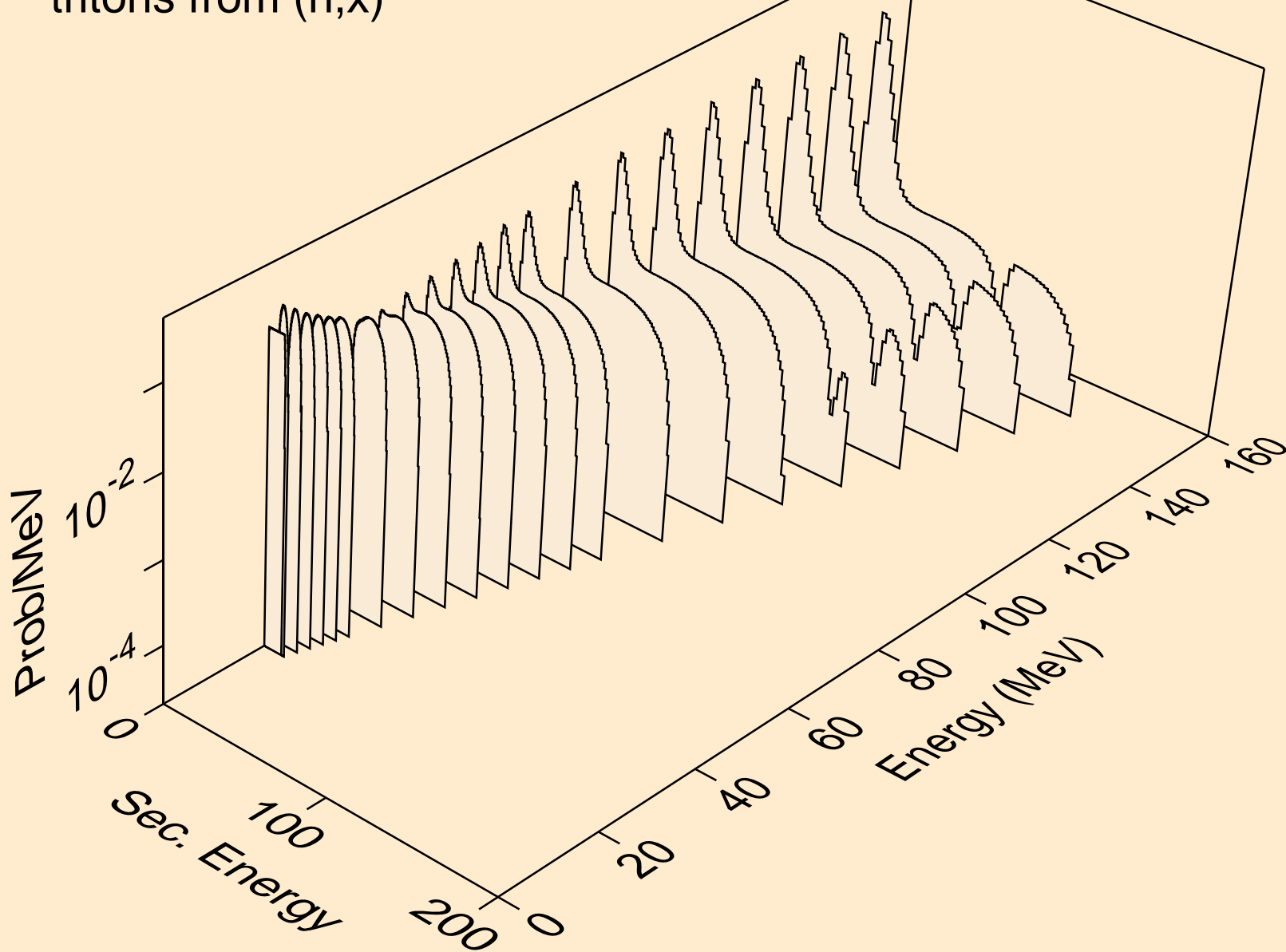

42-MO-97 FOR FENDL-3B2 FROM JENDL-HE WITH NJOY99.304+
tritons from (n,xt)

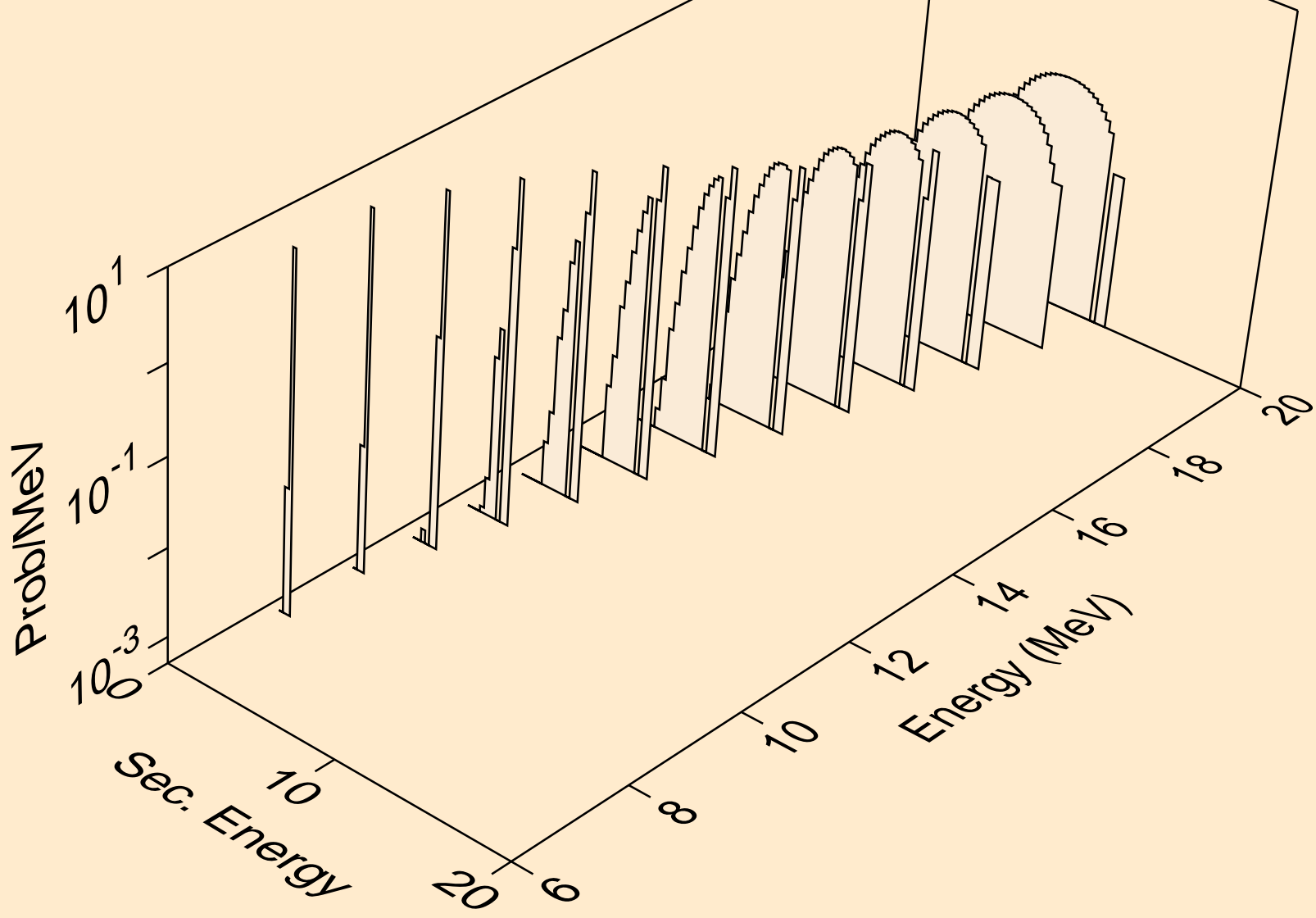

42-MO-97 FOR FENDL-3B2 FROM JENDL-HE WITH NJOY99.304+
he3s from (n,xhe3)

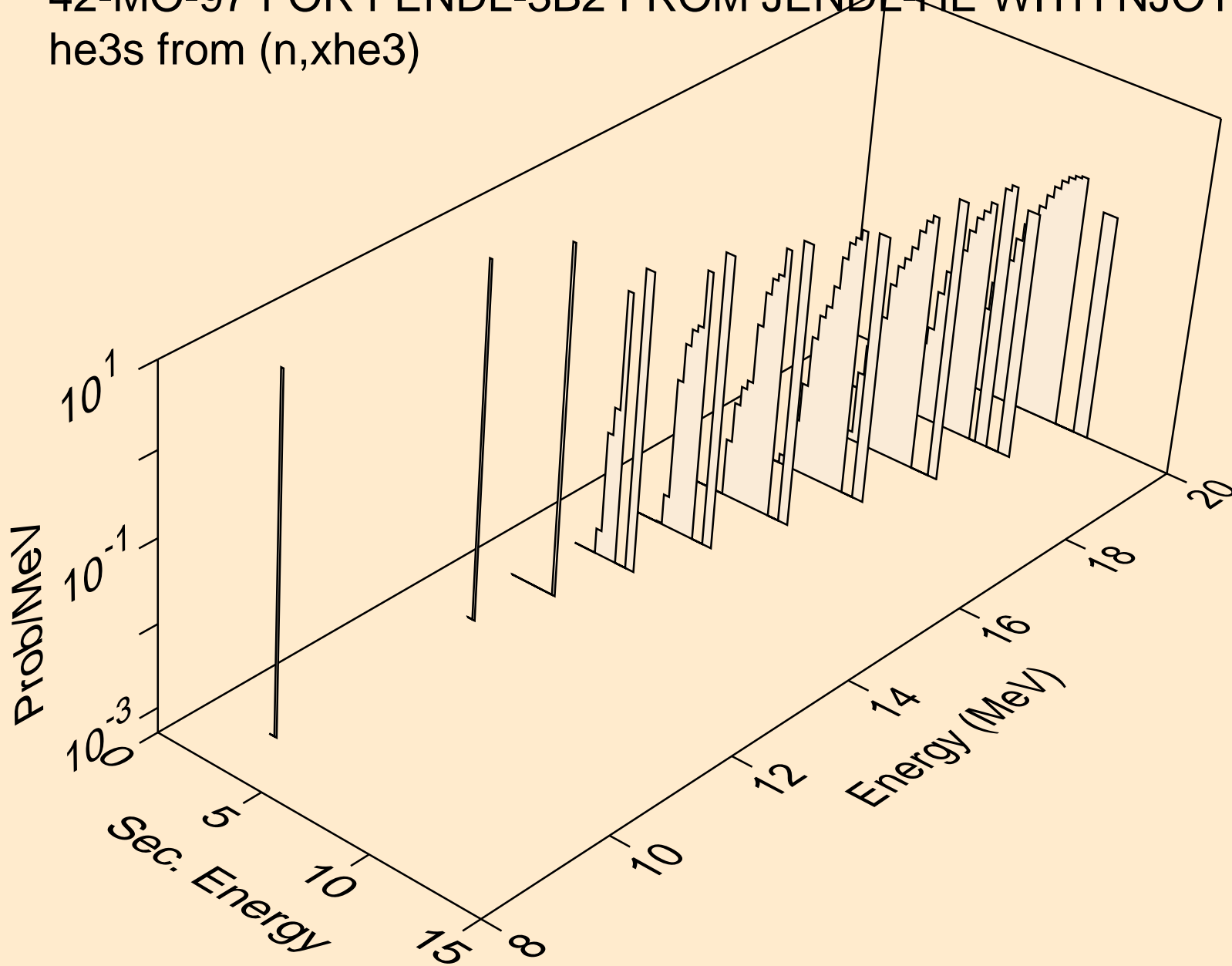

42-MO-97 FOR FENDL-3B2 FROM JENDL-HE WITH NJOY99.304+
alphas from (n,x)

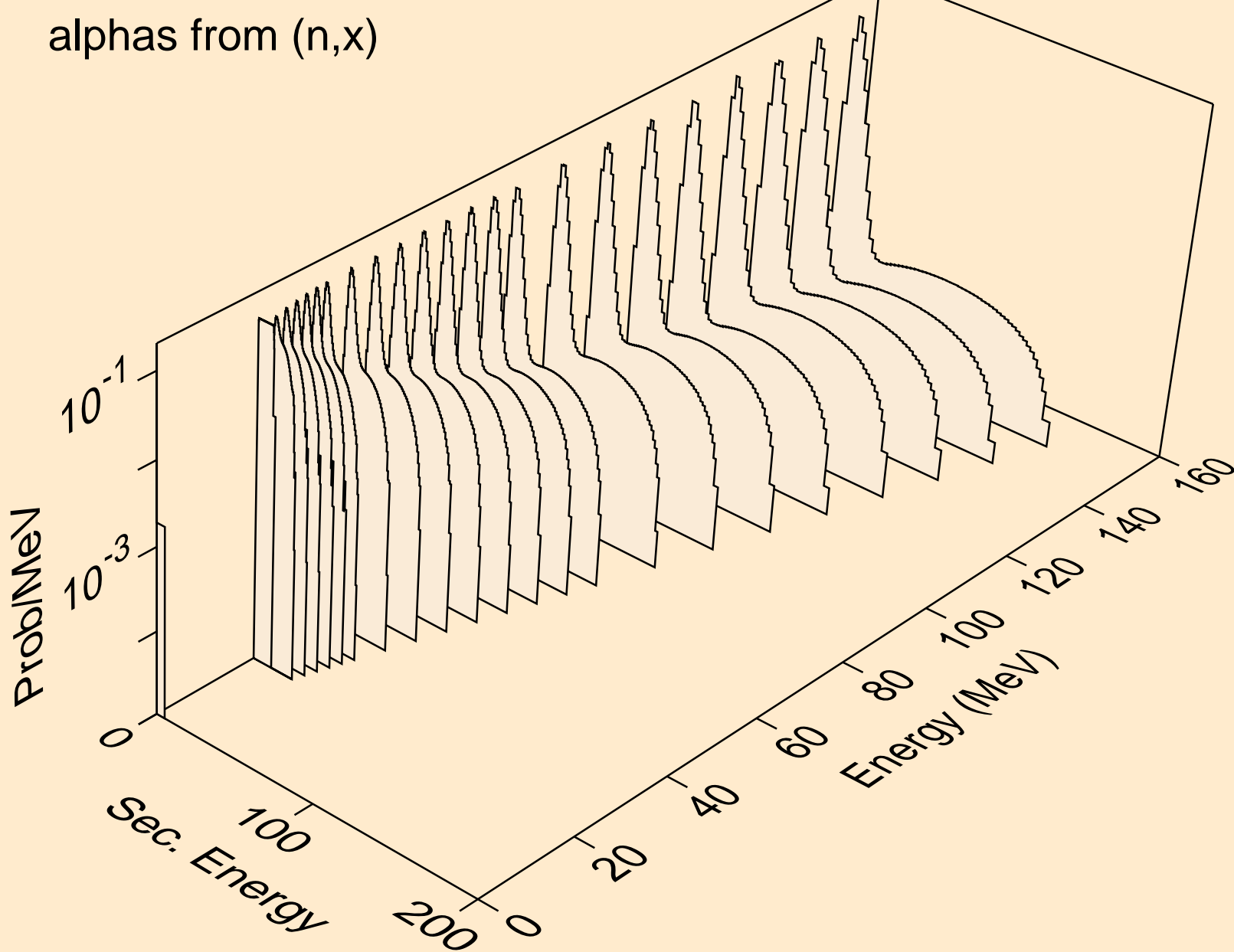

42-MO-97 FOR FENDL-3B2 FROM JENDL-HE WITH NJOY99.304+
alphas from (n,xa)

