

74-W-183 FOR FENDL-3B2 FROM ENDF/B-VII WITH NJOY99.304+
Principal cross sections

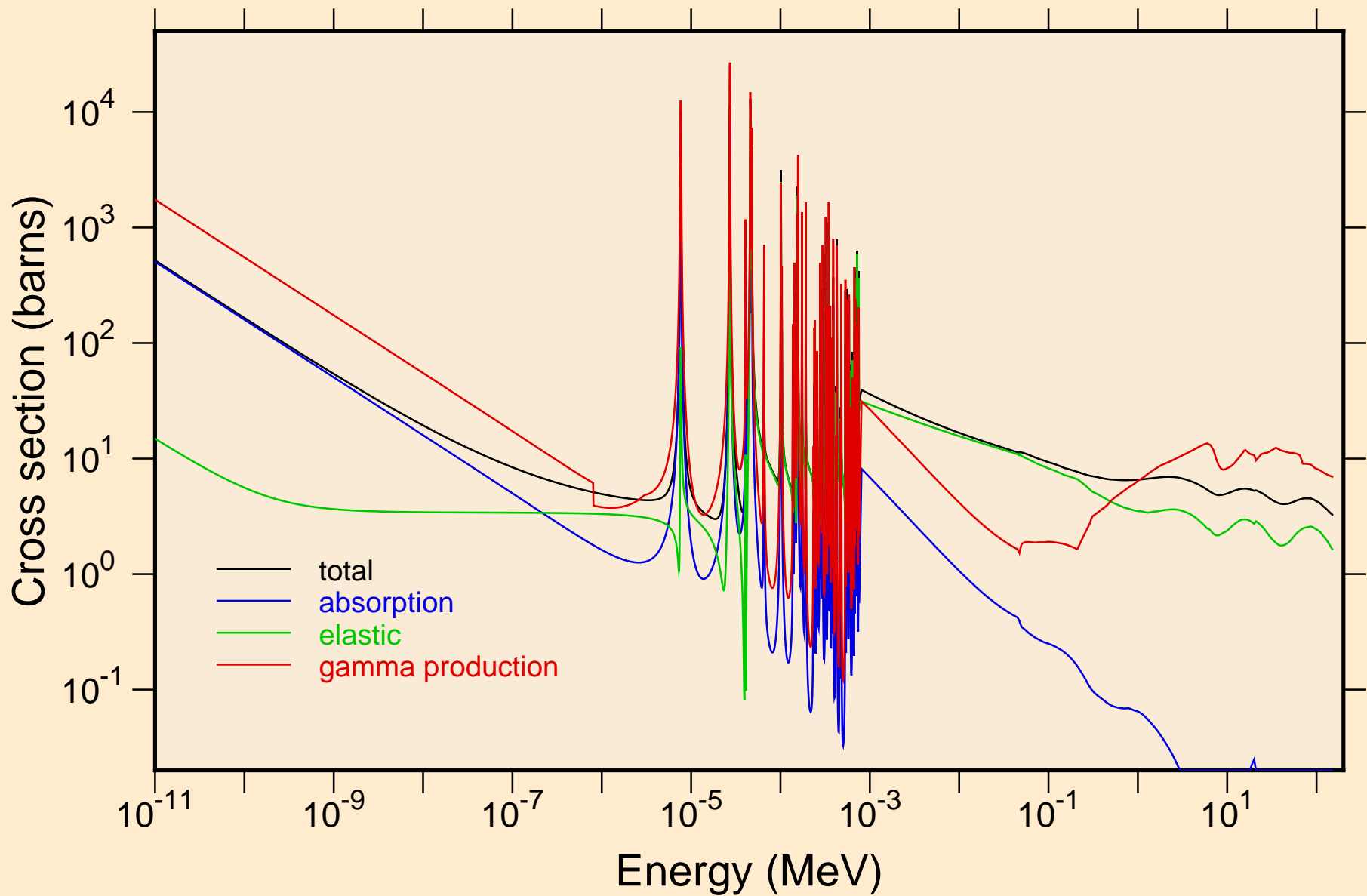

74-W-183 FOR FENDL-3B2 FROM ENDF/B-VII WITH NJOY99.304+
resonance total cross section

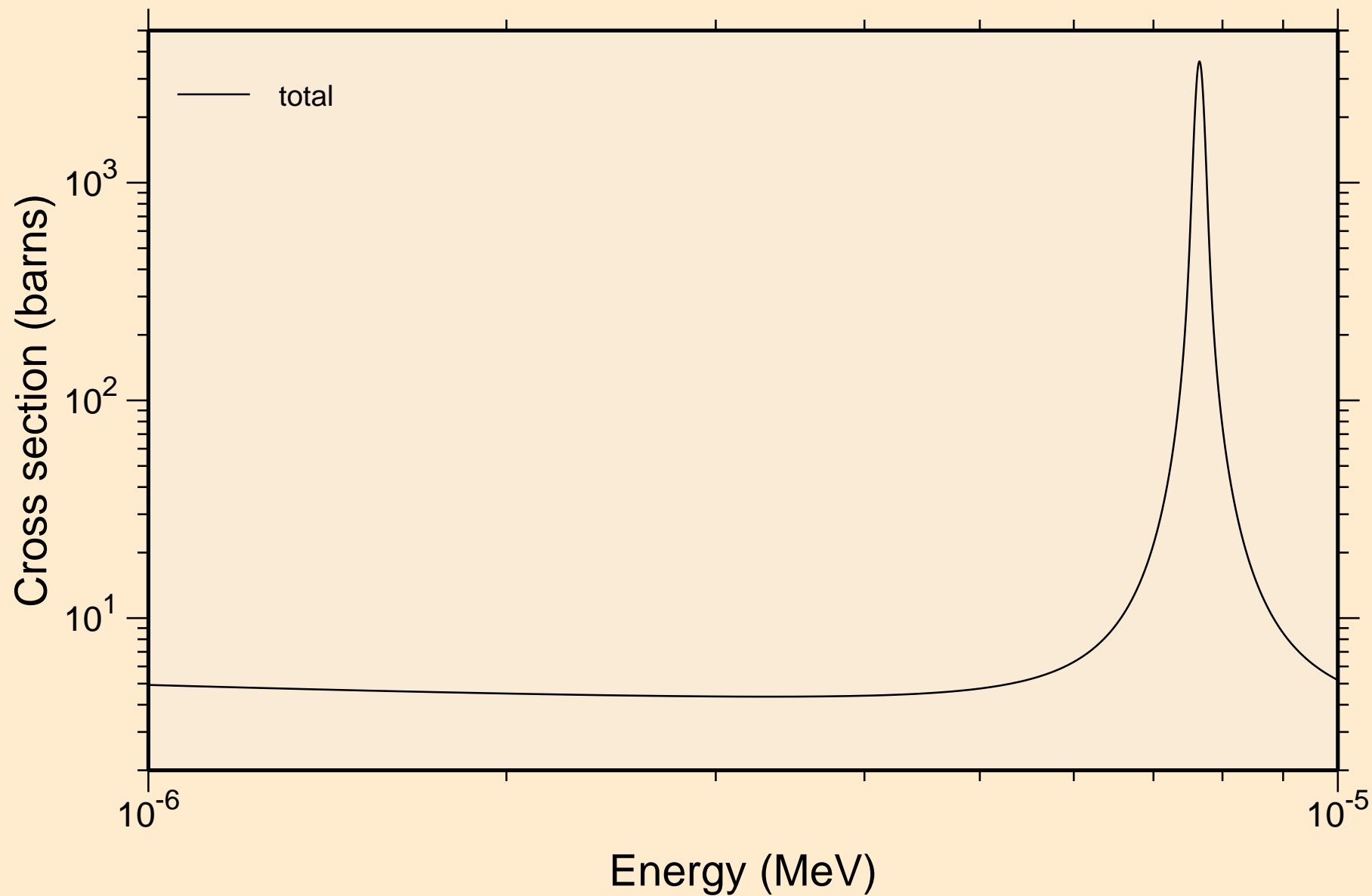

74-W-183 FOR FENDL-3B2 FROM ENDF/B-VII WITH NJOY99.304+
resonance total cross section

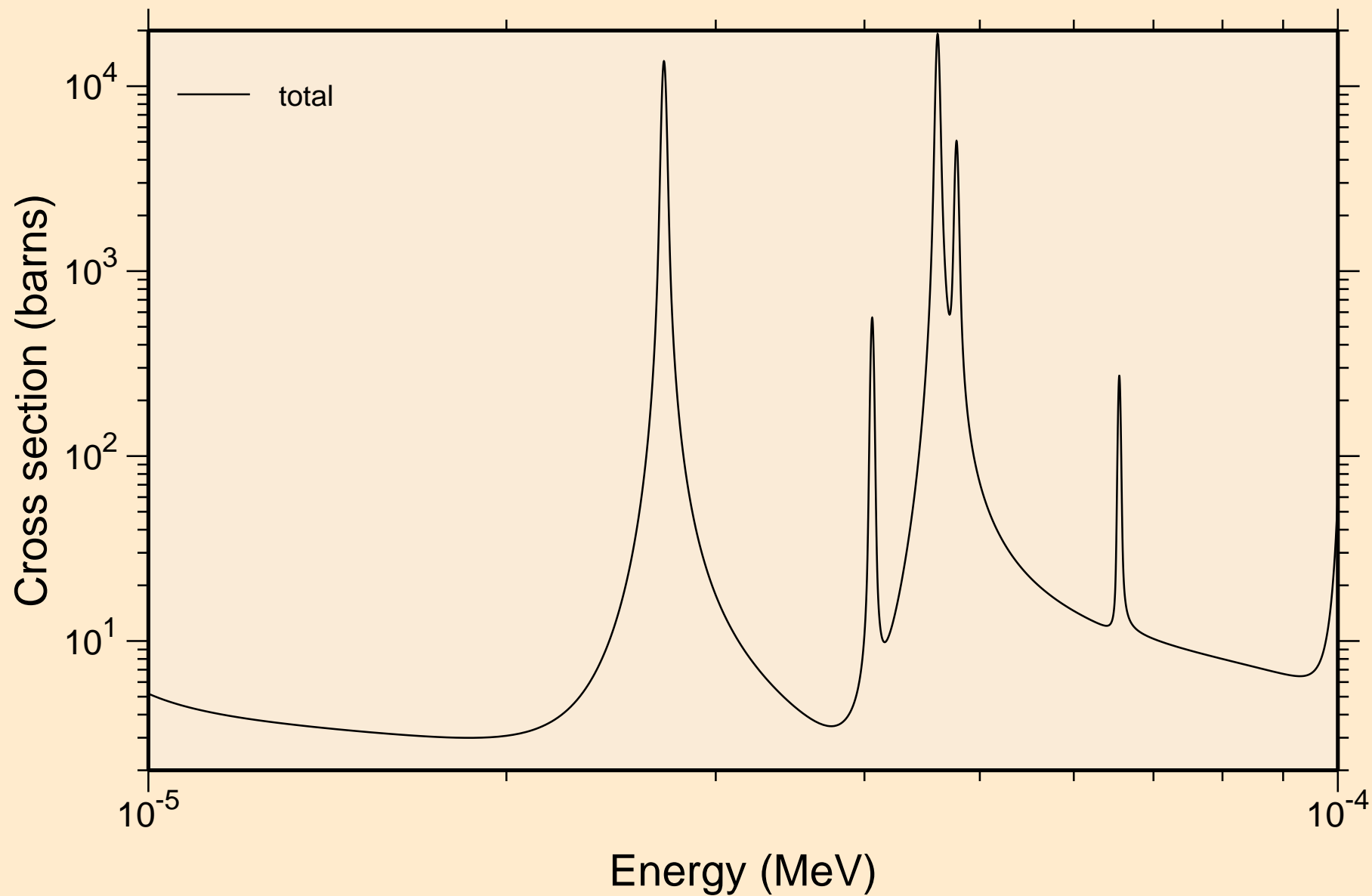

74-W-183 FOR FENDL-3B2 FROM ENDF/B-VII WITH NJOY99.304+
resonance total cross section

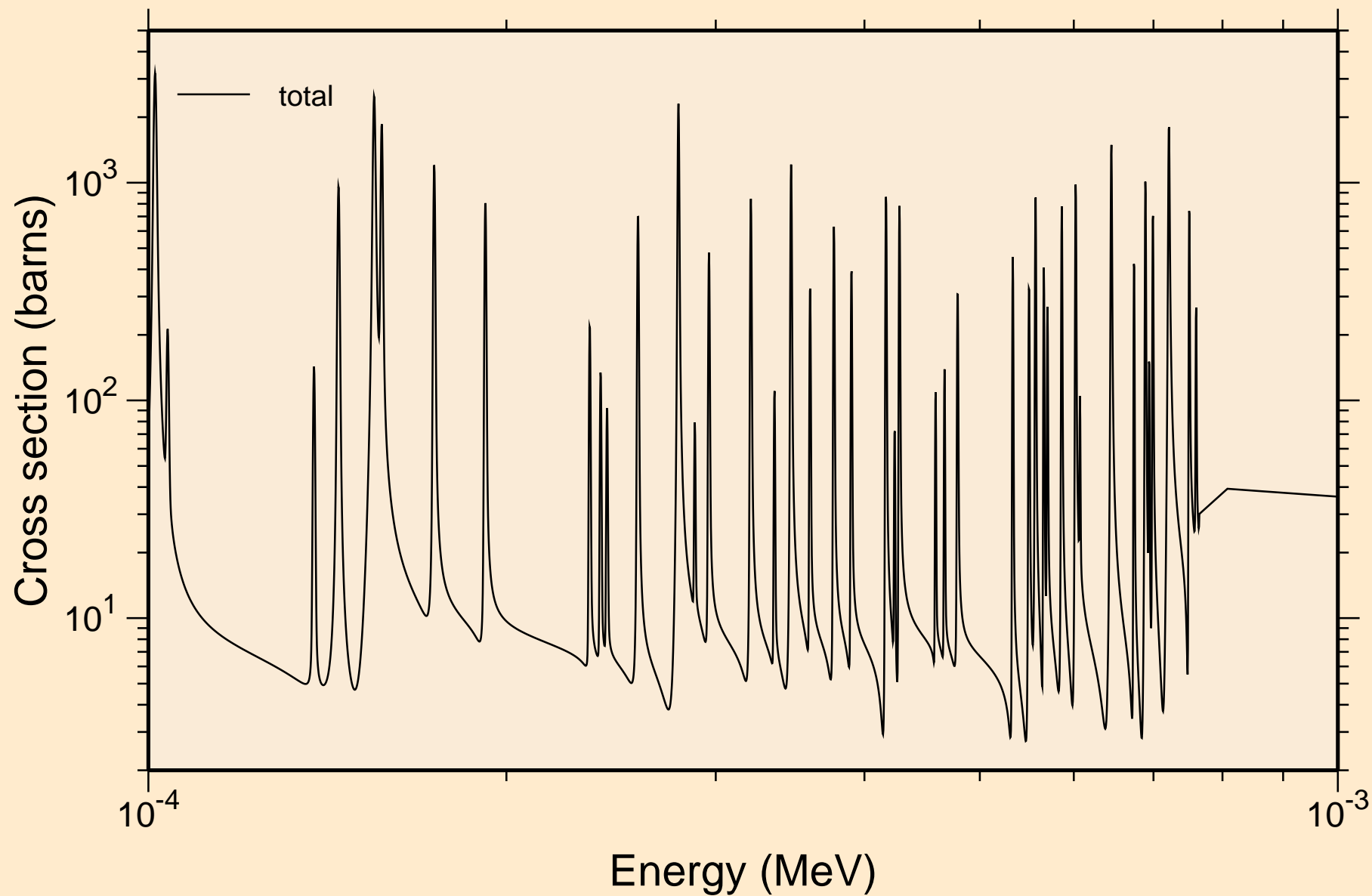

74-W-183 FOR FENDL-3B2 FROM ENDF/B-VII WITH NJOY99.304+
resonance total cross section

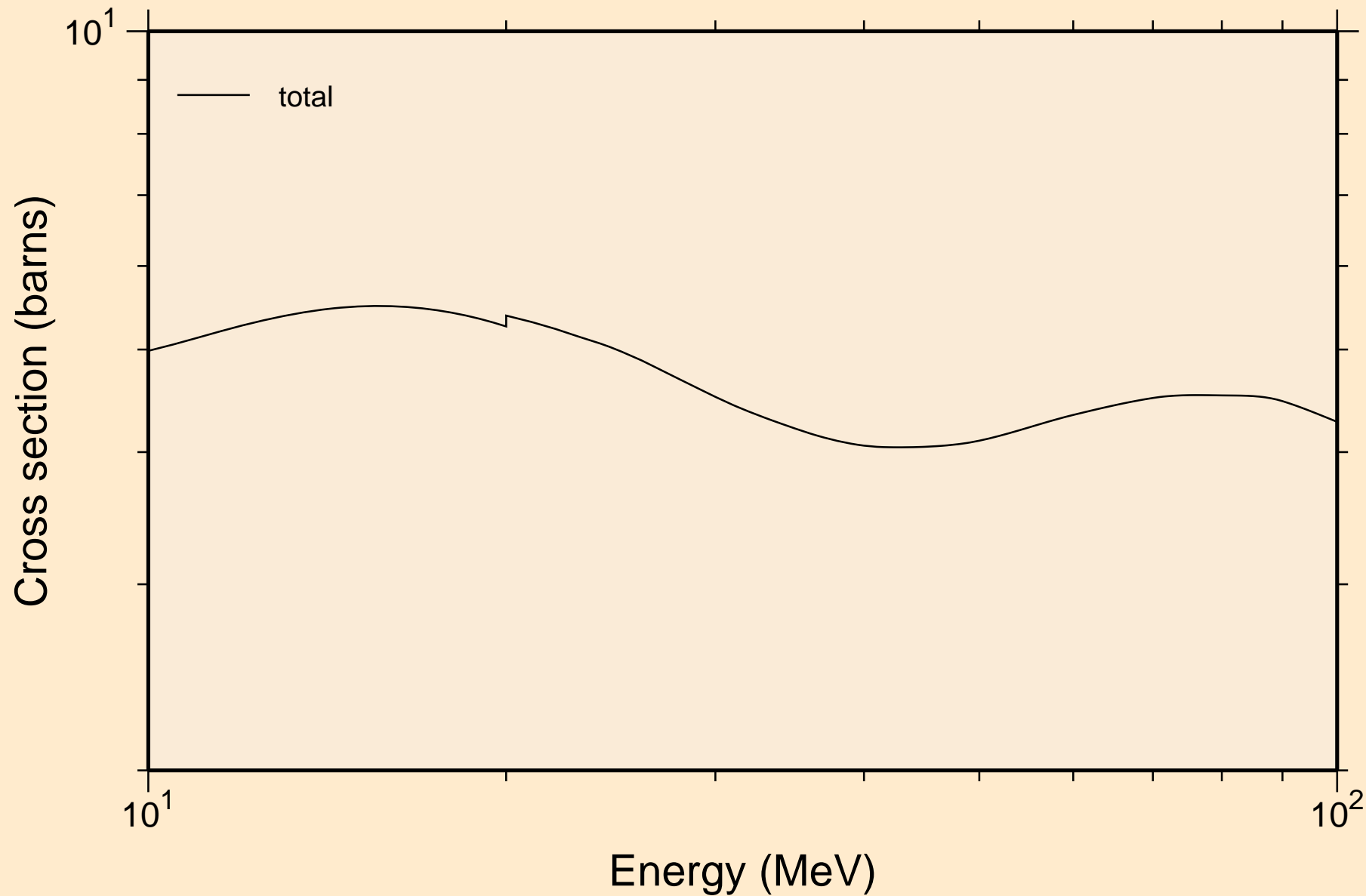

74-W-183 FOR FENDL-3B2 FROM ENDF/B-VII WITH NJOY99.304+
resonance absorption cross sections

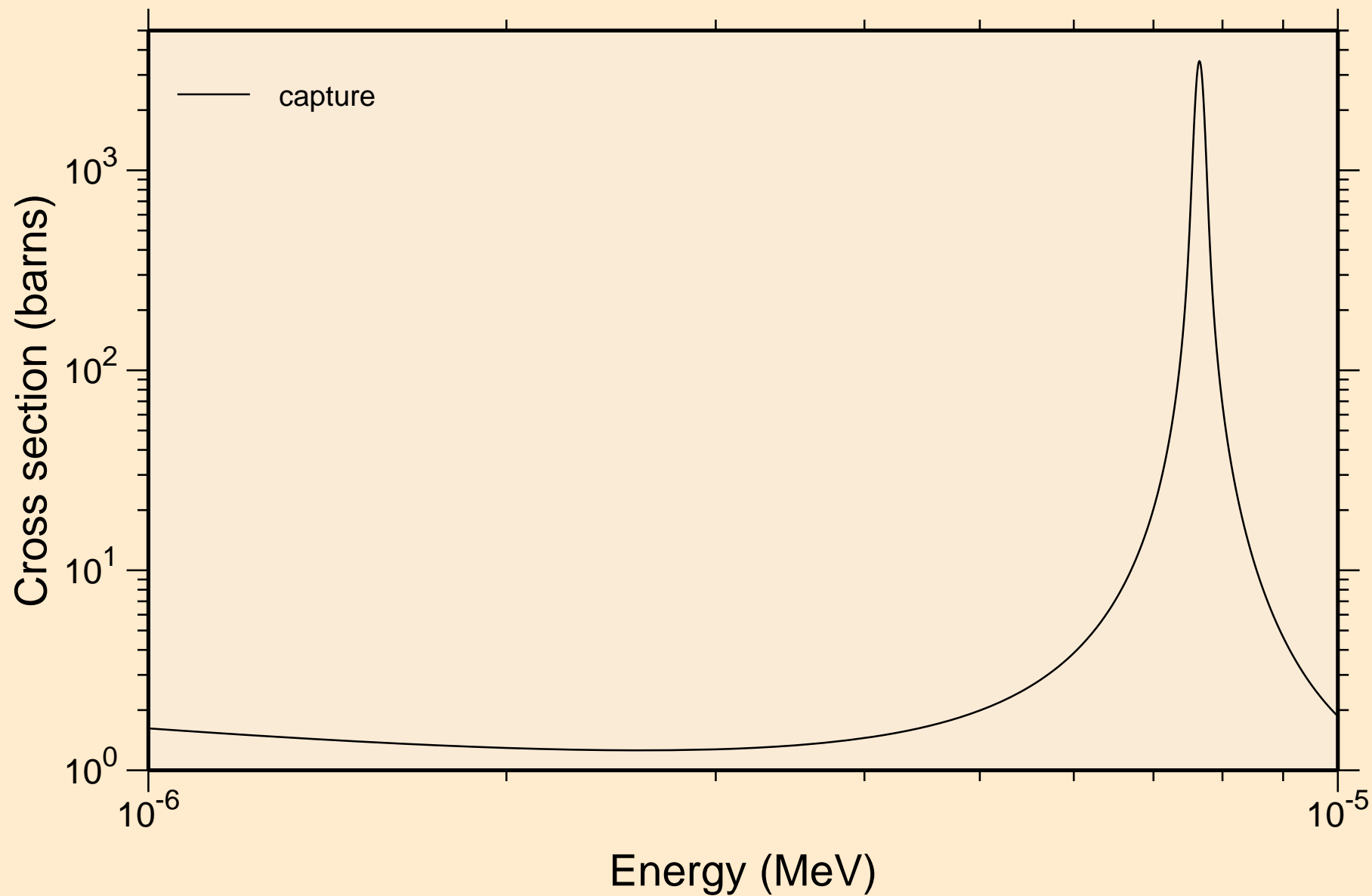

74-W-183 FOR FENDL-3B2 FROM ENDF/B-VII WITH NJOY99.304+
resonance absorption cross sections

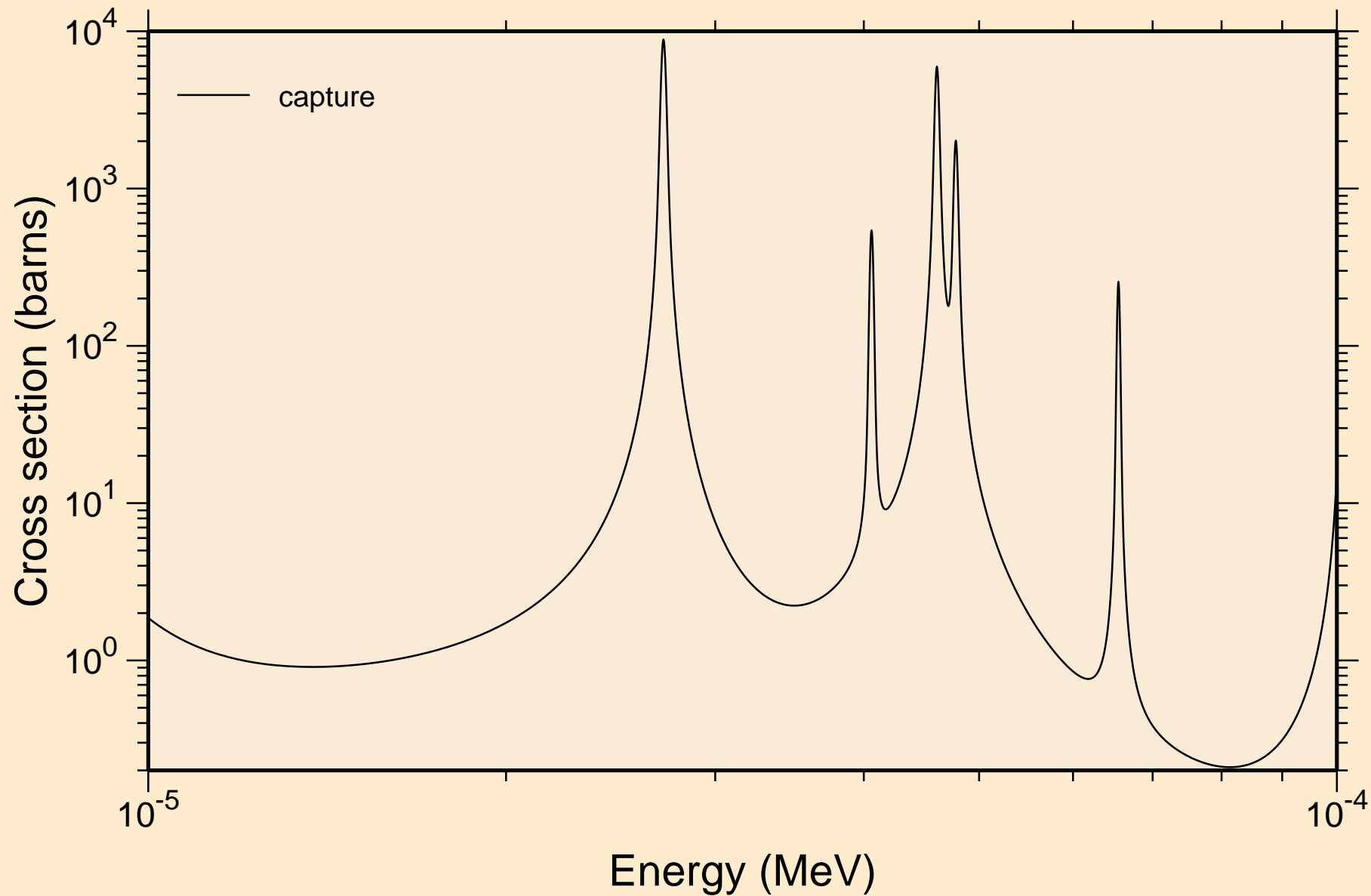

74-W-183 FOR FENDL-3B2 FROM ENDF/B-VII WITH NJOY99.304+
resonance absorption cross sections

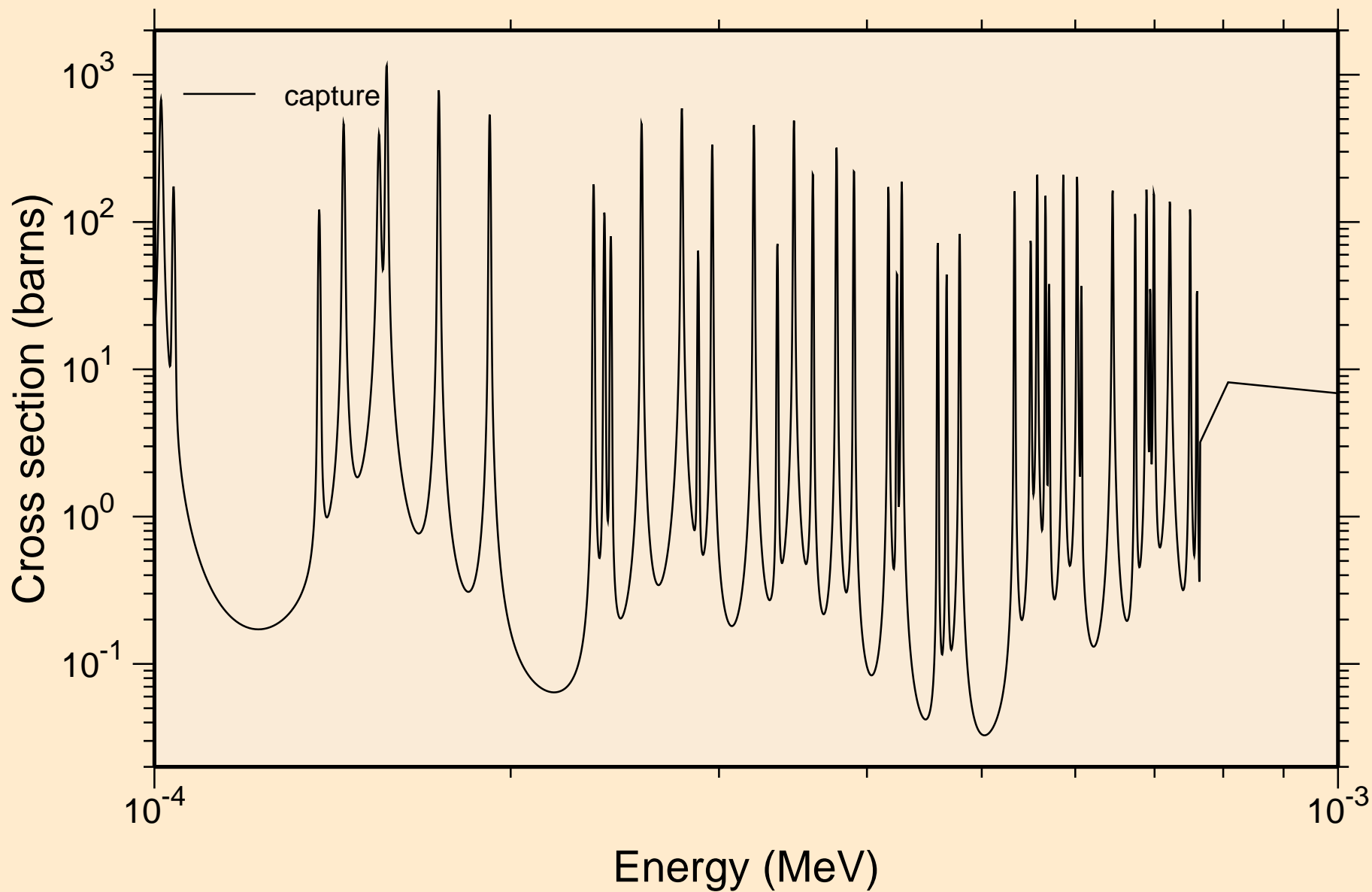

74-W-183 FOR FENDL-3B2 FROM ENDF/B-VII WITH NJOY99.304+
resonance absorption cross sections

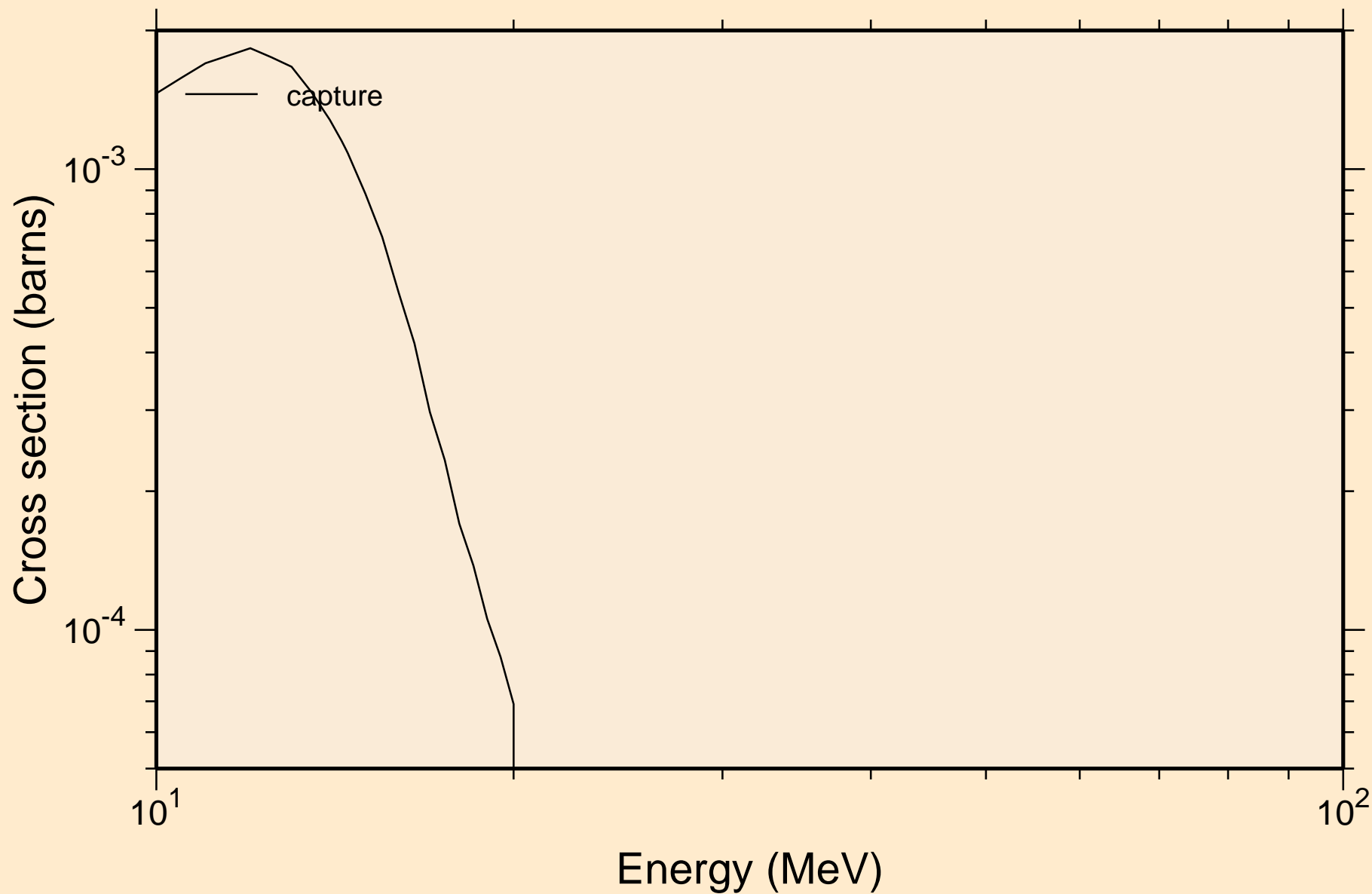

74-W-183 FOR FENDL-3B2 FROM ENDF/B-VII WITH NJOY99.304+
UR total cross section

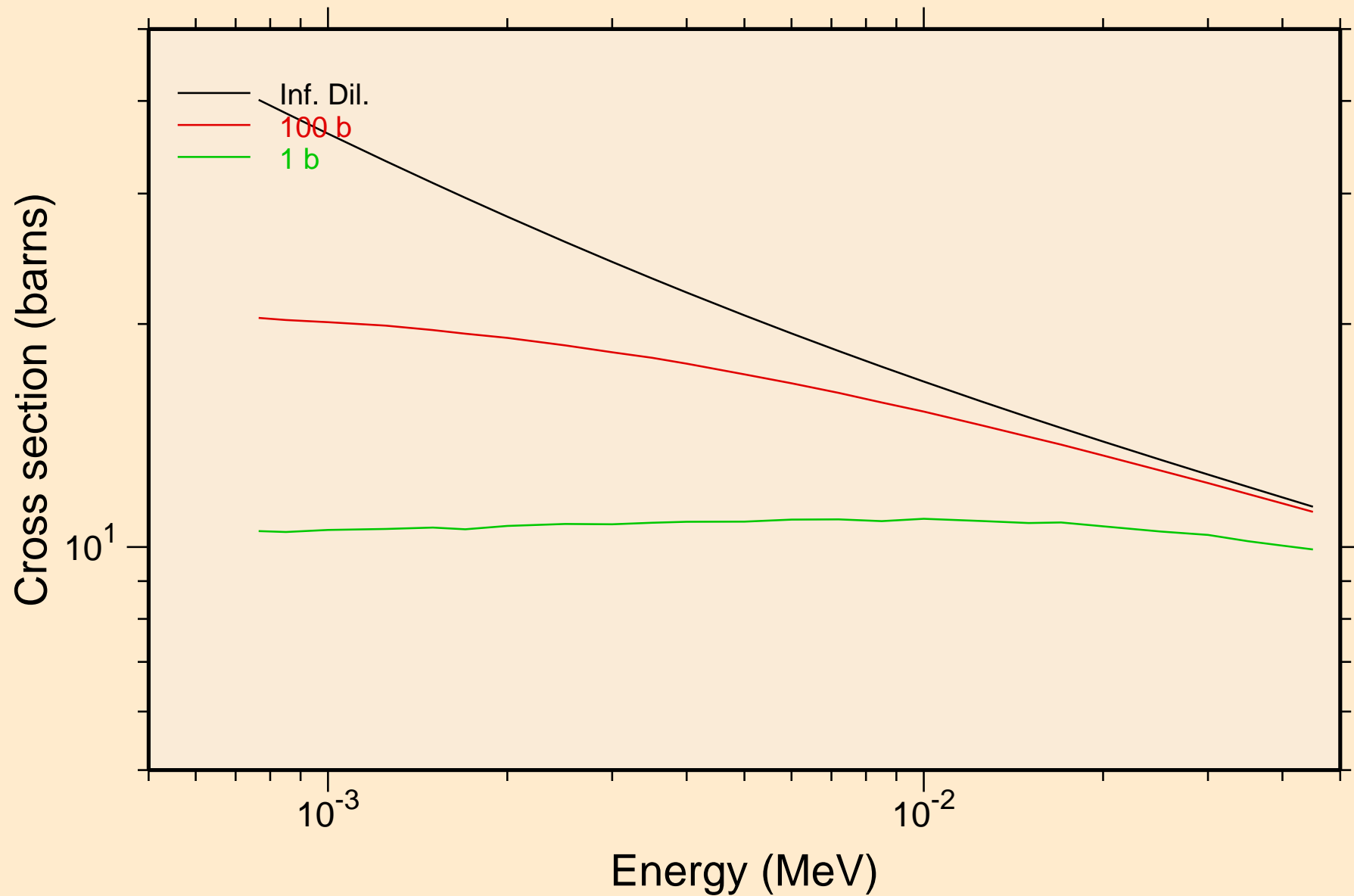

74-W-183 FOR FENDL-3B2 FROM ENDF/B-VII WITH NJOY99.304+
UR elastic cross section

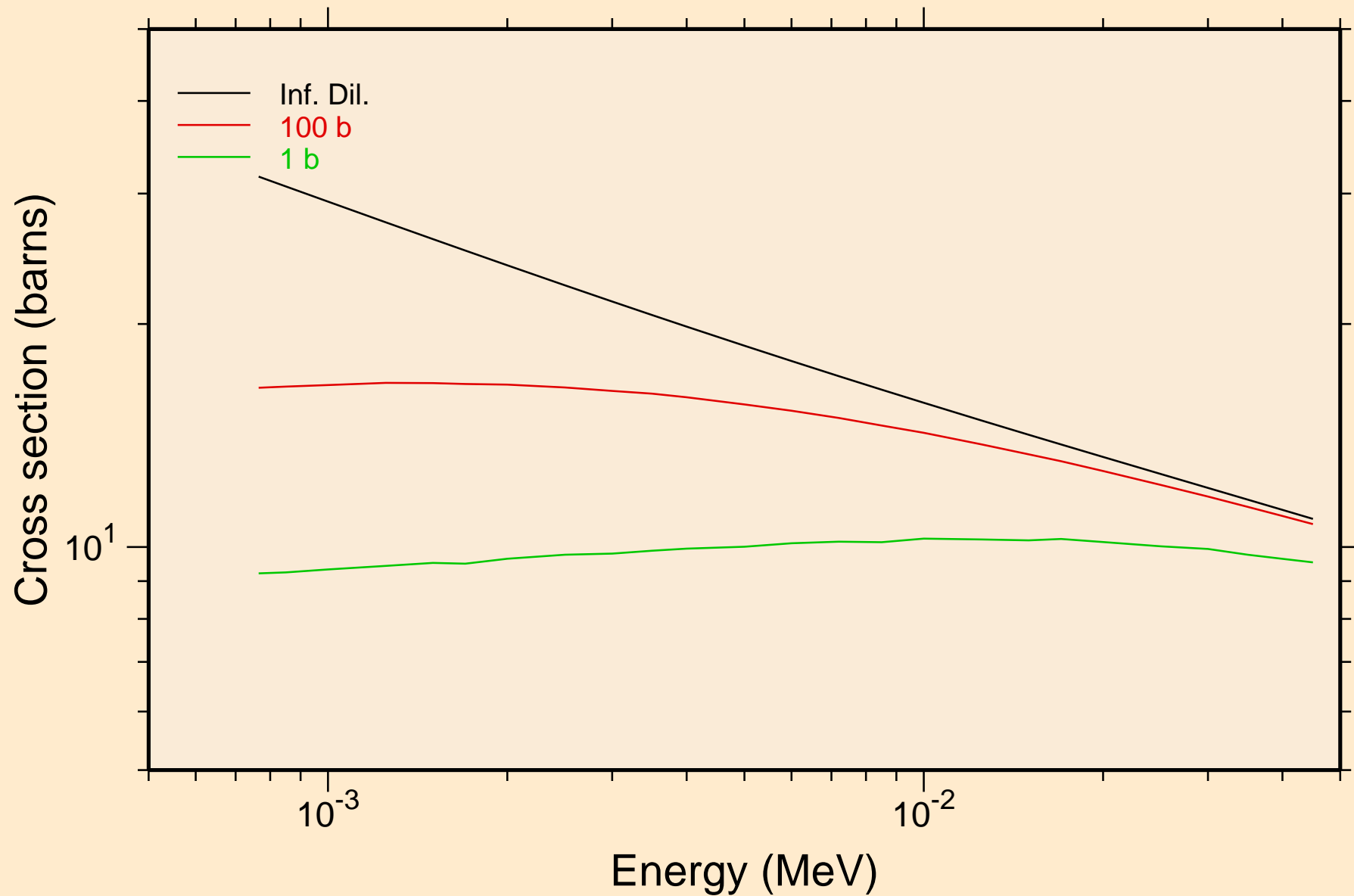

74-W-183 FOR FENDL-3B2 FROM ENDF/B-VII WITH NJOY99.304+
UR capture cross section

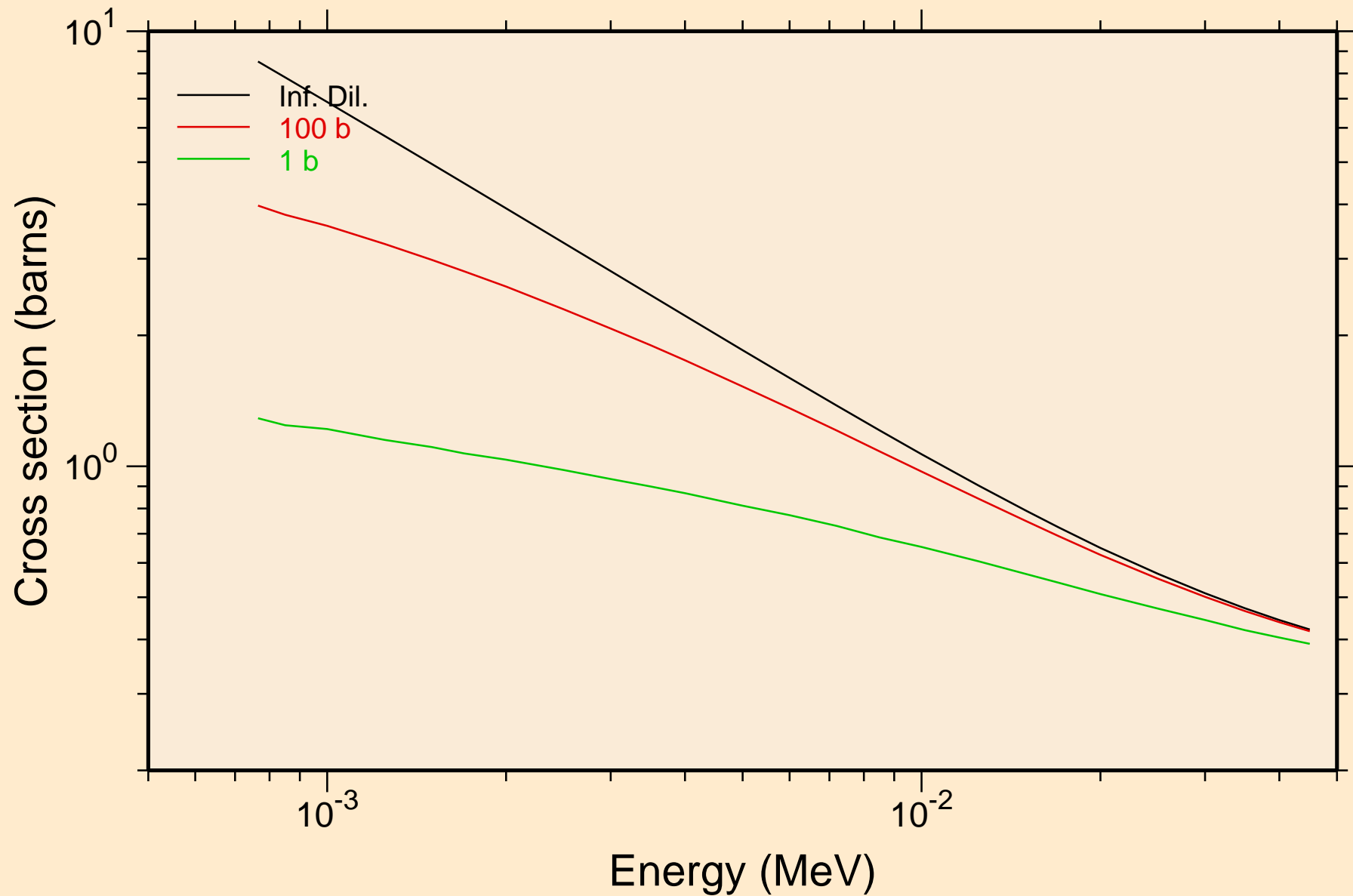

74-W-183 FOR FENDL-3B2 FROM ENDF/B-VII WITH NJOY99.304+ Heating

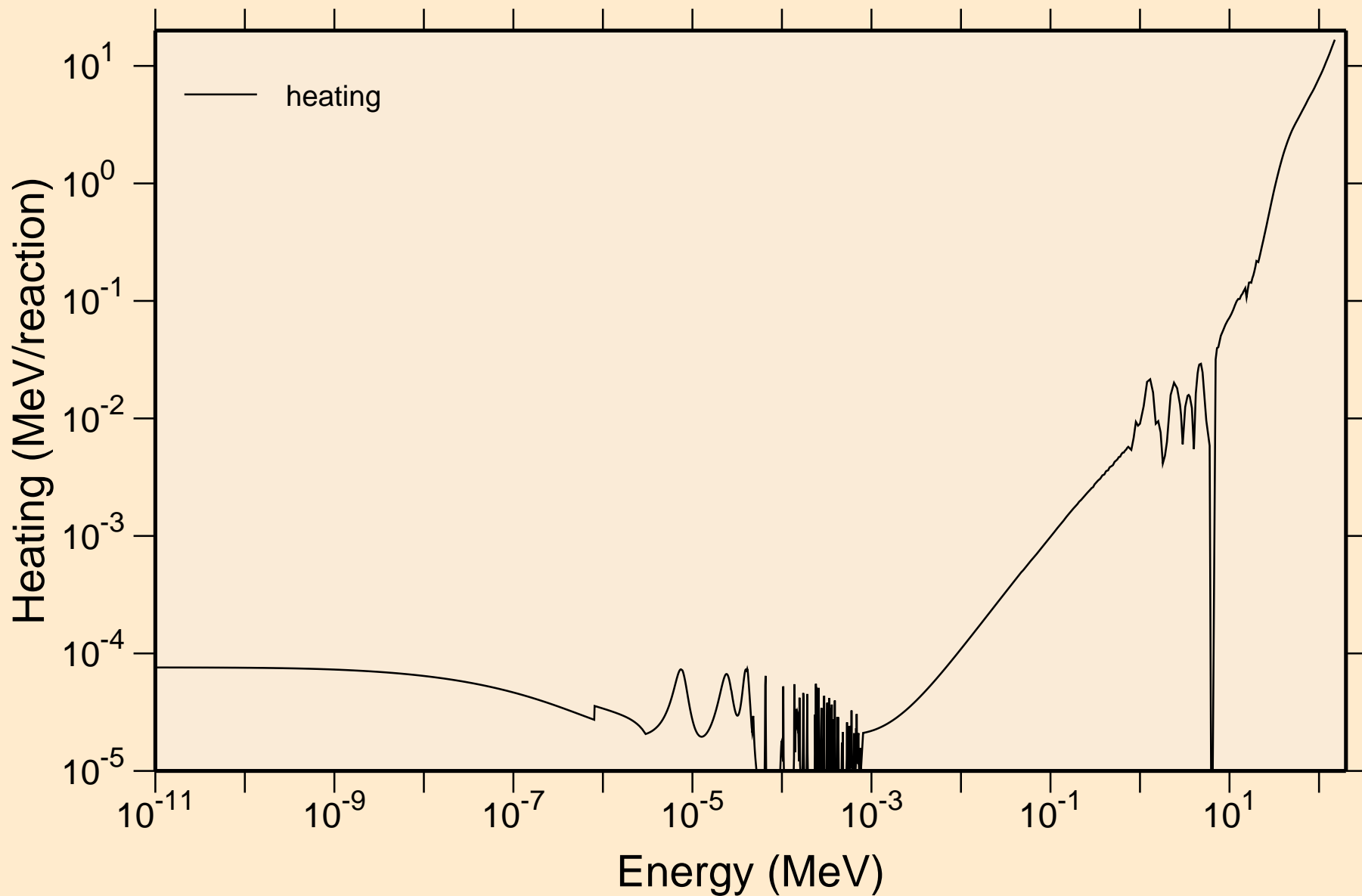

74-W-183 FOR FENDL-3B2 FROM ENDF/B-VII WITH NJOY99.304+ Damage

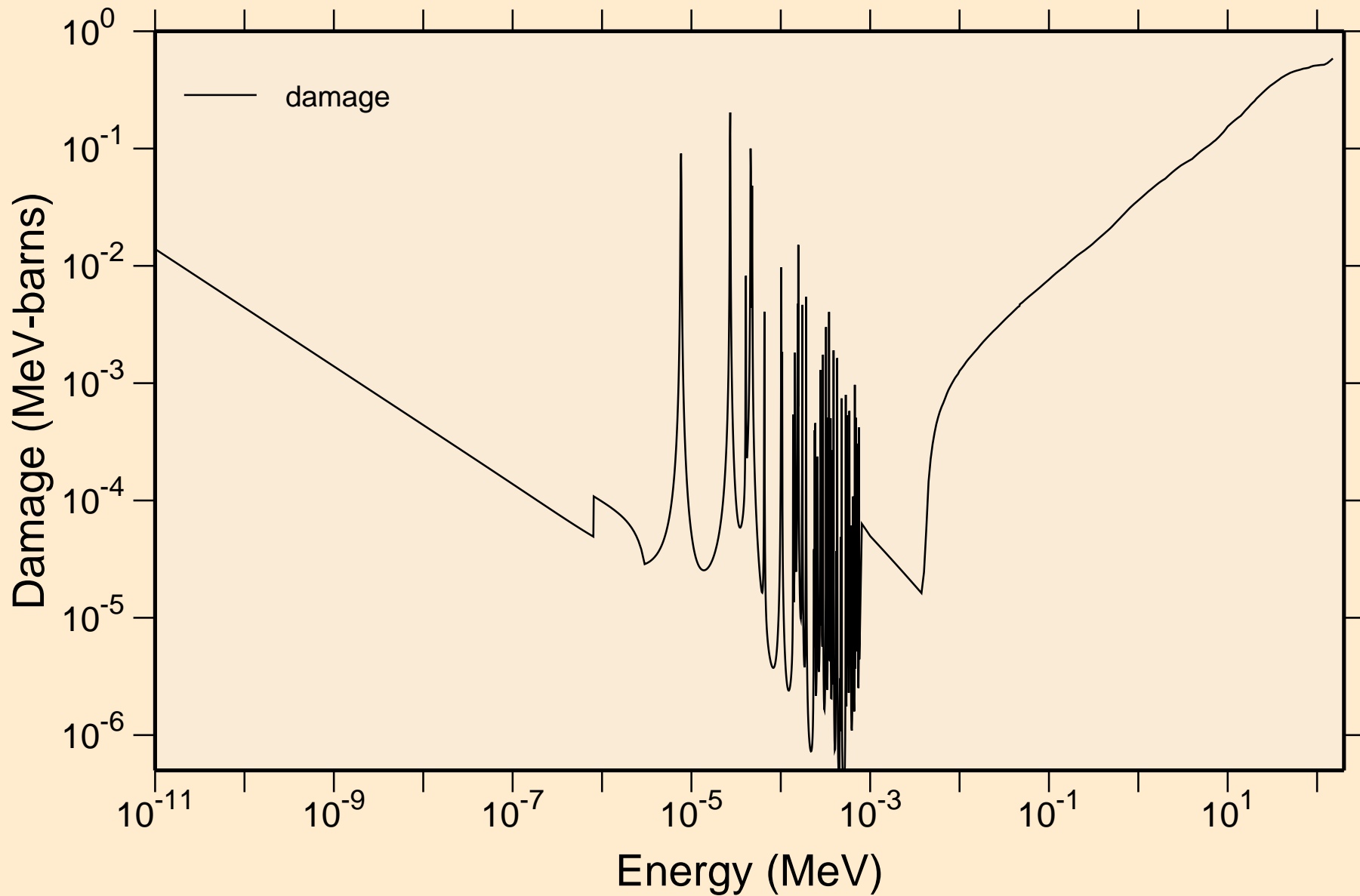

74-W-183 FOR FENDL-3B2 FROM ENDF/B-VII WITH NJOY99.304+
Non-threshold reactions

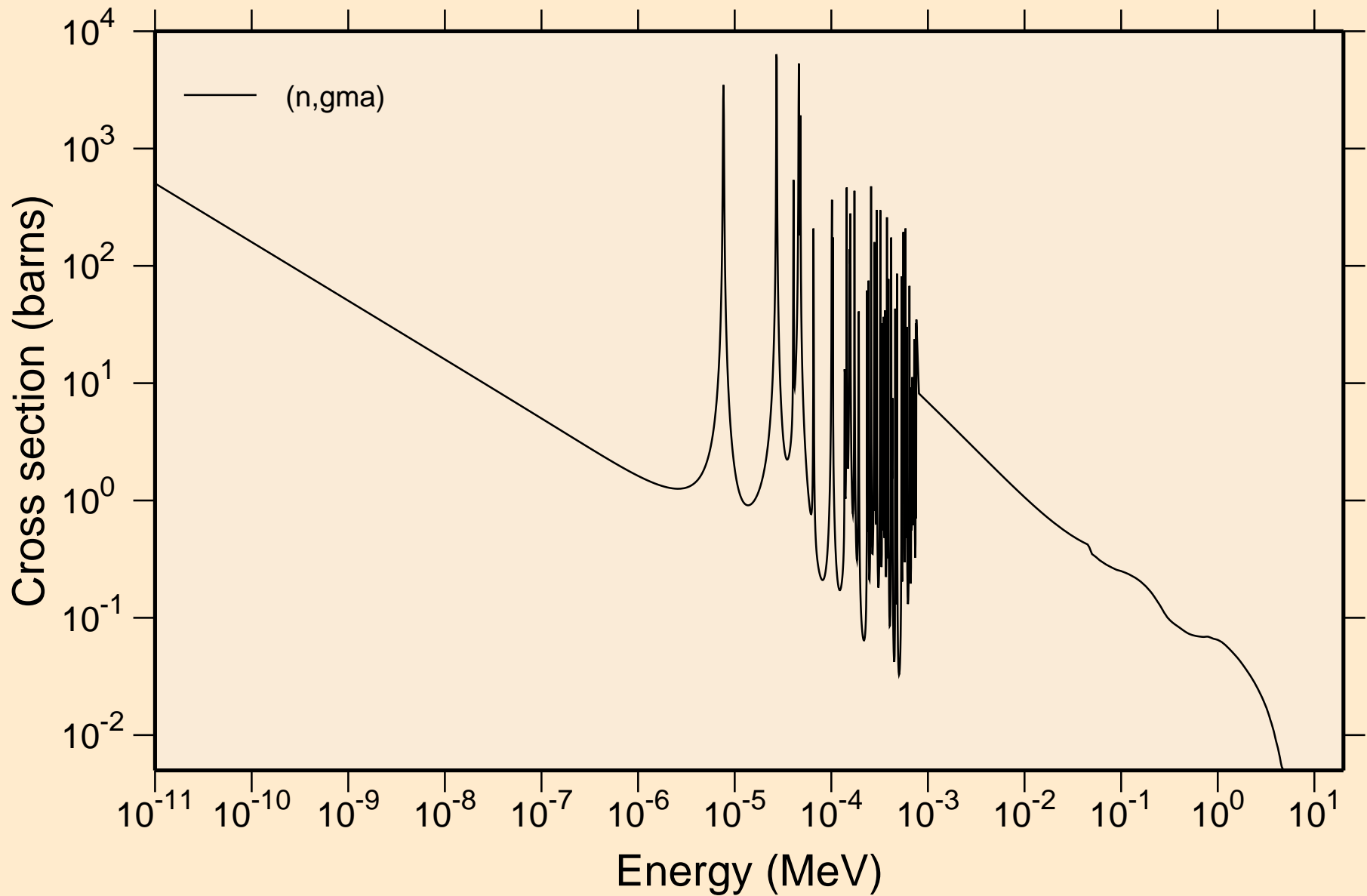

74-W-183 FOR FENDL-3B2 FROM ENDF/B-VII WITH NJOY99.304+

Principal cross sections

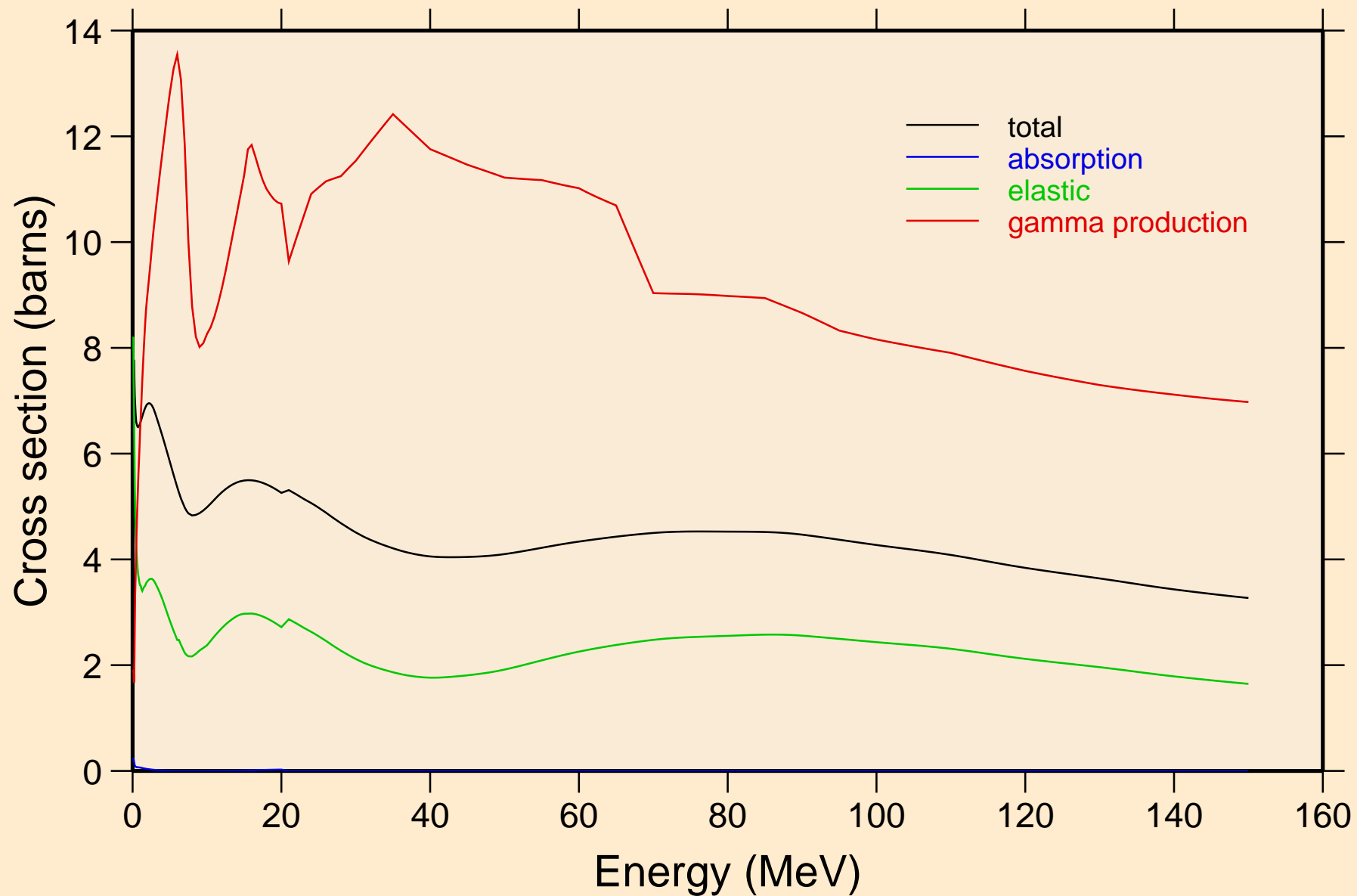

74-W-183 FOR FENDL-3B2 FROM ENDF/B-VII WITH NJOY99.304+ Heating

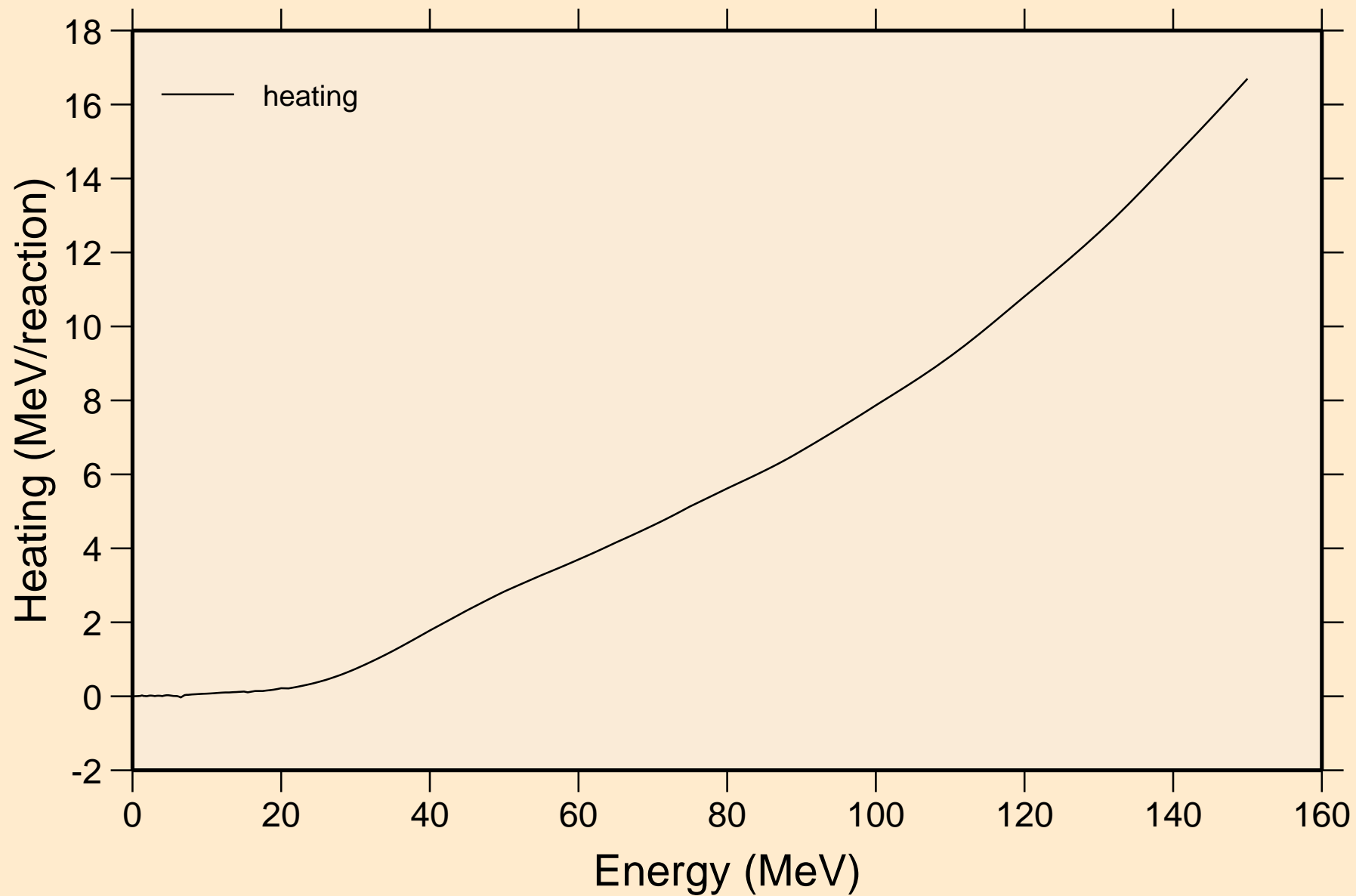

74-W-183 FOR FENDL-3B2 FROM ENDF/B-VII WITH NJOY99.304+ Damage

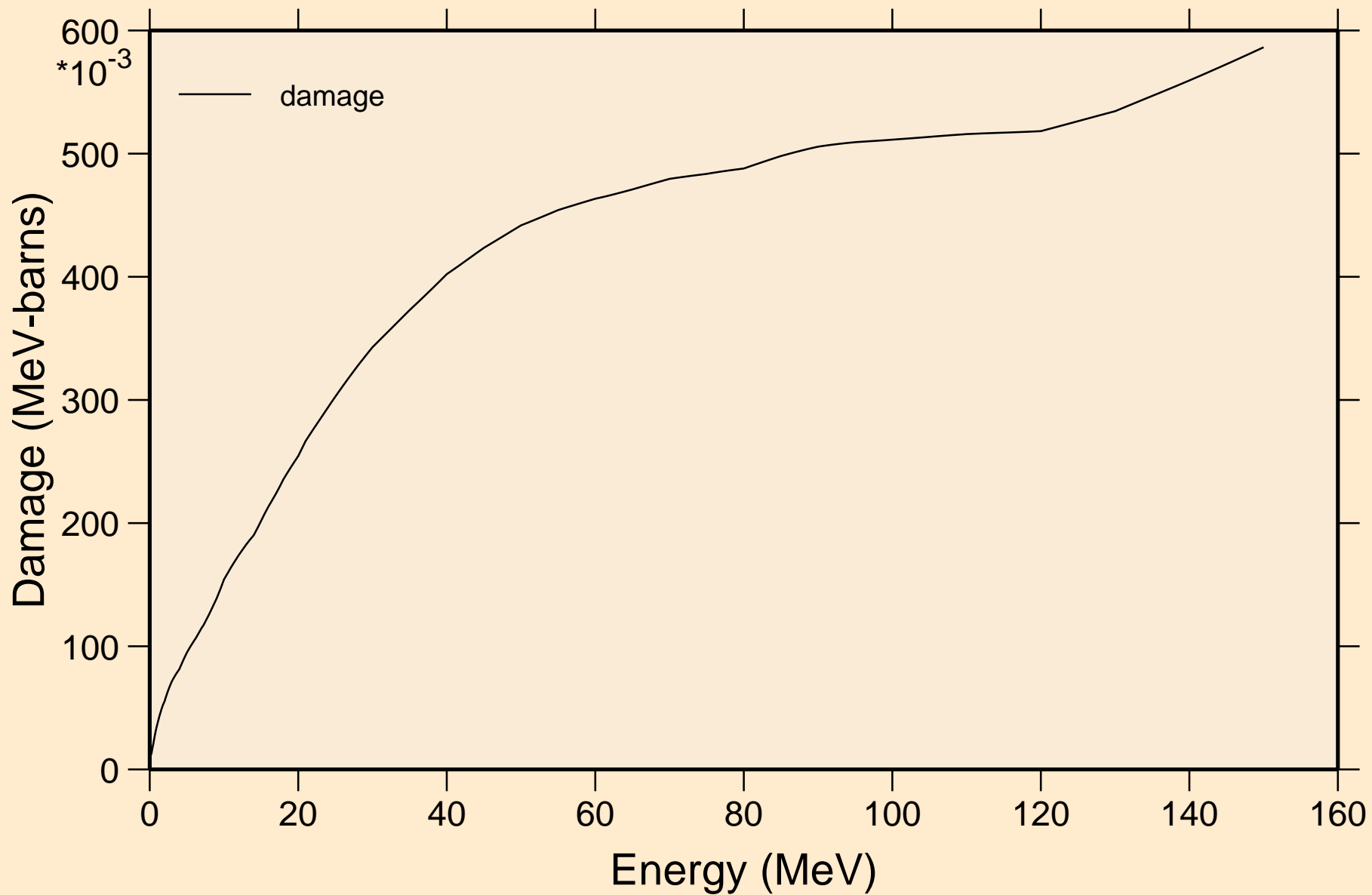

74-W-183 FOR FENDL-3B2 FROM ENDF/B-VII WITH NJOY99.304+
Non-threshold reactions

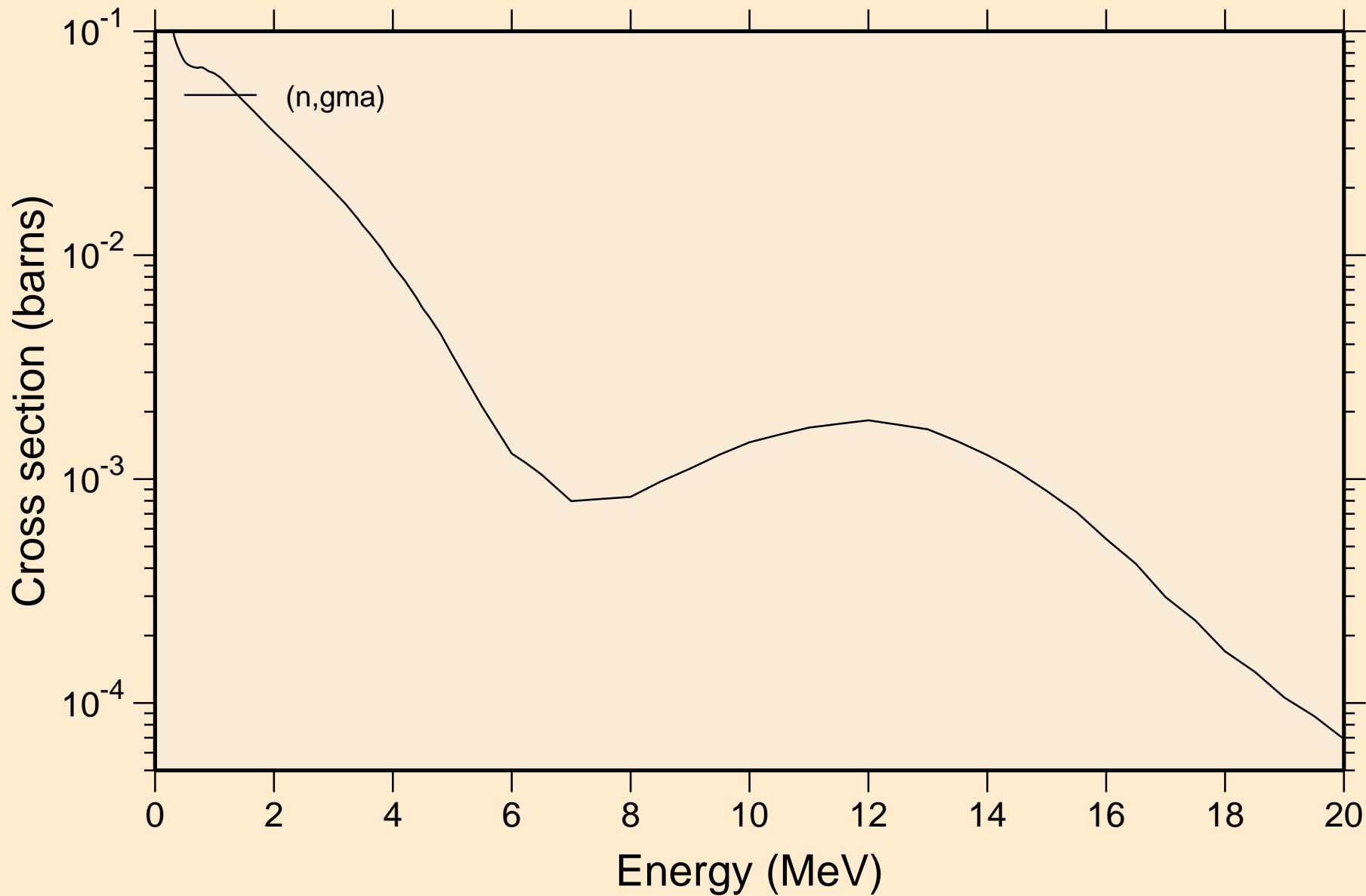

74-W-183 FOR FENDL-3B2 FROM ENDF/B-VII WITH NJOY99.304+
Inelastic levels

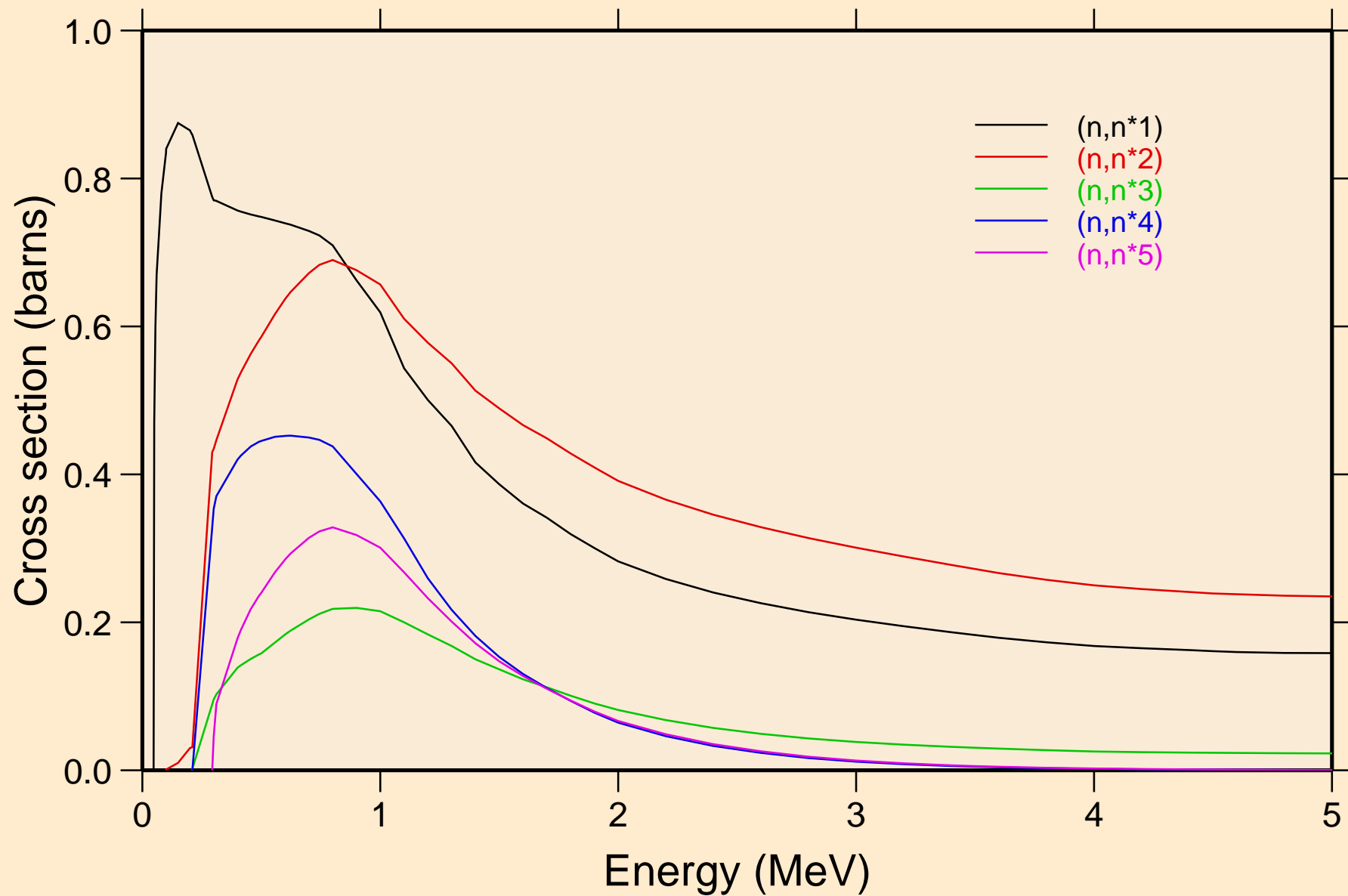

74-W-183 FOR FENDL-3B2 FROM ENDF/B-VII WITH NJOY99.304+
Inelastic levels

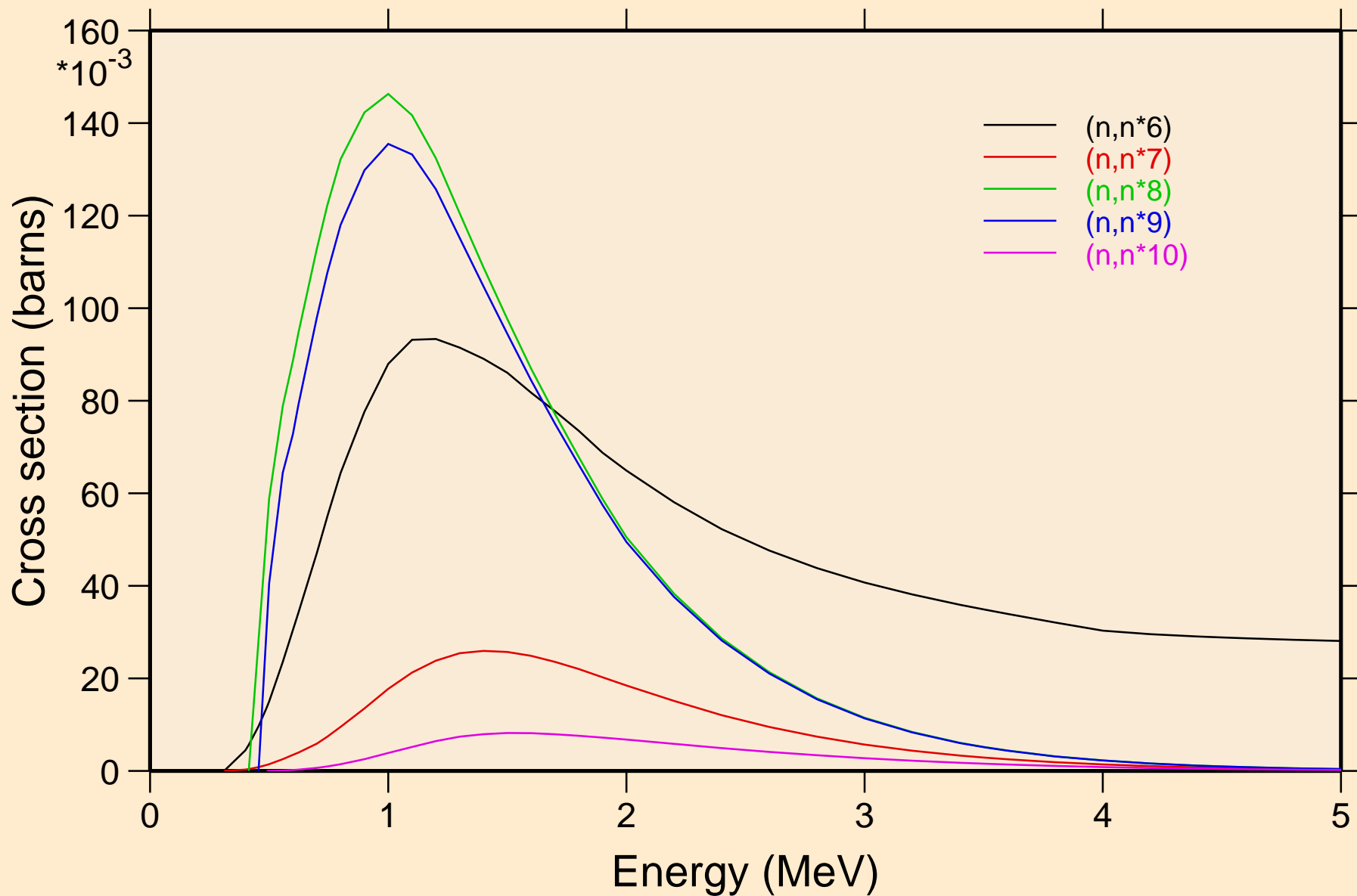

74-W-183 FOR FENDL-3B2 FROM ENDF/B-VII WITH NJOY99.304+
Inelastic levels

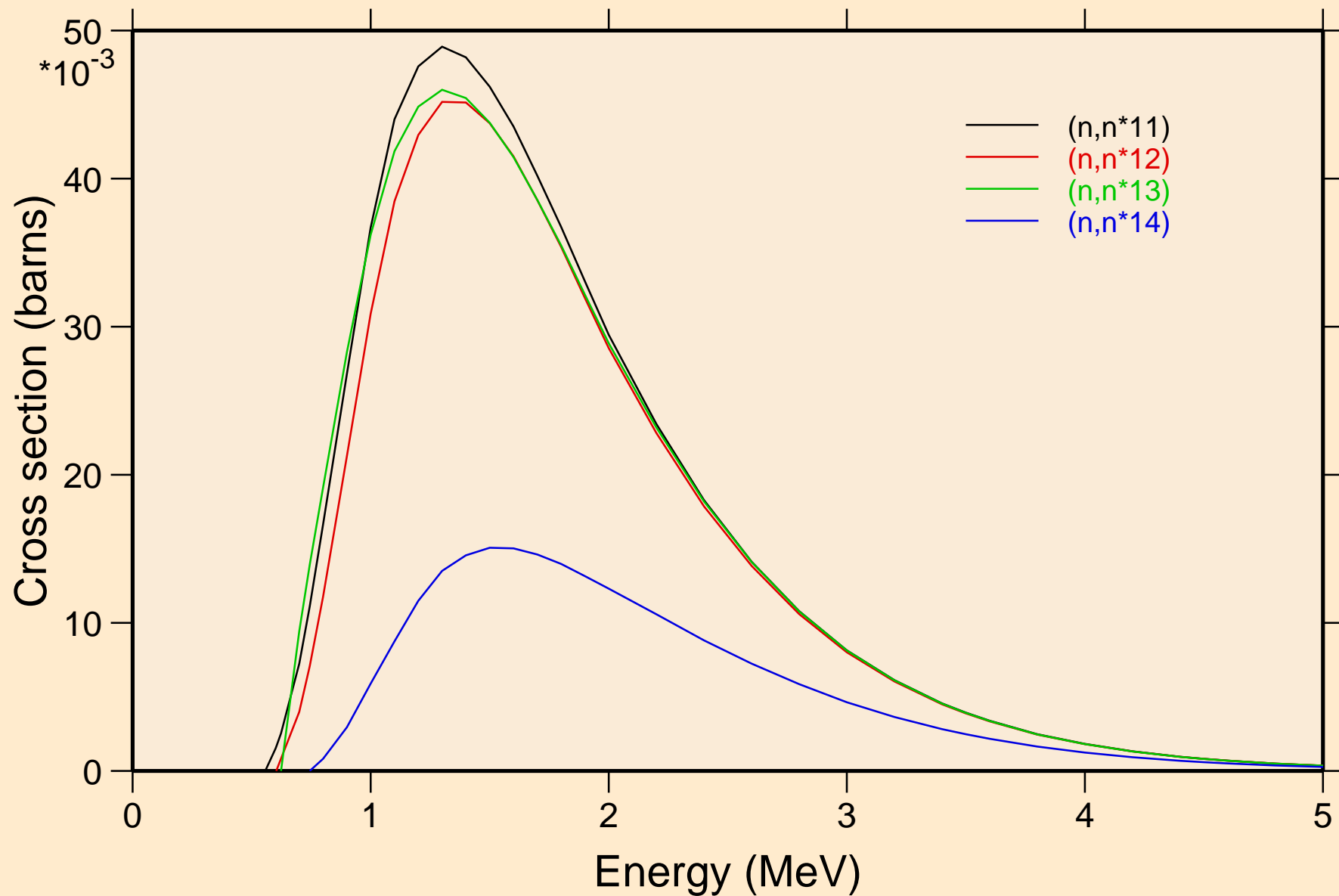

74-W-183 FOR FENDL-3B2 FROM ENDF/B-VII WITH NJOY99.304+
Threshold reactions

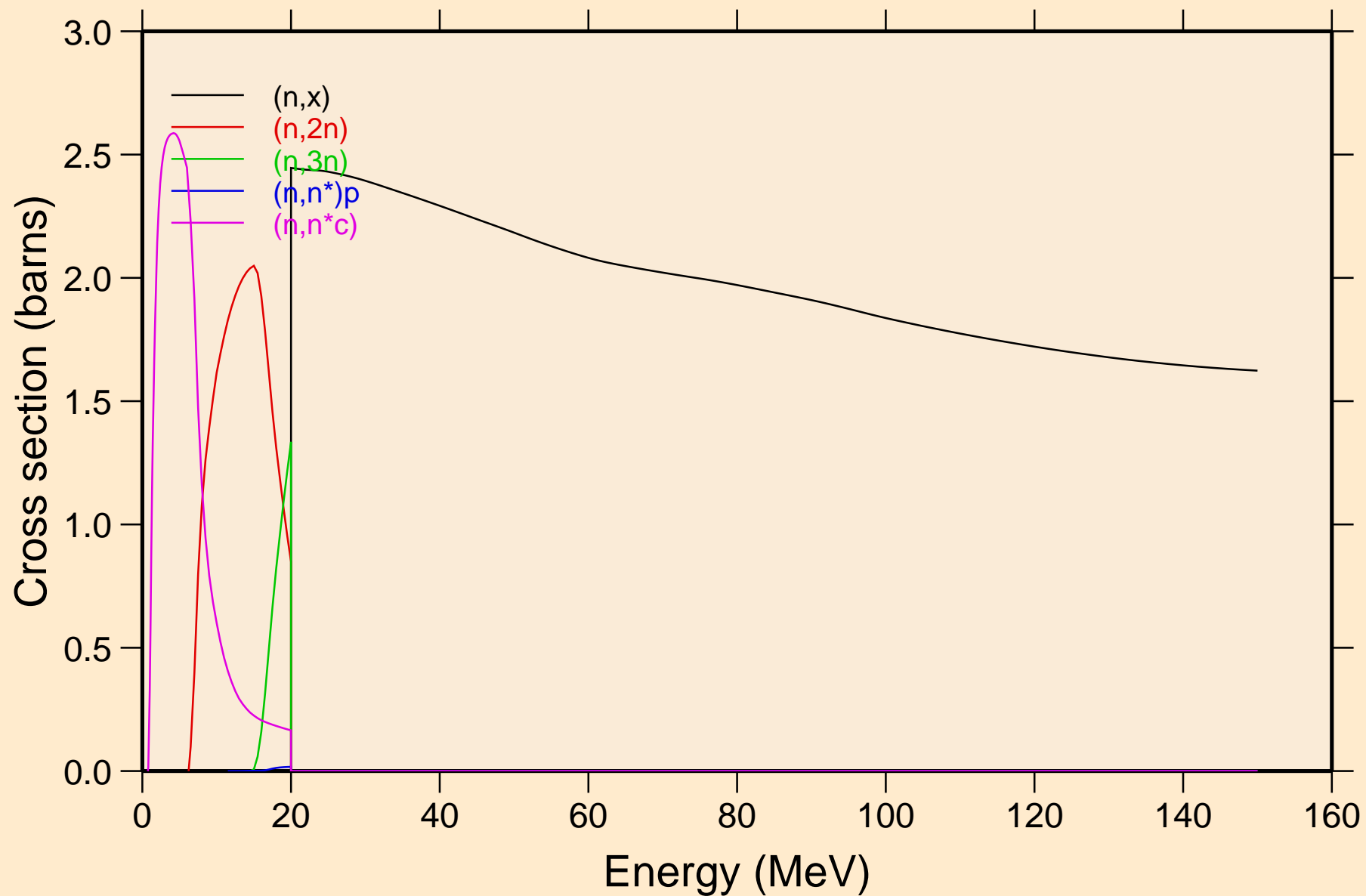

74-W-183 FOR FENDL-3B2 FROM ENDF/B-VII WITH NJOY99.304+
Threshold reactions

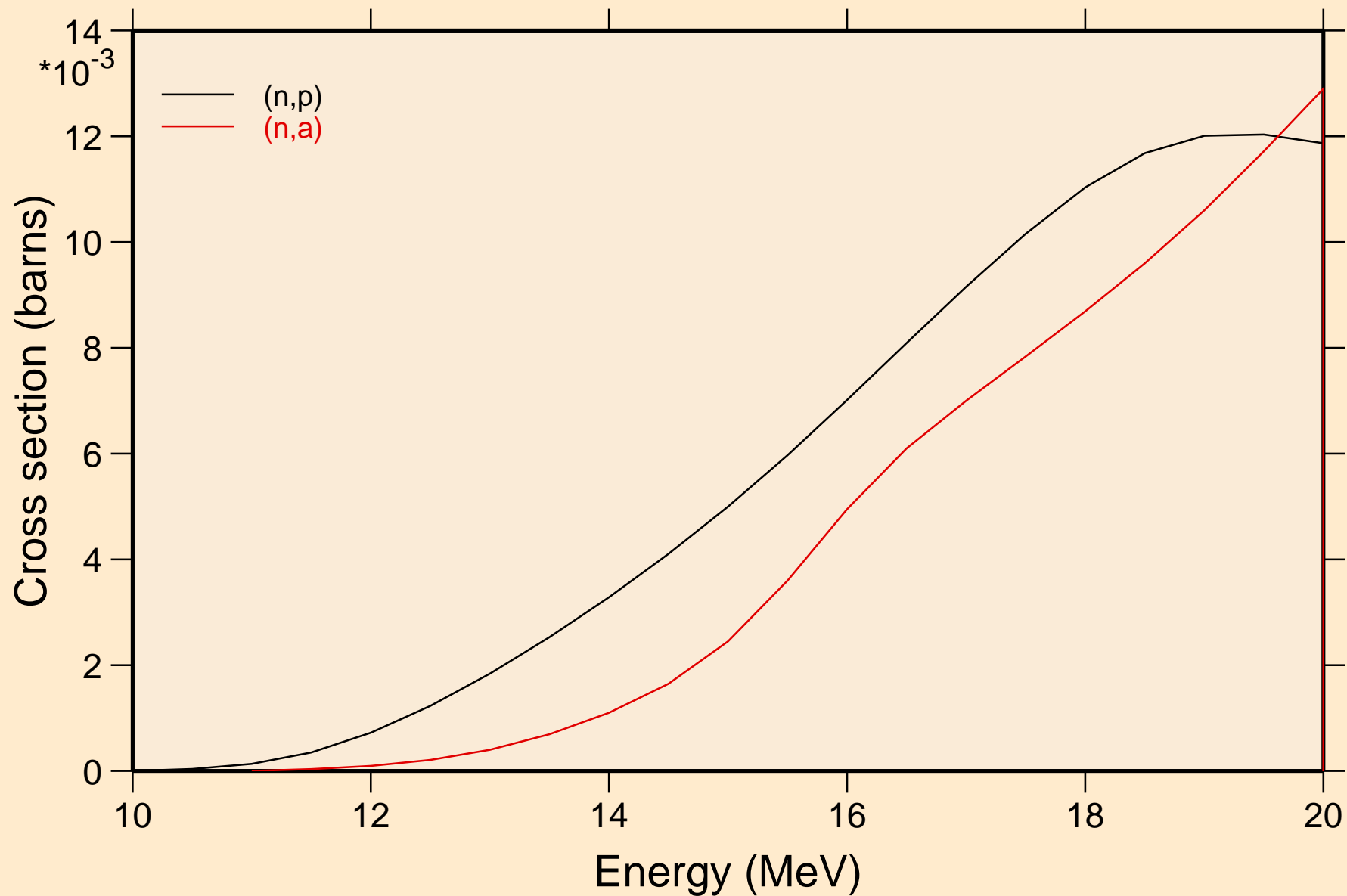

74-W-183 FOR FENDL-3B2 FROM ENDF/B-VII WITH NJOY99.304+
Threshold reactions

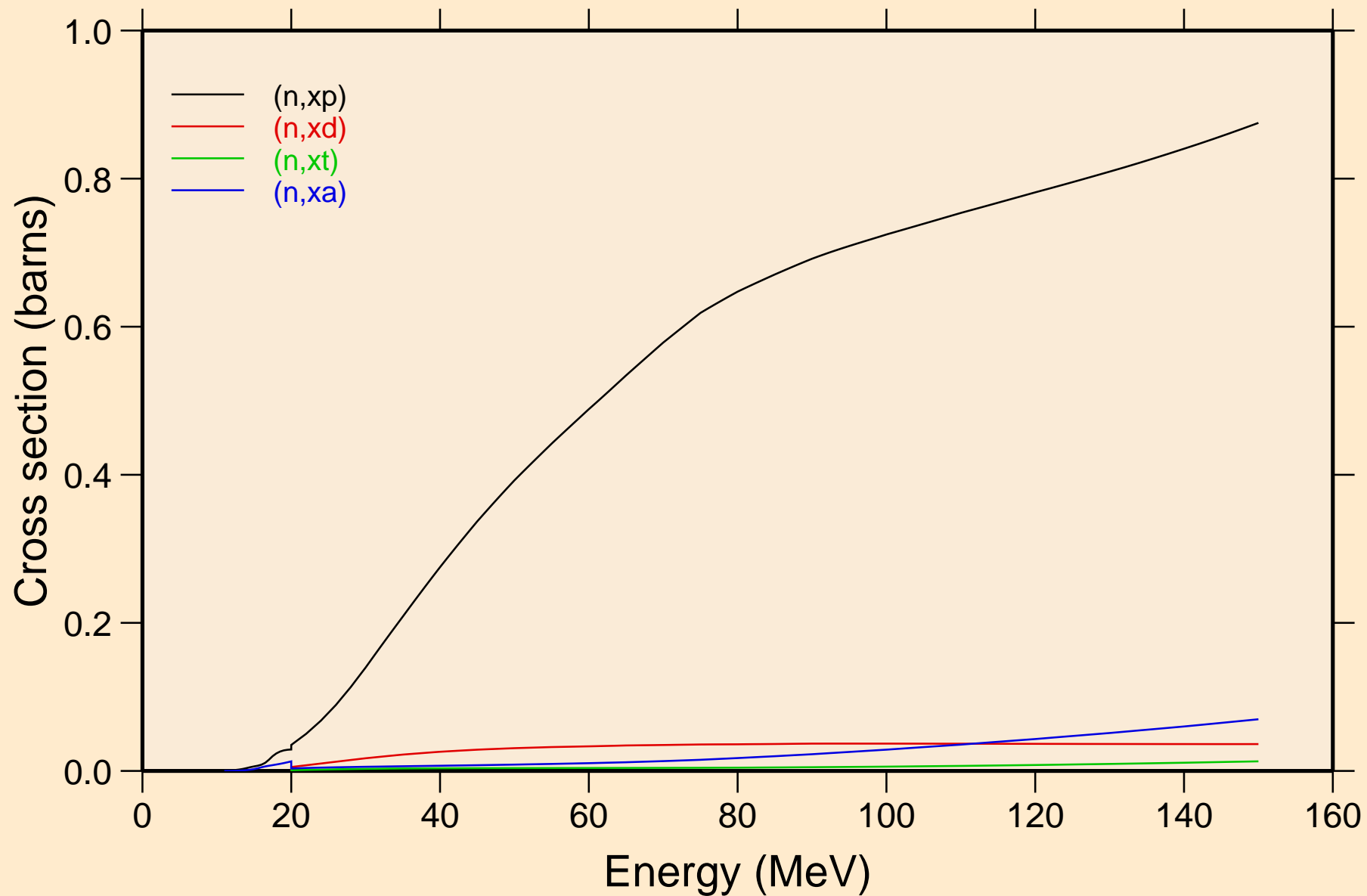

74-W-183 FOR FENDL-3B2 FROM ENDF/B-VII WITH NJOY99.304+
angular distribution for elastic

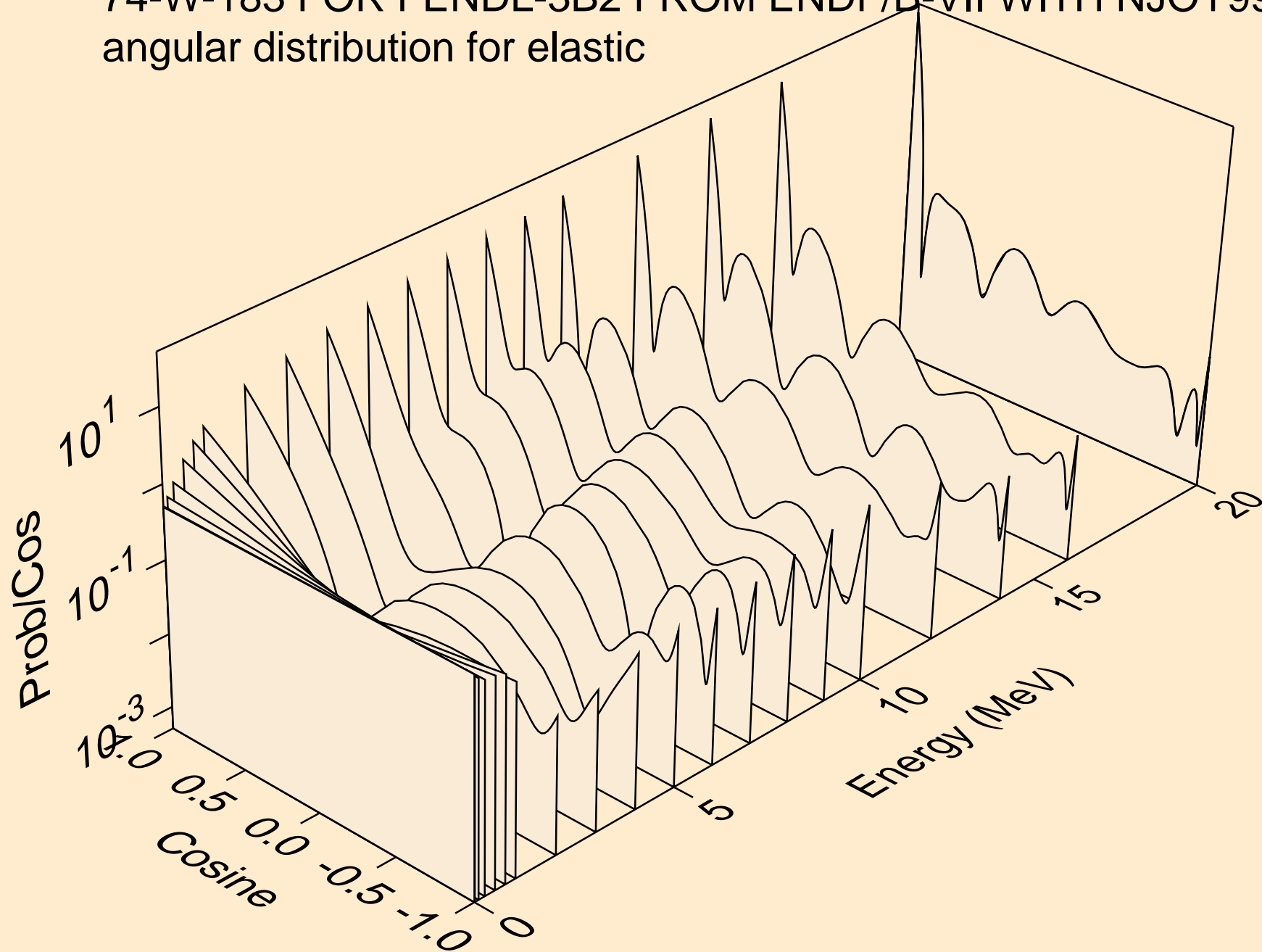

74-W-183 FOR FENDL-3B2 FROM ENDF/B-VII WITH NJOY99.304+
angular distribution for elastic

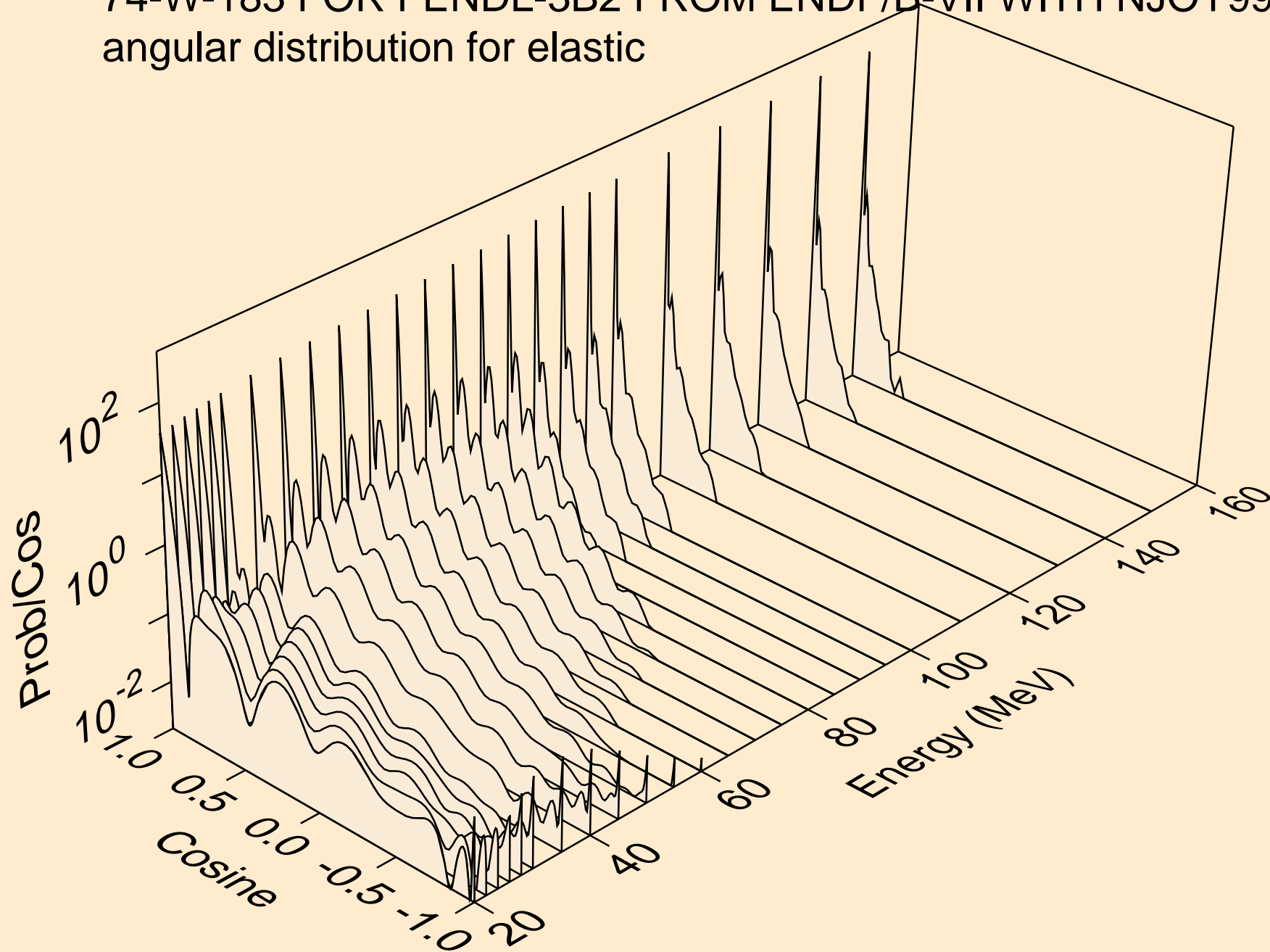

74-W-183 FOR FENDL-3B2 FROM ENDF/B-VII WITH NJOY99.304+
angular distribution for (n,2n)

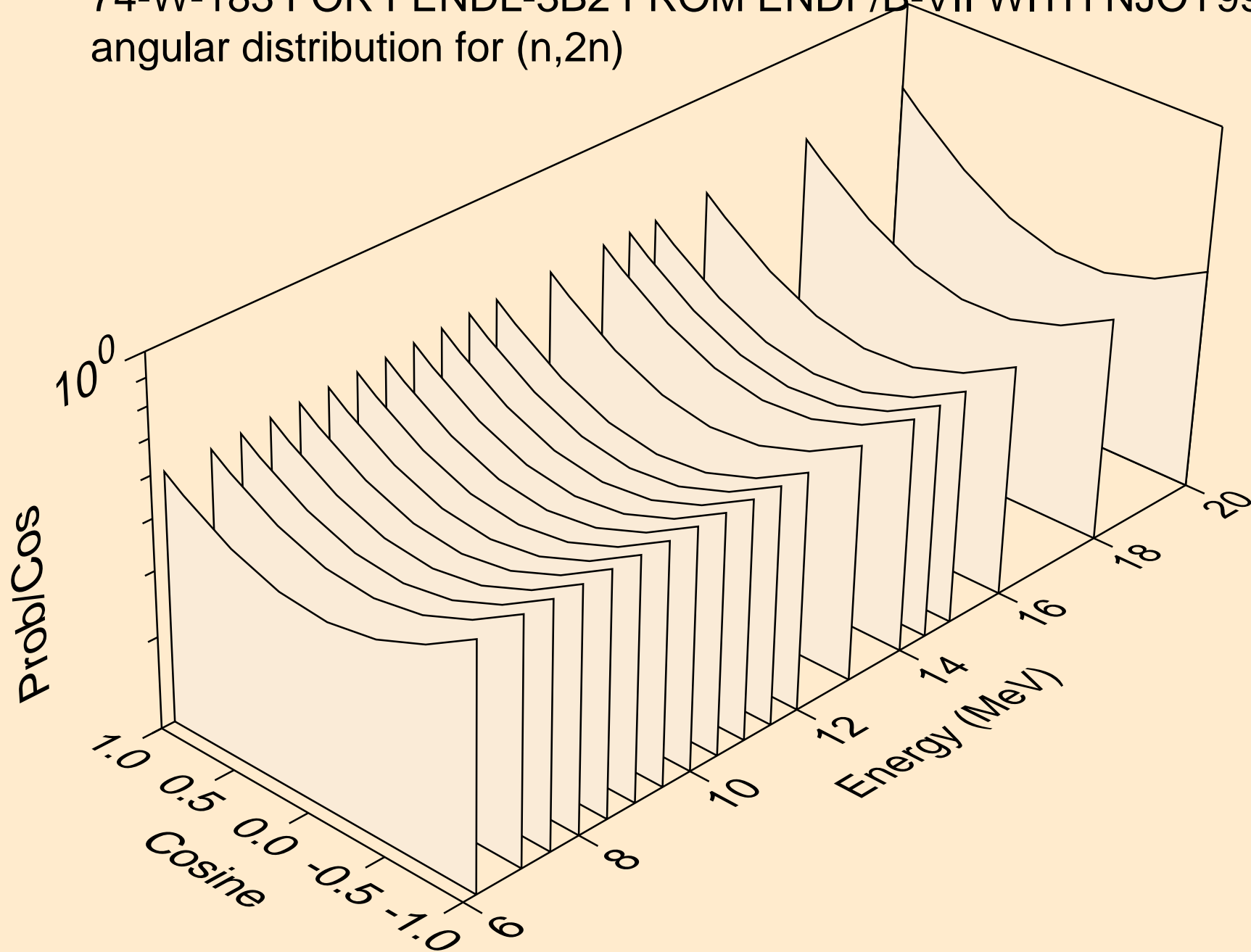

74-W-183 FOR FENDL-3B2 FROM ENDF/B-VII WITH NJOY99.304+
angular distribution for (n,3n)

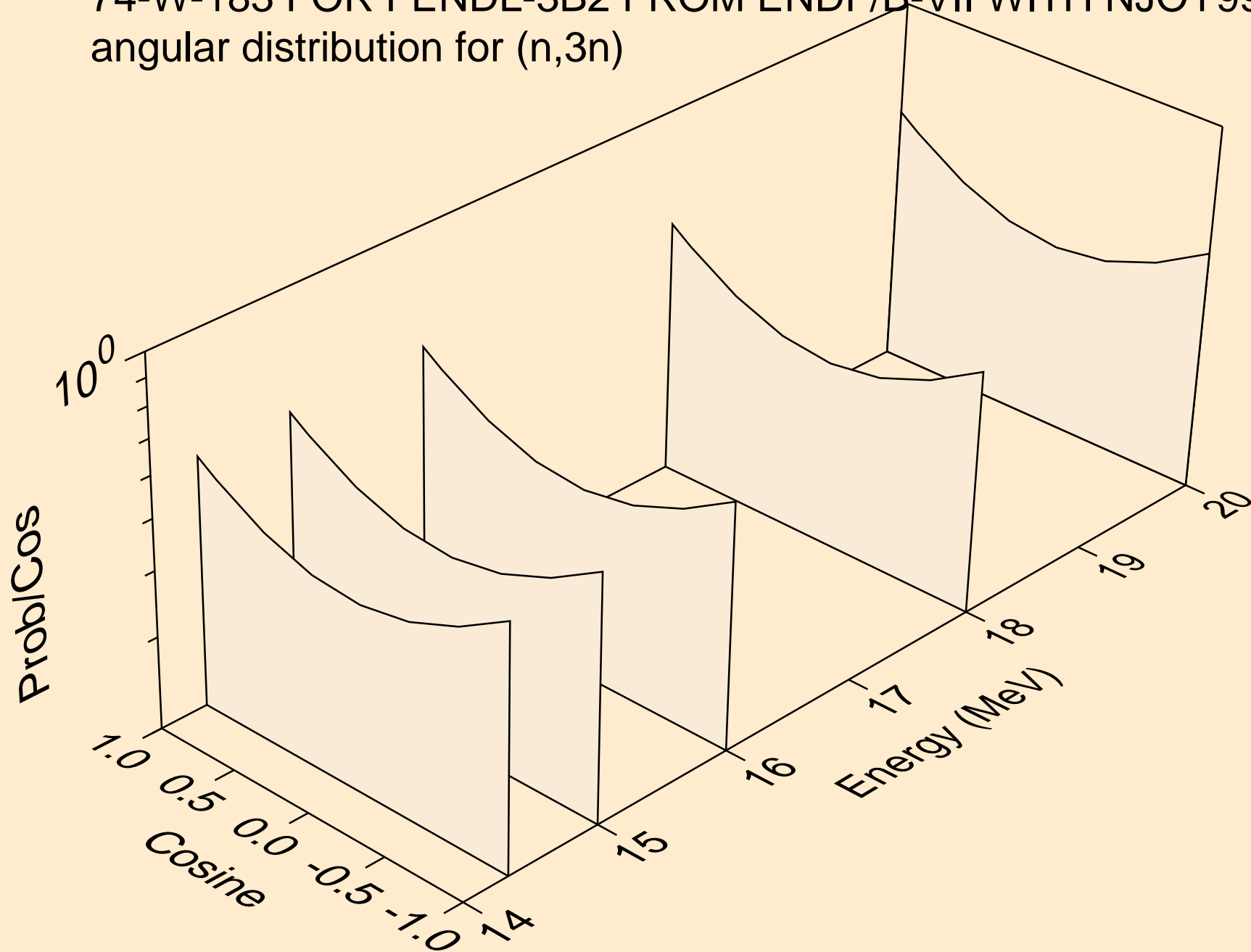

74-W-183 FOR FENDL-3B2 FROM ENDF/B-VII WITH NJOY99.304+
angular distribution for (n,n*)p

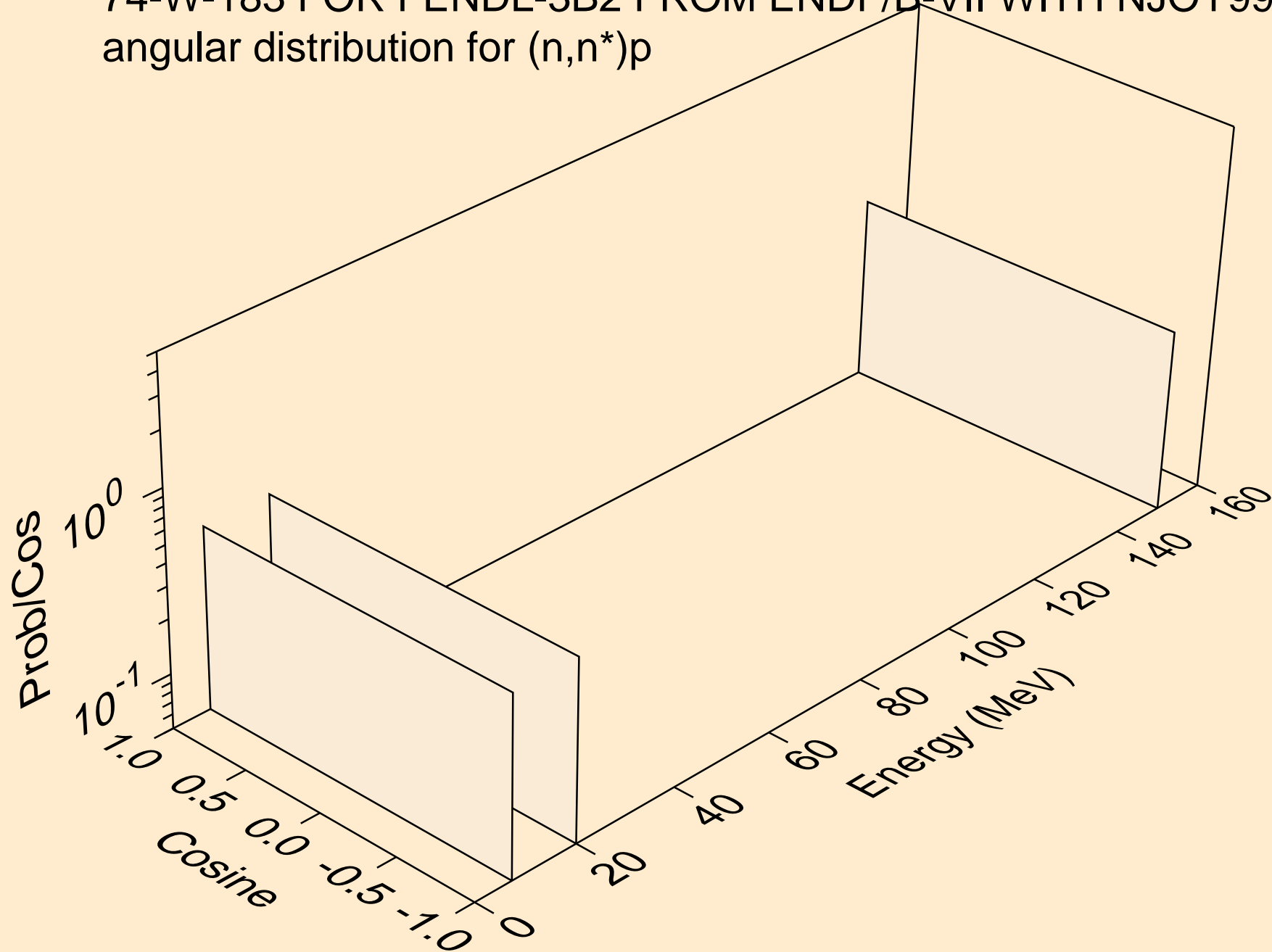

74-W-183 FOR FENDL-3B2 FROM ENDF/B-VII WITH NJOY99.304+
angular distribution for (n,n*1)

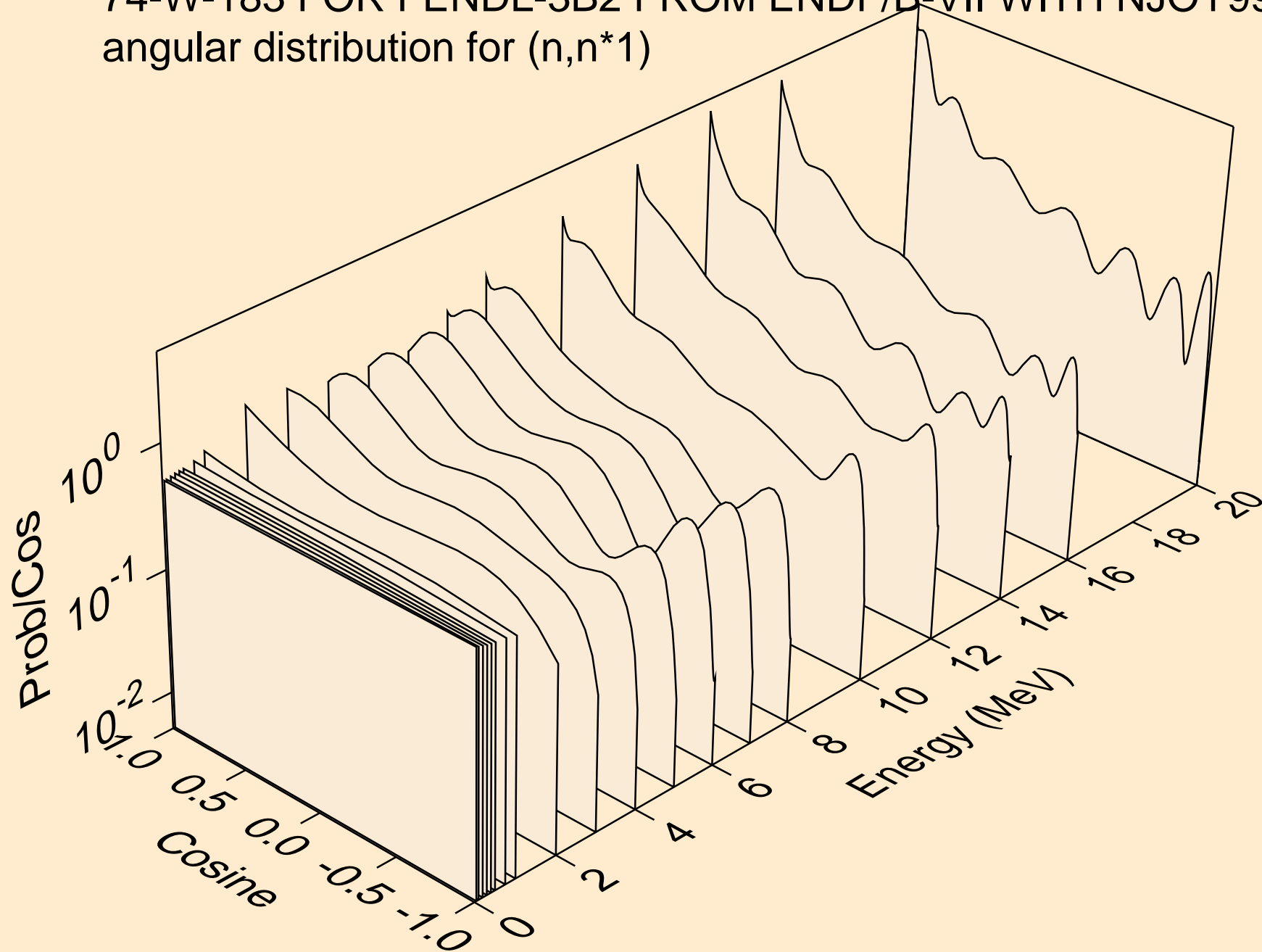

74-W-183 FOR FENDL-3B2 FROM ENDF/B-VII WITH NJOY99.304+
angular distribution for (n,n*2)

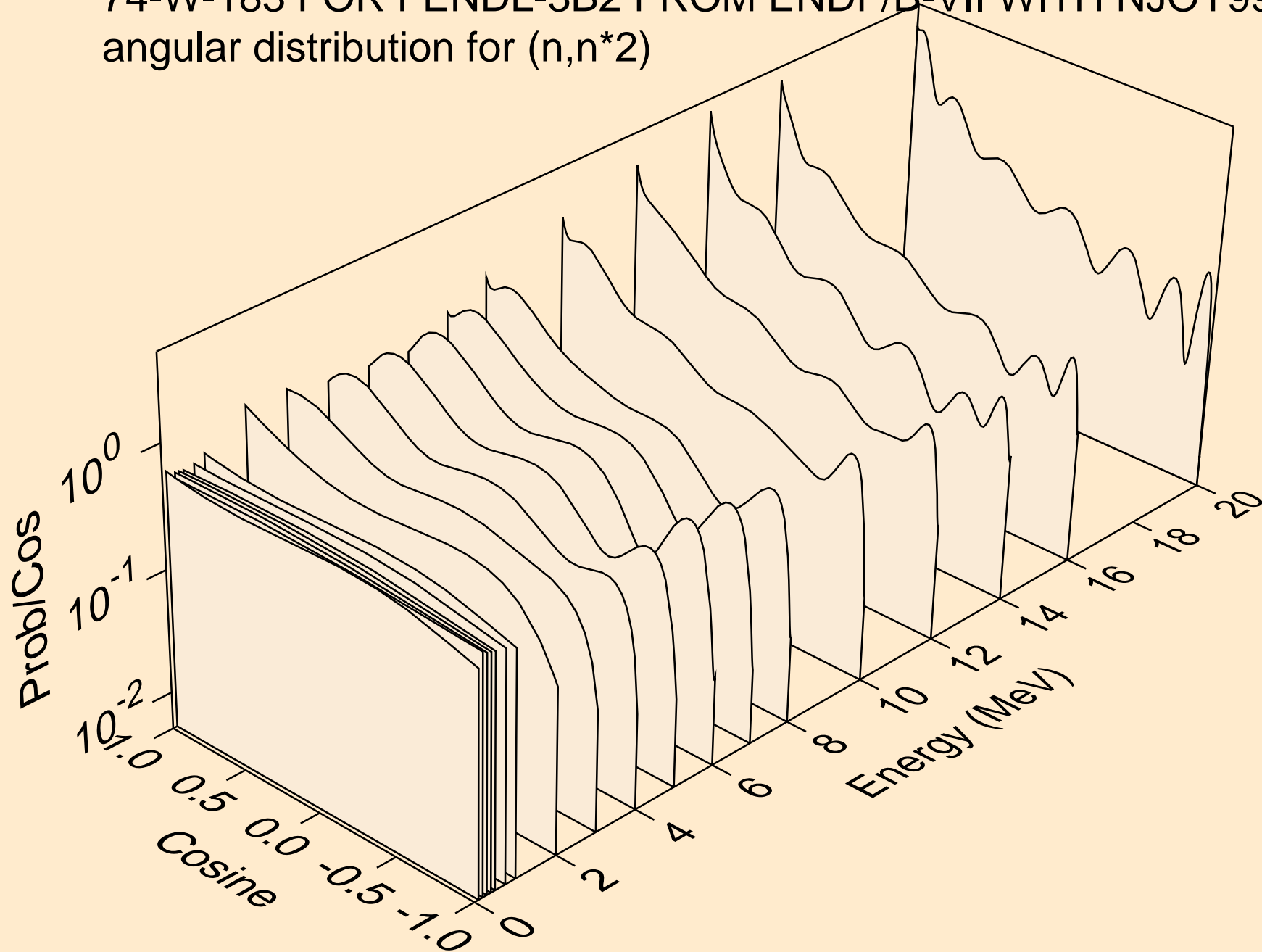

74-W-183 FOR FENDL-3B2 FROM ENDF/B-VII WITH NJOY99.304+
angular distribution for (n,n*3)

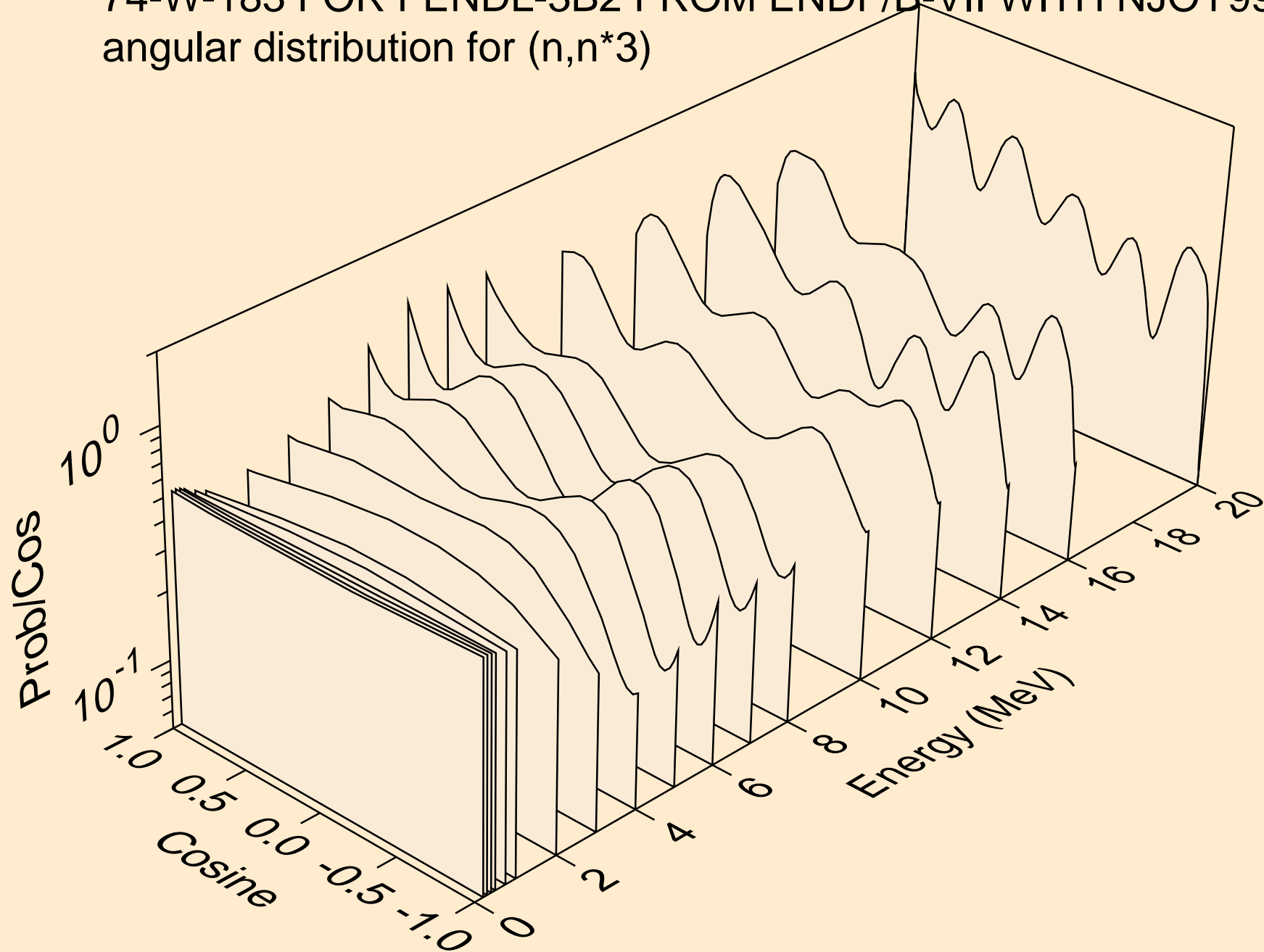

74-W-183 FOR FENDL-3B2 FROM ENDF/B-VII WITH NJOY99.304+
angular distribution for (n,n*4)

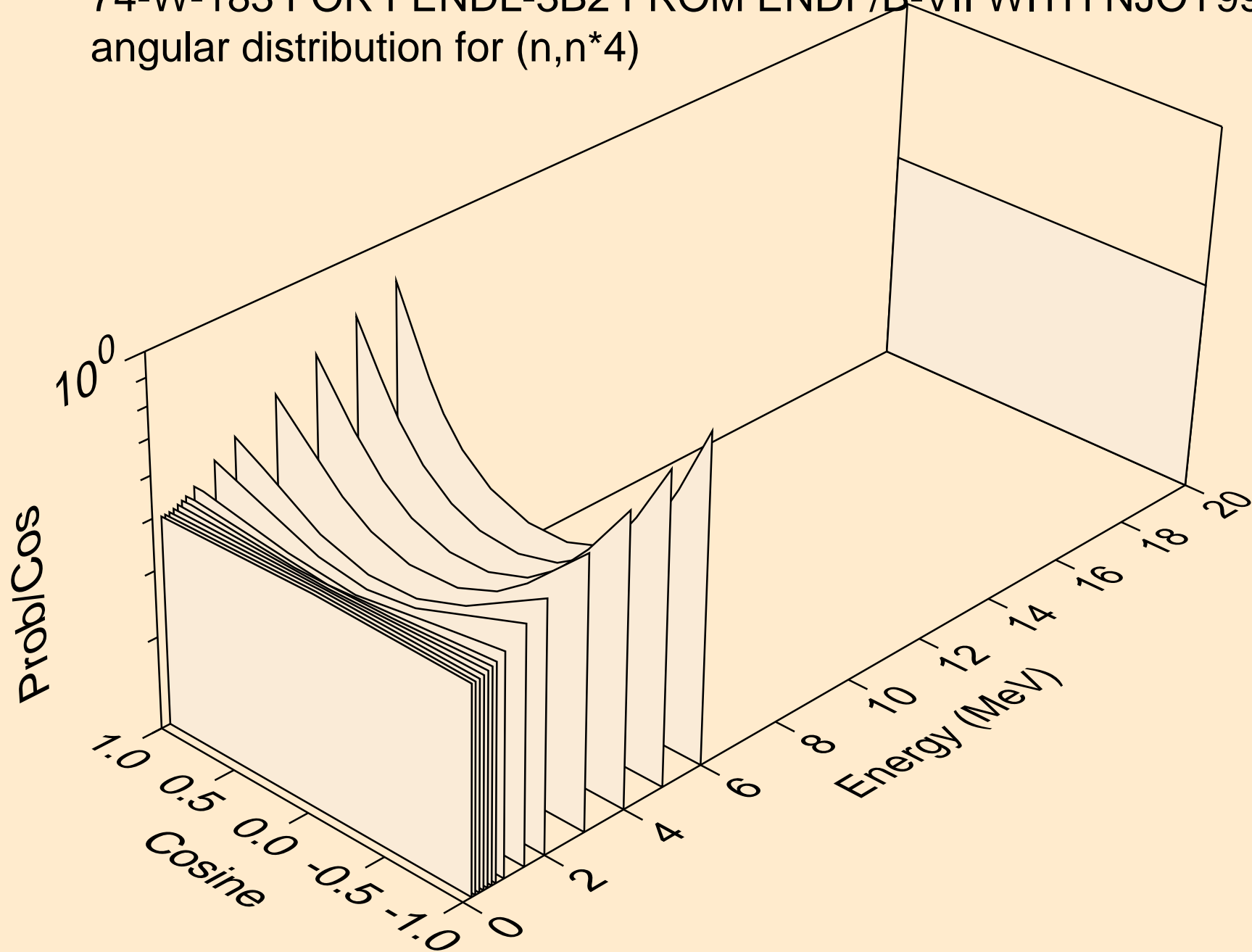

74-W-183 FOR FENDL-3B2 FROM ENDF/B-VII WITH NJOY99.304+
angular distribution for (n,n*5)

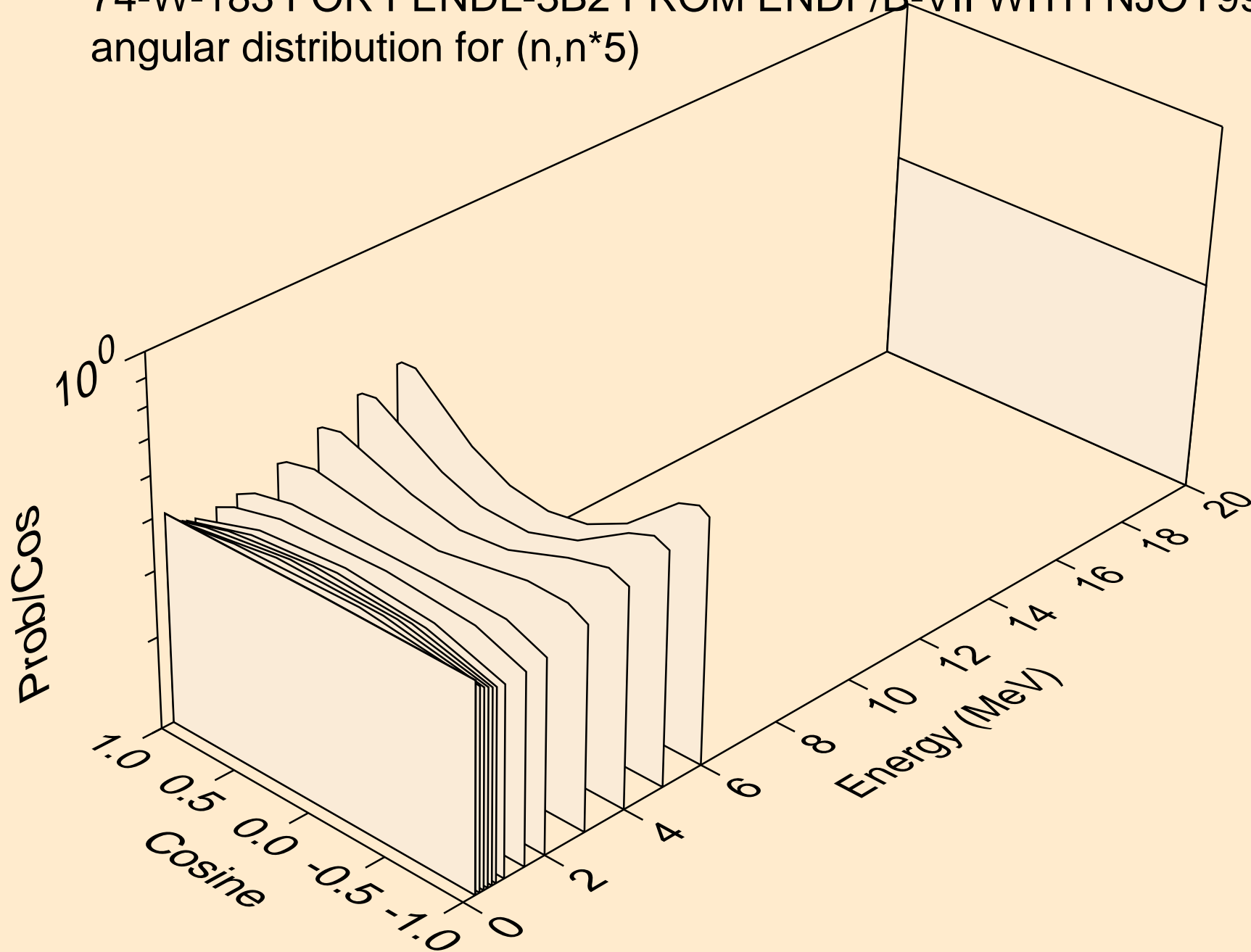

74-W-183 FOR FENDL-3B2 FROM ENDF/B-VII WITH NJOY99.304+
angular distribution for (n,n*6)

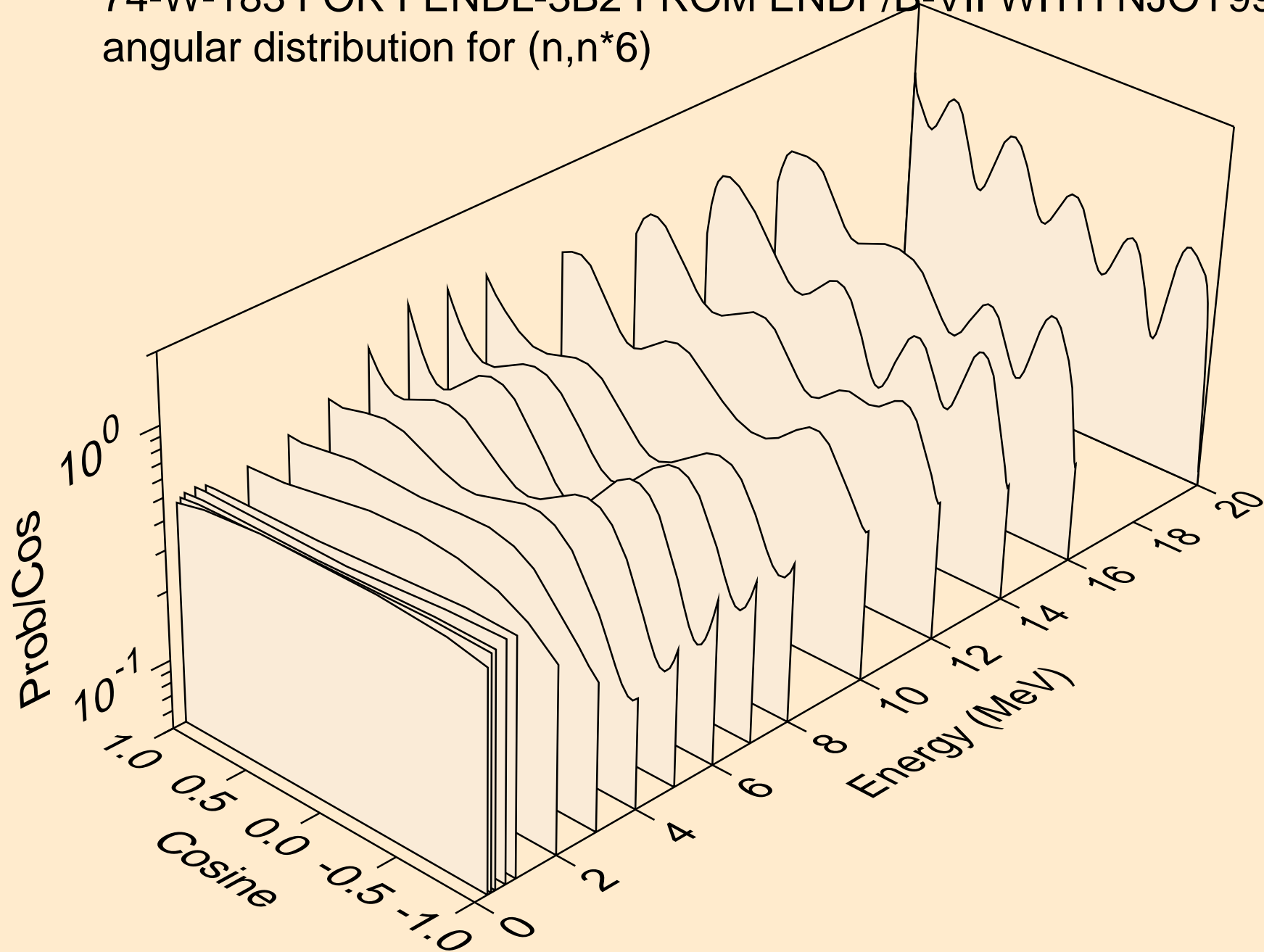

74-W-183 FOR FENDL-3B2 FROM ENDF/B-VII WITH NJOY99.304+
angular distribution for (n,n*7)

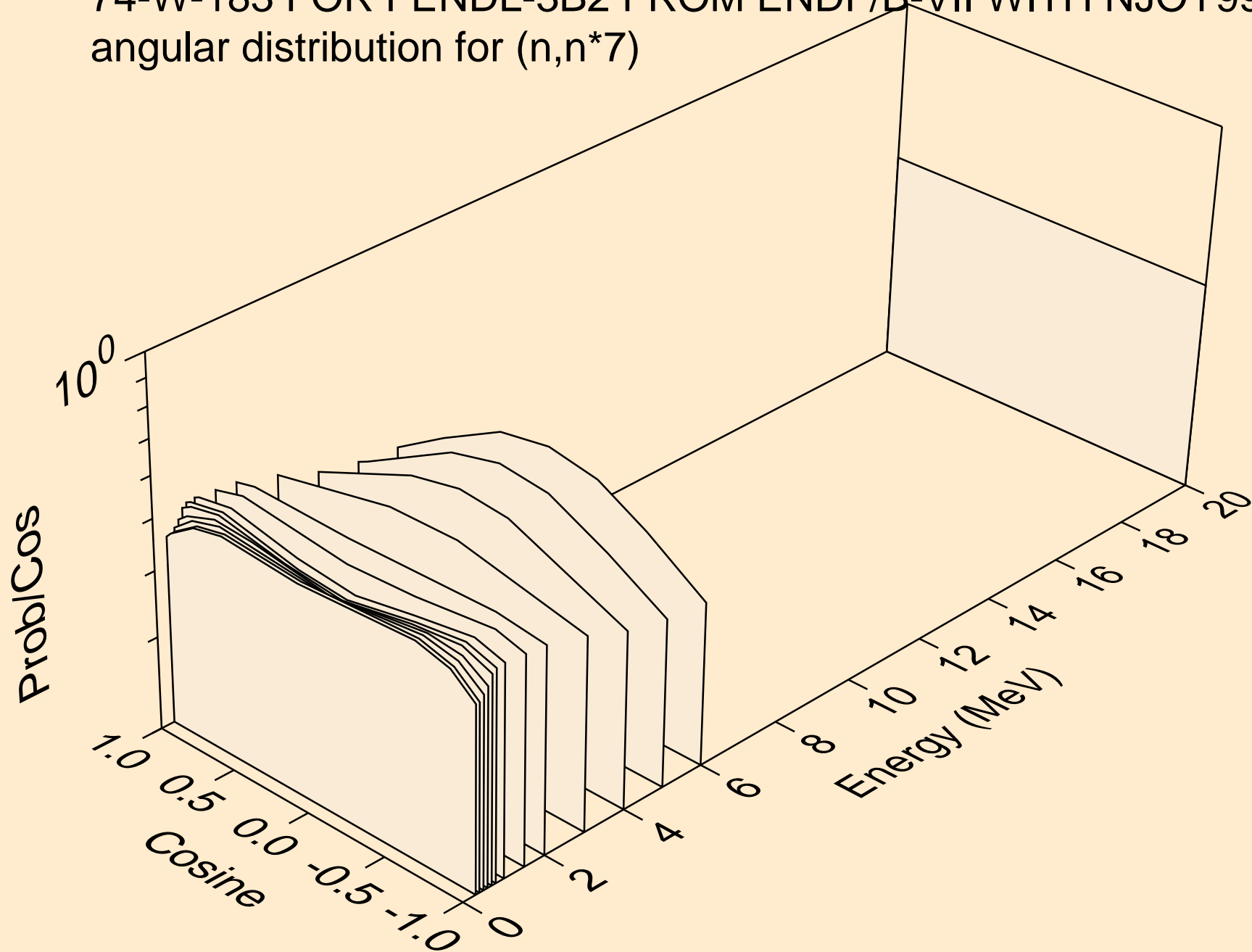

74-W-183 FOR FENDL-3B2 FROM ENDF/B-VII WITH NJOY99.304+
angular distribution for (n,n*8)

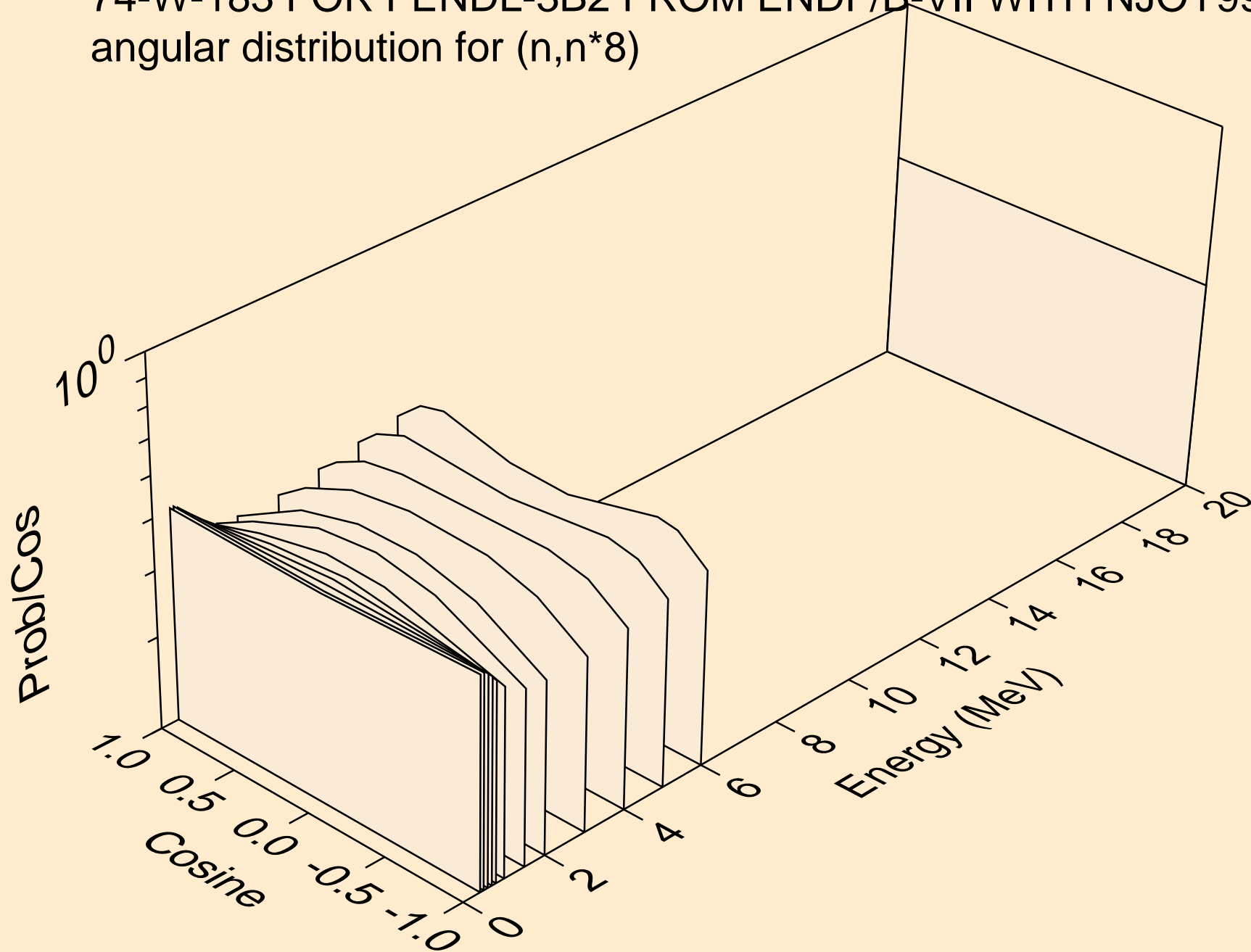

74-W-183 FOR FENDL-3B2 FROM ENDF/B-VII WITH NJOY99.304+
angular distribution for (n,n*9)

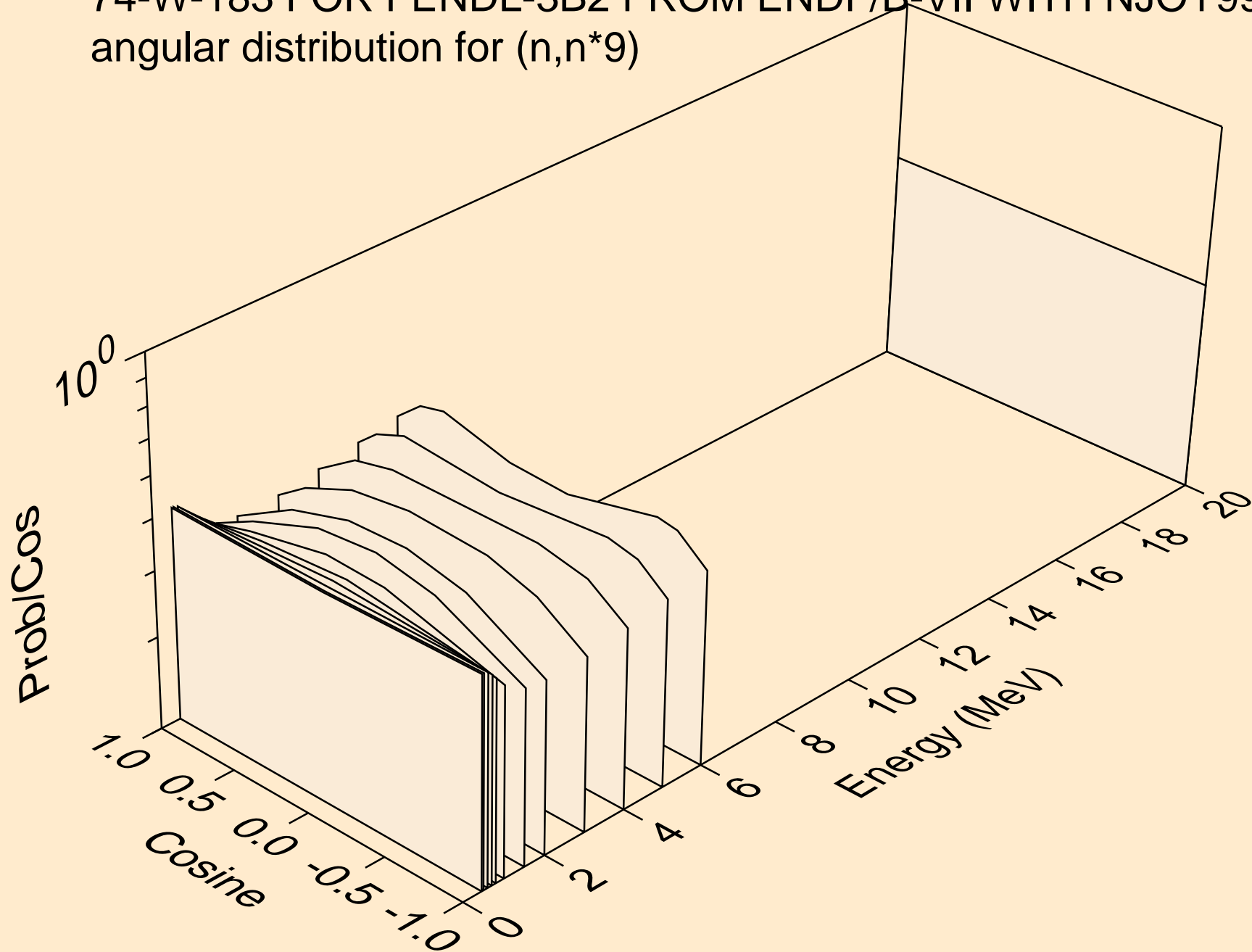

74-W-183 FOR FENDL-3B2 FROM ENDF/B-VII WITH NJOY99.304+
angular distribution for (n,n*10)

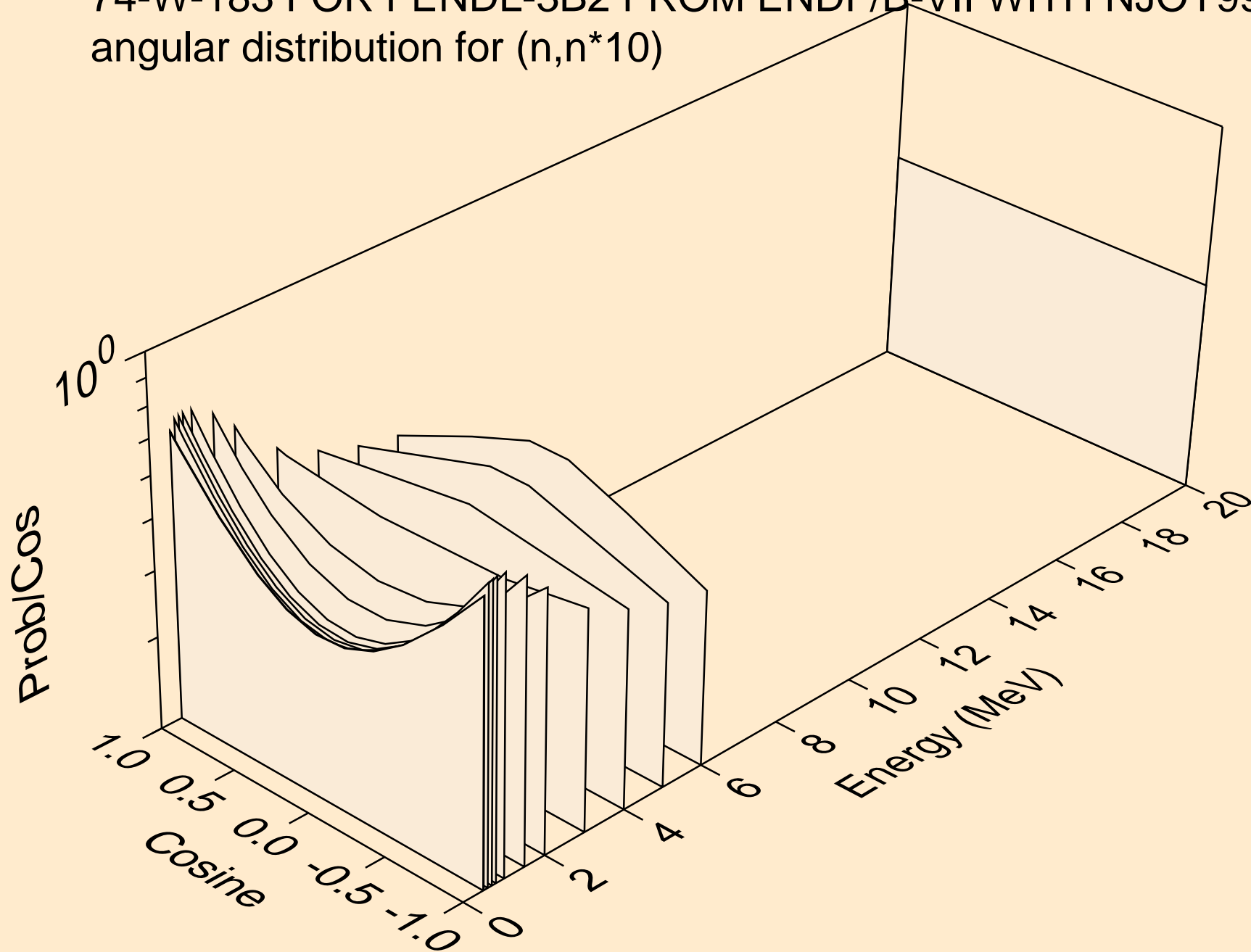

74-W-183 FOR FENDL-3B2 FROM ENDF/B-VII WITH NJOY99.304+
angular distribution for (n,n*11)

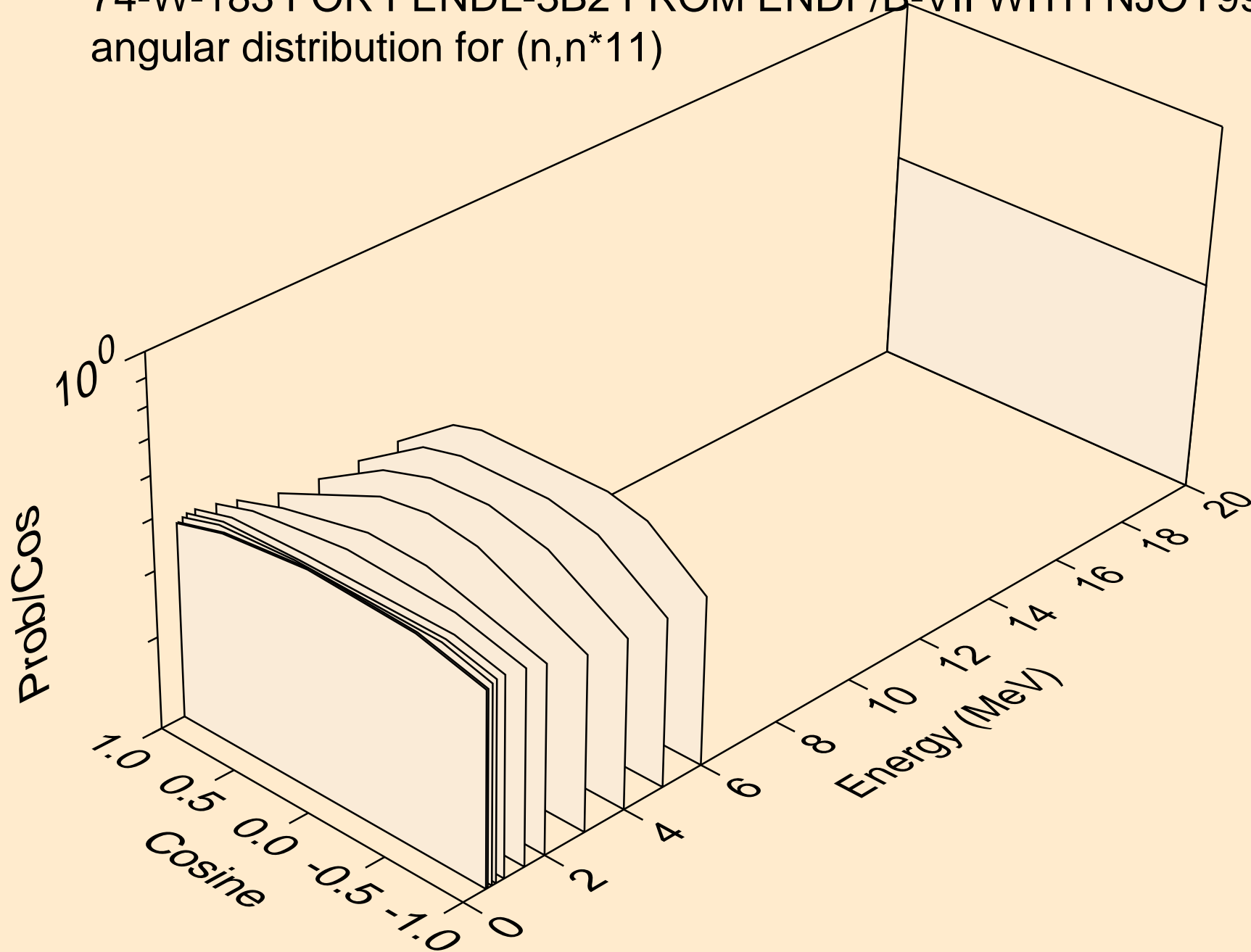

74-W-183 FOR FENDL-3B2 FROM ENDF/B-VII WITH NJOY99.304+
angular distribution for (n,n*12)

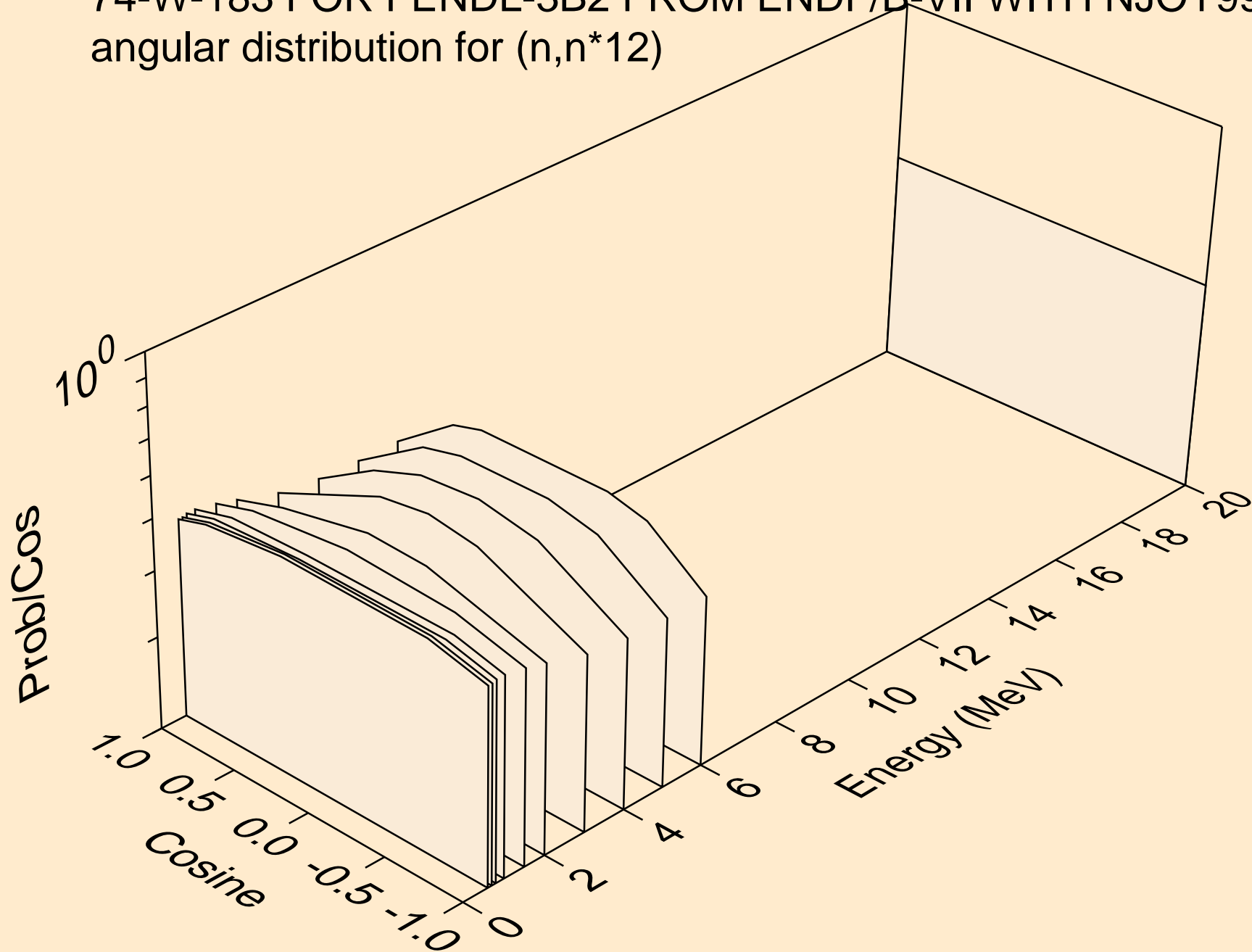

74-W-183 FOR FENDL-3B2 FROM ENDF/B-VII WITH NJOY99.304+
angular distribution for (n,n*13)

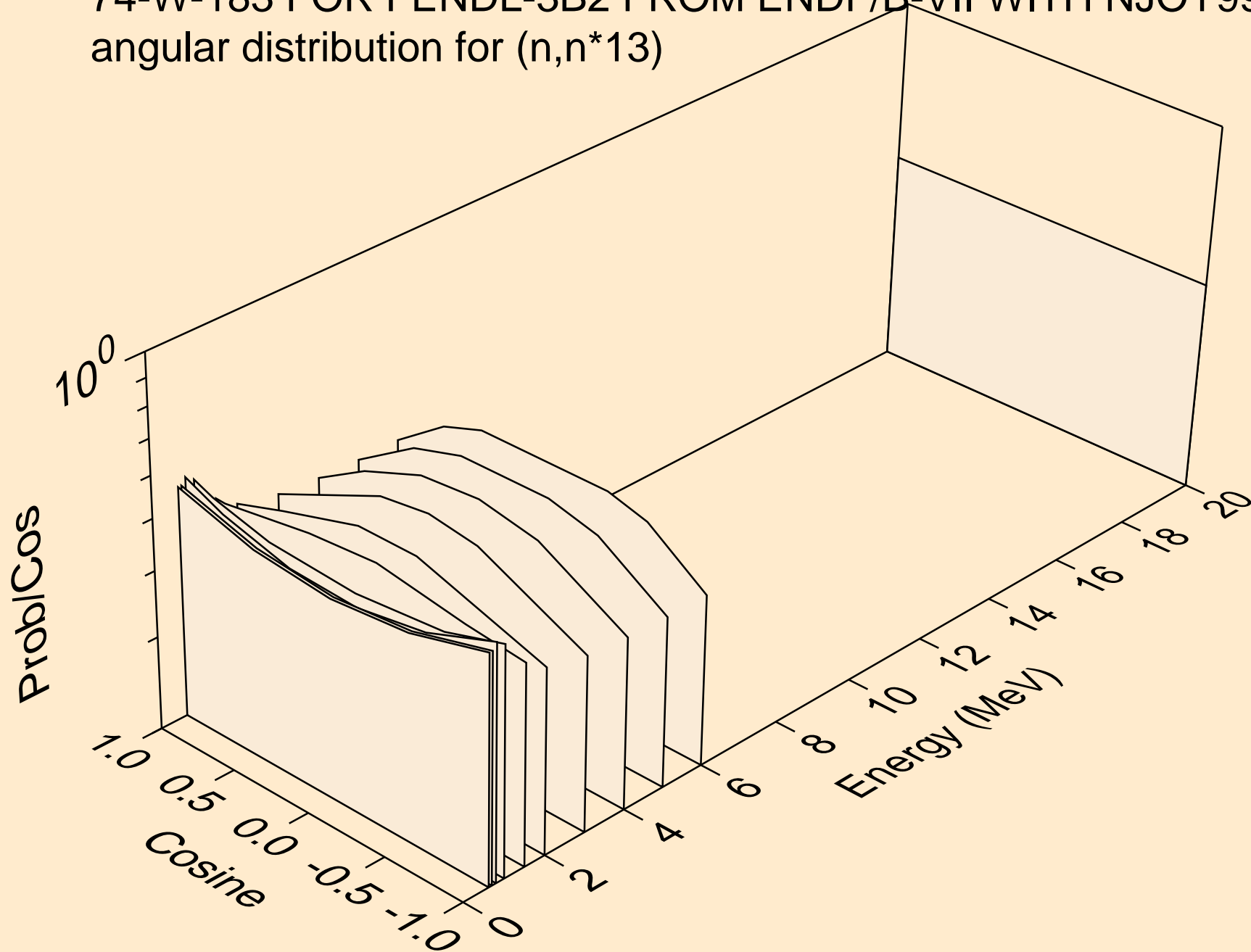

74-W-183 FOR FENDL-3B2 FROM ENDF/B-VII WITH NJOY99.304+
angular distribution for (n,n*14)

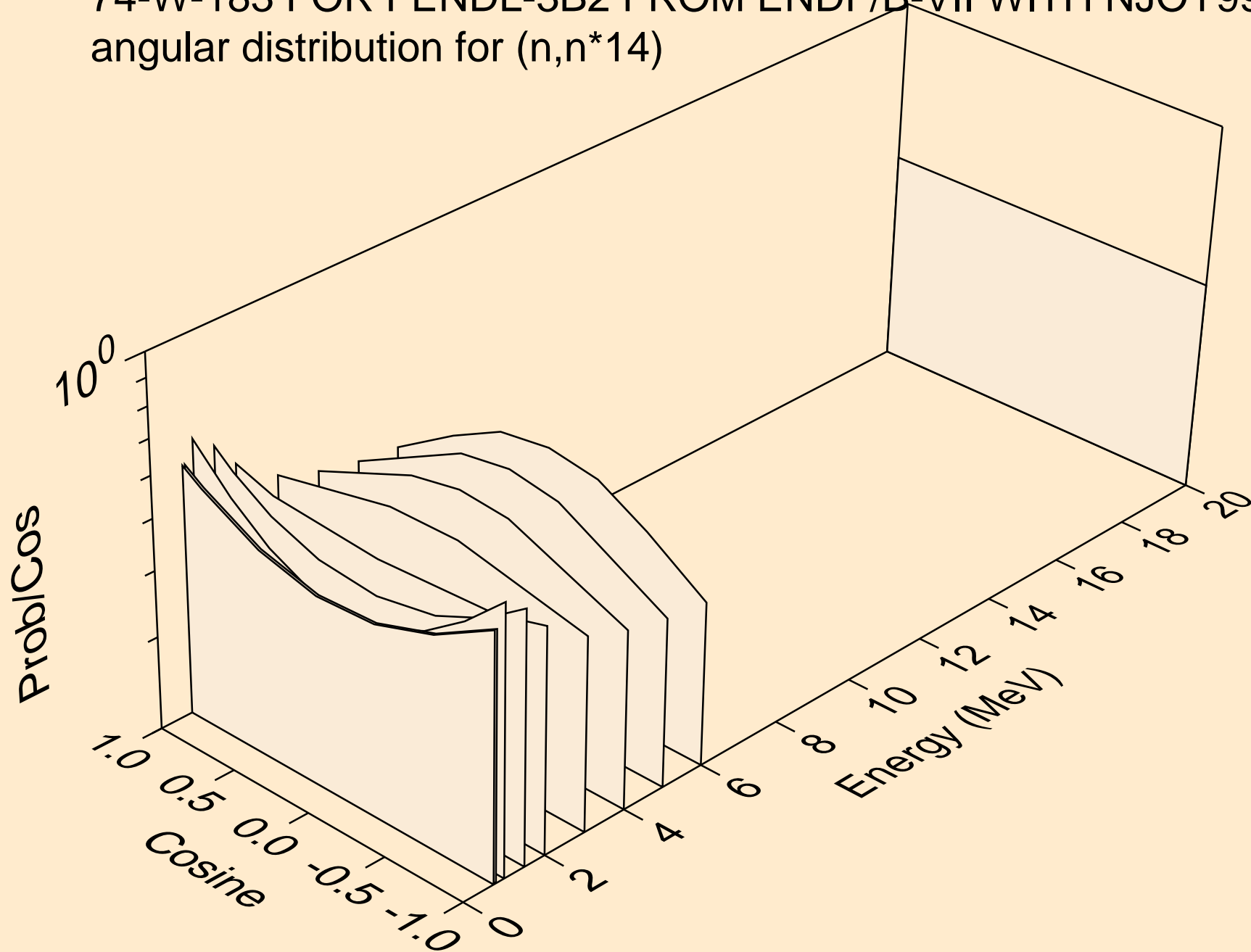

74-W-183 FOR FENDL-3B2 FROM ENDF/B-VII WITH NJOY99.304+
angular distribution for (n,n*c)

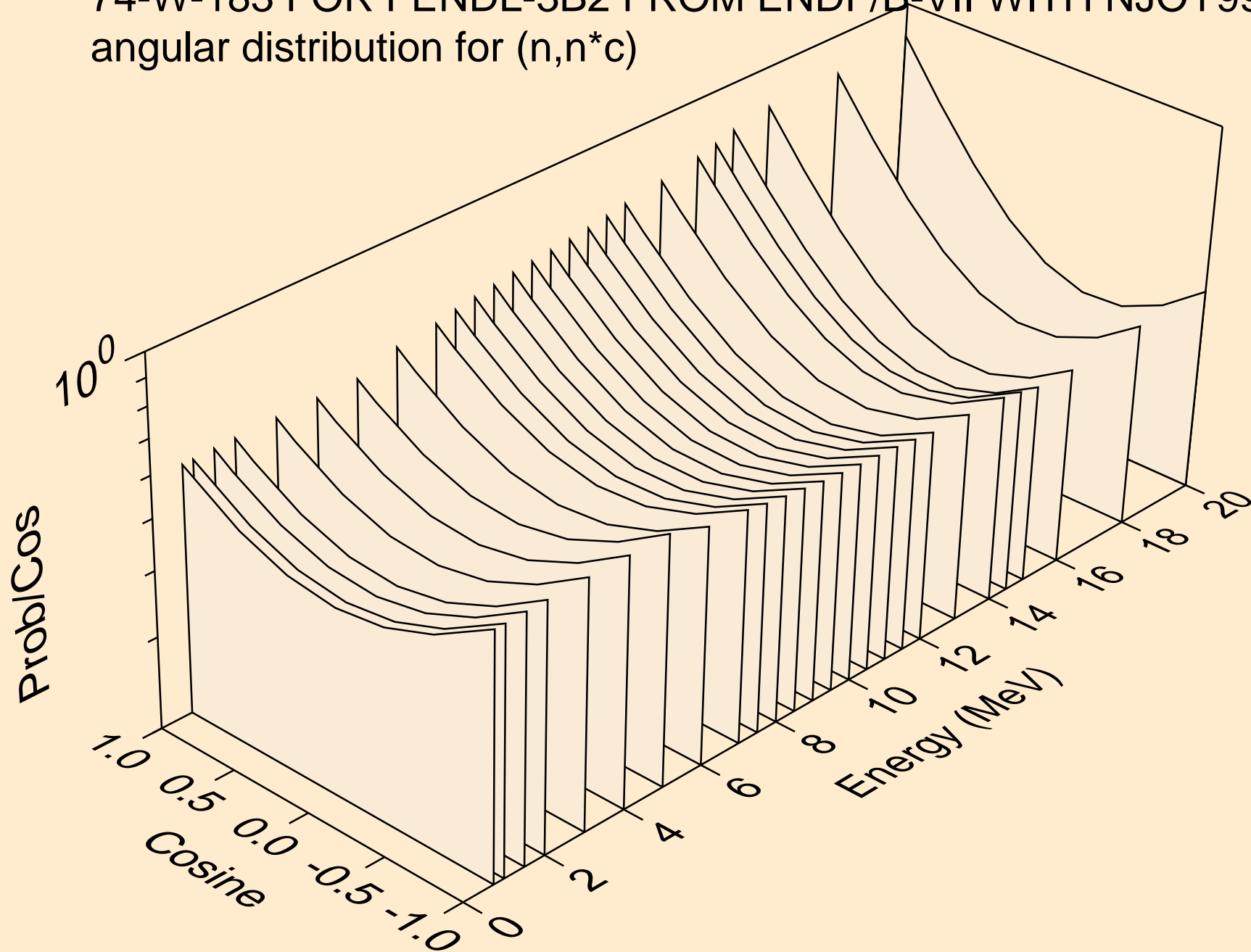

74-W-183 FOR FENDL-3B2 FROM ENDF/B-VII WITH NJOY99.304+
Neutron emission for (n,x)

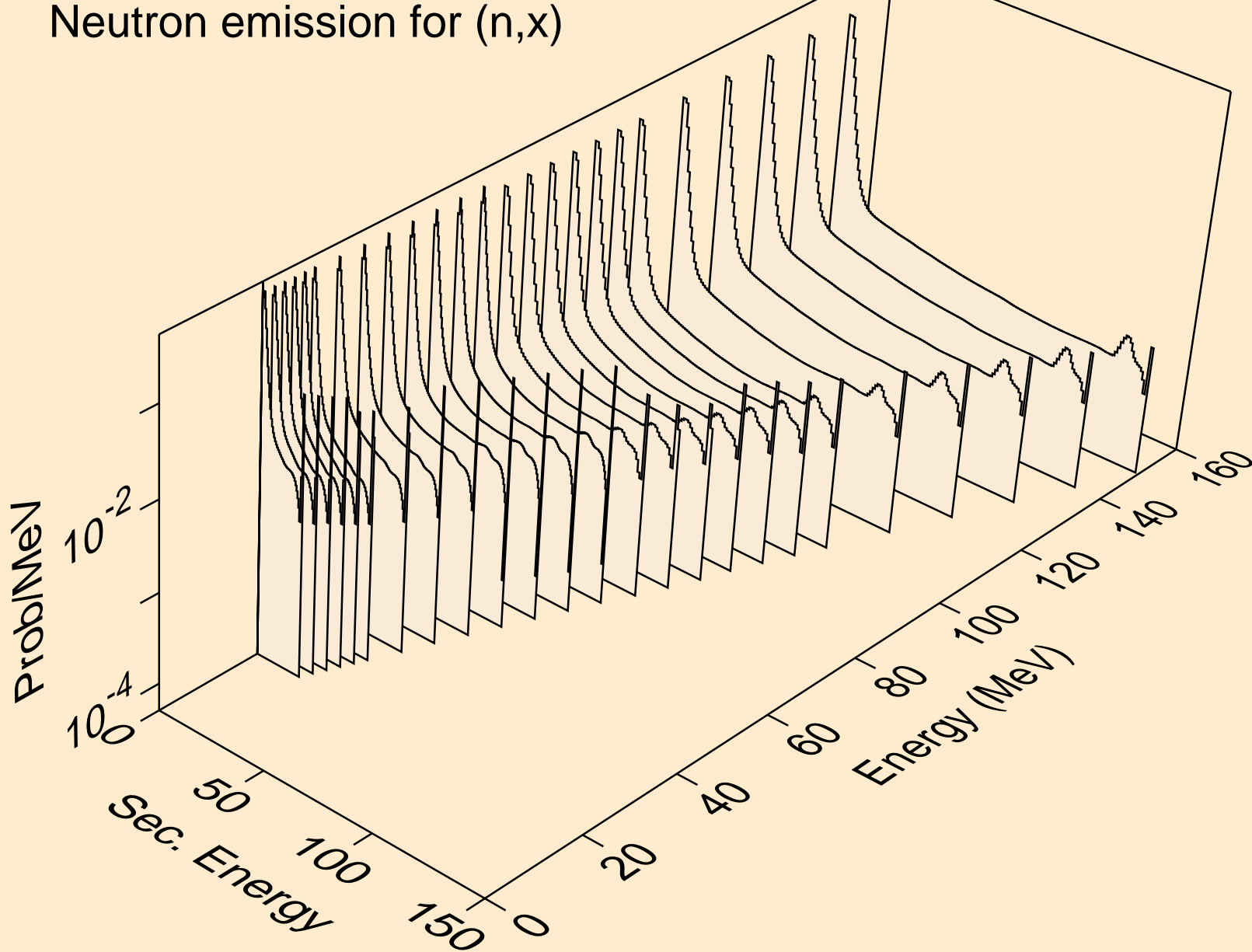

74-W-183 FOR FENDL-3B2 FROM ENDF/B-VII WITH NJOY99.304+
Neutron emission for (n,2n)

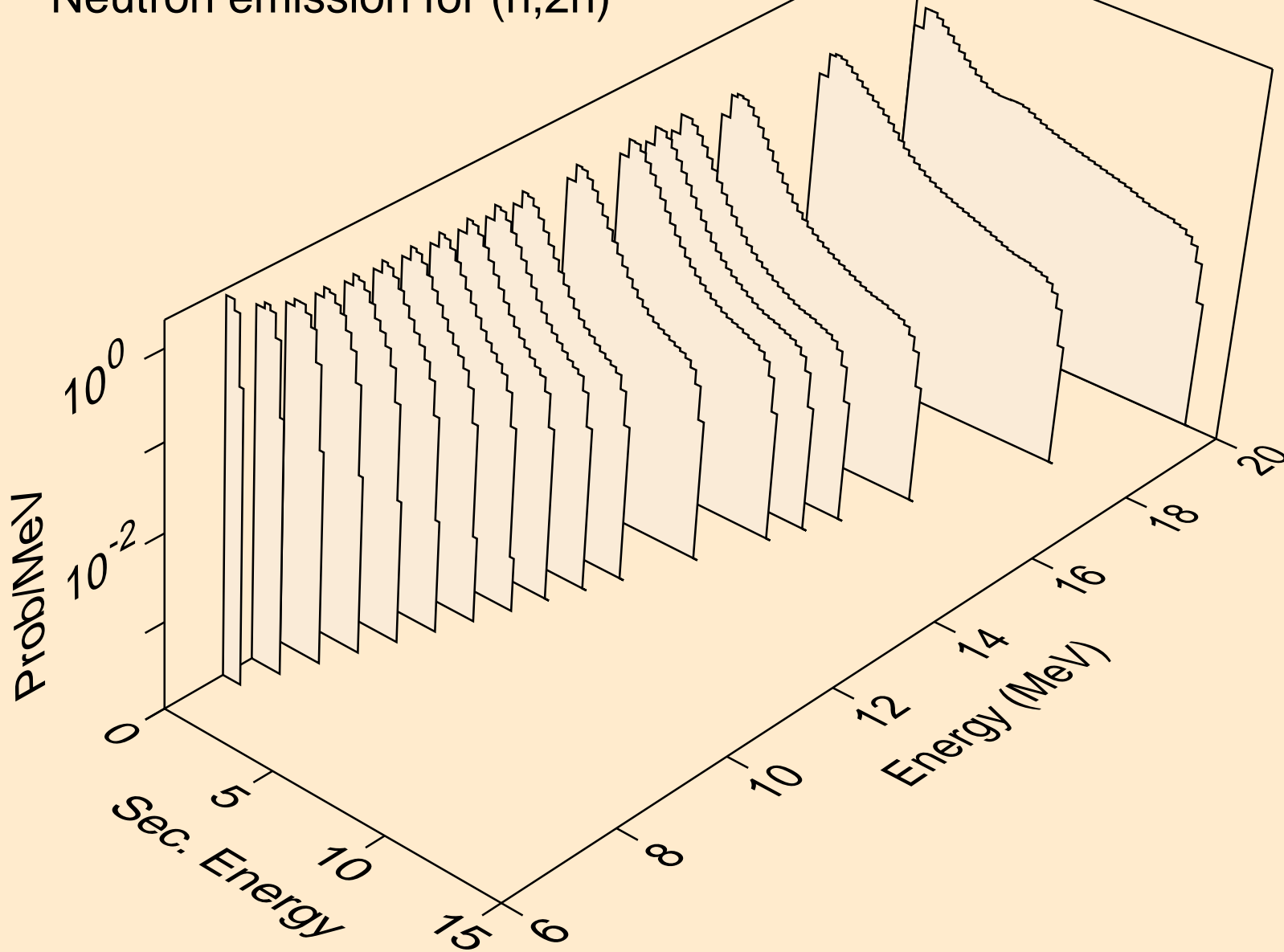

74-W-183 FOR FENDL-3B2 FROM ENDF/B-VII WITH NJOY99.304+
Neutron emission for (n,3n)

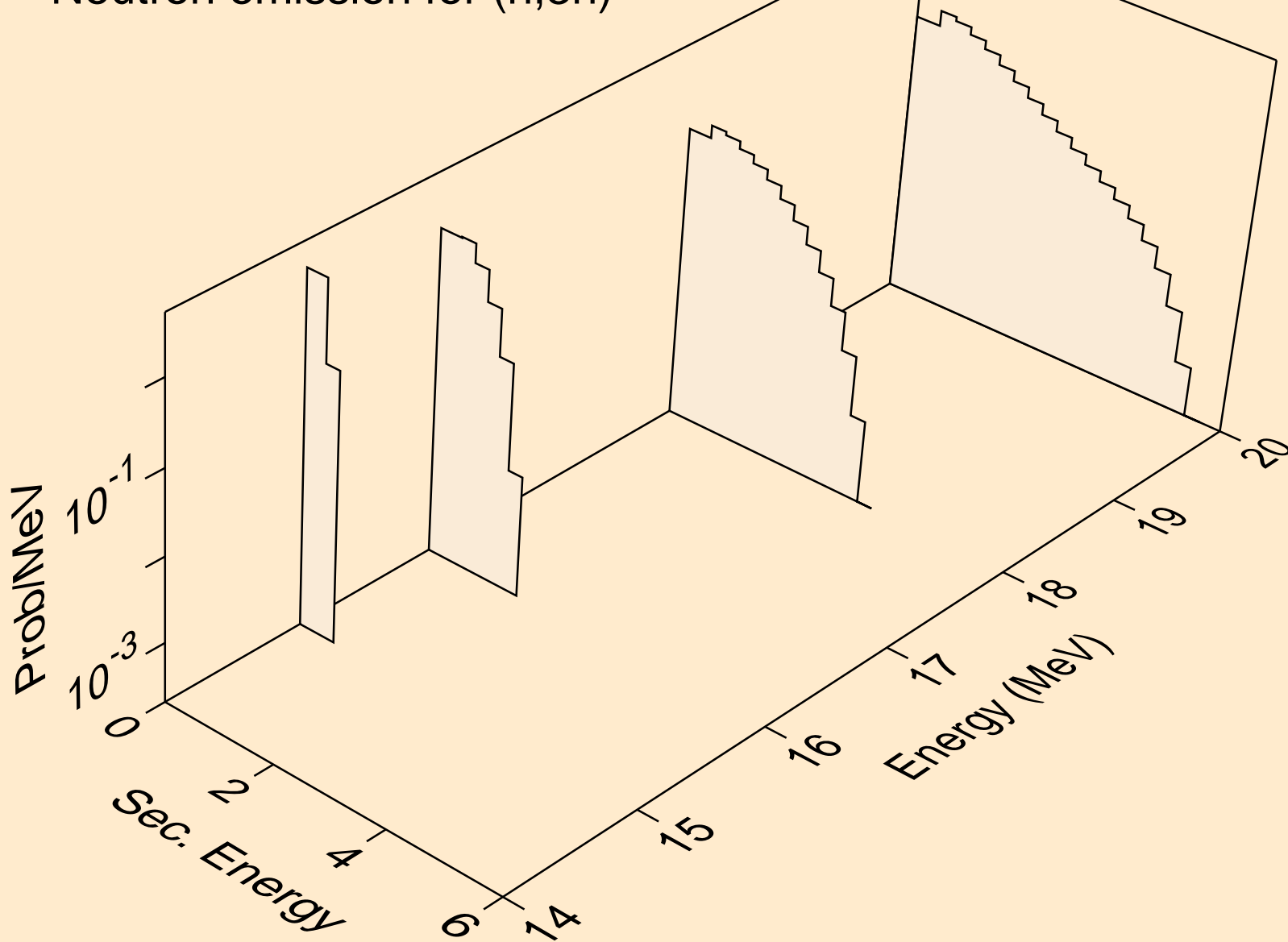

74-W-183 FOR FENDL-3B2 FROM ENDF/B-VII WITH NJOY99.304+
Neutron emission for (n,n*c)

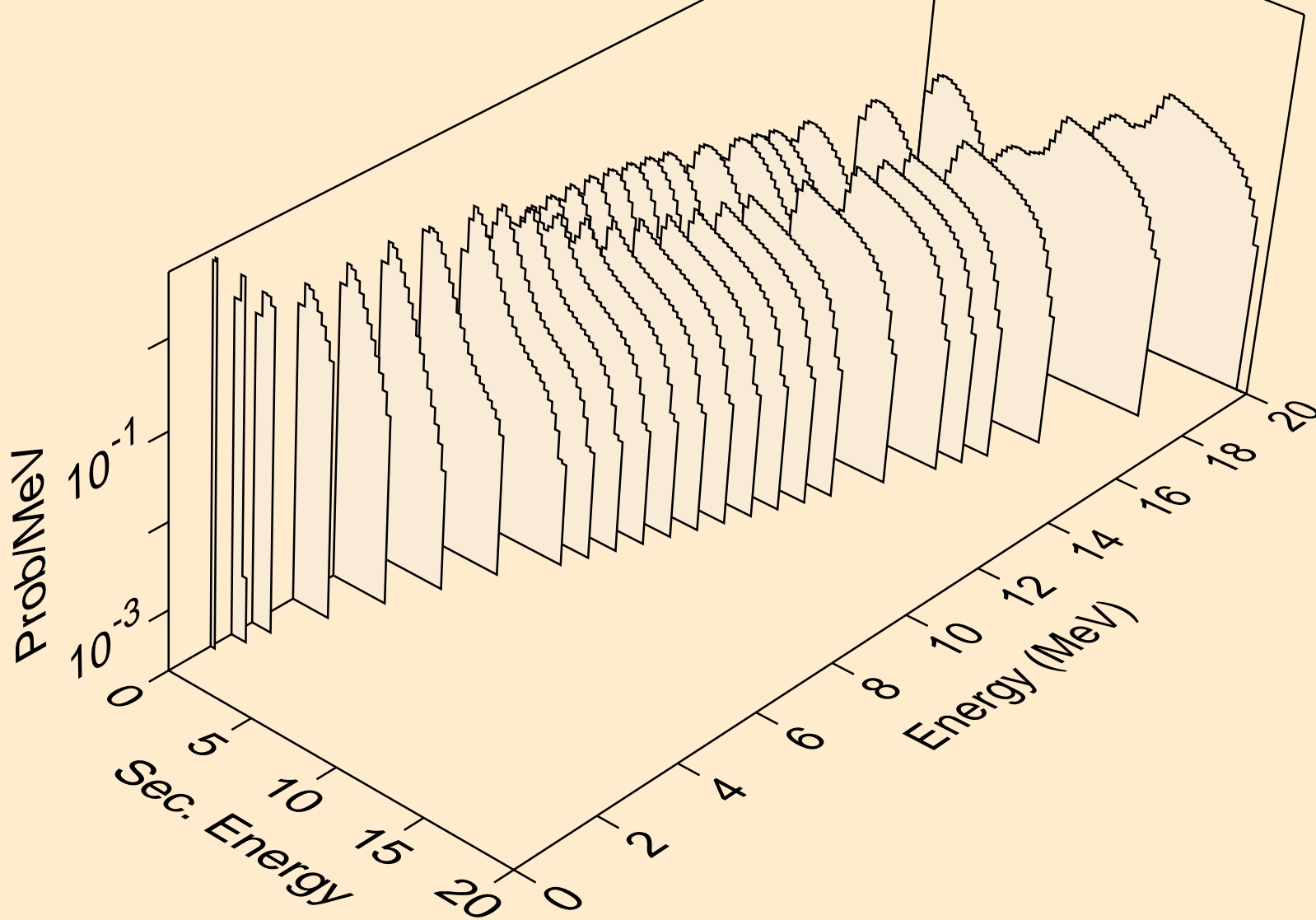

74-W-183 FOR FENDL-3B2 FROM ENDF/B-VII WITH NJOY99.304+
Photon emission for (n,gma)

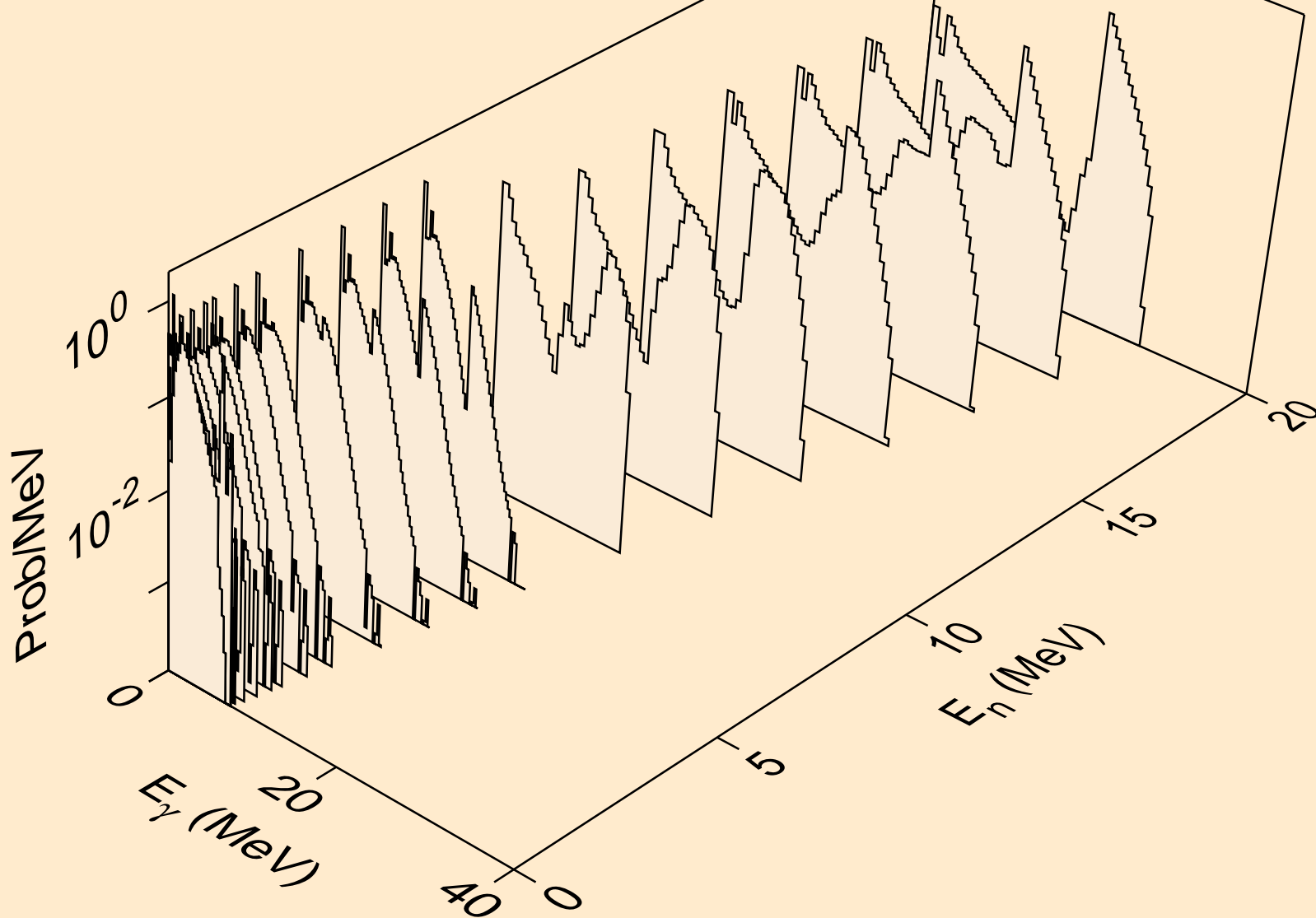

74-W-183 FOR FENDL-3B2 FROM ENDF/B-VII WITH NJOY99.304+
Photon emission for inelastic

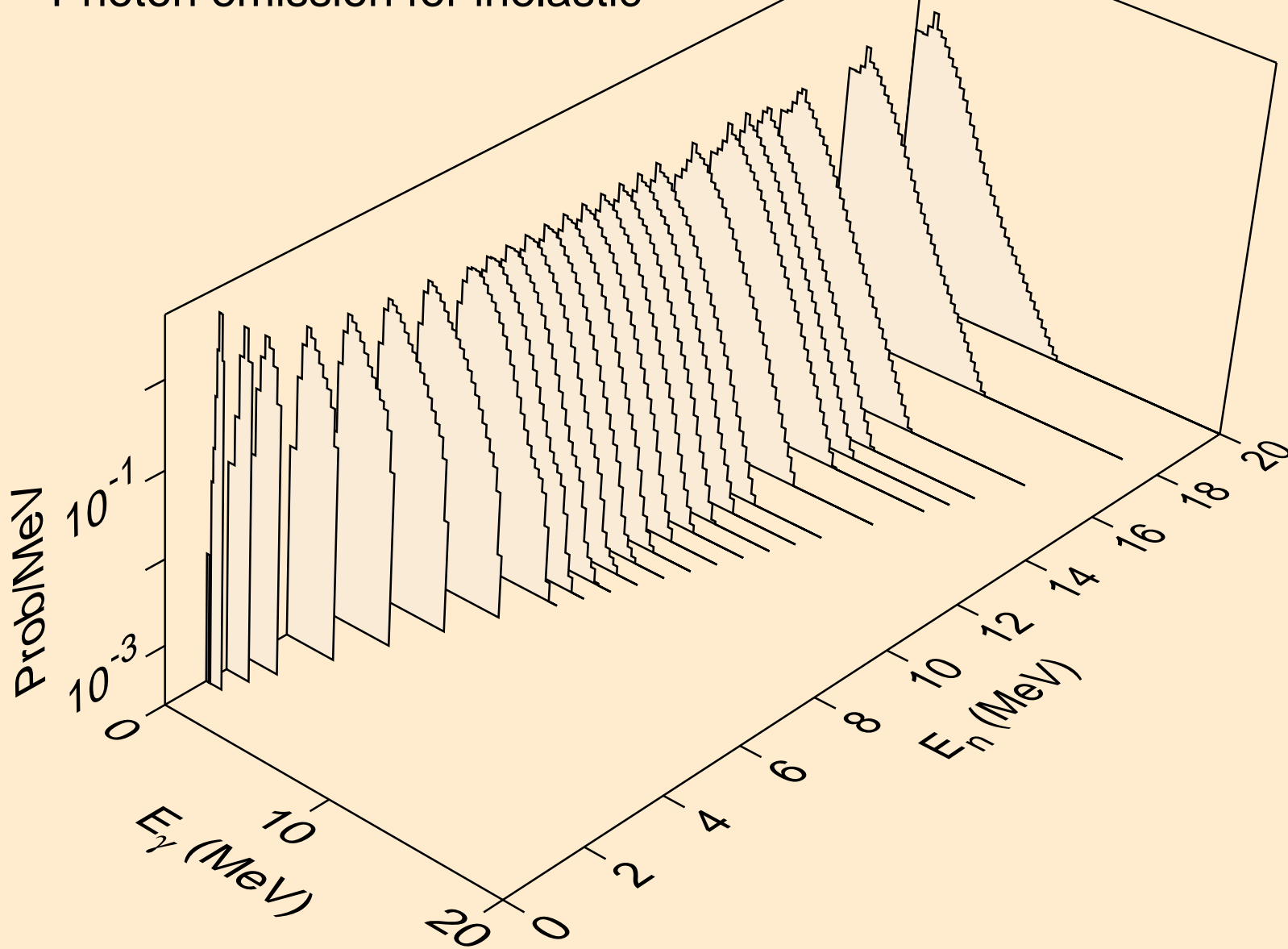

74-W-183 FOR FENDL-3B2 FROM ENDF-B-VII WITH NJOY99.304+
Photon emission for (n,2n)

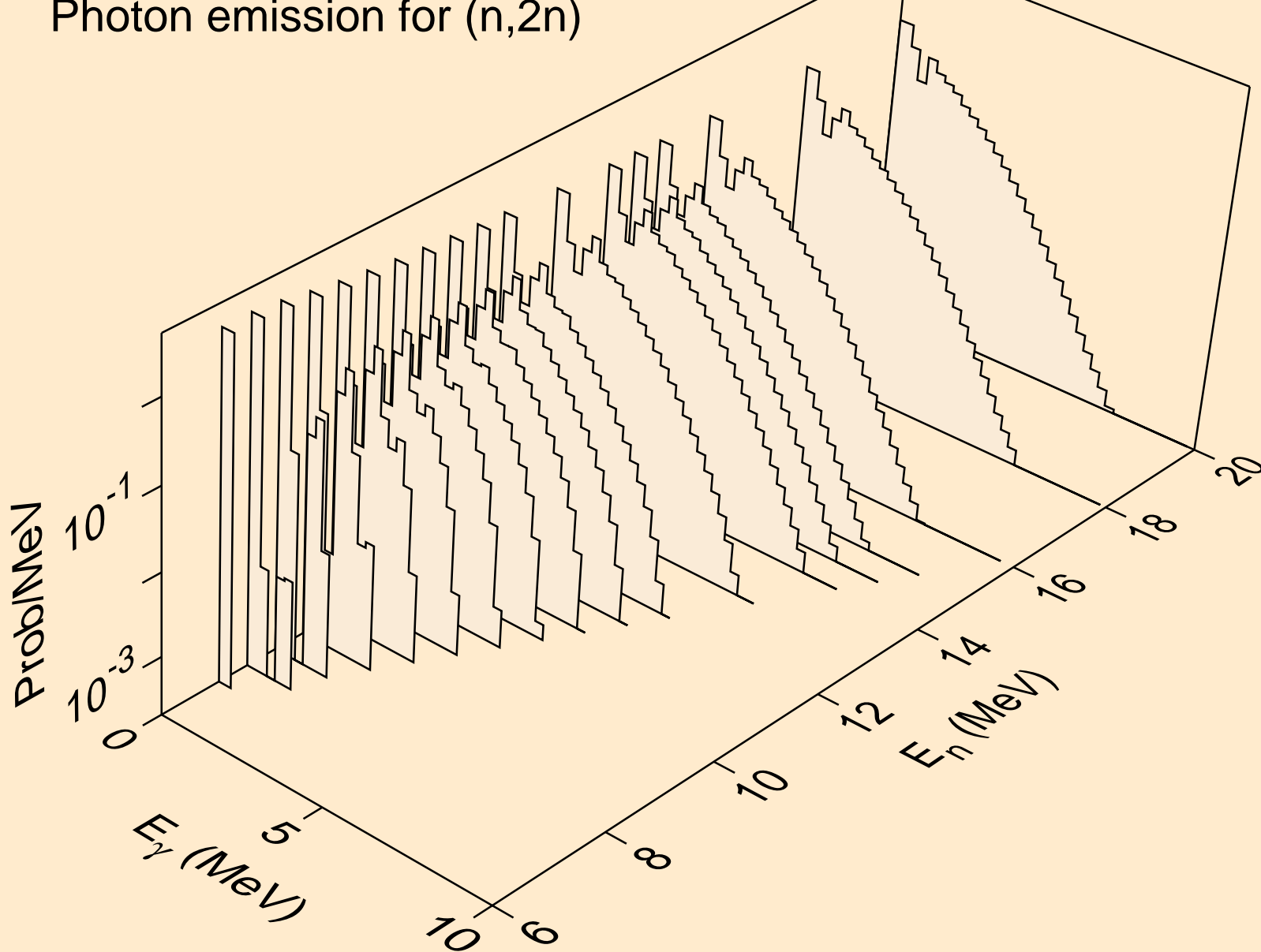

74-W-183 FOR FENDL-3B2 FROM ENDF-B-VII WITH NJOY99.304+
Photon emission for (n,3n)

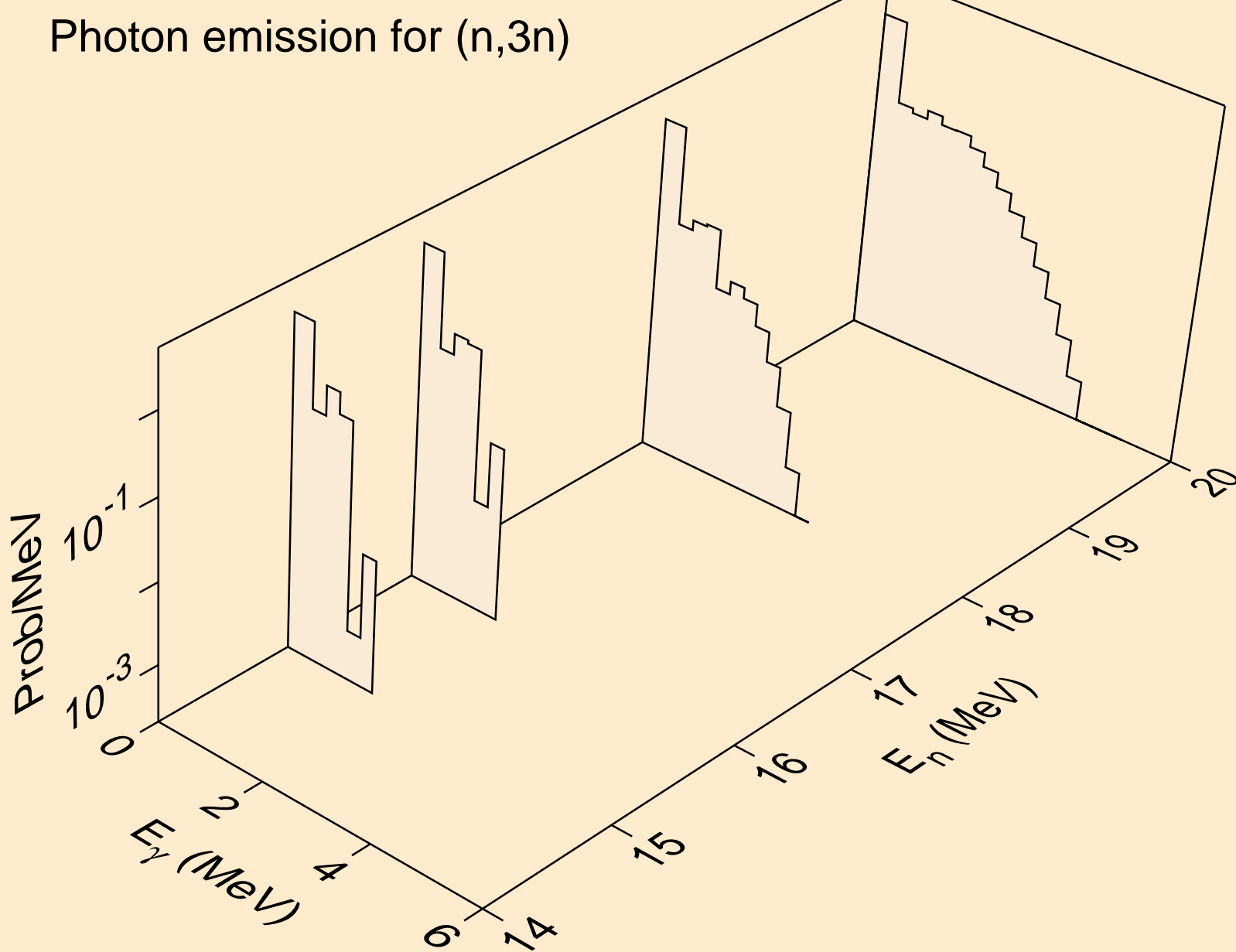

74-W-183 FOR FENDL-3B2 FROM ENDF/B-VII WITH NJOY99.304+
Photon emission for (n,x)

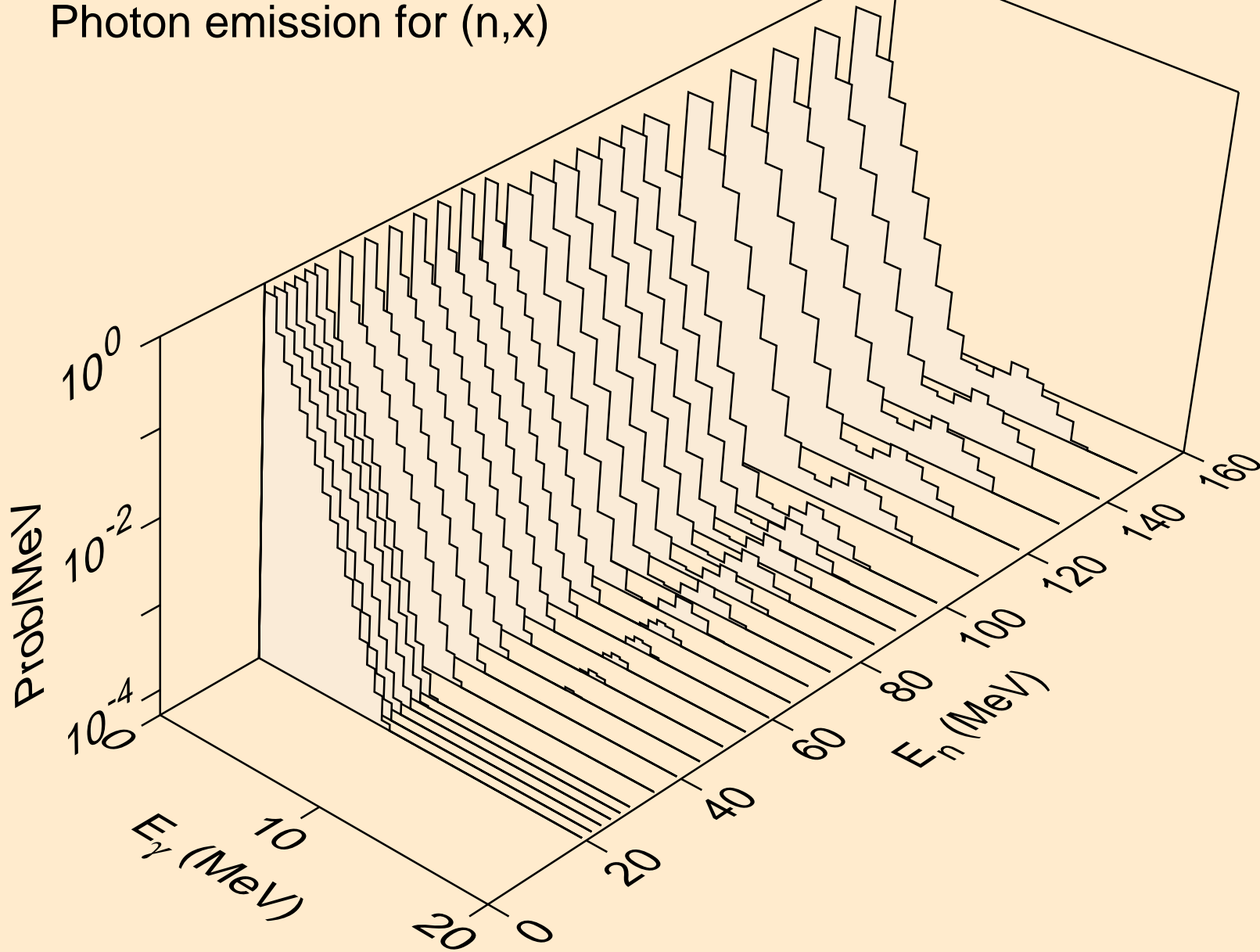

74-W-183 FOR FENDL-3B2 FROM ENDF/B-VII WITH NJOY99.304+
thermal capture photon spectrum

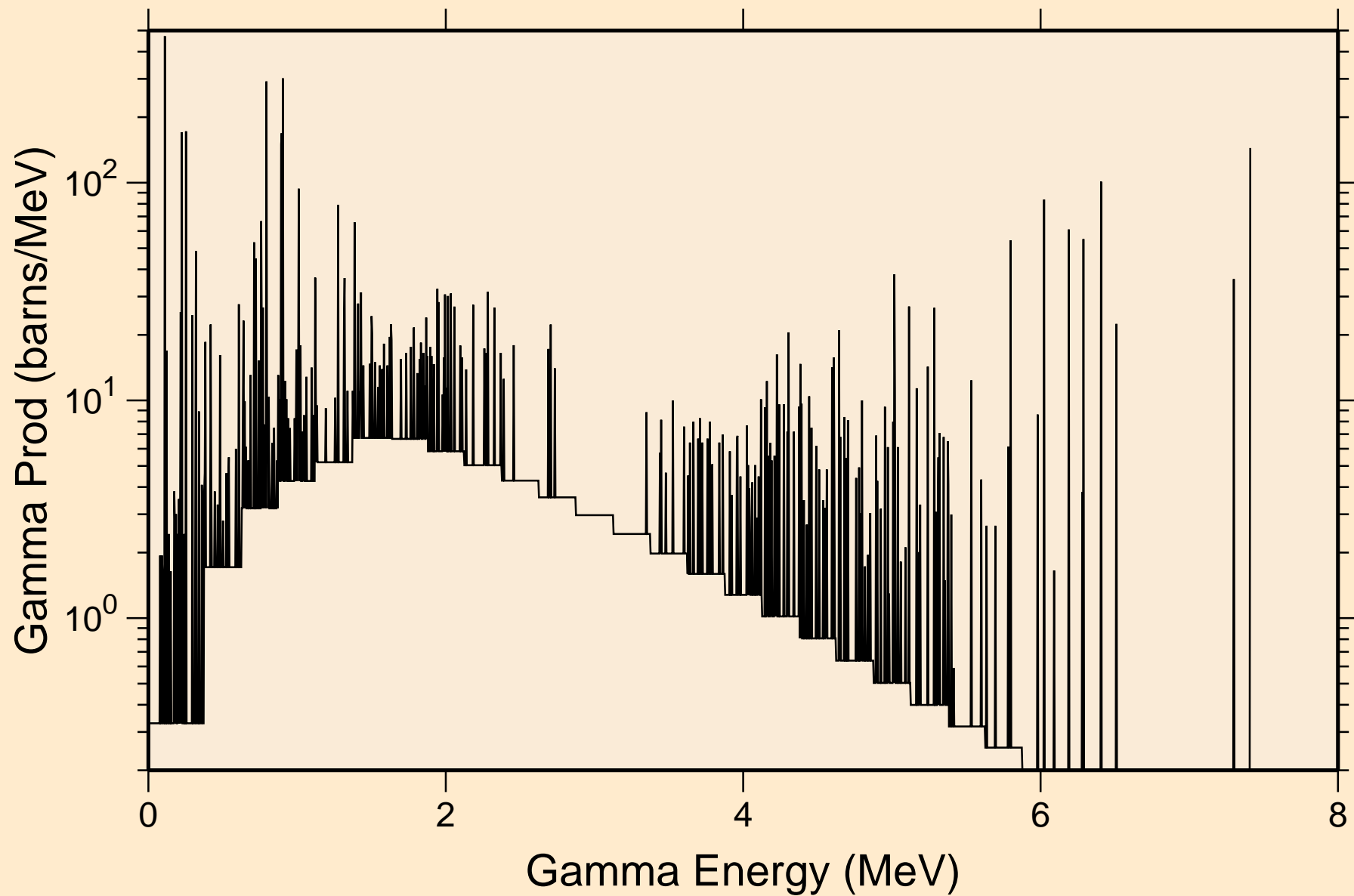

74-W-183 FOR FENDL-3B2 FROM ENDF/B-VII WITH NJOY99.304-
14 MeV photon spectrum

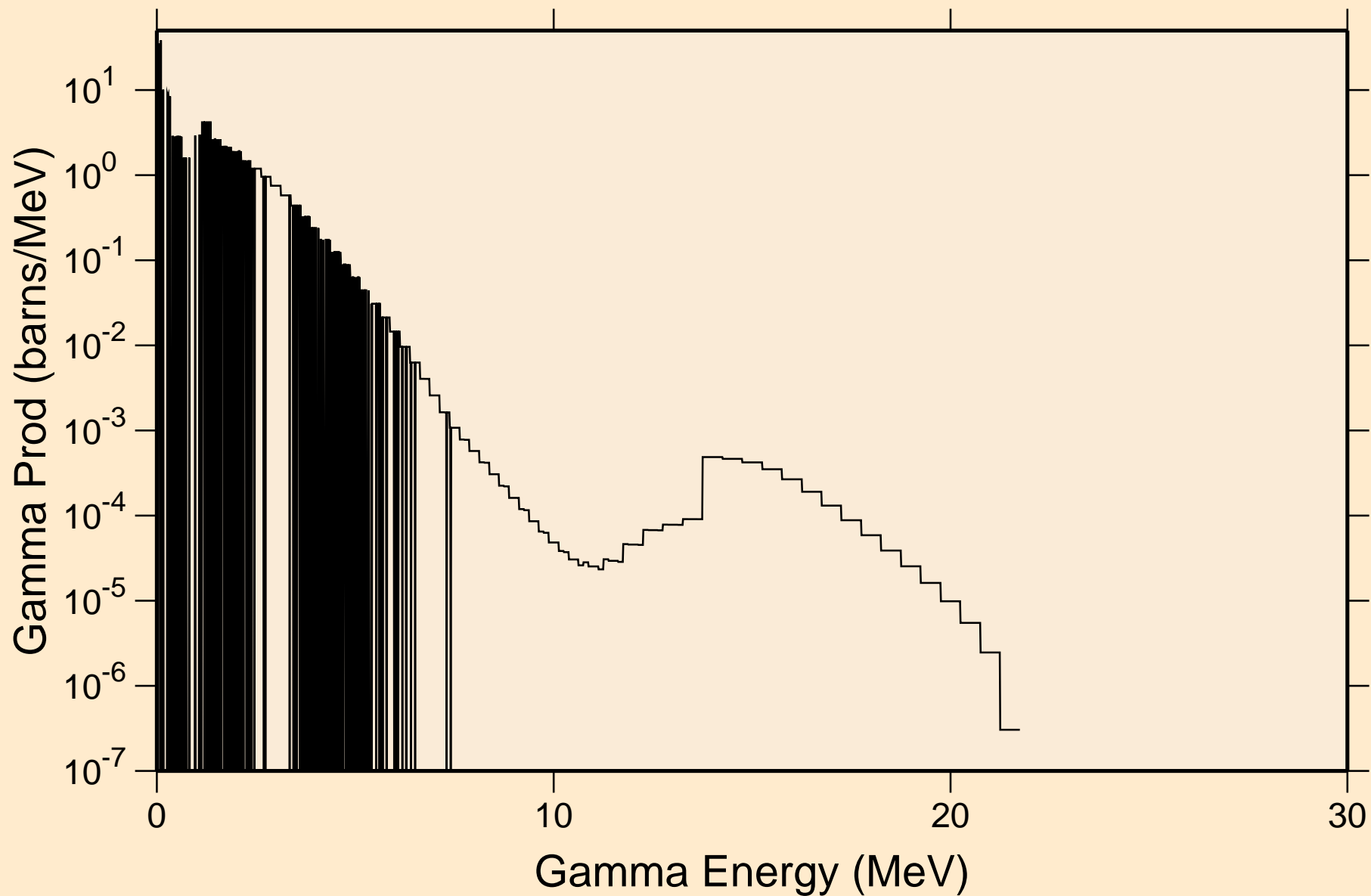

74-W-183 FOR FENDL-3B2 FROM ENDF/B-VII WITH NJOY99.304+ Particle heating contributions

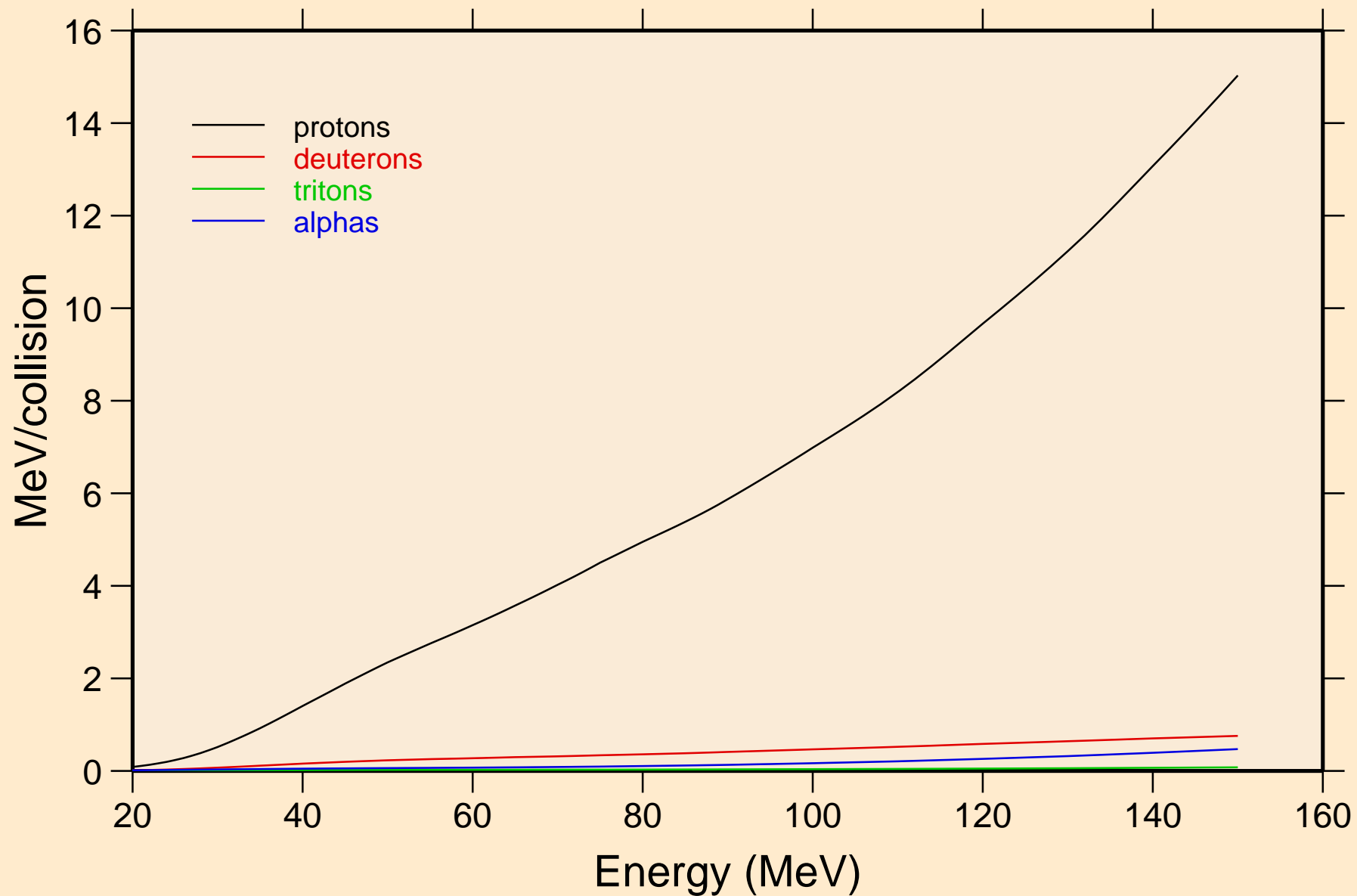

74-W-183 FOR FENDL-3B2 FROM ENDF/B-VII WITH NJOY99.304+
Recoil Heating

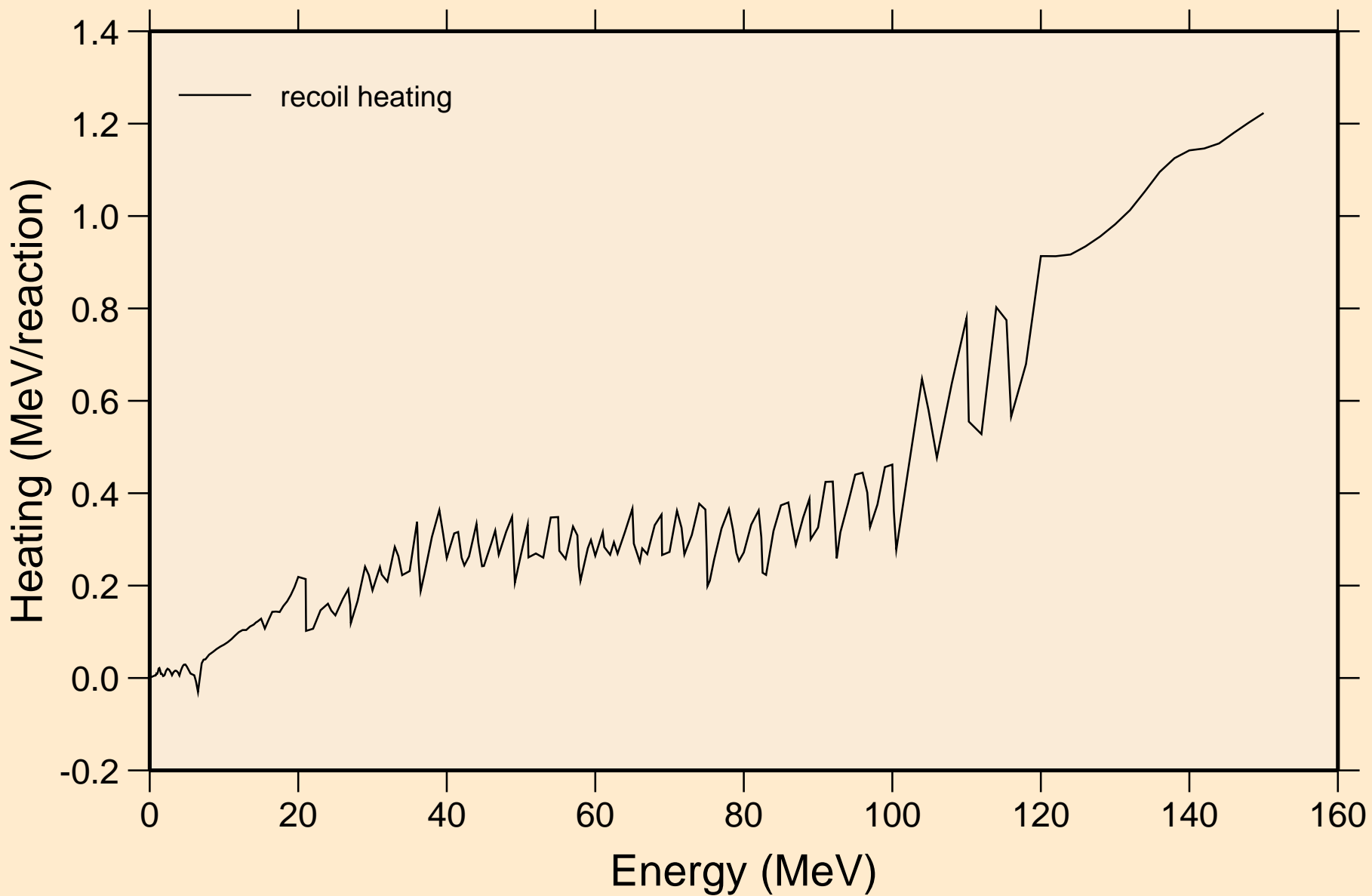

74-W-183 FOR FENDL-3B2 FROM ENDF/B-VII WITH NJOY99.304+

Particle production cross sections

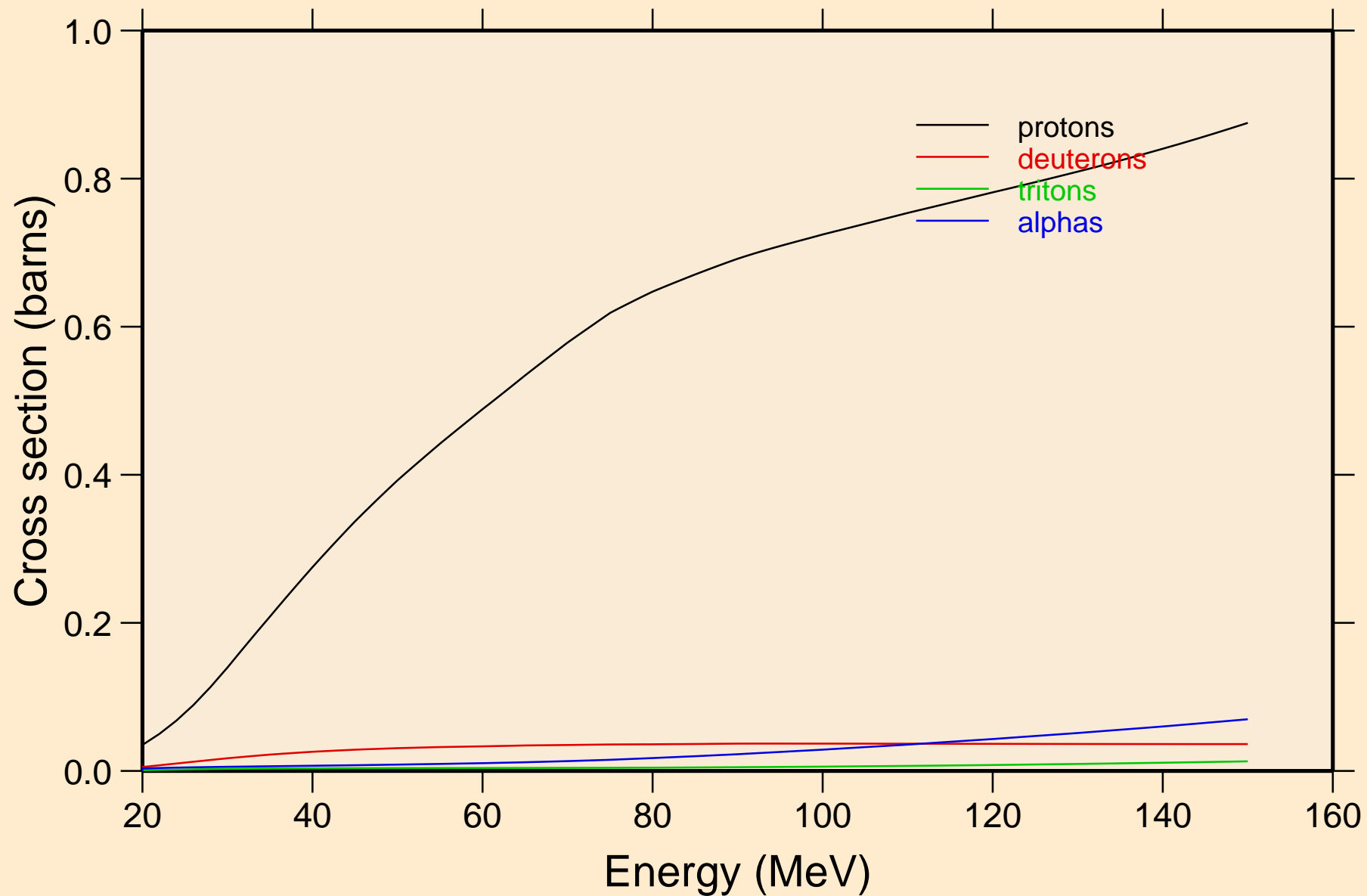

74-W-183 FOR FENDL-3B2 FROM ENDF/B-VII WITH NJOY99.304+
protons from (n,x)

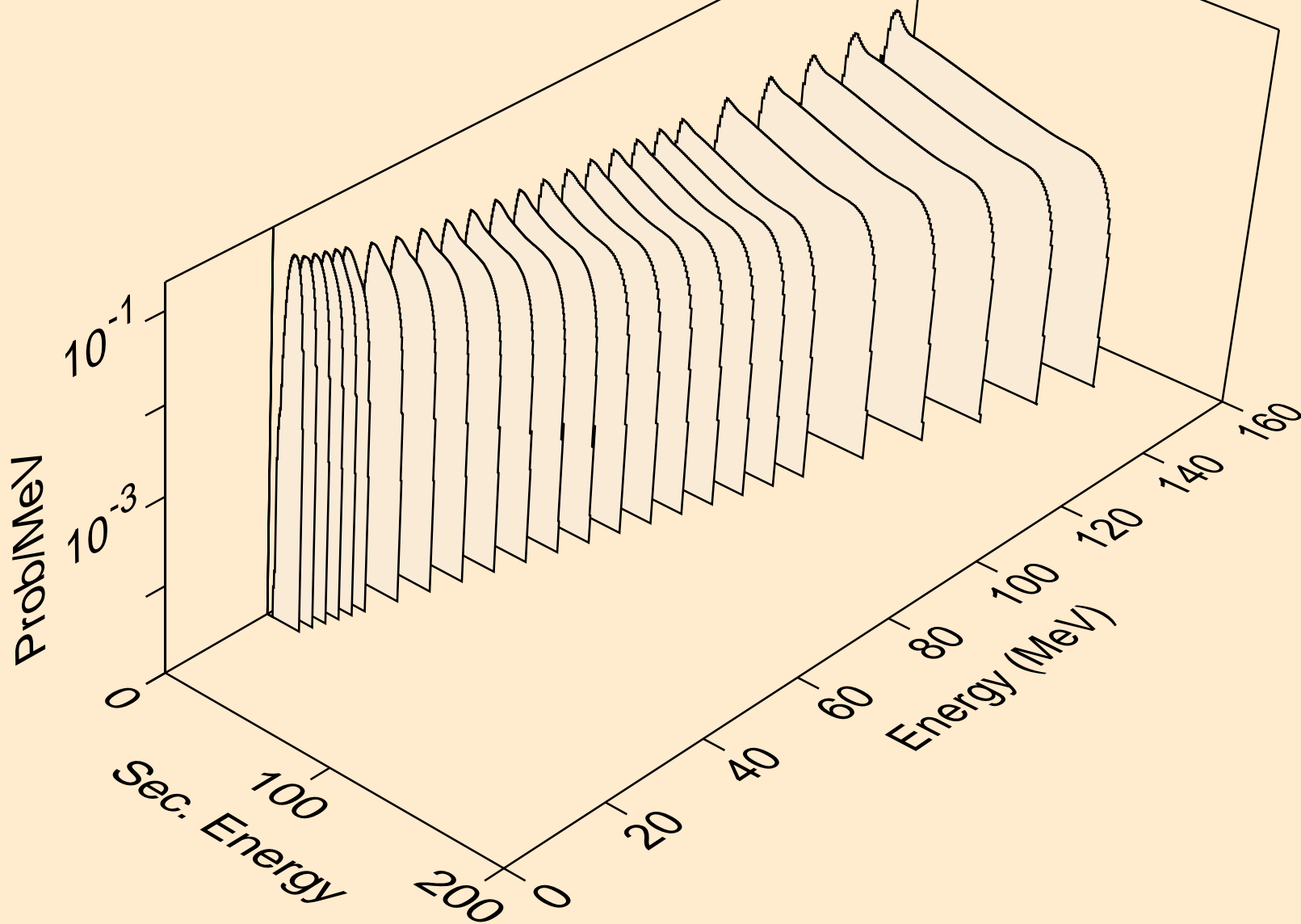

74-W-183 FOR FENDL-3B2 FROM ENDF/B-VII WITH NJOY99.304+
deuterons from (n,x)

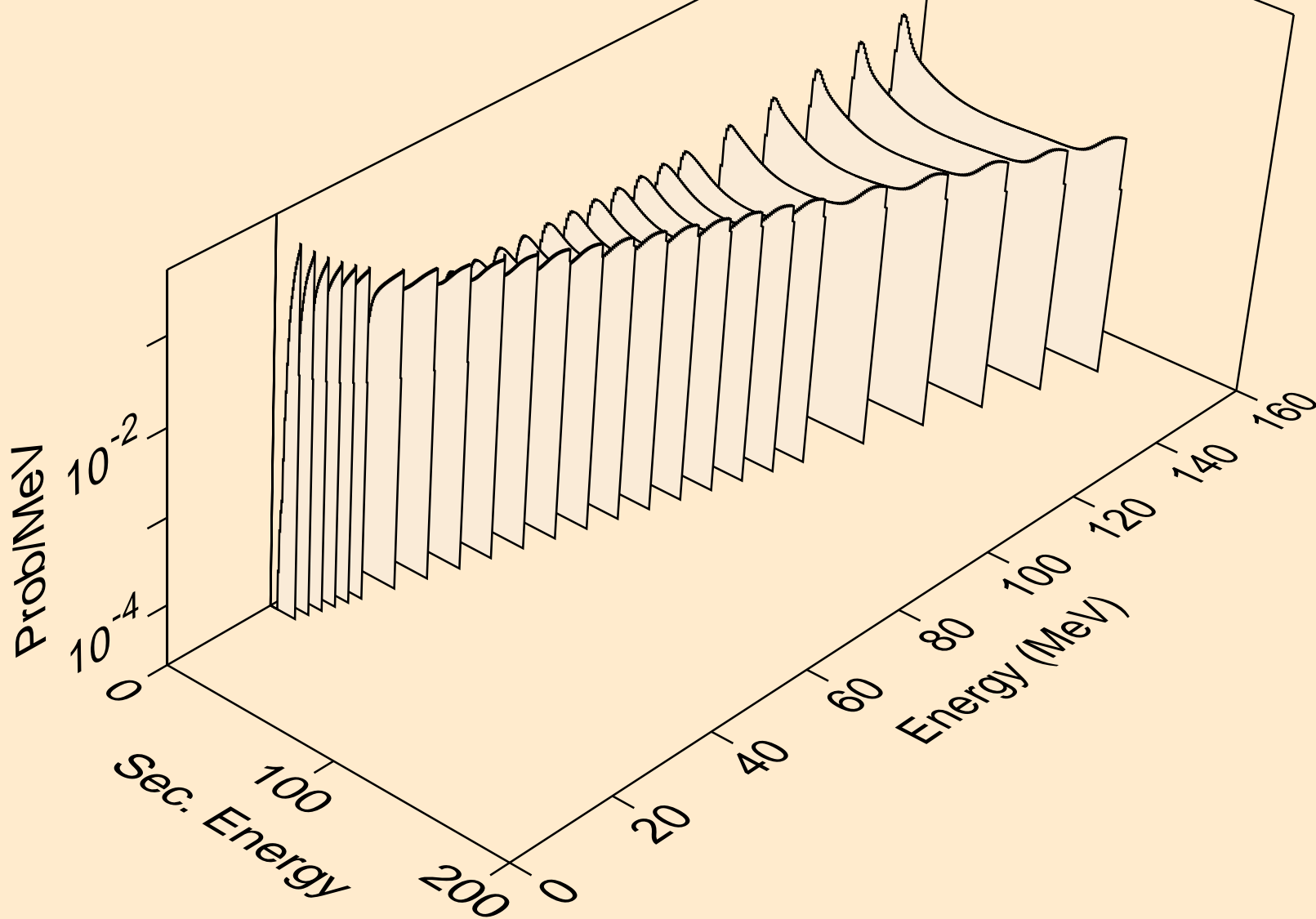

74-W-183 FOR FENDL-3B2 FROM ENDF/B-VII WITH NJOY99.304+
tritons from (n,x)

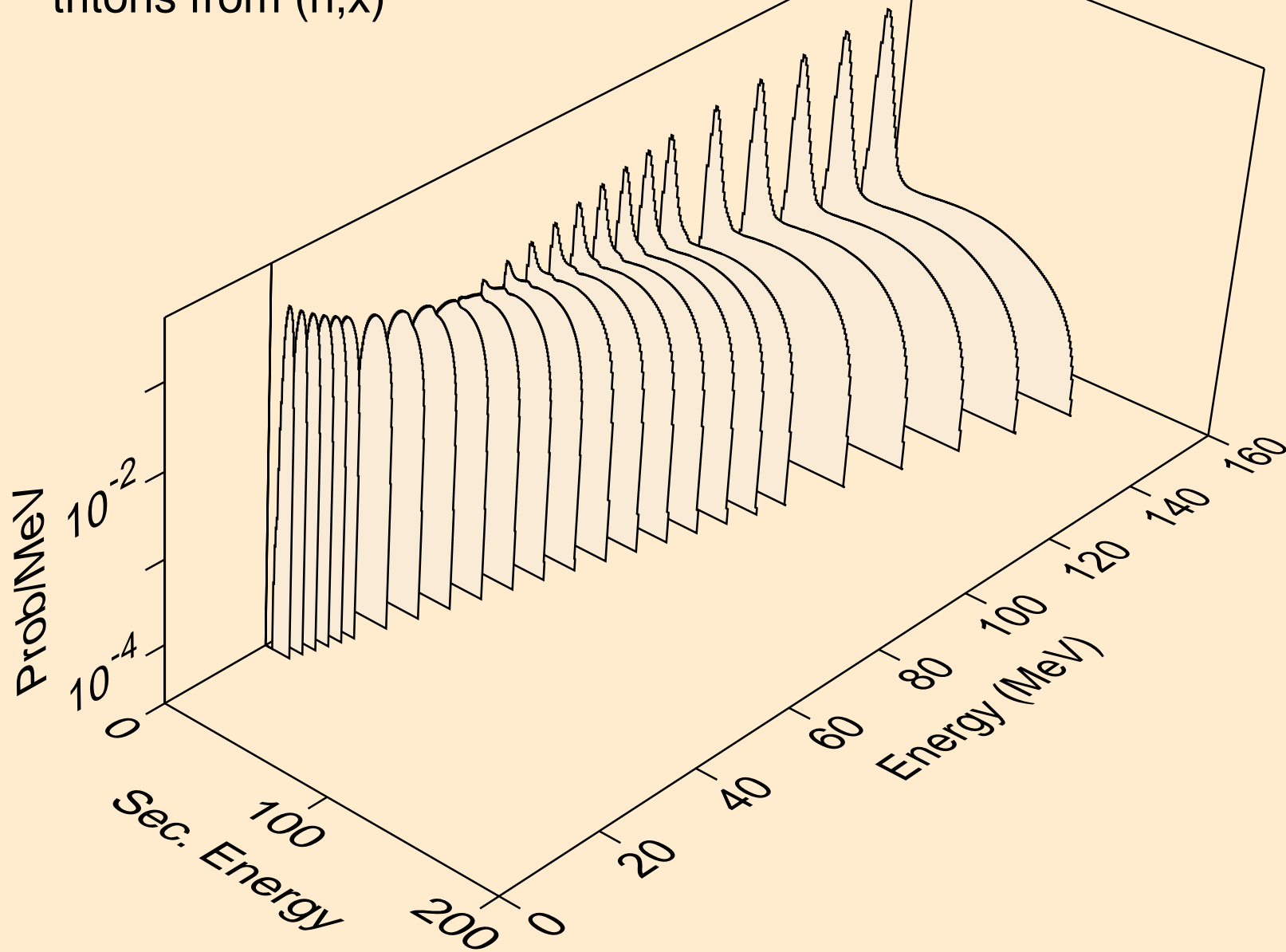

74-W-183 FOR FENDL-3B2 FROM ENDF-B-VII WITH NJOY99.304+
alphas from (n,x)

