

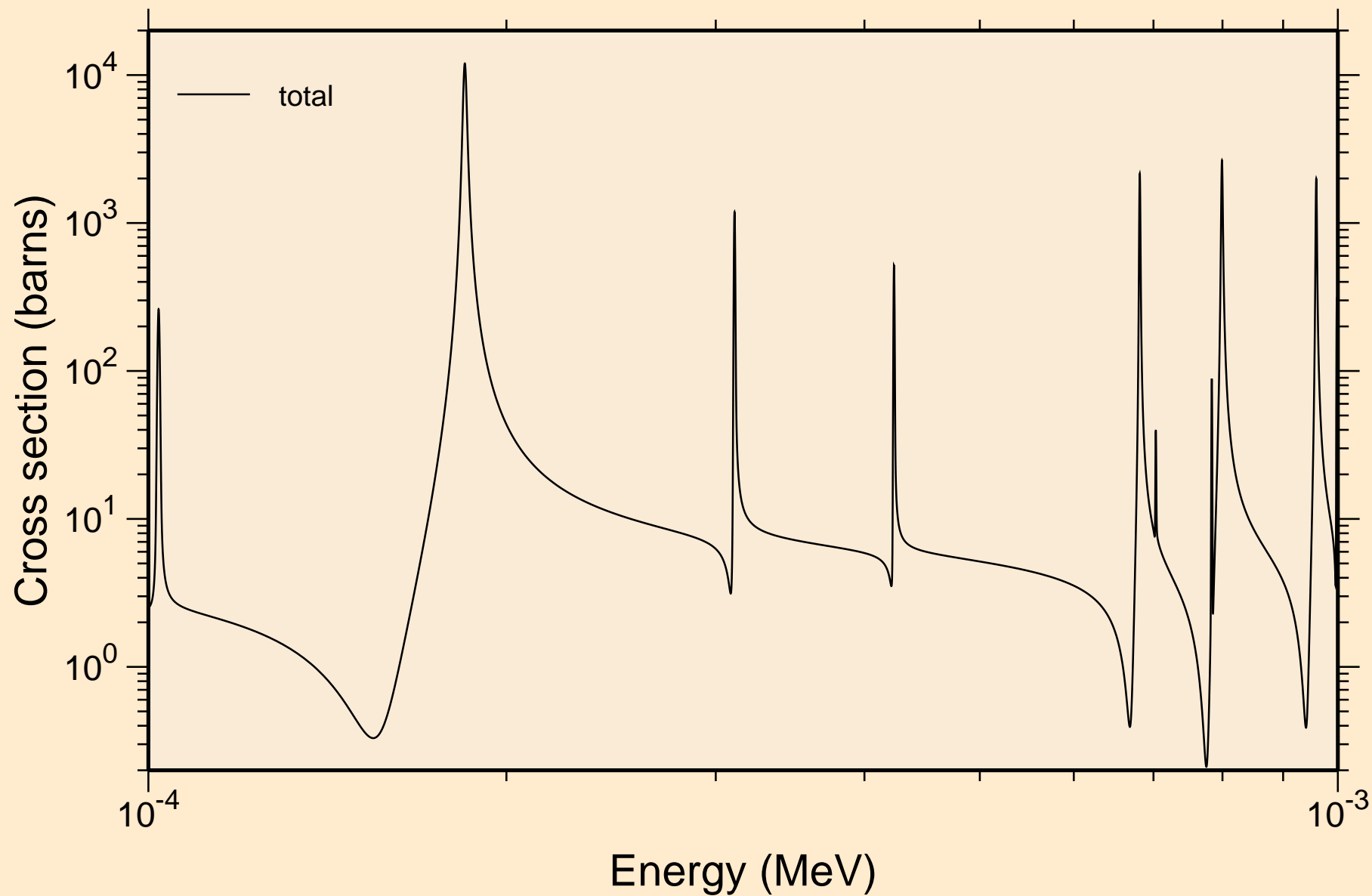

74-W-184 FOR FENDL-3B2 FROM ENDF/B-VII WITH NJOY99.304+  
resonance total cross section

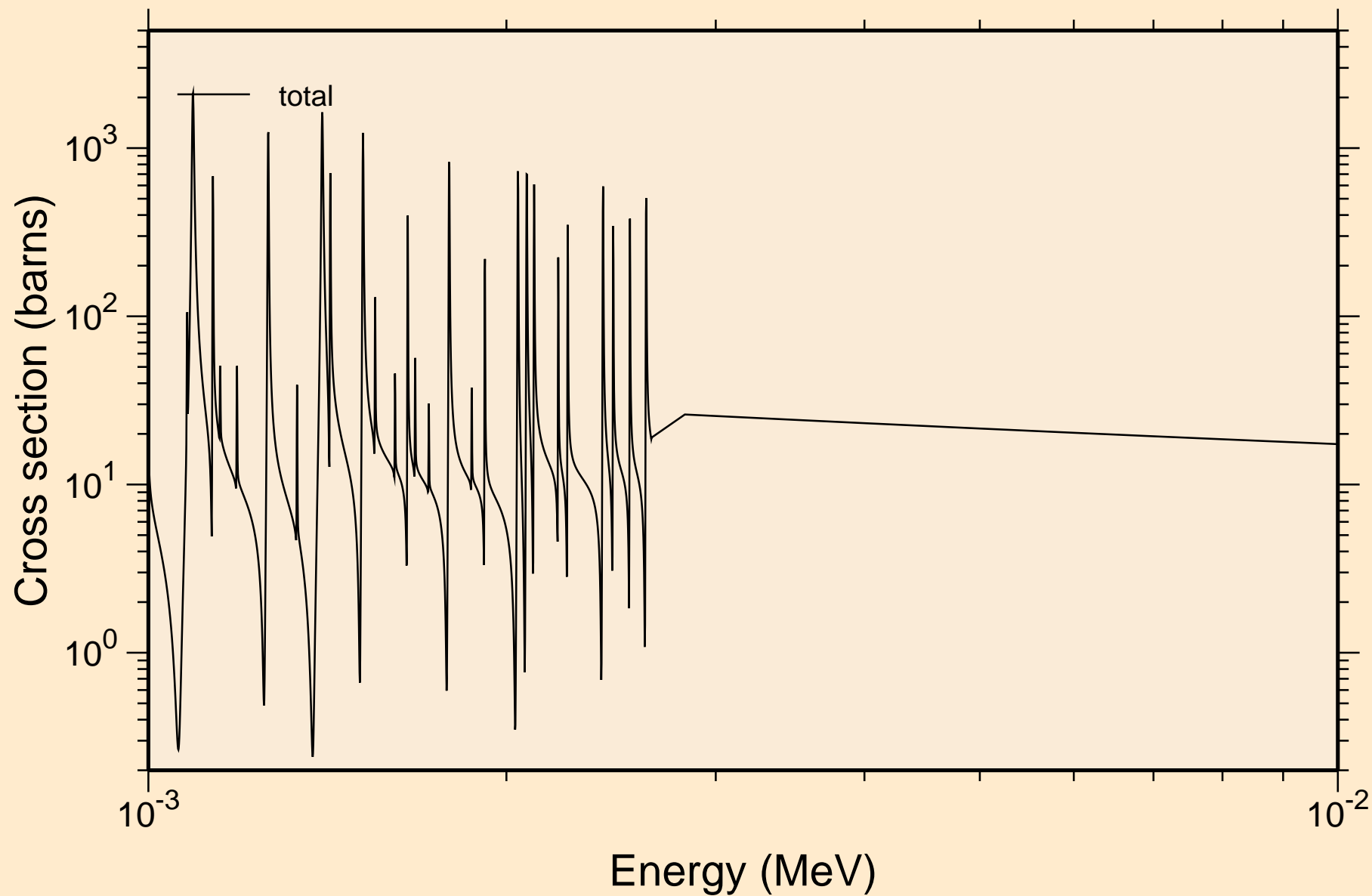

74-W-184 FOR FENDL-3B2 FROM ENDF/B-VII WITH NJOY99.304+  
resonance total cross section



74-W-184 FOR FENDL-3B2 FROM ENDF/B-VII WITH NJOY99.304+  
resonance total cross section

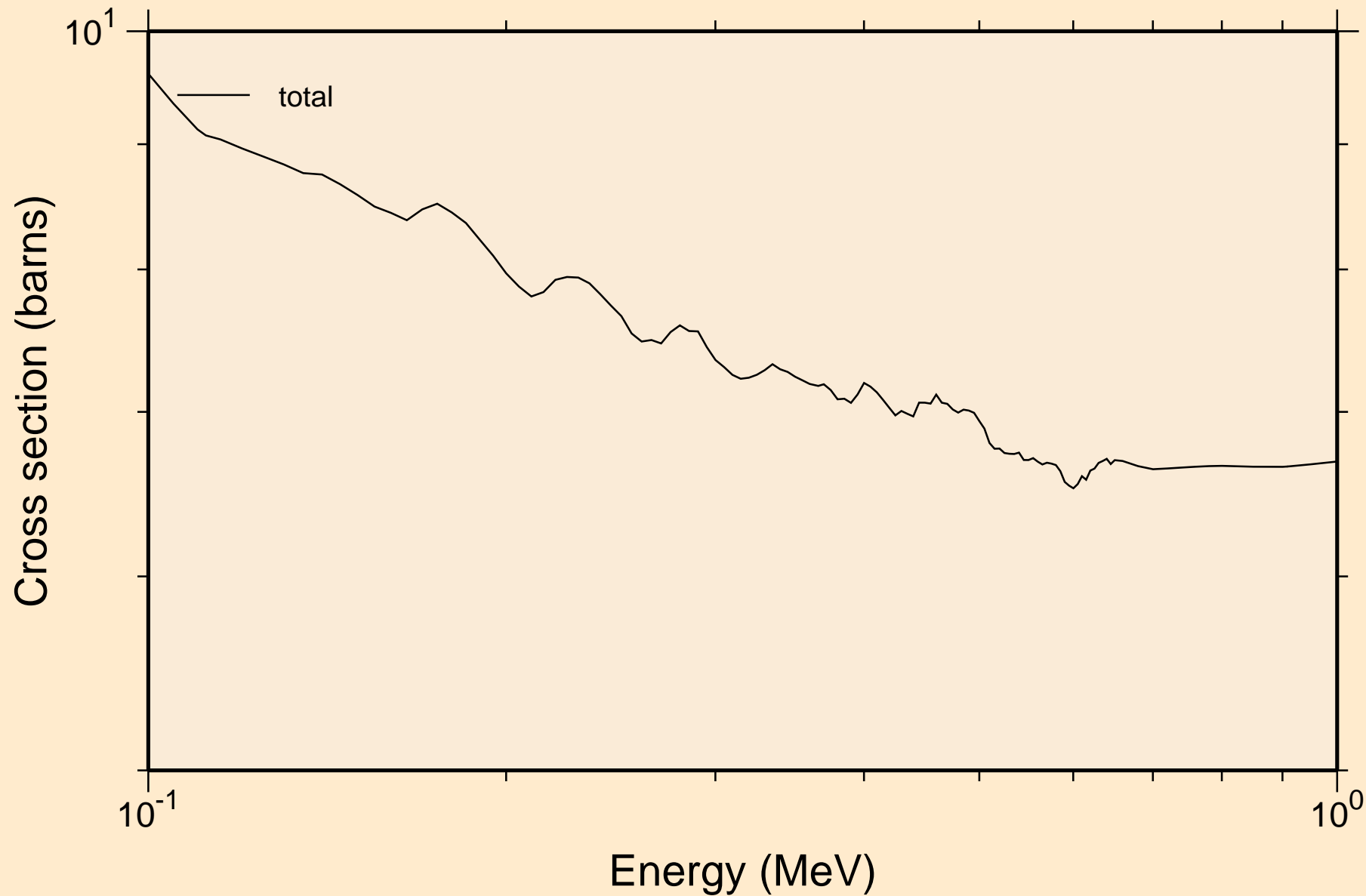

74-W-184 FOR FENDL-3B2 FROM ENDF/B-VII WITH NJOY99.304+  
resonance total cross section

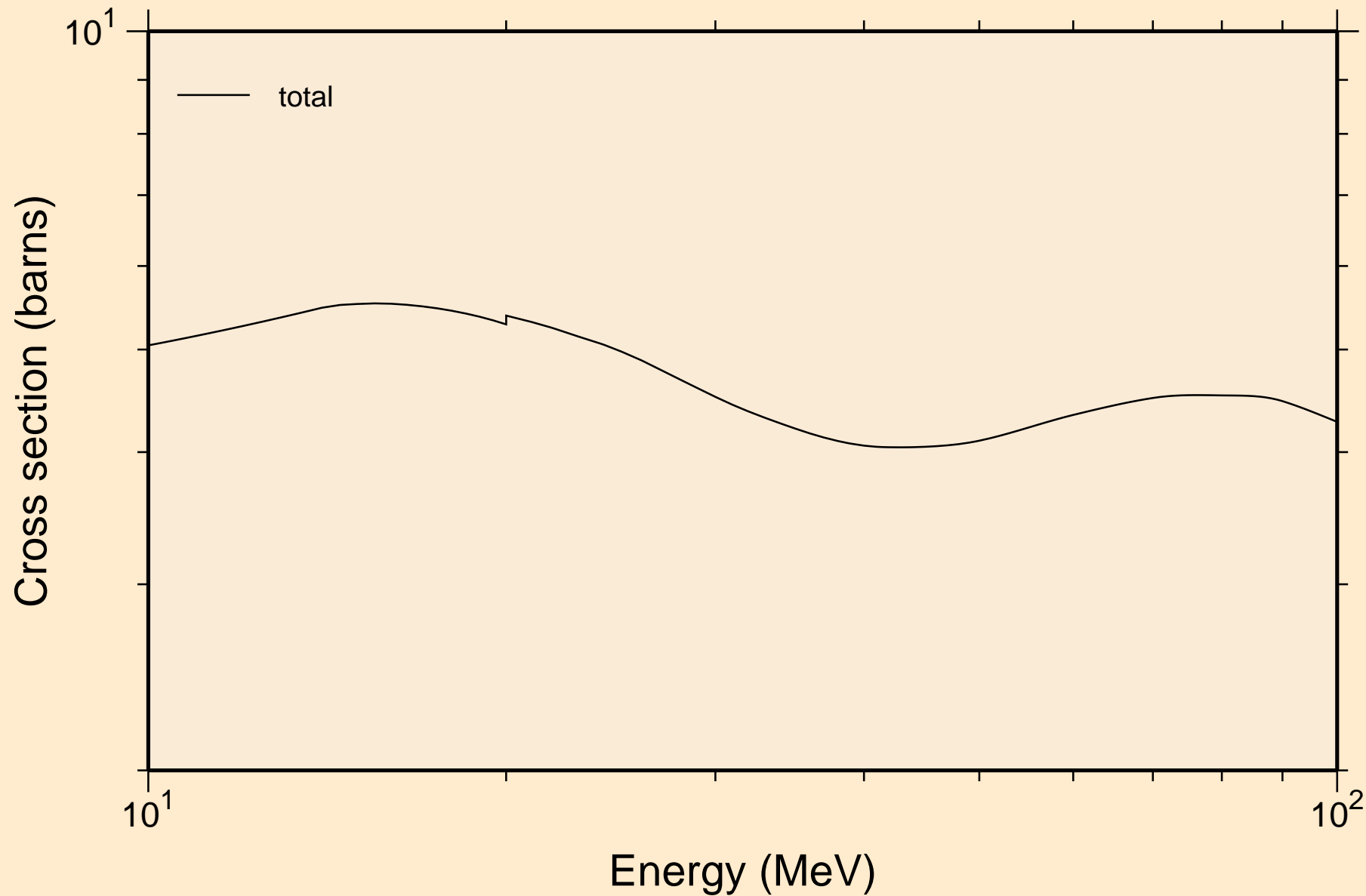

74-W-184 FOR FENDL-3B2 FROM ENDF/B-VII WITH NJOY99.304+  
resonance absorption cross sections

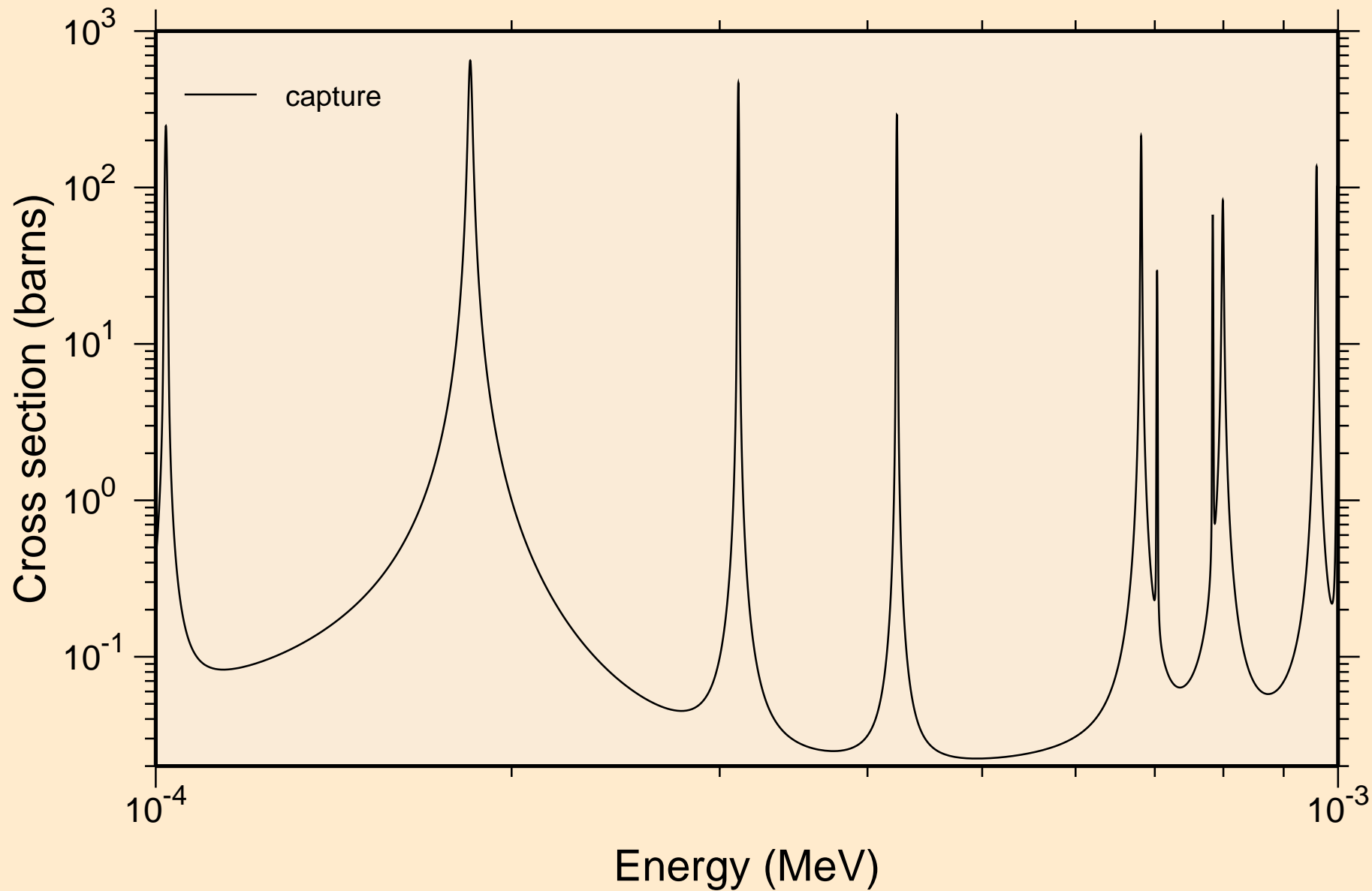

74-W-184 FOR FENDL-3B2 FROM ENDF/B-VII WITH NJOY99.304+  
resonance absorption cross sections

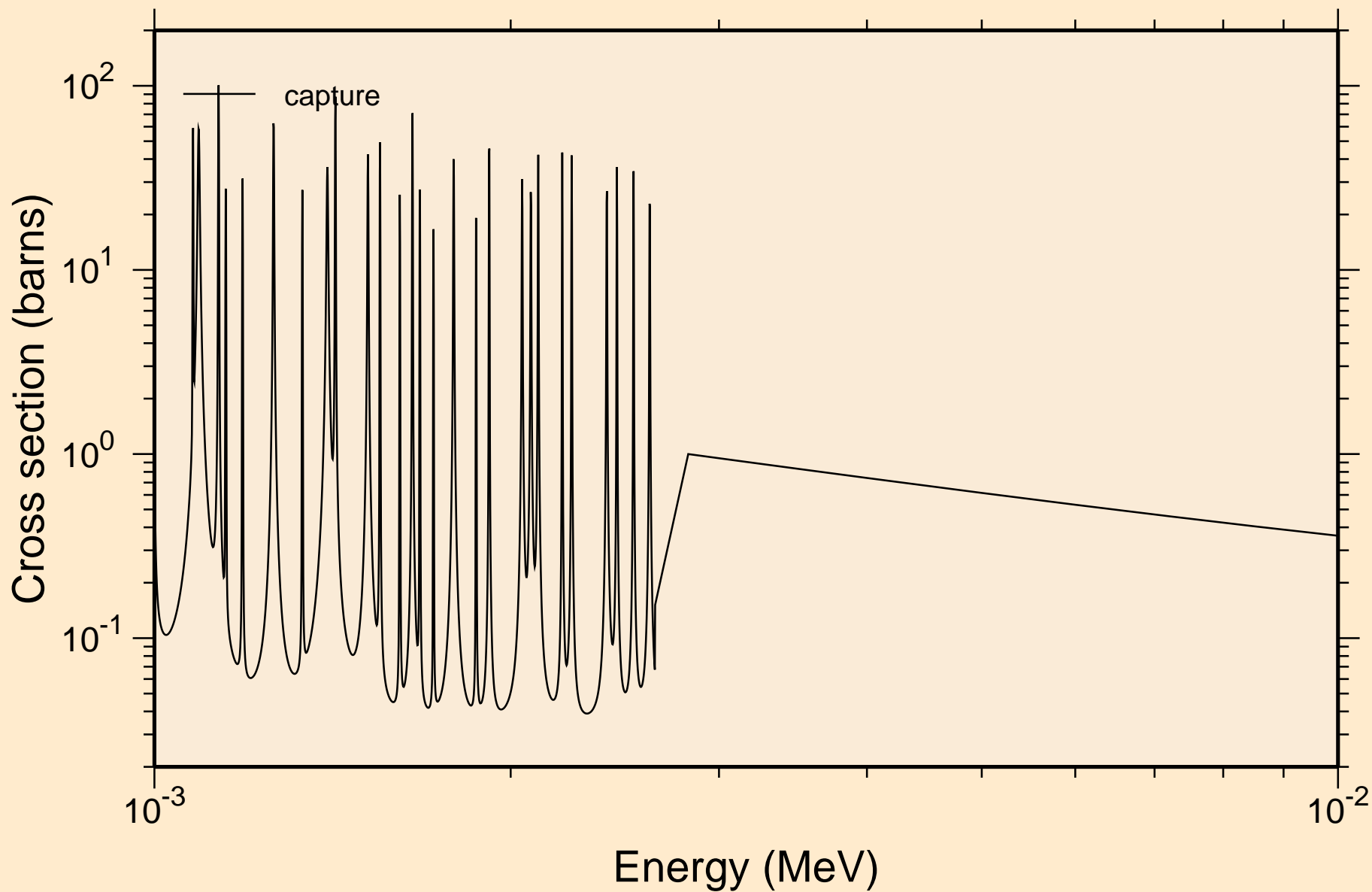

74-W-184 FOR FENDL-3B2 FROM ENDF/B-VII WITH NJOY99.304+  
resonance absorption cross sections

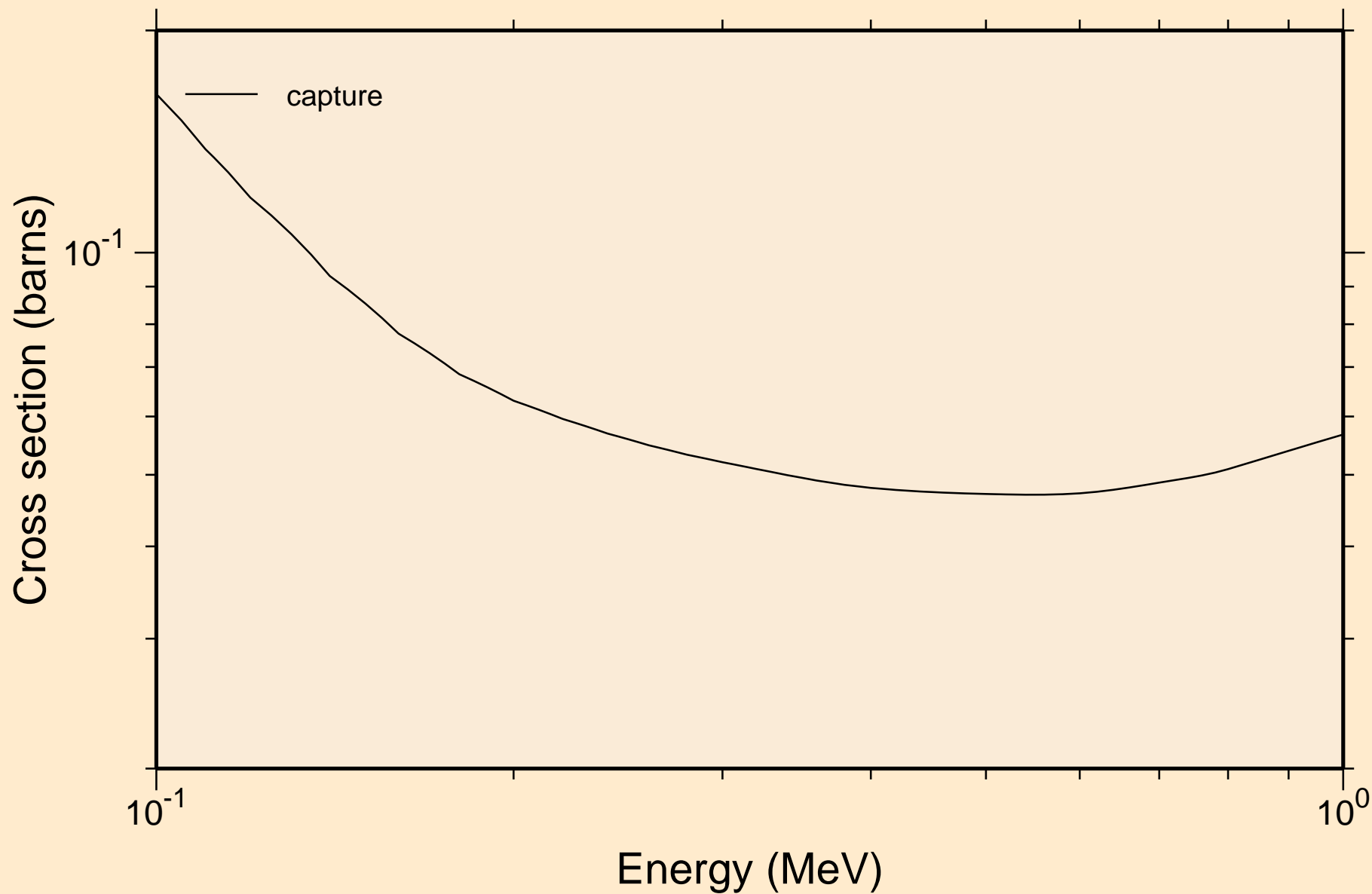



74-W-184 FOR FENDL-3B2 FROM ENDF/B-VII WITH NJOY99.304+  
resonance absorption cross sections

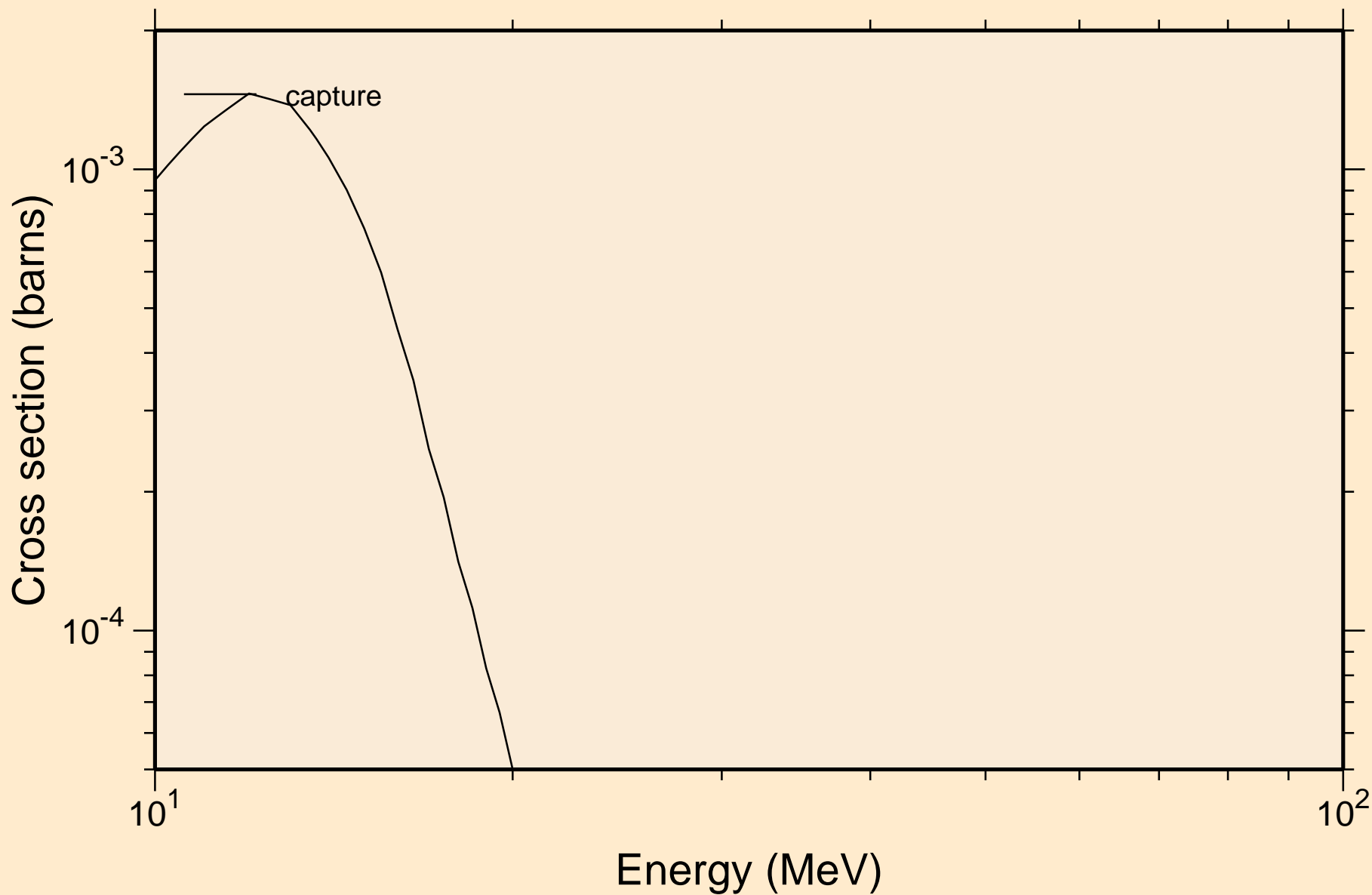

74-W-184 FOR FENDL-3B2 FROM ENDF/B-VII WITH NJOY99.304+  
UR total cross section

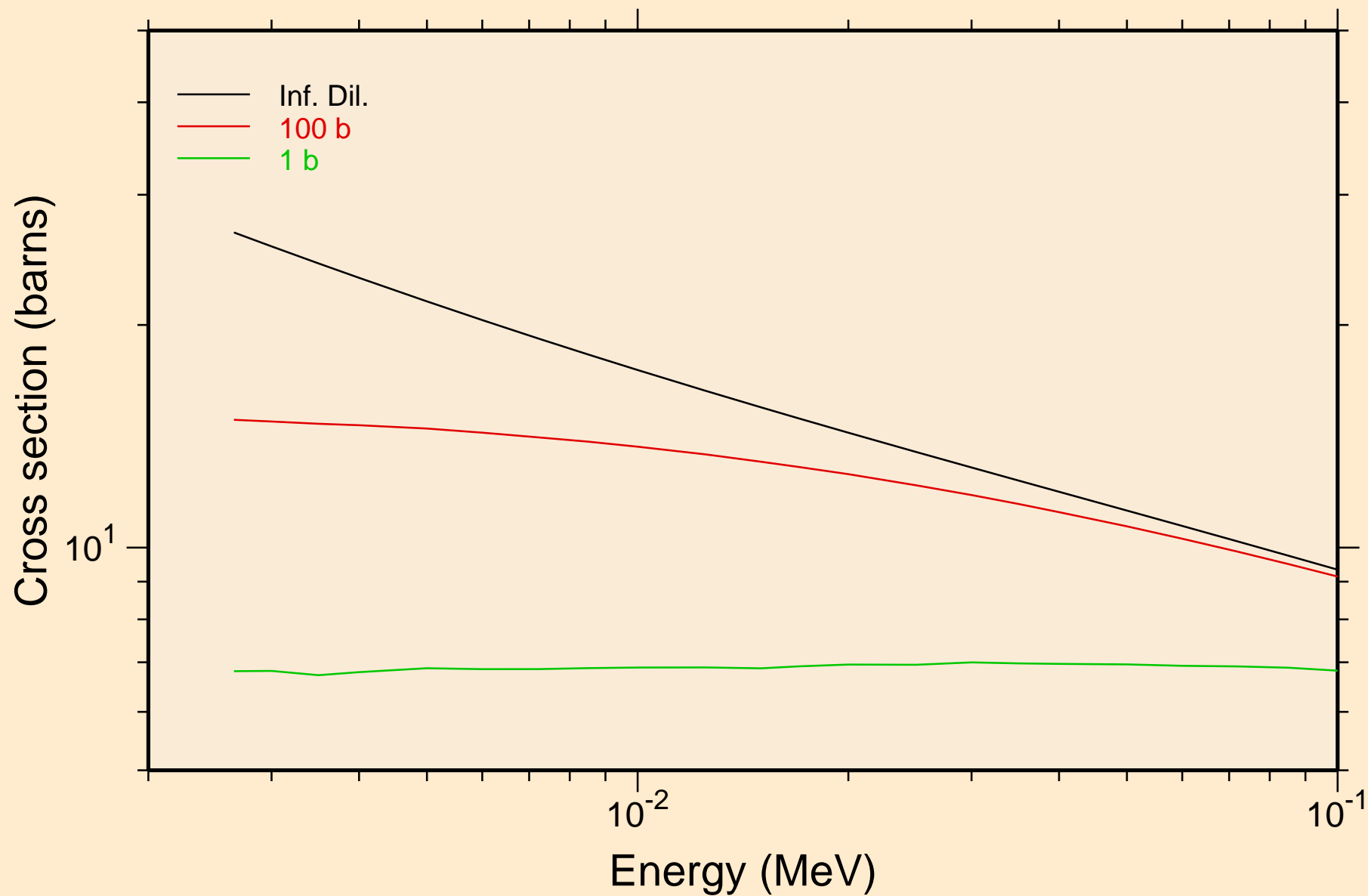

74-W-184 FOR FENDL-3B2 FROM ENDF/B-VII WITH NJOY99.304+  
UR elastic cross section

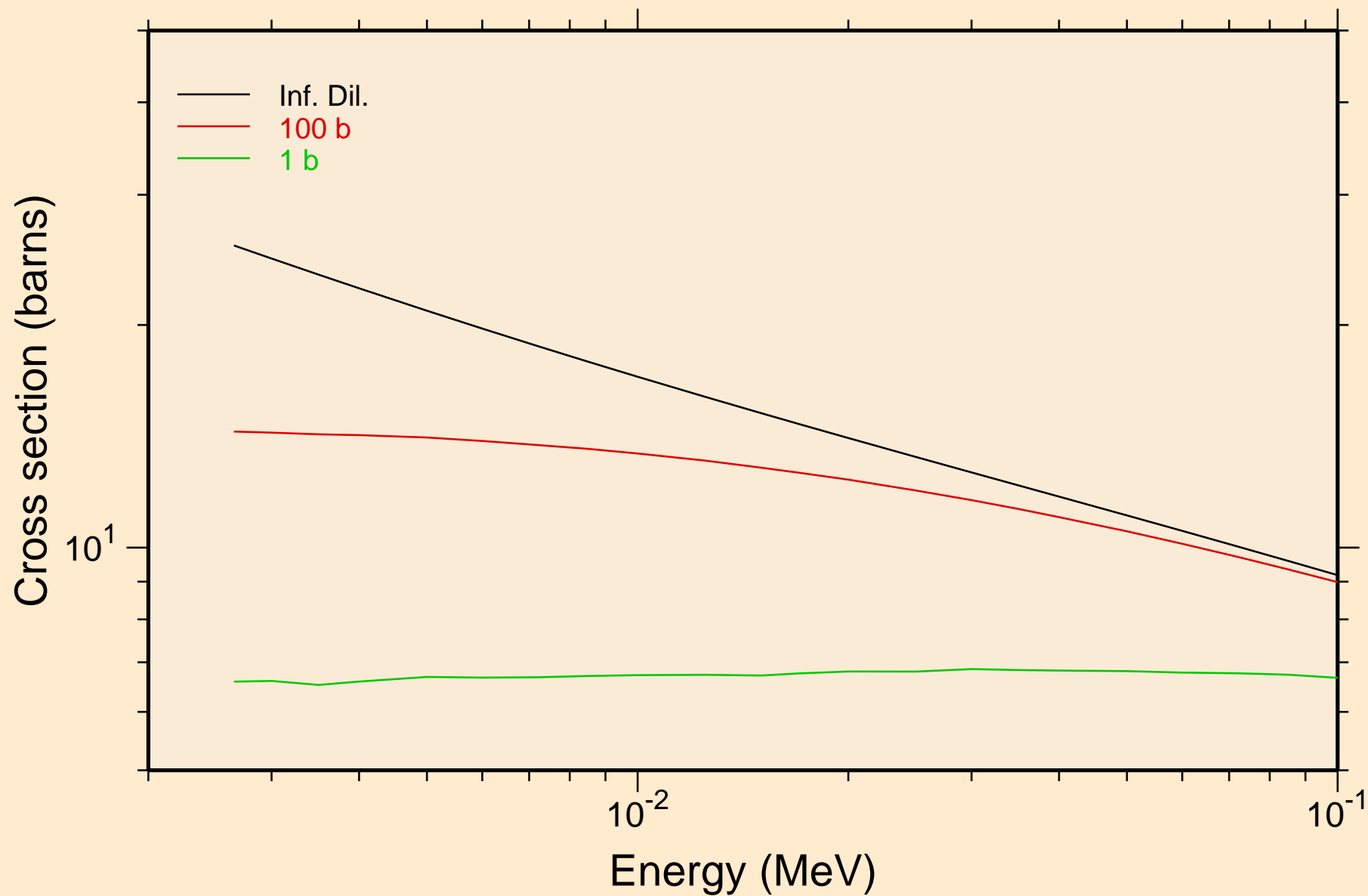

74-W-184 FOR FENDL-3B2 FROM ENDF/B-VII WITH NJOY99.304+  
UR capture cross section

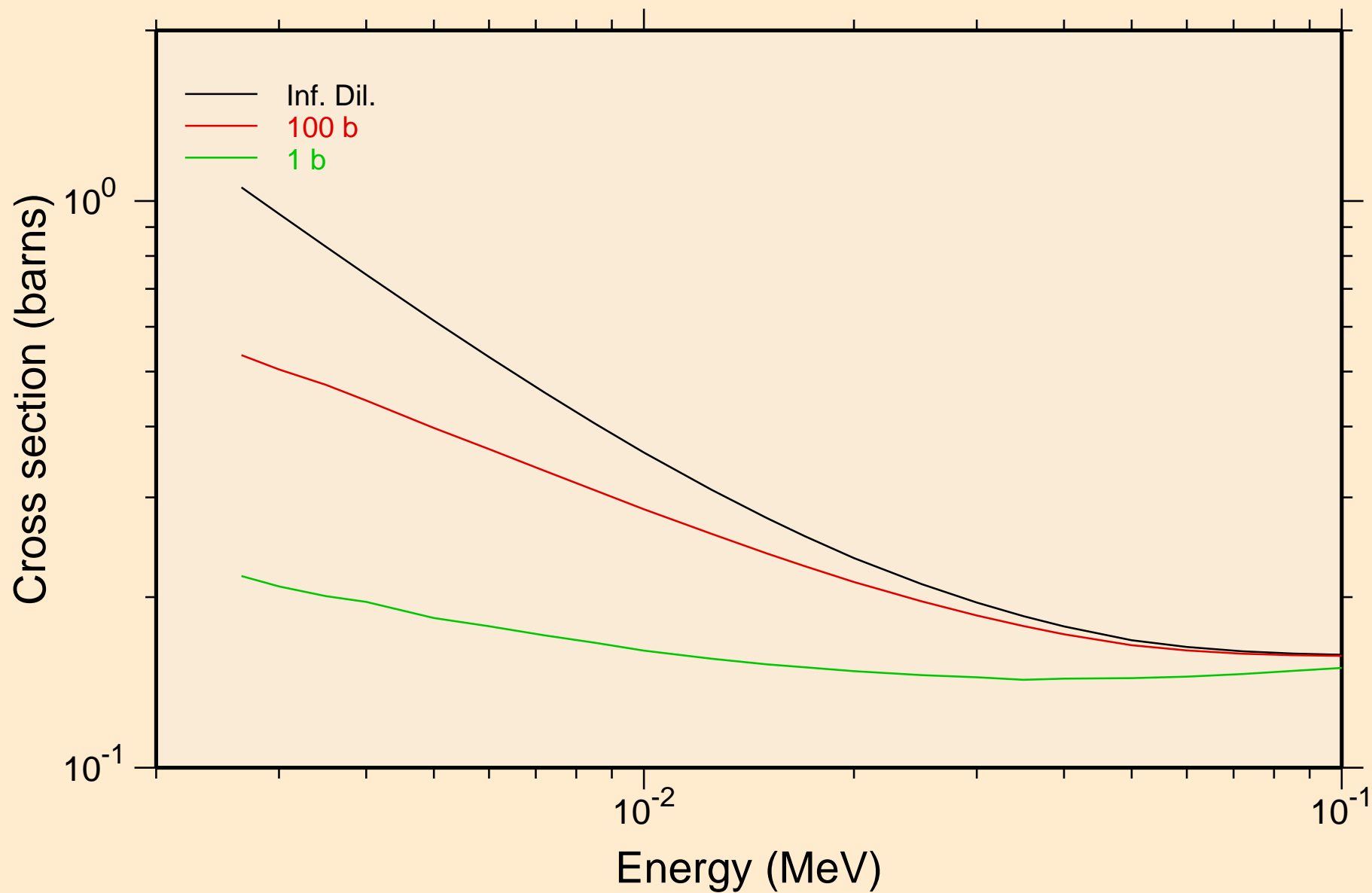

# 74-W-184 FOR FENDL-3B2 FROM ENDF/B-VII WITH NJOY99.304+ Heating

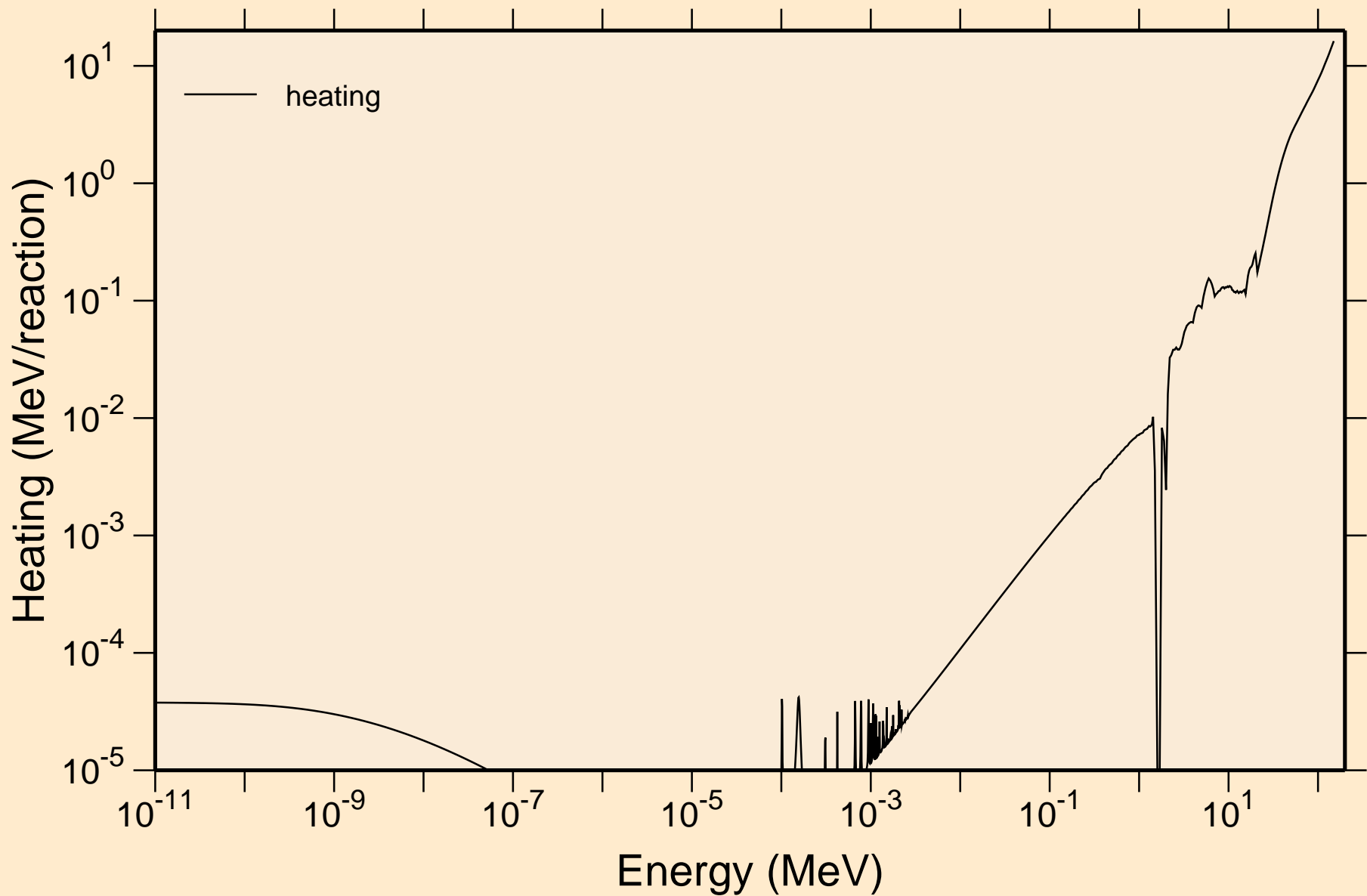

# 74-W-184 FOR FENDL-3B2 FROM ENDF/B-VII WITH NJOY99.304+ Damage

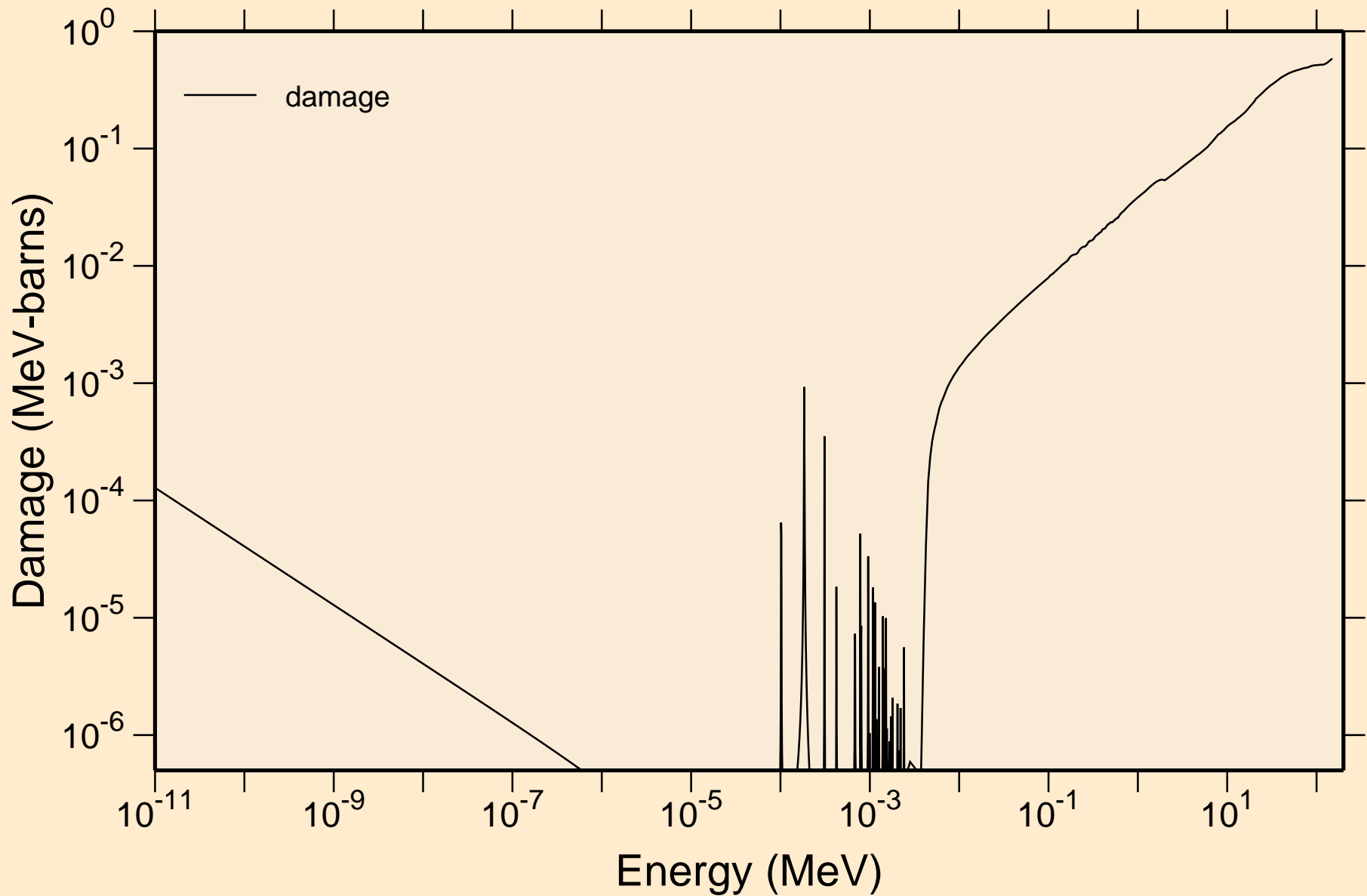

74-W-184 FOR FENDL-3B2 FROM ENDF/B-VII WITH NJOY99.304+  
Non-threshold reactions

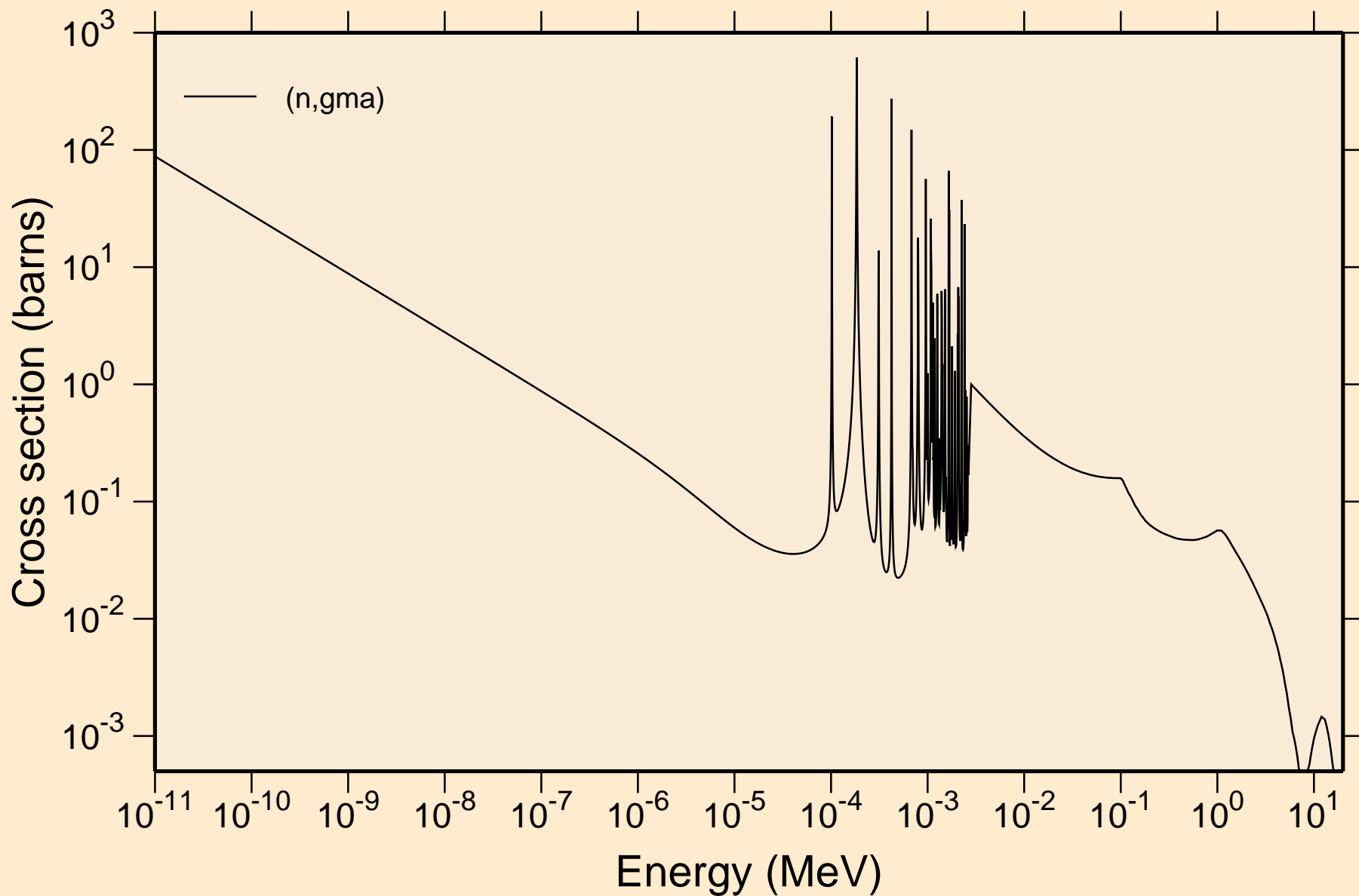

74-W-184 FOR FENDL-3B2 FROM ENDF/B-VII WITH NJOY99.304+

### Principal cross sections

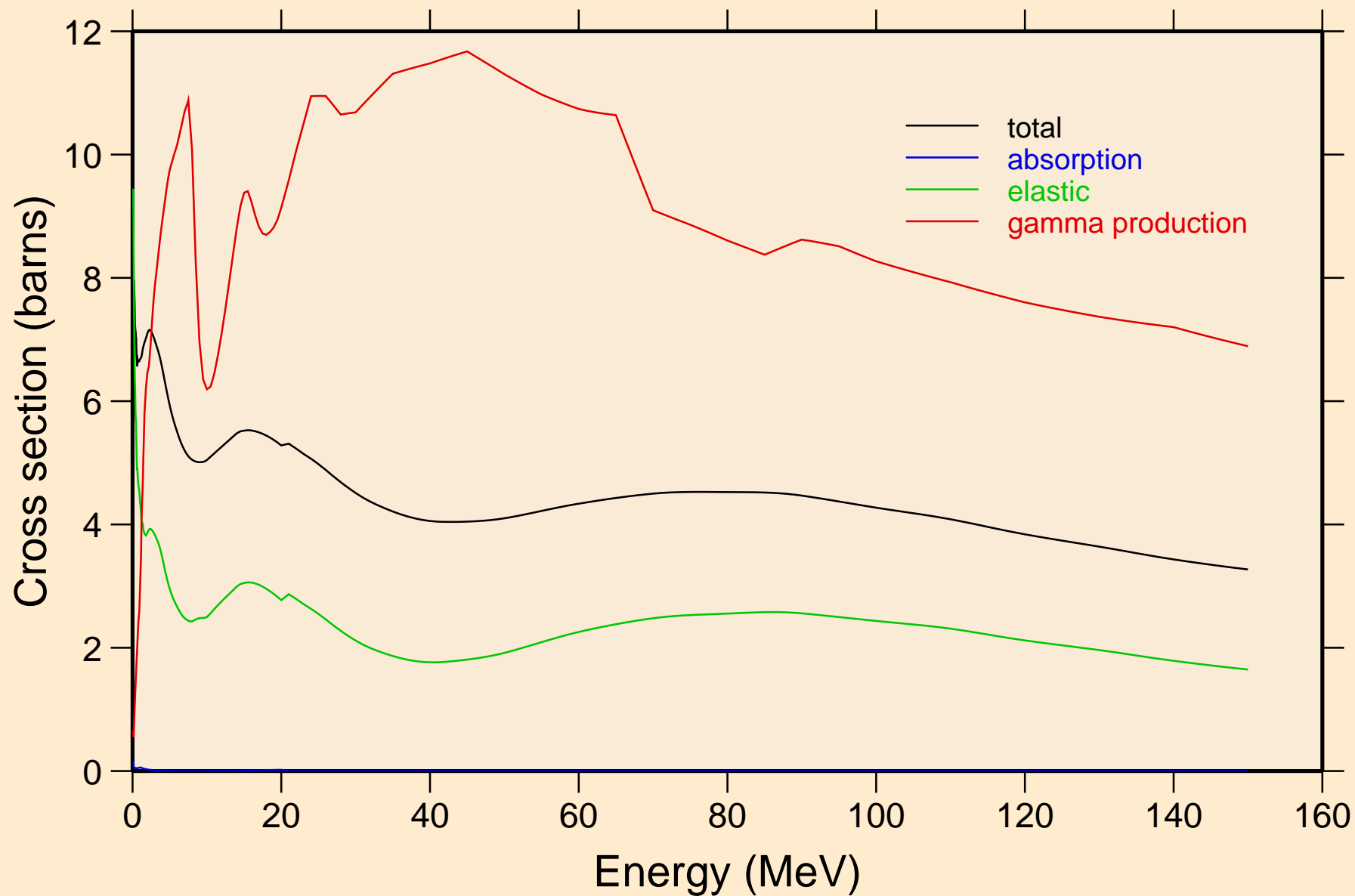



# 74-W-184 FOR FENDL-3B2 FROM ENDF/B-VII WITH NJOY99.304+ Heating

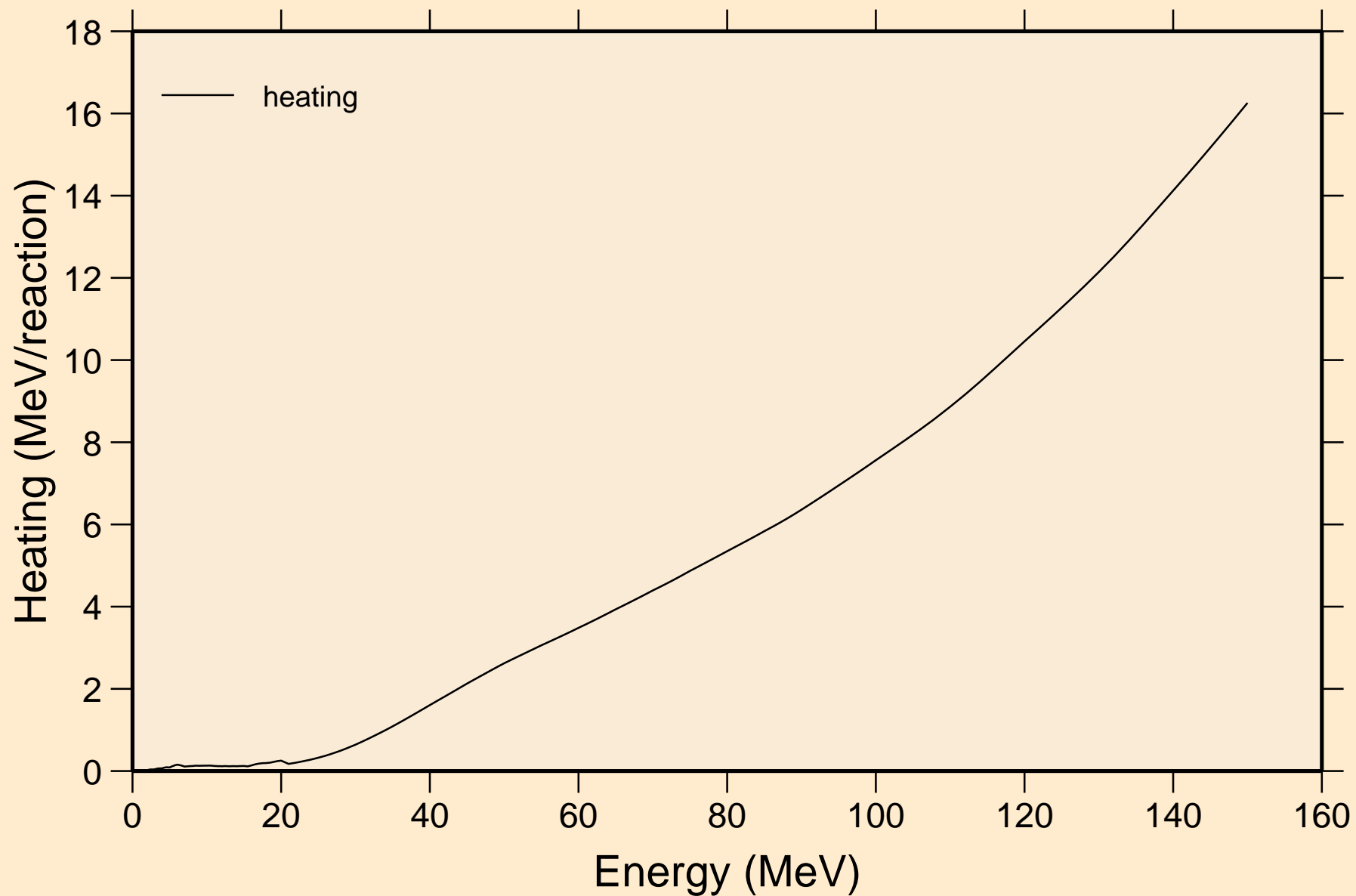

# 74-W-184 FOR FENDL-3B2 FROM ENDF/B-VII WITH NJOY99.304+ Damage

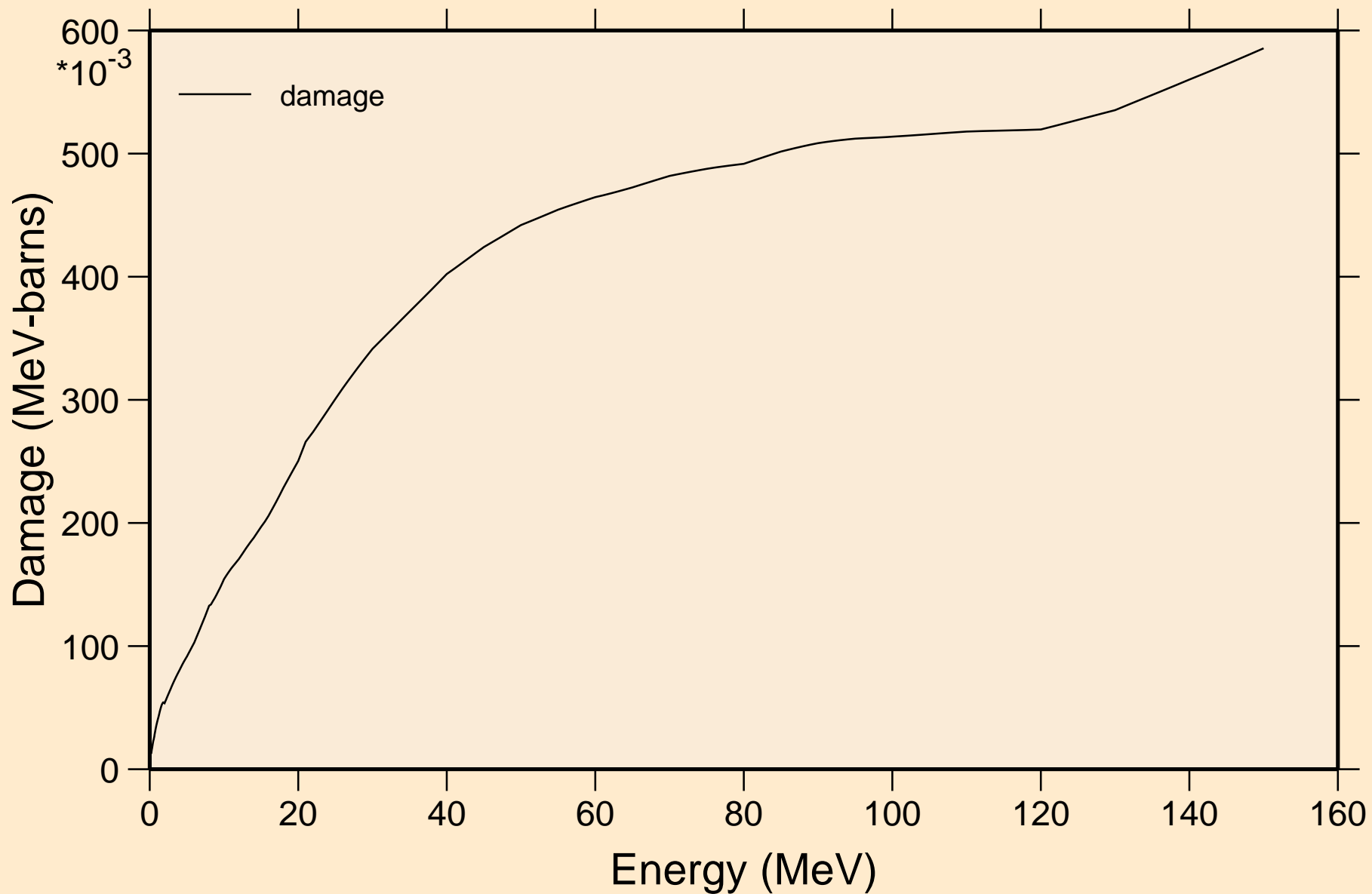

74-W-184 FOR FENDL-3B2 FROM ENDF/B-VII WITH NJOY99.304+  
Non-threshold reactions

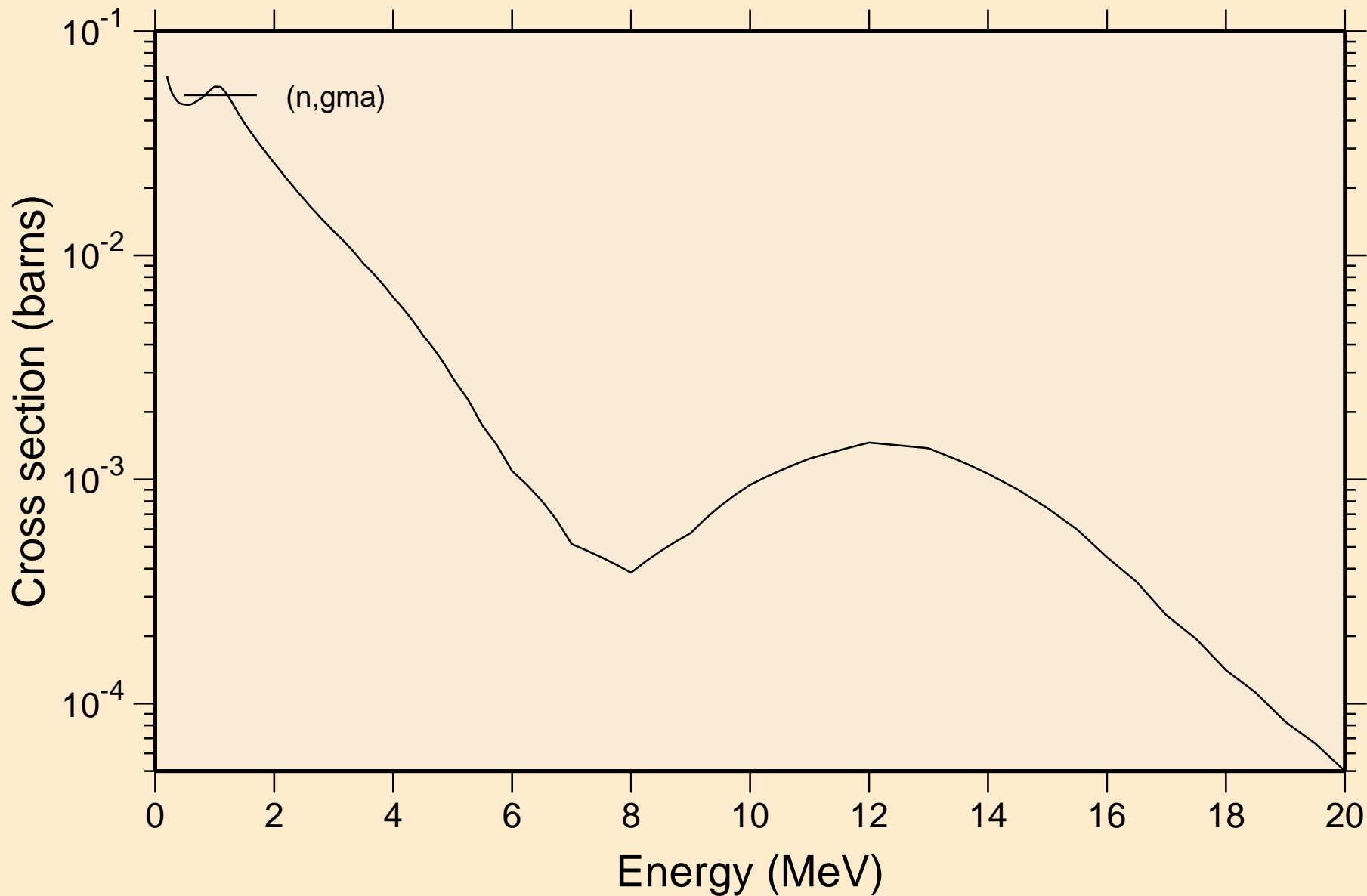

74-W-184 FOR FENDL-3B2 FROM ENDF/B-VII WITH NJOY99.304+  
Inelastic levels

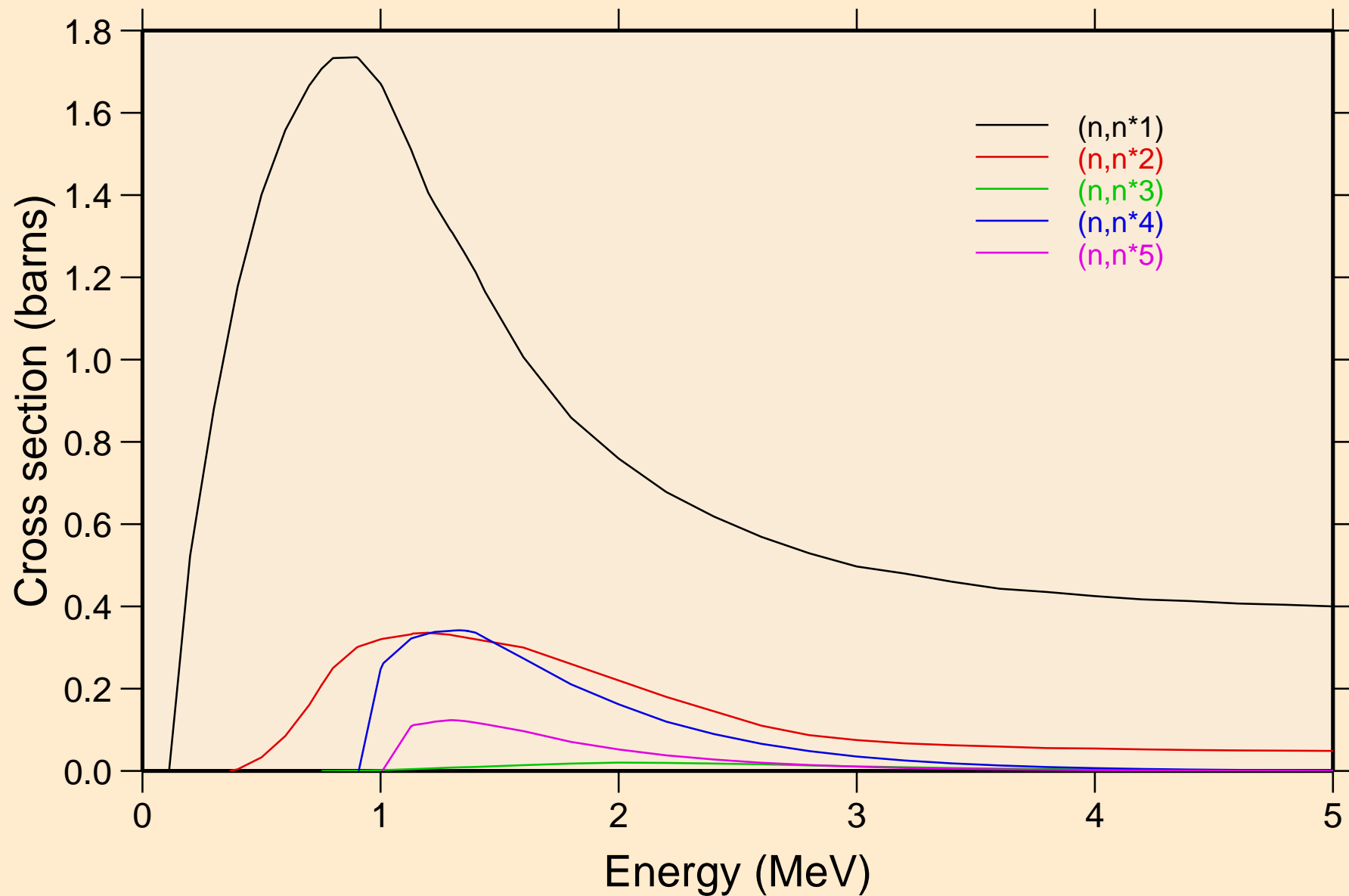

74-W-184 FOR FENDL-3B2 FROM ENDF/B-VII WITH NJOY99.304+  
Inelastic levels

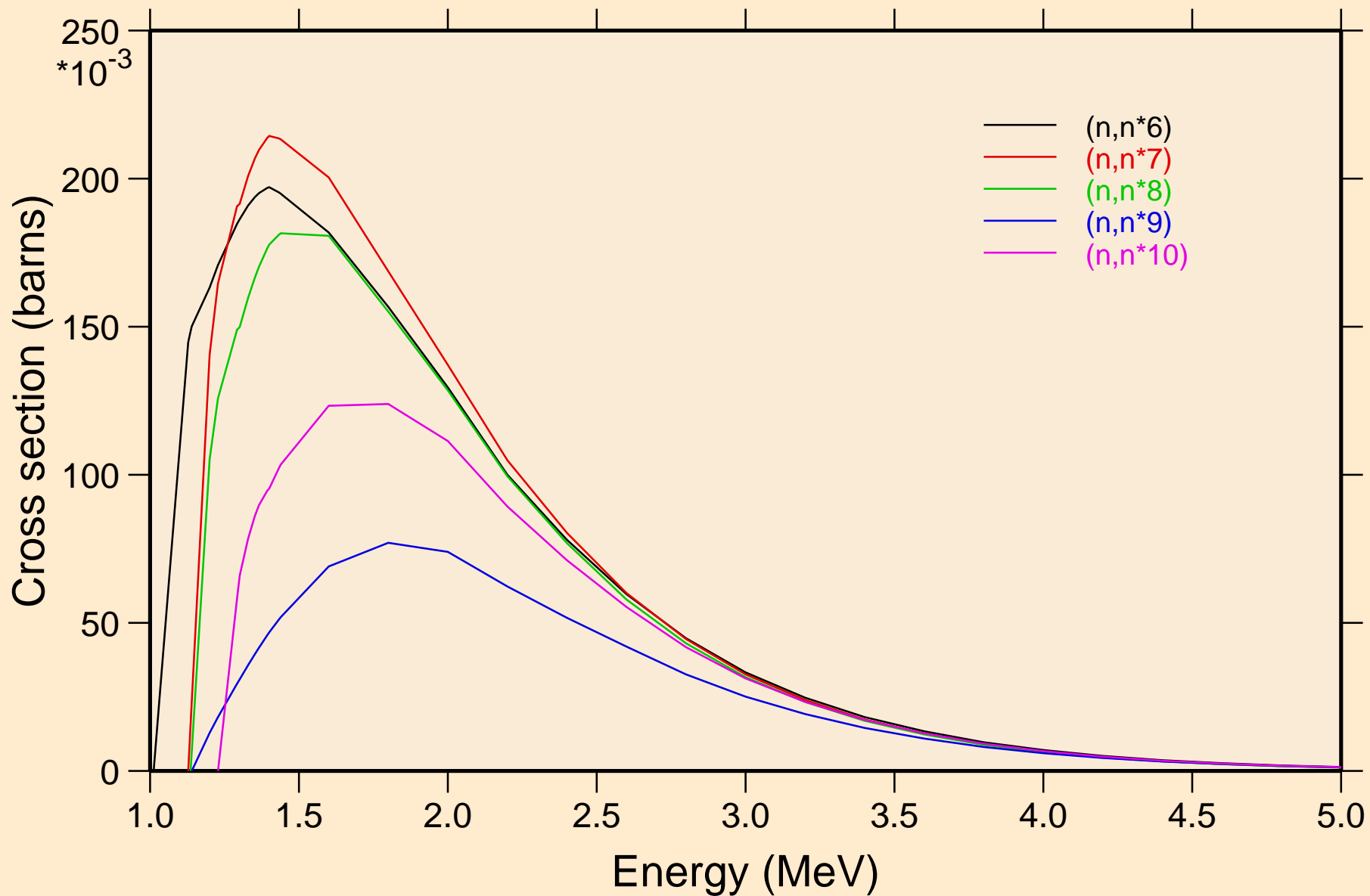

74-W-184 FOR FENDL-3B2 FROM ENDF/B-VII WITH NJOY99.304+  
Inelastic levels

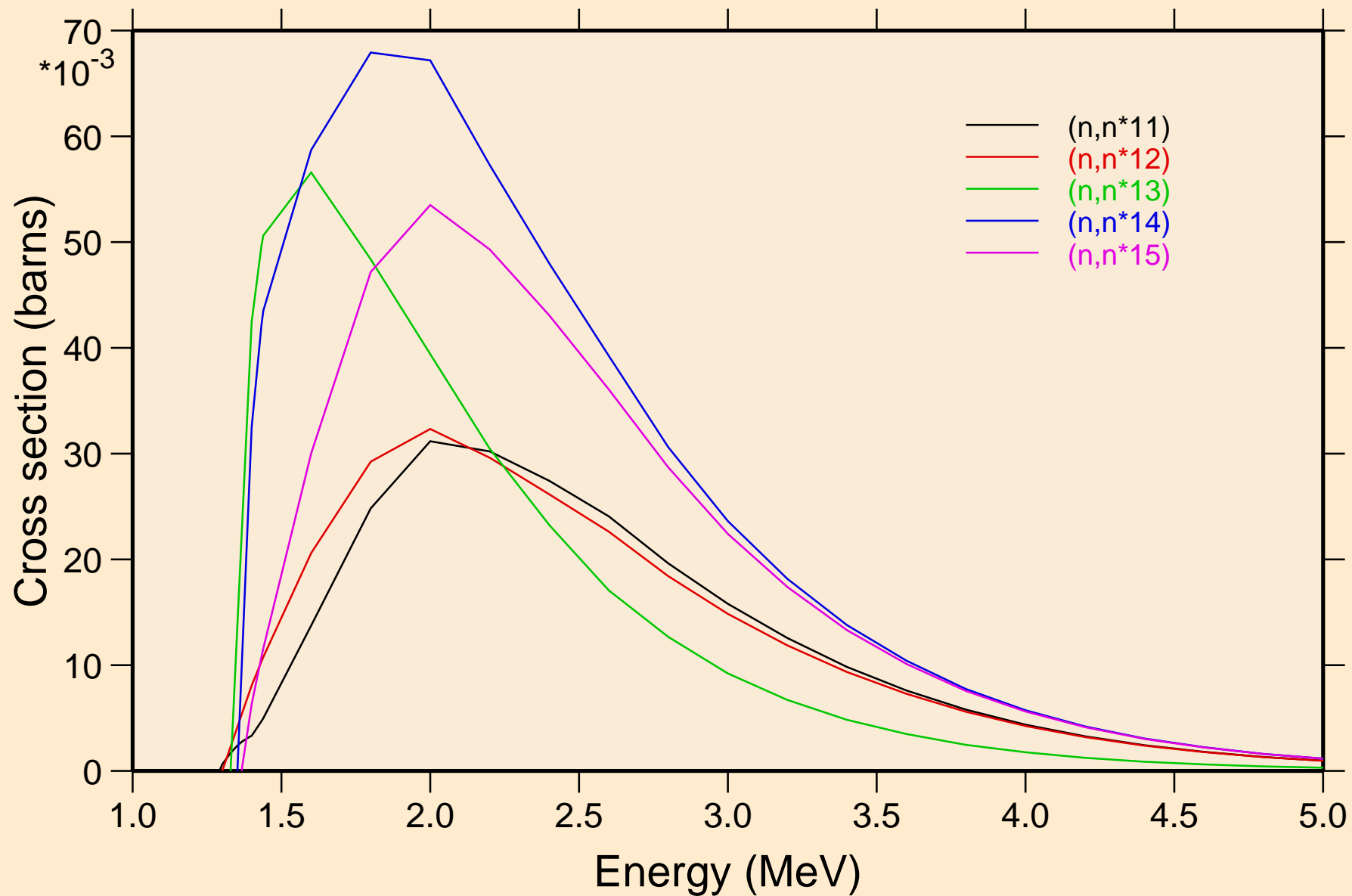

74-W-184 FOR FENDL-3B2 FROM ENDF/B-VII WITH NJOY99.304+  
Inelastic levels

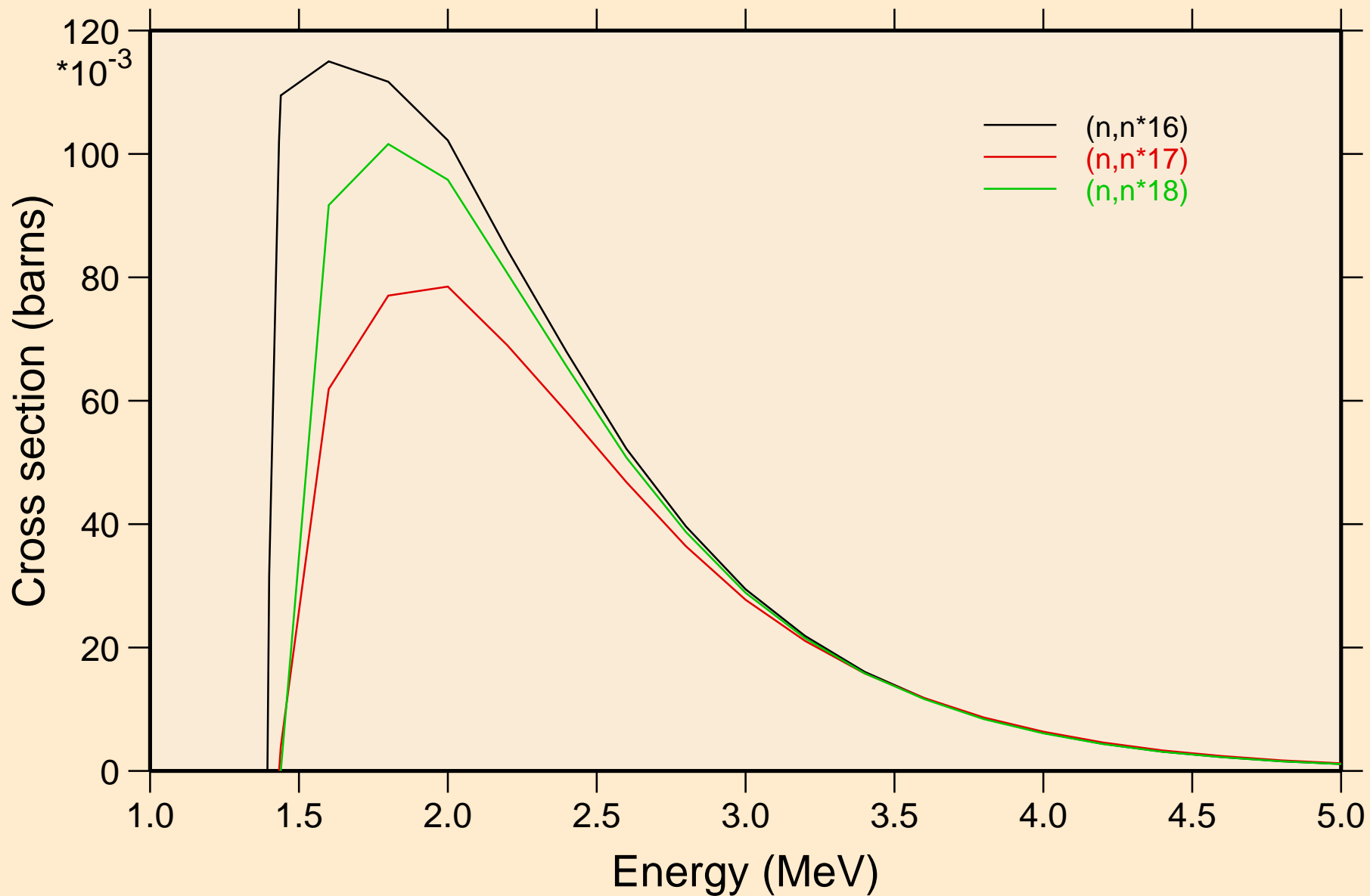

# 74-W-184 FOR FENDL-3B2 FROM ENDF/B-VII WITH NJOY99.304+ Threshold reactions

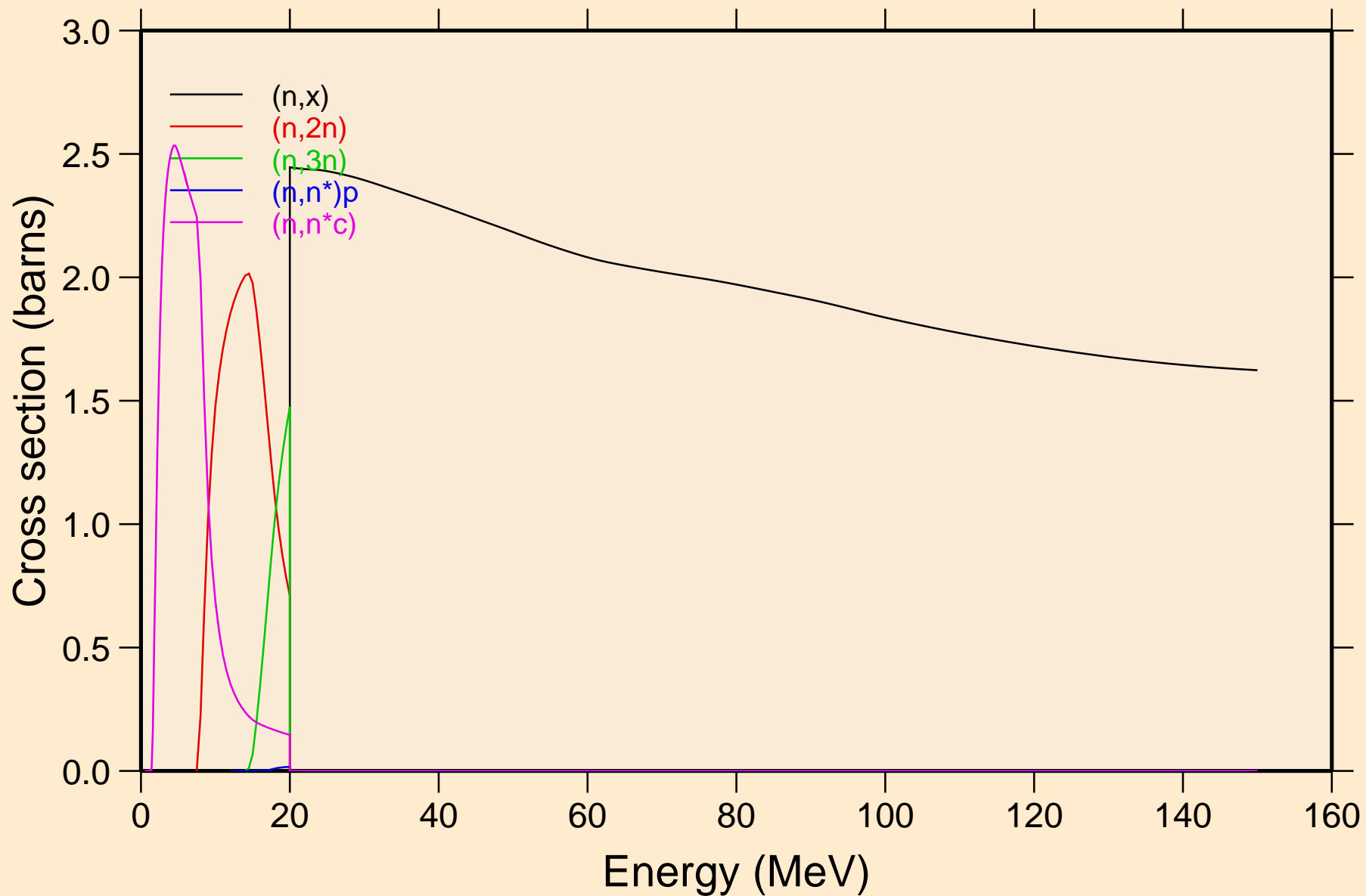



74-W-184 FOR FENDL-3B2 FROM ENDF/B-VII WITH NJOY99.304+  
Threshold reactions

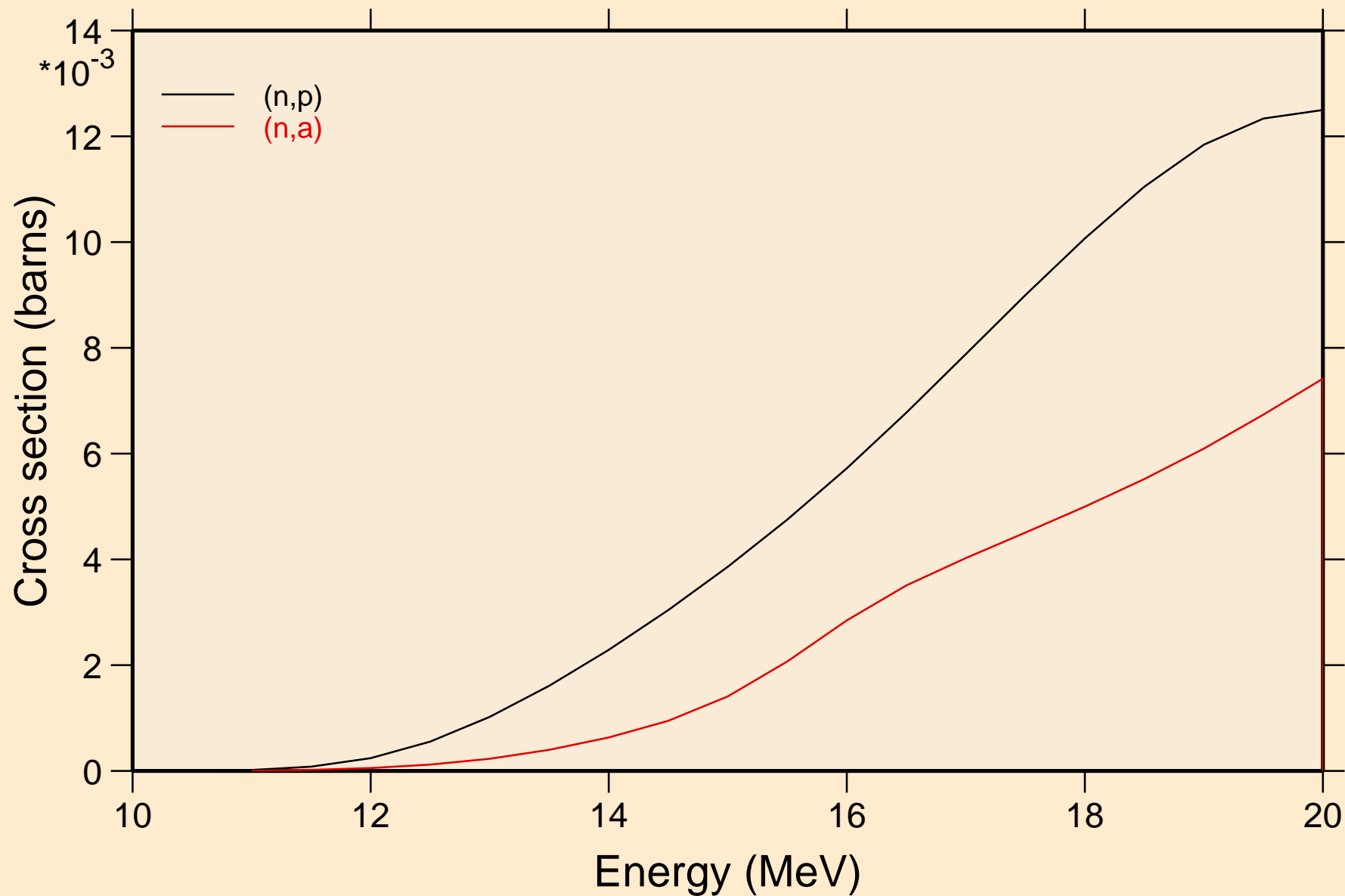

74-W-184 FOR FENDL-3B2 FROM ENDF/B-VII WITH NJOY99.304+  
Threshold reactions

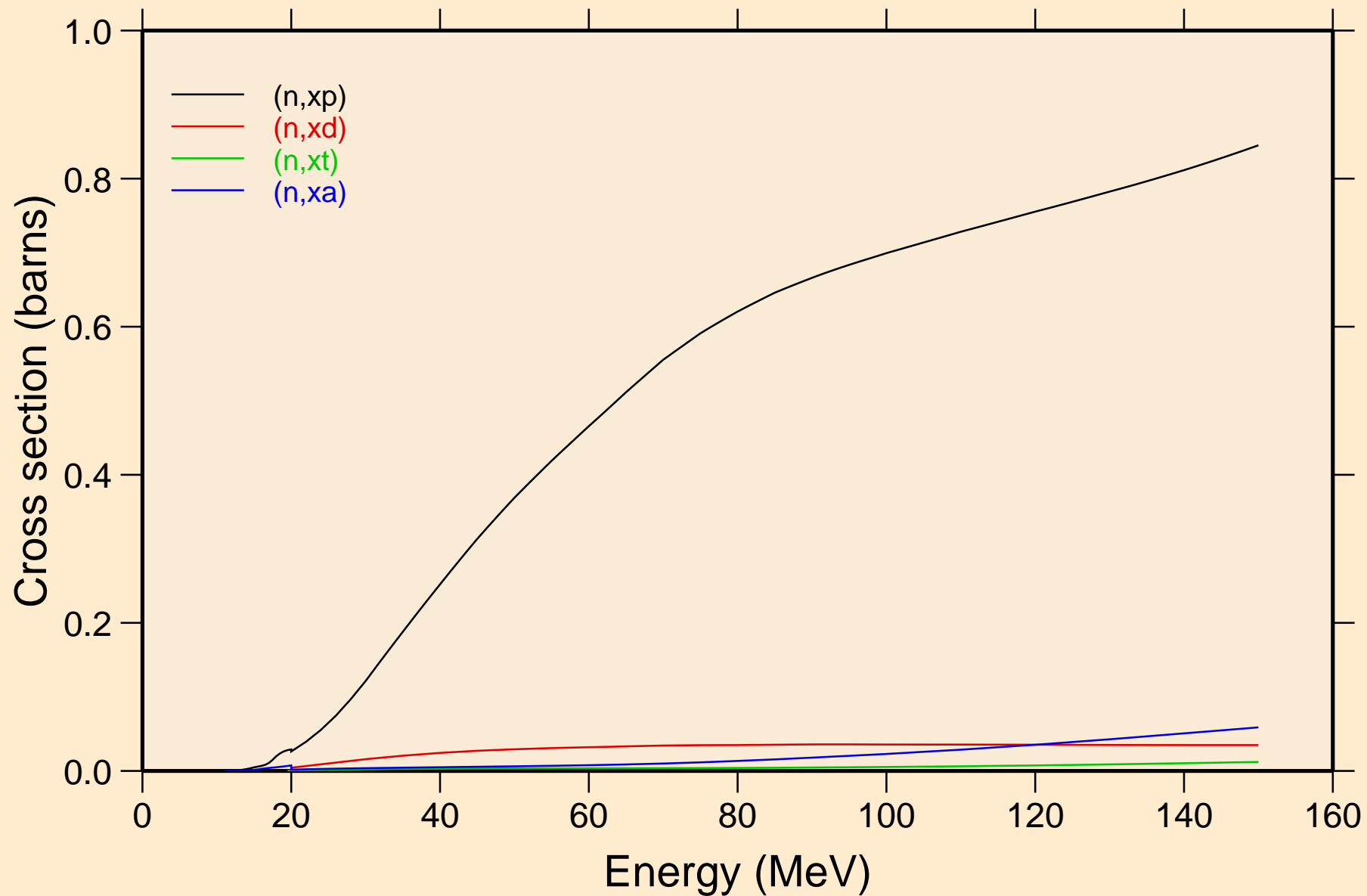

74-W-184 FOR FENDL-3B2 FROM ENDF/B-VII WITH NJOY99.304+  
angular distribution for elastic

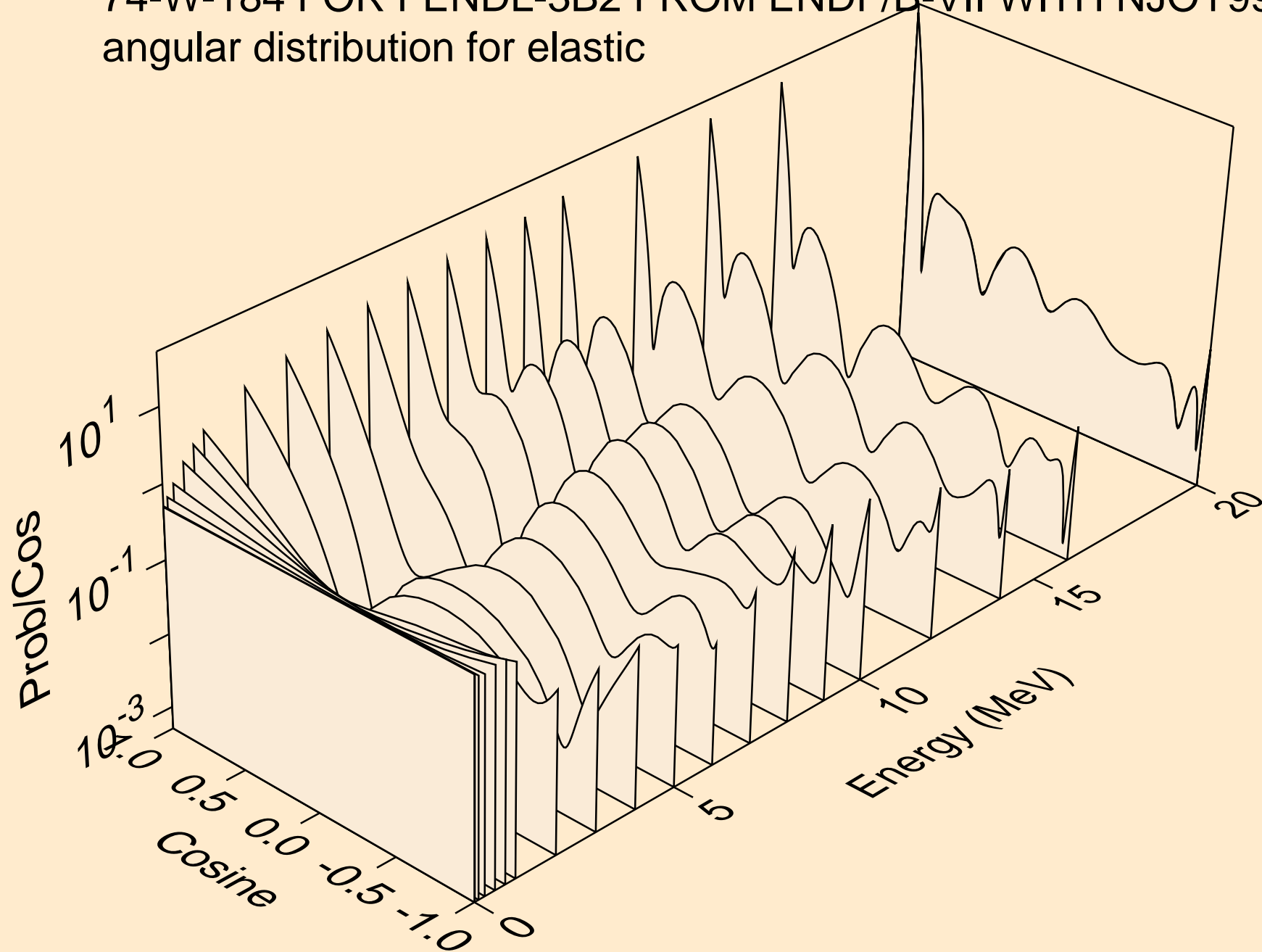

74-W-184 FOR FENDL-3B2 FROM ENDF/B-VII WITH NJOY99.304+  
angular distribution for elastic

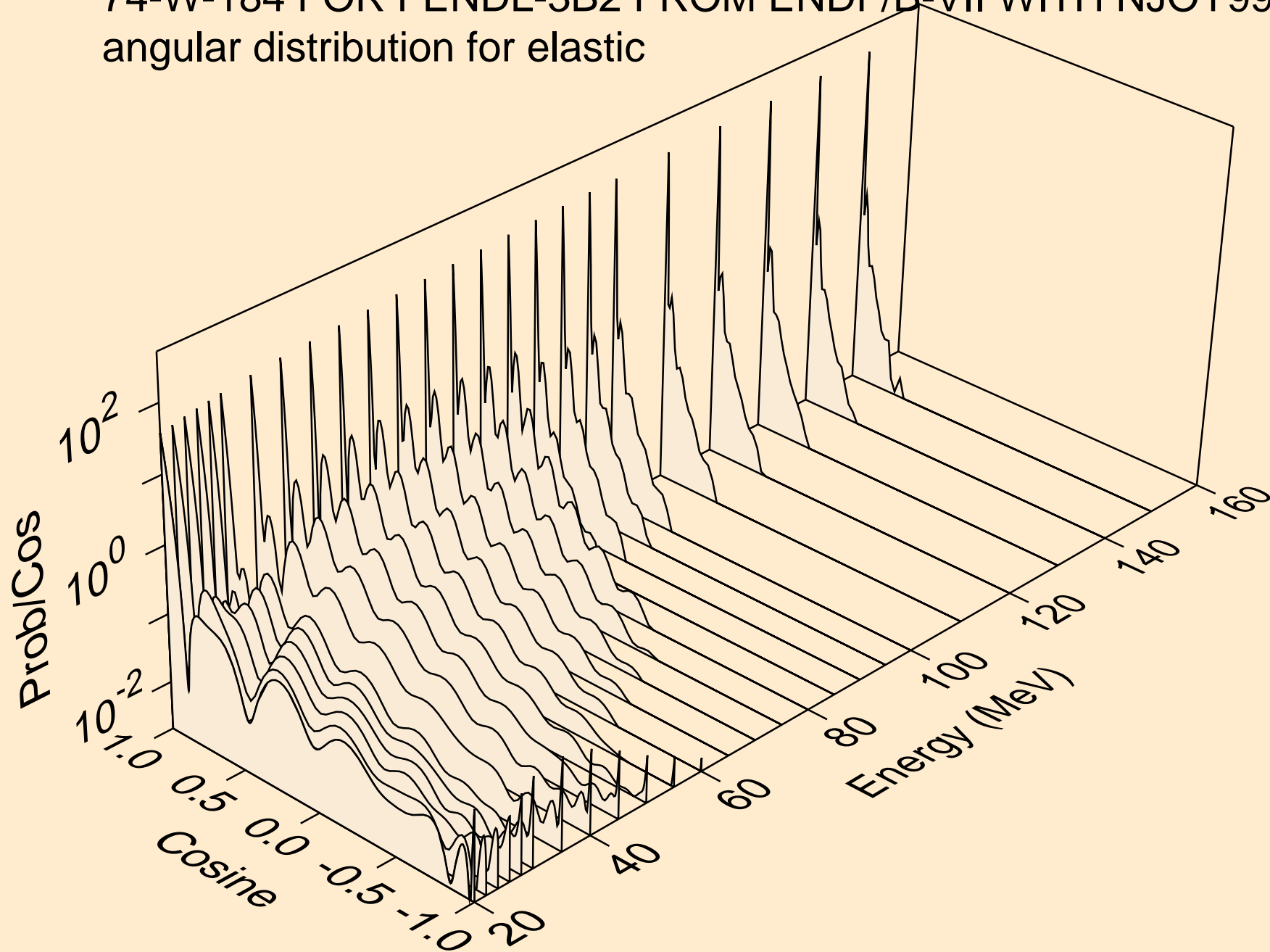

74-W-184 FOR FENDL-3B2 FROM ENDF/B-VII WITH NJOY99.304+  
angular distribution for (n,2n)

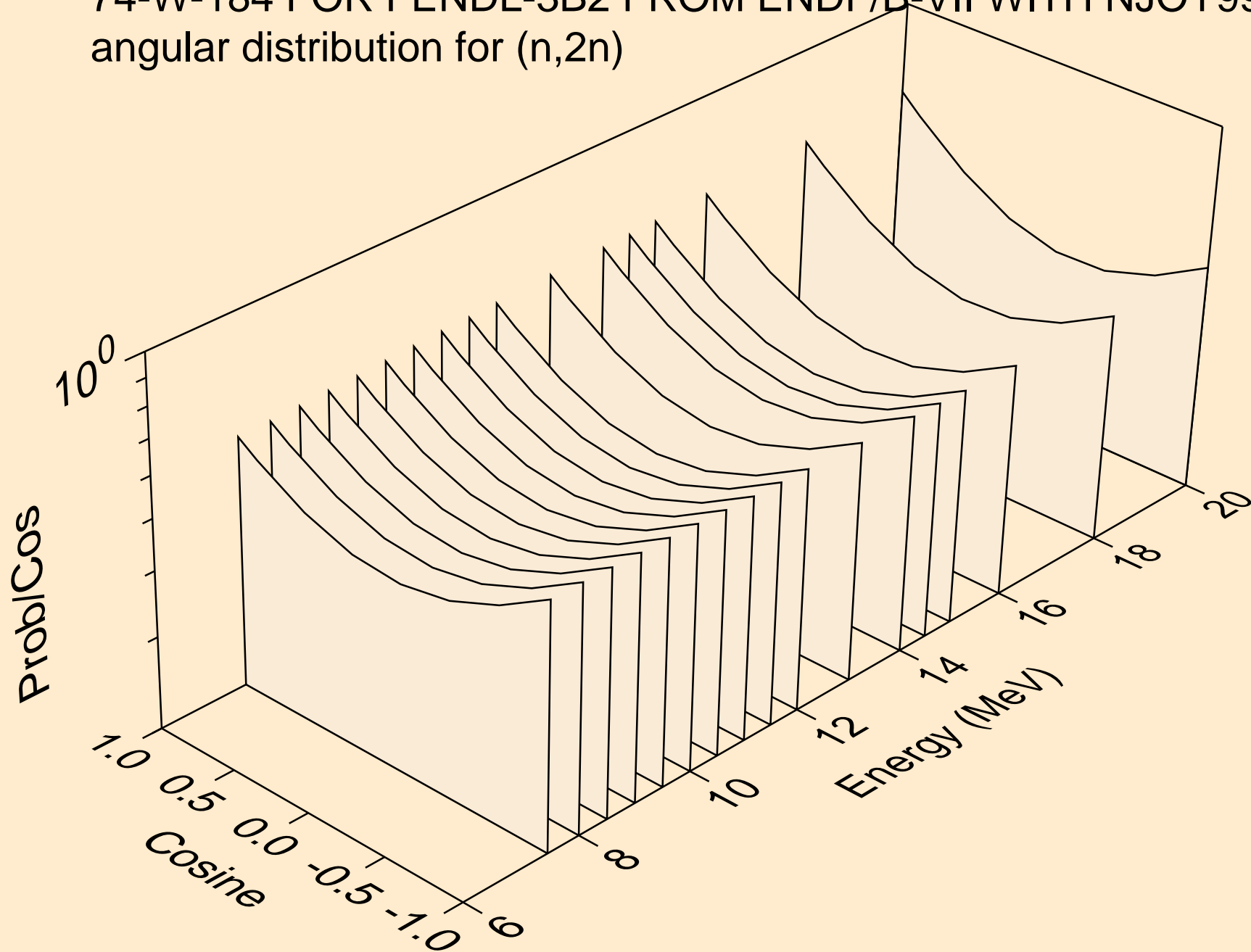

74-W-184 FOR FENDL-3B2 FROM ENDF/B-VII WITH NJOY99.304+  
angular distribution for (n,3n)

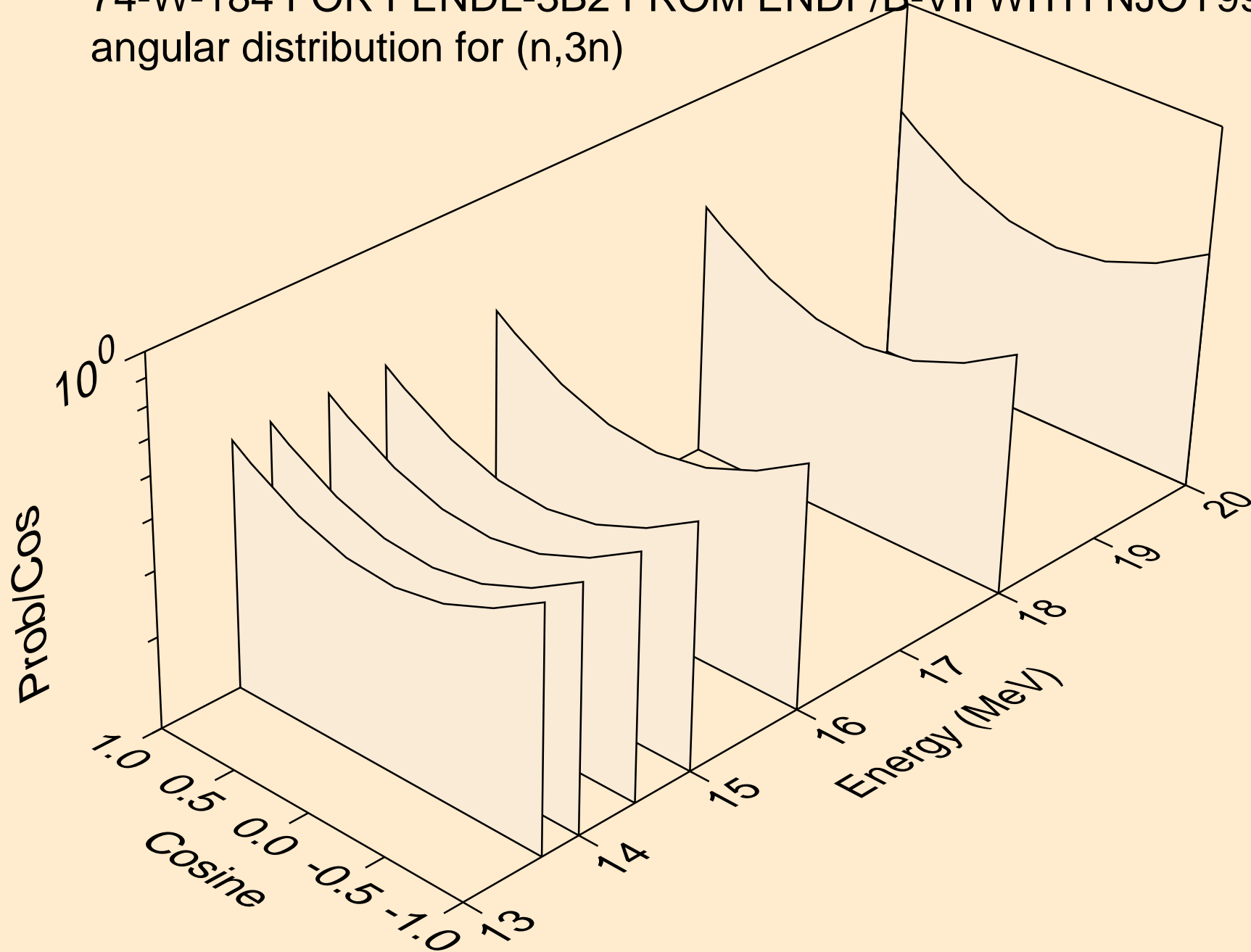

74-W-184 FOR FENDL-3B2 FROM ENDF/B-VII WITH NJOY99.304+  
angular distribution for (n,n\*)p

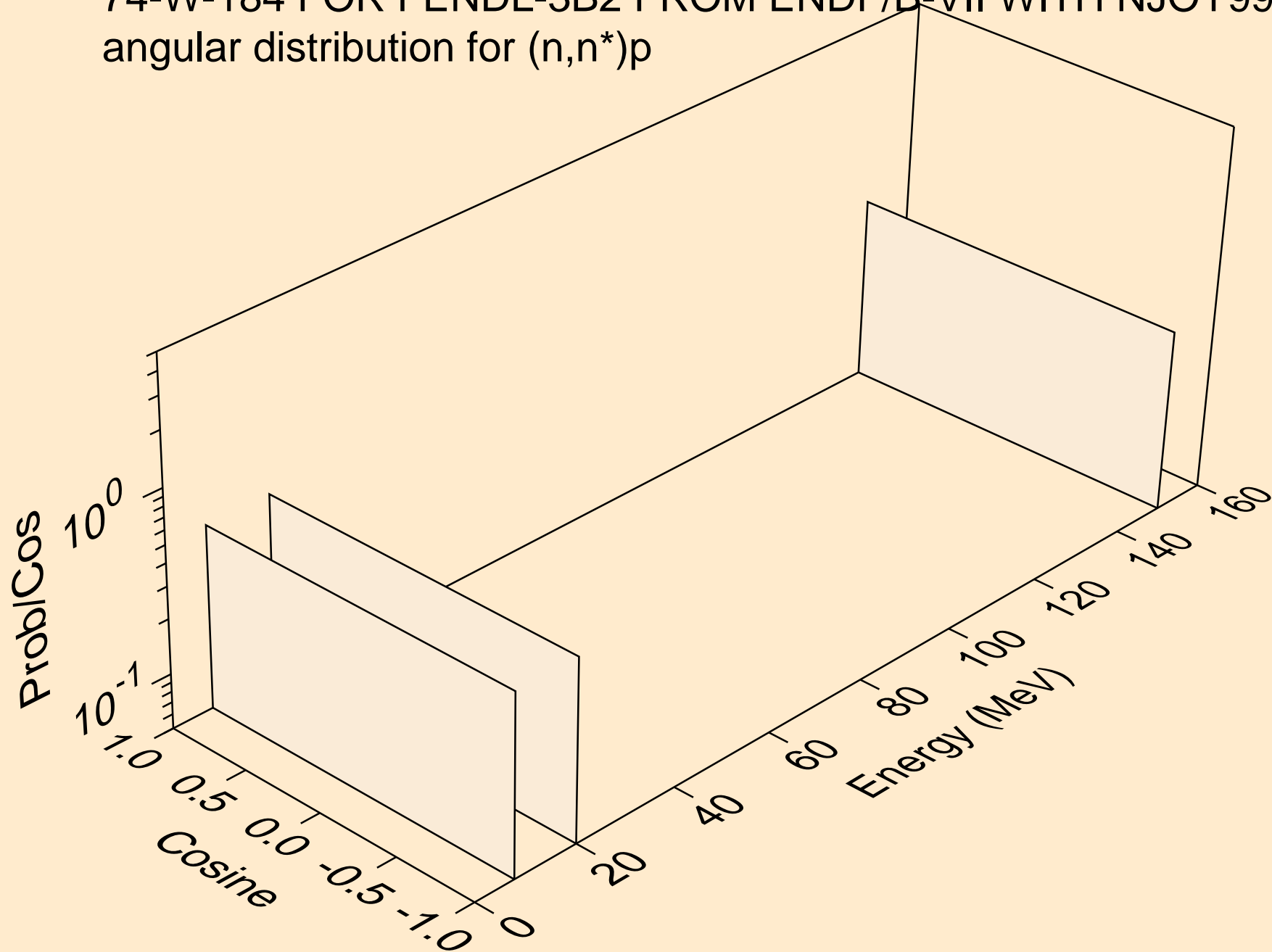

74-W-184 FOR FENDL-3B2 FROM ENDF/B-VII WITH NJOY99.304+  
angular distribution for (n,n\*1)

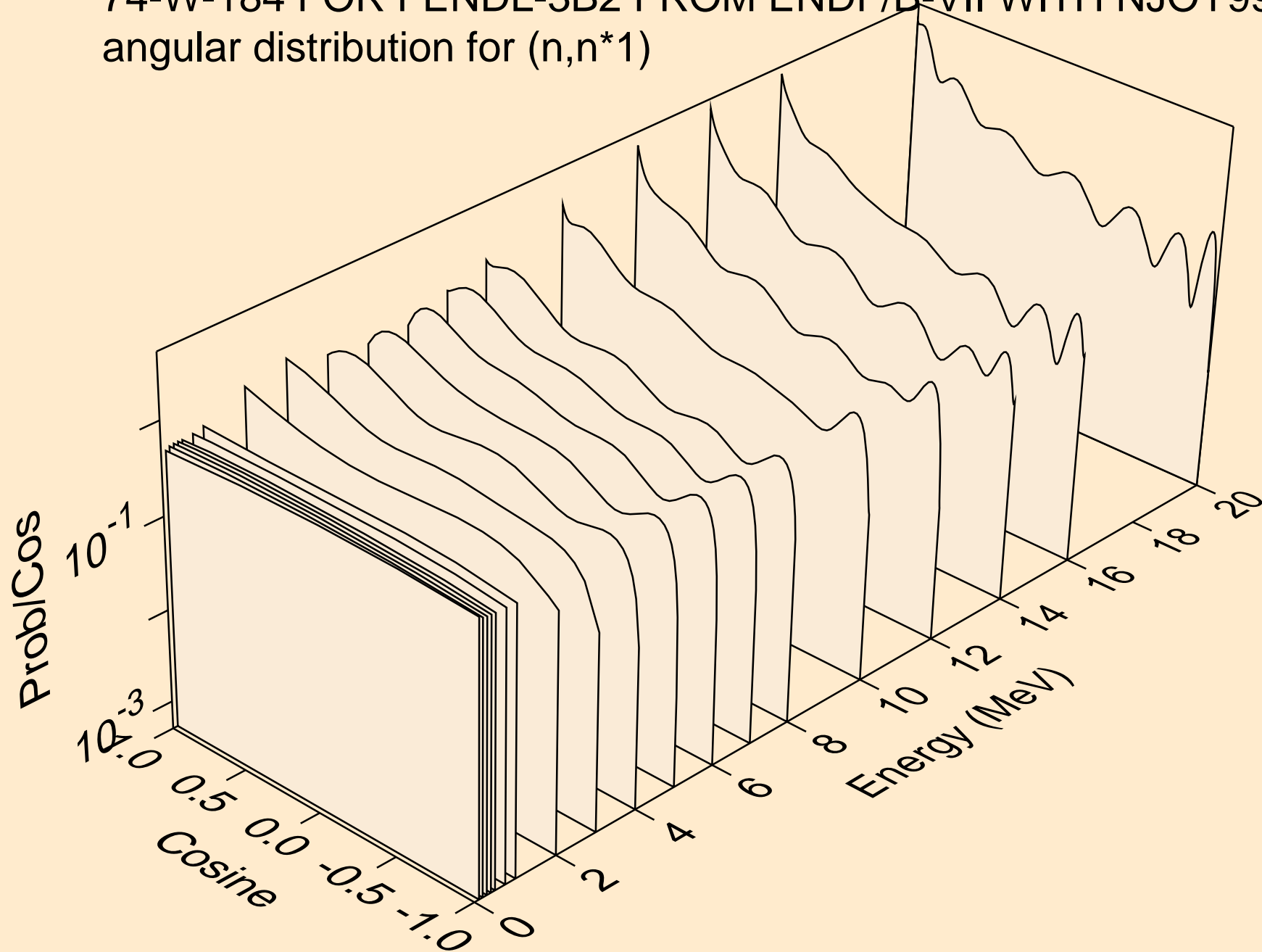



74-W-184 FOR FENDL-3B2 FROM ENDF/B-VII WITH NJOY99.304+  
angular distribution for (n,n\*2)

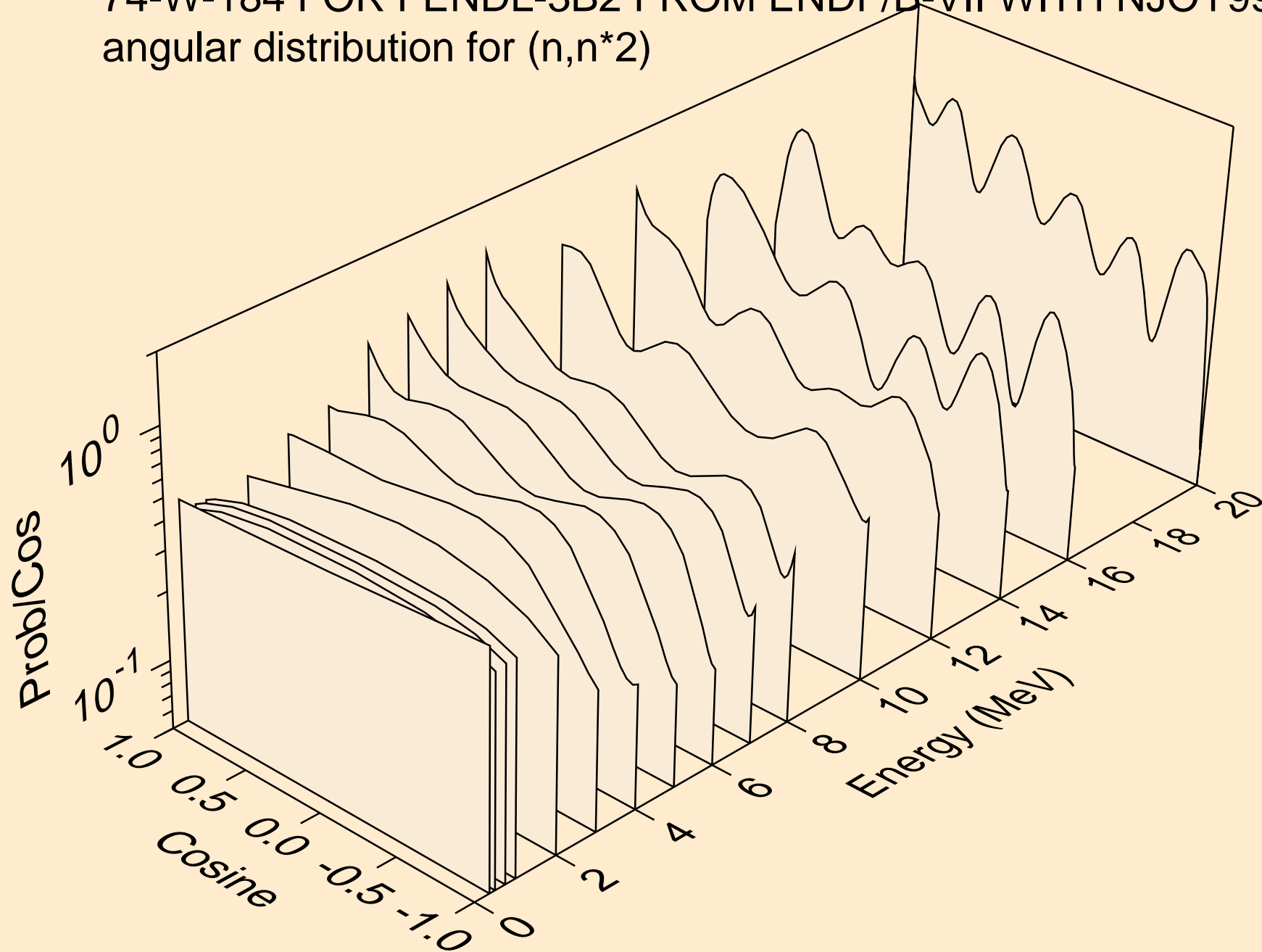

74-W-184 FOR FENDL-3B2 FROM ENDF/B-VII WITH NJOY99.304+  
angular distribution for (n,n\*3)

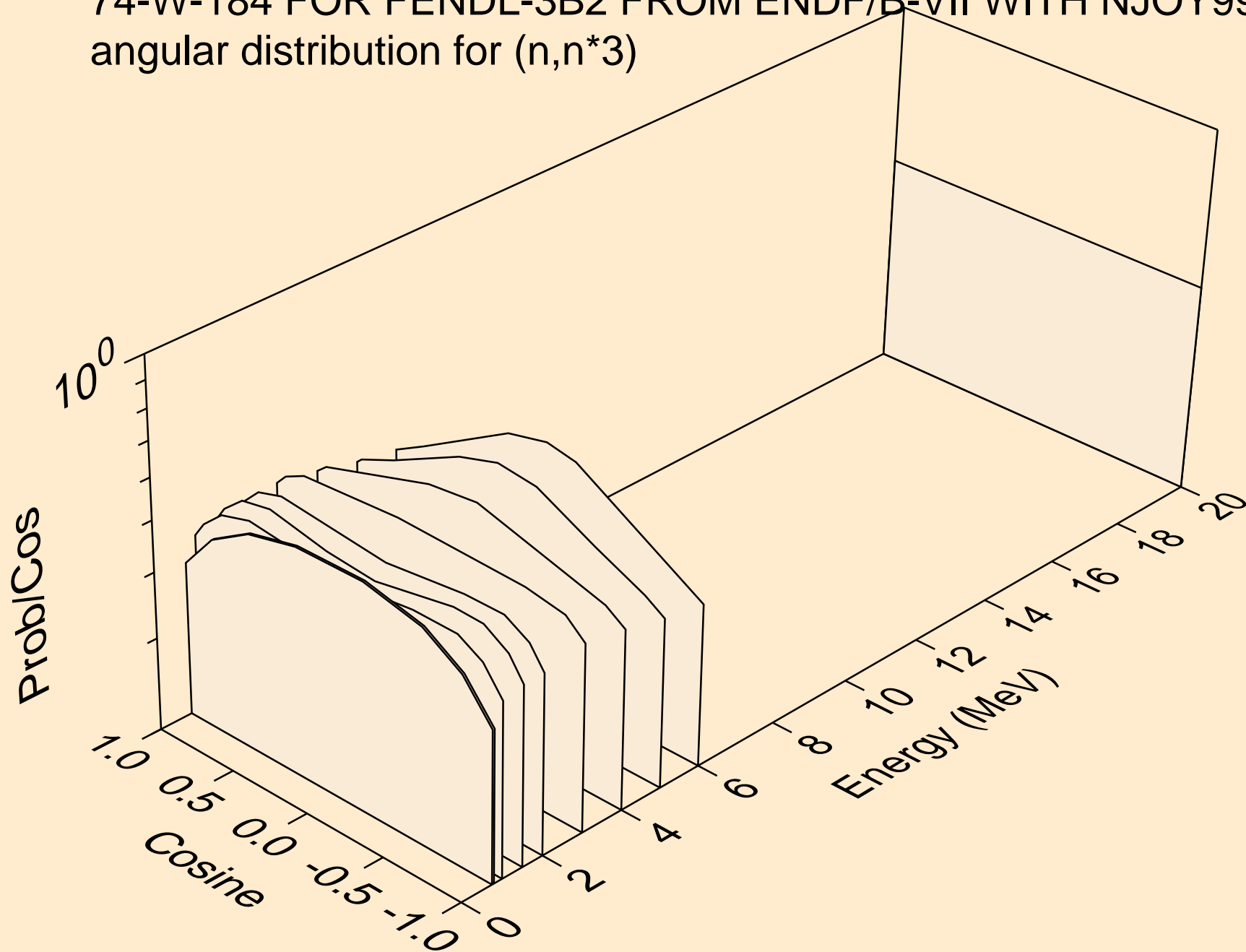

74-W-184 FOR FENDL-3B2 FROM ENDF/B-VII WITH NJOY99.304+  
angular distribution for (n,n\*4)

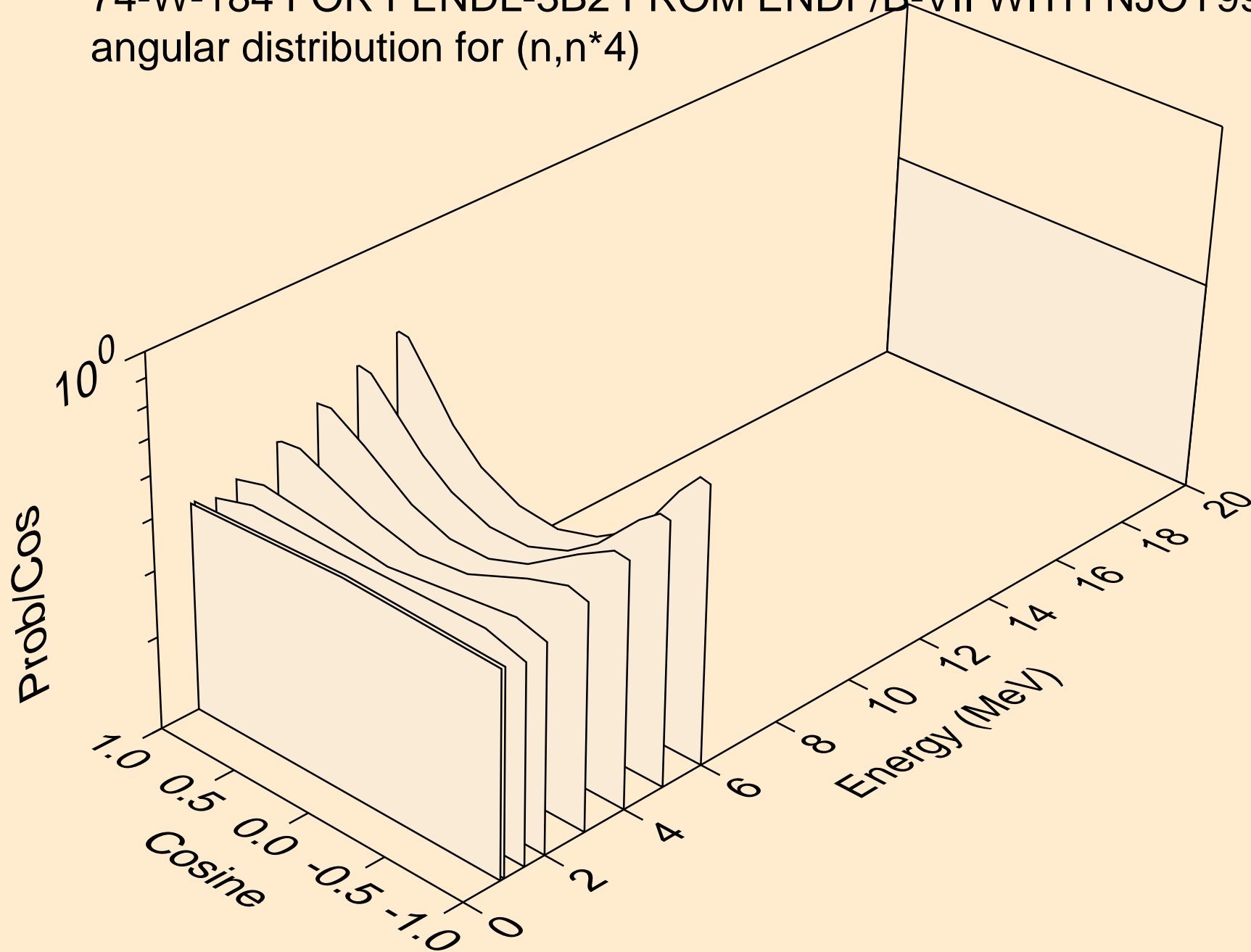

74-W-184 FOR FENDL-3B2 FROM ENDF/B-VII WITH NJOY99.304+  
angular distribution for (n,n\*5)

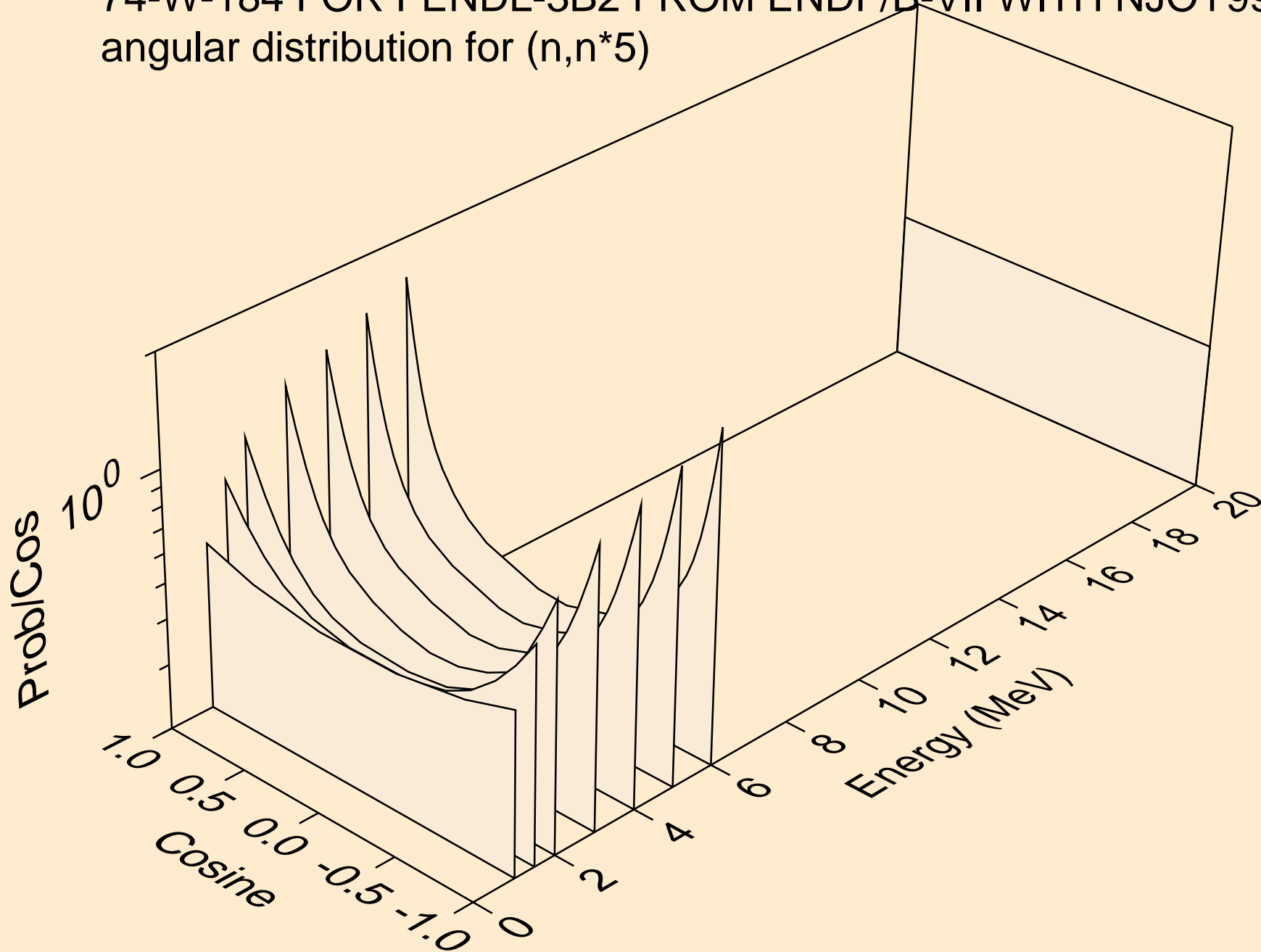

74-W-184 FOR FENDL-3B2 FROM ENDF/B-VII WITH NJOY99.304+  
angular distribution for (n,n\*6)

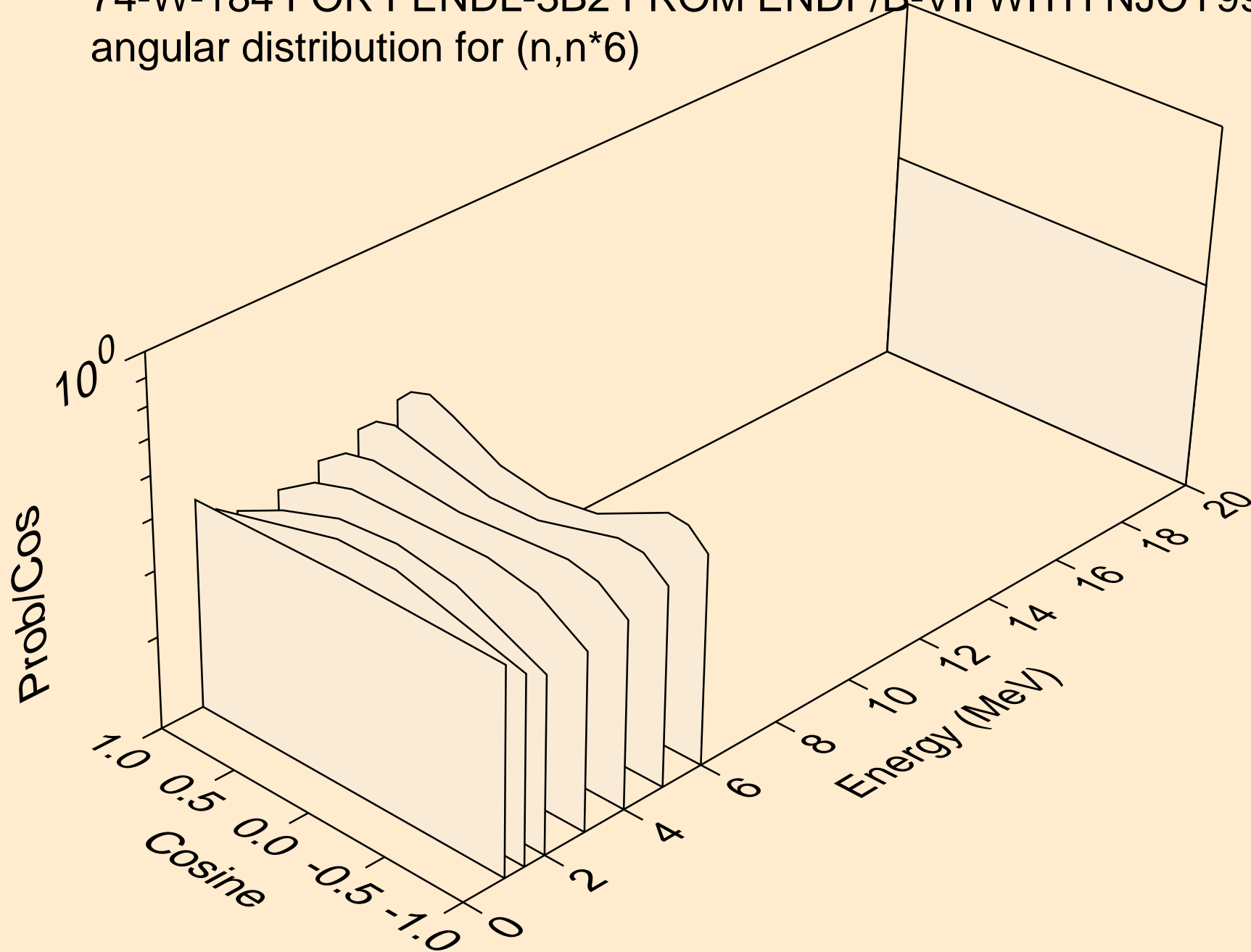

74-W-184 FOR FENDL-3B2 FROM ENDF/B-VII WITH NJOY99.304+  
angular distribution for (n,n\*7)

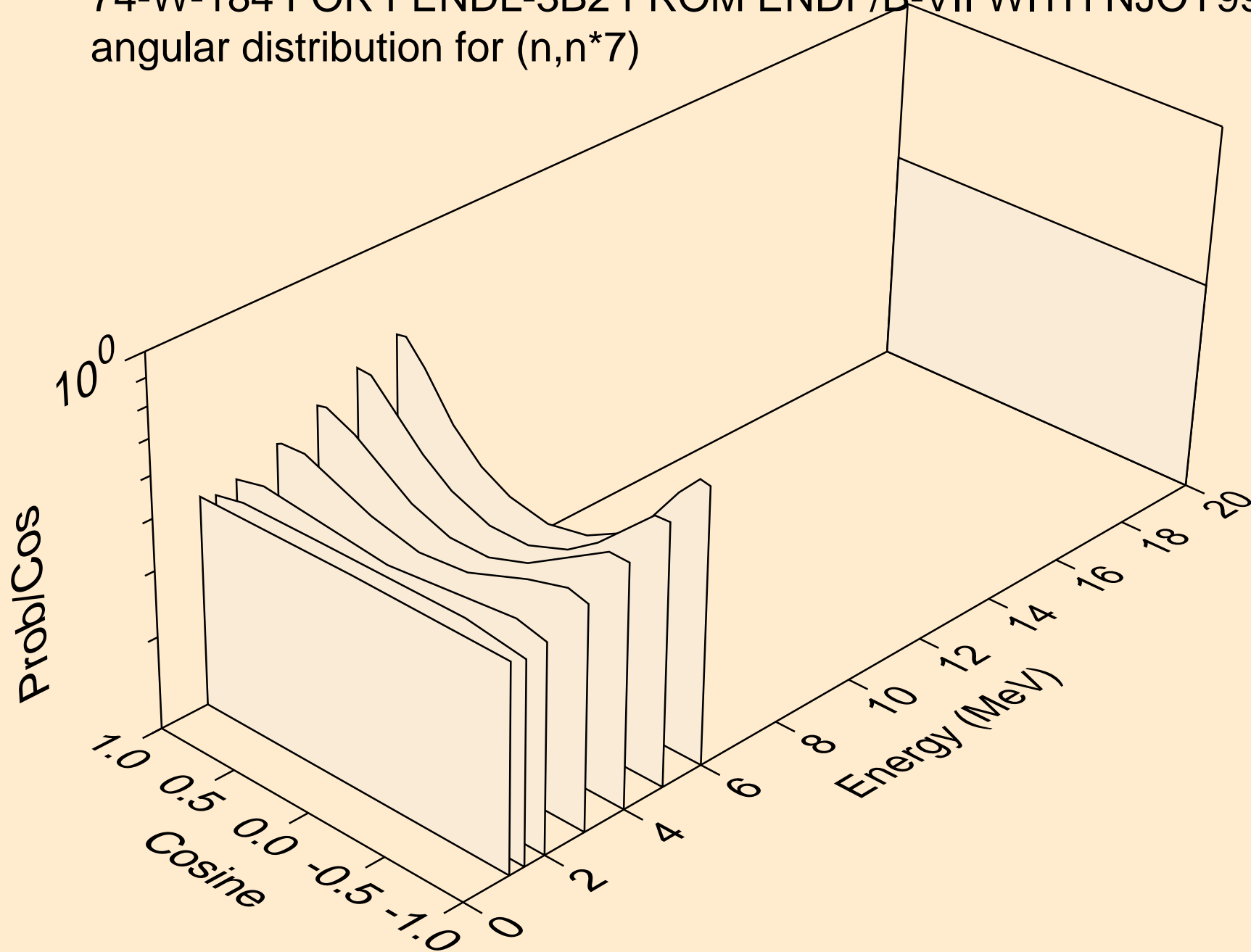

74-W-184 FOR FENDL-3B2 FROM ENDF/B-VII WITH NJOY99.304+  
angular distribution for (n,n\*8)

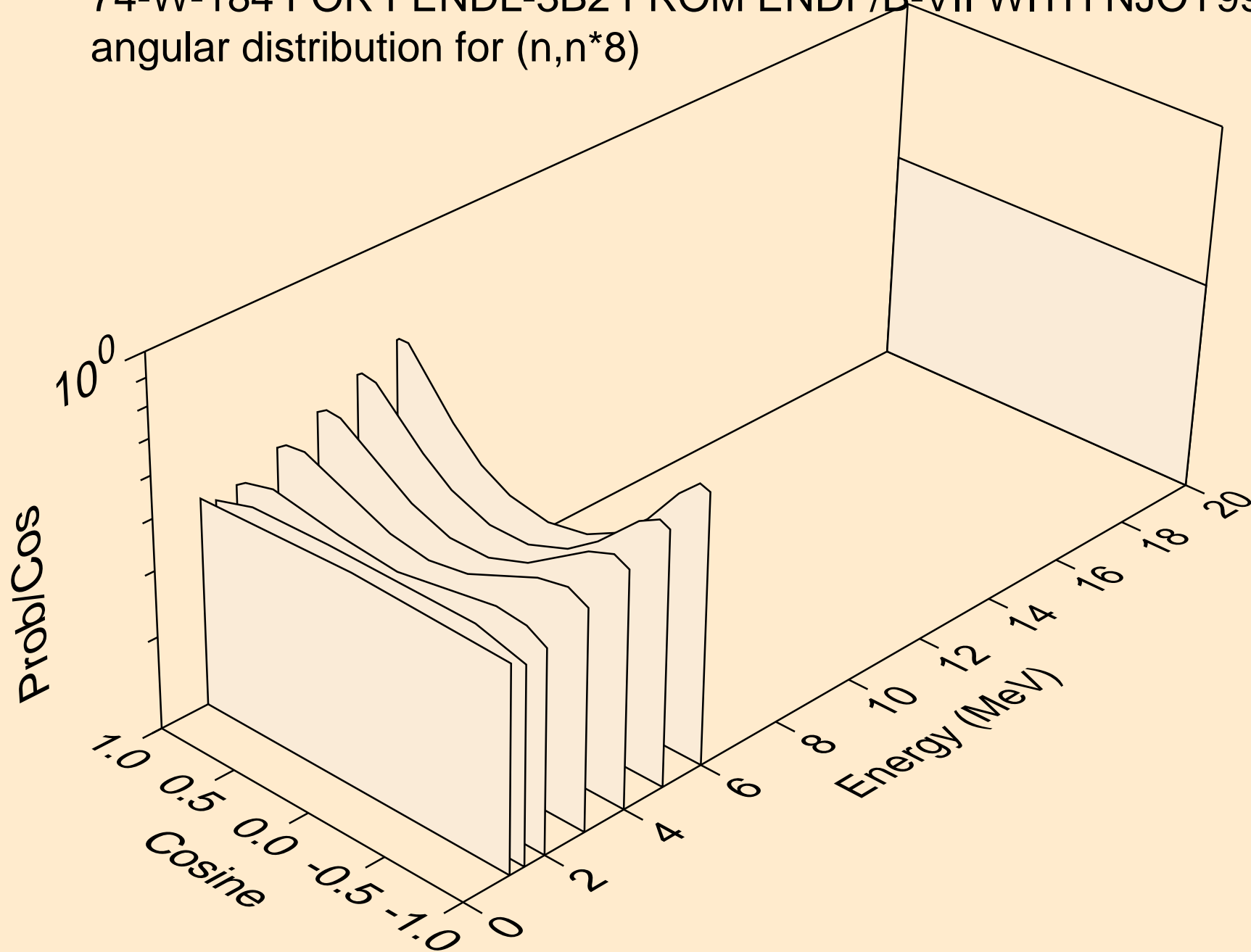

74-W-184 FOR FENDL-3B2 FROM ENDF/B-VII WITH NJOY99.304+  
angular distribution for (n,n\*9)

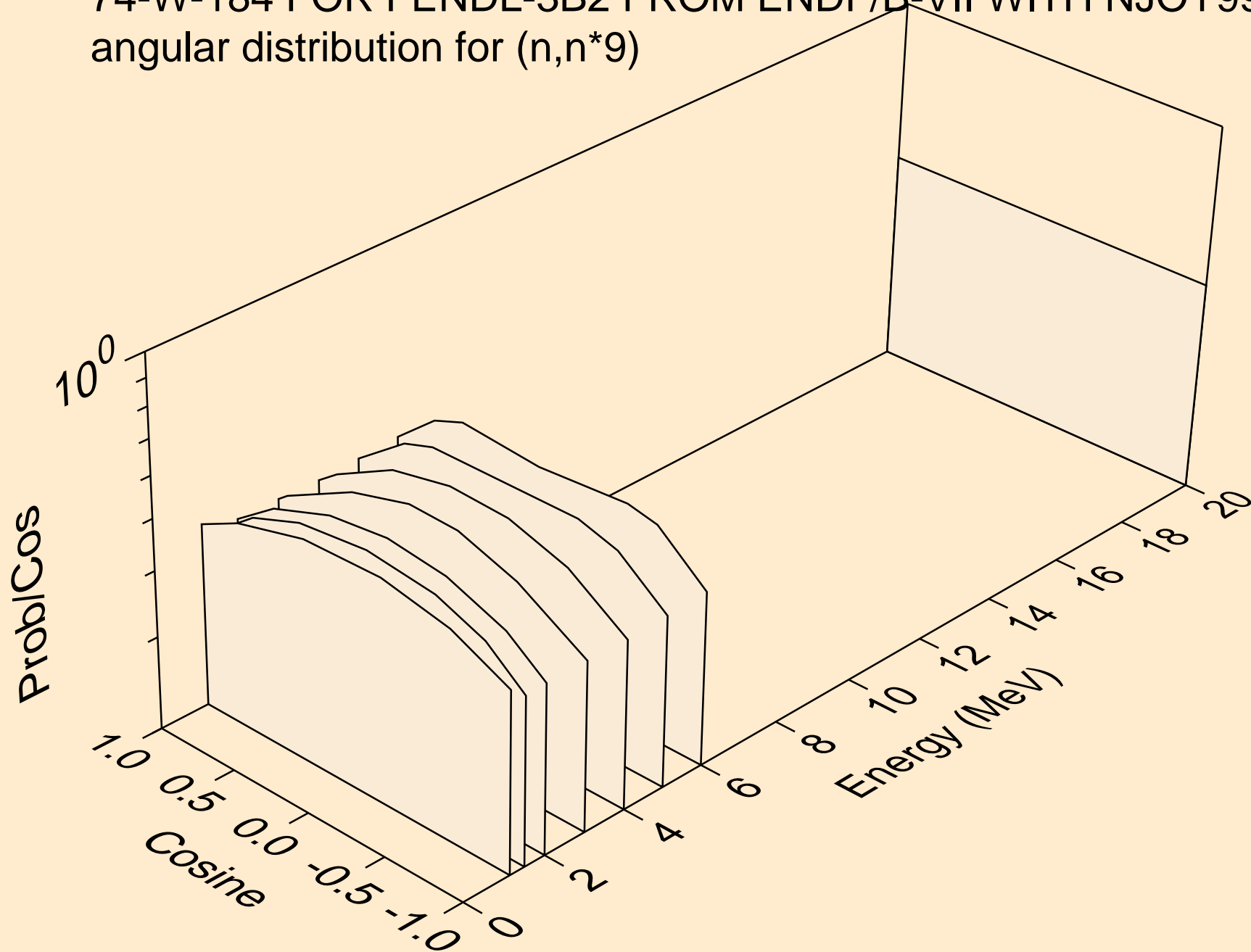



74-W-184 FOR FENDL-3B2 FROM ENDF/B-VII WITH NJOY99.304+  
angular distribution for (n,n\*10)

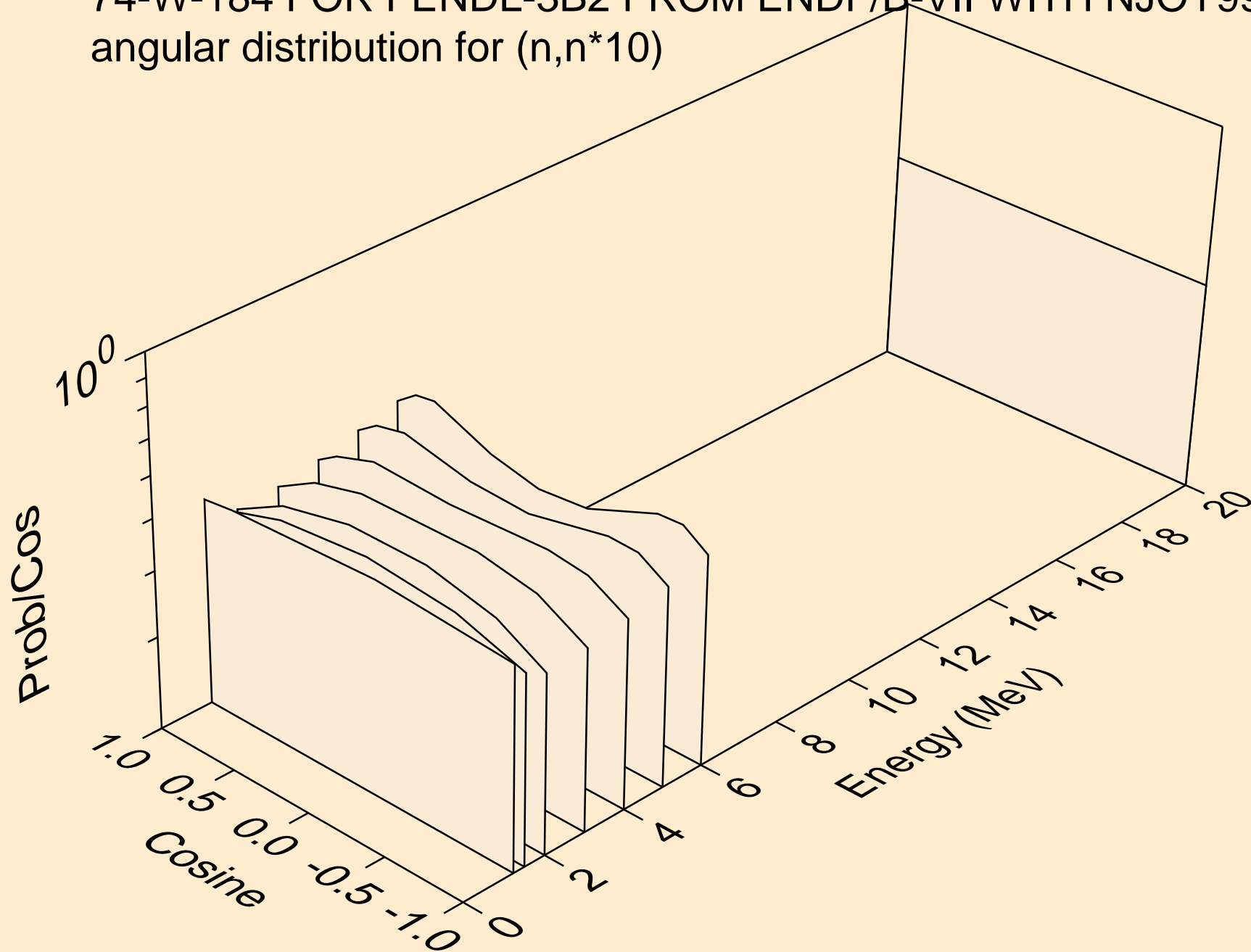

74-W-184 FOR FENDL-3B2 FROM ENDF/B-VII WITH NJOY99.304+  
angular distribution for (n,n\*11)

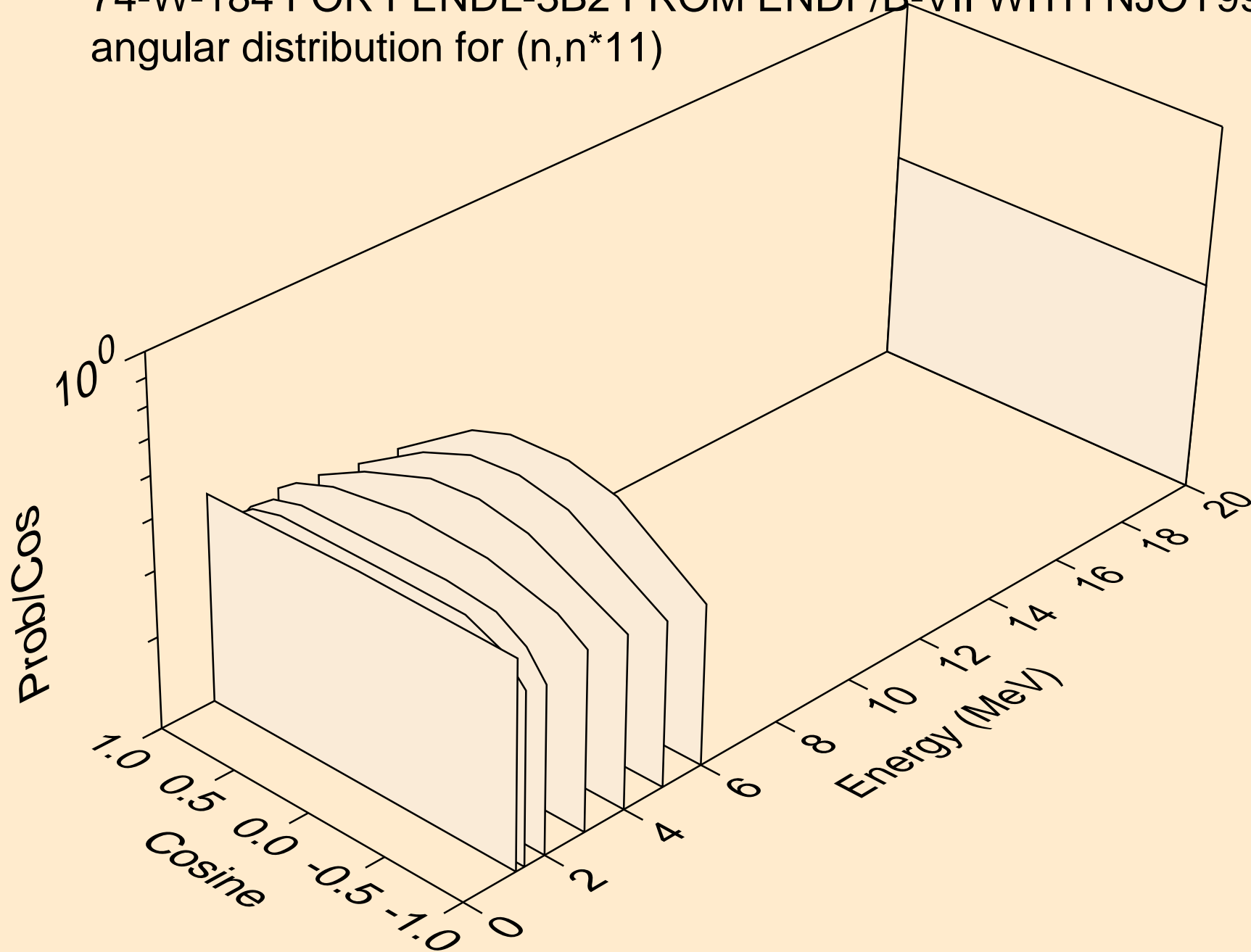

74-W-184 FOR FENDL-3B2 FROM ENDF/B-VII WITH NJOY99.304+  
angular distribution for (n,n\*12)

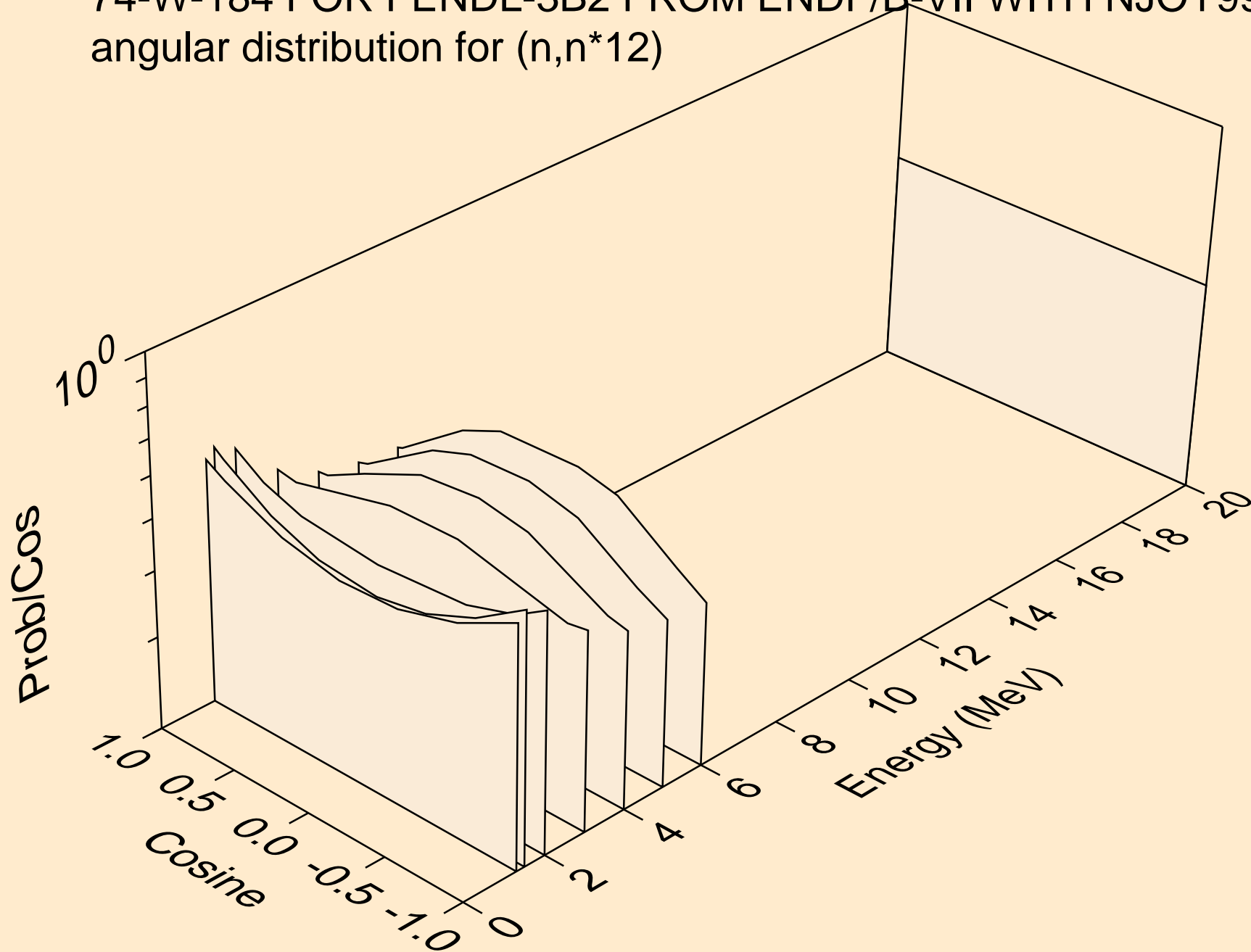

74-W-184 FOR FENDL-3B2 FROM ENDF/B-VII WITH NJOY99.304+  
angular distribution for (n,n\*13)

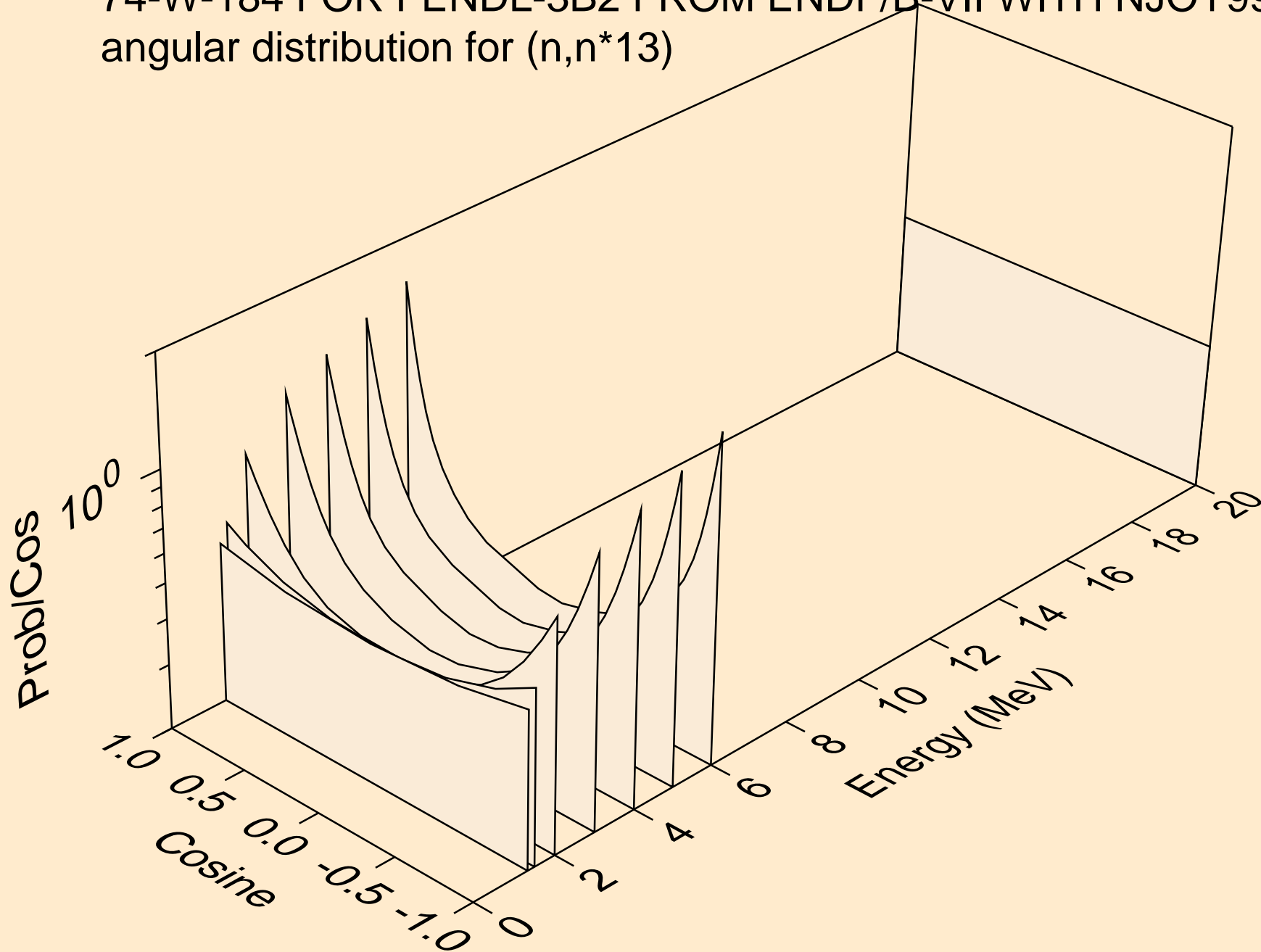

74-W-184 FOR FENDL-3B2 FROM ENDF/B-VII WITH NJOY99.304+  
angular distribution for (n,n\*14)

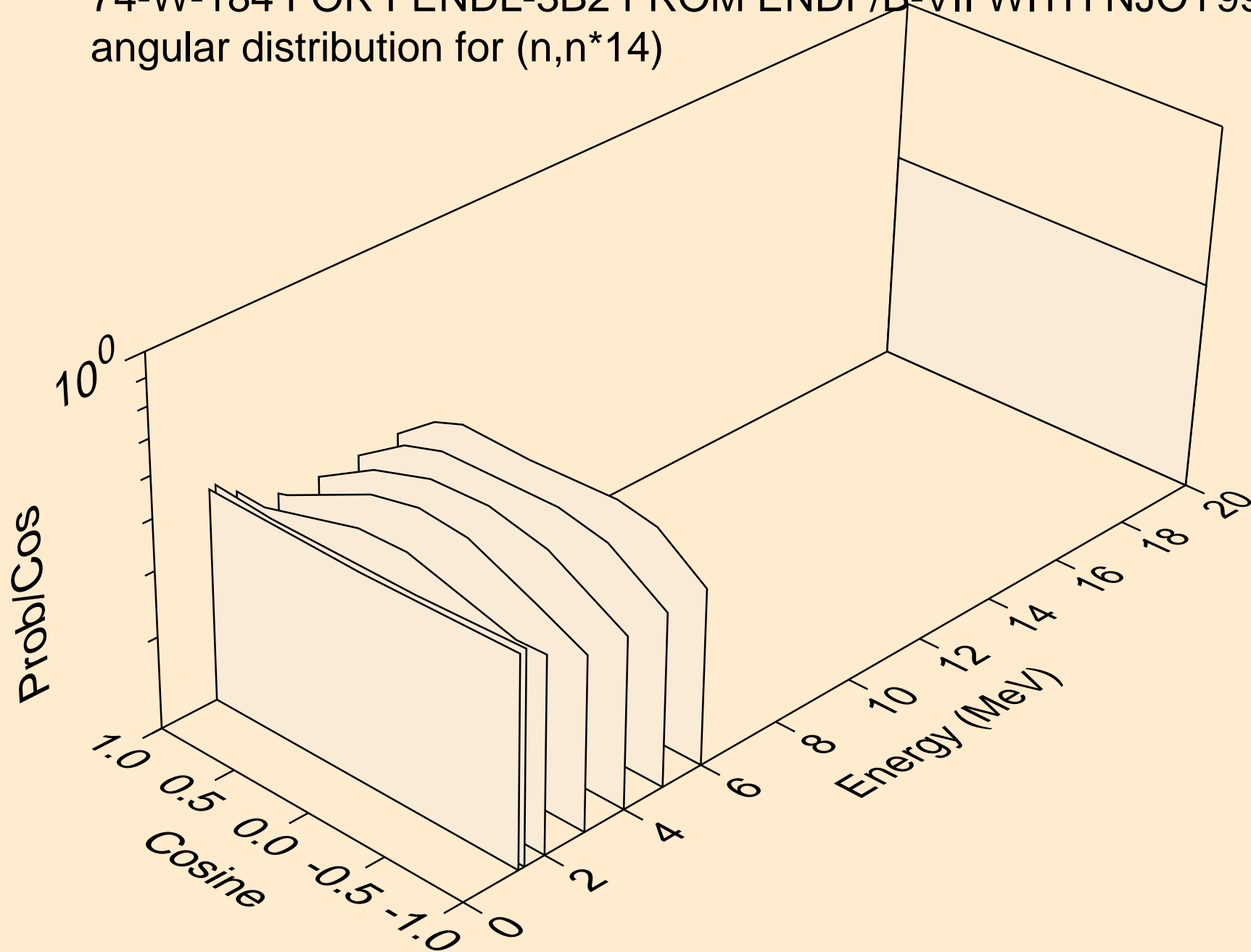

74-W-184 FOR FENDL-3B2 FROM ENDF/B-VII WITH NJOY99.304+  
angular distribution for (n,n\*15)

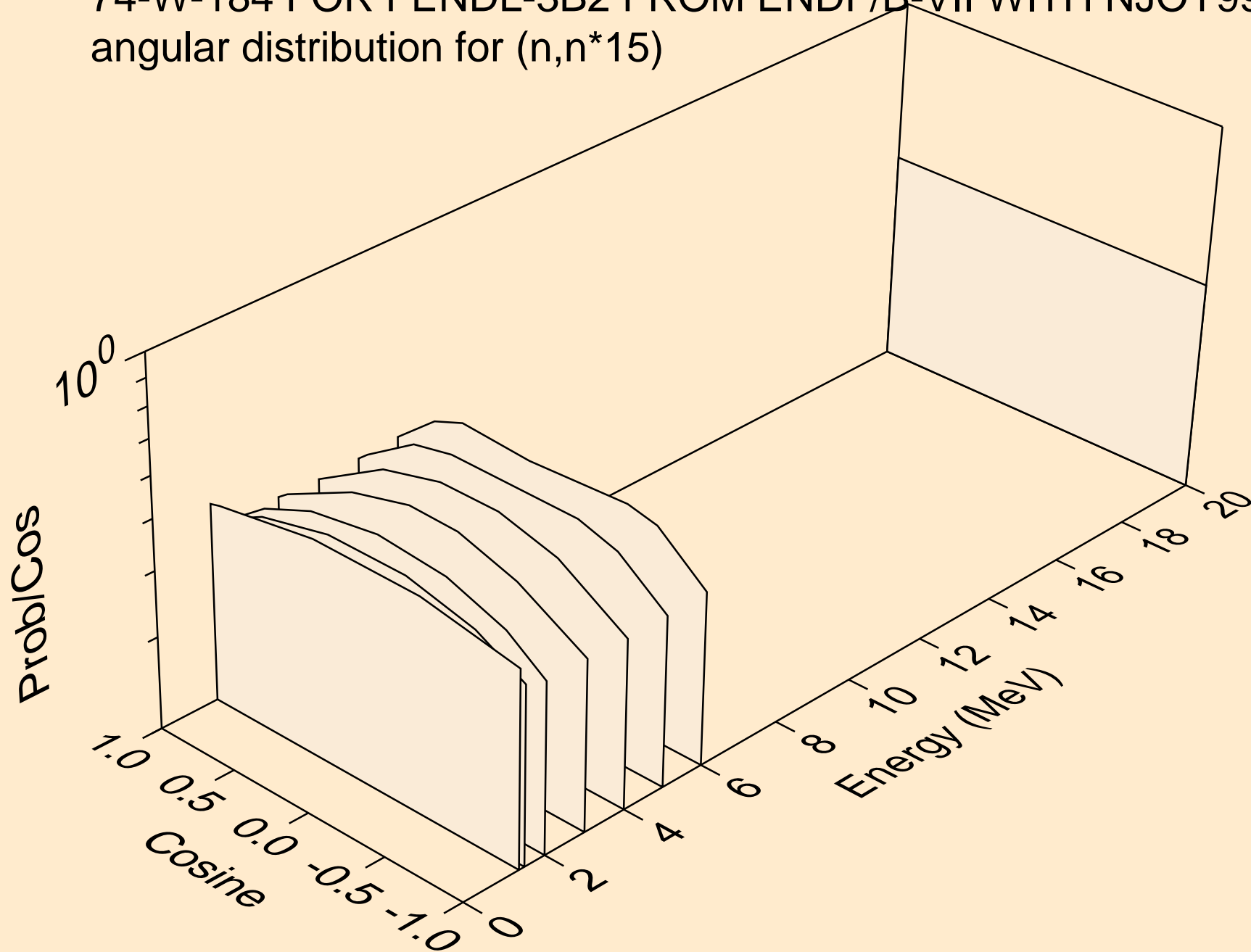

74-W-184 FOR FENDL-3B2 FROM ENDF/B-VII WITH NJOY99.304+  
angular distribution for (n,n\*16)

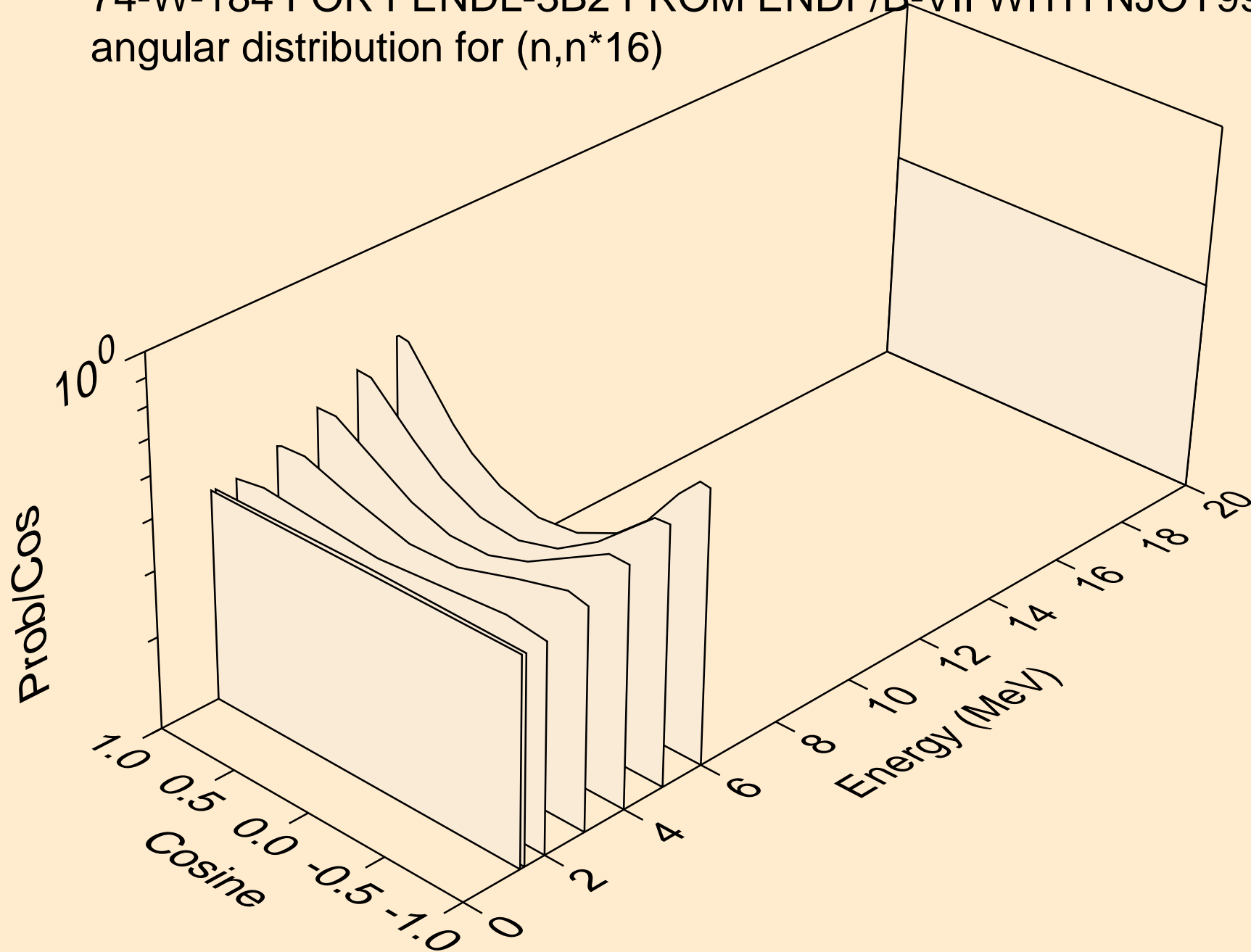

74-W-184 FOR FENDL-3B2 FROM ENDF/B-VII WITH NJOY99.304+  
angular distribution for (n,n\*17)

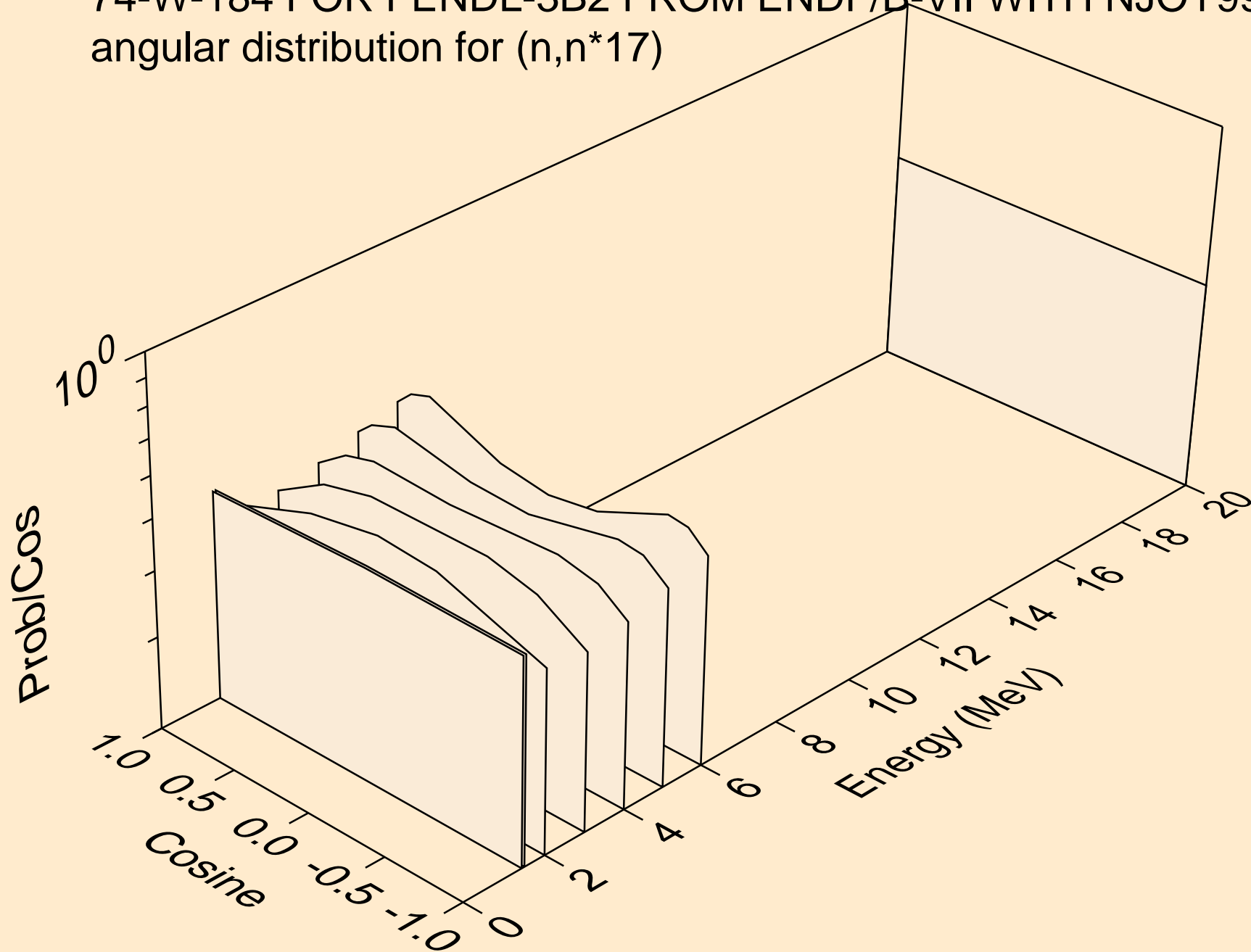



74-W-184 FOR FENDL-3B2 FROM ENDF/B-VII WITH NJOY99.304+  
angular distribution for (n,n\*18)

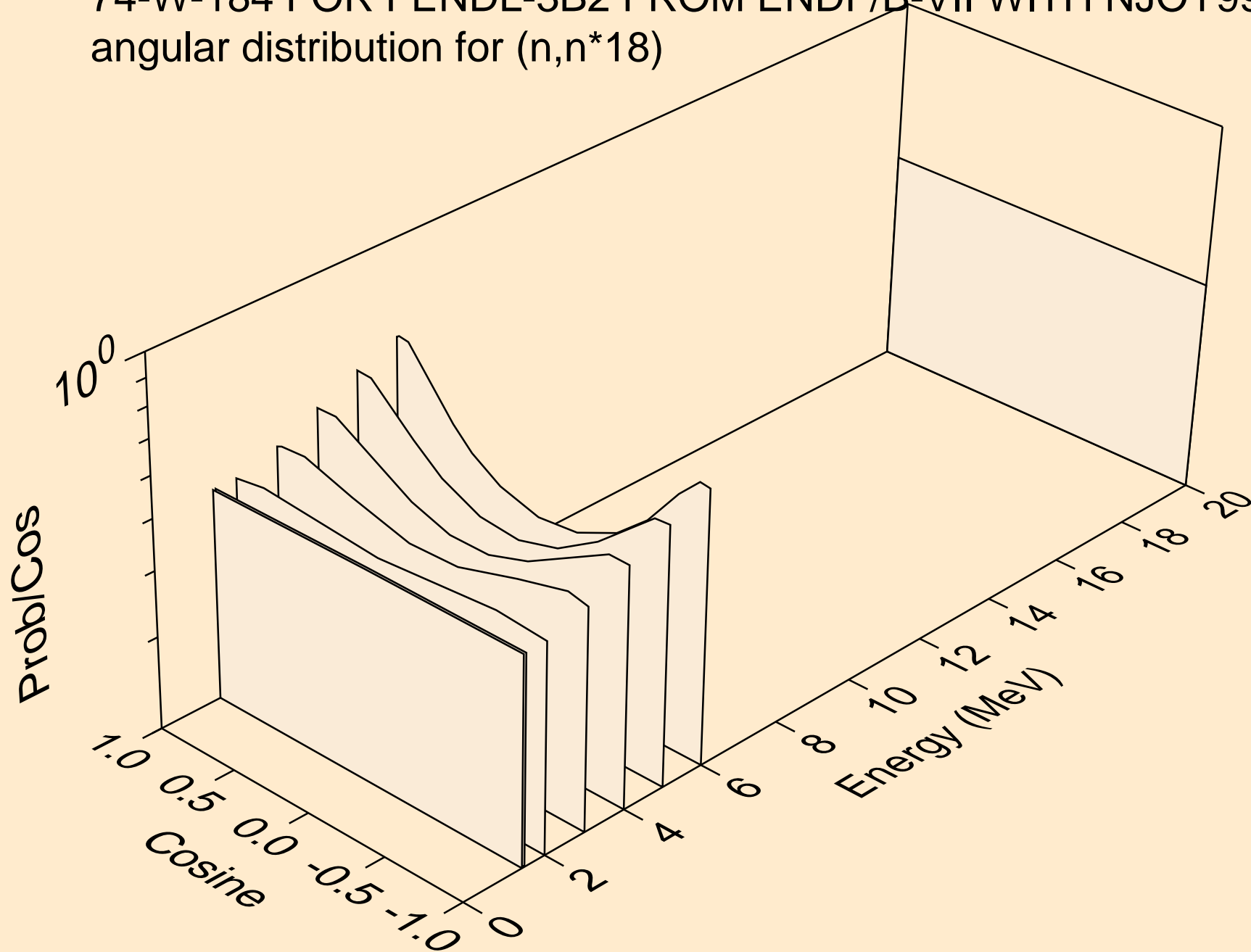

74-W-184 FOR FENDL-3B2 FROM ENDF/B-VII WITH NJOY99.304+  
angular distribution for (n,n\*c)

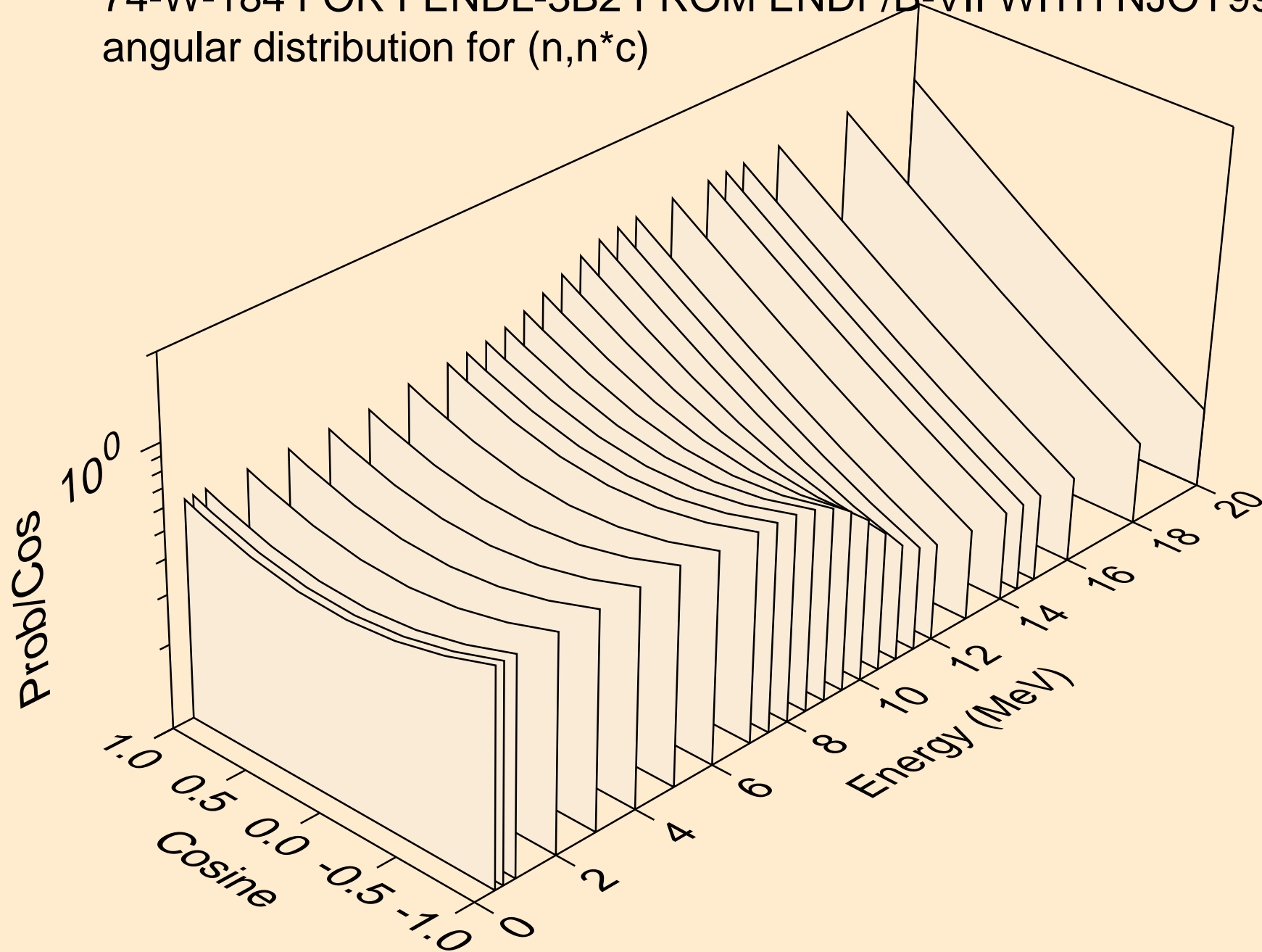

74-W-184 FOR FENDL-3B2 FROM ENDF/B-VII WITH NJOY99.304+  
Neutron emission for (n,x)

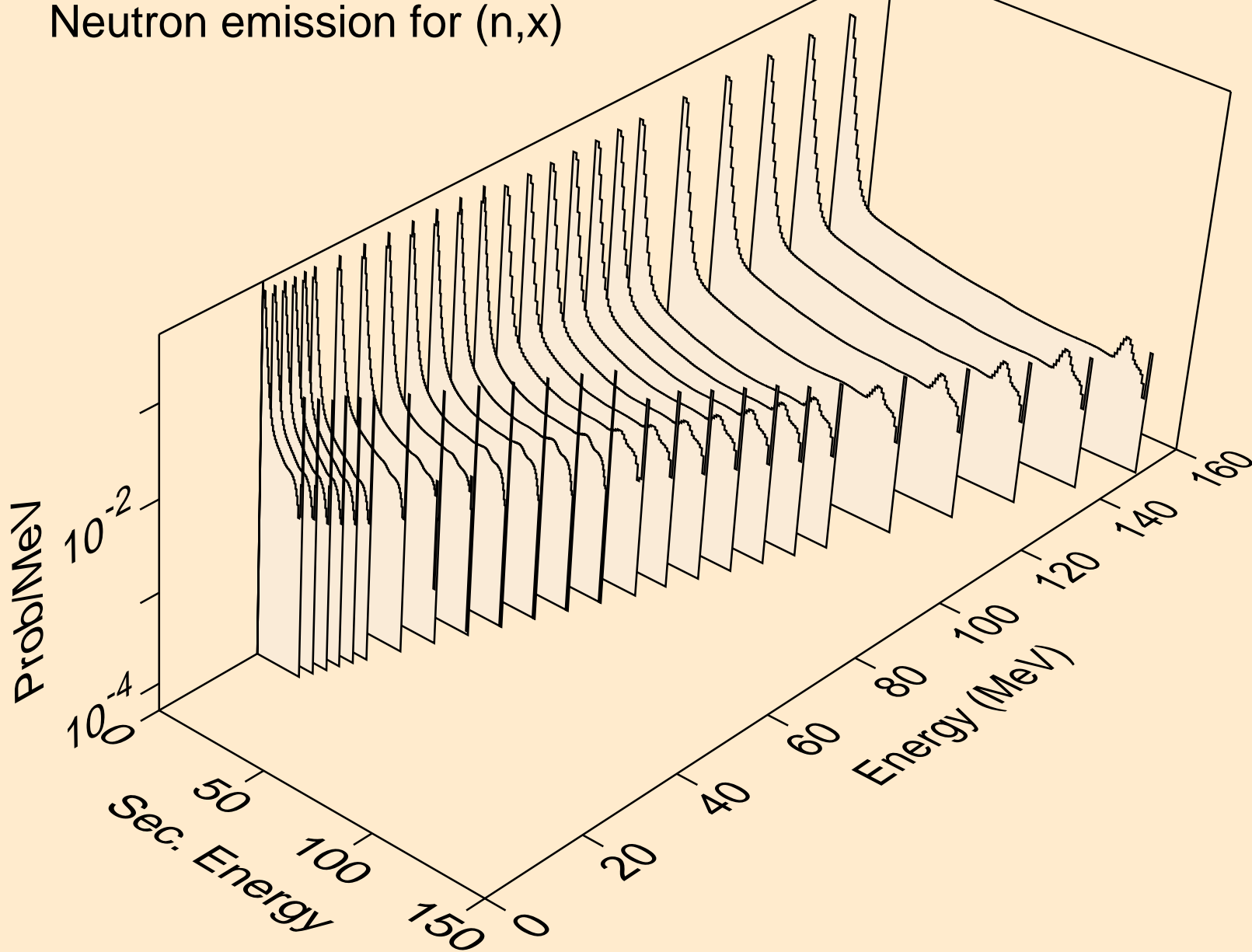

74-W-184 FOR FENDL-3B2 FROM ENDF/B-VII WITH NJOY99.304+  
Neutron emission for (n,2n)

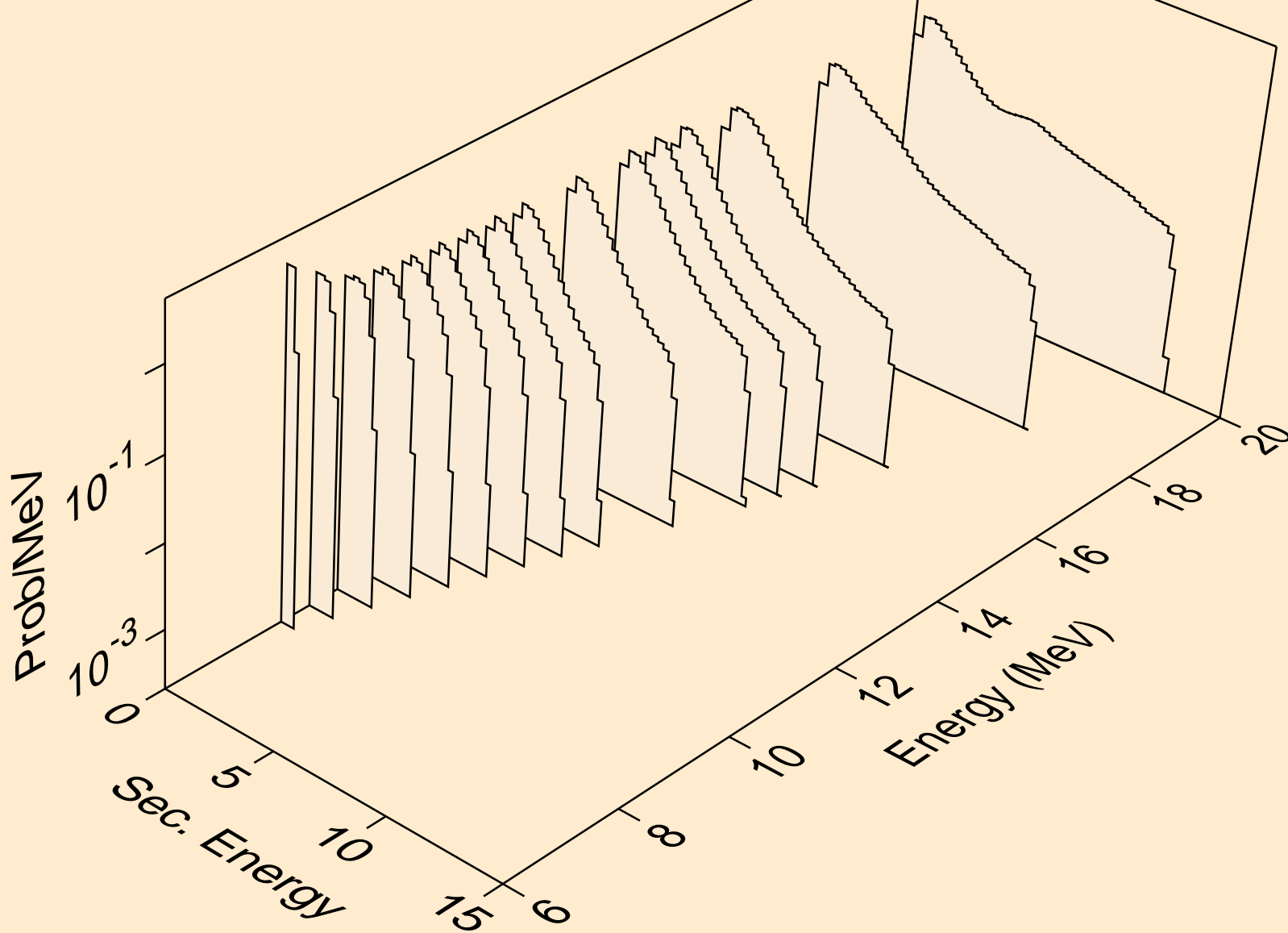

74-W-184 FOR FENDL-3B2 FROM ENDF/B-VII WITH NJOY99.304+  
Neutron emission for (n,3n)

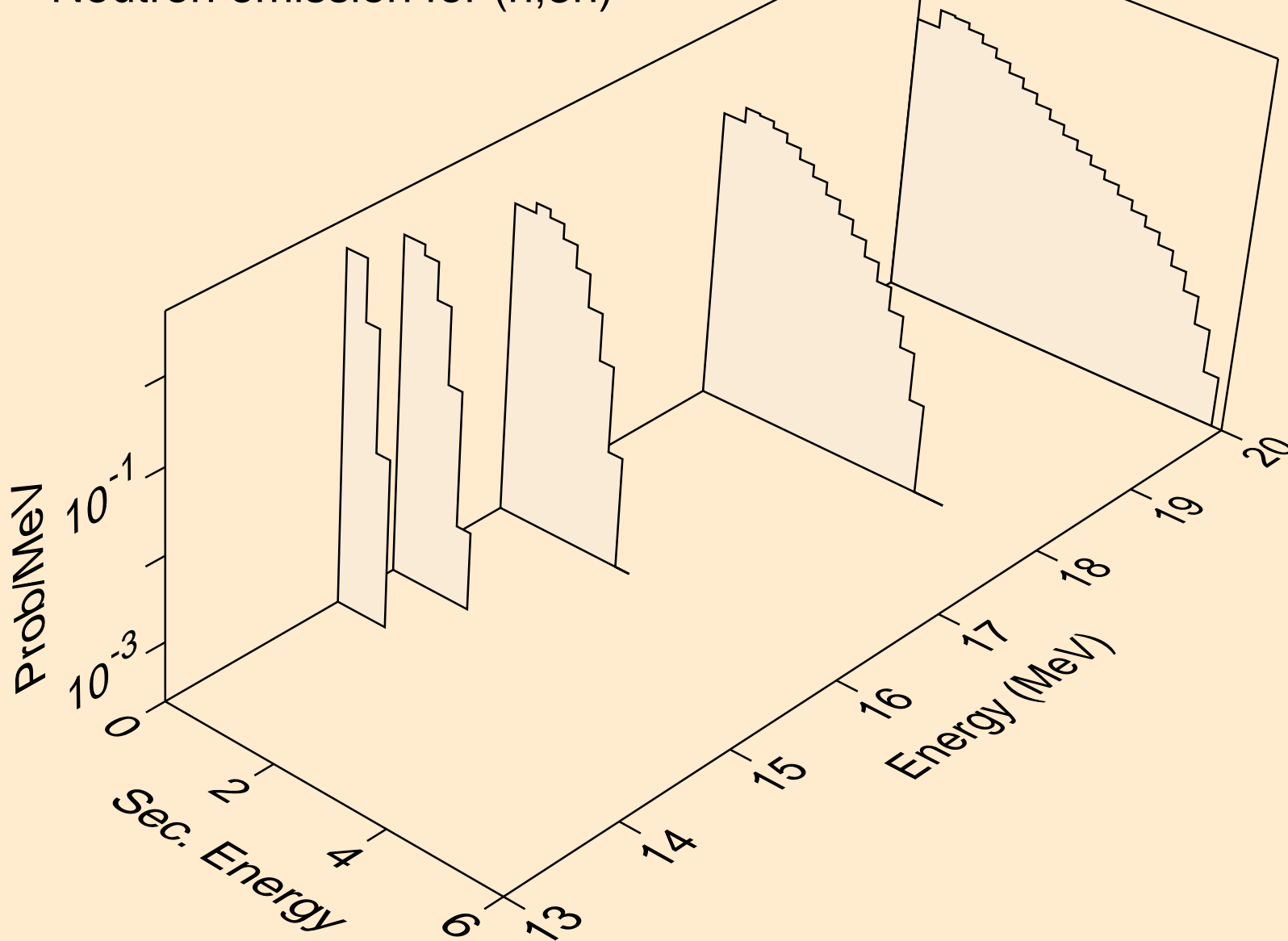

74-W-184 FOR FENDL-3B2 FROM ENDF/B-VII WITH NJOY99.304+  
Neutron emission for (n,n\*c)

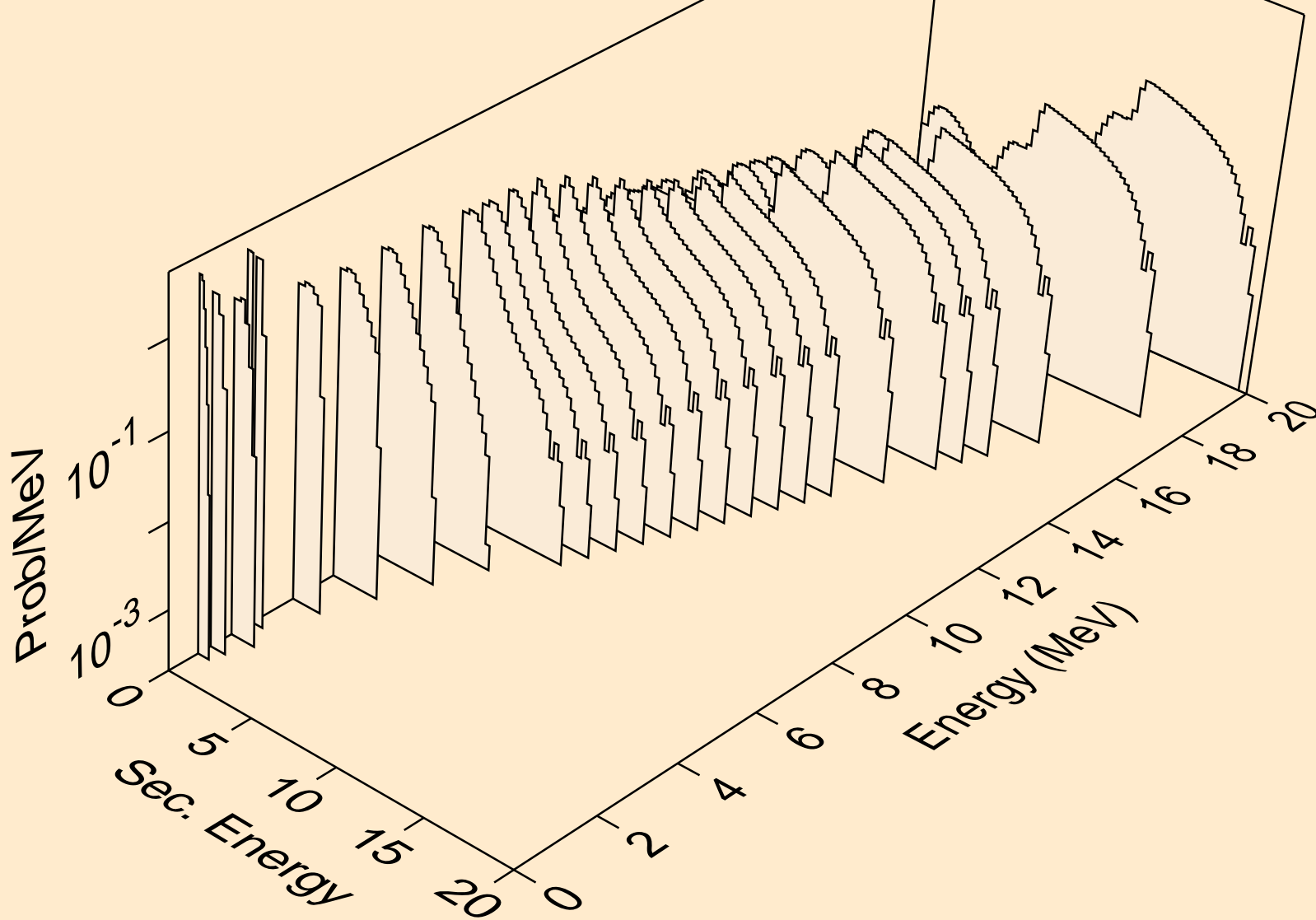

74-W-184 FOR FENDL-3B2 FROM ENDF/B-VII WITH NJOY99.304+  
Photon emission for (n,gma)

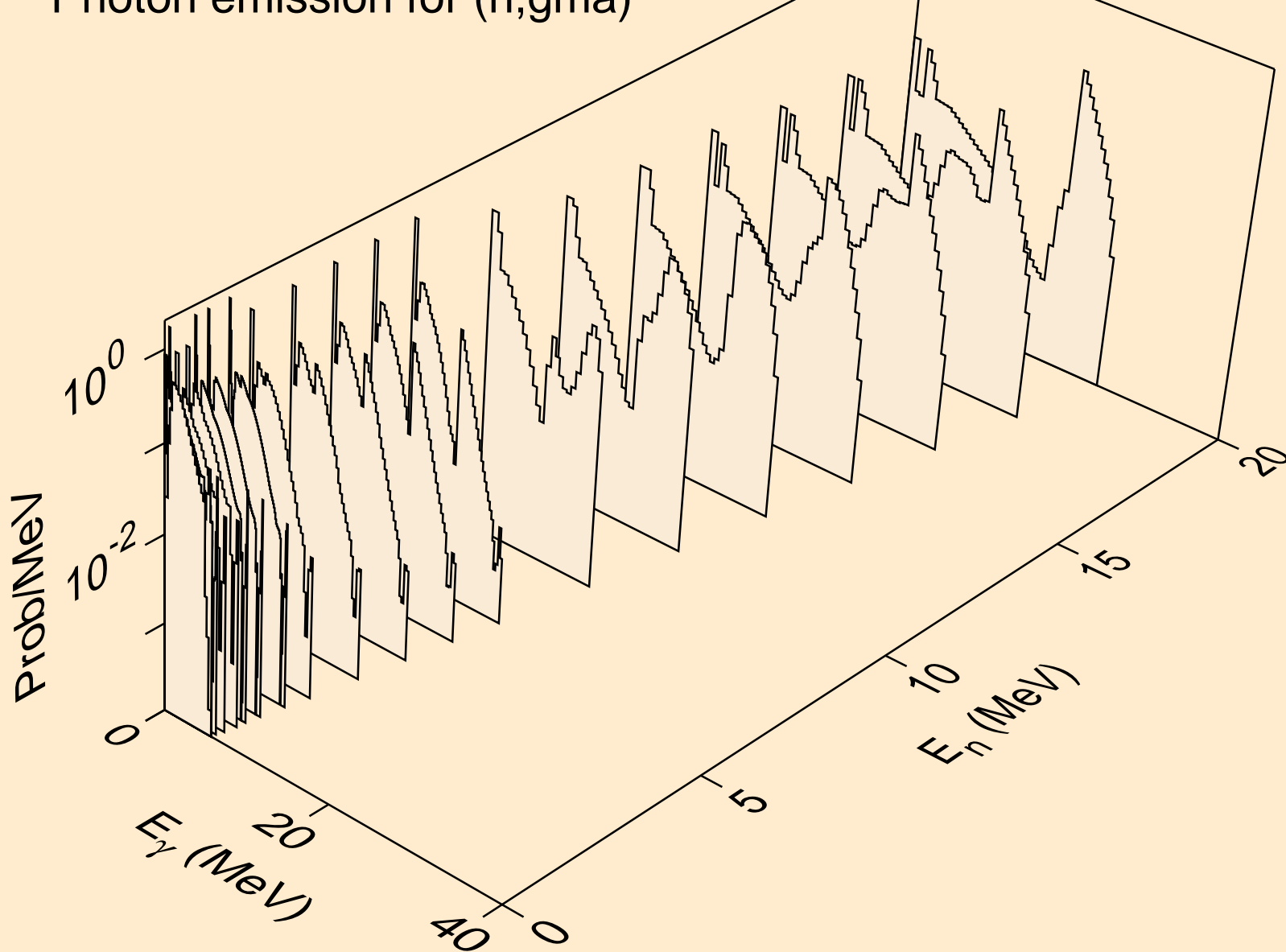

74-W-184 FOR FENDL-3B2 FROM ENDF-B-VII WITH NJOY99.304+  
Photon emission for inelastic

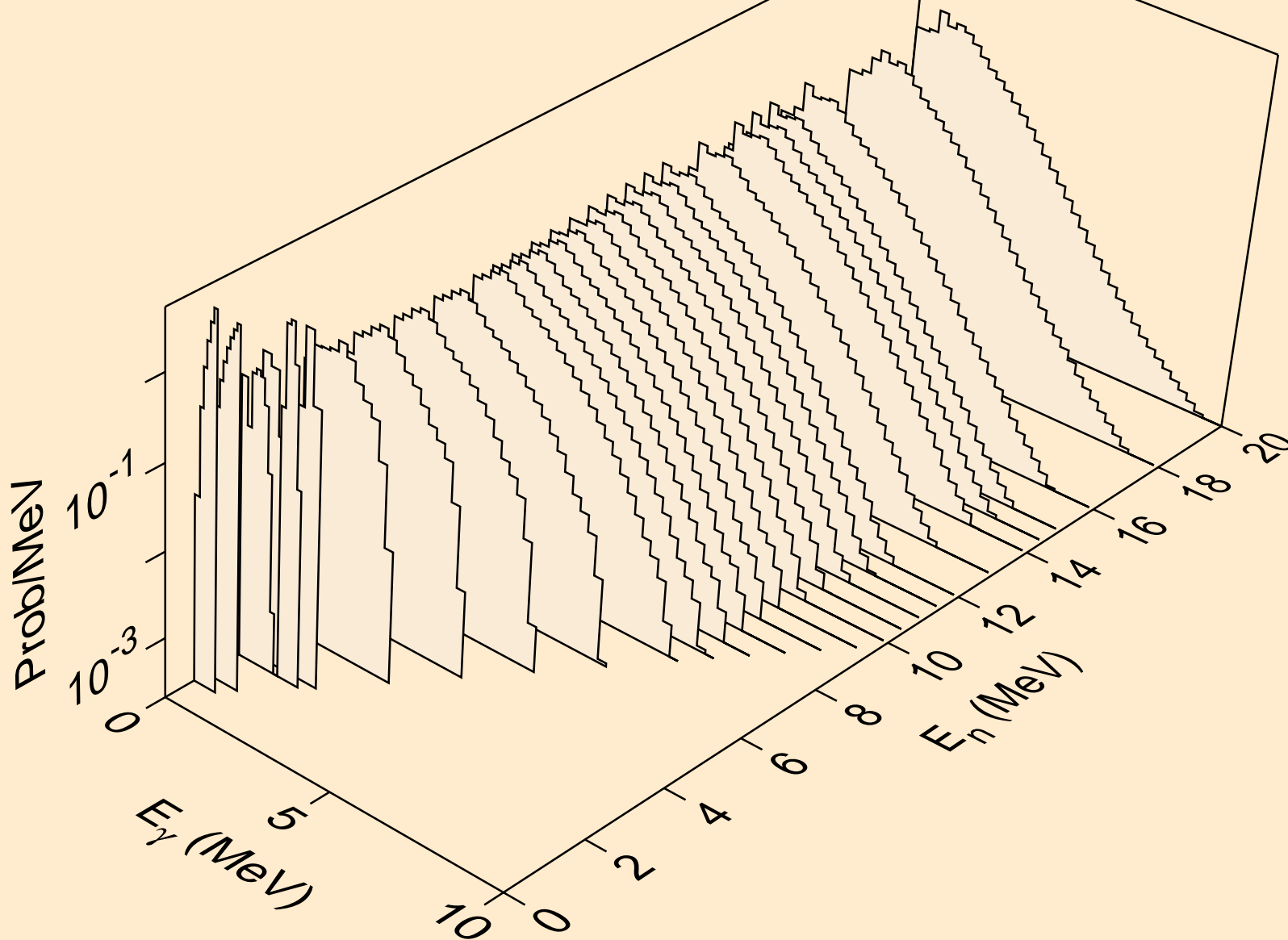



74-W-184 FOR FENDL-3B2 FROM ENDF-B-VII WITH NJOY99.304+  
Photon emission for (n,2n)

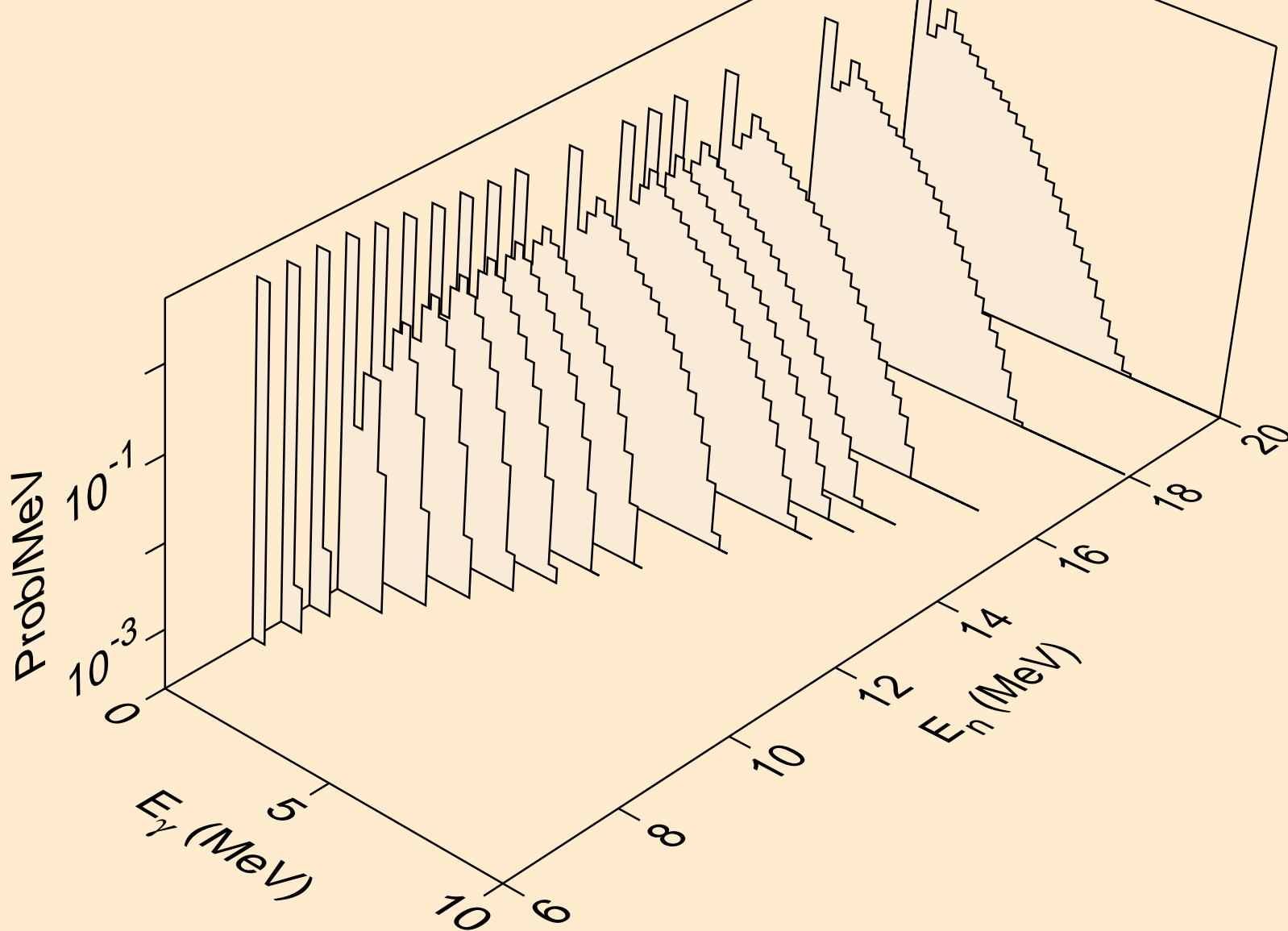

74-W-184 FOR FENDL-3B2 FROM ENDF/B-VII WITH NJOY99.304+  
Photon emission for (n,3n)

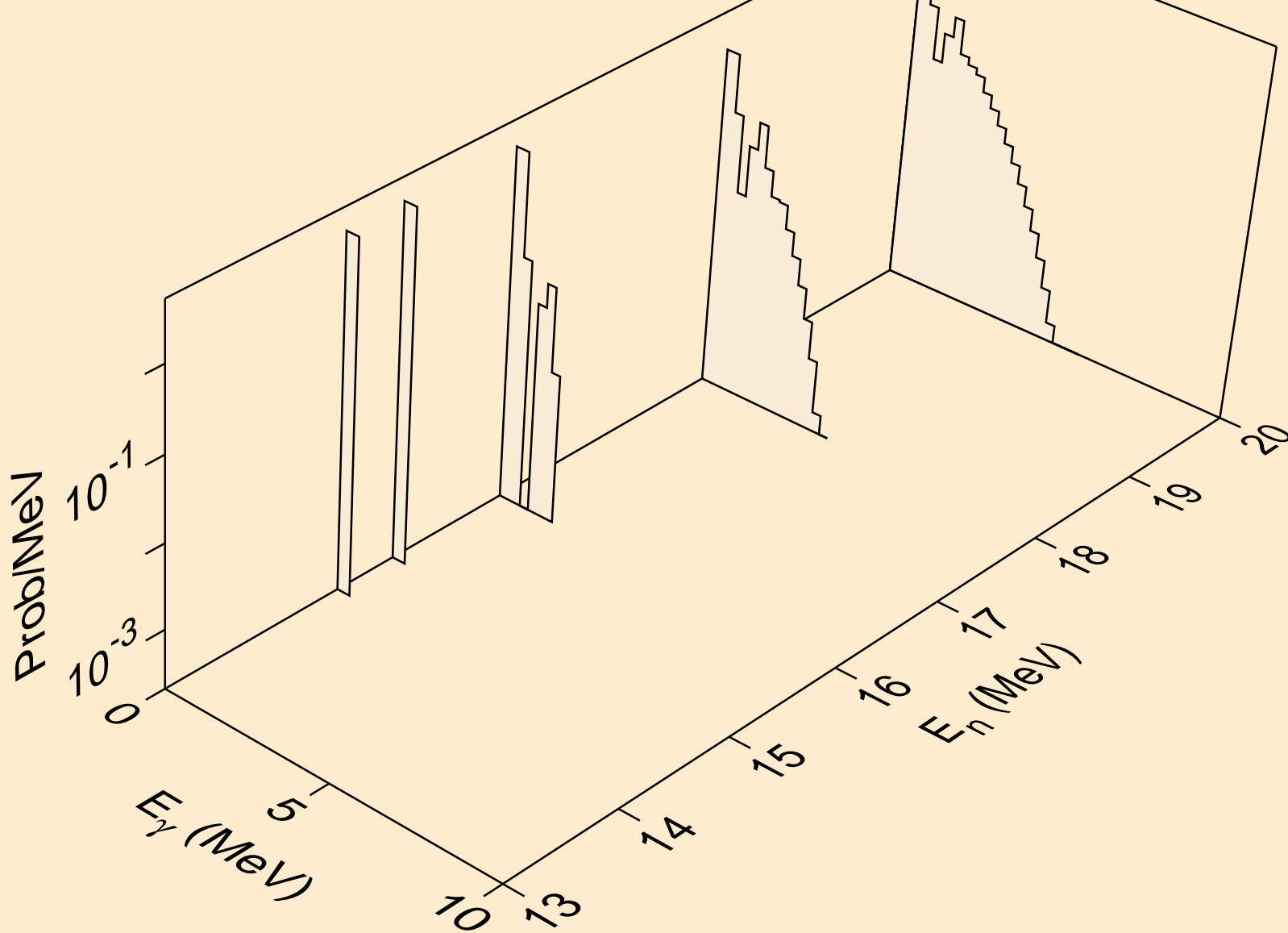

74-W-184 FOR FENDL-3B2 FROM ENDF/B-VII WITH NJOY99.304+  
Photon emission for (n,x)

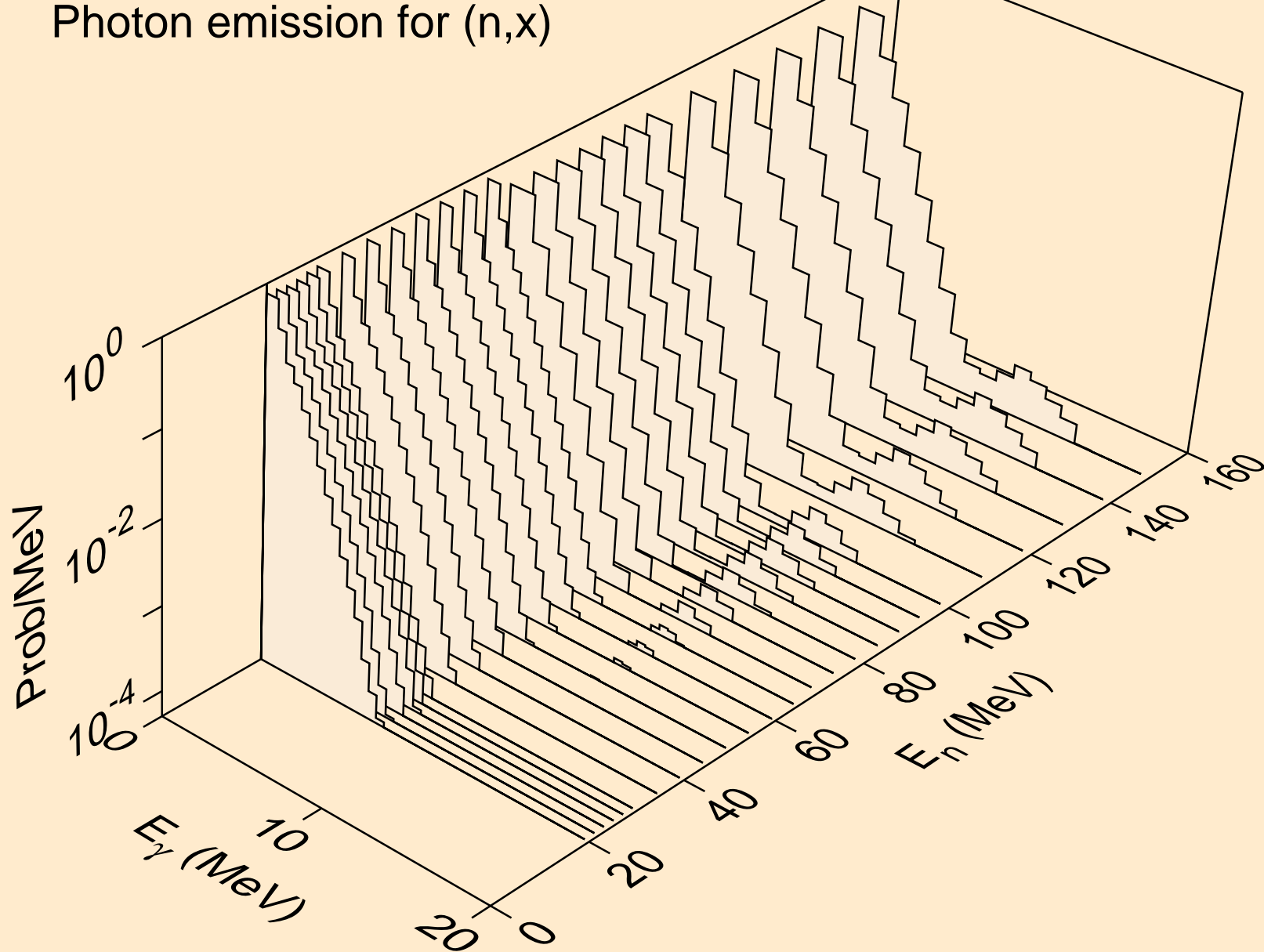

74-W-184 FOR FENDL-3B2 FROM ENDF/B-VII WITH NJOY99.304+  
thermal capture photon spectrum

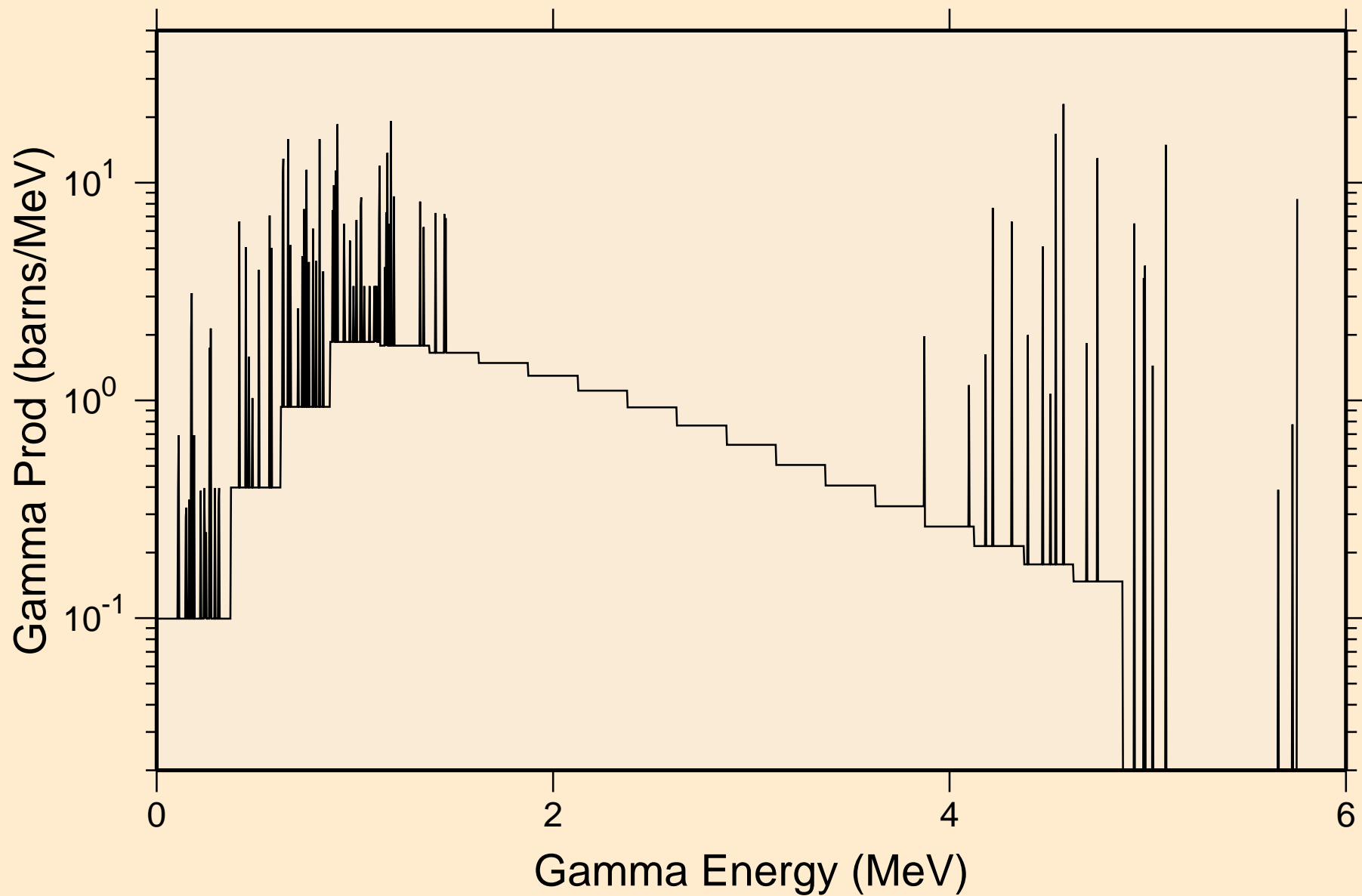

74-W-184 FOR FENDL-3B2 FROM ENDF/B-VII WITH NJOY99.304+  
14 MeV photon spectrum

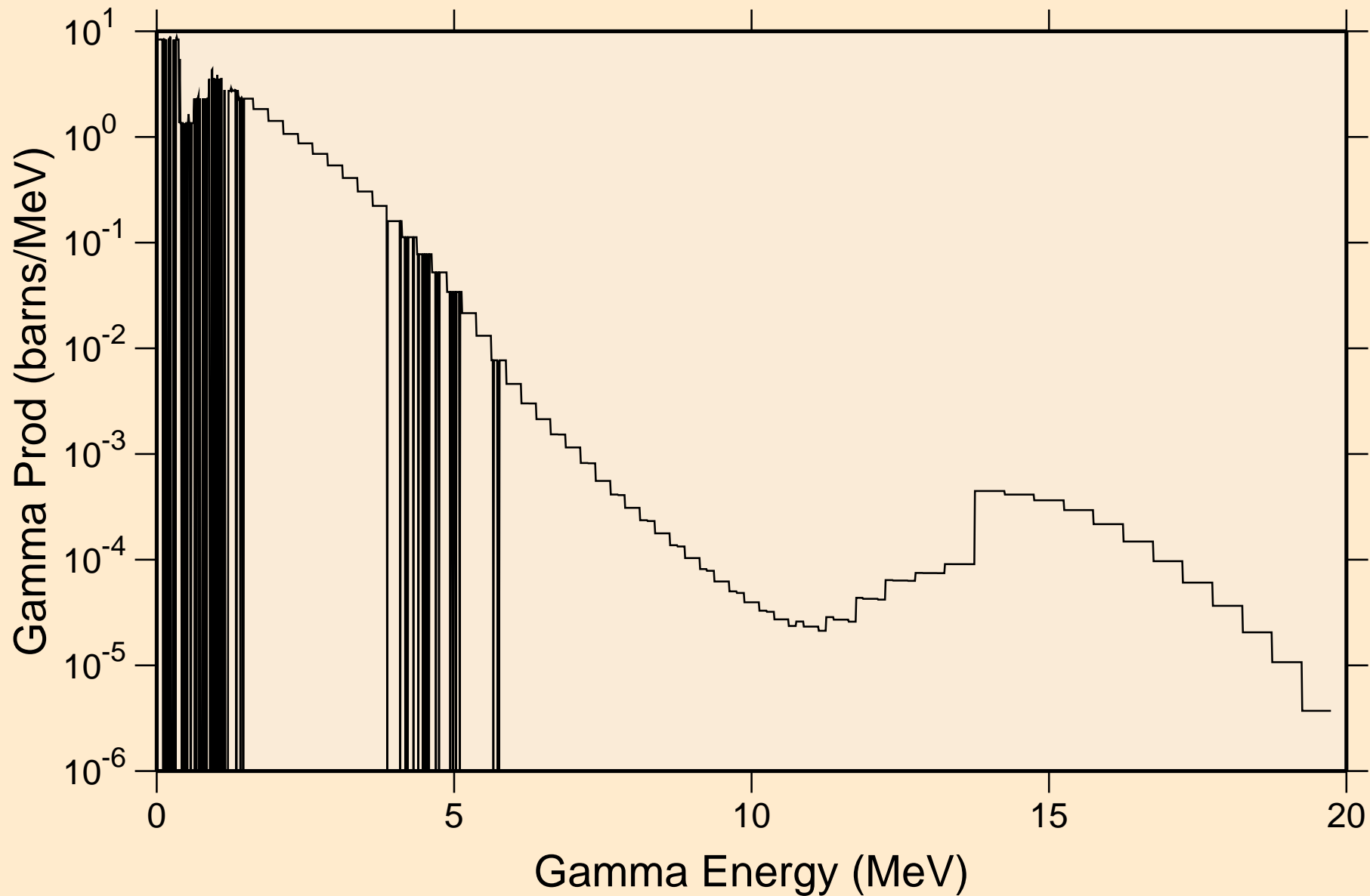

# 74-W-184 FOR FENDL-3B2 FROM ENDF/B-VII WITH NJOY99.304+ Particle heating contributions

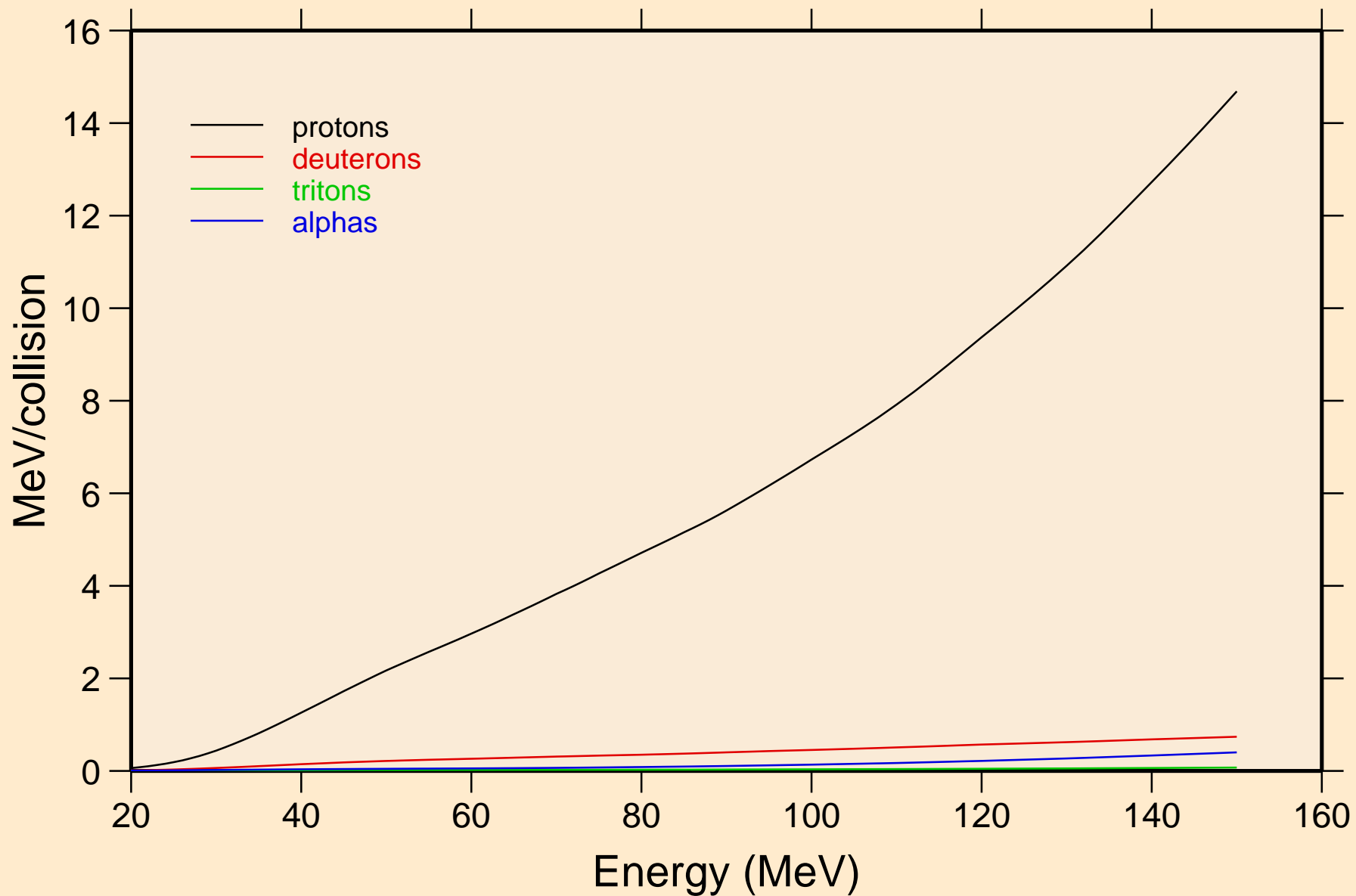

# 74-W-184 FOR FENDL-3B2 FROM ENDF/B-VII WITH NJOY99.304+ Recoil Heating

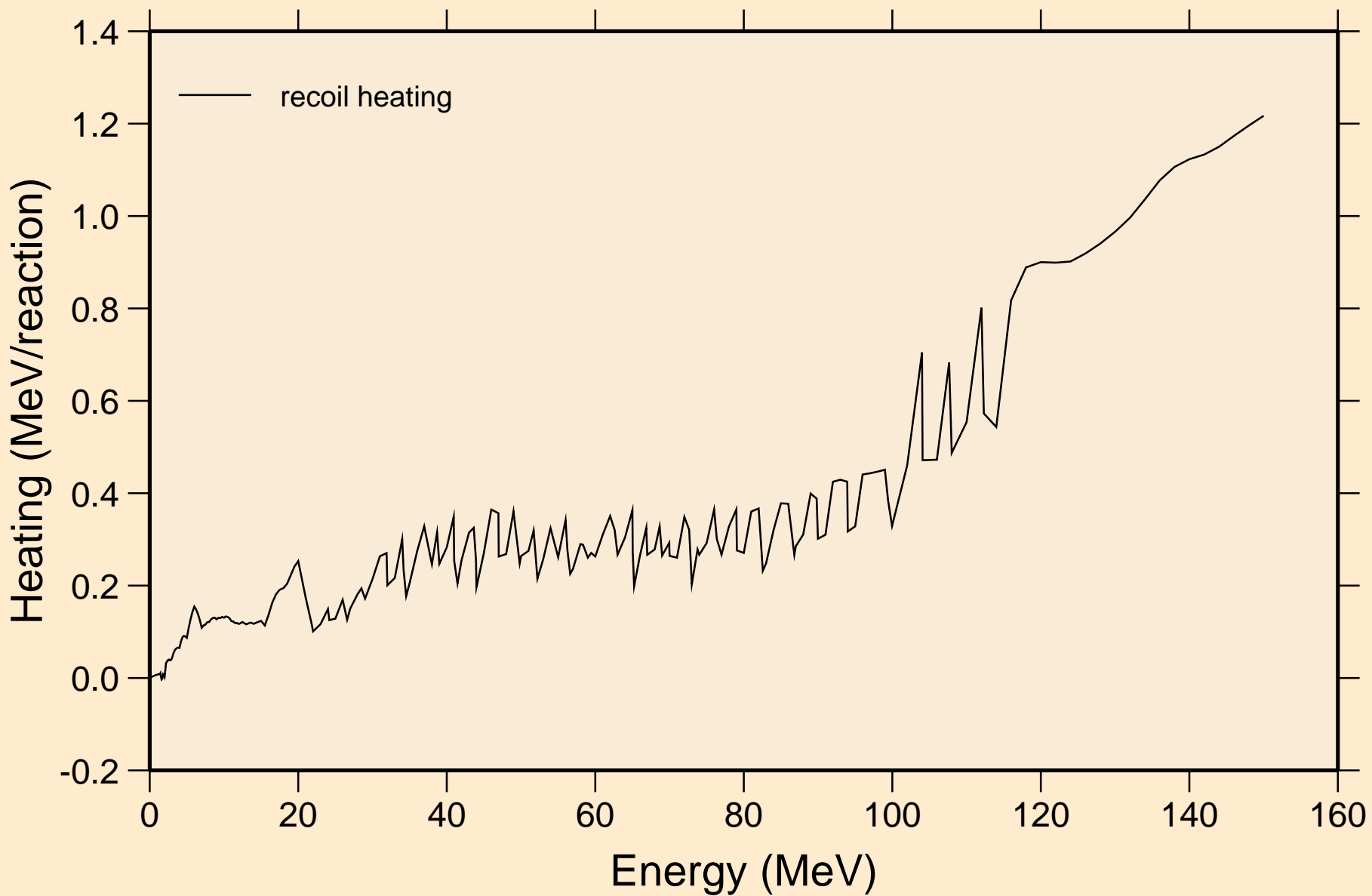

74-W-184 FOR FENDL-3B2 FROM ENDF/B-VII WITH NJOY99.304+  
Particle production cross sections

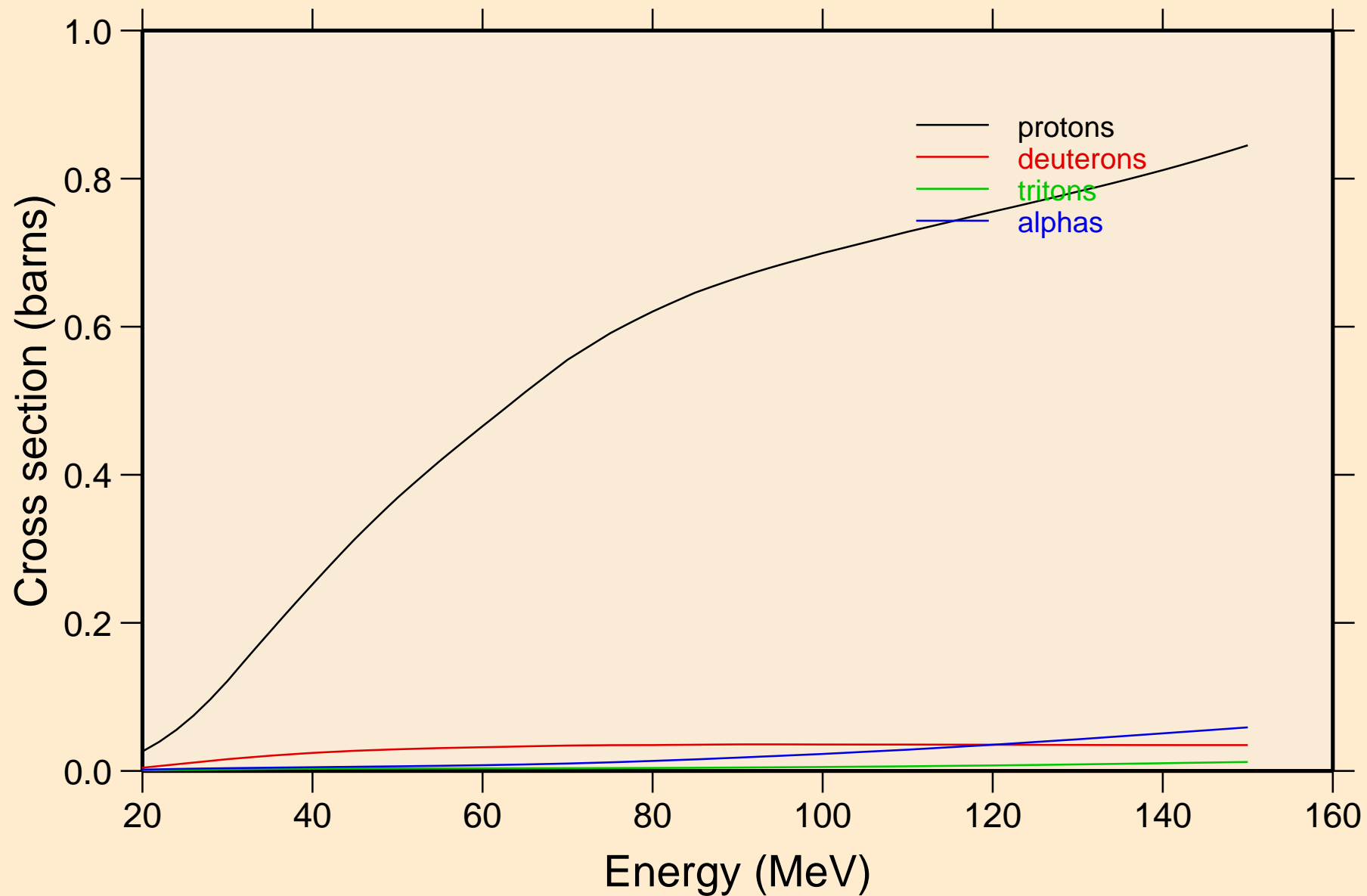



74-W-184 FOR FENDL-3B2 FROM ENDF/B-VII WITH NJOY99.304+  
protons from (n,x)

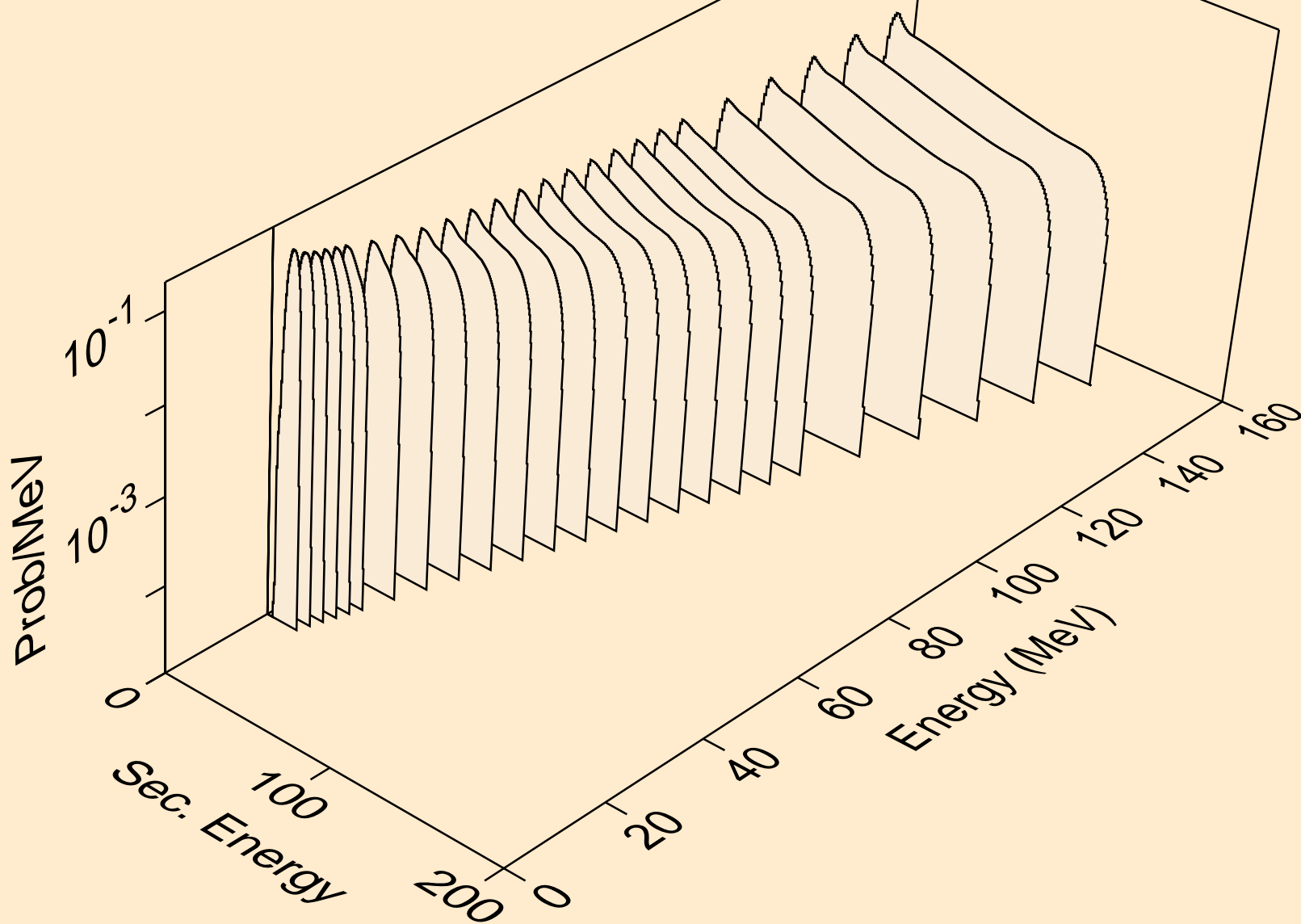

74-W-184 FOR FENDL-3B2 FROM ENDF/B-VII WITH NJOY99.304+  
deuterons from (n,x)

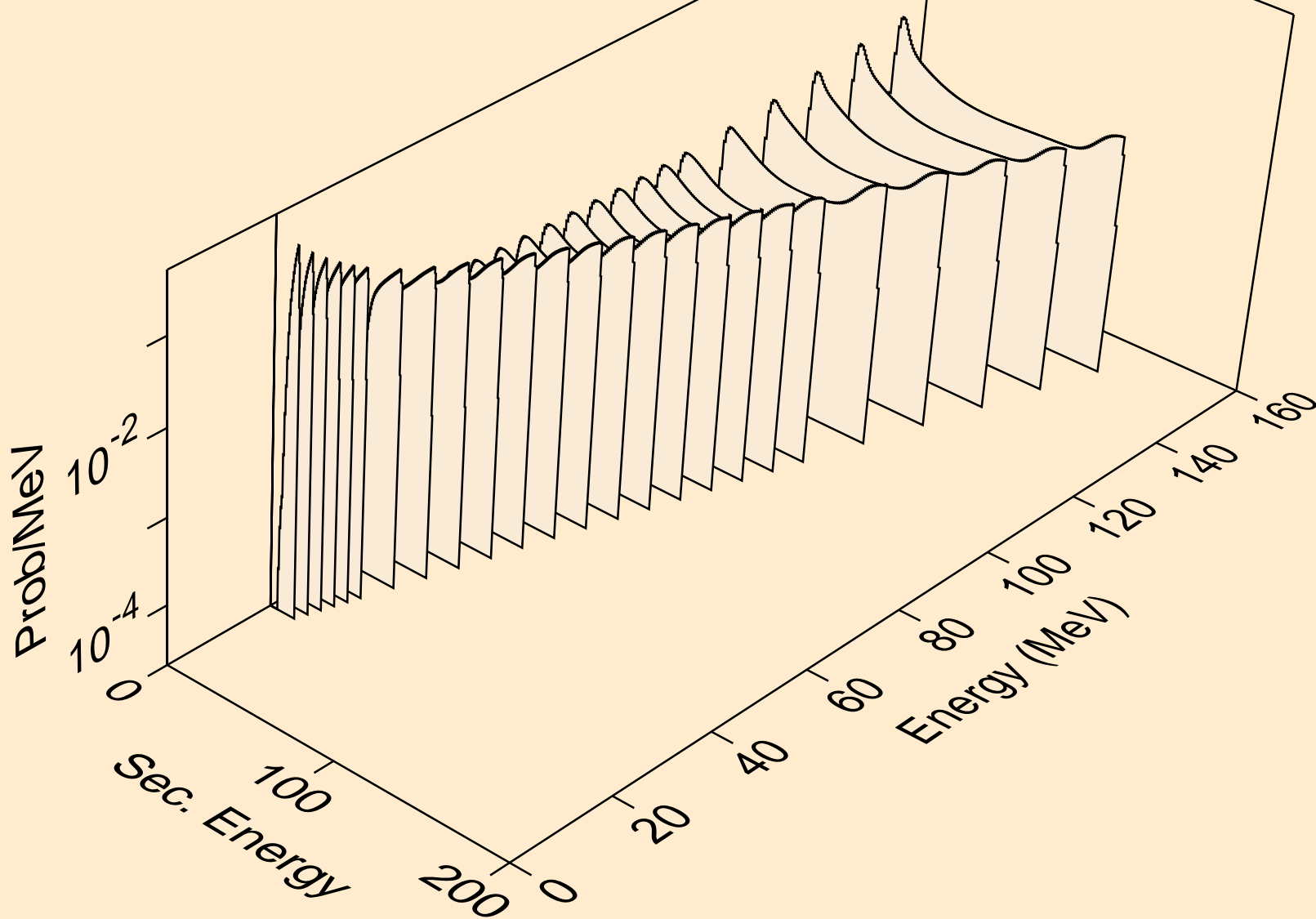

74-W-184 FOR FENDL-3B2 FROM ENDF/B-VII WITH NJOY99.304+  
tritons from (n,x)

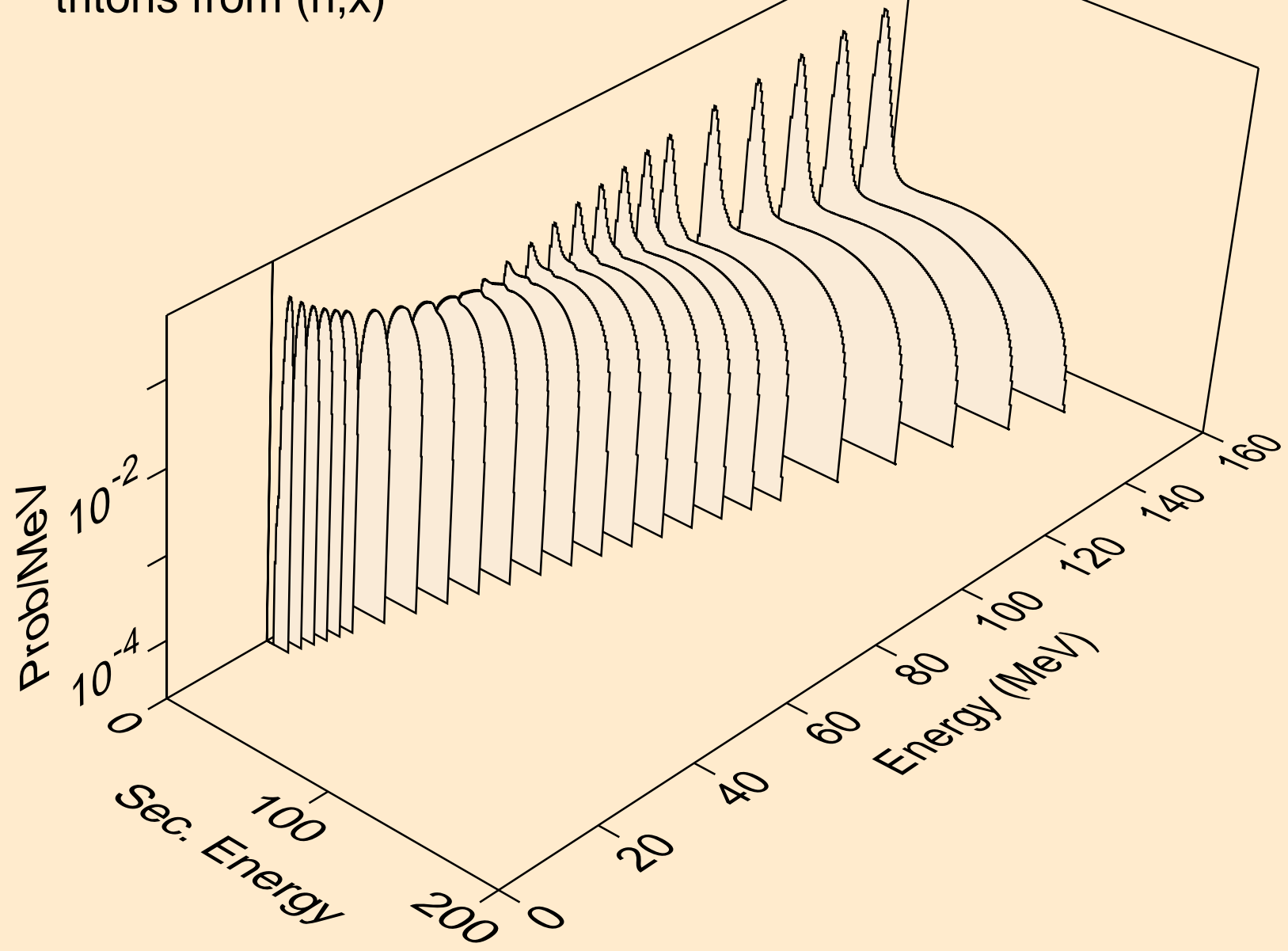

74-W-184 FOR FENDL-3B2 FROM ENDF-B-VII WITH NJOY99.304+  
alphas from (n,x)

