

82-PB-206 FOR FENDL-3B2 FROM ENDF/B-VII WITH NJOY99.304
Principal cross sections

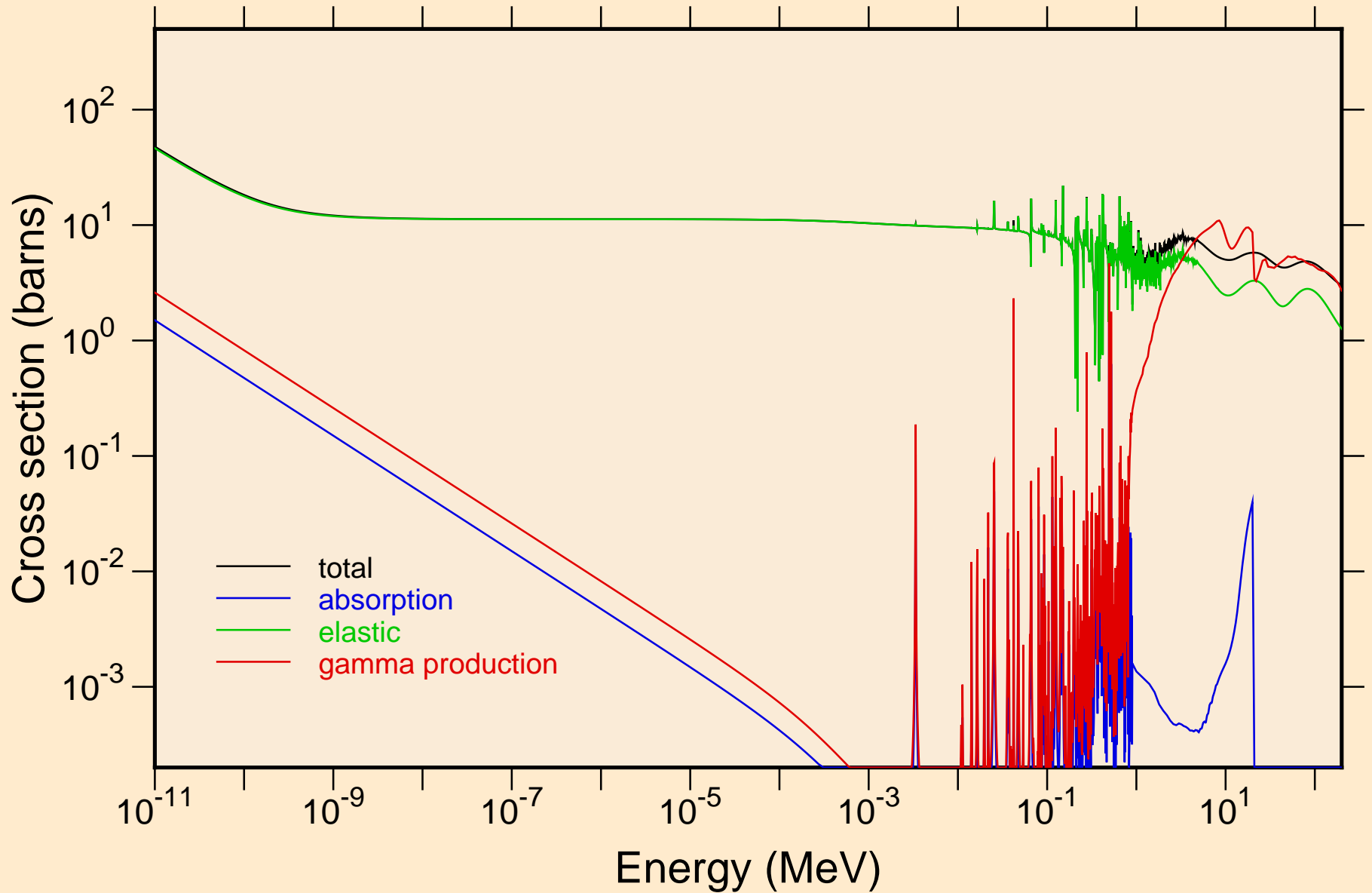

82-PB-206 FOR FENDL-3B2 FROM ENDF/B-VII WITH NJOY99.304
resonance total cross section

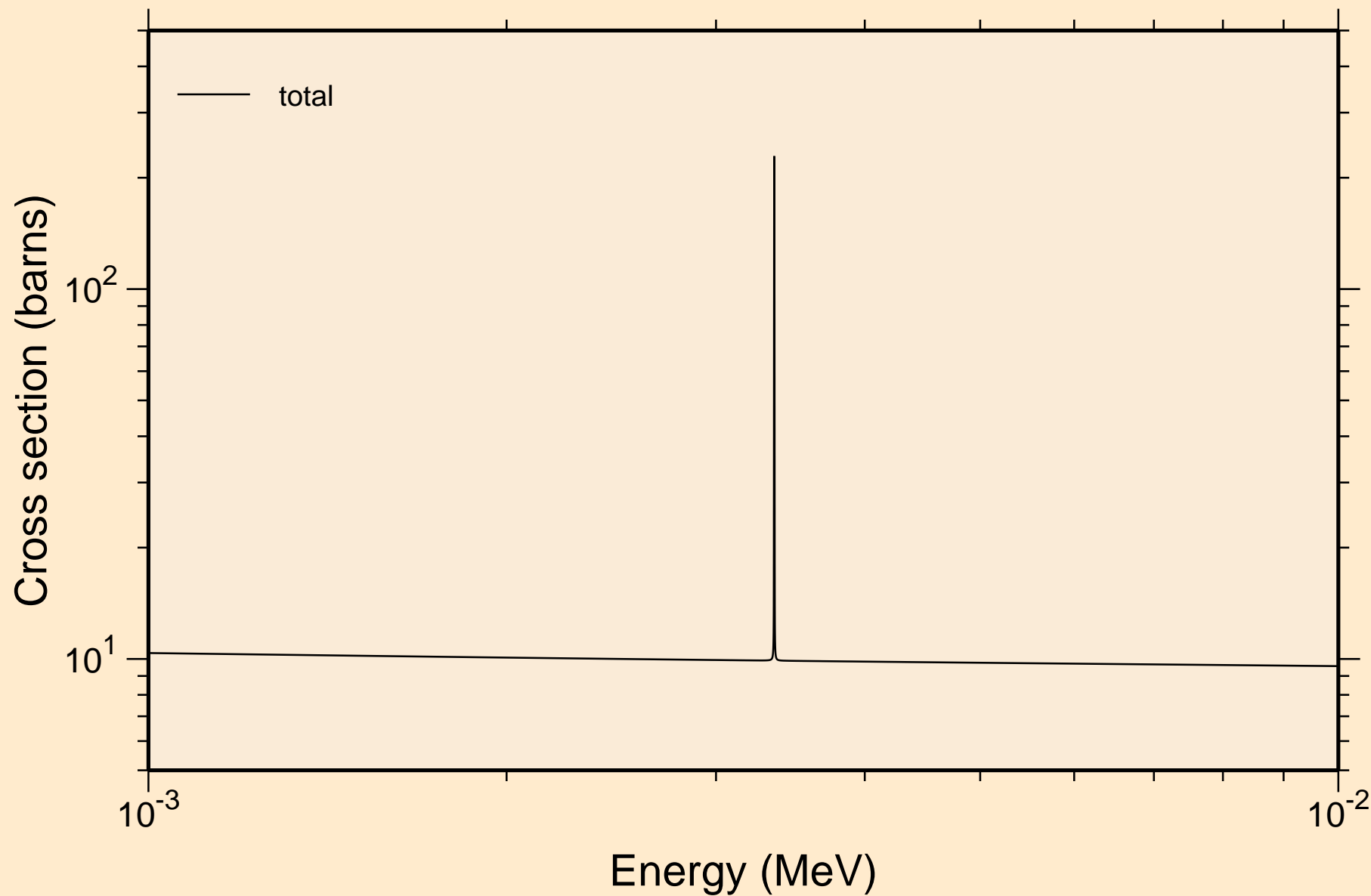

82-PB-206 FOR FENDL-3B2 FROM ENDF/B-VII WITH NJOY99.304
resonance total cross section

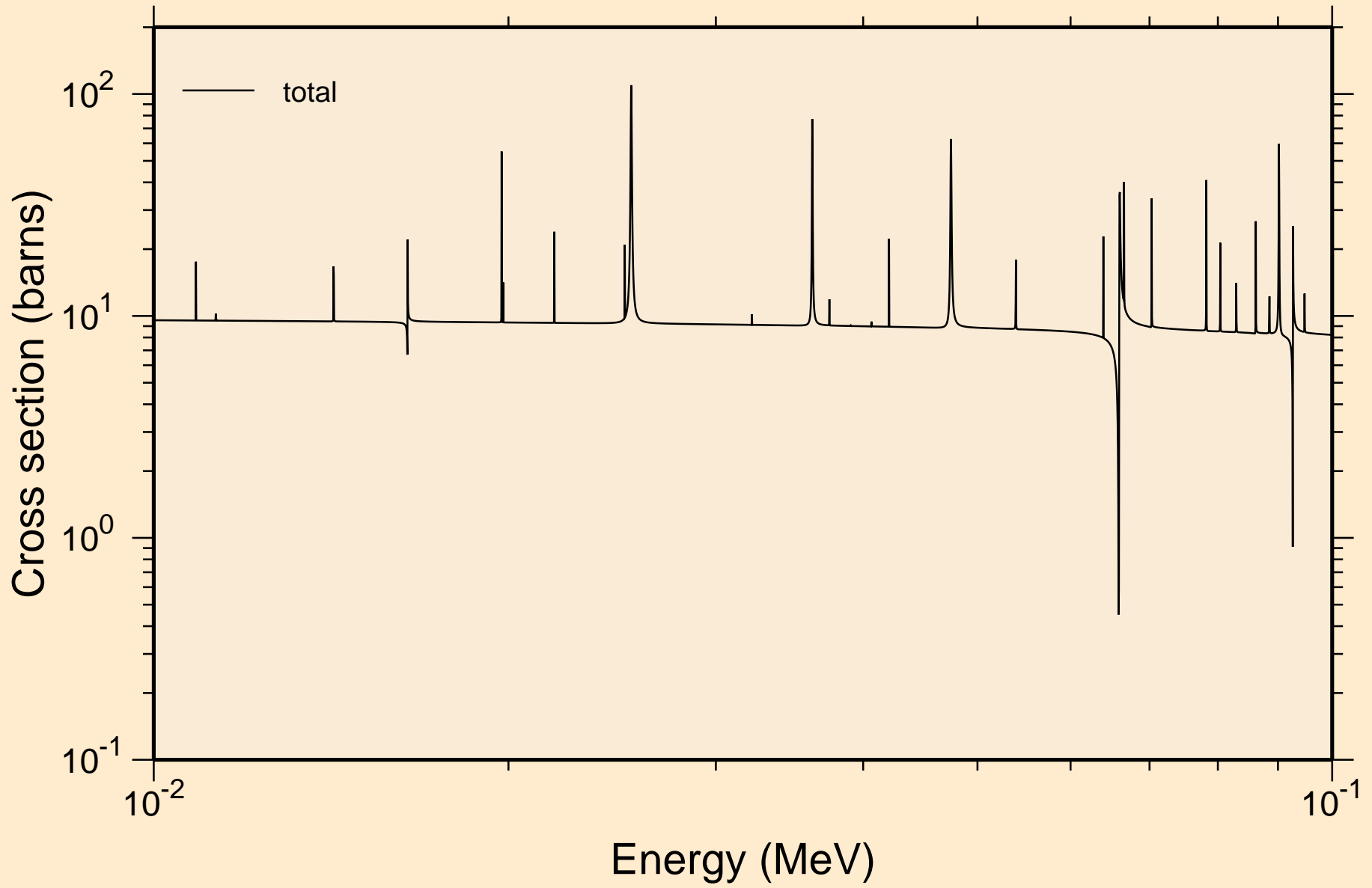

82-PB-206 FOR FENDL-3B2 FROM ENDF/B-VII WITH NJOY99.304
resonance total cross section

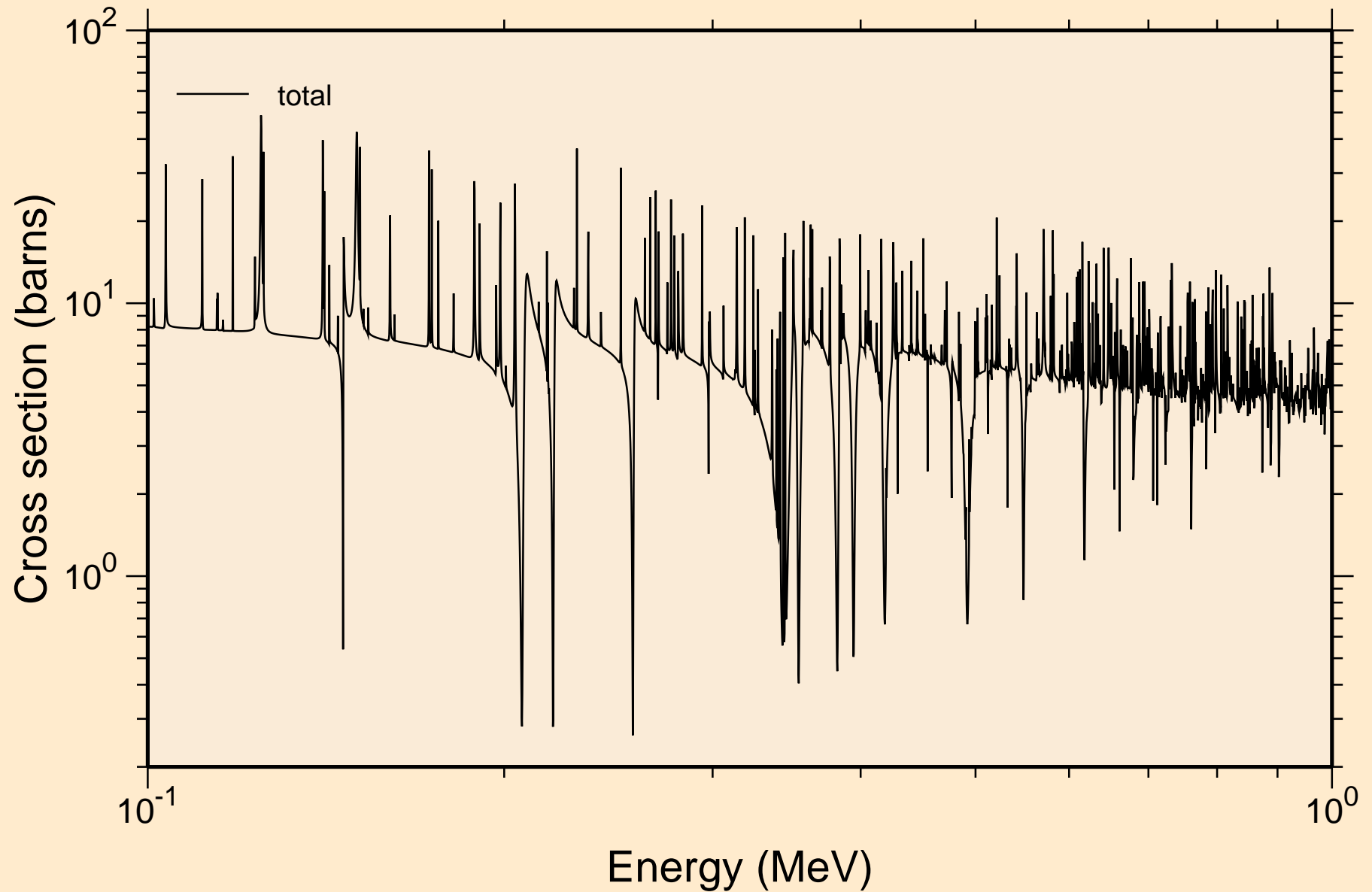

82-PB-206 FOR FENDL-3B2 FROM ENDF/B-VII WITH NJOY99.304
resonance total cross section

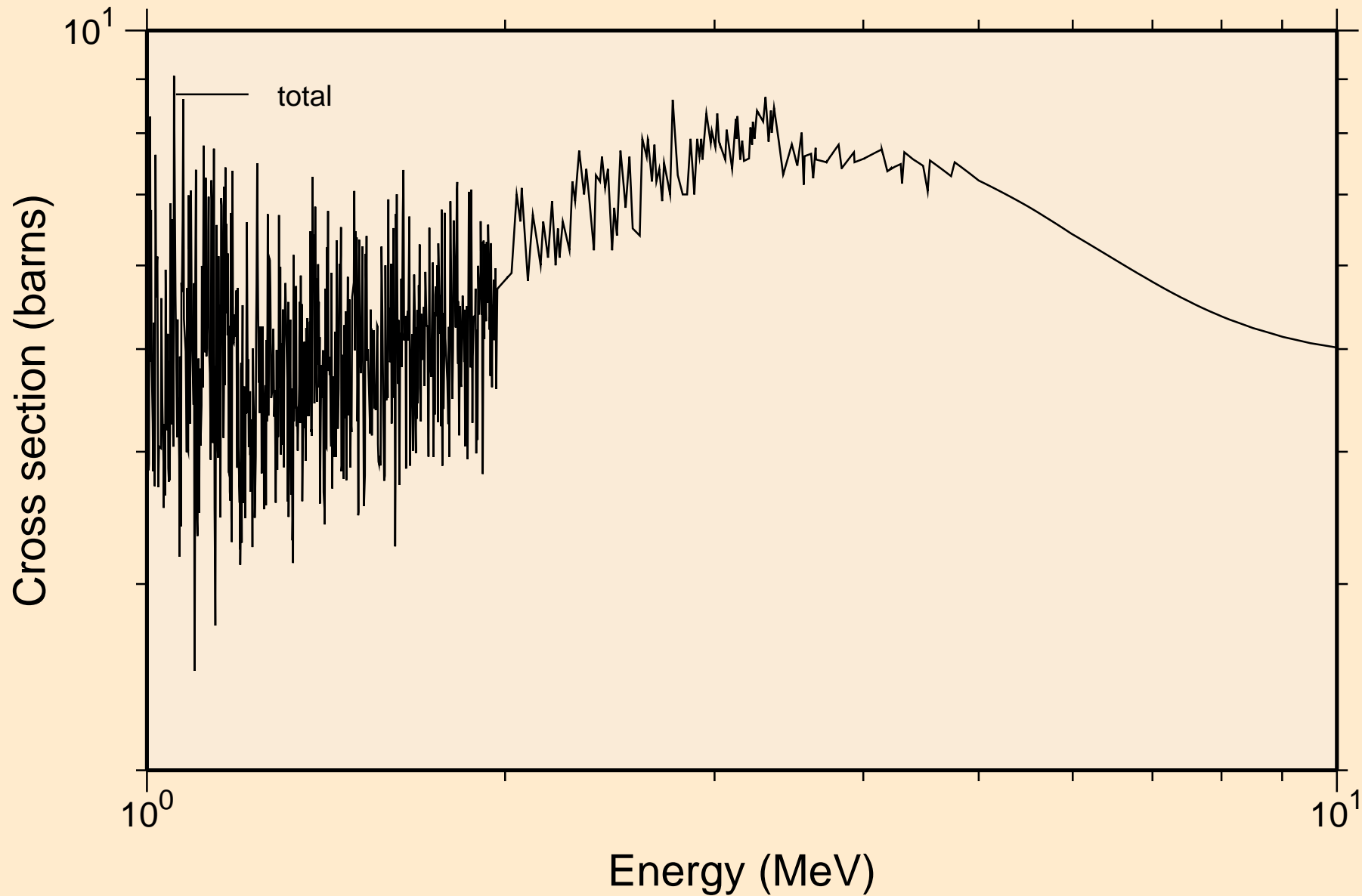

82-PB-206 FOR FENDL-3B2 FROM ENDF/B-VII WITH NJOY99.304
resonance absorption cross sections

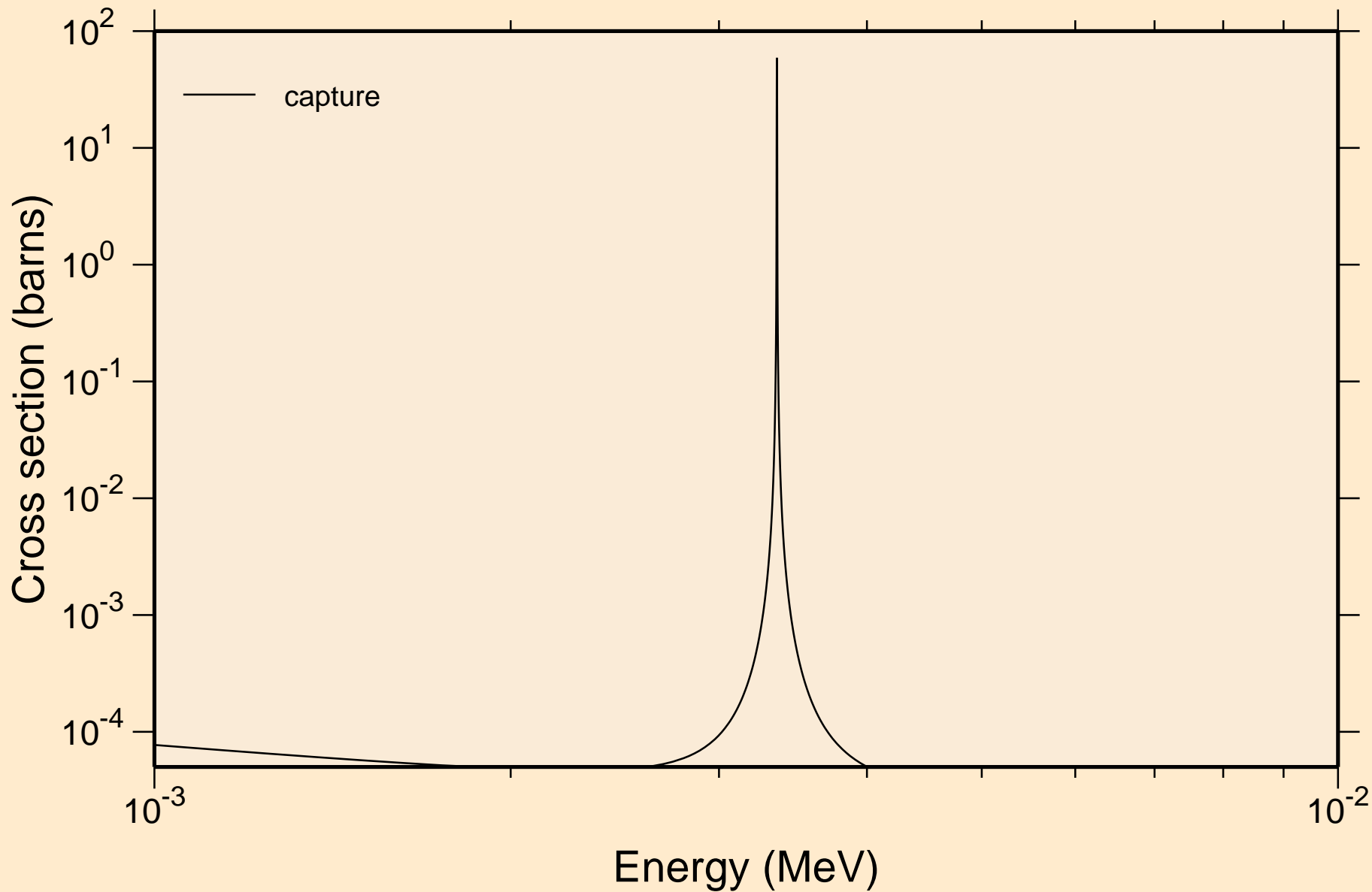

82-PB-206 FOR FENDL-3B2 FROM ENDF/B-VII WITH NJOY99.304
resonance absorption cross sections

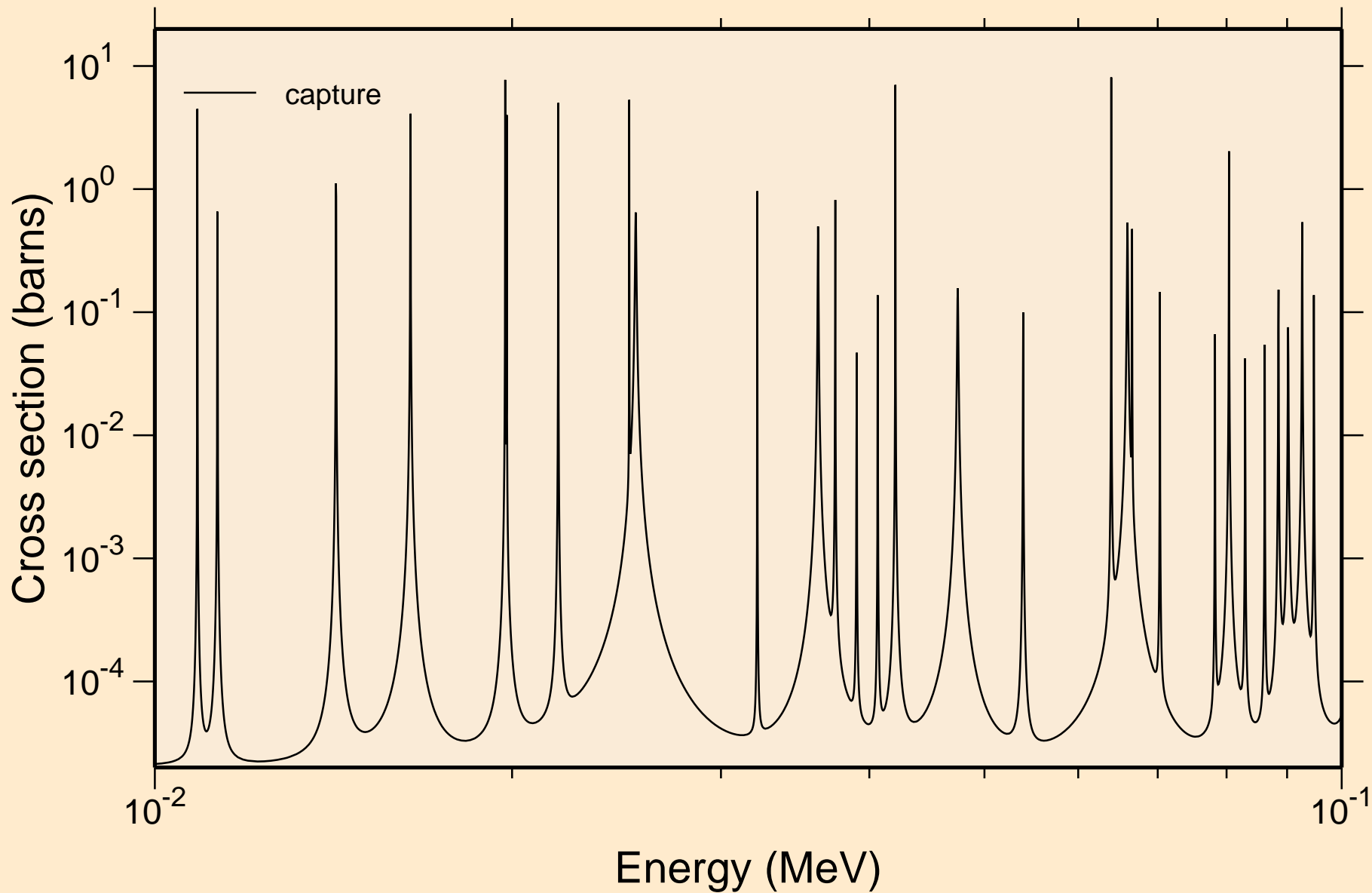

82-PB-206 FOR FENDL-3B2 FROM ENDF/B-VII WITH NJOY99.304
resonance absorption cross sections

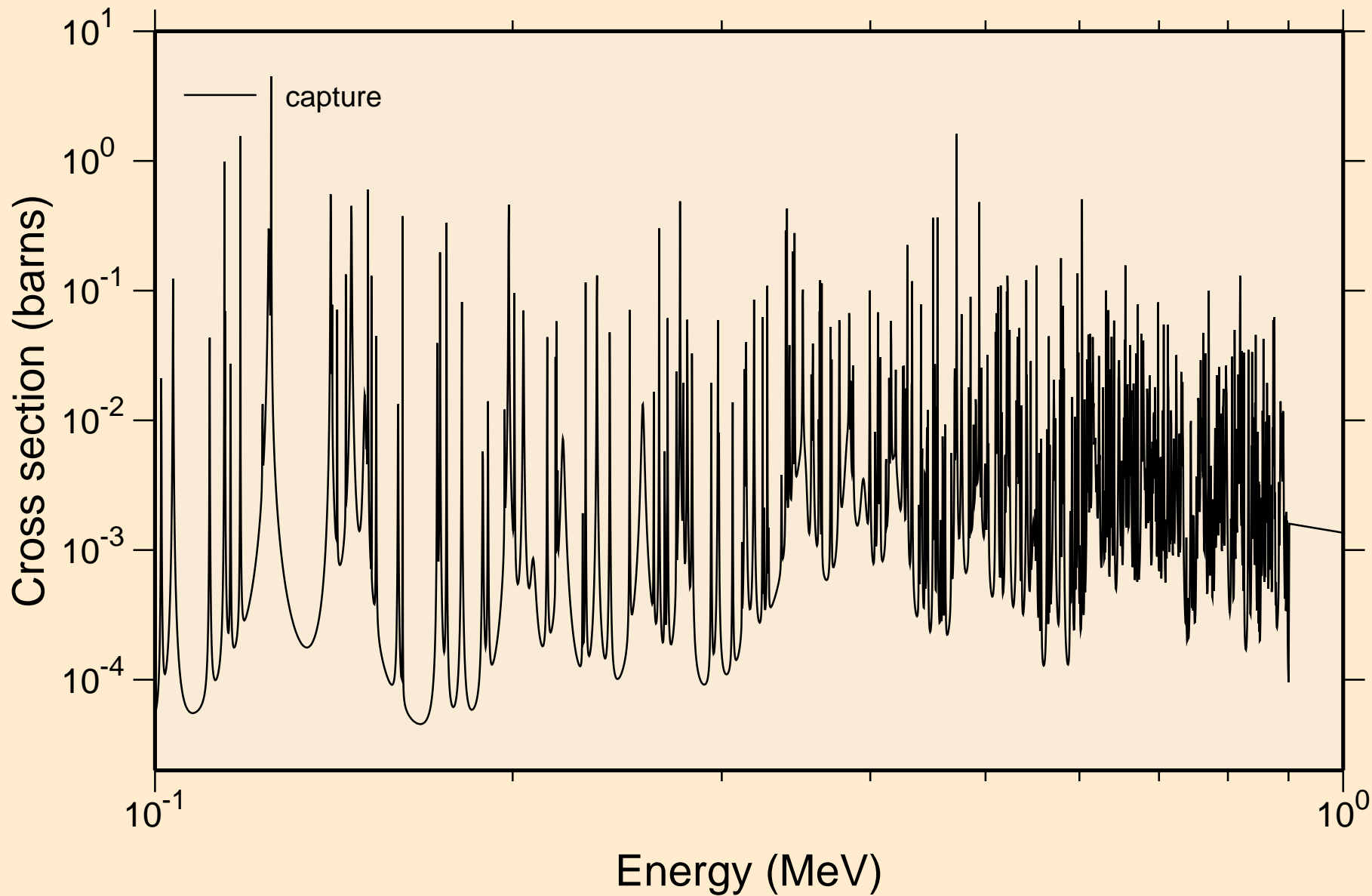

82-PB-206 FOR FENDL-3B2 FROM ENDF/B-VII WITH NJOY99.304
resonance absorption cross sections

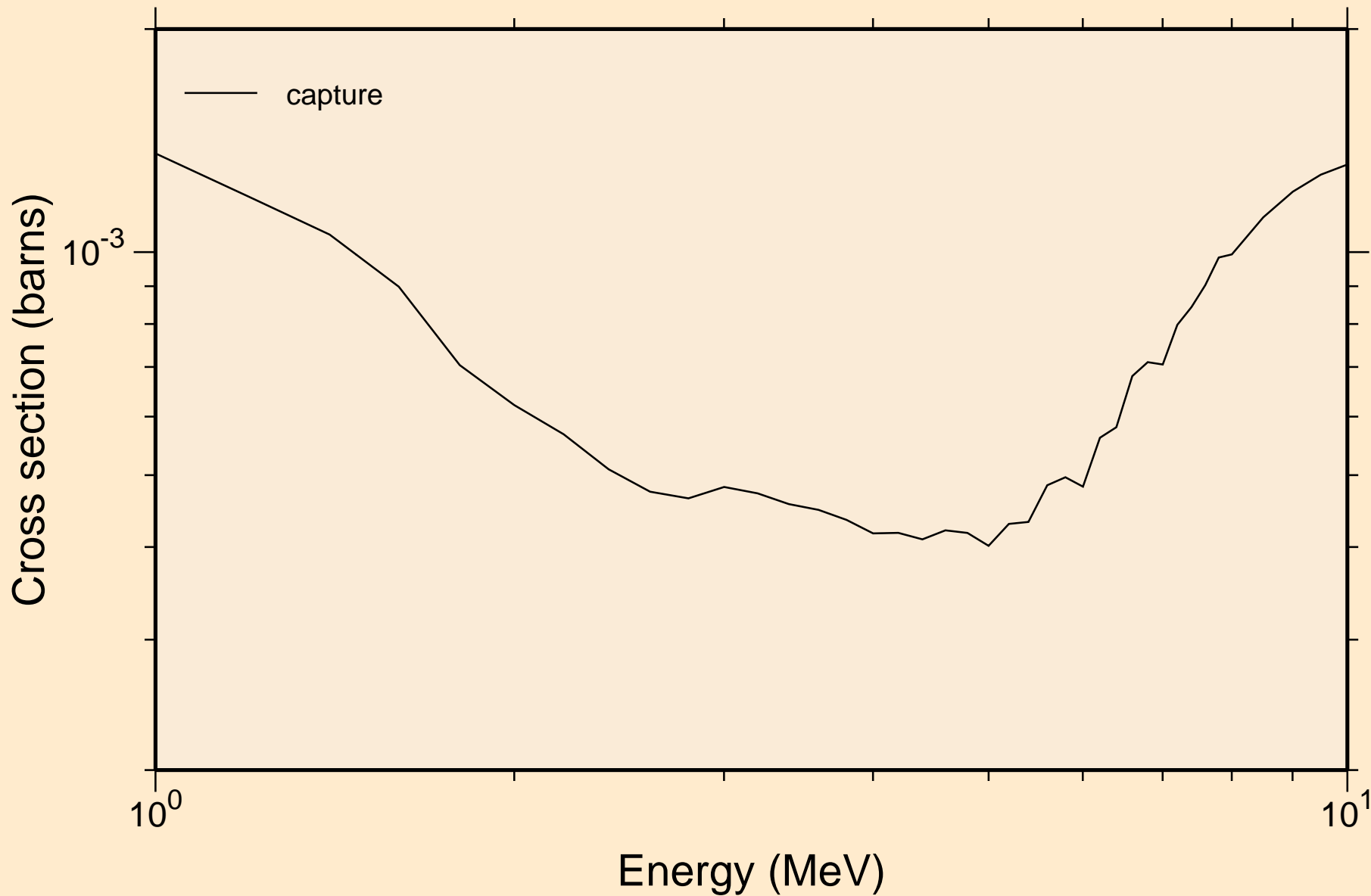

82-PB-206 FOR FENDL-3B2 FROM ENDF/B-VII WITH NJOY99.304
Heating

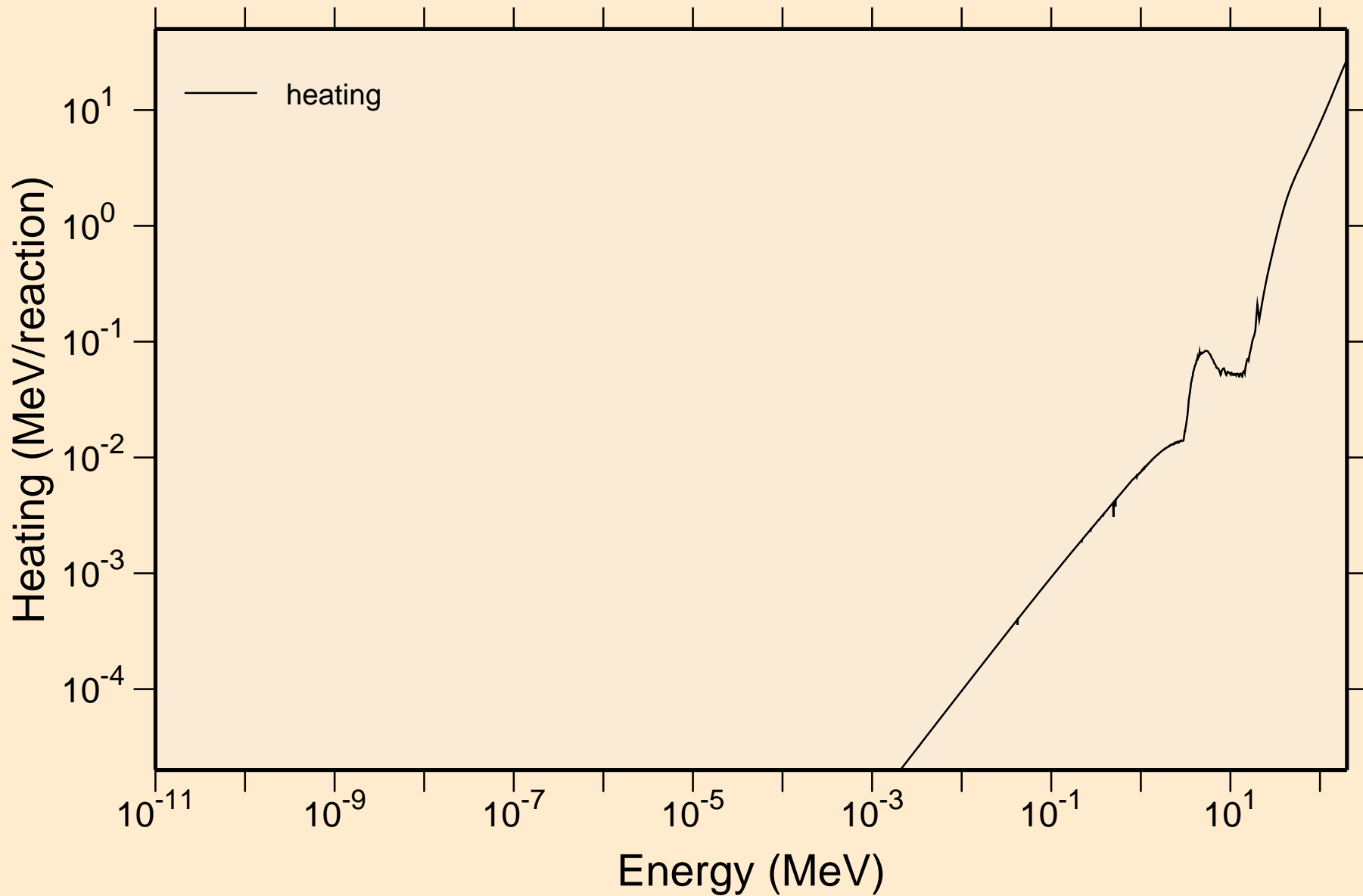

82-PB-206 FOR FENDL-3B2 FROM ENDF/B-VII WITH NJOY99.304
Damage

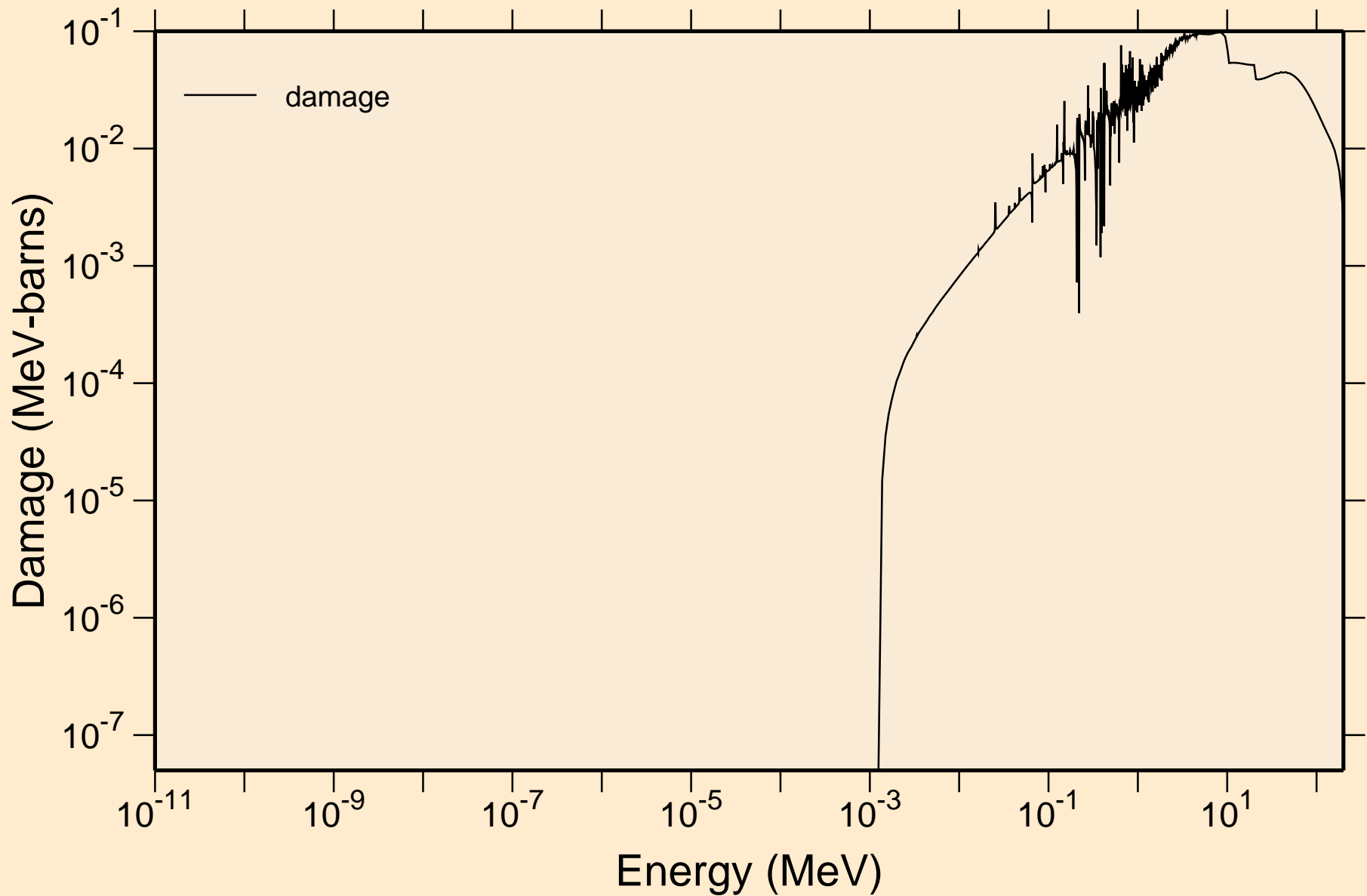

82-PB-206 FOR FENDL-3B2 FROM ENDF/B-VII WITH NJOY99.304
Non-threshold reactions

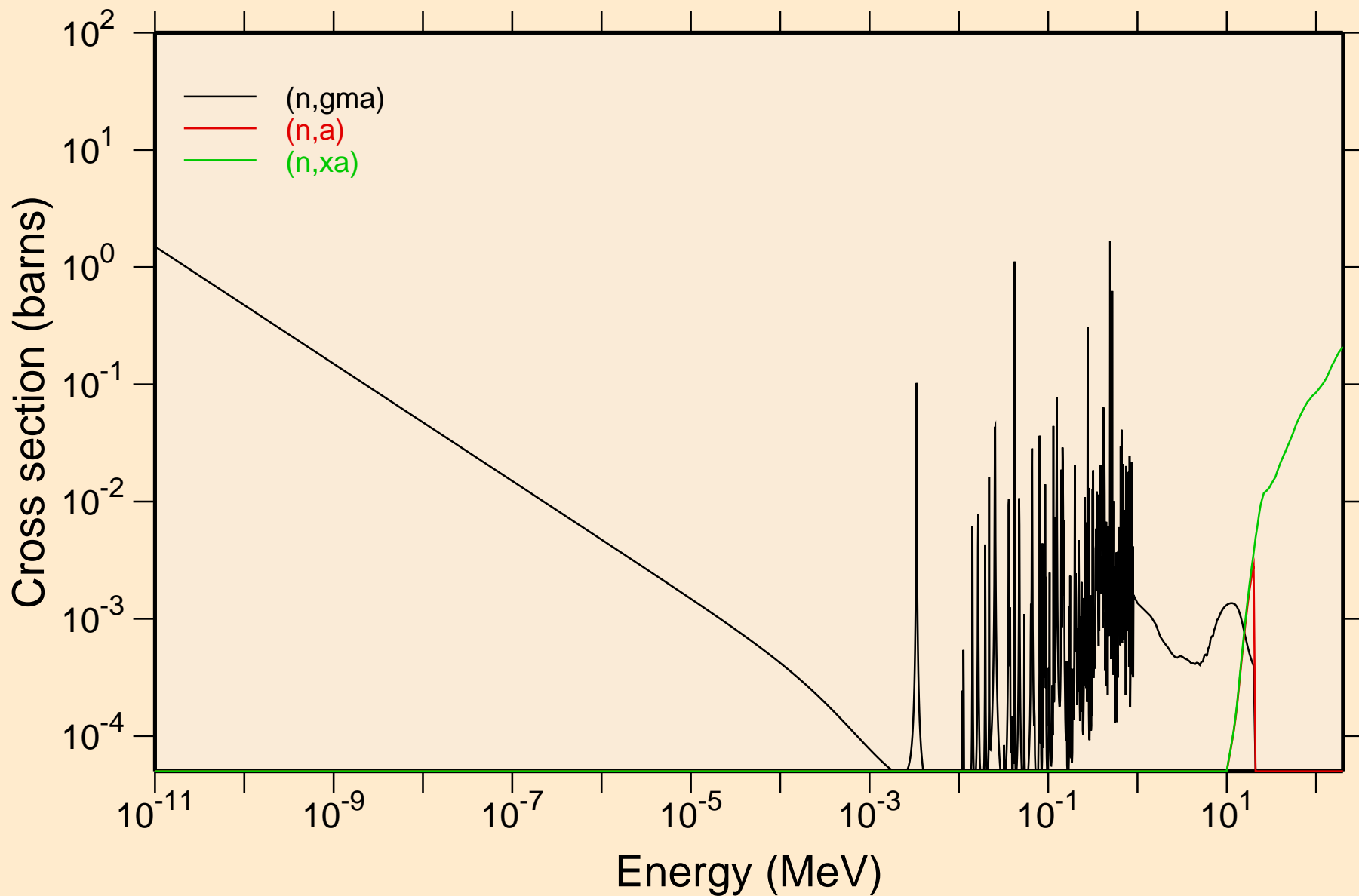

82-PB-206 FOR FENDL-3B2 FROM ENDF/B-VII WITH NJOY99.304
Principal cross sections

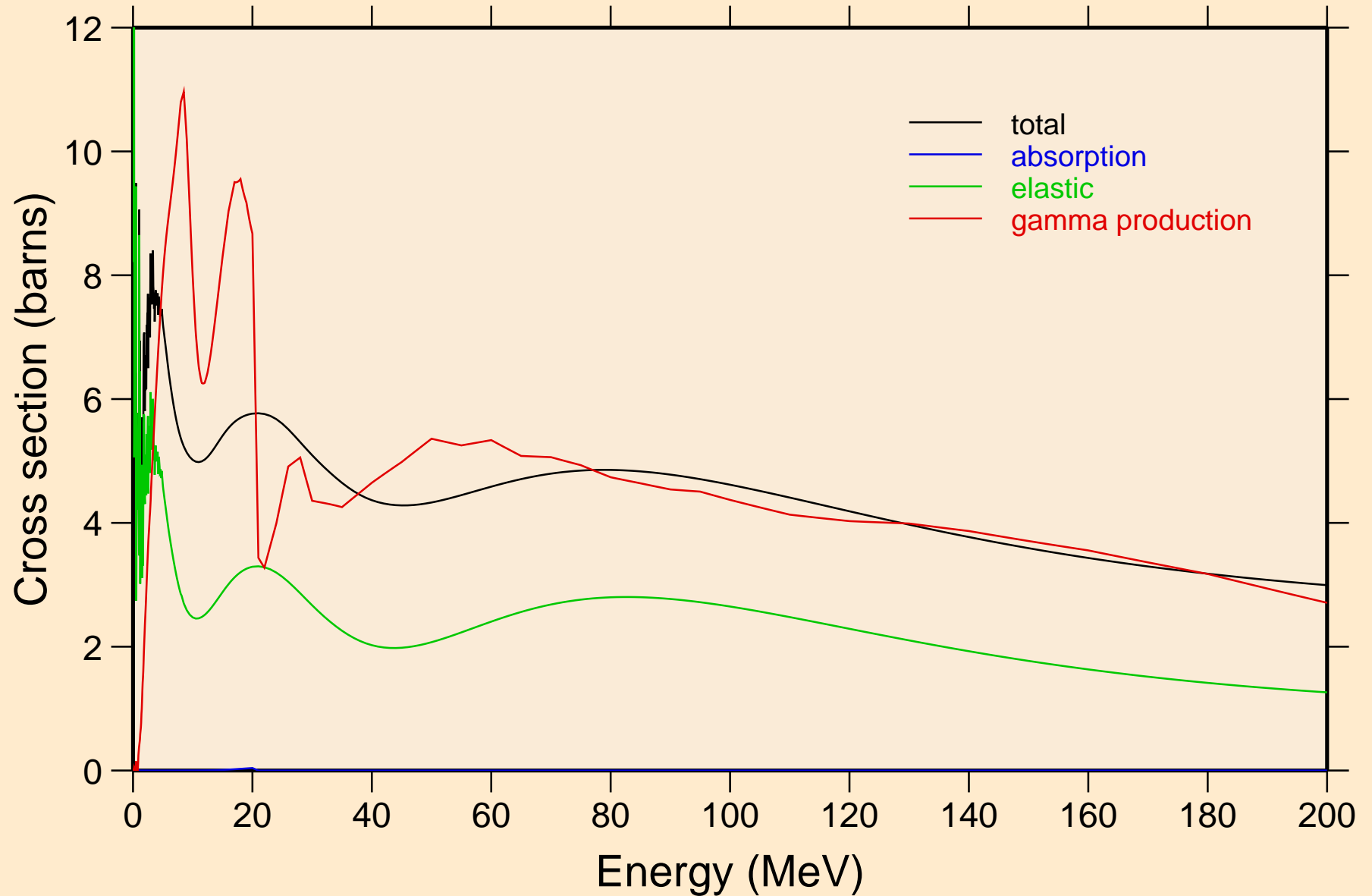

82-PB-206 FOR FENDL-3B2 FROM ENDF/B-VII WITH NJOY99.304
Heating

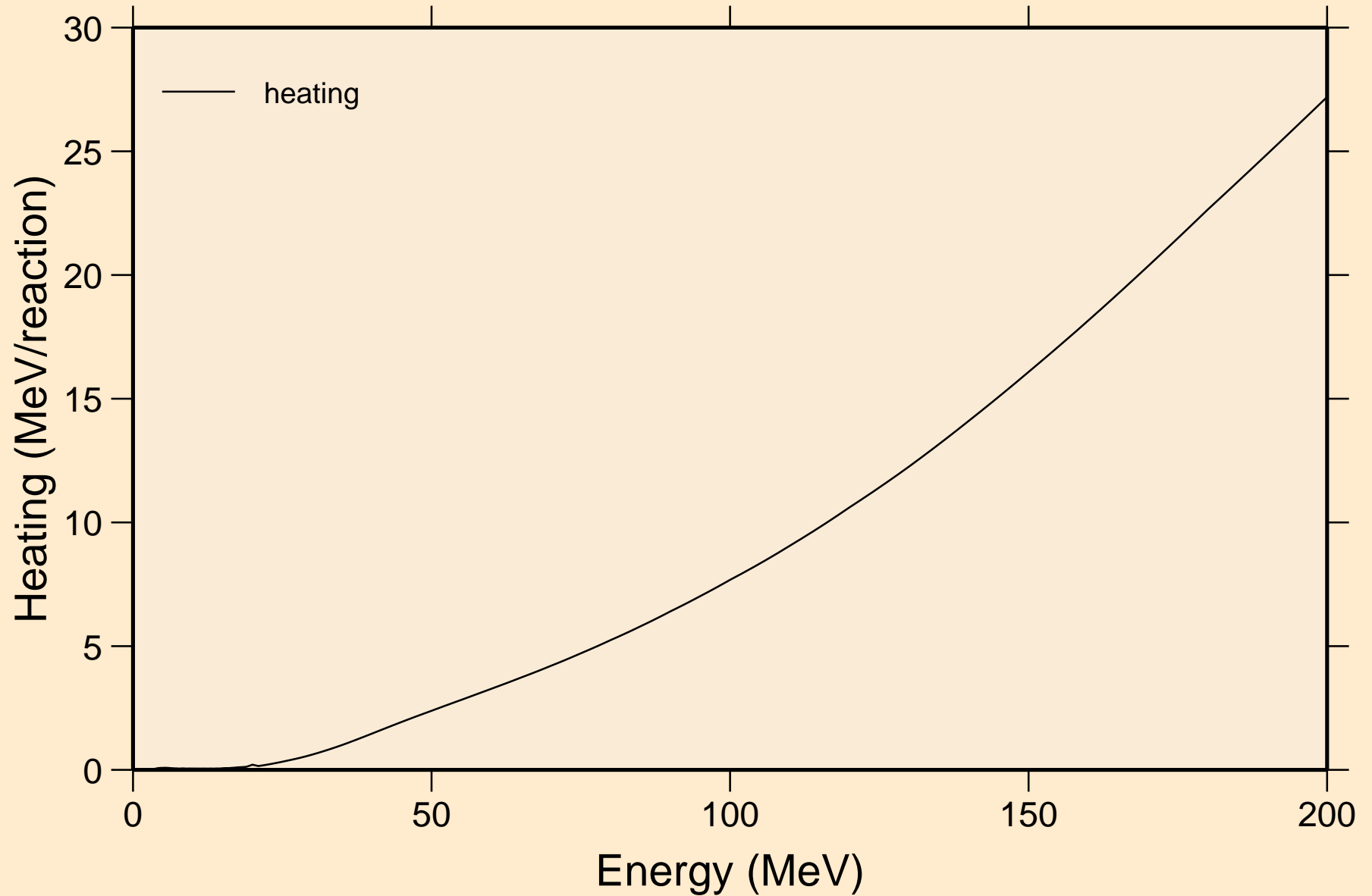

82-PB-206 FOR FENDL-3B2 FROM ENDF/B-VII WITH NJOY99.304
Damage

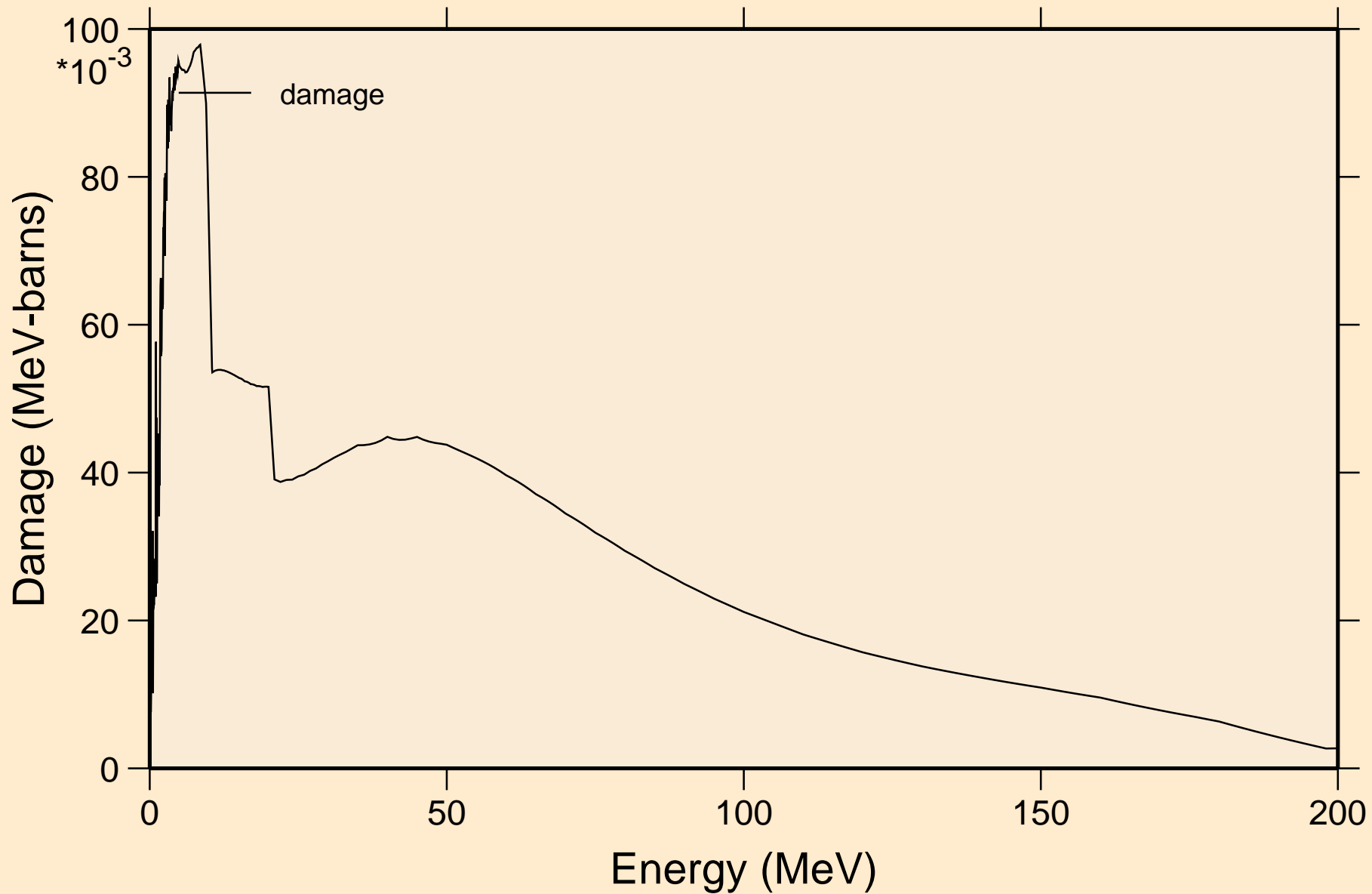

82-PB-206 FOR FENDL-3B2 FROM ENDF/B-VII WITH NJOY99.304
Non-threshold reactions

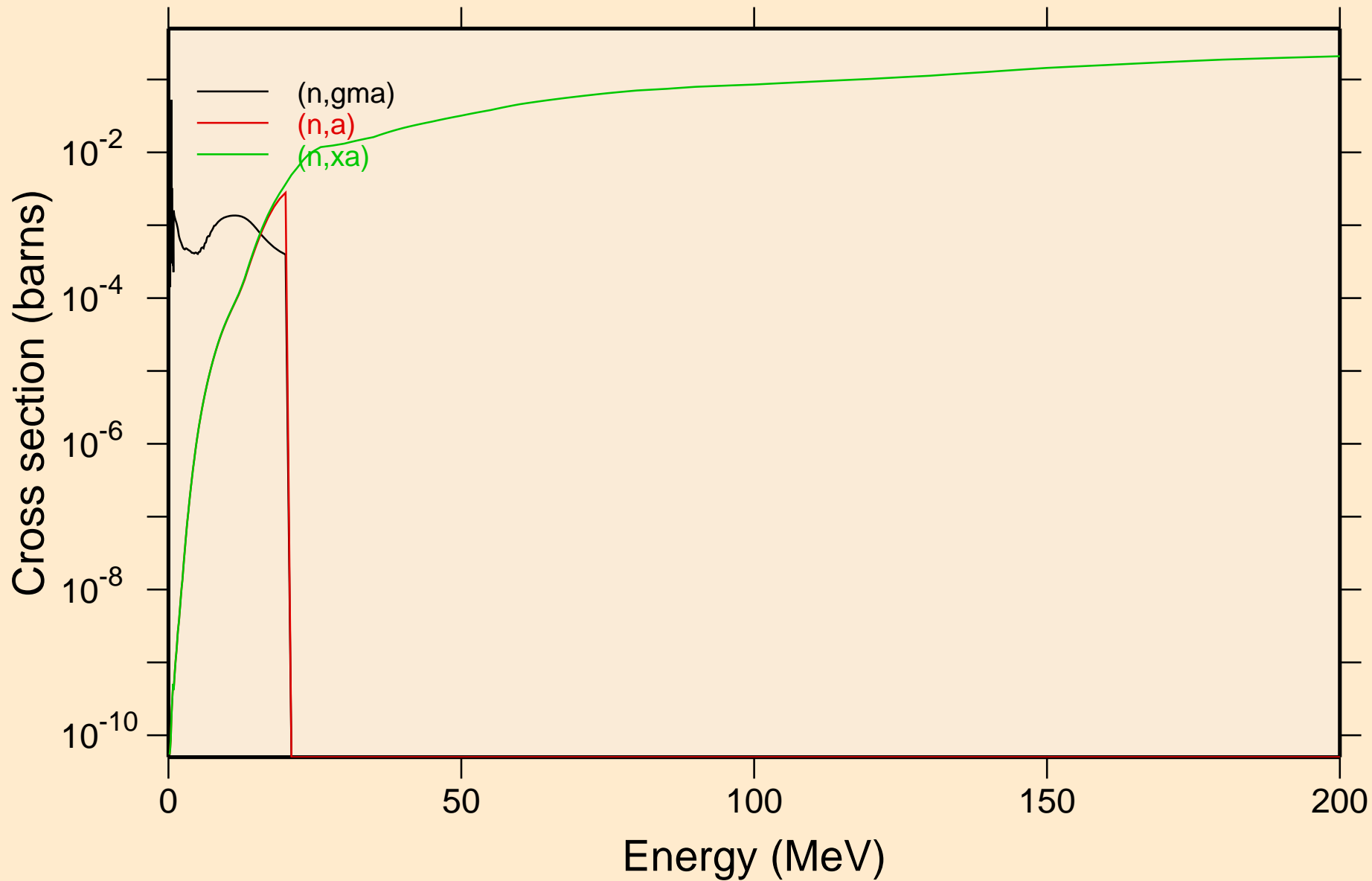

82-PB-206 FOR FENDL-3B2 FROM ENDF/B-VII WITH NJOY99.304
Inelastic levels

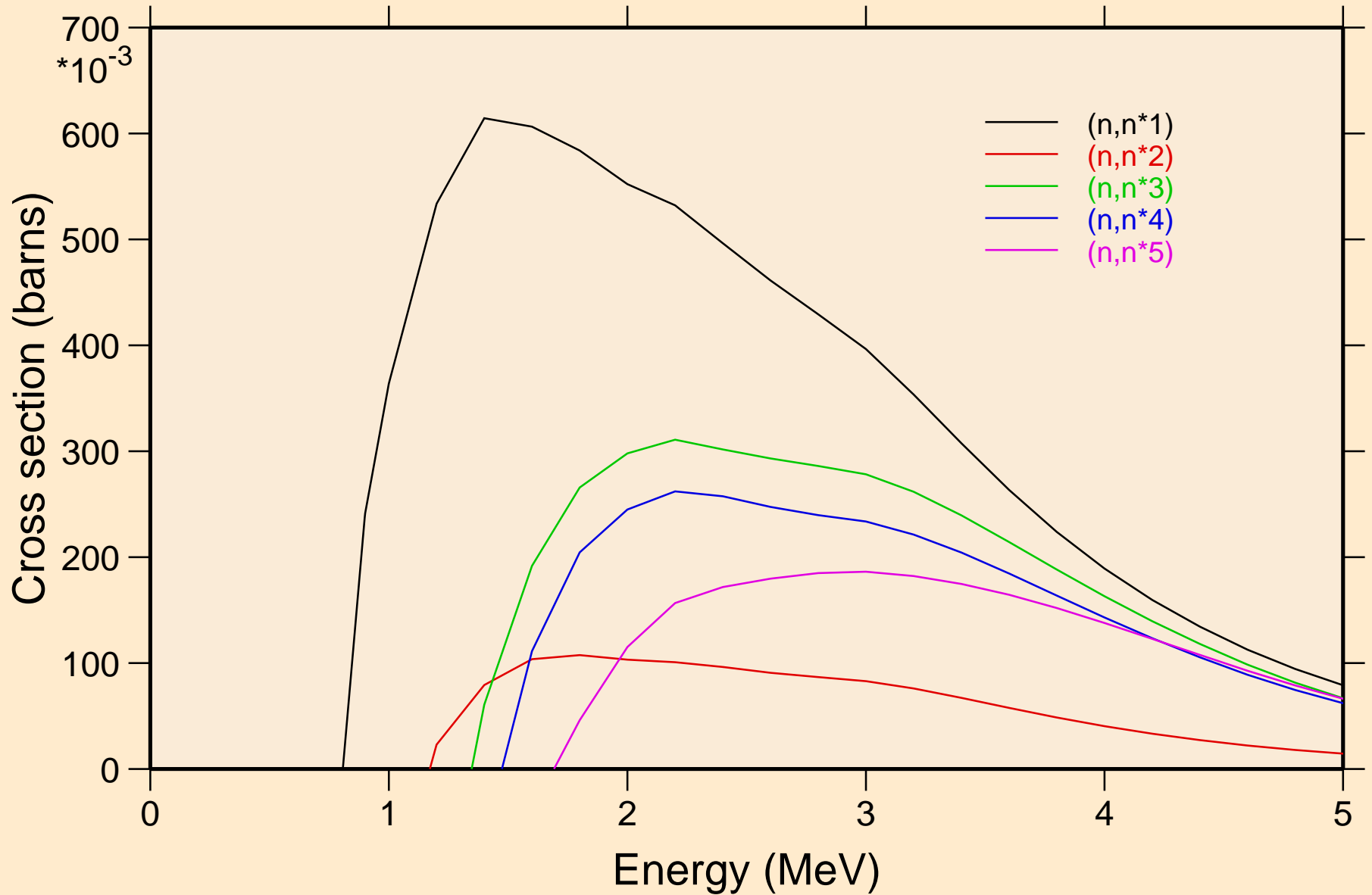

82-PB-206 FOR FENDL-3B2 FROM ENDF/B-VII WITH NJOY99.304
Inelastic levels

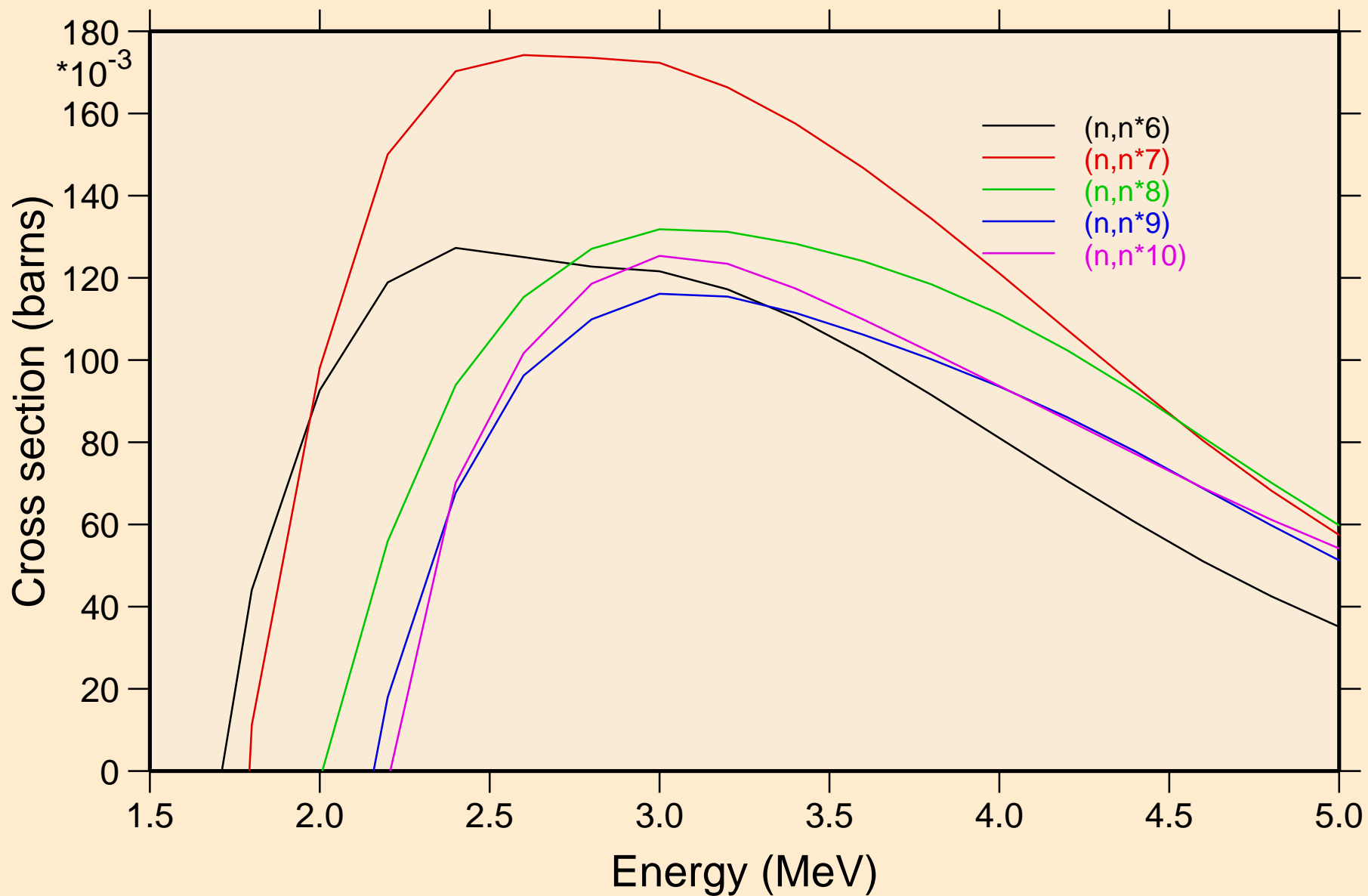

82-PB-206 FOR FENDL-3B2 FROM ENDF/B-VII WITH NJOY99.304
Inelastic levels

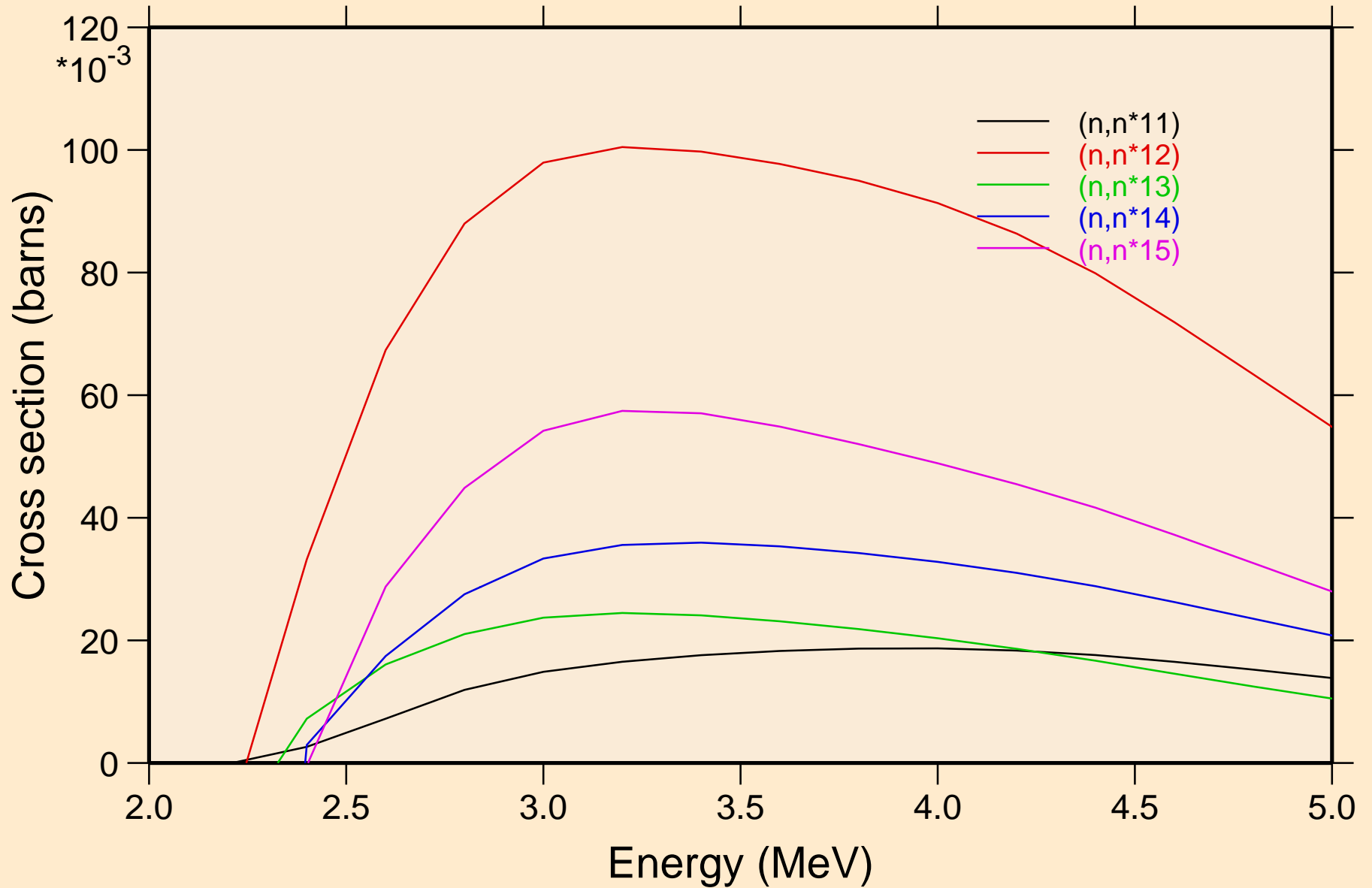

82-PB-206 FOR FENDL-3B2 FROM ENDF/B-VII WITH NJOY99.304
Inelastic levels

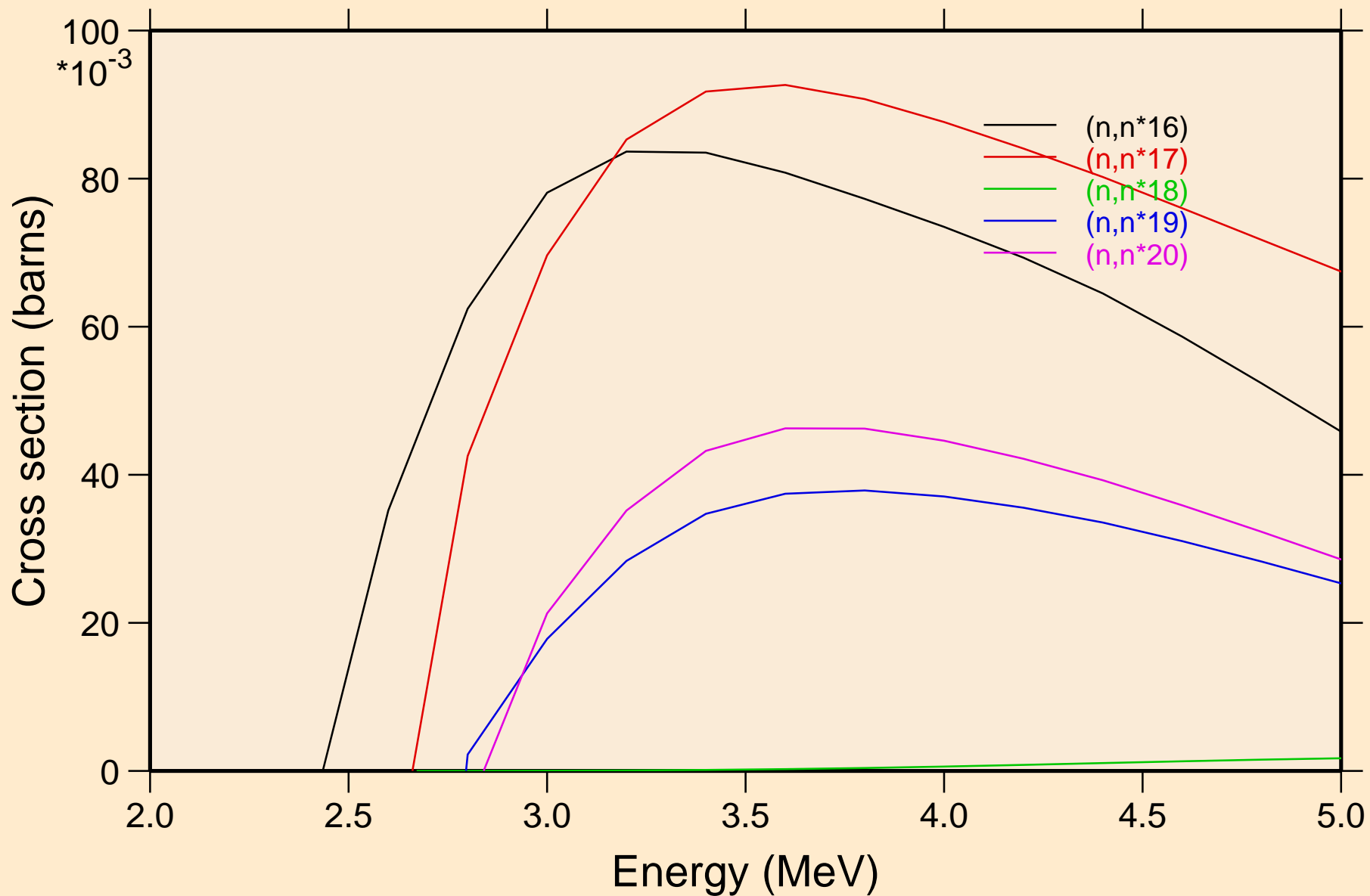

82-PB-206 FOR FENDL-3B2 FROM ENDF/B-VII WITH NJOY99.304
Inelastic levels

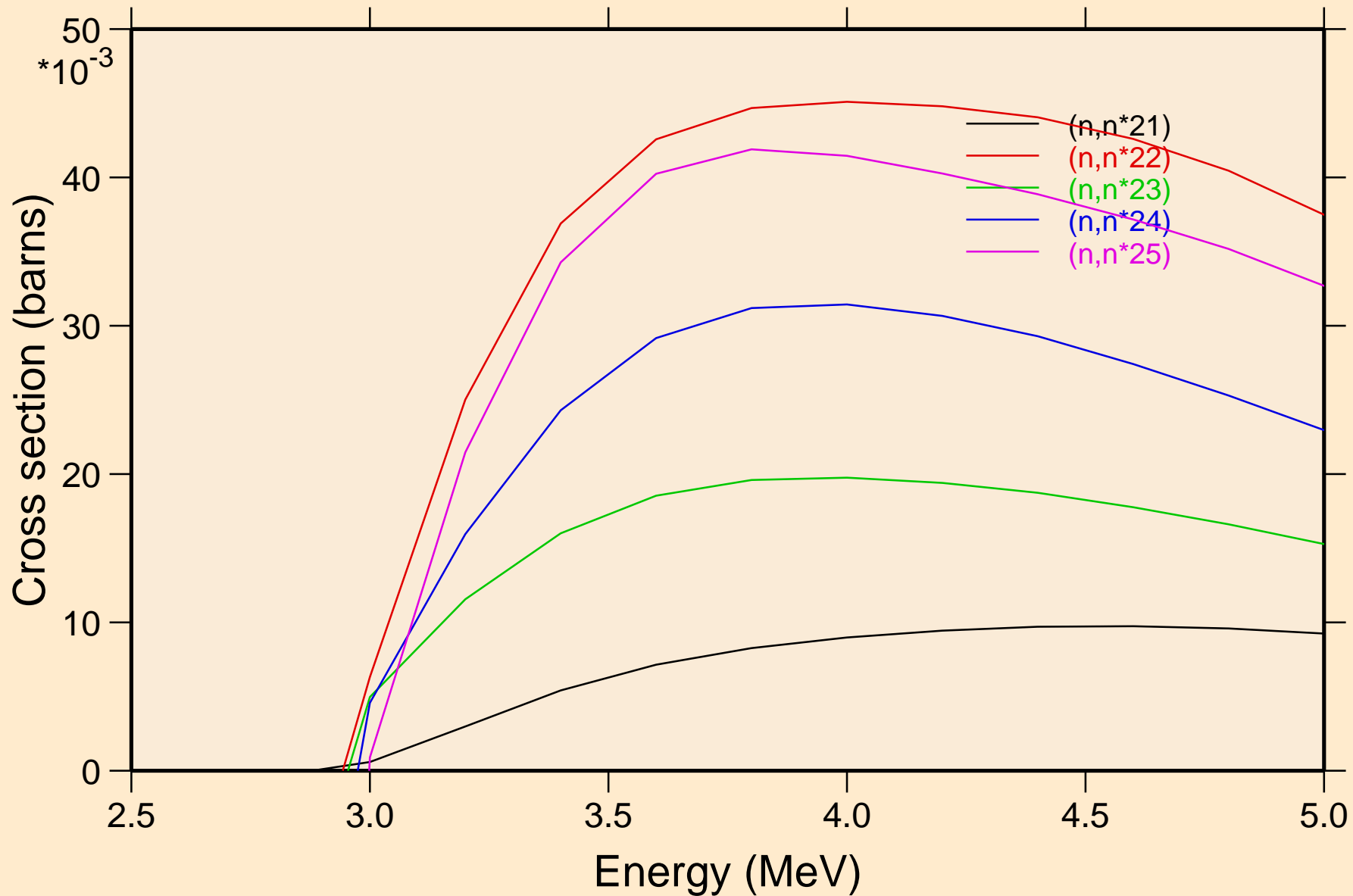

82-PB-206 FOR FENDL-3B2 FROM ENDF/B-VII WITH NJOY99.304
Threshold reactions

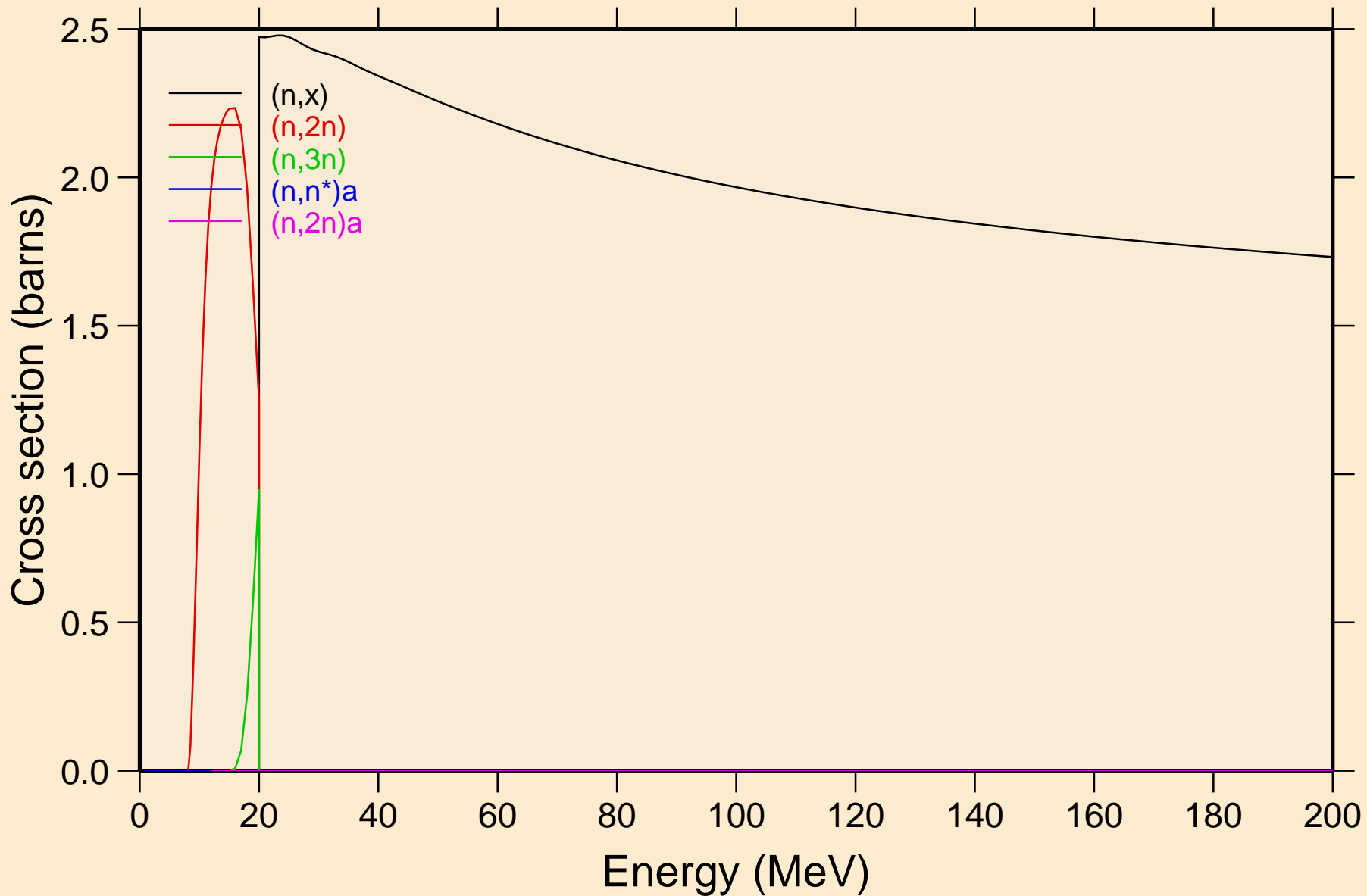

82-PB-206 FOR FENDL-3B2 FROM ENDF/B-VII WITH NJOY99.304
Threshold reactions

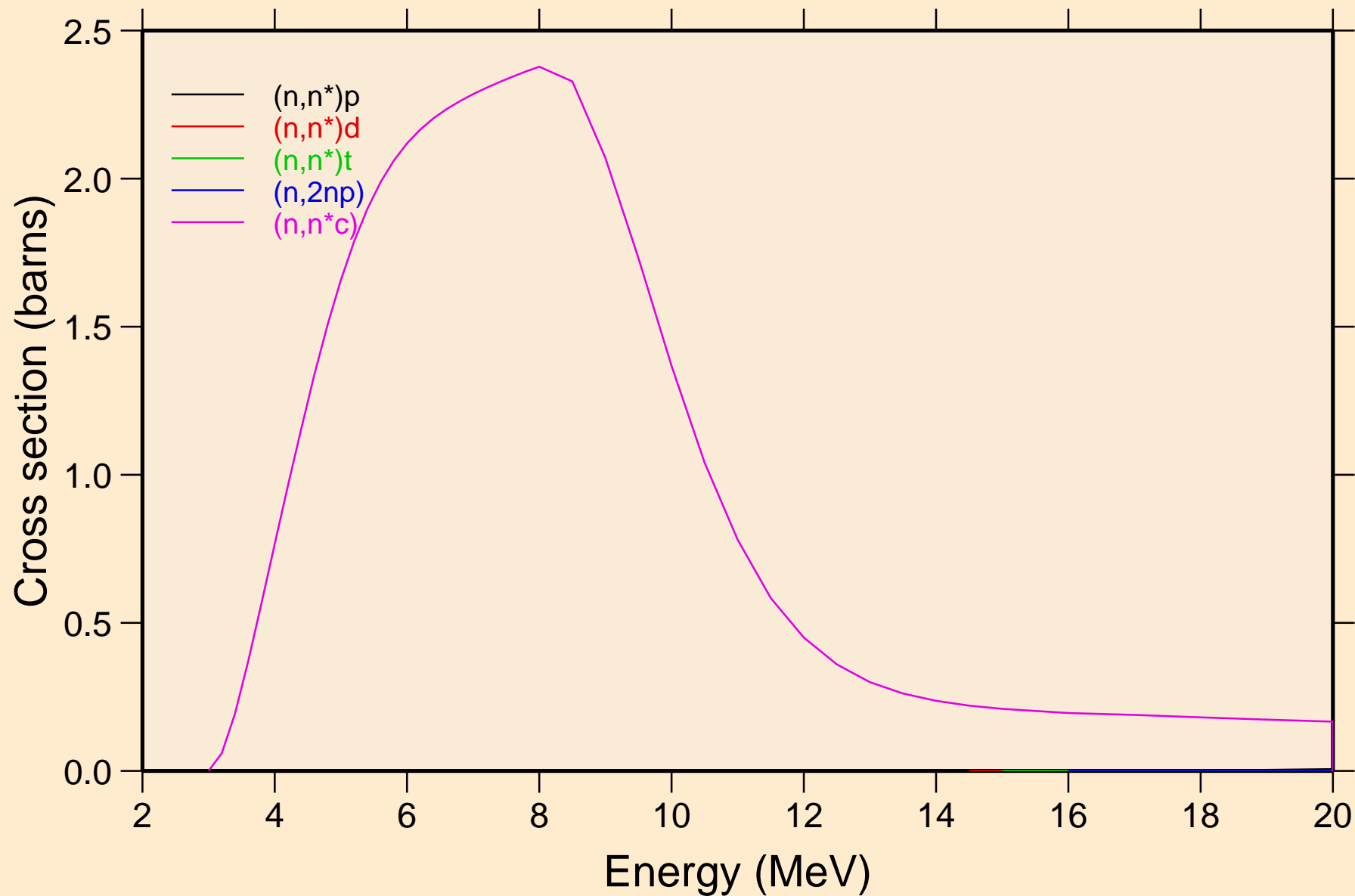

82-PB-206 FOR FENDL-3B2 FROM ENDF/B-VII WITH NJOY99.304
Threshold reactions

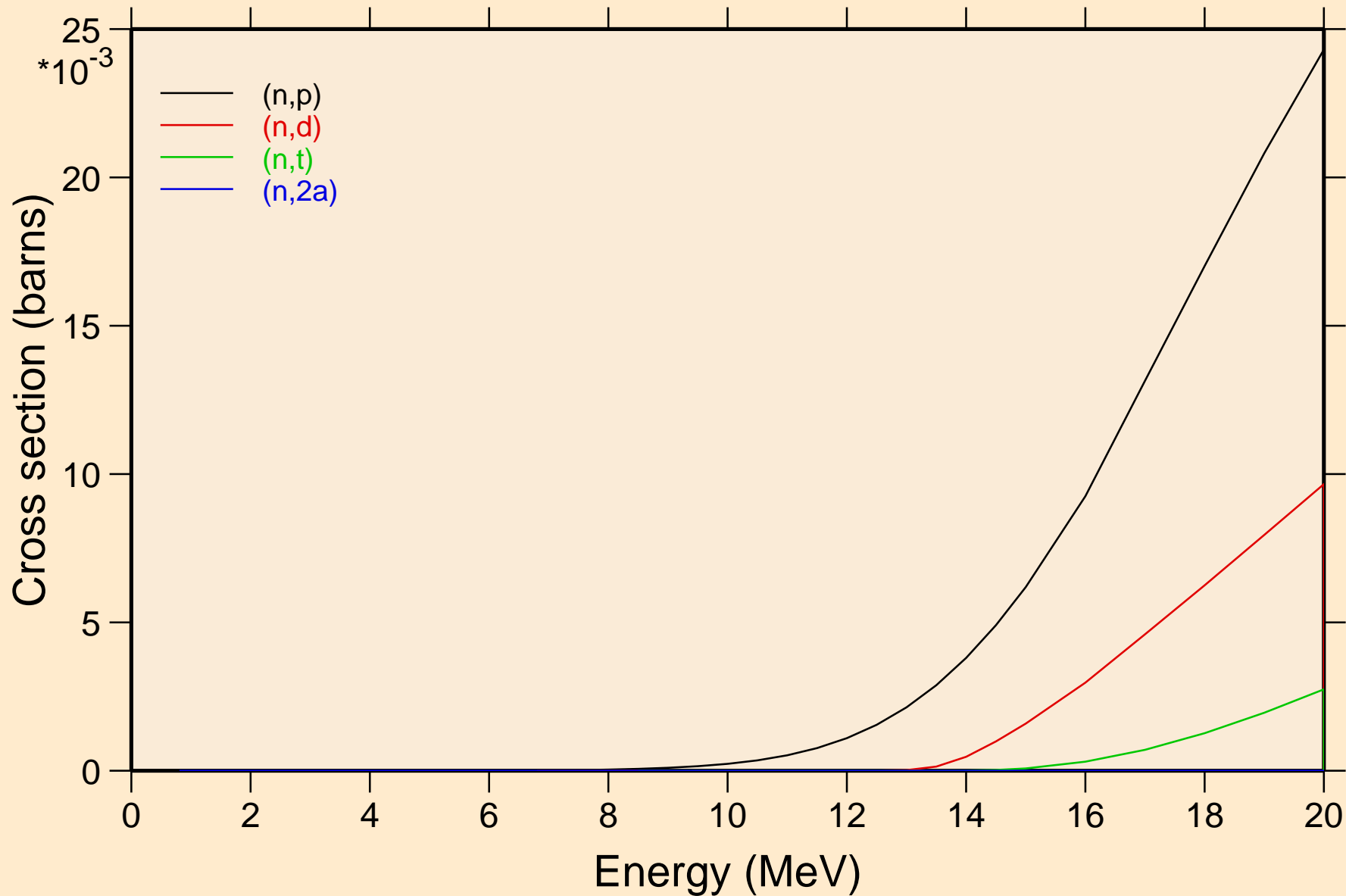

82-PB-206 FOR FENDL-3B2 FROM ENDF/B-VII WITH NJOY99.304
Threshold reactions

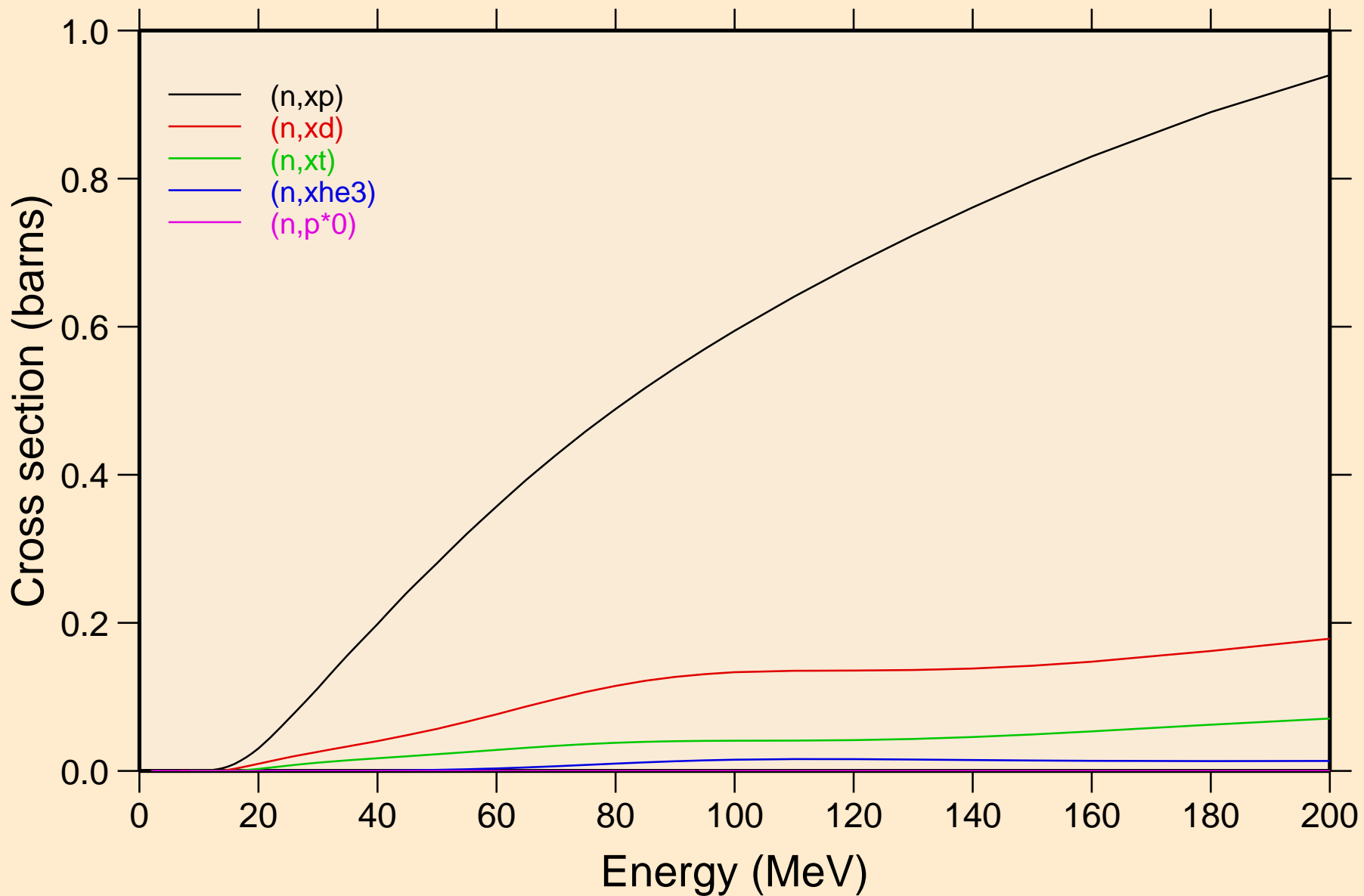

82-PB-206 FOR FENDL-3B2 FROM ENDF/B-VII WITH NJOY99.304
Threshold reactions

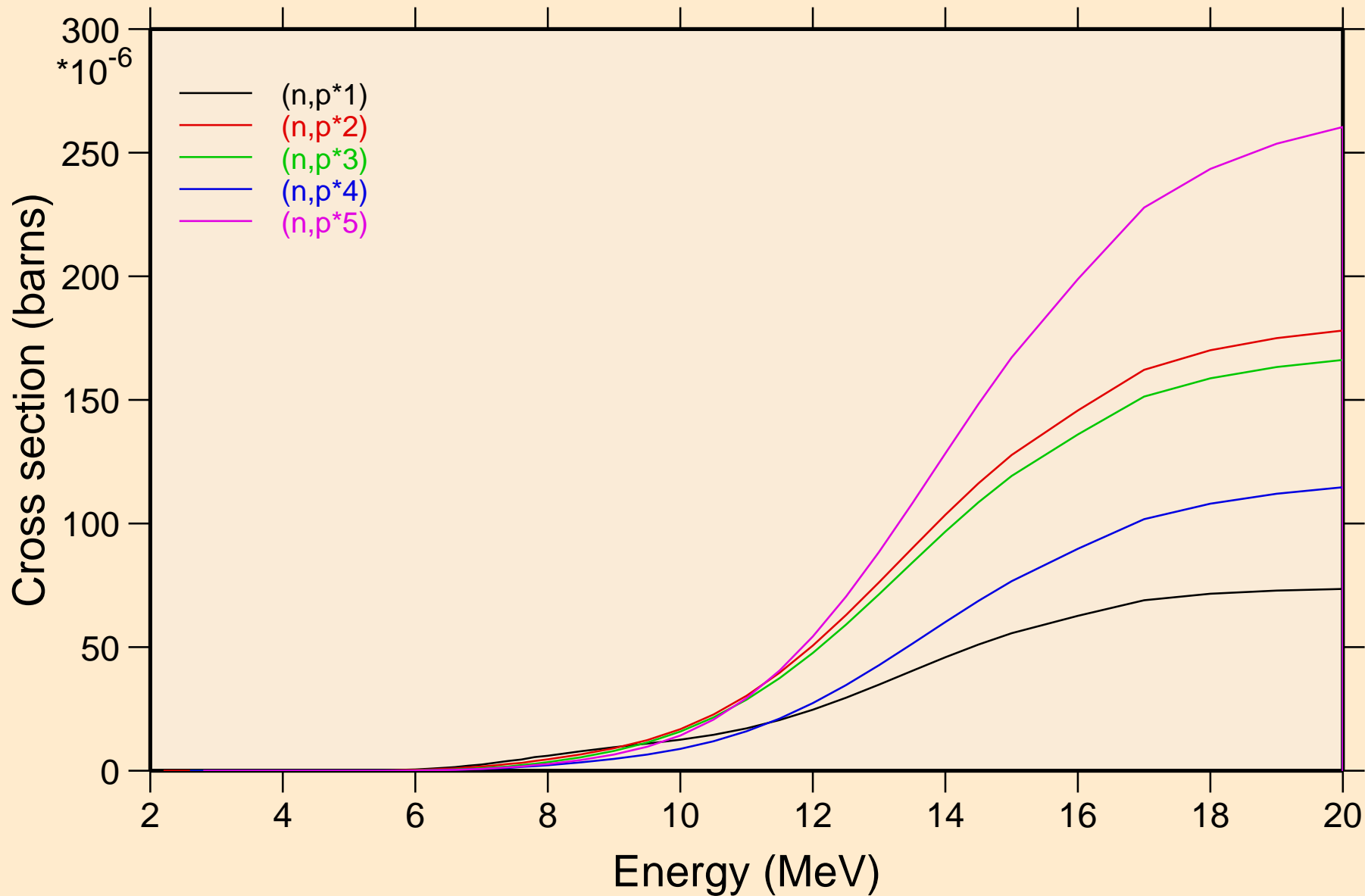

82-PB-206 FOR FENDL-3B2 FROM ENDF/B-VII WITH NJOY99.304
Threshold reactions

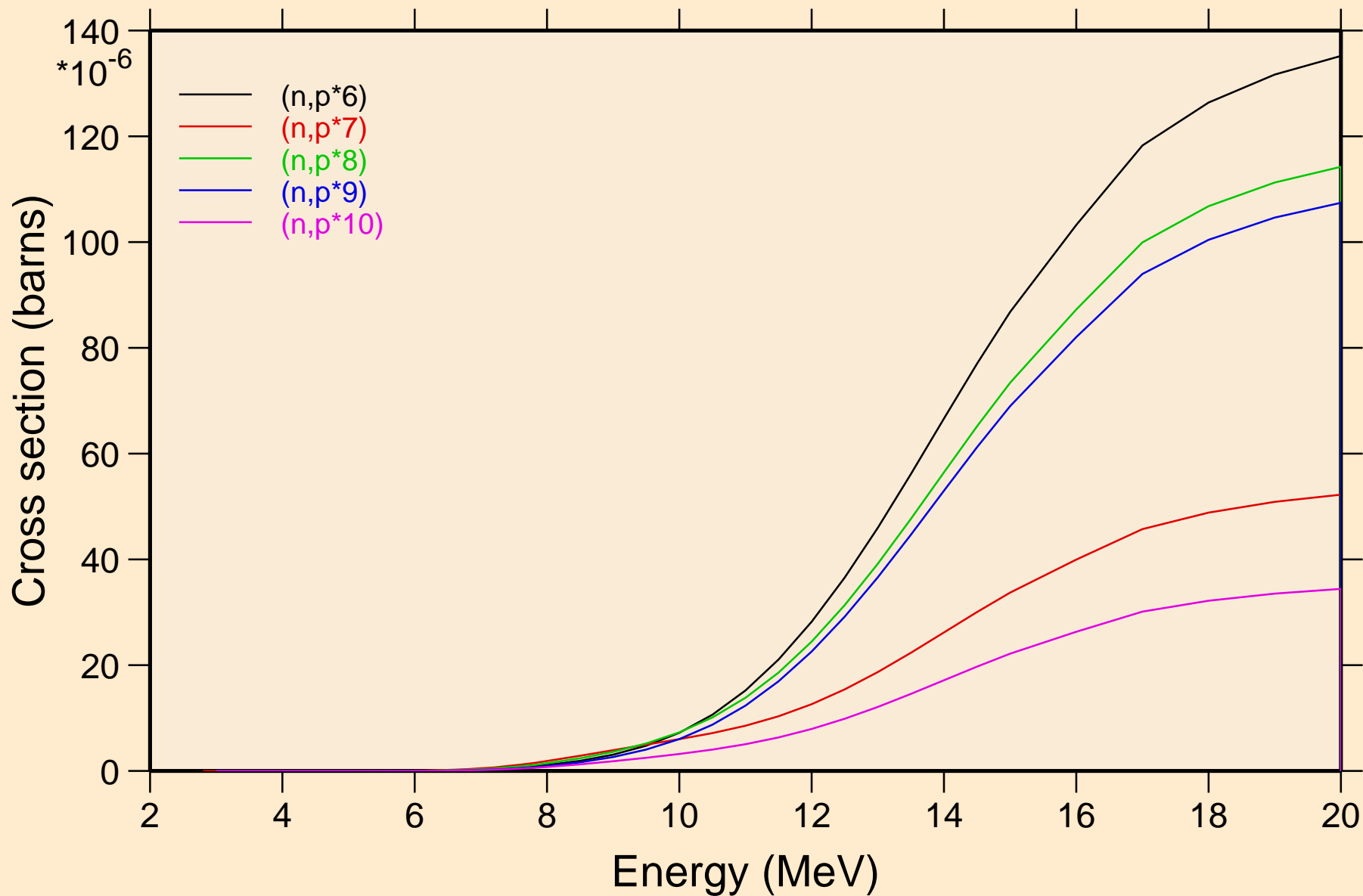

82-PB-206 FOR FENDL-3B2 FROM ENDF/B-VII WITH NJOY99.304
Threshold reactions

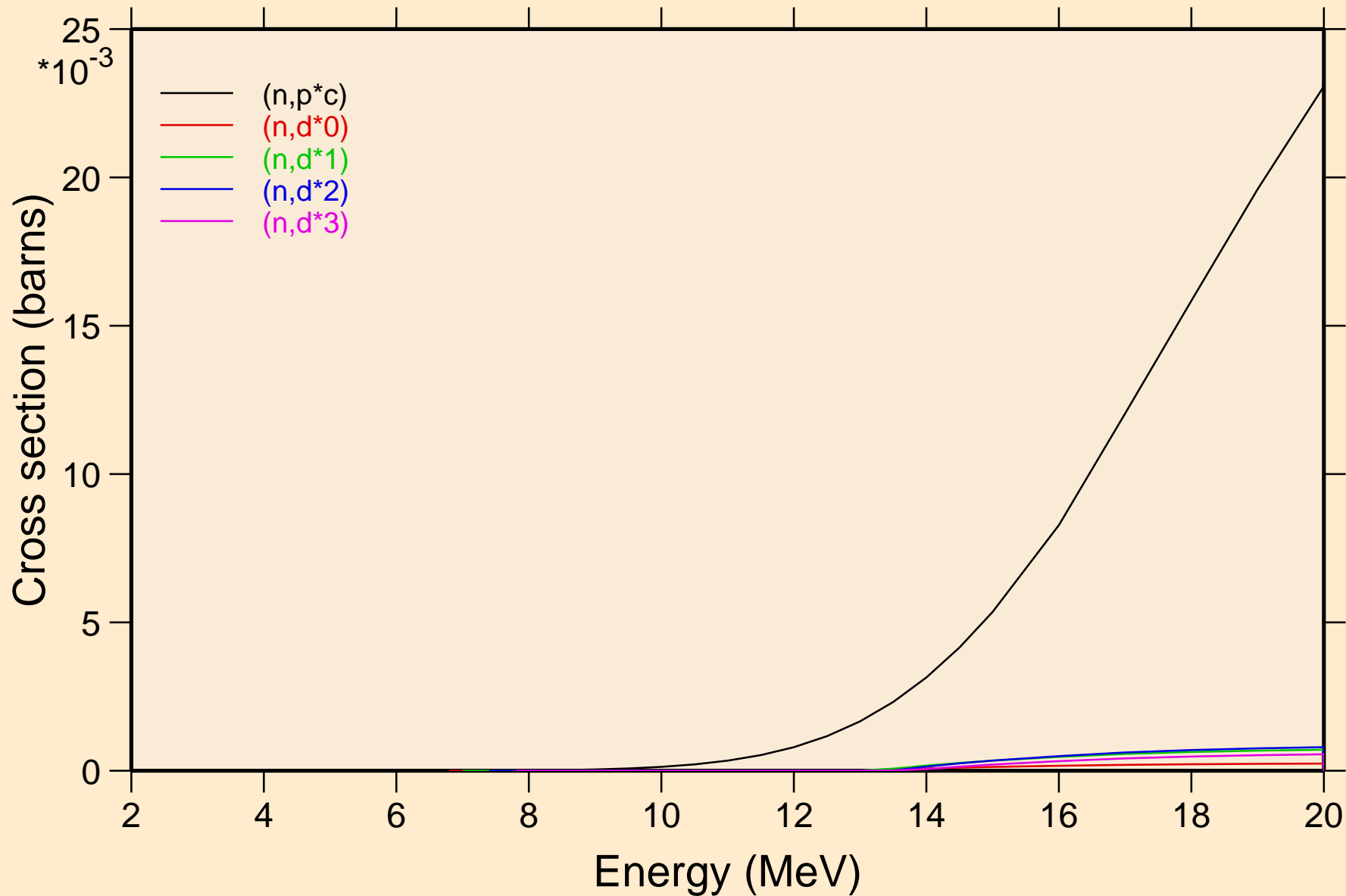

82-PB-206 FOR FENDL-3B2 FROM ENDF/B-VII WITH NJOY99.304
Threshold reactions

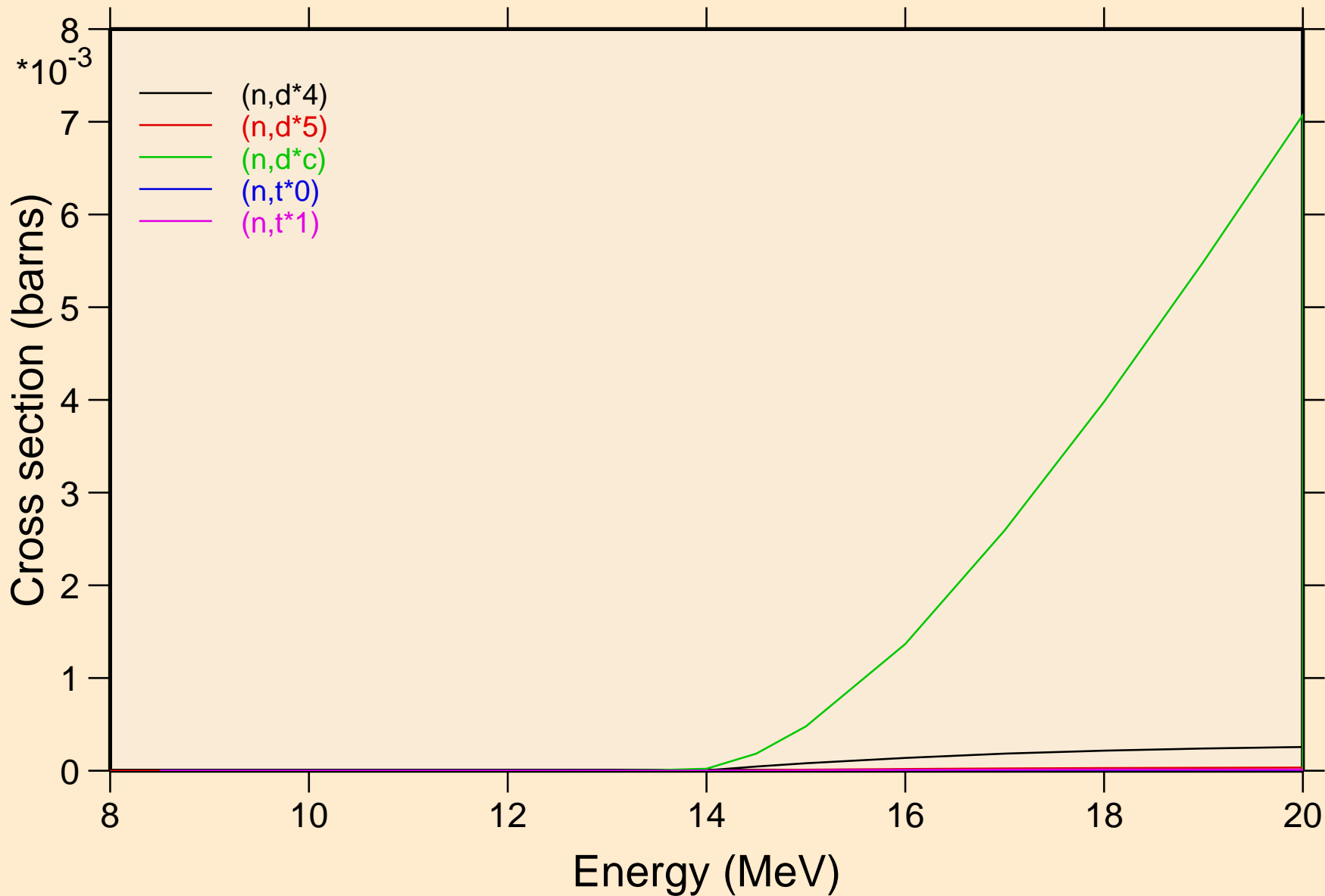

82-PB-206 FOR FENDL-3B2 FROM ENDF/B-VII WITH NJOY99.304
Threshold reactions

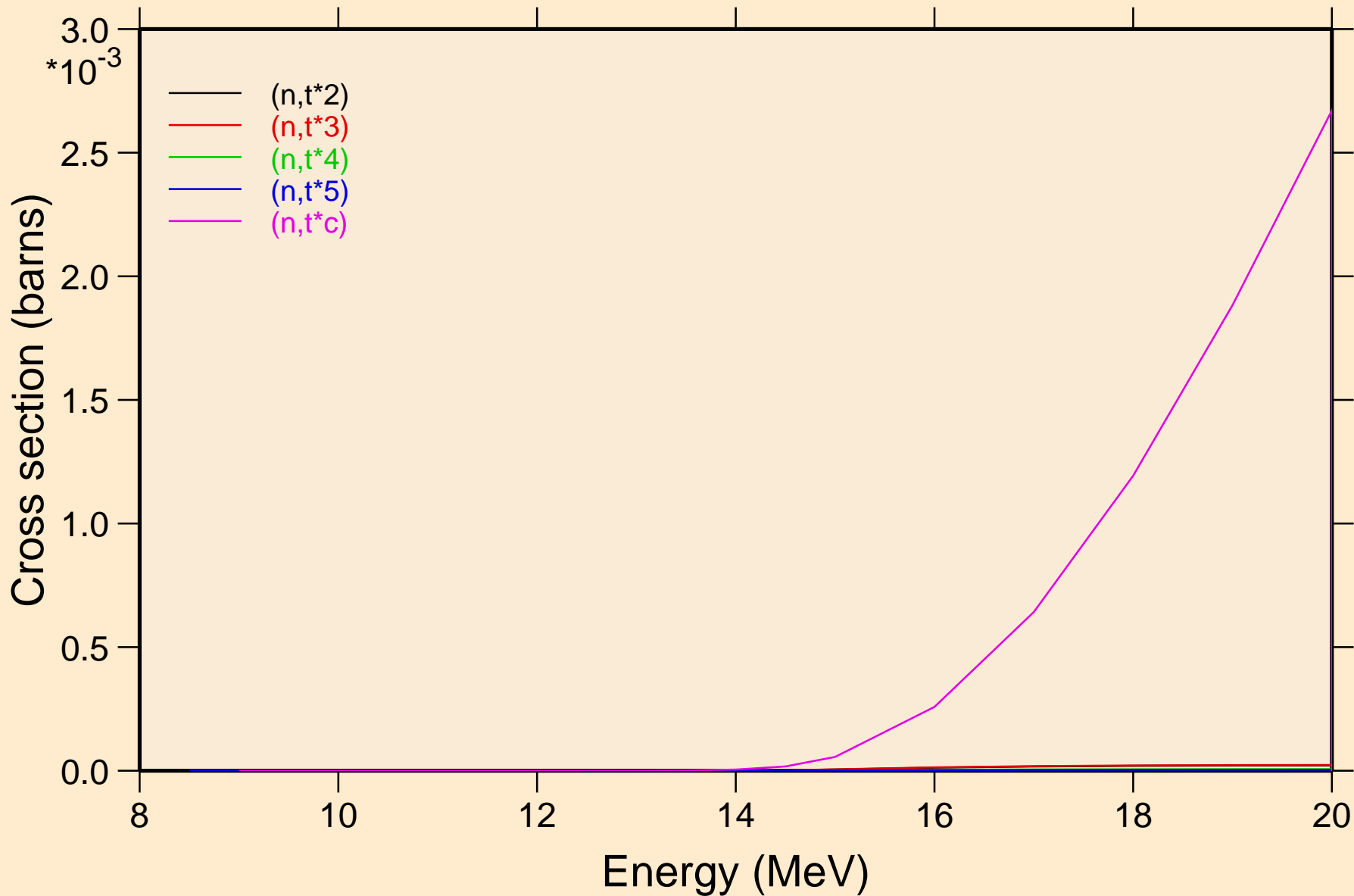

82-PB-206 FOR FENDL-3B2 FROM ENDF/B-VII WITH NJOY99.304
angular distribution for elastic

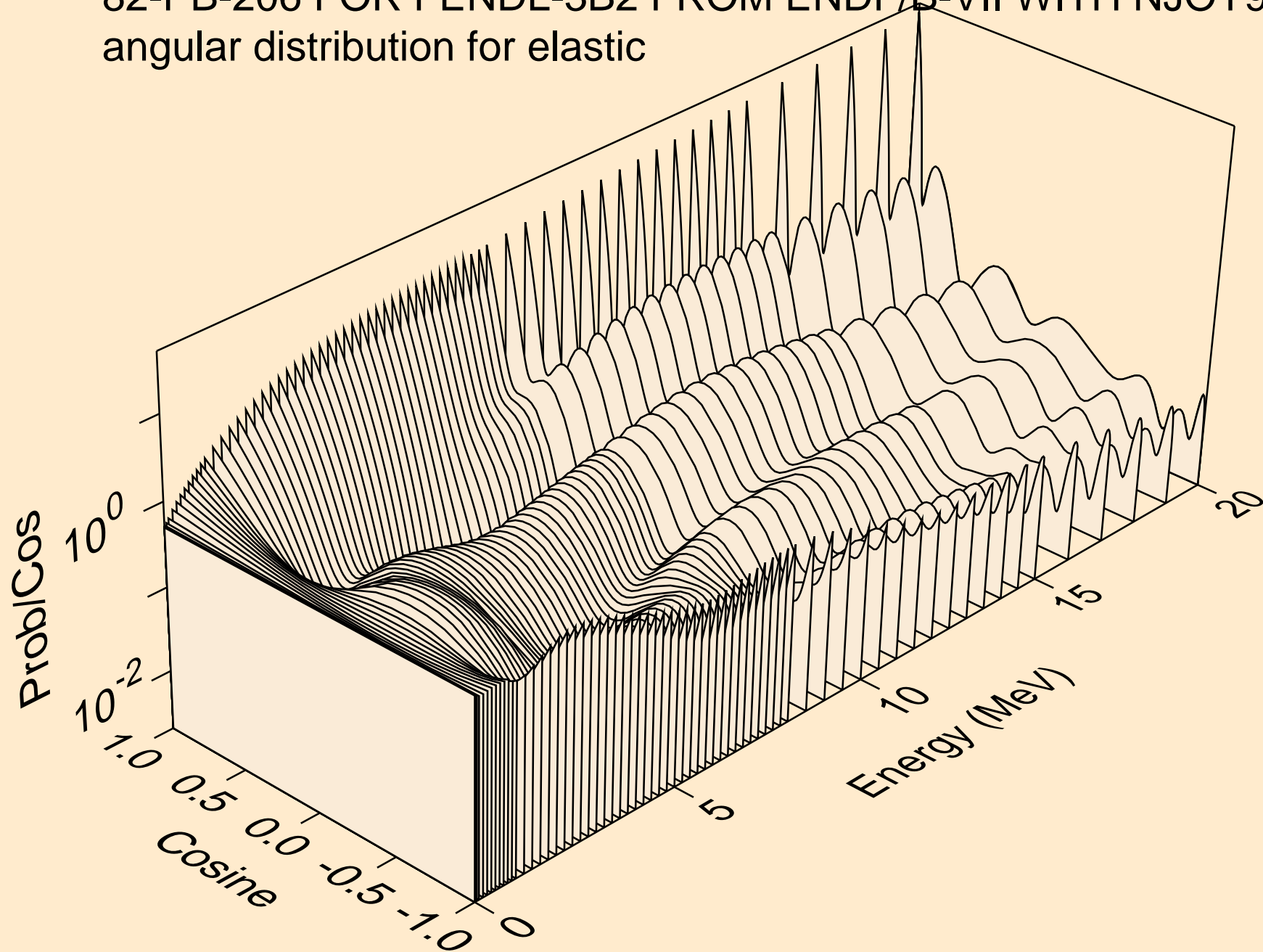

82-PB-206 FOR FENDL-3B2 FROM ENDF/B-VII WITH NJOY99.304
angular distribution for elastic

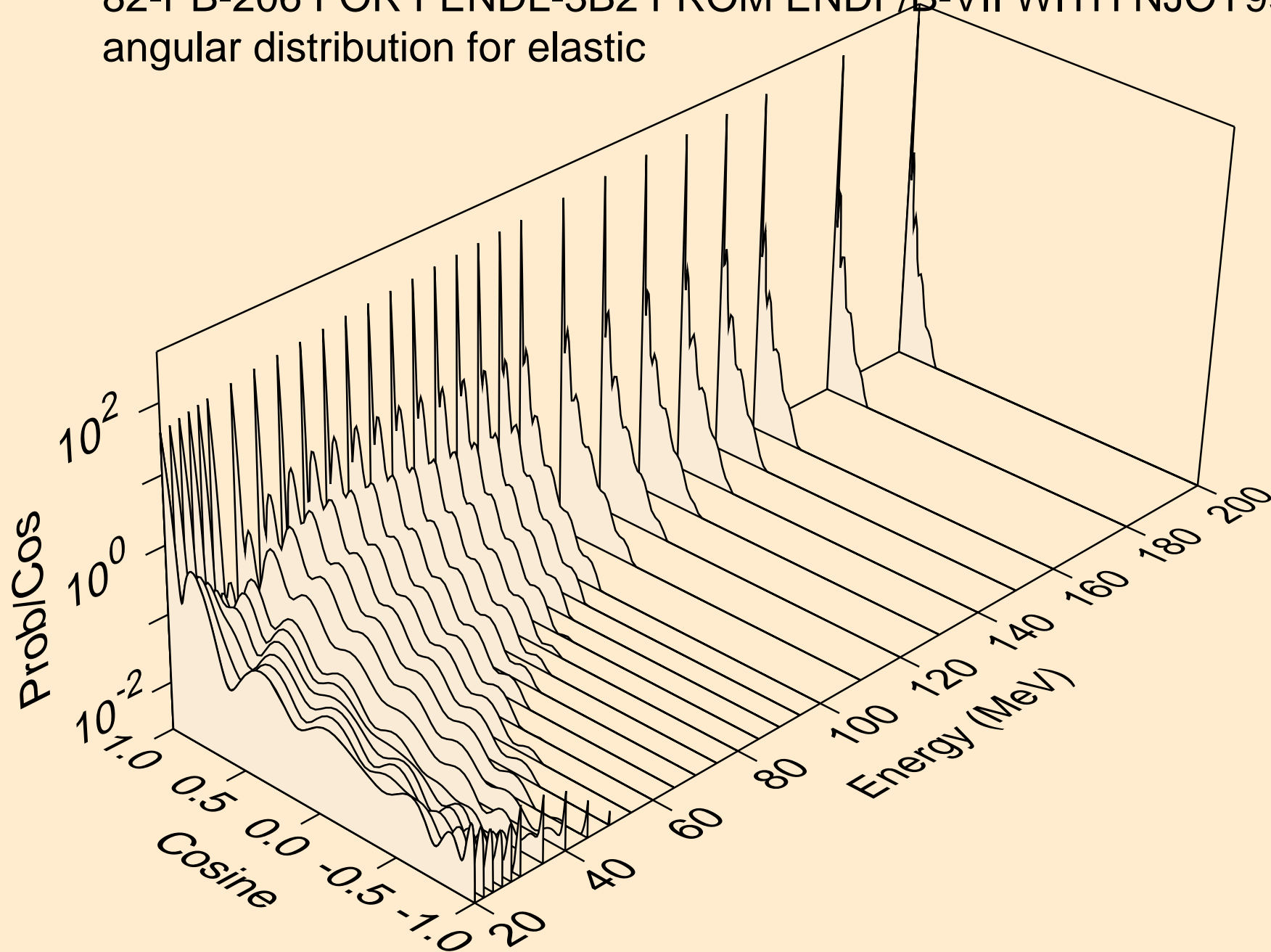

82-PB-206 FOR FENDL-3B2 FROM ENDF/B-VII WITH NJOY99.304
angular distribution for (n,n*1)

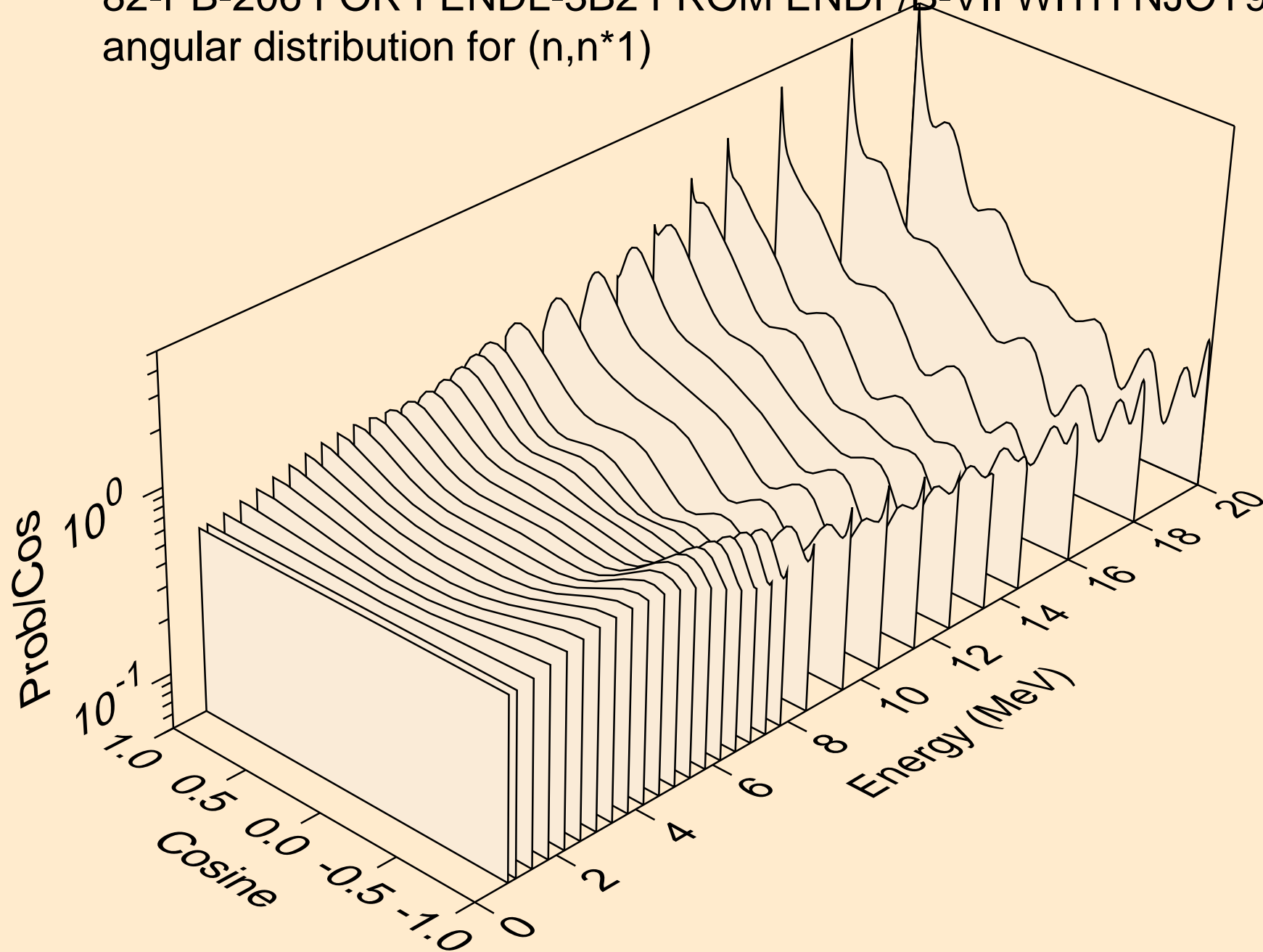

82-PB-206 FOR FENDL-3B2 FROM ENDF/B-VII WITH NJOY99.304
angular distribution for (n,n*2)

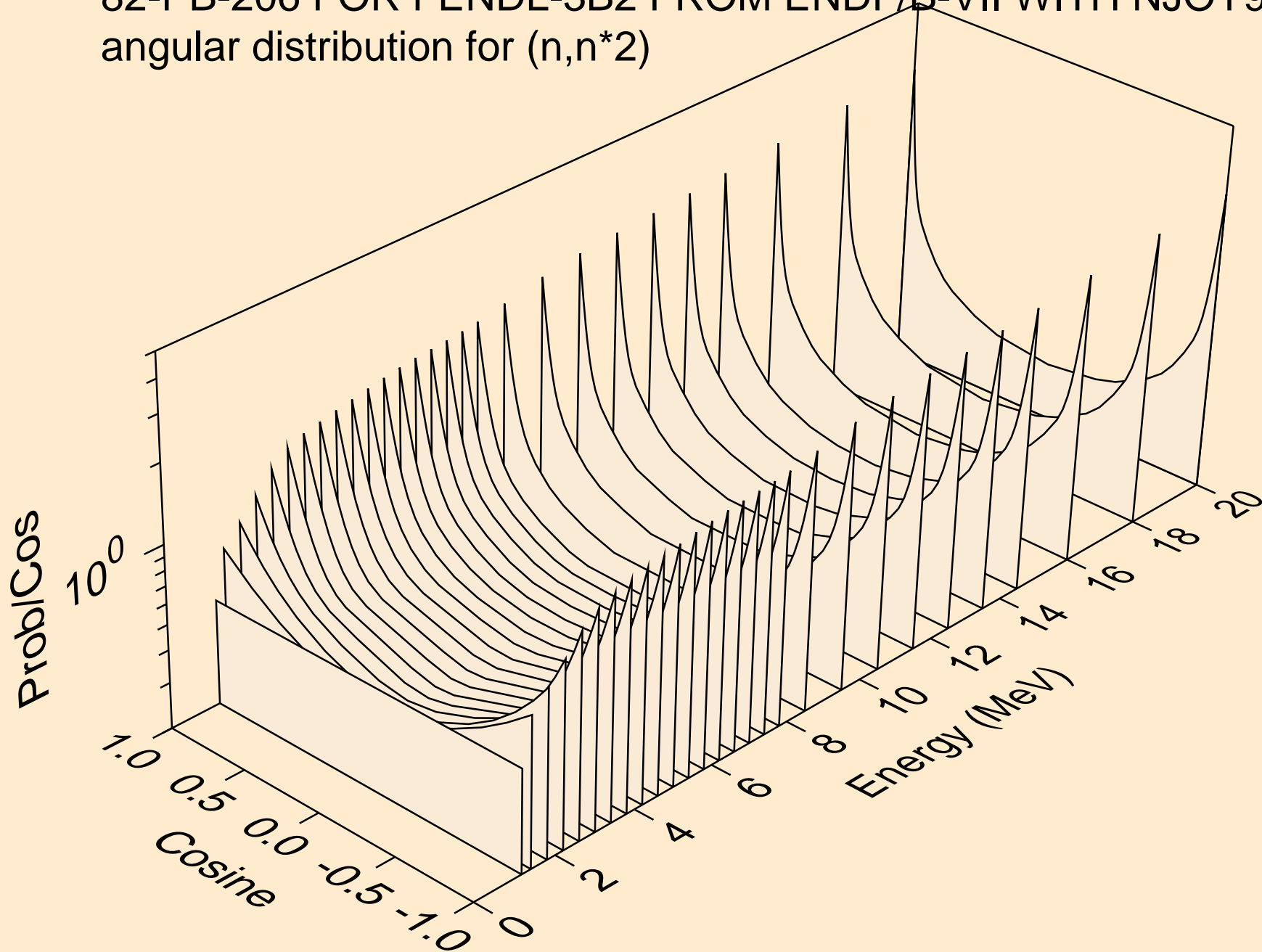

82-PB-206 FOR FENDL-3B2 FROM ENDF/B-VII WITH NJOY99.304
angular distribution for (n,n*3)

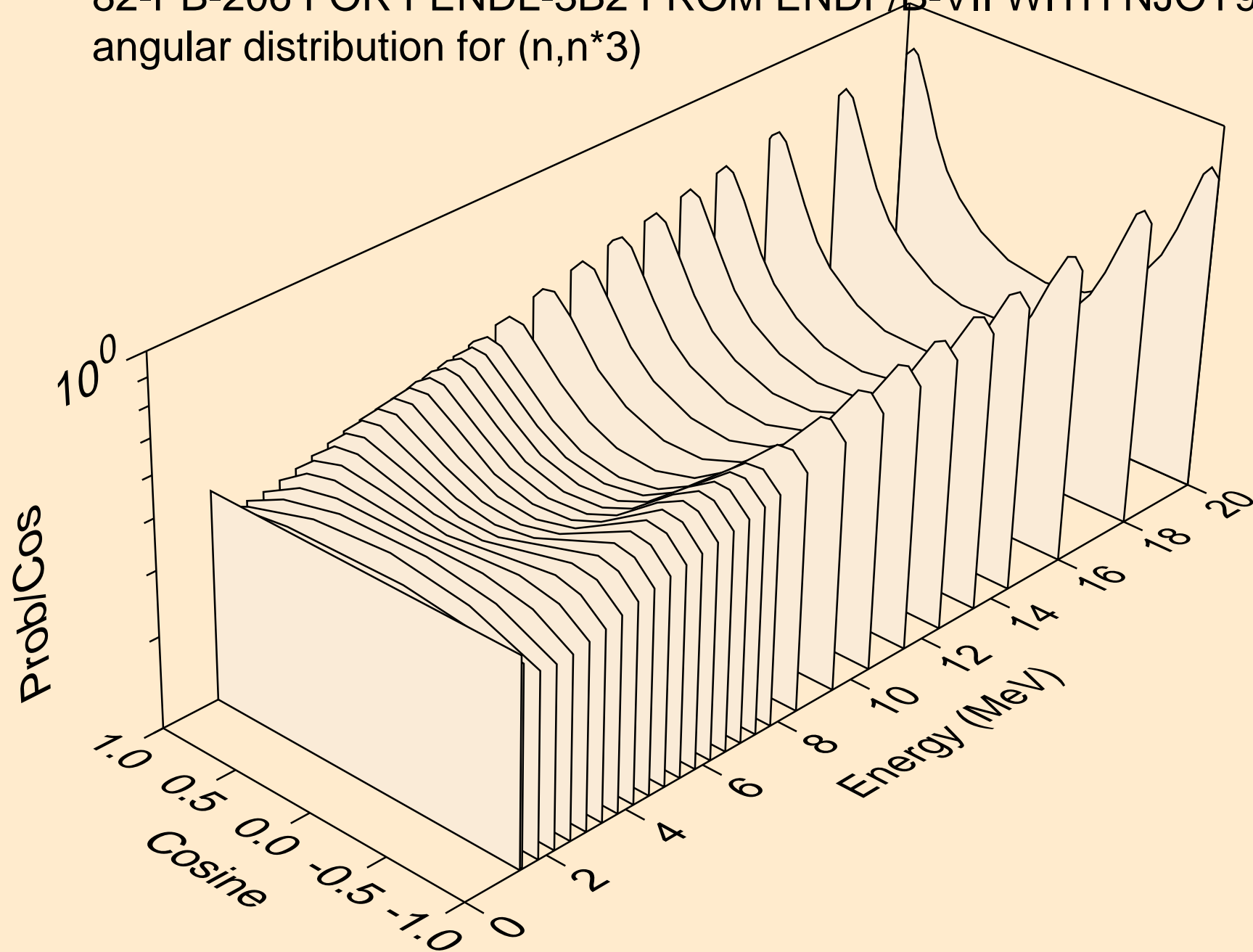

82-PB-206 FOR FENDL-3B2 FROM ENDF/B-VII WITH NJOY99.304
angular distribution for (n,n*4)

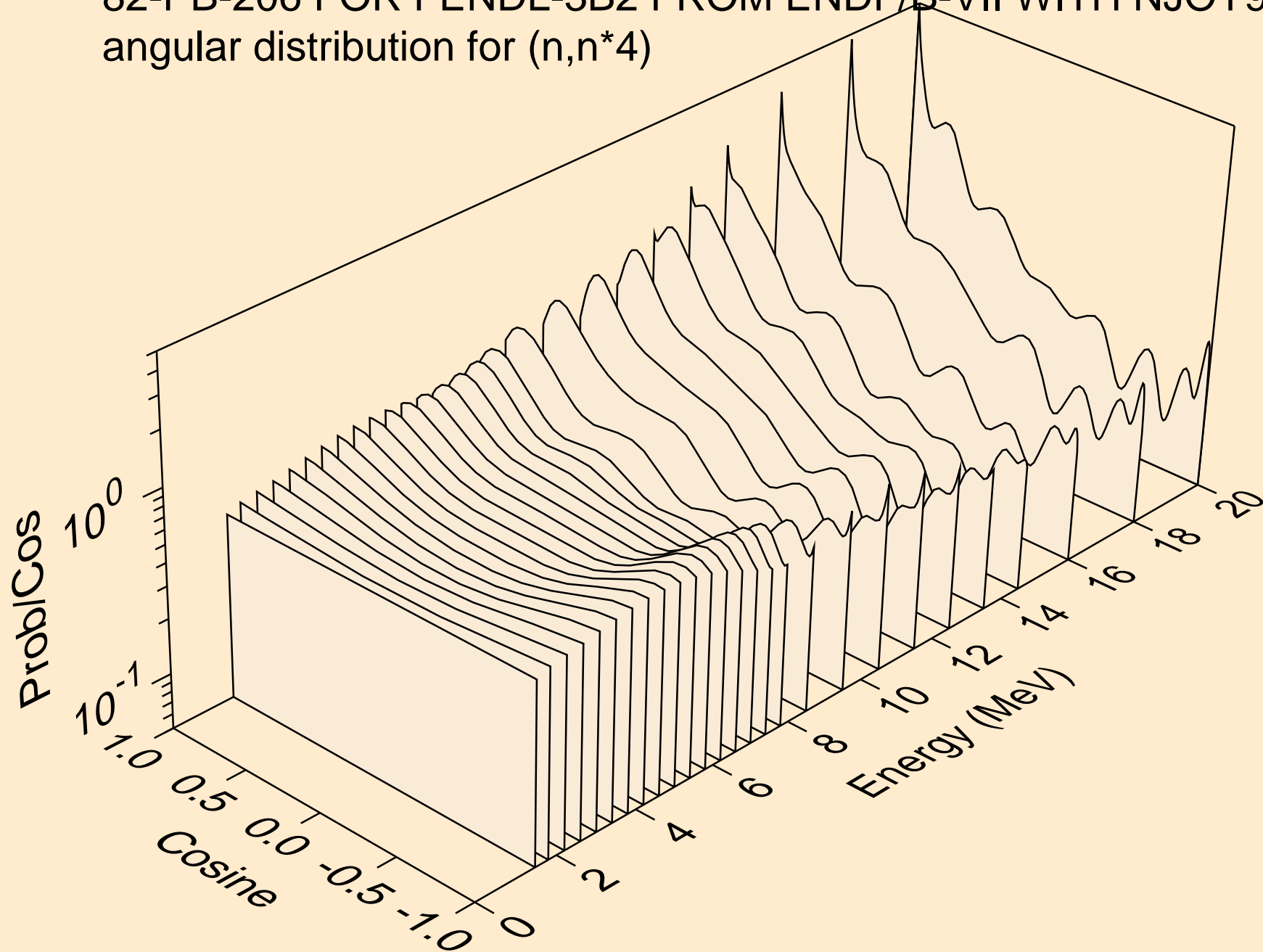

82-PB-206 FOR FENDL-3B2 FROM ENDF/B-VII WITH NJOY99.304
angular distribution for (n,n*5)

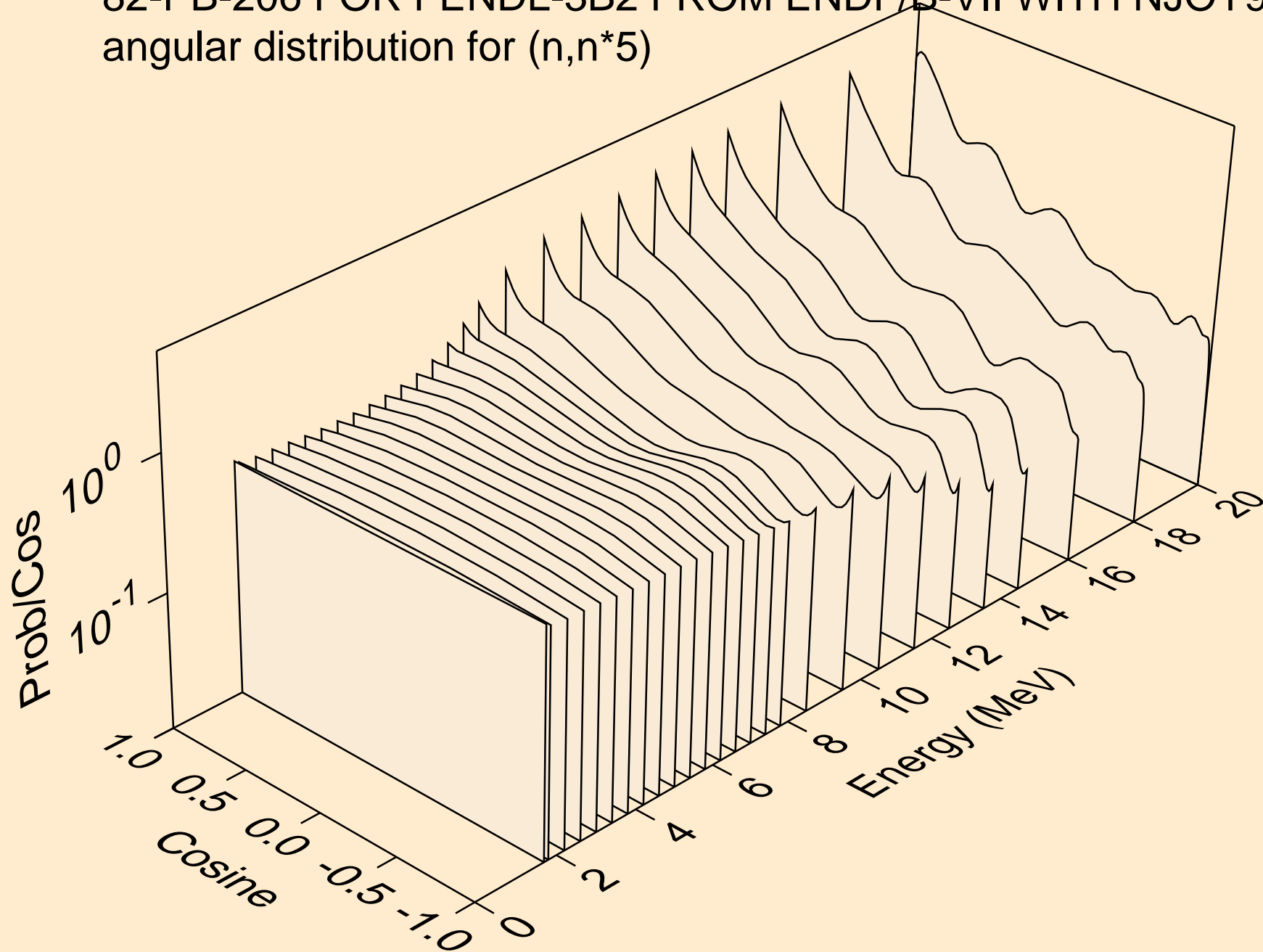

82-PB-206 FOR FENDL-3B2 FROM ENDF/B-VII WITH NJOY99.304
angular distribution for (n,n*6)

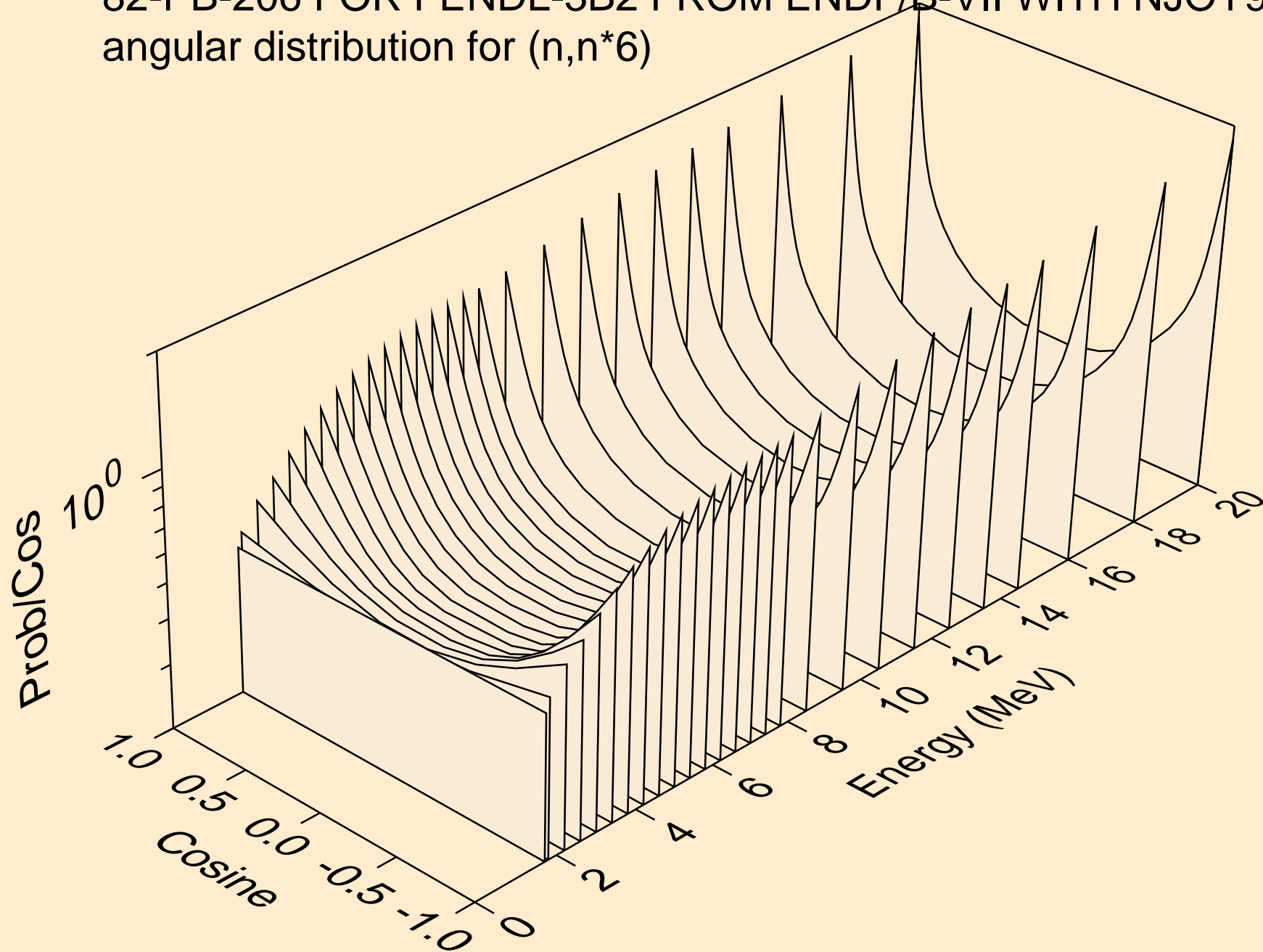

82-PB-206 FOR FENDL-3B2 FROM ENDF/B-VII WITH NJOY99.304
angular distribution for (n,n*7)

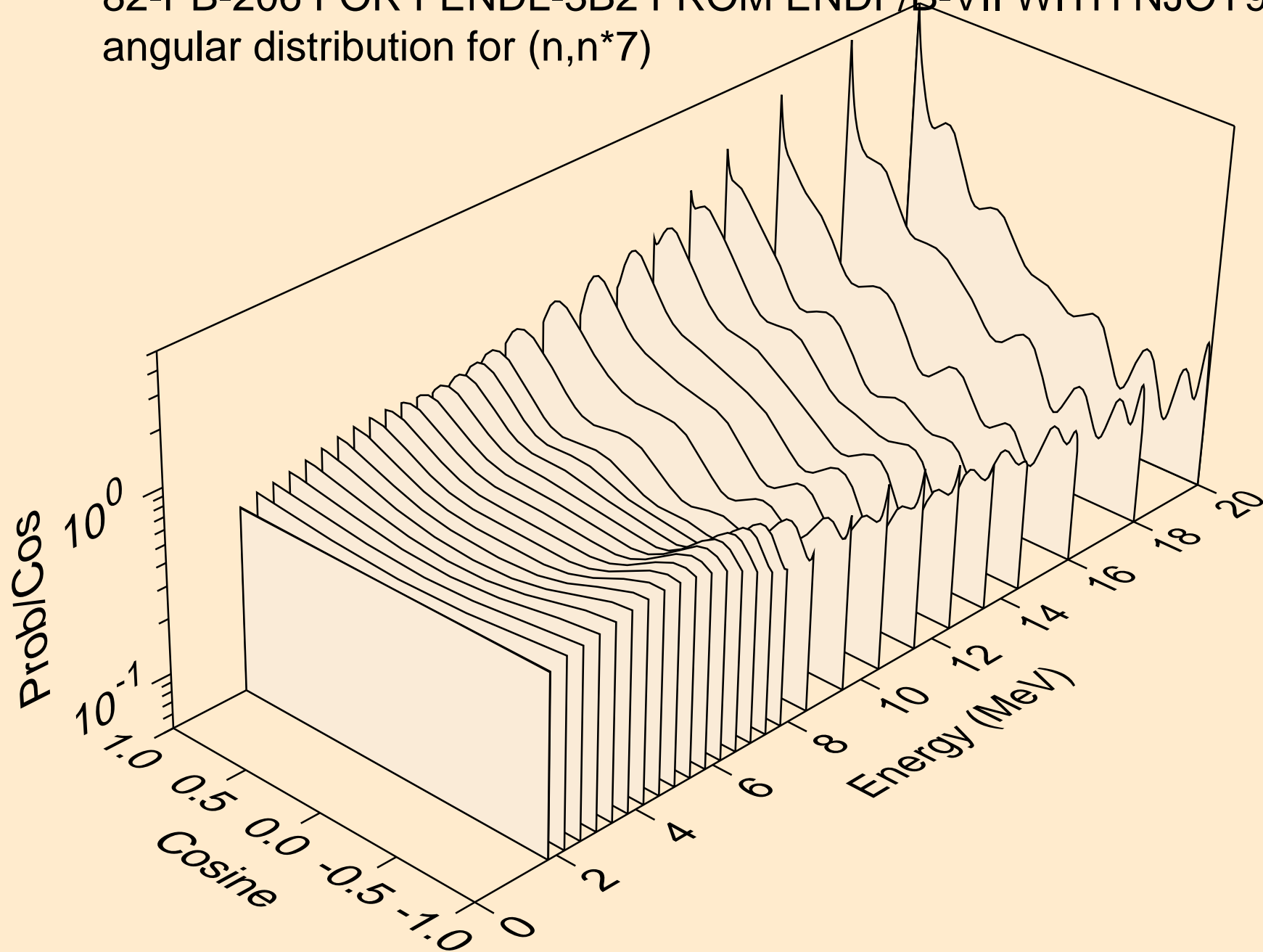

82-PB-206 FOR FENDL-3B2 FROM ENDF/B-VII WITH NJOY99.304
angular distribution for (n,n*8)

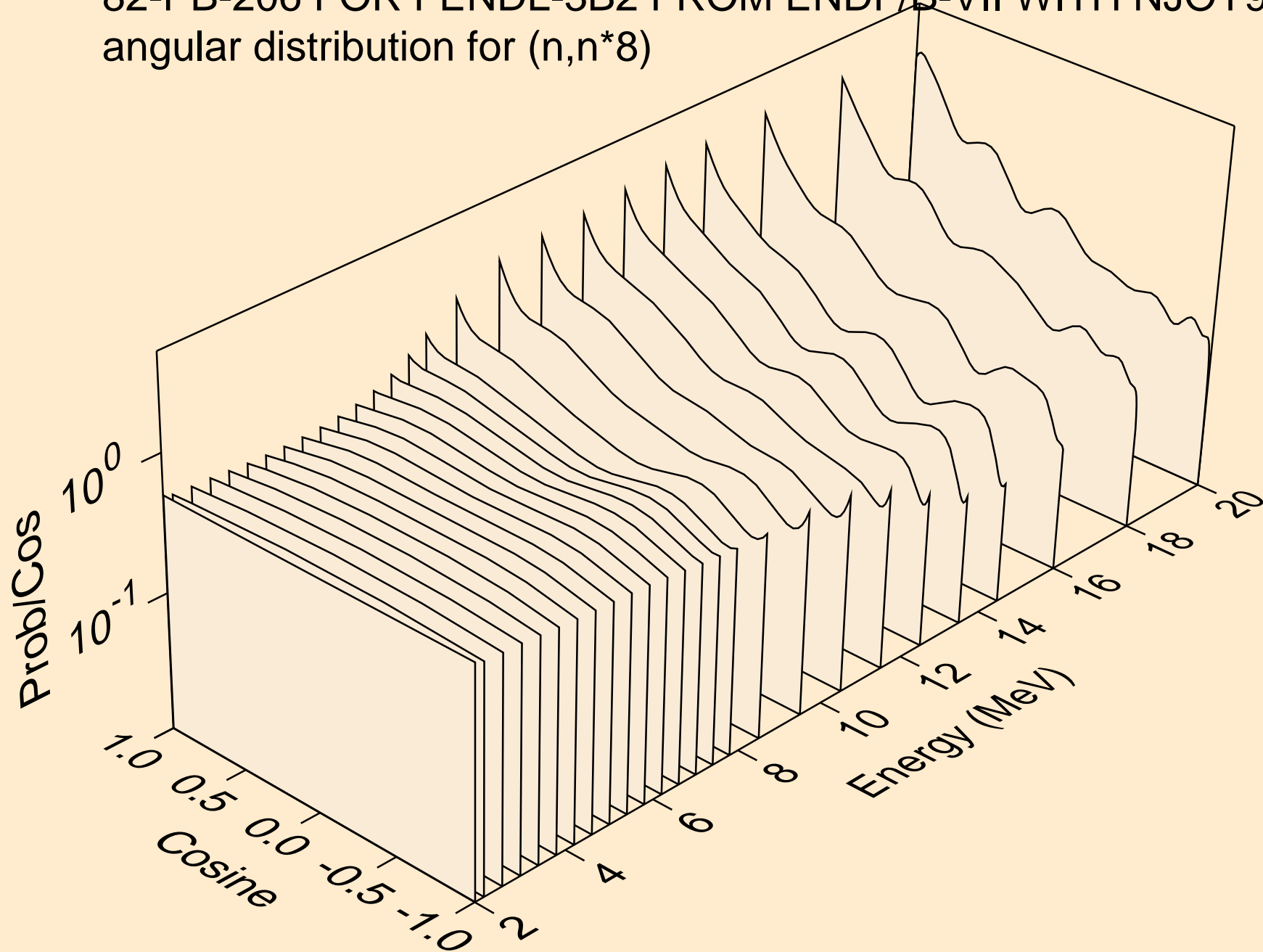

82-PB-206 FOR FENDL-3B2 FROM ENDF/B-VII WITH NJOY99.304
angular distribution for (n,n*9)

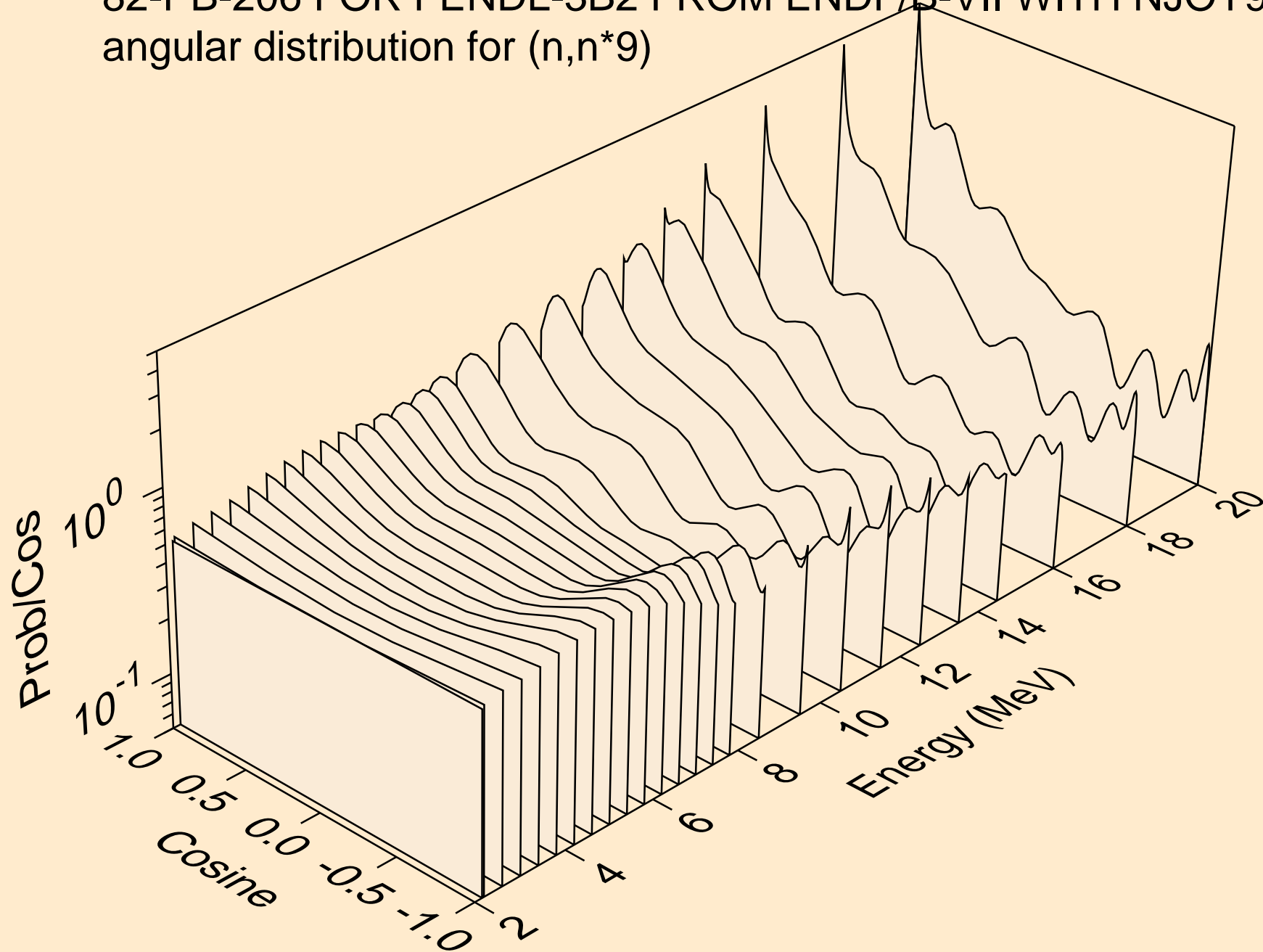

82-PB-206 FOR FENDL-3B2 FROM ENDF/B-VII WITH NJOY99.304
angular distribution for (n,n*10)

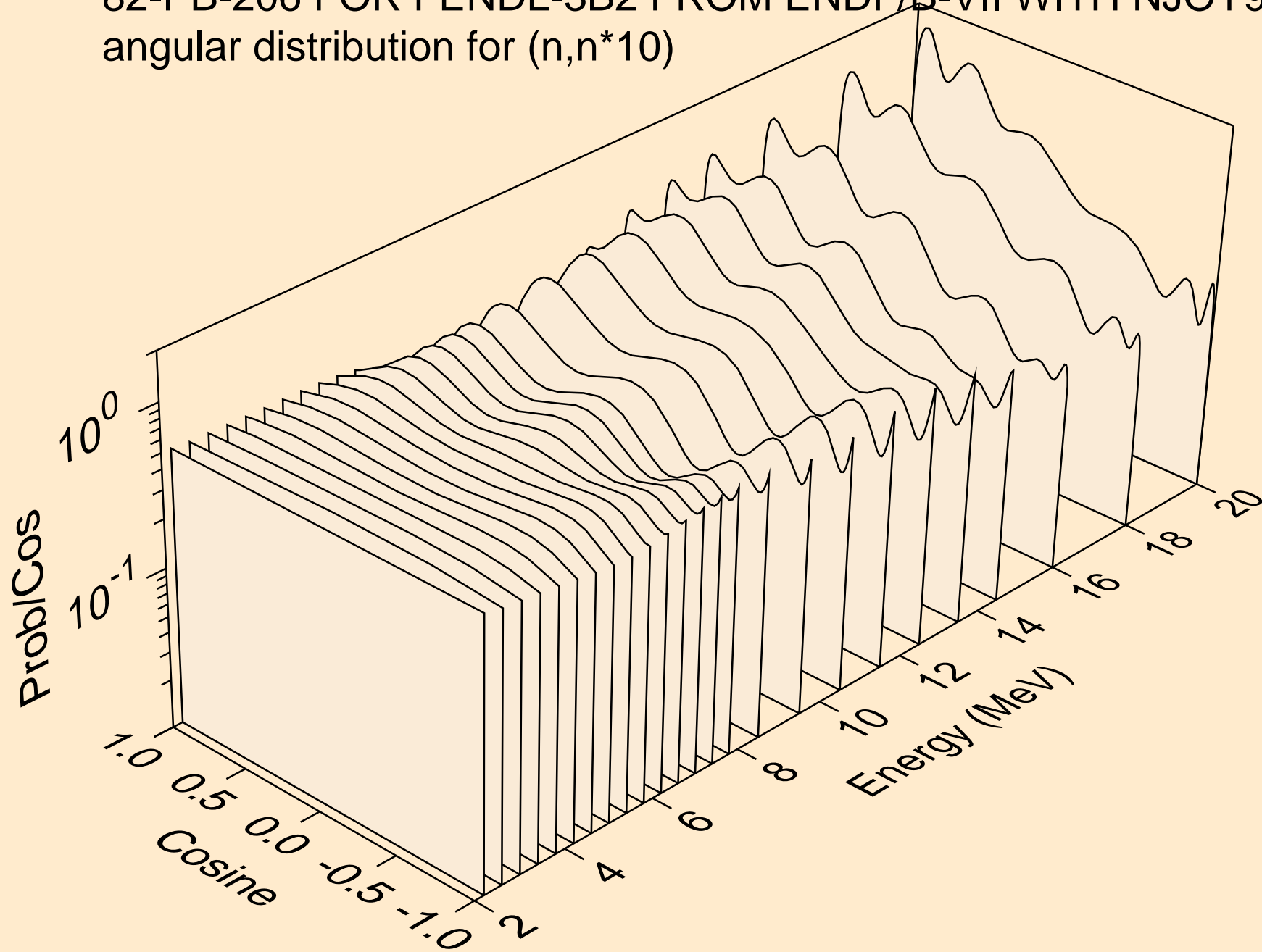

82-PB-206 FOR FENDL-3B2 FROM ENDF/B-VII WITH NJOY99.304
angular distribution for (n,n*11)

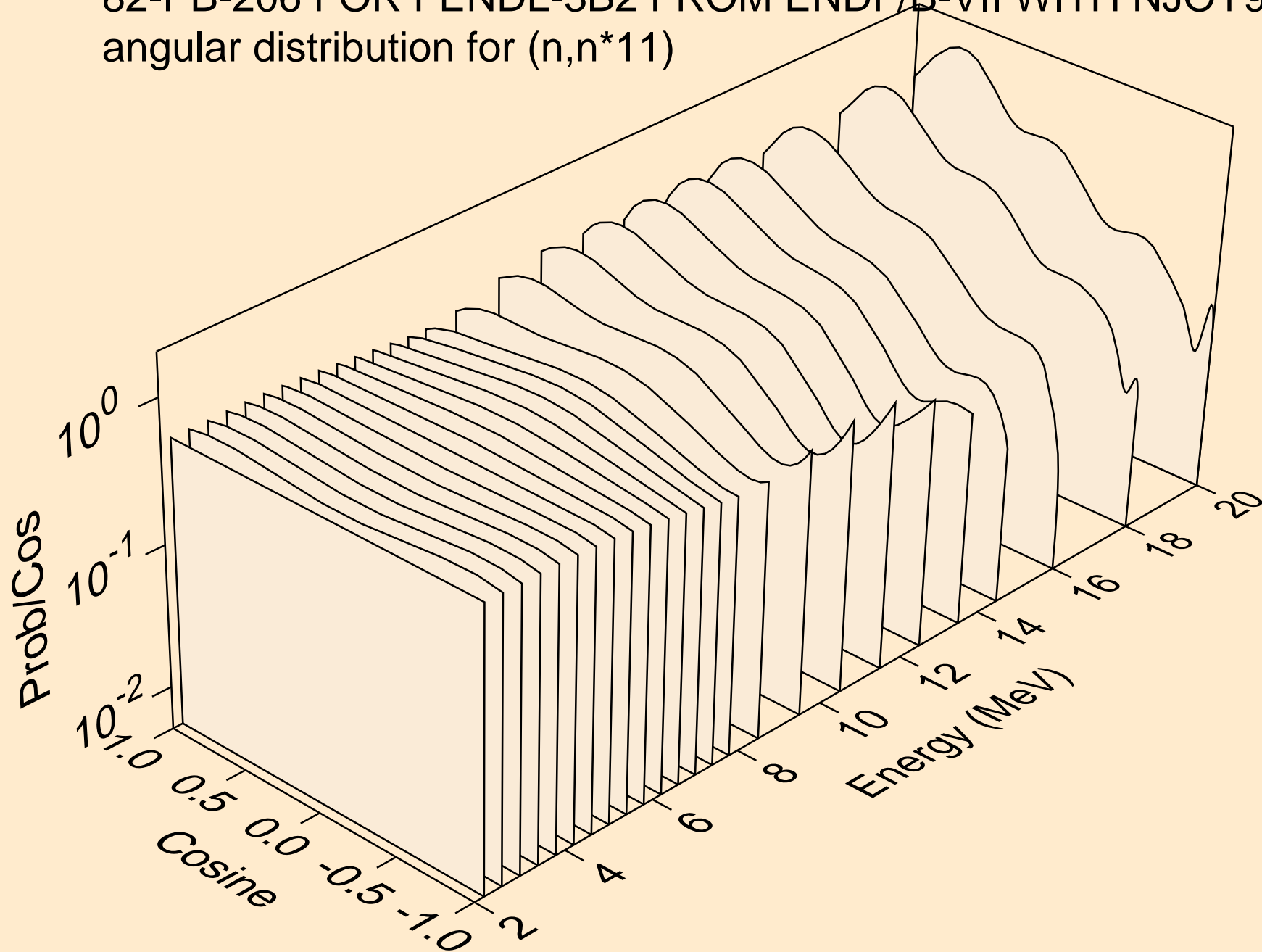

82-PB-206 FOR FENDL-3B2 FROM ENDF/B-VII WITH NJOY99.304
angular distribution for (n,n*12)

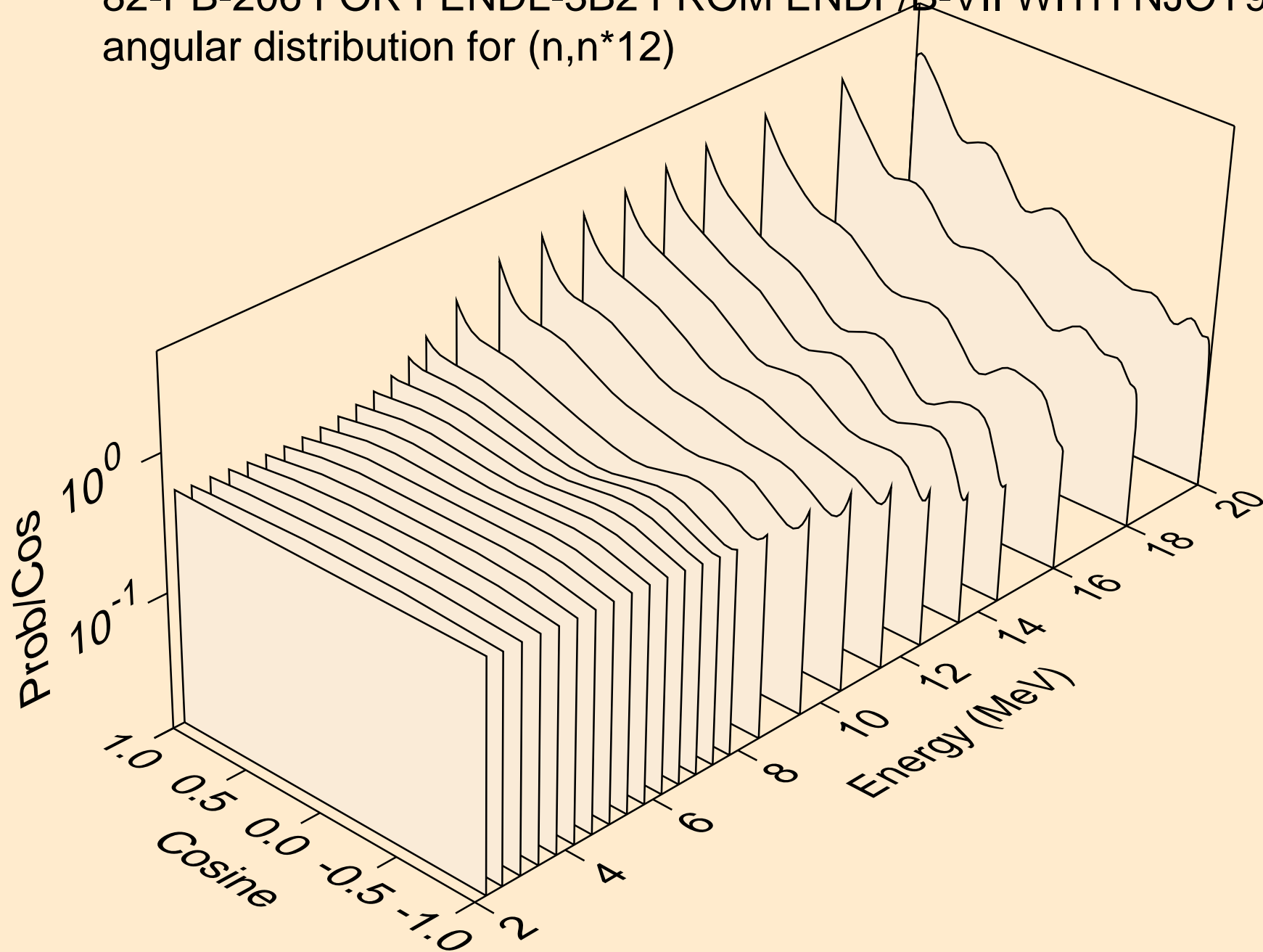

82-PB-206 FOR FENDL-3B2 FROM ENDF/B-VII WITH NJOY99.304
angular distribution for (n,n*13)

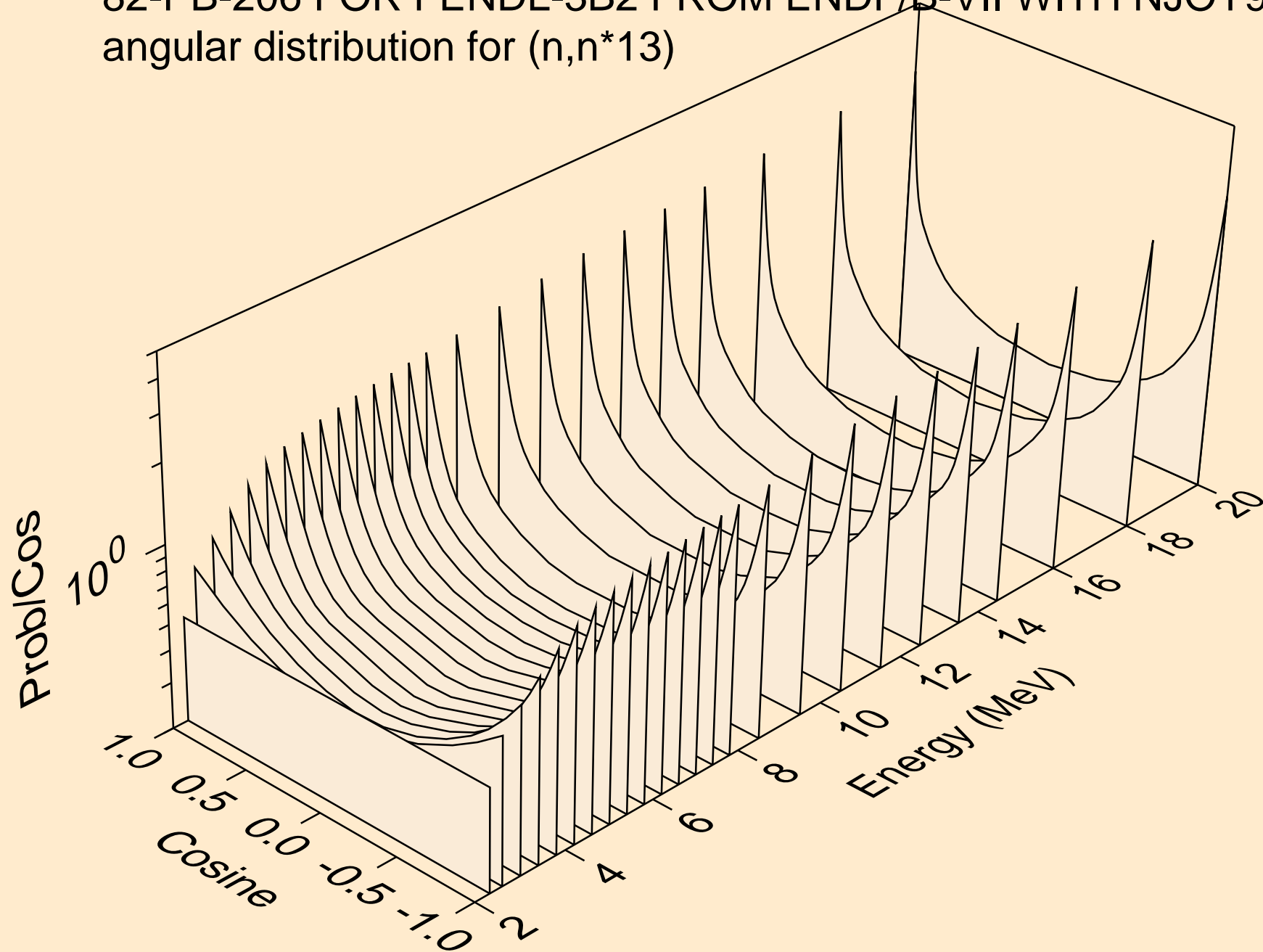

82-PB-206 FOR FENDL-3B2 FROM ENDF/B-VII WITH NJOY99.304
angular distribution for (n,n*14)

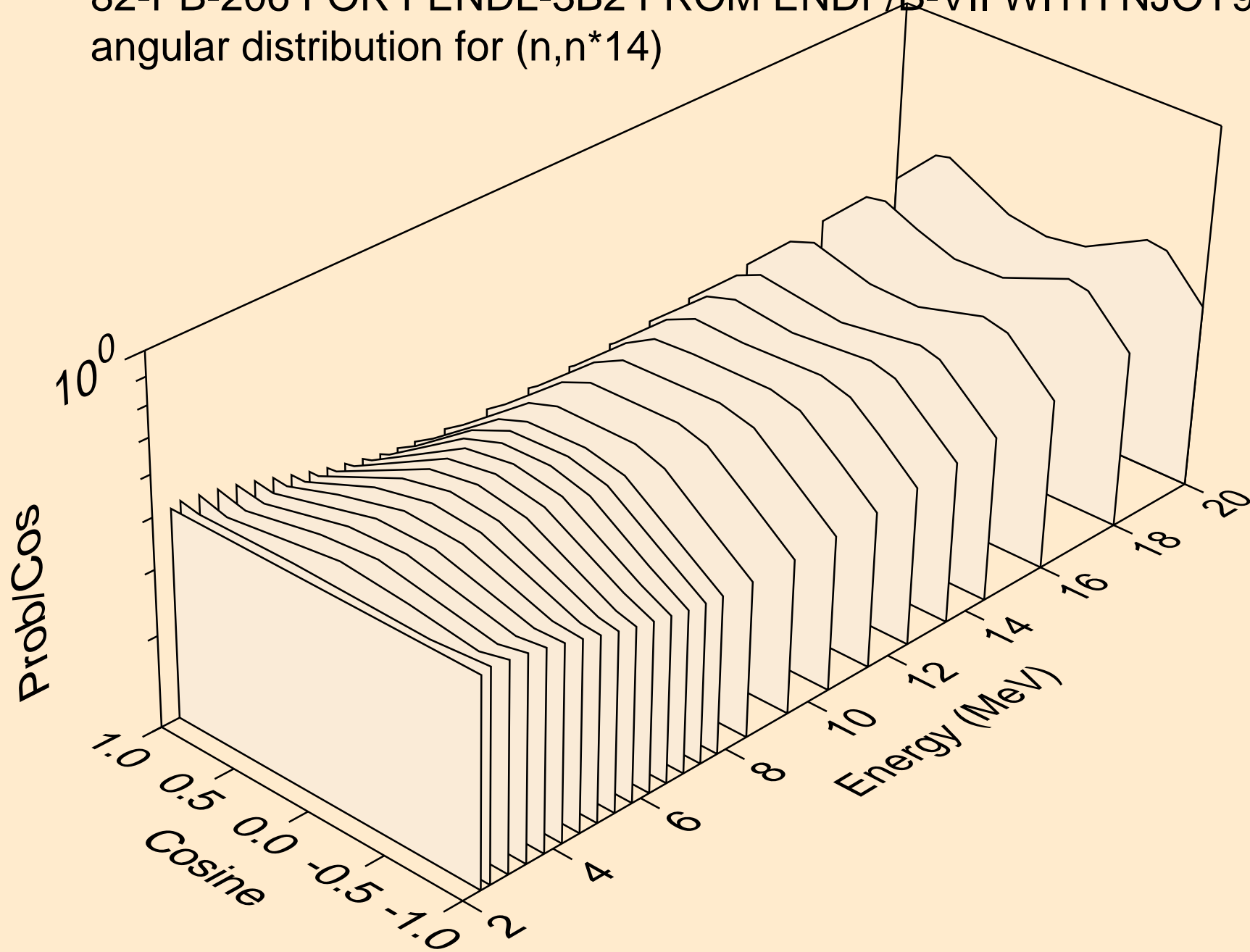

82-PB-206 FOR FENDL-3B2 FROM ENDF/B-VII WITH NJOY99.304
angular distribution for (n,n*15)

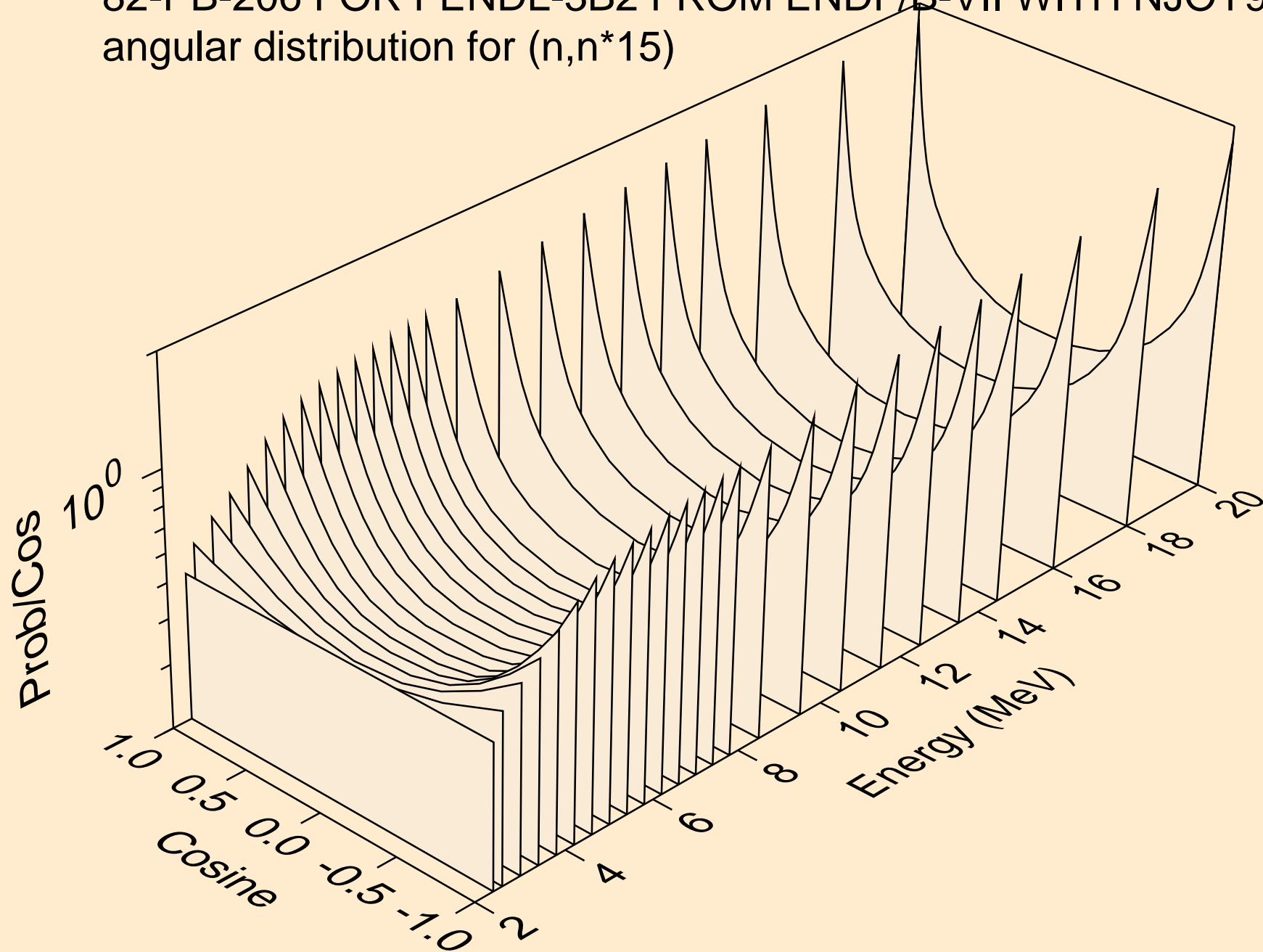

82-PB-206 FOR FENDL-3B2 FROM ENDF/B-VII WITH NJOY99.304
angular distribution for (n,n*16)

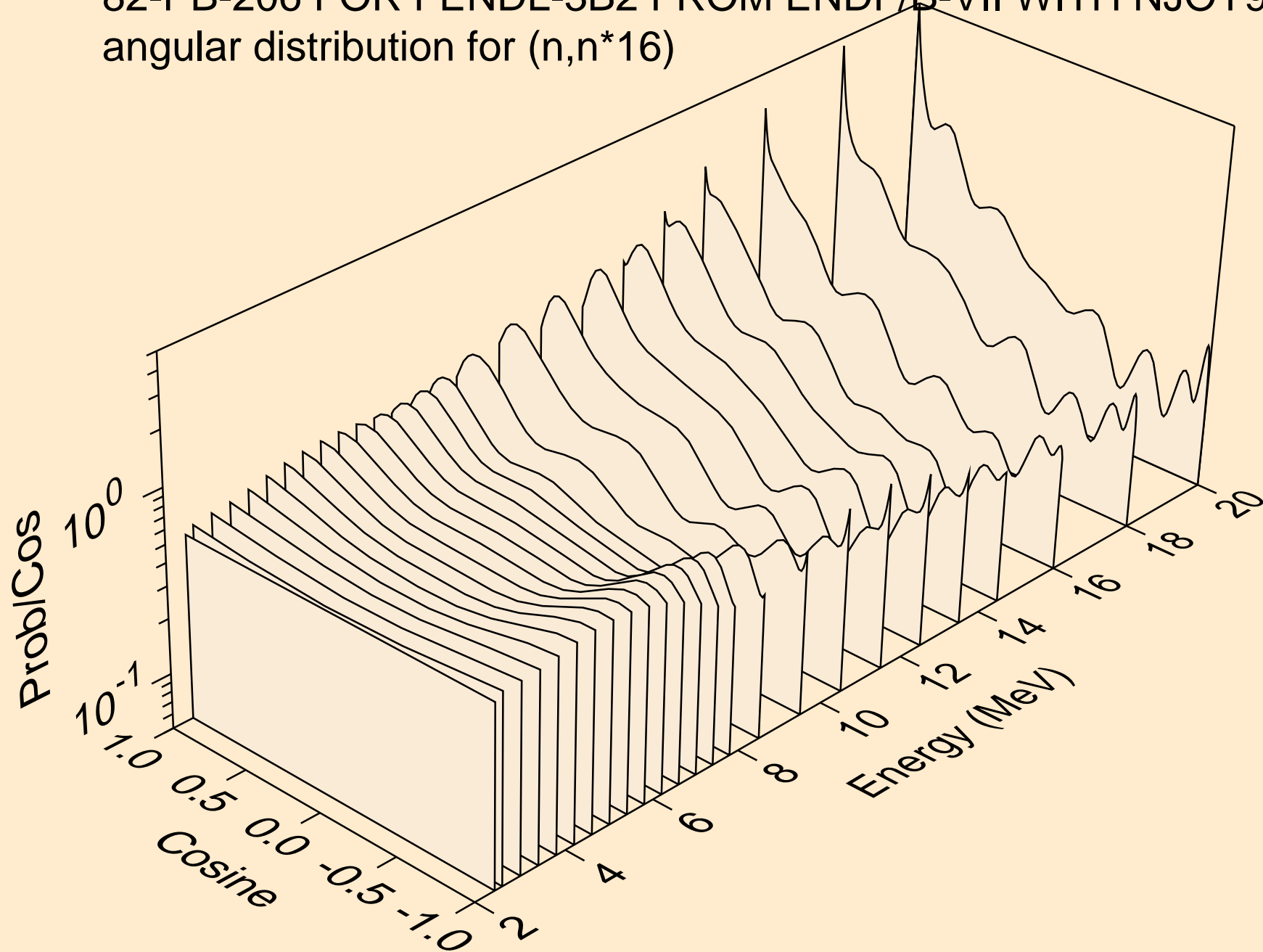

82-PB-206 FOR FENDL-3B2 FROM ENDF/B-VII WITH NJOY99.304
angular distribution for (n,n*17)

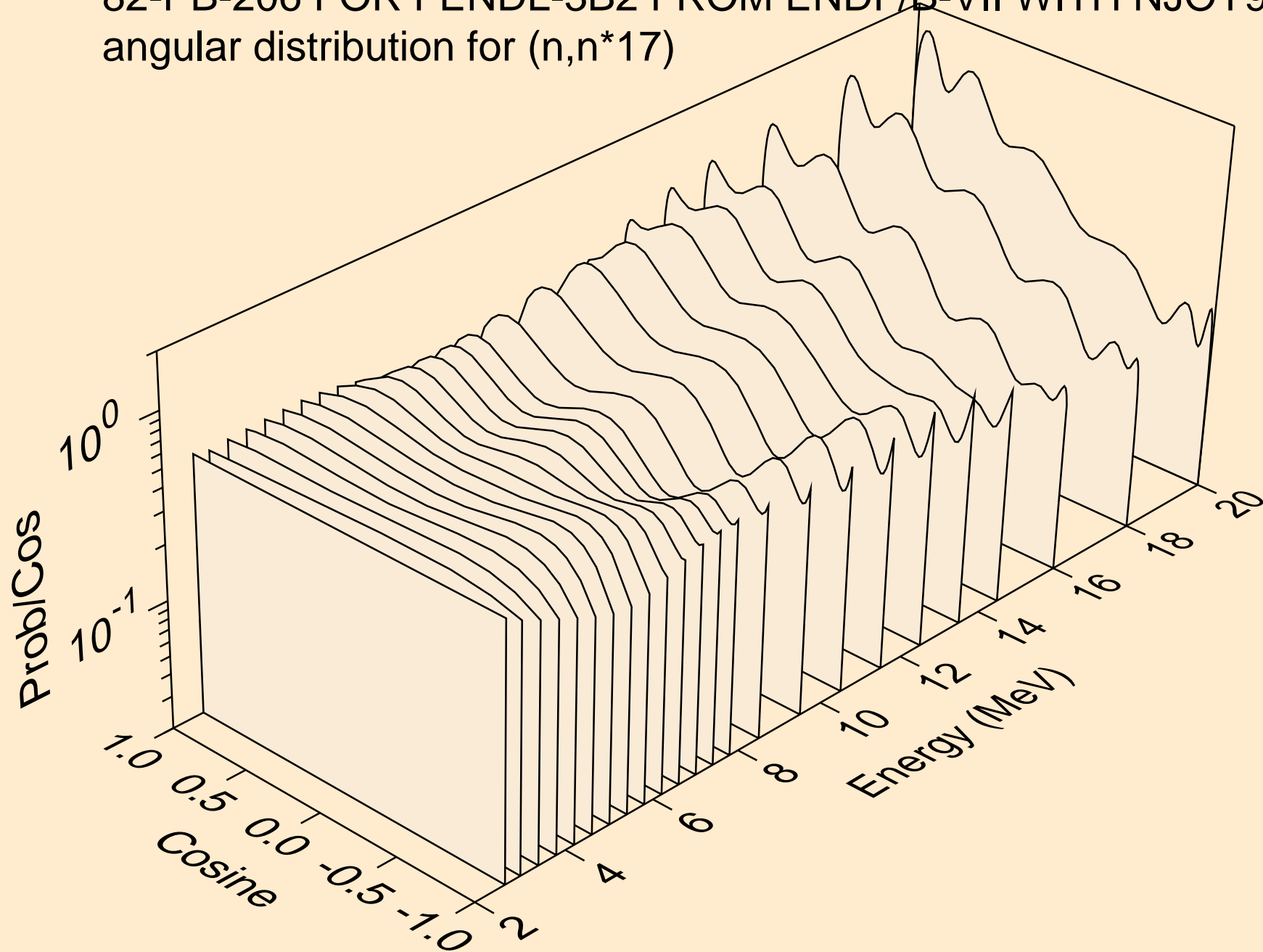

82-PB-206 FOR FENDL-3B2 FROM ENDF/B-VII WITH NJOY99.304
angular distribution for (n,n*18)

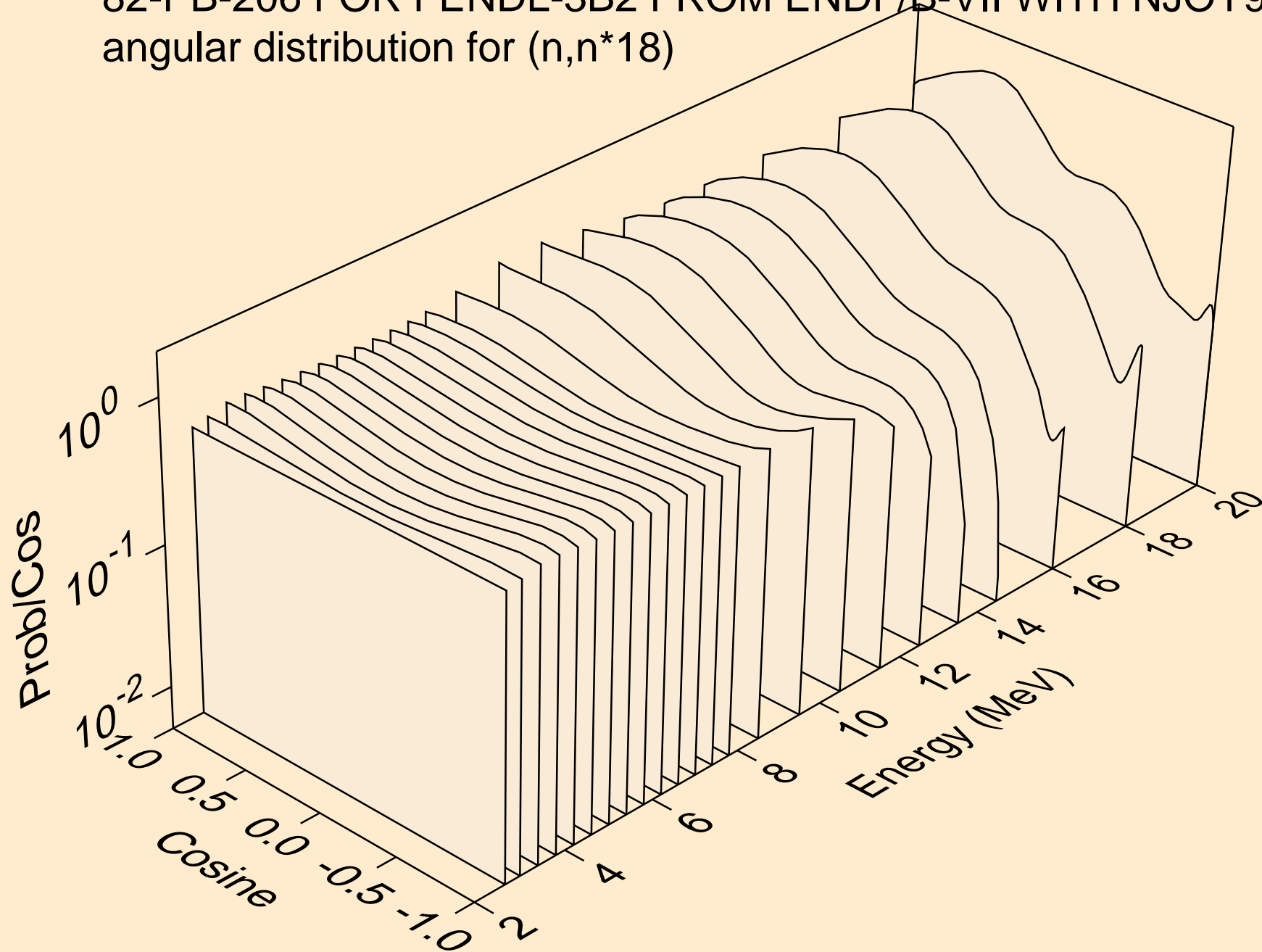

82-PB-206 FOR FENDL-3B2 FROM ENDF/B-VII WITH NJOY99.304
angular distribution for (n,n*19)

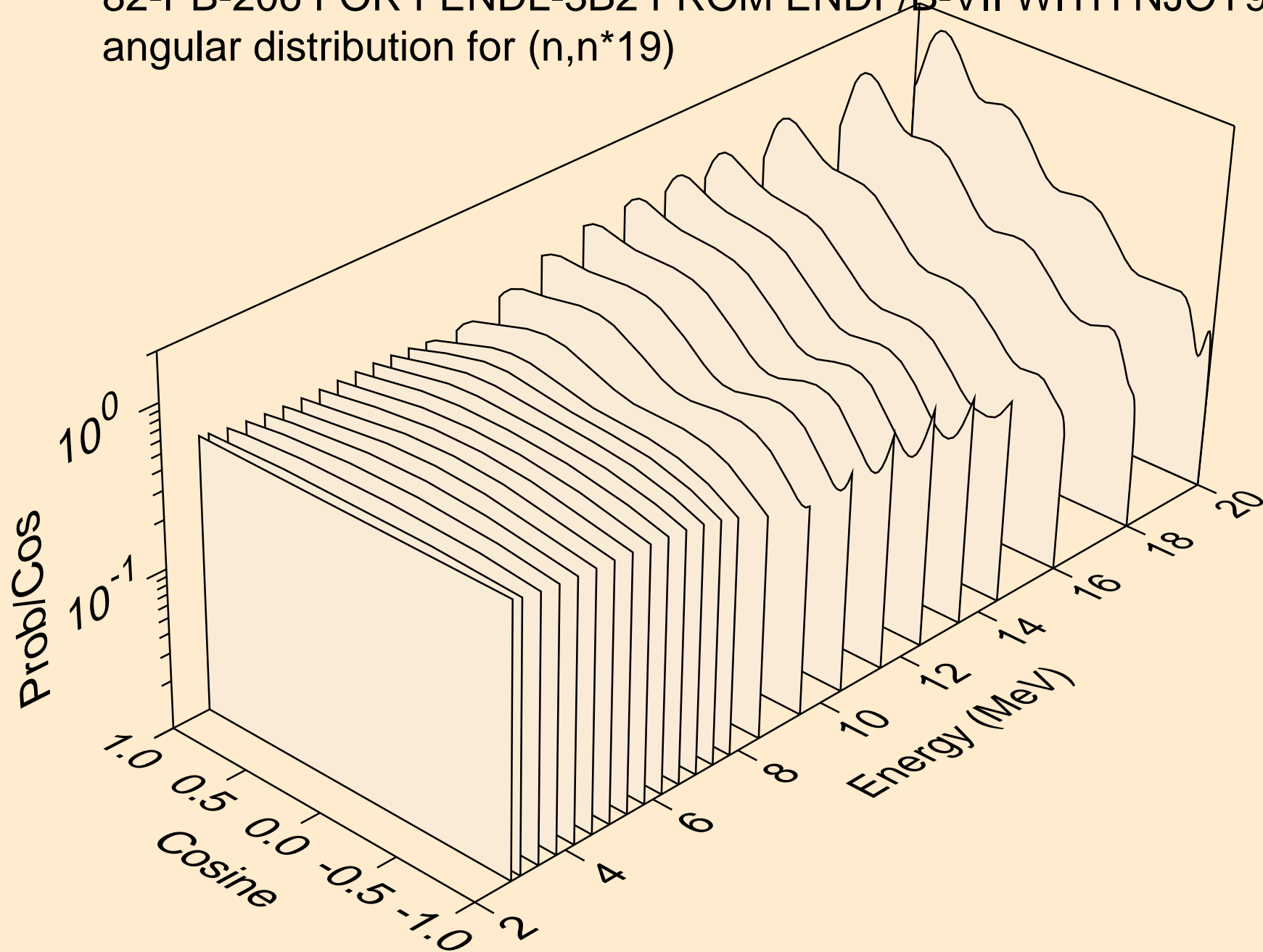

82-PB-206 FOR FENDL-3B2 FROM ENDF/B-VII WITH NJOY99.304
angular distribution for (n,n*20)

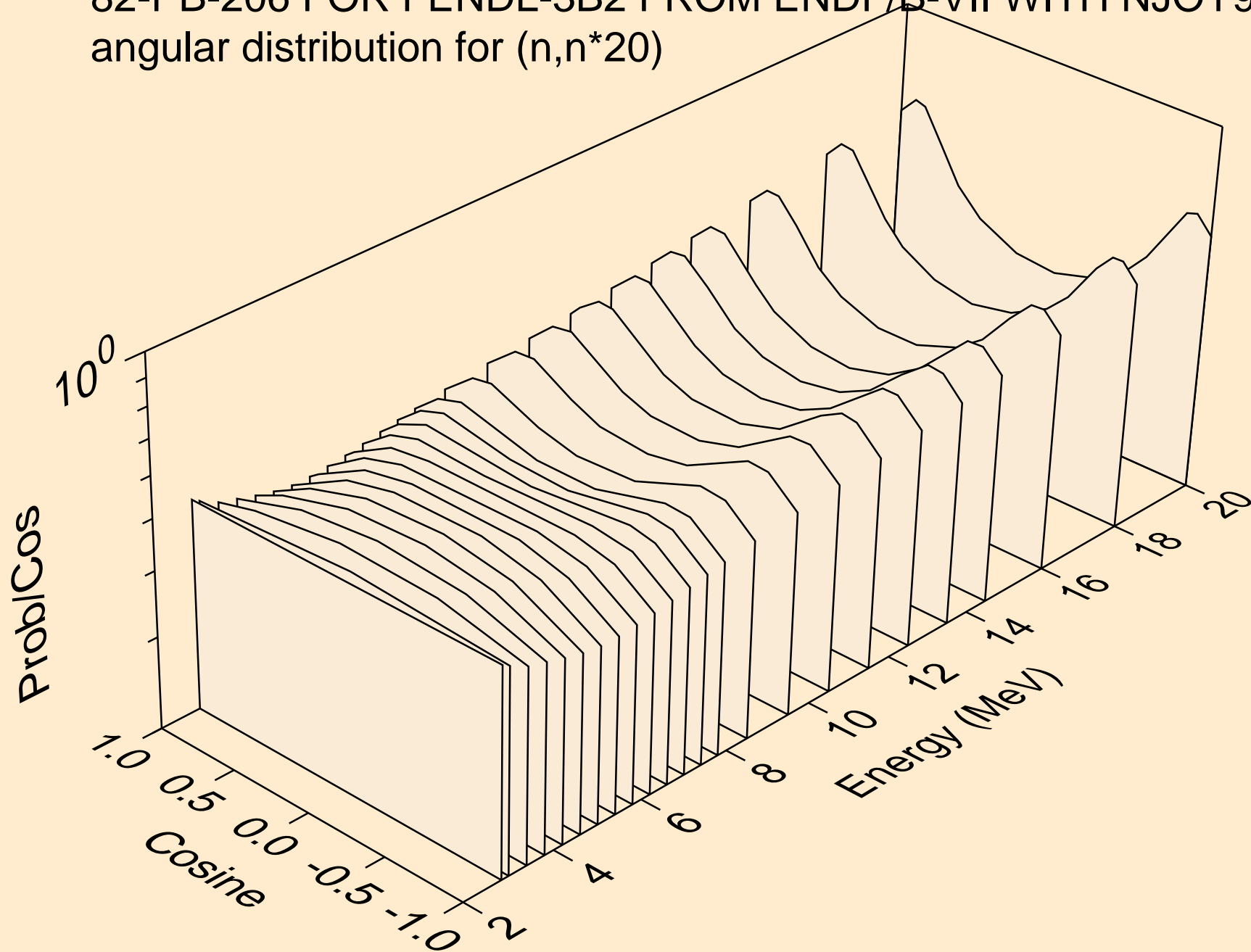

82-PB-206 FOR FENDL-3B2 FROM ENDF/B-VII WITH NJOY99.304
angular distribution for (n,n*21)

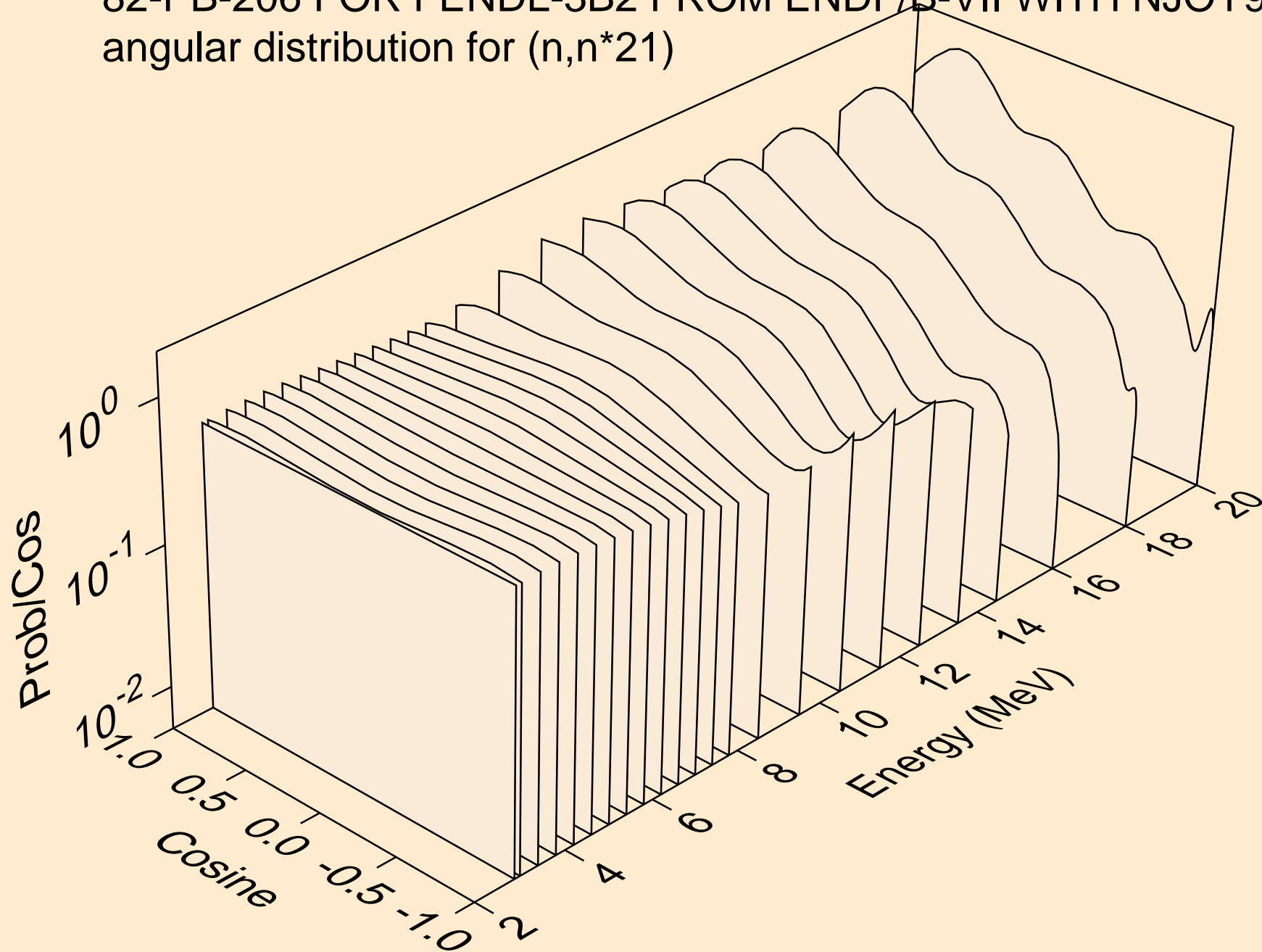

82-PB-206 FOR FENDL-3B2 FROM ENDF/B-VII WITH NJOY99.304
angular distribution for (n,n*22)

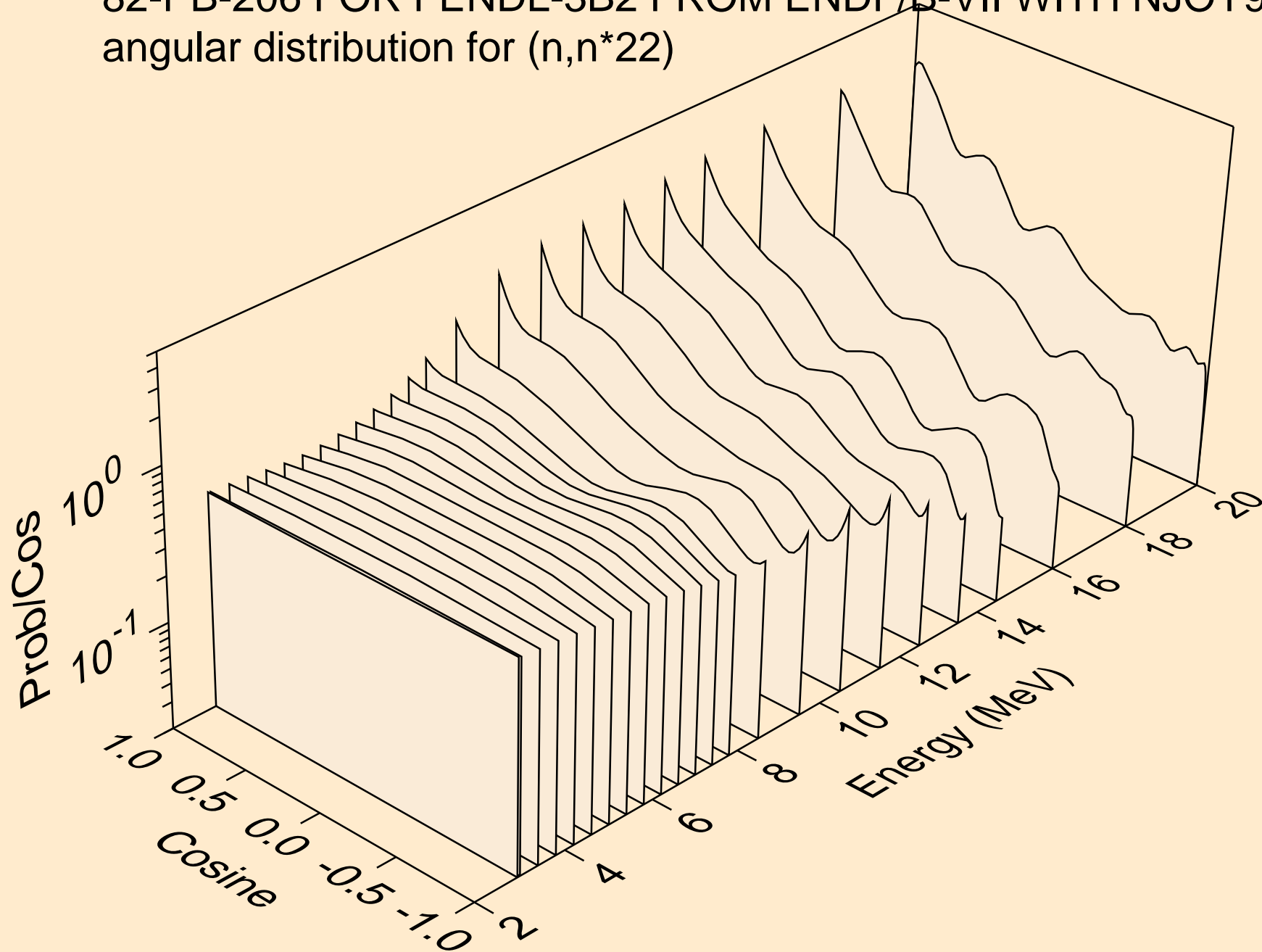

82-PB-206 FOR FENDL-3B2 FROM ENDF/B-VII WITH NJOY99.304
angular distribution for (n,n*23)

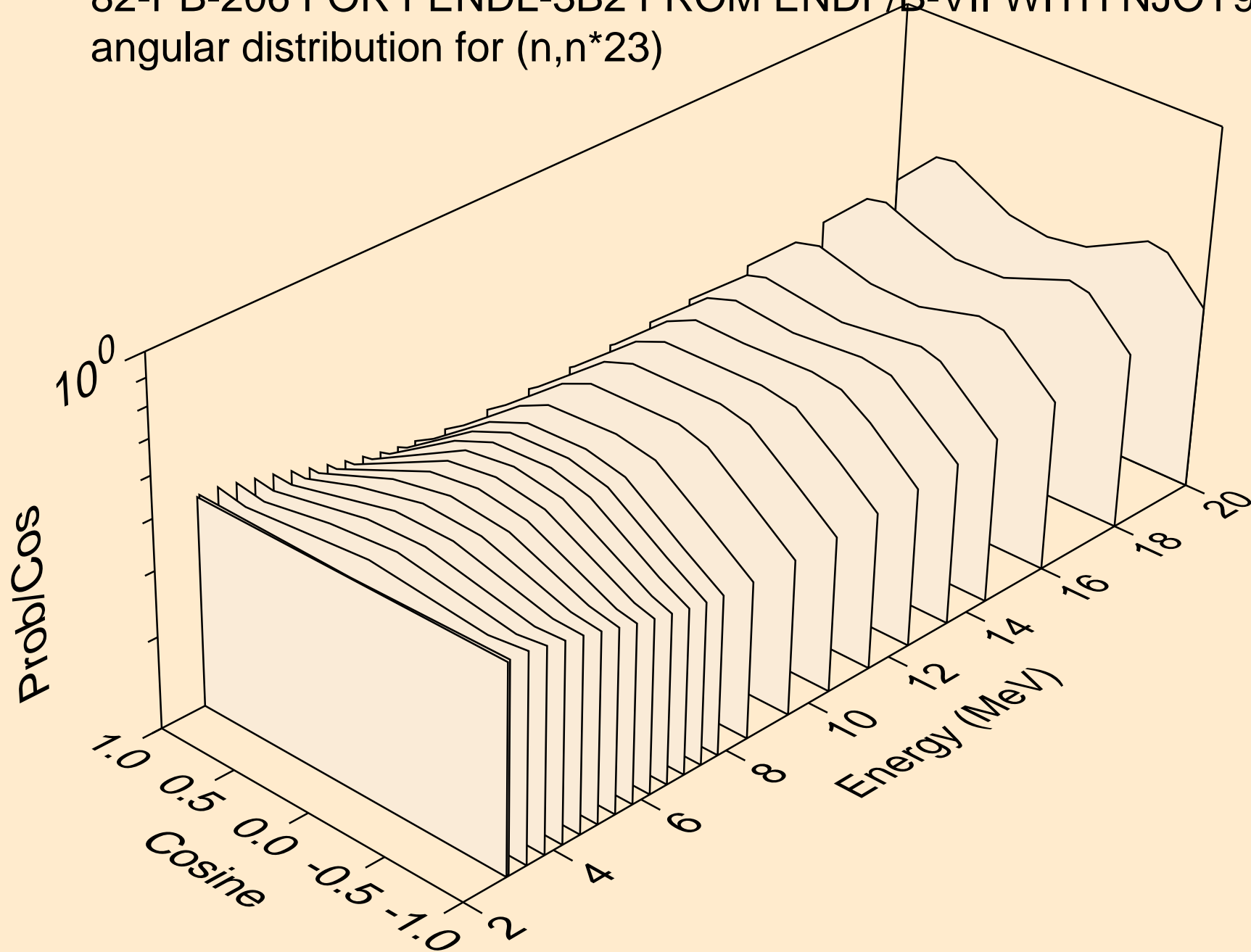

82-PB-206 FOR FENDL-3B2 FROM ENDF/B-VII WITH NJOY99.304
angular distribution for (n,n*24)

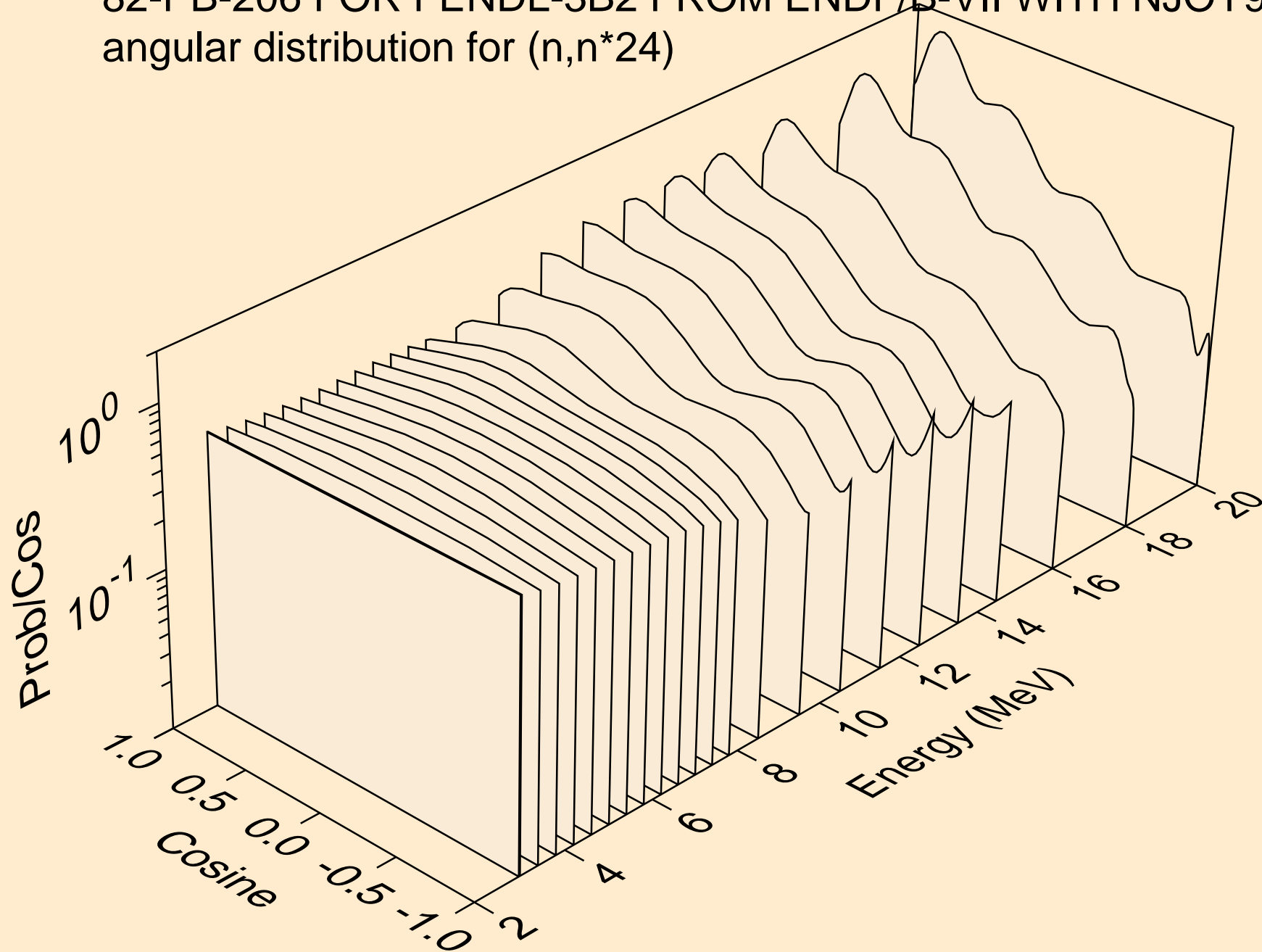

82-PB-206 FOR FENDL-3B2 FROM ENDF/B-VII WITH NJOY99.304
angular distribution for (n,n*25)

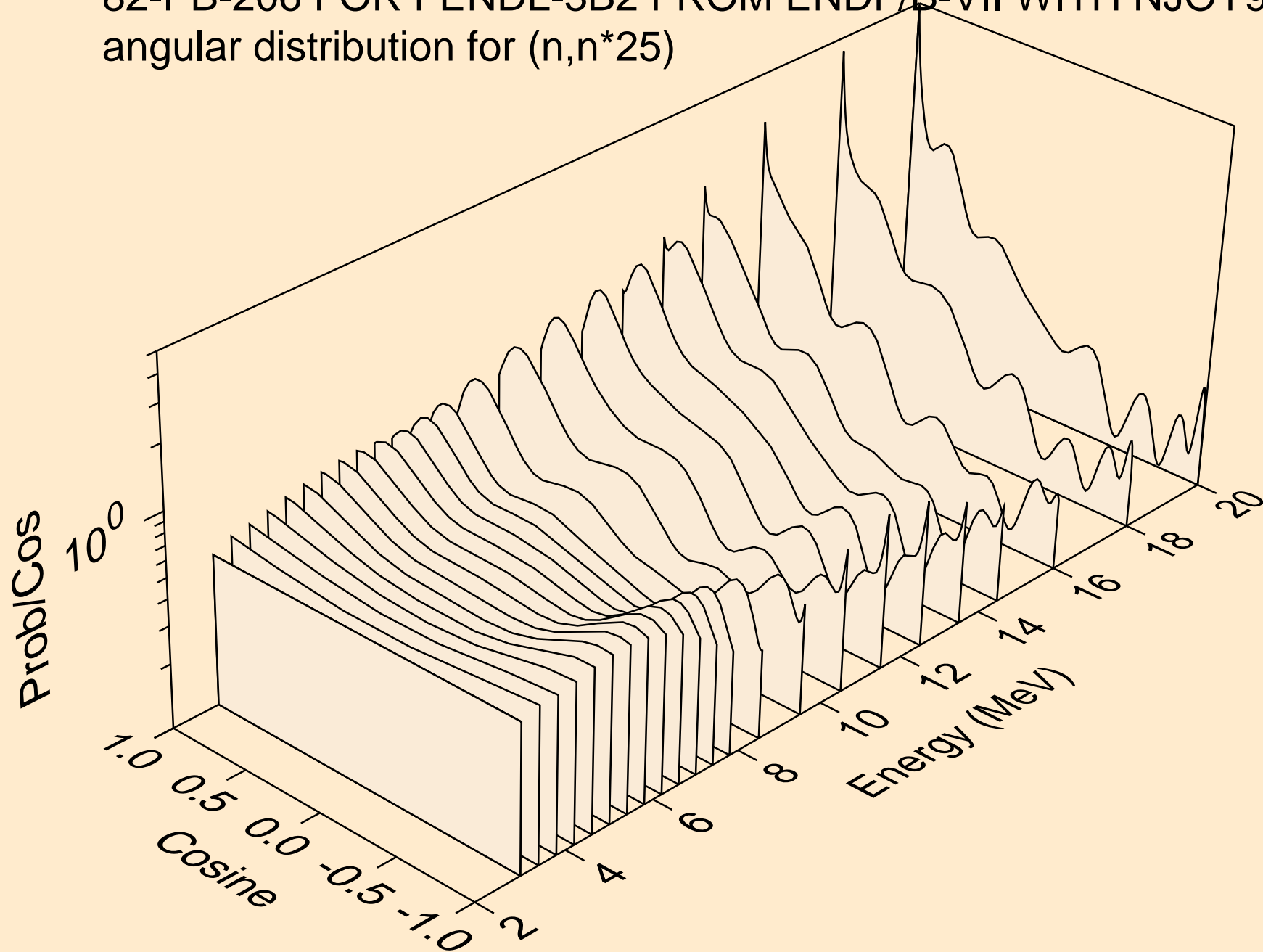

82-PB-206 FOR FENDL-3B2 FROM ENDF/B-VII WITH NJOY99.304
Neutron emission for (n,x)

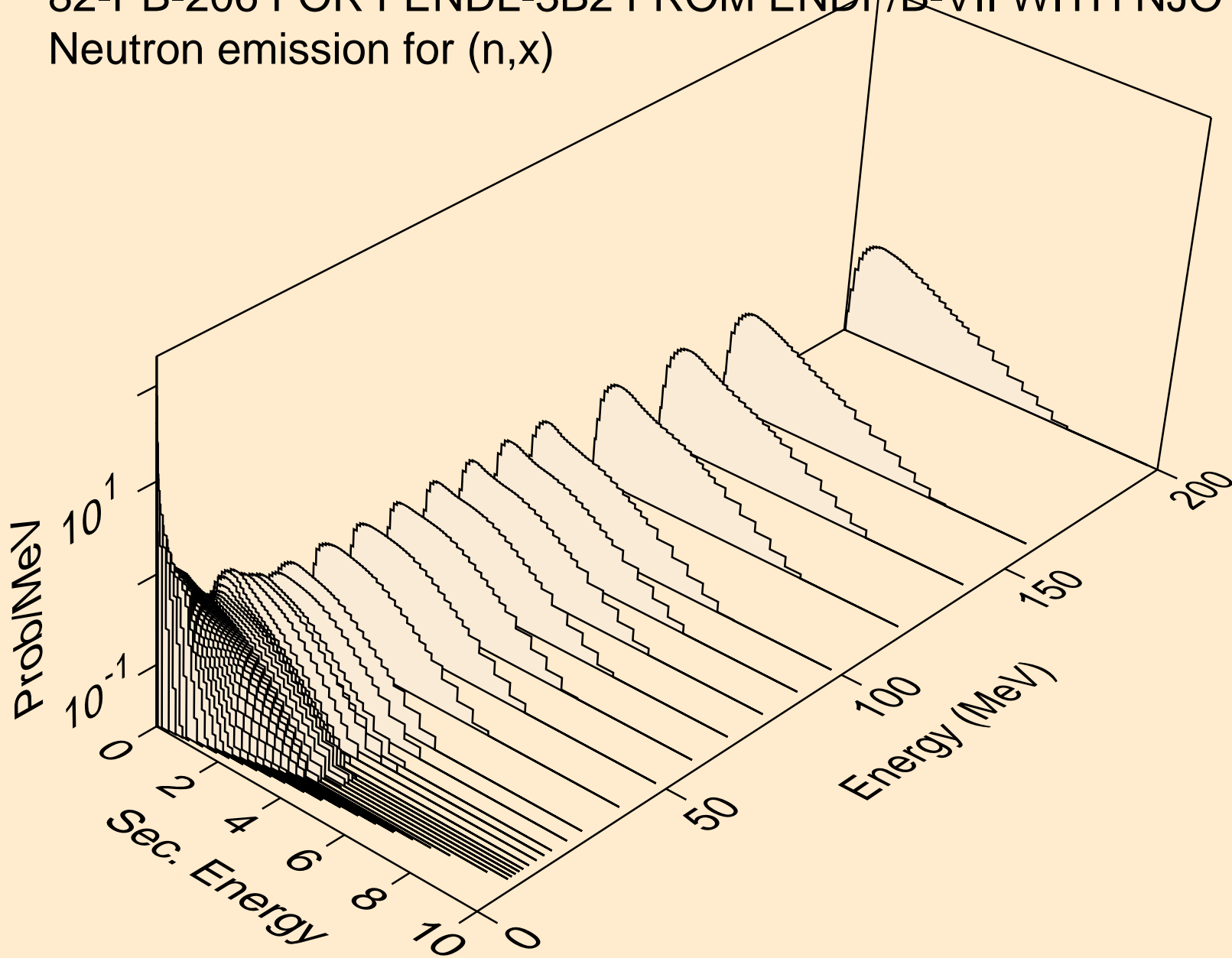

82-PB-206 FOR FENDL-3B2 FROM ENDF/B-VII WITH NJOY99.304
Neutron emission for (n,2n)

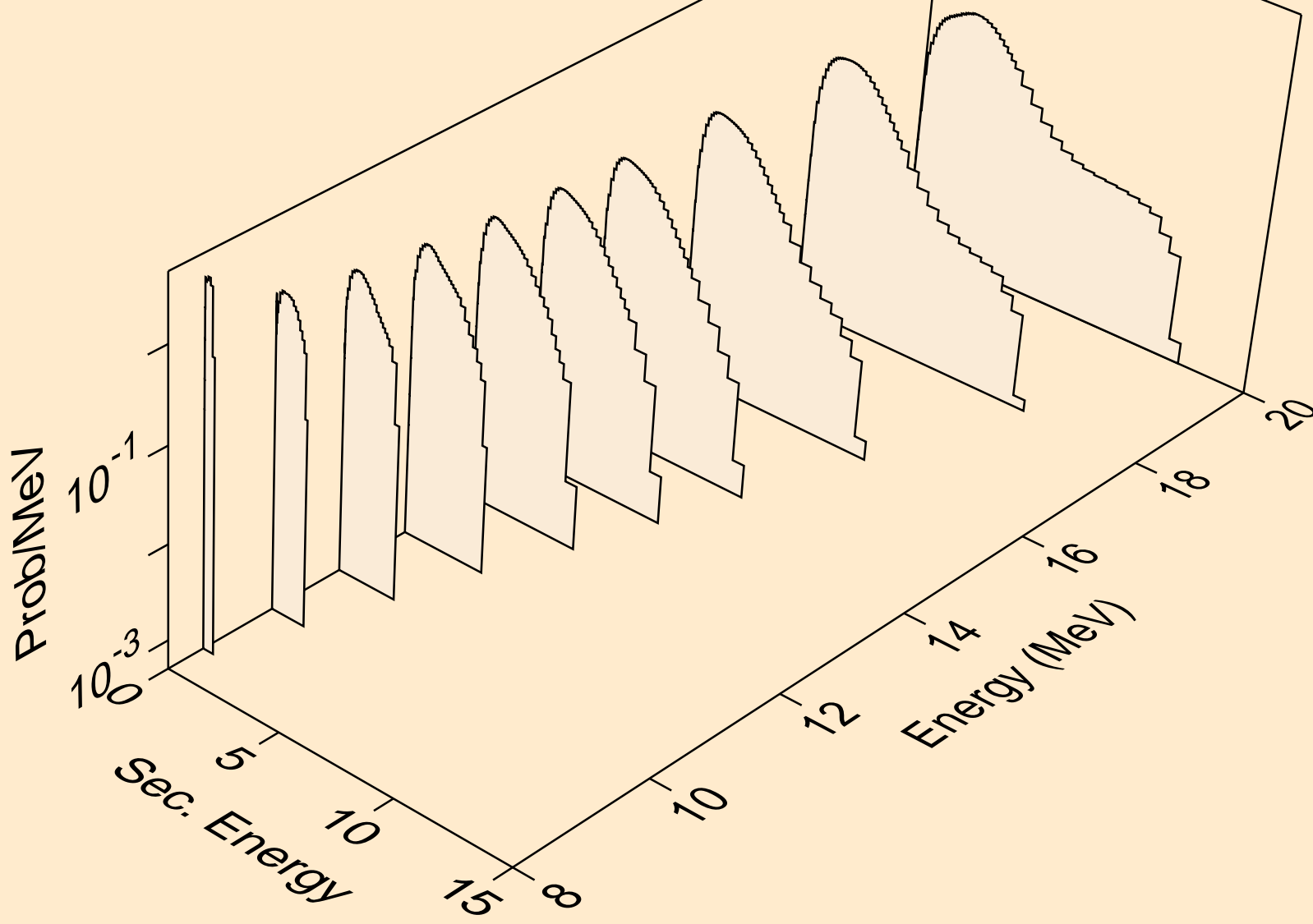

82-PB-206 FOR FENDL-3B2 FROM ENDF/B-VII WITH NJOY99.304
Neutron emission for (n,3n)

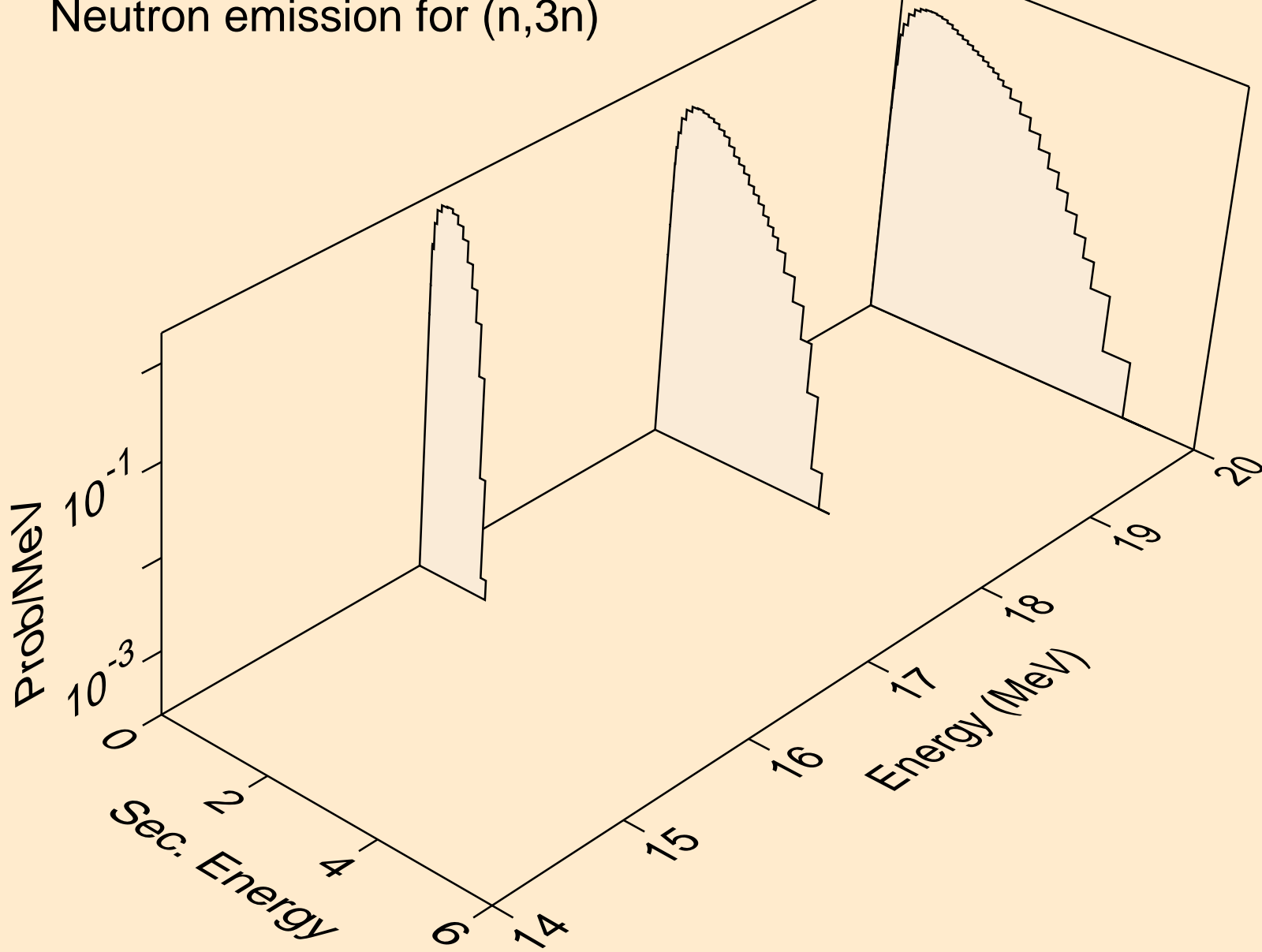

82-PB-206 FOR FENDL-3B2 FROM ENDF/B-VII WITH NJOY99.304
Neutron emission for (n,n*)a

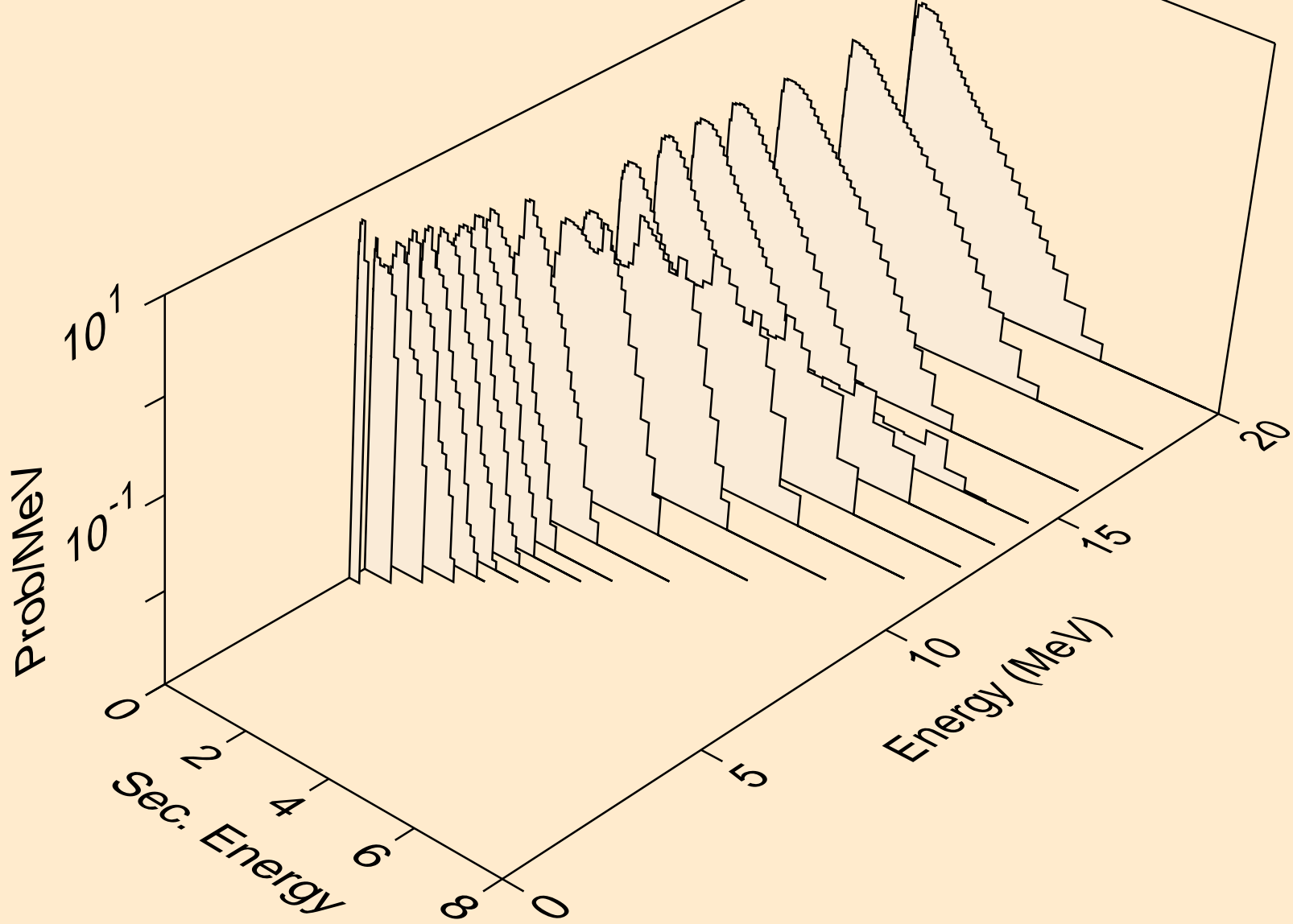

82-PB-206 FOR FENDL-3B2 FROM ENDF/B-VII WITH NJOY99.304
Neutron emission for (n,2n)a

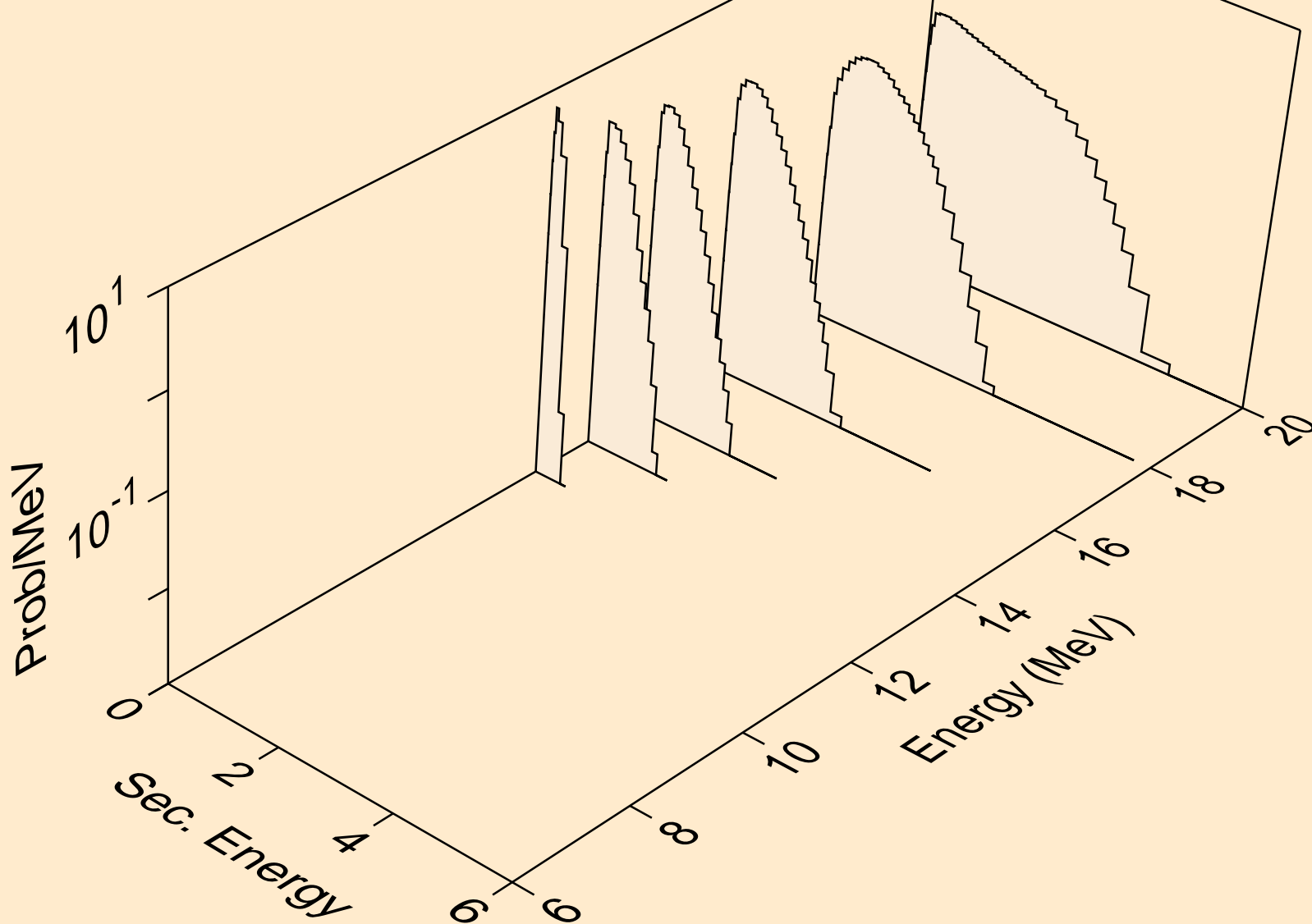

82-PB-206 FOR FENDL-3B2 FROM ENDF/B-VII WITH NJOY99.304
Neutron emission for (n,n*)p

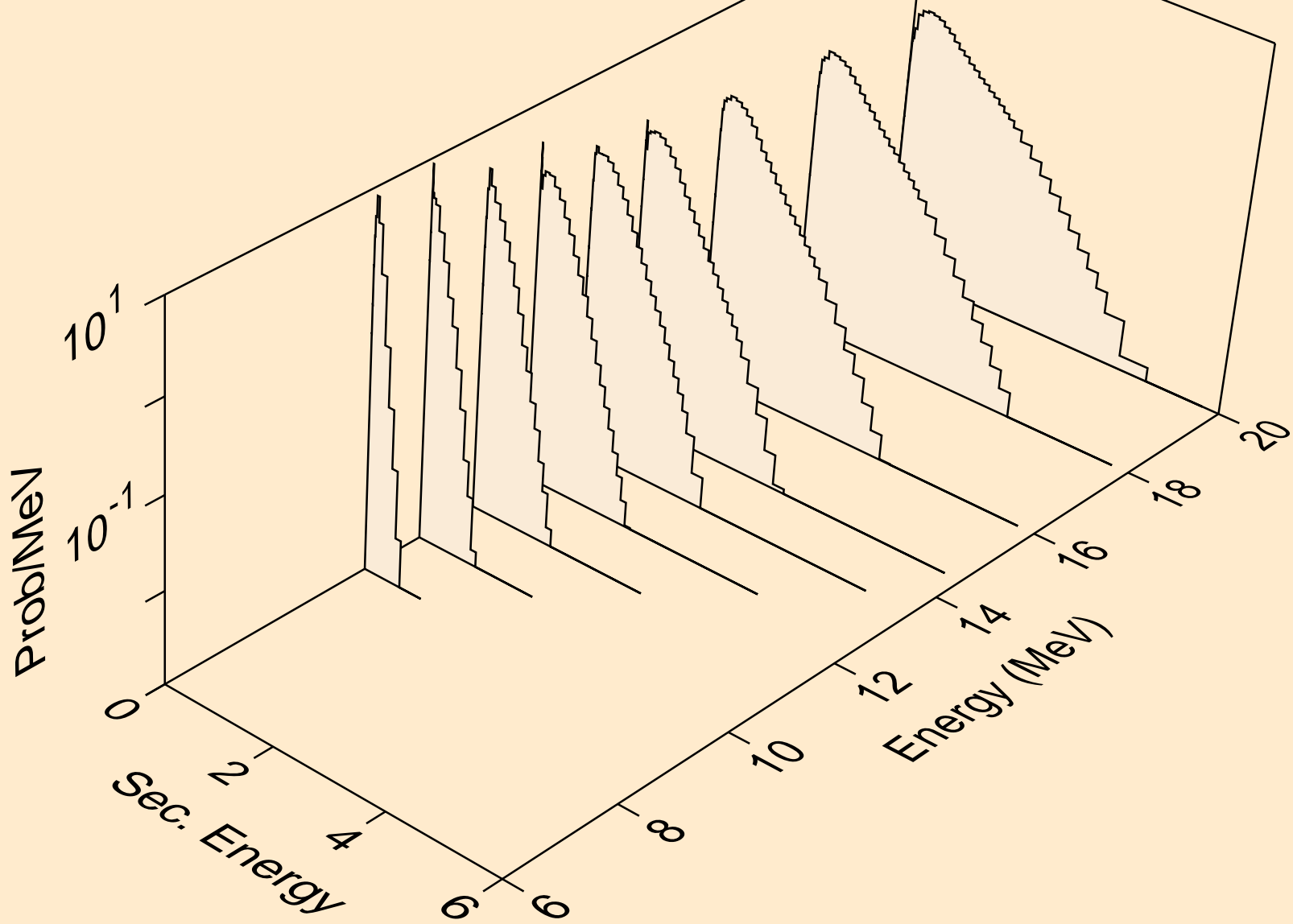

82-PB-206 FOR FENDL-3B2 FROM ENDF/B-VII WITH NJOY99.304
Neutron emission for (n,n*)d

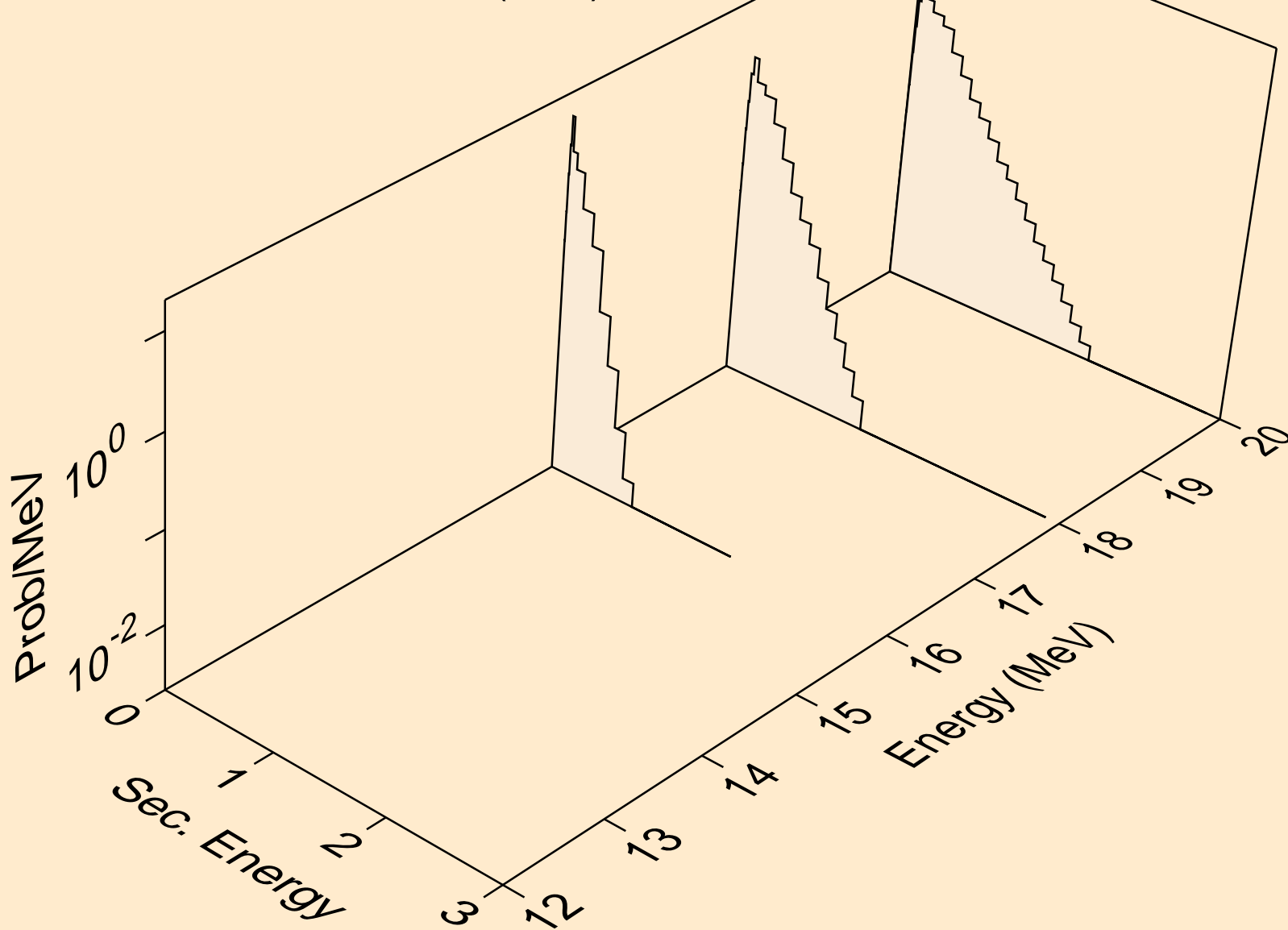

82-PB-206 FOR FENDL-3B2 FROM ENDF/B-VII WITH NJOY99.304
Neutron emission for (n,n*)t

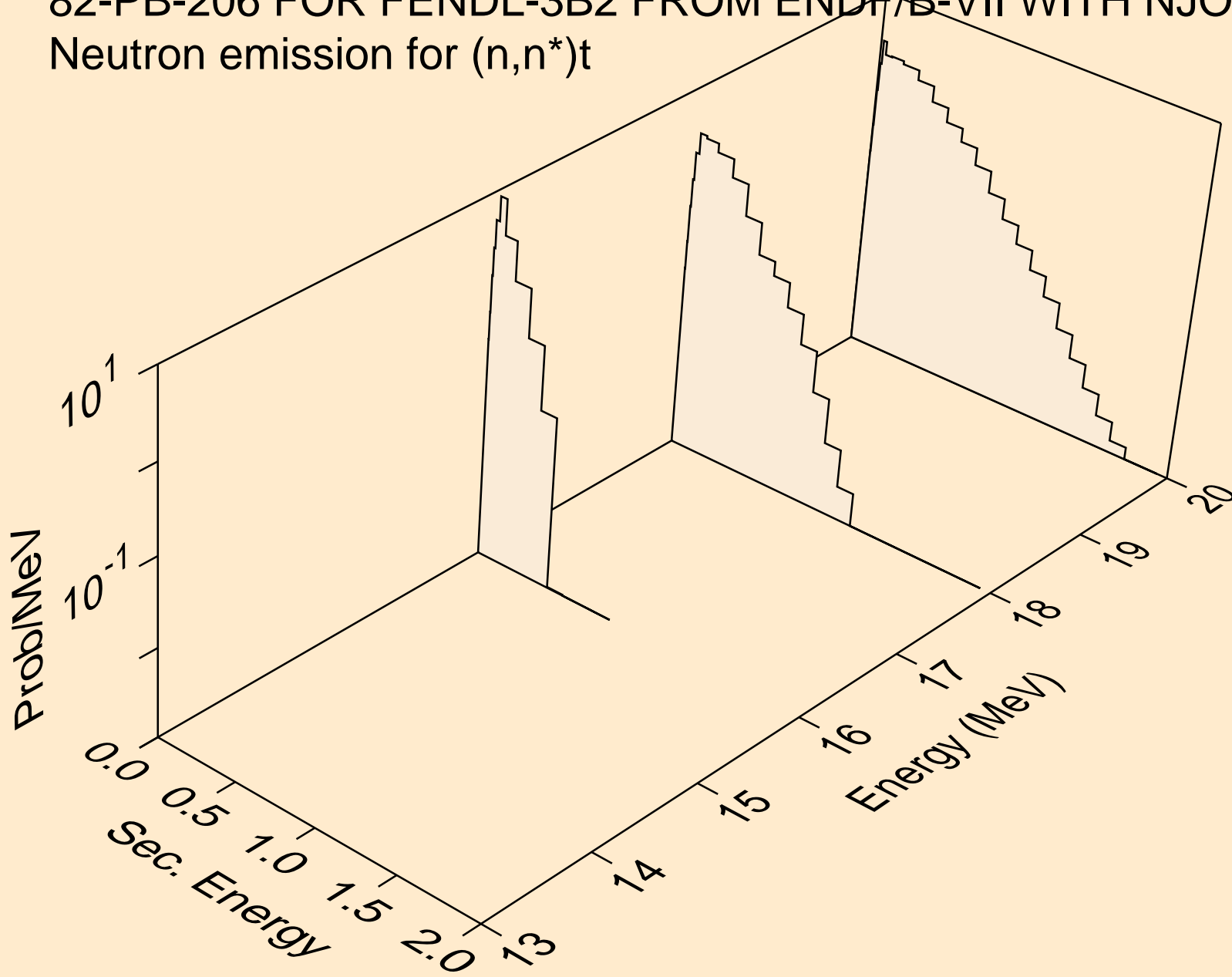

82-PB-206 FOR FENDL-3B2 FROM ENDF/B-VII WITH NJOY99.304
Neutron emission for (n,2np)

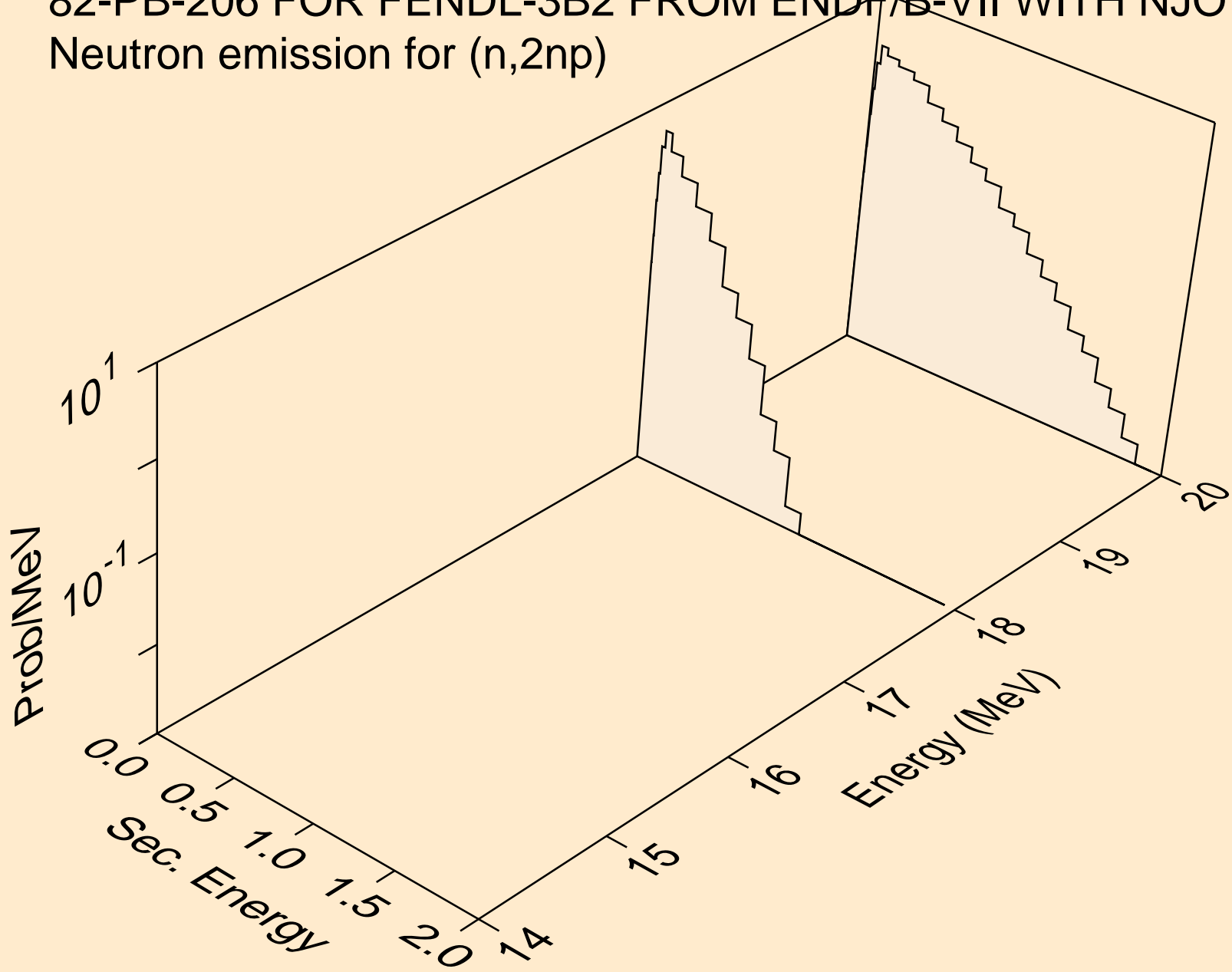

82-PB-206 FOR FENDL-3B2 FROM ENDF/B-VII WITH NJOY99.304
Neutron emission for (n,n*c)

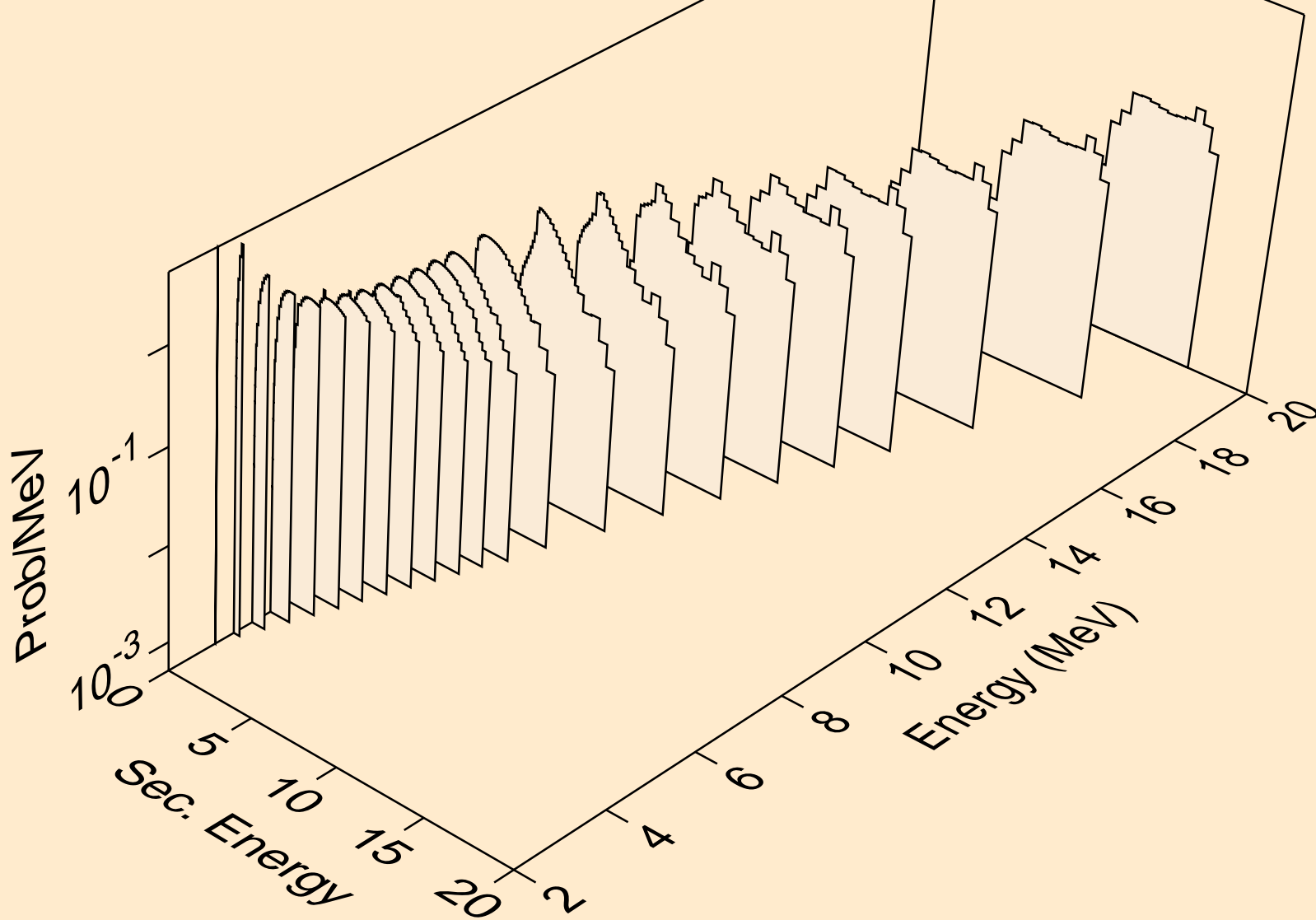

82-PB-206 FOR FENDL-3B2 FROM ENDF/B-VII WITH NJOY99.304
Photon emission for (n,x)

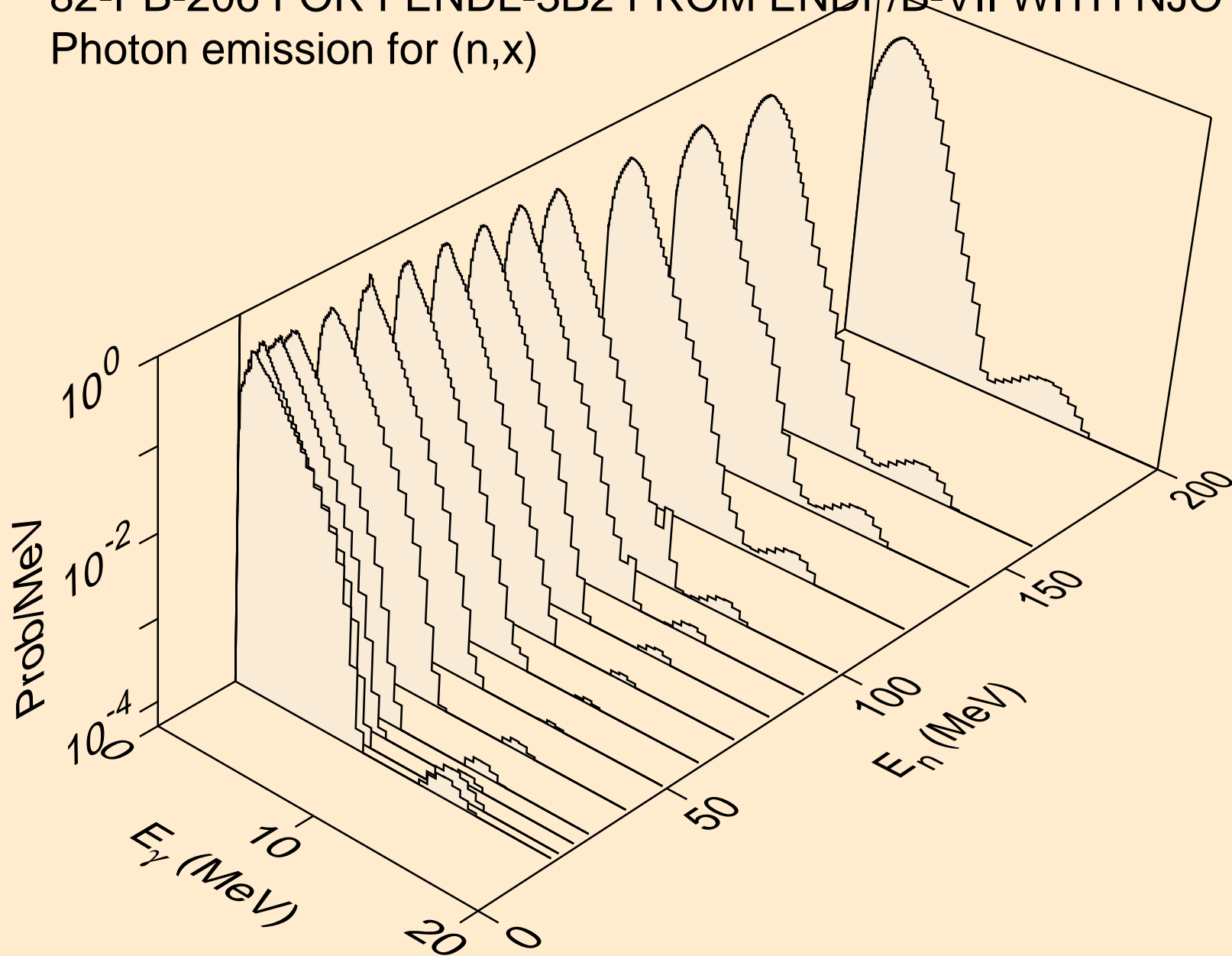

82-PB-206 FOR FENDL-3B2 FROM ENDF/B-VII WITH NJOY99.304
Photon emission for (n,2n)

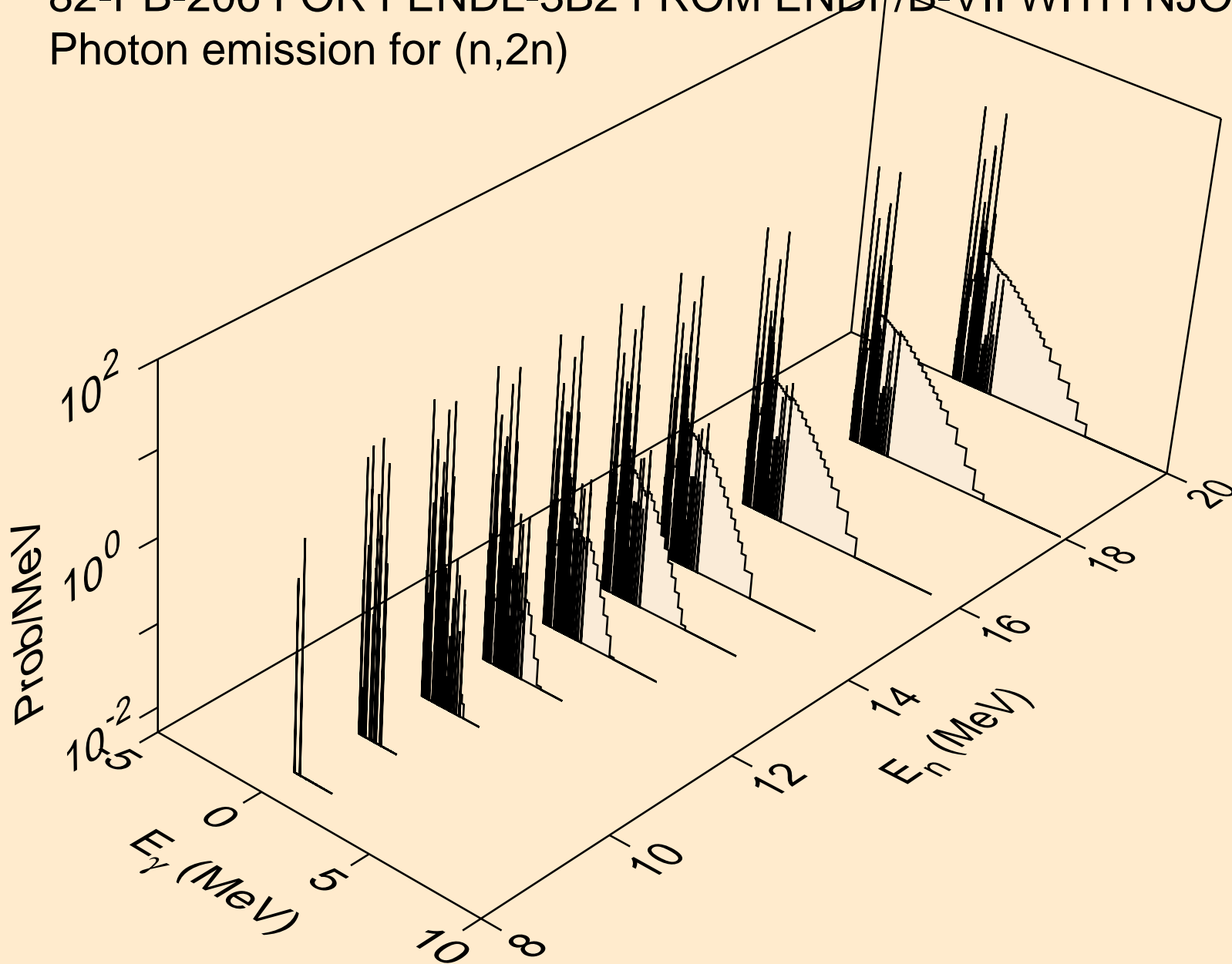

82-PB-206 FOR FENDL-3B2 FROM ENDF/B-VII WITH NJOY99.304
Photon emission for (n,3n)

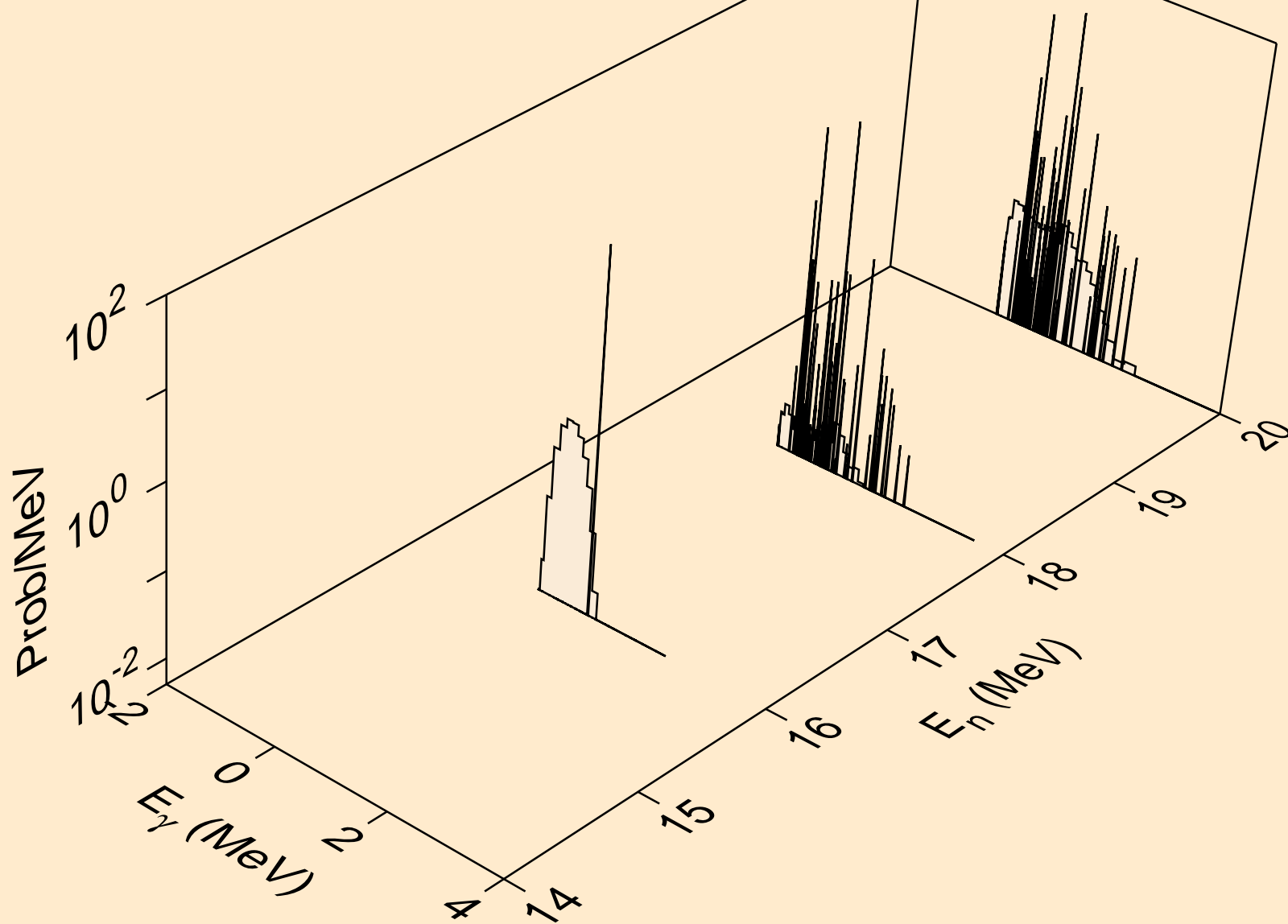

82-PB-206 FOR FENDL-3B2 FROM ENDF/B-VII WITH NJOY99.304
Photon emission for (n,n*)a

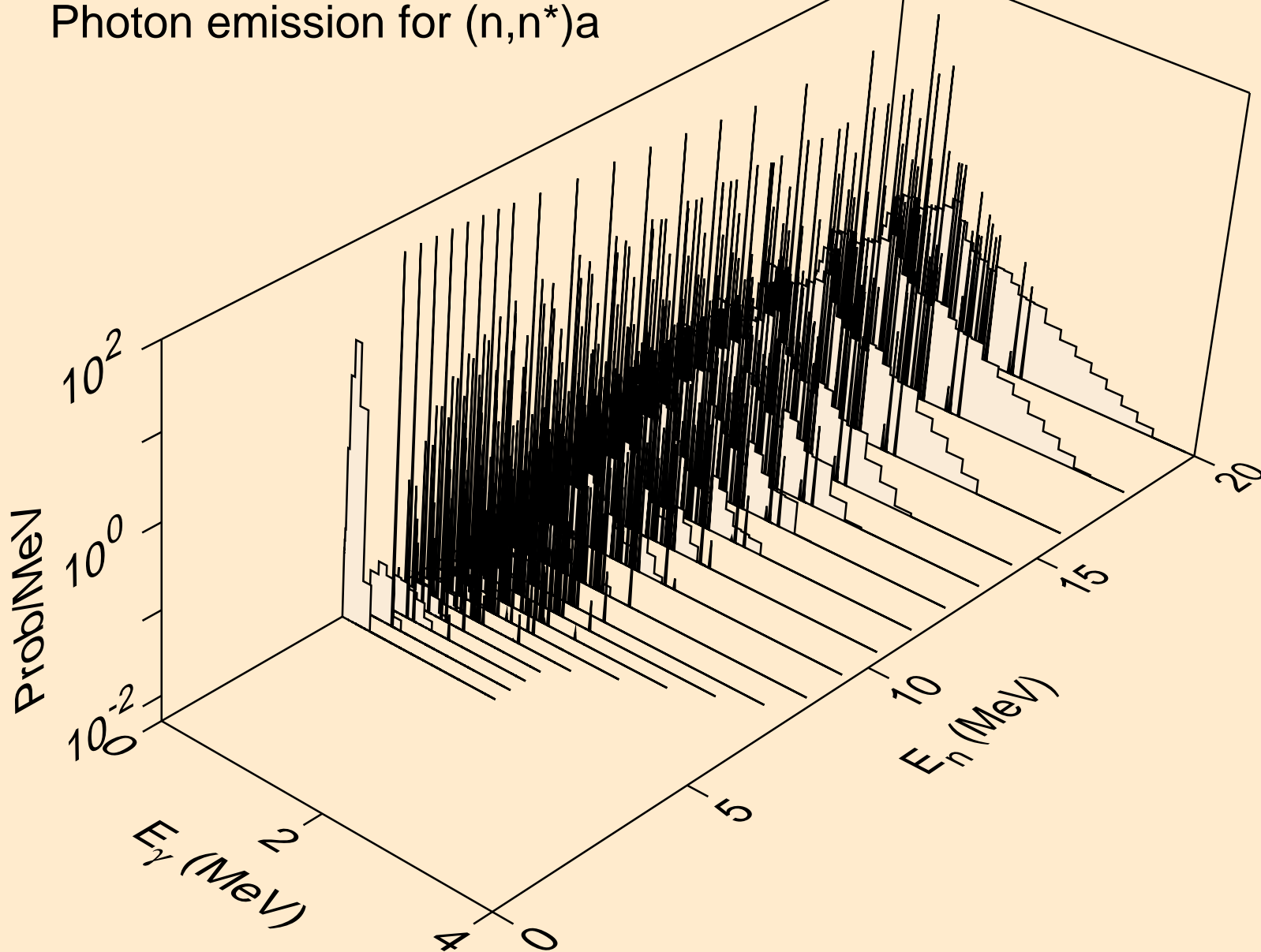

82-PB-206 FOR FENDL-3B2 FROM ENDF/B-VII WITH NJOY99.304
Photon emission for (n,2n)a

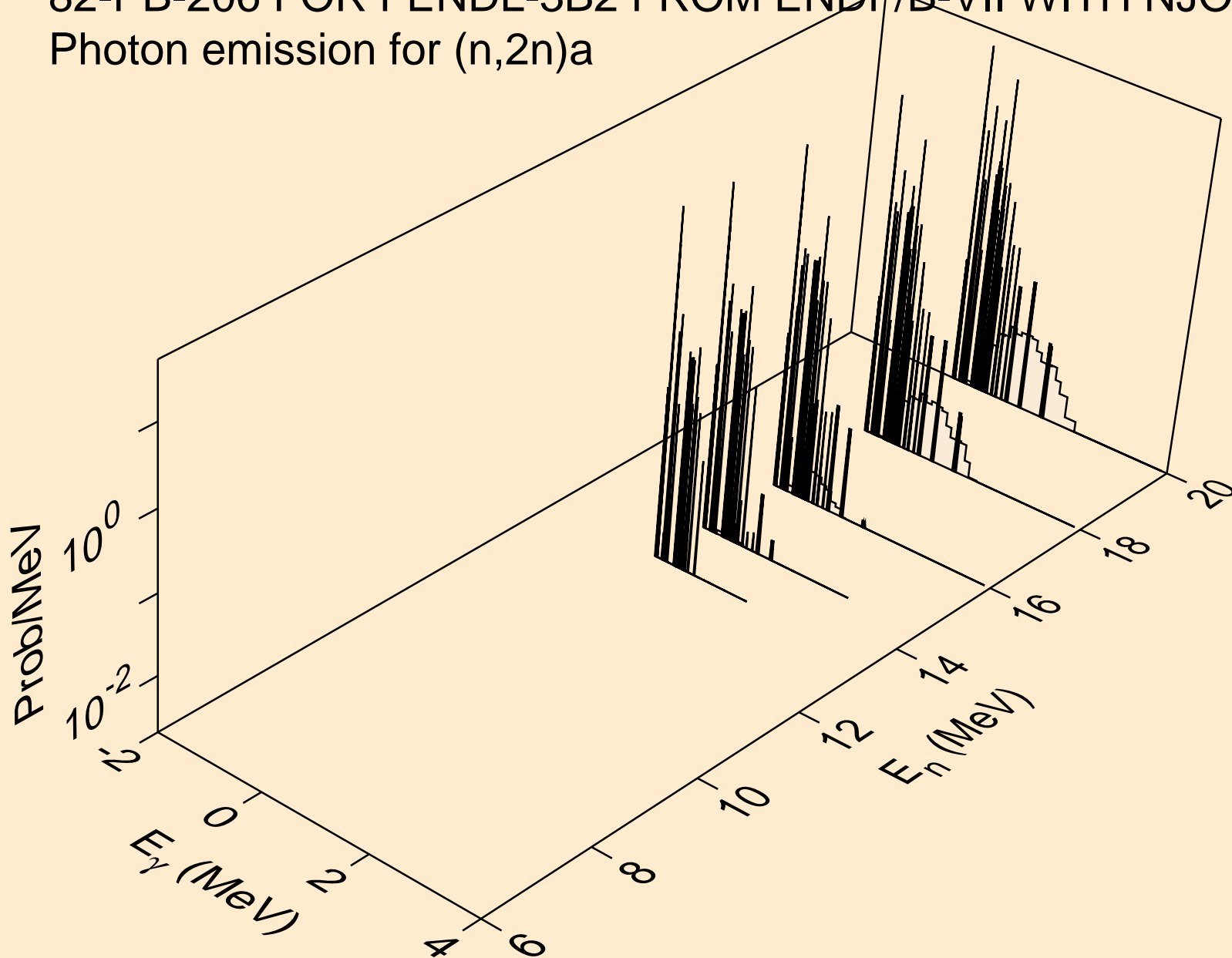

82-PB-206 FOR FENDL-3B2 FROM ENDF/B-VII WITH NJOY99.304
Photon emission for (n,n*)p

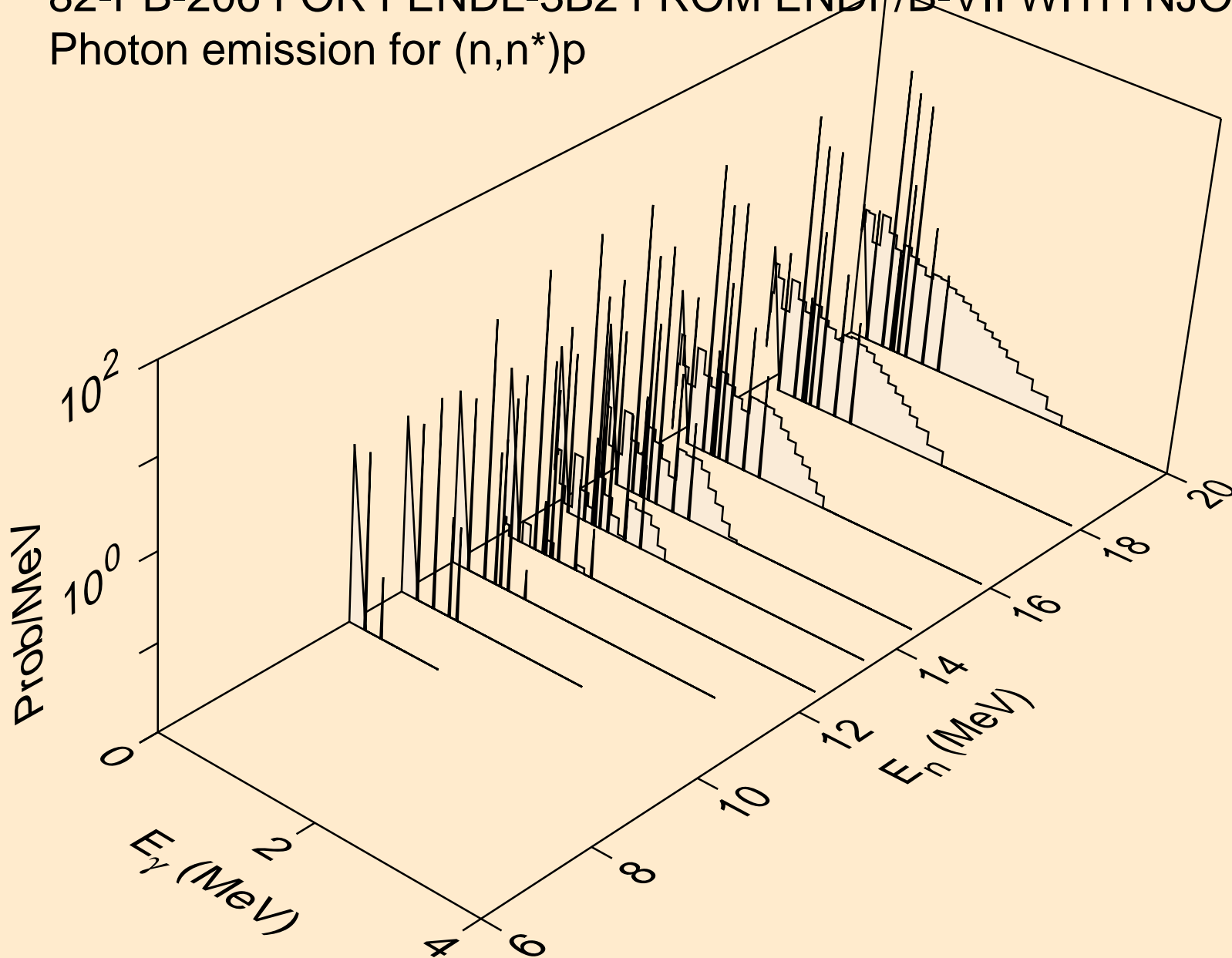

82-PB-206 FOR FENDL-3B2 FROM ENDF/B-VII WITH NJOY99.304
Photon emission for (n,n*)d

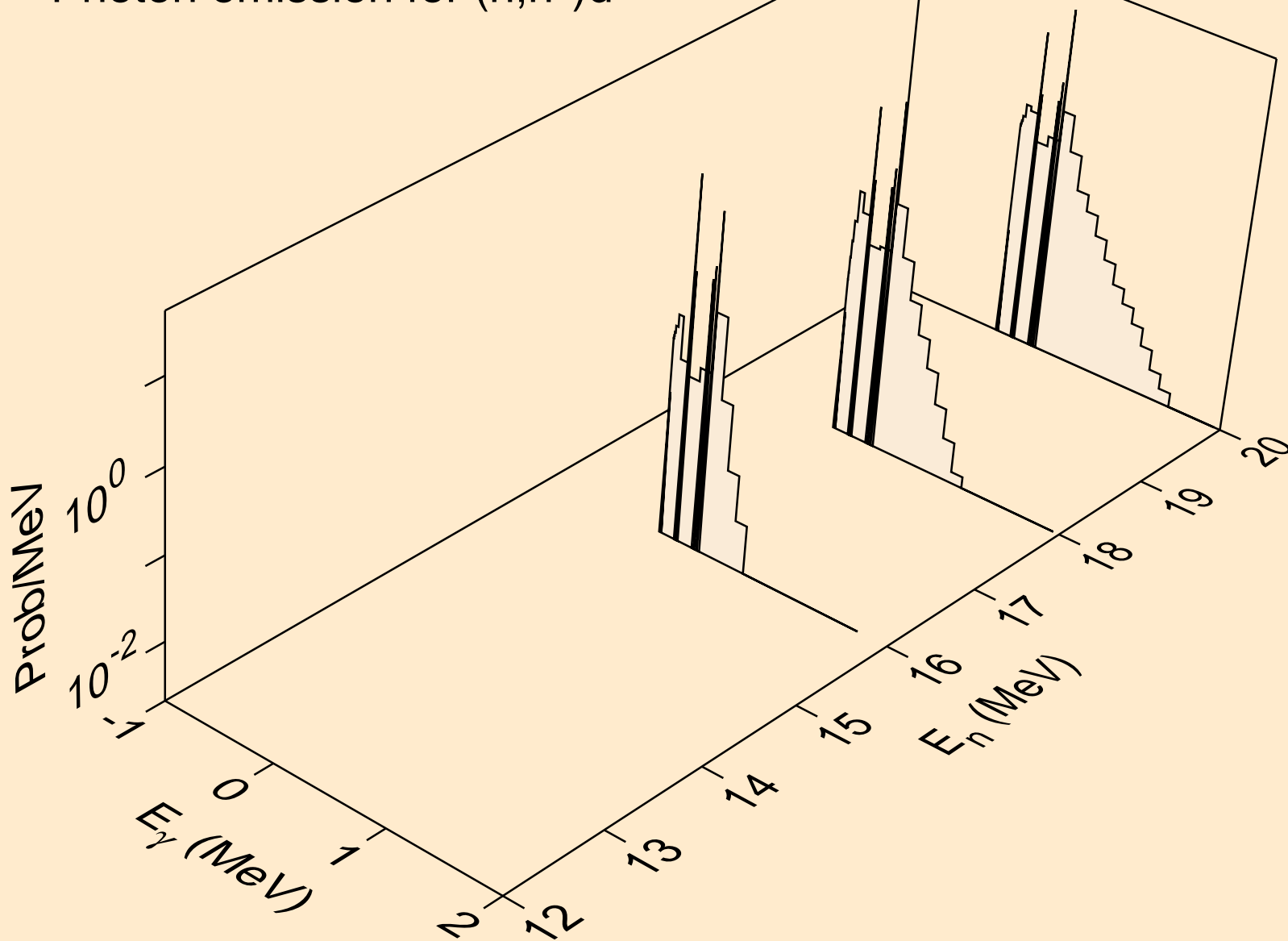

82-PB-206 FOR FENDL-3B2 FROM ENDF/B-VII WITH NJOY99.304
Photon emission for (n,n*)t

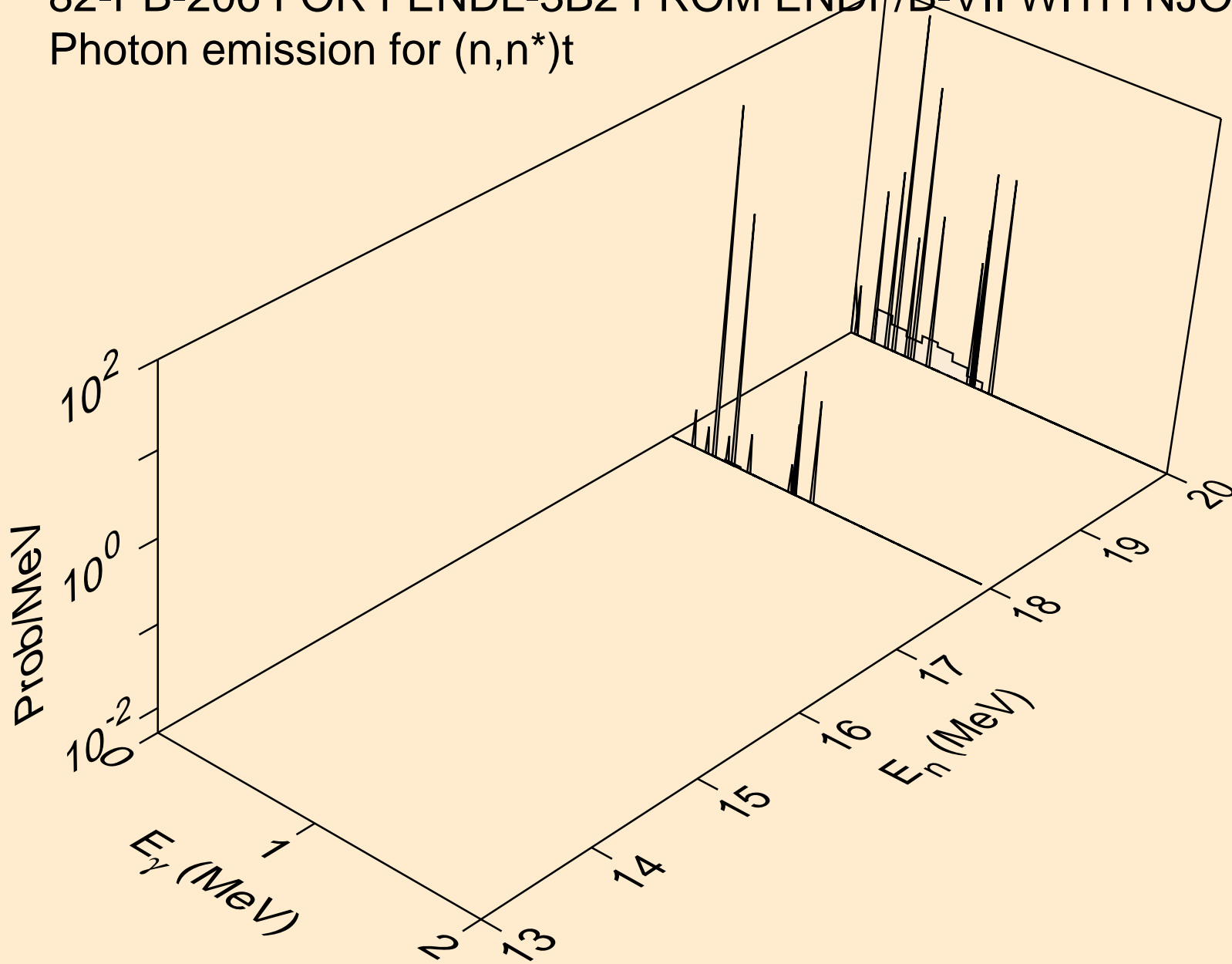

82-PB-206 FOR FENDL-3B2 FROM ENDF/B-VII WITH NJOY99.304
Photon emission for (n,2np)

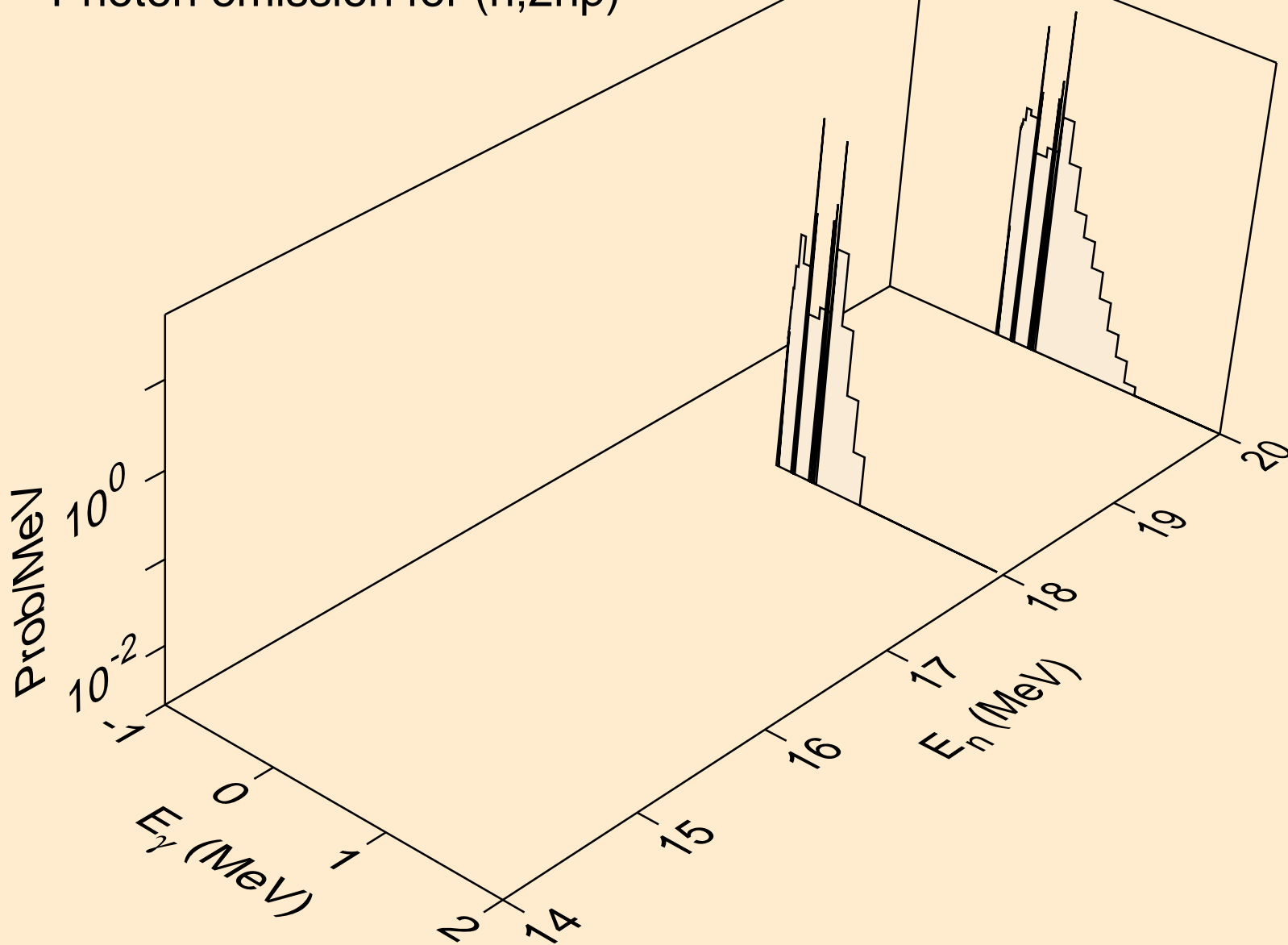

82-PB-206 FOR FENDL-3B2 FROM ENDF/B-VII WITH NJOY99.304
Photon emission for (n,n*1)

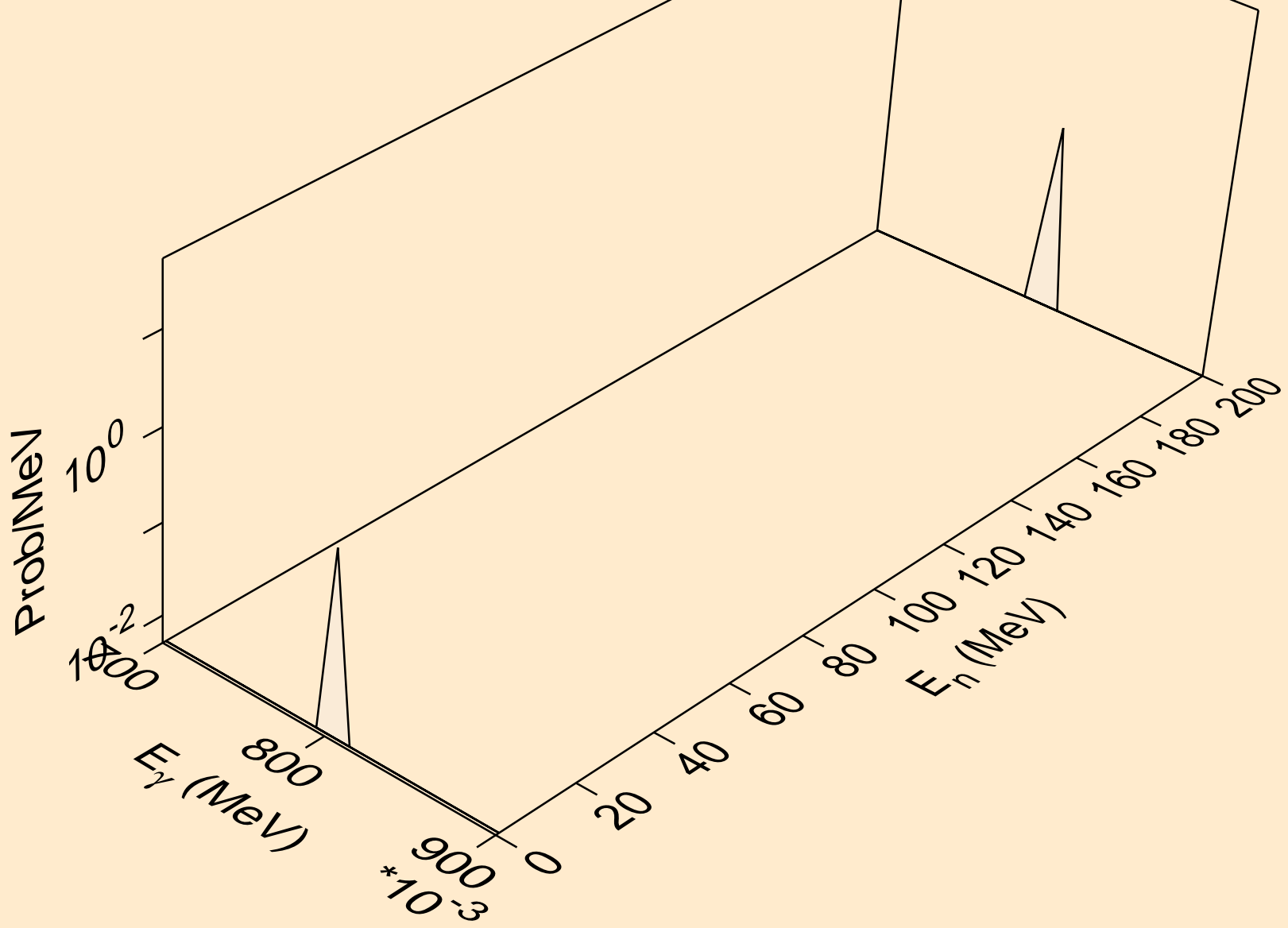

82-PB-206 FOR FENDL-3B2 FROM ENDF/B-VII WITH NJOY99.304
Photon emission for (n,n*2)

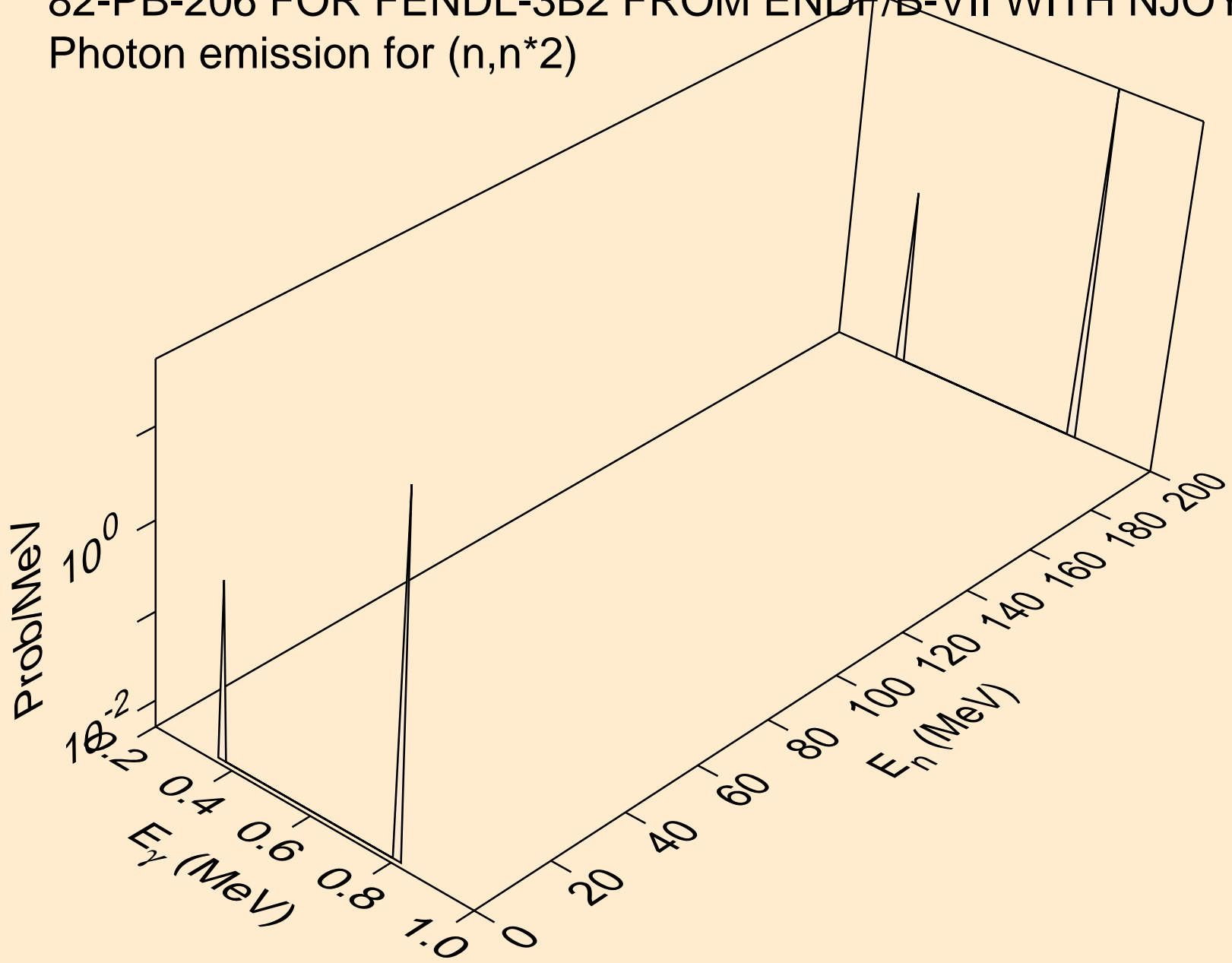

82-PB-206 FOR FENDL-3B2 FROM ENDF/B-VII WITH NJOY99.304
Photon emission for (n,n*3)

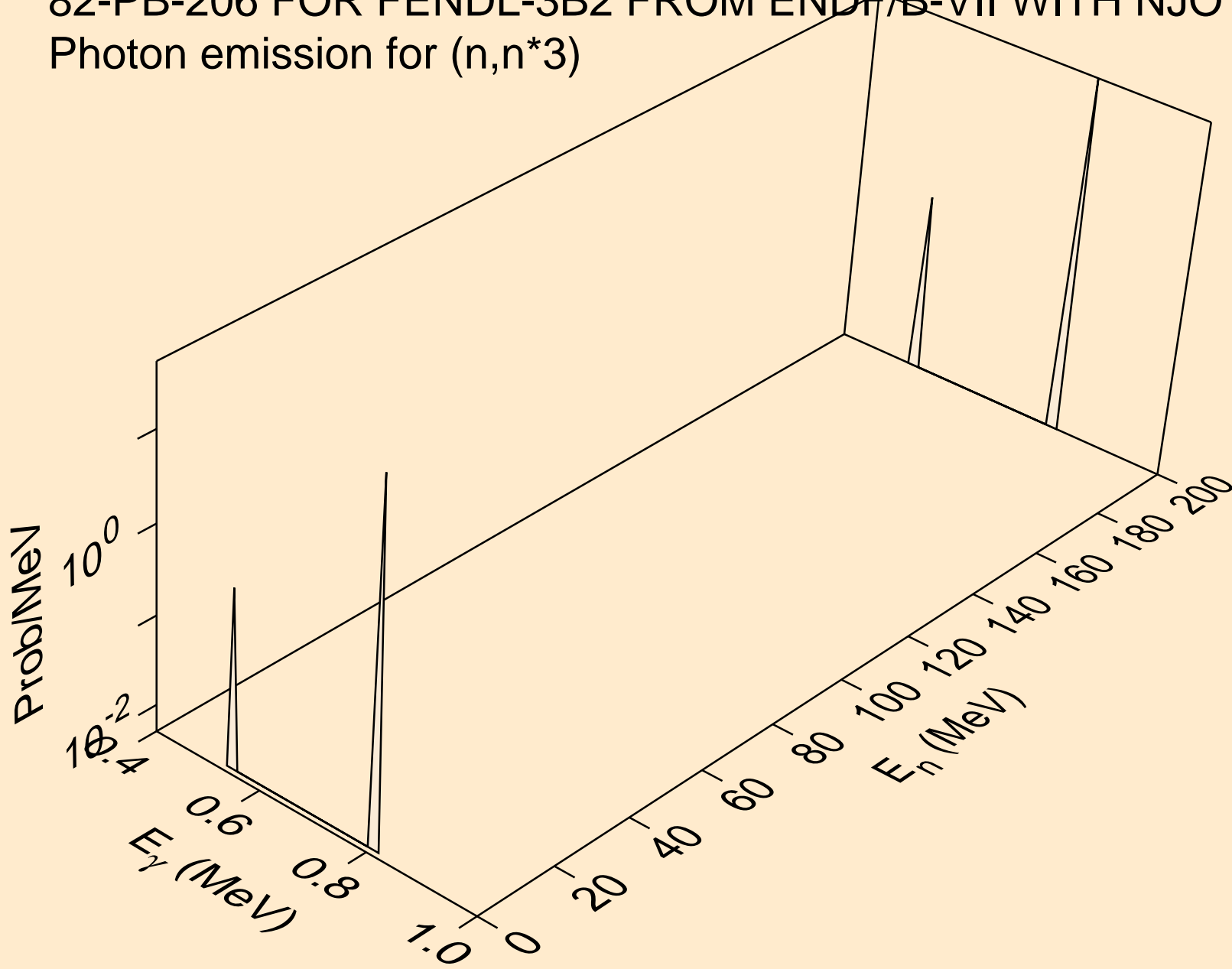

82-PB-206 FOR FENDL-3B2 FROM ENDF/B-VII WITH NJOY99.304
Photon emission for (n,n*4)

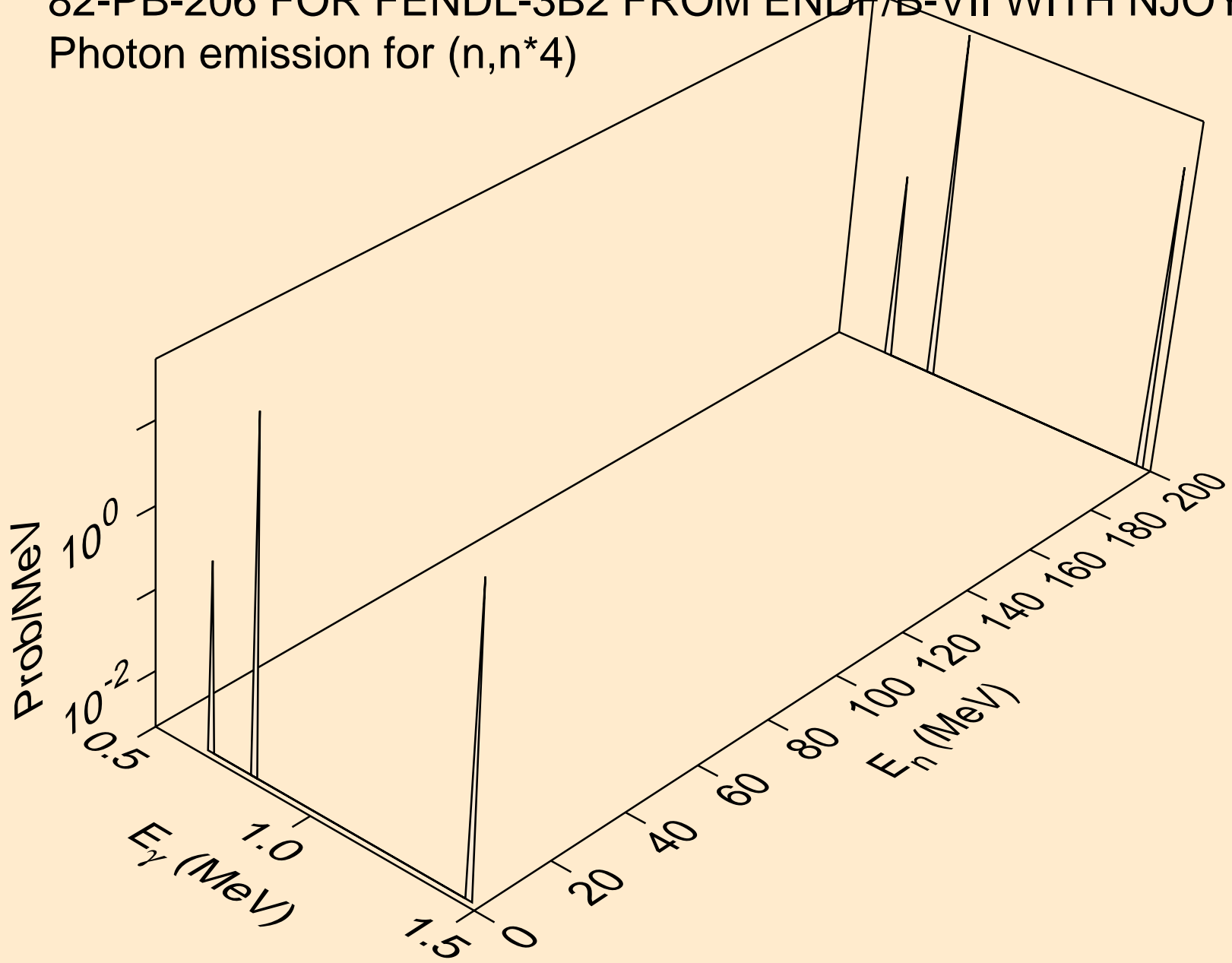

82-PB-206 FOR FENDL-3B2 FROM ENDF/B-VII WITH NJOY99.304
Photon emission for (n,n*5)

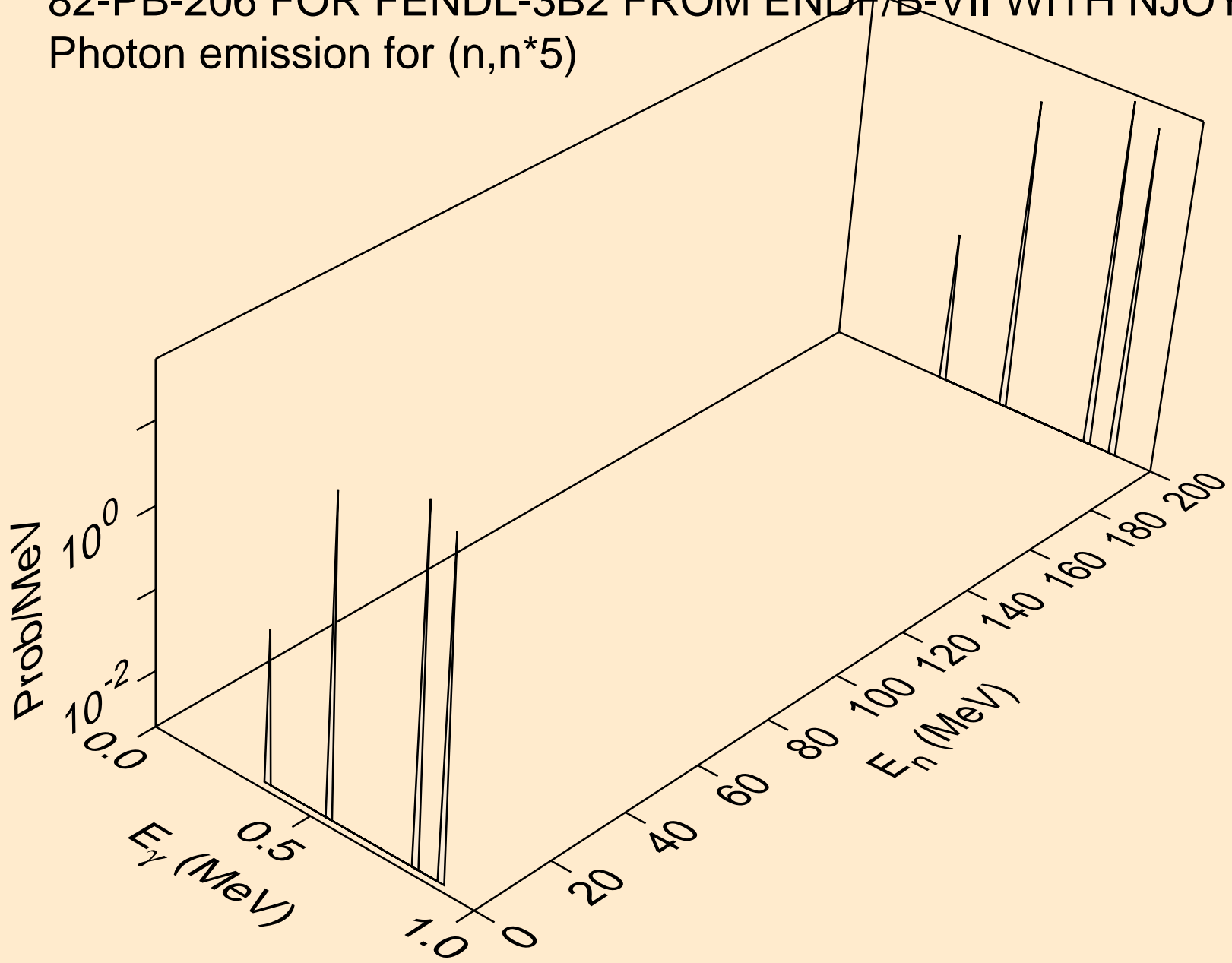

82-PB-206 FOR FENDL-3B2 FROM ENDF/B-VII WITH NJOY99.304
Photon emission for (n,n*6)

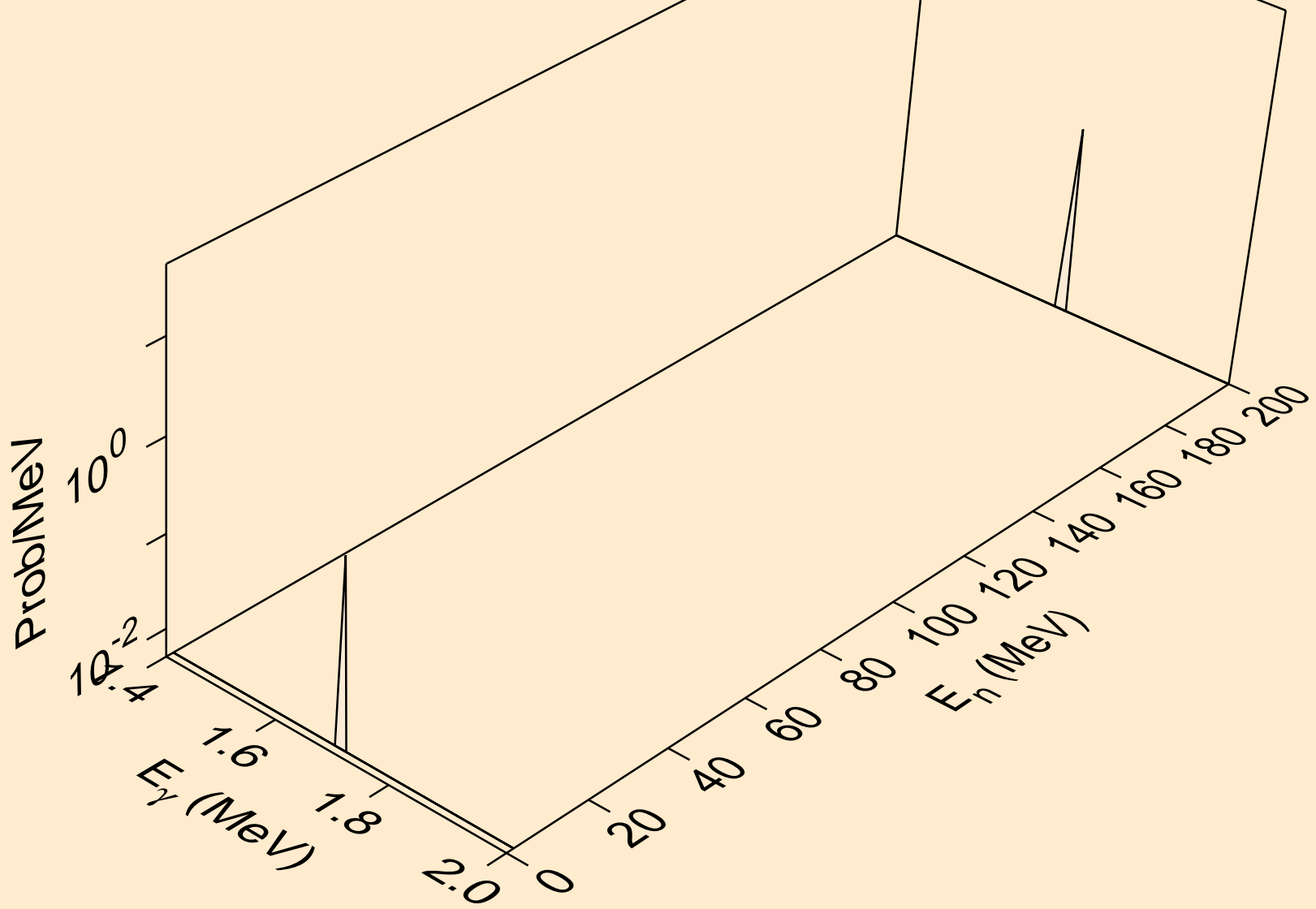

82-PB-206 FOR FENDL-3B2 FROM ENDF/B-VII WITH NJOY99.304
Photon emission for (n,n*7)

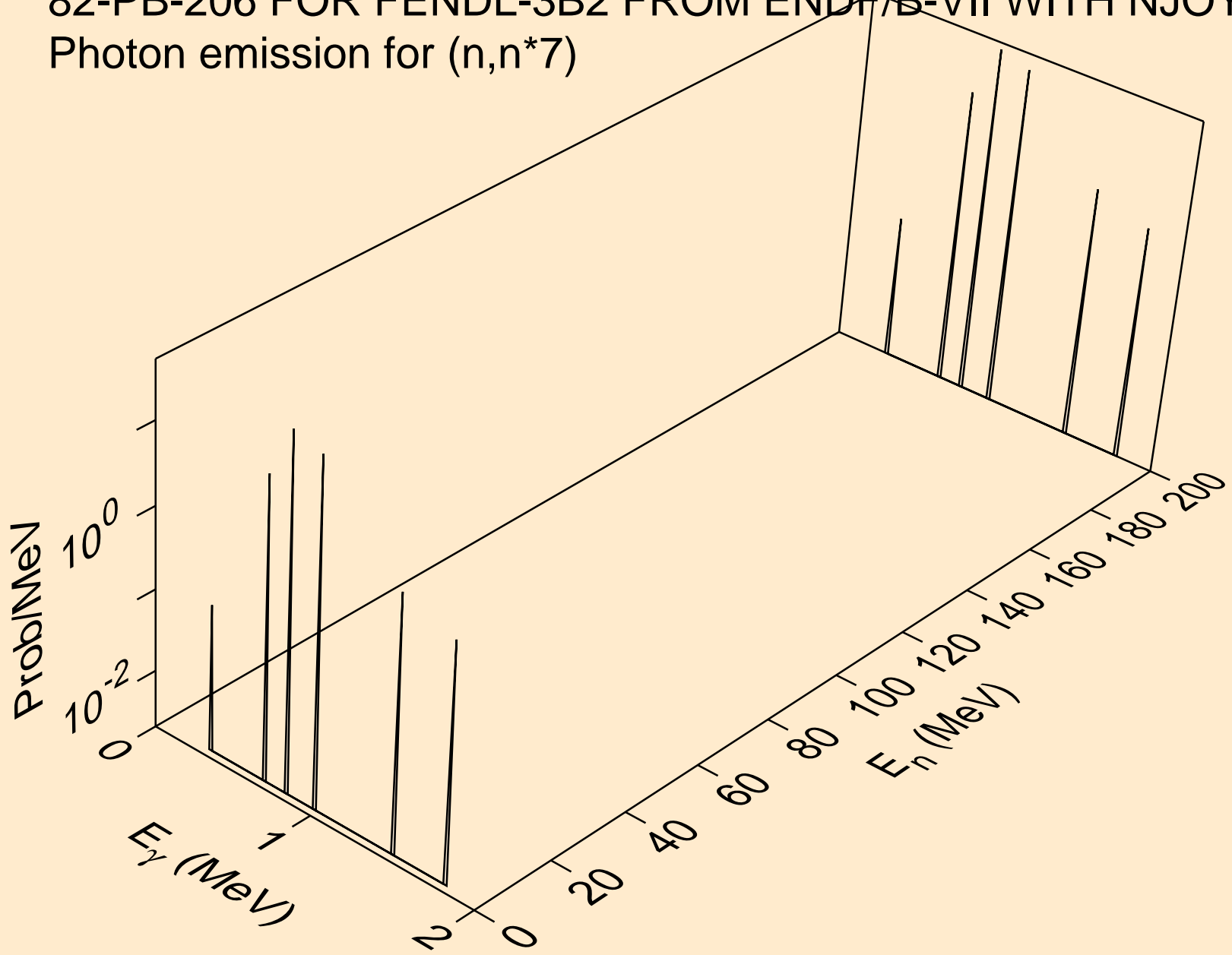

82-PB-206 FOR FENDL-3B2 FROM ENDF/B-VII WITH NJOY99.304
Photon emission for (n,n*8)

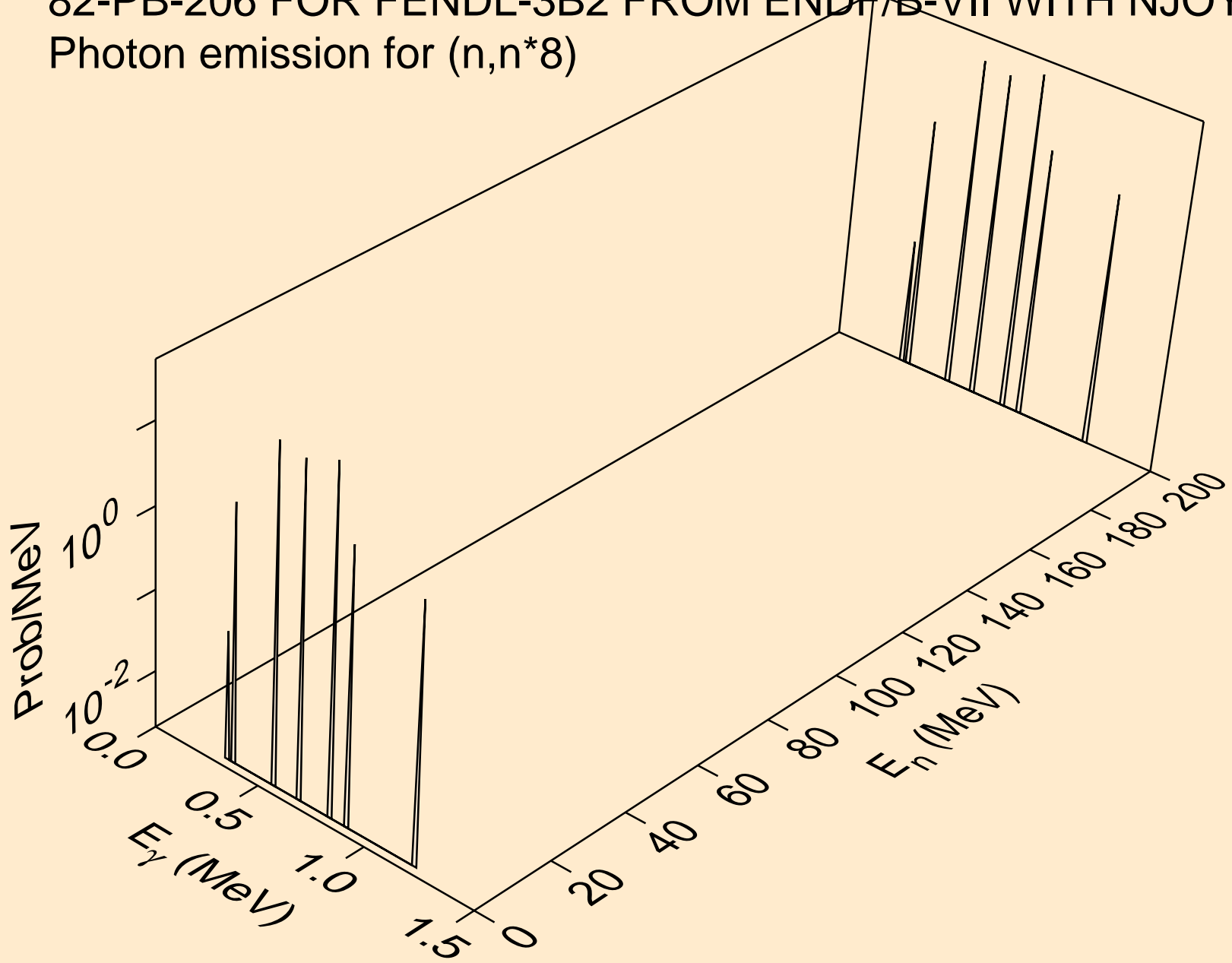

82-PB-206 FOR FENDL-3B2 FROM ENDF/B-VII WITH NJOY99.304
Photon emission for (n,n*9)

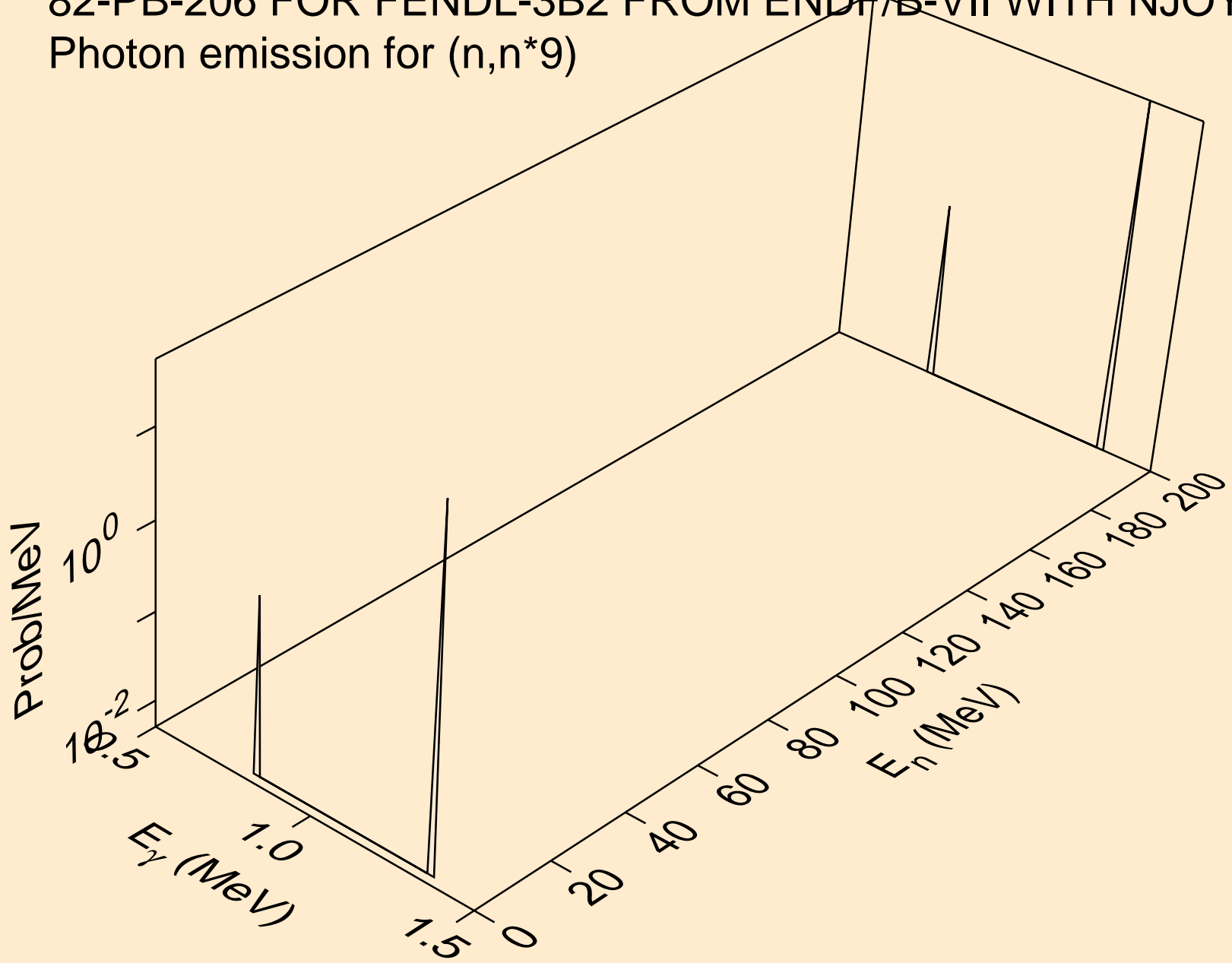

82-PB-206 FOR FENDL-3B2 FROM ENDF/B-VII WITH NJOY99.304
Photon emission for (n,n*10)

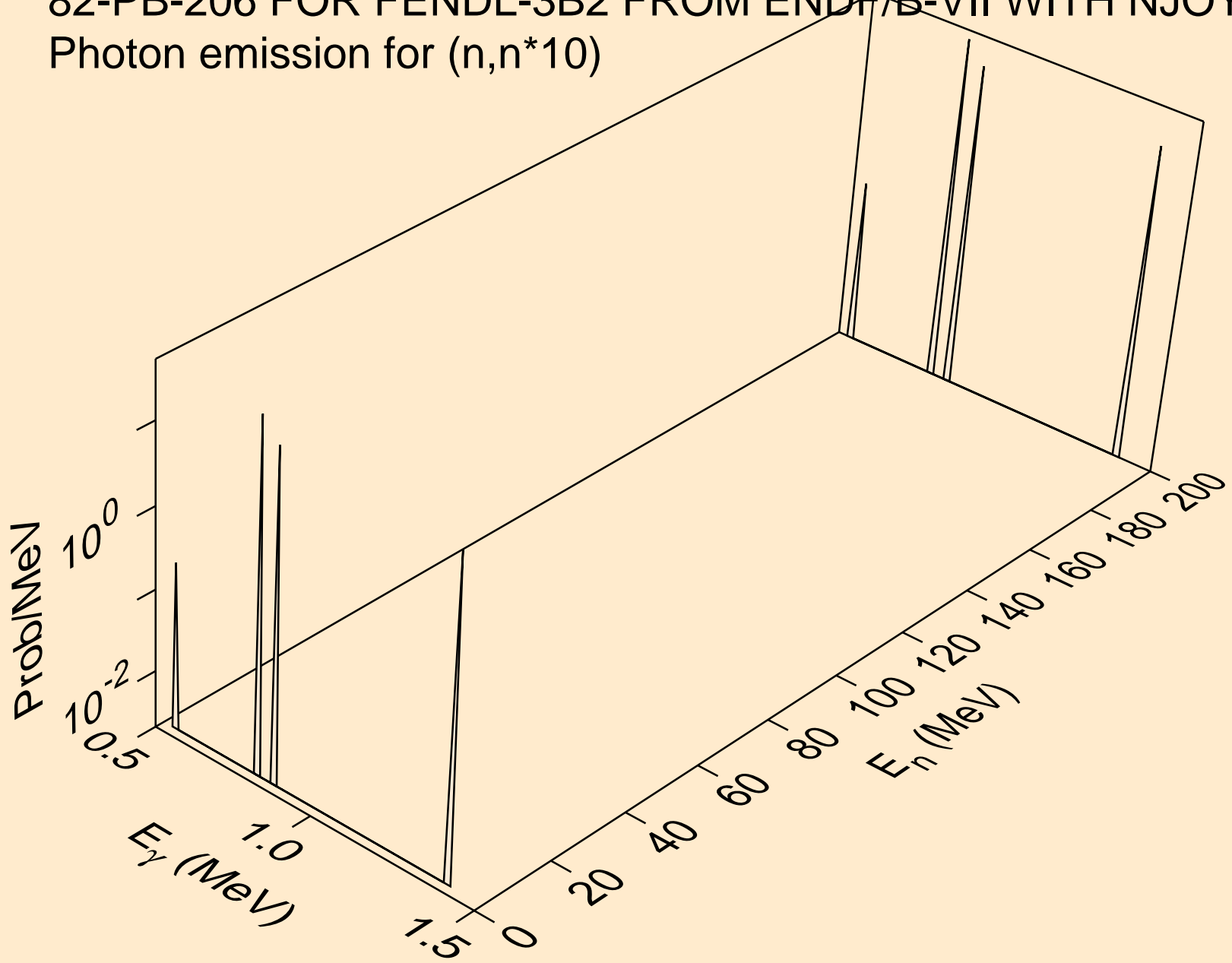

82-PB-206 FOR FENDL-3B2 FROM ENDF/B-VII WITH NJOY99.304
Photon emission for (n,n*11)

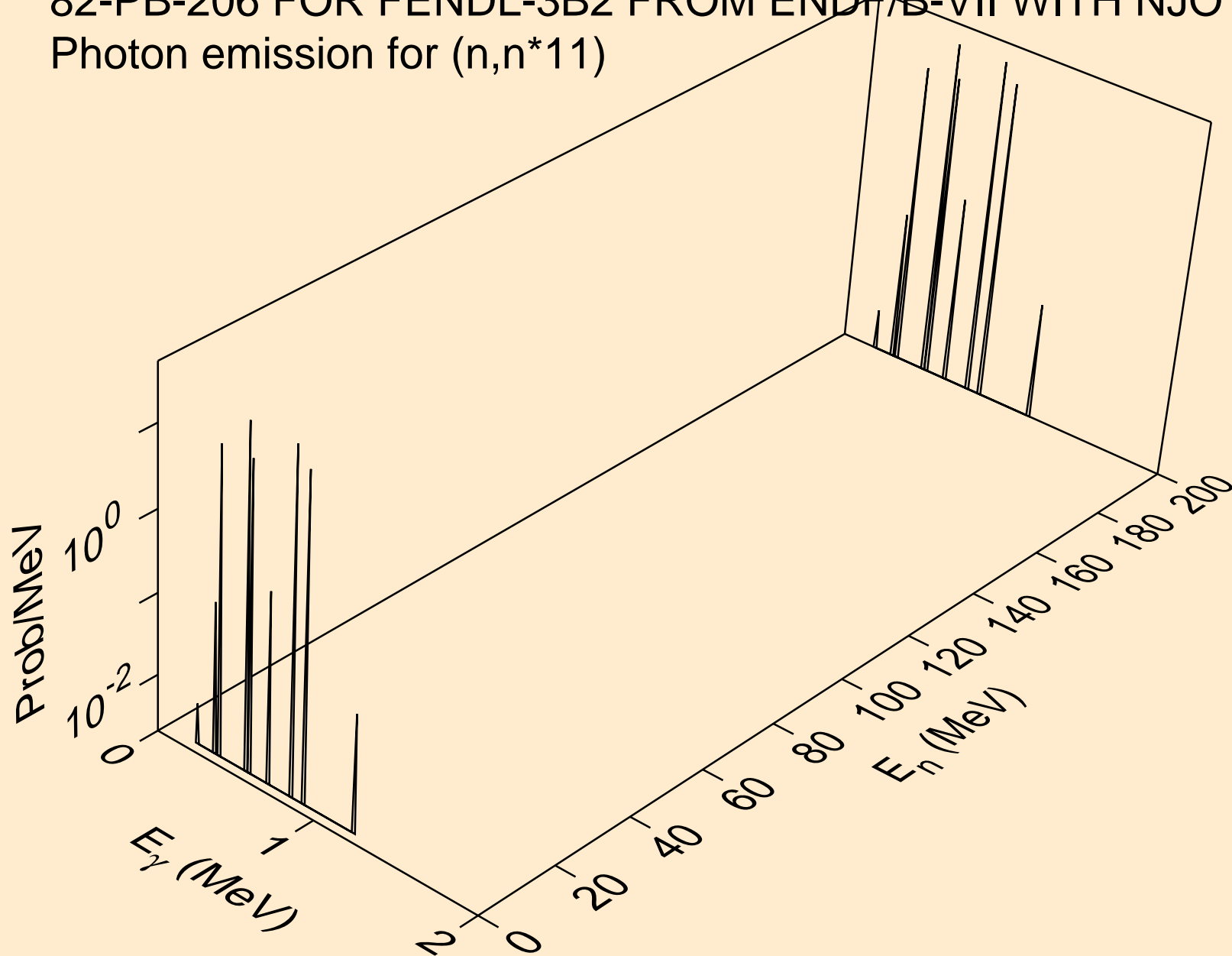

82-PB-206 FOR FENDL-3B2 FROM ENDF/B-VII WITH NJOY99.304
Photon emission for (n,n*12)

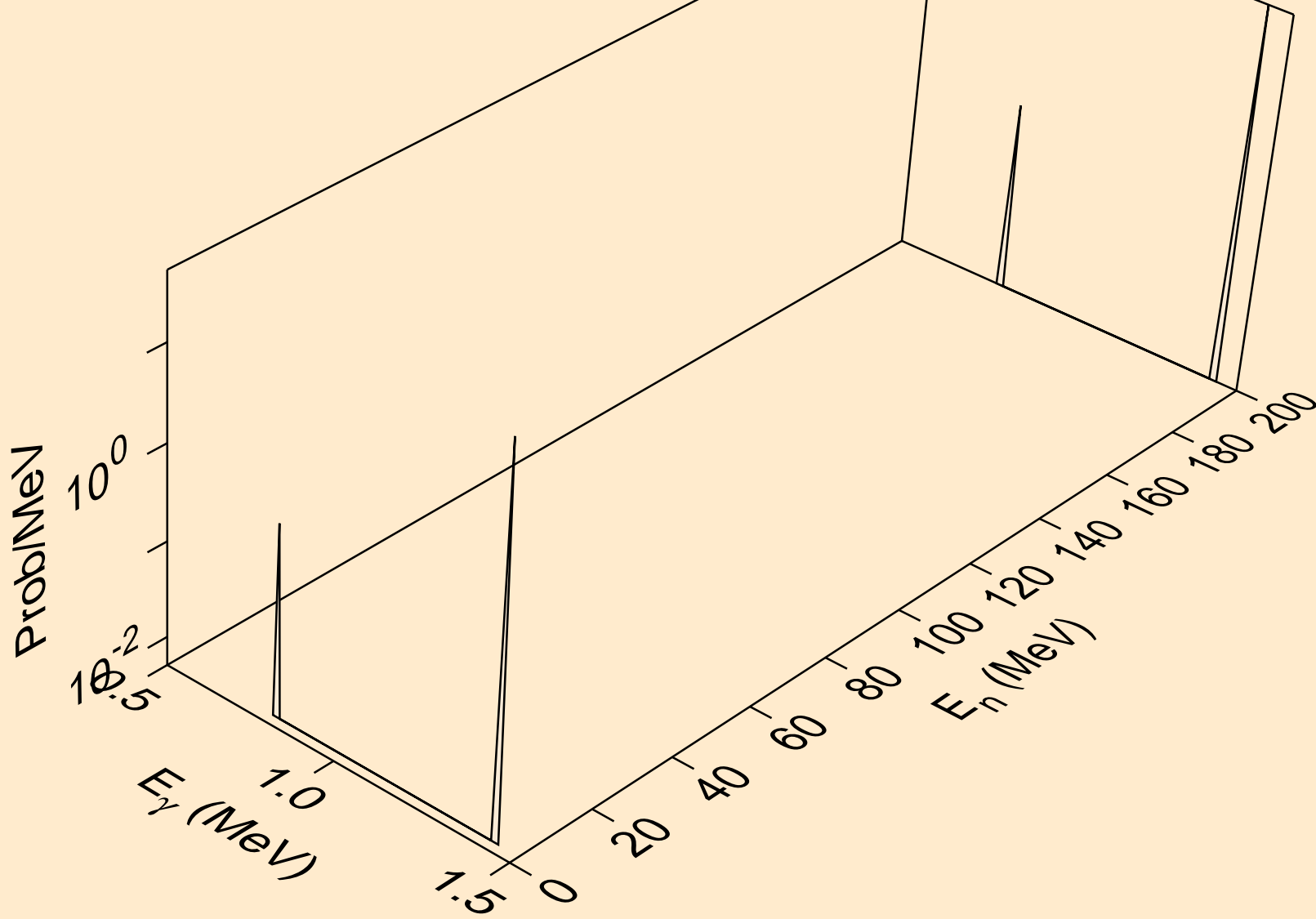

82-PB-206 FOR FENDL-3B2 FROM ENDF/B-VII WITH NJOY99.304
Photon emission for (n,n*13)

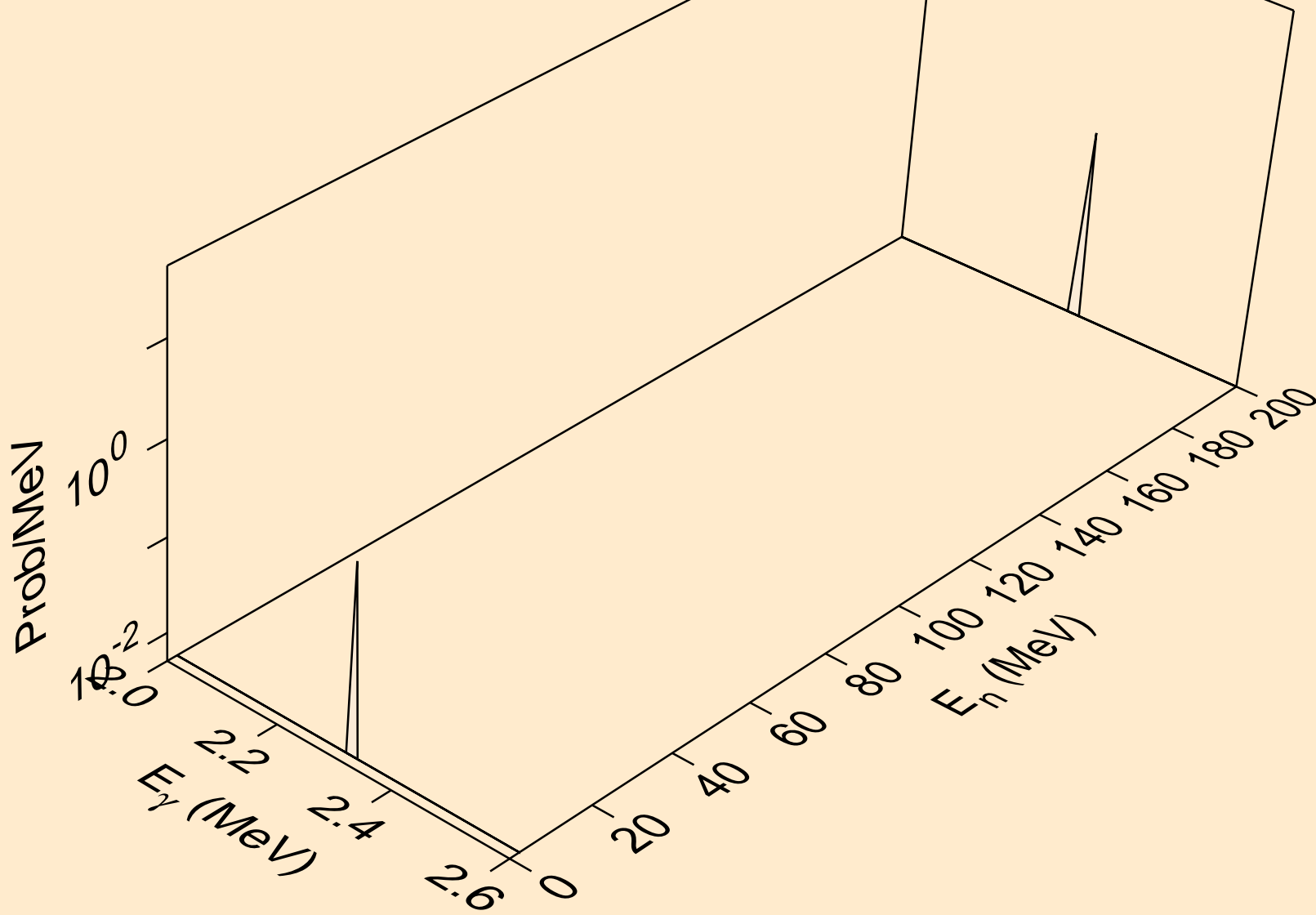

82-PB-206 FOR FENDL-3B2 FROM ENDF/B-VII WITH NJOY99.304
Photon emission for (n,n*14)

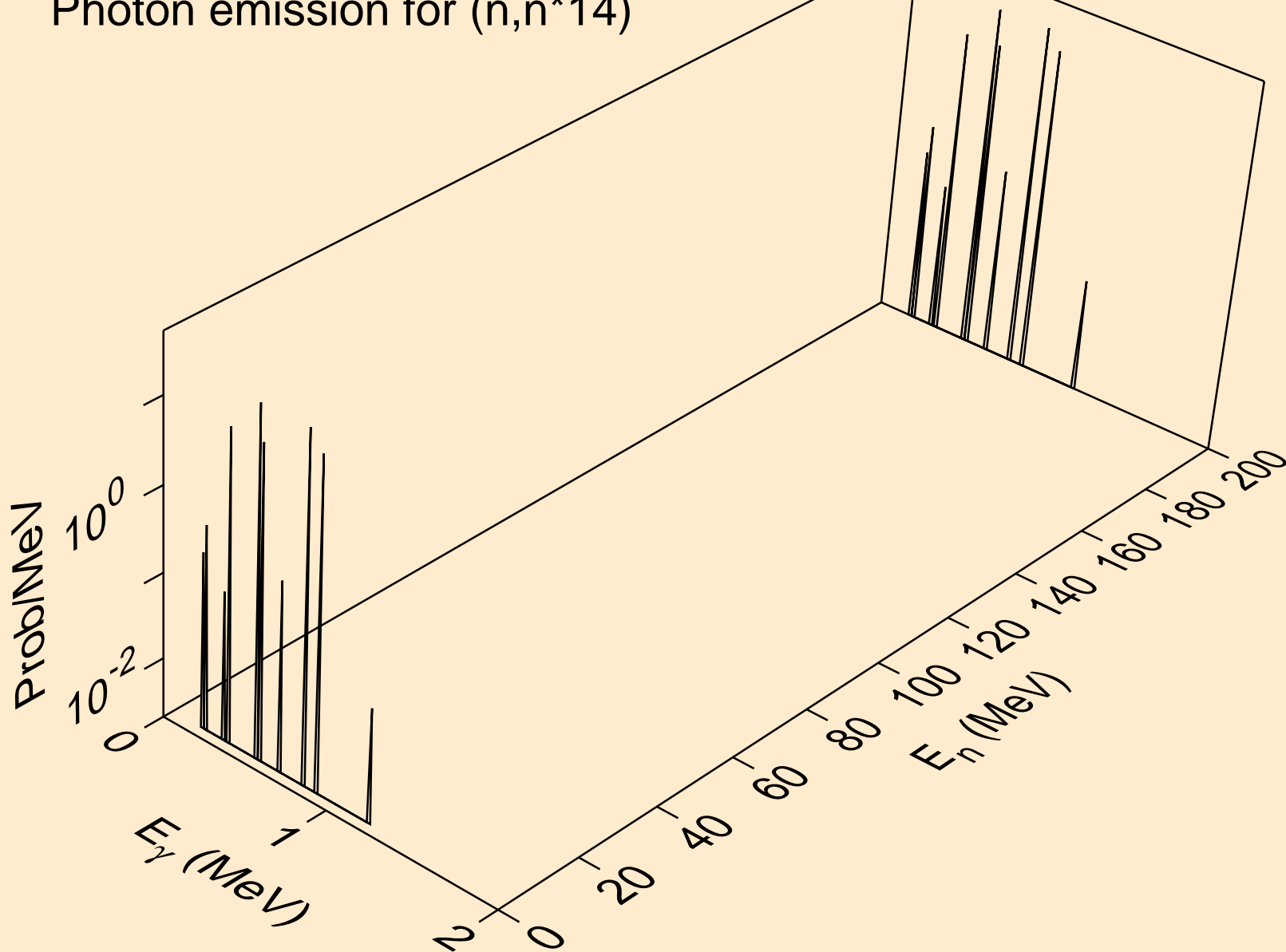

82-PB-206 FOR FENDL-3B2 FROM ENDF/B-VII WITH NJOY99.304
Photon emission for (n,n*15)

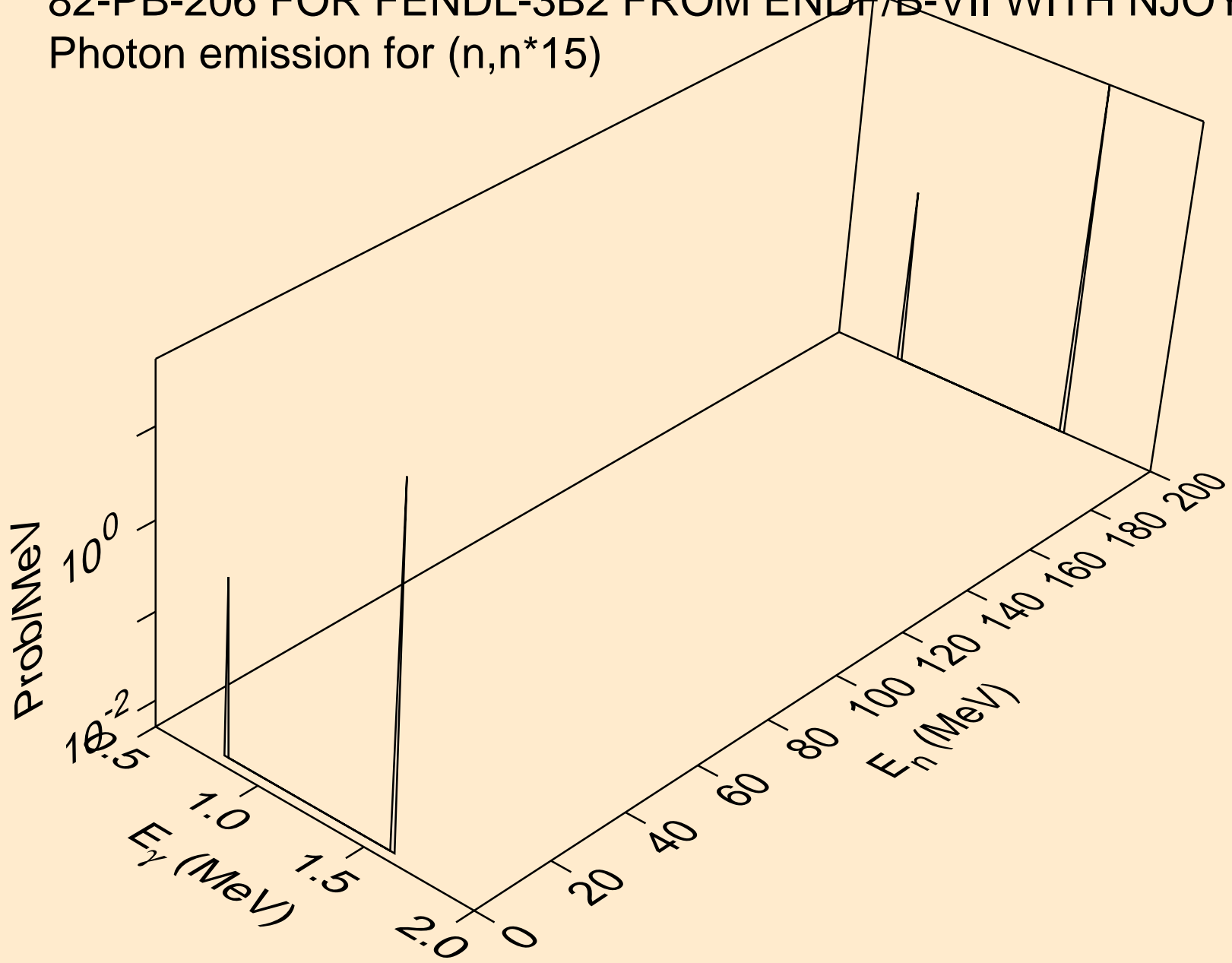

82-PB-206 FOR FENDL-3B2 FROM ENDF/B-VII WITH NJOY99.304
Photon emission for (n,n*16)

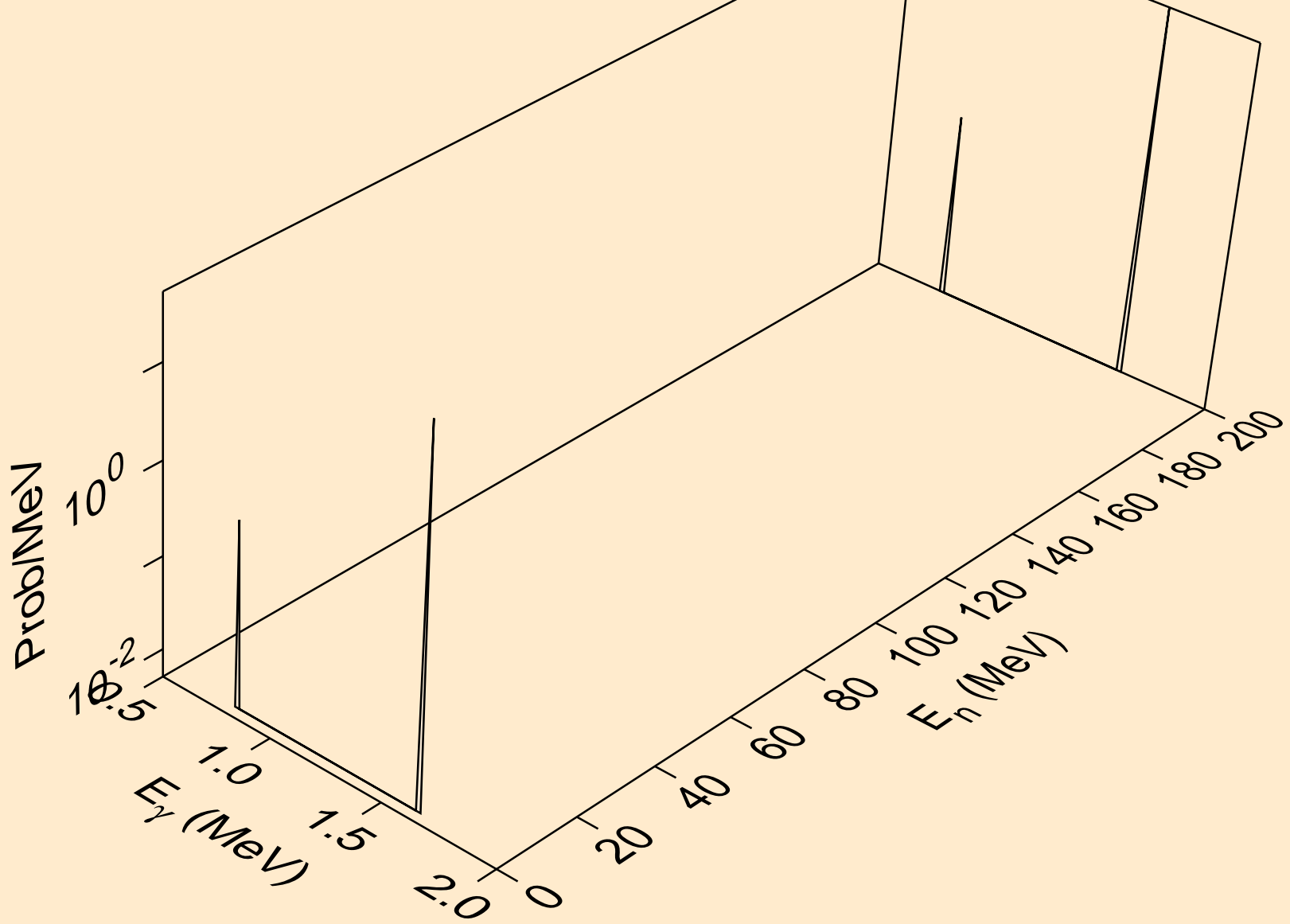

82-PB-206 FOR FENDL-3B2 FROM ENDF/B-VII WITH NJOY99.304
Photon emission for (n,n*17)

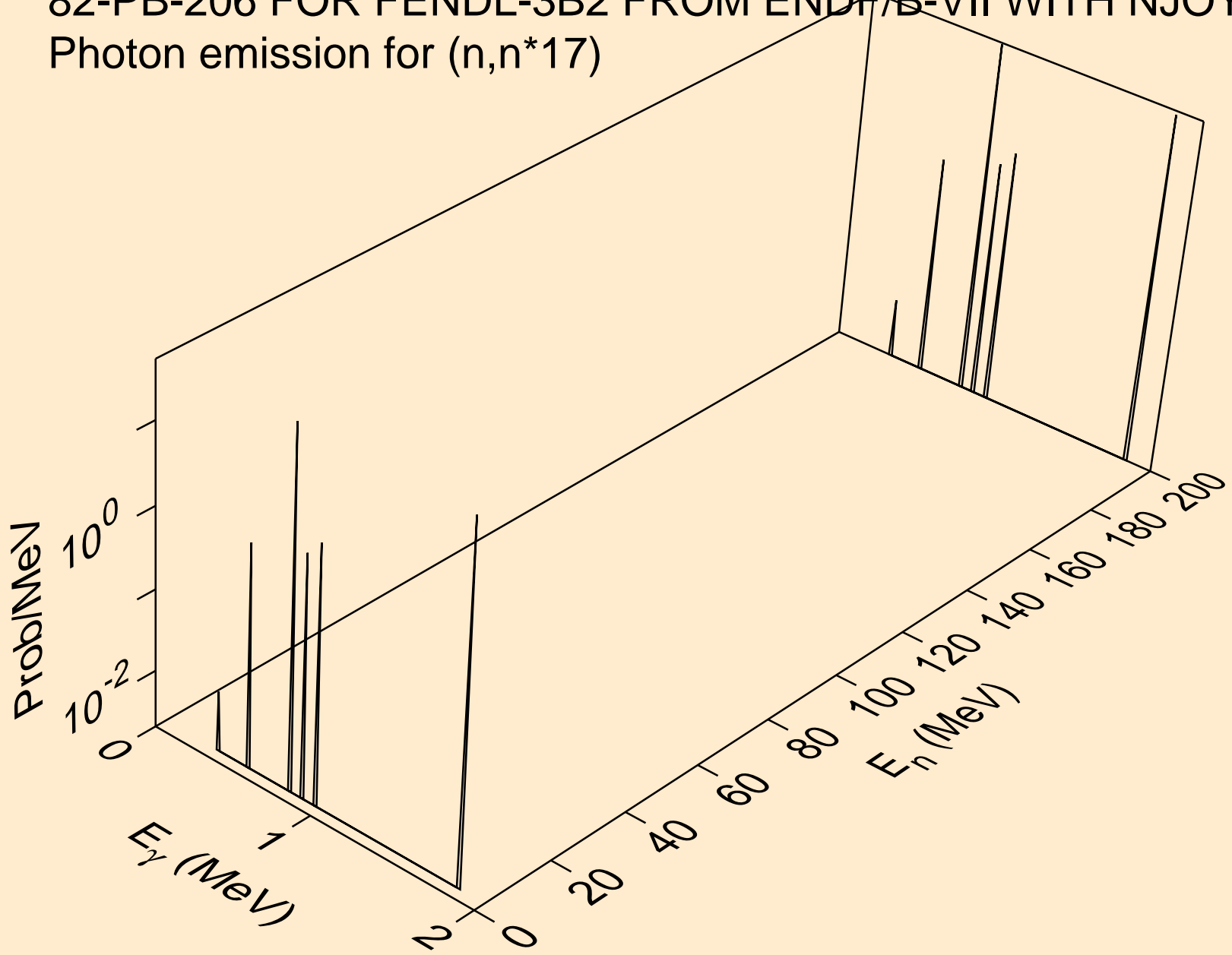

82-PB-206 FOR FENDL-3B2 FROM ENDF/B-VII WITH NJOY99.304
Photon emission for (n,n*18)

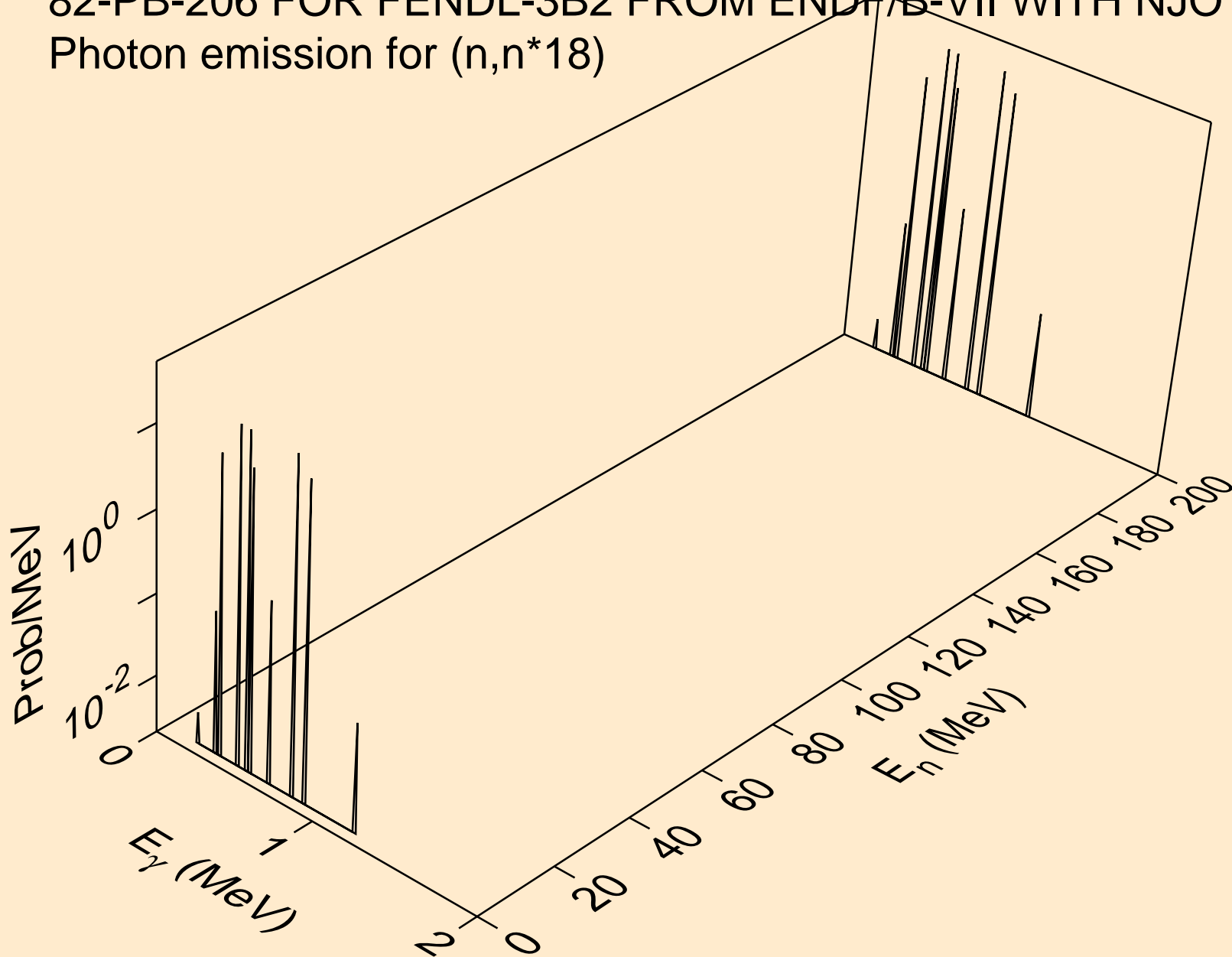

82-PB-206 FOR FENDL-3B2 FROM ENDF/B-VII WITH NJOY99.304
Photon emission for (n,n*19)

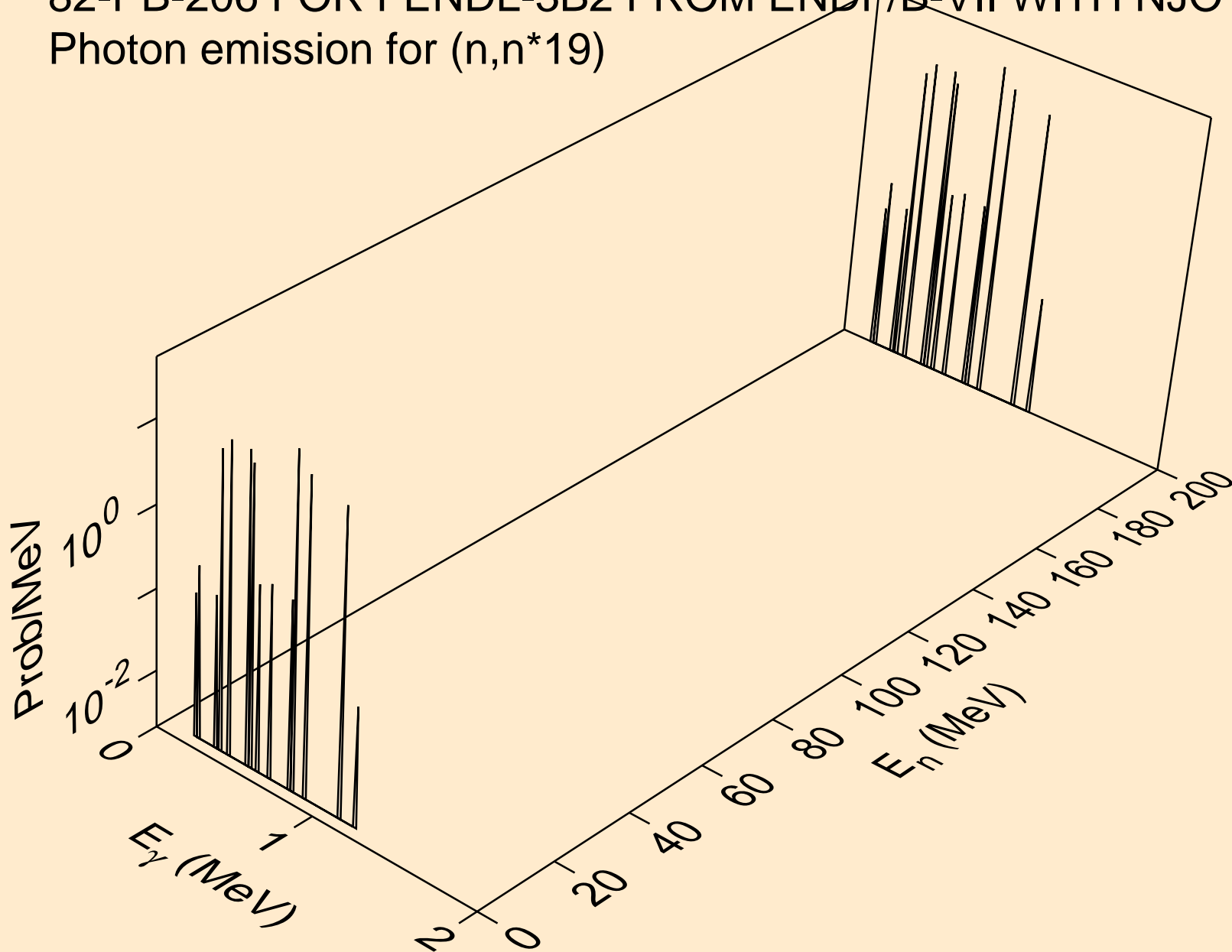

82-PB-206 FOR FENDL-3B2 FROM ENDF/B-VII WITH NJOY99.304
Photon emission for (n,n*20)

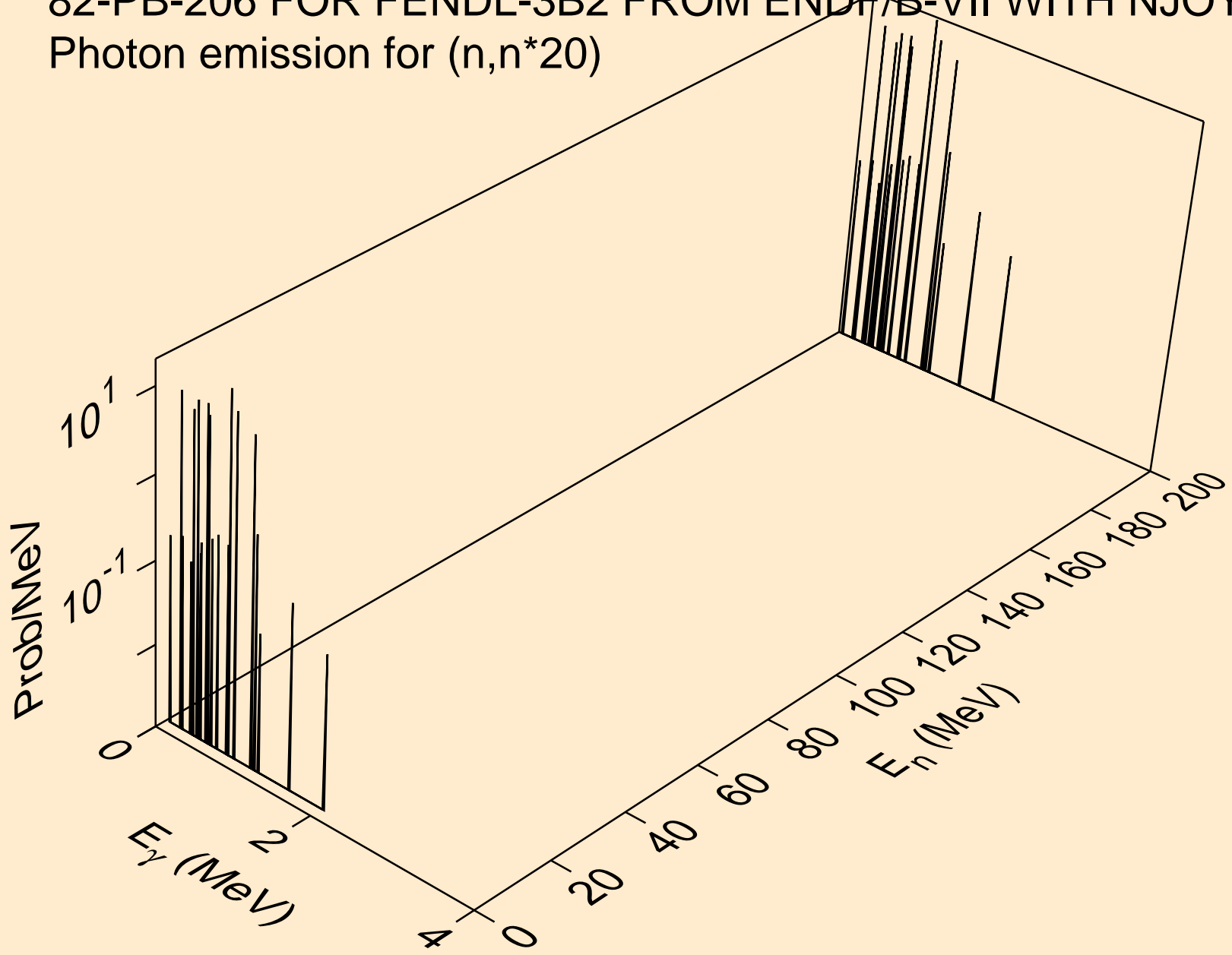

82-PB-206 FOR FENDL-3B2 FROM ENDF/B-VII WITH NJOY99.304
Photon emission for (n,n*21)

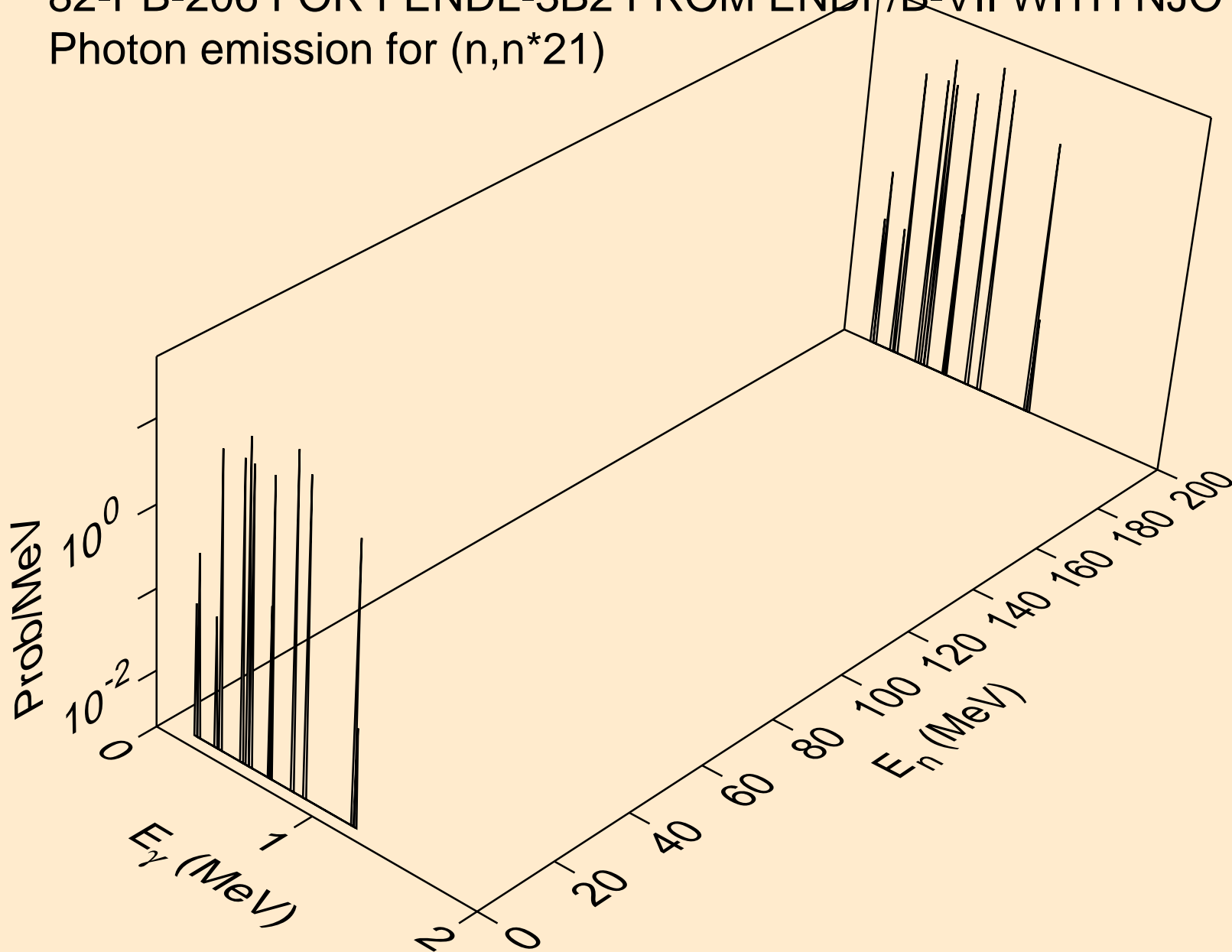

82-PB-206 FOR FENDL-3B2 FROM ENDF/B-VII WITH NJOY99.304
Photon emission for (n,n*22)

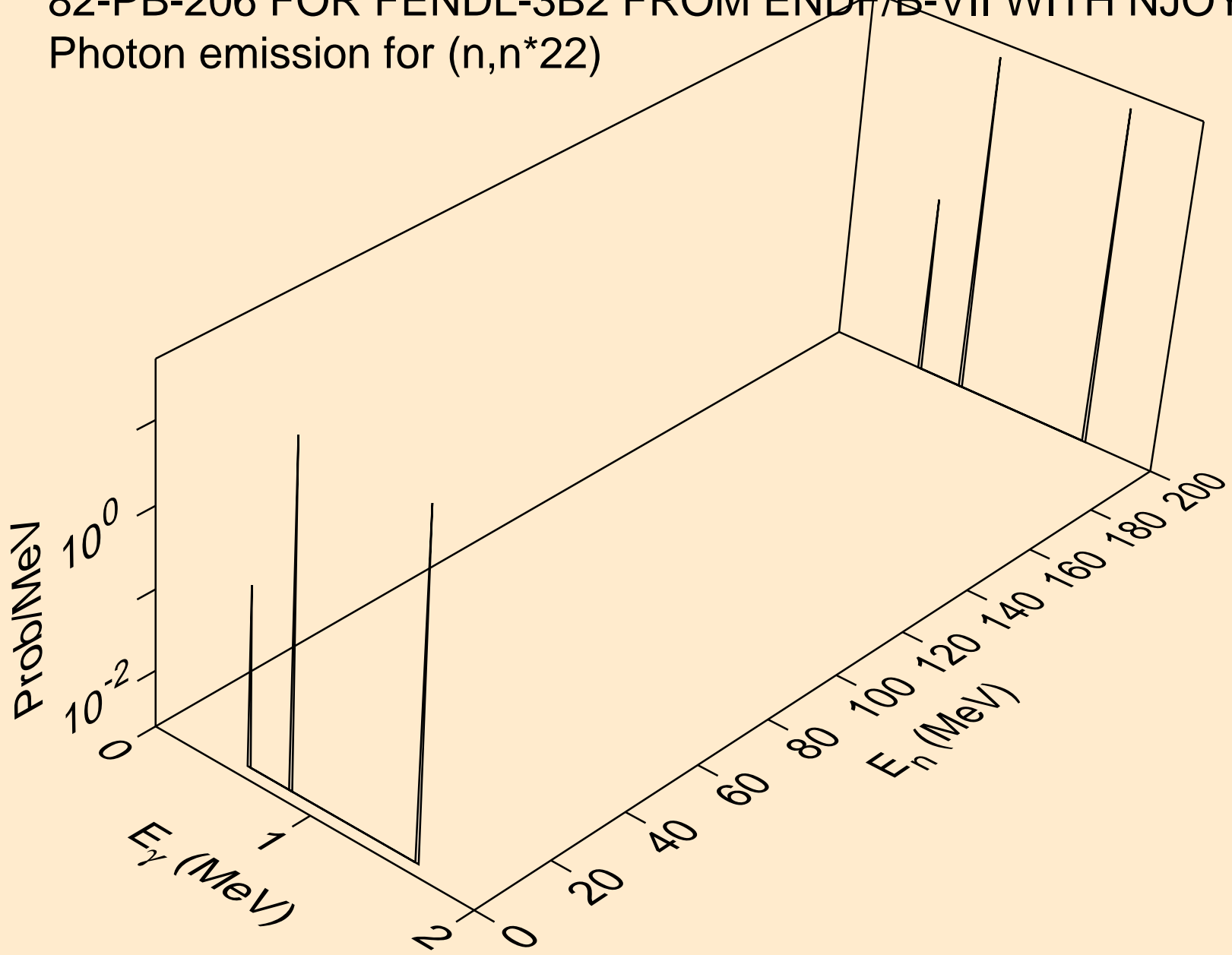

82-PB-206 FOR FENDL-3B2 FROM ENDF/B-VII WITH NJOY99.304
Photon emission for (n,n*23)

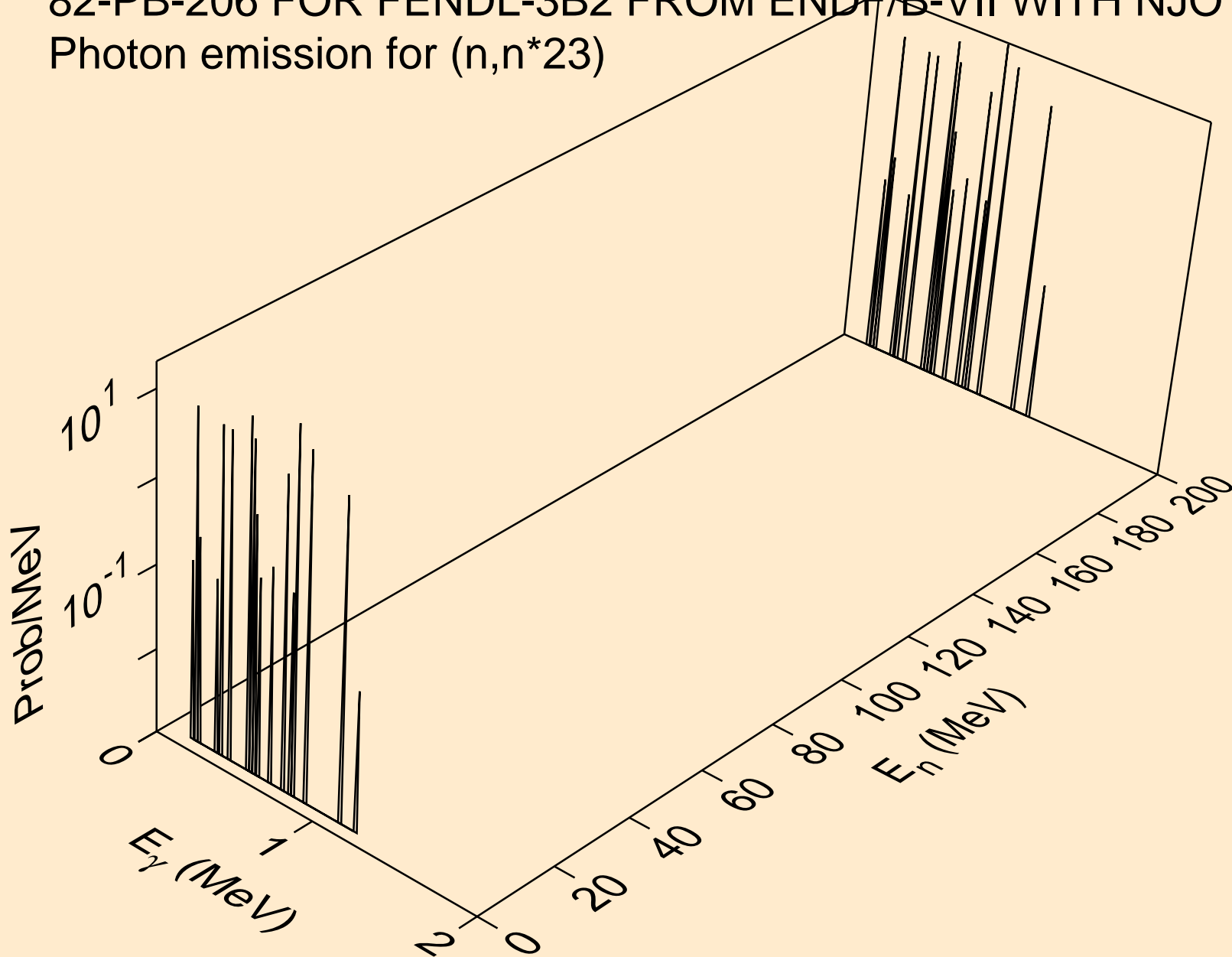

82-PB-206 FOR FENDL-3B2 FROM ENDF/B-VII WITH NJOY99.304
Photon emission for (n,n*24)

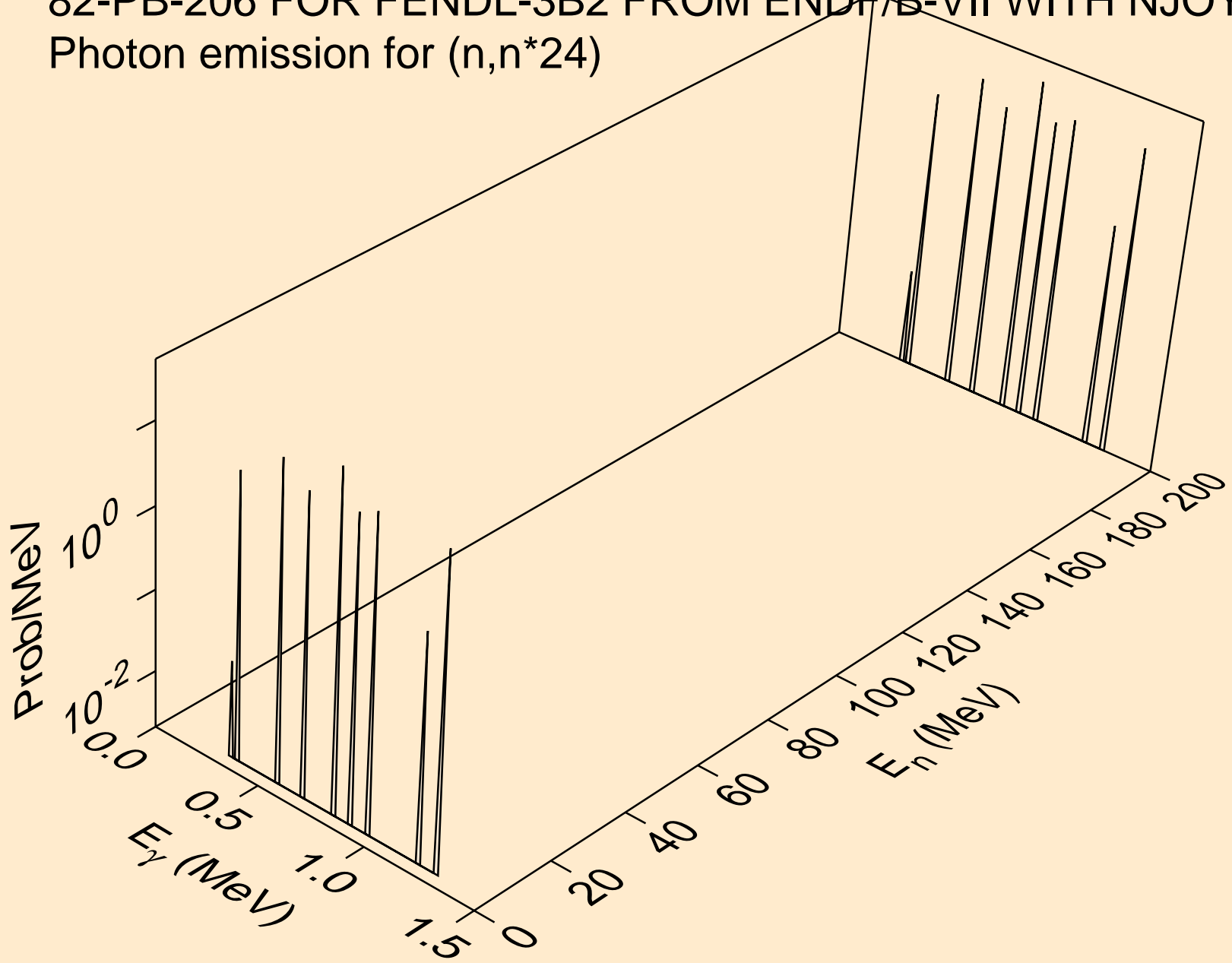

82-PB-206 FOR FENDL-3B2 FROM ENDF/B-VII WITH NJOY99.304
Photon emission for (n,n*25)

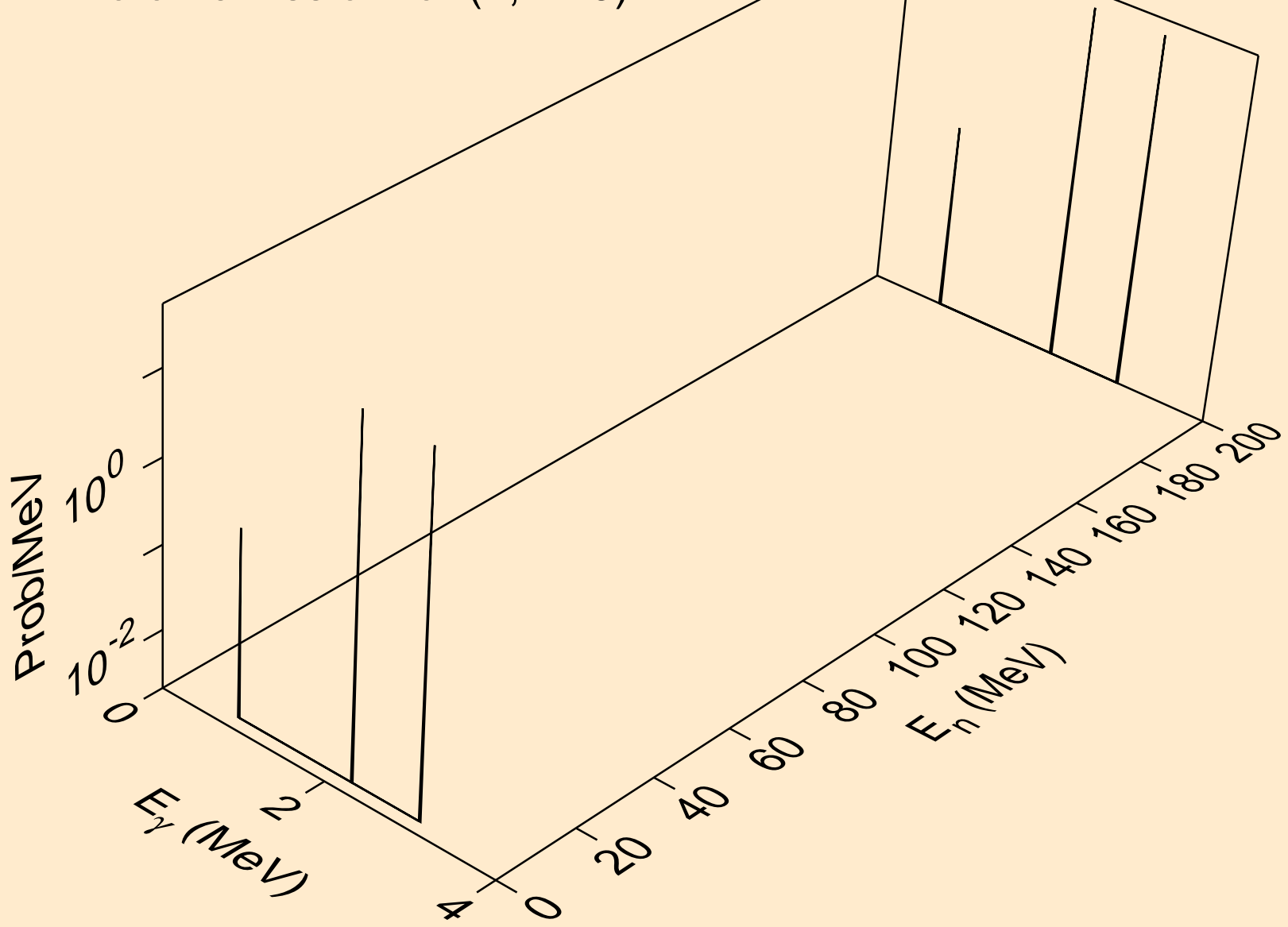

82-PB-206 FOR FENDL-3B2 FROM ENDF/B-VII WITH NJOY99.304
Photon emission for (n,n*c)

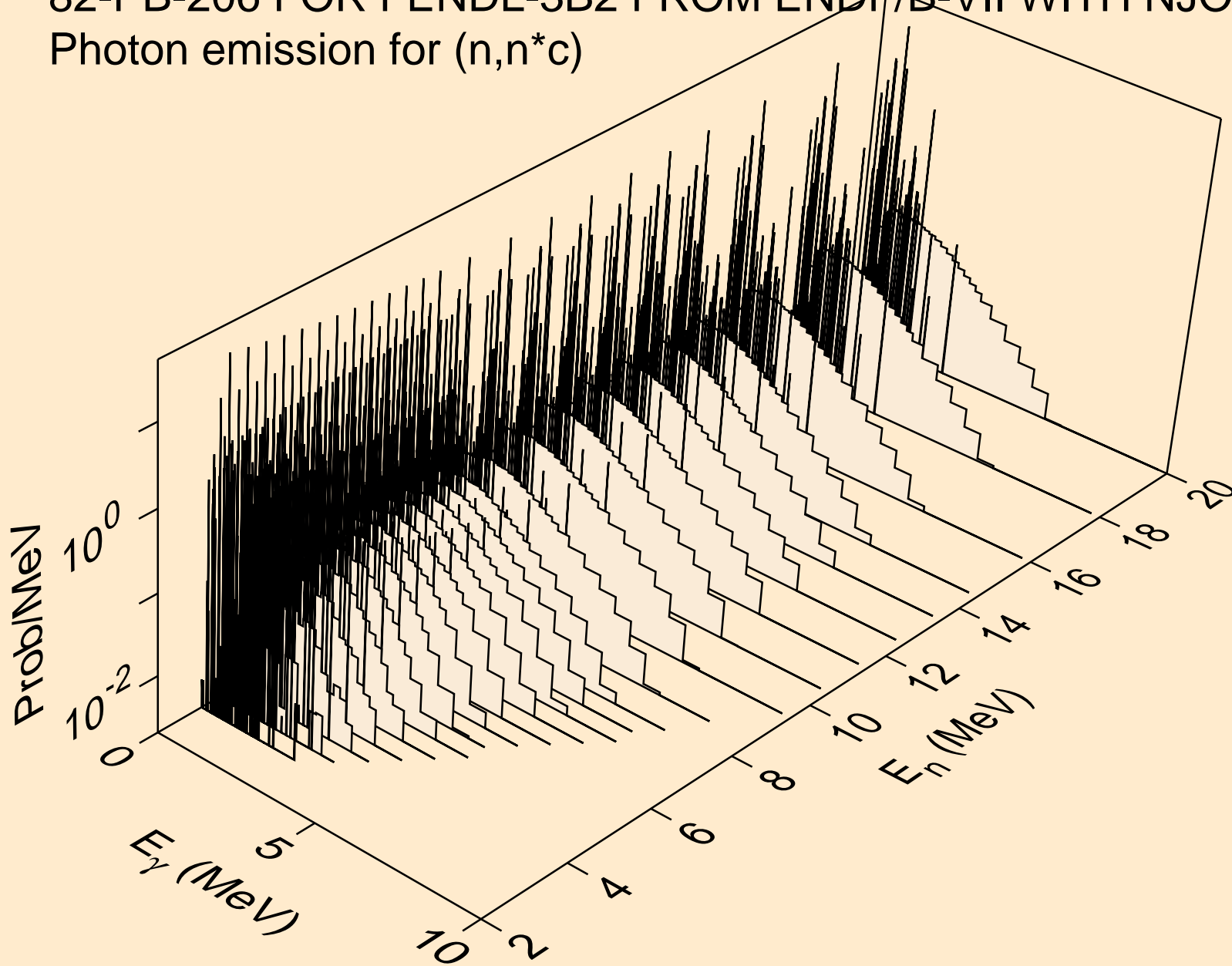

82-PB-206 FOR FENDL-3B2 FROM ENDF/B-VII WITH NJOY99.304
Photon emission for (n,gma)

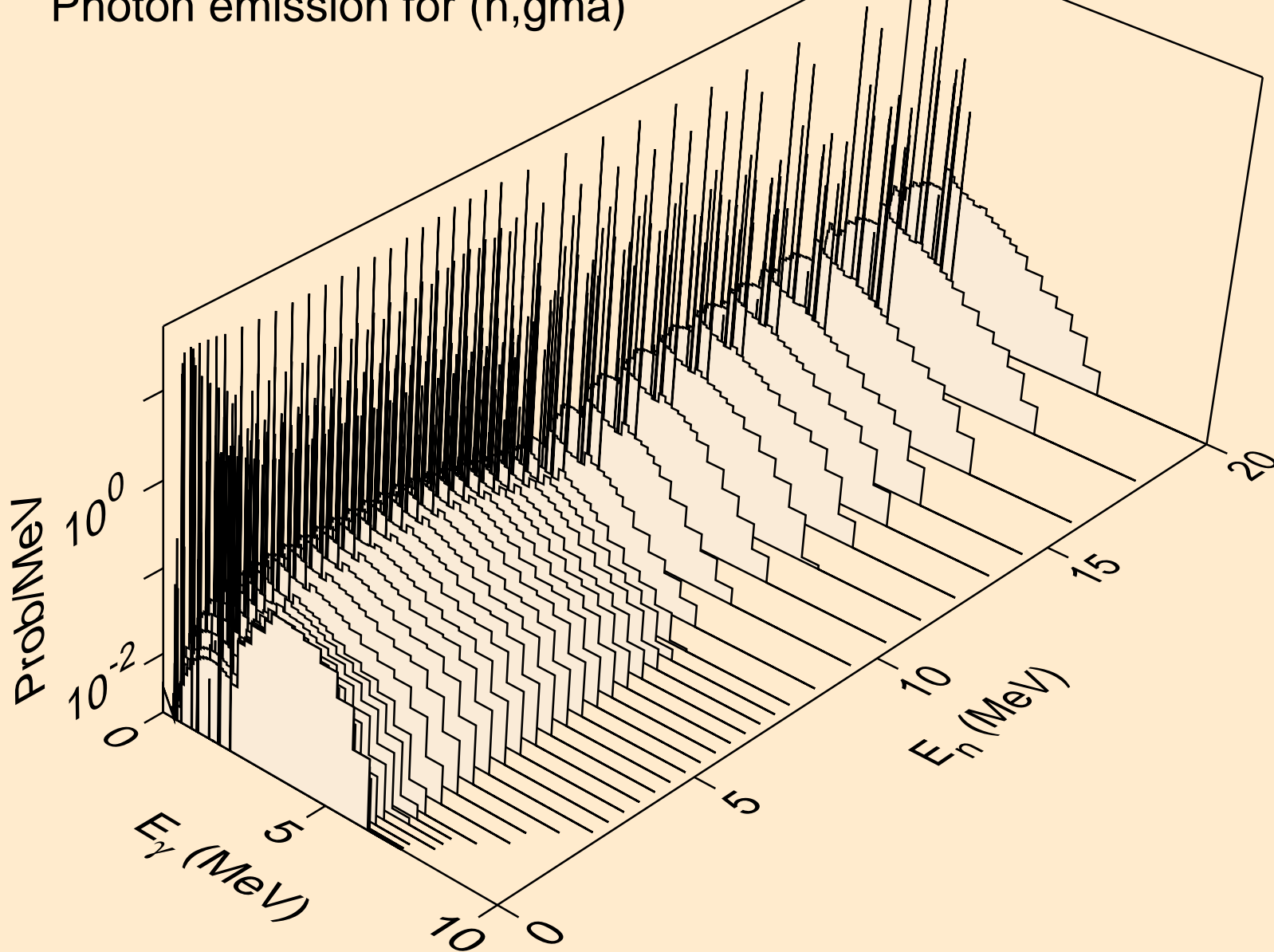

82-PB-206 FOR FENDL-3B2 FROM ENDF/B-VII WITH NJOY99.304
Photon emission for (n,2a)

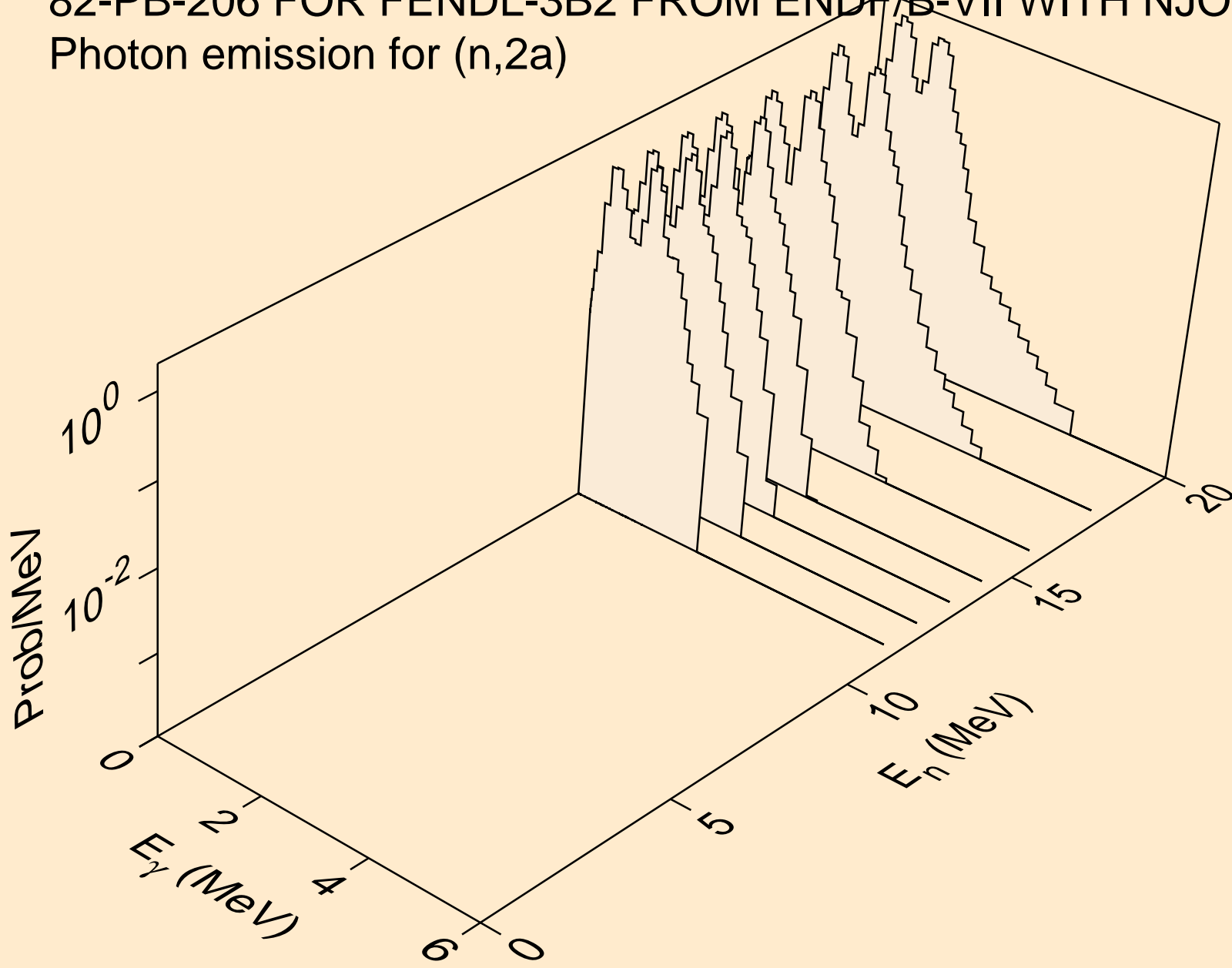

82-PB-206 FOR FENDL-3B2 FROM ENDF/B-VII WITH NJOY99.304
Photon emission for (n,p*1)

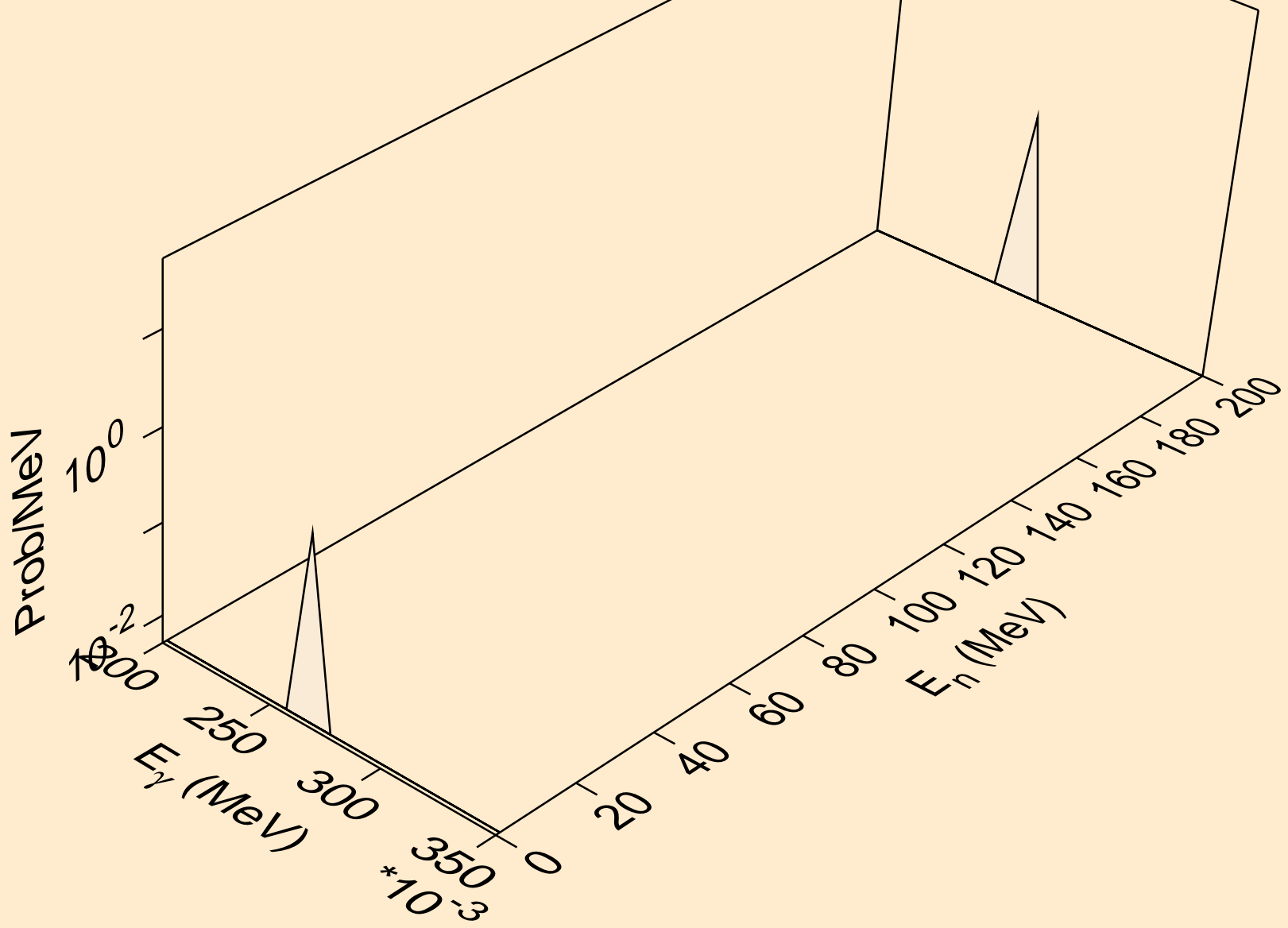

82-PB-206 FOR FENDL-3B2 FROM ENDF/B-VII WITH NJOY99.304
Photon emission for (n,p*2)

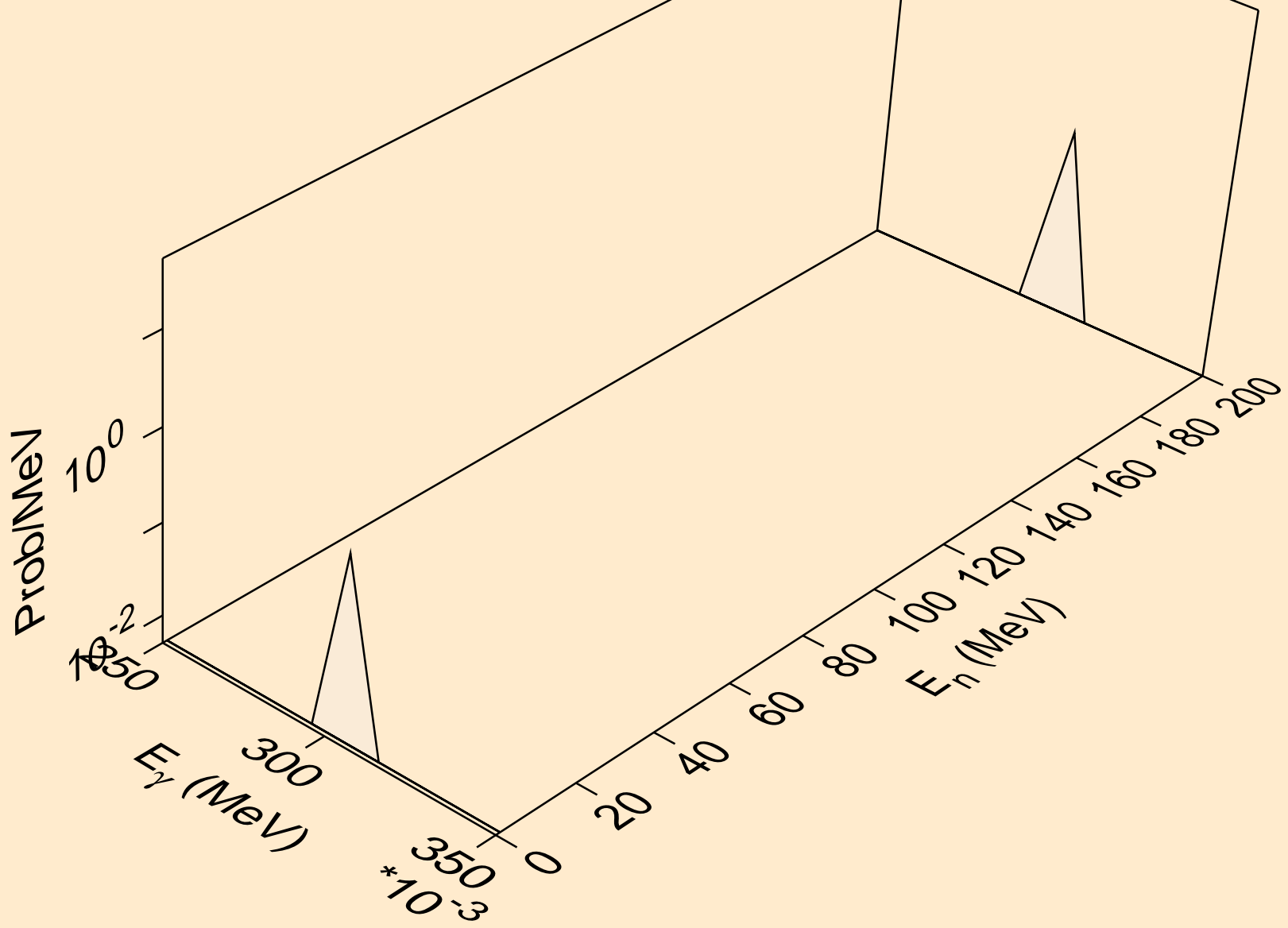

82-PB-206 FOR FENDL-3B2 FROM ENDF/B-VII WITH NJOY99.304
Photon emission for (n,p*3)

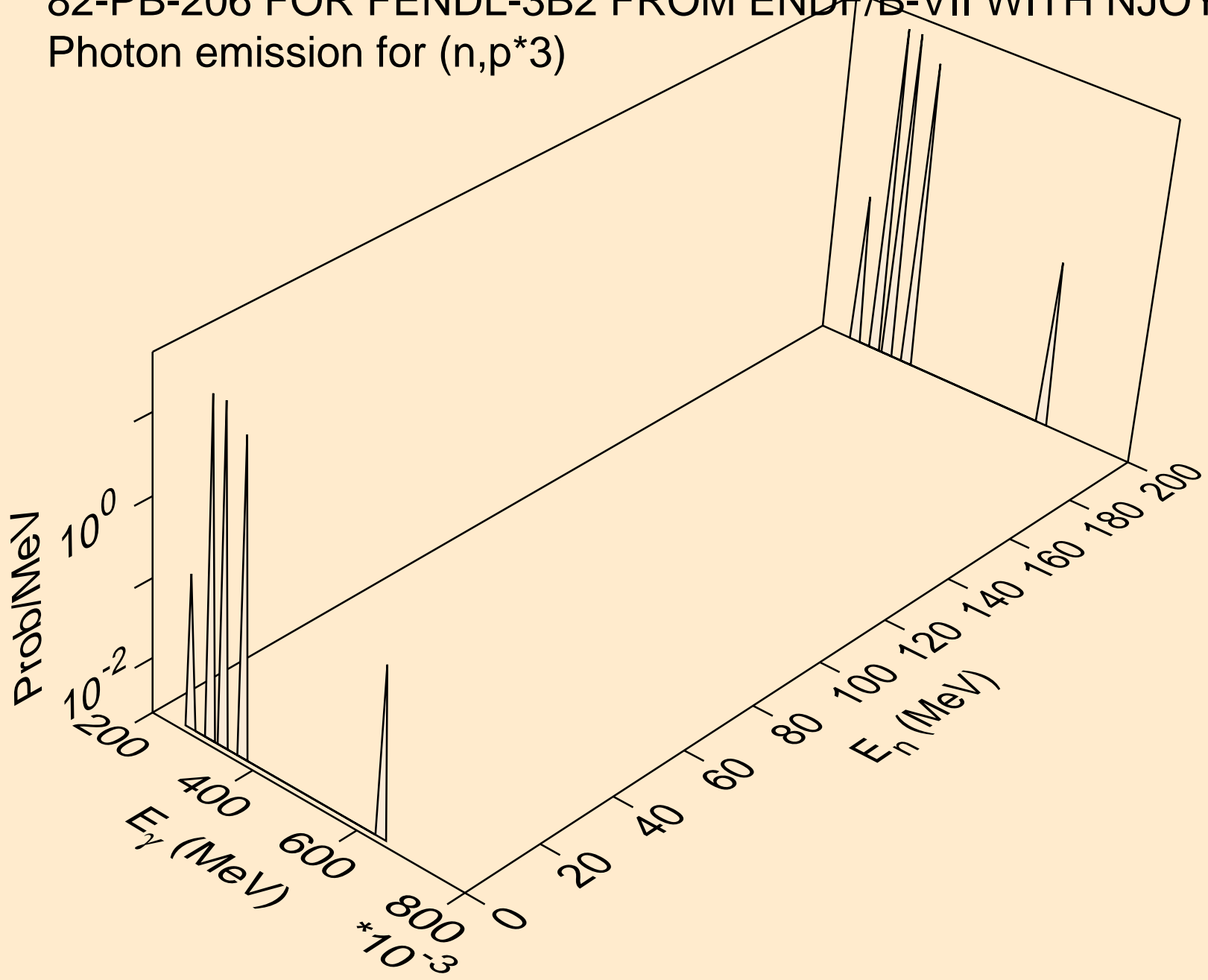

82-PB-206 FOR FENDL-3B2 FROM ENDF/B-VII WITH NJOY99.304
Photon emission for (n,p*4)

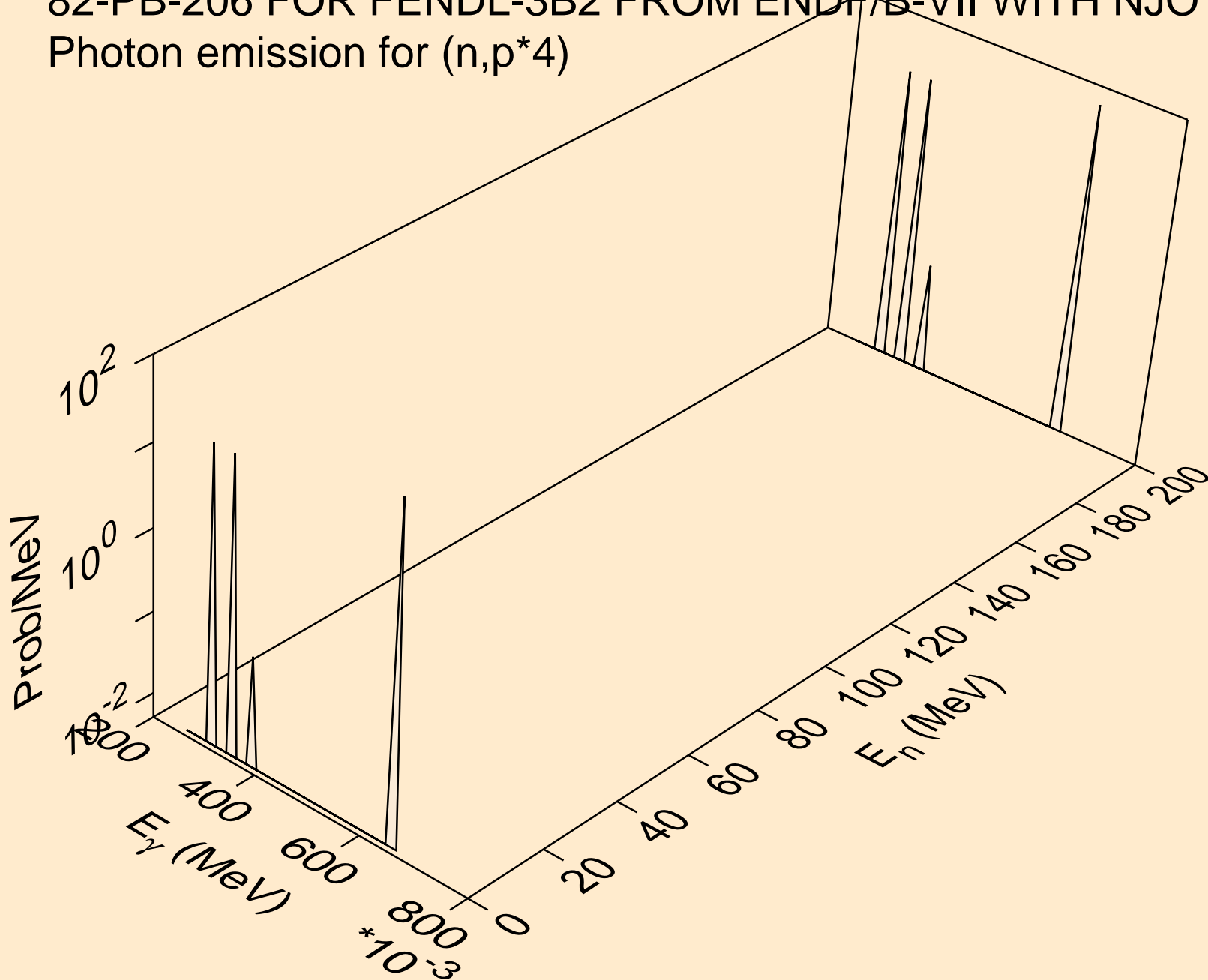

82-PB-206 FOR FENDL-3B2 FROM ENDF/B-VII WITH NJOY99.304
Photon emission for (n,p*5)

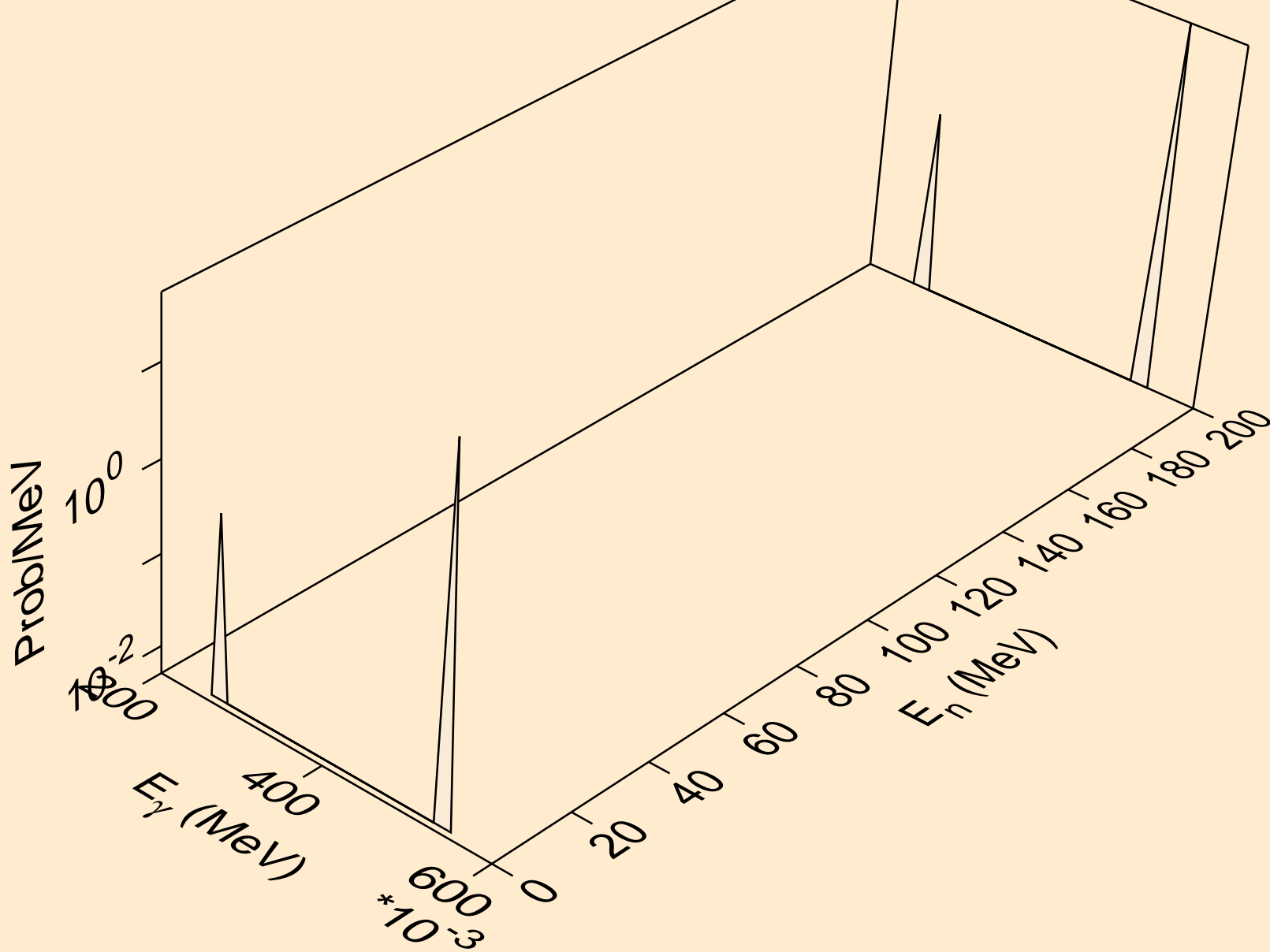

82-PB-206 FOR FENDL-3B2 FROM ENDF/B-VII WITH NJOY99.304
Photon emission for (n,p*6)

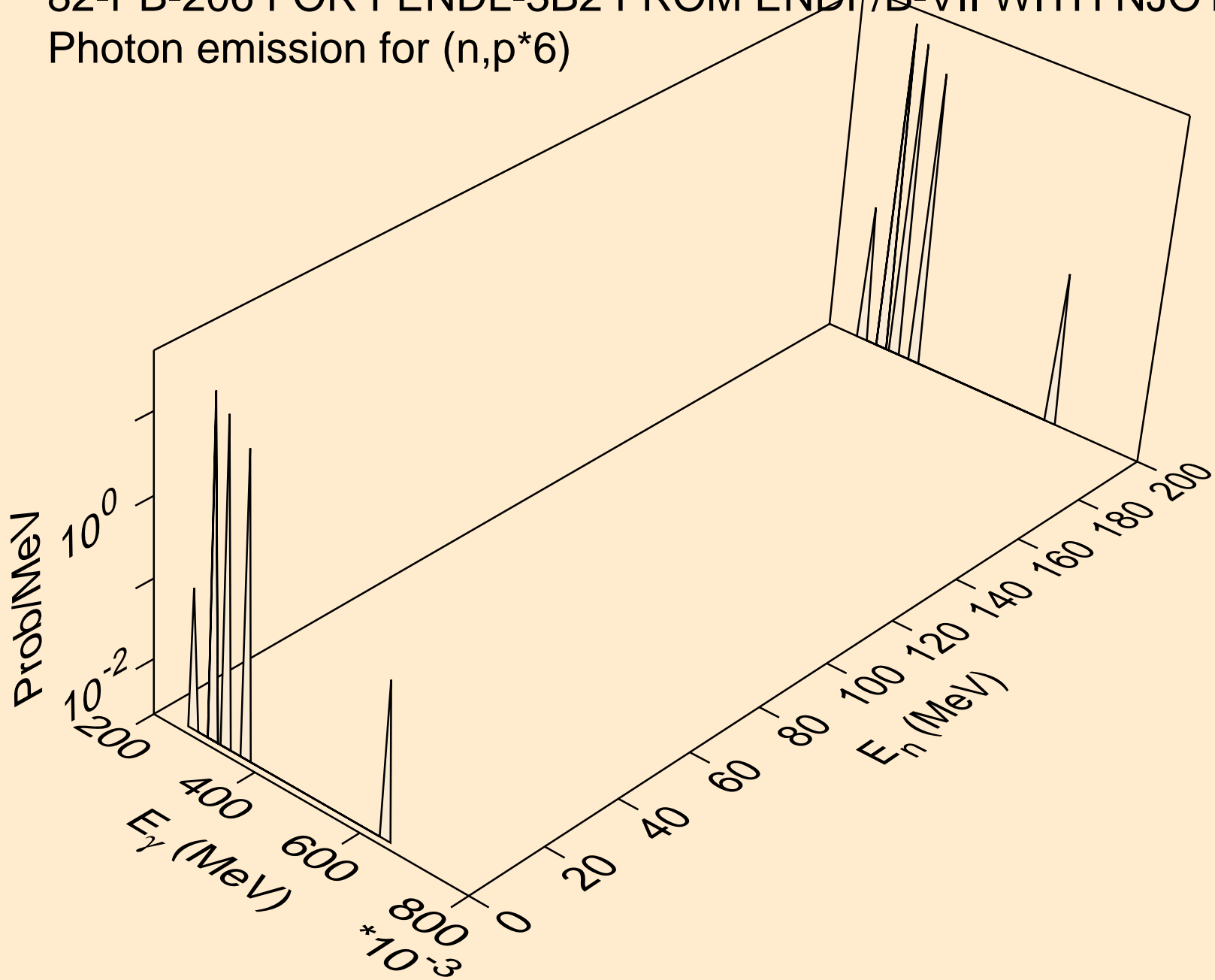

82-PB-206 FOR FENDL-3B2 FROM ENDF/B-VII WITH NJOY99.304
Photon emission for (n,p*7)

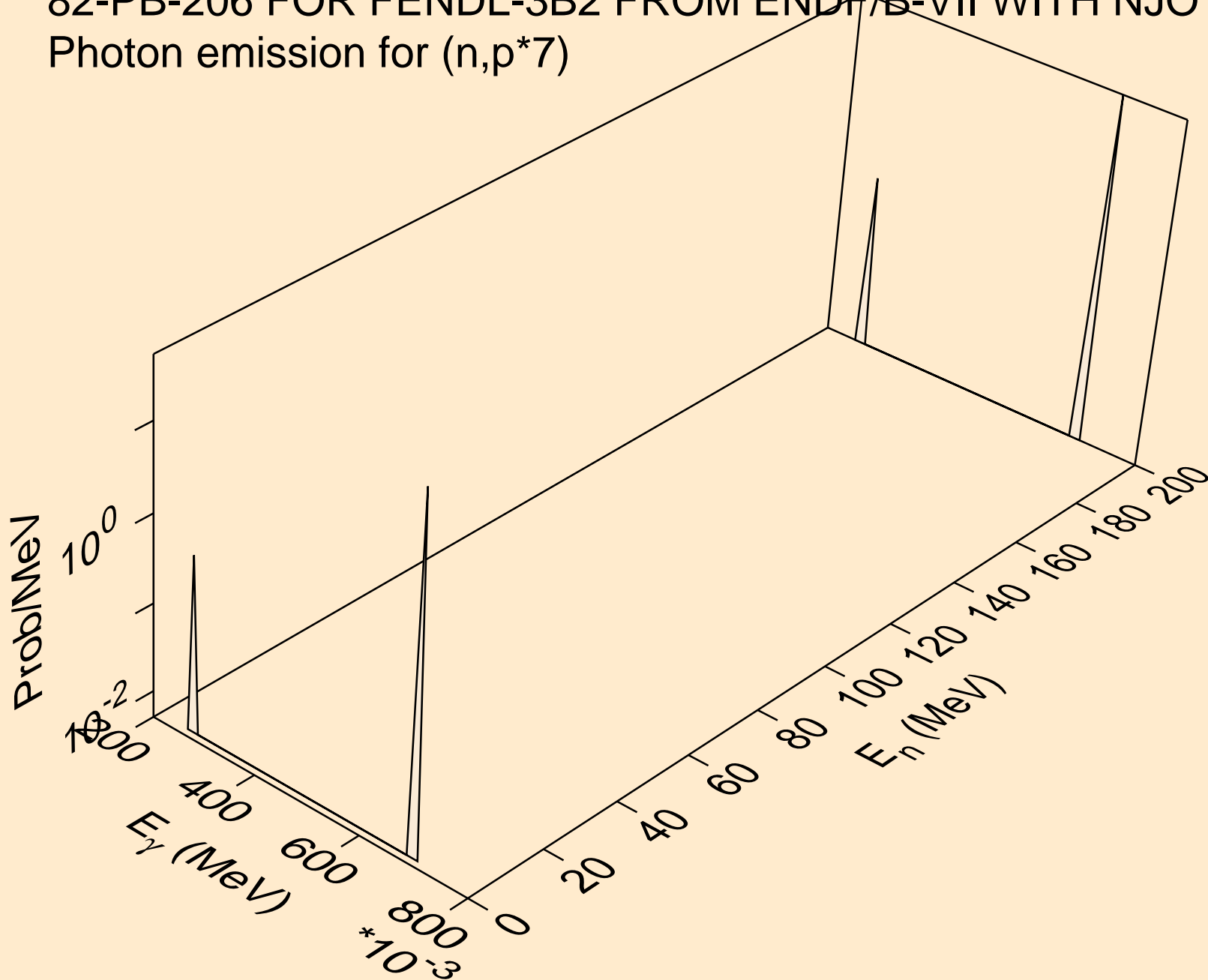

82-PB-206 FOR FENDL-3B2 FROM ENDF/B-VII WITH NJOY99.304
Photon emission for (n,p*8)

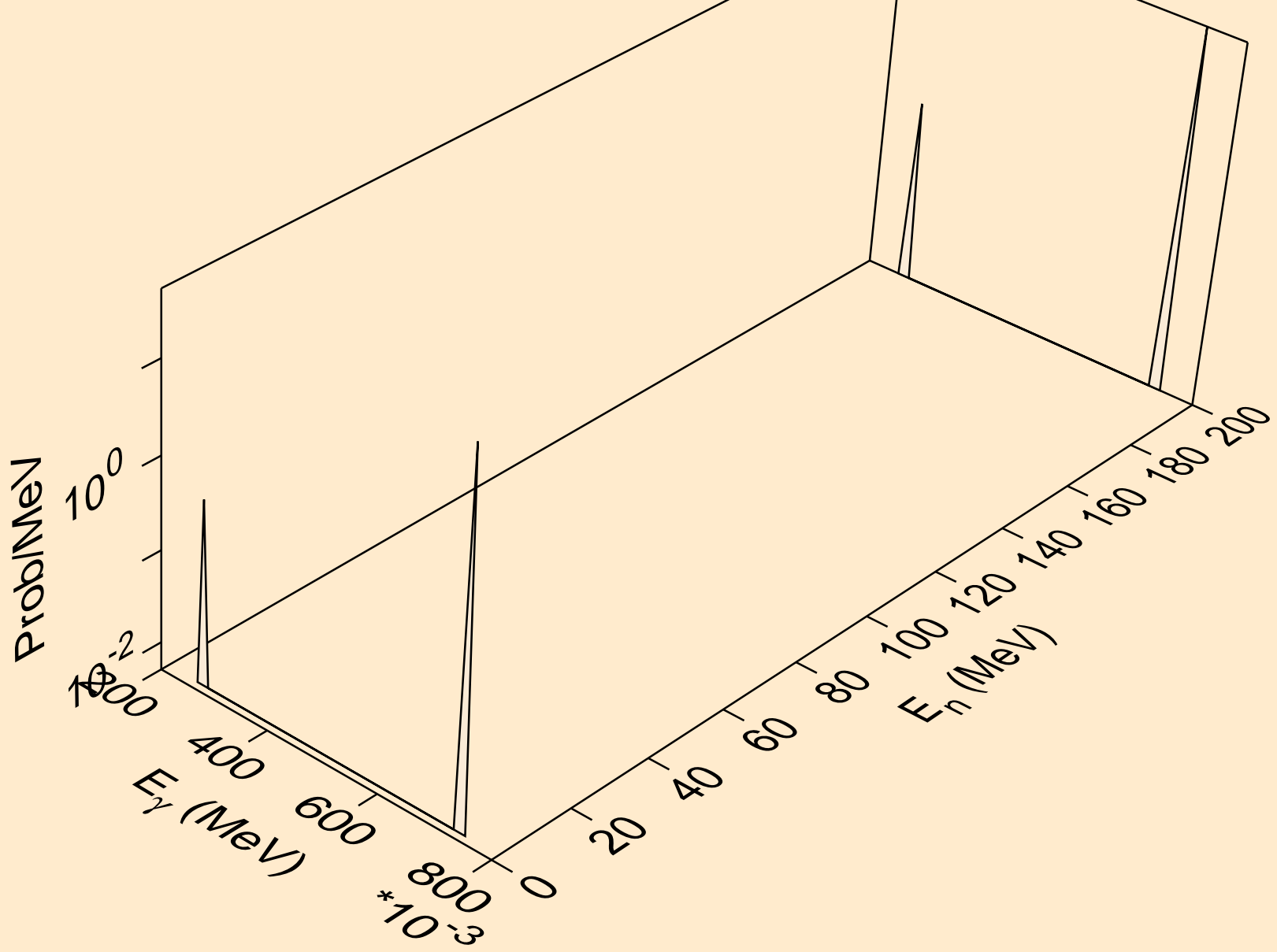

82-PB-206 FOR FENDL-3B2 FROM ENDF/B-VII WITH NJOY99.304
Photon emission for (n,p*9)

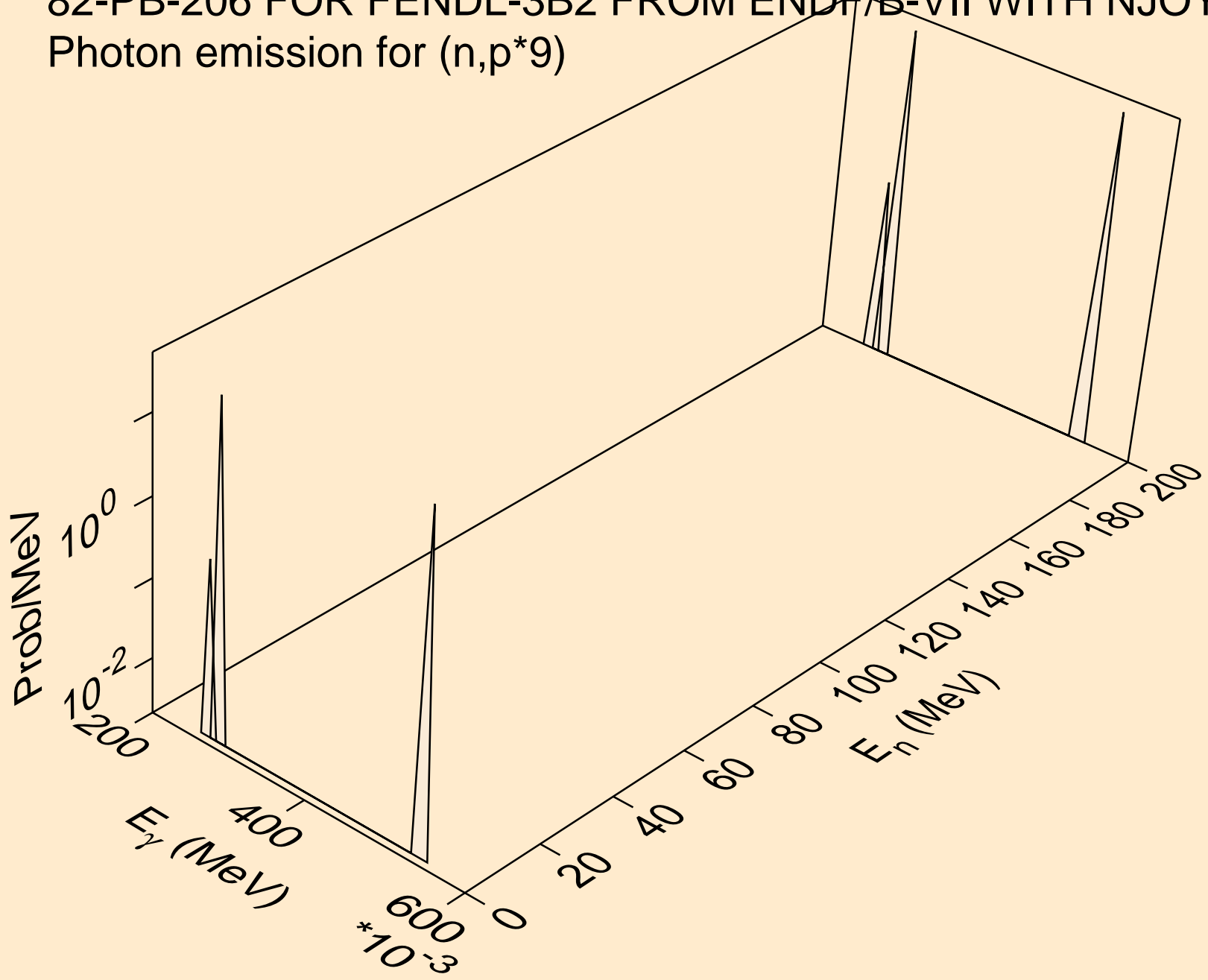

82-PB-206 FOR FENDL-3B2 FROM ENDF/B-VII WITH NJOY99.304
Photon emission for (n,p*10)

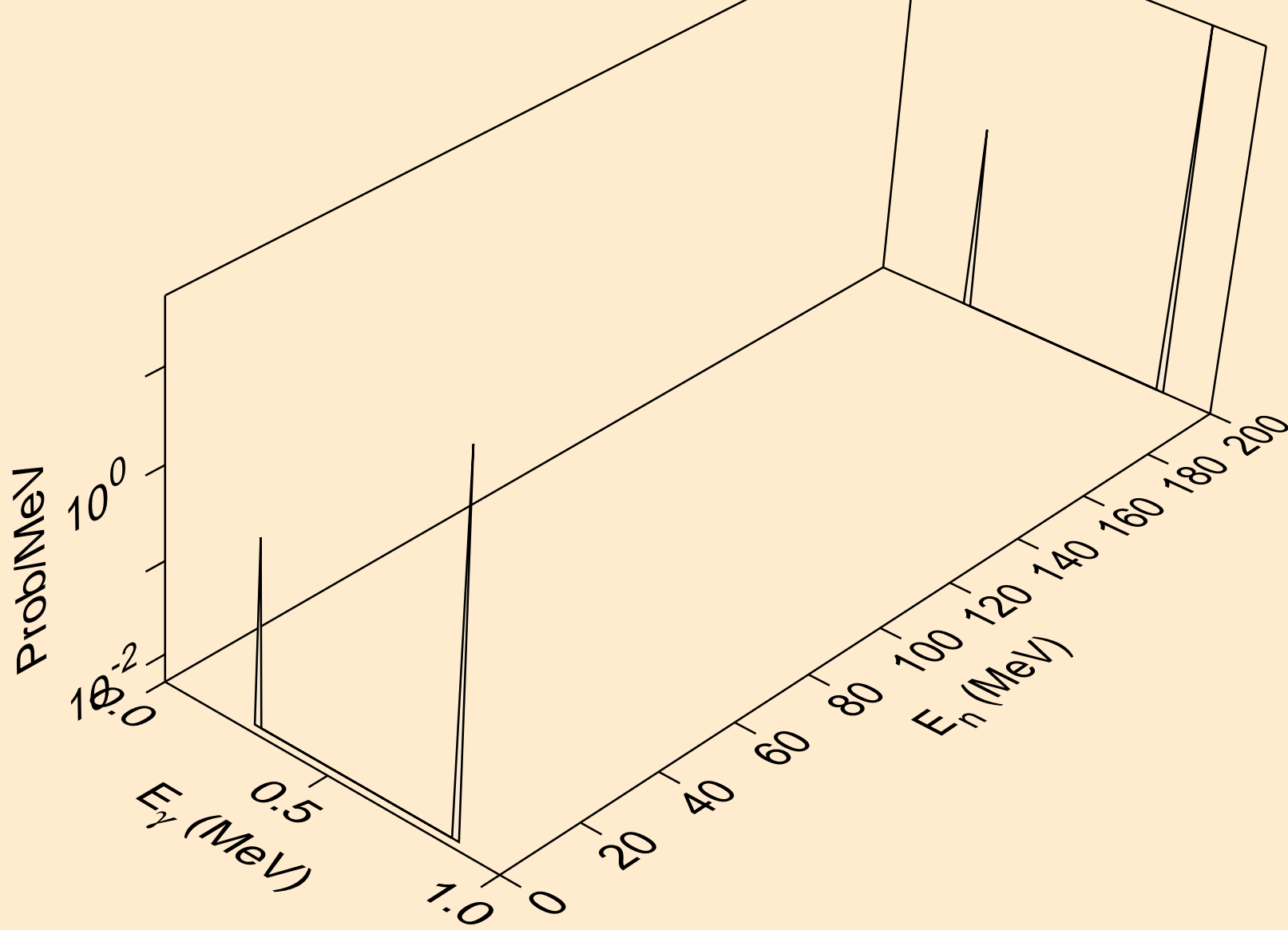

82-PB-206 FOR FENDL-3B2 FROM ENDF/B-VII WITH NJOY99.304
Photon emission for (n,p*c)

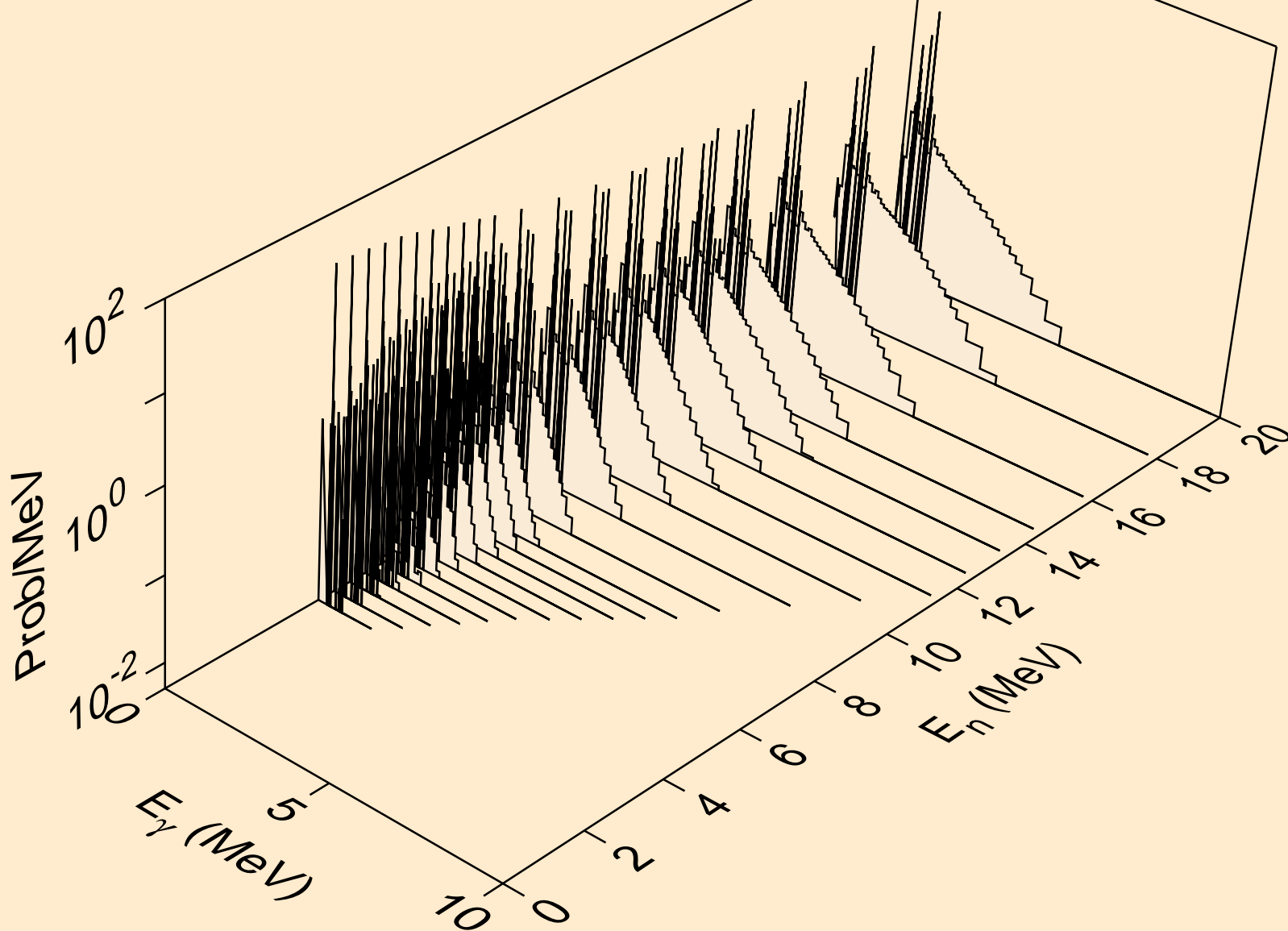

82-PB-206 FOR FENDL-3B2 FROM ENDF/B-VII WITH NJOY99.304
Photon emission for (n,d*1)

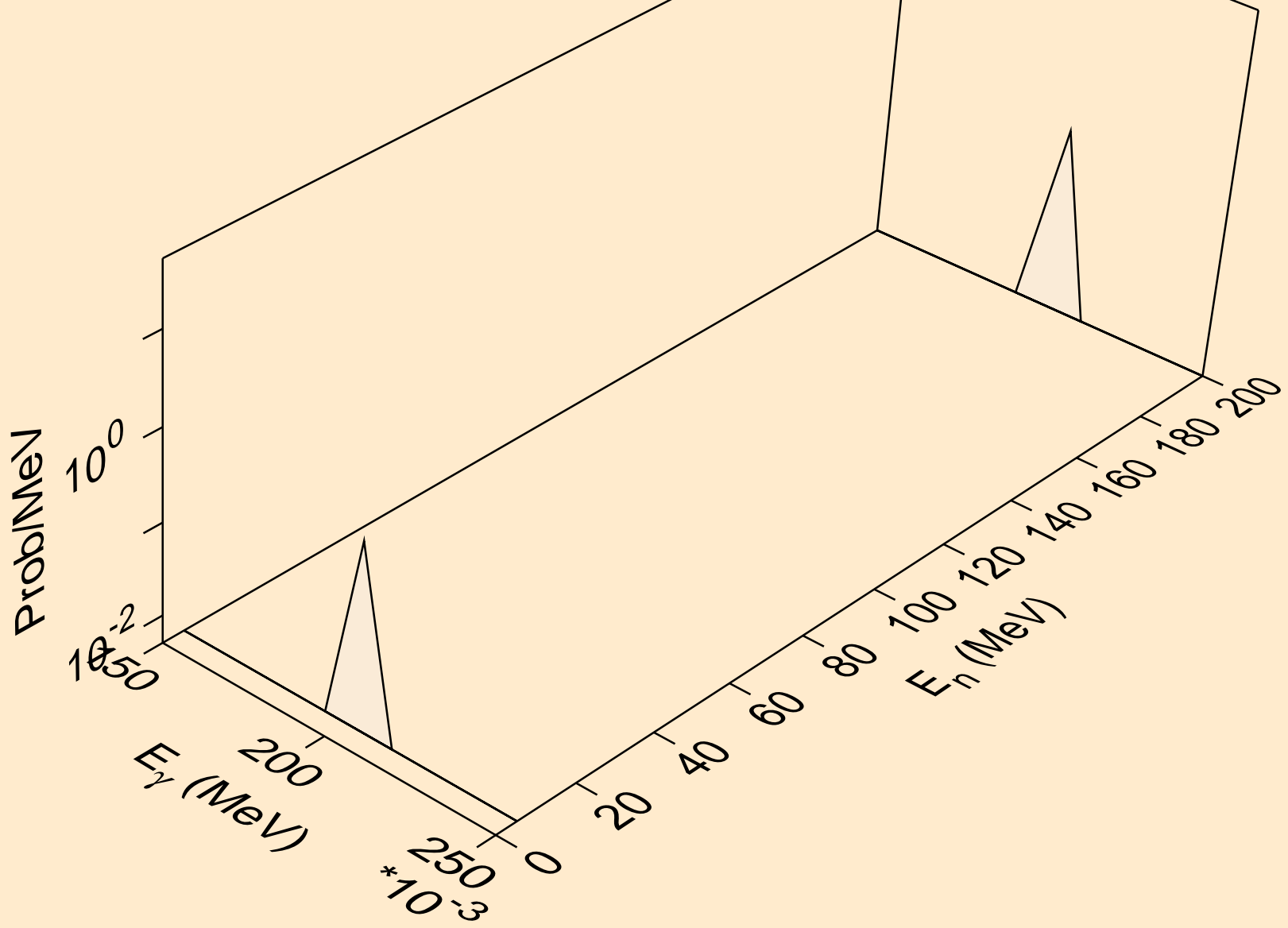

82-PB-206 FOR FENDL-3B2 FROM ENDF/B-VII WITH NJOY99.304
Photon emission for (n,d*2)

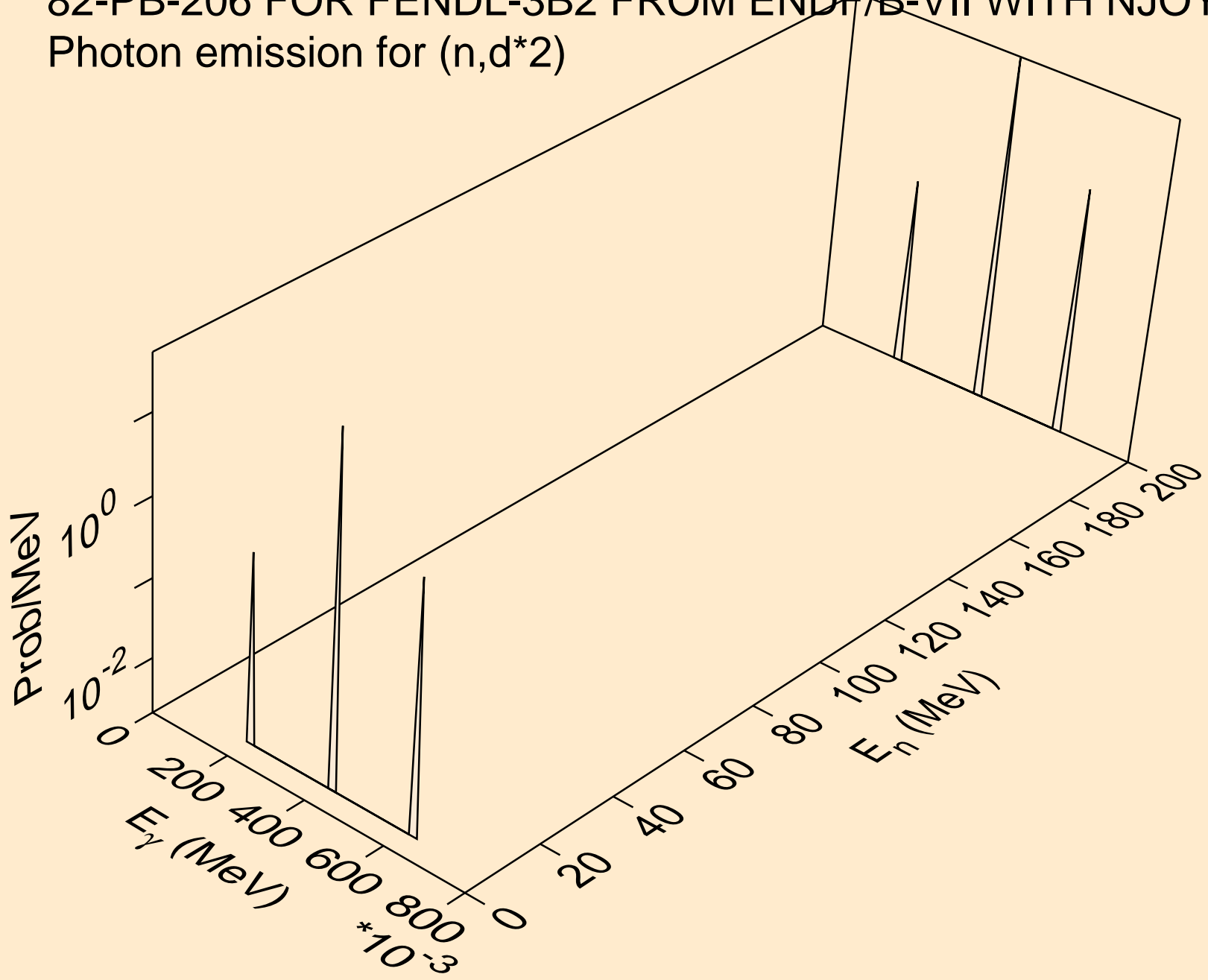

82-PB-206 FOR FENDL-3B2 FROM ENDF/B-VII WITH NJOY99.304
Photon emission for (n,d*3)

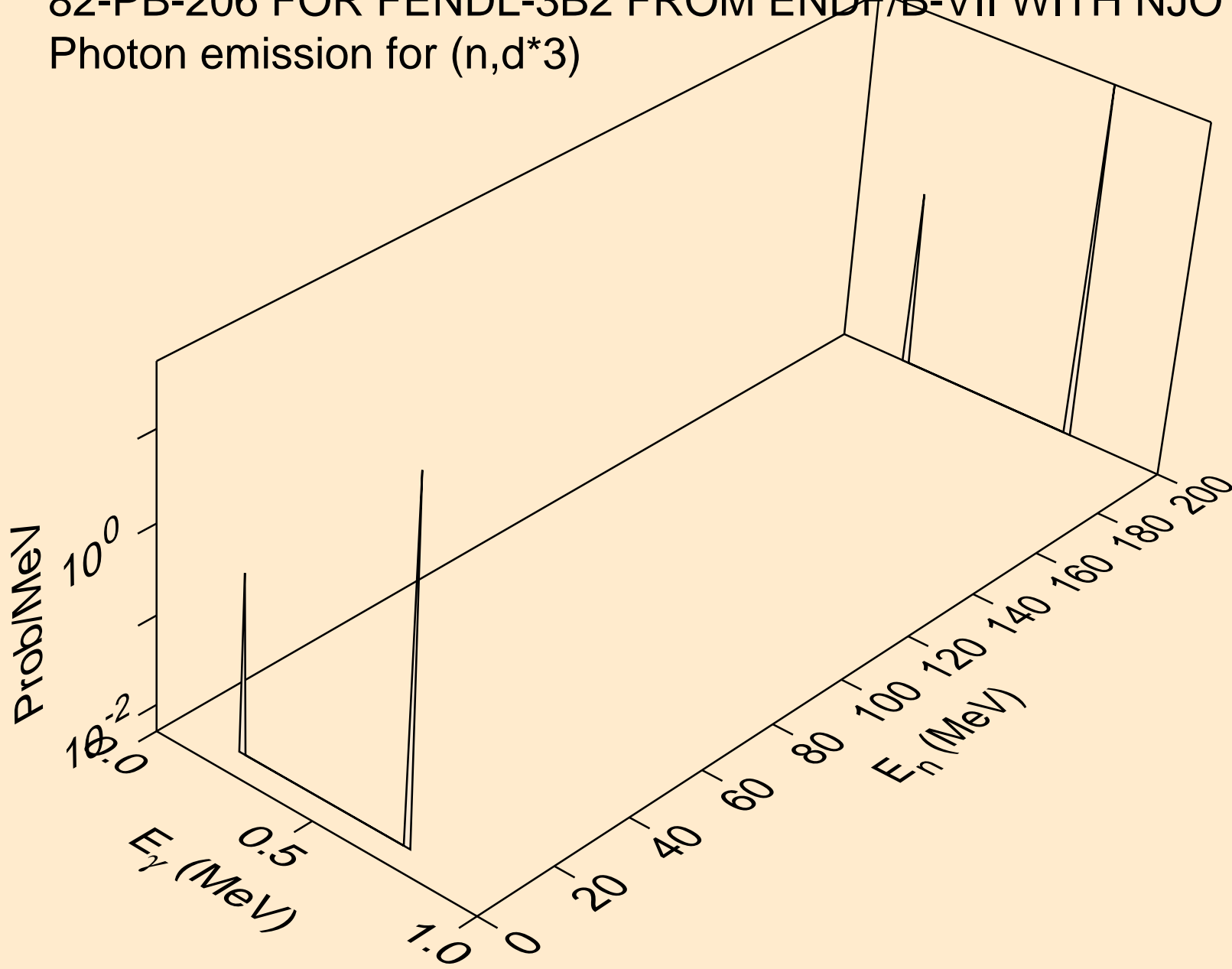

82-PB-206 FOR FENDL-3B2 FROM ENDF/B-VII WITH NJOY99.304
Photon emission for (n,d*4)

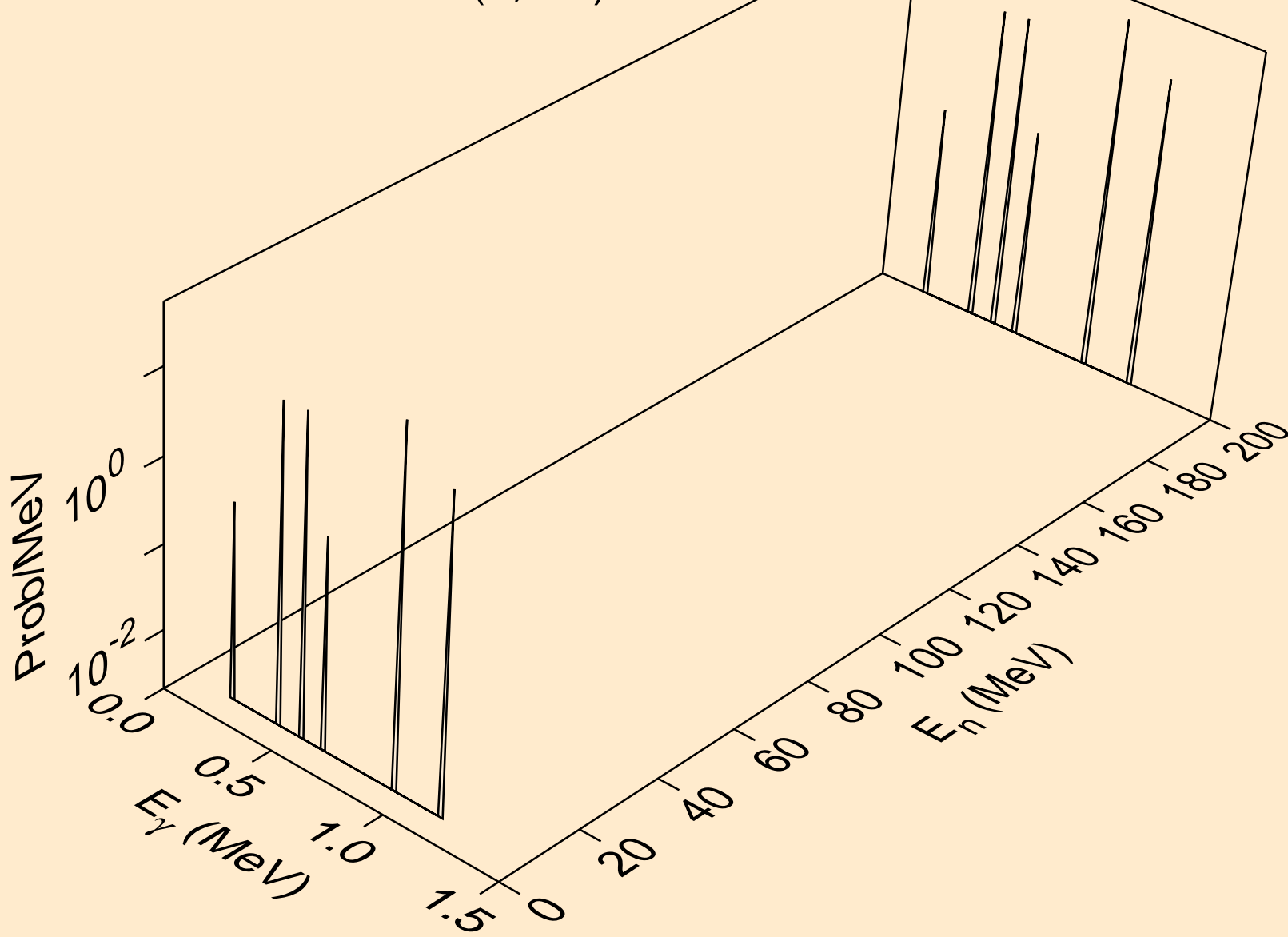

82-PB-206 FOR FENDL-3B2 FROM ENDF/B-VII WITH NJOY99.304
Photon emission for (n,d*5)

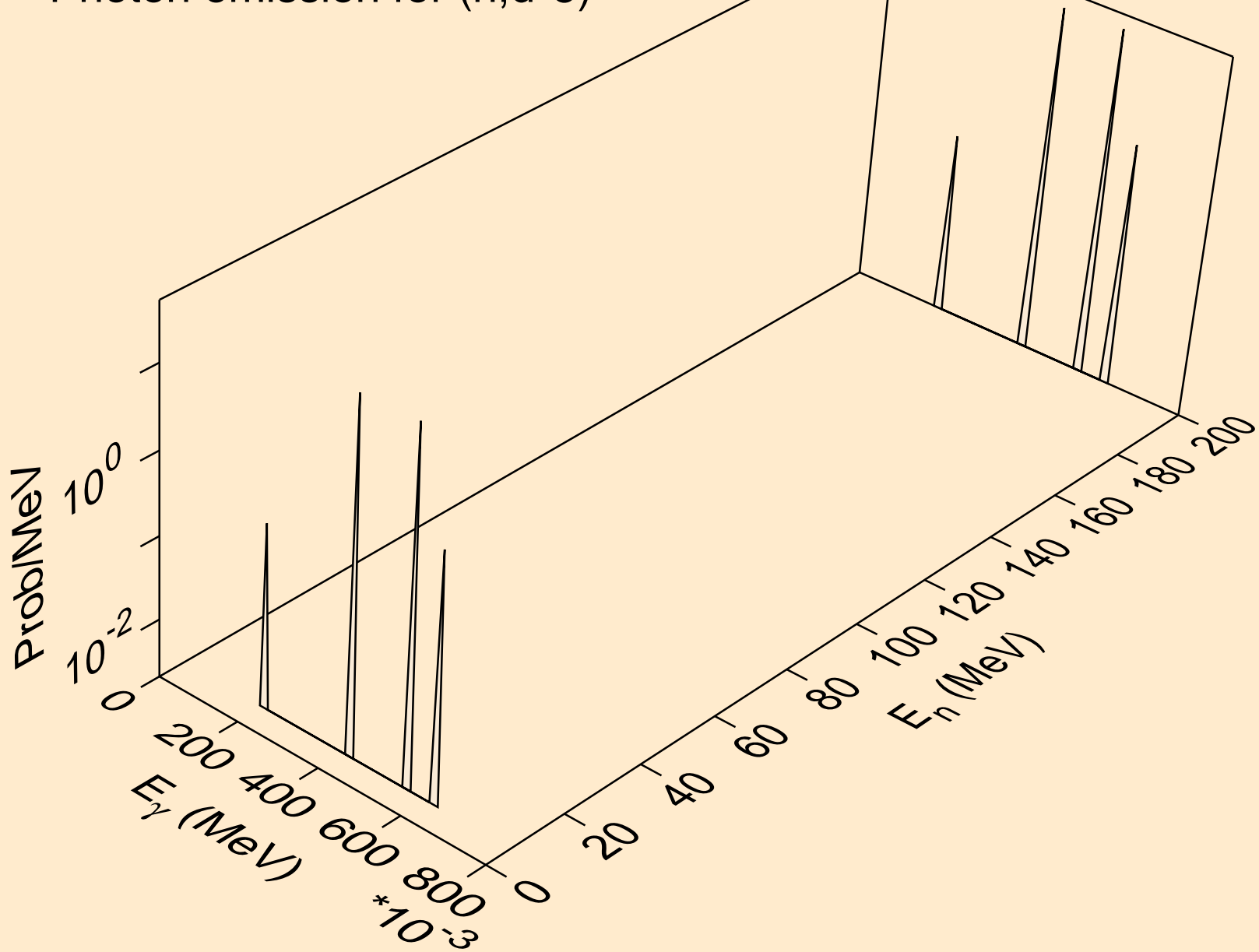

82-PB-206 FOR FENDL-3B2 FROM ENDF/B-VII WITH NJOY99.304
Photon emission for (n,d*c)

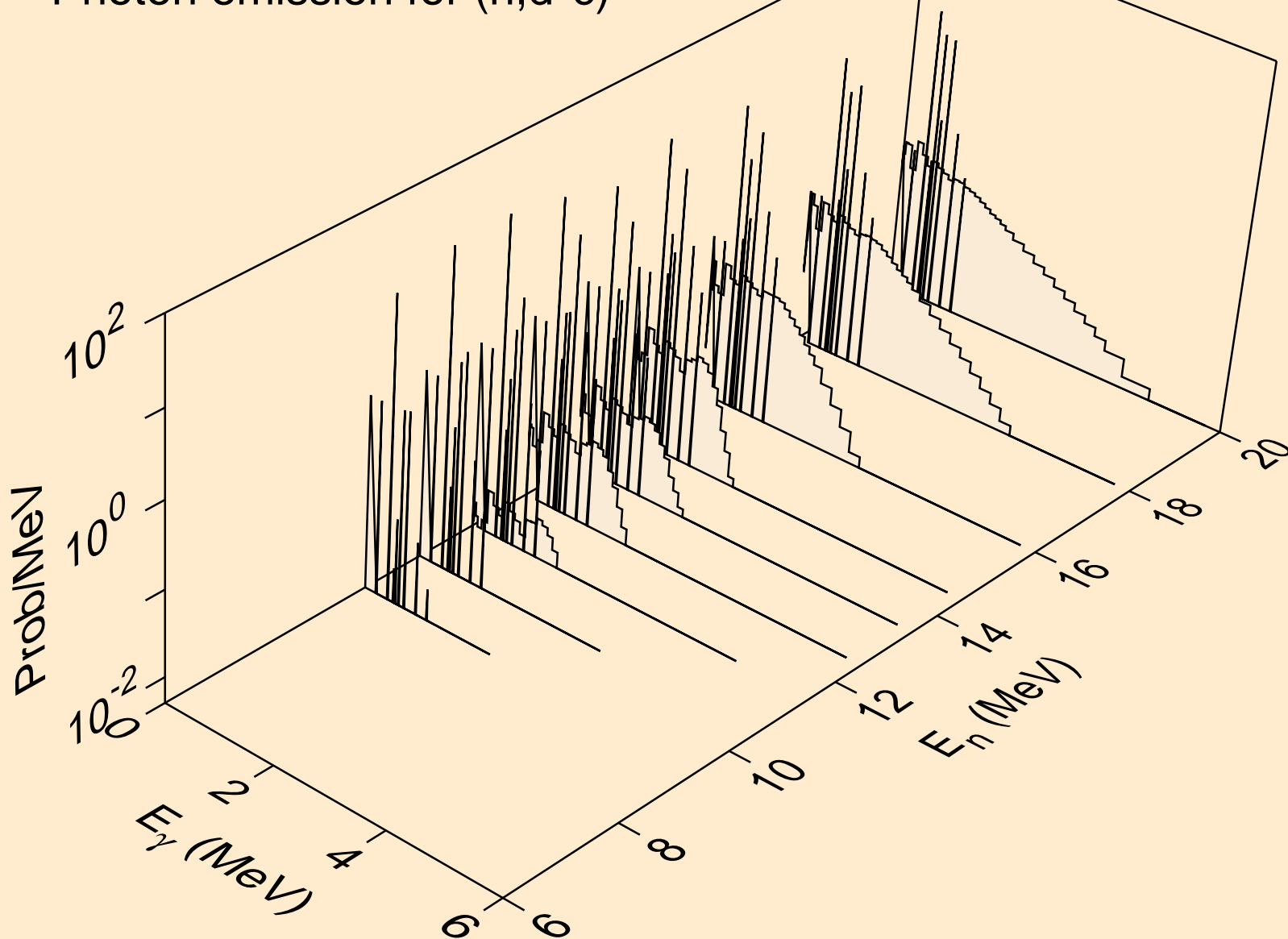

82-PB-206 FOR FENDL-3B2 FROM ENDF/B-VII WITH NJOY99.304
Photon emission for (n,t*1)

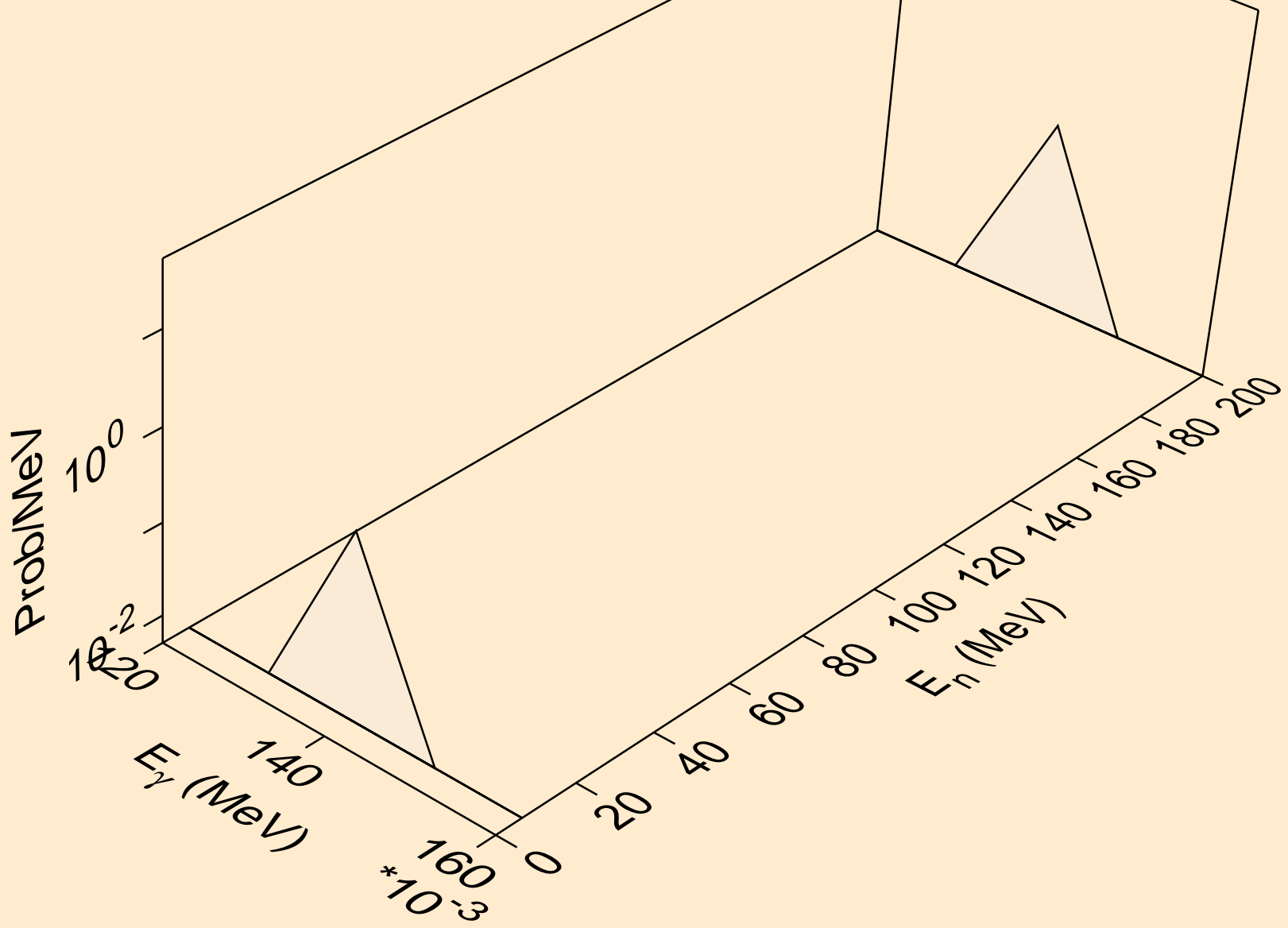

82-PB-206 FOR FENDL-3B2 FROM ENDF/B-VII WITH NJOY99.304
Photon emission for (n,t*2)

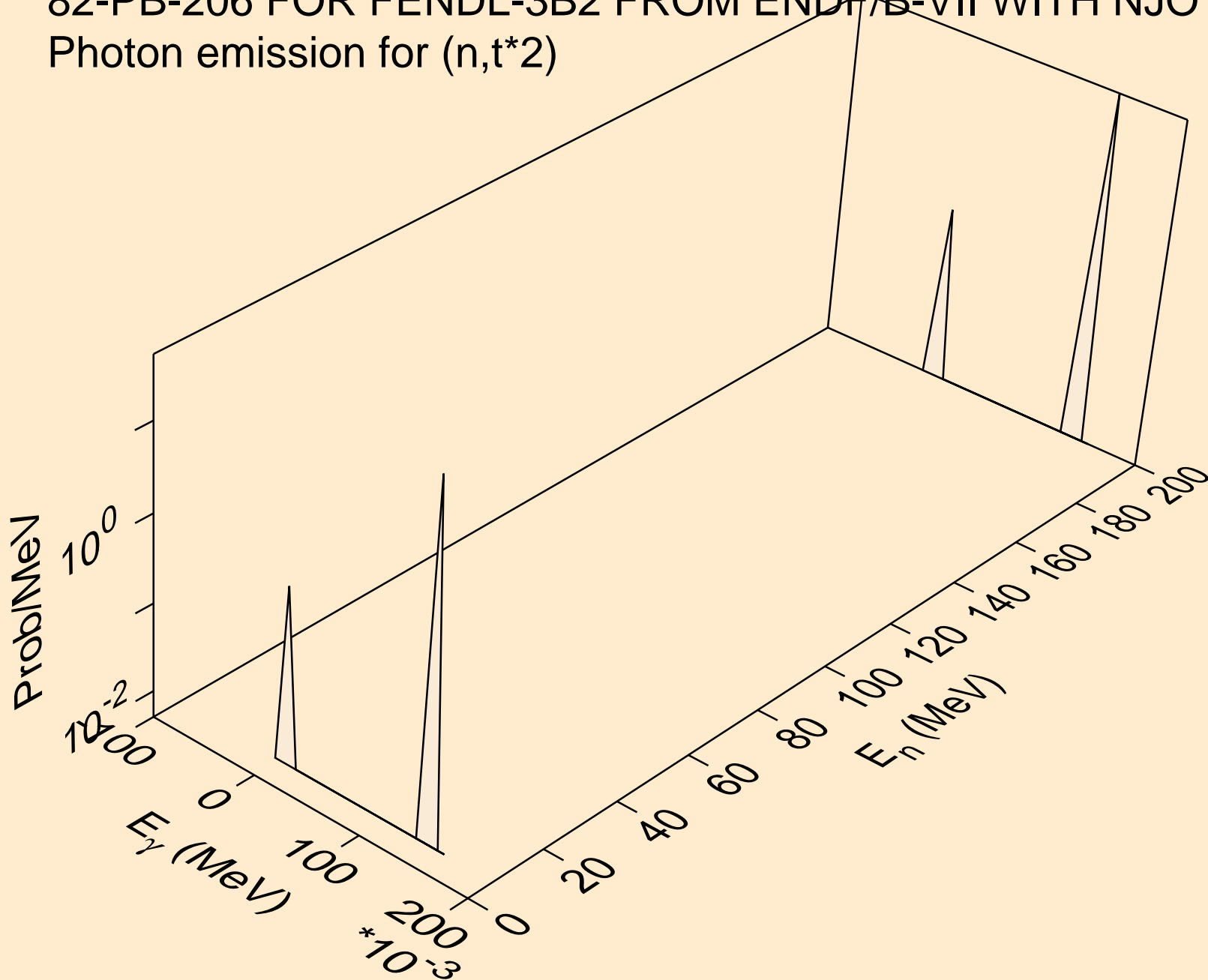

82-PB-206 FOR FENDL-3B2 FROM ENDF/B-VII WITH NJOY99.304
Photon emission for (n,t*3)

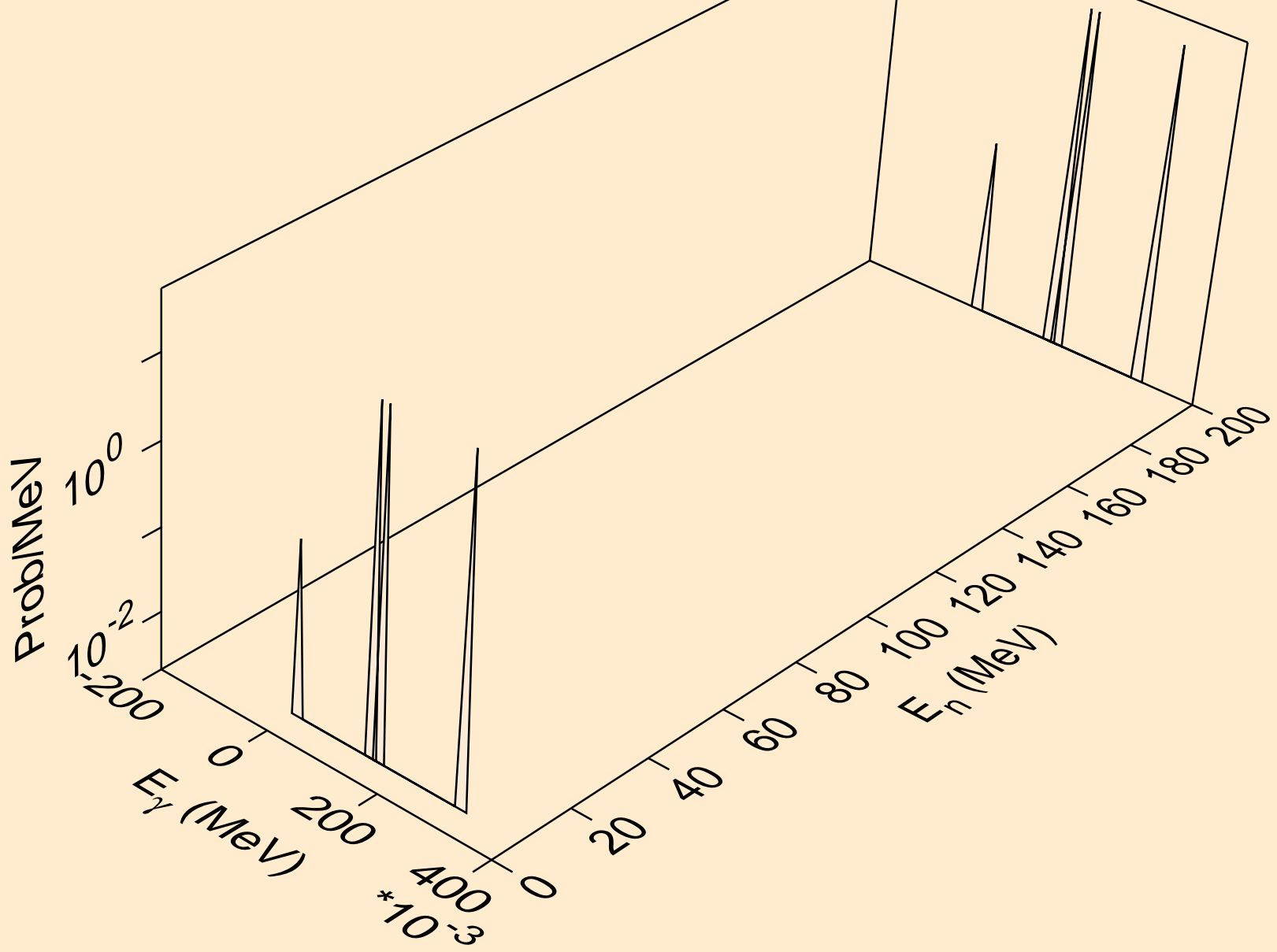

82-PB-206 FOR FENDL-3B2 FROM ENDF/B-VII WITH NJOY99.304
Photon emission for (n,t*4)

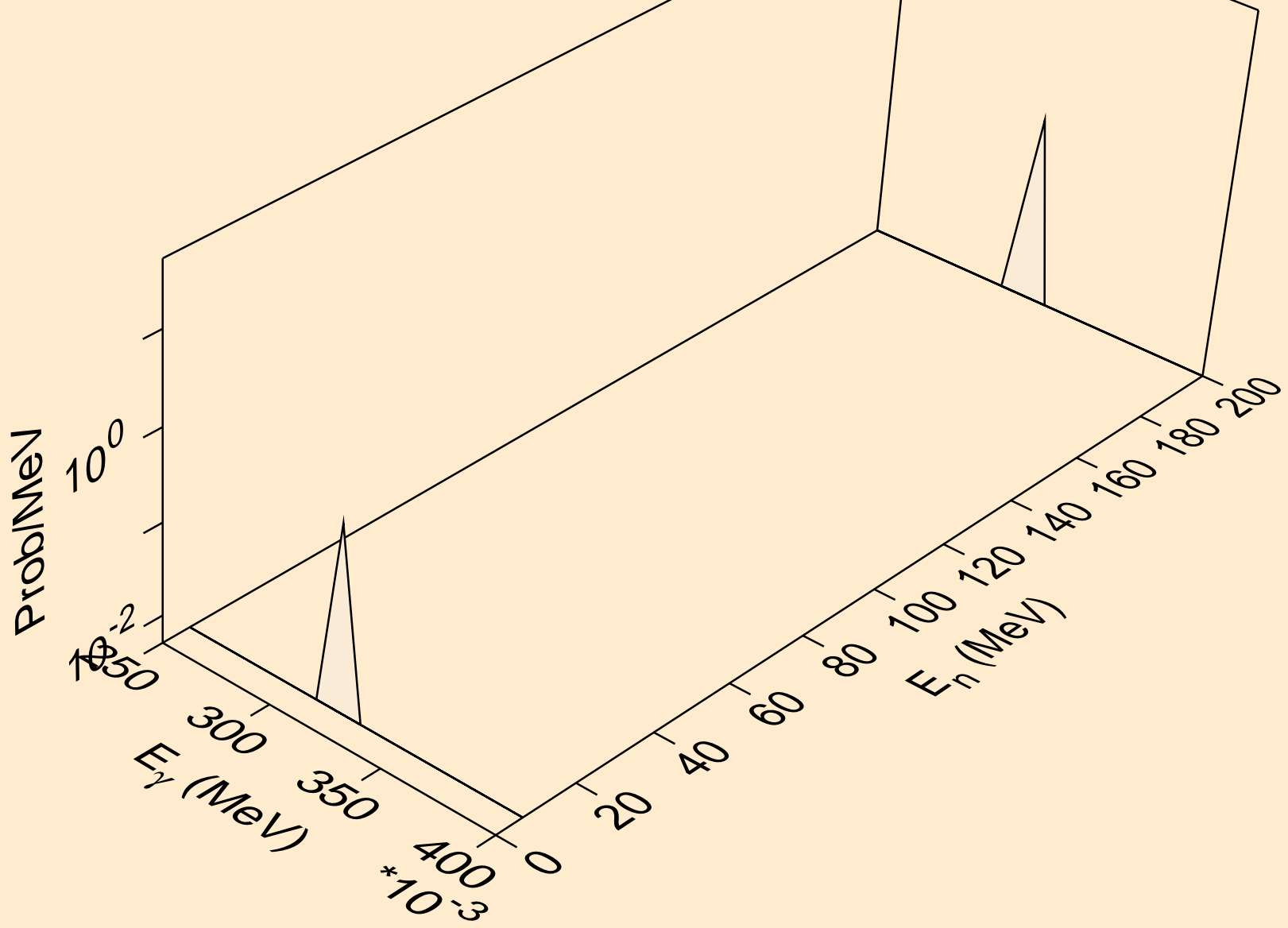

82-PB-206 FOR FENDL-3B2 FROM ENDF/B-VII WITH NJOY99.304
Photon emission for (n,t*5)

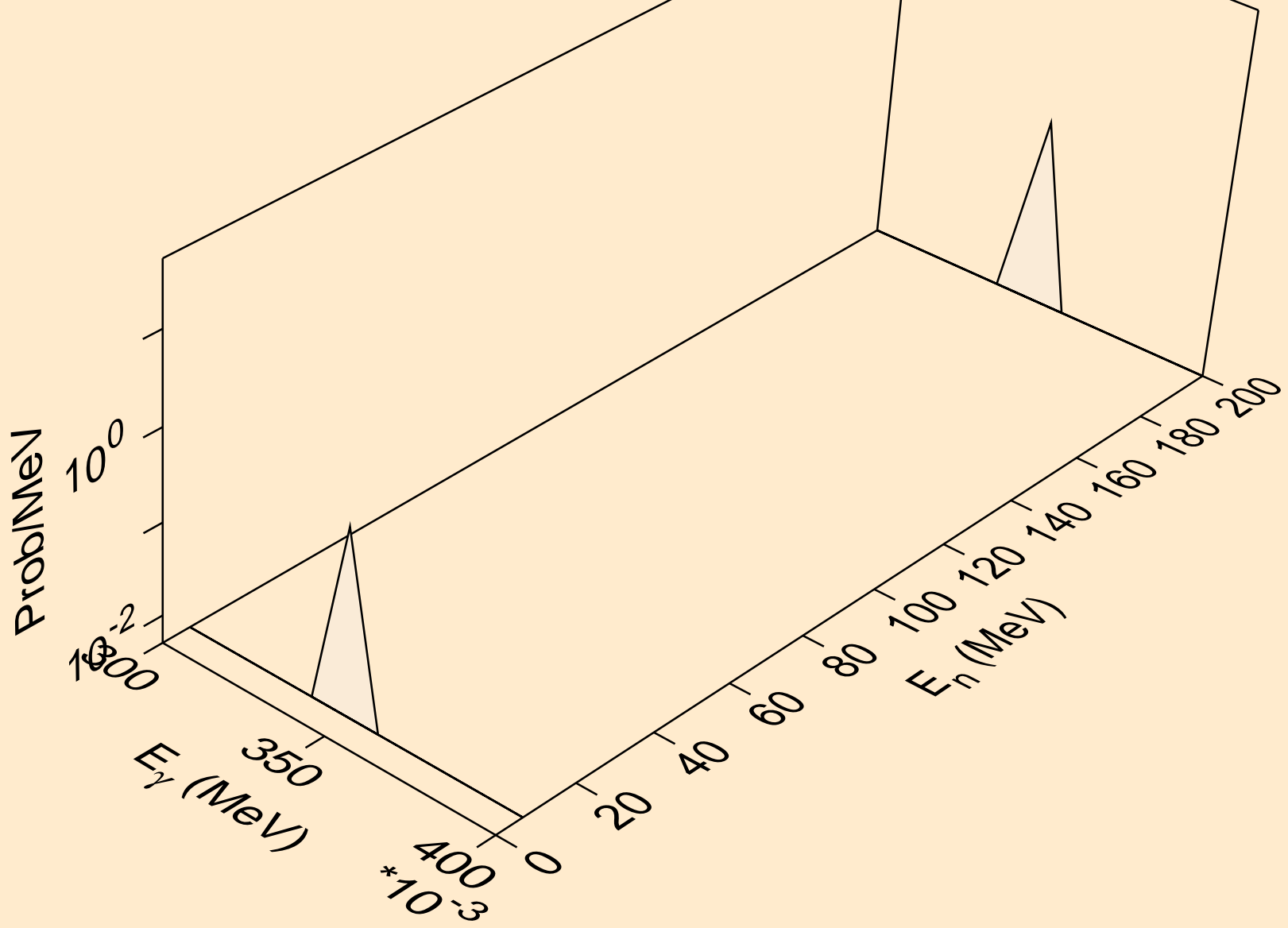

82-PB-206 FOR FENDL-3B2 FROM ENDF/B-VII WITH NJOY99.304
Photon emission for (n,t*c)

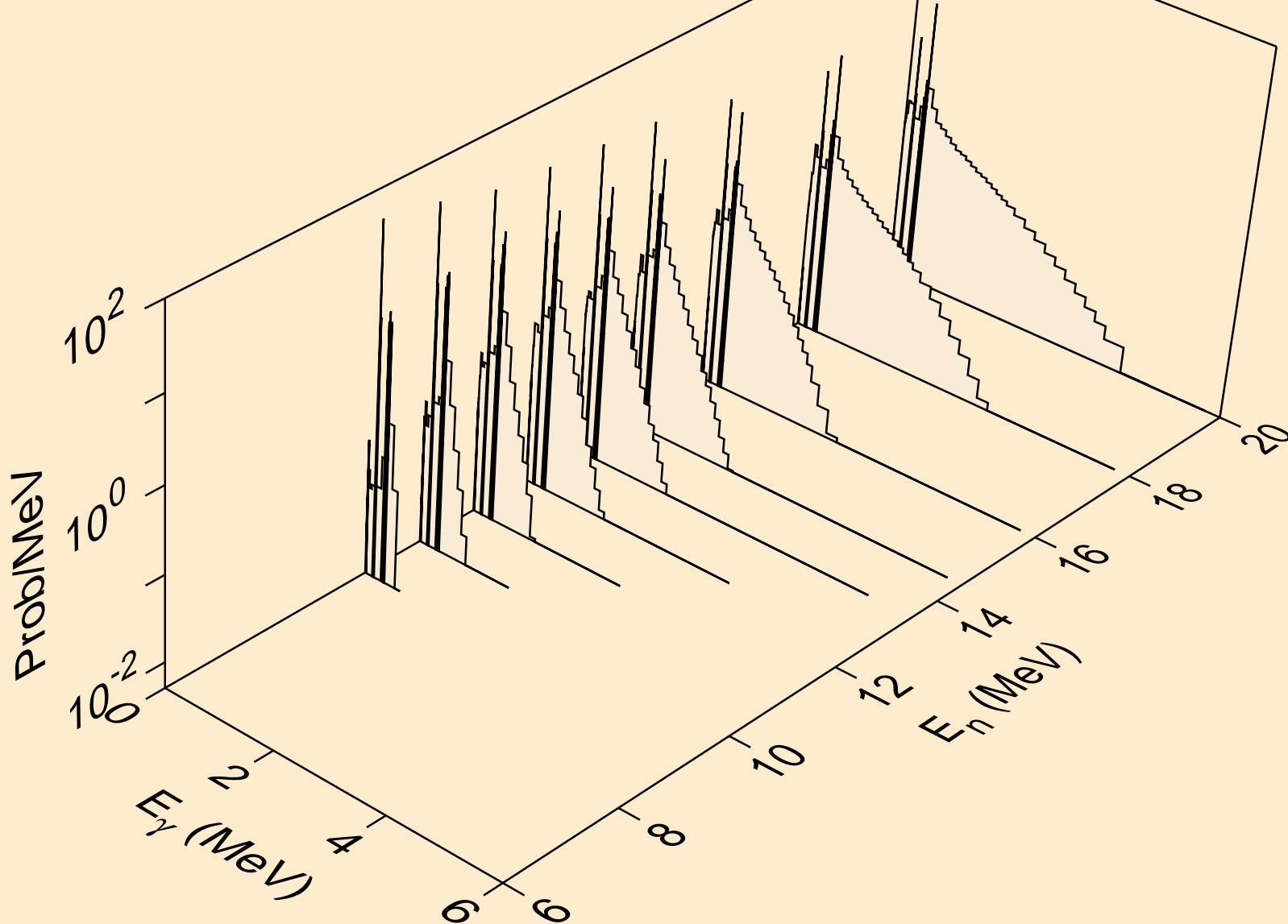

82-PB-206 FOR FENDL-3B2 FROM ENDF/B-VII WITH NJOY99.304
Photon emission for (n,a*1)

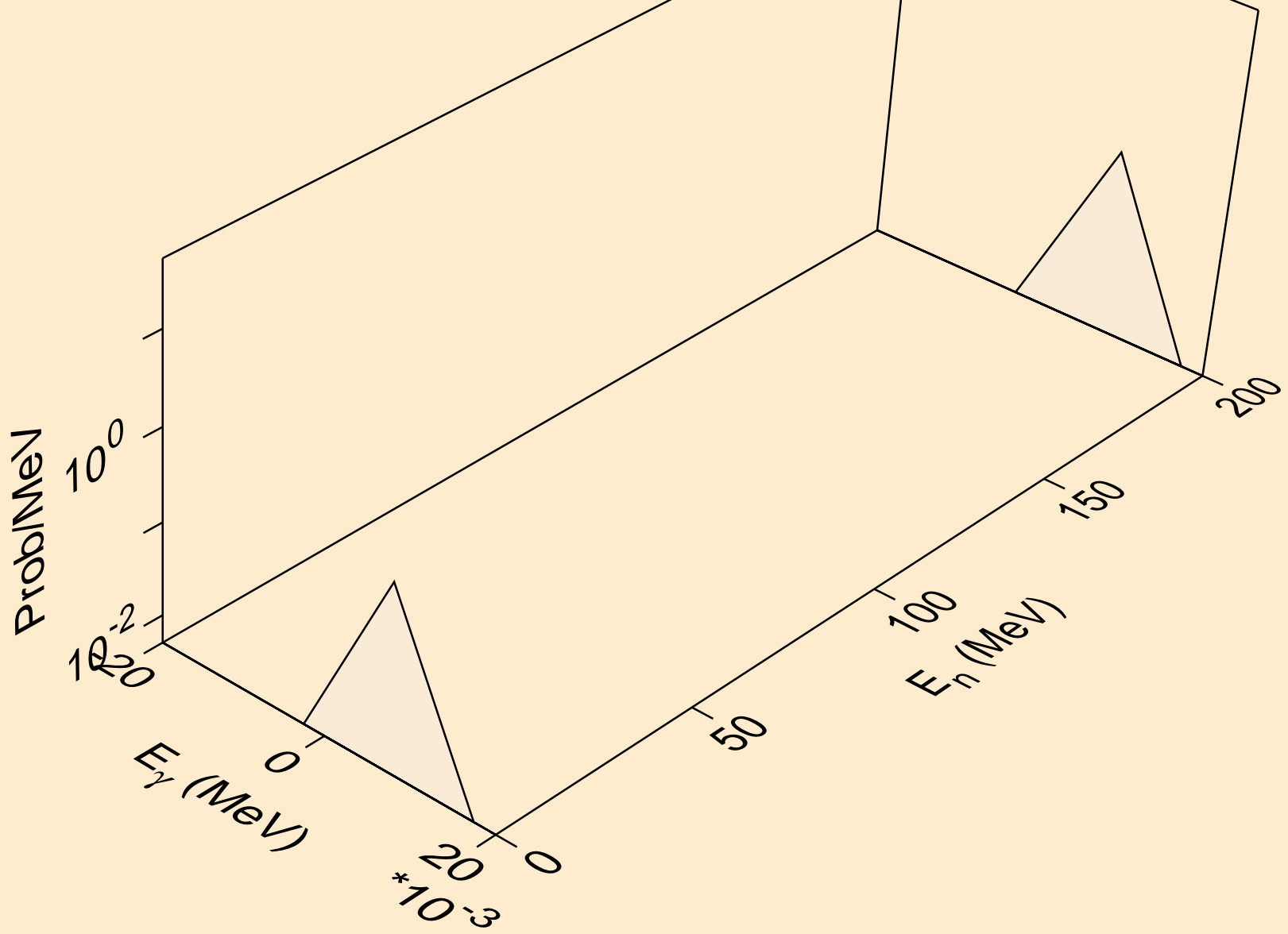

82-PB-206 FOR FENDL-3B2 FROM ENDF/B-VII WITH NJOY99.304
Photon emission for (n,a*2)

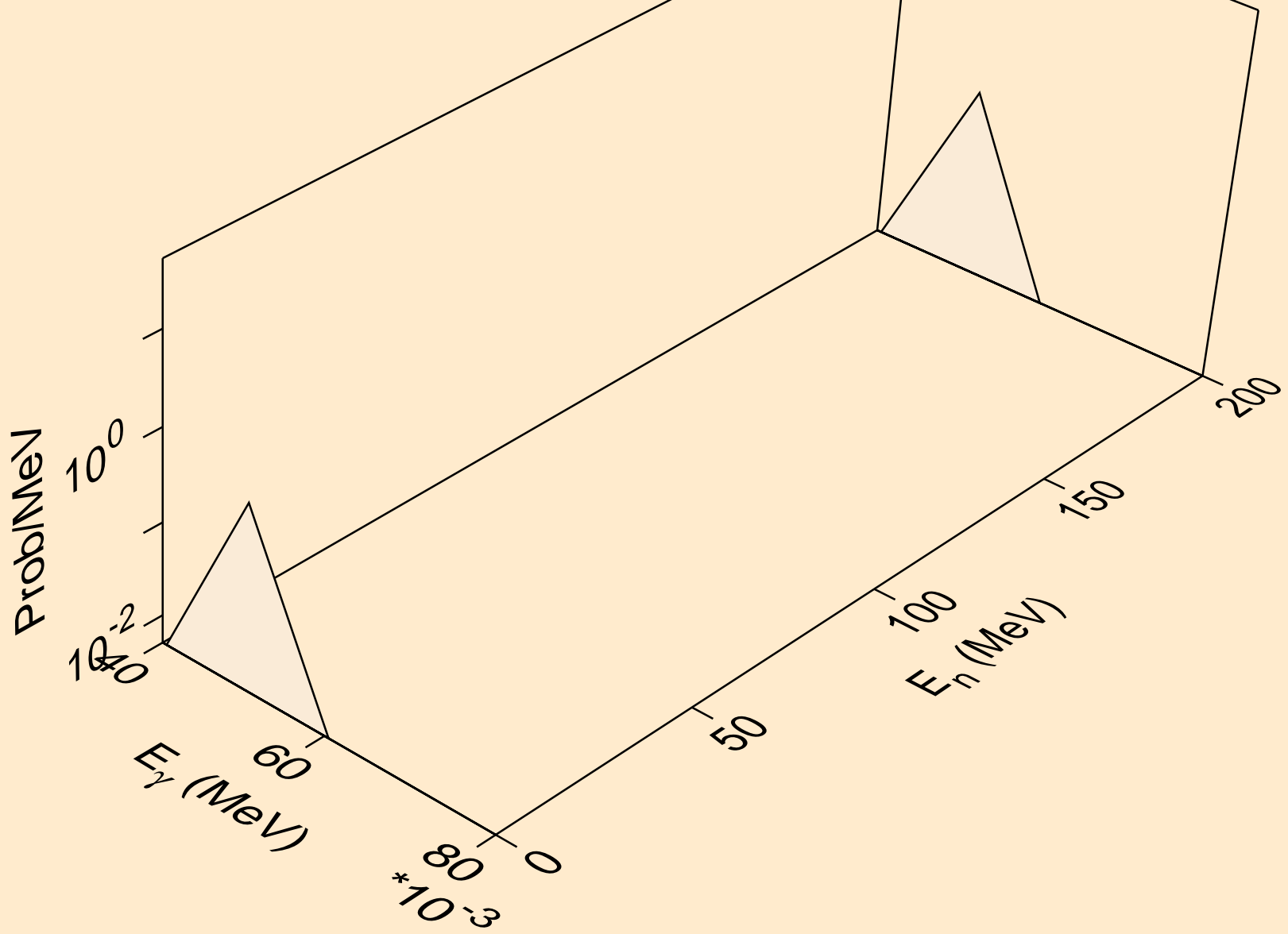

82-PB-206 FOR FENDL-3B2 FROM ENDF/B-VII WITH NJOY99.304
Photon emission for (n,a*3)

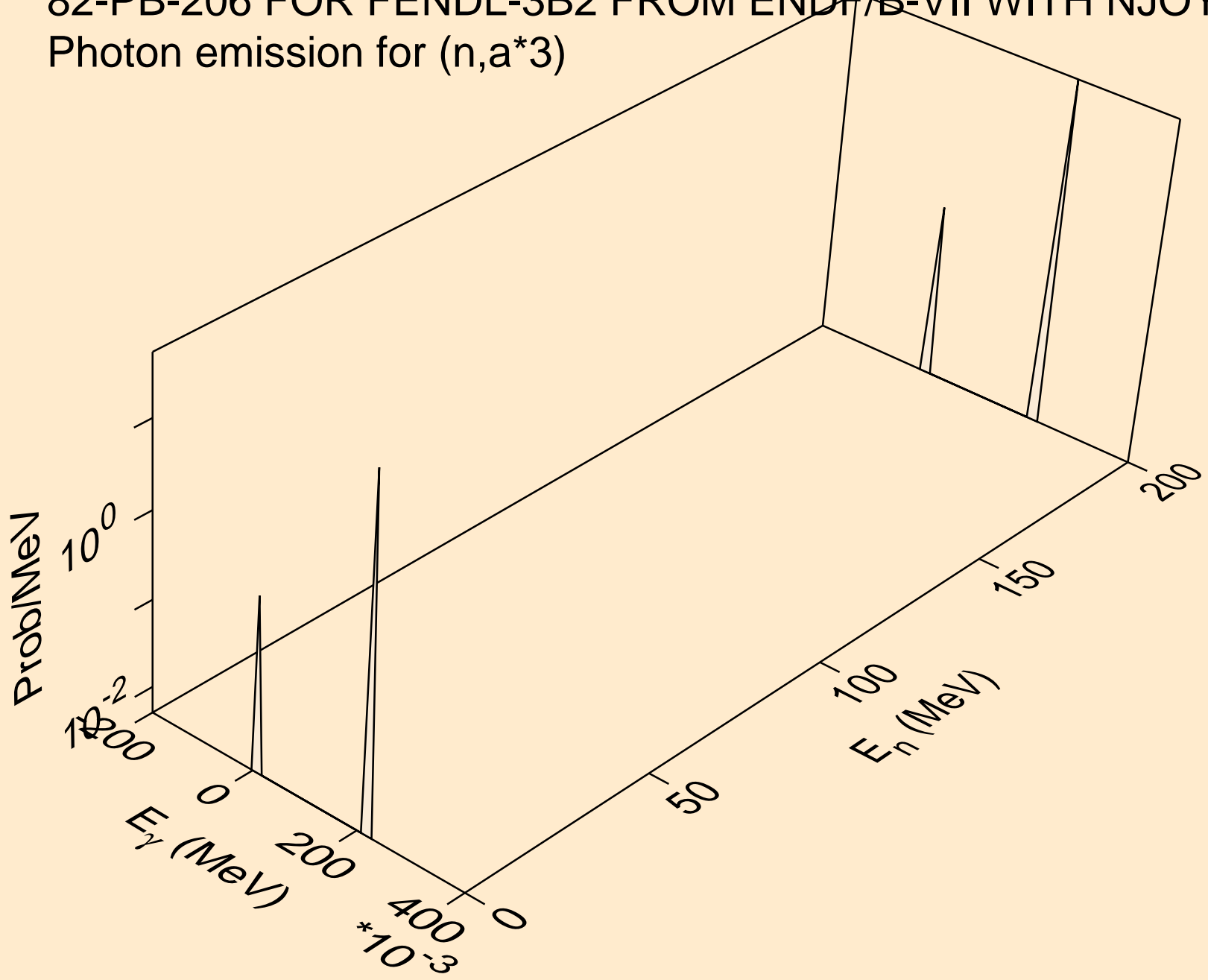

82-PB-206 FOR FENDL-3B2 FROM ENDF/B-VII WITH NJOY99.304
Photon emission for (n,a*4)

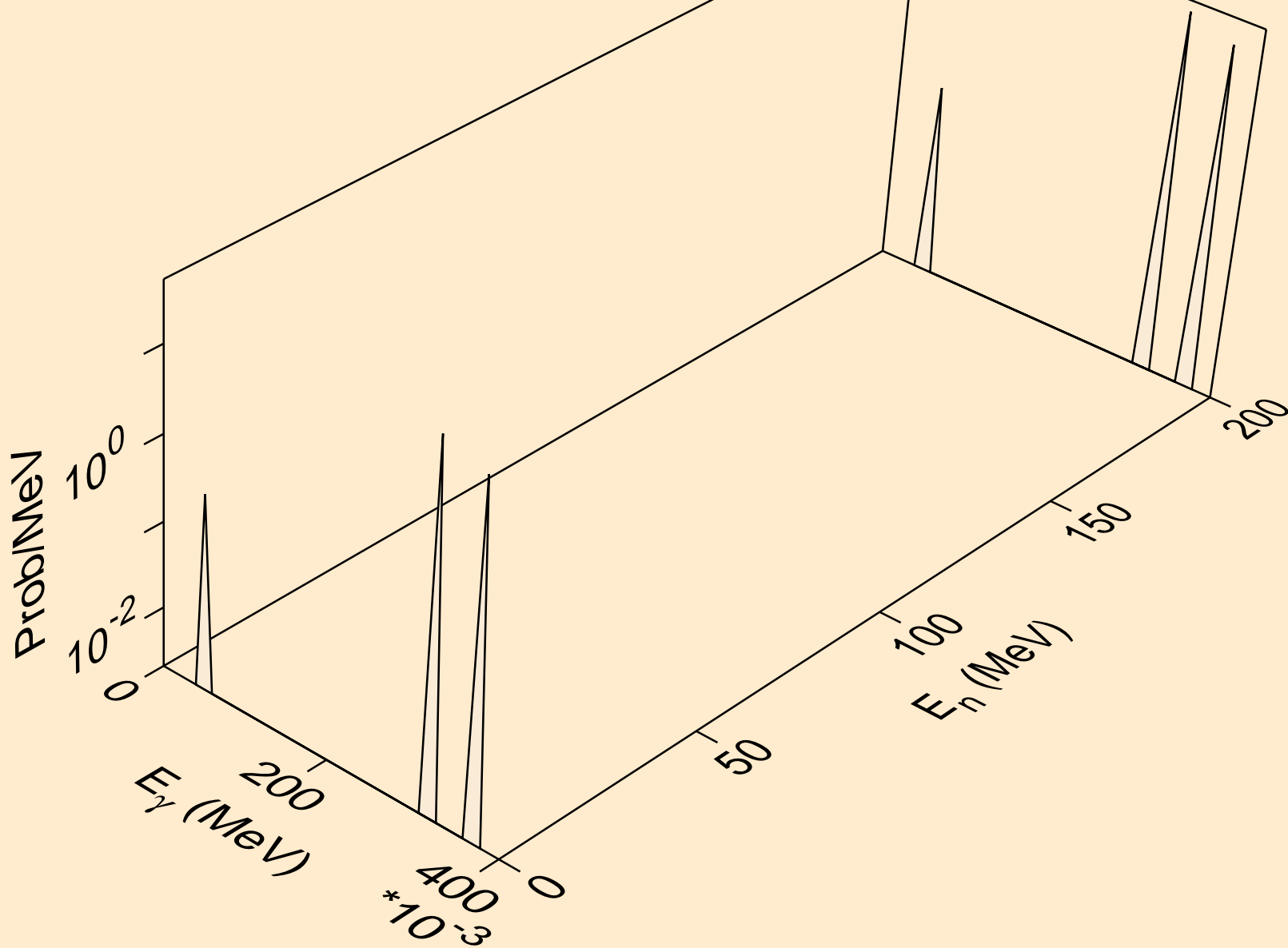

82-PB-206 FOR FENDL-3B2 FROM ENDF/B-VII WITH NJOY99.304
Photon emission for (n,a*5)

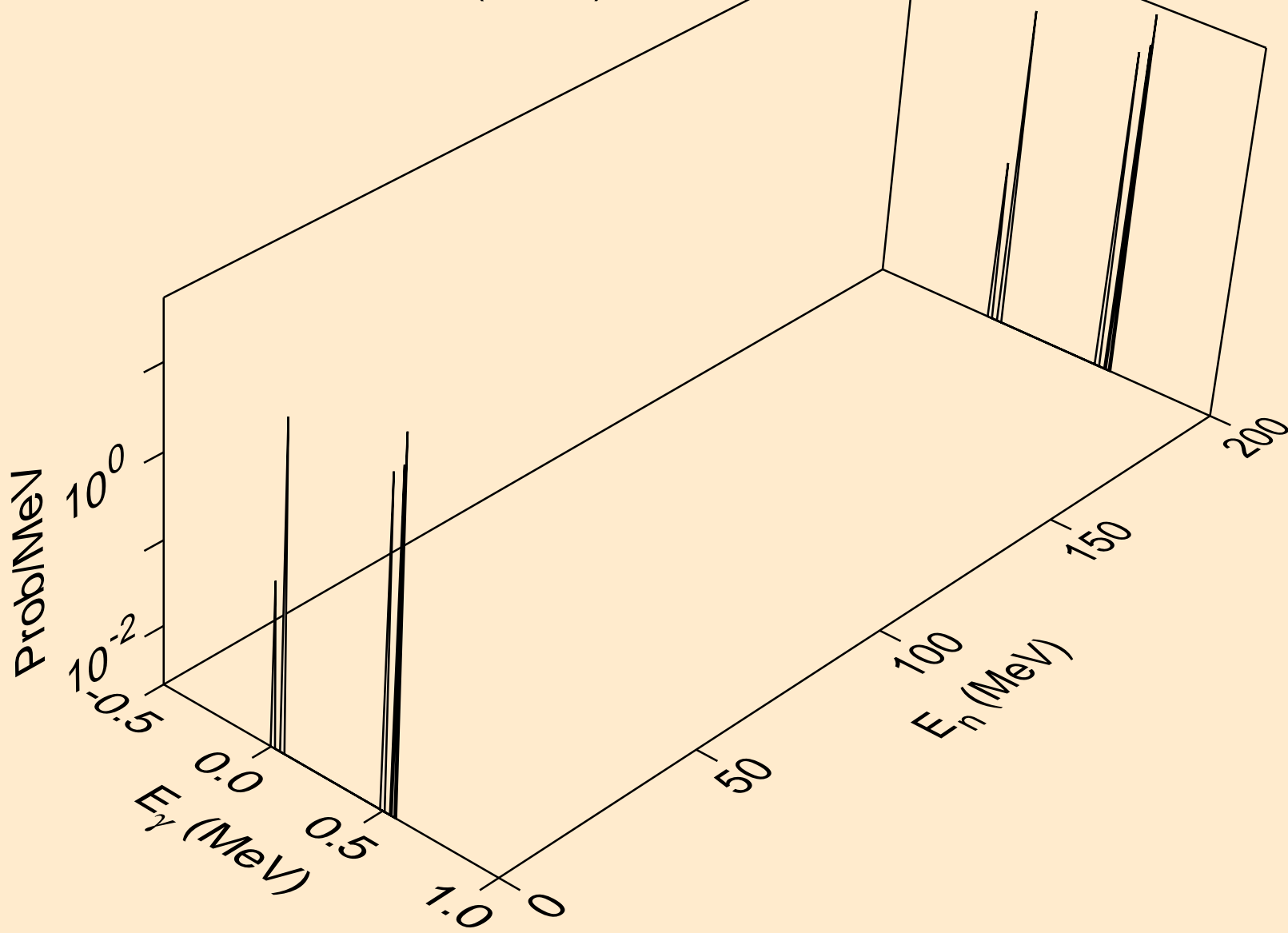

82-PB-206 FOR FENDL-3B2 FROM ENDF/B-VII WITH NJOY99.304
Photon emission for (n,a*6)

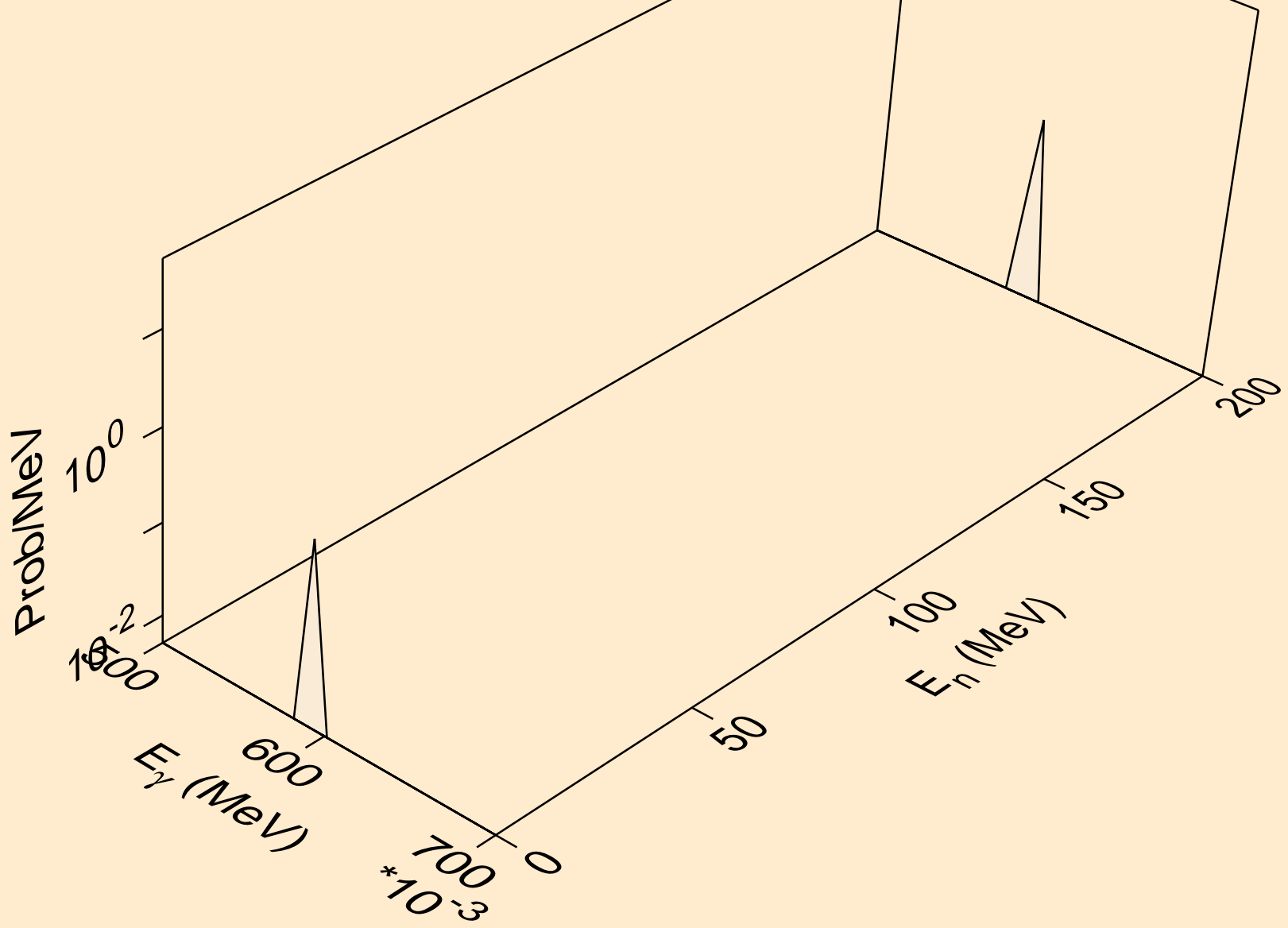

82-PB-206 FOR FENDL-3B2 FROM ENDF/B-VII WITH NJOY99.304
Photon emission for (n,a*7)

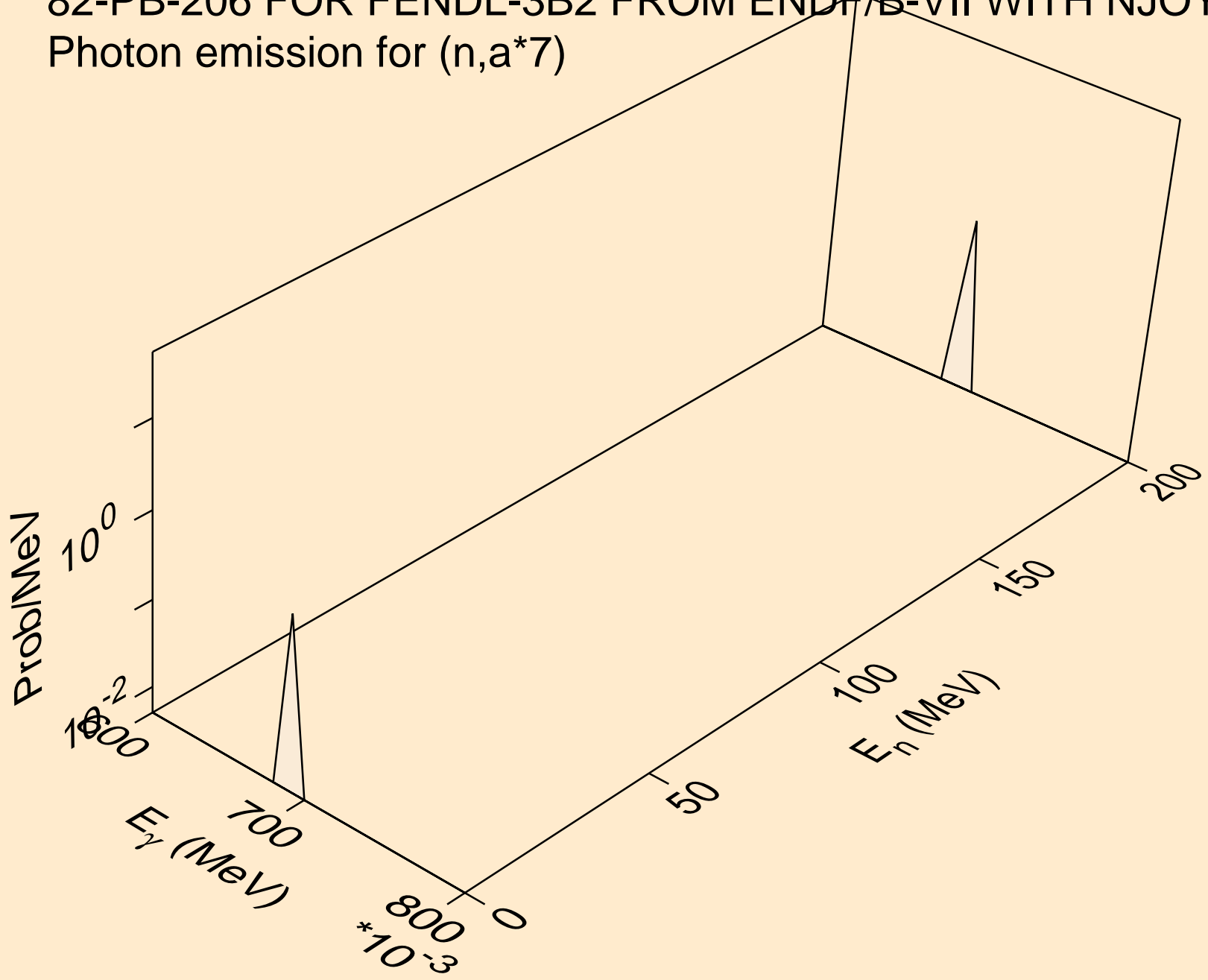

82-PB-206 FOR FENDL-3B2 FROM ENDF/B-VII WITH NJOY99.304
Photon emission for (n,a*8)

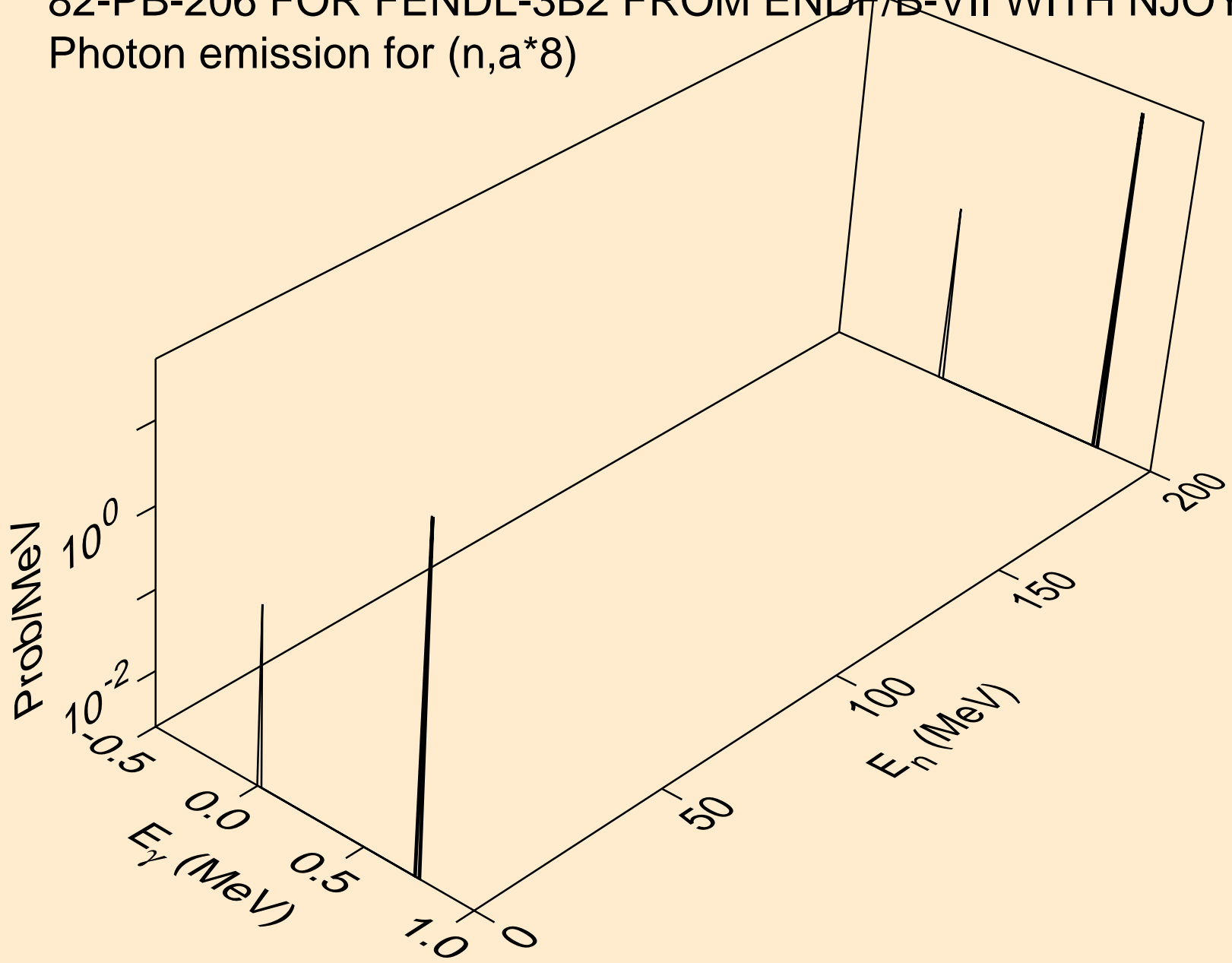

82-PB-206 FOR FENDL-3B2 FROM ENDF/B-VII WITH NJOY99.304
Photon emission for (n,a*9)

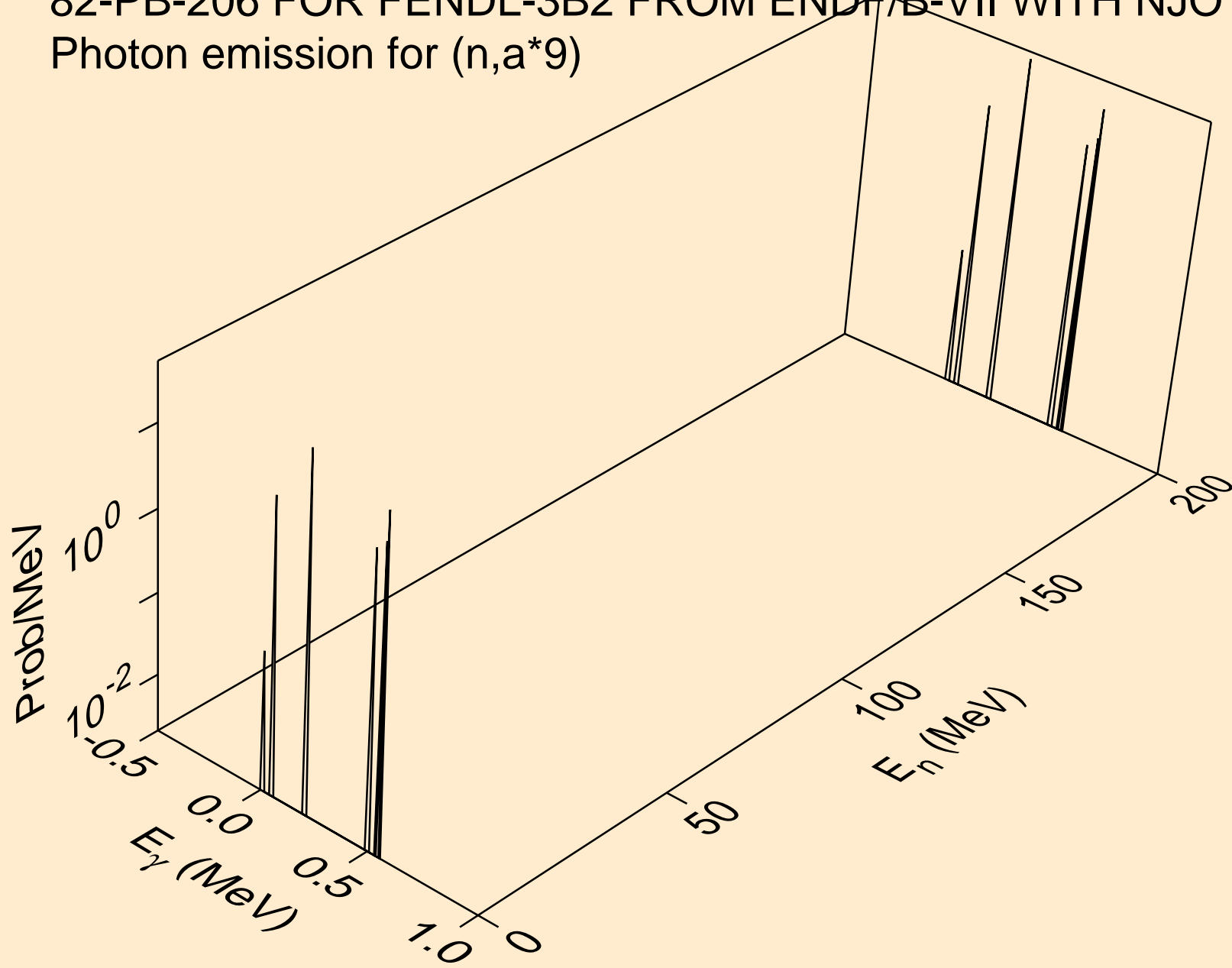

82-PB-206 FOR FENDL-3B2 FROM ENDF/B-VII WITH NJOY99.304
Photon emission for (n,a*10)

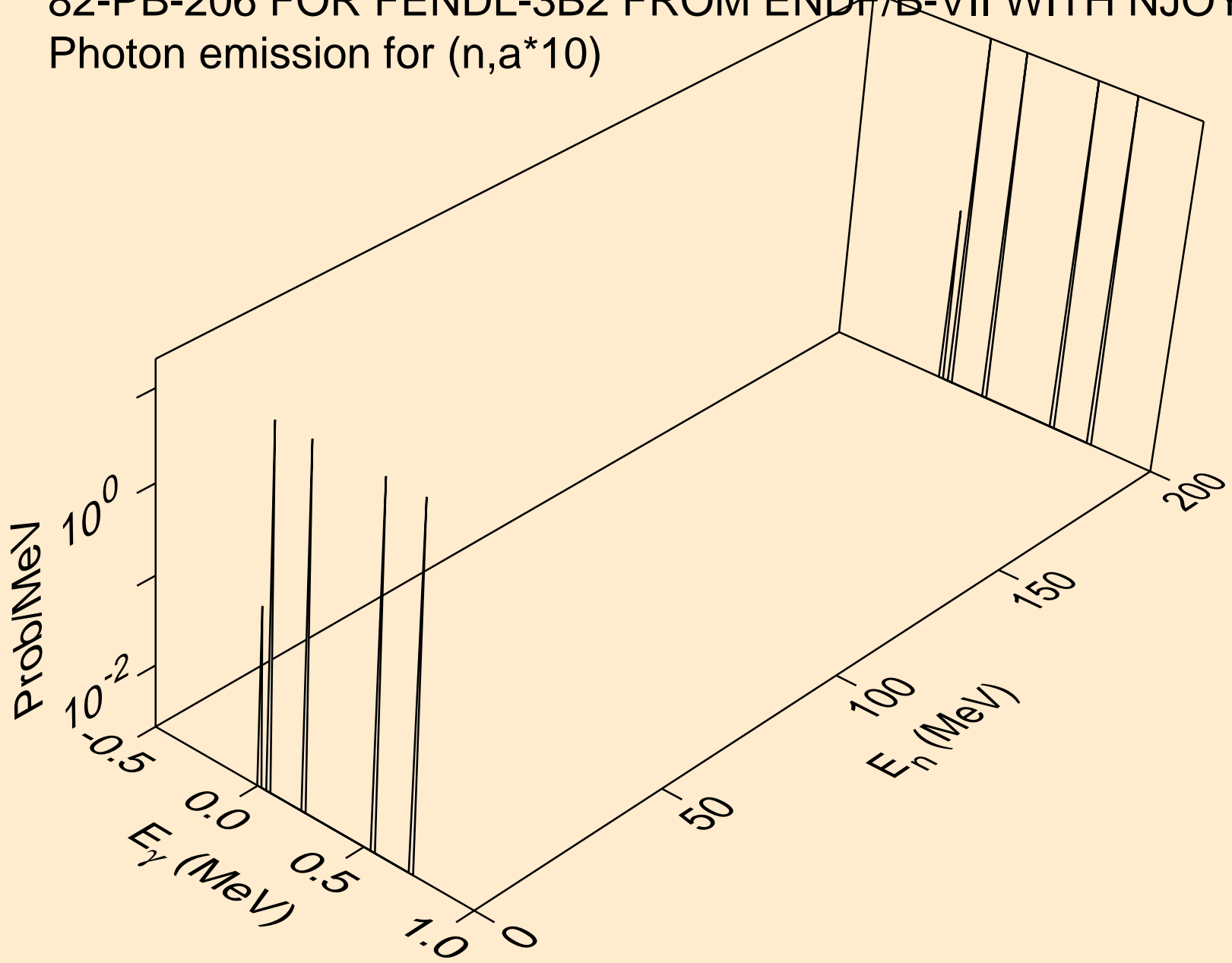

82-PB-206 FOR FENDL-3B2 FROM ENDF/B-VII WITH NJOY99.304
Photon emission for (n,a*c)

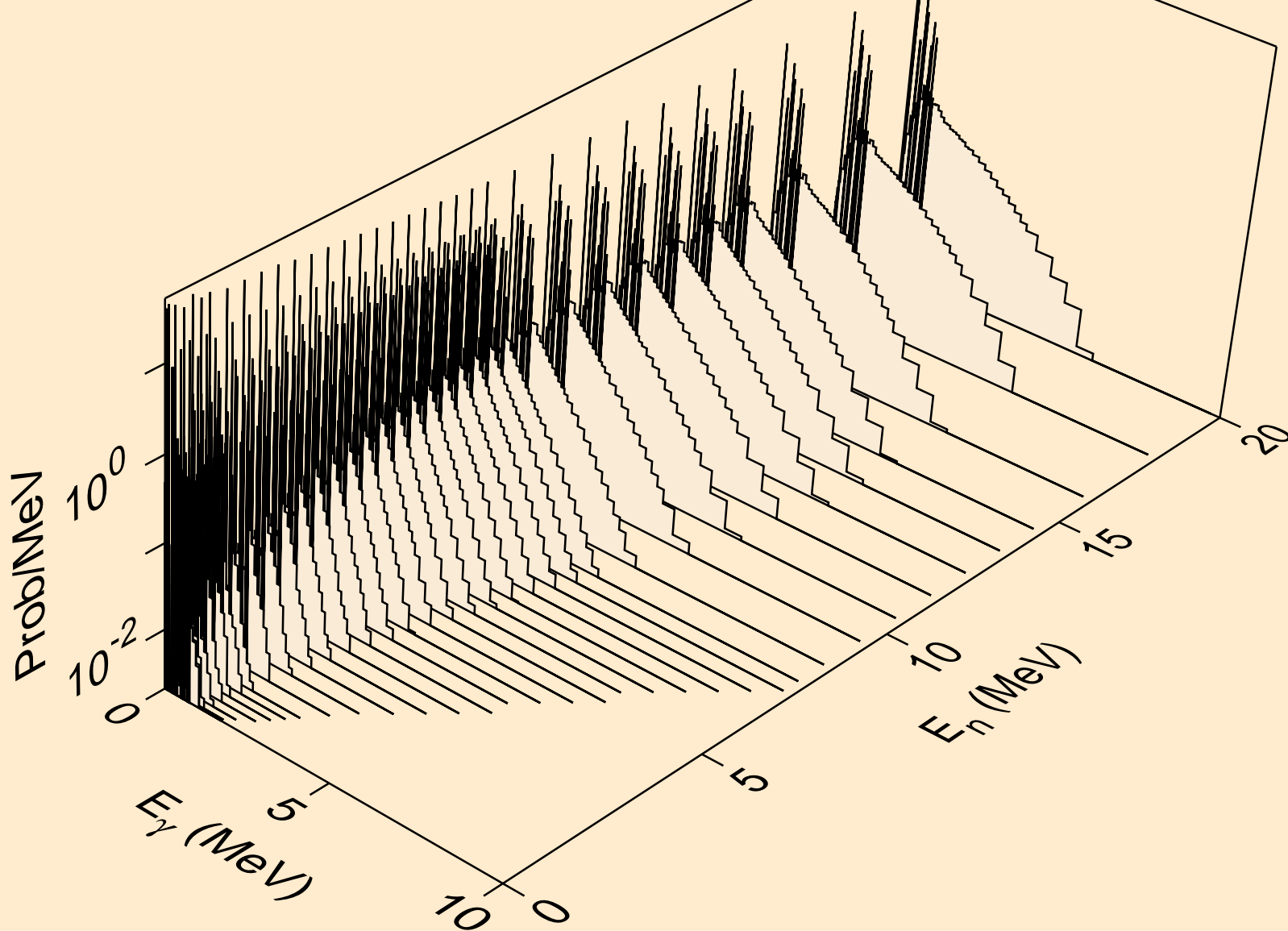

82-PB-206 FOR FENDL-3B2 FROM ENDF/B-VII WITH NJOY99.304
thermal capture photon spectrum

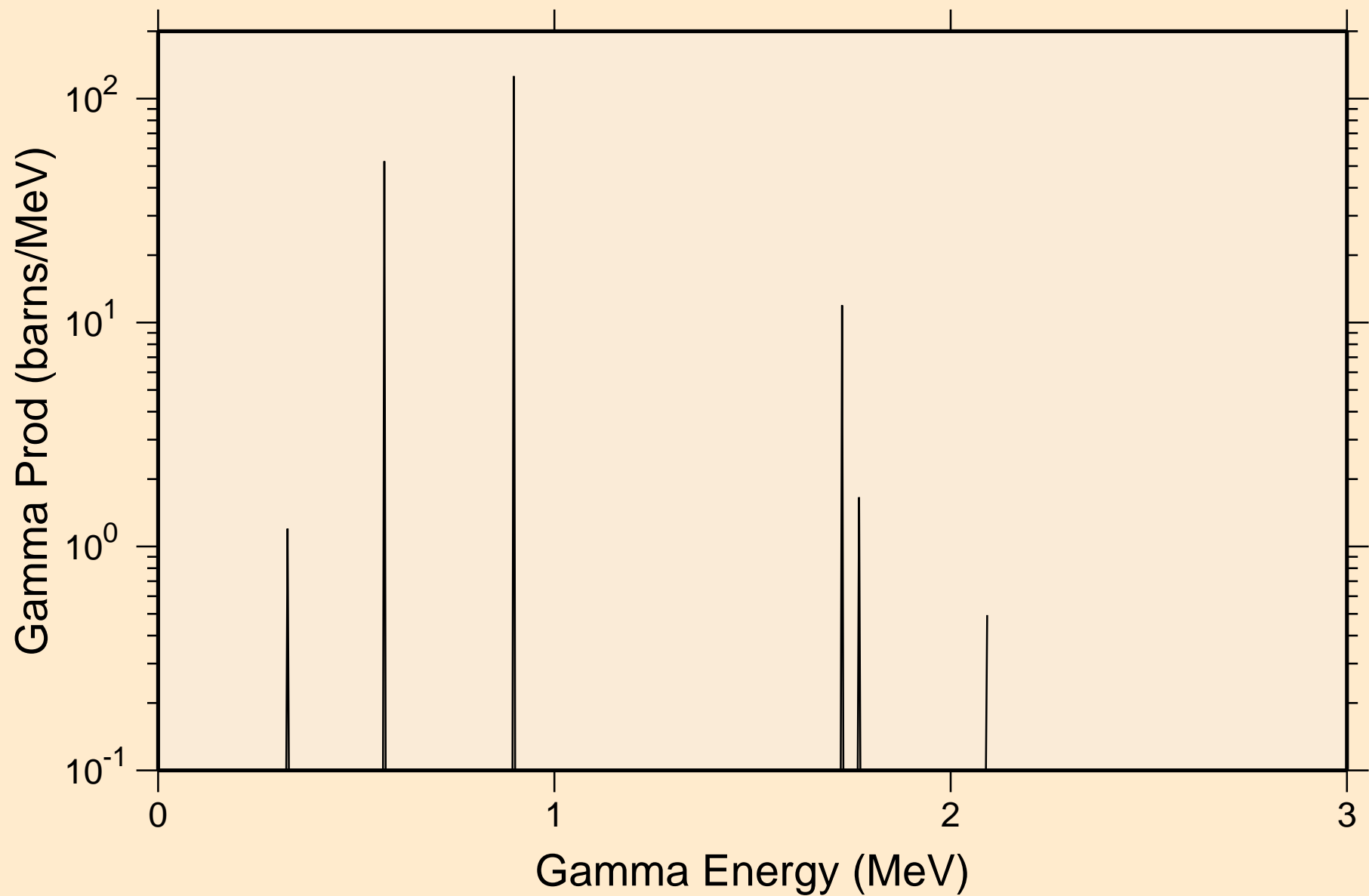

82-PB-206 FOR FENDL-3B2 FROM ENDF/B-VII WITH NJOY99.304
14 MeV photon spectrum

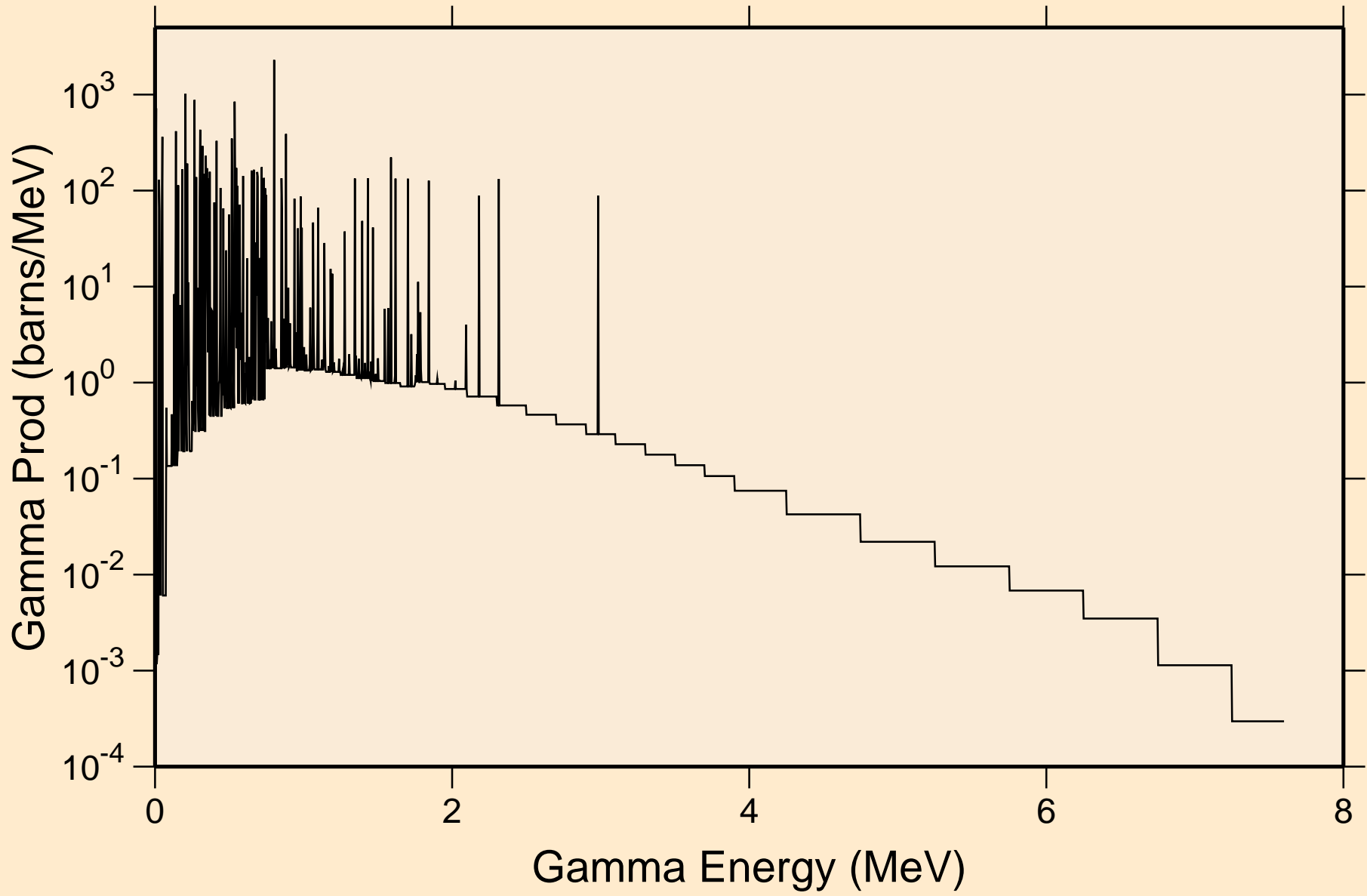

82-PB-206 FOR FENDL-3B2 FROM ENDF/B-VII WITH NJOY99.304
Particle heating contributions

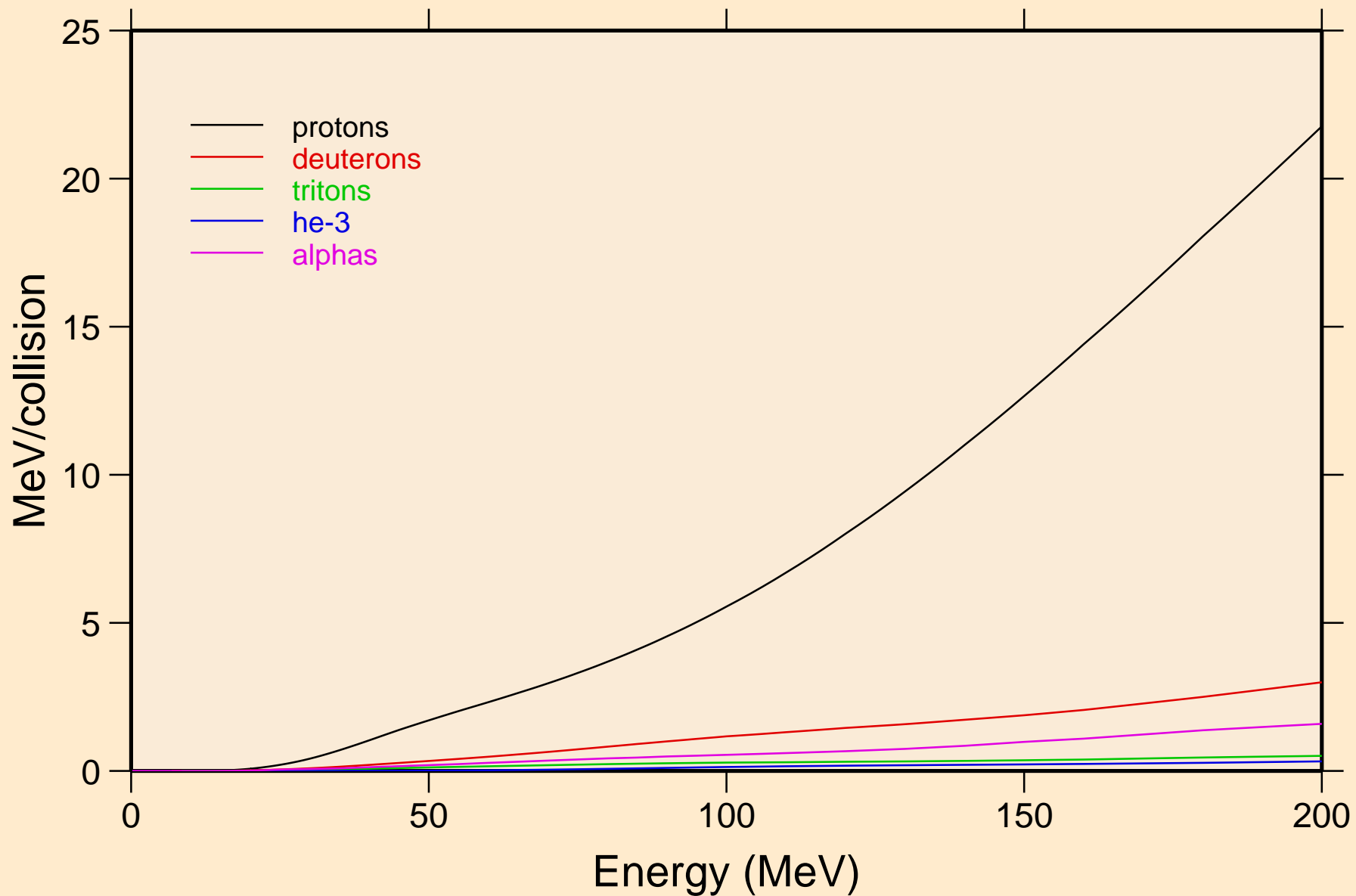

82-PB-206 FOR FENDL-3B2 FROM ENDF/B-VII WITH NJOY99.304
Recoil Heating

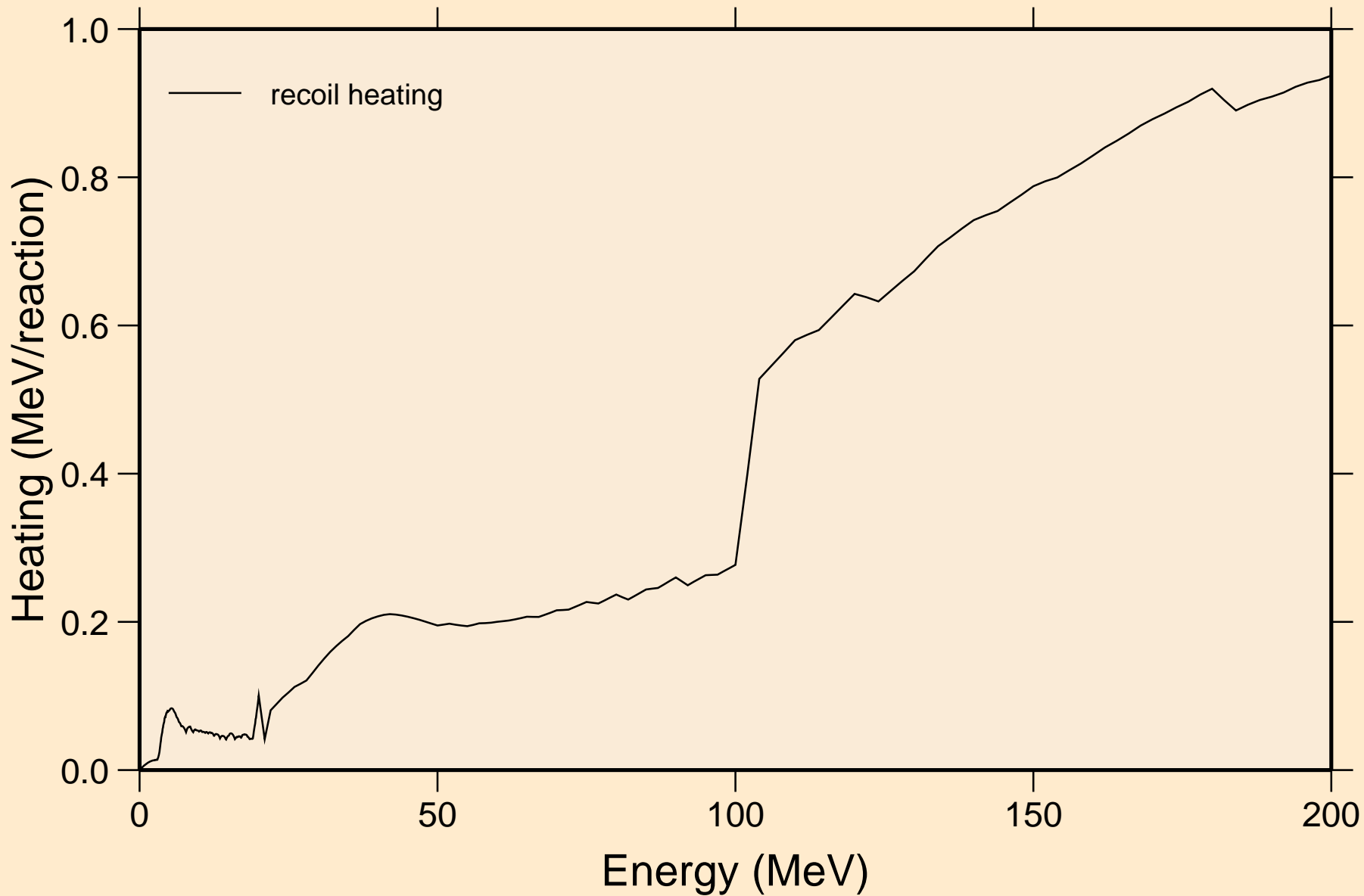

82-PB-206 FOR FENDL-3B2 FROM ENDF/B-VII WITH NJOY99.304
Particle production cross sections

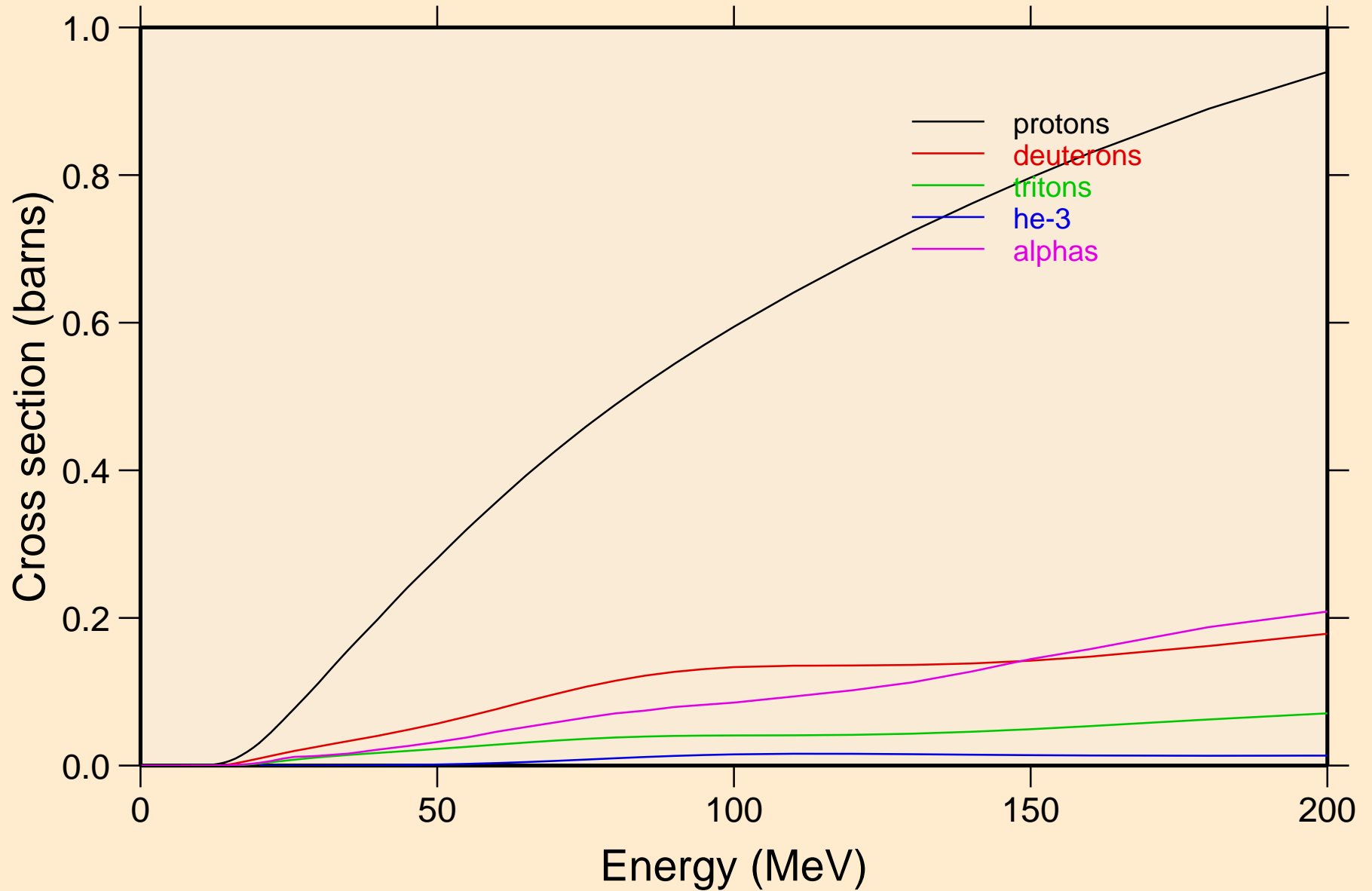

82-PB-206 FOR FENDL-3B2 FROM ENDF/B-VII WITH NJOY99.304
protons from (n,x)

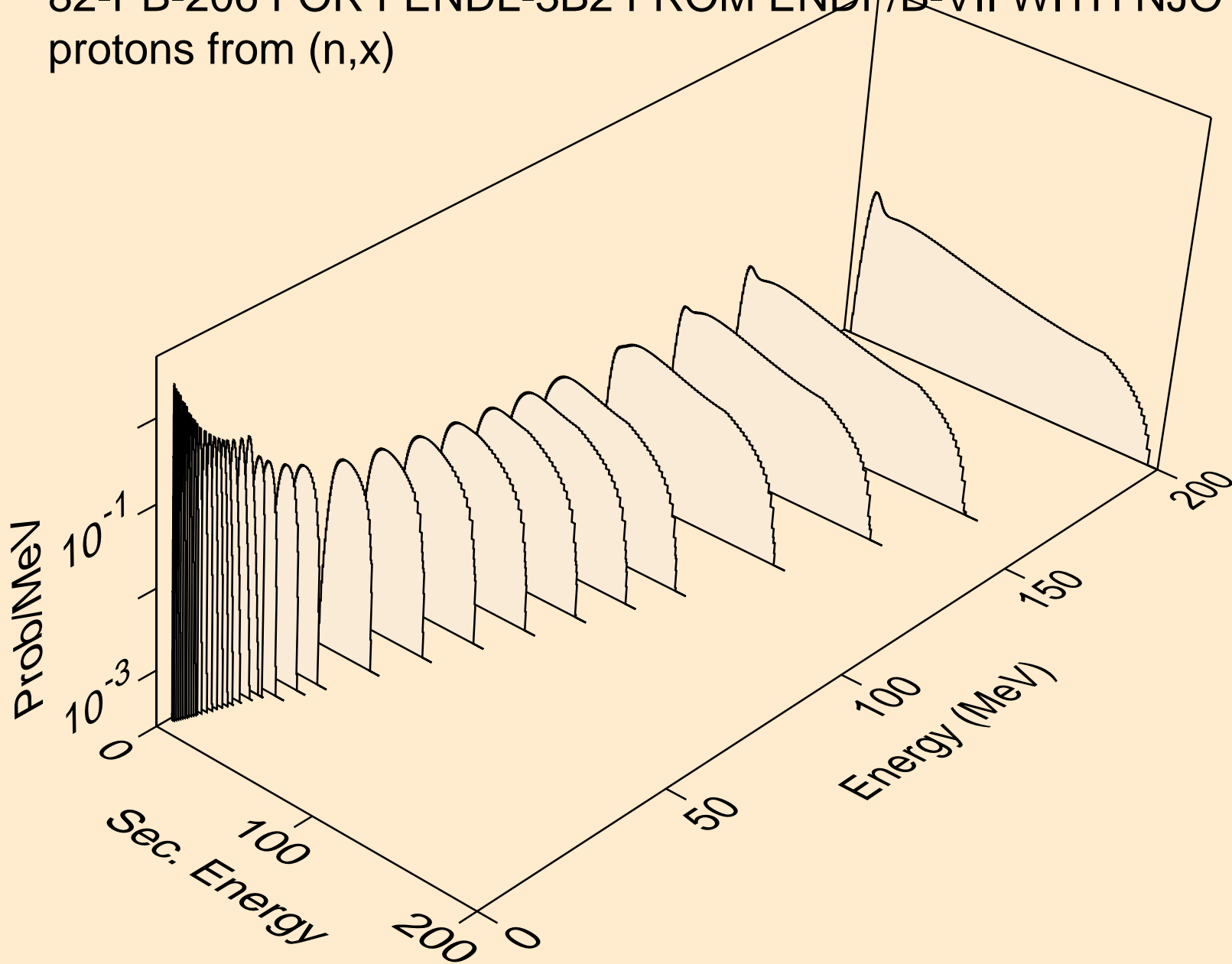

82-PB-206 FOR FENDL-3B2 FROM ENDF/B-VII WITH NJOY99.304
protons from (n,n*)p

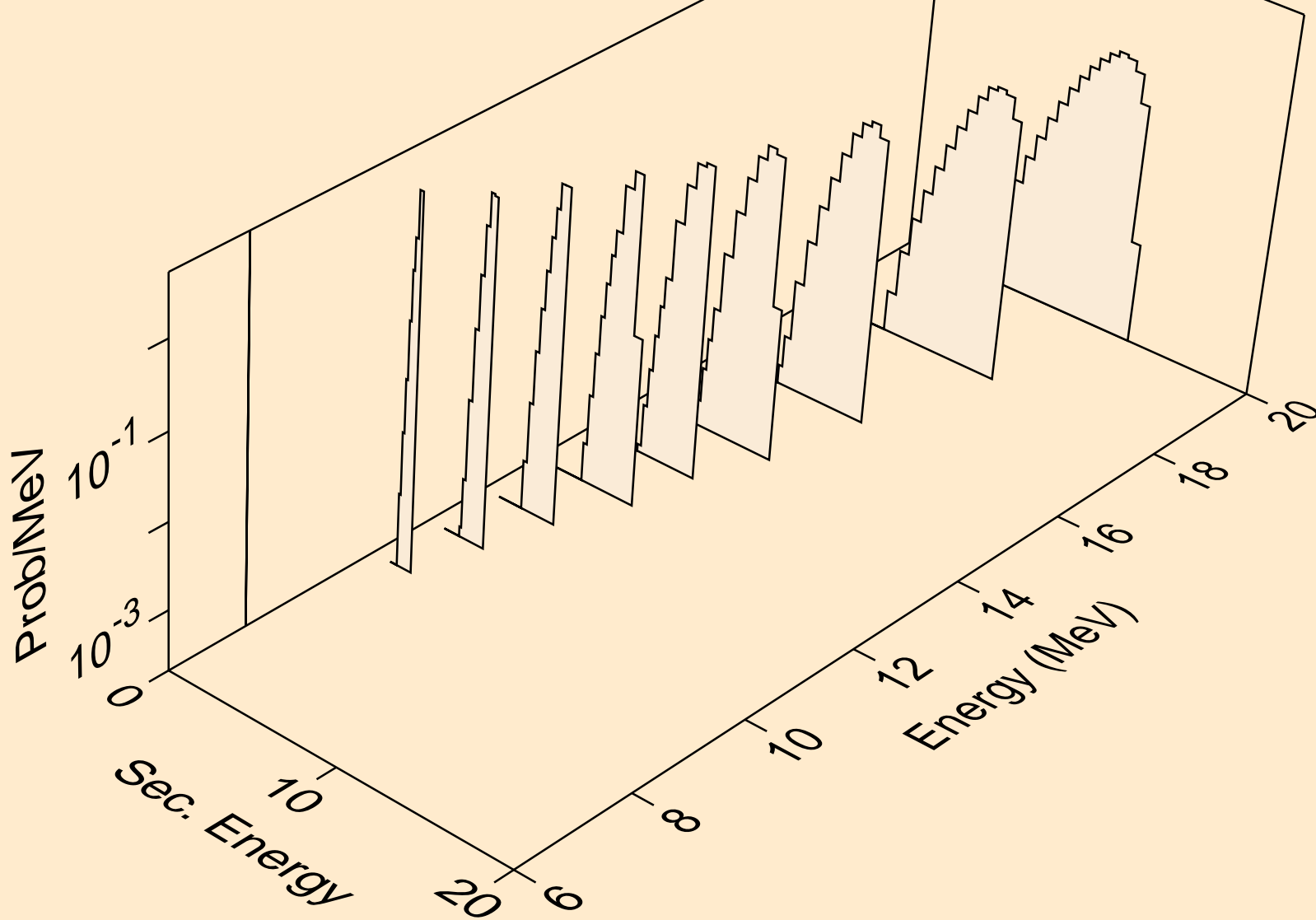

82-PB-206 FOR FENDL-3B2 FROM ENDF/B-VII WITH NJOY99.304
protons from (n,2np)

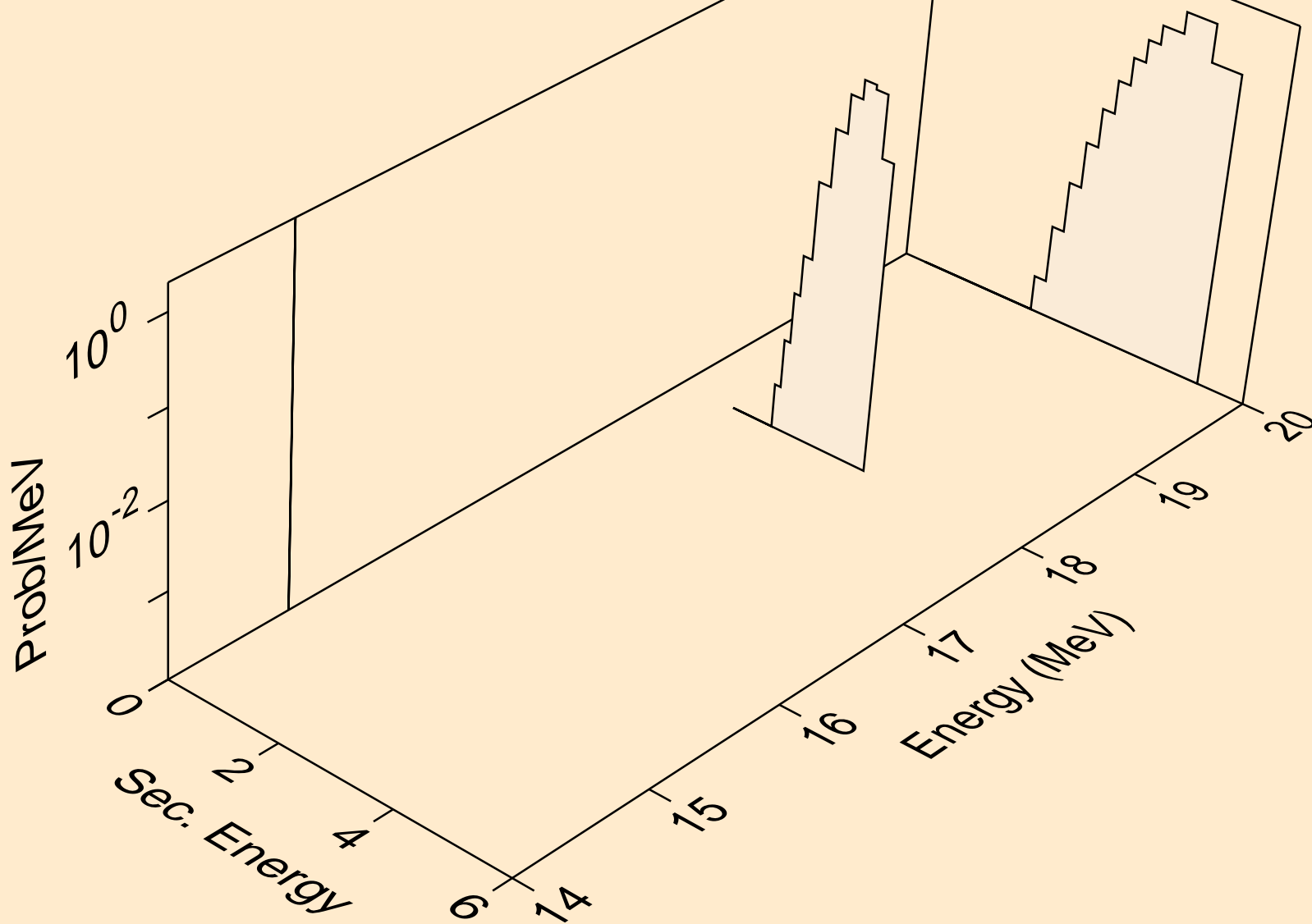

82-PB-206 FOR FENDL-3B2 FROM ENDF/B-VII WITH NJOY99.304
angular distribution for (n,p*0) proton

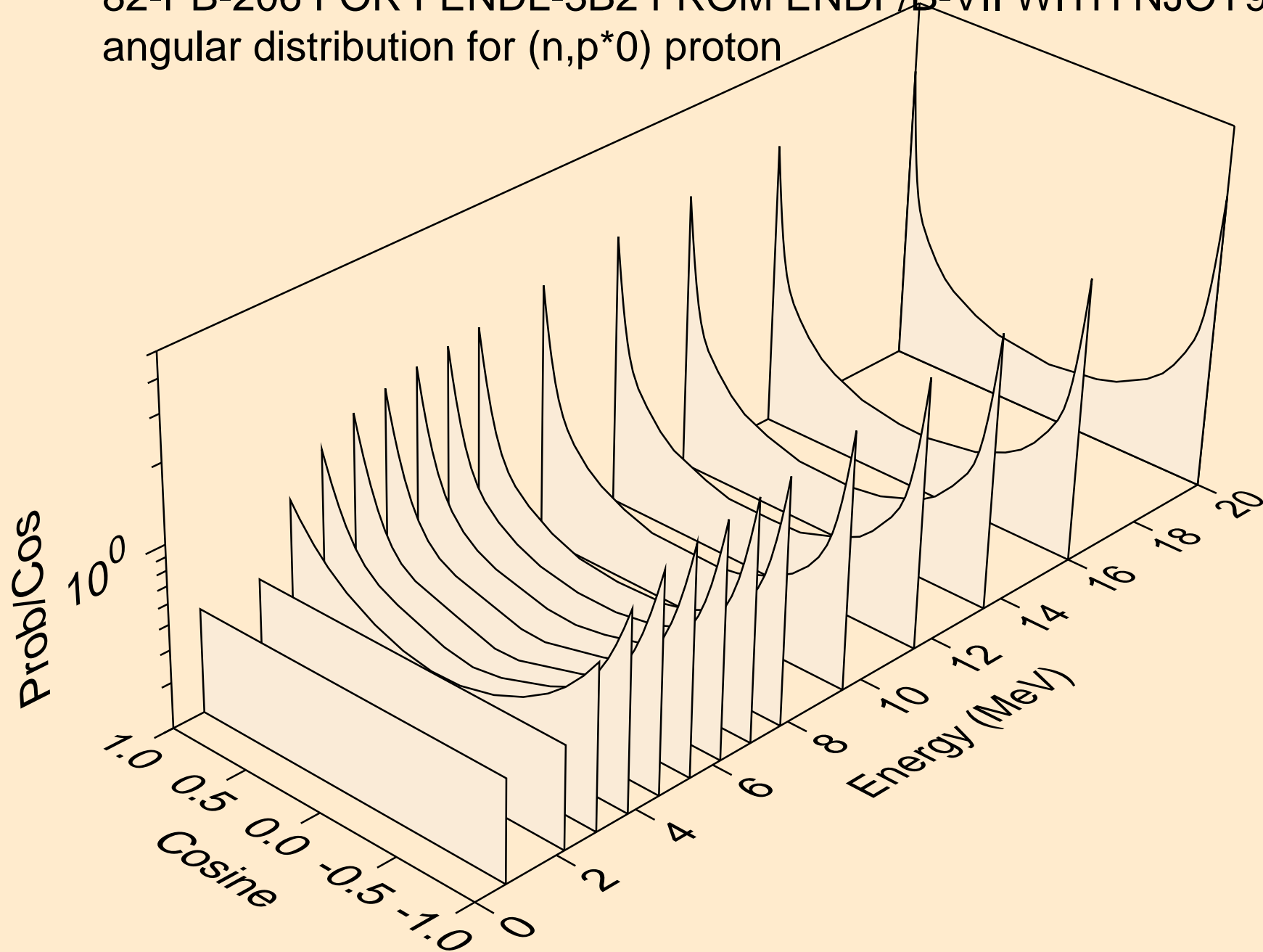

82-PB-206 FOR FENDL-3B2 FROM ENDF/B-VII WITH NJOY99.304
angular distribution for (n,p*1) proton

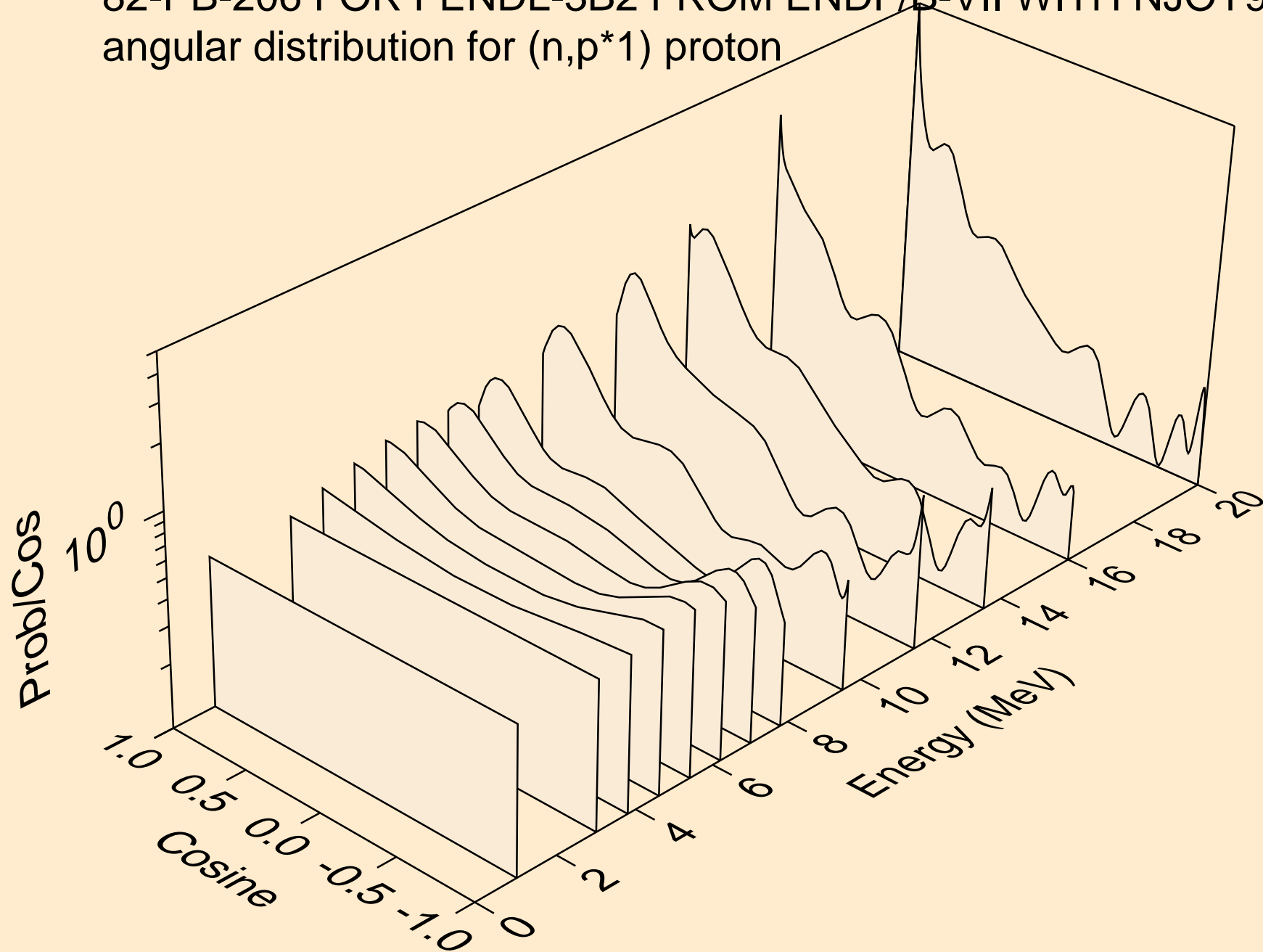

82-PB-206 FOR FENDL-3B2 FROM ENDF/B-VII WITH NJOY99.304
angular distribution for (n,p*2) proton

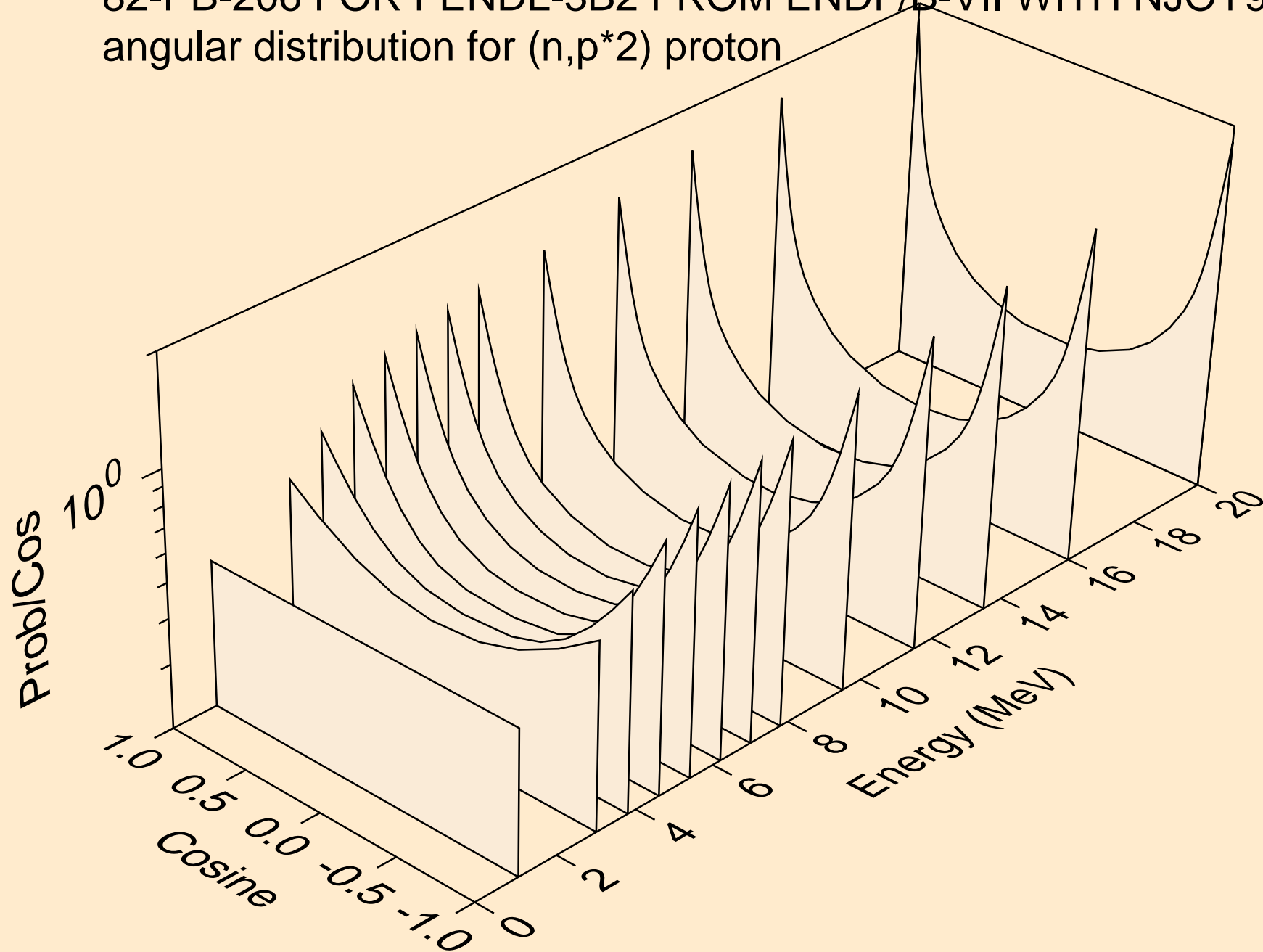

82-PB-206 FOR FENDL-3B2 FROM ENDF/B-VII WITH NJOY99.304
angular distribution for (n,p*3) proton

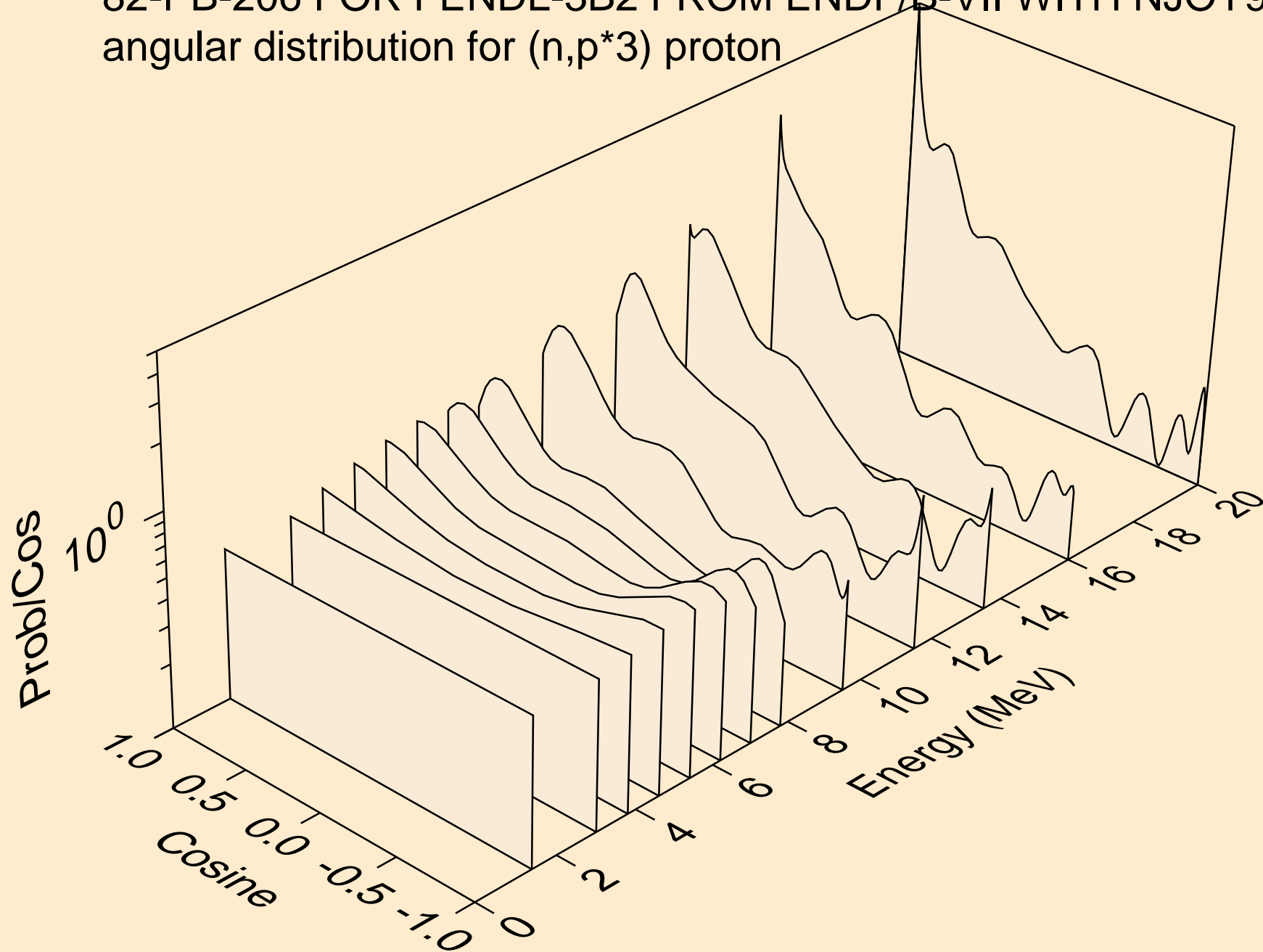

82-PB-206 FOR FENDL-3B2 FROM ENDF/B-VII WITH NJOY99.304
angular distribution for (n,p*4) proton

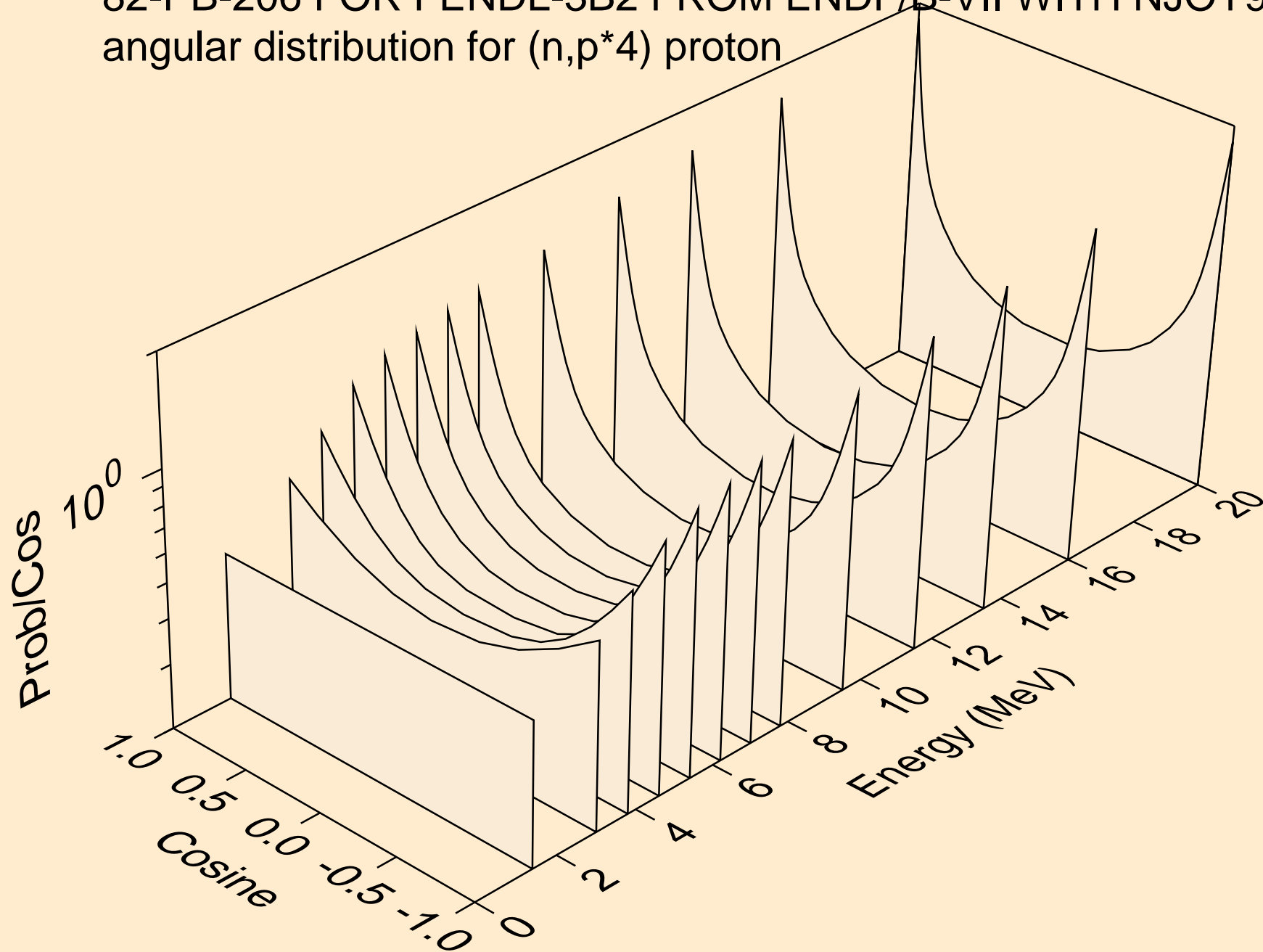

82-PB-206 FOR FENDL-3B2 FROM ENDF/B-VII WITH NJOY99.304
angular distribution for (n,p*5) proton

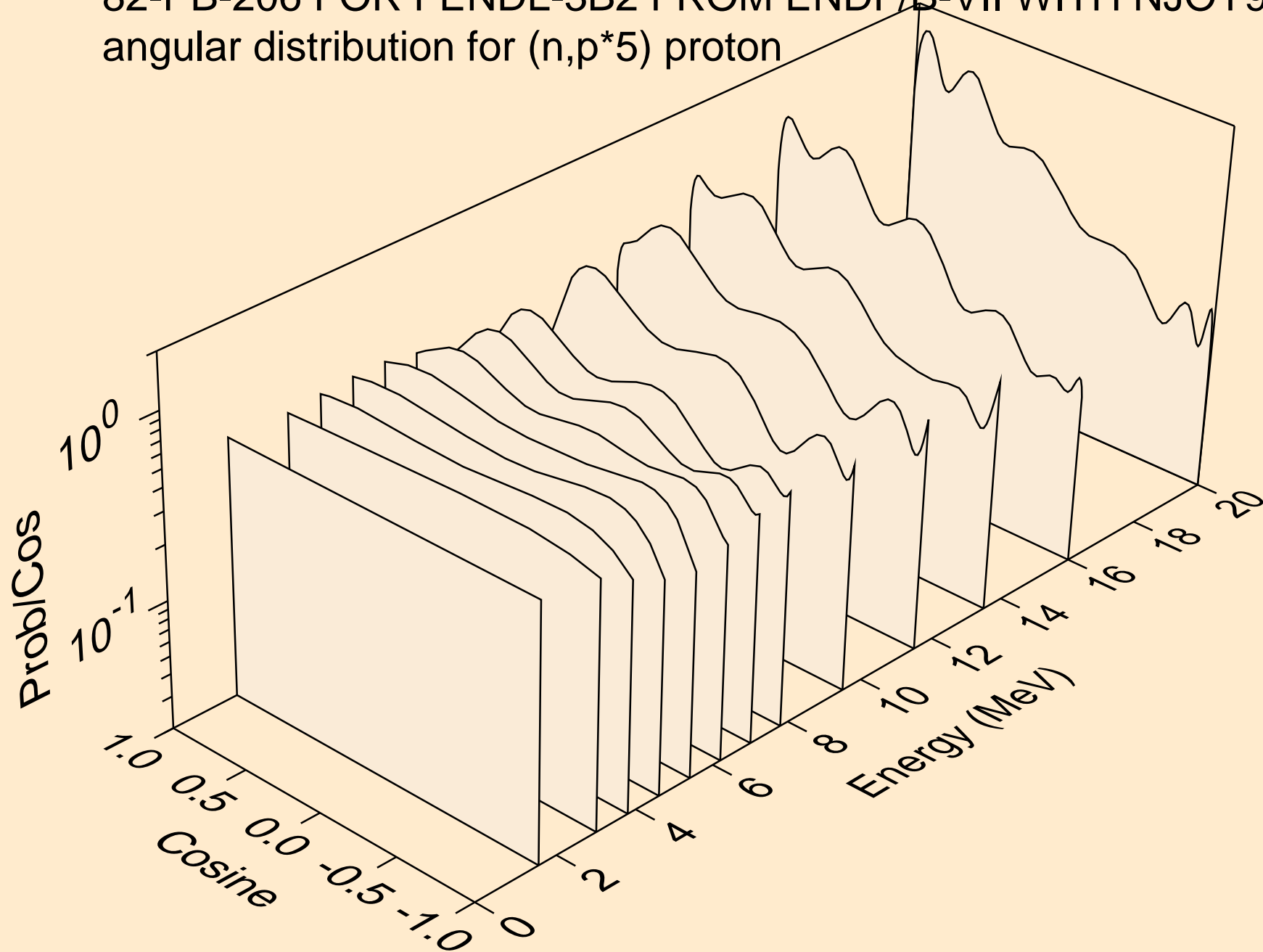

82-PB-206 FOR FENDL-3B2 FROM ENDF/B-VII WITH NJOY99.304
angular distribution for (n,p*6) proton

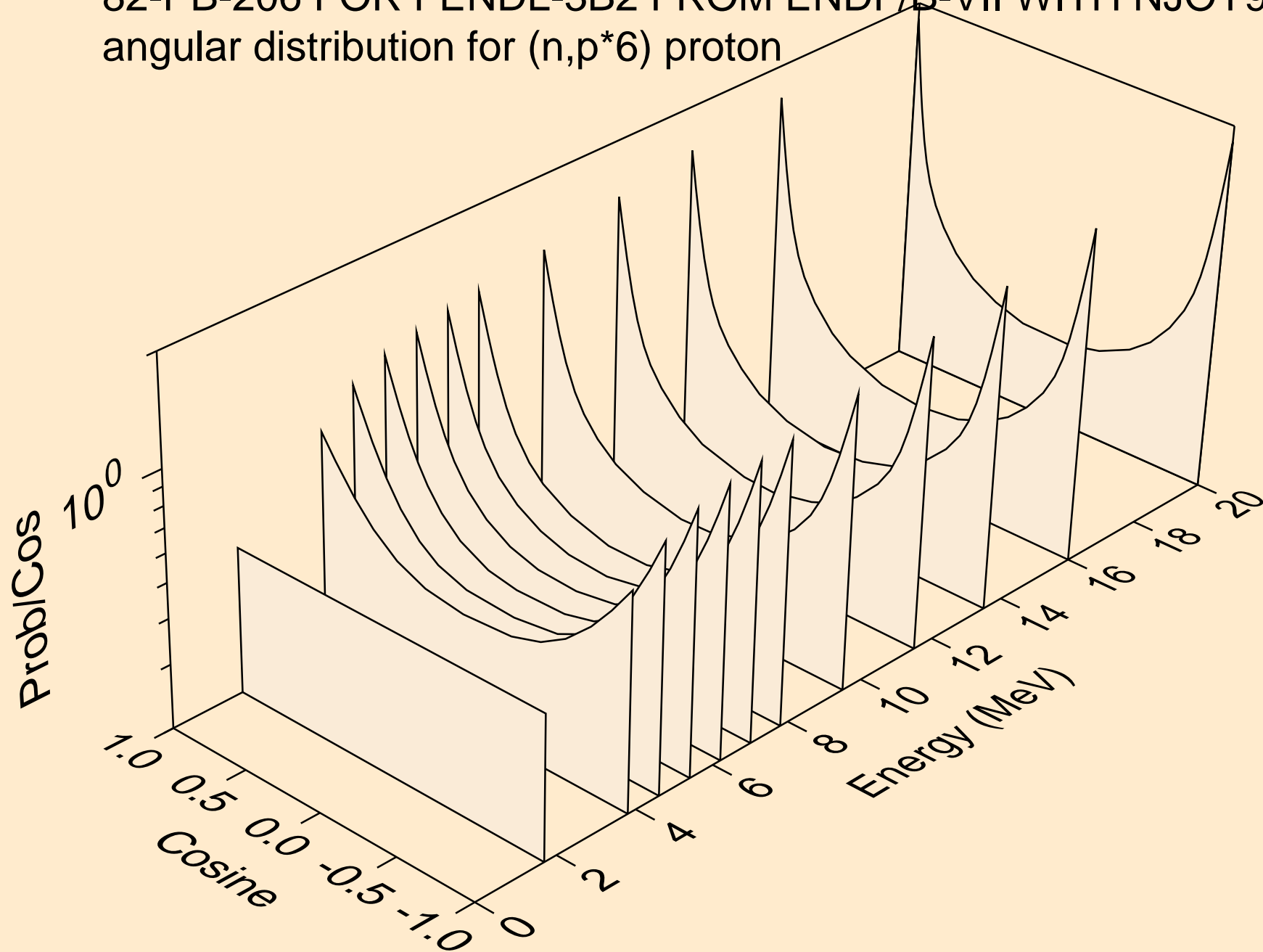

82-PB-206 FOR FENDL-3B2 FROM ENDF/B-VII WITH NJOY99.304
angular distribution for (n,p*7) proton

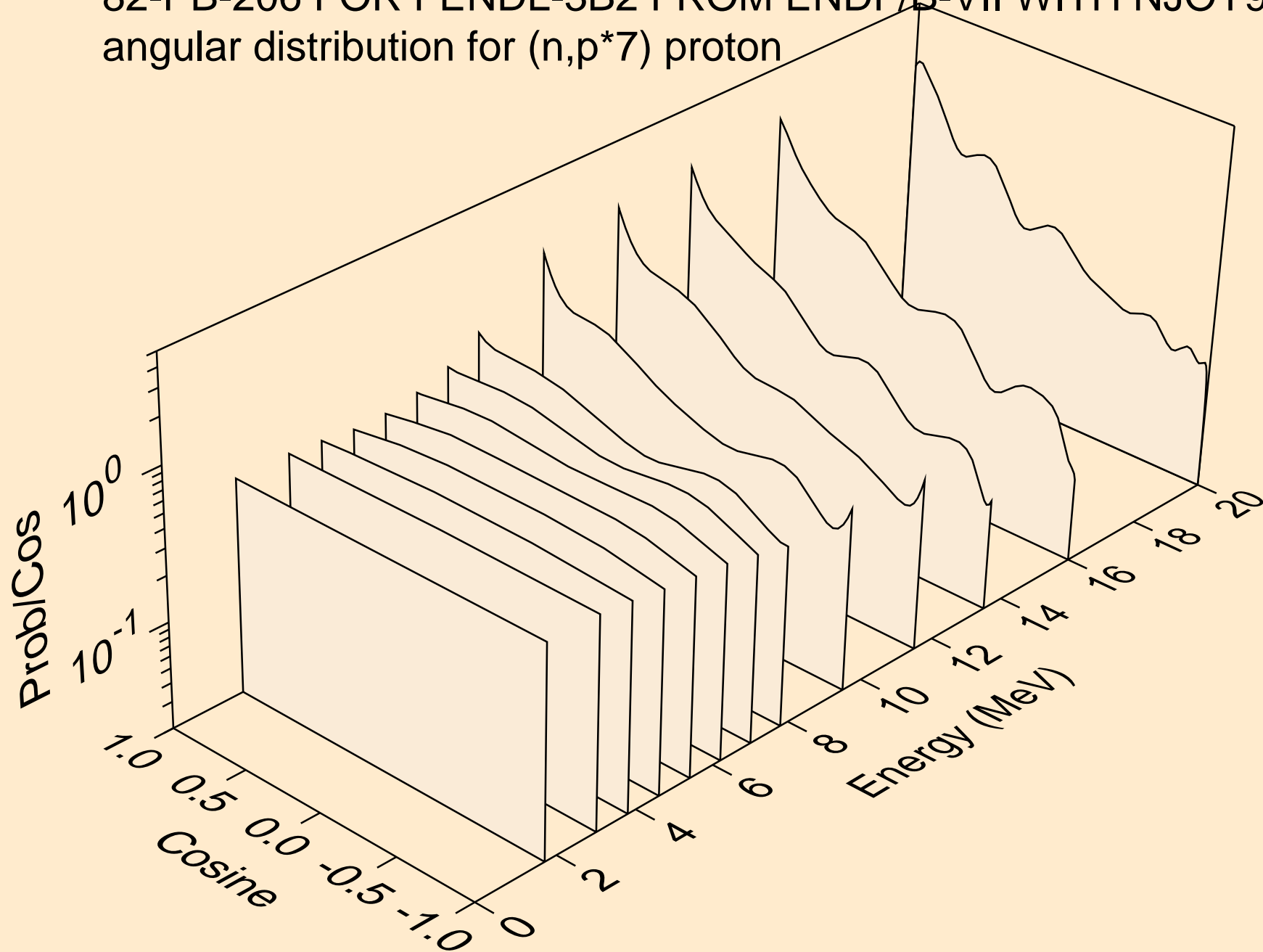

82-PB-206 FOR FENDL-3B2 FROM ENDF/B-VII WITH NJOY99.304
angular distribution for (n,p*8) proton

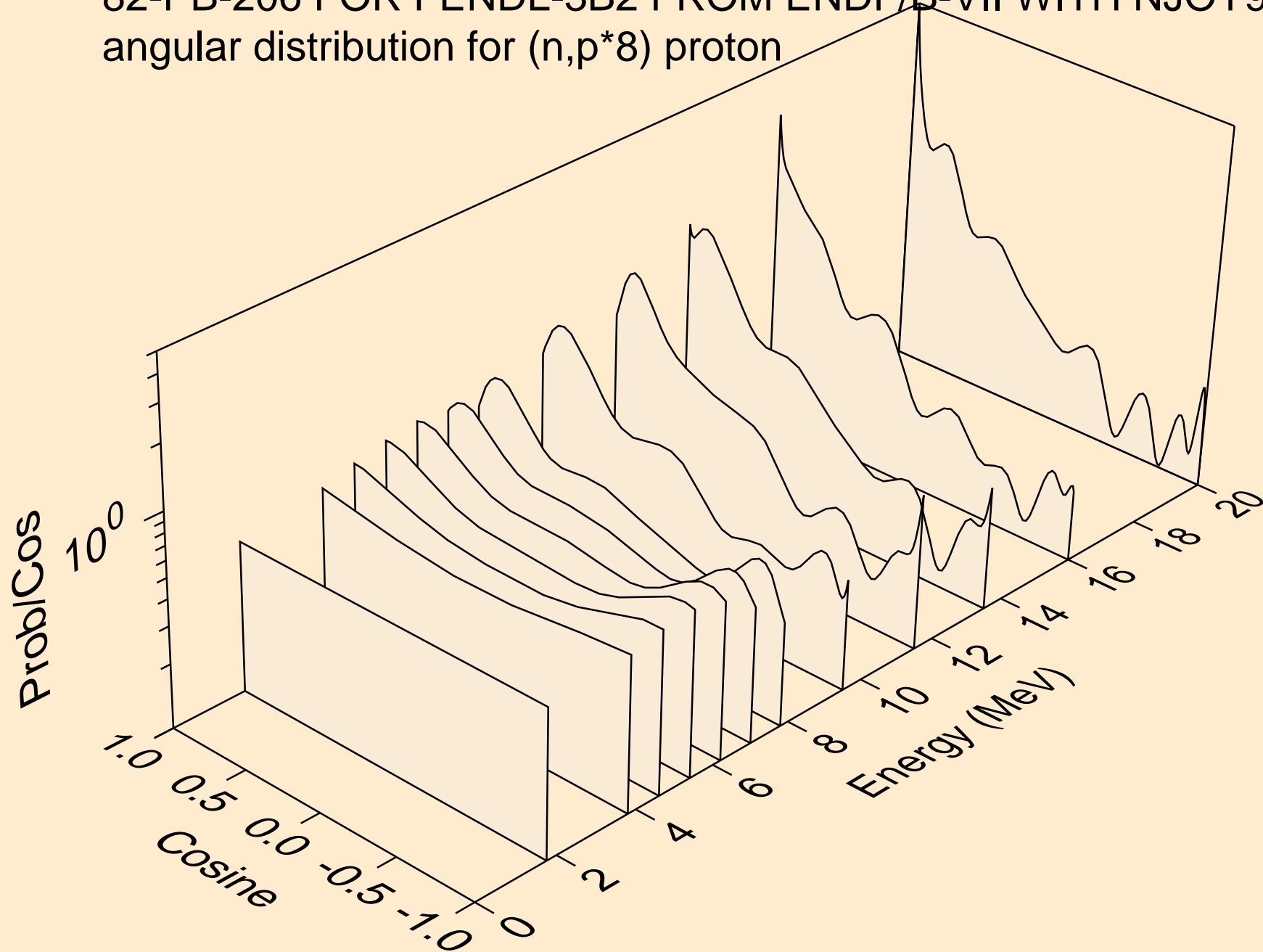

82-PB-206 FOR FENDL-3B2 FROM ENDF/B-VII WITH NJOY99.304
angular distribution for (n,p*9) proton

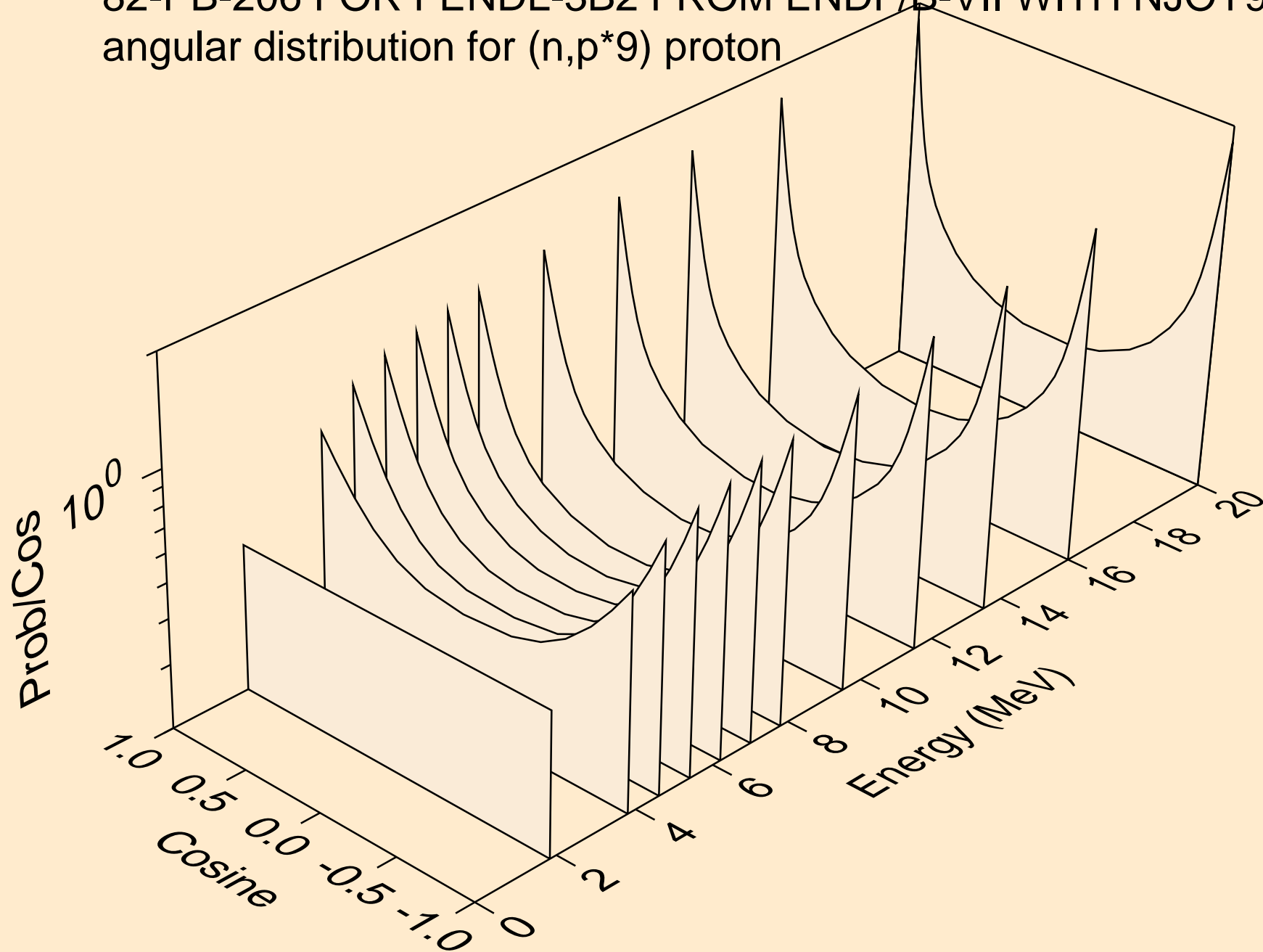

82-PB-206 FOR FENDL-3B2 FROM ENDF/B-VII WITH NJOY99.304
angular distribution for (n,p*10) proton

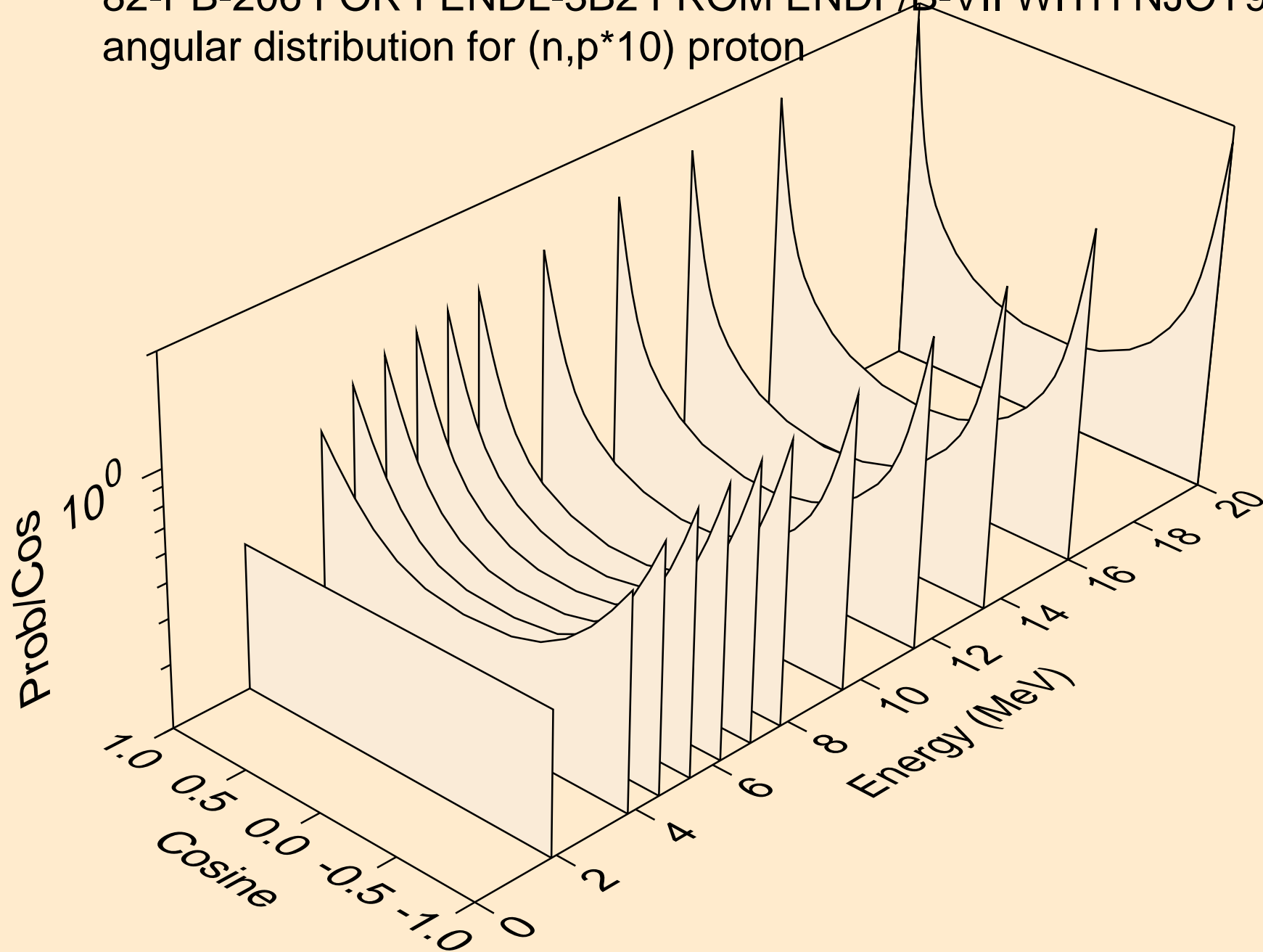

82-PB-206 FOR FENDL-3B2 FROM ENDF/B-VII WITH NJOY99.304
protons from (n,p*c)

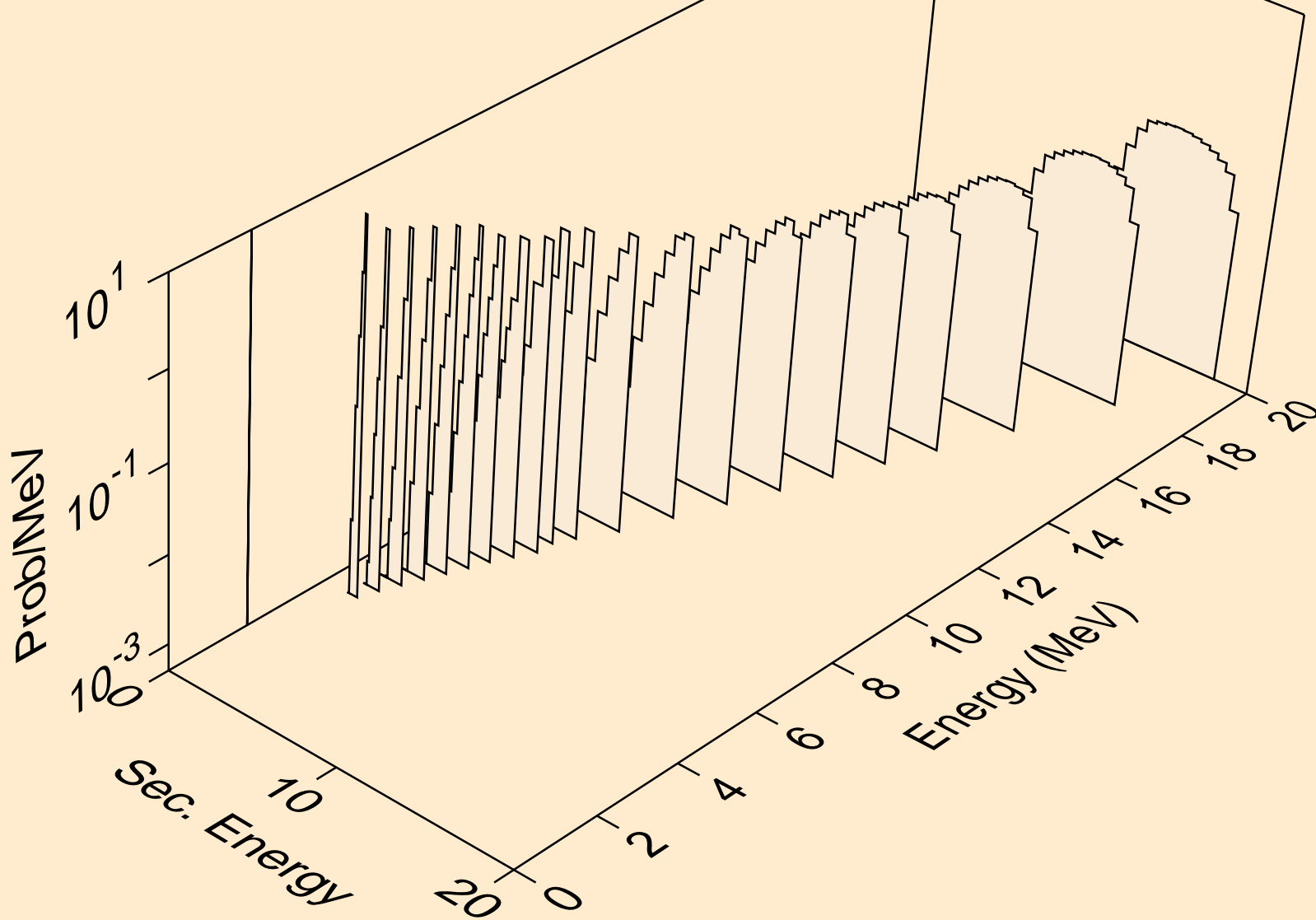

82-PB-206 FOR FENDL-3B2 FROM ENDF/B-VII WITH NJOY99.304
deuterons from (n,x)

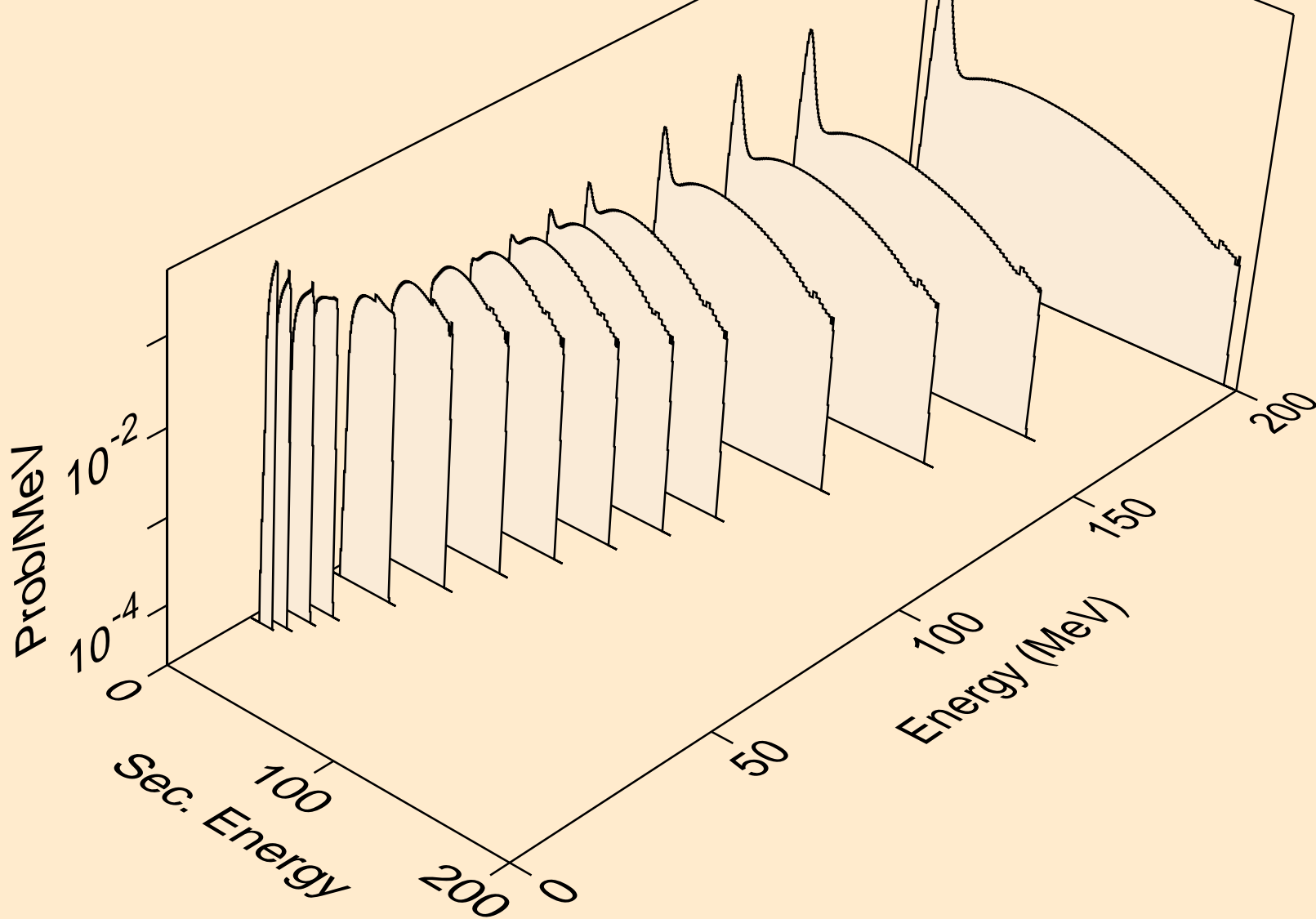

82-PB-206 FOR FENDL-3B2 FROM ENDF/B-VII WITH NJOY99.304
deuterons from (n,n*)d

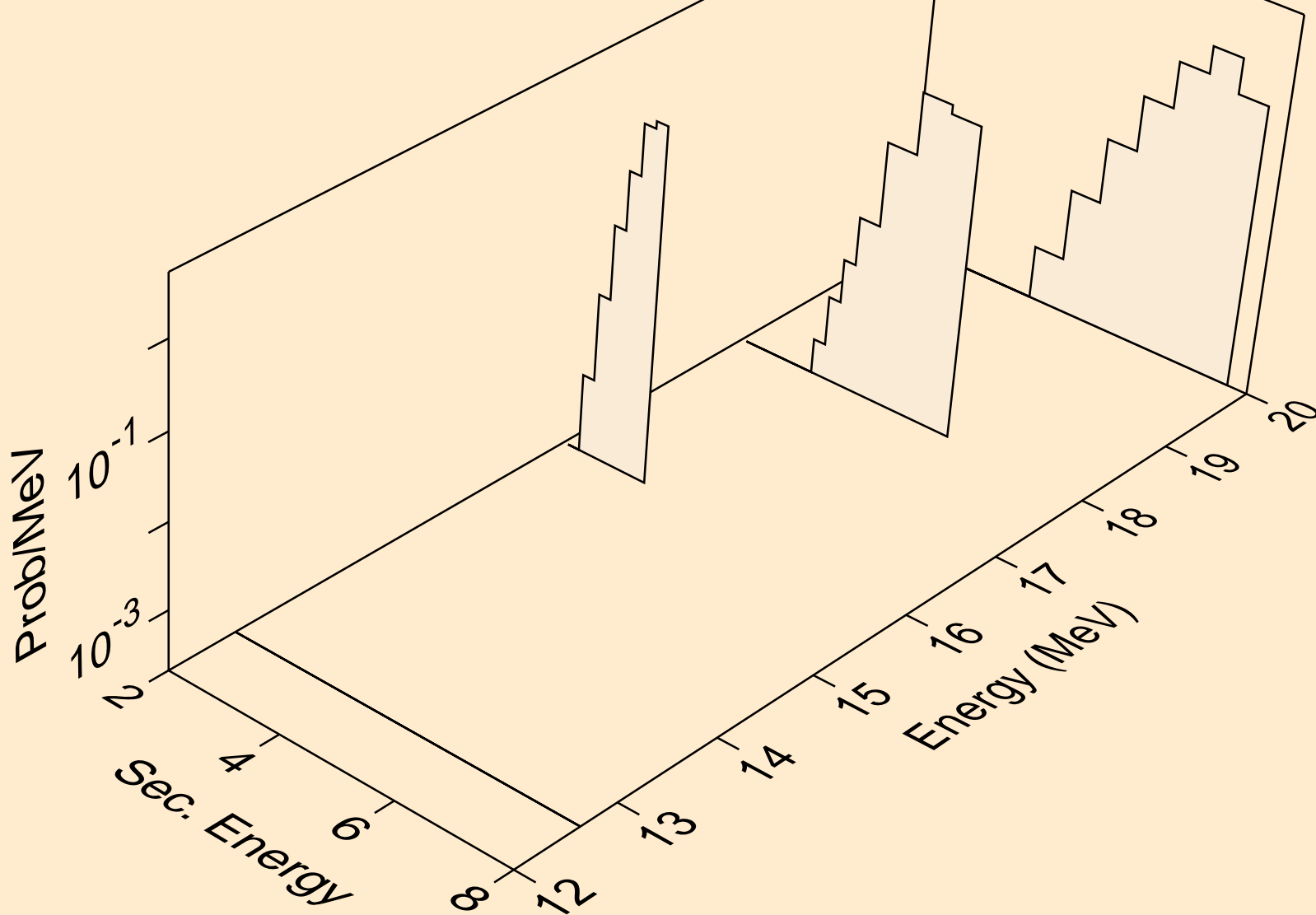

82-PB-206 FOR FENDL-3B2 FROM ENDF/B-VII WITH NJOY99.304
angular distribution for (n,d*0) deuteron

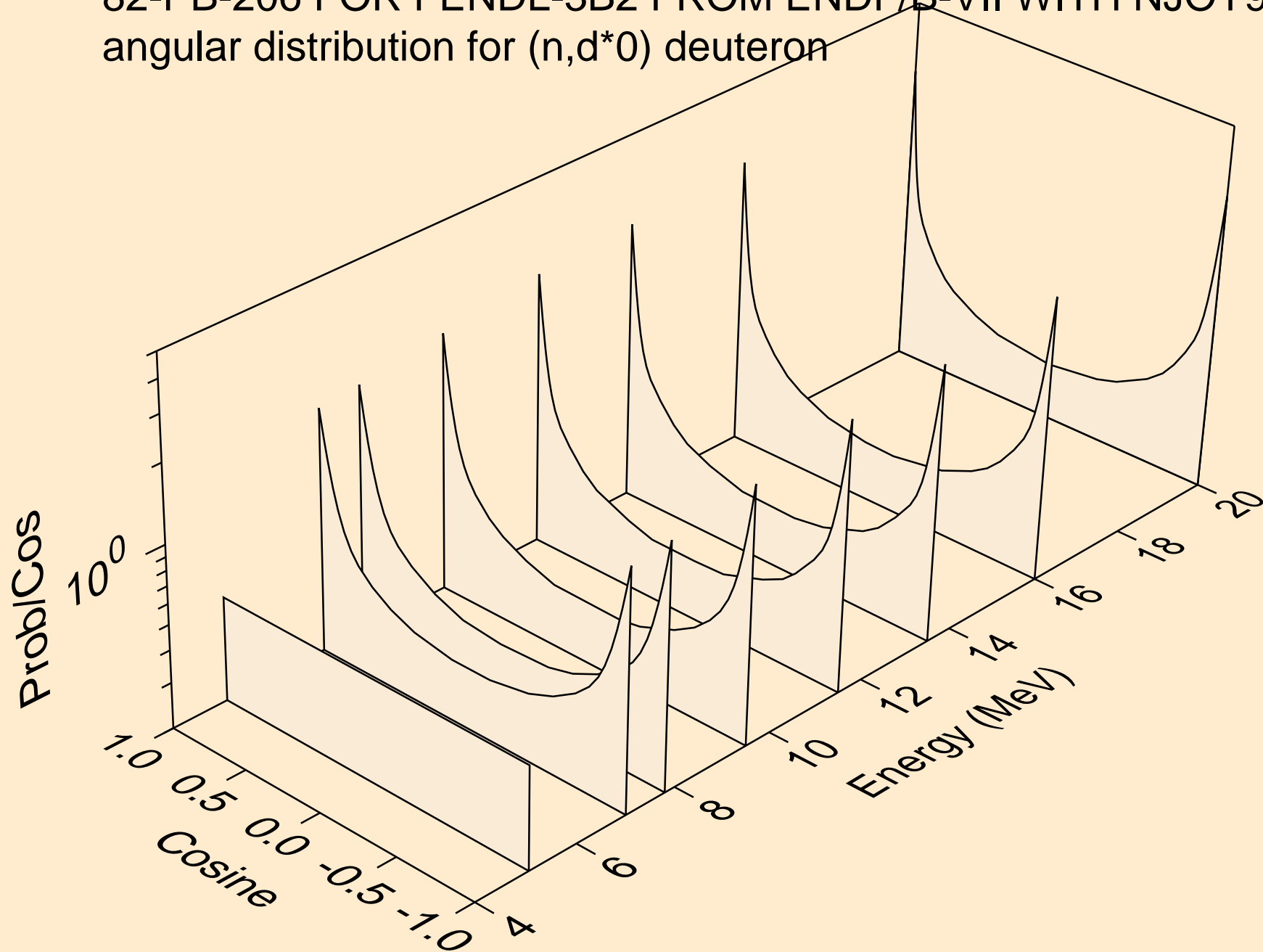

82-PB-206 FOR FENDL-3B2 FROM ENDF/B-VII WITH NJOY99.304
angular distribution for (n,d*1) deuteron

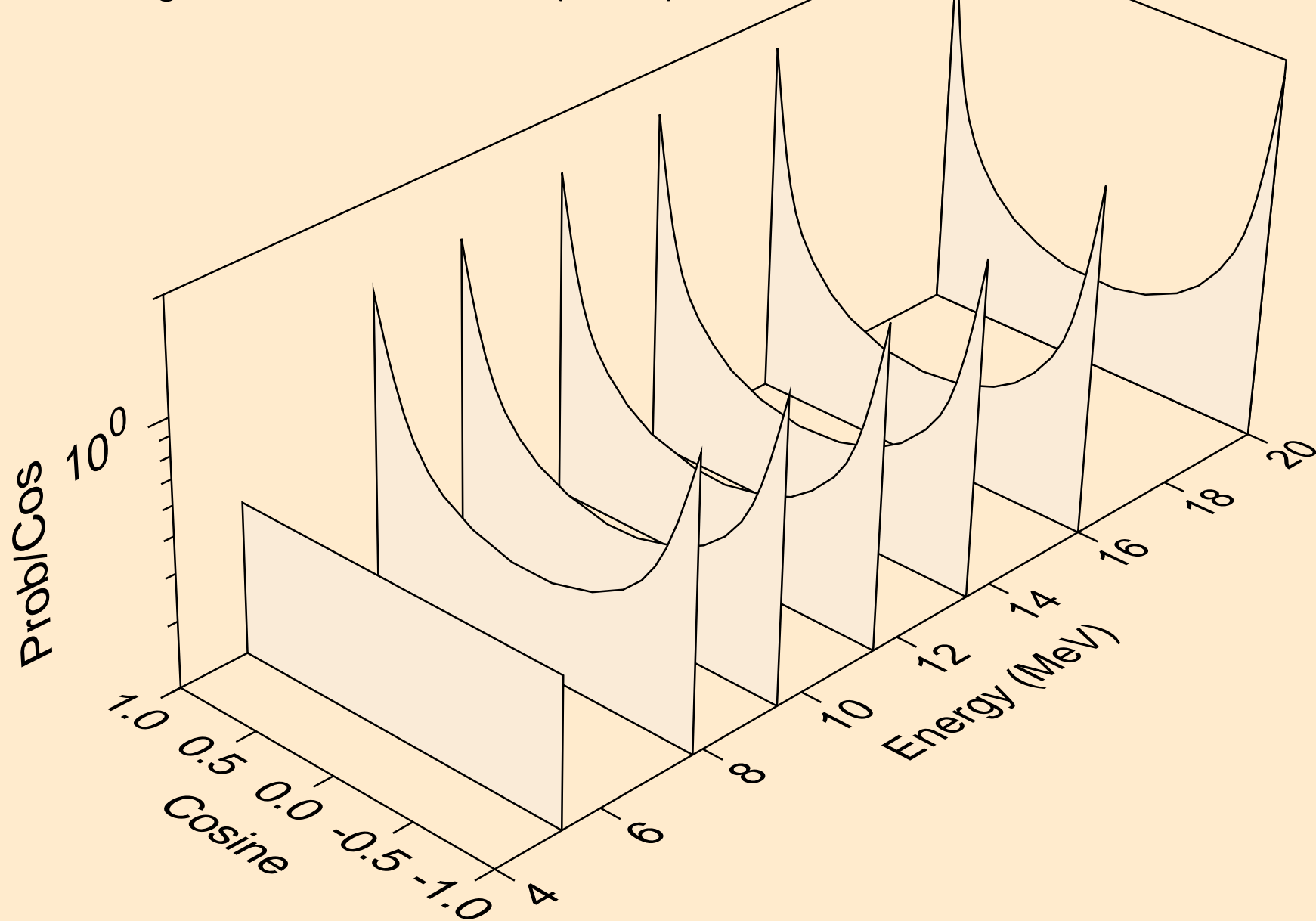

82-PB-206 FOR FENDL-3B2 FROM ENDF/B-VII WITH NJOY99.304
angular distribution for (n,d*2) deuteron

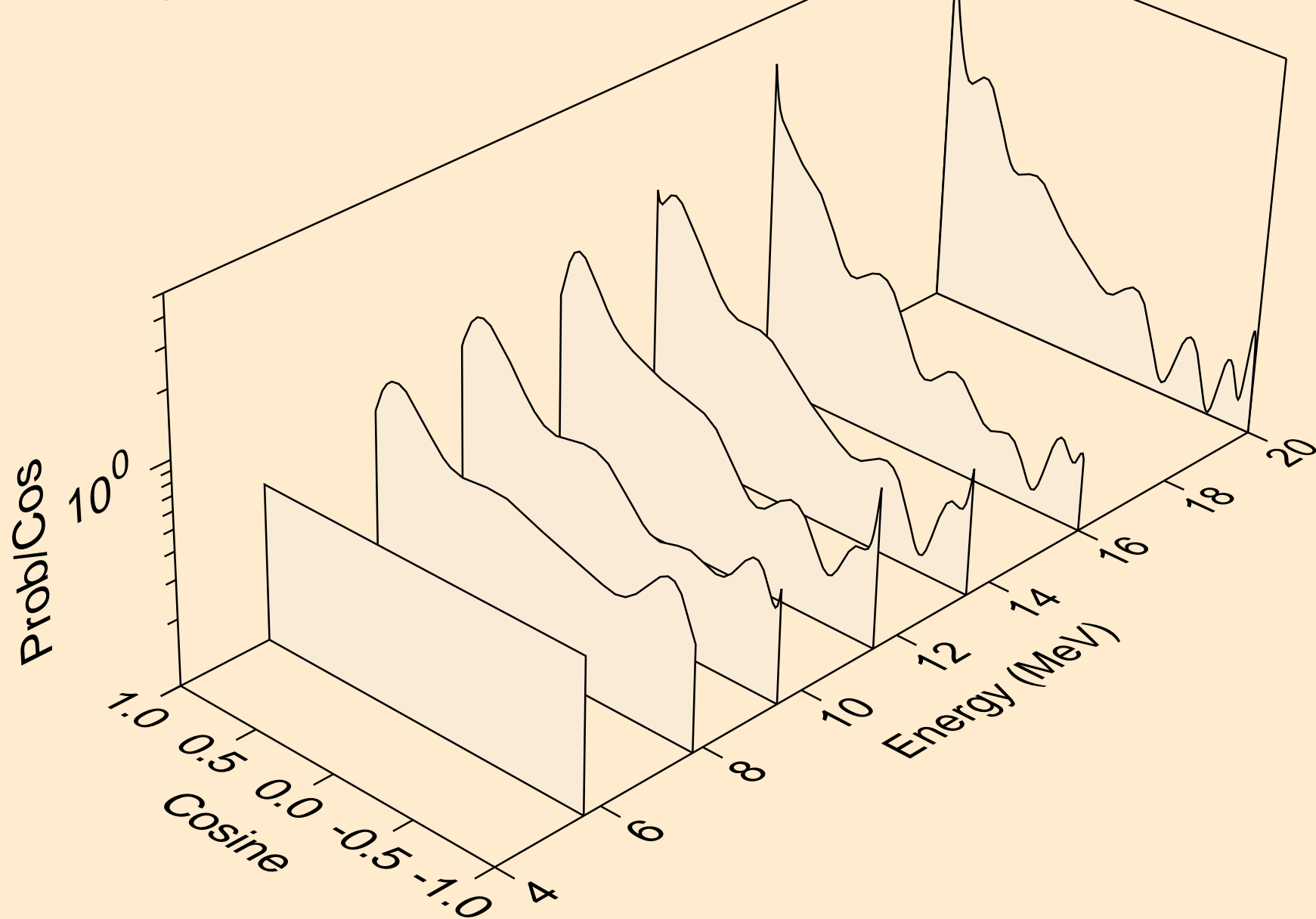

82-PB-206 FOR FENDL-3B2 FROM ENDF/B-VII WITH NJOY99.304
angular distribution for (n,d*3) deuteron

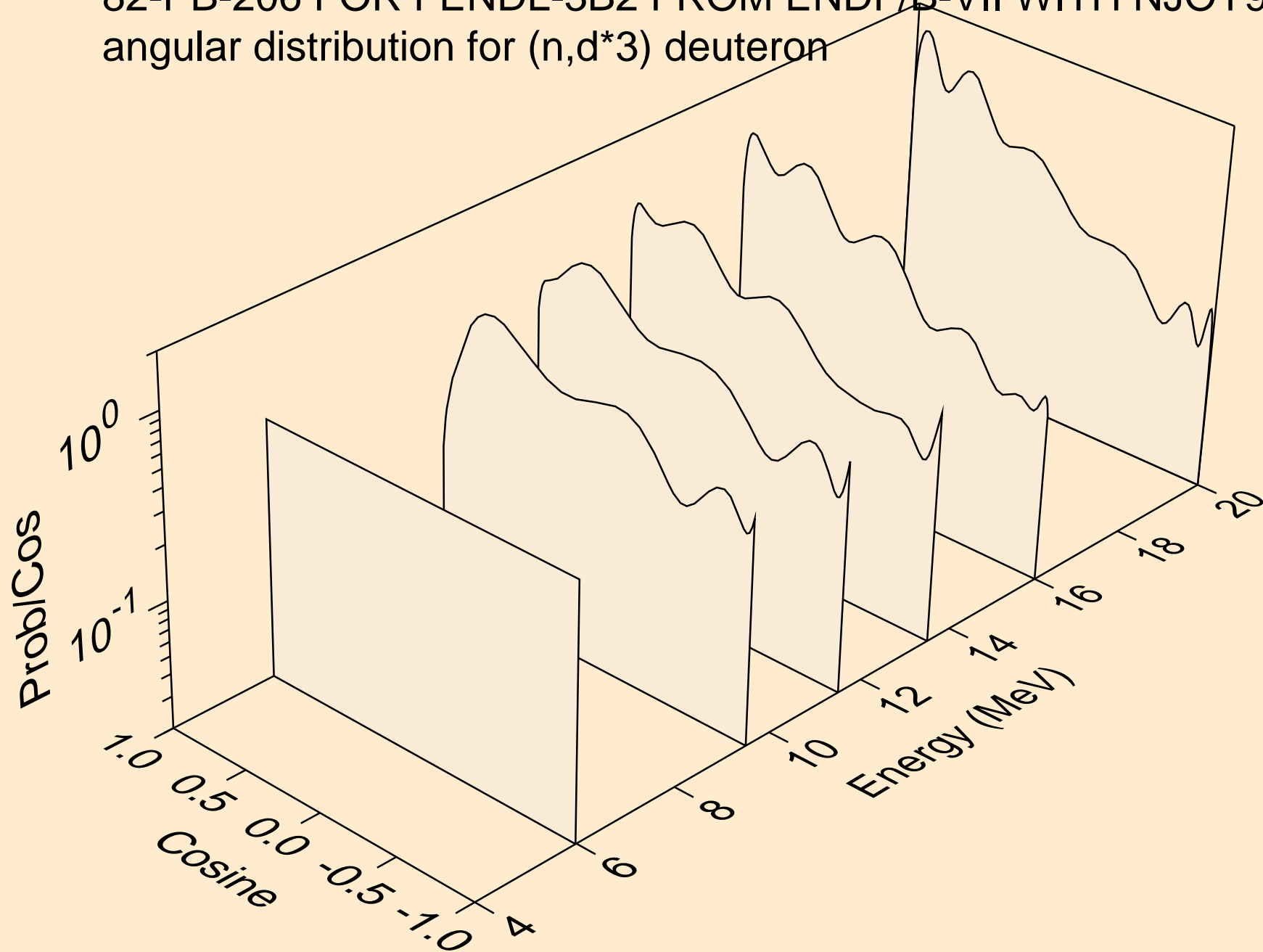

82-PB-206 FOR FENDL-3B2 FROM ENDF/B-VII WITH NJOY99.304
angular distribution for (n,d*4) deuteron

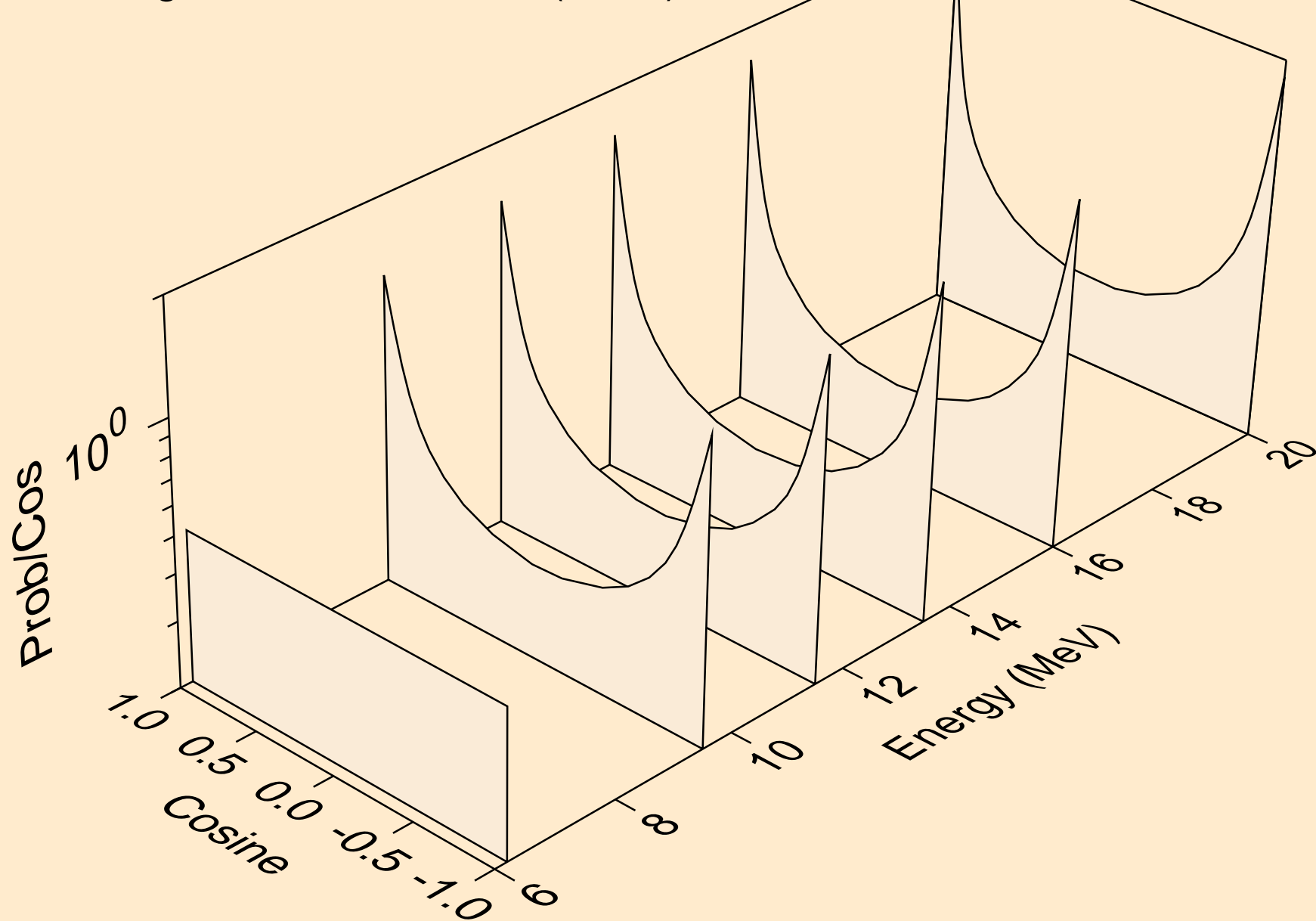

82-PB-206 FOR FENDL-3B2 FROM ENDF/B-VII WITH NJOY99.304
angular distribution for (n,d*5) deuteron

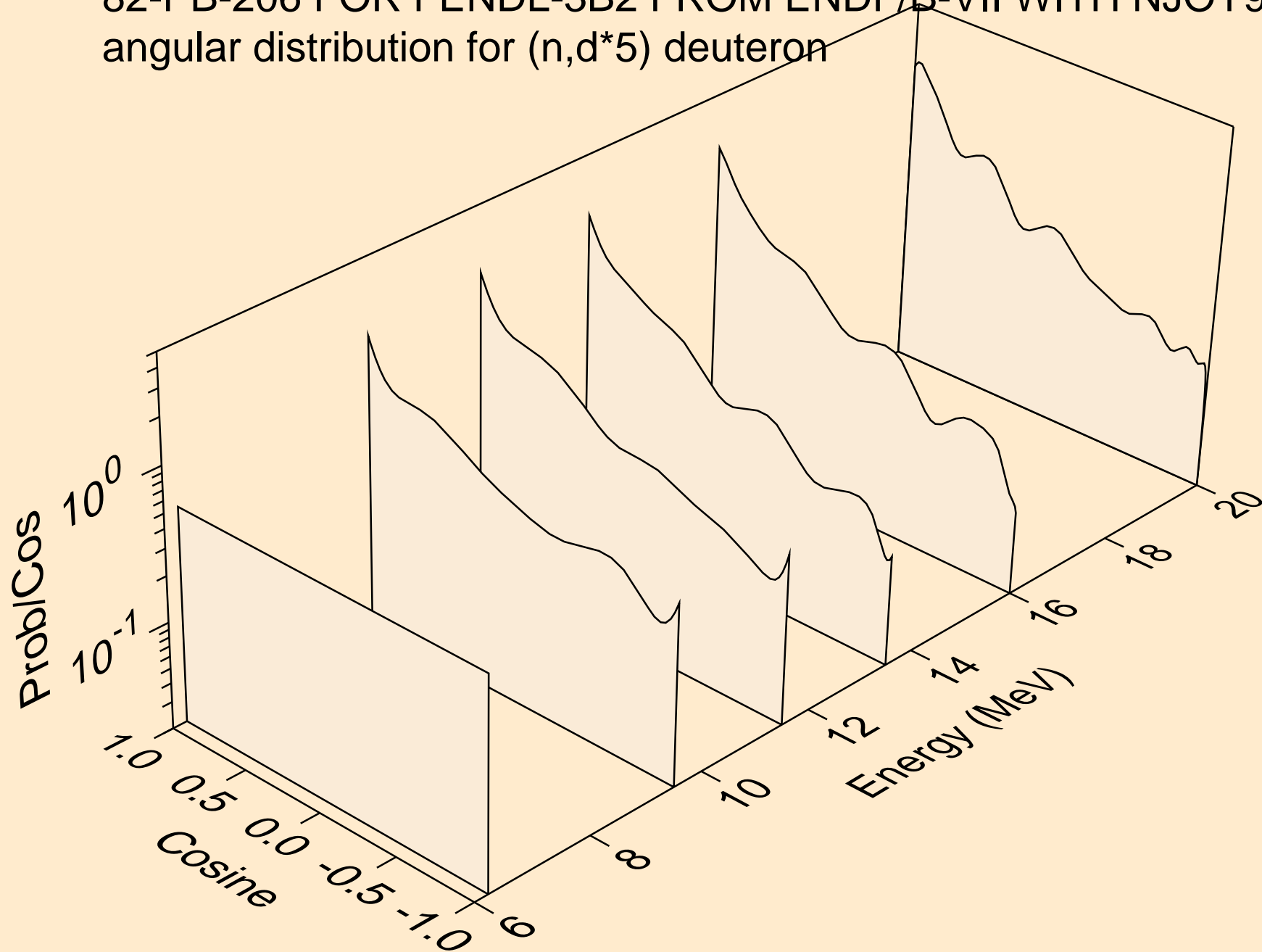

82-PB-206 FOR FENDL-3B2 FROM ENDF/B-VII WITH NJOY99.304
deuterons from (n,d*c)

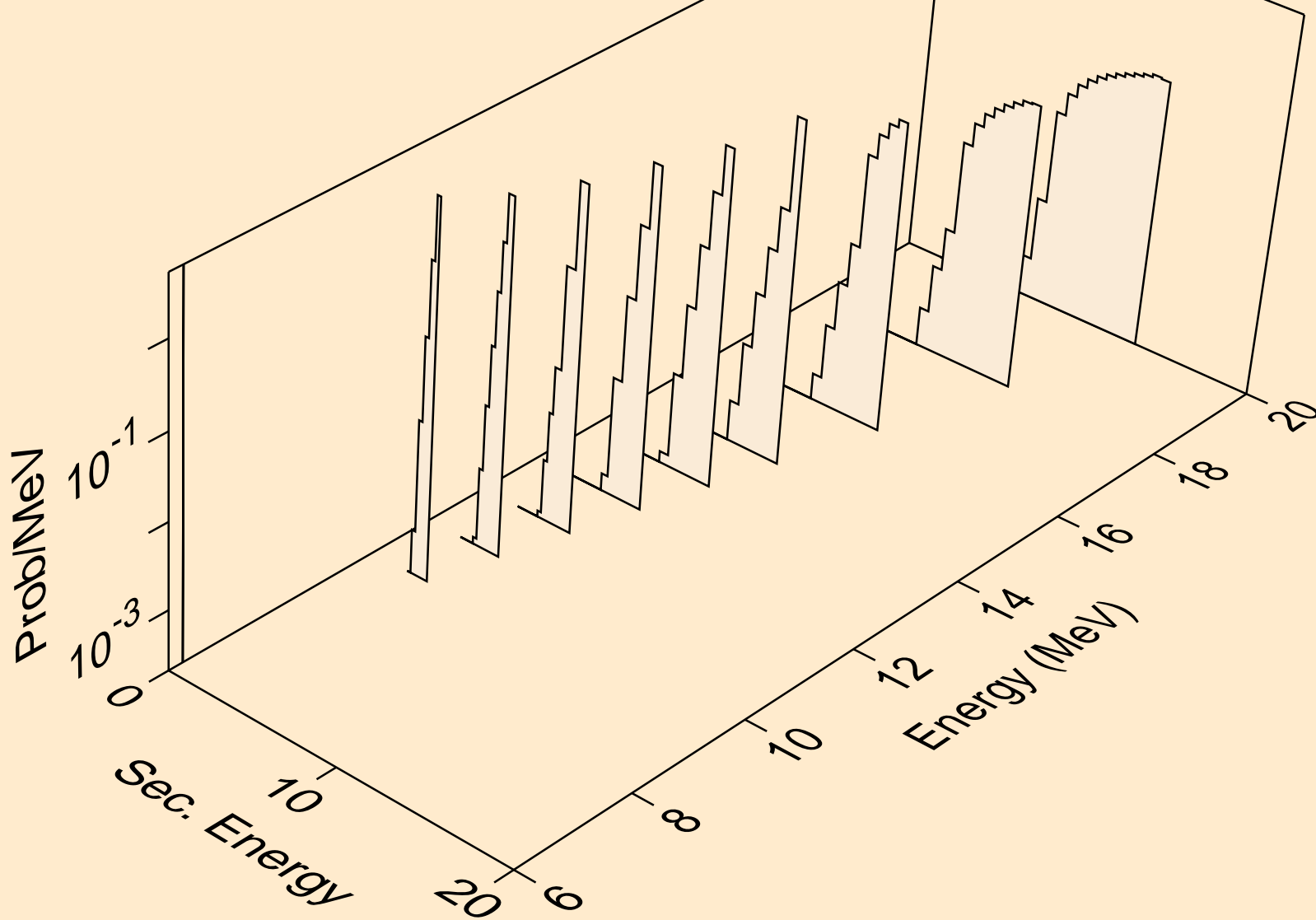

82-PB-206 FOR FENDL-3B2 FROM ENDF/B-VII WITH NJOY99.304
tritons from (n,x)

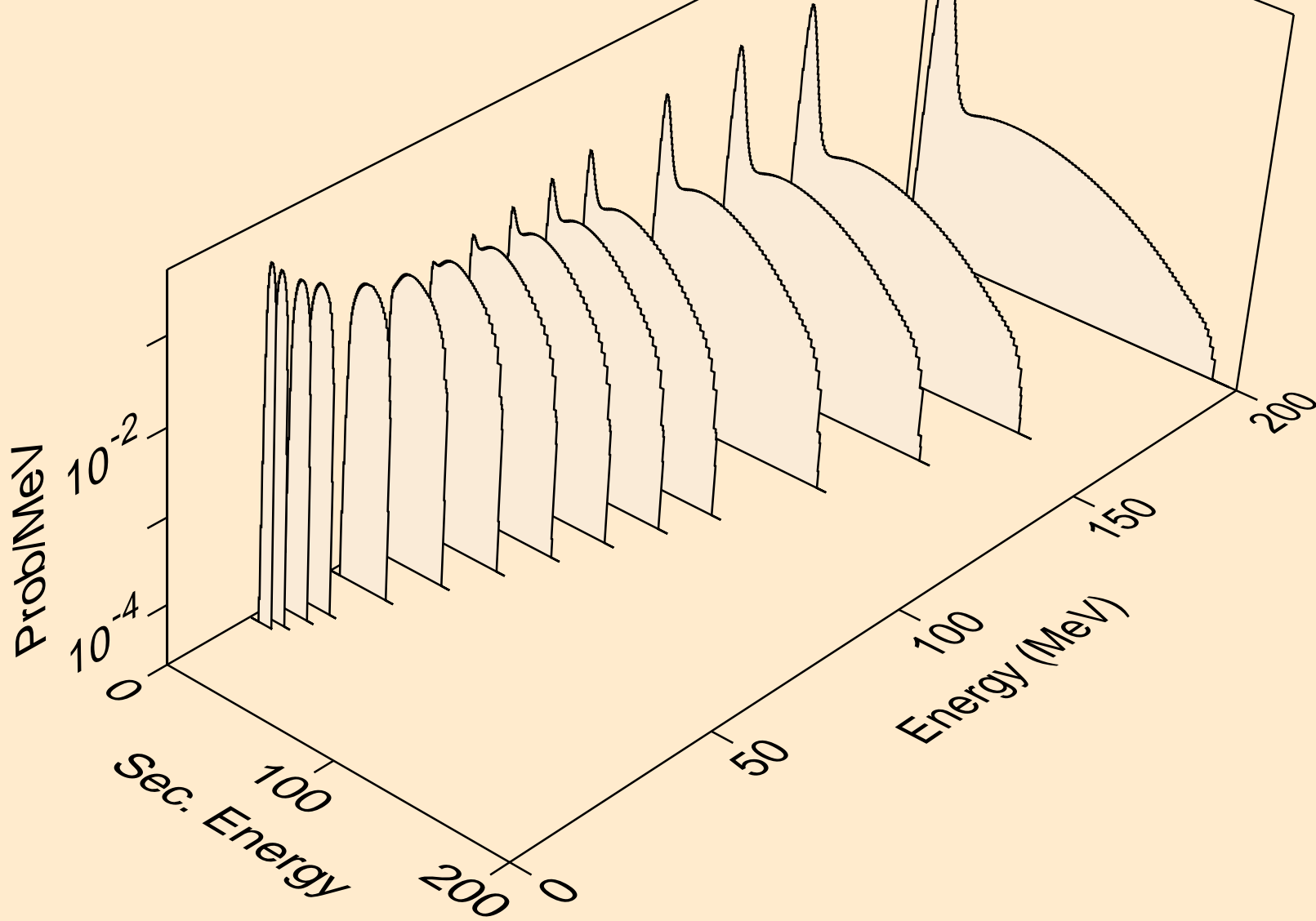

82-PB-206 FOR FENDL-3B2 FROM ENDF/B-VII WITH NJOY99.304
tritons from (n,n*)t

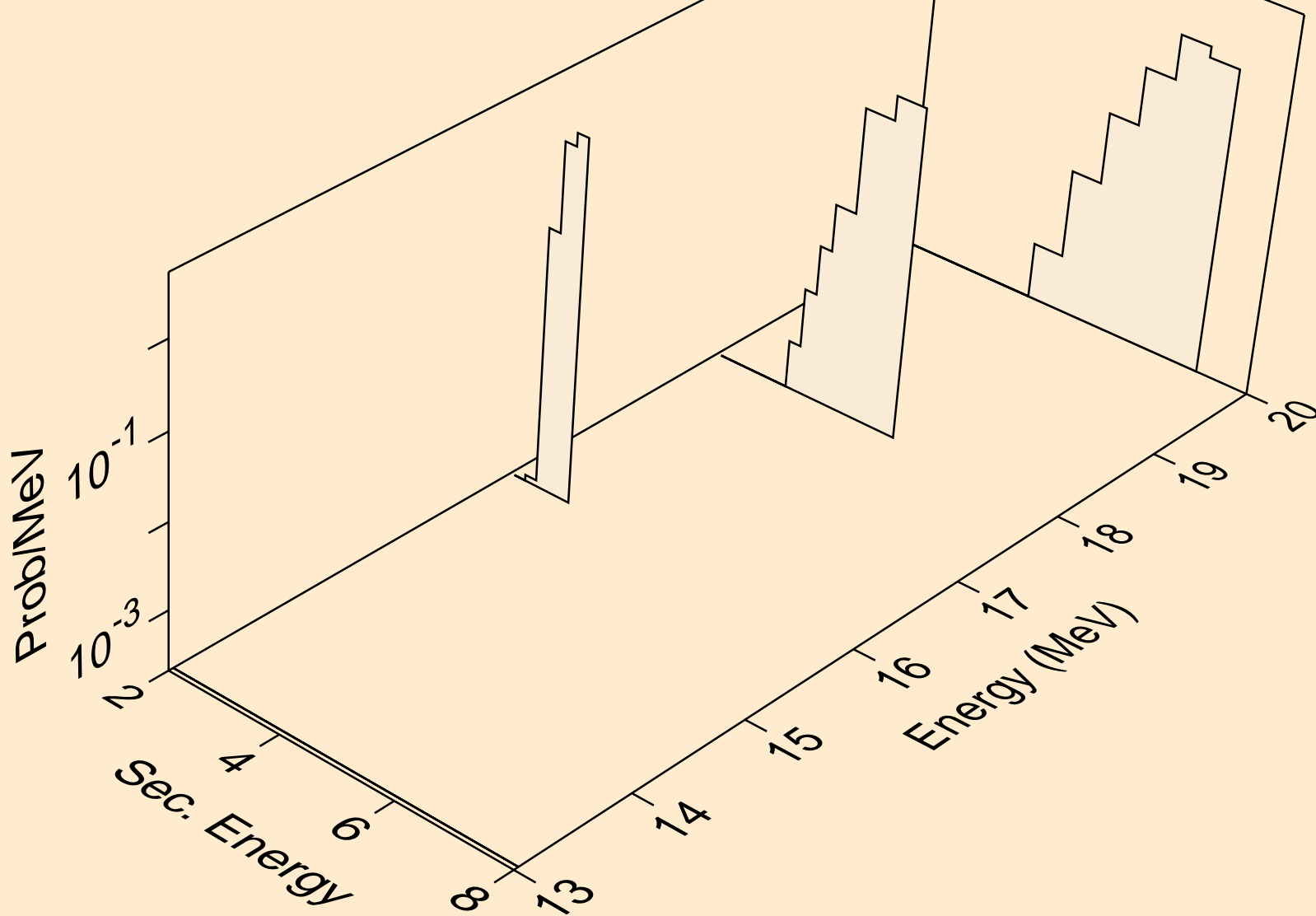

82-PB-206 FOR FENDL-3B2 FROM ENDF/B-VII WITH NJOY99.304
angular distribution for (n,t*0) triton

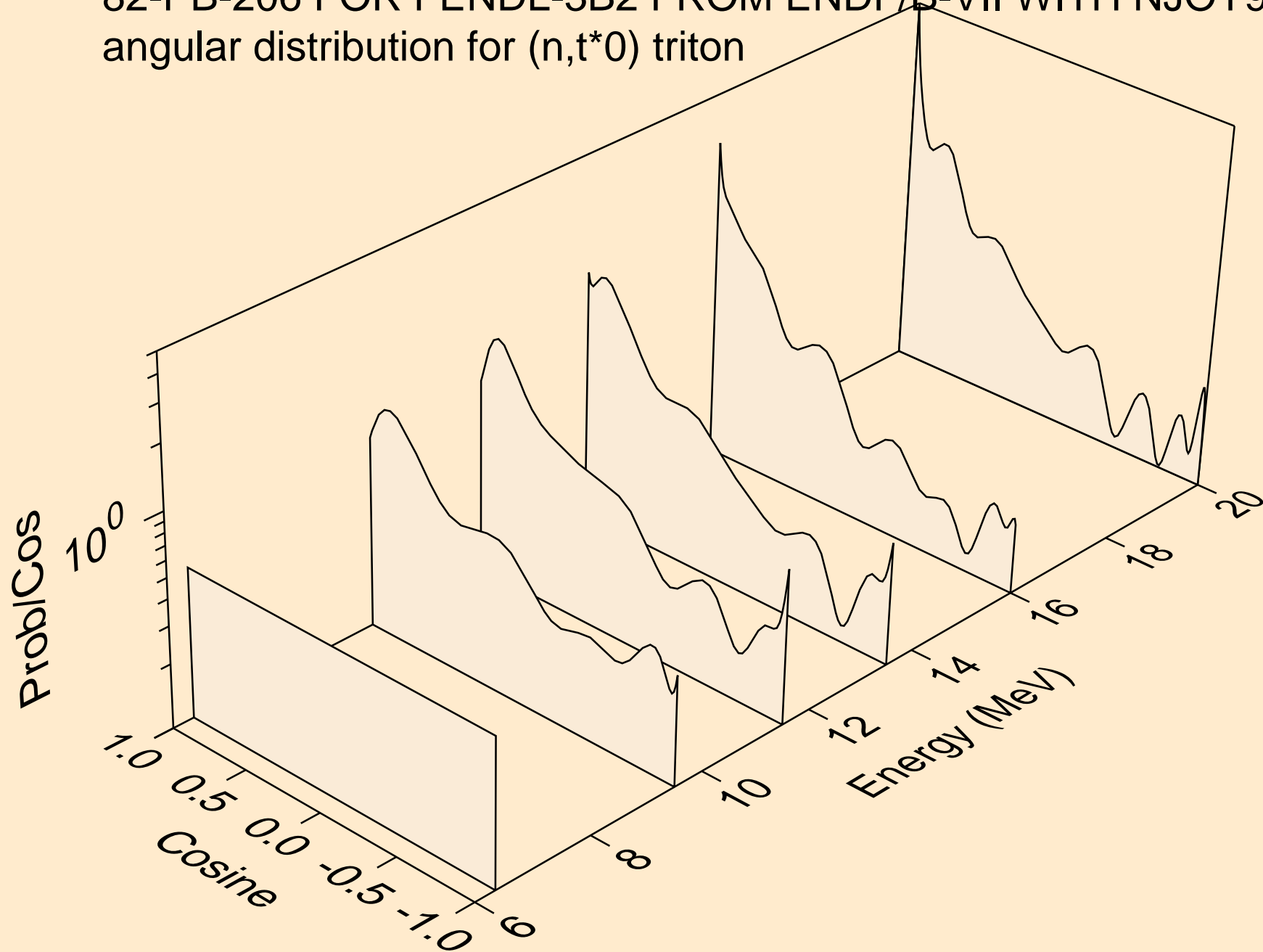

82-PB-206 FOR FENDL-3B2 FROM ENDF/B-VII WITH NJOY99.304
angular distribution for (n,t*1) triton

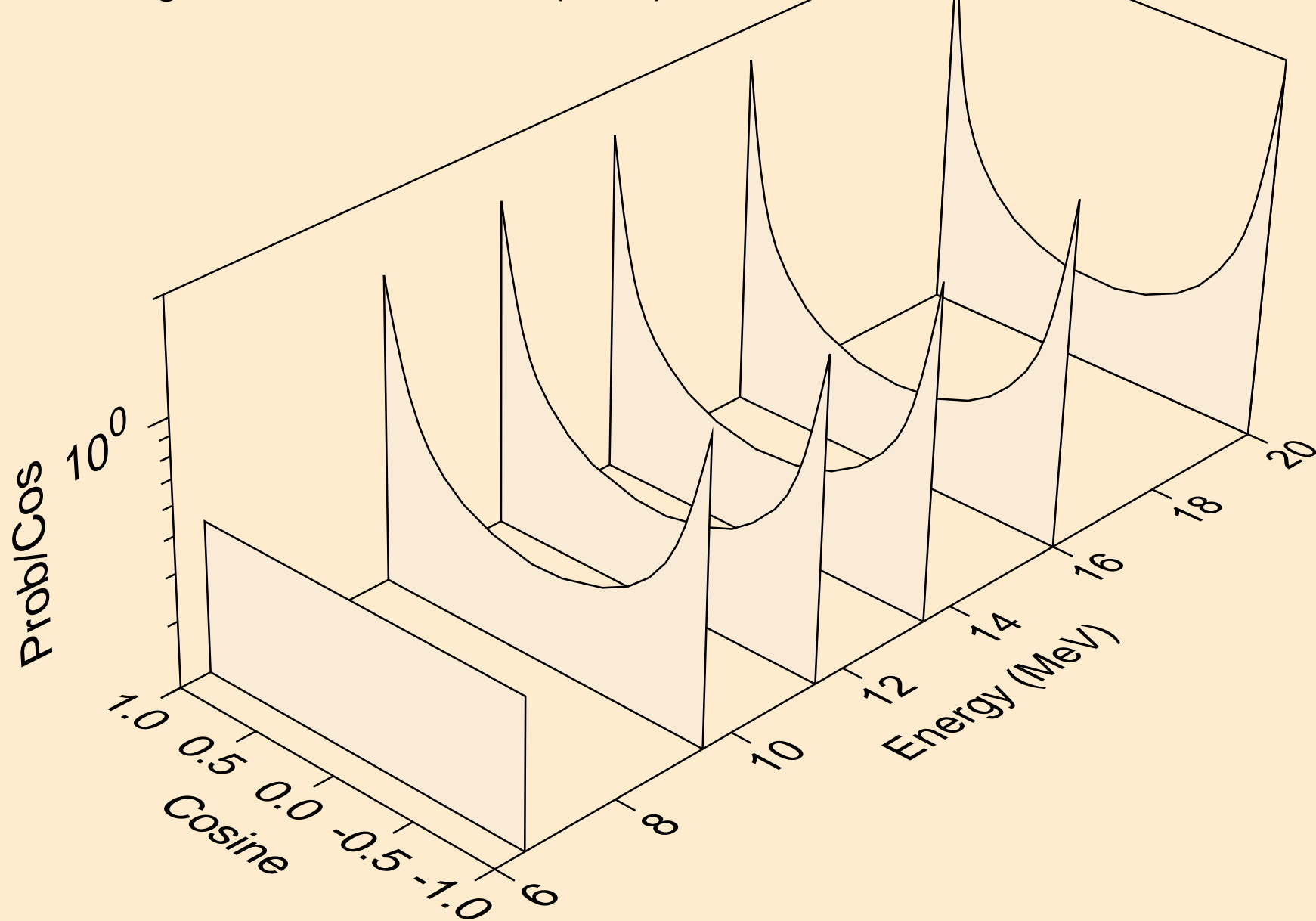

82-PB-206 FOR FENDL-3B2 FROM ENDF/B-VII WITH NJOY99.304
angular distribution for (n,t*2) triton

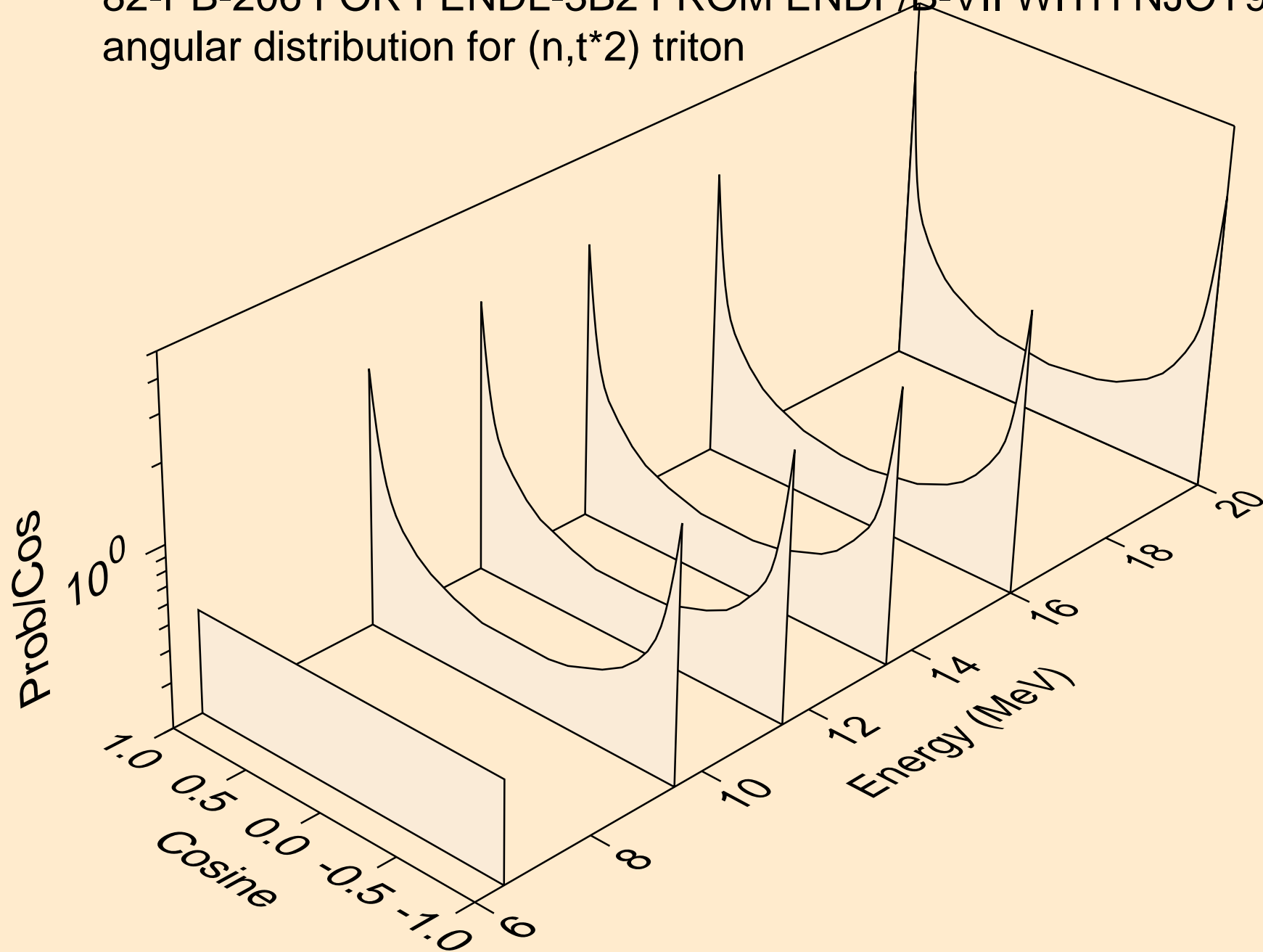

82-PB-206 FOR FENDL-3B2 FROM ENDF/B-VII WITH NJOY99.304
angular distribution for (n,t*3) triton

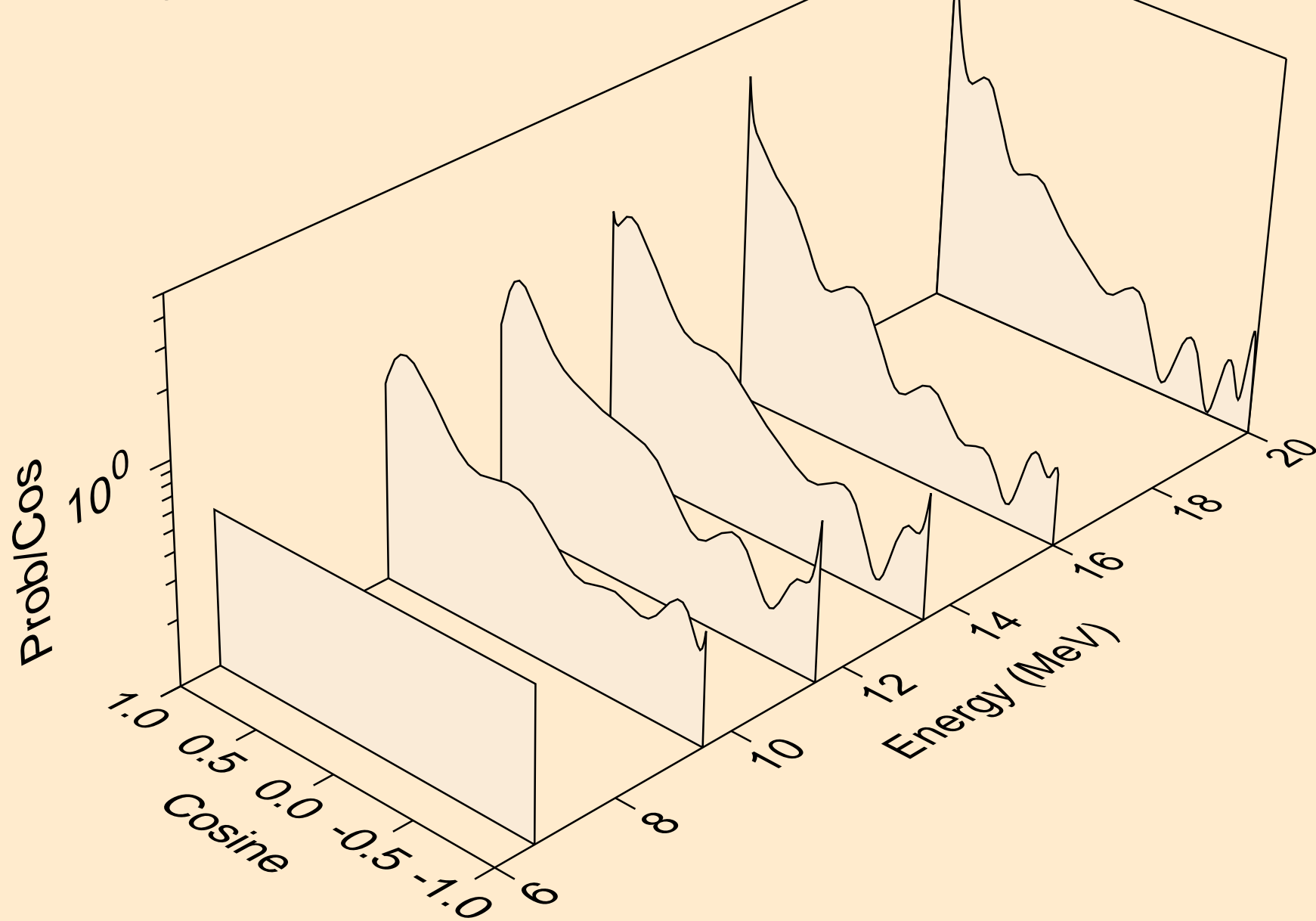

82-PB-206 FOR FENDL-3B2 FROM ENDF/B-VII WITH NJOY99.304
angular distribution for (n,t*4) triton

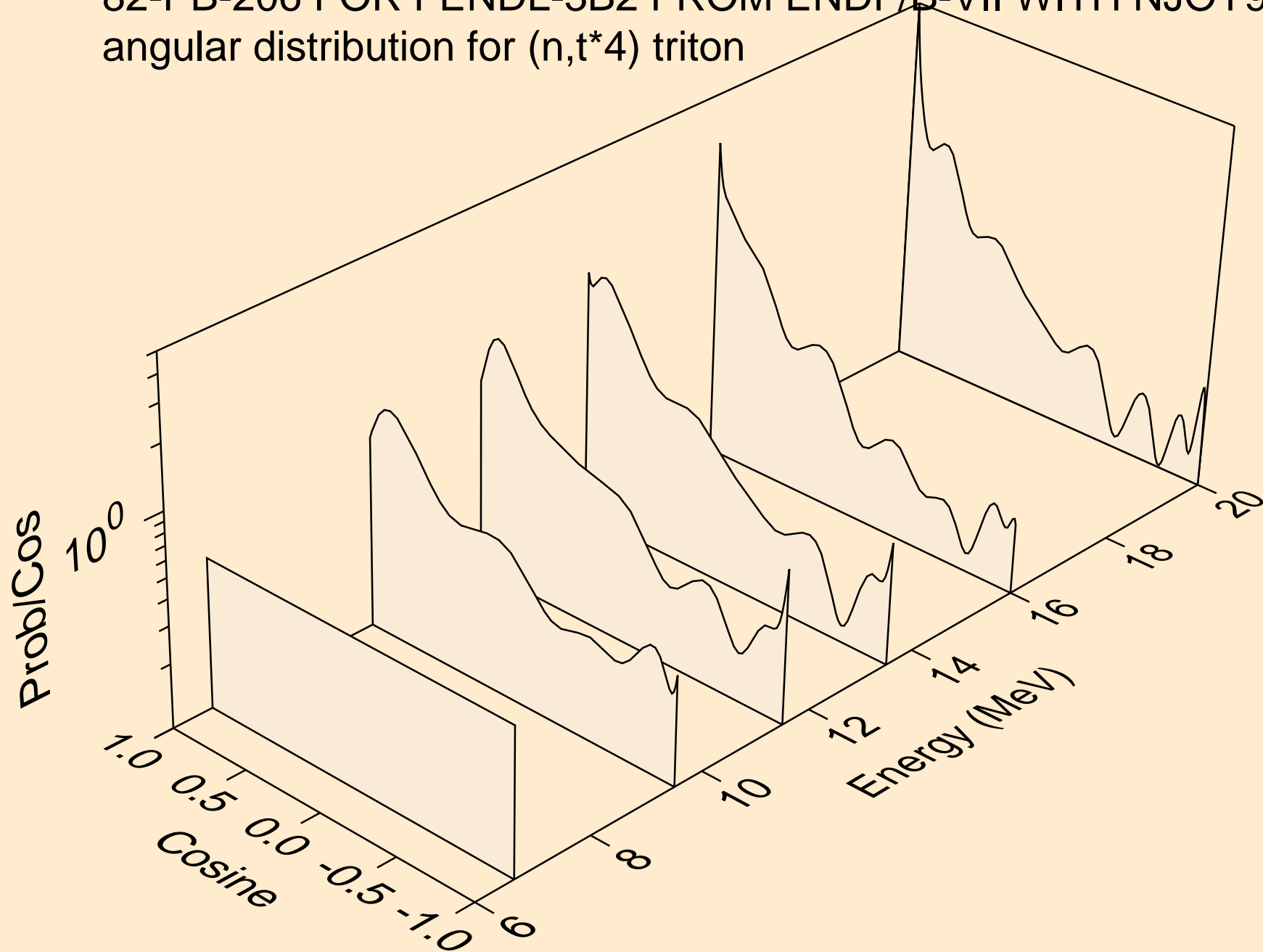

82-PB-206 FOR FENDL-3B2 FROM ENDF/B-VII WITH NJOY99.304
angular distribution for (n,t*5) triton

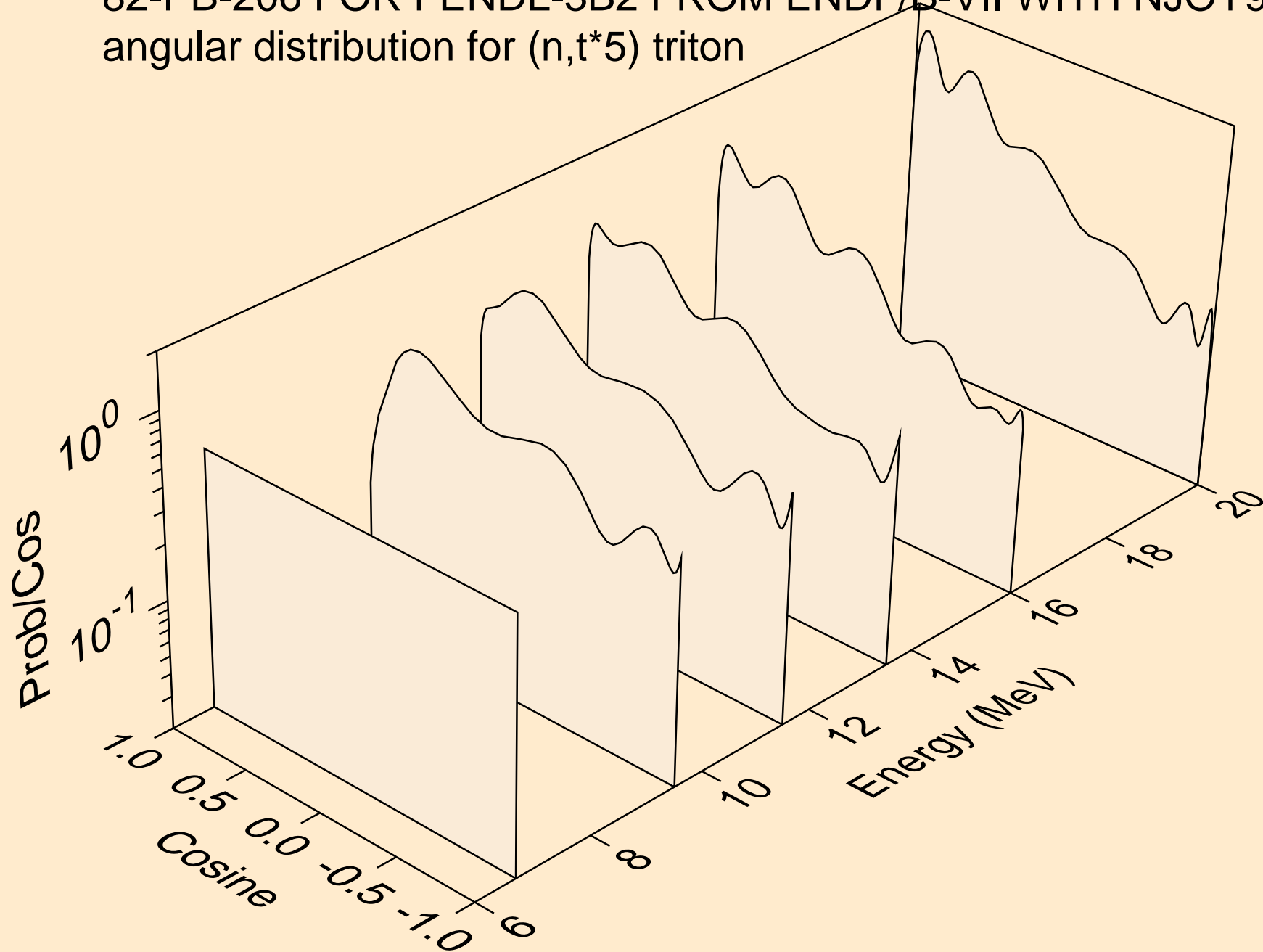

82-PB-206 FOR FENDL-3B2 FROM ENDF/B-VII WITH NJOY99.304
tritons from (n,t*c)

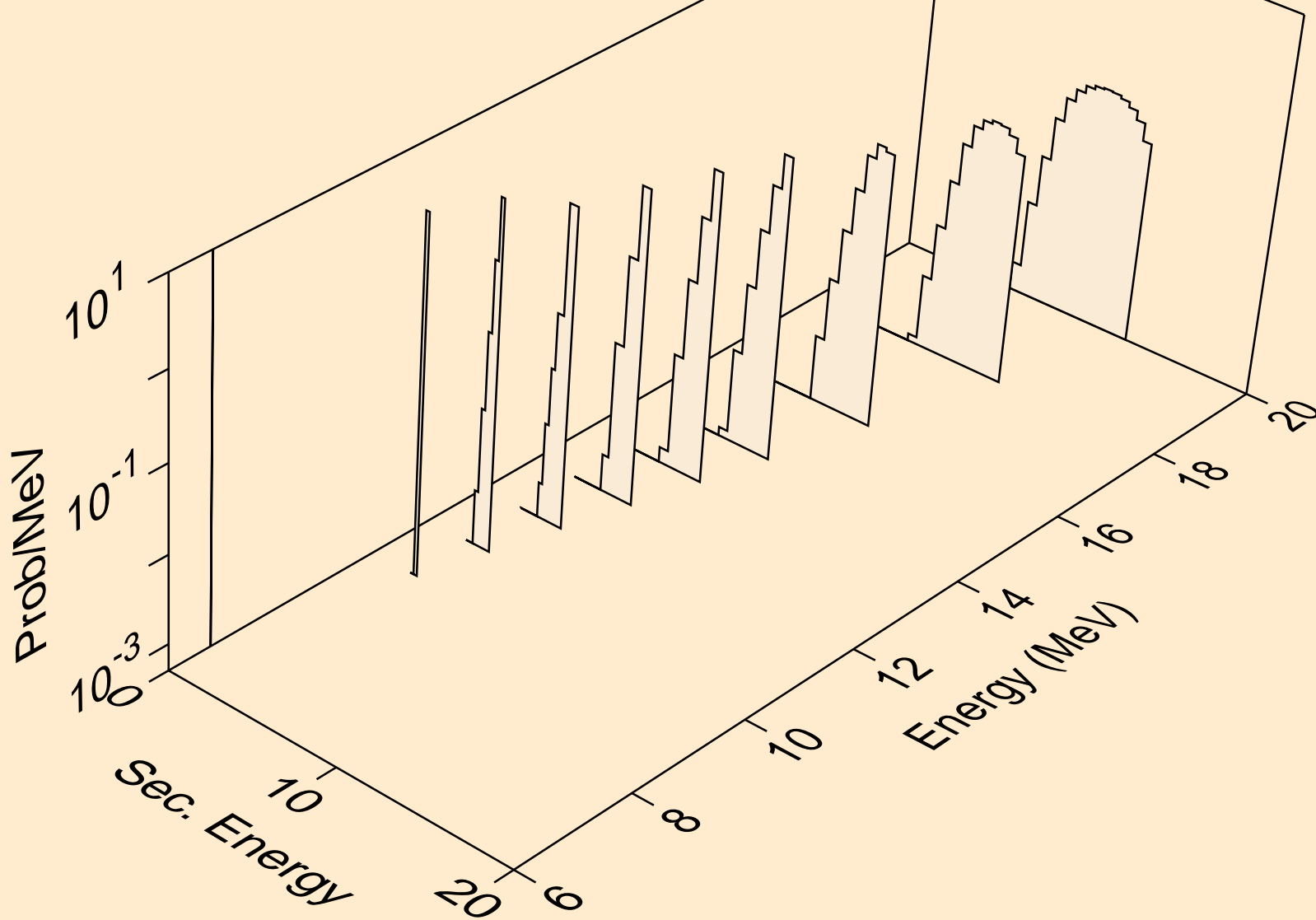

82-PB-206 FOR FENDL-3B2 FROM ENDF/B-VII WITH NJOY99.304
he3s from (n,x)

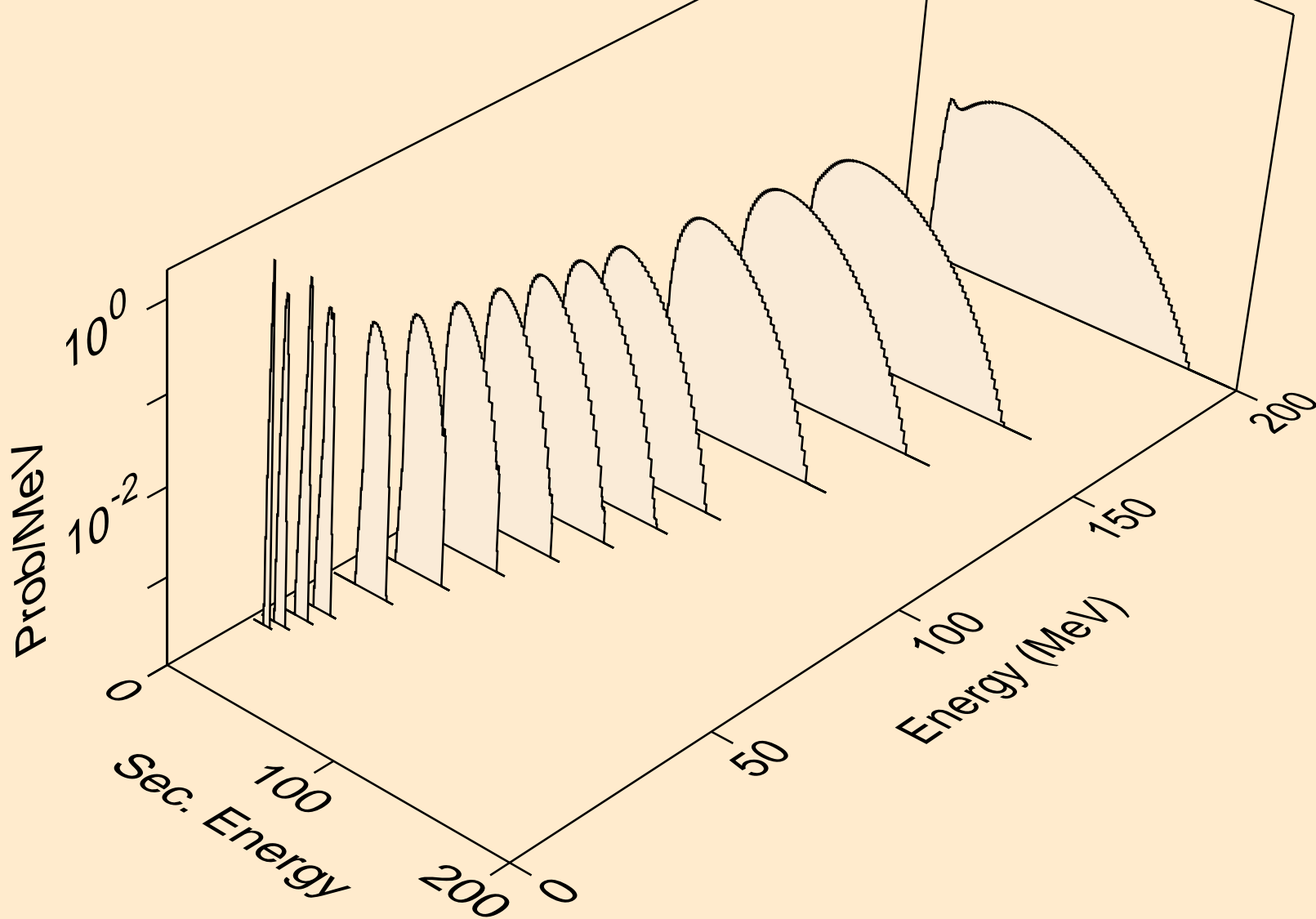

82-PB-206 FOR FENDL-3B2 FROM ENDF/B-VII WITH NJOY99.304
alphas from (n,x)

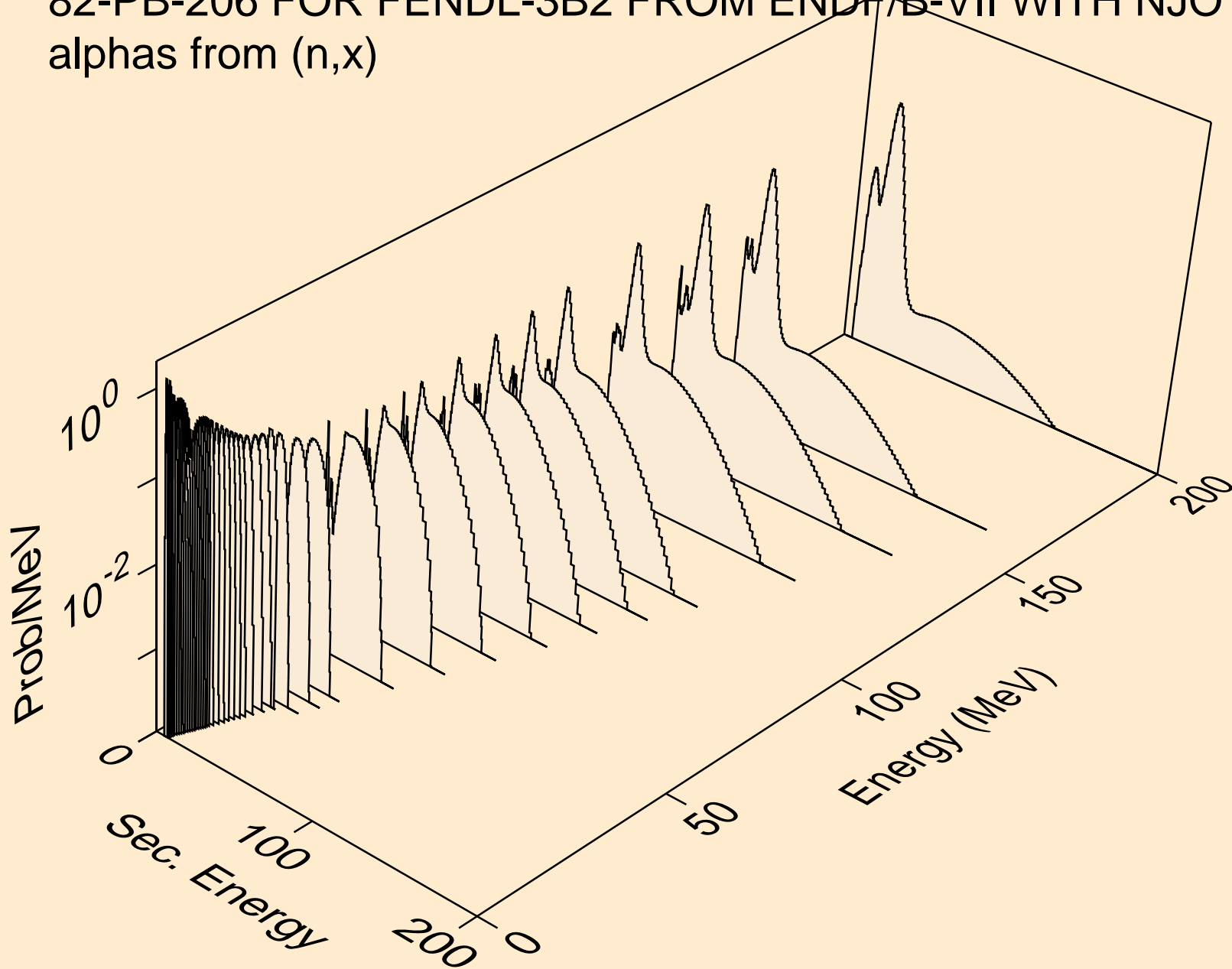

82-PB-206 FOR FENDL-3B2 FROM ENDF/B-VII WITH NJOY99.304
alphas from (n,n*)a

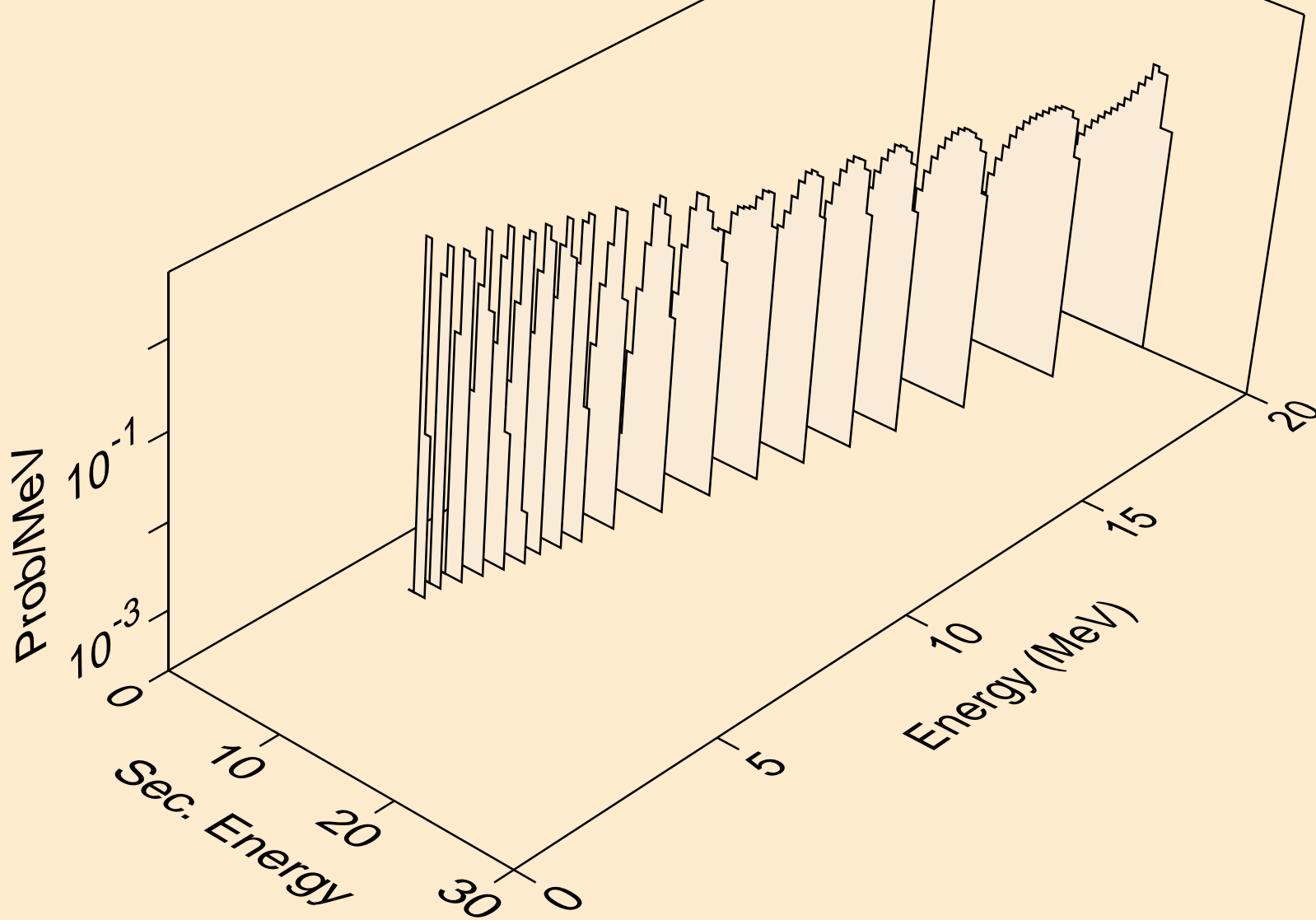

82-PB-206 FOR FENDL-3B2 FROM ENDF/B-VII WITH NJOY99.304
alphas from (n,2n)a

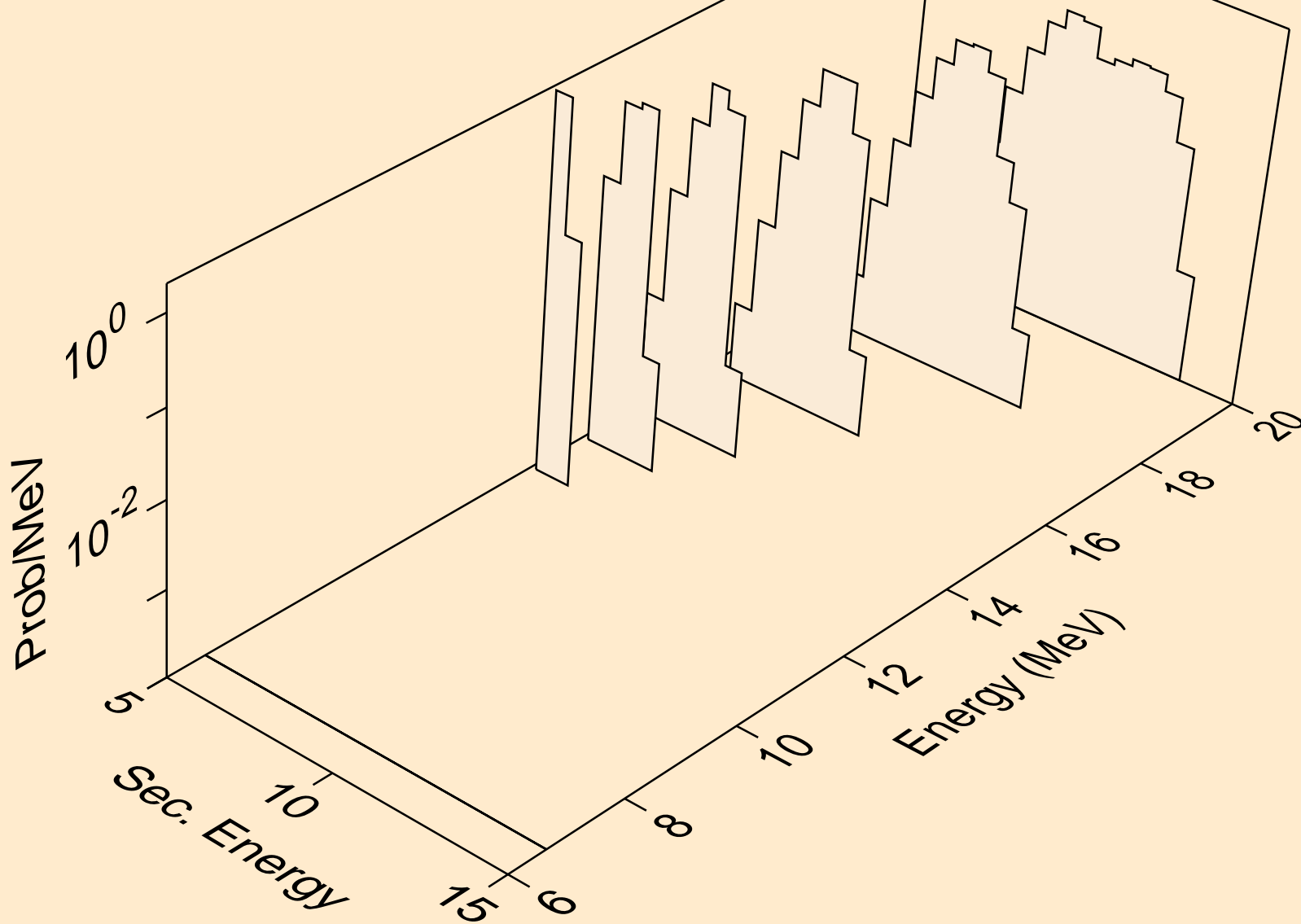

82-PB-206 FOR FENDL-3B2 FROM ENDF/B-VII WITH NJOY99.304
alphas from (n,2a)

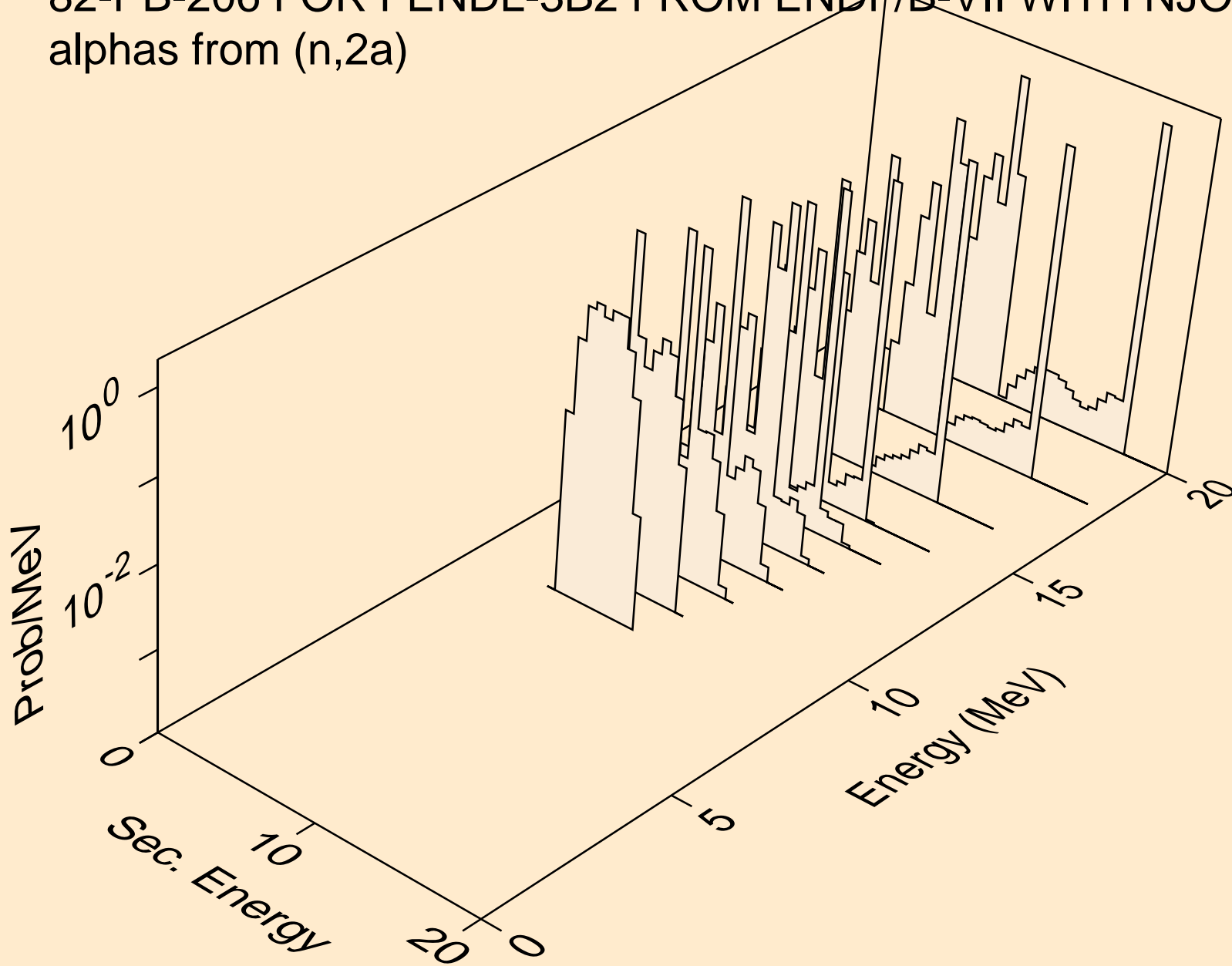

82-PB-206 FOR FENDL-3B2 FROM ENDF/B-VII WITH NJOY99.304
angular distribution for (n,a*0) alpha

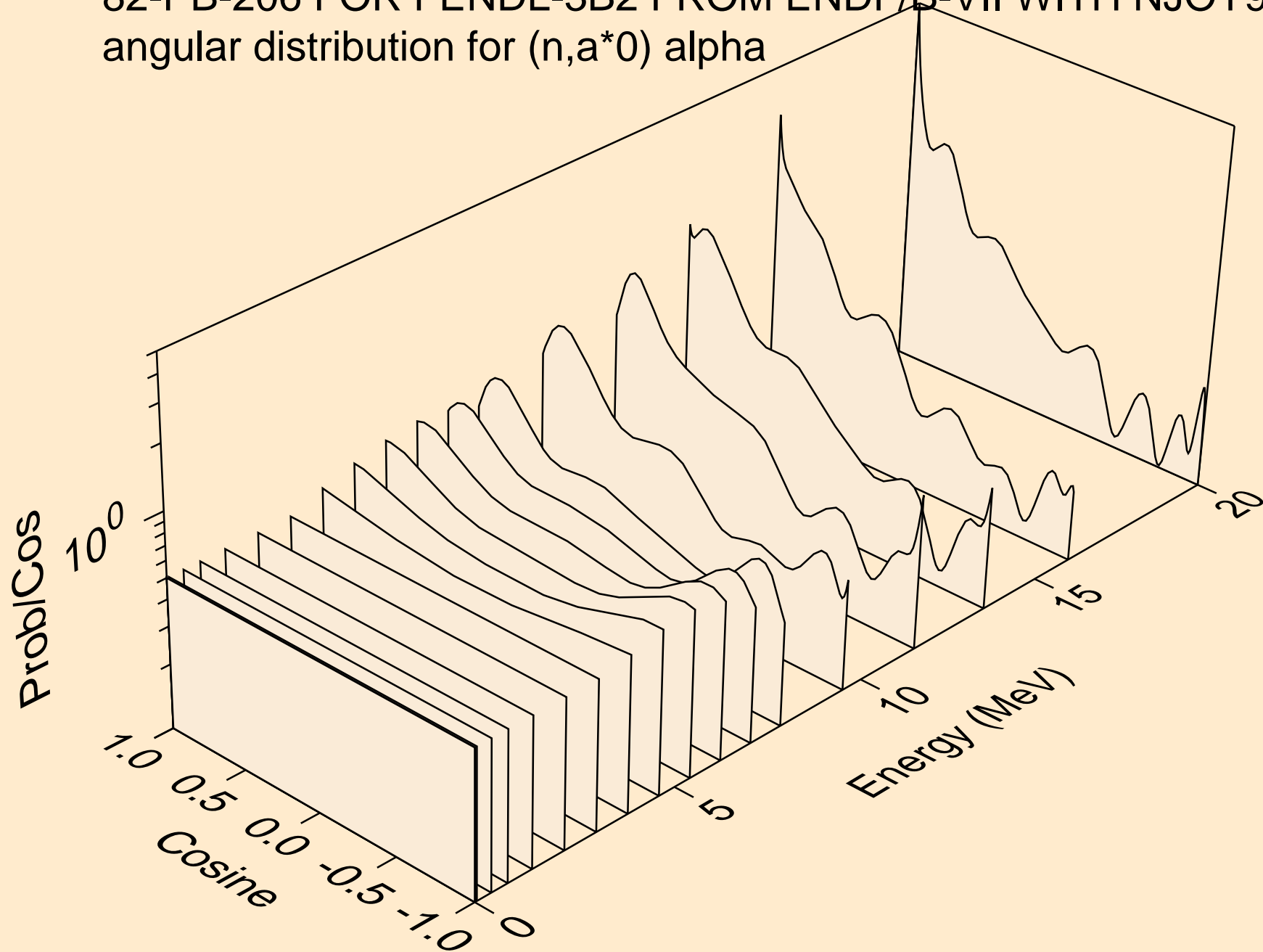

82-PB-206 FOR FENDL-3B2 FROM ENDF/B-VII WITH NJOY99.304
angular distribution for (n, α *1) alpha

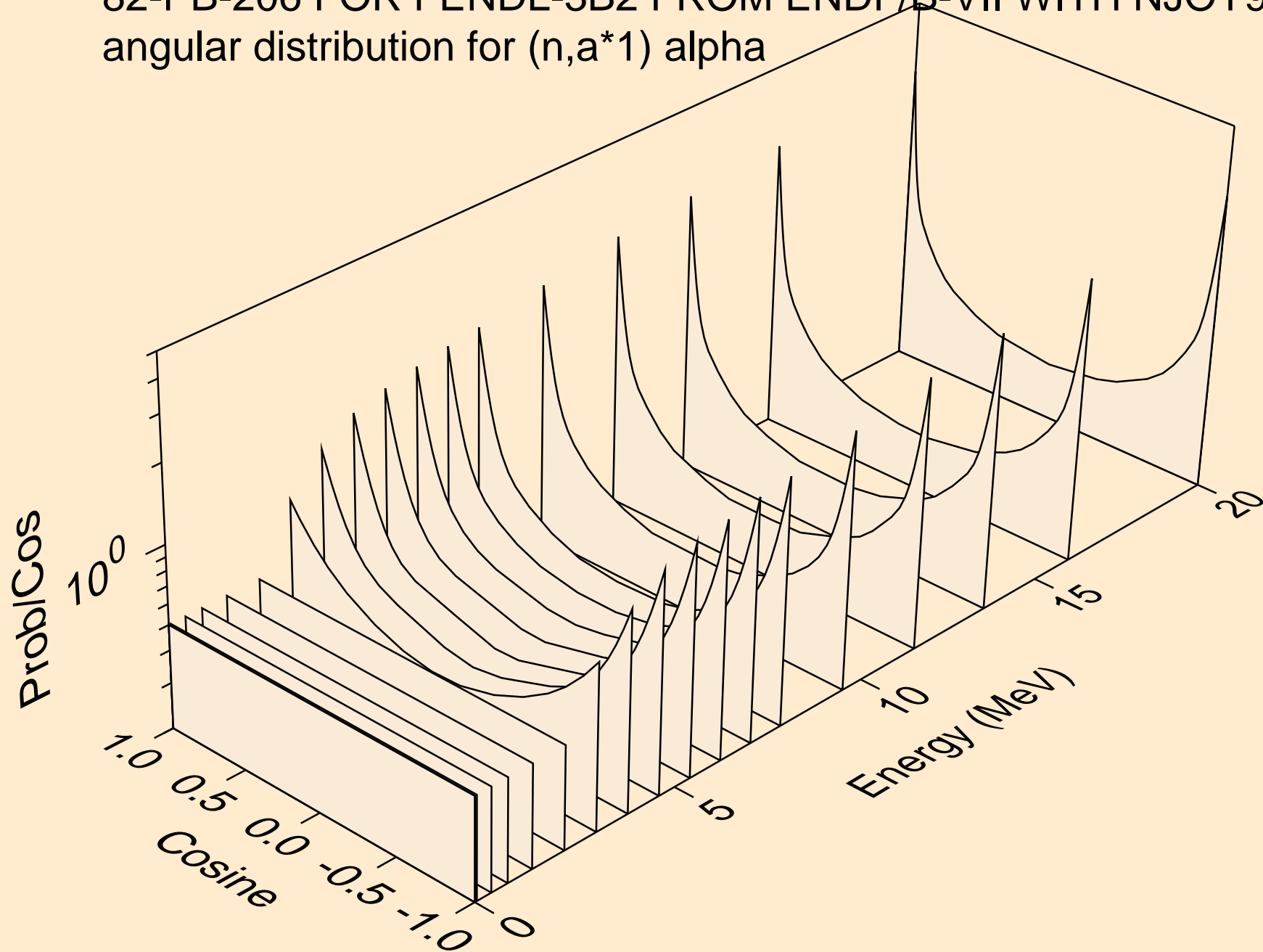

82-PB-206 FOR FENDL-3B2 FROM ENDF/B-VII WITH NJOY99.304
angular distribution for (n, α *2) alpha

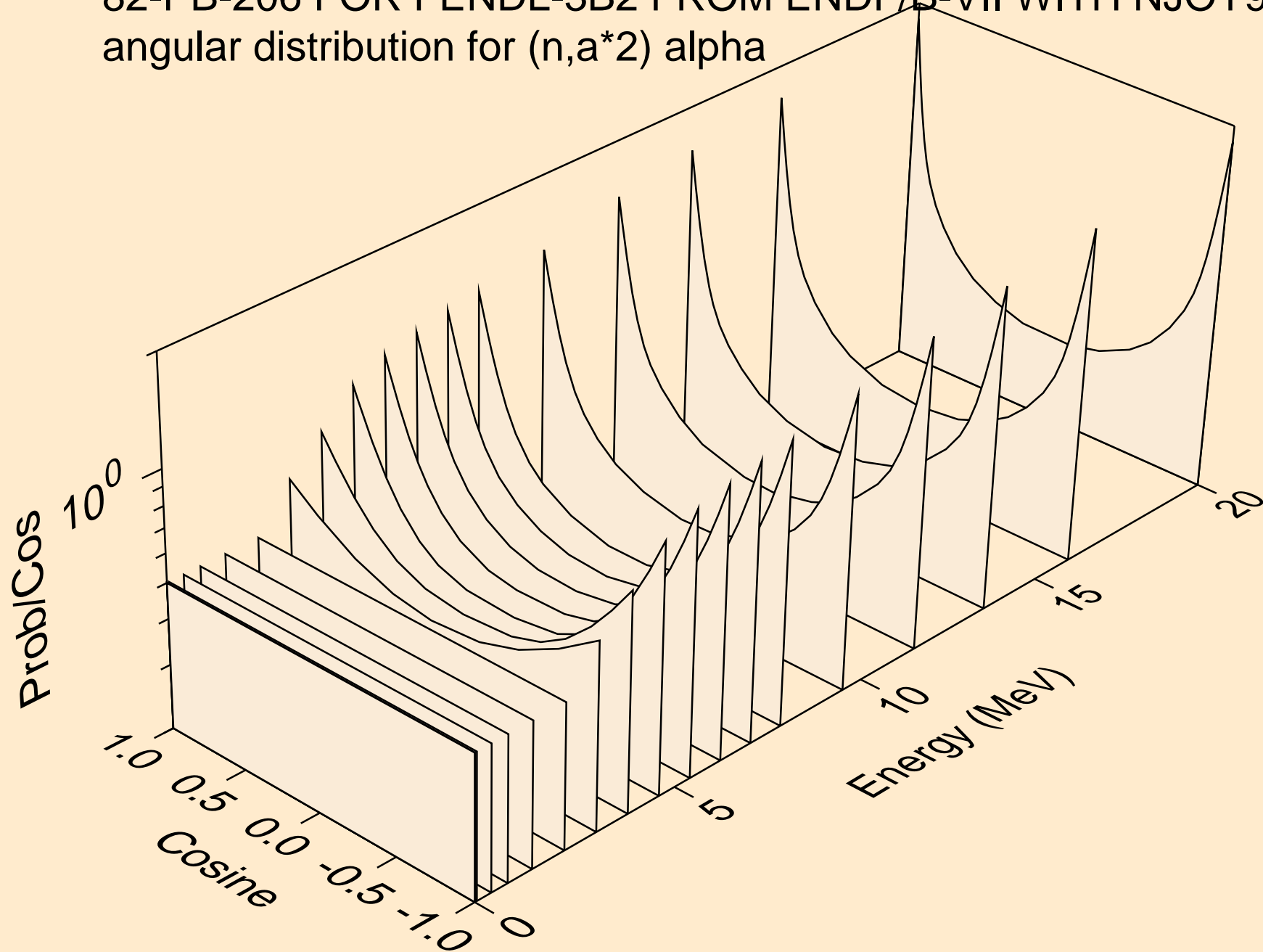

82-PB-206 FOR FENDL-3B2 FROM ENDF/B-VII WITH NJOY99.304
angular distribution for (n, α *3) alpha

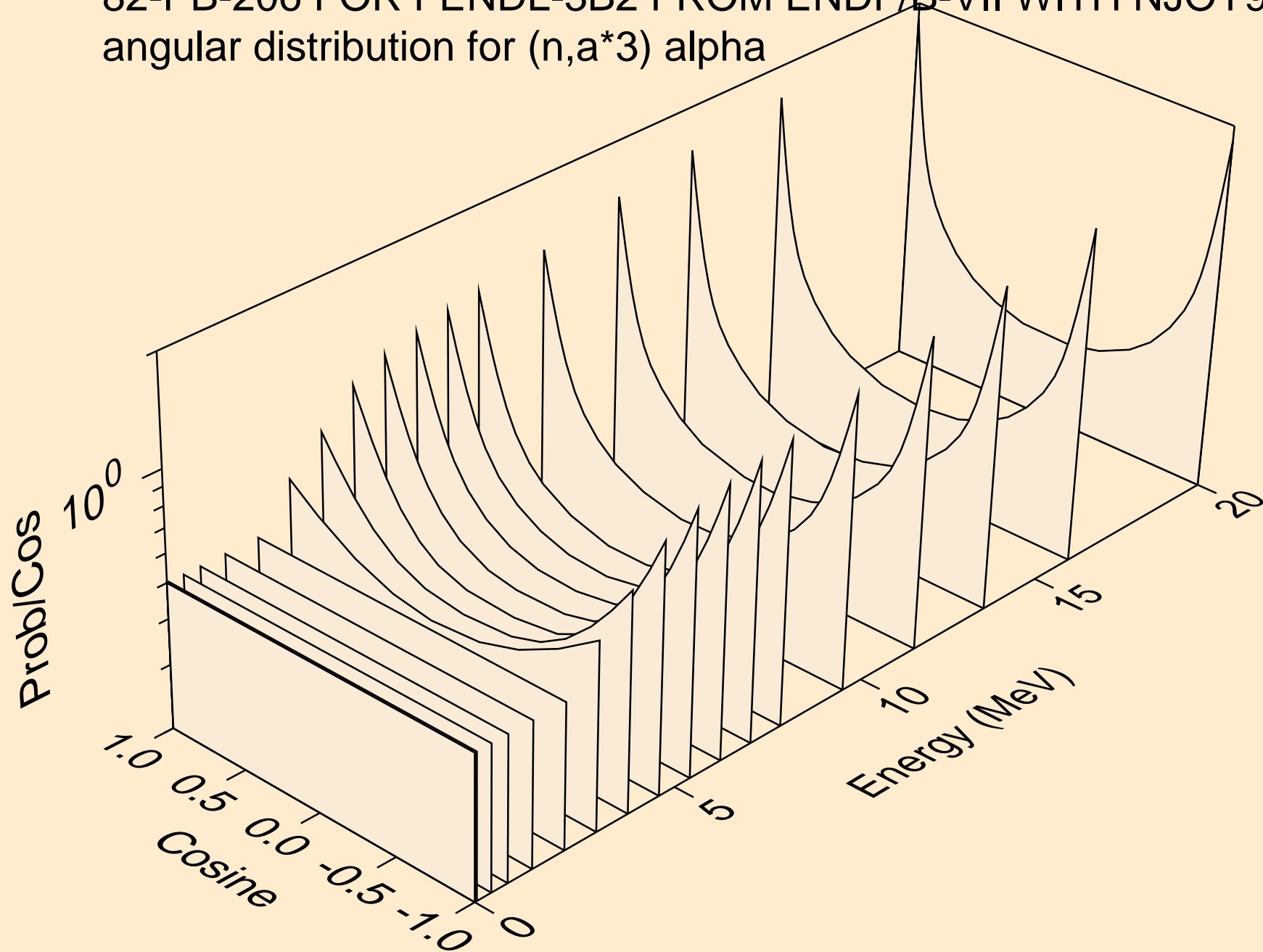

82-PB-206 FOR FENDL-3B2 FROM ENDF/B-VII WITH NJOY99.304
angular distribution for (n, α) alpha

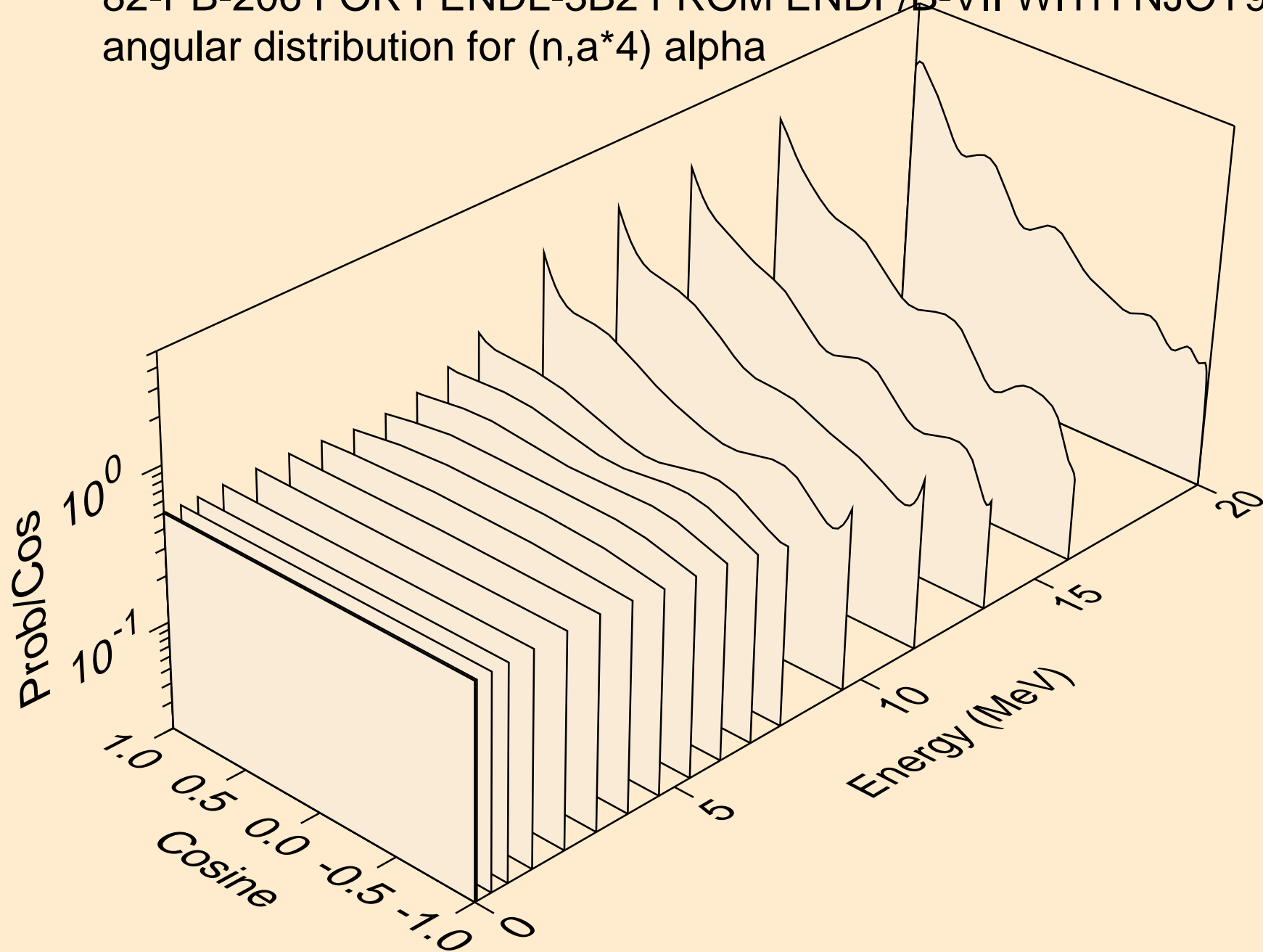

82-PB-206 FOR FENDL-3B2 FROM ENDF/B-VII WITH NJOY99.304
angular distribution for (n, α *5) alpha

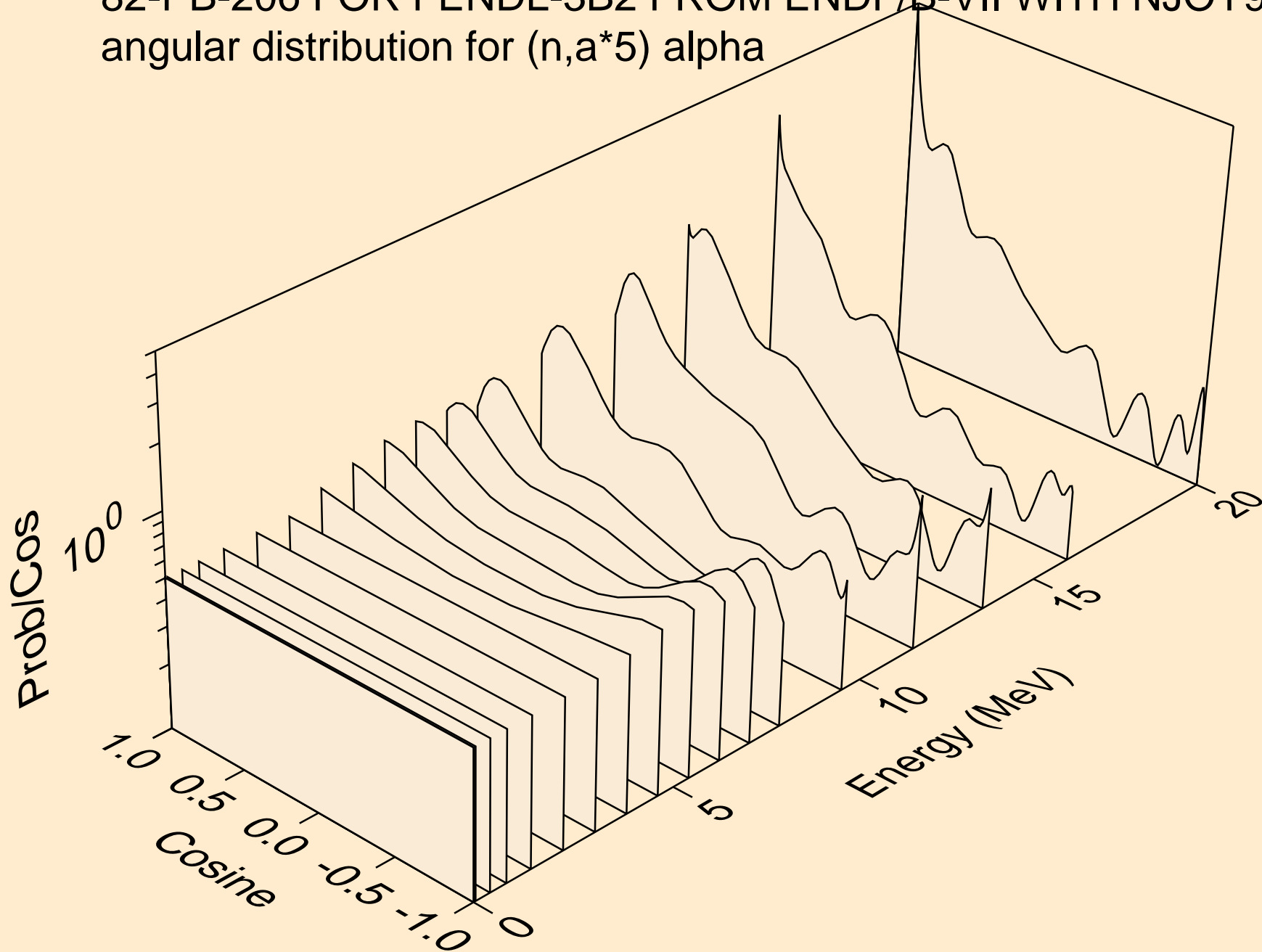

82-PB-206 FOR FENDL-3B2 FROM ENDF/B-VII WITH NJOY99.304
angular distribution for (n, α) alpha

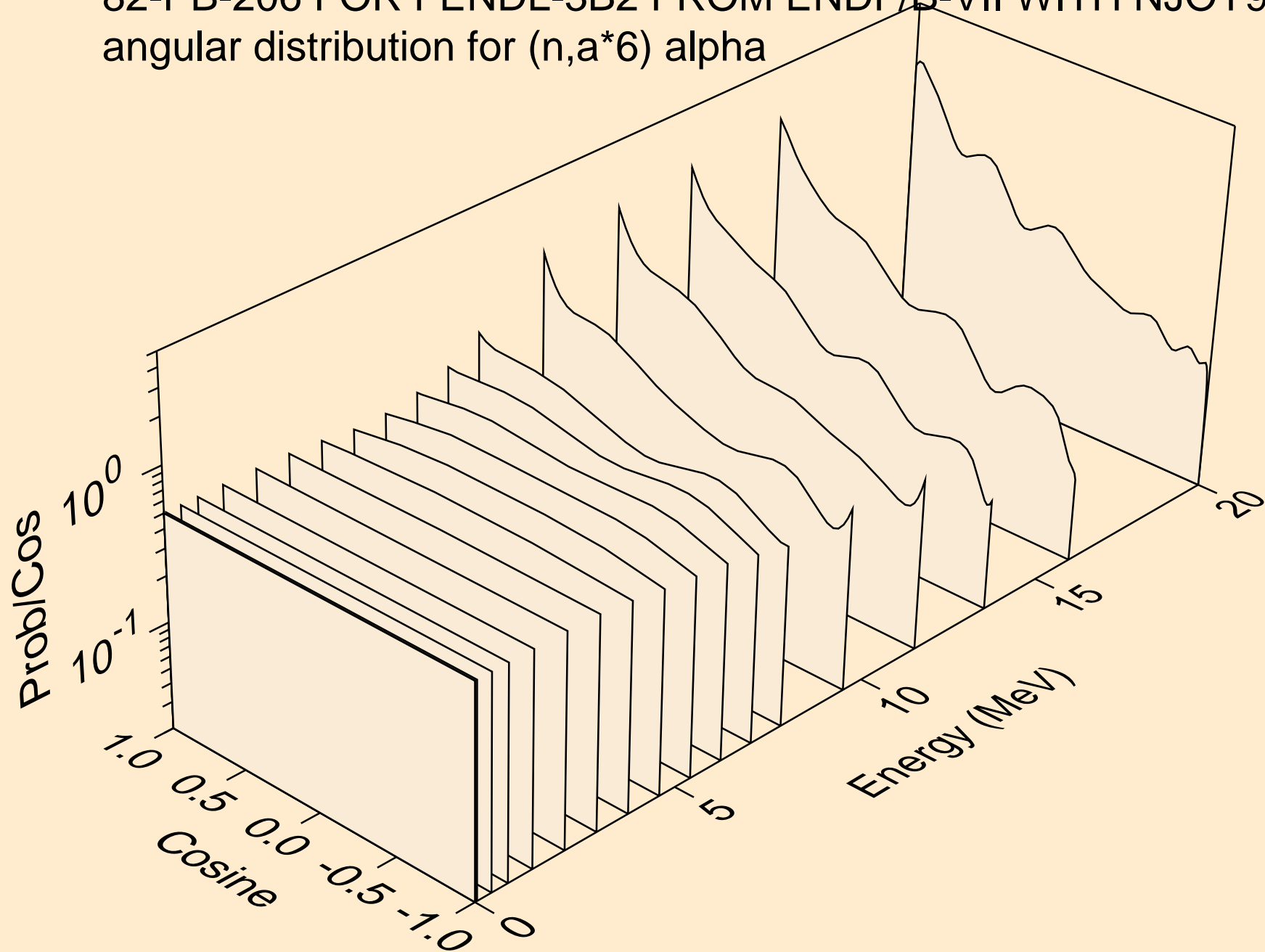

82-PB-206 FOR FENDL-3B2 FROM ENDF/B-VII WITH NJOY99.304
angular distribution for (n, α *7) alpha

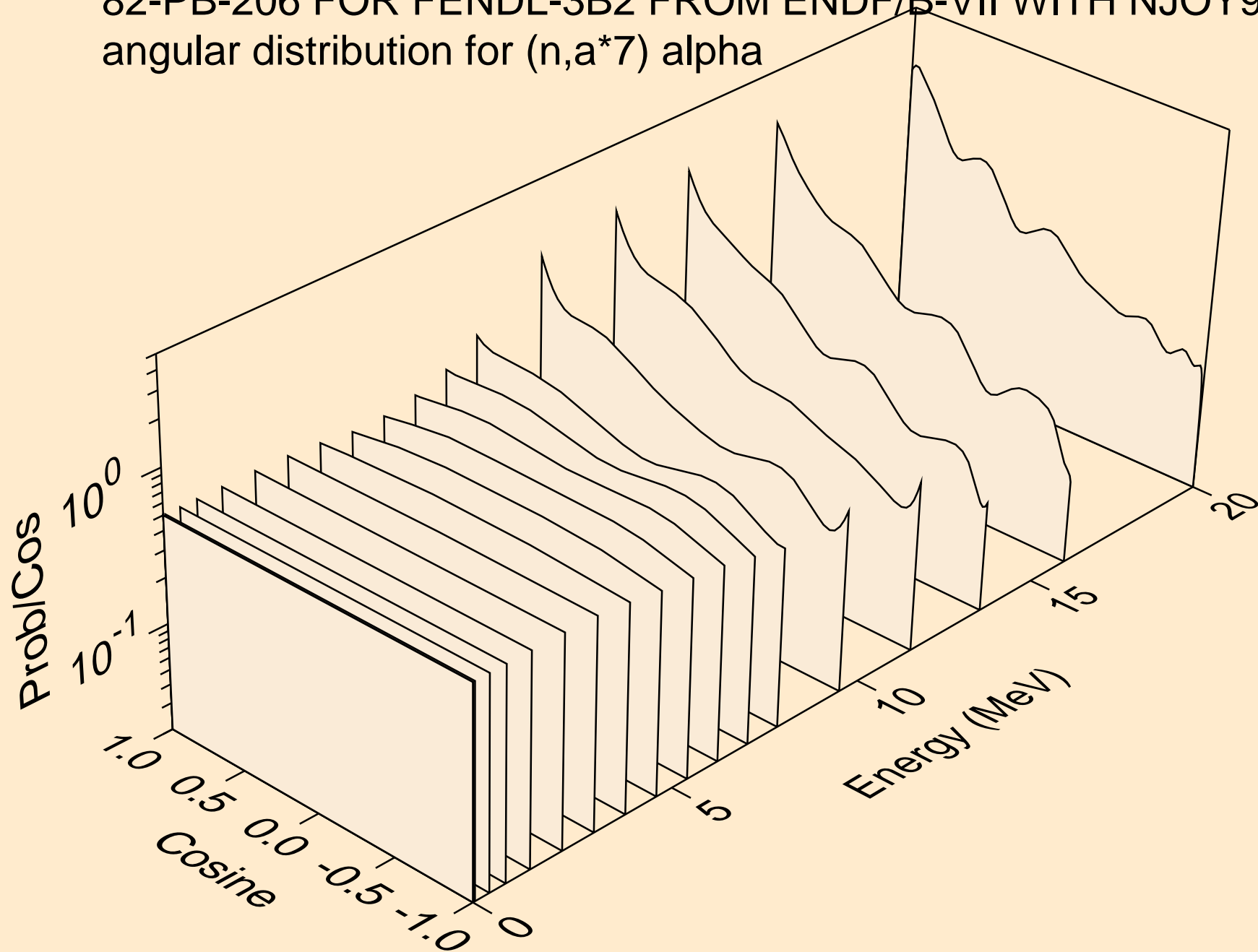

82-PB-206 FOR FENDL-3B2 FROM ENDF/B-VII WITH NJOY99.304
angular distribution for (n, α *8) alpha

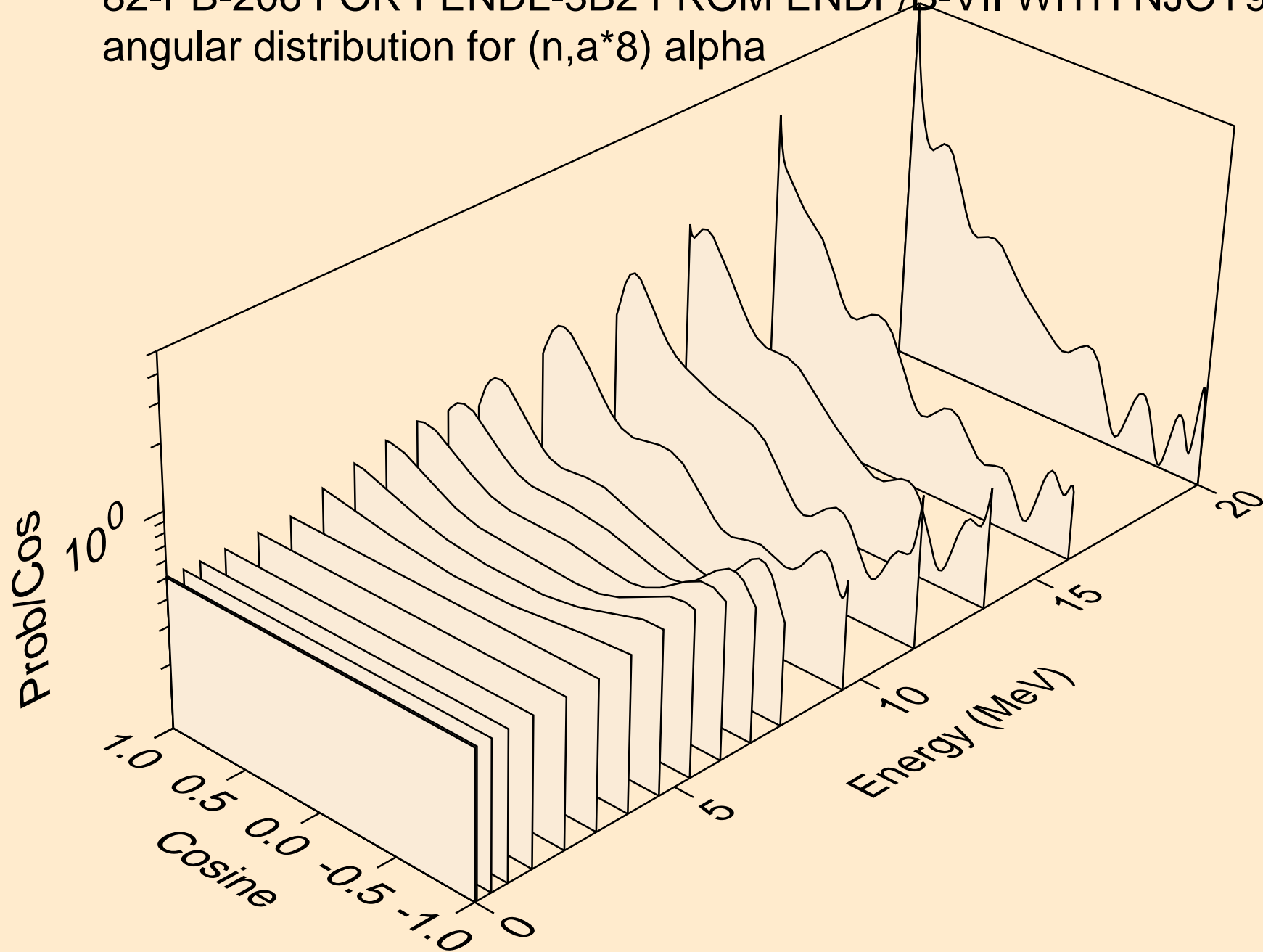

82-PB-206 FOR FENDL-3B2 FROM ENDF/B-VII WITH NJOY99.304
angular distribution for (n, α) alpha

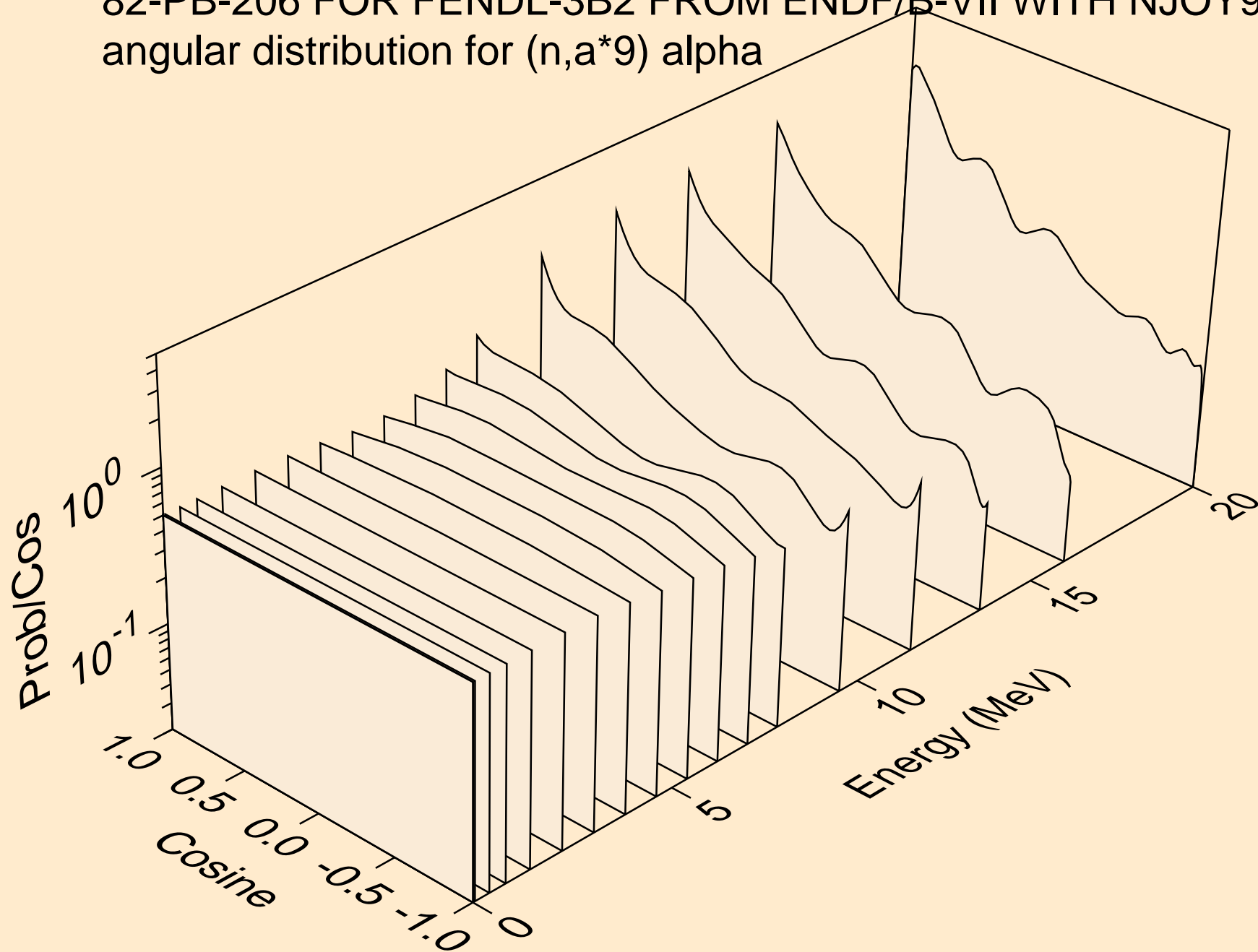

82-PB-206 FOR FENDL-3B2 FROM ENDF/B-VII WITH NJOY99.304
angular distribution for (n, α *10) alpha

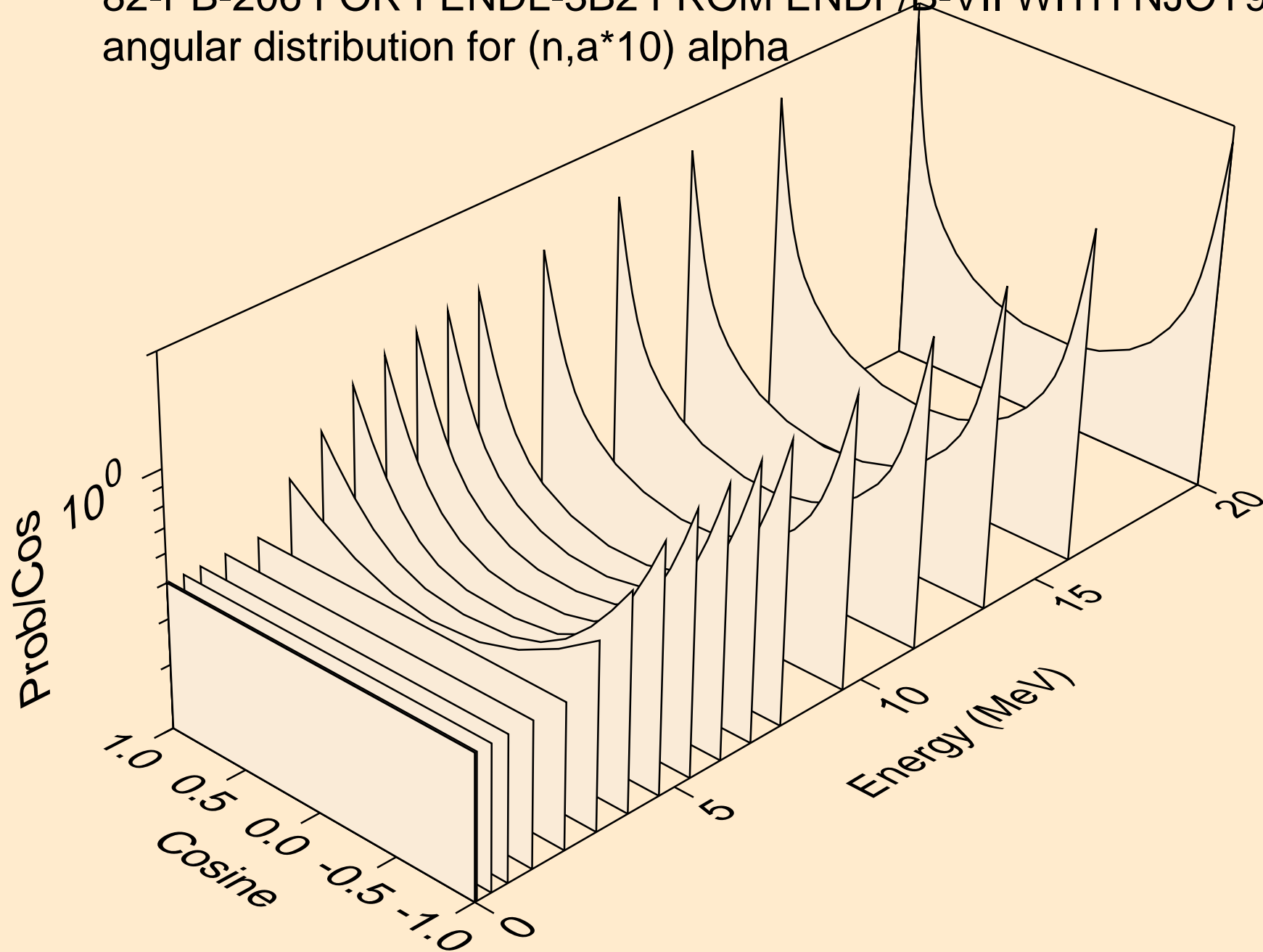

82-PB-206 FOR FENDL-3B2 FROM ENDF/B-VII WITH NJOY99.304
alphas from (n,a*c)

