

30-ZN-67 FOR FENDL-3.1 FROM FENDL-3.1 WITH NJOY2012.50+
Principal cross sections

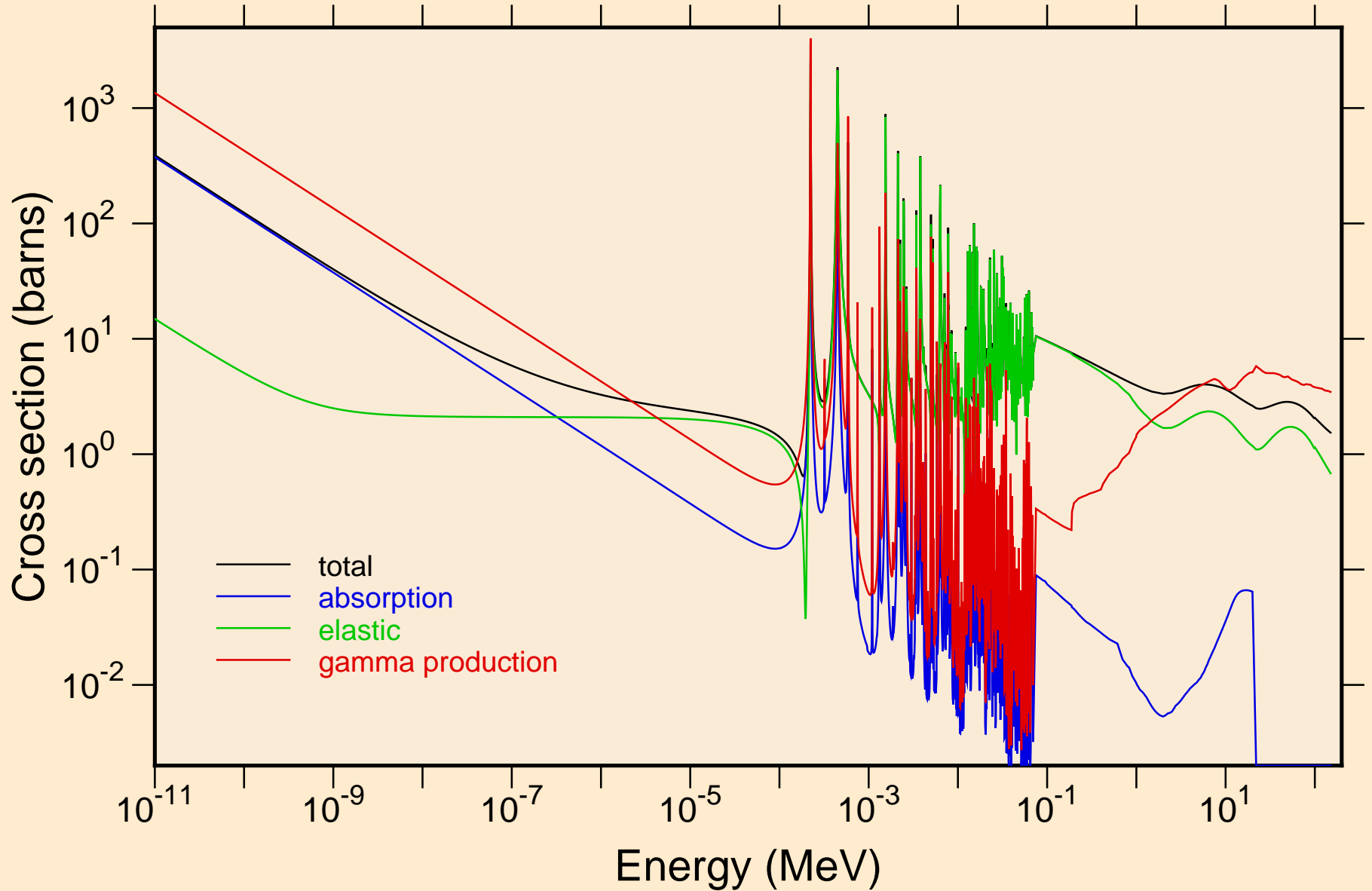

30-ZN-67 FOR FENDL-3.1 FROM FENDL-3.1 WITH NJOY2012.50+
resonance total cross section

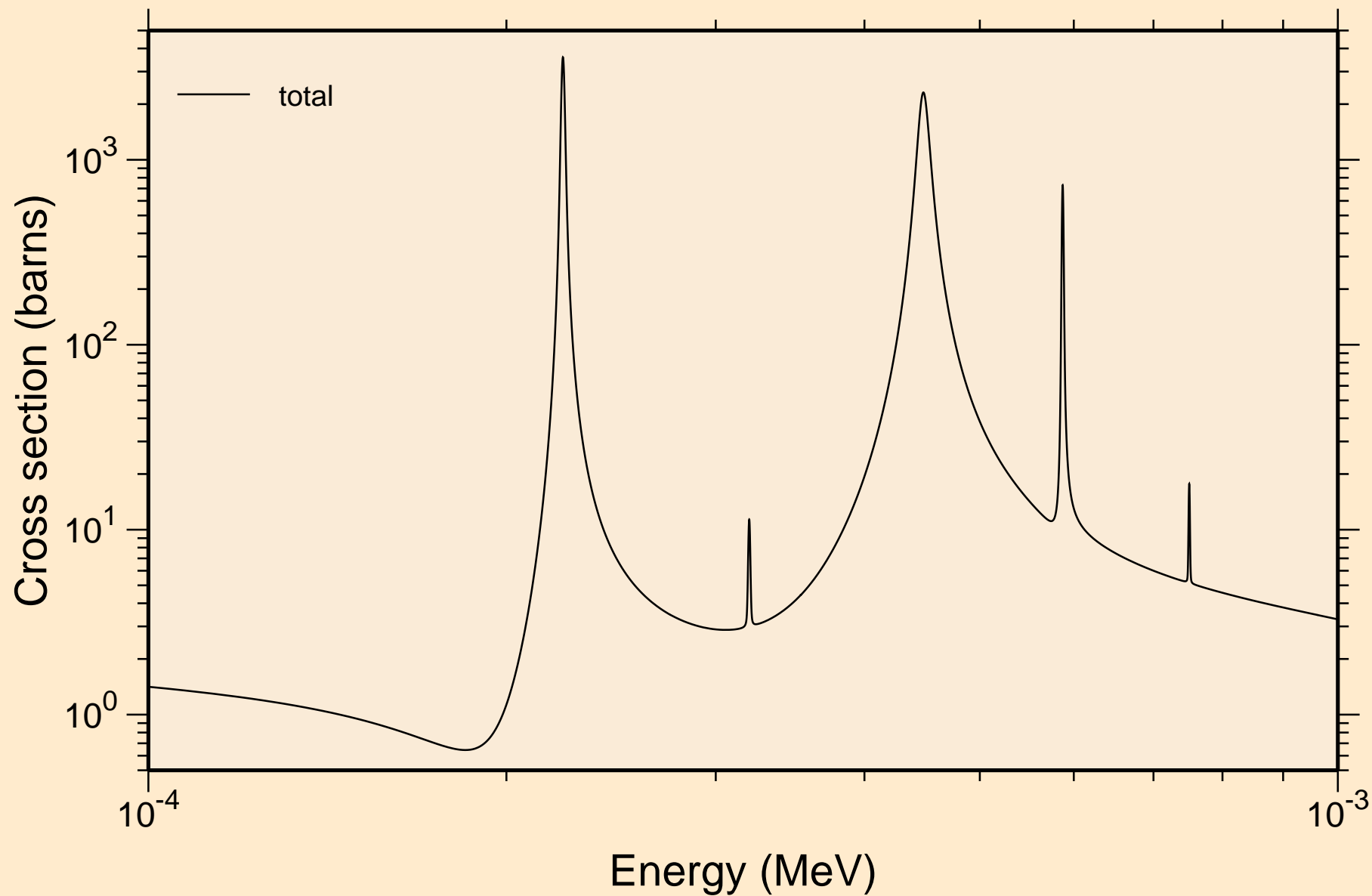

30-ZN-67 FOR FENDL-3.1 FROM FENDL-3.1 WITH NJOY2012.50+
resonance total cross section

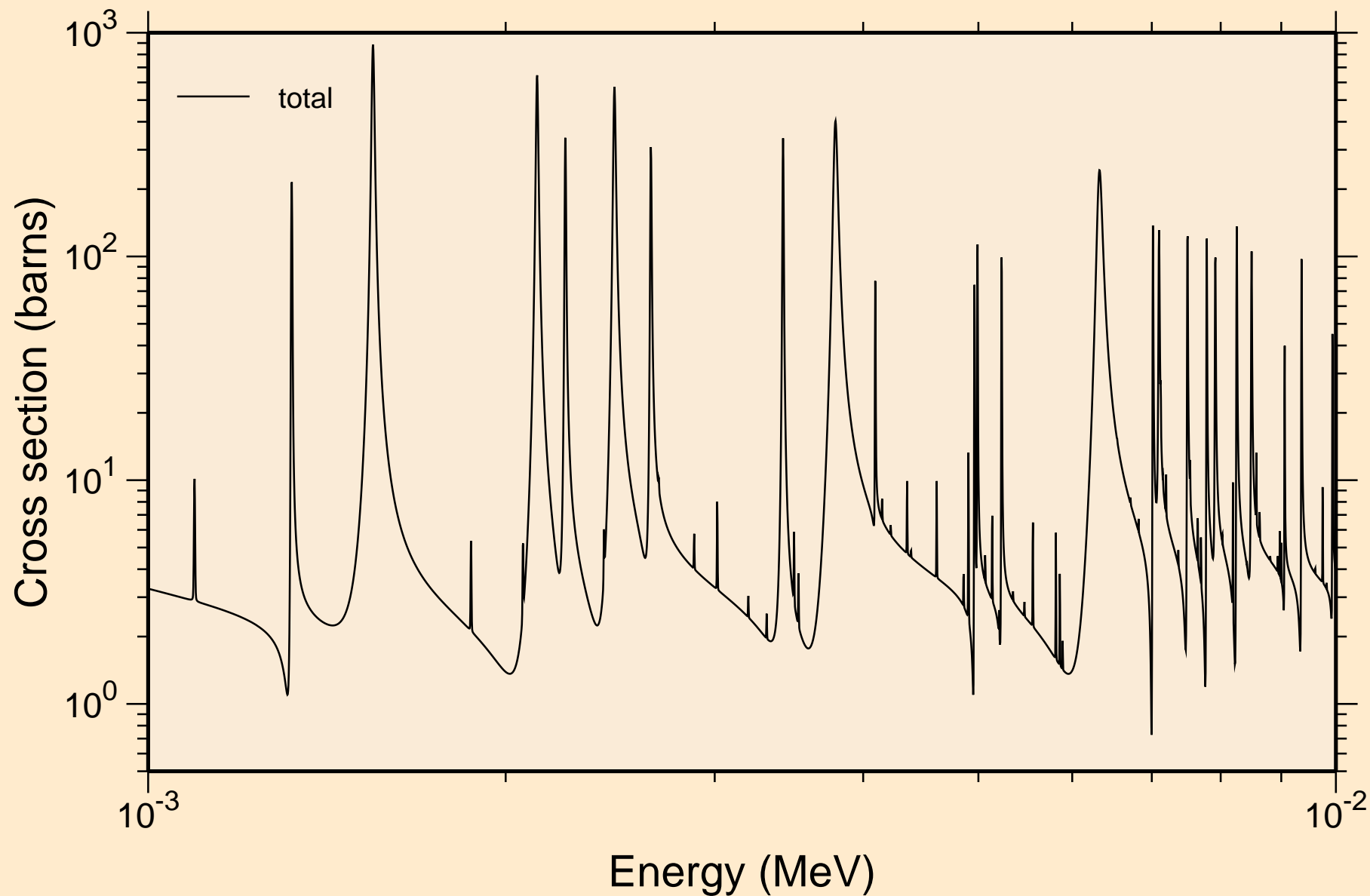

30-ZN-67 FOR FENDL-3.1 FROM FENDL-3.1 WITH NJOY2012.50+
resonance total cross section

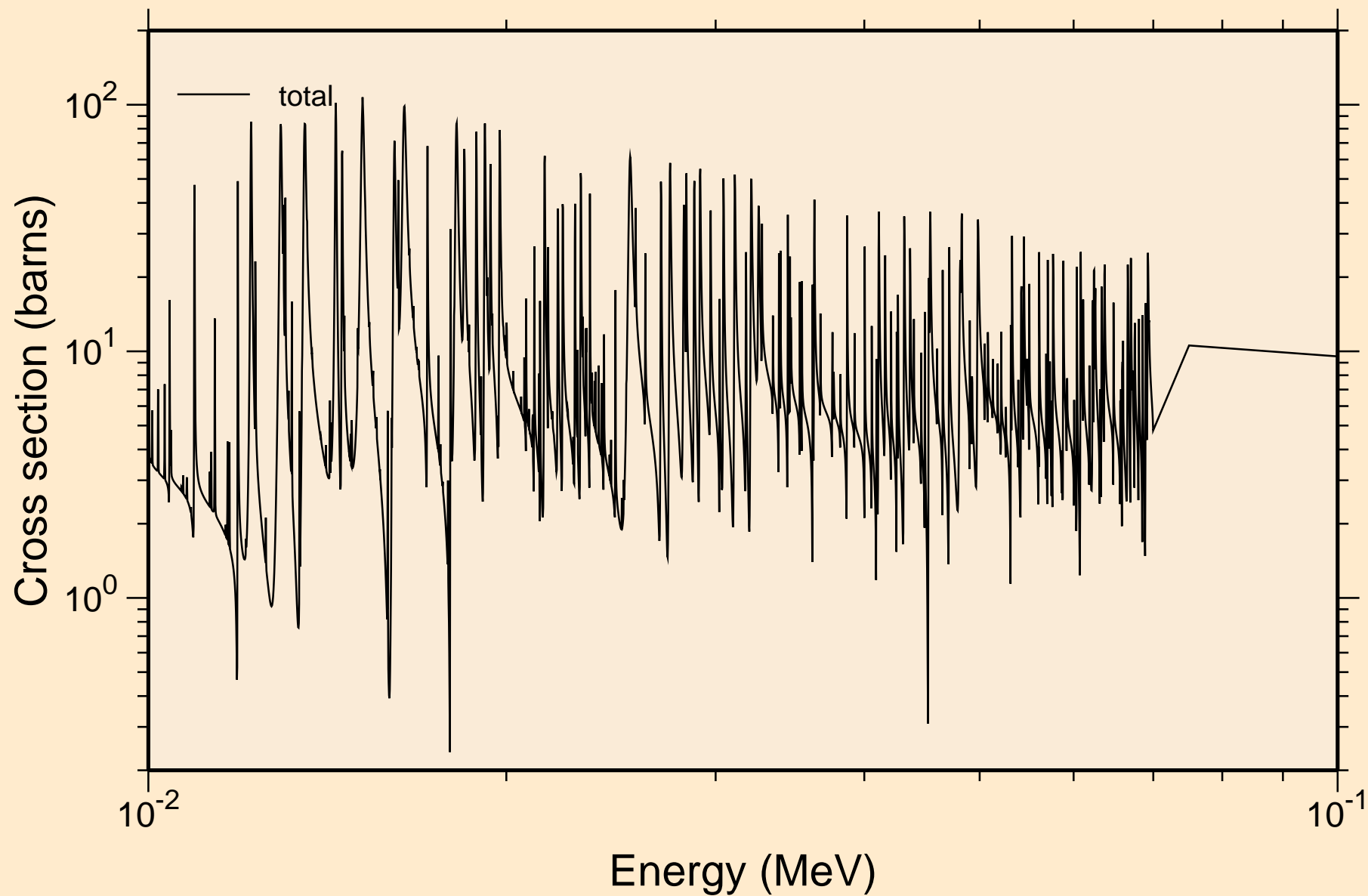

30-ZN-67 FOR FENDL-3.1 FROM FENDL-3.1 WITH NJOY2012.50+
resonance total cross section

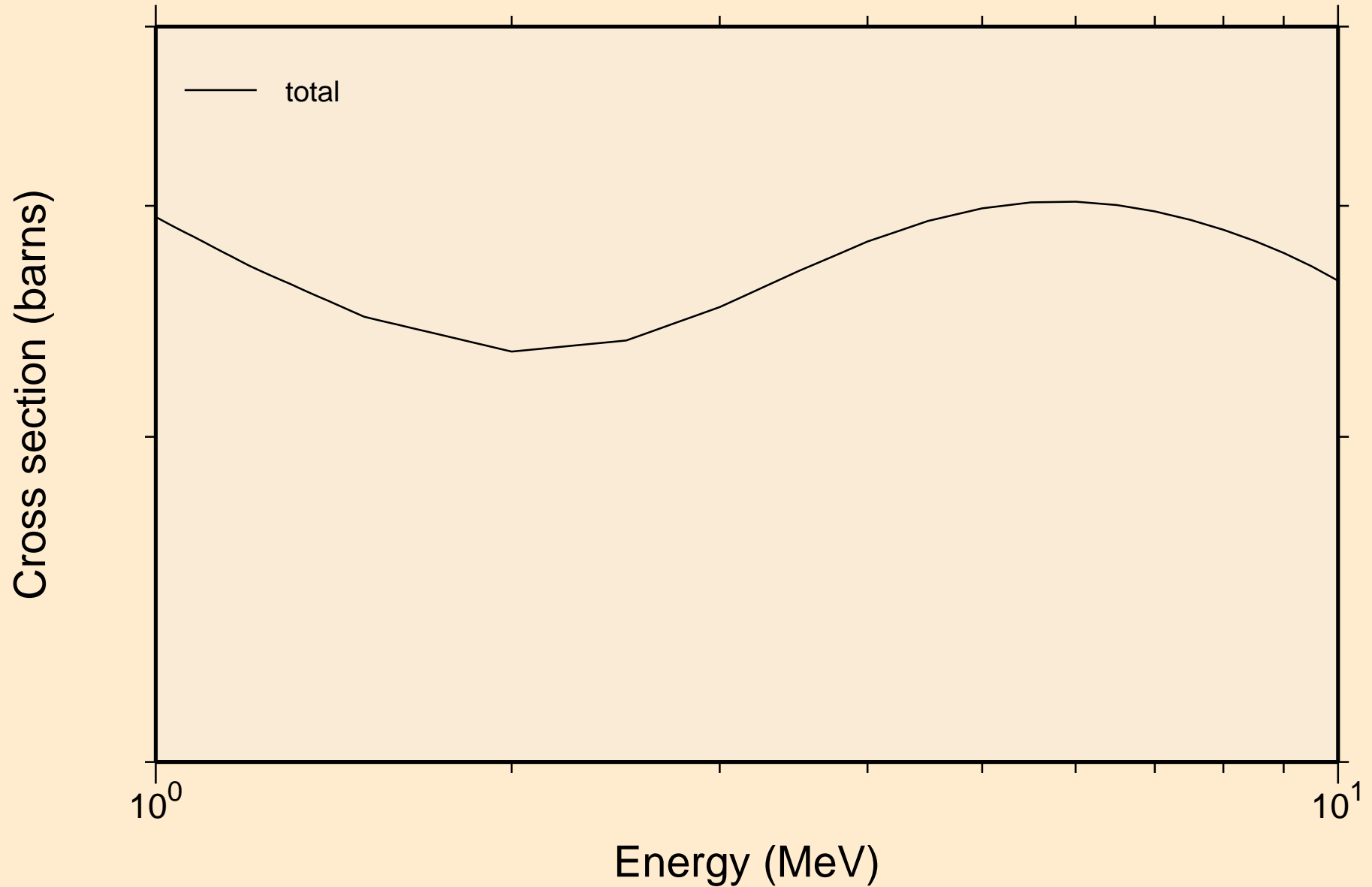

30-ZN-67 FOR FENDL-3.1 FROM FENDL-3.1 WITH NJOY2012.50+
resonance absorption cross sections

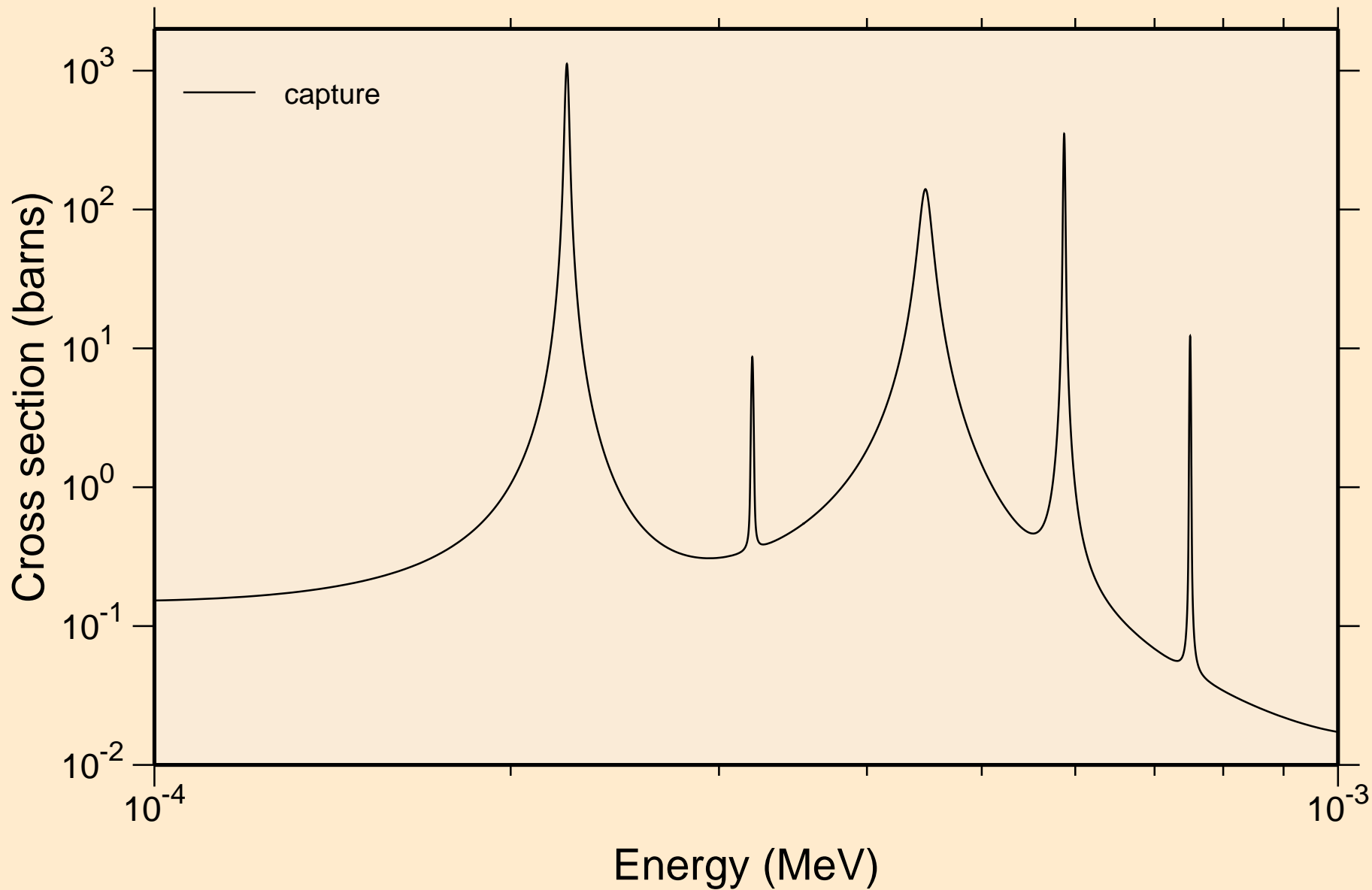

30-ZN-67 FOR FENDL-3.1 FROM FENDL-3.1 WITH NJOY2012.50+
resonance absorption cross sections

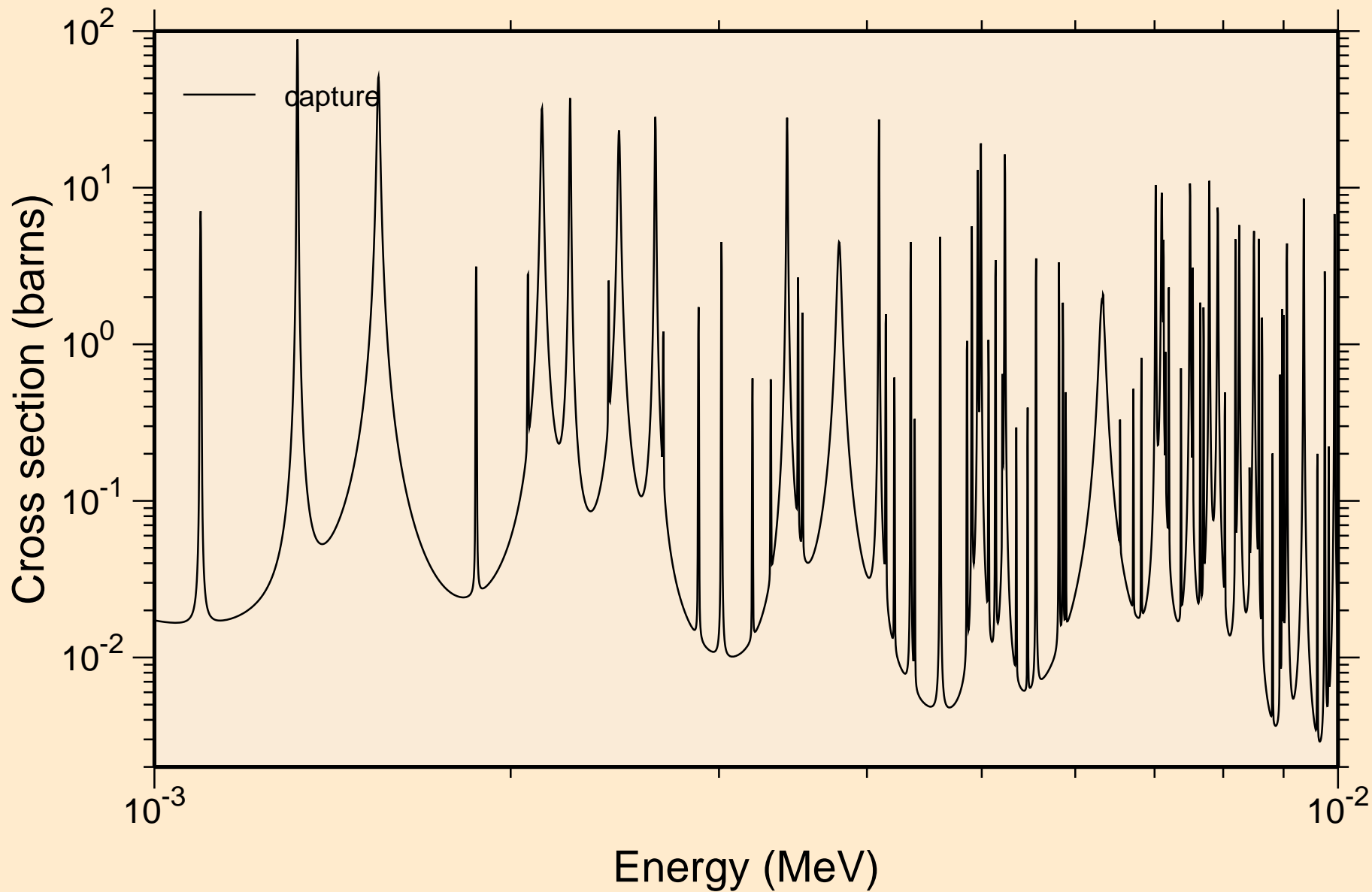

30-ZN-67 FOR FENDL-3.1 FROM FENDL-3.1 WITH NJOY2012.50+
resonance absorption cross sections

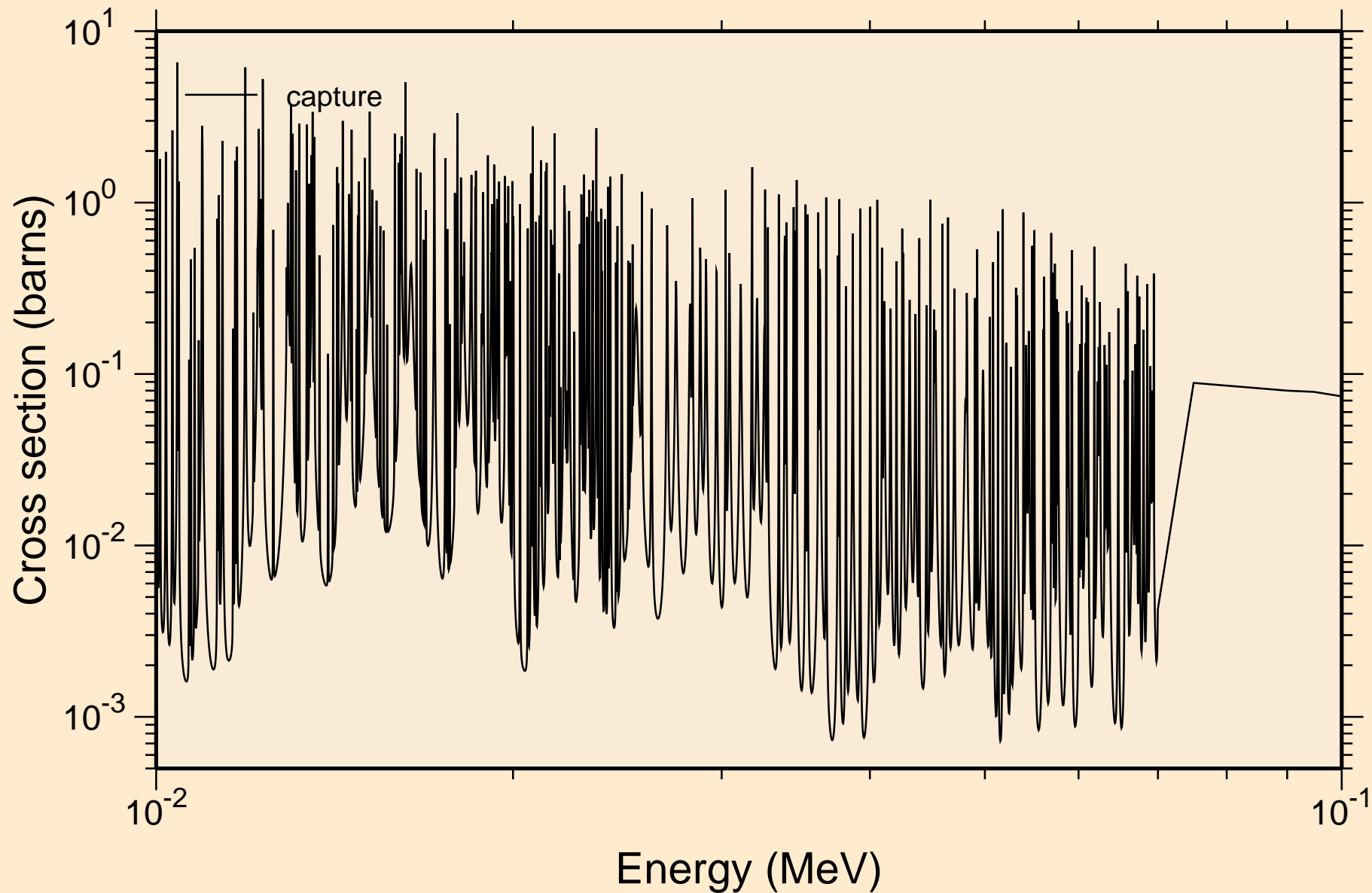

30-ZN-67 FOR FENDL-3.1 FROM FENDL-3.1 WITH NJOY2012.50+
resonance absorption cross sections

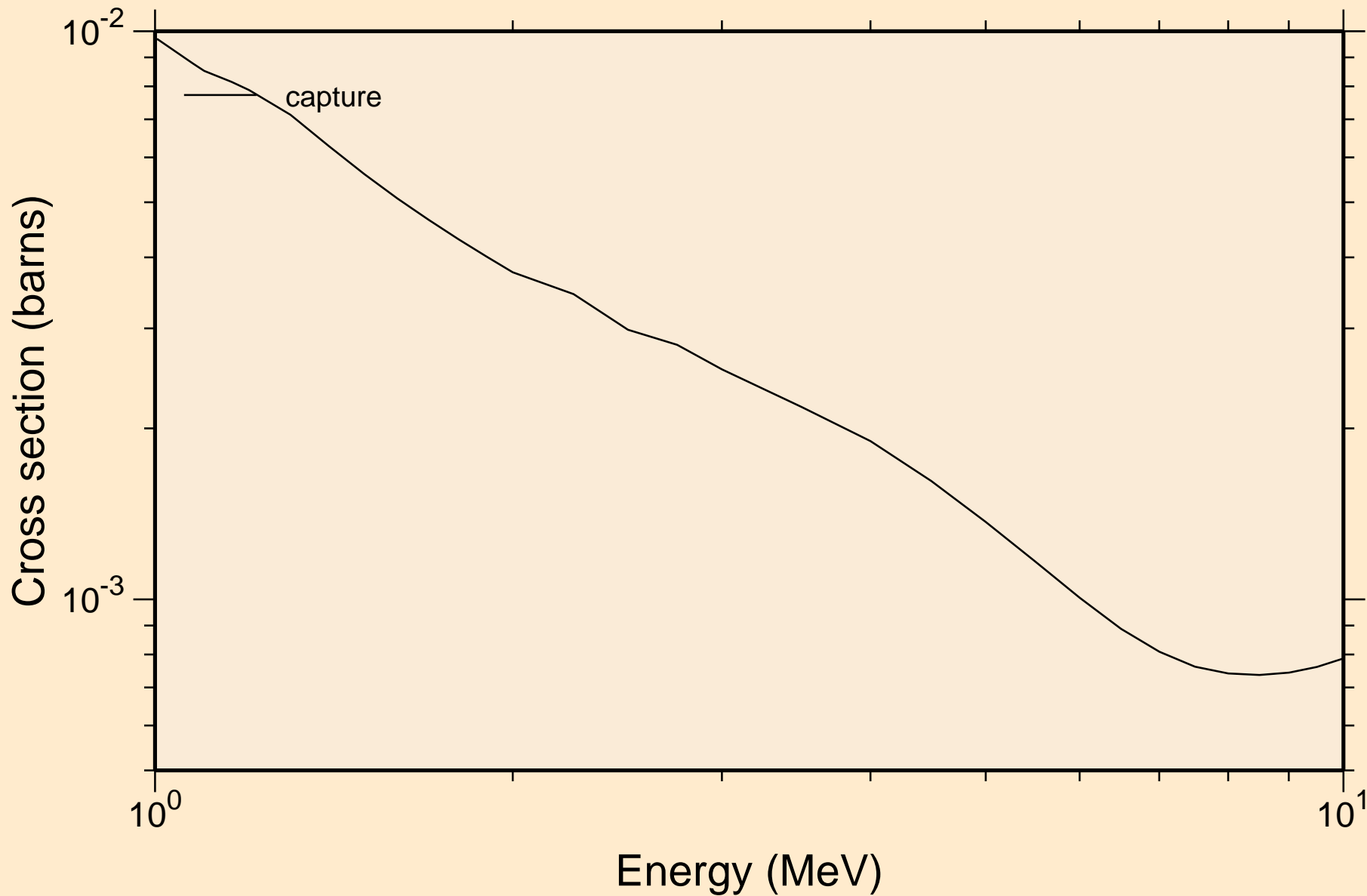

30-ZN-67 FOR FENDL-3.1 FROM FENDL-3.1 WITH NJOY2012.50+
UR total cross section

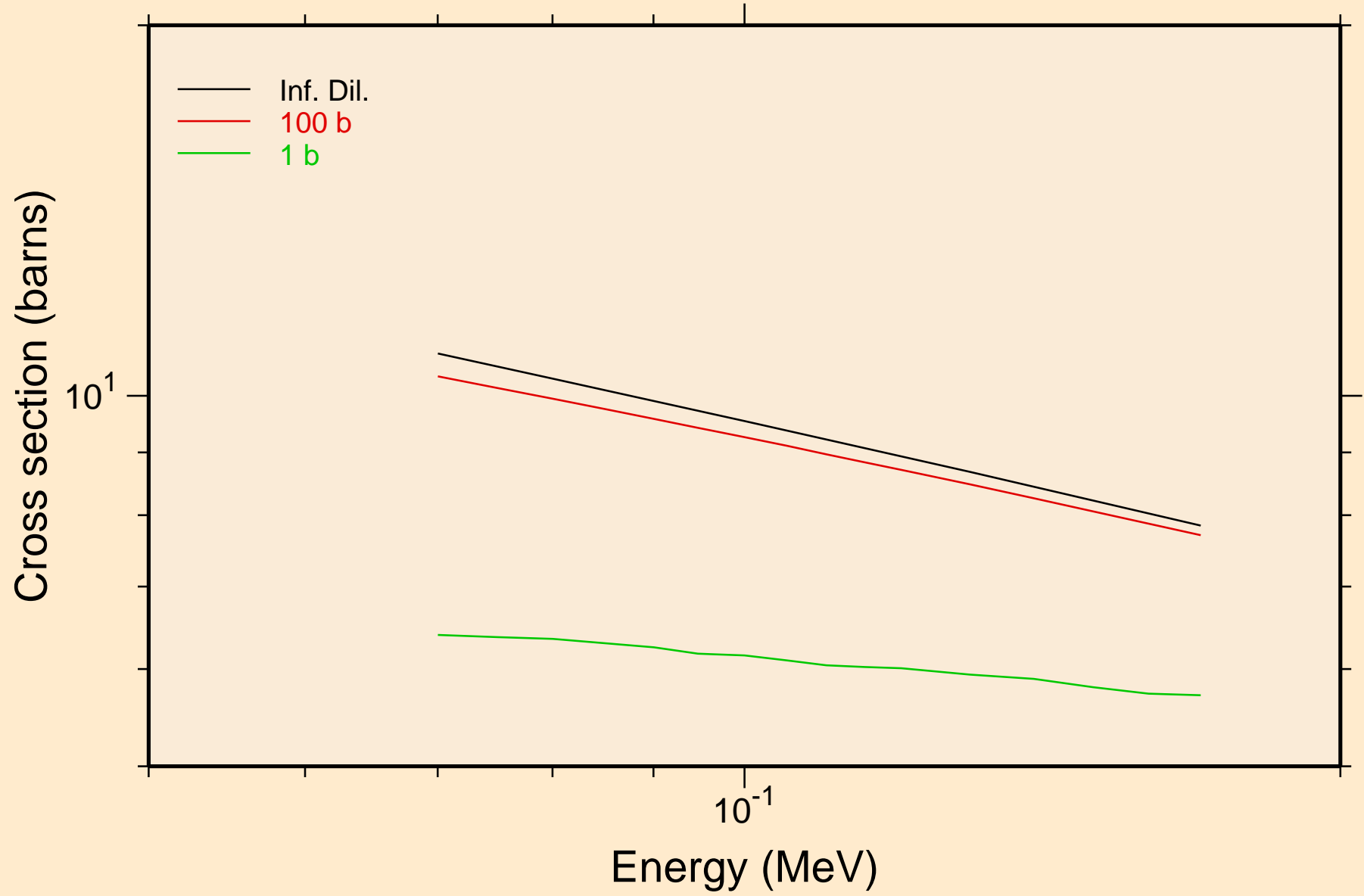

30-ZN-67 FOR FENDL-3.1 FROM FENDL-3.1 WITH NJOY2012.50+
UR elastic cross section

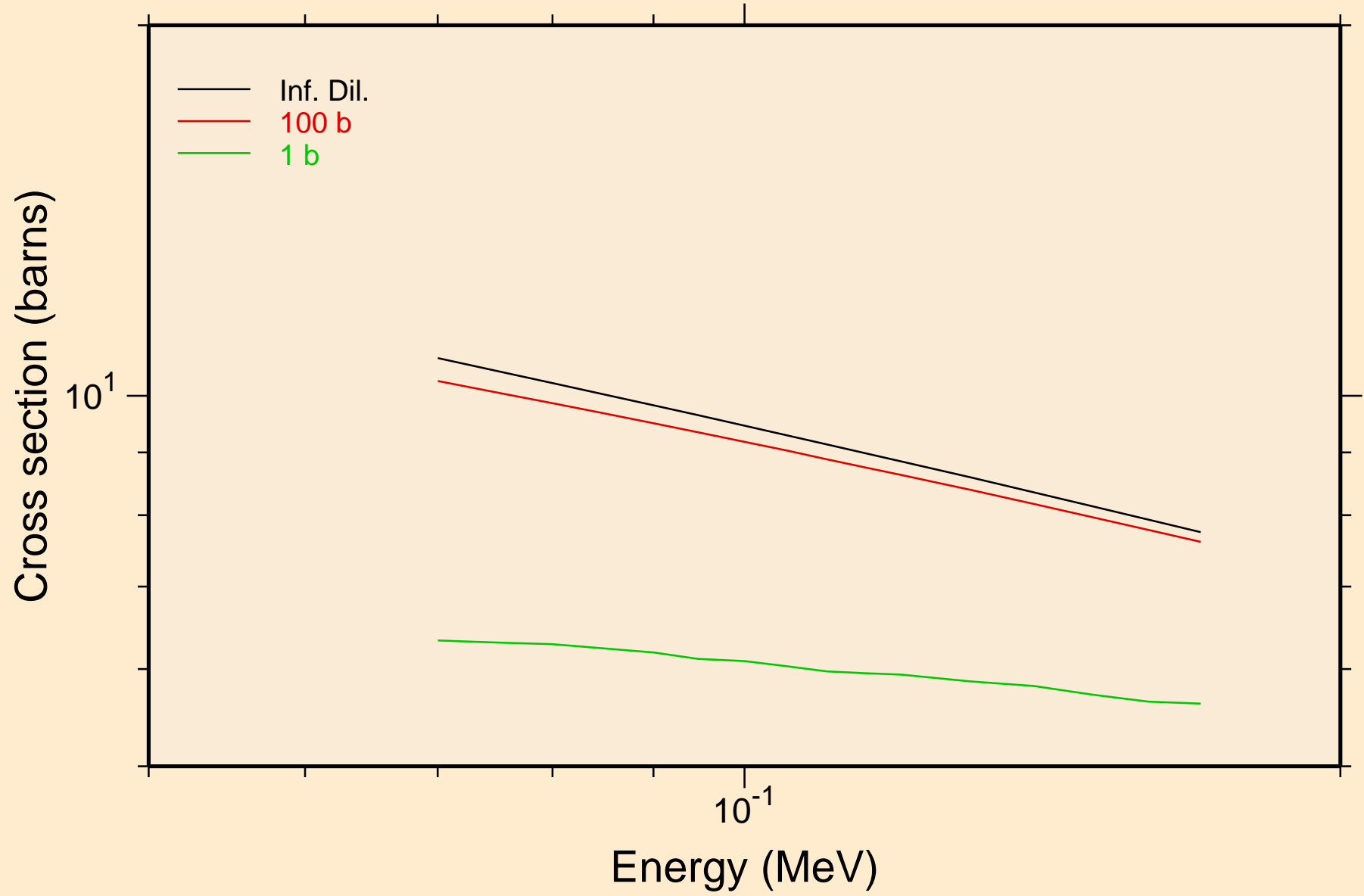

30-ZN-67 FOR FENDL-3.1 FROM FENDL-3.1 WITH NJOY2012.50+
UR capture cross section

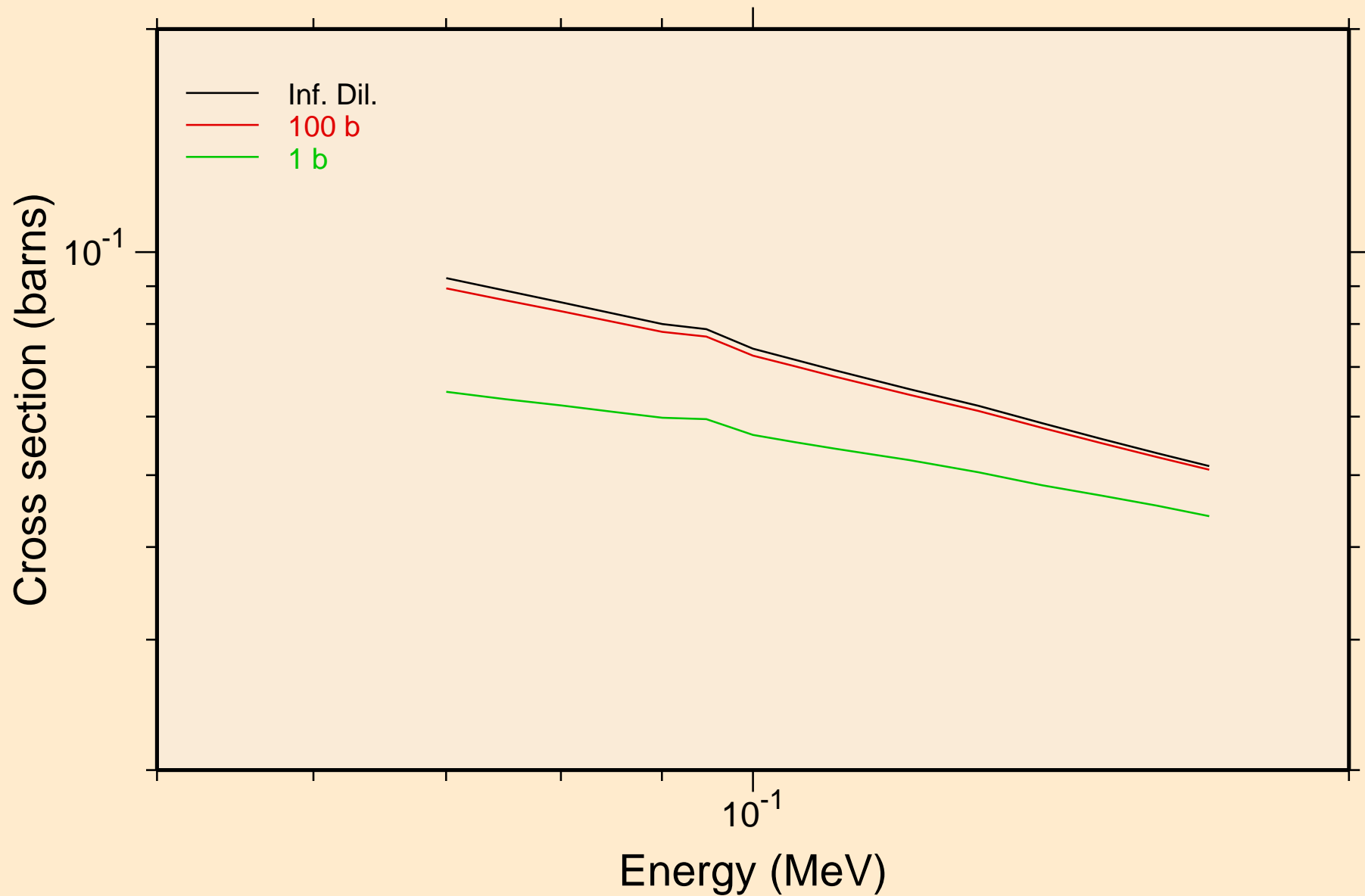

30-ZN-67 FOR FENDL-3.1 FROM FENDL-3.1 WITH NJOY2012.50+ Heating

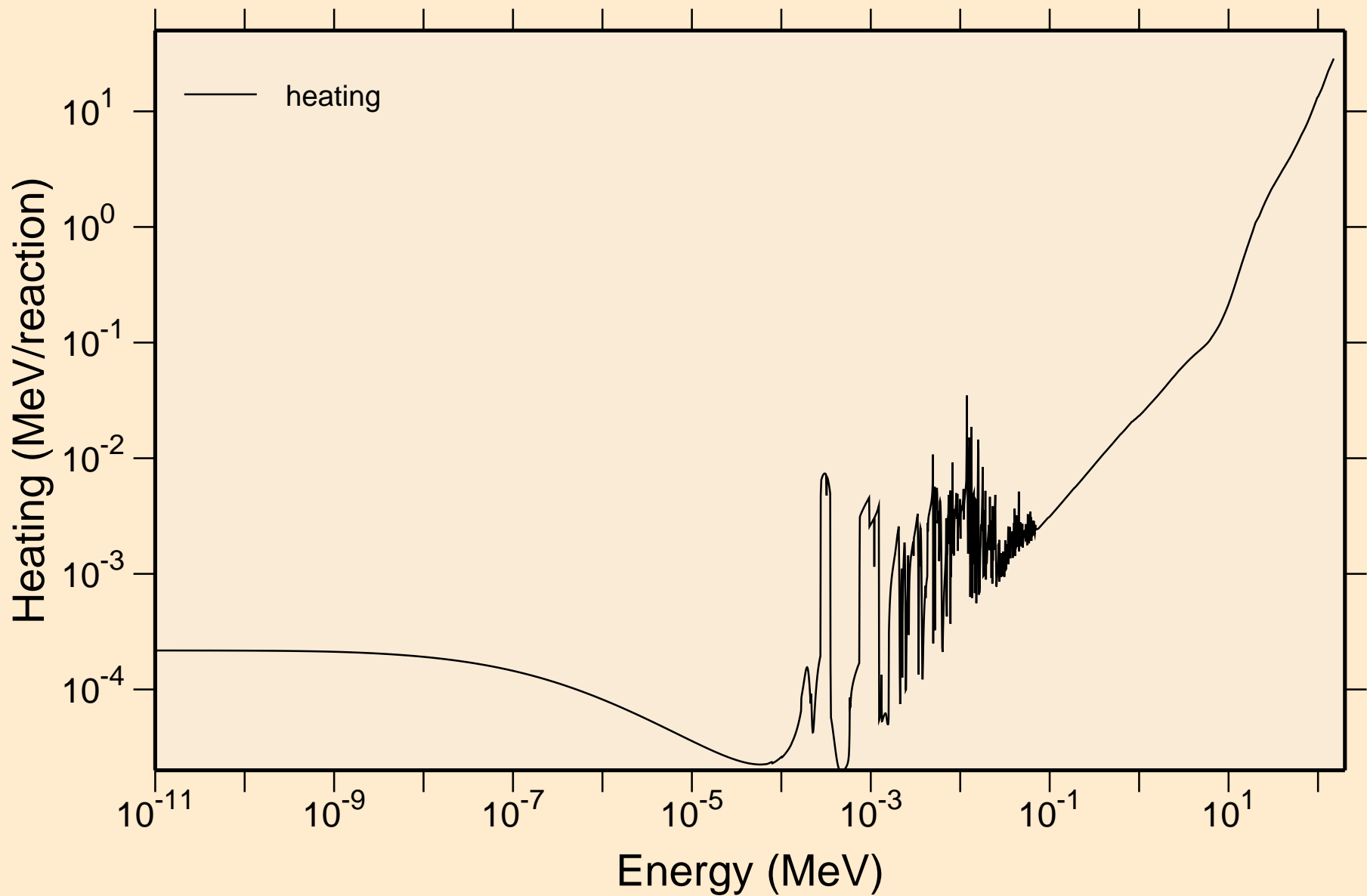

30-ZN-67 FOR FENDL-3.1 FROM FENDL-3.1 WITH NJOY2012.50+ Damage

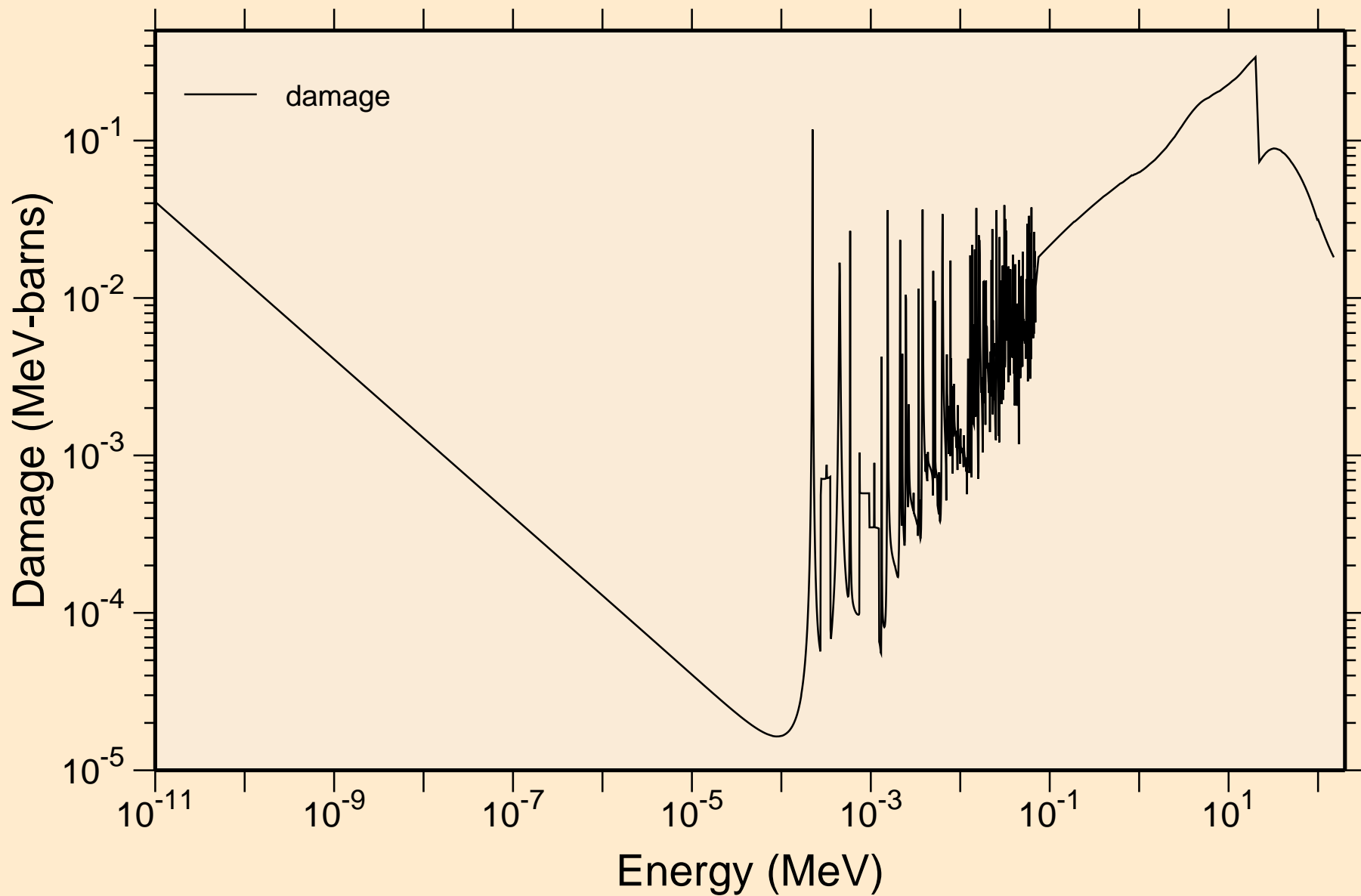

30-ZN-67 FOR FENDL-3.1 FROM FENDL-3.1 WITH NJOY2012.50+
Non-threshold reactions

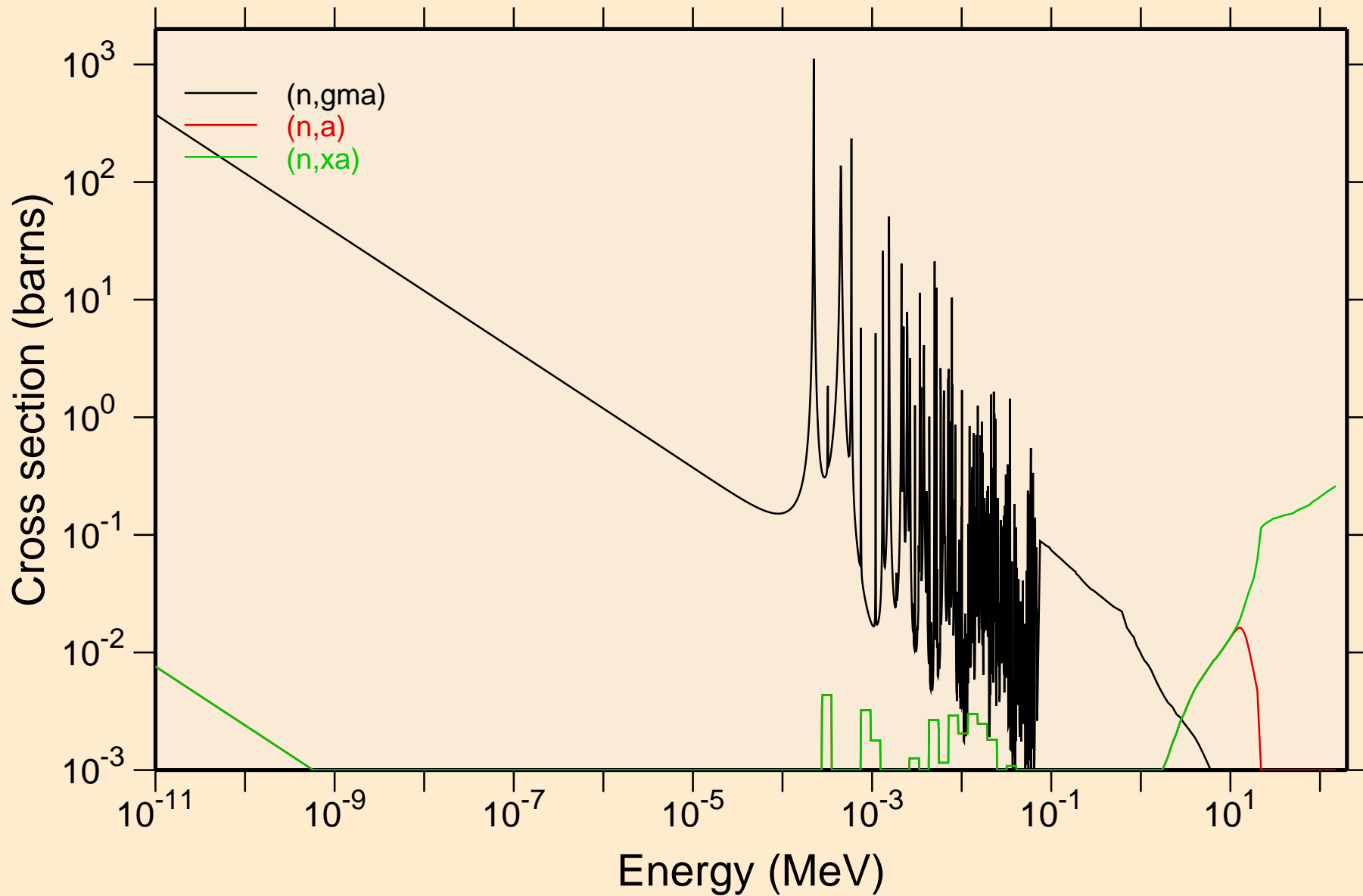

30-ZN-67 FOR FENDL-3.1 FROM FENDL-3.1 WITH NJOY2012.50+
Principal cross sections

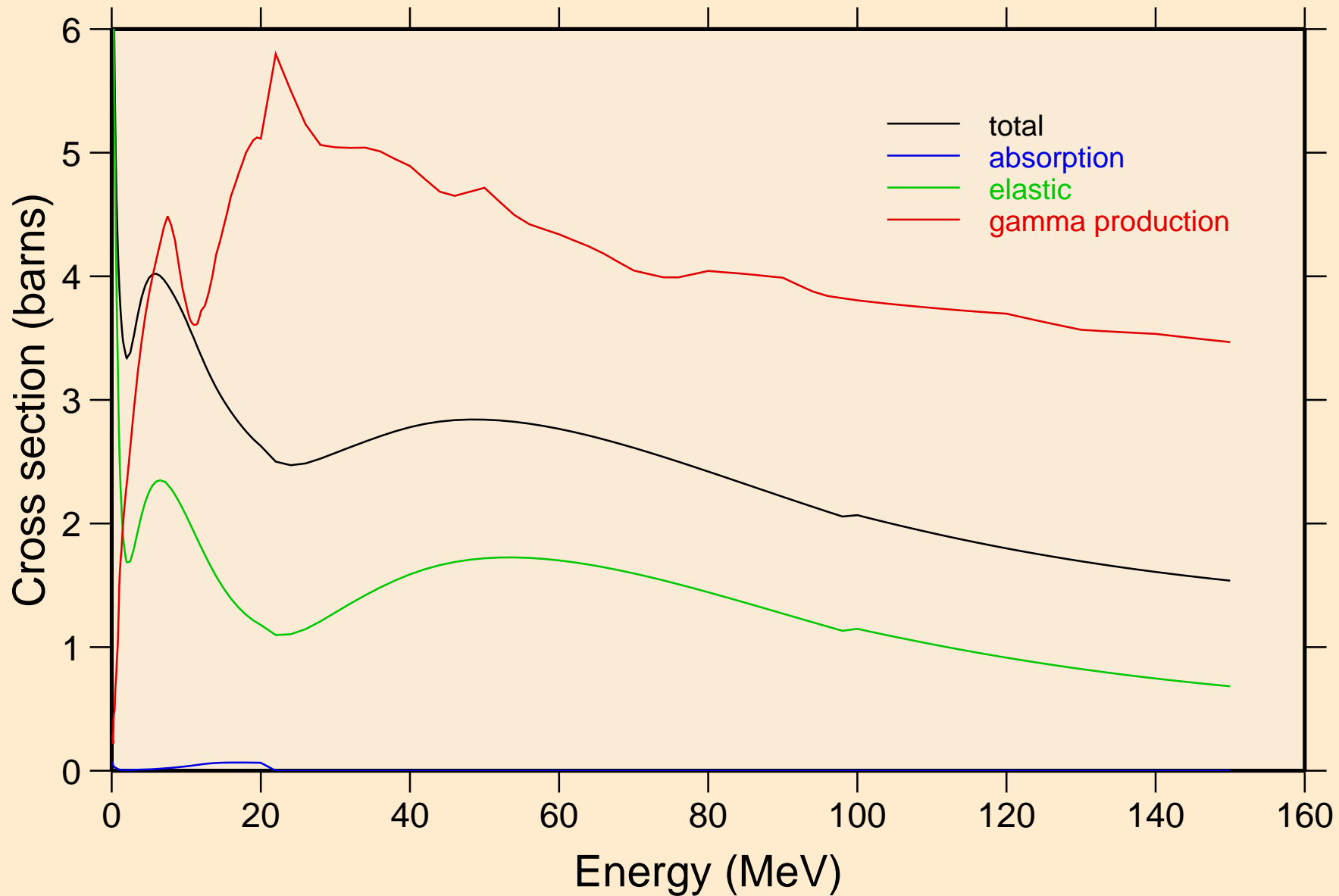

30-ZN-67 FOR FENDL-3.1 FROM FENDL-3.1 WITH NJOY2012.50+ Heating

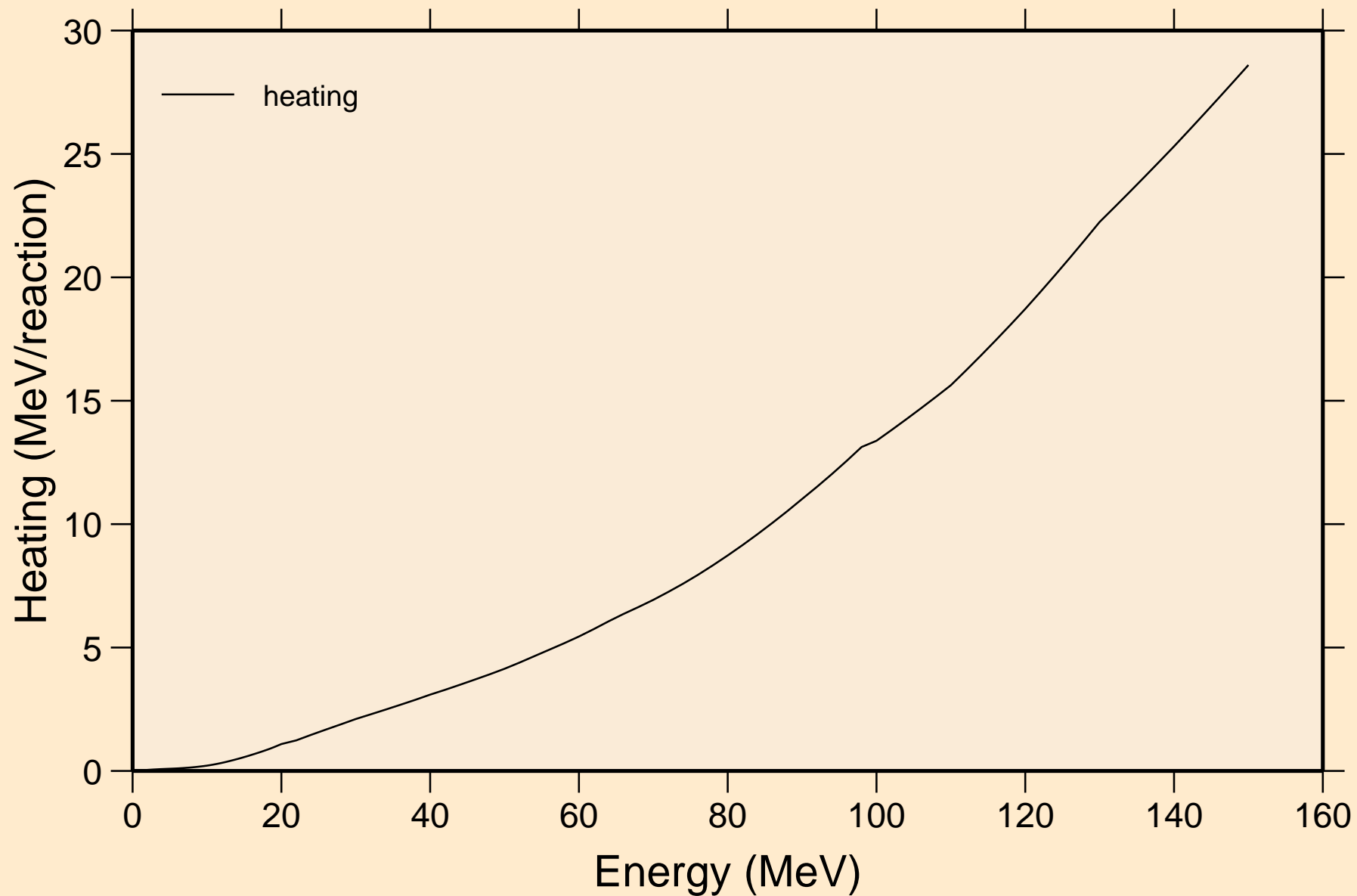

30-ZN-67 FOR FENDL-3.1 FROM FENDL-3.1 WITH NJOY2012.50+ Damage

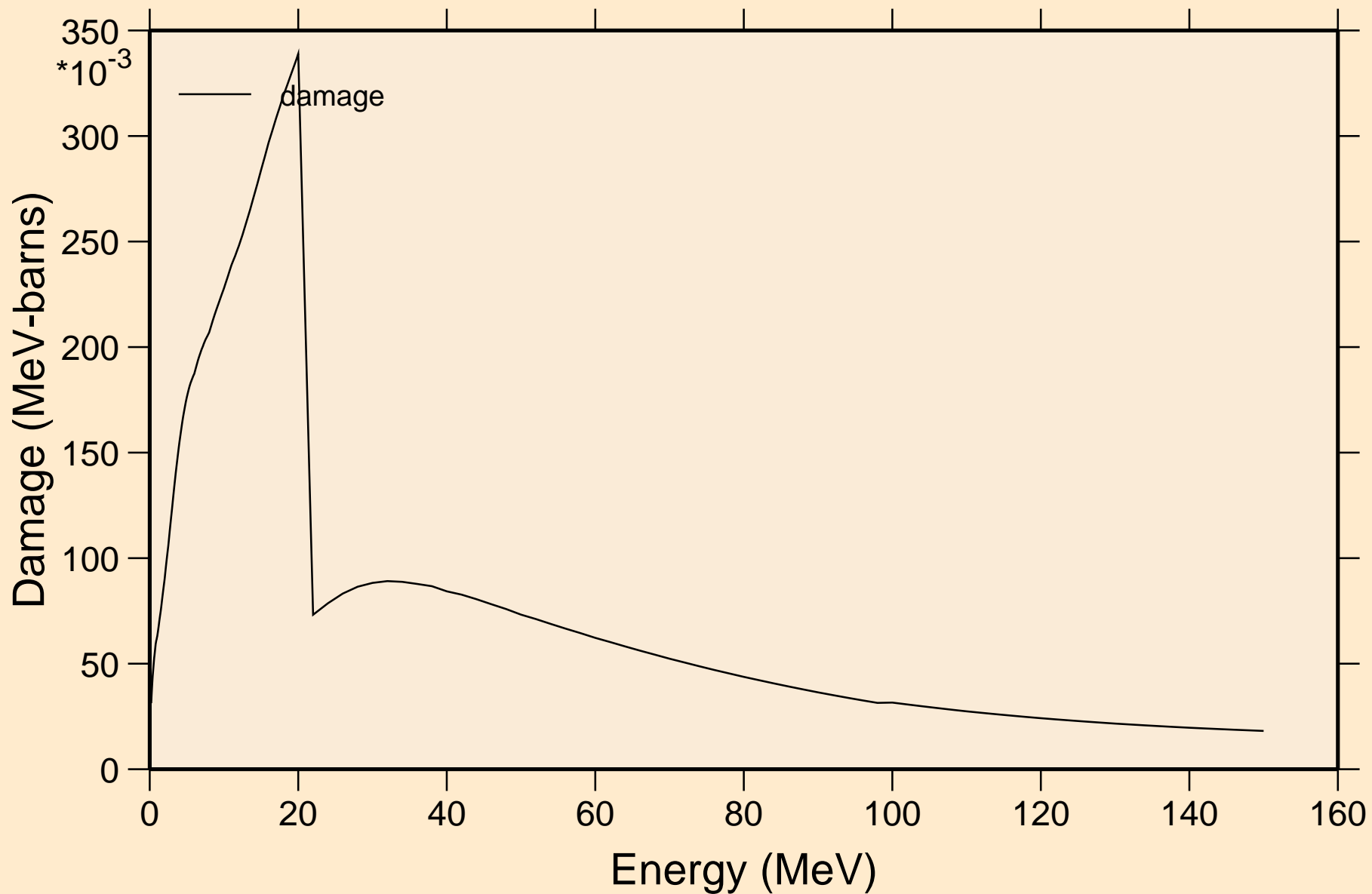

30-ZN-67 FOR FENDL-3.1 FROM FENDL-3.1 WITH NJOY2012.50+
Non-threshold reactions

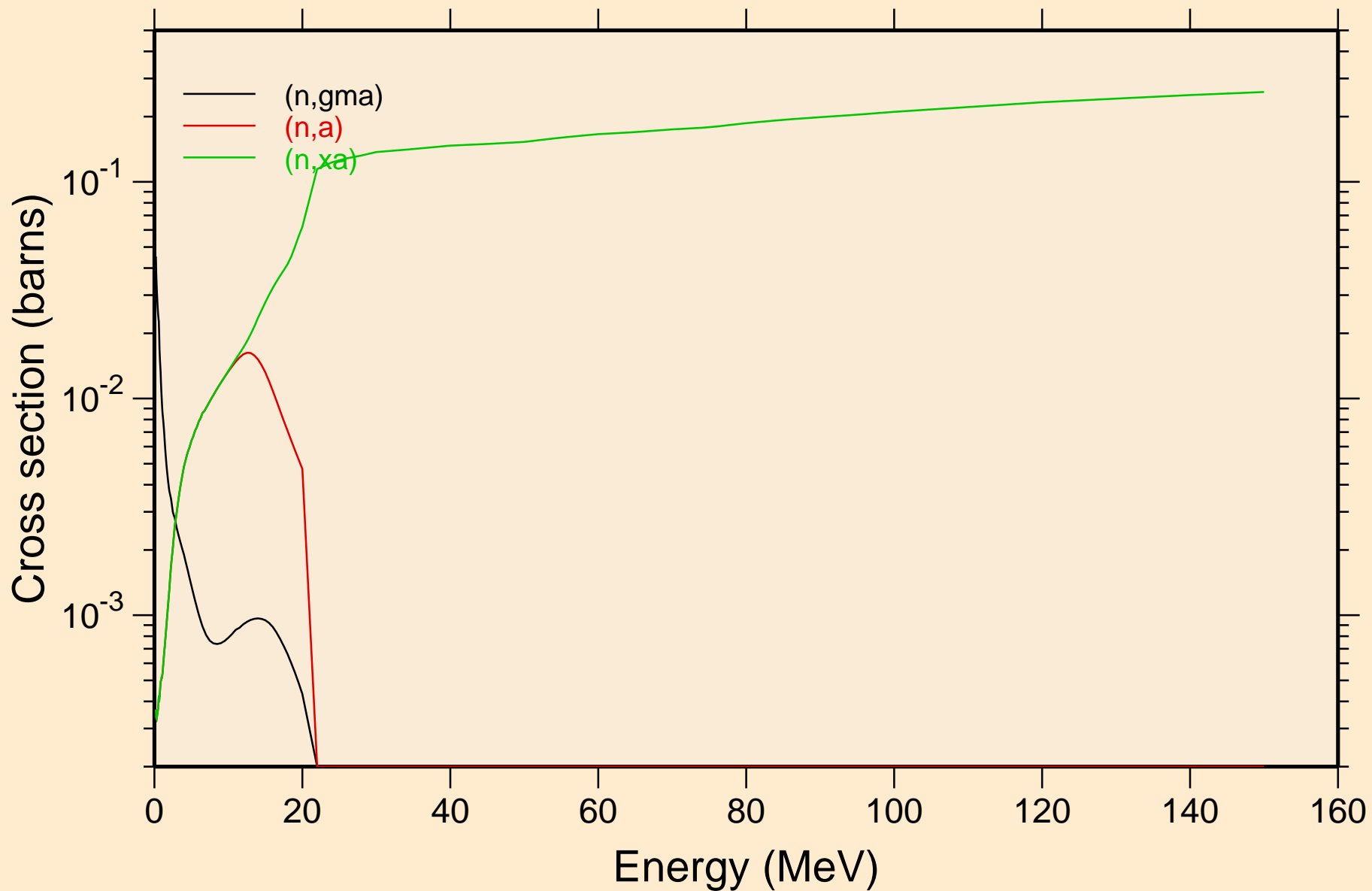

30-ZN-67 FOR FENDL-3.1 FROM FENDL-3.1 WITH NJOY2012.50+ Inelastic levels

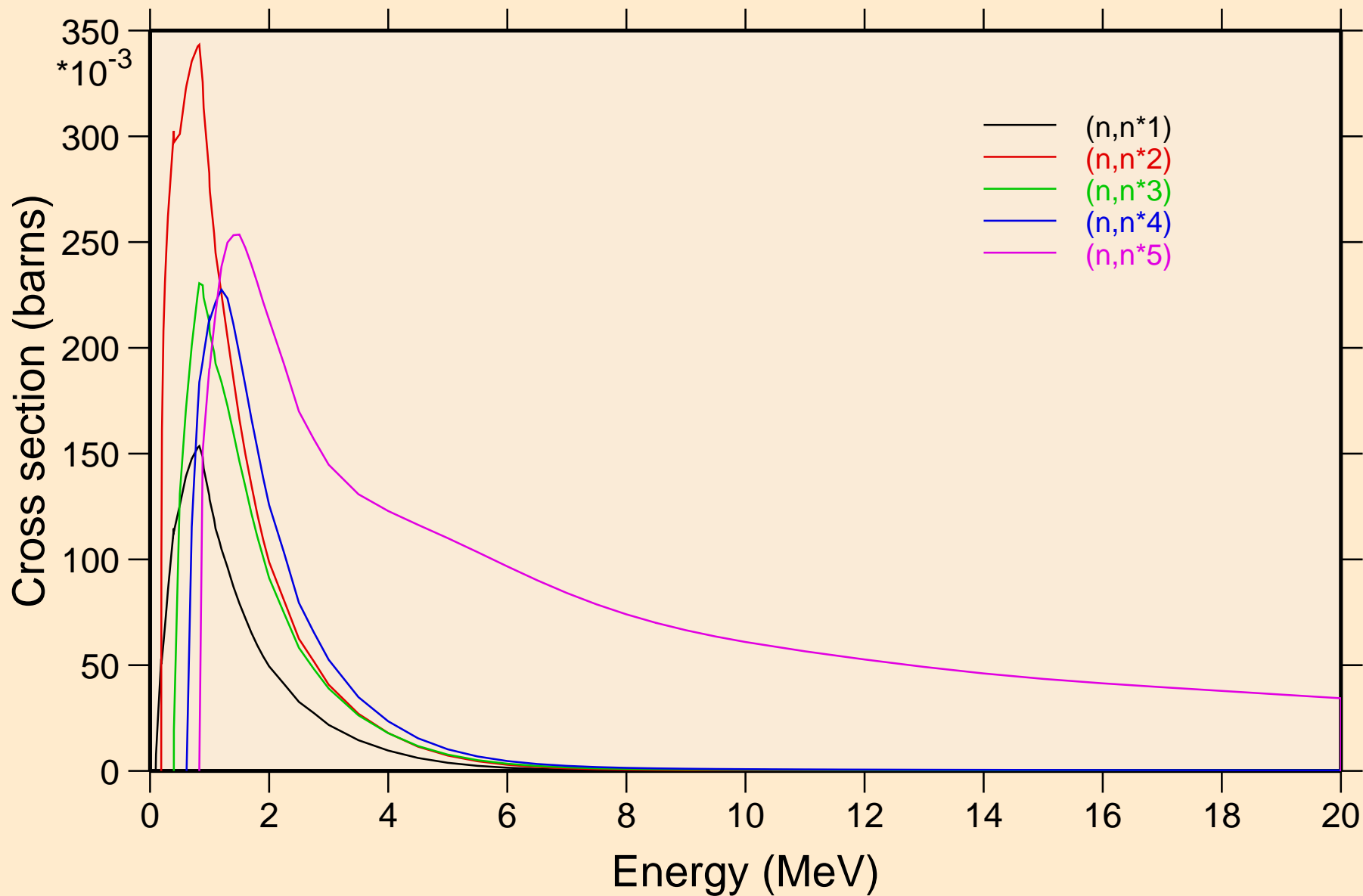

30-ZN-67 FOR FENDL-3.1 FROM FENDL-3.1 WITH NJOY2012.50+ Inelastic levels

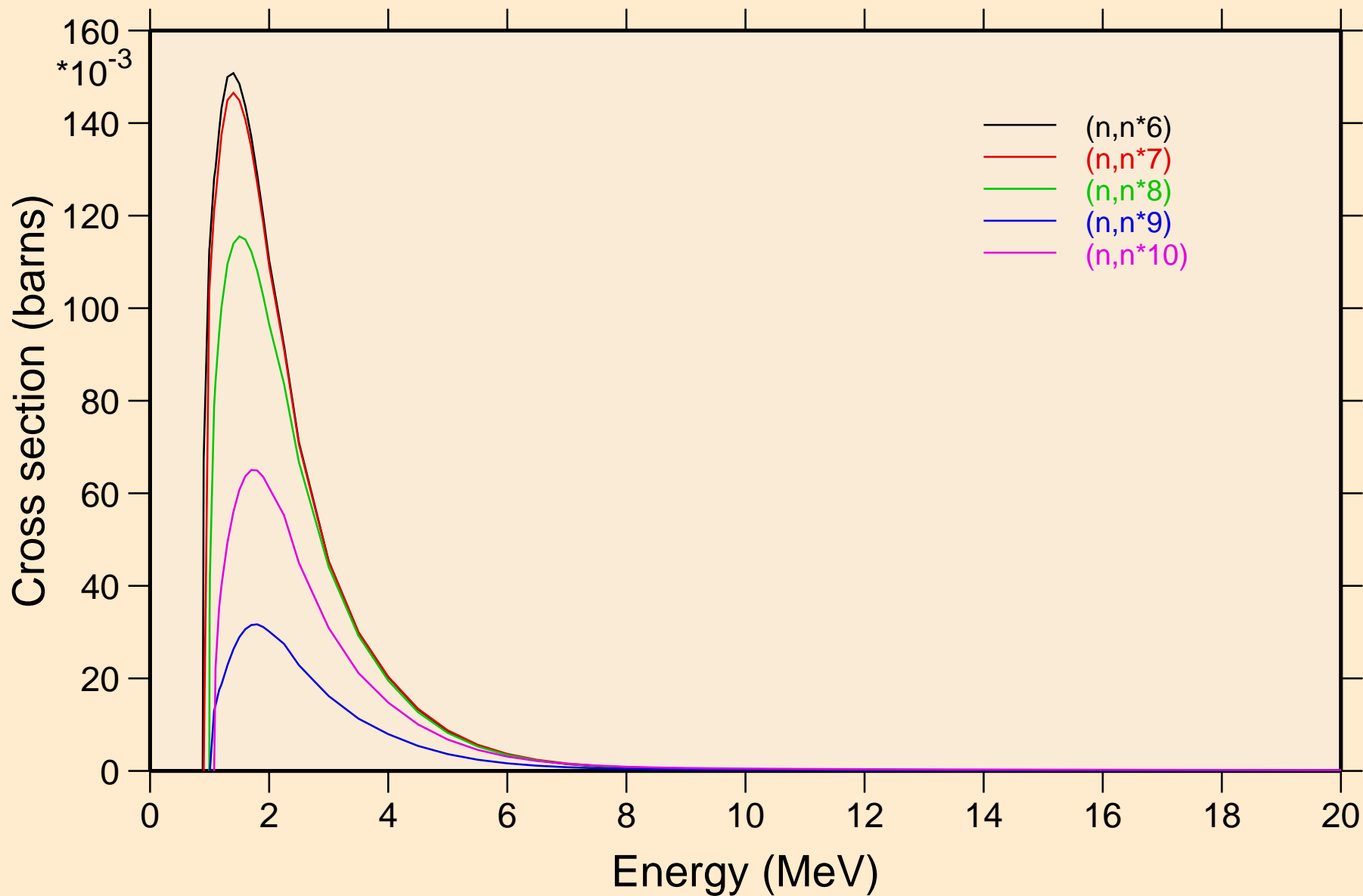

30-ZN-67 FOR FENDL-3.1 FROM FENDL-3.1 WITH NJOY2012.50+
Inelastic levels

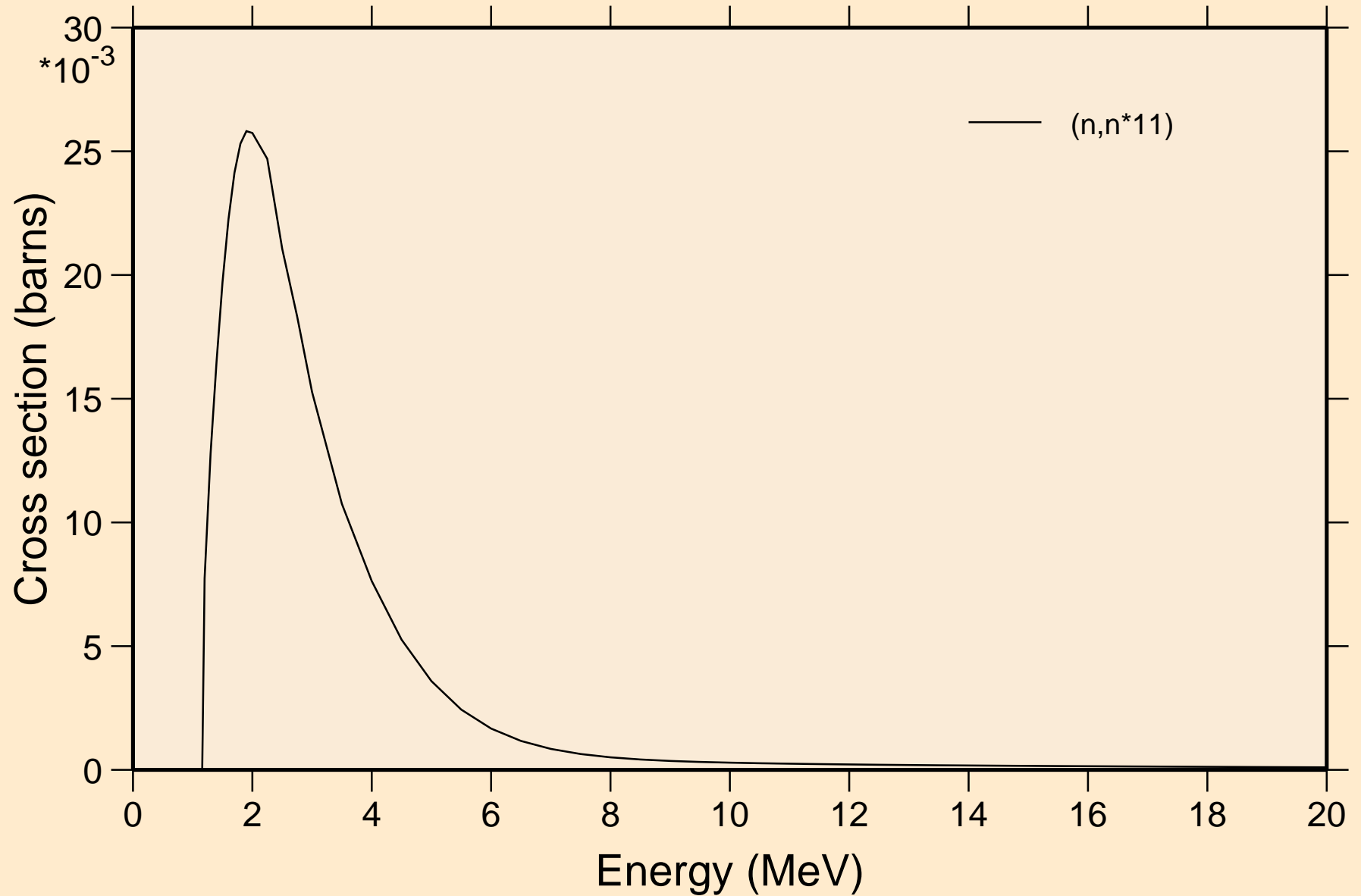

30-ZN-67 FOR FENDL-3.1 FROM FENDL-3.1 WITH NJOY2012.50+ Threshold reactions

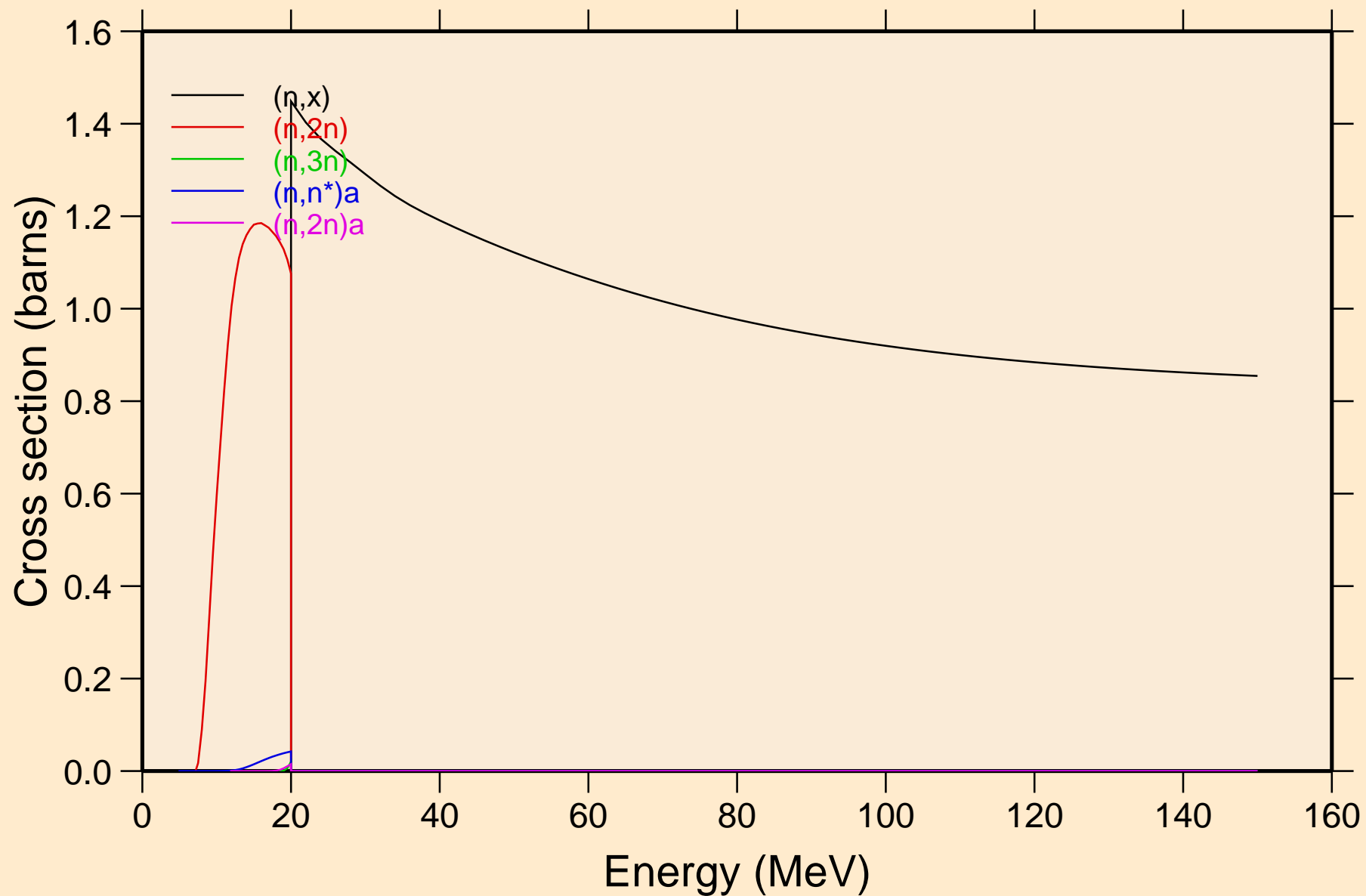

30-ZN-67 FOR FENDL-3.1 FROM FENDL-3.1 WITH NJOY2012.50+
Threshold reactions

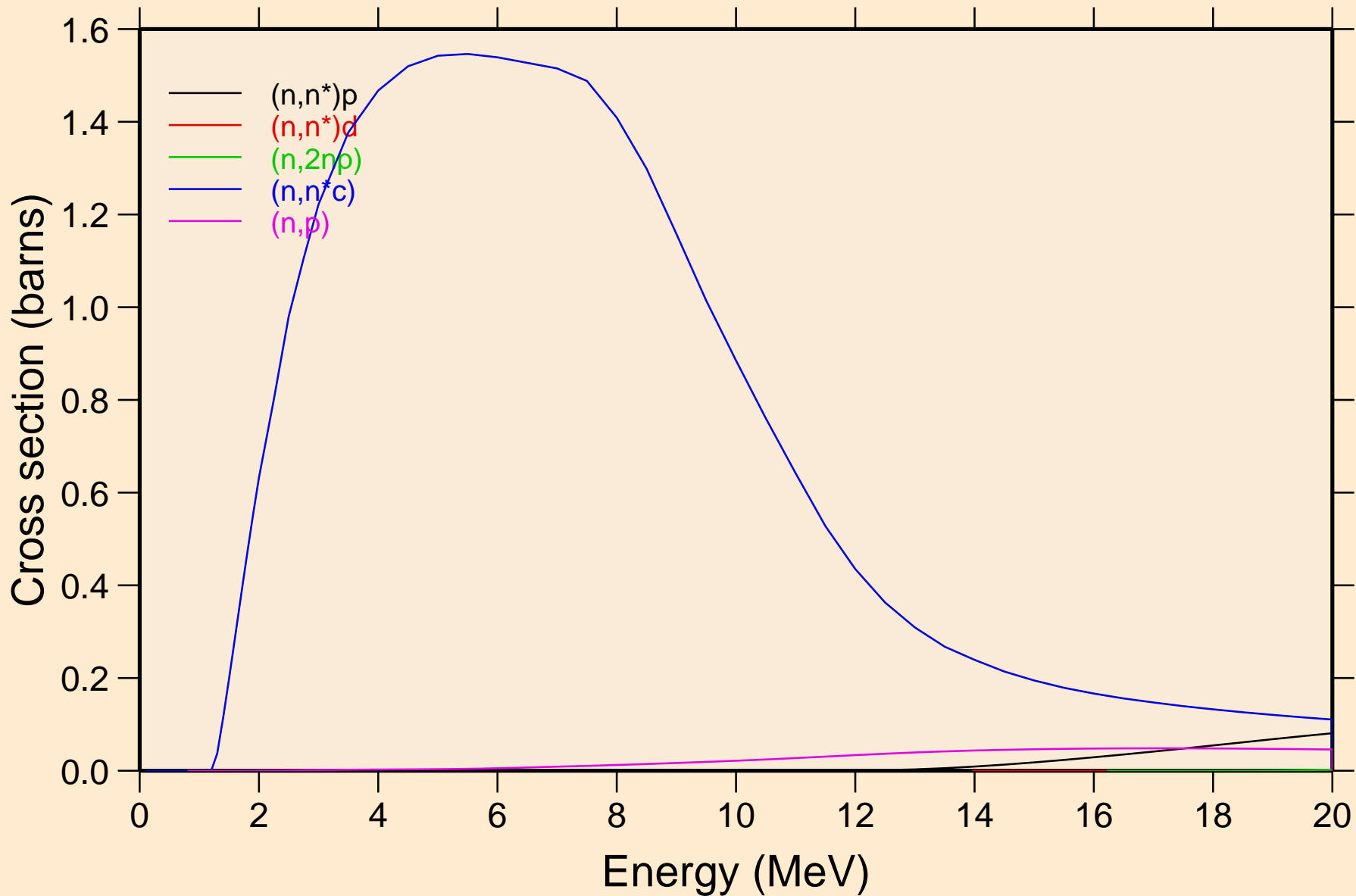

30-ZN-67 FOR FENDL-3.1 FROM FENDL-3.1 WITH NJOY2012.50+

Threshold reactions

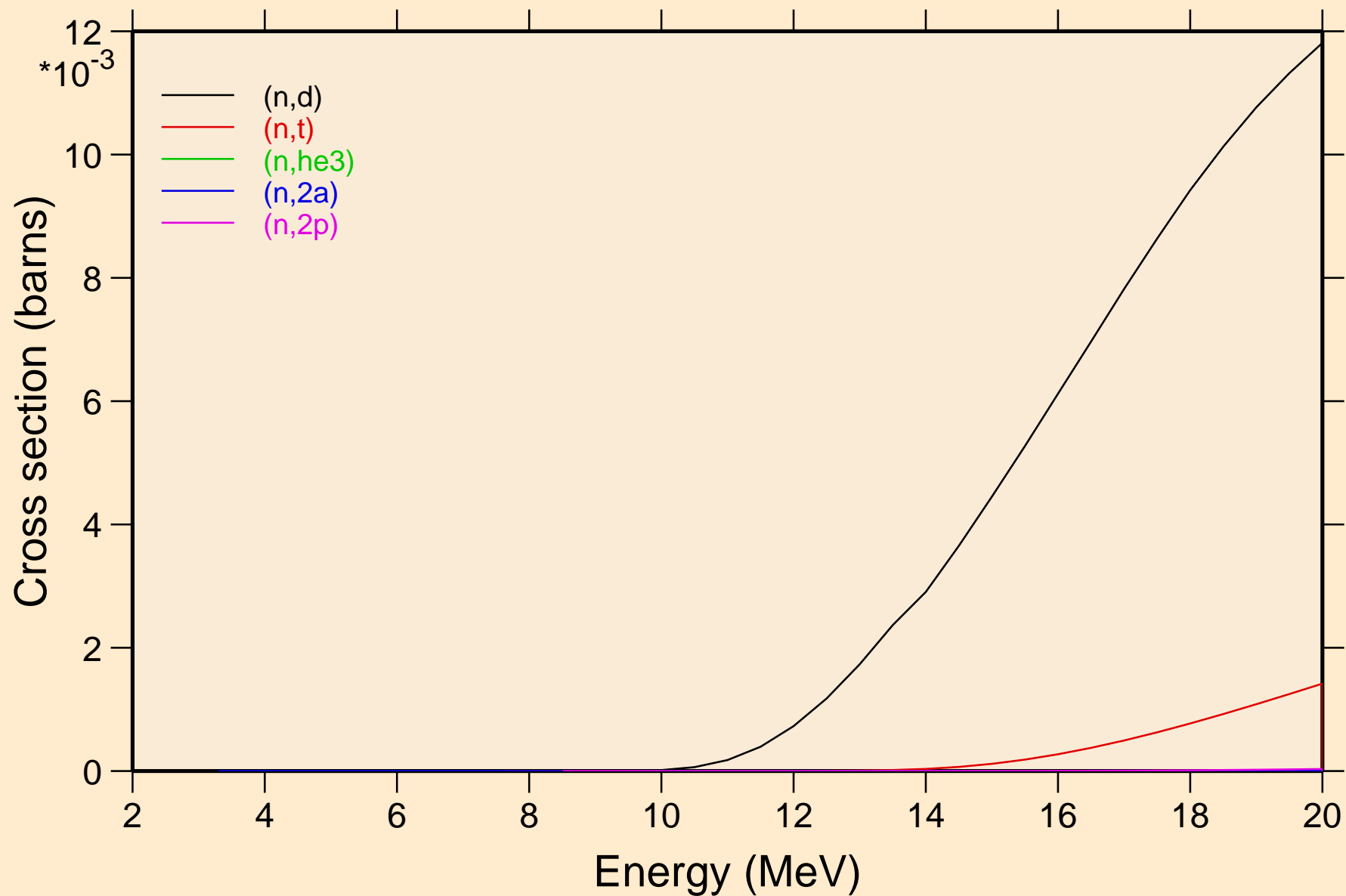

30-ZN-67 FOR FENDL-3.1 FROM FENDL-3.1 WITH NJOY2012.50+
Threshold reactions

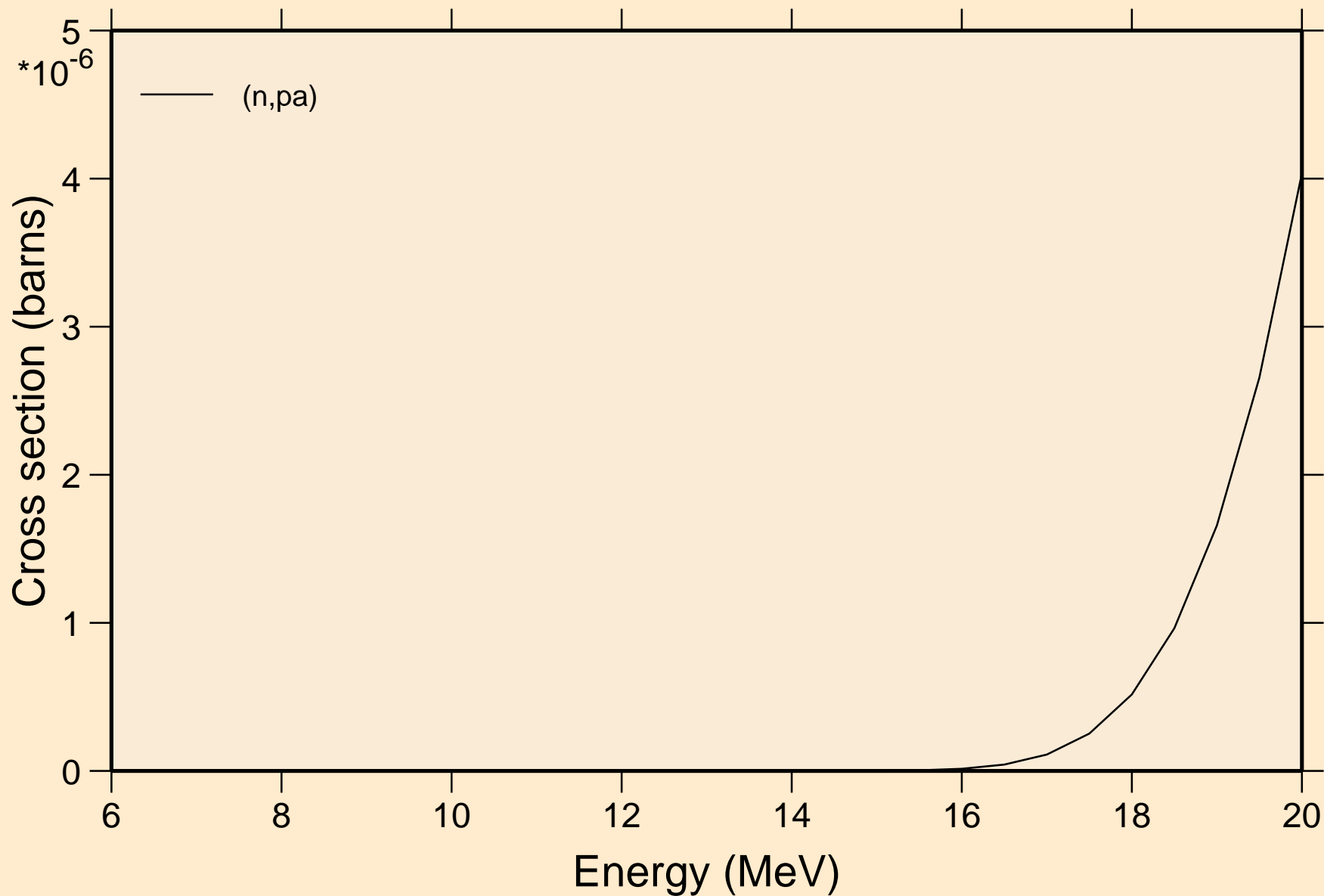

30-ZN-67 FOR FENDL-3.1 FROM FENDL-3.1 WITH NJOY2012.50+
Threshold reactions

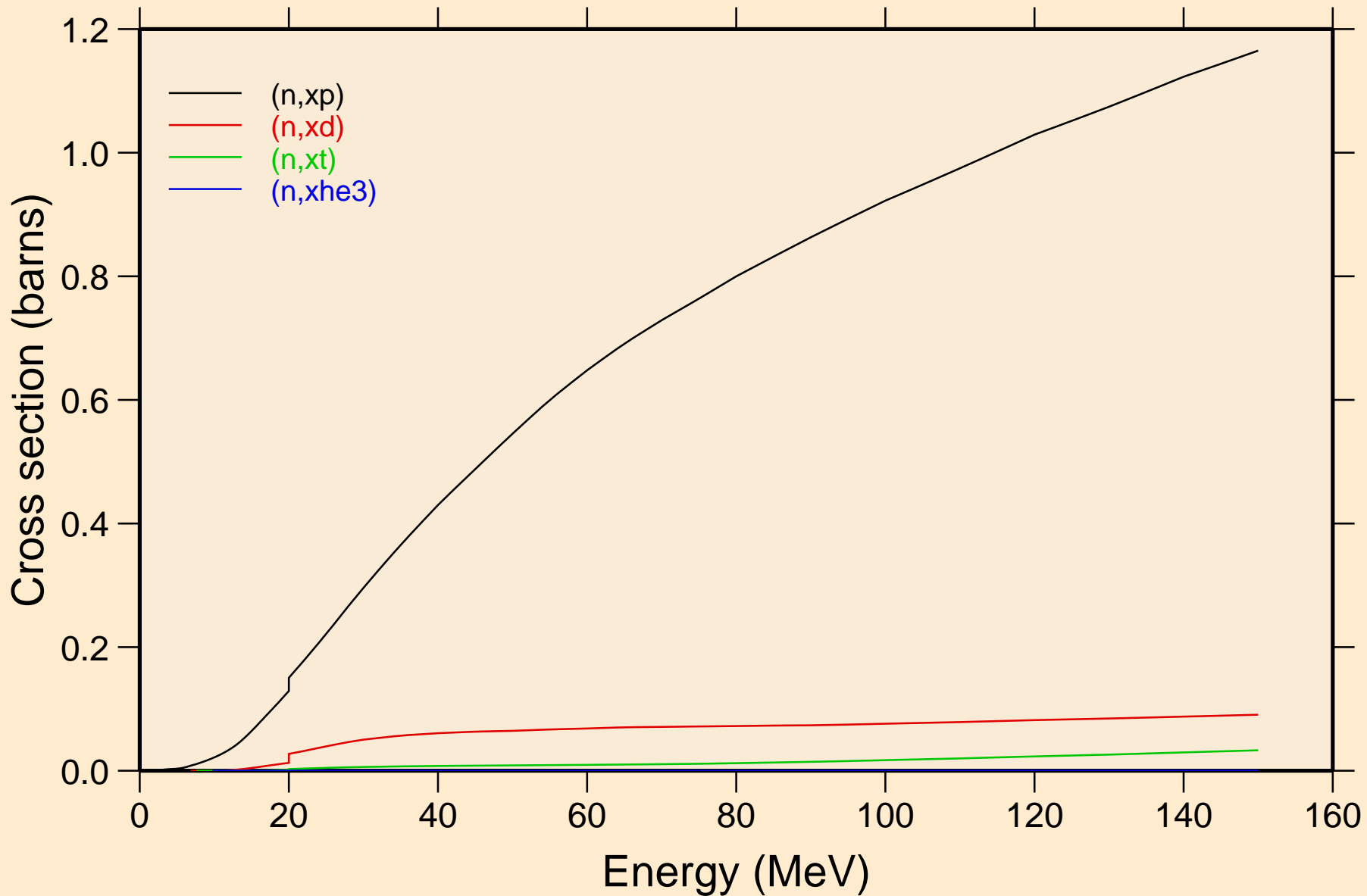

30-ZN-67 FOR FENDL-3.1 FROM FENDL-3.1 WITH NJOY2012.50+
angular distribution for elastic

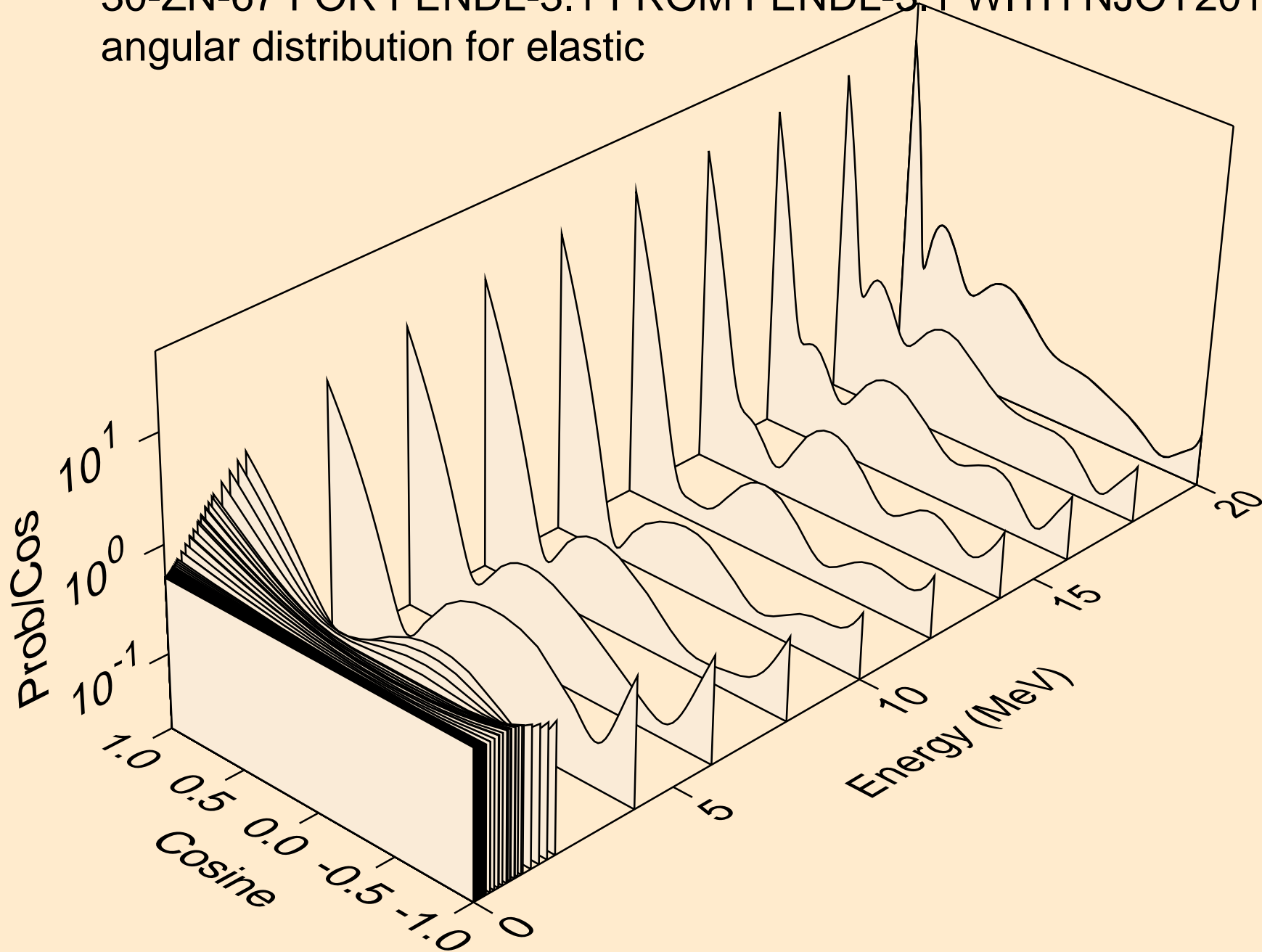

30-ZN-67 FOR FENDL-3.1 FROM FENDL-3.1 WITH NJOY2012.50+
angular distribution for elastic

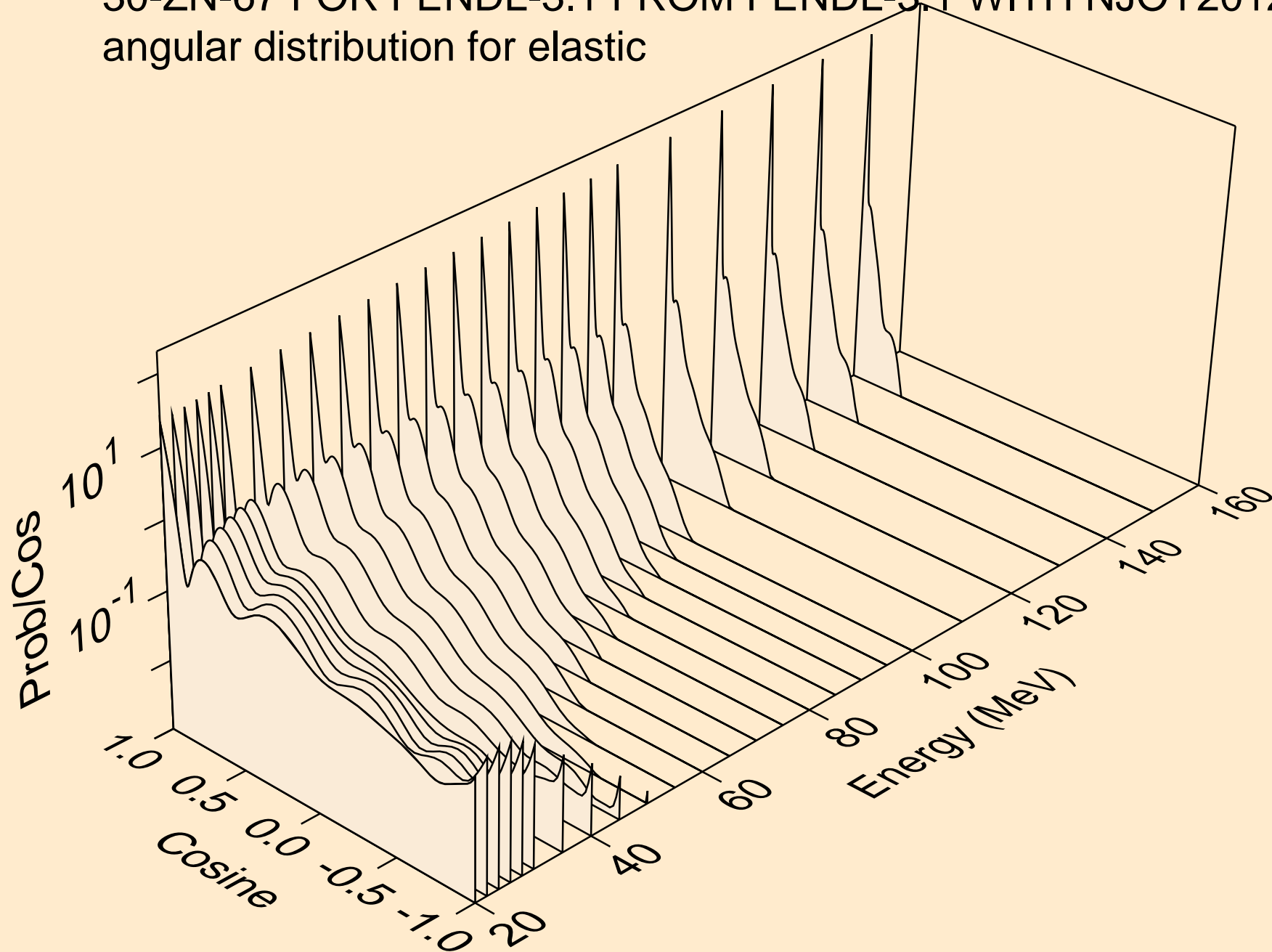

30-ZN-67 FOR FENDL-3.1 FROM FENDL-3.1 WITH NJOY2012.50+
angular distribution for (n,n*1)

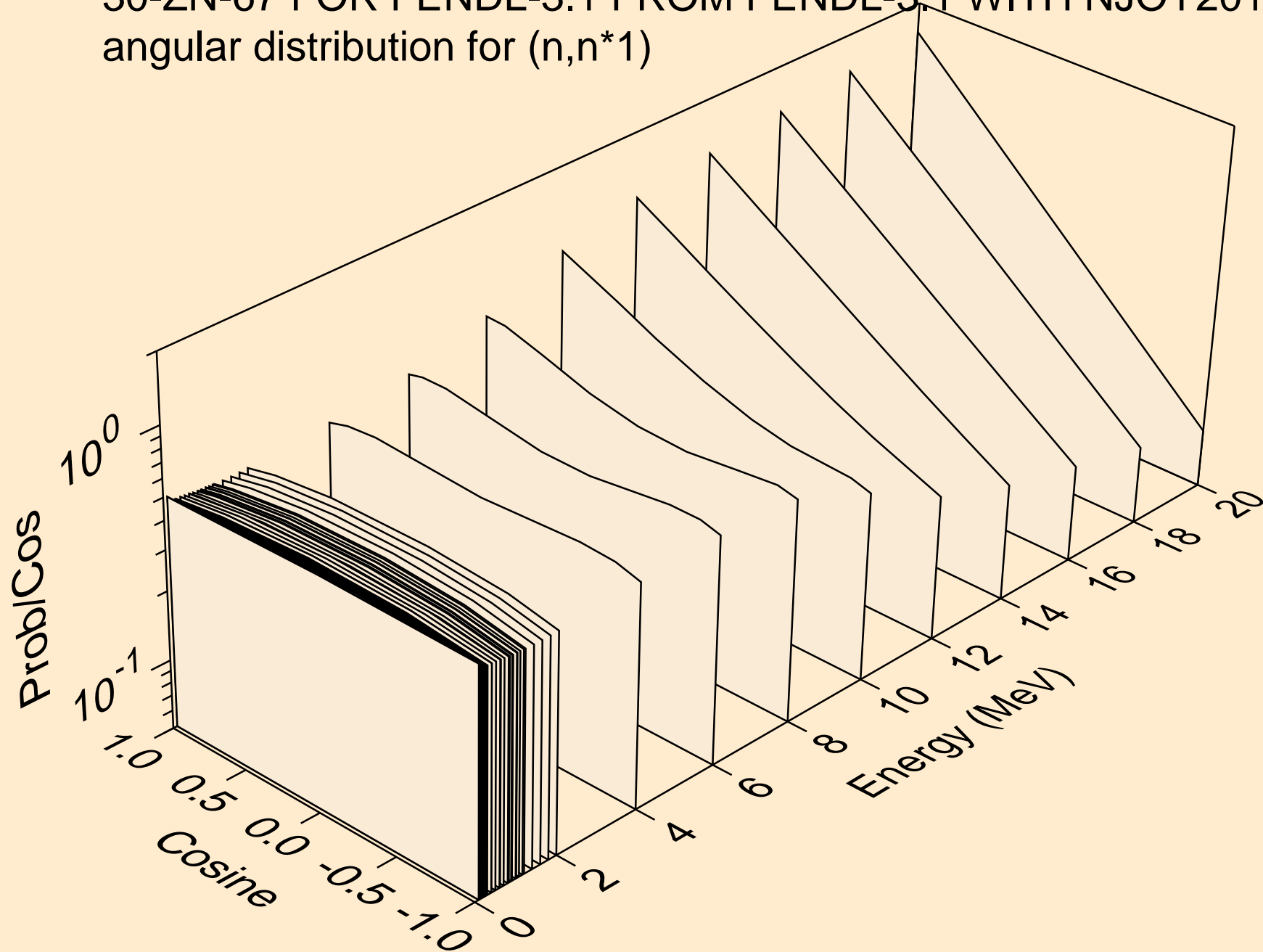

30-ZN-67 FOR FENDL-3.1 FROM FENDL-3.1 WITH NJOY2012.50+
angular distribution for (n,n*2)

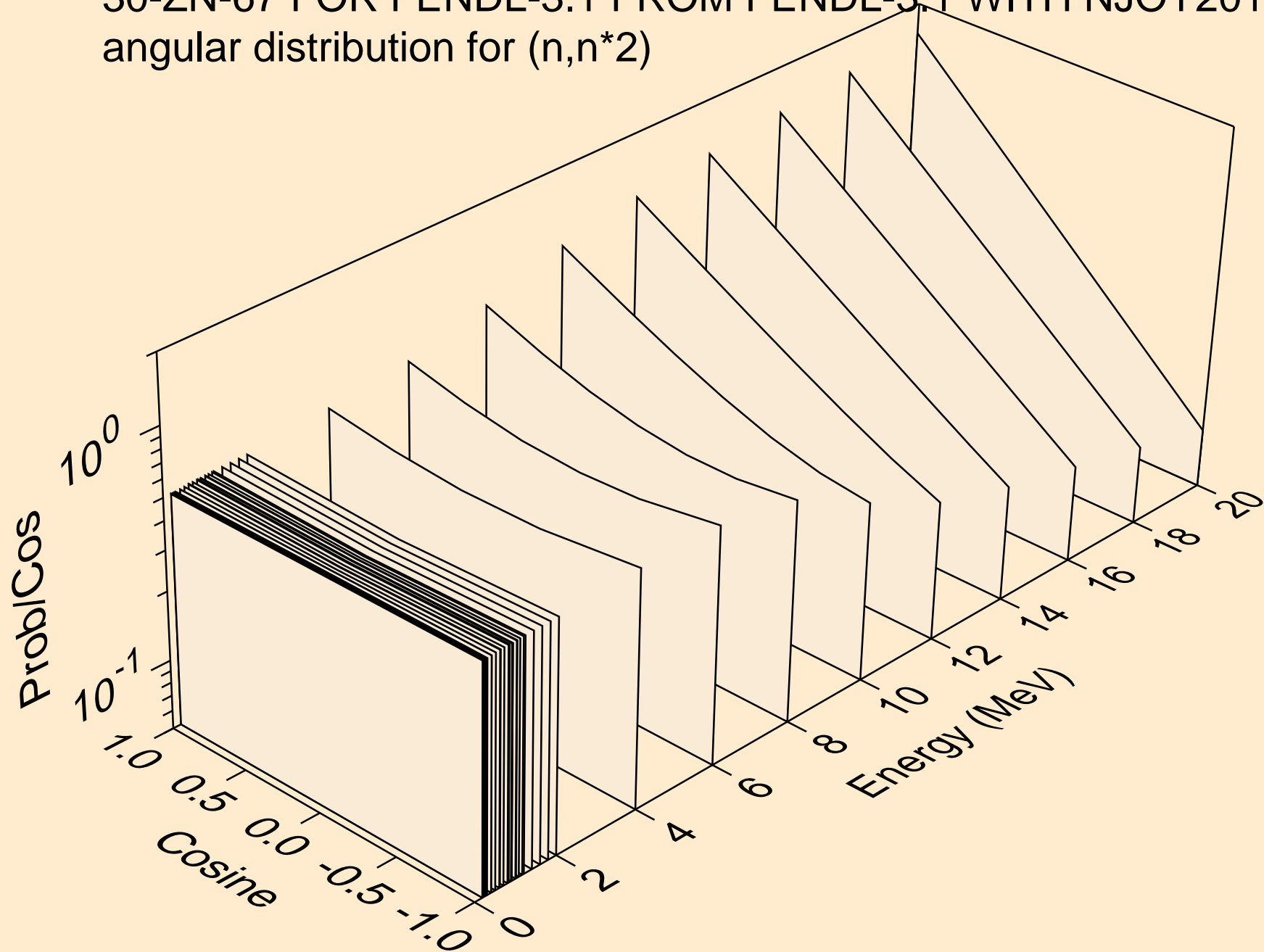

30-ZN-67 FOR FENDL-3.1 FROM FENDL-3.1 WITH NJOY2012.50+
angular distribution for (n,n*3)

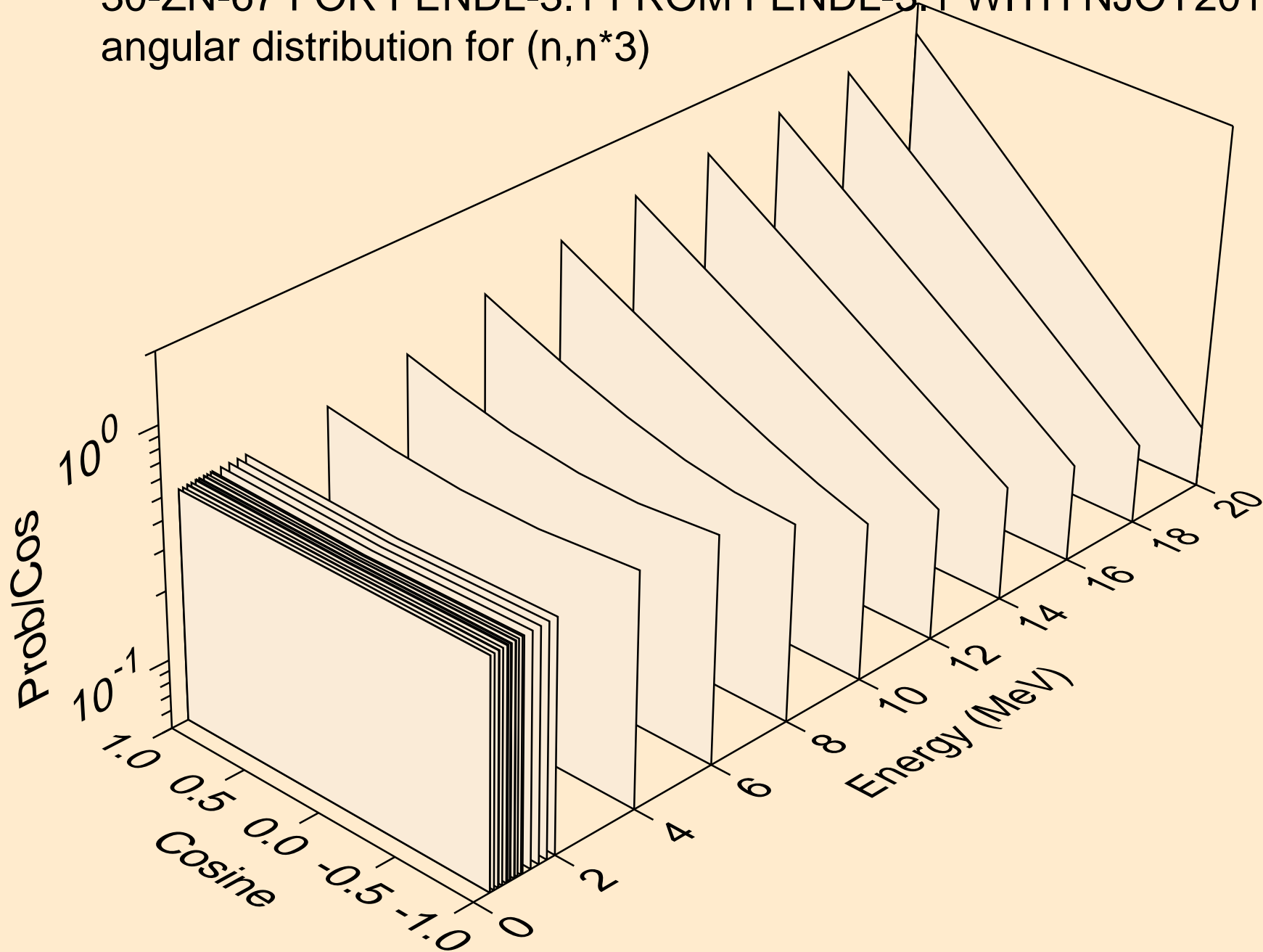

30-ZN-67 FOR FENDL-3.1 FROM FENDL-3.1 WITH NJOY2012.50+
angular distribution for (n,n*4)

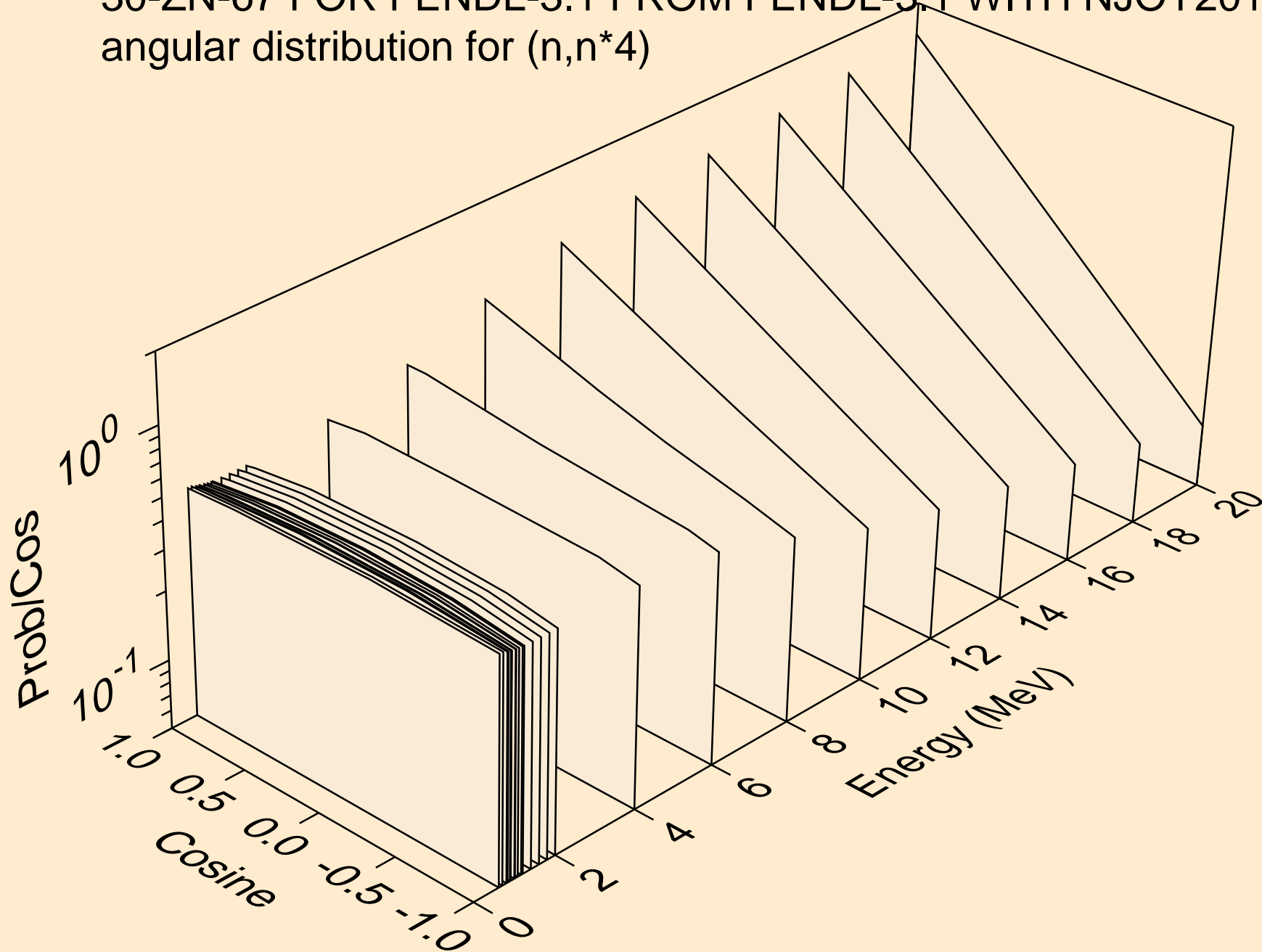

30-ZN-67 FOR FENDL-3.1 FROM FENDL-3.1 WITH NJOY2012.50+
angular distribution for (n,n*5)

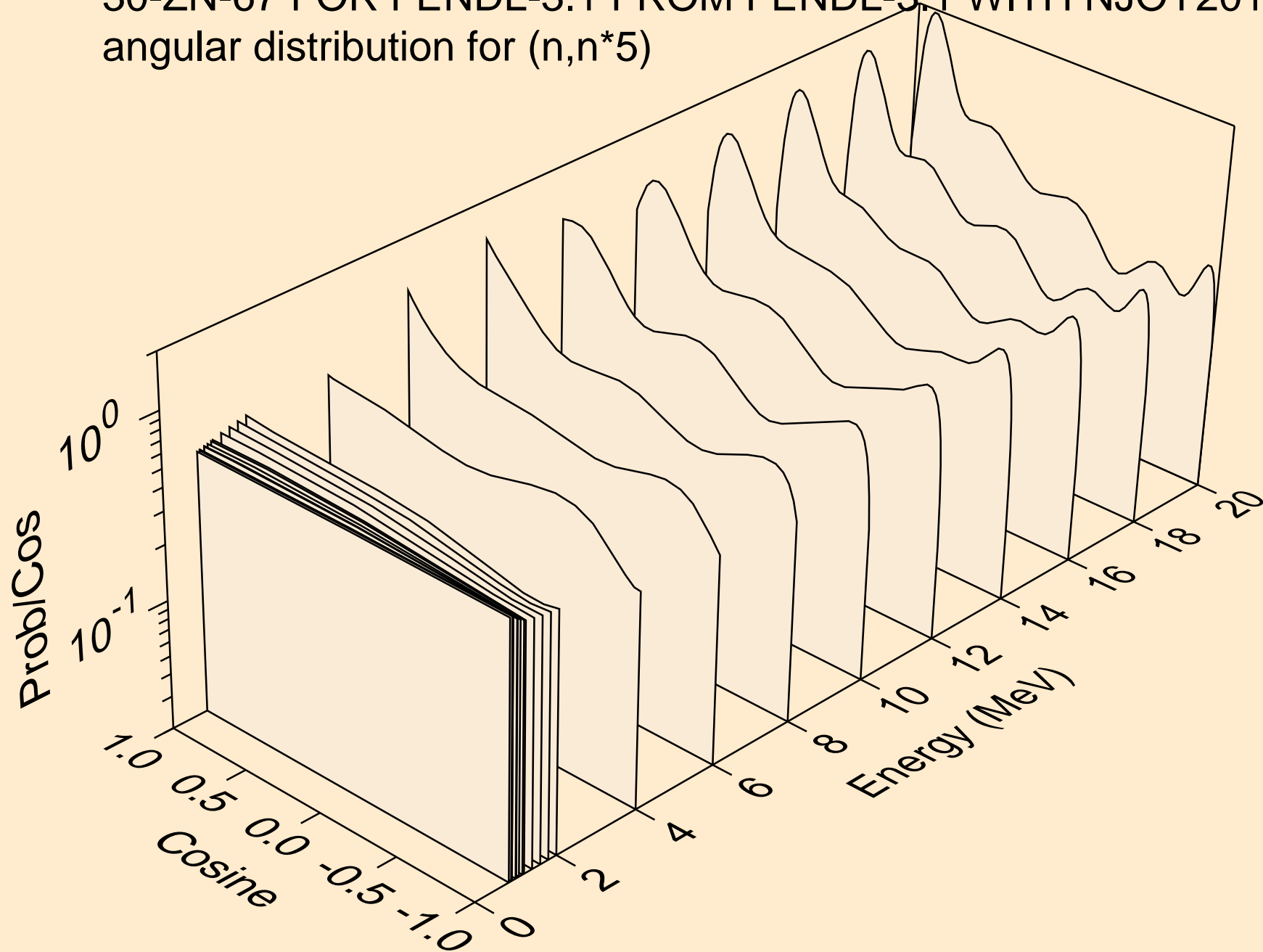

30-ZN-67 FOR FENDL-3.1 FROM FENDL-3.1 WITH NJOY2012.50+
angular distribution for (n,n*6)

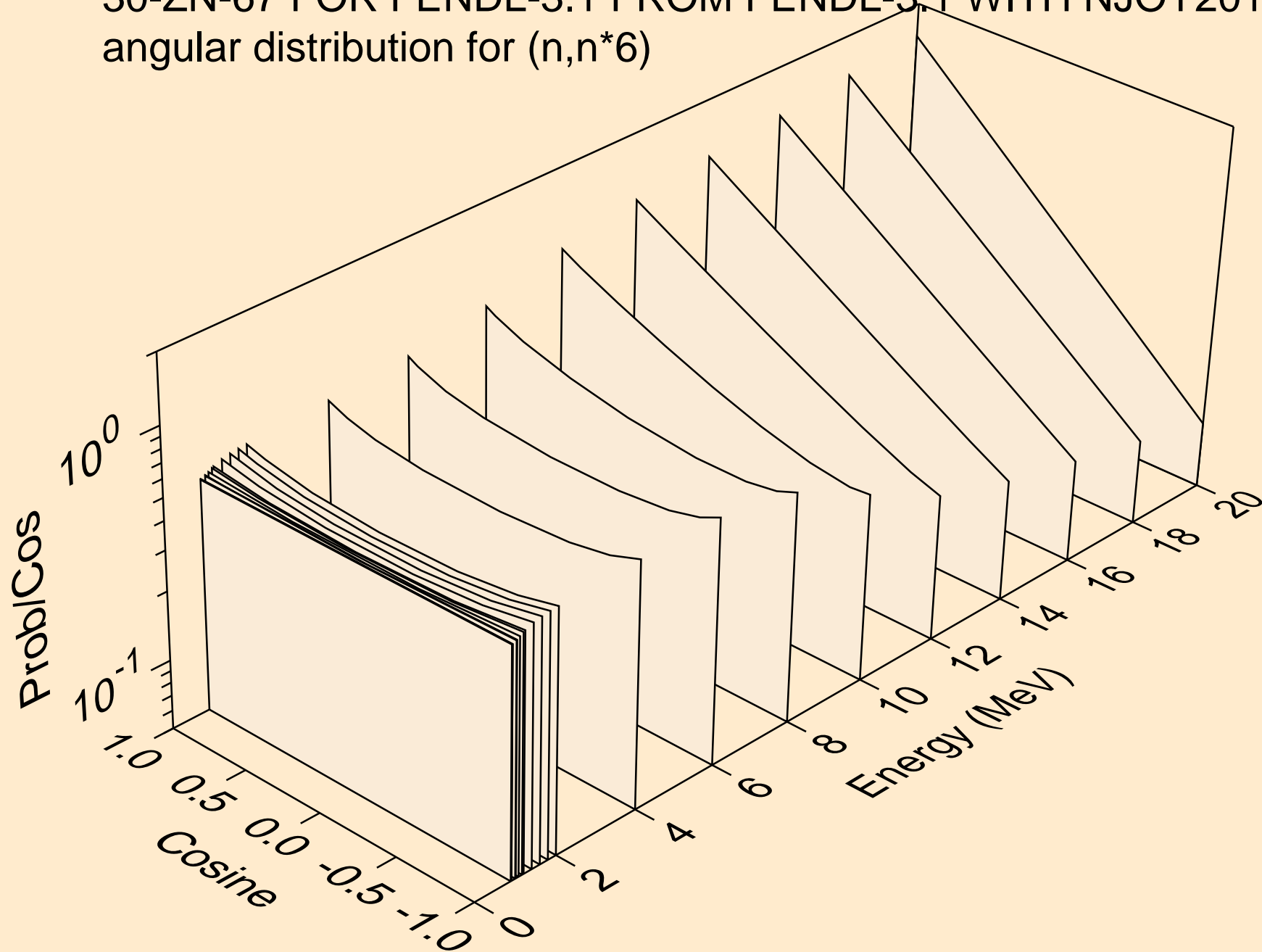

30-ZN-67 FOR FENDL-3.1 FROM FENDL-3.1 WITH NJOY2012.50+
angular distribution for (n,n*7)

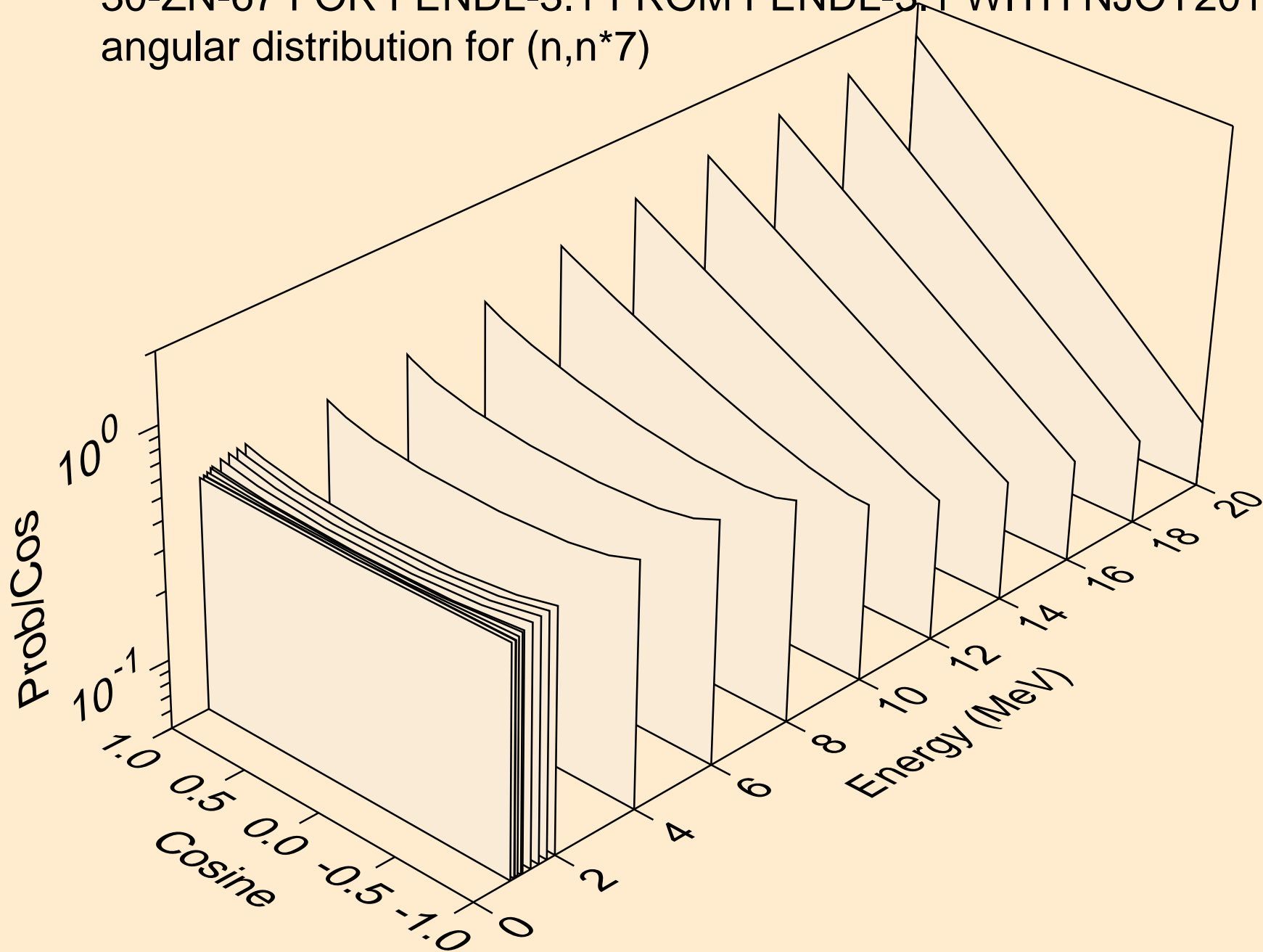

30-ZN-67 FOR FENDL-3.1 FROM FENDL-3.1 WITH NJOY2012.50+
angular distribution for (n,n*8)

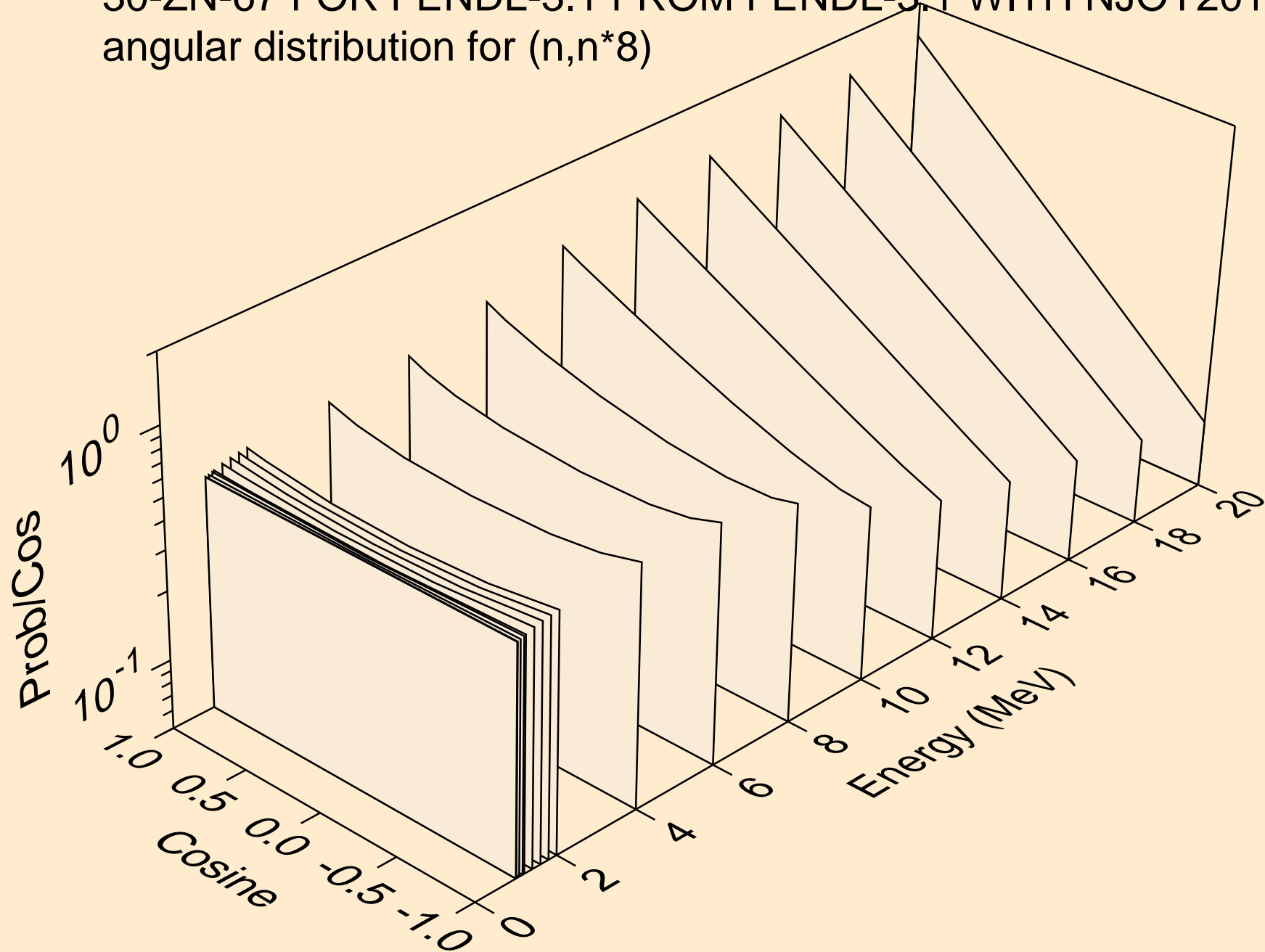

30-ZN-67 FOR FENDL-3.1 FROM FENDL-3.1 WITH NJOY2012.50+
angular distribution for (n,n*9)

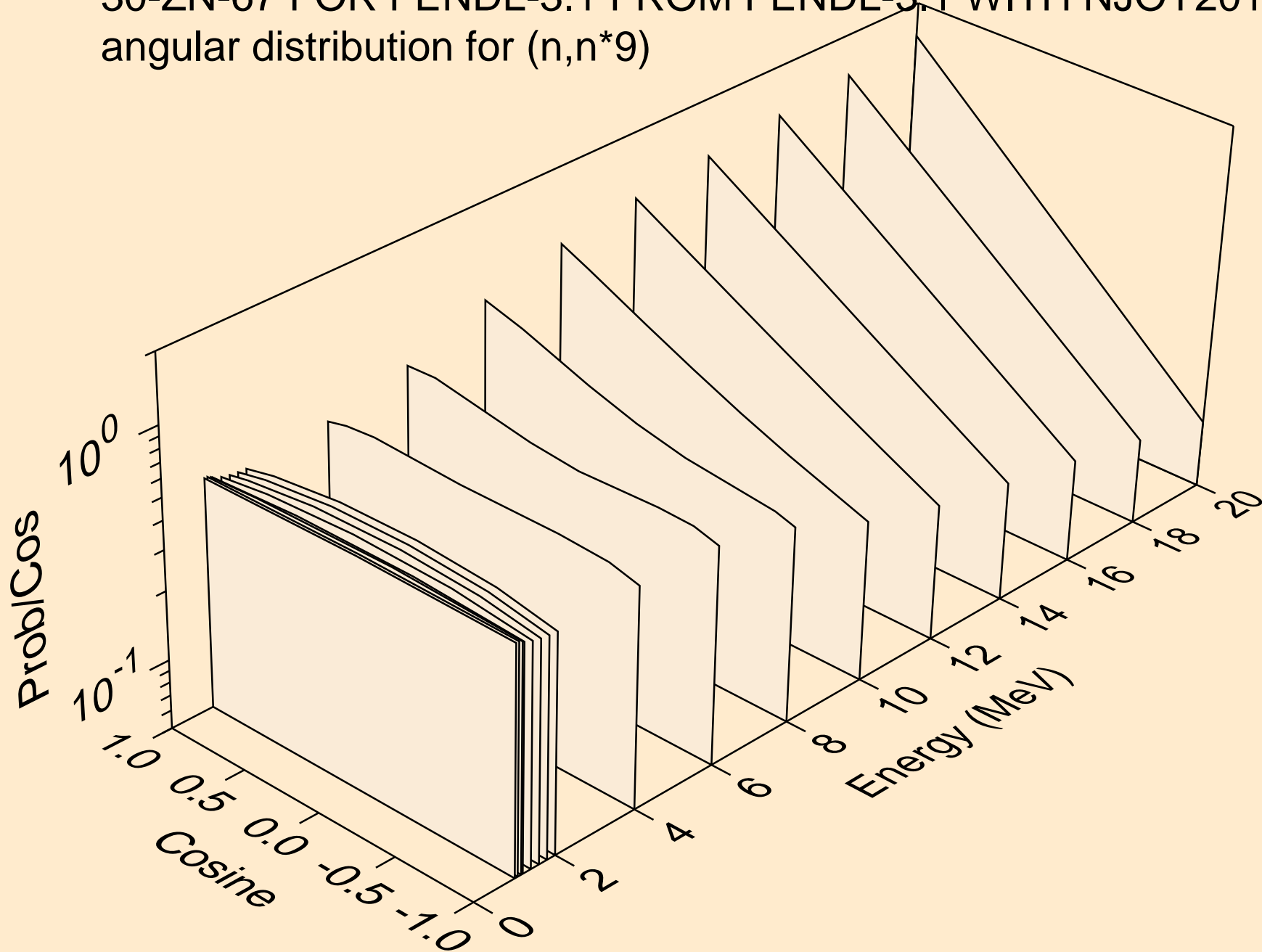

30-ZN-67 FOR FENDL-3.1 FROM FENDL-3.1 WITH NJOY2012.50+
angular distribution for (n,n*10)

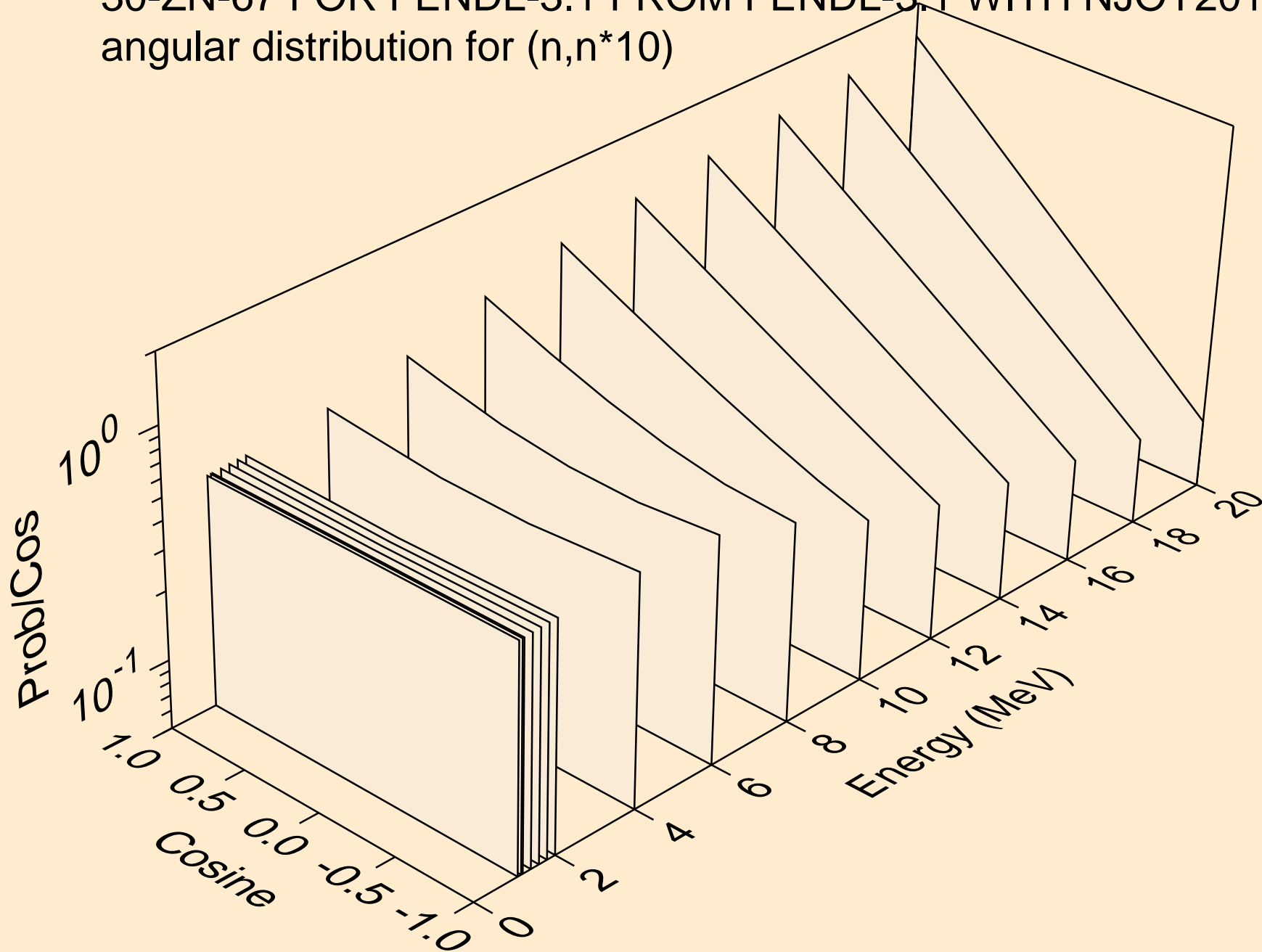

30-ZN-67 FOR FENDL-3.1 FROM FENDL-3.1 WITH NJOY2012.50+
angular distribution for (n,n*11)

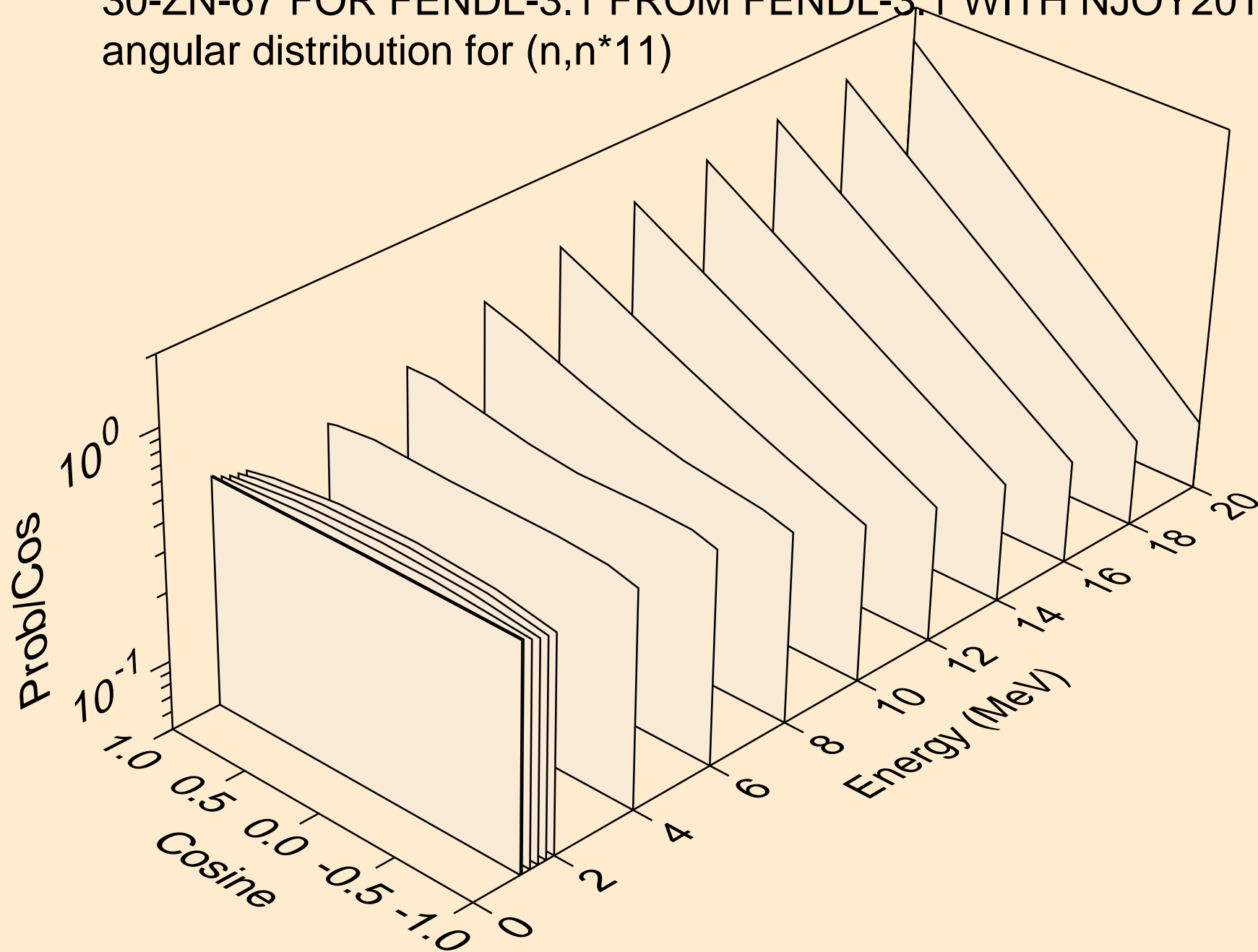

30-ZN-67 FOR FENDL-3.1 FROM FENDL-3.1 WITH NJOY2012.50+
Neutron emission for (n,x)

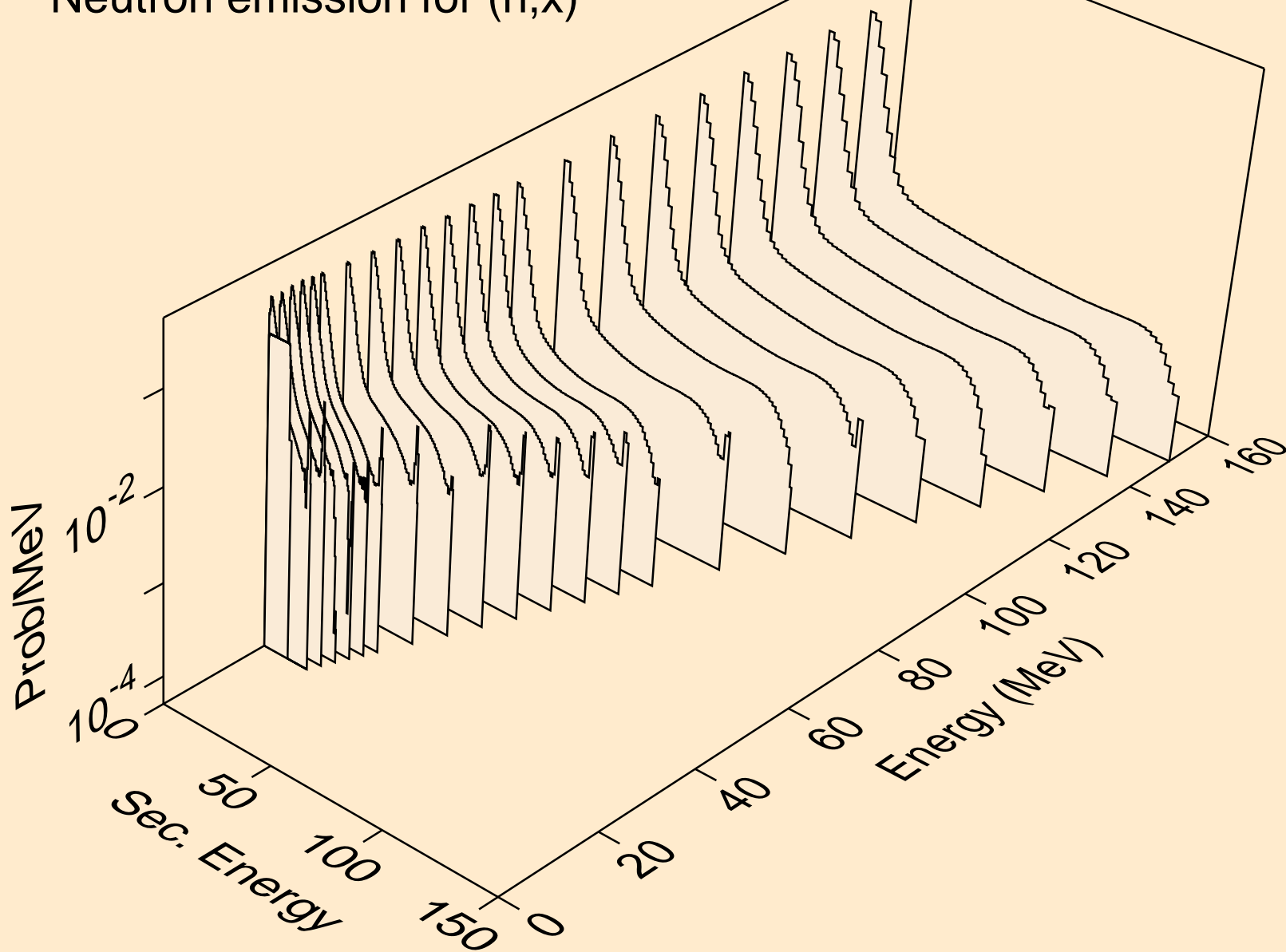

30-ZN-67 FOR FENDL-3.1 FROM FENDL-3.1 WITH NJOY2012.50+
Neutron emission for (n,2n)

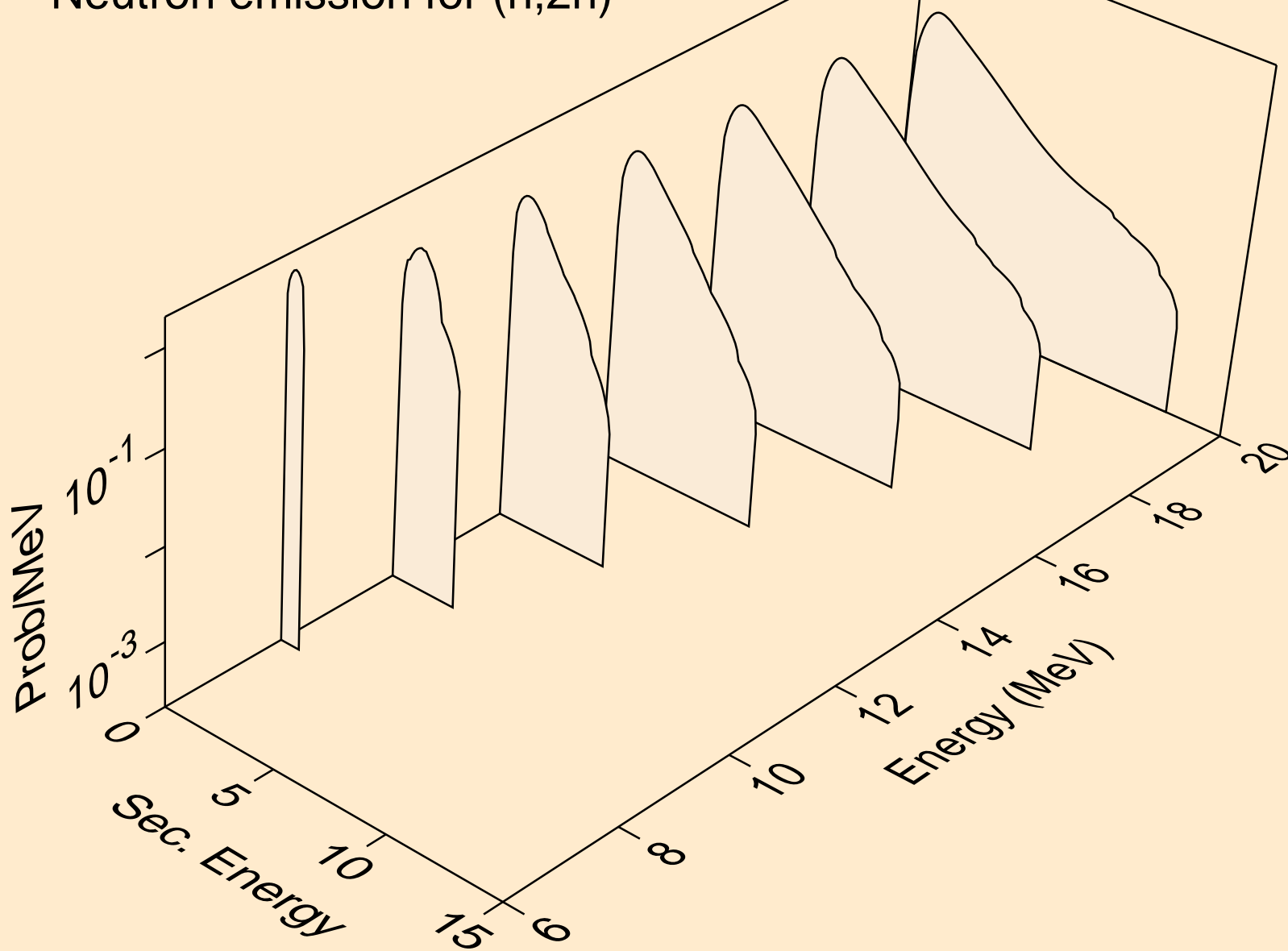

30-ZN-67 FOR FENDL-3.1 FROM FENDL-3.1 WITH NJOY2012.50+
Neutron emission for (n,3n)

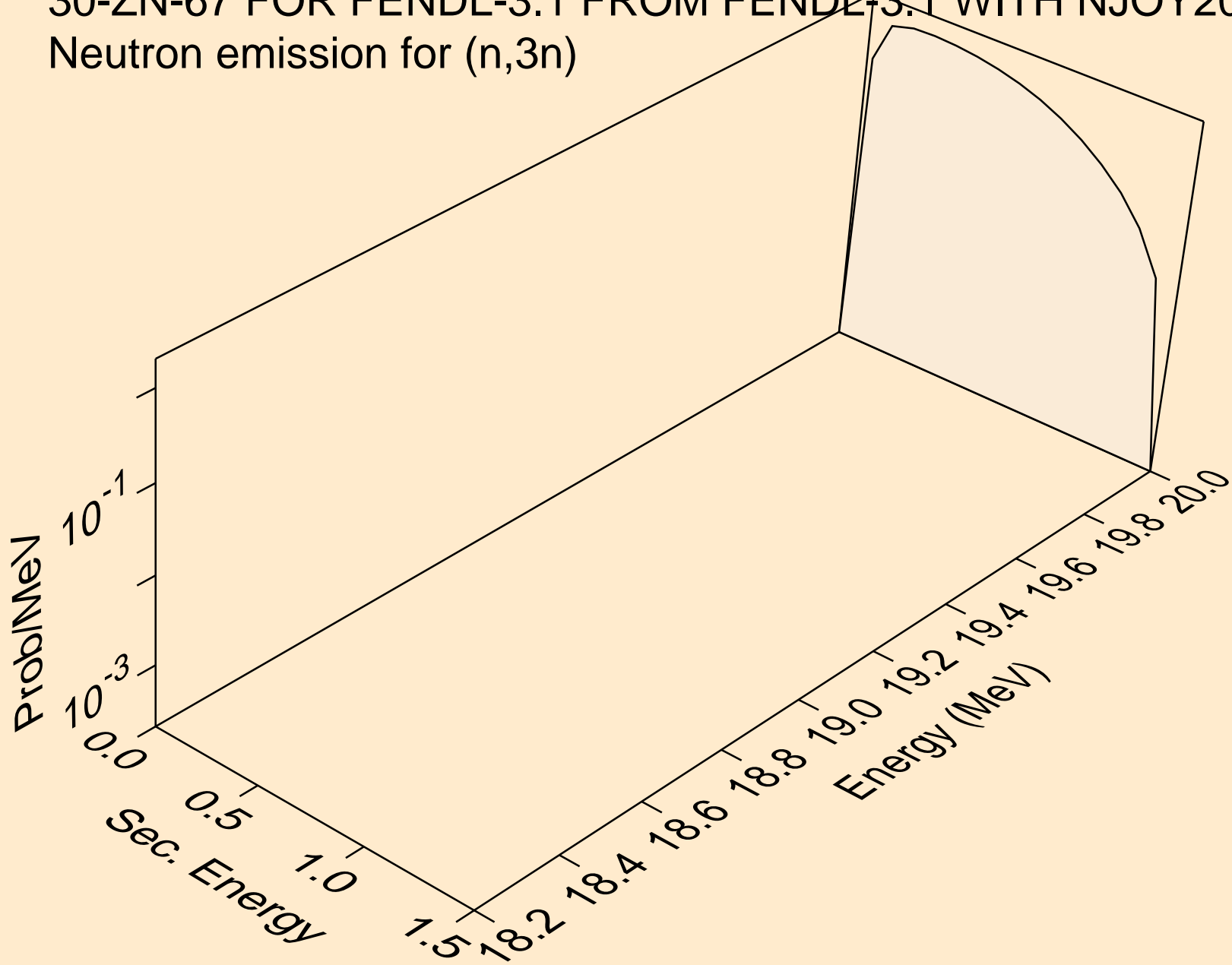

30-ZN-67 FOR FENDL-3.1 FROM FENDL-3.1 WITH NJOY2012.50+
Neutron emission for (n,n*)a

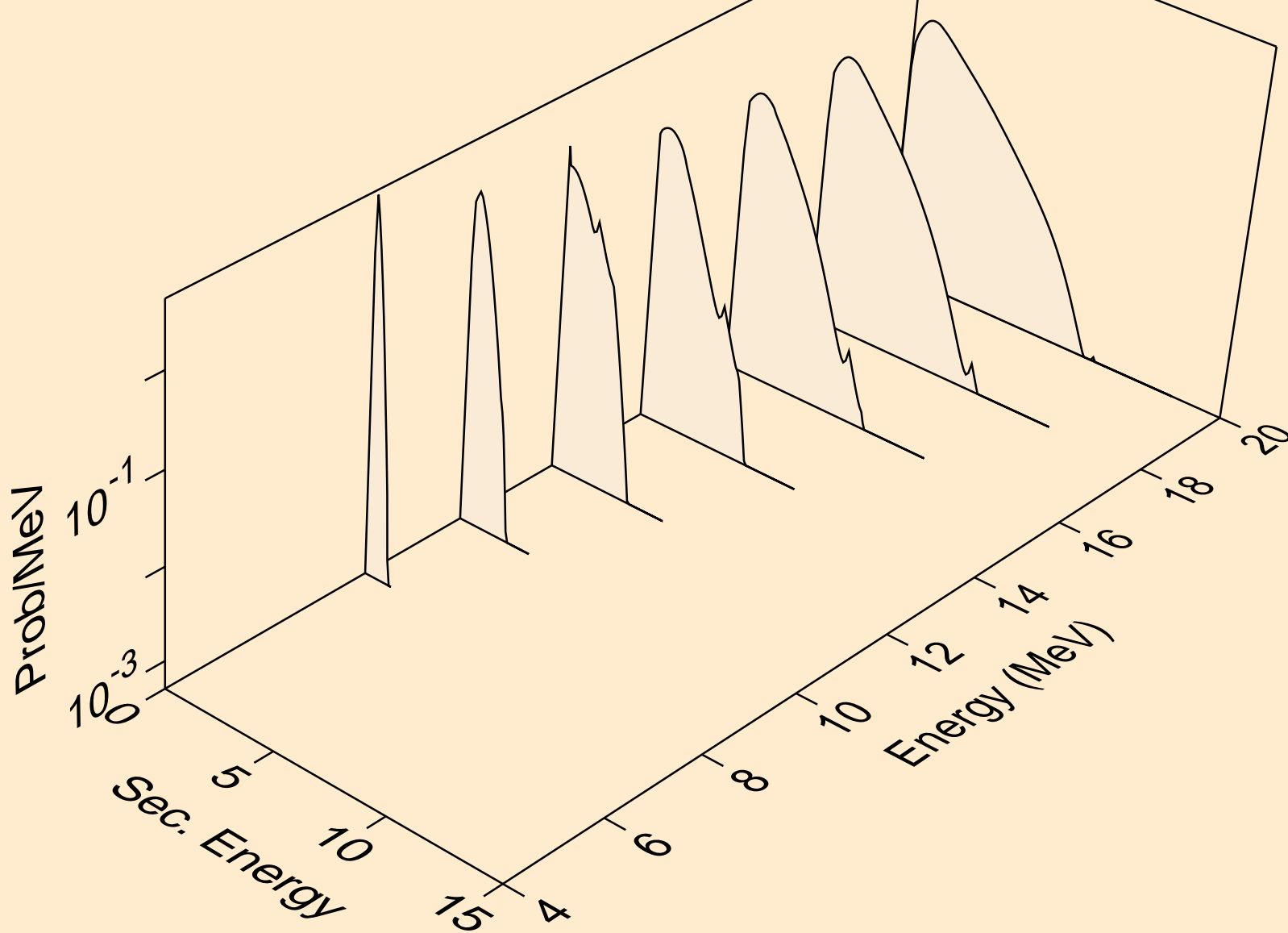

30-ZN-67 FOR FENDL-3.1 FROM FENDL-3.1 WITH NJOY2012.50+
Neutron emission for (n,2n)a

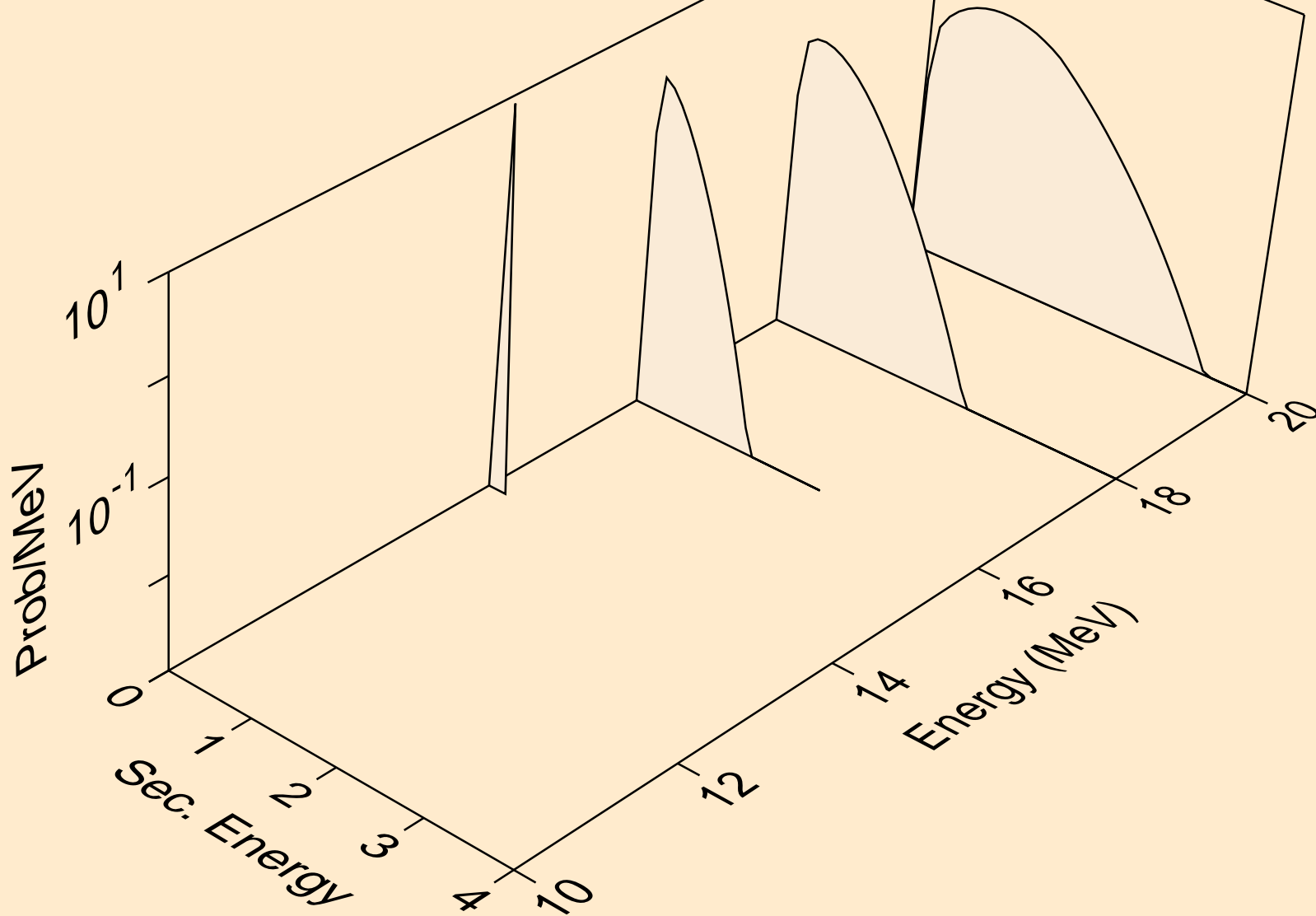

30-ZN-67 FOR FENDL-3.1 FROM FENDL-3.1 WITH NJOY2012.50+
Neutron emission for (n,n*)p

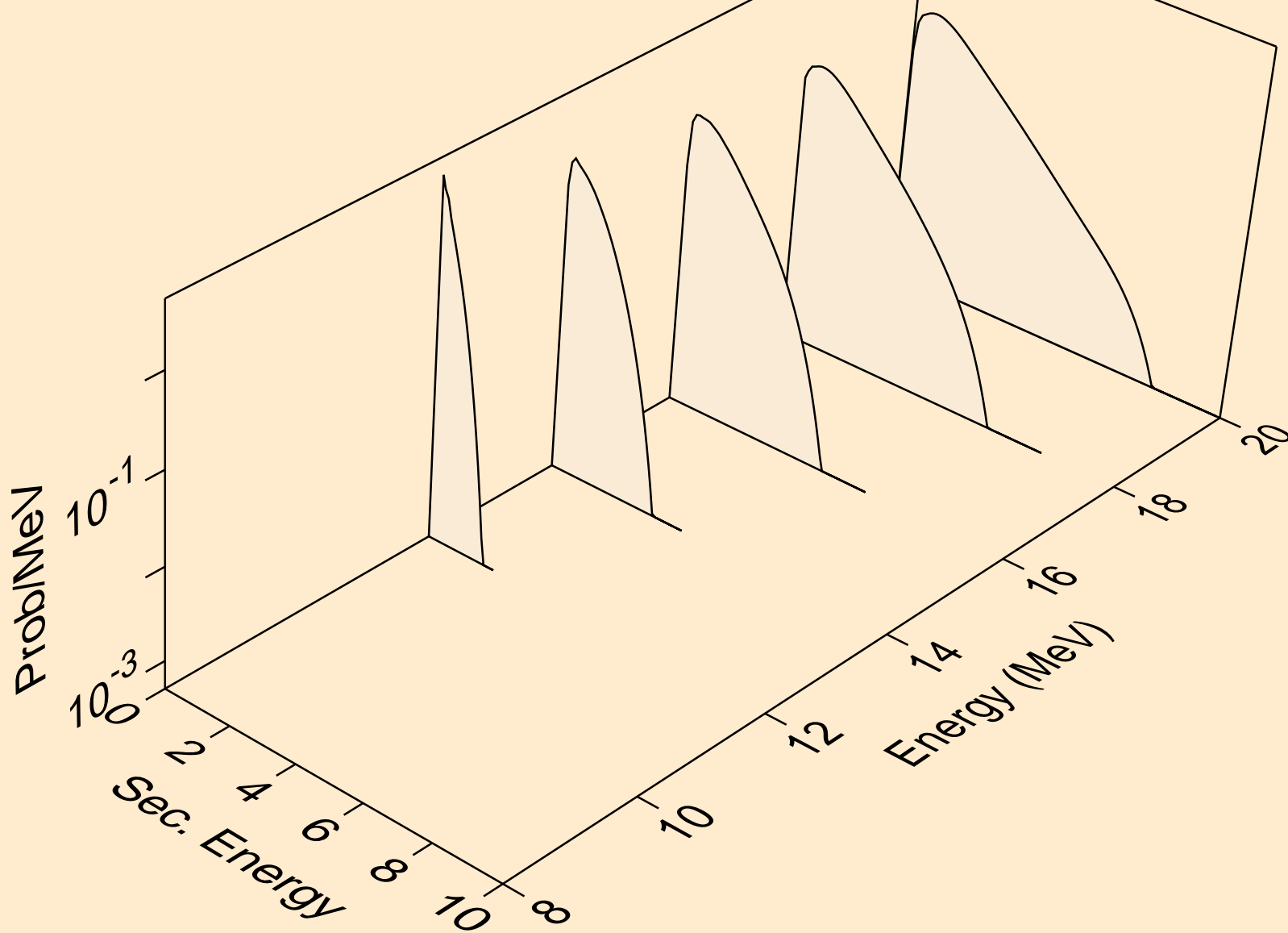

30-ZN-67 FOR FENDL-3.1 FROM FENDL-3.1 WITH NJOY2012.50+
Neutron emission for (n,n*)d

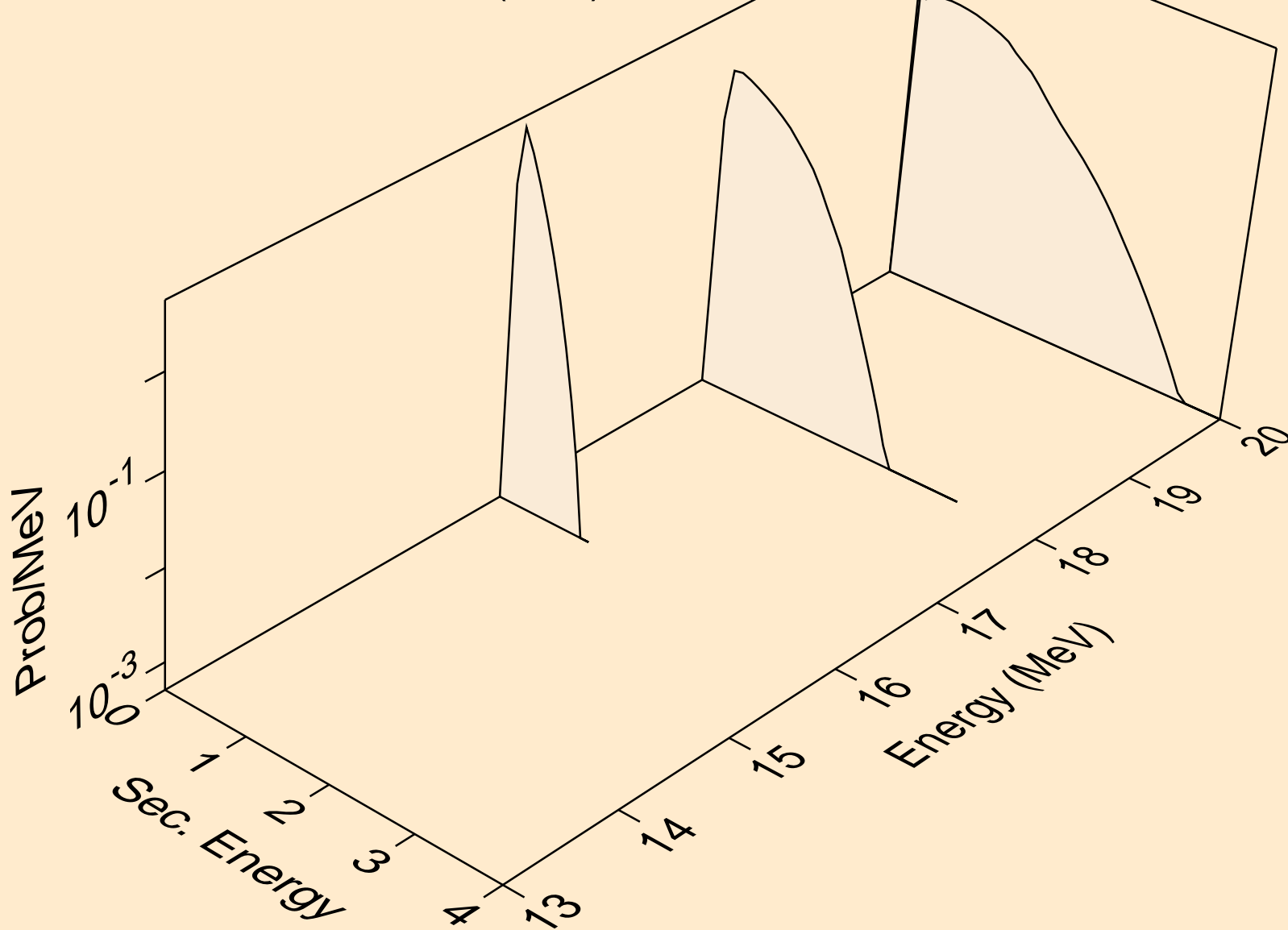

30-ZN-67 FOR FENDL-3.1 FROM FENDL-3.1 WITH NJOY2012.50+
Neutron emission for (n,2np)

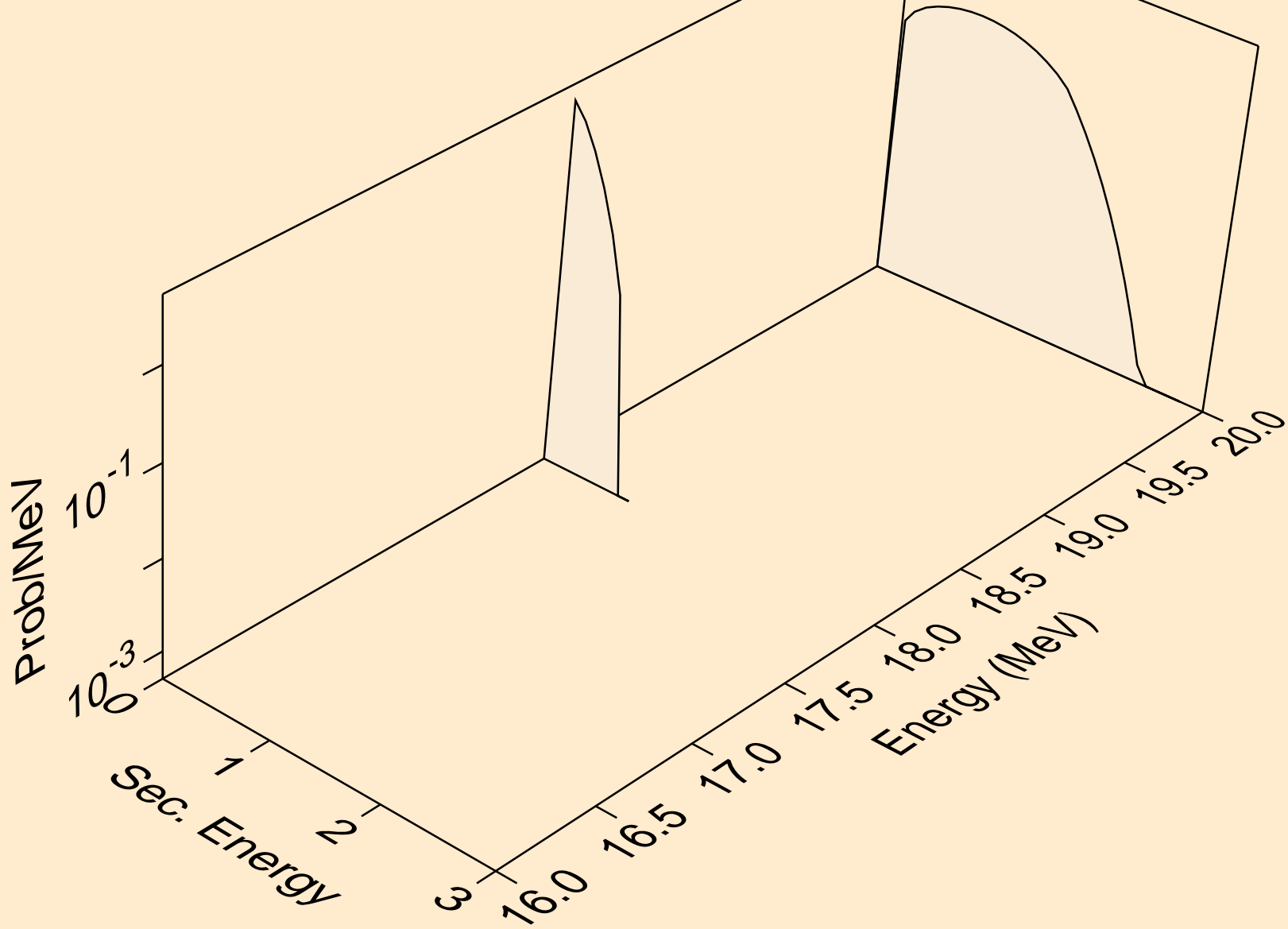

30-ZN-67 FOR FENDL-3.1 FROM FENDL-3.1 WITH NJOY2012.50+
Neutron emission for (n,n*c)

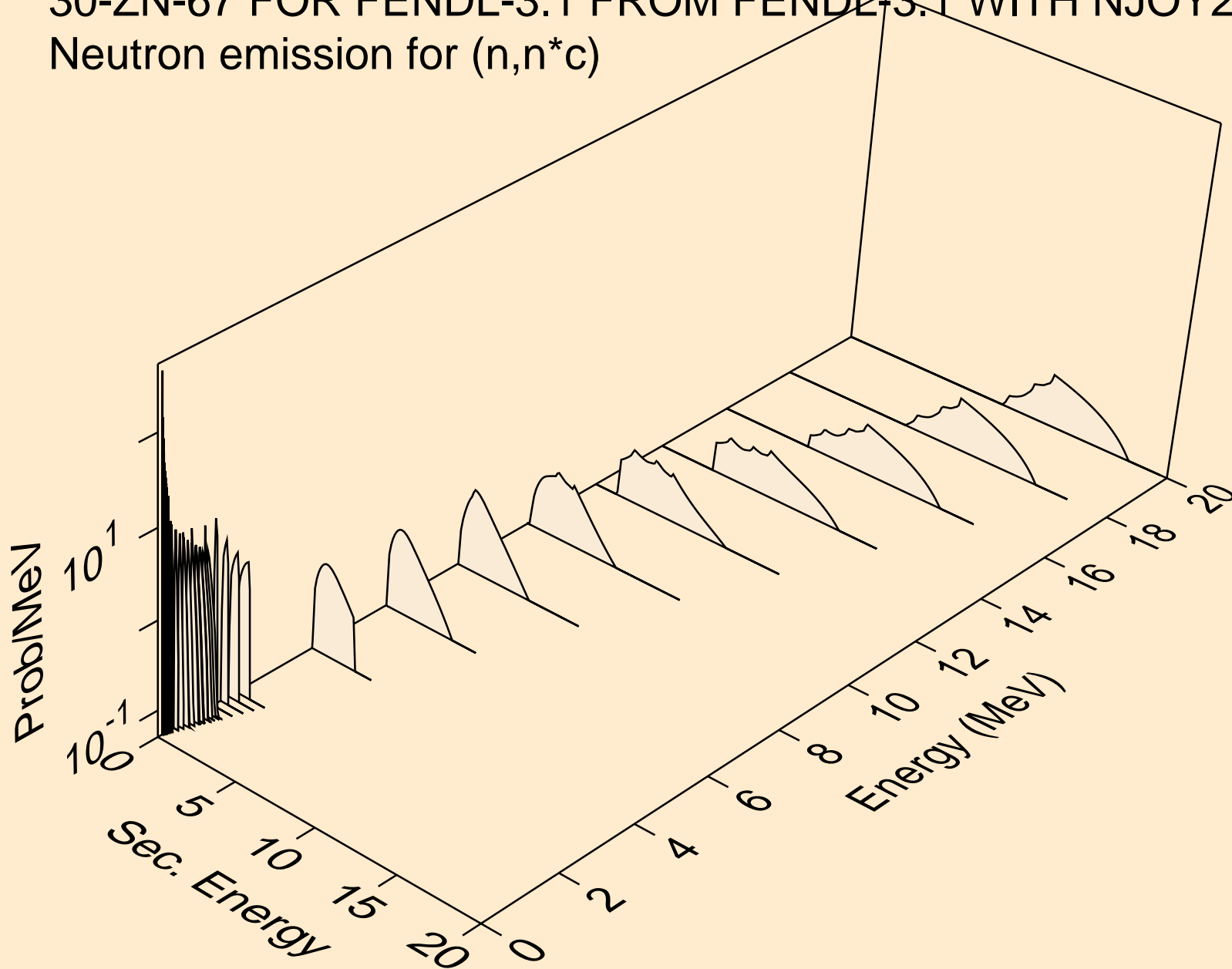

30-ZN-67 FOR FENDL-3.1 FROM FENDL-3.1 WITH NJOY2012.50+
Photon emission for (n,x)

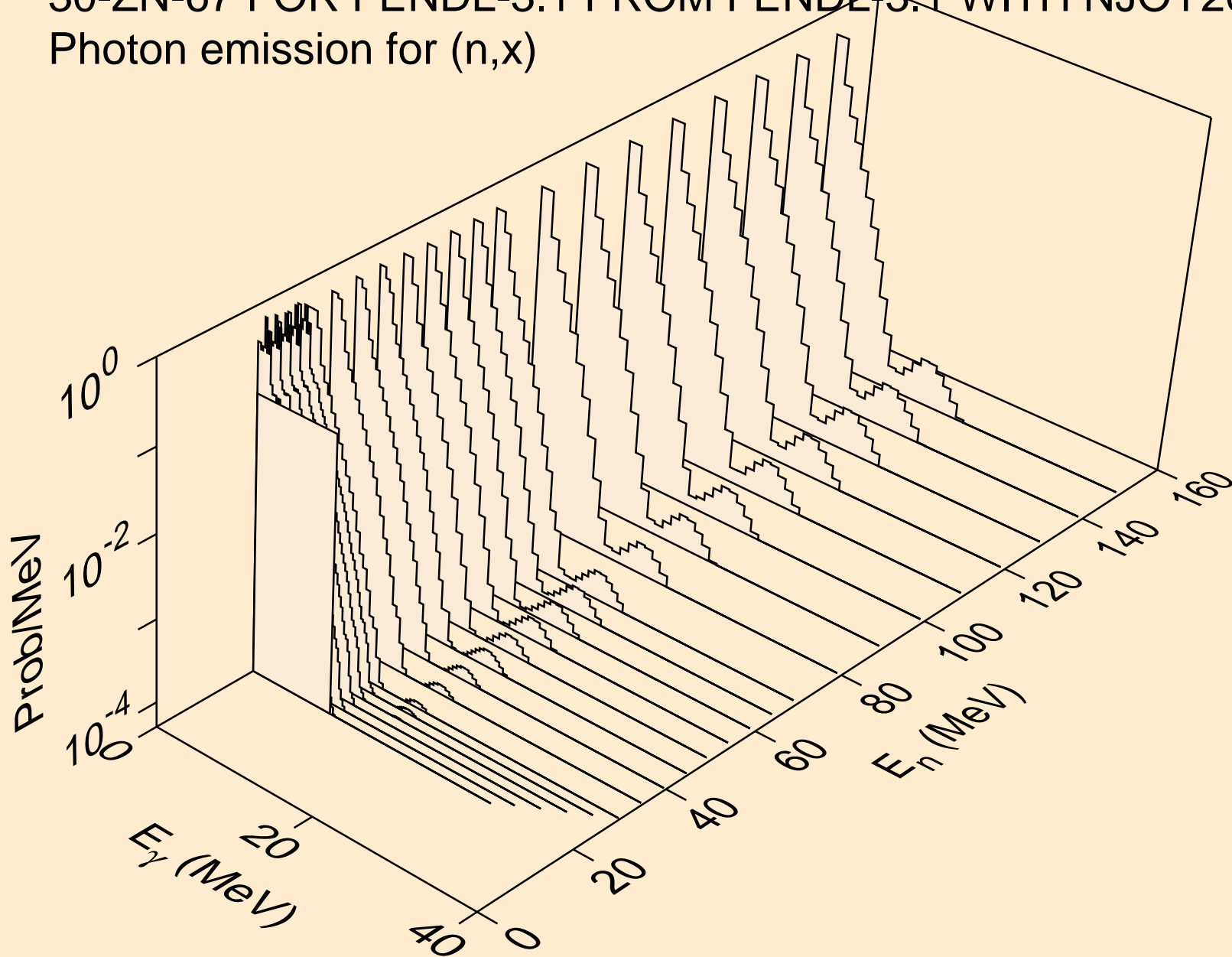

30-ZN-67 FOR FENDL-3.1 FROM FENDL-3.1 WITH NJOY2012.50+
Photon emission for (n,2n)

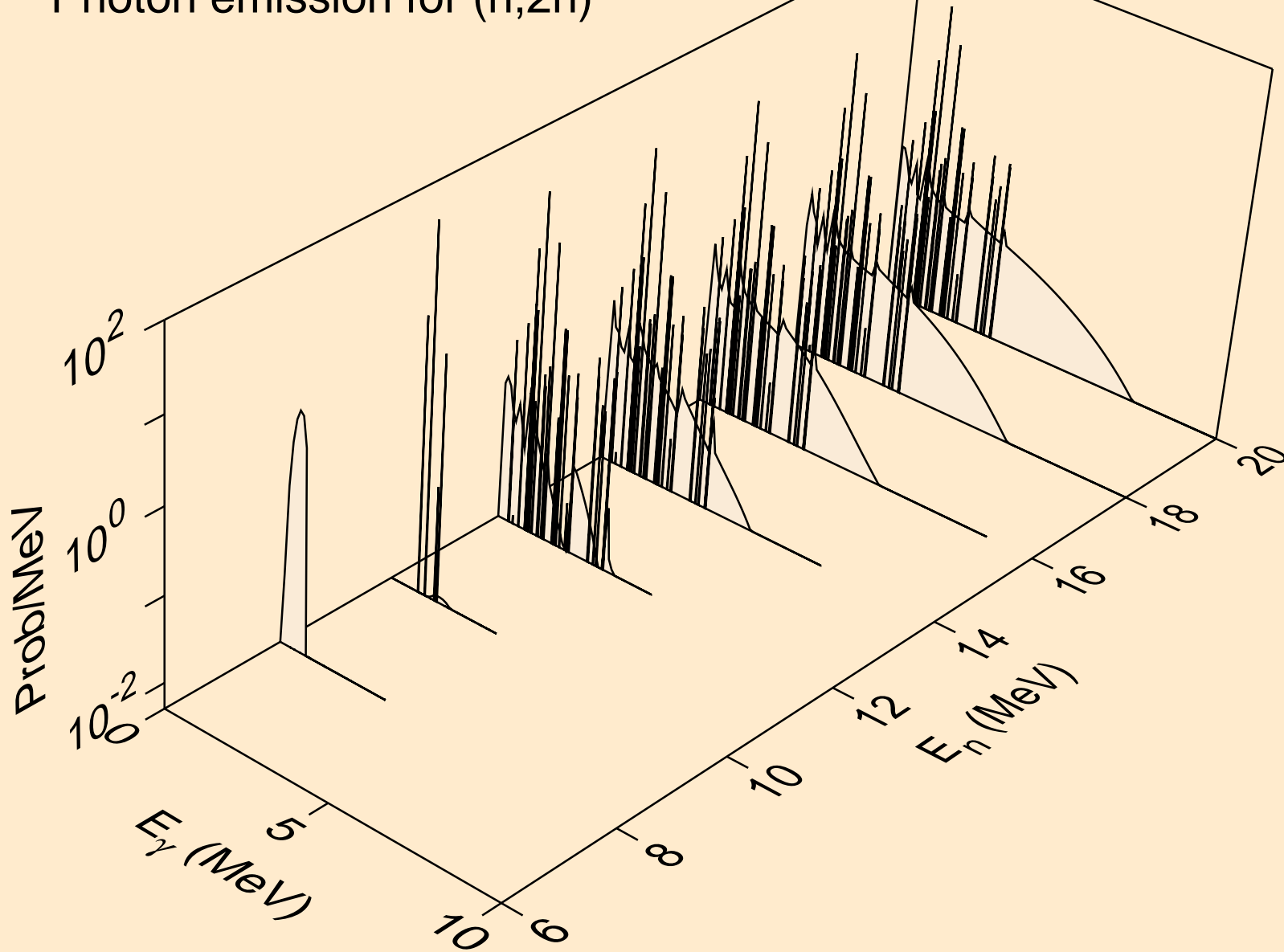

30-ZN-67 FOR FENDL-3.1 FROM FENDL-3.1 WITH NJOY2012.50+
Photon emission for (n,3n)

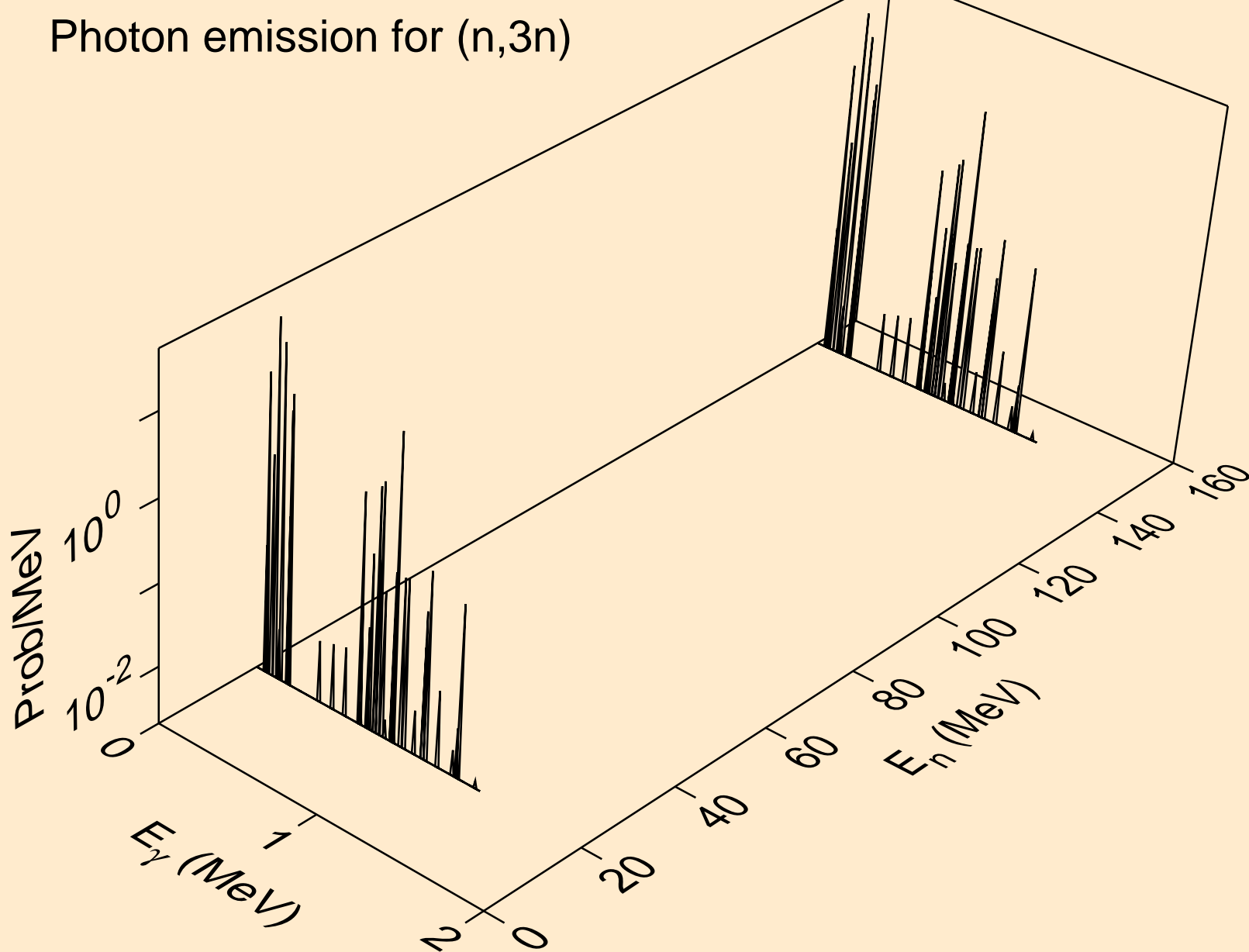

30-ZN-67 FOR FENDL-3.1 FROM FENDL-3.1 WITH NJOY2012.50+
Photon emission for (n,n*)a

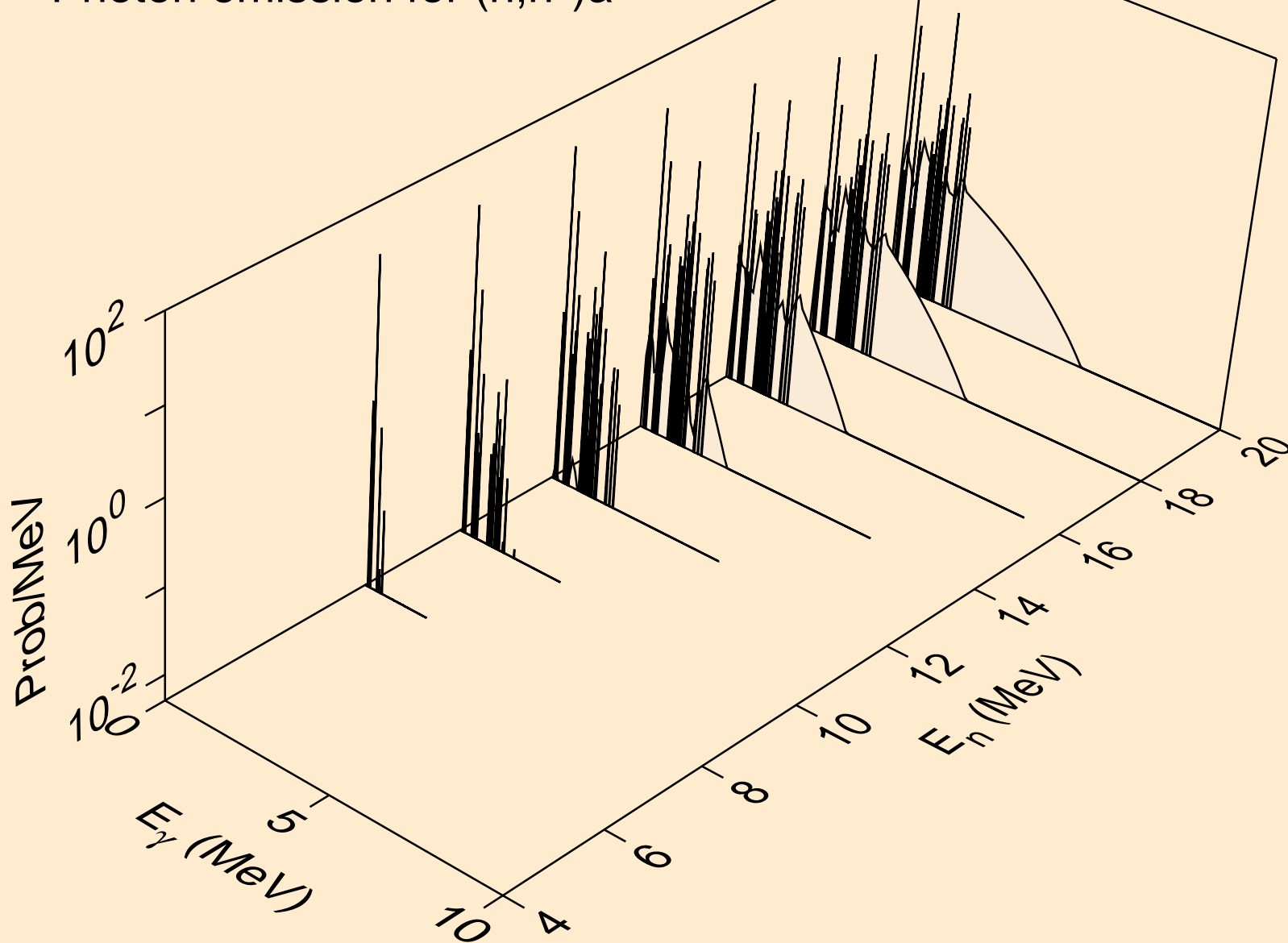

30-ZN-67 FOR FENDL-3.1 FROM FENDL-3.1 WITH NJOY2012.50+
Photon emission for (n,2n)a

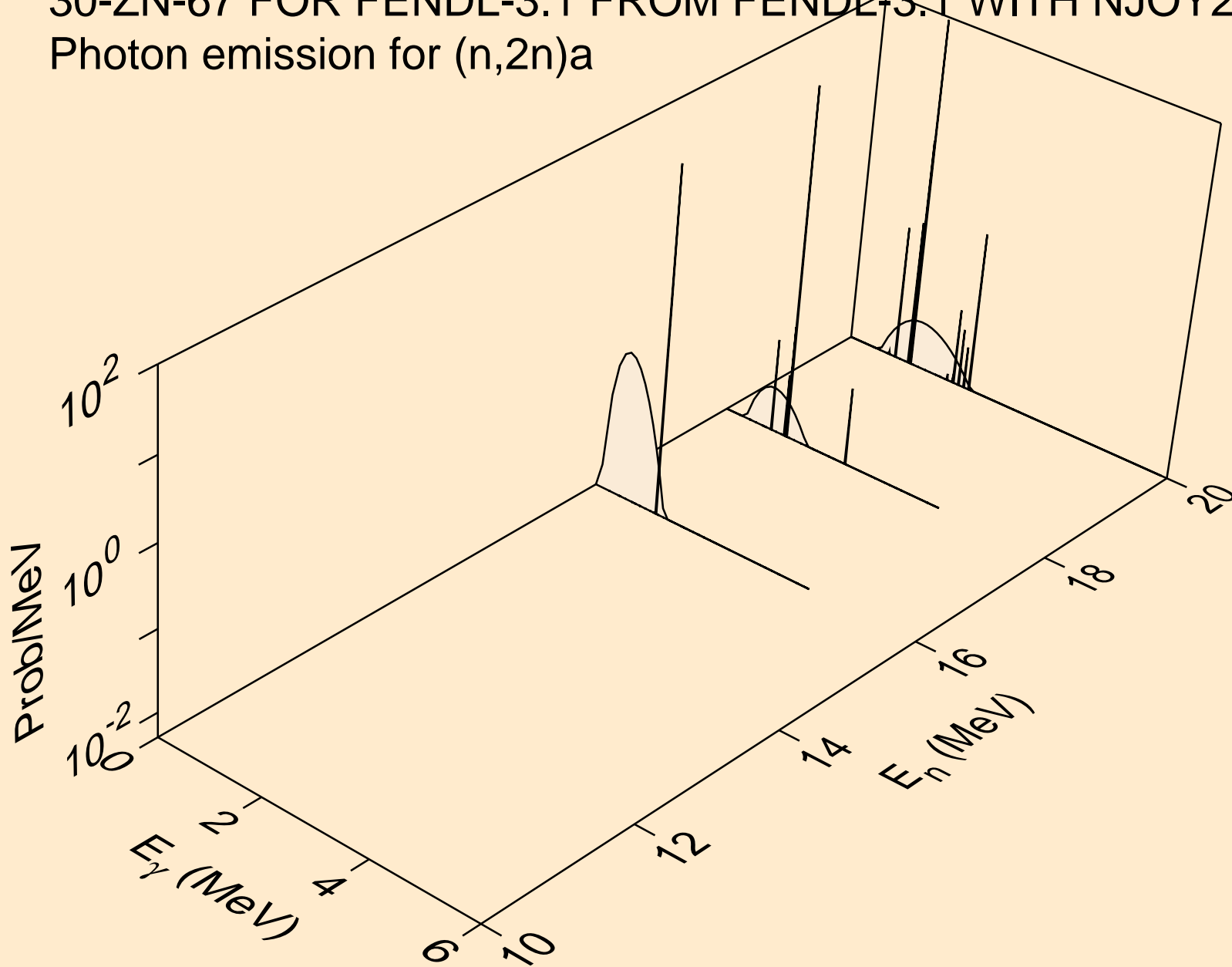

30-ZN-67 FOR FENDL-3.1 FROM FENDL-3.1 WITH NJOY2012.50+
Photon emission for (n,n*)p

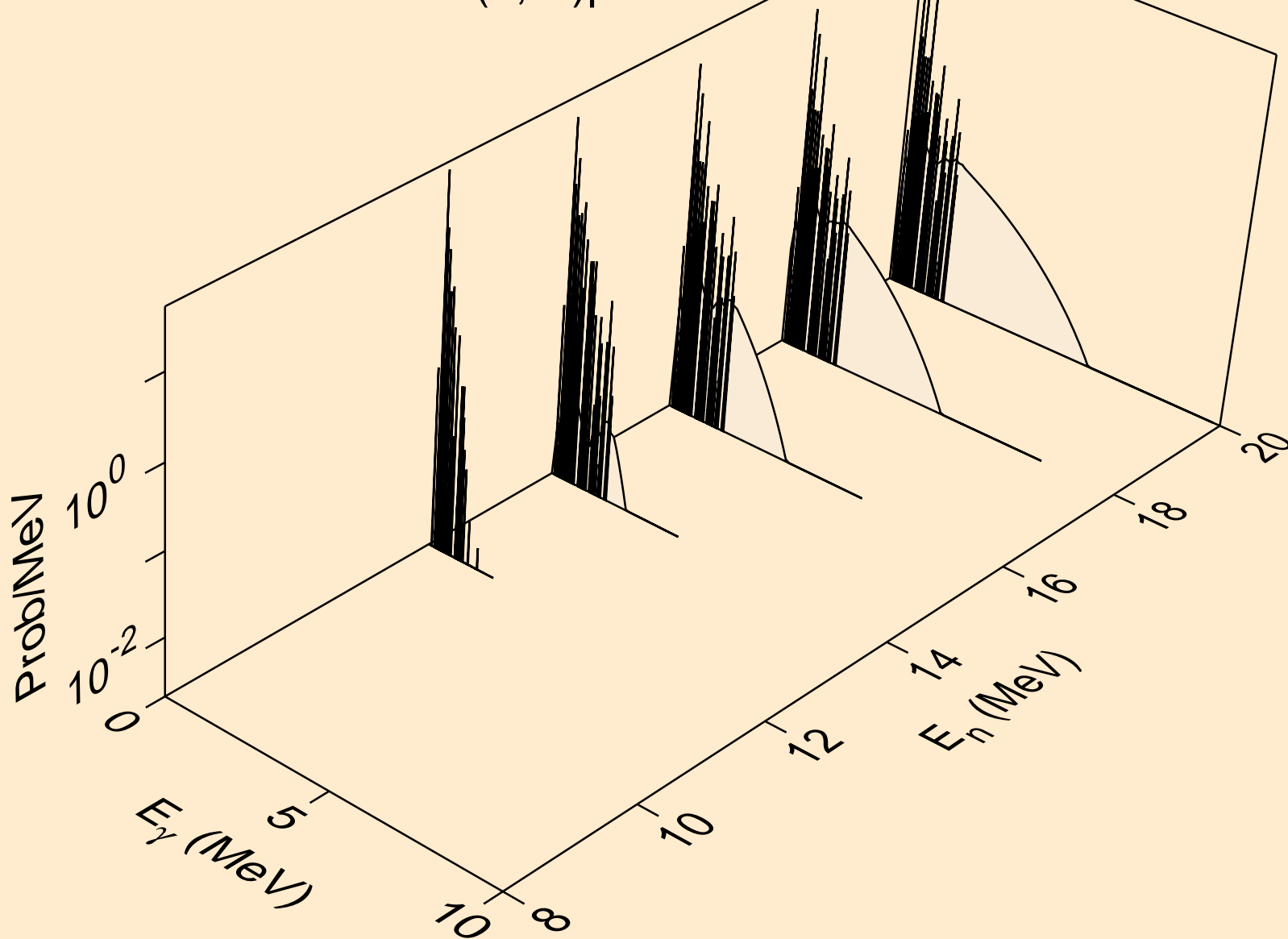

30-ZN-67 FOR FENDL-3.1 FROM FENDL-3.1 WITH NJOY2012.50+
Photon emission for (n,n*)d

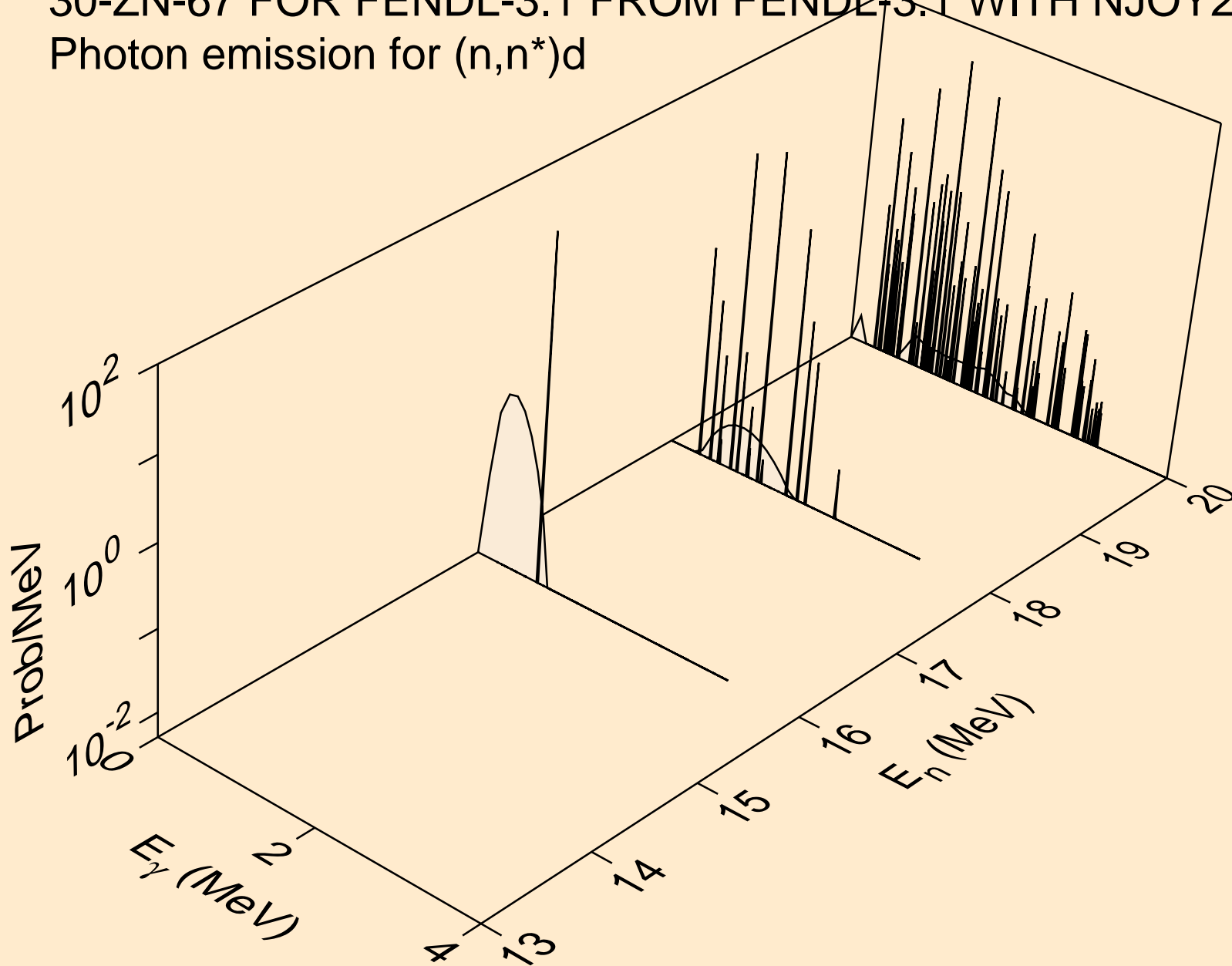

30-ZN-67 FOR FENDL-3.1 FROM FENDL-3.1 WITH NJOY2012.50+
Photon emission for (n,2np)

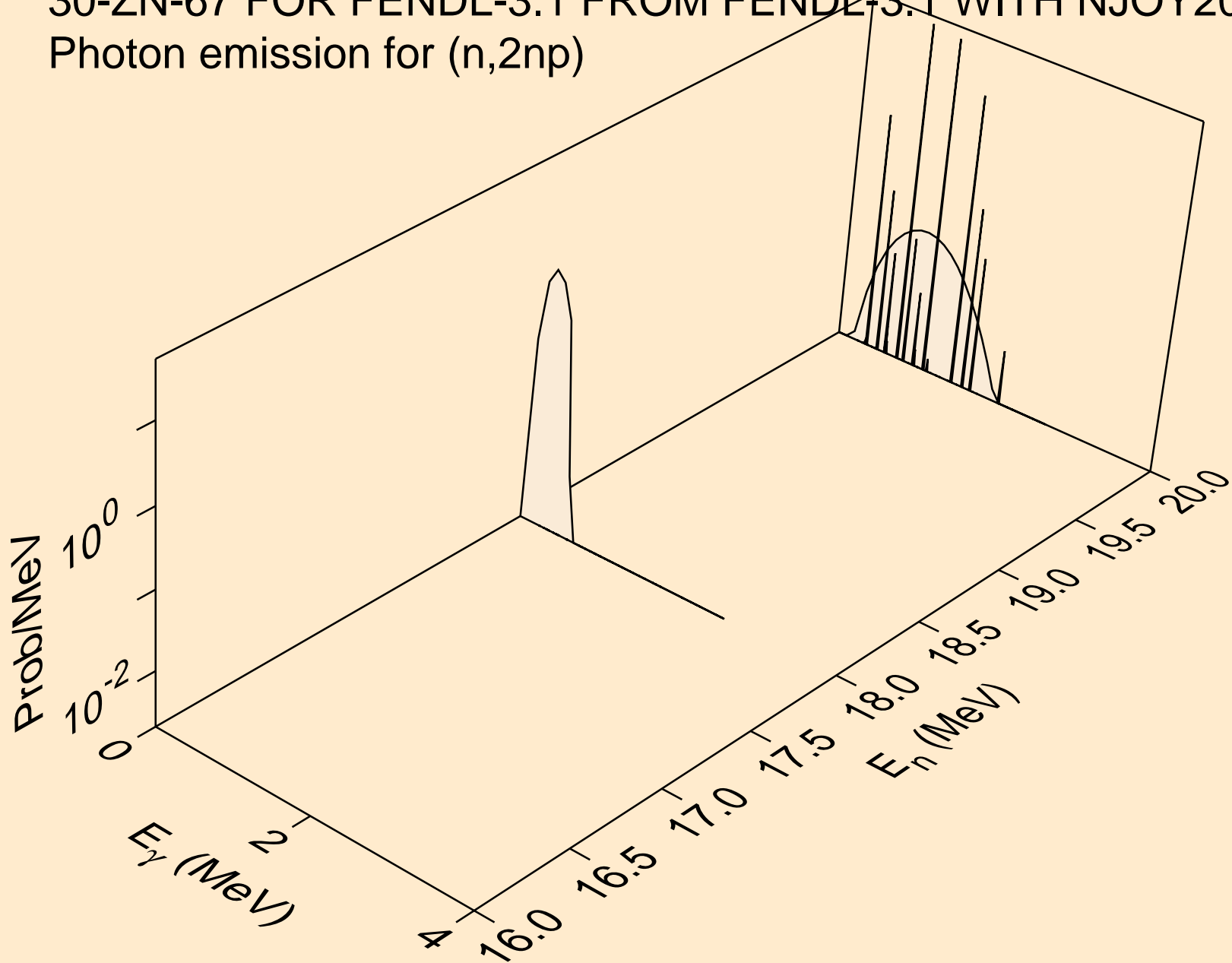

30-ZN-67 FOR FENDL-3.1 FROM FENDL-3.1 WITH NJOY2012.50+
Photon emission for (n,n*1)

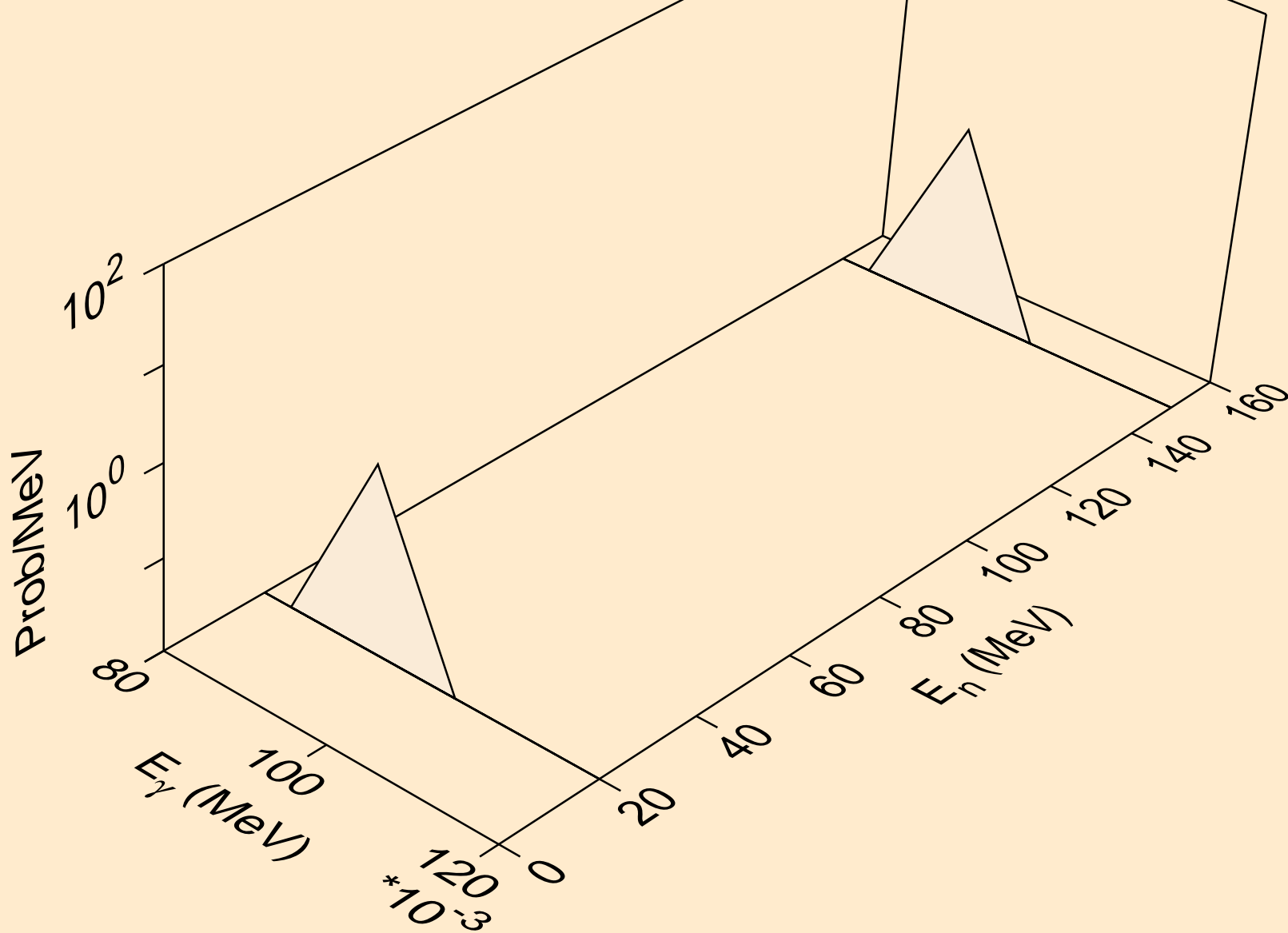

30-ZN-67 FOR FENDL-3.1 FROM FENDL-3.1 WITH NJOY2012.50+
Photon emission for (n,n*2)

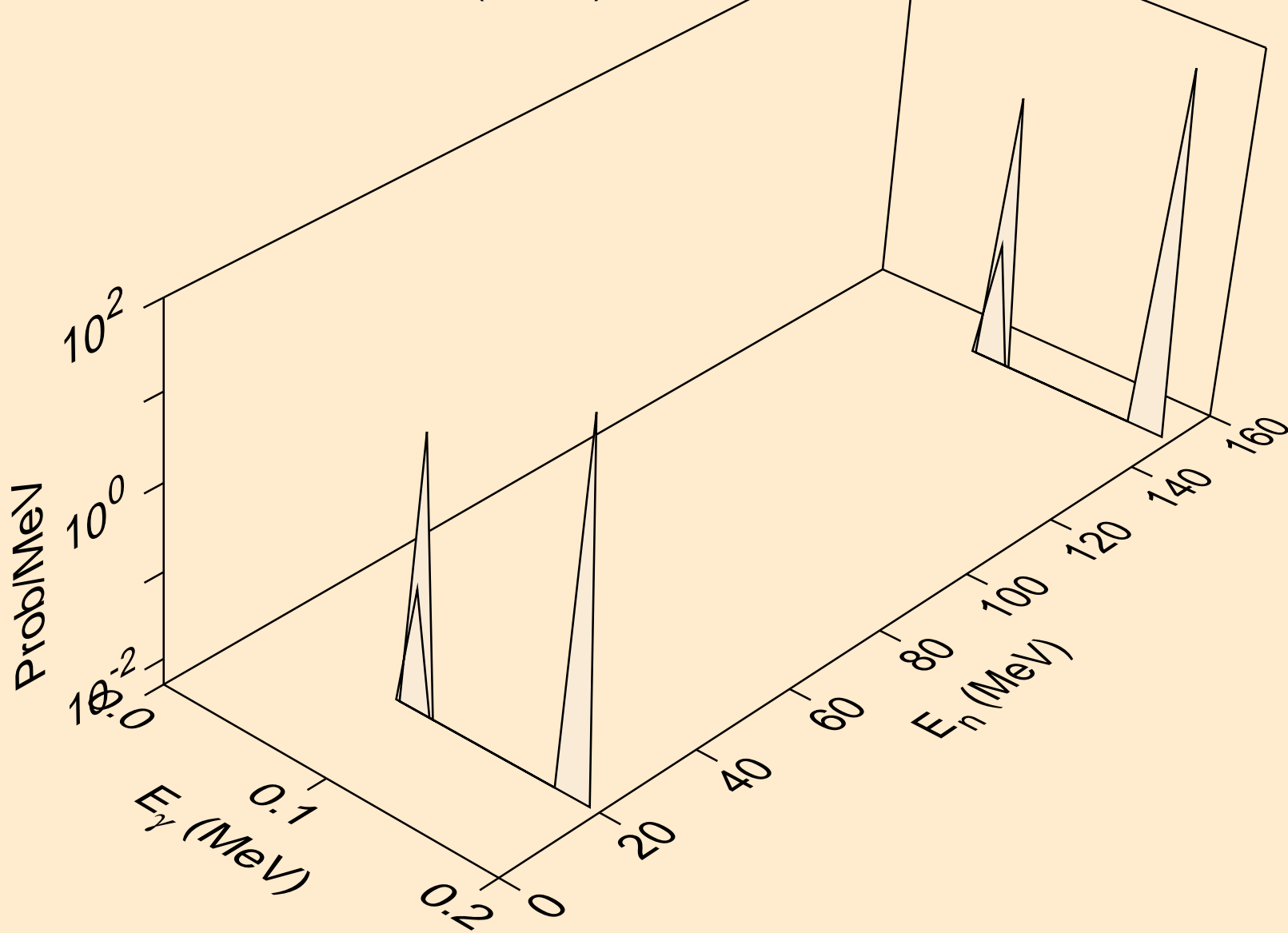

30-ZN-67 FOR FENDL-3.1 FROM FENDL-3.1 WITH NJOY2012.50+
Photon emission for (n,n*3)

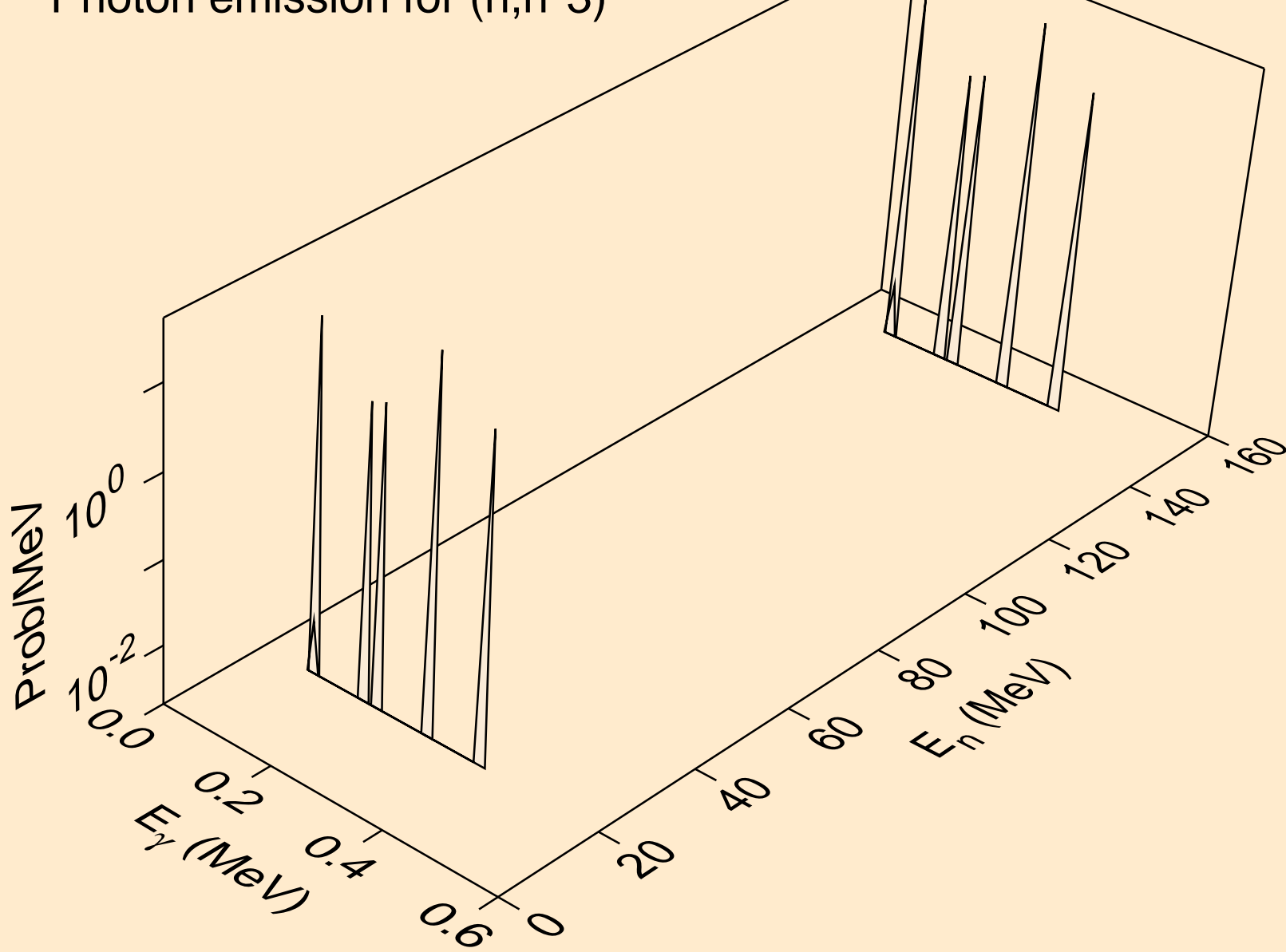

30-ZN-67 FOR FENDL-3.1 FROM FENDL-3.1 WITH NJOY2012.50+
Photon emission for (n,n*4)

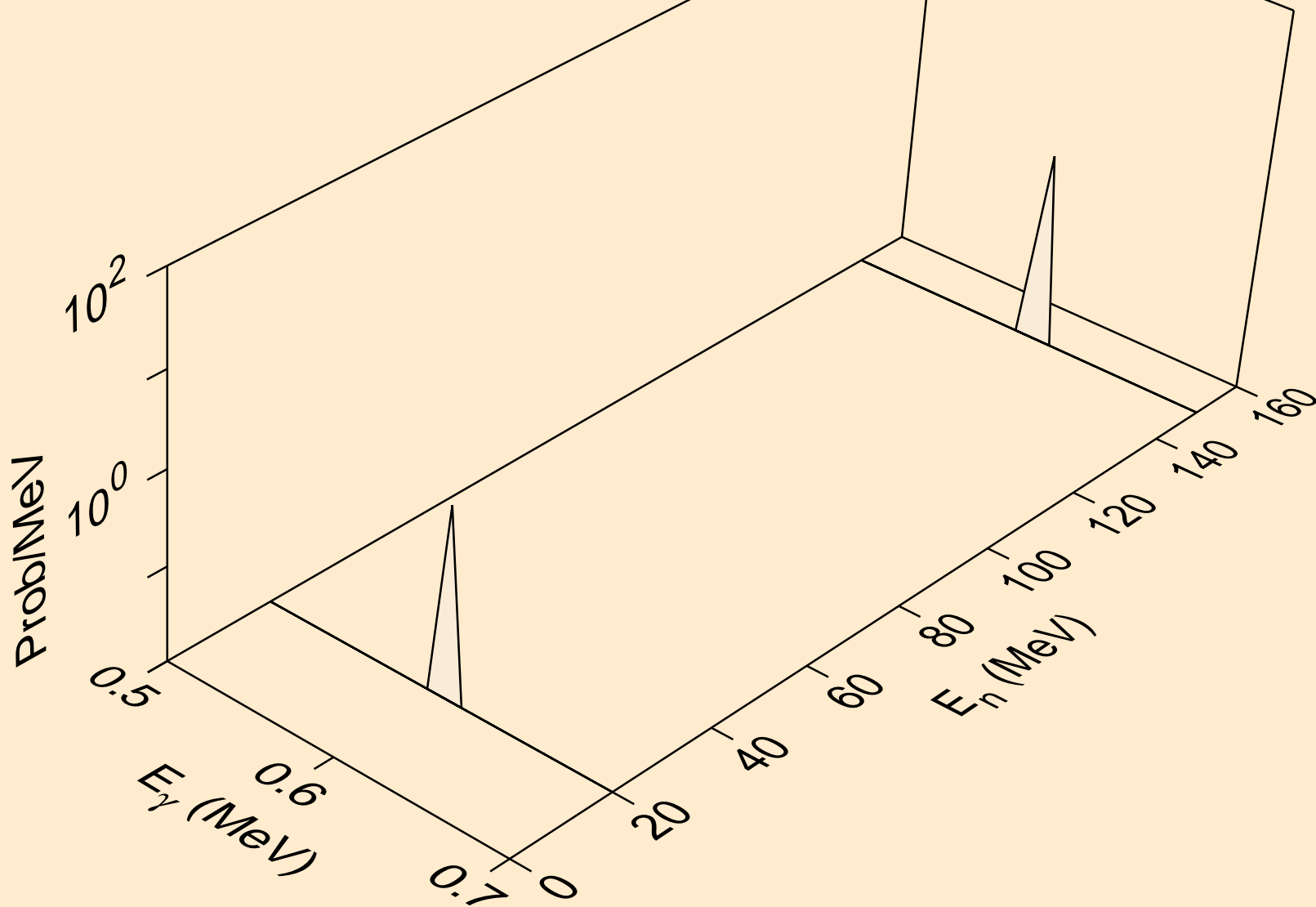

30-ZN-67 FOR FENDL-3.1 FROM FENDL-3.1 WITH NJOY2012.50+
Photon emission for (n,n*5)

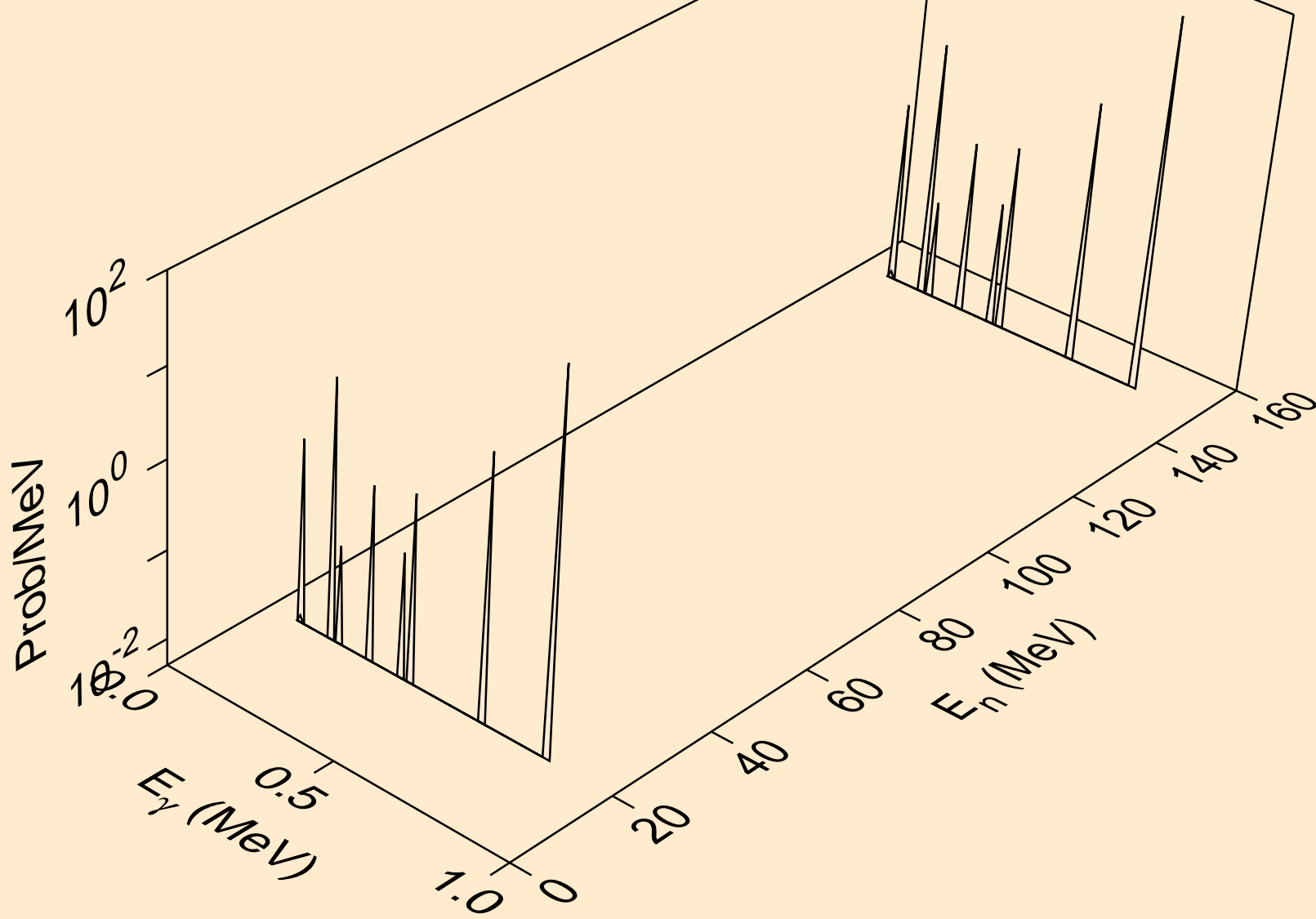

30-ZN-67 FOR FENDL-3.1 FROM FENDL-3.1 WITH NJOY2012.50+
Photon emission for (n,n*6)

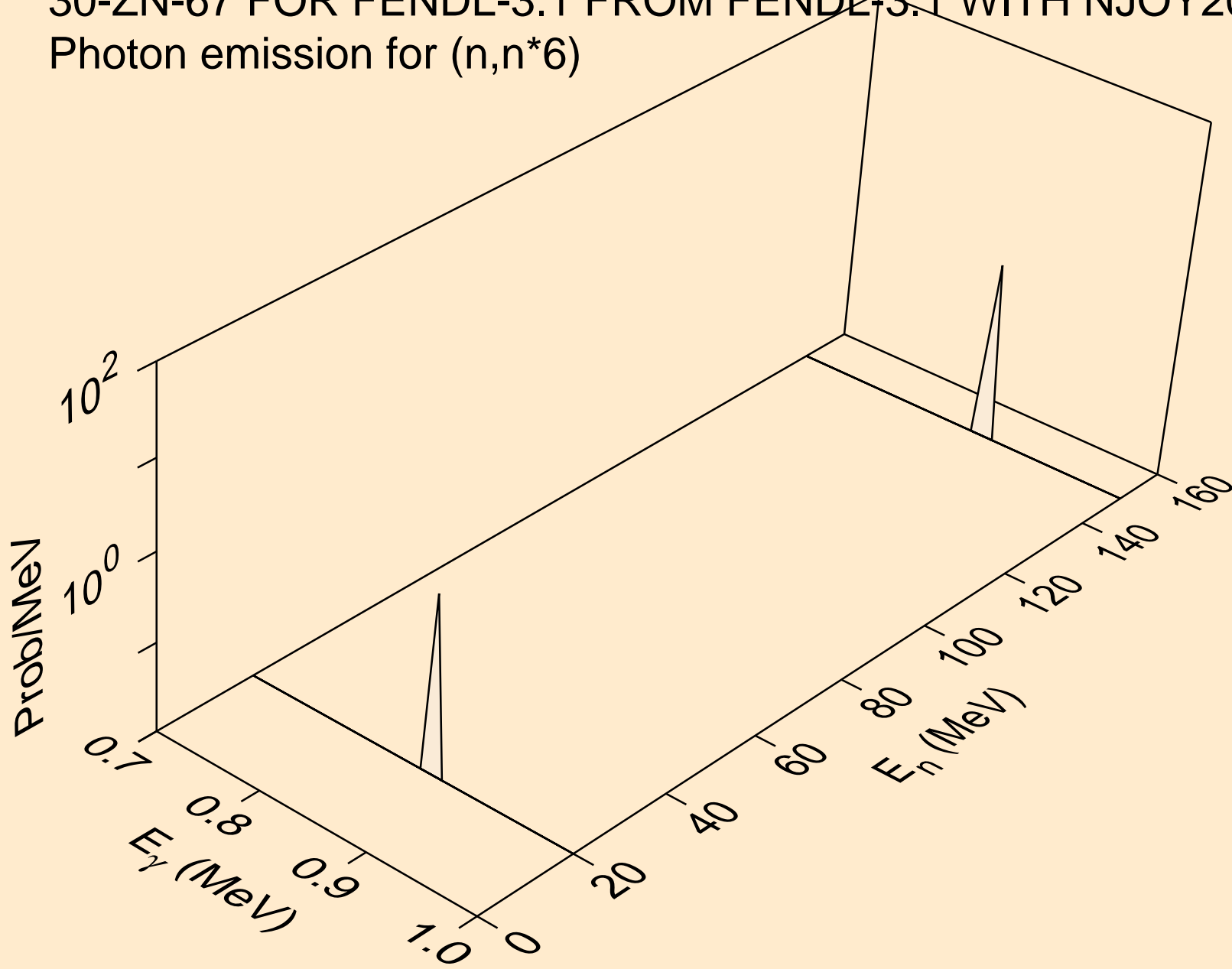

30-ZN-67 FOR FENDL-3.1 FROM FENDL-3.1 WITH NJOY2012.50+
Photon emission for (n,n*7)

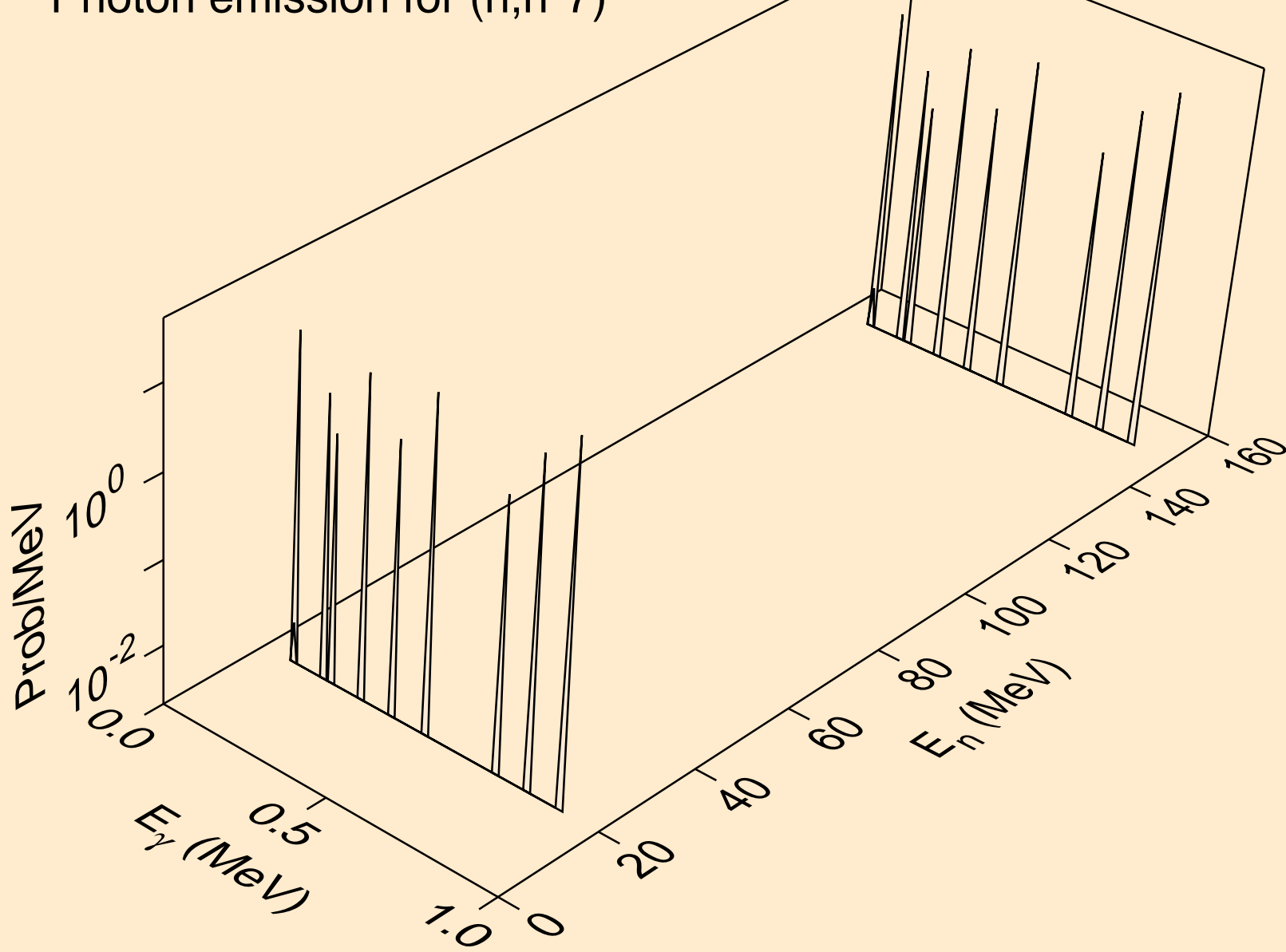

30-ZN-67 FOR FENDL-3.1 FROM FENDL-3.1 WITH NJOY2012.50+
Photon emission for (n,n*8)

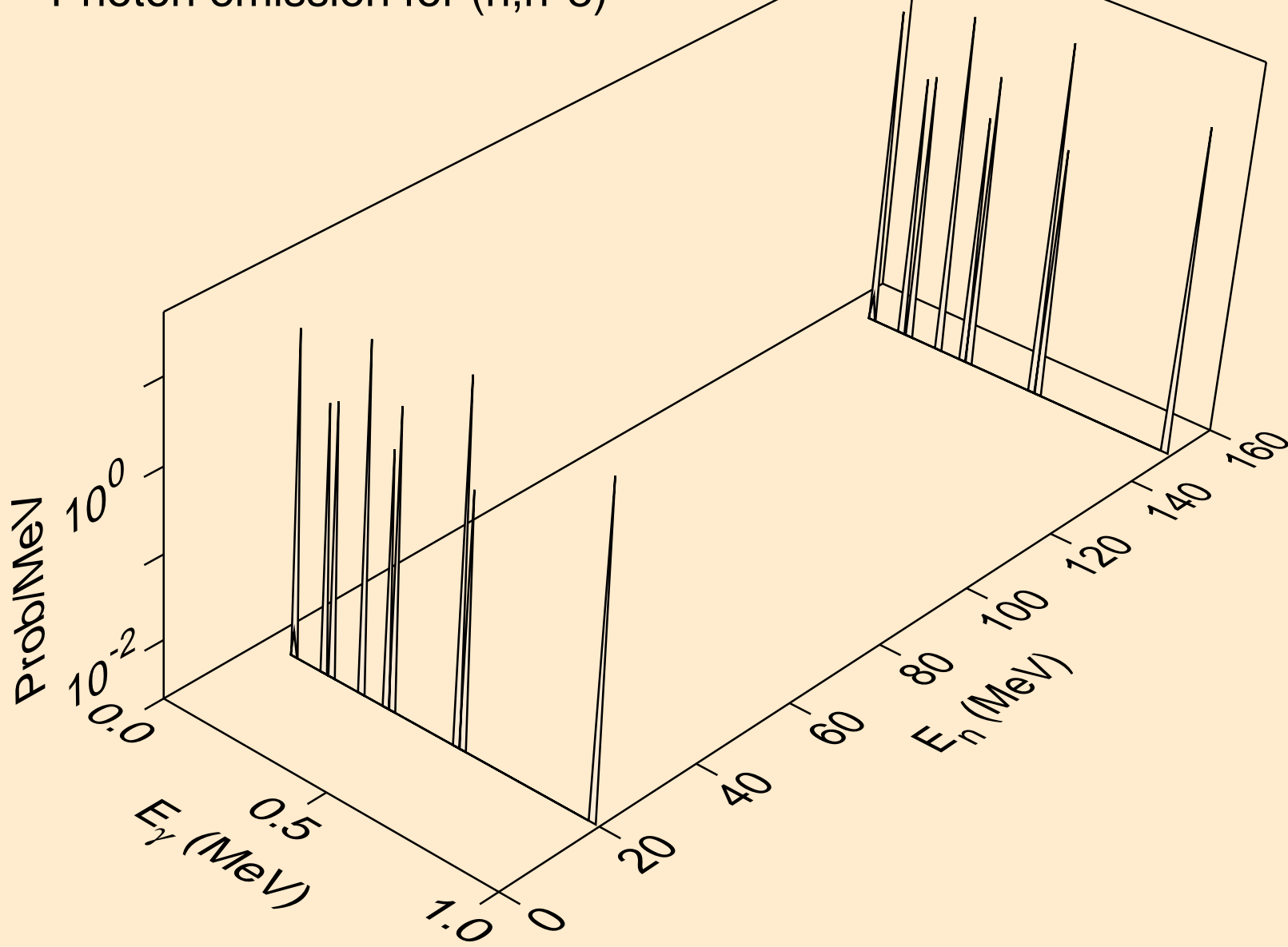

30-ZN-67 FOR FENDL-3.1 FROM FENDL-3.1 WITH NJOY2012.50+
Photon emission for (n,n*9)

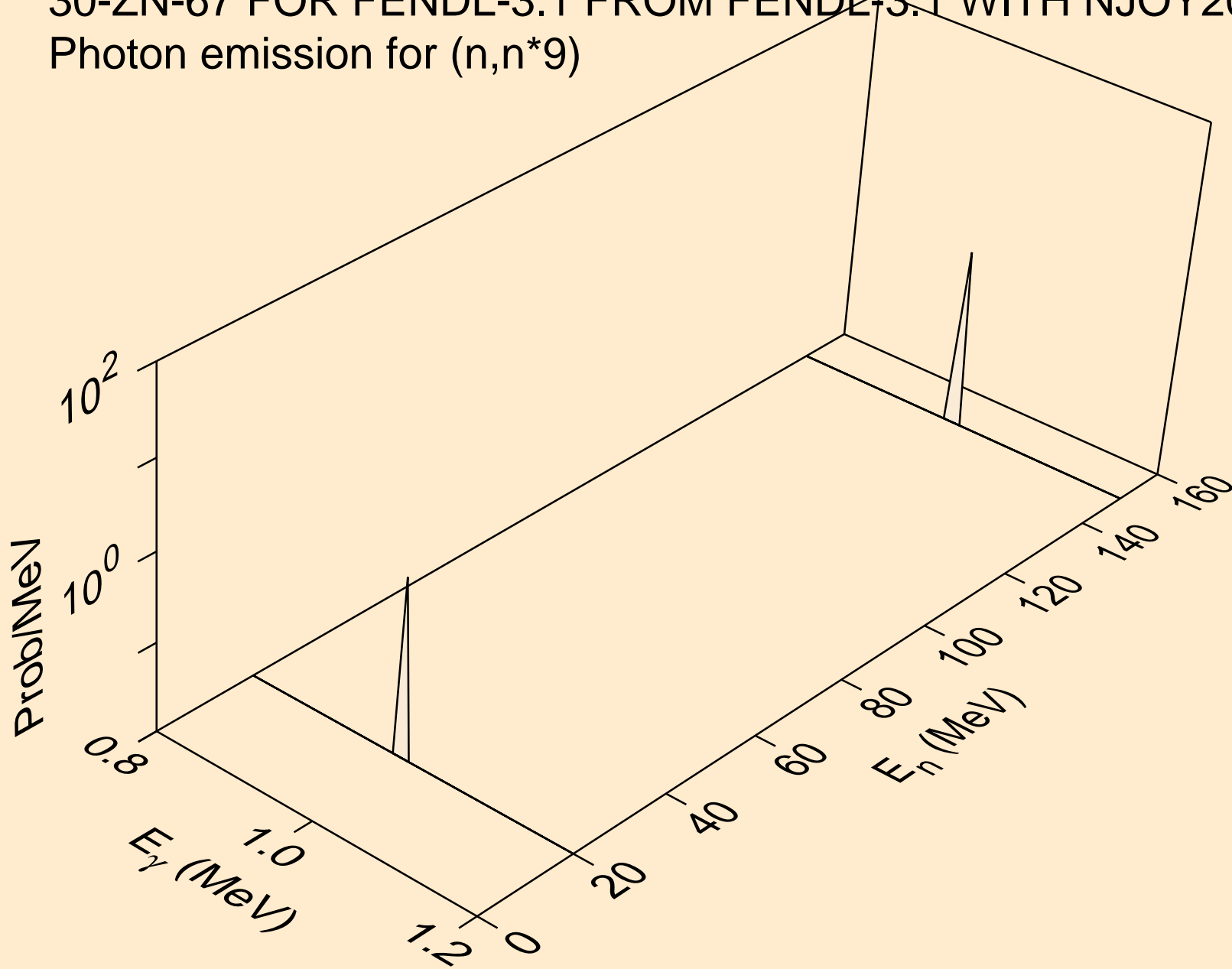

30-ZN-67 FOR FENDL-3.1 FROM FENDL-3.1 WITH NJOY2012.50+
Photon emission for (n,n*10)

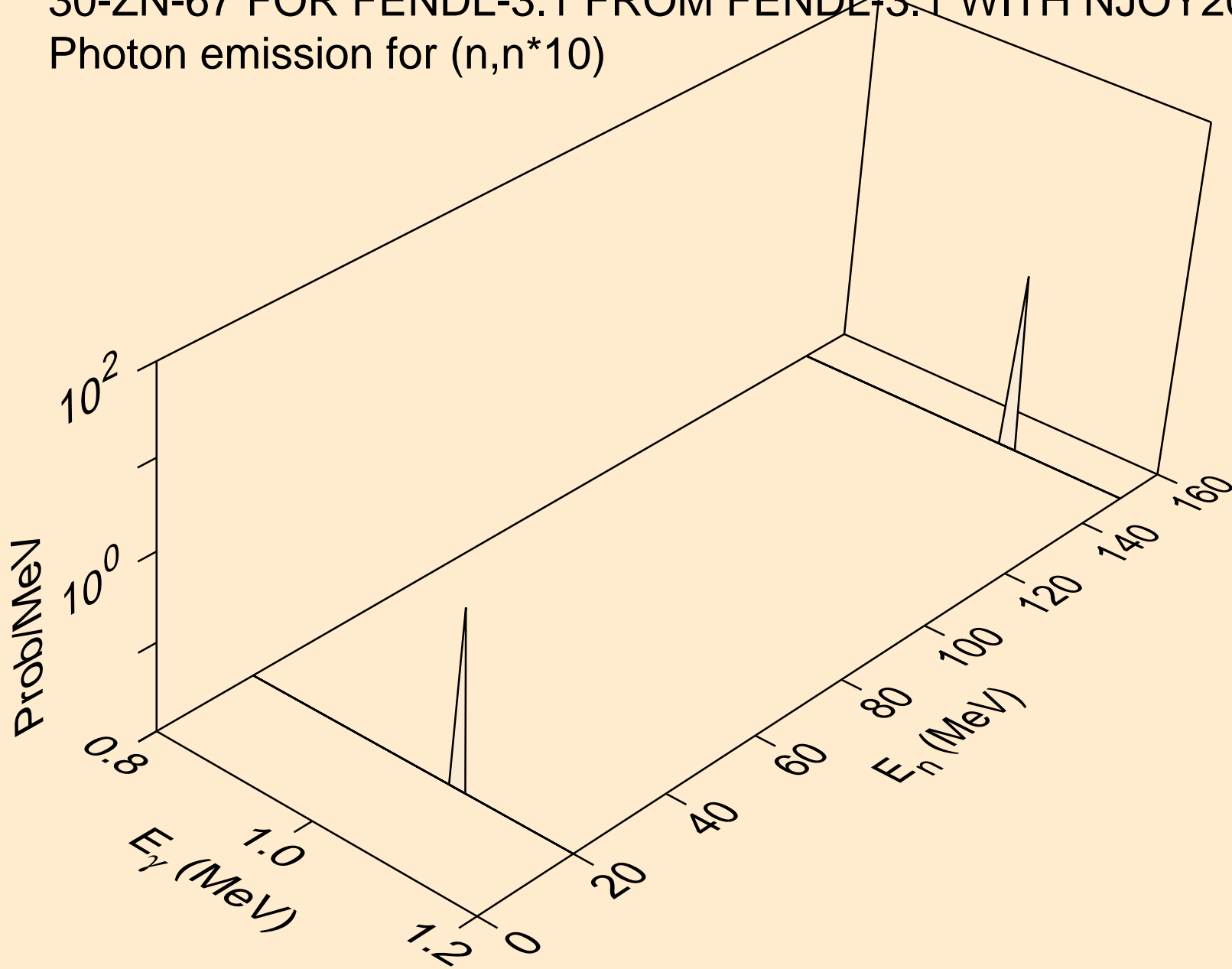

30-ZN-67 FOR FENDL-3.1 FROM FENDL-3.1 WITH NJOY2012.50+
Photon emission for (n,n*11)

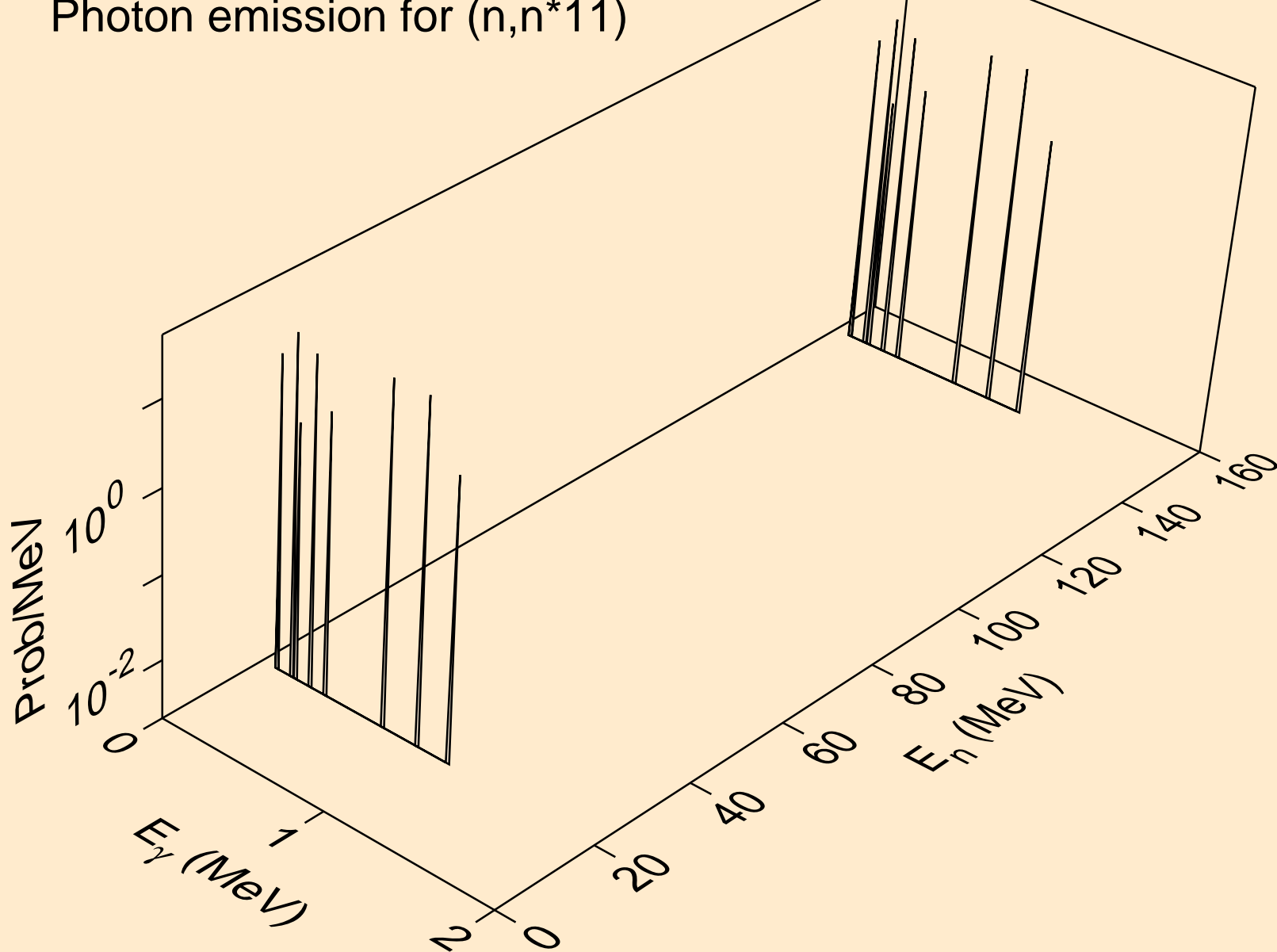

30-ZN-67 FOR FENDL-3.1 FROM FENDL-3.1 WITH NJOY2012.50+
Photon emission for (n,n*c)

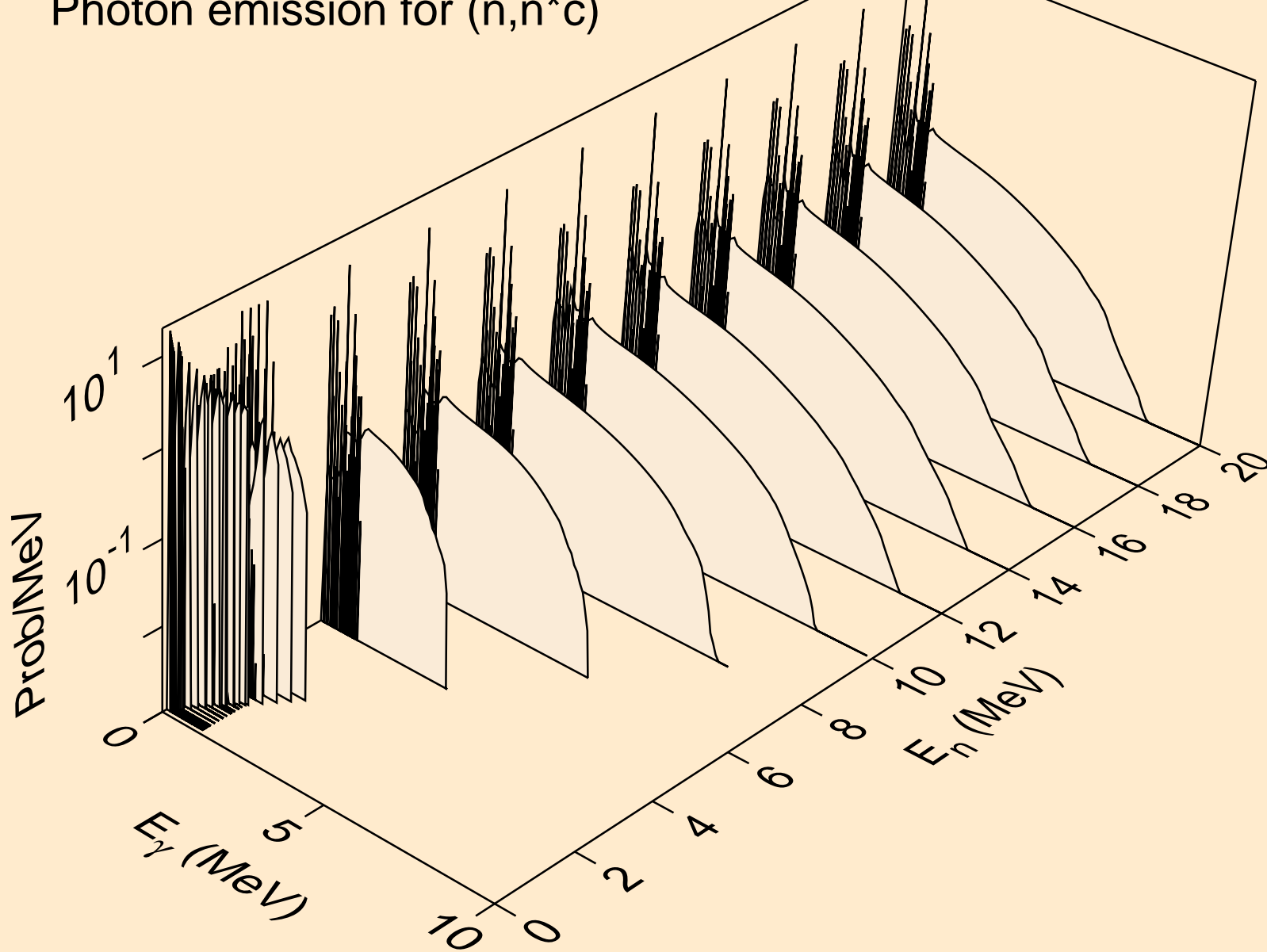

30-ZN-67 FOR FENDL-3.1 FROM FENDL-3.1 WITH NJOY2012.50+
Photon emission for (n,gma)

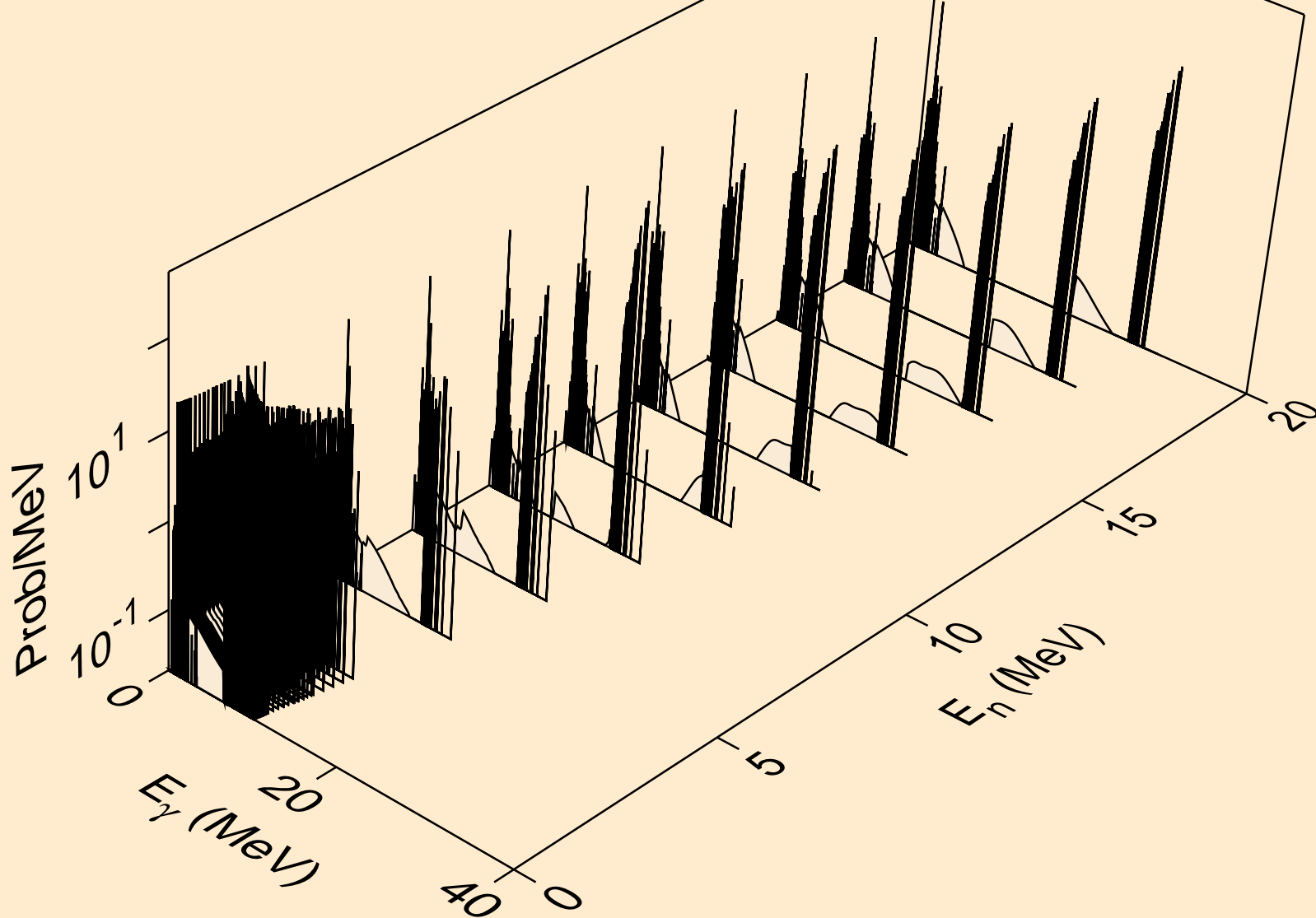

30-ZN-67 FOR FENDL-3.1 FROM FENDL-3.1 WITH NJOY2012.50+
thermal capture photon spectrum

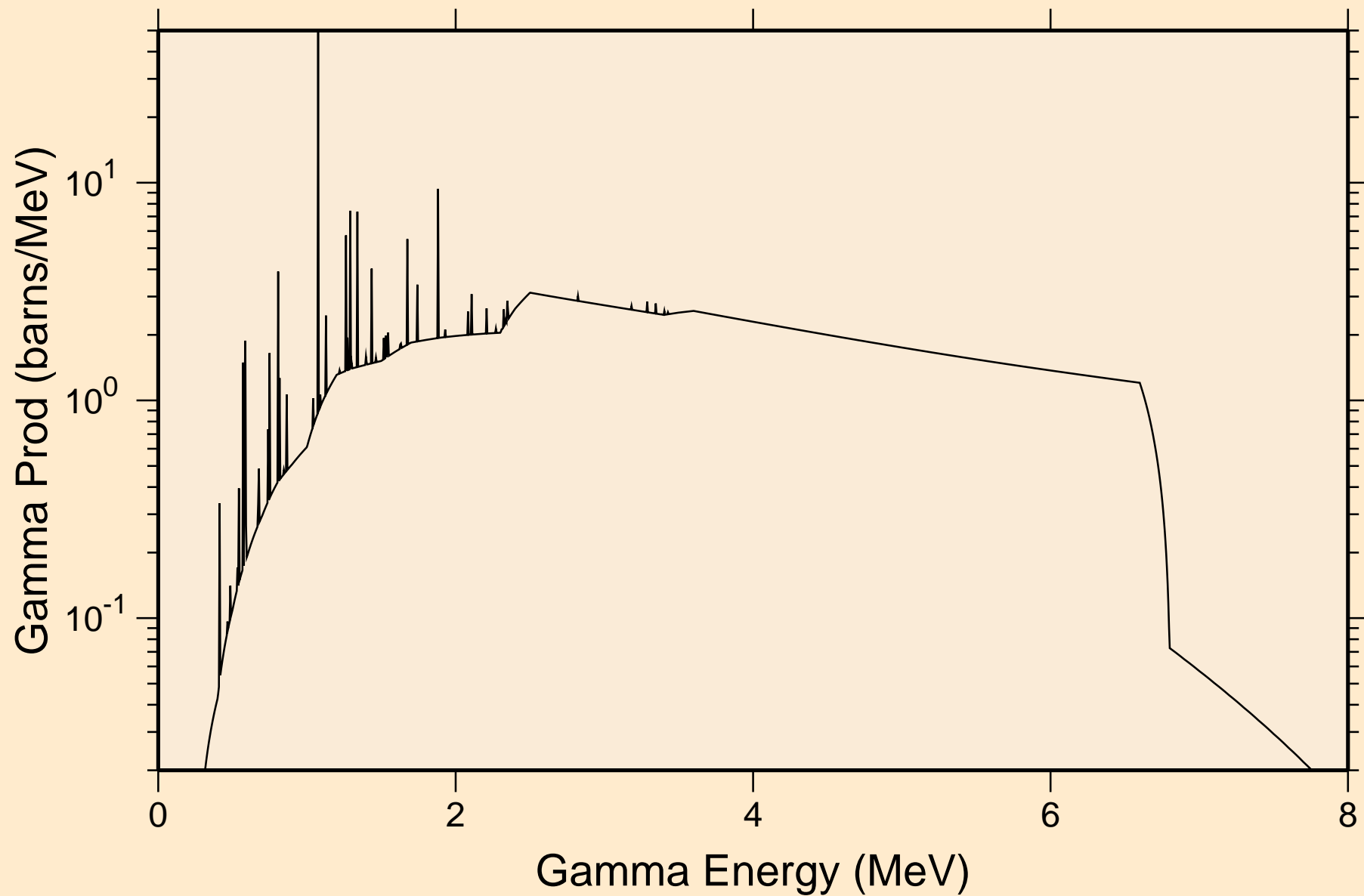

30-ZN-67 FOR FENDL-3.1 FROM FENDL-3.1 WITH NJOY2012.50+
14 MeV photon spectrum

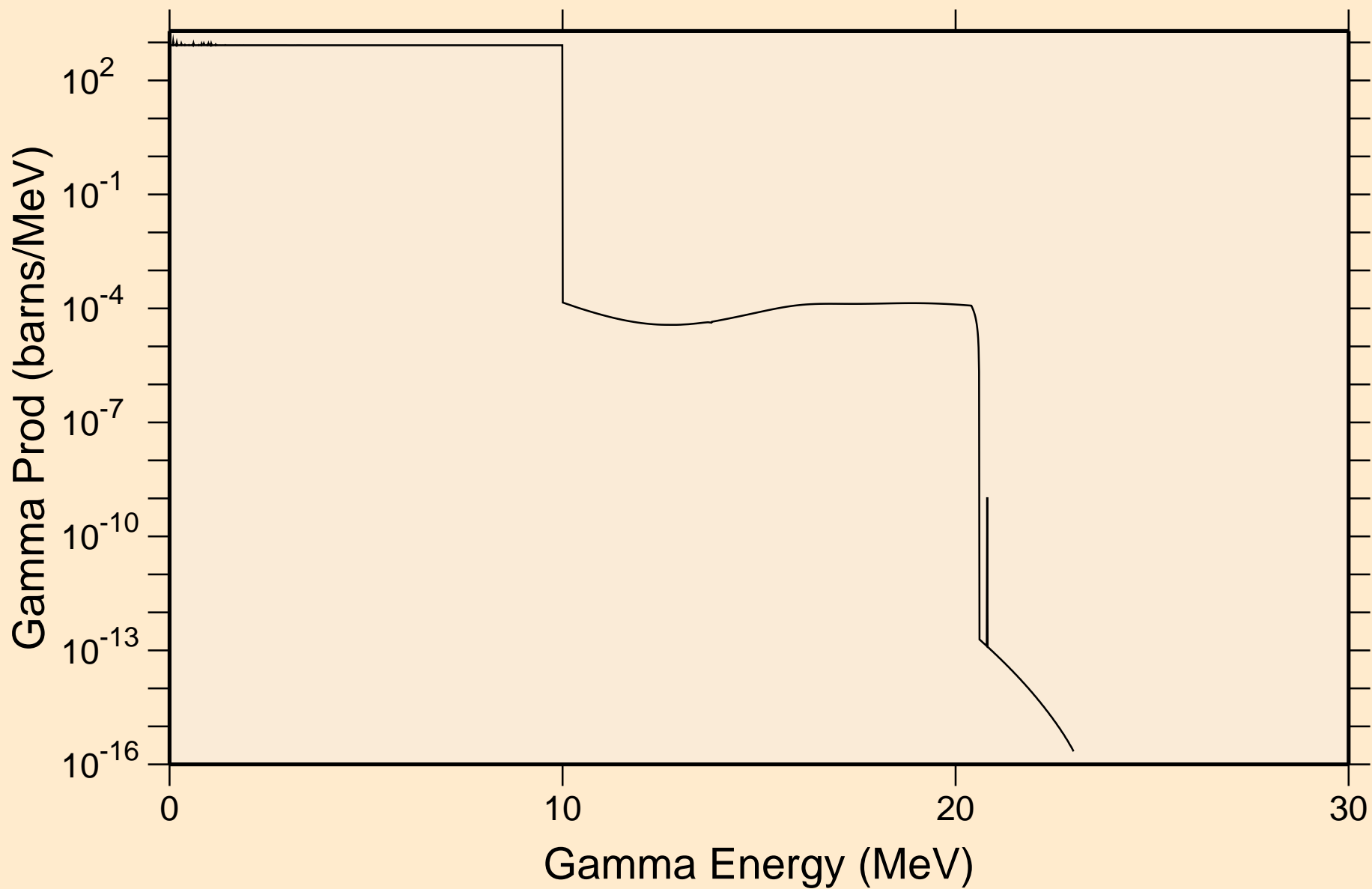

30-ZN-67 FOR FENDL-3.1 FROM FENDL-3.1 WITH NJOY2012.50+

Particle heating contributions

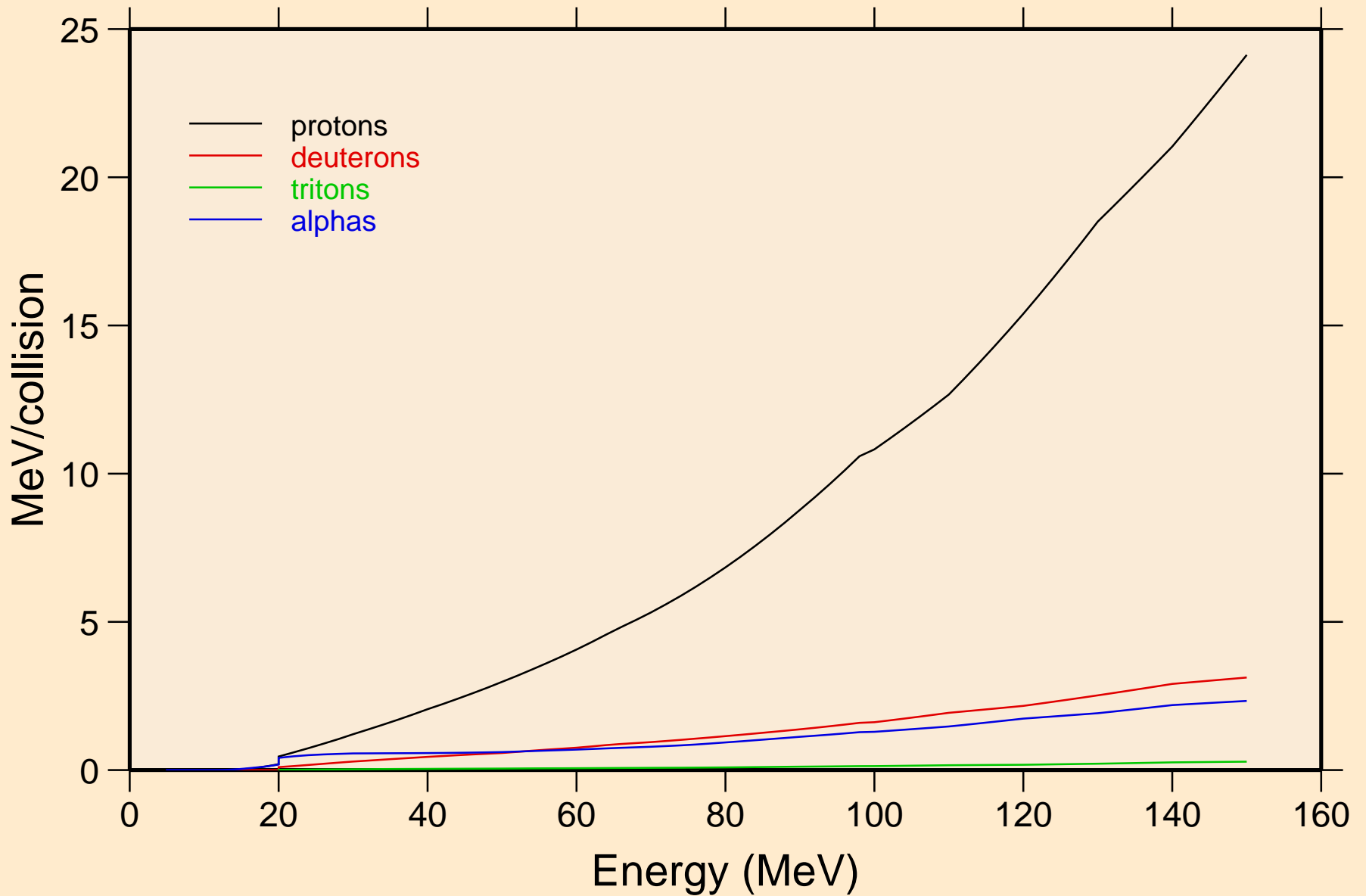

30-ZN-67 FOR FENDL-3.1 FROM FENDL-3.1 WITH NJOY2012.50+ Recoil Heating

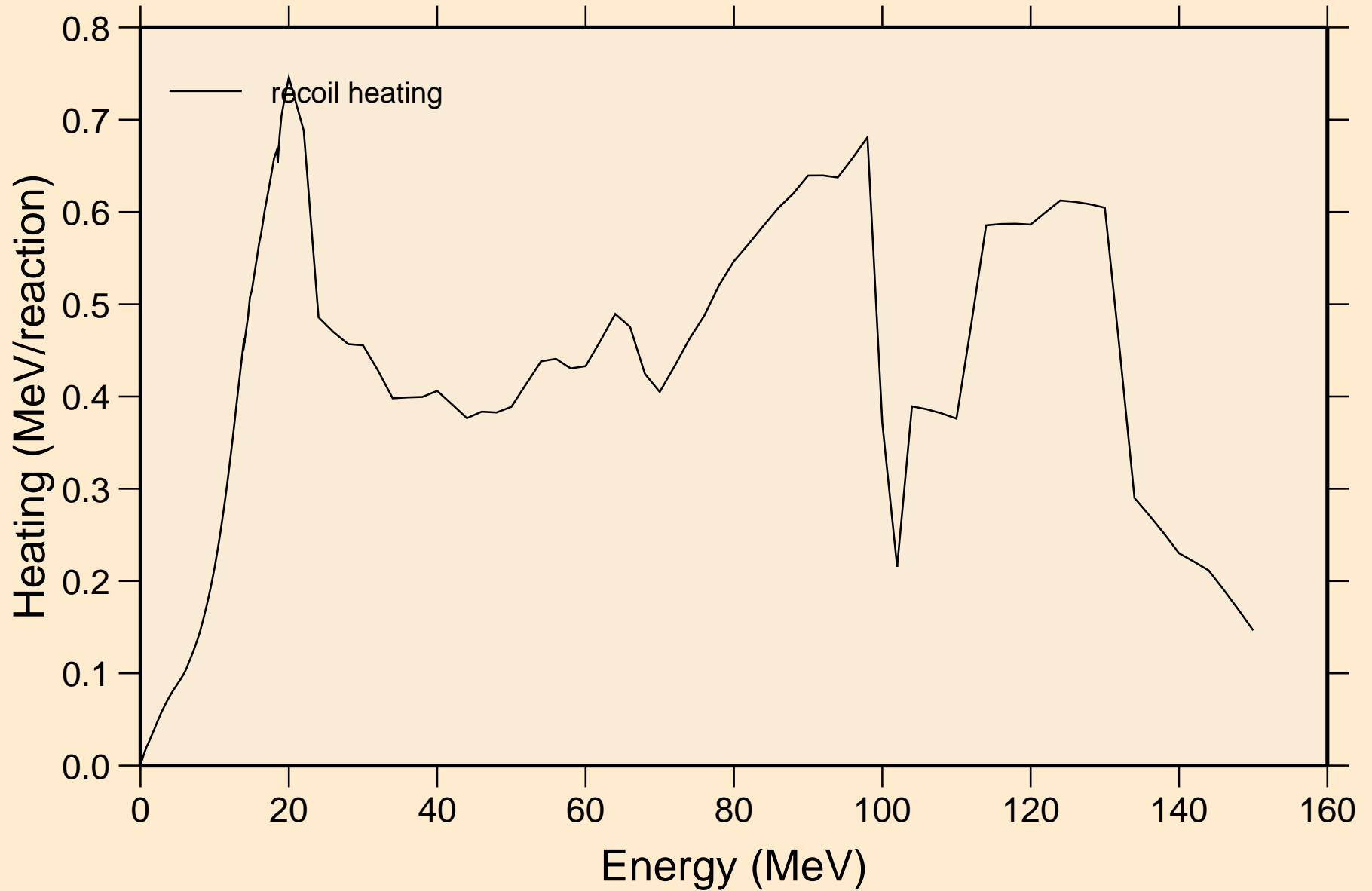

30-ZN-67 FOR FENDL-3.1 FROM FENDL-3.1 WITH NJOY2012.50+
Particle production cross sections

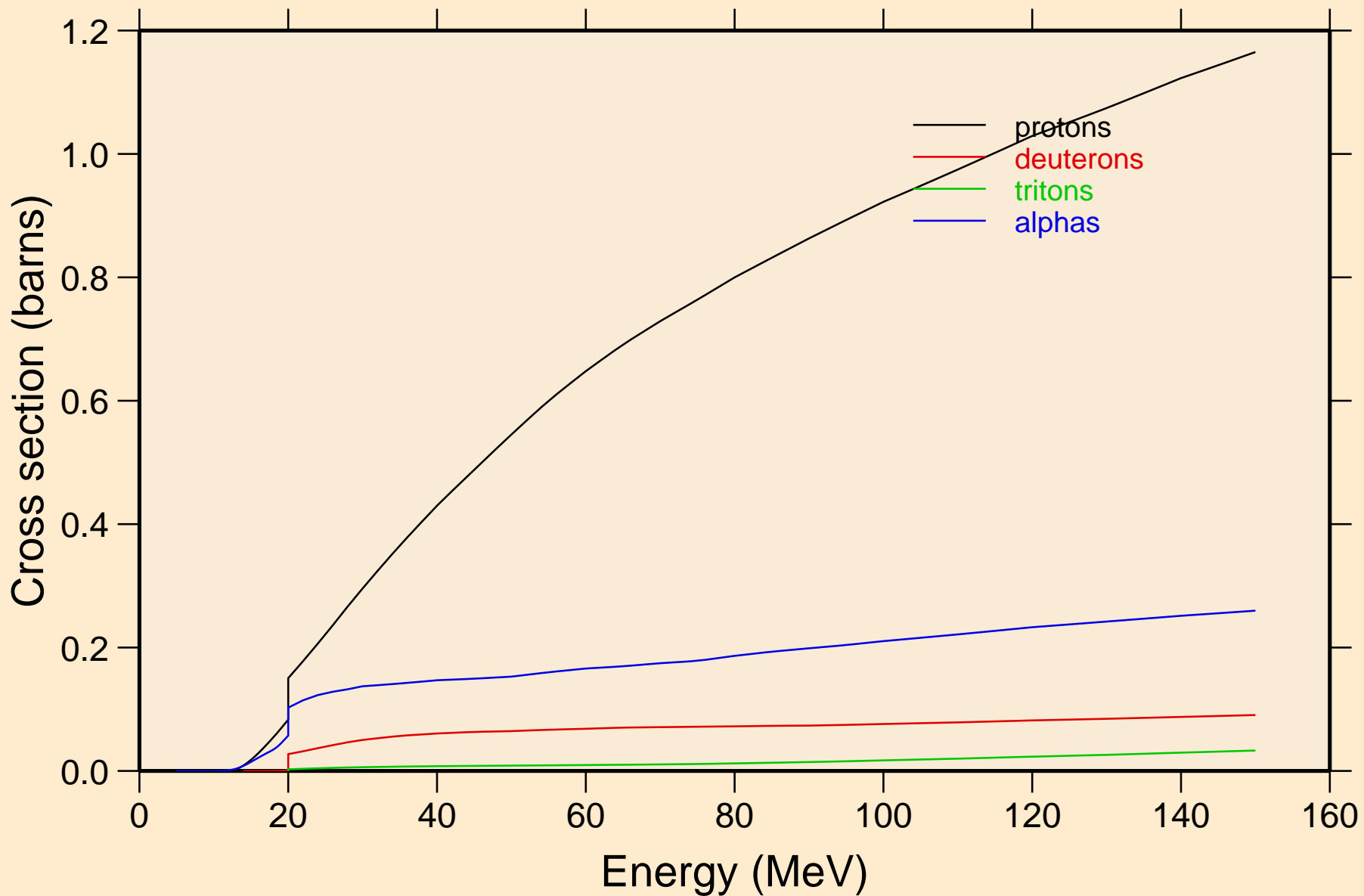

30-ZN-67 FOR FENDL-3.1 FROM FENDL-3.1 WITH NJOY2012.50+
protons from (n,x)

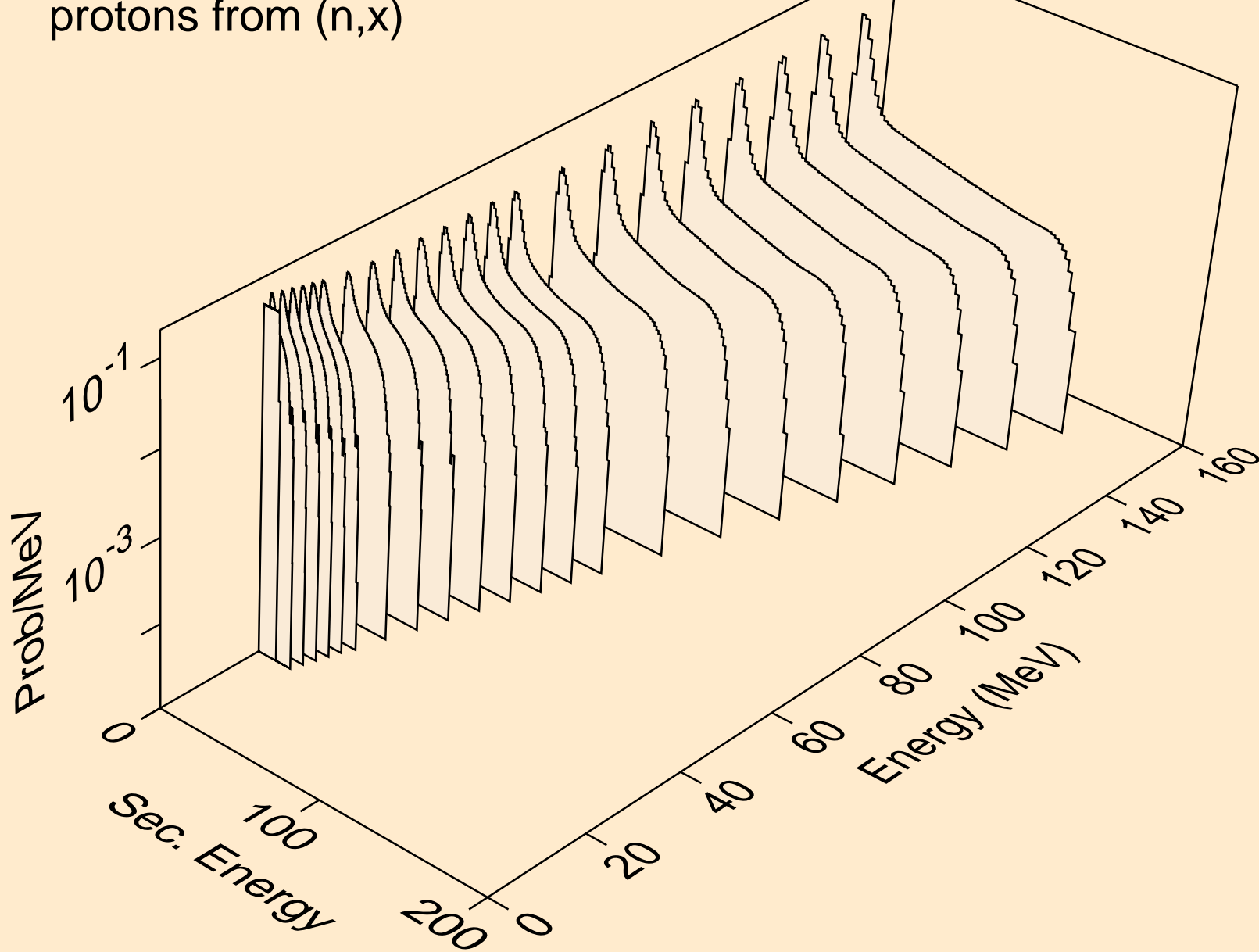

30-ZN-67 FOR FENDL-3.1 FROM FENDL-3.1 WITH NJOY2012.50+
protons from (n,n*)p

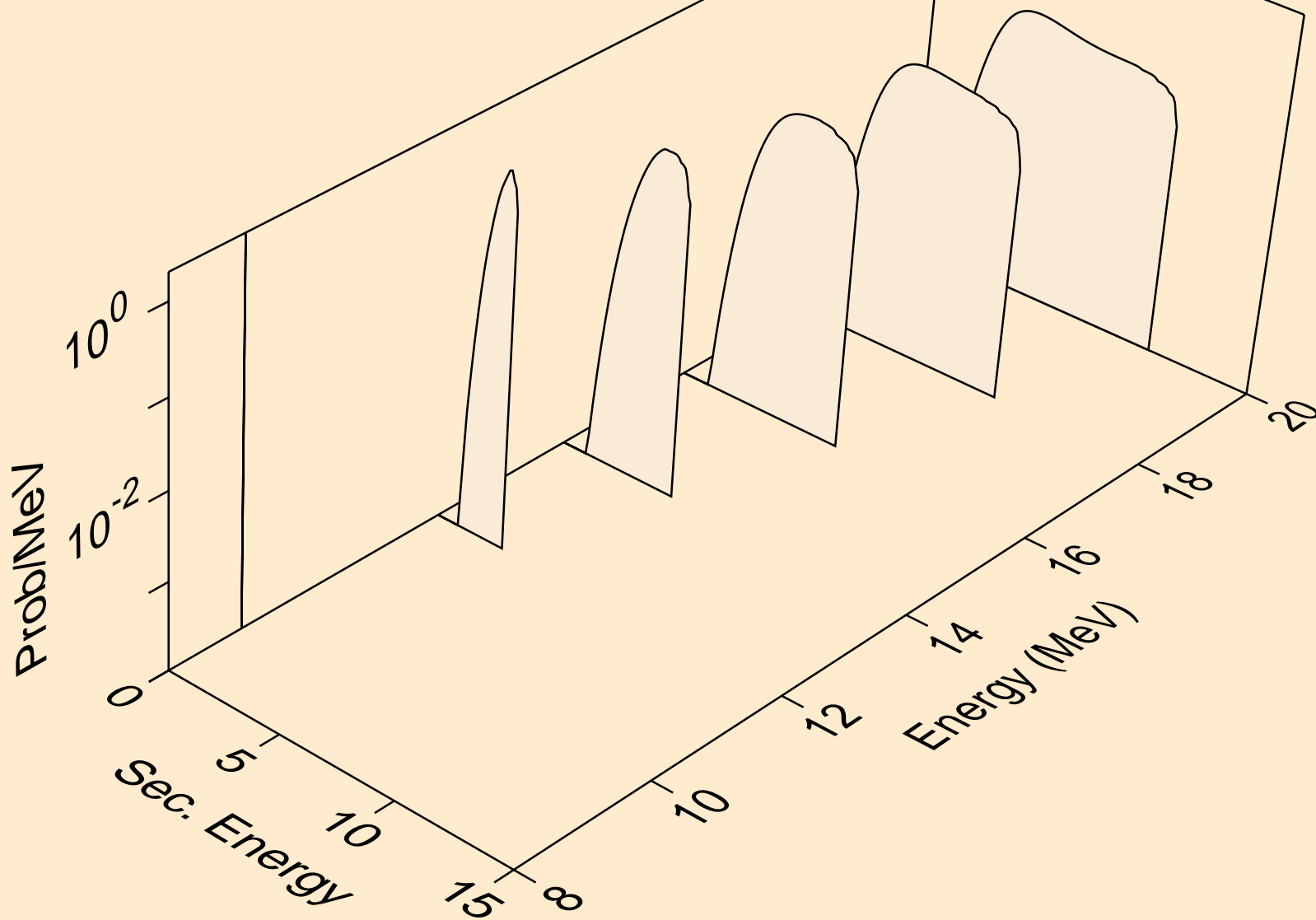

30-ZN-67 FOR FENDL-3.1 FROM FENDL-3.1 WITH NJOY2012.50+
protons from (n,2np)

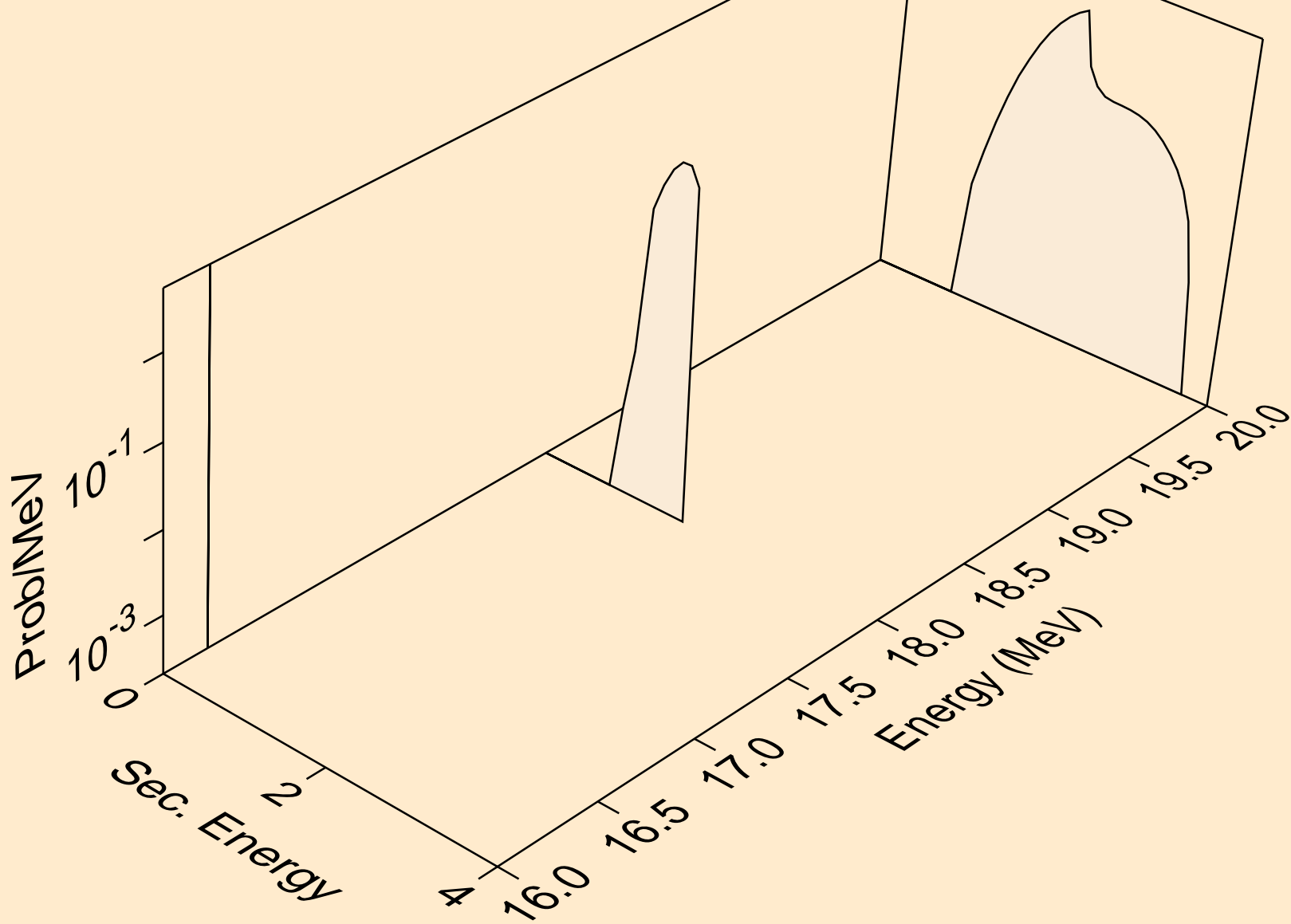

30-ZN-67 FOR FENDL-3.1 FROM FENDL-3.1 WITH NJOY2012.50+
deuterons from (n,x)

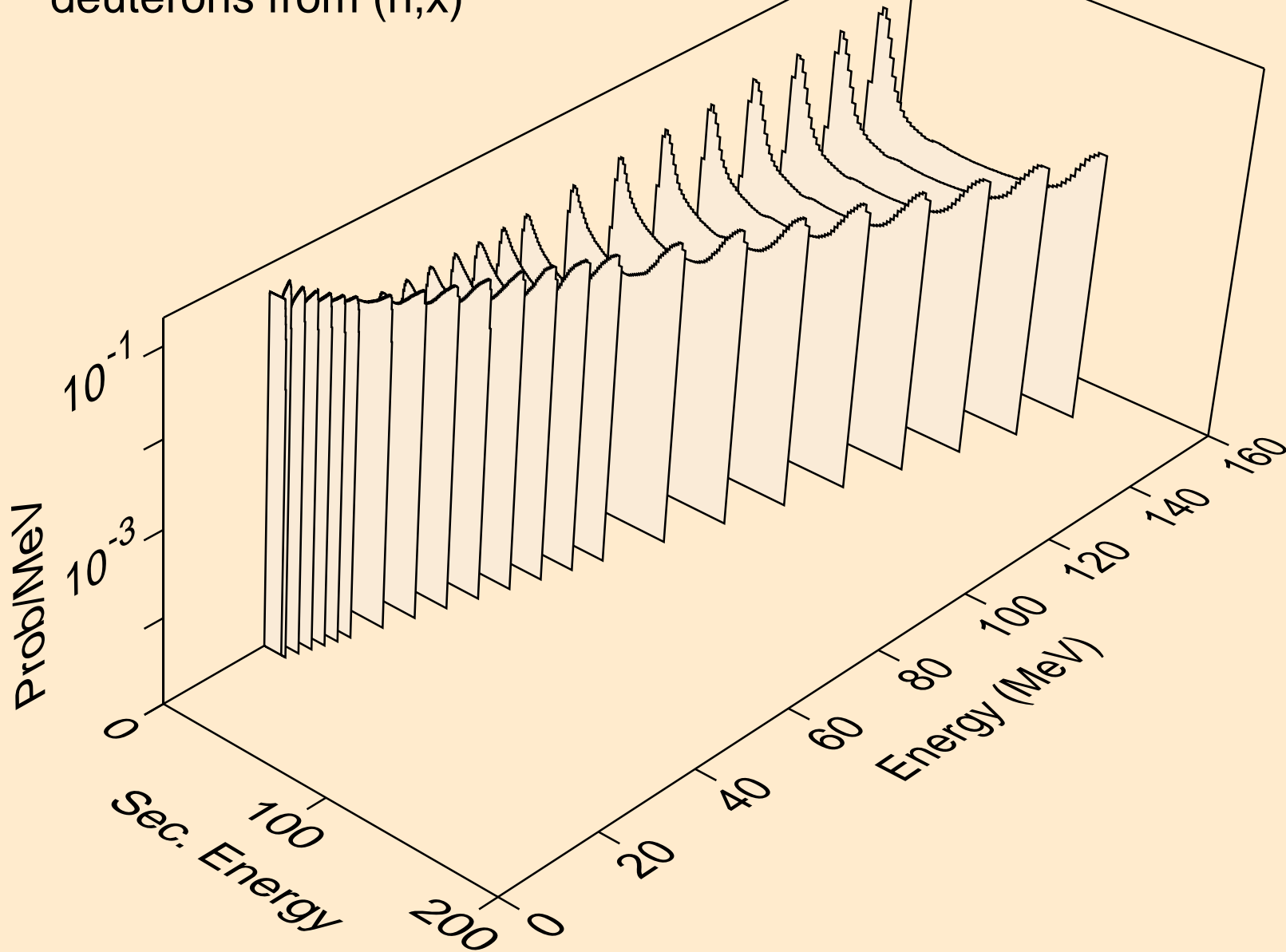

30-ZN-67 FOR FENDL-3.1 FROM FENDL-3.1 WITH NJOY2012.50+
deuterons from (n,n*)d

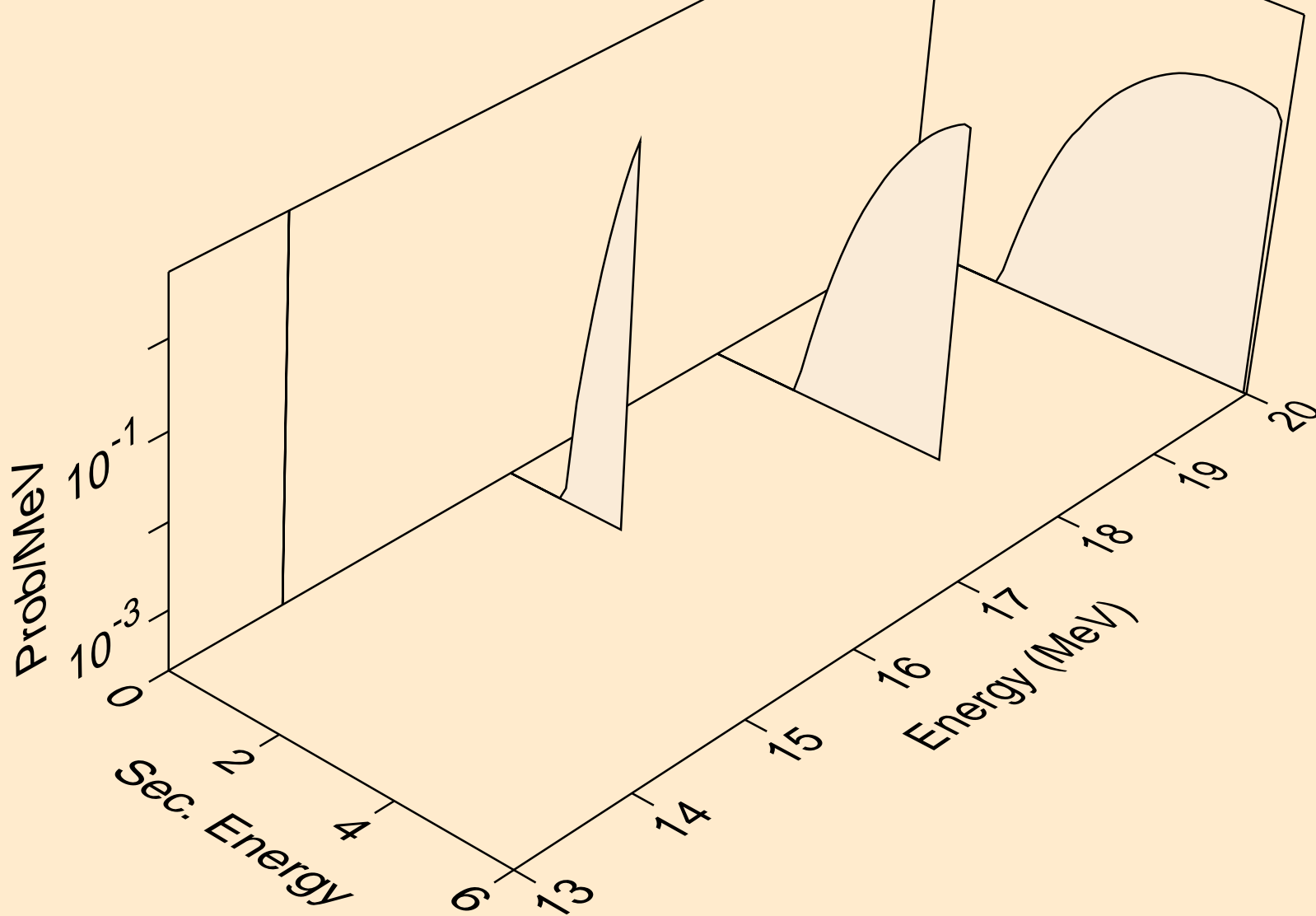

30-ZN-67 FOR FENDL-3.1 FROM FENDL-3.1 WITH NJOY2012.50+
tritons from (n,x)

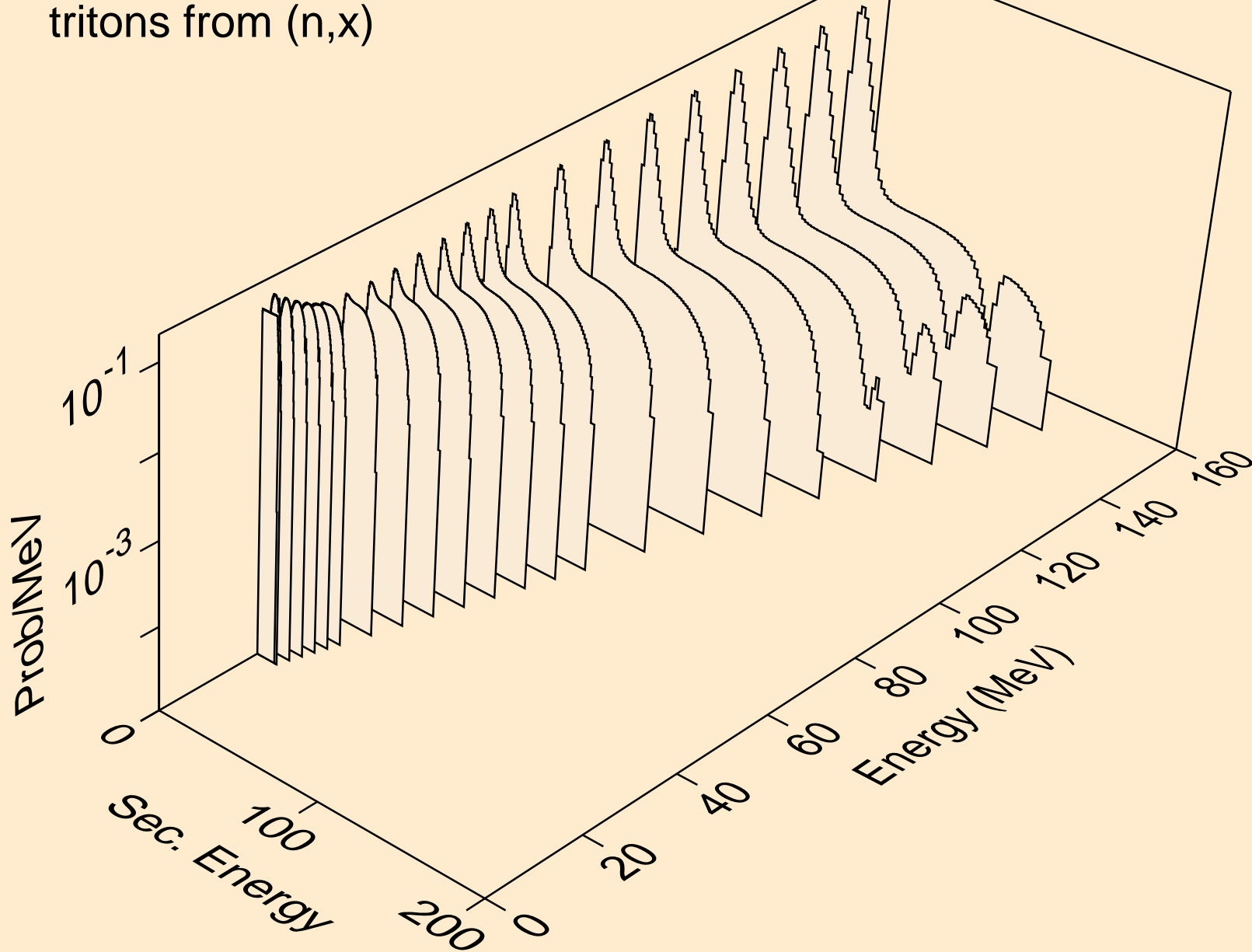

30-ZN-67 FOR FENDL-3.1 FROM FENDL-3.1 WITH NJOY2012.50+
alphas from (n,x)

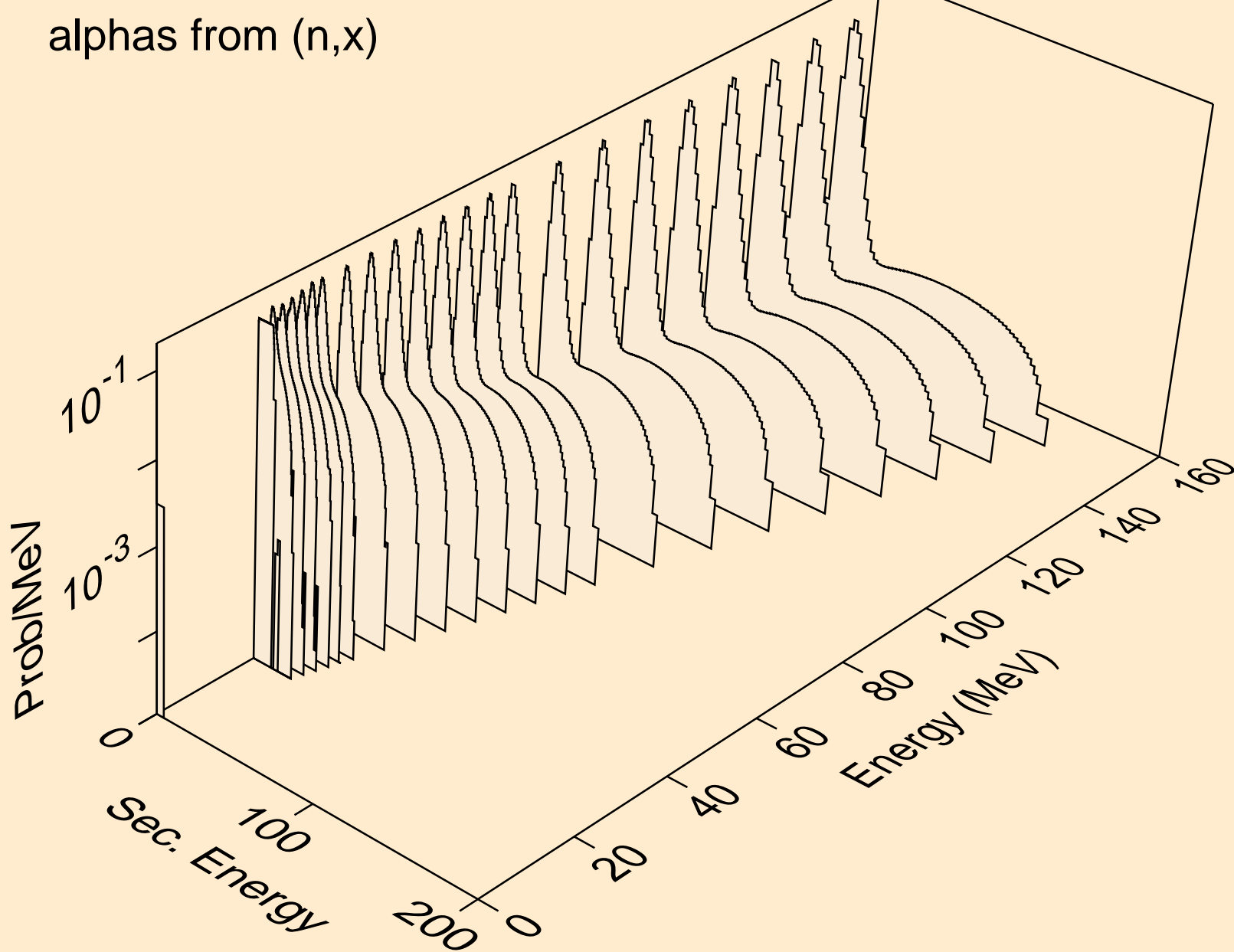

30-ZN-67 FOR FENDL-3.1 FROM FENDL-3.1 WITH NJOY2012.50+
alphas from (n,n*)a

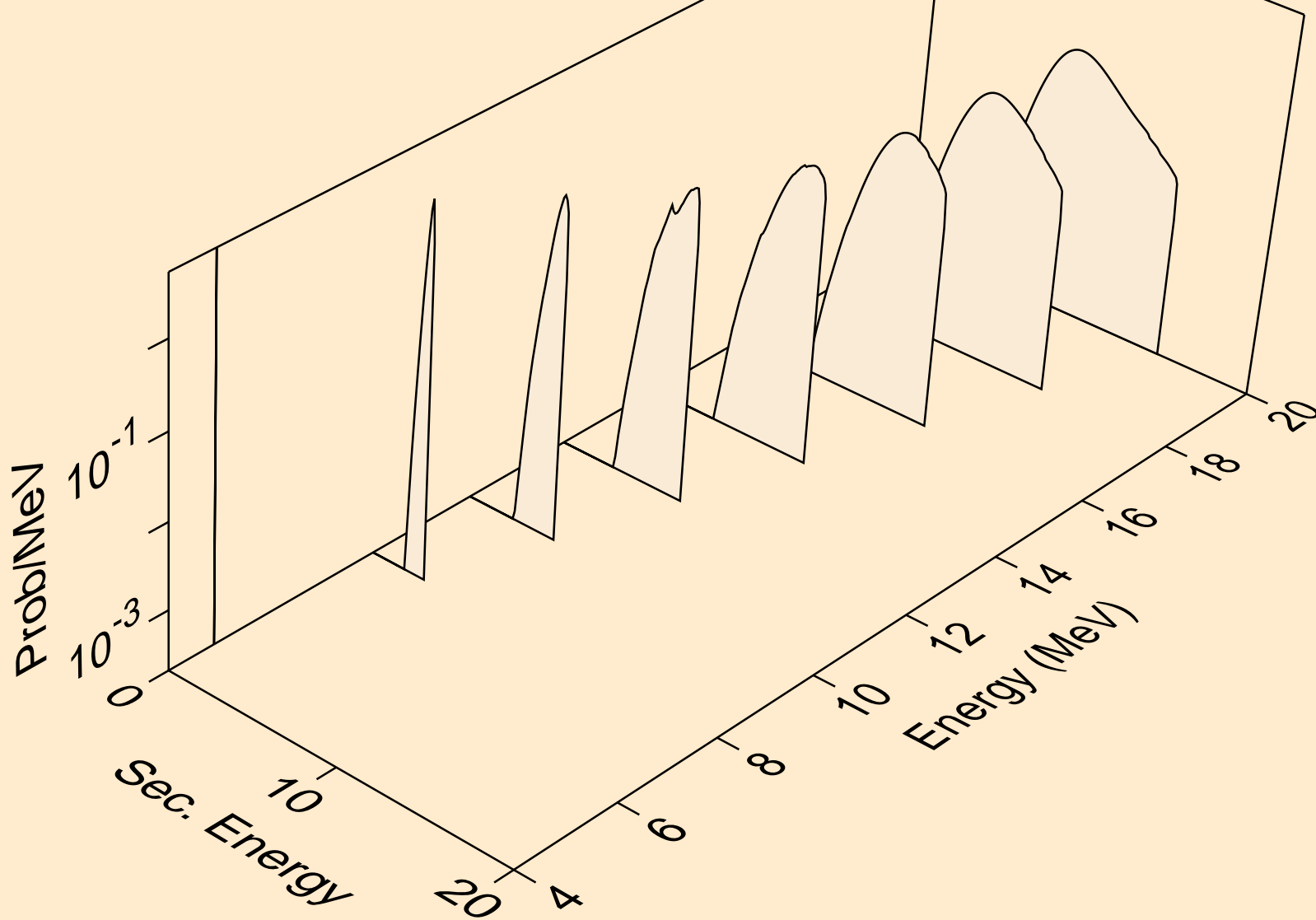

30-ZN-67 FOR FENDL-3.1 FROM FENDL-3.1 WITH NJOY2012.50+
alphas from (n,2n)a

