

42-MO-95 FOR FENDL-3.1 FROM FENDL-3.1 WITH NJOY2012.50-  
Principal cross sections

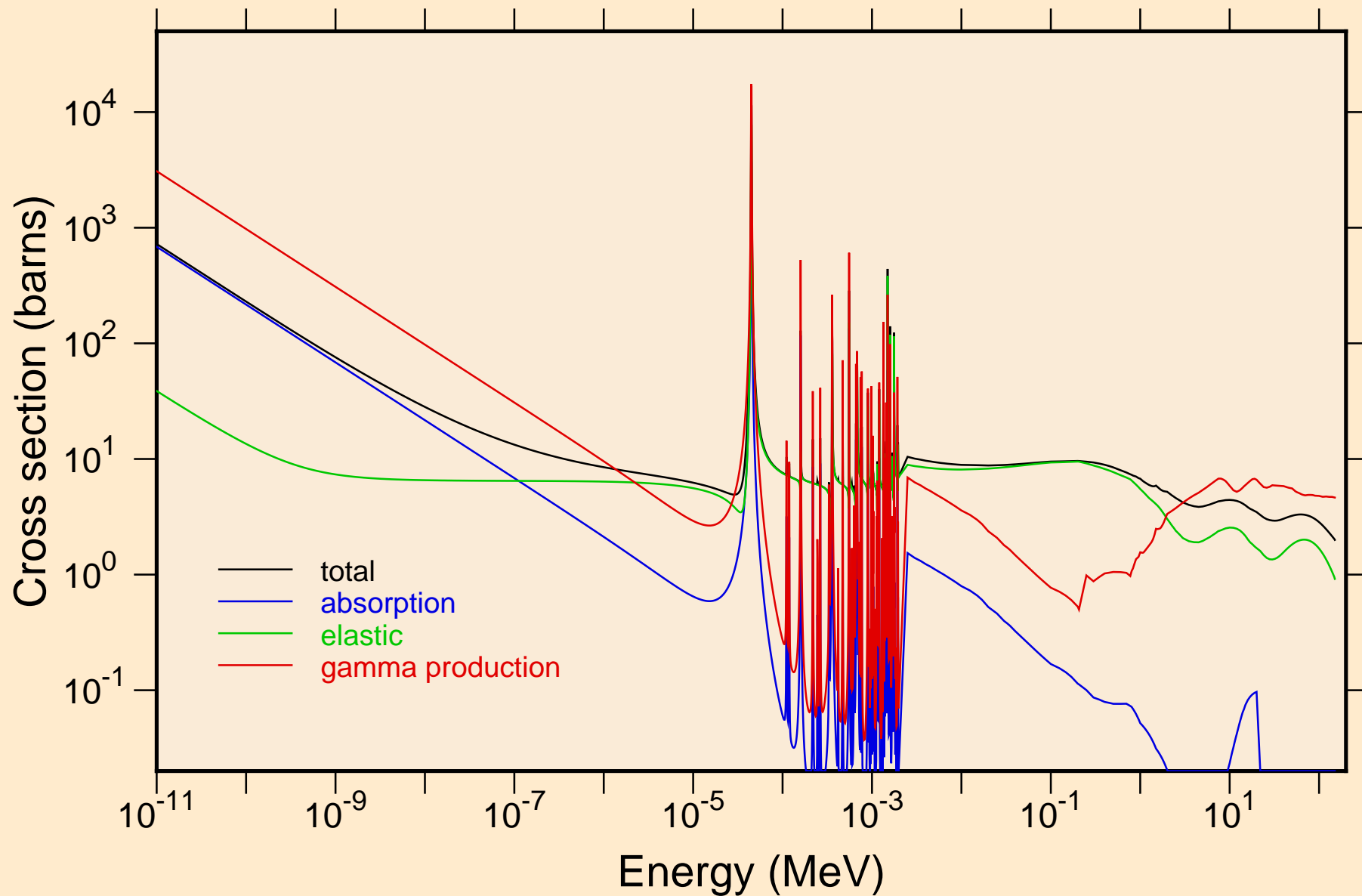

42-MO-95 FOR FENDL-3.1 FROM FENDL-3.1 WITH NJOY2012.50-  
resonance total cross section

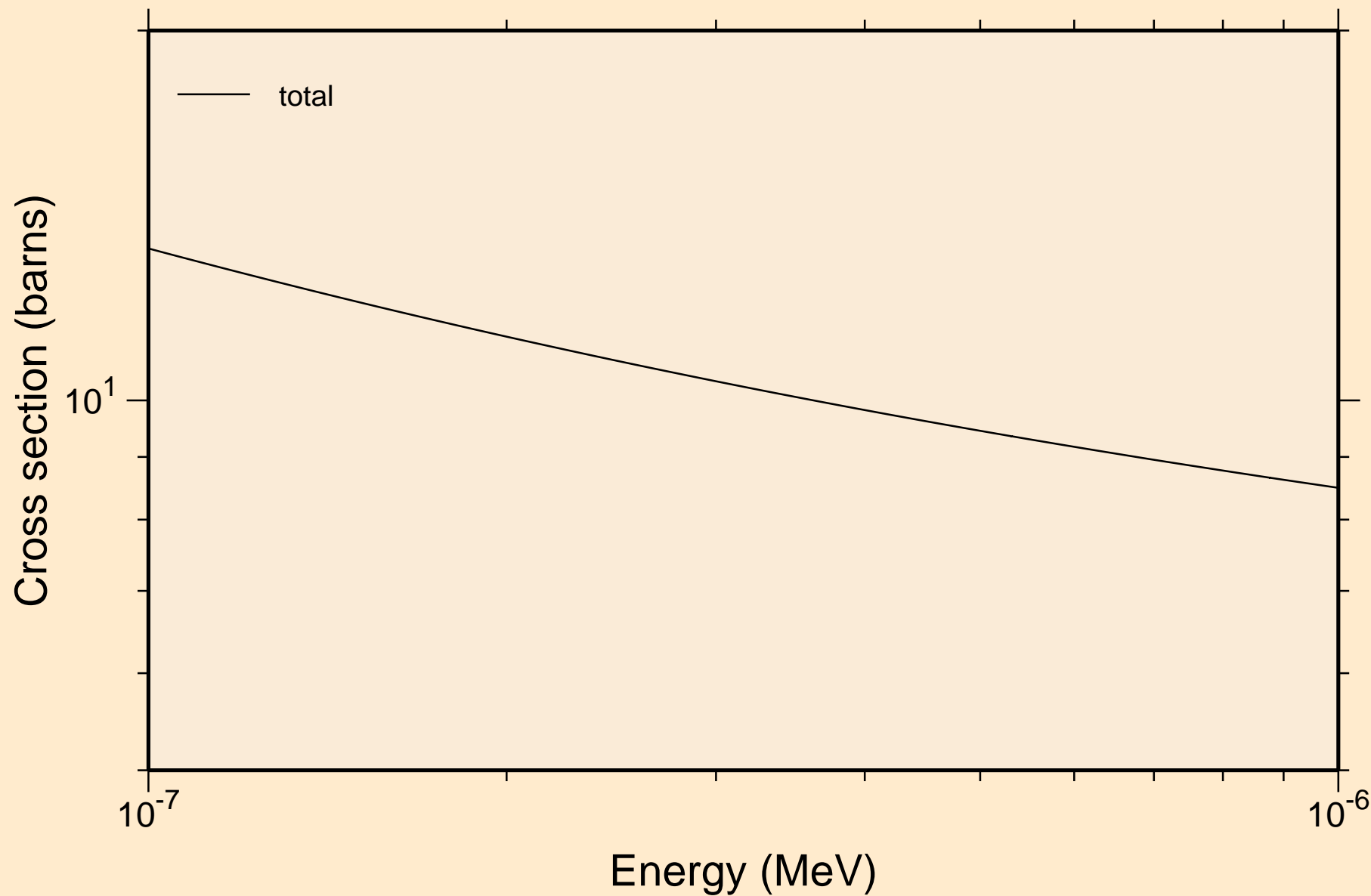

42-MO-95 FOR FENDL-3.1 FROM FENDL-3.1 WITH NJOY2012.50-  
resonance total cross section

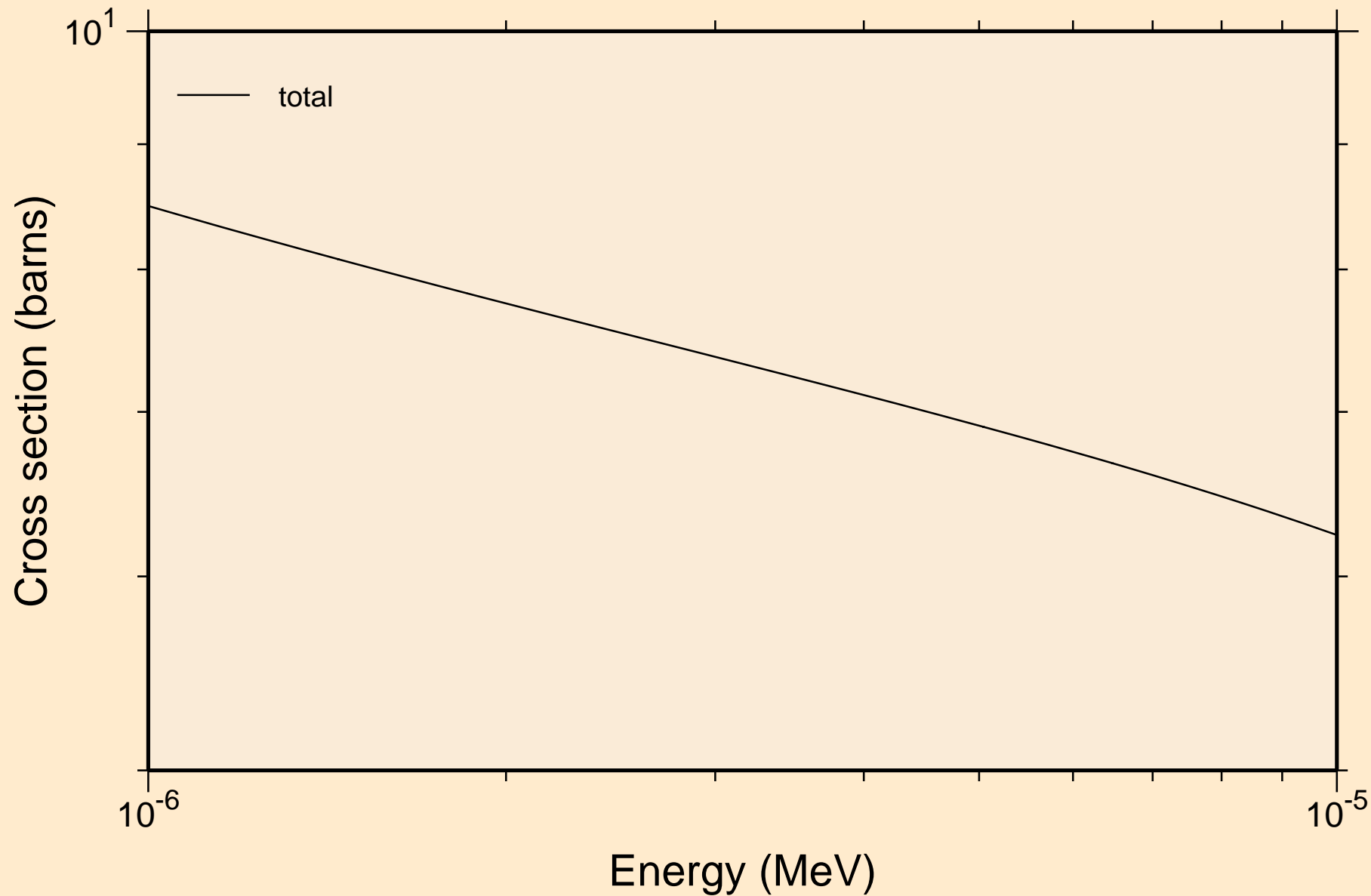

42-MO-95 FOR FENDL-3.1 FROM FENDL-3.1 WITH NJOY2012.50-  
resonance total cross section

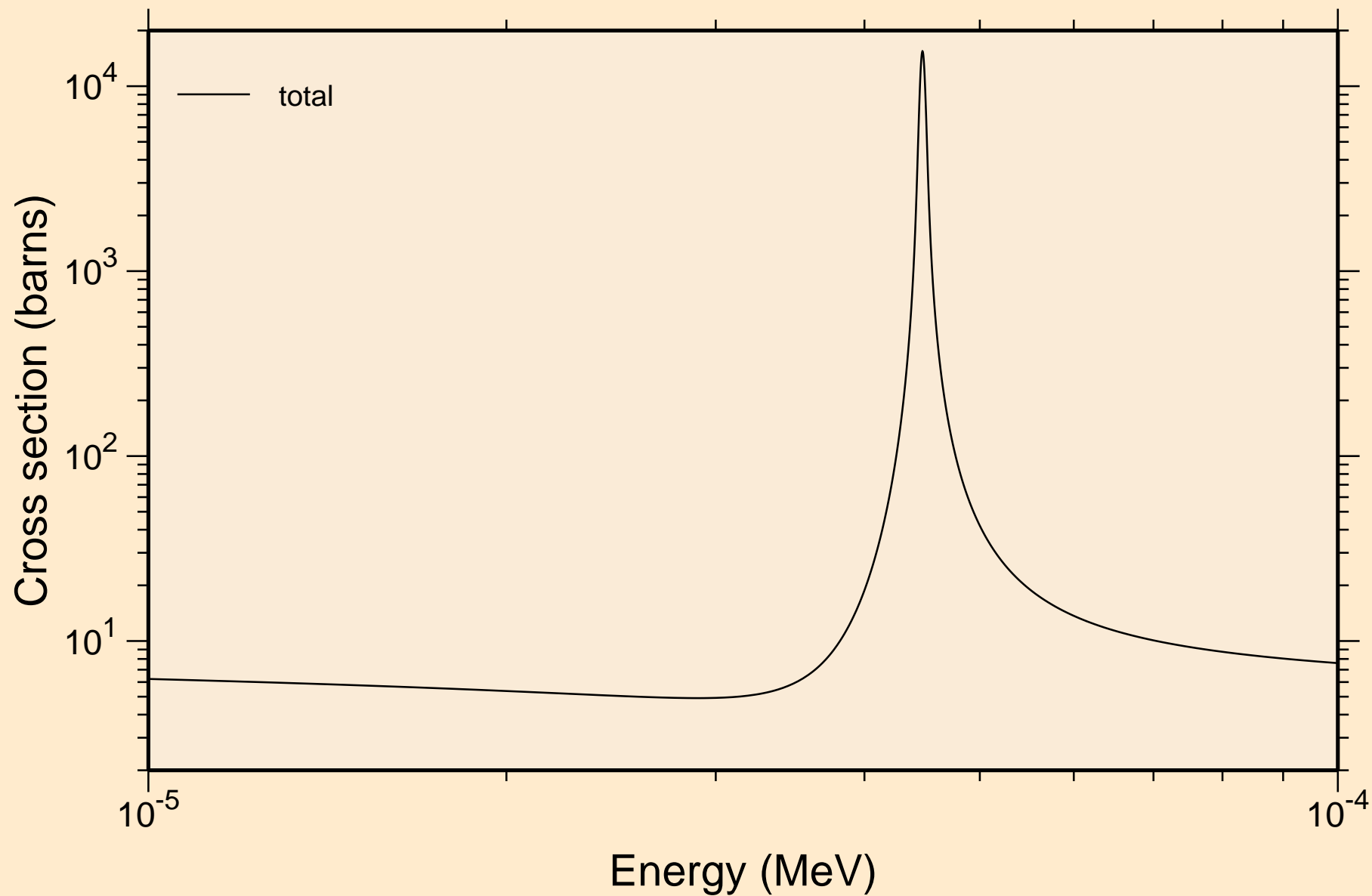

42-MO-95 FOR FENDL-3.1 FROM FENDL-3.1 WITH NJOY2012.50-  
resonance total cross section

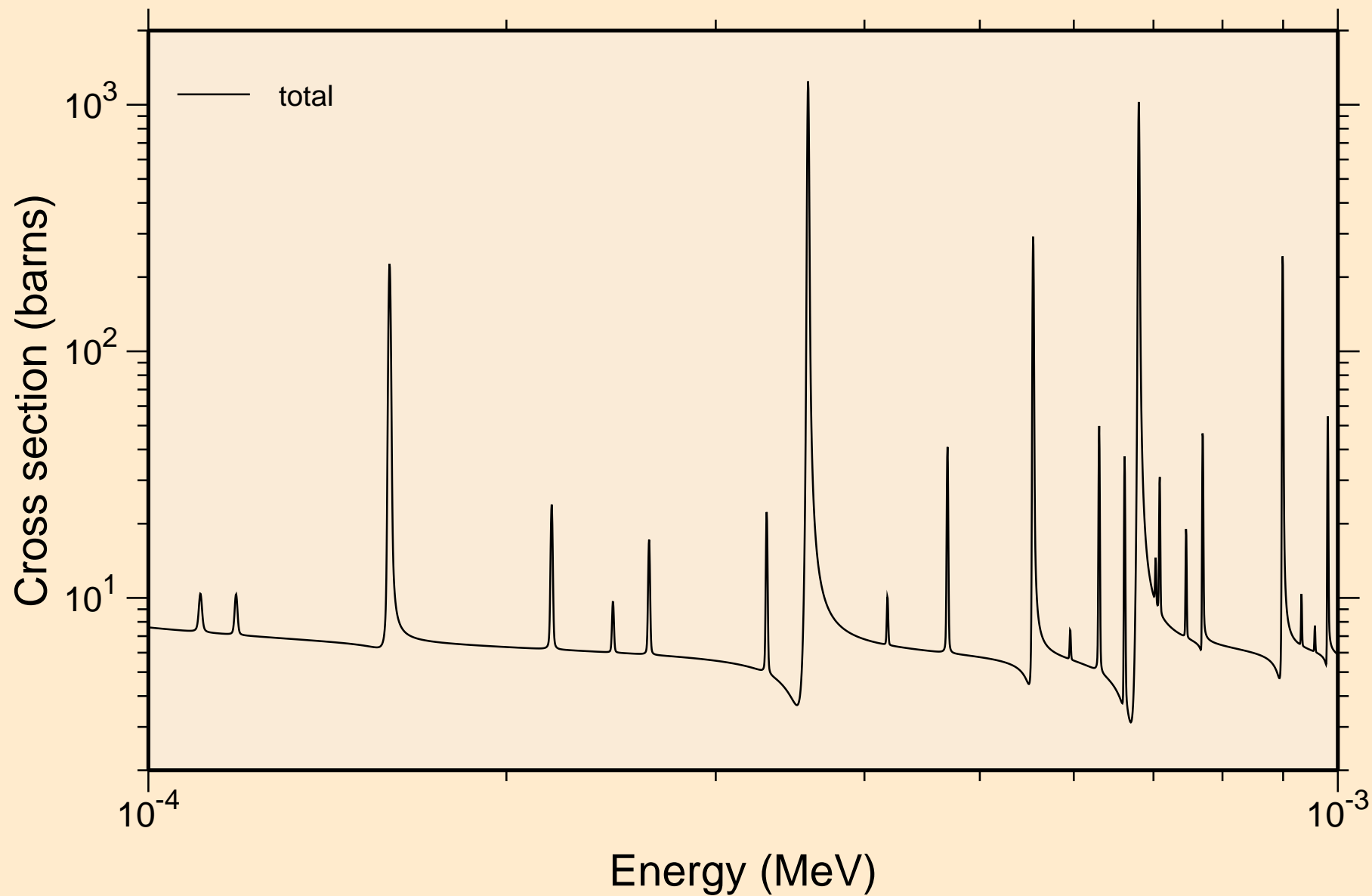

42-MO-95 FOR FENDL-3.1 FROM FENDL-3.1 WITH NJOY2012.50-  
resonance total cross section

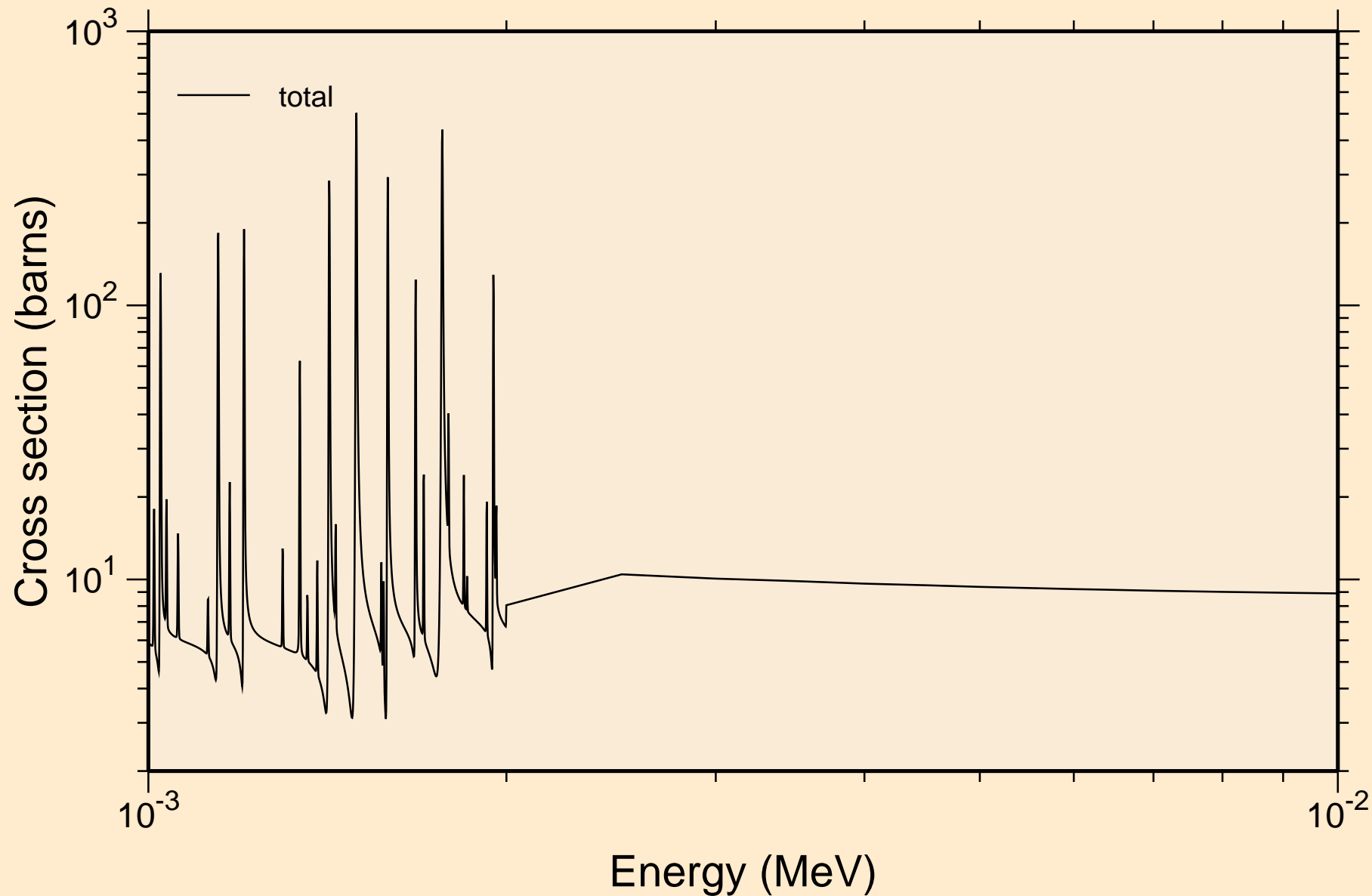

42-MO-95 FOR FENDL-3.1 FROM FENDL-3.1 WITH NJOY2012.50-  
resonance total cross section

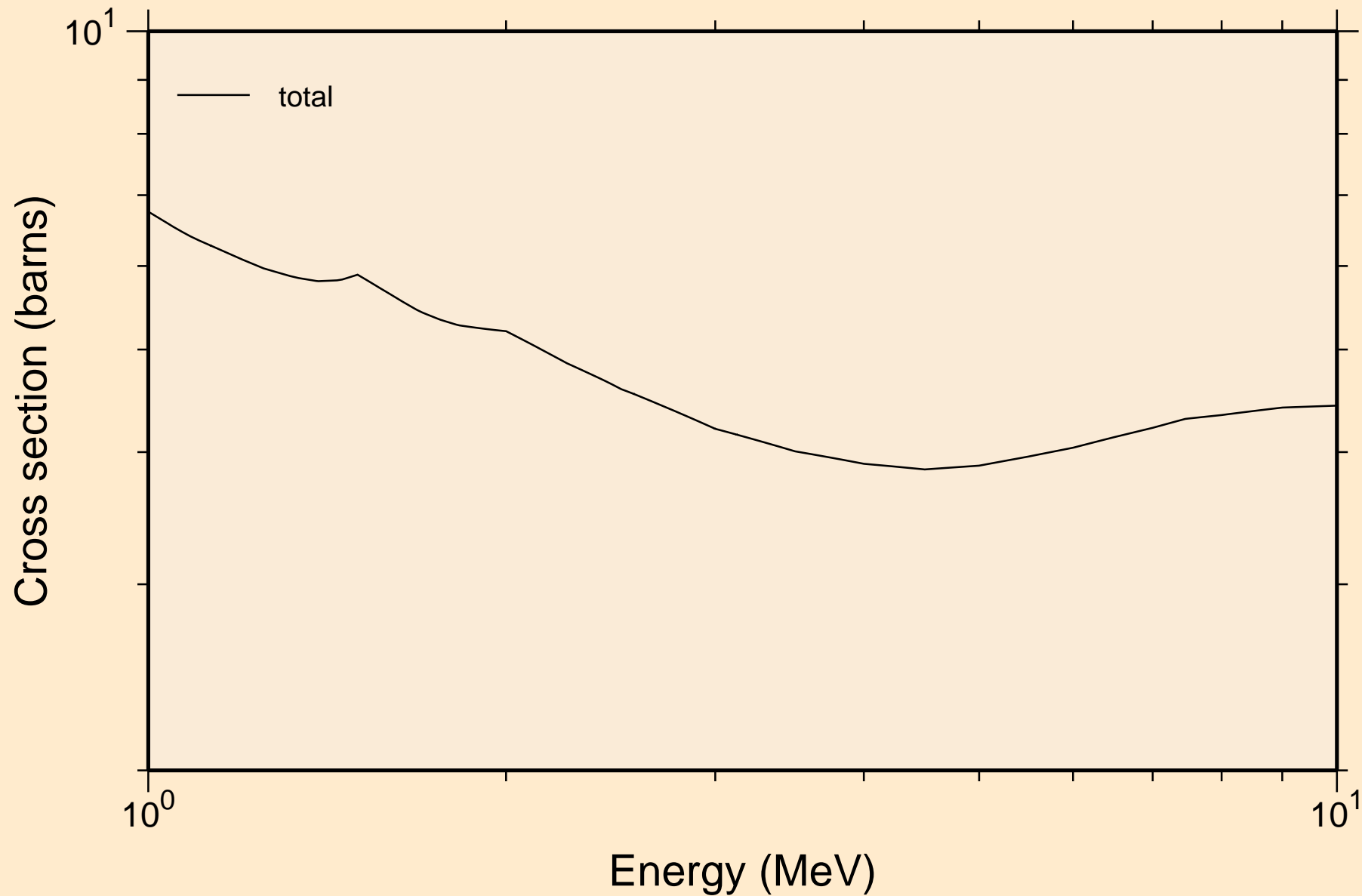

42-MO-95 FOR FENDL-3.1 FROM FENDL-3.1 WITH NJOY2012.50-  
resonance absorption cross sections

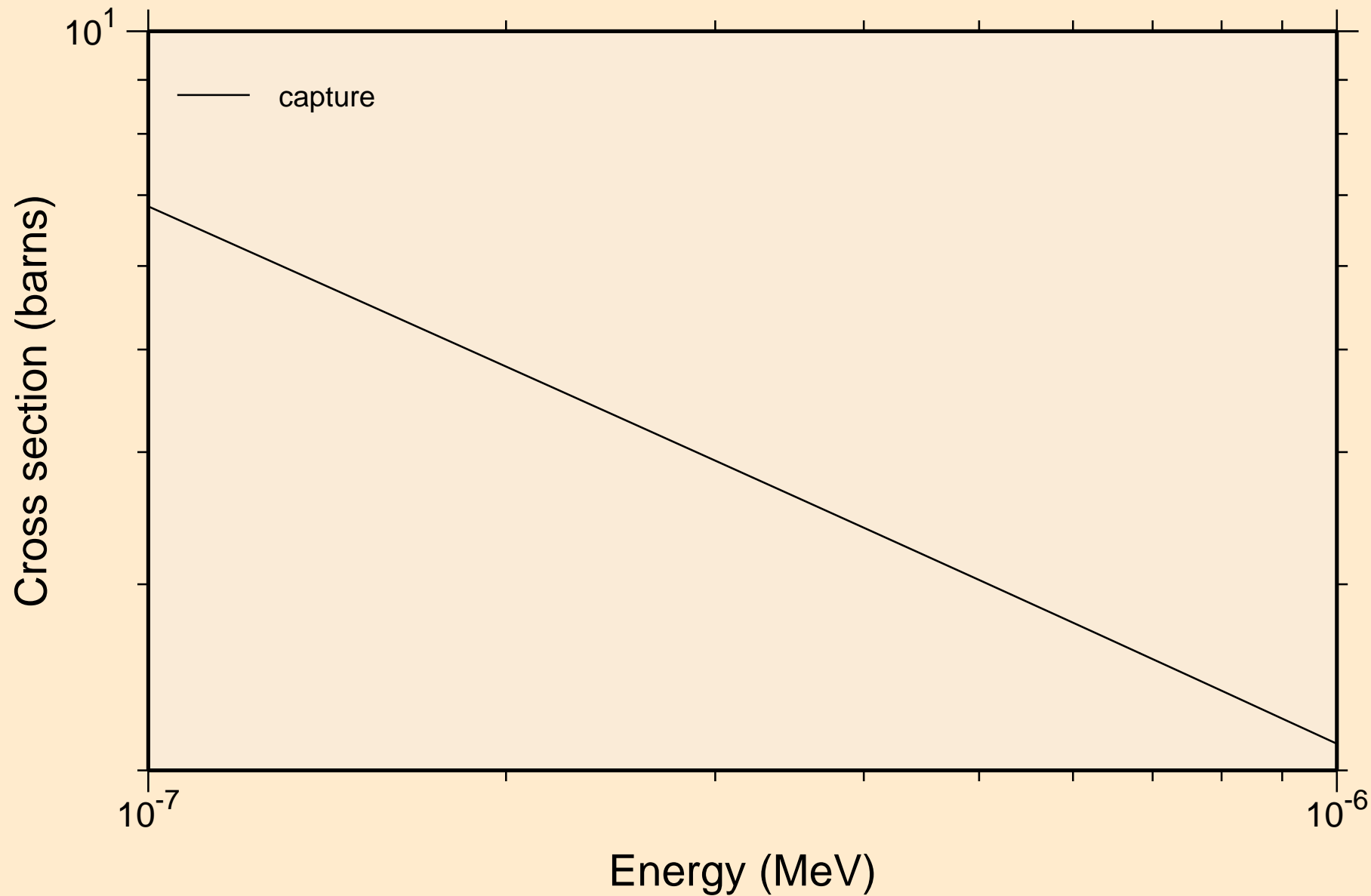



42-MO-95 FOR FENDL-3.1 FROM FENDL-3.1 WITH NJOY2012.50-  
resonance absorption cross sections

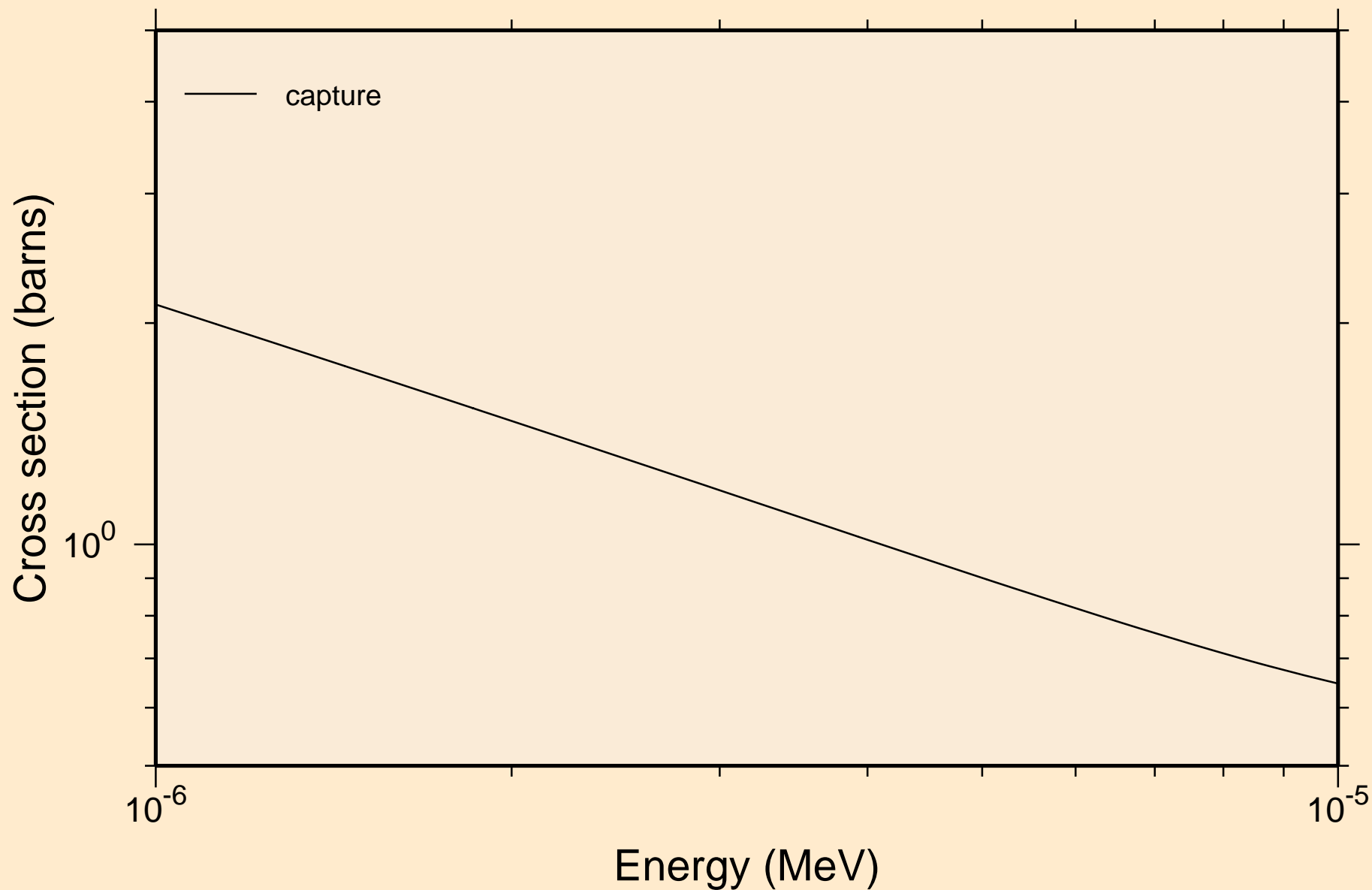

42-MO-95 FOR FENDL-3.1 FROM FENDL-3.1 WITH NJOY2012.50-  
resonance absorption cross sections

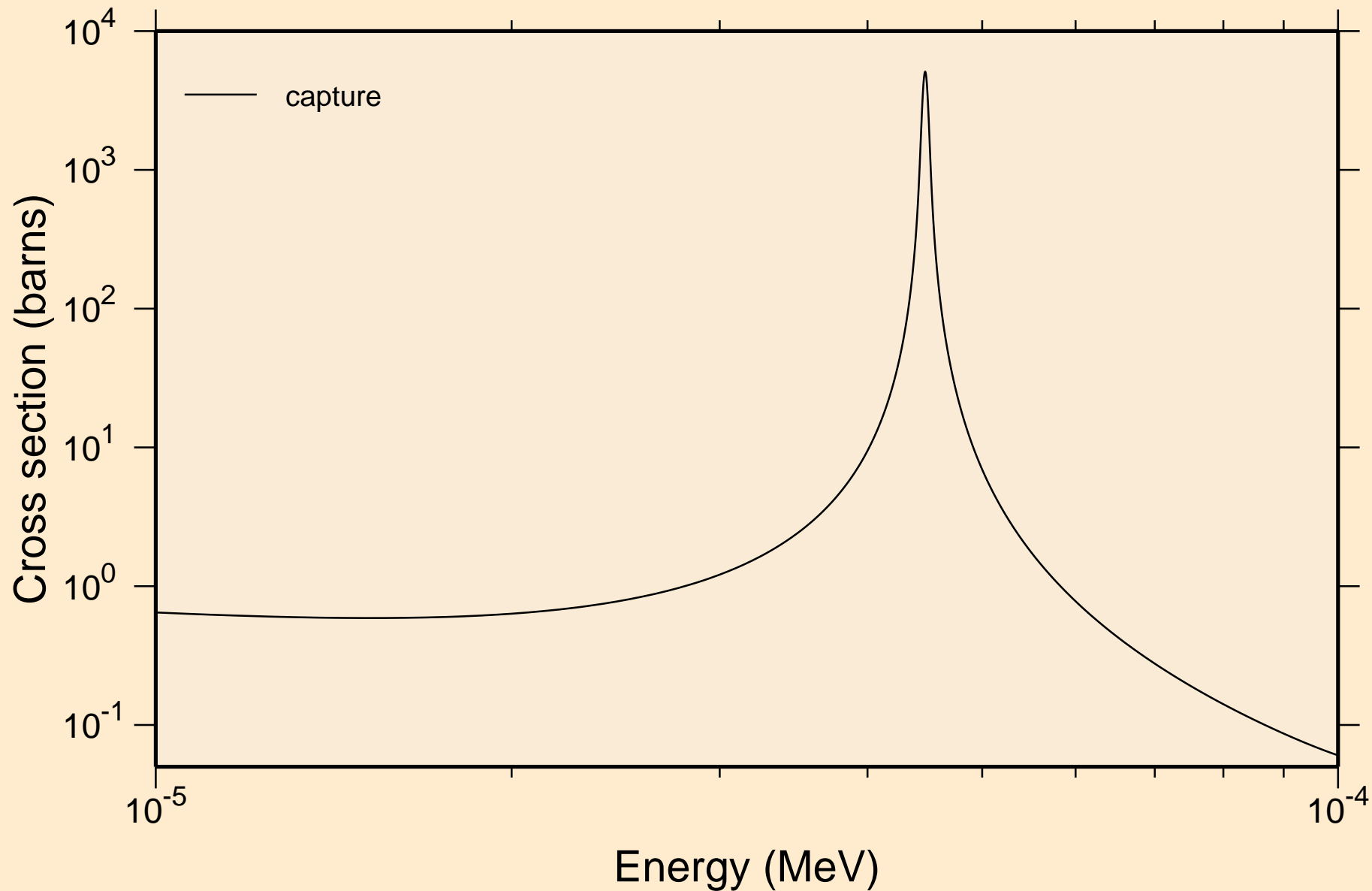

42-MO-95 FOR FENDL-3.1 FROM FENDL-3.1 WITH NJOY2012.50-  
resonance absorption cross sections

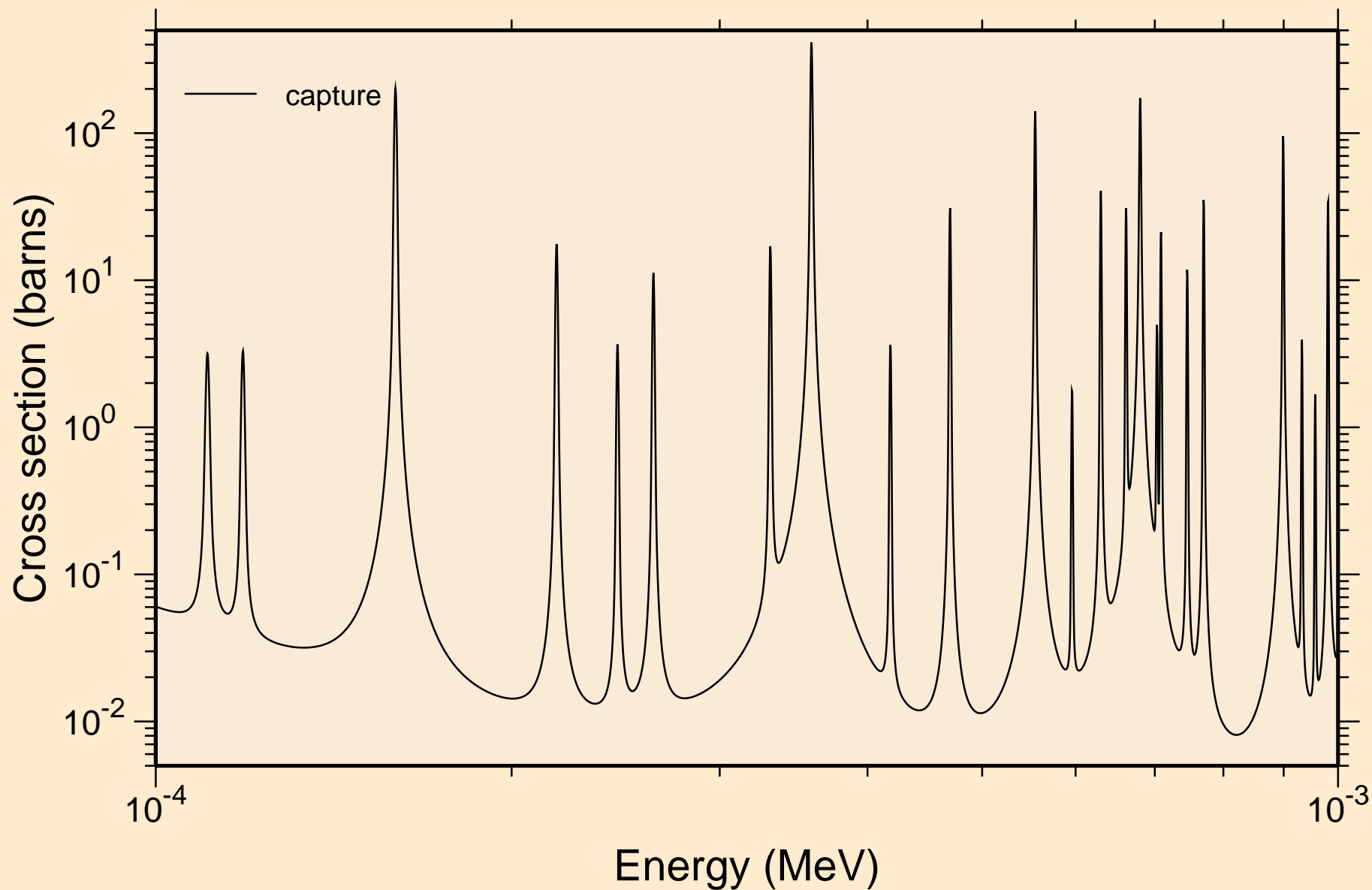

42-MO-95 FOR FENDL-3.1 FROM FENDL-3.1 WITH NJOY2012.50-  
resonance absorption cross sections

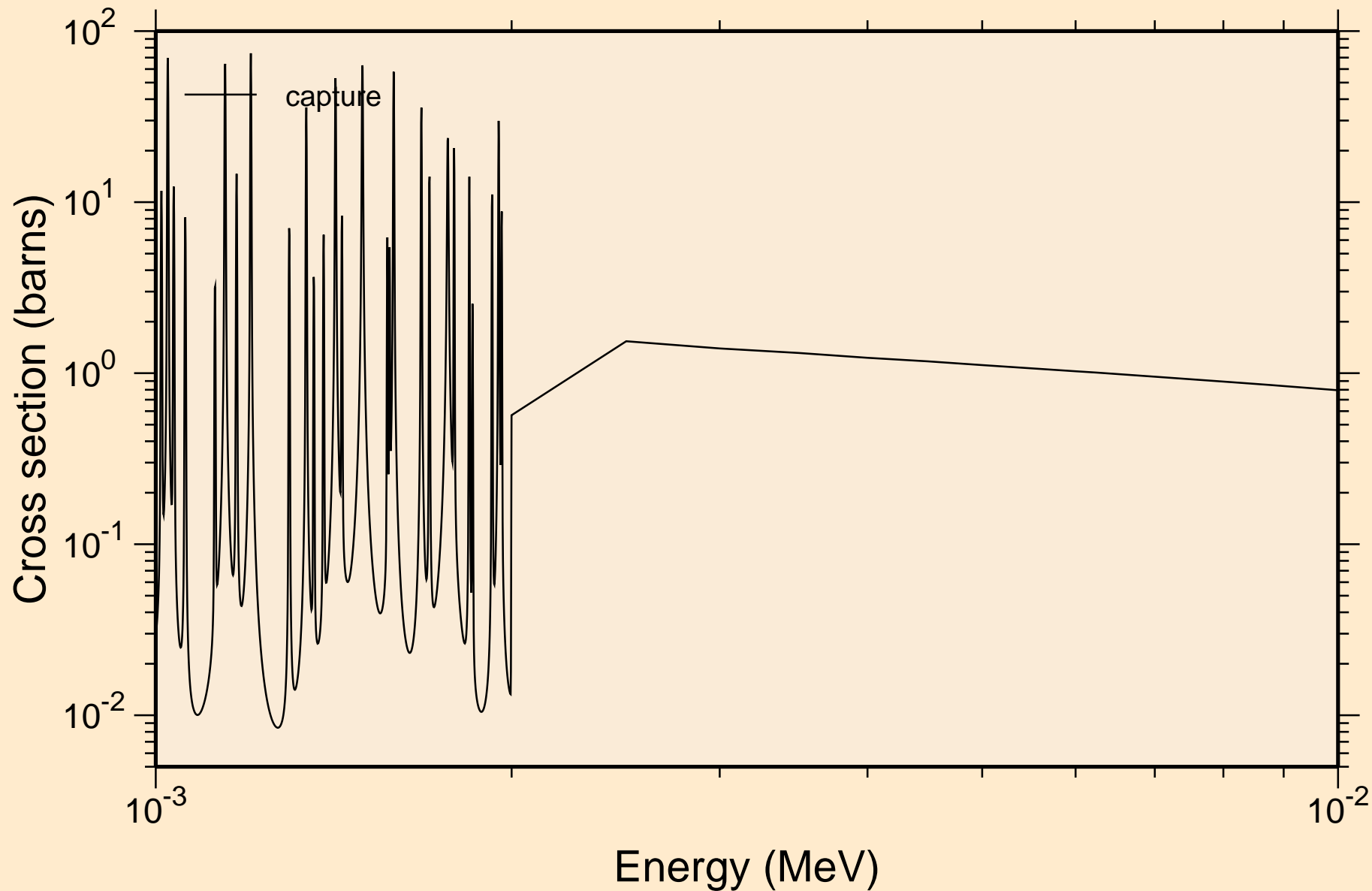

42-MO-95 FOR FENDL-3.1 FROM FENDL-3.1 WITH NJOY2012.50-  
resonance absorption cross sections

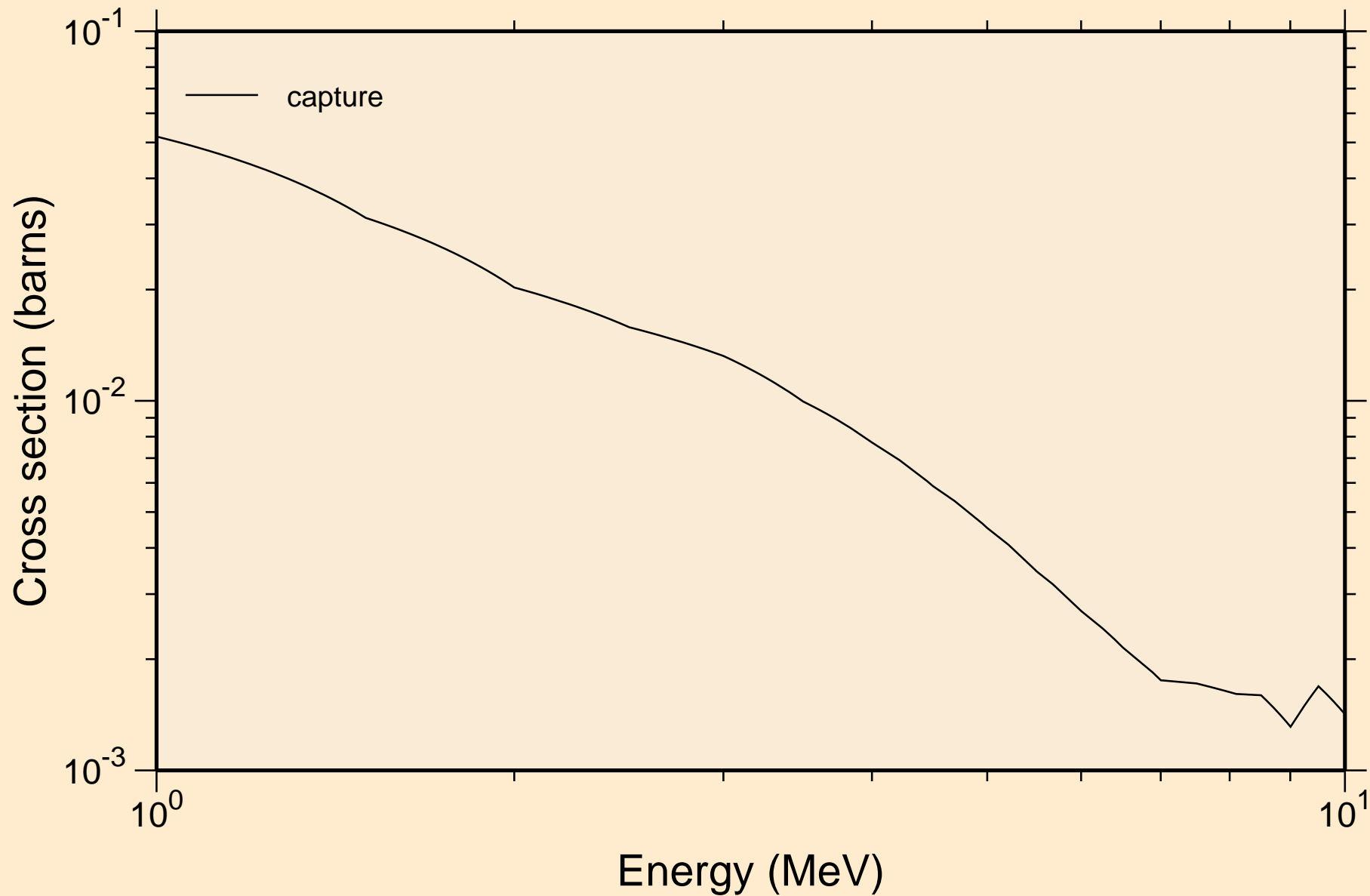

42-MO-95 FOR FENDL-3.1 FROM FENDL-3.1 WITH NJOY2012.50-  
UR total cross section

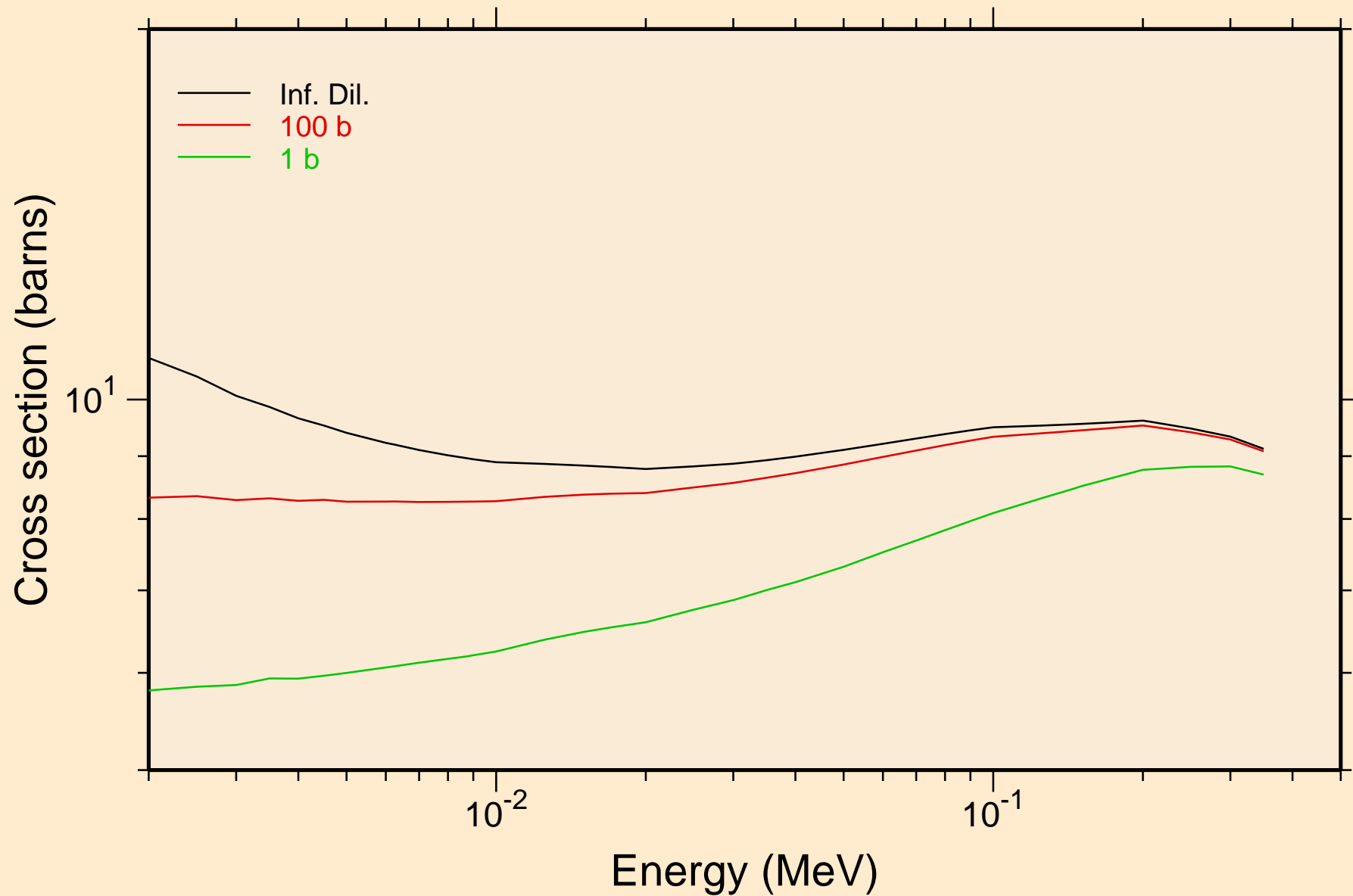

42-MO-95 FOR FENDL-3.1 FROM FENDL-3.1 WITH NJOY2012.50-  
UR elastic cross section

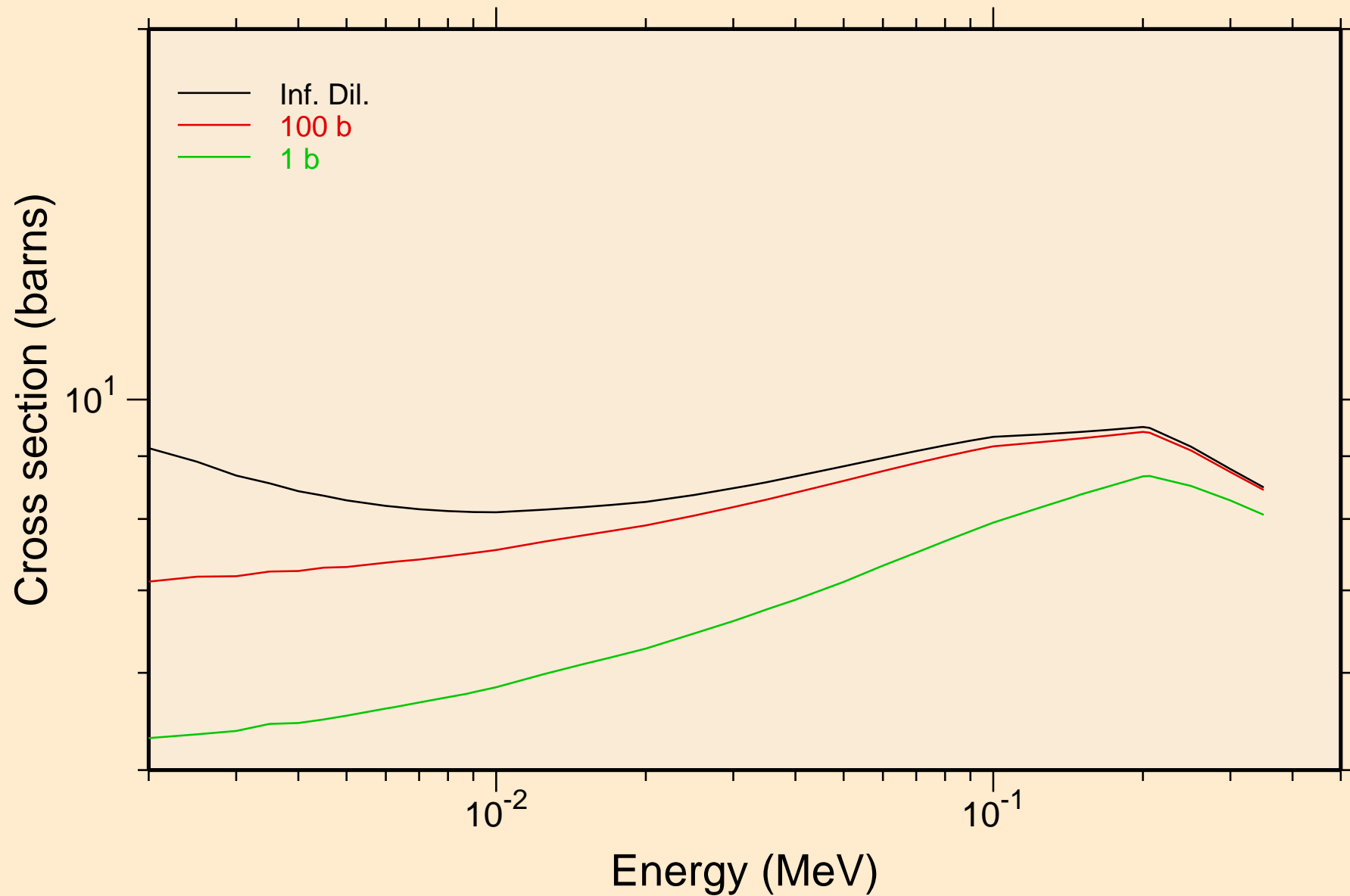

42-MO-95 FOR FENDL-3.1 FROM FENDL-3.1 WITH NJOY2012.50-  
UR capture cross section

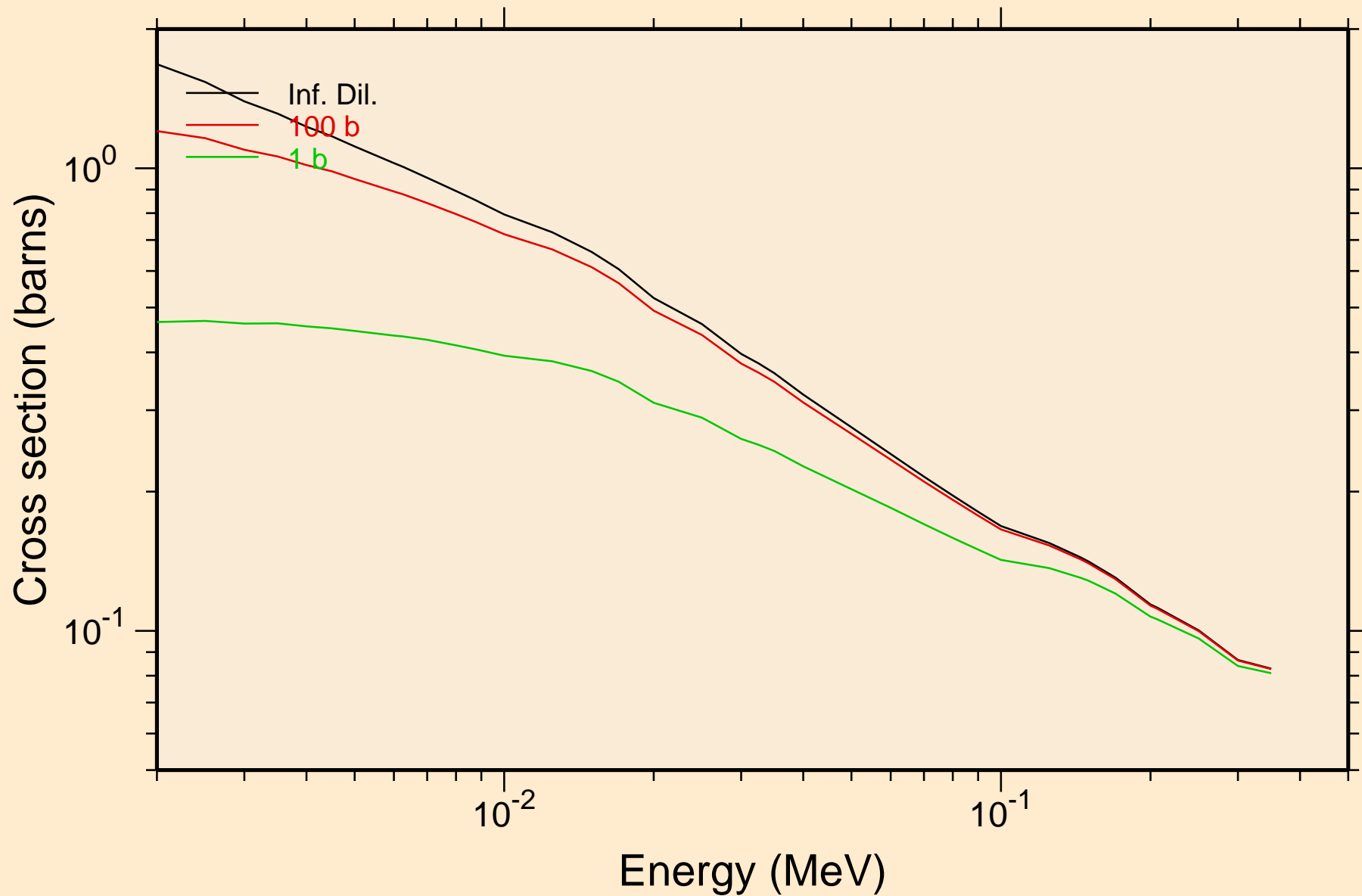



42-MO-95 FOR FENDL-3.1 FROM FENDL-3.1 WITH NJOY2012.50-  
Heating

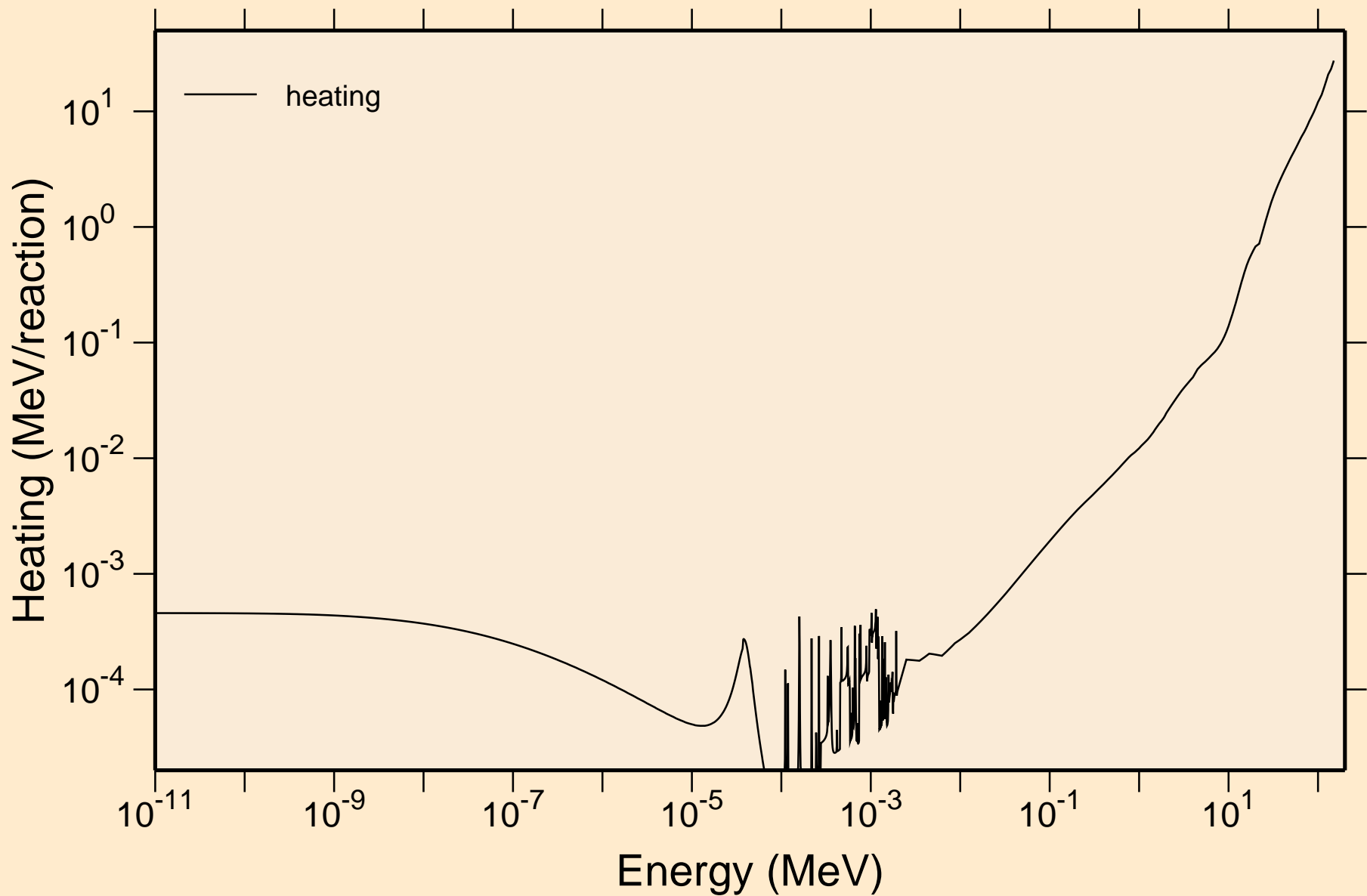

# 42-MO-95 FOR FENDL-3.1 FROM FENDL-3.1 WITH NJOY2012.50-Damage

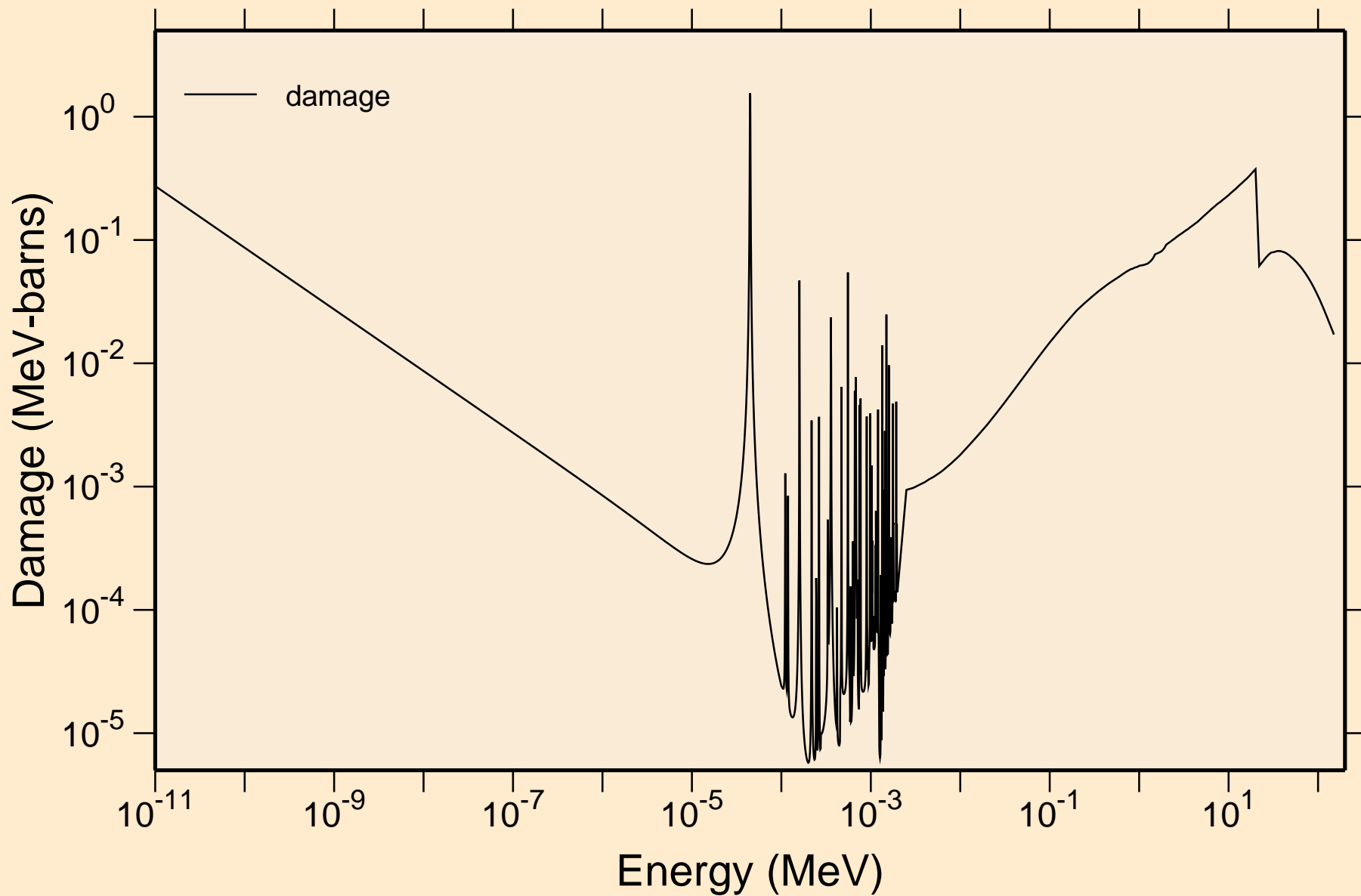

42-MO-95 FOR FENDL-3.1 FROM FENDL-3.1 WITH NJOY2012.50-  
Non-threshold reactions

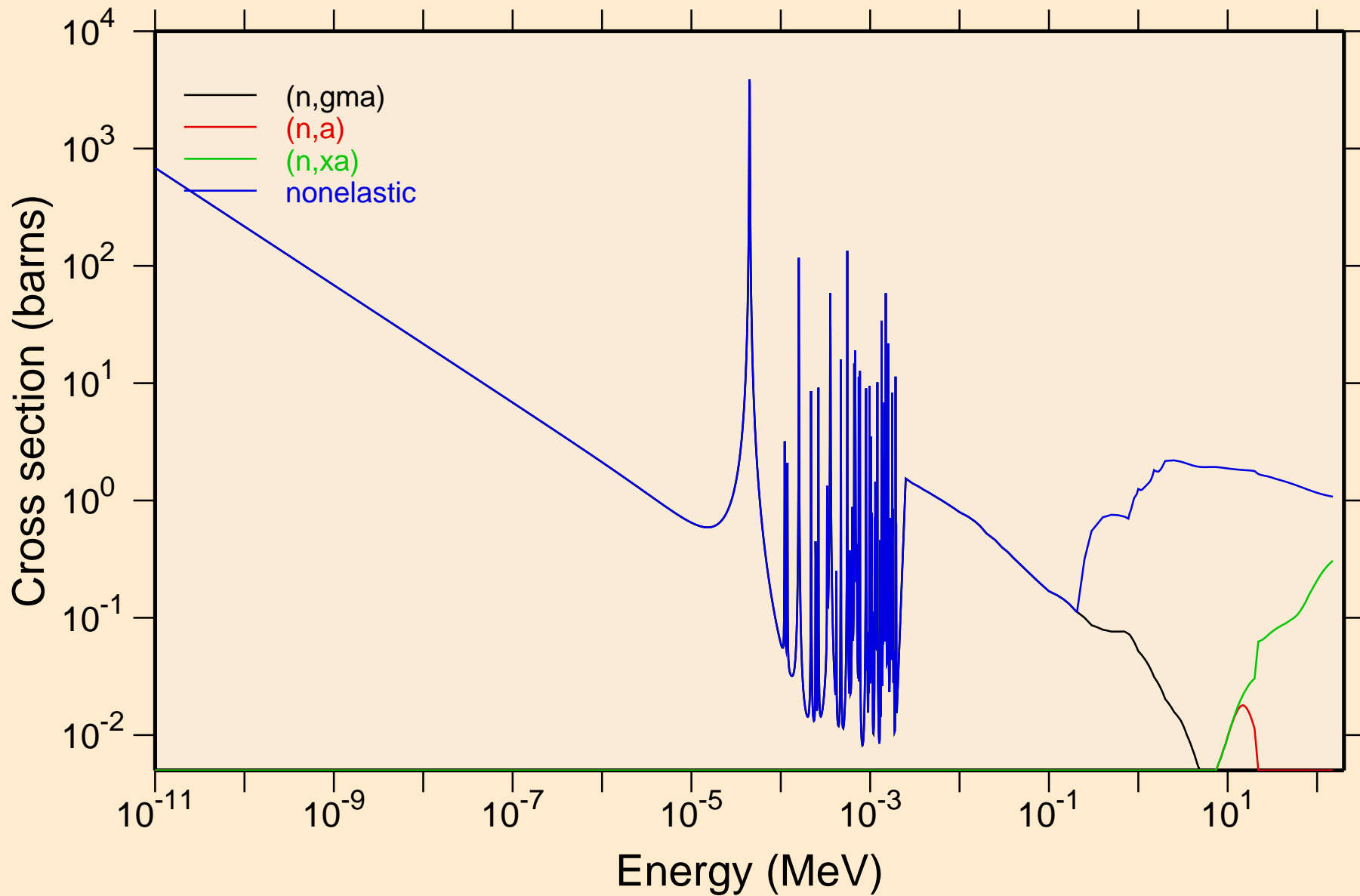

42-MO-95 FOR FENDL-3.1 FROM FENDL-3.1 WITH NJOY2012.50-  
Non-threshold reactions

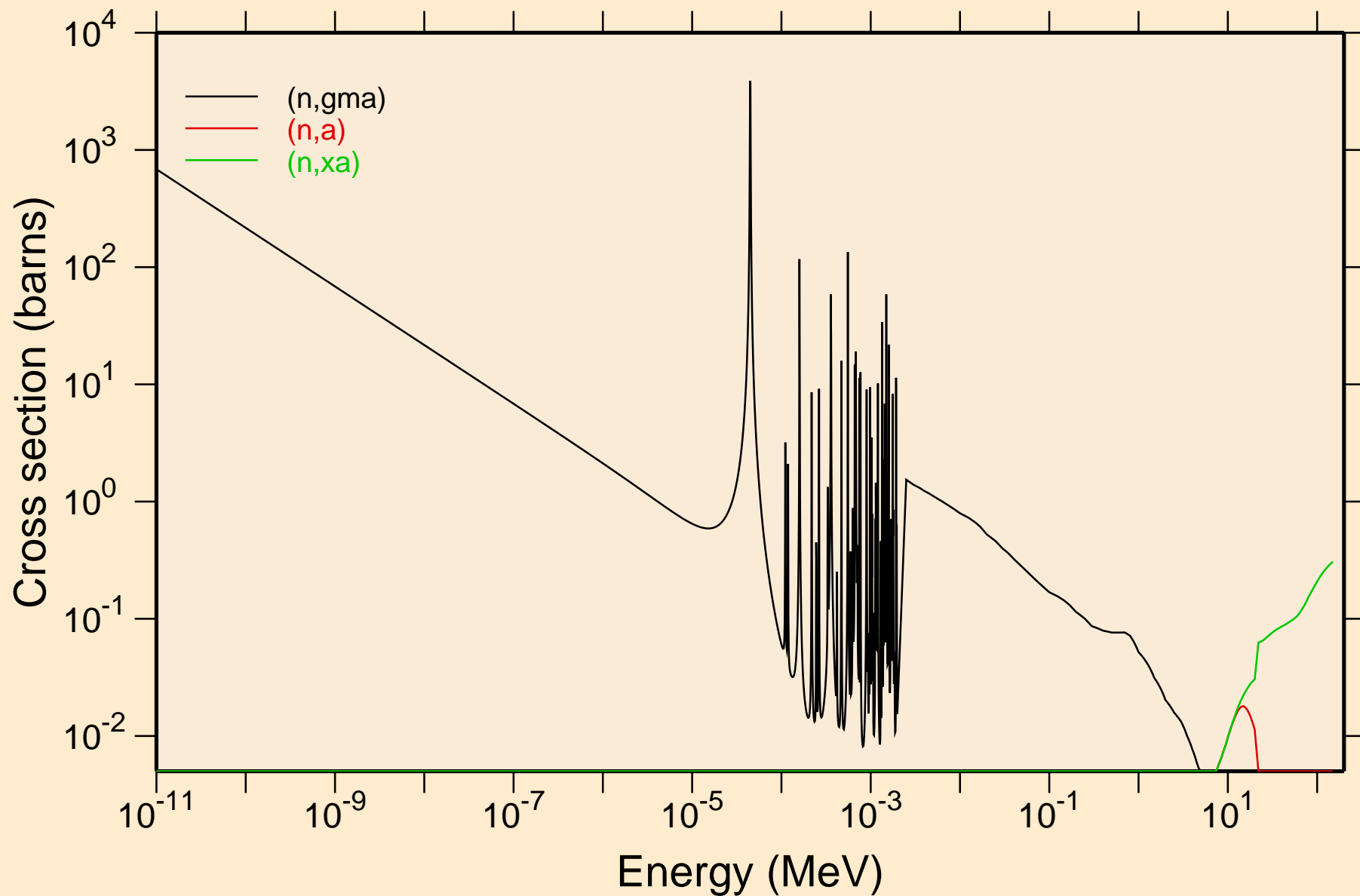

42-MO-95 FOR FENDL-3.1 FROM FENDL-3.1 WITH NJOY2012.50-  
Principal cross sections

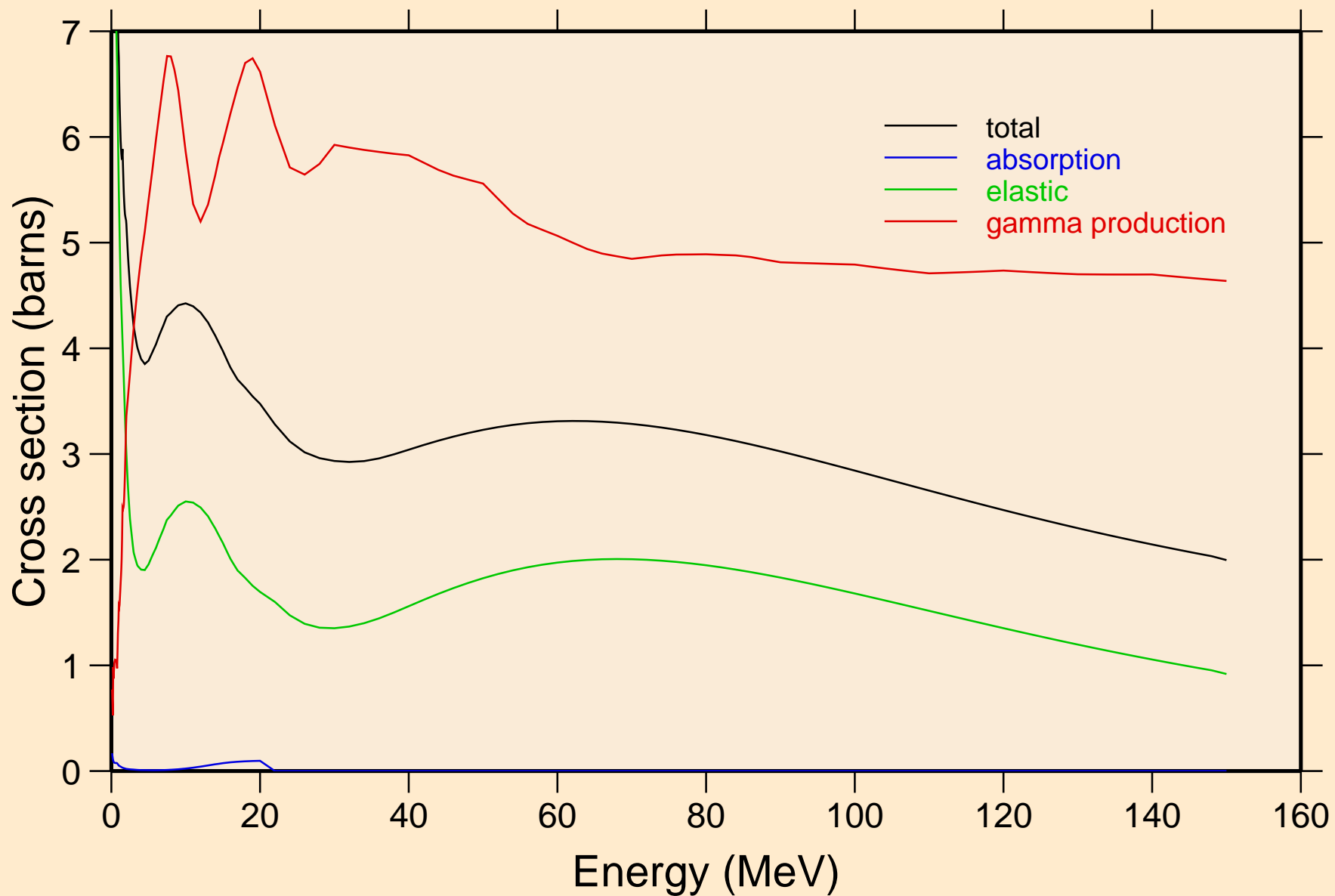

# 42-MO-95 FOR FENDL-3.1 FROM FENDL-3.1 WITH NJOY2012.50- Heating

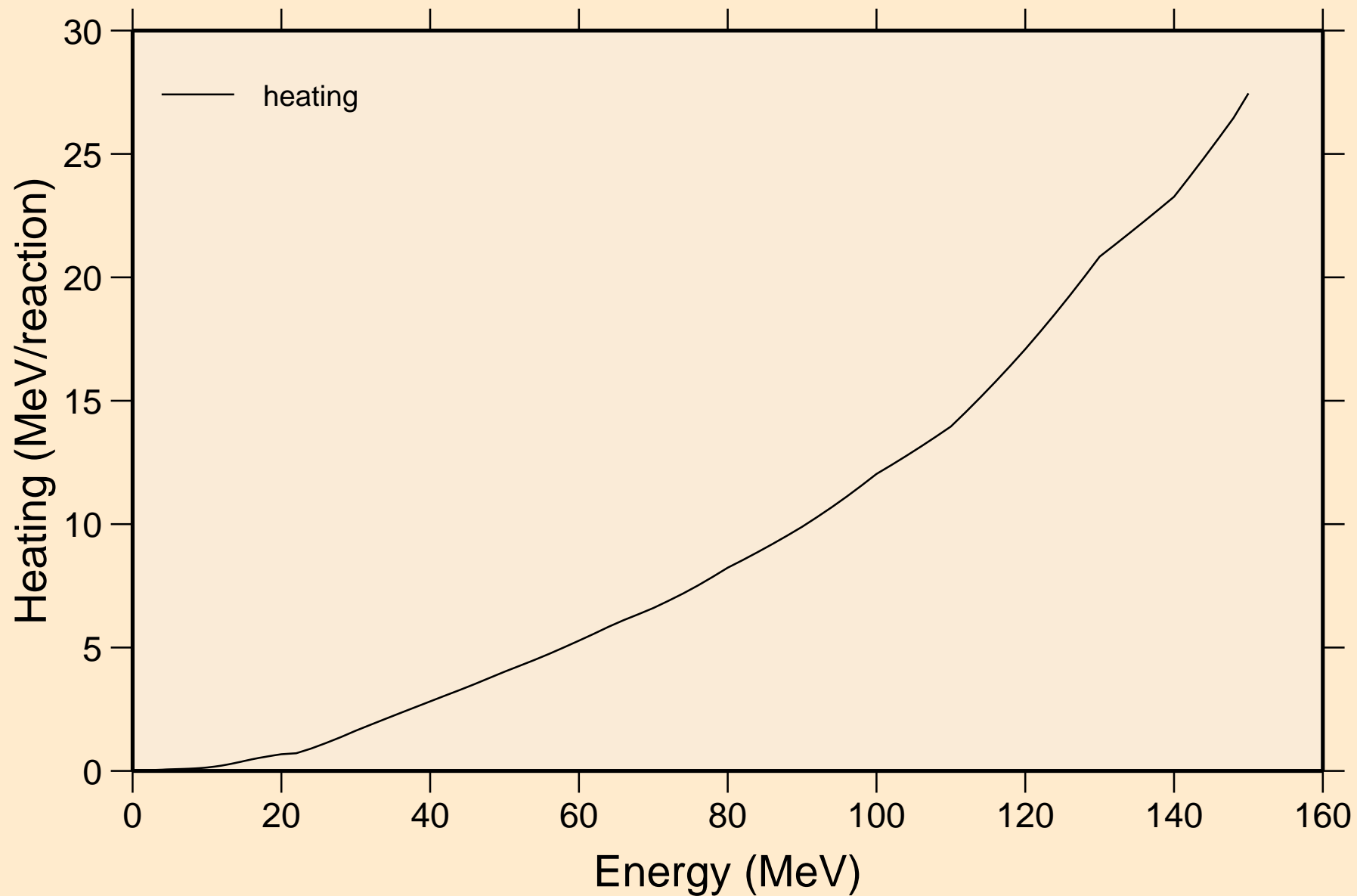

# 42-MO-95 FOR FENDL-3.1 FROM FENDL-3.1 WITH NJOY2012.50- Damage

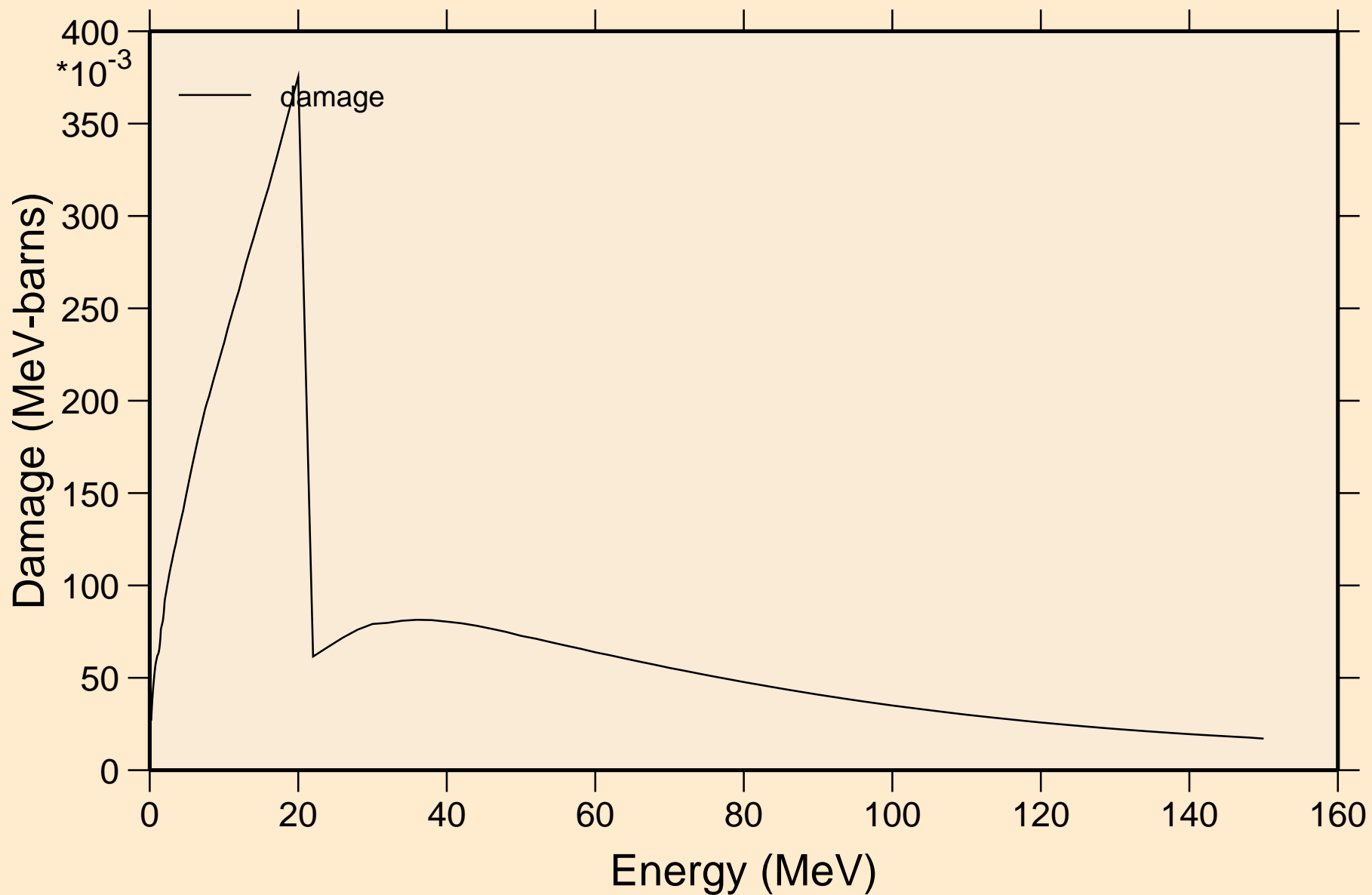

42-MO-95 FOR FENDL-3.1 FROM FENDL-3.1 WITH NJOY2012.50-  
Non-threshold reactions

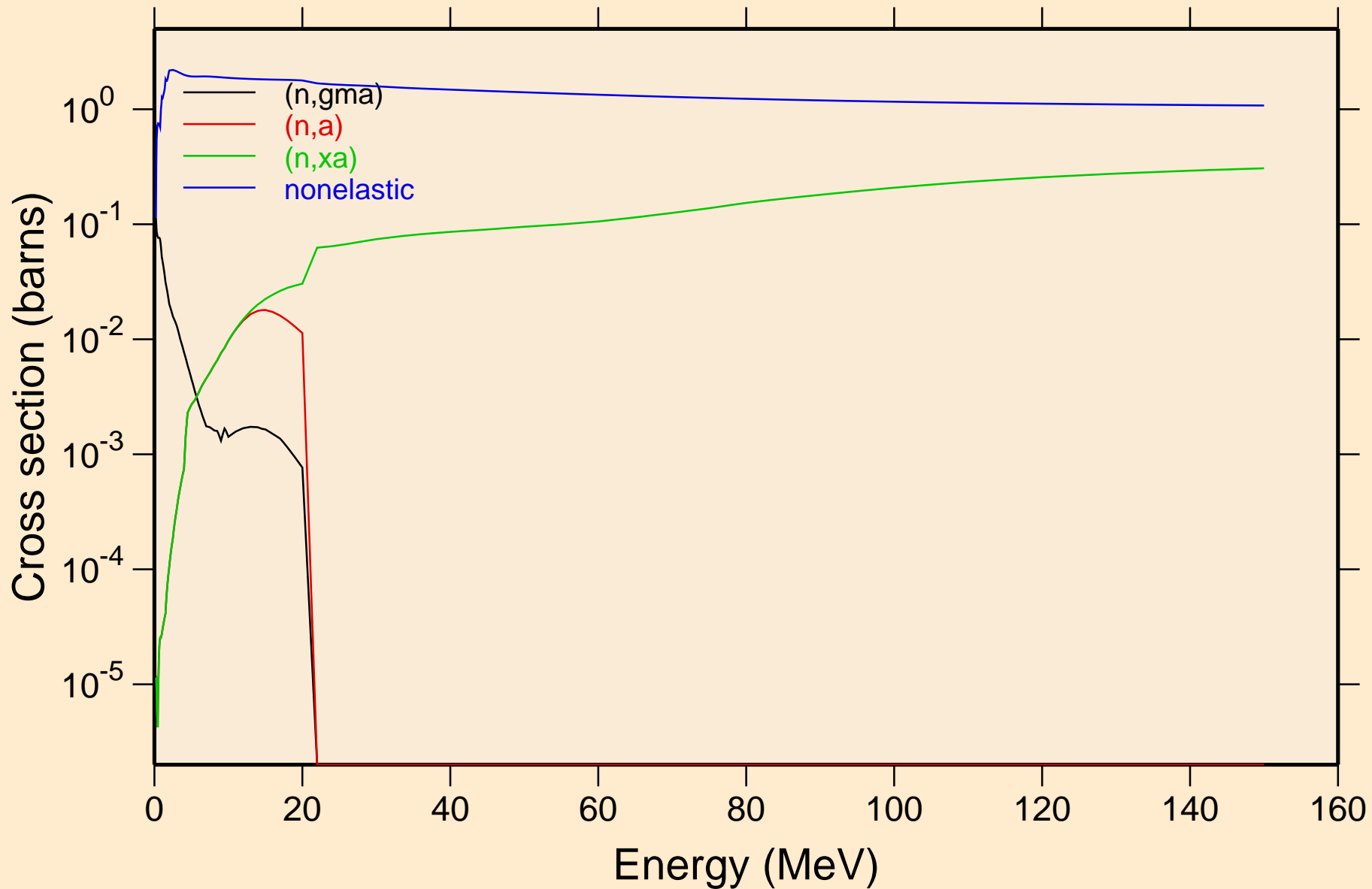



42-MO-95 FOR FENDL-3.1 FROM FENDL-3.1 WITH NJOY2012.50-  
Non-threshold reactions

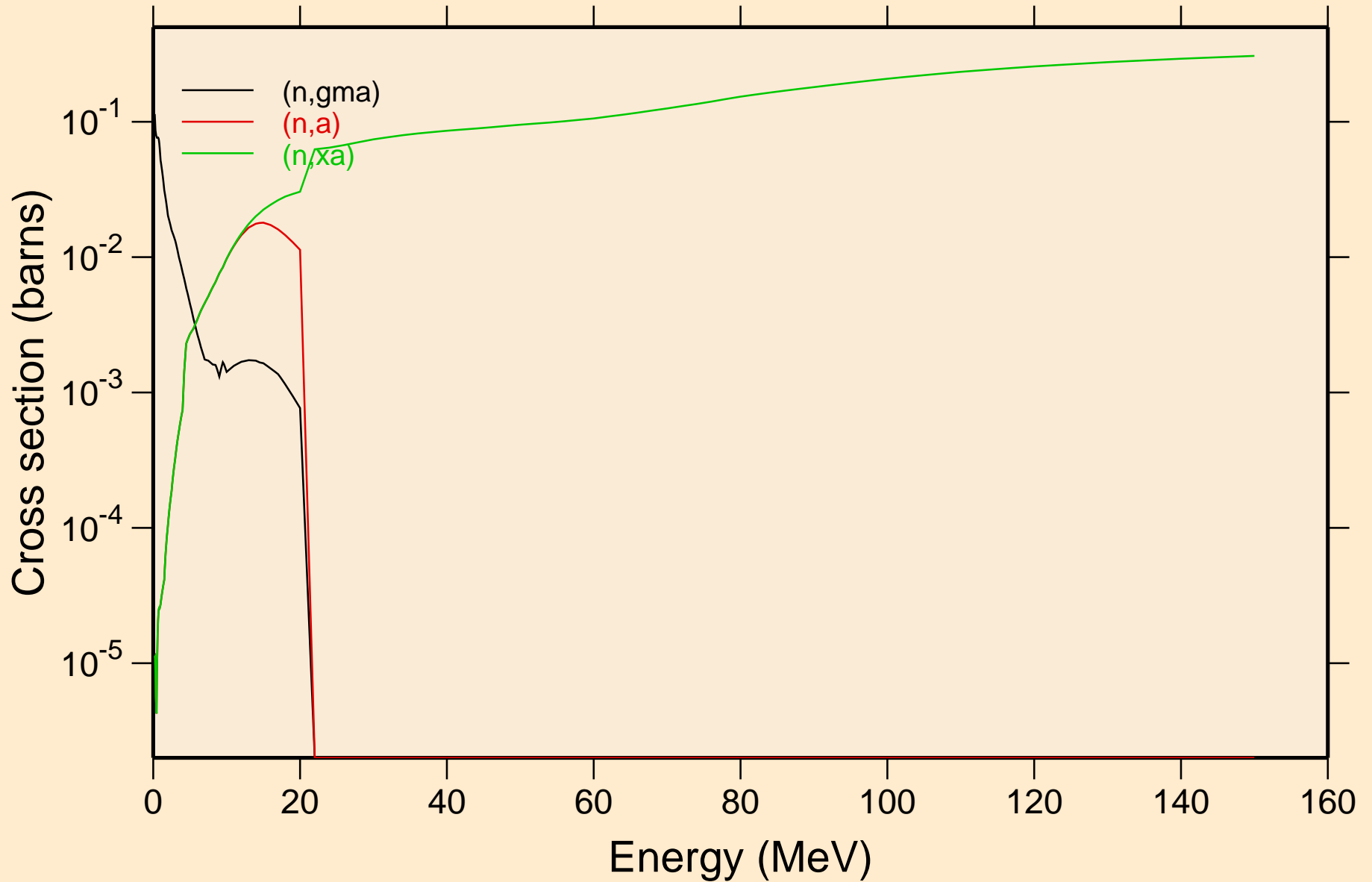

42-MO-95 FOR FENDL-3.1 FROM FENDL-3.1 WITH NJOY2012.50-  
Inelastic levels

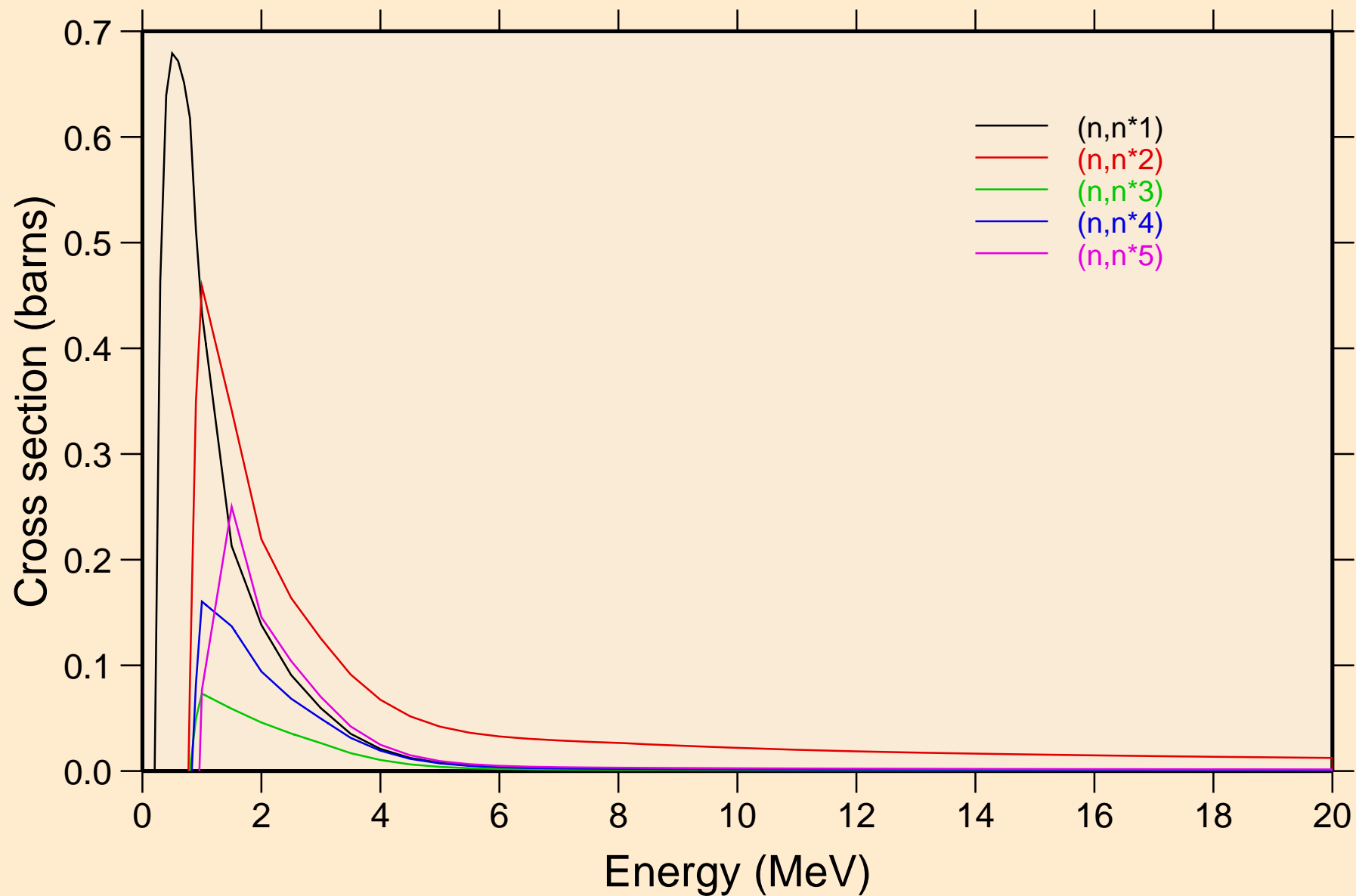

42-MO-95 FOR FENDL-3.1 FROM FENDL-3.1 WITH NJOY2012.50-  
Inelastic levels

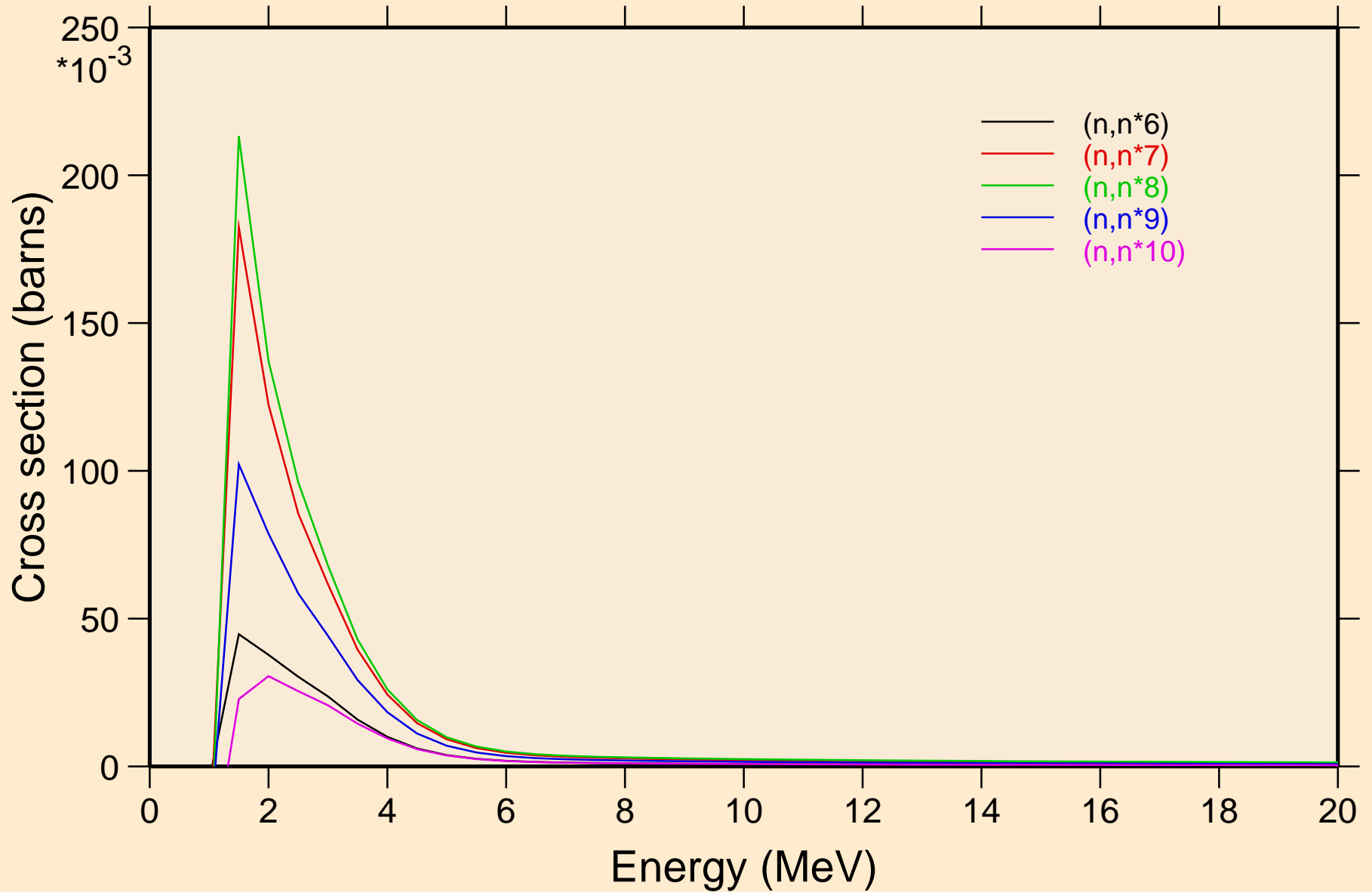

42-MO-95 FOR FENDL-3.1 FROM FENDL-3.1 WITH NJOY2012.50-  
Inelastic levels

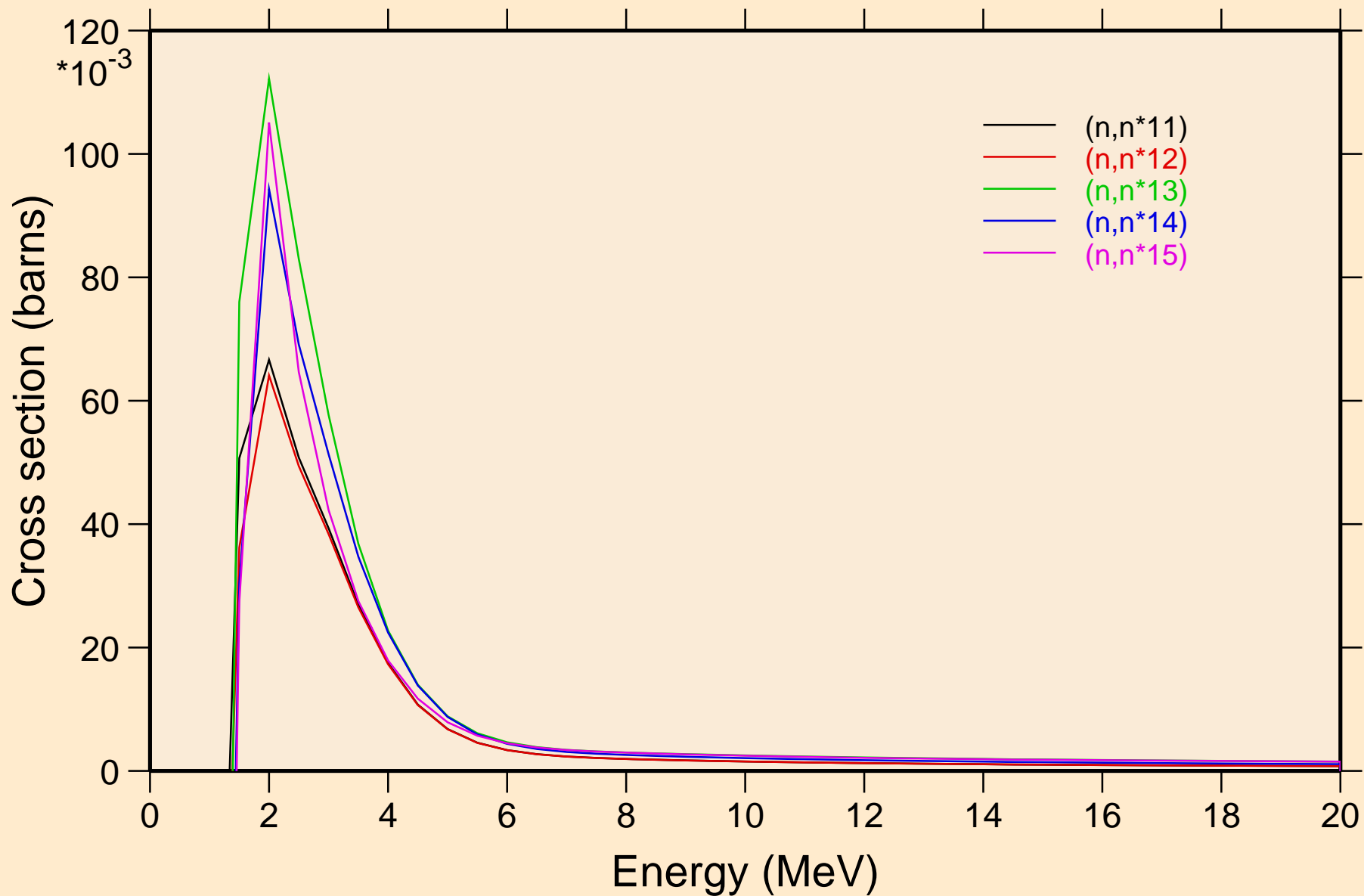

42-MO-95 FOR FENDL-3.1 FROM FENDL-3.1 WITH NJOY2012.50-  
Inelastic levels

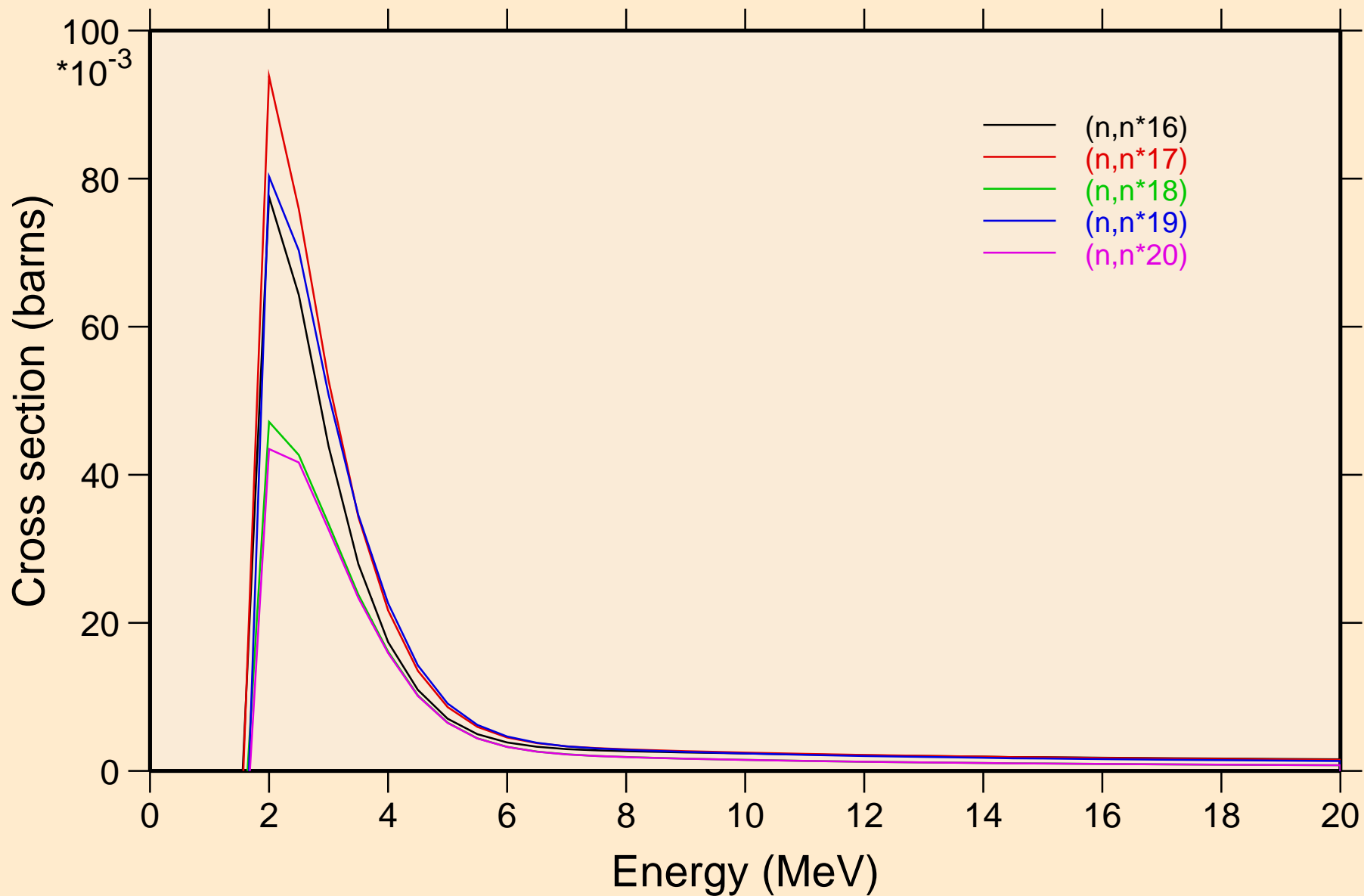

# 42-MO-95 FOR FENDL-3.1 FROM FENDL-3.1 WITH NJOY2012.50- Inelastic levels

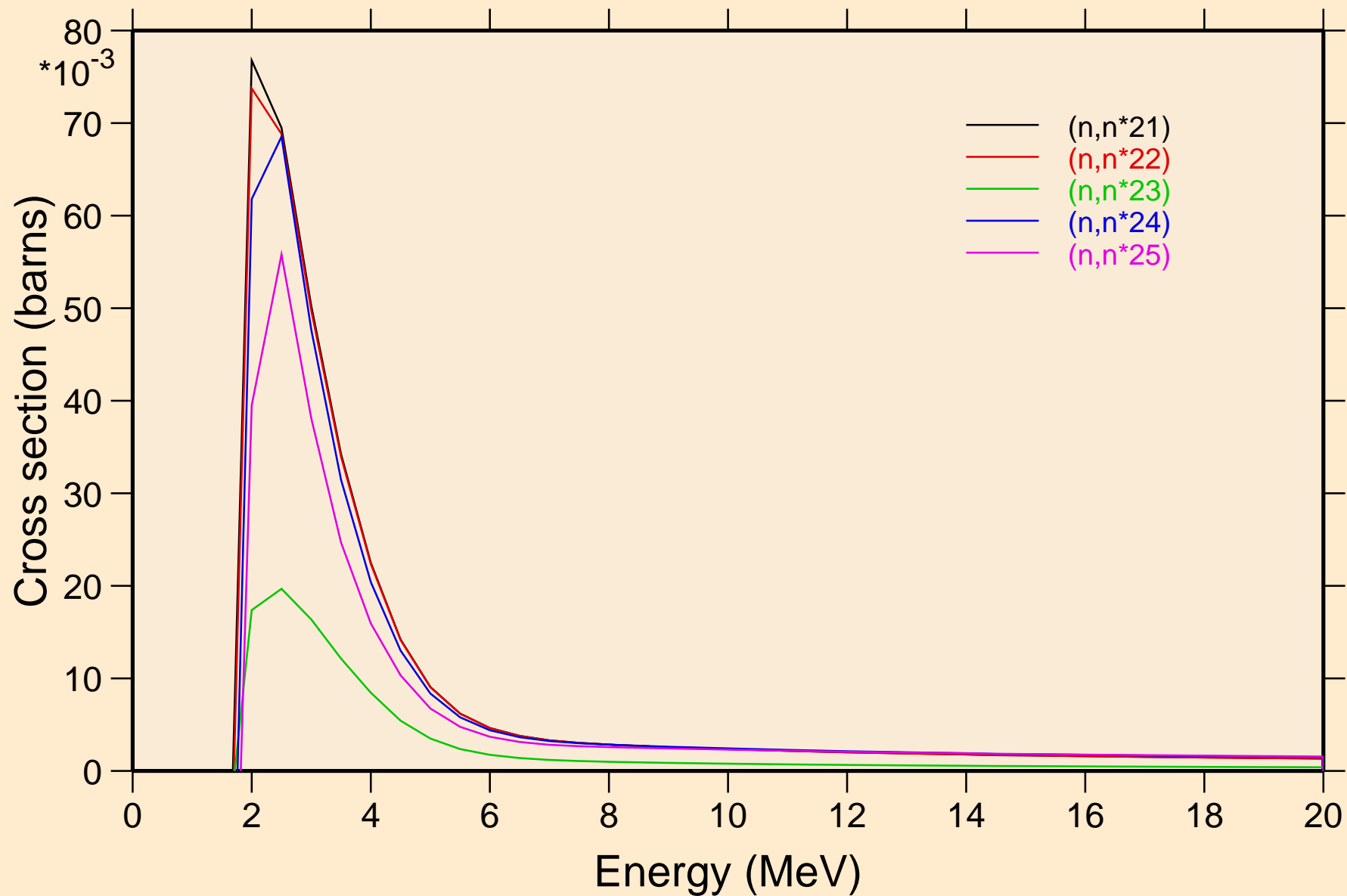

42-MO-95 FOR FENDL-3.1 FROM FENDL-3.1 WITH NJOY2012.50-  
Inelastic levels

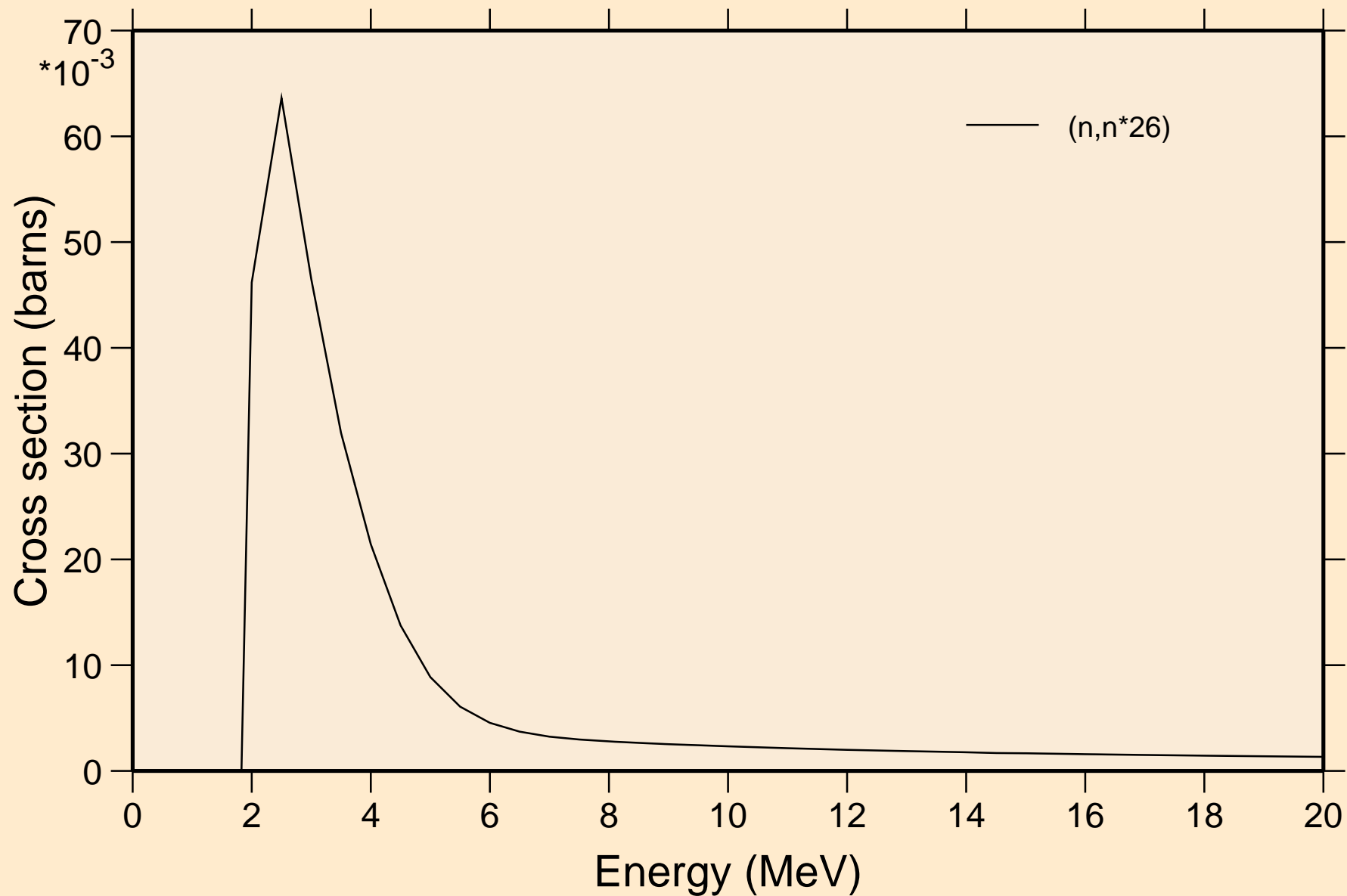

42-MO-95 FOR FENDL-3.1 FROM FENDL-3.1 WITH NJOY2012.50-  
Threshold reactions

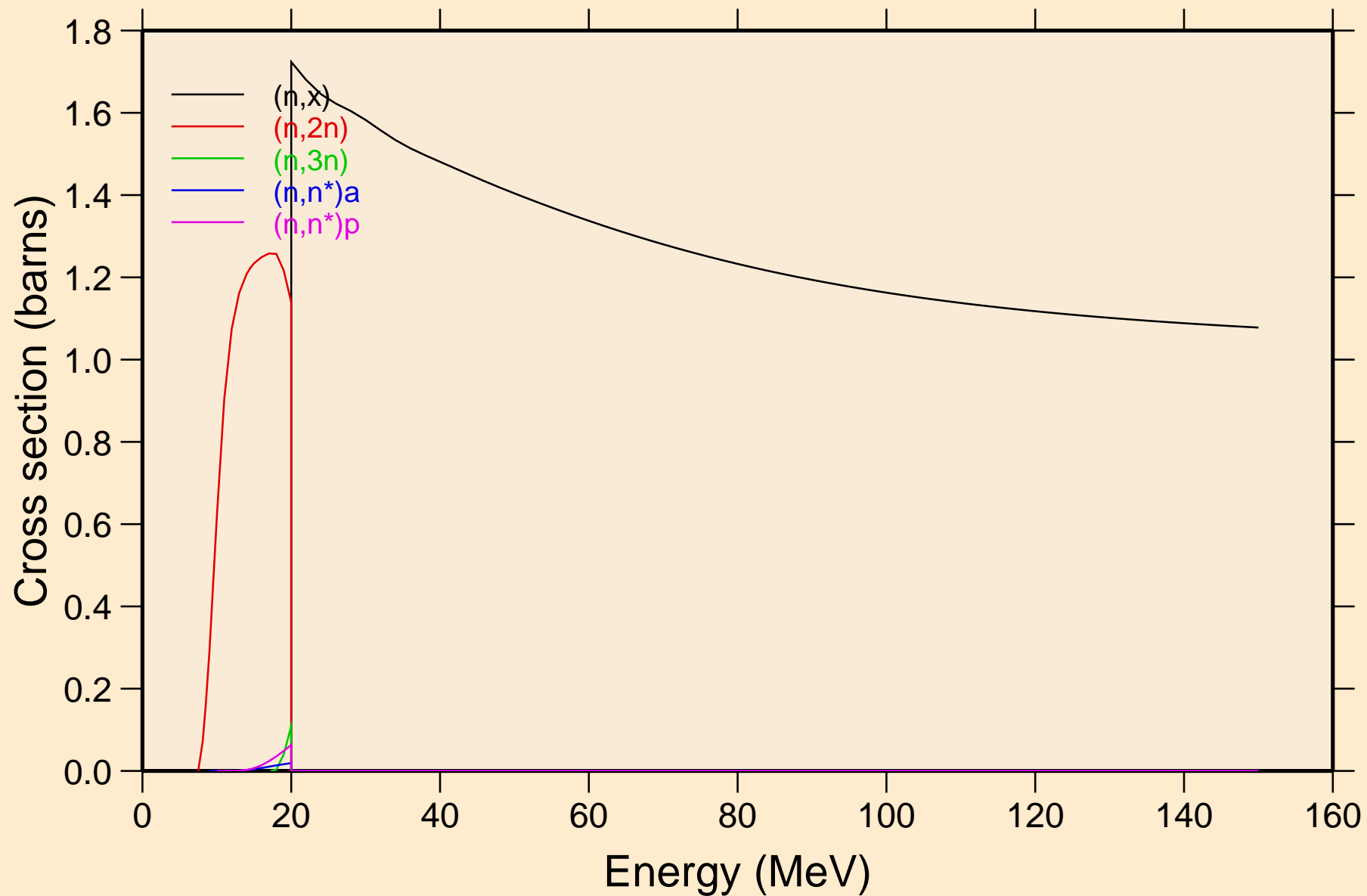



# 42-MO-95 FOR FENDL-3.1 FROM FENDL-3.1 WITH NJOY2012.50- Threshold reactions

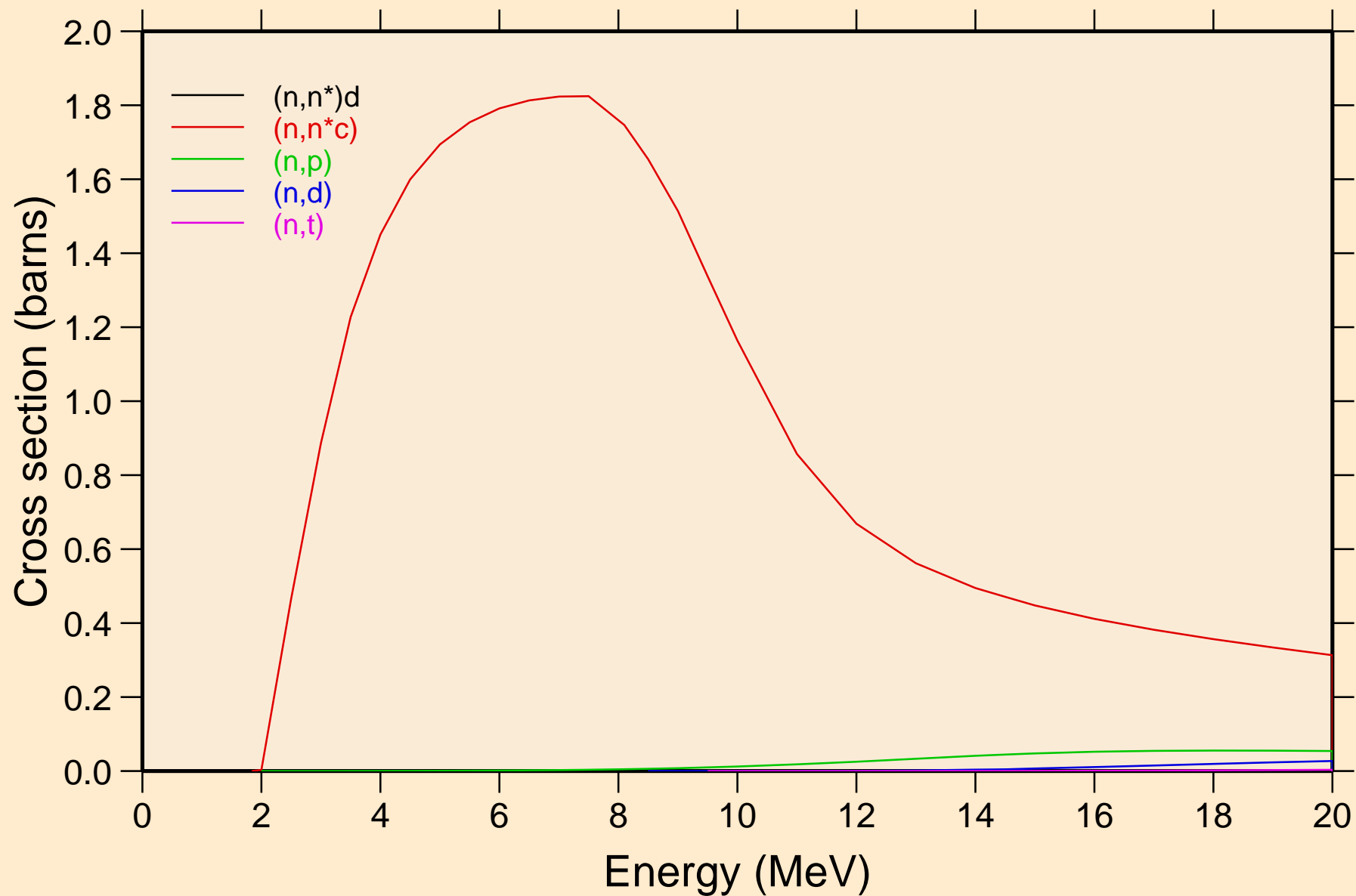

42-MO-95 FOR FENDL-3.1 FROM FENDL-3.1 WITH NJOY2012.50-  
Threshold reactions

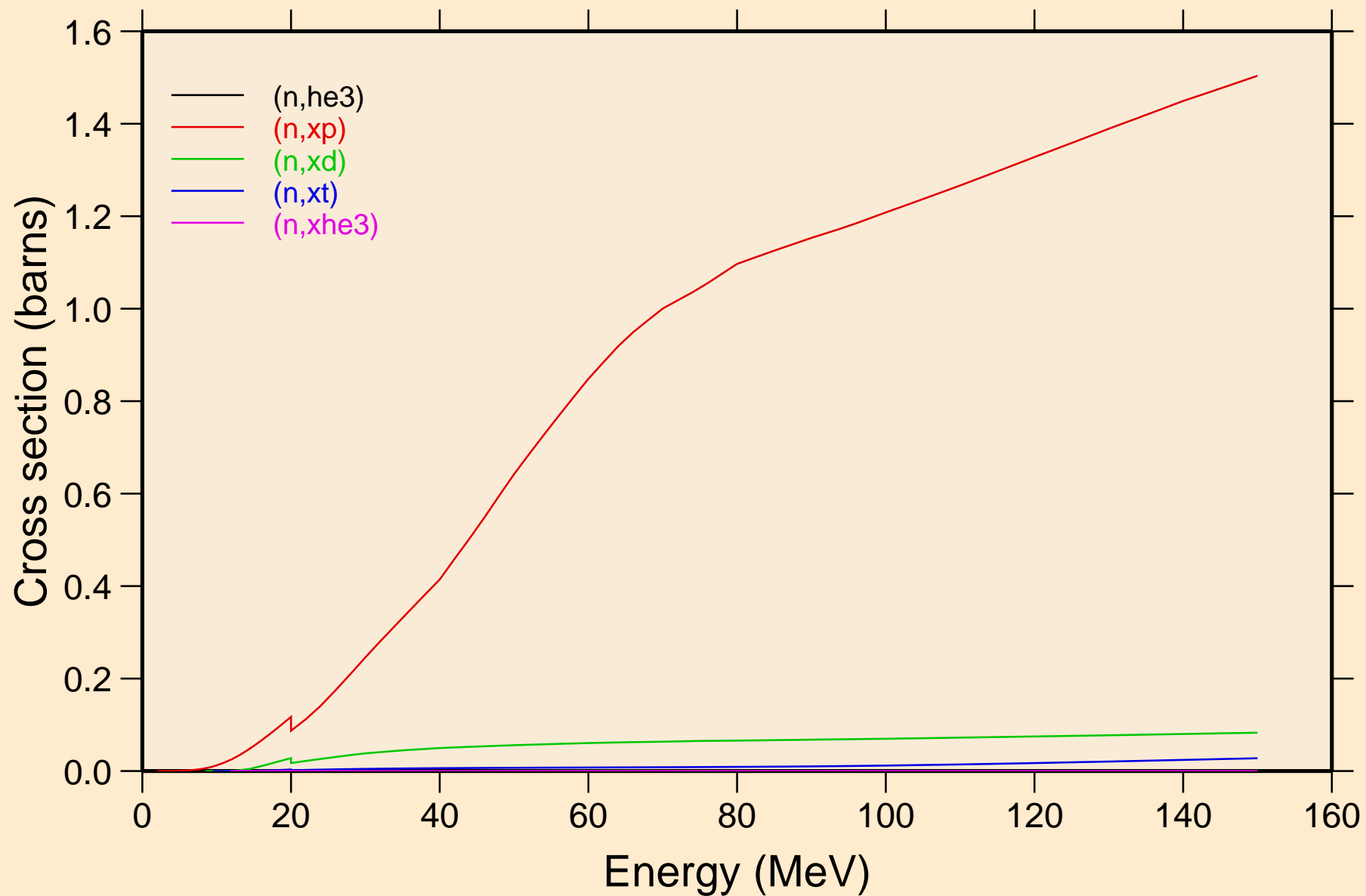

42-MO-95 FOR FENDL-3.1 FROM FENDL-3.1 WITH NJOY2012.50-  
angular distribution for elastic

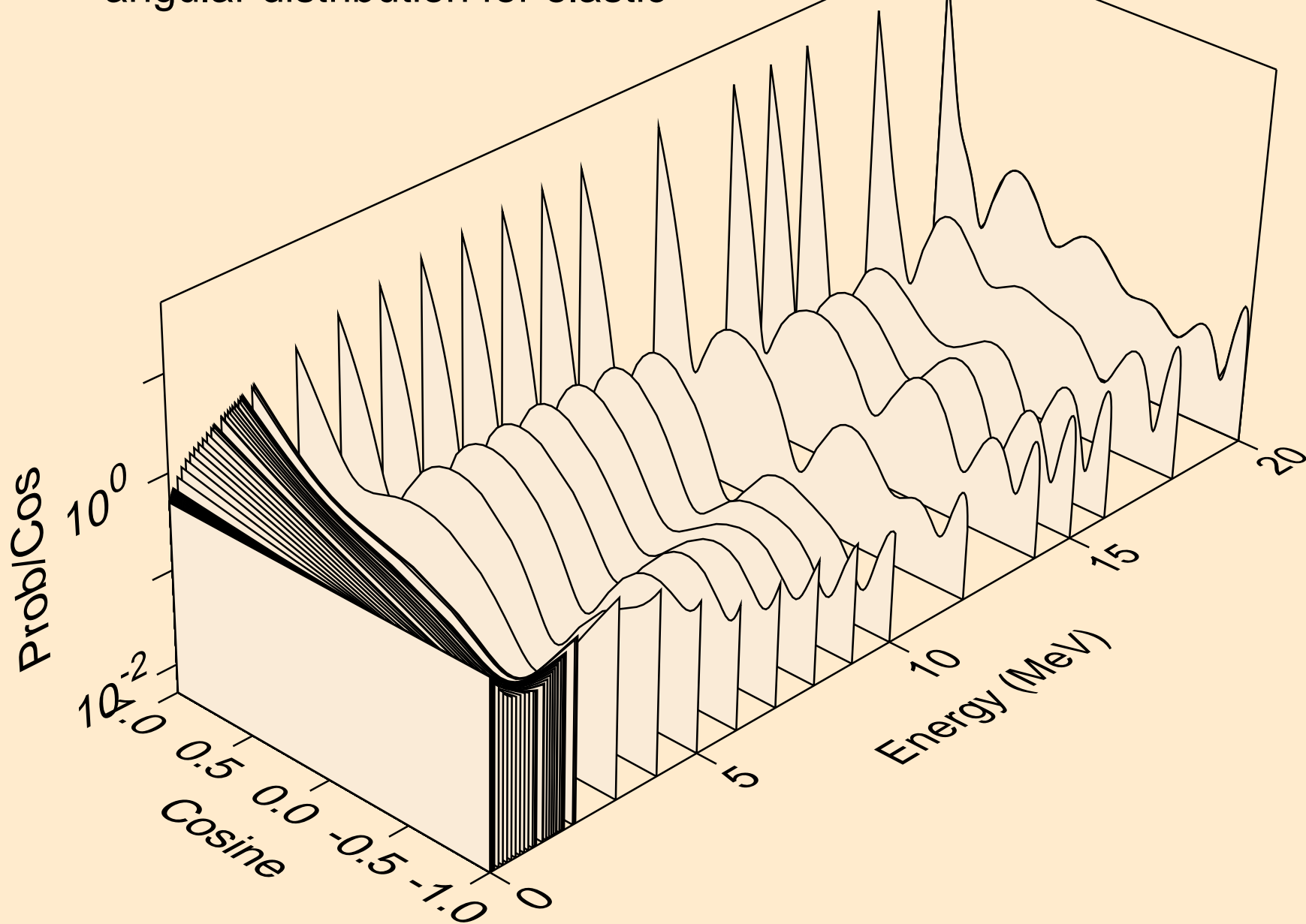

42-MO-95 FOR FENDL-3.1 FROM FENDL-3.1 WITH NJOY2012.50-  
angular distribution for elastic

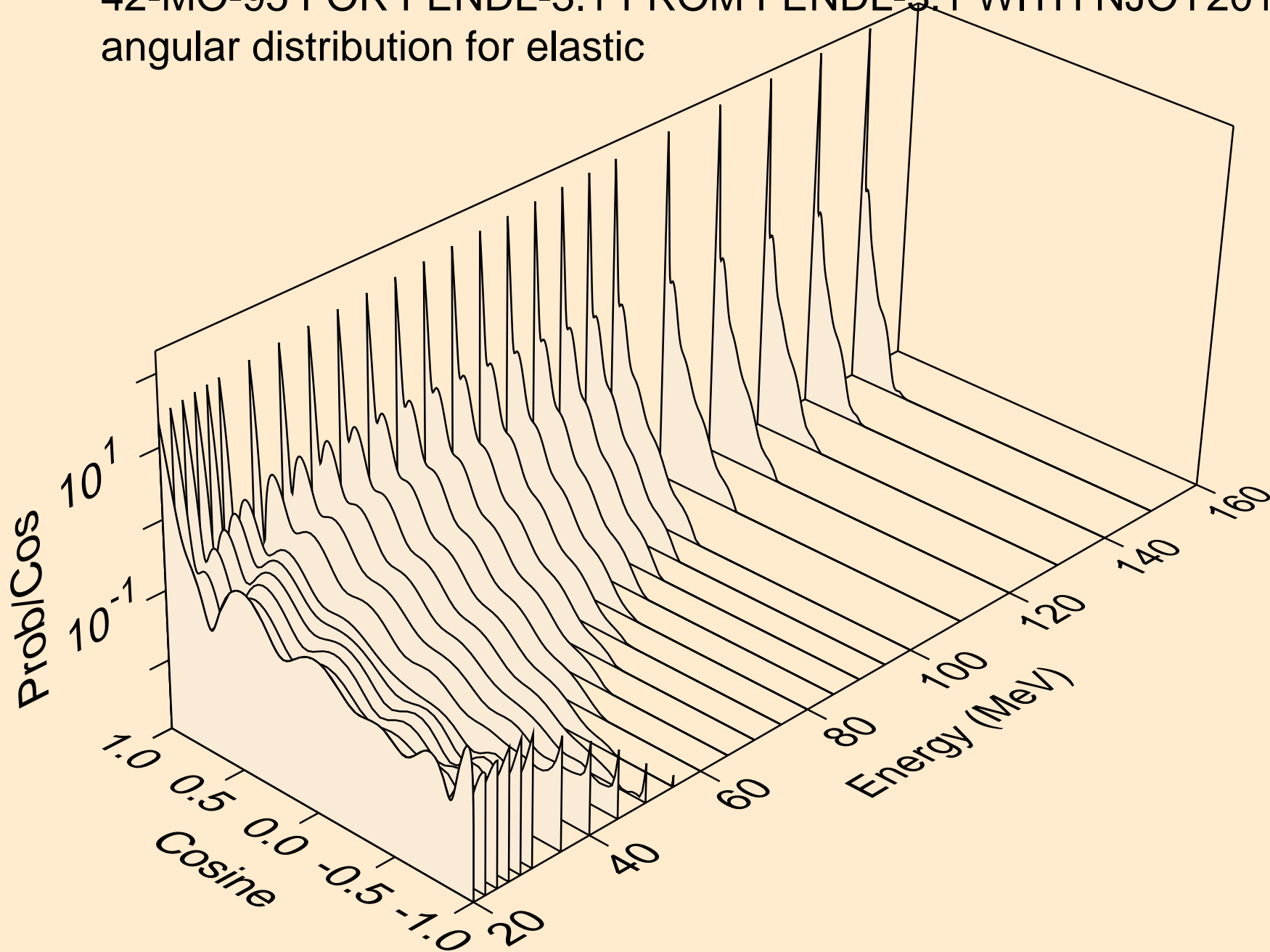

42-MO-95 FOR FENDL-3.1 FROM FENDL-3.1 WITH NJOY2012.50-  
angular distribution for (n,n\*1)

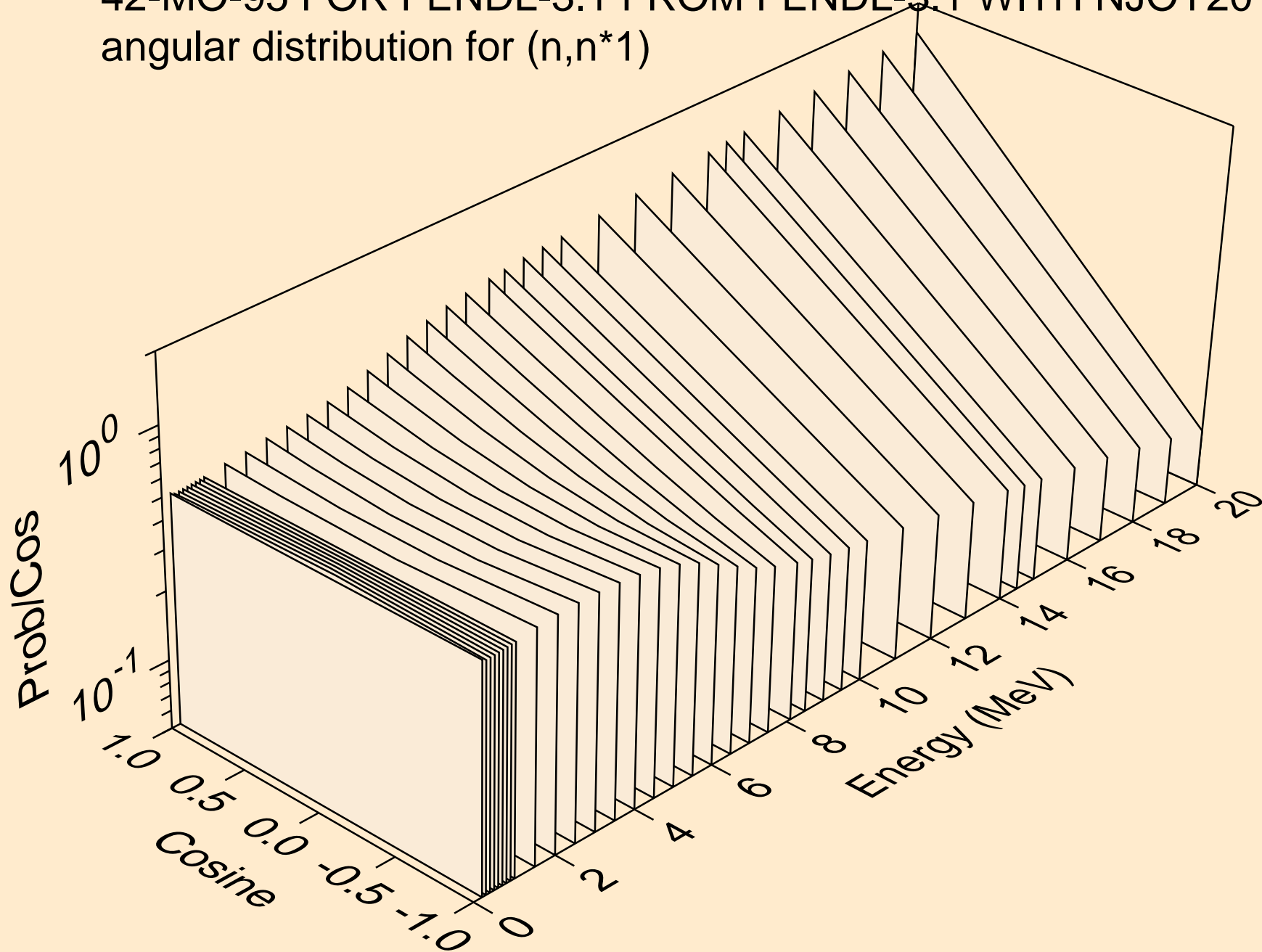

42-MO-95 FOR FENDL-3.1 FROM FENDL-3.1 WITH NJOY2012.50-  
angular distribution for (n,n\*2)

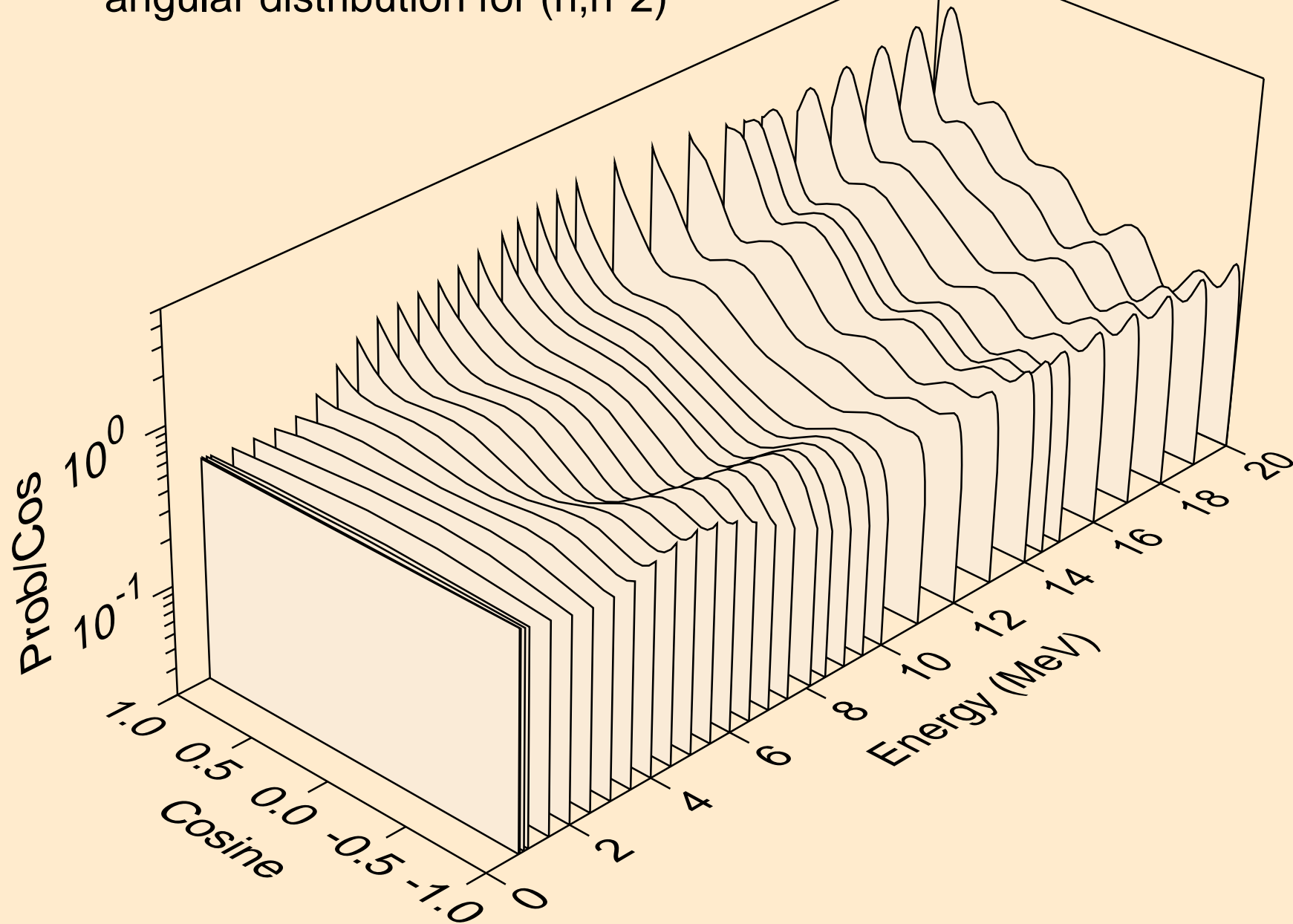

42-MO-95 FOR FENDL-3.1 FROM FENDL-3.1 WITH NJOY2012.50-  
angular distribution for (n,n\*3)

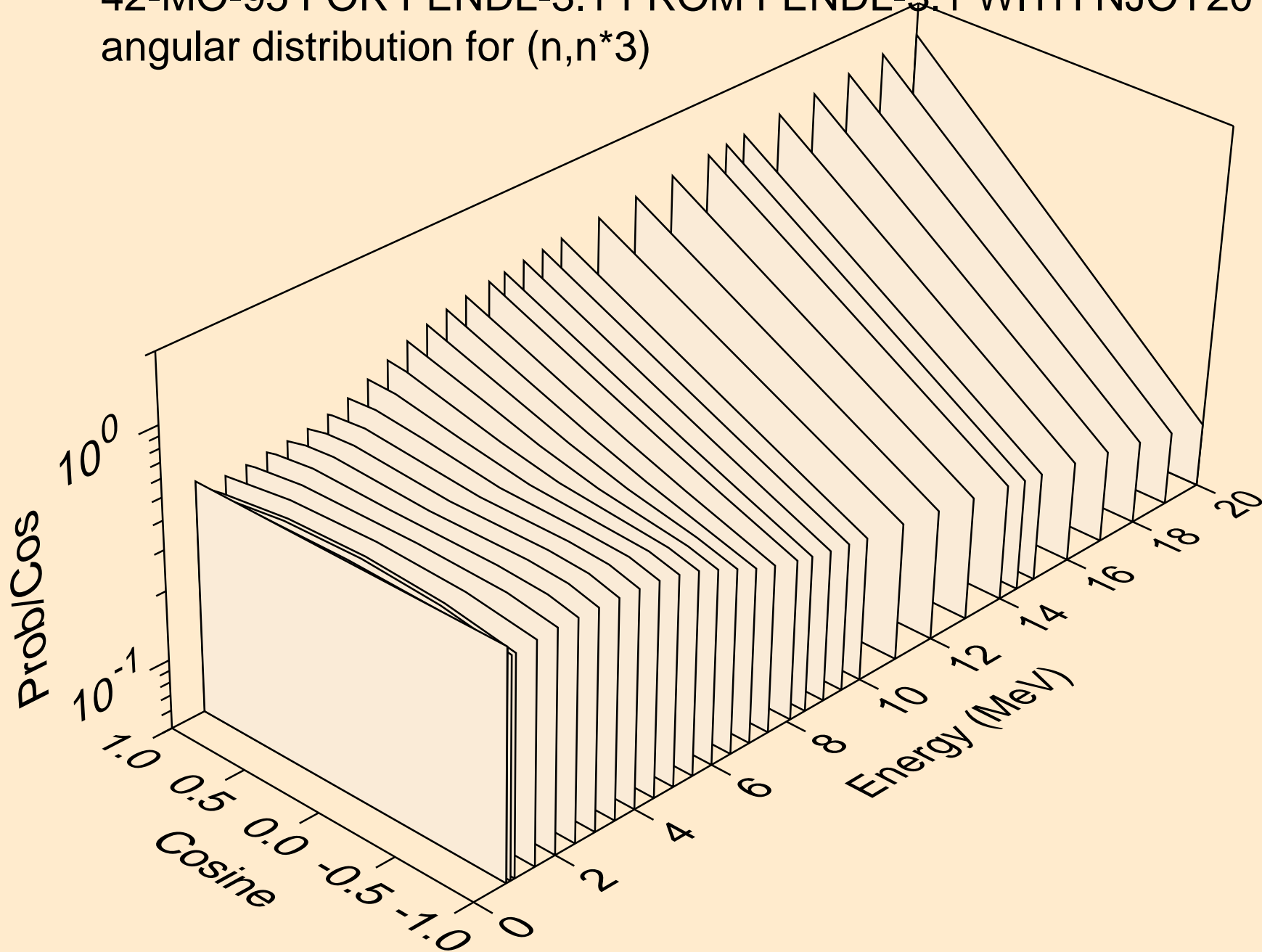

42-MO-95 FOR FENDL-3.1 FROM FENDL-3.1 WITH NJOY2012.50-  
angular distribution for (n,n\*4)

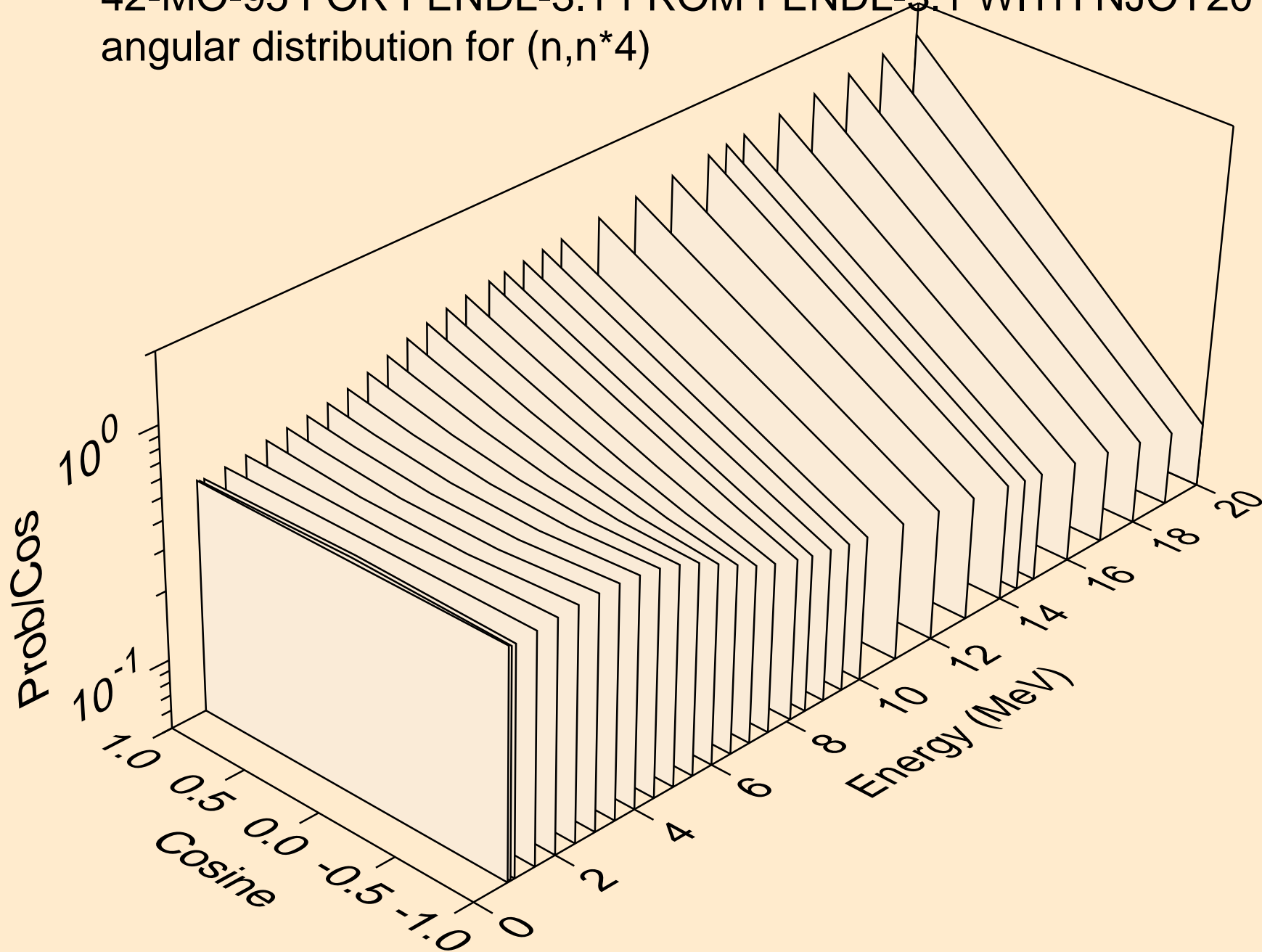



42-MO-95 FOR FENDL-3.1 FROM FENDL-3.1 WITH NJOY2012.50-  
angular distribution for (n,n\*5)

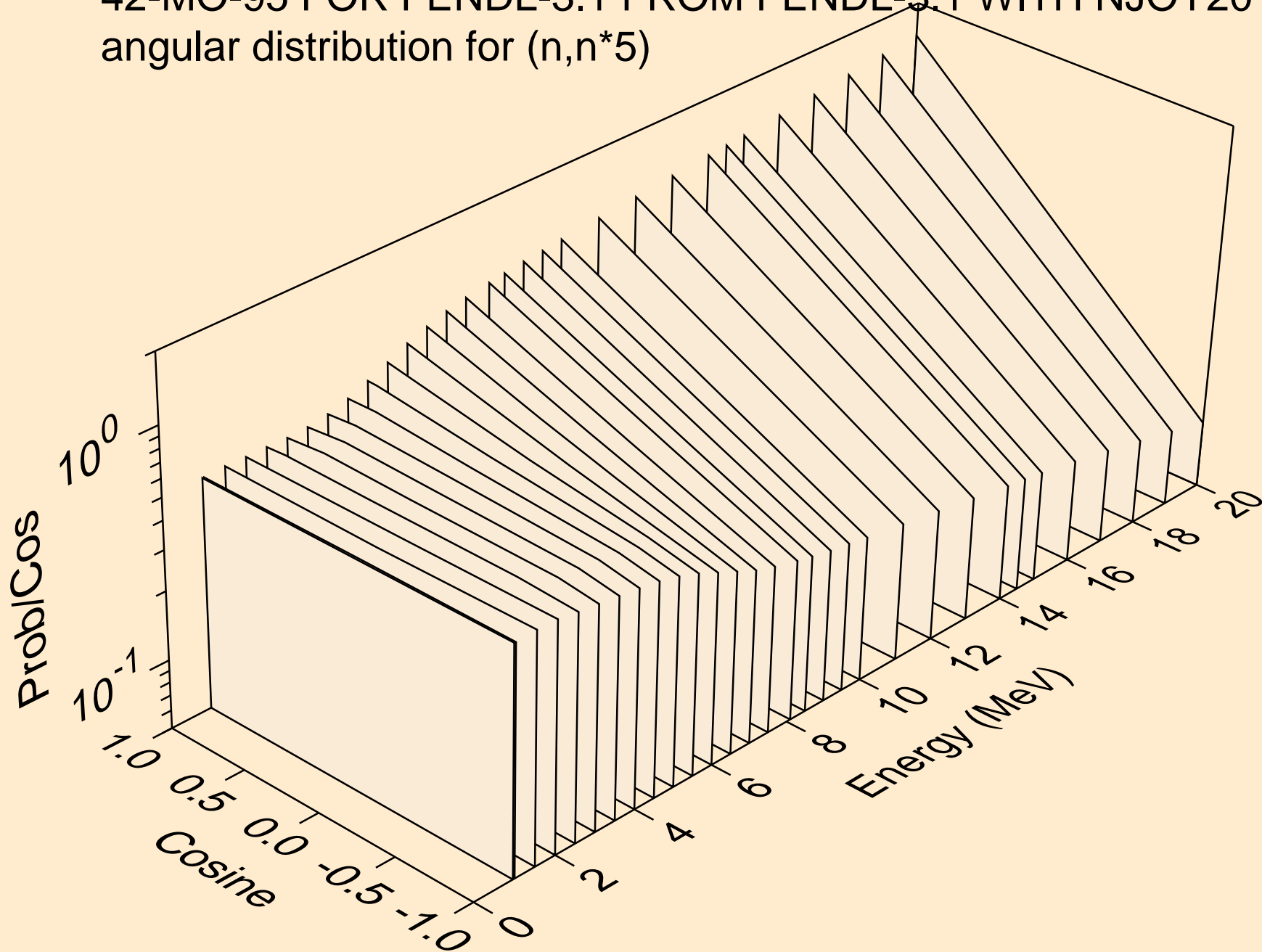

42-MO-95 FOR FENDL-3.1 FROM FENDL-3.1 WITH NJOY2012.50-  
angular distribution for (n,n\*6)

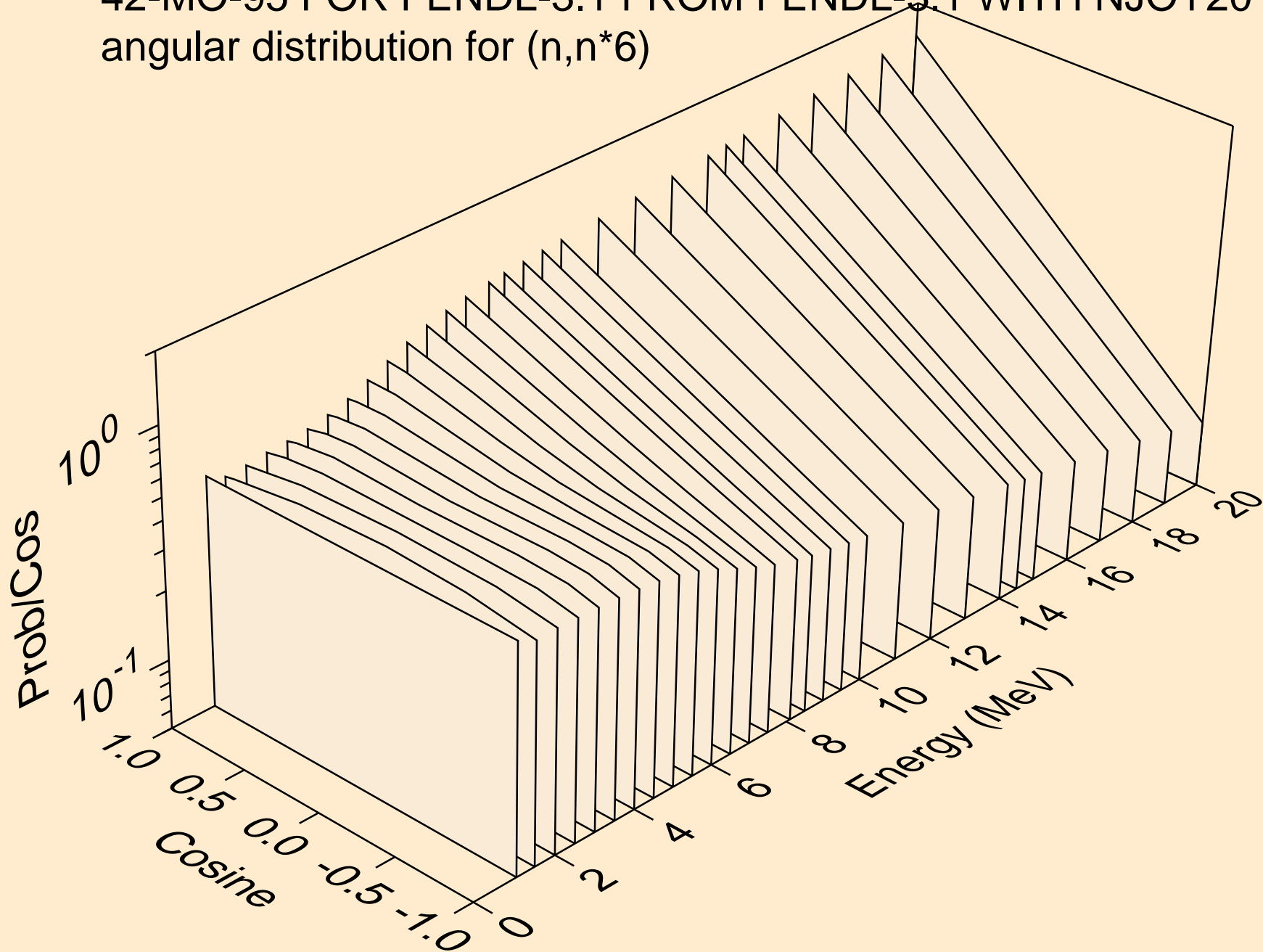

42-MO-95 FOR FENDL-3.1 FROM FENDL-3.1 WITH NJOY2012.50-  
angular distribution for (n,n\*7)

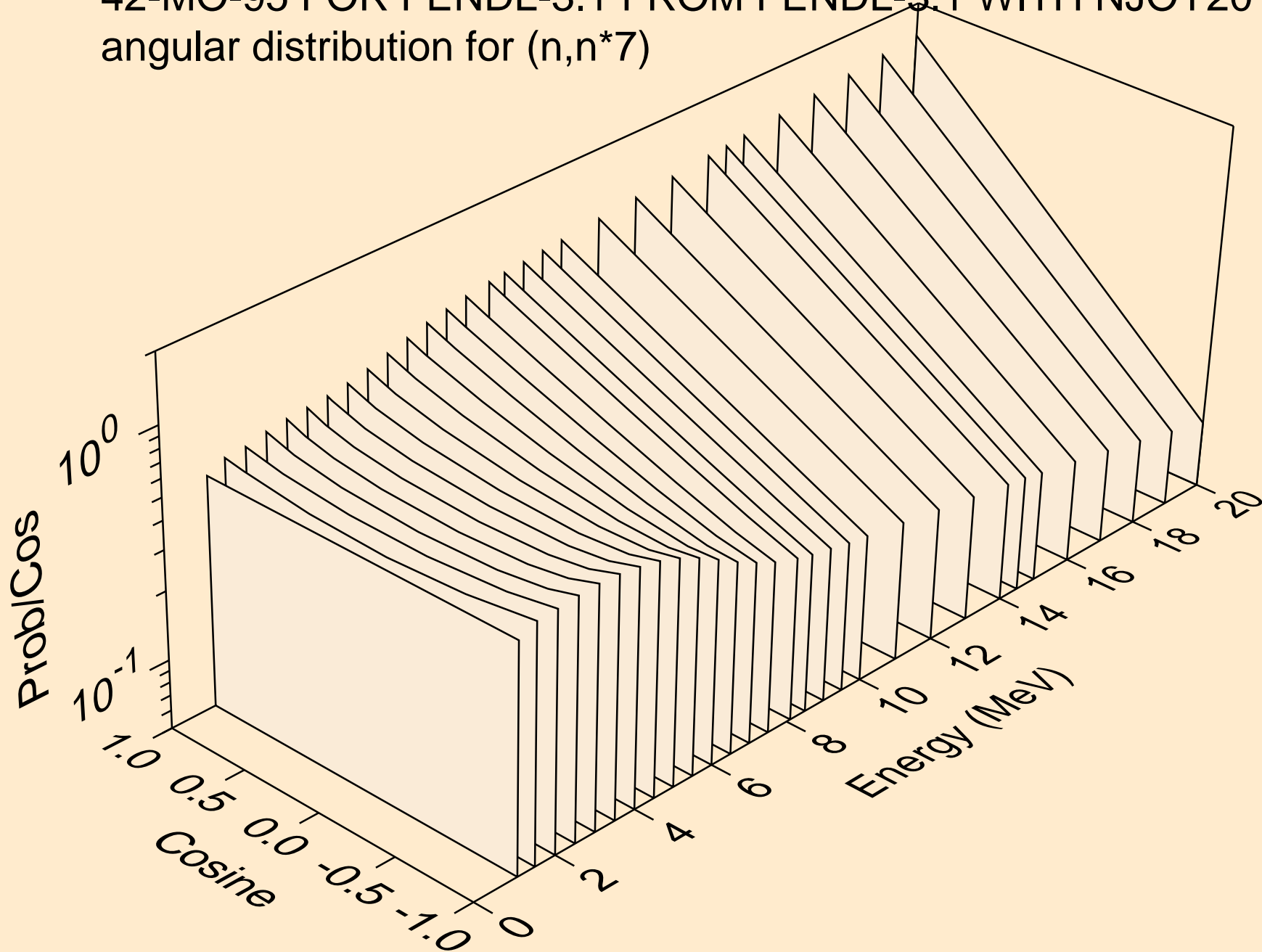

42-MO-95 FOR FENDL-3.1 FROM FENDL-3.1 WITH NJOY2012.50-  
angular distribution for (n,n\*8)

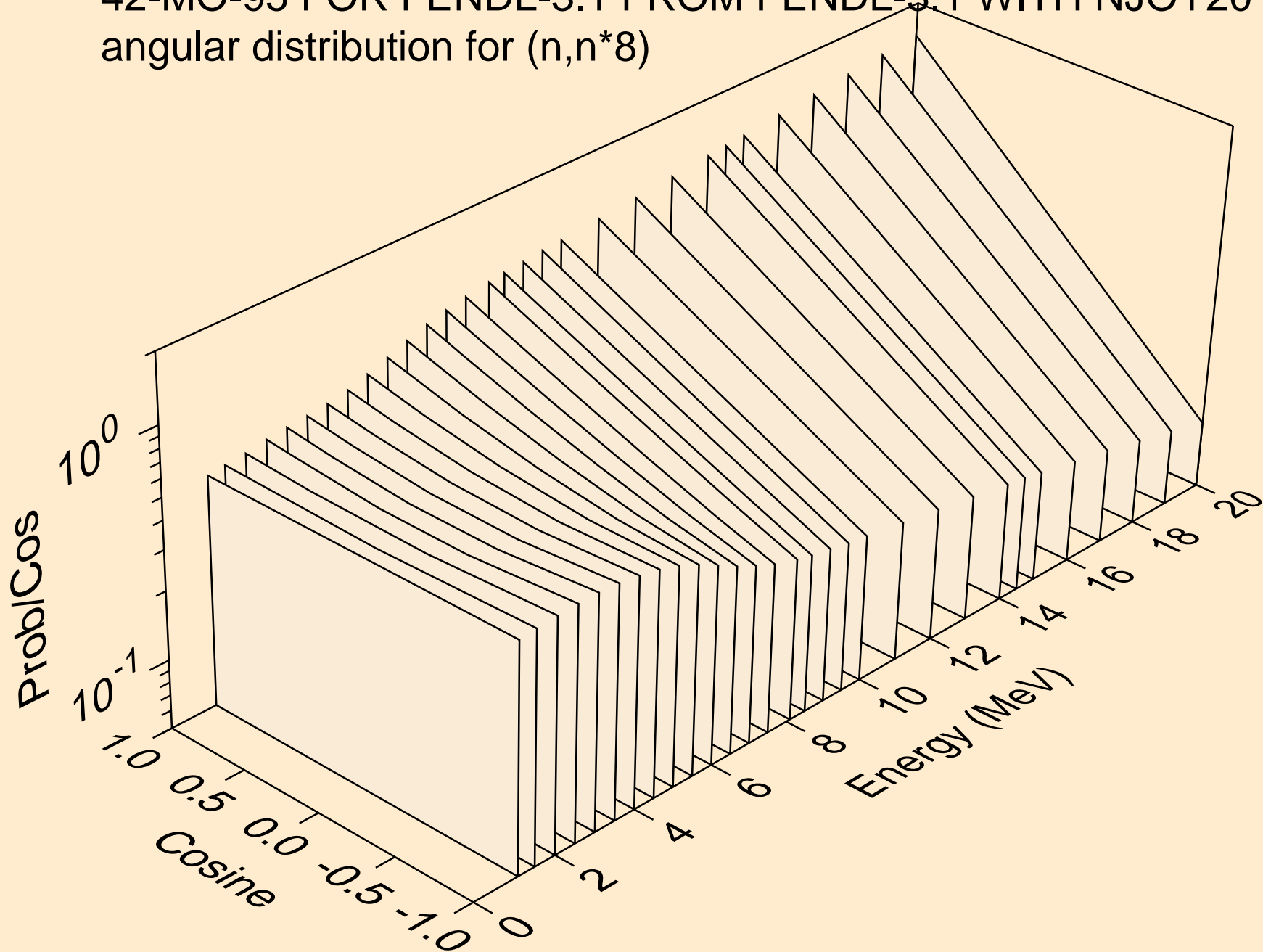

42-MO-95 FOR FENDL-3.1 FROM FENDL-3.1 WITH NJOY2012.50-  
angular distribution for (n,n\*9)

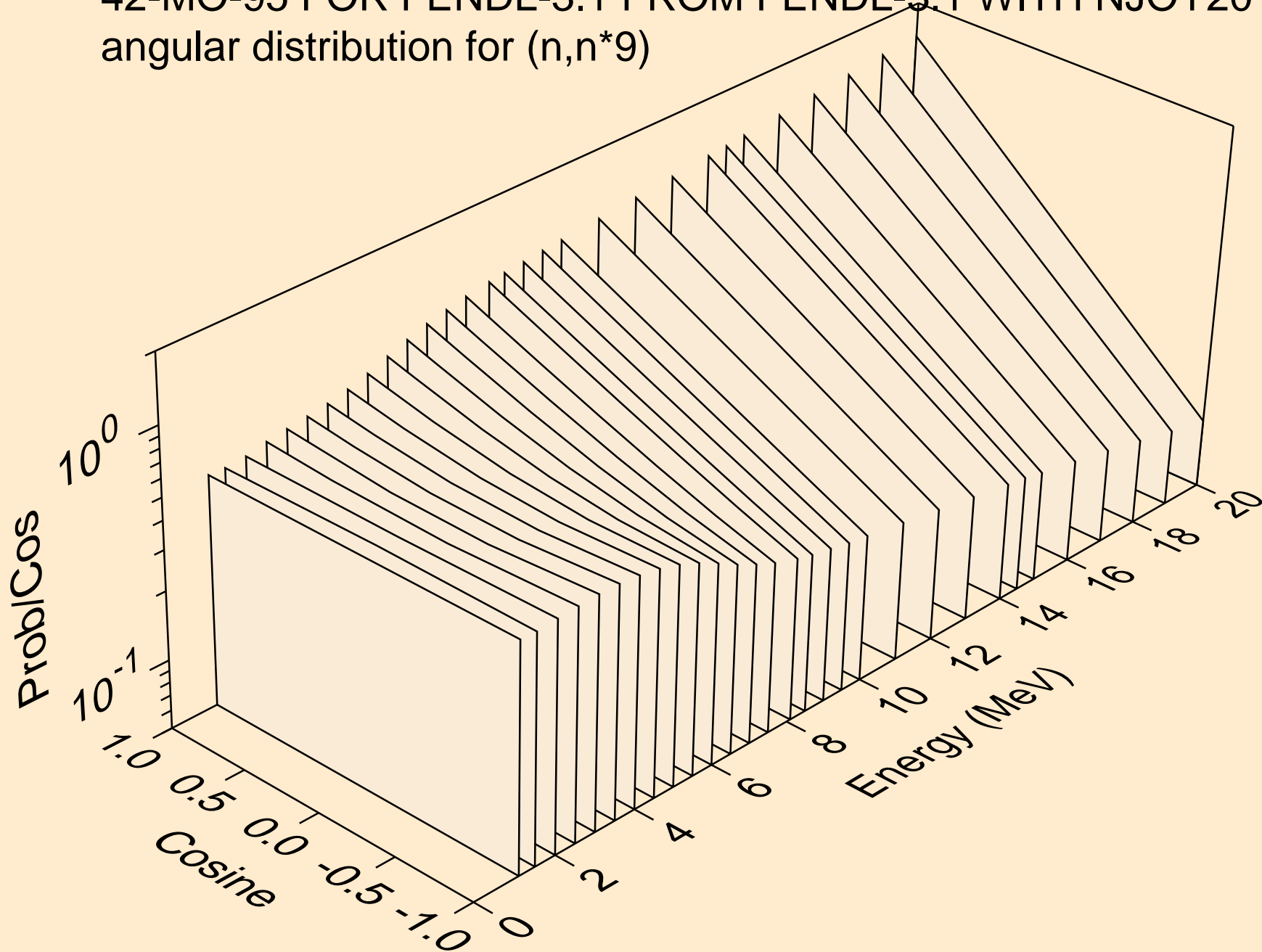

42-MO-95 FOR FENDL-3.1 FROM FENDL-3.1 WITH NJOY2012.50-  
angular distribution for (n,n\*10)

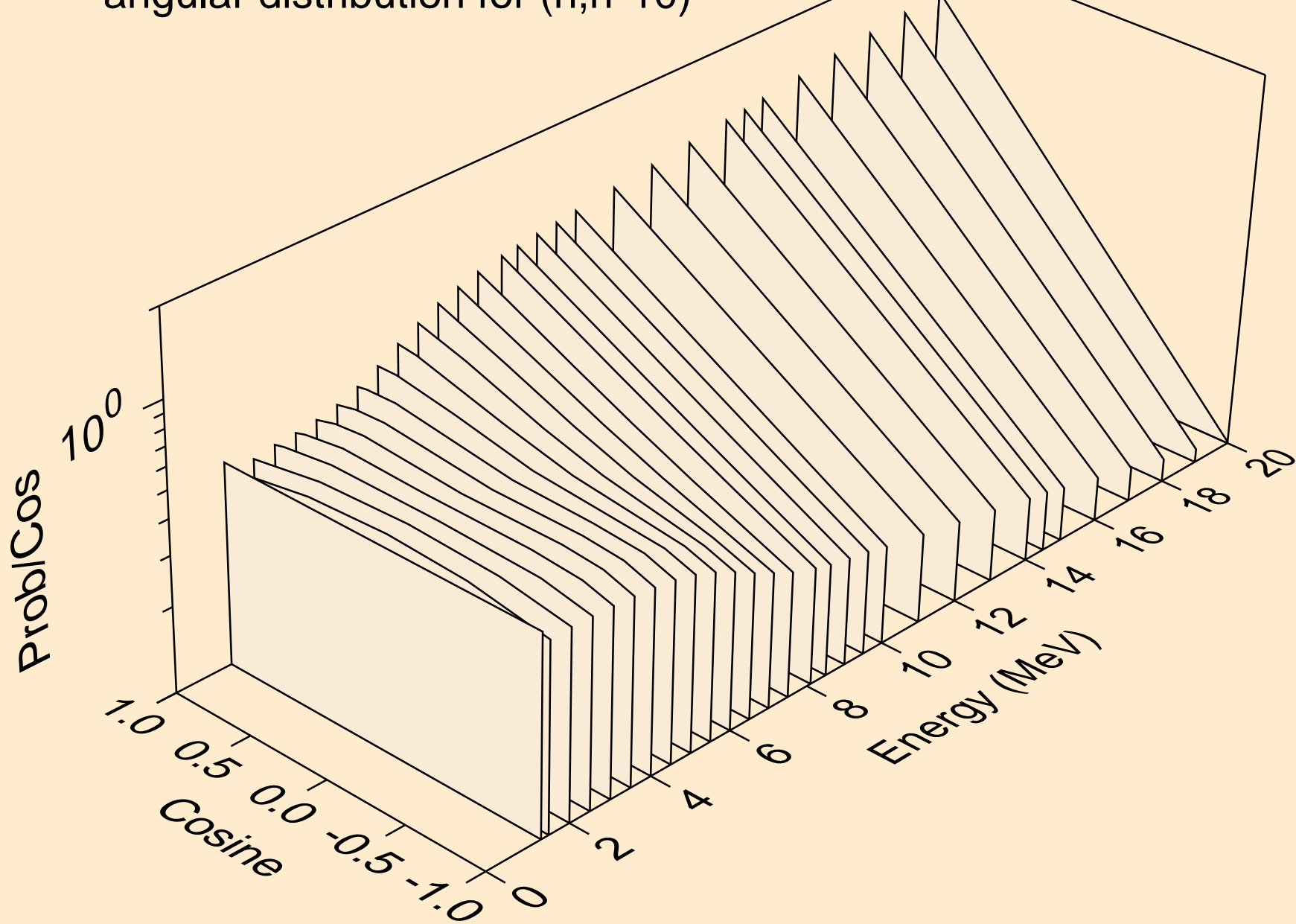

42-MO-95 FOR FENDL-3.1 FROM FENDL-3.1 WITH NJOY2012.50-  
angular distribution for (n,n\*11)

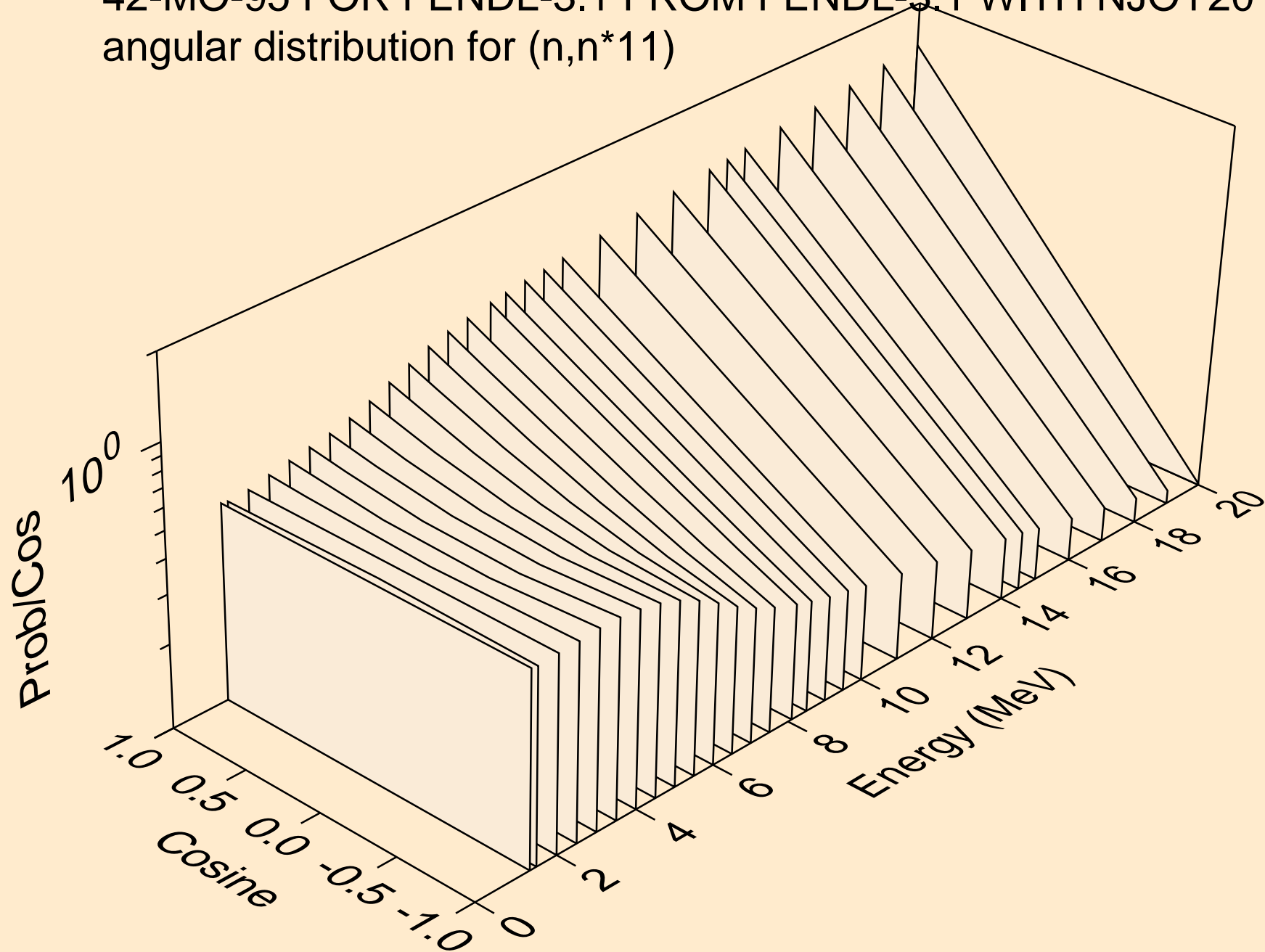

42-MO-95 FOR FENDL-3.1 FROM FENDL-3.1 WITH NJOY2012.50-  
angular distribution for (n,n\*12)

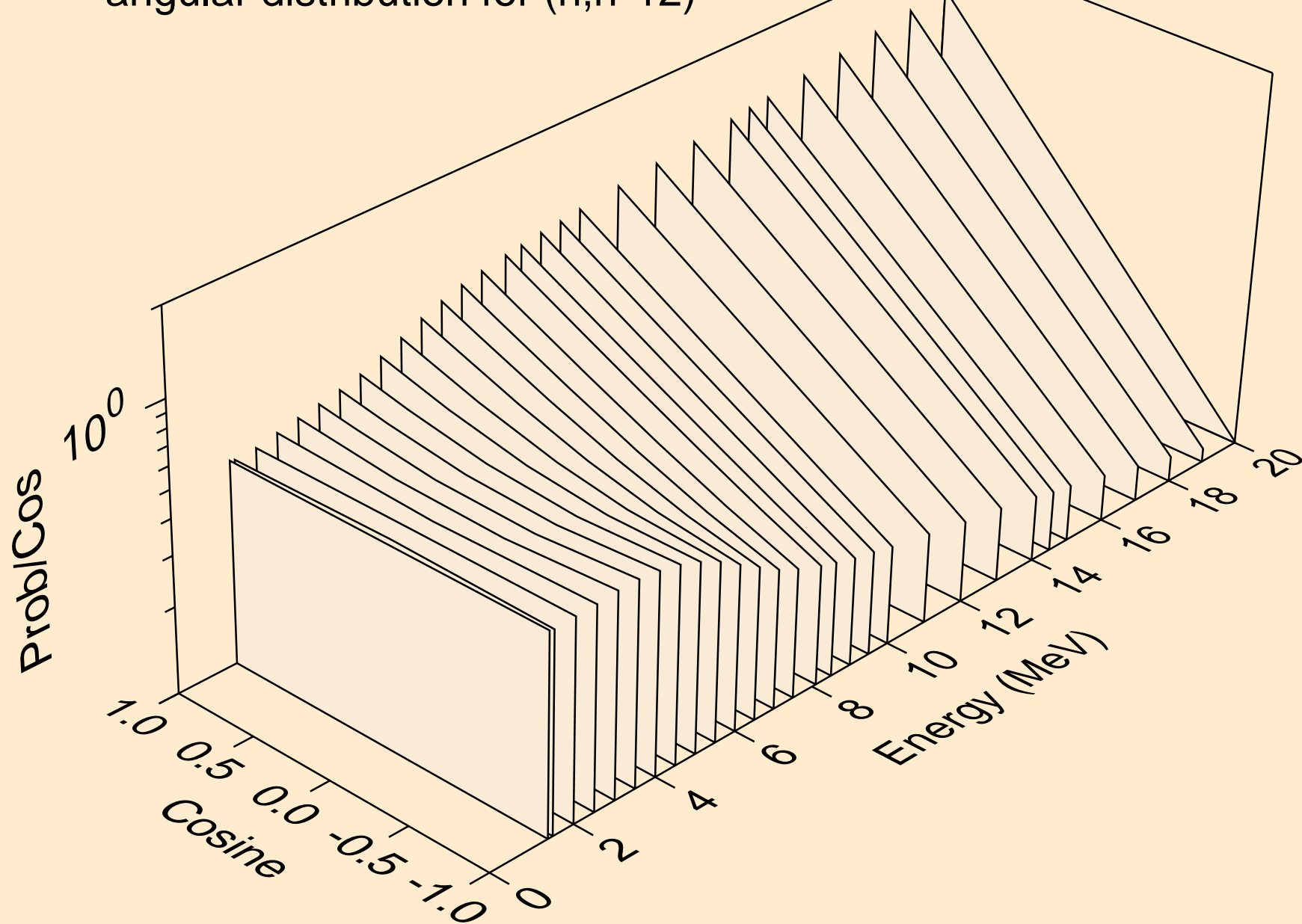



42-MO-95 FOR FENDL-3.1 FROM FENDL-3.1 WITH NJOY2012.50-  
angular distribution for (n,n\*13)

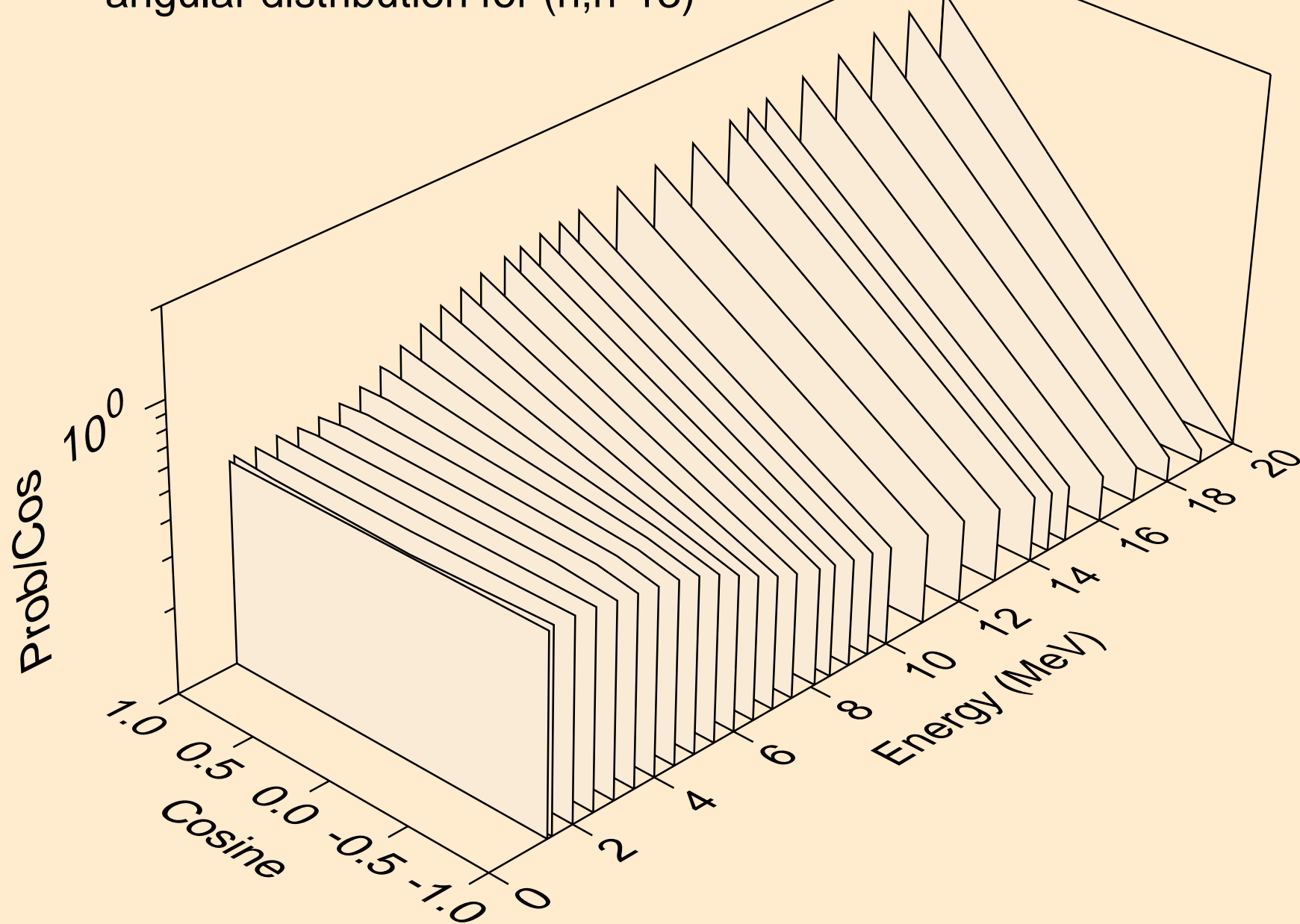

42-MO-95 FOR FENDL-3.1 FROM FENDL-3.1 WITH NJOY2012.50-  
angular distribution for (n,n\*14)

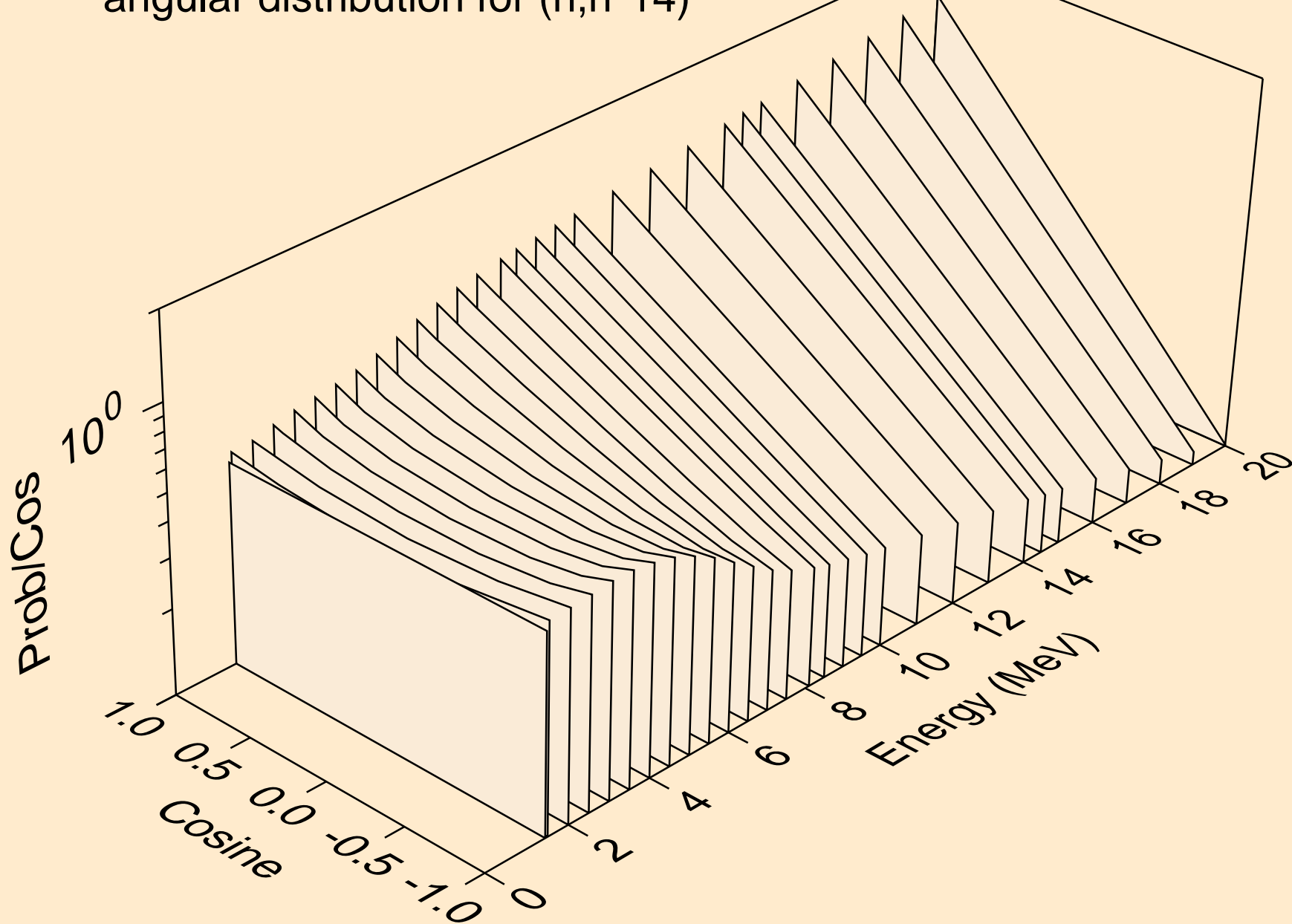

42-MO-95 FOR FENDL-3.1 FROM FENDL-3.1 WITH NJOY2012.50-  
angular distribution for (n,n\*15)

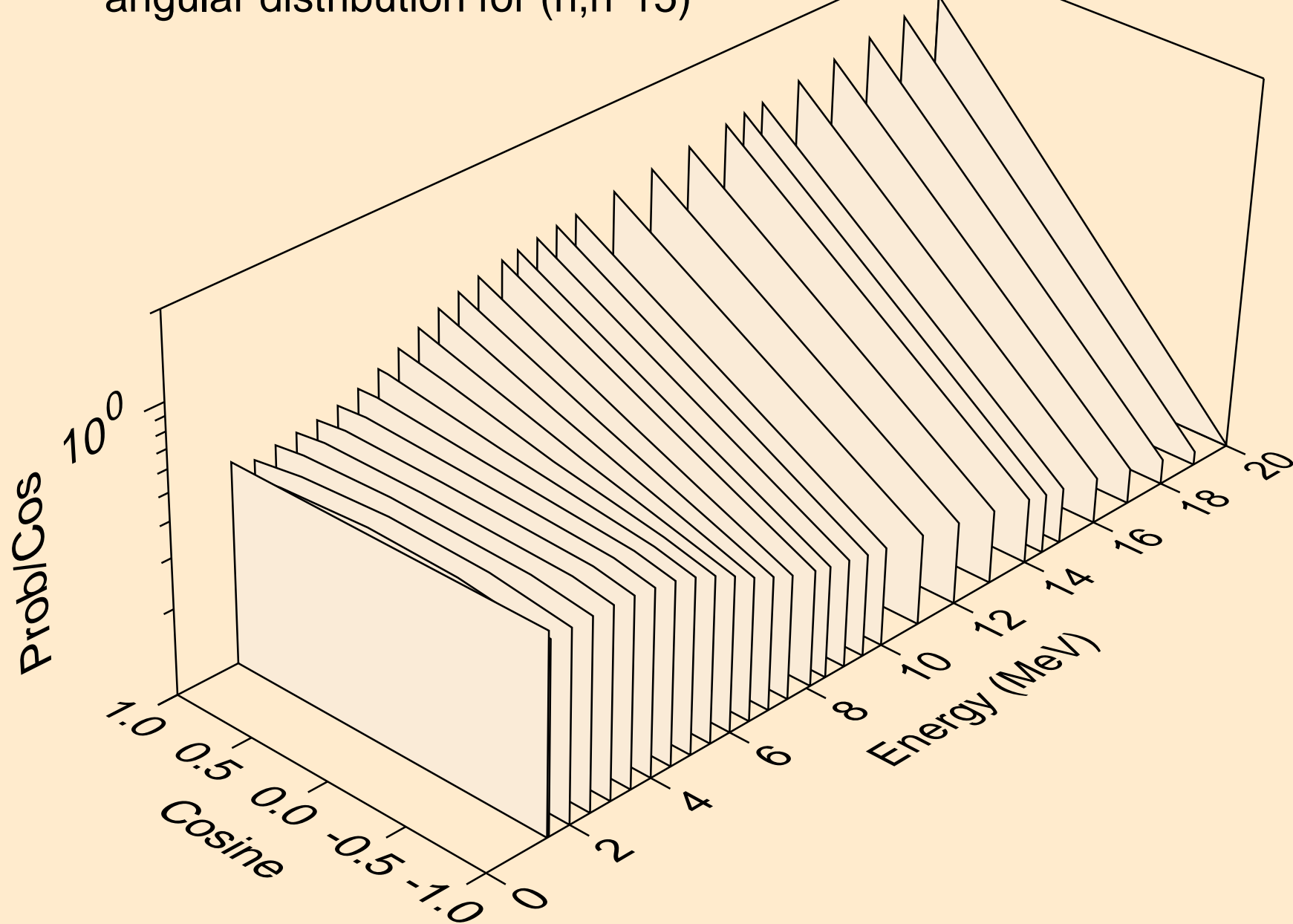

42-MO-95 FOR FENDL-3.1 FROM FENDL-3.1 WITH NJOY2012.50-  
angular distribution for (n,n\*16)

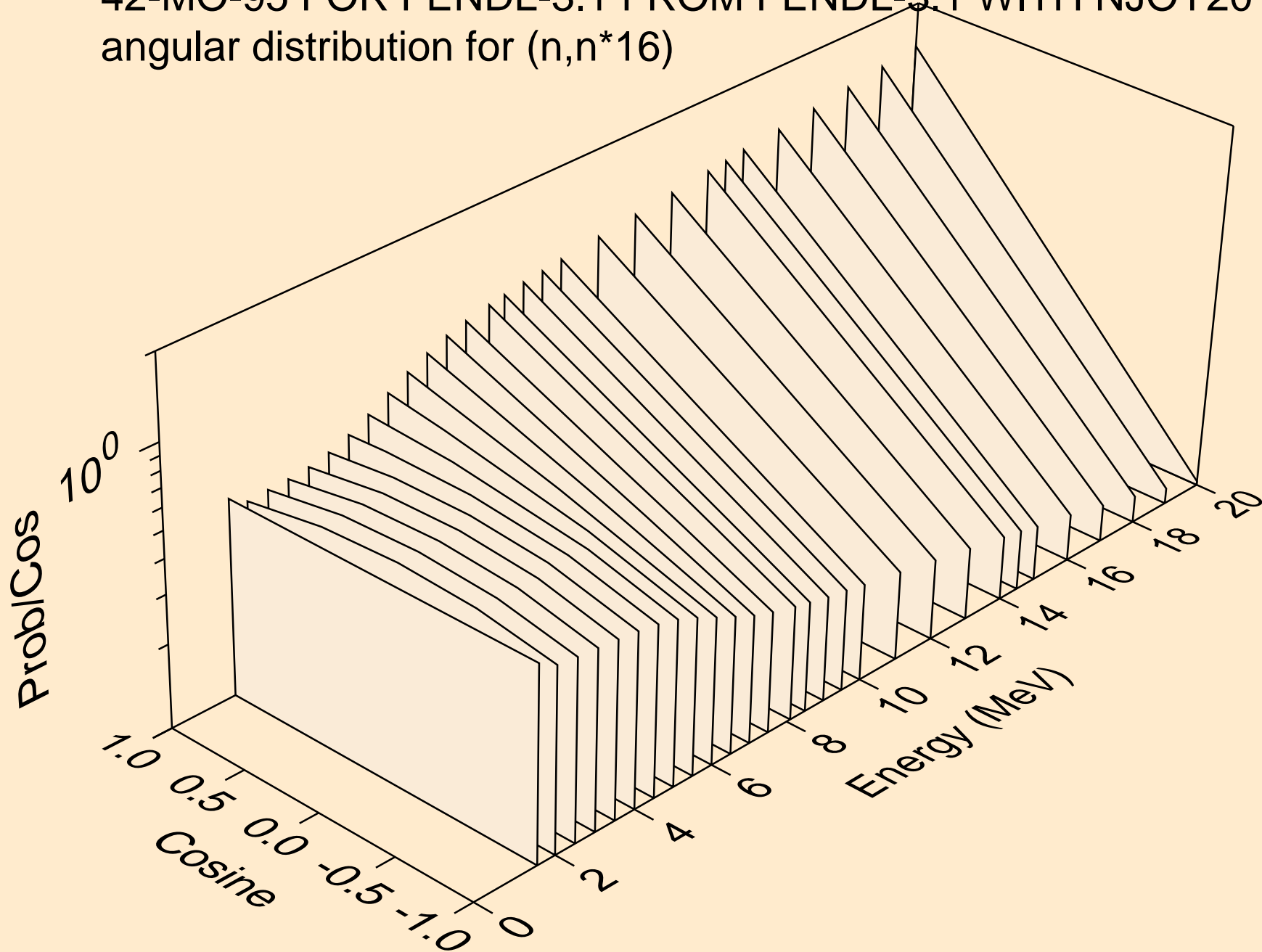

42-MO-95 FOR FENDL-3.1 FROM FENDL-3.1 WITH NJOY2012.50-  
angular distribution for (n,n\*17)

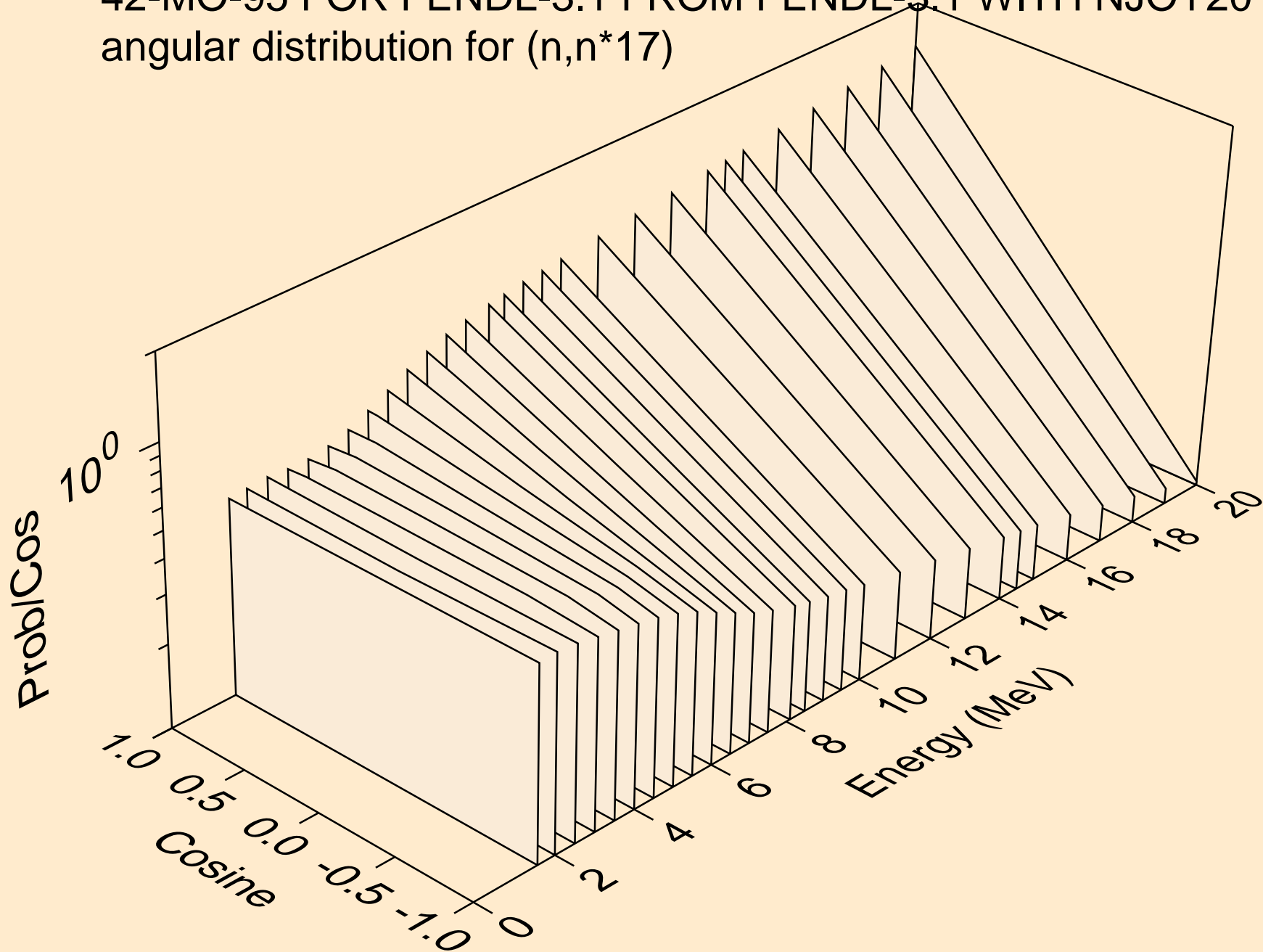

42-MO-95 FOR FENDL-3.1 FROM FENDL-3.1 WITH NJOY2012.50-  
angular distribution for (n,n\*18)

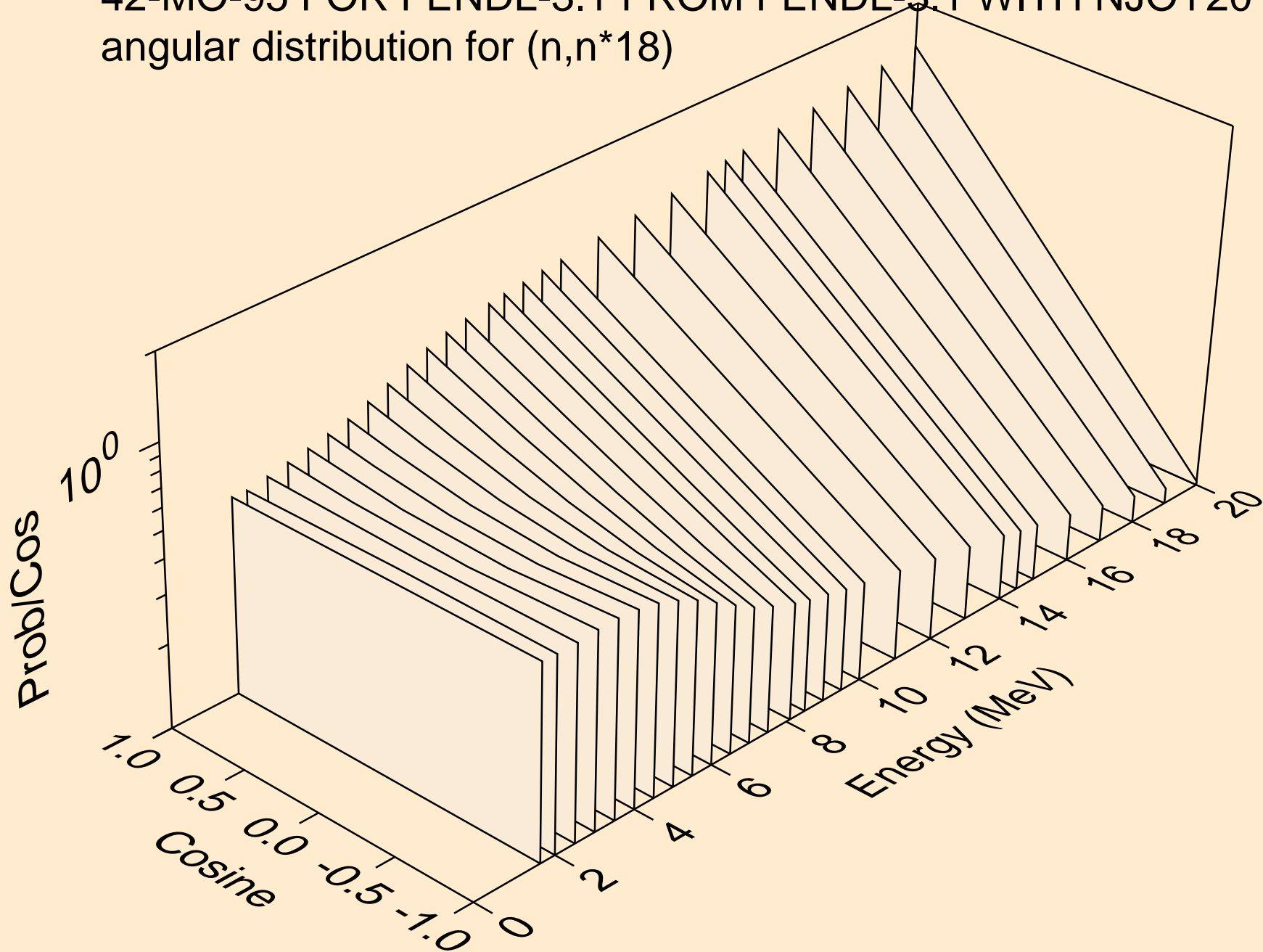

42-MO-95 FOR FENDL-3.1 FROM FENDL-3.1 WITH NJOY2012.50-  
angular distribution for (n,n\*19)

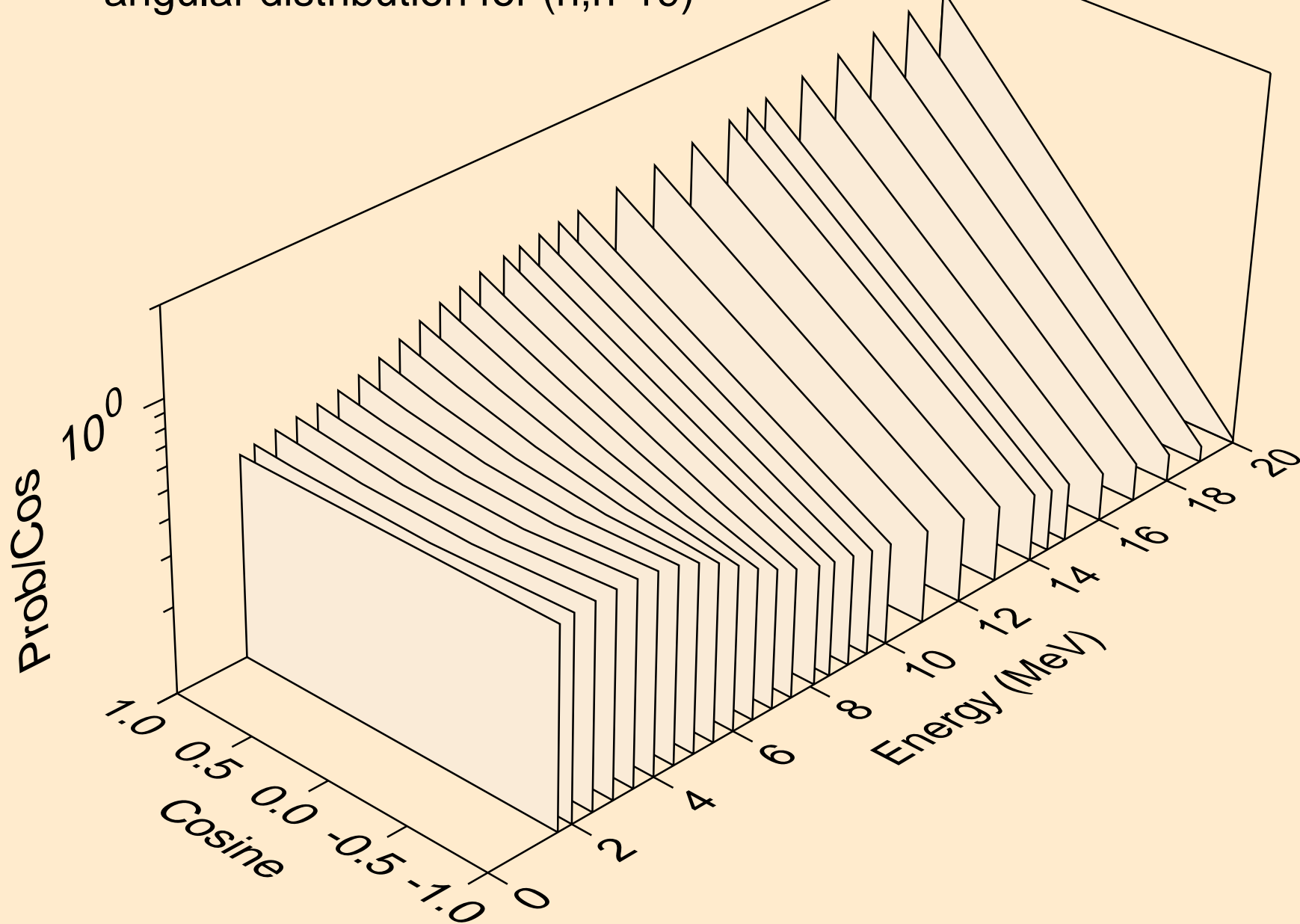

42-MO-95 FOR FENDL-3.1 FROM FENDL-3.1 WITH NJOY2012.50-  
angular distribution for (n,n\*20)

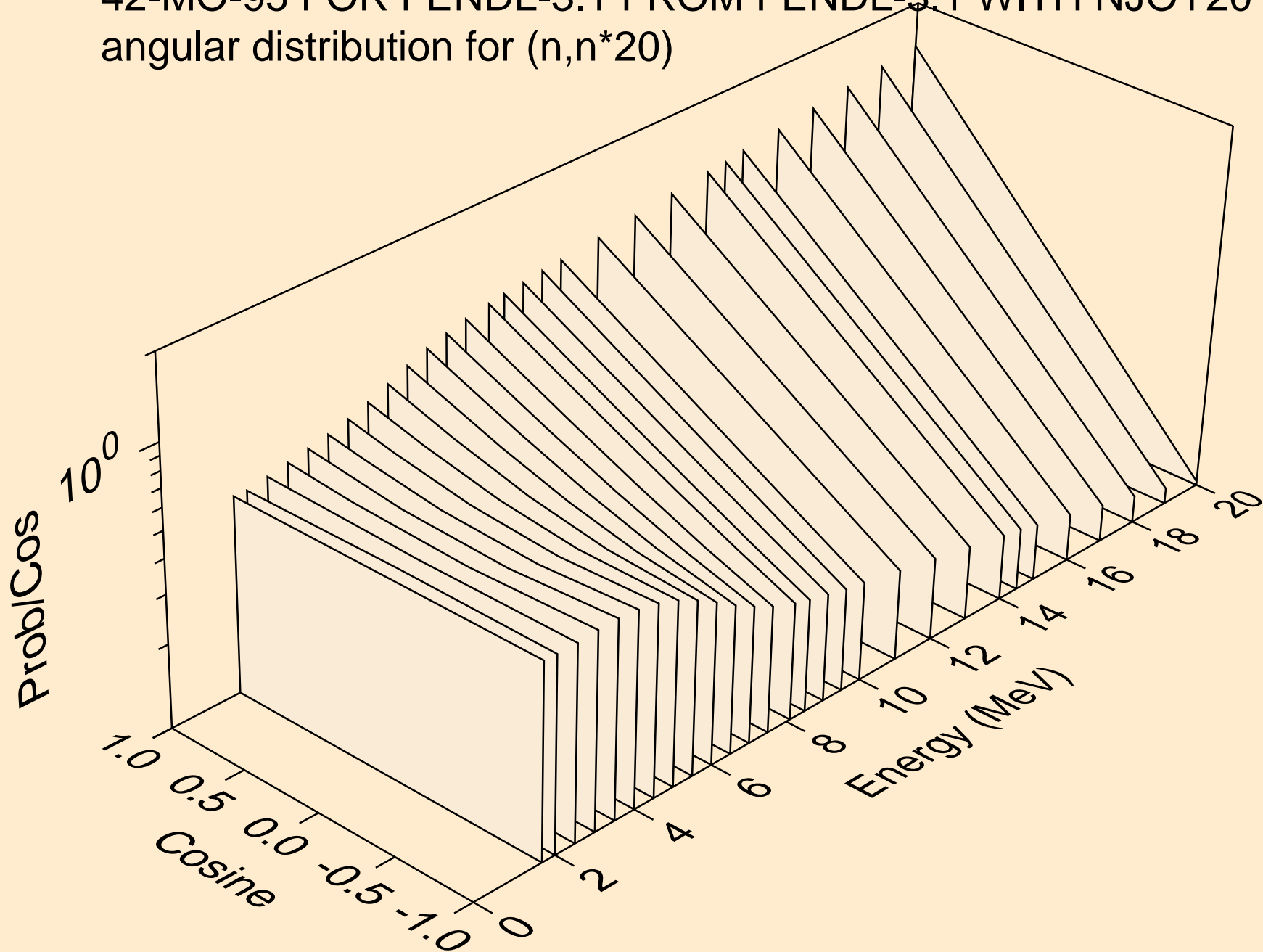



42-MO-95 FOR FENDL-3.1 FROM FENDL-3.1 WITH NJOY2012.50-  
angular distribution for (n,n\*21)

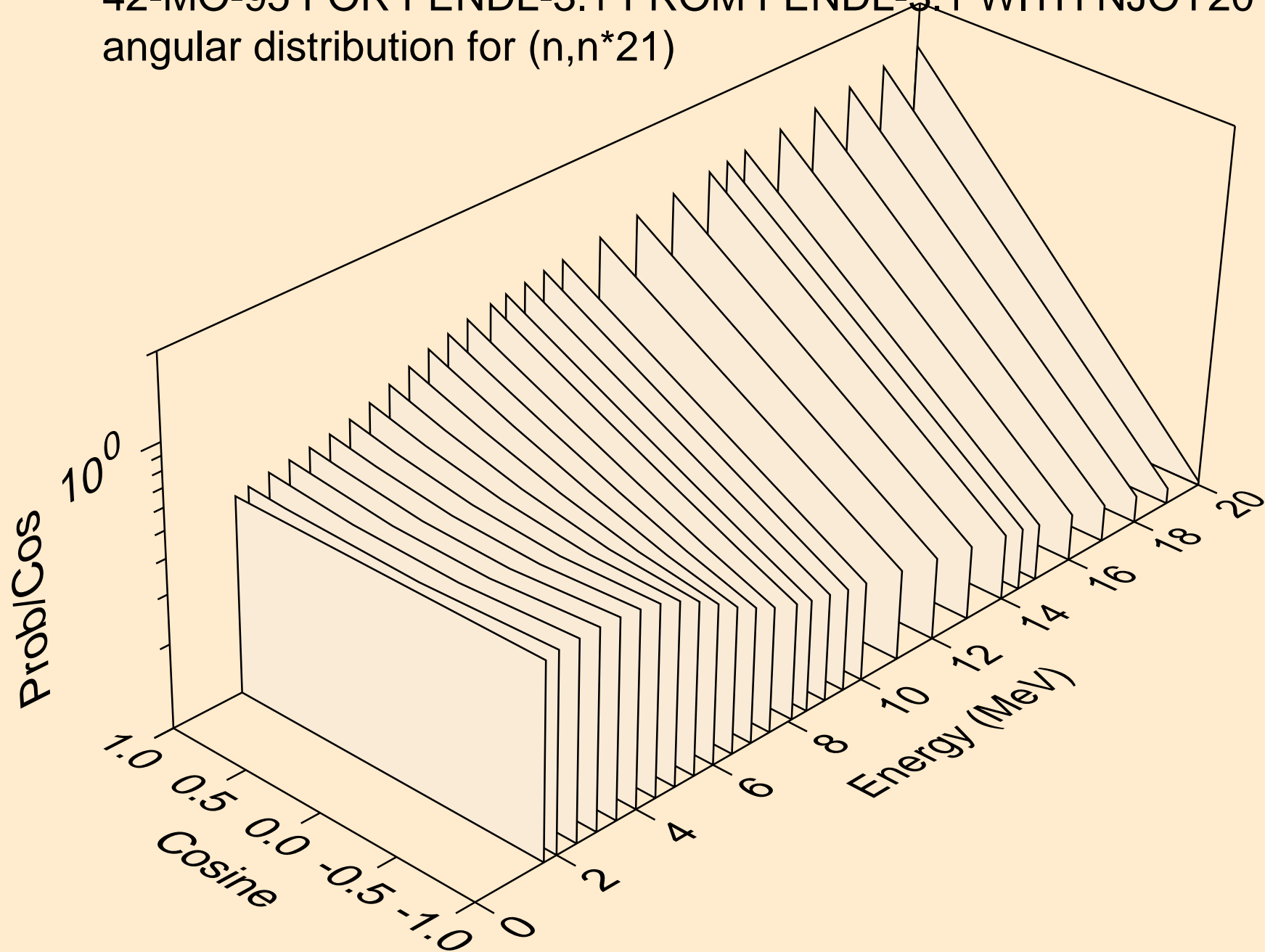

42-MO-95 FOR FENDL-3.1 FROM FENDL-3.1 WITH NJOY2012.50-  
angular distribution for (n,n\*22)

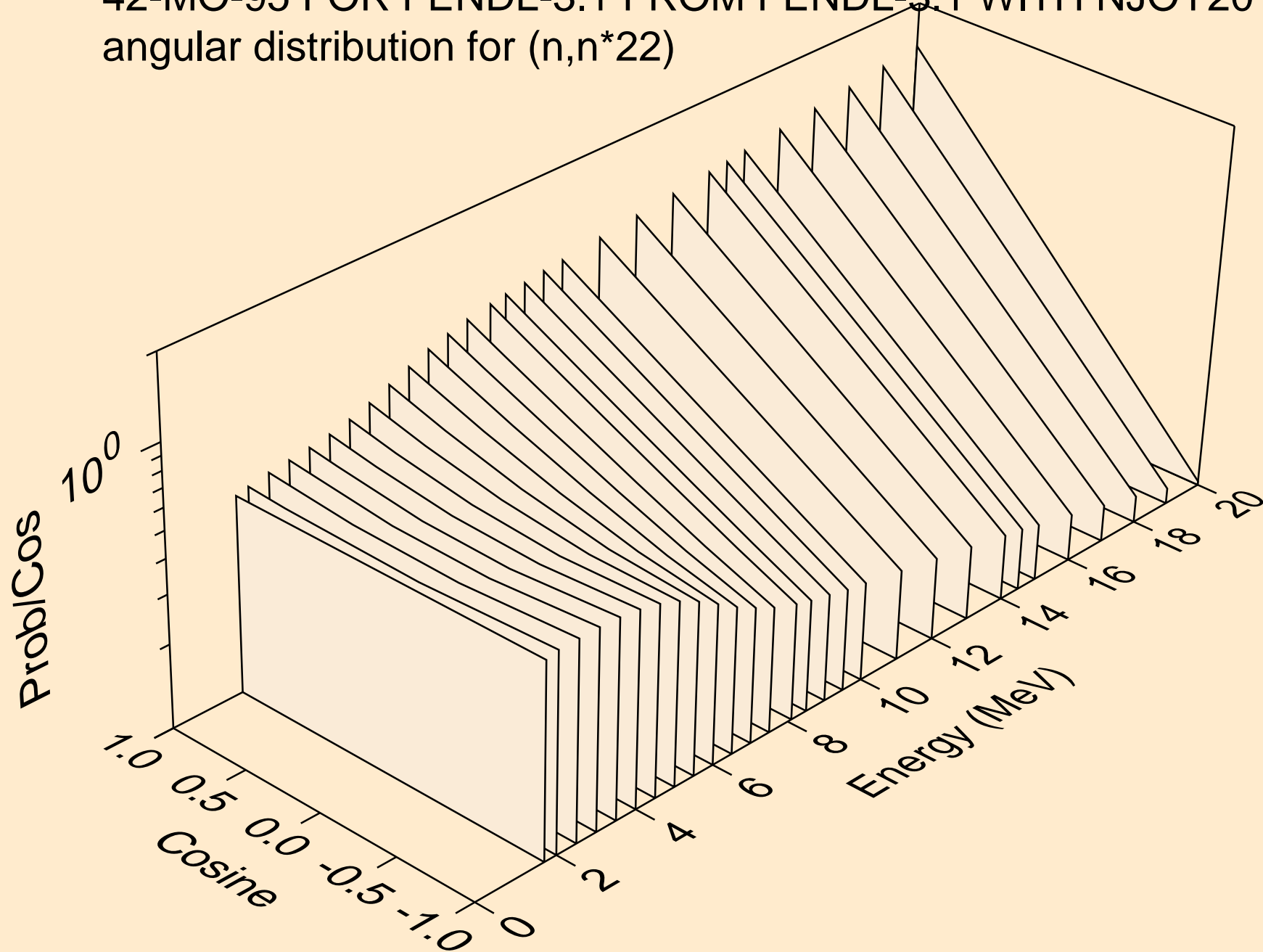

42-MO-95 FOR FENDL-3.1 FROM FENDL-3.1 WITH NJOY2012.50-  
angular distribution for (n,n\*23)

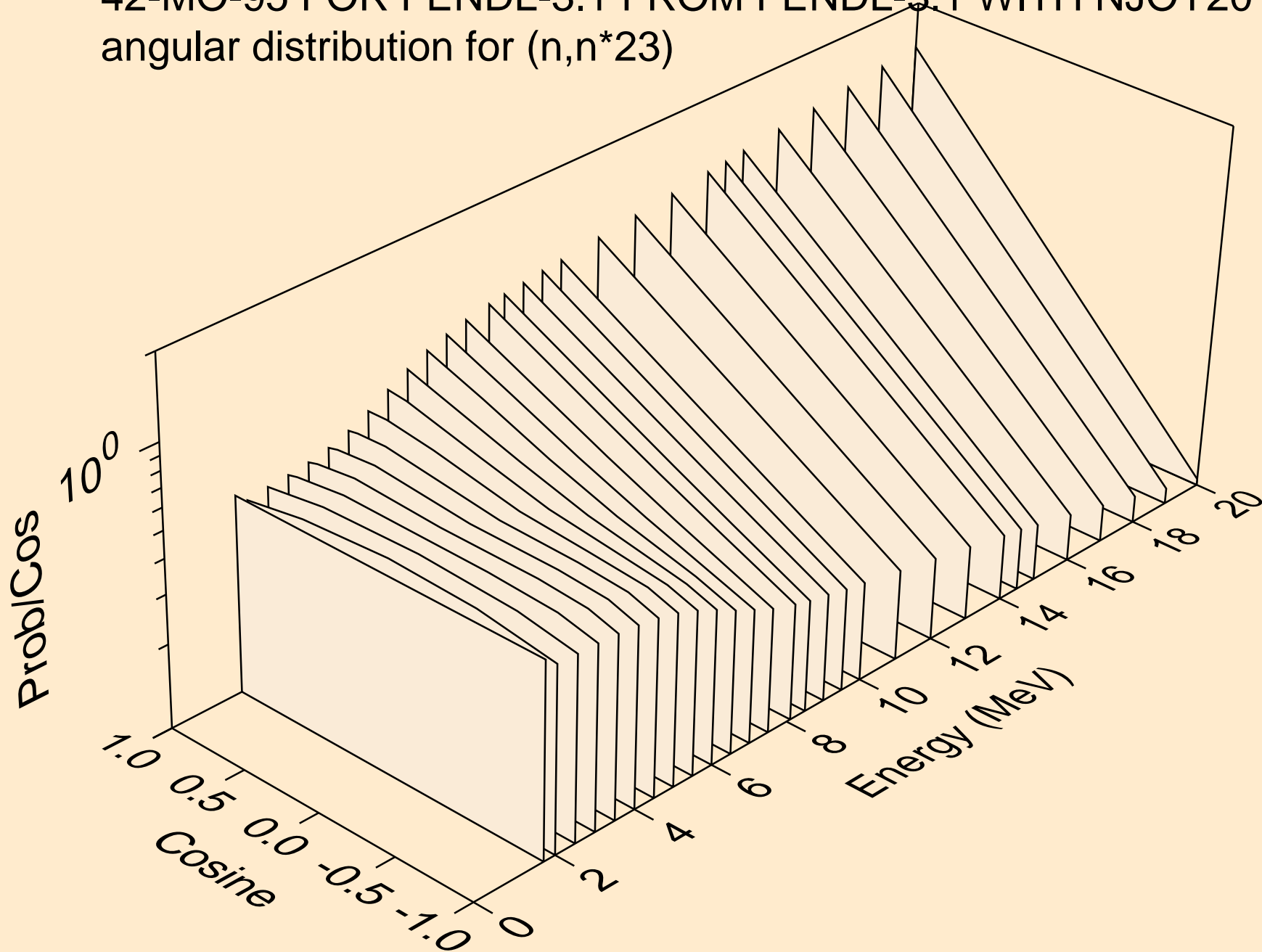

42-MO-95 FOR FENDL-3.1 FROM FENDL-3.1 WITH NJOY2012.50-  
angular distribution for (n,n\*24)

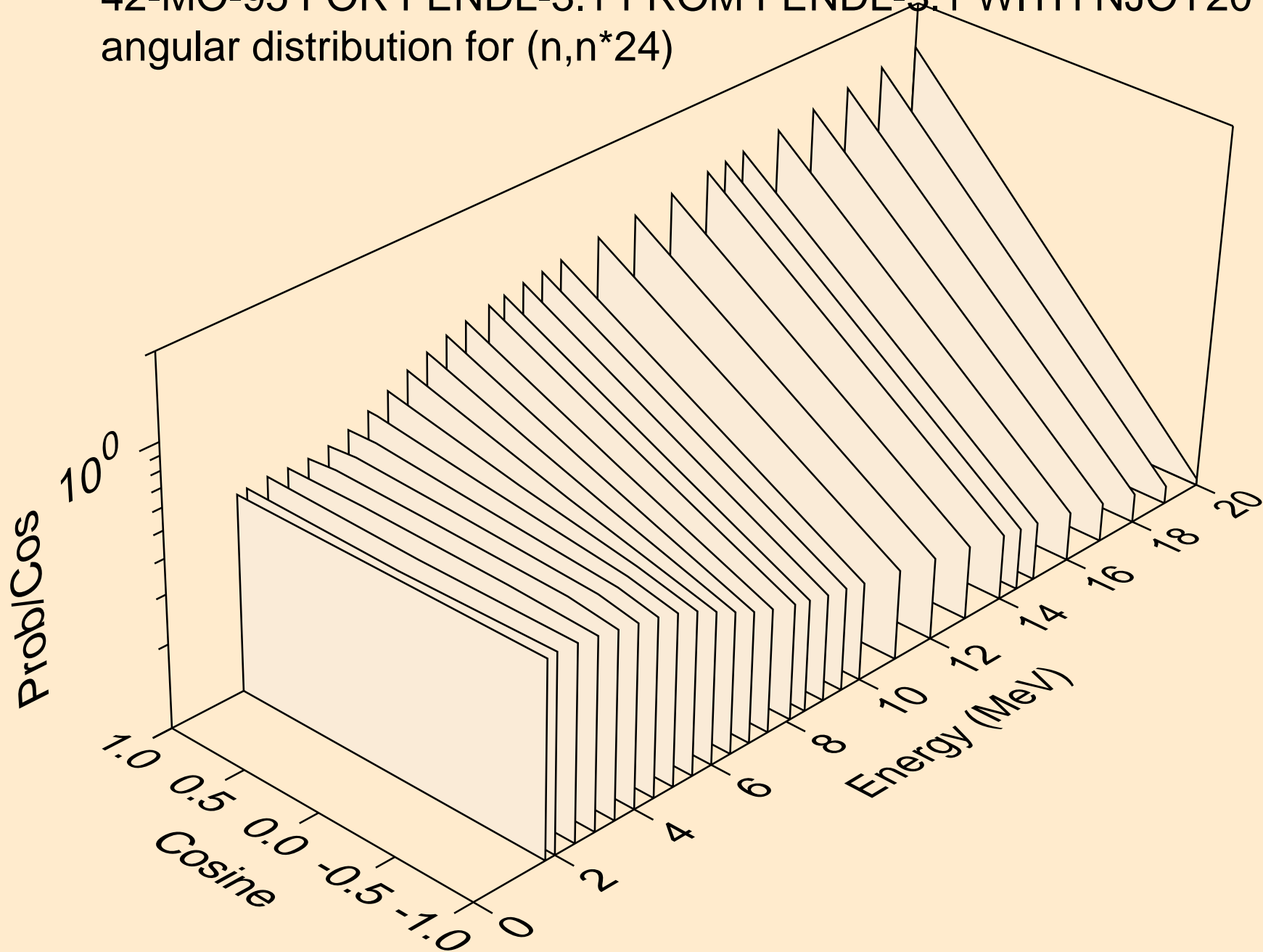

42-MO-95 FOR FENDL-3.1 FROM FENDL-3.1 WITH NJOY2012.50-  
angular distribution for (n,n\*25)

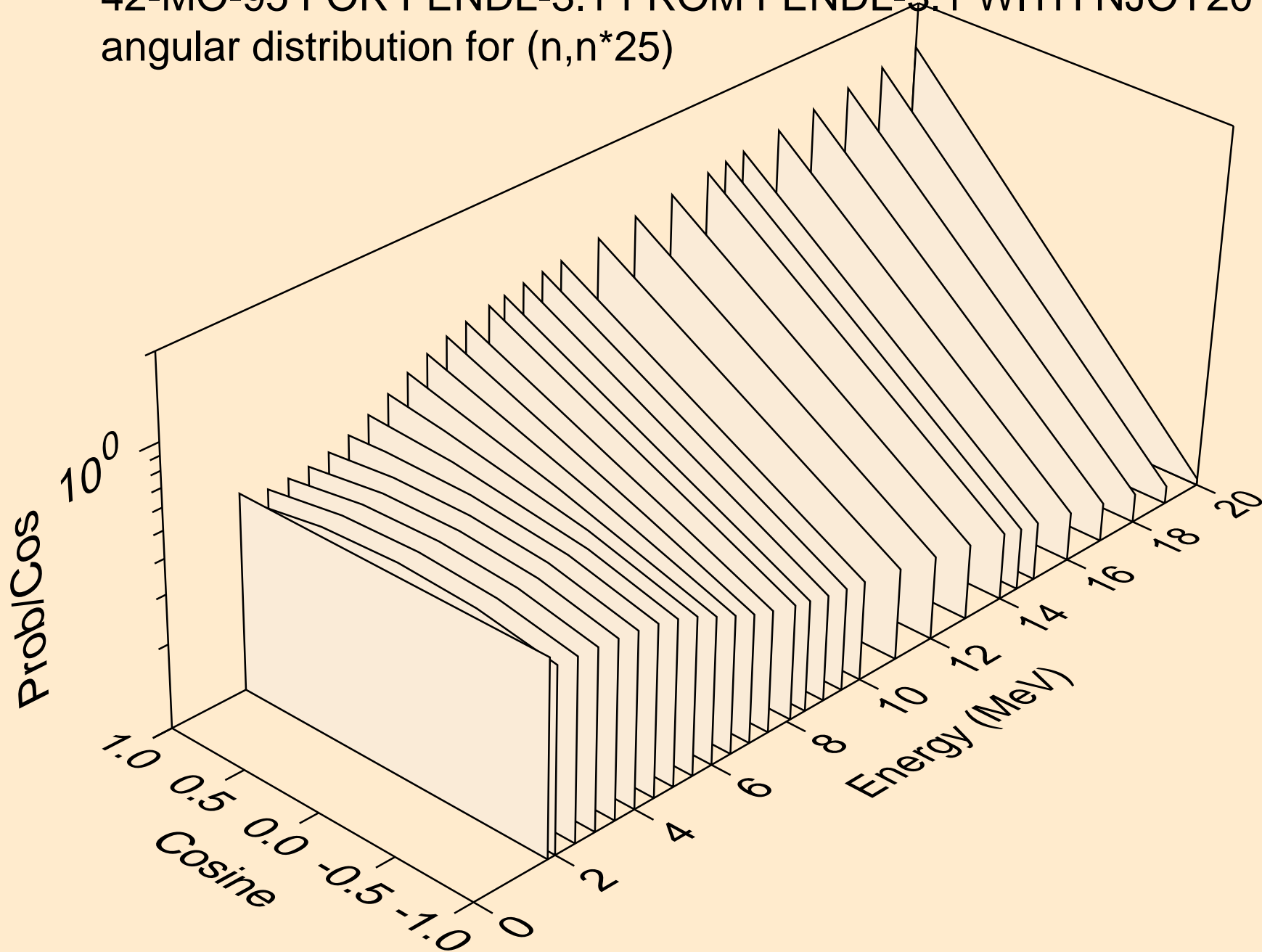

42-MO-95 FOR FENDL-3.1 FROM FENDL-3.1 WITH NJOY2012.50-  
angular distribution for (n,n\*26)

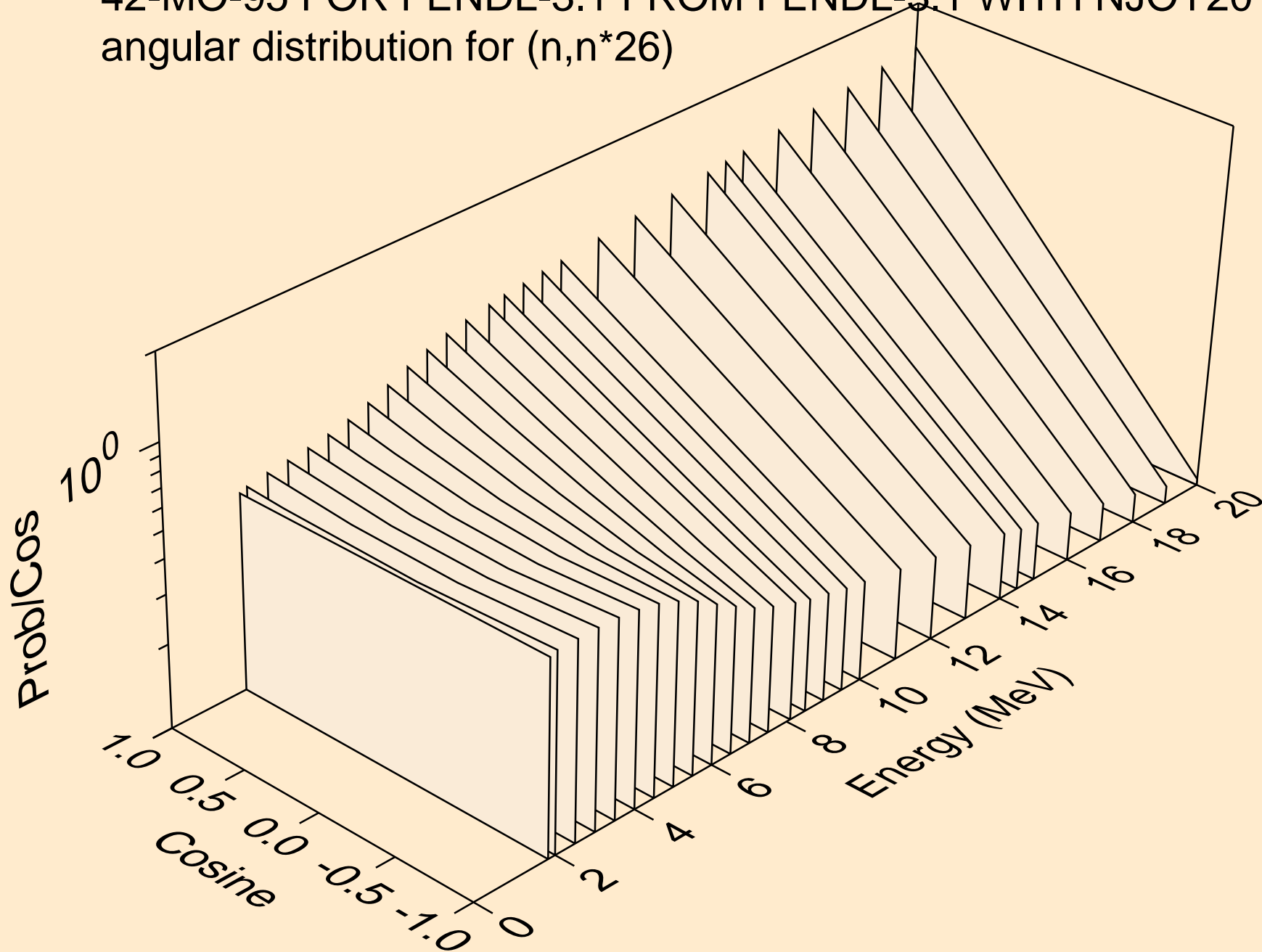

42-MO-95 FOR FENDL-3.1 FROM FENDL-3.1 WITH NJOY2012.50-  
Neutron emission for (n,x)

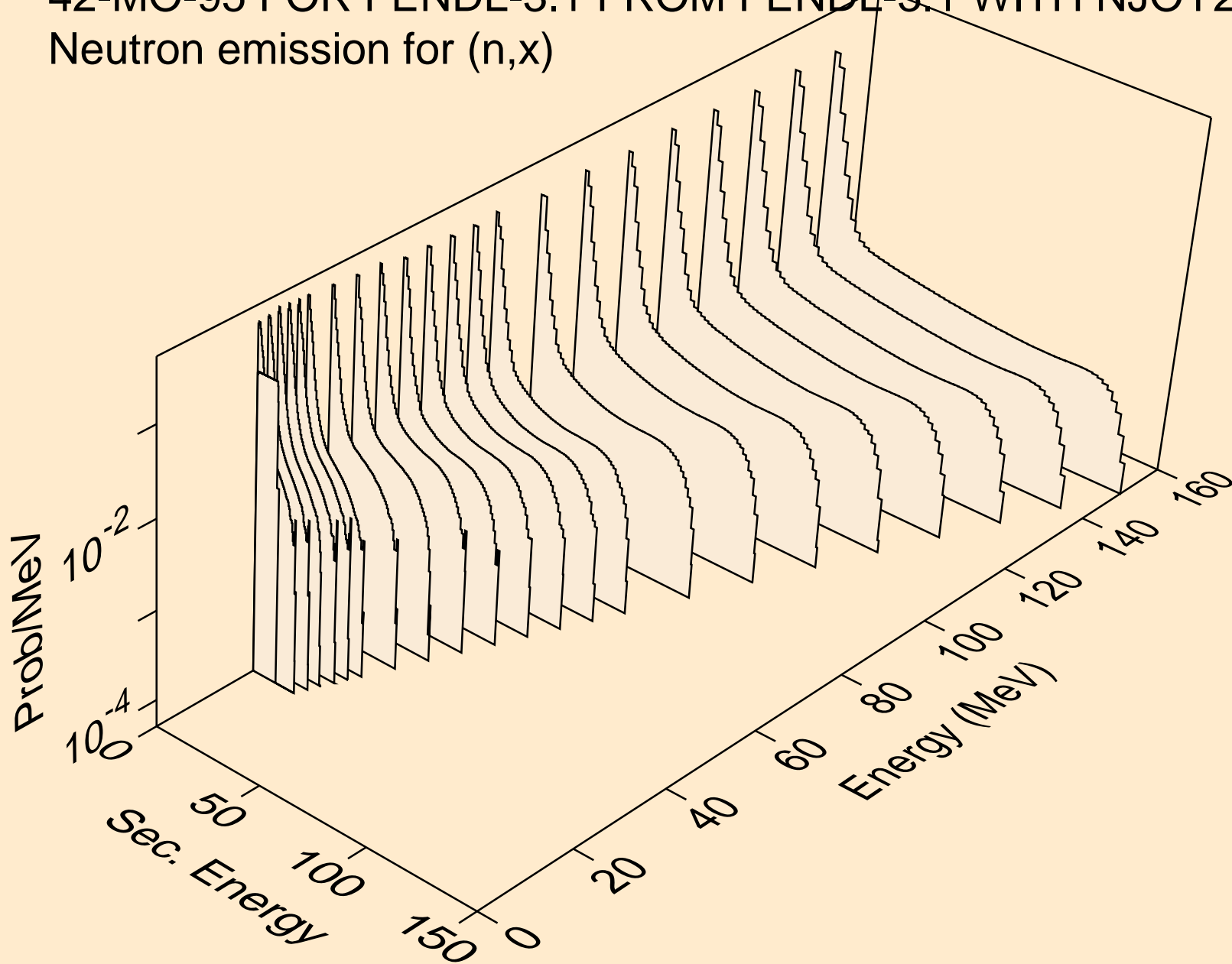

42-MO-95 FOR FENDL-3.1 FROM FENDL-3.1 WITH NJOY2012.50-  
Neutron emission for (n,2n)

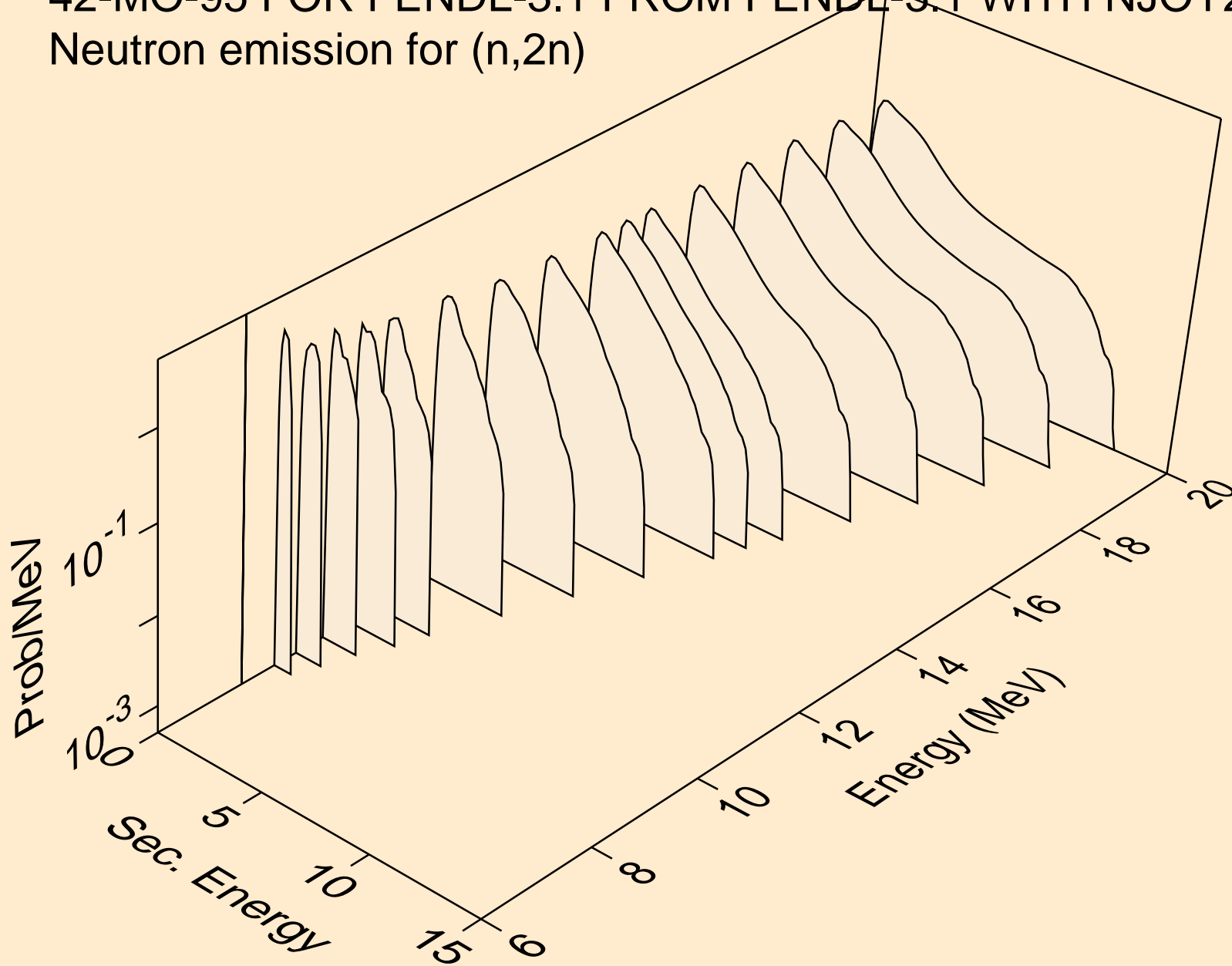



42-MO-95 FOR FENDL-3.1 FROM FENDL-3.1 WITH NJOY2012.50-  
Neutron emission for (n,3n)

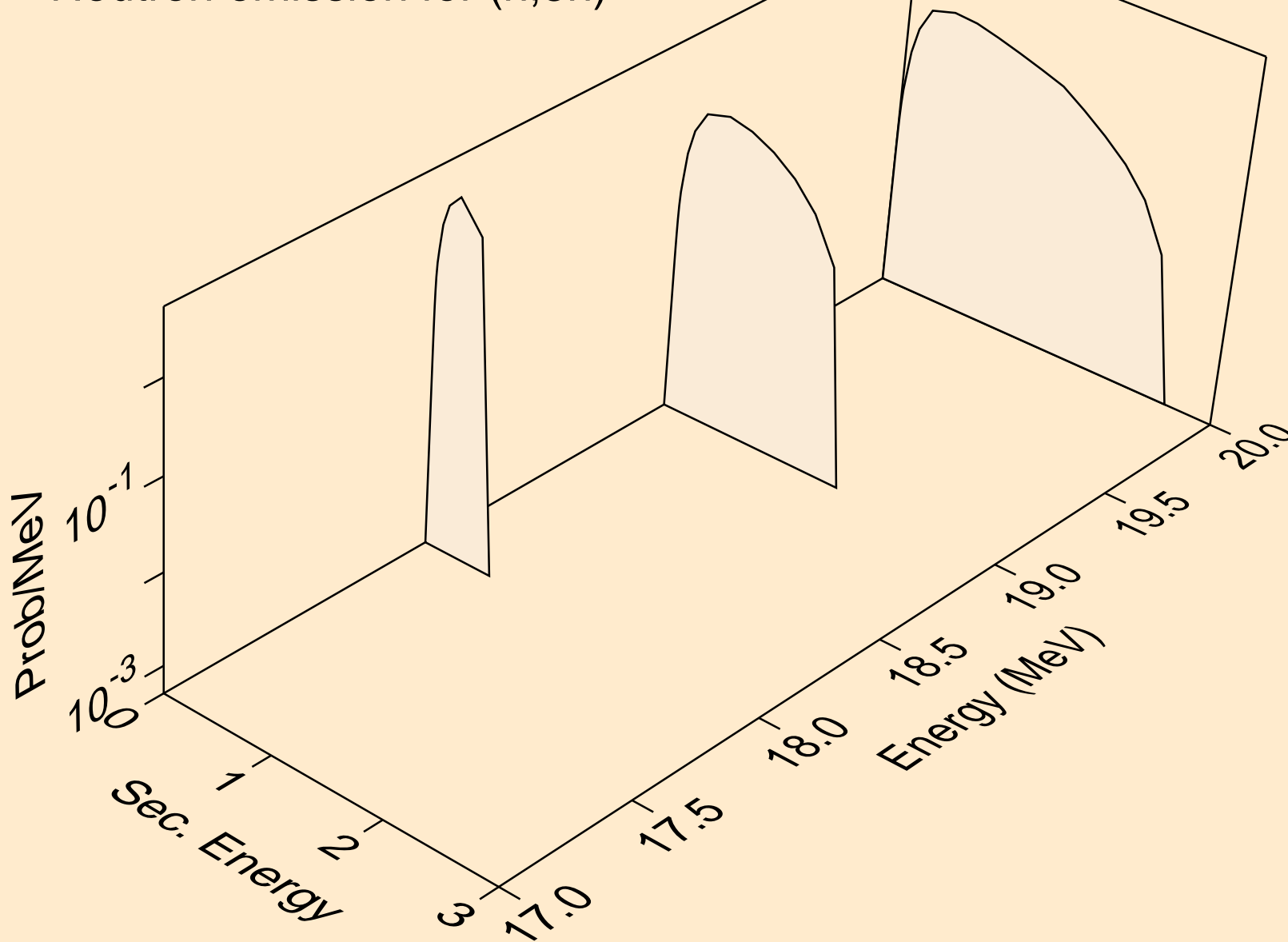

42-MO-95 FOR FENDL-3.1 FROM FENDL-3.1 WITH NJOY2012.50-  
Neutron emission for (n,n\*)a

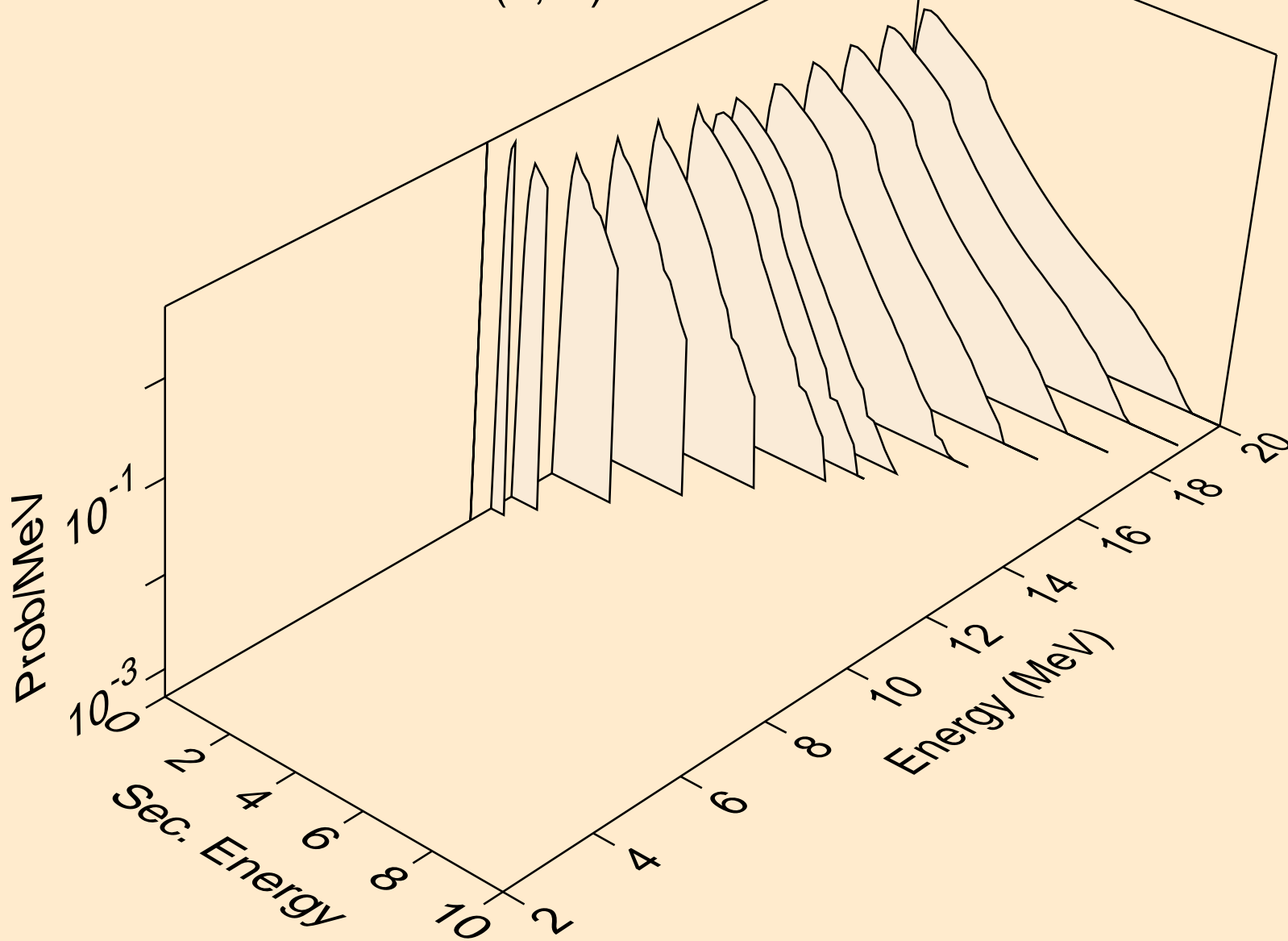

42-MO-95 FOR FENDL-3.1 FROM FENDL-3.1 WITH NJOY2012.50-  
Neutron emission for (n,n\*)p

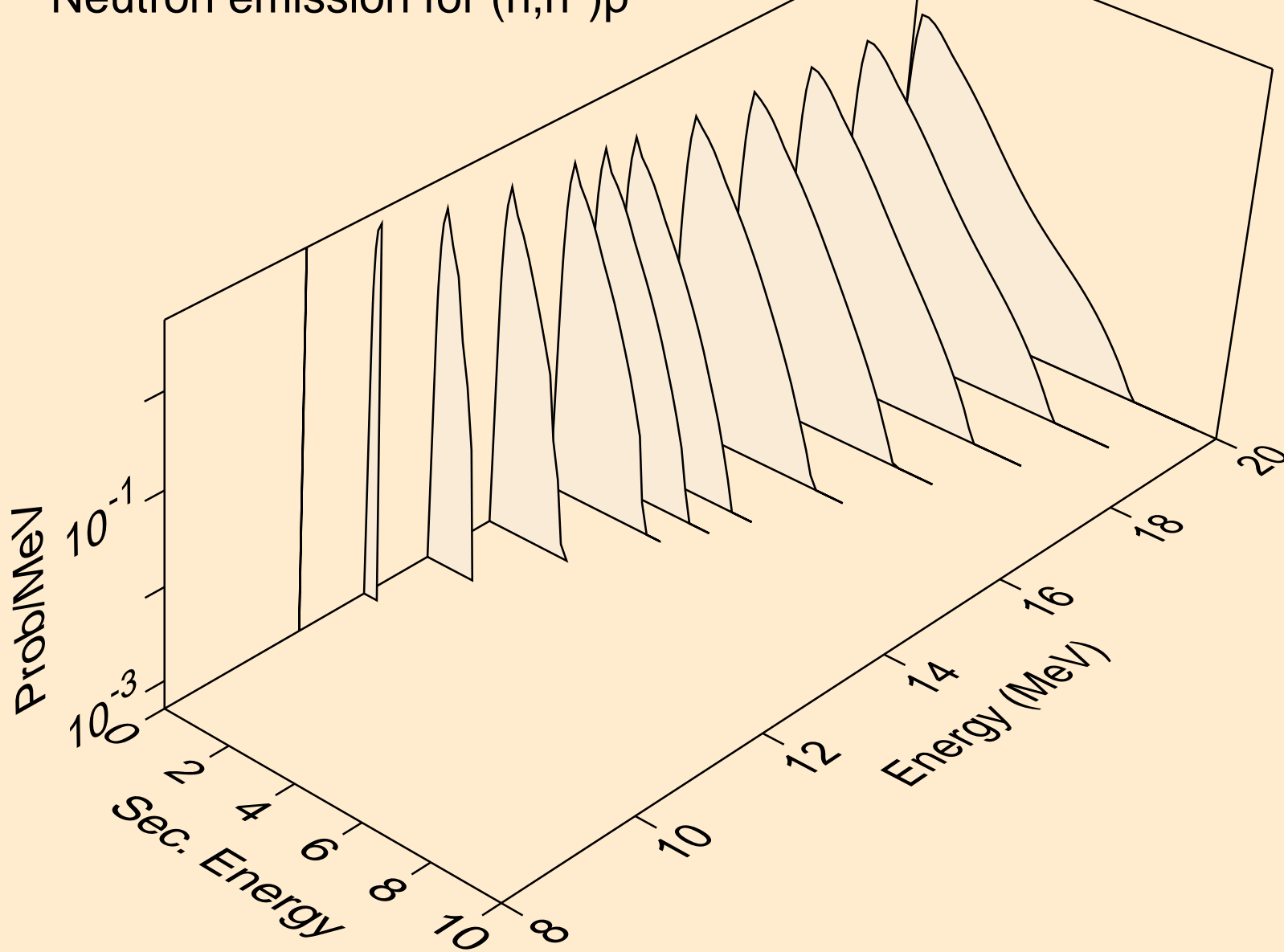

42-MO-95 FOR FENDL-3.1 FROM FENDL-3.1 WITH NJOY2012.50-  
Neutron emission for (n,n\*)d

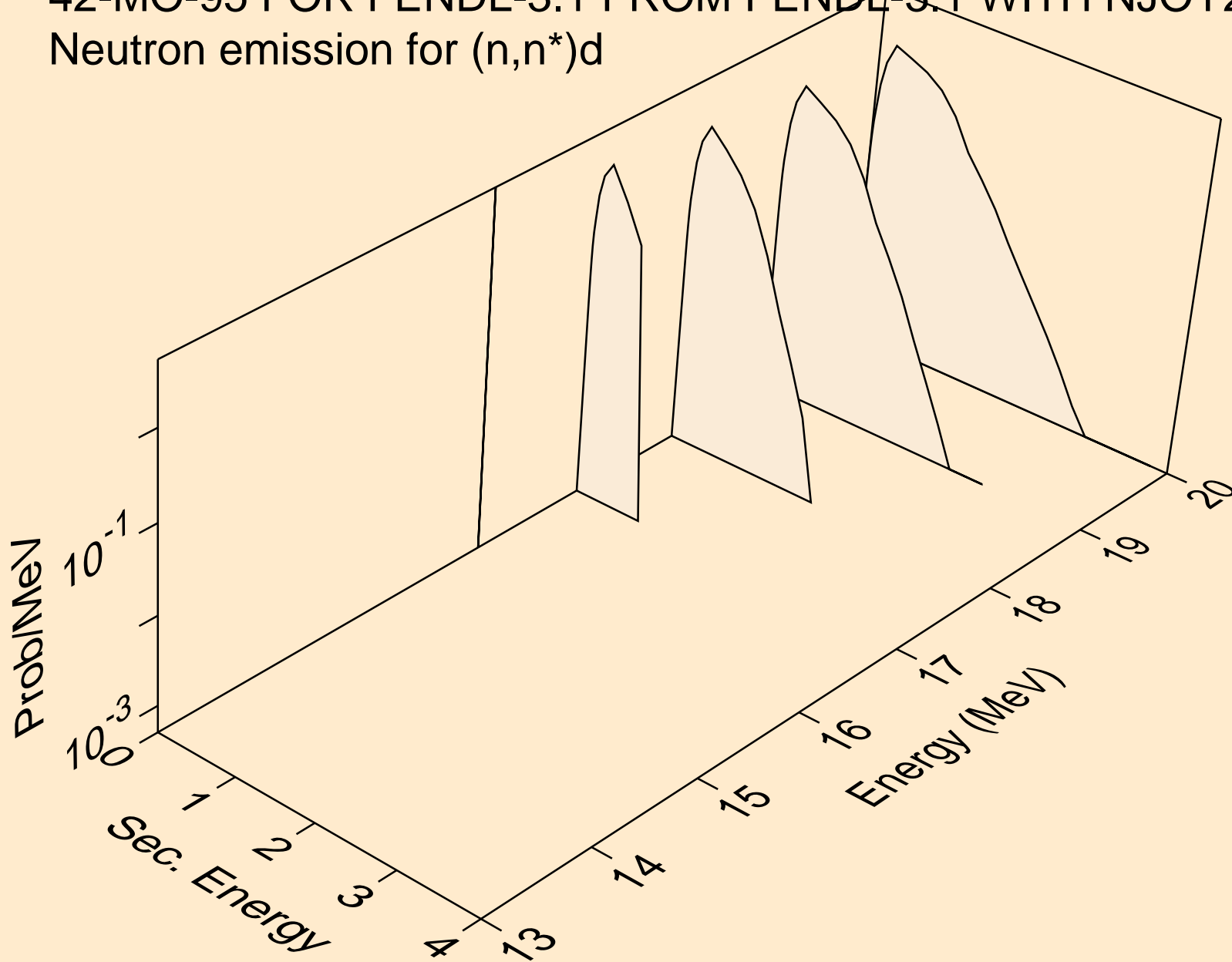

42-MO-95 FOR FENDL-3.1 FROM FENDL-3.1 WITH NJOY2012.50-  
Neutron emission for (n,n\*c)

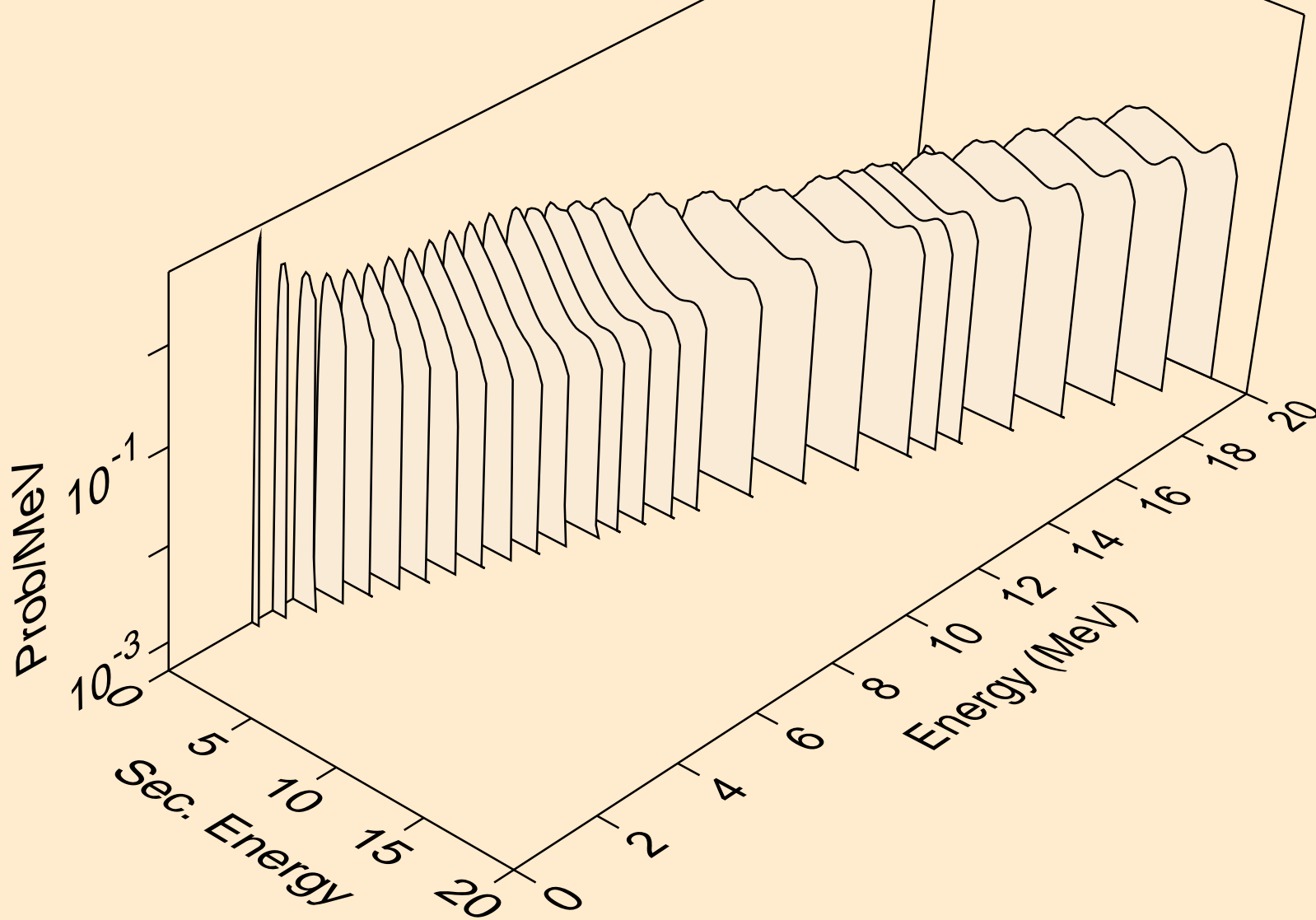

42-MO-95 FOR FENDL-3.1 FROM FENDL-3.1 WITH NJOY2012.50-  
Photon emission for nonelastic

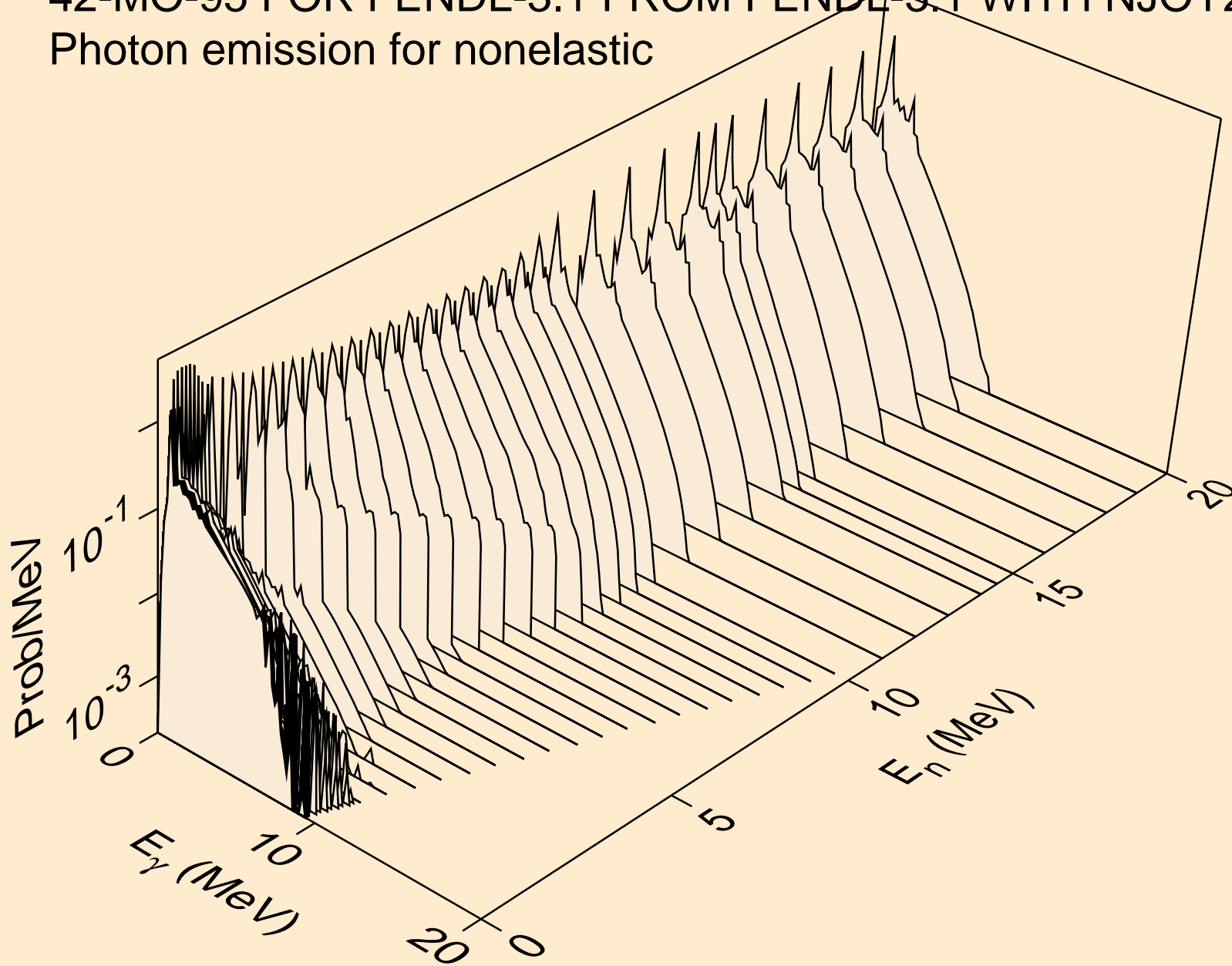

42-MO-95 FOR FENDL-3.1 FROM FENDL-3.1 WITH NJOY2012.50-  
Photon emission for (n,x)

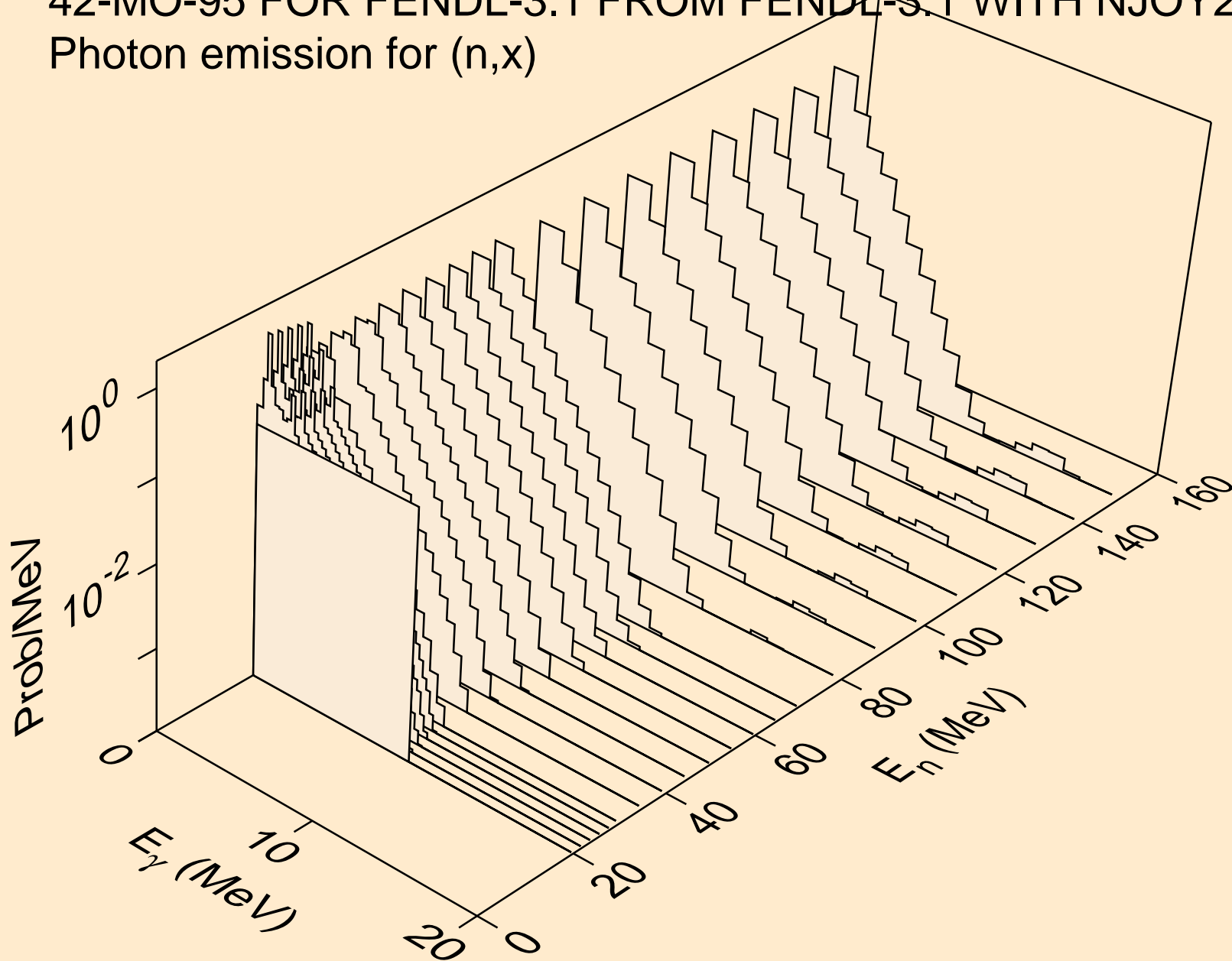

42-MO-95 FOR FENDL-3.1 FROM FENDL-3.1 WITH NJOY2012.50-  
14 MeV photon spectrum

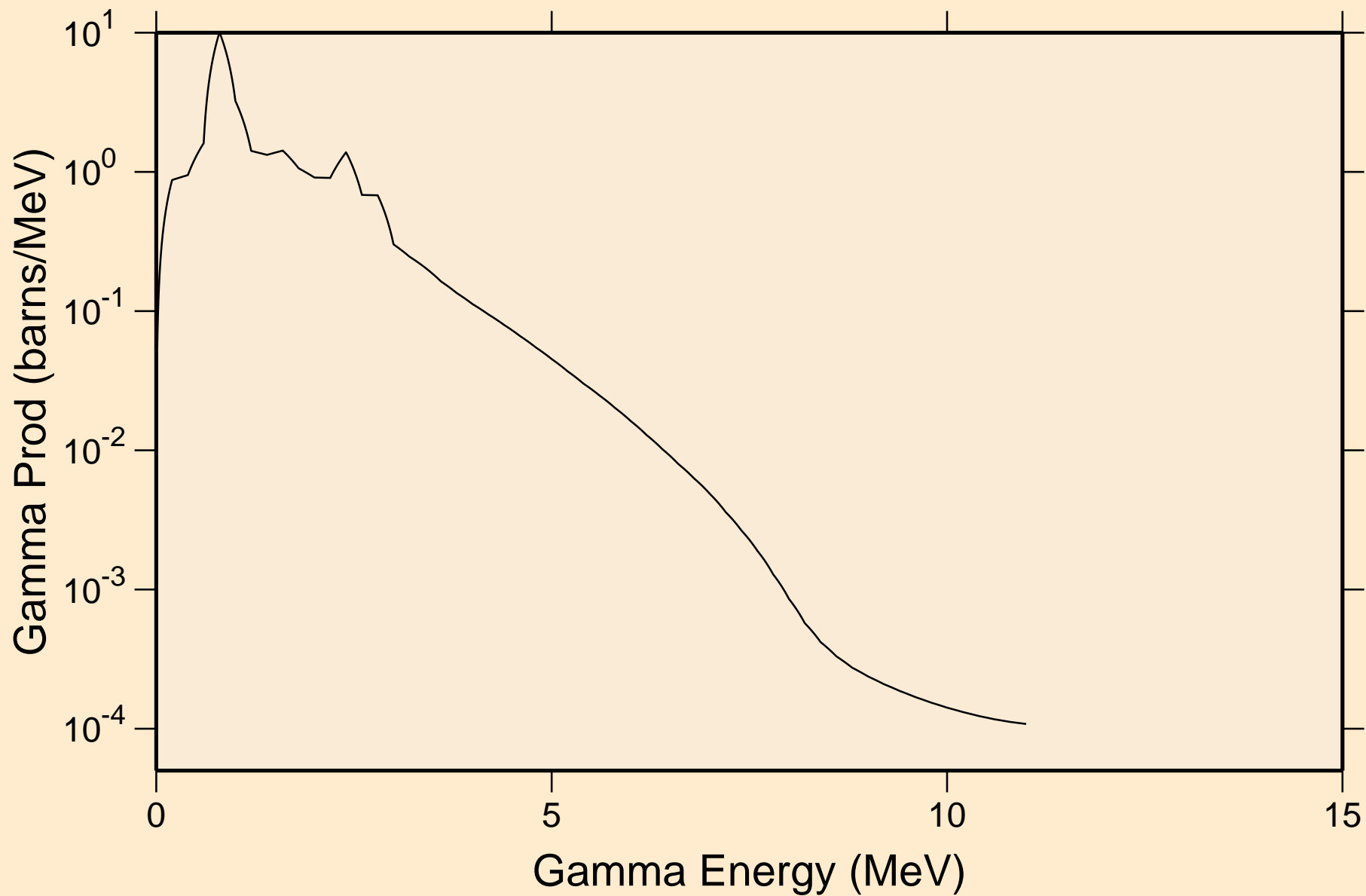



# 42-MO-95 FOR FENDL-3.1 FROM FENDL-3.1 WITH NJOY2012.50- Particle heating contributions

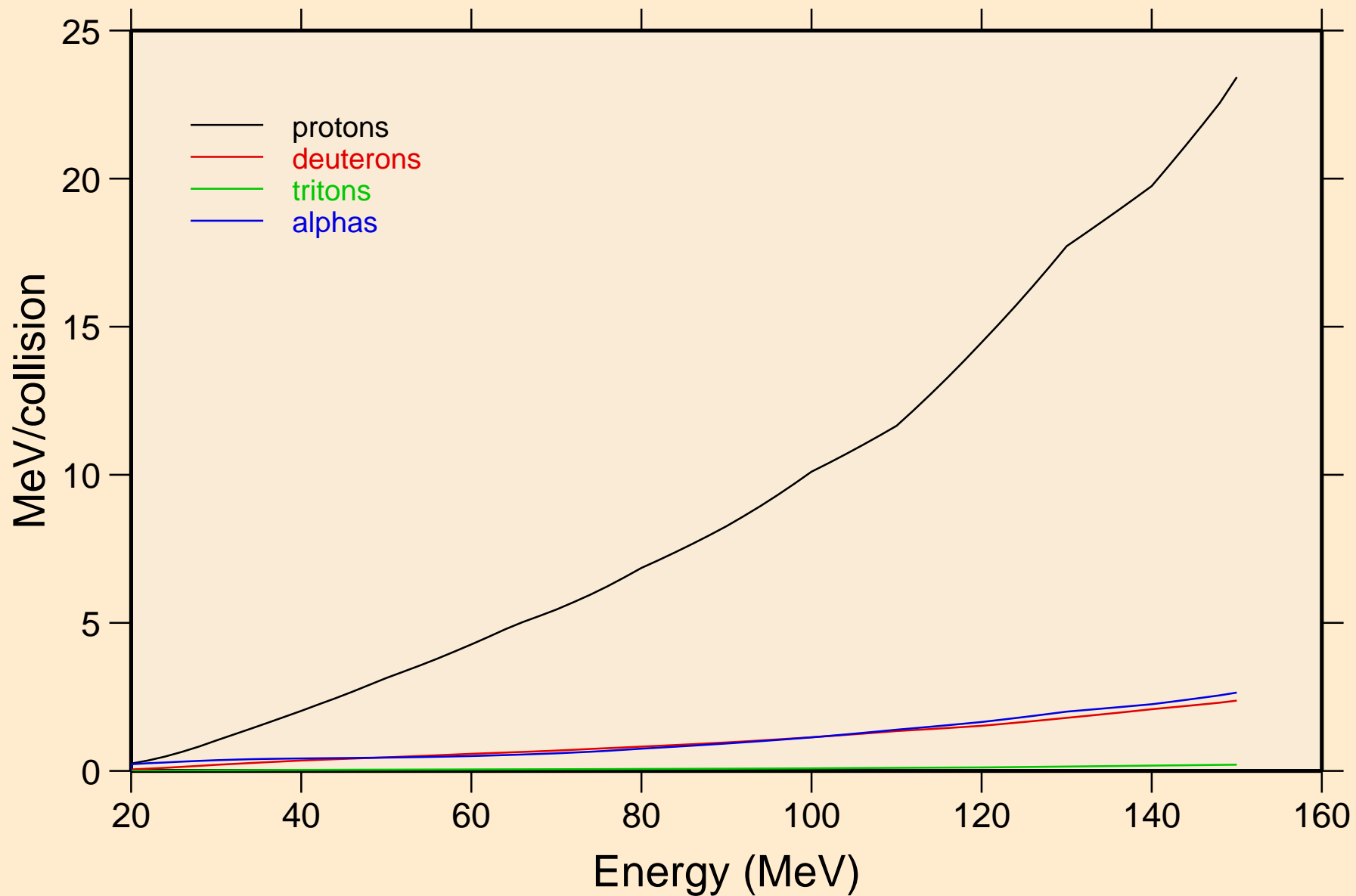

# 42-MO-95 FOR FENDL-3.1 FROM FENDL-3.1 WITH NJOY2012.50- Recoil Heating

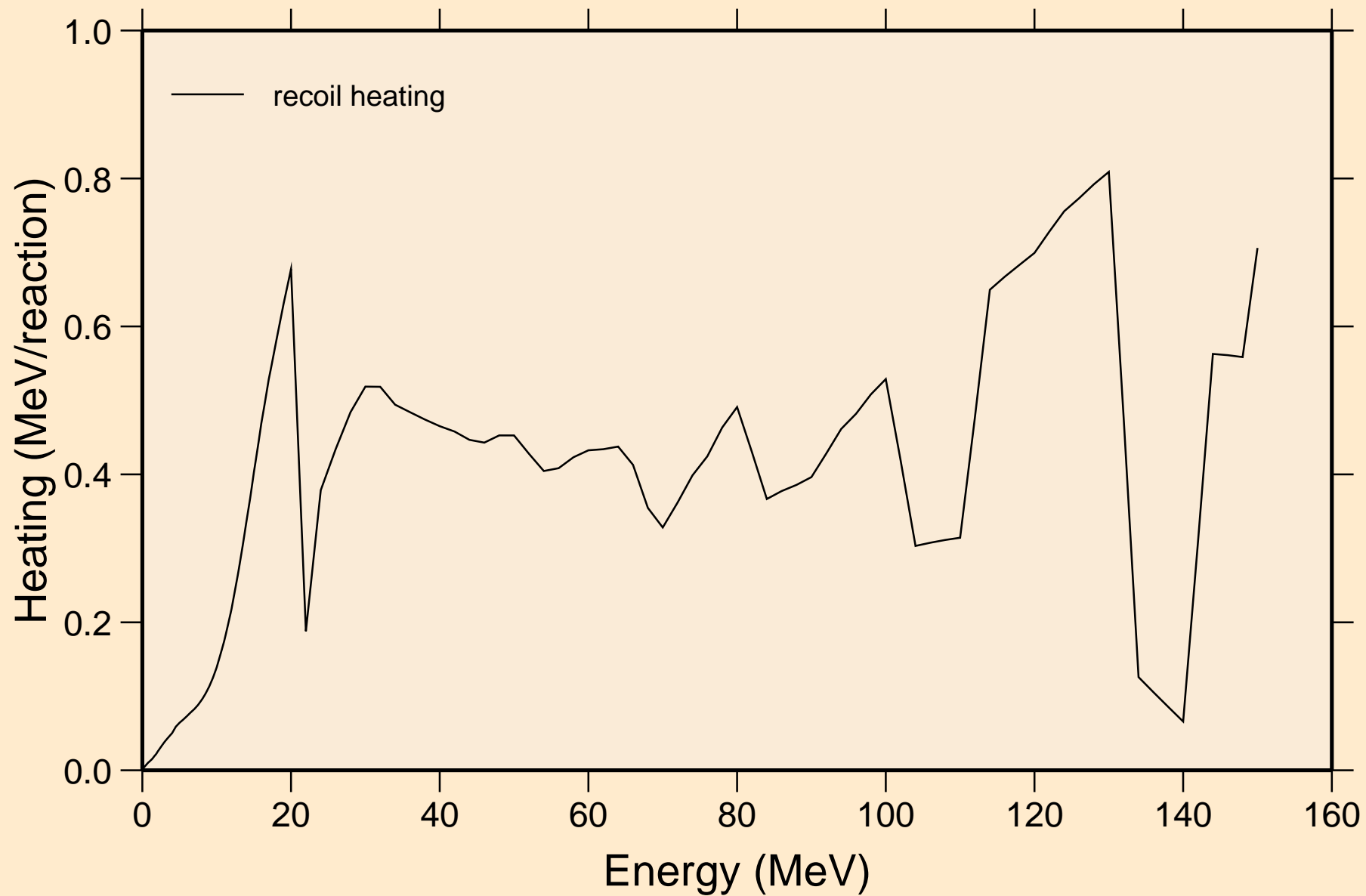

42-MO-95 FOR FENDL-3.1 FROM FENDL-3.1 WITH NJOY2012.50-  
Particle production cross sections

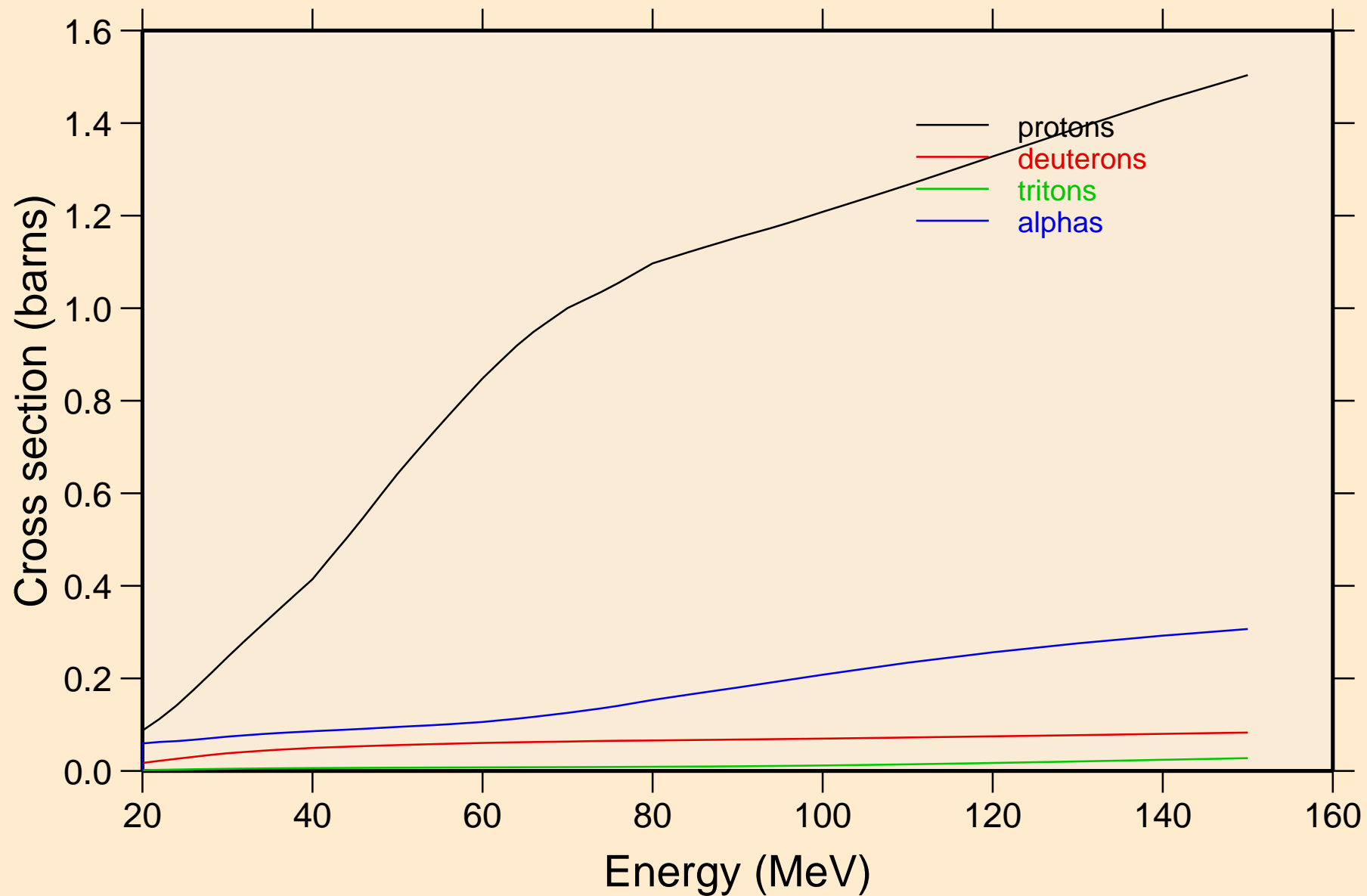

42-MO-95 FOR FENDL-3.1 FROM FENDL-3.1 WITH NJOY2012.50-  
protons from (n,x)

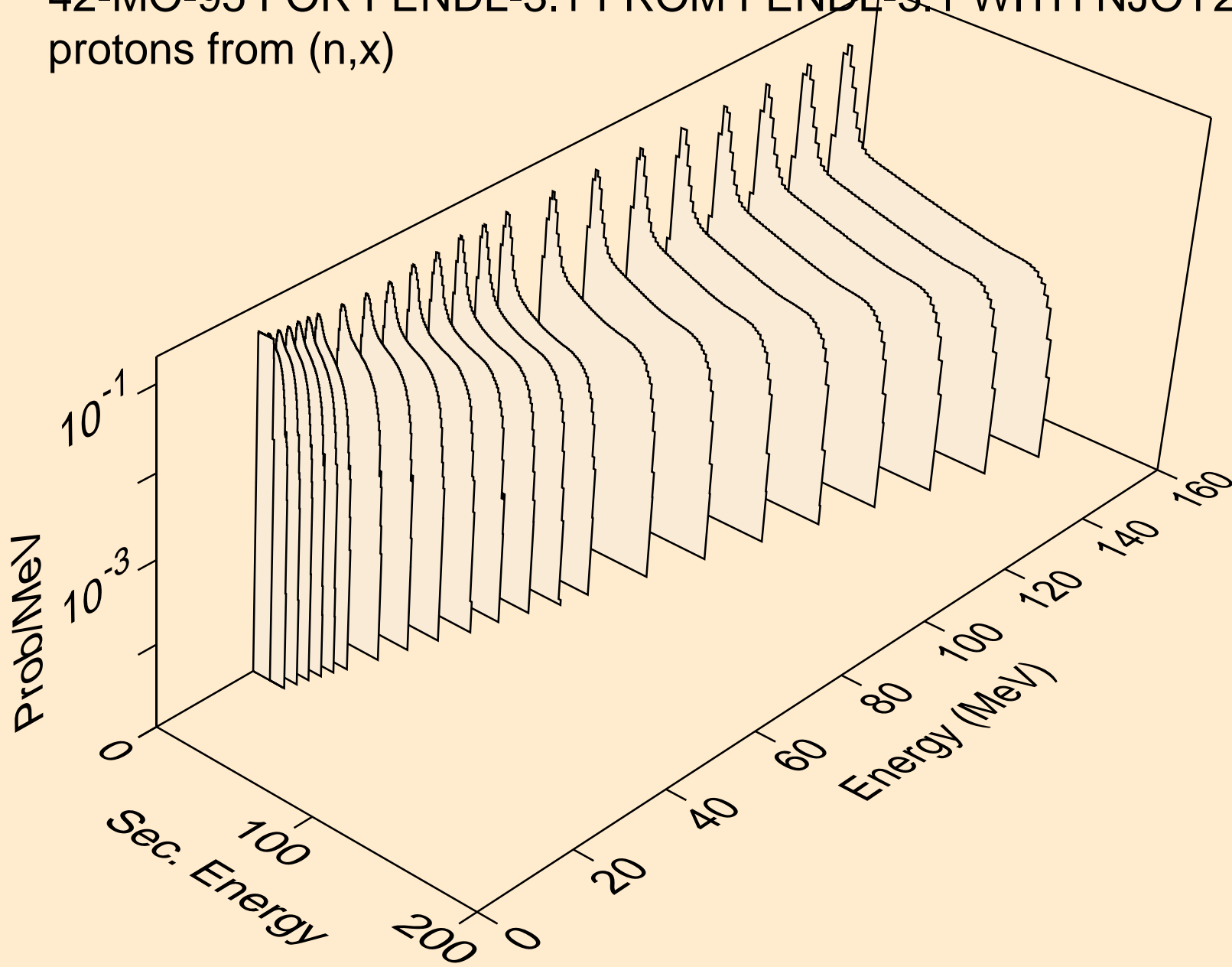

42-MO-95 FOR FENDL-3.1 FROM FENDL-3.1 WITH NJOY2012.50-  
deuterons from (n,x)

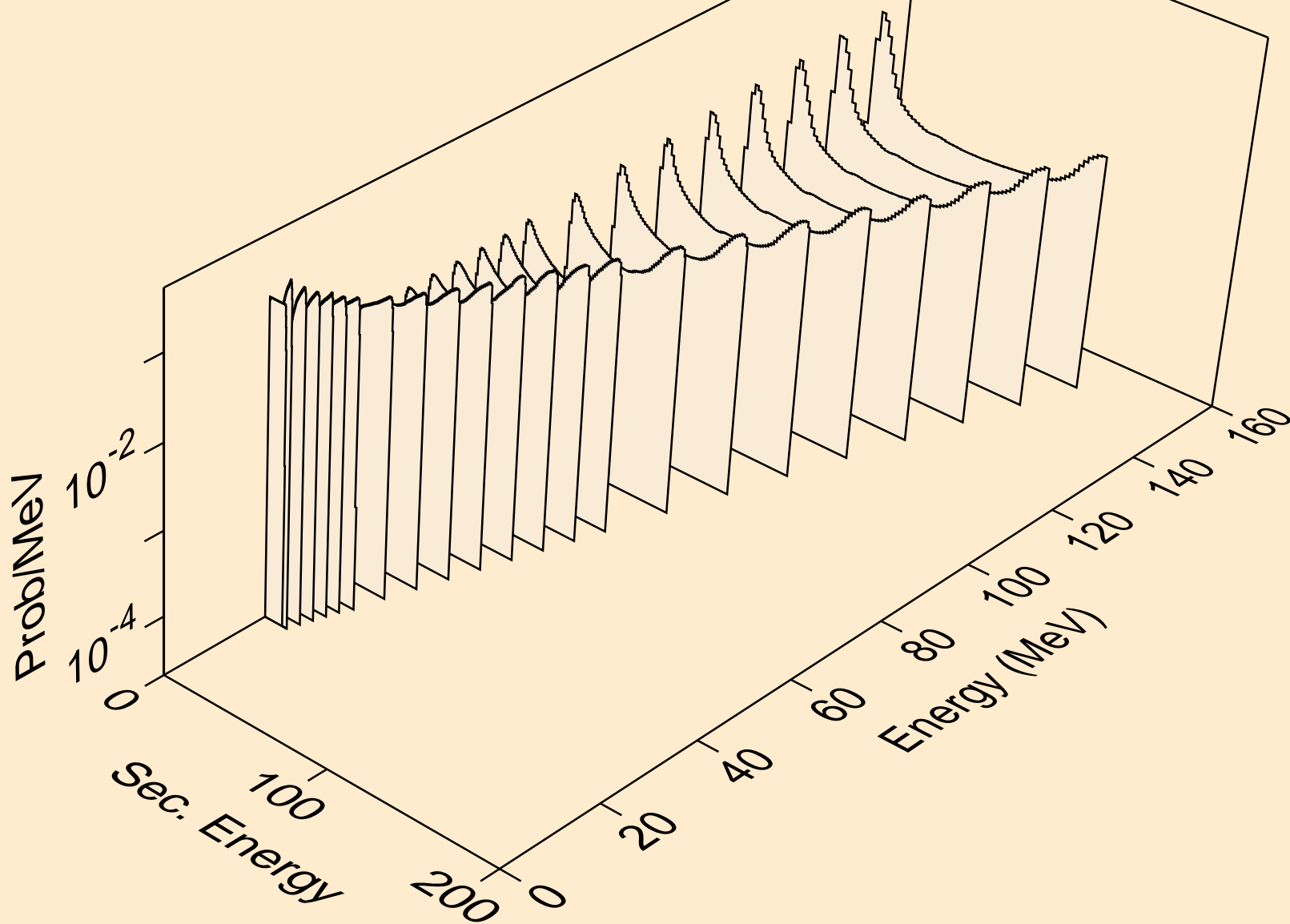

42-MO-95 FOR FENDL-3.1 FROM FENDL-3.1 WITH NJOY2012.50-  
tritons from (n,x)

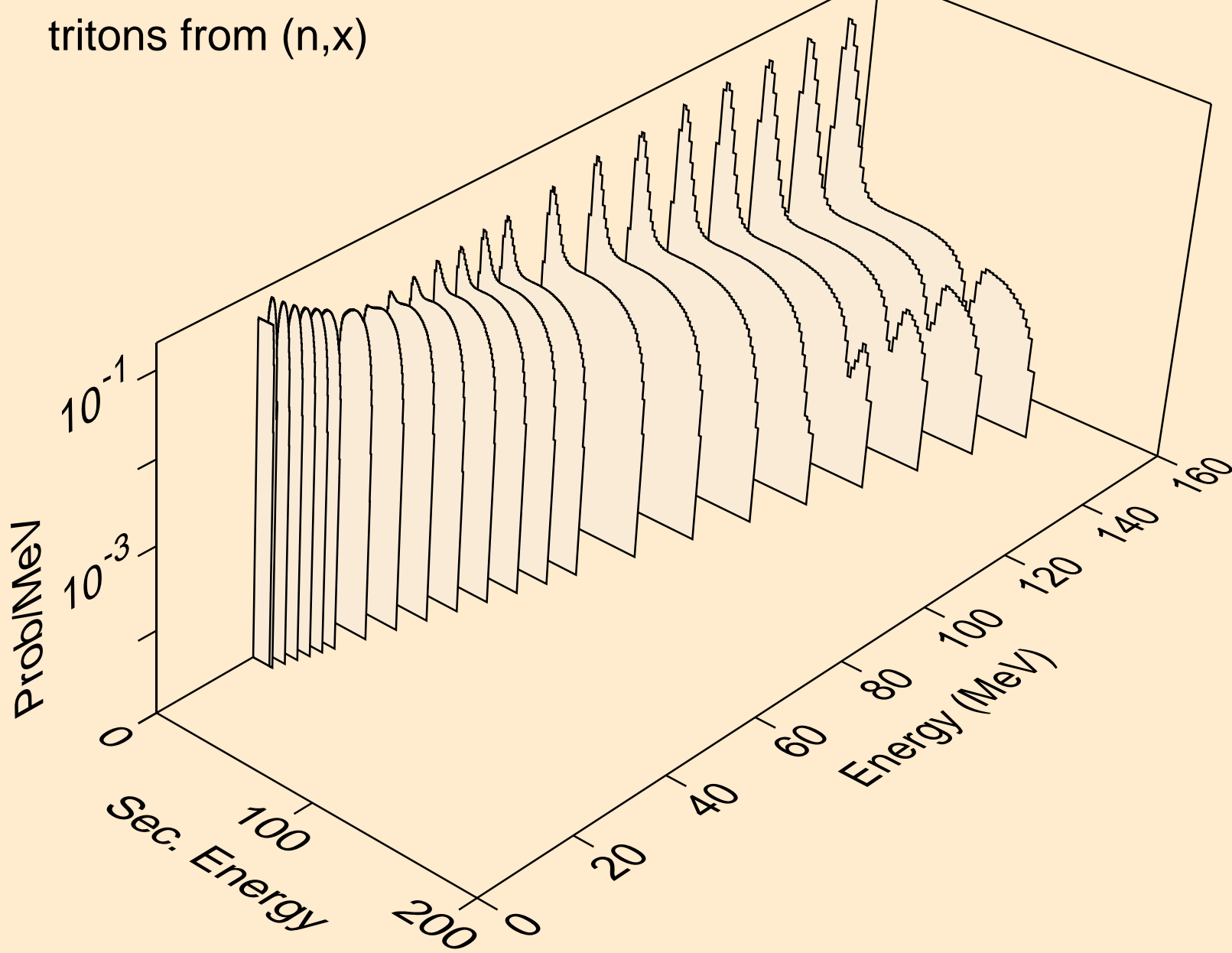

42-MO-95 FOR FENDL-3.1 FROM FENDL-3.1 WITH NJOY2012.50-  
alphas from (n,x)

