

42-MO-98 FOR FENDL-3.1 FROM FENDL-3.1 WITH NJOY2012.50-
Principal cross sections

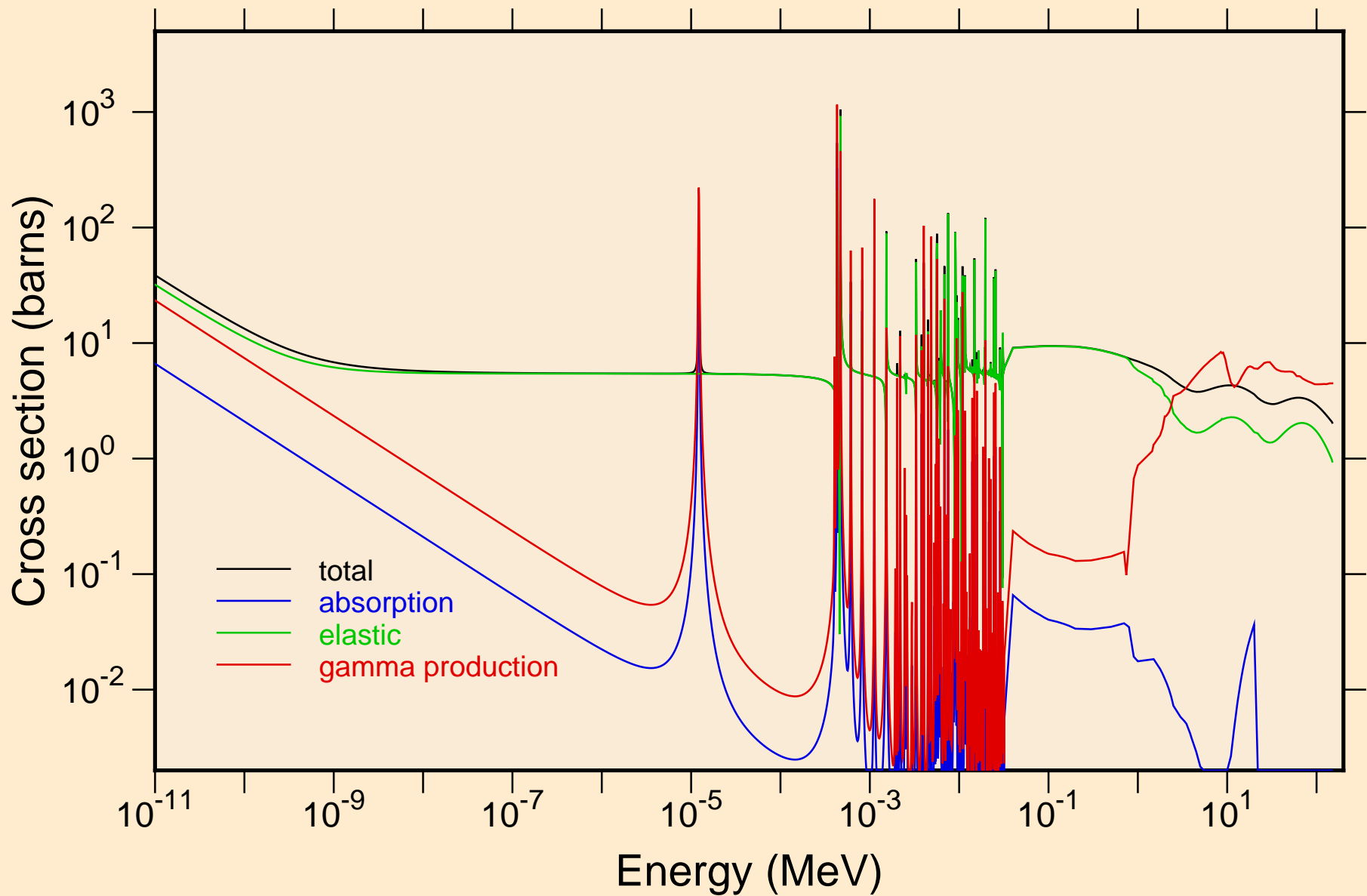

42-MO-98 FOR FENDL-3.1 FROM FENDL-3.1 WITH NJOY2012.50-
resonance total cross section

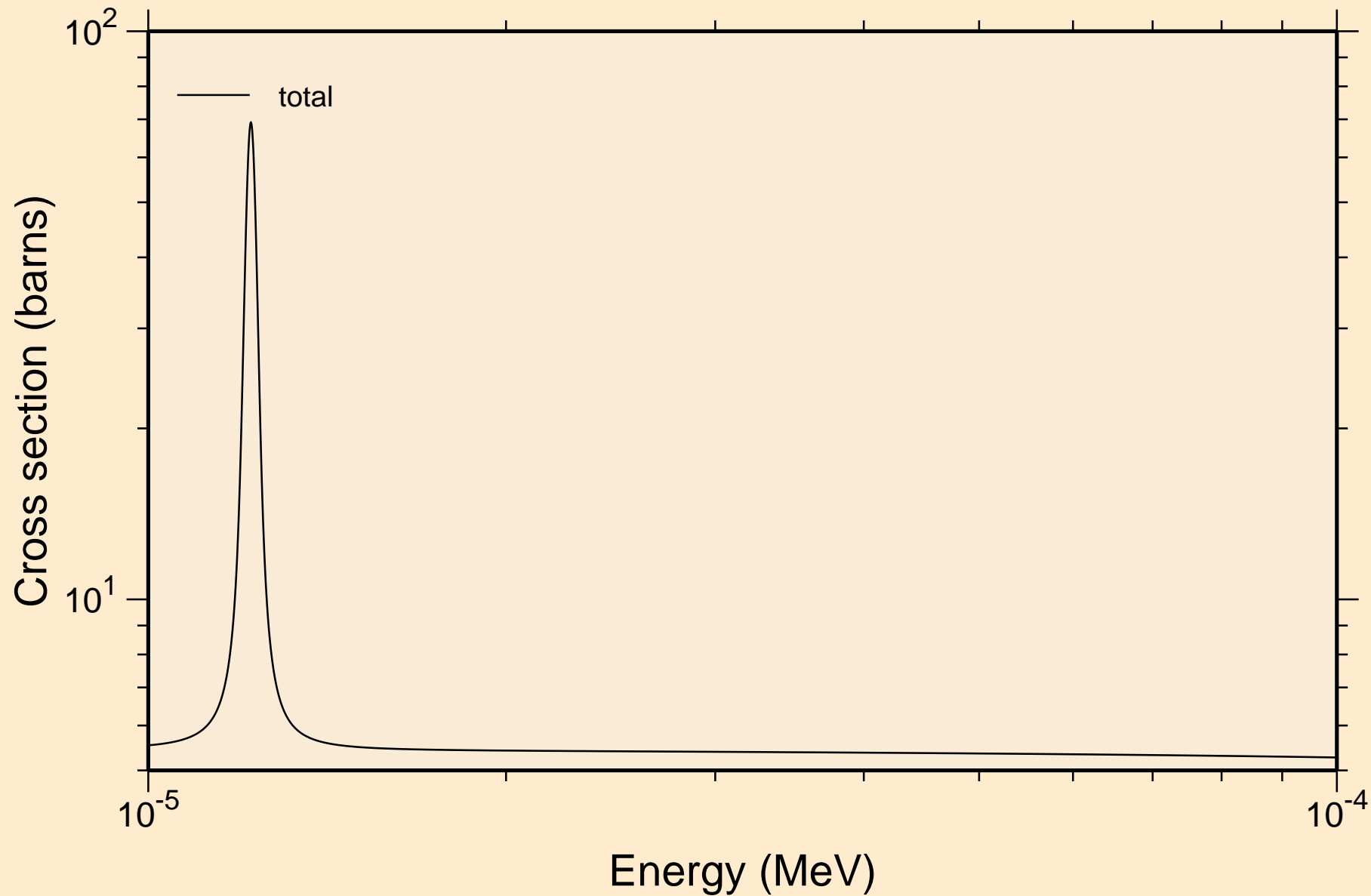

42-MO-98 FOR FENDL-3.1 FROM FENDL-3.1 WITH NJOY2012.50-
resonance total cross section

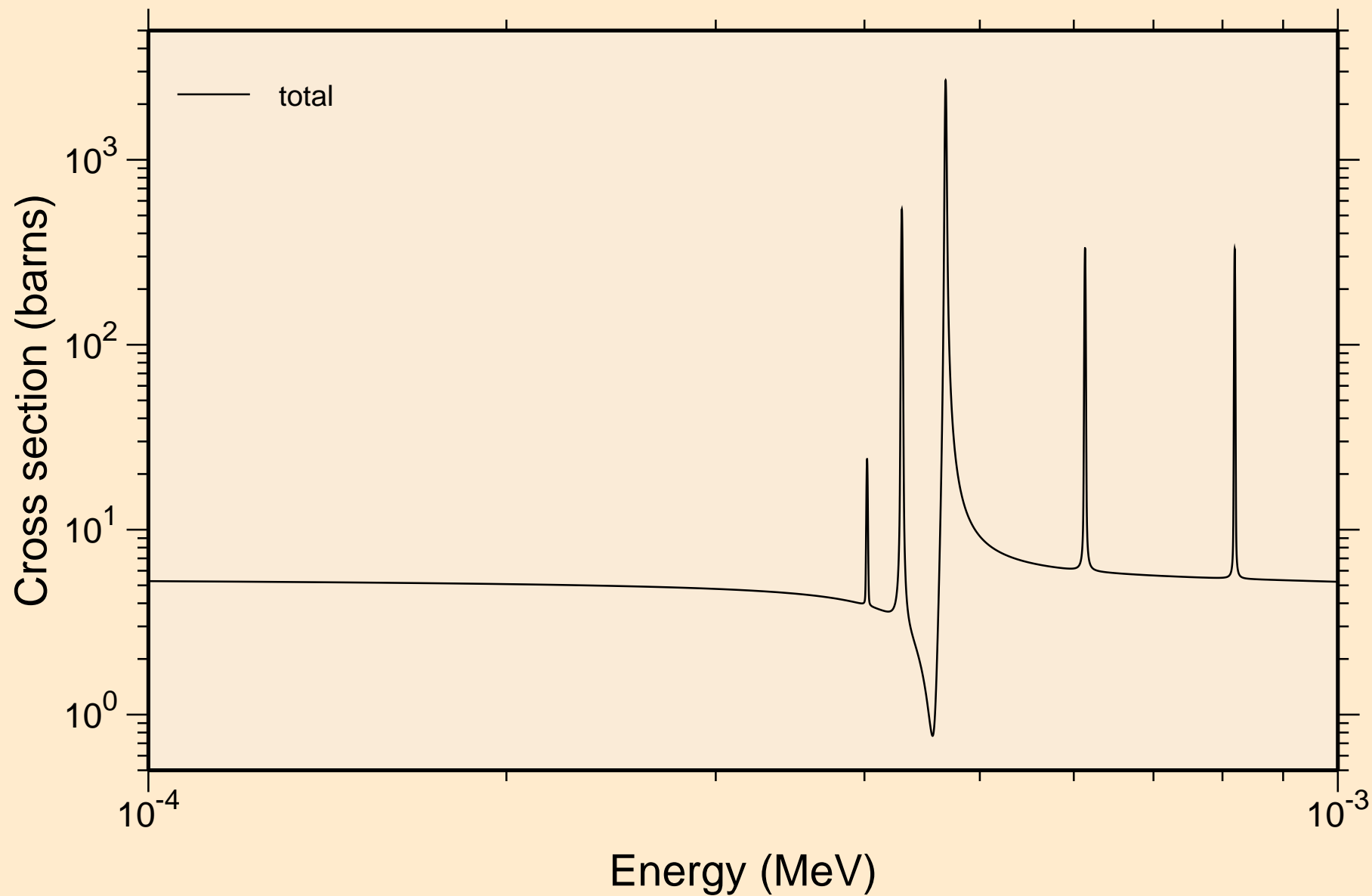

42-MO-98 FOR FENDL-3.1 FROM FENDL-3.1 WITH NJOY2012.50-
resonance total cross section

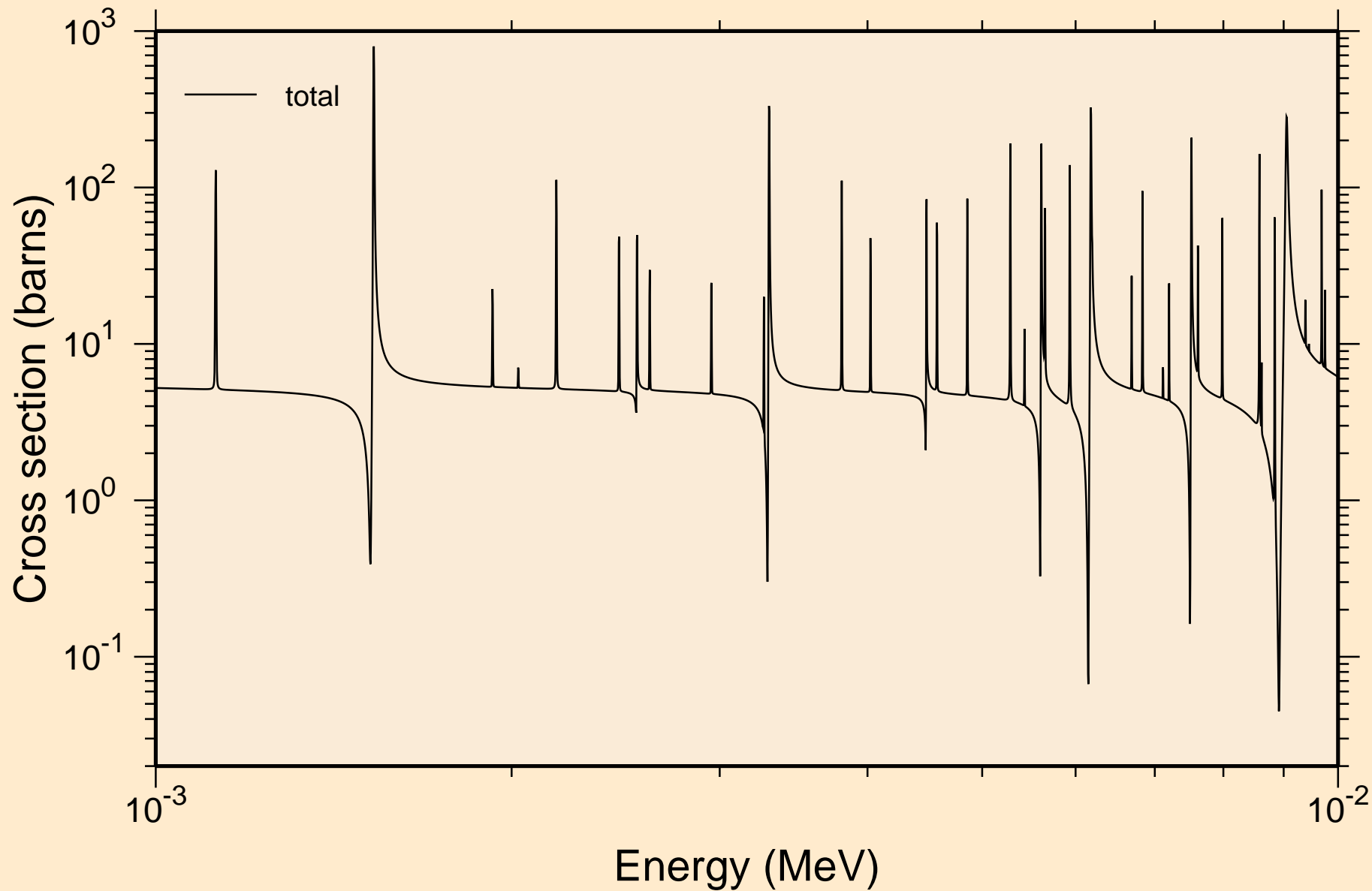

42-MO-98 FOR FENDL-3.1 FROM FENDL-3.1 WITH NJOY2012.50-
resonance total cross section

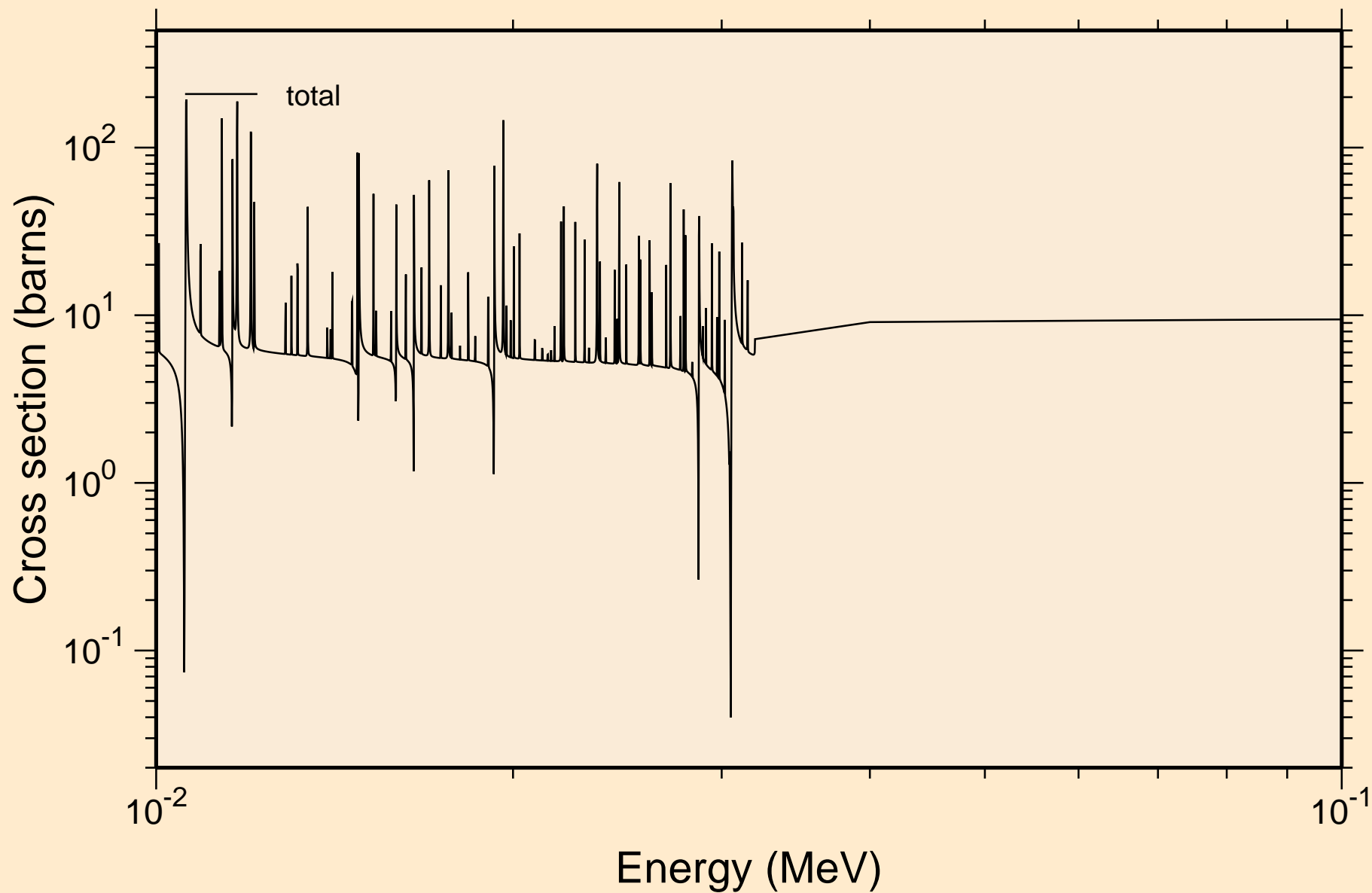

42-MO-98 FOR FENDL-3.1 FROM FENDL-3.1 WITH NJOY2012.50-
resonance absorption cross sections

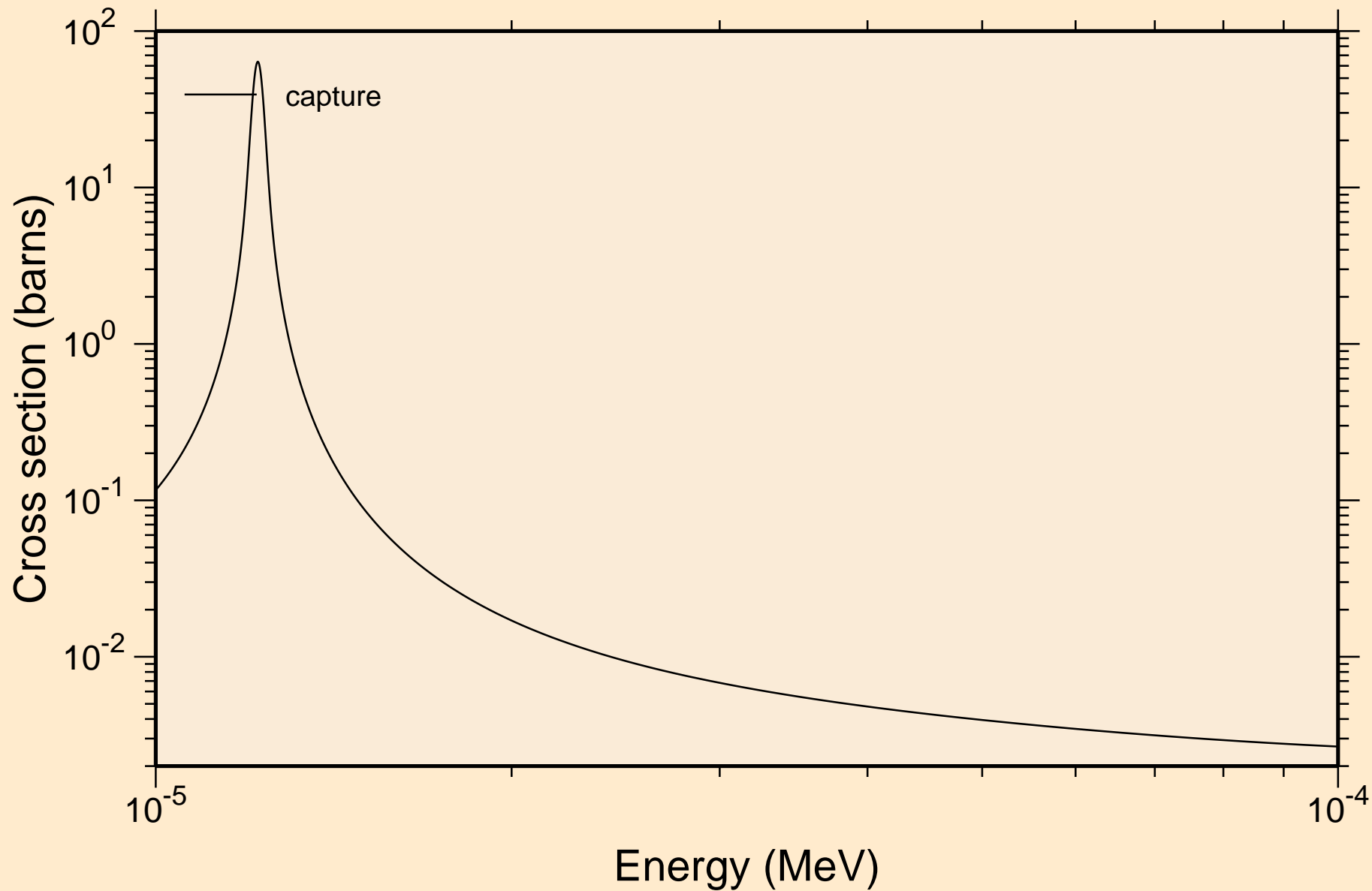

42-MO-98 FOR FENDL-3.1 FROM FENDL-3.1 WITH NJOY2012.50-
resonance absorption cross sections

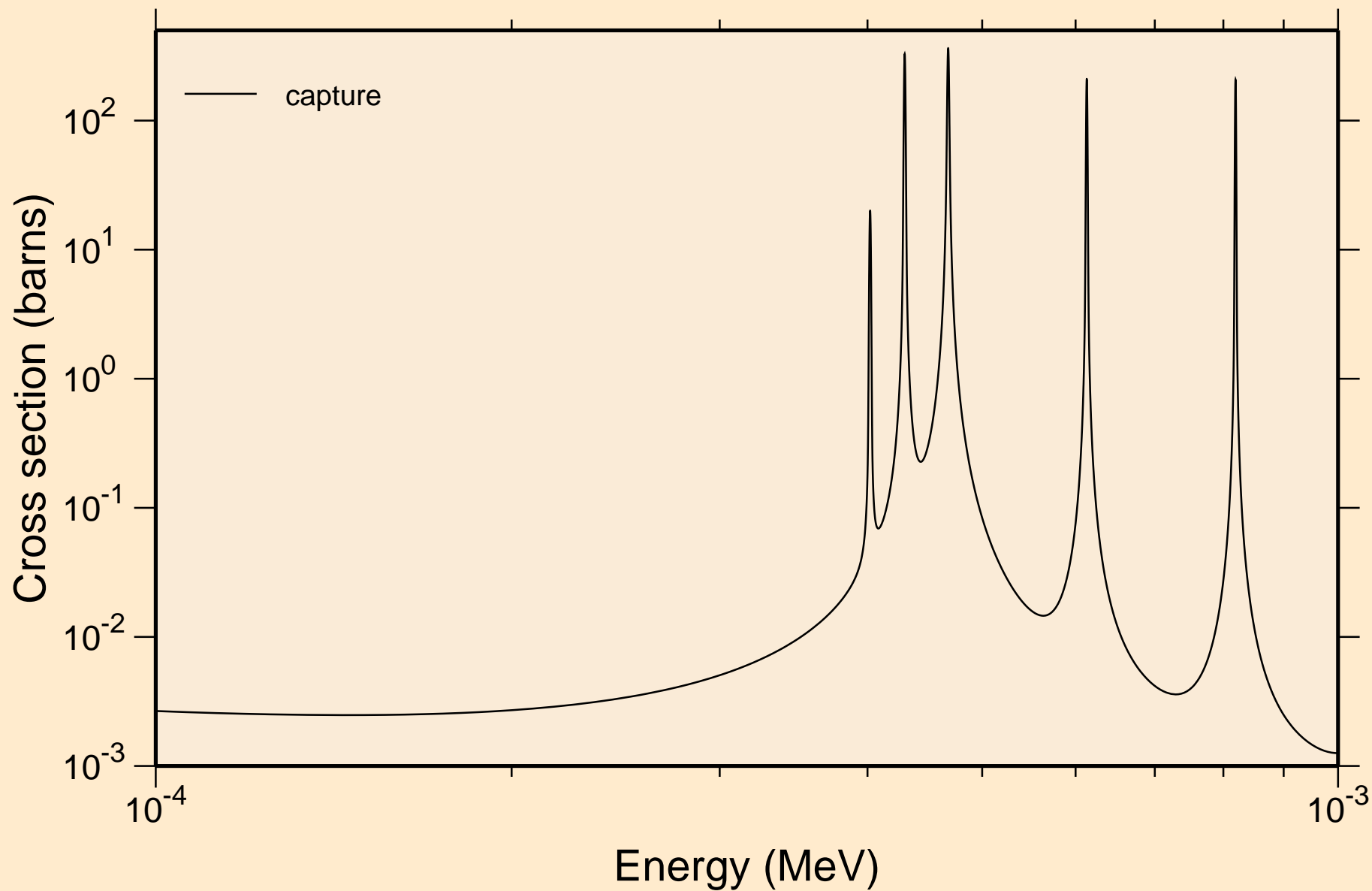

42-MO-98 FOR FENDL-3.1 FROM FENDL-3.1 WITH NJOY2012.50-
resonance absorption cross sections

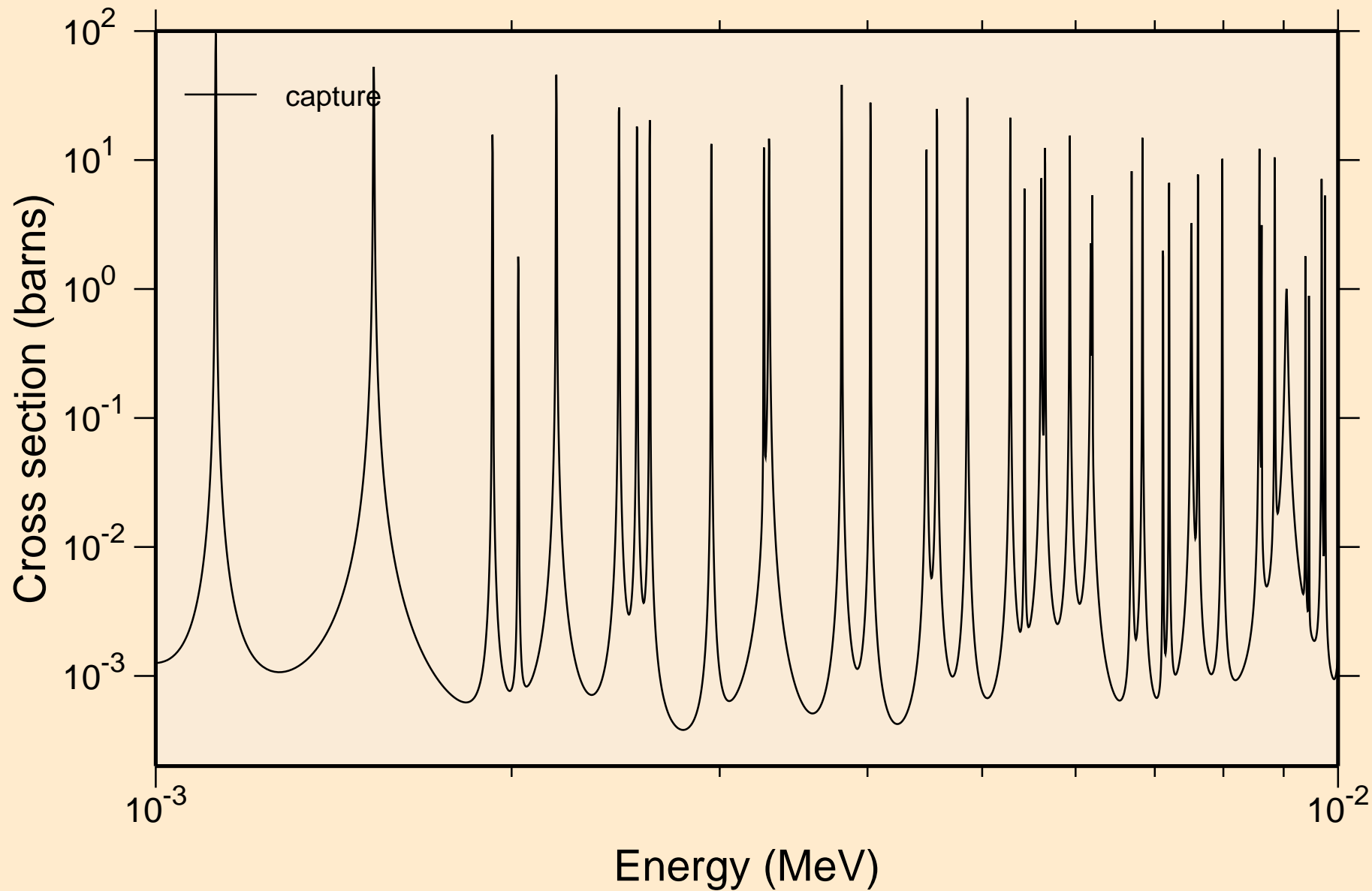

42-MO-98 FOR FENDL-3.1 FROM FENDL-3.1 WITH NJOY2012.50-
resonance absorption cross sections

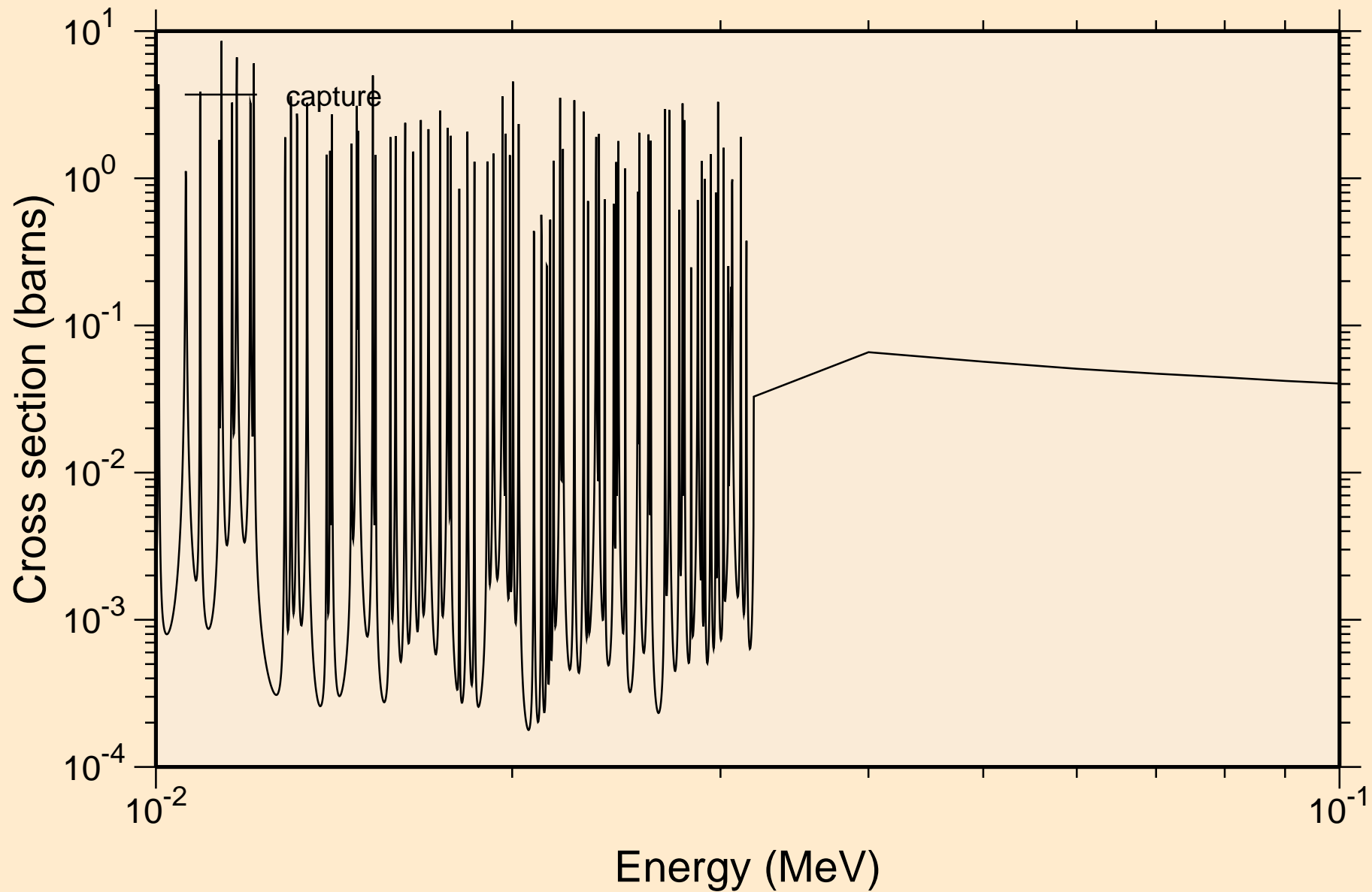

42-MO-98 FOR FENDL-3.1 FROM FENDL-3.1 WITH NJOY2012.50-
UR total cross section

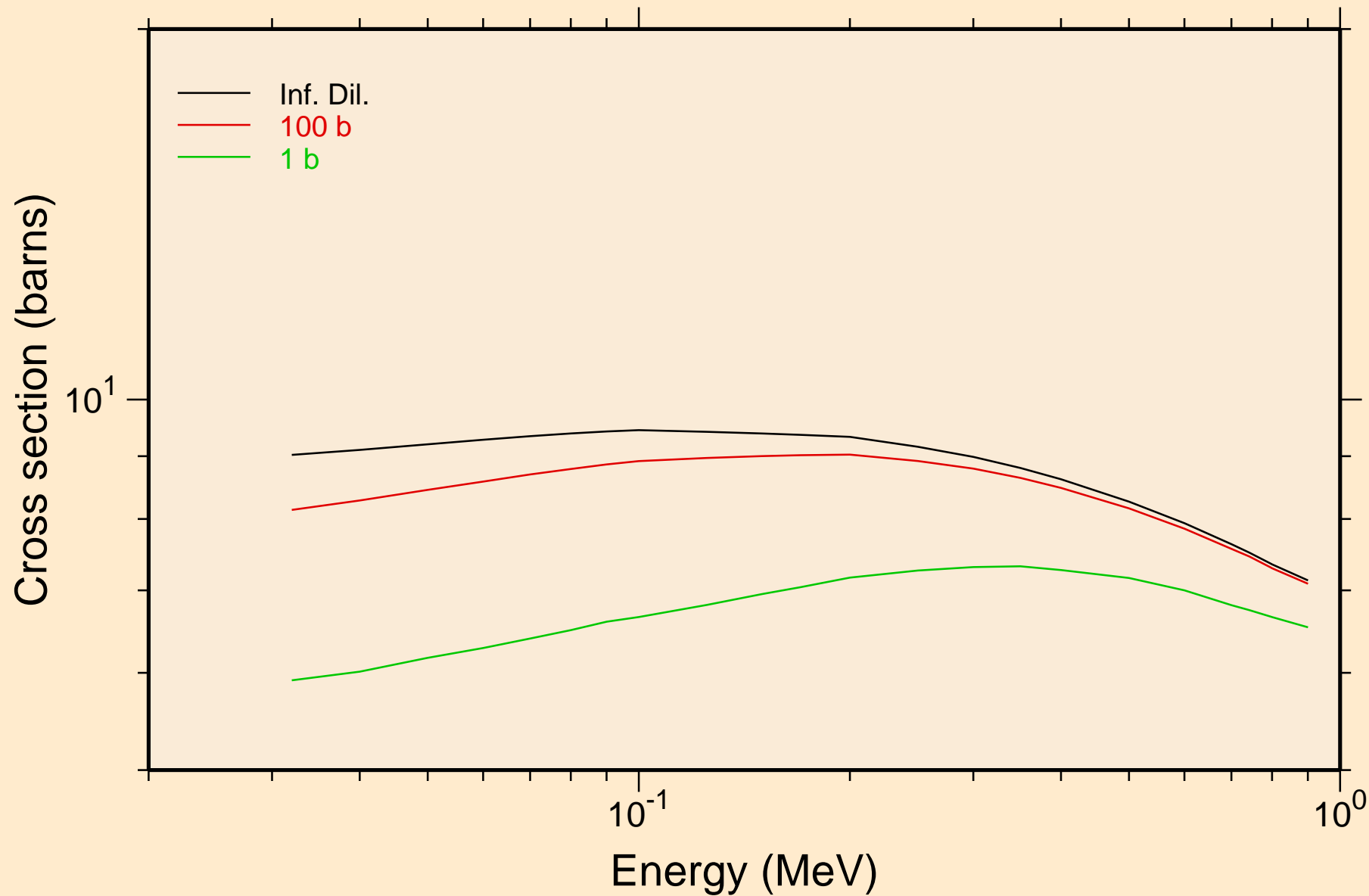

42-MO-98 FOR FENDL-3.1 FROM FENDL-3.1 WITH NJOY2012.50-
UR elastic cross section

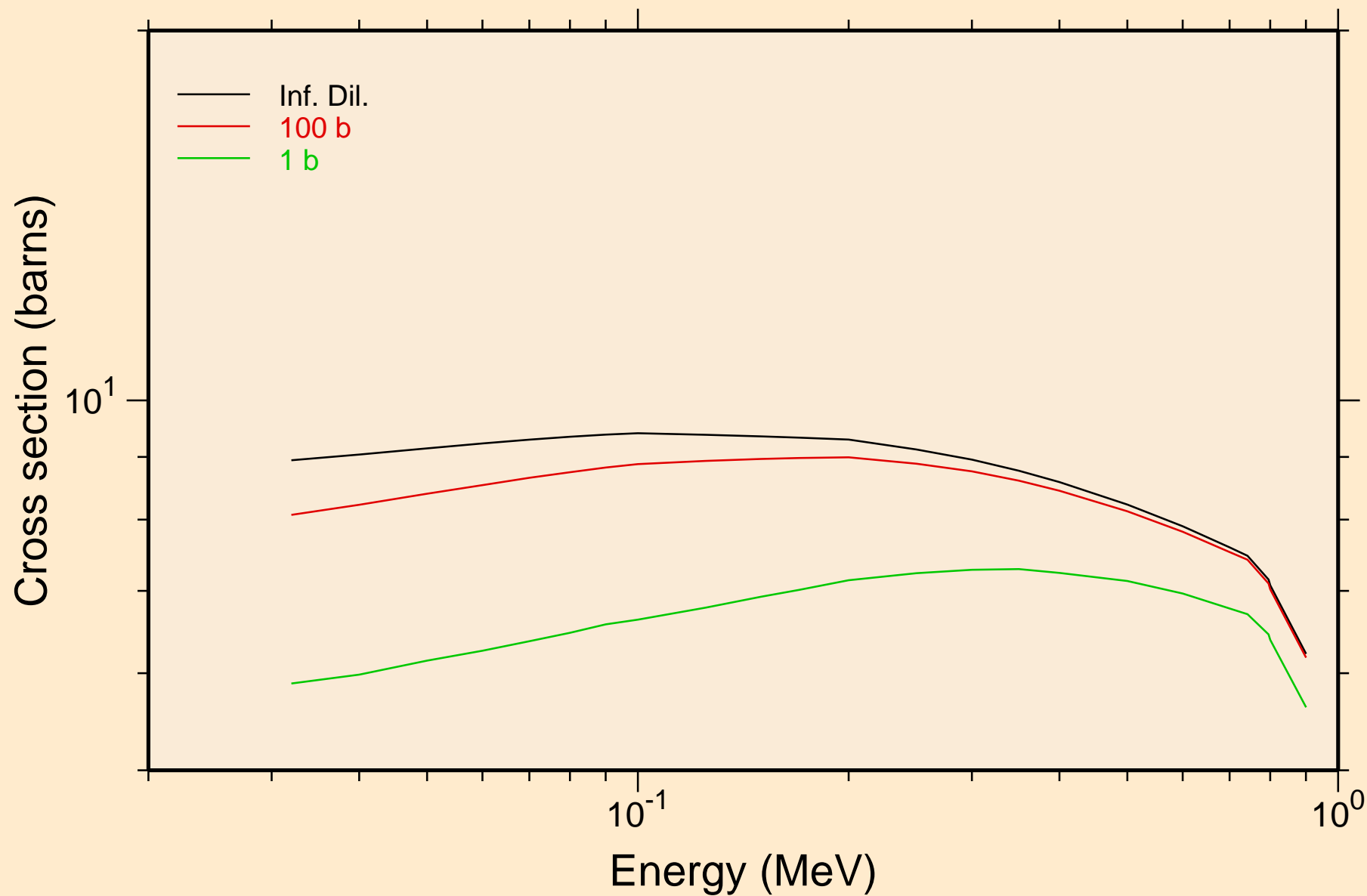

42-MO-98 FOR FENDL-3.1 FROM FENDL-3.1 WITH NJOY2012.50-
UR capture cross section

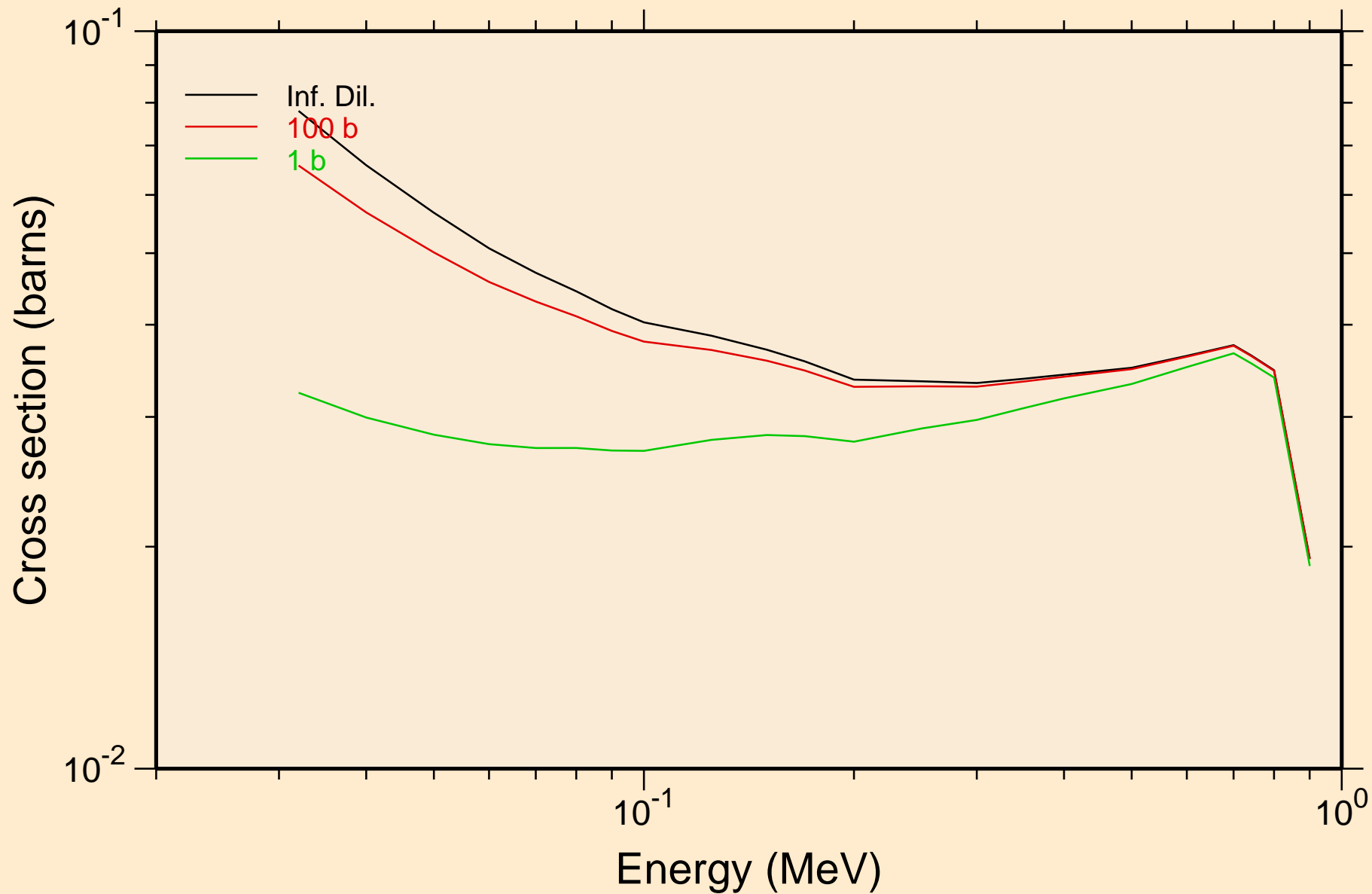

42-MO-98 FOR FENDL-3.1 FROM FENDL-3.1 WITH NJOY2012.50- Heating

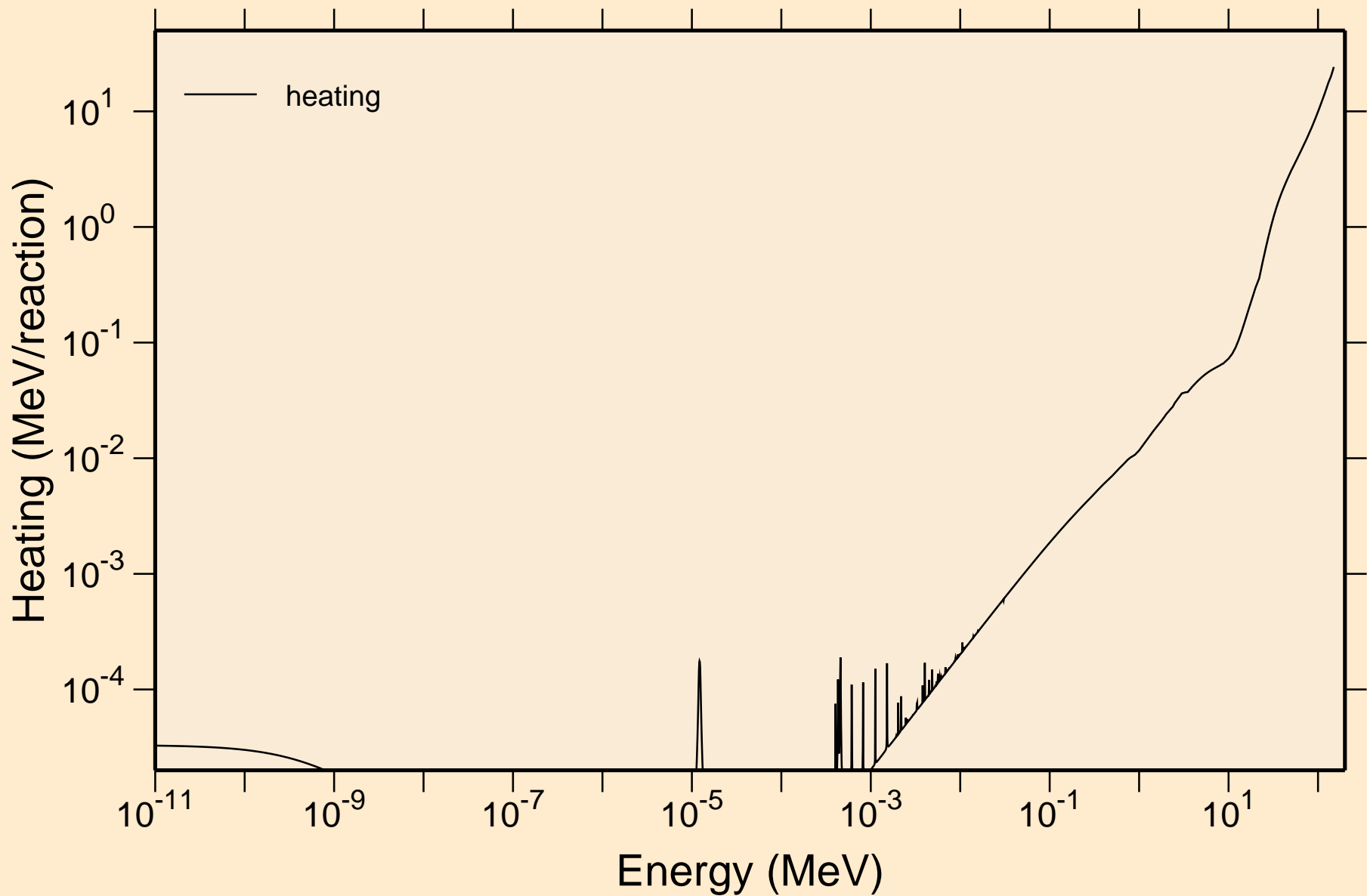

42-MO-98 FOR FENDL-3.1 FROM FENDL-3.1 WITH NJOY2012.50- Damage

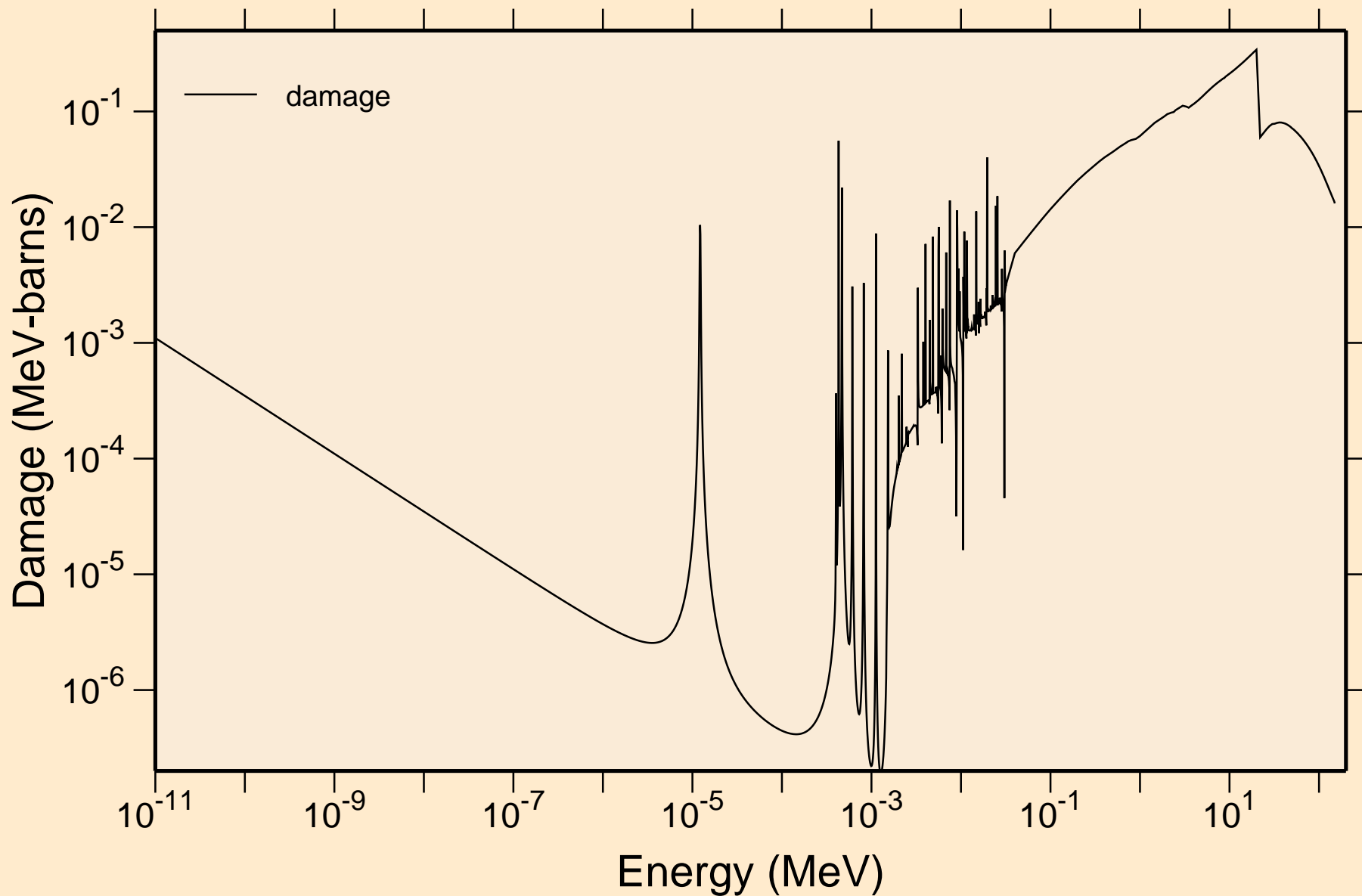

42-MO-98 FOR FENDL-3.1 FROM FENDL-3.1 WITH NJOY2012.50-
Non-threshold reactions

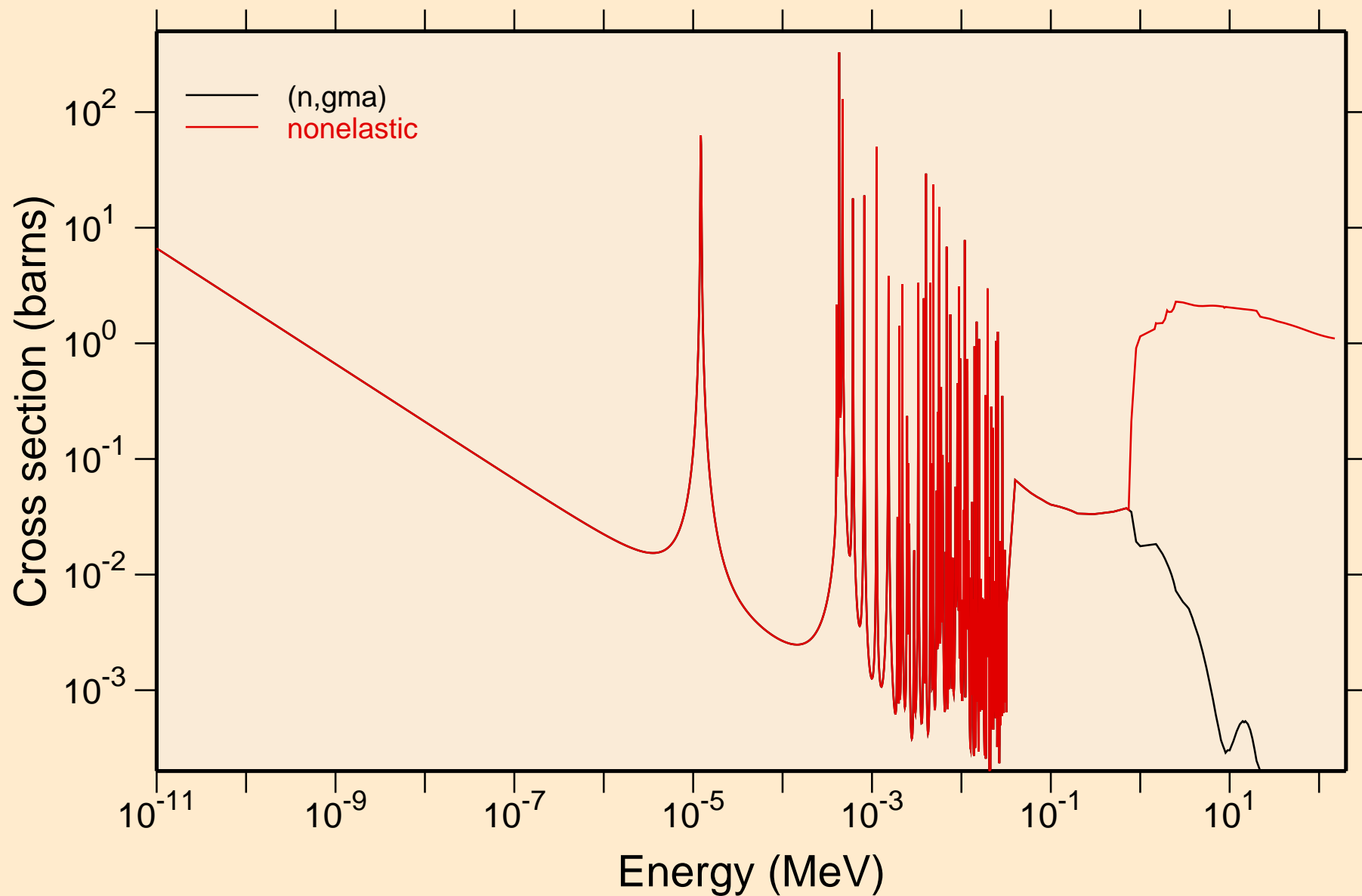

42-MO-98 FOR FENDL-3.1 FROM FENDL-3.1 WITH NJOY2012.50-
Non-threshold reactions

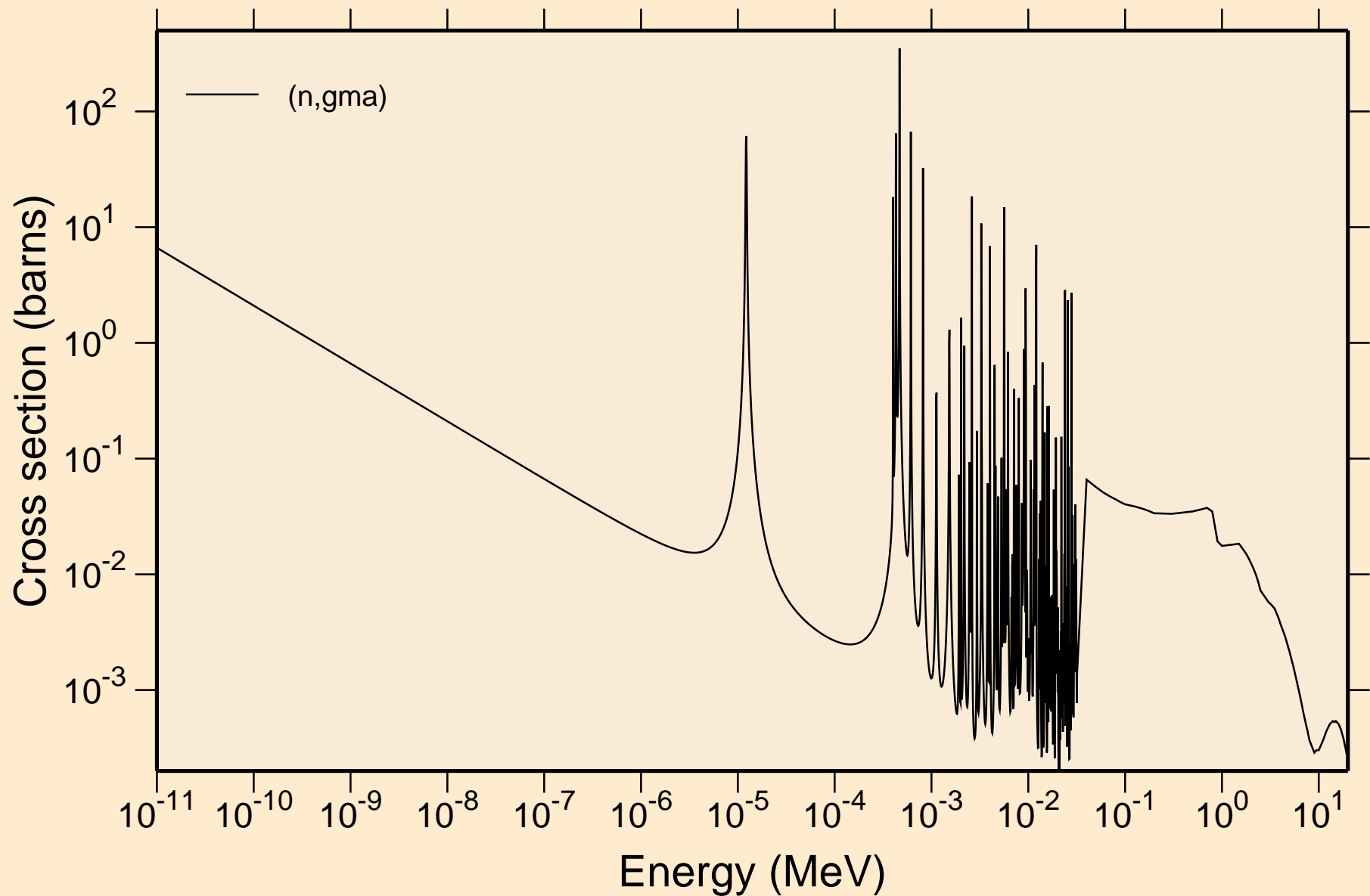

42-MO-98 FOR FENDL-3.1 FROM FENDL-3.1 WITH NJOY2012.50-
Principal cross sections

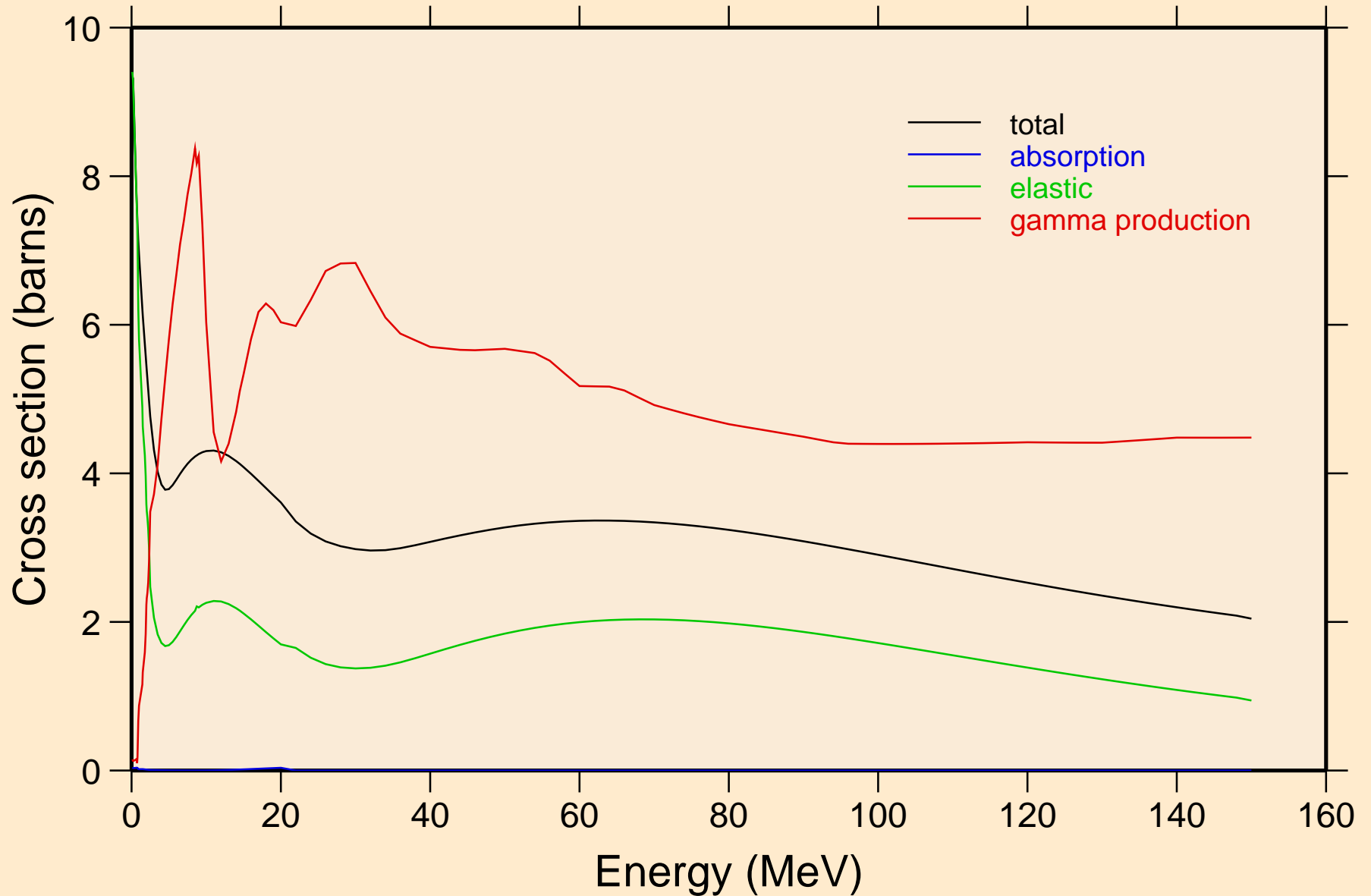

42-MO-98 FOR FENDL-3.1 FROM FENDL-3.1 WITH NJOY2012.50- Heating

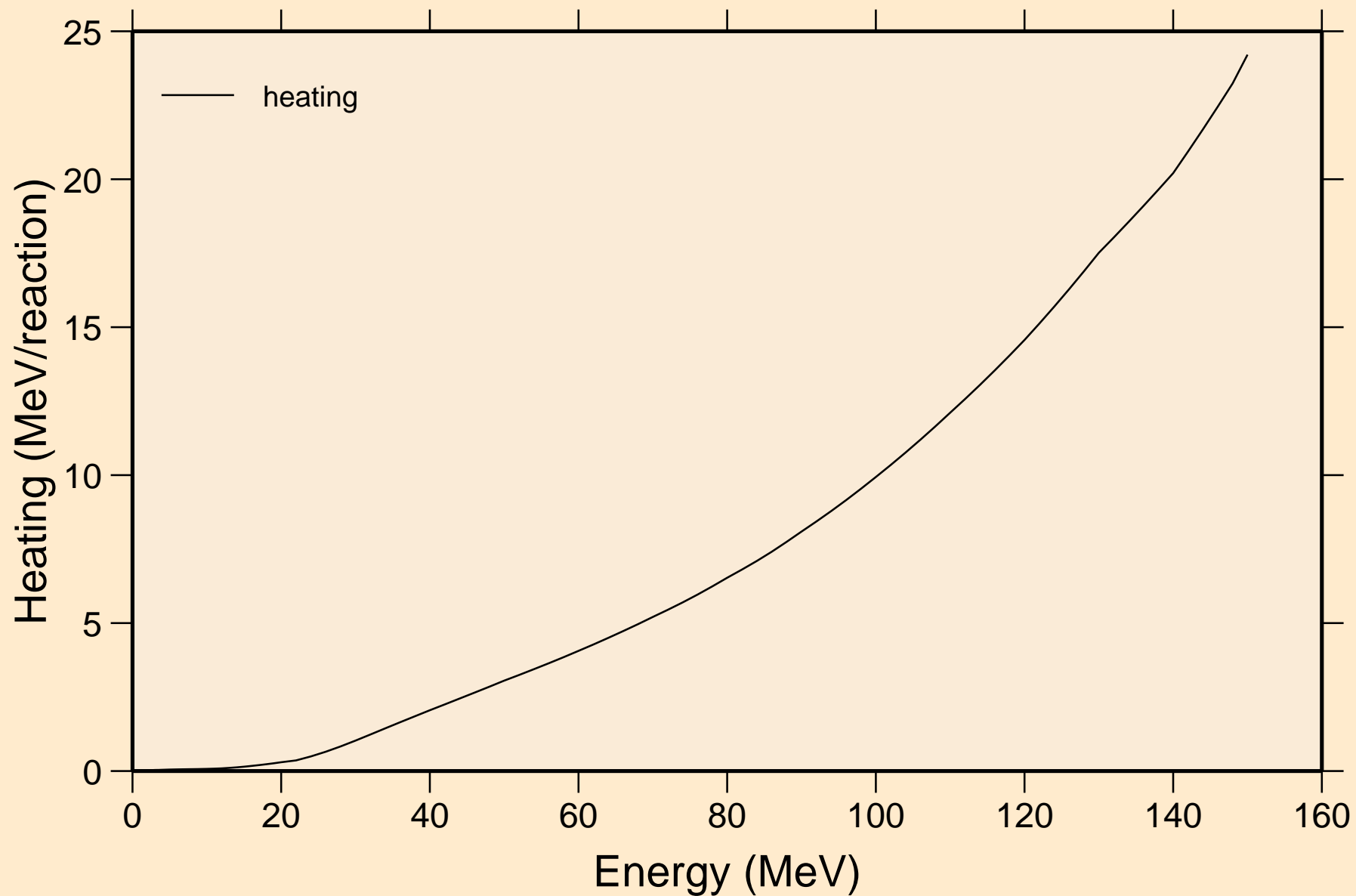

42-MO-98 FOR FENDL-3.1 FROM FENDL-3.1 WITH NJOY2012.50- Damage

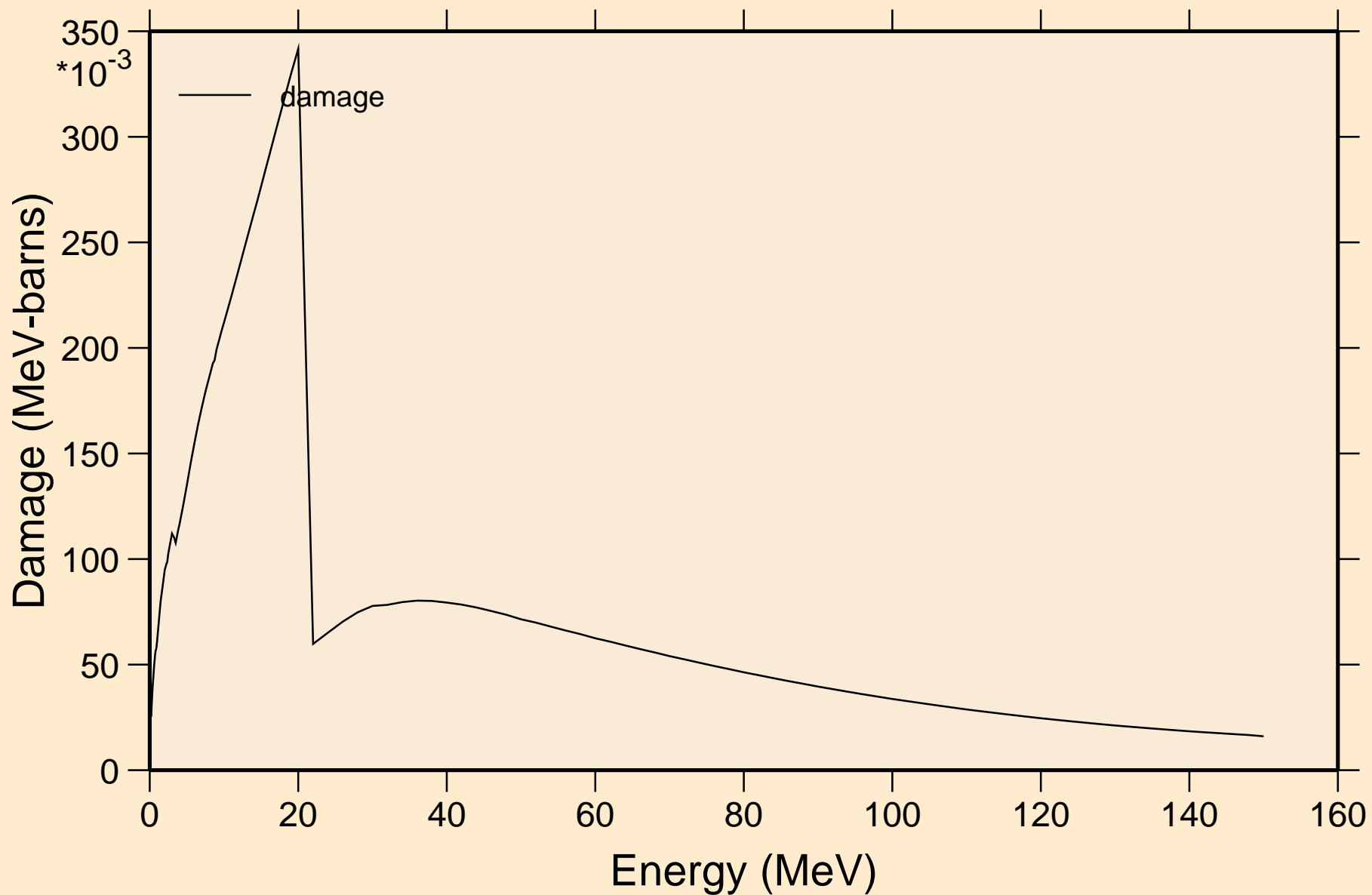

42-MO-98 FOR FENDL-3.1 FROM FENDL-3.1 WITH NJOY2012.50-
Non-threshold reactions

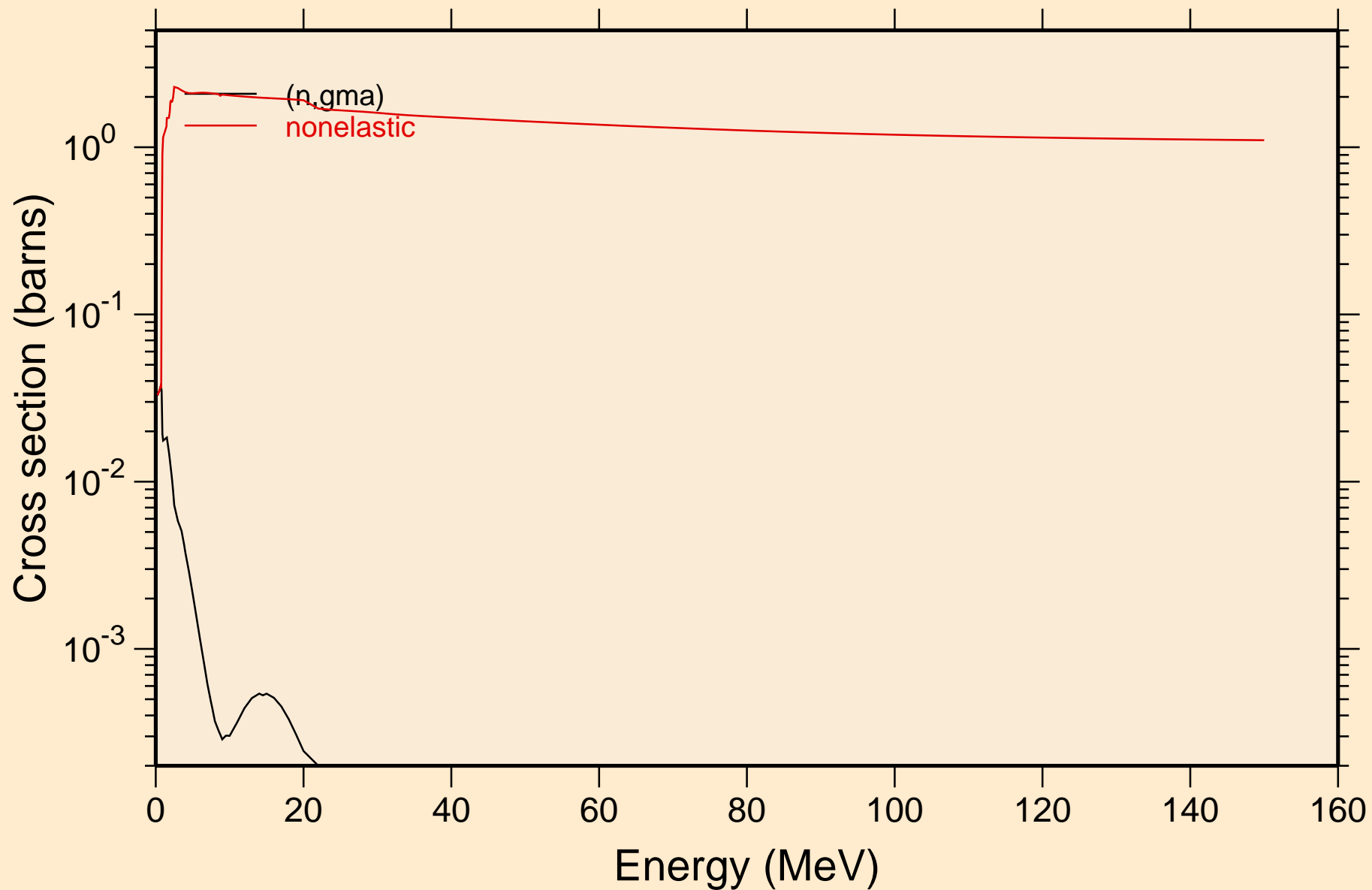

42-MO-98 FOR FENDL-3.1 FROM FENDL-3.1 WITH NJOY2012.50-
Non-threshold reactions

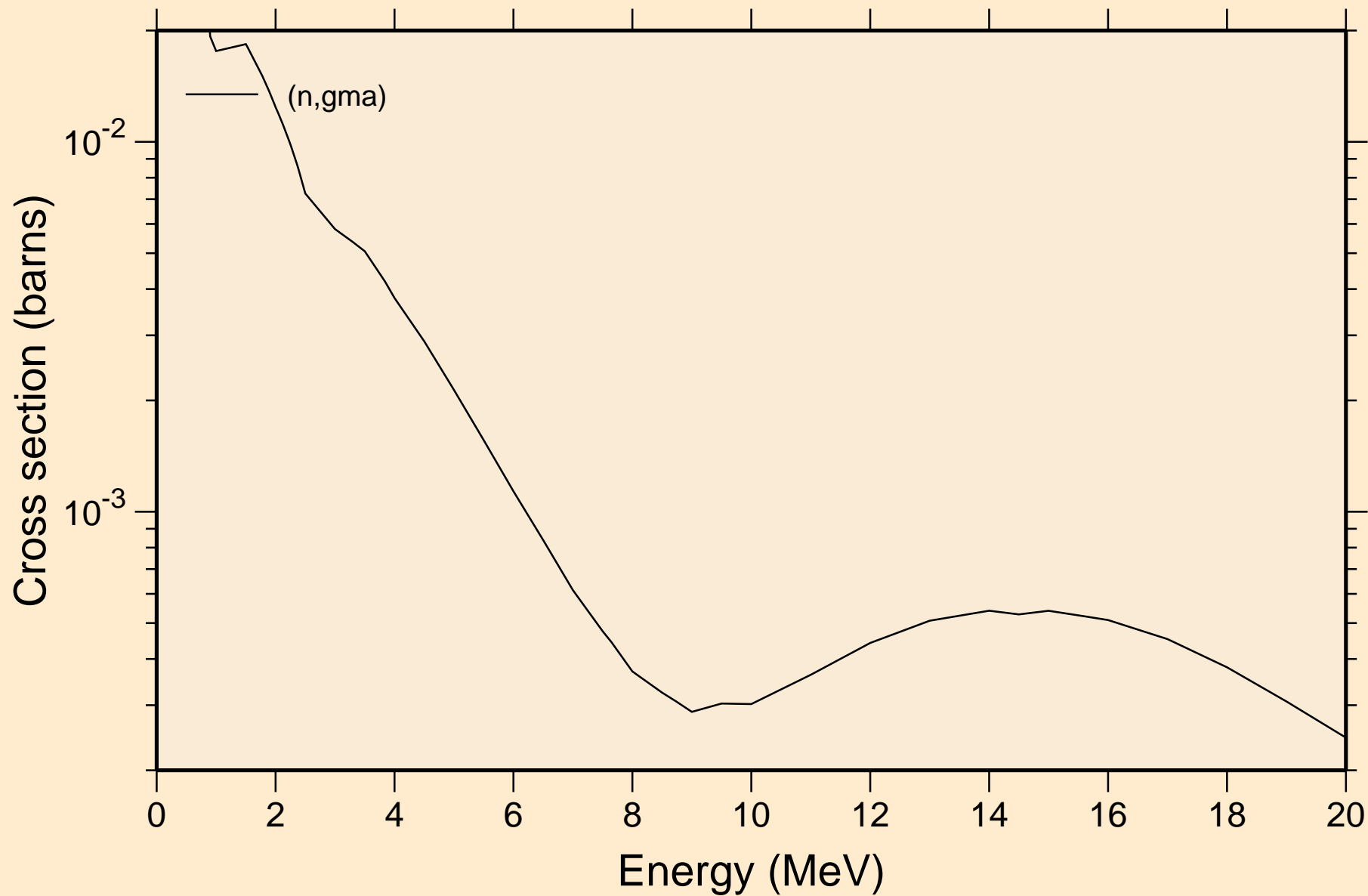

42-MO-98 FOR FENDL-3.1 FROM FENDL-3.1 WITH NJOY2012.50-
Inelastic levels

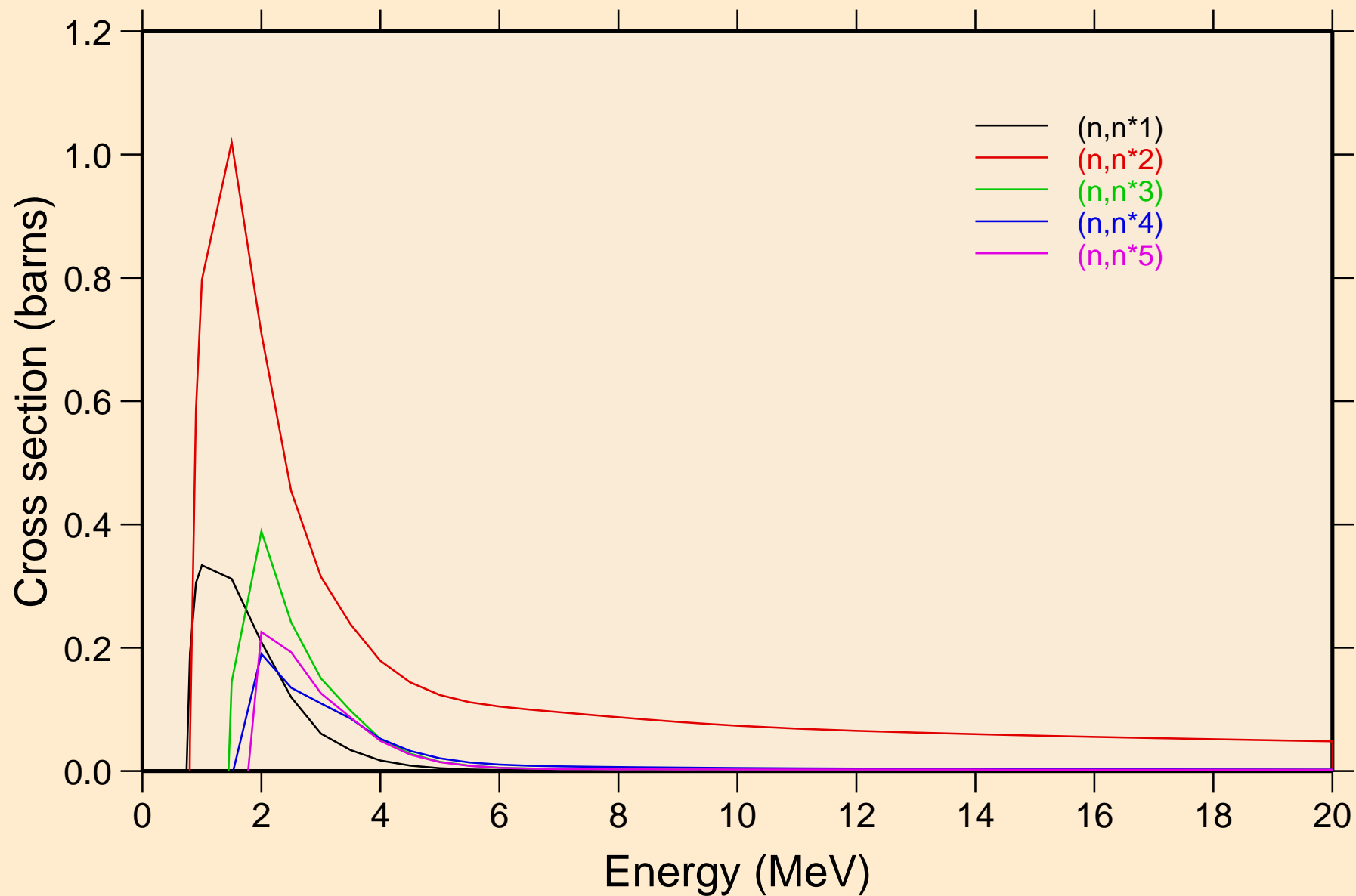

42-MO-98 FOR FENDL-3.1 FROM FENDL-3.1 WITH NJOY2012.50- Inelastic levels

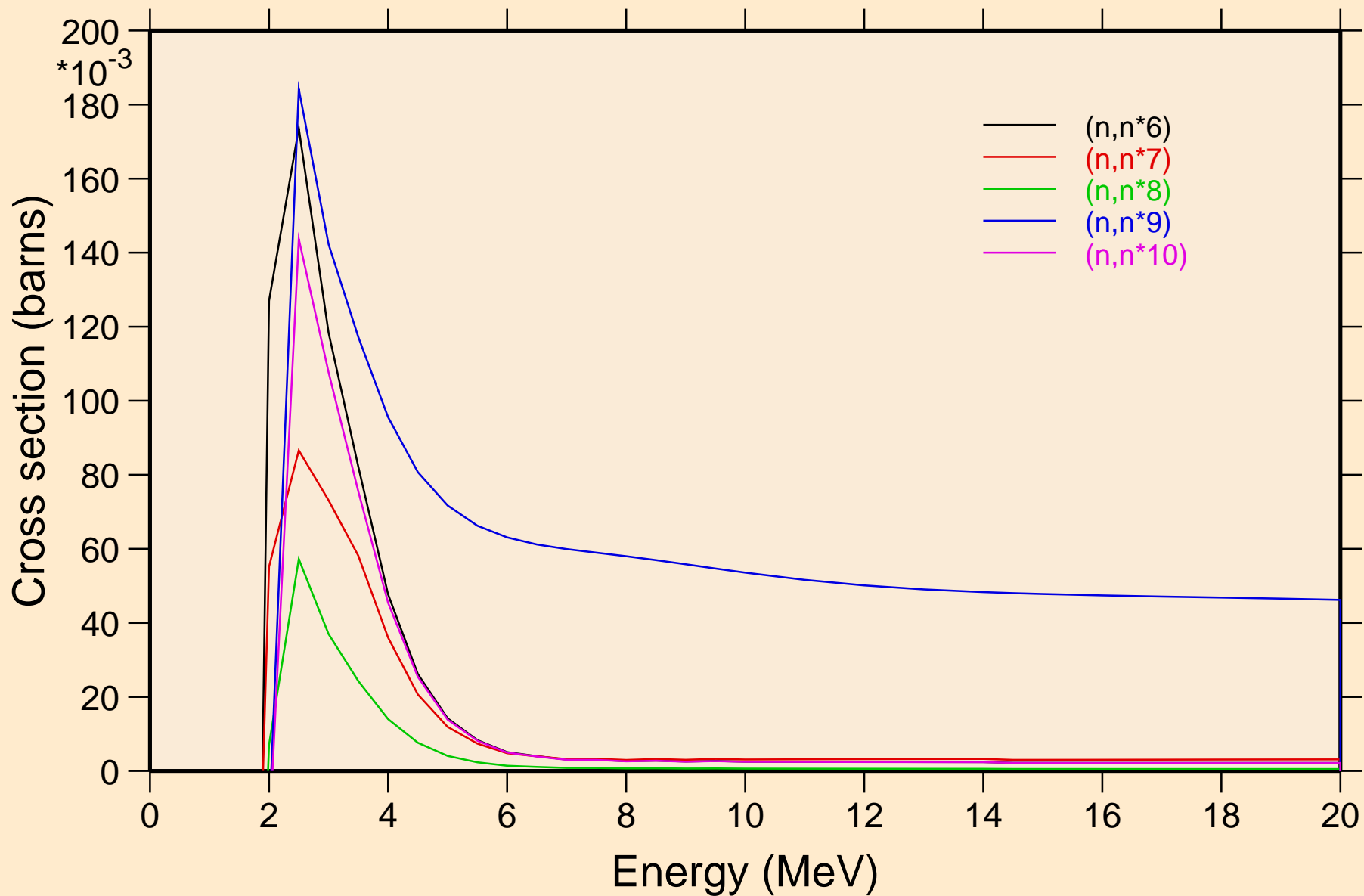

42-MO-98 FOR FENDL-3.1 FROM FENDL-3.1 WITH NJOY2012.50-
Inelastic levels

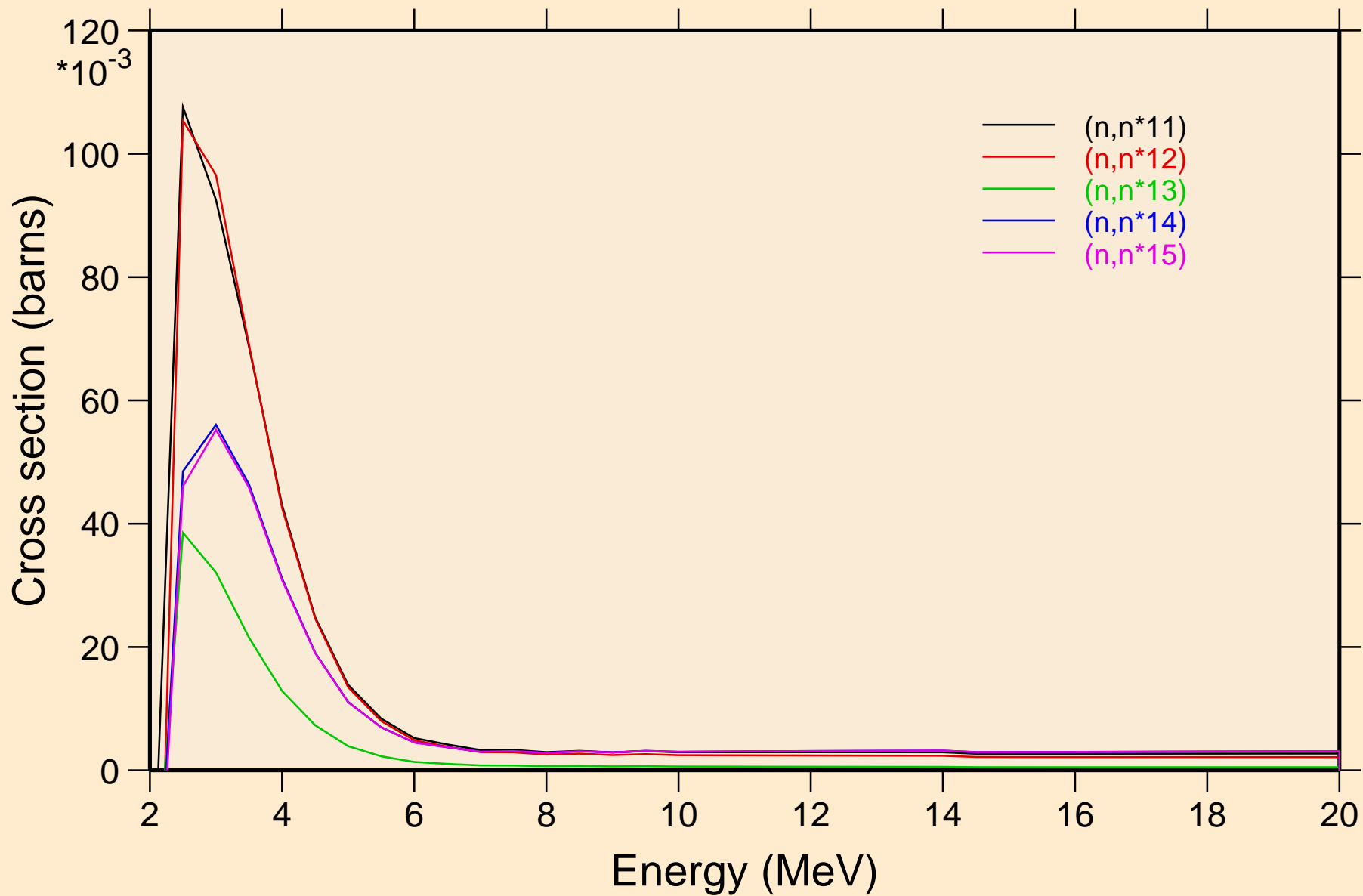

42-MO-98 FOR FENDL-3.1 FROM FENDL-3.1 WITH NJOY2012.50-
Inelastic levels

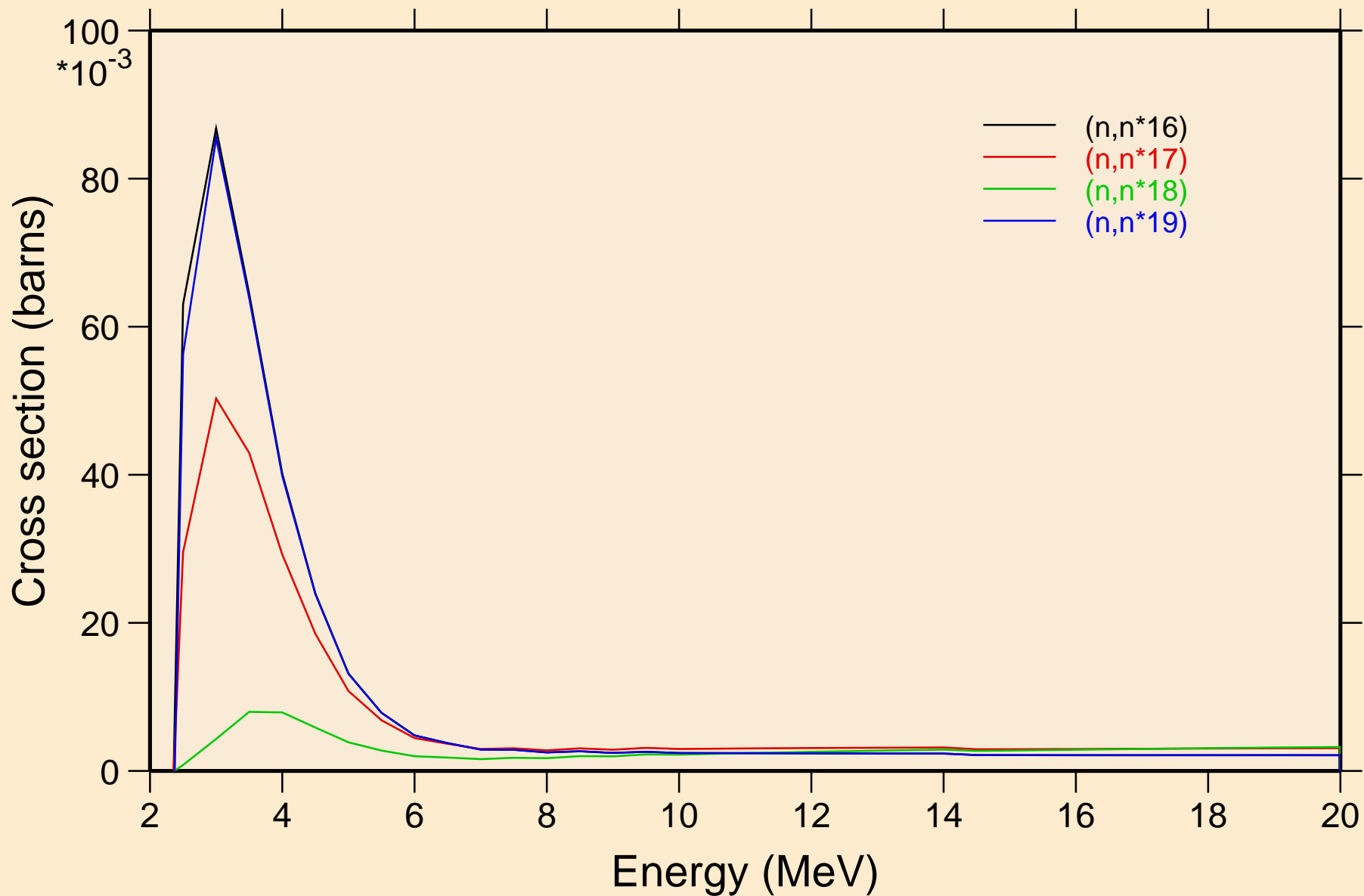

42-MO-98 FOR FENDL-3.1 FROM FENDL-3.1 WITH NJOY2012.50-
Threshold reactions

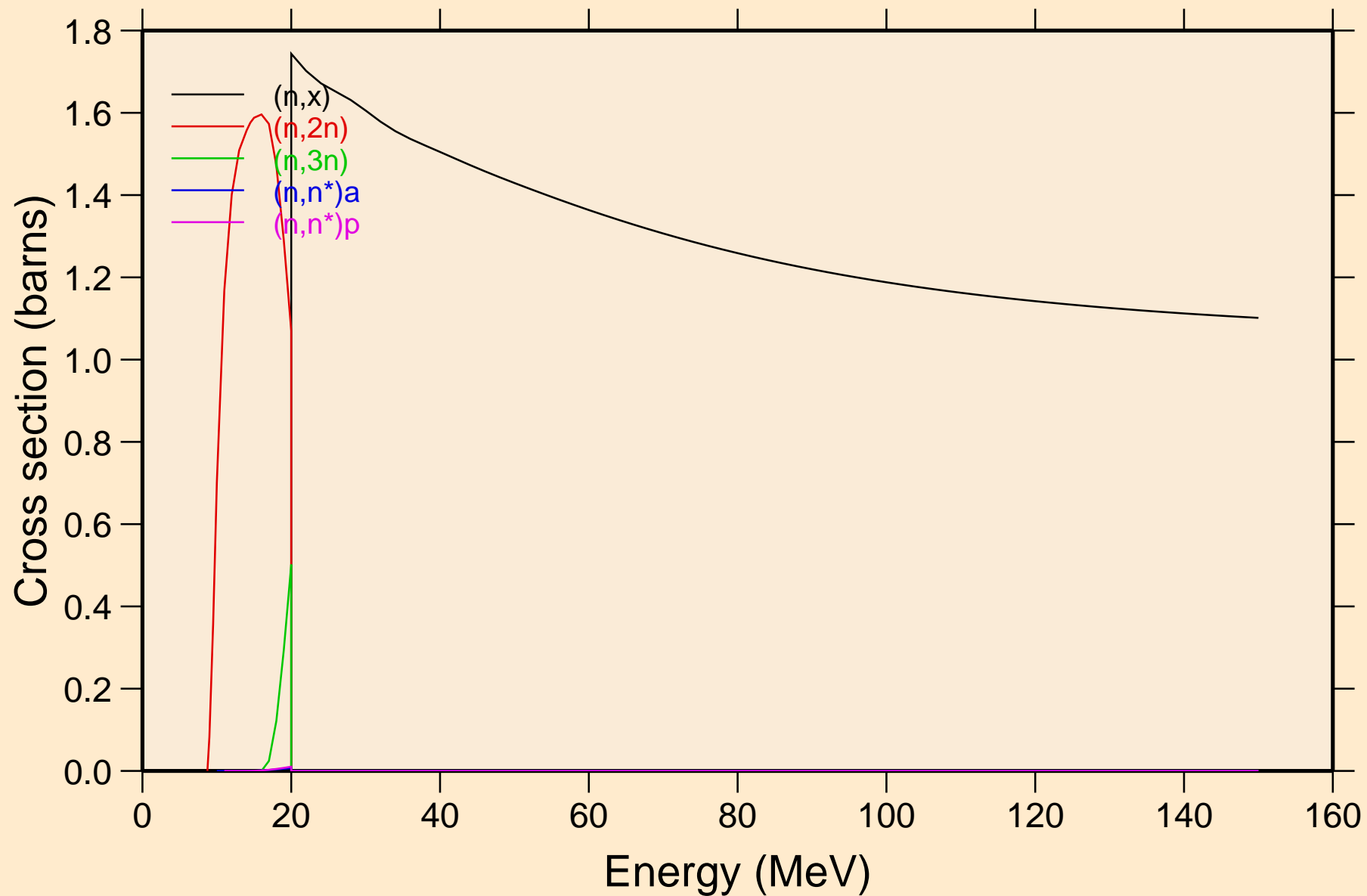

42-MO-98 FOR FENDL-3.1 FROM FENDL-3.1 WITH NJOY2012.50-
Threshold reactions

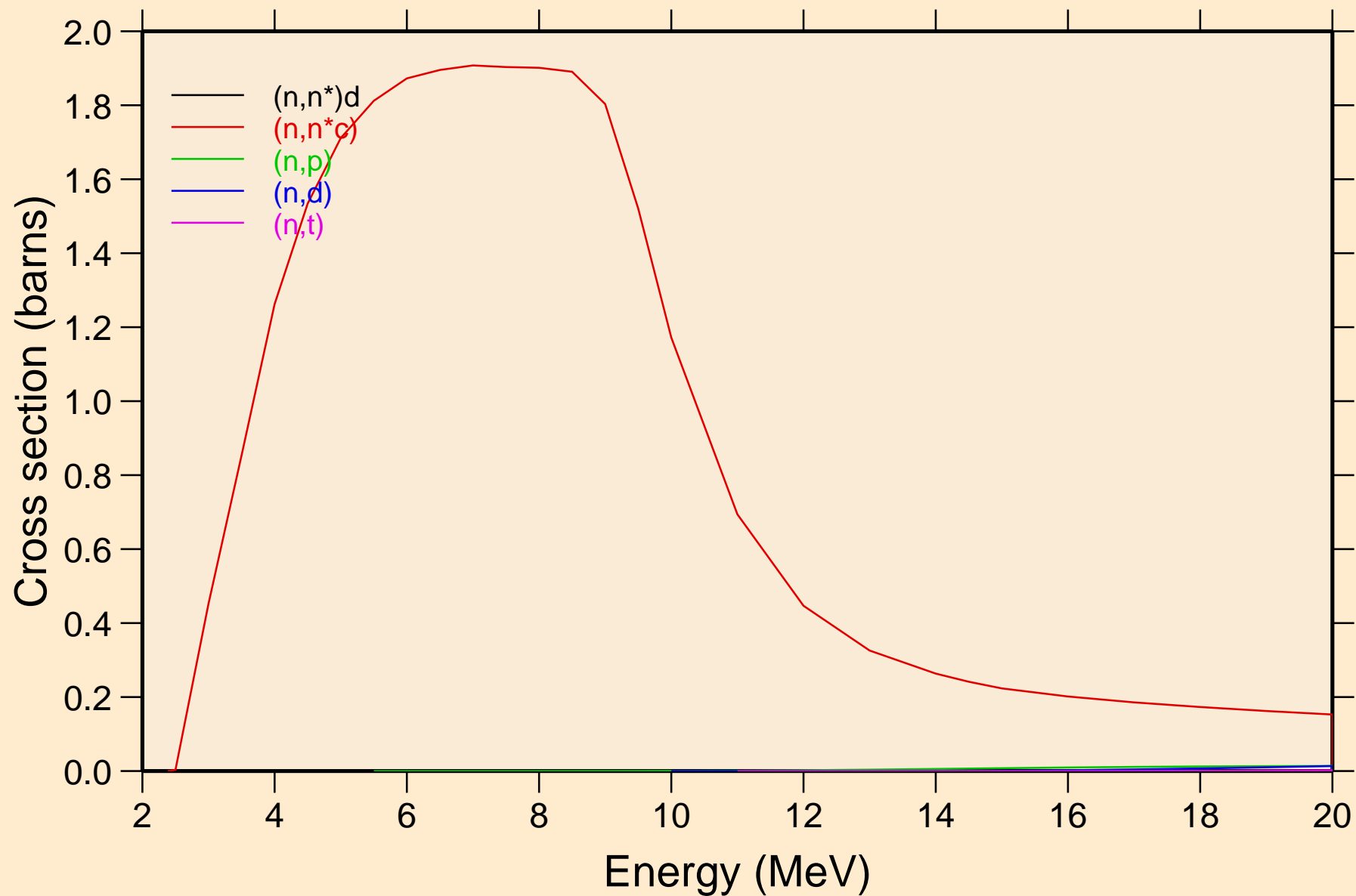

42-MO-98 FOR FENDL-3.1 FROM FENDL-3.1 WITH NJOY2012.50-
Threshold reactions

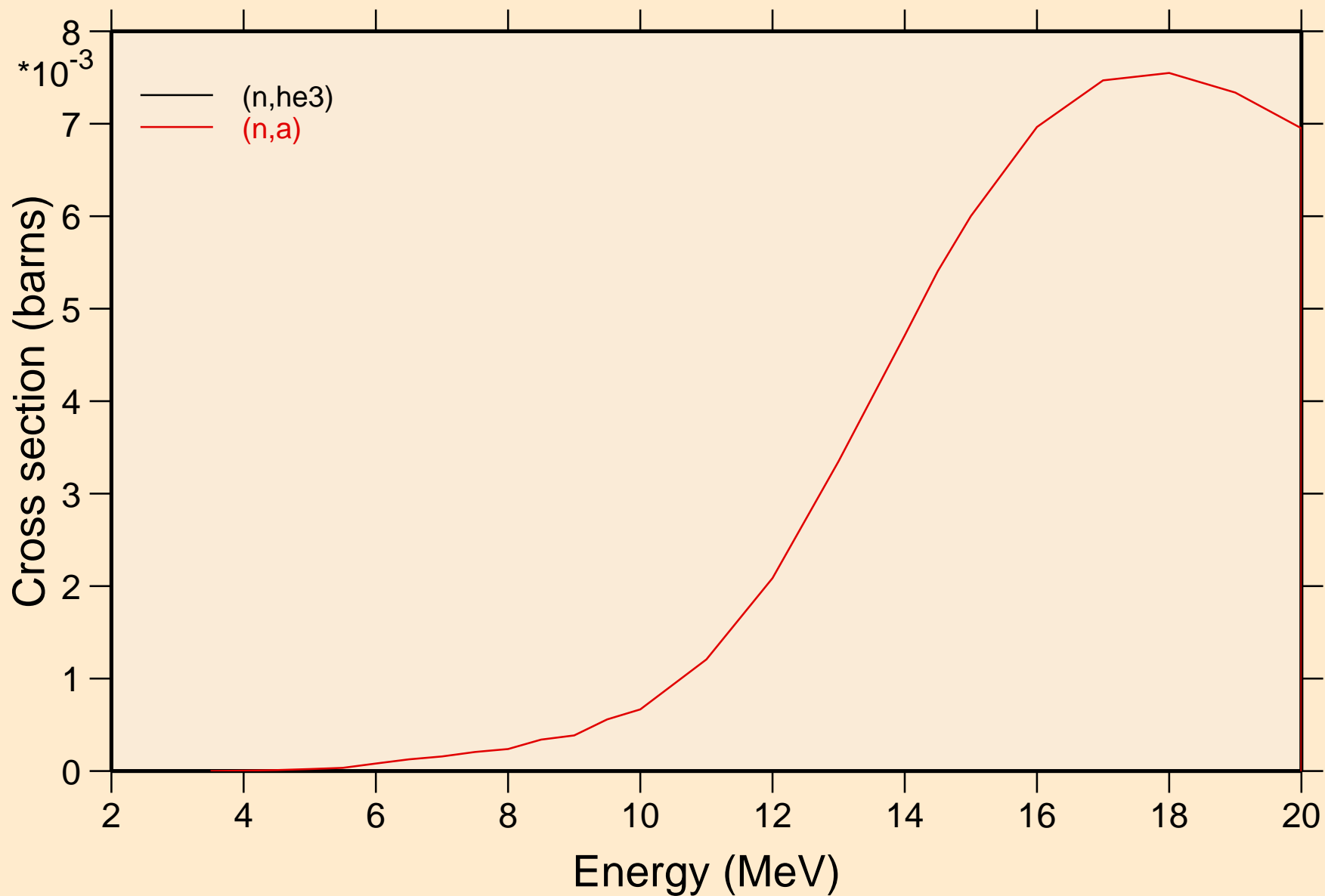

42-MO-98 FOR FENDL-3.1 FROM FENDL-3.1 WITH NJOY2012.50-
Threshold reactions

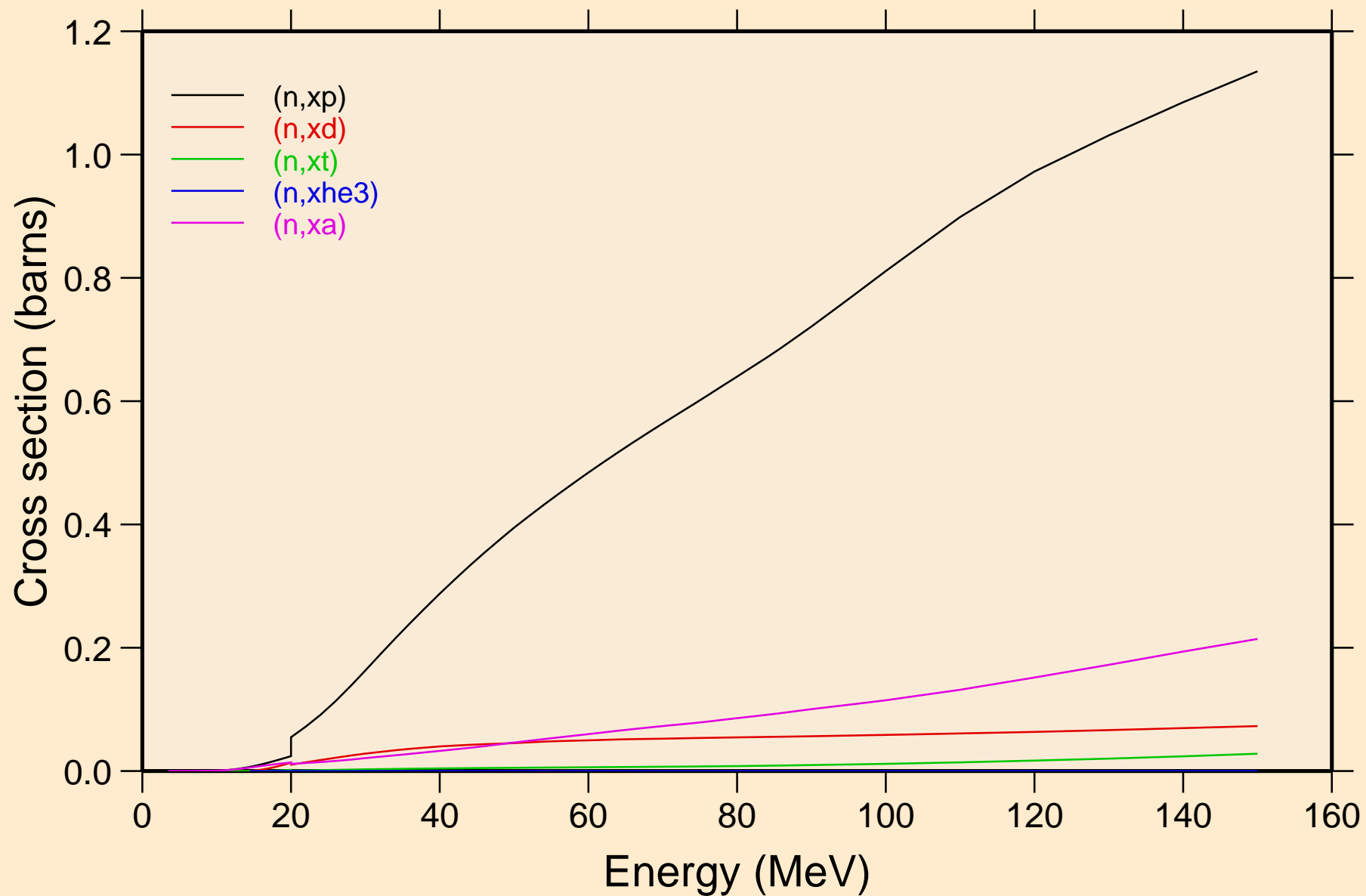

42-MO-98 FOR FENDL-3.1 FROM FENDL-3.1 WITH NJOY2012.50-
angular distribution for elastic

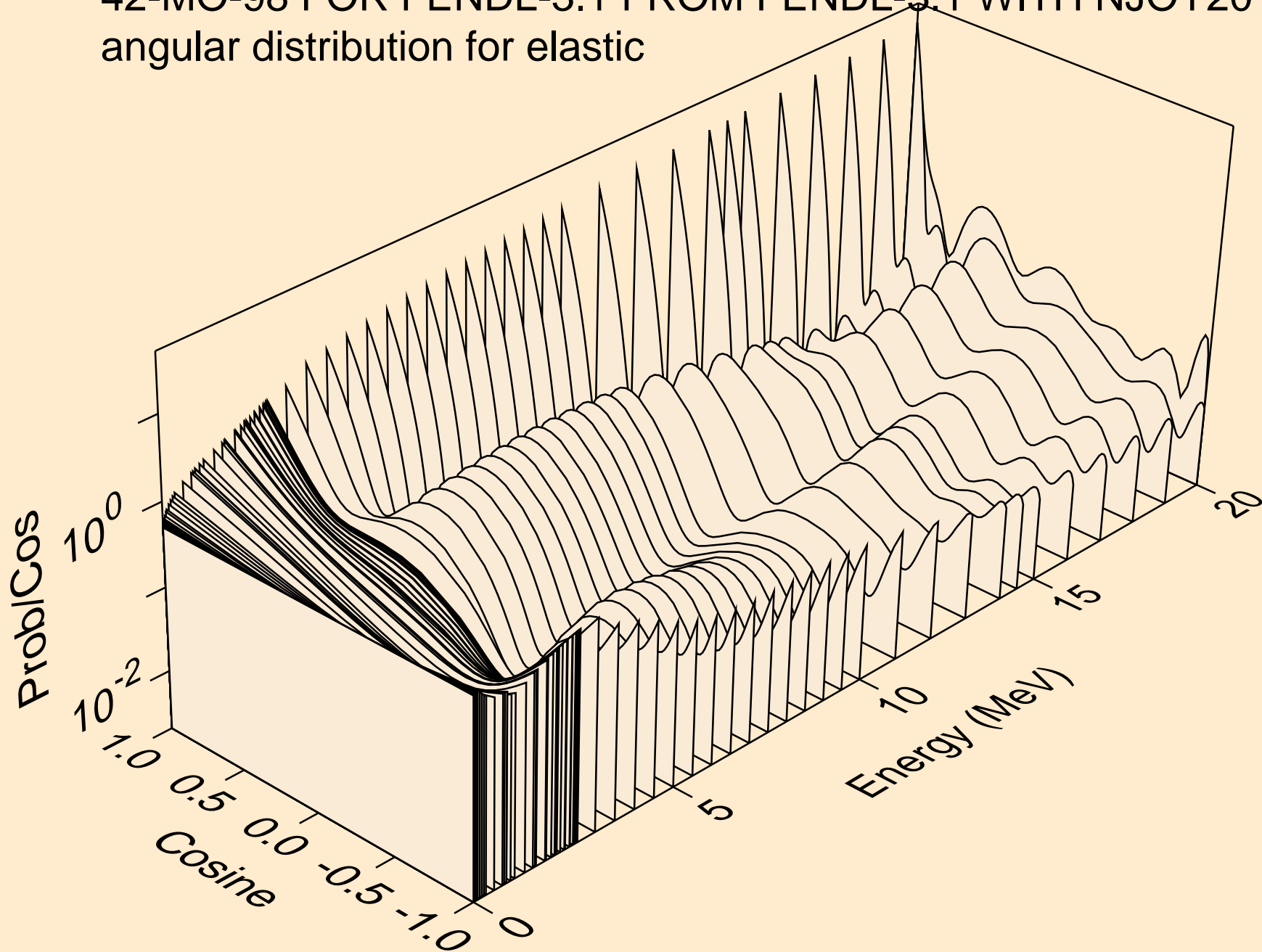

42-MO-98 FOR FENDL-3.1 FROM FENDL-3.1 WITH NJOY2012.50-
angular distribution for elastic

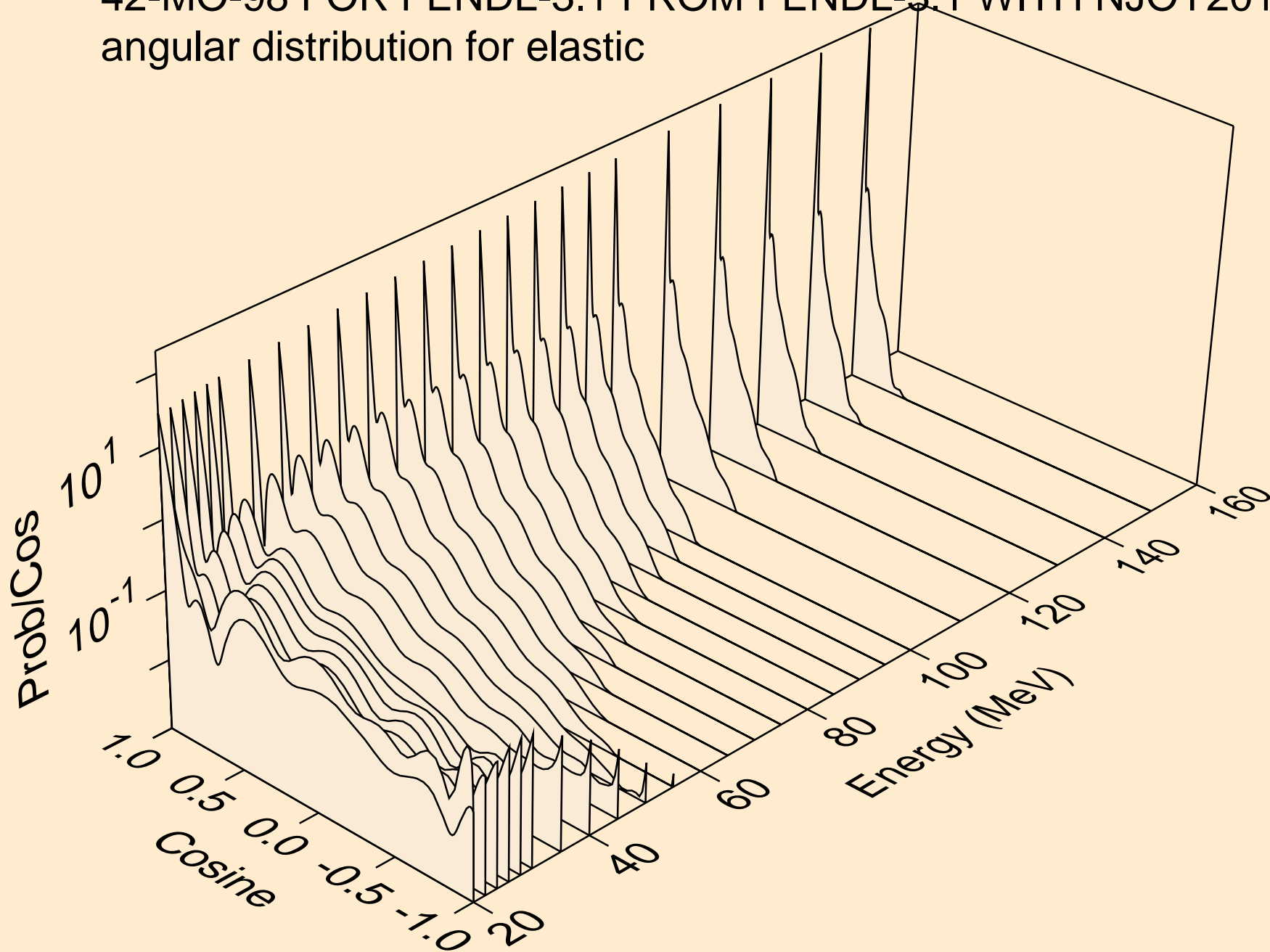

42-MO-98 FOR FENDL-3.1 FROM FENDL-3.1 WITH NJOY2012.50-
angular distribution for (n,n*1)

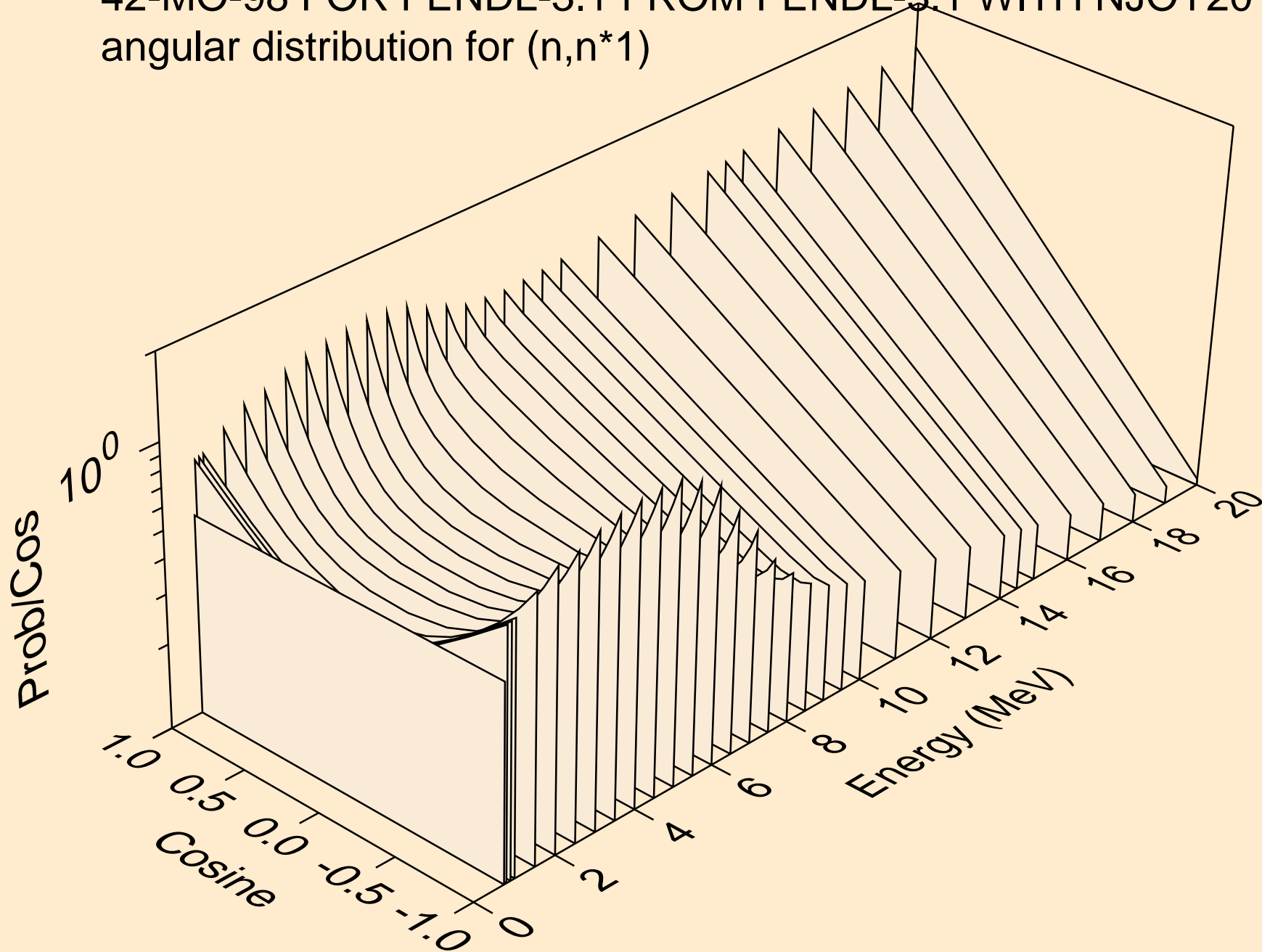

42-MO-98 FOR FENDL-3.1 FROM FENDL-3.1 WITH NJOY2012.50-
angular distribution for (n,n*2)

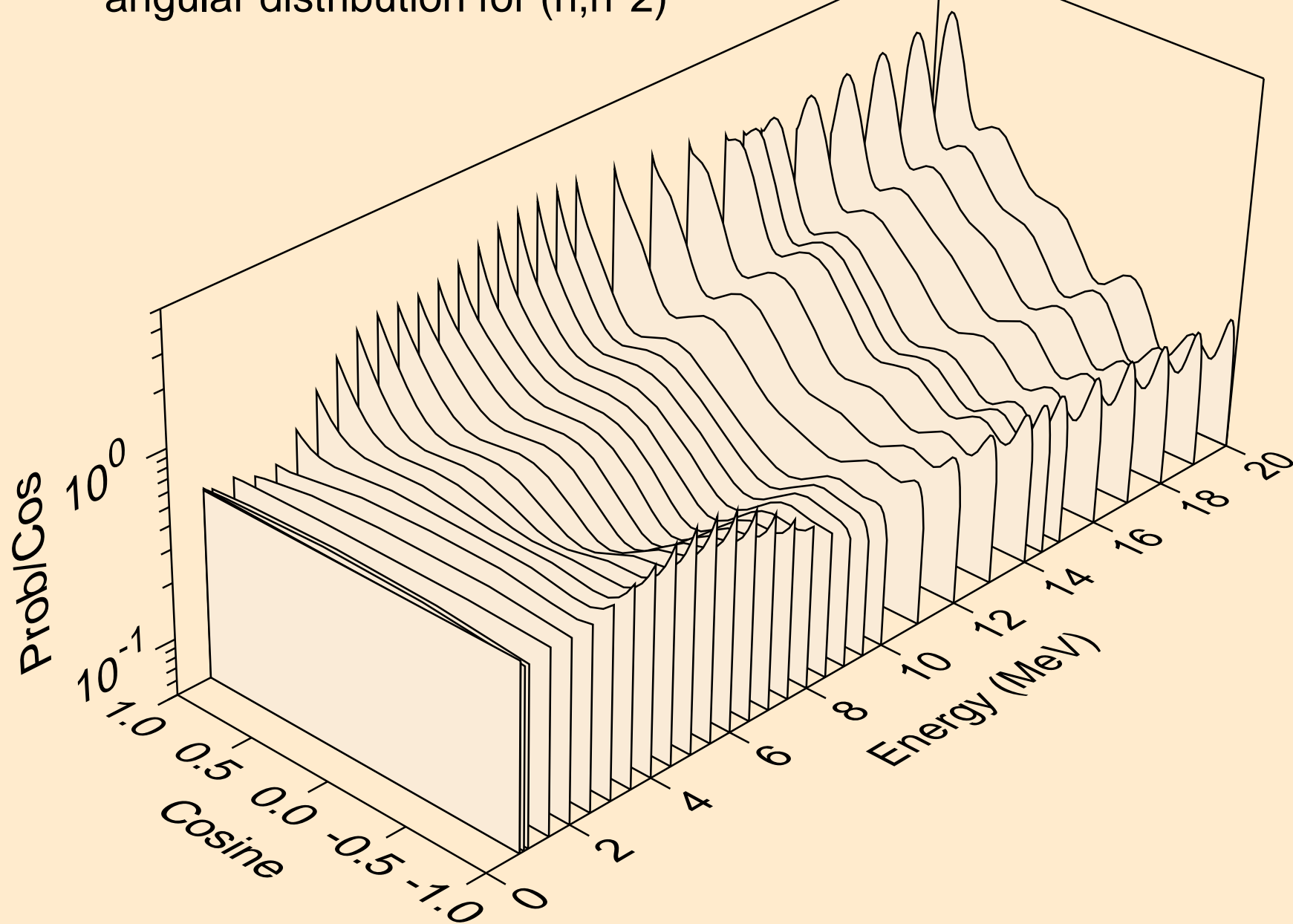

42-MO-98 FOR FENDL-3.1 FROM FENDL-3.1 WITH NJOY2012.50-
angular distribution for (n,n*3)

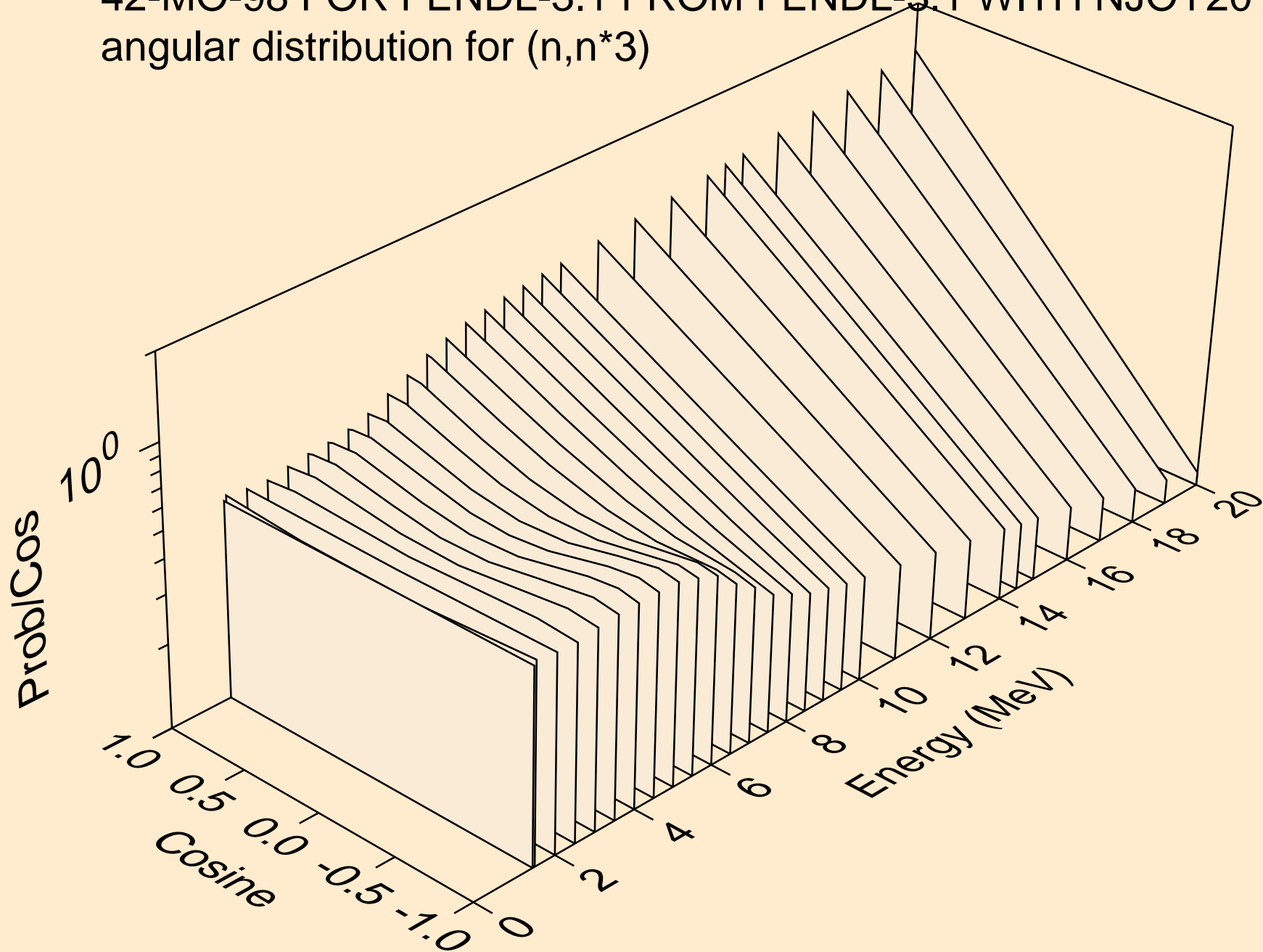

42-MO-98 FOR FENDL-3.1 FROM FENDL-3.1 WITH NJOY2012.50-
angular distribution for (n,n*4)

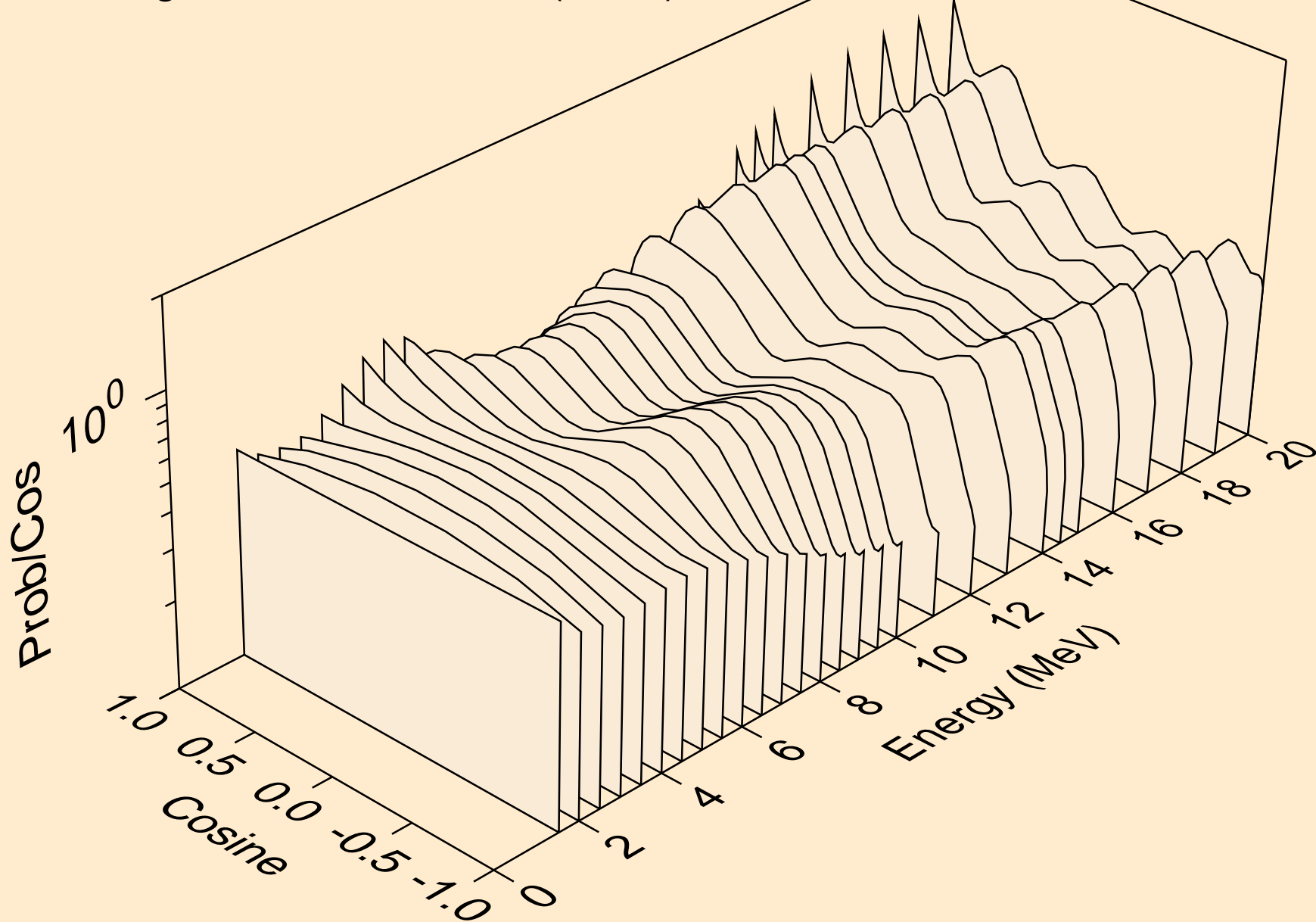

42-MO-98 FOR FENDL-3.1 FROM FENDL-3.1 WITH NJOY2012.50-
angular distribution for (n,n*5)

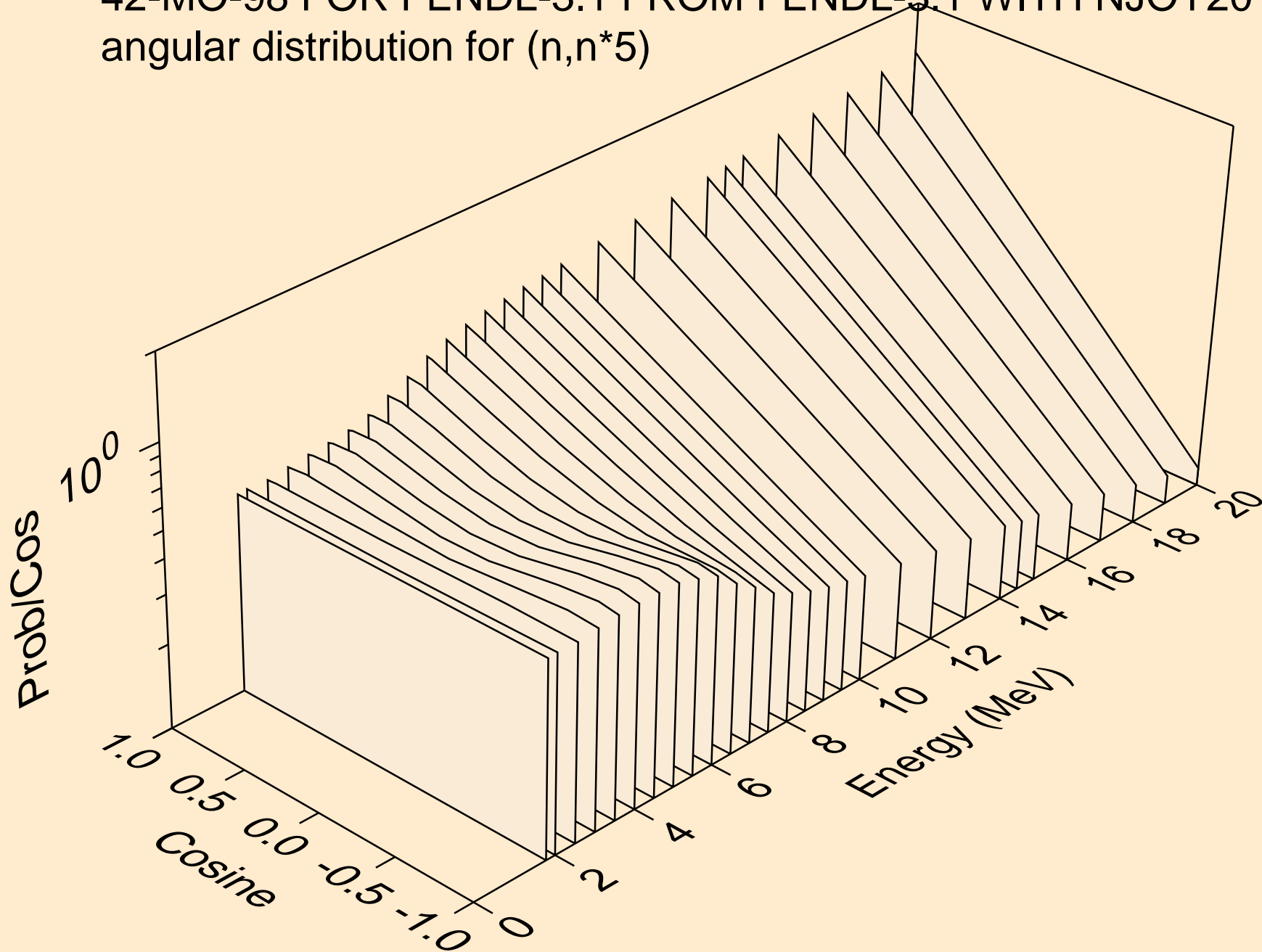

42-MO-98 FOR FENDL-3.1 FROM FENDL-3.1 WITH NJOY2012.50-
angular distribution for (n,n*6)

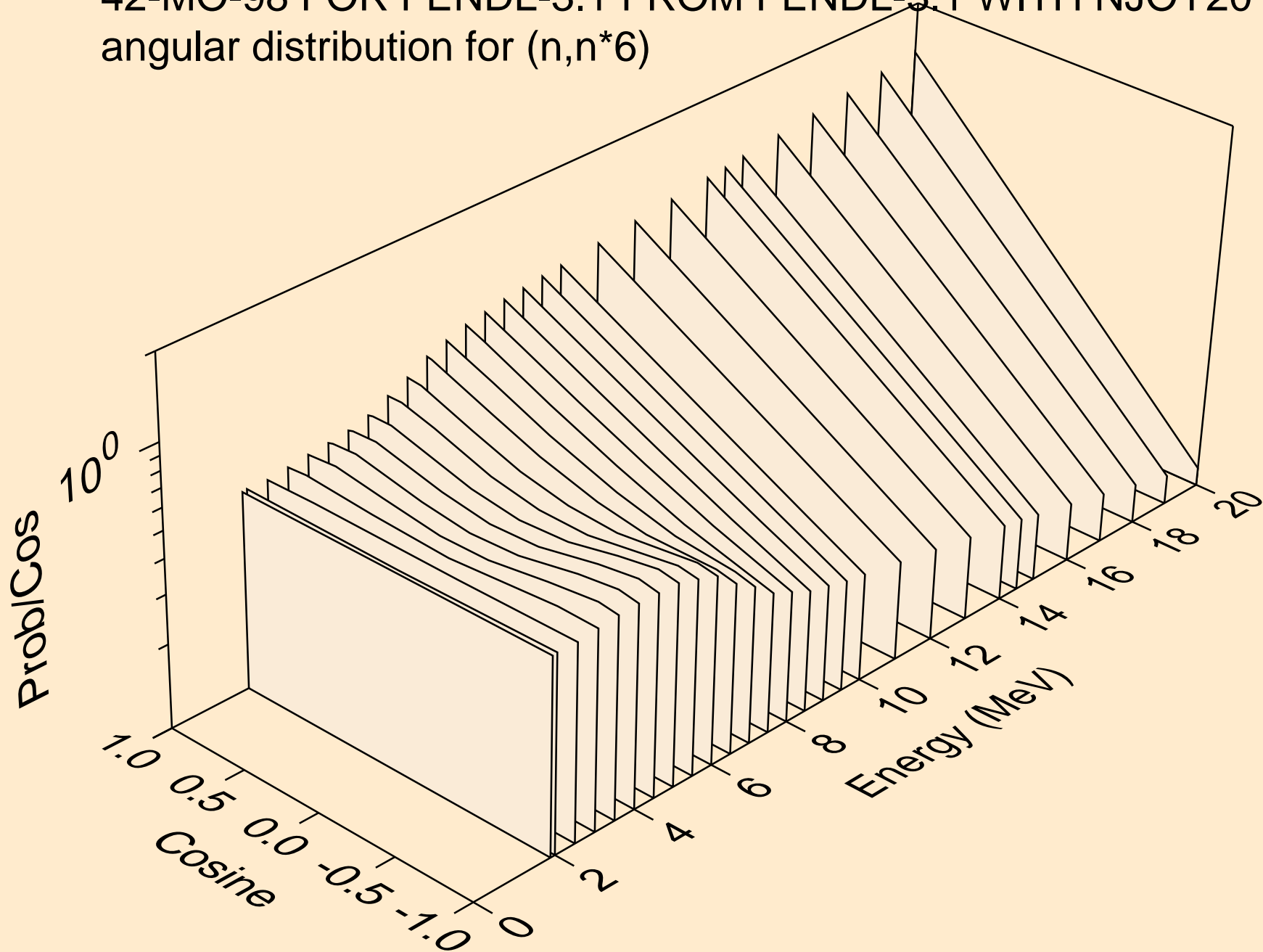

42-MO-98 FOR FENDL-3.1 FROM FENDL-3.1 WITH NJOY2012.50-
angular distribution for (n,n*7)

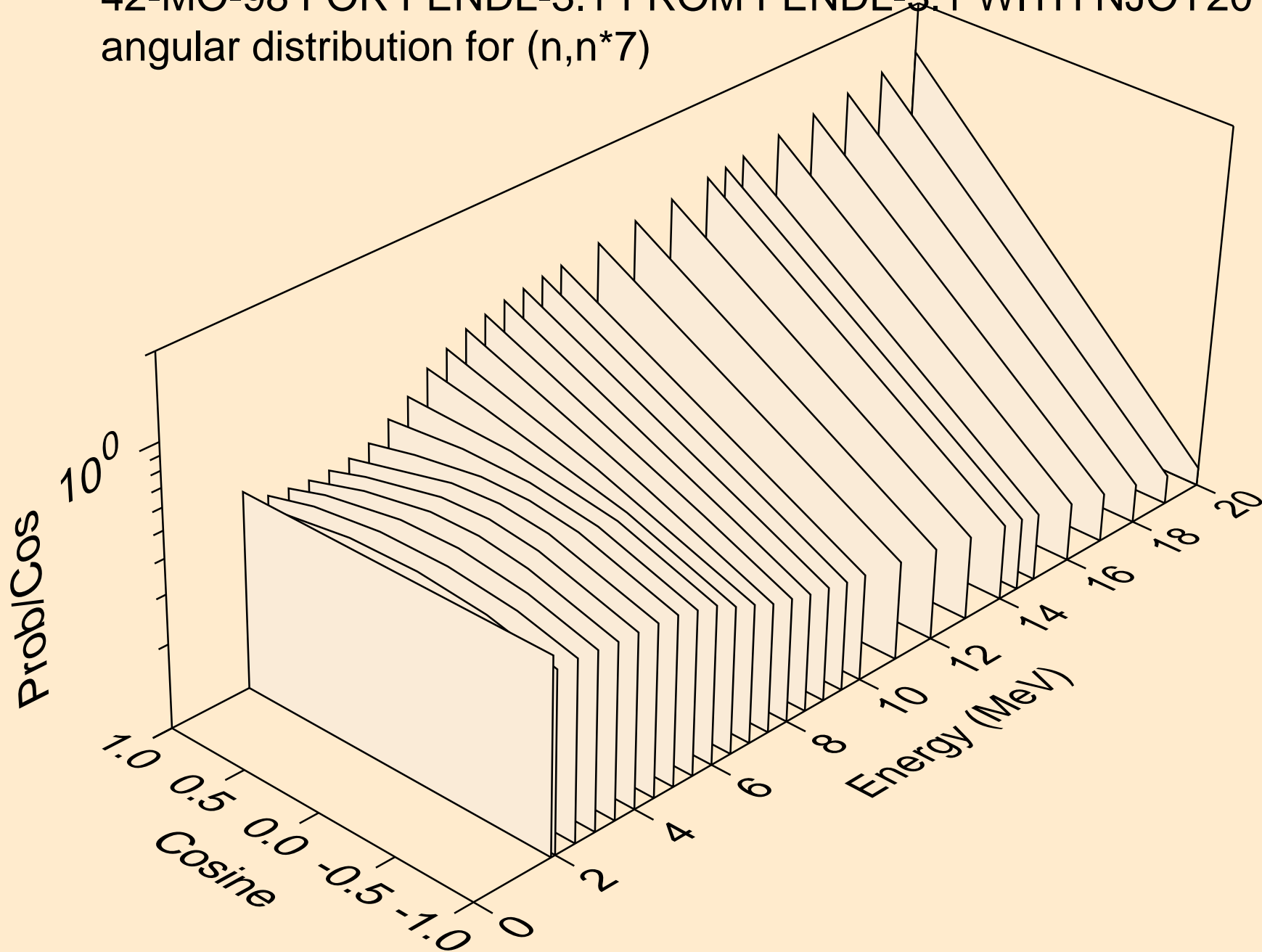

42-MO-98 FOR FENDL-3.1 FROM FENDL-3.1 WITH NJOY2012.50-
angular distribution for (n,n*8)

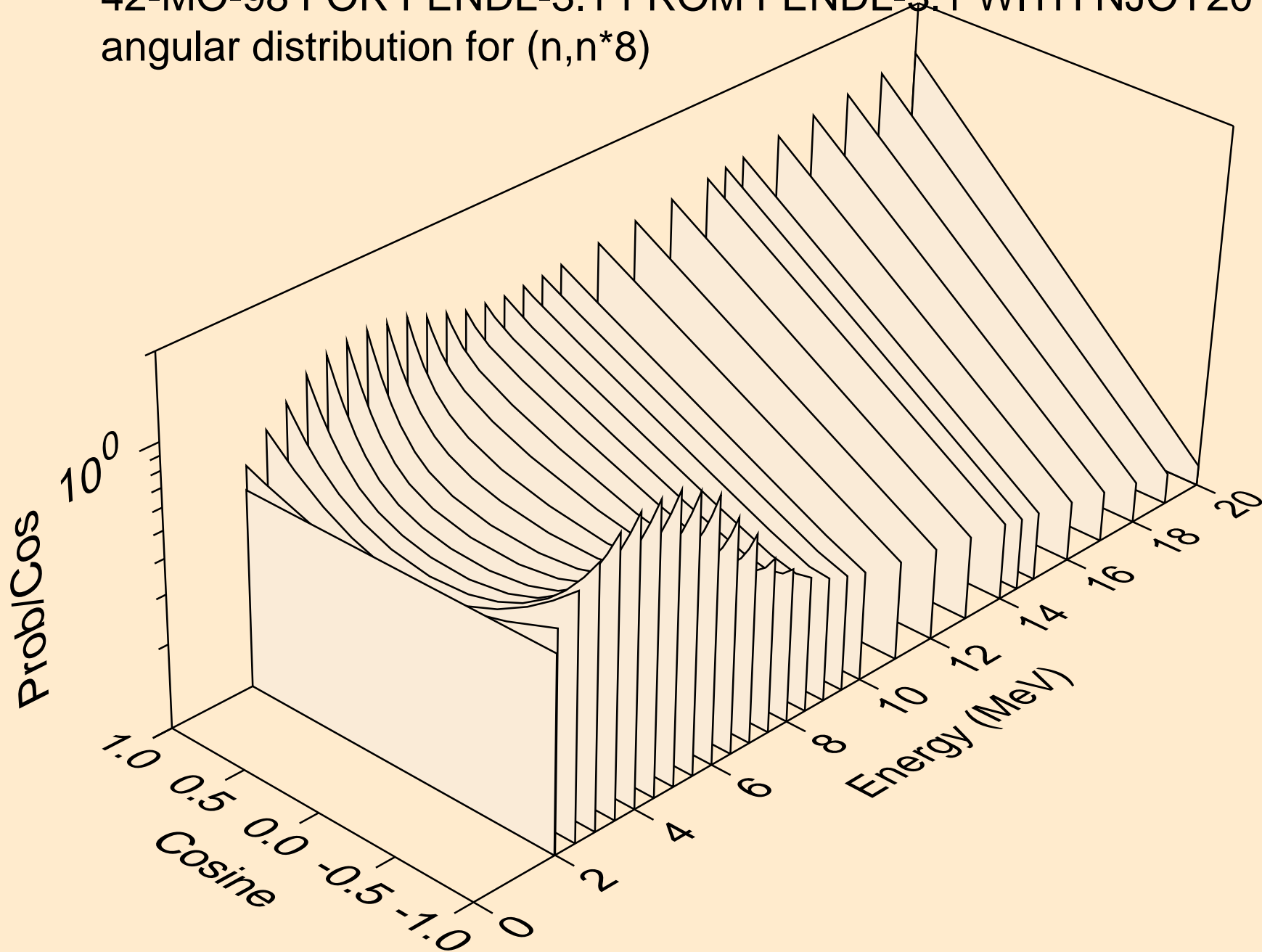

42-MO-98 FOR FENDL-3.1 FROM FENDL-3.1 WITH NJOY2012.50-
angular distribution for (n,n*9)

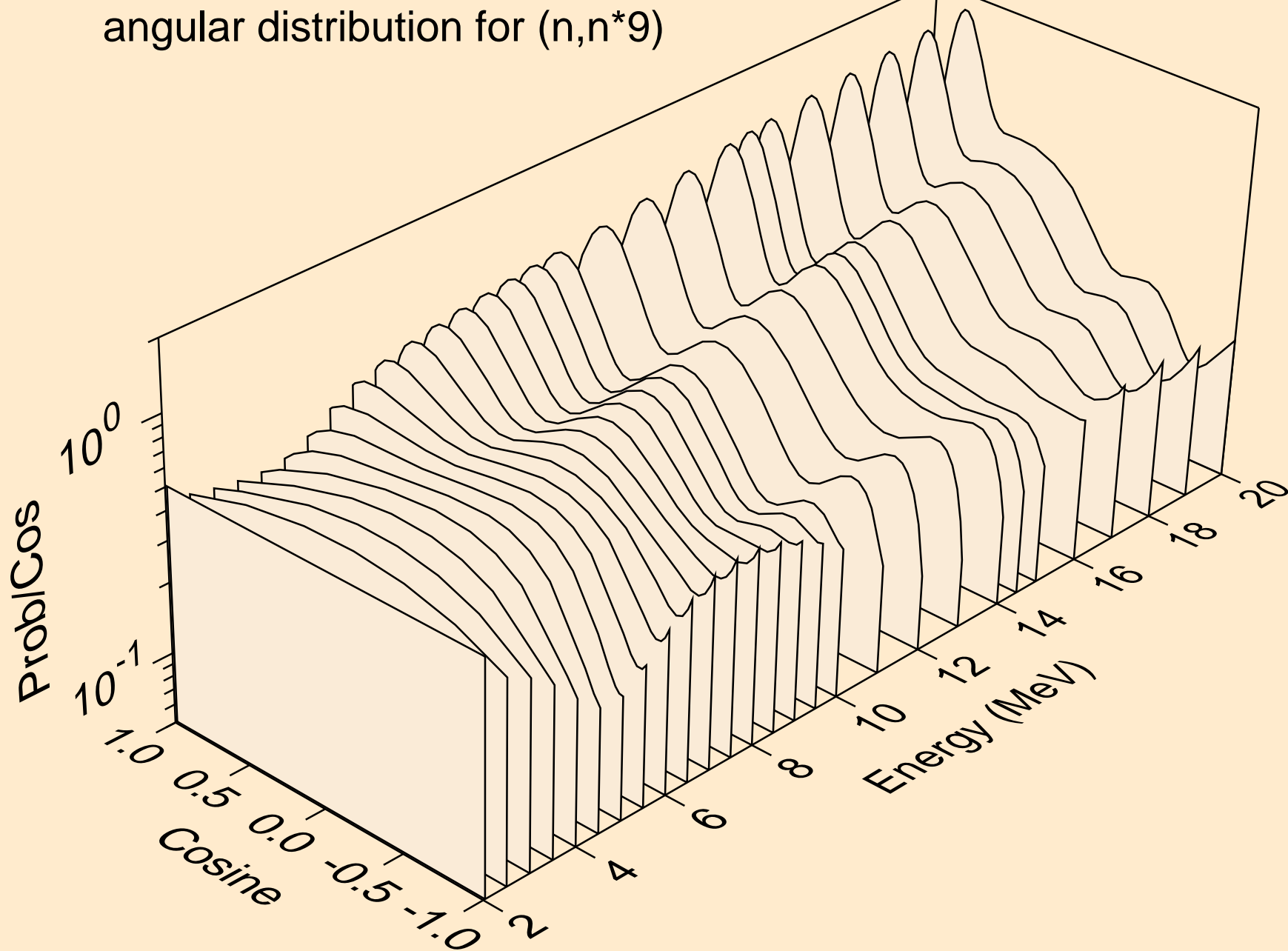

42-MO-98 FOR FENDL-3.1 FROM FENDL-3.1 WITH NJOY2012.50-
angular distribution for (n,n*10)

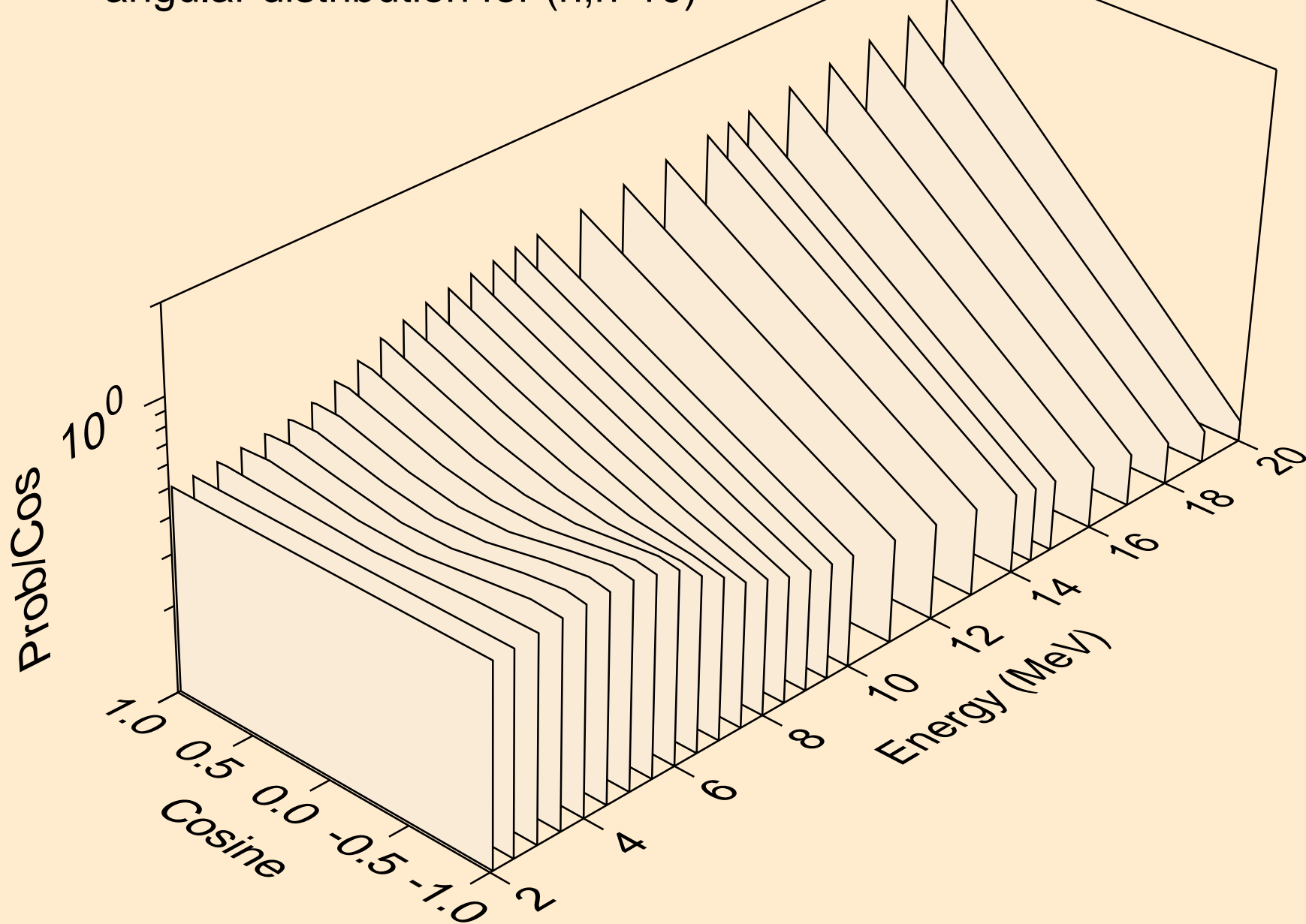

42-MO-98 FOR FENDL-3.1 FROM FENDL-3.1 WITH NJOY2012.50-
angular distribution for (n,n*11)

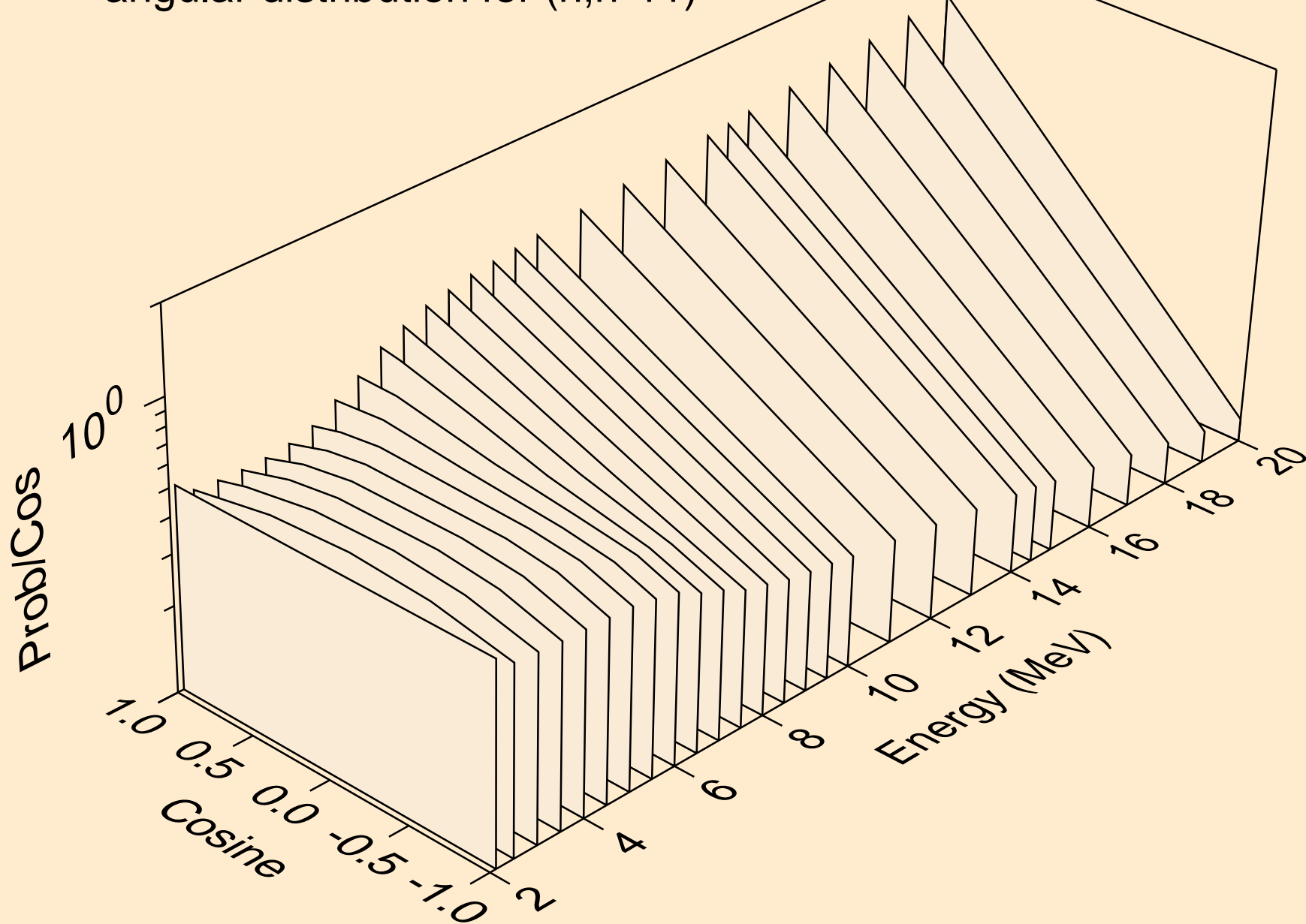

42-MO-98 FOR FENDL-3.1 FROM FENDL-3.1 WITH NJOY2012.50-
angular distribution for (n,n*12)

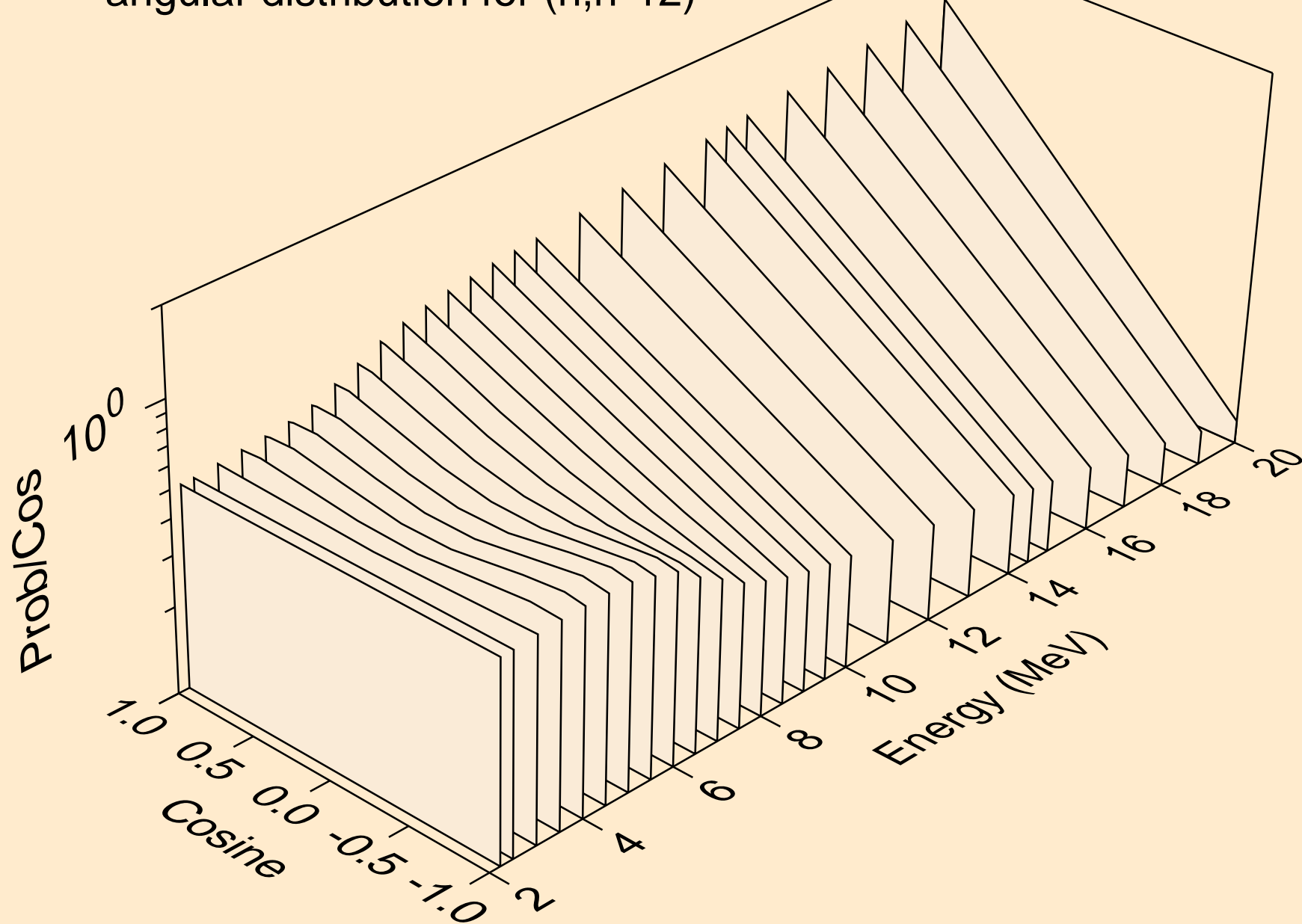

42-MO-98 FOR FENDL-3.1 FROM FENDL-3.1 WITH NJOY2012.50-
angular distribution for (n,n*13)

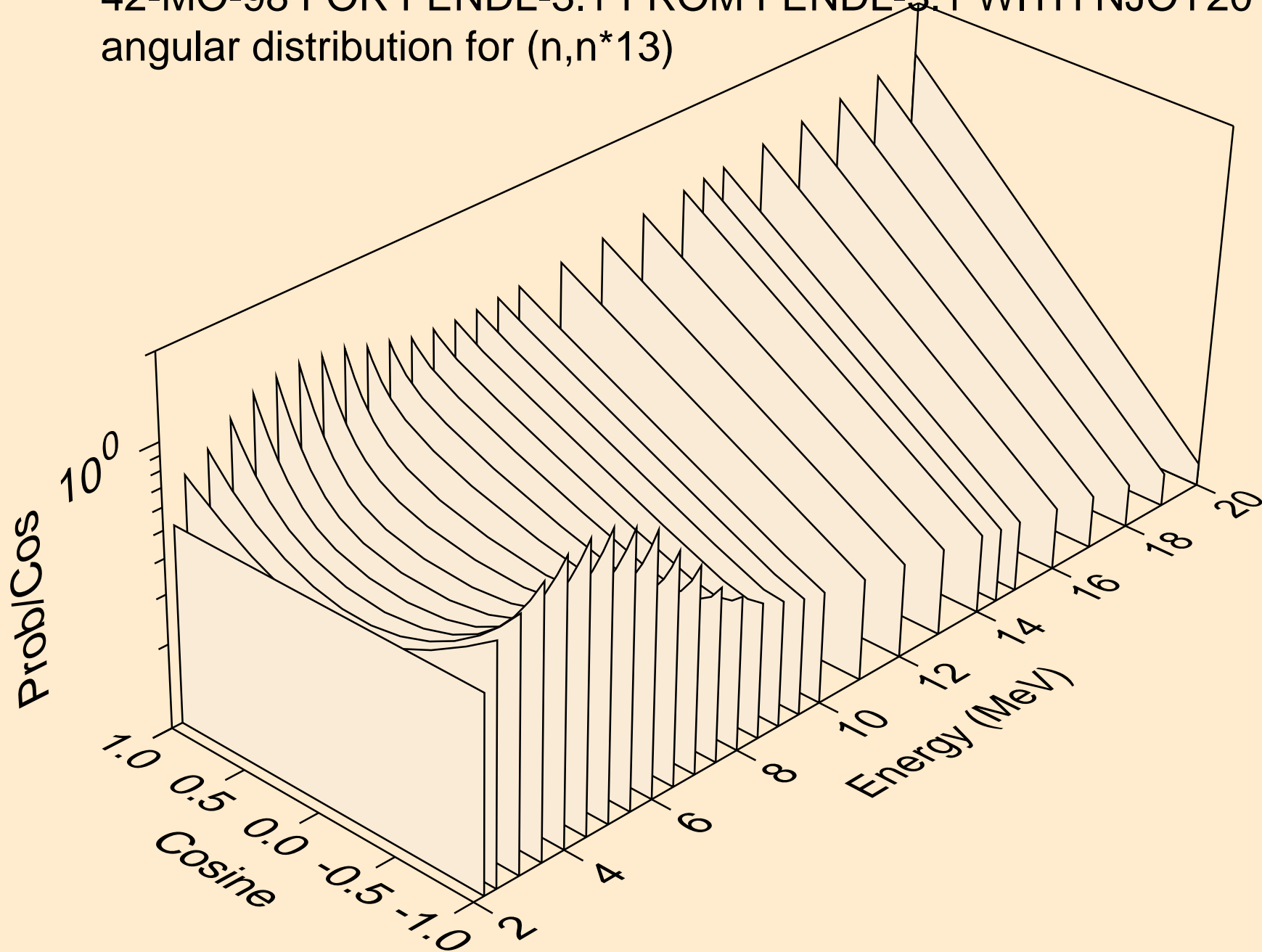

42-MO-98 FOR FENDL-3.1 FROM FENDL-3.1 WITH NJOY2012.50-
angular distribution for (n,n*14)

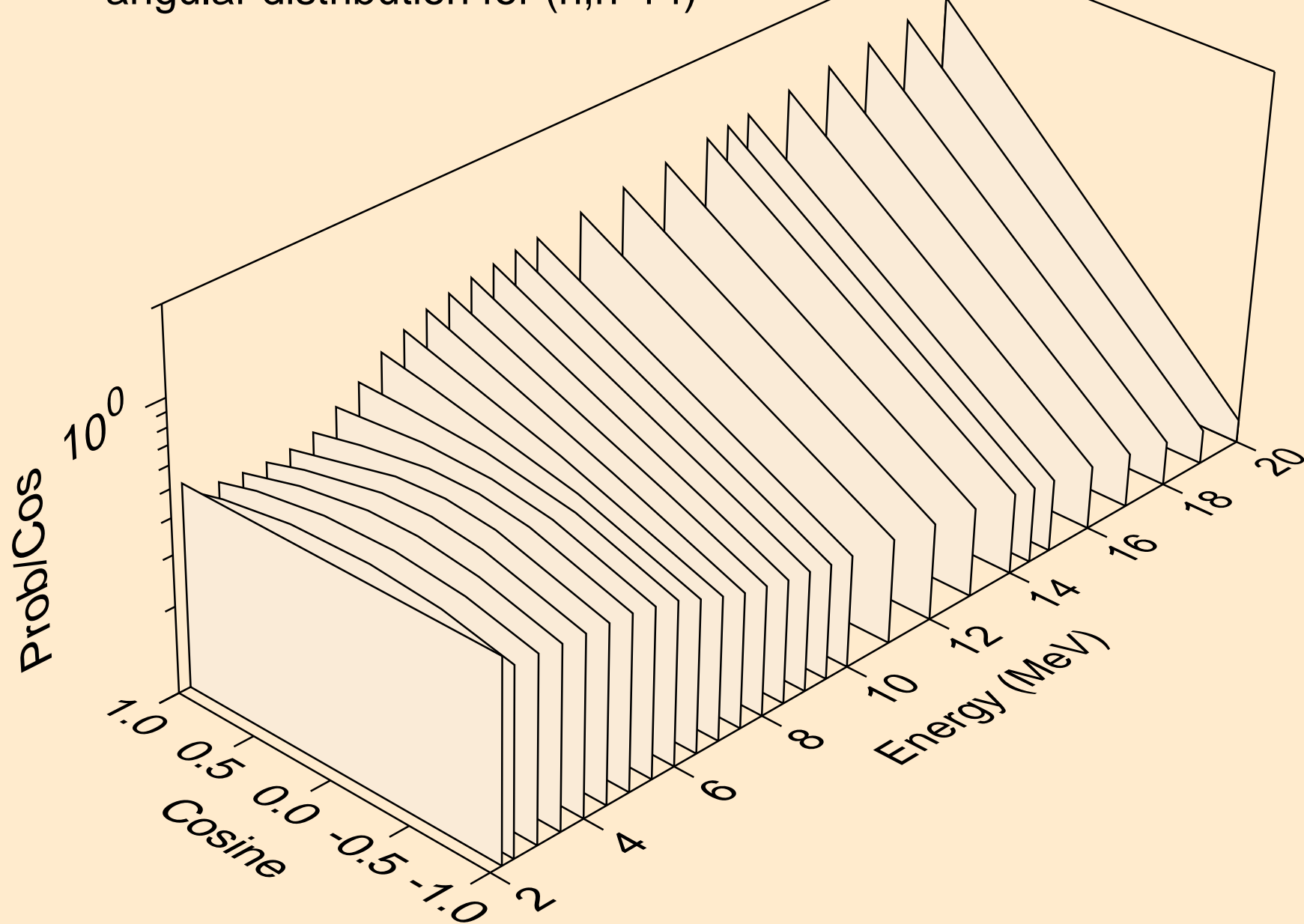

42-MO-98 FOR FENDL-3.1 FROM FENDL-3.1 WITH NJOY2012.50-
angular distribution for (n,n*15)

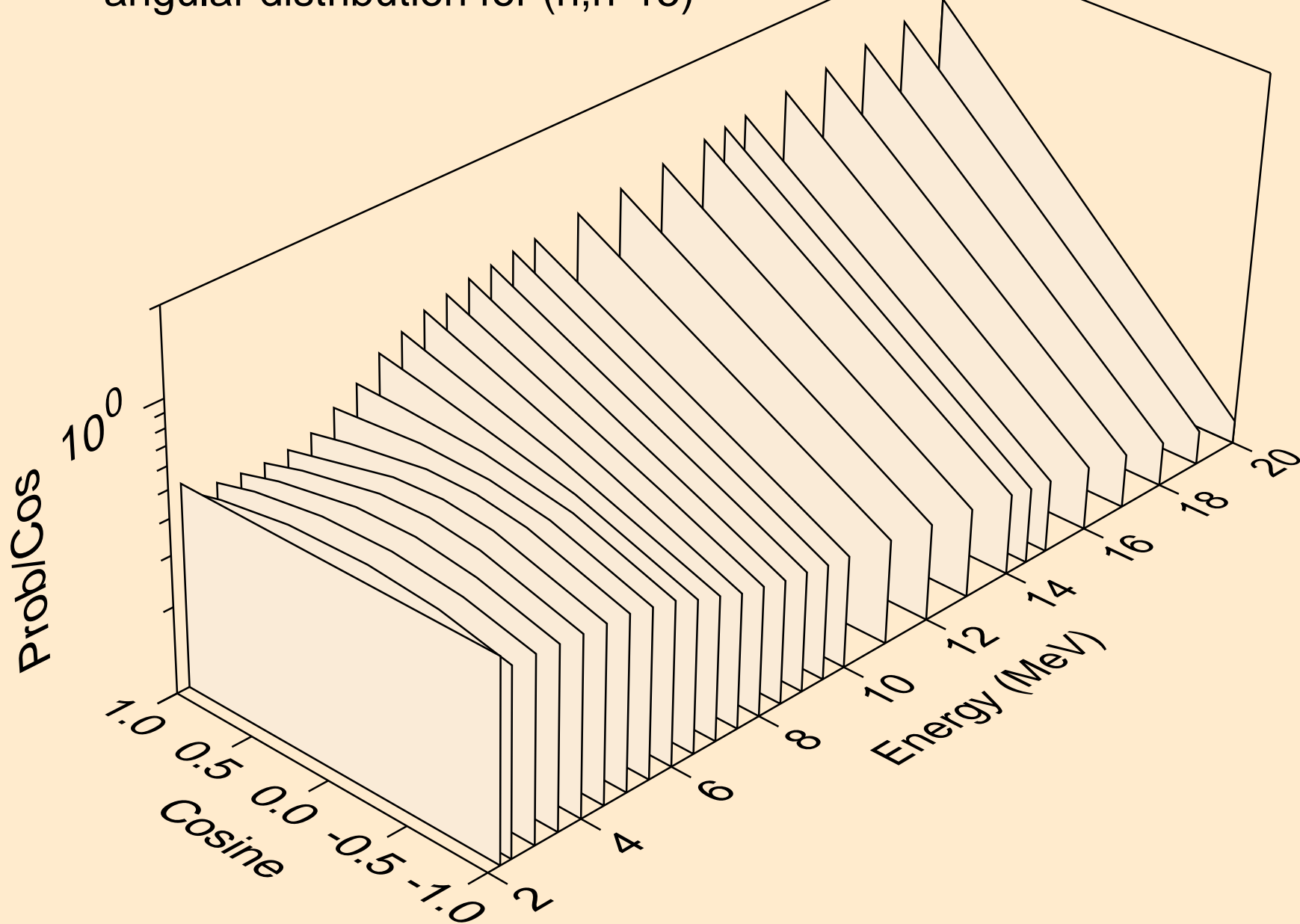

42-MO-98 FOR FENDL-3.1 FROM FENDL-3.1 WITH NJOY2012.50-
angular distribution for (n,n*16)

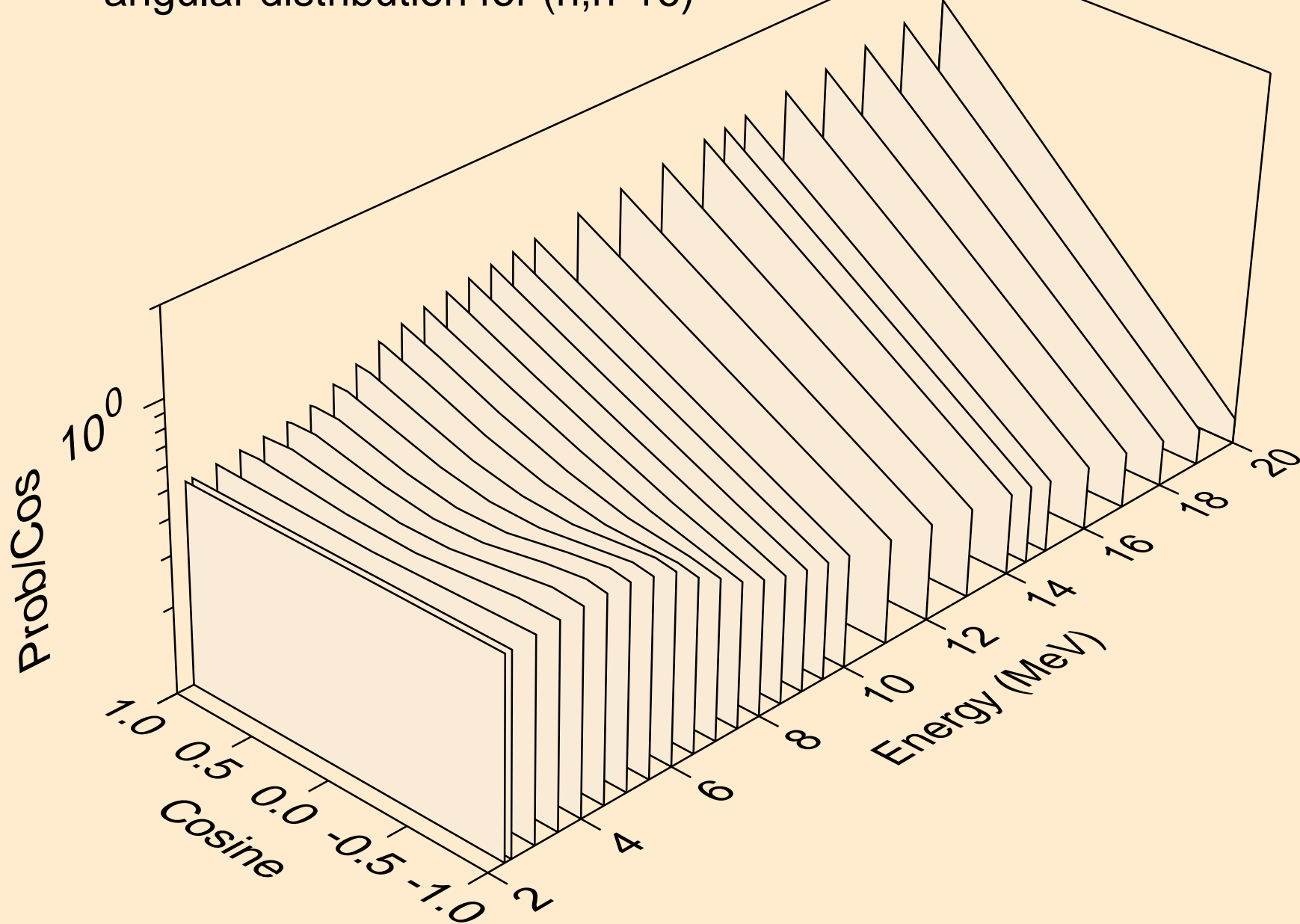

42-MO-98 FOR FENDL-3.1 FROM FENDL-3.1 WITH NJOY2012.50-
angular distribution for (n,n*17)

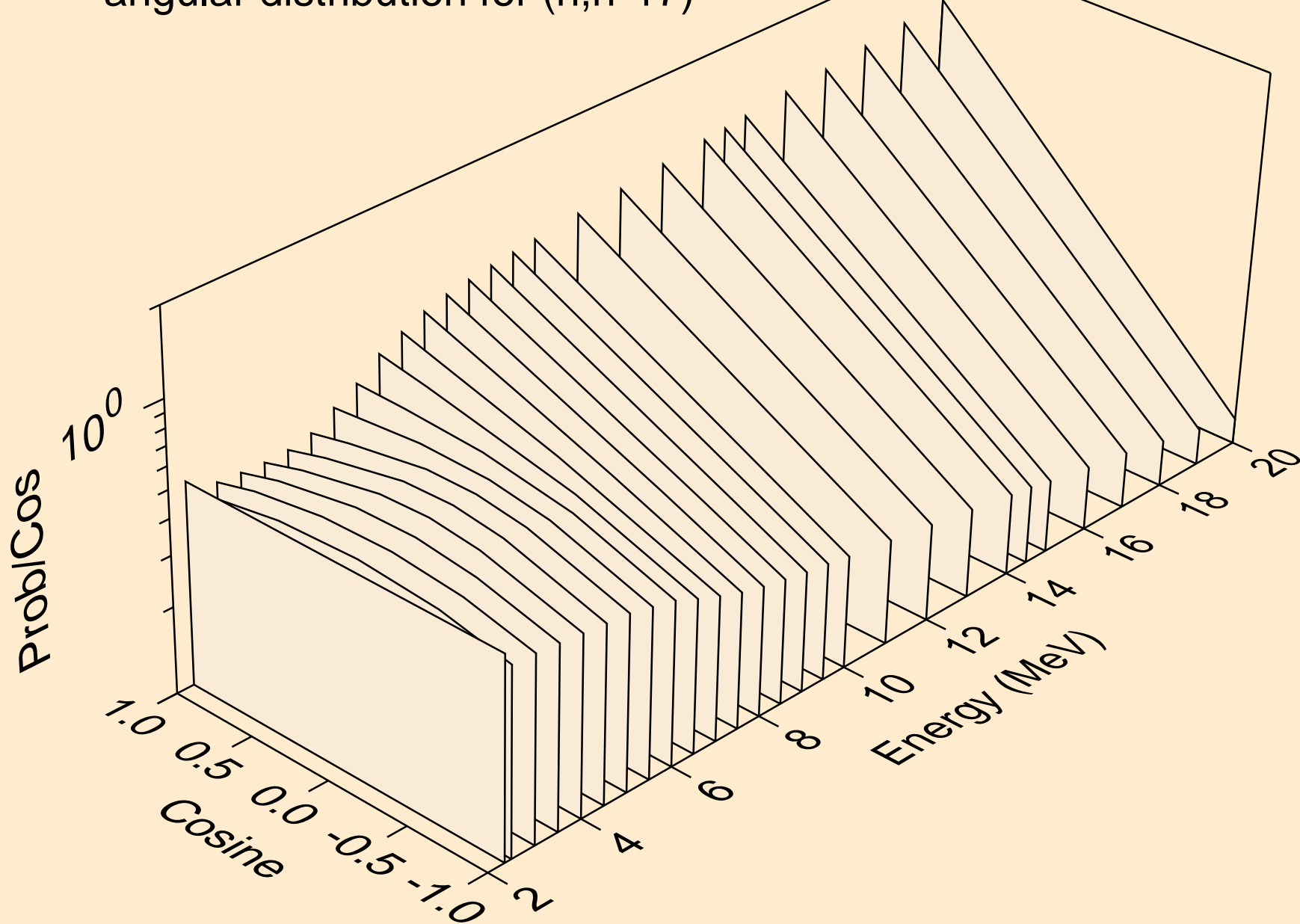

42-MO-98 FOR FENDL-3.1 FROM FENDL-3.1 WITH NJOY2012.50-
angular distribution for (n,n*18)

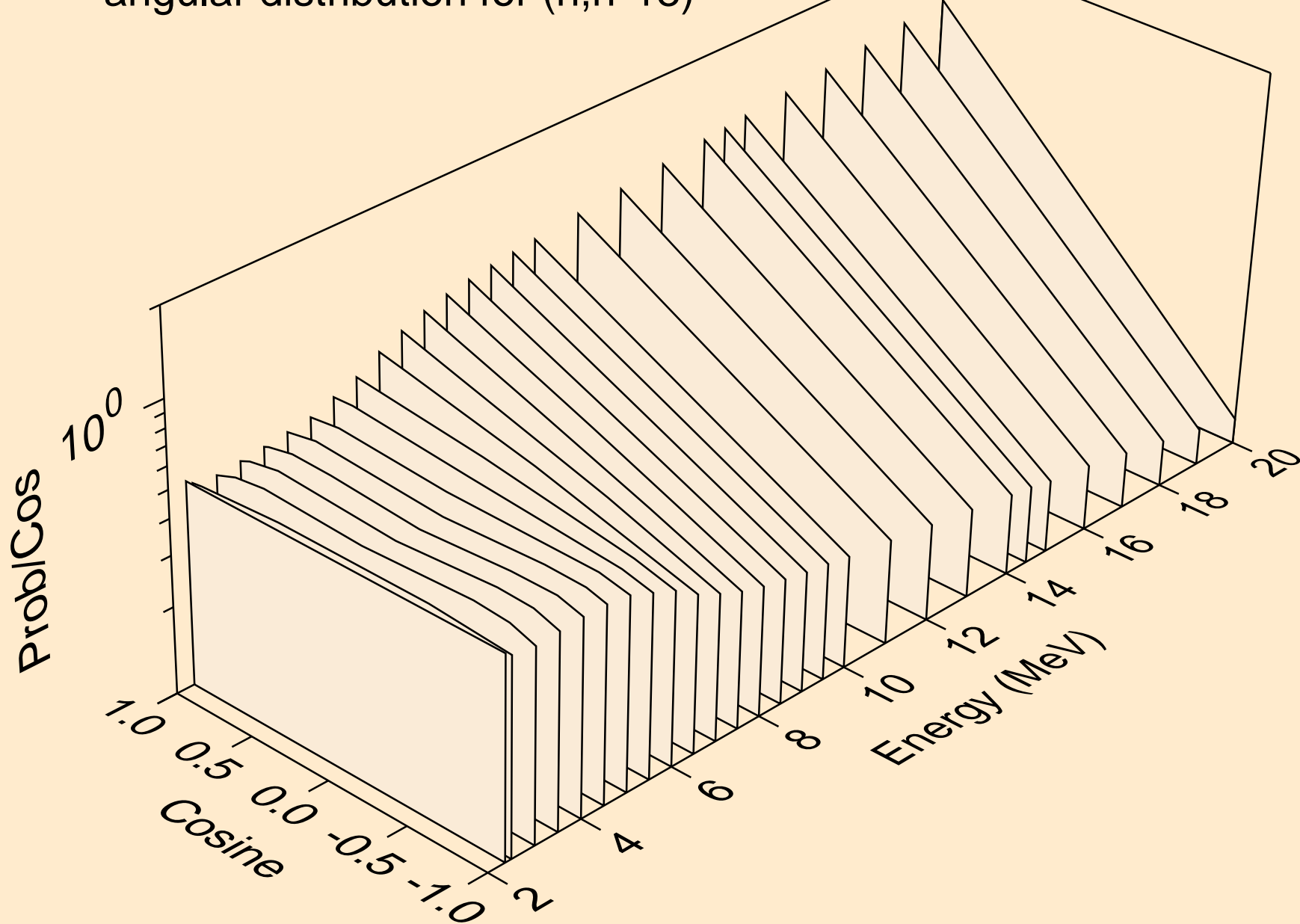

42-MO-98 FOR FENDL-3.1 FROM FENDL-3.1 WITH NJOY2012.50-
angular distribution for (n,n*19)

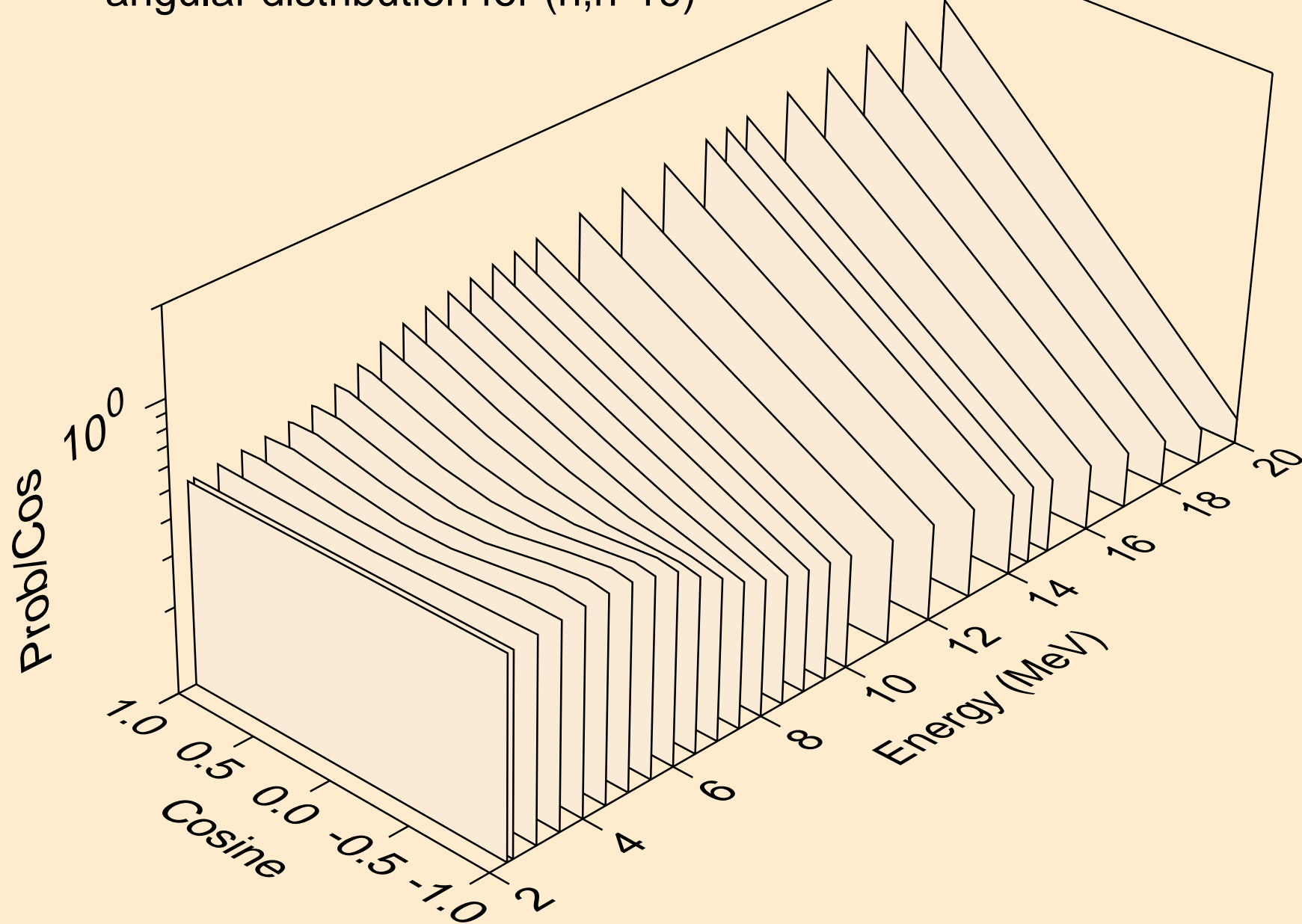

42-MO-98 FOR FENDL-3.1 FROM FENDL-3.1 WITH NJOY2012.50-
Neutron emission for (n,x)

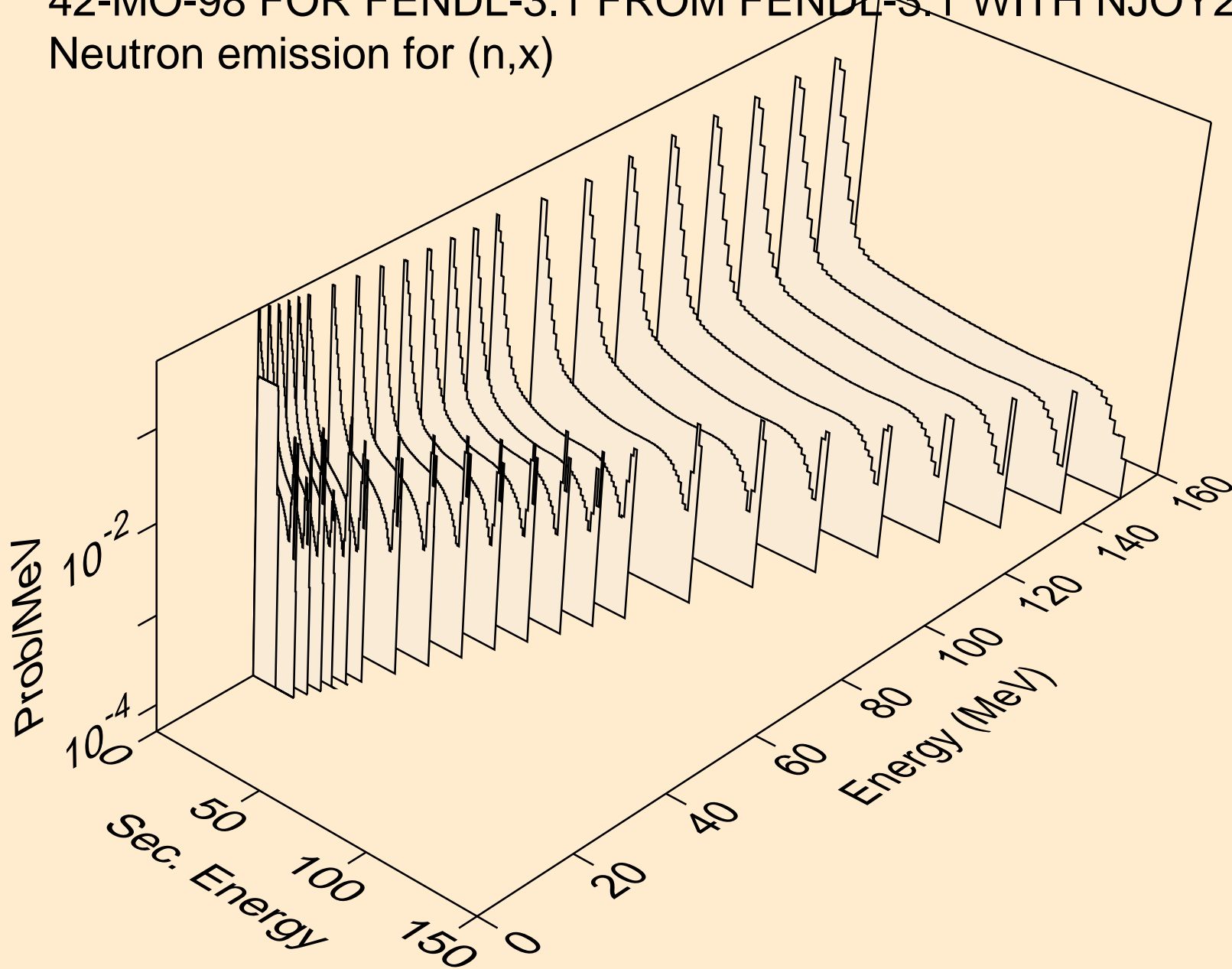

42-MO-98 FOR FENDL-3.1 FROM FENDL-3.1 WITH NJOY2012.50-
Neutron emission for (n,2n)

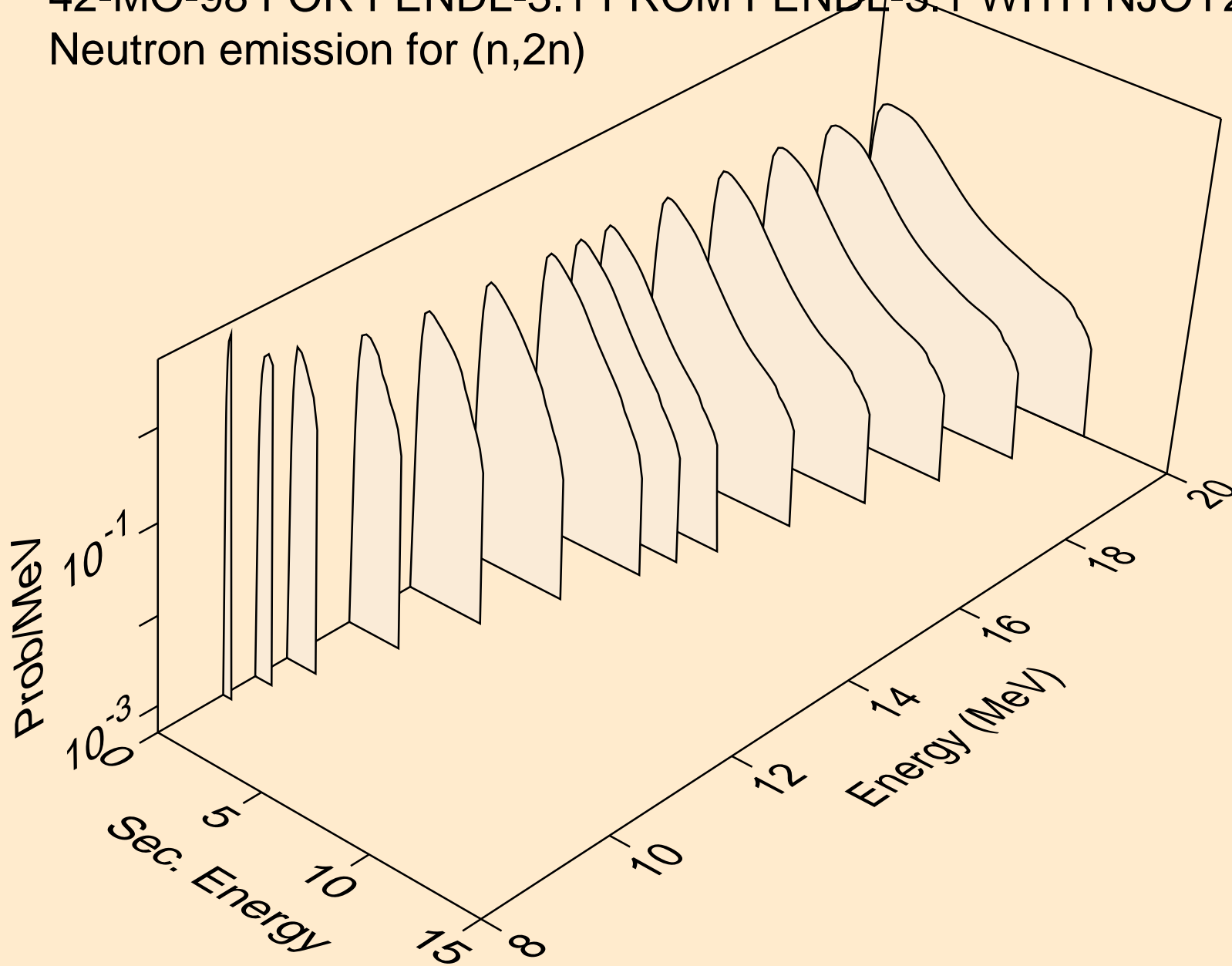

42-MO-98 FOR FENDL-3.1 FROM FENDL-3.1 WITH NJOY2012.50-
Neutron emission for (n,3n)

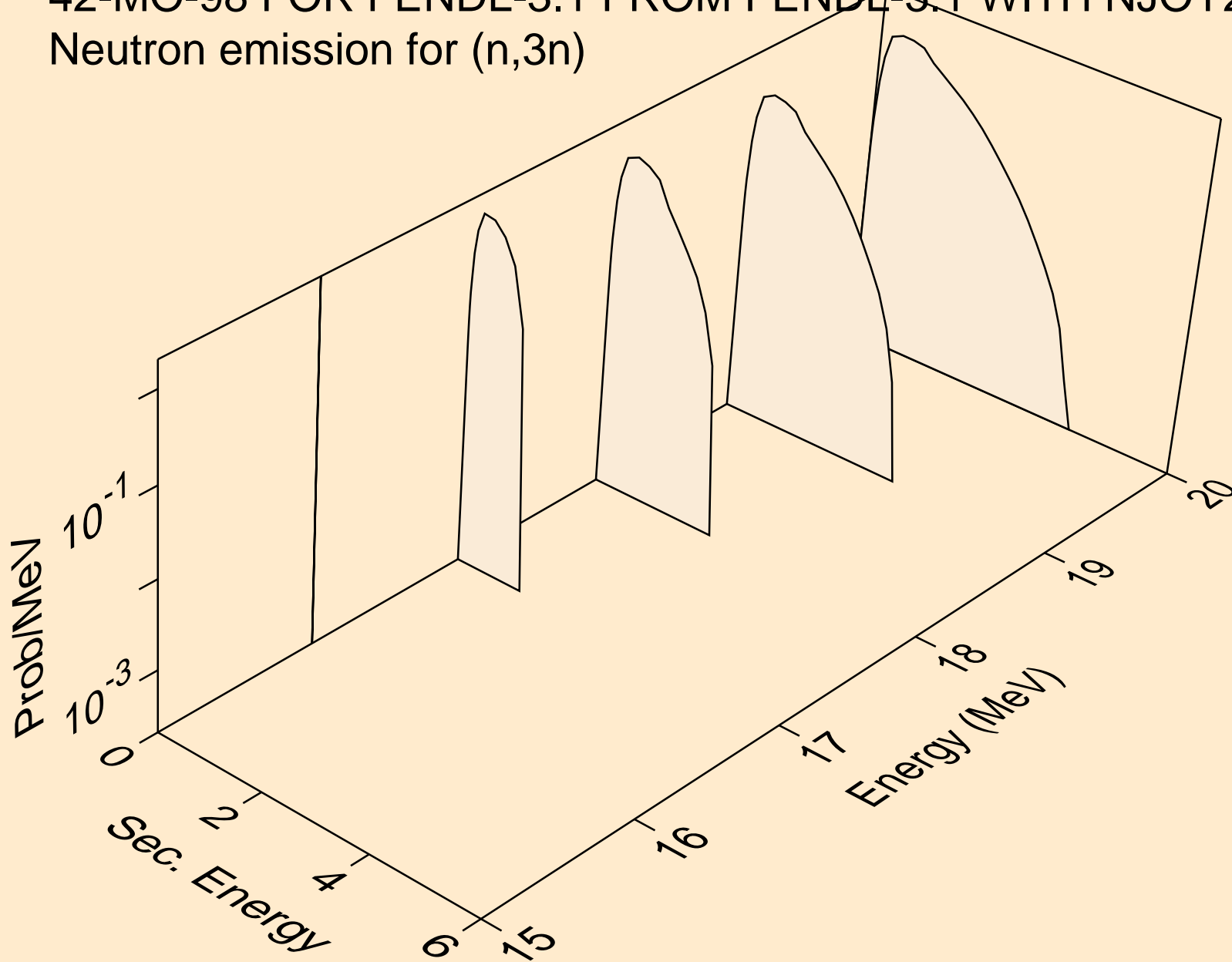

42-MO-98 FOR FENDL-3.1 FROM FENDL-3.1 WITH NJOY2012.50-
Neutron emission for (n,n*)a

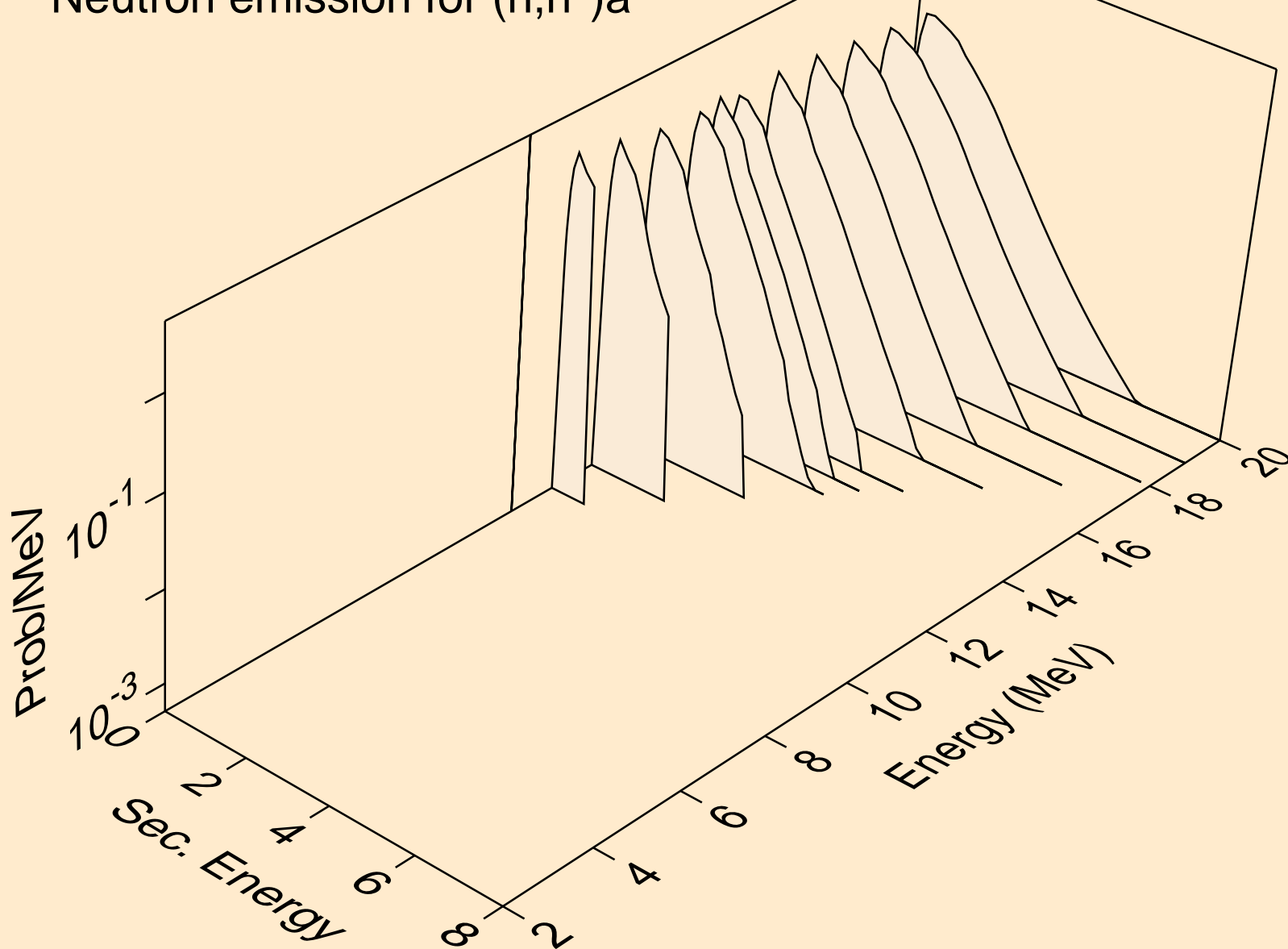

42-MO-98 FOR FENDL-3.1 FROM FENDL-3.1 WITH NJOY2012.50-
Neutron emission for (n,n*)p

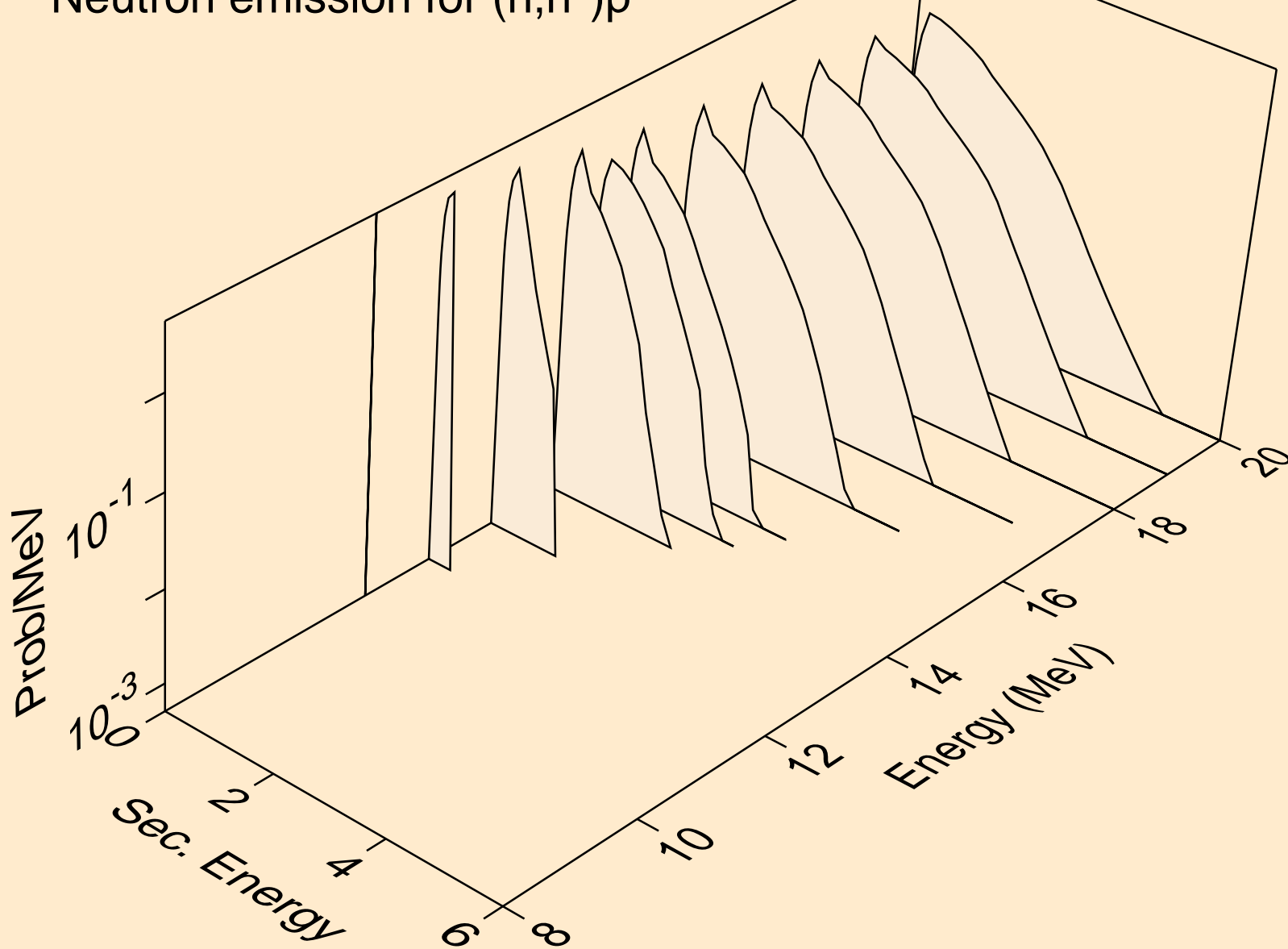

42-MO-98 FOR FENDL-3.1 FROM FENDL-3.1 WITH NJOY2012.50-
Neutron emission for (n,n*)d

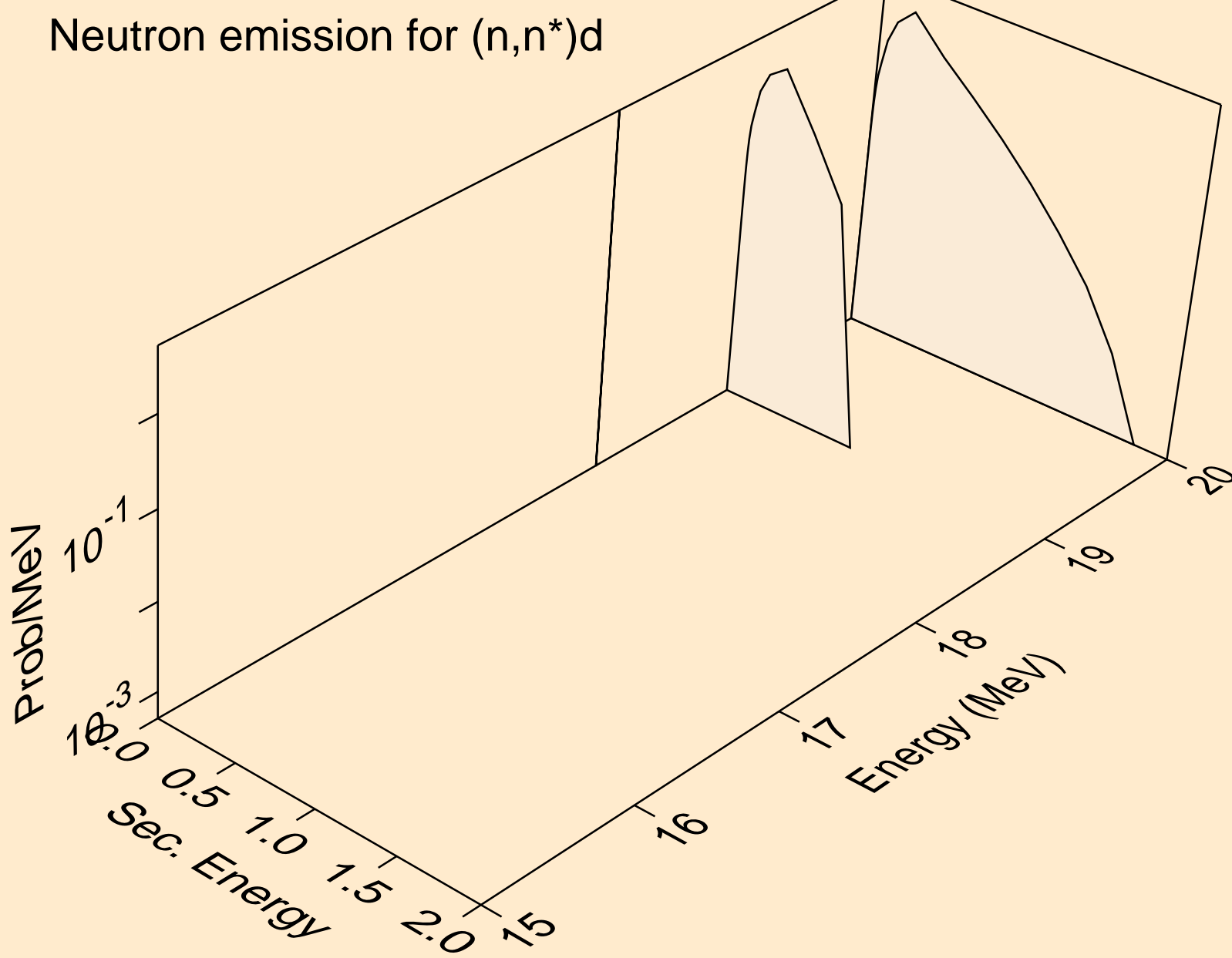

42-MO-98 FOR FENDL-3.1 FROM FENDL-3.1 WITH NJOY2012.50-
Neutron emission for (n,n*c)

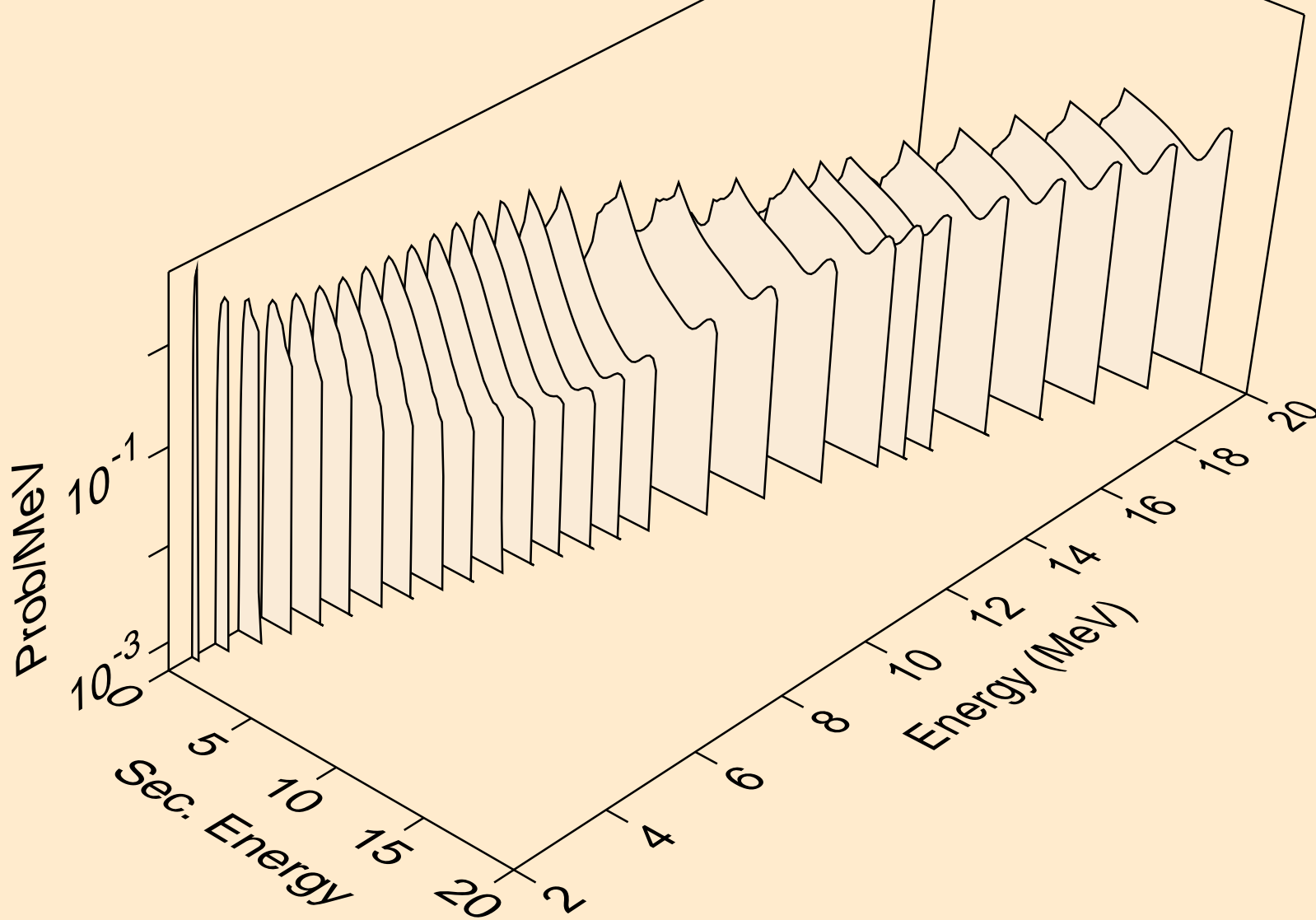

42-MO-98 FOR FENDL-3.1 FROM FENDL-3.1 WITH NJOY2012.50-
Photon emission for nonelastic

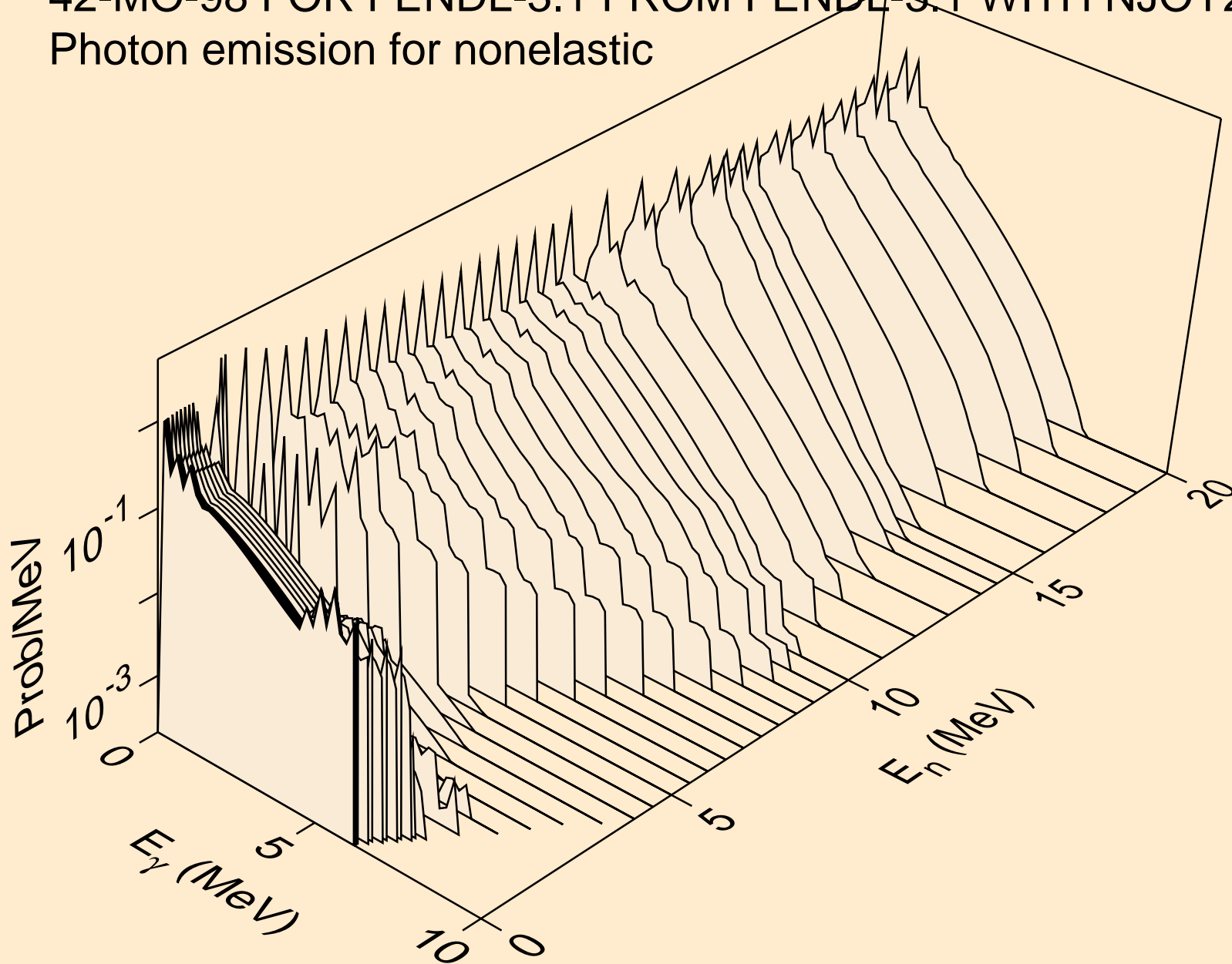

42-MO-98 FOR FENDL-3.1 FROM FENDL-3.1 WITH NJOY2012.50-
Photon emission for (n,x)

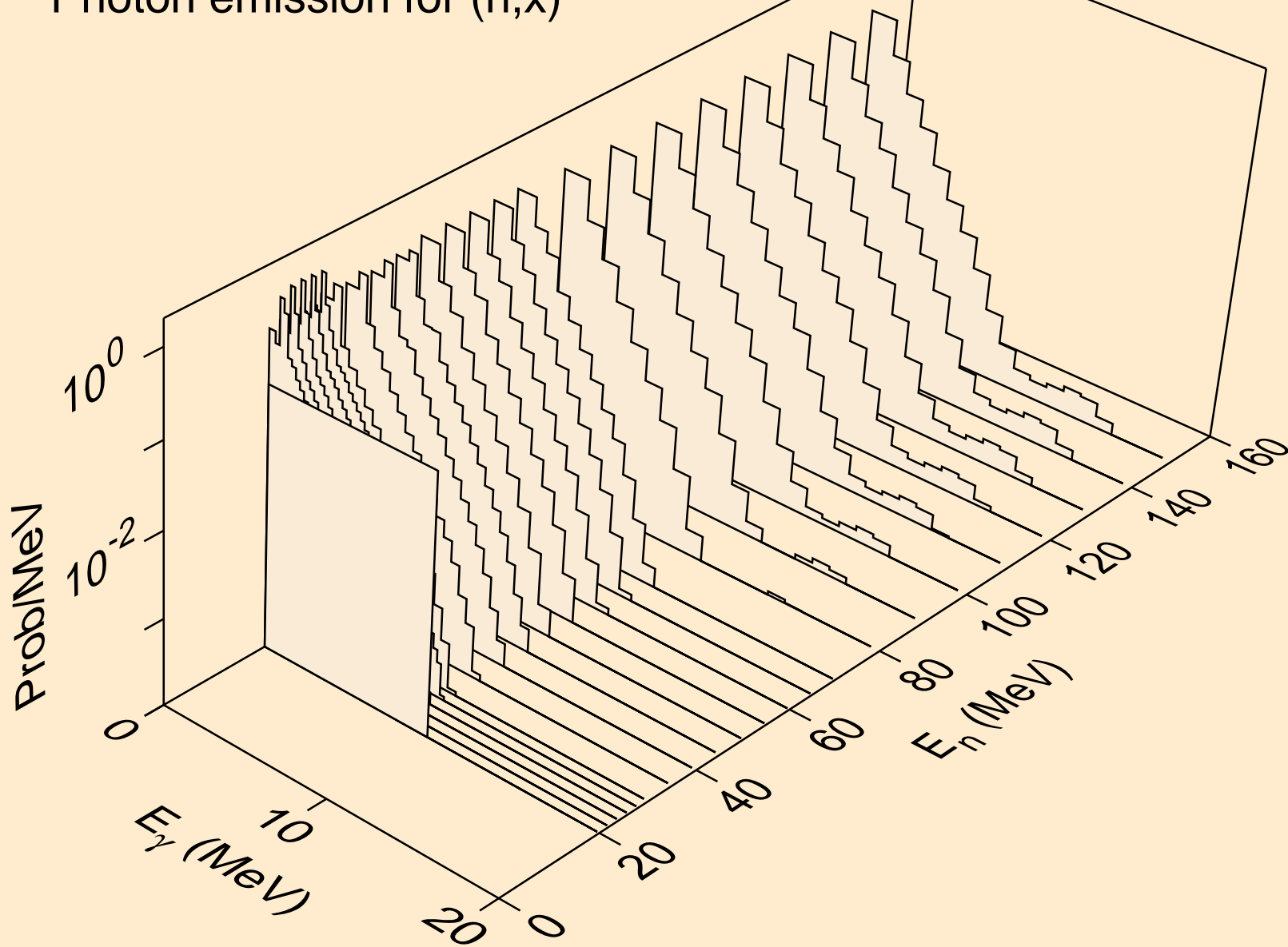

42-MO-98 FOR FENDL-3.1 FROM FENDL-3.1 WITH NJOY2012.50-
14 MeV photon spectrum

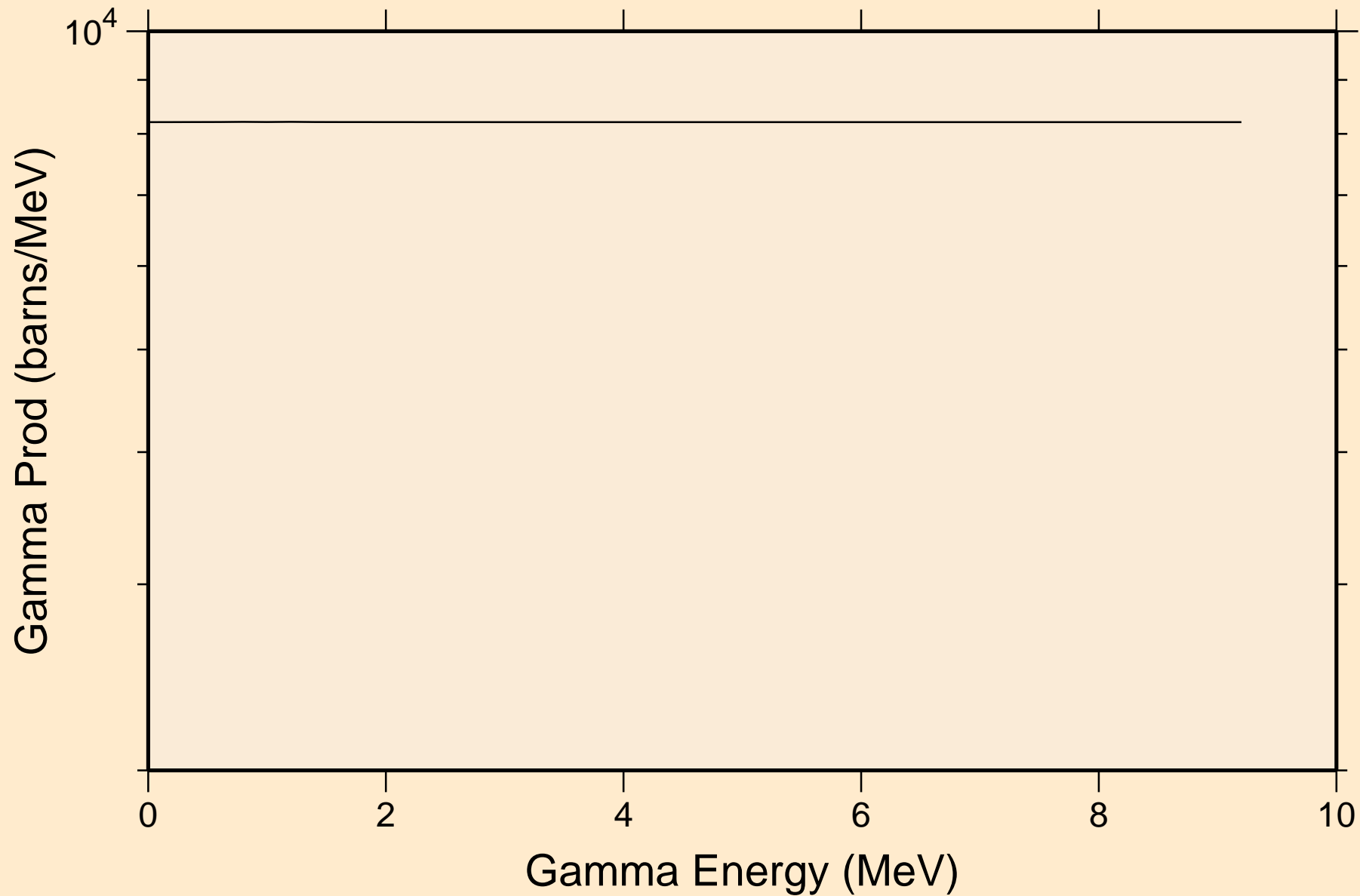

42-MO-98 FOR FENDL-3.1 FROM FENDL-3.1 WITH NJOY2012.50- Particle heating contributions

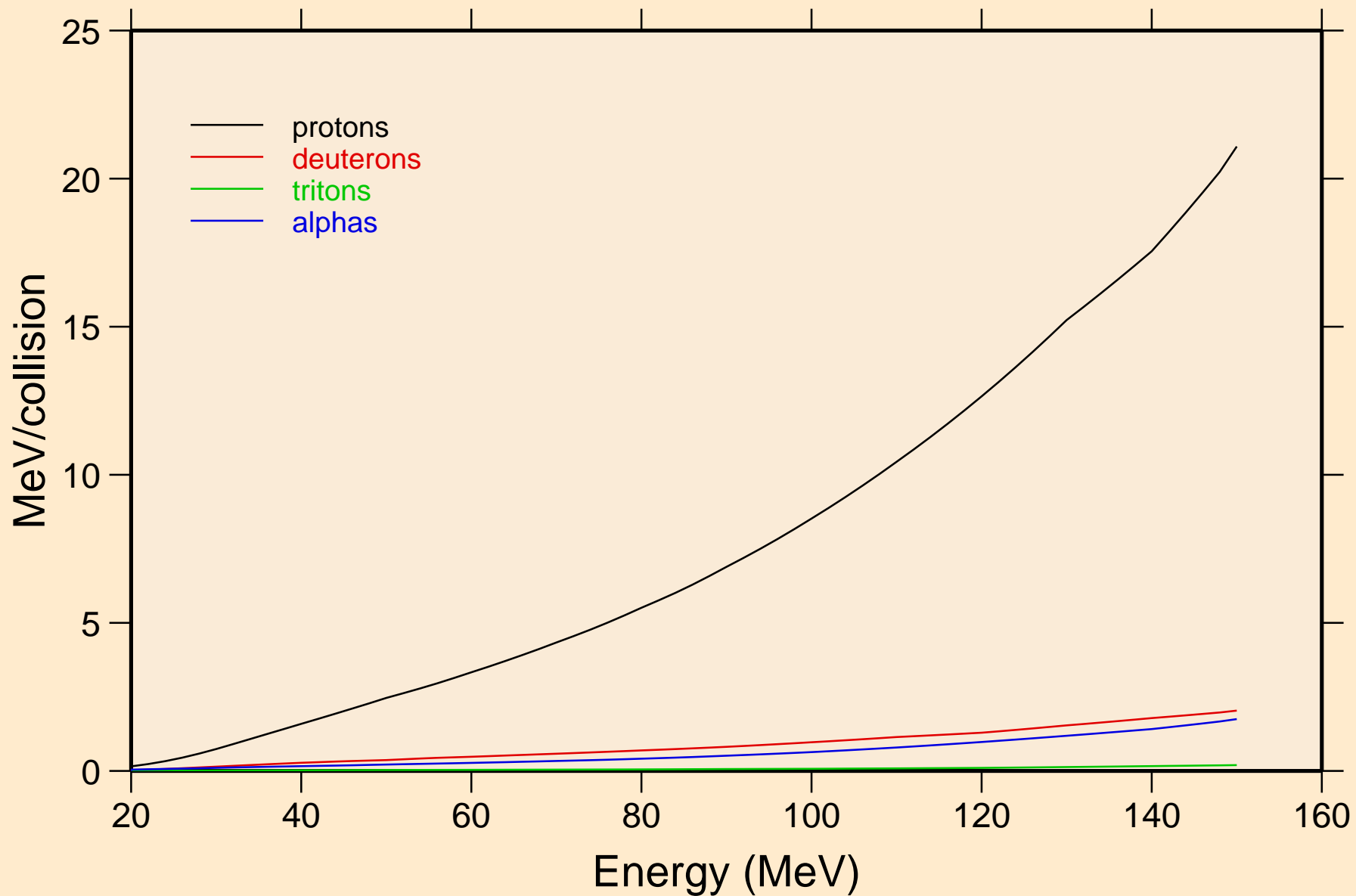

42-MO-98 FOR FENDL-3.1 FROM FENDL-3.1 WITH NJOY2012.50-
Recoil Heating

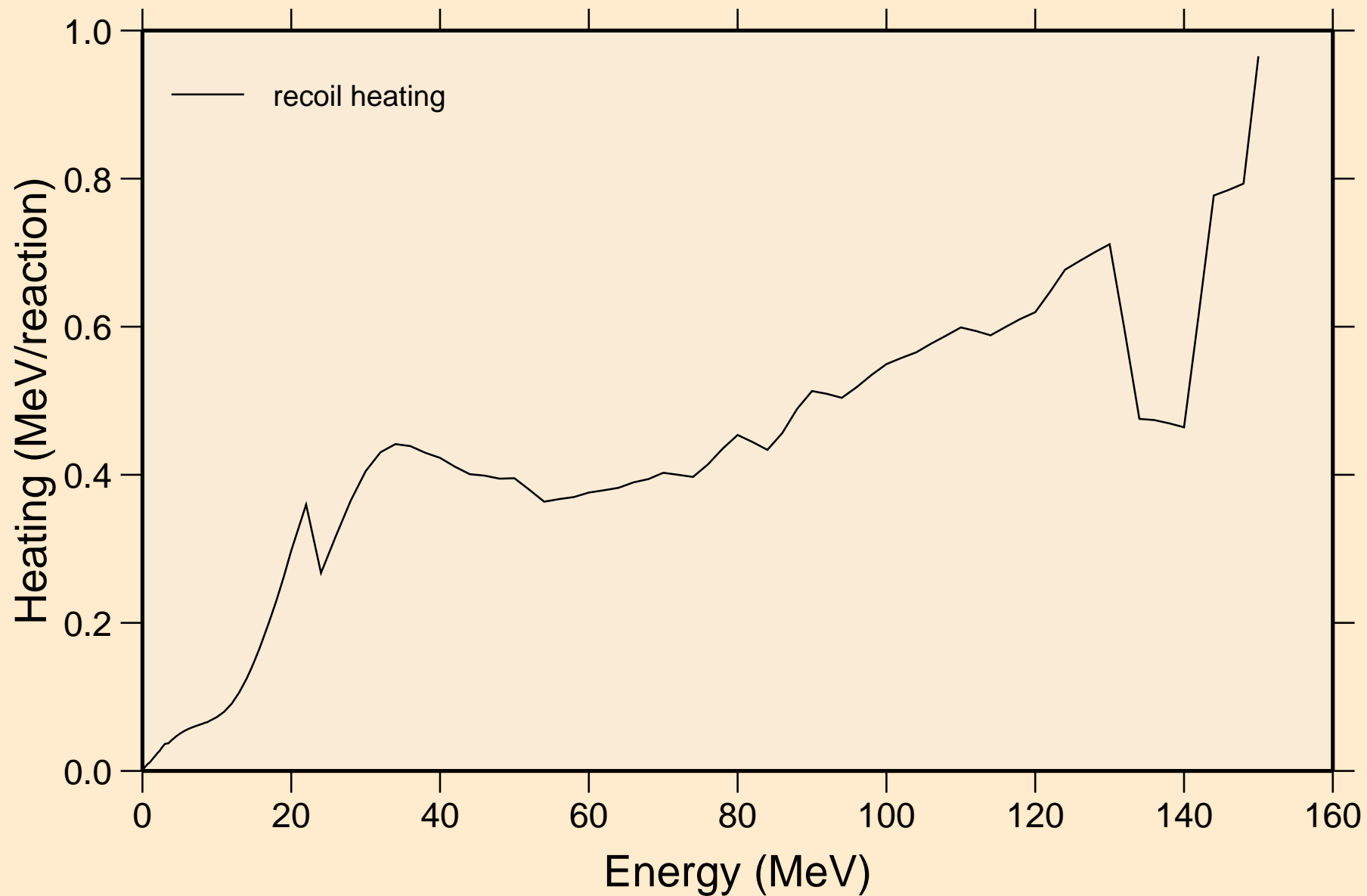

42-MO-98 FOR FENDL-3.1 FROM FENDL-3.1 WITH NJOY2012.50-
Particle production cross sections

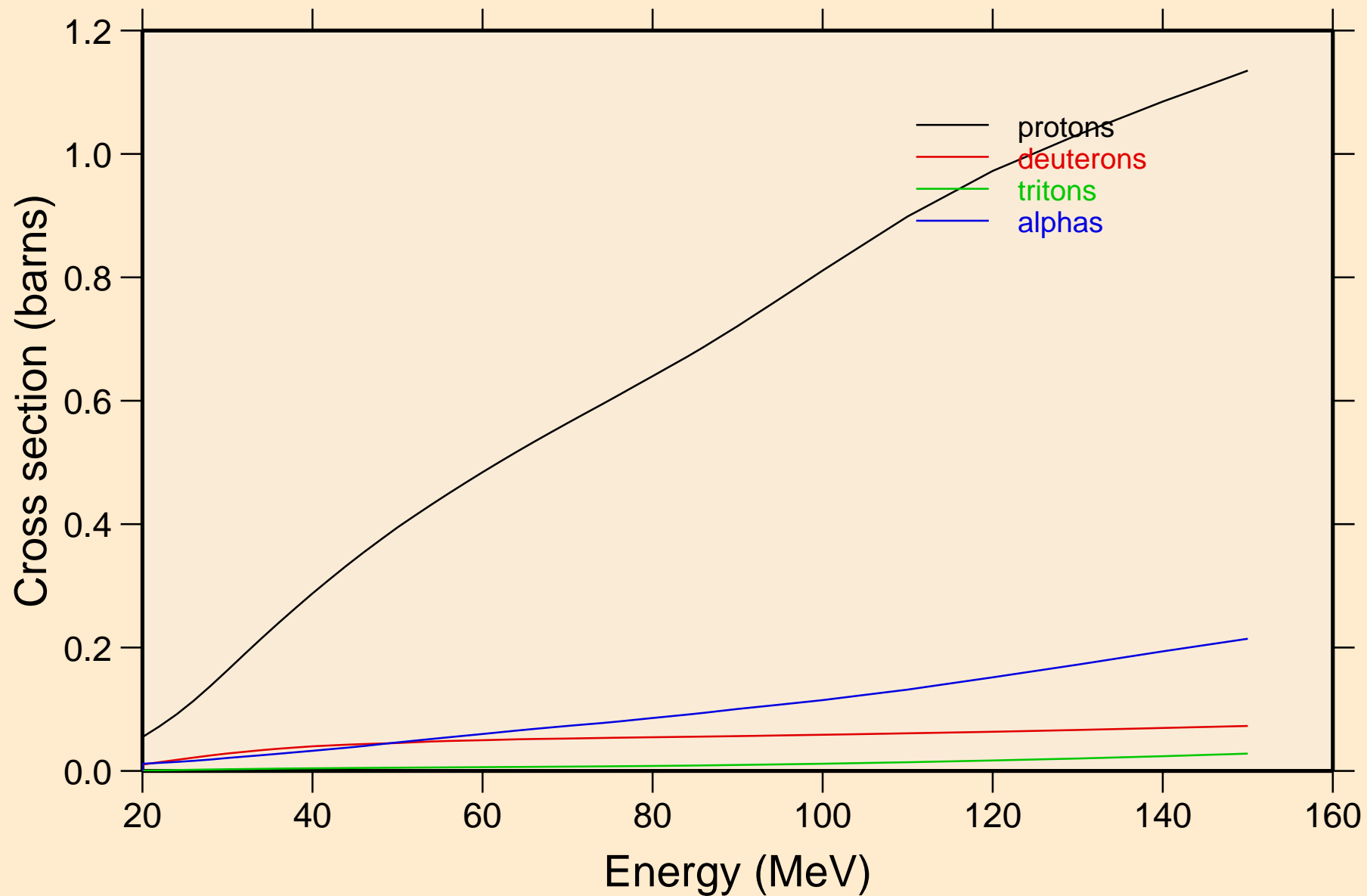

42-MO-98 FOR FENDL-3.1 FROM FENDL-3.1 WITH NJOY2012.50-
protons from (n,x)

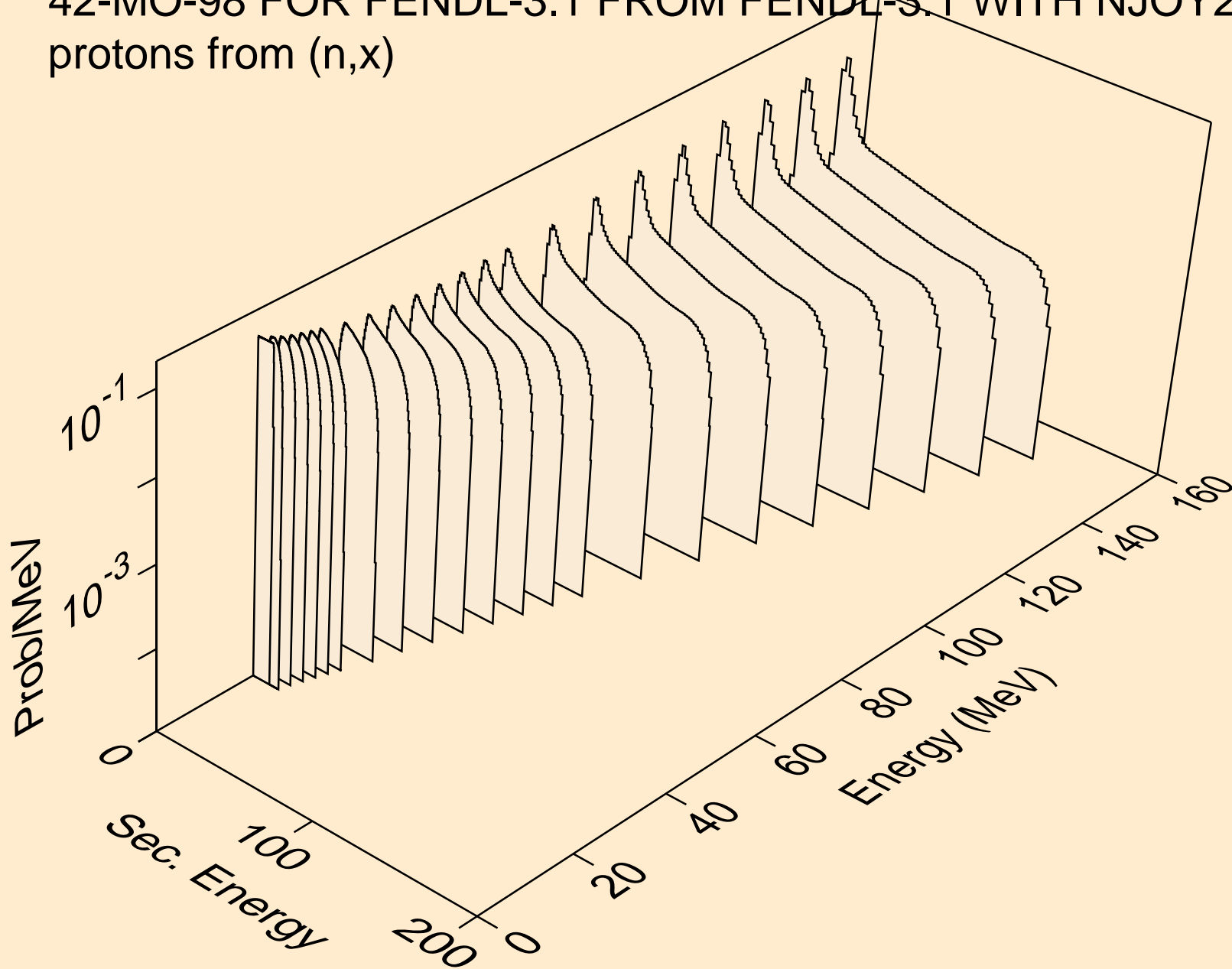

42-MO-98 FOR FENDL-3.1 FROM FENDL-3.1 WITH NJOY2012.50-
deuterons from (n,x)

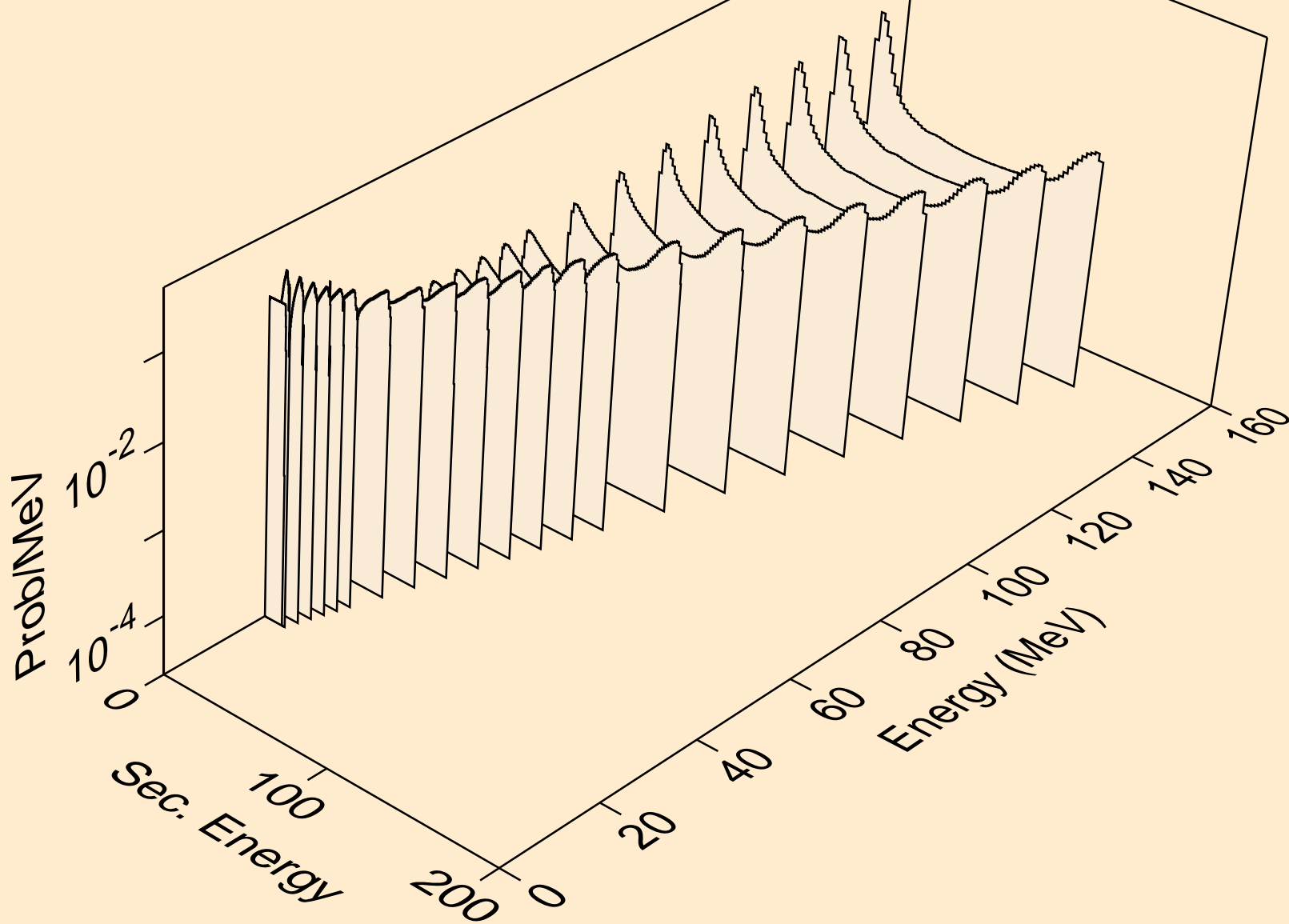

42-MO-98 FOR FENDL-3.1 FROM FENDL-3.1 WITH NJOY2012.50-
tritons from (n,x)

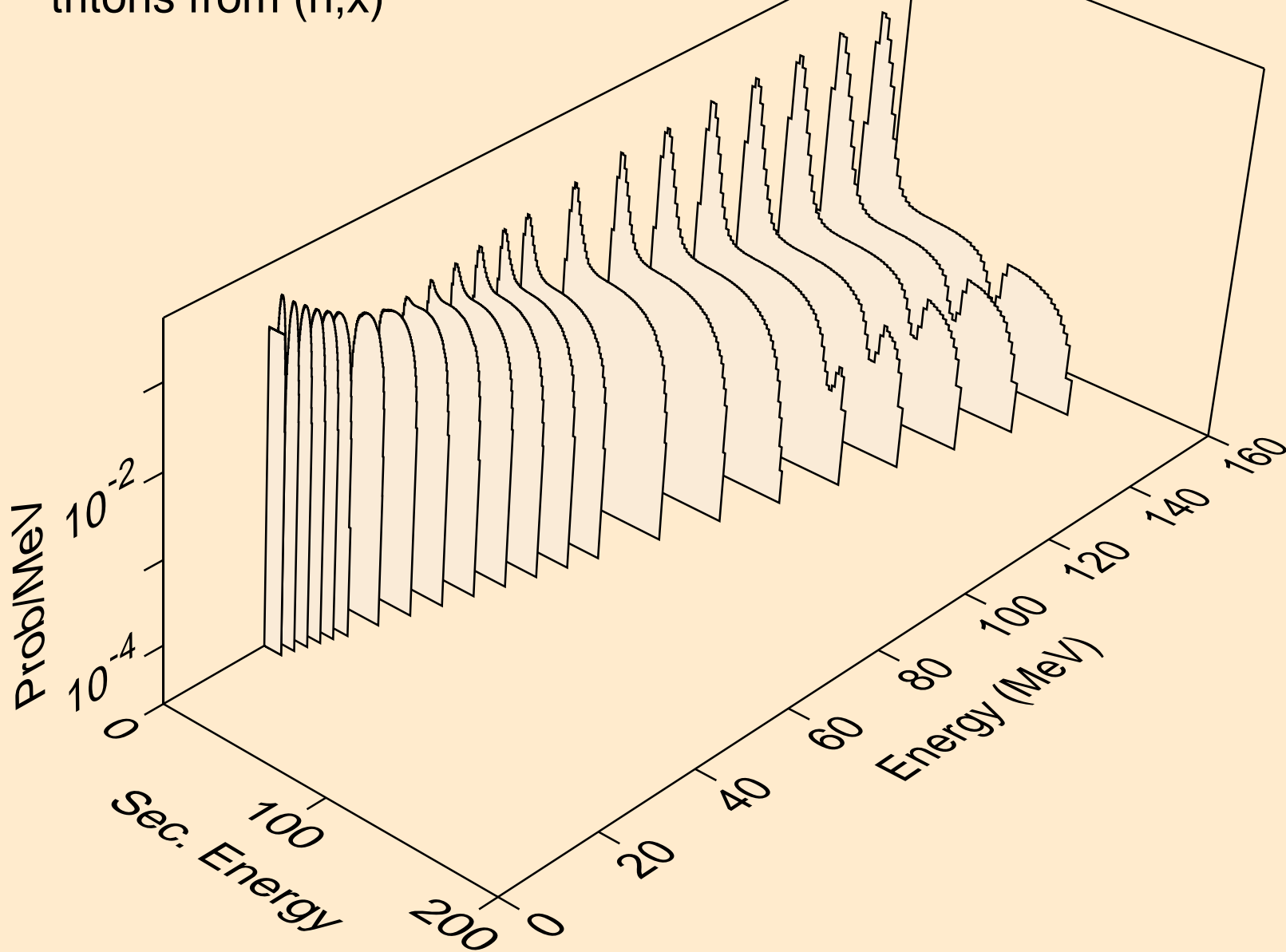

42-MO-98 FOR FENDL-3.1 FROM FENDL-3.1 WITH NJOY2012.50-
alphas from (n,x)

