

78-PT-198 FOR FENDL-3.1 FROM TENDL-2010 WITH NJOY2012.5
Principal cross sections

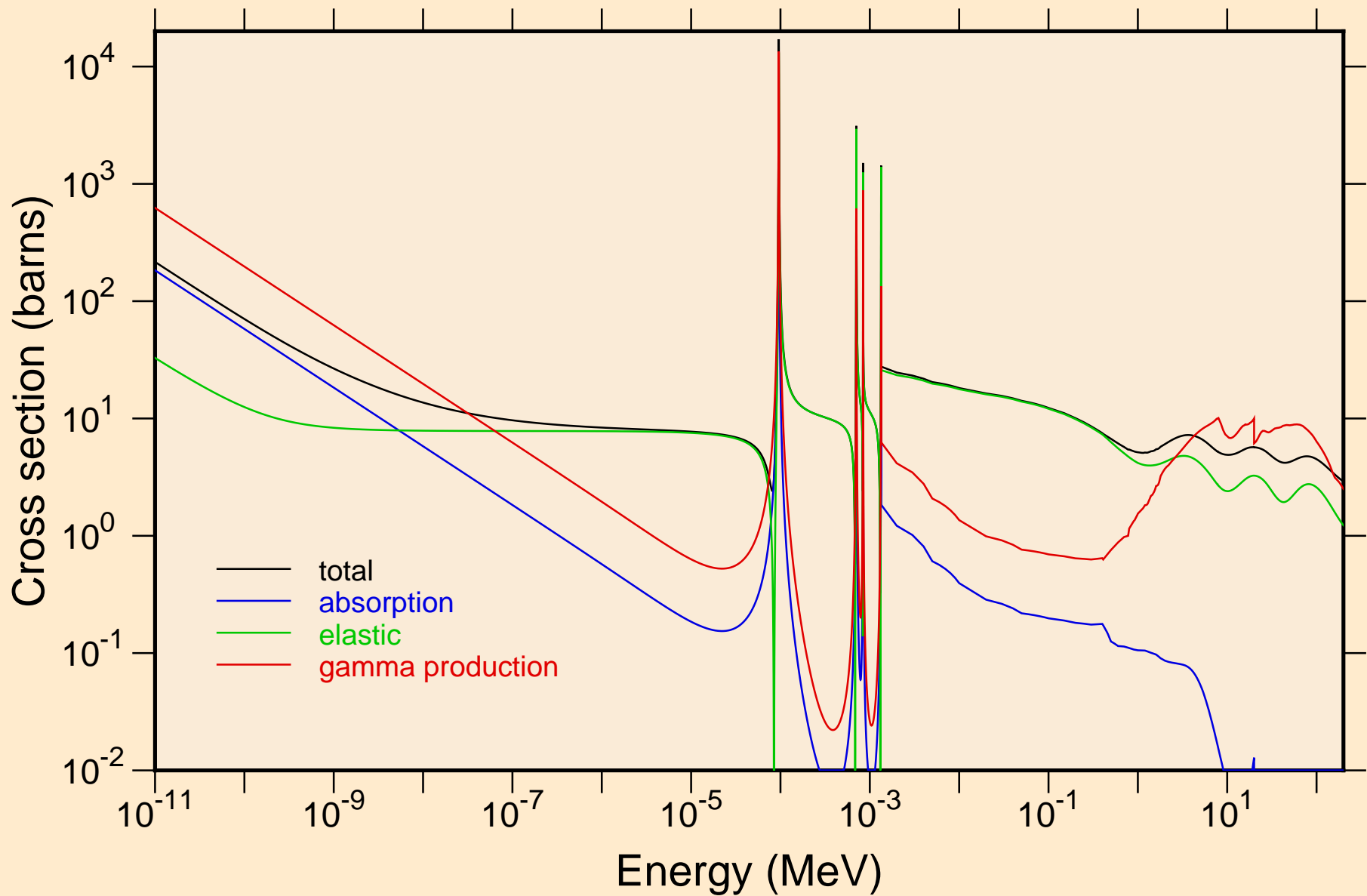

78-PT-198 FOR FENDL-3.1 FROM TENDL-2010 WITH NJOY2012.5
resonance total cross section

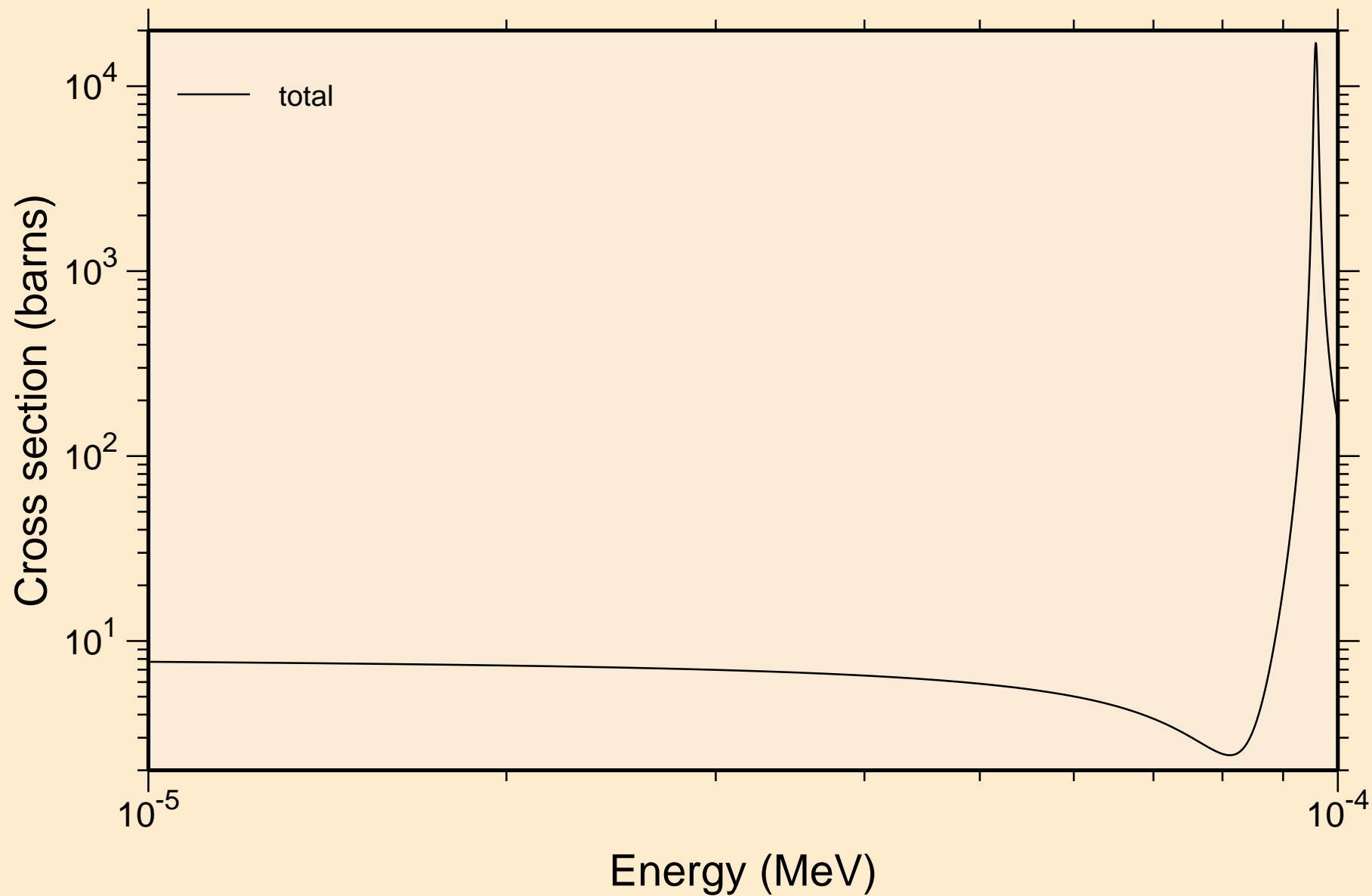

78-PT-198 FOR FENDL-3.1 FROM TENDL-2010 WITH NJOY2012.5
resonance total cross section

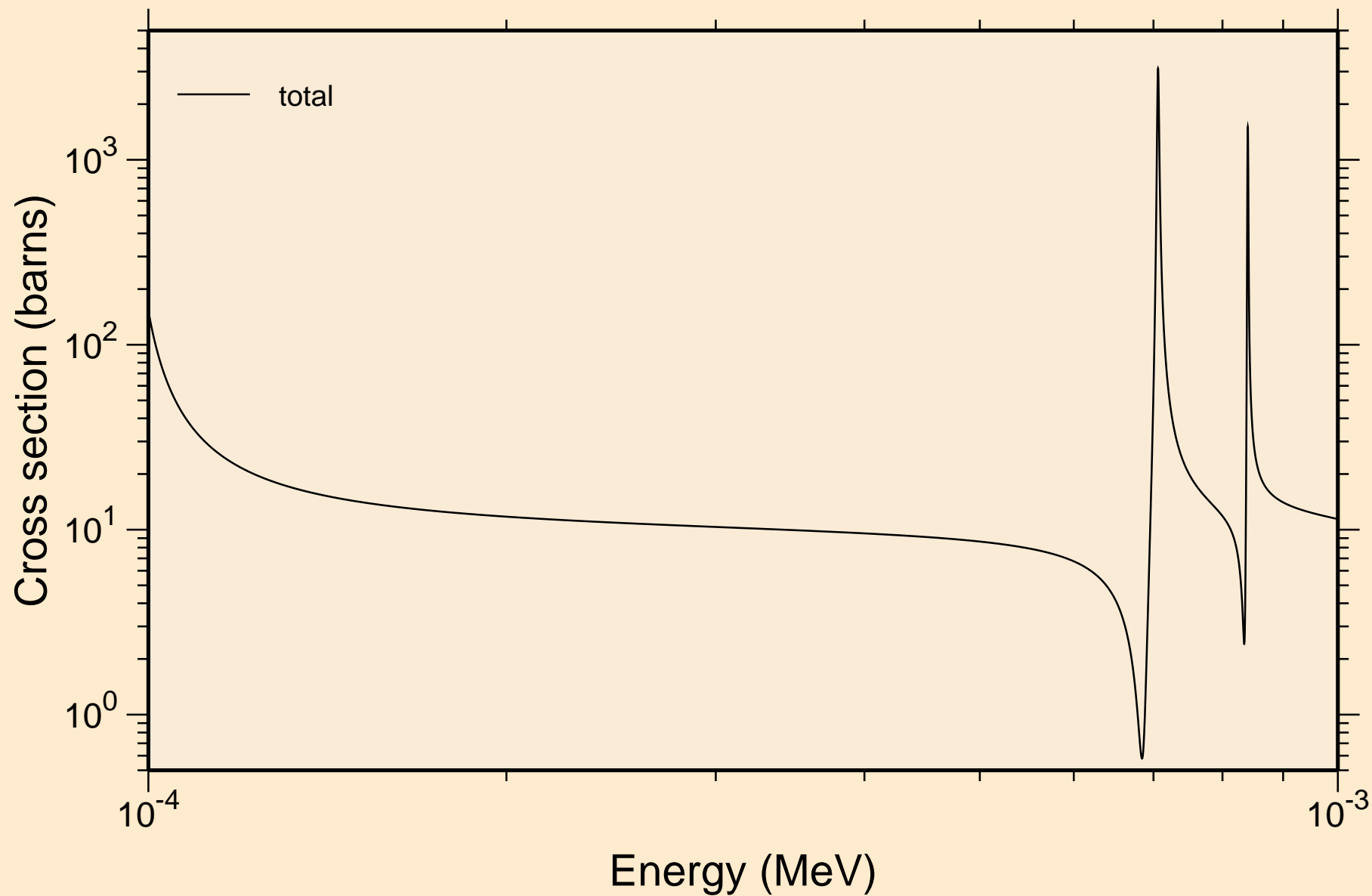

78-PT-198 FOR FENDL-3.1 FROM TENDL-2010 WITH NJOY2012.5
resonance total cross section

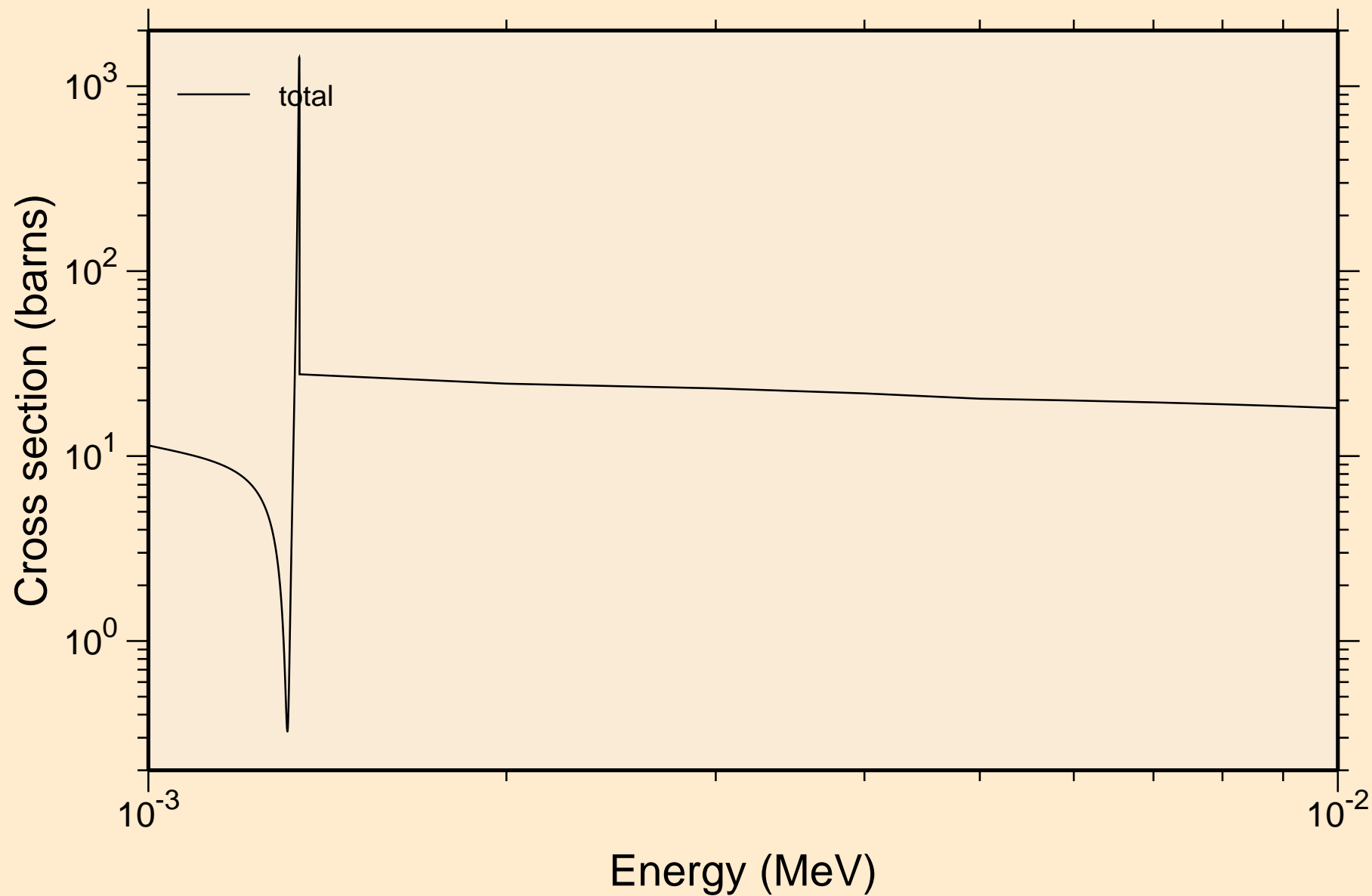

78-PT-198 FOR FENDL-3.1 FROM TENDL-2010 WITH NJOY2012.5
resonance total cross section

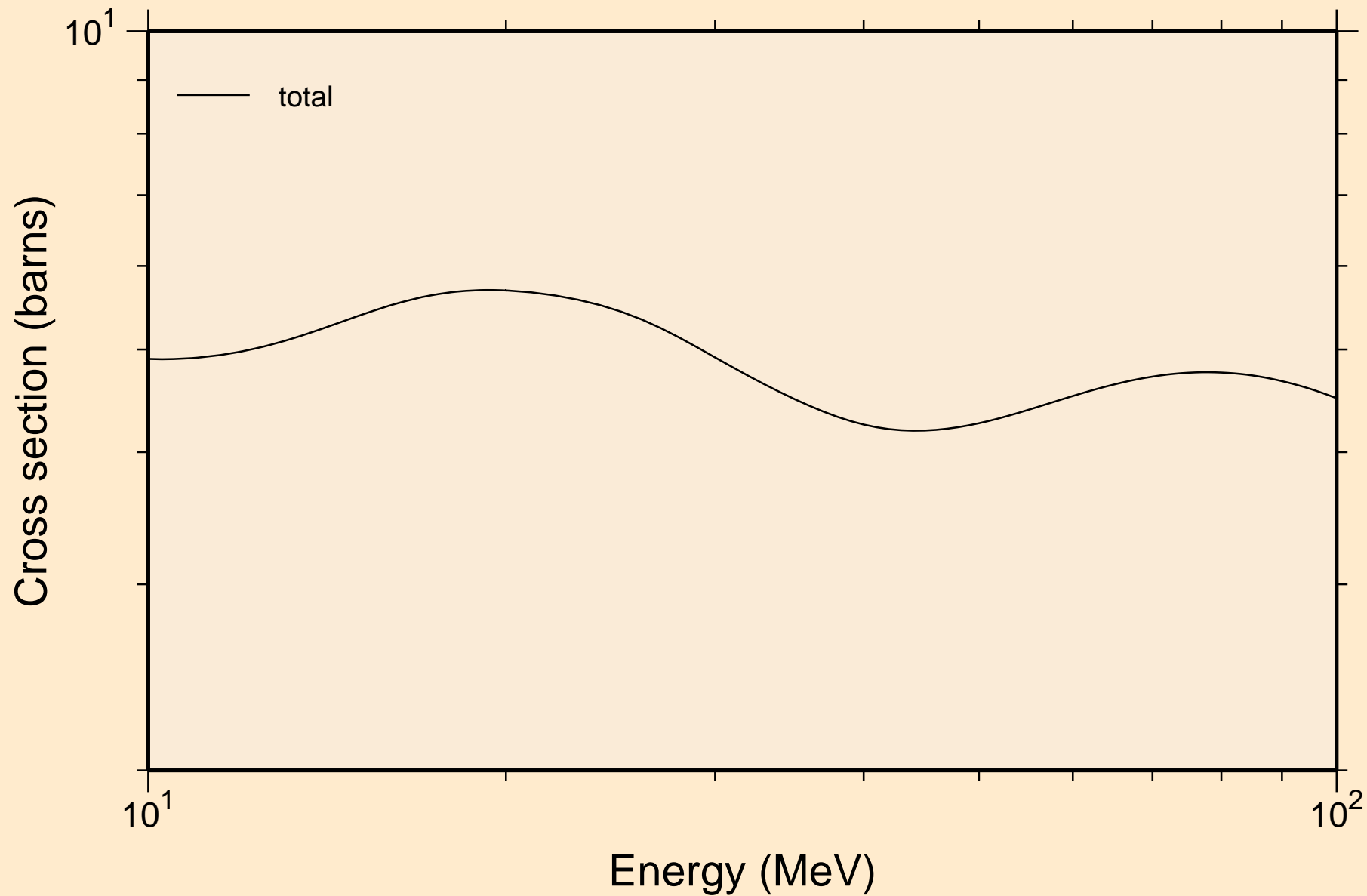

78-PT-198 FOR FENDL-3.1 FROM TENDL-2010 WITH NJOY2012.5
resonance absorption cross sections

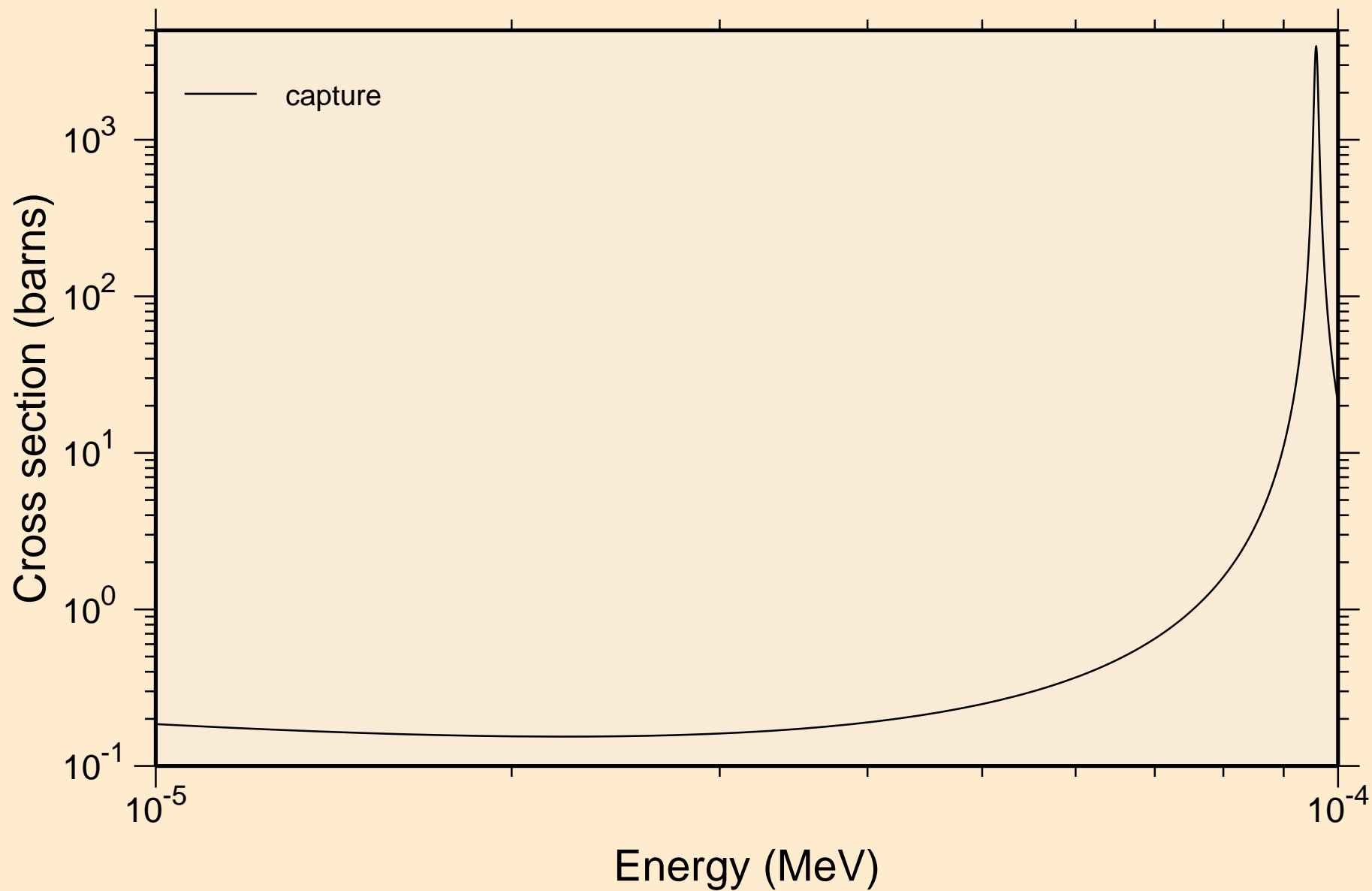

78-PT-198 FOR FENDL-3.1 FROM TENDL-2010 WITH NJOY2012.5
resonance absorption cross sections

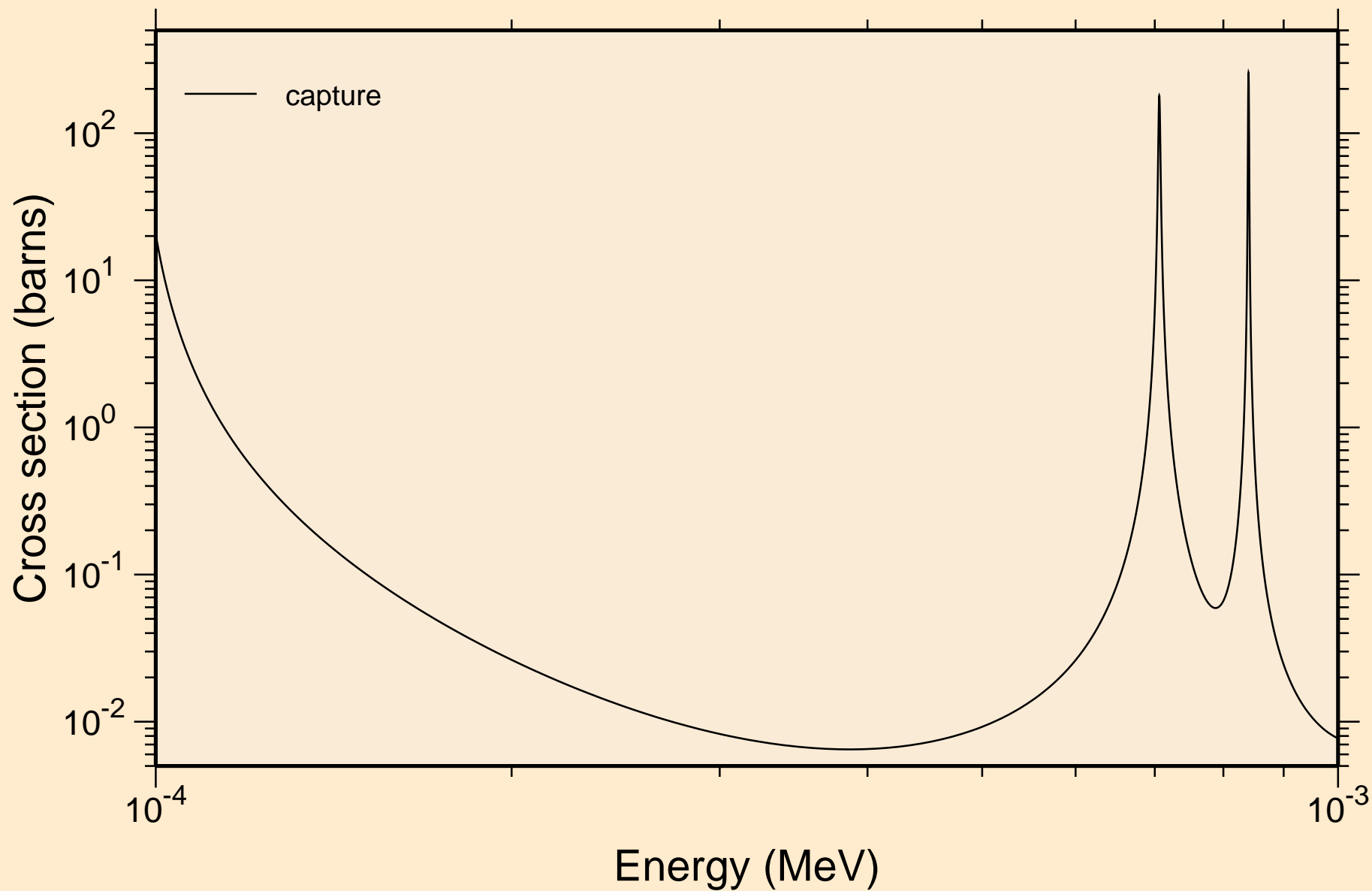

78-PT-198 FOR FENDL-3.1 FROM TENDL-2010 WITH NJOY2012.5
resonance absorption cross sections

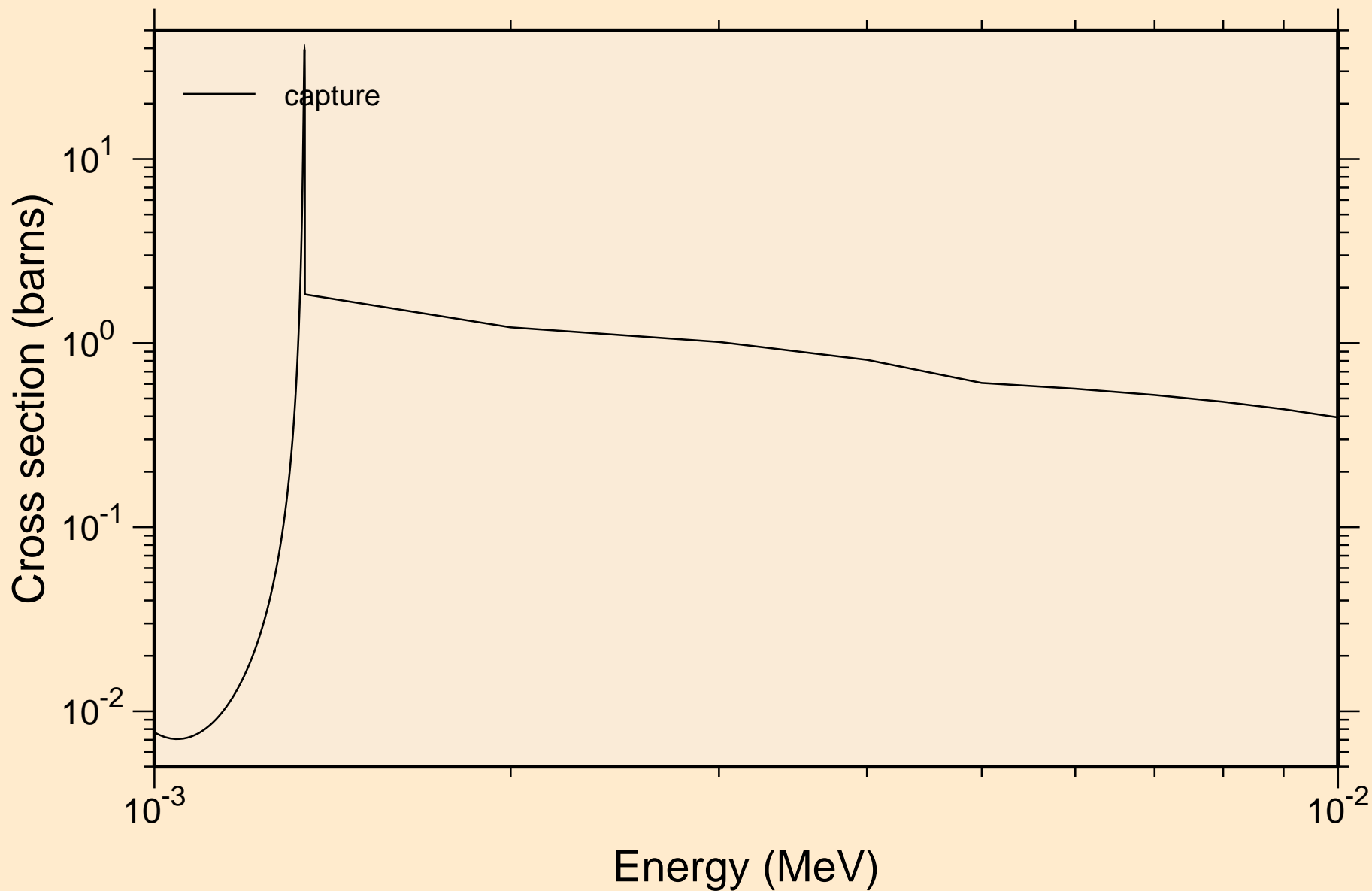

78-PT-198 FOR FENDL-3.1 FROM TENDL-2010 WITH NJOY2012.5
resonance absorption cross sections

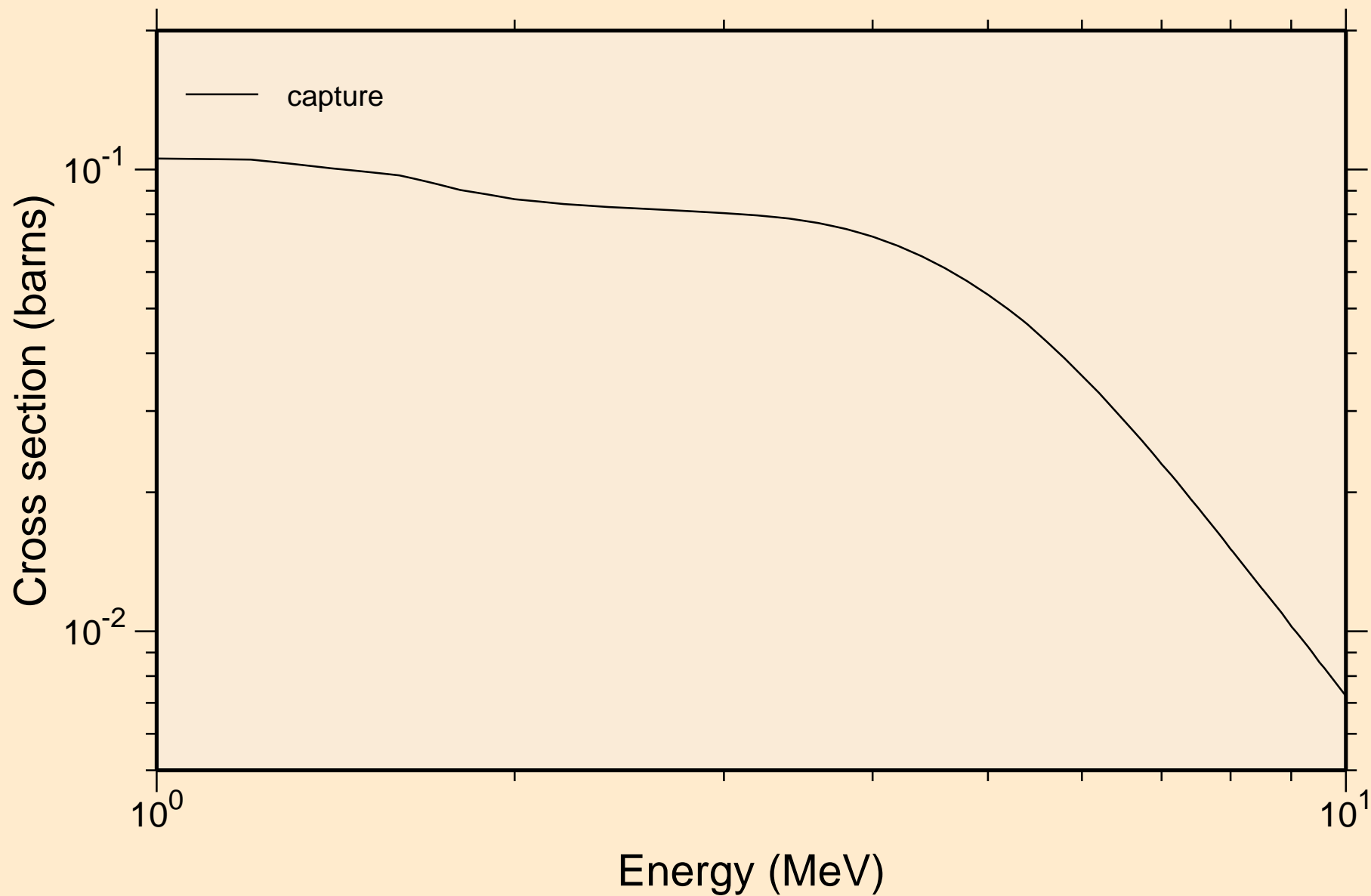

78-PT-198 FOR FENDL-3.1 FROM TENDL-2010 WITH NJOY2012.5 Heating

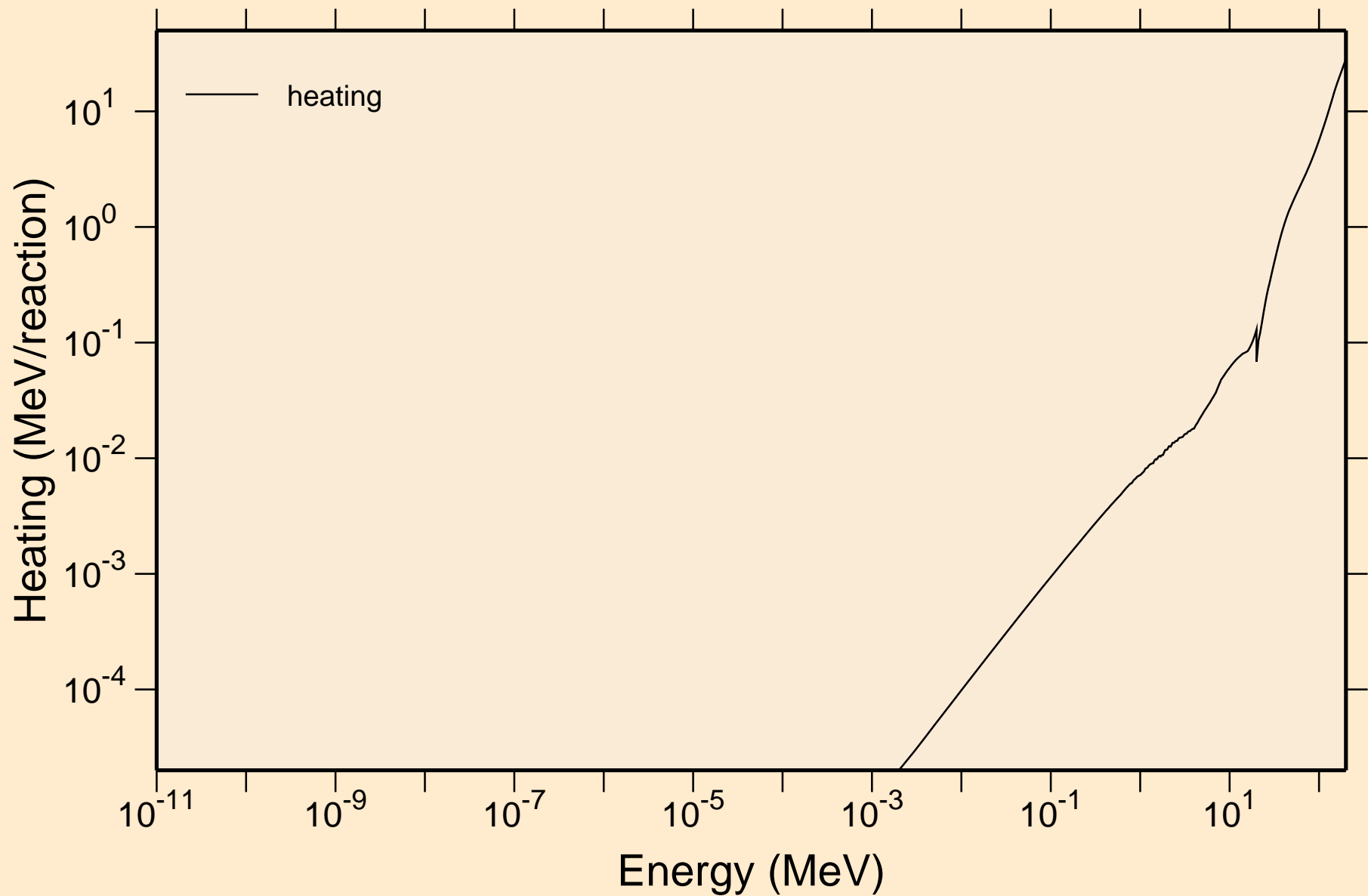

78-PT-198 FOR FENDL-3.1 FROM TENDL-2010 WITH NJOY2012.5 Damage

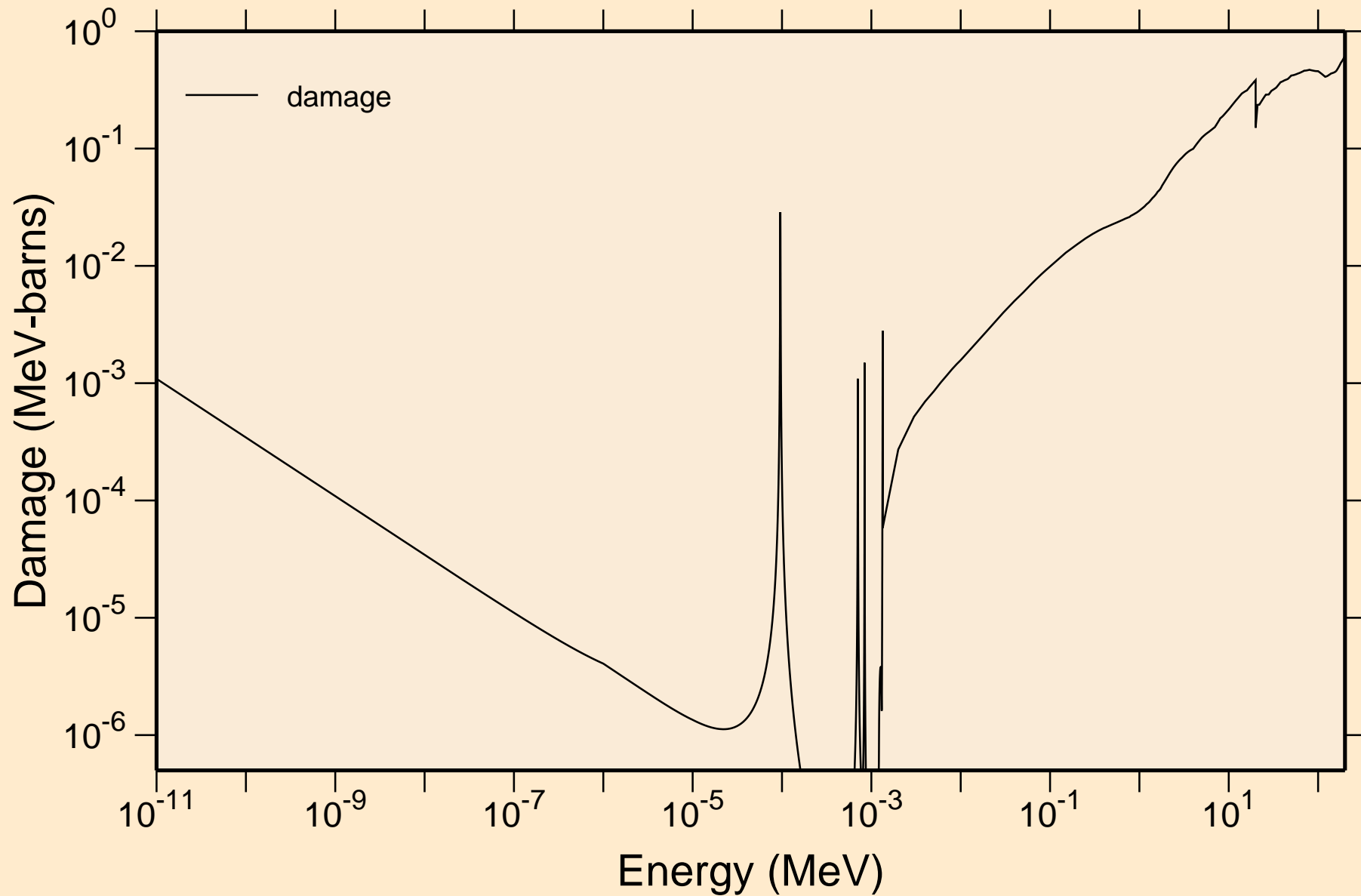

78-PT-198 FOR FENDL-3.1 FROM TENDL-2010 WITH NJOY2012.5
Non-threshold reactions

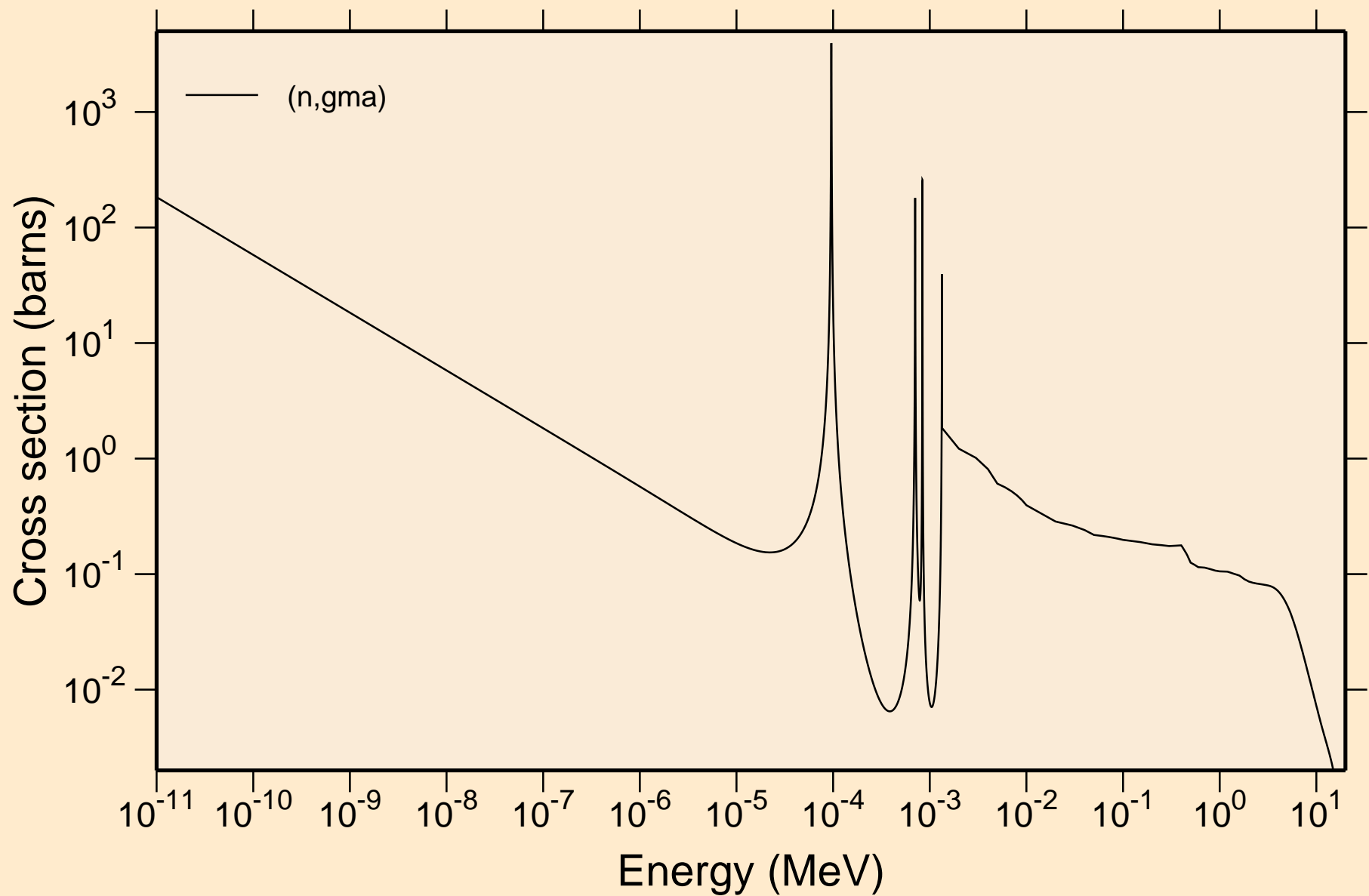

78-PT-198 FOR FENDL-3.1 FROM TENDL-2010 WITH NJOY2012.5

Principal cross sections

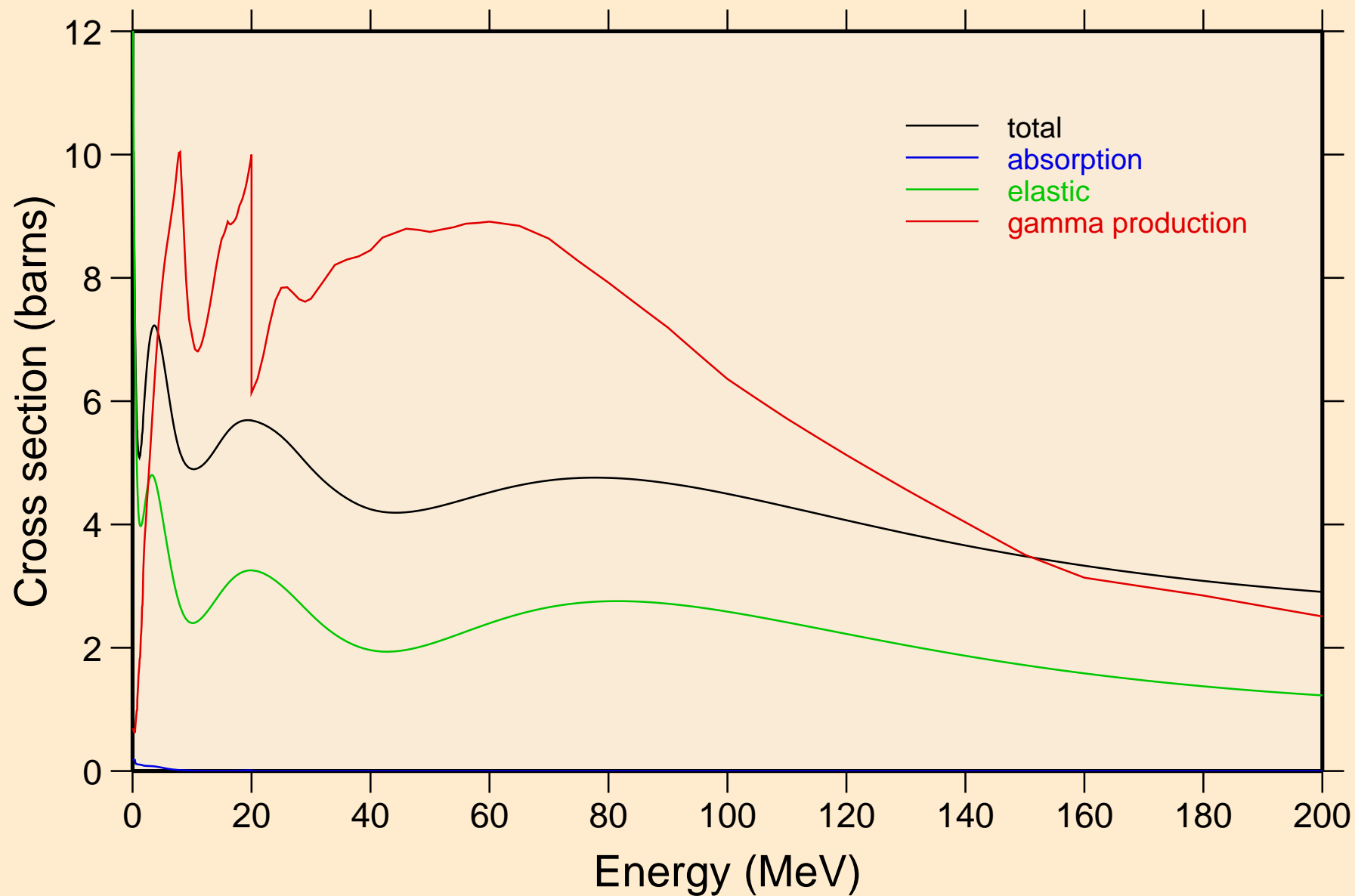

78-PT-198 FOR FENDL-3.1 FROM TENDL-2010 WITH NJOY2012.5
Heating

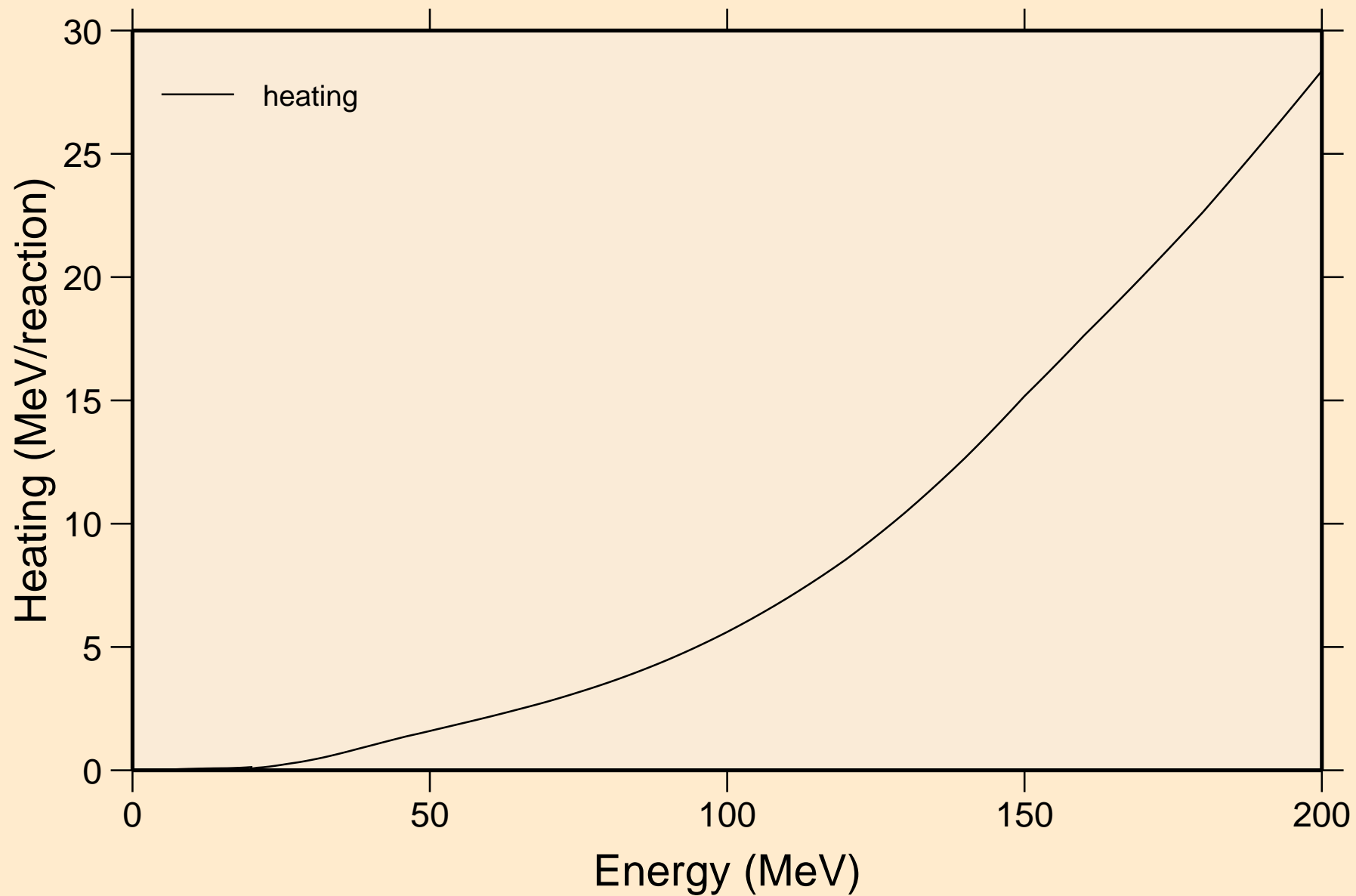

78-PT-198 FOR FENDL-3.1 FROM TENDL-2010 WITH NJOY2012.5 Damage

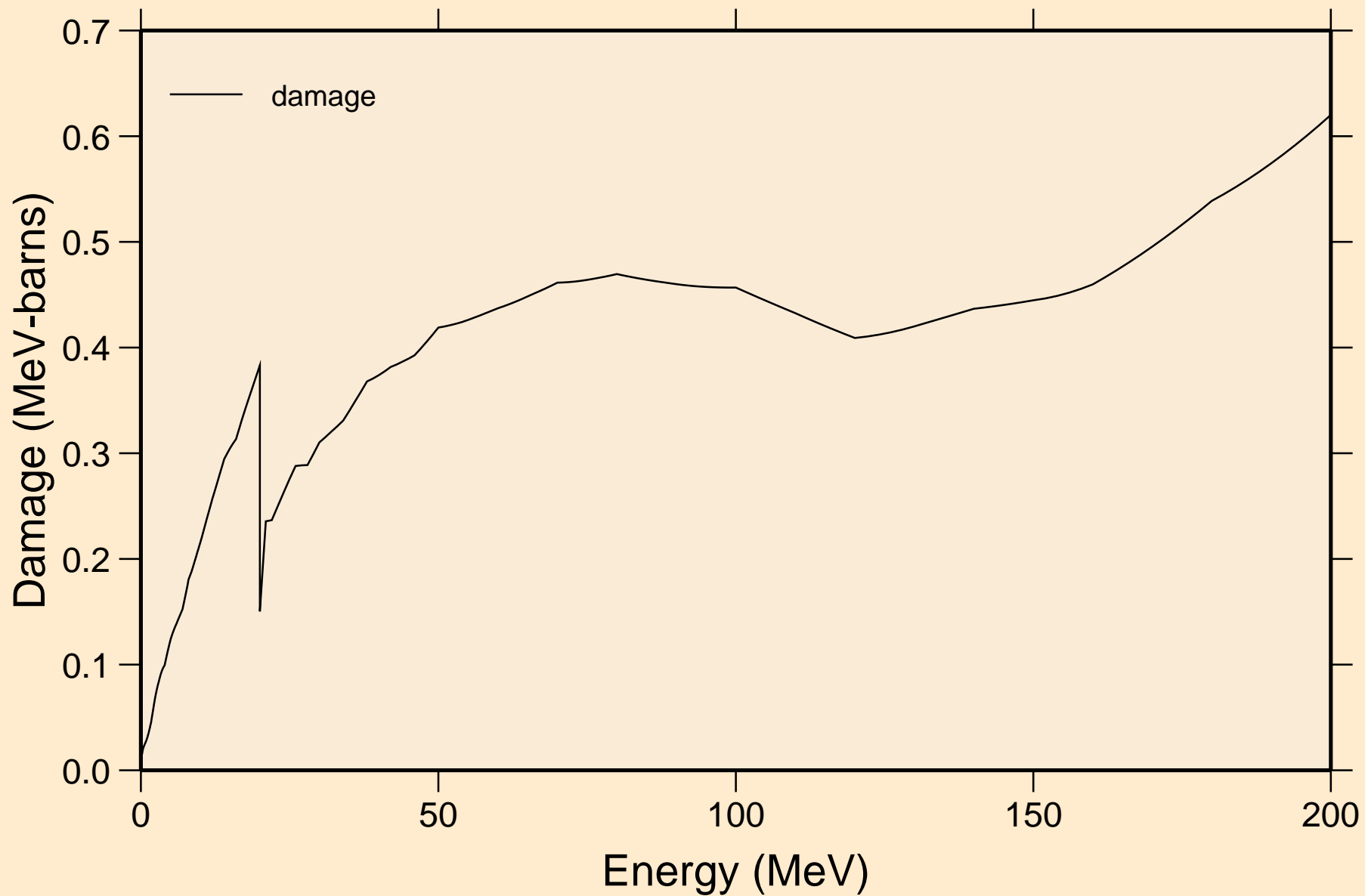

78-PT-198 FOR FENDL-3.1 FROM TENDL-2010 WITH NJOY2012.5
Non-threshold reactions

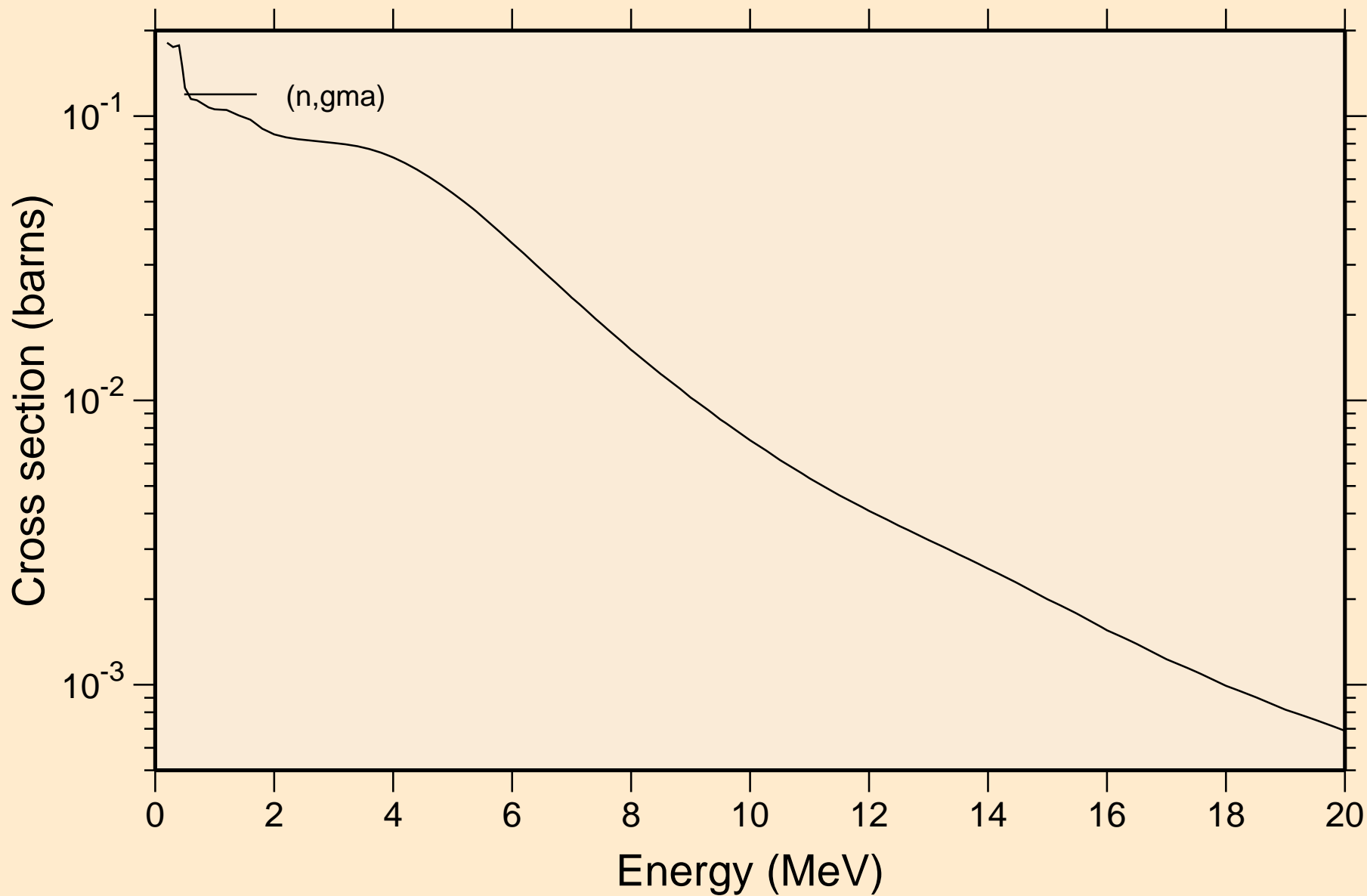

78-PT-198 FOR FENDL-3.1 FROM TENDL-2010 WITH NJOY2012.5
Inelastic levels

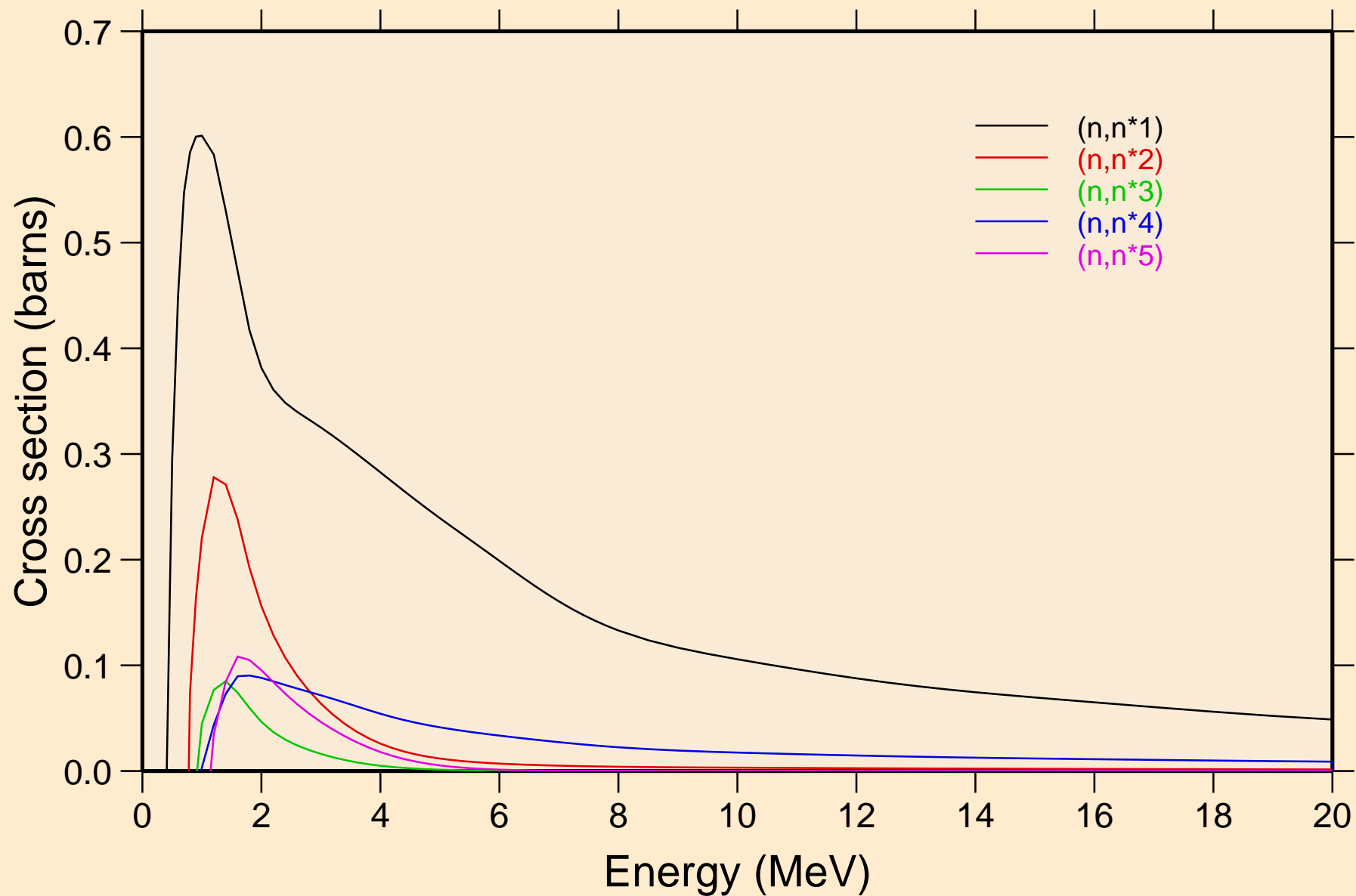

78-PT-198 FOR FENDL-3.1 FROM TENDL-2010 WITH NJOY2012.5
Inelastic levels

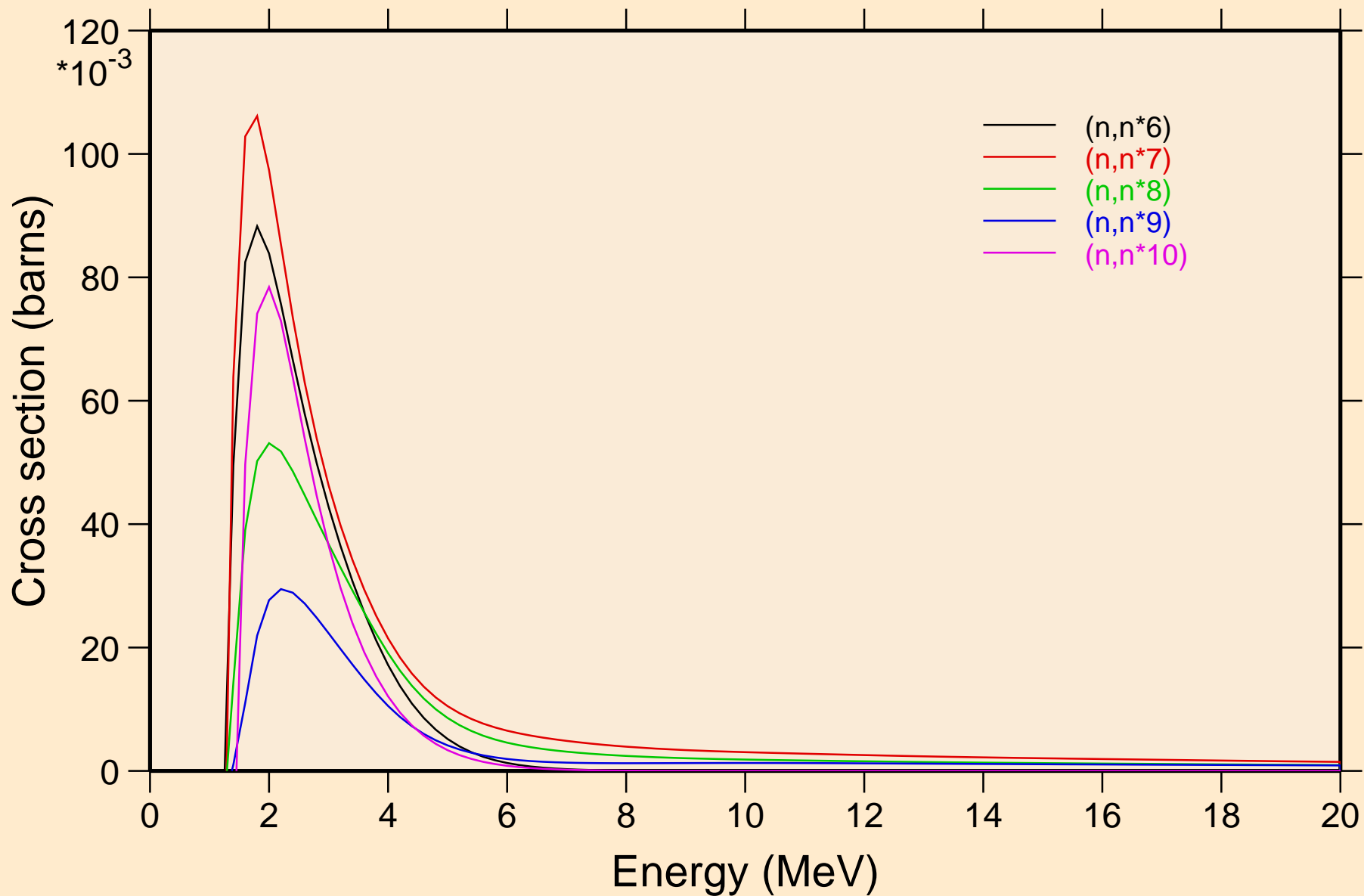

78-PT-198 FOR FENDL-3.1 FROM TENDL-2010 WITH NJOY2012.5
Inelastic levels

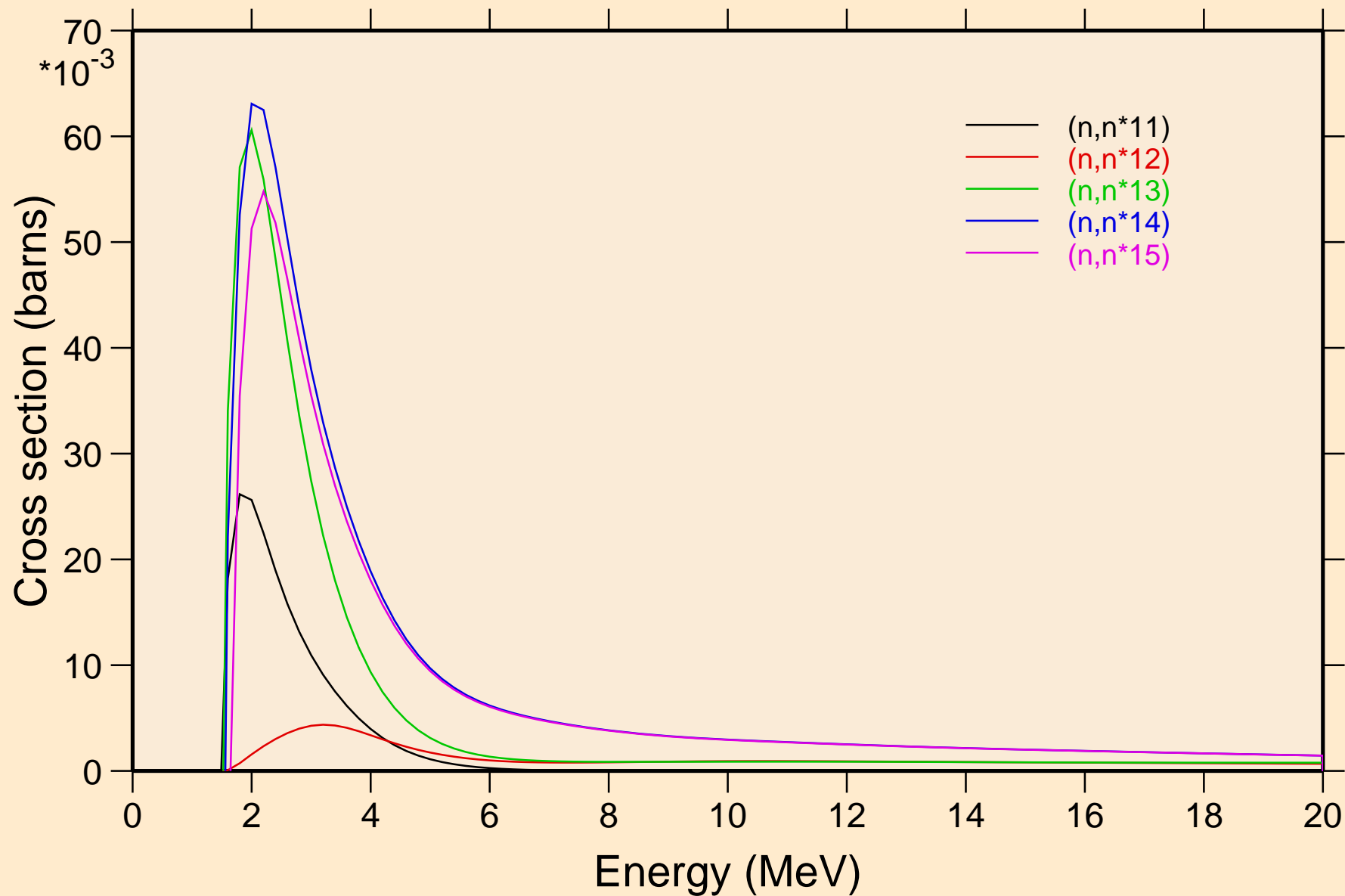

78-PT-198 FOR FENDL-3.1 FROM TENDL-2010 WITH NJOY2012.5
Inelastic levels

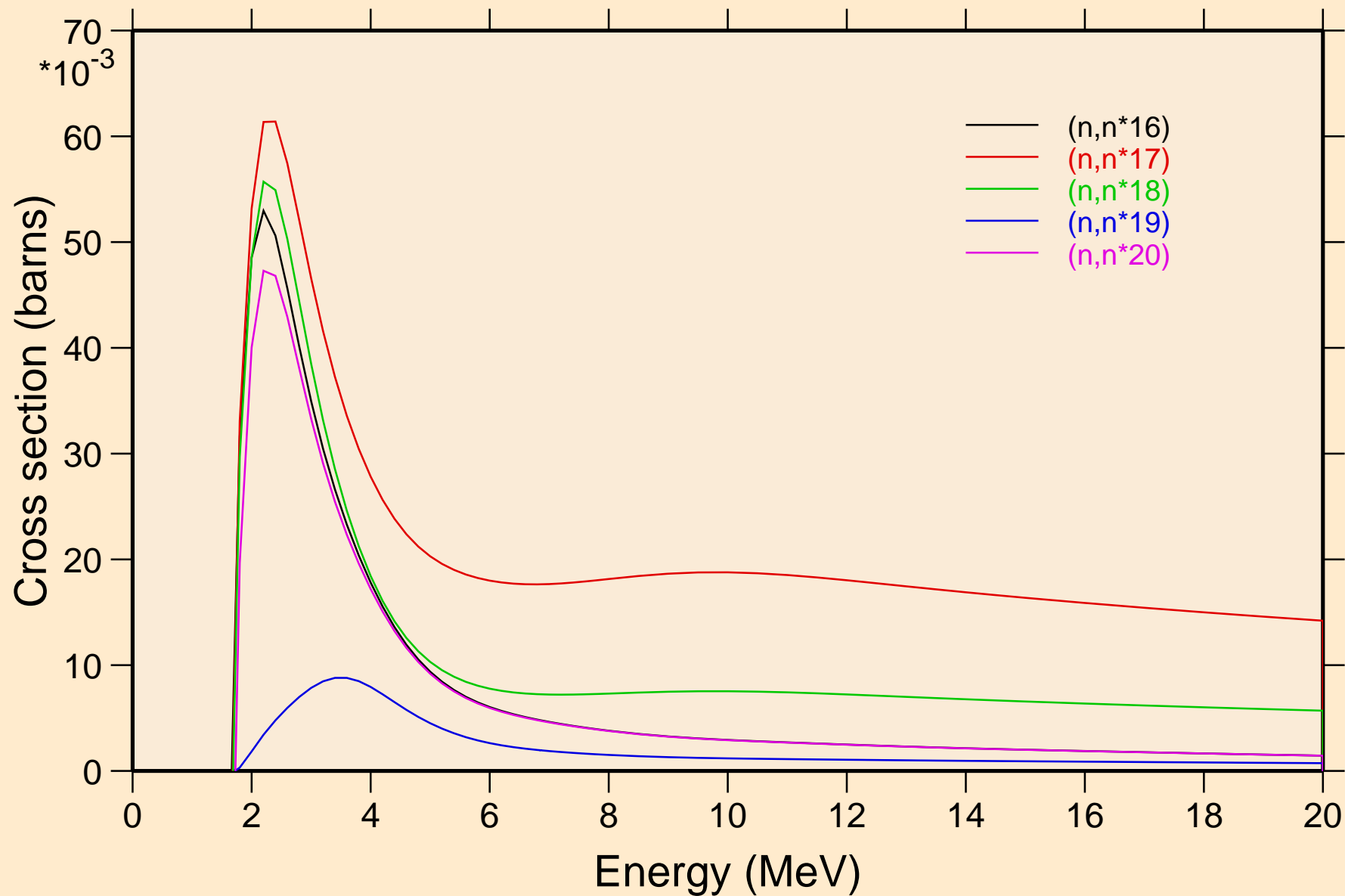

78-PT-198 FOR FENDL-3.1 FROM TENDL-2010 WITH NJOY2012.5
Threshold reactions

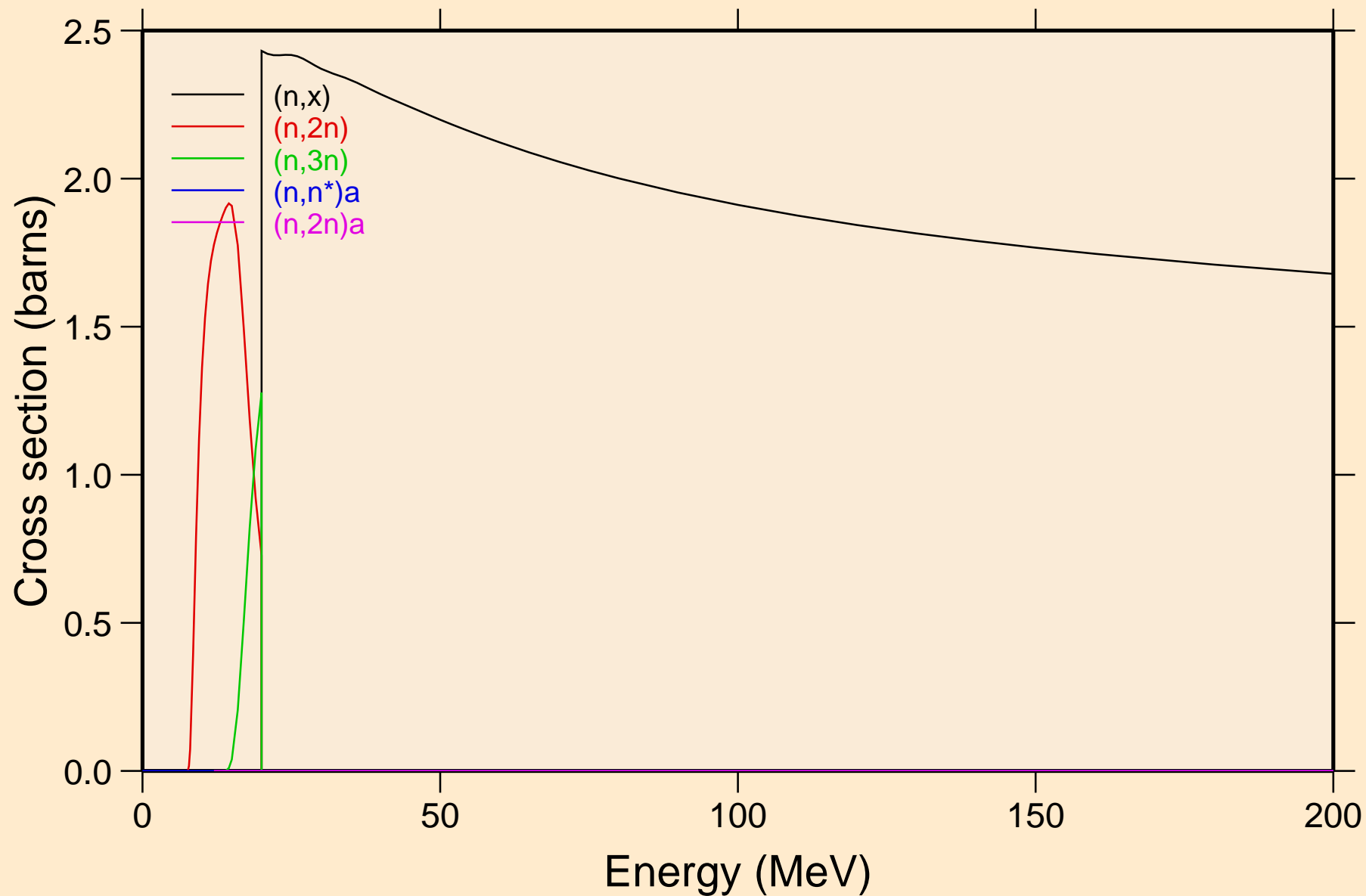

78-PT-198 FOR FENDL-3.1 FROM TENDL-2010 WITH NJOY2012.5
Threshold reactions

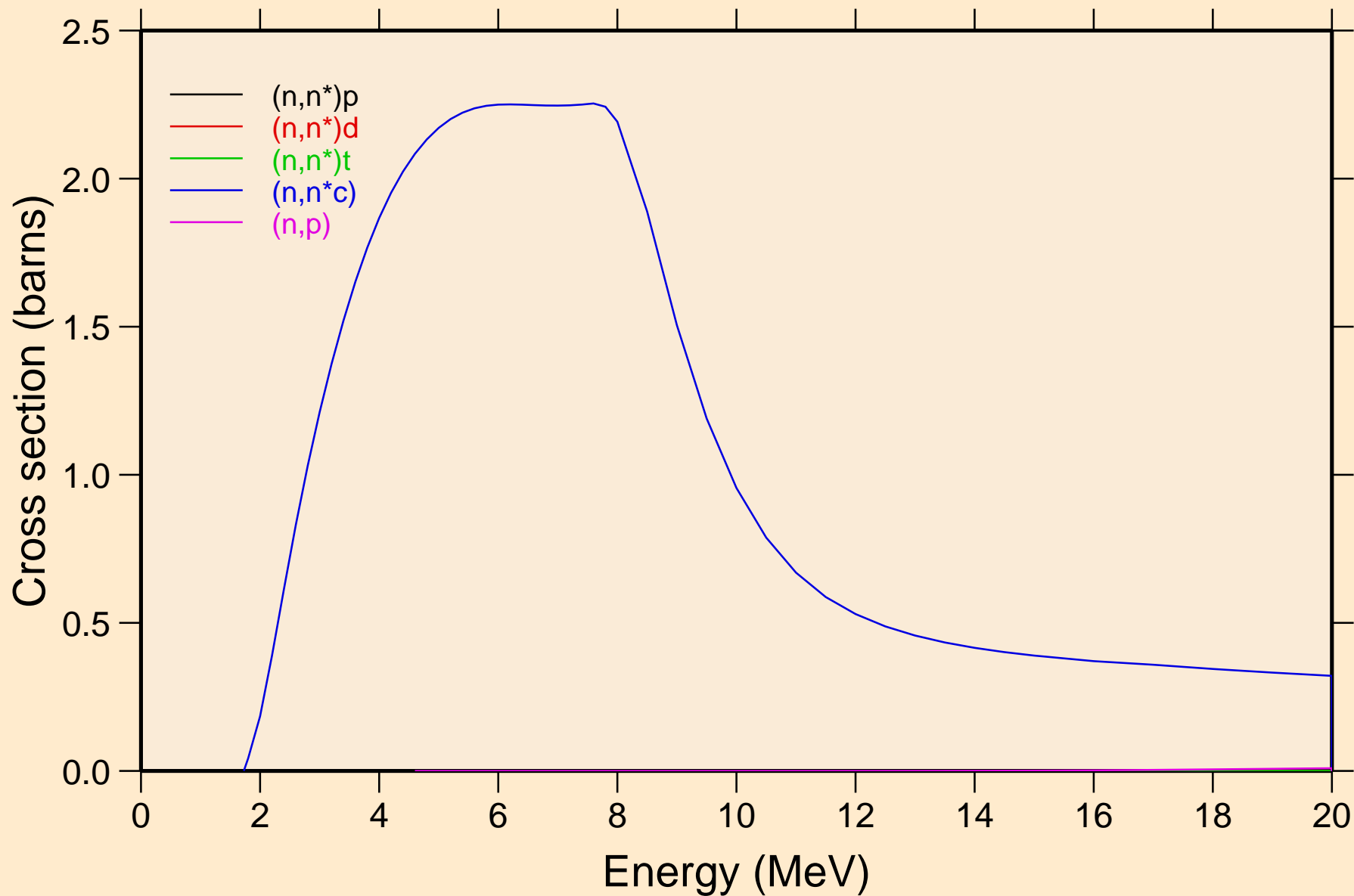

78-PT-198 FOR FENDL-3.1 FROM TENDL-2010 WITH NJOY2012.5
Threshold reactions

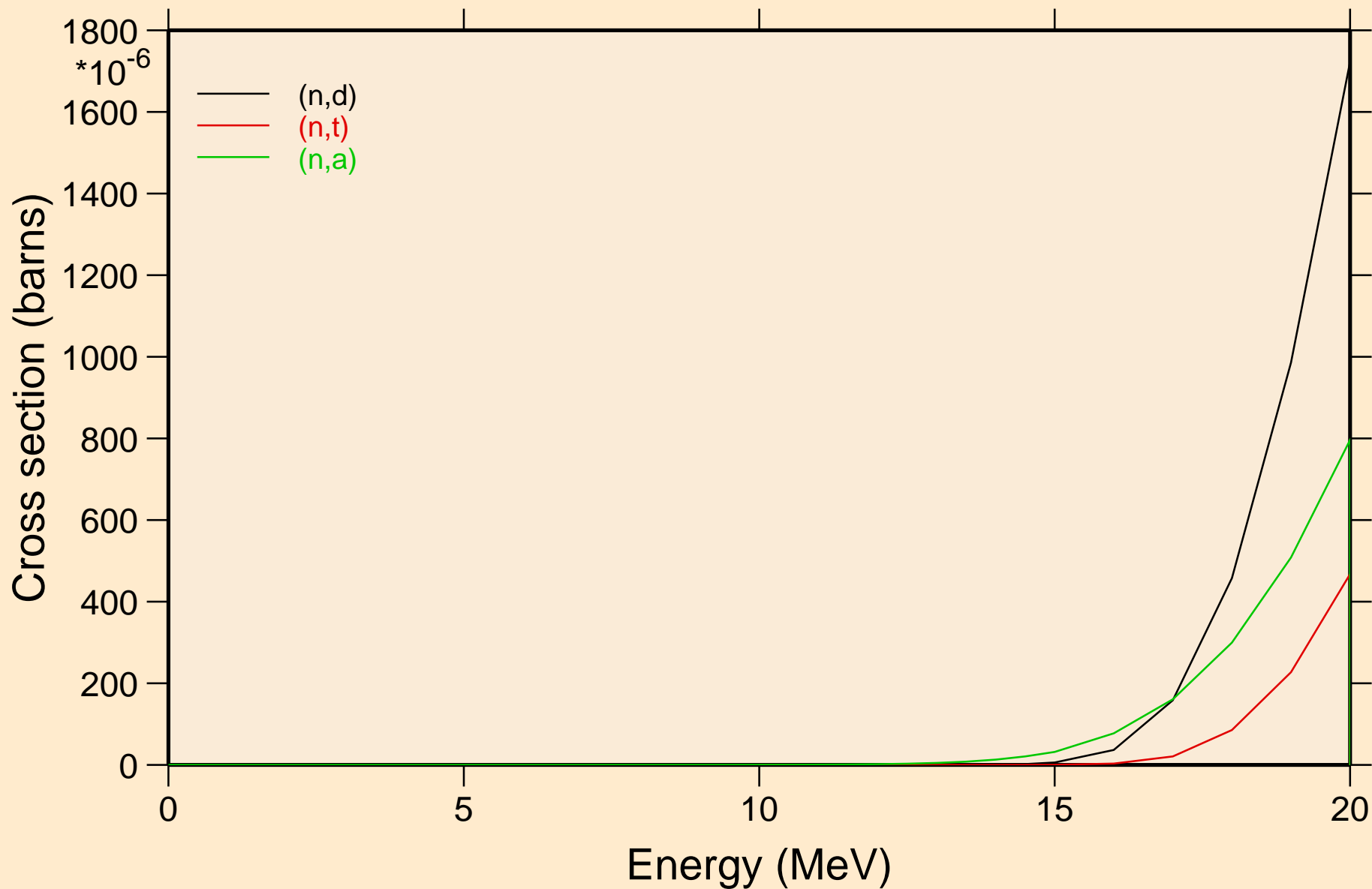

78-PT-198 FOR FENDL-3.1 FROM TENDL-2010 WITH NJOY2012.5
Threshold reactions

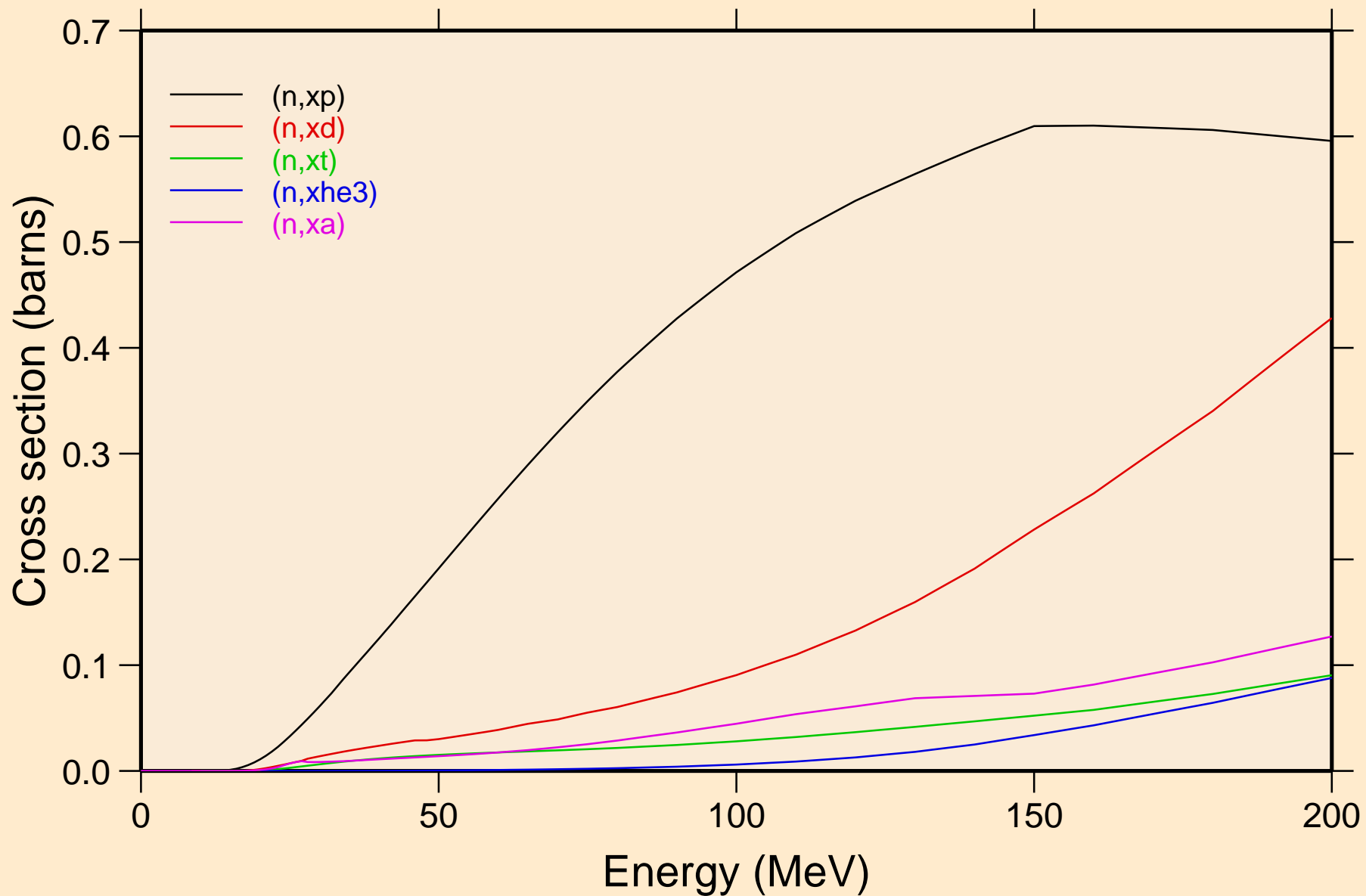

78-PT-198 FOR FENDL-3.1 FROM TENDL-2010 WITH NJOY2012.5
Threshold reactions

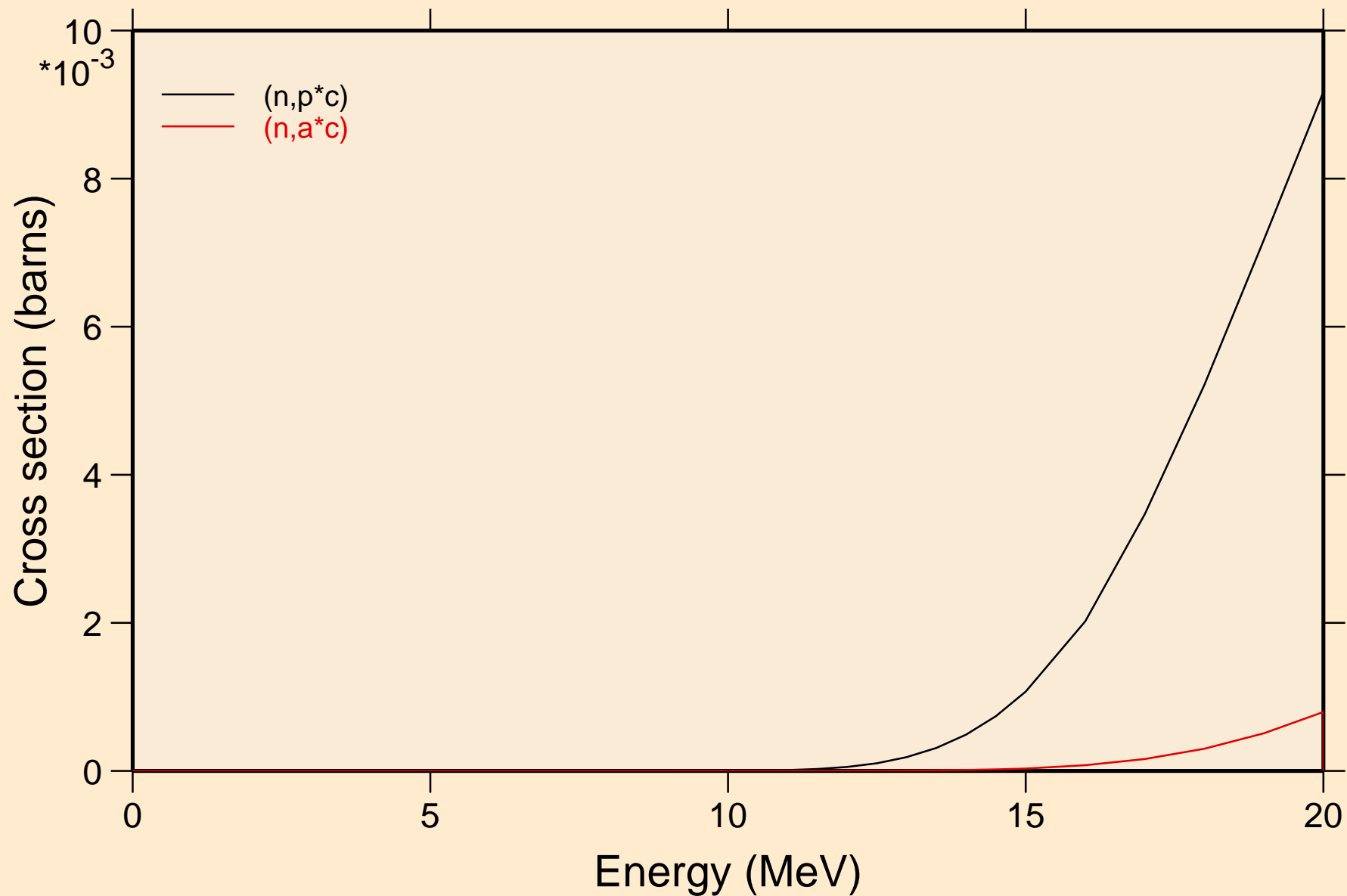

78-PT-198 FOR FENDL-3.1 FROM TENDL-2010 WITH NJOY2012.5
angular distribution for elastic

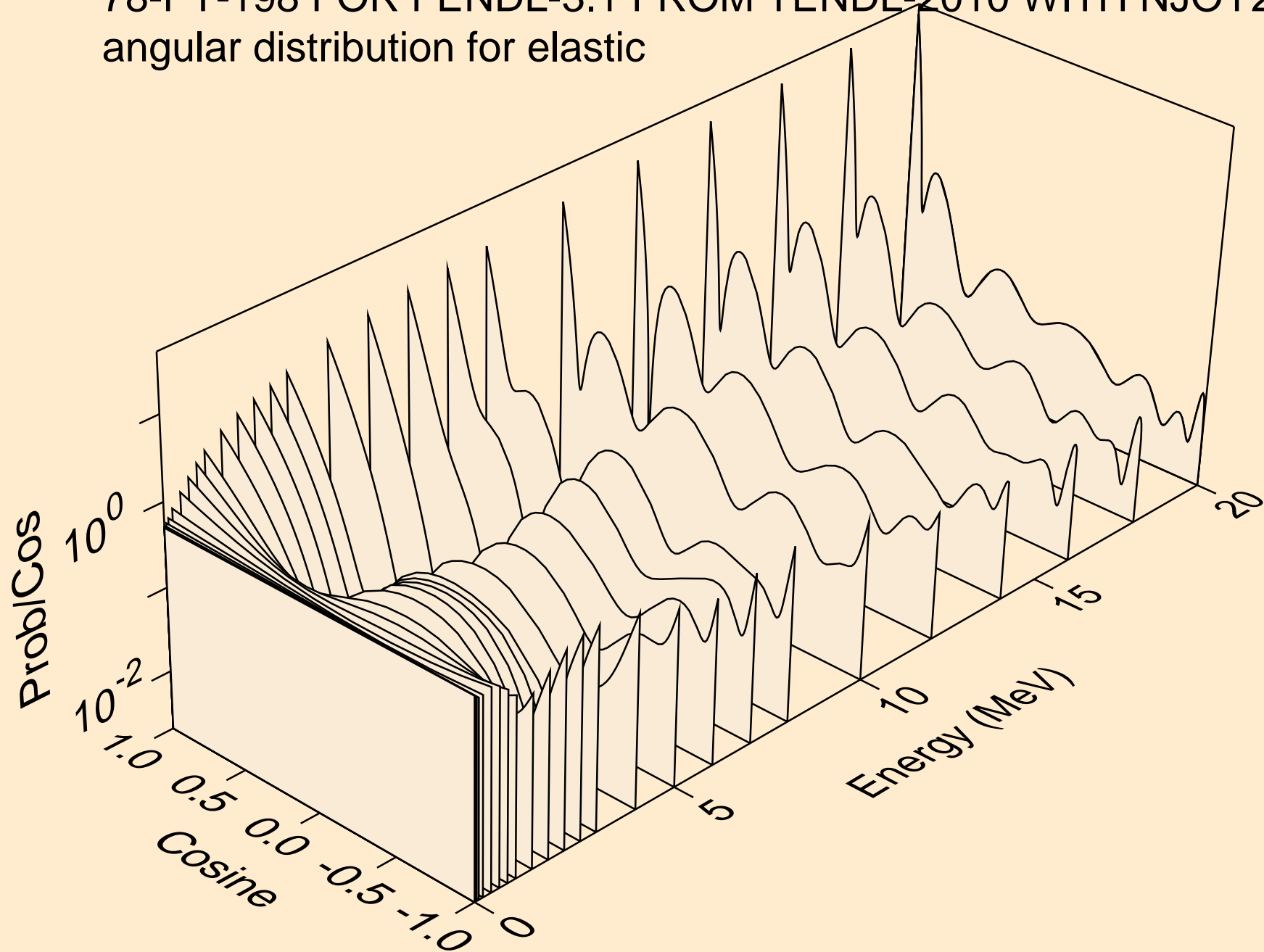

78-PT-198 FOR FENDL-3.1 FROM TENDL-2010 WITH NJOY2012.5
angular distribution for elastic

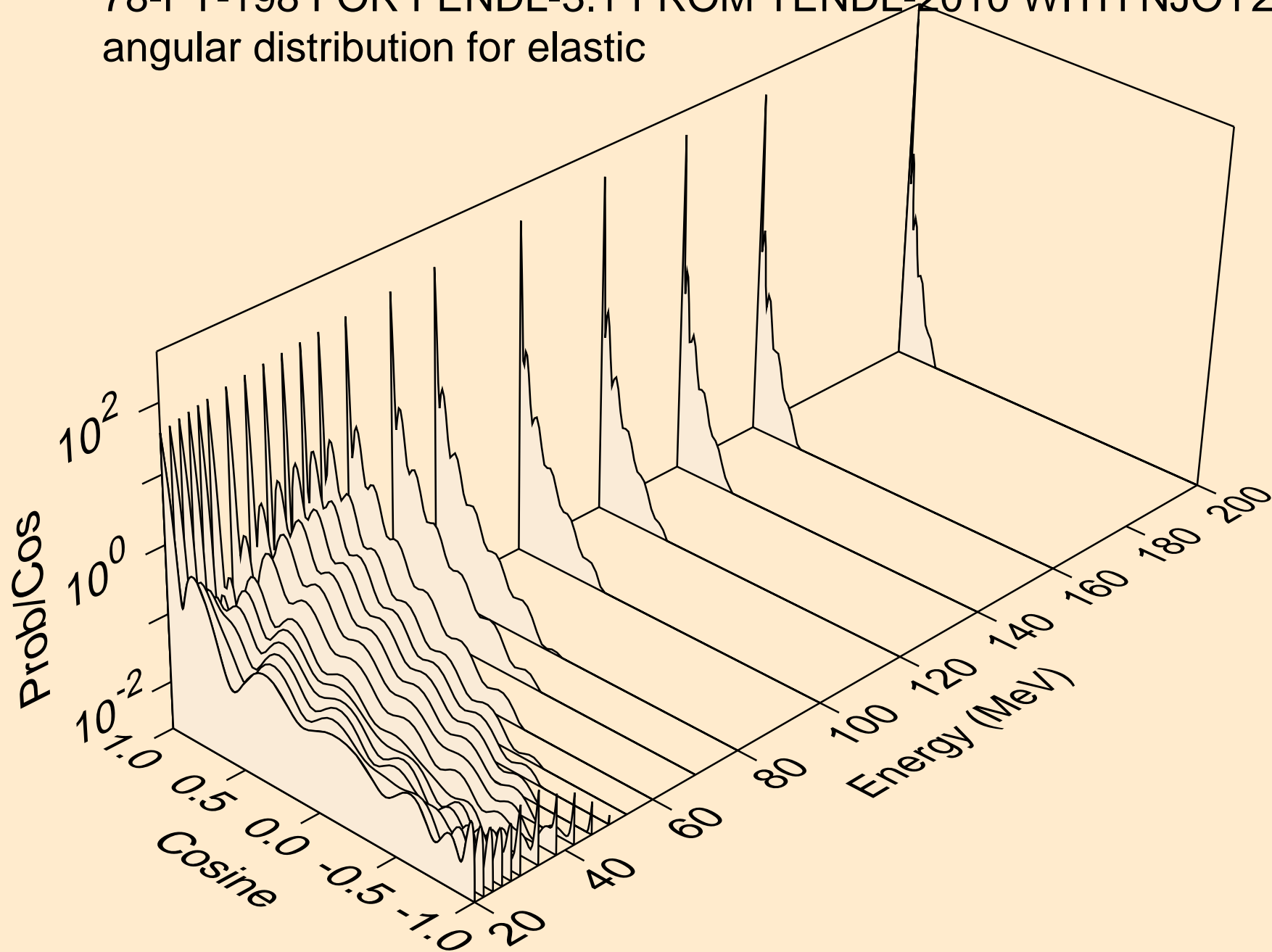

78-PT-198 FOR FENDL-3.1 FROM TENDL-2010 WITH NJOY2012.5
angular distribution for (n,n*1)

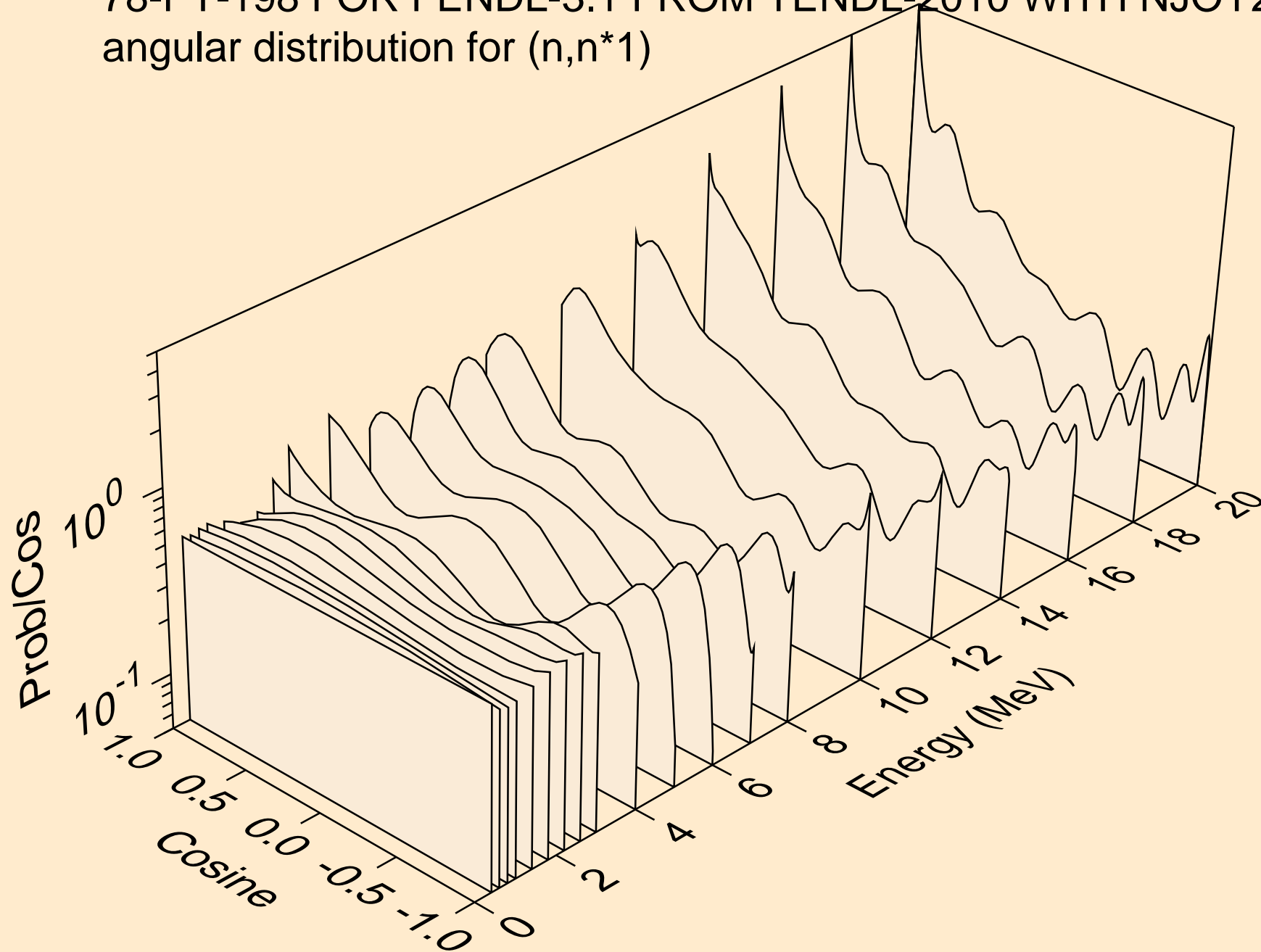

78-PT-198 FOR FENDL-3.1 FROM TENDL-2010 WITH NJOY2012.5
angular distribution for (n,n*2)

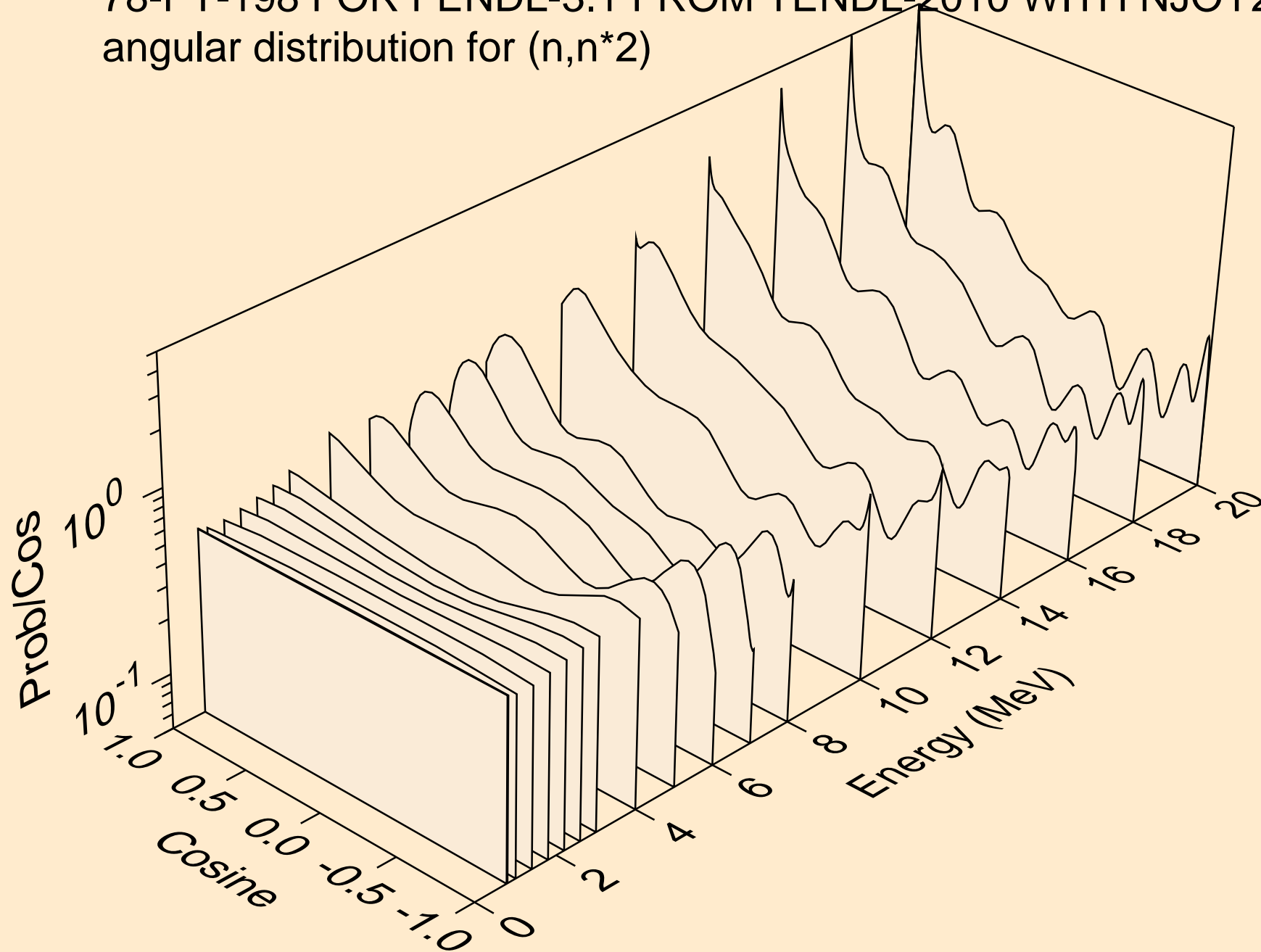

78-PT-198 FOR FENDL-3.1 FROM TENDL-2010 WITH NJOY2012.5
angular distribution for (n,n*3)

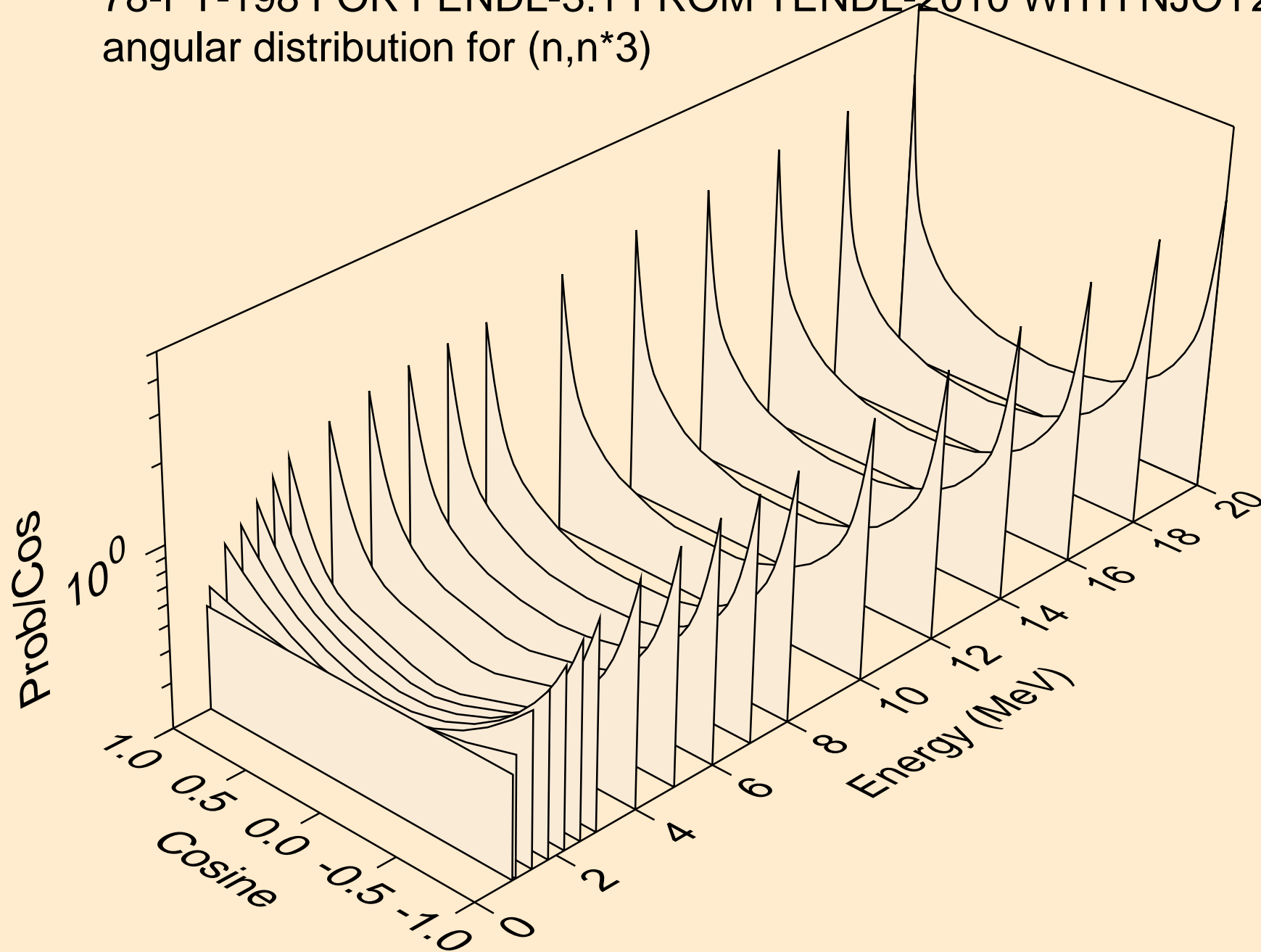

78-PT-198 FOR FENDL-3.1 FROM TENDL-2010 WITH NJOY2012.5
angular distribution for (n,n*4)

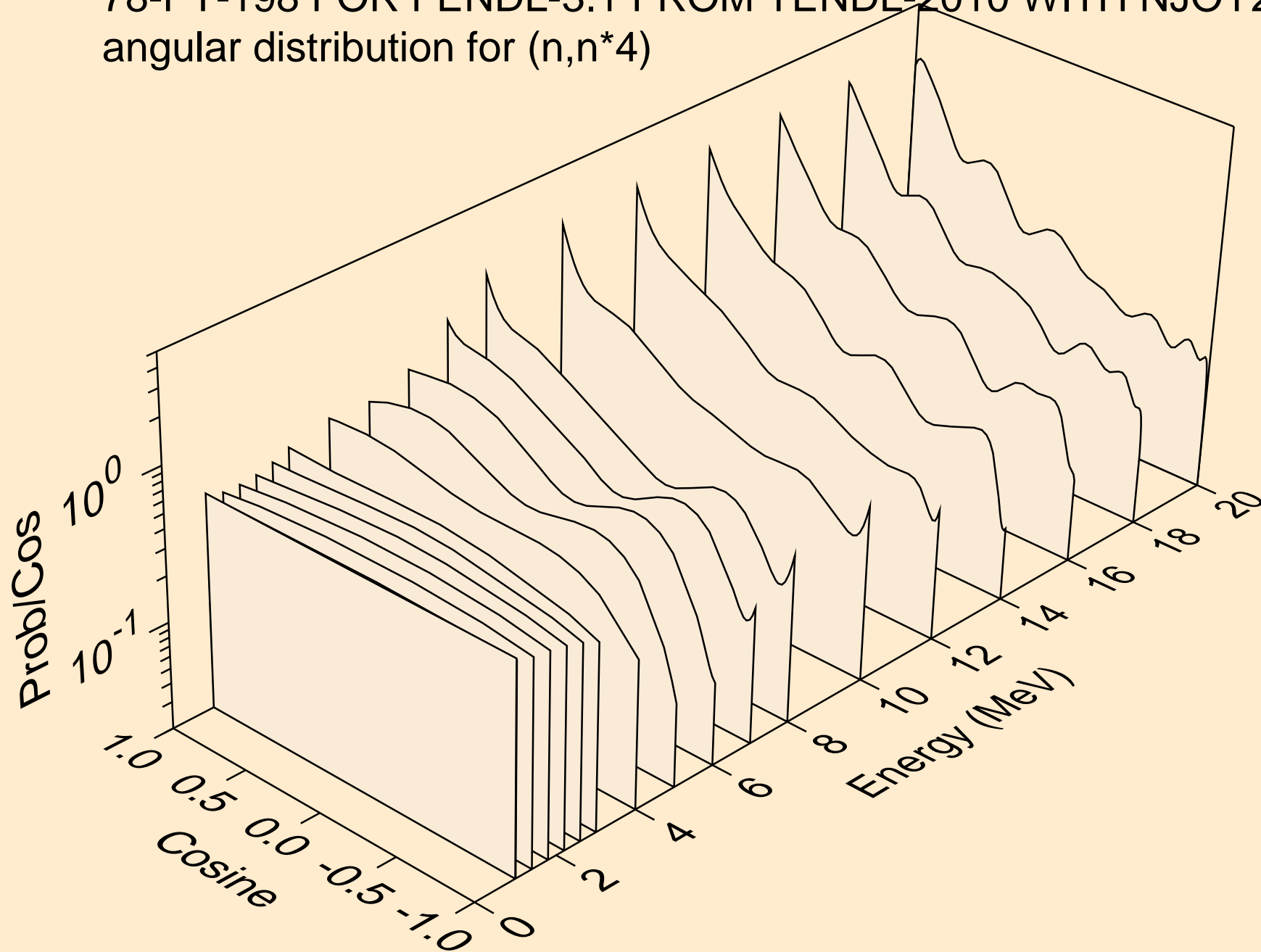

78-PT-198 FOR FENDL-3.1 FROM TENDL-2010 WITH NJOY2012.5
angular distribution for (n,n*5)

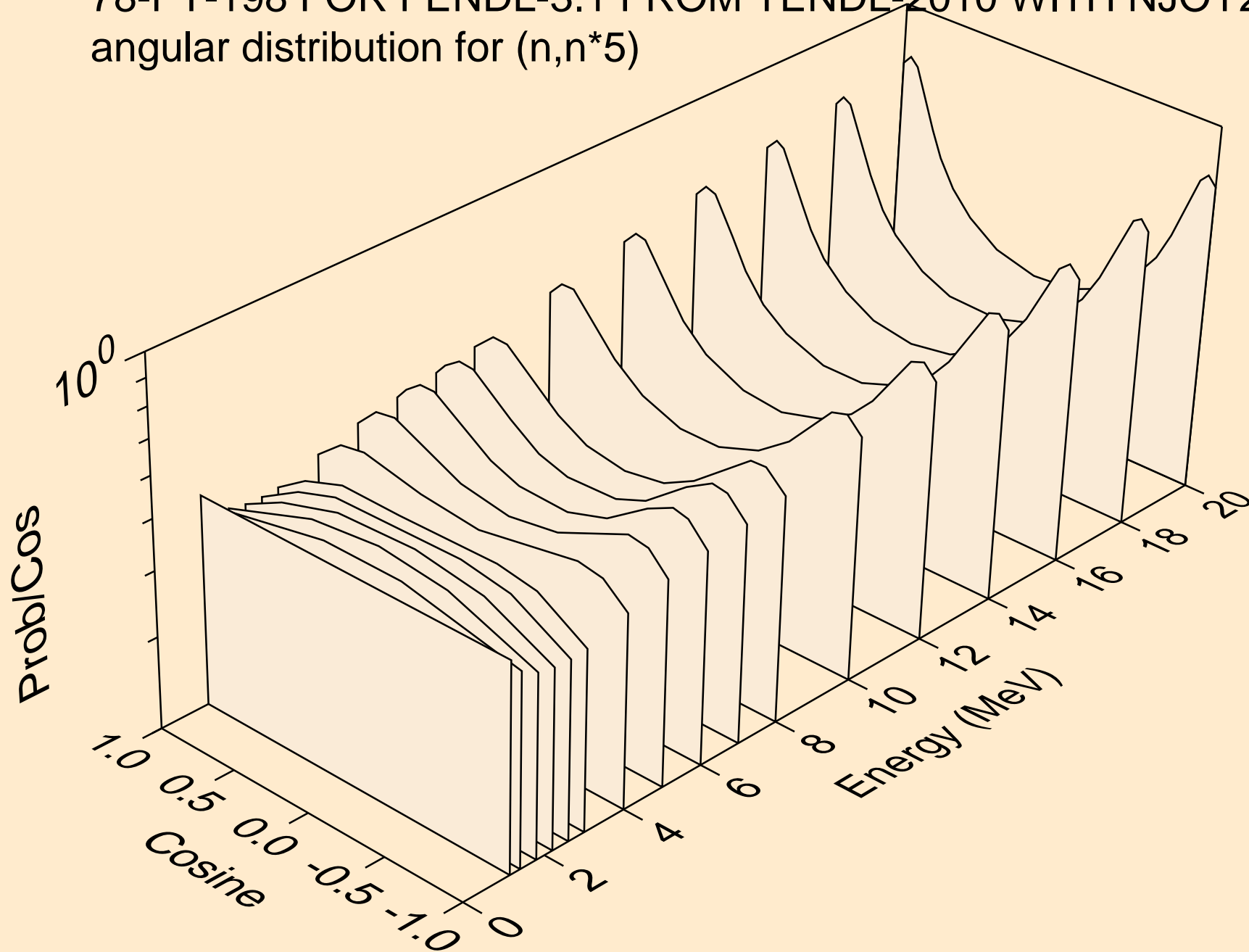

78-PT-198 FOR FENDL-3.1 FROM TENDL-2010 WITH NJOY2012.5
angular distribution for (n,n*6)

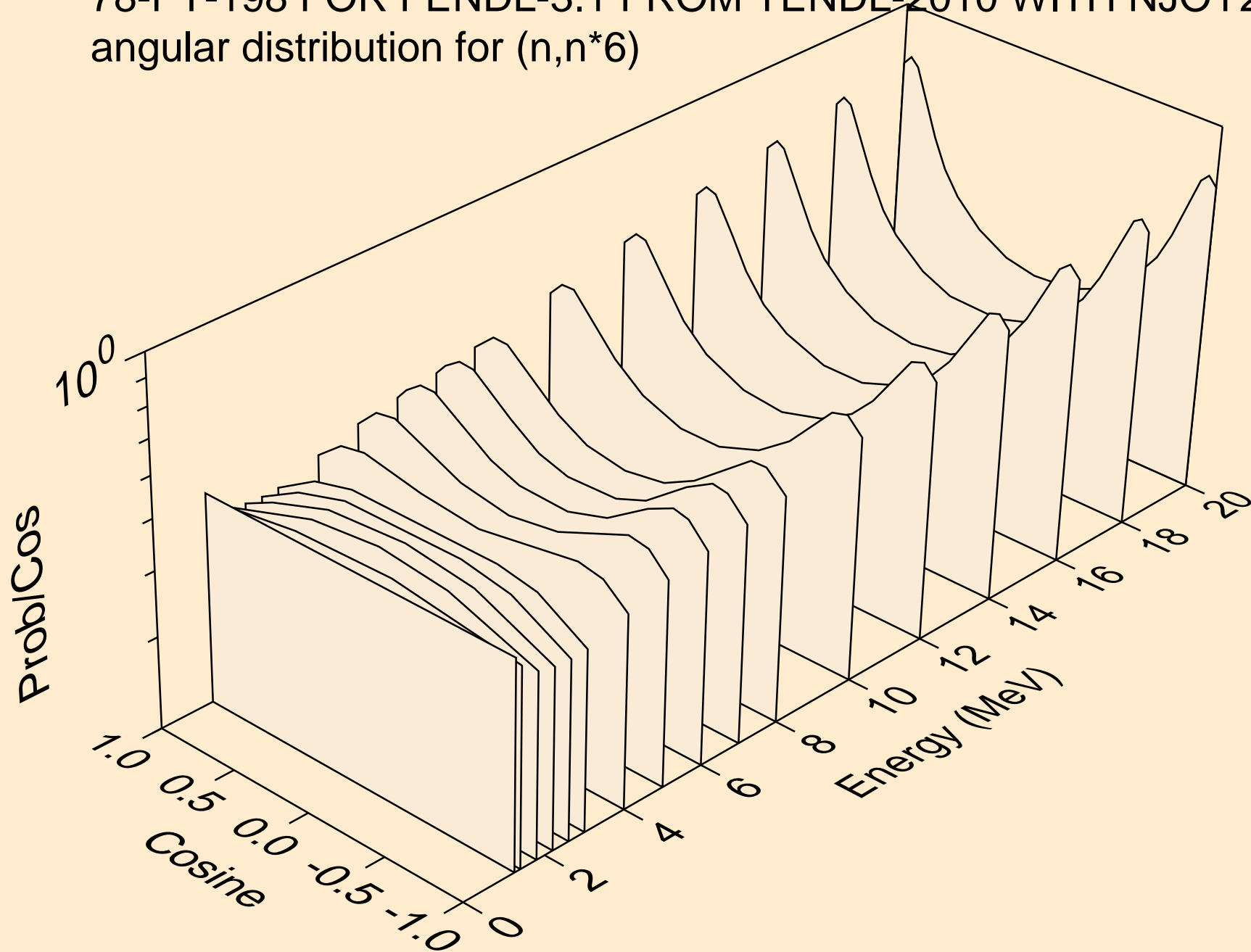

78-PT-198 FOR FENDL-3.1 FROM TENDL-2010 WITH NJOY2012.5
angular distribution for (n,n*7)

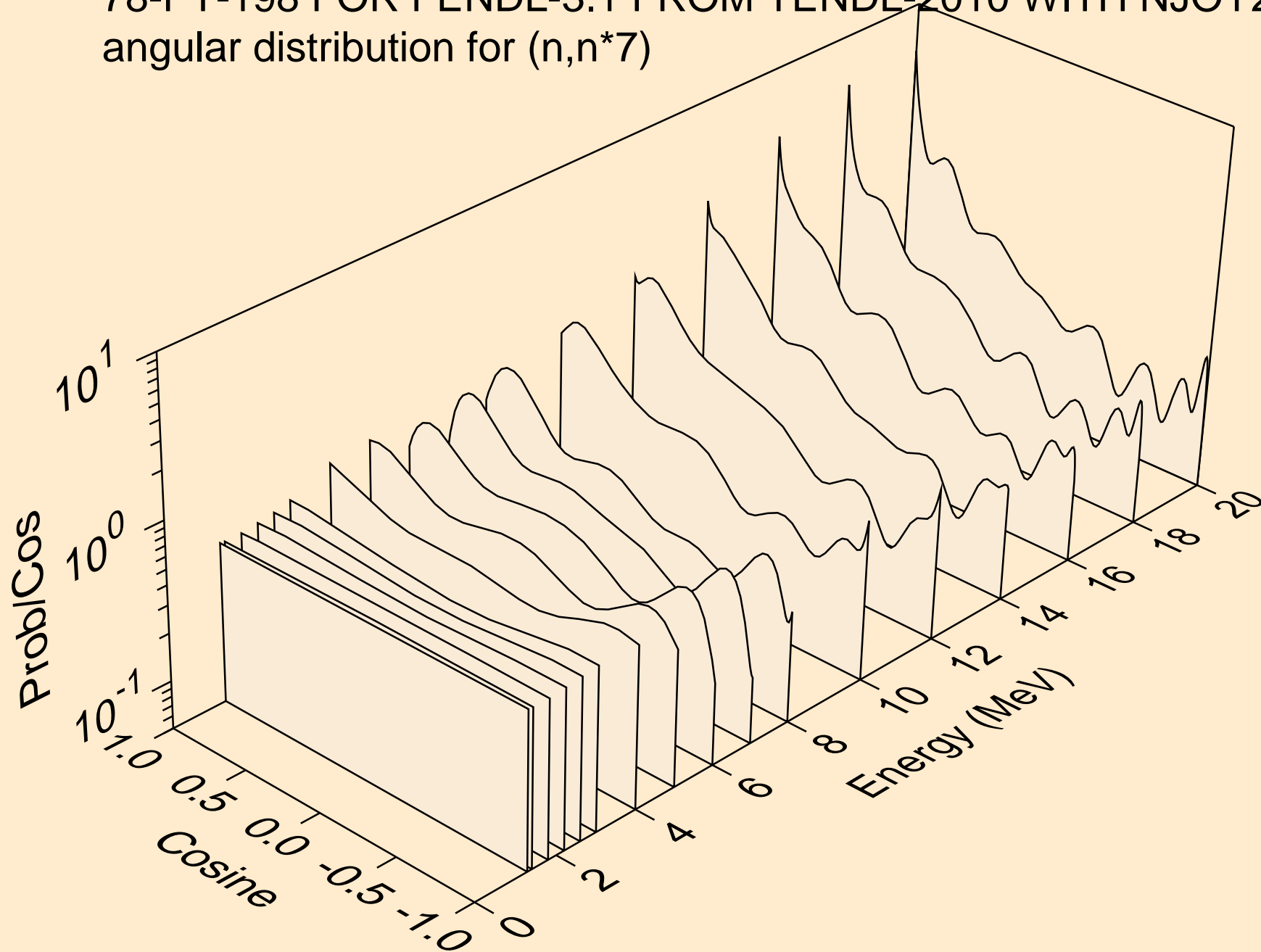

78-PT-198 FOR FENDL-3.1 FROM TENDL-2010 WITH NJOY2012.5
angular distribution for (n,n*8)

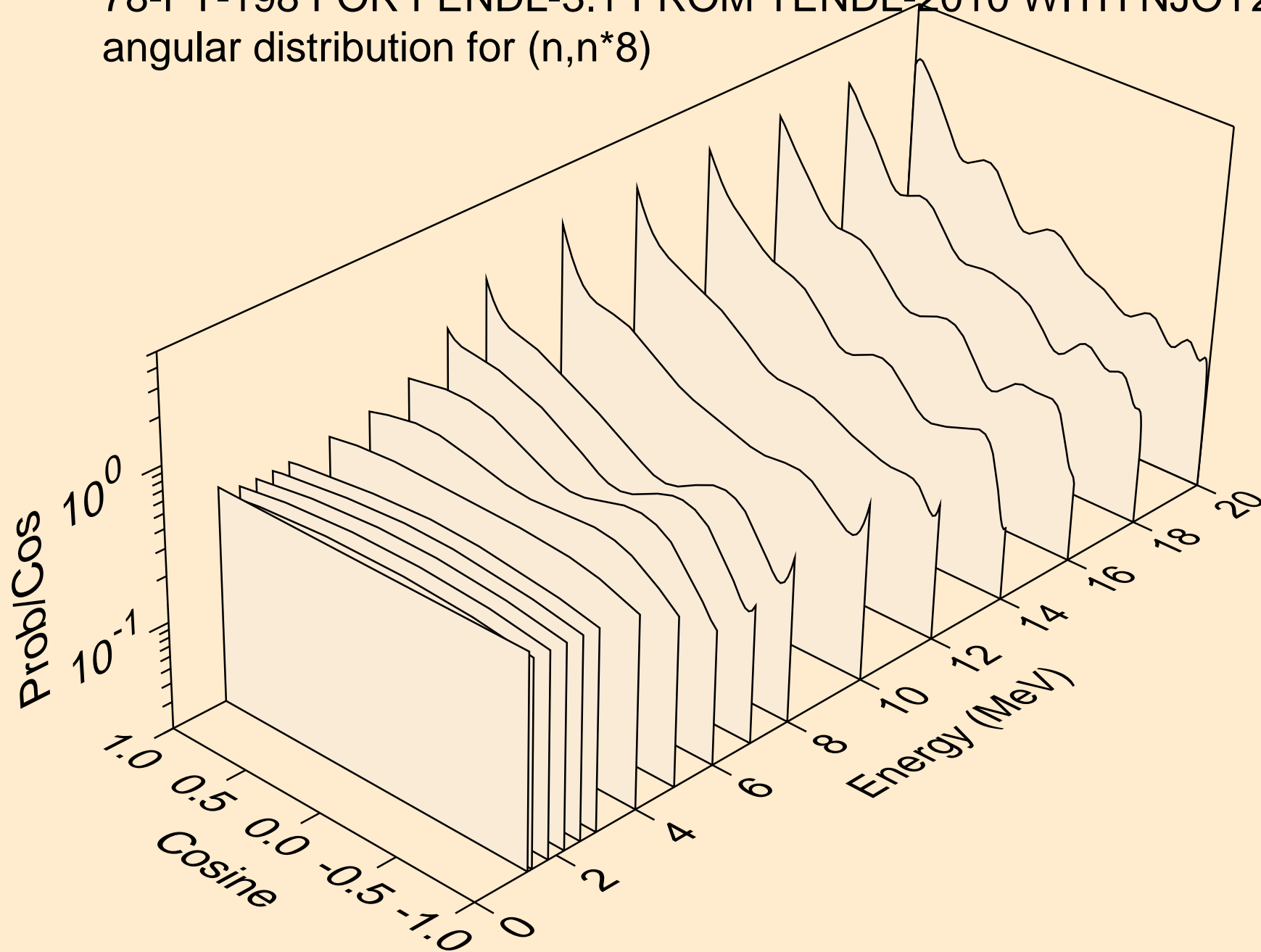

78-PT-198 FOR FENDL-3.1 FROM TENDL-2010 WITH NJOY2012.5
angular distribution for (n,n*9)

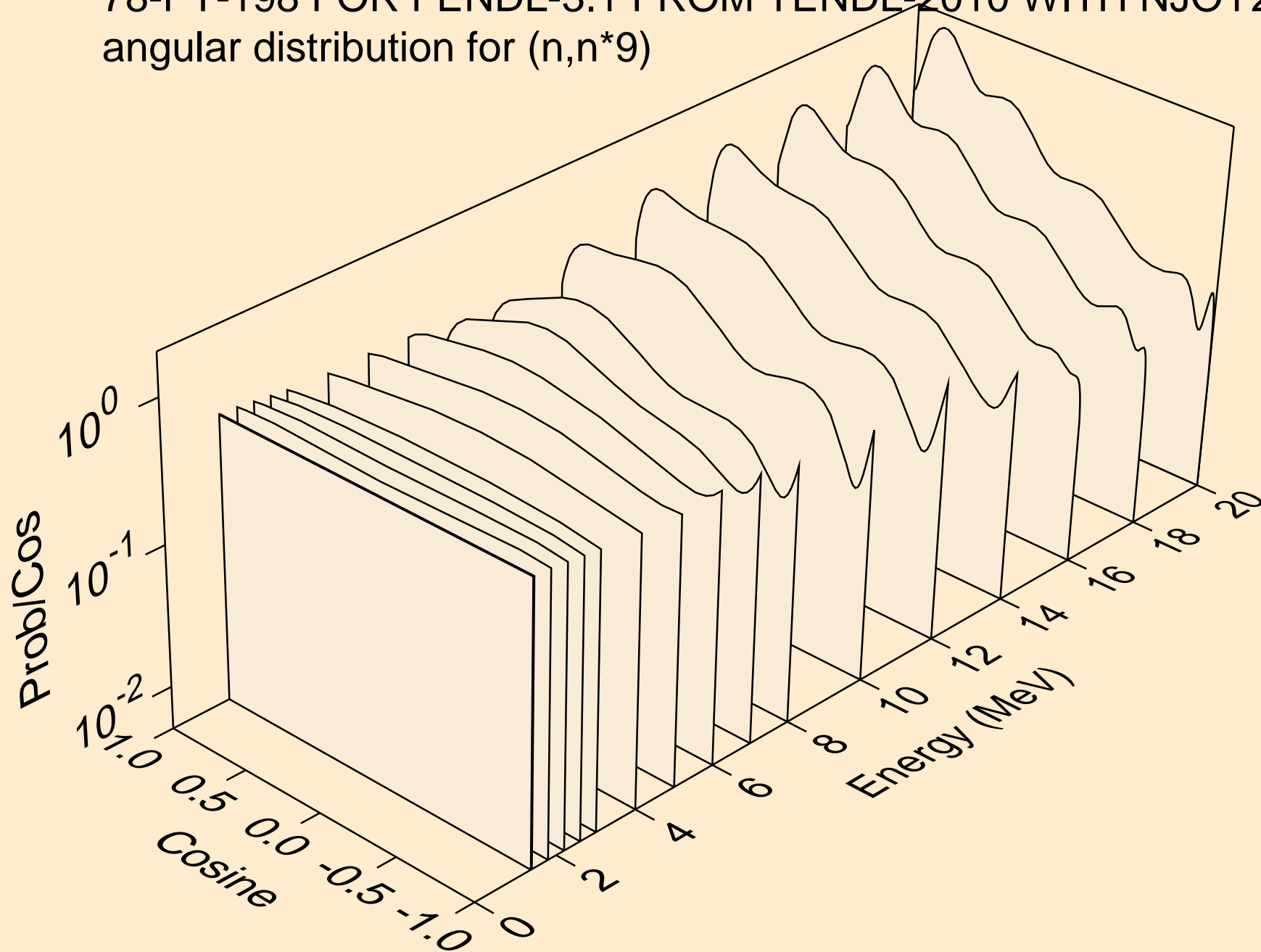

78-PT-198 FOR FENDL-3.1 FROM TENDL-2010 WITH NJOY2012.5
angular distribution for (n,n*10)

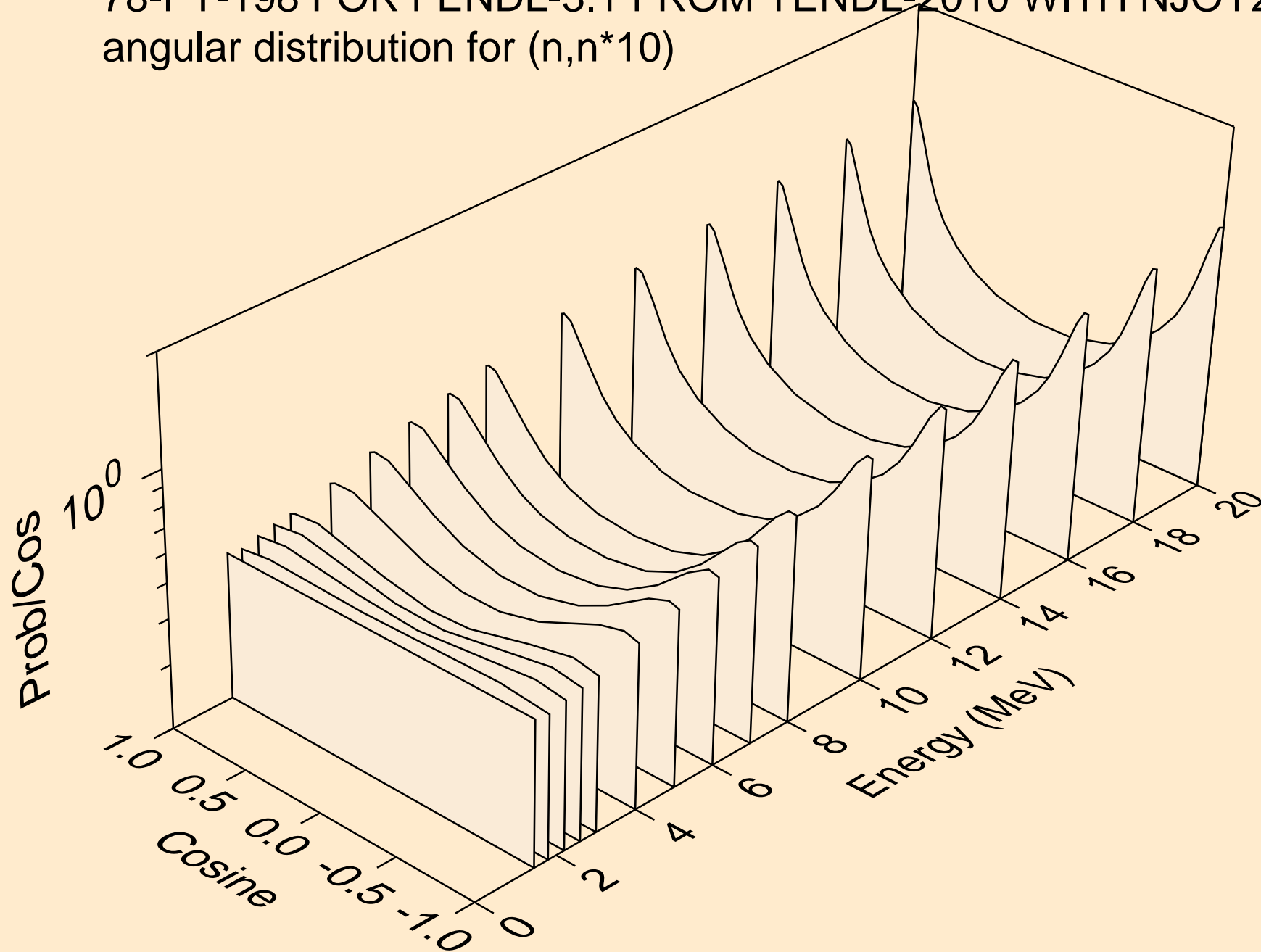

78-PT-198 FOR FENDL-3.1 FROM TENDL-2010 WITH NJOY2012.5
angular distribution for (n,n*11)

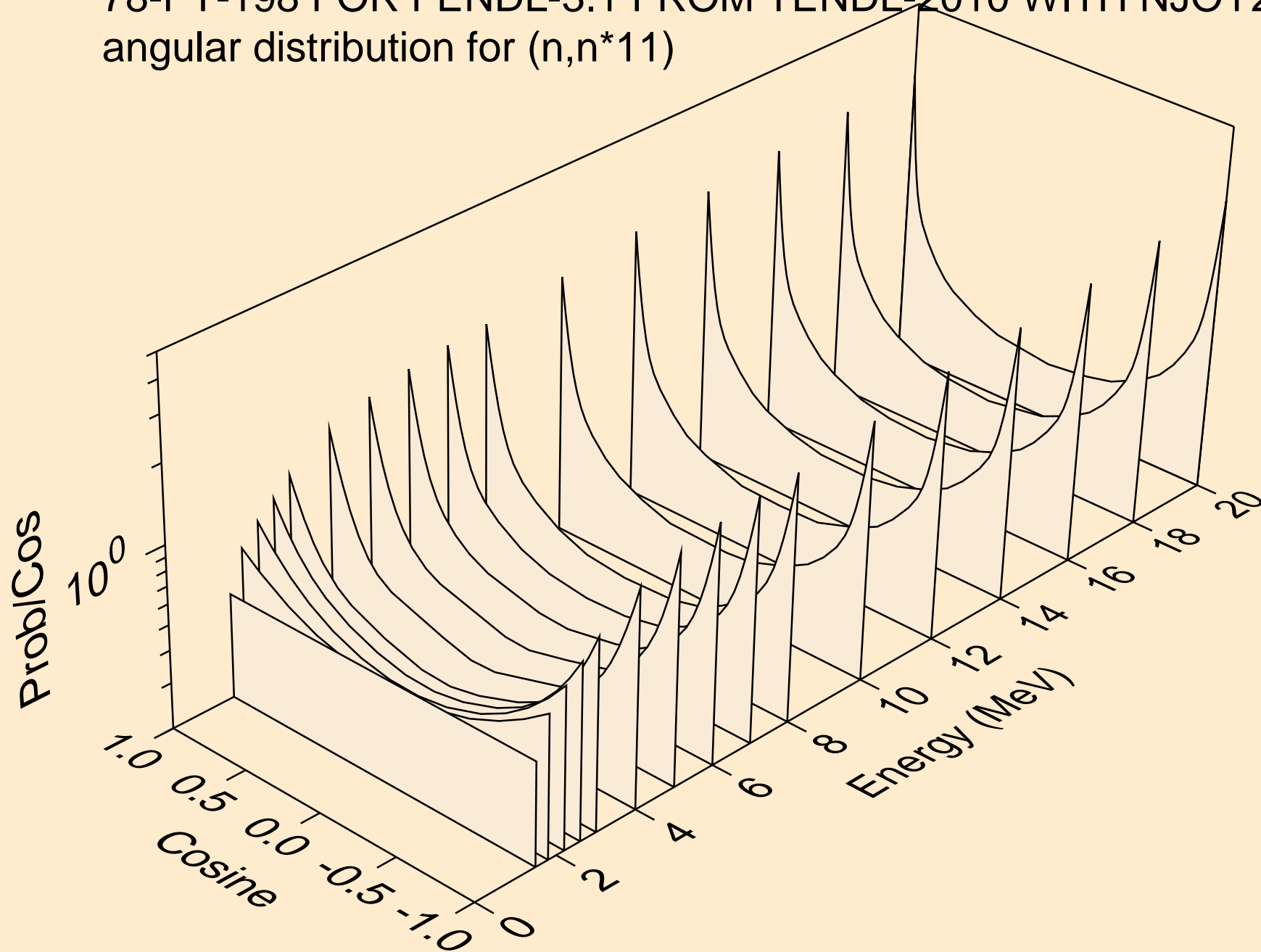

78-PT-198 FOR FENDL-3.1 FROM TENDL-2010 WITH NJOY2012.5
angular distribution for (n,n*12)

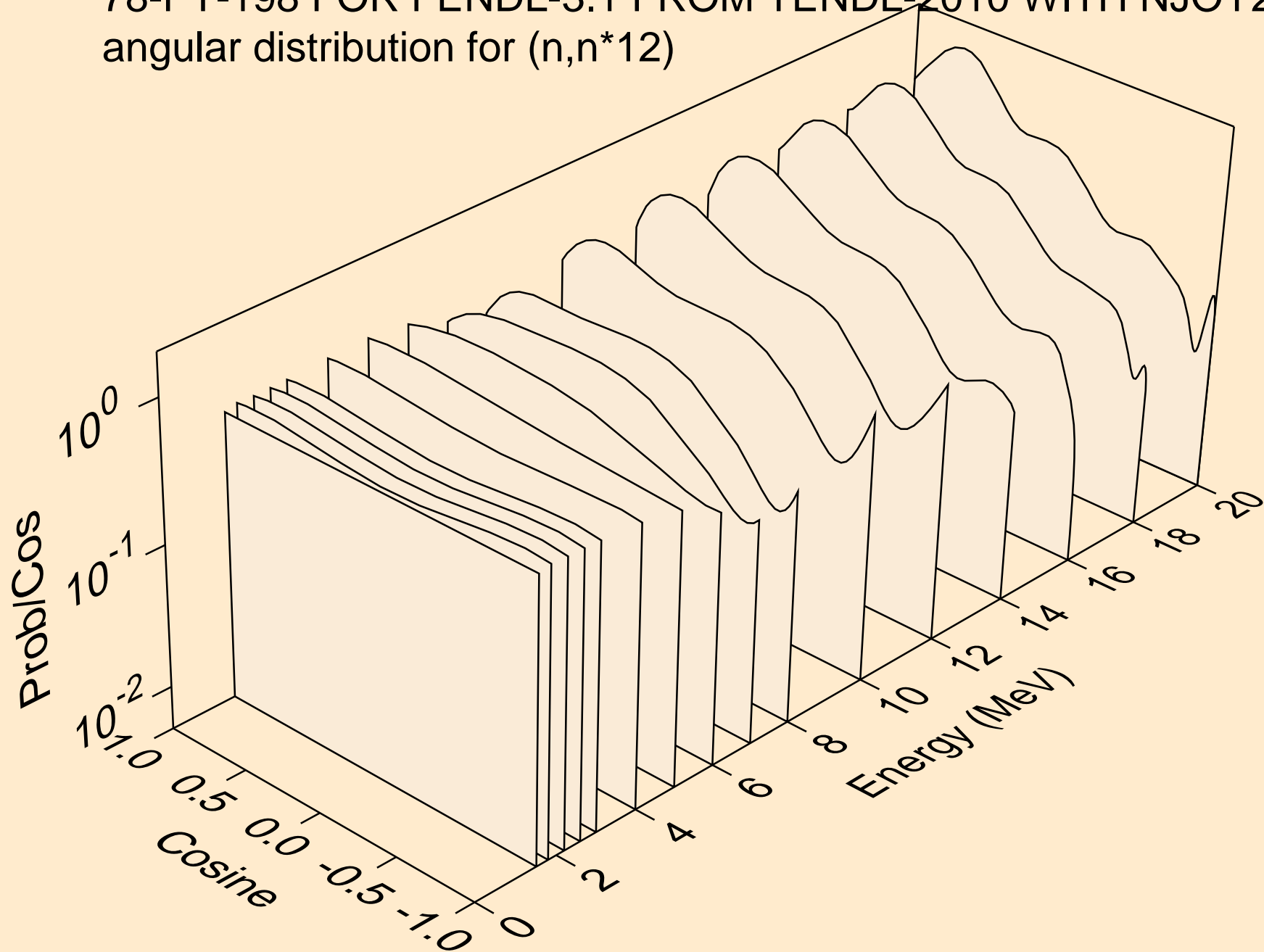

78-PT-198 FOR FENDL-3.1 FROM TENDL-2010 WITH NJOY2012.5
angular distribution for (n,n*13)

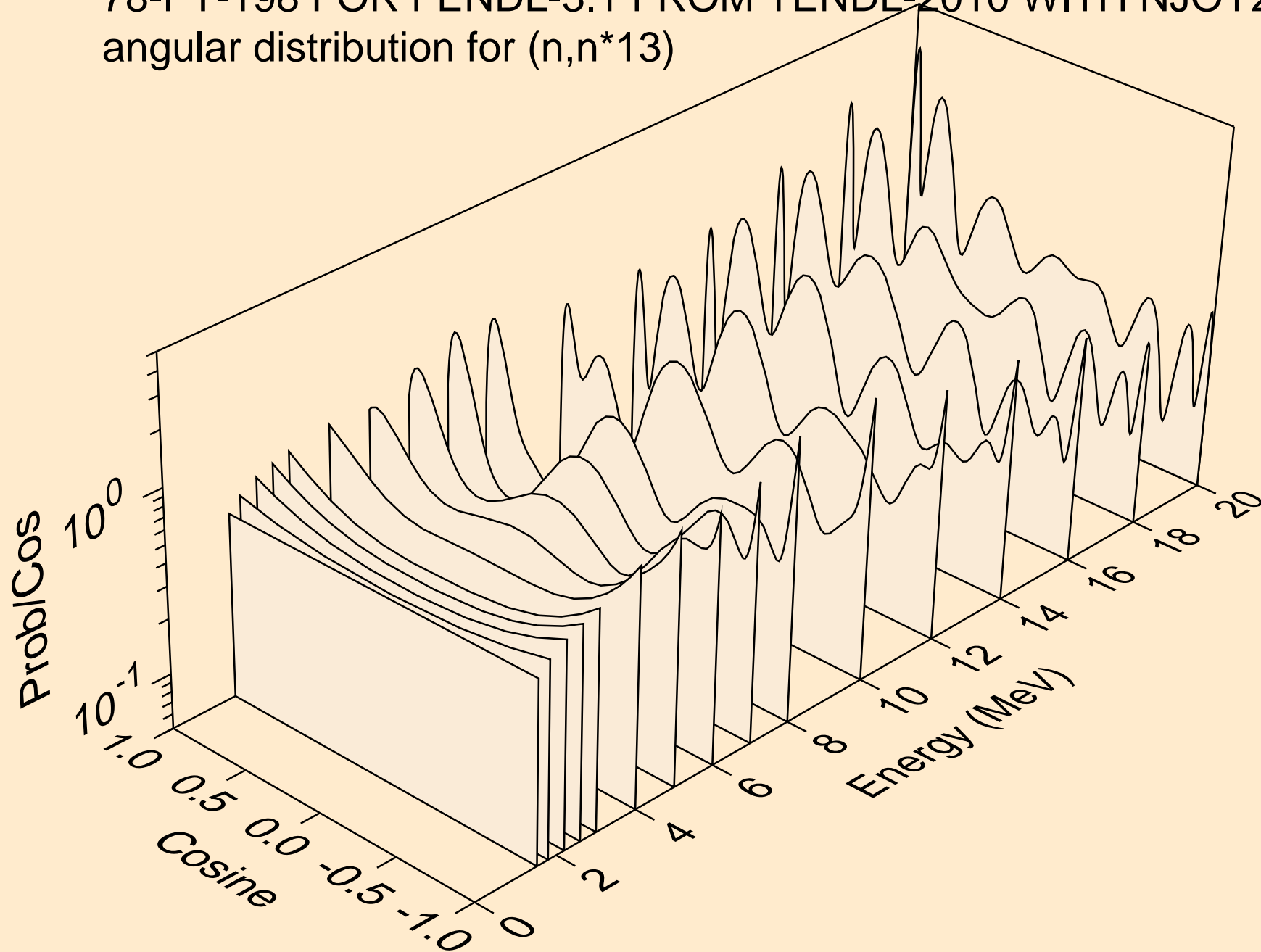

78-PT-198 FOR FENDL-3.1 FROM TENDL-2010 WITH NJOY2012.5
angular distribution for (n,n*14)

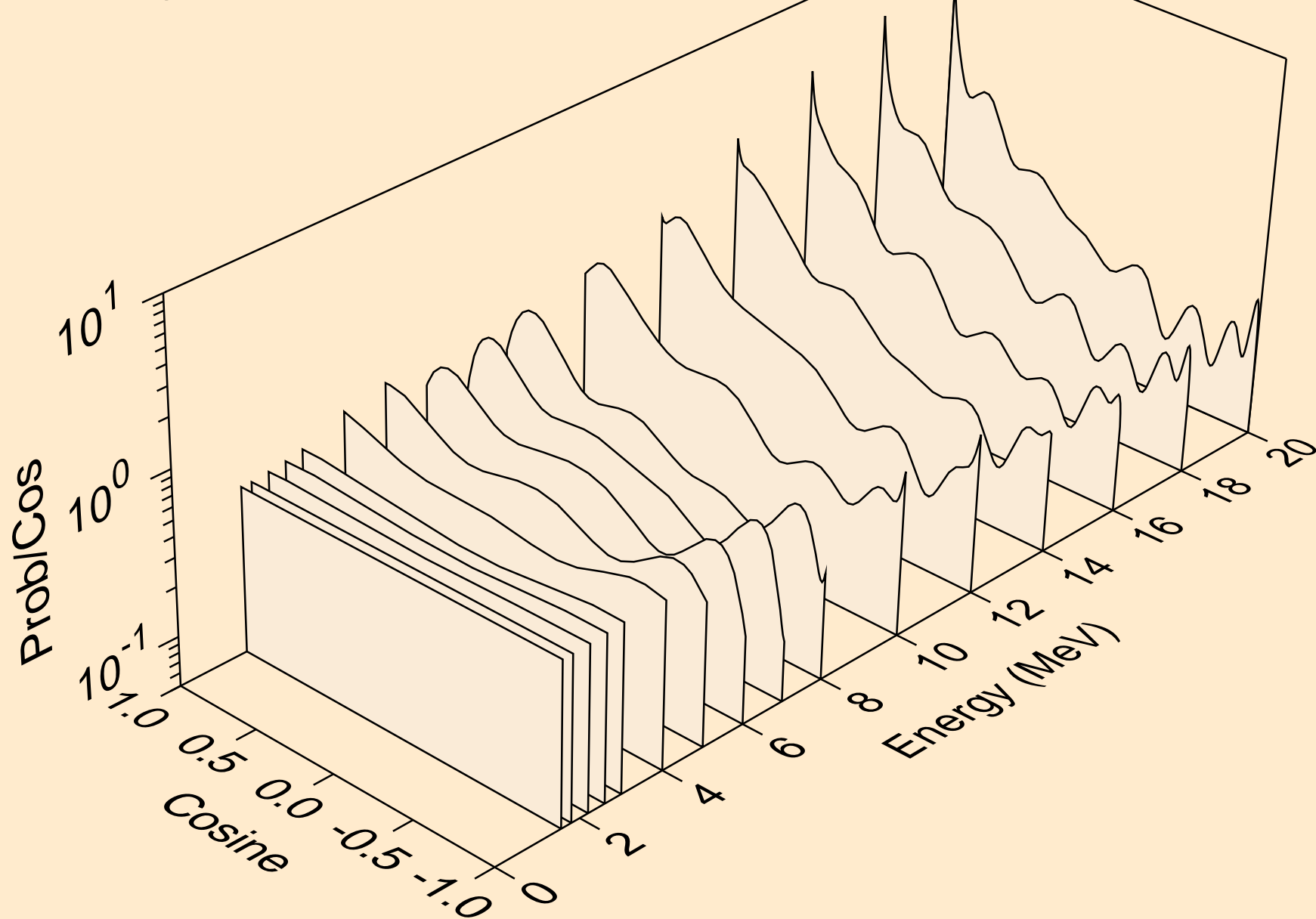

78-PT-198 FOR FENDL-3.1 FROM TENDL-2010 WITH NJOY2012.5
angular distribution for (n,n*15)

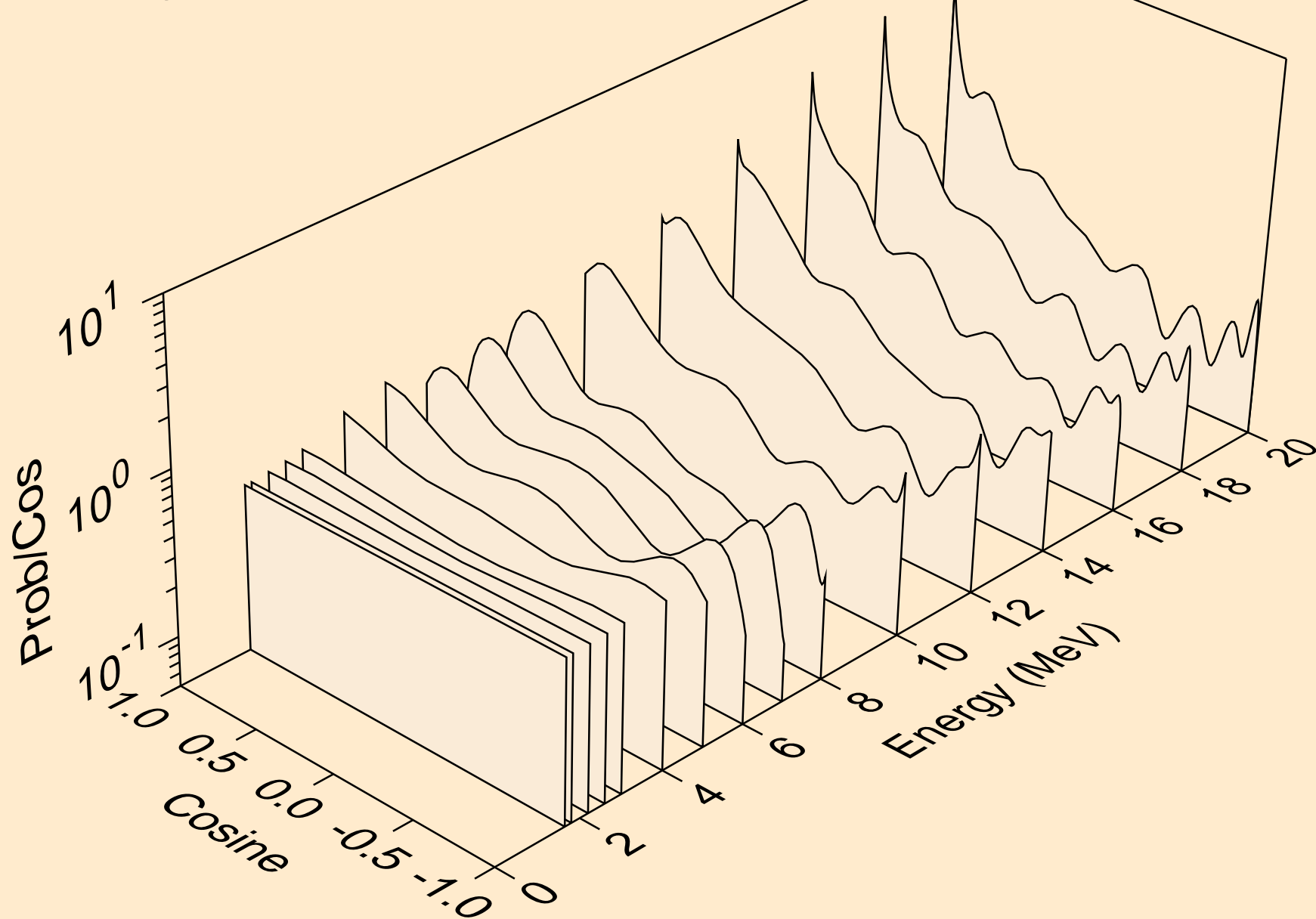

78-PT-198 FOR FENDL-3.1 FROM TENDL-2010 WITH NJOY2012.5
angular distribution for (n,n*16)

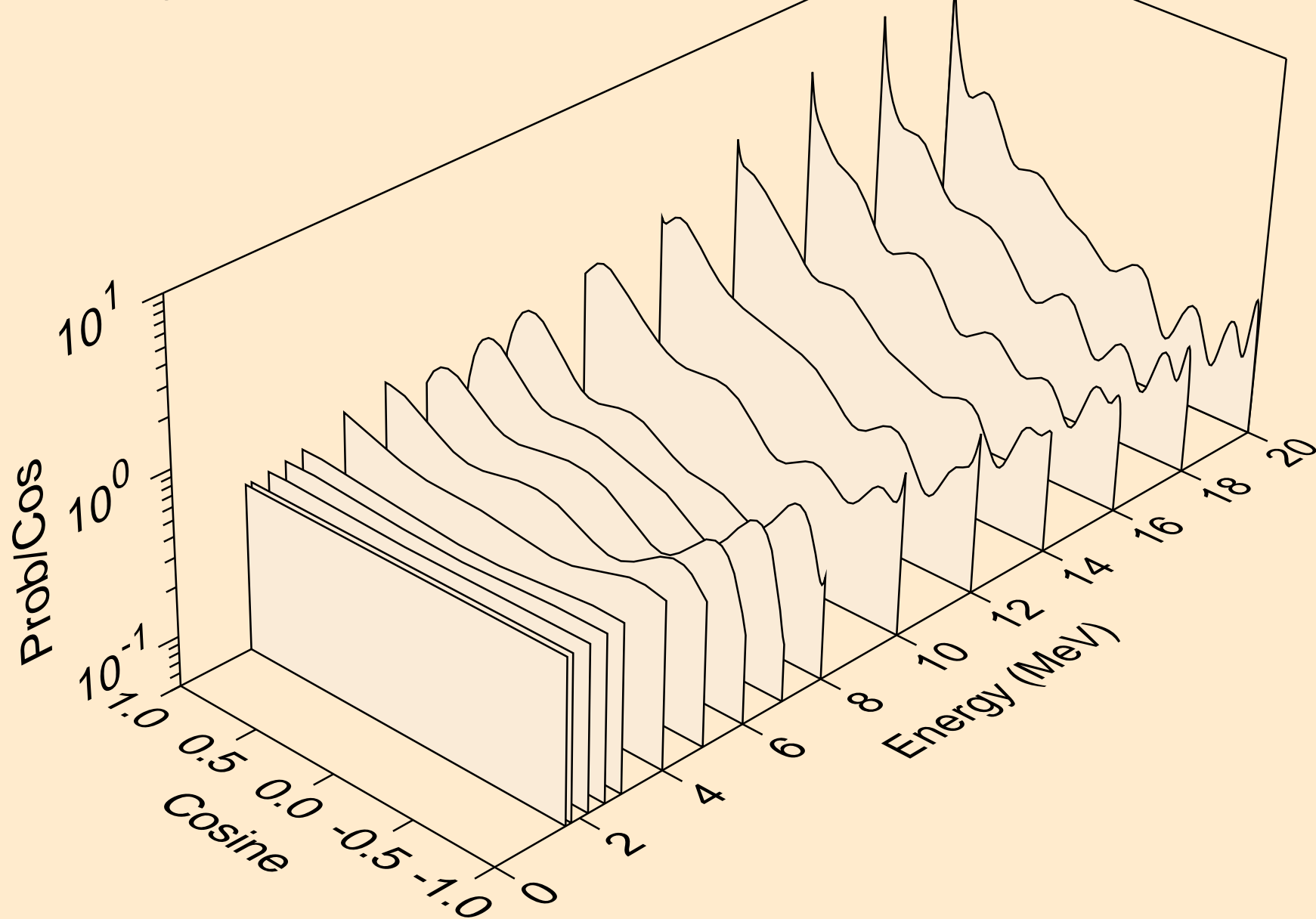

78-PT-198 FOR FENDL-3.1 FROM TENDL-2010 WITH NJOY2012.5
angular distribution for (n,n*17)

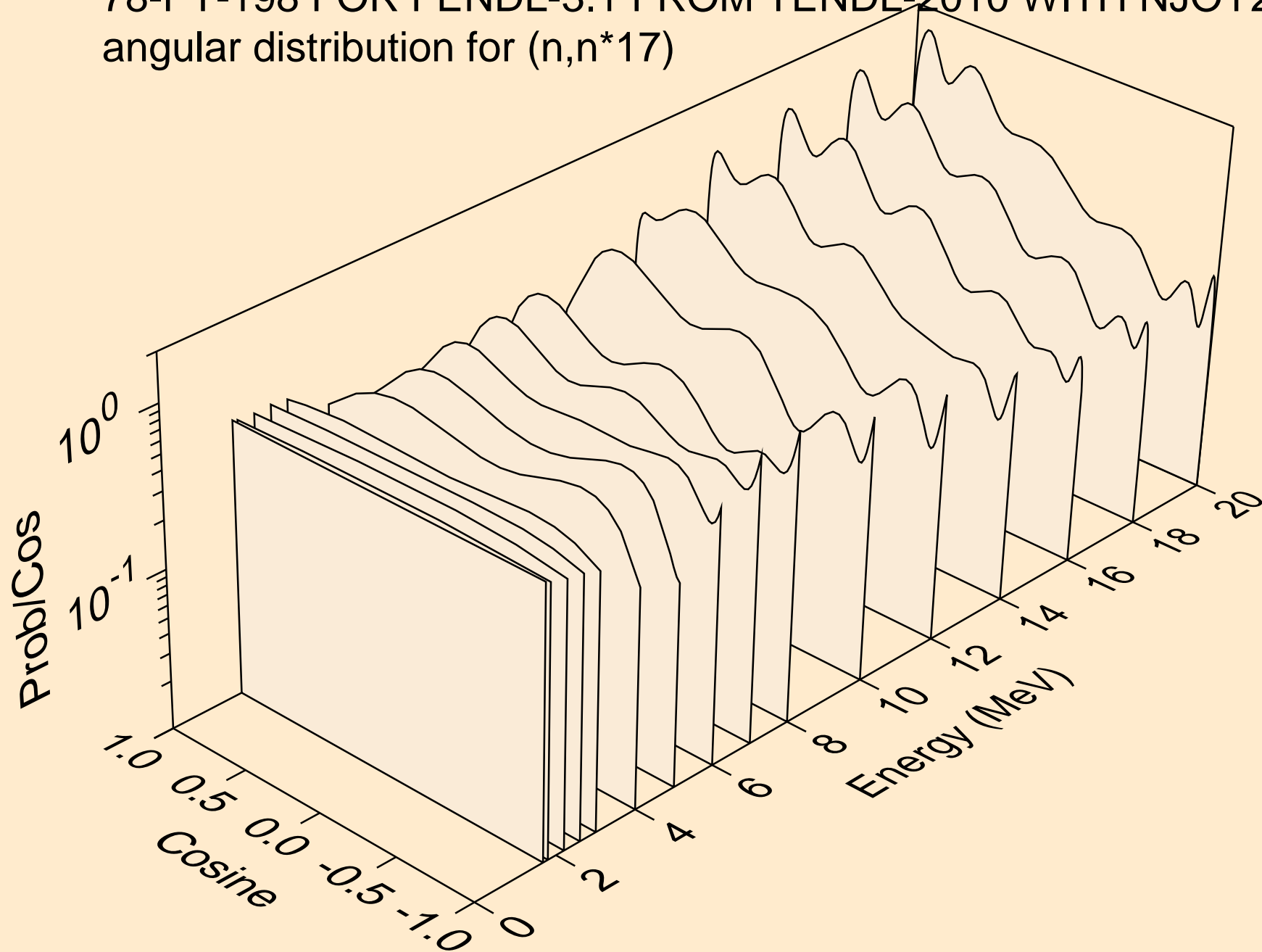

78-PT-198 FOR FENDL-3.1 FROM TENDL-2010 WITH NJOY2012.5
angular distribution for (n,n*18)

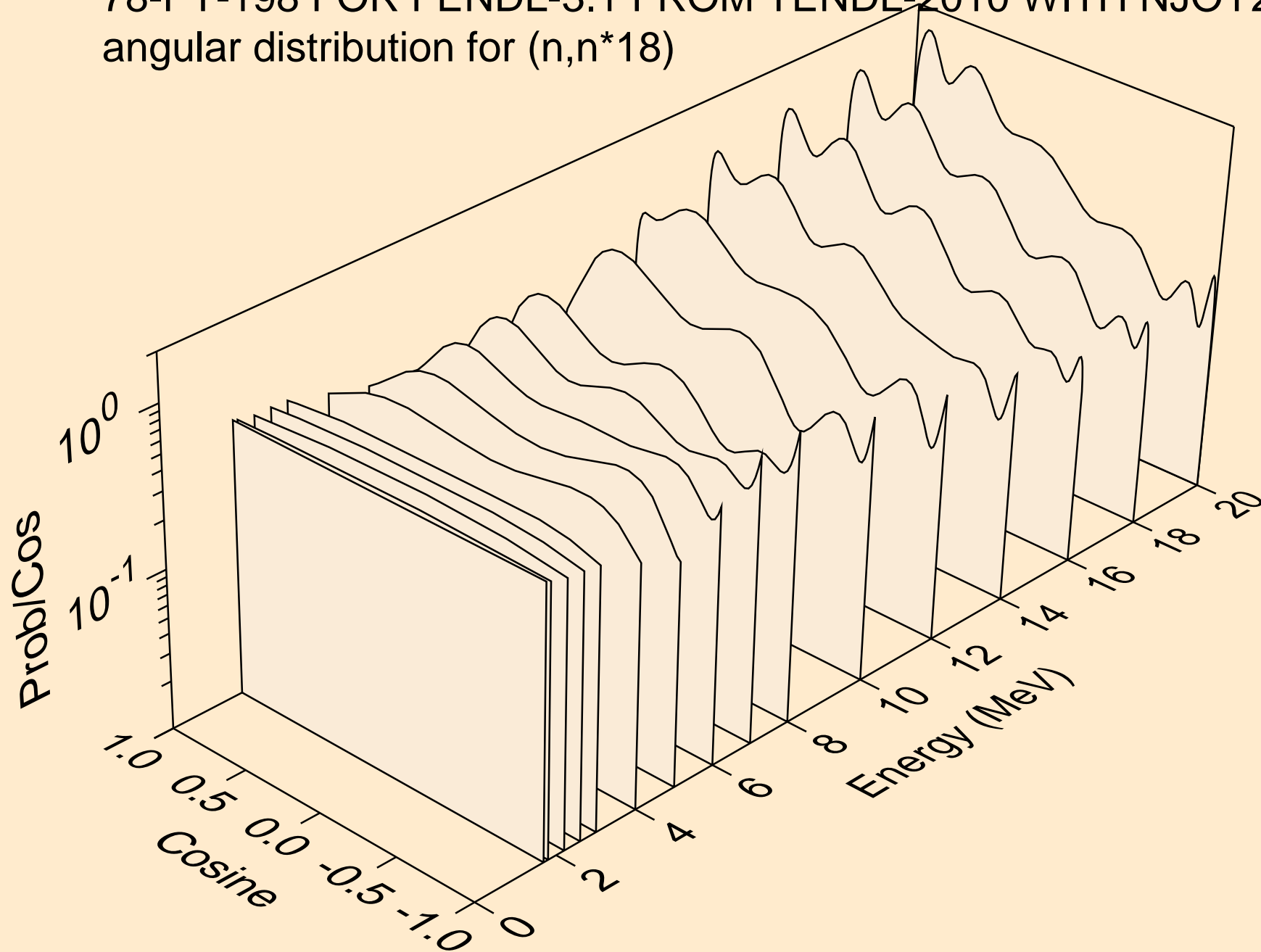

78-PT-198 FOR FENDL-3.1 FROM TENDL-2010 WITH NJOY2012.5
angular distribution for (n,n*19)

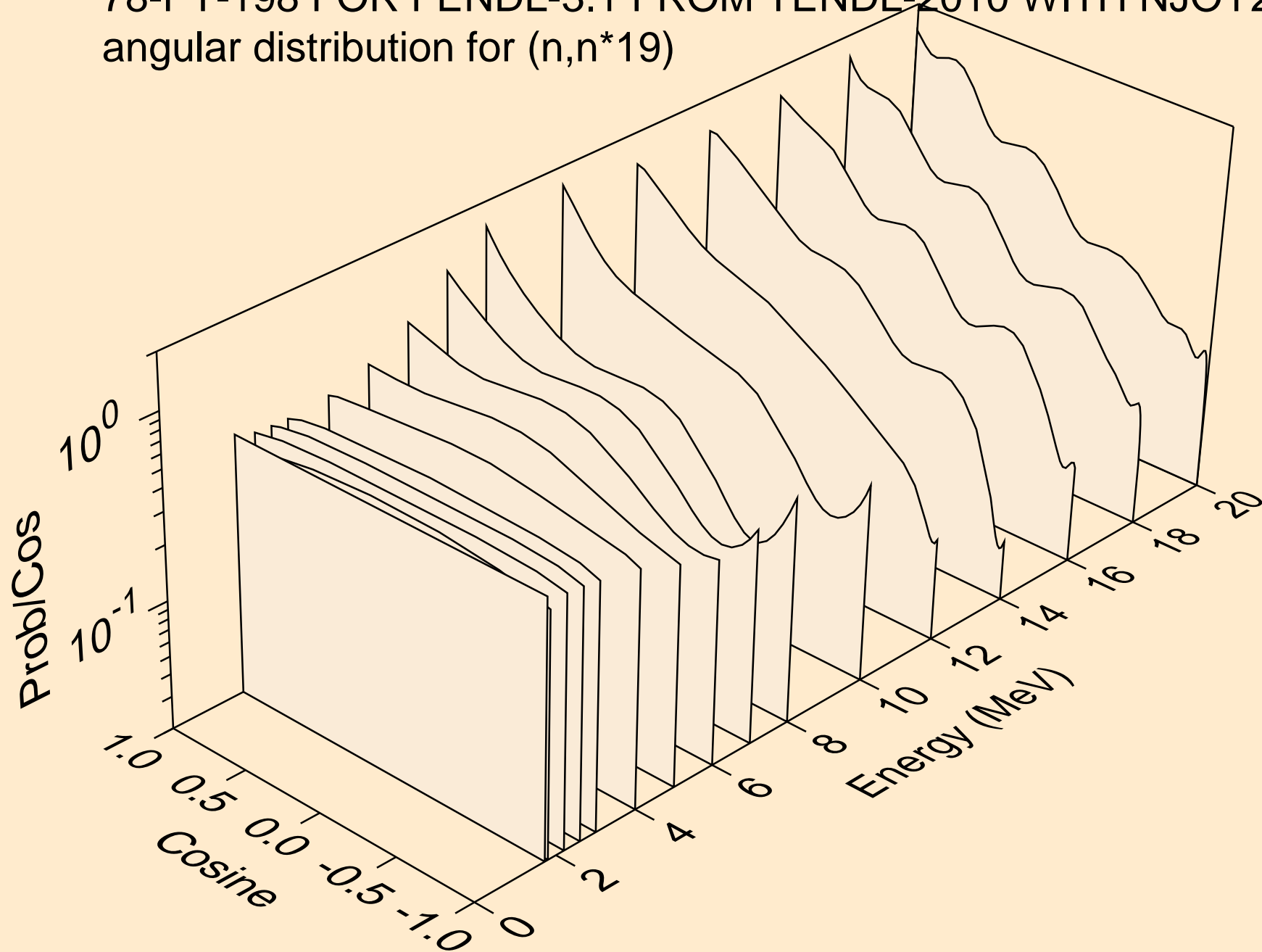

78-PT-198 FOR FENDL-3.1 FROM TENDL-2010 WITH NJOY2012.5
angular distribution for (n,n*20)

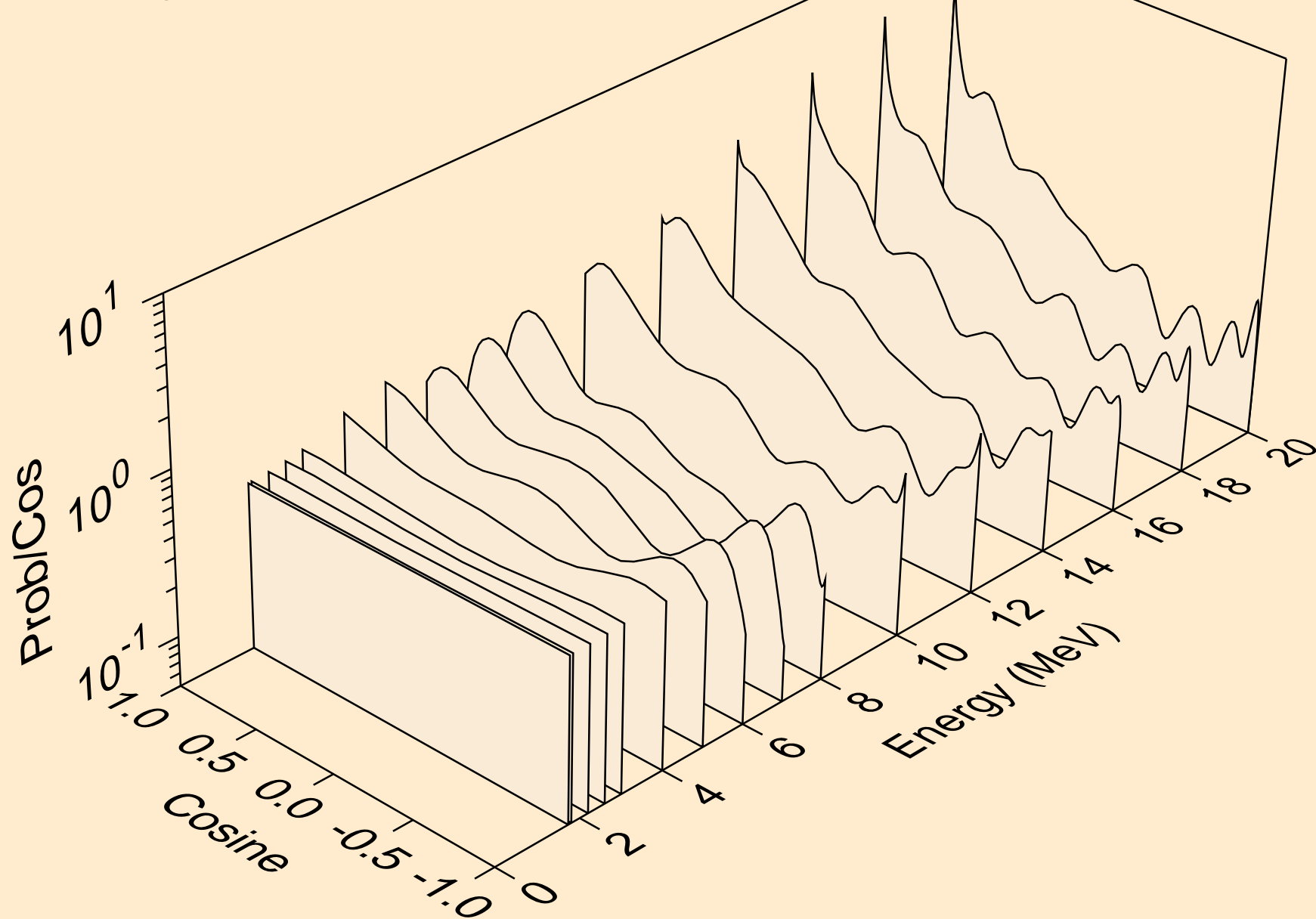

78-PT-198 FOR FENDL-3.1 FROM TENDL-2010 WITH NJOY2012.5
Neutron emission for (n,x)

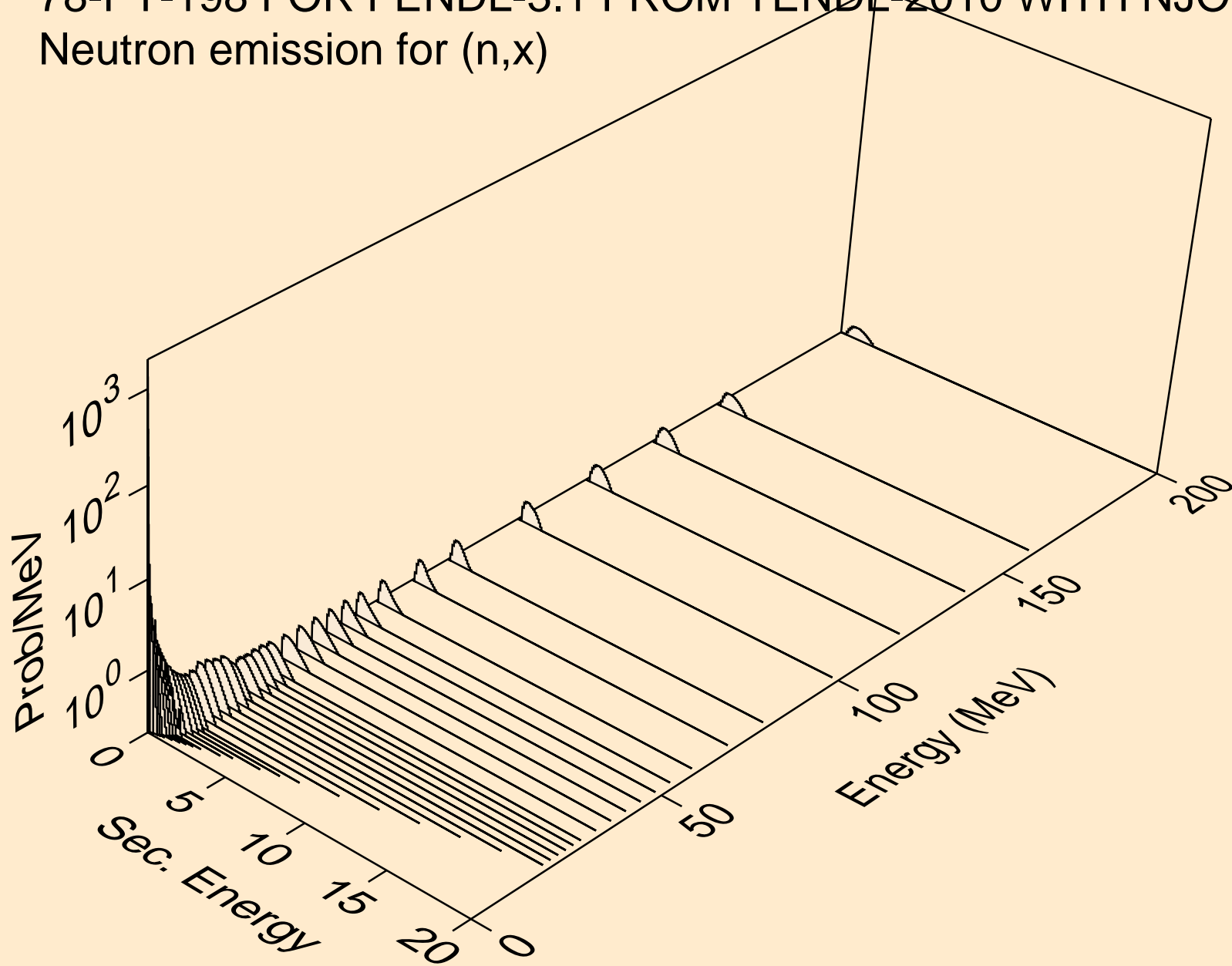

78-PT-198 FOR FENDL-3.1 FROM TENDL-2010 WITH NJOY2012.5
Neutron emission for (n,2n)

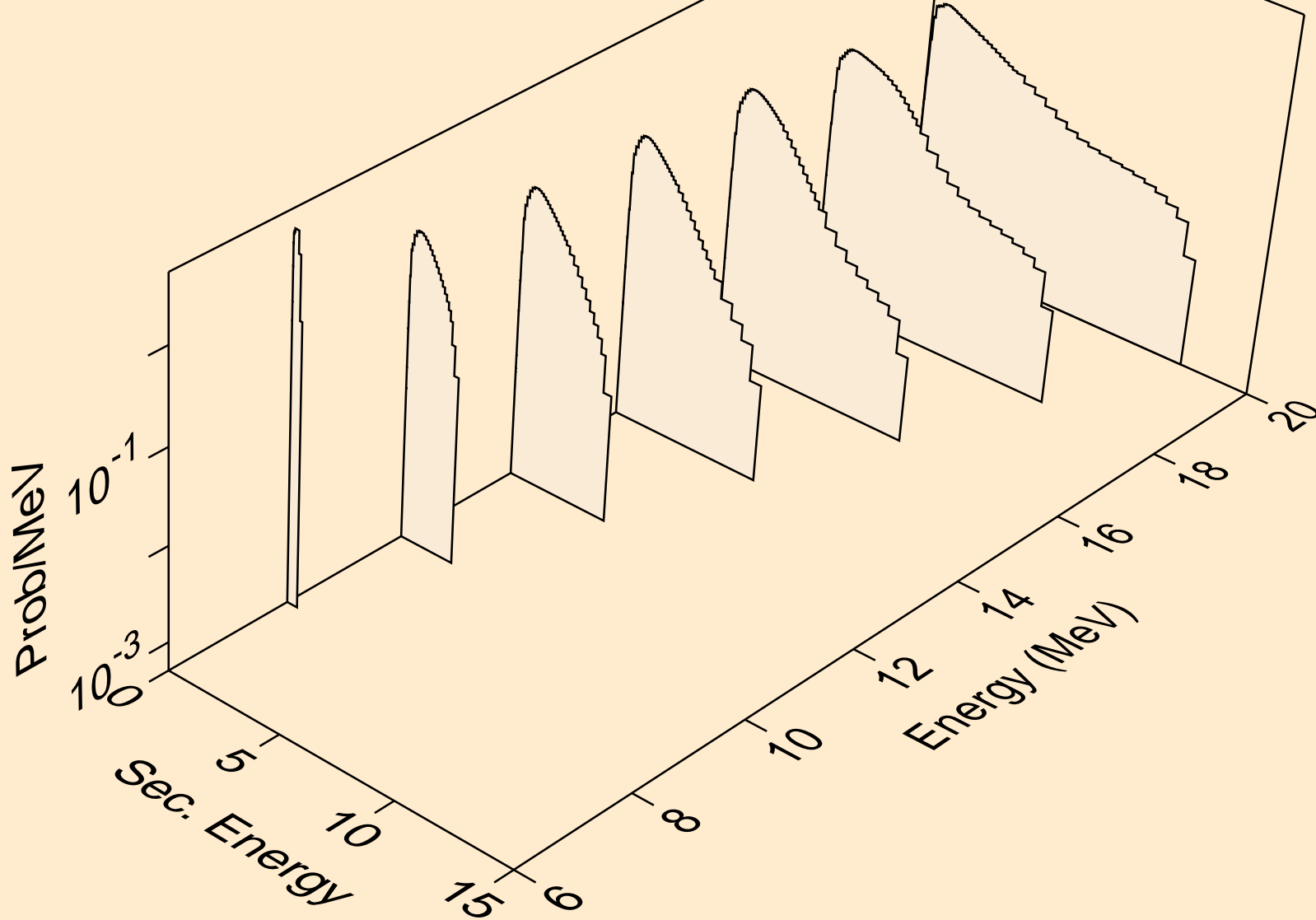

78-PT-198 FOR FENDL-3.1 FROM TENDL-2010 WITH NJOY2012.5
Neutron emission for (n,3n)

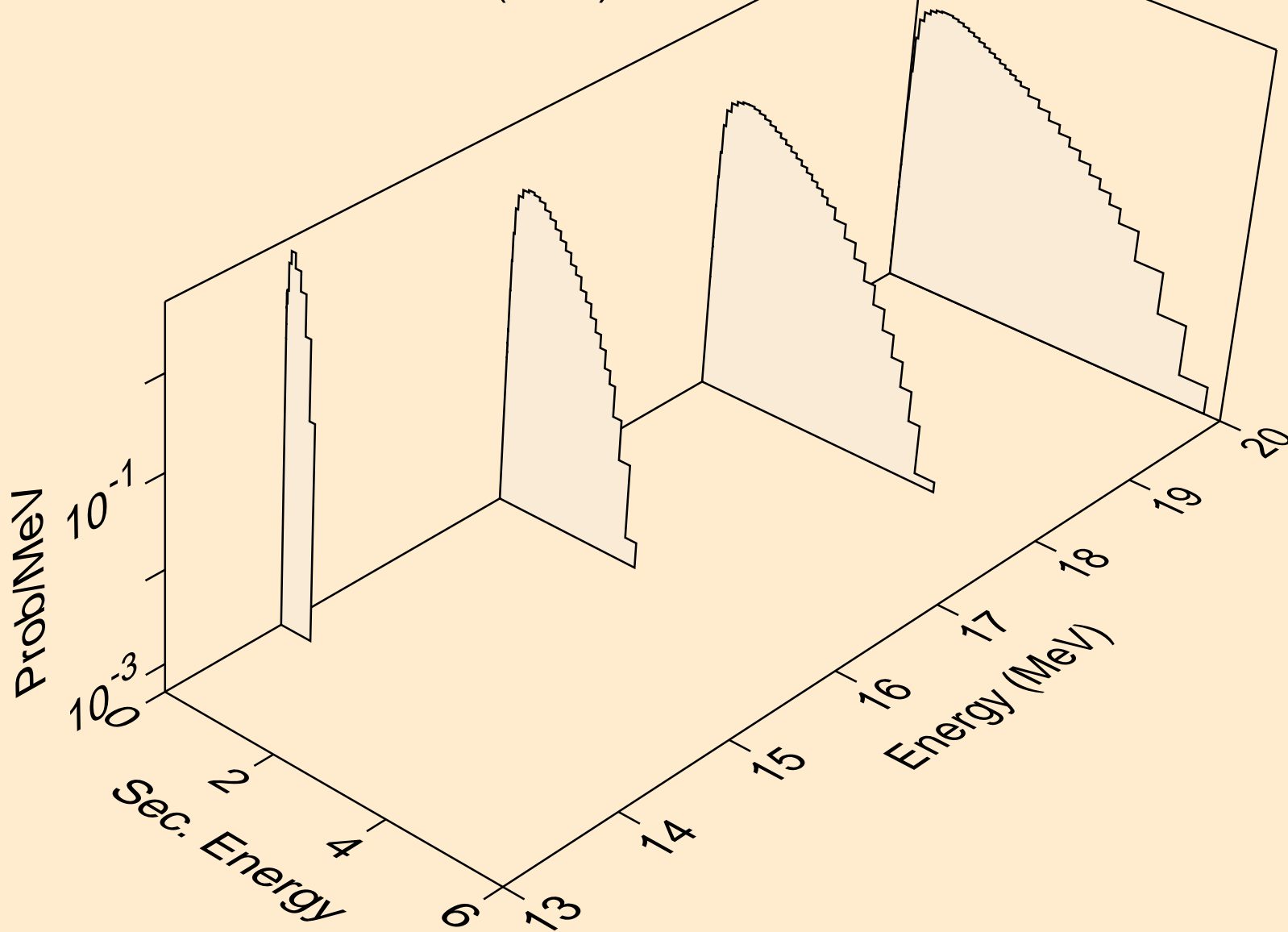

78-PT-198 FOR FENDL-3.1 FROM TENDL-2010 WITH NJOY2012.5
Neutron emission for (n,n*)a

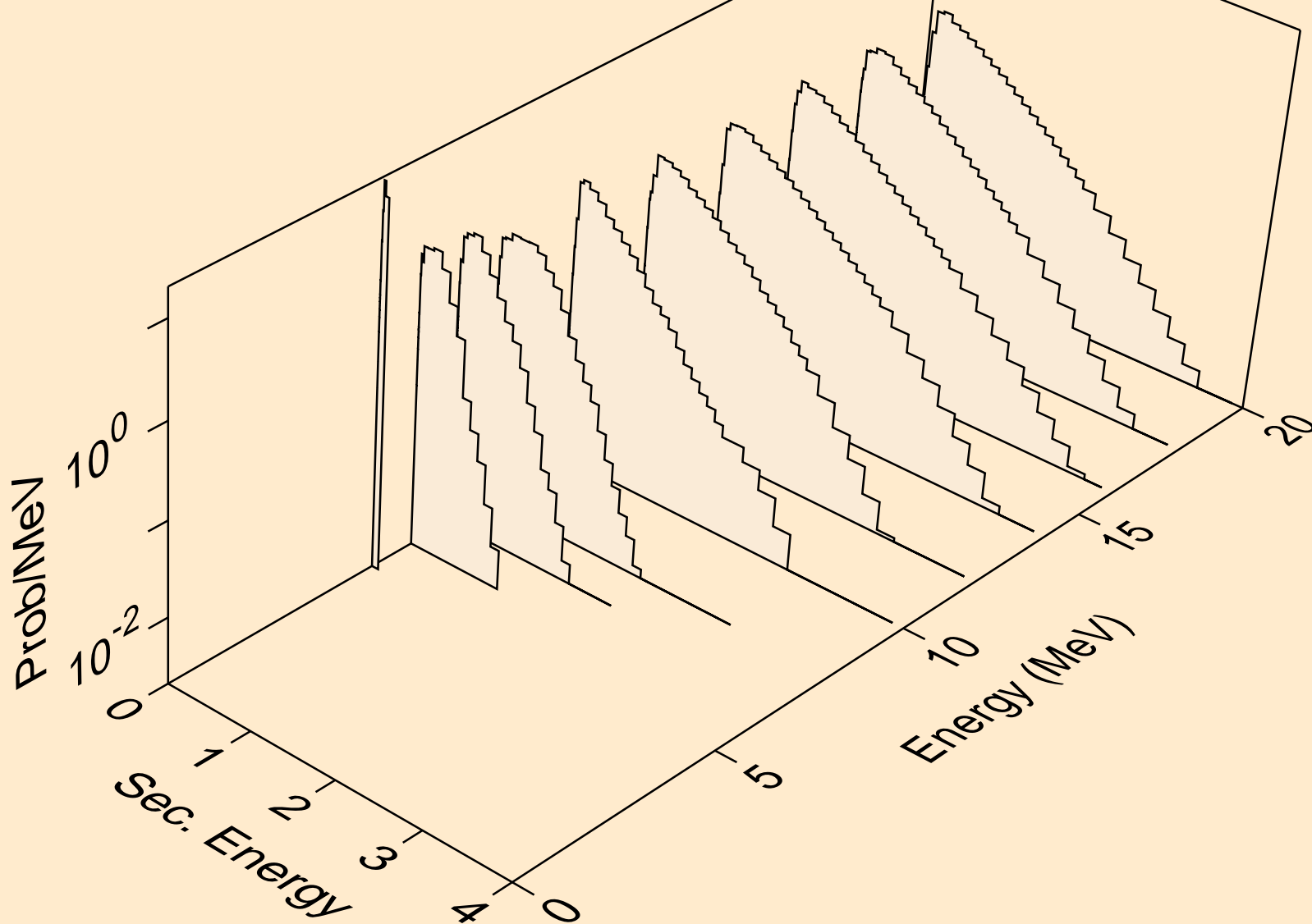

78-PT-198 FOR FENDL-3.1 FROM TENDL-2010 WITH NJOY2012.5
Neutron emission for (n,2n)a

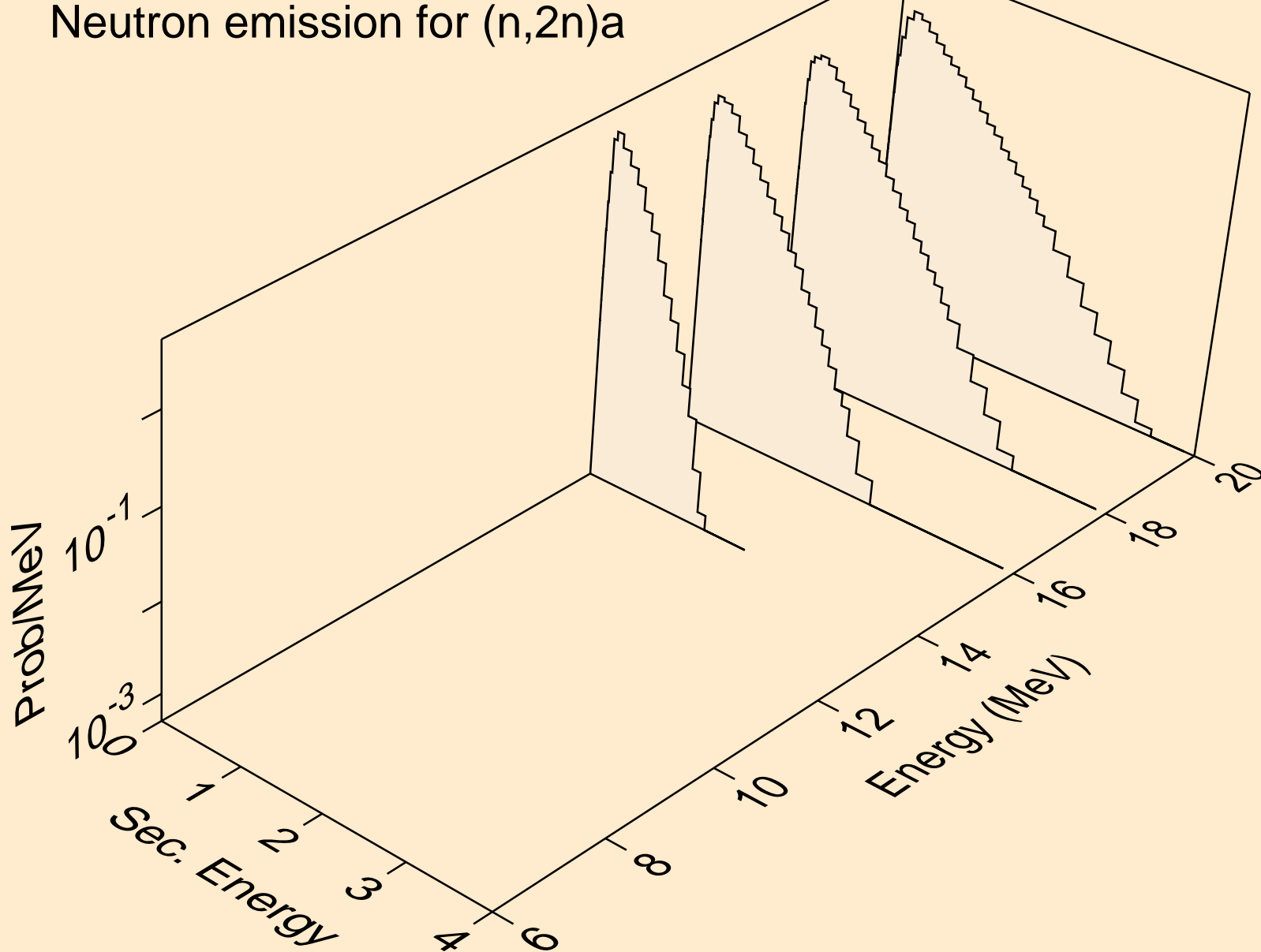

78-PT-198 FOR FENDL-3.1 FROM TENDL-2010 WITH NJOY2012.5
Neutron emission for (n,n*)p

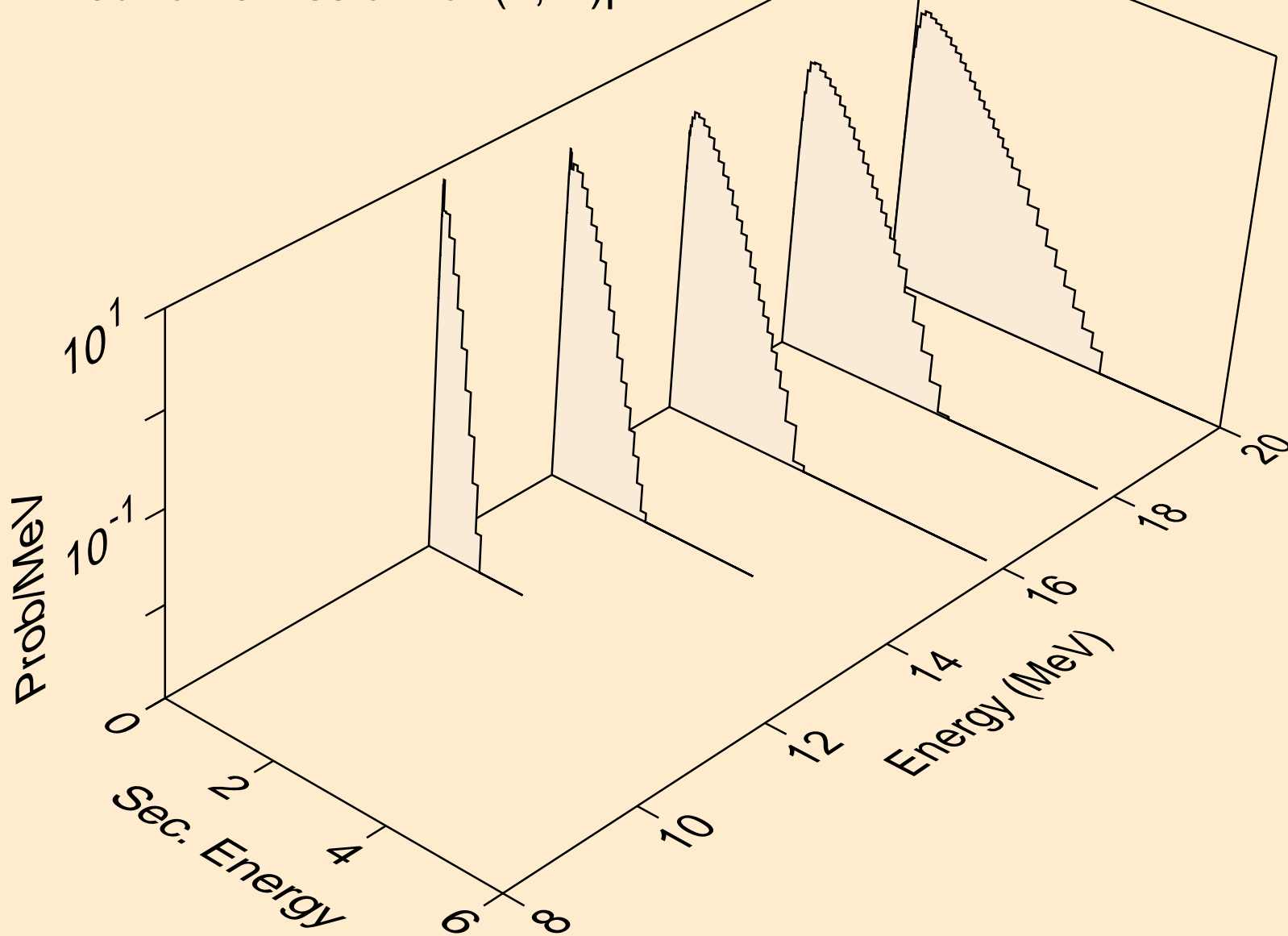

78-PT-198 FOR FENDL-3.1 FROM TENDL-2010 WITH NJOY2012.5
Neutron emission for (n,n*)d

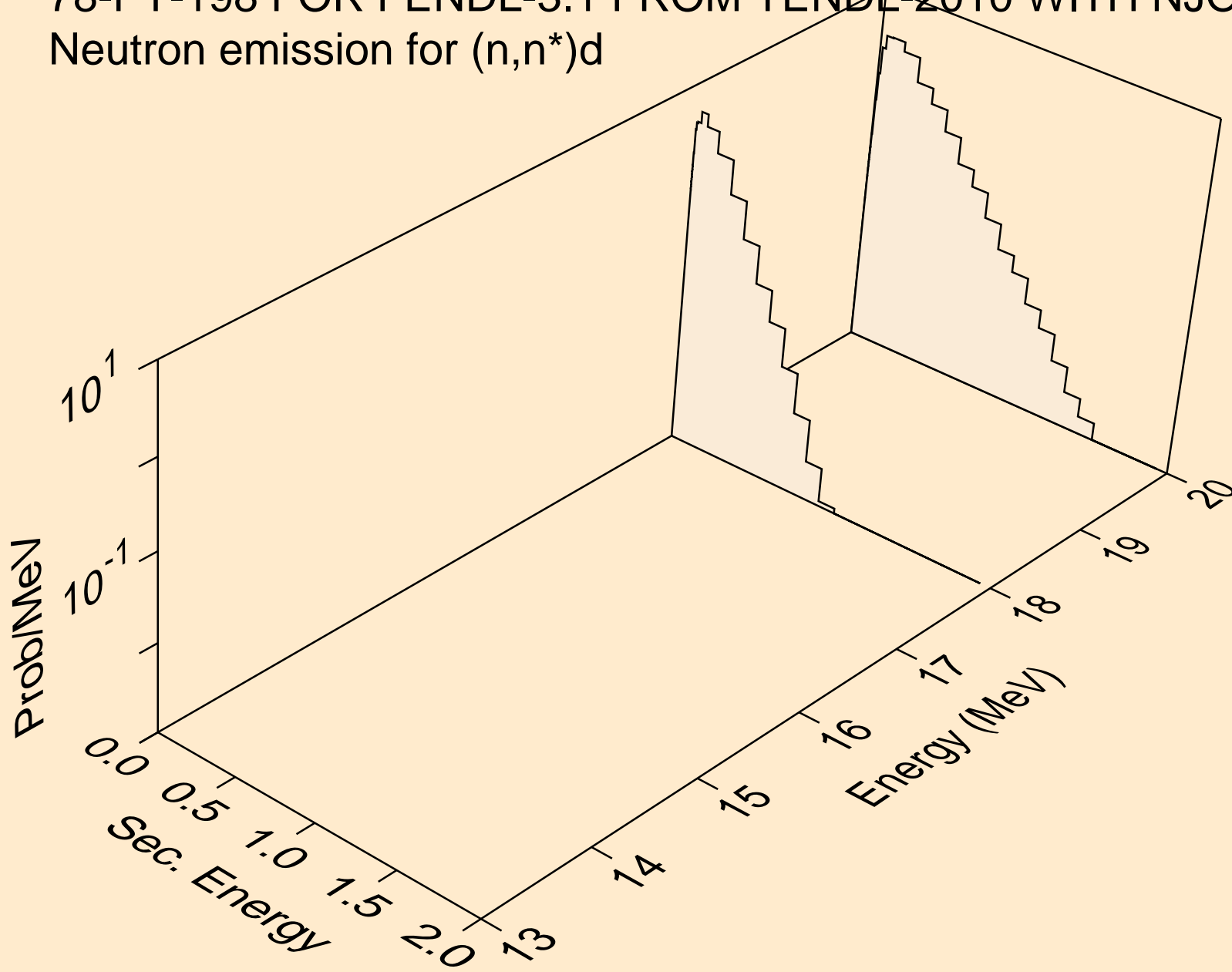

78-PT-198 FOR FENDL-3.1 FROM TENDL-2010 WITH NJOY2012.5
Neutron emission for (n,n*)t

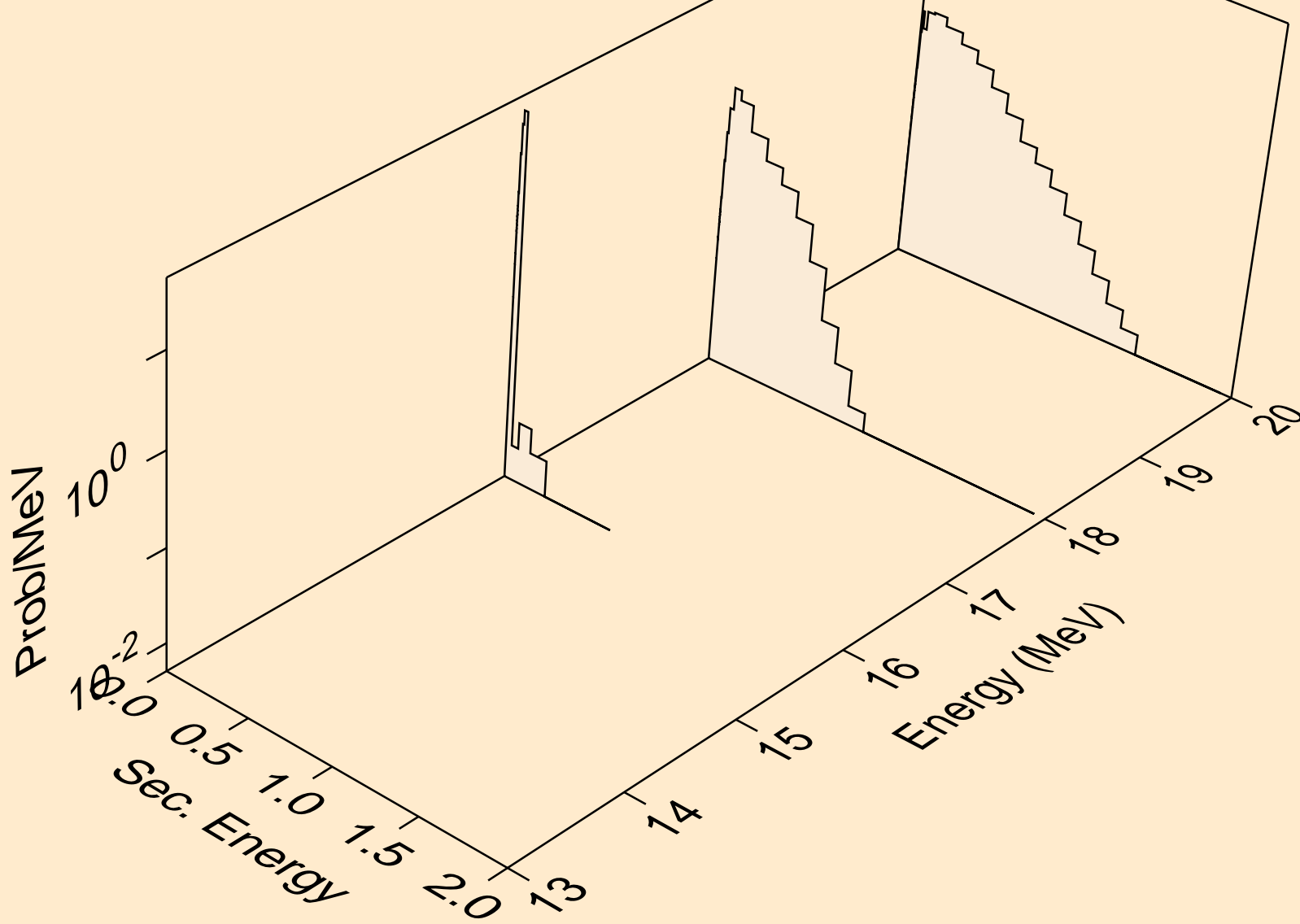

78-PT-198 FOR FENDL-3.1 FROM TENDL-2010 WITH NJOY2012.5
Neutron emission for (n,n*c)

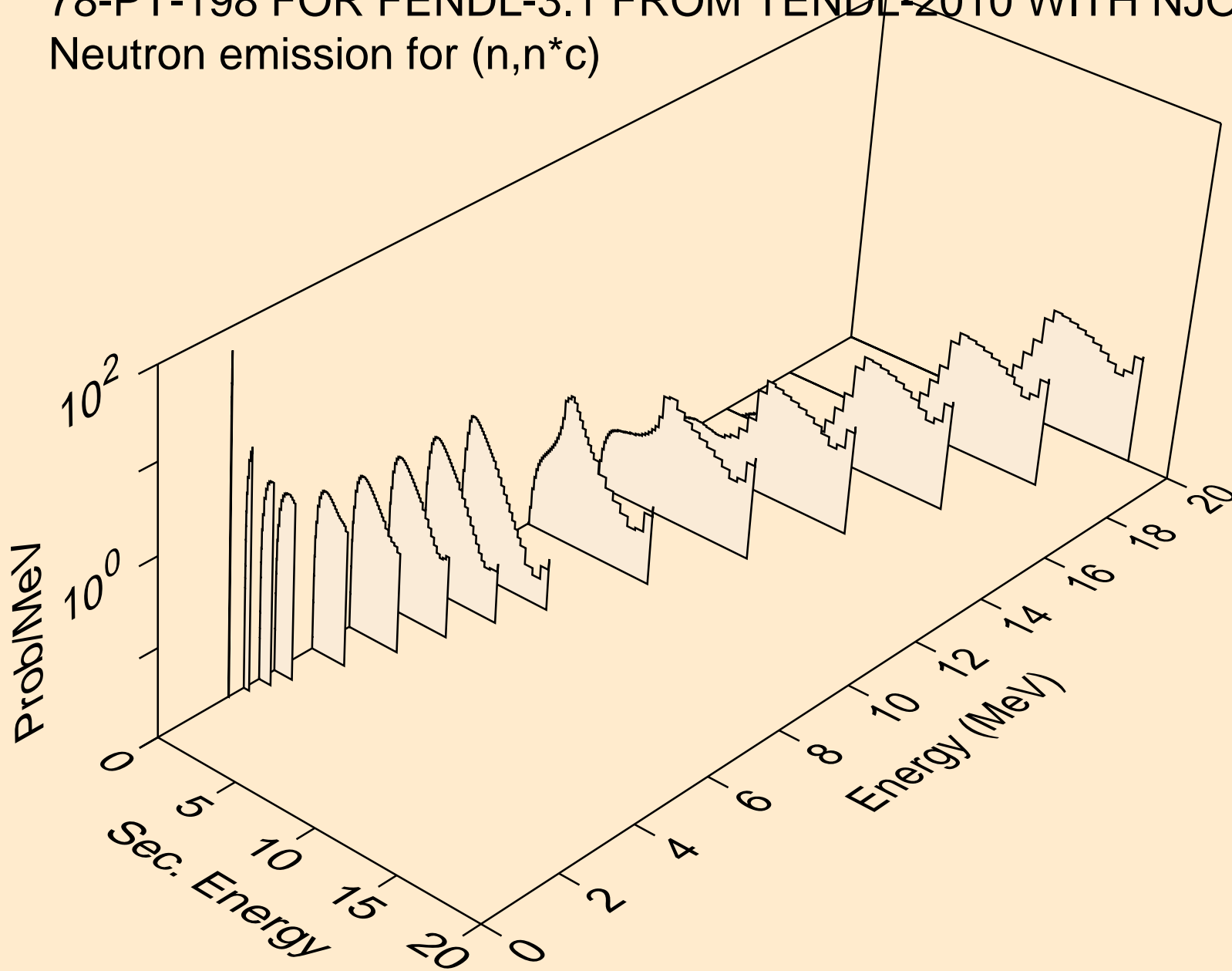

78-PT-198 FOR FENDL-3.1 FROM TENDL-2010 WITH NJOY2012.5
Photon emission for (n,x)

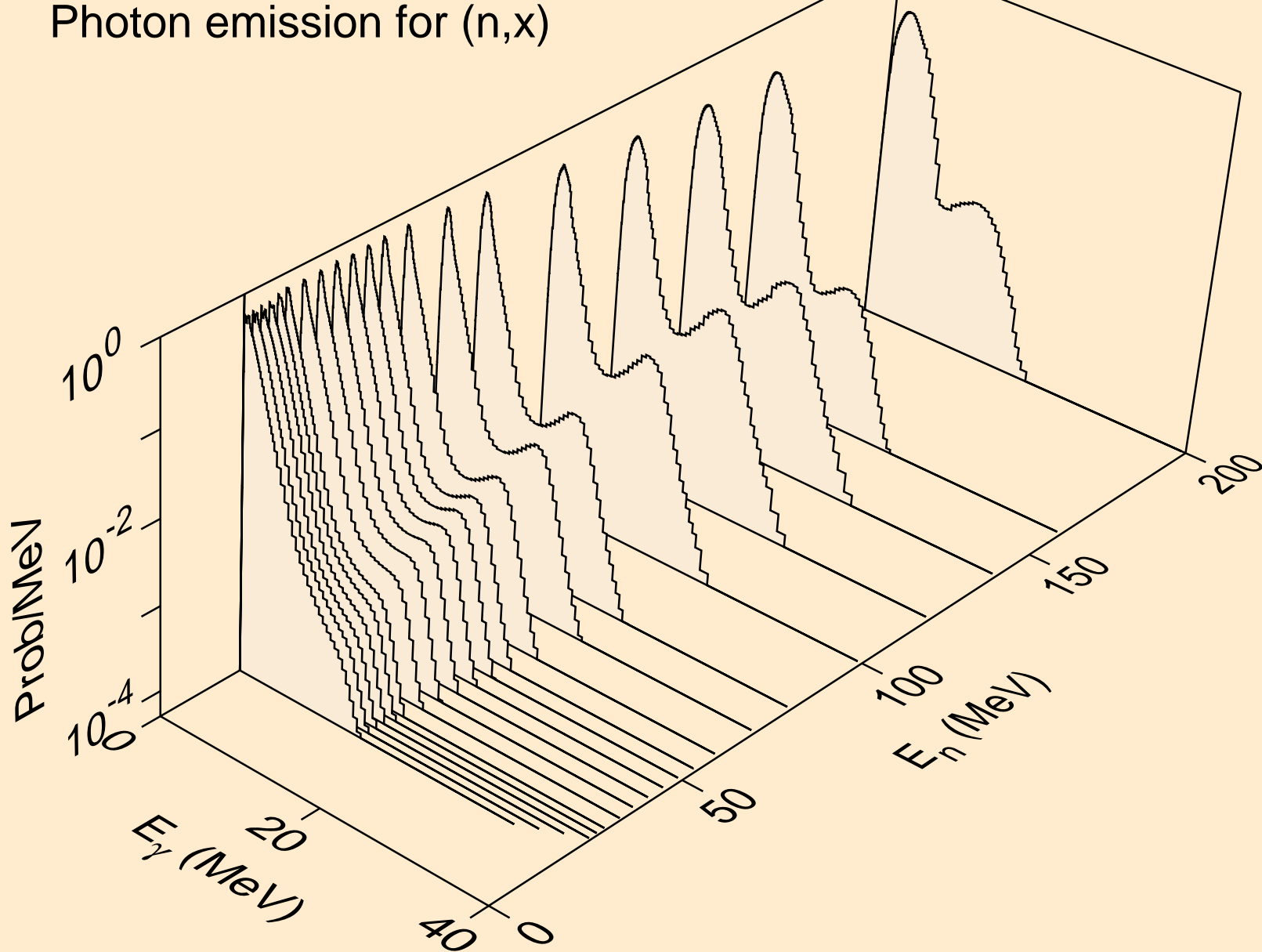

78-PT-198 FOR FENDL-3.1 FROM TENDL-2010 WITH NJOY2012.5
Photon emission for (n,2n)

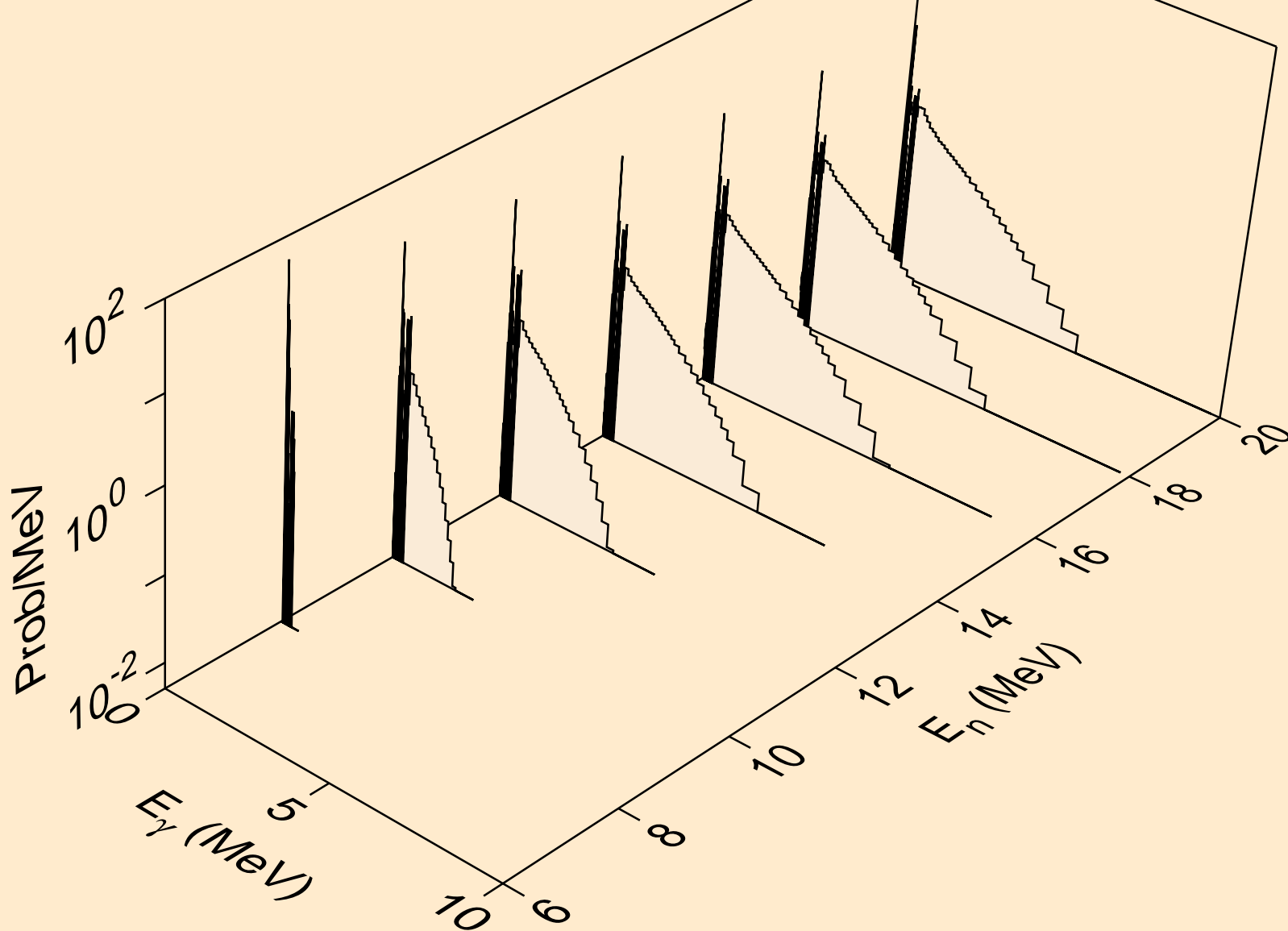

78-PT-198 FOR FENDL-3.1 FROM TENDL-2010 WITH NJOY2012.5
Photon emission for (n,3n)

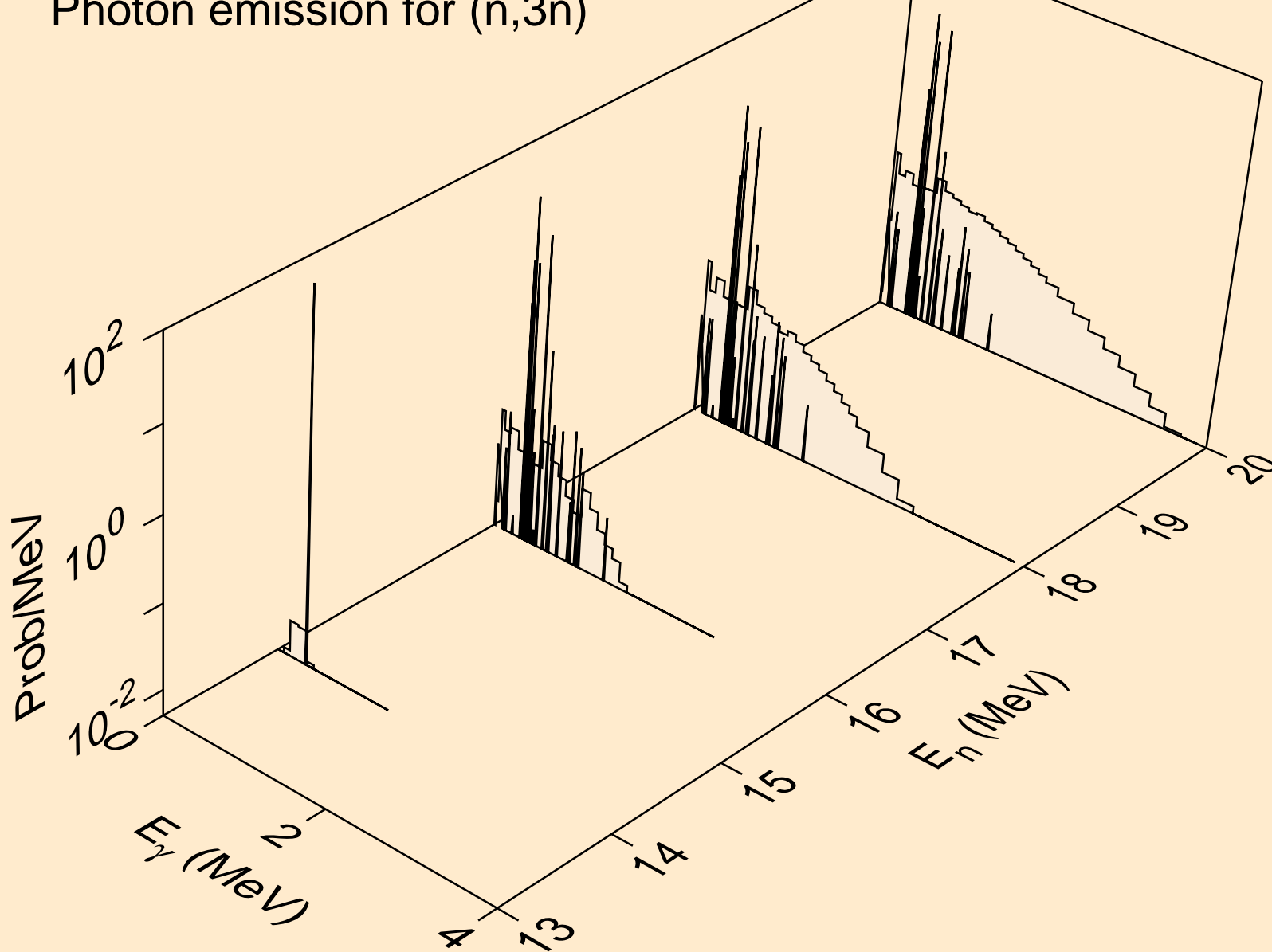

78-PT-198 FOR FENDL-3.1 FROM TENDL-2010 WITH NJOY2012.5
Photon emission for (n,n*)a

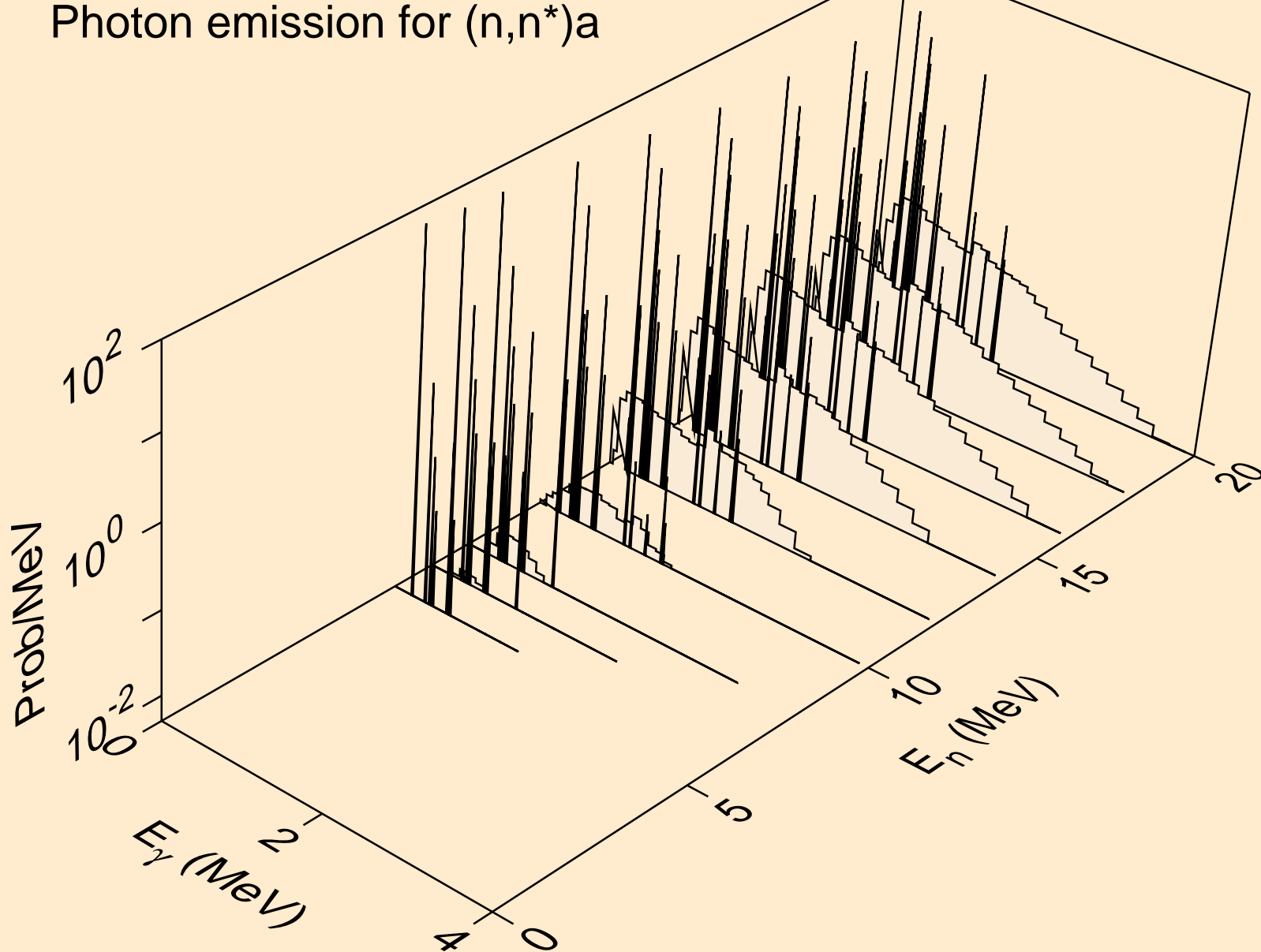

78-PT-198 FOR FENDL-3.1 FROM TENDL-2010 WITH NJOY2012.5
Photon emission for (n,2n)a

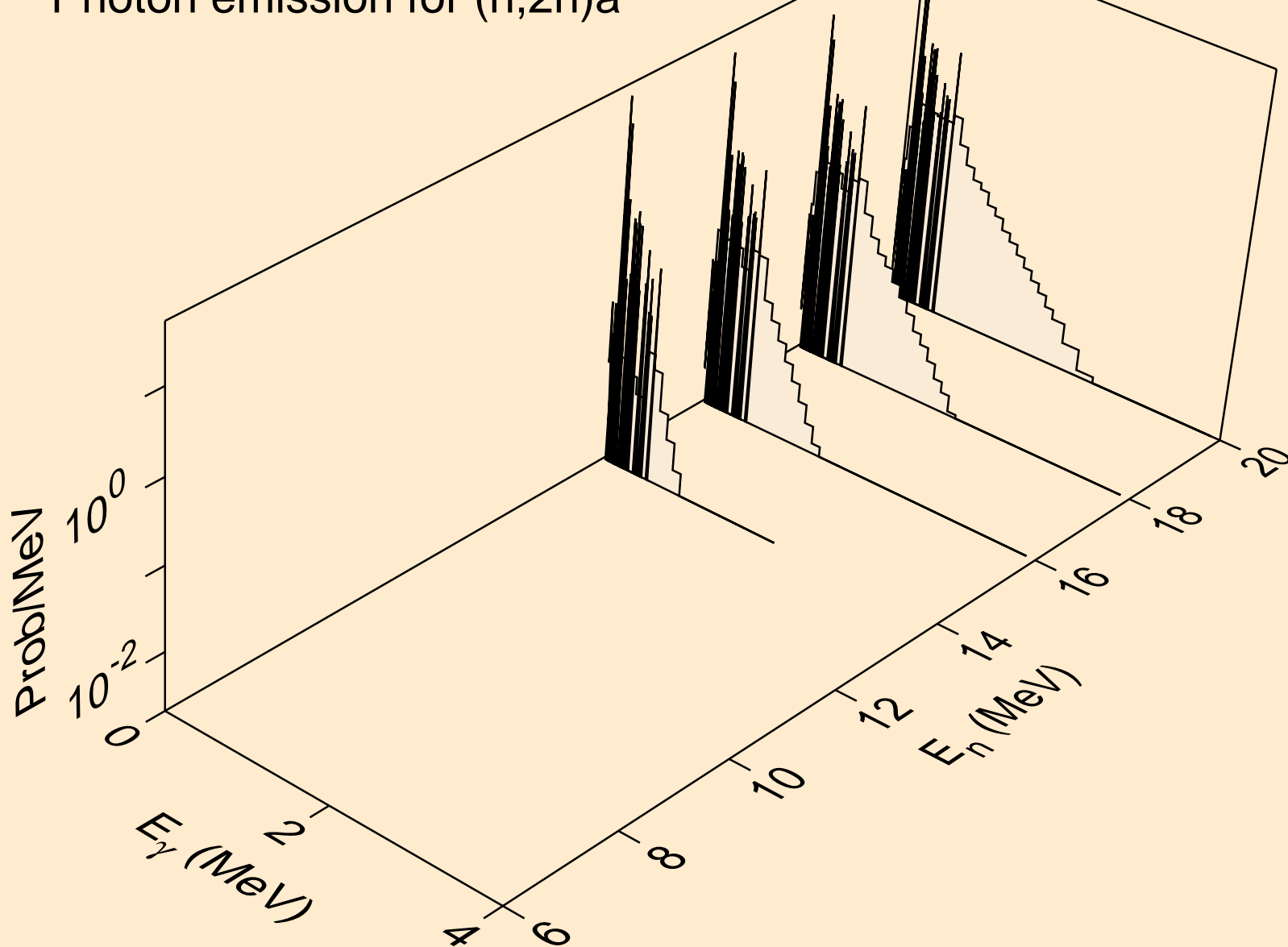

78-PT-198 FOR FENDL-3.1 FROM TENDL-2010 WITH NJOY2012.5
Photon emission for (n,n*)p

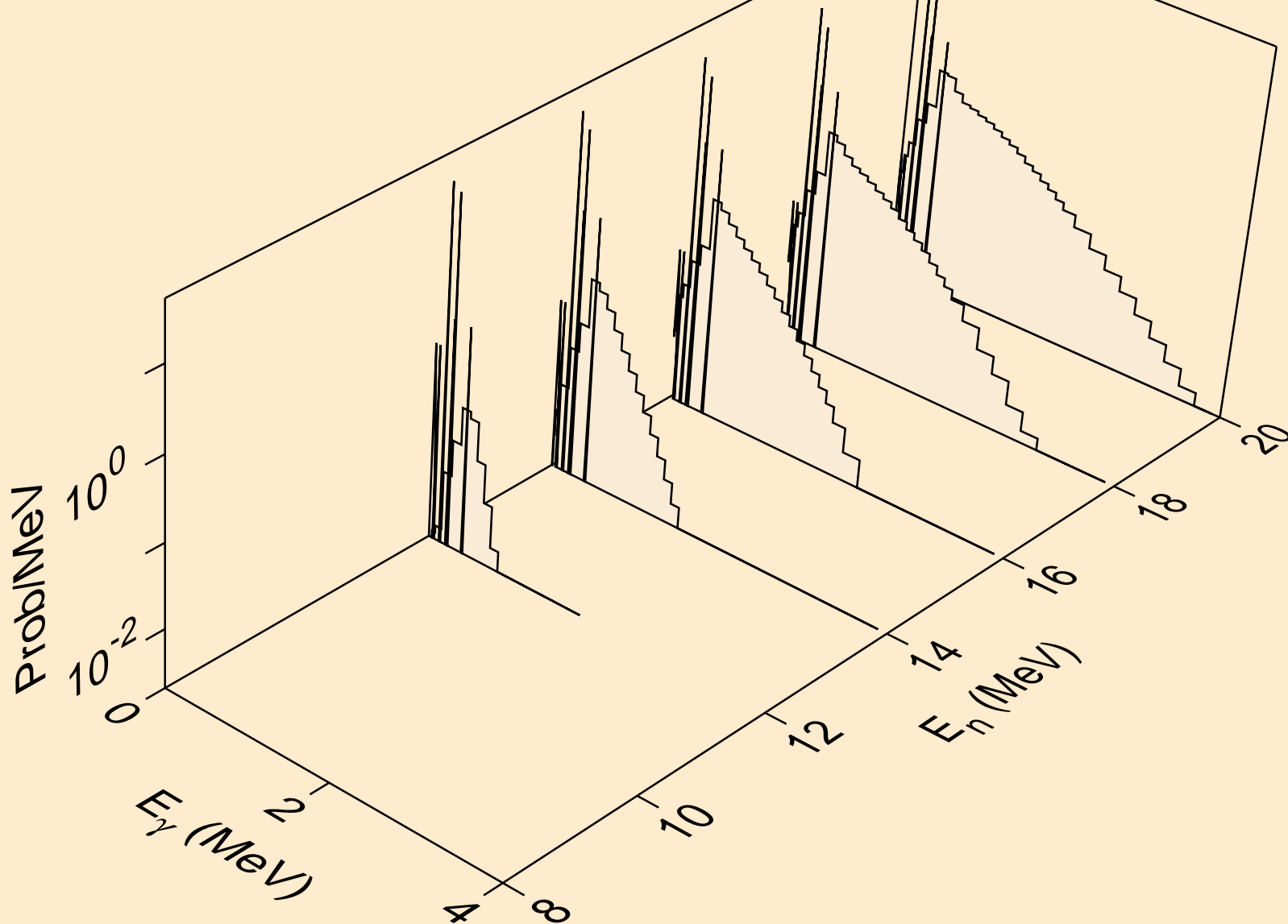

78-PT-198 FOR FENDL-3.1 FROM TENDL-2010 WITH NJOY2012.5
Photon emission for (n,n*)d

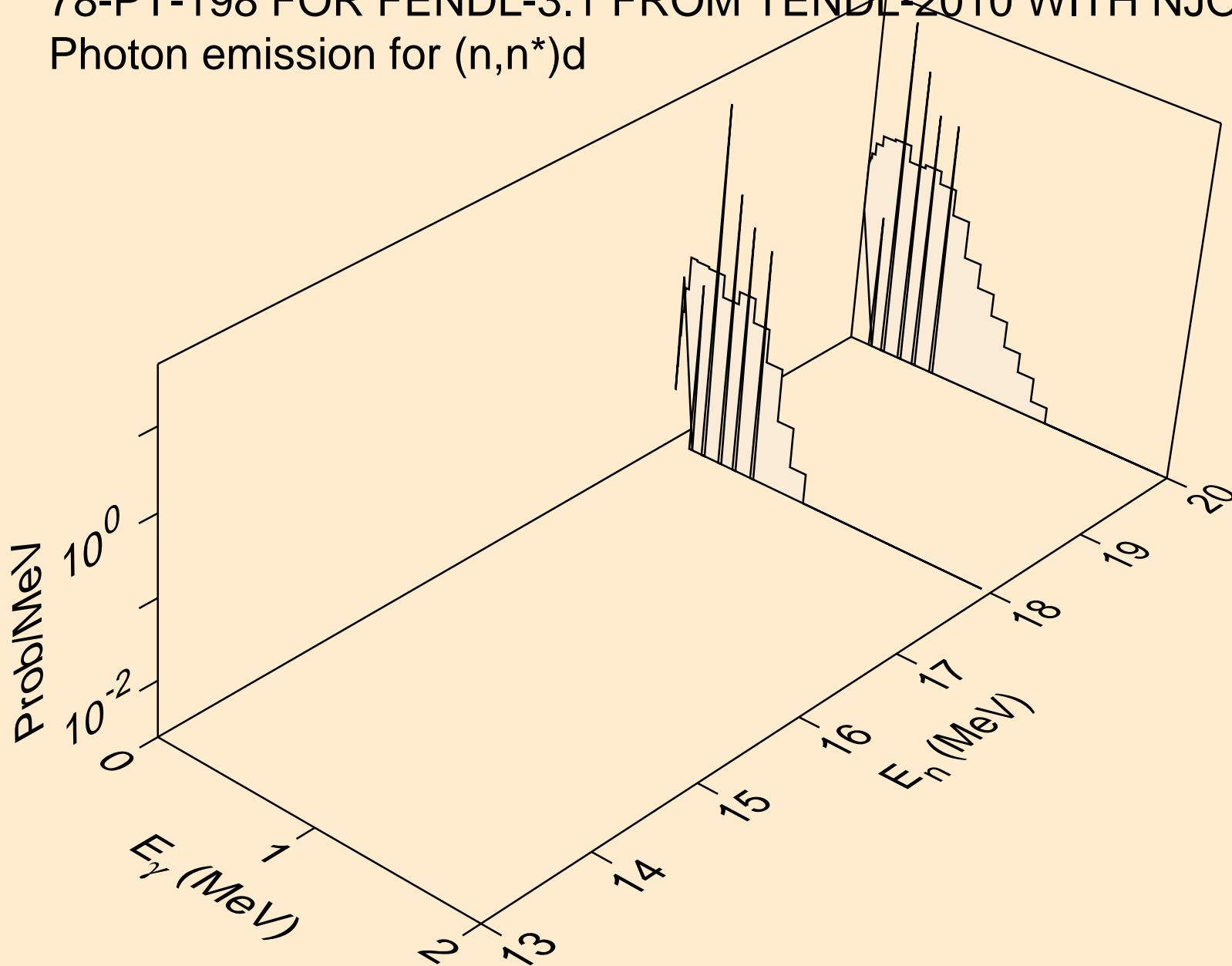

78-PT-198 FOR FENDL-3.1 FROM TENDL-2010 WITH NJOY2012.5
Photon emission for (n,n*)t

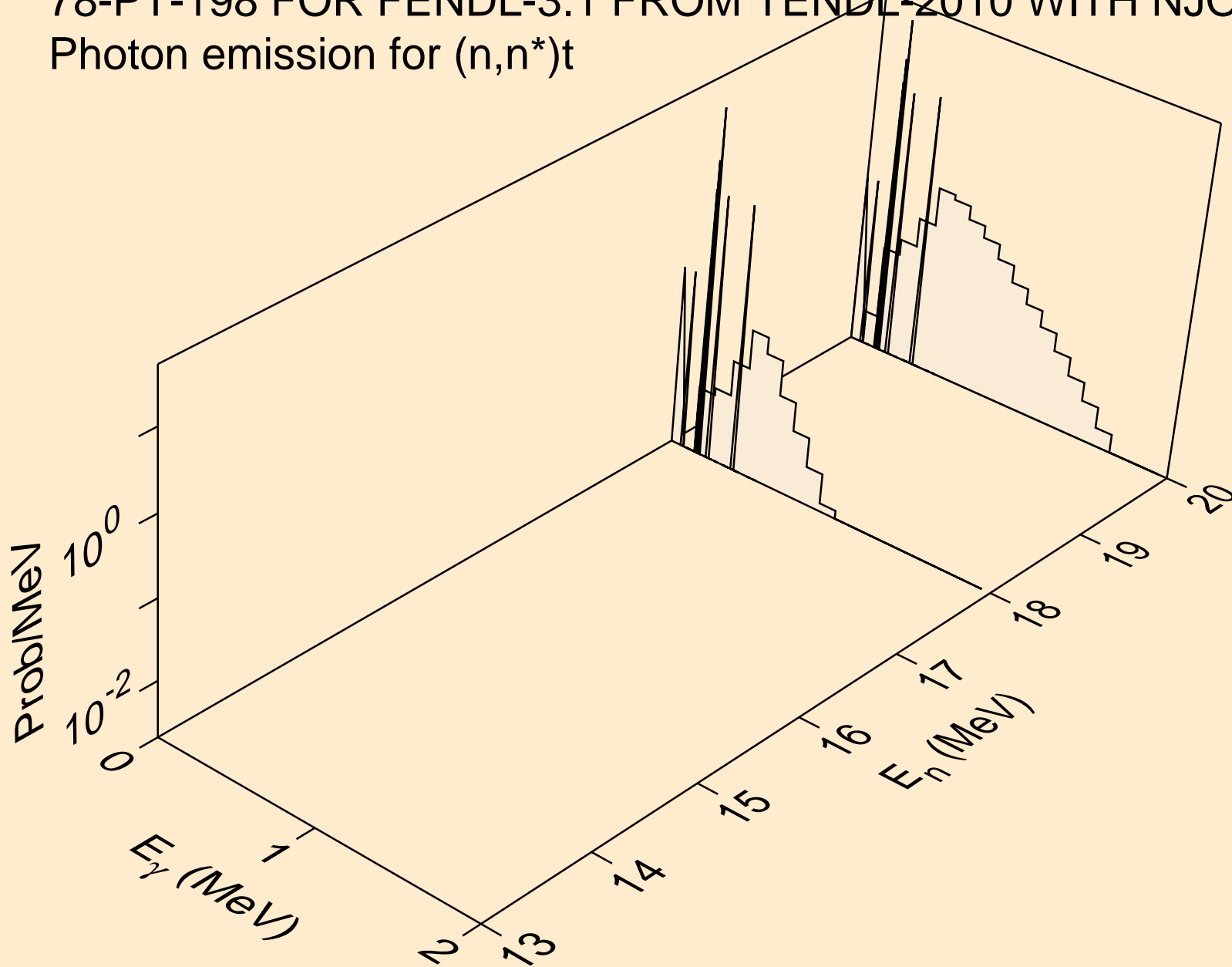

78-PT-198 FOR FENDL-3.1 FROM TENDL-2010 WITH NJOY2012.5
Photon emission for (n,n*c)

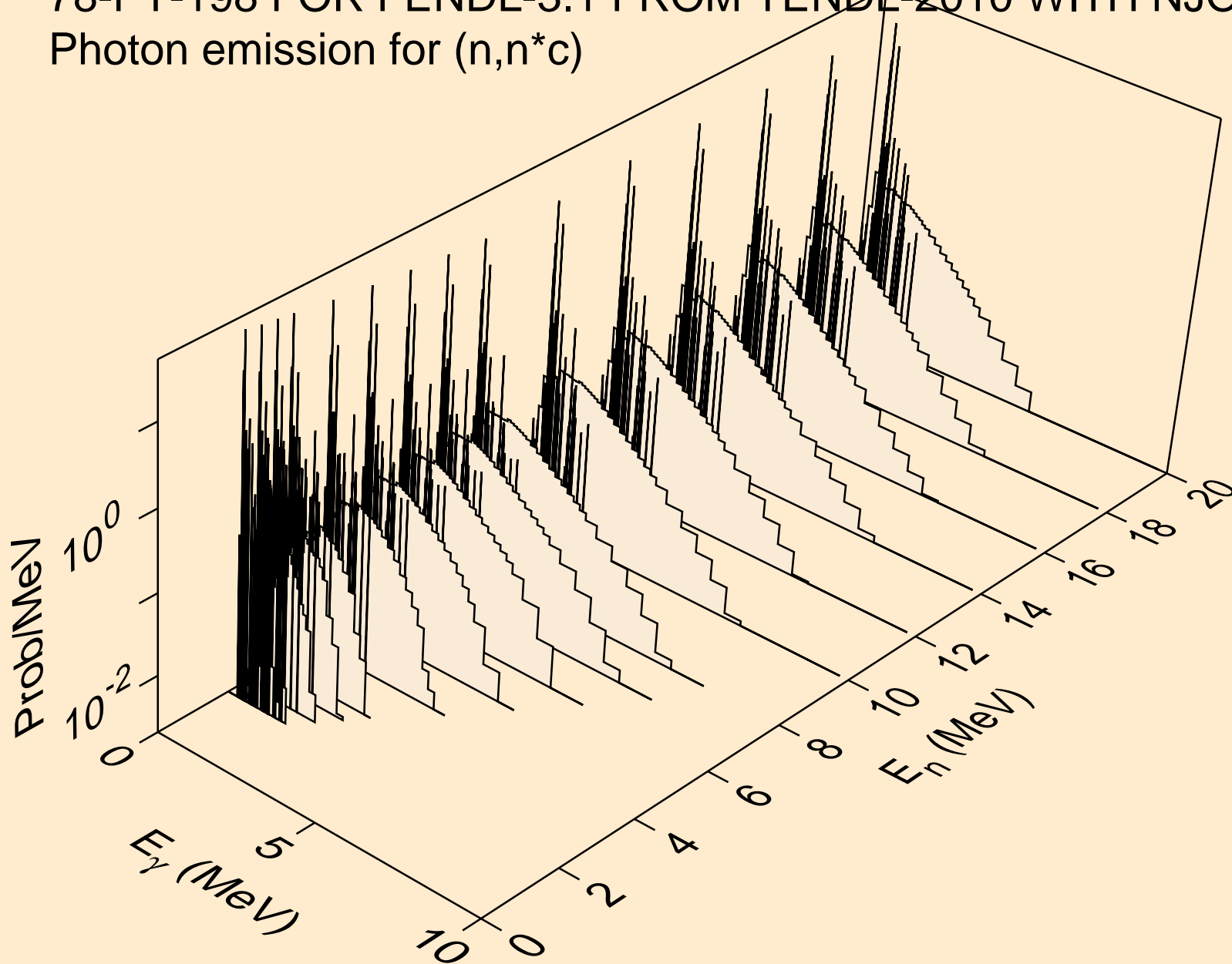

78-PT-198 FOR FENDL-3.1 FROM TENDL-2010 WITH NJOY2012.5
Photon emission for (n,gma)

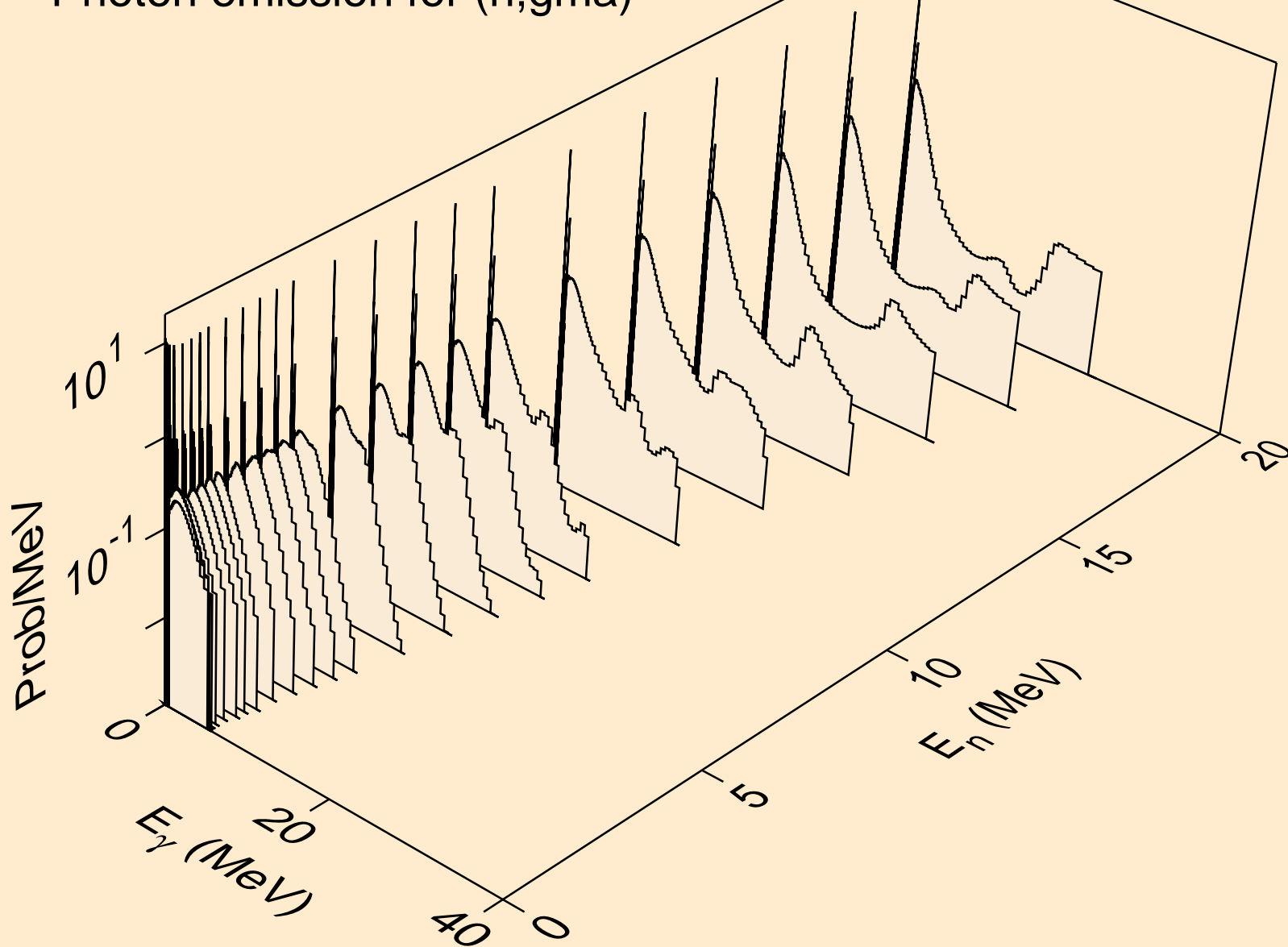

78-PT-198 FOR FENDL-3.1 FROM TENDL-2010 WITH NJOY2012.5
Photon emission for (n,p*c)

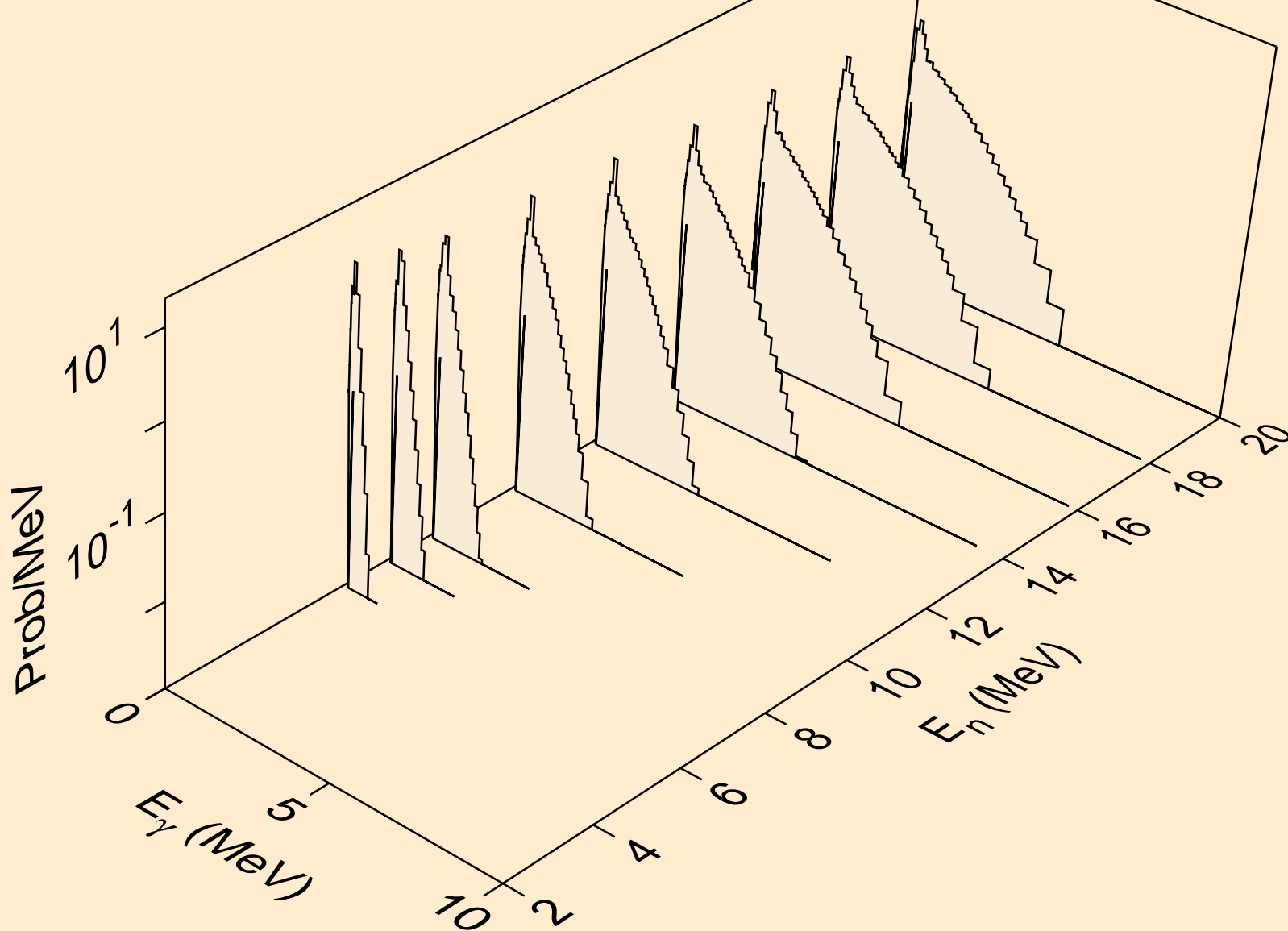

78-PT-198 FOR FENDL-3.1 FROM TENDL-2010 WITH NJOY2012.5
Photon emission for (n,a*c)

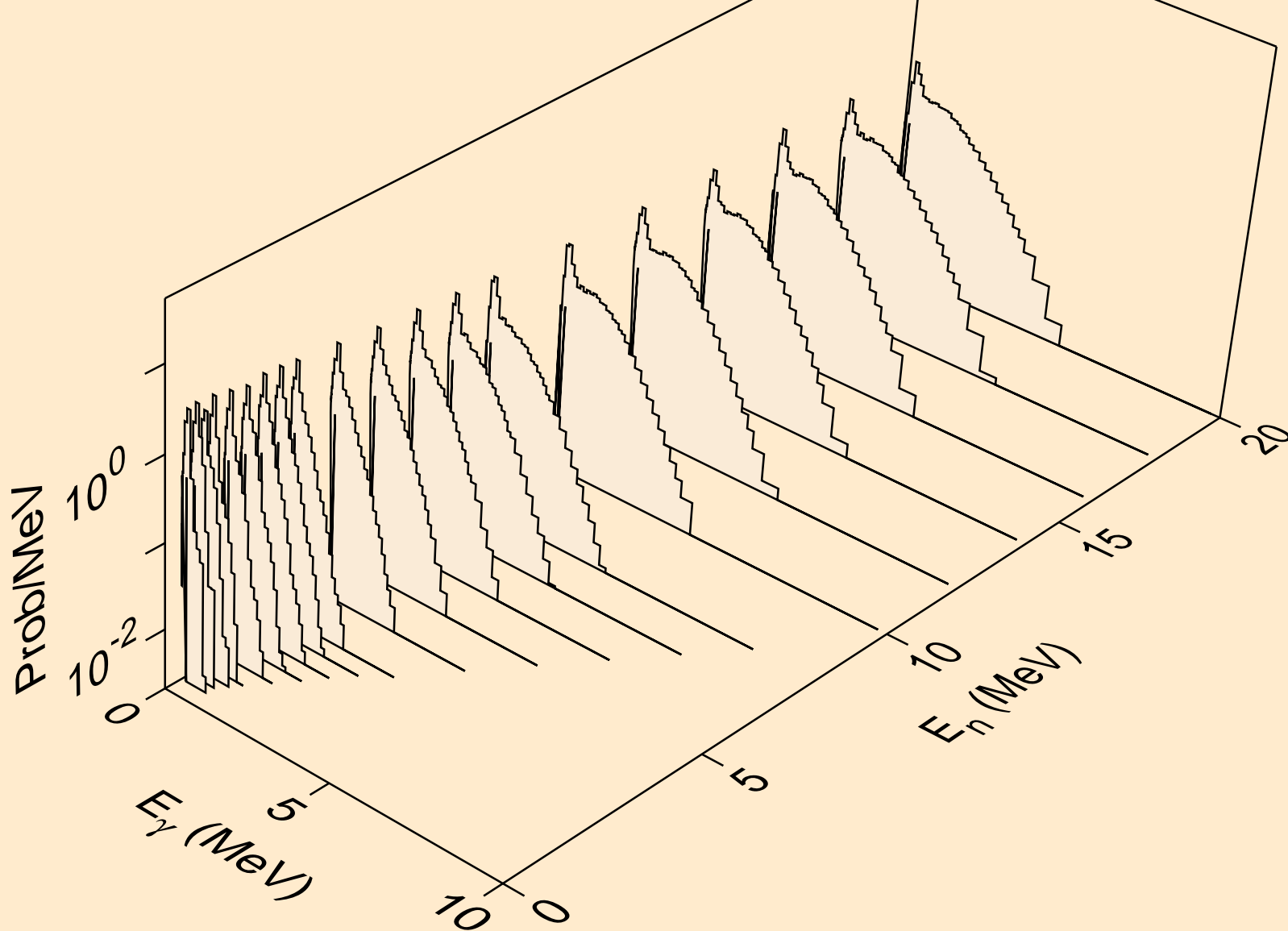

78-PT-198 FOR FENDL-3.1 FROM TENDL-2010 WITH NJOY2012.5
thermal capture photon spectrum

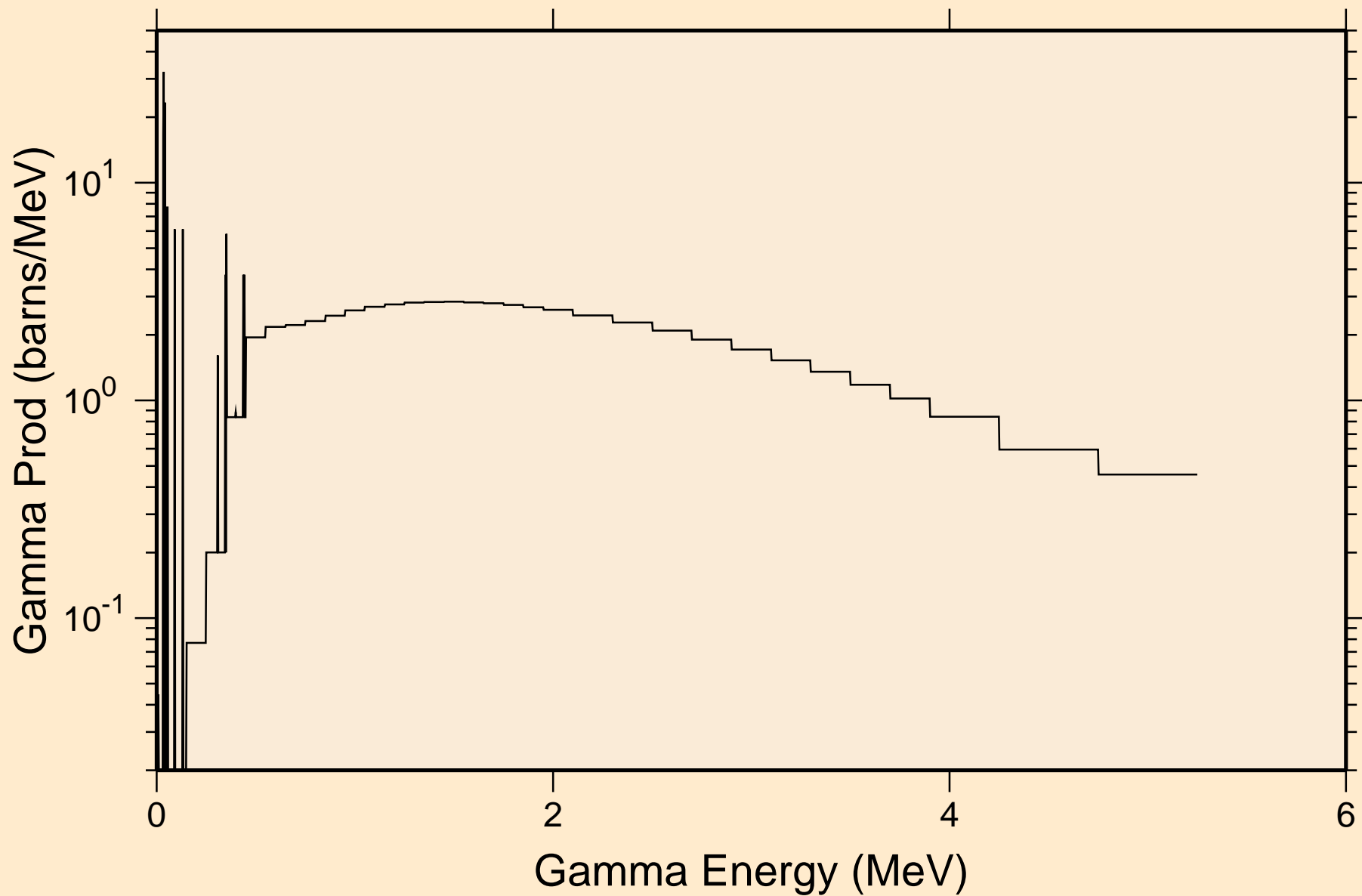

78-PT-198 FOR FENDL-3.1 FROM TENDL-2010 WITH NJOY2012.5
14 MeV photon spectrum

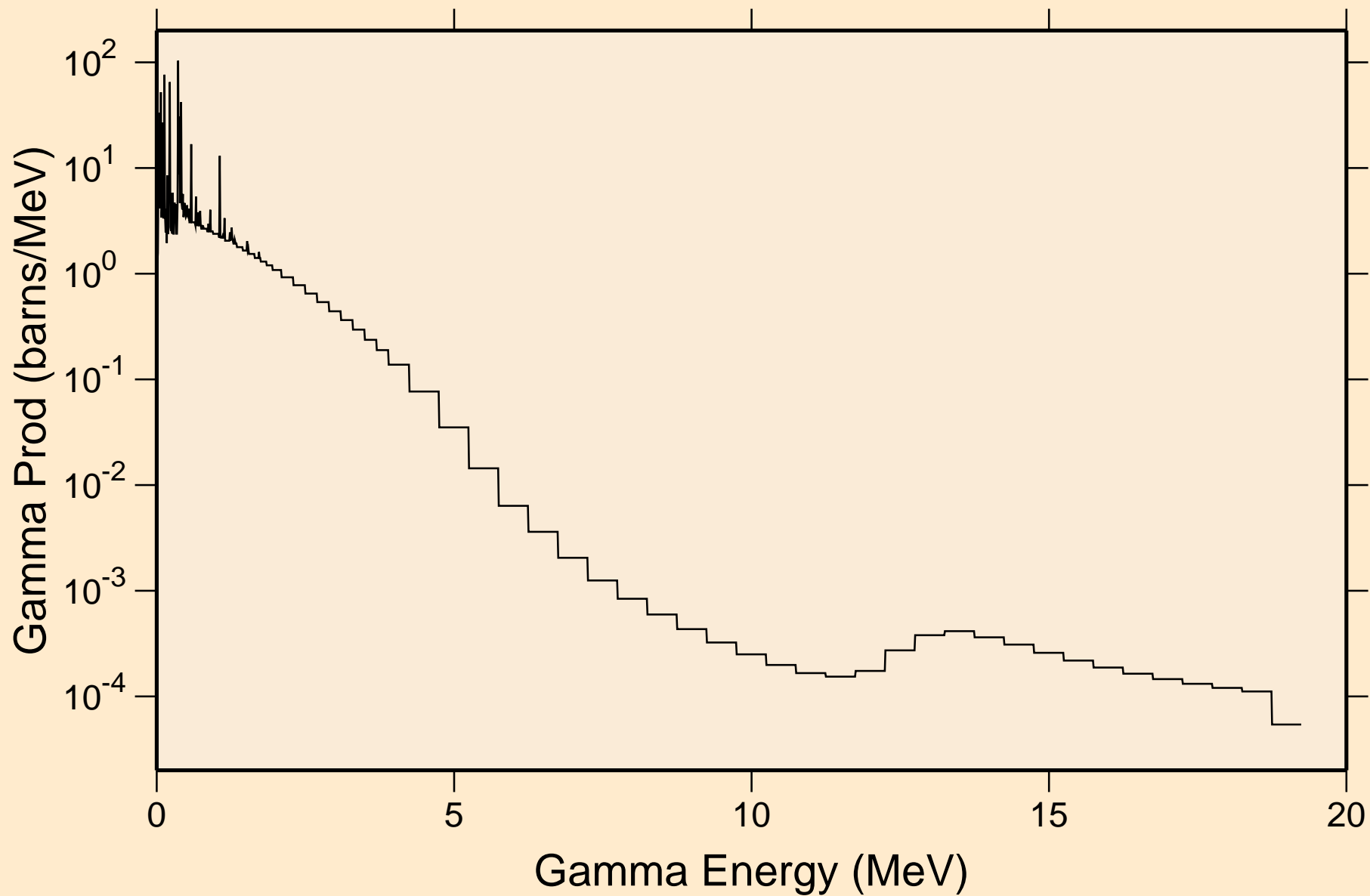

78-PT-198 FOR FENDL-3.1 FROM TENDL-2010 WITH NJOY2012.5

Particle heating contributions

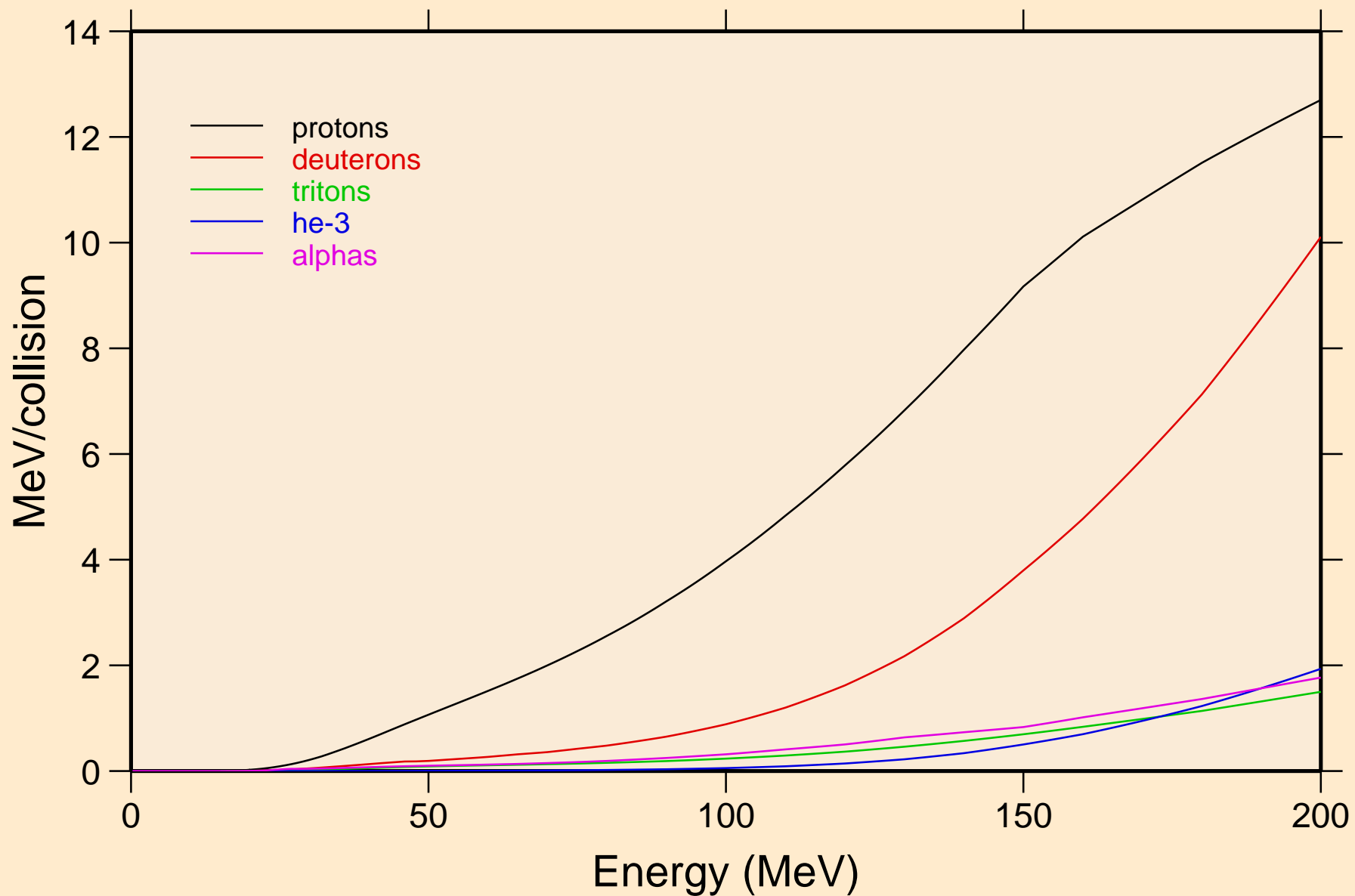

78-PT-198 FOR FENDL-3.1 FROM TENDL-2010 WITH NJOY2012.5
Recoil Heating

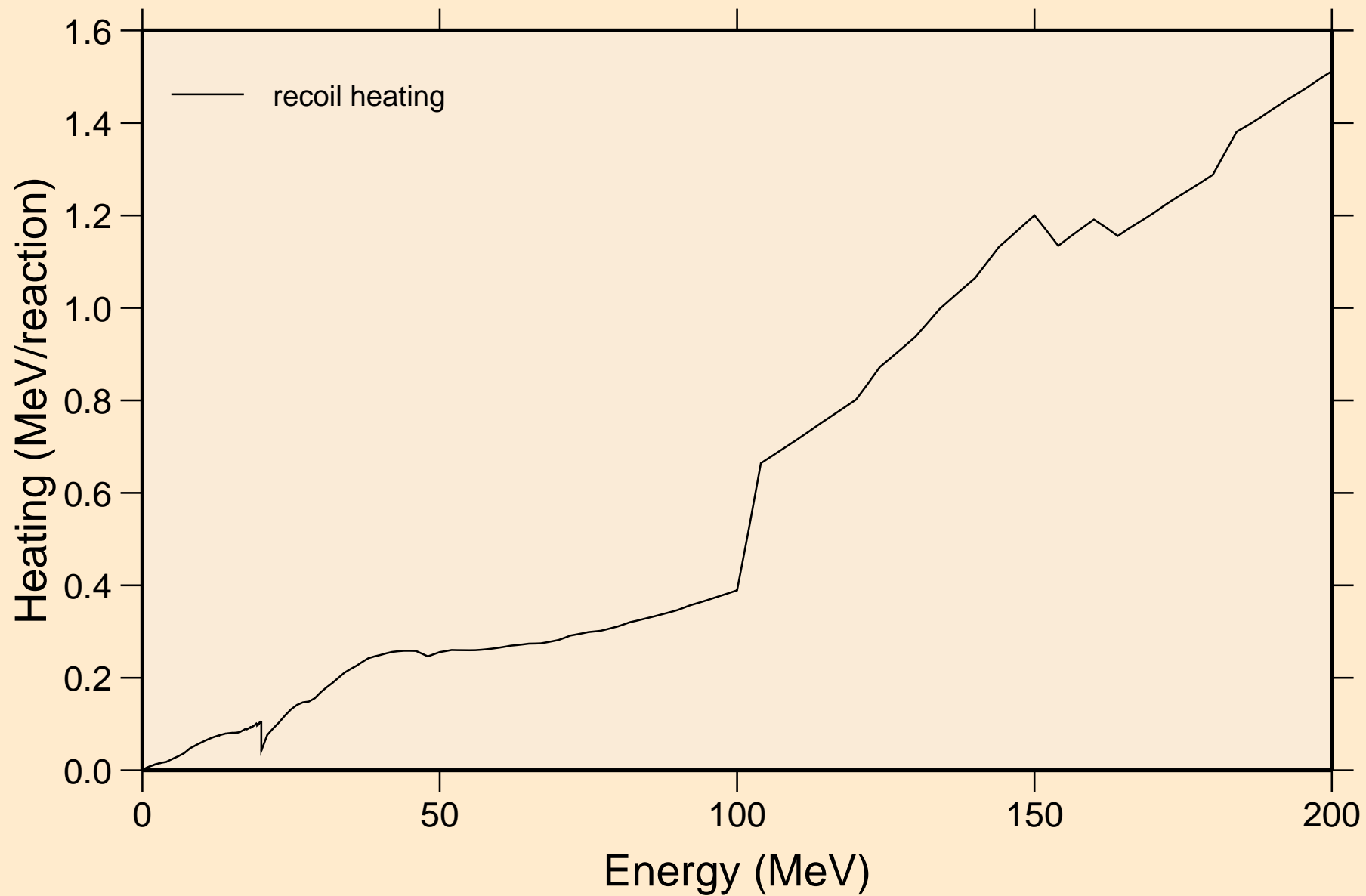

78-PT-198 FOR FENDL-3.1 FROM TENDL-2010 WITH NJOY2012.5
Particle production cross sections

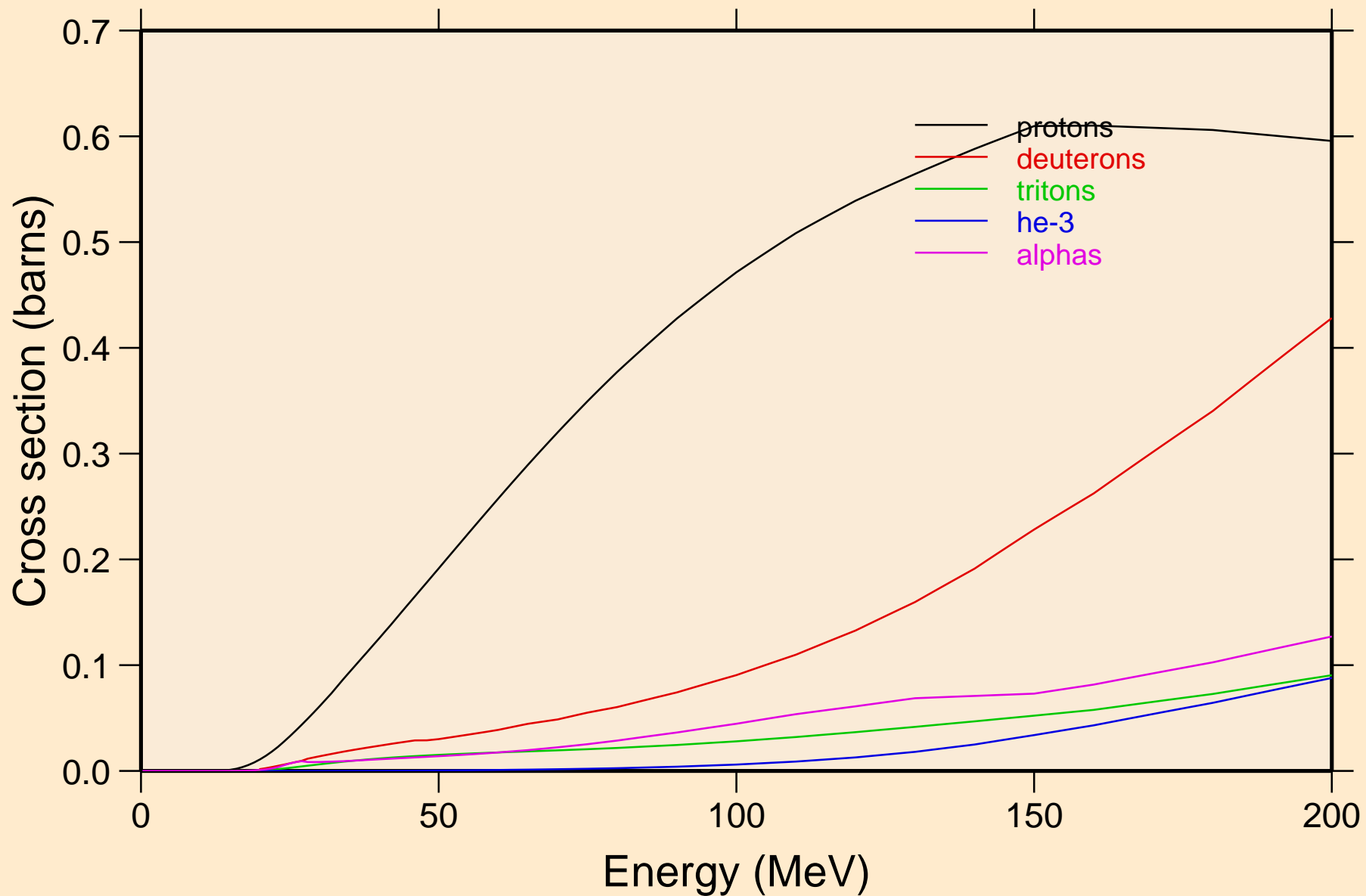

78-PT-198 FOR FENDL-3.1 FROM TENDL-2010 WITH NJOY2012.5
protons from (n,x)

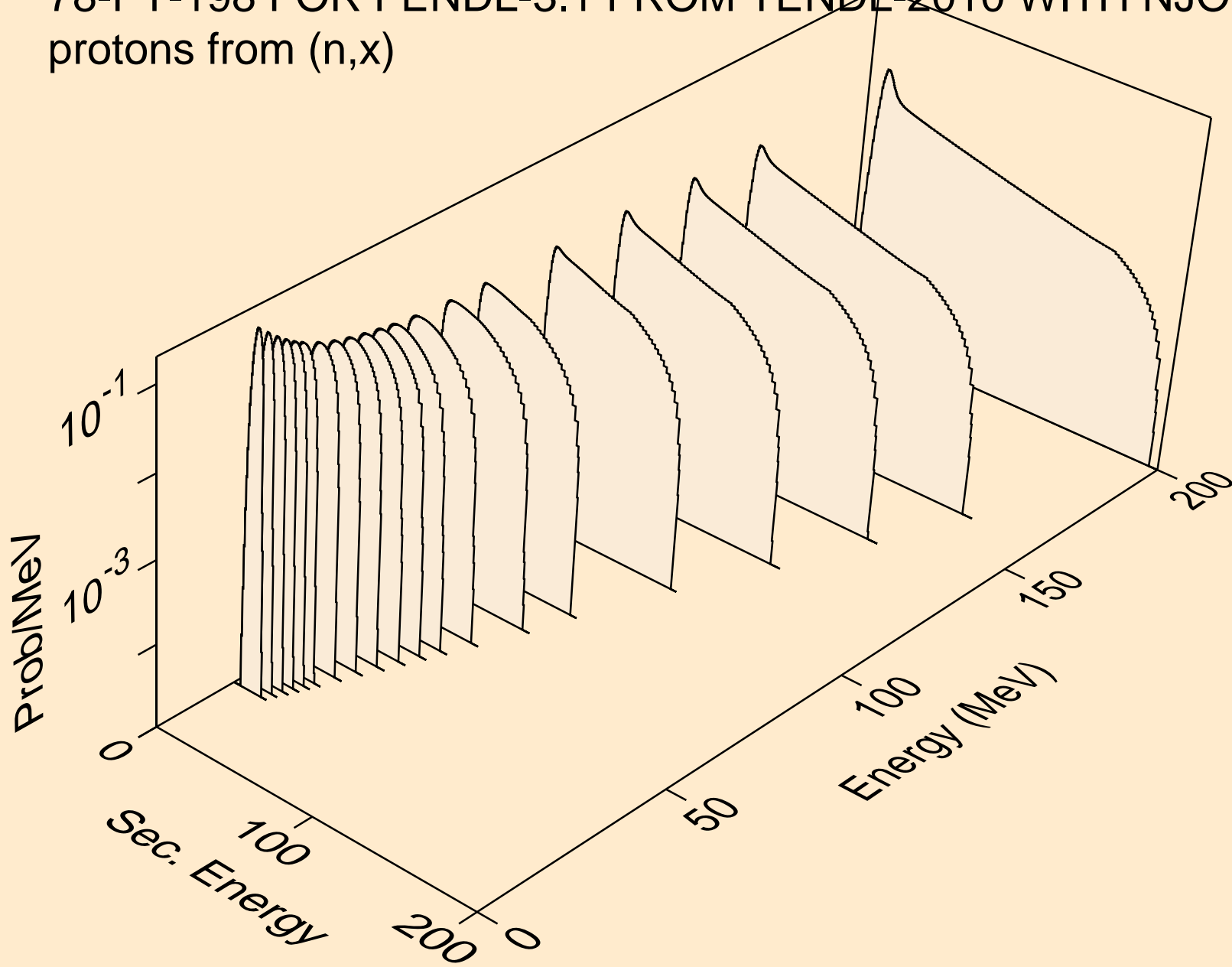

78-PT-198 FOR FENDL-3.1 FROM TENDL-2010 WITH NJOY2012.5
protons from (n,n*)p

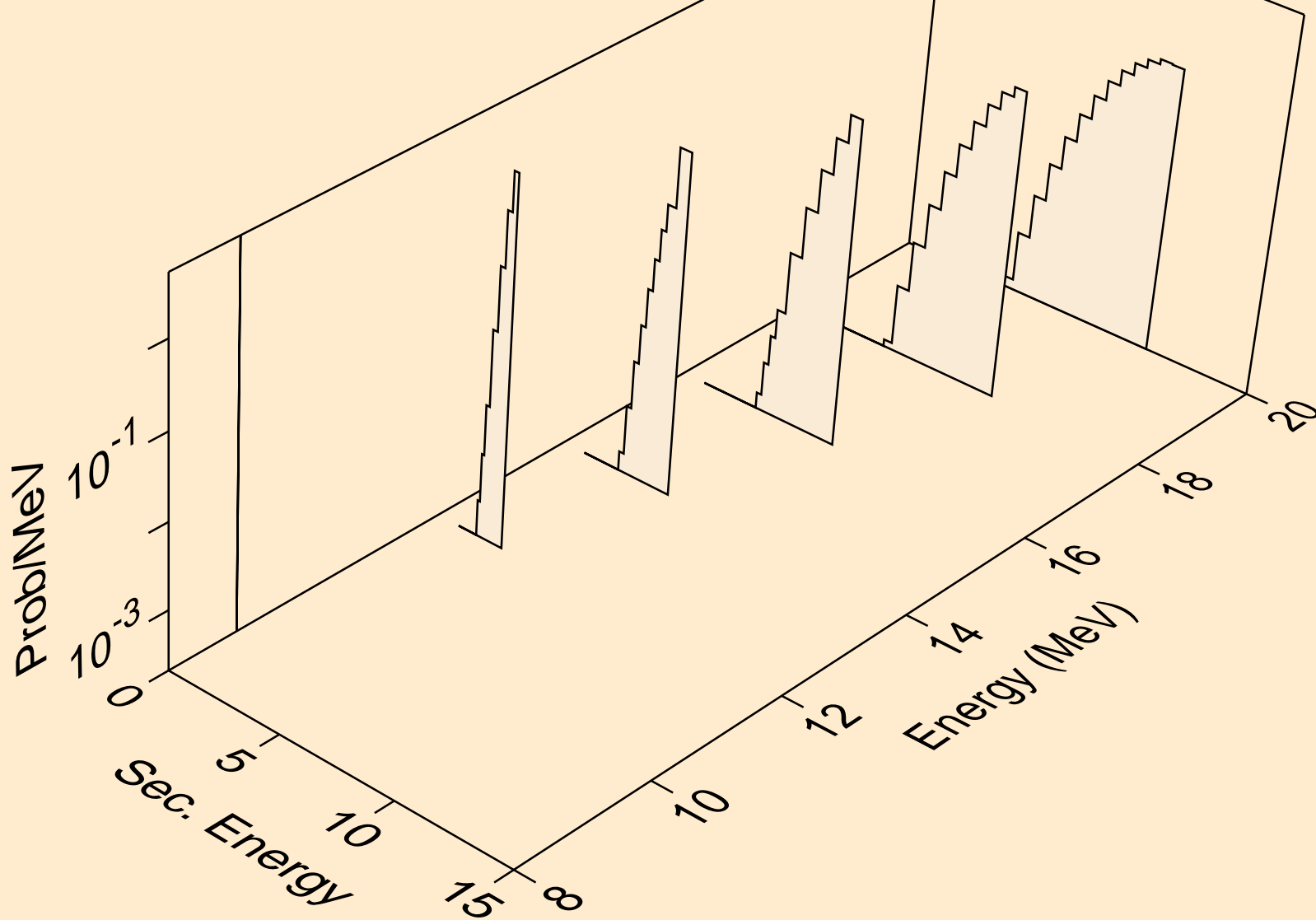

78-PT-198 FOR FENDL-3.1 FROM TENDL-2010 WITH NJOY2012.5
protons from (n,p*c)

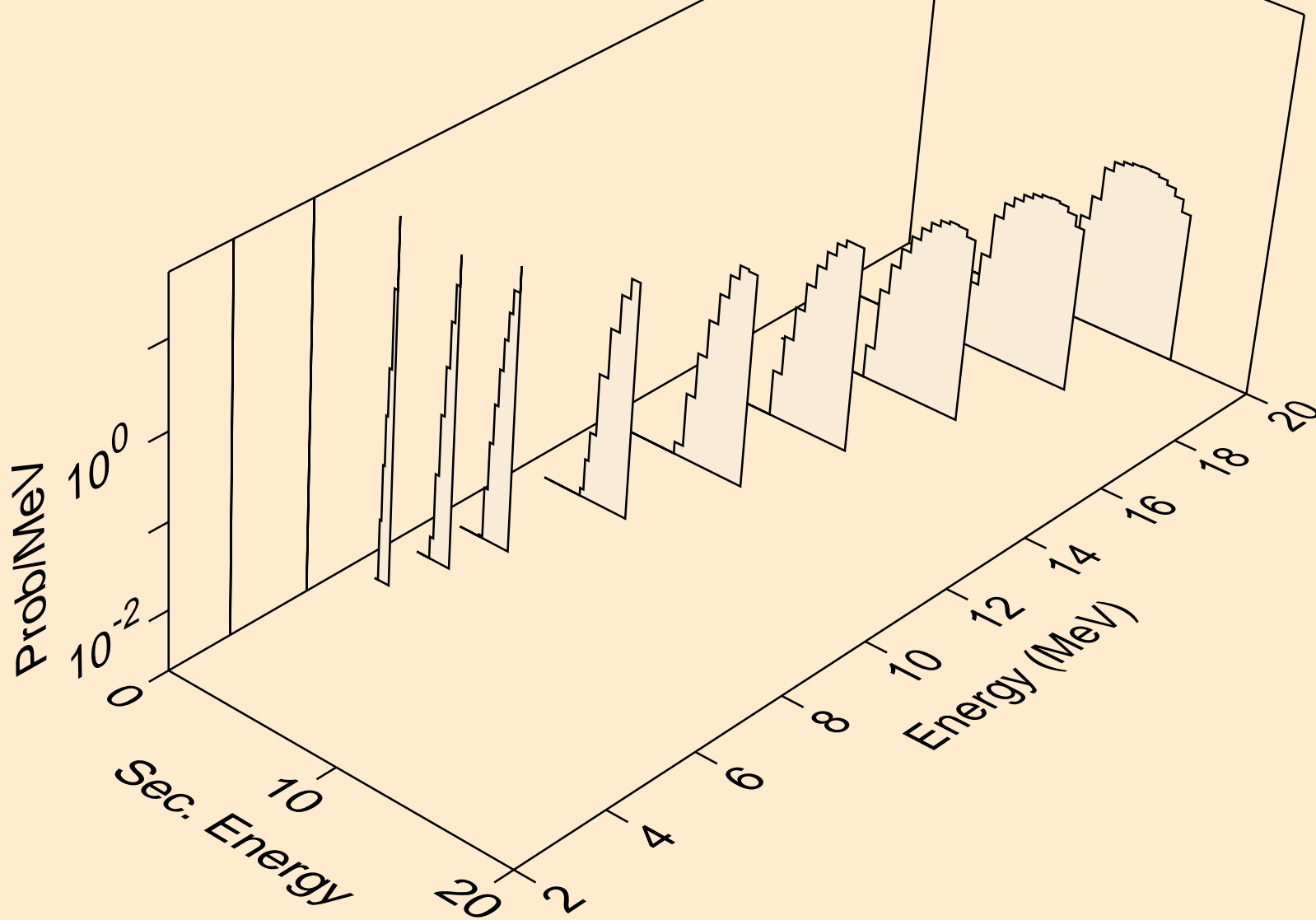

78-PT-198 FOR FENDL-3.1 FROM TENDL-2010 WITH NJOY2012.5
deuterons from (n,x)

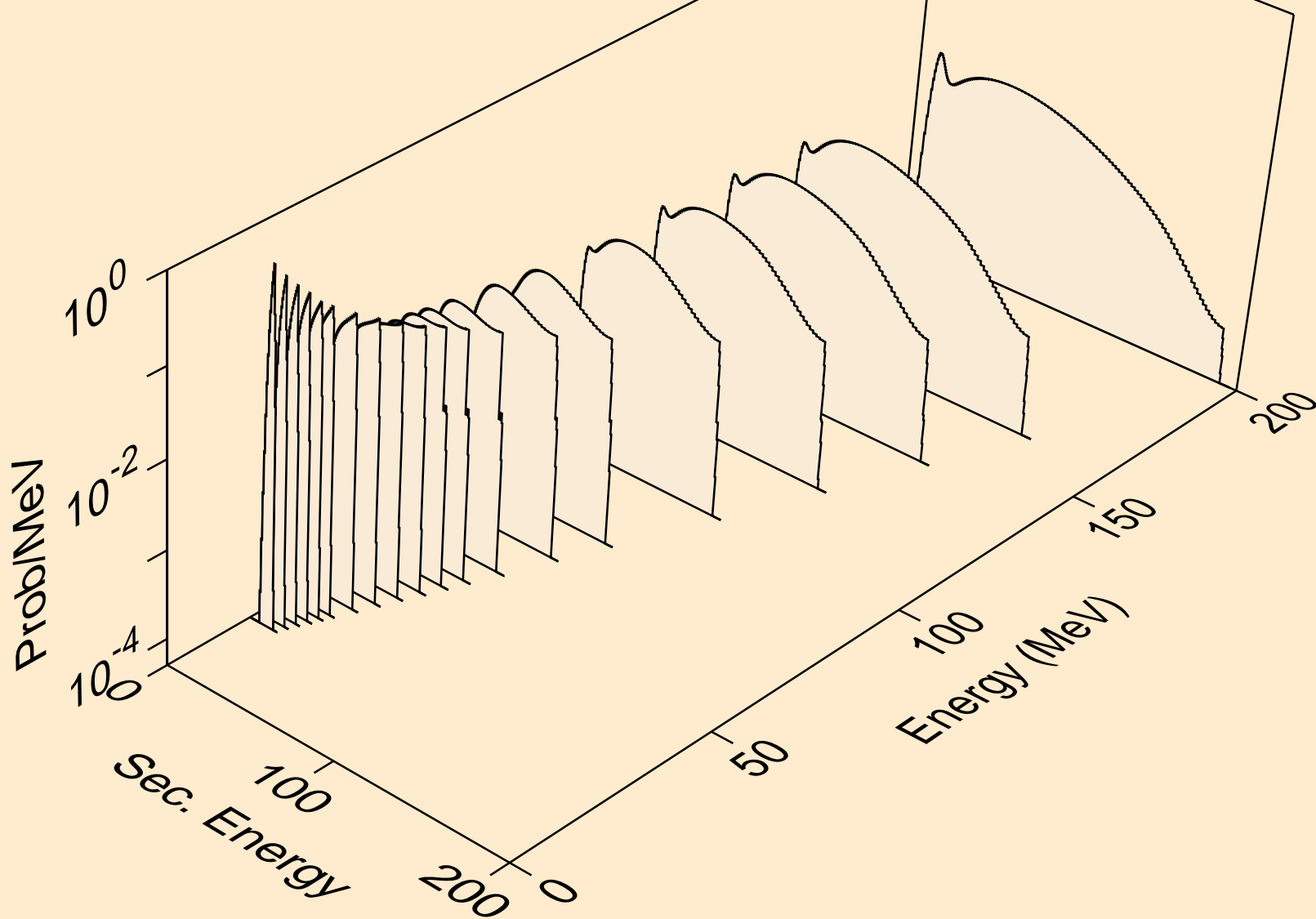

78-PT-198 FOR FENDL-3.1 FROM TENDL-2010 WITH NJOY2012.5
deuterons from (n,n*)d

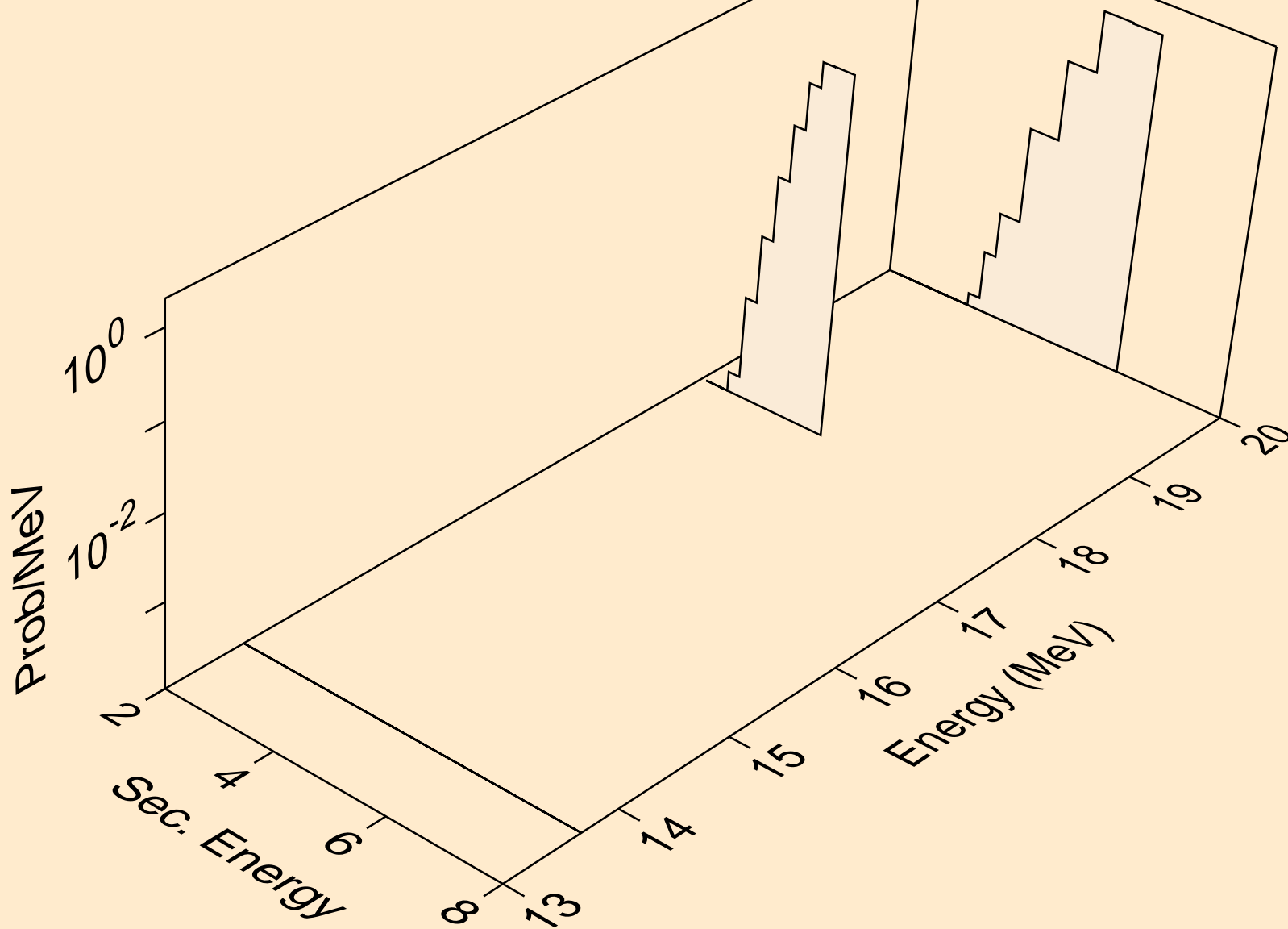

78-PT-198 FOR FENDL-3.1 FROM TENDL-2010 WITH NJOY2012.5
tritons from (n,x)

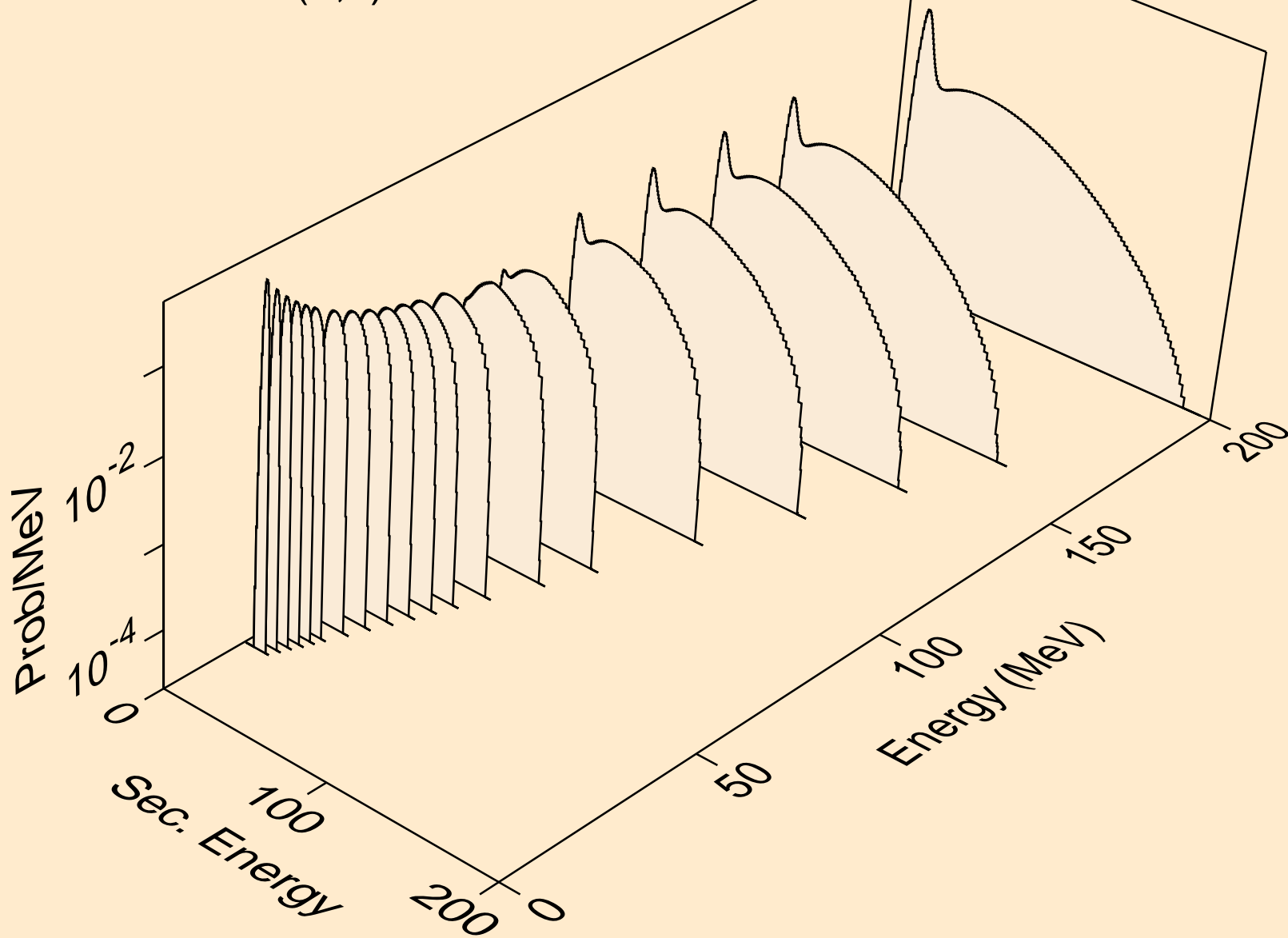

78-PT-198 FOR FENDL-3.1 FROM TENDL-2010 WITH NJOY2012.5
tritons from (n,n*)t

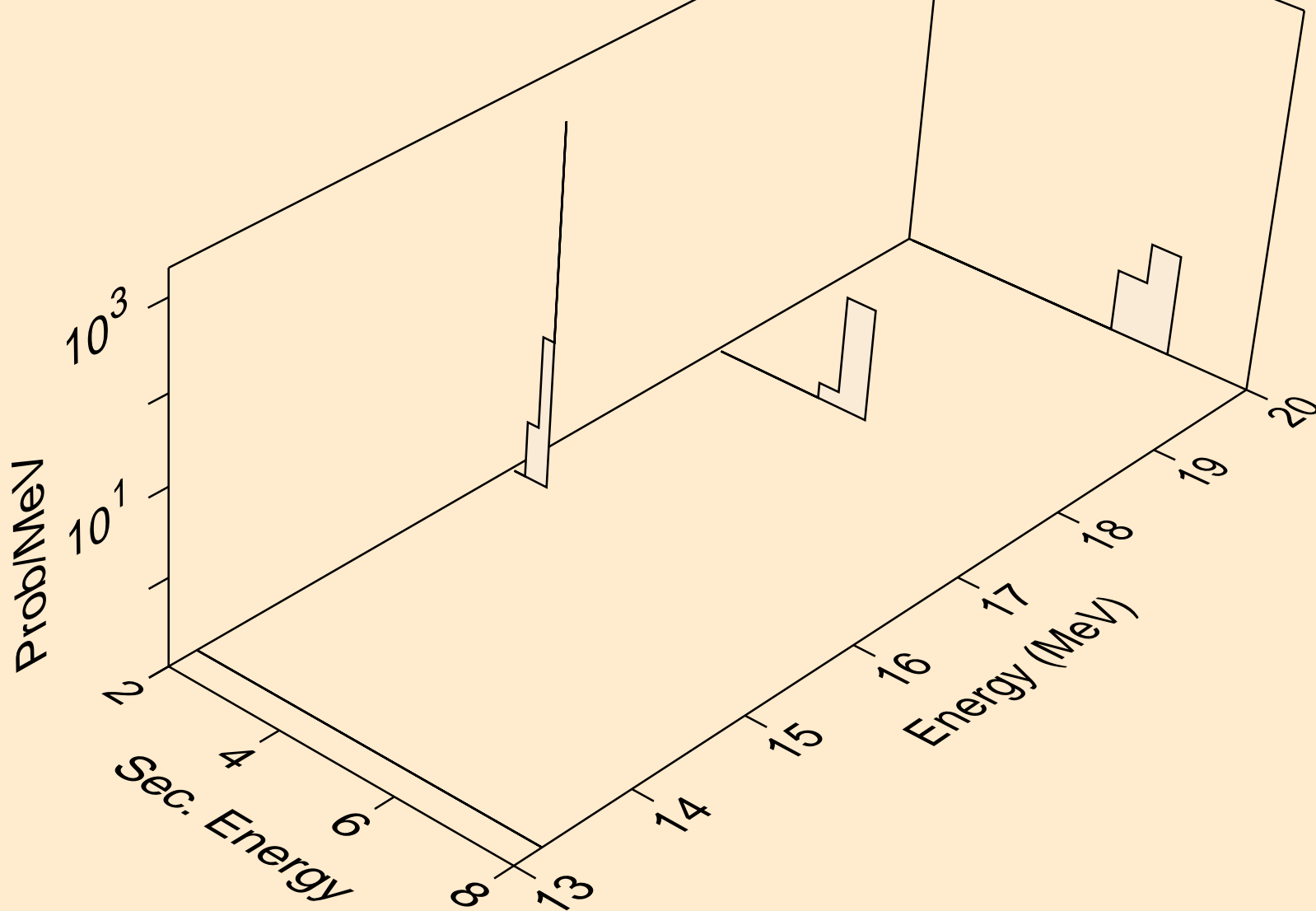

78-PT-198 FOR FENDL-3.1 FROM TENDL-2010 WITH NJOY2012.5
he3s from (n,x)

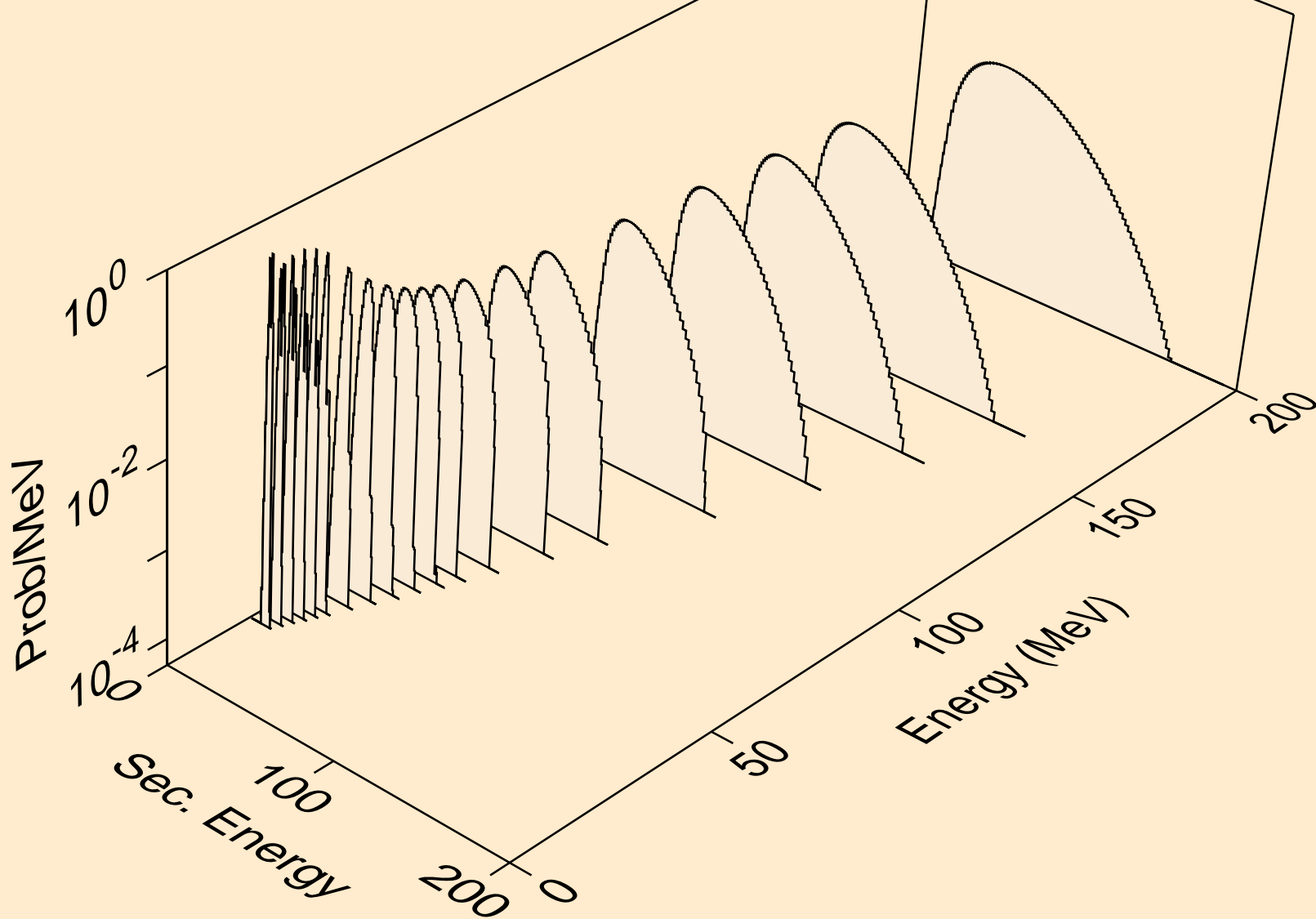

78-PT-198 FOR FENDL-3.1 FROM TENDL-2010 WITH NJOY2012.5
alphas from (n,x)

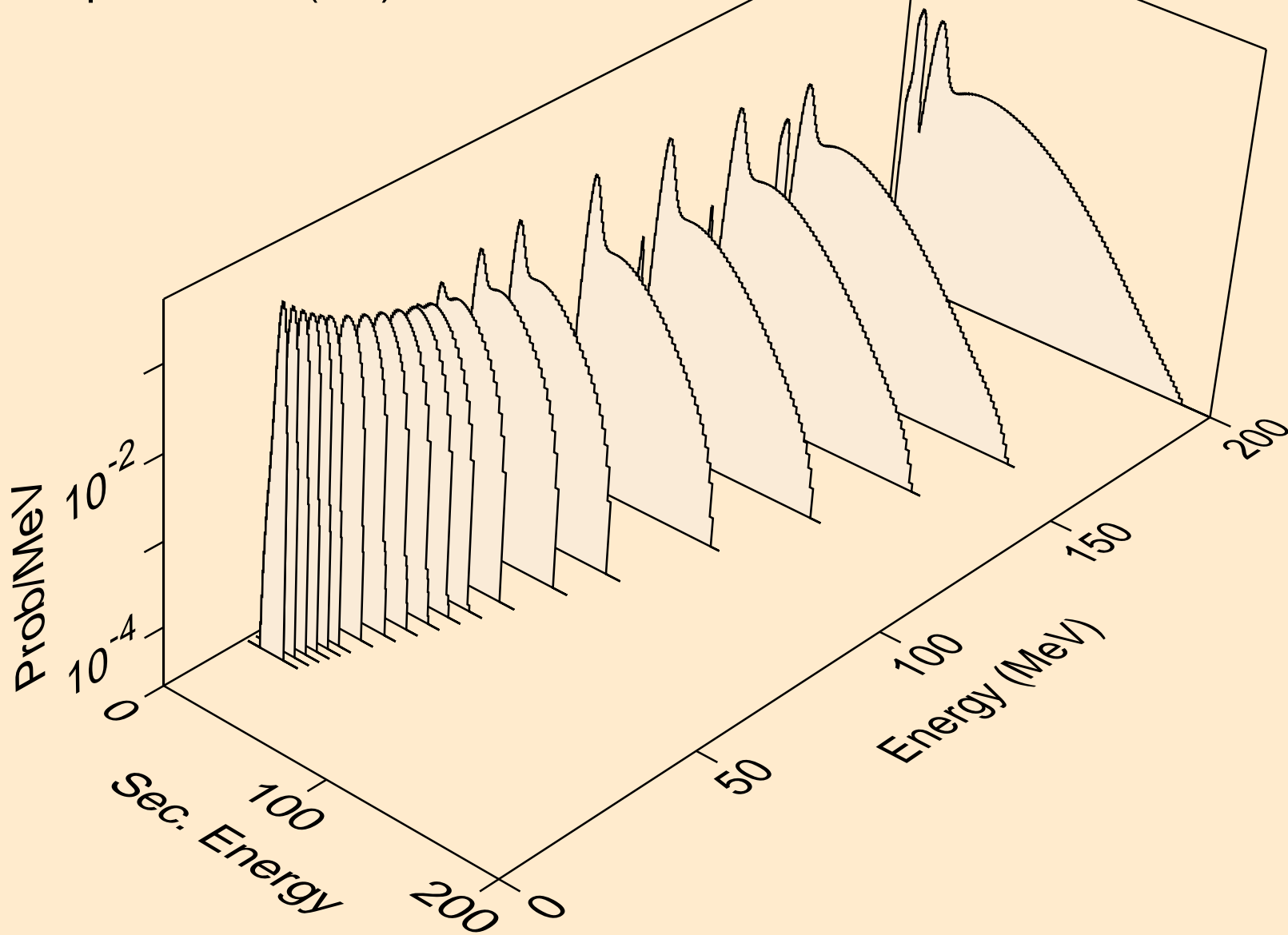

78-PT-198 FOR FENDL-3.1 FROM TENDL-2010 WITH NJOY2012.5
alphas from (n,n*)a

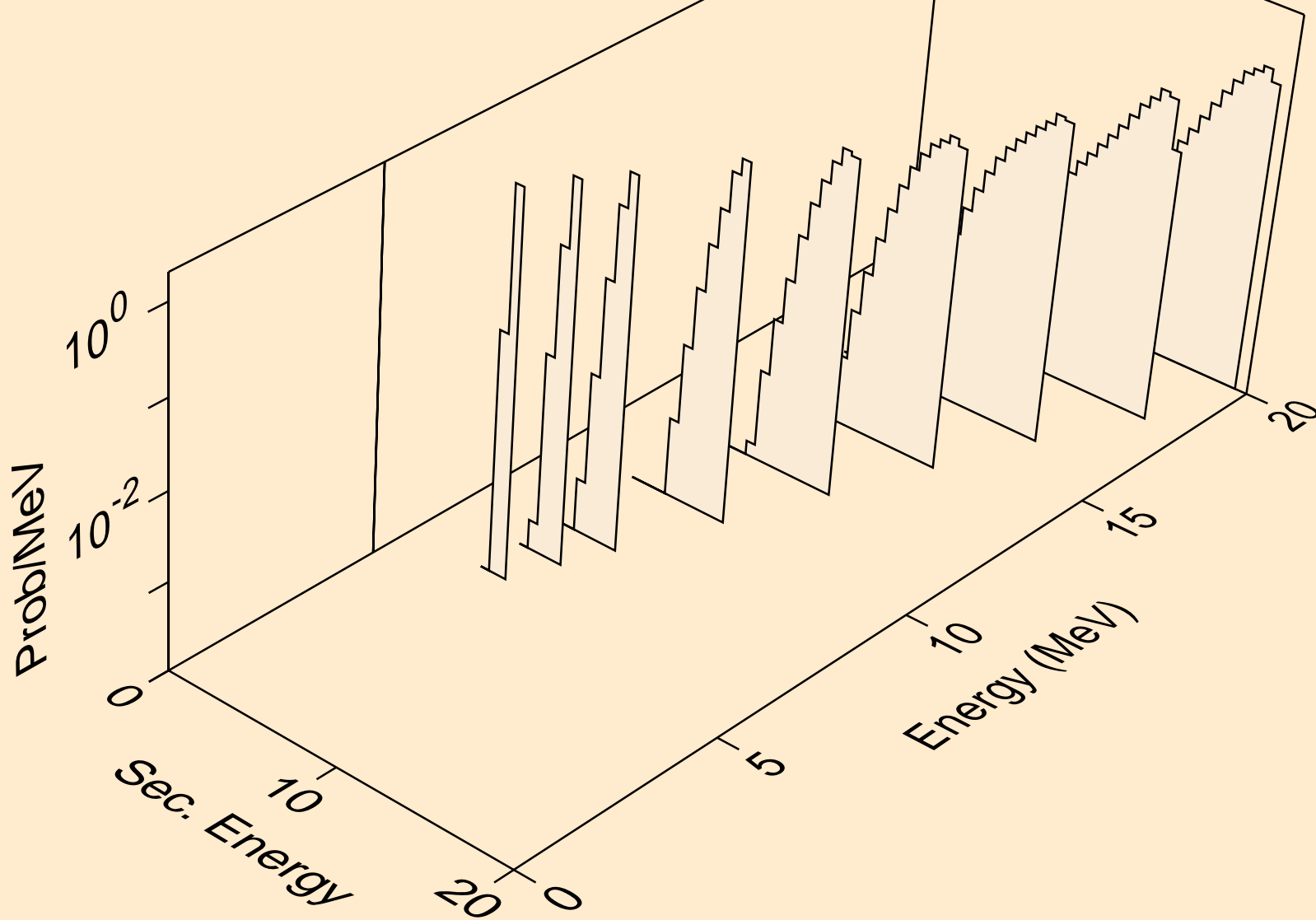

78-PT-198 FOR FENDL-3.1 FROM TENDL-2010 WITH NJOY2012.5
alphas from (n,2n)a

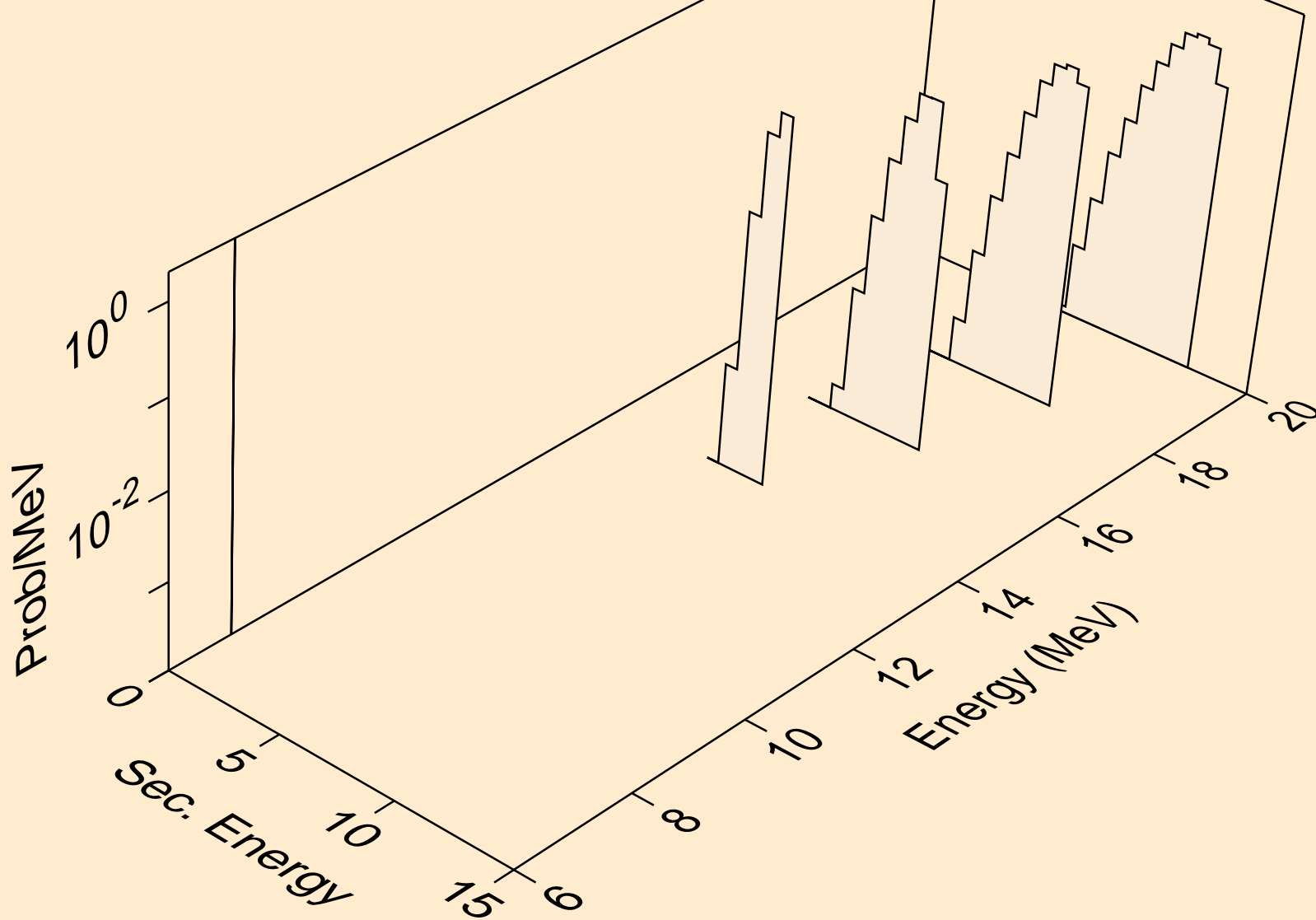

78-PT-198 FOR FENDL-3.1 FROM TENDL-2010 WITH NJOY2012.5
alphas from (n,a*c)

