

3-LI-6 FOR FENDL-3.2 FROM FENDL-3.2 BY NJOY2016.60+ ON F  
Principal cross sections

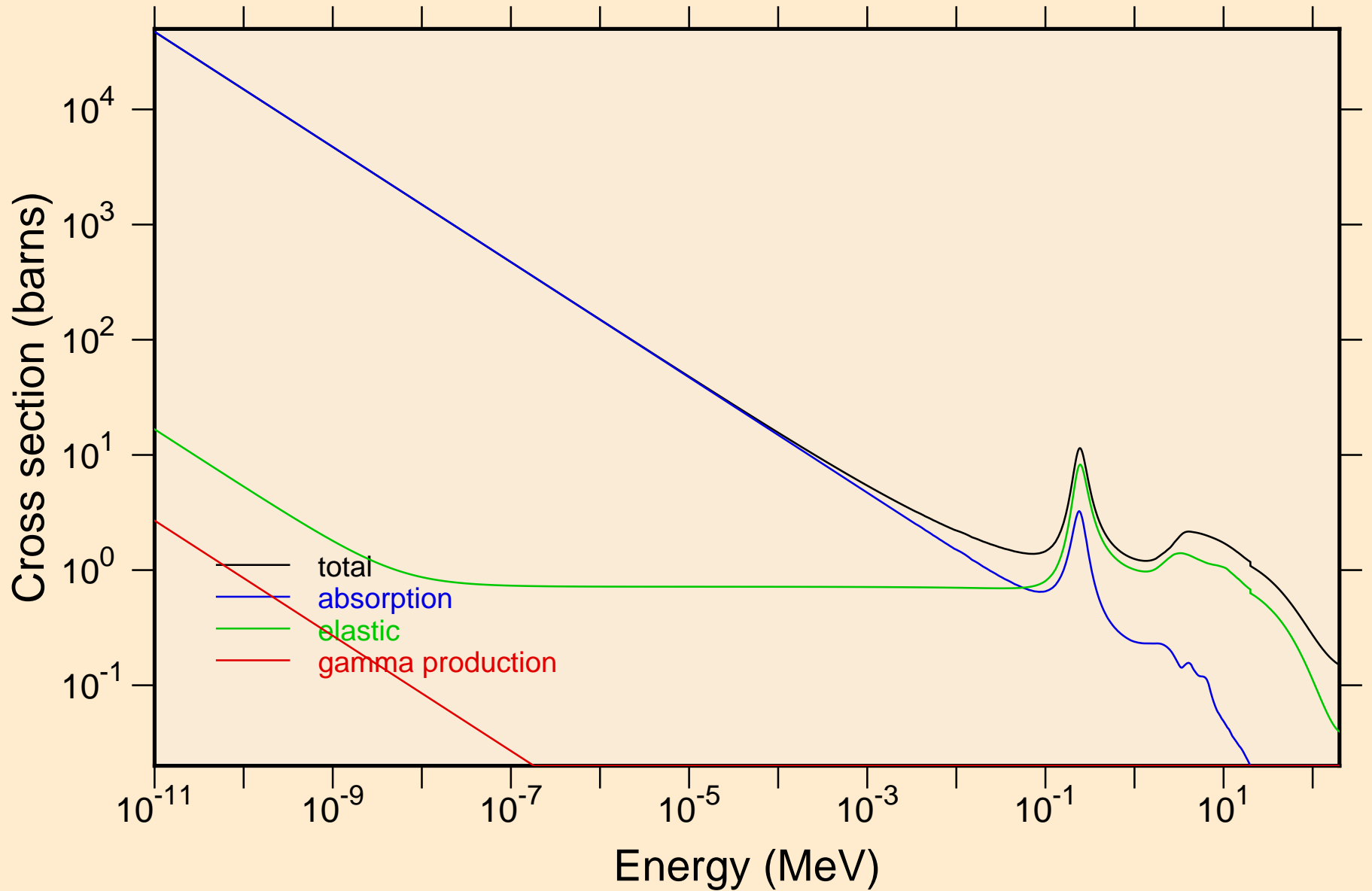

# 3-LI-6 FOR FENDL-3.2 FROM FENDL-3.2 BY NJOY2016.60+ ON F Heating

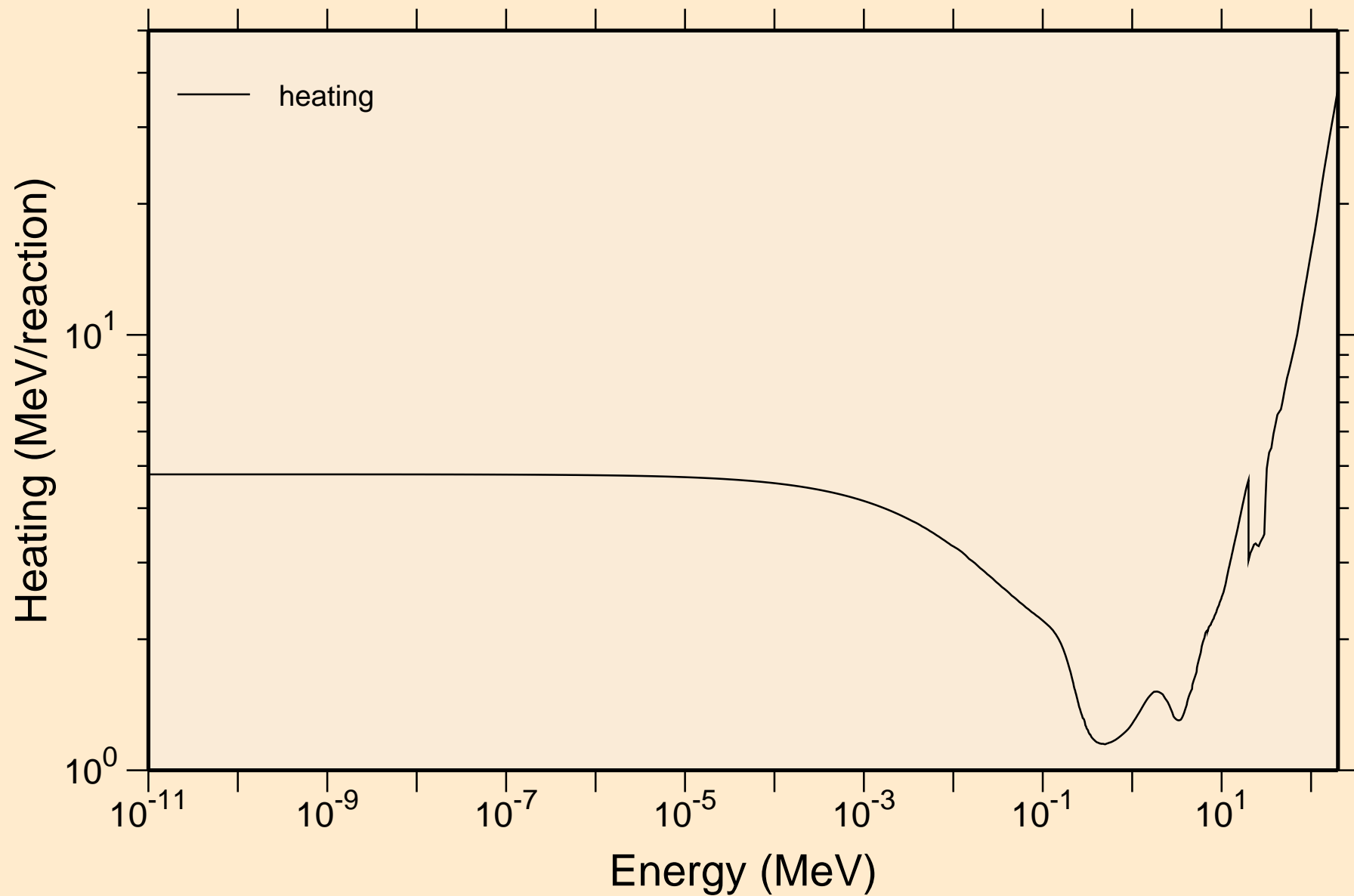

3-LI-6 FOR FENDL-3.2 FROM FENDL-3.2 BY NJOY2016.60+ ON F  
Damage

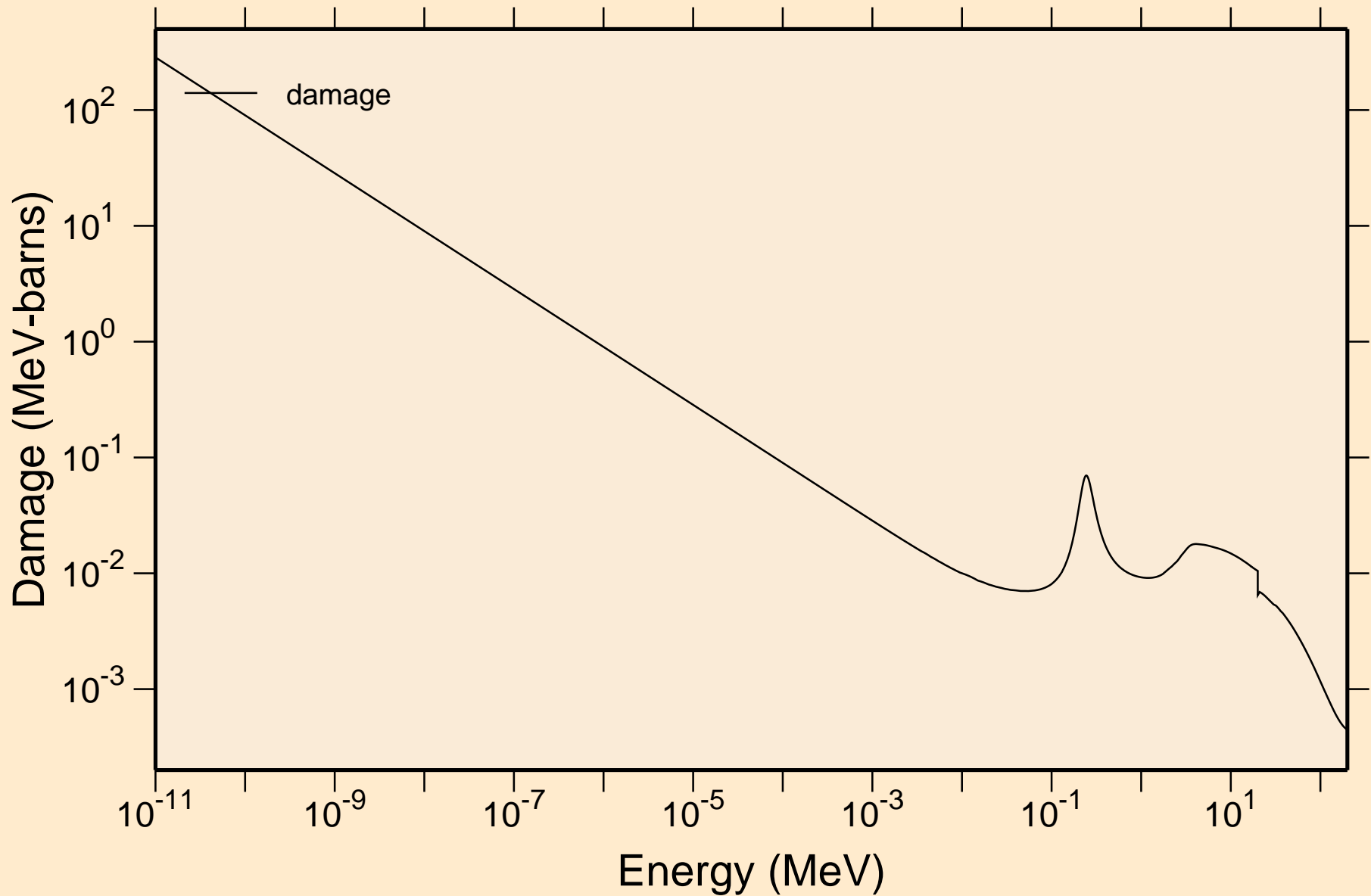

3-LI-6 FOR FENDL-3.2 FROM FENDL-3.2 BY NJOY2016.60+ ON F  
Non-threshold reactions

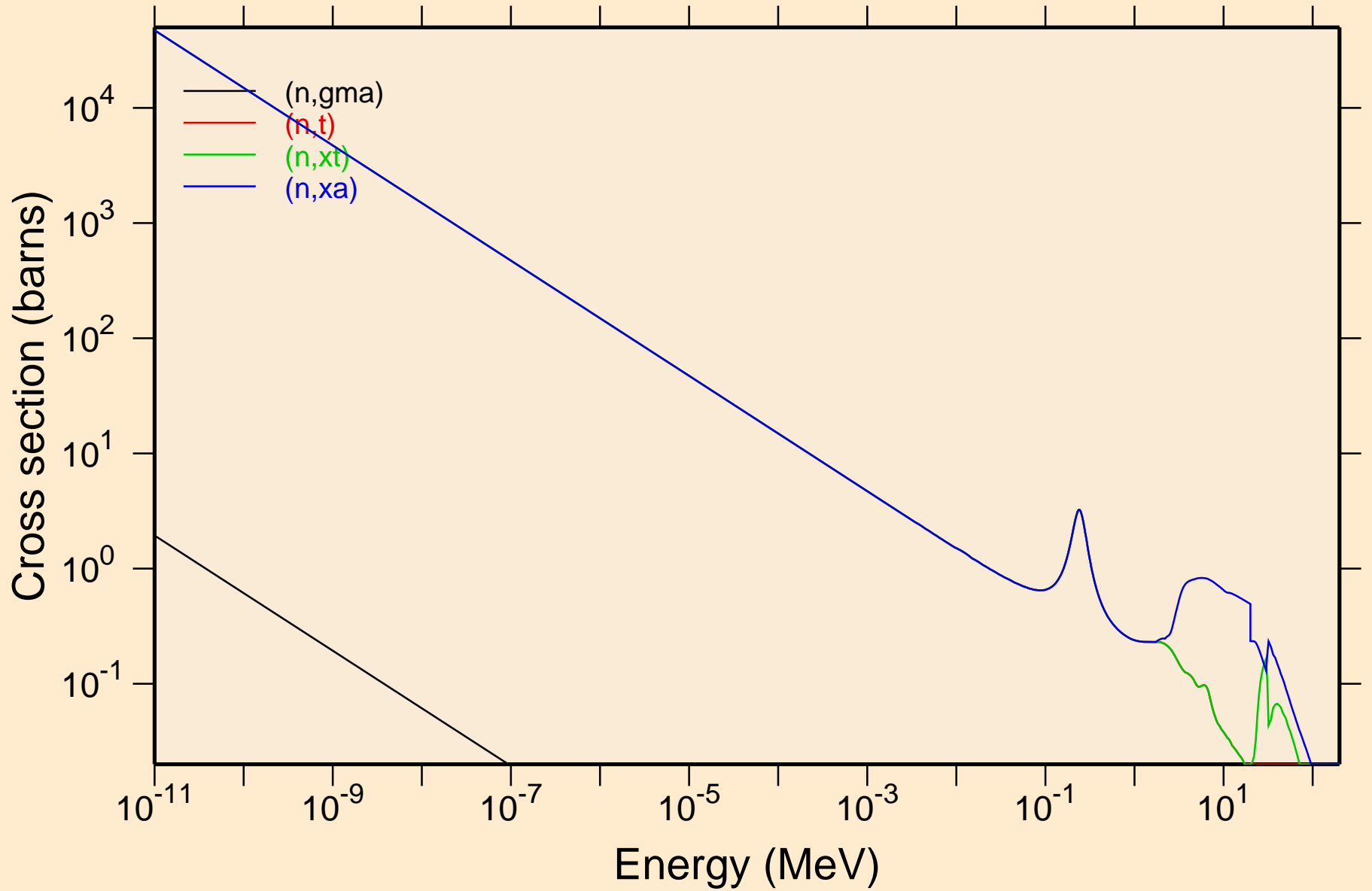

# 3-LI-6 FOR FENDL-3.2 FROM FENDL-3.2 BY NJOY2016.60+ ON F

## Principal cross sections

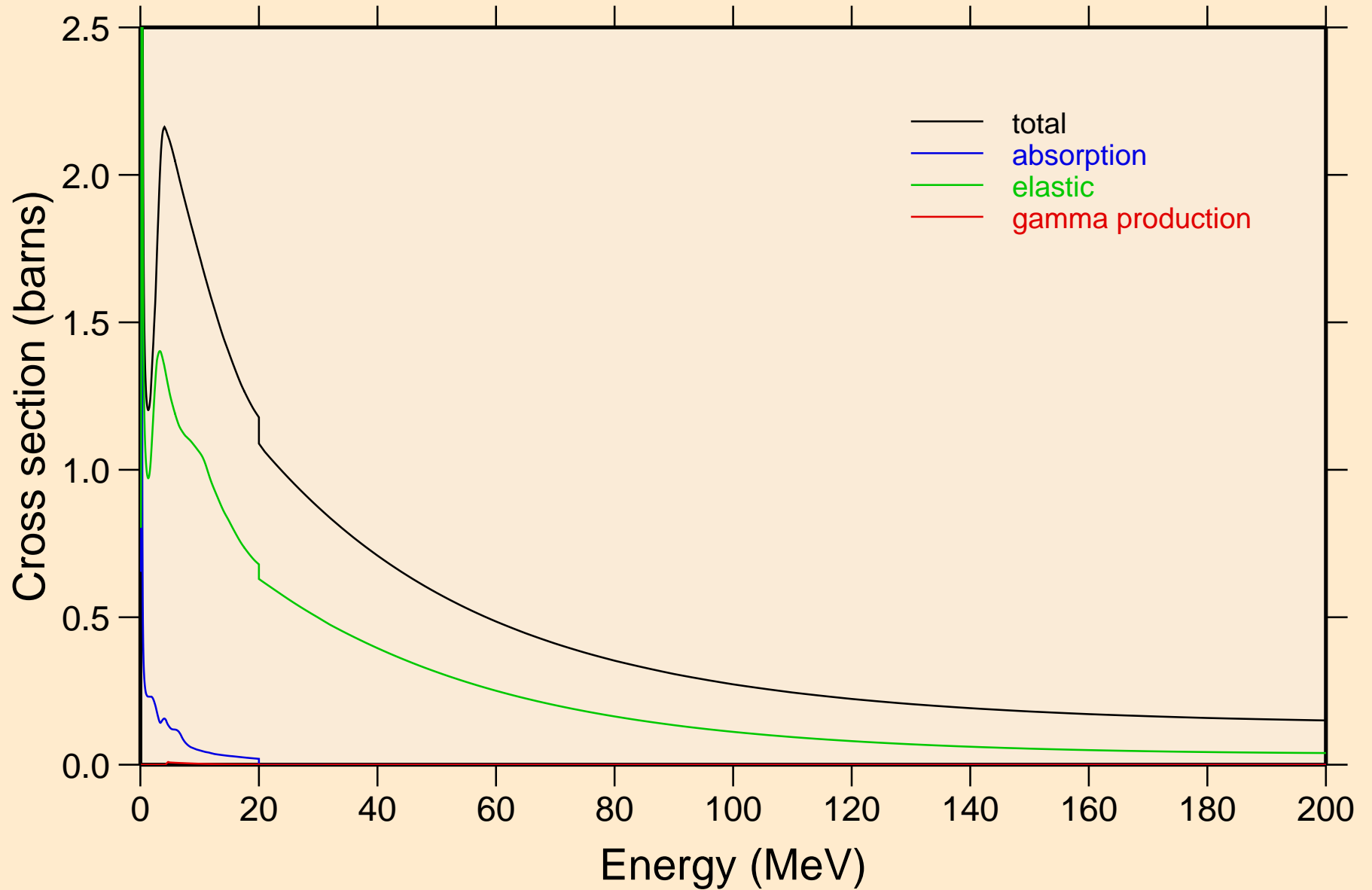

# 3-LI-6 FOR FENDL-3.2 FROM FENDL-3.2 BY NJOY2016.60+ ON F Heating

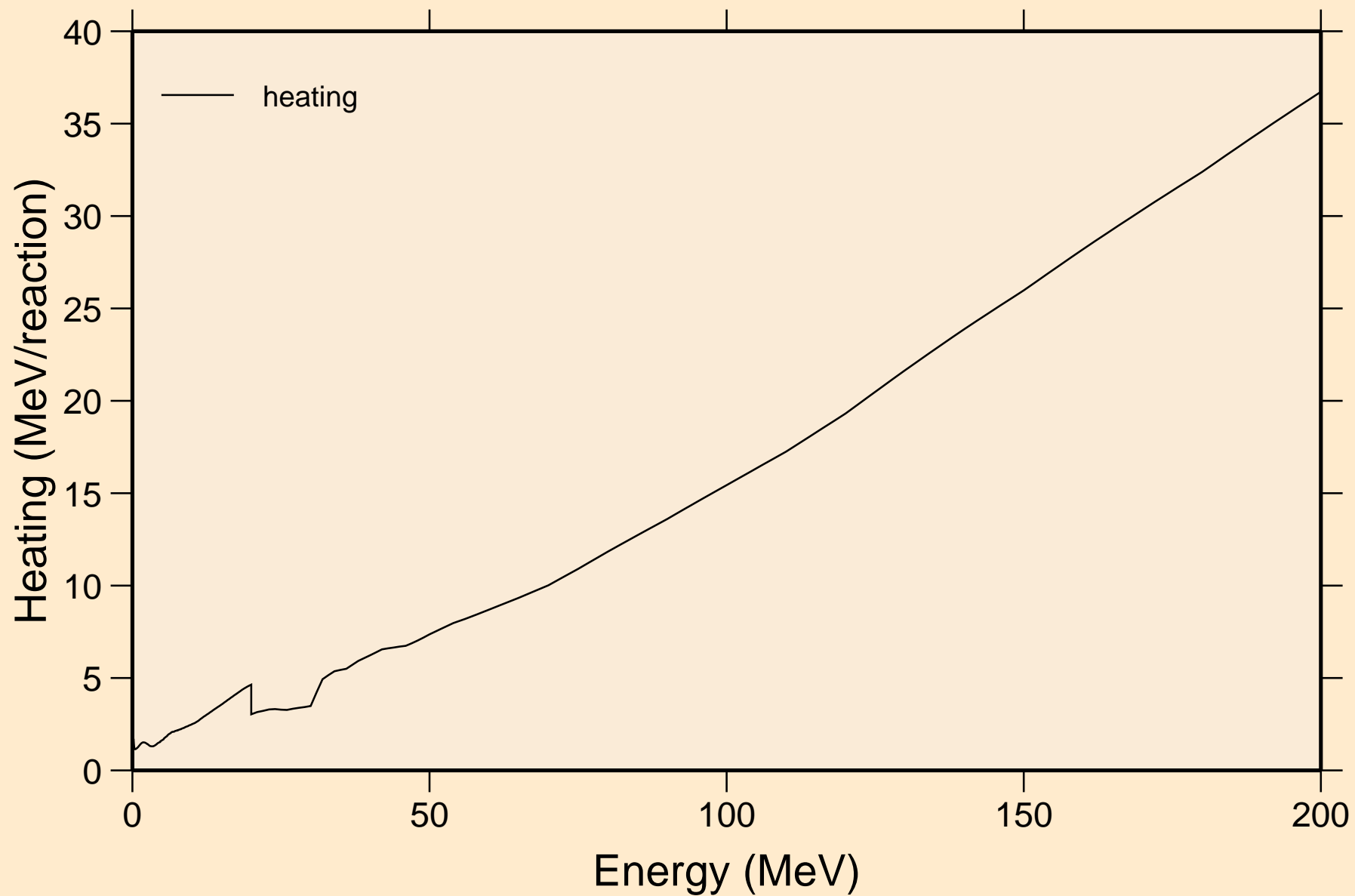

3-LI-6 FOR FENDL-3.2 FROM FENDL-3.2 BY NJOY2016.60+ ON F  
Damage

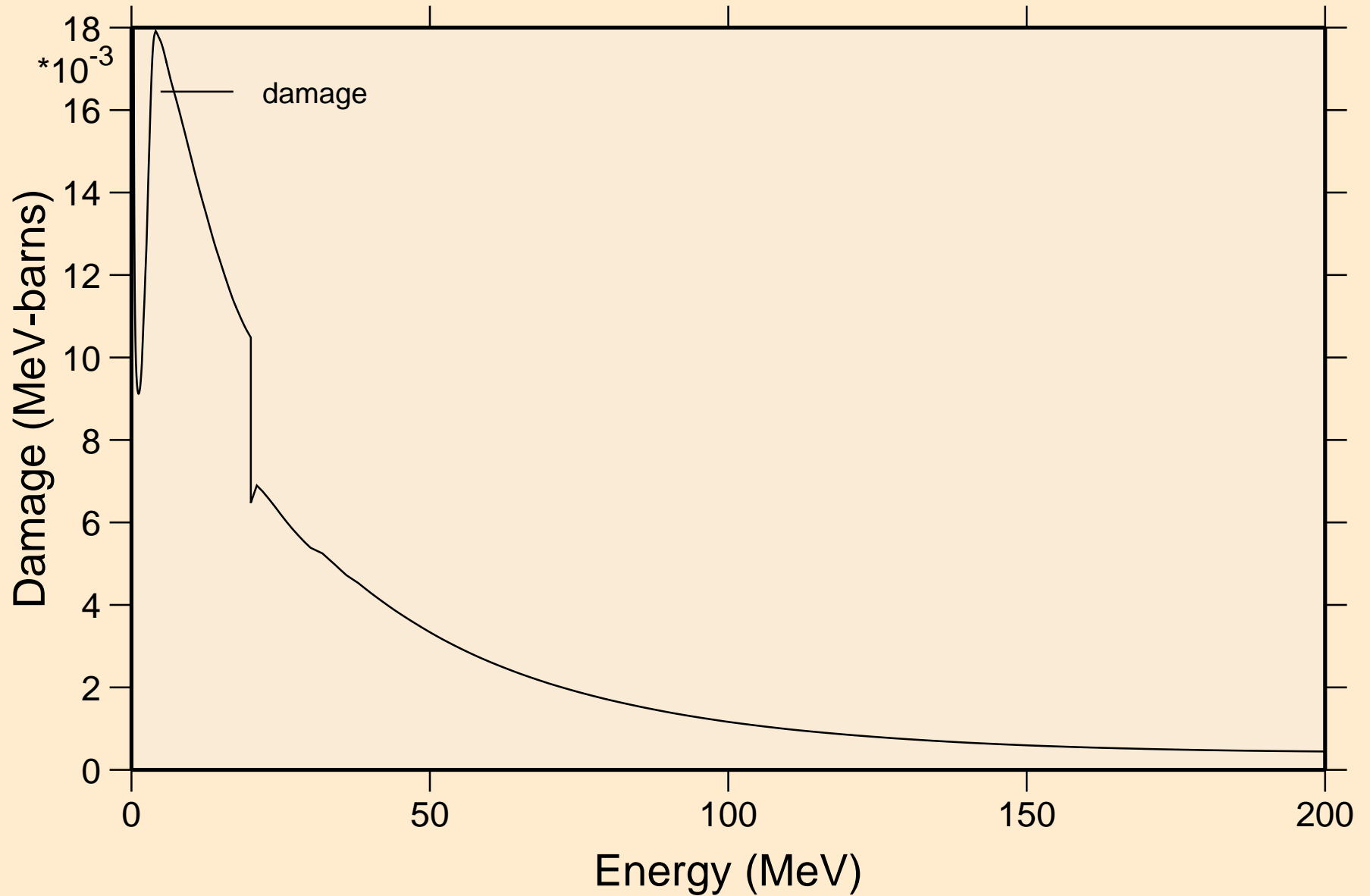

# 3-LI-6 FOR FENDL-3.2 FROM FENDL-3.2 BY NJOY2016.60+ ON F Non-threshold reactions

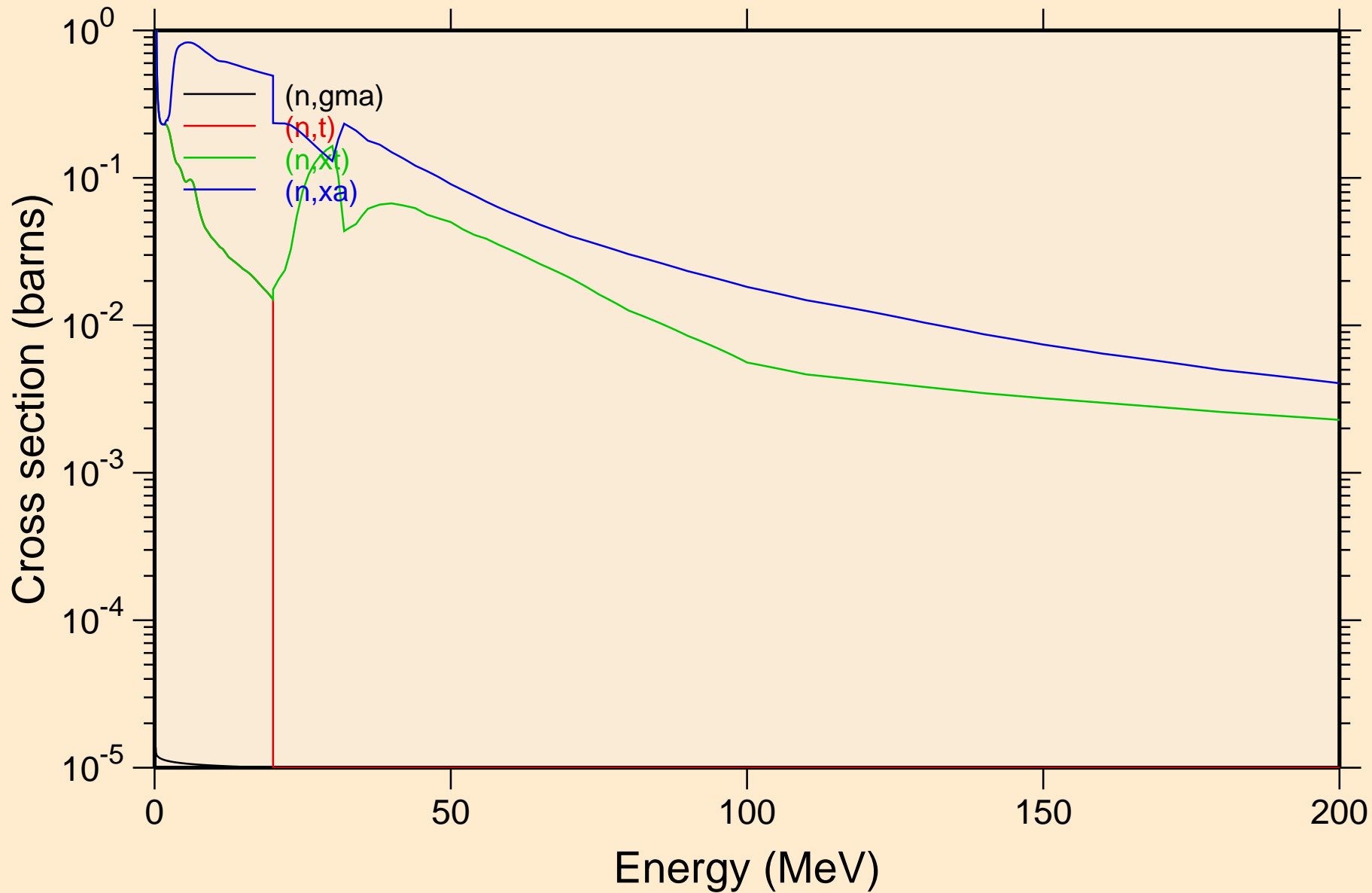



# 3-LI-6 FOR FENDL-3.2 FROM FENDL-3.2 BY NJOY2016.60+ ON F Inelastic levels

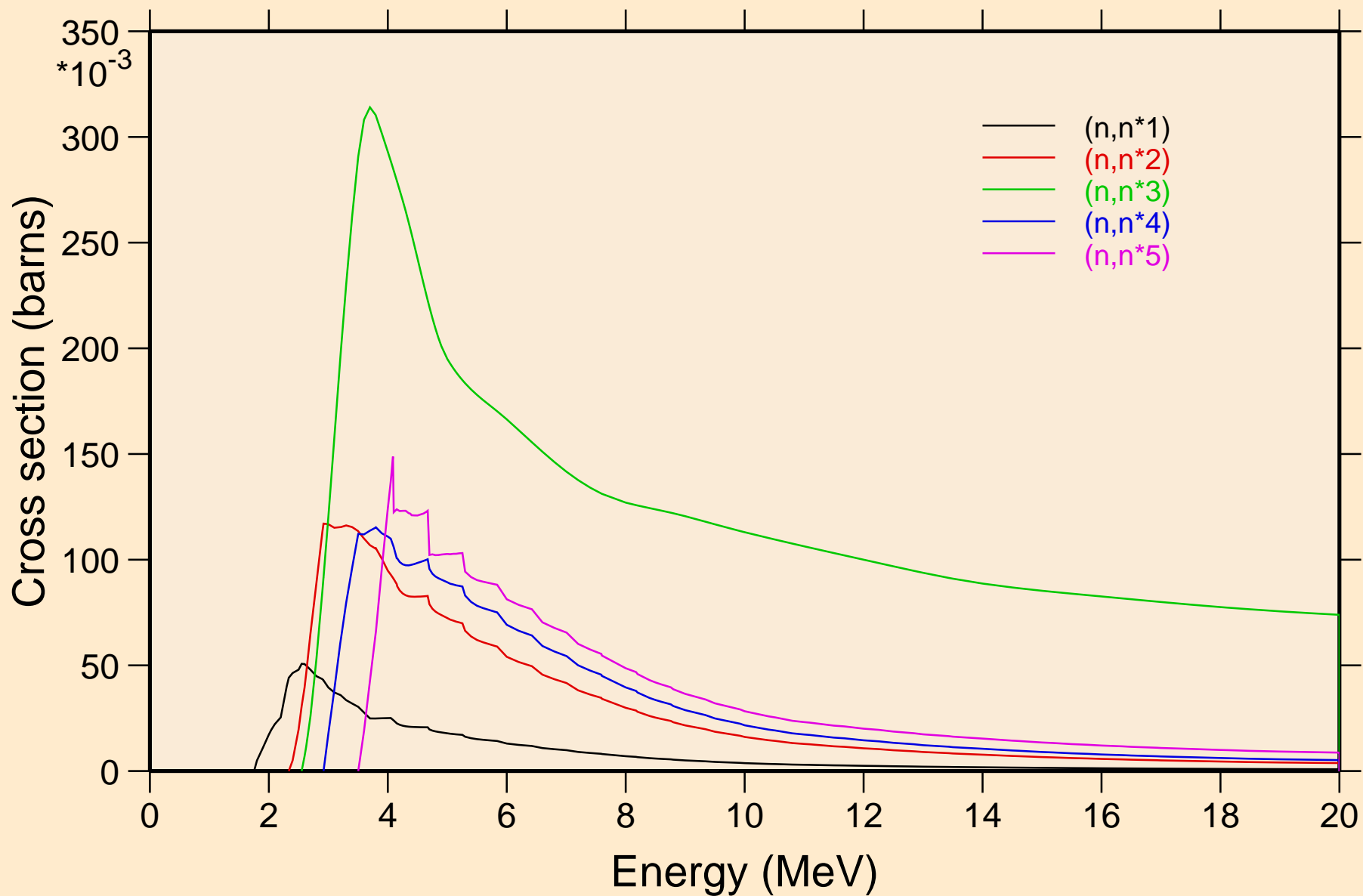

# 3-LI-6 FOR FENDL-3.2 FROM FENDL-3.2 BY NJOY2016.60+ ON F Inelastic levels

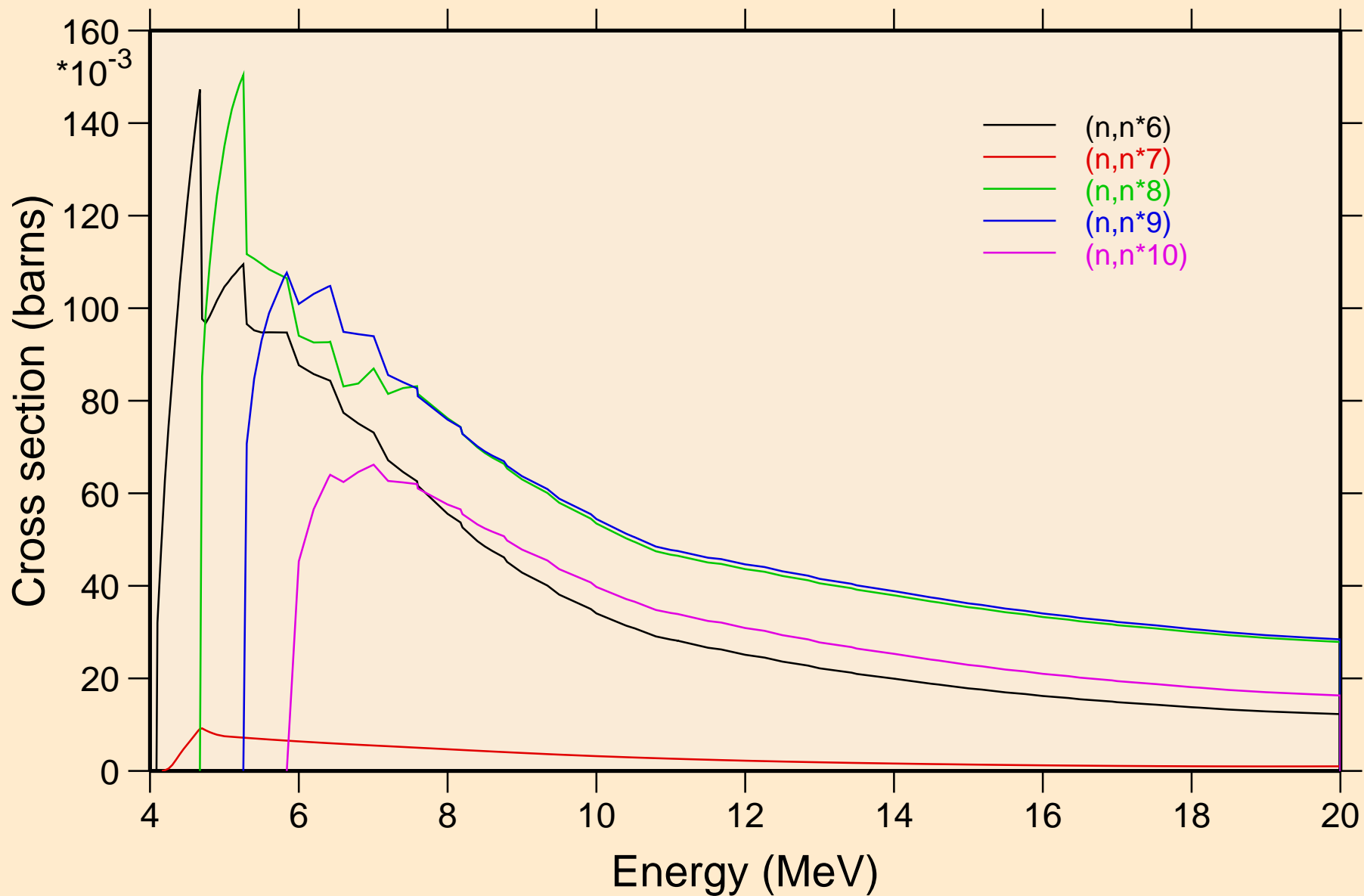

# 3-LI-6 FOR FENDL-3.2 FROM FENDL-3.2 BY NJOY2016.60+ ON F Inelastic levels

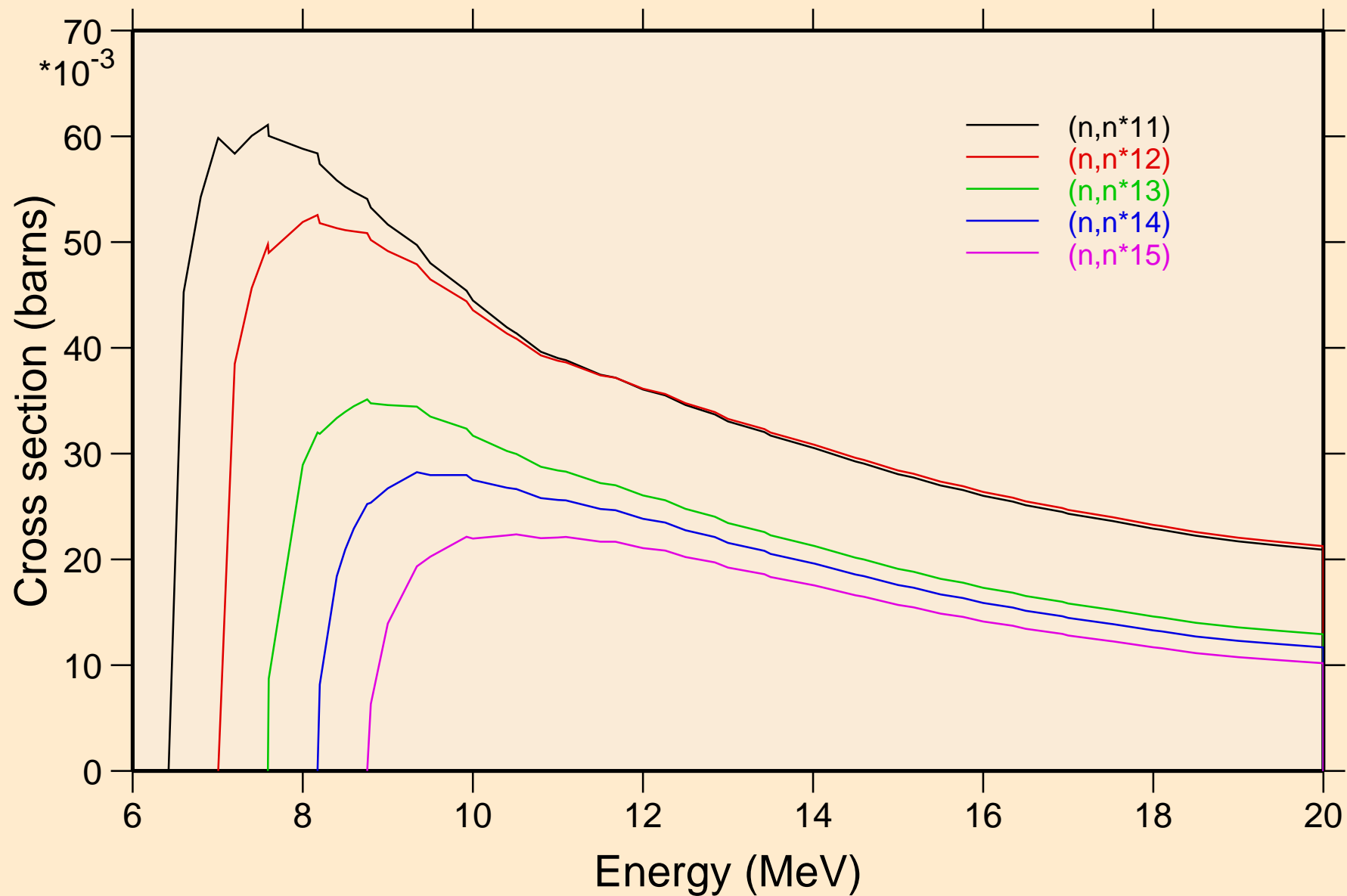

# 3-LI-6 FOR FENDL-3.2 FROM FENDL-3.2 BY NJOY2016.60+ ON F Inelastic levels

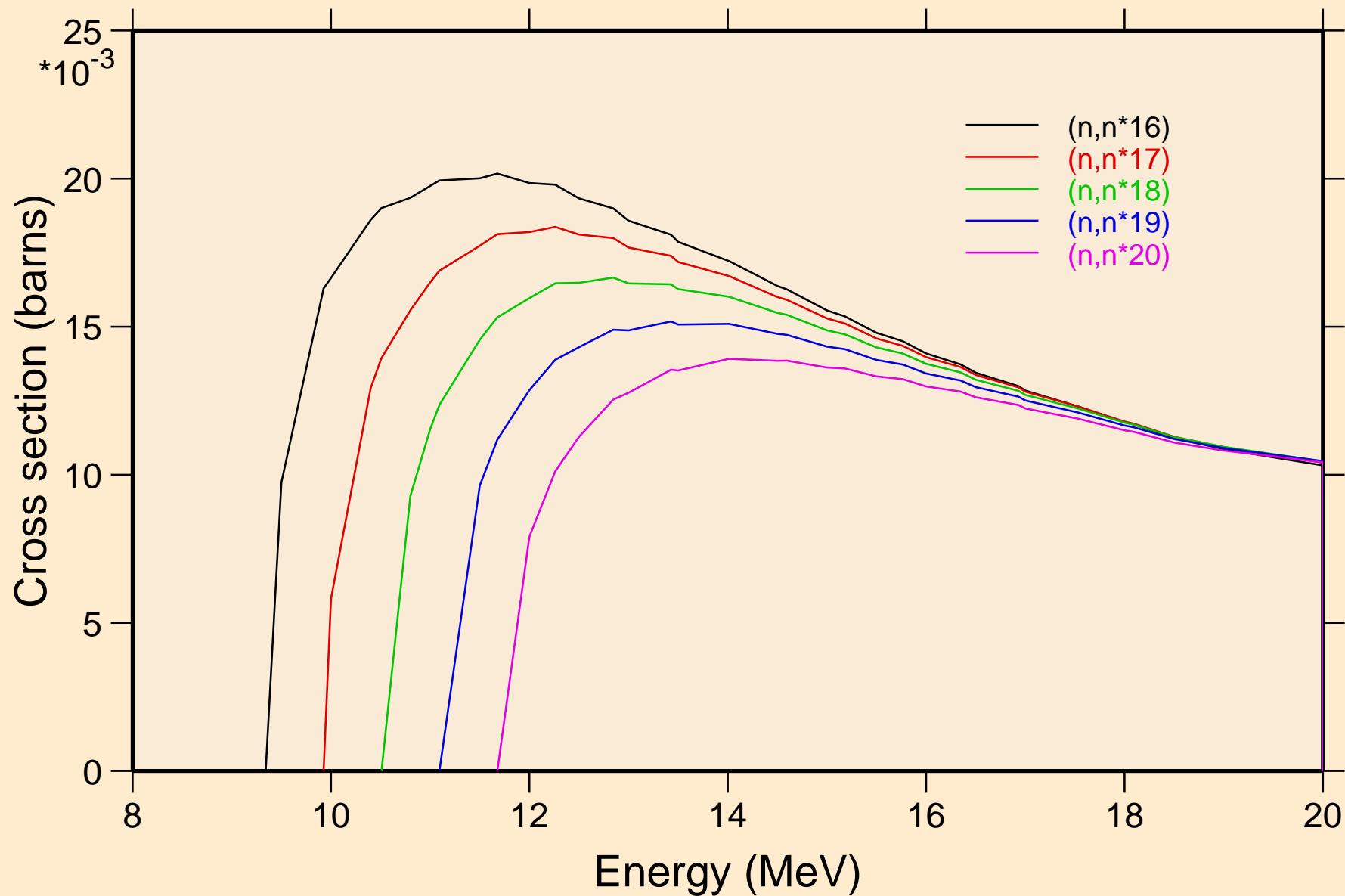

# 3-LI-6 FOR FENDL-3.2 FROM FENDL-3.2 BY NJOY2016.60+ ON F Inelastic levels

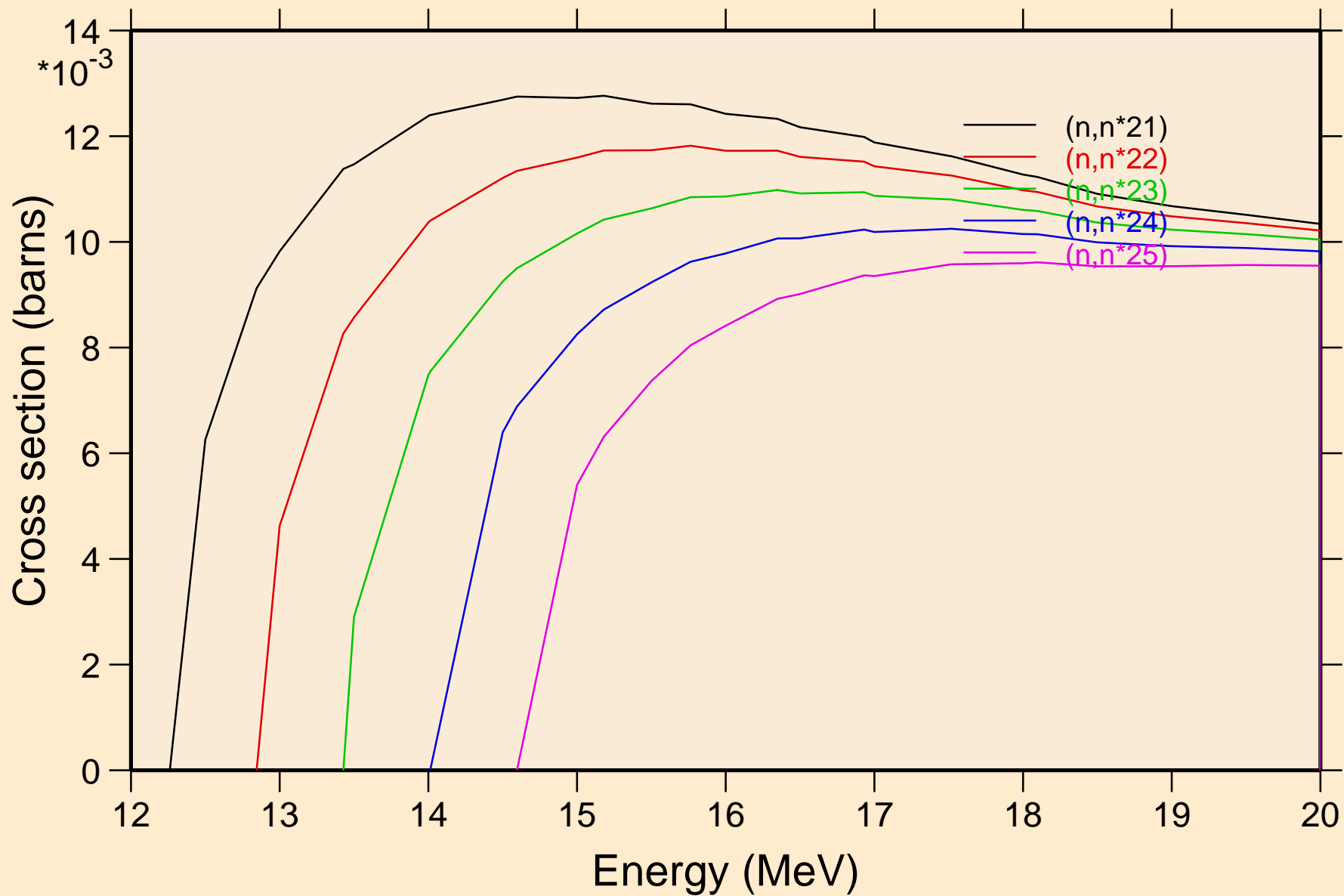

# 3-LI-6 FOR FENDL-3.2 FROM FENDL-3.2 BY NJOY2016.60+ ON F Inelastic levels

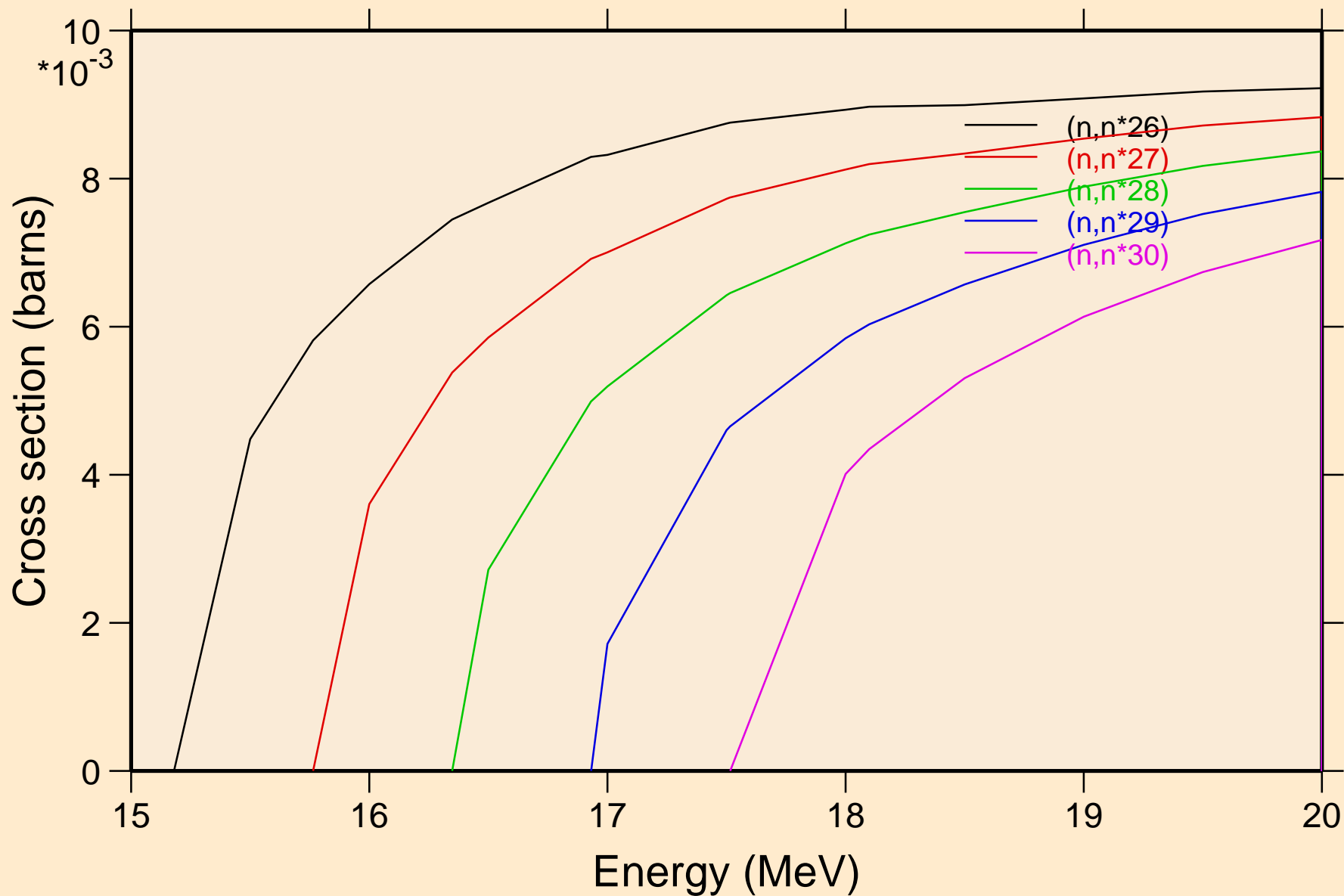

3-LI-6 FOR FENDL-3.2 FROM FENDL-3.2 BY NJOY2016.60+ ON F  
Inelastic levels

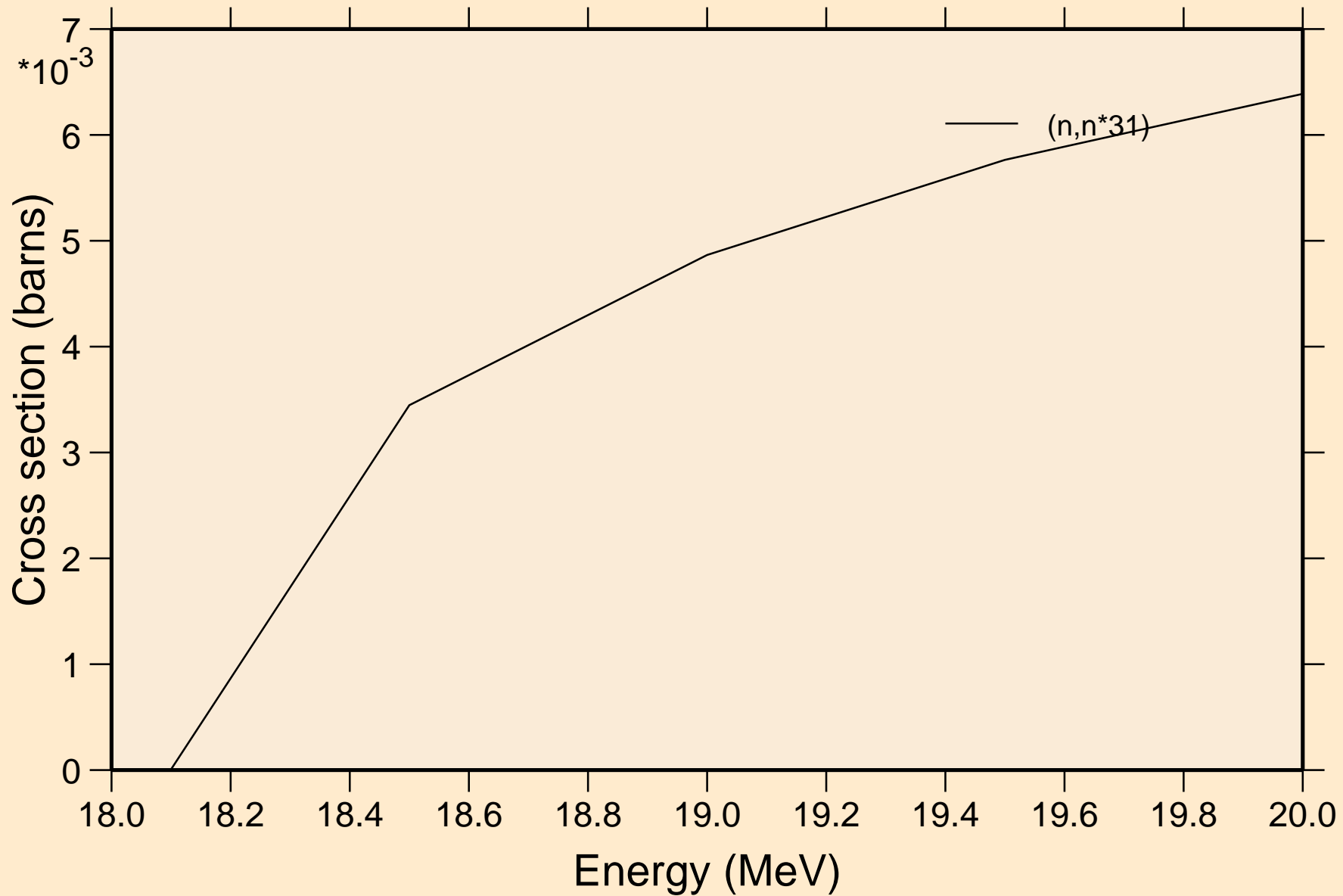

# 3-LI-6 FOR FENDL-3.2 FROM FENDL-3.2 BY NJOY2016.60+ ON F Threshold reactions

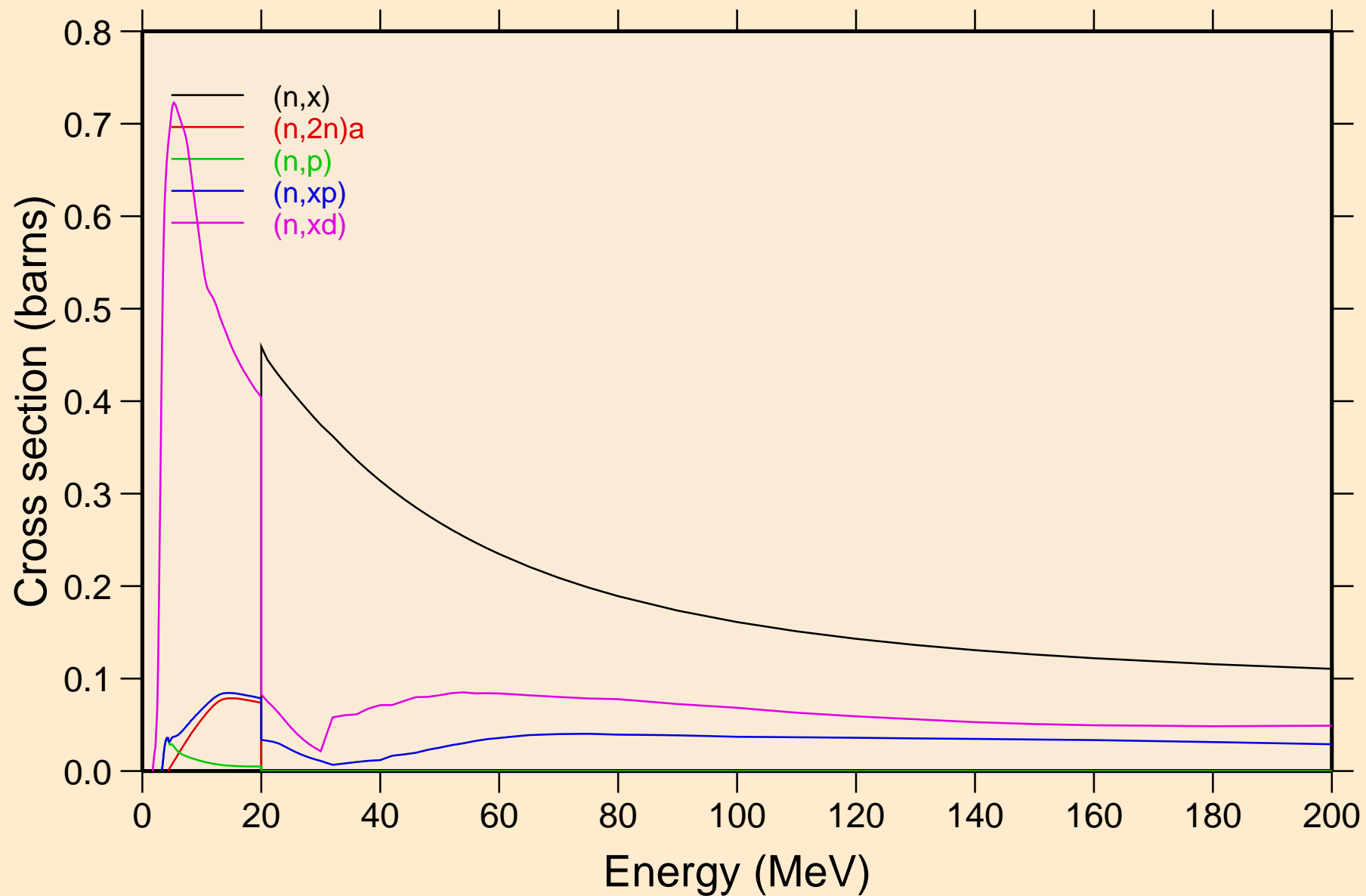



3-LI-6 FOR FENDL-3.2 FROM FENDL-3.2 BY NJOY2016.60+ ON F  
Threshold reactions

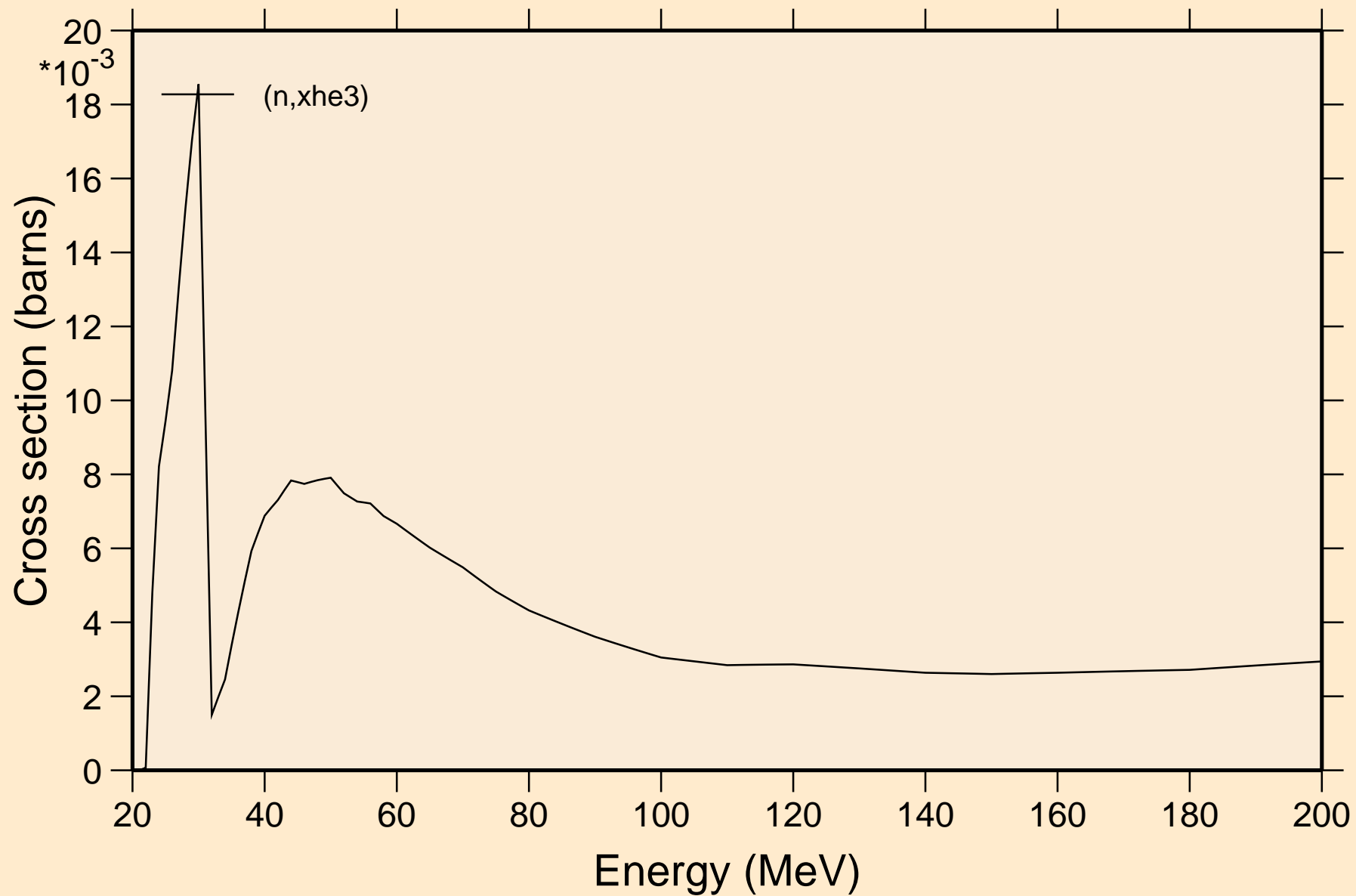

3-LI-6 FOR FENDL-3.2 FROM FENDL-3.2 BY NJOY2016.60+ ON F  
angular distribution for elastic

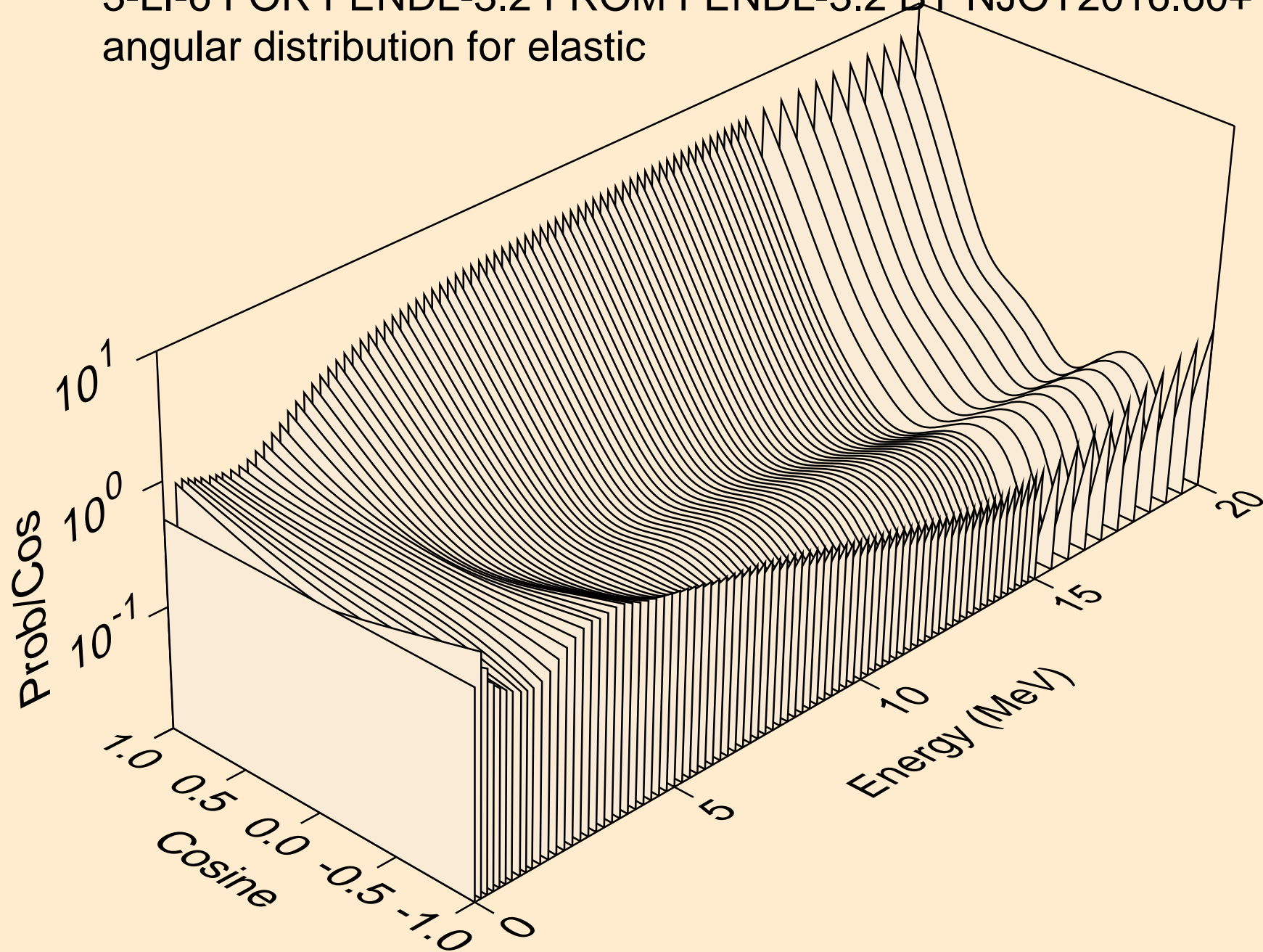

3-LI-6 FOR FENDL-3.2 FROM FENDL-3.2 BY NJOY2016.60+ ON F  
angular distribution for elastic

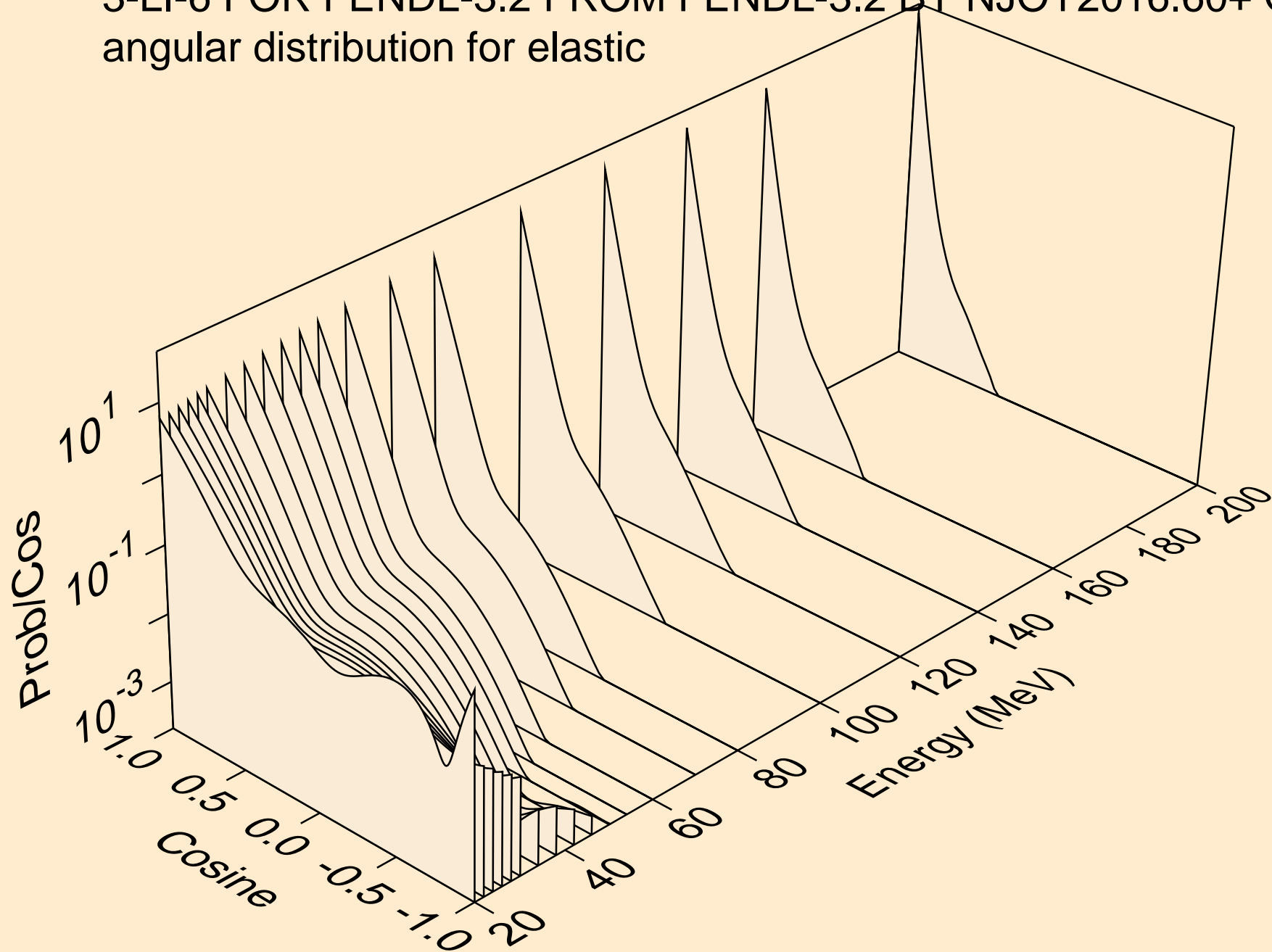

3-LI-6 FOR FENDL-3.2 FROM FENDL-3.2 BY NJOY2016.60+ ON F  
angular distribution for (n,2n)a

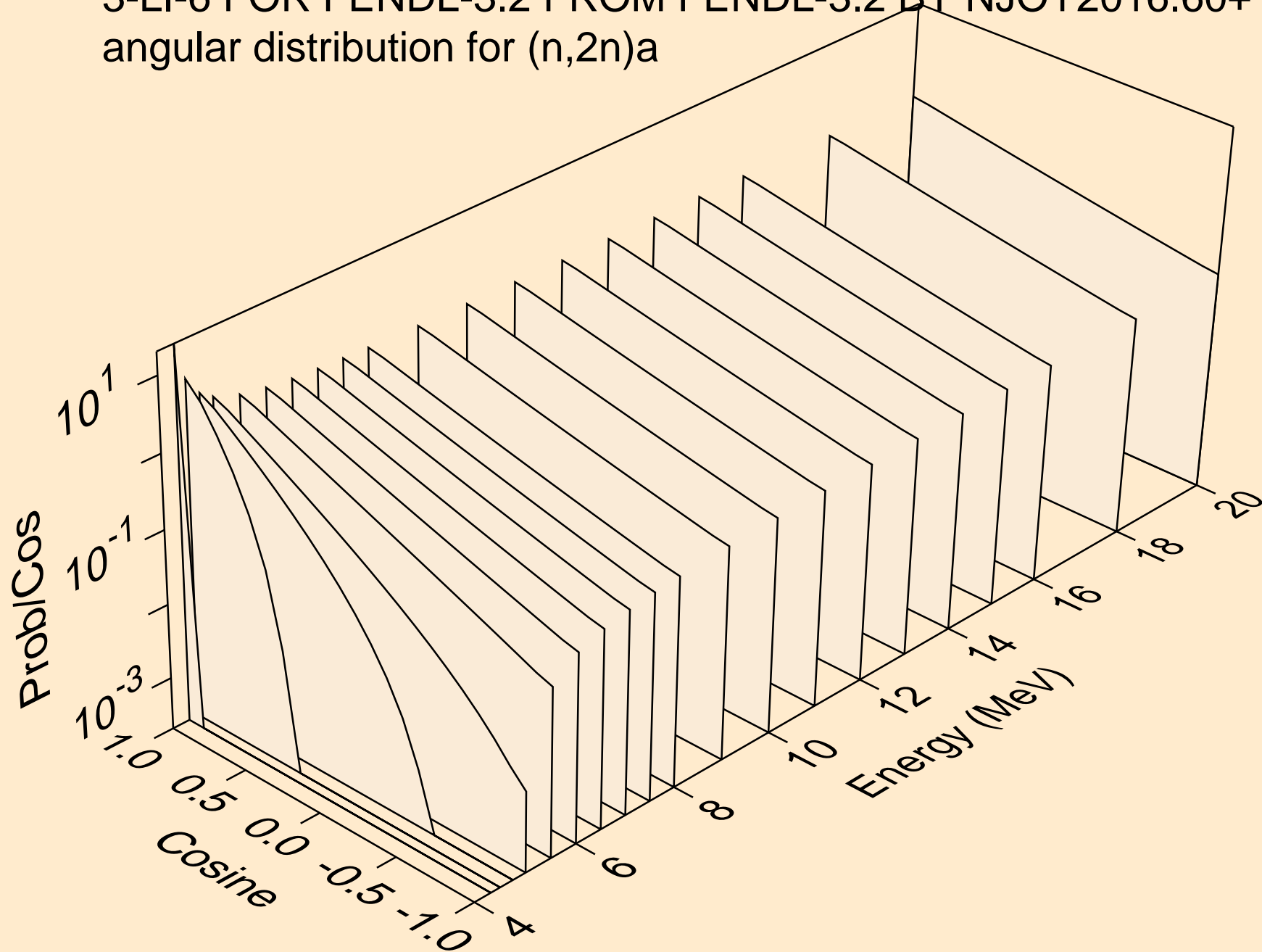

3-LI-6 FOR FENDL-3.2 FROM FENDL-3.2 BY NJOY2016.60+ ON F  
angular distribution for (n,n\*1)

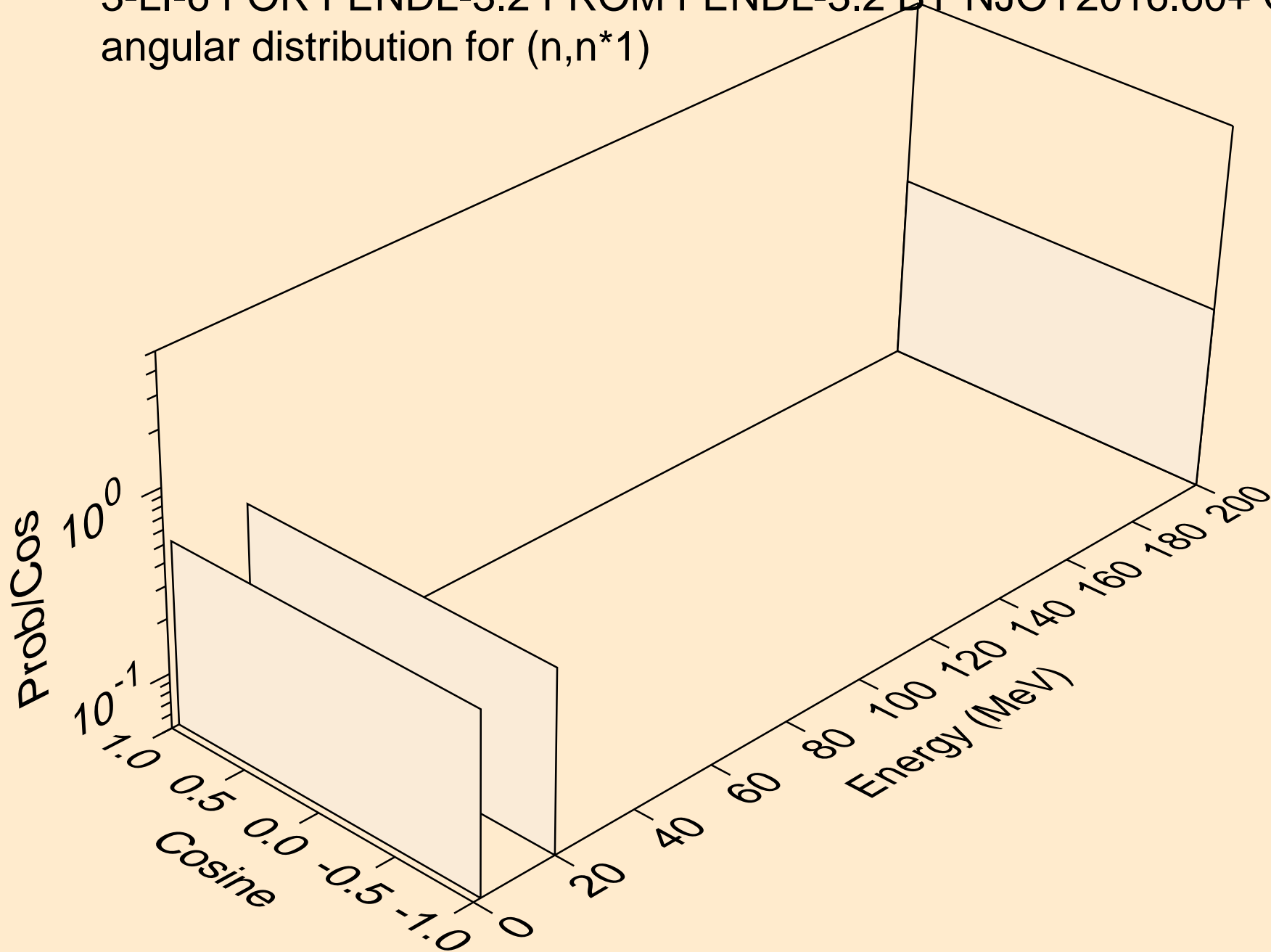

3-LI-6 FOR FENDL-3.2 FROM FENDL-3.2 BY NJOY2016.60+ ON F  
angular distribution for (n,n\*2)

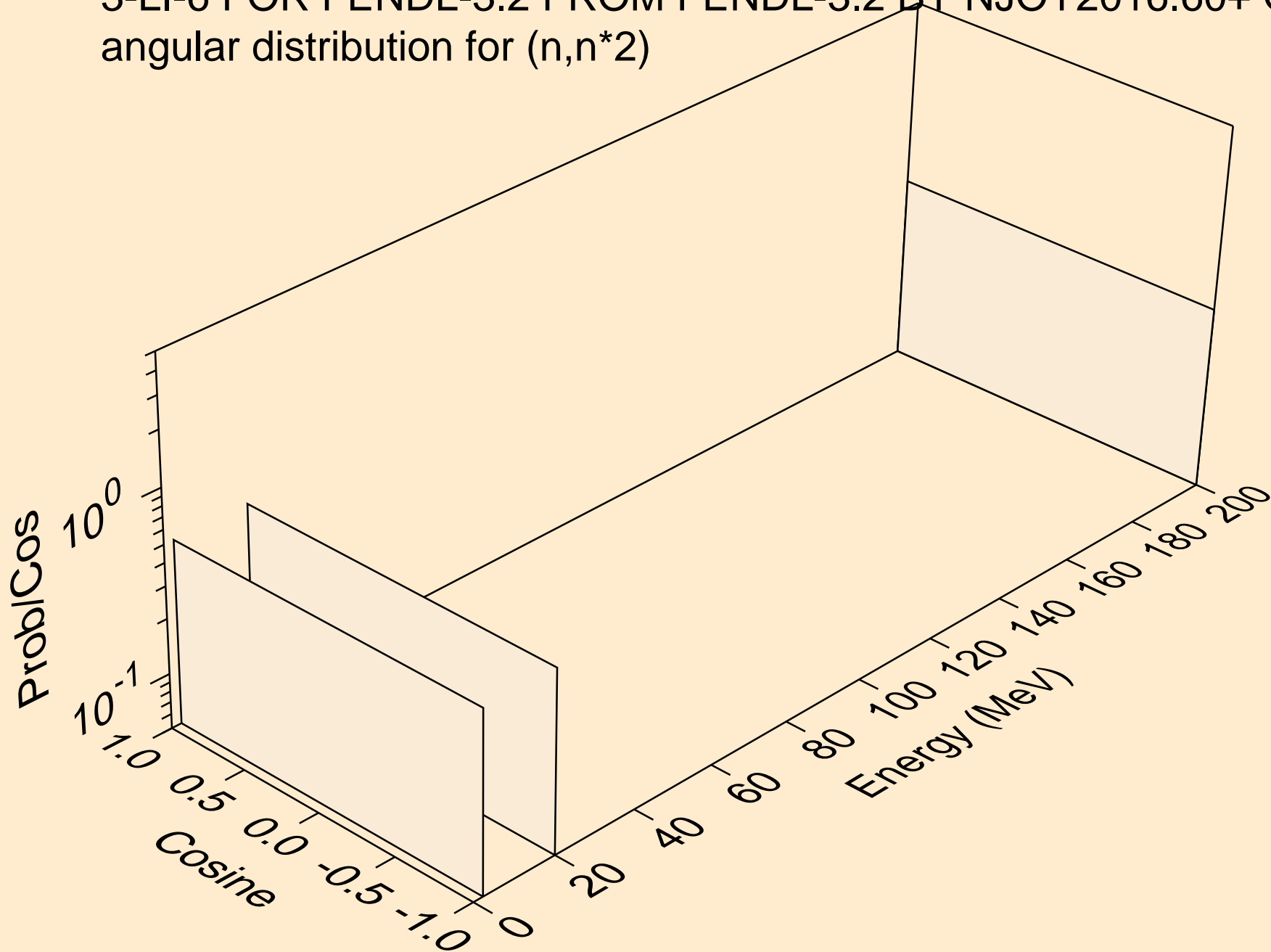

3-LI-6 FOR FENDL-3.2 FROM FENDL-3.2 BY NJOY2016.60+ ON F  
angular distribution for (n,n\*3)

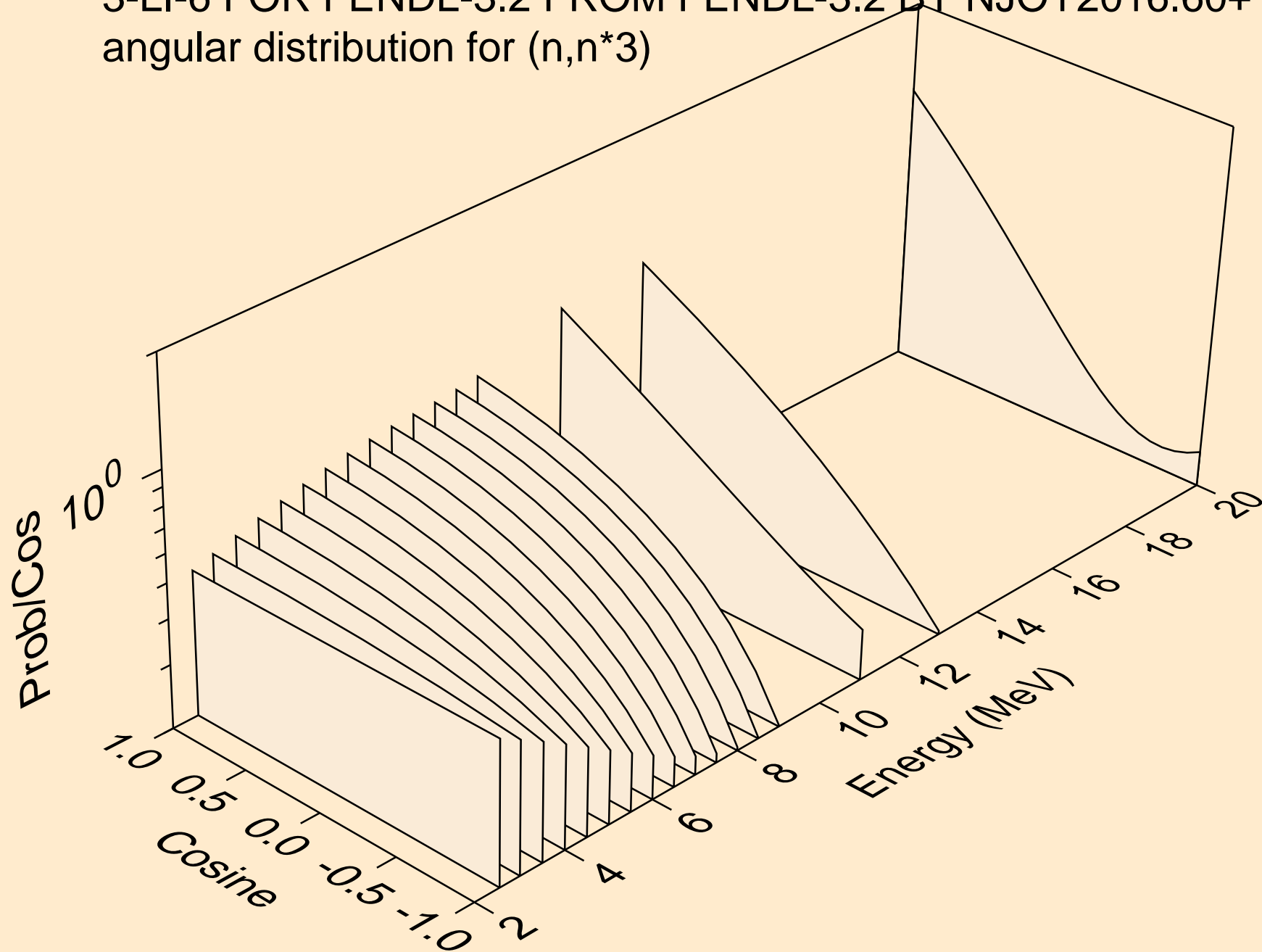

3-LI-6 FOR FENDL-3.2 FROM FENDL-3.2 BY NJOY2016.60+ ON F  
angular distribution for (n,n\*4)

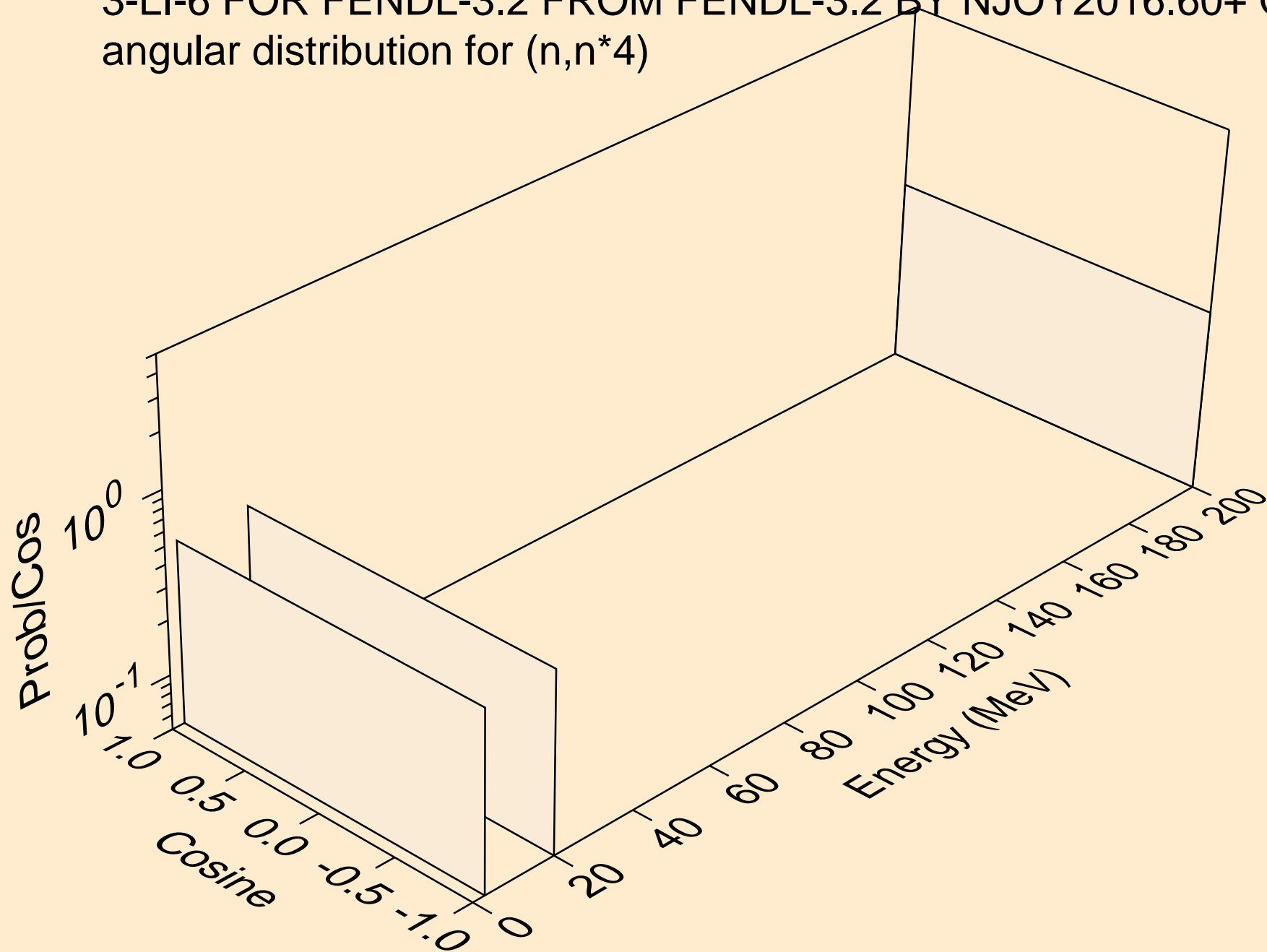



3-LI-6 FOR FENDL-3.2 FROM FENDL-3.2 BY NJOY2016.60+ ON F  
angular distribution for (n,n\*5)

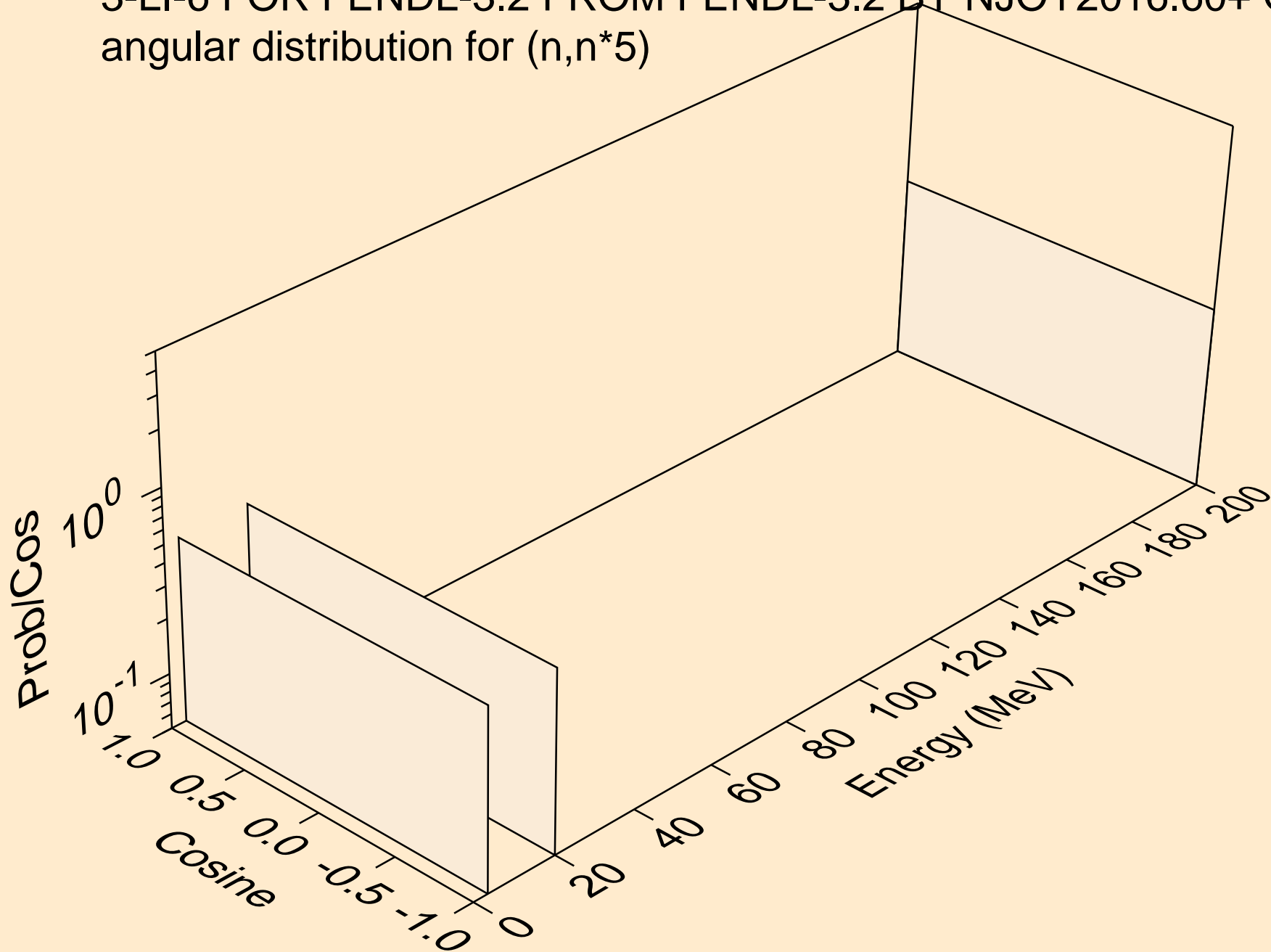

3-LI-6 FOR FENDL-3.2 FROM FENDL-3.2 BY NJOY2016.60+ ON F  
angular distribution for (n,n\*6)

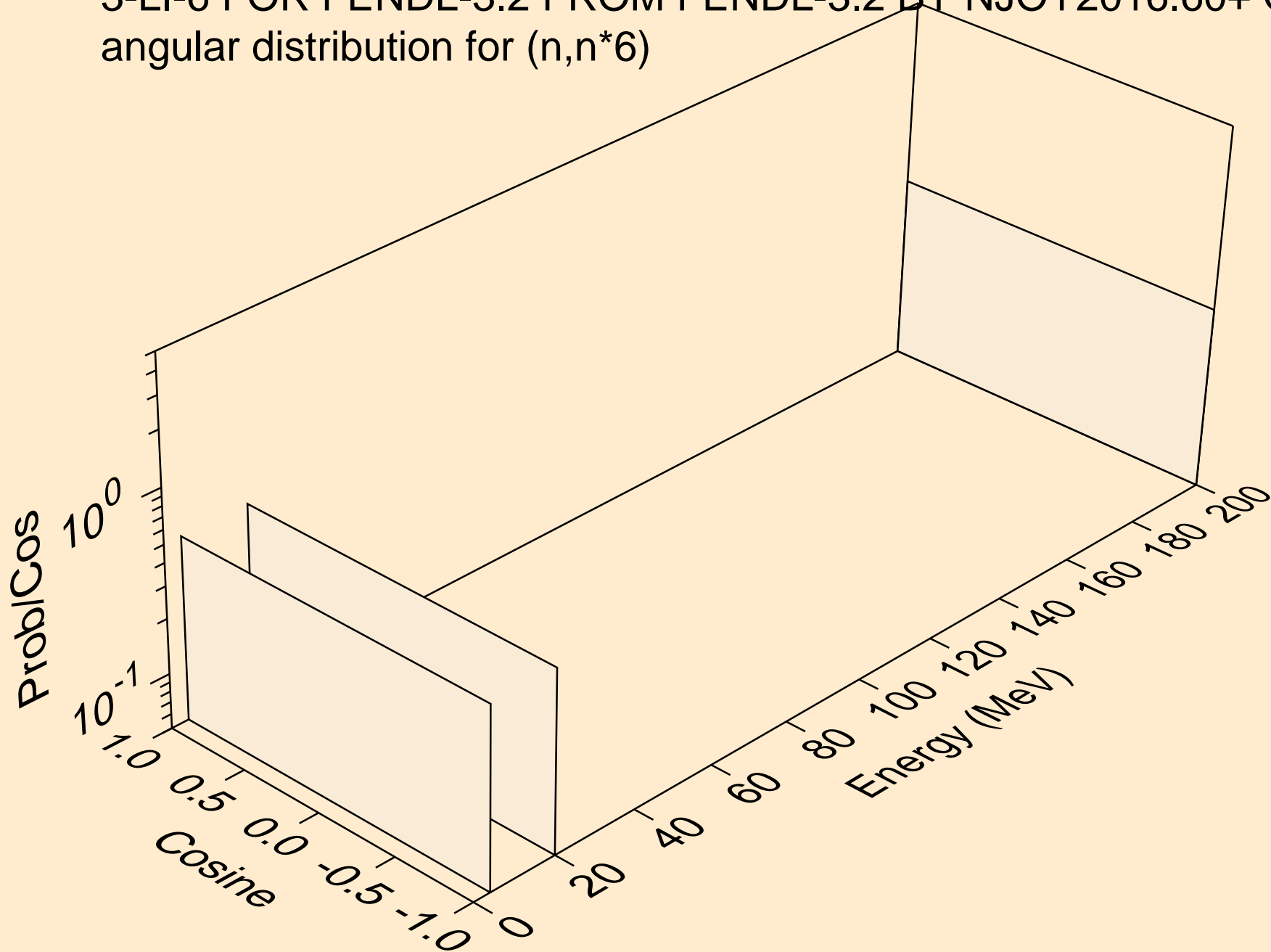

3-LI-6 FOR FENDL-3.2 FROM FENDL-3.2 BY NJOY2016.60+ ON F  
angular distribution for (n,n\*7)

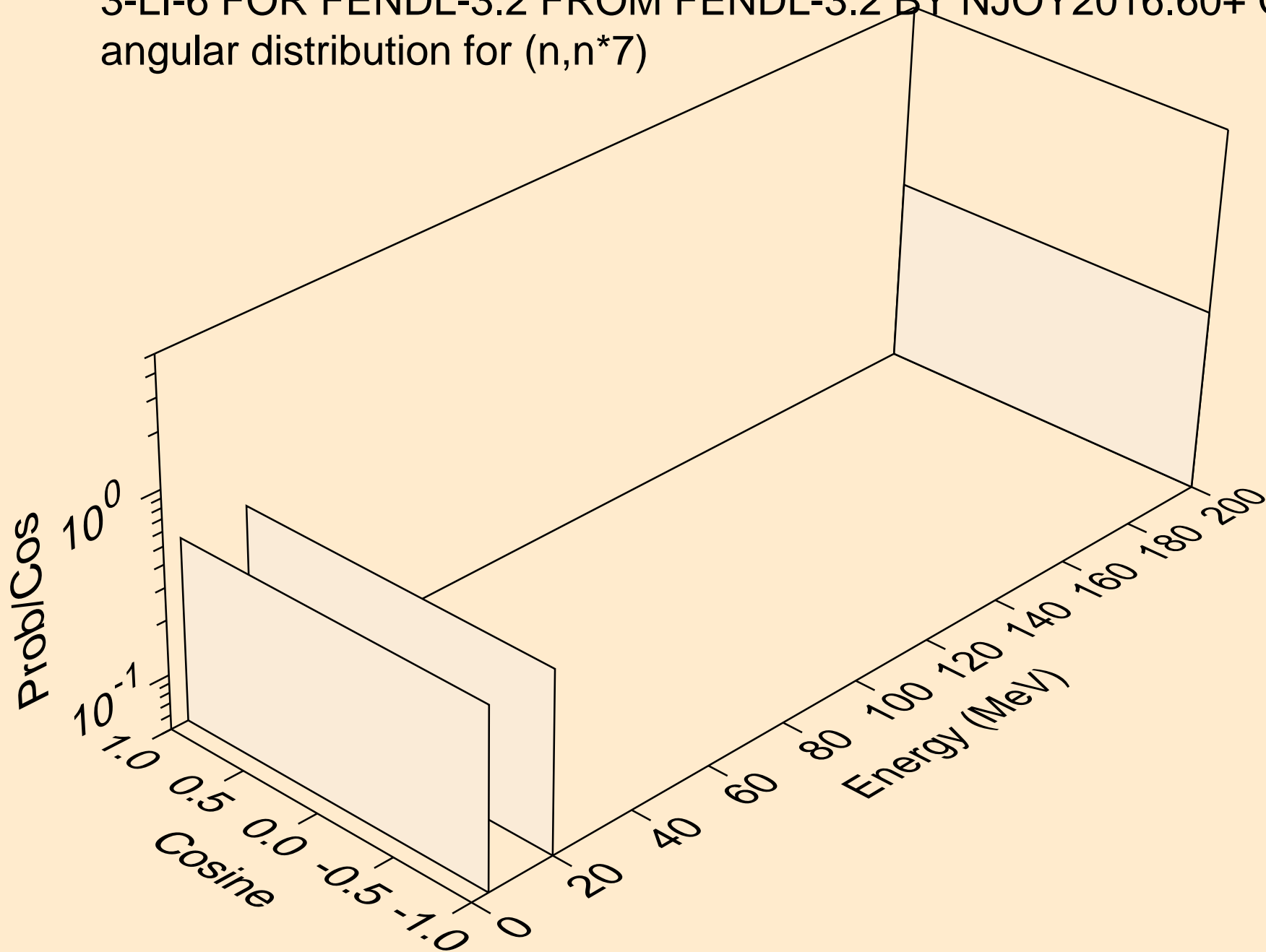

3-LI-6 FOR FENDL-3.2 FROM FENDL-3.2 BY NJOY2016.60+ ON F  
angular distribution for (n,n\*8)

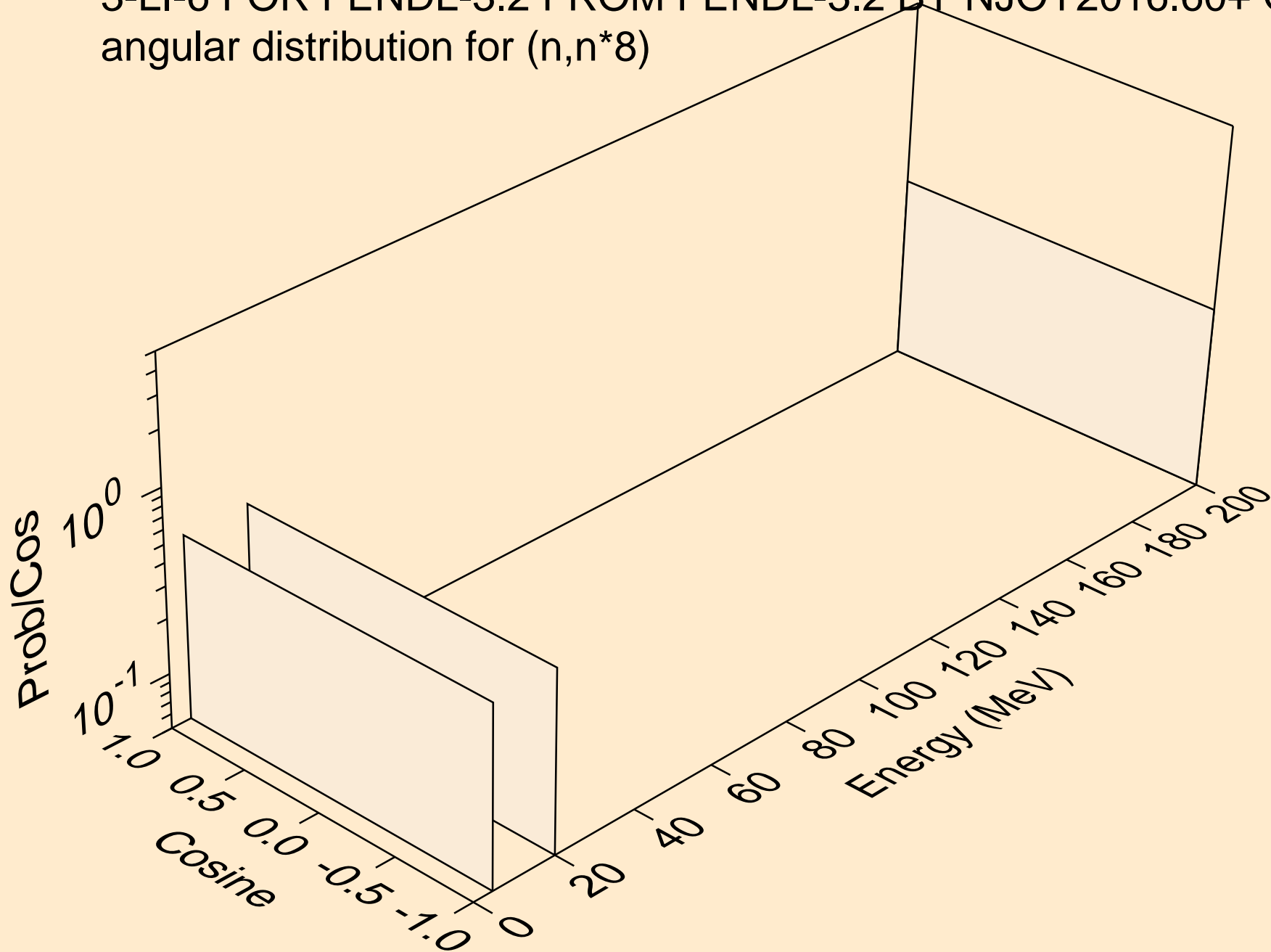

3-LI-6 FOR FENDL-3.2 FROM FENDL-3.2 BY NJOY2016.60+ ON F  
angular distribution for (n,n\*9)

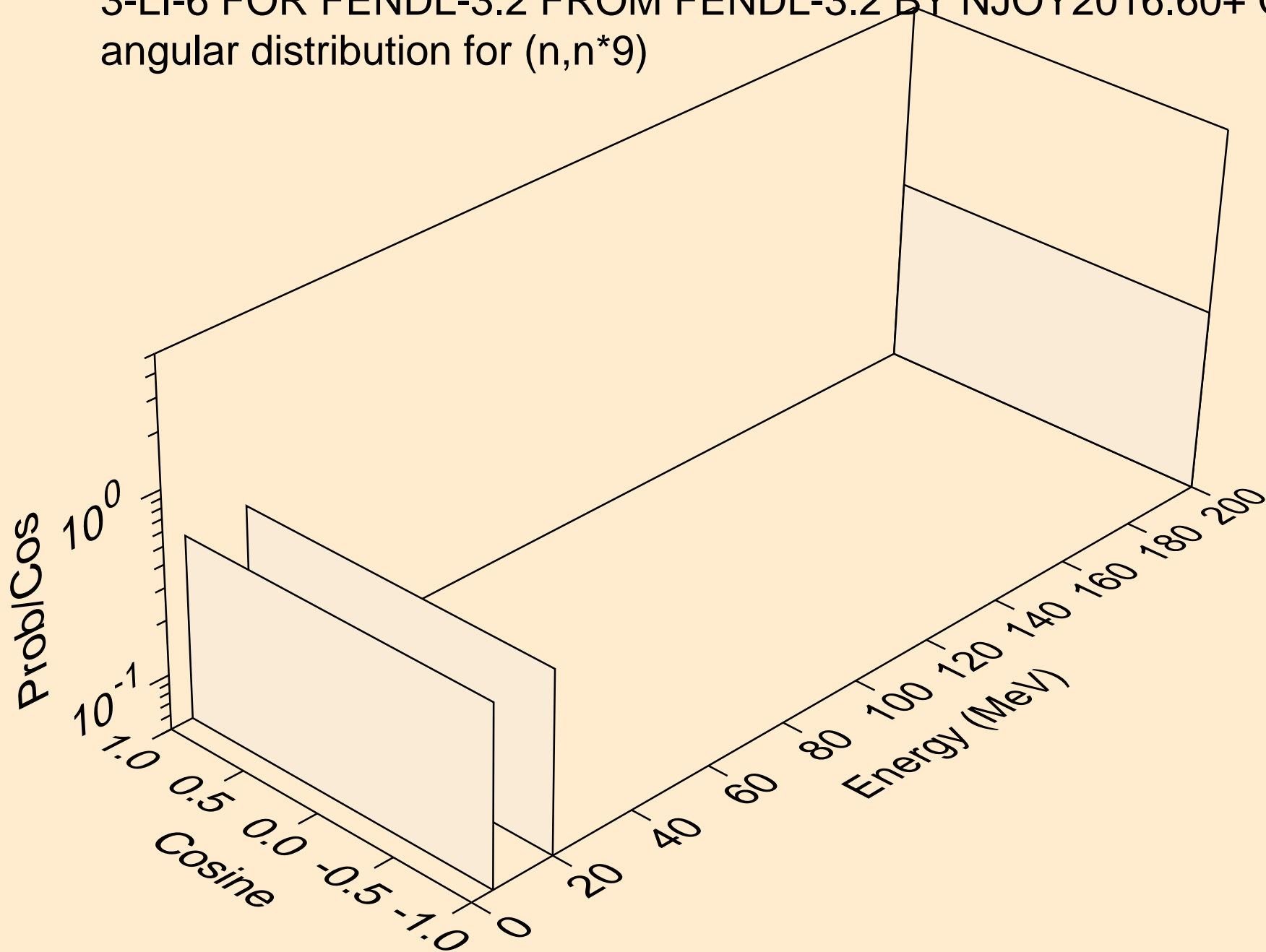

3-LI-6 FOR FENDL-3.2 FROM FENDL-3.2 BY NJOY2016.60+ ON F  
angular distribution for (n,n\*10)

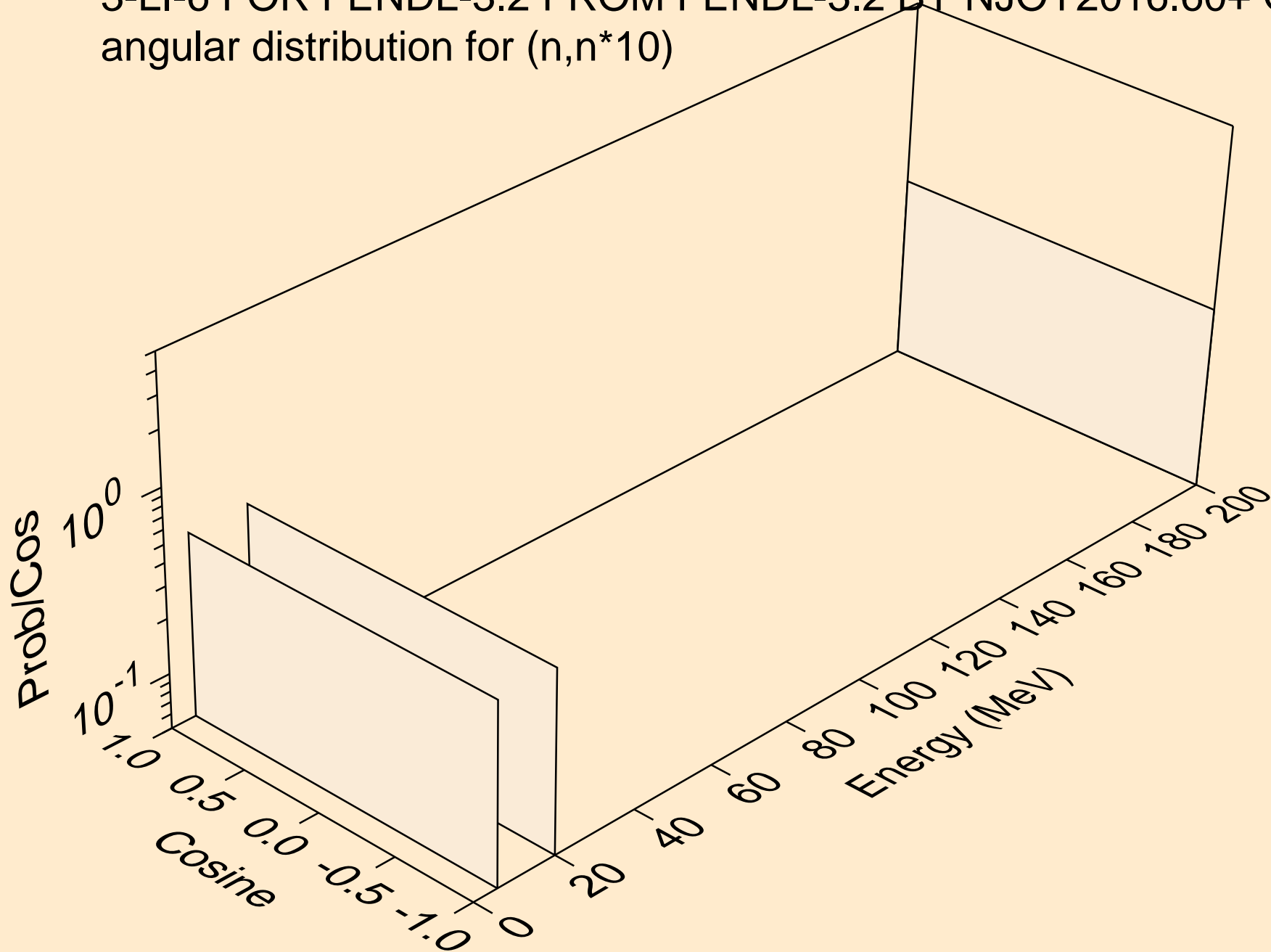

3-LI-6 FOR FENDL-3.2 FROM FENDL-3.2 BY NJOY2016.60+ ON F  
angular distribution for (n,n\*11)

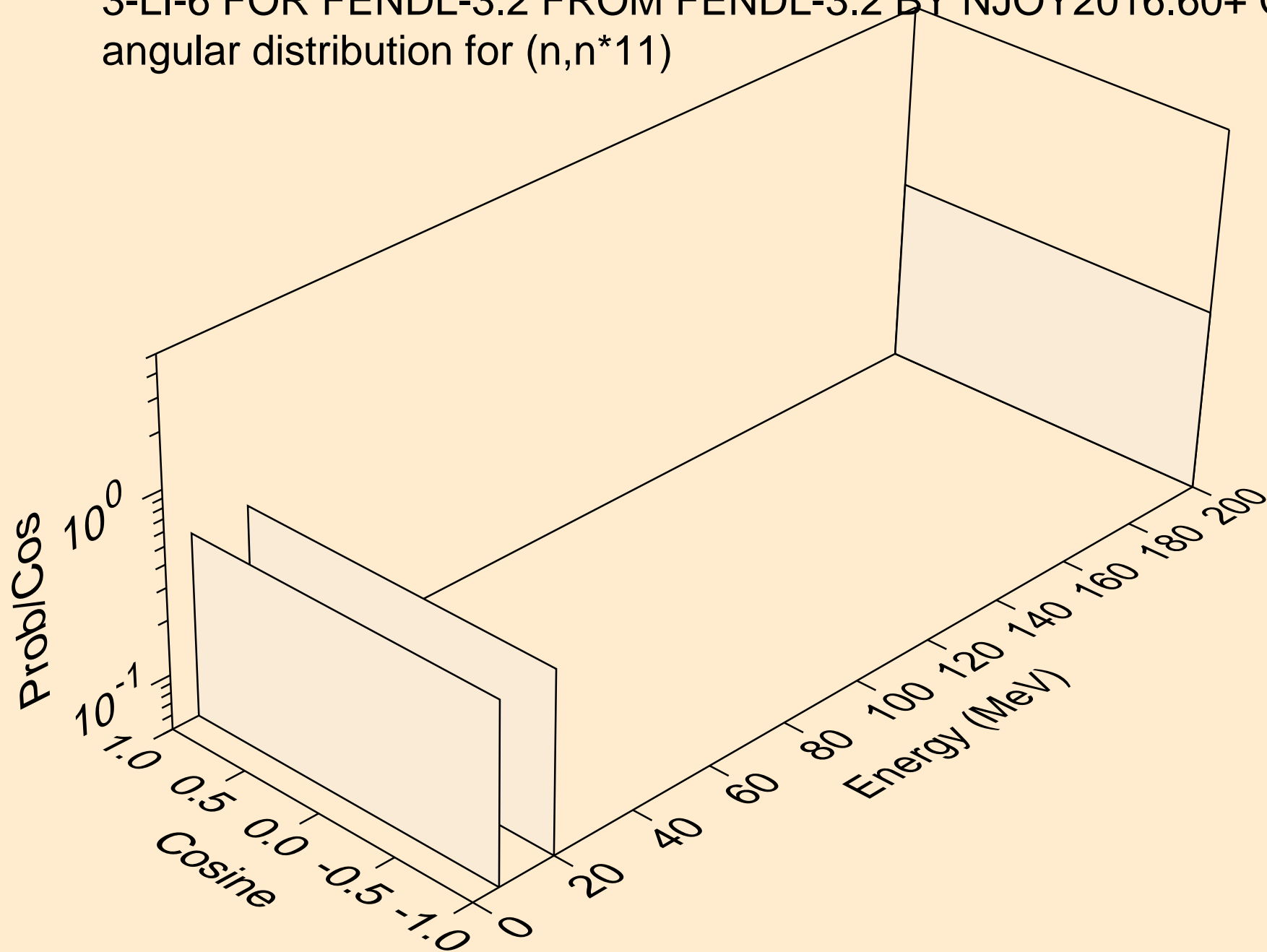

3-LI-6 FOR FENDL-3.2 FROM FENDL-3.2 BY NJOY2016.60+ ON F  
angular distribution for (n,n\*12)

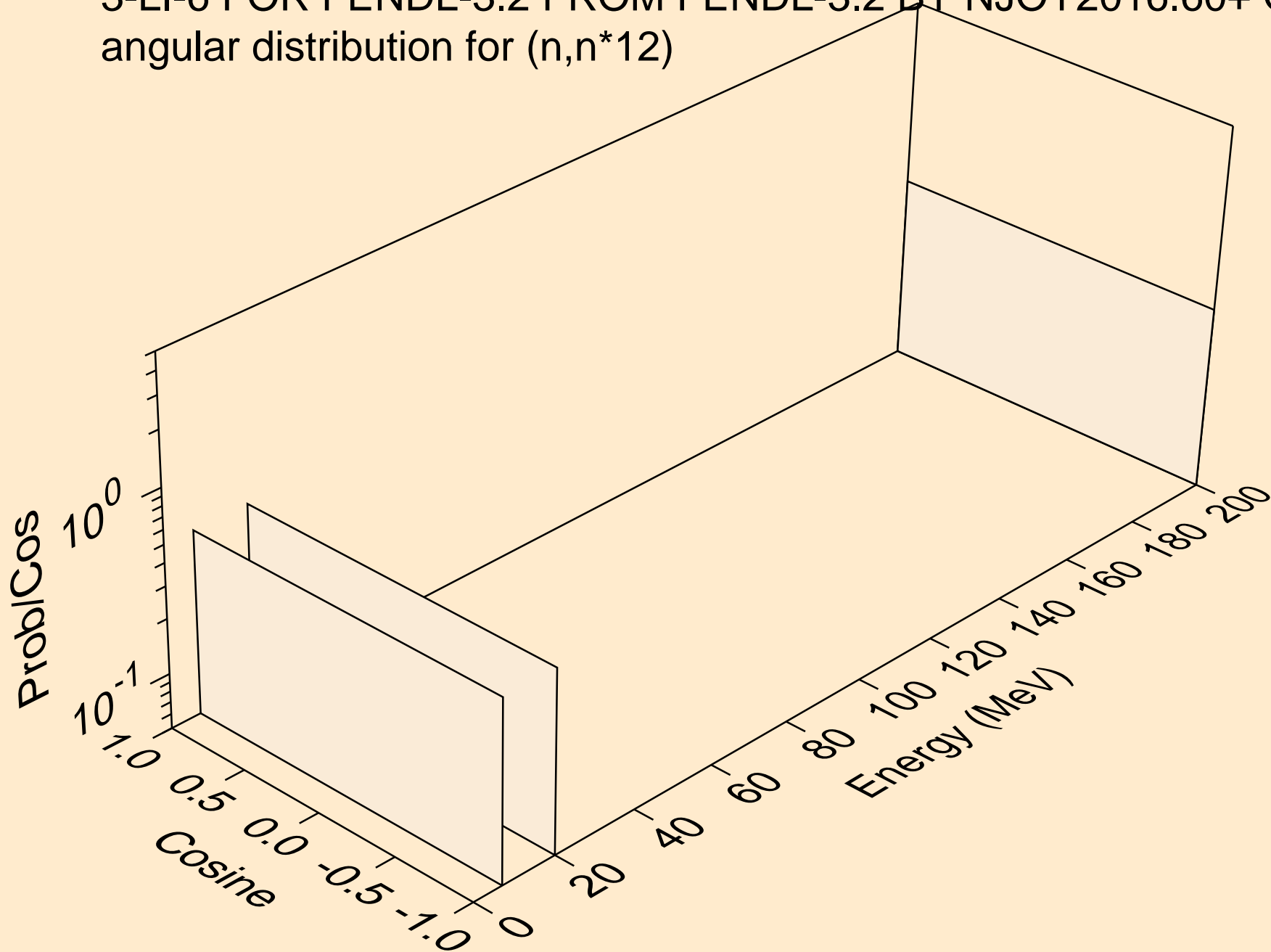



3-LI-6 FOR FENDL-3.2 FROM FENDL-3.2 BY NJOY2016.60+ ON F  
angular distribution for (n,n\*13)

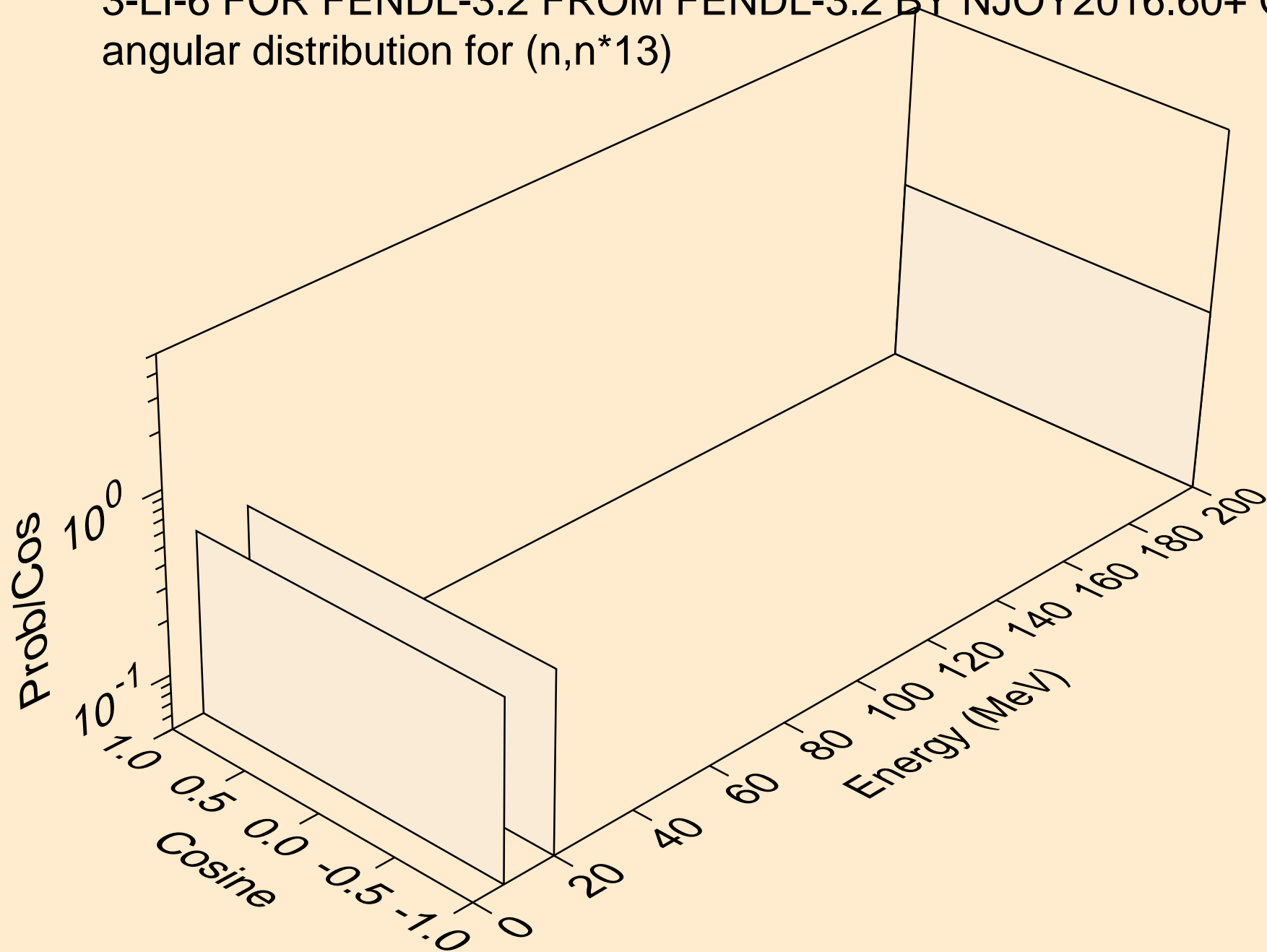

3-LI-6 FOR FENDL-3.2 FROM FENDL-3.2 BY NJOY2016.60+ ON F  
angular distribution for (n,n\*14)

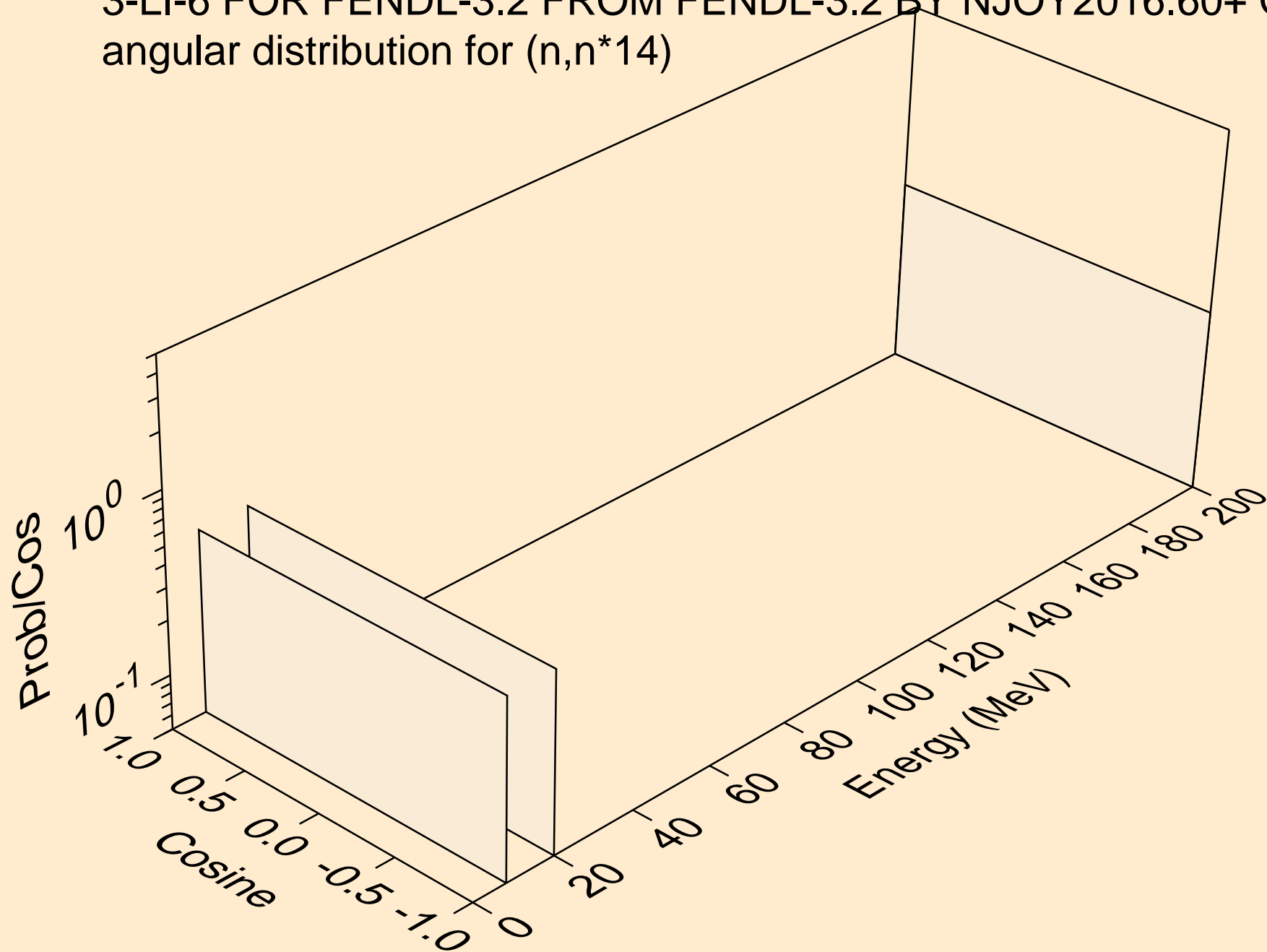

3-LI-6 FOR FENDL-3.2 FROM FENDL-3.2 BY NJOY2016.60+ ON F  
angular distribution for (n,n\*15)

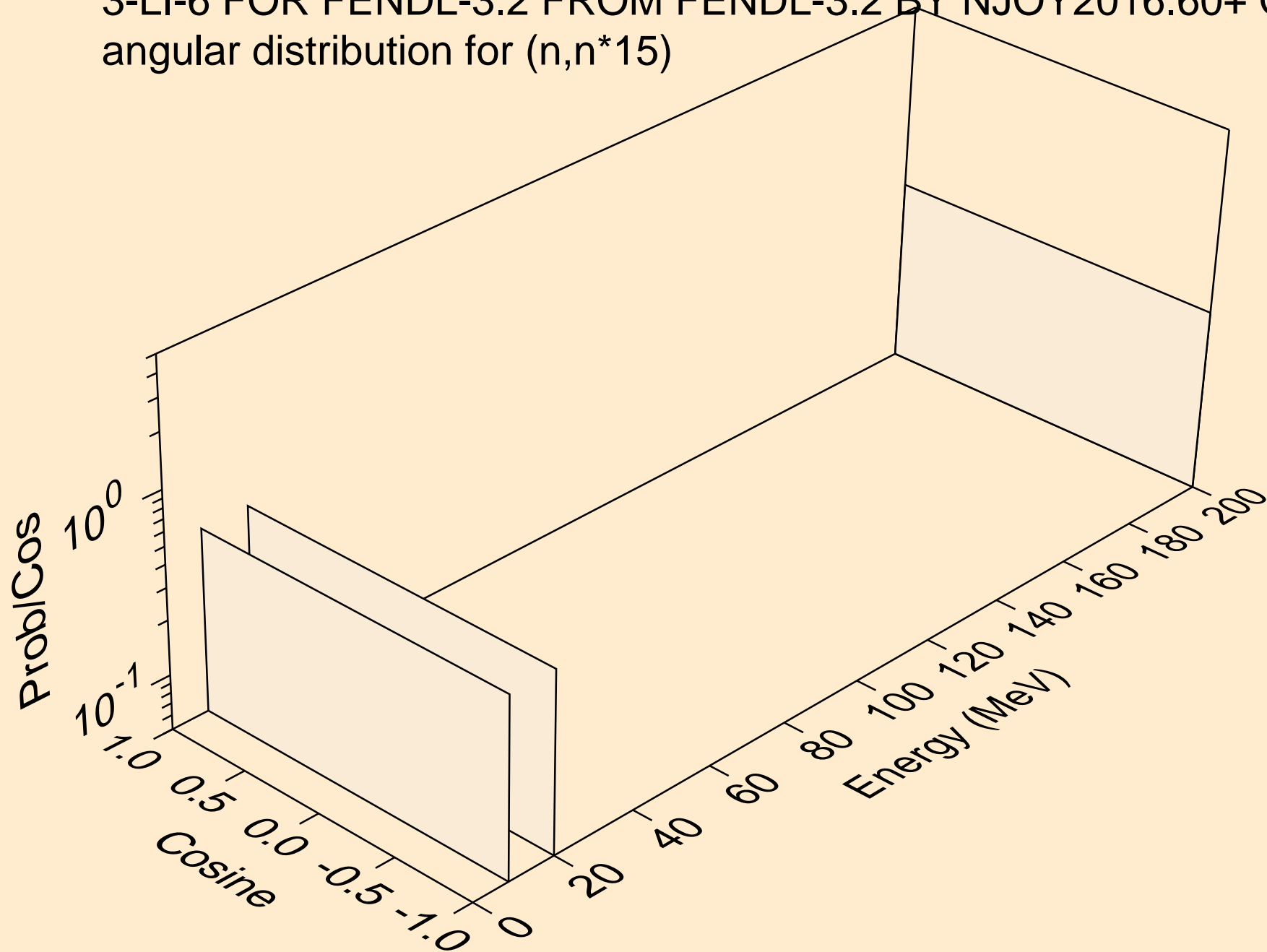

3-LI-6 FOR FENDL-3.2 FROM FENDL-3.2 BY NJOY2016.60+ ON F  
angular distribution for (n,n\*16)

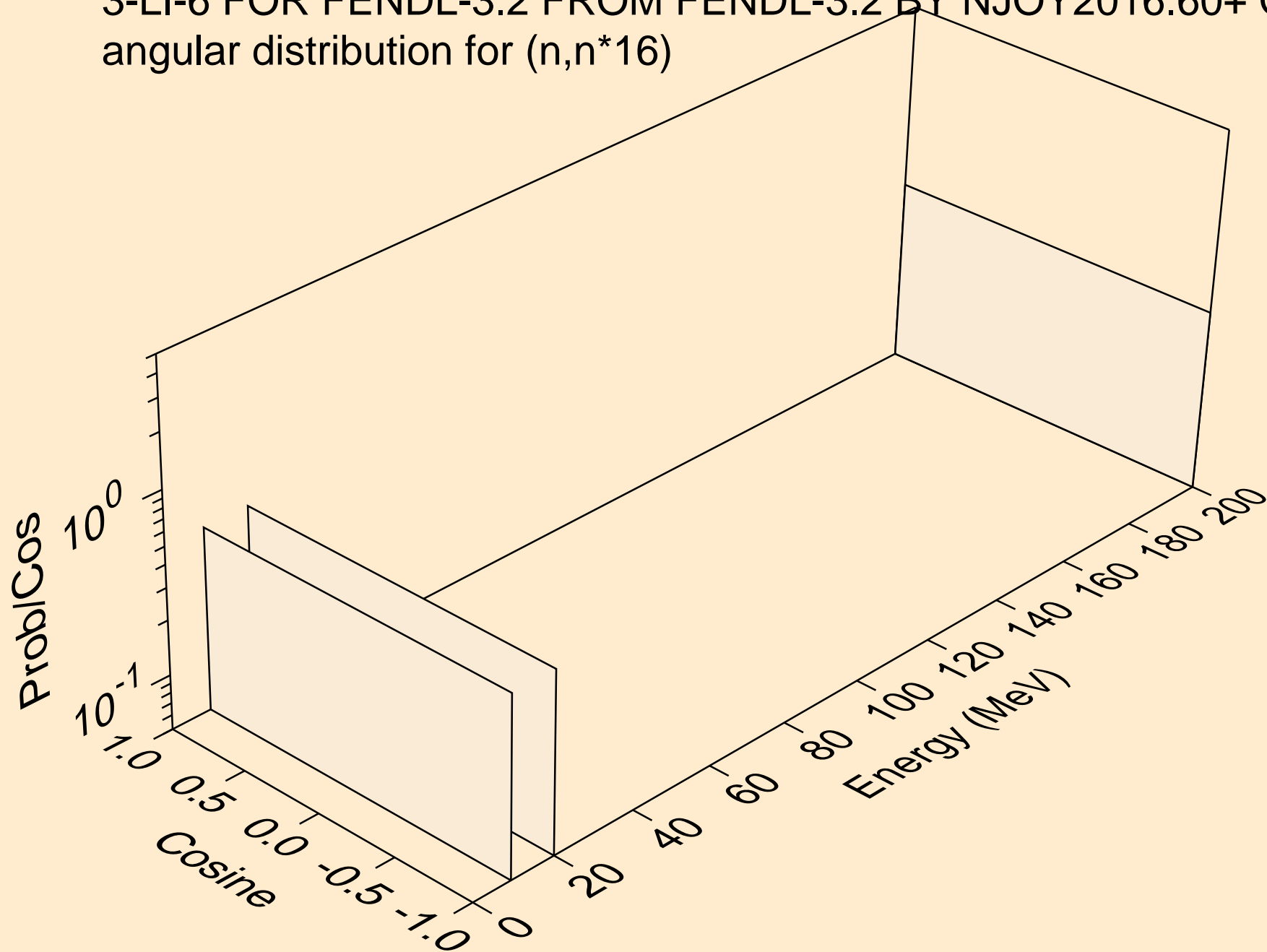

3-LI-6 FOR FENDL-3.2 FROM FENDL-3.2 BY NJOY2016.60+ ON F  
angular distribution for (n,n\*17)

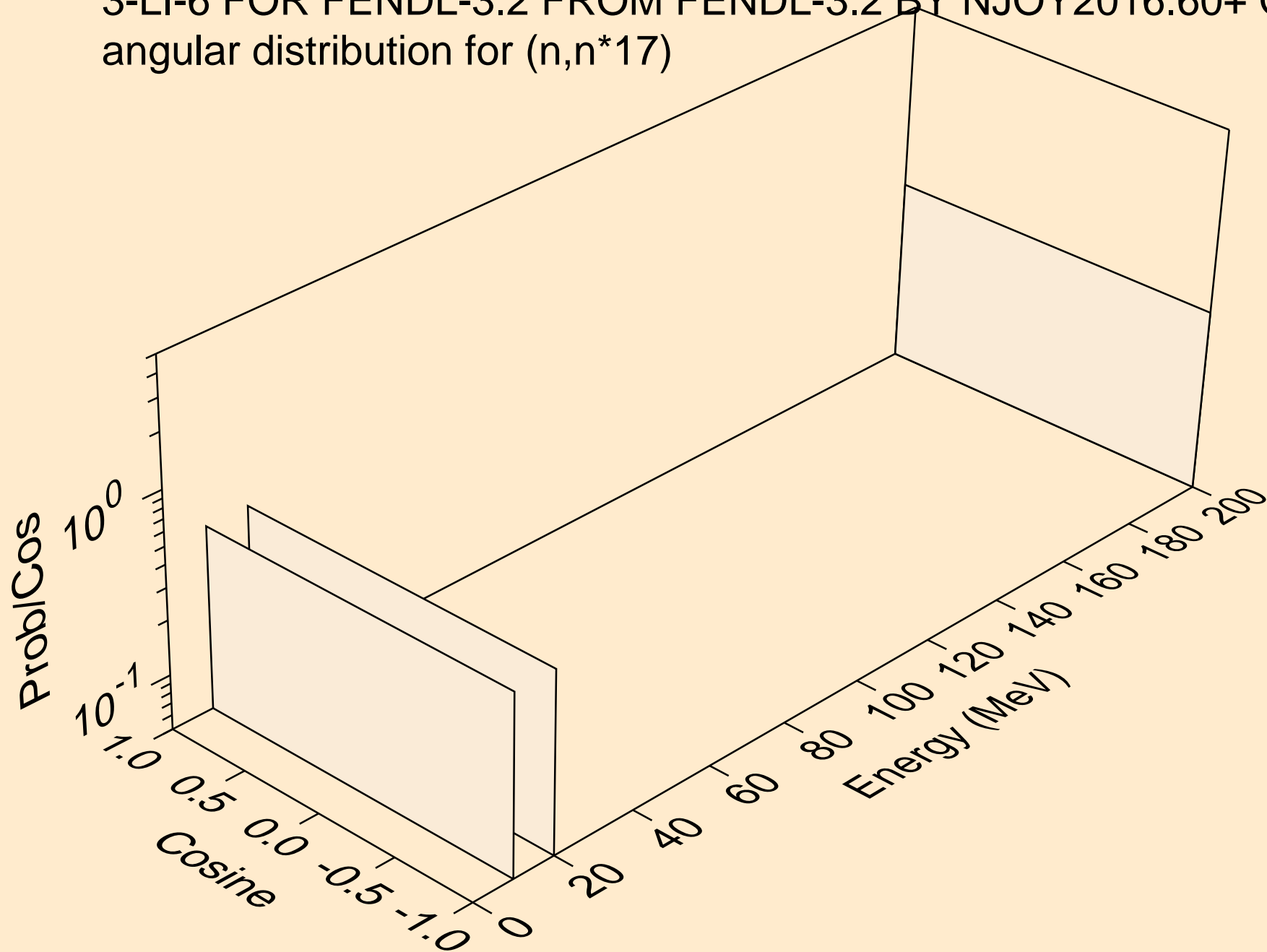

3-LI-6 FOR FENDL-3.2 FROM FENDL-3.2 BY NJOY2016.60+ ON F  
angular distribution for (n,n\*18)

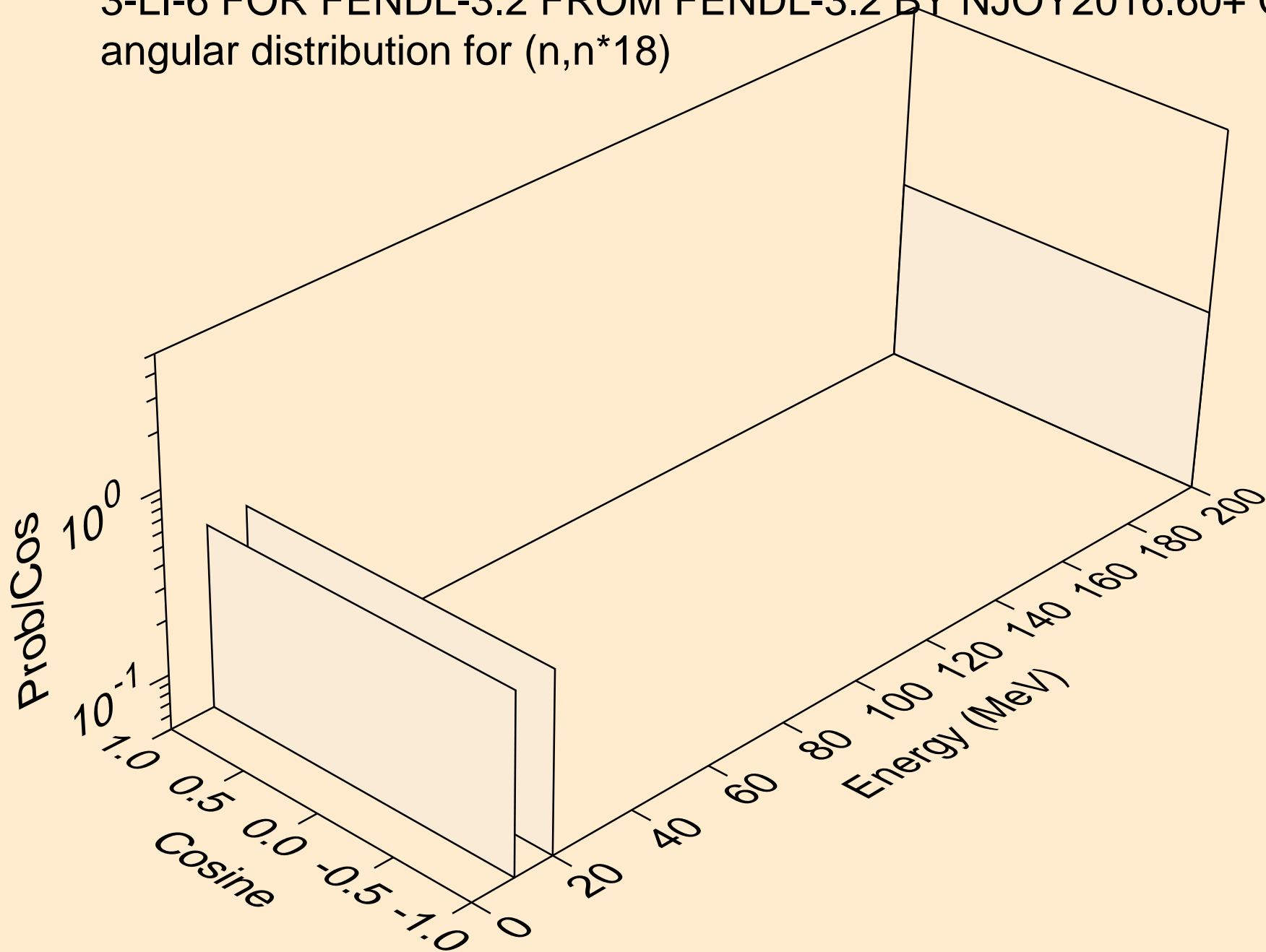

3-LI-6 FOR FENDL-3.2 FROM FENDL-3.2 BY NJOY2016.60+ ON F  
angular distribution for (n,n\*19)

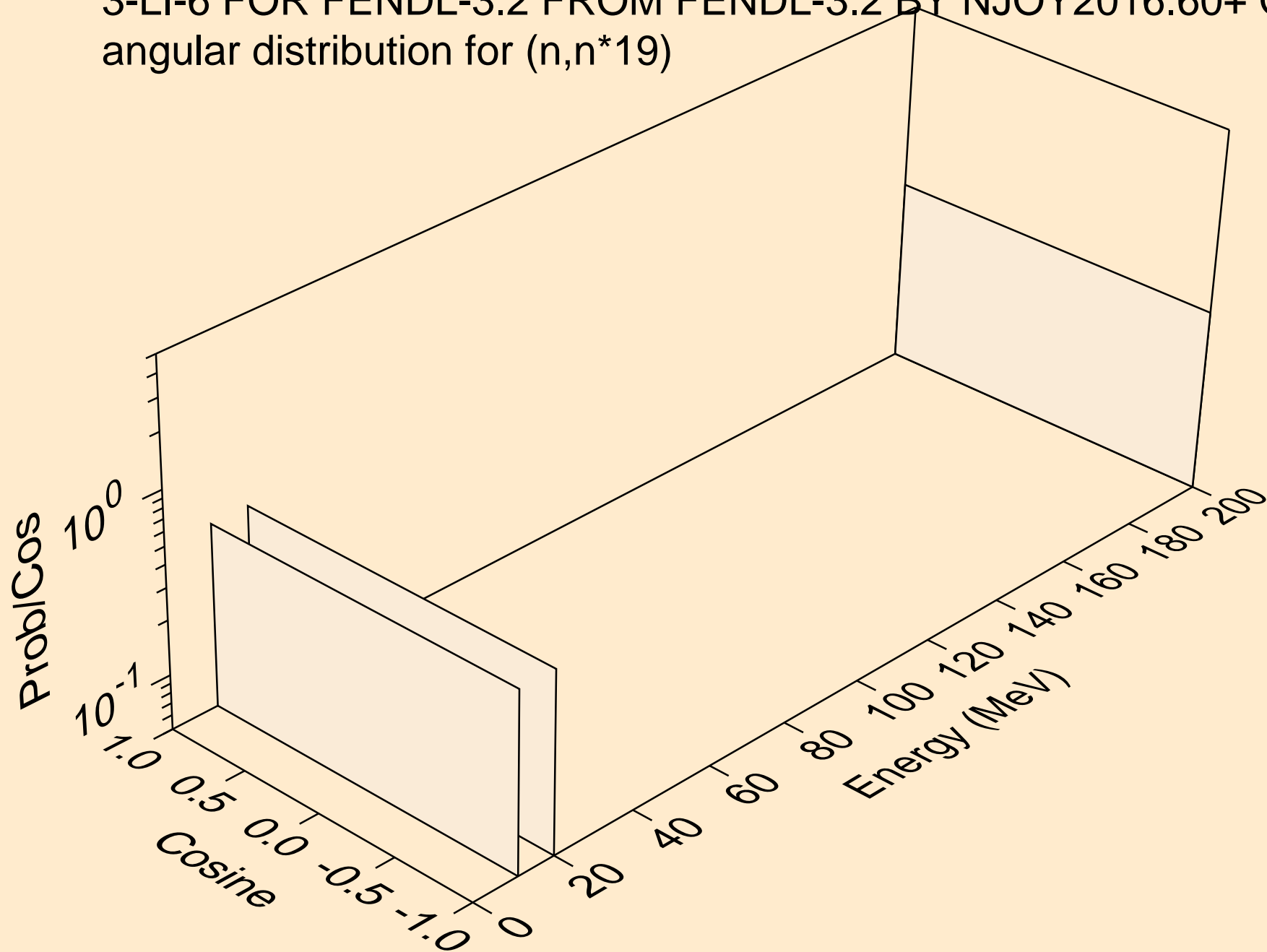

3-LI-6 FOR FENDL-3.2 FROM FENDL-3.2 BY NJOY2016.60+ ON F  
angular distribution for (n,n\*20)

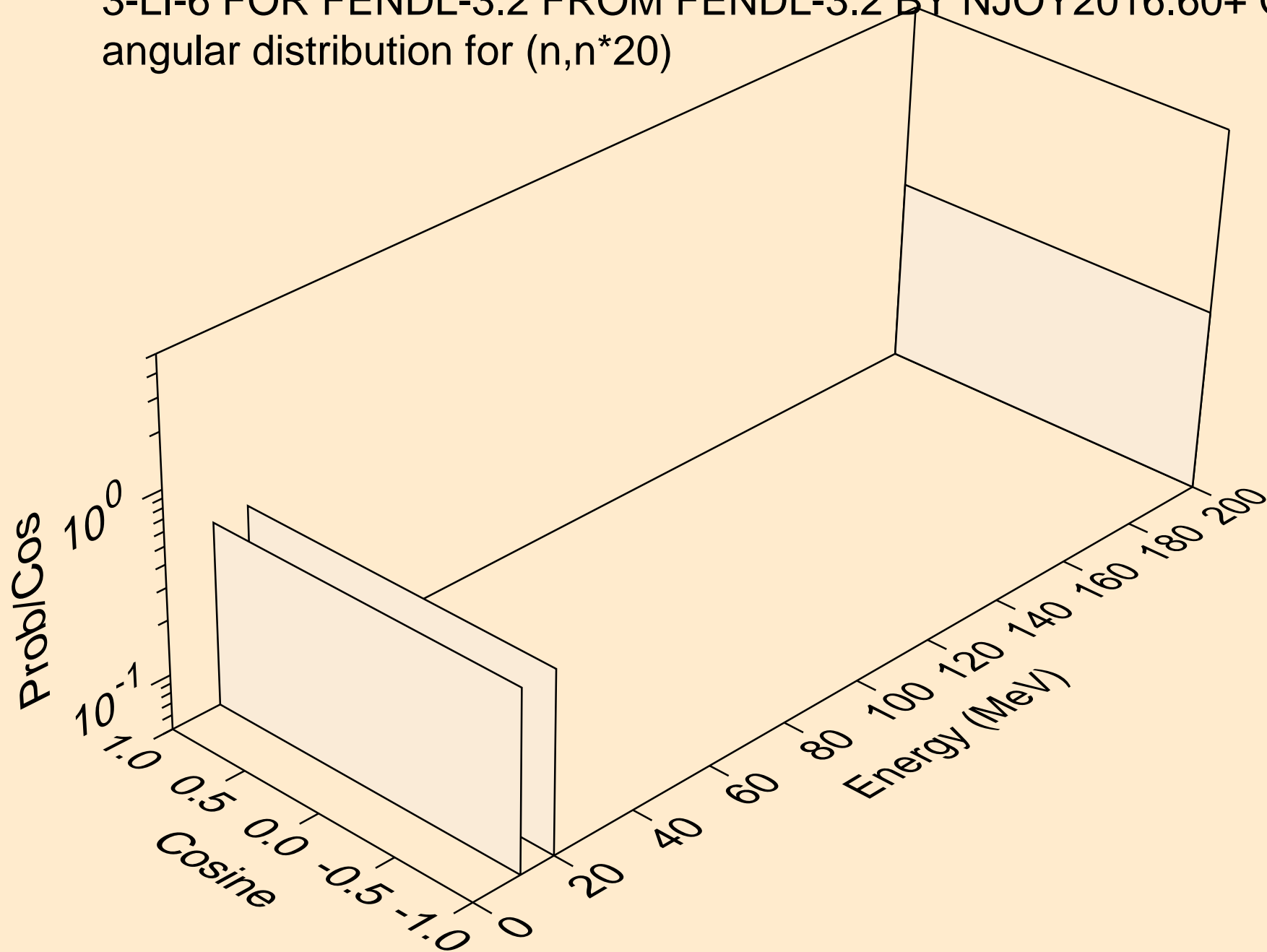



3-LI-6 FOR FENDL-3.2 FROM FENDL-3.2 BY NJOY2016.60+ ON F  
angular distribution for (n,n\*21)

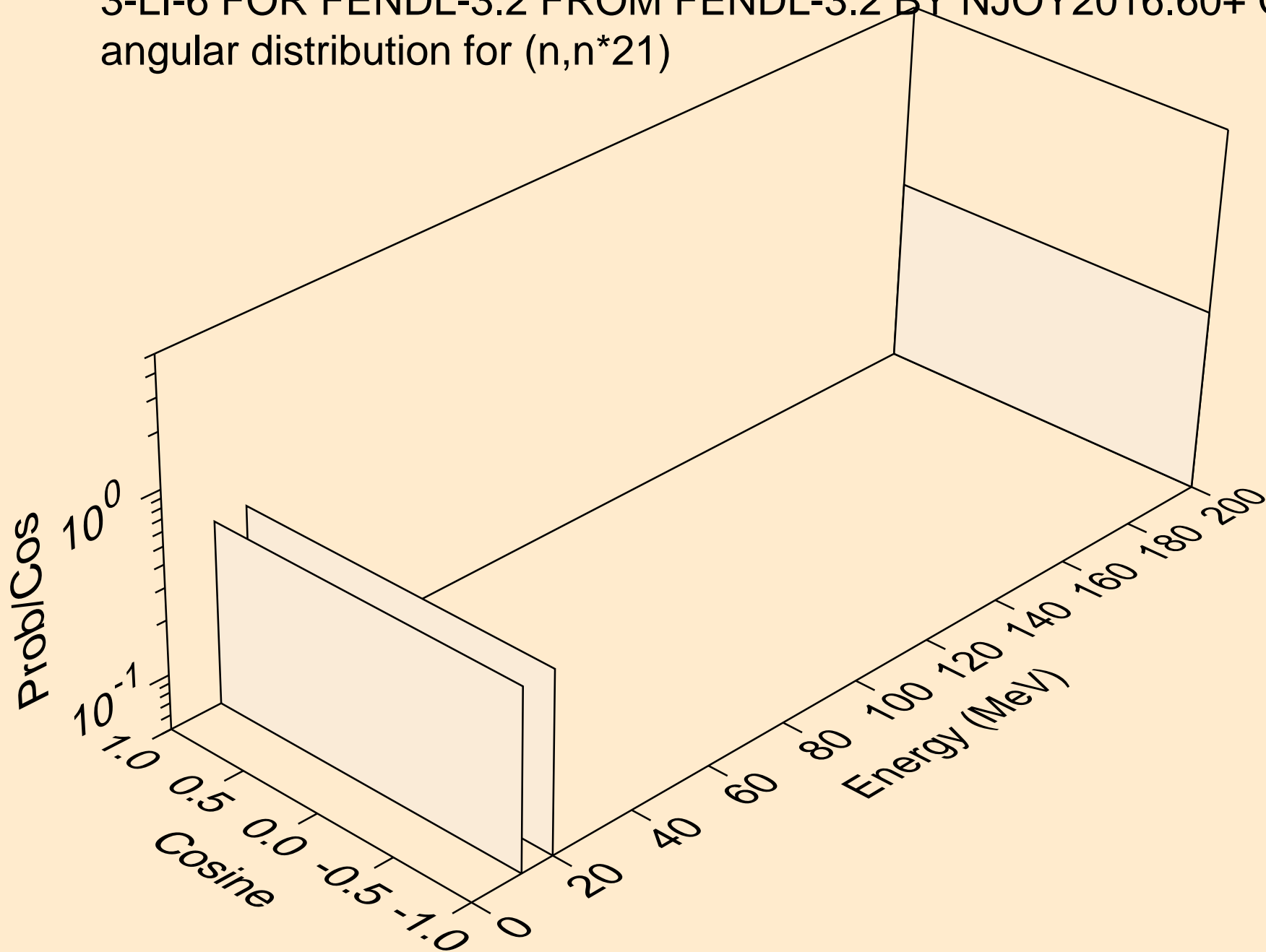

3-LI-6 FOR FENDL-3.2 FROM FENDL-3.2 BY NJOY2016.60+ ON F  
angular distribution for (n,n\*22)

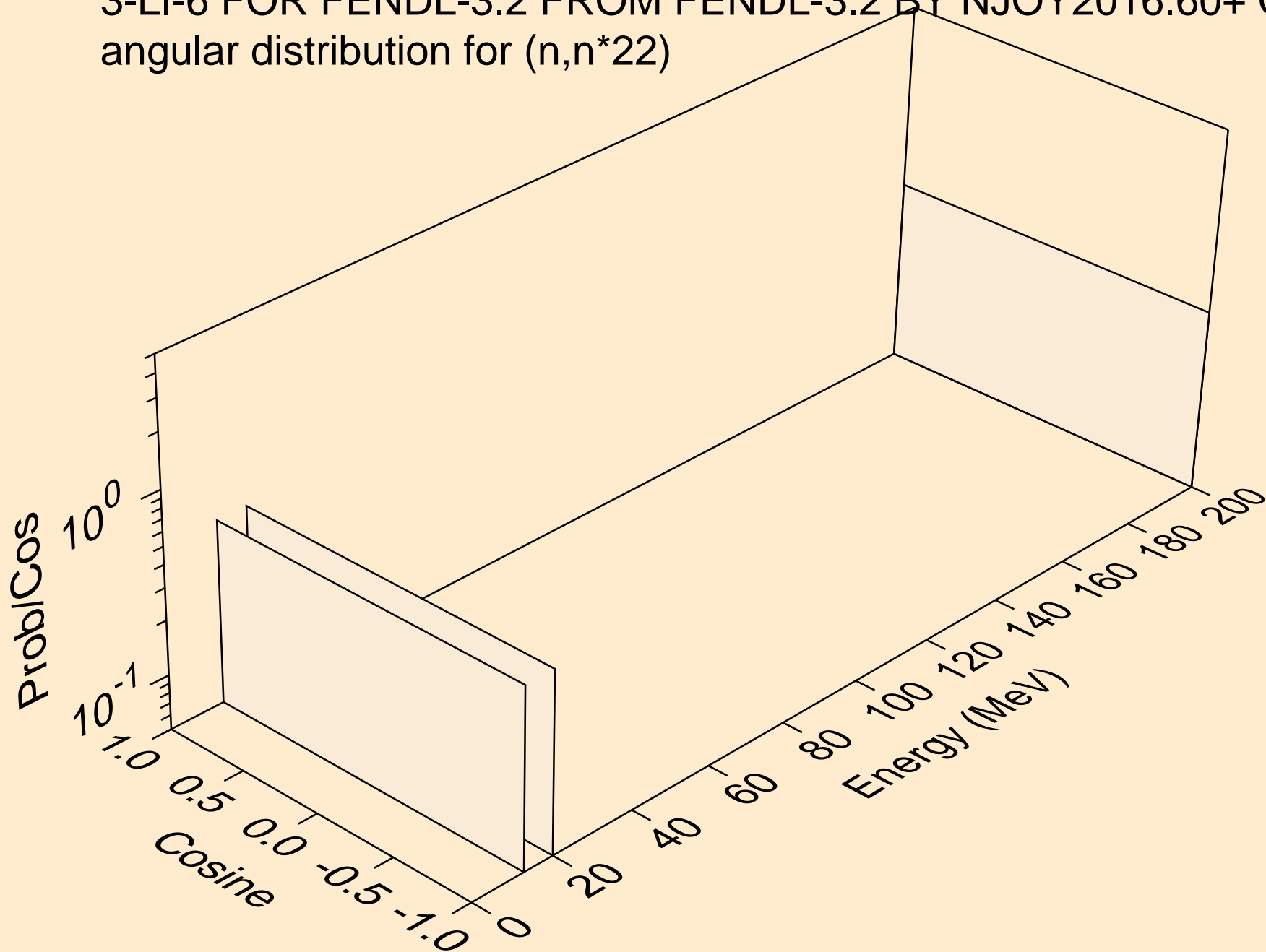

3-LI-6 FOR FENDL-3.2 FROM FENDL-3.2 BY NJOY2016.60+ ON F  
angular distribution for (n,n\*23)

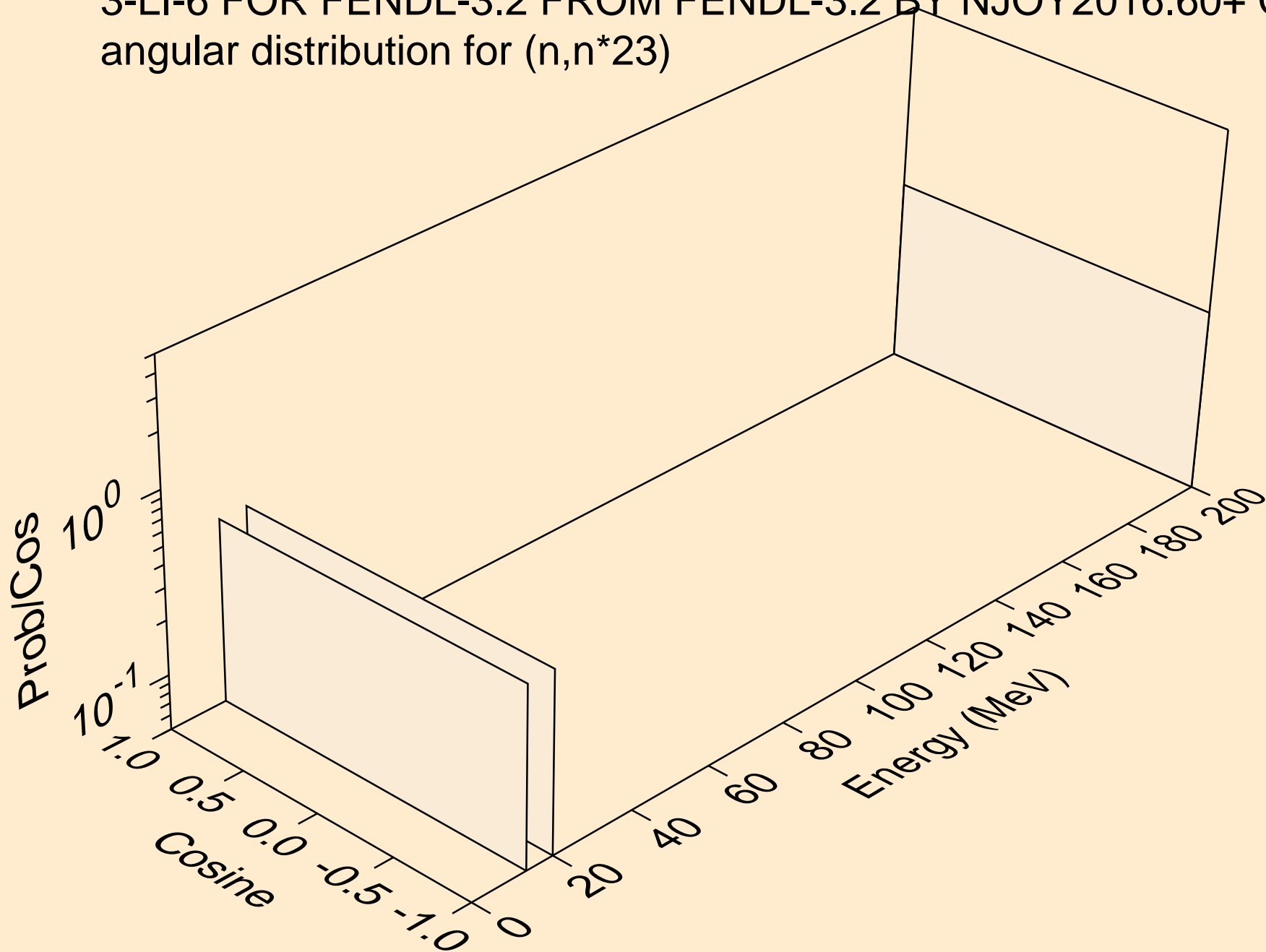

3-LI-6 FOR FENDL-3.2 FROM FENDL-3.2 BY NJOY2016.60+ ON F  
angular distribution for (n,n\*24)

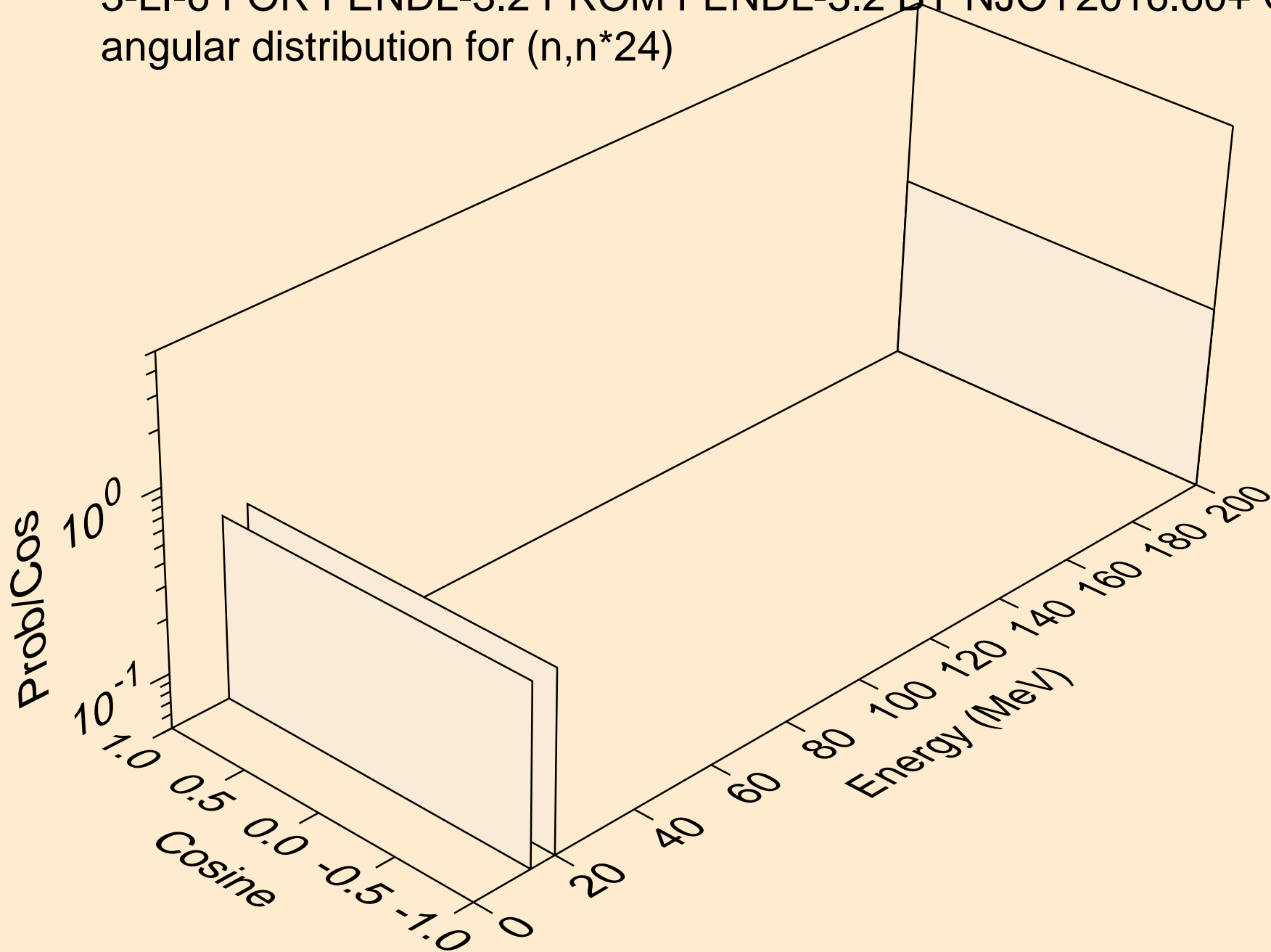

3-LI-6 FOR FENDL-3.2 FROM FENDL-3.2 BY NJOY2016.60+ ON F  
angular distribution for (n,n\*25)

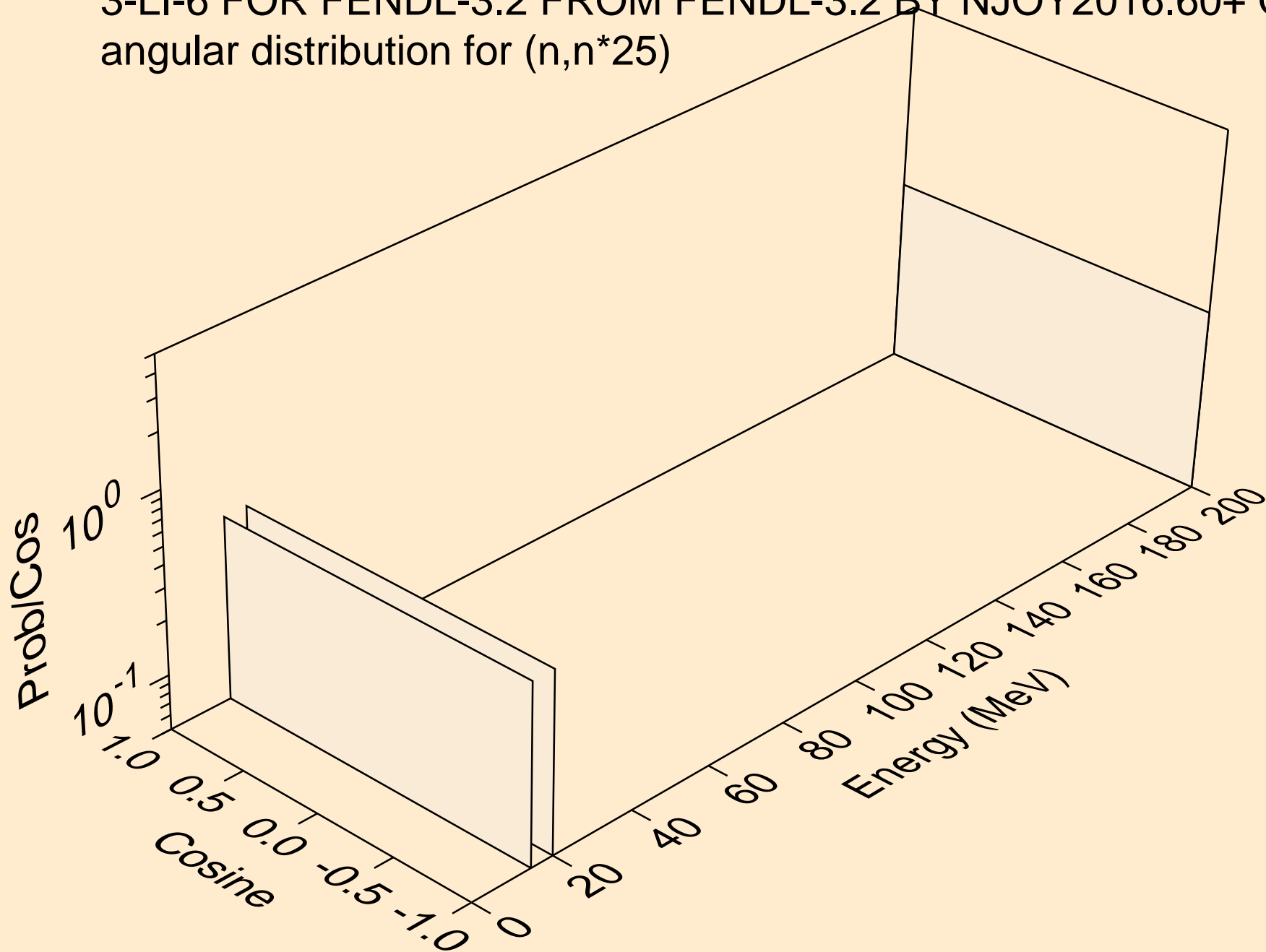

3-LI-6 FOR FENDL-3.2 FROM FENDL-3.2 BY NJOY2016.60+ ON F  
angular distribution for (n,n\*26)

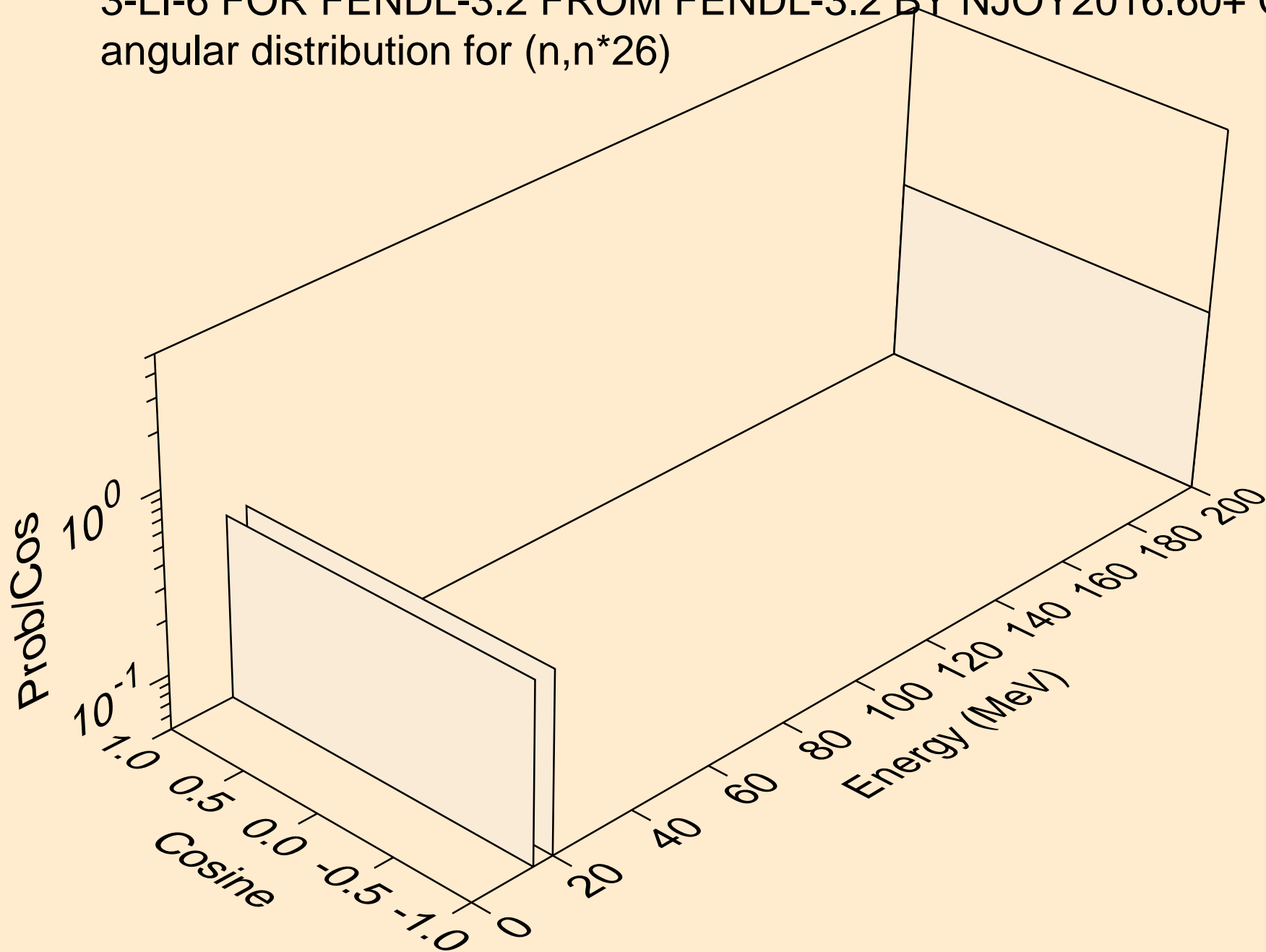

3-LI-6 FOR FENDL-3.2 FROM FENDL-3.2 BY NJOY2016.60+ ON F  
angular distribution for (n,n\*27)

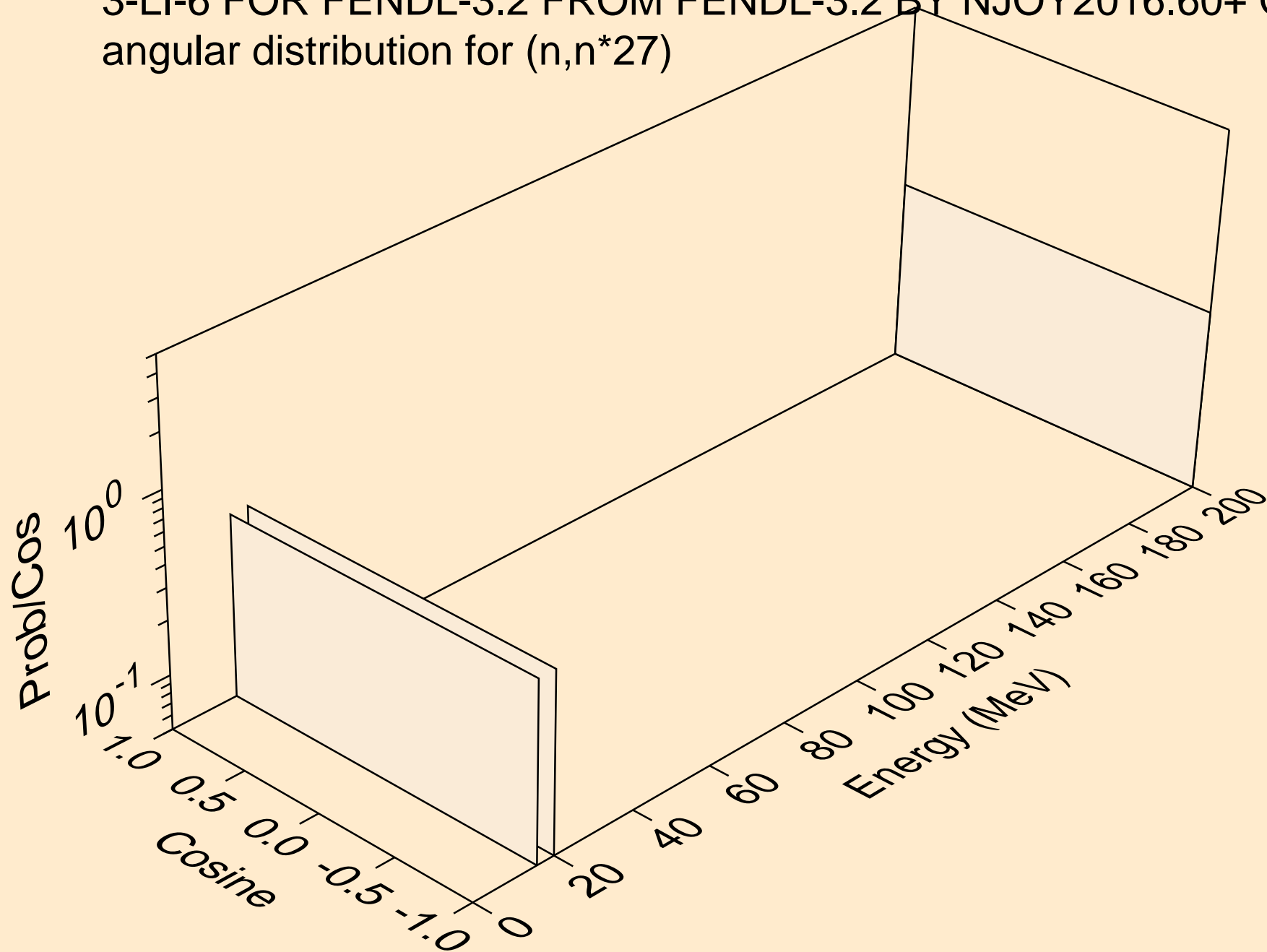

3-LI-6 FOR FENDL-3.2 FROM FENDL-3.2 BY NJOY2016.60+ ON F  
angular distribution for (n,n\*28)

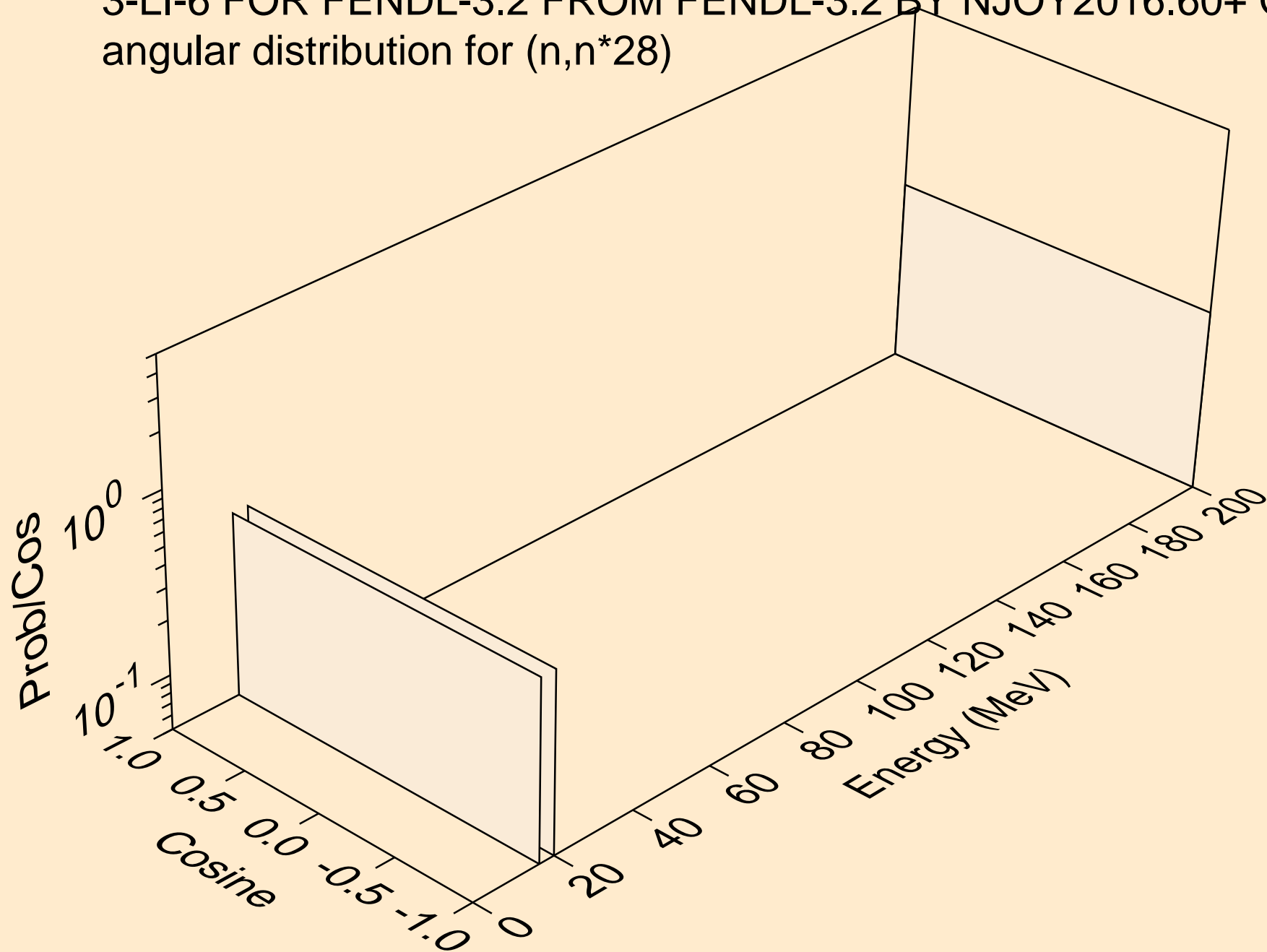



3-LI-6 FOR FENDL-3.2 FROM FENDL-3.2 BY NJOY2016.60+ ON F  
angular distribution for (n,n\*29)

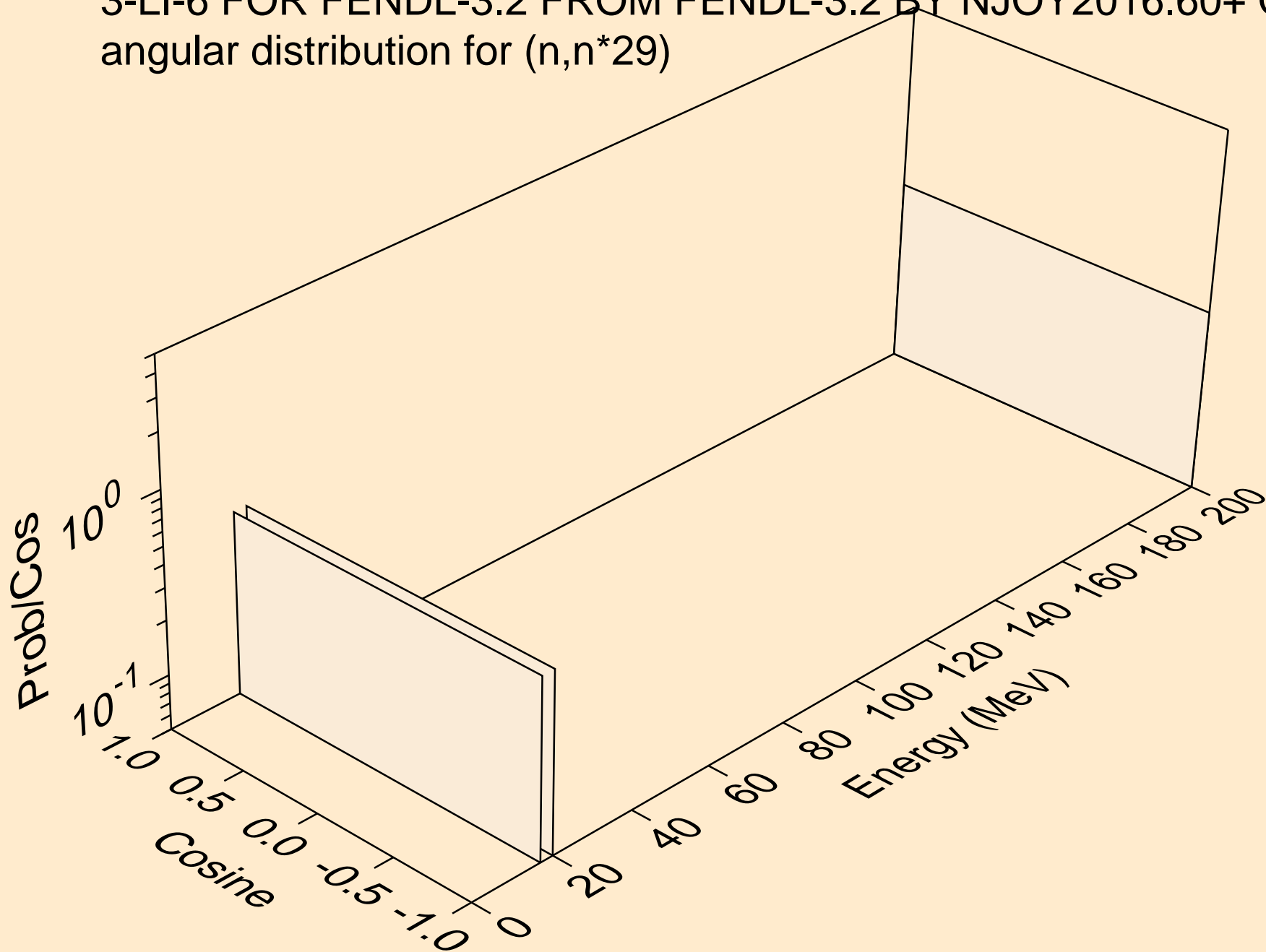

3-LI-6 FOR FENDL-3.2 FROM FENDL-3.2 BY NJOY2016.60+ ON F  
angular distribution for (n,n\*30)

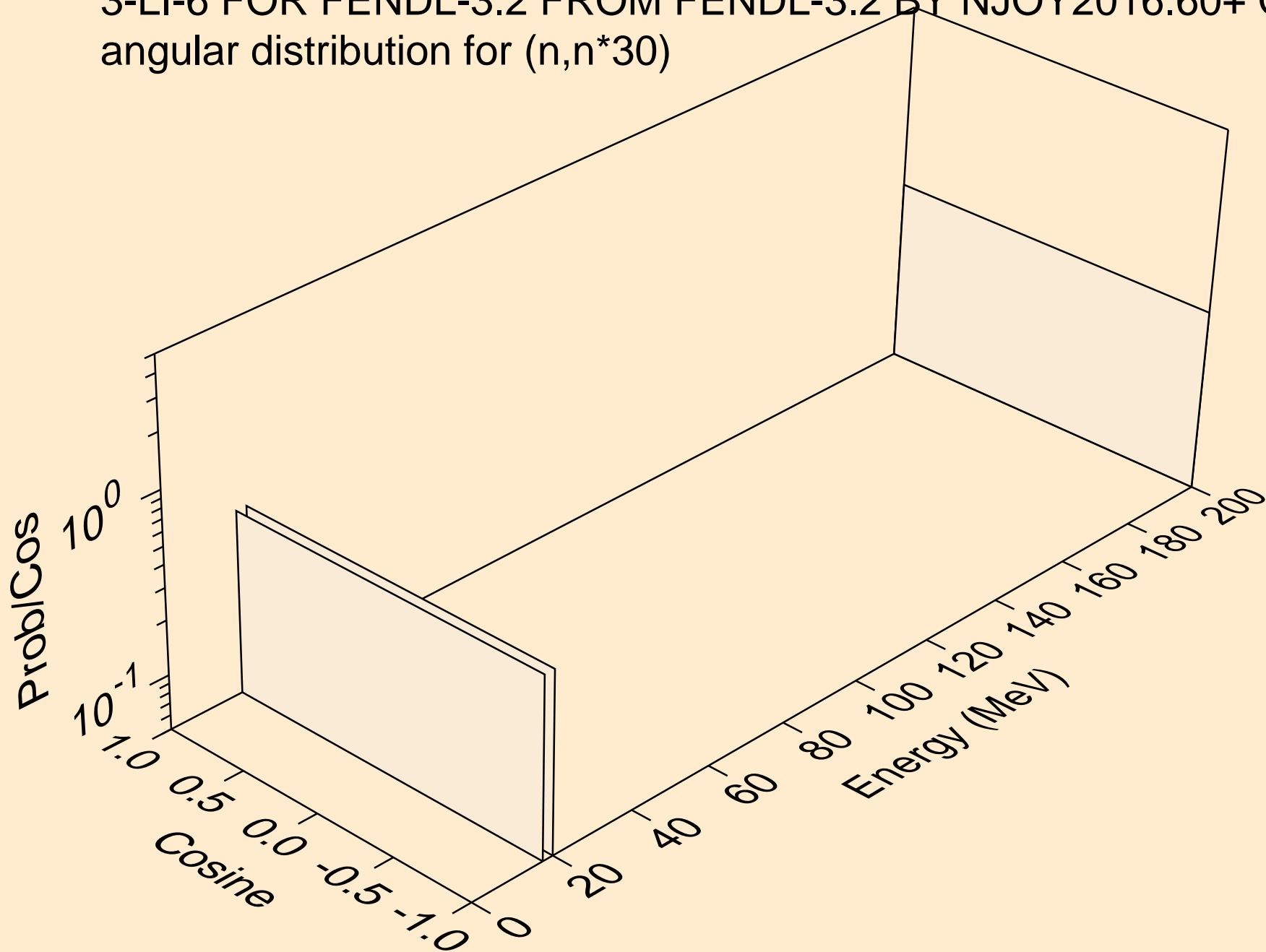

3-LI-6 FOR FENDL-3.2 FROM FENDL-3.2 BY NJOY2016.60+ ON F  
angular distribution for (n,n\*31)

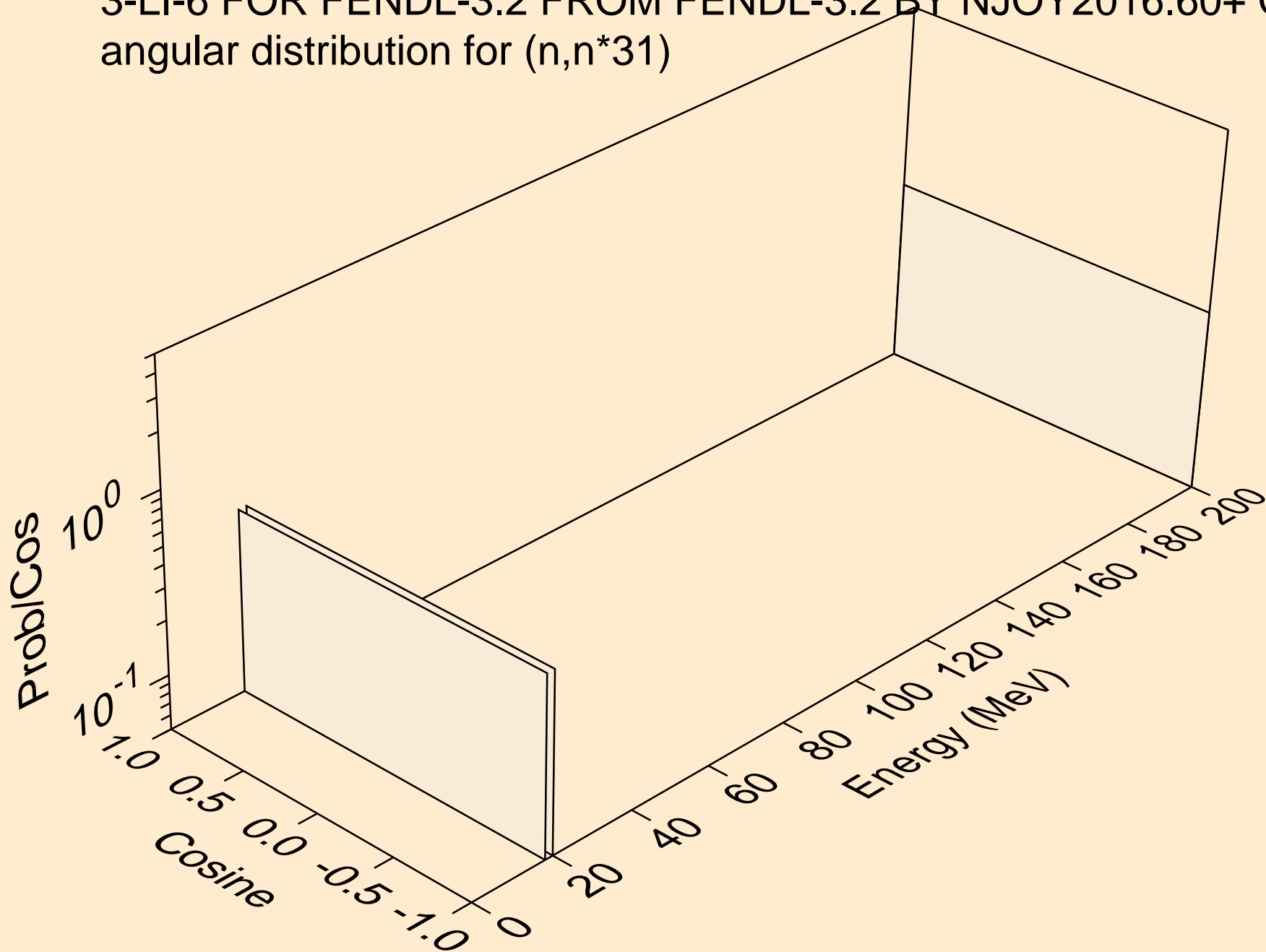

3-LI-6 FOR FENDL-3.2 FROM FENDL-3.2 BY NJOY2016.60+ ON F  
Neutron emission for (n,x)

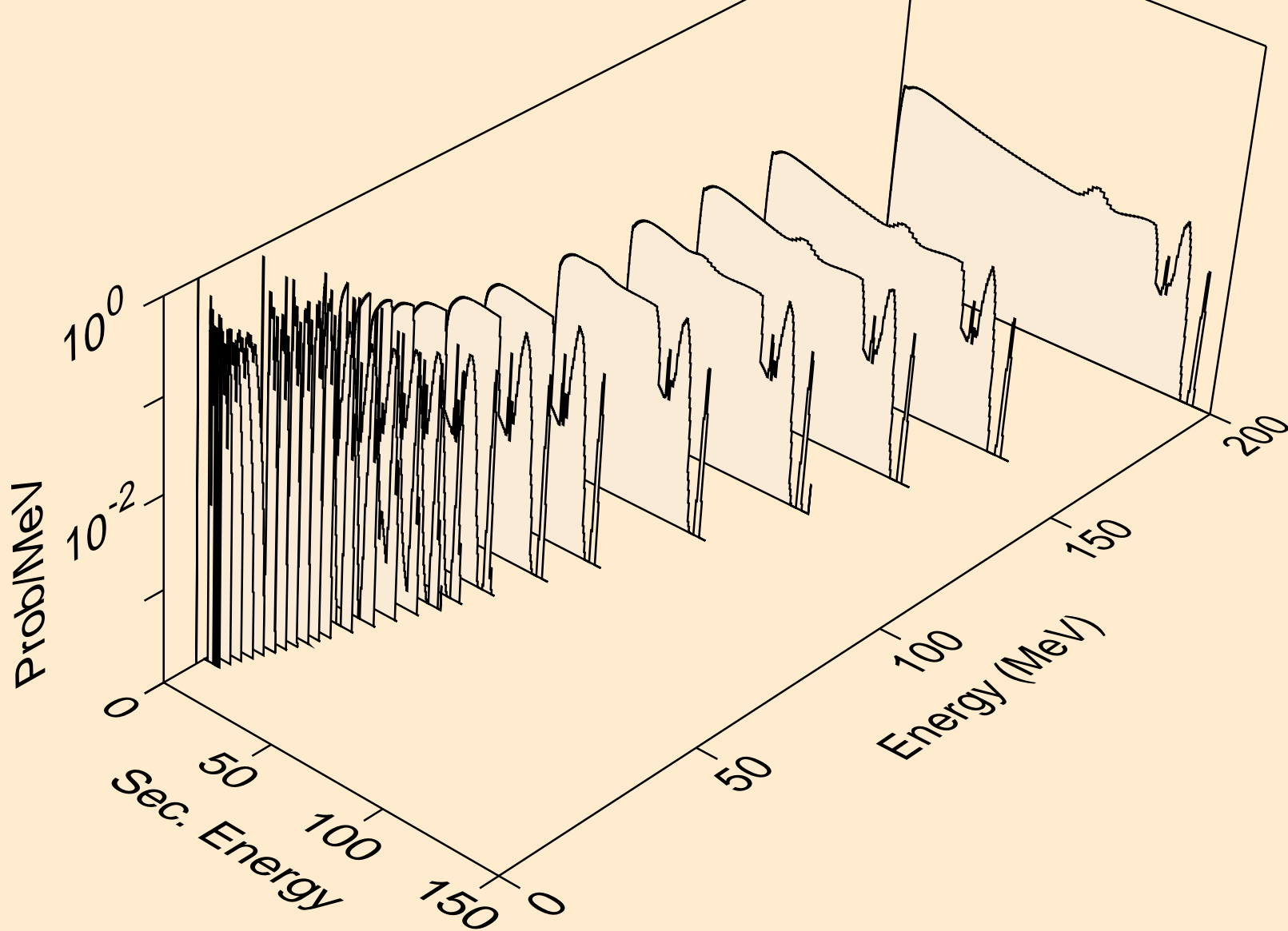

3-LI-6 FOR FENDL-3.2 FROM FENDL-3.2 BY NJOY2016.60+ ON F  
Neutron emission for (n,2n)a

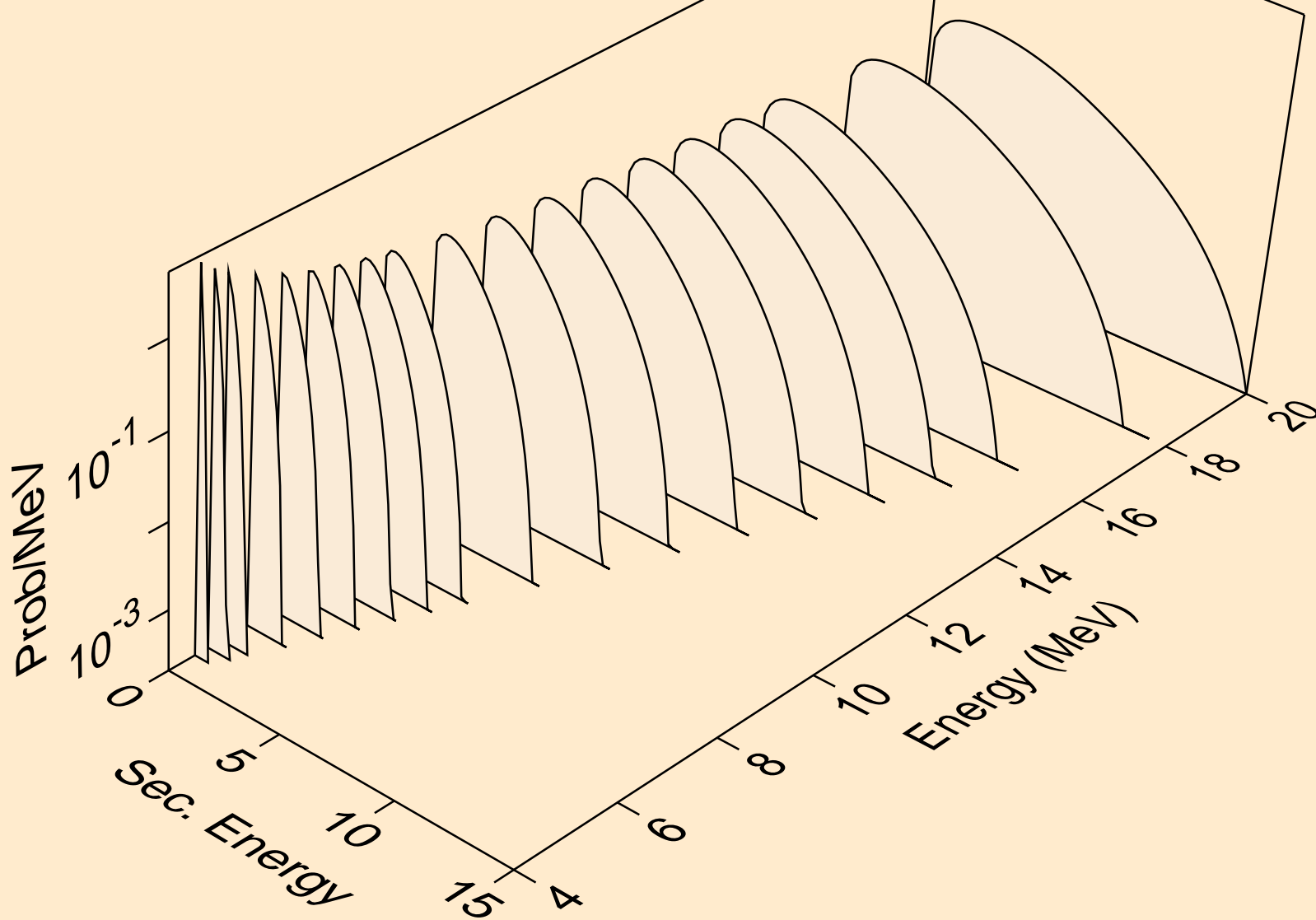

3-LI-6 FOR FENDL-3.2 FROM FENDL-3.2 BY NJOY2016.60+ ON F  
Photon emission for (n,x)

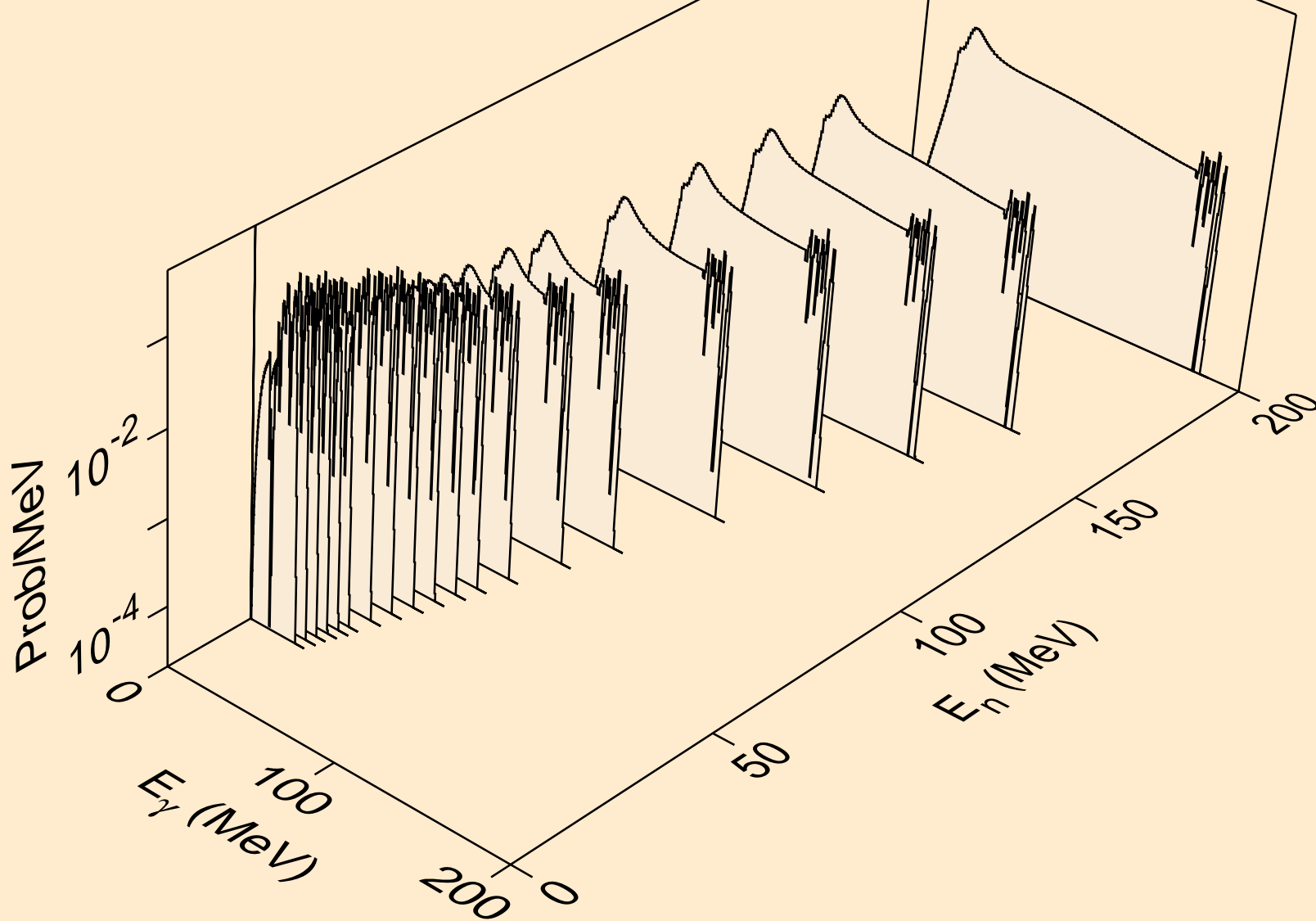

3-LI-6 FOR FENDL-3.2 FROM FENDL-3.2 BY NJOY2016.60+ ON F  
thermal capture photon spectrum

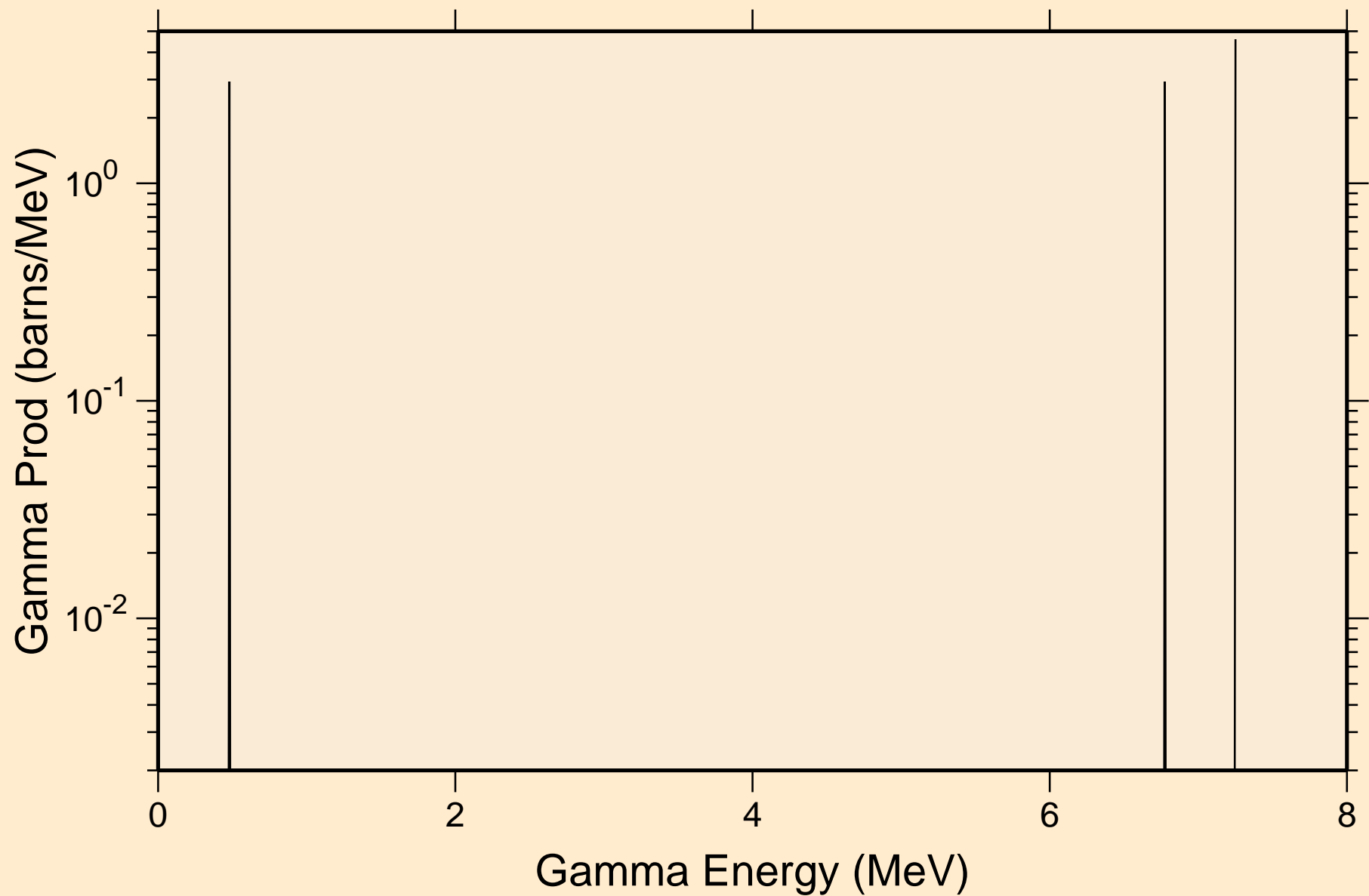

3-LI-6 FOR FENDL-3.2 FROM FENDL-3.2 BY NJOY2016.60+ ON F  
14 MeV photon spectrum

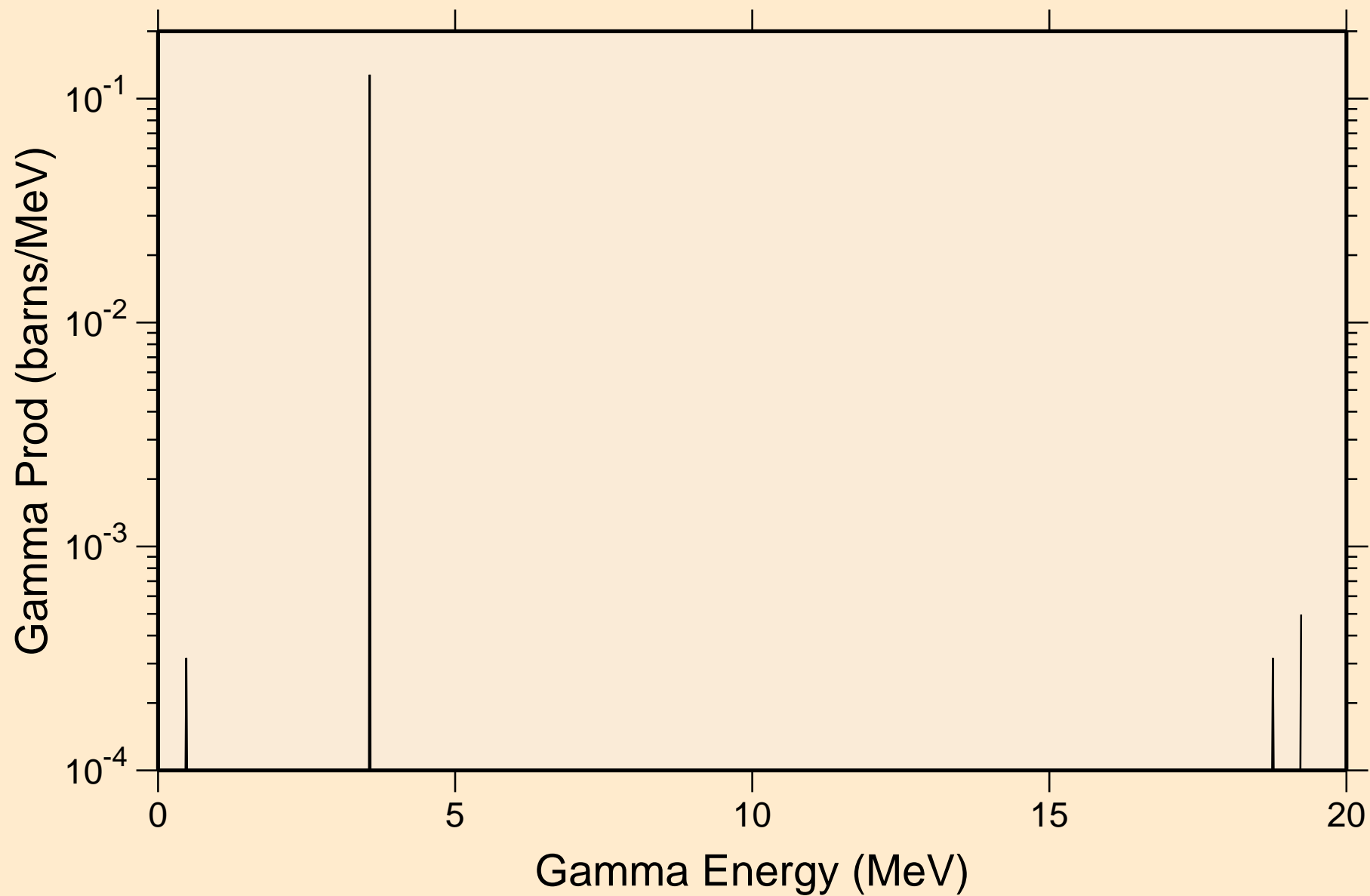



# 3-LI-6 FOR FENDL-3.2 FROM FENDL-3.2 BY NJOY2016.60+ ON F

## Particle heating contributions

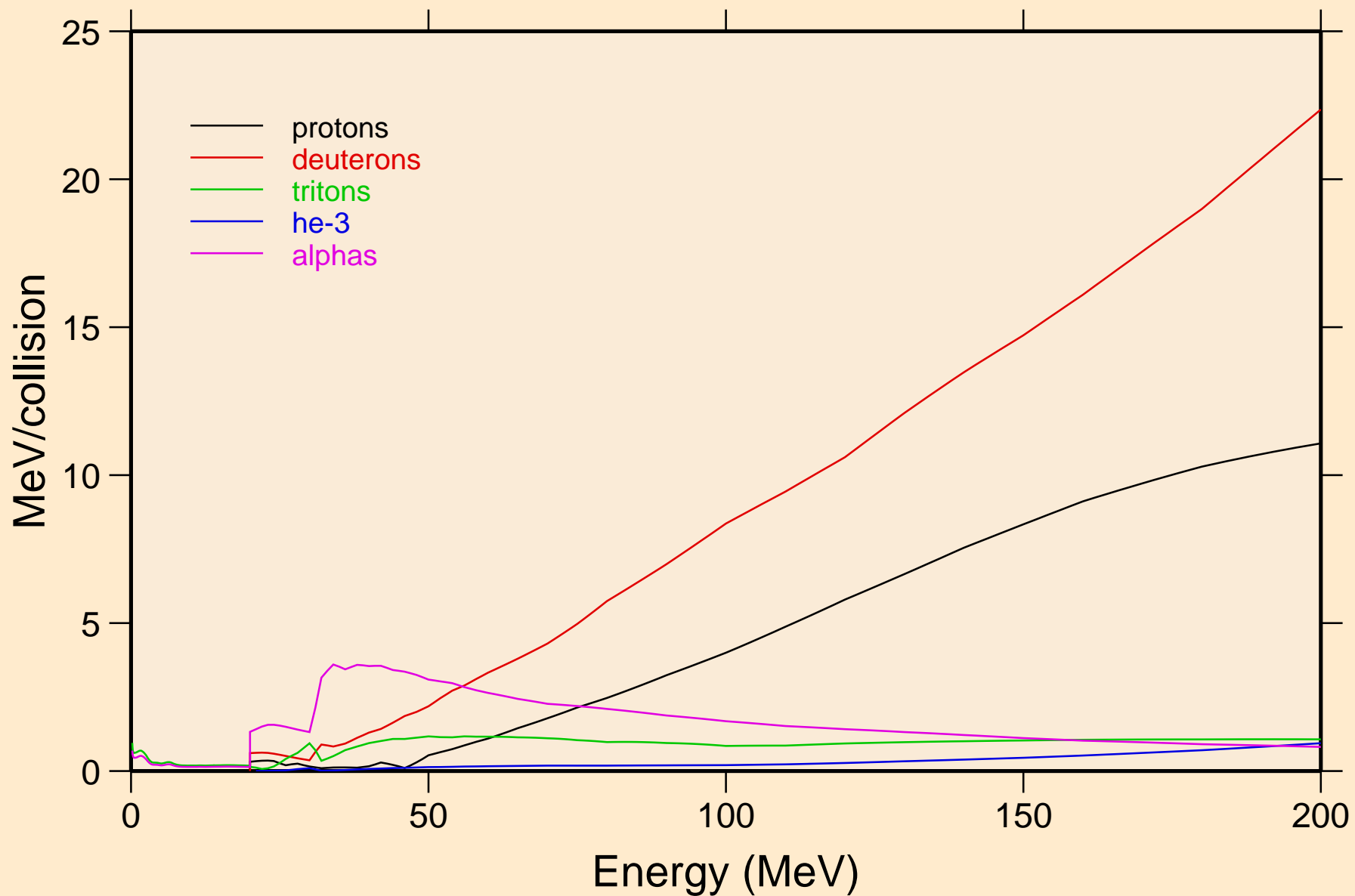

# 3-LI-6 FOR FENDL-3.2 FROM FENDL-3.2 BY NJOY2016.60+ ON F Recoil Heating

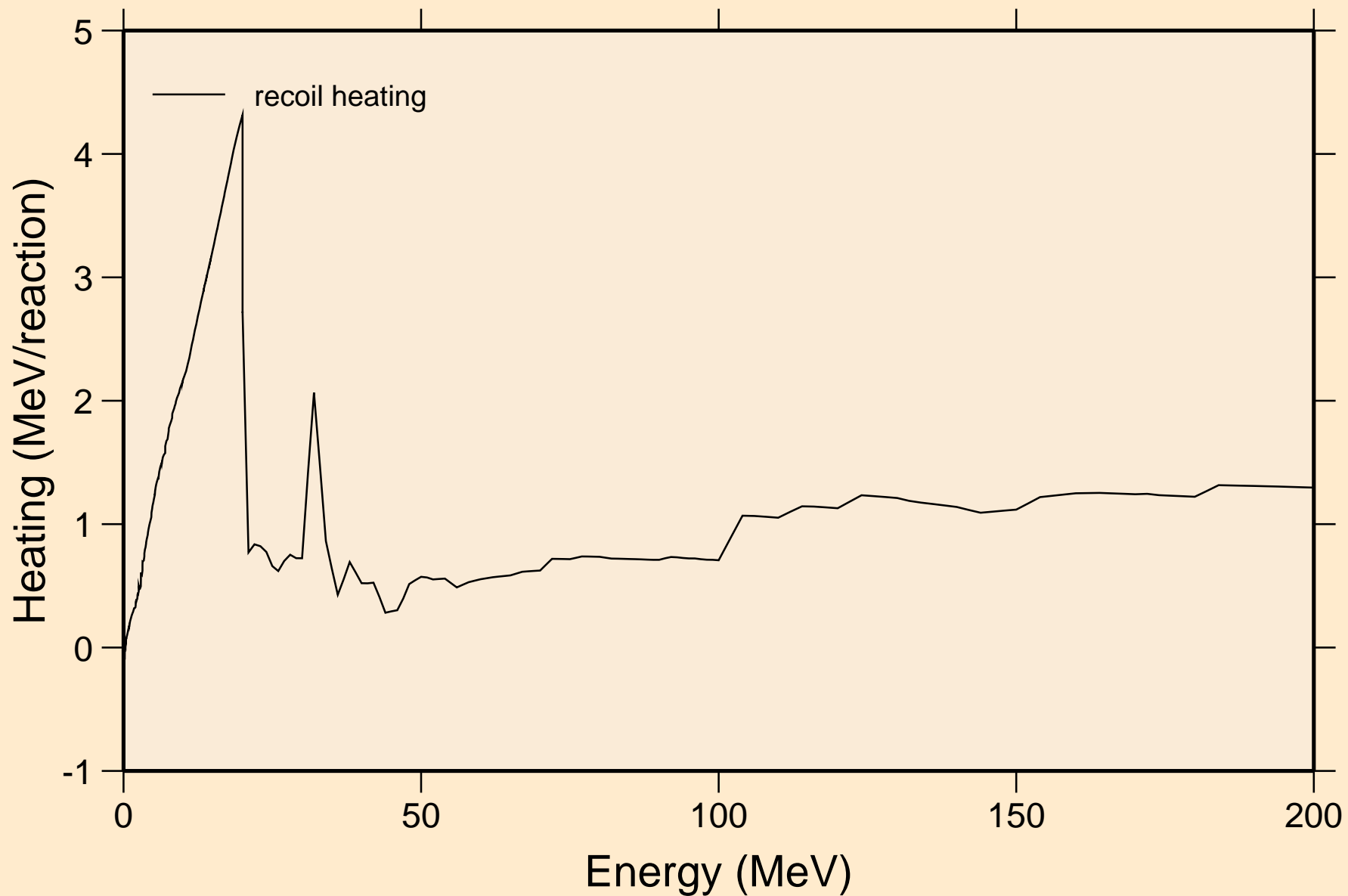

# 3-LI-6 FOR FENDL-3.2 FROM FENDL-3.2 BY NJOY2016.60+ ON F

## Particle production cross sections

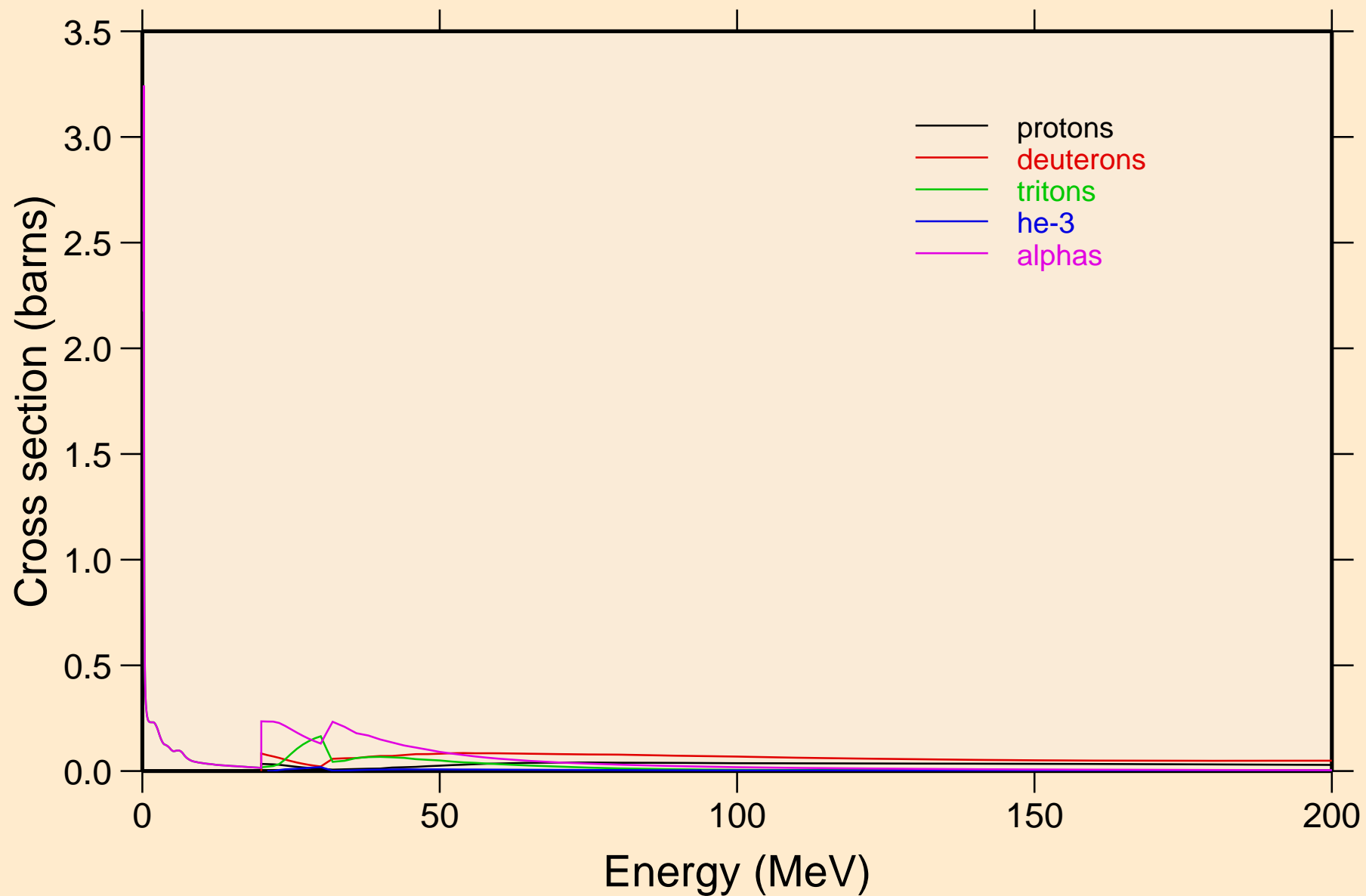

3-LI-6 FOR FENDL-3.2 FROM FENDL-3.2 BY NJOY2016.60+ ON F  
protons from (n,x)

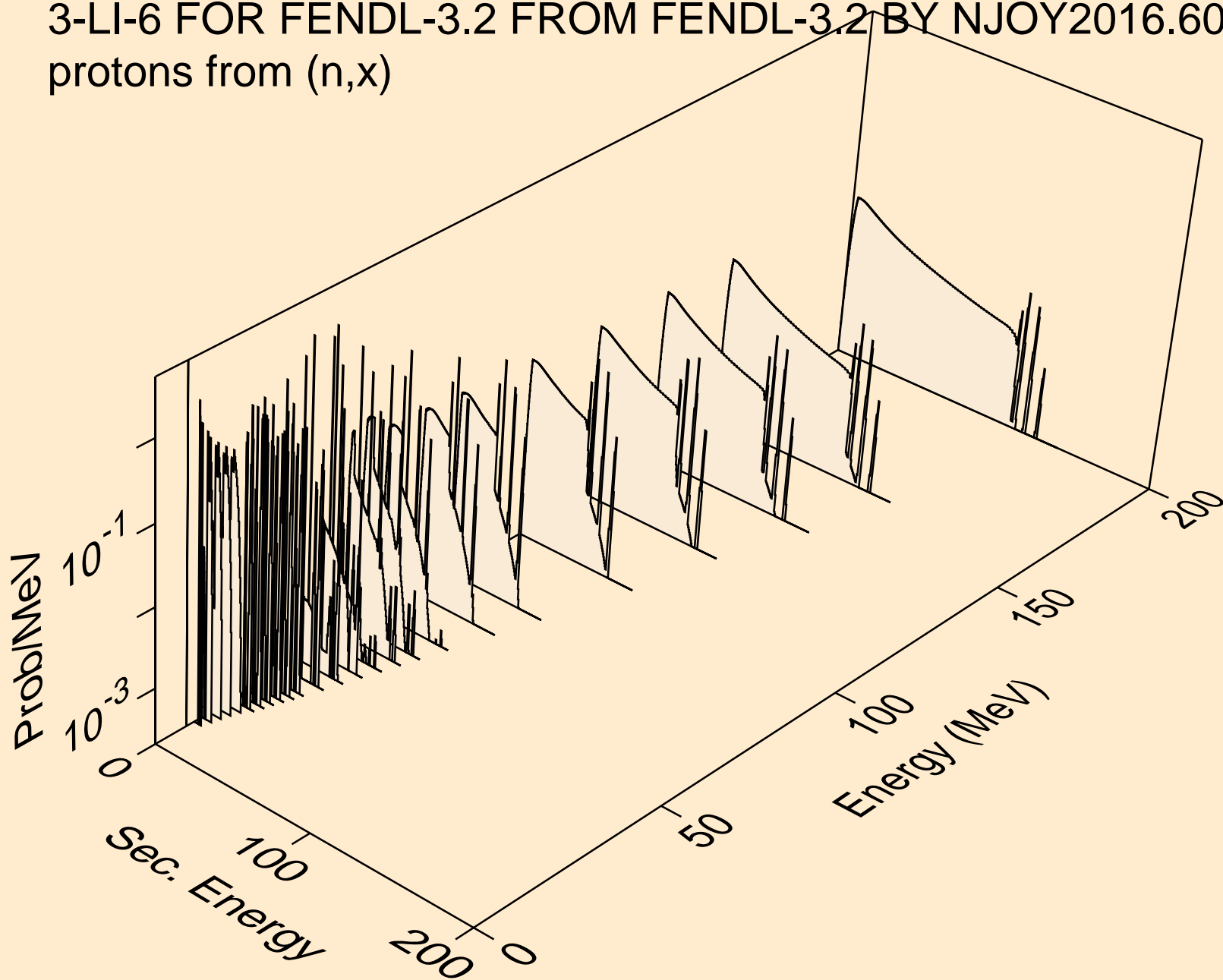

3-LI-6 FOR FENDL-3.2 FROM FENDL-3.2 BY NJOY2016.60+ ON F  
deuterons from (n,x)

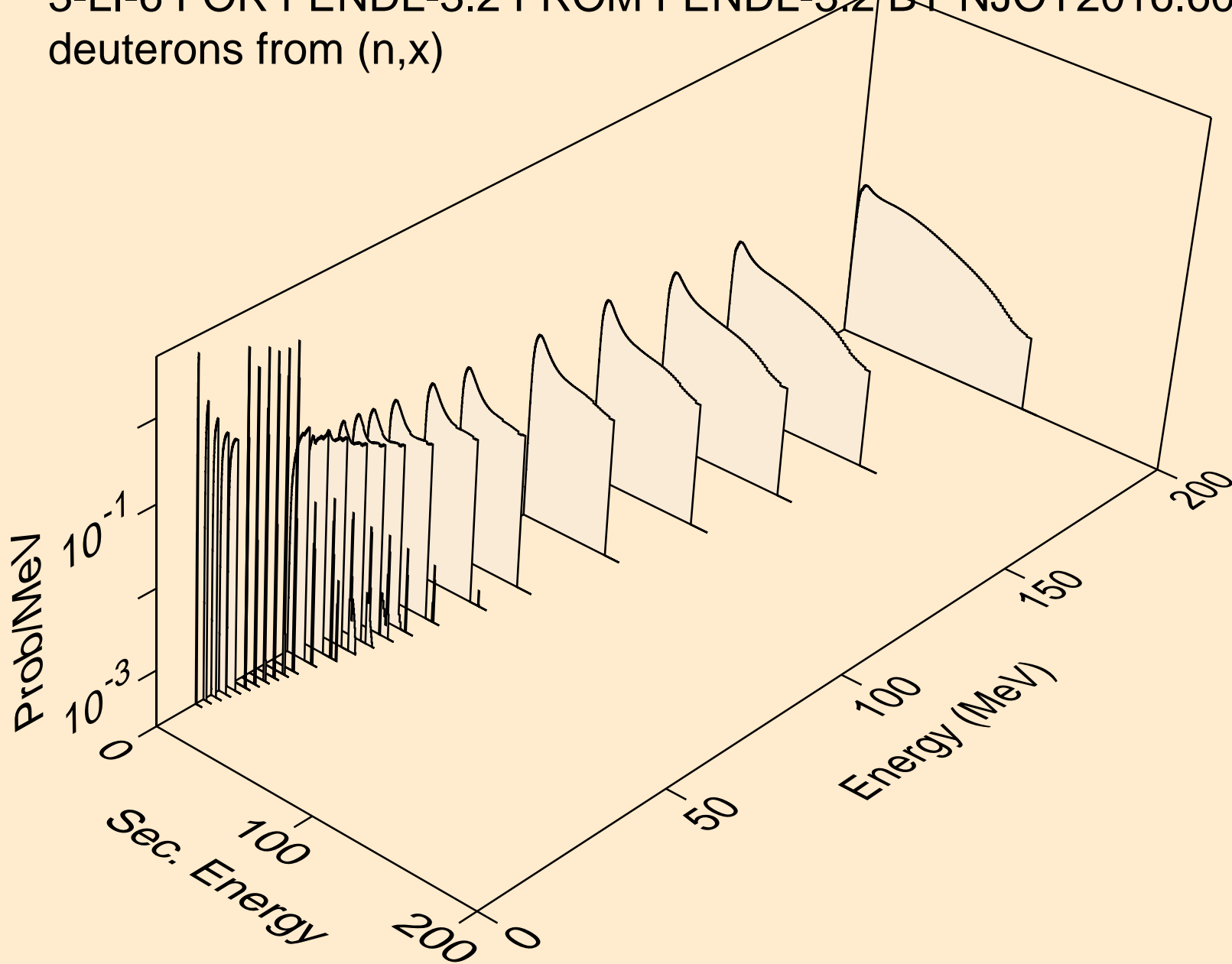

3-LI-6 FOR FENDL-3.2 FROM FENDL-3.2 BY NJOY2016.60+ ON F  
tritons from (n,x)

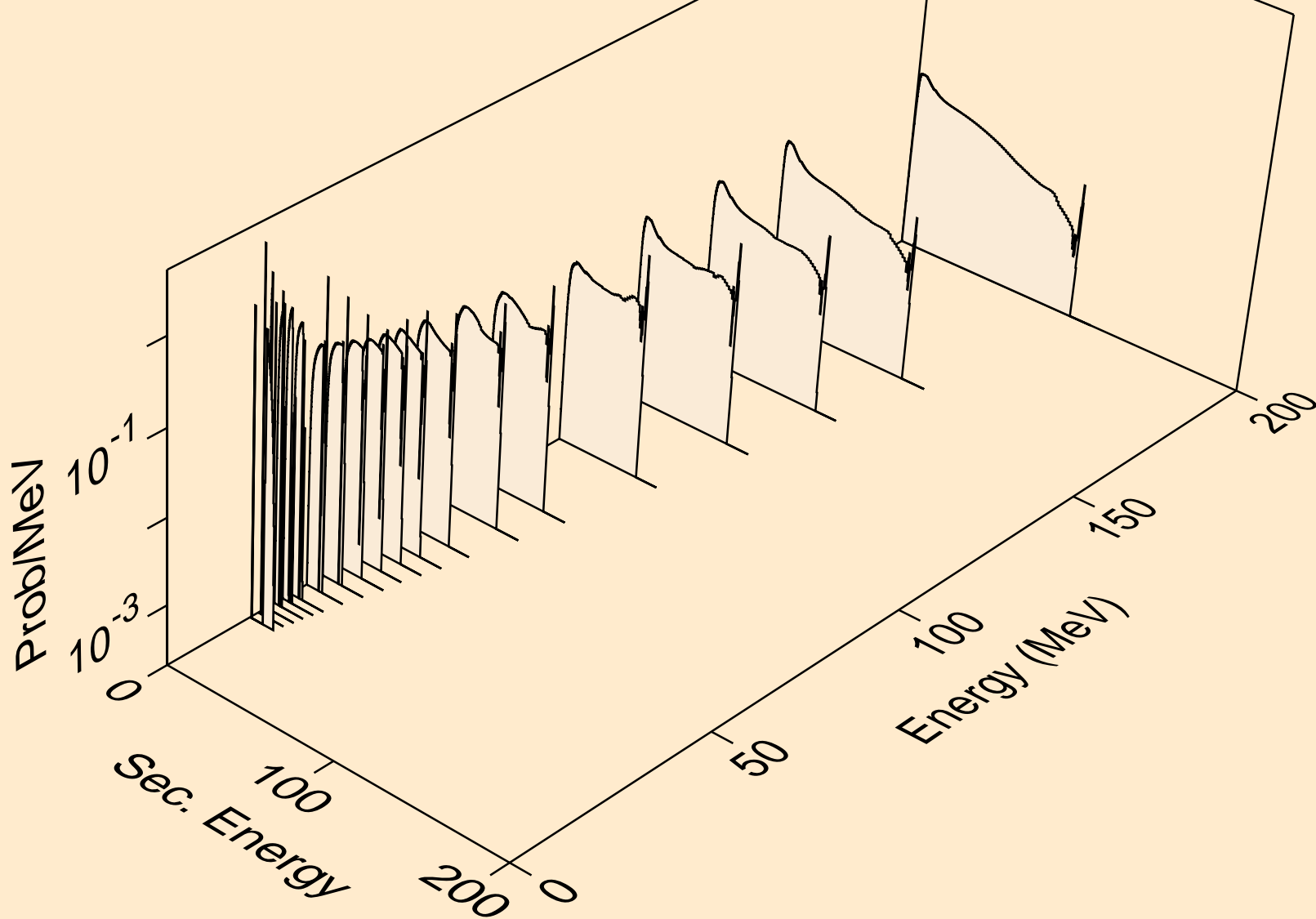

3-LI-6 FOR FENDL-3.2 FROM FENDL-3.2 BY NJOY2016.60+ ON F  
angular distribution for (n,t) triton

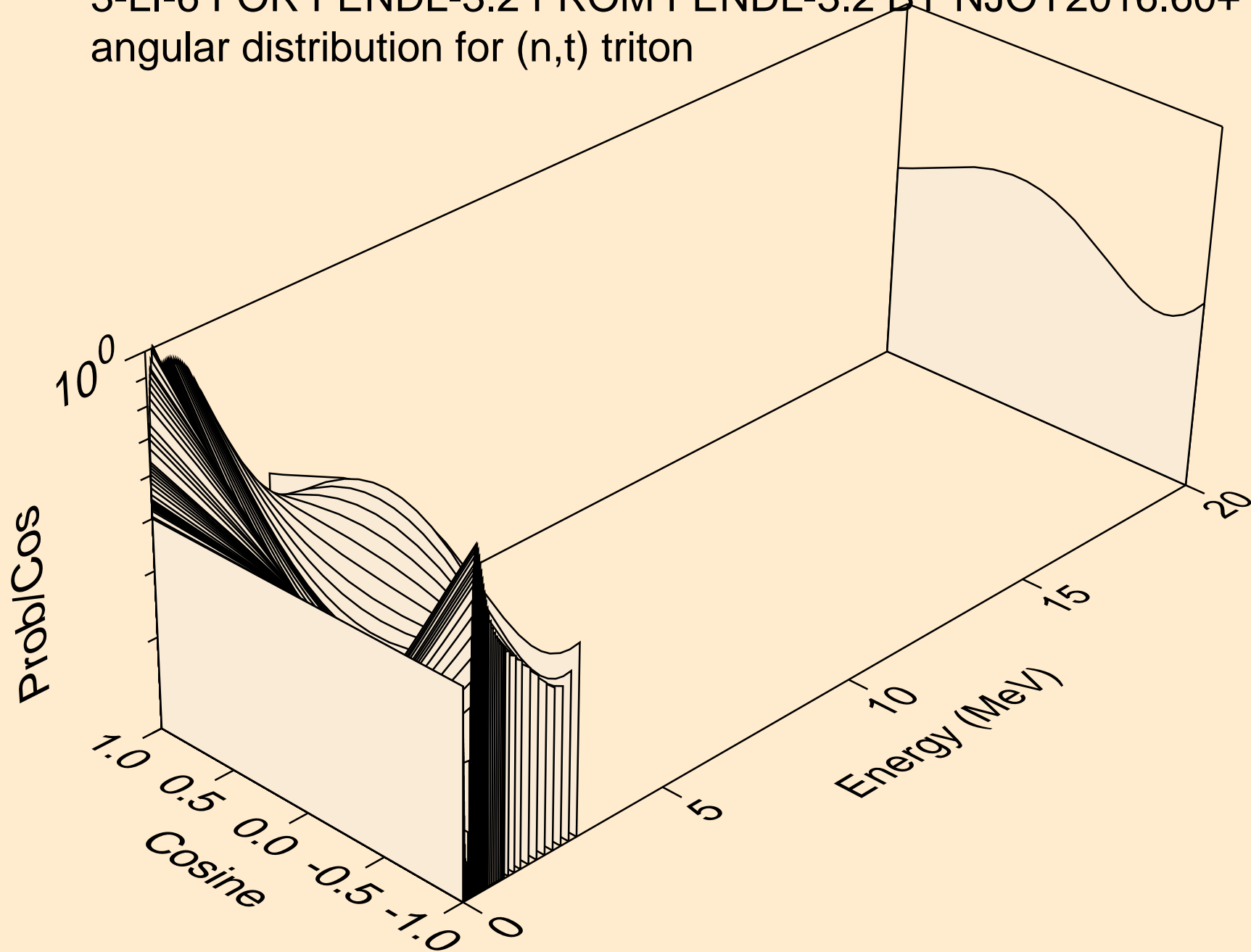

3-LI-6 FOR FENDL-3.2 FROM FENDL-3.2 BY NJOY2016.60+ ON F  
he3s from (n,x)

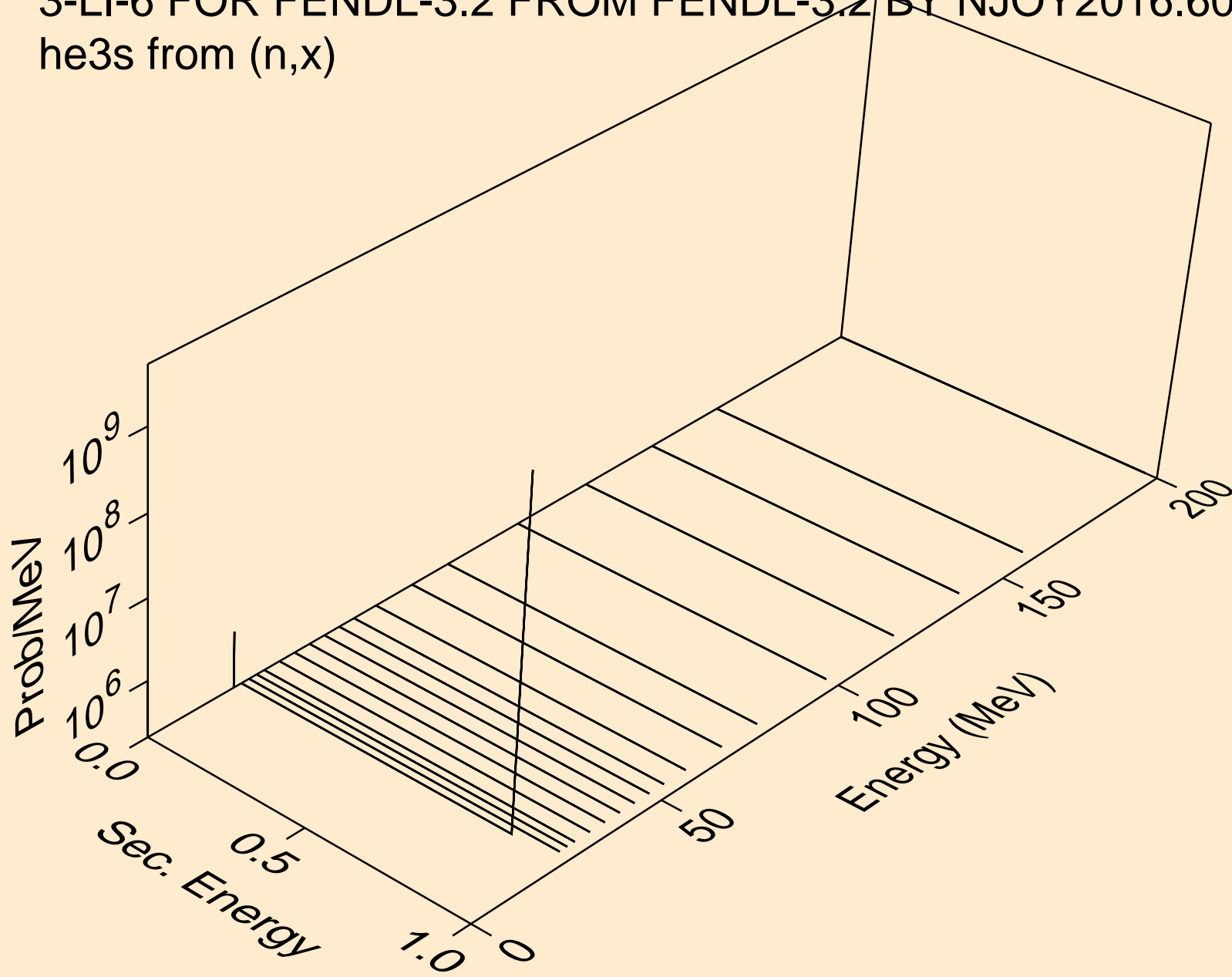



3-LI-6 FOR FENDL-3.2 FROM FENDL-3.2 BY NJOY2016.60+ ON F  
alphas from (n,x)

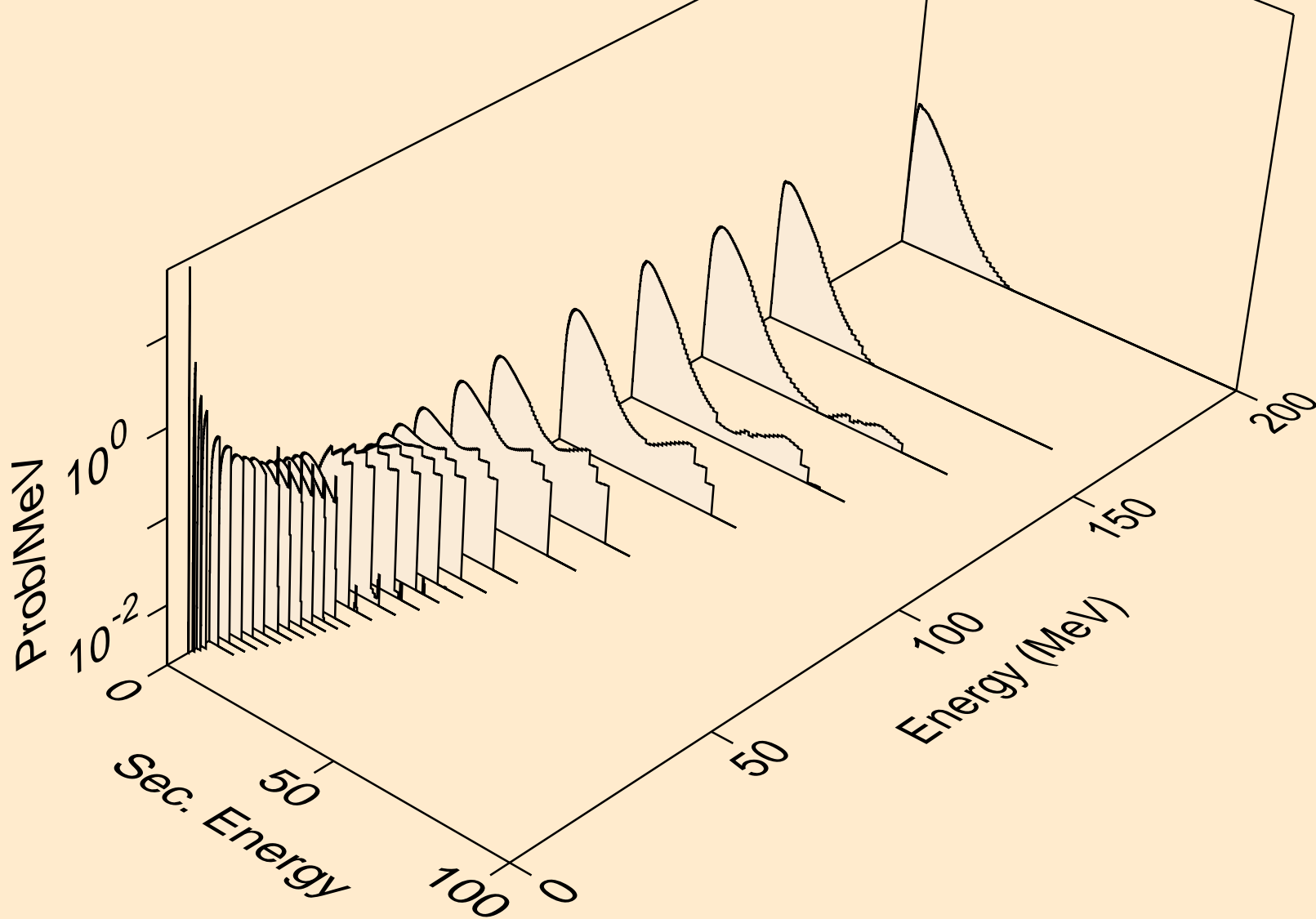

3-LI-6 FOR FENDL-3.2 FROM FENDL-3.2 BY NJOY2016.60+ ON F  
angular distribution for (n,t) alpha

