

10-NE-20 FOR FENDL-3.2 FROM TENDL-2019 BY NJOY2016.60+
Principal cross sections

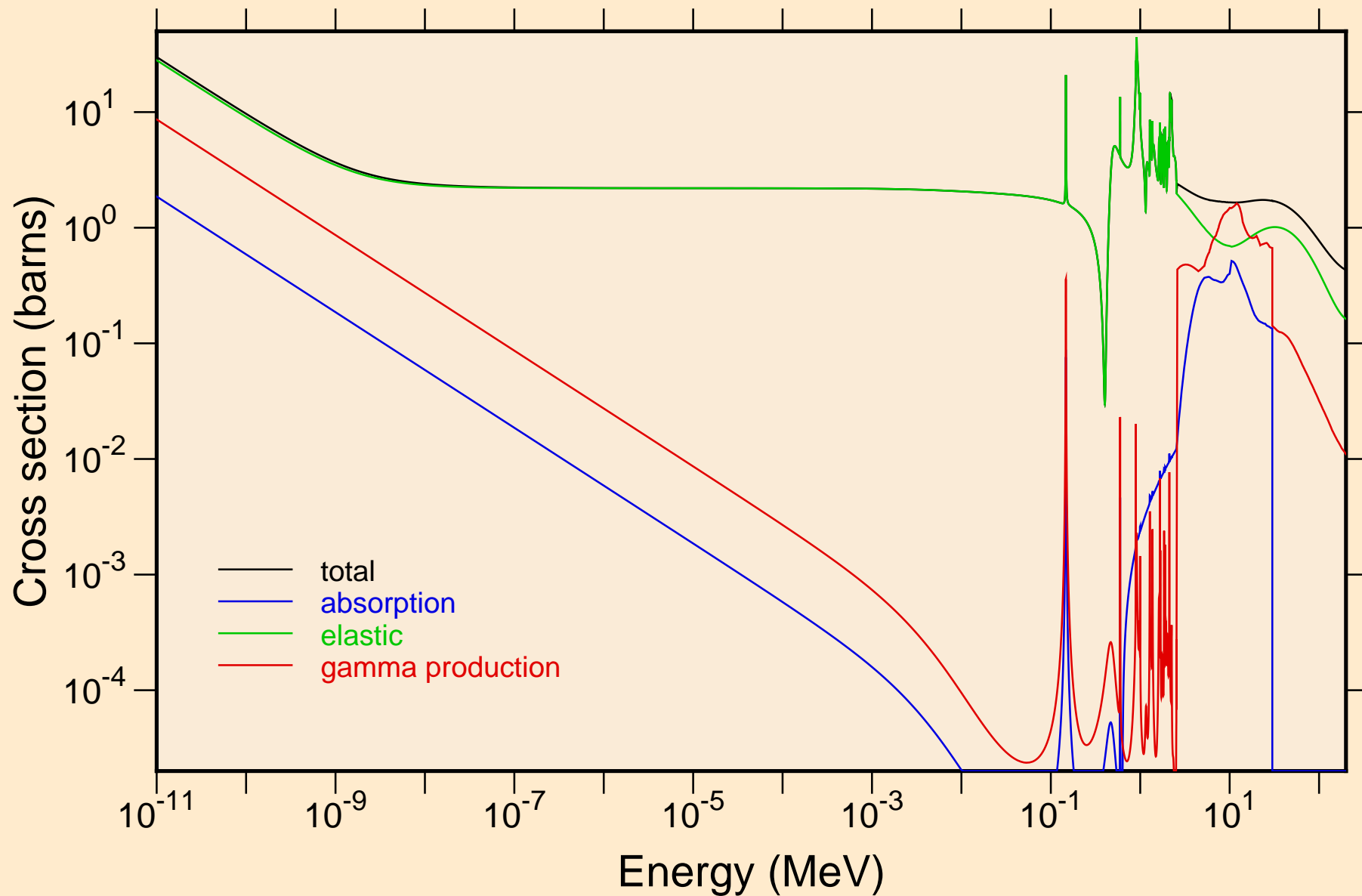

10-NE-20 FOR FENDL-3.2 FROM TENDL-2019 BY NJOY2016.60+
resonance total cross section

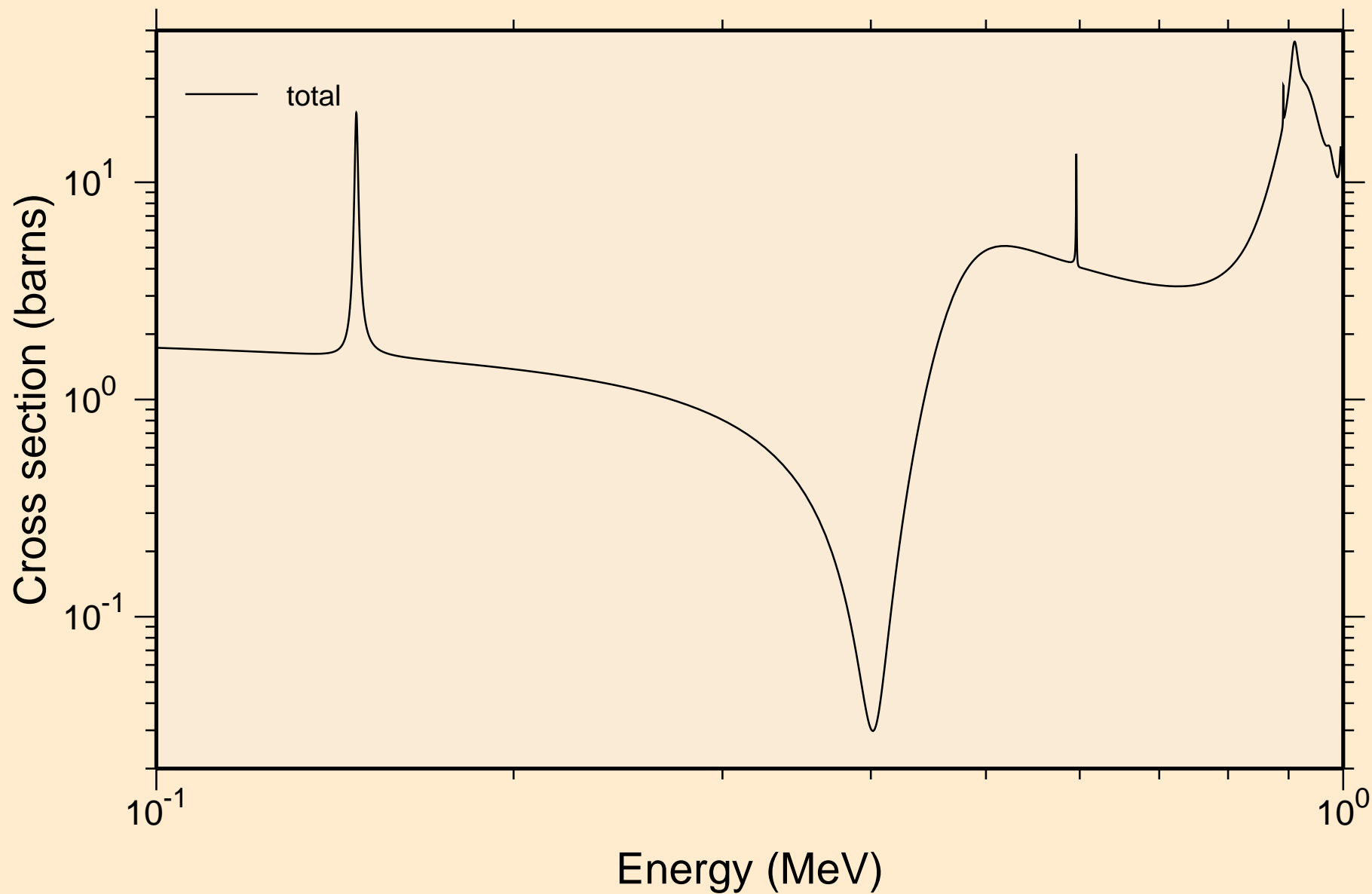

10-NE-20 FOR FENDL-3.2 FROM TENDL-2019 BY NJOY2016.60+
resonance total cross section

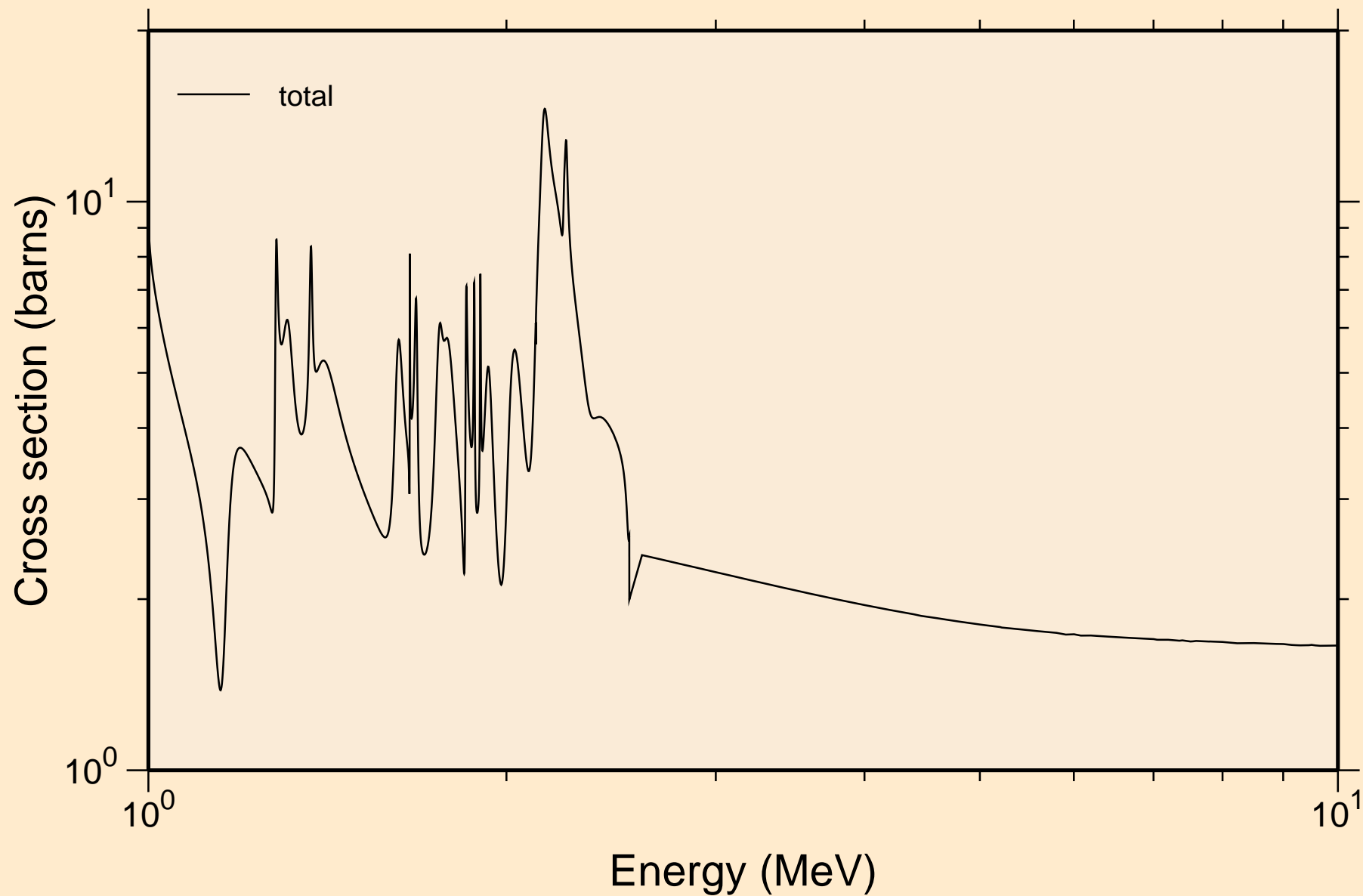

10-NE-20 FOR FENDL-3.2 FROM TENDL-2019 BY NJOY2016.60+
resonance absorption cross sections

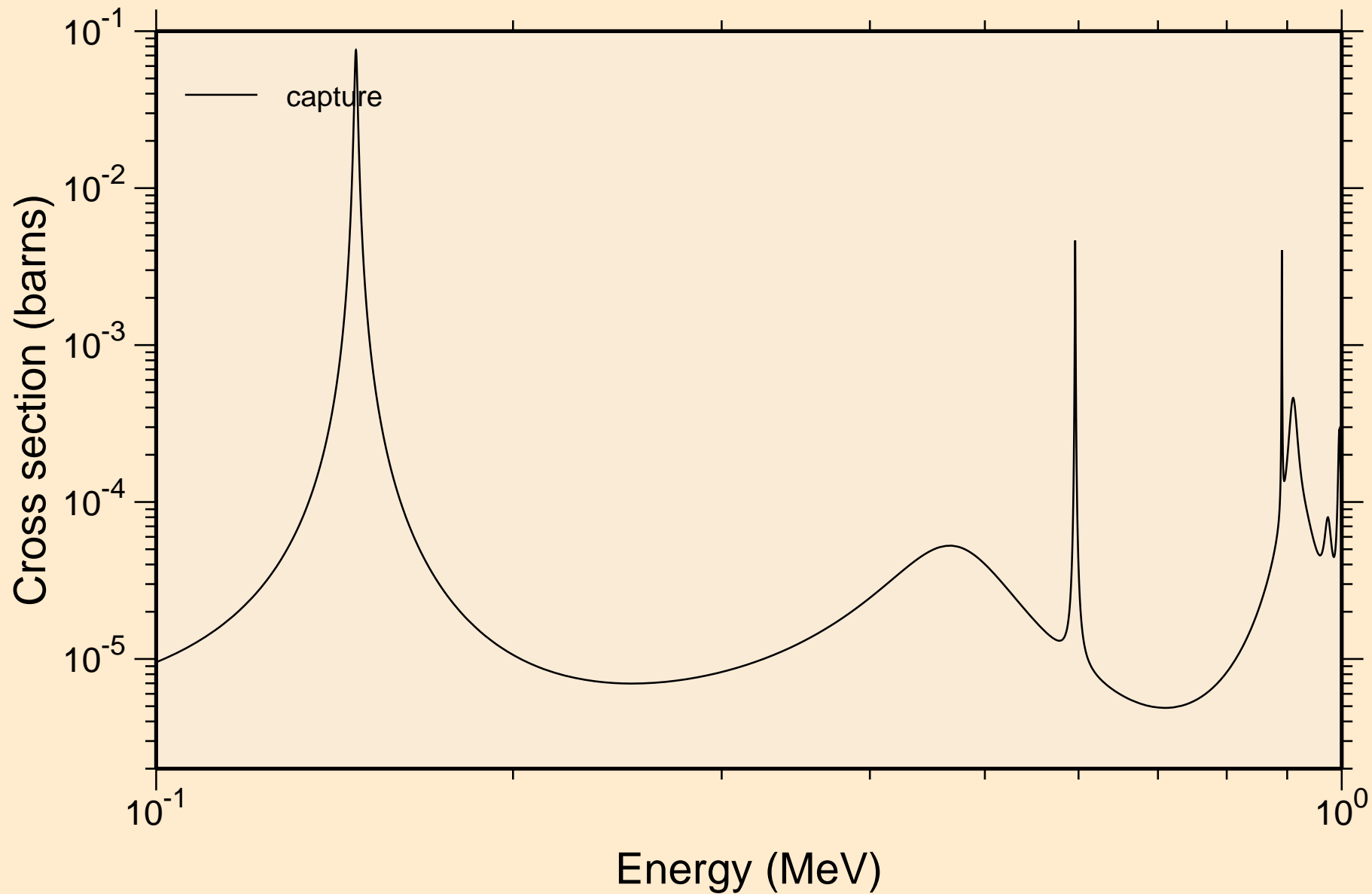

10-NE-20 FOR FENDL-3.2 FROM TENDL-2019 BY NJOY2016.60+
resonance absorption cross sections

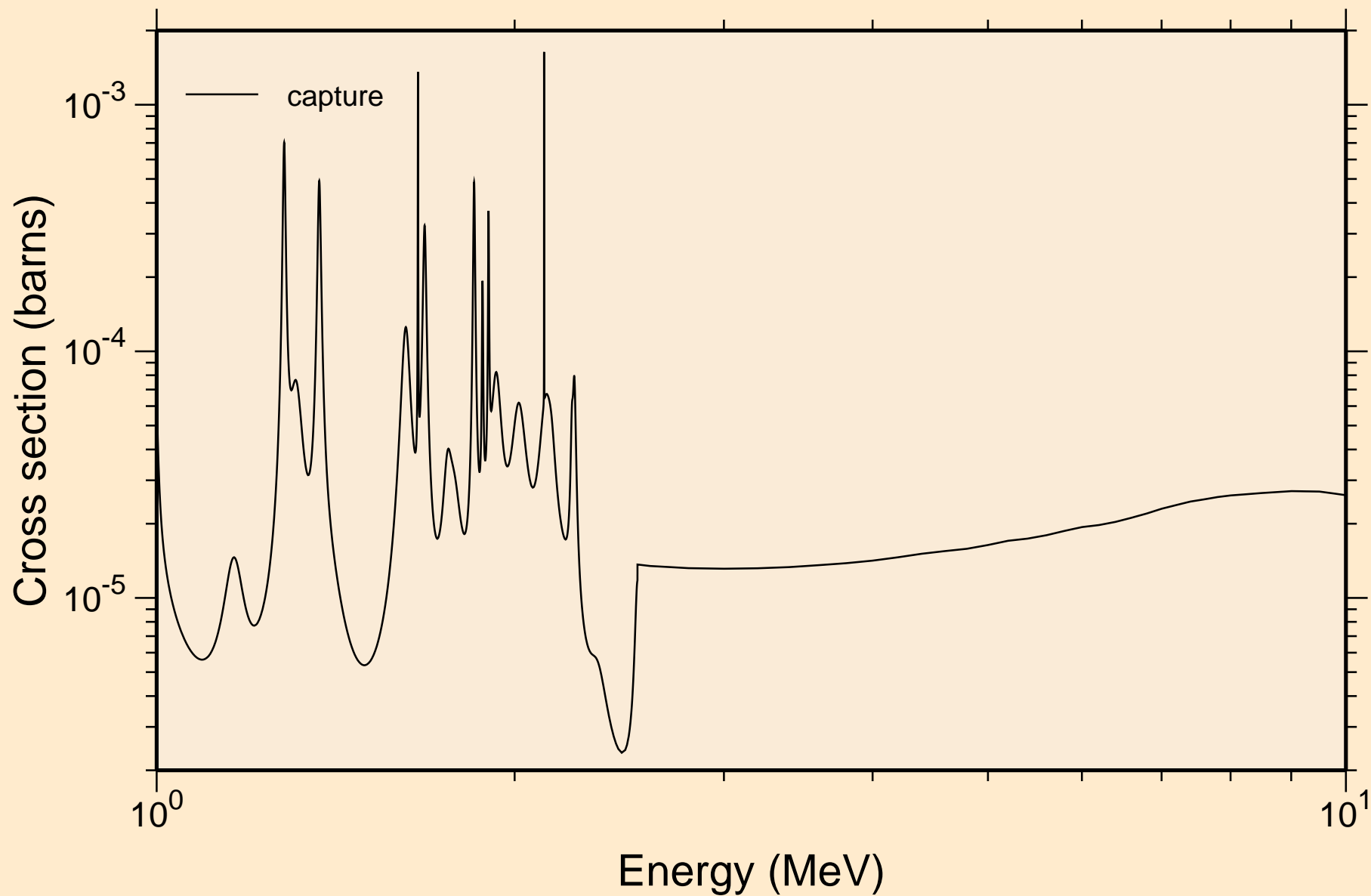

10-NE-20 FOR FENDL-3.2 FROM TENDL-2019 BY NJOY2016.60+
Heating

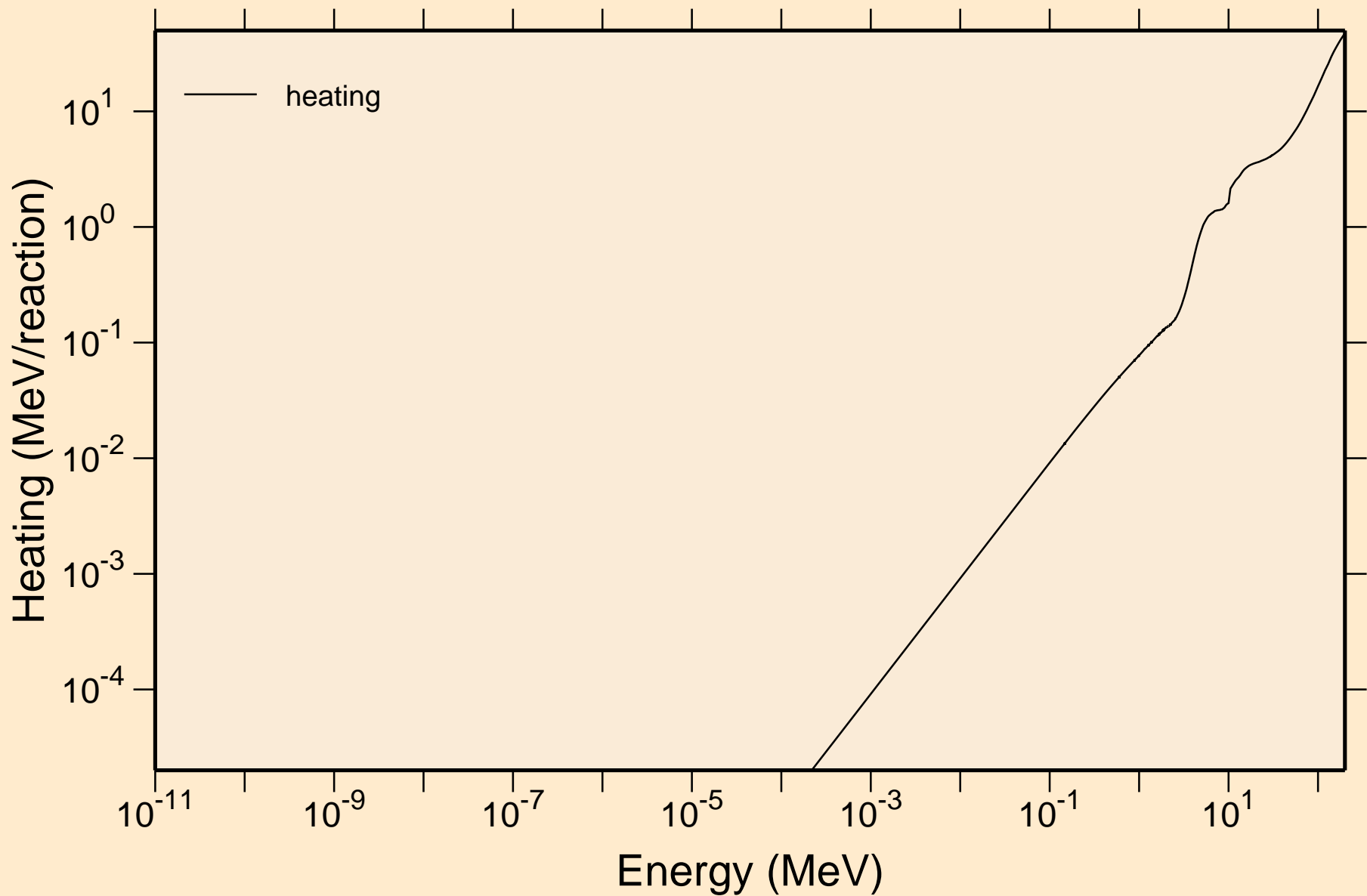

10-NE-20 FOR FENDL-3.2 FROM TENDL-2019 BY NJOY2016.60+ Damage

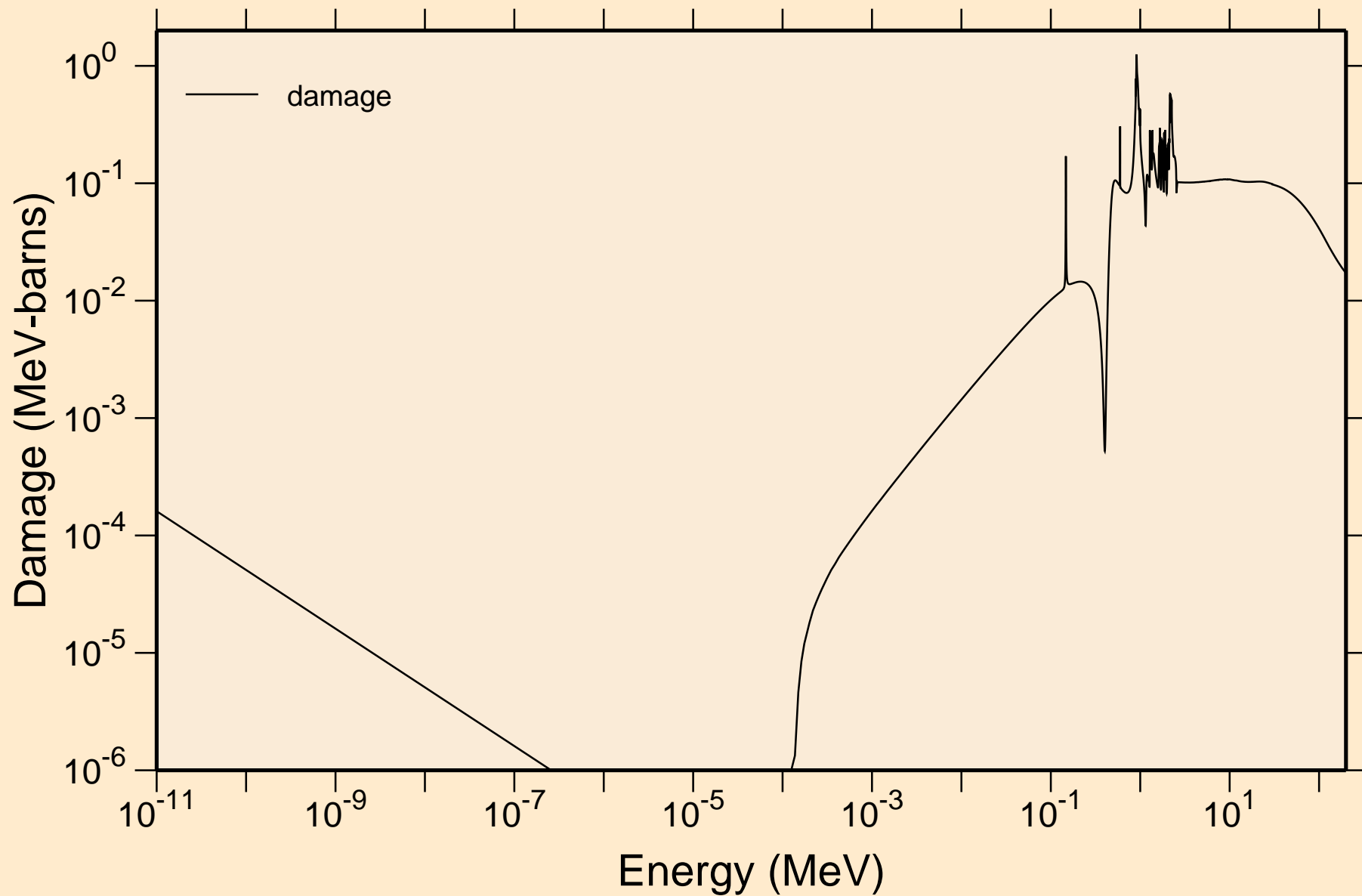

10-NE-20 FOR FENDL-3.2 FROM TENDL-2019 BY NJOY2016.60+
Non-threshold reactions

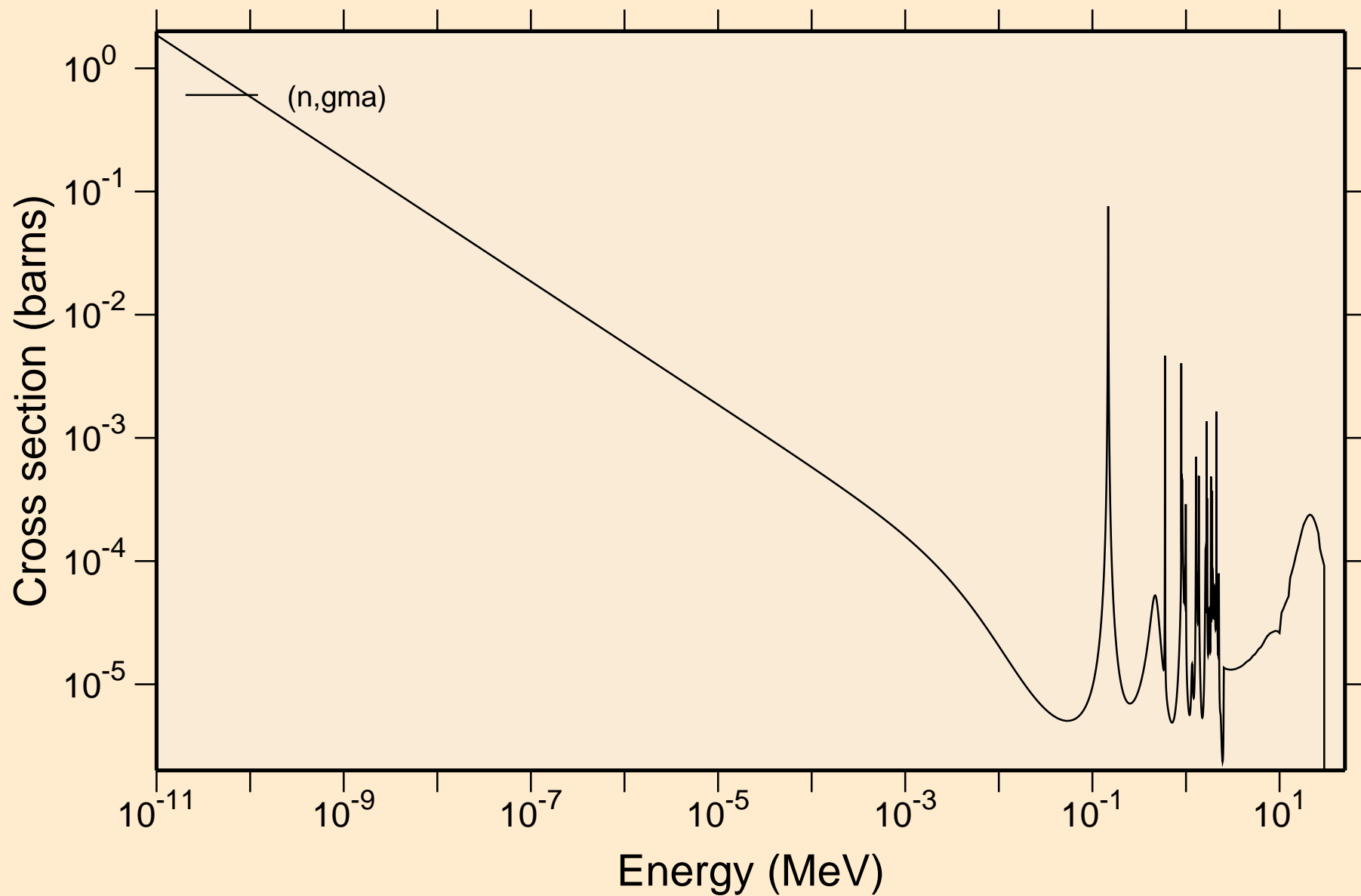

10-NE-20 FOR FENDL-3.2 FROM TENDL-2019 BY NJOY2016.60+

Principal cross sections

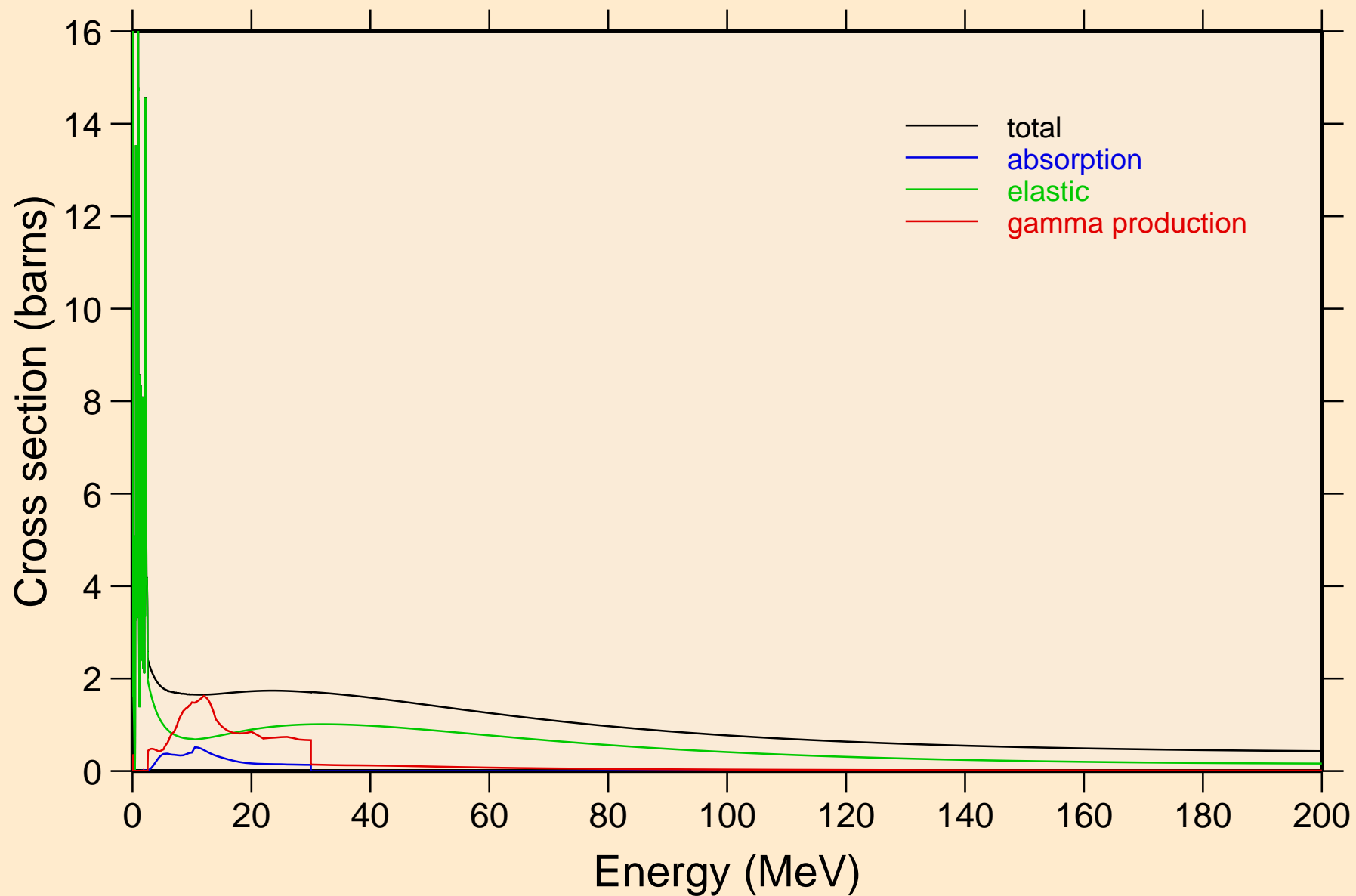

10-NE-20 FOR FENDL-3.2 FROM TENDL-2019 BY NJOY2016.60+ Heating

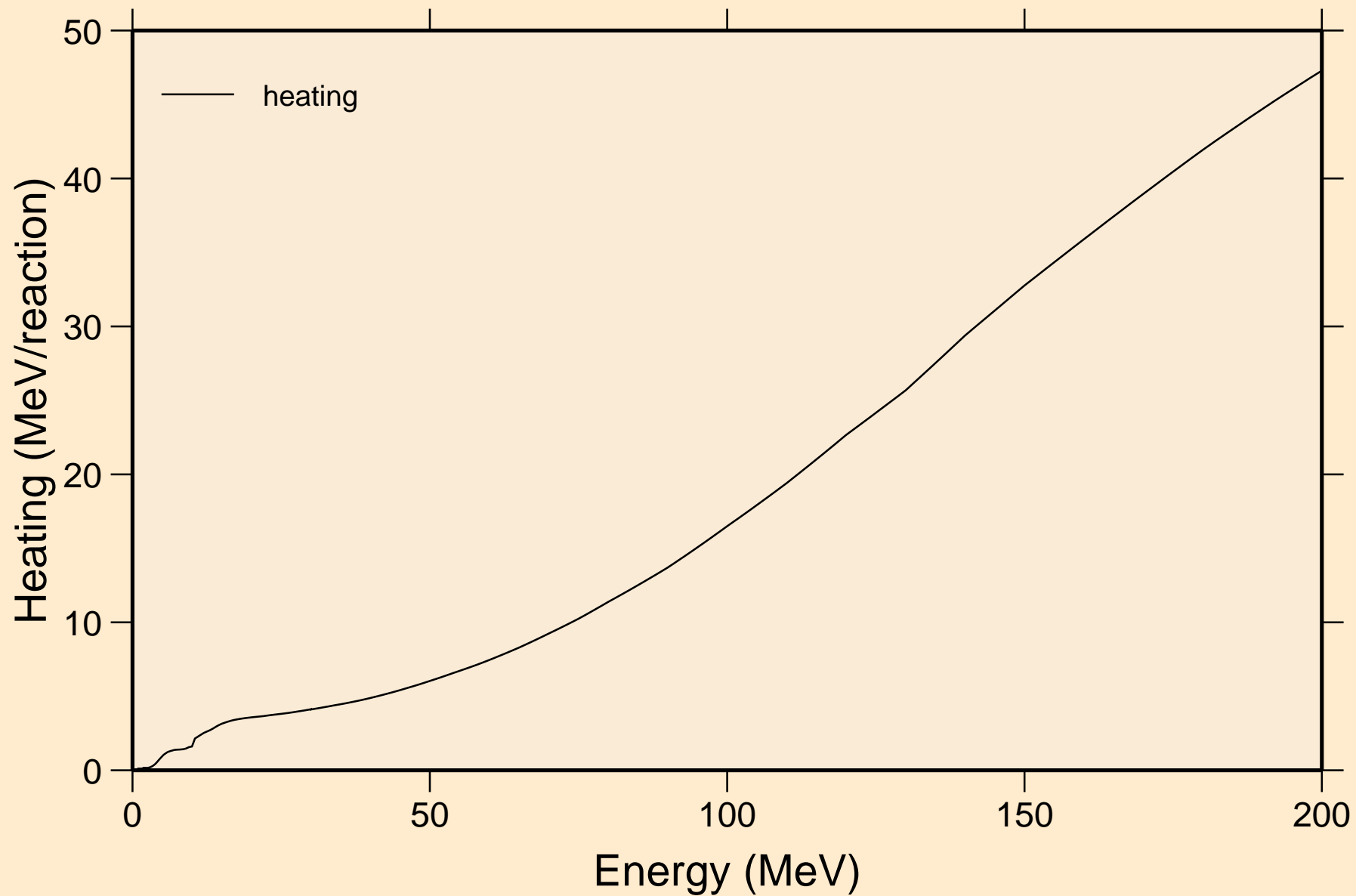

10-NE-20 FOR FENDL-3.2 FROM TENDL-2019 BY NJOY2016.60+ Damage

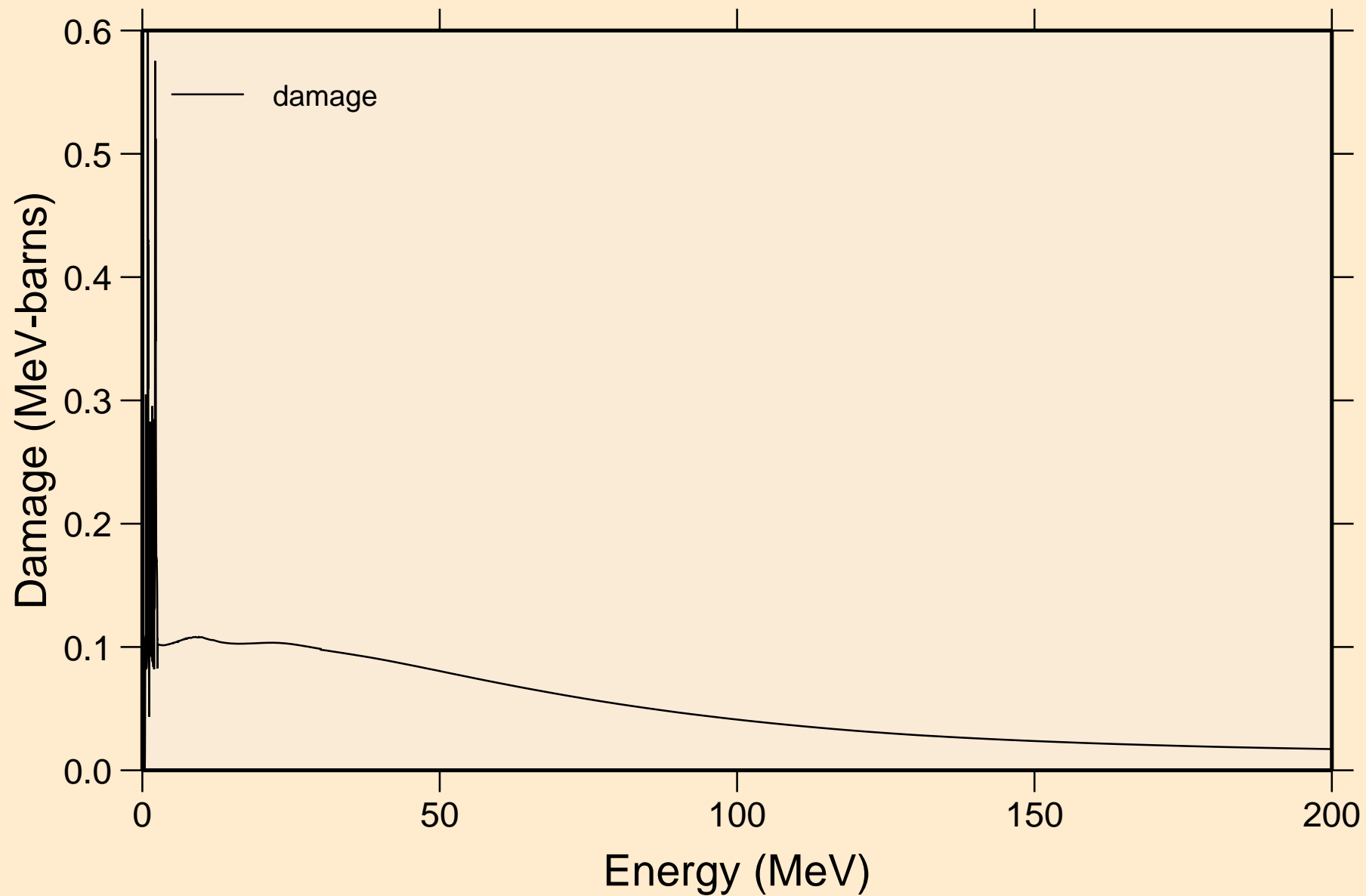

10-NE-20 FOR FENDL-3.2 FROM TENDL-2019 BY NJOY2016.60+
Non-threshold reactions

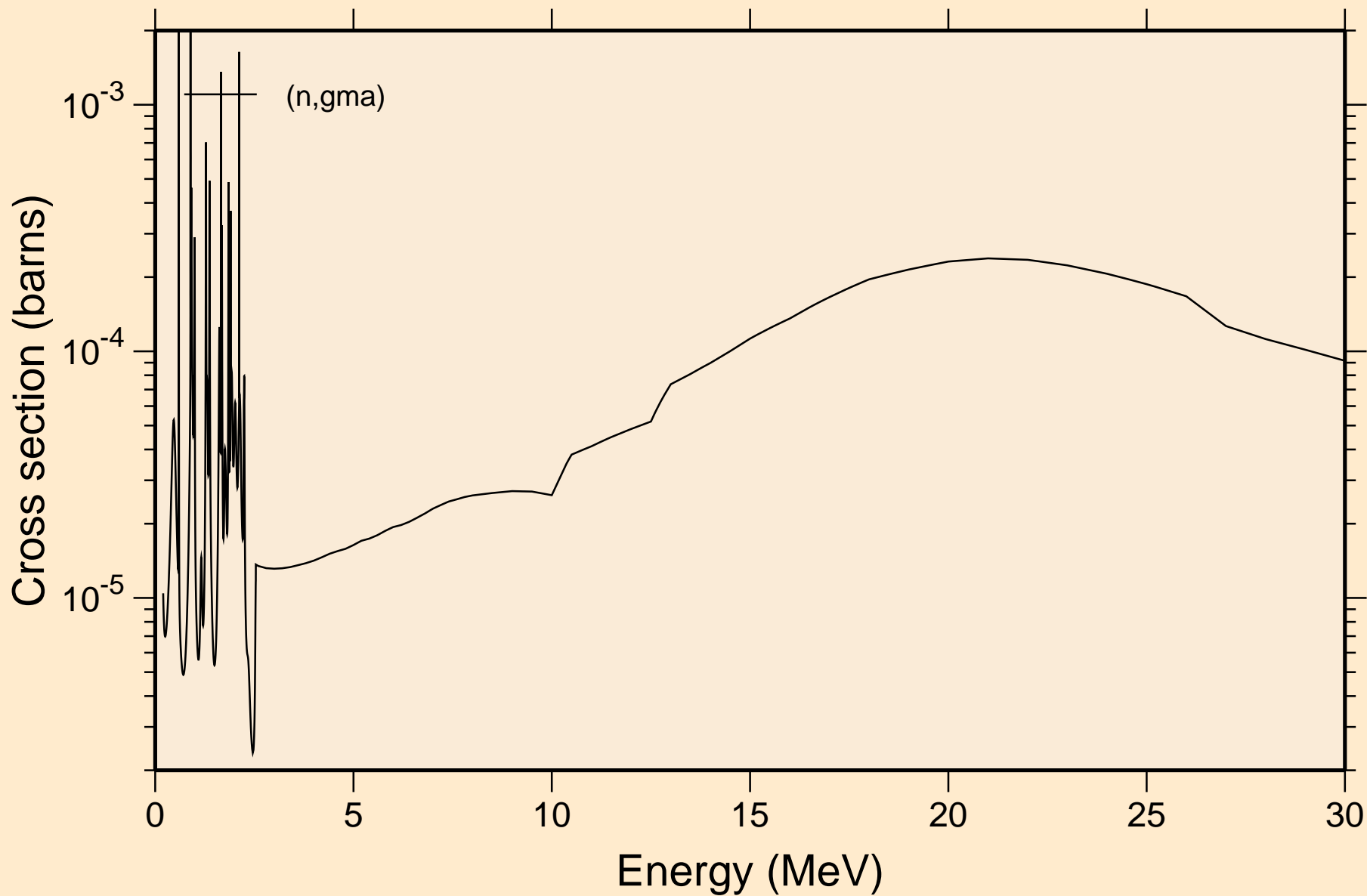

10-NE-20 FOR FENDL-3.2 FROM TENDL-2019 BY NJOY2016.60+
Inelastic levels

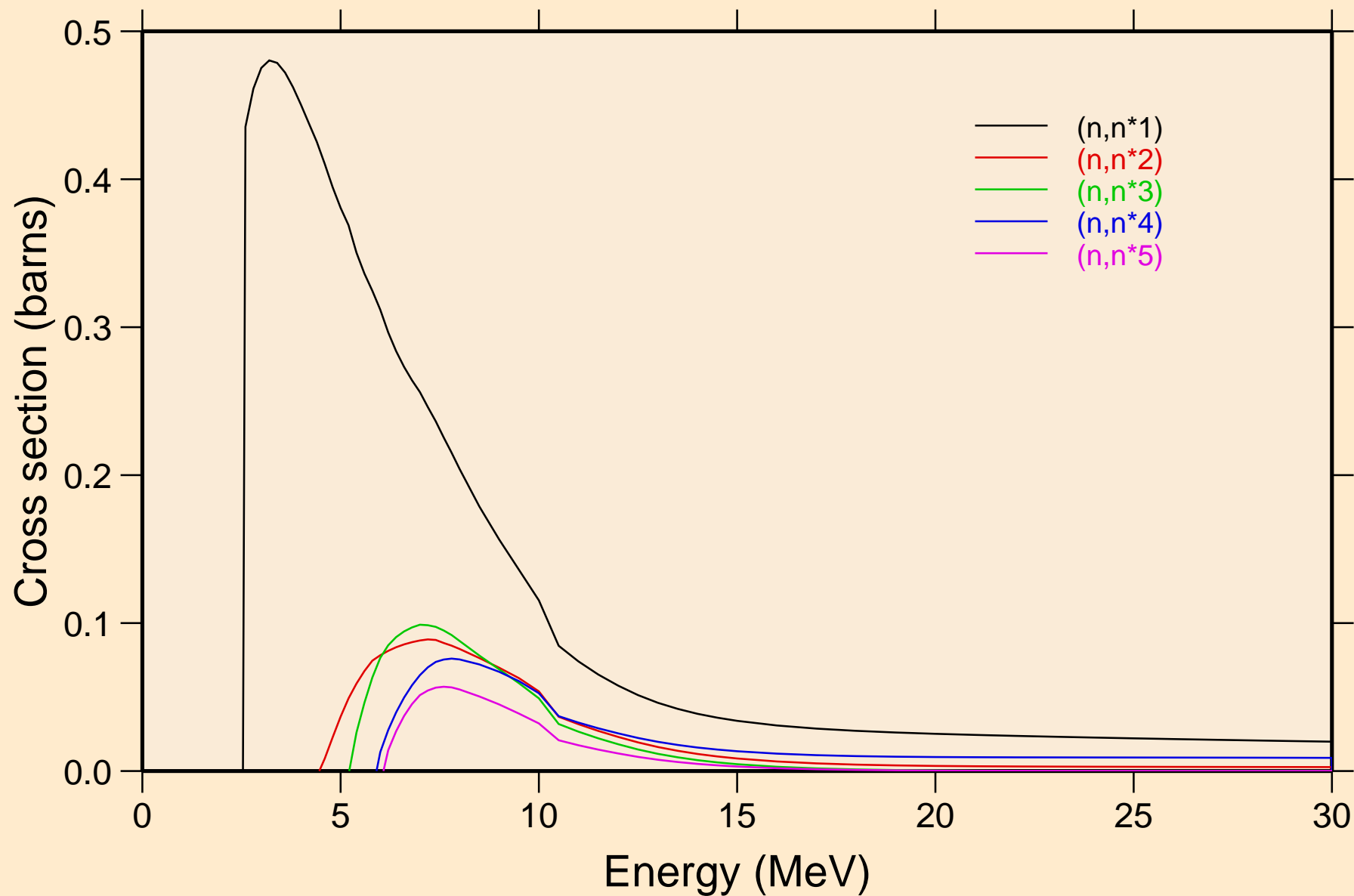

10-NE-20 FOR FENDL-3.2 FROM TENDL-2019 BY NJOY2016.60+ Inelastic levels

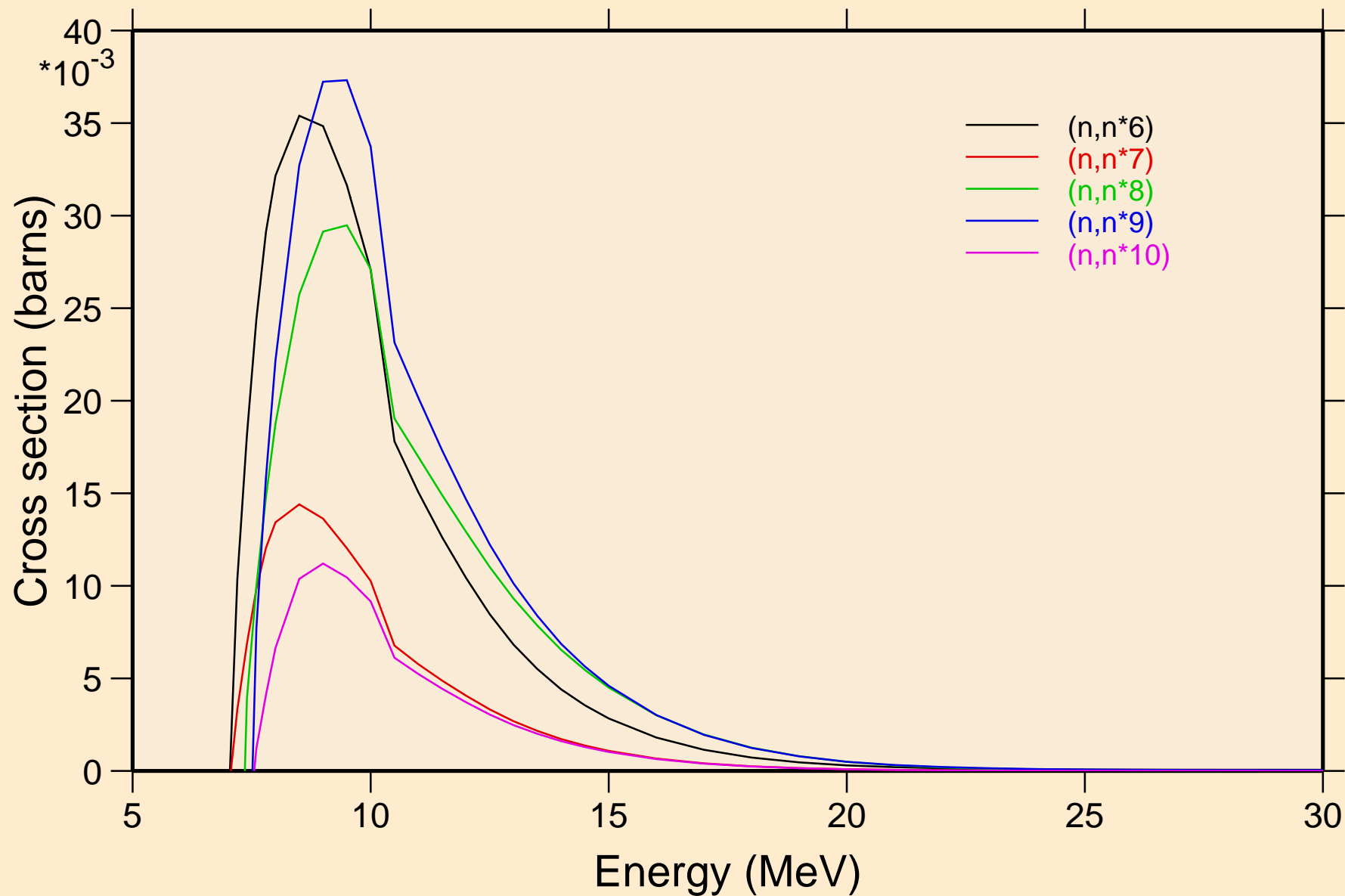

10-NE-20 FOR FENDL-3.2 FROM TENDL-2019 BY NJOY2016.60+

Inelastic levels

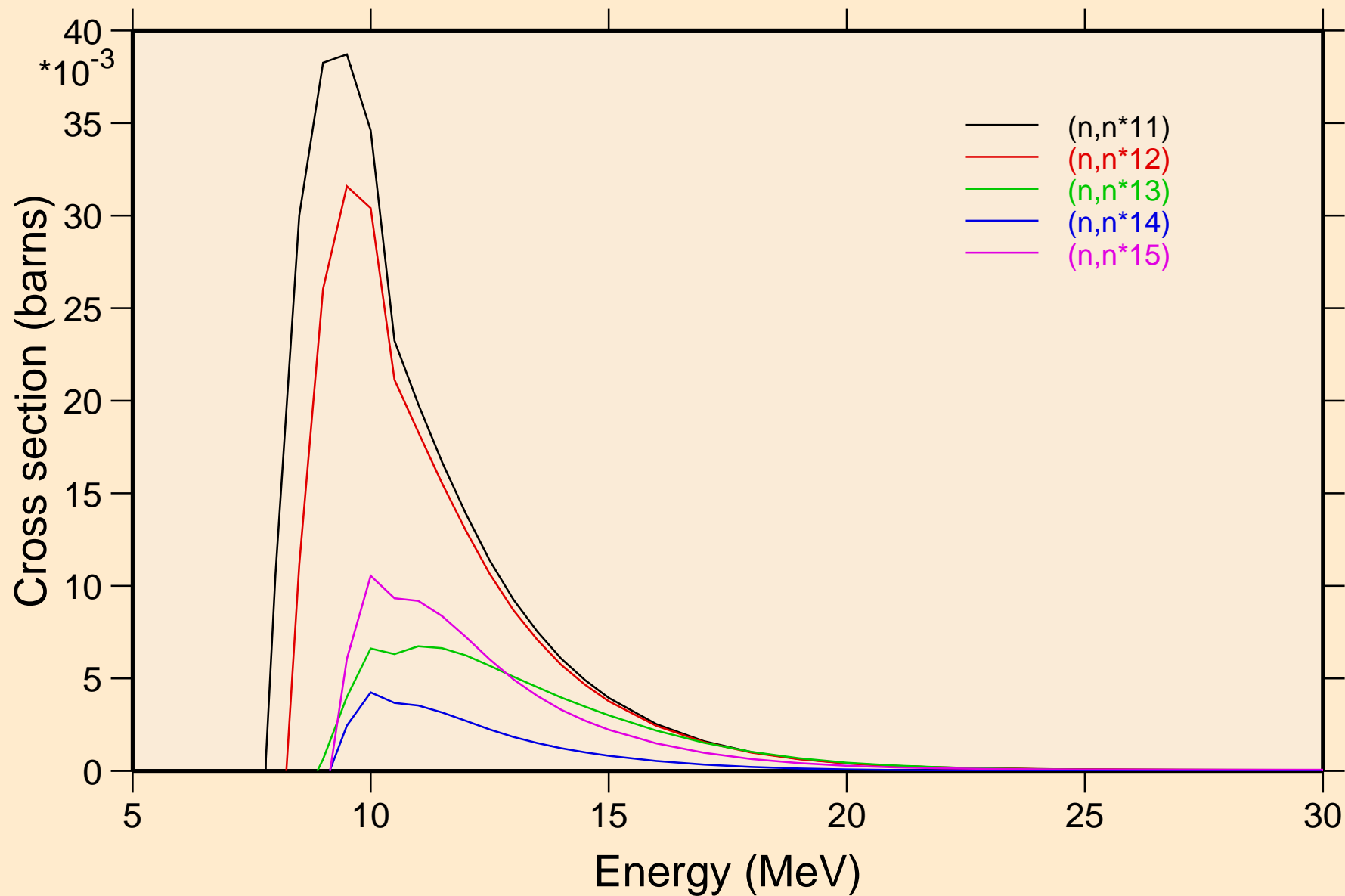

10-NE-20 FOR FENDL-3.2 FROM TENDL-2019 BY NJOY2016.60+

Inelastic levels

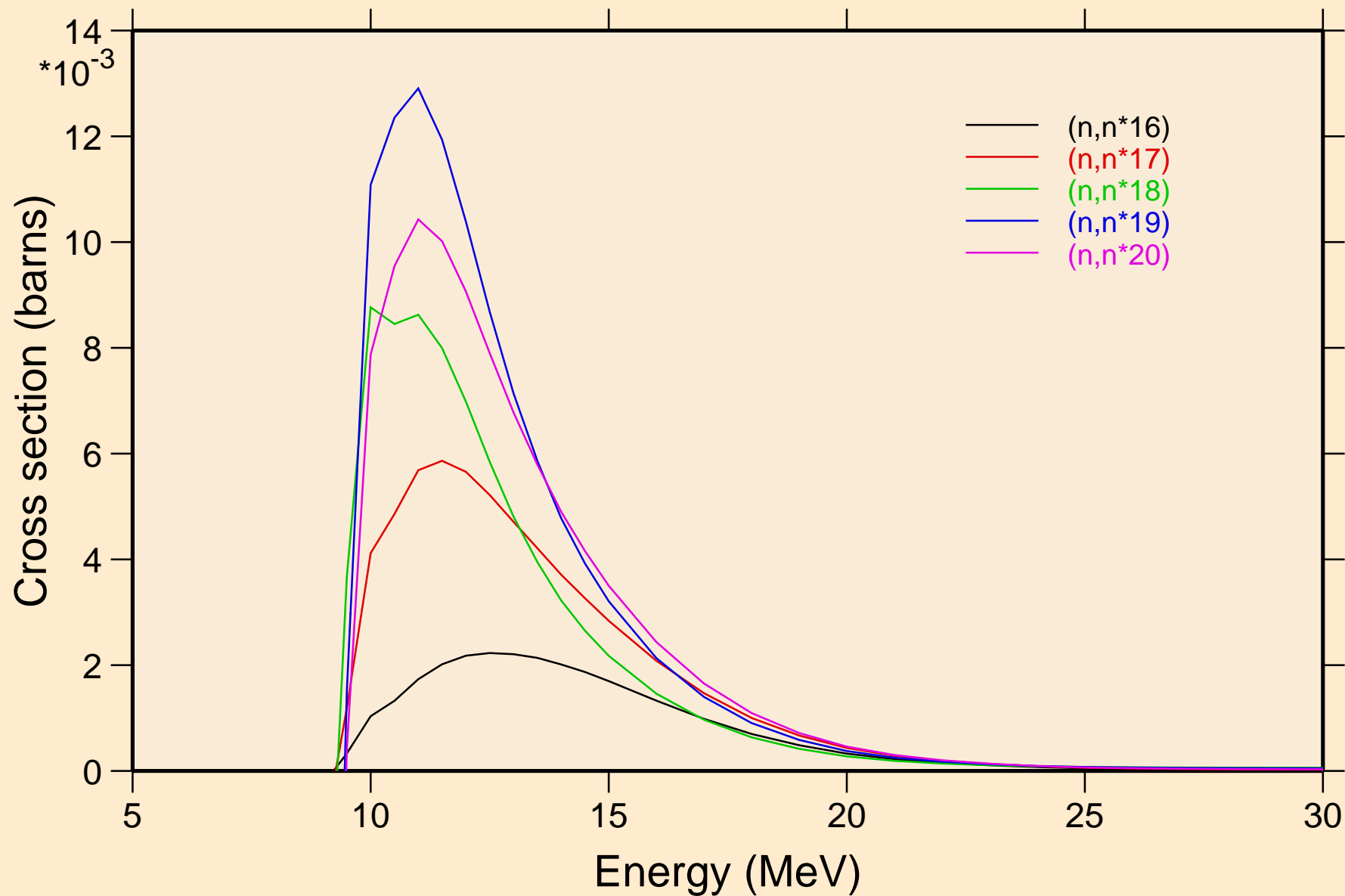

10-NE-20 FOR FENDL-3.2 FROM TENDL-2019 BY NJOY2016.60+
Inelastic levels

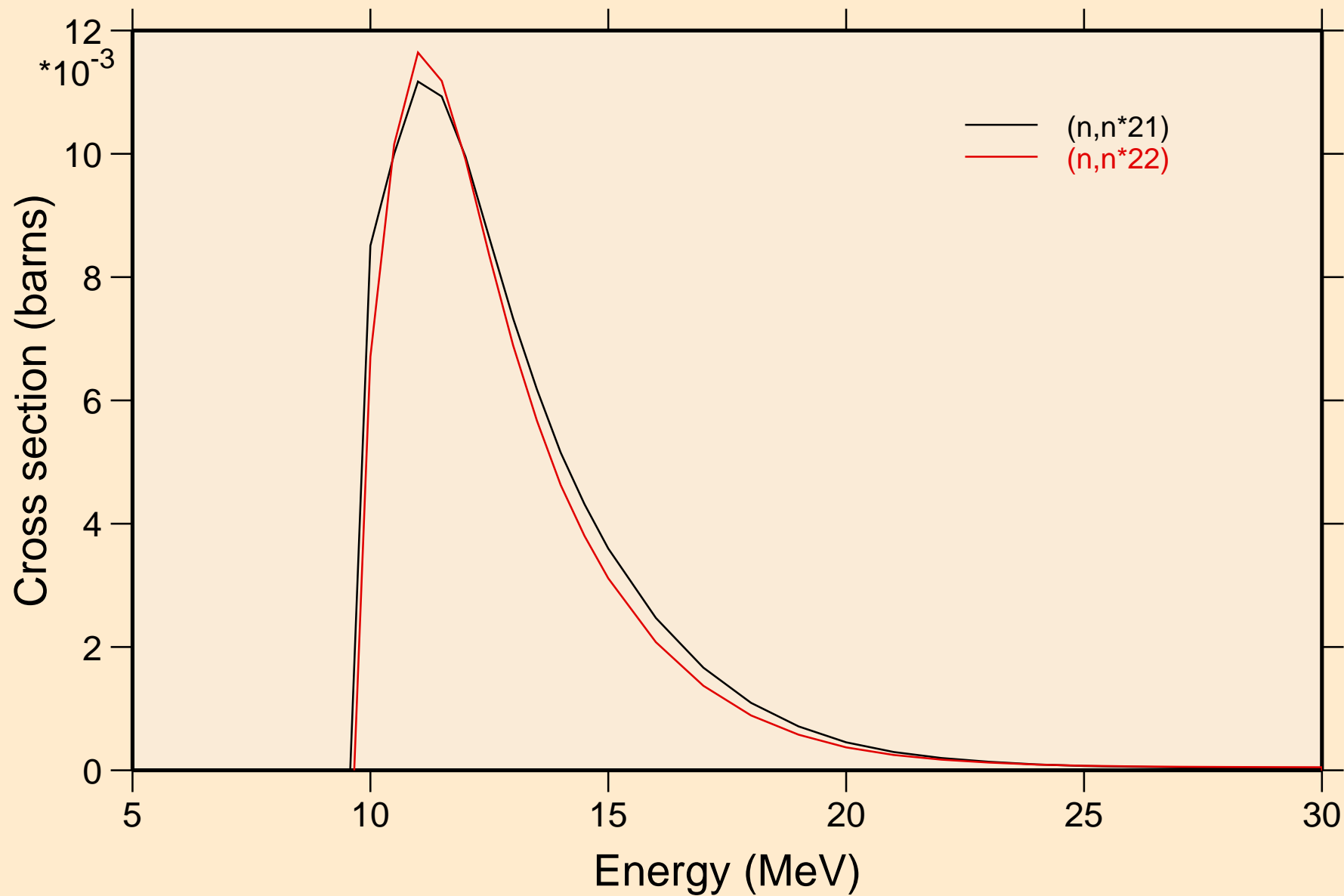

10-NE-20 FOR FENDL-3.2 FROM TENDL-2019 BY NJOY2016.60+
Threshold reactions

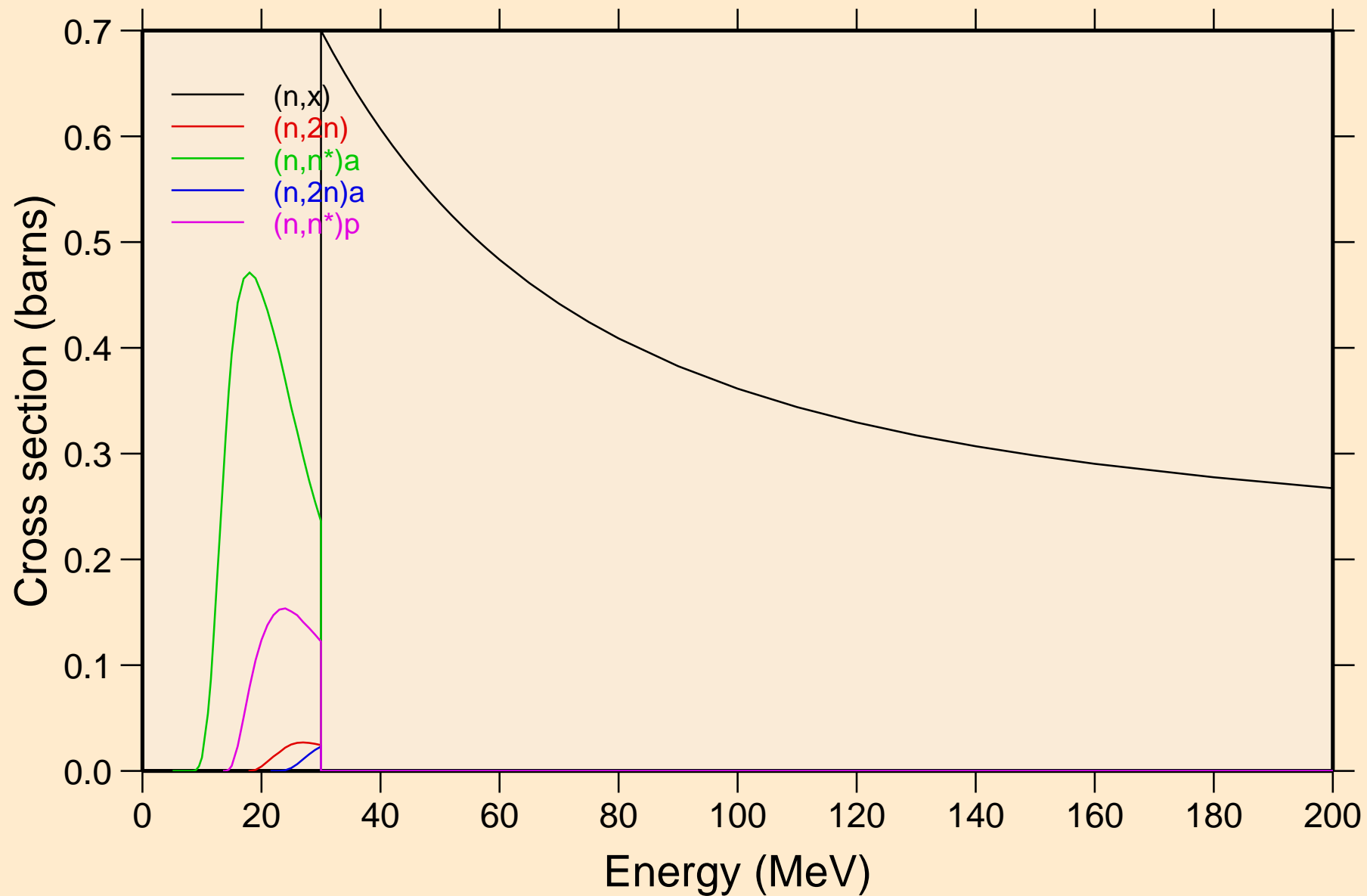

10-NE-20 FOR FENDL-3.2 FROM TENDL-2019 BY NJOY2016.60+
Threshold reactions

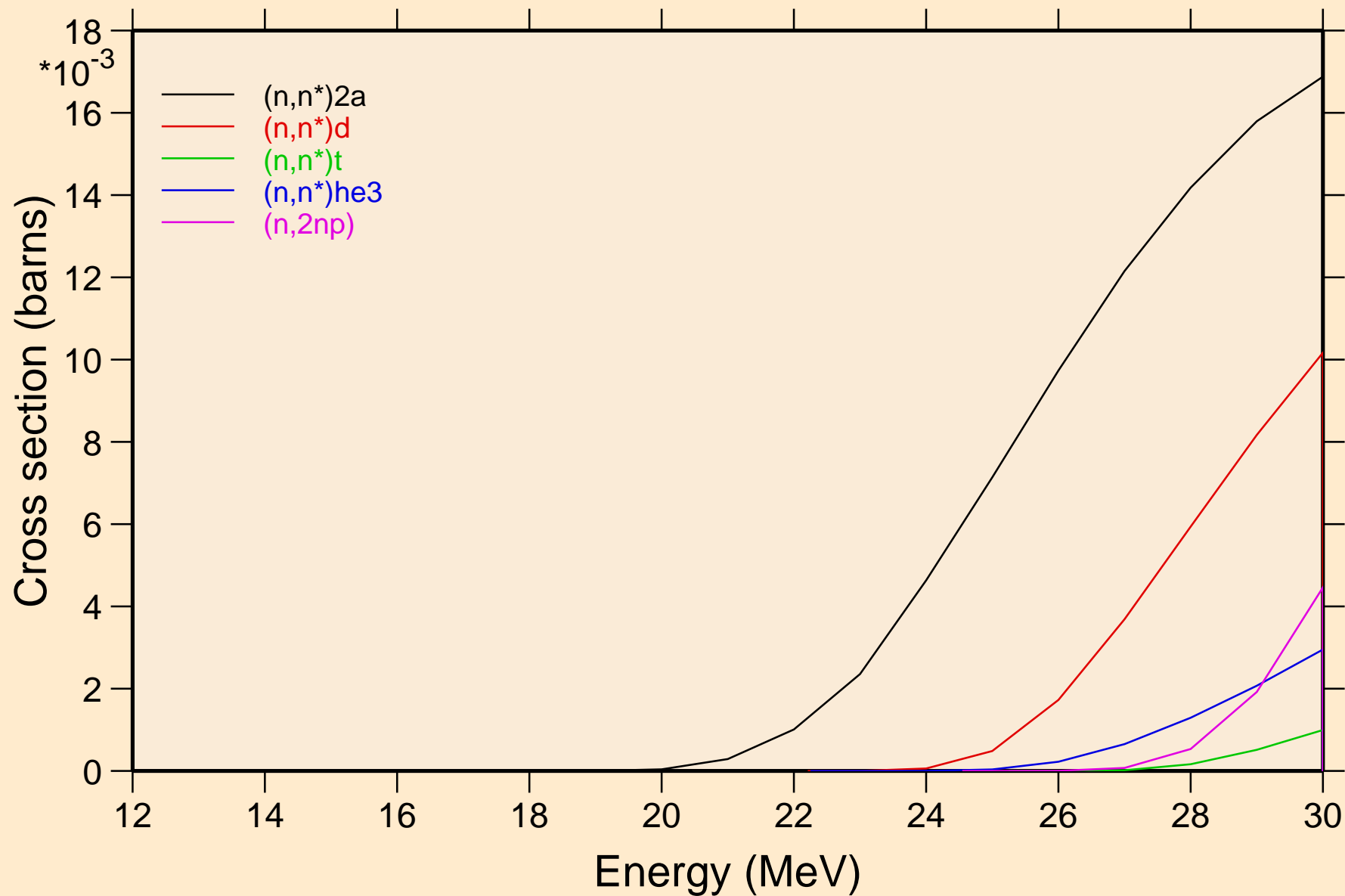

10-NE-20 FOR FENDL-3.2 FROM TENDL-2019 BY NJOY2016.60+

Threshold reactions

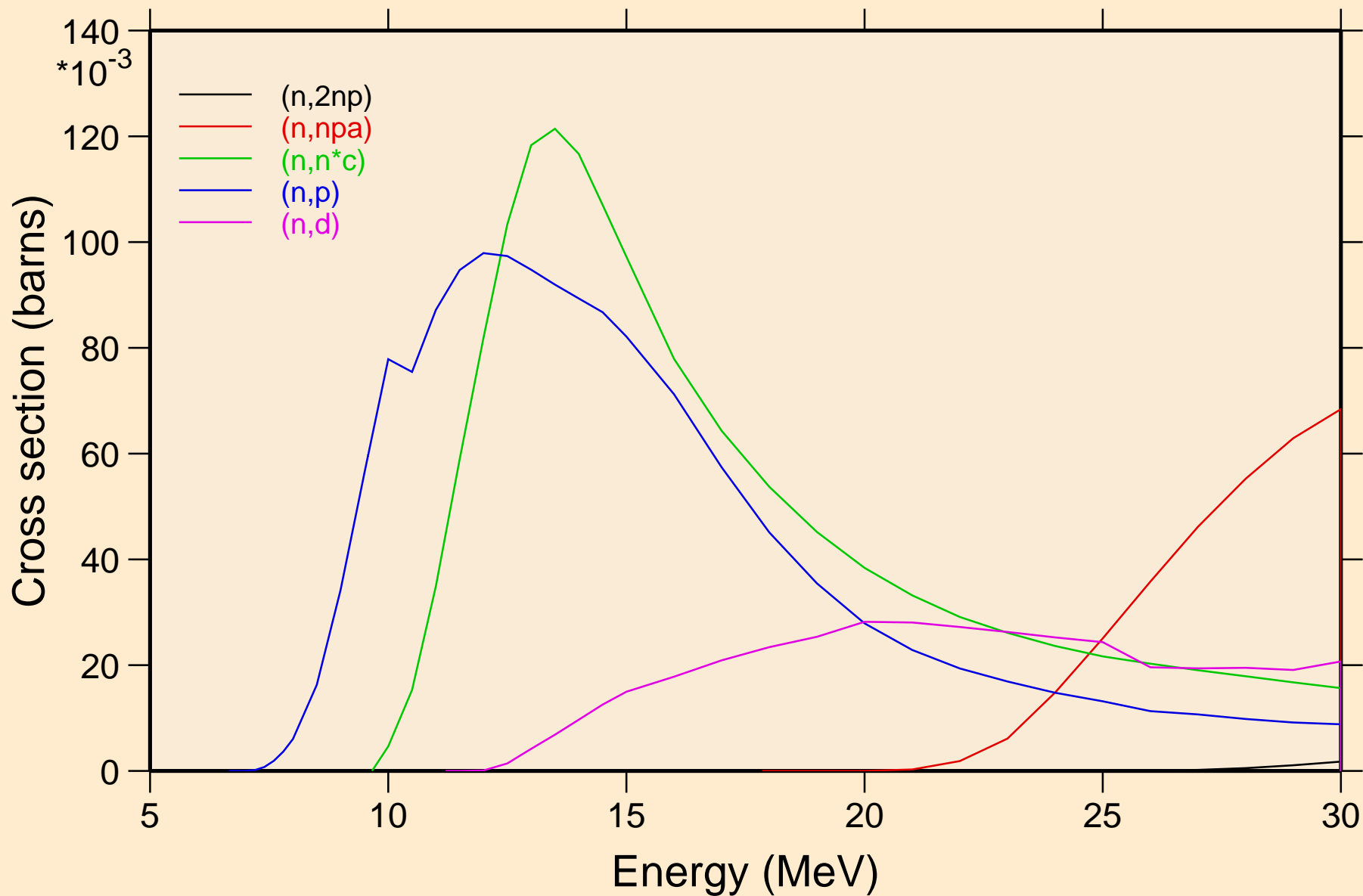

10-NE-20 FOR FENDL-3.2 FROM TENDL-2019 BY NJOY2016.60+
Threshold reactions

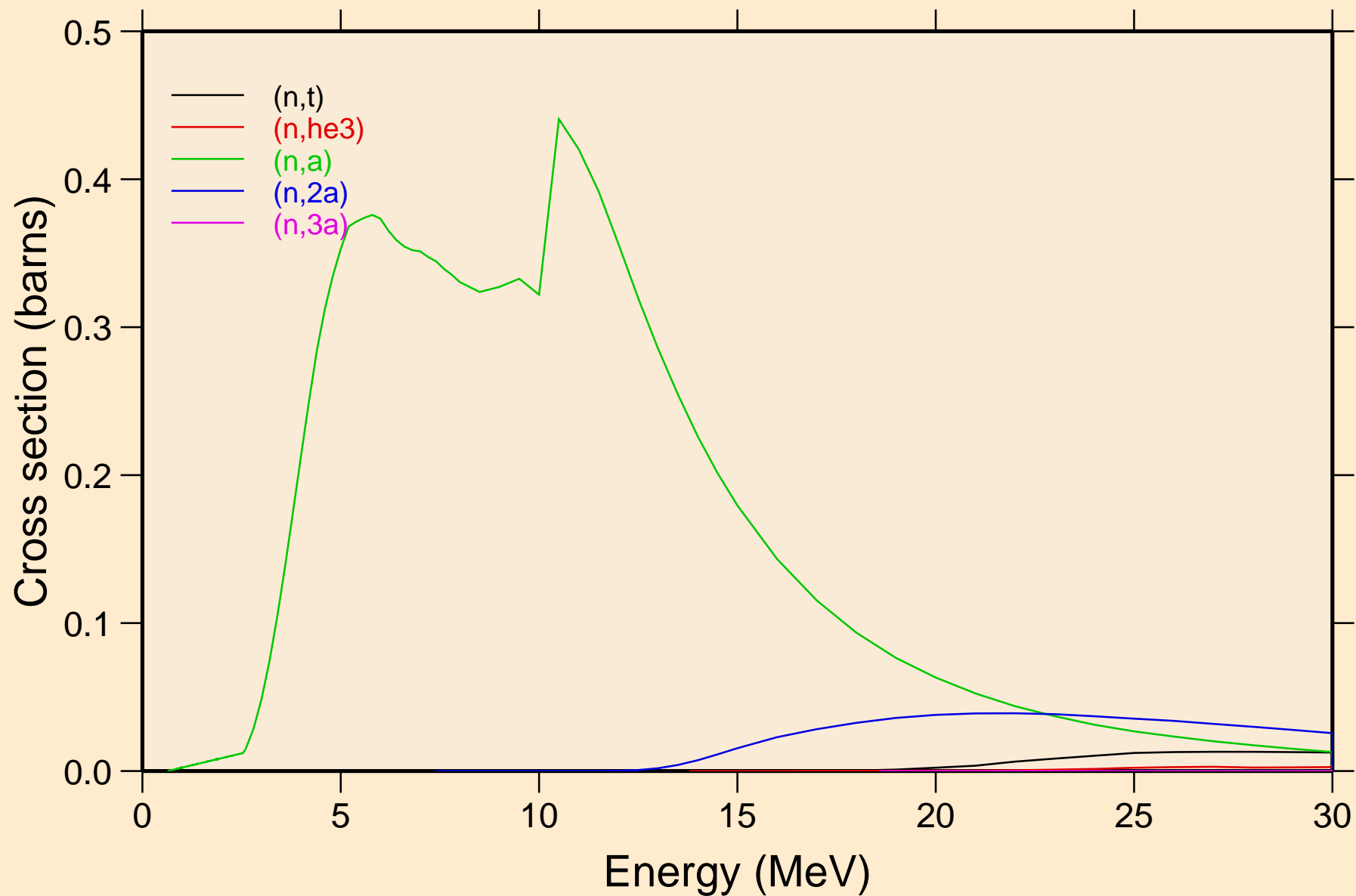

10-NE-20 FOR FENDL-3.2 FROM TENDL-2019 BY NJOY2016.60+

Threshold reactions

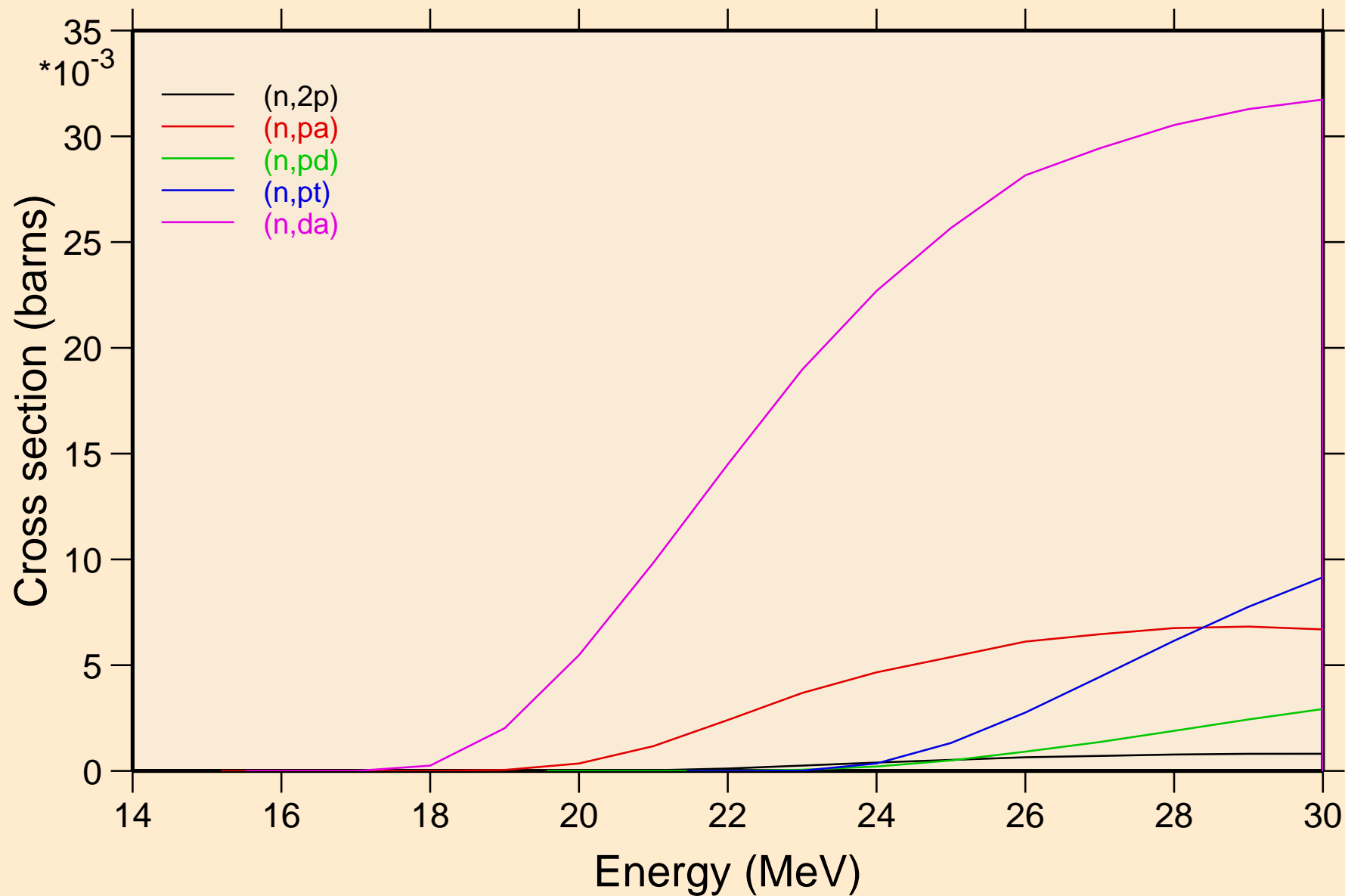

10-NE-20 FOR FENDL-3.2 FROM TENDL-2019 BY NJOY2016.60+

Threshold reactions

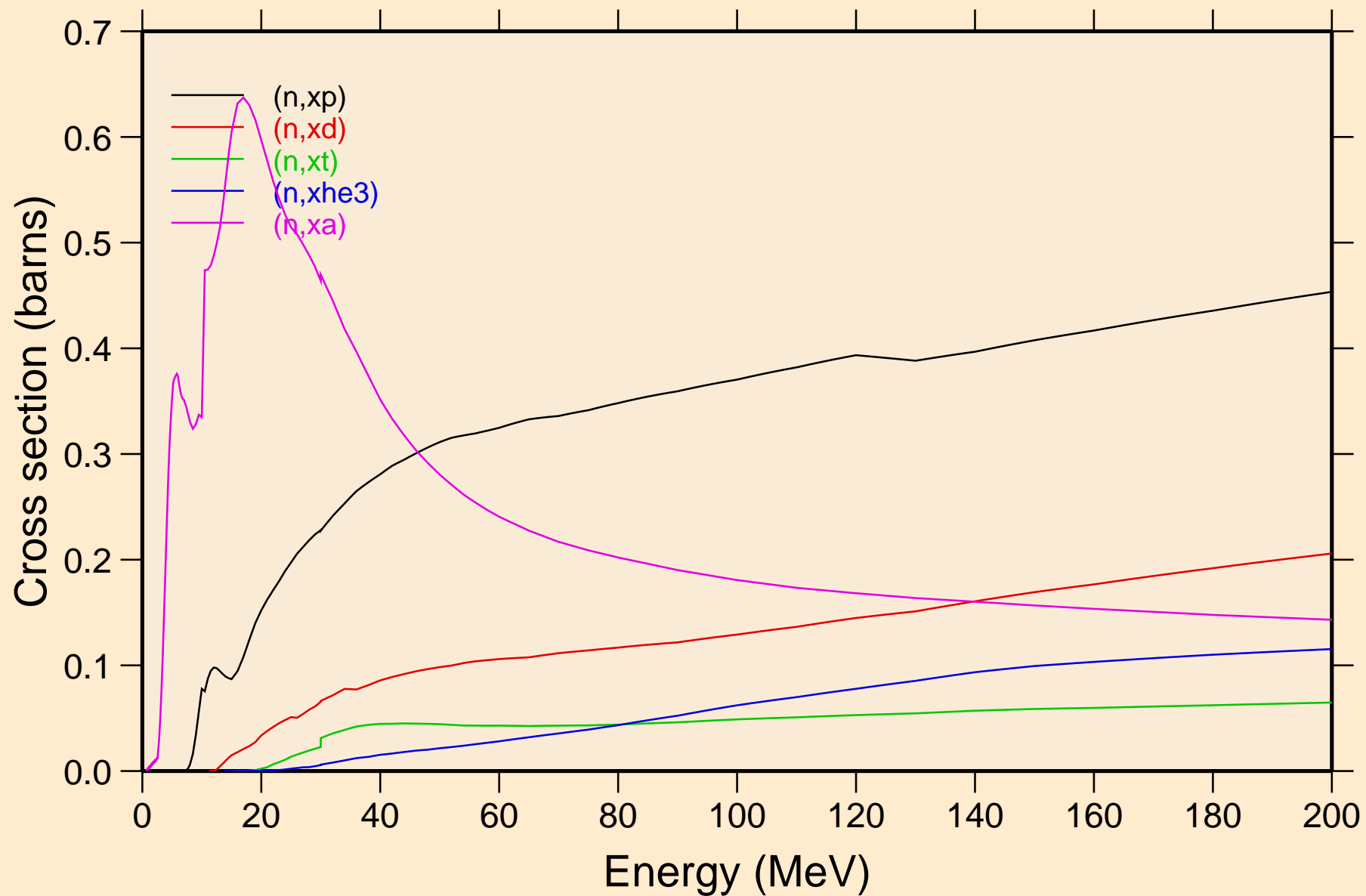

10-NE-20 FOR FENDL-3.2 FROM TENDL-2019 BY NJOY2016.60+
angular distribution for elastic

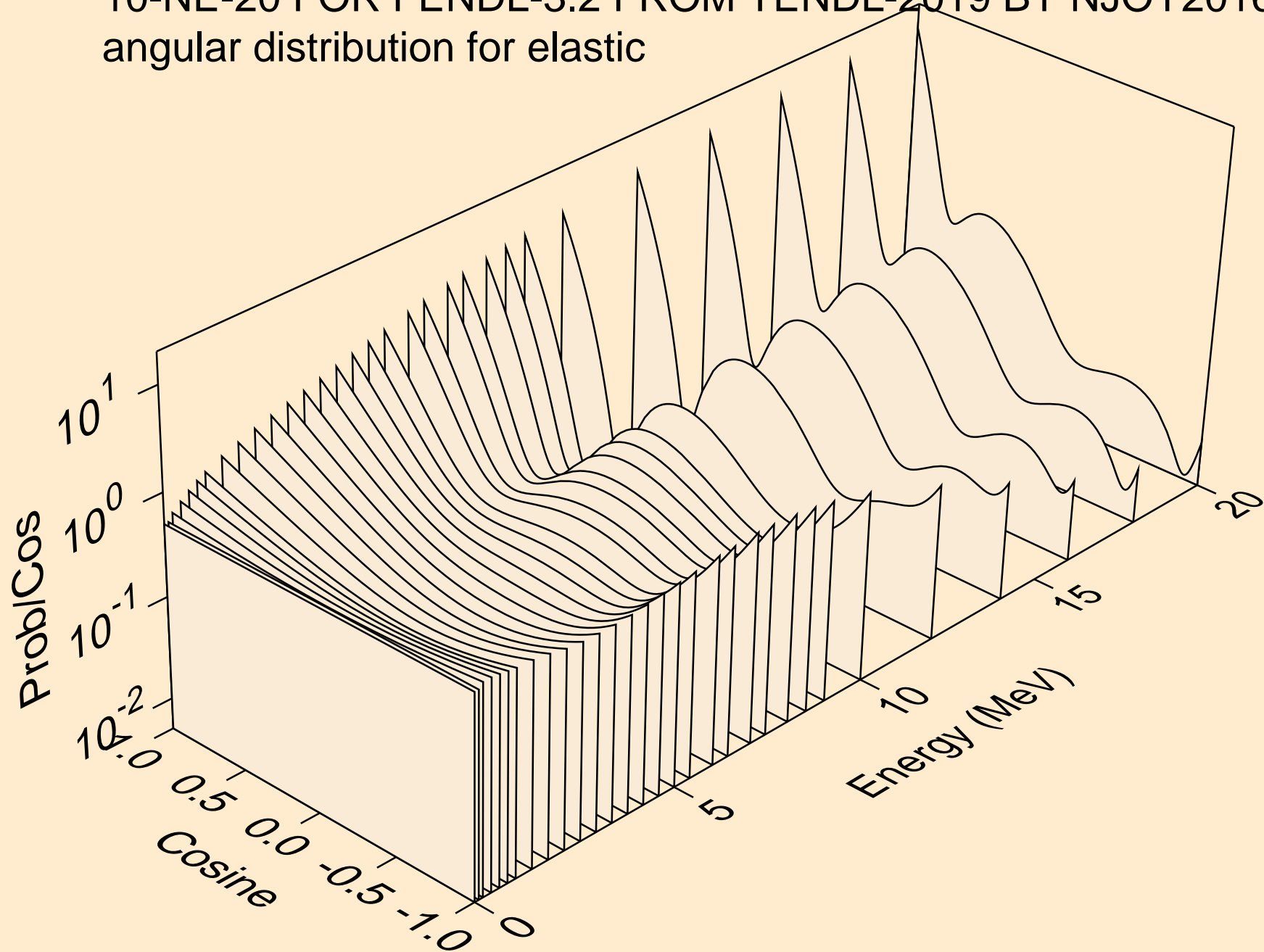

10-NE-20 FOR FENDL-3.2 FROM TENDL-2019 BY NJOY2016.60+
angular distribution for elastic

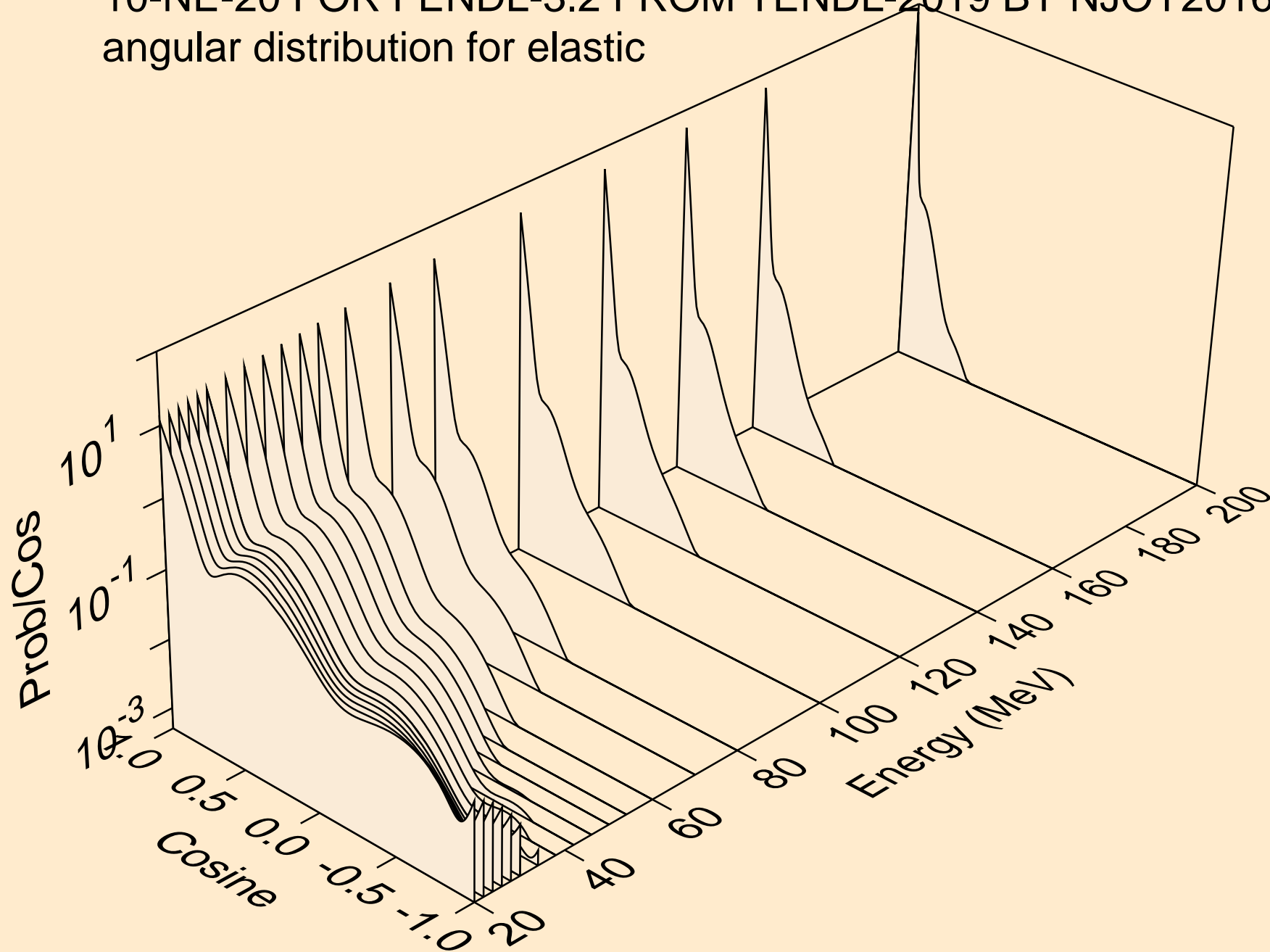

10-NE-20 FOR FENDL-3.2 FROM TENDL-2019 BY NJOY2016.60+
angular distribution for (n,n*1)

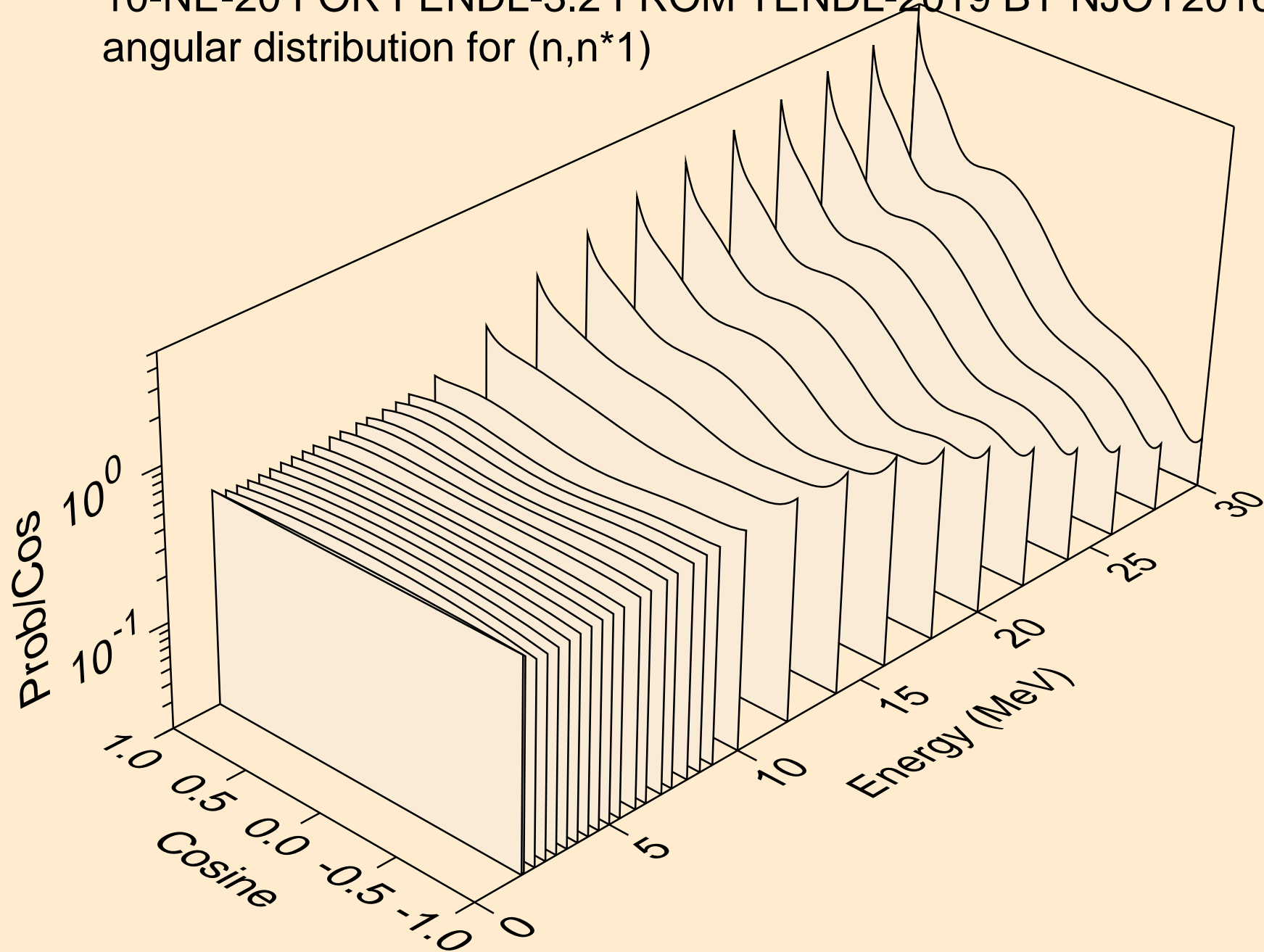

10-NE-20 FOR FENDL-3.2 FROM TENDL-2019 BY NJOY2016.60+
angular distribution for (n,n*2)

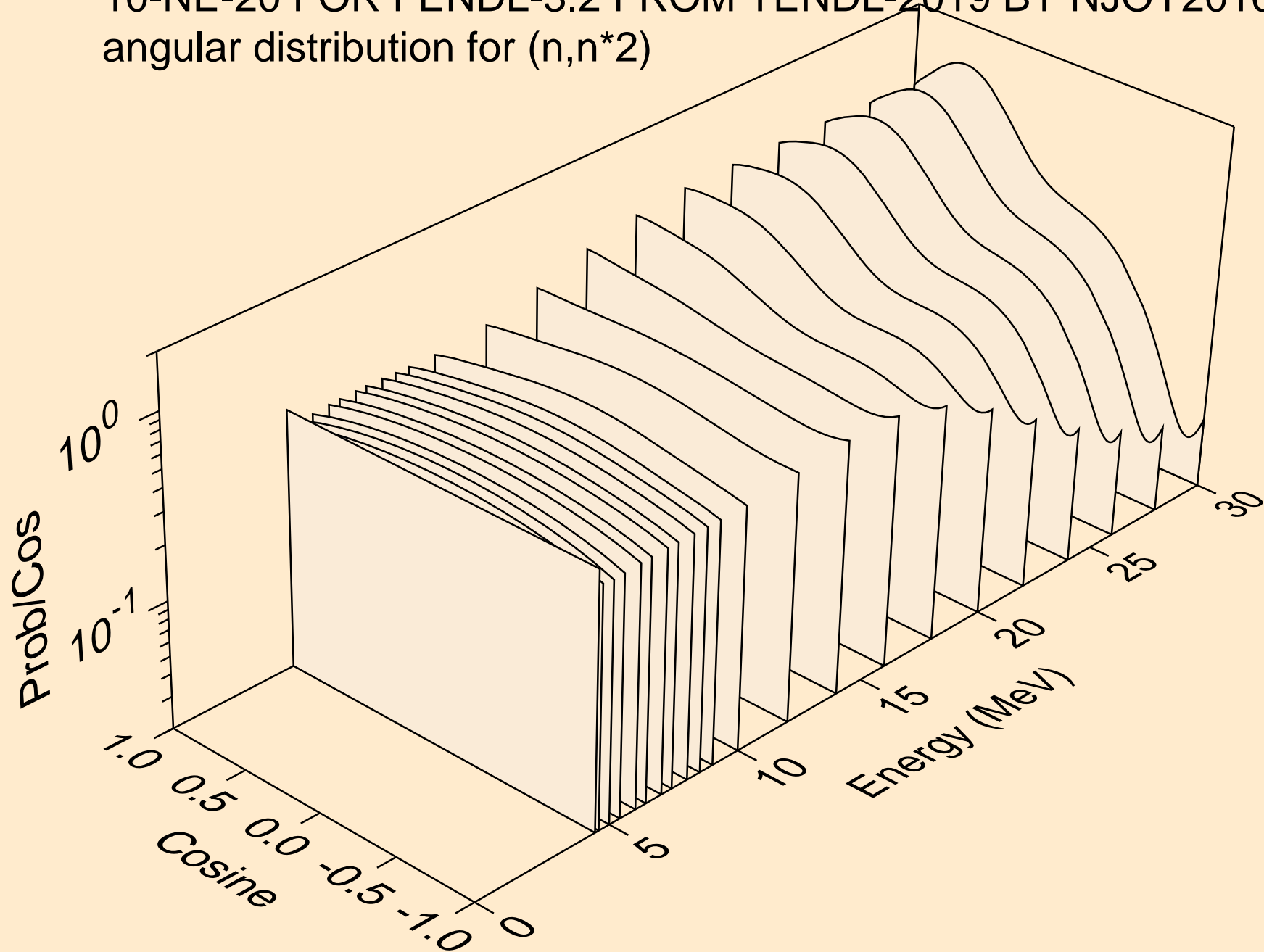

10-NE-20 FOR FENDL-3.2 FROM TENDL-2019 BY NJOY2016.60+
angular distribution for (n,n*3)

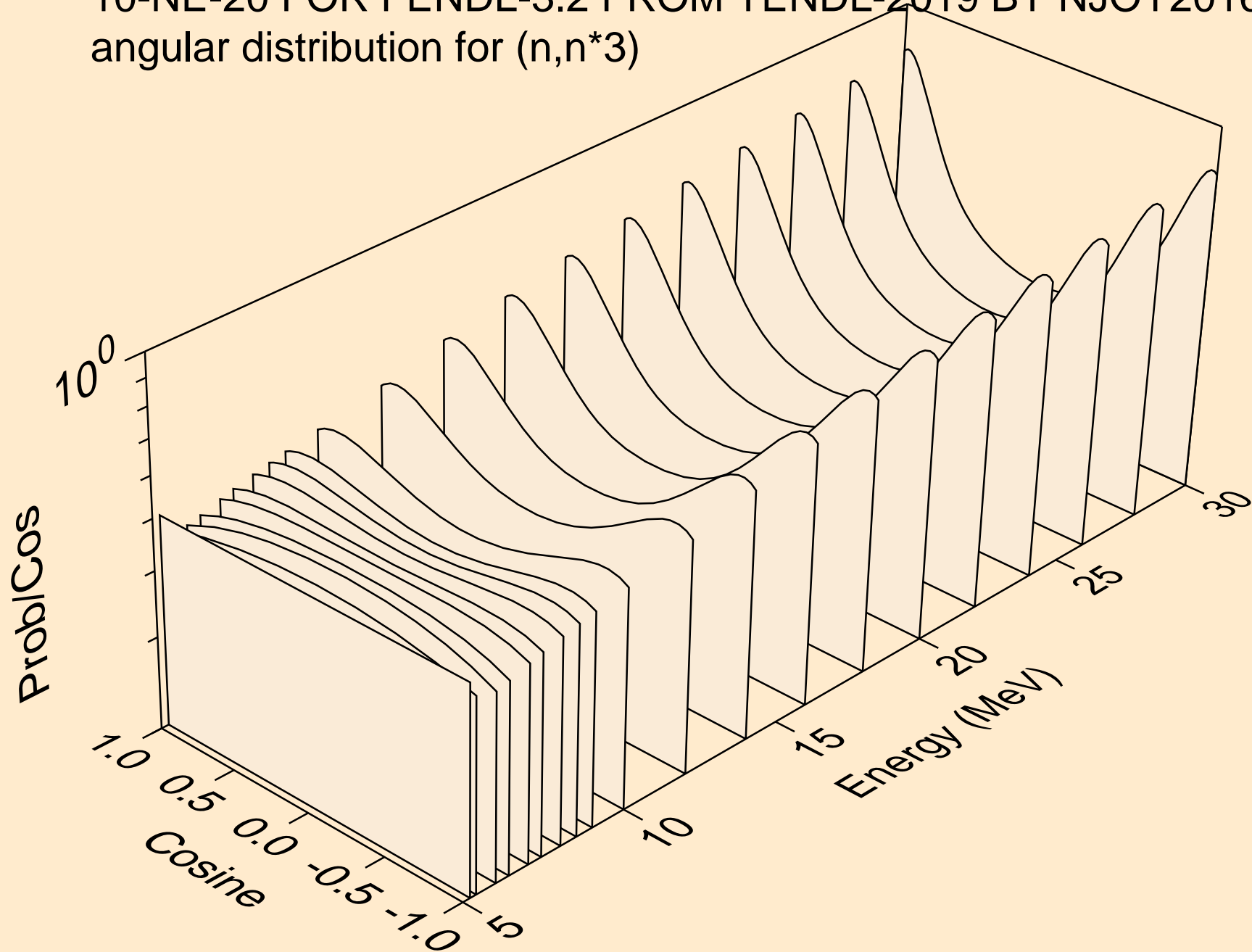

10-NE-20 FOR FENDL-3.2 FROM TENDL-2019 BY NJOY2016.60+
angular distribution for (n,n*4)

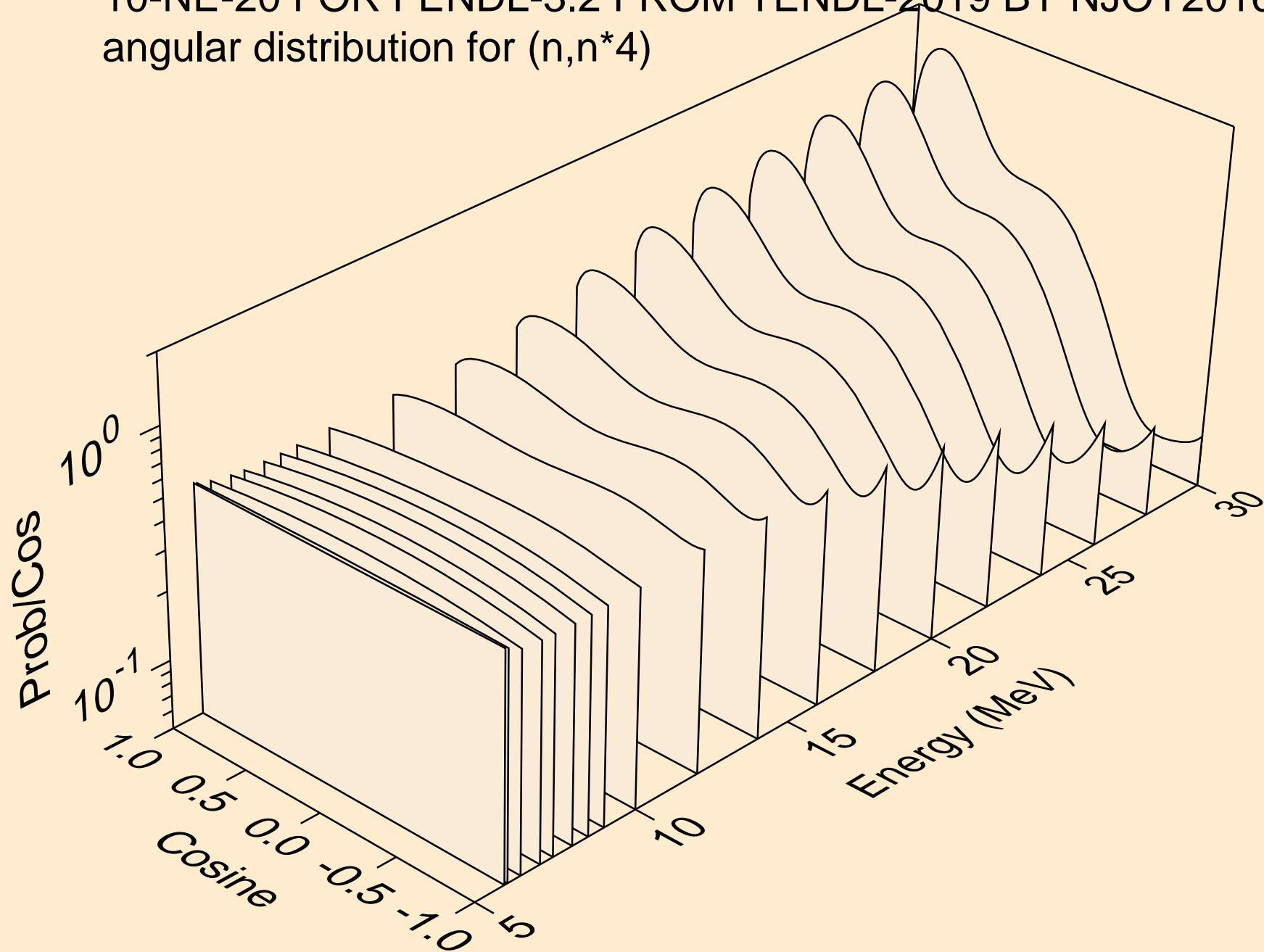

10-NE-20 FOR FENDL-3.2 FROM TENDL-2019 BY NJOY2016.60+
angular distribution for (n,n*5)

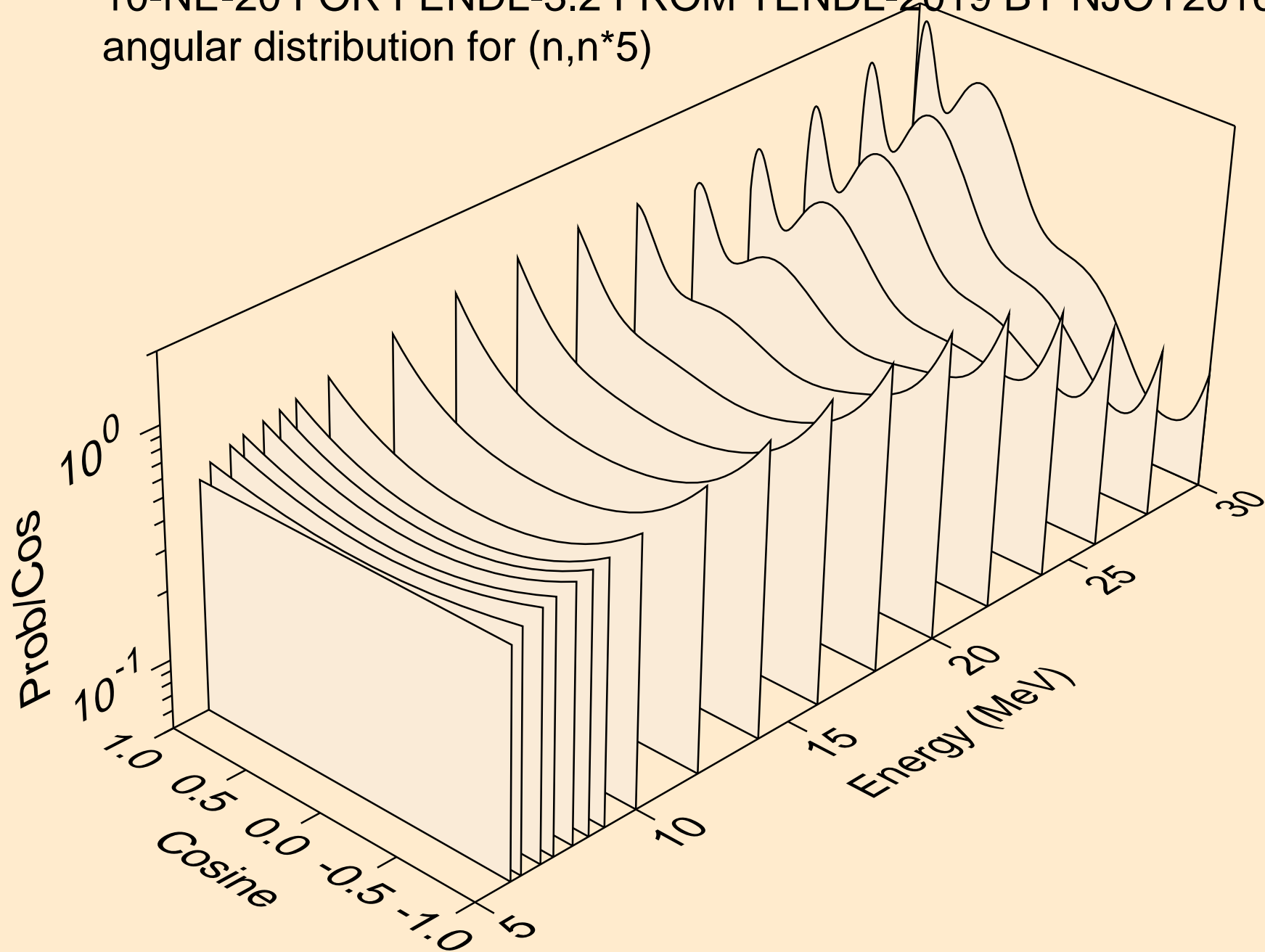

10-NE-20 FOR FENDL-3.2 FROM TENDL-2019 BY NJOY2016.60+
angular distribution for (n,n*6)

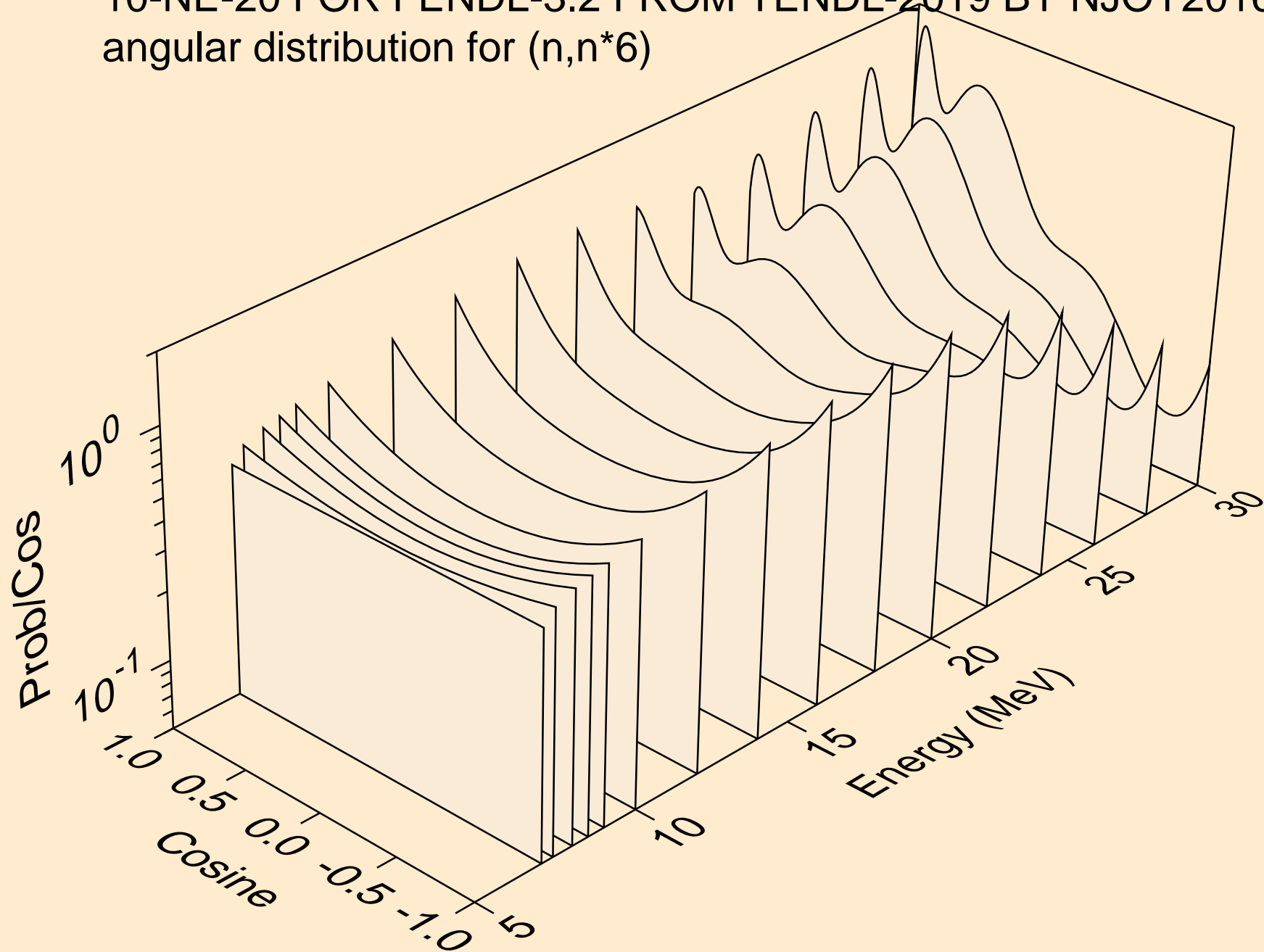

10-NE-20 FOR FENDL-3.2 FROM TENDL-2019 BY NJOY2016.60+
angular distribution for (n,n*7)

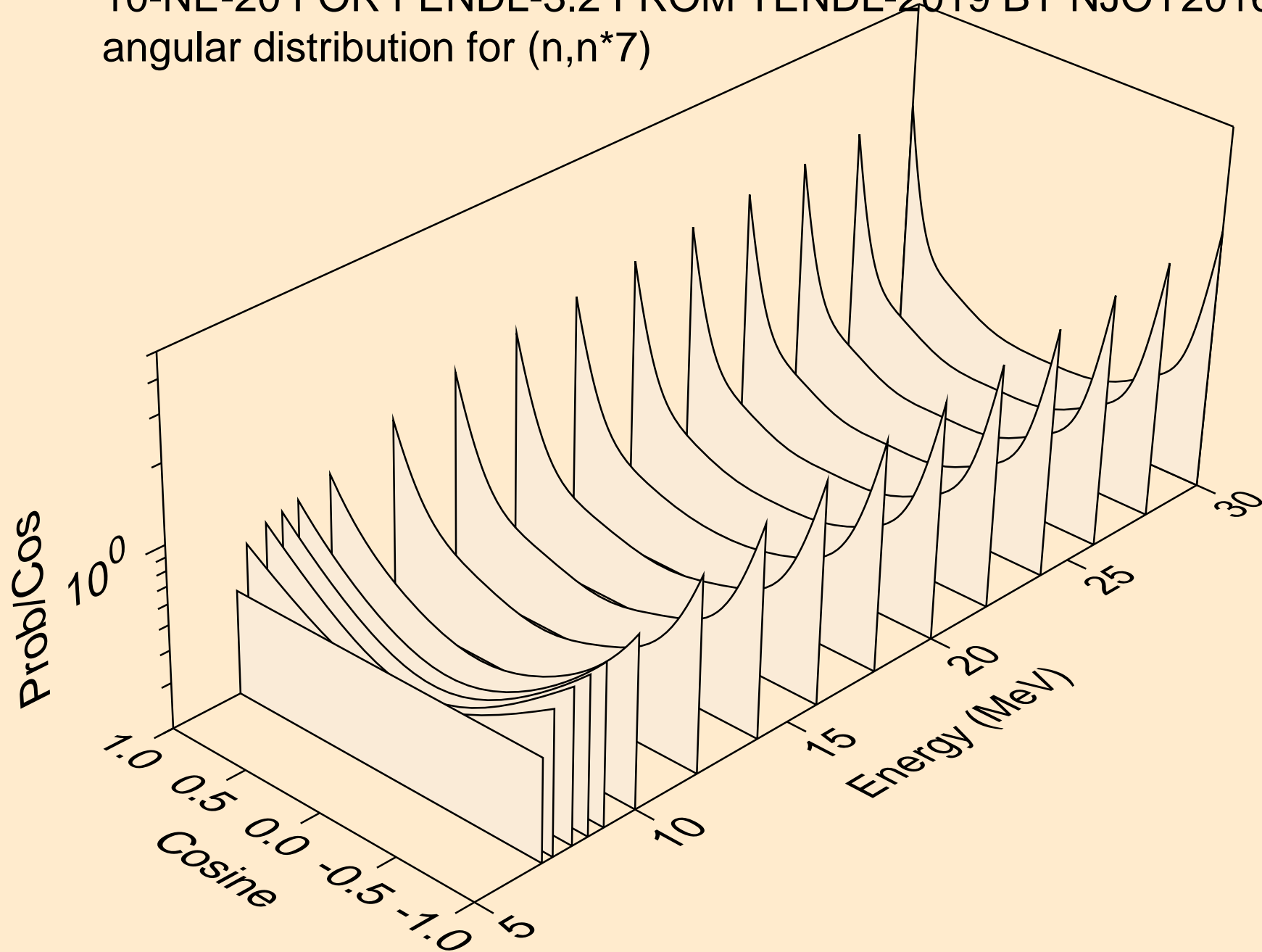

10-NE-20 FOR FENDL-3.2 FROM TENDL-2019 BY NJOY2016.60+
angular distribution for (n,n*8)

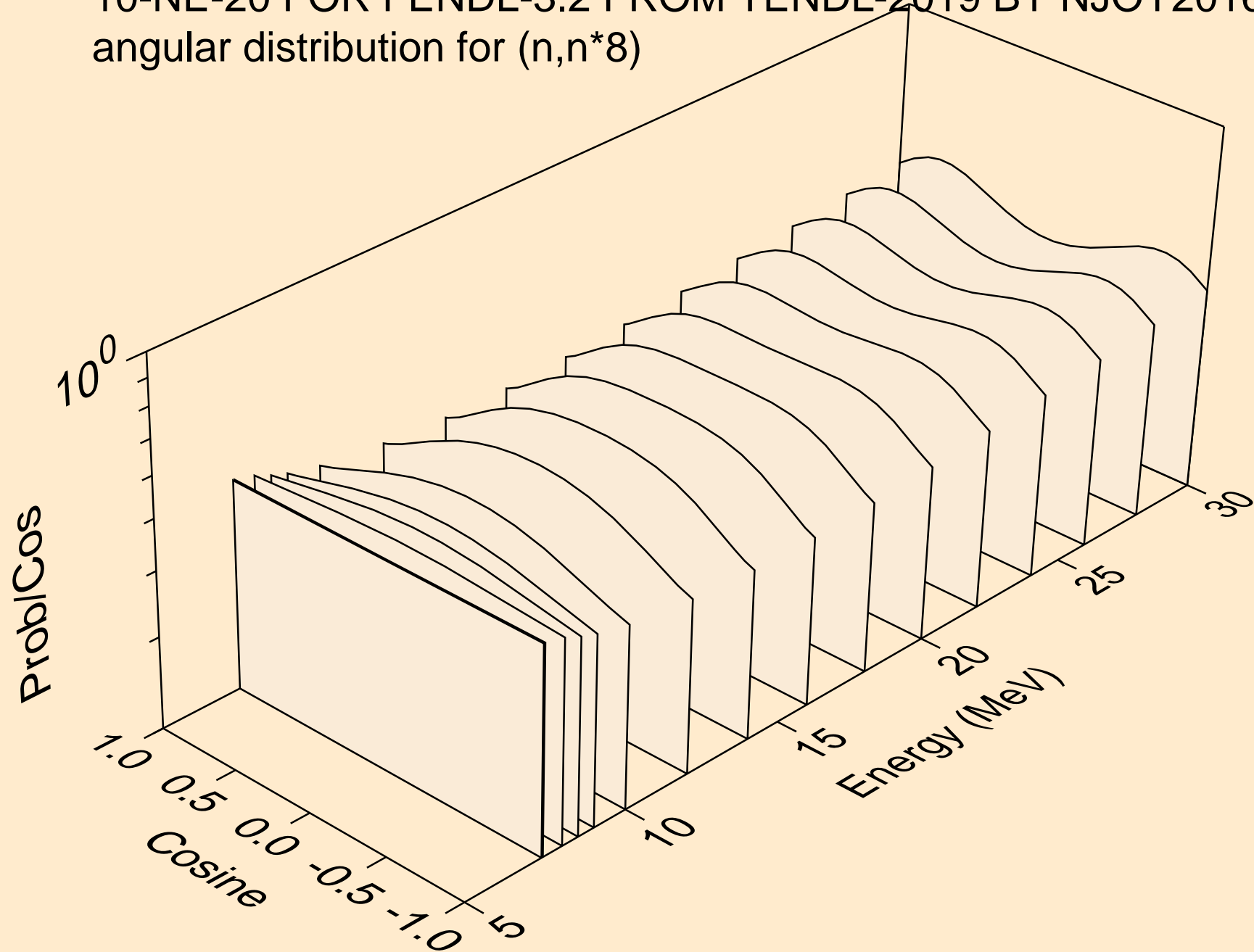

10-NE-20 FOR FENDL-3.2 FROM TENDL-2019 BY NJOY2016.60+
angular distribution for (n,n*9)

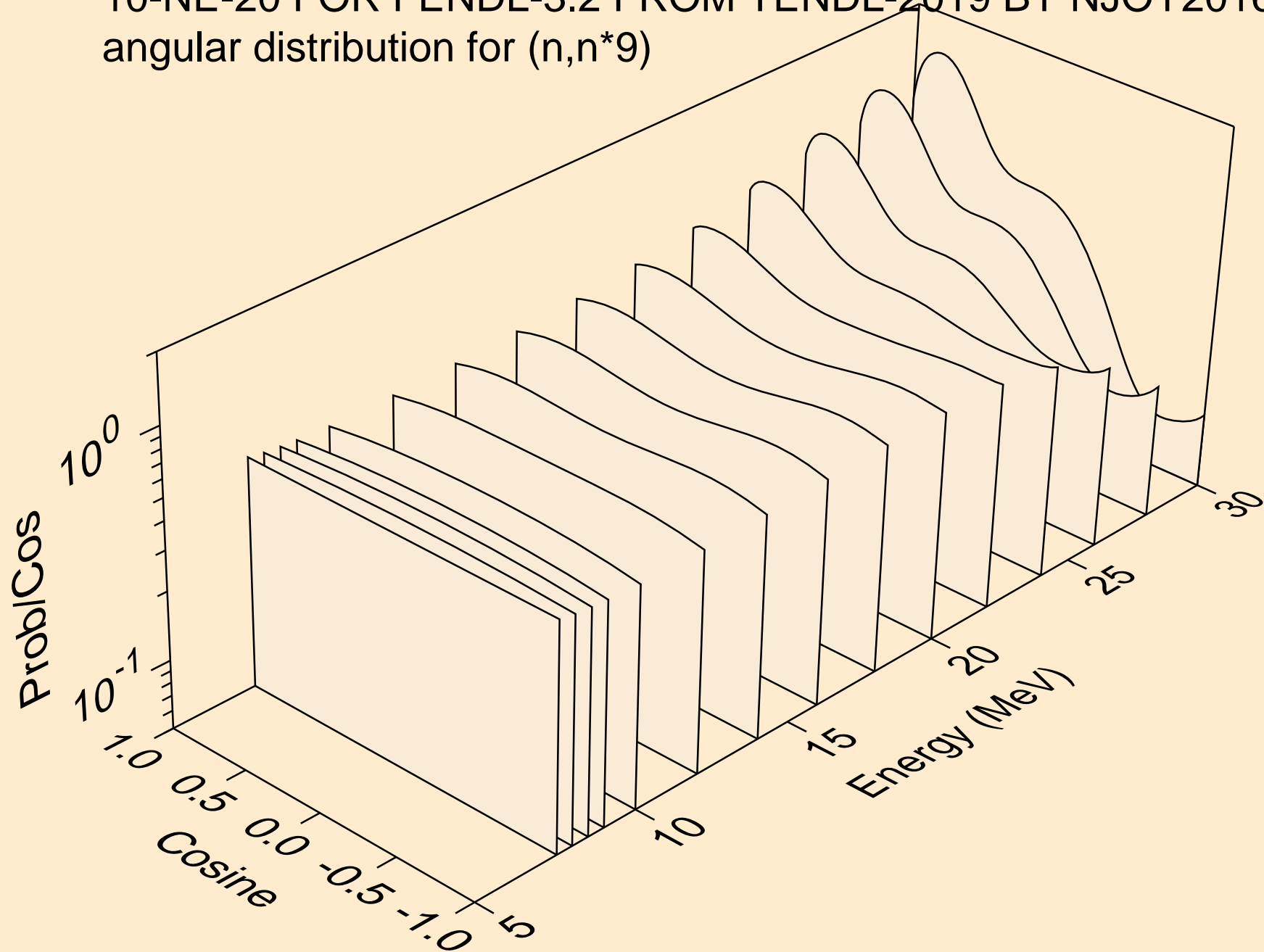

10-NE-20 FOR FENDL-3.2 FROM TENDL-2019 BY NJOY2016.60+
angular distribution for (n,n*10)

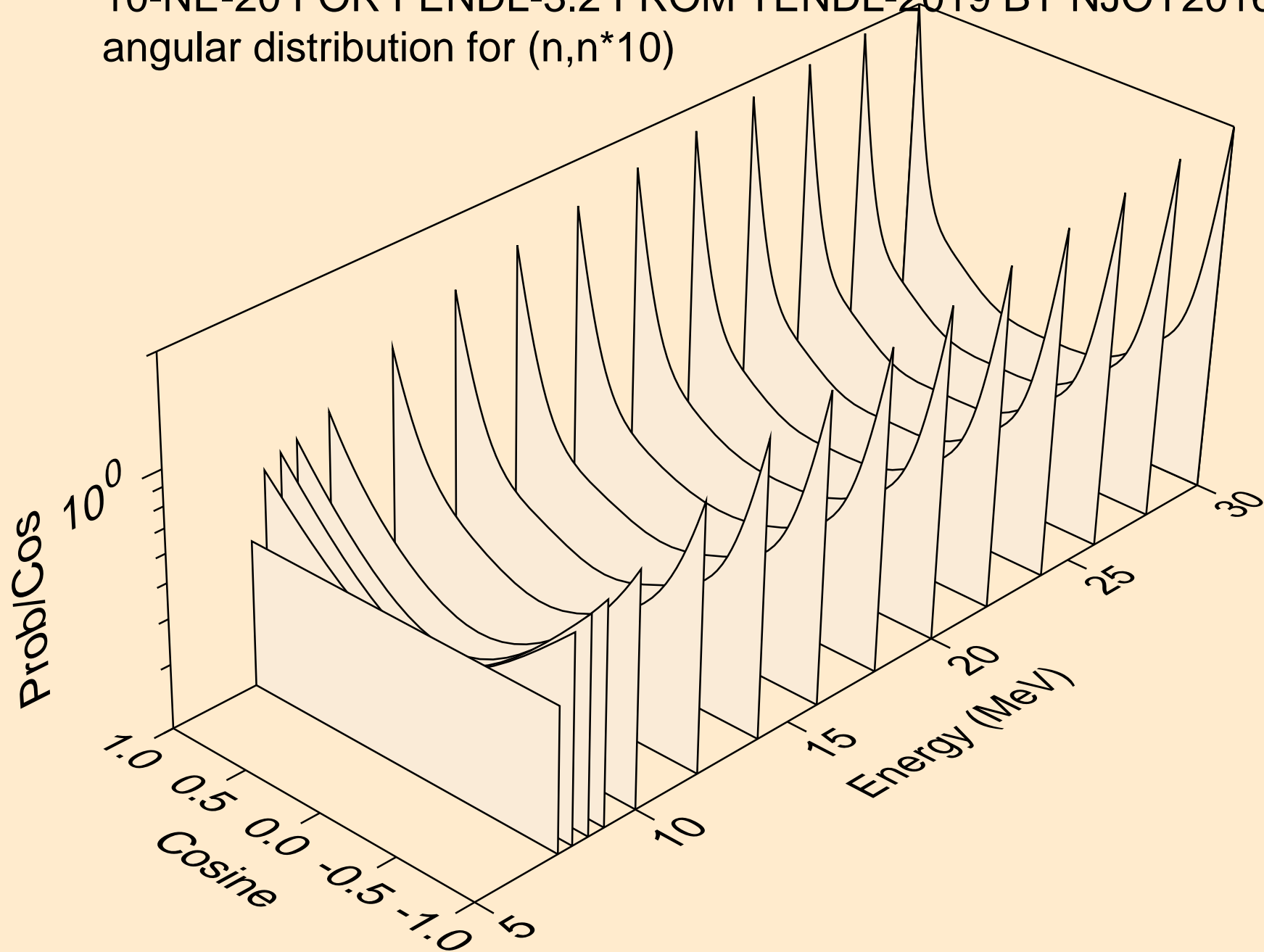

10-NE-20 FOR FENDL-3.2 FROM TENDL-2019 BY NJOY2016.60+
angular distribution for (n,n*11)

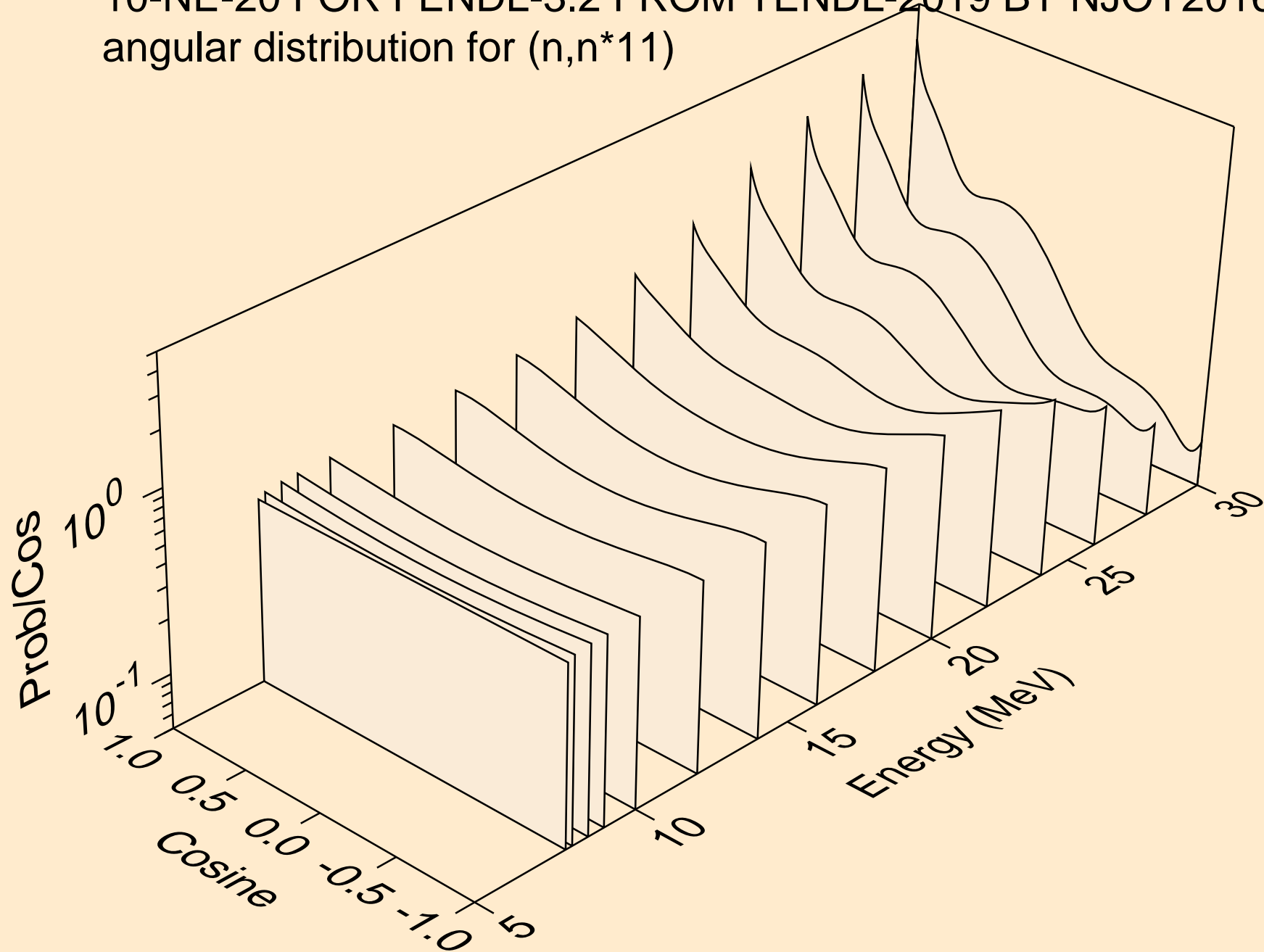

10-NE-20 FOR FENDL-3.2 FROM TENDL-2019 BY NJOY2016.60+
angular distribution for (n,n*12)

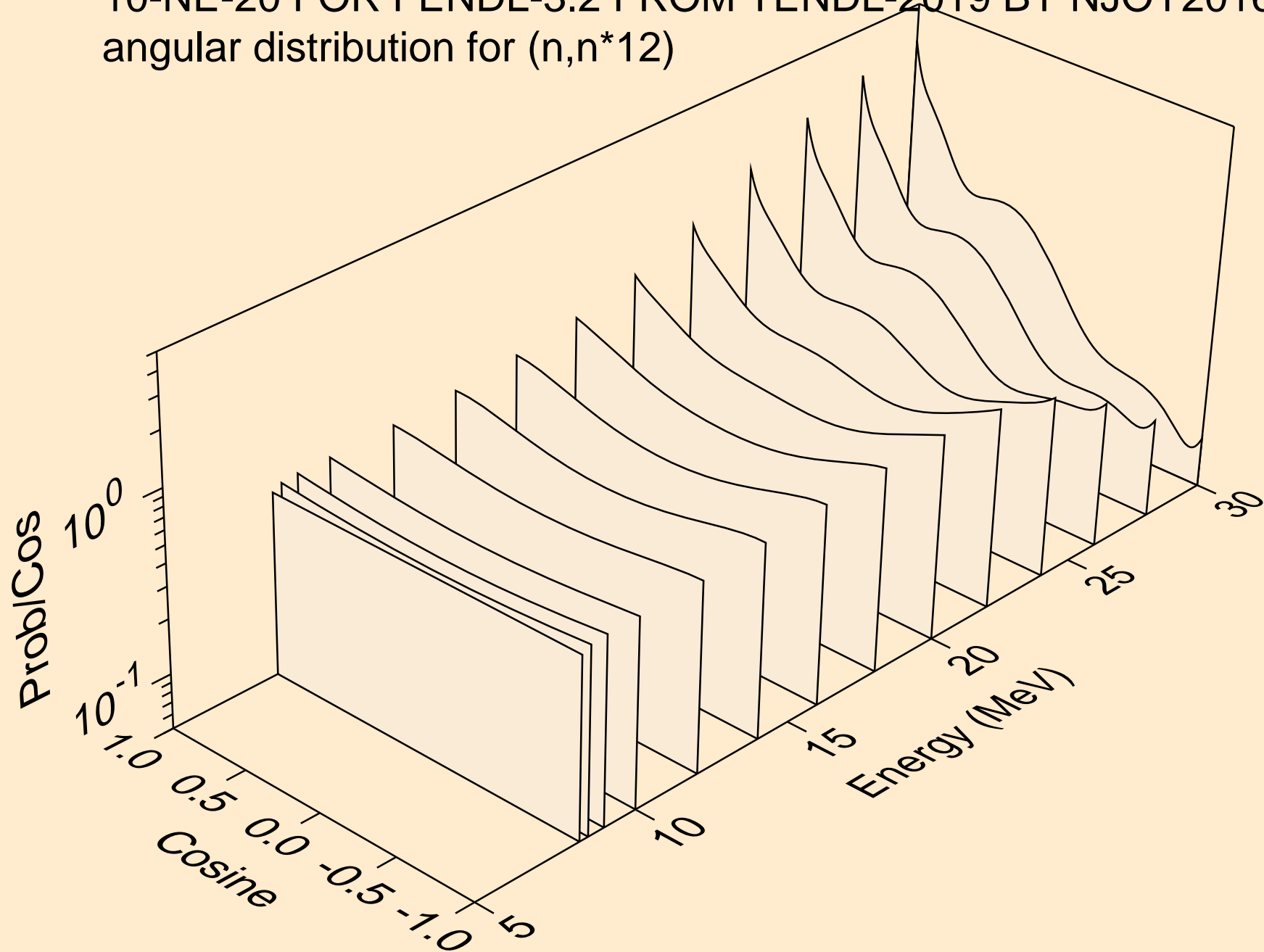

10-NE-20 FOR FENDL-3.2 FROM TENDL-2019 BY NJOY2016.60+
angular distribution for (n,n*13)

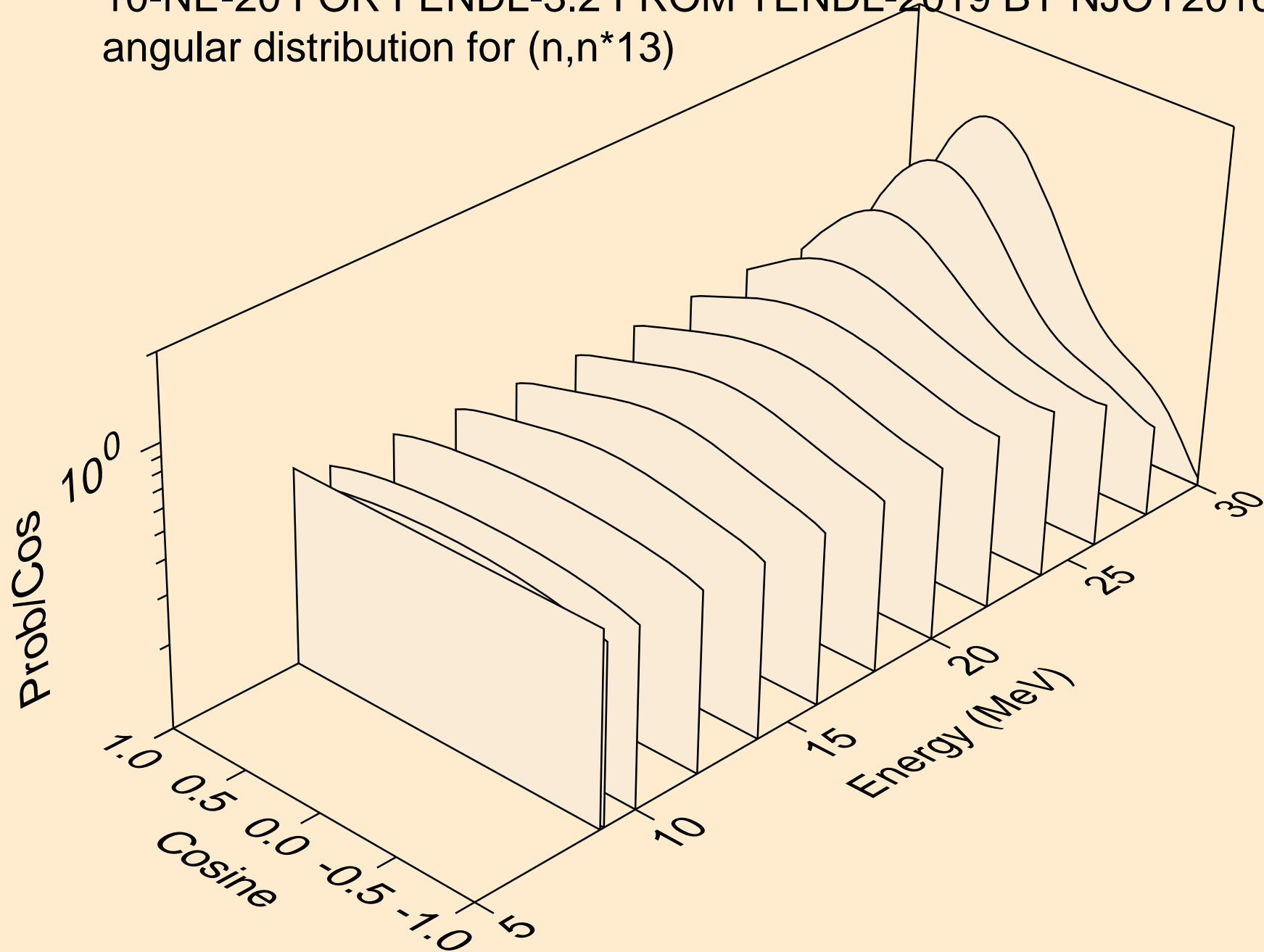

10-NE-20 FOR FENDL-3.2 FROM TENDL-2019 BY NJOY2016.60+
angular distribution for (n,n*14)

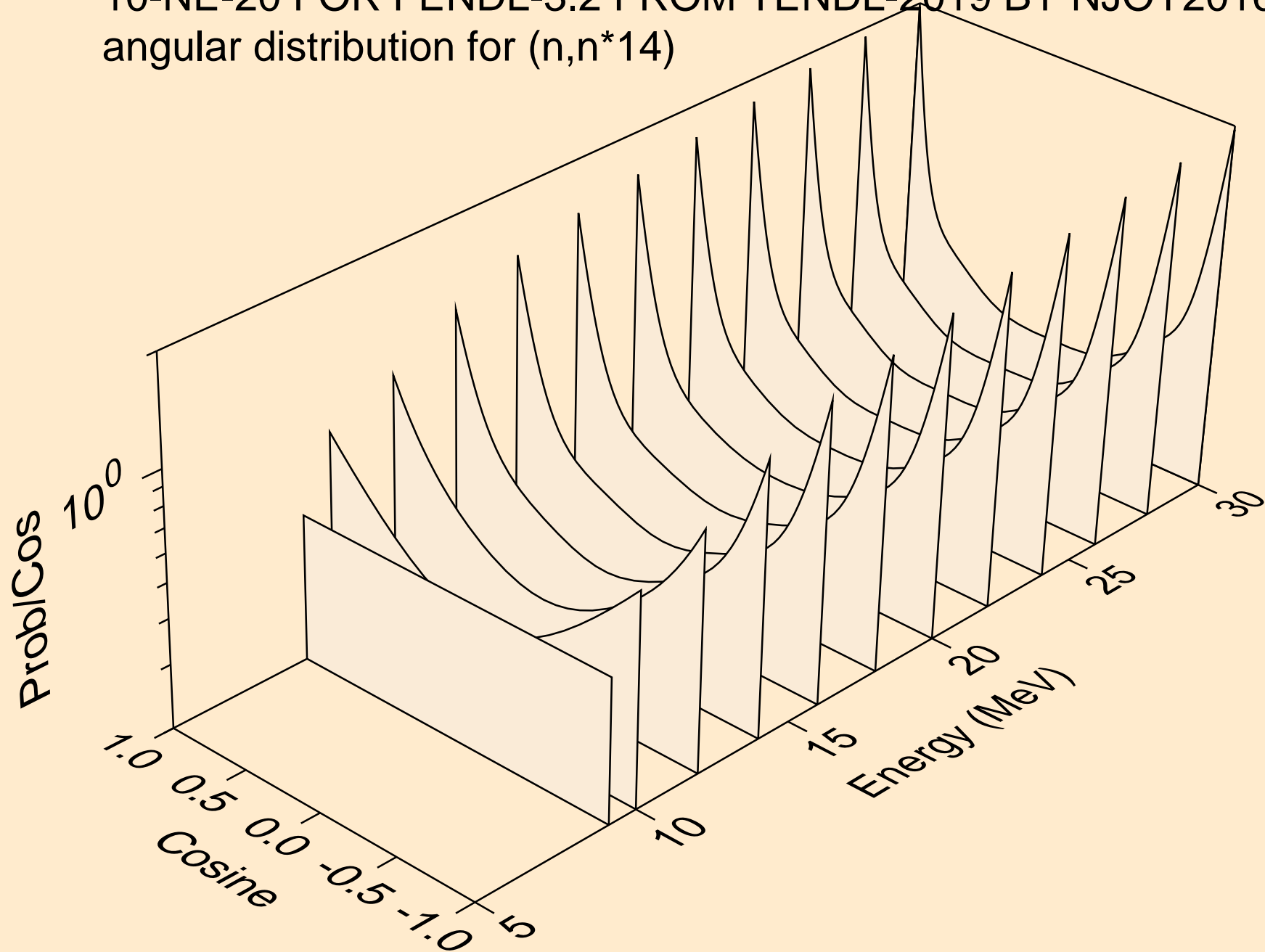

10-NE-20 FOR FENDL-3.2 FROM TENDL-2019 BY NJOY2016.60+
angular distribution for (n,n*15)

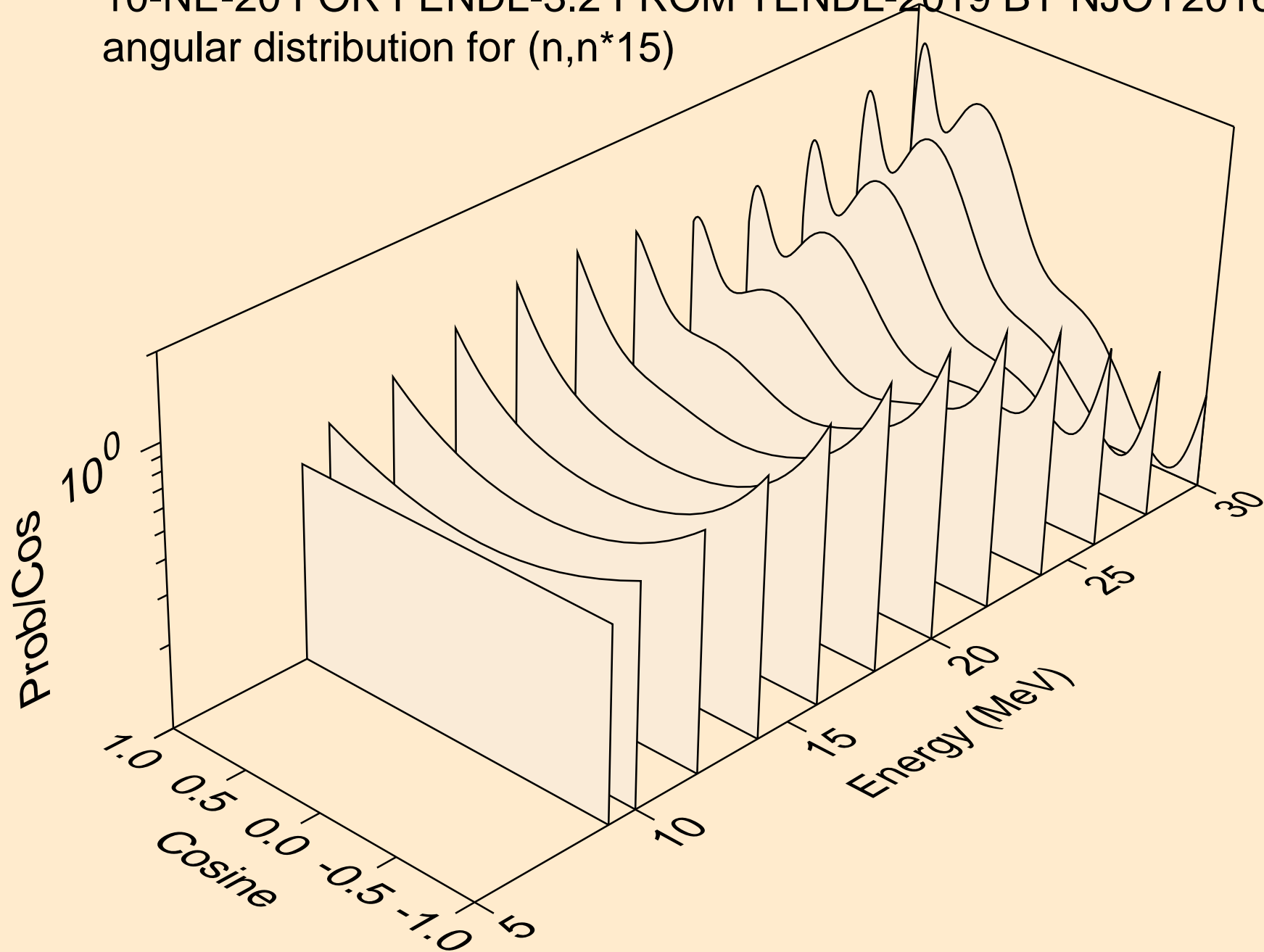

10-NE-20 FOR FENDL-3.2 FROM TENDL-2019 BY NJOY2016.60+
angular distribution for (n,n*16)

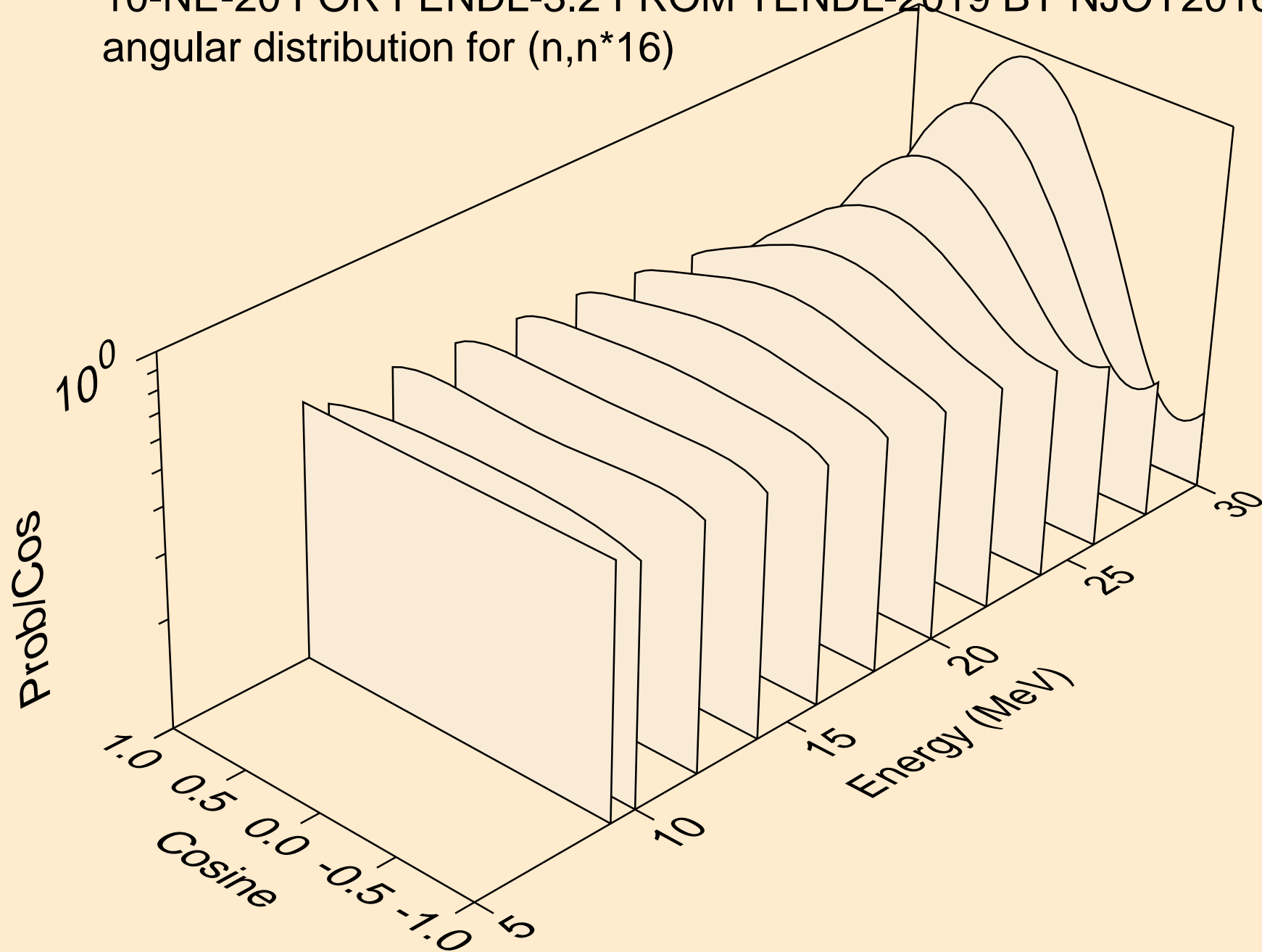

10-NE-20 FOR FENDL-3.2 FROM TENDL-2019 BY NJOY2016.60+
angular distribution for (n,n*17)

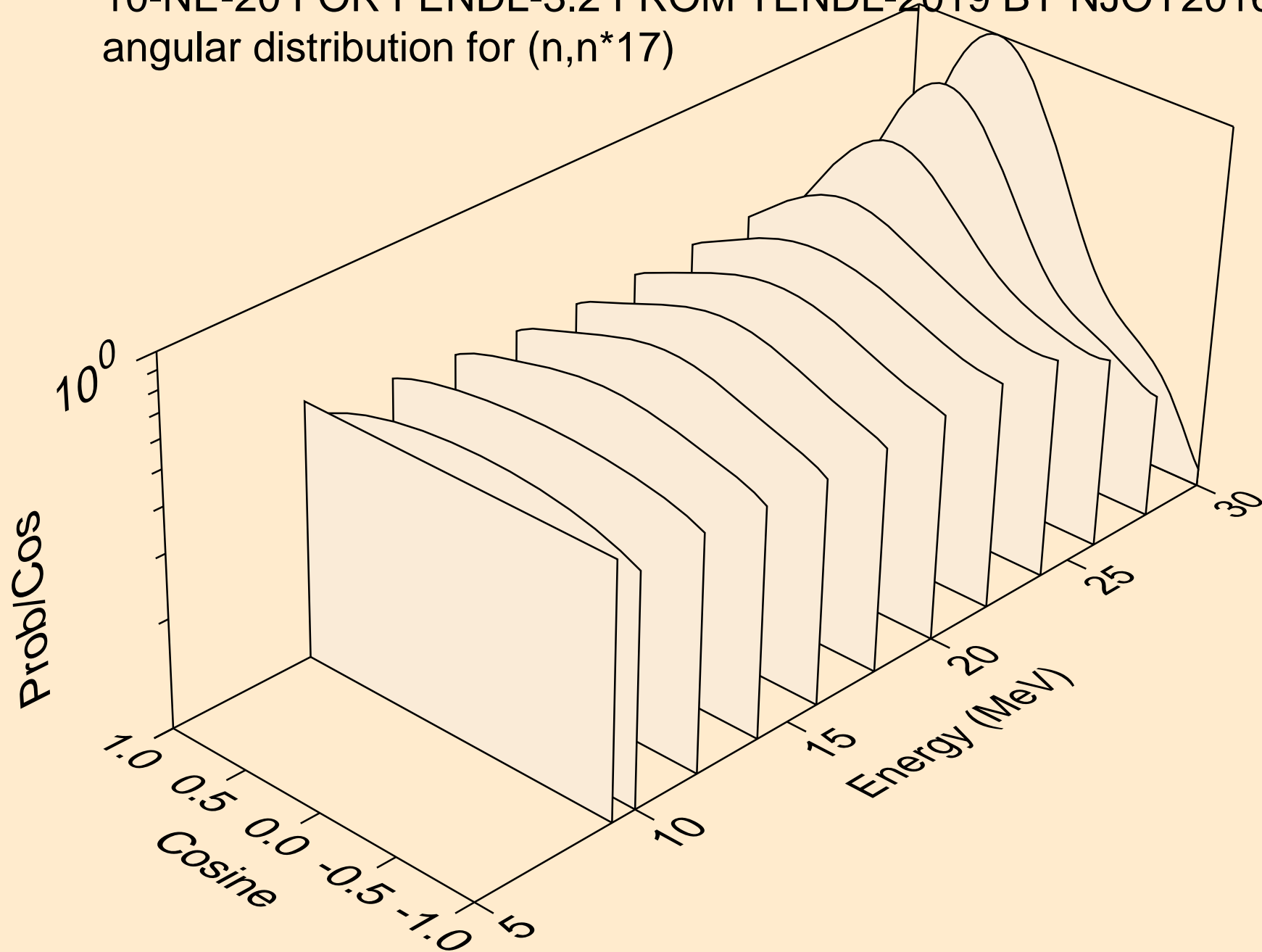

10-NE-20 FOR FENDL-3.2 FROM TENDL-2019 BY NJOY2016.60+
angular distribution for (n,n*18)

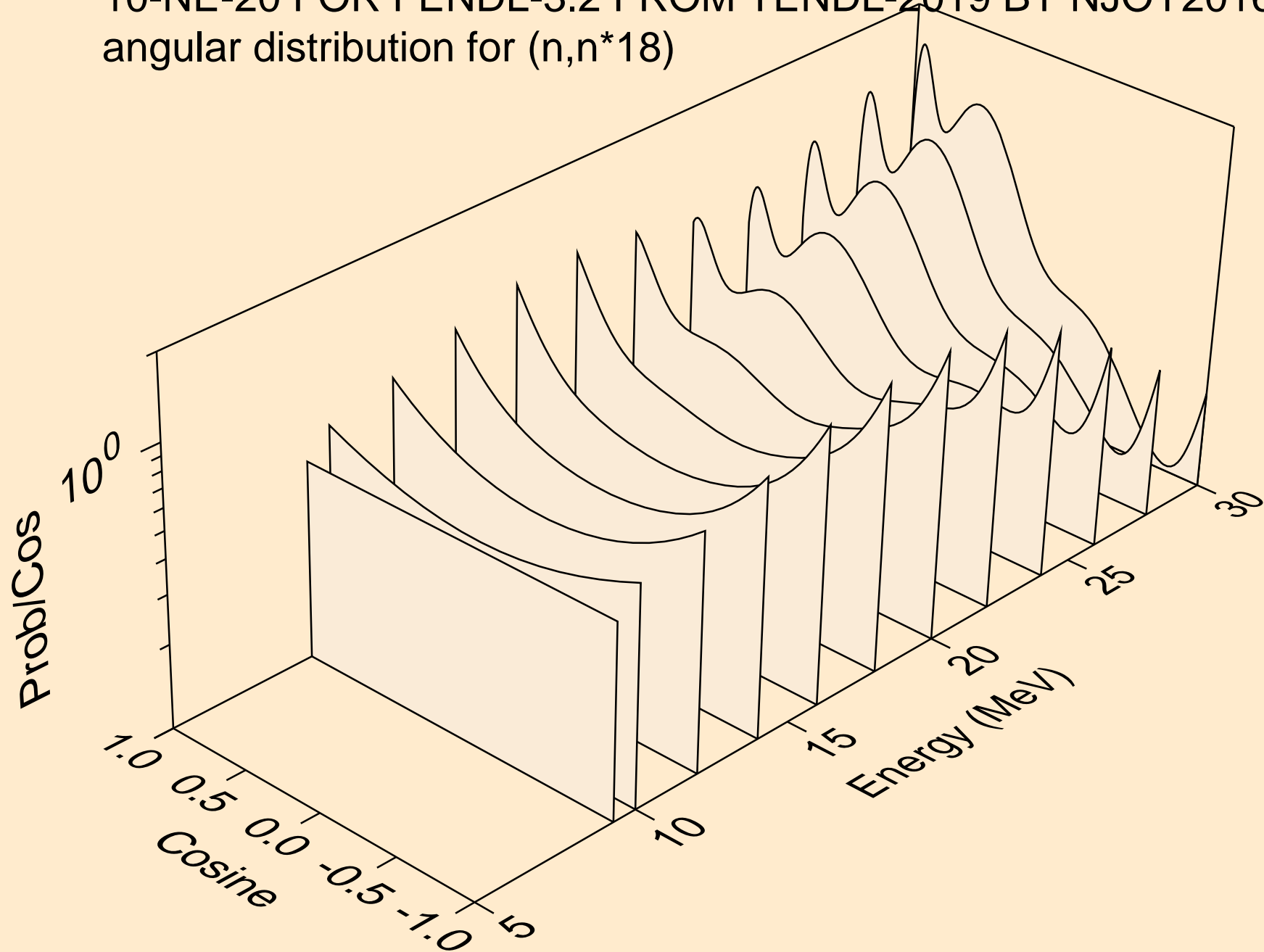

10-NE-20 FOR FENDL-3.2 FROM TENDL-2019 BY NJOY2016.60+
angular distribution for (n,n*19)

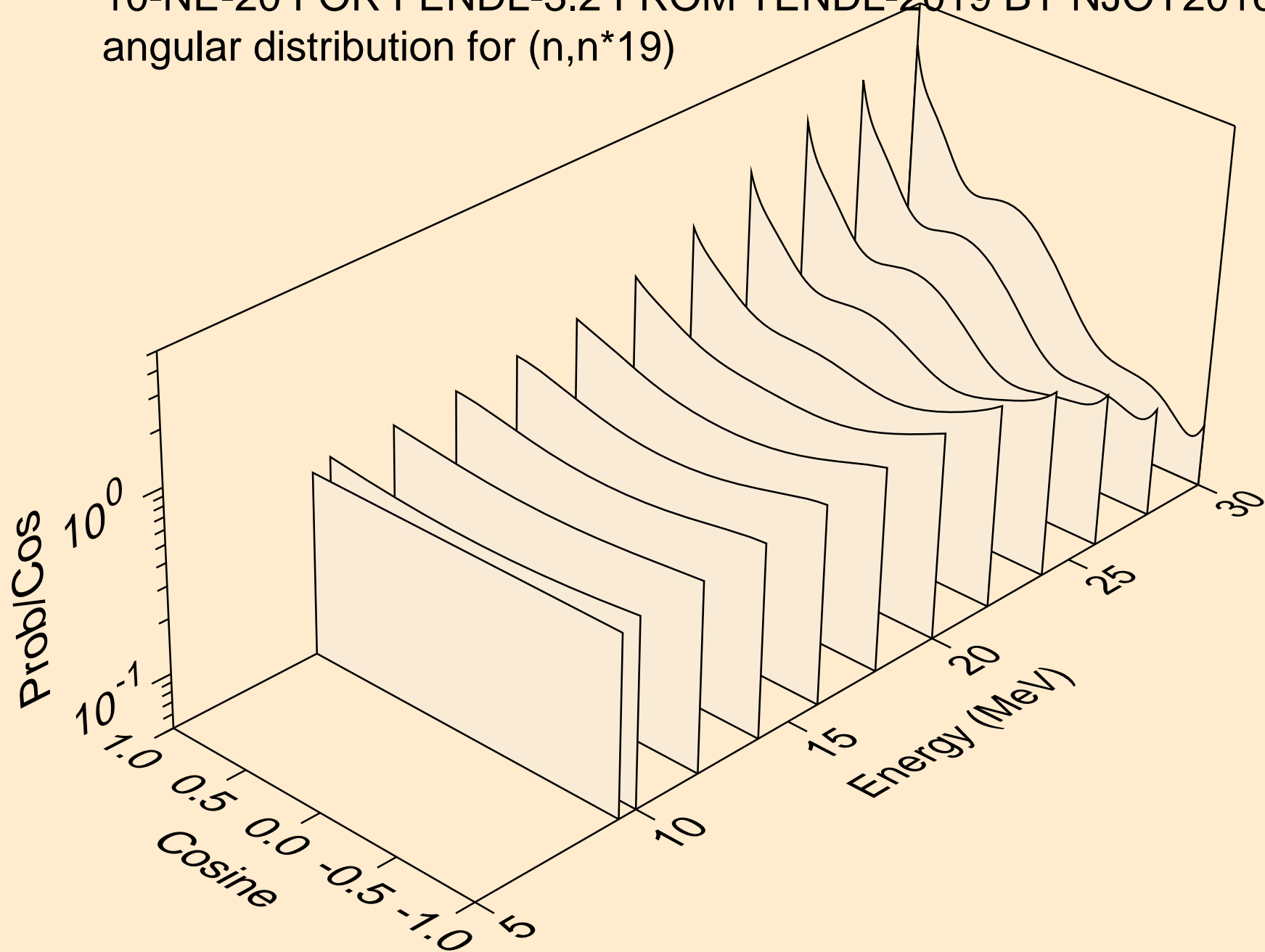

10-NE-20 FOR FENDL-3.2 FROM TENDL-2019 BY NJOY2016.60+
angular distribution for (n,n*20)

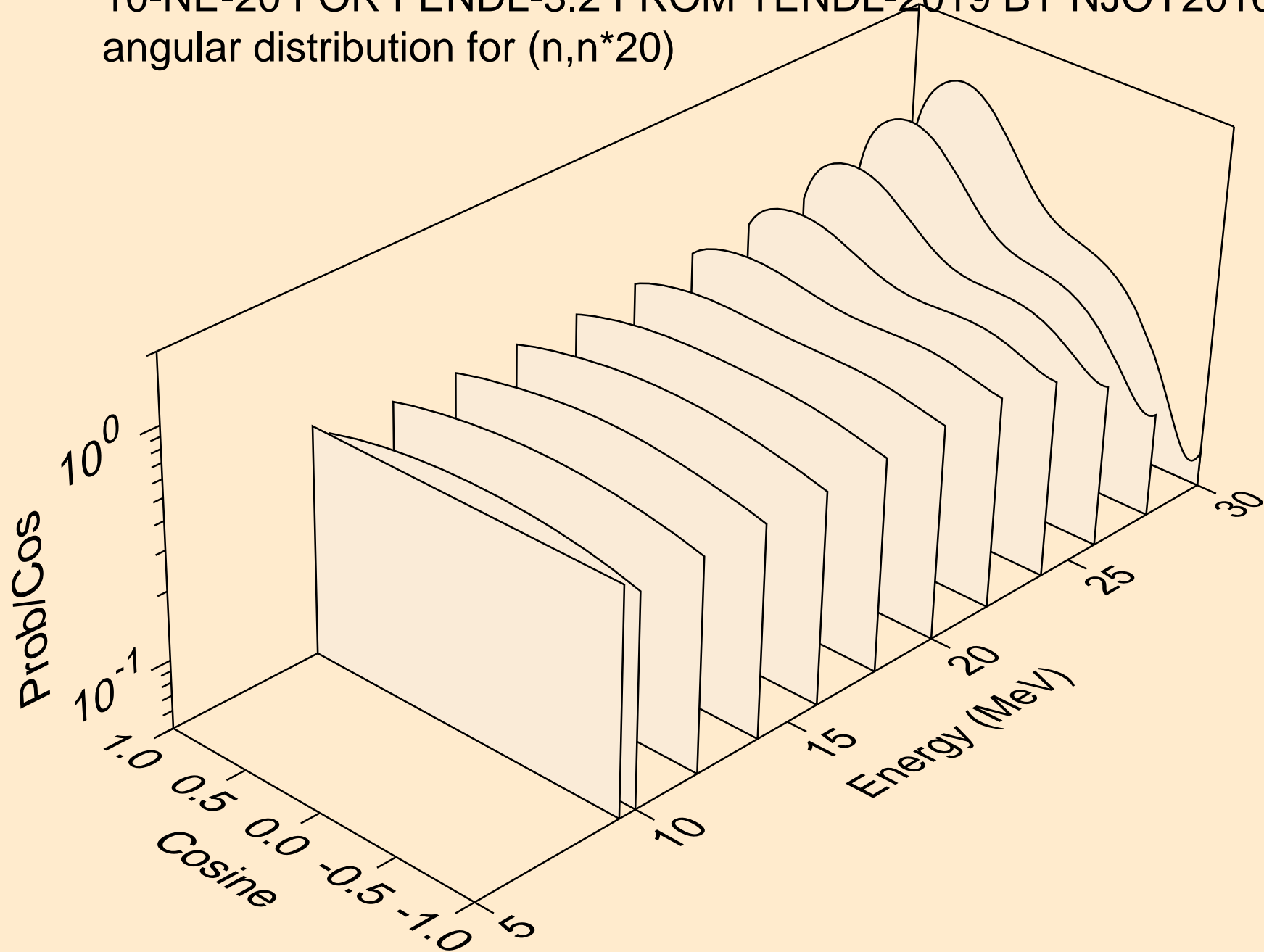

10-NE-20 FOR FENDL-3.2 FROM TENDL-2019 BY NJOY2016.60+
angular distribution for (n,n*21)

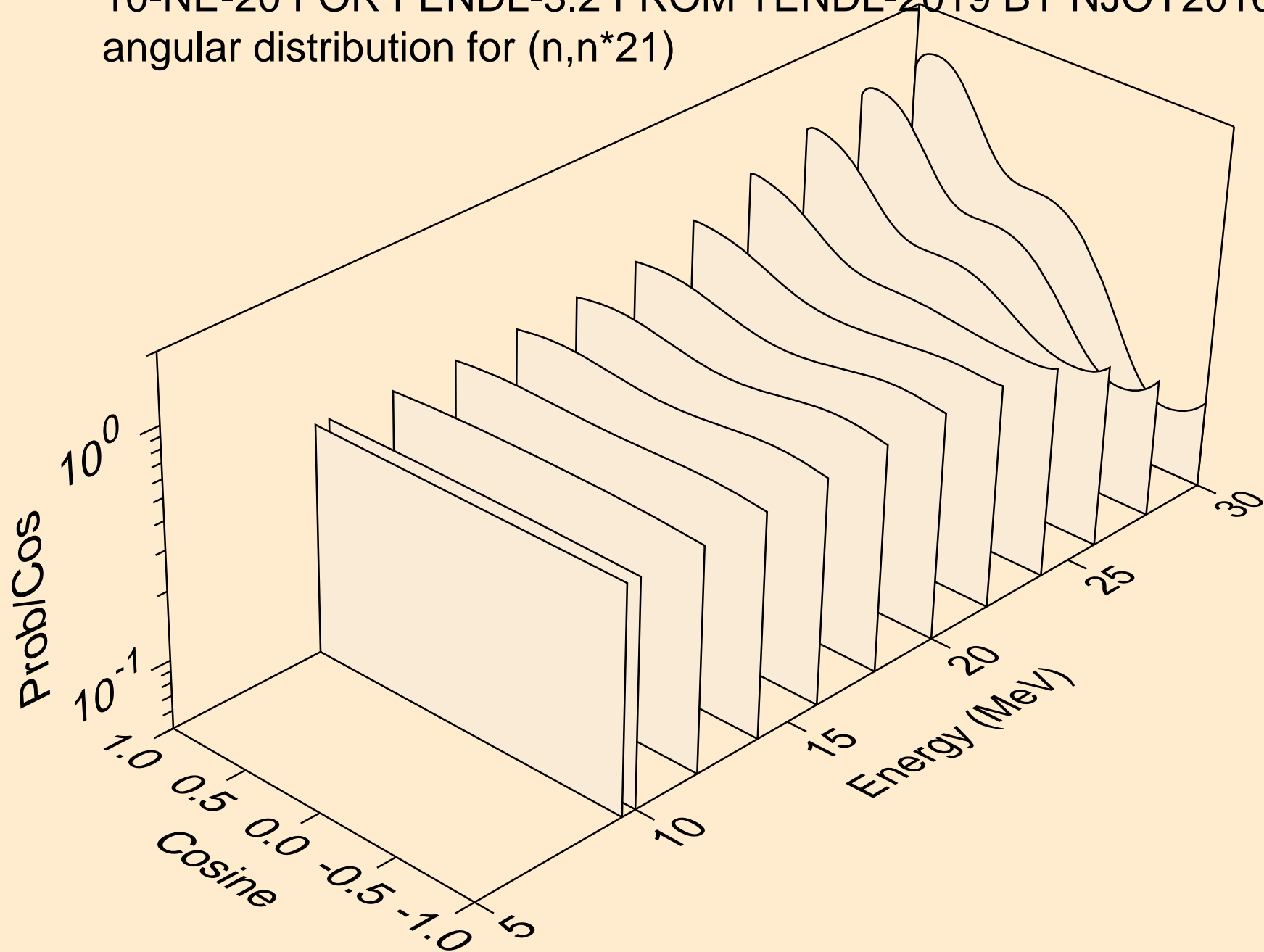

10-NE-20 FOR FENDL-3.2 FROM TENDL-2019 BY NJOY2016.60+
angular distribution for (n,n*22)

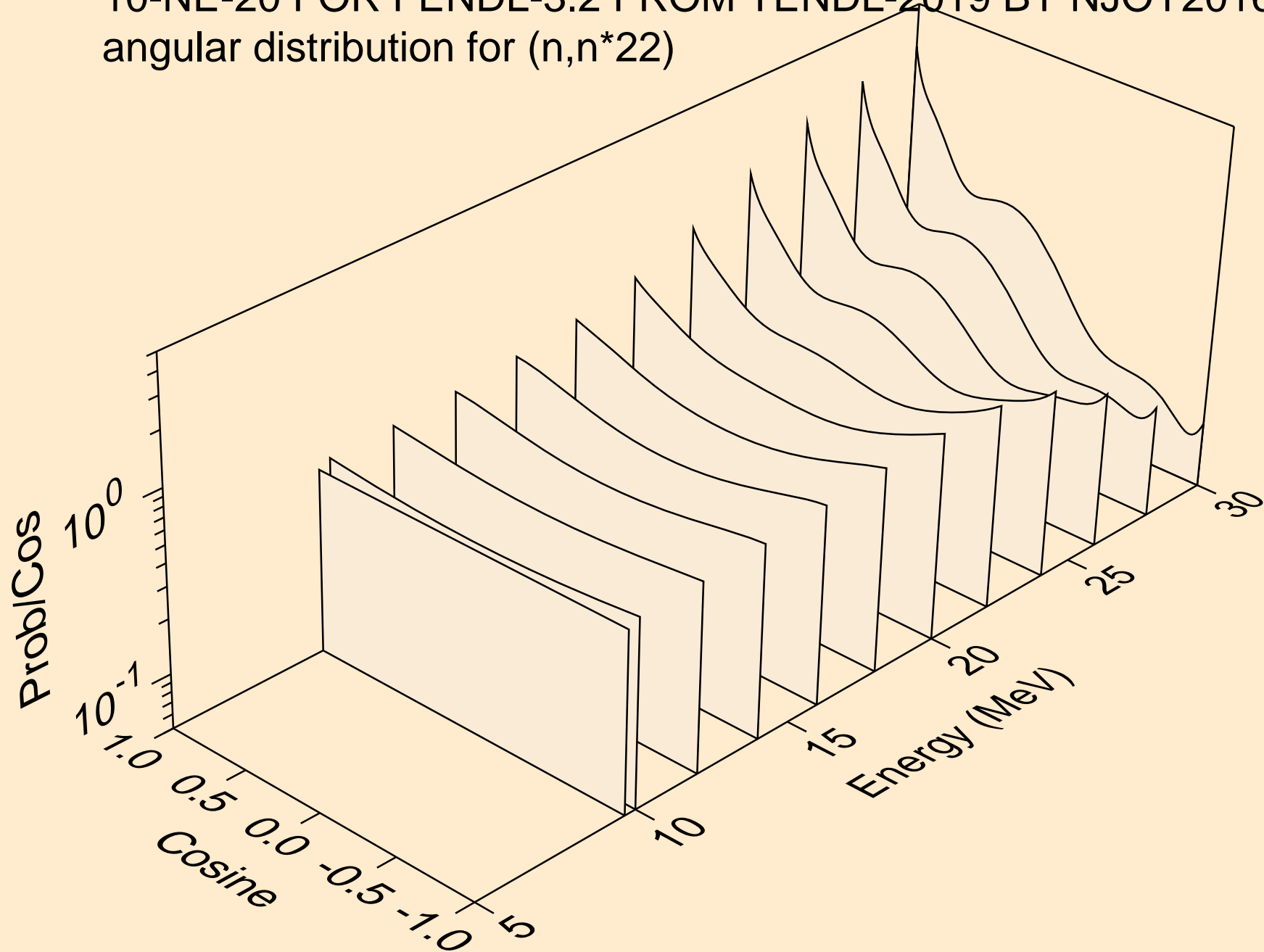

10-NE-20 FOR FENDL-3.2 FROM TENDL-2019 BY NJOY2016.60+
Neutron emission for (n,x)

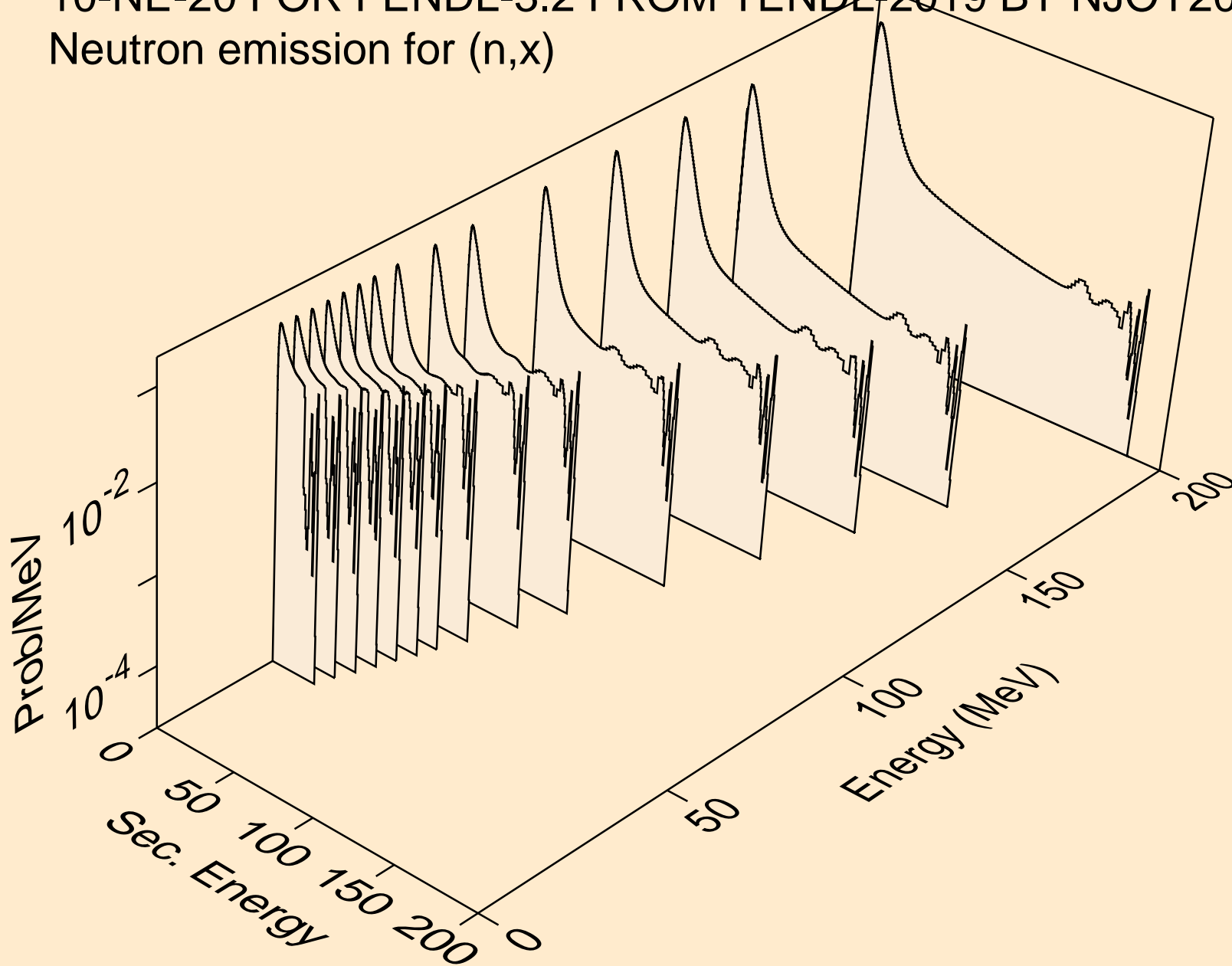

10-NE-20 FOR FENDL-3.2 FROM TENDL-2019 BY NJOY2016.60+
Neutron emission for (n,2n)

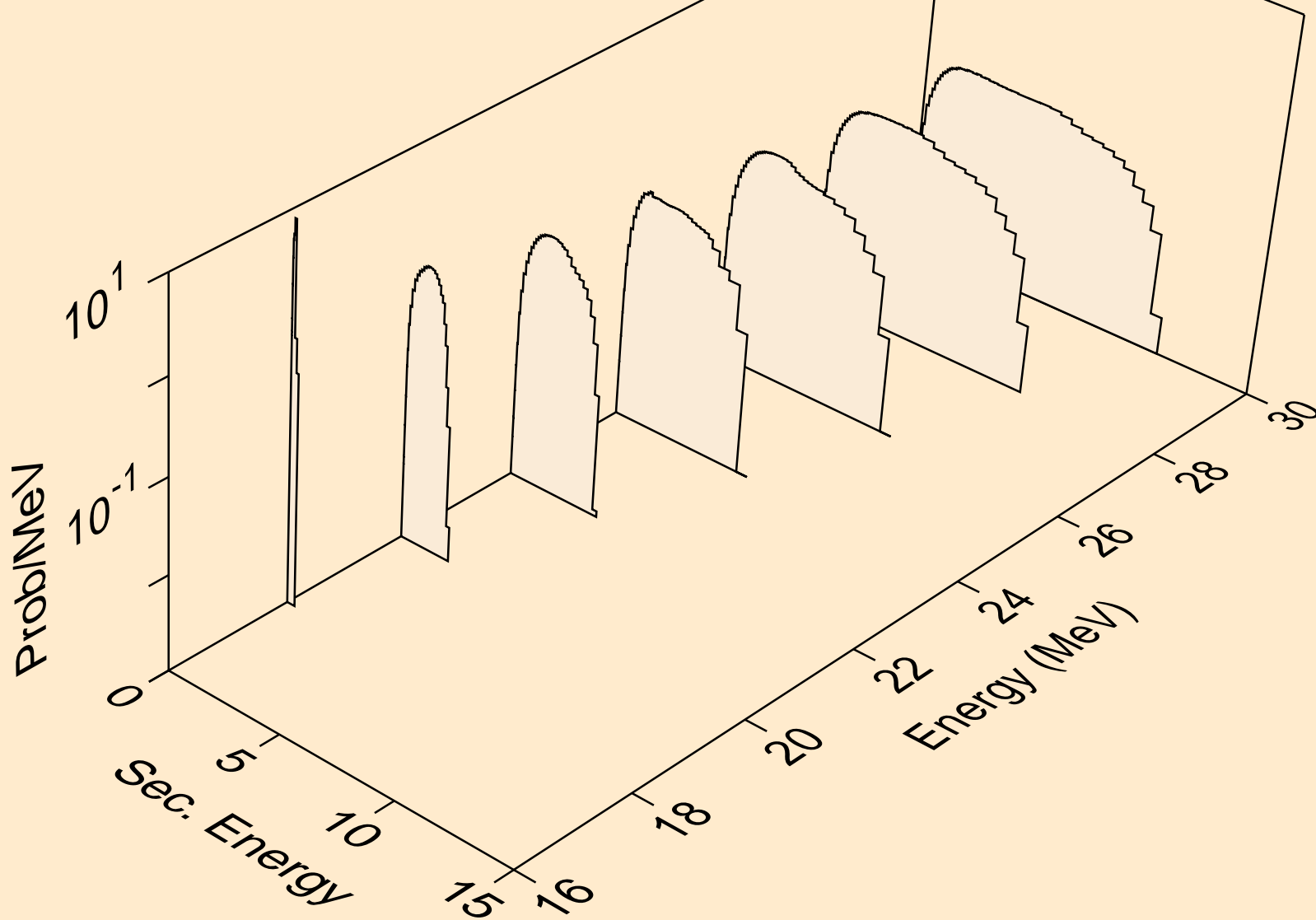

10-NE-20 FOR FENDL-3.2 FROM TENDL-2019 BY NJOY2016.60+
Neutron emission for (n,n*)a

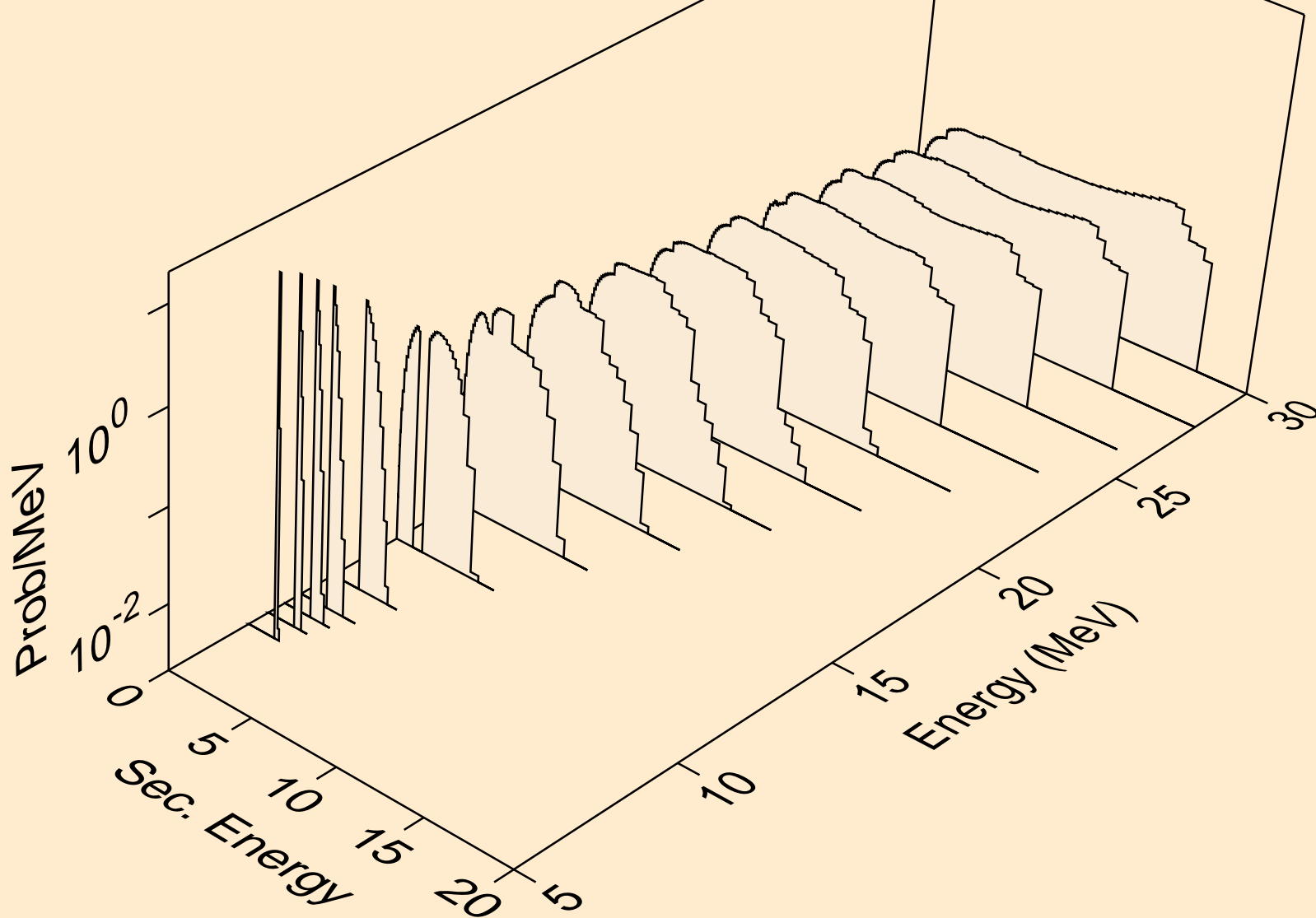

10-NE-20 FOR FENDL-3.2 FROM TENDL-2019 BY NJOY2016.60+
Neutron emission for (n,2n)a

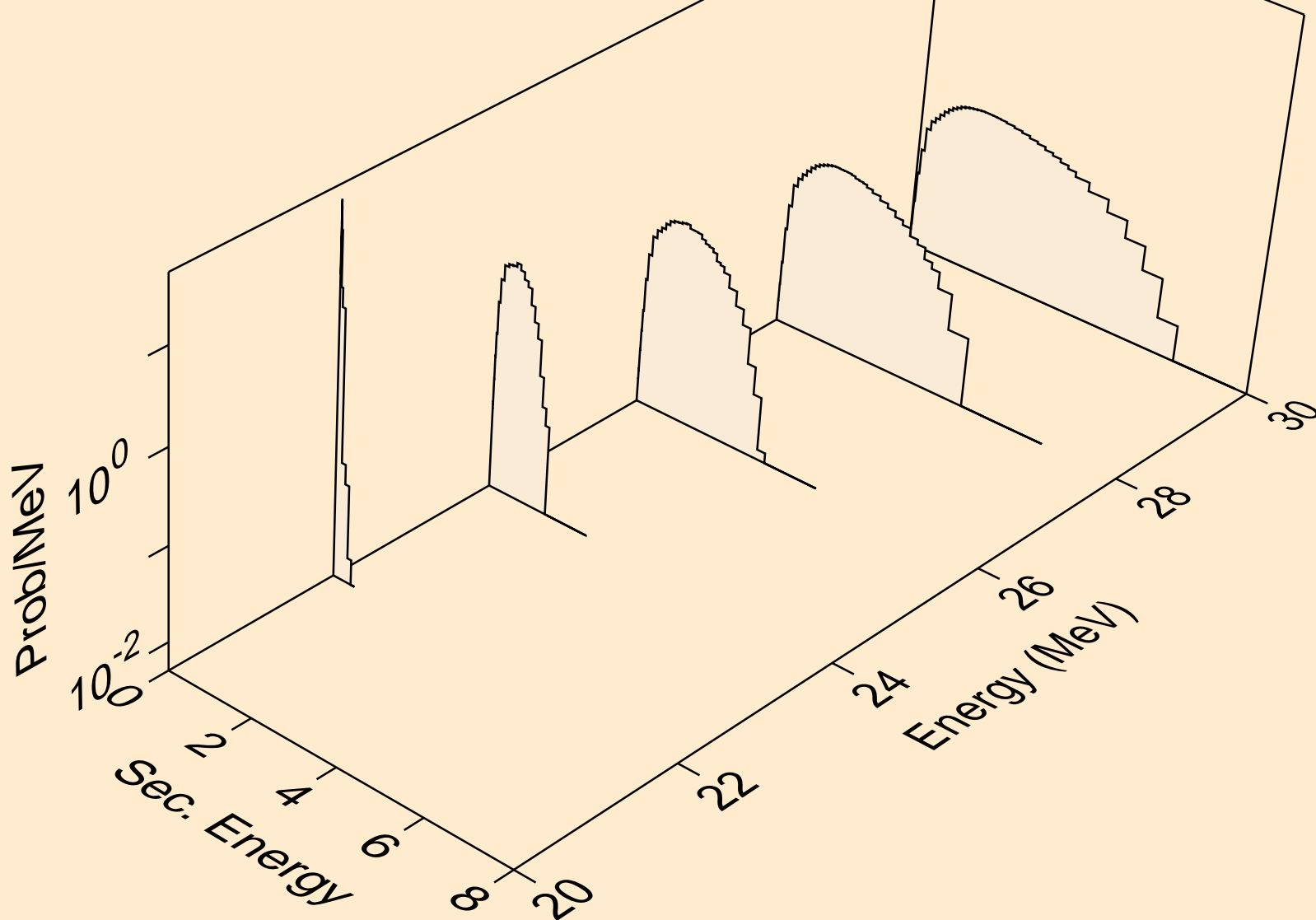

10-NE-20 FOR FENDL-3.2 FROM TENDL-2019 BY NJOY2016.60+
Neutron emission for (n,n*)p

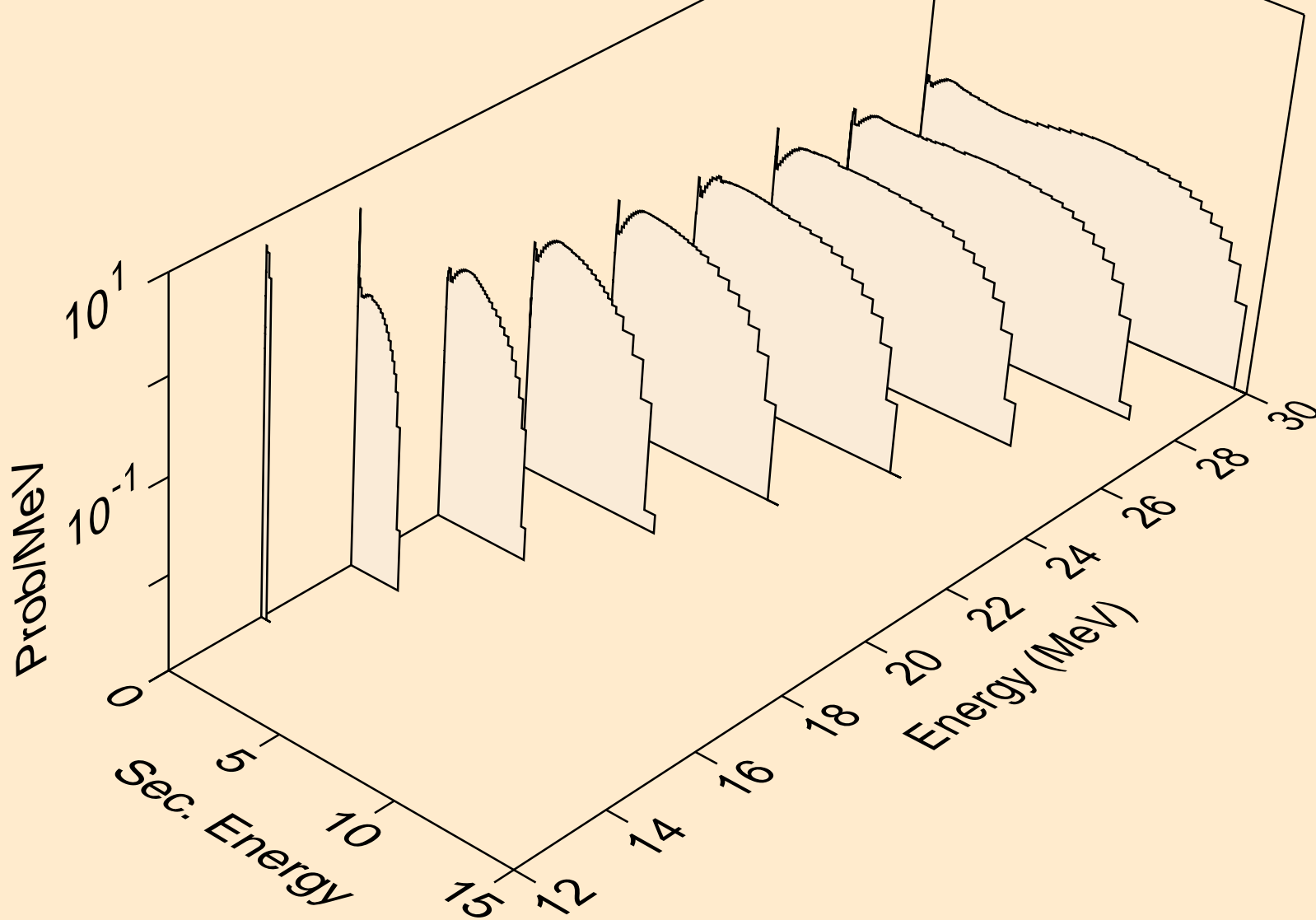

10-NE-20 FOR FENDL-3.2 FROM TENDL-2019 BY NJOY2016.60+
Neutron emission for (n,n*)2a

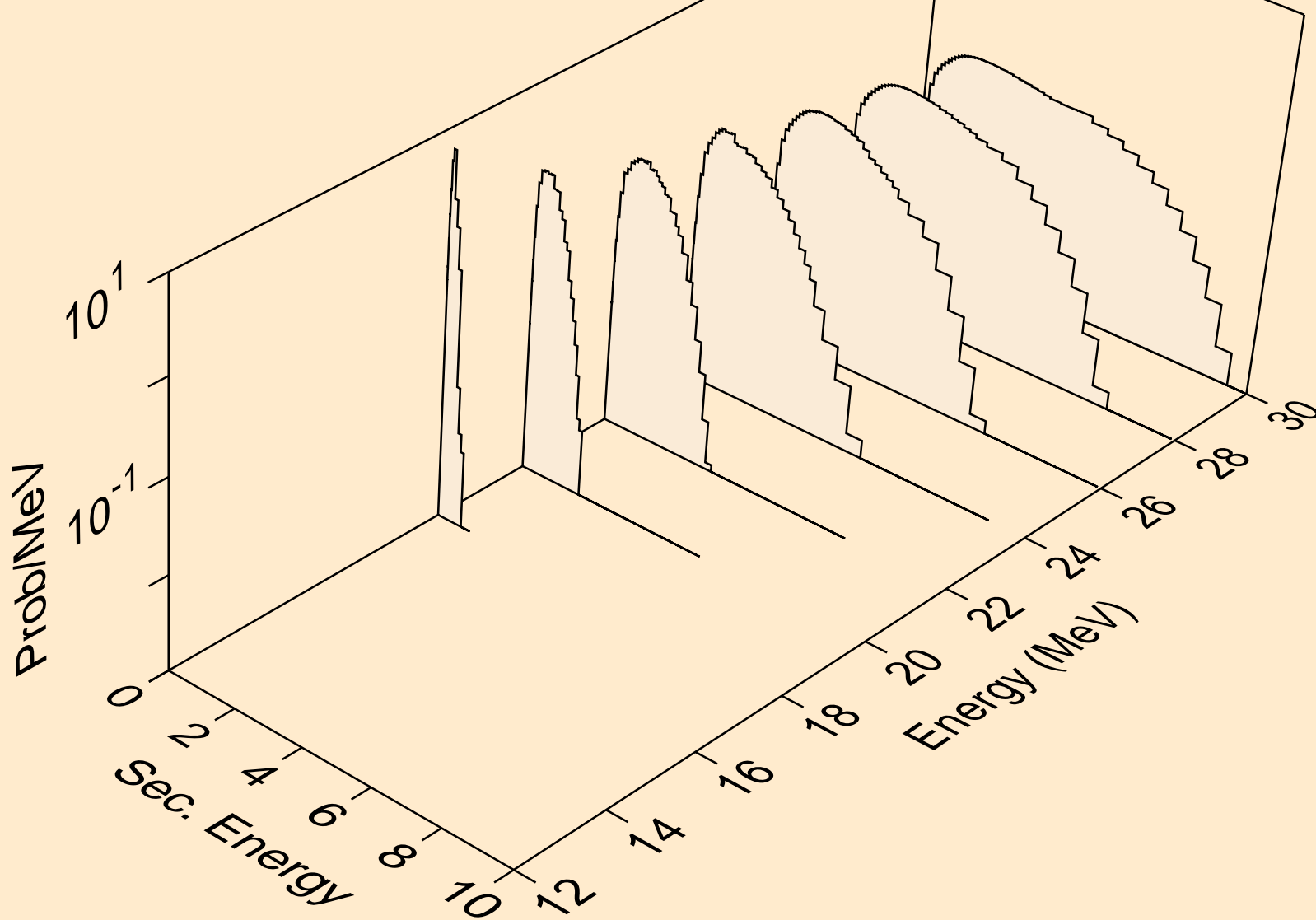

10-NE-20 FOR FENDL-3.2 FROM TENDL-2019 BY NJOY2016.60+
Neutron emission for (n,n*)d

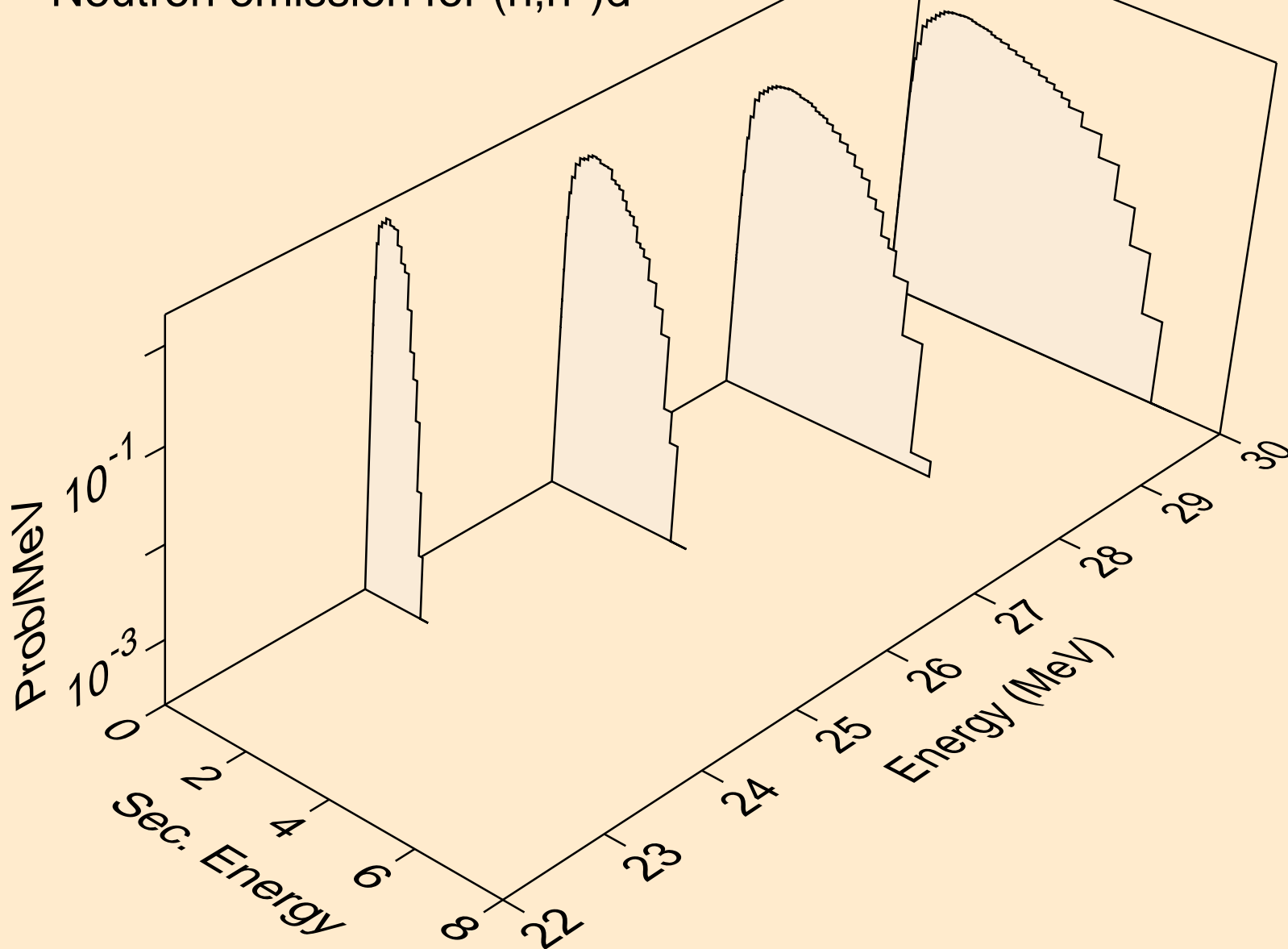

10-NE-20 FOR FENDL-3.2 FROM TENDL-2019 BY NJOY2016.60+
Neutron emission for (n,n*)t

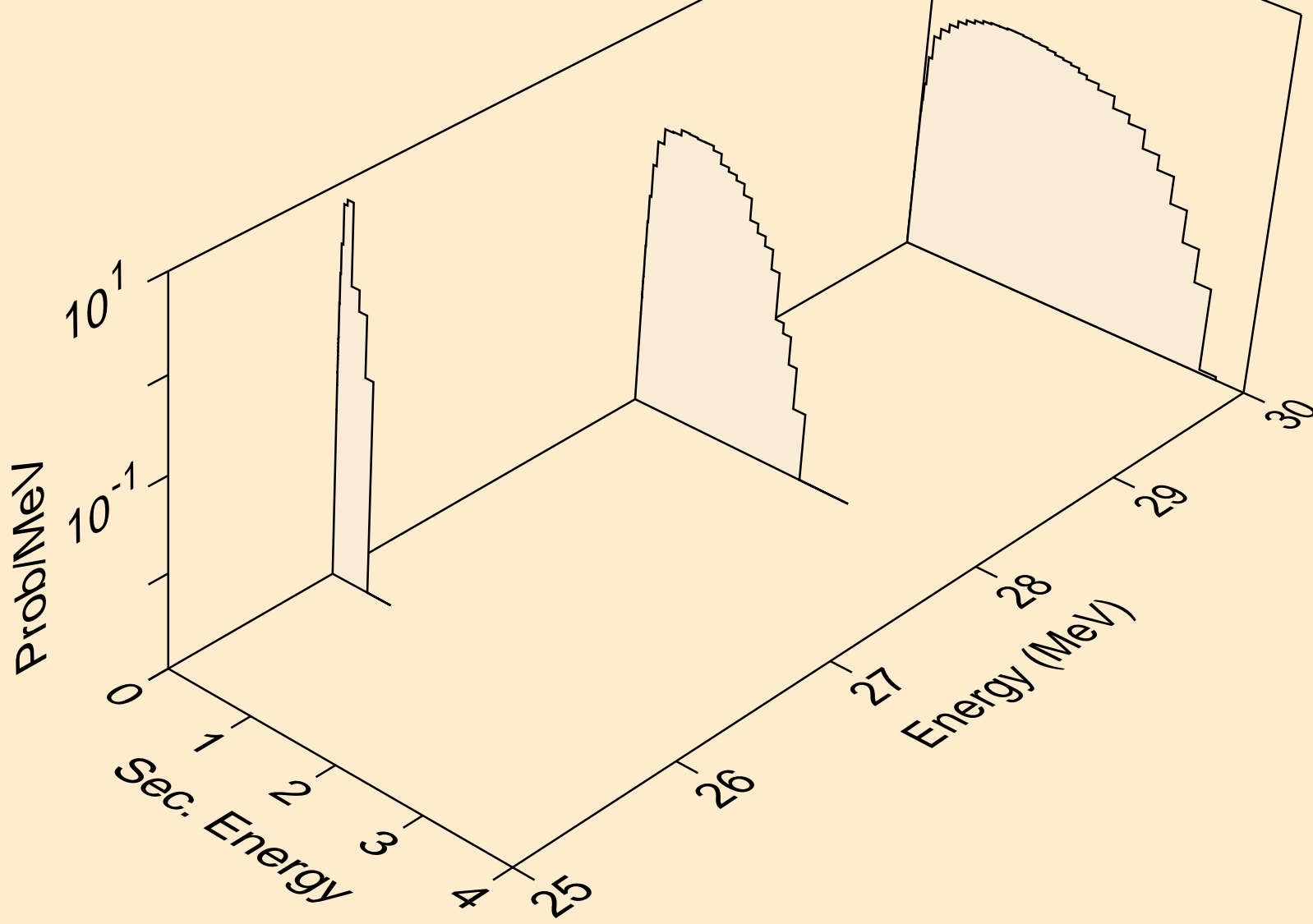

10-NE-20 FOR FENDL-3.2 FROM TENDL-2019 BY NJOY2016.60+
Neutron emission for (n,n*)he3

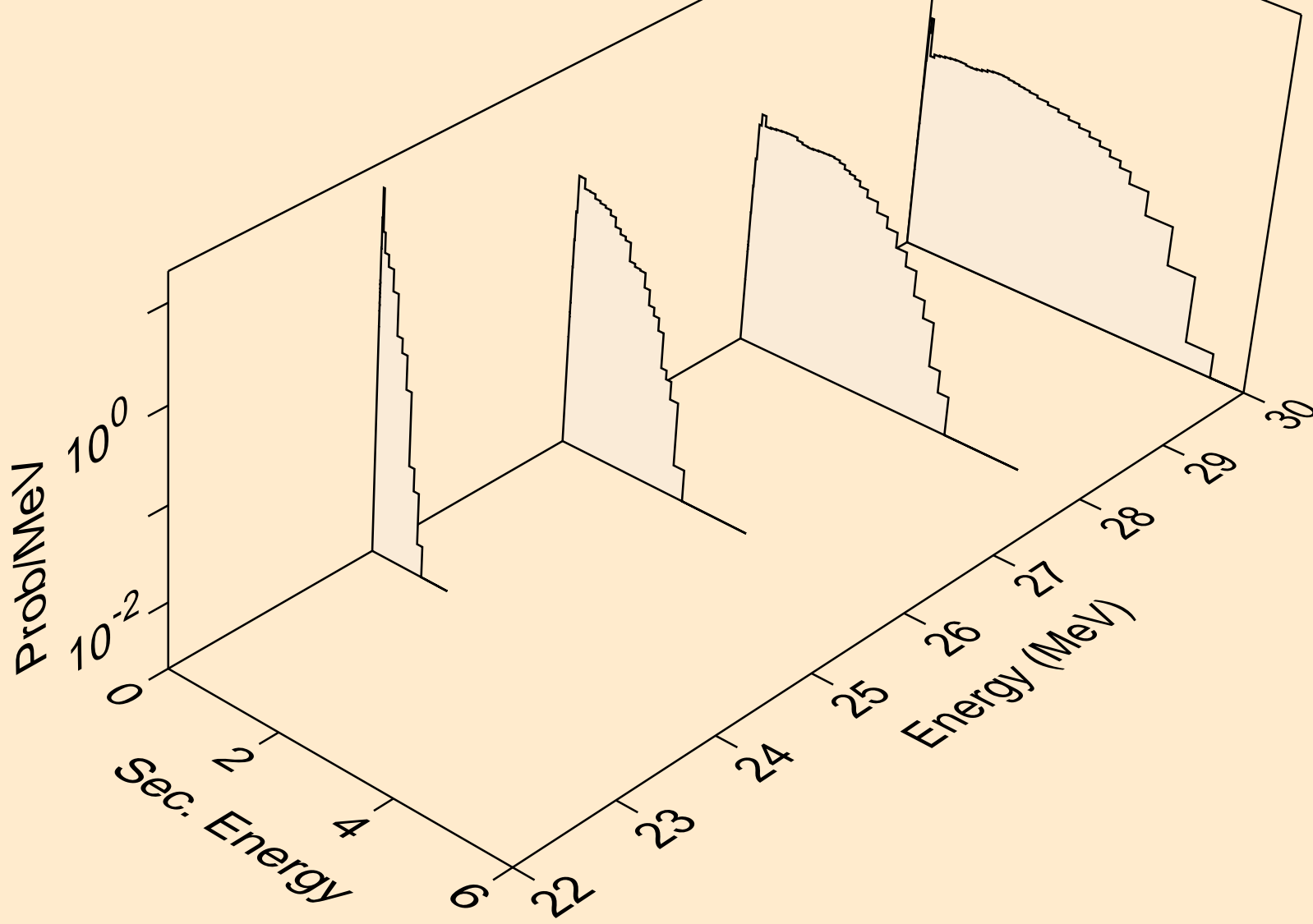

10-NE-20 FOR FENDL-3.2 FROM TENDL-2019 BY NJOY2016.60+
Neutron emission for (n,2np)

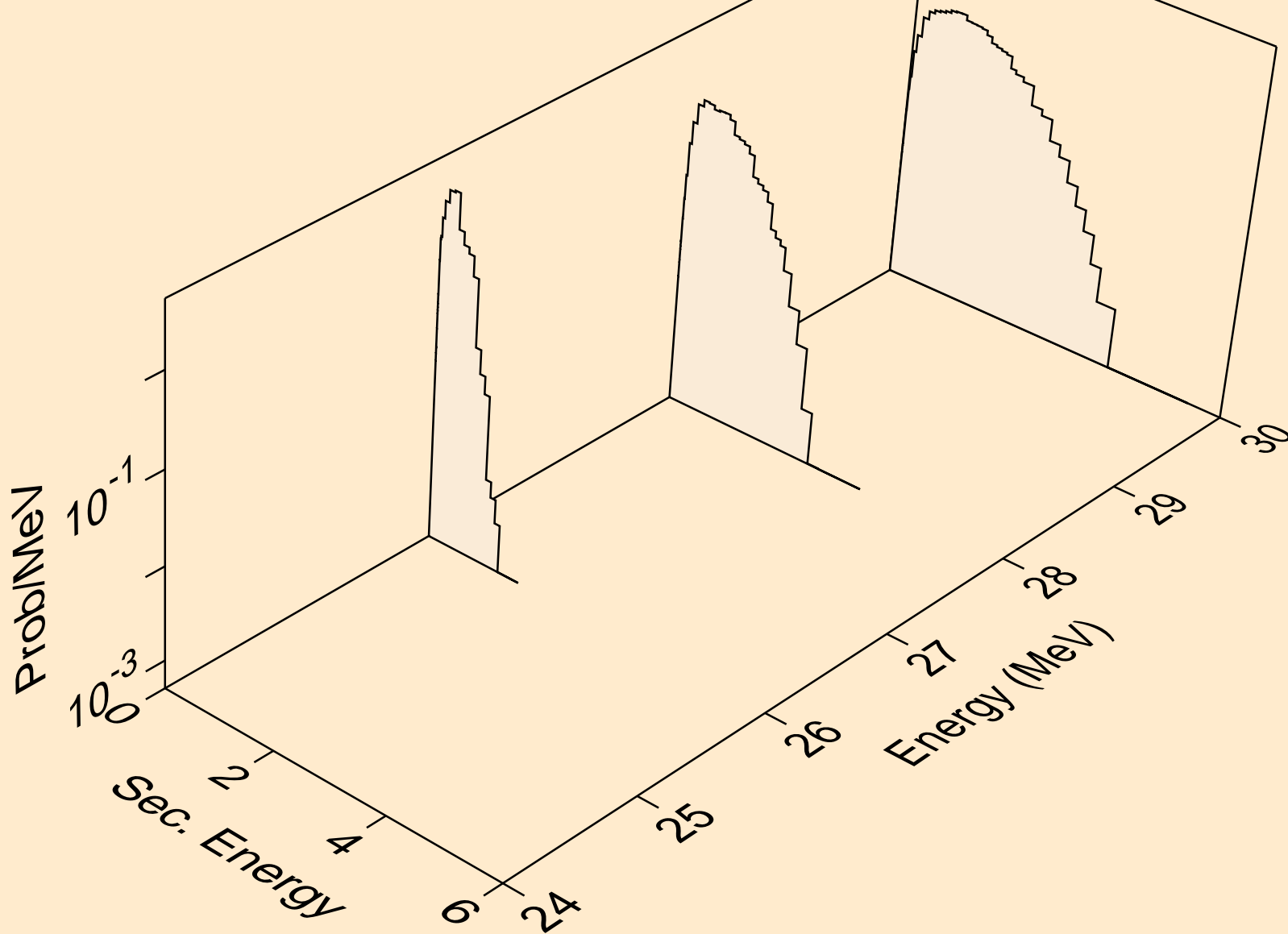

10-NE-20 FOR FENDL-3.2 FROM TENDL-2019 BY NJOY2016.60+
Neutron emission for (n,2np)

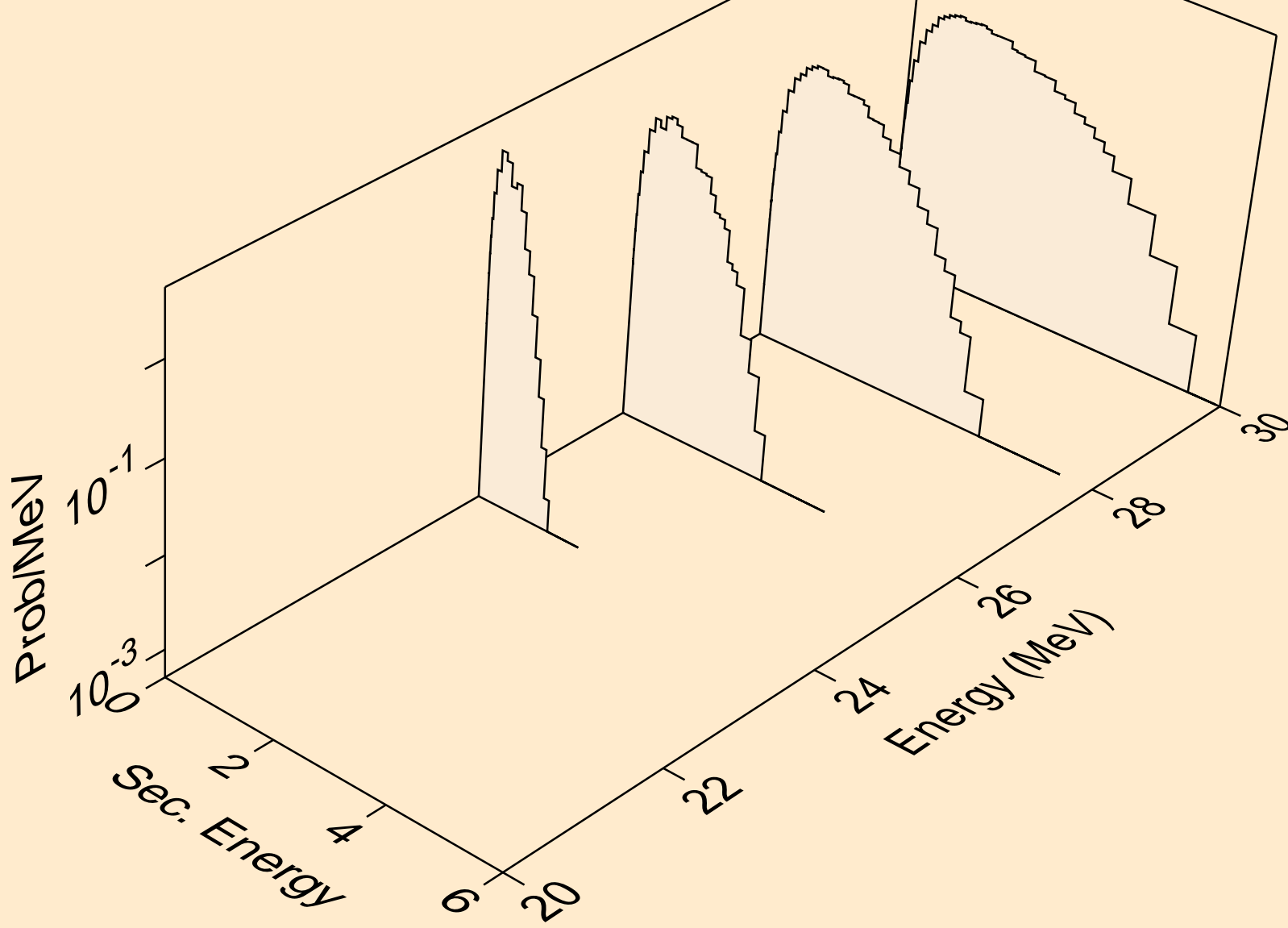

10-NE-20 FOR FENDL-3.2 FROM TENDL-2019 BY NJOY2016.60+
Neutron emission for (n,npa)

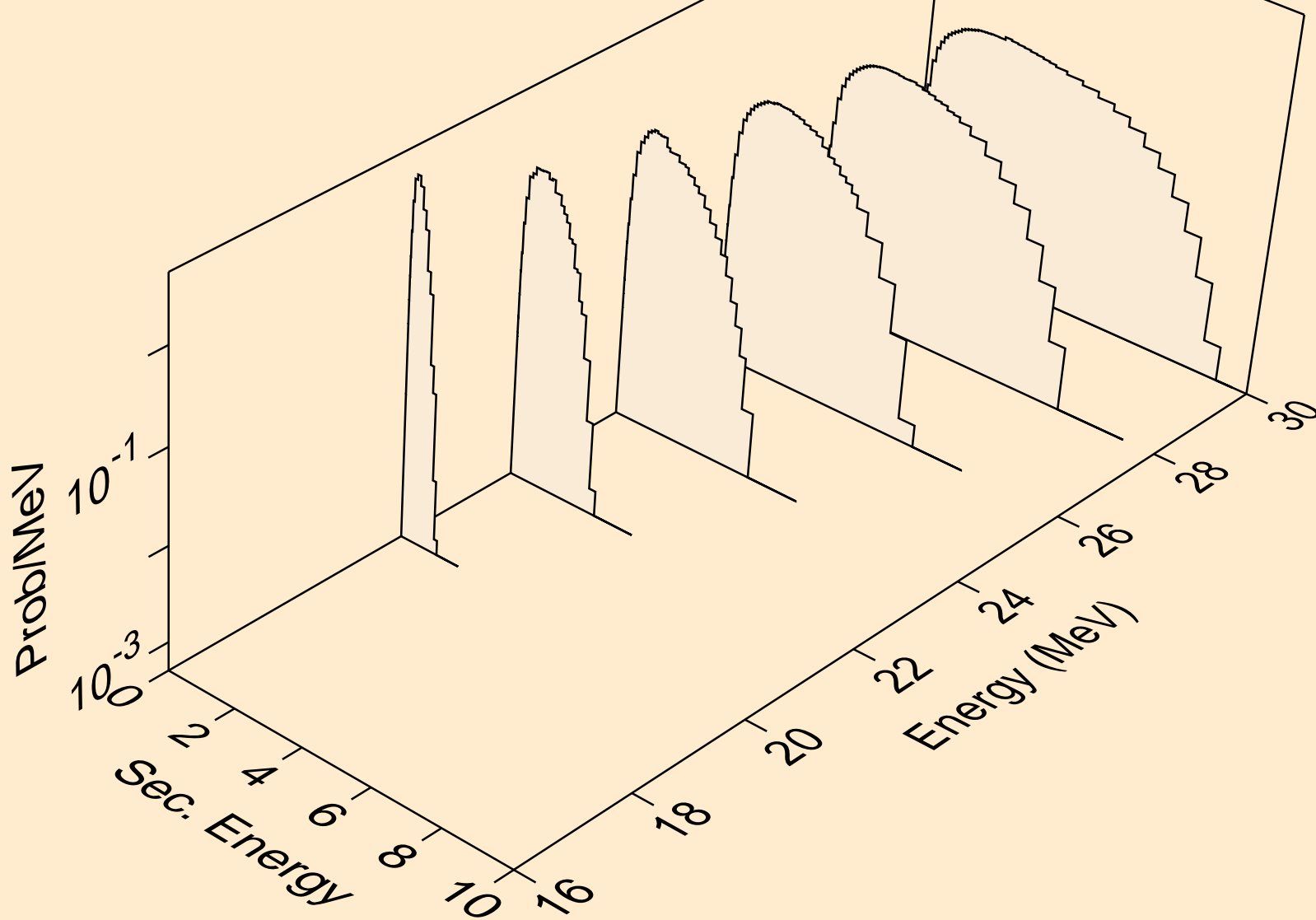

10-NE-20 FOR FENDL-3.2 FROM TENDL-2019 BY NJOY2016.60+
Neutron emission for (n,n*c)

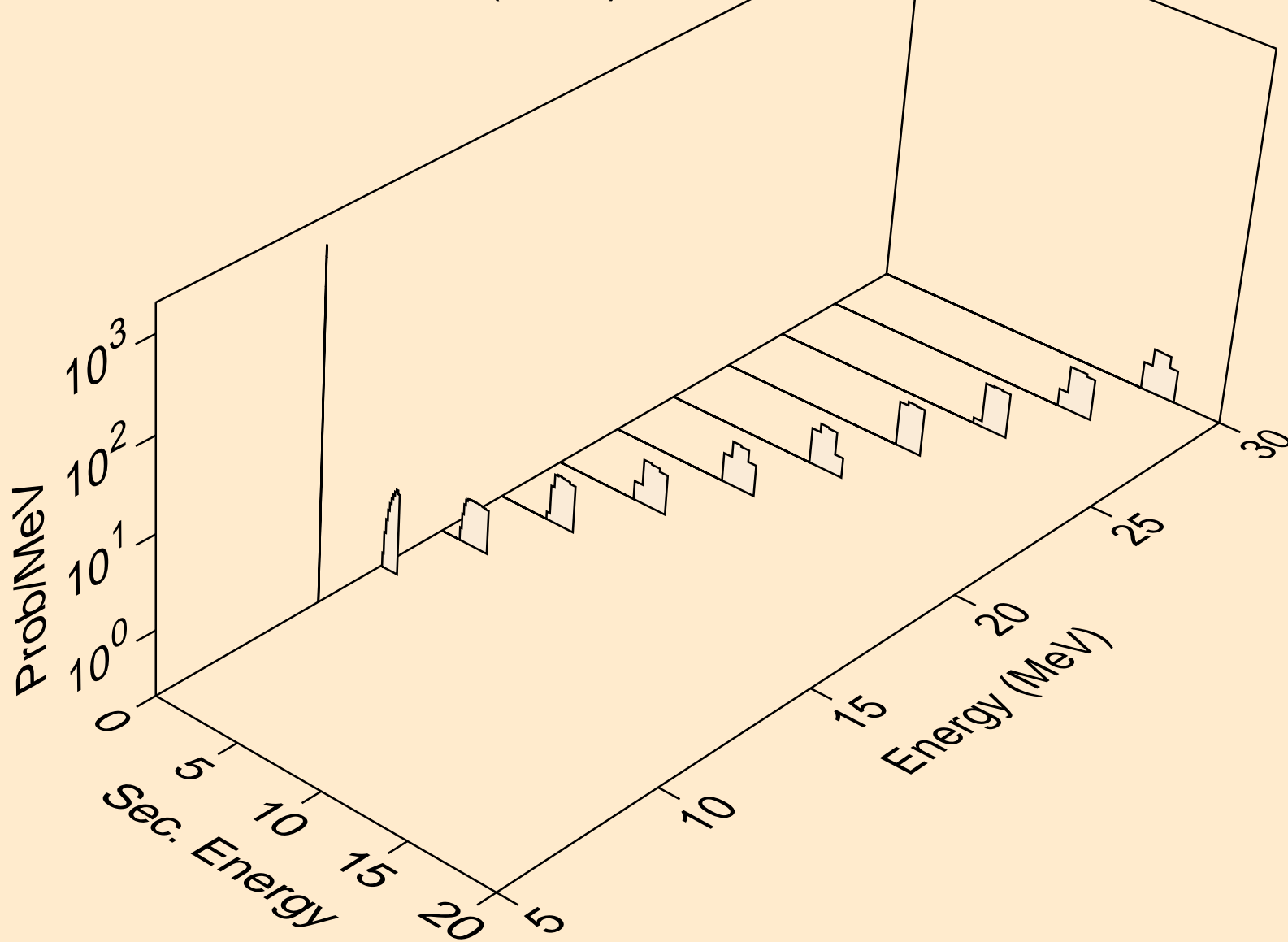

10-NE-20 FOR FENDL-3.2 FROM TENDL-2019 BY NJOY2016.60+
Photon emission for (n,x)

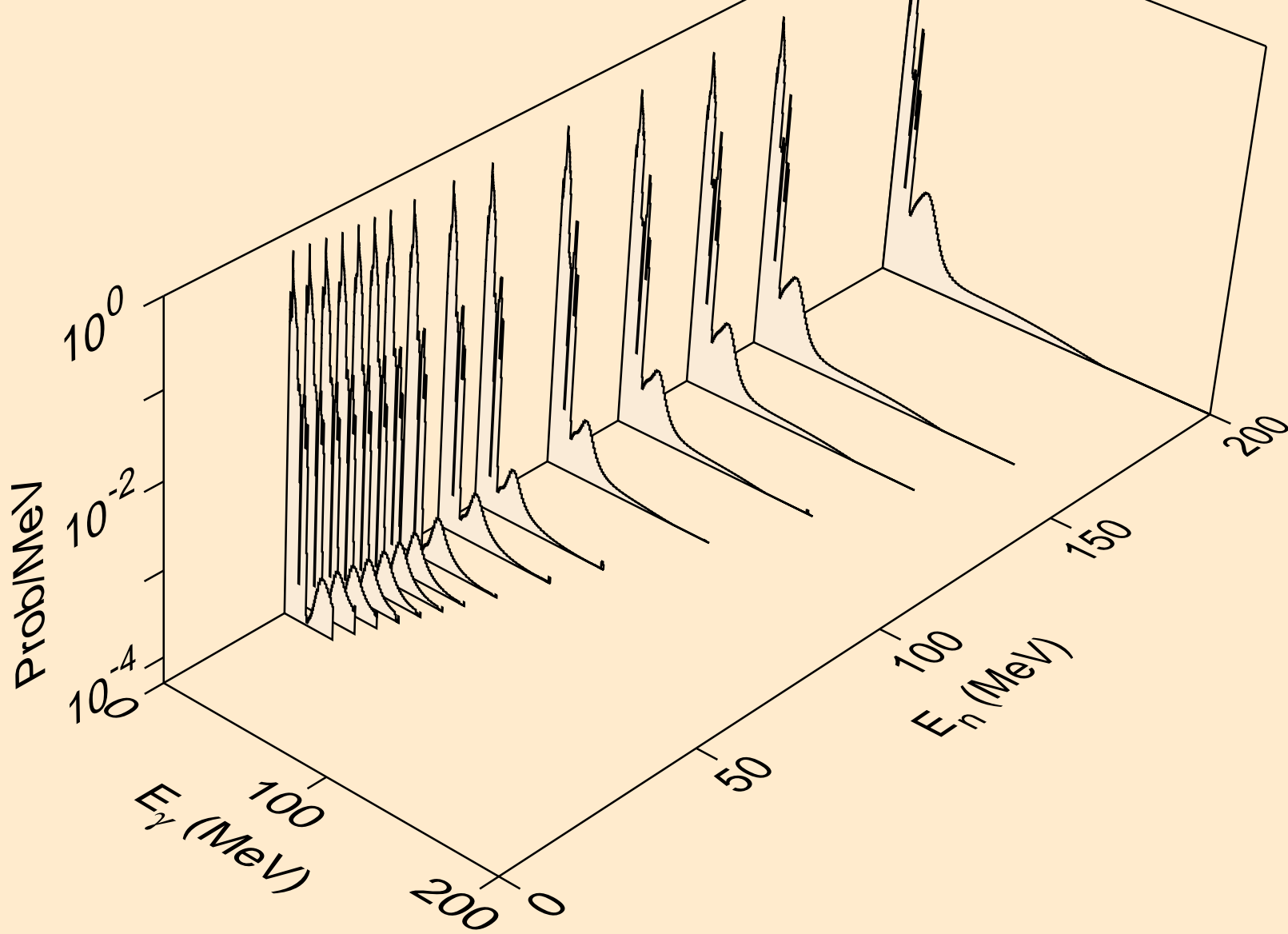

10-NE-20 FOR FENDL-3.2 FROM TENDL-2019 BY NJOY2016.60+
Photon emission for (n,2n)

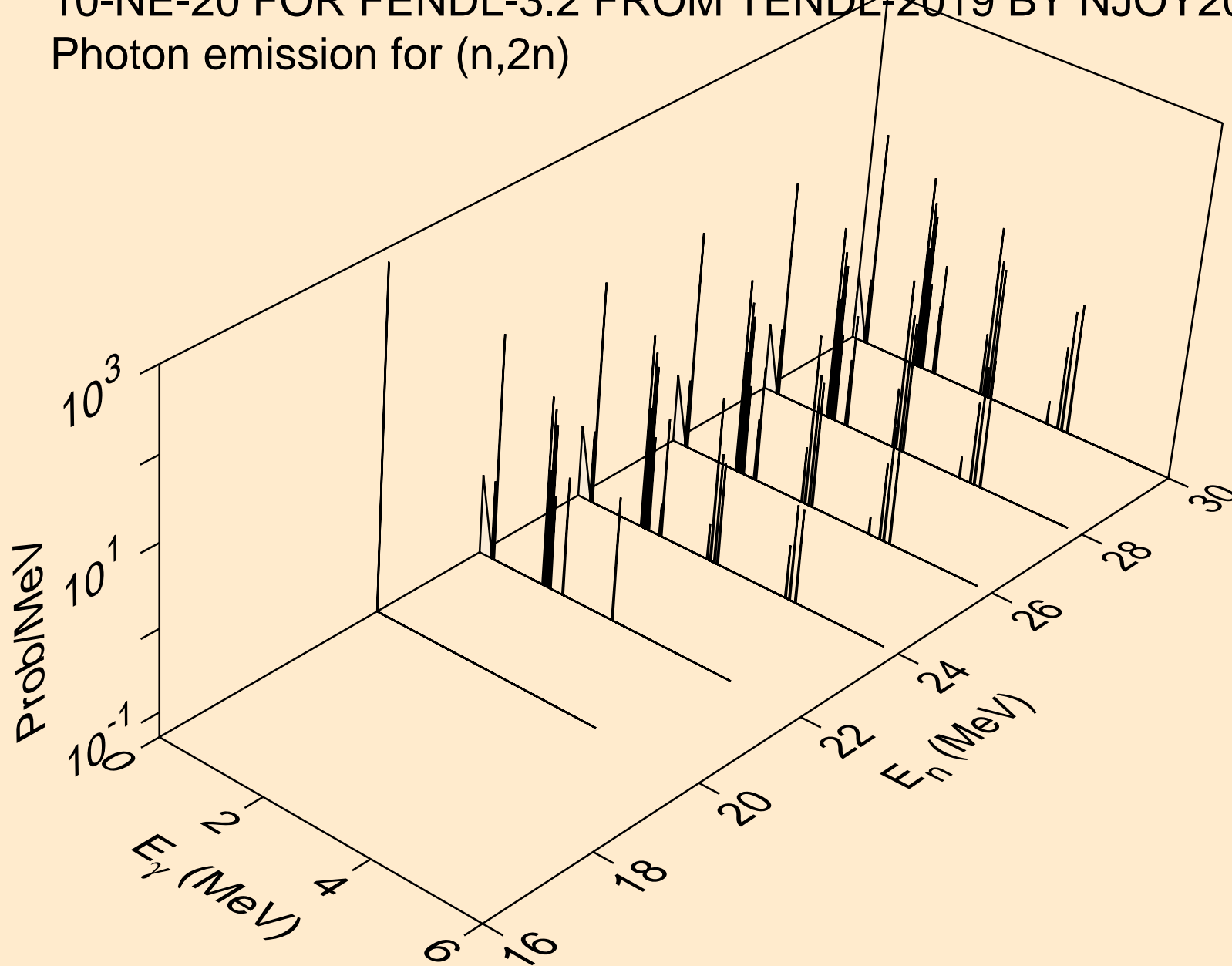

10-NE-20 FOR FENDL-3.2 FROM TENDL-2019 BY NJOY2016.60+
Photon emission for (n,n*)a

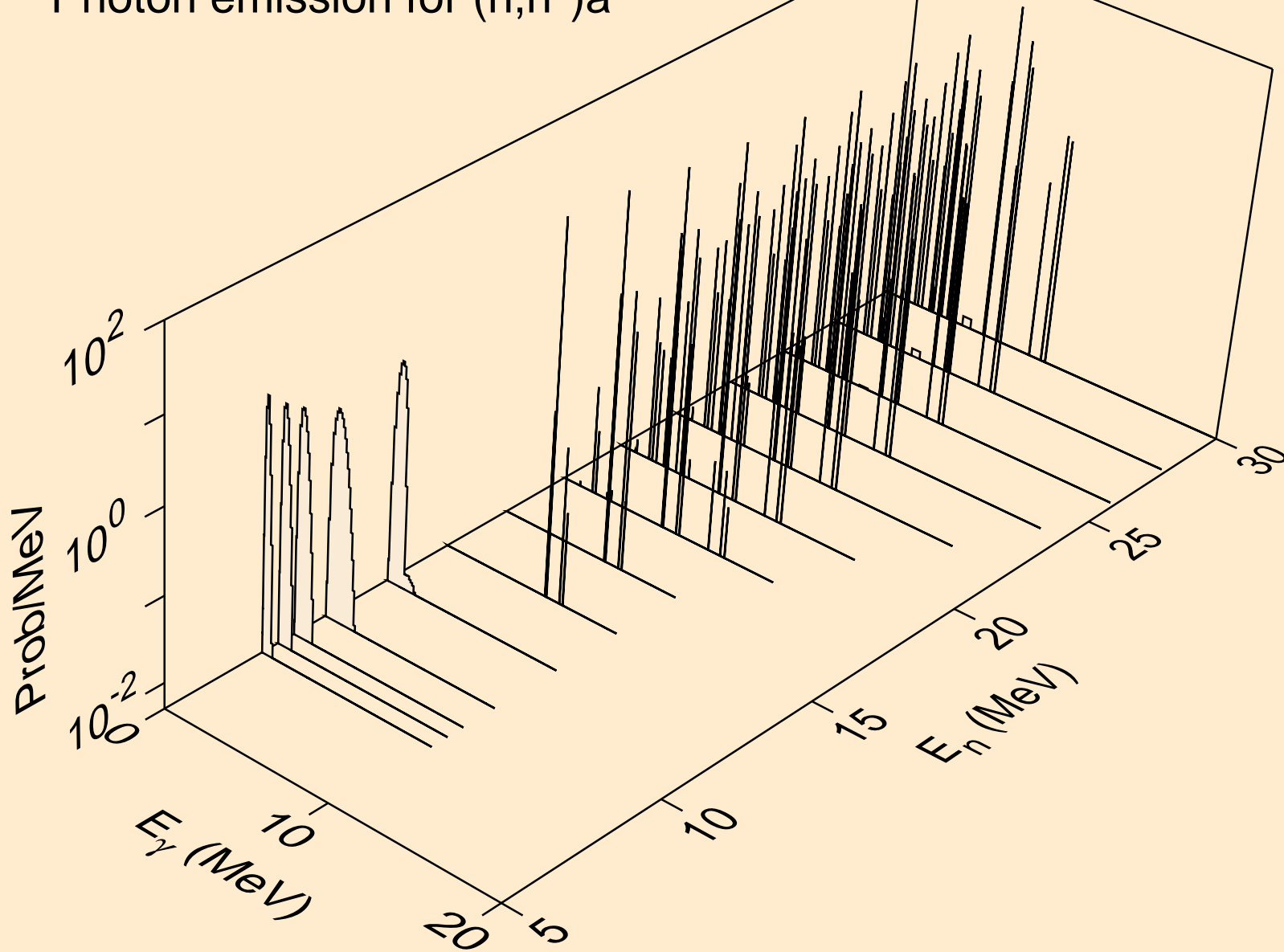

10-NE-20 FOR FENDL-3.2 FROM TENDL-2019 BY NJOY2016.60+
Photon emission for (n,2n)a

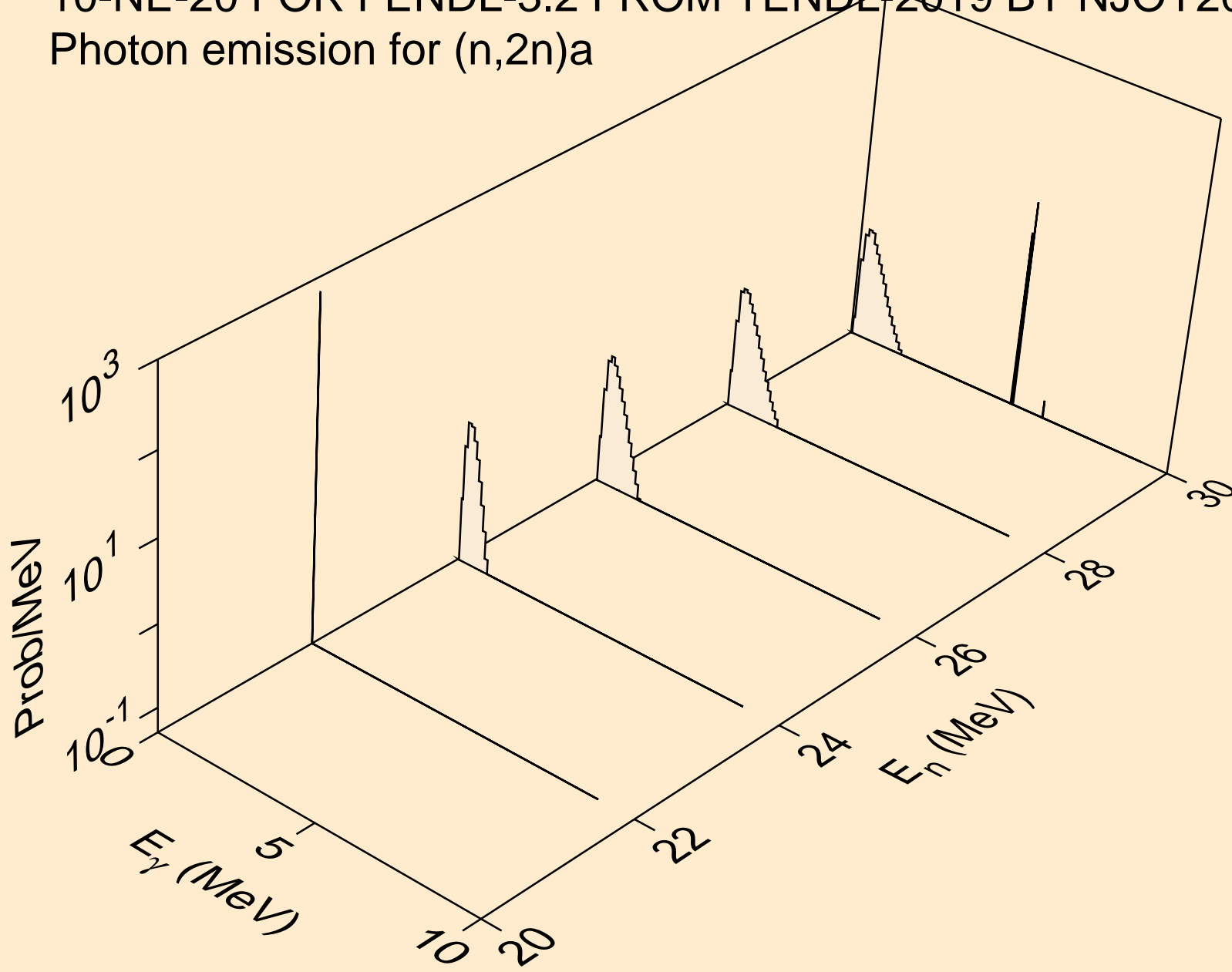

10-NE-20 FOR FENDL-3.2 FROM TENDL-2019 BY NJOY2016.60+
Photon emission for (n,n*)p

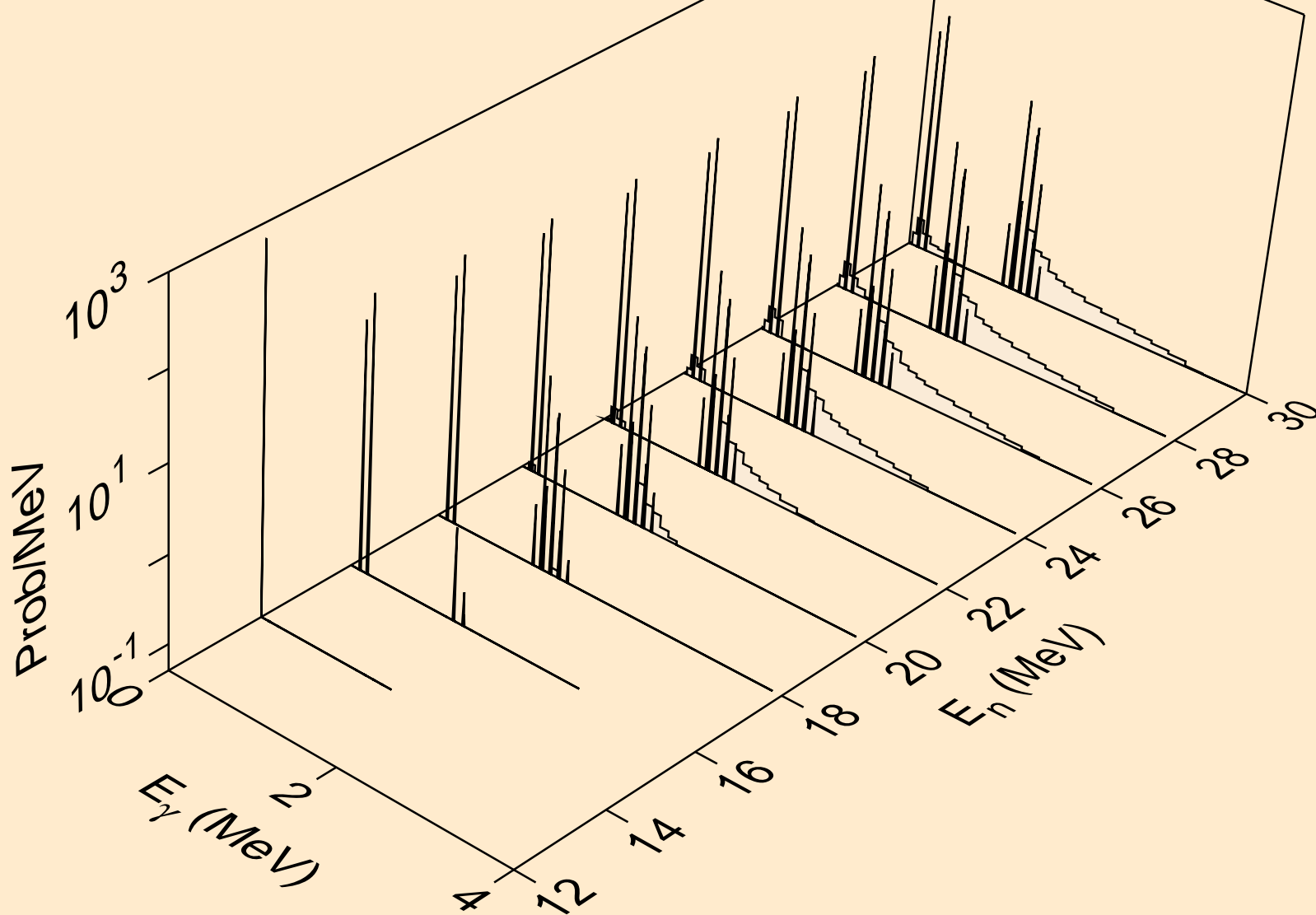

10-NE-20 FOR FENDL-3.2 FROM TENDL-2019 BY NJOY2016.60+
Photon emission for (n,n*)2a

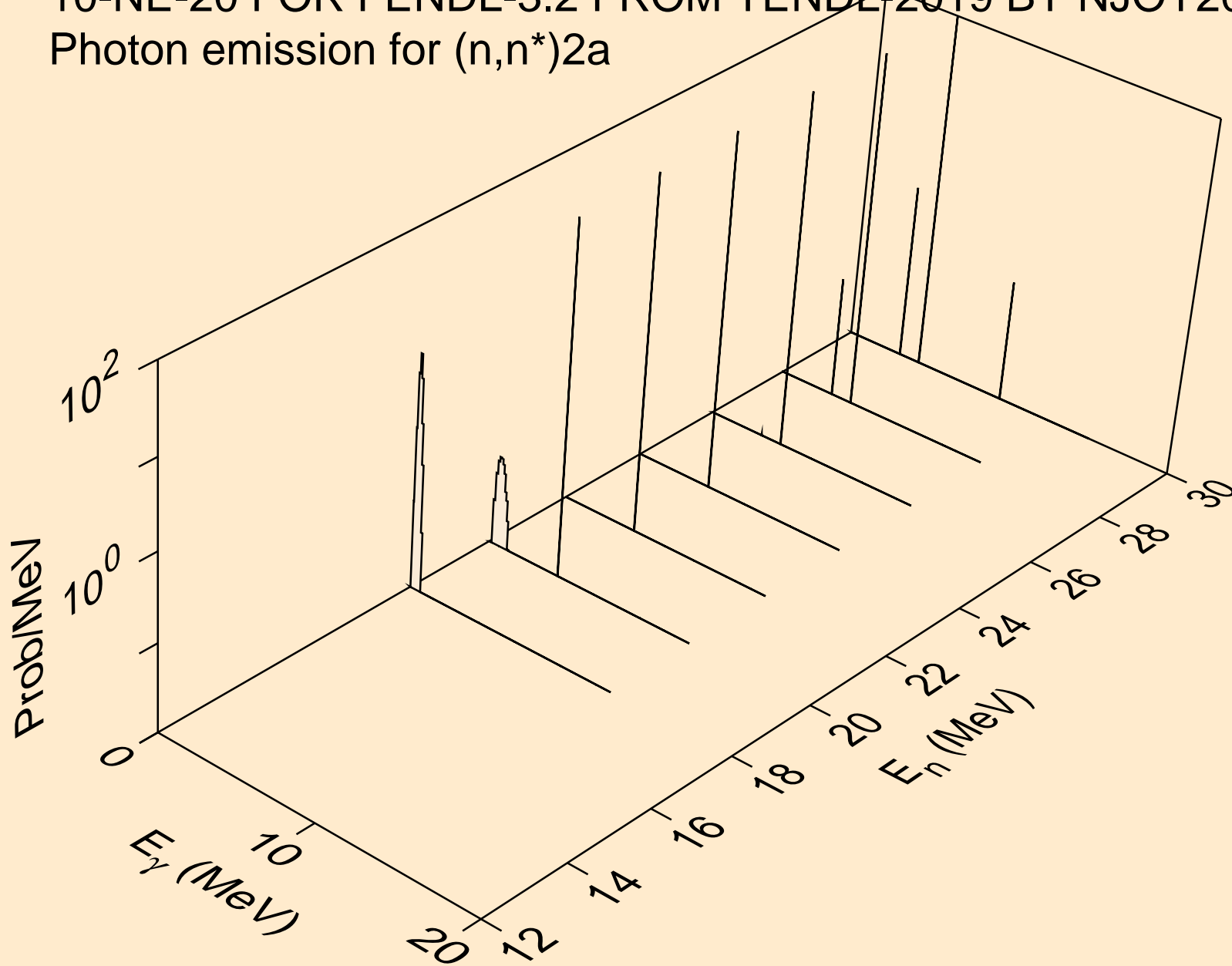

10-NE-20 FOR FENDL-3.2 FROM TENDL-2019 BY NJOY2016.60+
Photon emission for (n,n*)d

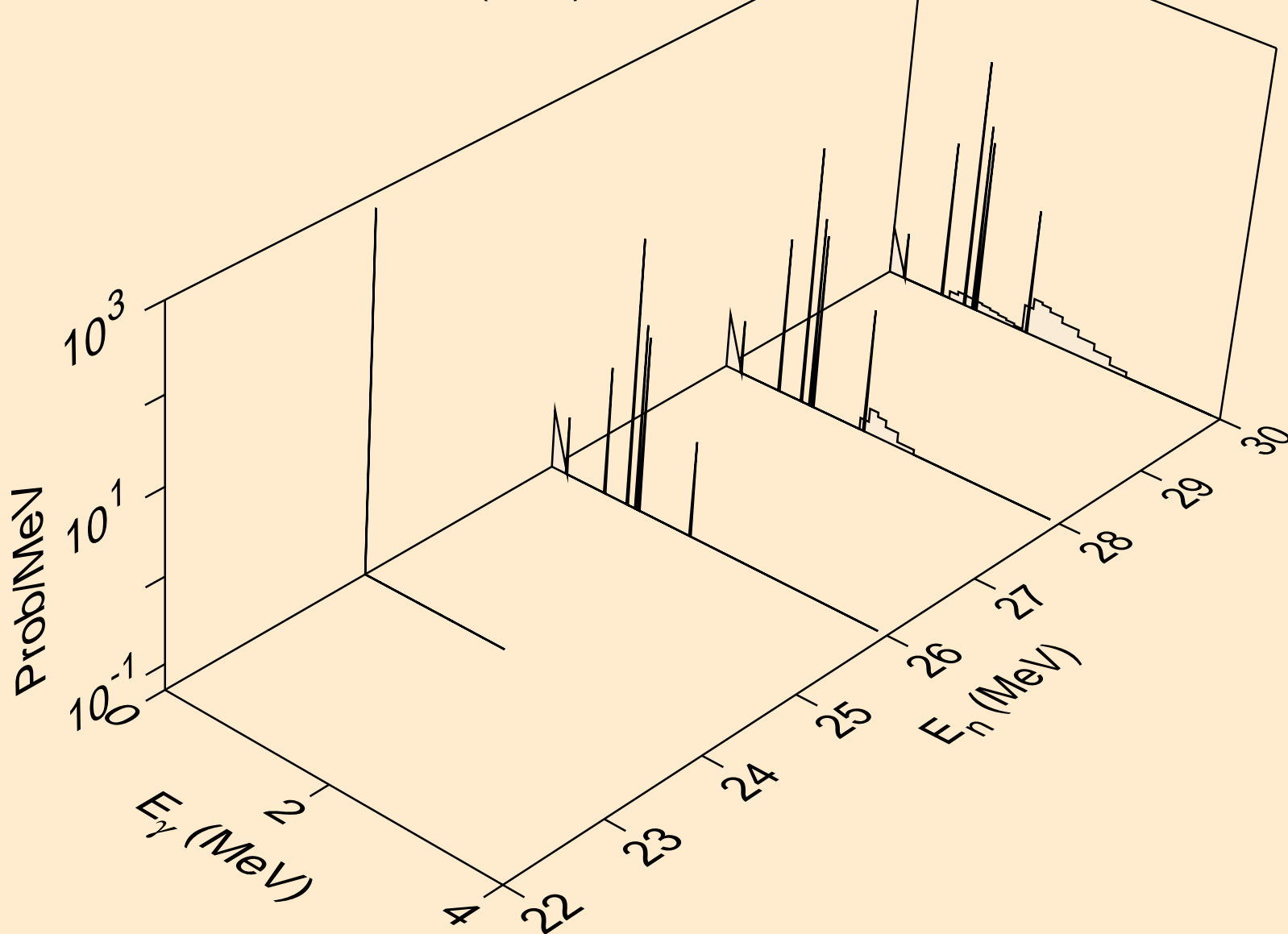

10-NE-20 FOR FENDL-3.2 FROM TENDL-2019 BY NJOY2016.60+
Photon emission for (n,n*)t

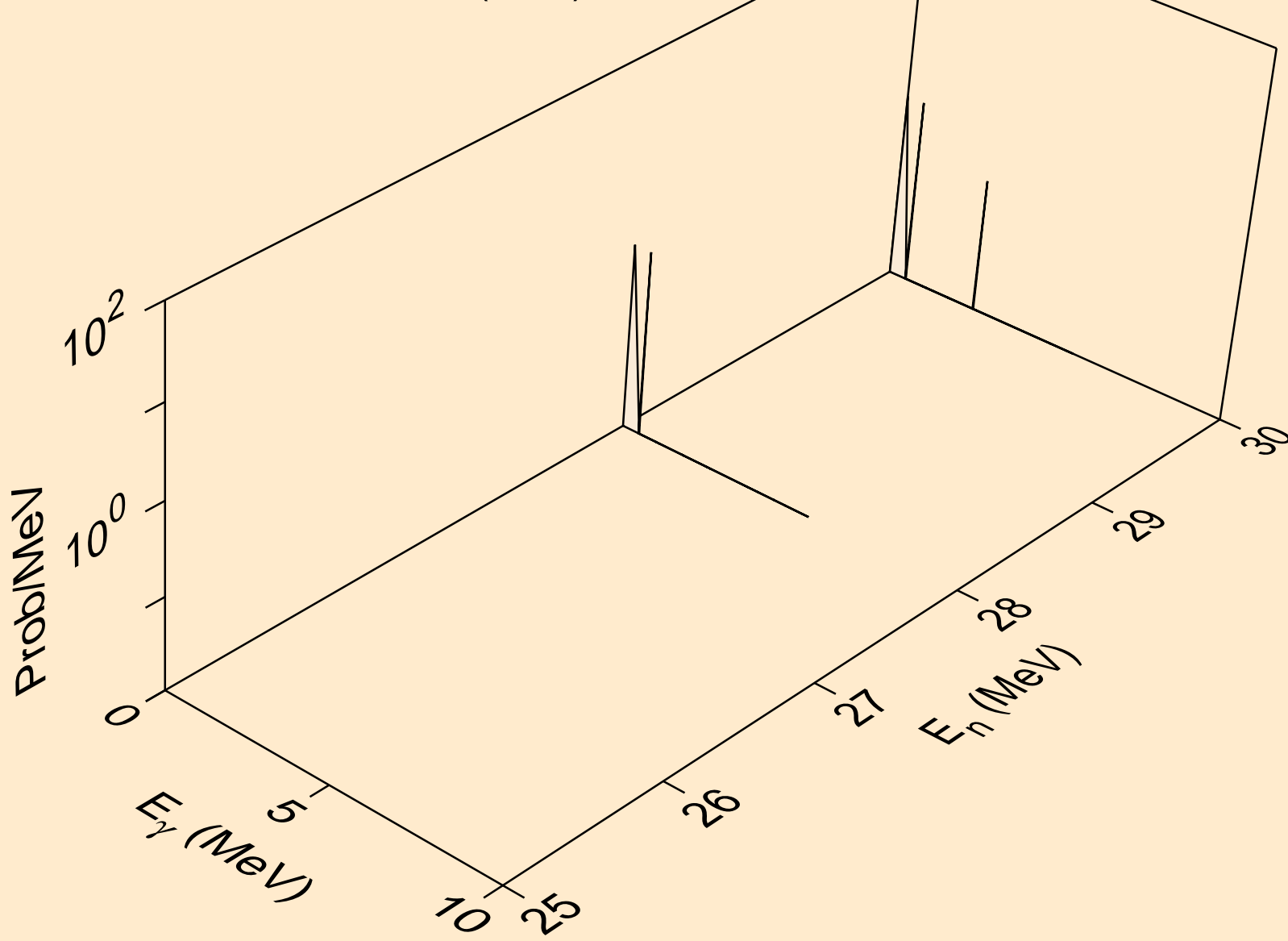

10-NE-20 FOR FENDL-3.2 FROM TENDL-2019 BY NJOY2016.60+
Photon emission for (n,n*)he3

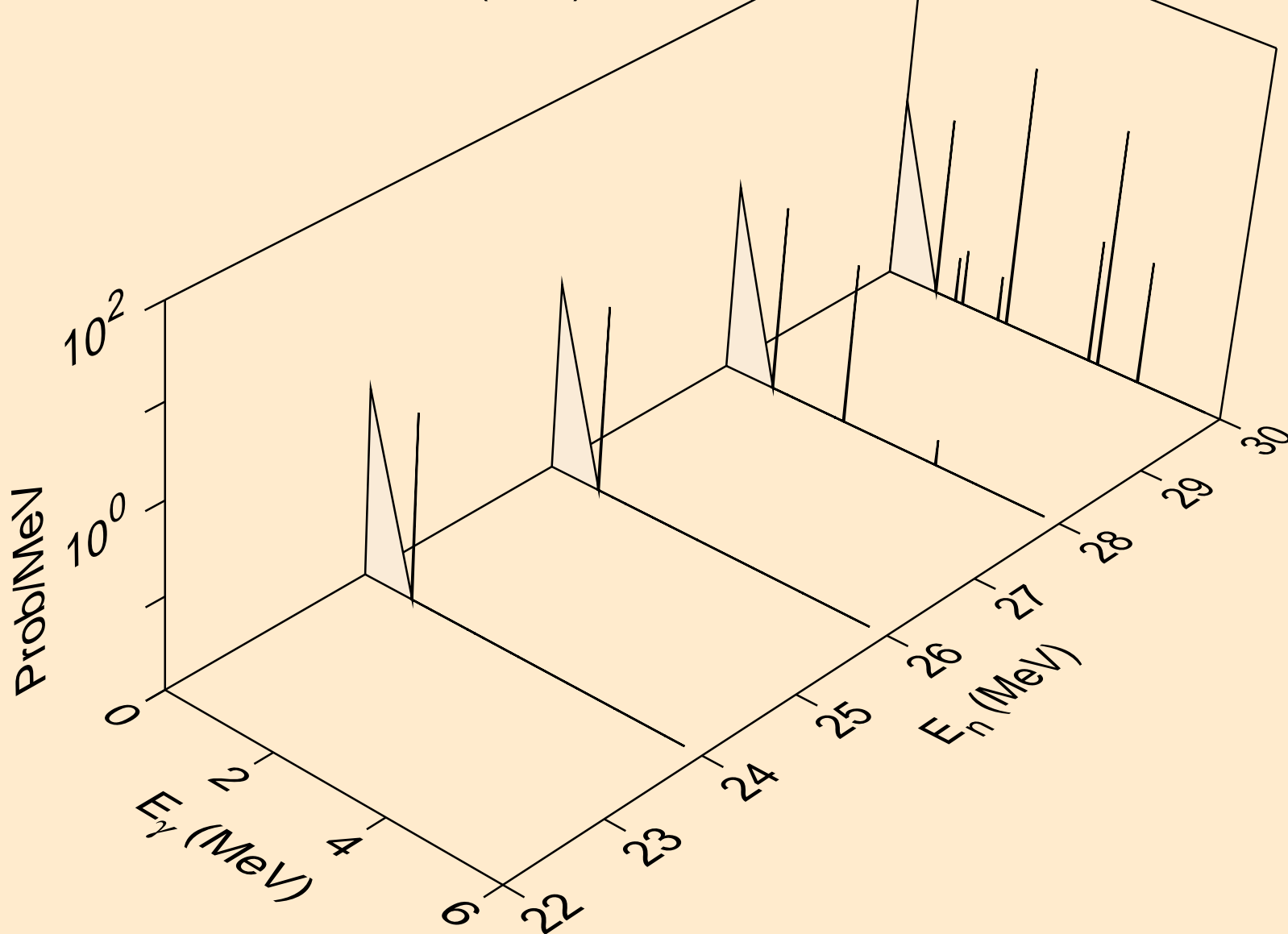

10-NE-20 FOR FENDL-3.2 FROM TENDL-2019 BY NJOY2016.60+
Photon emission for (n,2np)

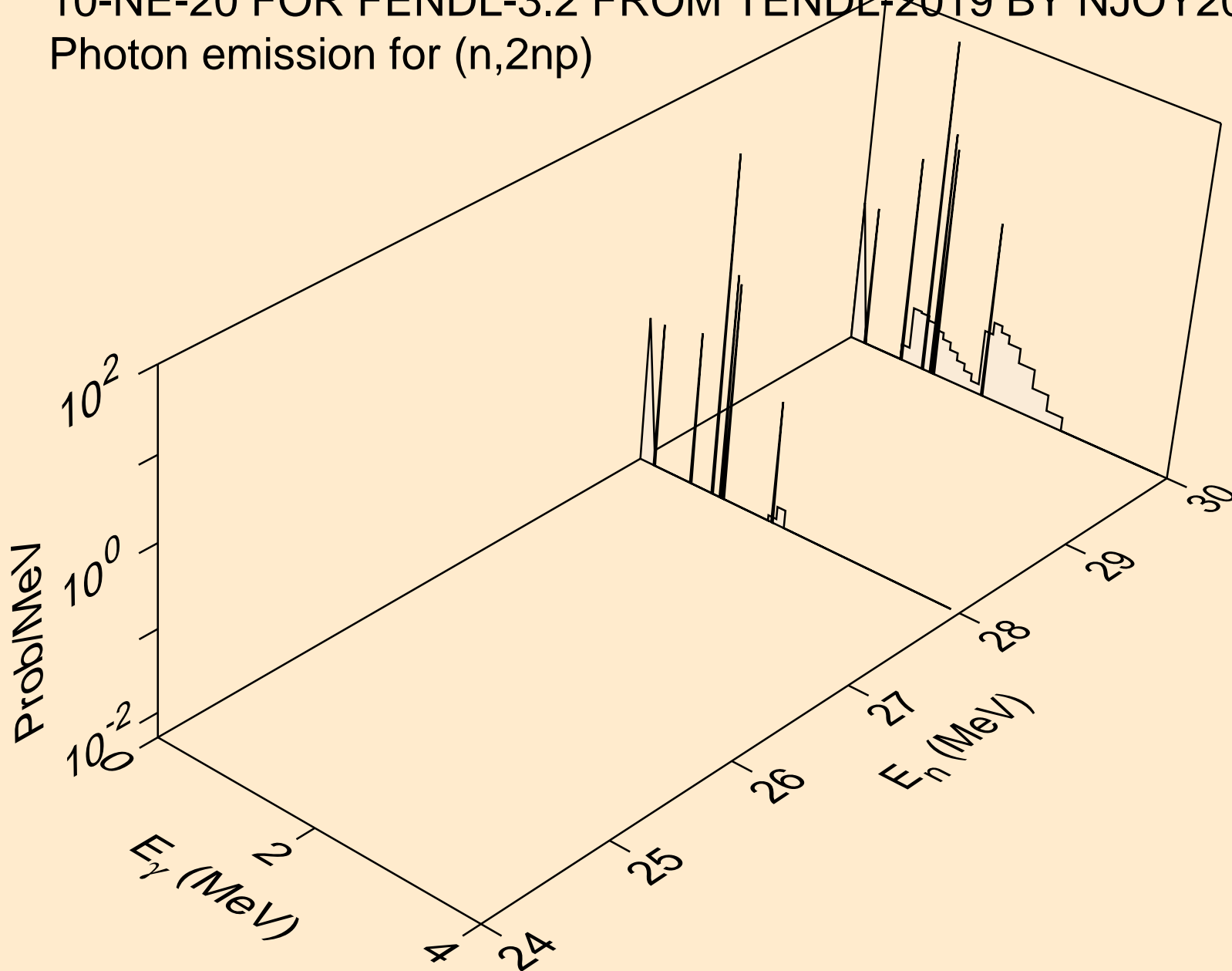

10-NE-20 FOR FENDL-3.2 FROM TENDL-2019 BY NJOY2016.60+
Photon emission for (n,2np)

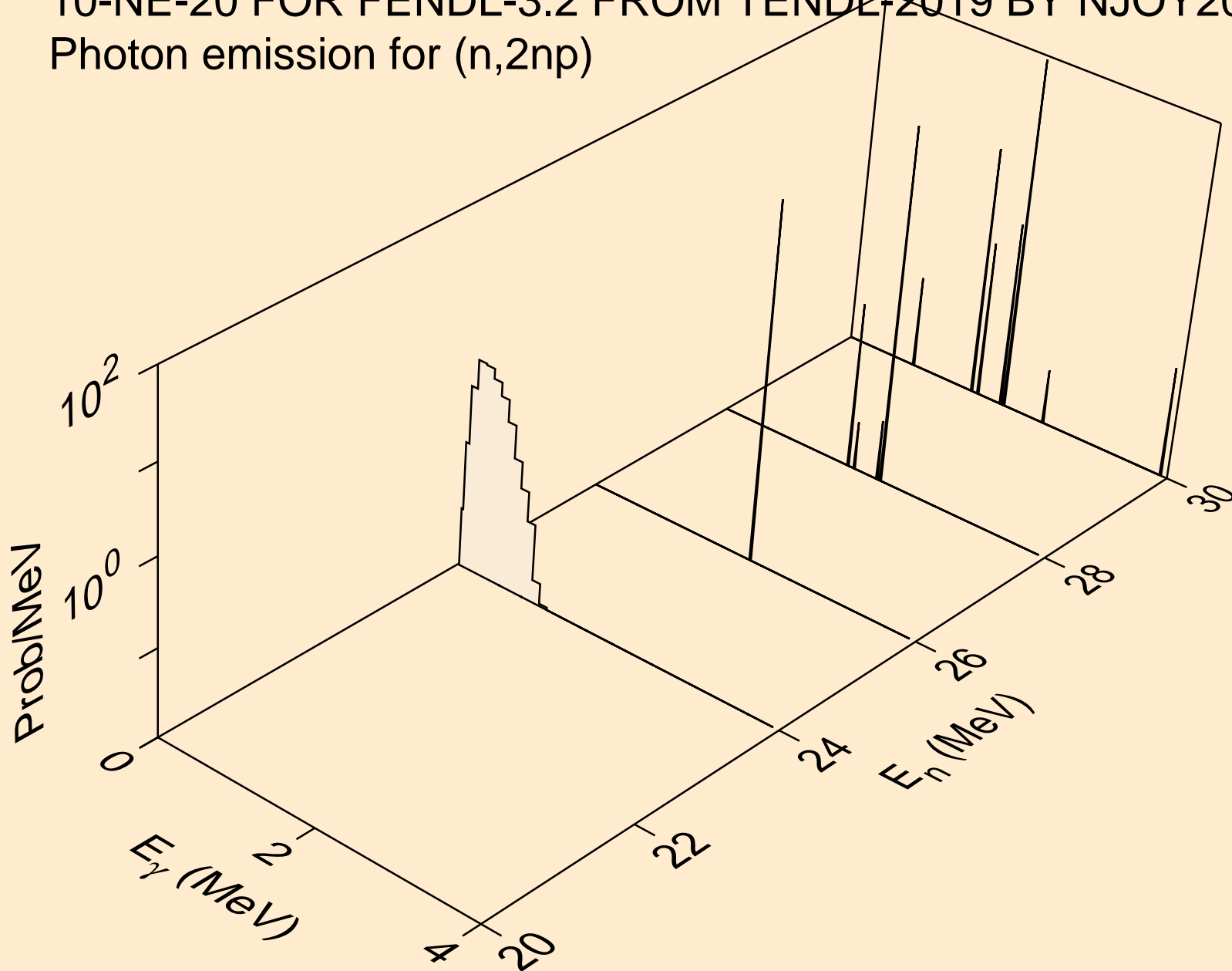

10-NE-20 FOR FENDL-3.2 FROM TENDL-2019 BY NJOY2016.60+
Photon emission for (n,npa)

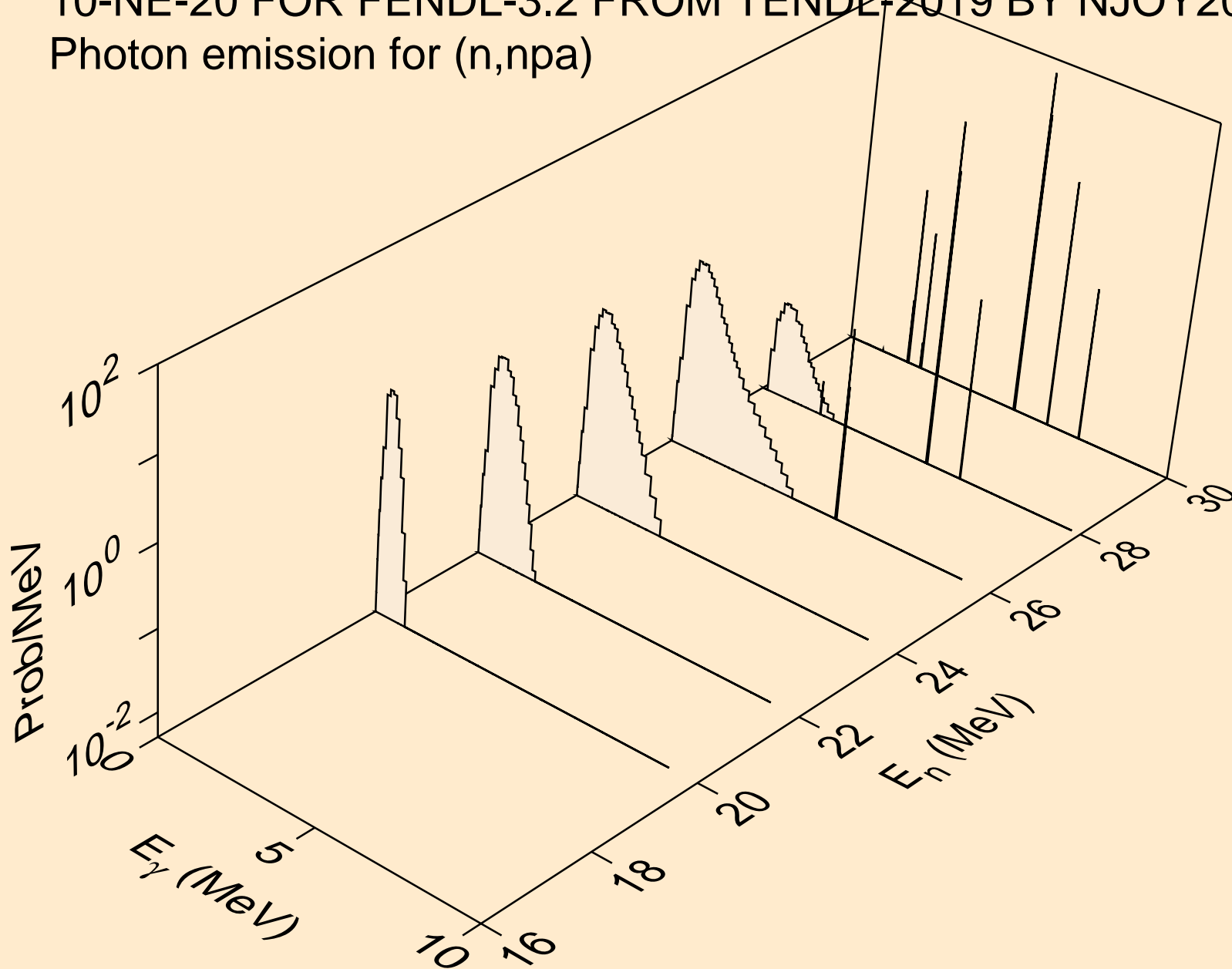

10-NE-20 FOR FENDL-3.2 FROM TENDL-2019 BY NJOY2016.60+
Photon emission for (n,n*c)

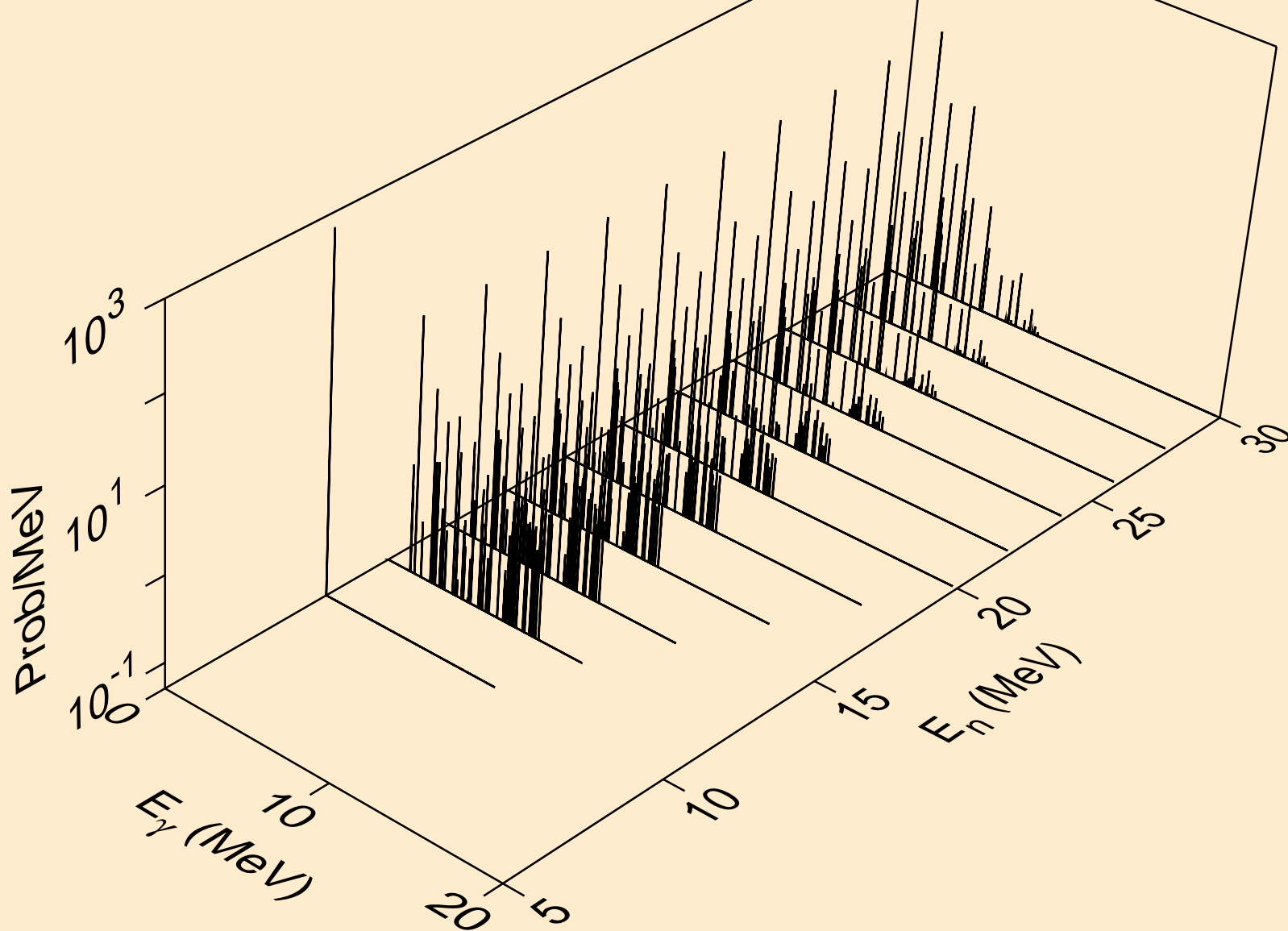

10-NE-20 FOR FENDL-3.2 FROM TENDL-2019 BY NJOY2016.60+
Photon emission for (n,gma)

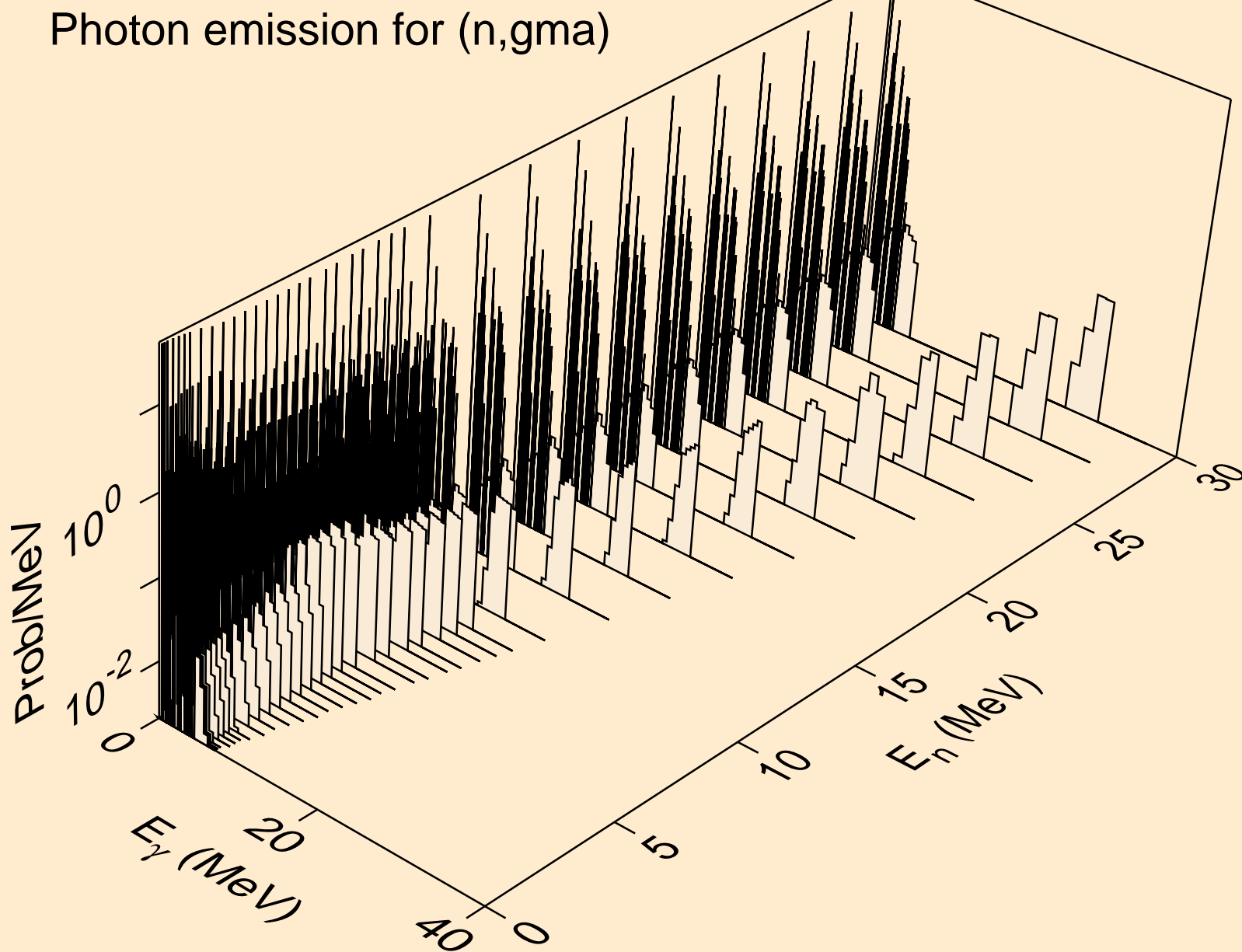

10-NE-20 FOR FENDL-3.2 FROM TENDL-2019 BY NJOY2016.60+
Photon emission for (n,p)

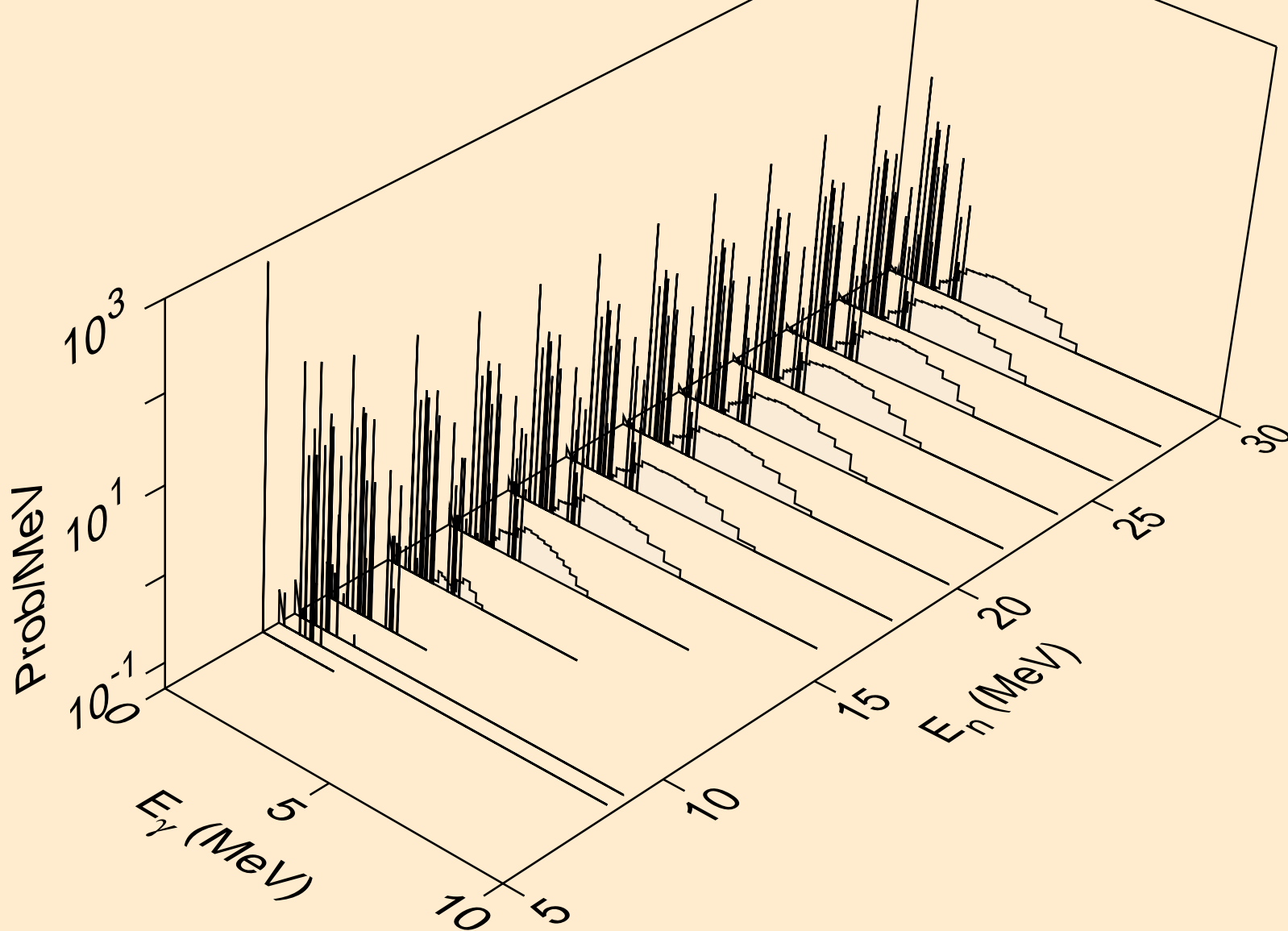

10-NE-20 FOR FENDL-3.2 FROM TENDL-2019 BY NJOY2016.60+
Photon emission for (n,d)

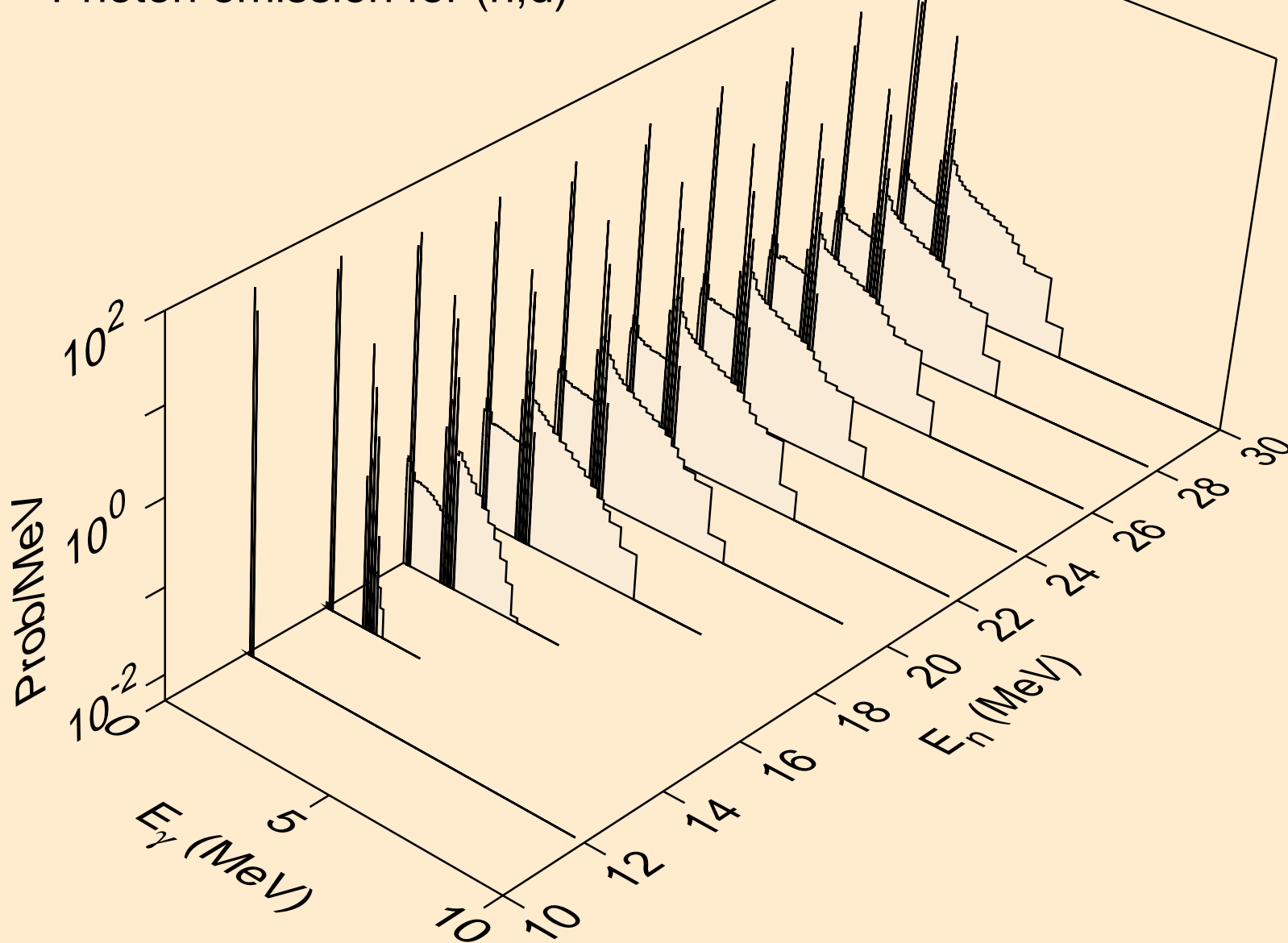

10-NE-20 FOR FENDL-3.2 FROM TENDL-2019 BY NJOY2016.60+
Photon emission for (n,t)

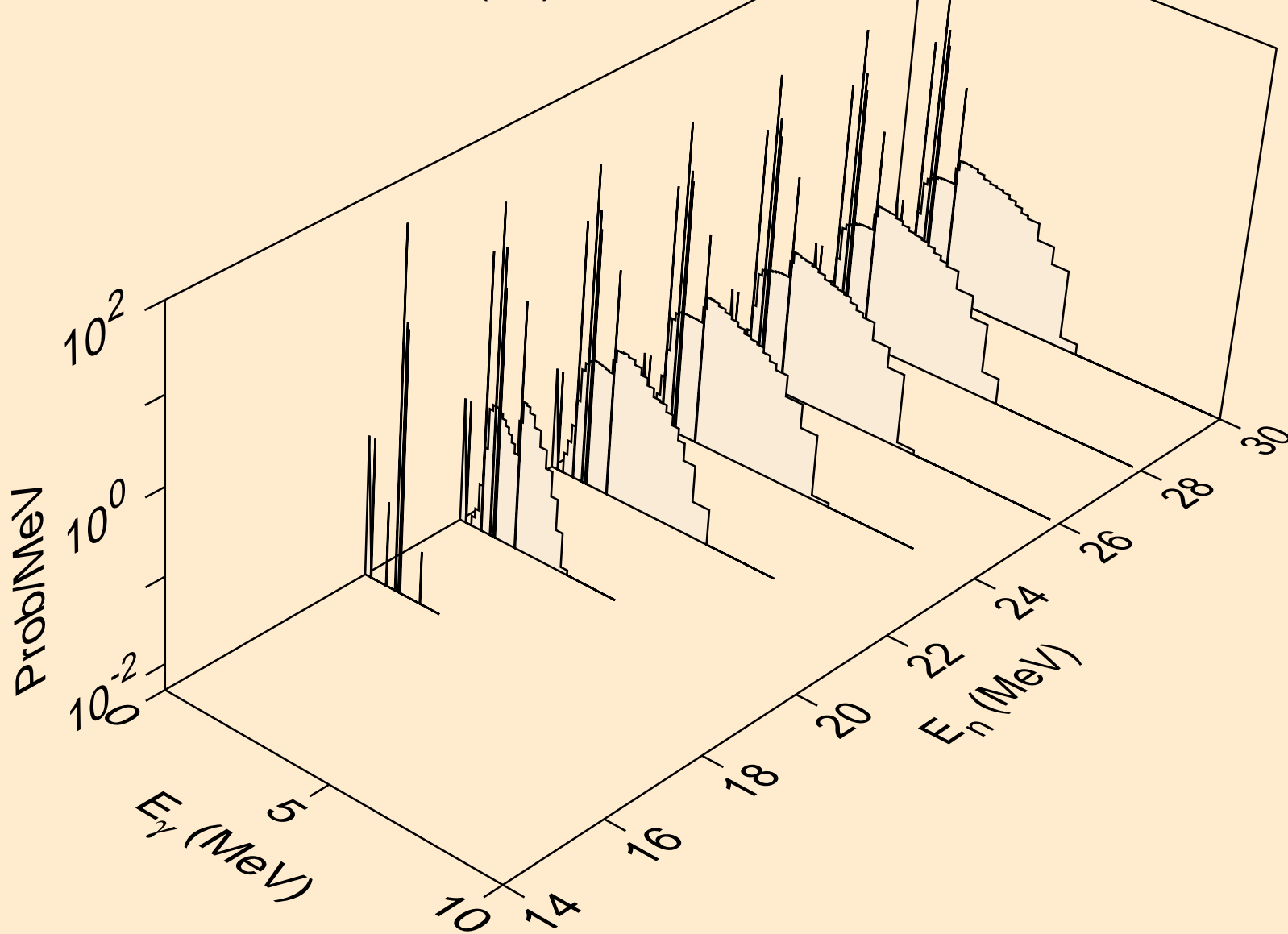

10-NE-20 FOR FENDL-3.2 FROM TENDL-2019 BY NJOY2016.60+
Photon emission for (n,he3)

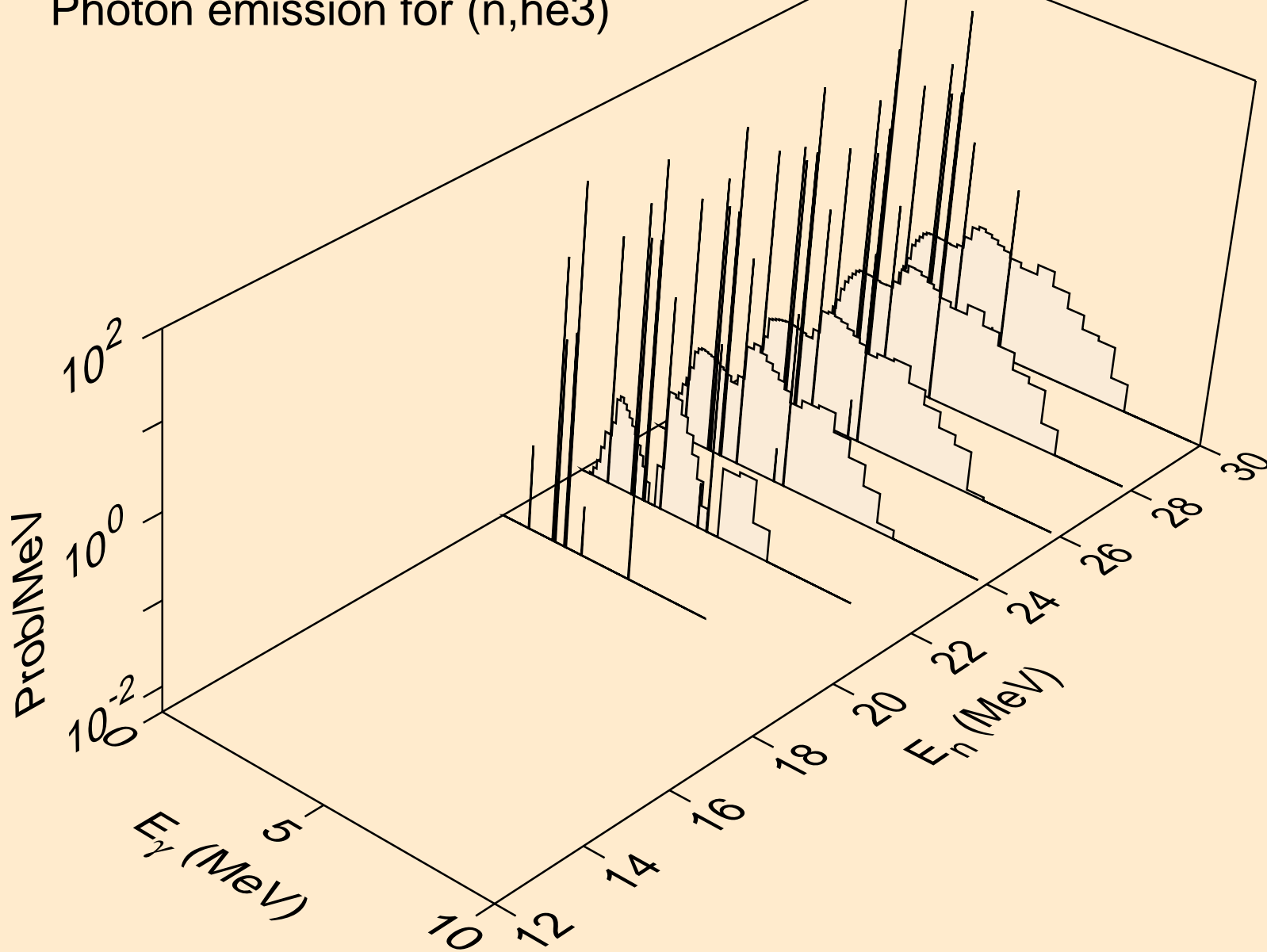

10-NE-20 FOR FENDL-3.2 FROM TENDL-2019 BY NJOY2016.60+
Photon emission for (n,a)

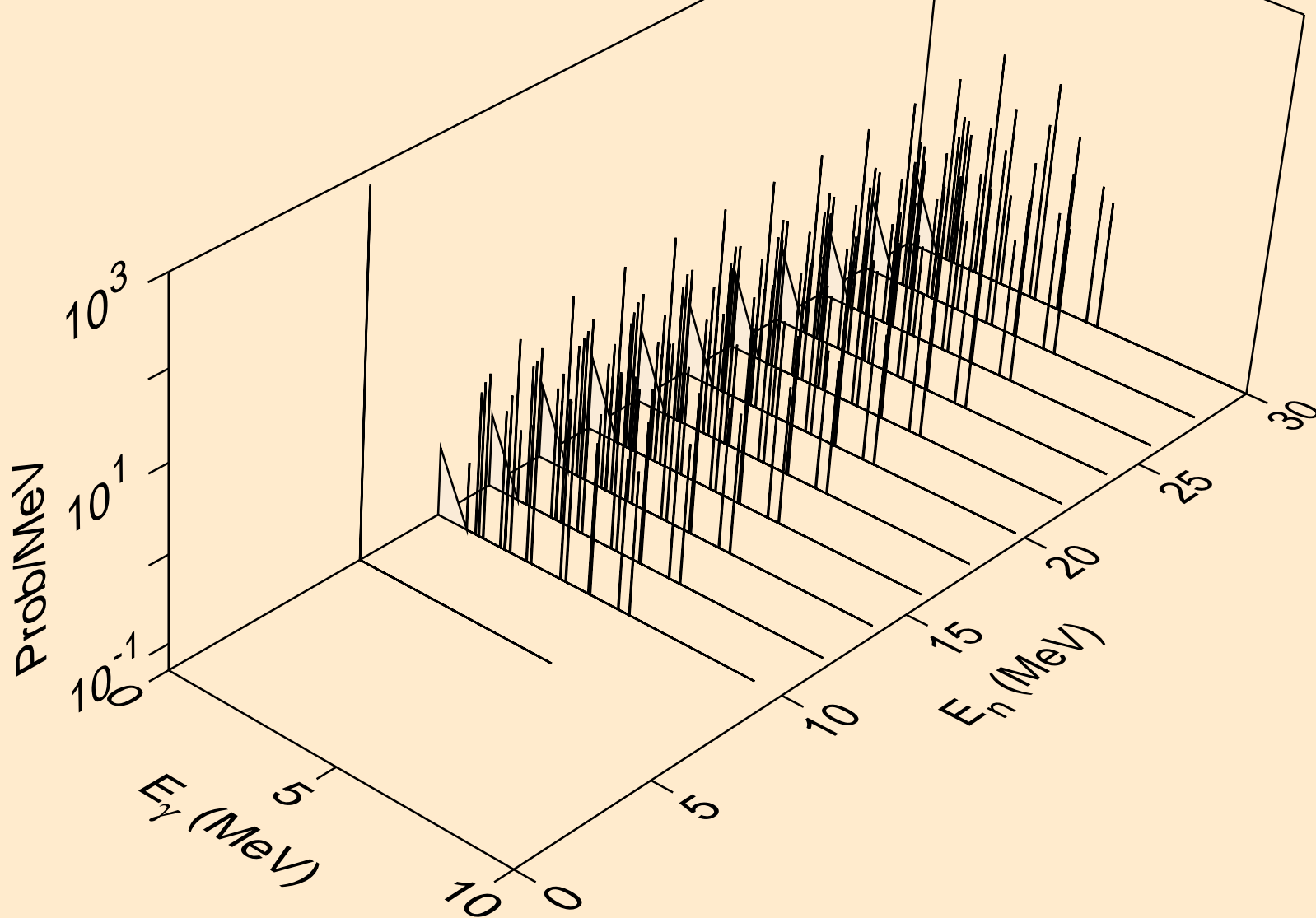

10-NE-20 FOR FENDL-3.2 FROM TENDL-2019 BY NJOY2016.60+
Photon emission for (n,2a)

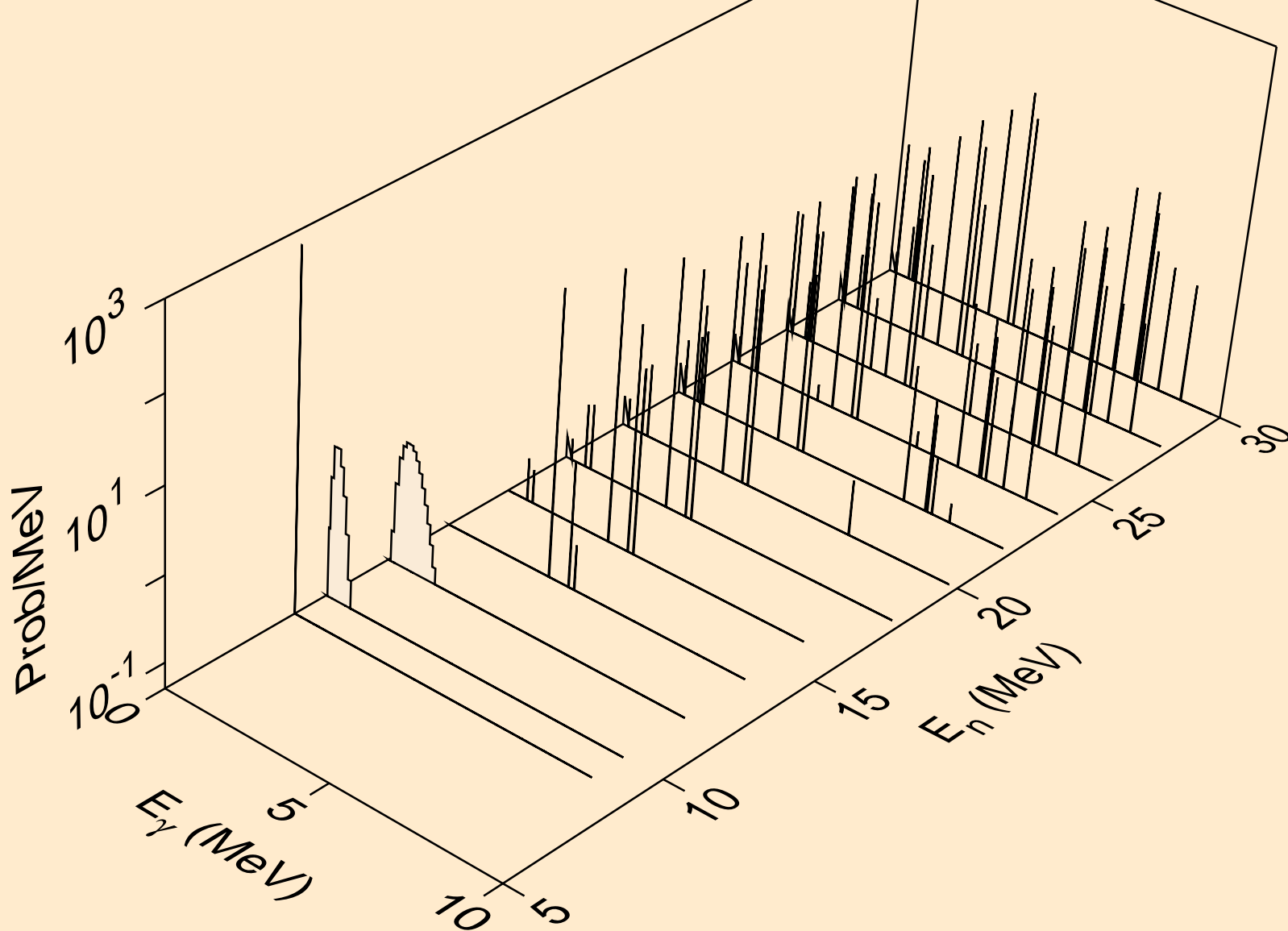

10-NE-20 FOR FENDL-3.2 FROM TENDL-2019 BY NJOY2016.60+
Photon emission for (n,3a)

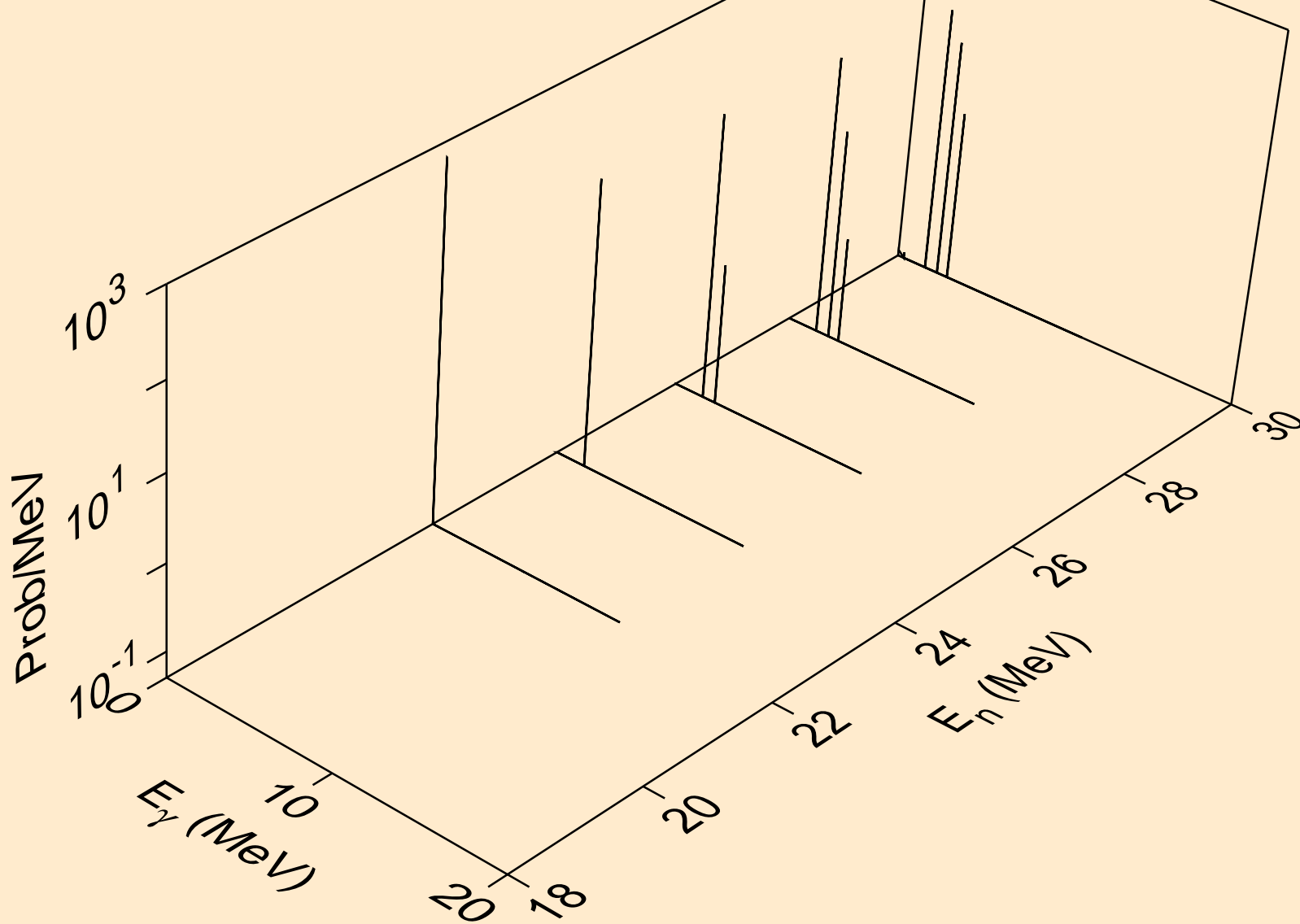

10-NE-20 FOR FENDL-3.2 FROM TENDL-2019 BY NJOY2016.60+
Photon emission for (n,2p)

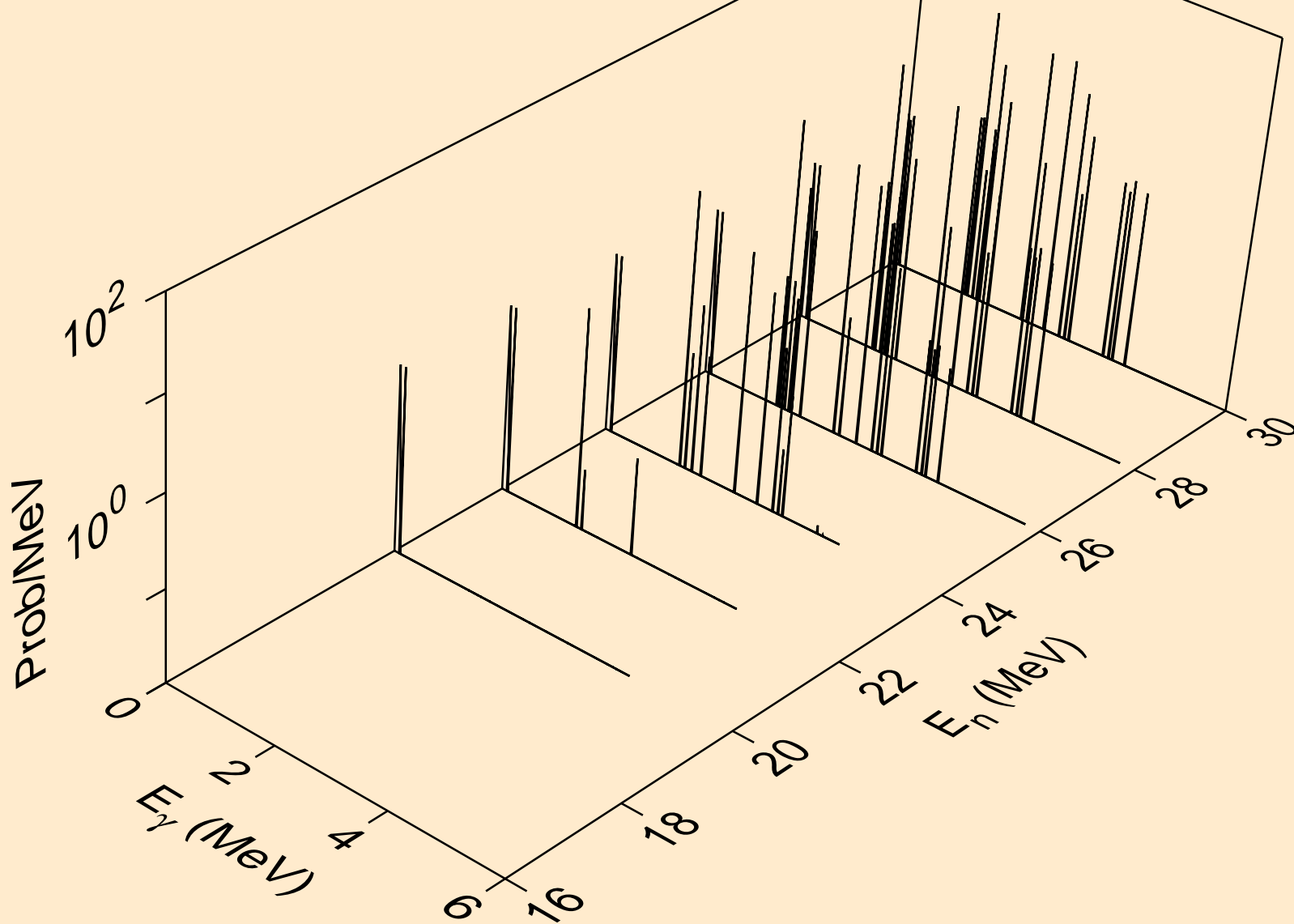

10-NE-20 FOR FENDL-3.2 FROM TENDL-2019 BY NJOY2016.60+
Photon emission for (n,pa)

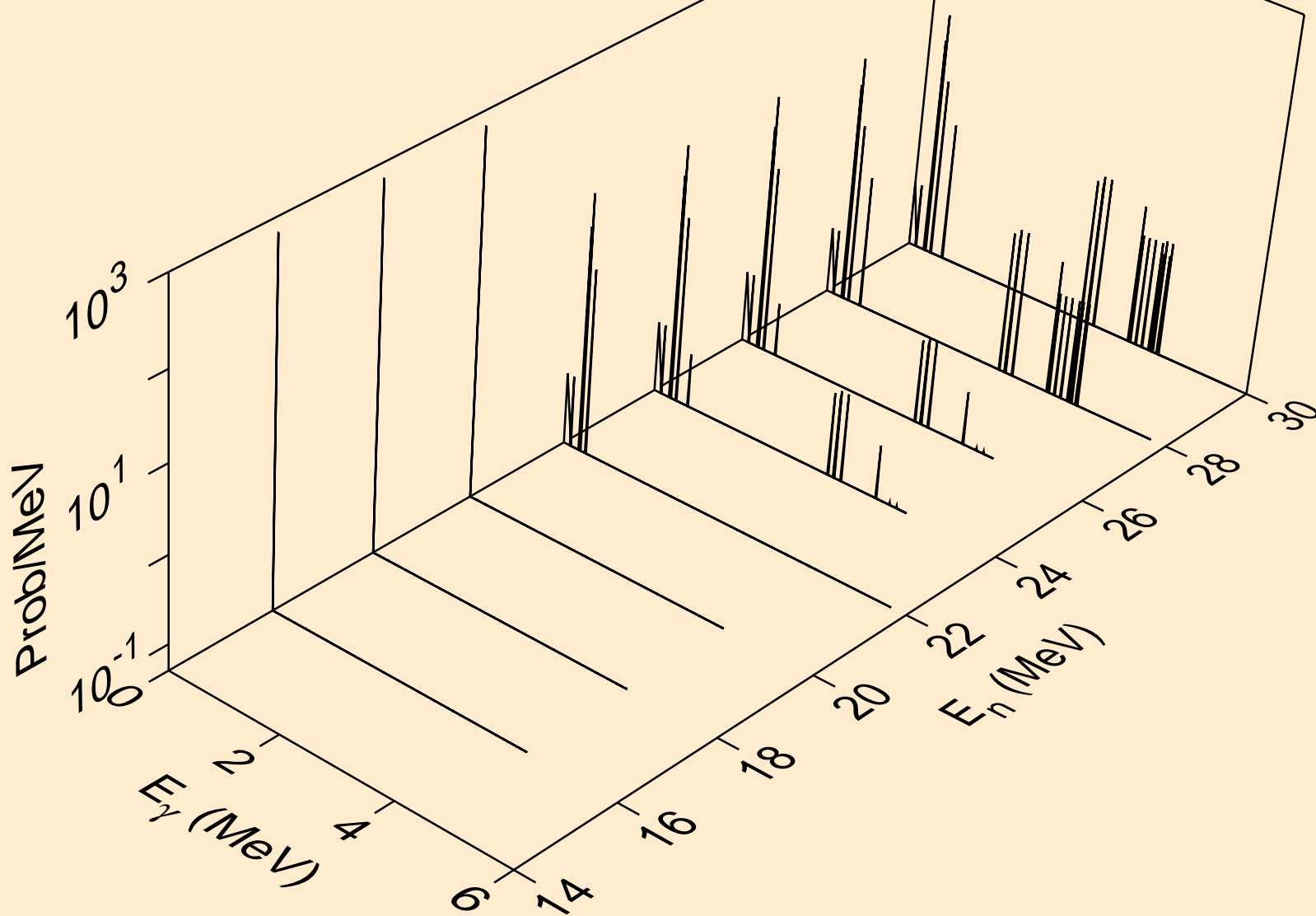

10-NE-20 FOR FENDL-3.2 FROM TENDL-2019 BY NJOY2016.60+
Photon emission for (n,pd)

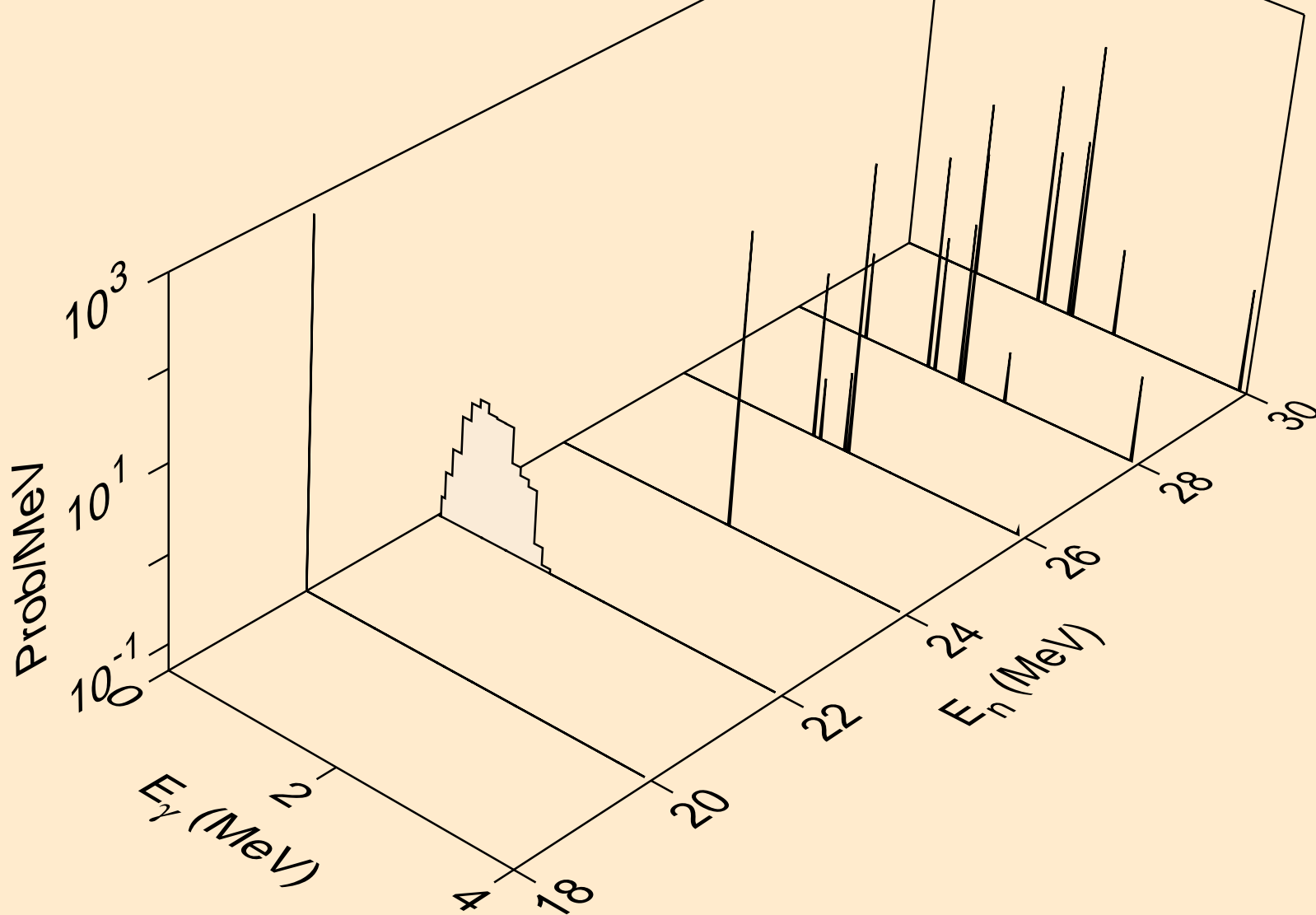

10-NE-20 FOR FENDL-3.2 FROM TENDL-2019 BY NJOY2016.60+
Photon emission for (n,pt)

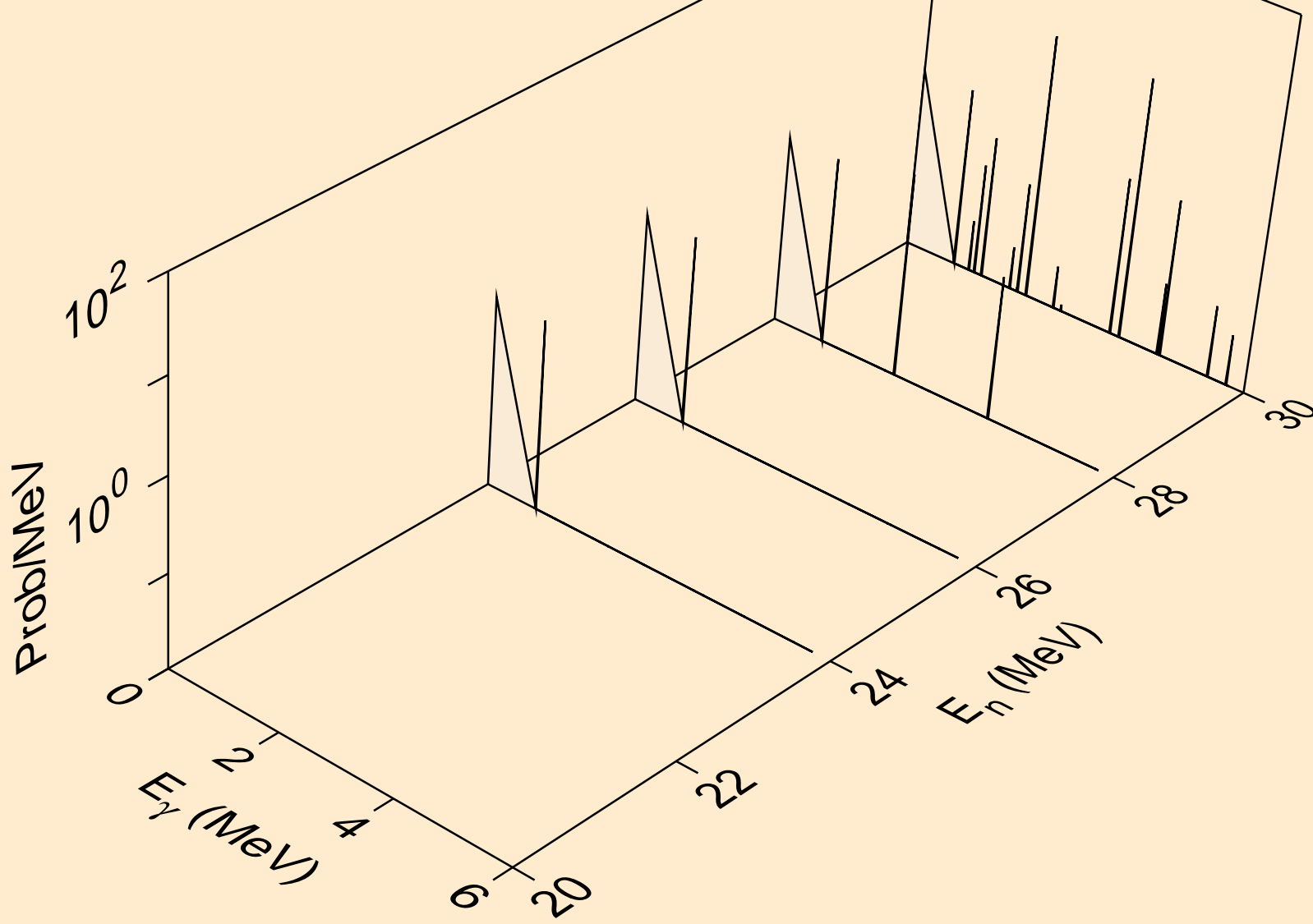

10-NE-20 FOR FENDL-3.2 FROM TENDL-2019 BY NJOY2016.60+
Photon emission for (n,da)

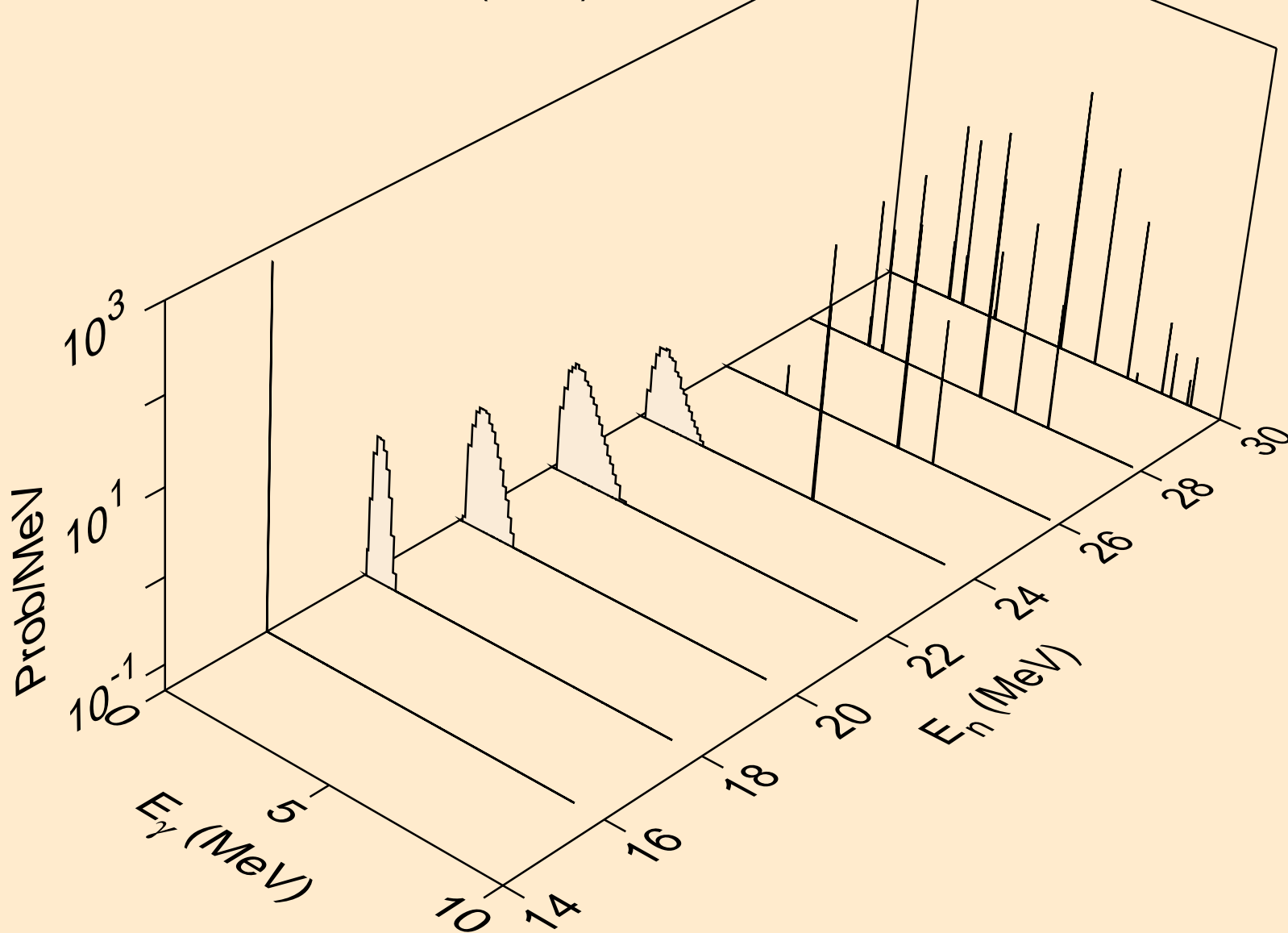

10-NE-20 FOR FENDL-3.2 FROM TENDL-2019 BY NJOY2016.60+
thermal capture photon spectrum

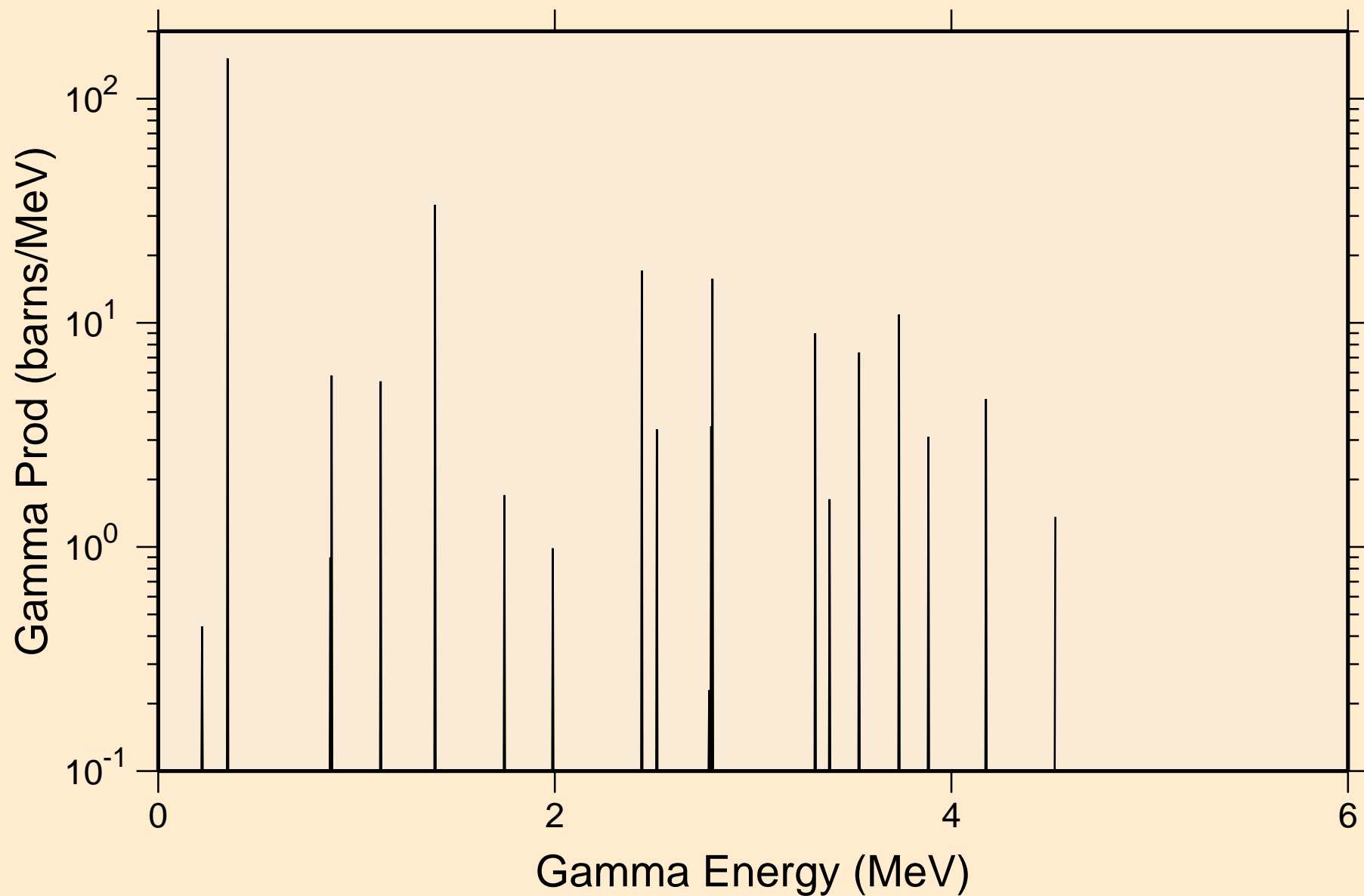

10-NE-20 FOR FENDL-3.2 FROM TENDL-2019 BY NJOY2016.60+
14 MeV photon spectrum

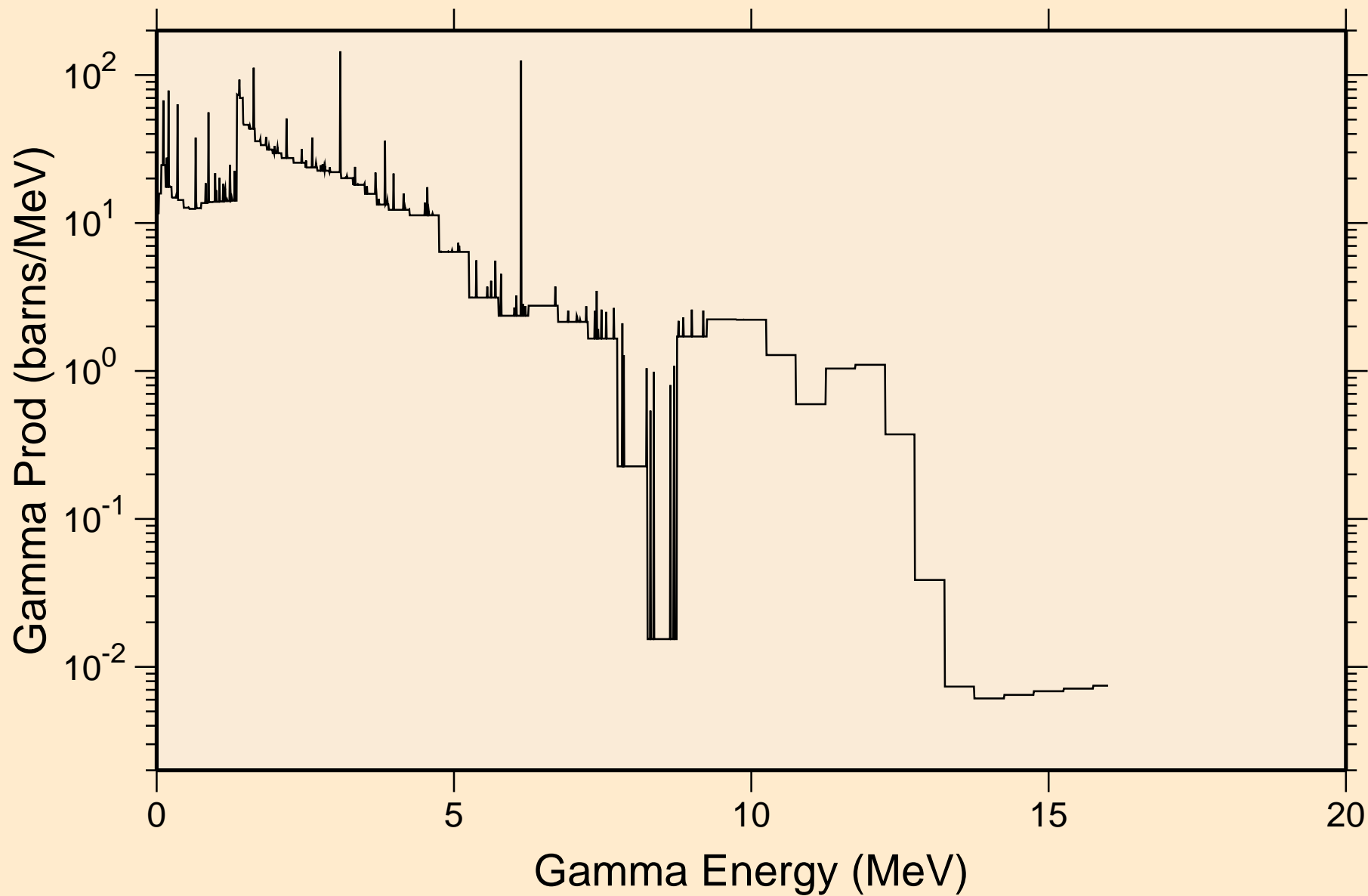

10-NE-20 FOR FENDL-3.2 FROM TENDL-2019 BY NJOY2016.60+

Particle heating contributions

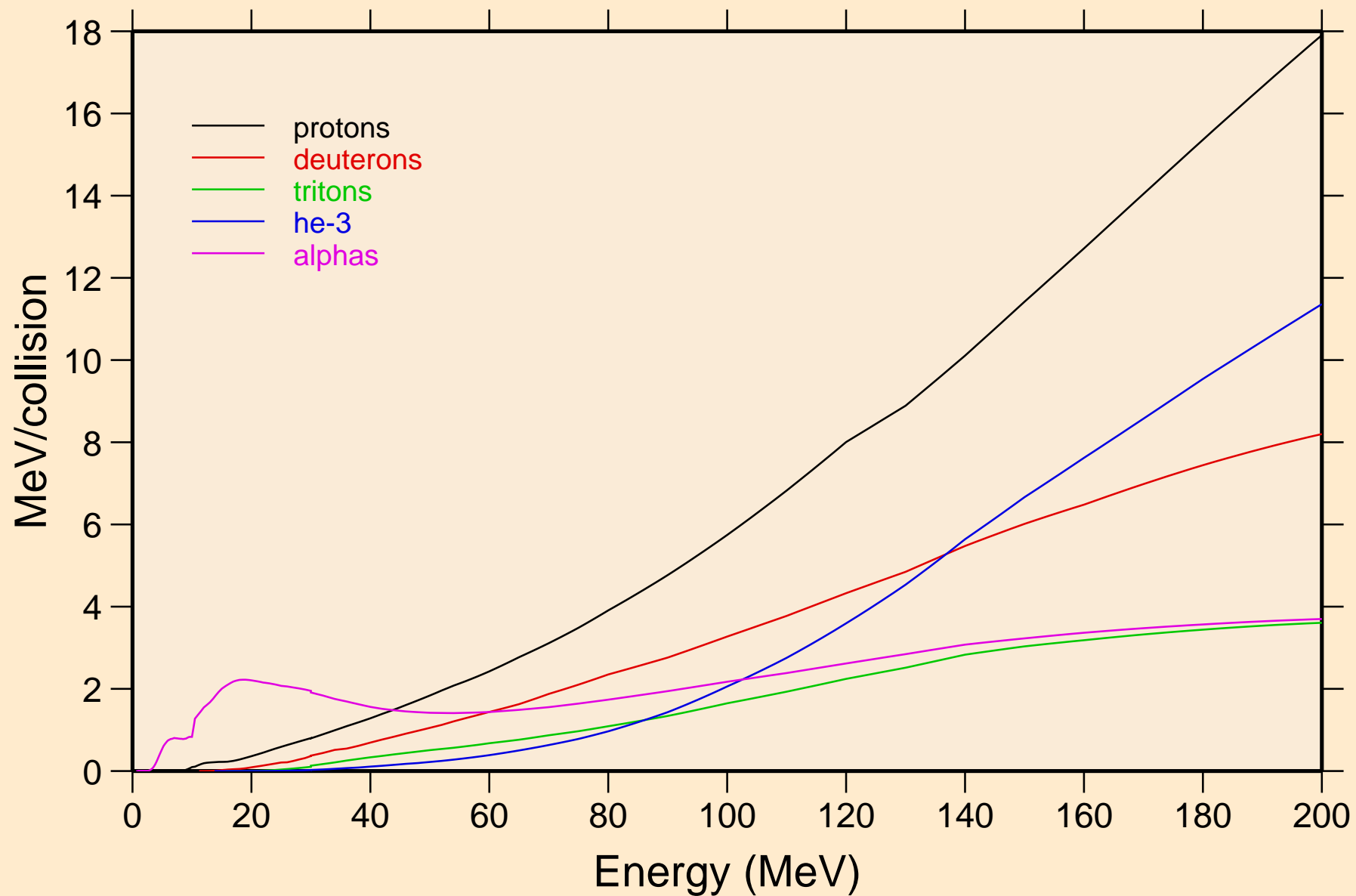

10-NE-20 FOR FENDL-3.2 FROM TENDL-2019 BY NJOY2016.60+

Recoil Heating

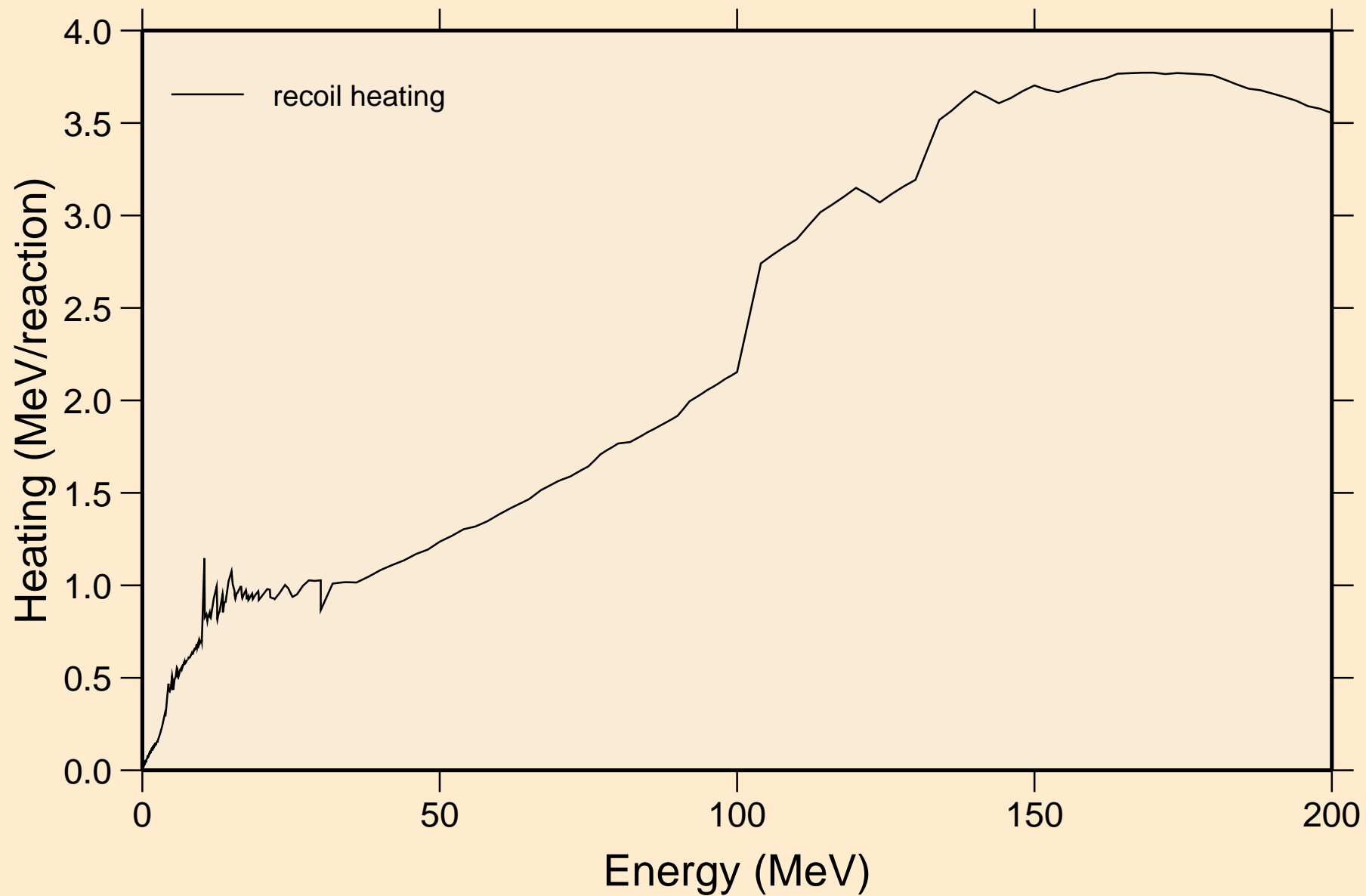

10-NE-20 FOR FENDL-3.2 FROM TENDL-2019 BY NJOY2016.60+
Particle production cross sections

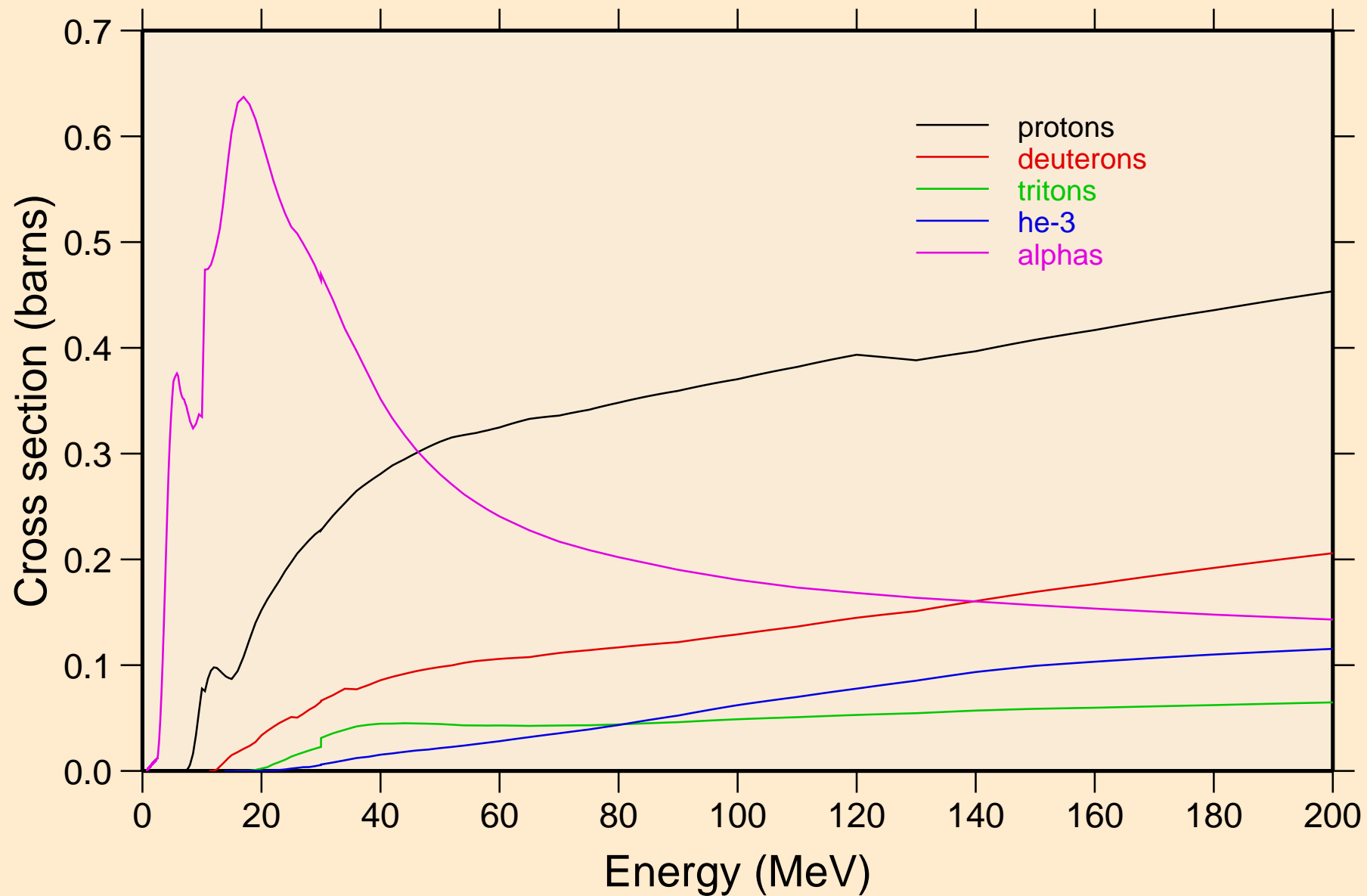

10-NE-20 FOR FENDL-3.2 FROM TENDL-2019 BY NJOY2016.60+
protons from (n,x)

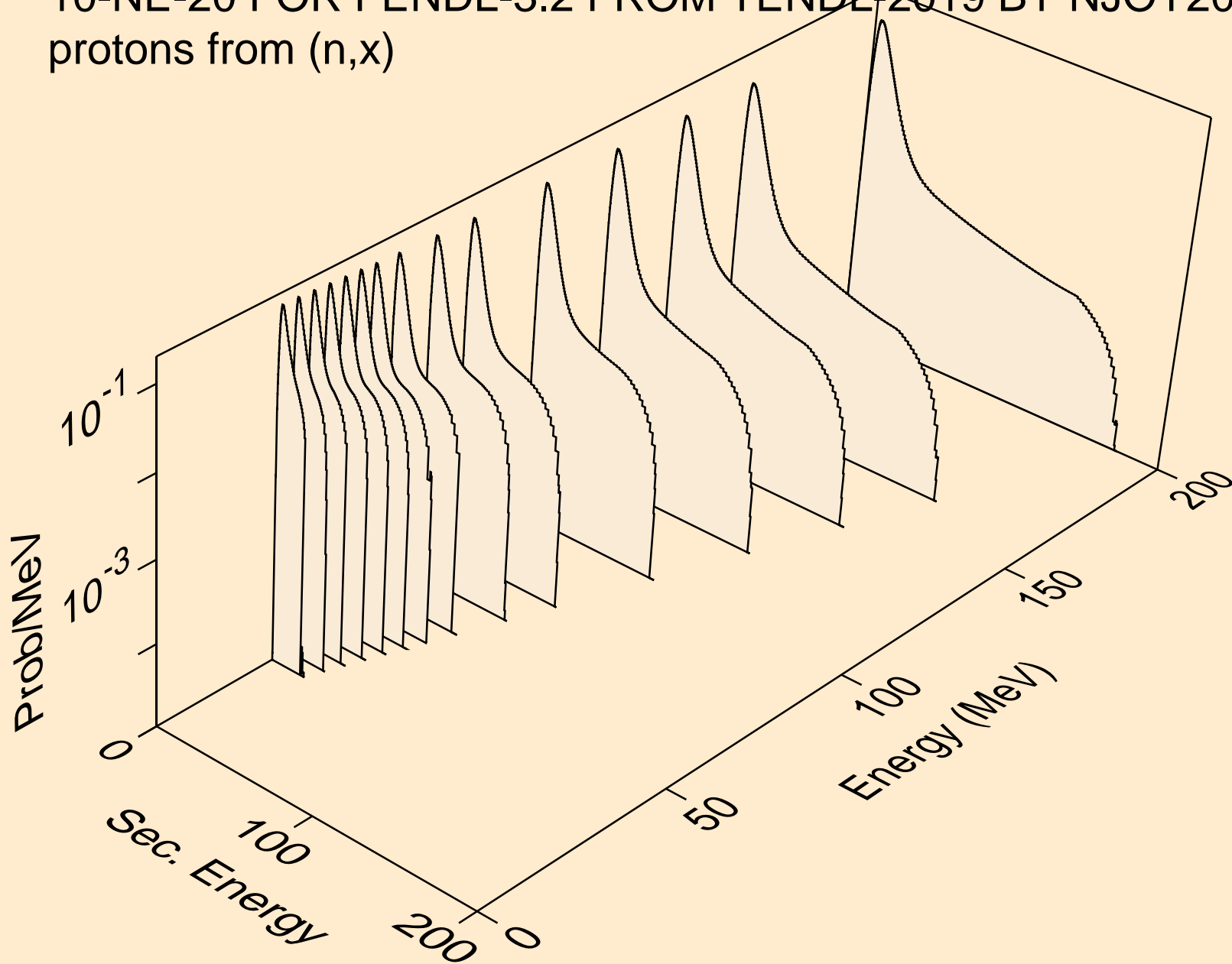

10-NE-20 FOR FENDL-3.2 FROM TENDL-2019 BY NJOY2016.60+
protons from (n,n*)p

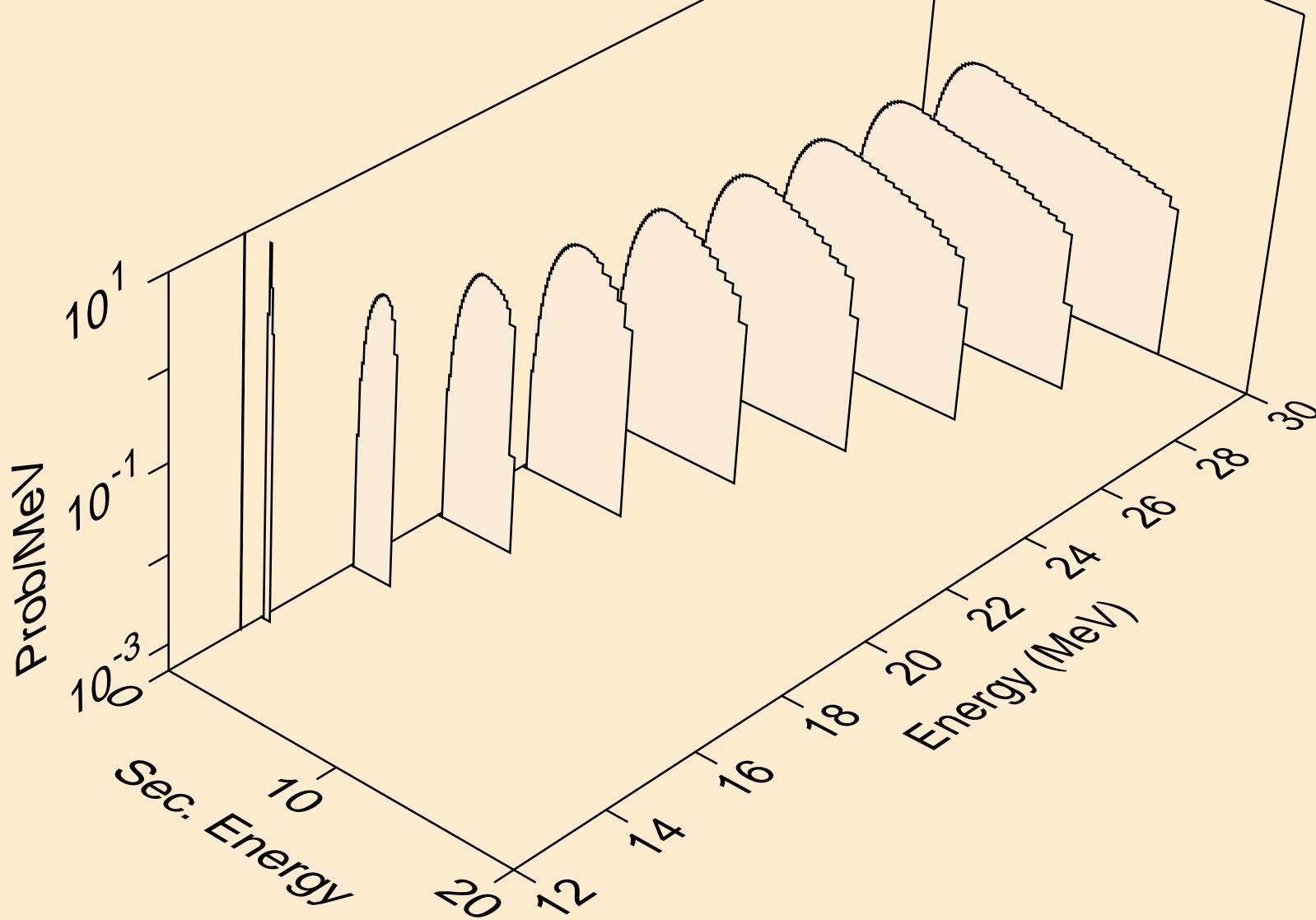

10-NE-20 FOR FENDL-3.2 FROM TENDL-2019 BY NJOY2016.60+
protons from (n,2np)

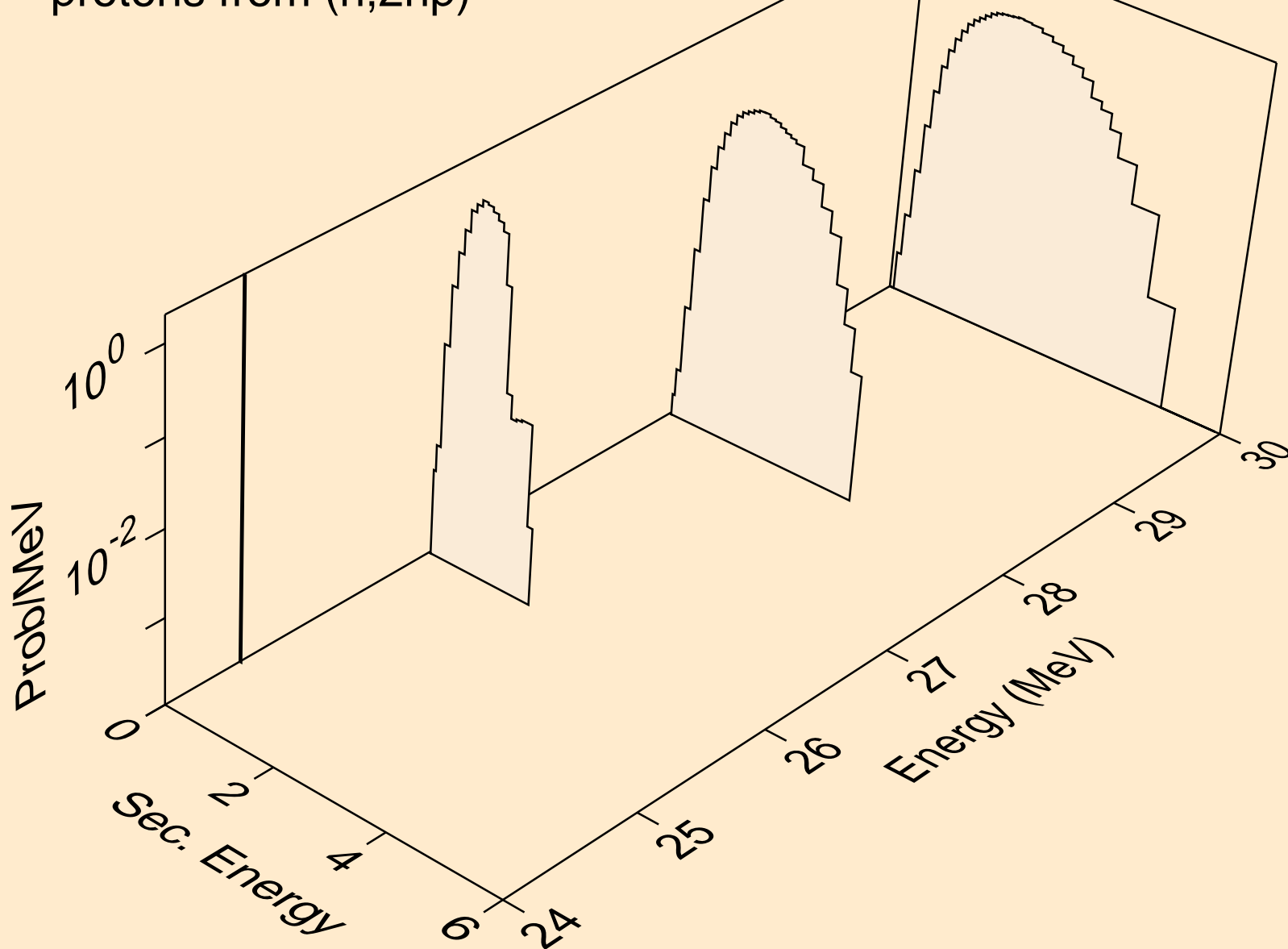

10-NE-20 FOR FENDL-3.2 FROM TENDL-2019 BY NJOY2016.60+
protons from (n,2np)

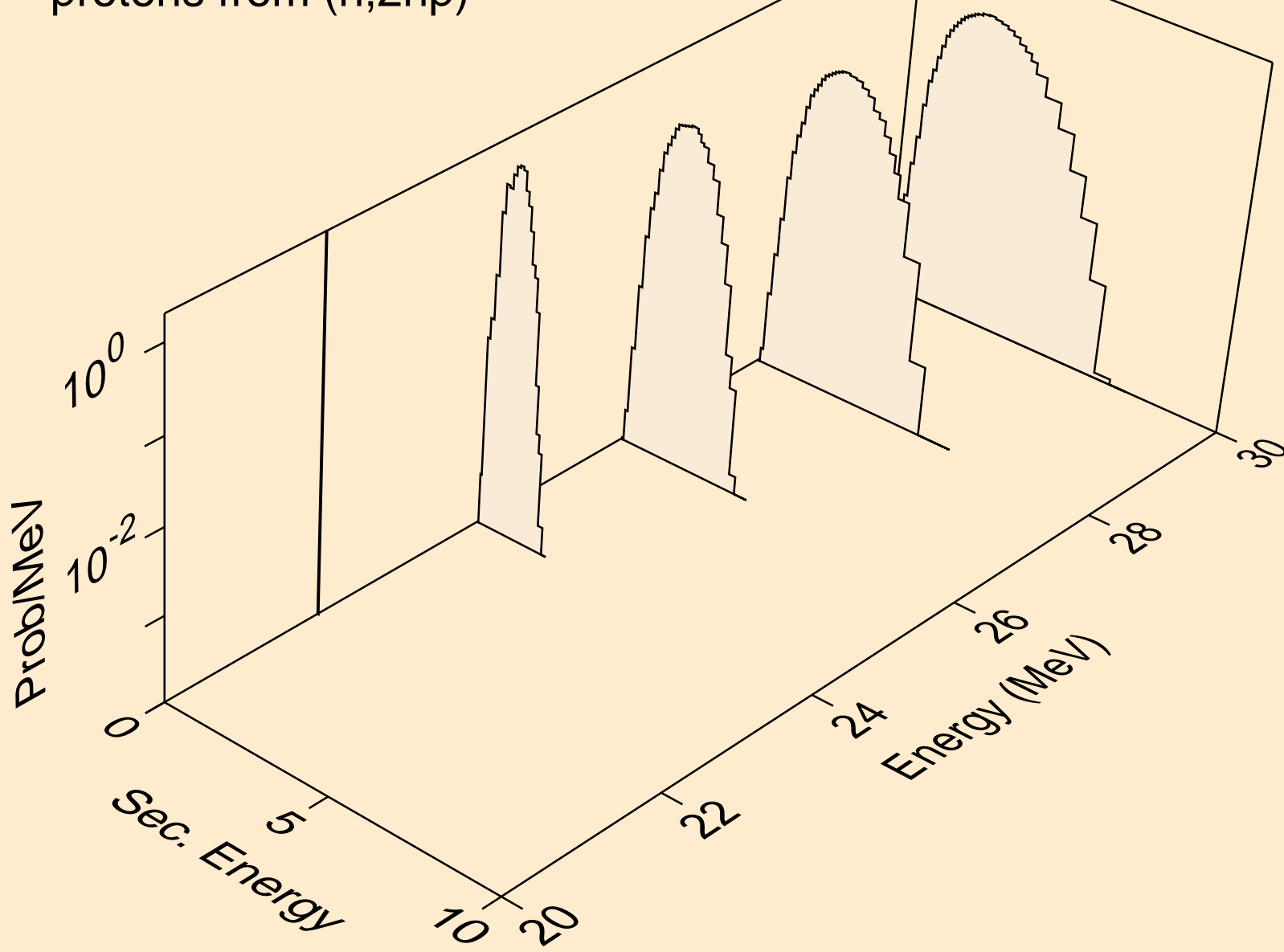

10-NE-20 FOR FENDL-3.2 FROM TENDL-2019 BY NJOY2016.60+
protons from (n,npa)

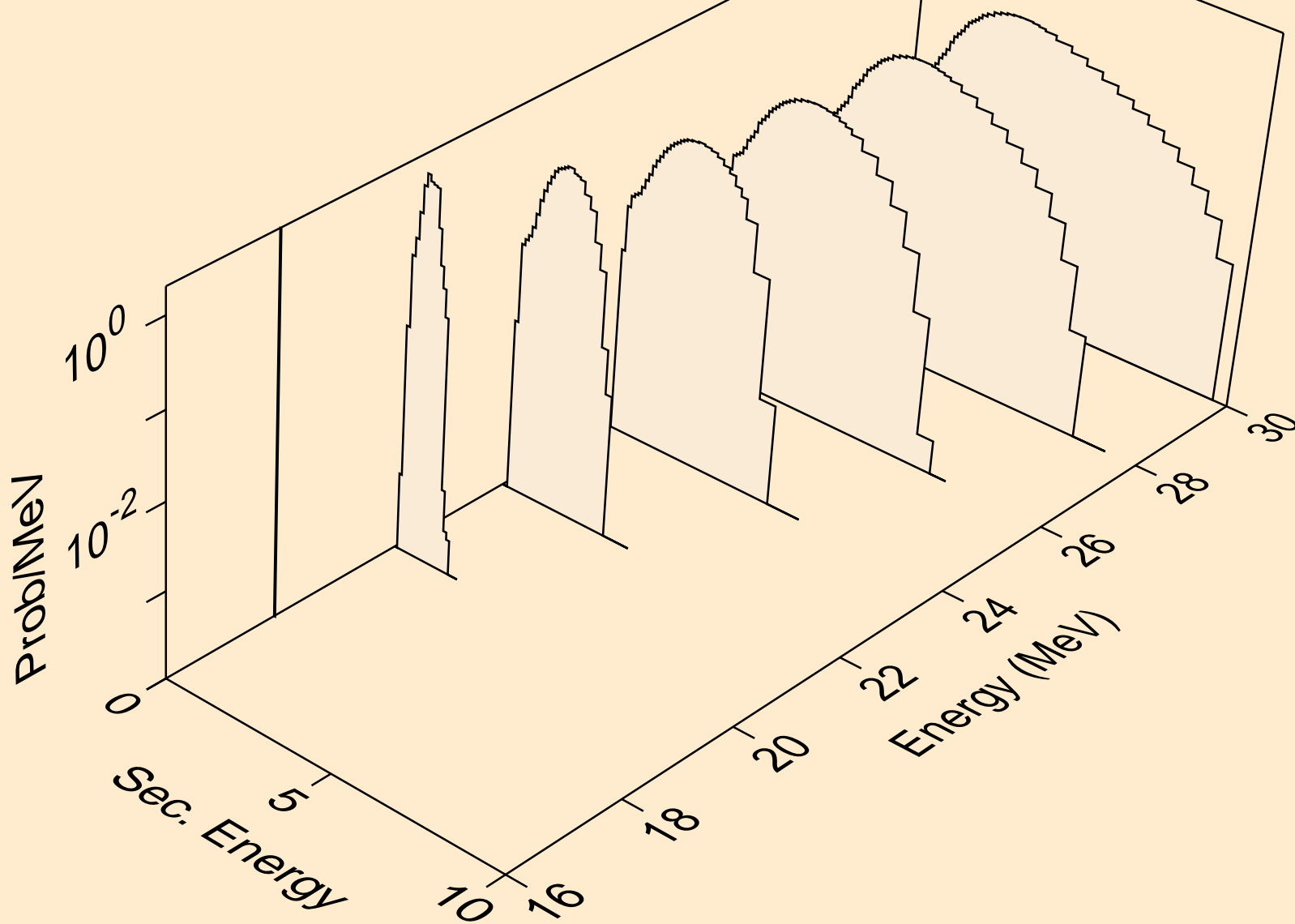

10-NE-20 FOR FENDL-3.2 FROM TENDL-2019 BY NJOY2016.60+
protons from (n,p)

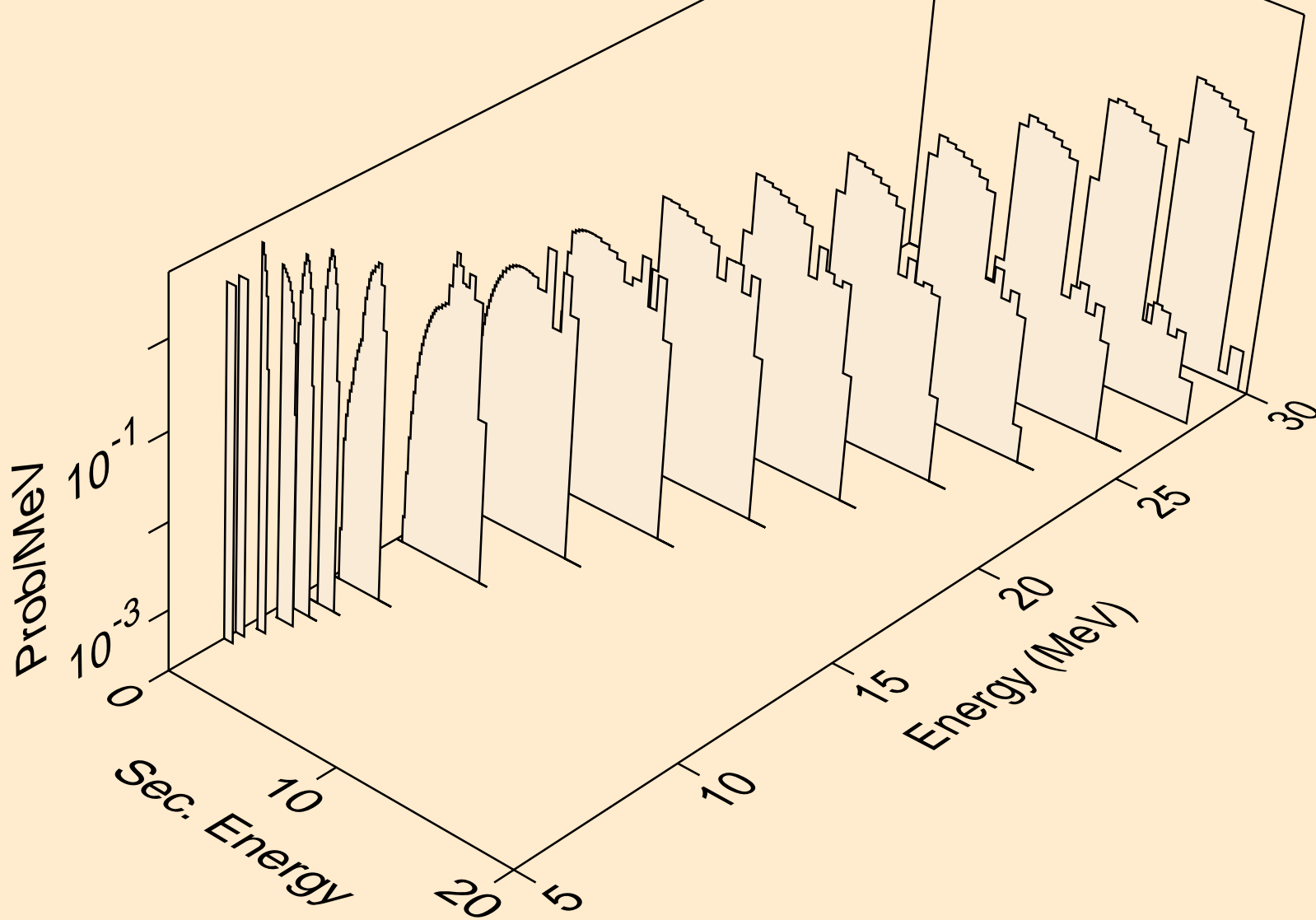

10-NE-20 FOR FENDL-3.2 FROM TENDL-2019 BY NJOY2016.60+
protons from (n,2p)

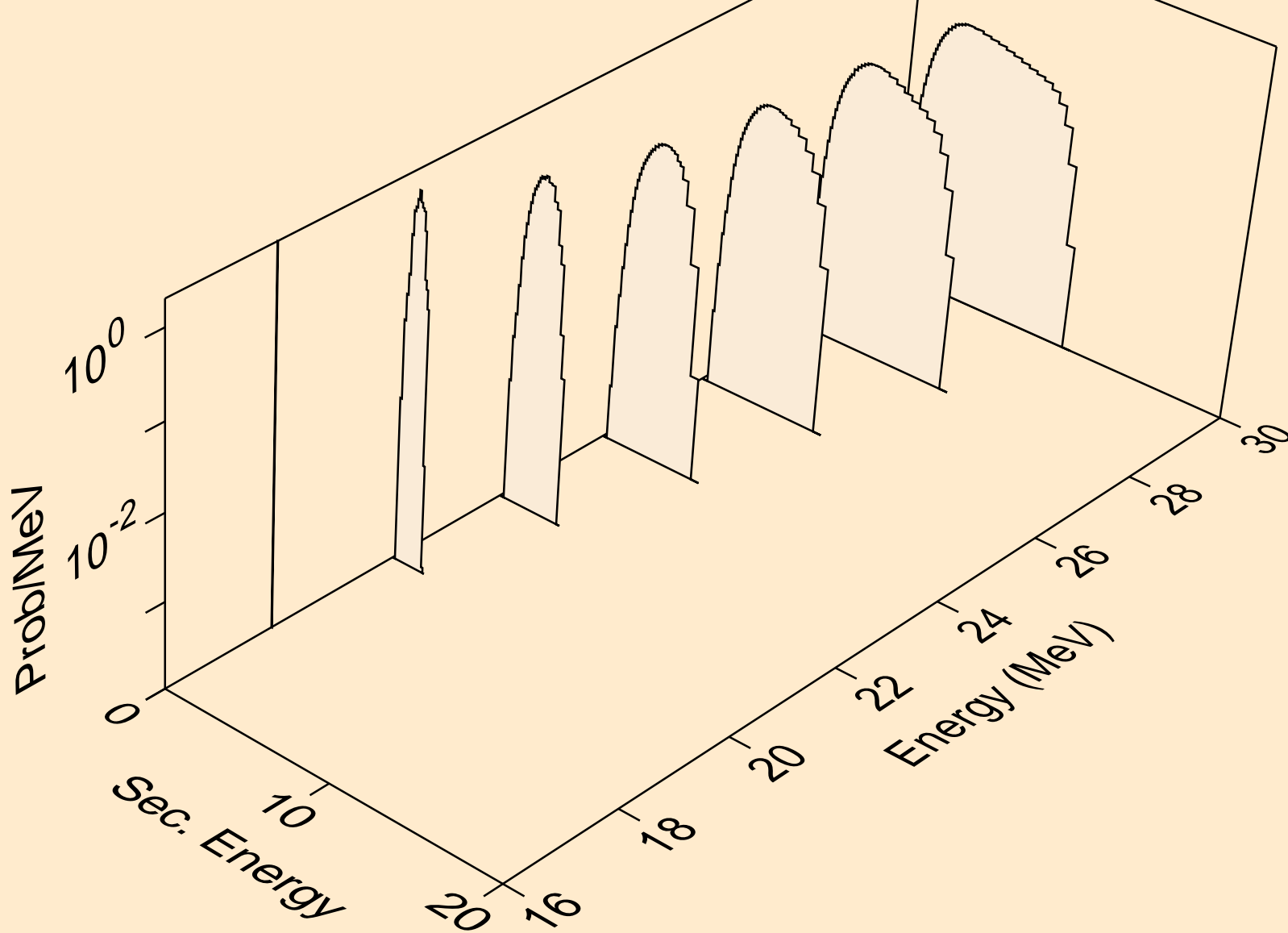

10-NE-20 FOR FENDL-3.2 FROM TENDL-2019 BY NJOY2016.60+
protons from (n,pa)

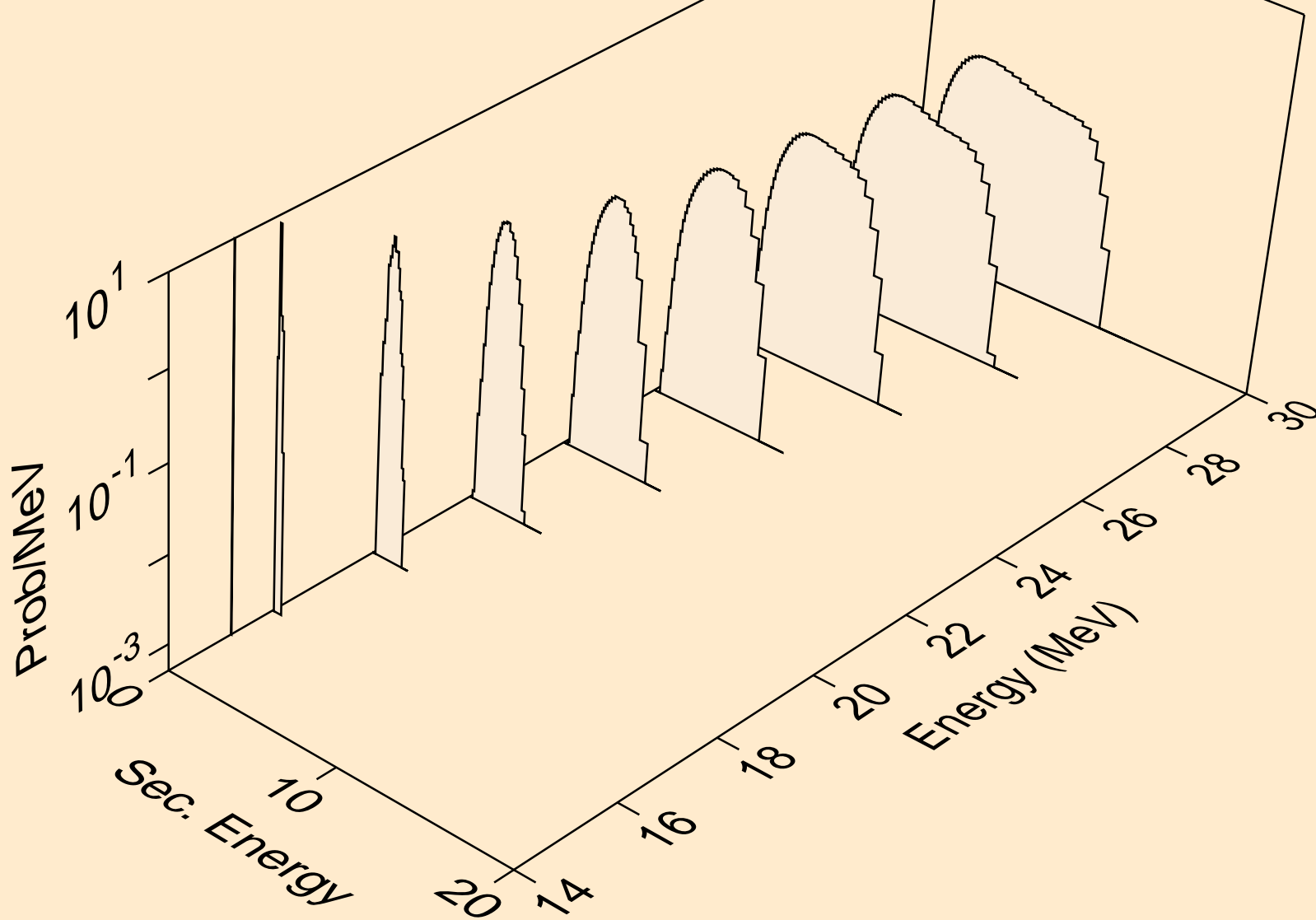

10-NE-20 FOR FENDL-3.2 FROM TENDL-2019 BY NJOY2016.60+
protons from (n,pd)

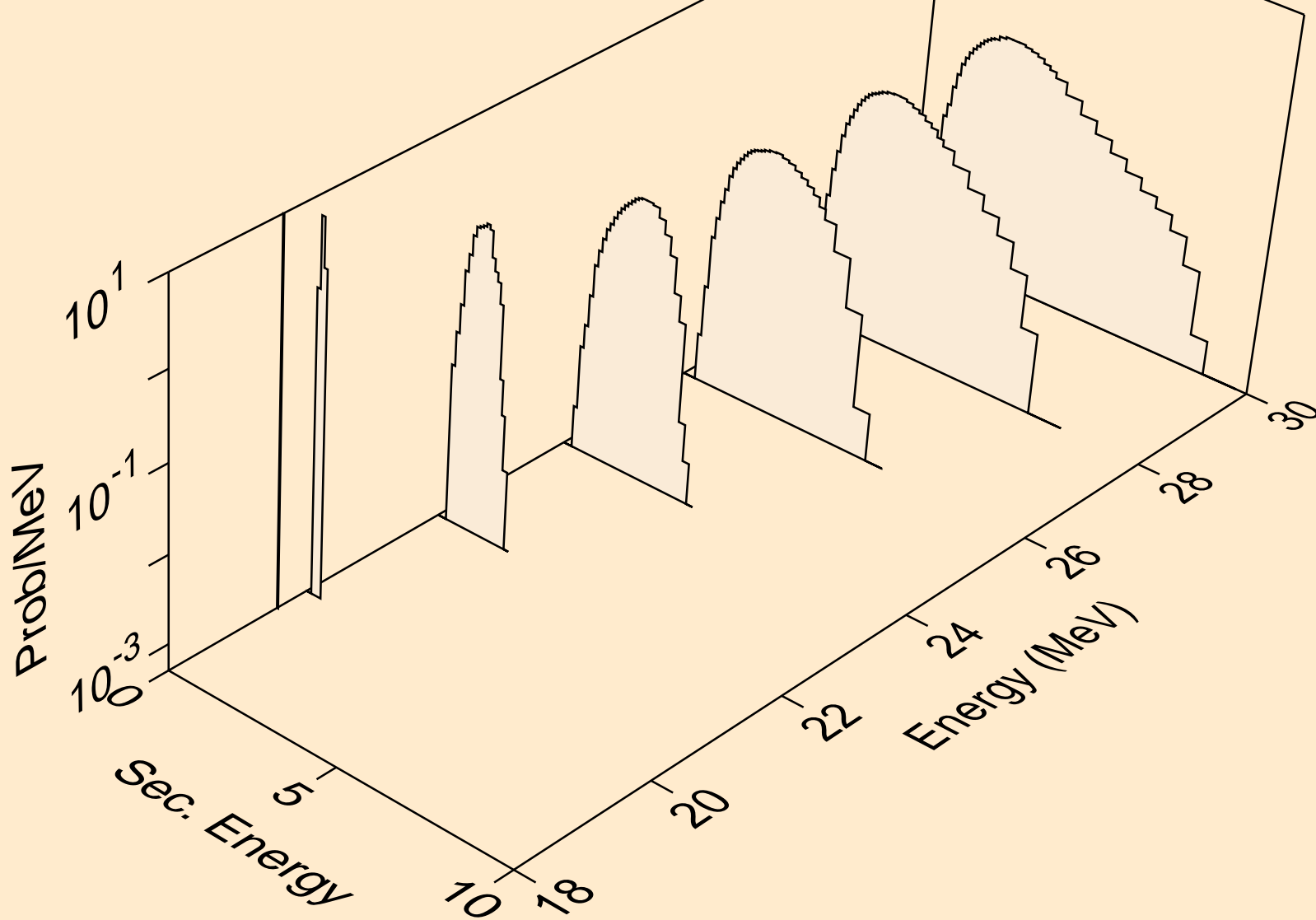

10-NE-20 FOR FENDL-3.2 FROM TENDL-2019 BY NJOY2016.60+
protons from (n,pt)

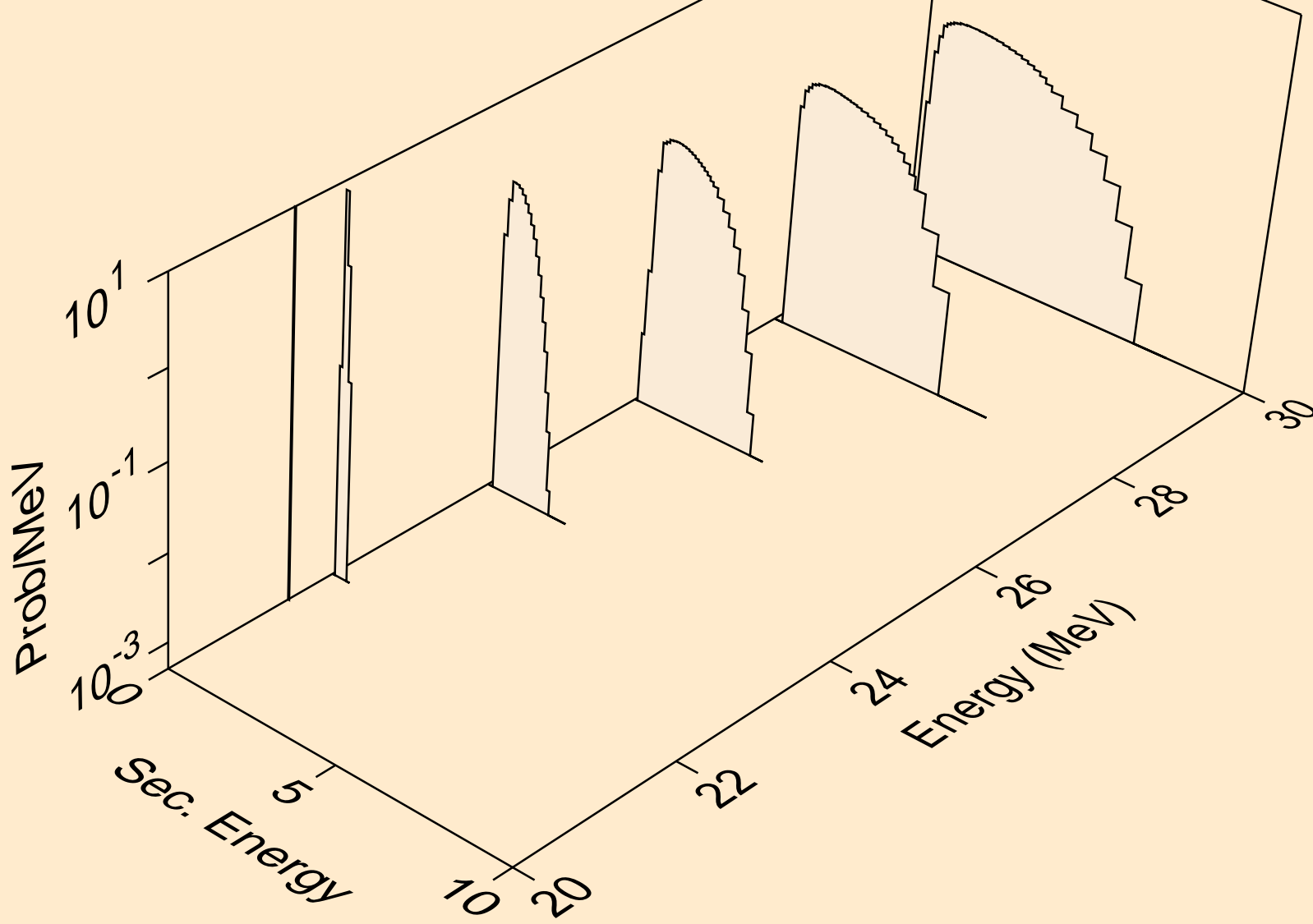

10-NE-20 FOR FENDL-3.2 FROM TENDL-2019 BY NJOY2016.60+
deuterons from (n,x)

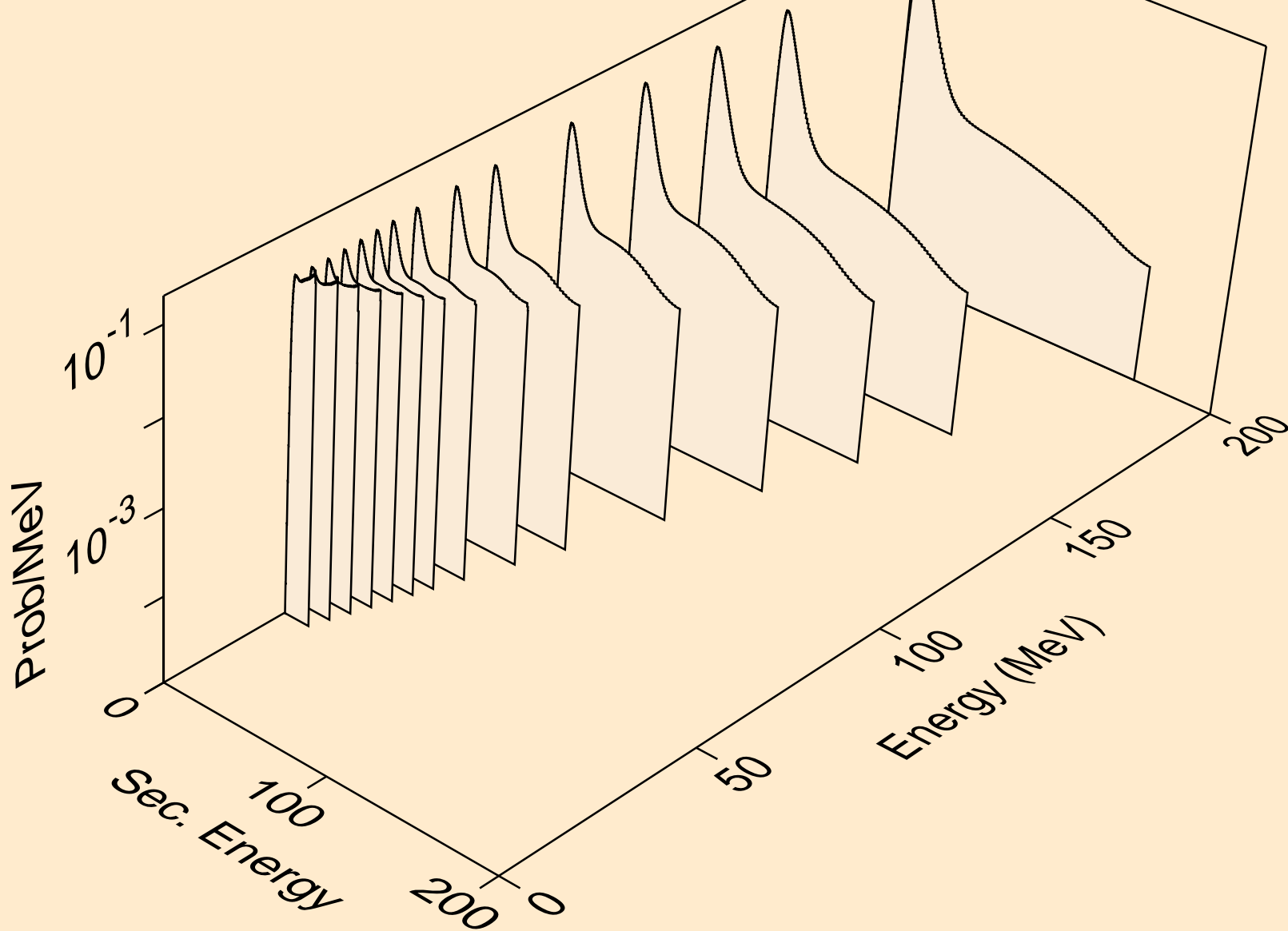

10-NE-20 FOR FENDL-3.2 FROM TENDL-2019 BY NJOY2016.60+
deuterons from (n,n*)d

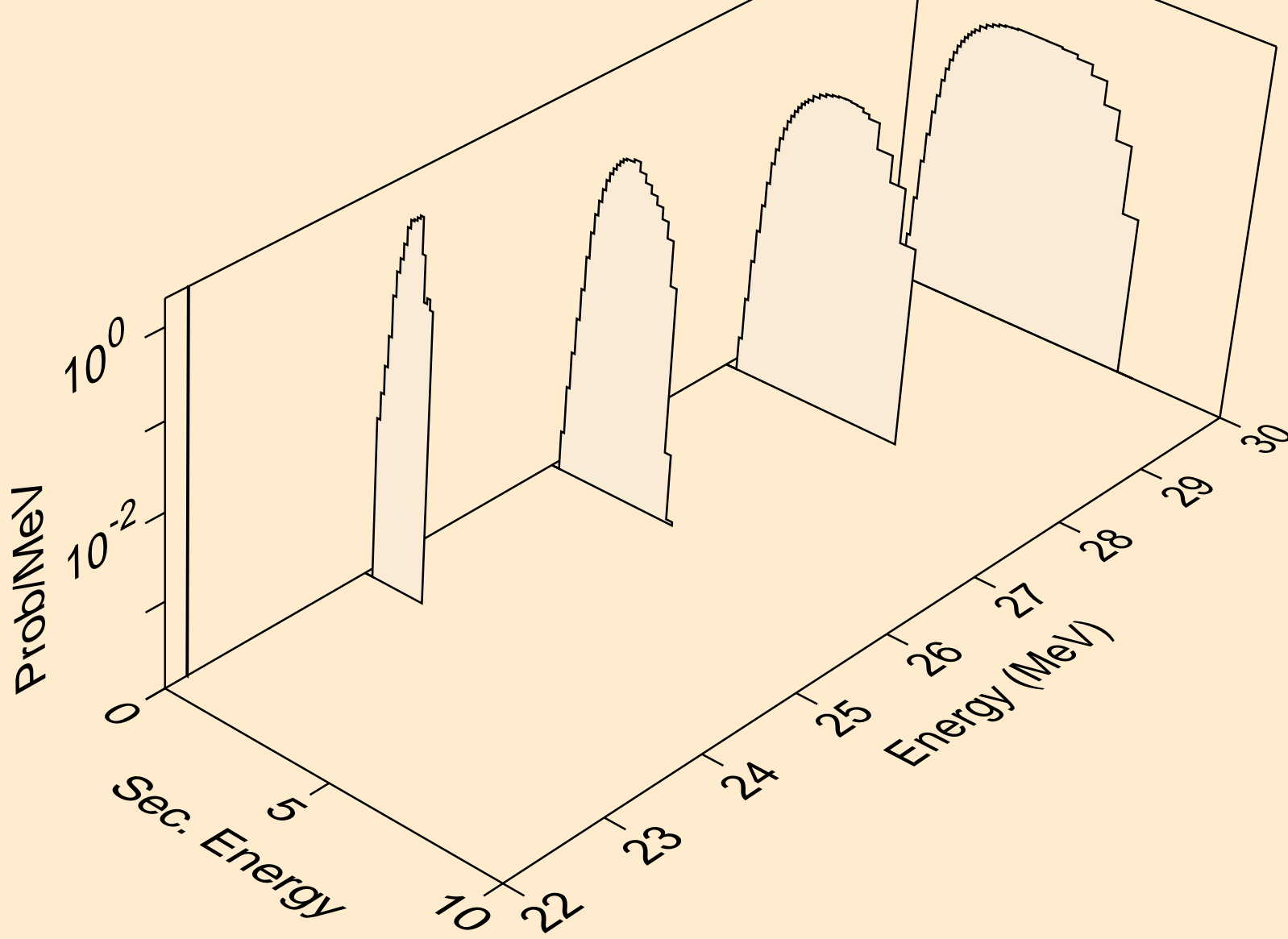

10-NE-20 FOR FENDL-3.2 FROM TENDL-2019 BY NJOY2016.60+
deuterons from (n,d)

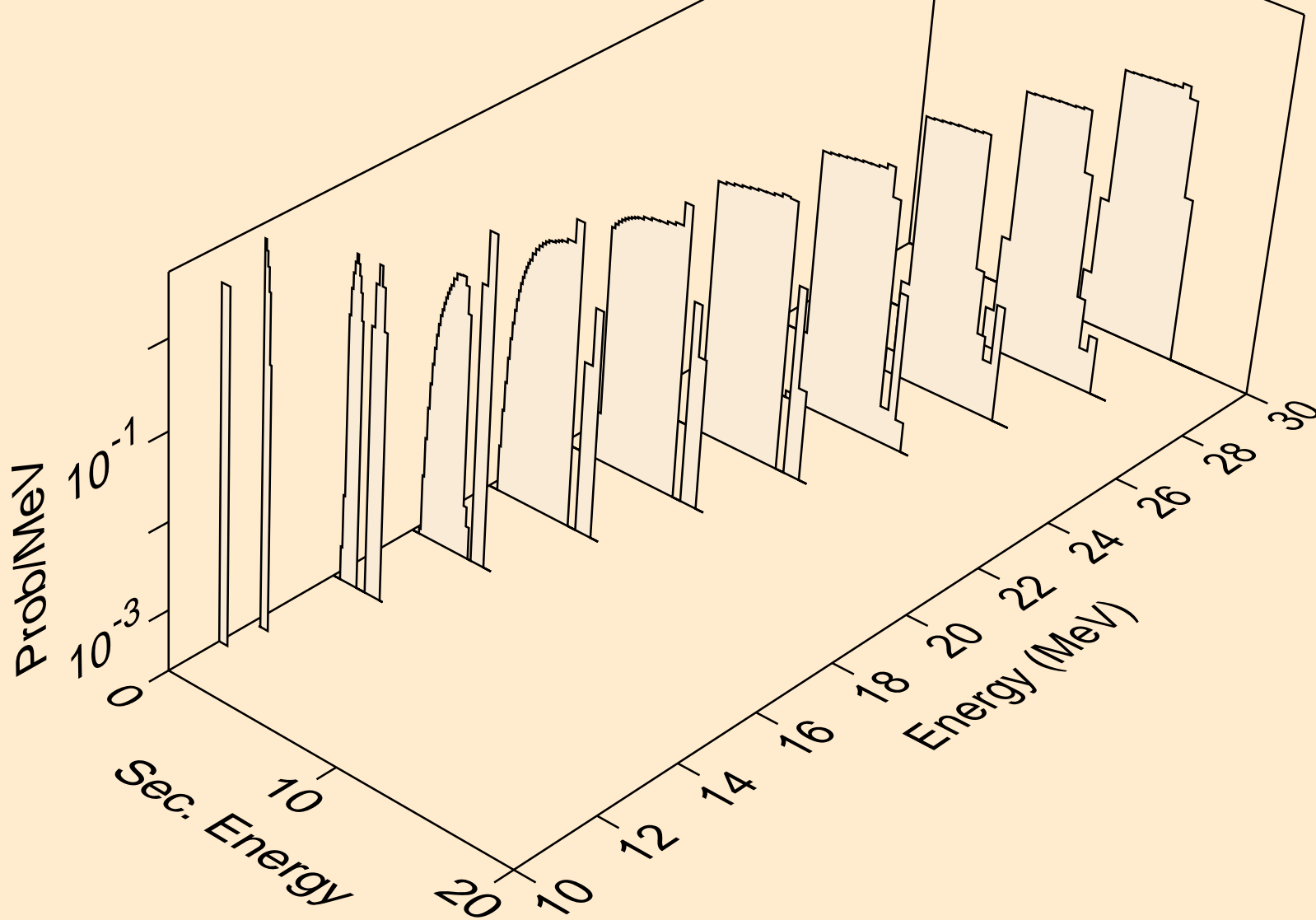

10-NE-20 FOR FENDL-3.2 FROM TENDL-2019 BY NJOY2016.60+
deuterons from (n,pd)

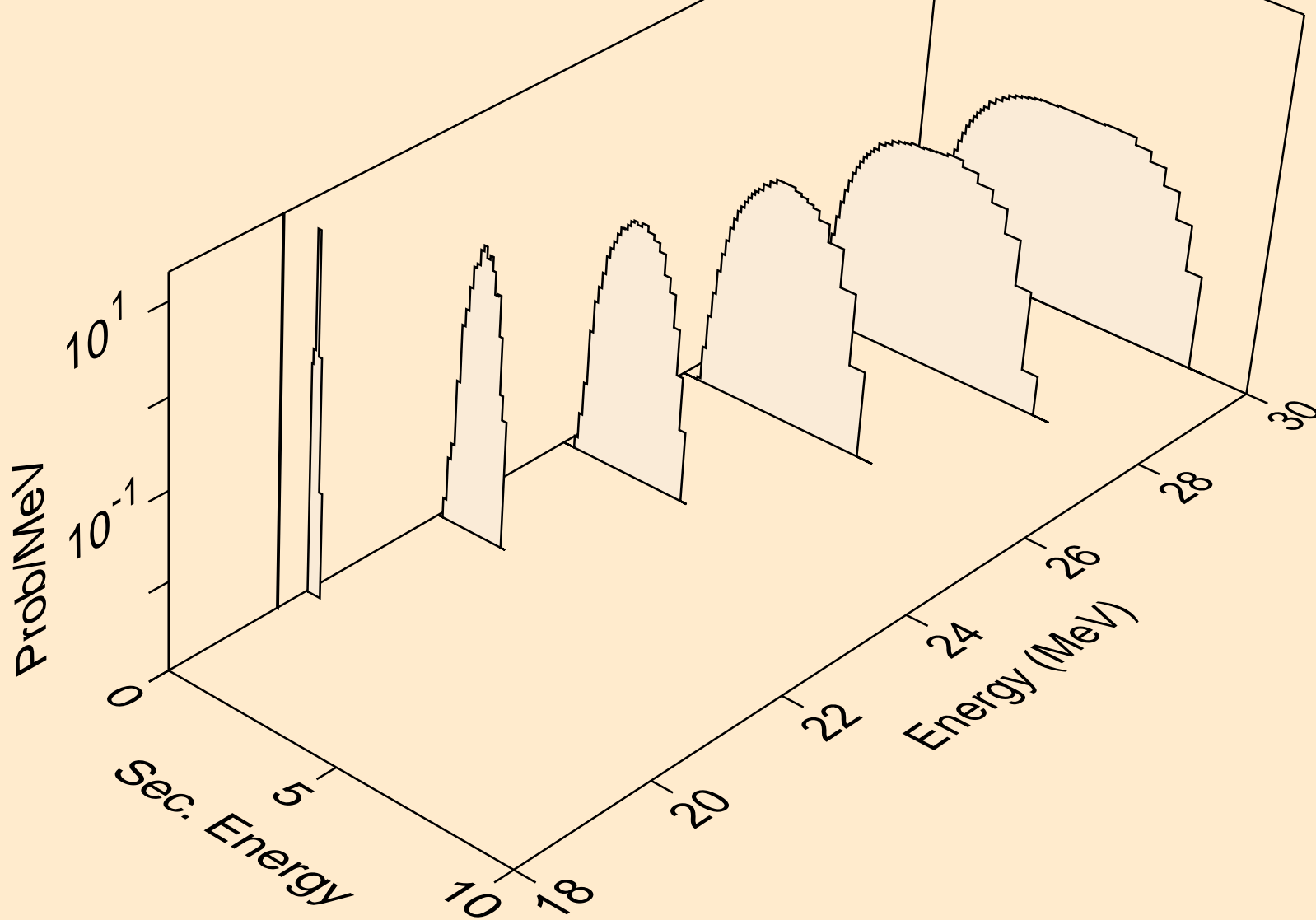

10-NE-20 FOR FENDL-3.2 FROM TENDL-2019 BY NJOY2016.60+
deuterons from (n,da)

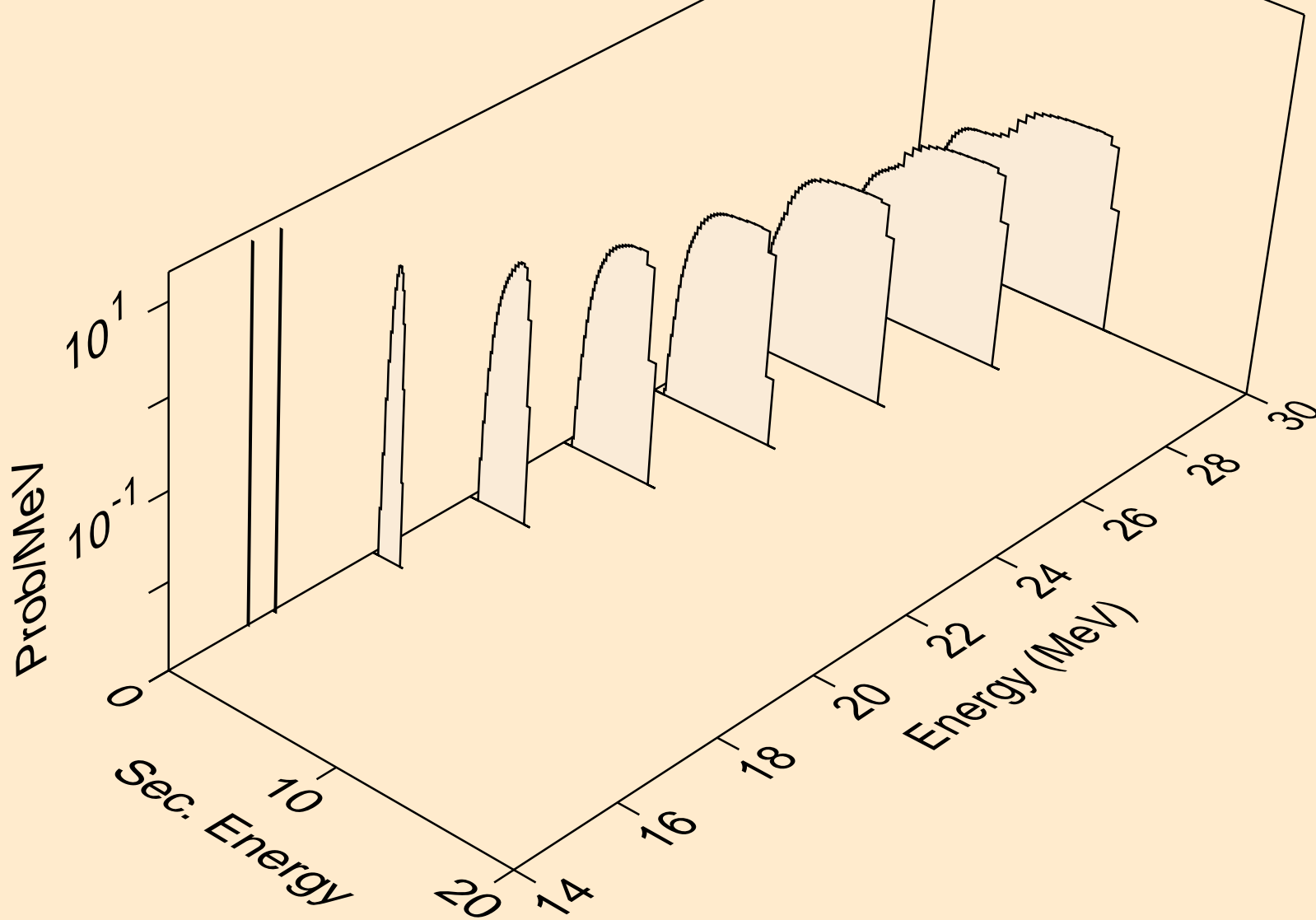

10-NE-20 FOR FENDL-3.2 FROM TENDL-2019 BY NJOY2016.60+
tritons from (n,x)

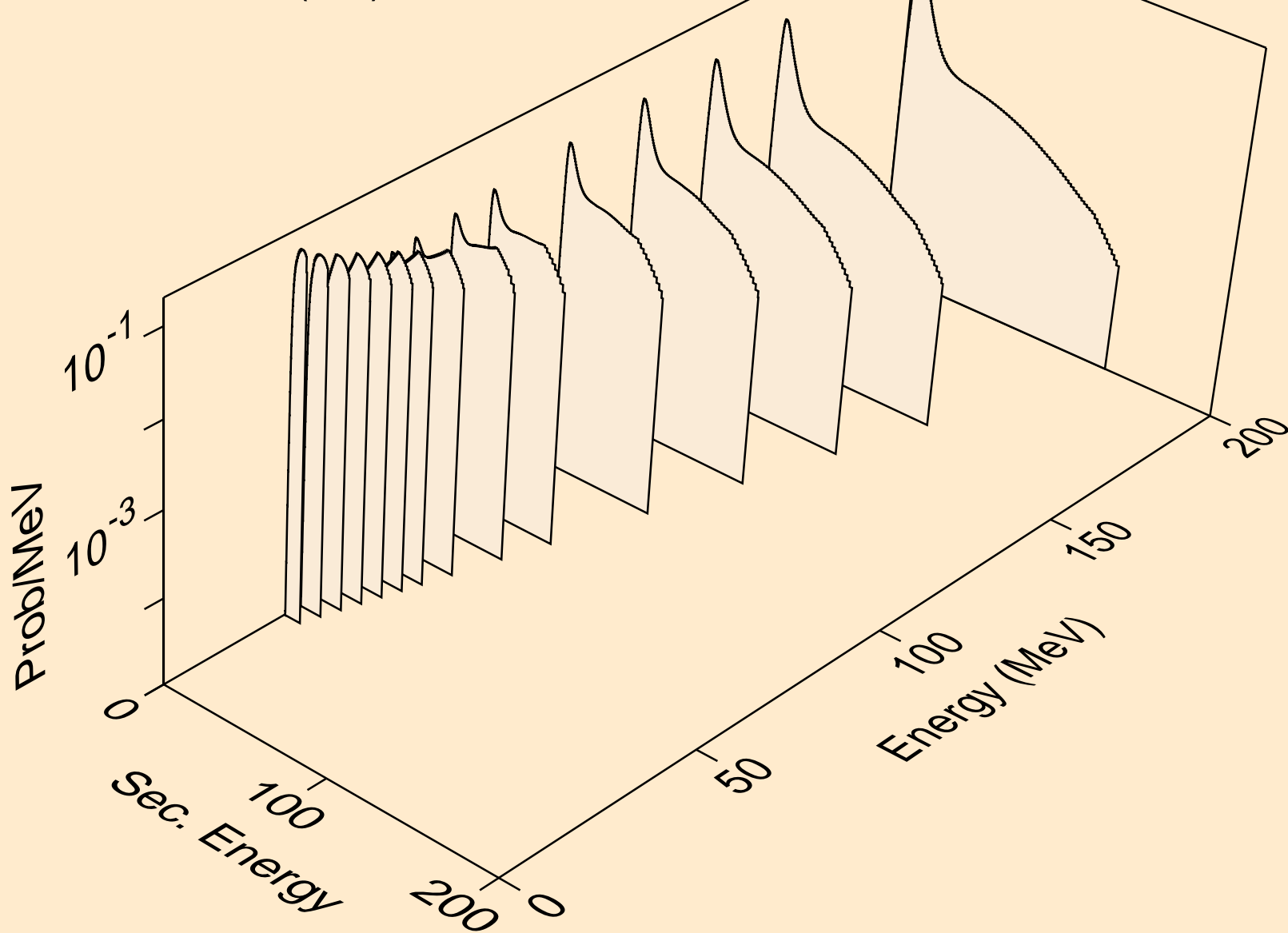

10-NE-20 FOR FENDL-3.2 FROM TENDL-2019 BY NJOY2016.60+
tritons from (n,n*)t

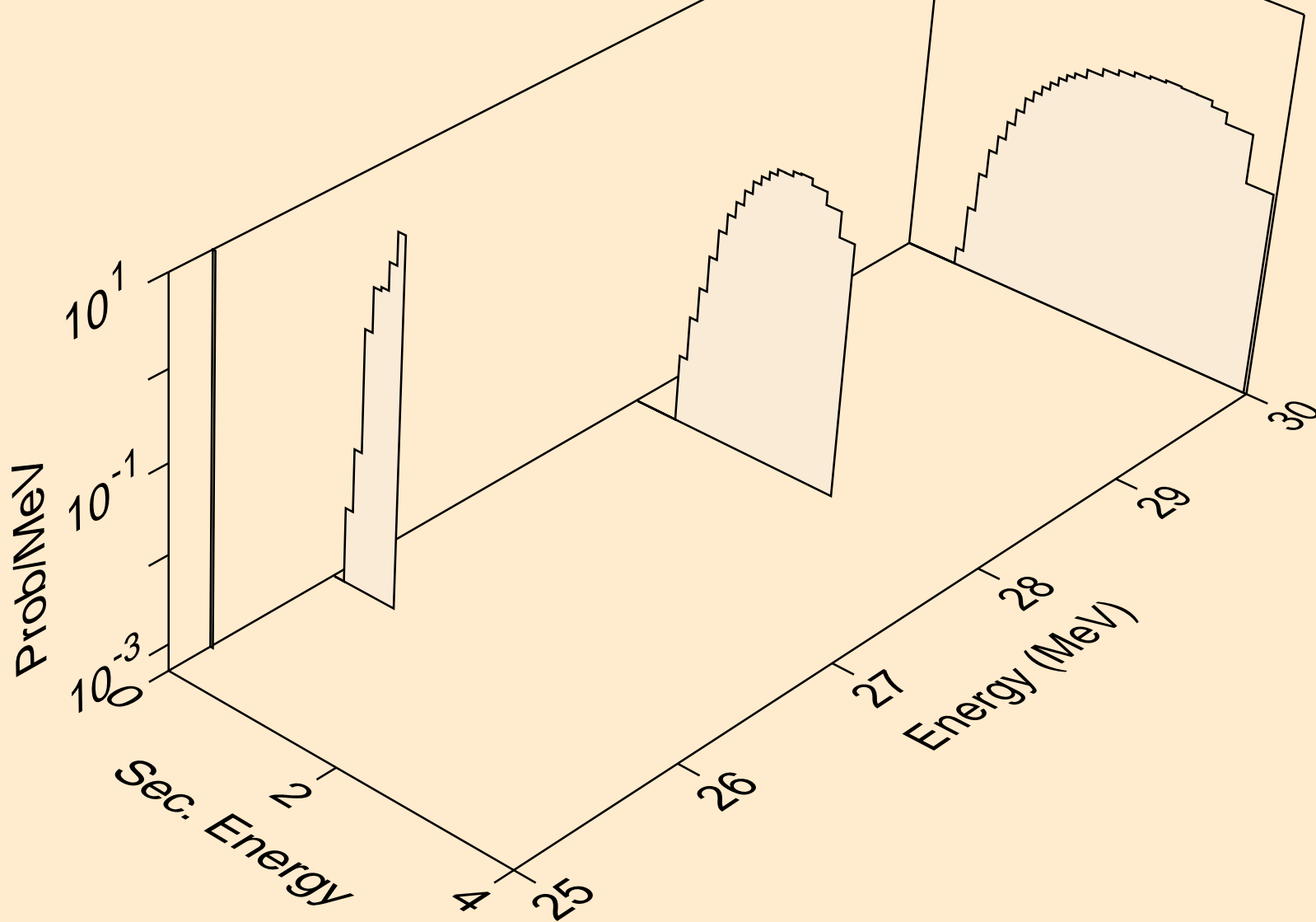

10-NE-20 FOR FENDL-3.2 FROM TENDL-2019 BY NJOY2016.60+
tritons from (n,t)

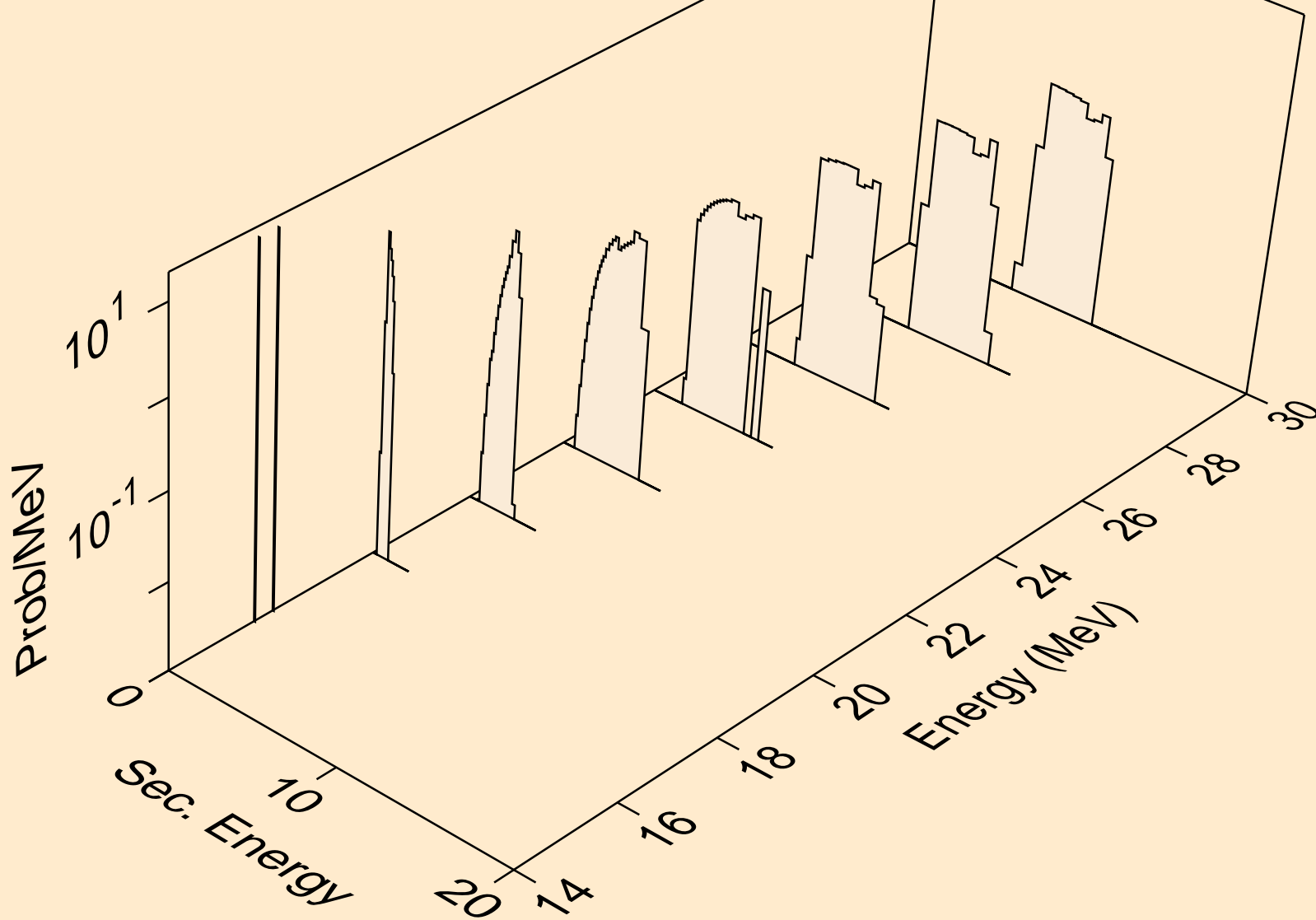

10-NE-20 FOR FENDL-3.2 FROM TENDL-2019 BY NJOY2016.60+
tritons from (n,pt)

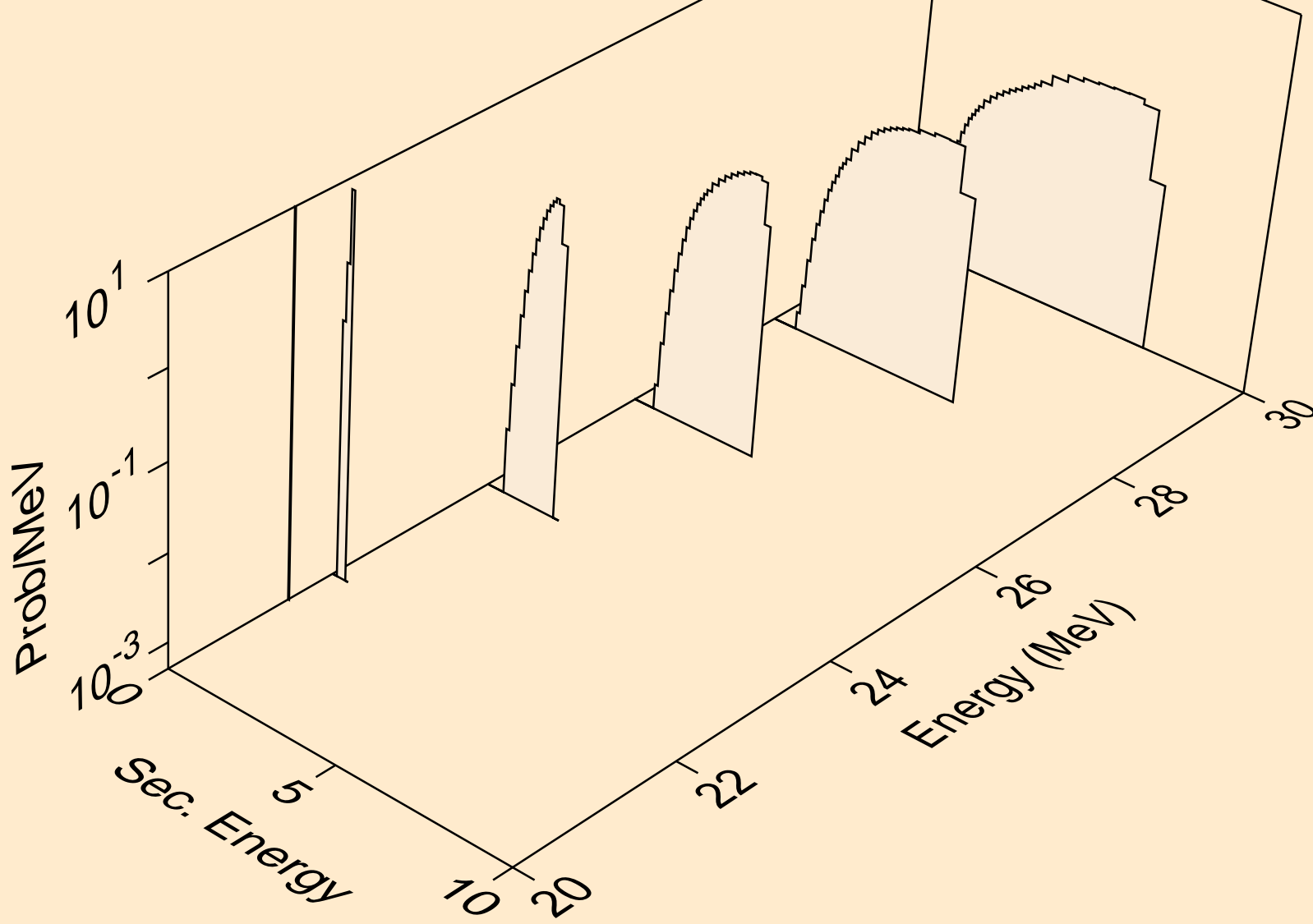

10-NE-20 FOR FENDL-3.2 FROM TENDL-2019 BY NJOY2016.60+
he3s from (n,x)

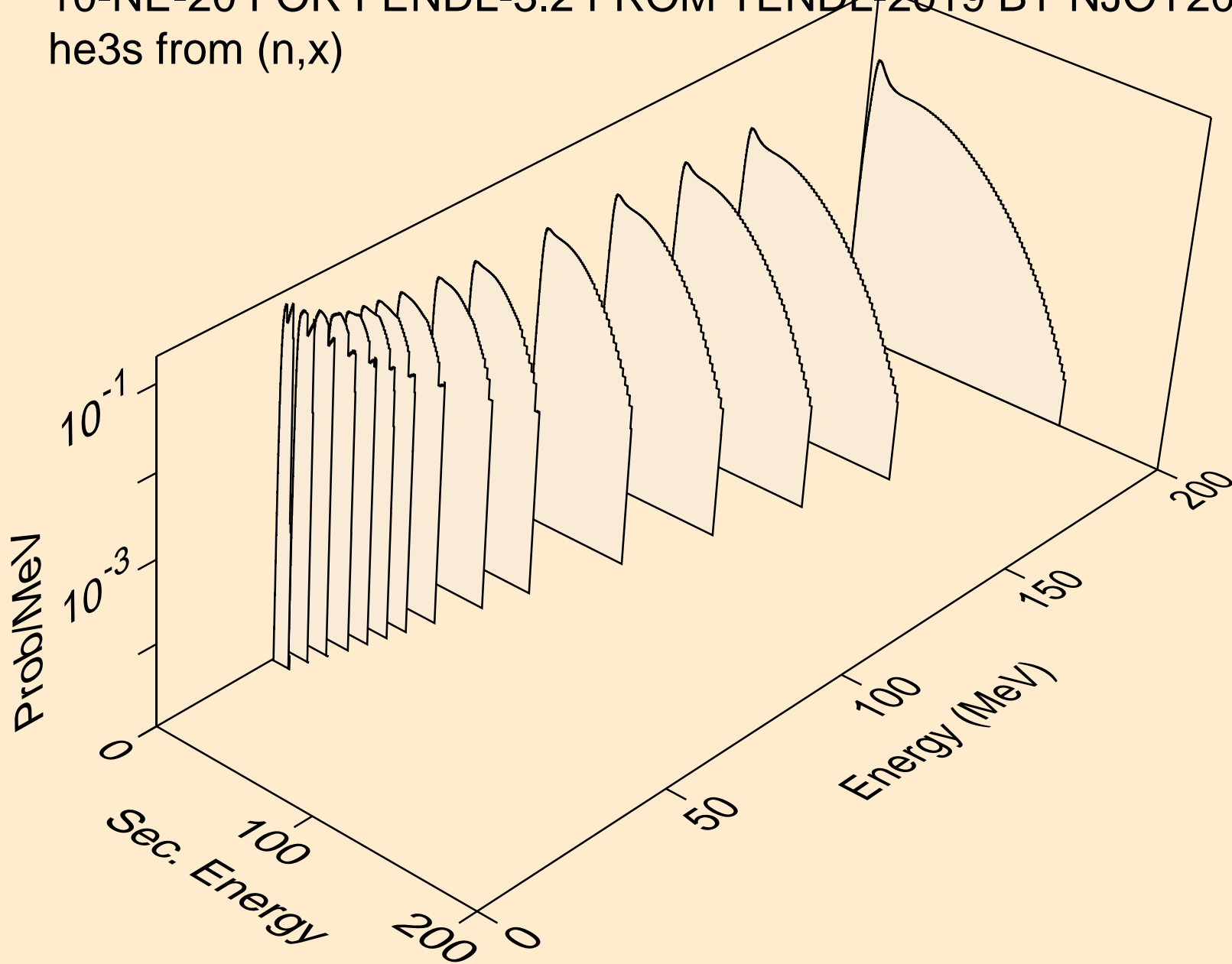

10-NE-20 FOR FENDL-3.2 FROM TENDL-2019 BY NJOY2016.60+
he3s from (n,n*)he3

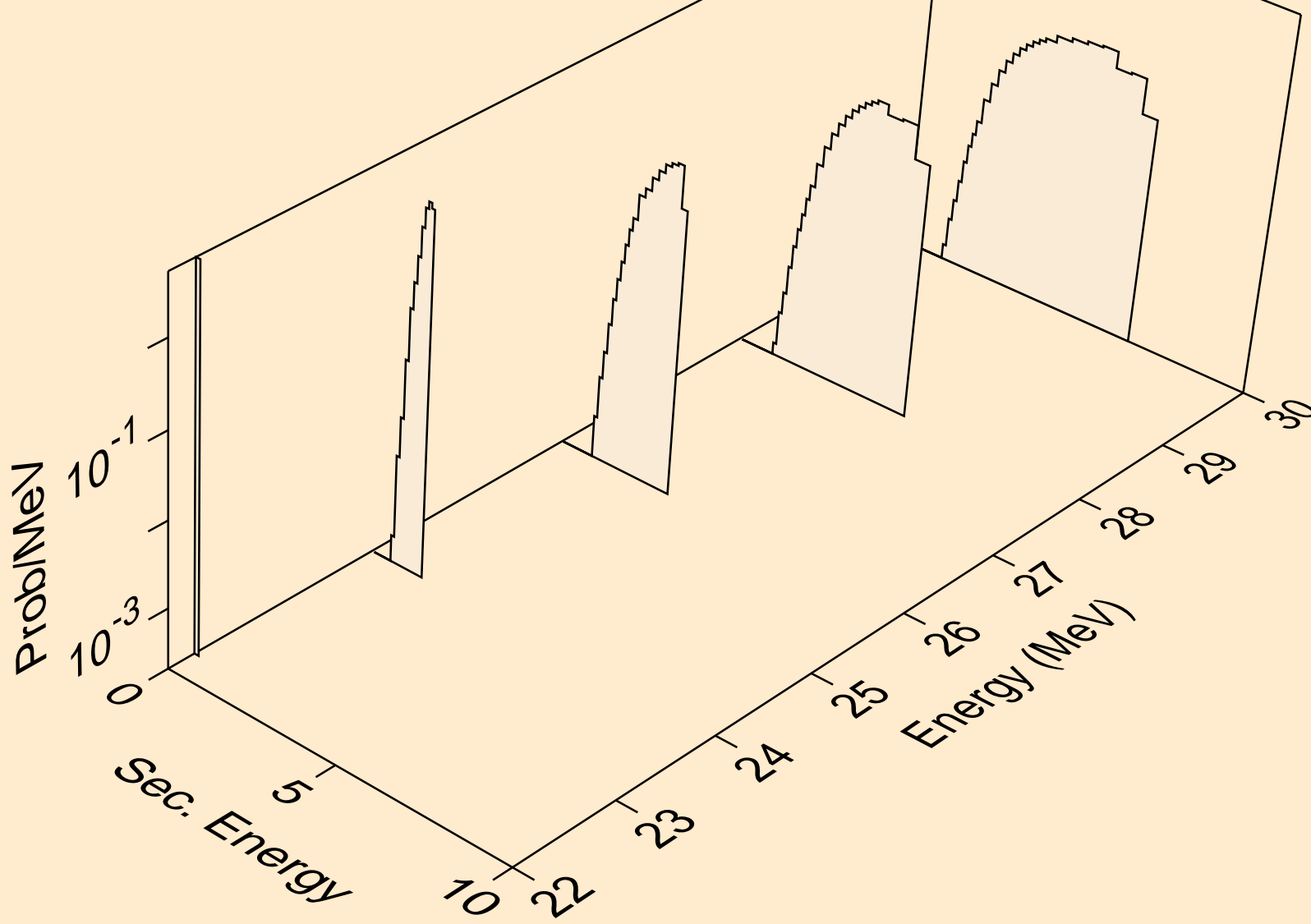

10-NE-20 FOR FENDL-3.2 FROM TENDL-2019 BY NJOY2016.60+
he3s from (n,he3)

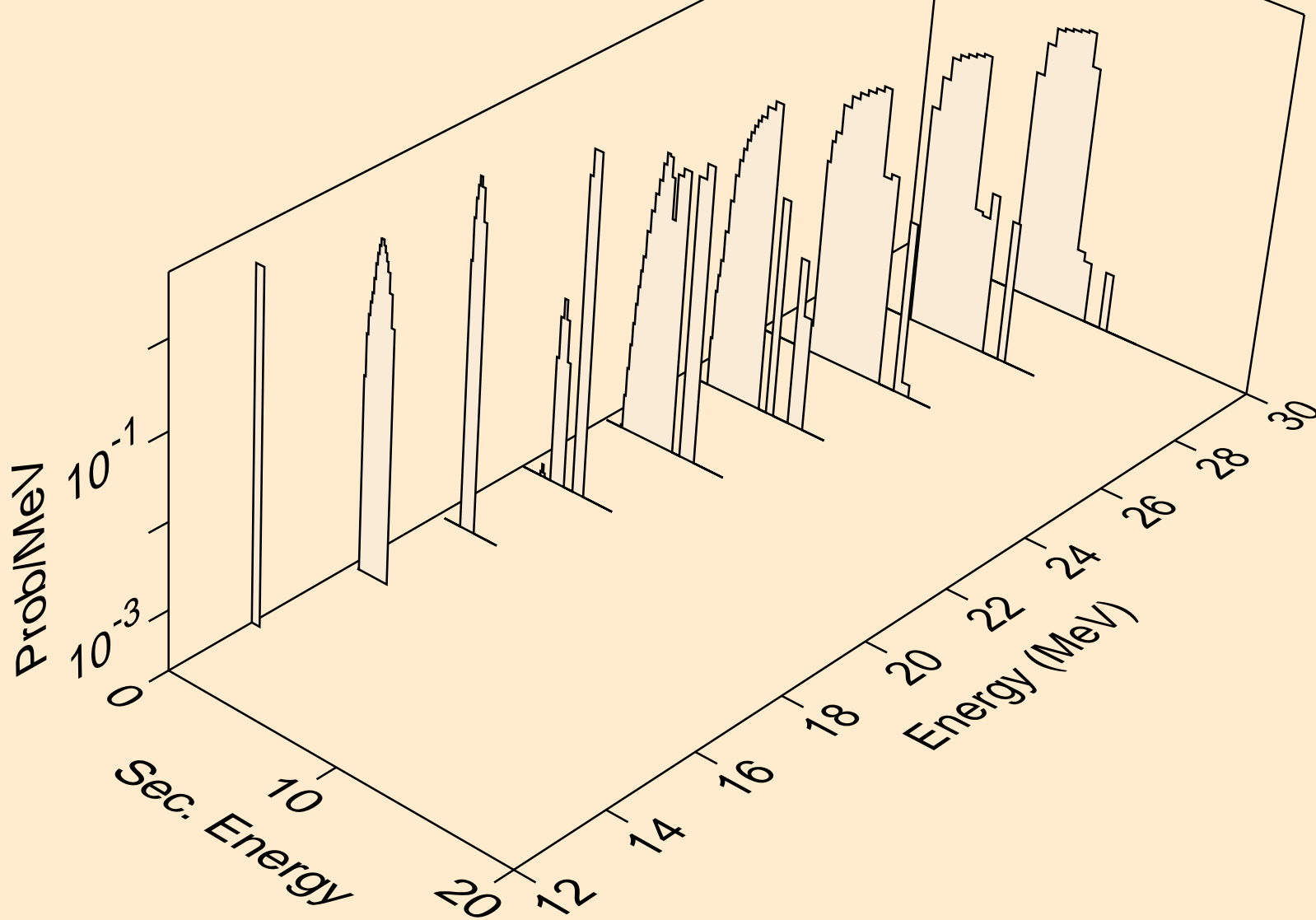

10-NE-20 FOR FENDL-3.2 FROM TENDL-2019 BY NJOY2016.60+
alphas from (n,x)

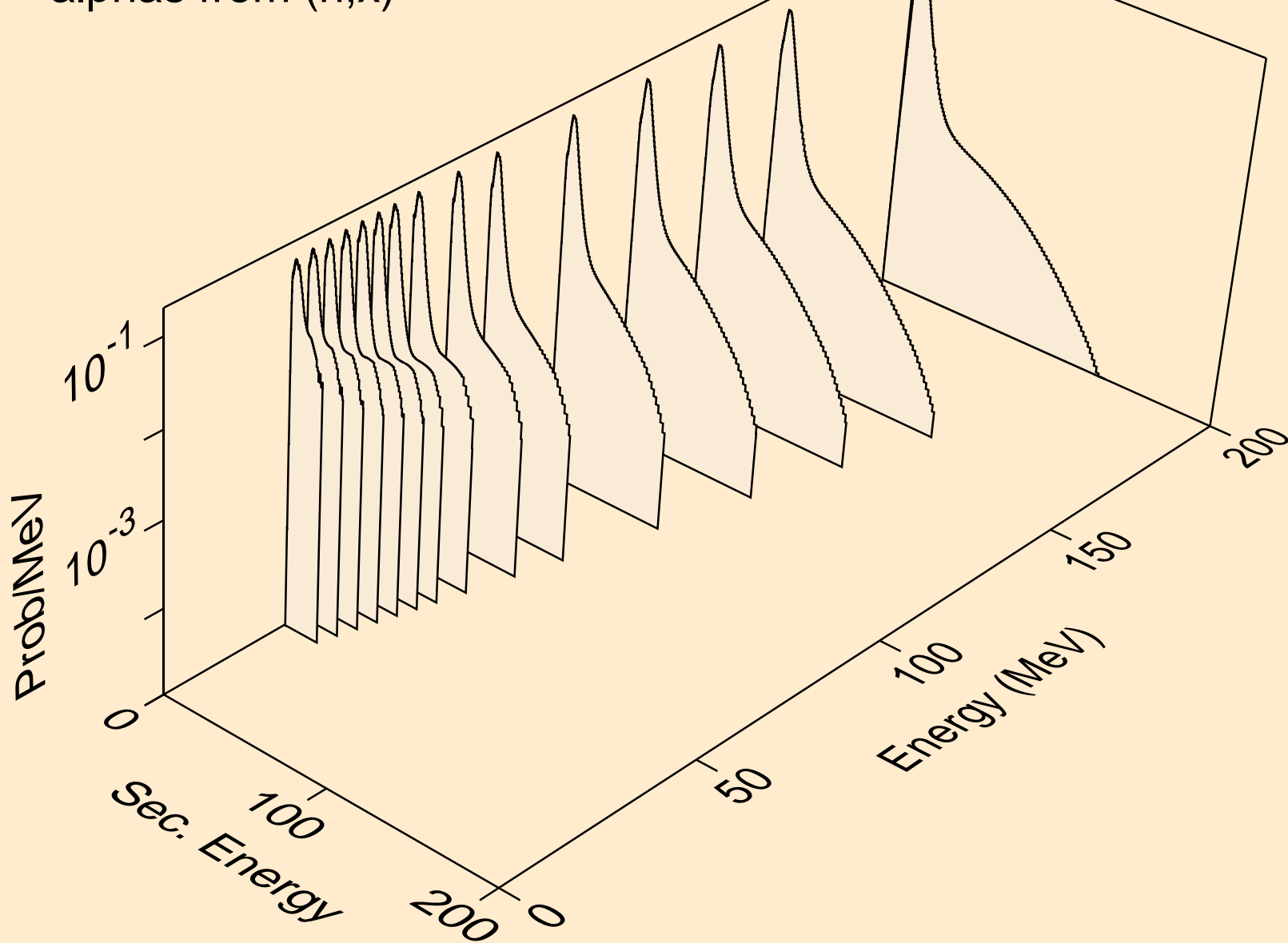

10-NE-20 FOR FENDL-3.2 FROM TENDL-2019 BY NJOY2016.60+
alphas from (n,n*)a

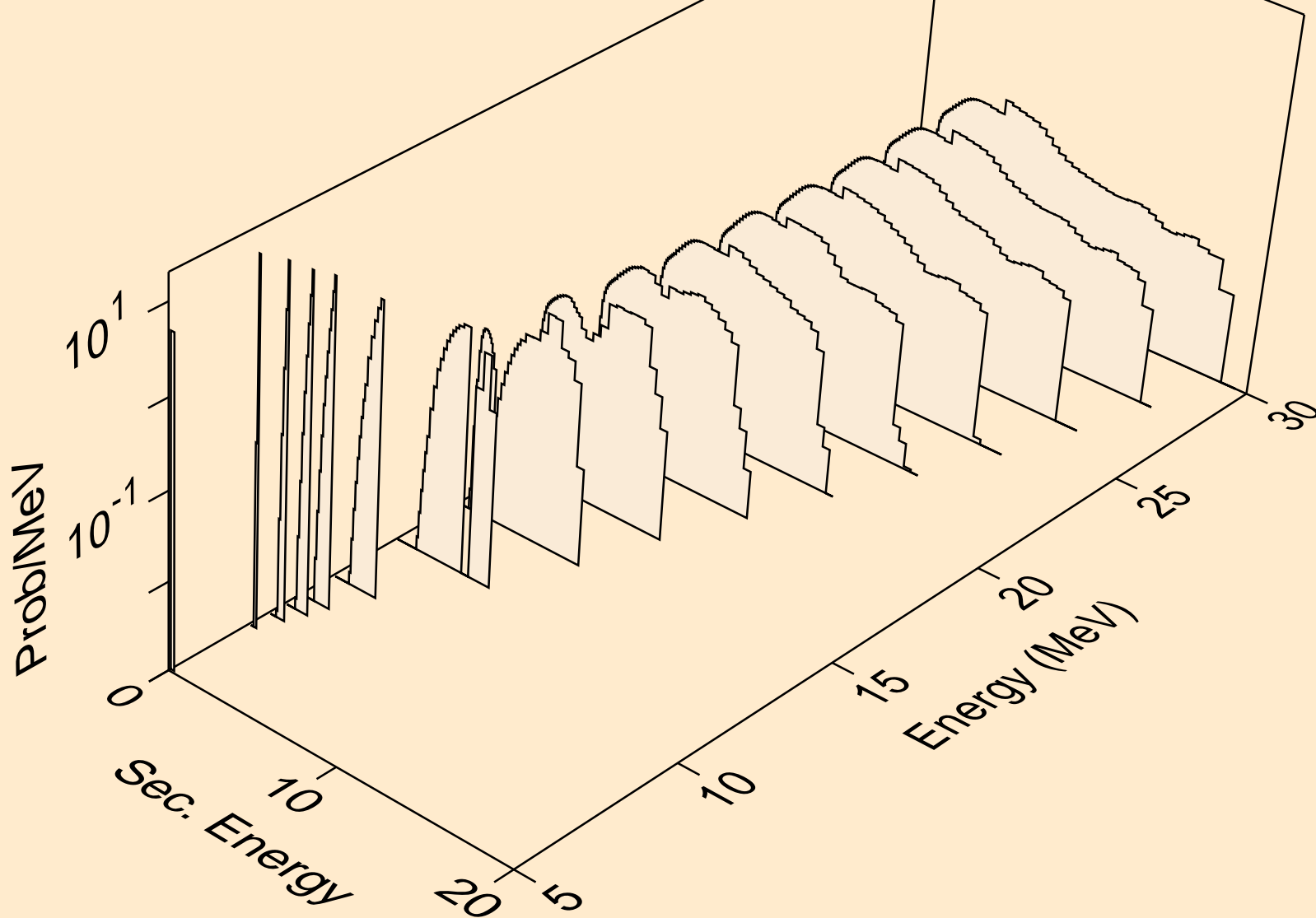

10-NE-20 FOR FENDL-3.2 FROM TENDL-2019 BY NJOY2016.60+
alphas from (n,2n)a

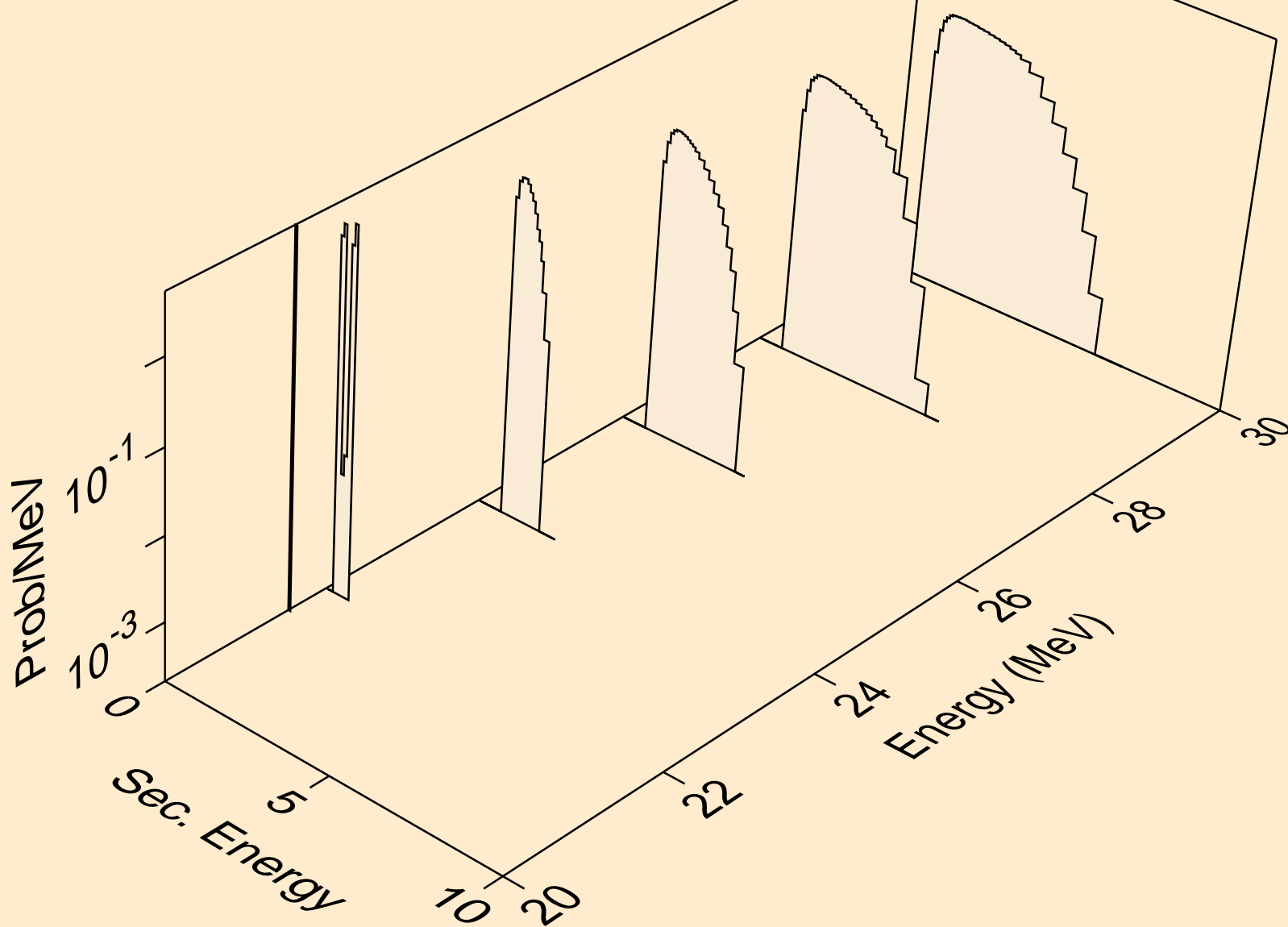

10-NE-20 FOR FENDL-3.2 FROM TENDL-2019 BY NJOY2016.60+
alphas from (n,n*)2a

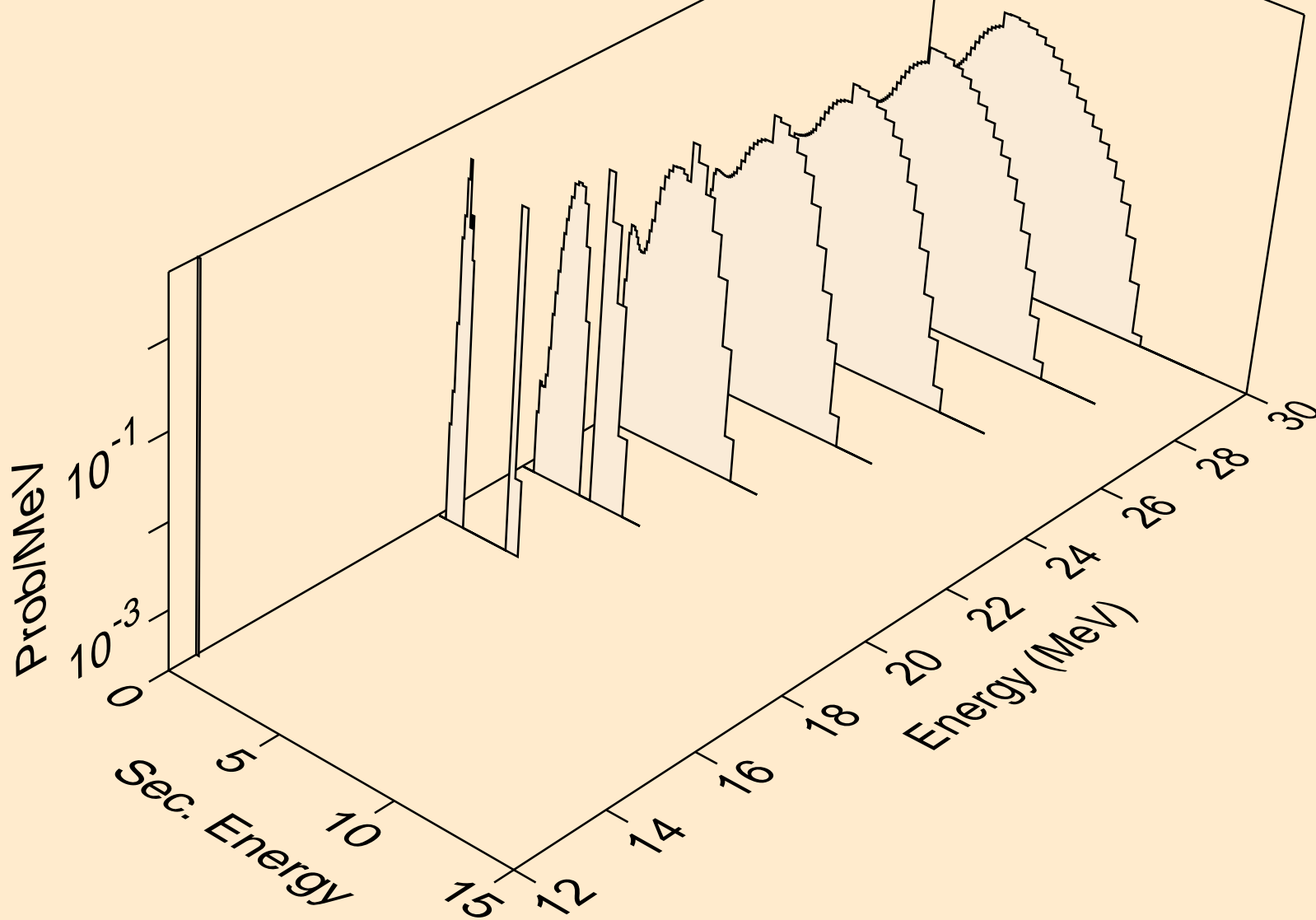

10-NE-20 FOR FENDL-3.2 FROM TENDL-2019 BY NJOY2016.60+
alphas from (n,npa)

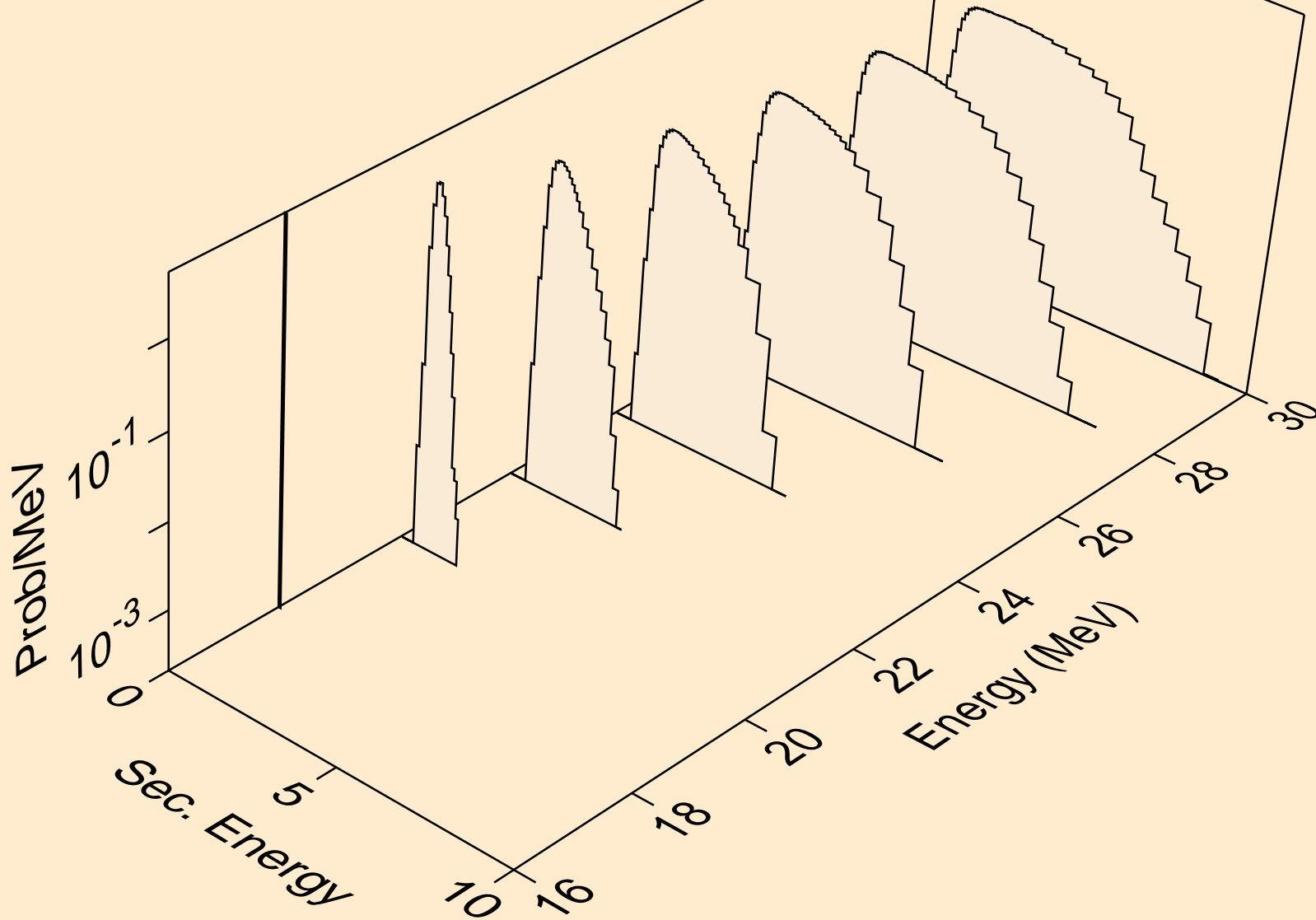

10-NE-20 FOR FENDL-3.2 FROM TENDL-2019 BY NJOY2016.60+
alphas from (n,a)

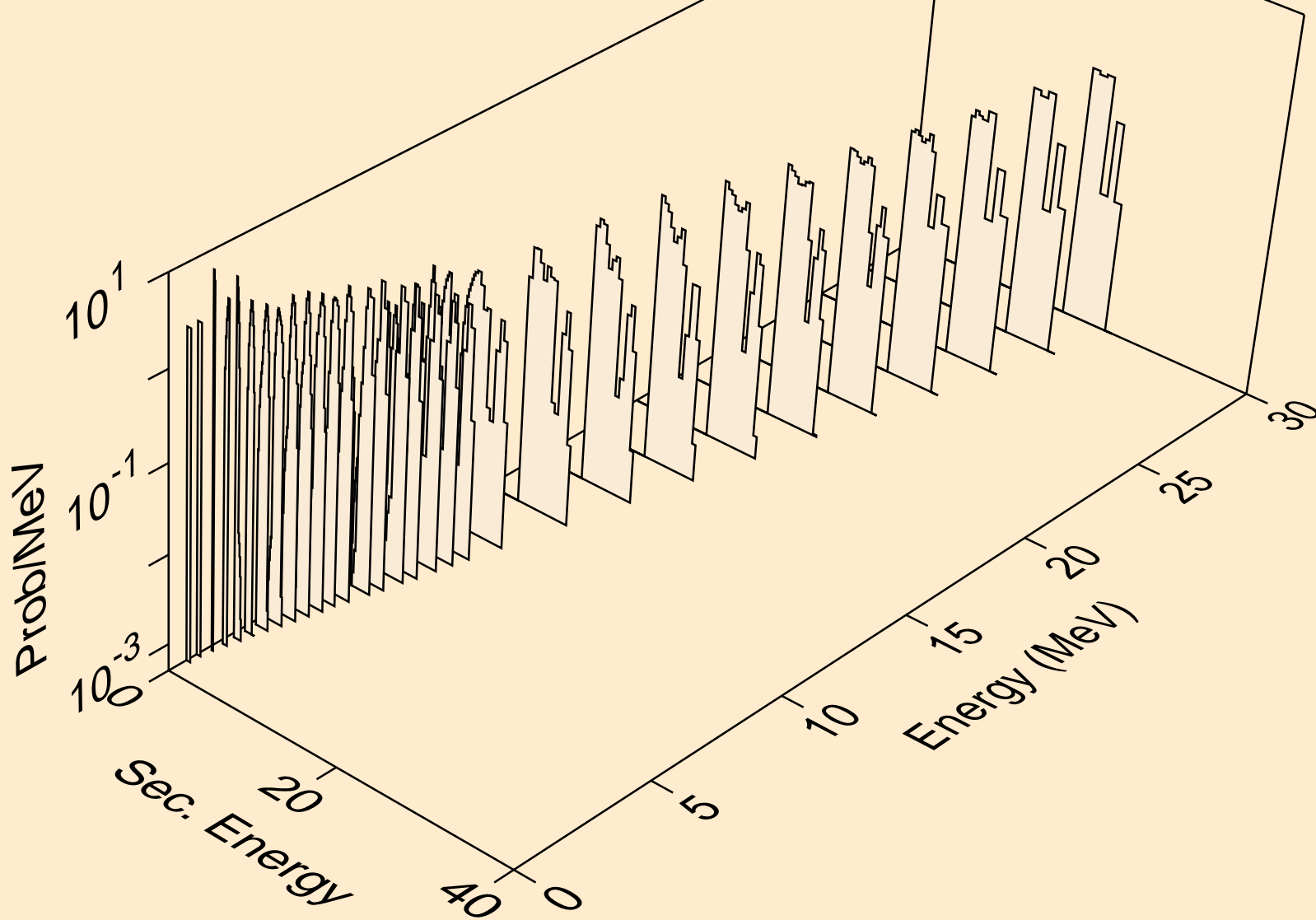

10-NE-20 FOR FENDL-3.2 FROM TENDL-2019 BY NJOY2016.60+
alphas from (n,2a)

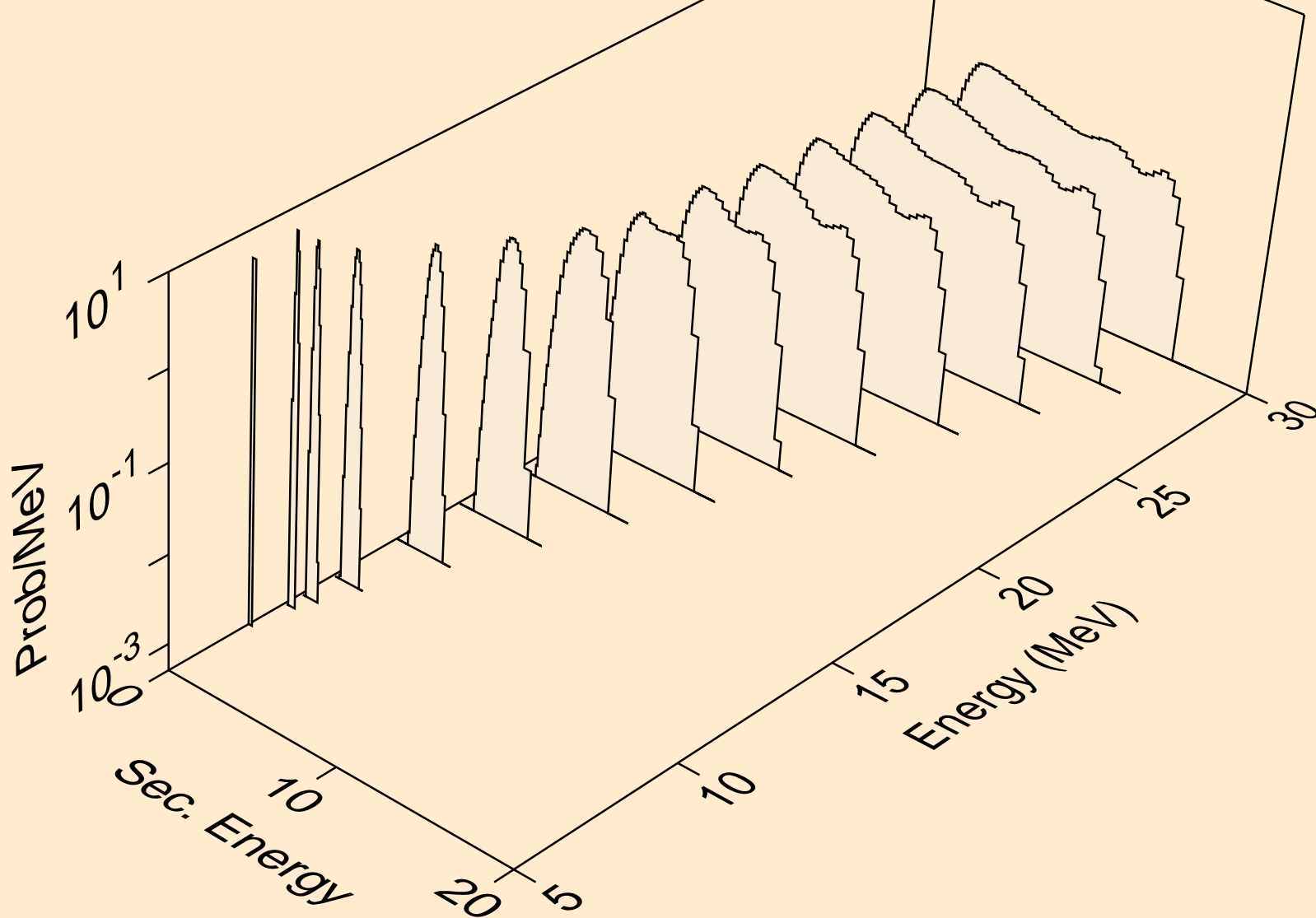

10-NE-20 FOR FENDL-3.2 FROM TENDL-2019 BY NJOY2016.60+
alphas from (n,3a)

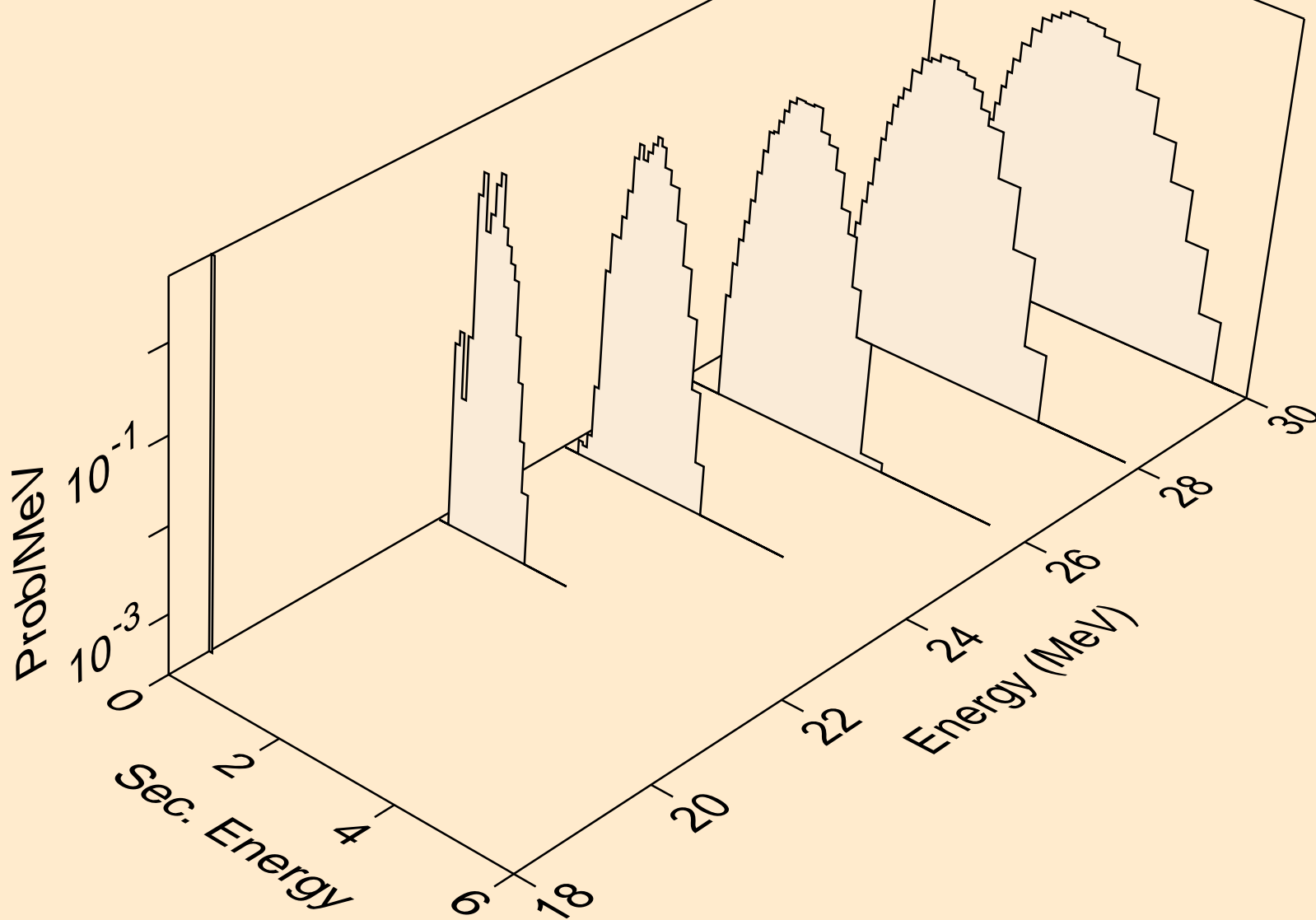

10-NE-20 FOR FENDL-3.2 FROM TENDL-2019 BY NJOY2016.60+
alphas from (n,pa)

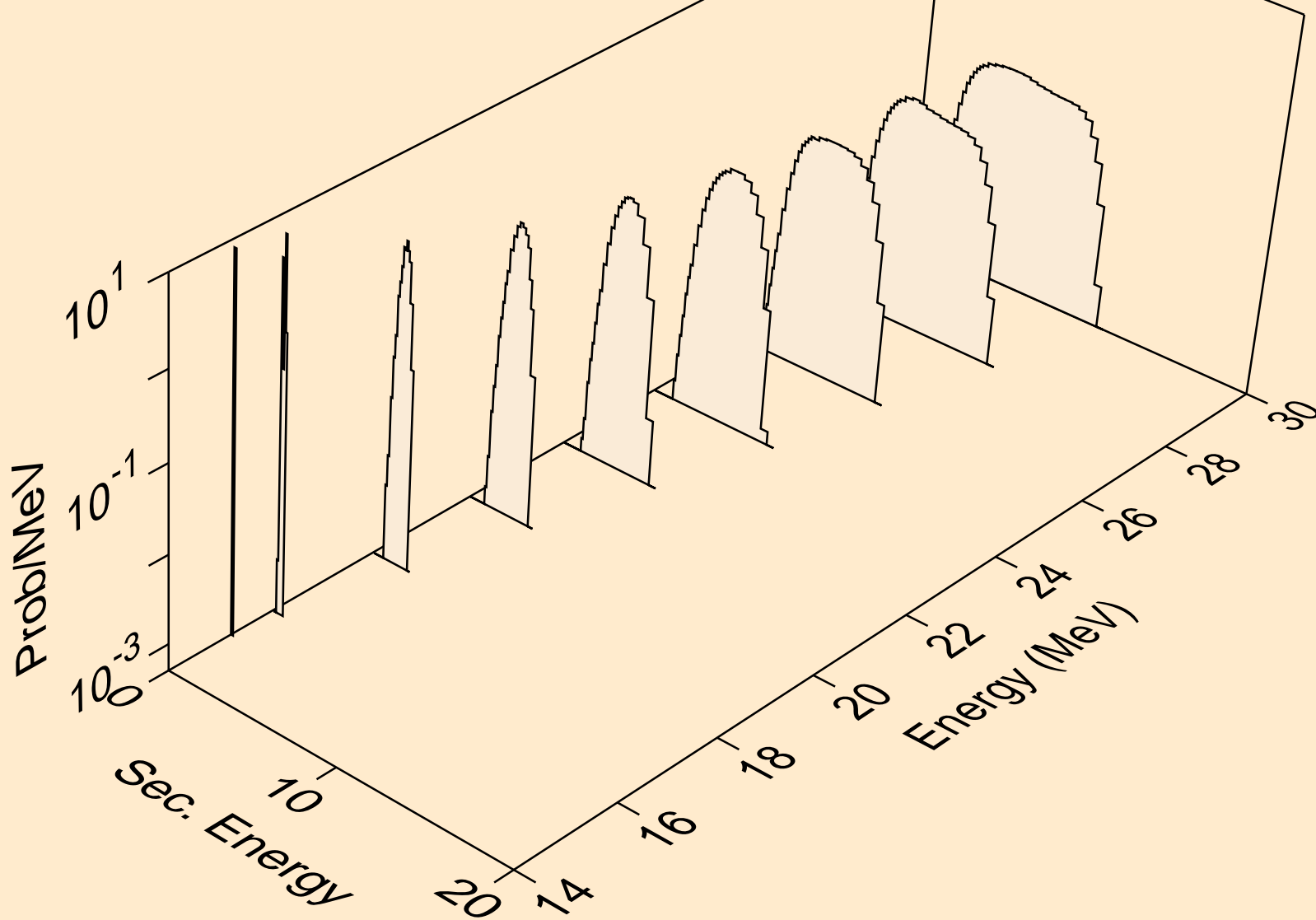

10-NE-20 FOR FENDL-3.2 FROM TENDL-2019 BY NJOY2016.60+
alphas from (n,da)

