

17-CL-37 FOR FENDL-3.2 FROM FENDL-3.2 BY NJOY2016.60+ OI
Principal cross sections

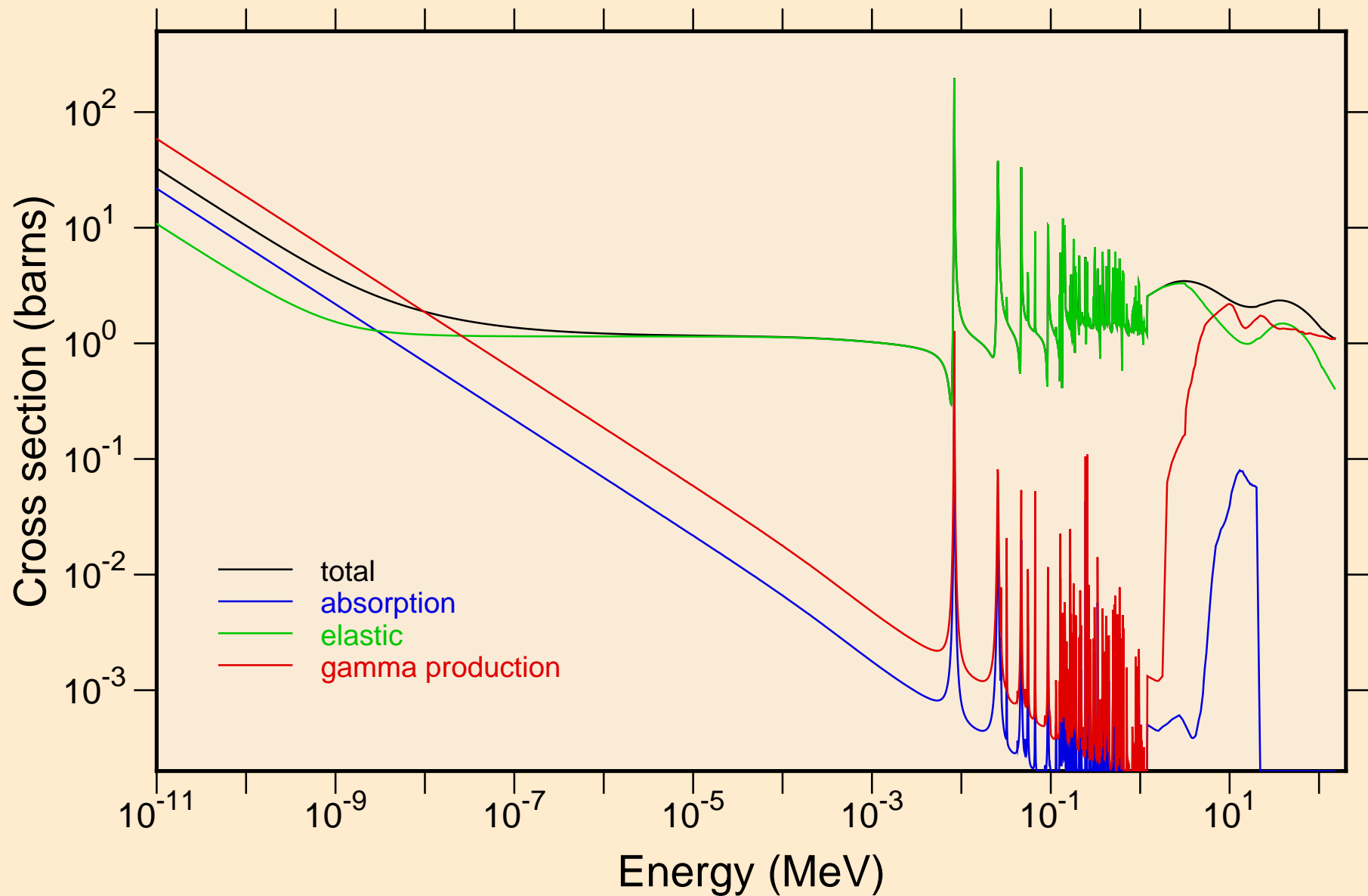

17-CL-37 FOR FENDL-3.2 FROM FENDL-3.2 BY NJOY2016.60+ OI
resonance total cross section

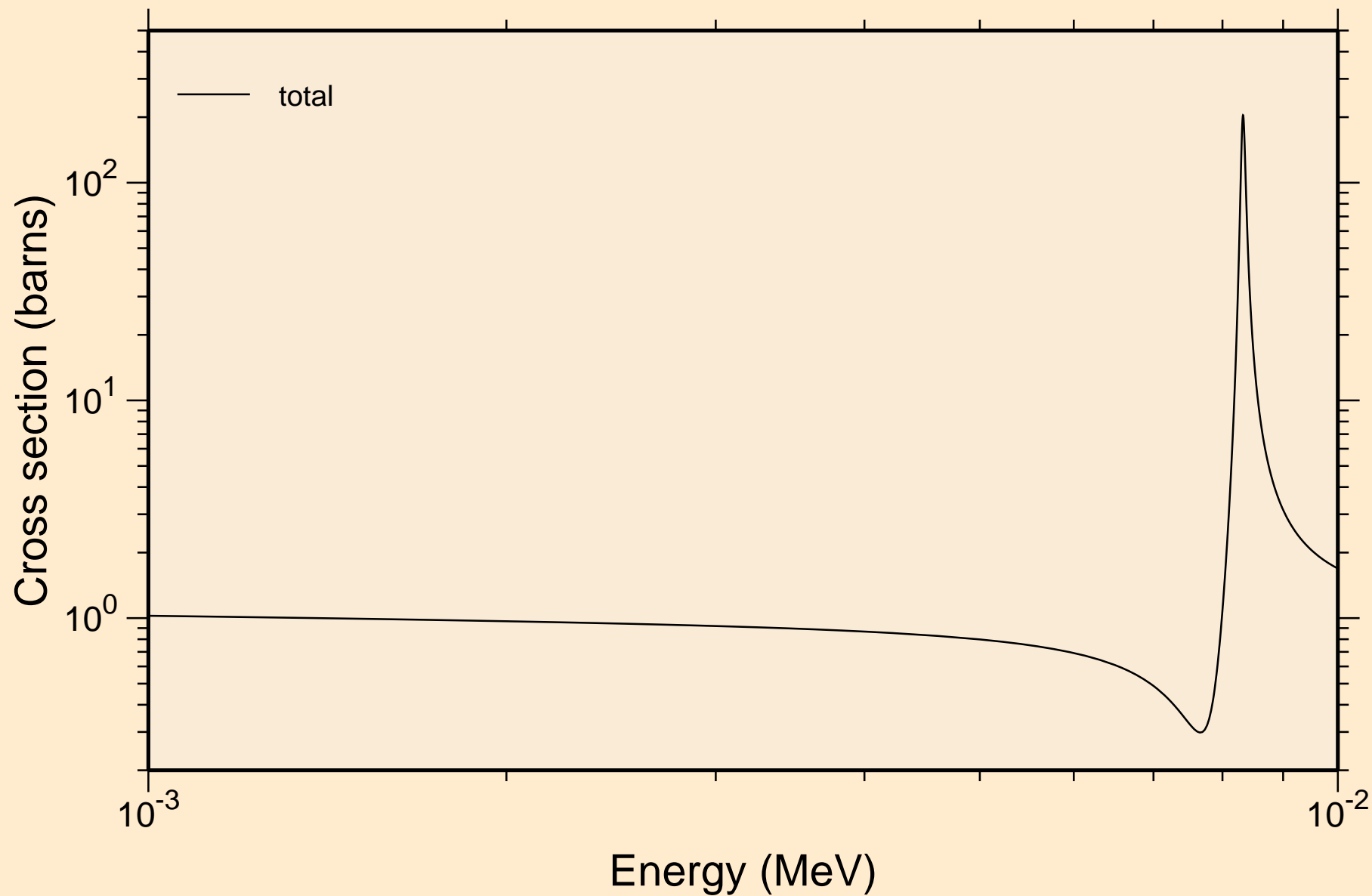

17-CL-37 FOR FENDL-3.2 FROM FENDL-3.2 BY NJOY2016.60+ OI
resonance total cross section

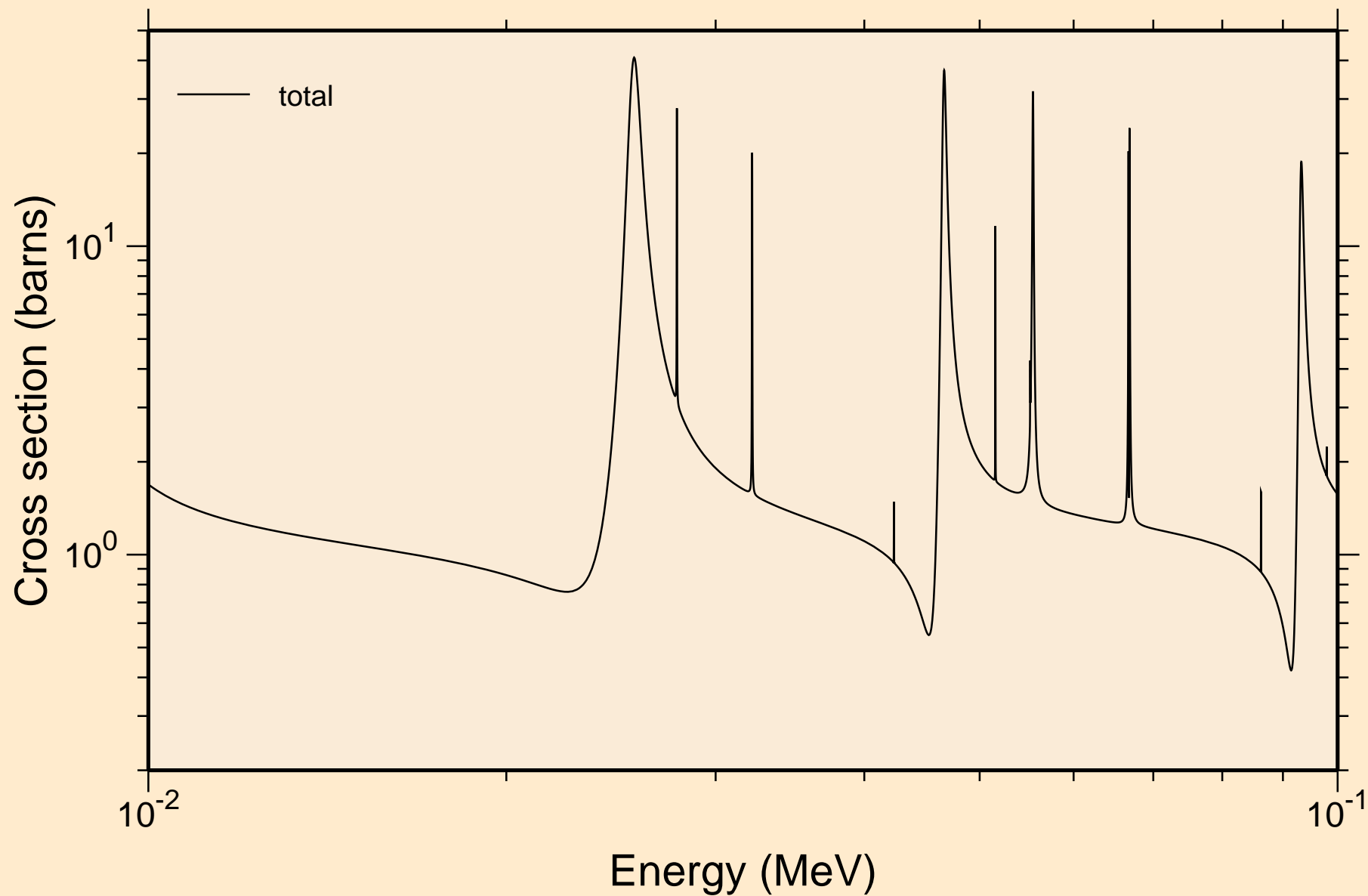

17-CL-37 FOR FENDL-3.2 FROM FENDL-3.2 BY NJOY2016.60+ OI
resonance total cross section

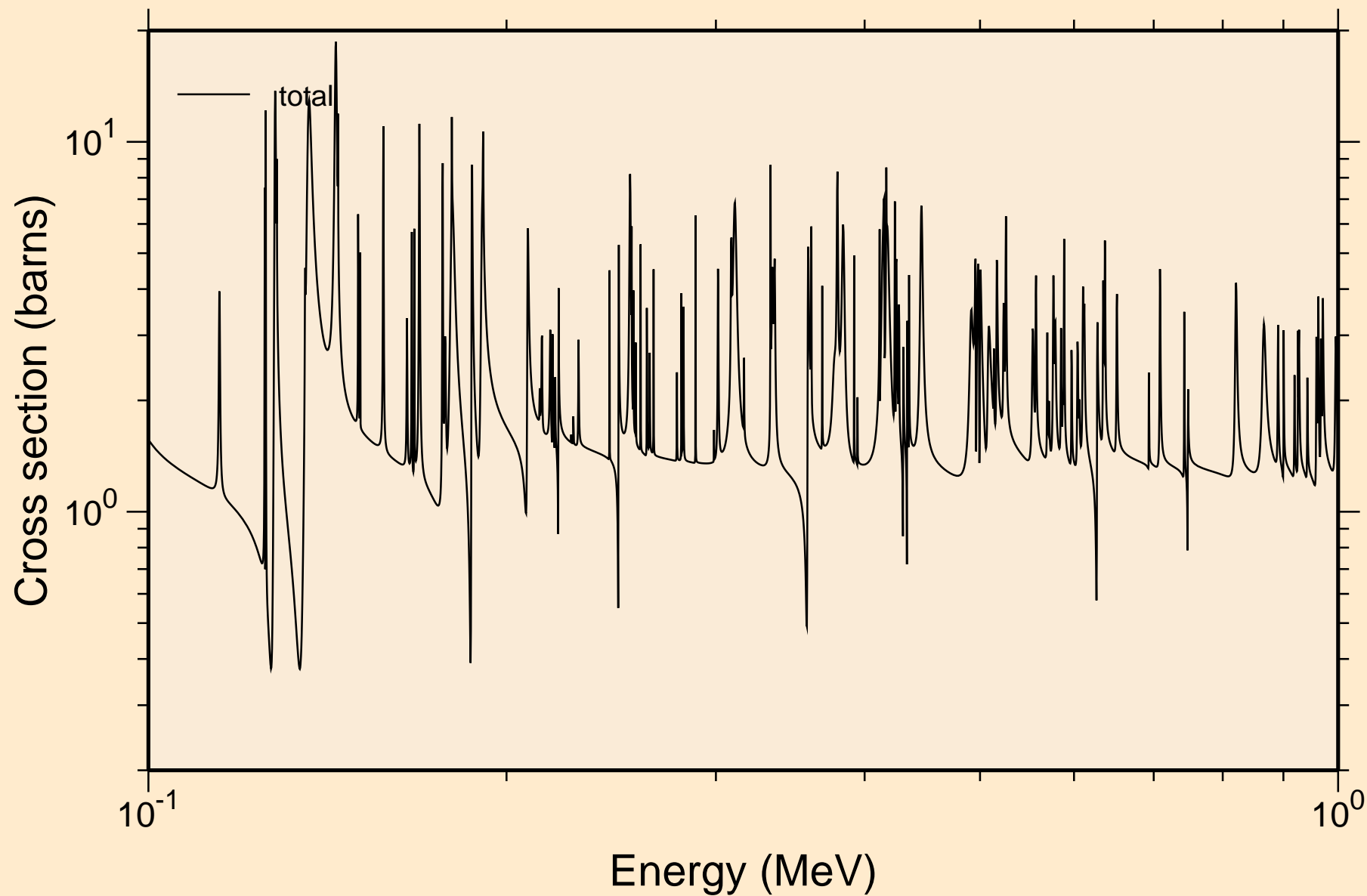

17-CL-37 FOR FENDL-3.2 FROM FENDL-3.2 BY NJOY2016.60+ OI
resonance total cross section

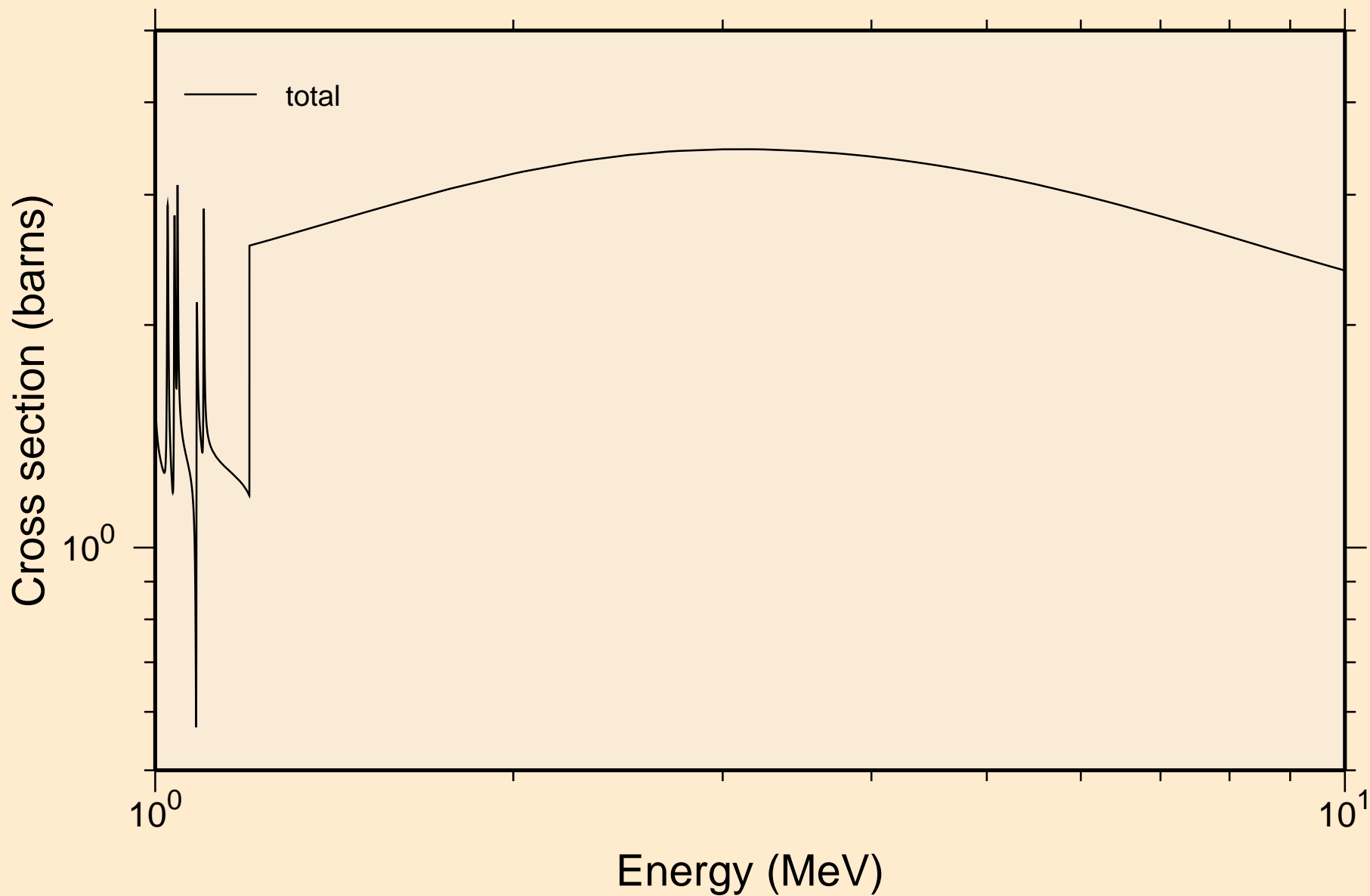

17-CL-37 FOR FENDL-3.2 FROM FENDL-3.2 BY NJOY2016.60+ OI
resonance absorption cross sections

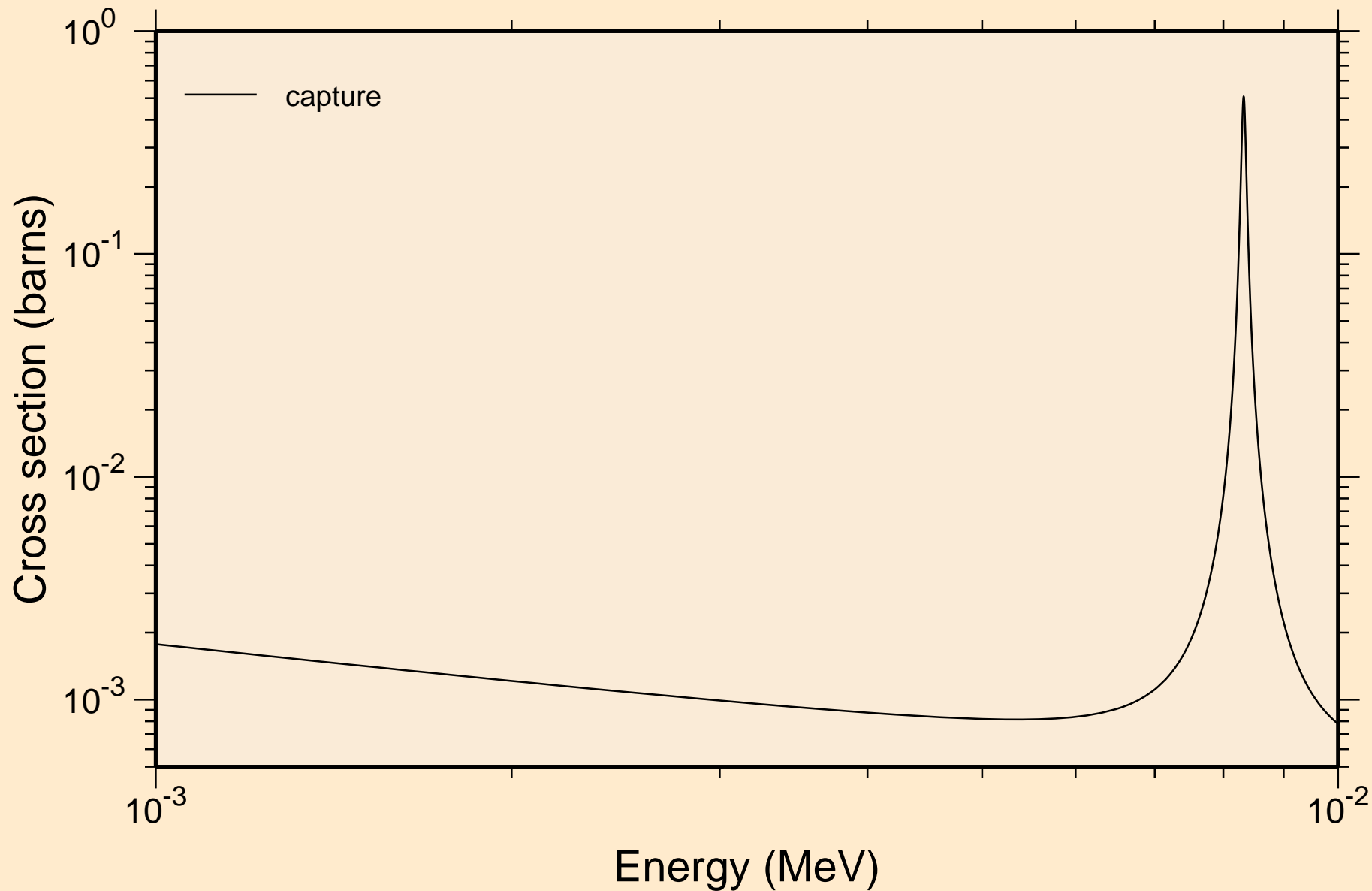

17-CL-37 FOR FENDL-3.2 FROM FENDL-3.2 BY NJOY2016.60+ OI
resonance absorption cross sections

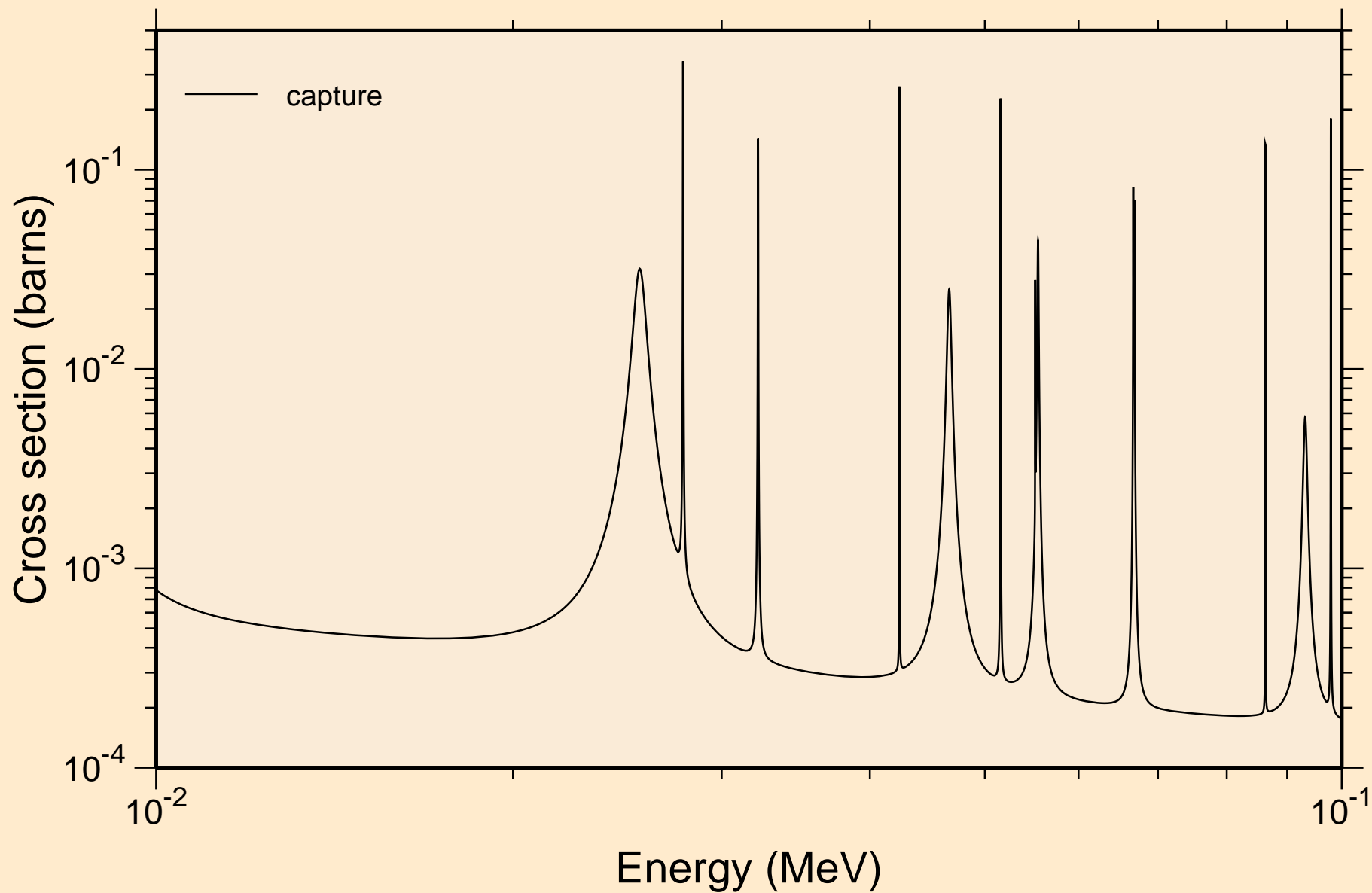

17-CL-37 FOR FENDL-3.2 FROM FENDL-3.2 BY NJOY2016.60+ OI
resonance absorption cross sections

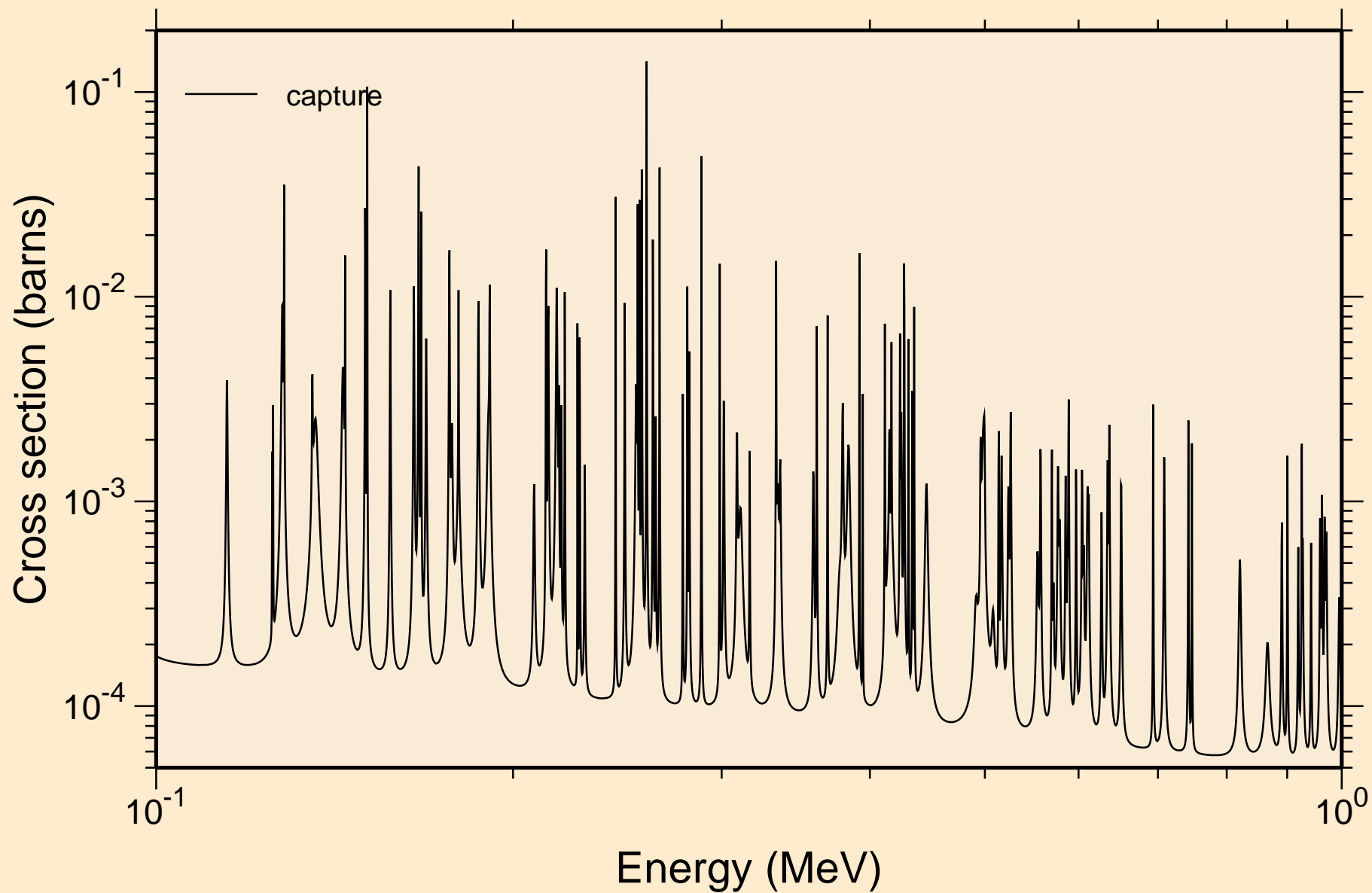

17-CL-37 FOR FENDL-3.2 FROM FENDL-3.2 BY NJOY2016.60+ OI
resonance absorption cross sections

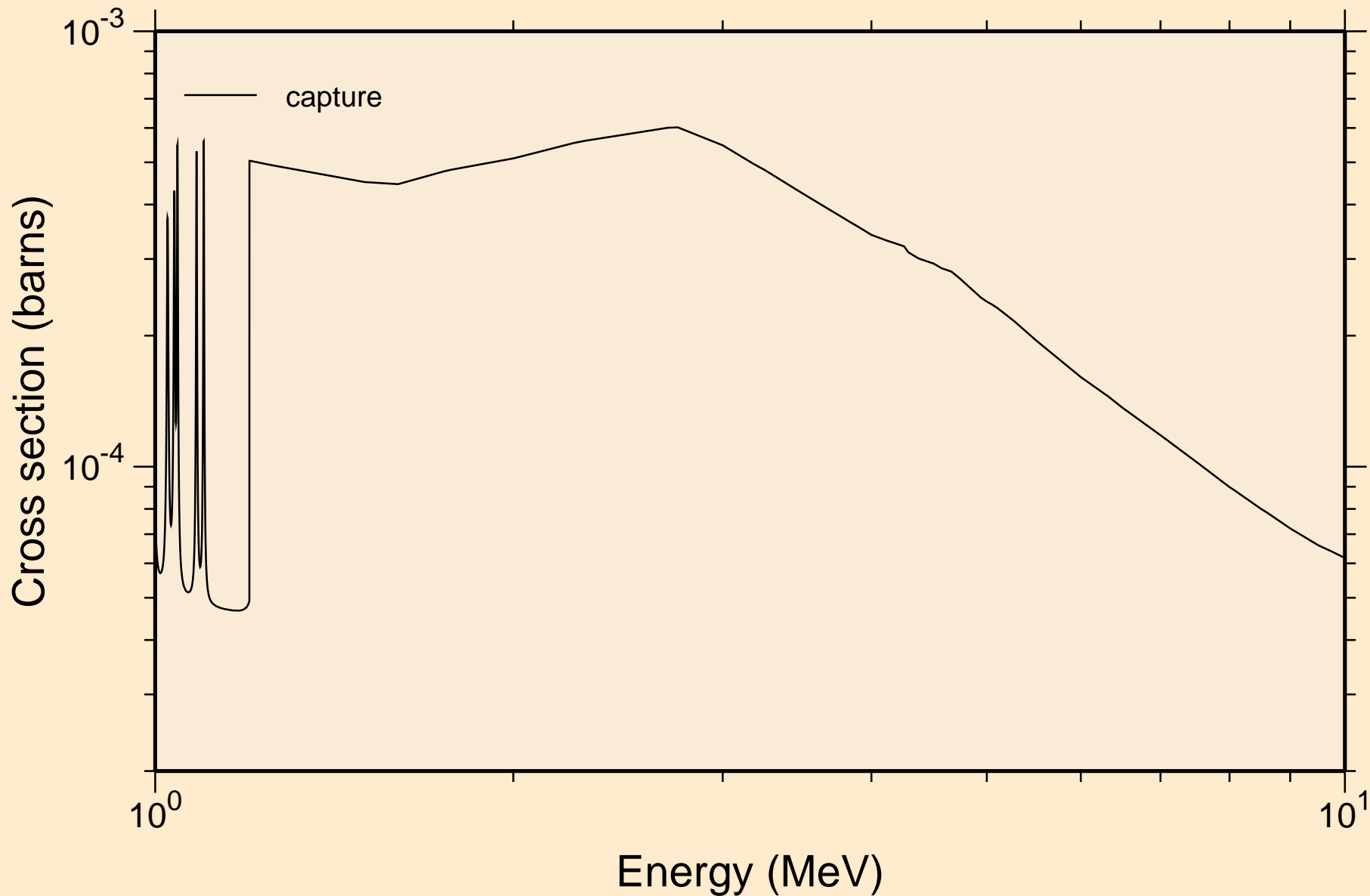

17-CL-37 FOR FENDL-3.2 FROM FENDL-3.2 BY NJOY2016.60+ OI Heating

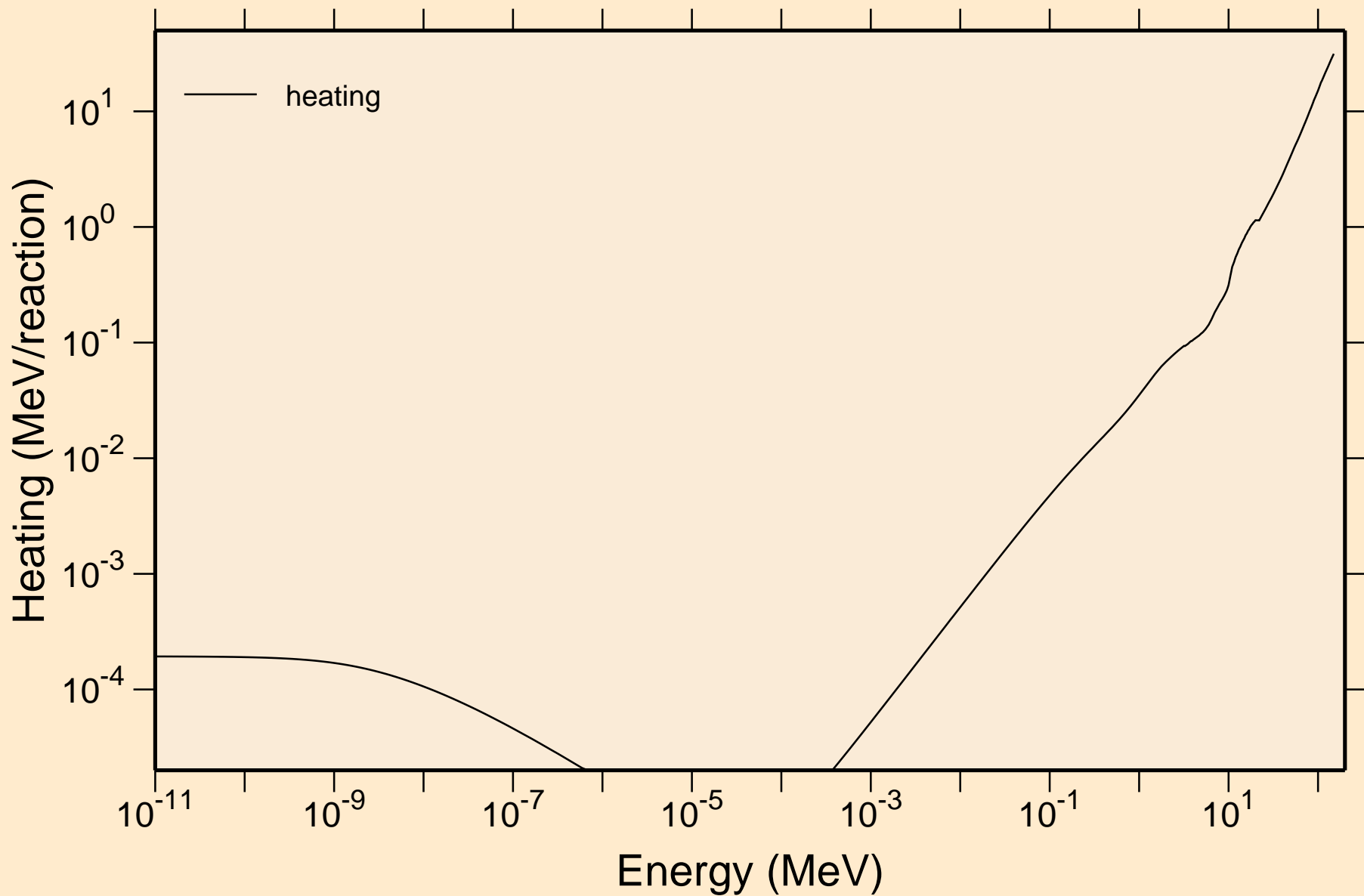

17-CL-37 FOR FENDL-3.2 FROM FENDL-3.2 BY NJOY2016.60+ OI Damage

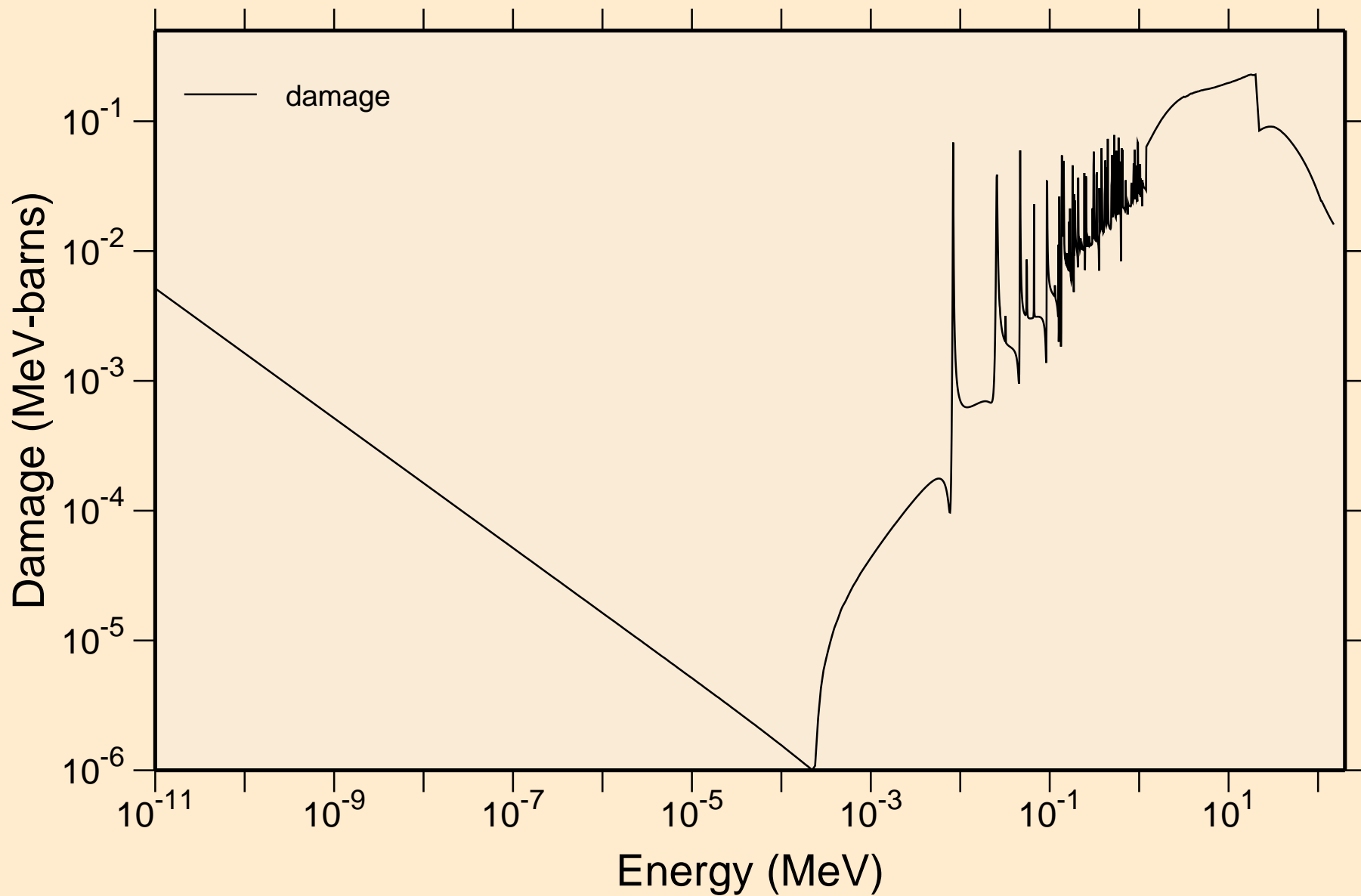

17-CL-37 FOR FENDL-3.2 FROM FENDL-3.2 BY NJOY2016.60+ OI
Non-threshold reactions

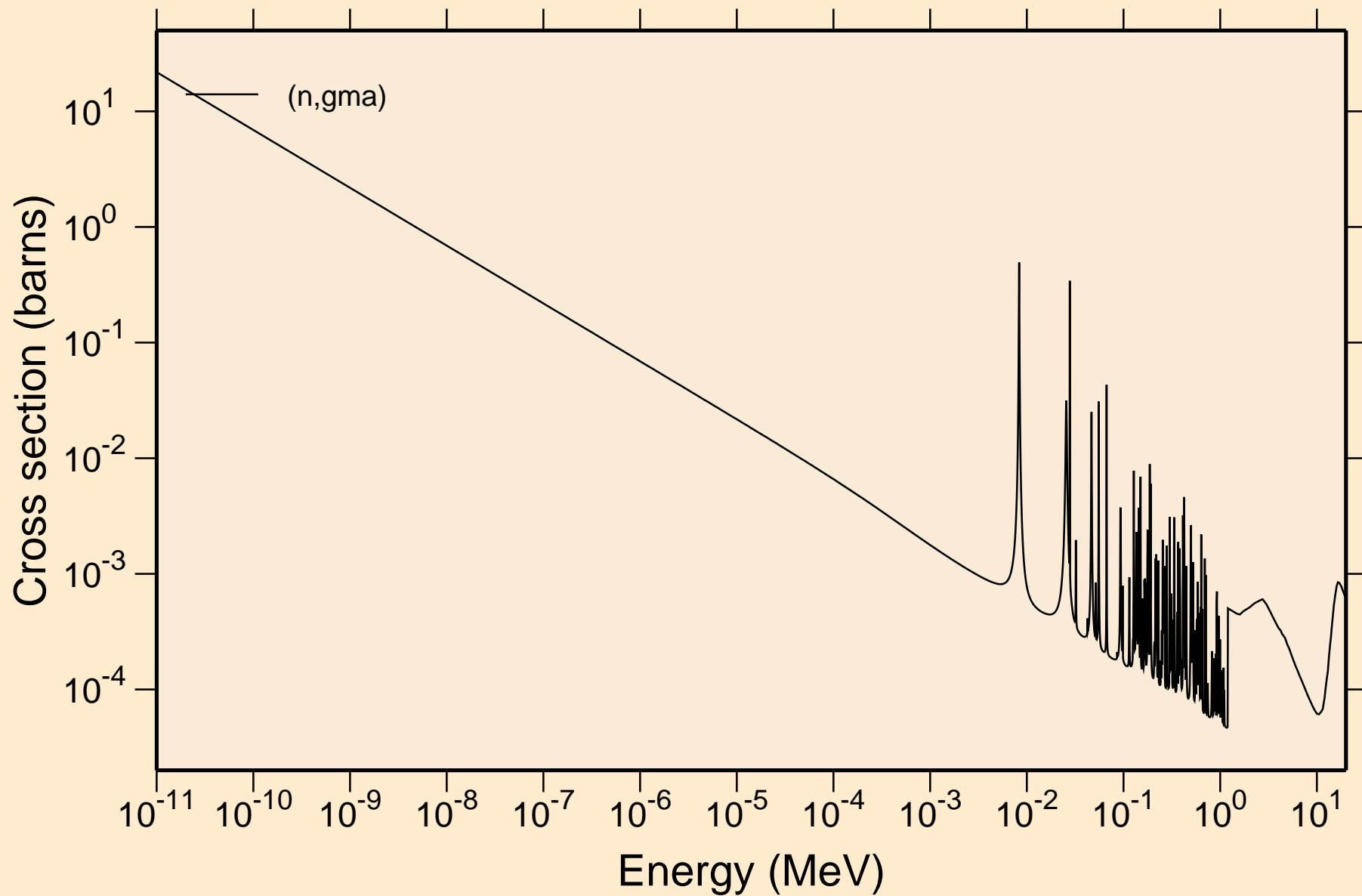

17-CL-37 FOR FENDL-3.2 FROM FENDL-3.2 BY NJOY2016.60+ OI

Principal cross sections

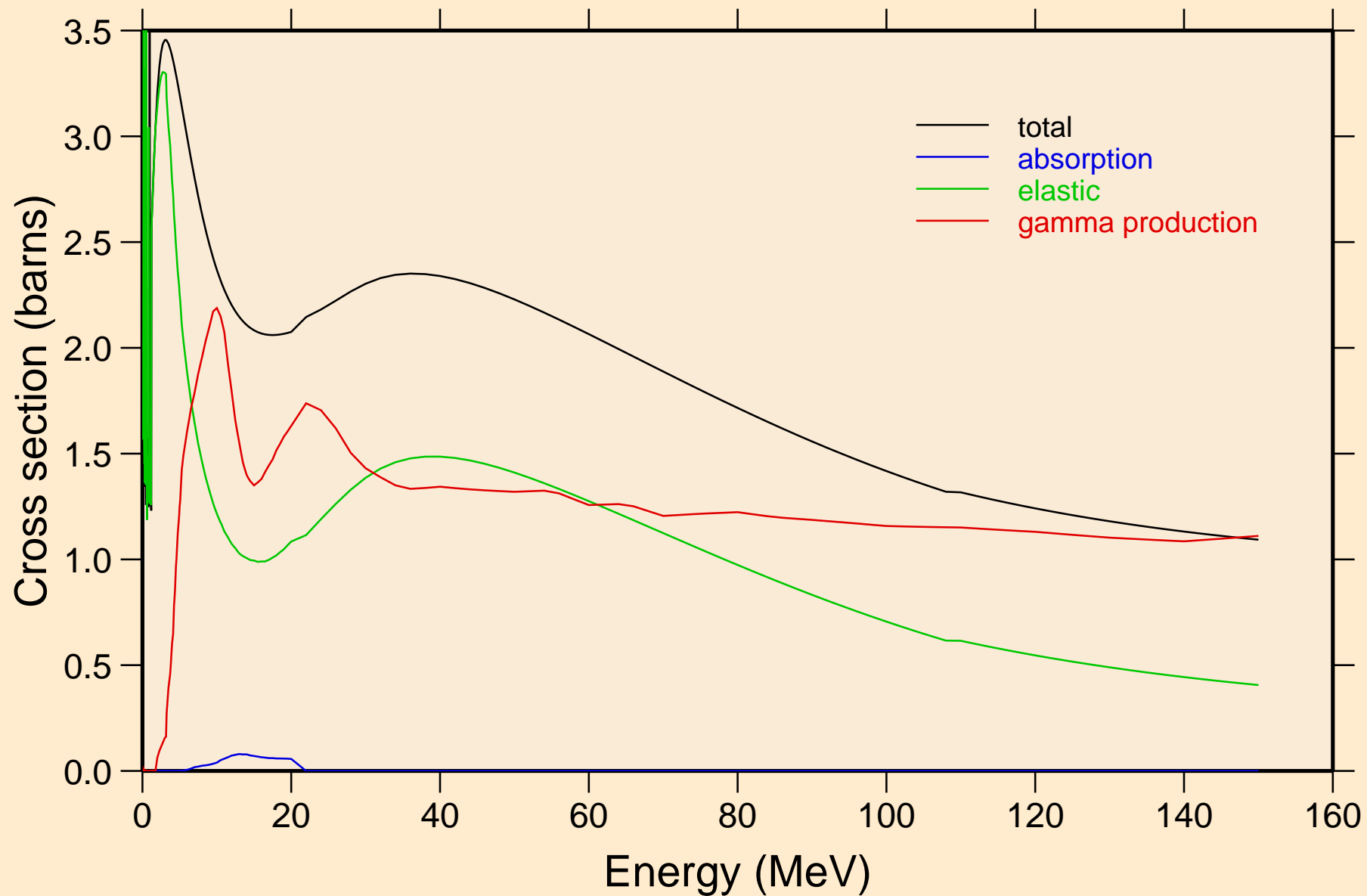

17-CL-37 FOR FENDL-3.2 FROM FENDL-3.2 BY NJOY2016.60+ OI Heating

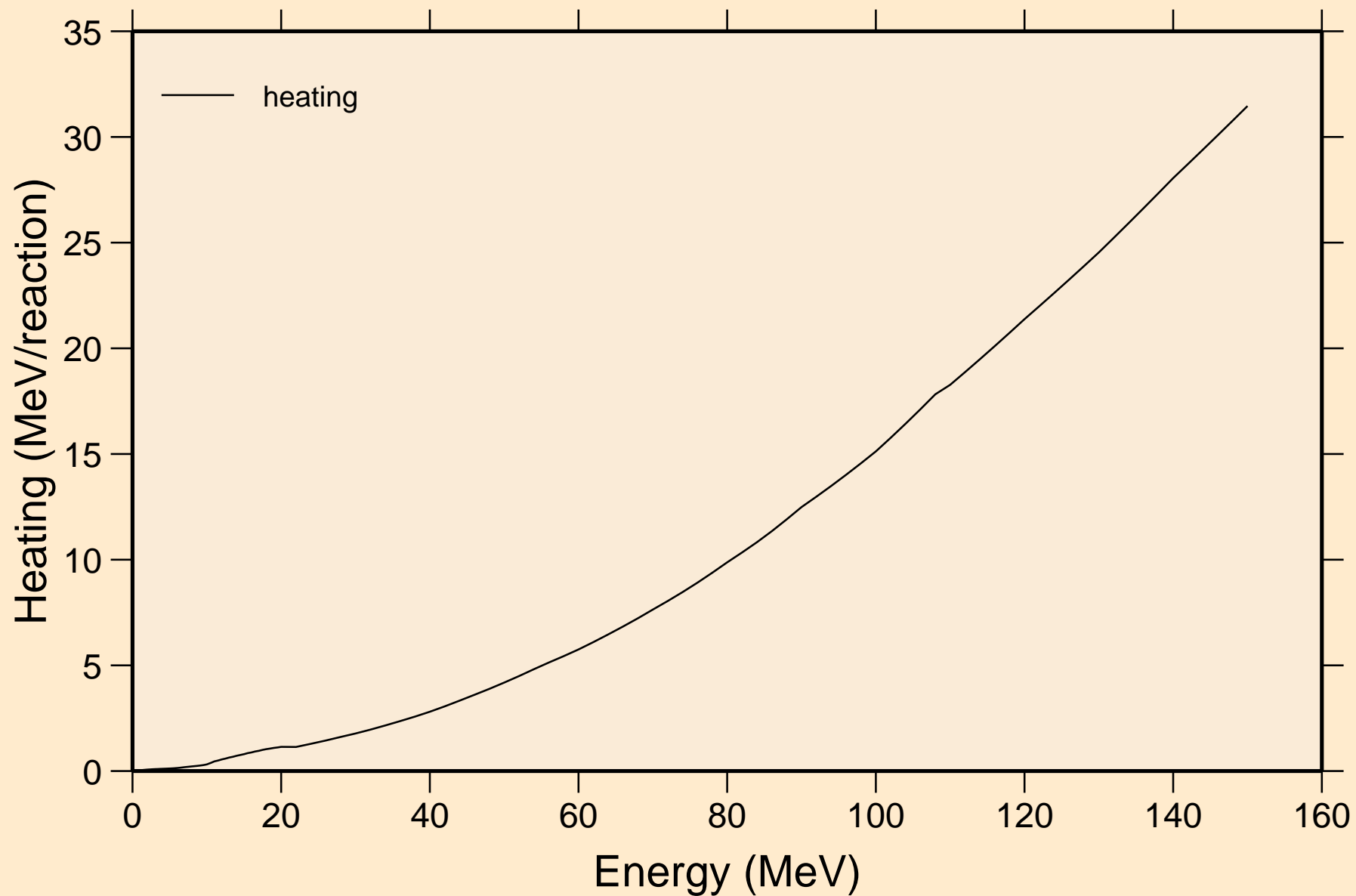

17-CL-37 FOR FENDL-3.2 FROM FENDL-3.2 BY NJOY2016.60+ OI Damage

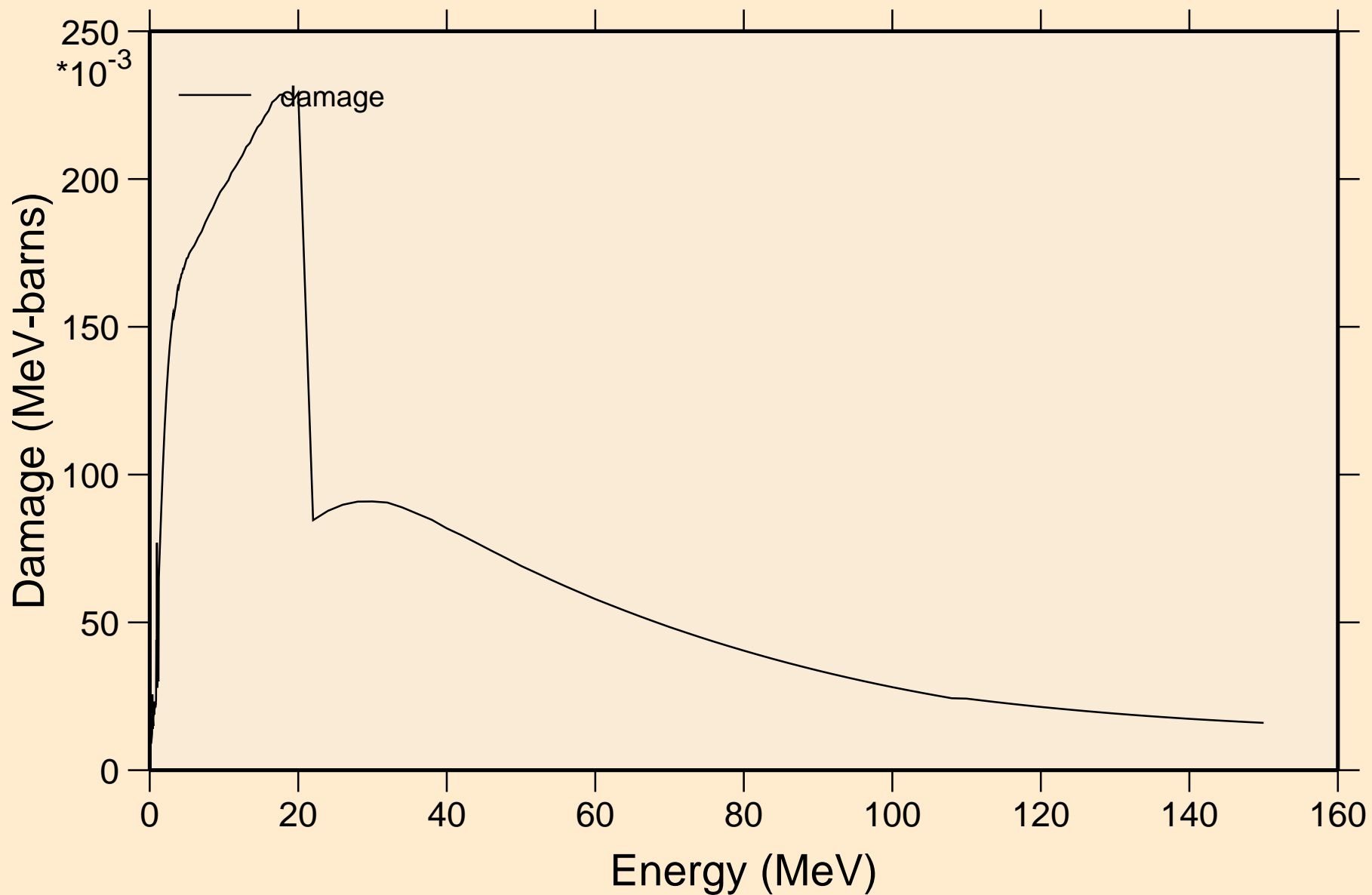

17-CL-37 FOR FENDL-3.2 FROM FENDL-3.2 BY NJOY2016.60+ OI
Non-threshold reactions

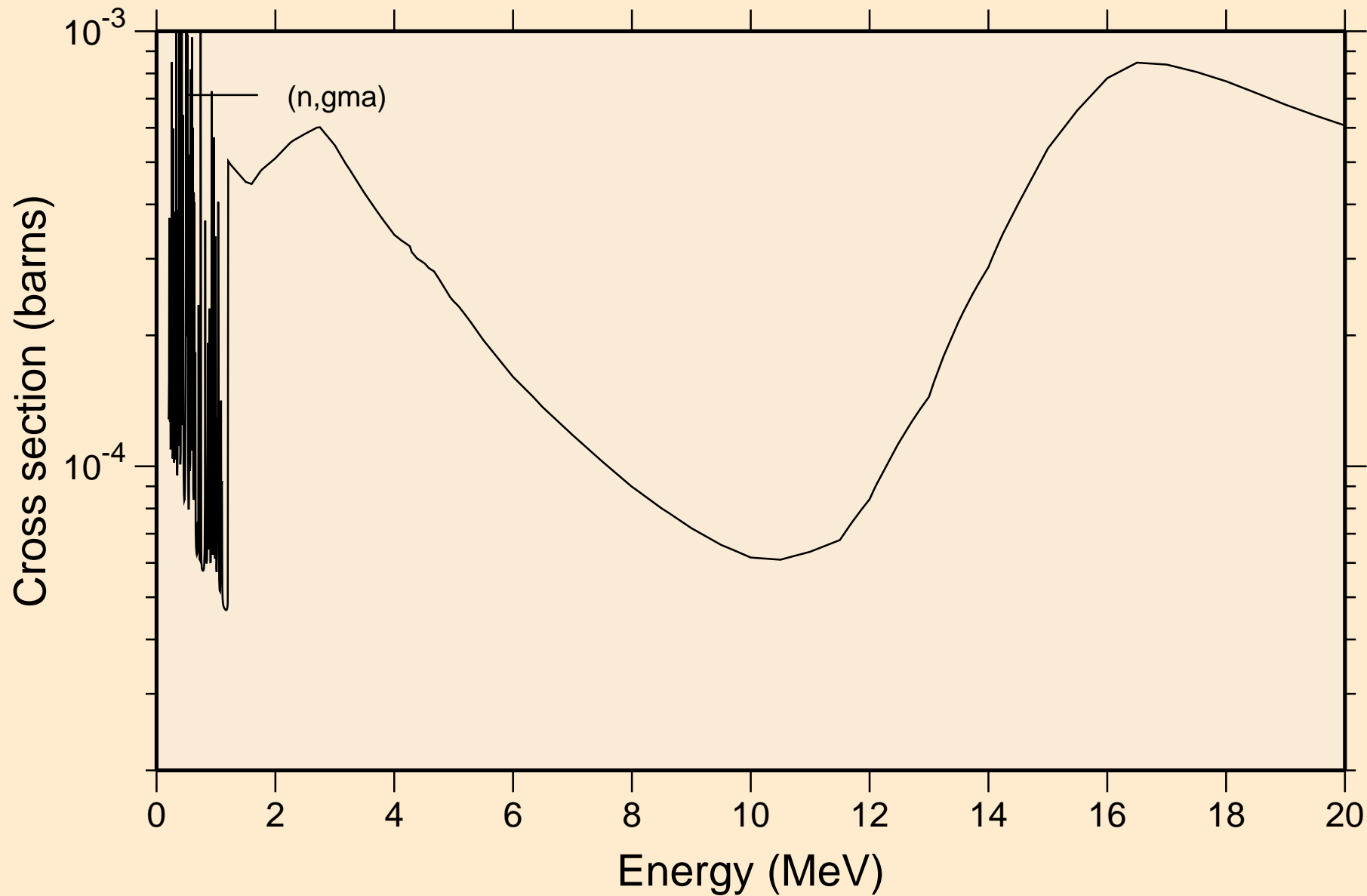

17-CL-37 FOR FENDL-3.2 FROM FENDL-3.2 BY NJOY2016.60+ OI Inelastic levels

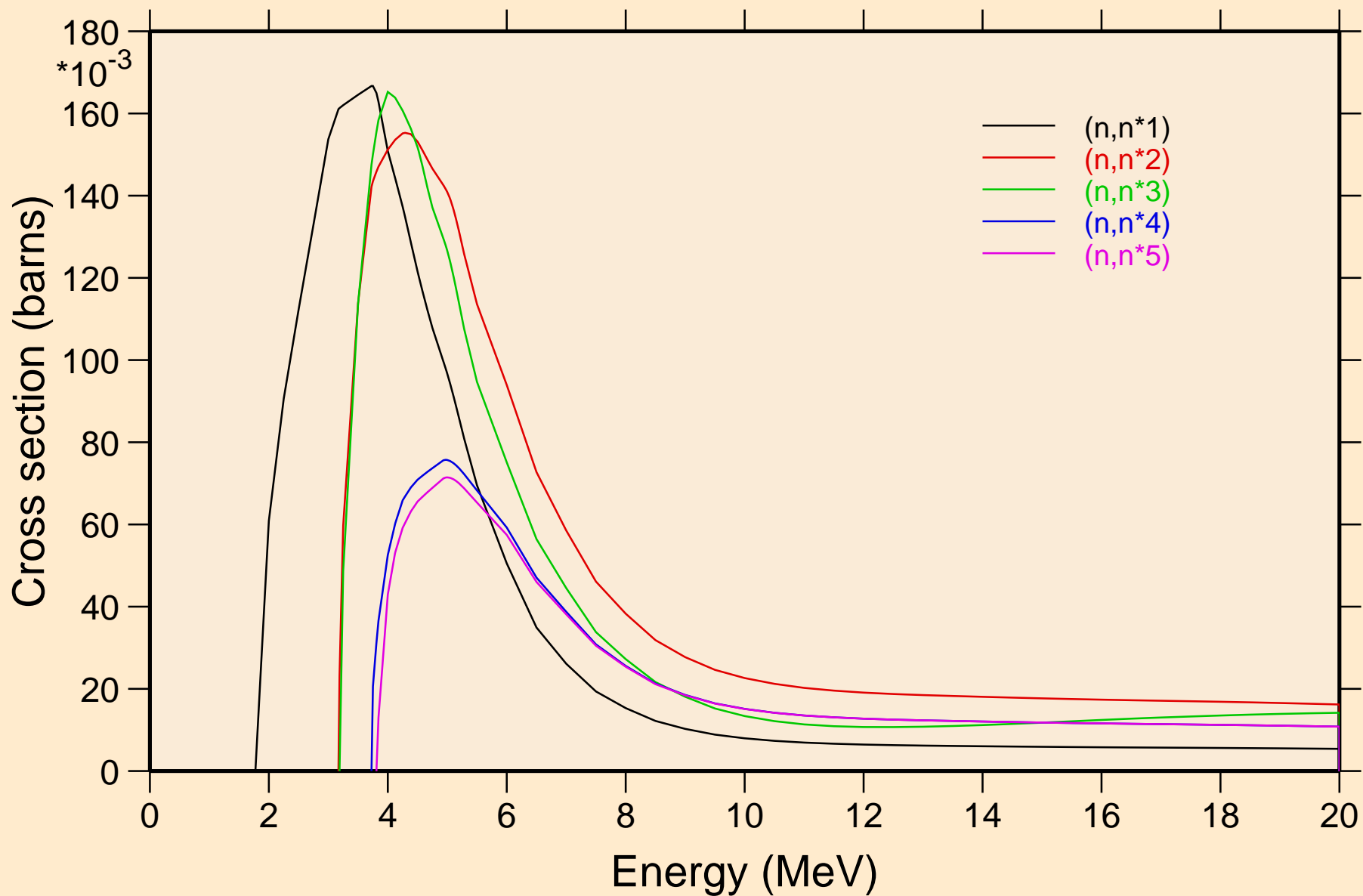

17-CL-37 FOR FENDL-3.2 FROM FENDL-3.2 BY NJOY2016.60+ OI Inelastic levels

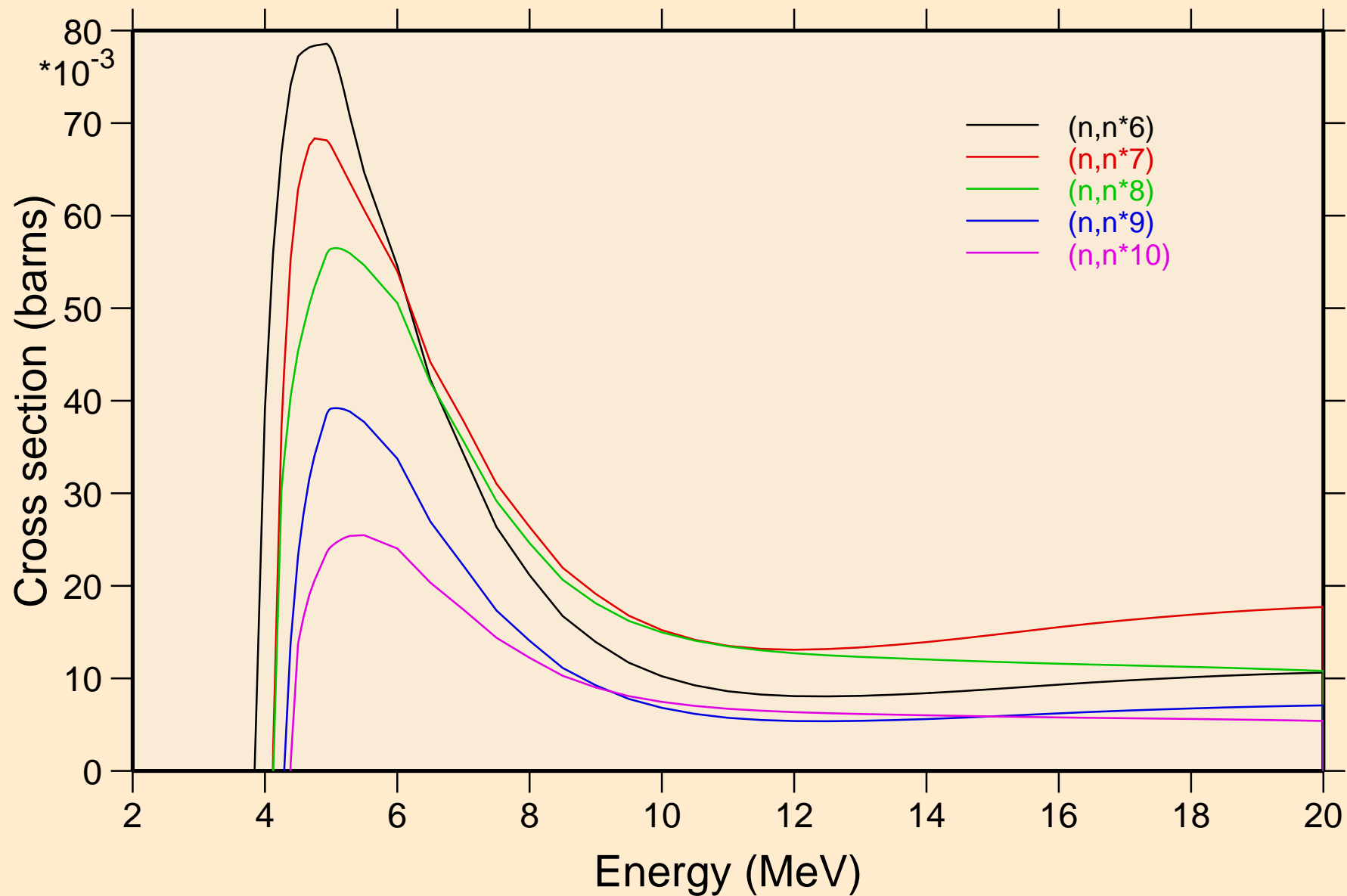

17-CL-37 FOR FENDL-3.2 FROM FENDL-3.2 BY NJOY2016.60+ OI Inelastic levels

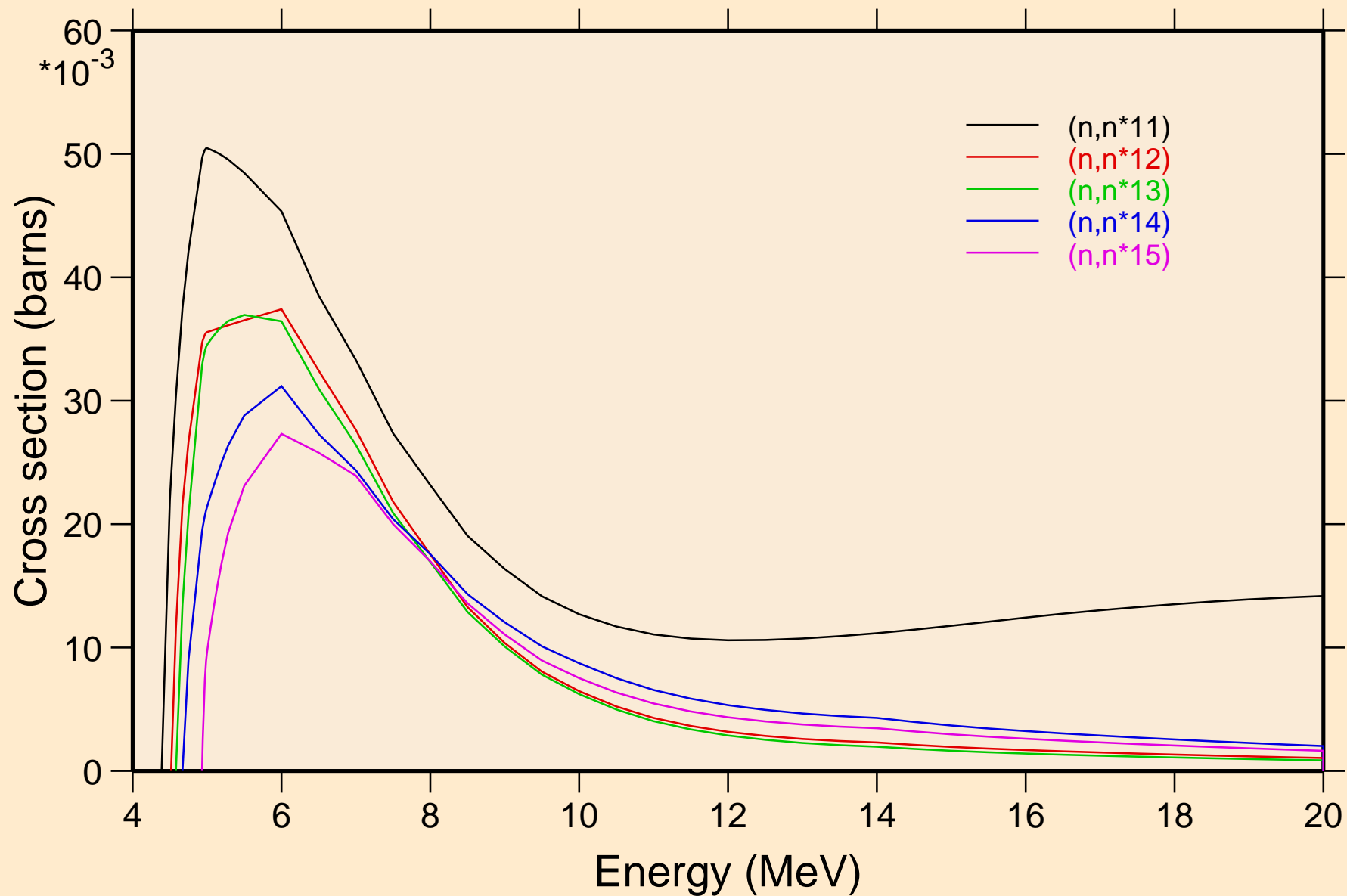

17-CL-37 FOR FENDL-3.2 FROM FENDL-3.2 BY NJOY2016.60+ OI Inelastic levels

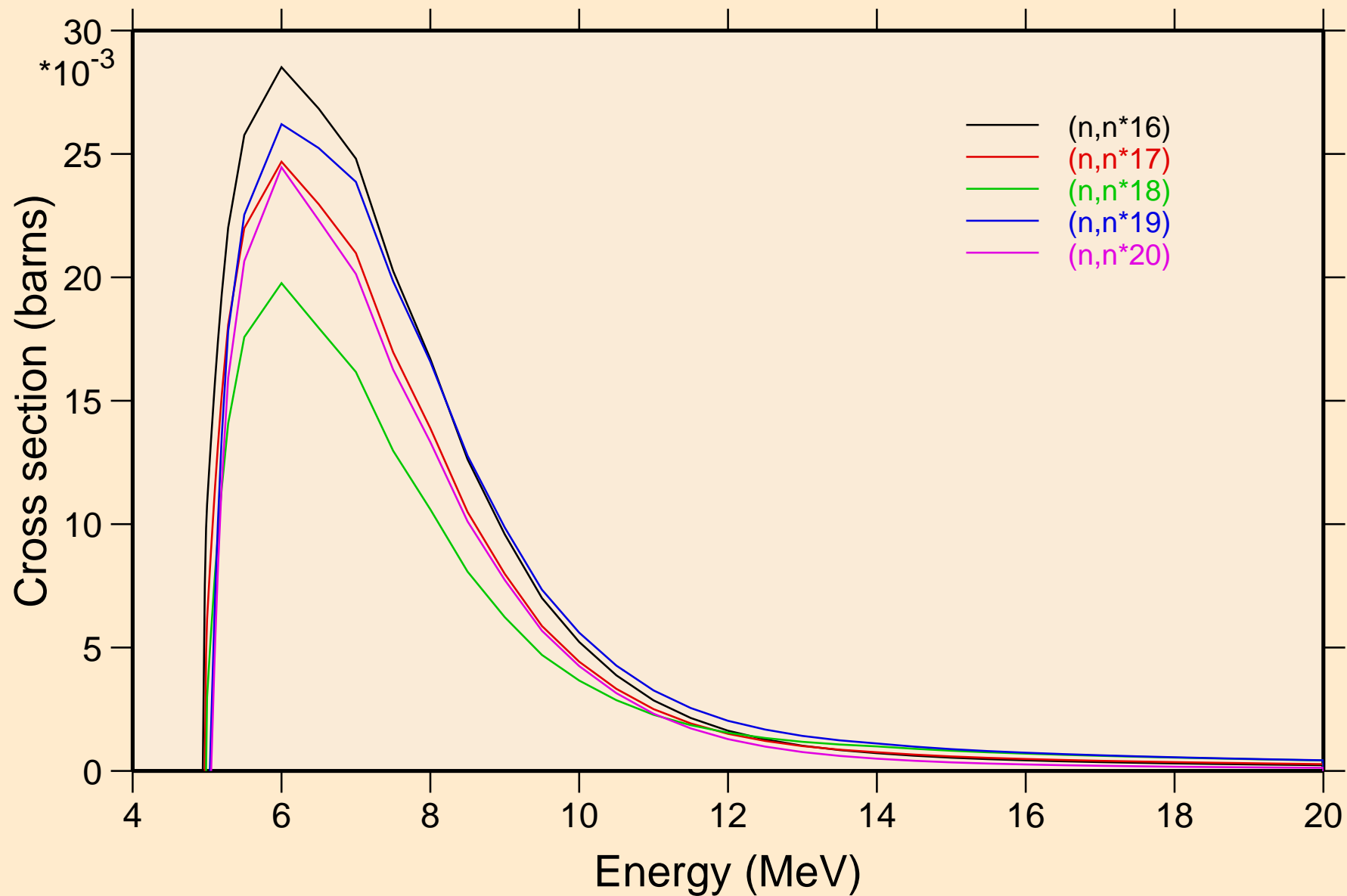

17-CL-37 FOR FENDL-3.2 FROM FENDL-3.2 BY NJOY2016.60+ OI Inelastic levels

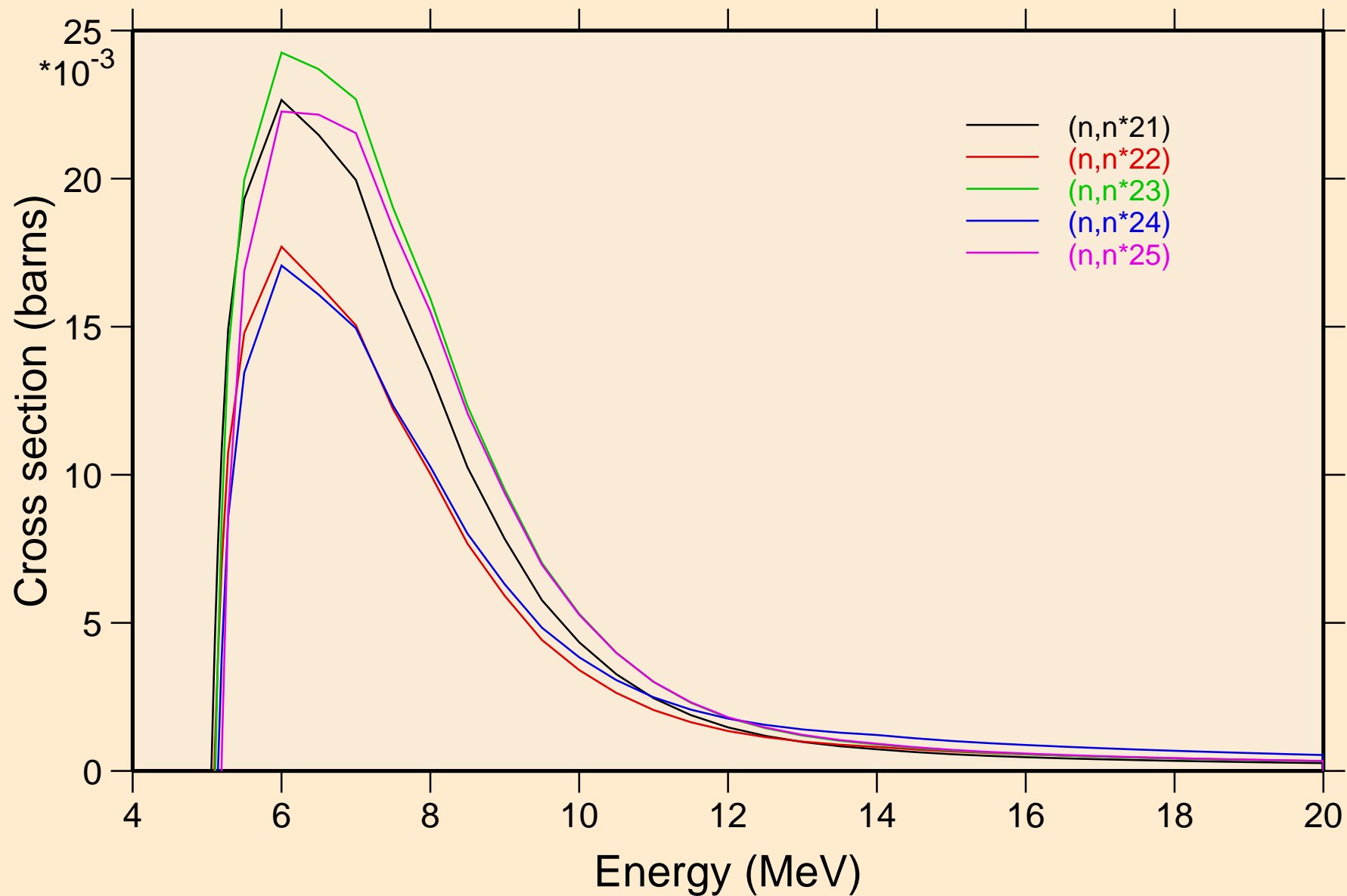

17-CL-37 FOR FENDL-3.2 FROM FENDL-3.2 BY NJOY2016.60+ OI
Inelastic levels

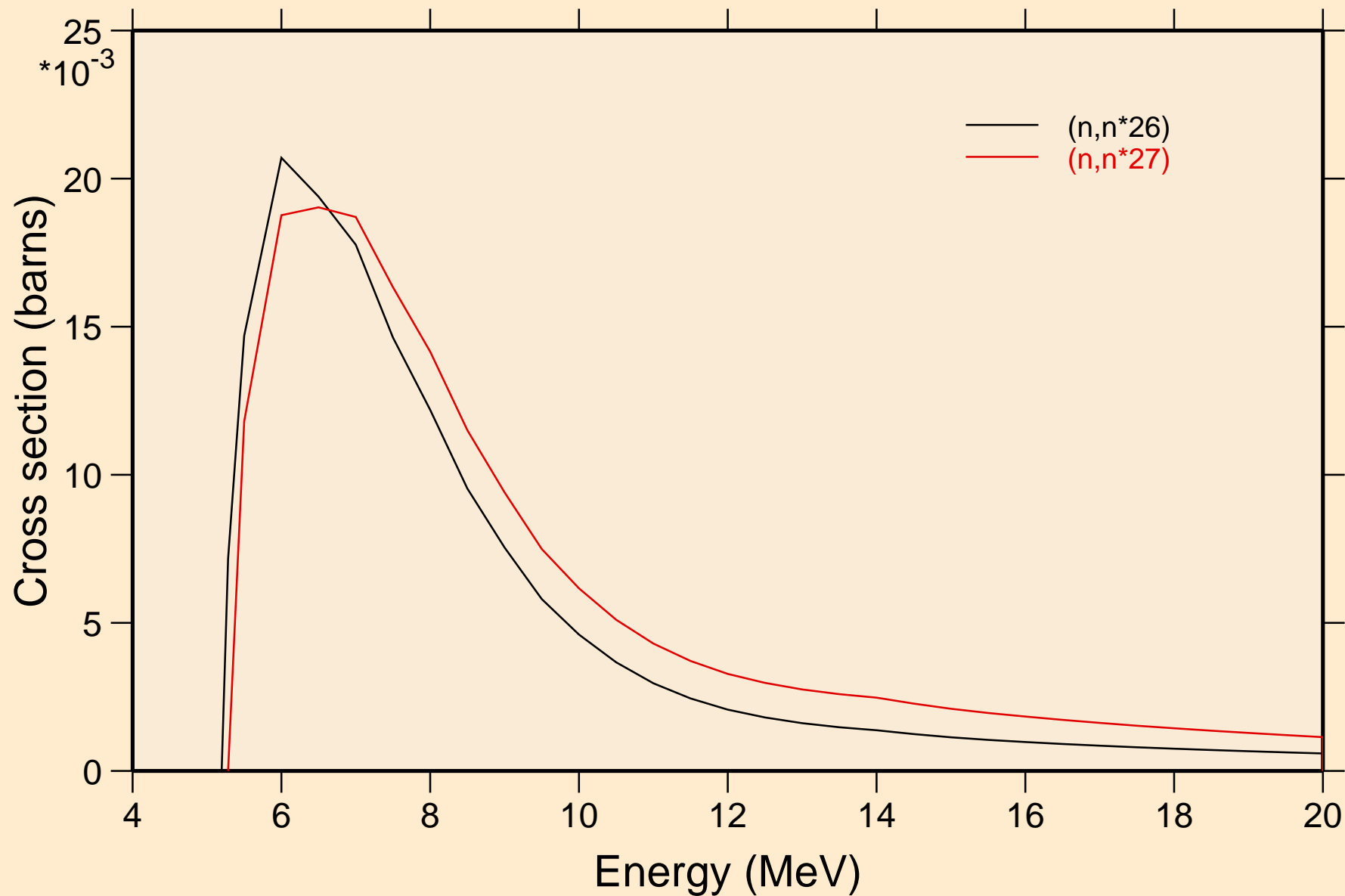

17-CL-37 FOR FENDL-3.2 FROM FENDL-3.2 BY NJOY2016.60+ OI
Threshold reactions

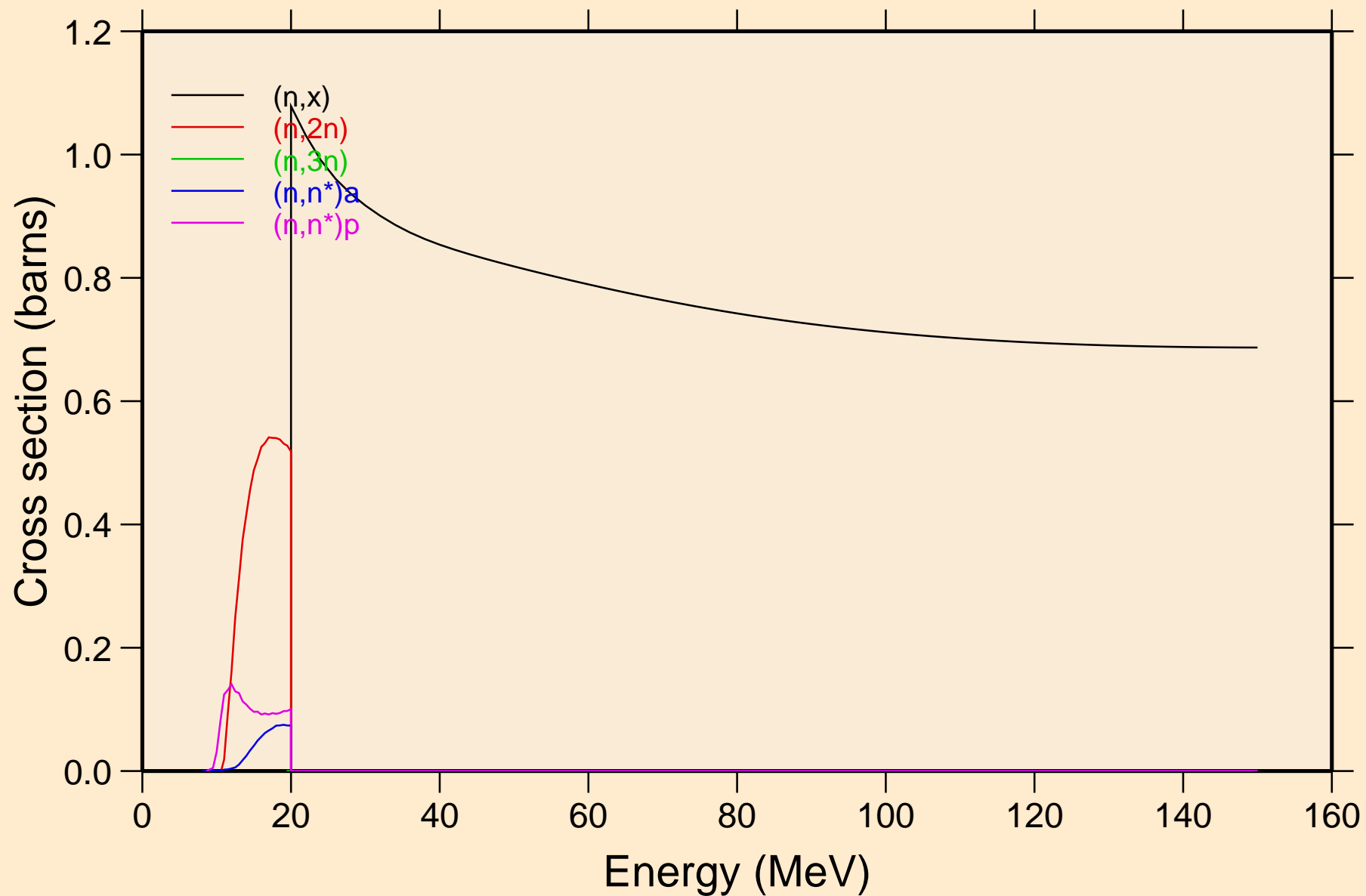

17-CL-37 FOR FENDL-3.2 FROM FENDL-3.2 BY NJOY2016.60+ OI
Threshold reactions

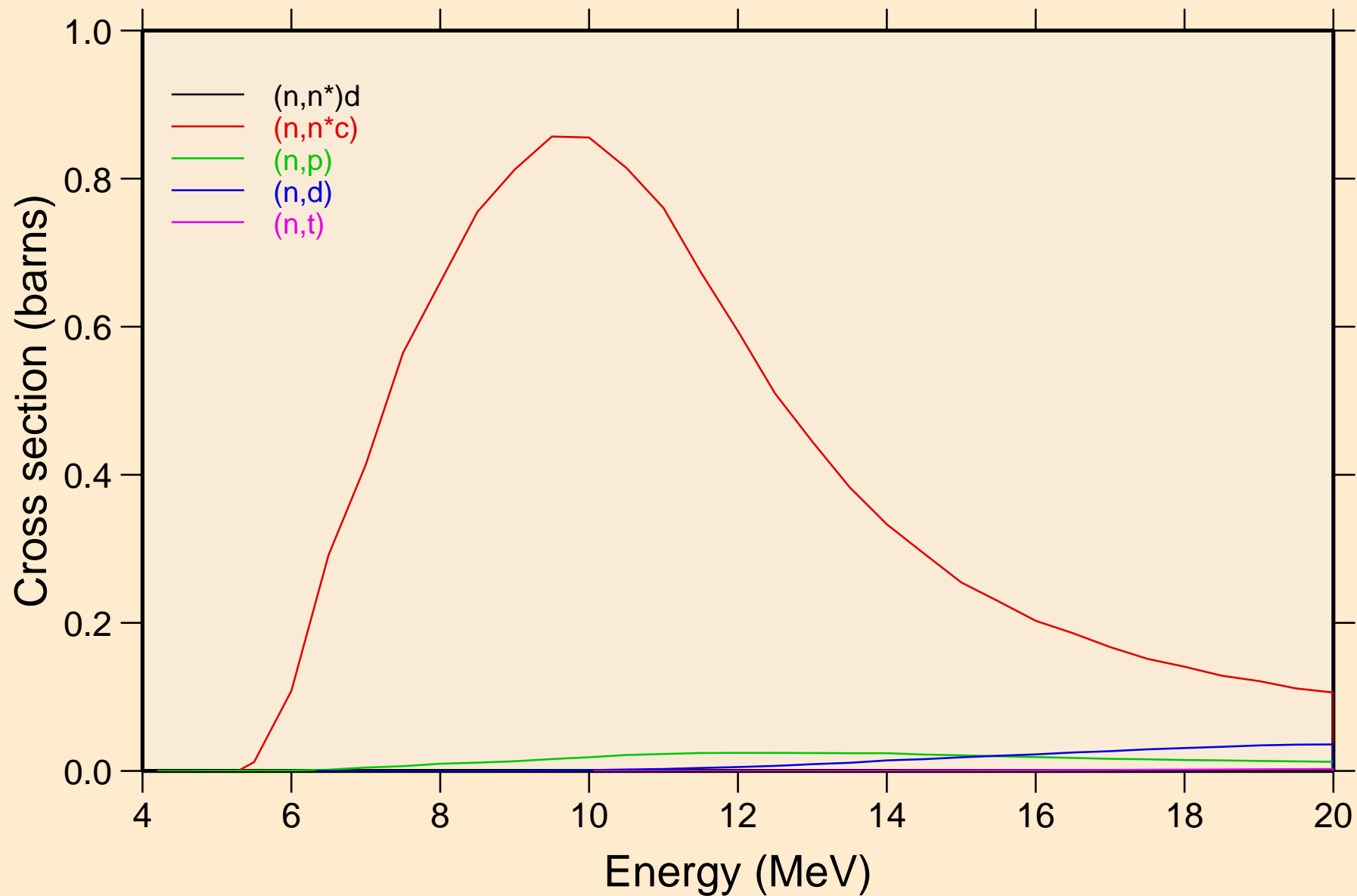

17-CL-37 FOR FENDL-3.2 FROM FENDL-3.2 BY NJOY2016.60+ OI
Threshold reactions

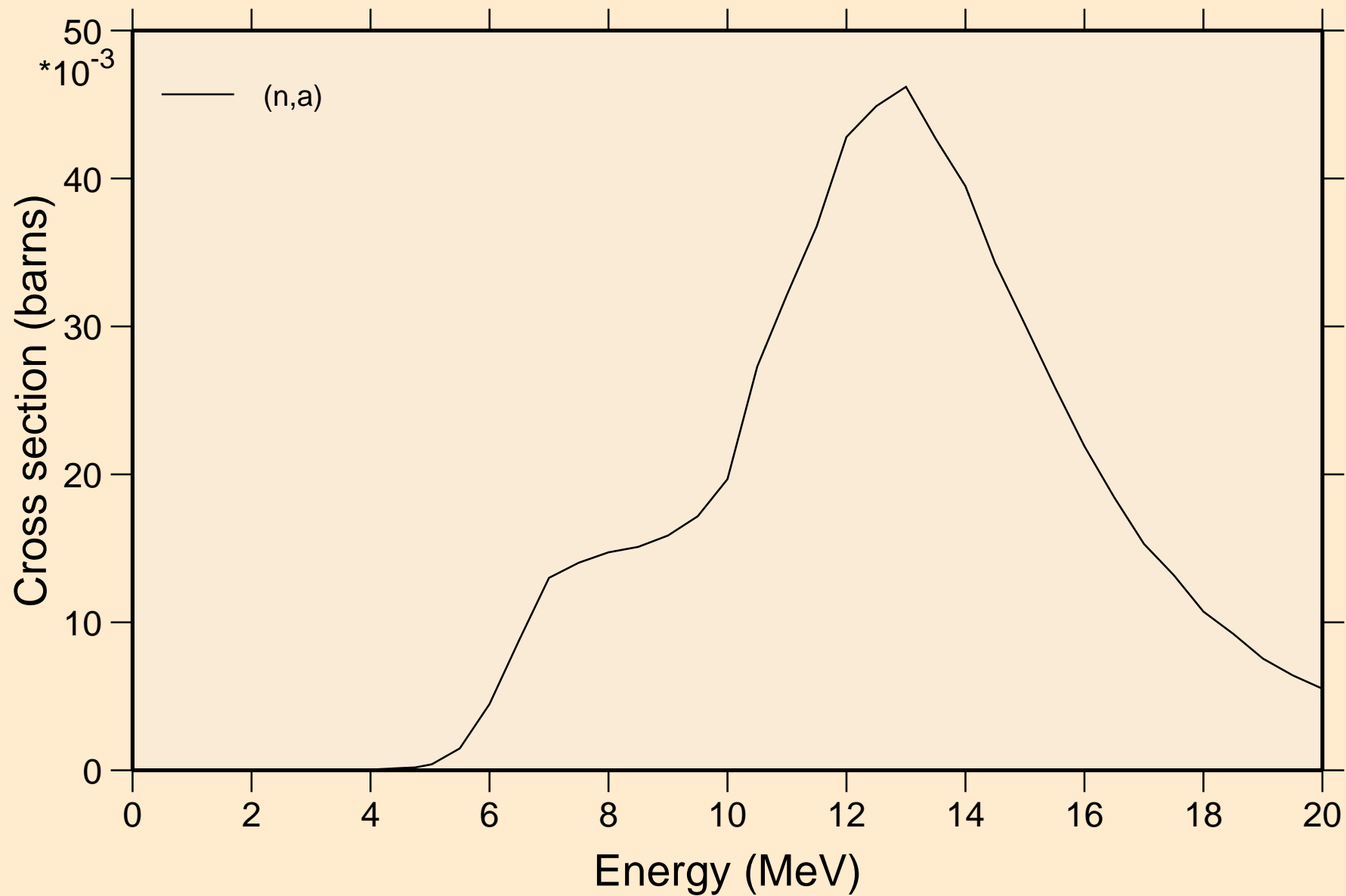

17-CL-37 FOR FENDL-3.2 FROM FENDL-3.2 BY NJOY2016.60+ OI Threshold reactions

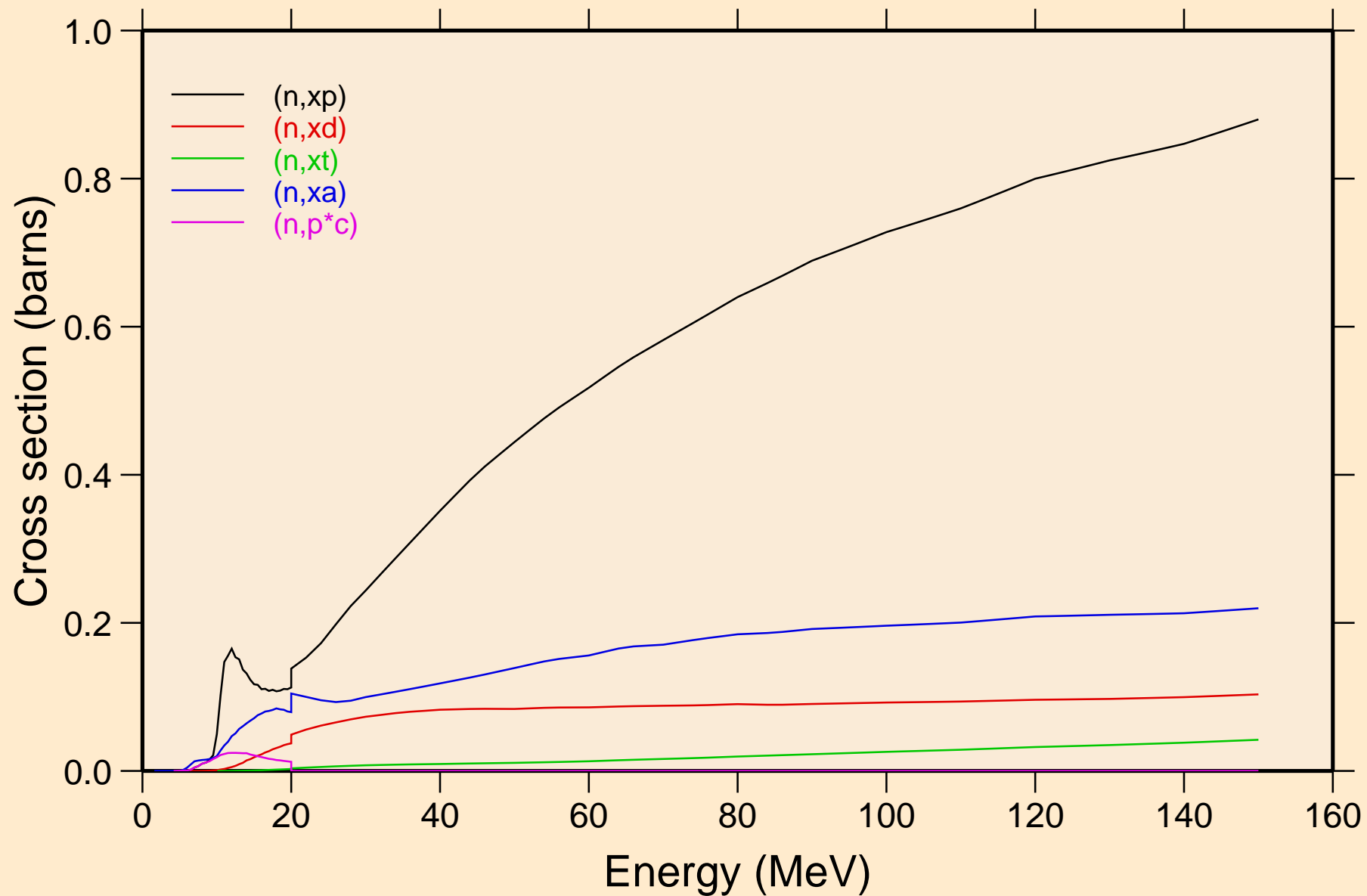

17-CL-37 FOR FENDL-3.2 FROM FENDL-3.2 BY NJOY2016.60+ OI
Threshold reactions

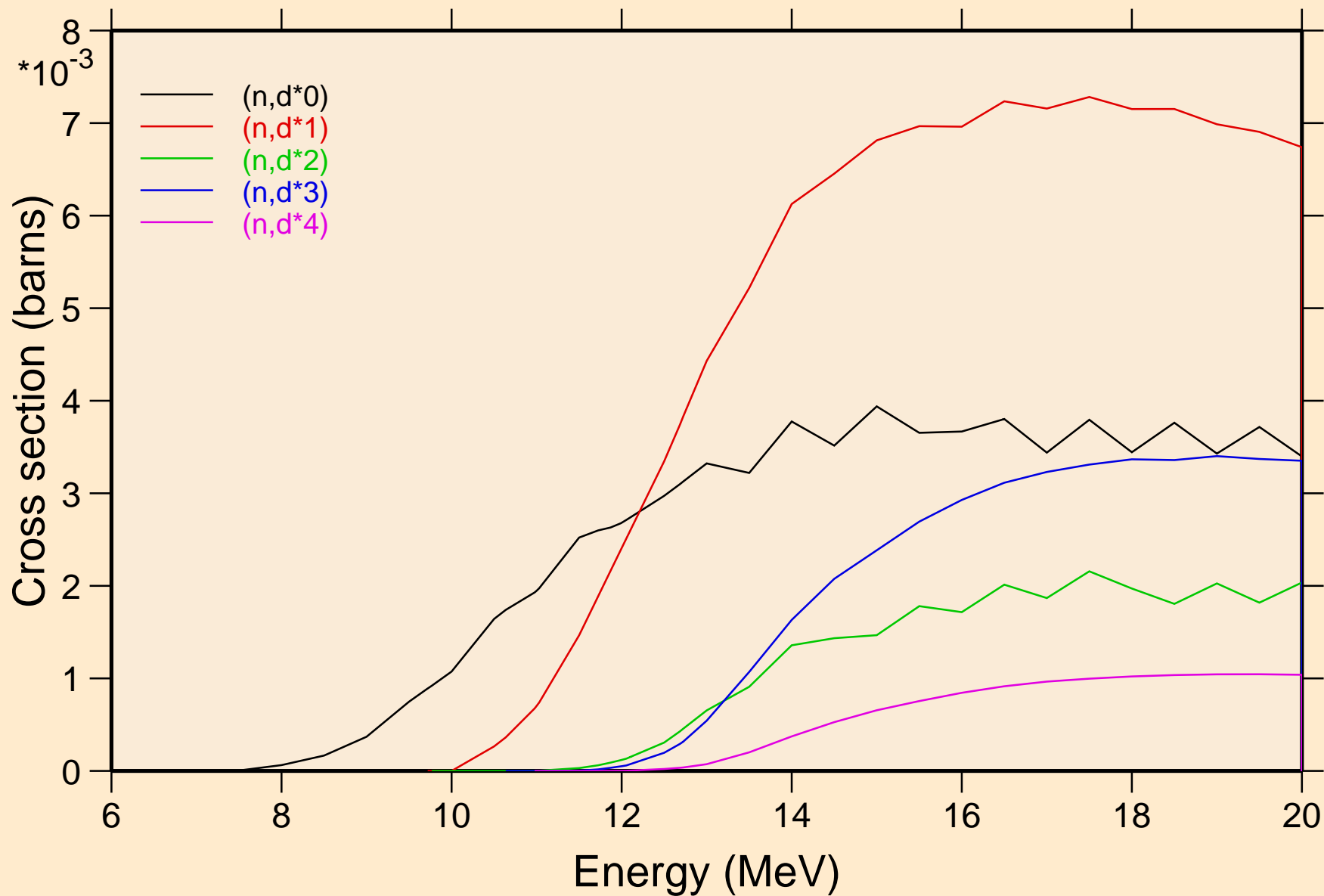

17-CL-37 FOR FENDL-3.2 FROM FENDL-3.2 BY NJOY2016.60+ OI
Threshold reactions

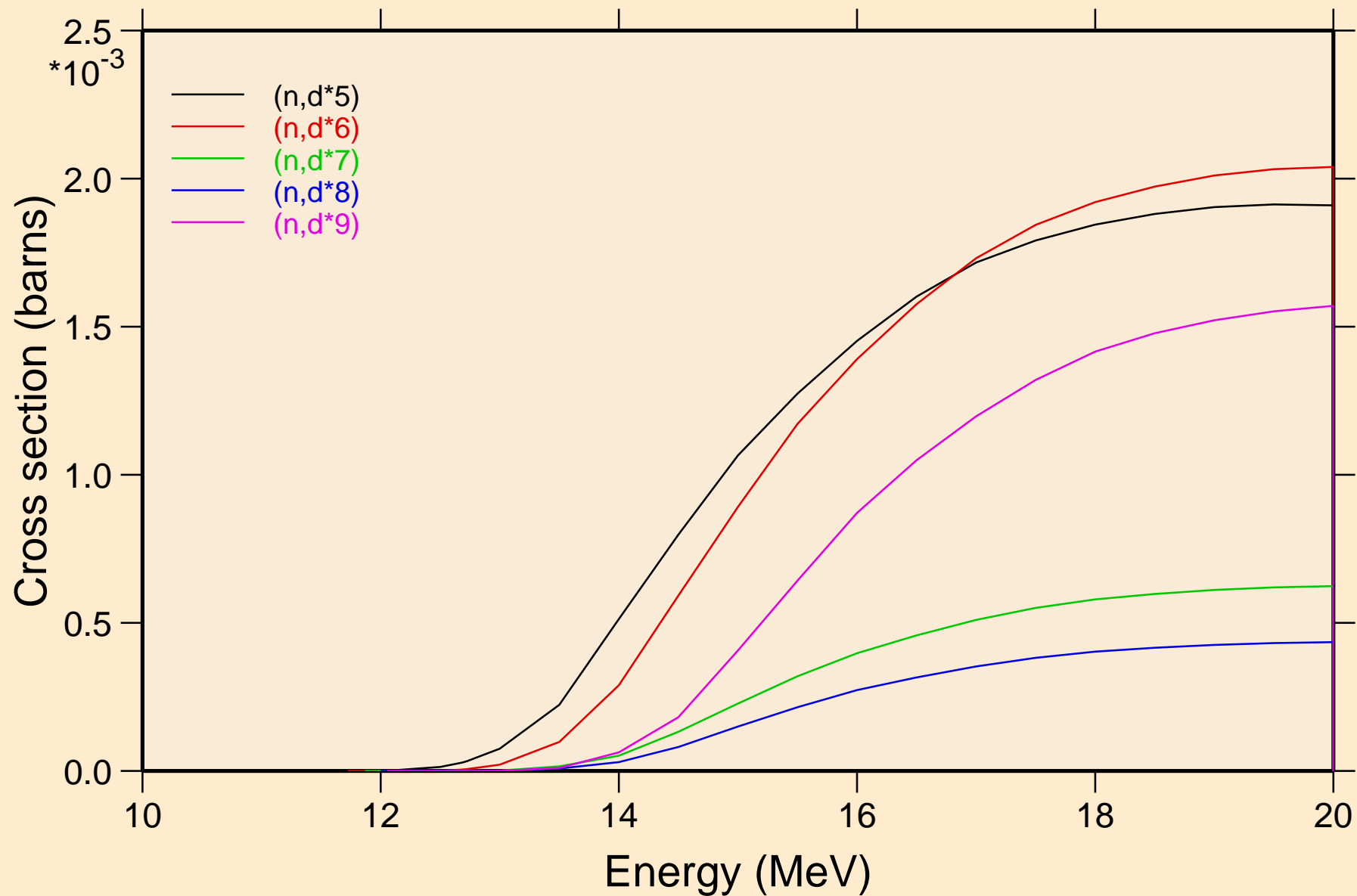

17-CL-37 FOR FENDL-3.2 FROM FENDL-3.2 BY NJOY2016.60+ OI
Threshold reactions

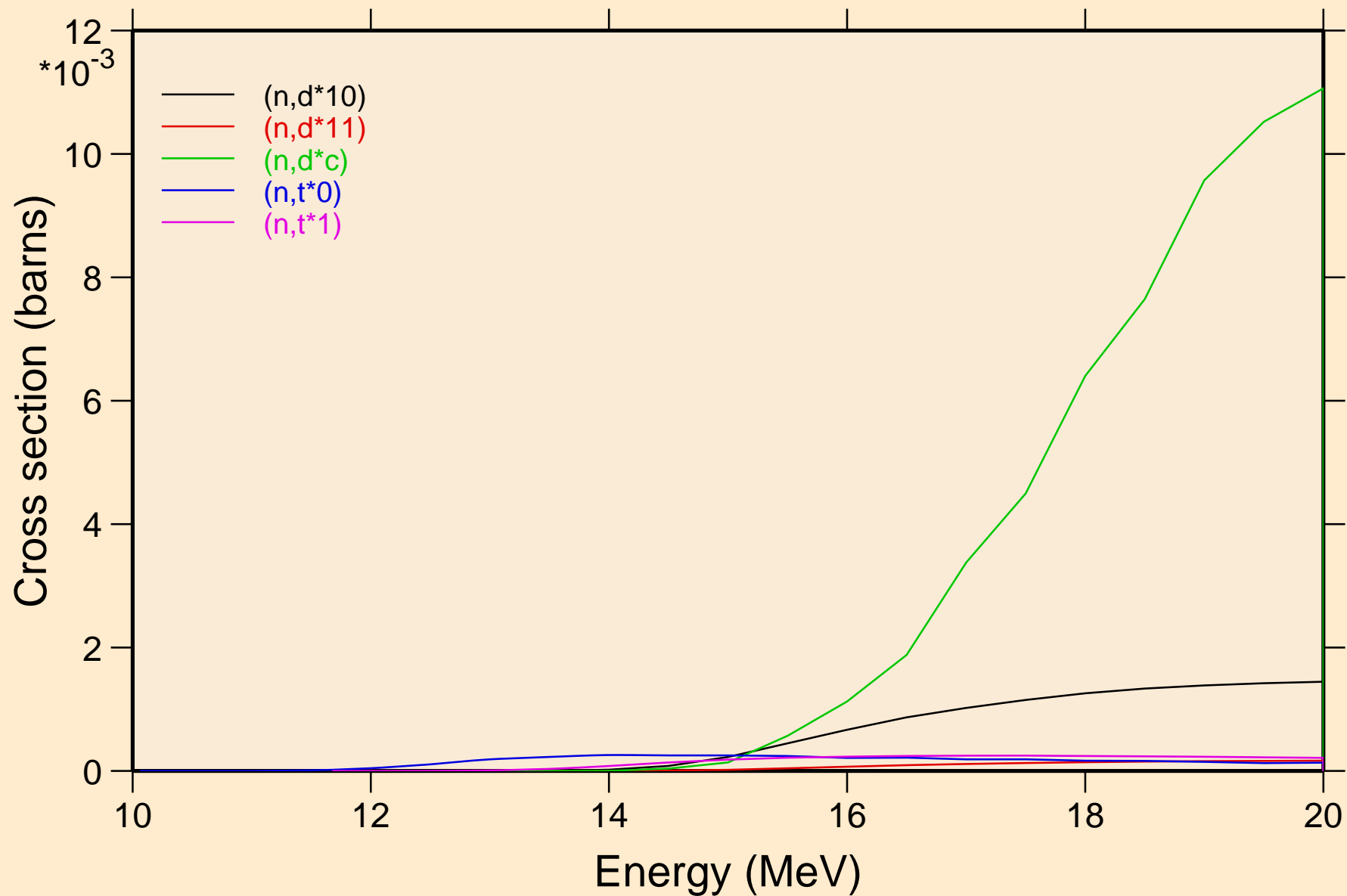

17-CL-37 FOR FENDL-3.2 FROM FENDL-3.2 BY NJOY2016.60+ OI
Threshold reactions

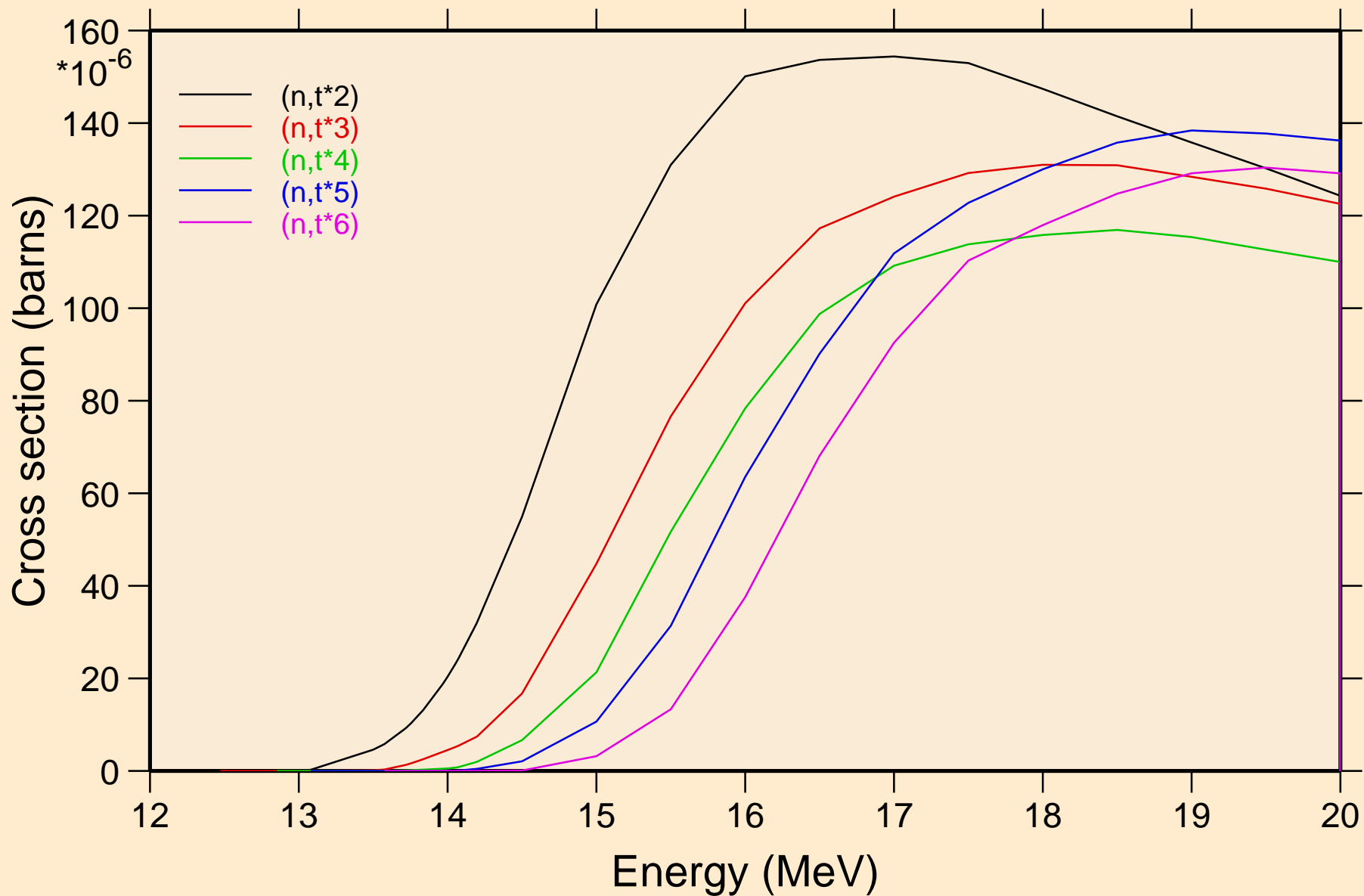

17-CL-37 FOR FENDL-3.2 FROM FENDL-3.2 BY NJOY2016.60+ OI Threshold reactions

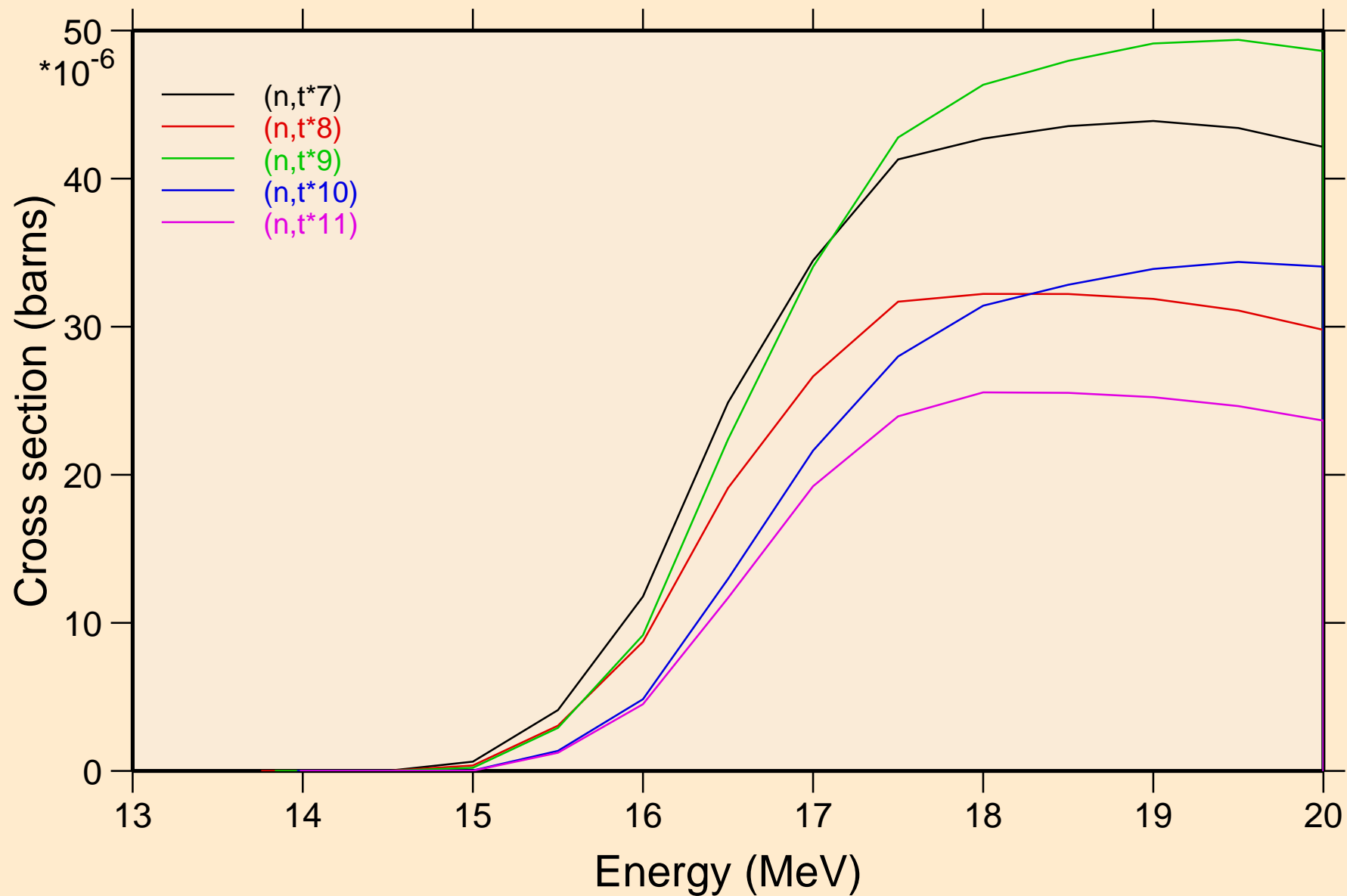

17-CL-37 FOR FENDL-3.2 FROM FENDL-3.2 BY NJOY2016.60+ OI Threshold reactions

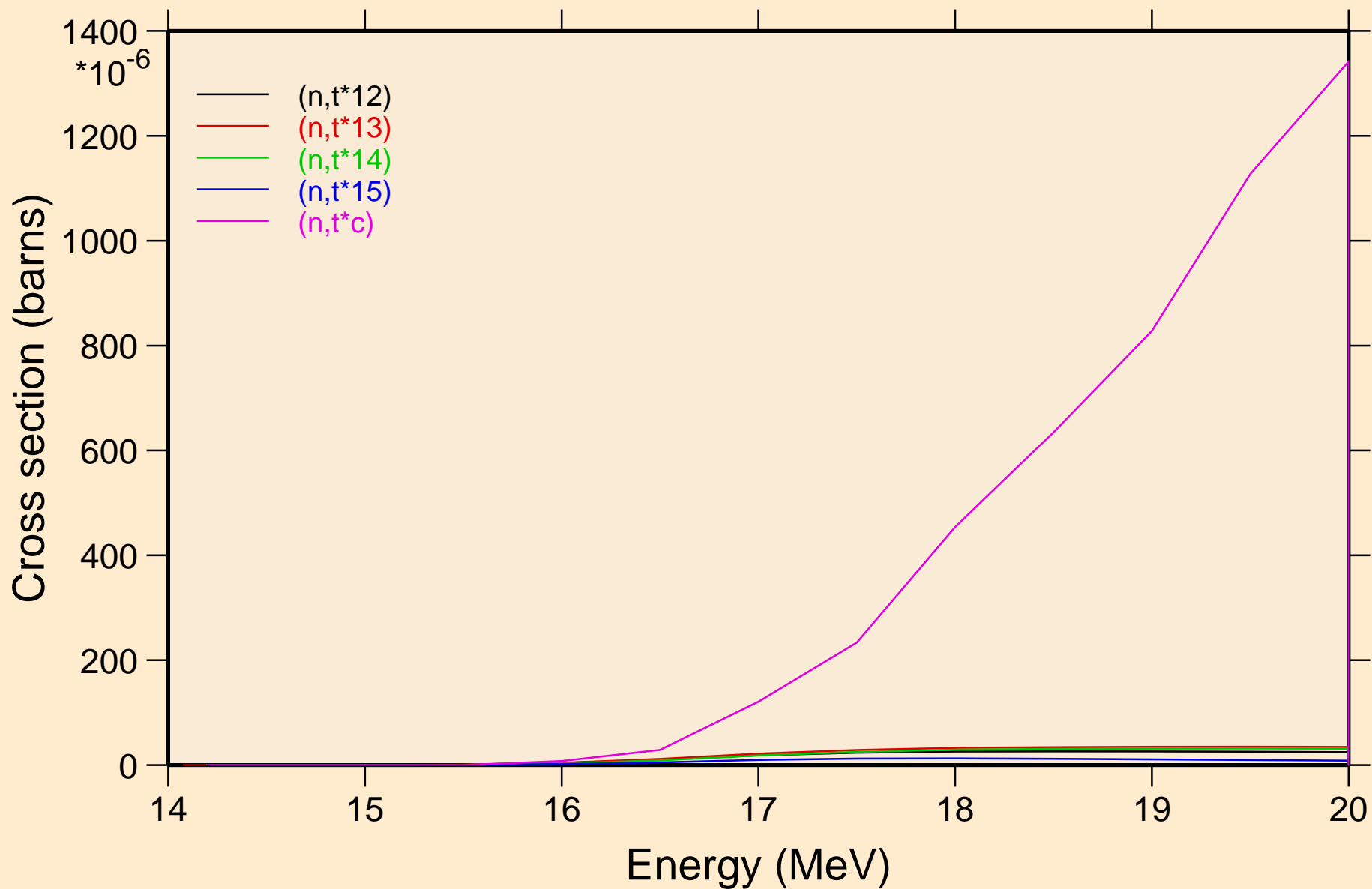

17-CL-37 FOR FENDL-3.2 FROM FENDL-3.2 BY NJOY2016.60+ OI
Threshold reactions

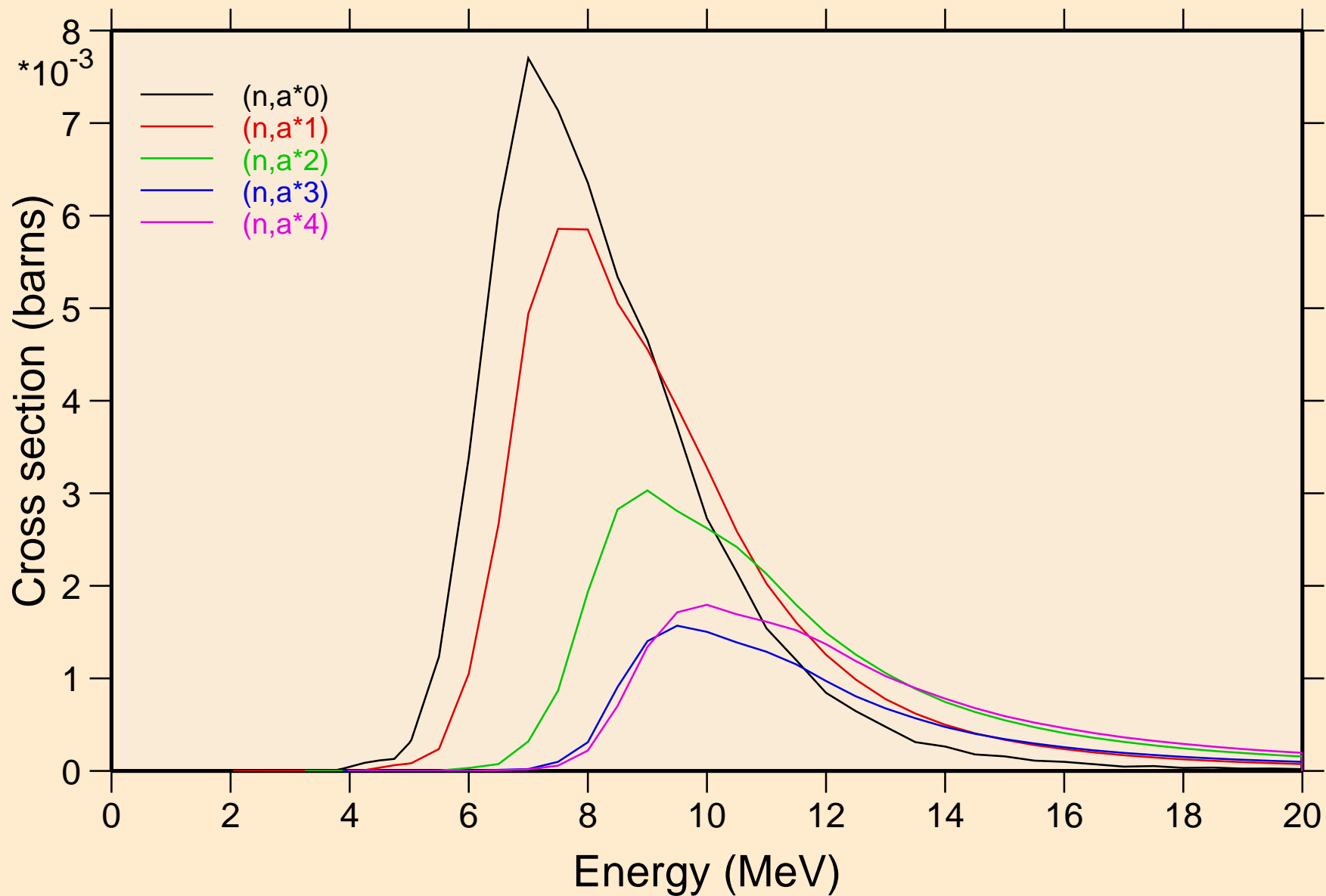

17-CL-37 FOR FENDL-3.2 FROM FENDL-3.2 BY NJOY2016.60+ OI
Threshold reactions

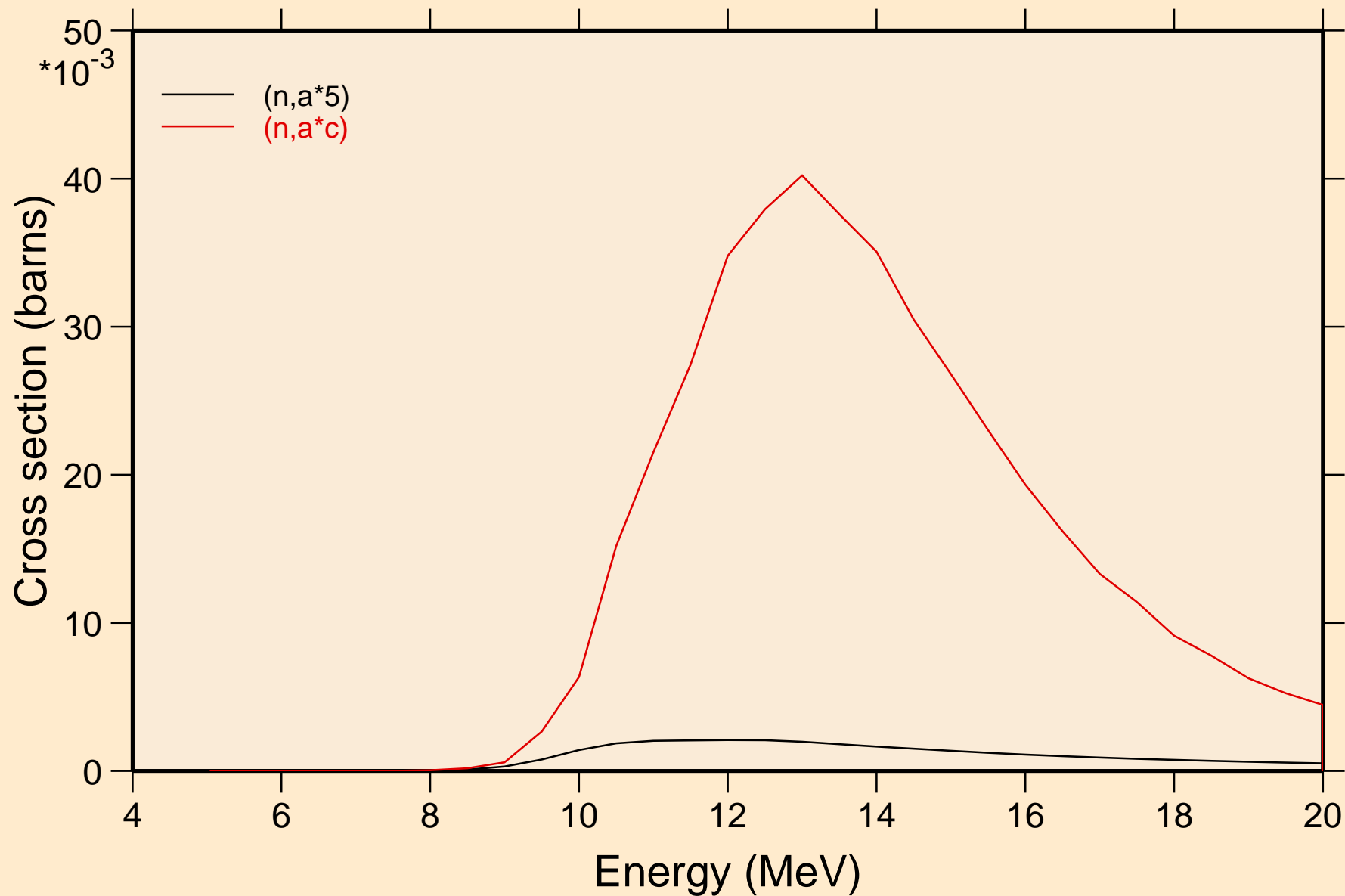

17-CL-37 FOR FENDL-3.2 FROM FENDL-3.2 BY NJOY2016.60+ OI
angular distribution for elastic

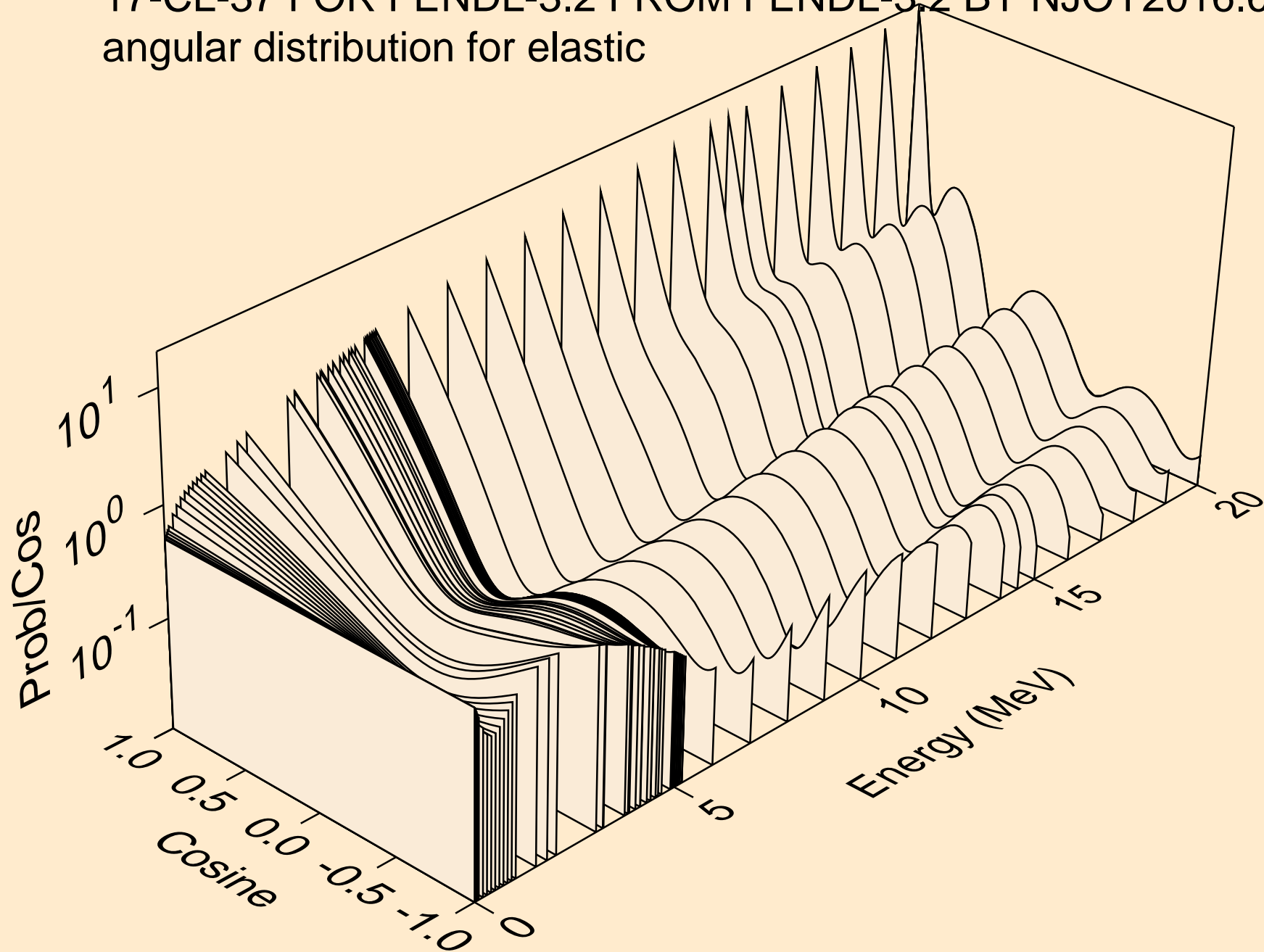

17-CL-37 FOR FENDL-3.2 FROM FENDL-3.2 BY NJOY2016.60+ OI
angular distribution for elastic

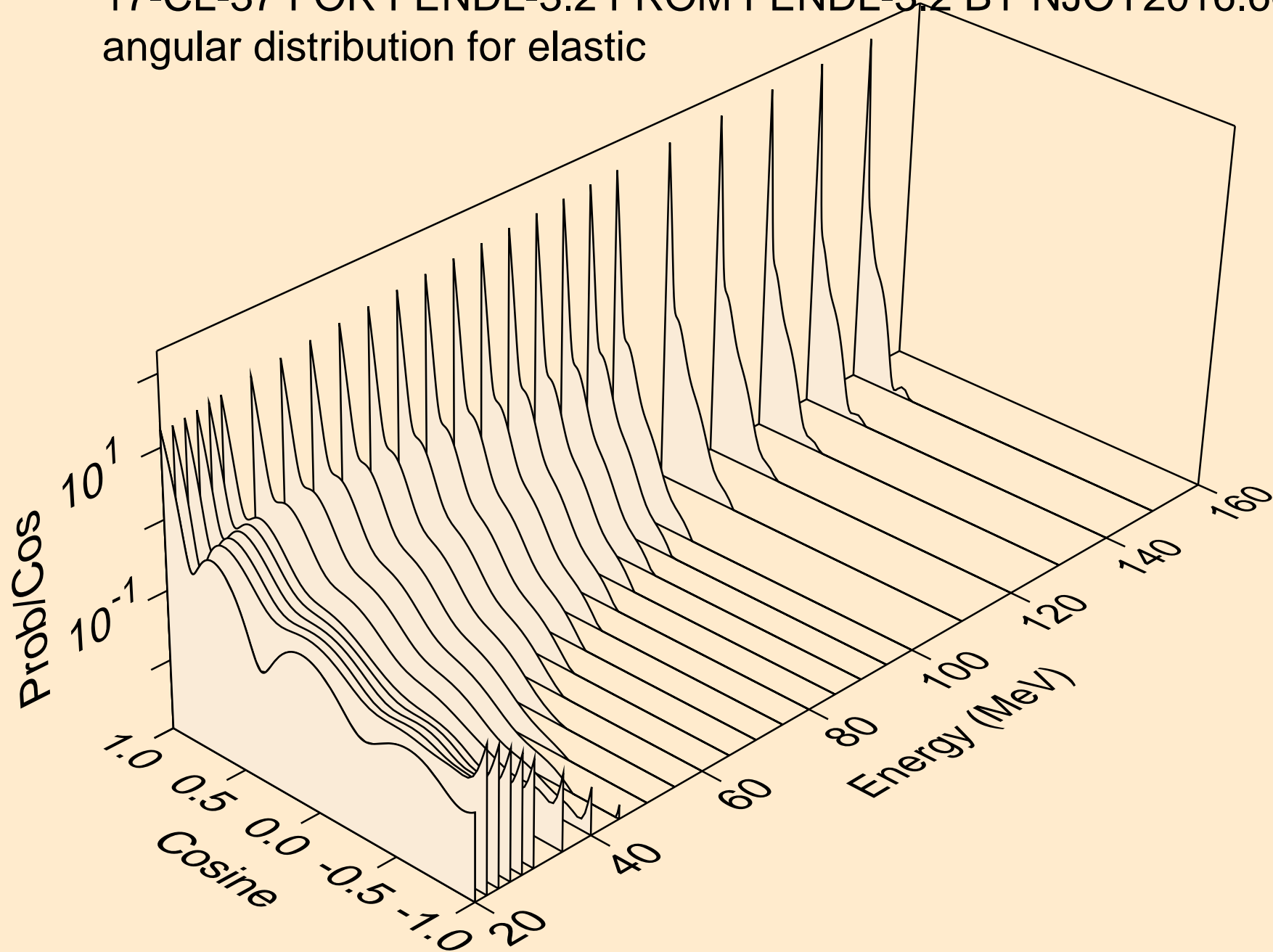

17-CL-37 FOR FENDL-3.2 FROM FENDL-3.2 BY NJOY2016.60+ OI
angular distribution for (n,n*1)

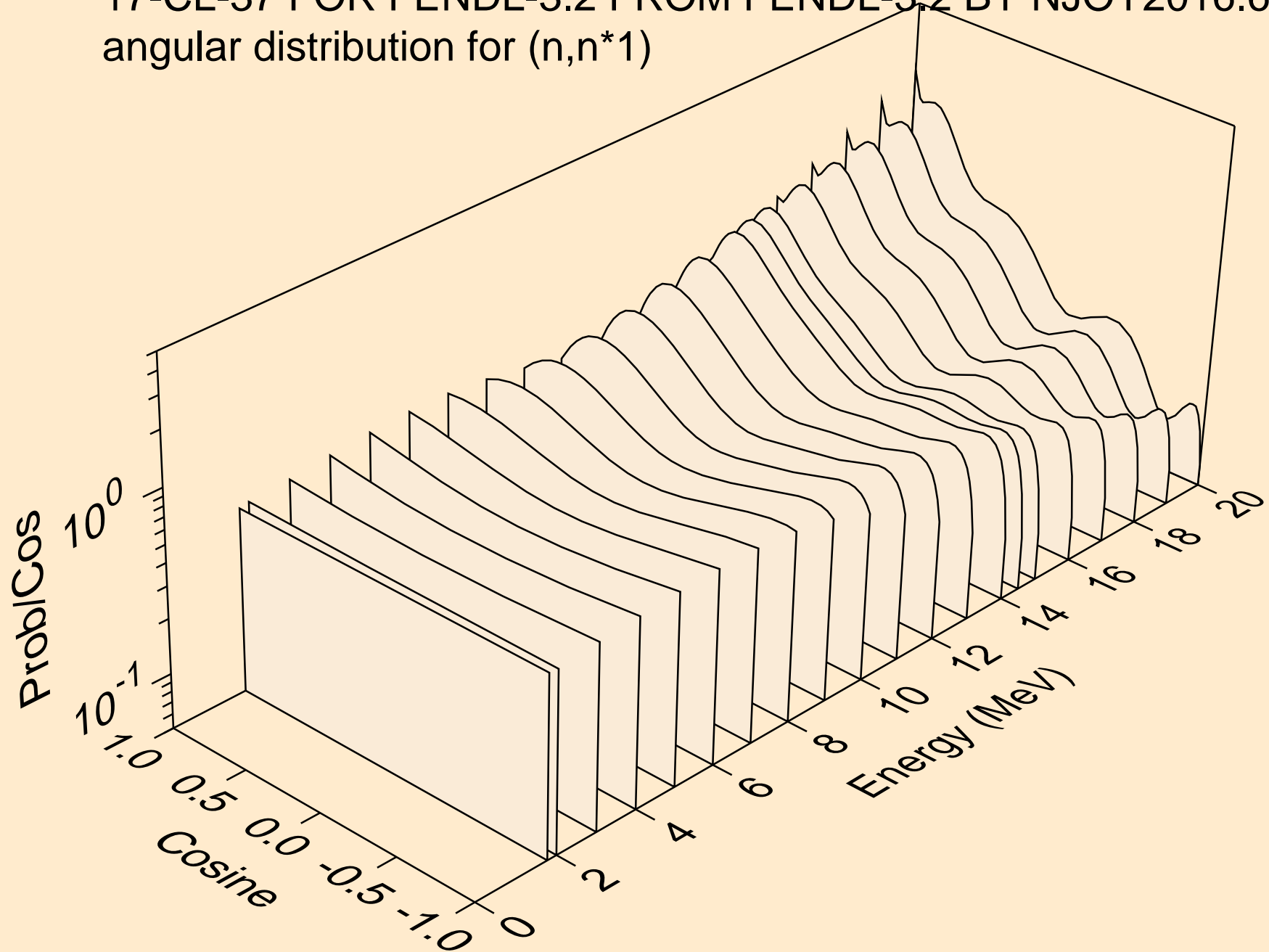

17-CL-37 FOR FENDL-3.2 FROM FENDL-3.2 BY NJOY2016.60+ OI
angular distribution for (n,n*2)

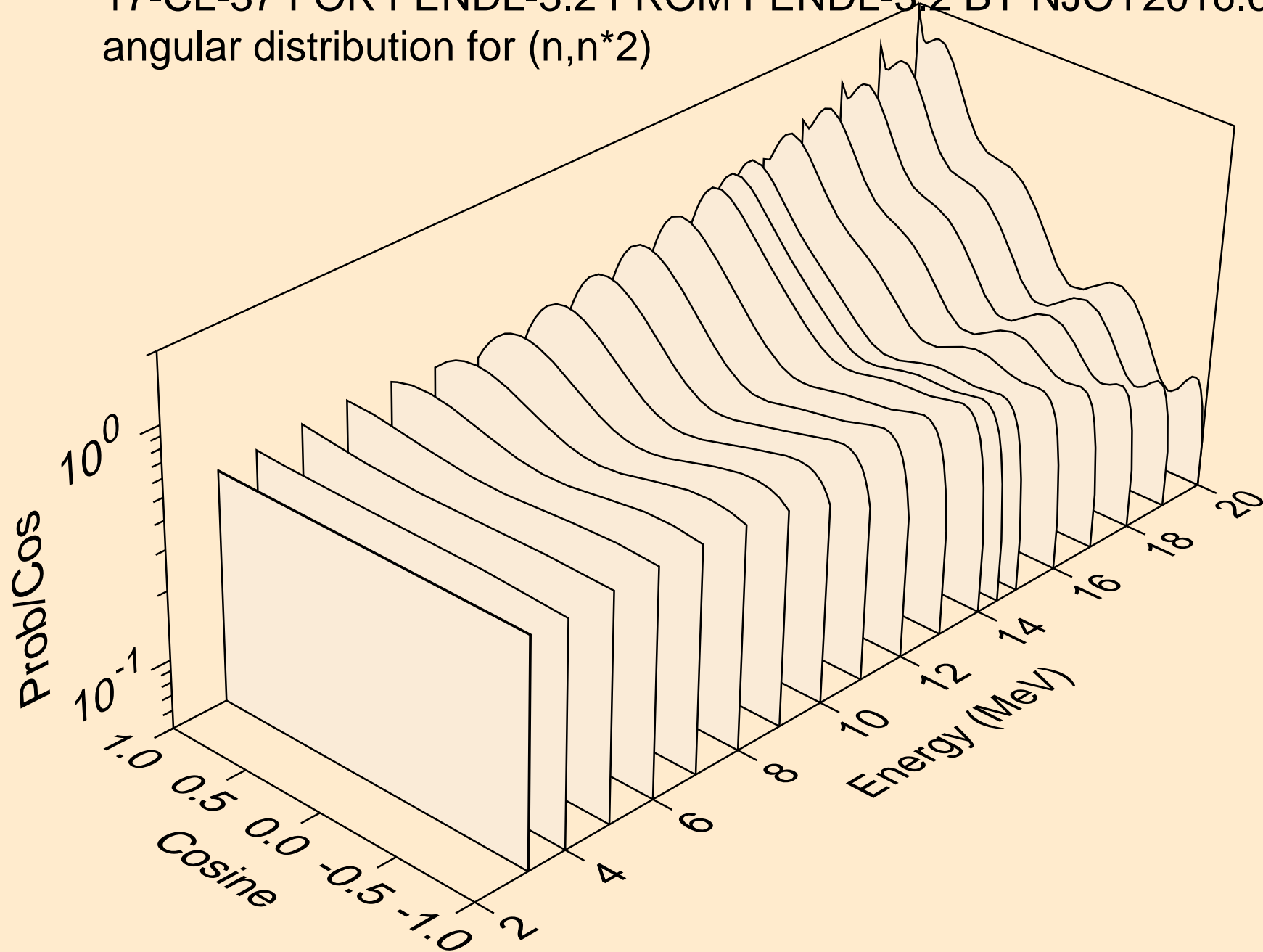

17-CL-37 FOR FENDL-3.2 FROM FENDL-3.2 BY NJOY2016.60+ OI
angular distribution for (n,n*3)

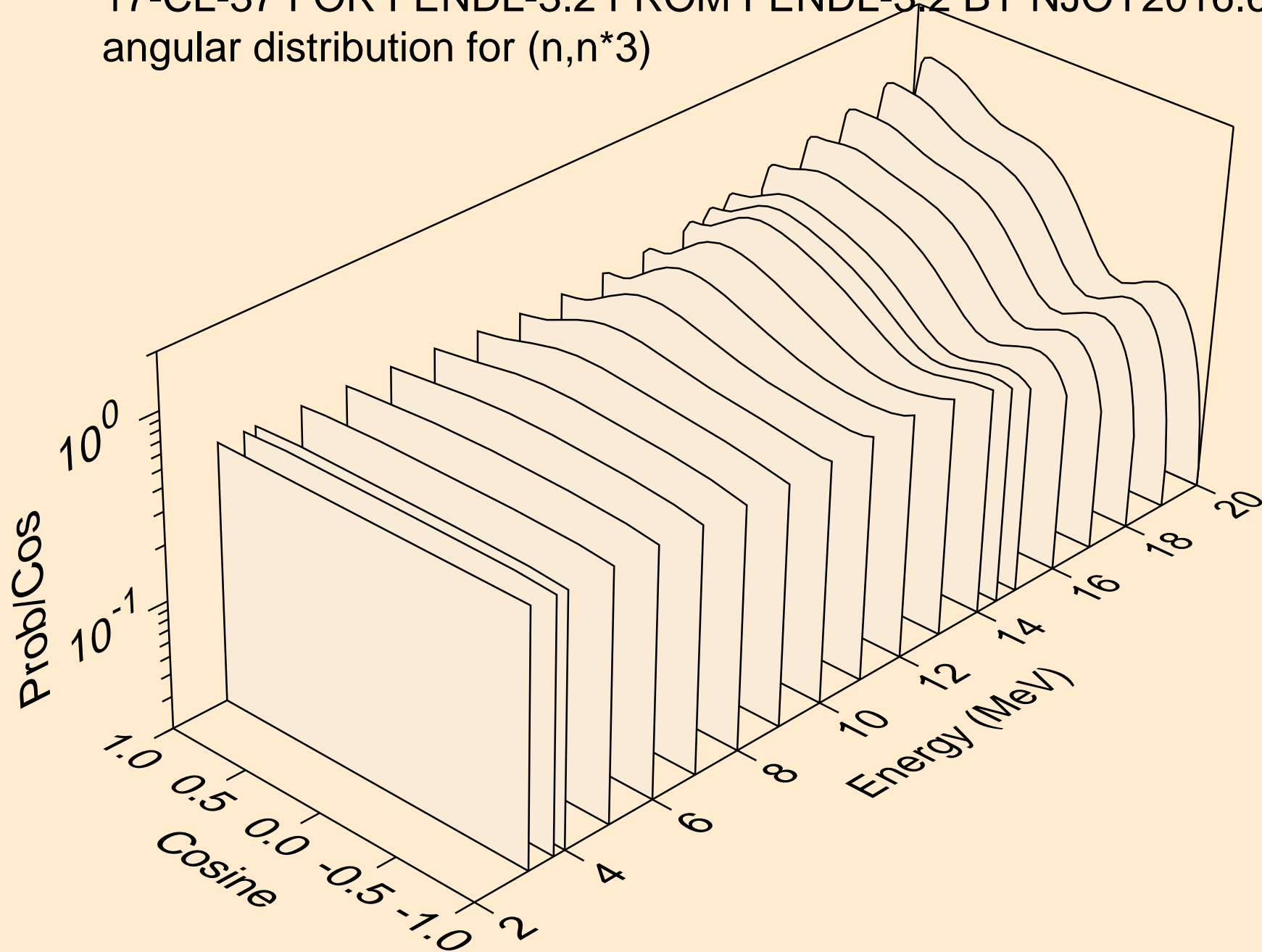

17-CL-37 FOR FENDL-3.2 FROM FENDL-3.2 BY NJOY2016.60+ OI
angular distribution for (n,n*4)

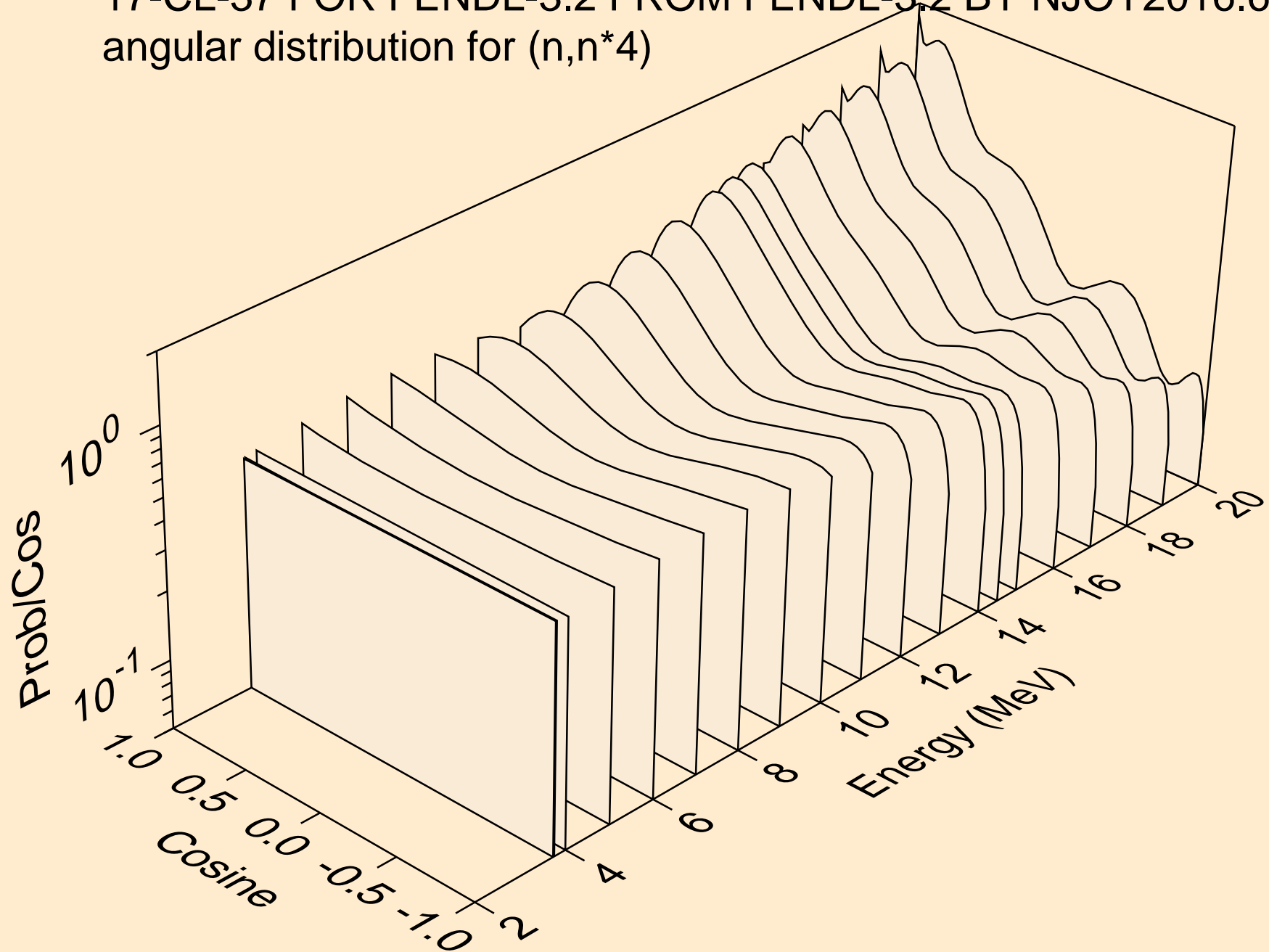

17-CL-37 FOR FENDL-3.2 FROM FENDL-3.2 BY NJOY2016.60+ OI
angular distribution for (n,n*5)

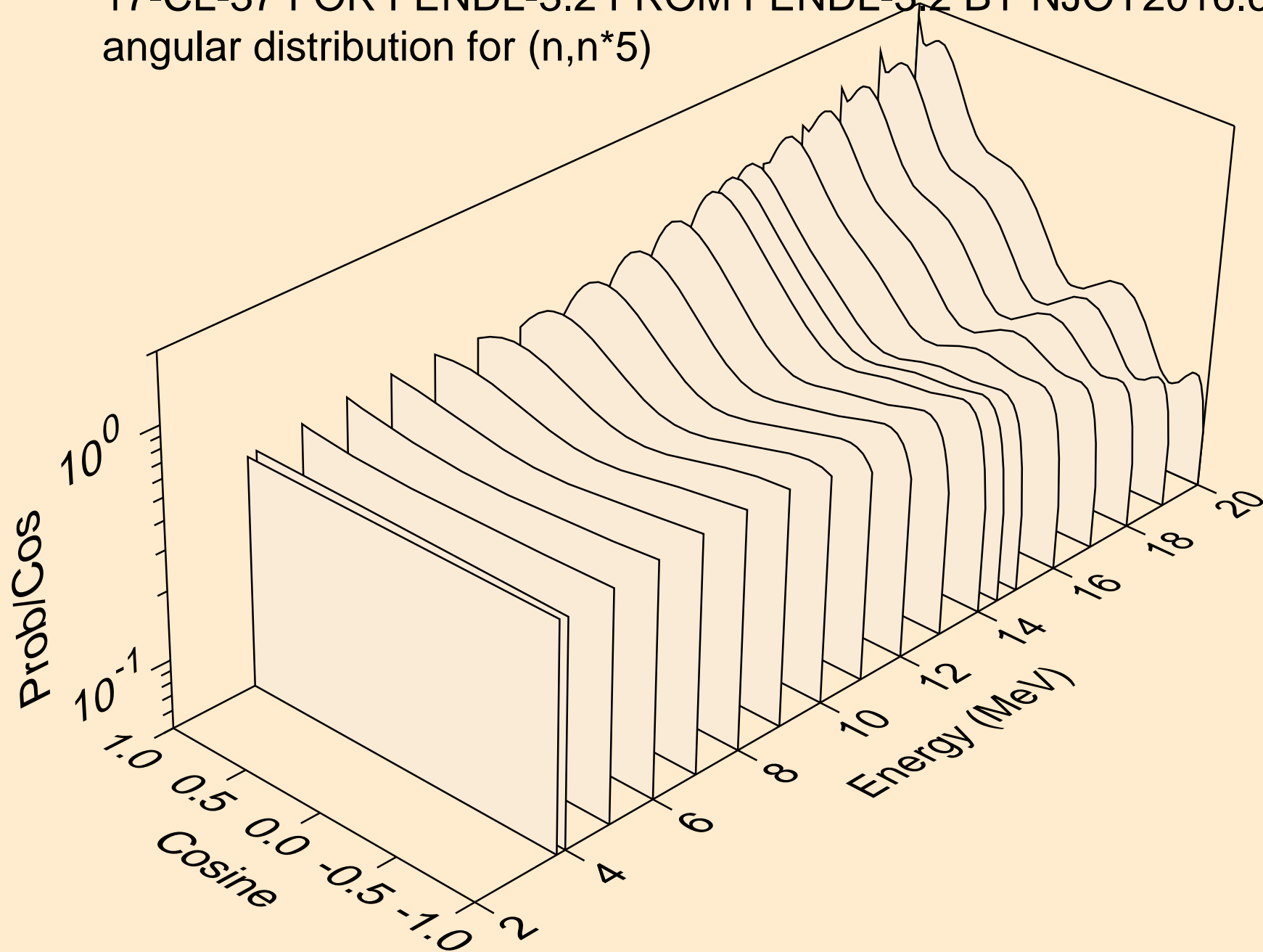

17-CL-37 FOR FENDL-3.2 FROM FENDL-3.2 BY NJOY2016.60+ OI
angular distribution for (n,n*6)

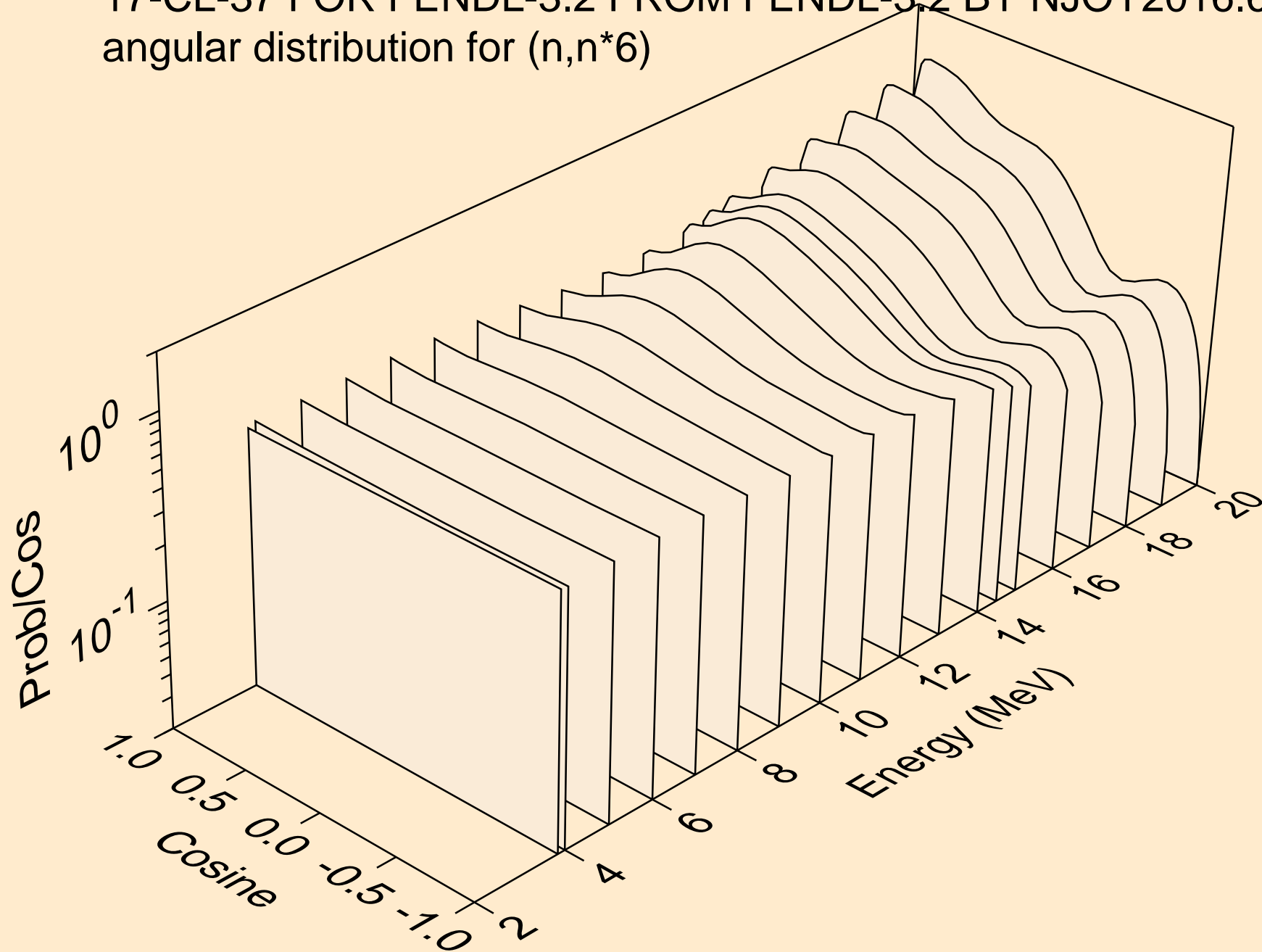

17-CL-37 FOR FENDL-3.2 FROM FENDL-3.2 BY NJOY2016.60+ OI
angular distribution for (n,n*7)

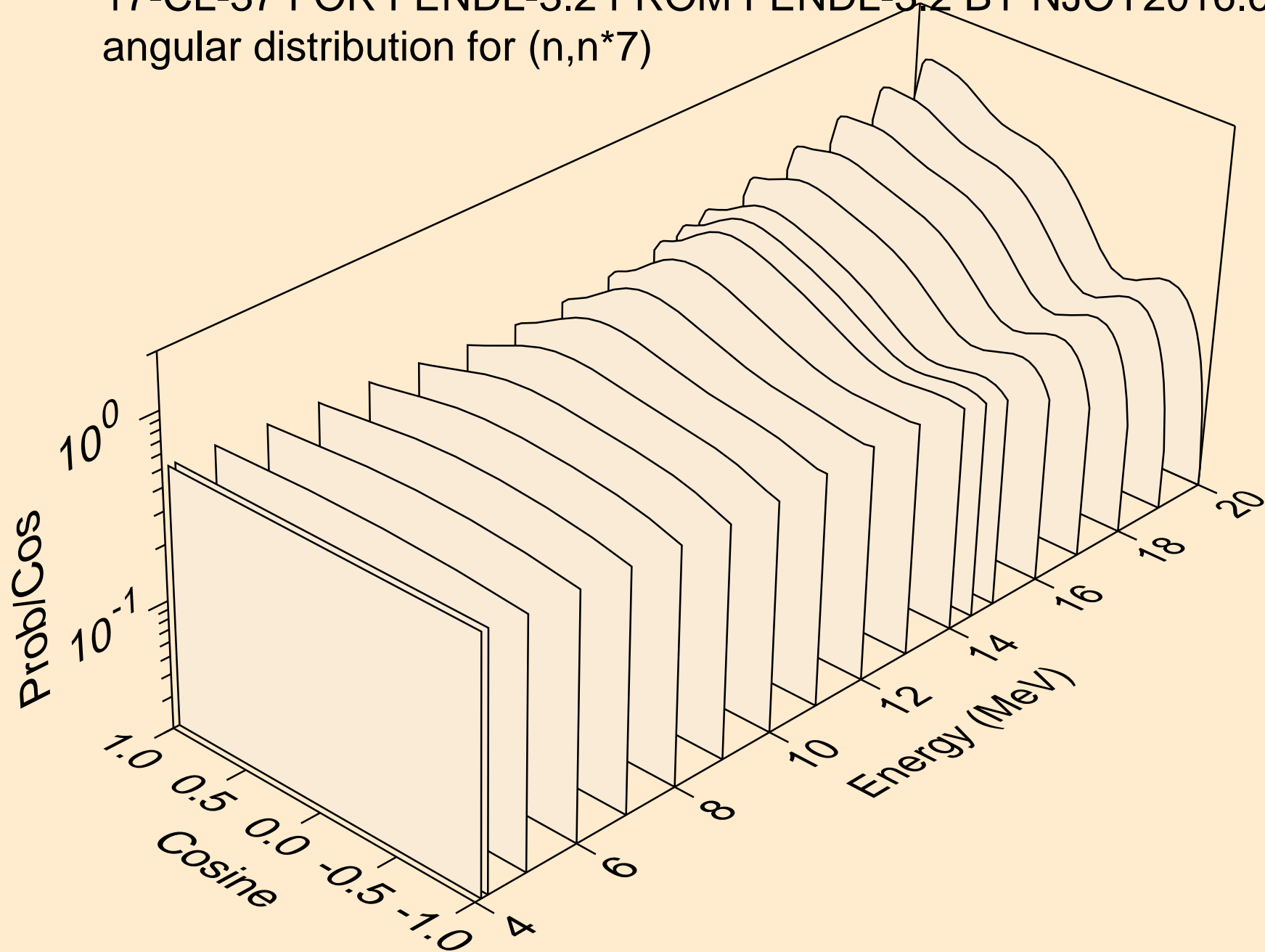

17-CL-37 FOR FENDL-3.2 FROM FENDL-3.2 BY NJOY2016.60+ OI
angular distribution for (n,n*8)

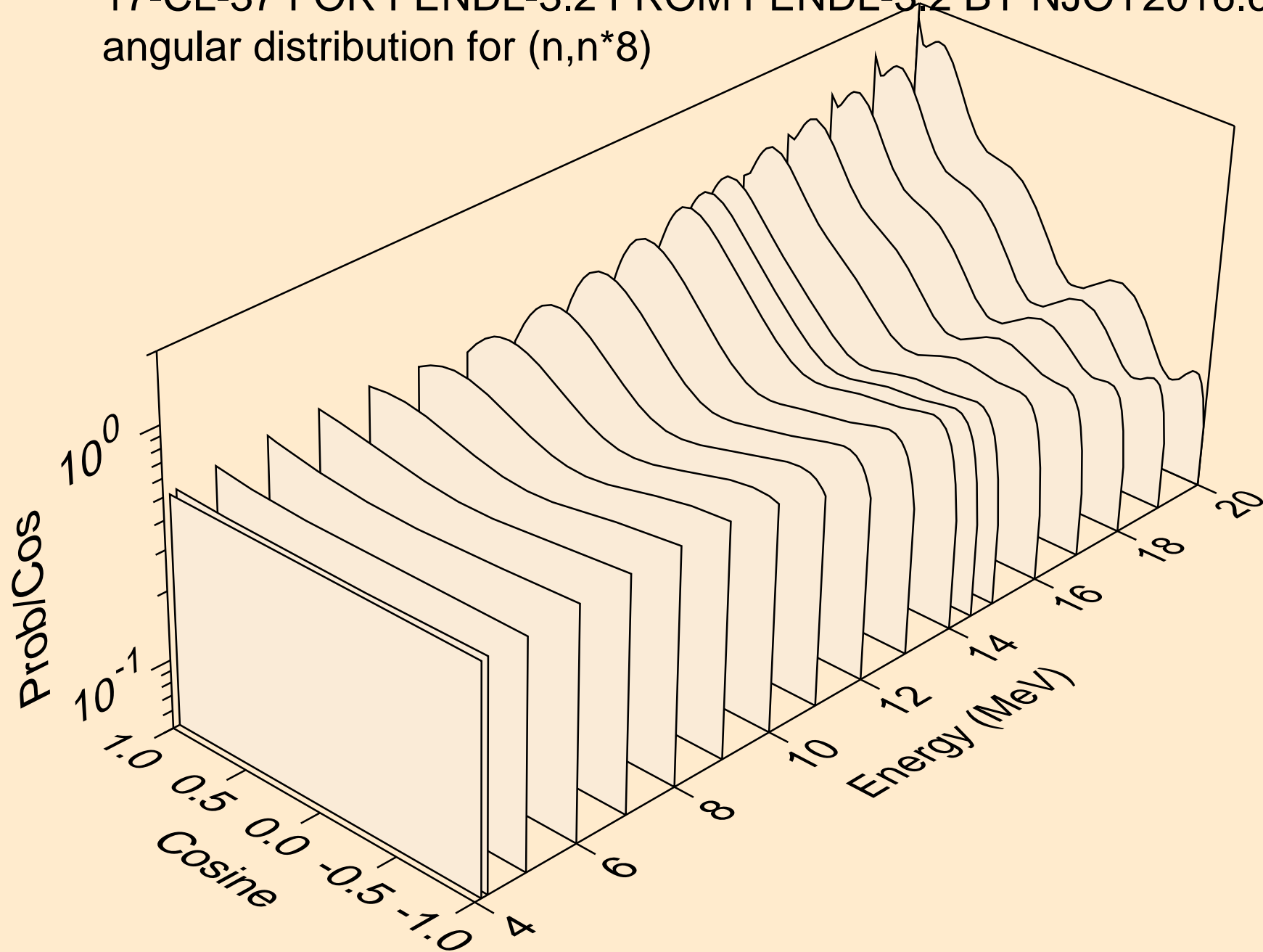

17-CL-37 FOR FENDL-3.2 FROM FENDL-3.2 BY NJOY2016.60+ OI
angular distribution for (n,n*9)

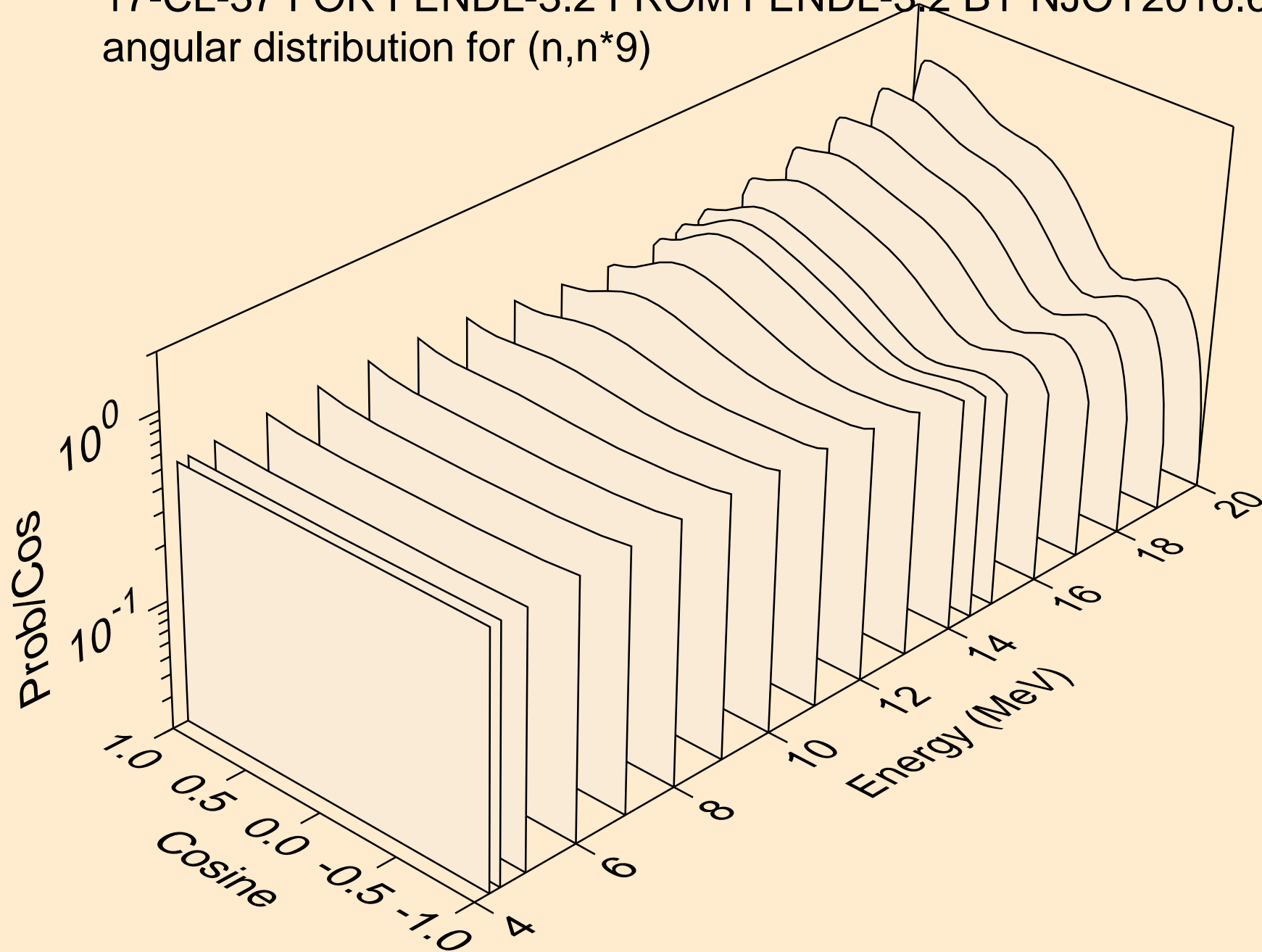

17-CL-37 FOR FENDL-3.2 FROM FENDL-3.2 BY NJOY2016.60+ OI
angular distribution for (n,n*10)

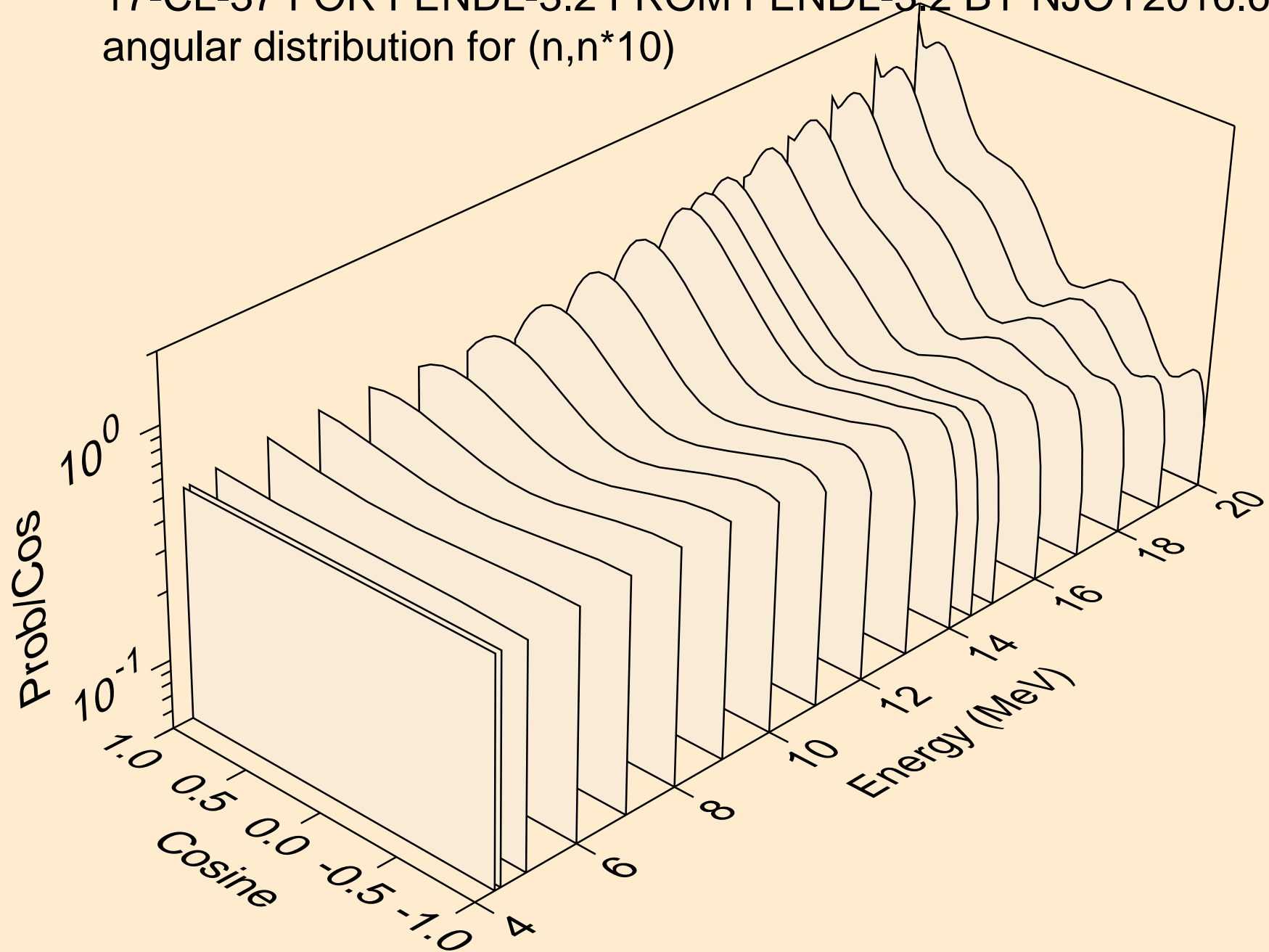

17-CL-37 FOR FENDL-3.2 FROM FENDL-3.2 BY NJOY2016.60+ OI
angular distribution for (n,n*11)

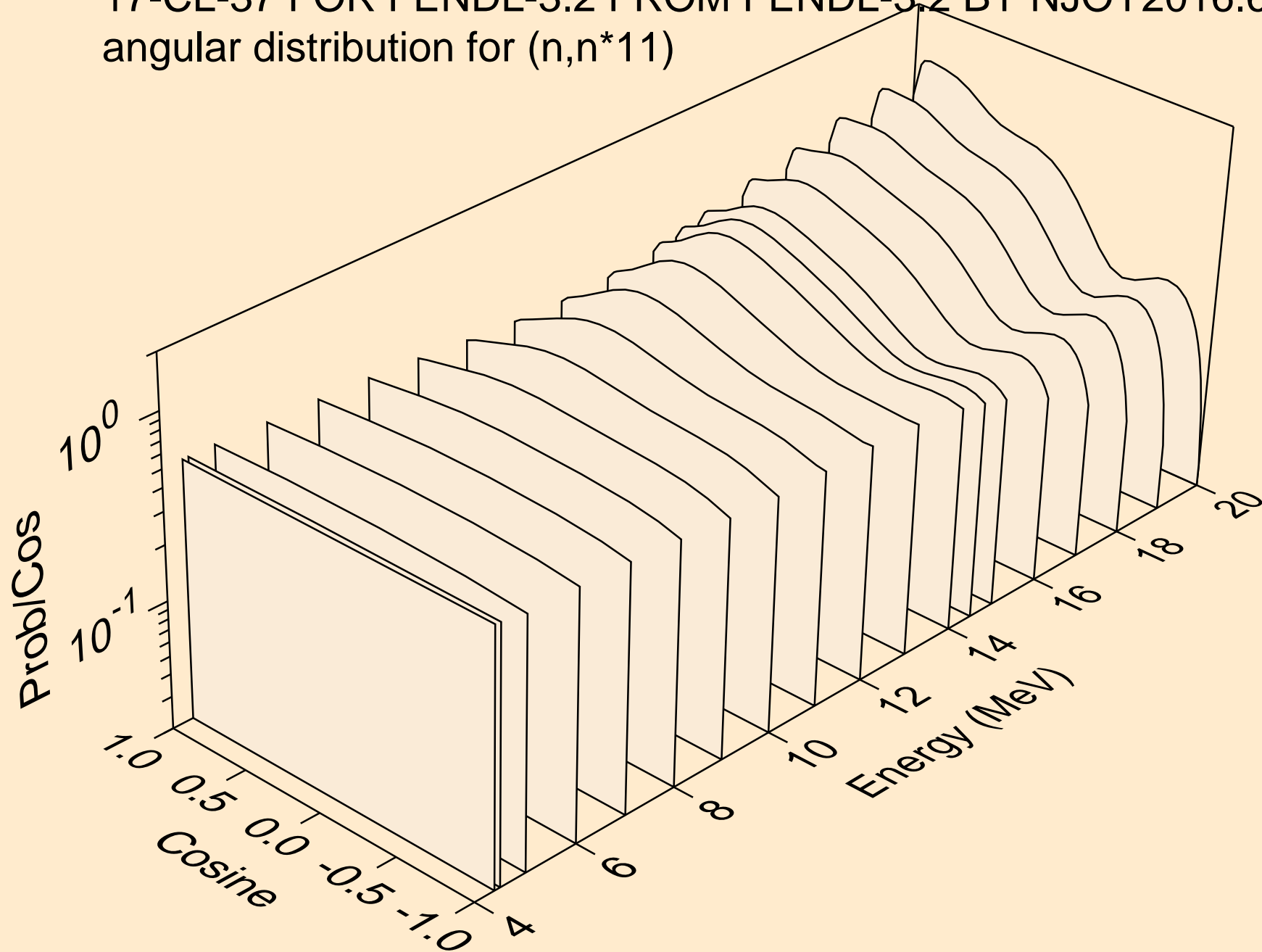

17-CL-37 FOR FENDL-3.2 FROM FENDL-3.2 BY NJOY2016.60+ OI
angular distribution for (n,n*12)

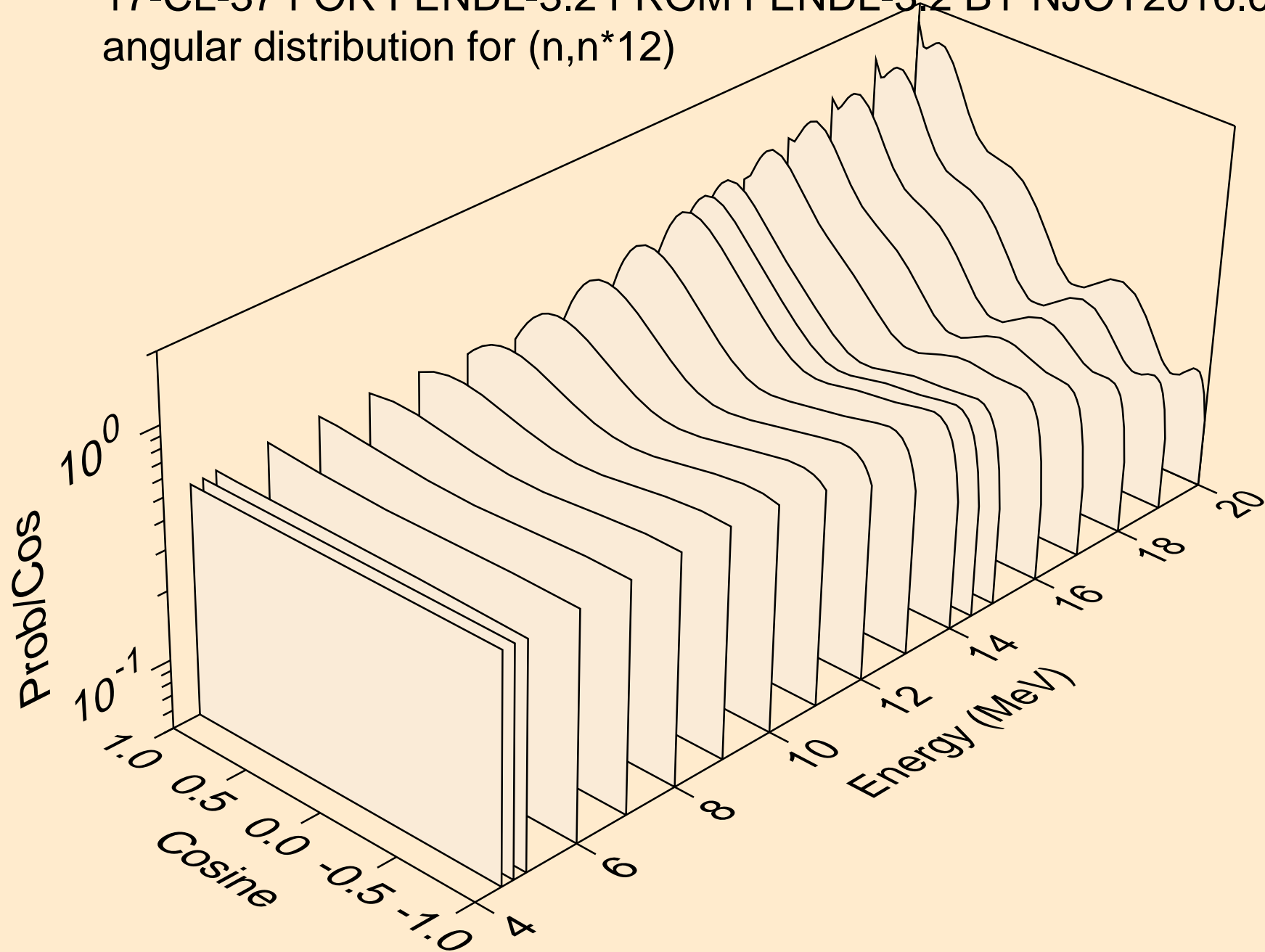

17-CL-37 FOR FENDL-3.2 FROM FENDL-3.2 BY NJOY2016.60+ OI
angular distribution for (n,n*13)

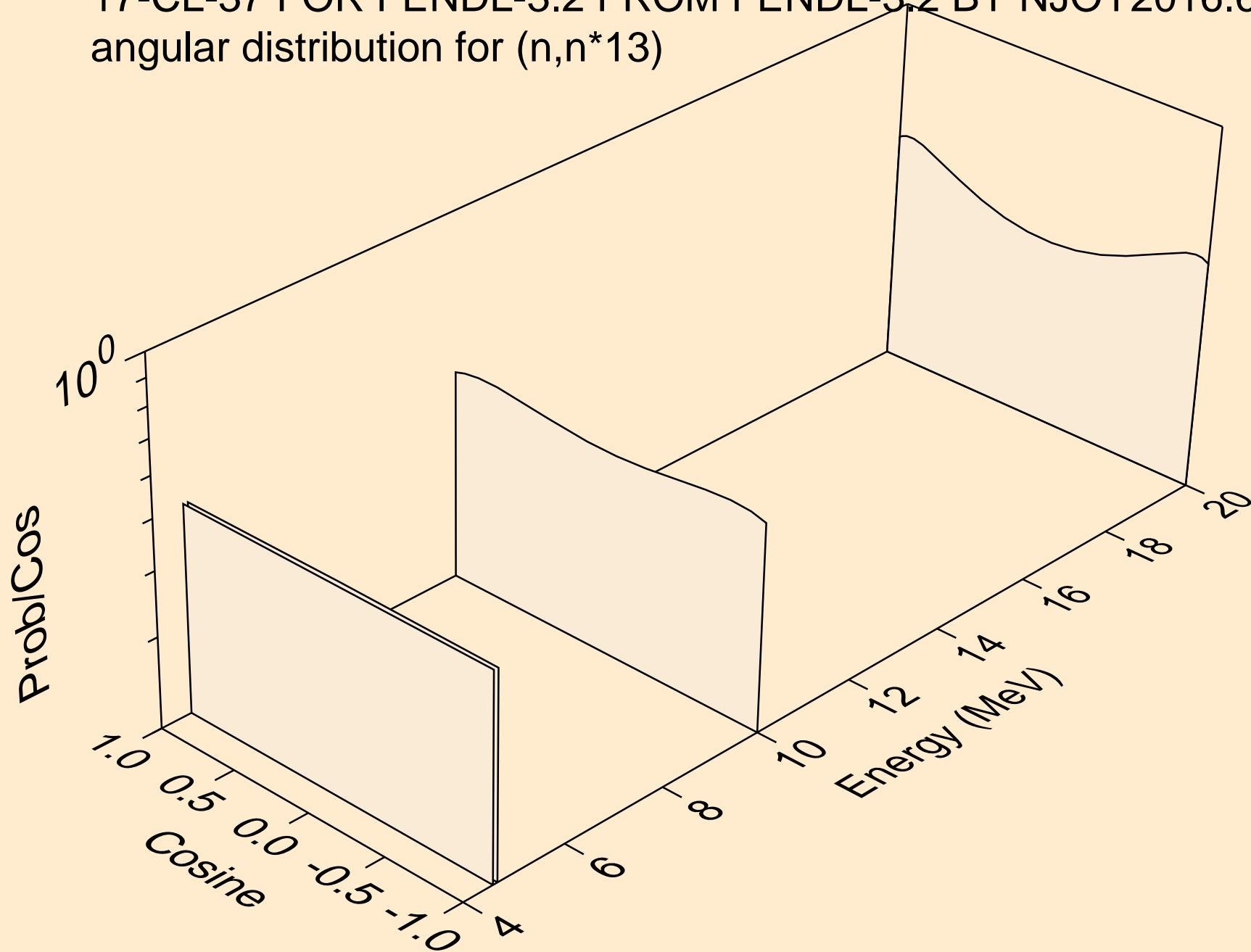

17-CL-37 FOR FENDL-3.2 FROM FENDL-3.2 BY NJOY2016.60+ OI
angular distribution for (n,n*14)

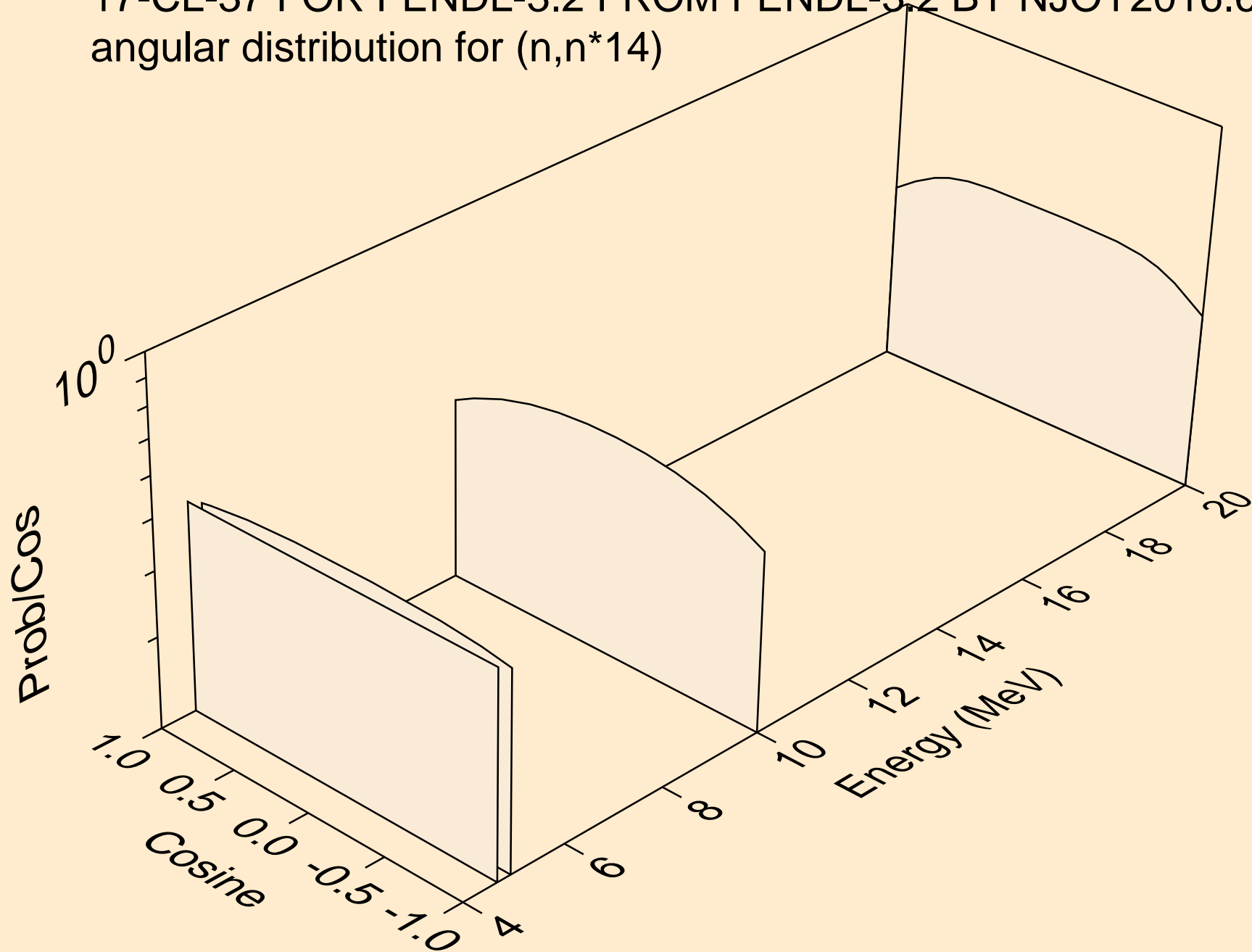

17-CL-37 FOR FENDL-3.2 FROM FENDL-3.2 BY NJOY2016.60+ OI
angular distribution for (n,n*15)

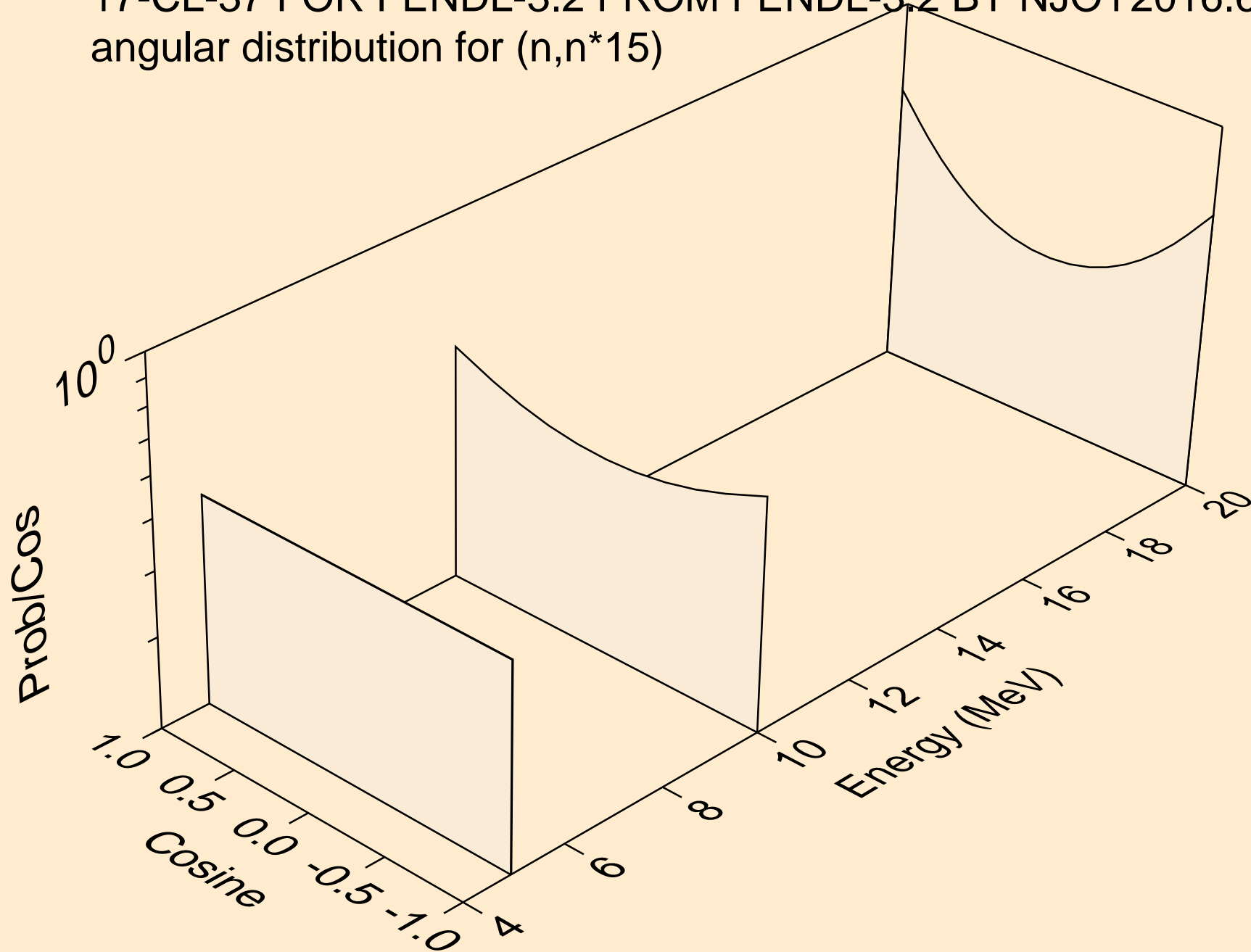

17-CL-37 FOR FENDL-3.2 FROM FENDL-3.2 BY NJOY2016.60+ OI
angular distribution for (n,n*16)

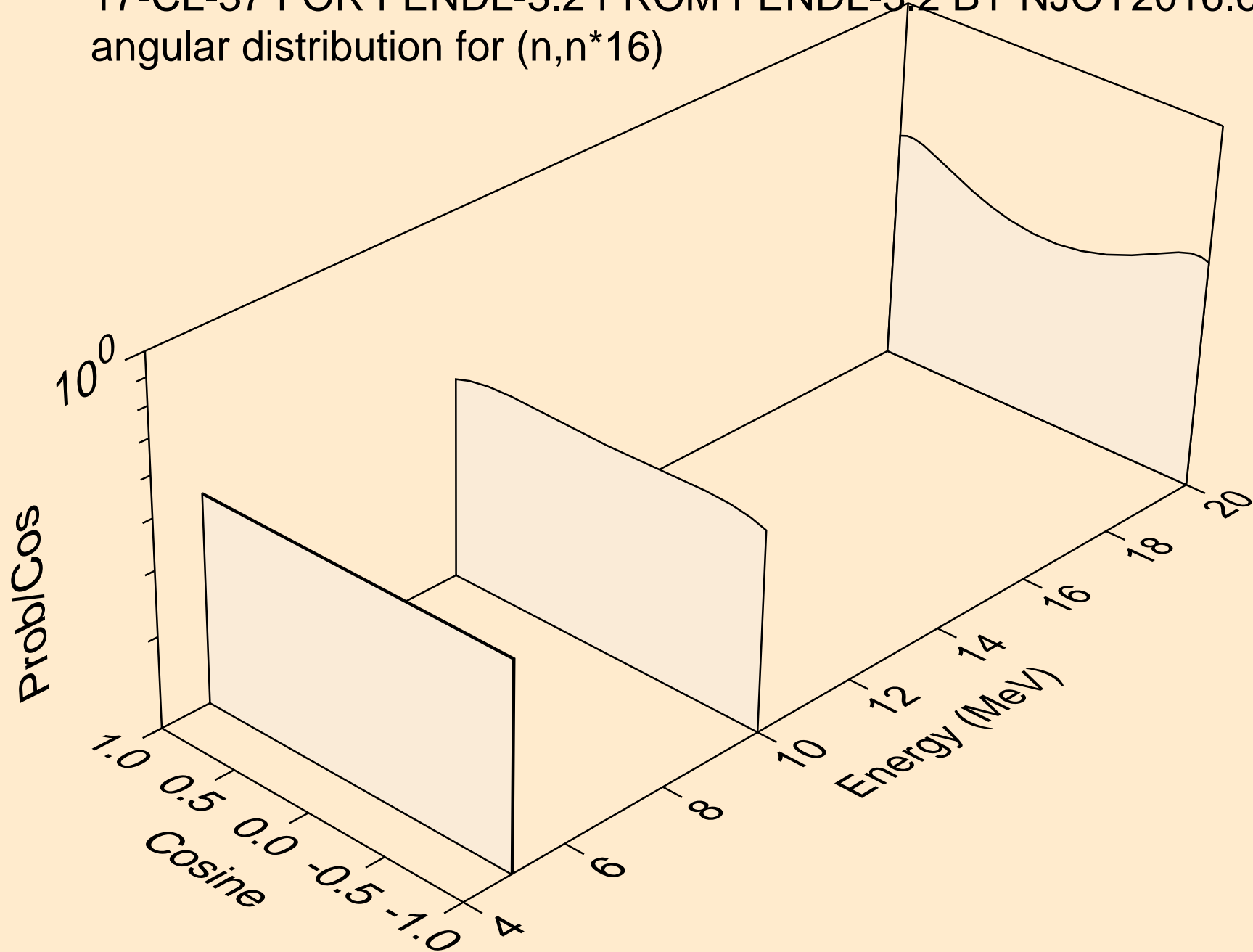

17-CL-37 FOR FENDL-3.2 FROM FENDL-3.2 BY NJOY2016.60+ OI
angular distribution for (n,n*17)

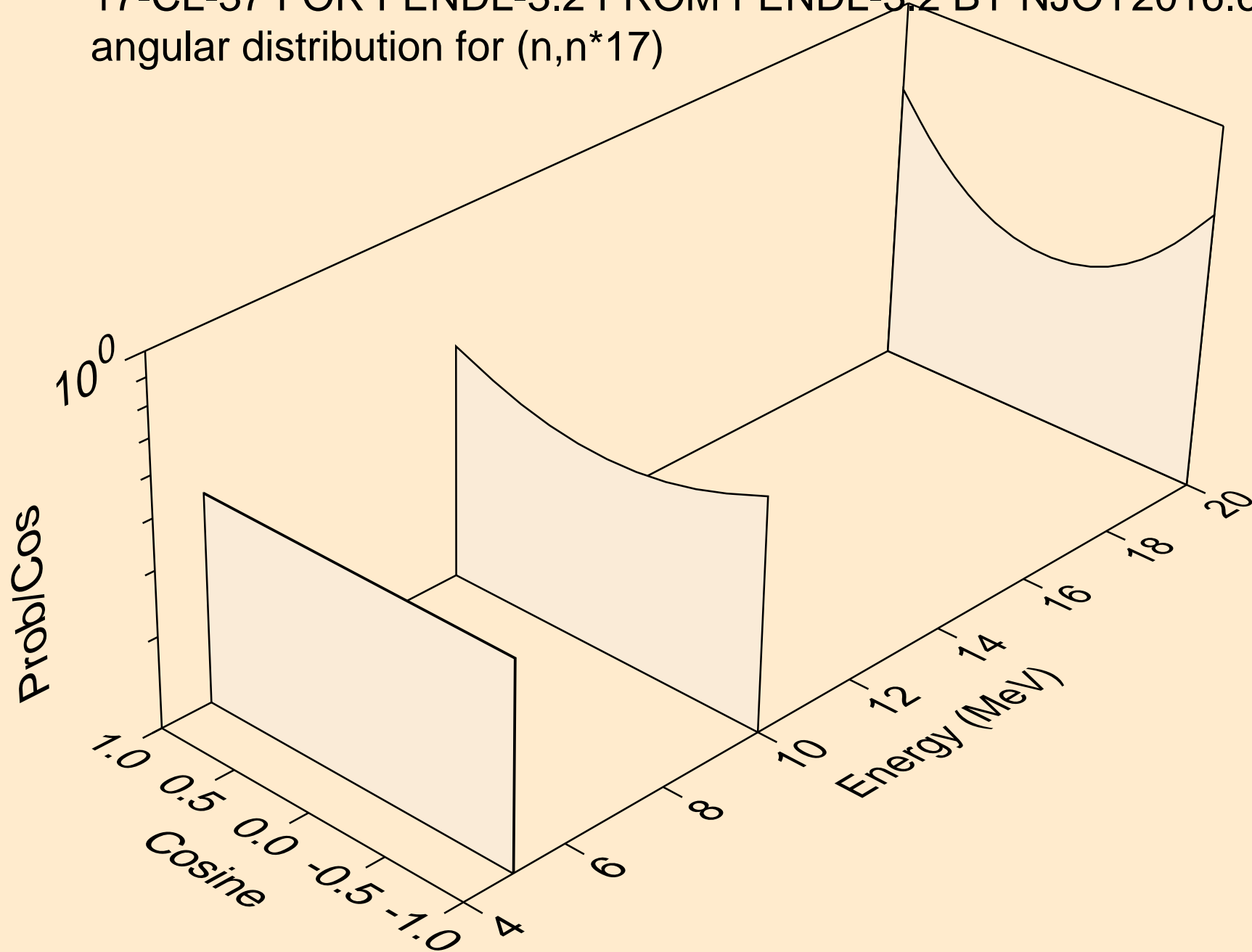

17-CL-37 FOR FENDL-3.2 FROM FENDL-3.2 BY NJOY2016.60+ OI
angular distribution for (n,n*18)

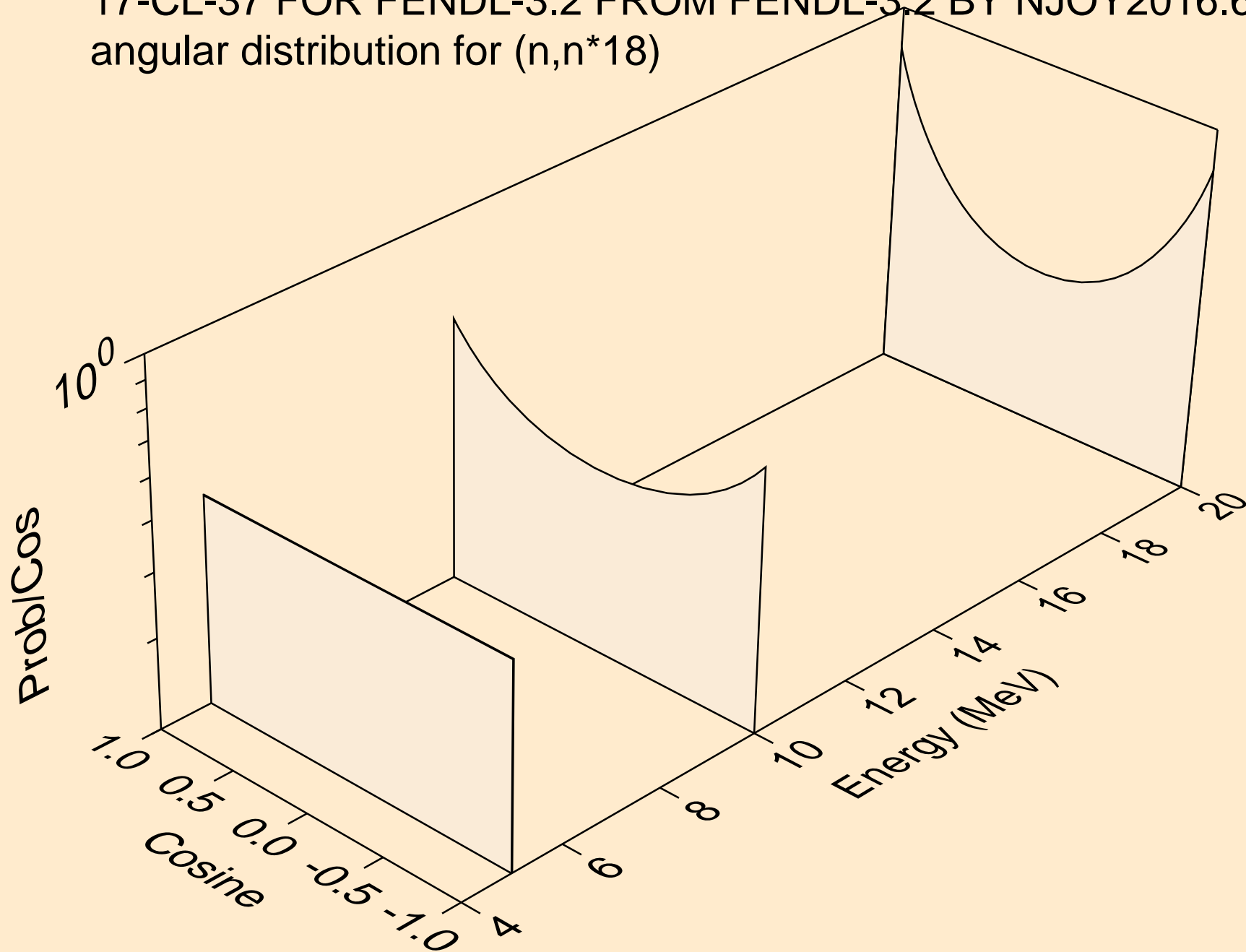

17-CL-37 FOR FENDL-3.2 FROM FENDL-3.2 BY NJOY2016.60+ OI
angular distribution for (n,n*19)

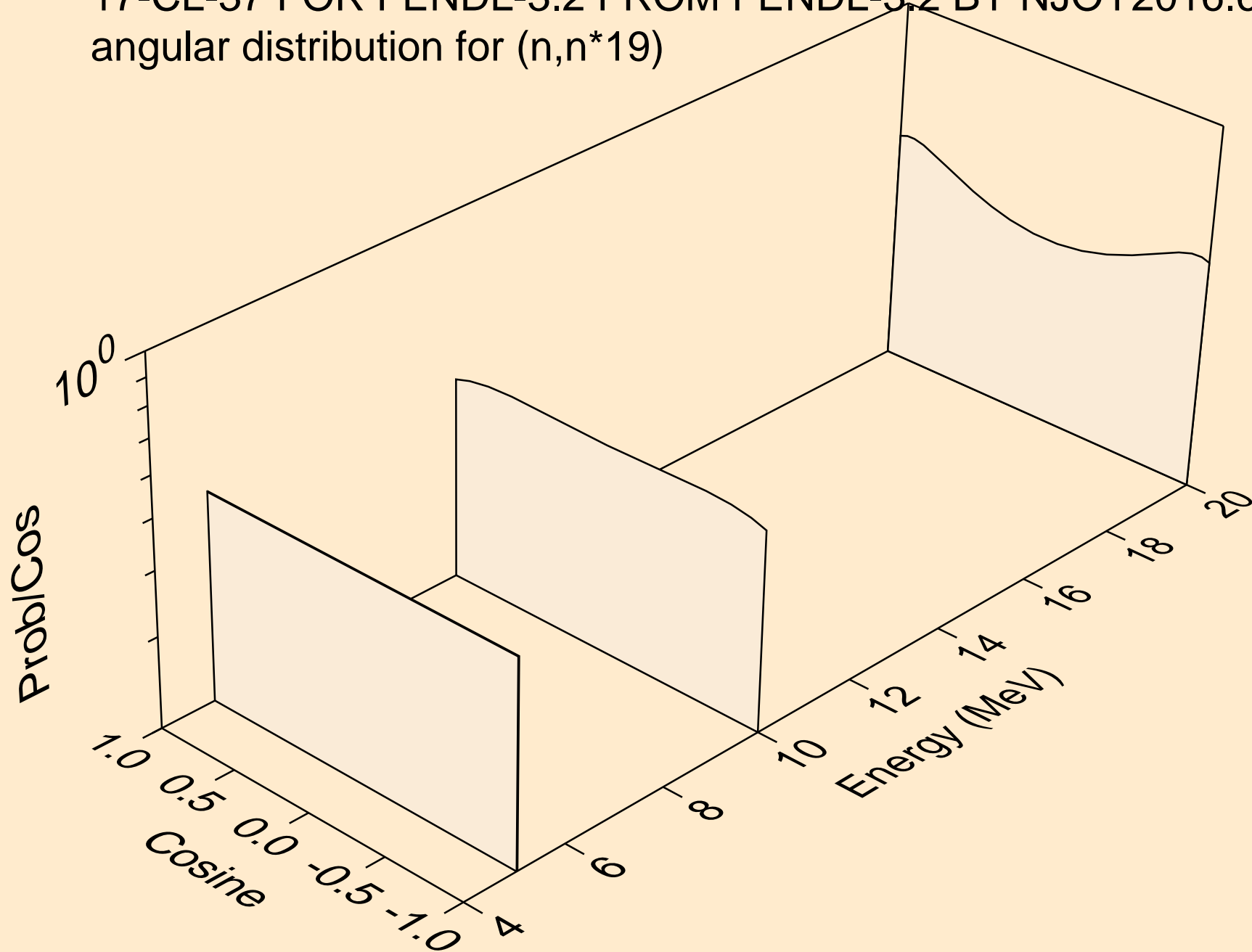

17-CL-37 FOR FENDL-3.2 FROM FENDL-3.2 BY NJOY2016.60+ OI
angular distribution for (n,n*20)

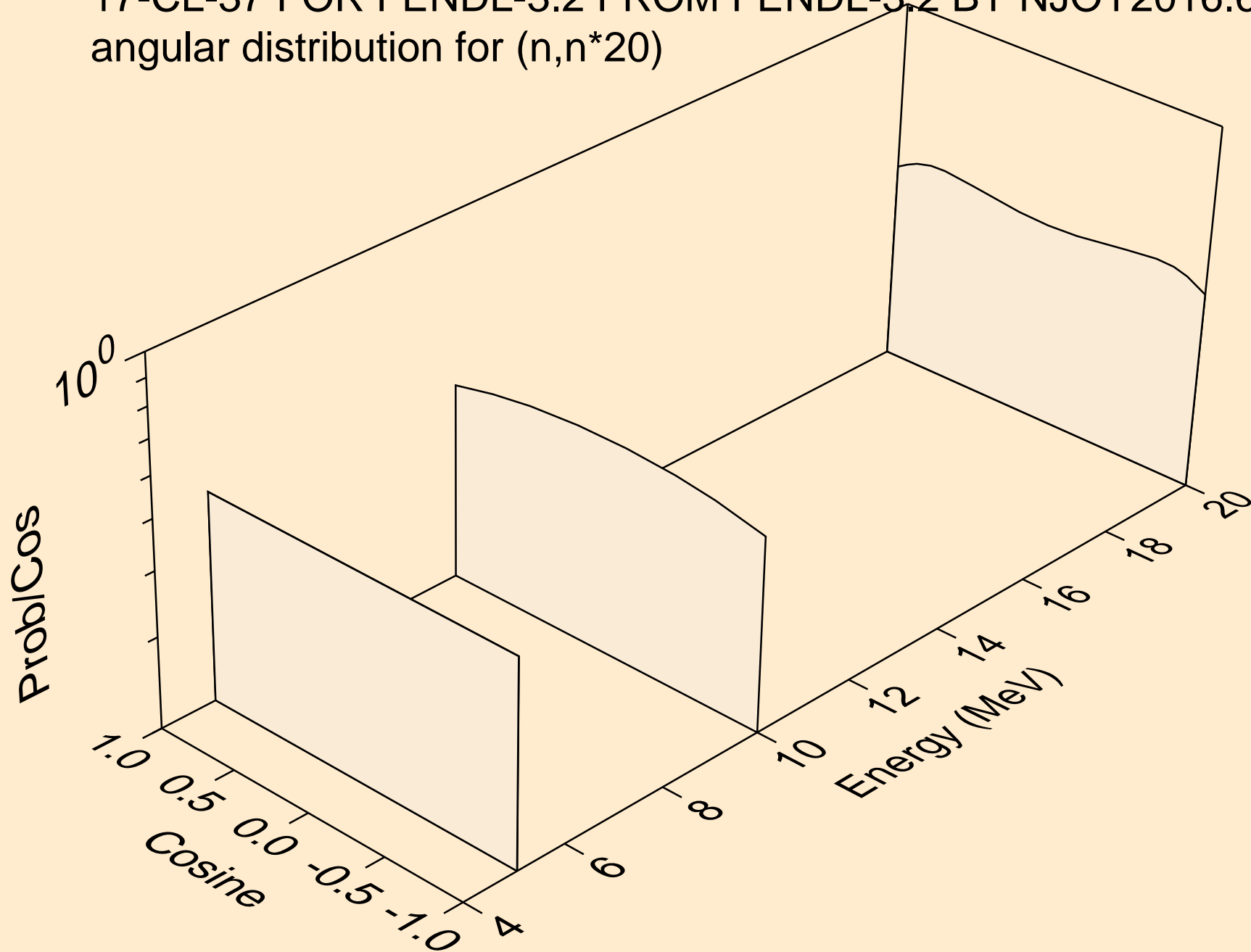

17-CL-37 FOR FENDL-3.2 FROM FENDL-3.2 BY NJOY2016.60+ OI
angular distribution for (n,n*21)

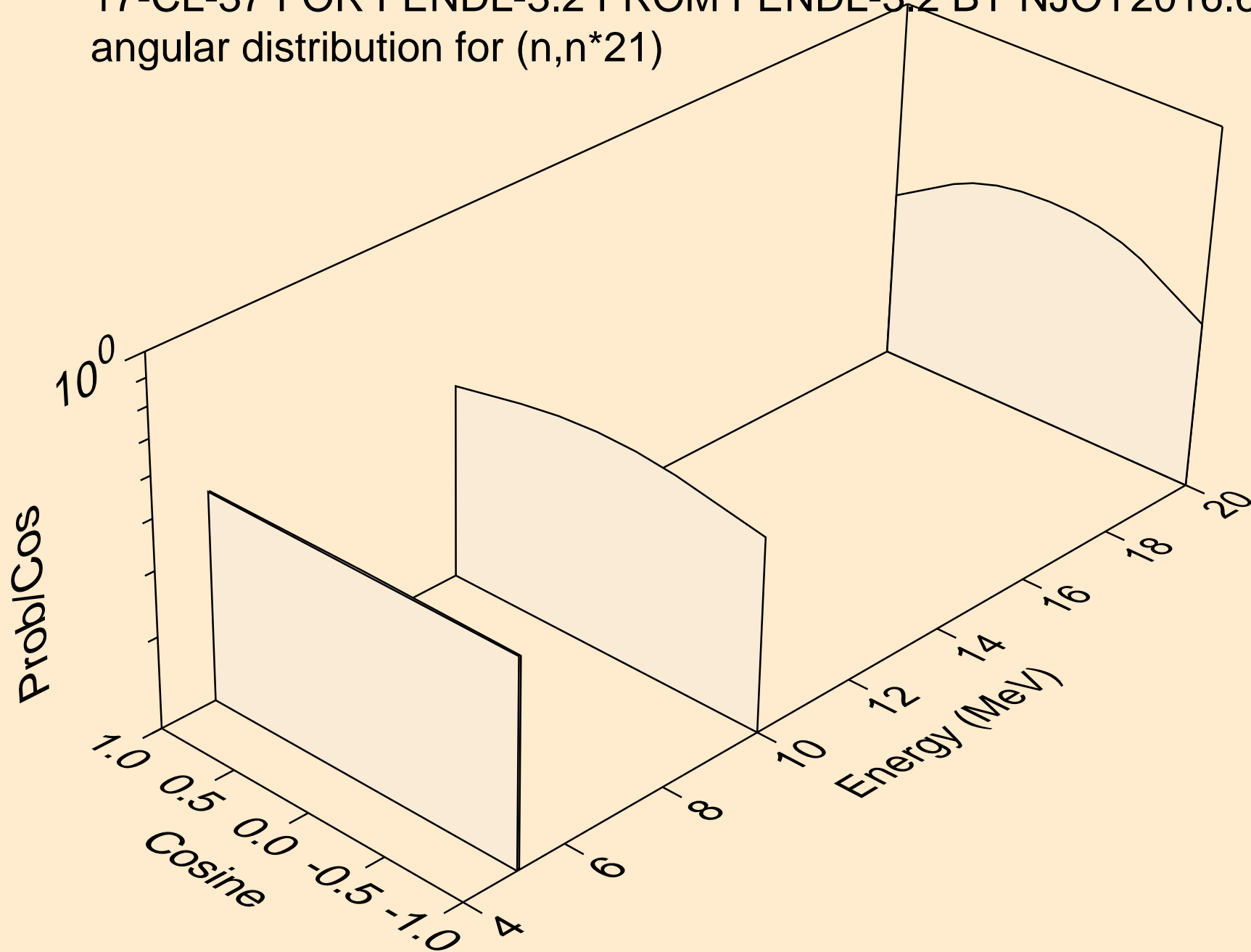

17-CL-37 FOR FENDL-3.2 FROM FENDL-3.2 BY NJOY2016.60+ OI
angular distribution for (n,n*22)

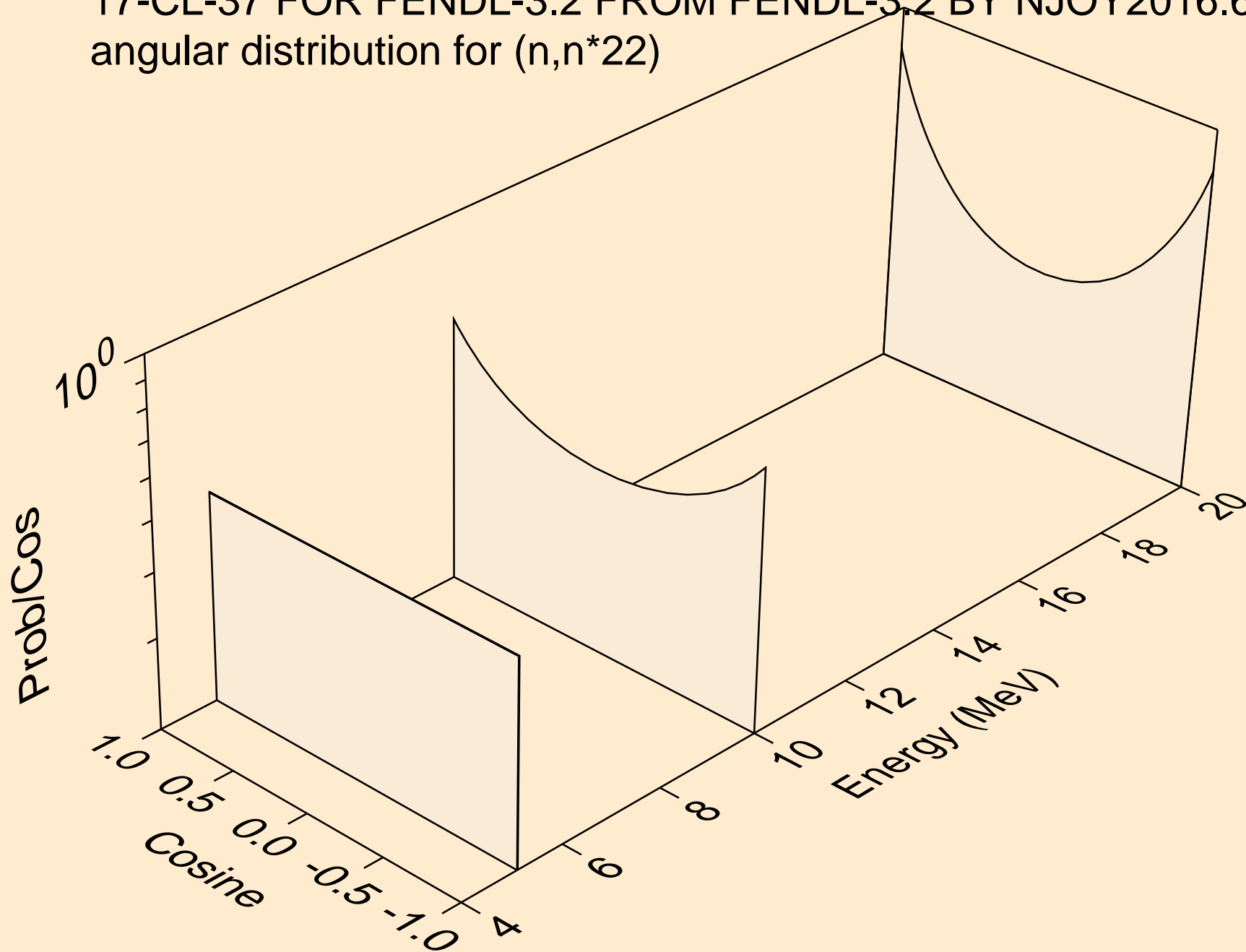

17-CL-37 FOR FENDL-3.2 FROM FENDL-3.2 BY NJOY2016.60+ OI
angular distribution for (n,n*23)

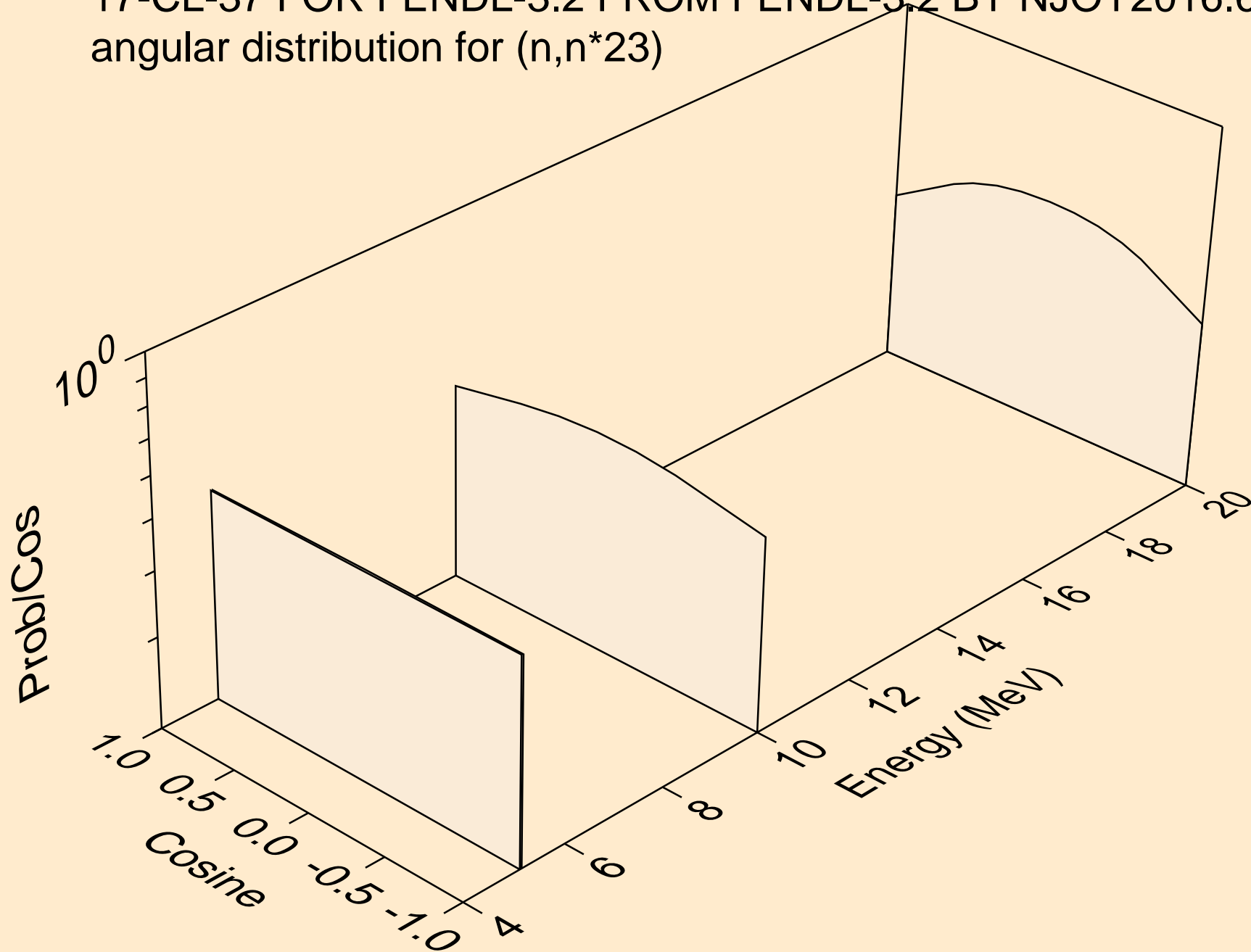

17-CL-37 FOR FENDL-3.2 FROM FENDL-3.2 BY NJOY2016.60+ OI
angular distribution for (n,n*24)

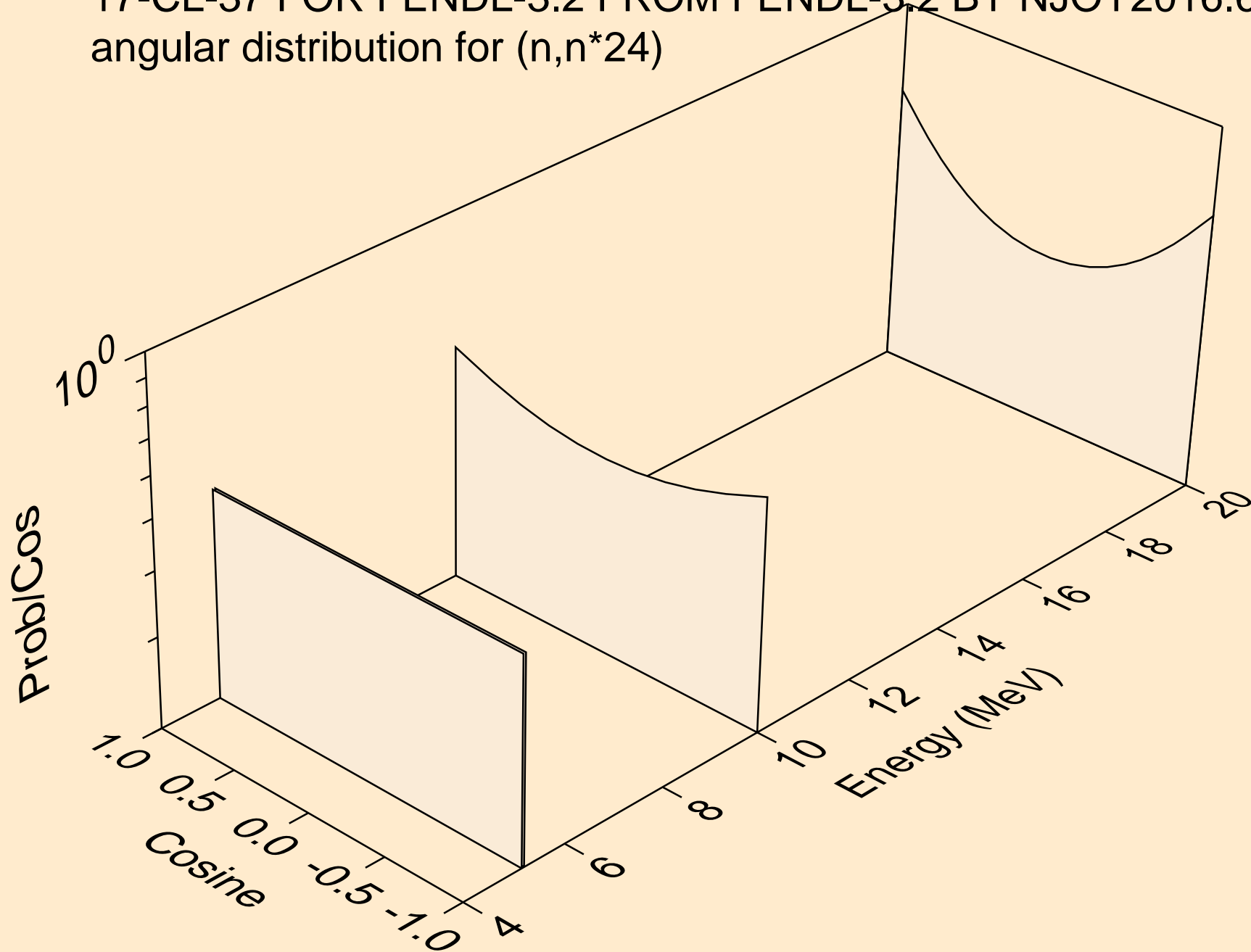

17-CL-37 FOR FENDL-3.2 FROM FENDL-3.2 BY NJOY2016.60+ OI
angular distribution for (n,n*25)

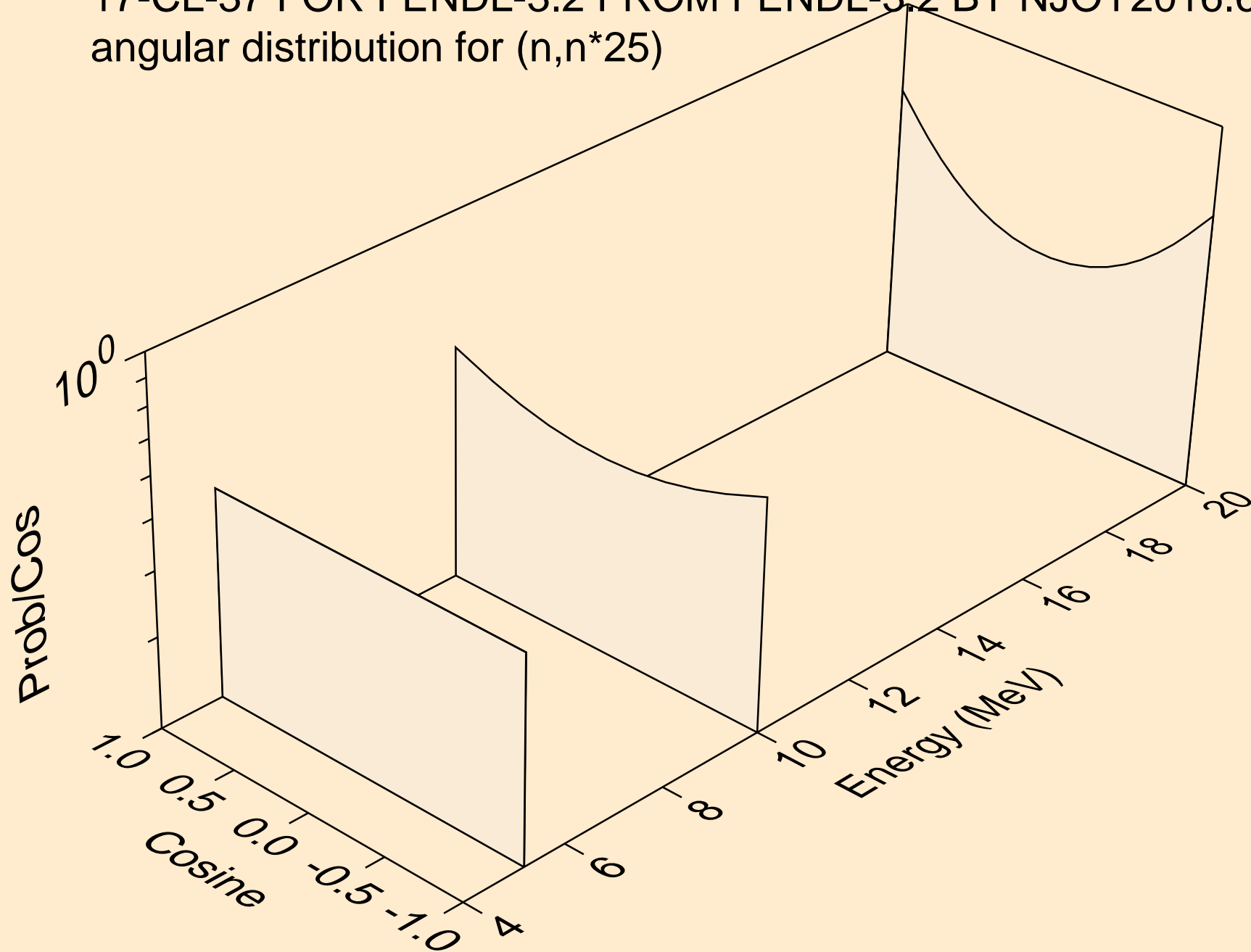

17-CL-37 FOR FENDL-3.2 FROM FENDL-3.2 BY NJOY2016.60+ OI
angular distribution for (n,n*26)

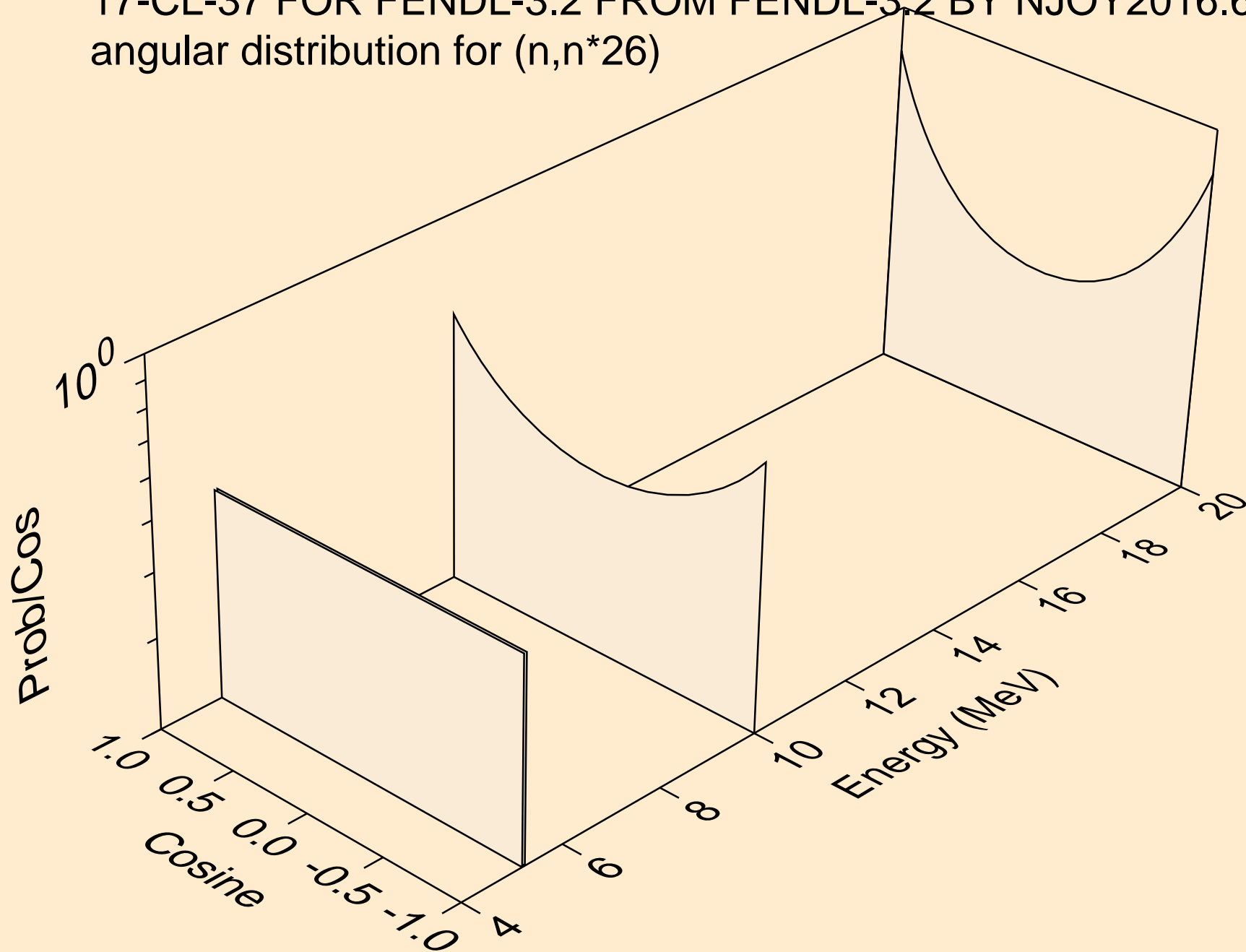

17-CL-37 FOR FENDL-3.2 FROM FENDL-3.2 BY NJOY2016.60+ OI
angular distribution for (n,n*27)

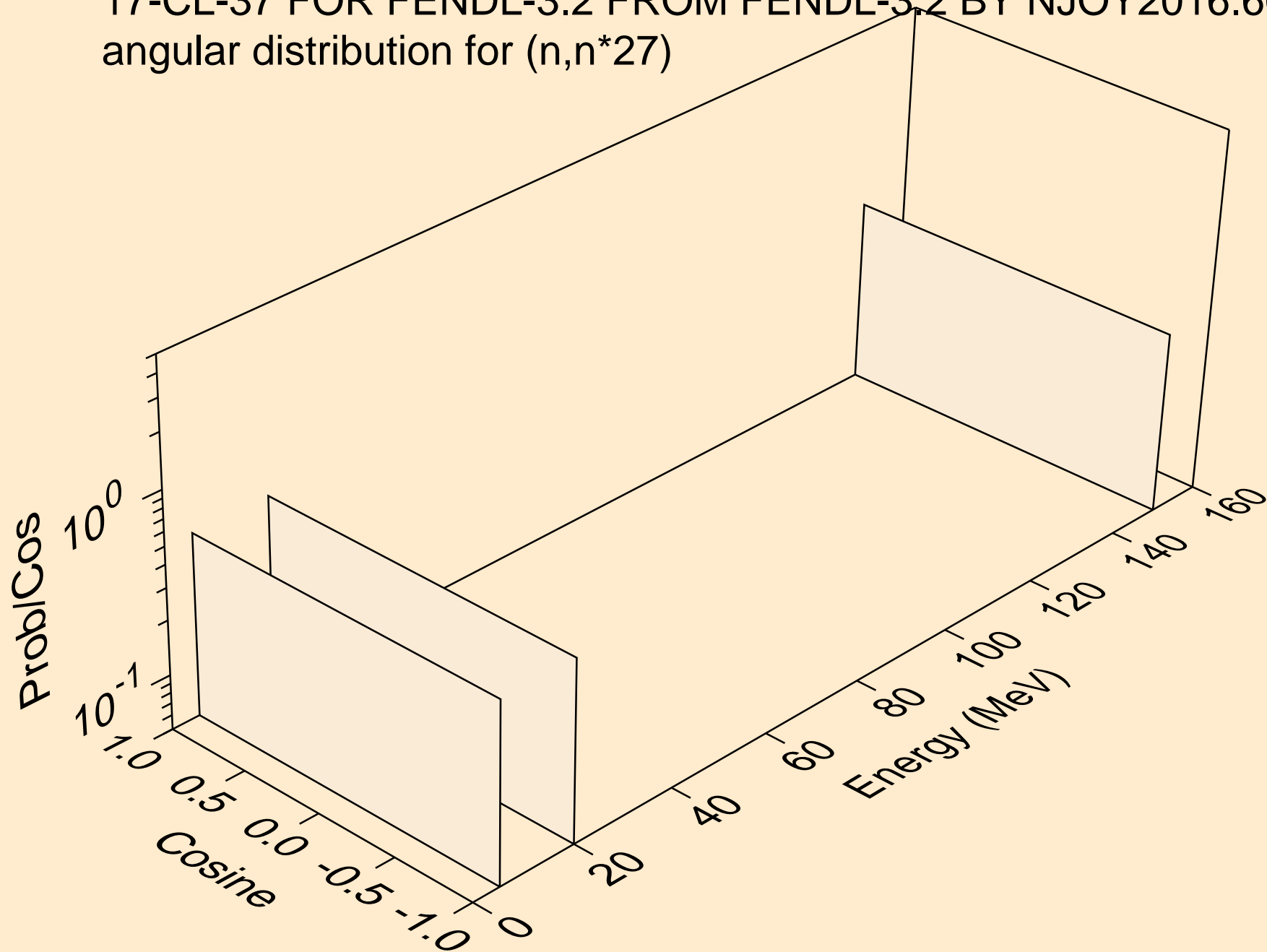

17-CL-37 FOR FENDL-3.2 FROM FENDL-3.2 BY NJOY2016.60+ OI
Neutron emission for (n,x)

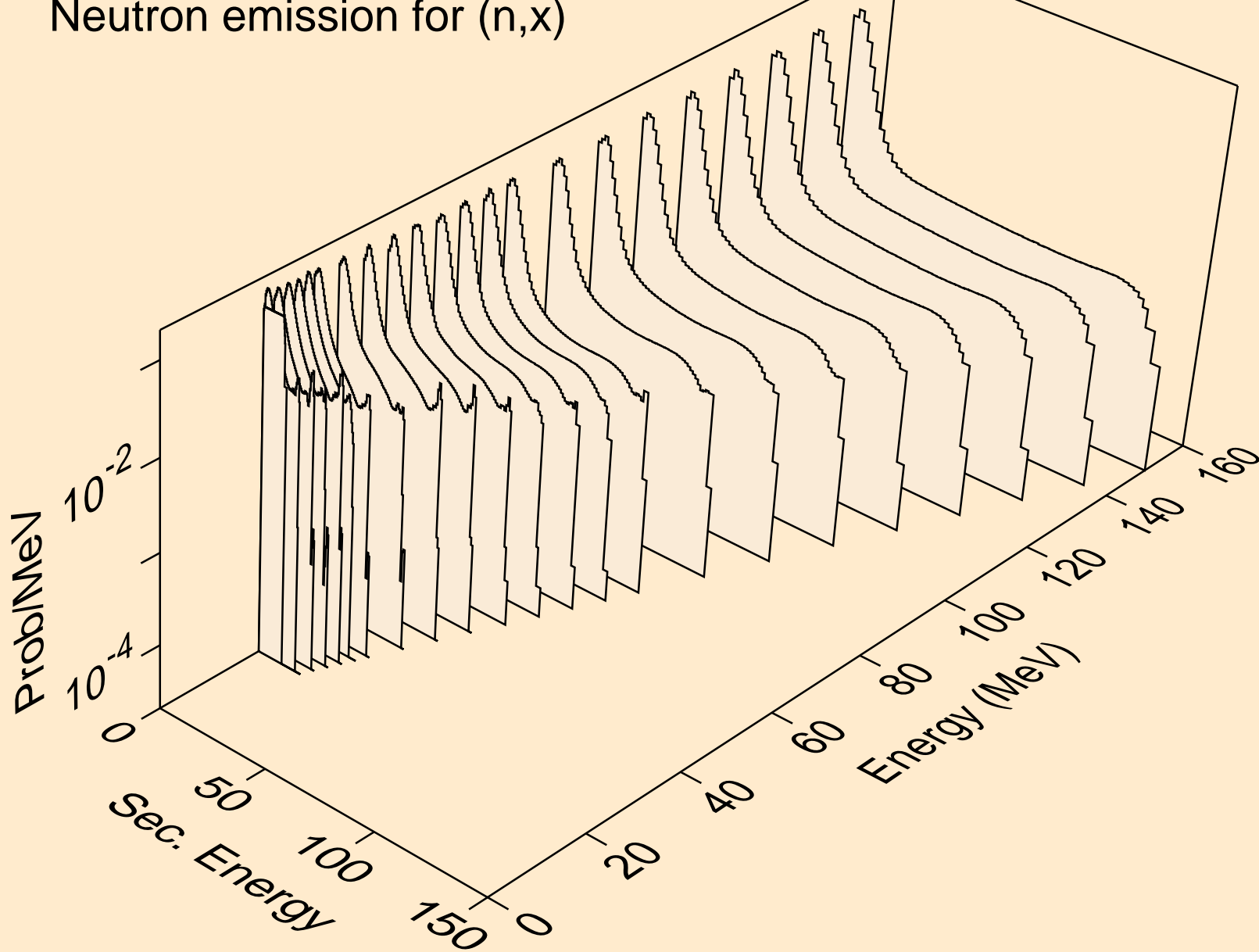

17-CL-37 FOR FENDL-3.2 FROM FENDL-3.2 BY NJOY2016.60+ OI
Neutron emission for (n,2n)

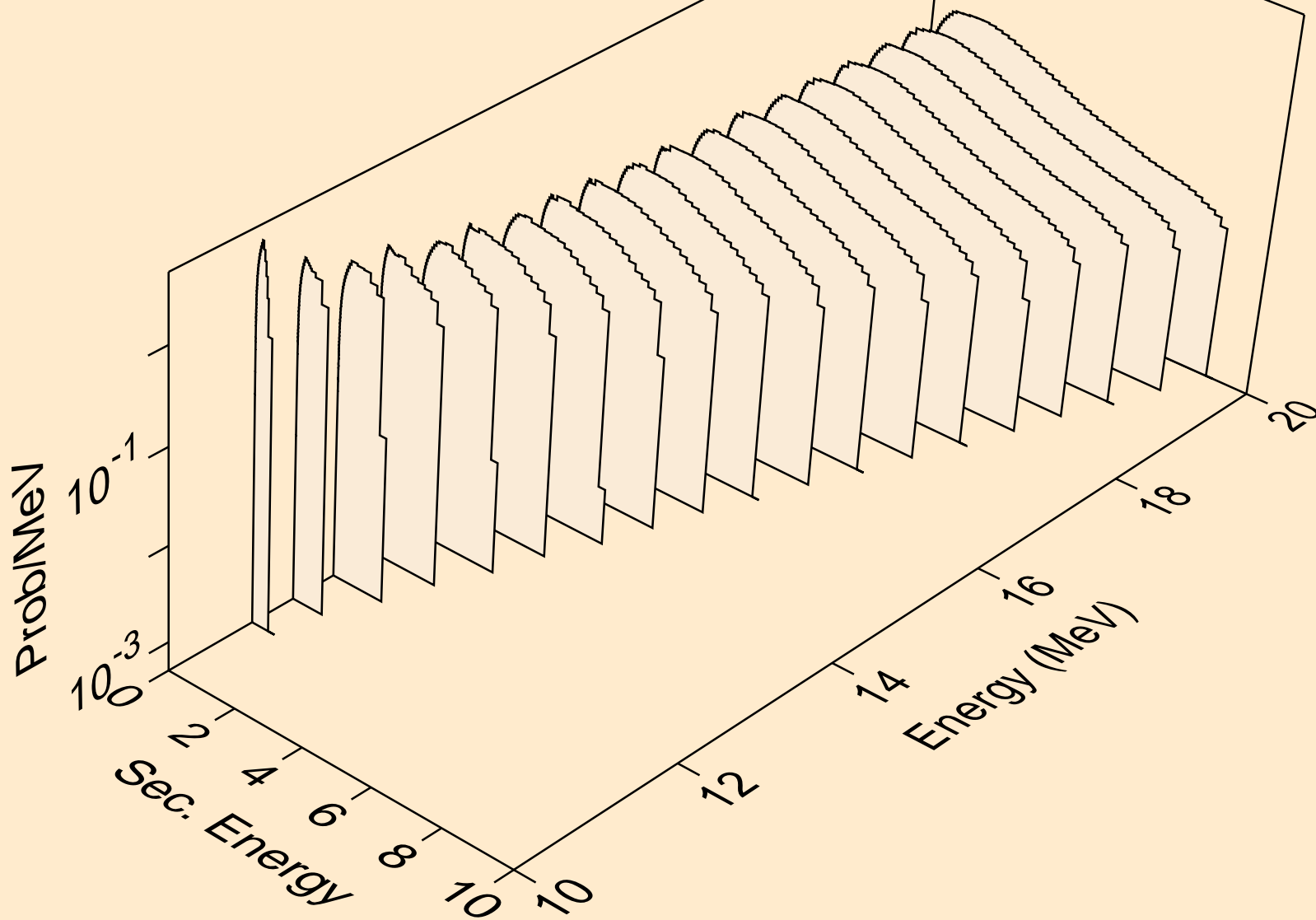

17-CL-37 FOR FENDL-3.2 FROM FENDL-3.2 BY NJOY2016.60+ OI
Neutron emission for (n,3n)

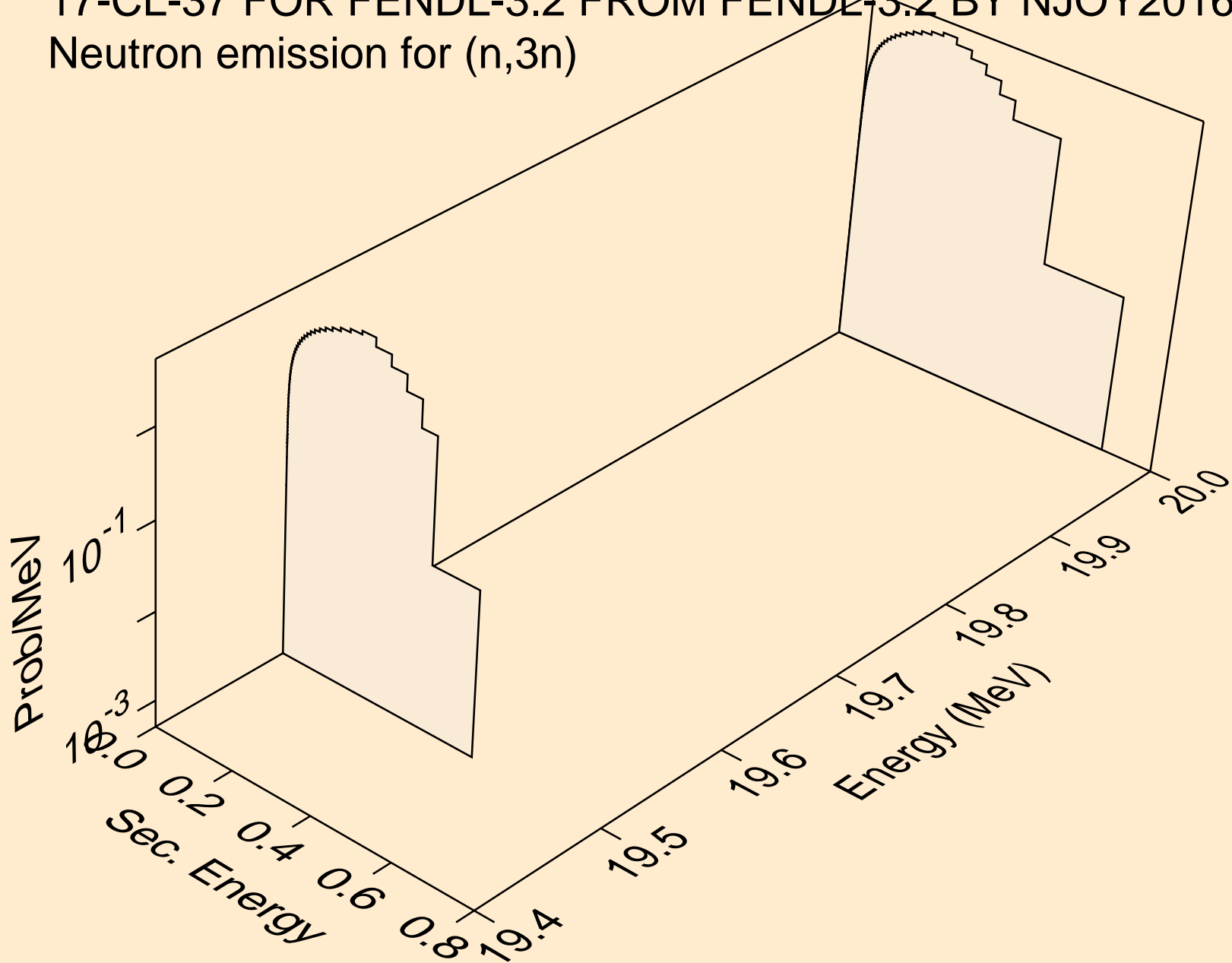

17-CL-37 FOR FENDL-3.2 FROM FENDL-3.2 BY NJOY2016.60+ OI
Neutron emission for (n,n*)a

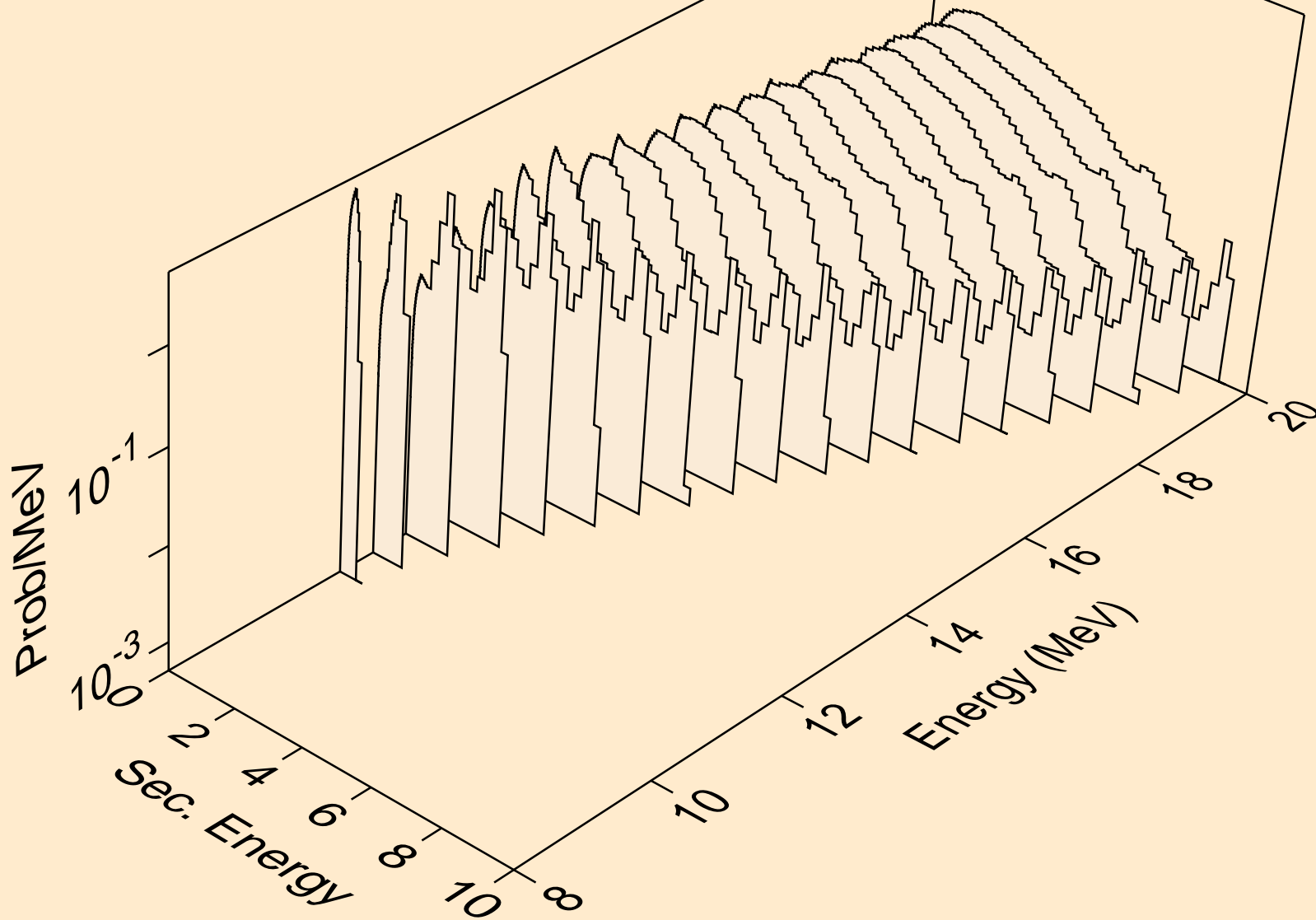

17-CL-37 FOR FENDL-3.2 FROM FENDL-3.2 BY NJOY2016.60+ OI
Neutron emission for (n,n*)p

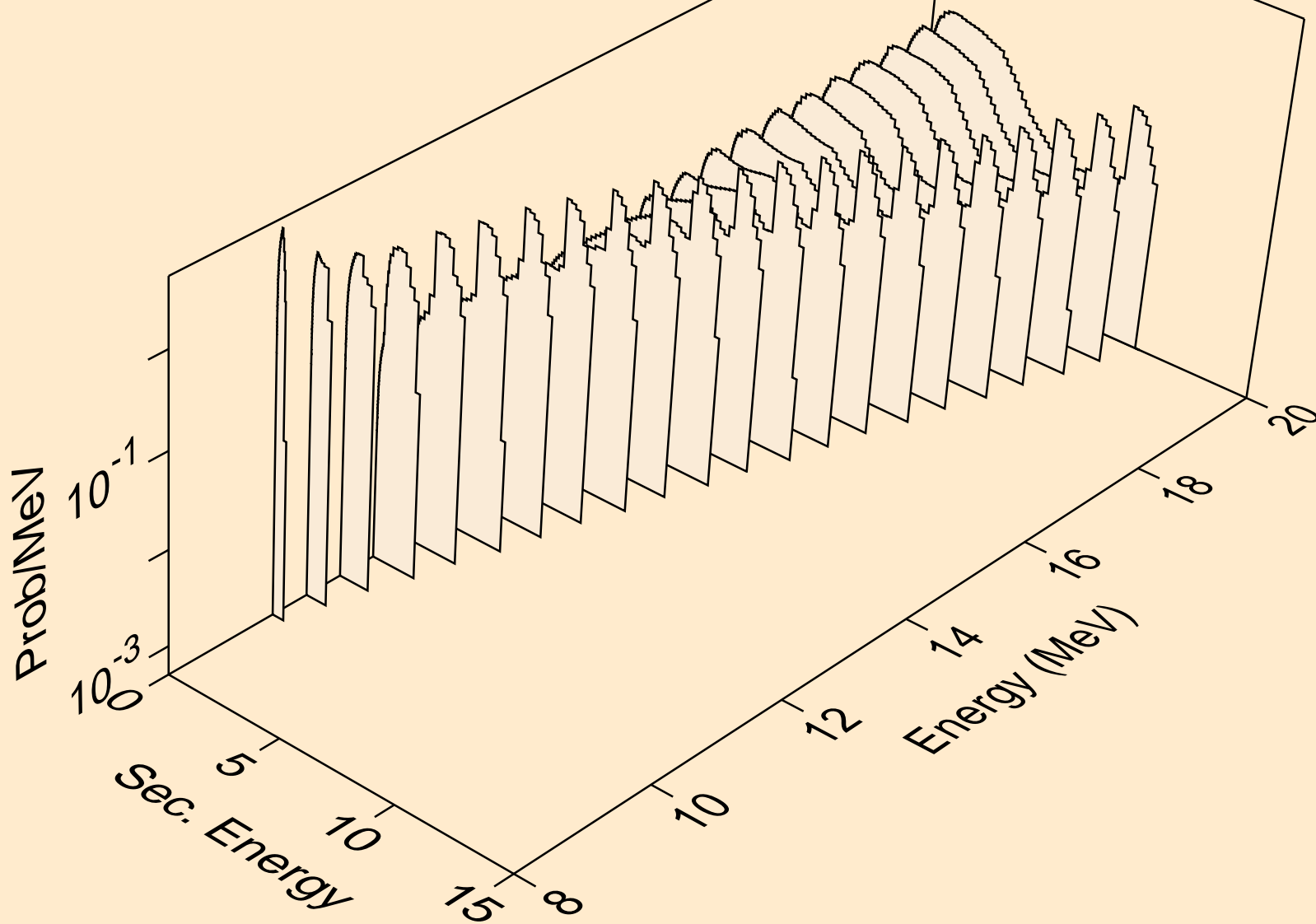

17-CL-37 FOR FENDL-3.2 FROM FENDL-3.2 BY NJOY2016.60+ OI
Neutron emission for (n,n*)d

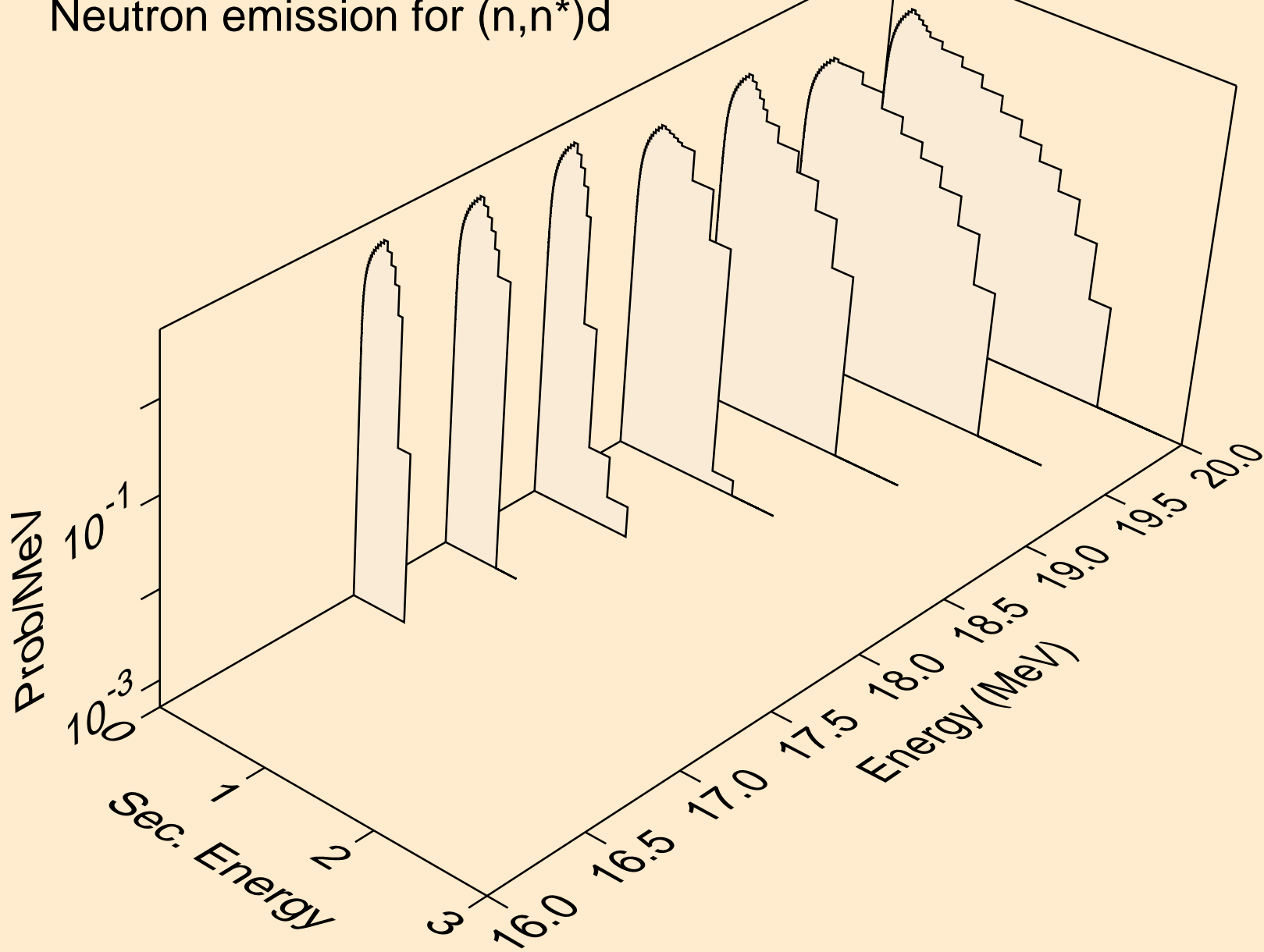

17-CL-37 FOR FENDL-3.2 FROM FENDL-3.2 BY NJOY2016.60+ OI
Neutron emission for (n,n*c)

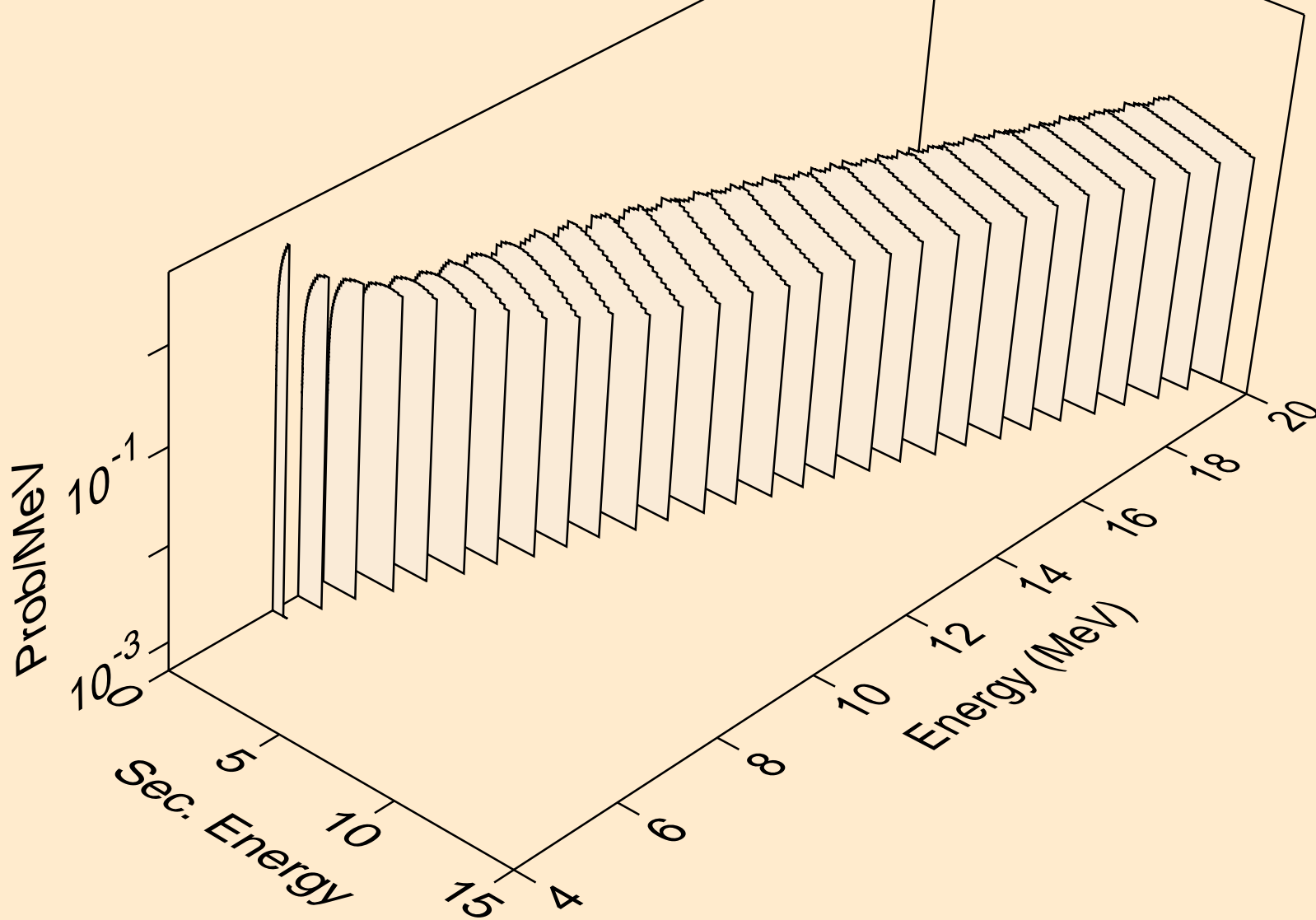

17-CL-37 FOR FENDL-3.2 FROM FENDL-3.2 BY NJOY2016.60+ OI
Photon emission for (n,gma)

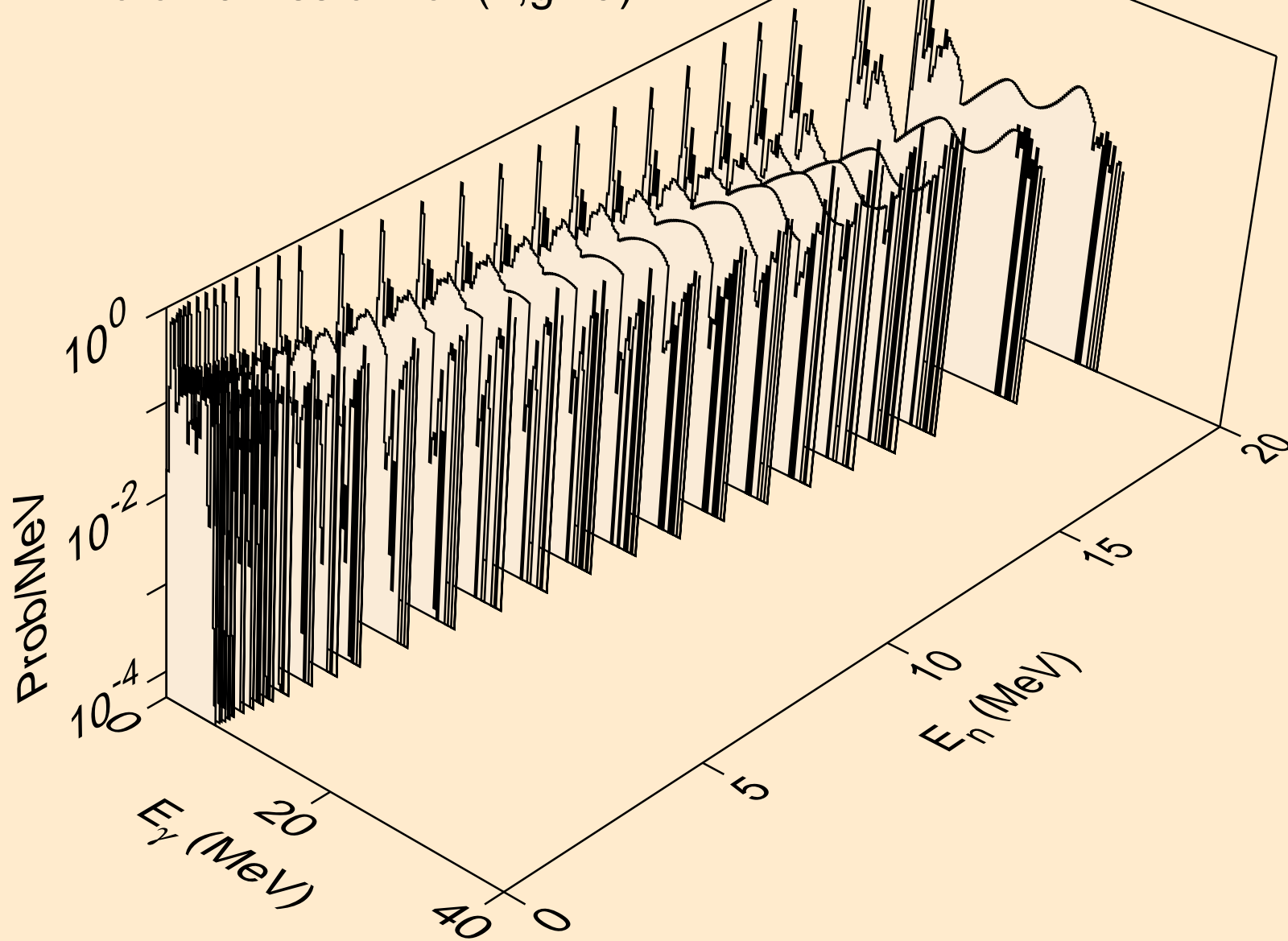

17-CL-37 FOR FENDL-3.2 FROM FENDL-3.2 BY NJOY2016.60+ OI
Photon emission for (n,x)

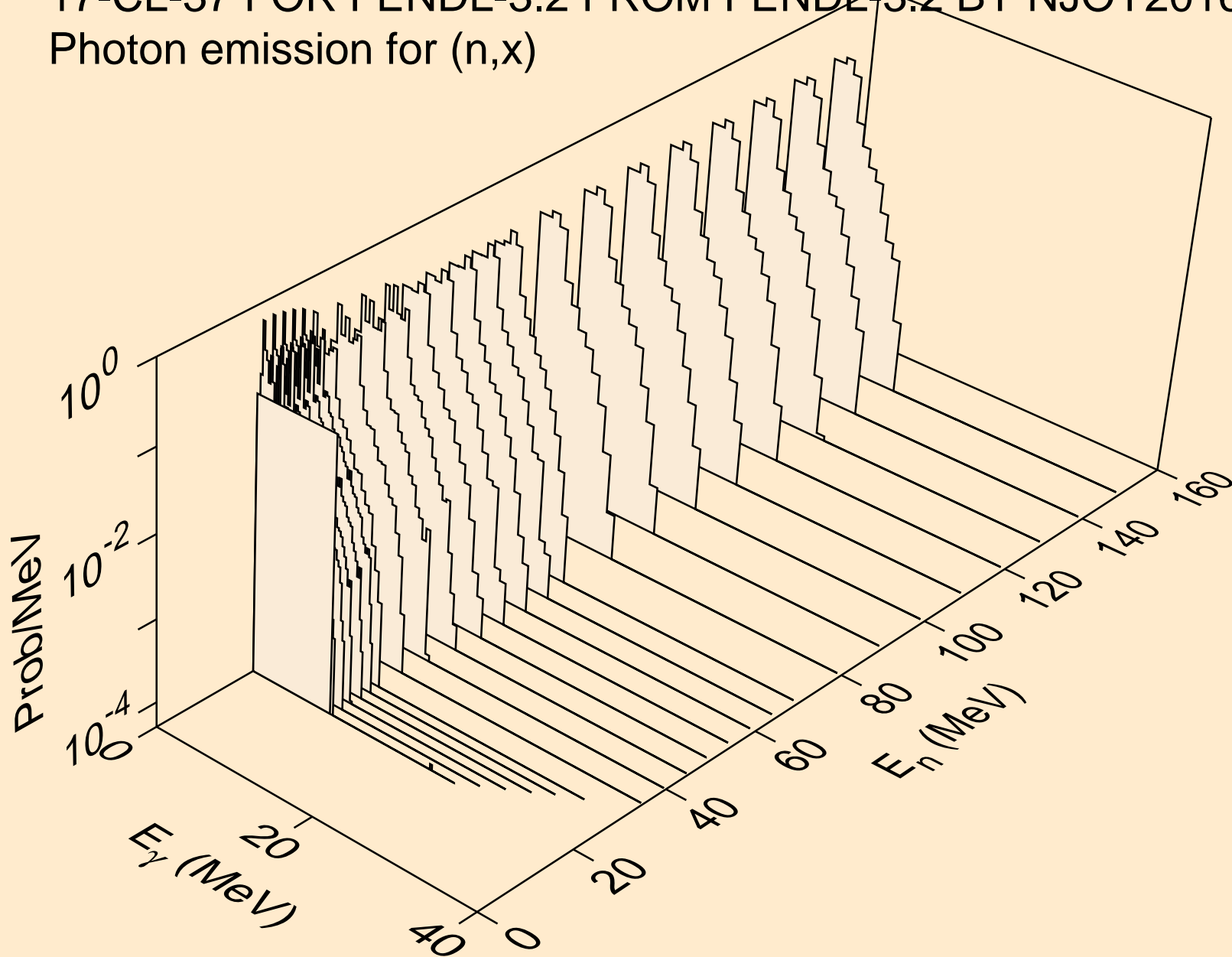

17-CL-37 FOR FENDL-3.2 FROM FENDL-3.2 BY NJOY2016.60+ OI
Photon emission for (n,2n)

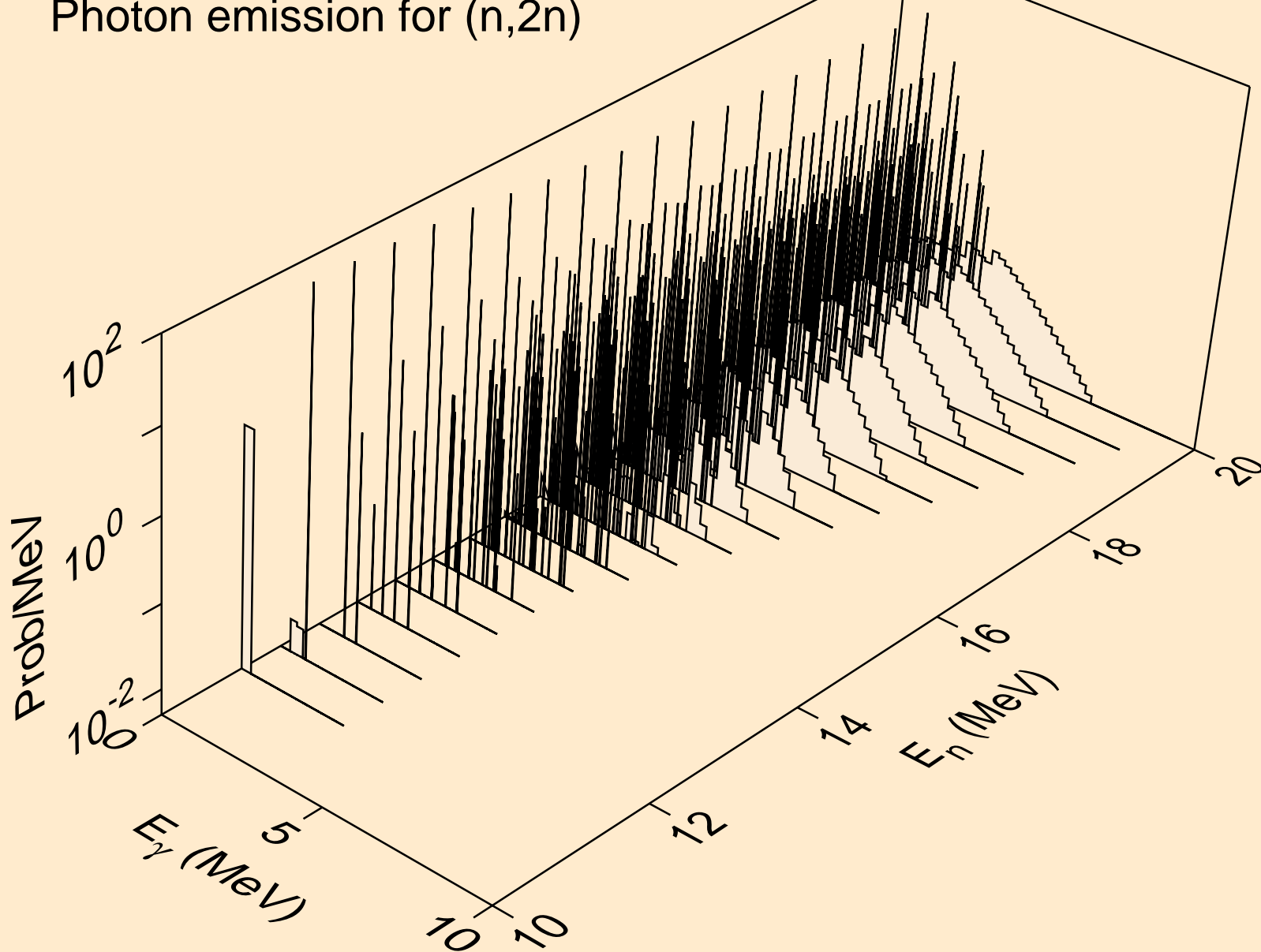

17-CL-37 FOR FENDL-3.2 FROM FENDL-3.2 BY NJOY2016.60+ OI
Photon emission for (n,3n)

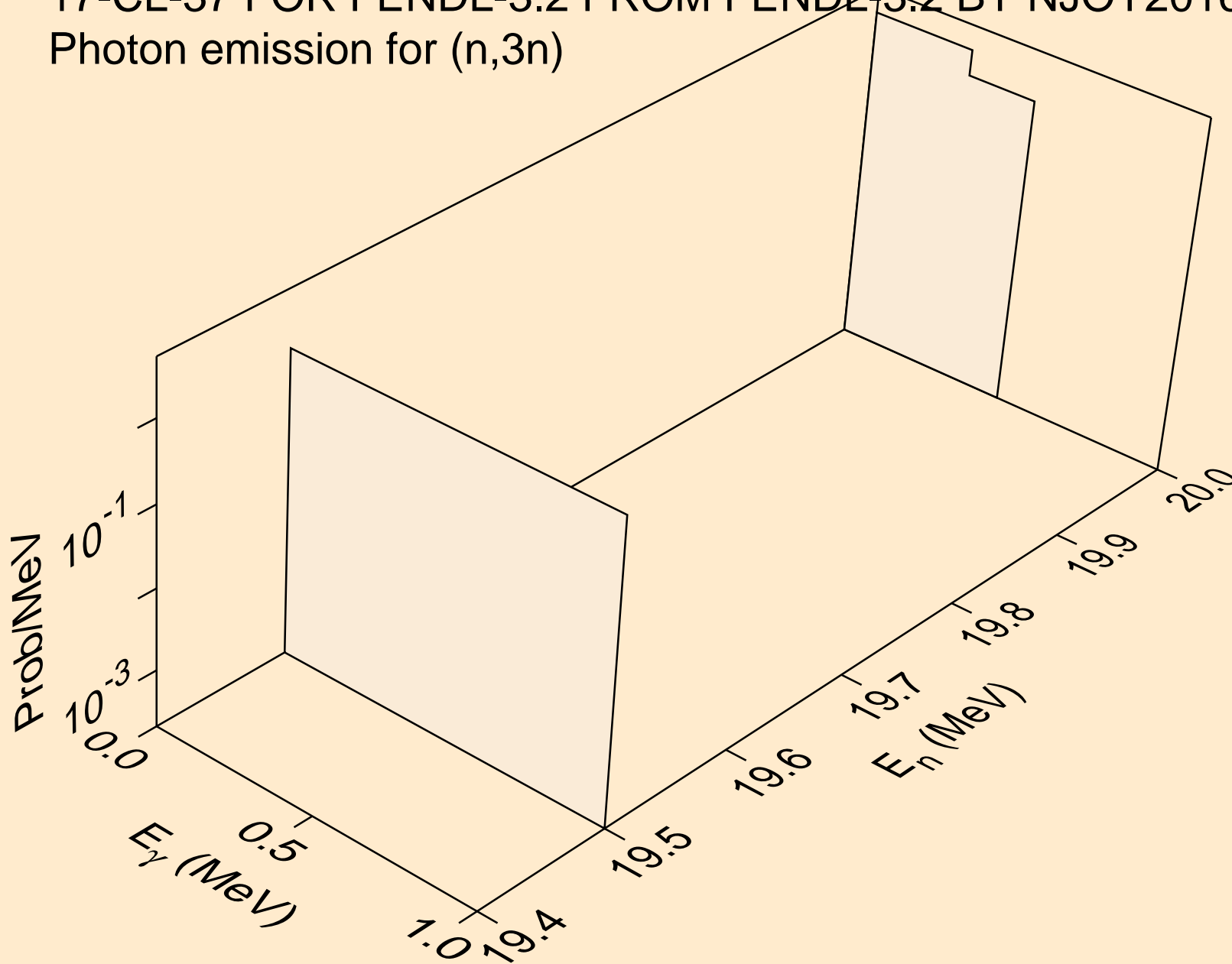

17-CL-37 FOR FENDL-3.2 FROM FENDL-3.2 BY NJOY2016.60+ OI
Photon emission for (n,n*)a

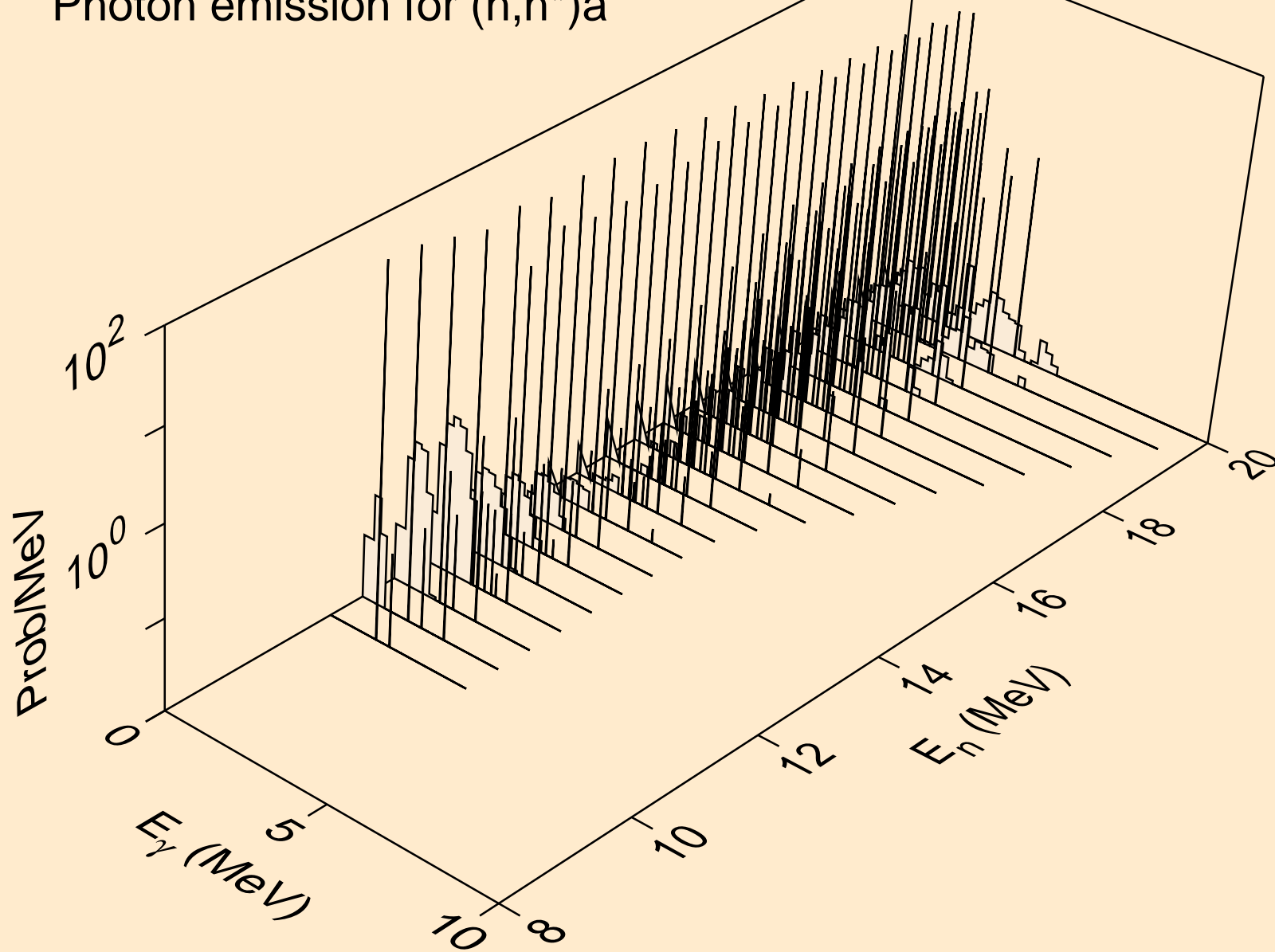

17-CL-37 FOR FENDL-3.2 FROM FENDL-3.2 BY NJOY2016.60+ OI
Photon emission for (n,n*)p

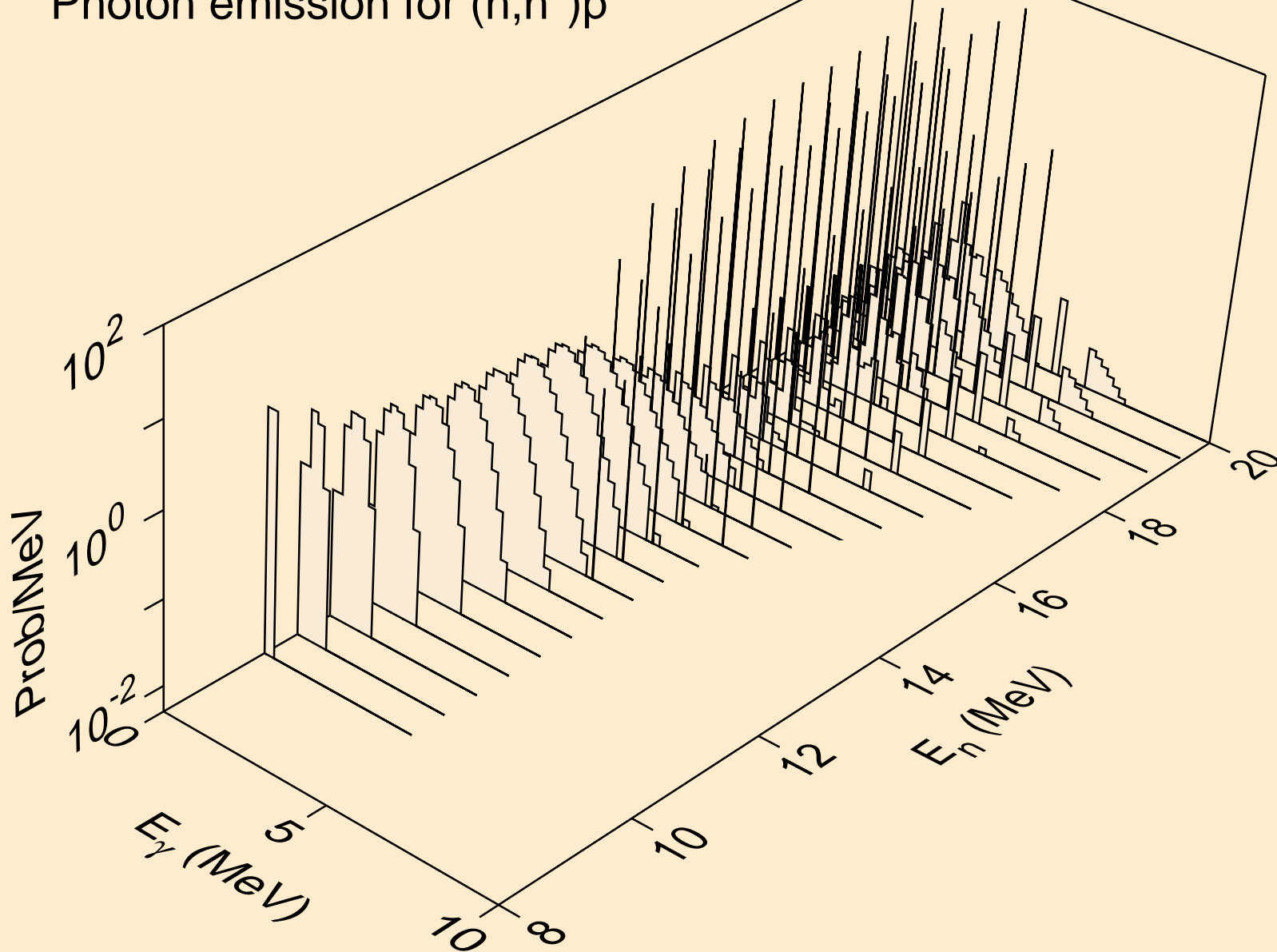

17-CL-37 FOR FENDL-3.2 FROM FENDL-3.2 BY NJOY2016.60+ OI
Photon emission for (n,n*)d

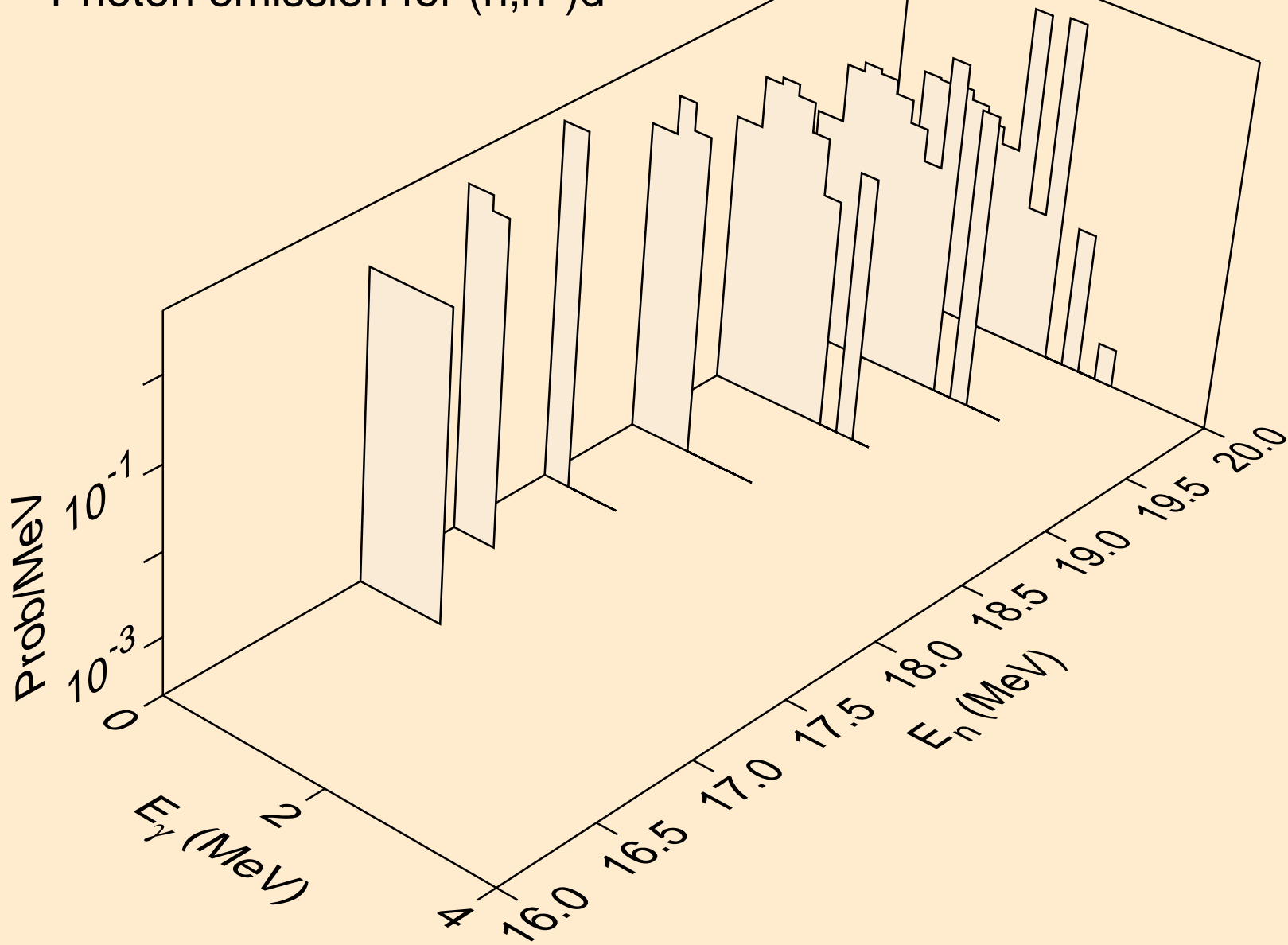

17-CL-37 FOR FENDL-3.2 FROM FENDL-3.2 BY NJOY2016.60+ OI
Photon emission for (n,n*1)

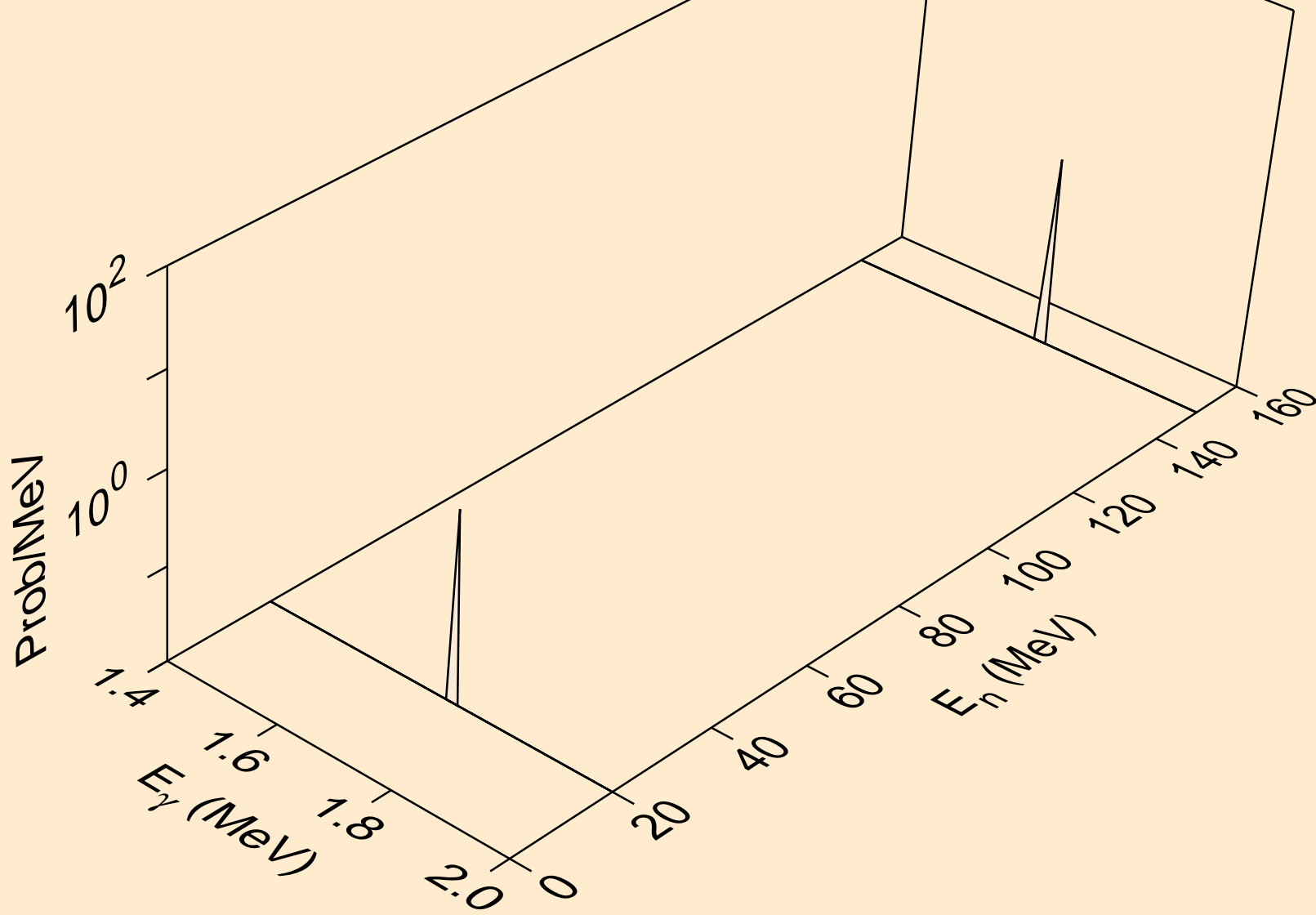

17-CL-37 FOR FENDL-3.2 FROM FENDL-3.2 BY NJOY2016.60+ OI
Photon emission for (n,n*2)

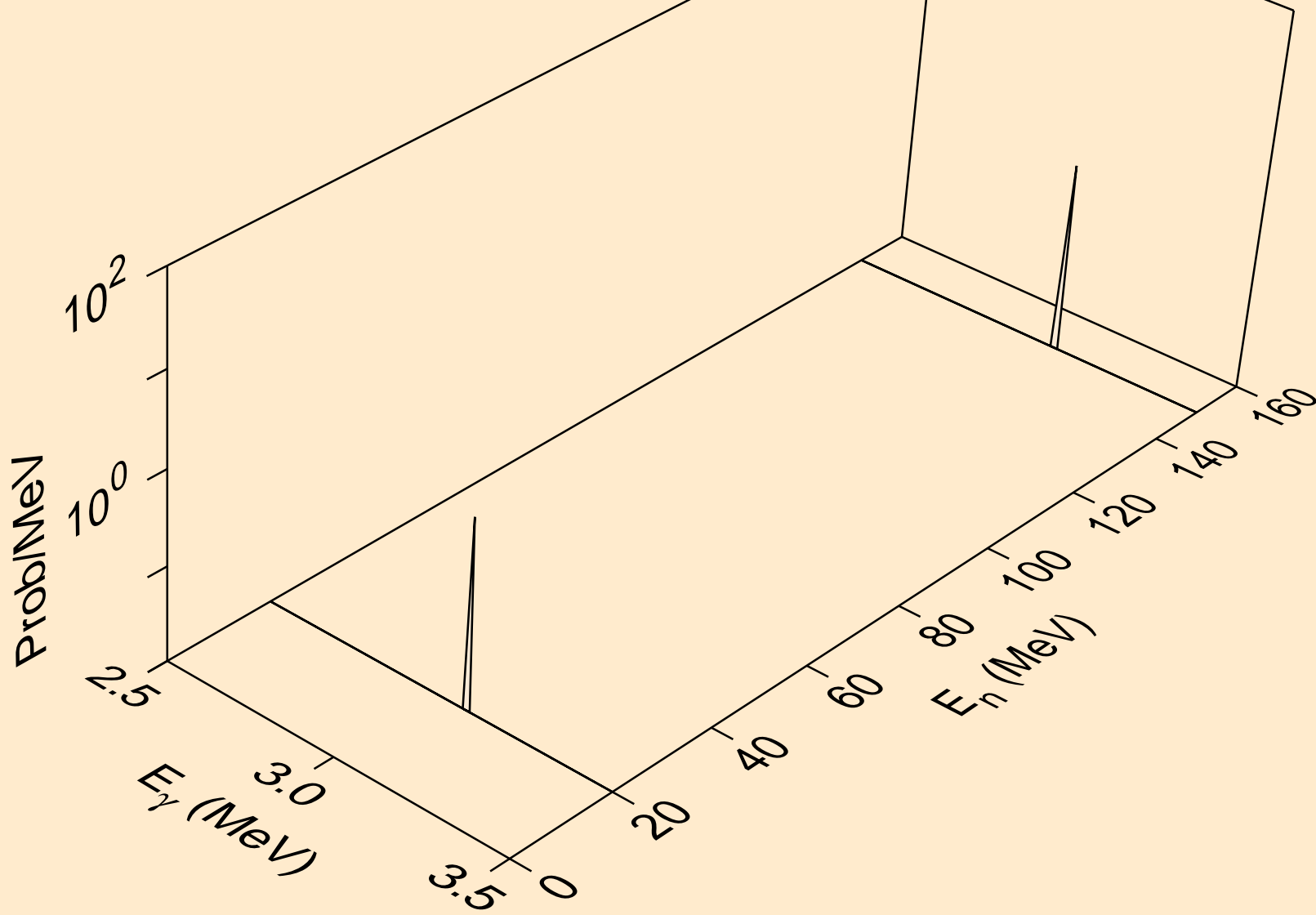

17-CL-37 FOR FENDL-3.2 FROM FENDL-3.2 BY NJOY2016.60+ OI
Photon emission for (n,n*3)

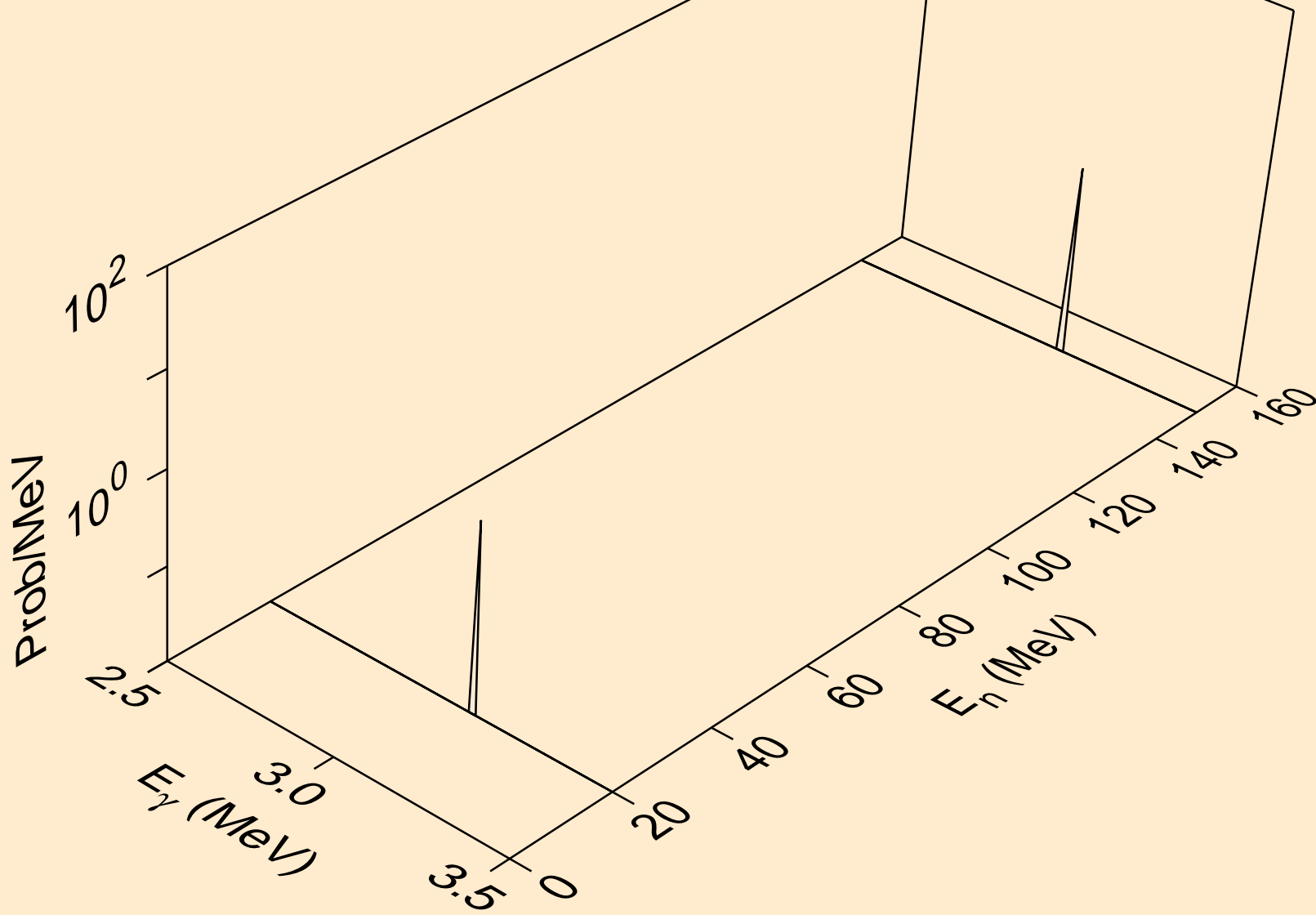

17-CL-37 FOR FENDL-3.2 FROM FENDL-3.2 BY NJOY2016.60+ OI
Photon emission for (n,n*4)

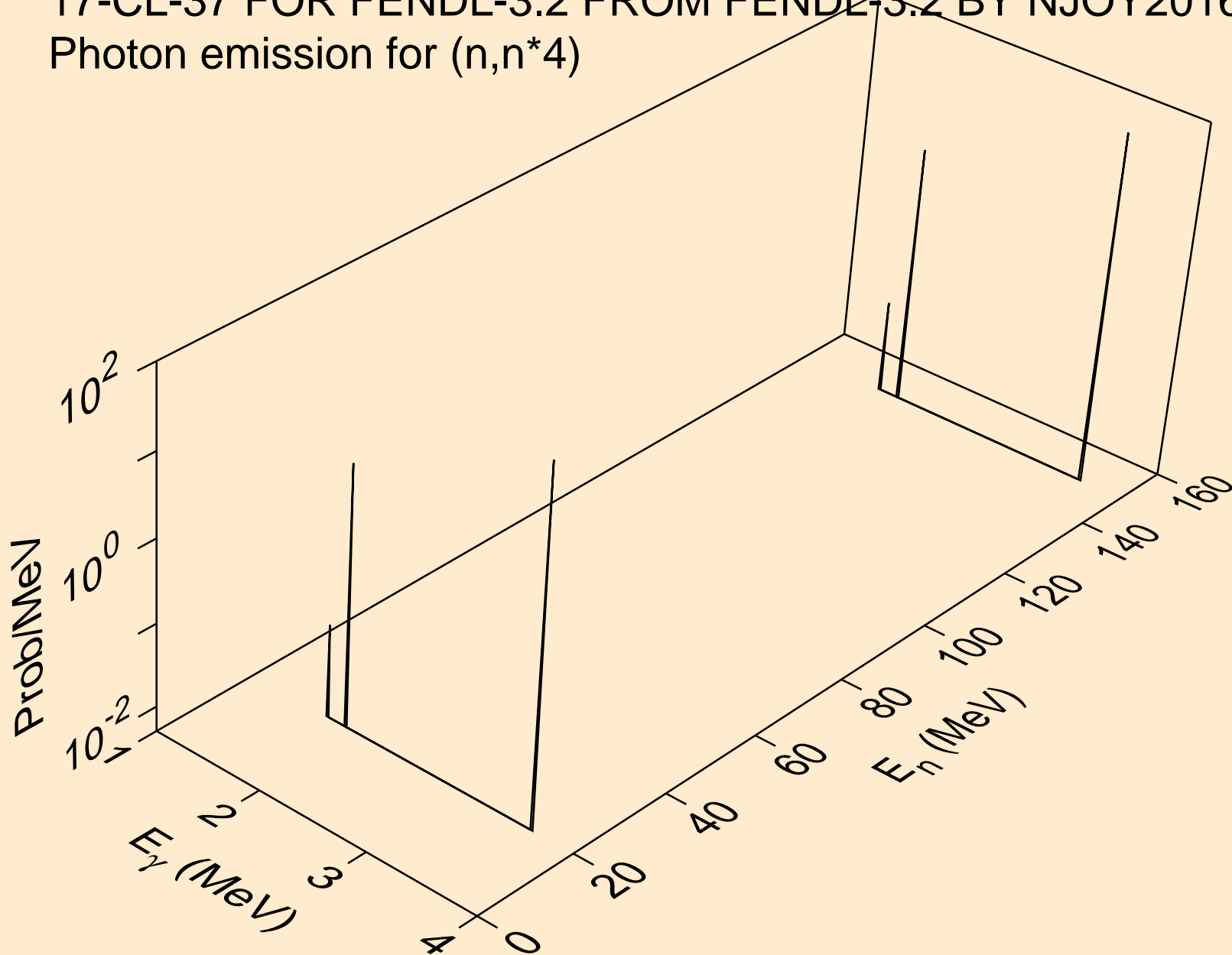

17-CL-37 FOR FENDL-3.2 FROM FENDL-3.2 BY NJOY2016.60+ OI
Photon emission for (n,n*5)

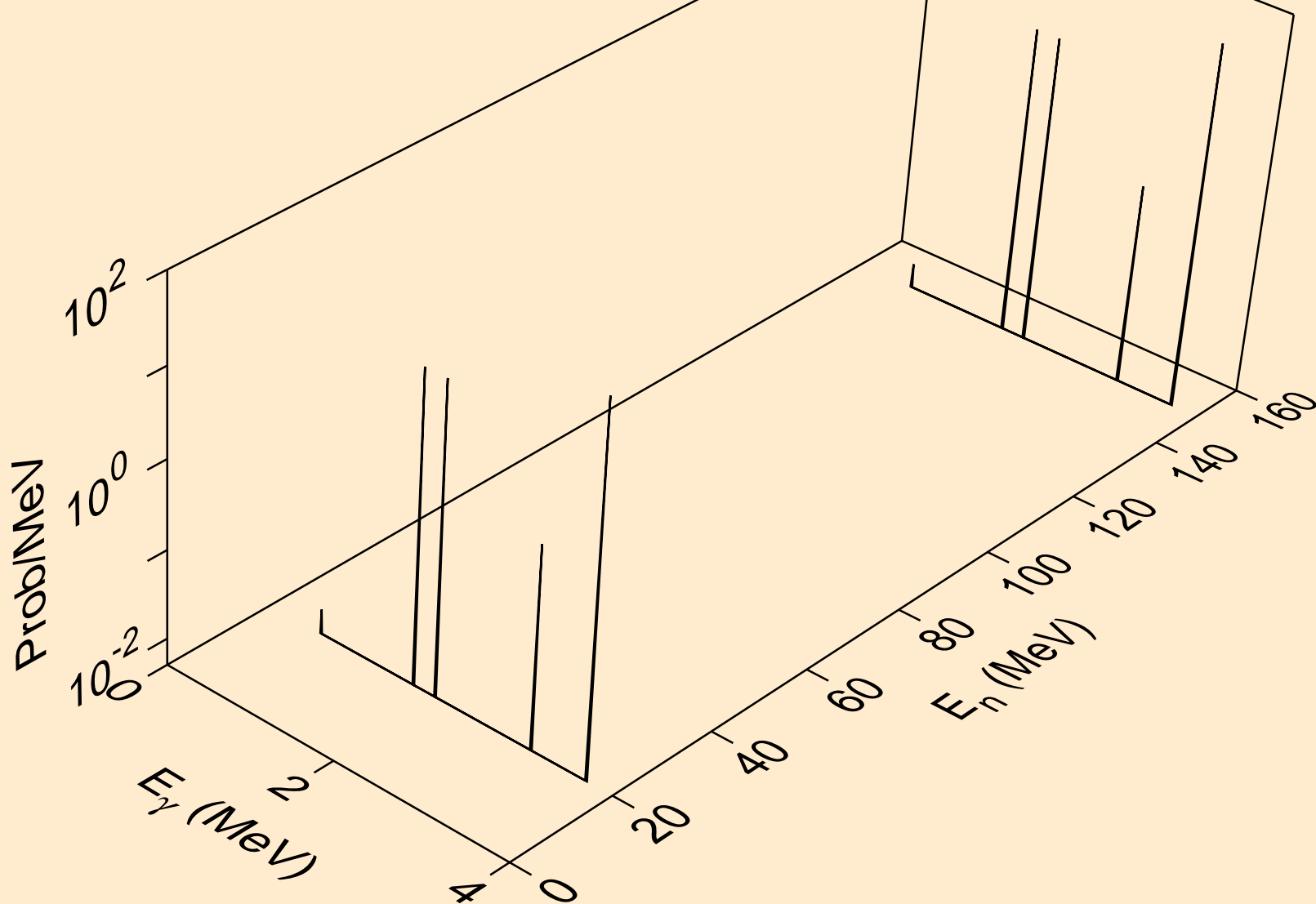

17-CL-37 FOR FENDL-3.2 FROM FENDL-3.2 BY NJOY2016.60+ OI
Photon emission for (n,n*6)

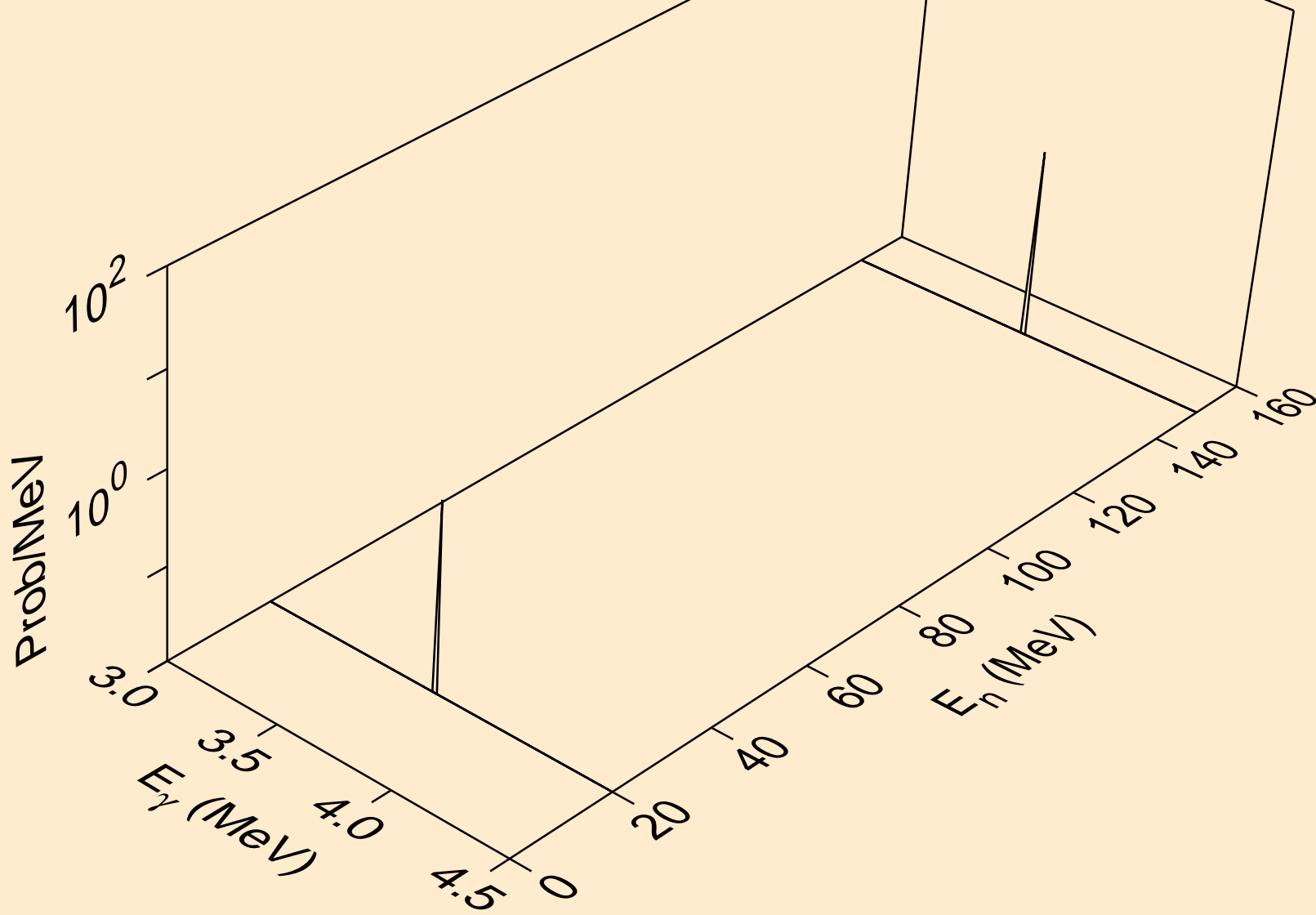

17-CL-37 FOR FENDL-3.2 FROM FENDL-3.2 BY NJOY2016.60+ OI
Photon emission for (n,n*7)

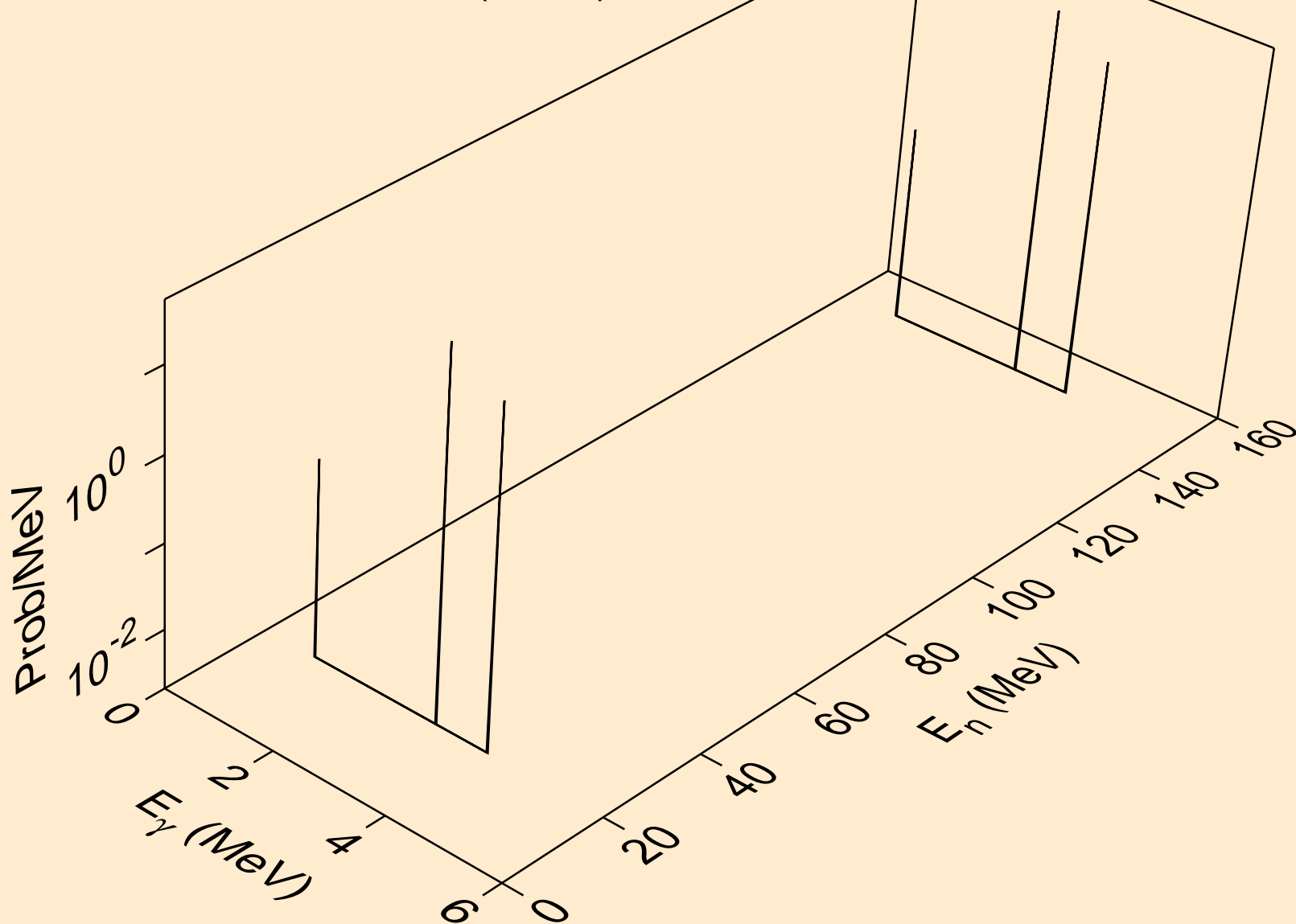

17-CL-37 FOR FENDL-3.2 FROM FENDL-3.2 BY NJOY2016.60+ OI
Photon emission for (n,n*8)

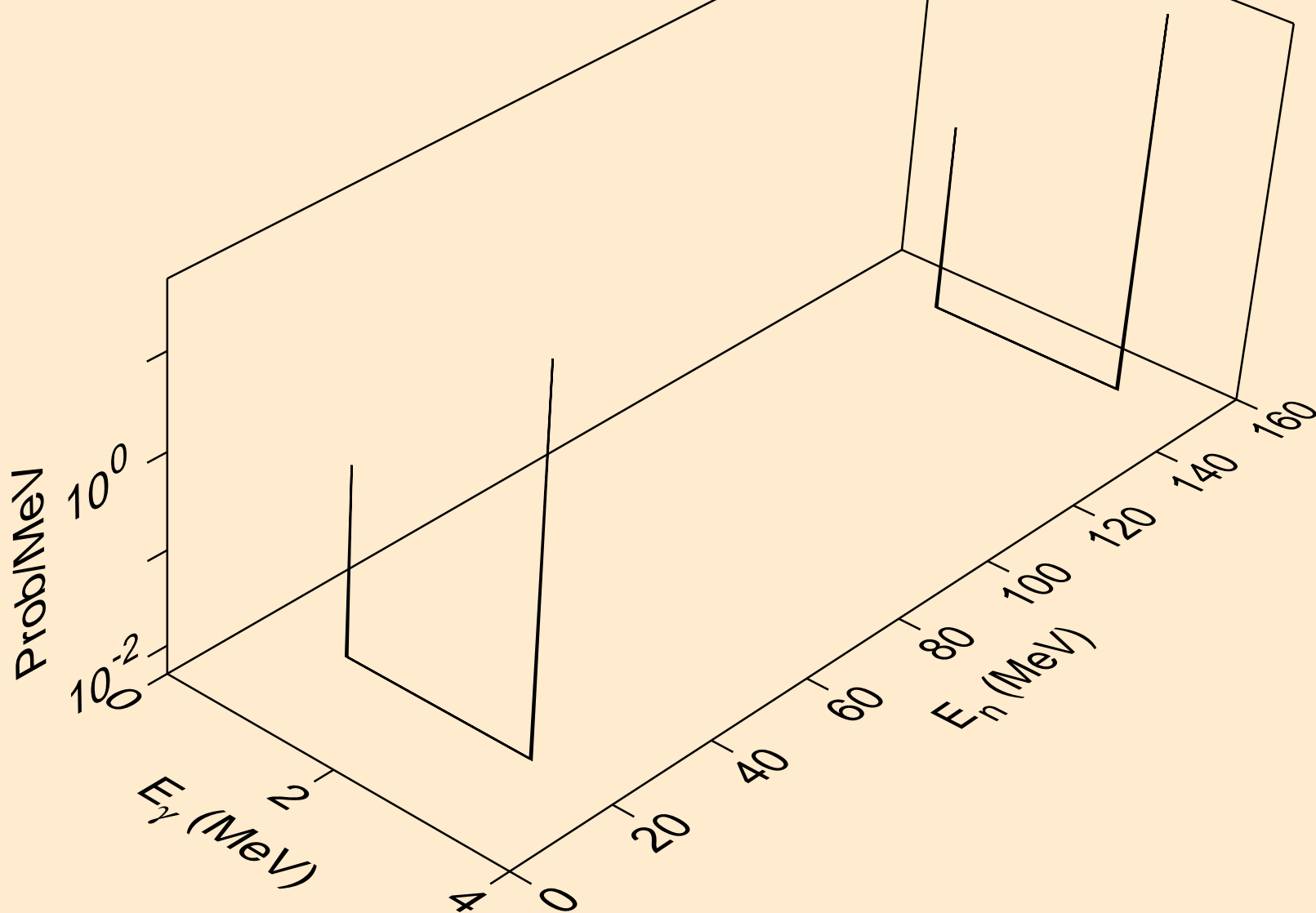

17-CL-37 FOR FENDL-3.2 FROM FENDL-3.2 BY NJOY2016.60+ OI
Photon emission for (n,n*9)

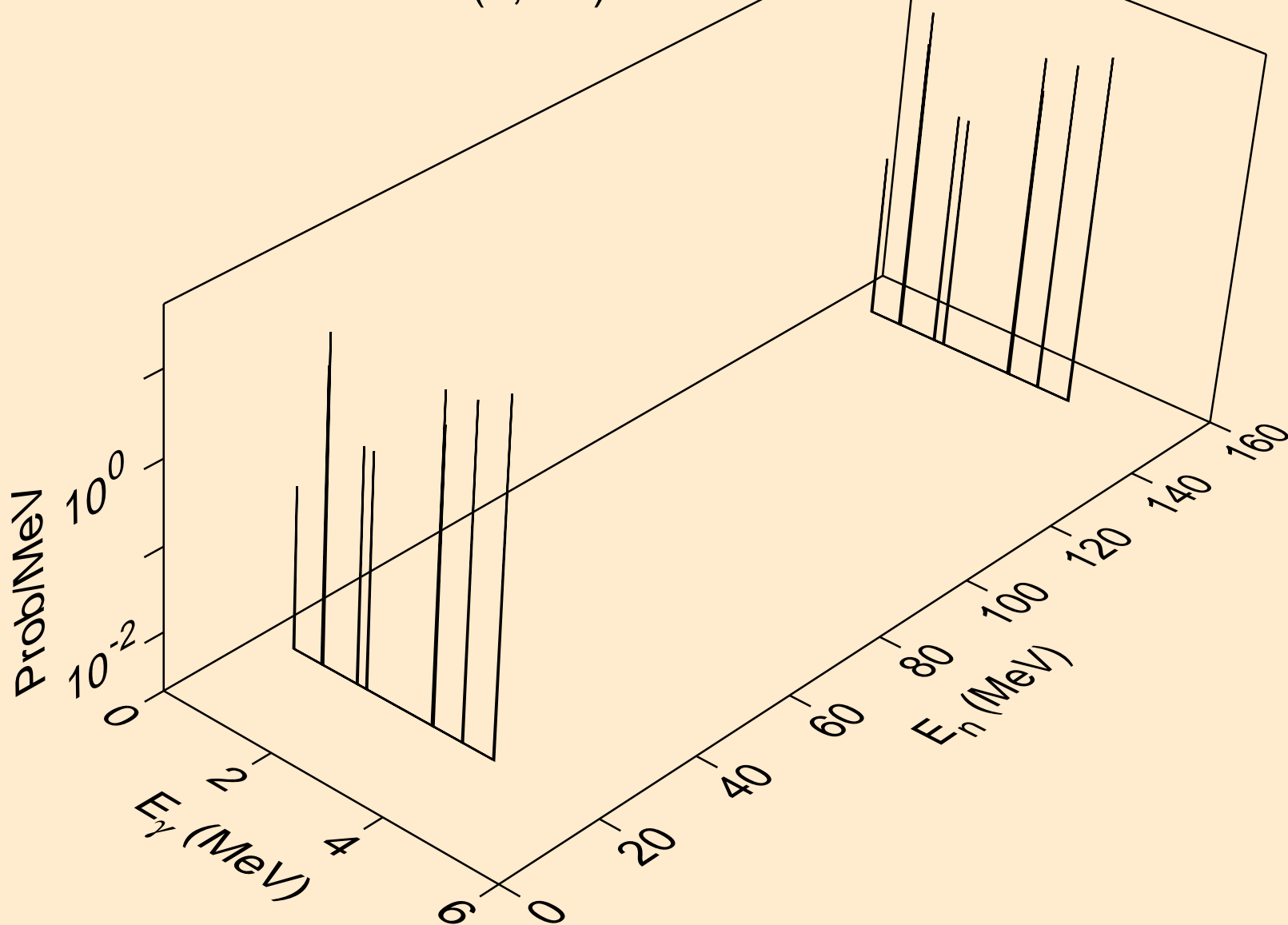

17-CL-37 FOR FENDL-3.2 FROM FENDL-3.2 BY NJOY2016.60+ OI
Photon emission for (n,n*10)

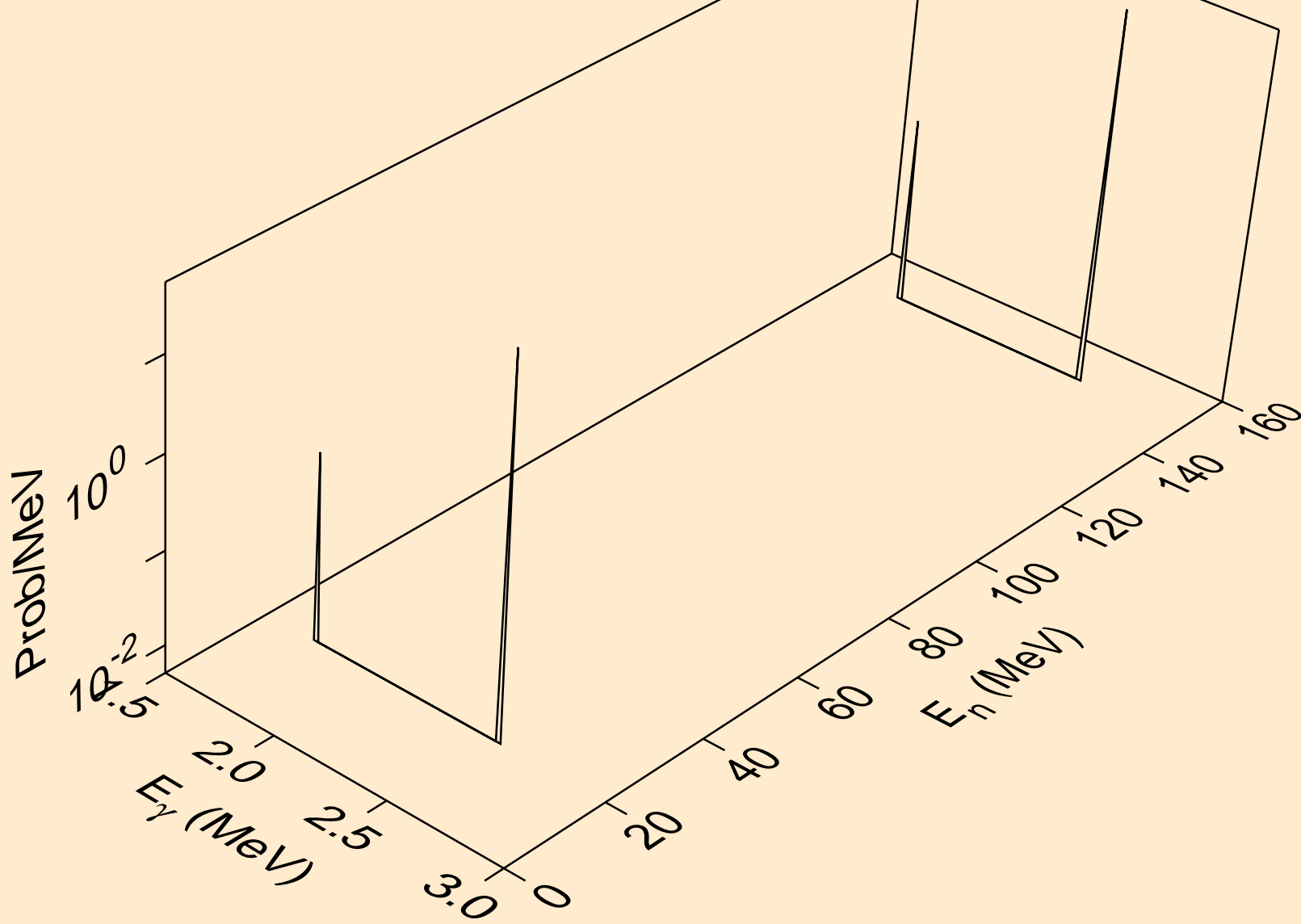

17-CL-37 FOR FENDL-3.2 FROM FENDL-3.2 BY NJOY2016.60+ OI
Photon emission for (n,n*11)

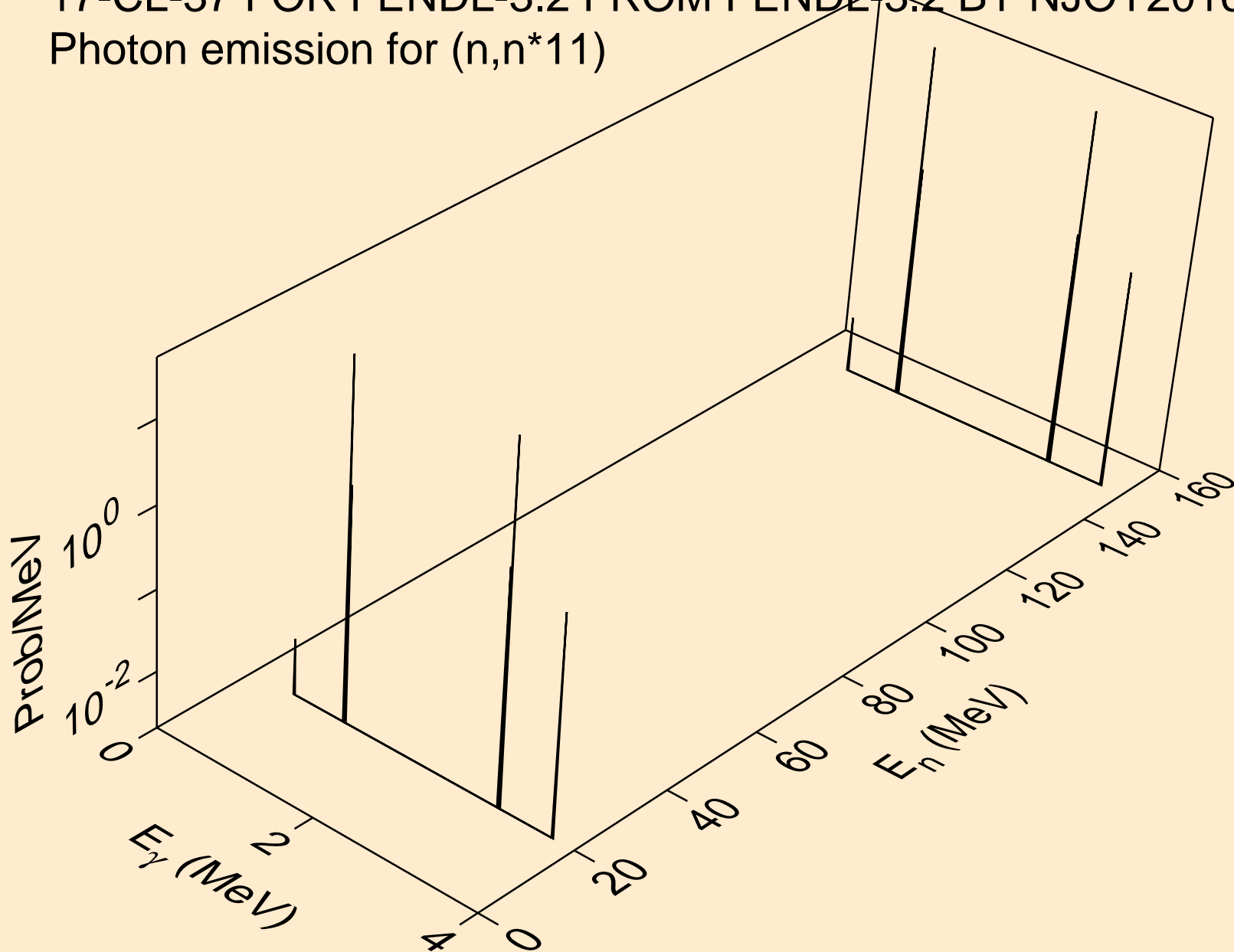

17-CL-37 FOR FENDL-3.2 FROM FENDL-3.2 BY NJOY2016.60+ OI
Photon emission for (n,n*12)

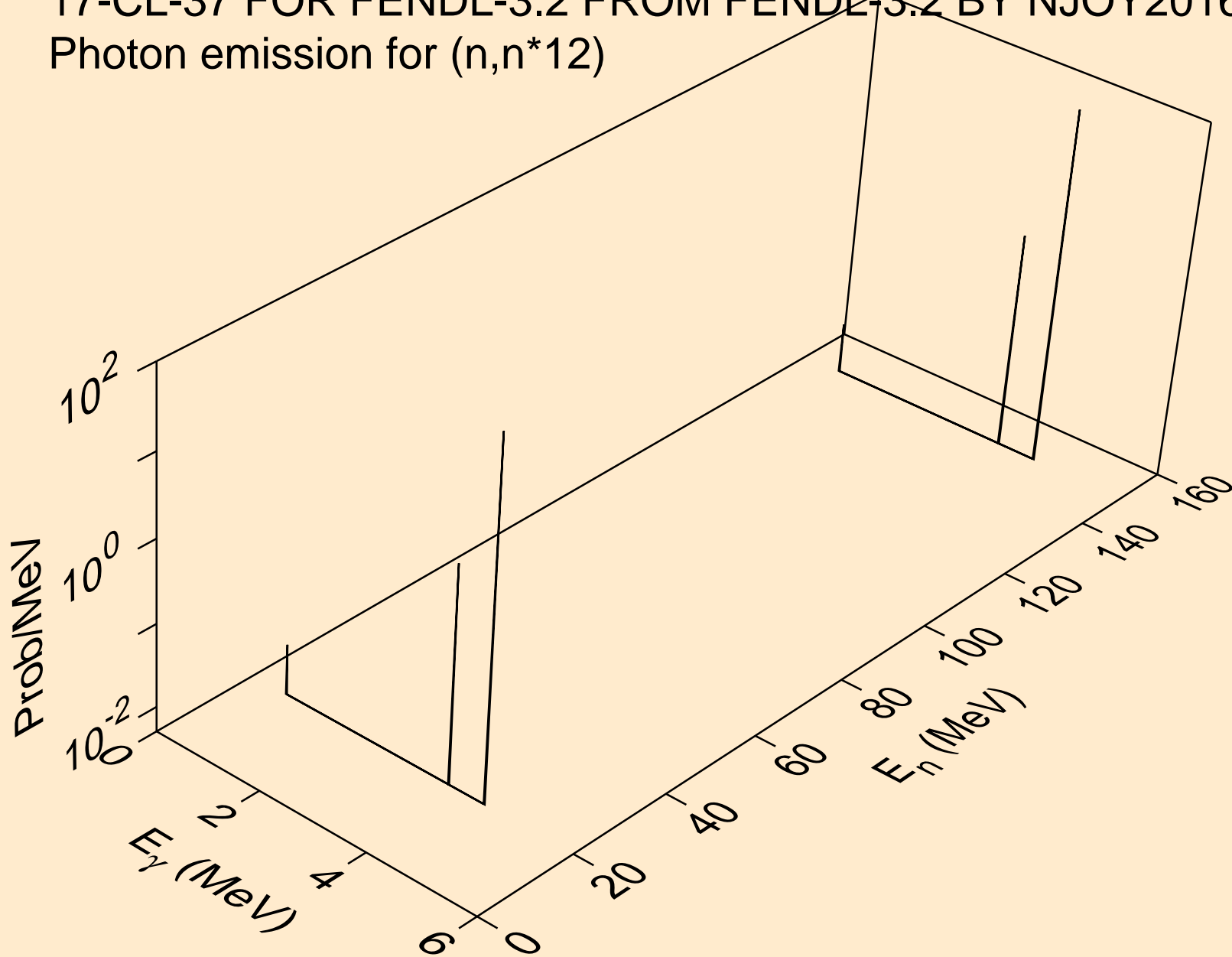

17-CL-37 FOR FENDL-3.2 FROM FENDL-3.2 BY NJOY2016.60+ OI
Photon emission for (n,n*13)

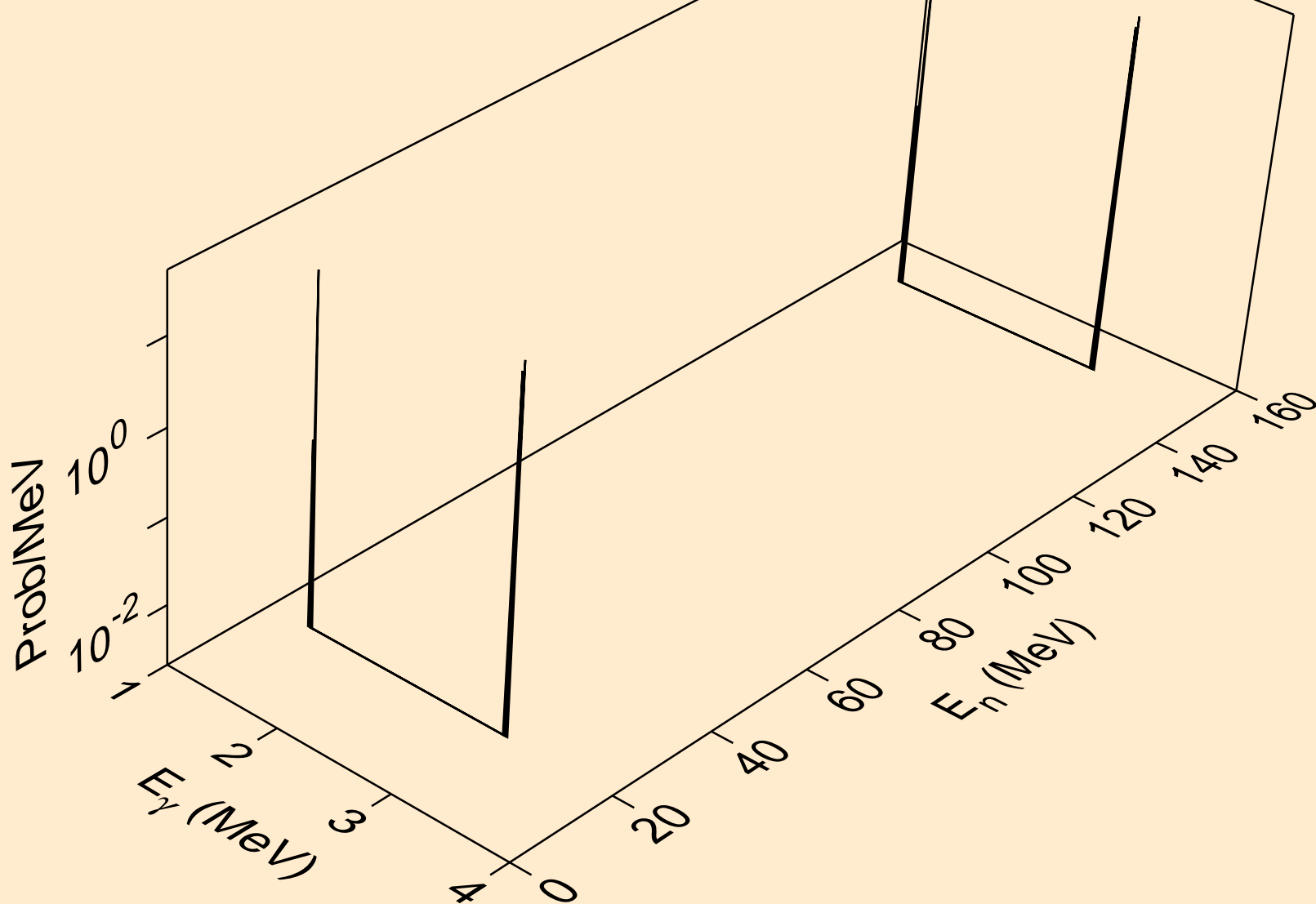

17-CL-37 FOR FENDL-3.2 FROM FENDL-3.2 BY NJOY2016.60+ OI
Photon emission for (n,n*14)

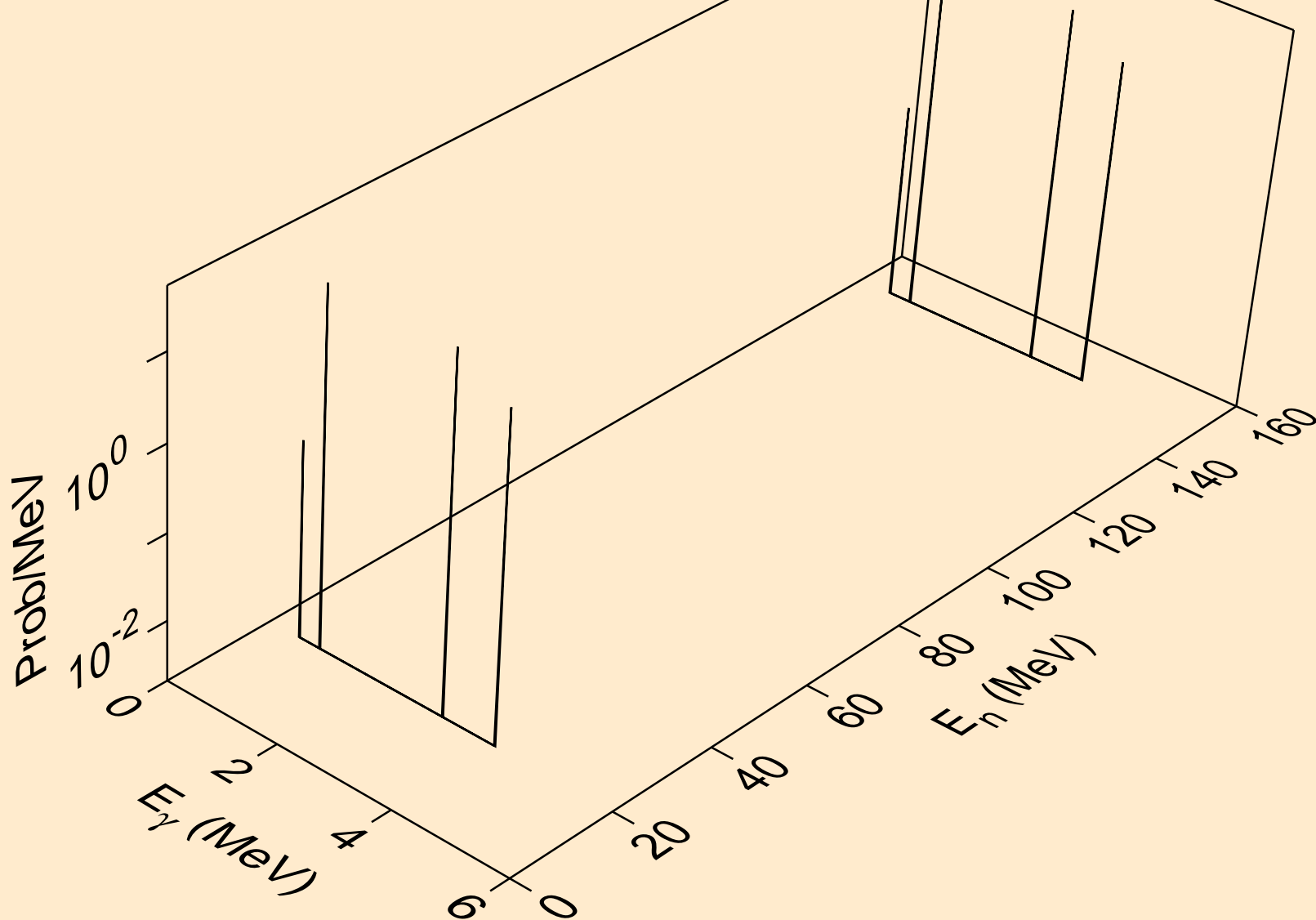

17-CL-37 FOR FENDL-3.2 FROM FENDL-3.2 BY NJOY2016.60+ OI
Photon emission for (n,n*15)

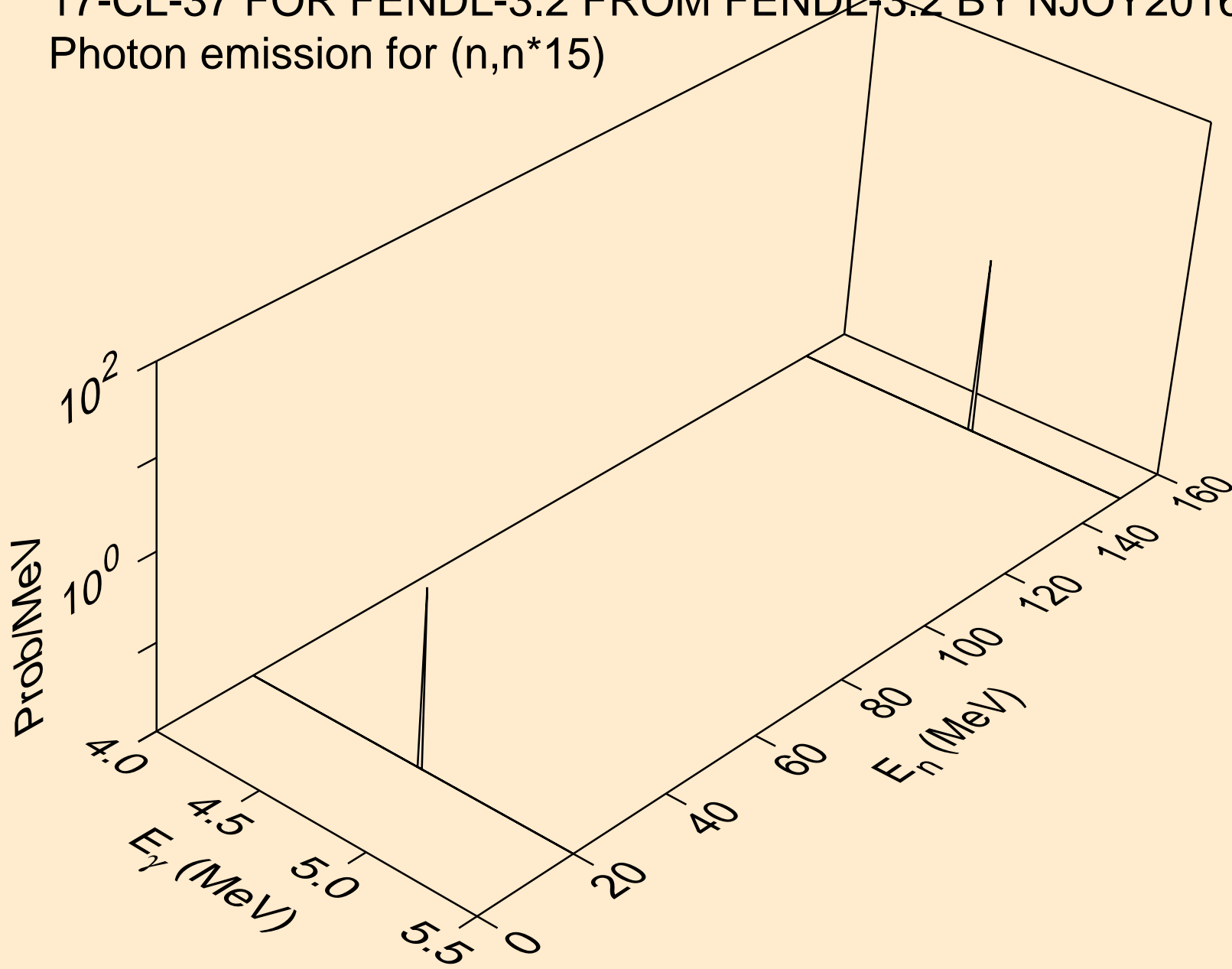

17-CL-37 FOR FENDL-3.2 FROM FENDL-3.2 BY NJOY2016.60+ OI
Photon emission for (n,n*16)

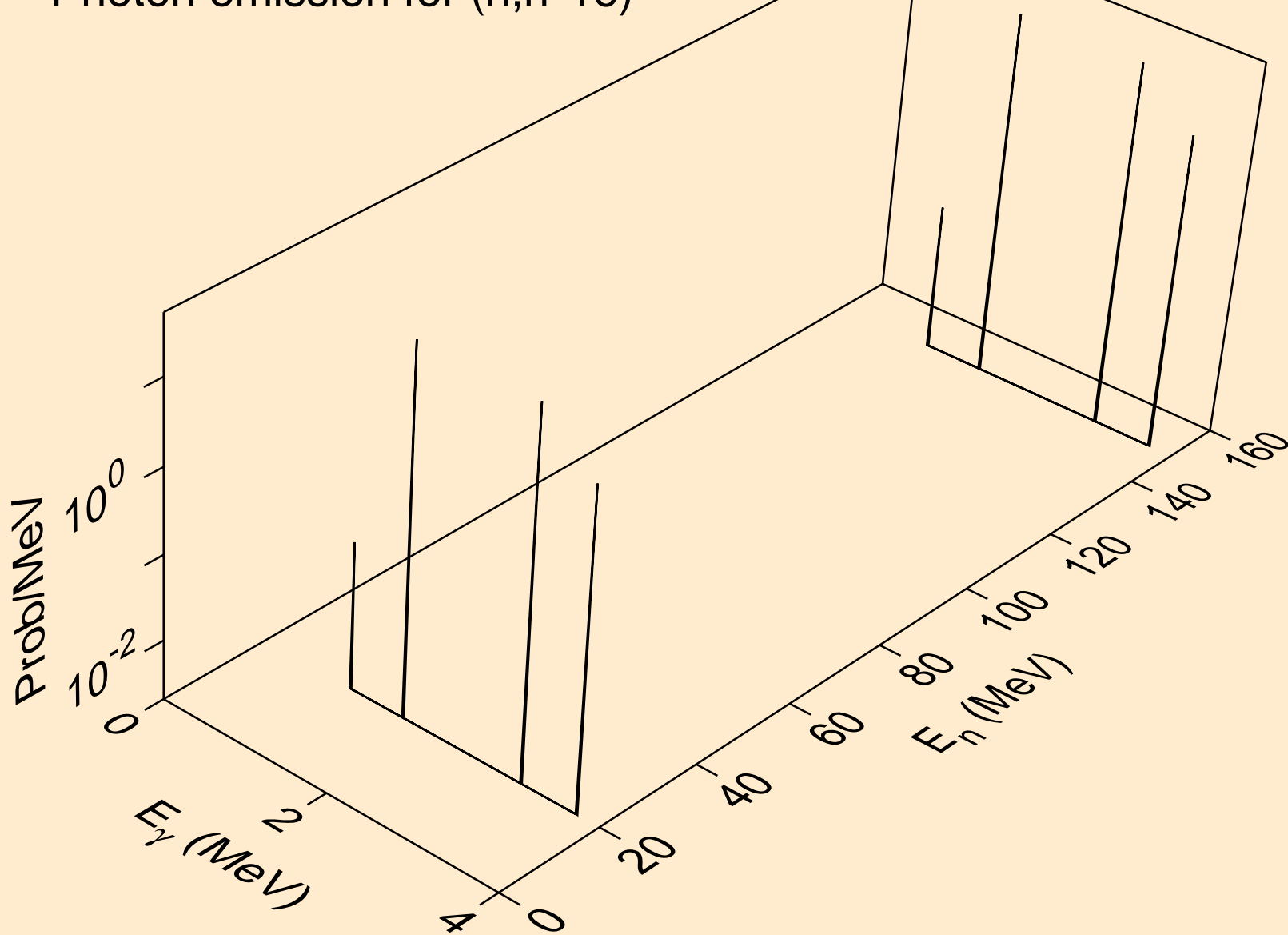

17-CL-37 FOR FENDL-3.2 FROM FENDL-3.2 BY NJOY2016.60+ OI
Photon emission for (n,n*17)

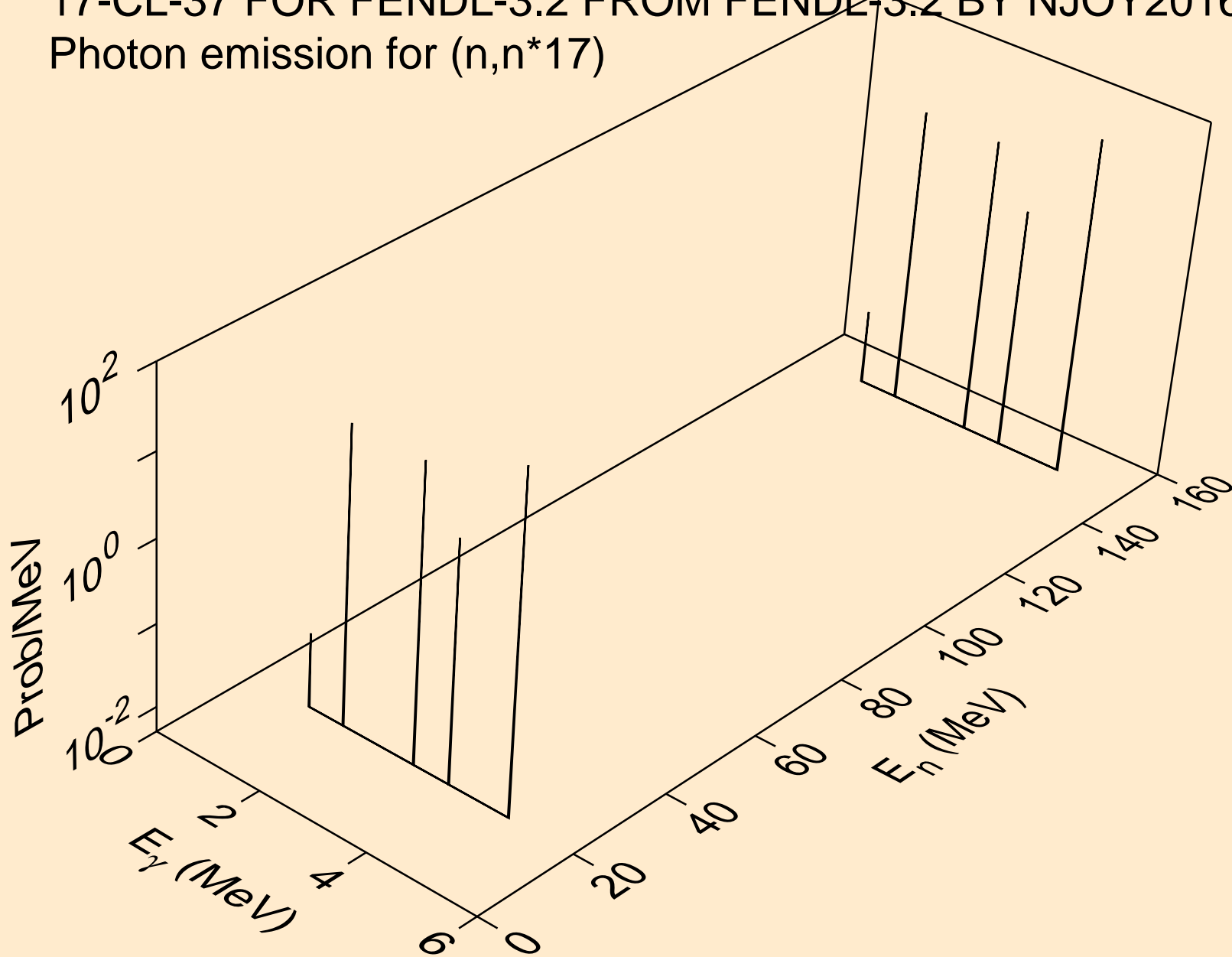

17-CL-37 FOR FENDL-3.2 FROM FENDL-3.2 BY NJOY2016.60+ OI
Photon emission for (n,n*18)

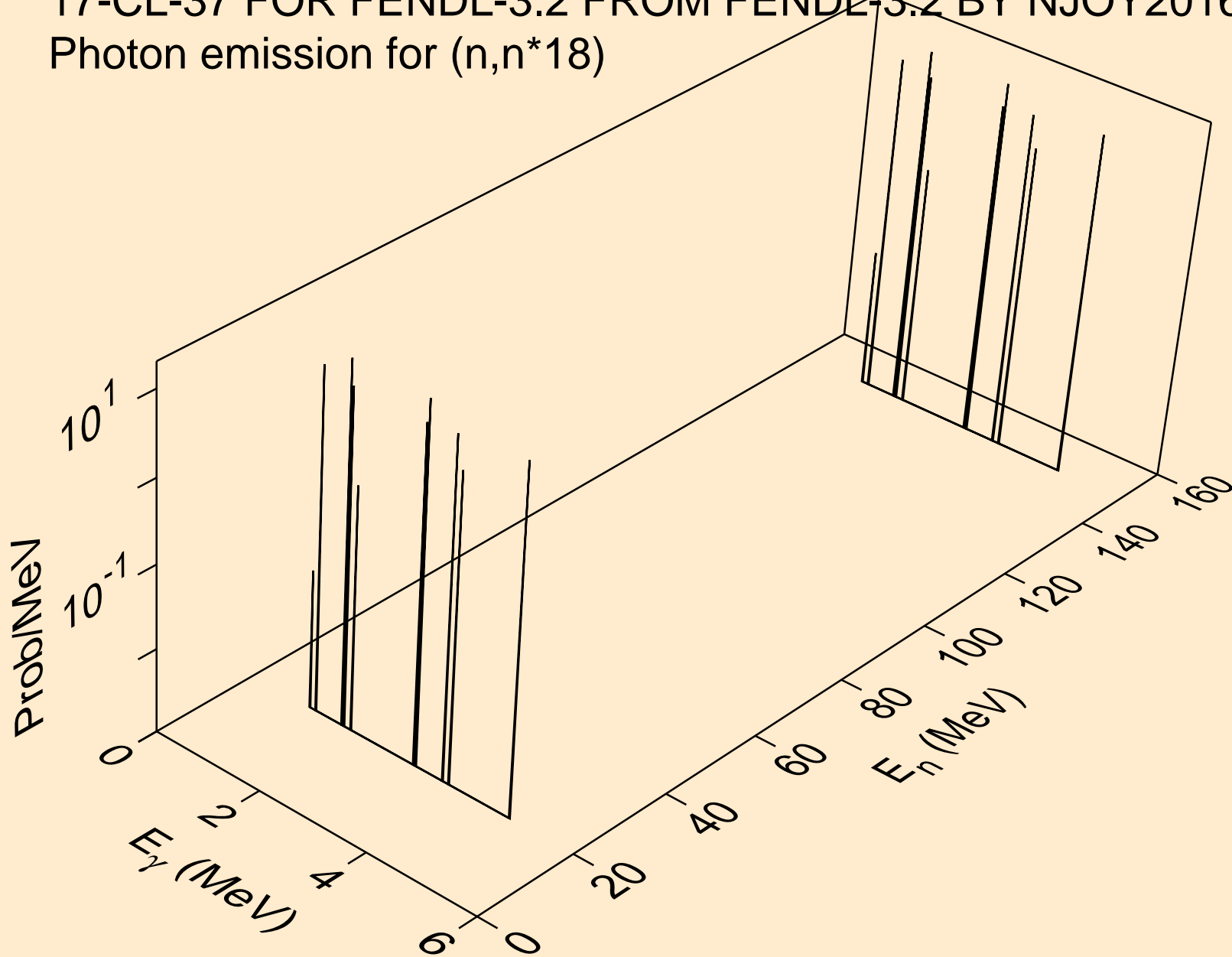

17-CL-37 FOR FENDL-3.2 FROM FENDL-3.2 BY NJOY2016.60+ OI
Photon emission for (n,n*19)

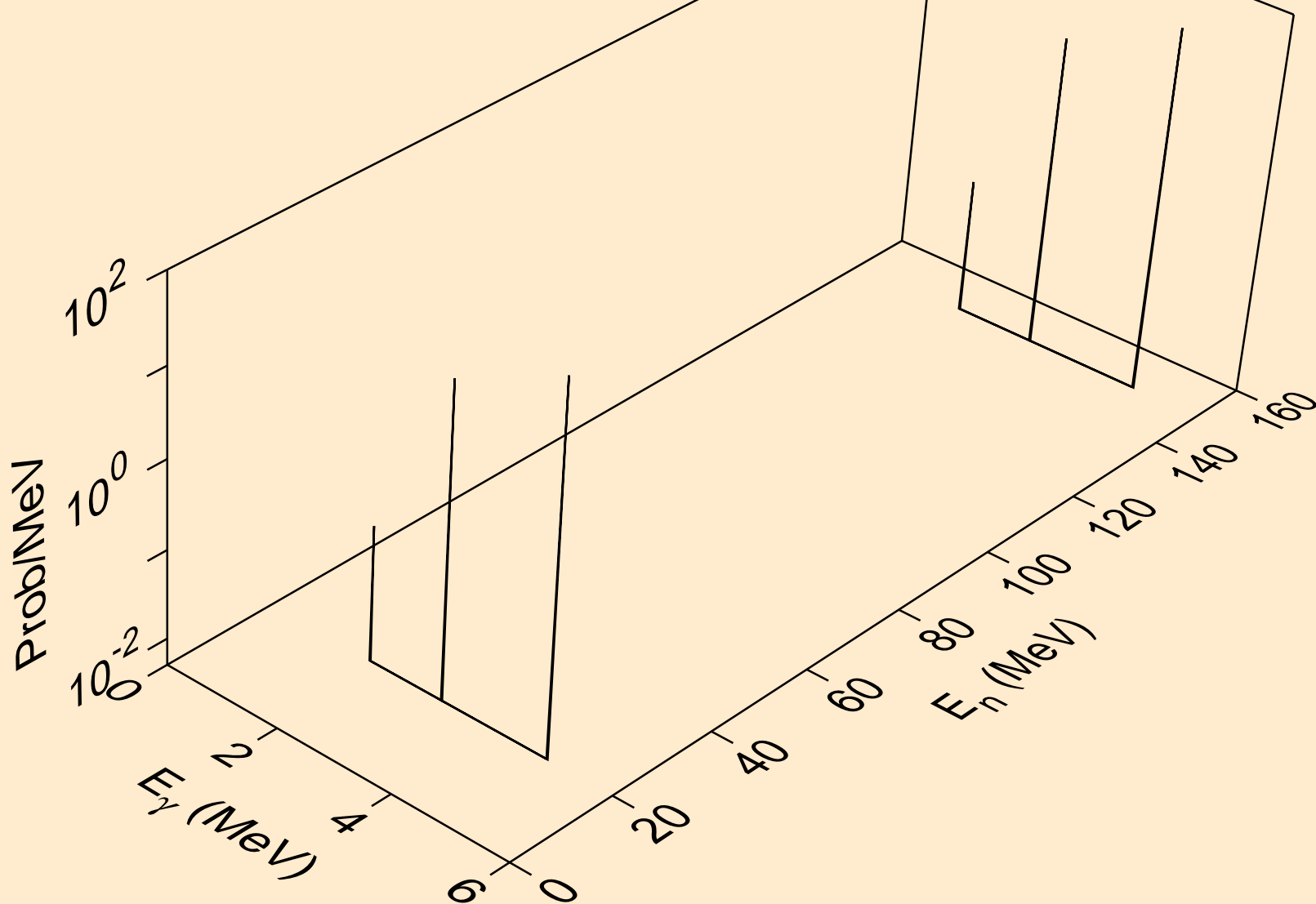

17-CL-37 FOR FENDL-3.2 FROM FENDL-3.2 BY NJOY2016.60+ OI
Photon emission for (n,n*20)

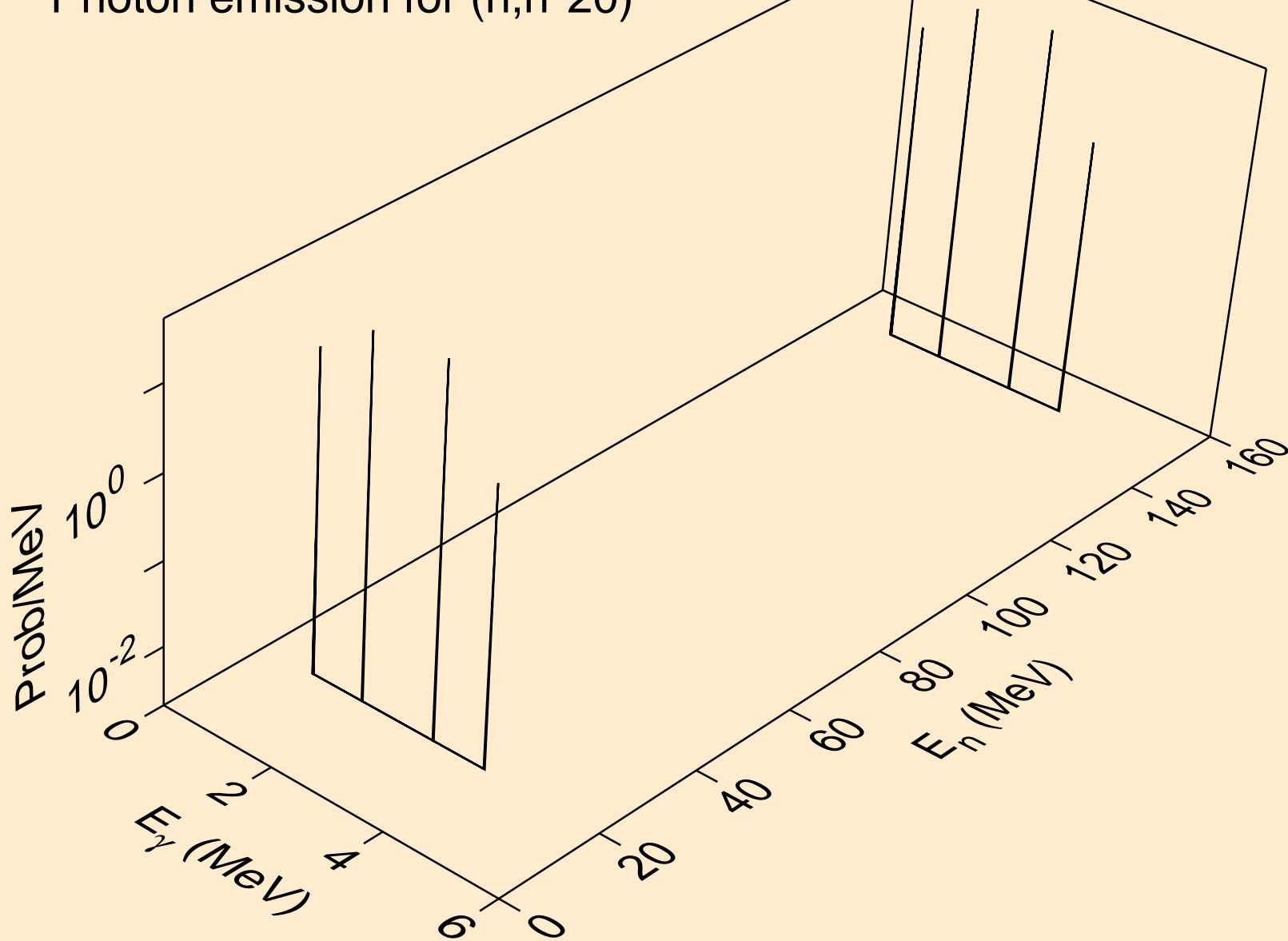

17-CL-37 FOR FENDL-3.2 FROM FENDL-3.2 BY NJOY2016.60+ OI
Photon emission for (n,n*21)

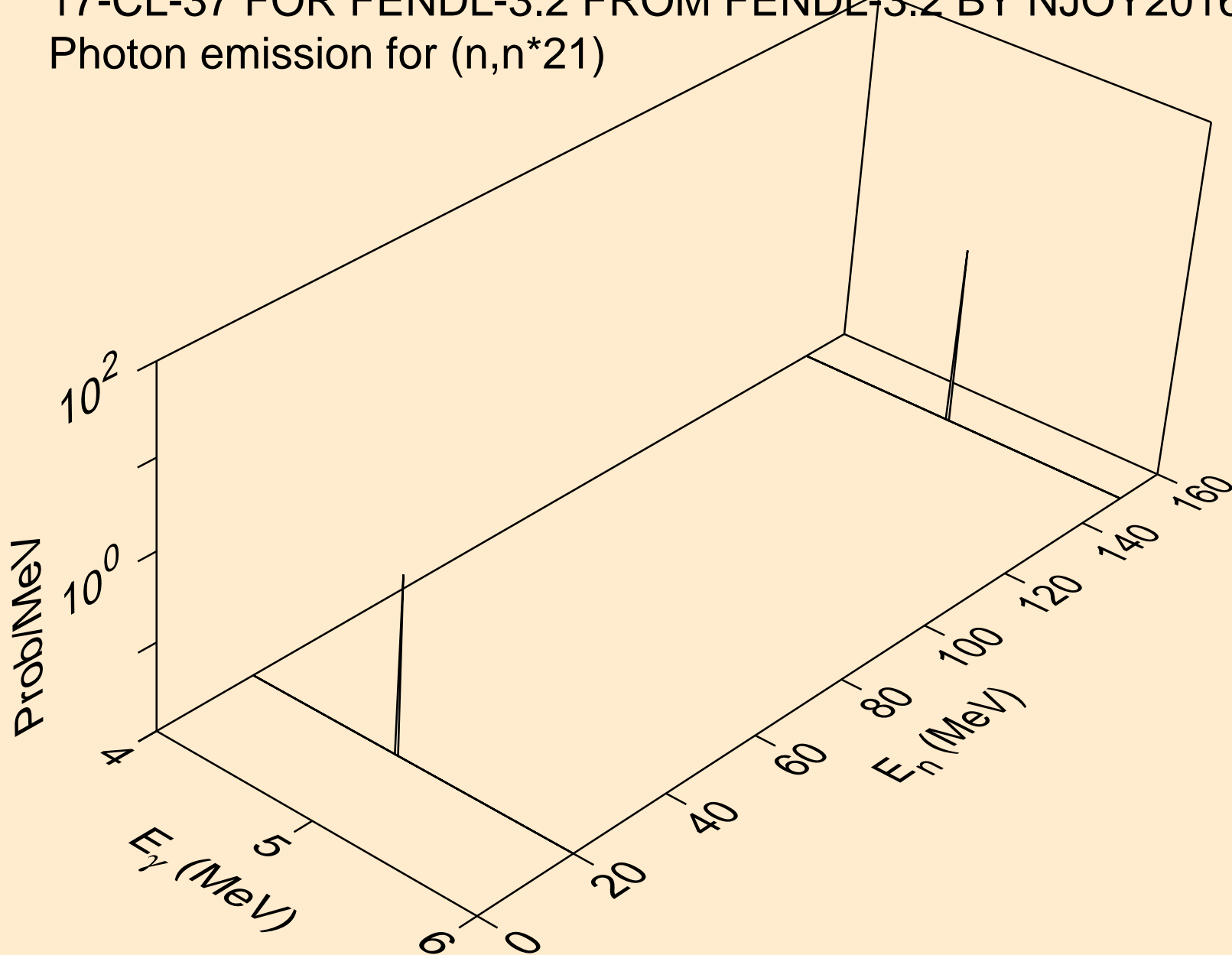

17-CL-37 FOR FENDL-3.2 FROM FENDL-3.2 BY NJOY2016.60+ OI
Photon emission for (n,n*22)

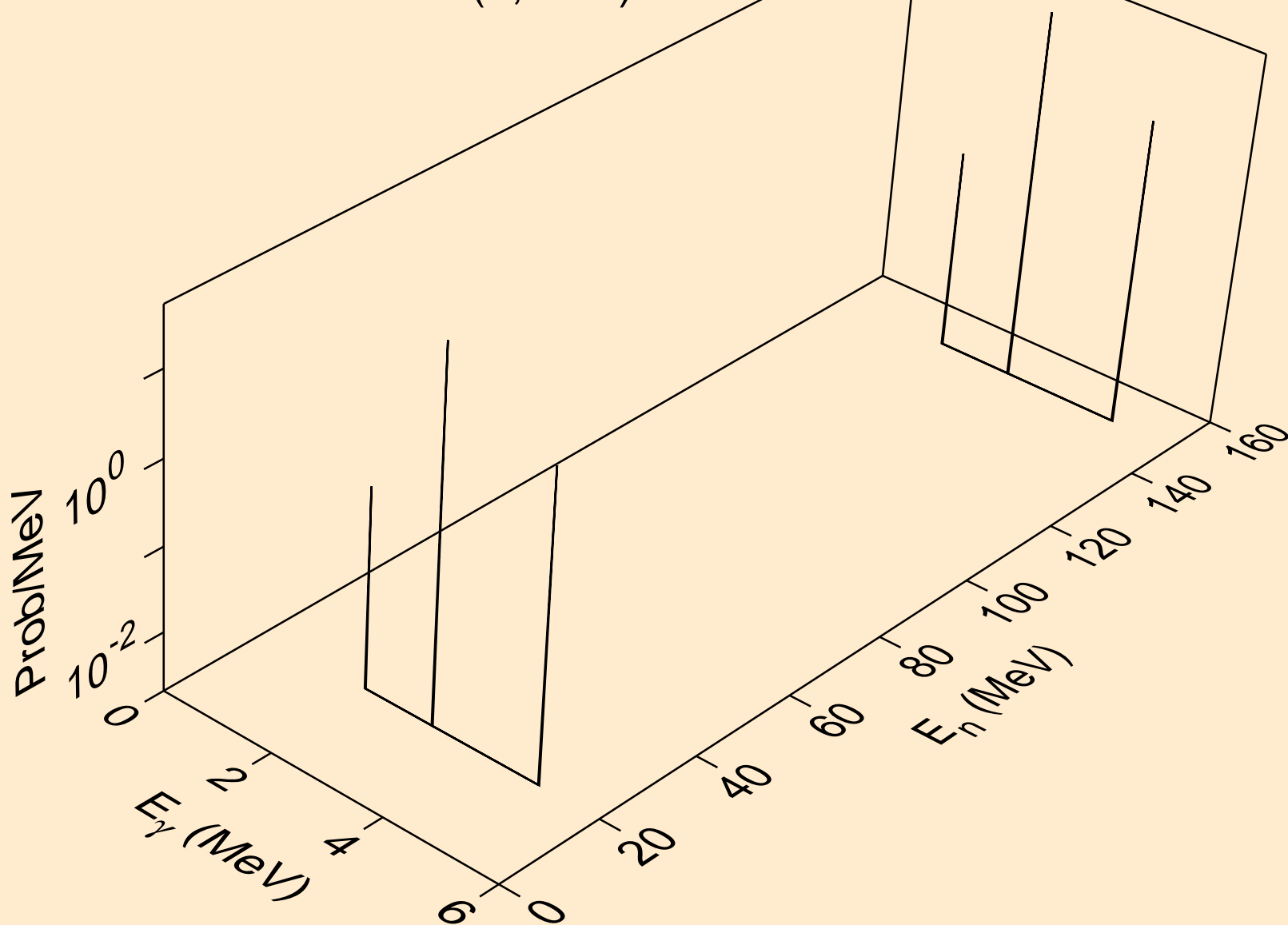

17-CL-37 FOR FENDL-3.2 FROM FENDL-3.2 BY NJOY2016.60+ OI
Photon emission for (n,n*23)

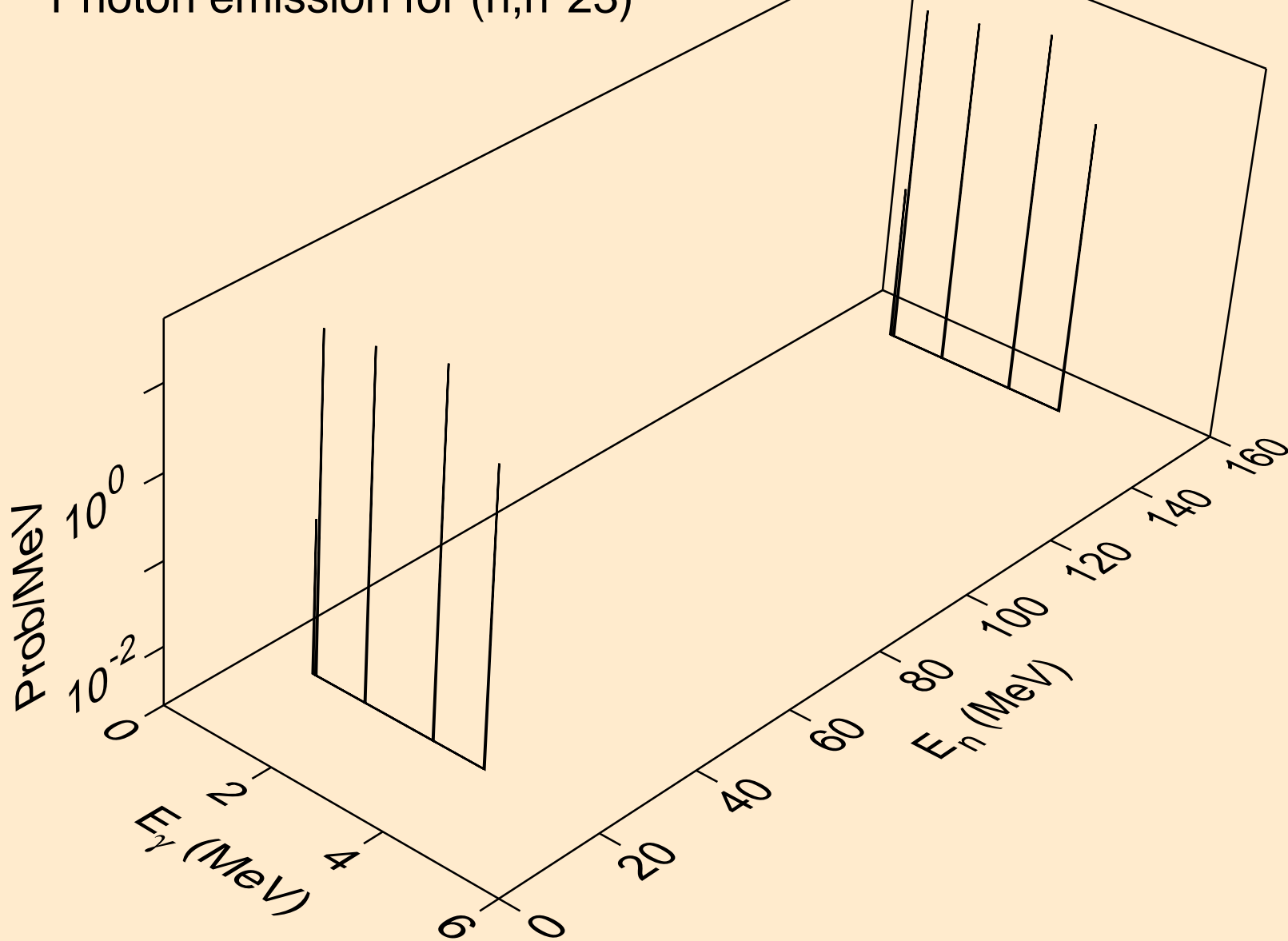

17-CL-37 FOR FENDL-3.2 FROM FENDL-3.2 BY NJOY2016.60+ OI
Photon emission for (n,n*24)

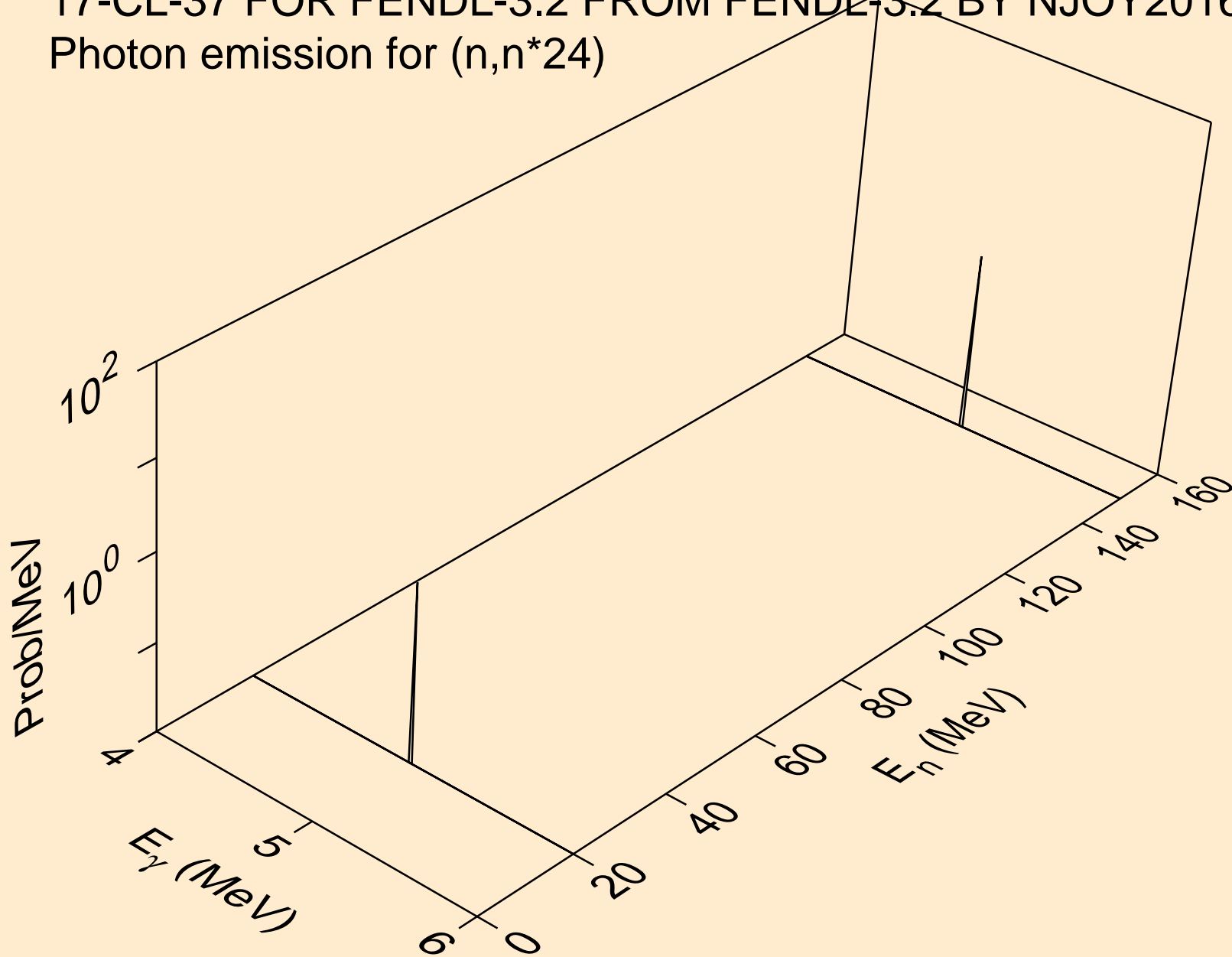

17-CL-37 FOR FENDL-3.2 FROM FENDL-3.2 BY NJOY2016.60+ OI
Photon emission for (n,n*25)

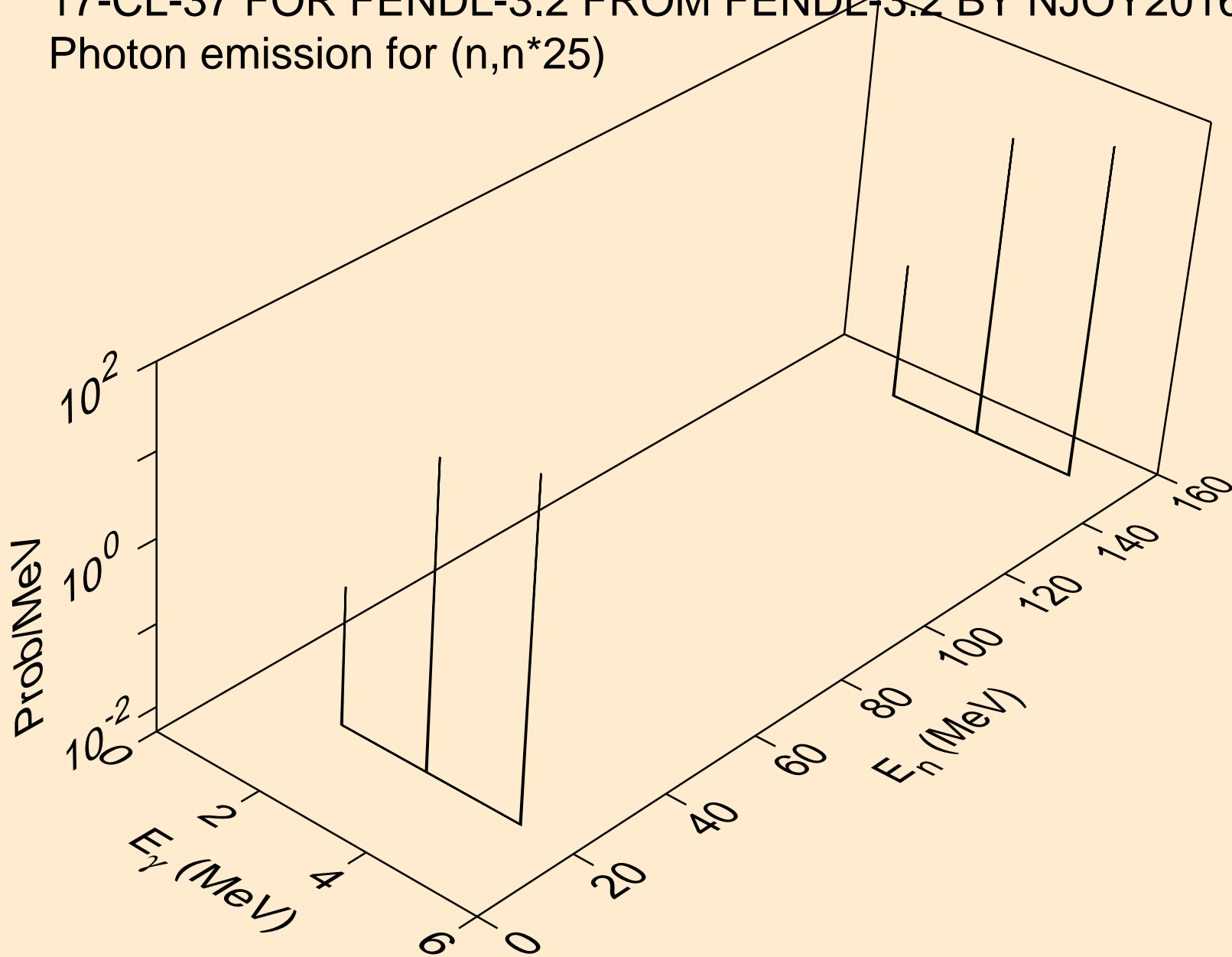

17-CL-37 FOR FENDL-3.2 FROM FENDL-3.2 BY NJOY2016.60+ OI
Photon emission for (n,n*26)

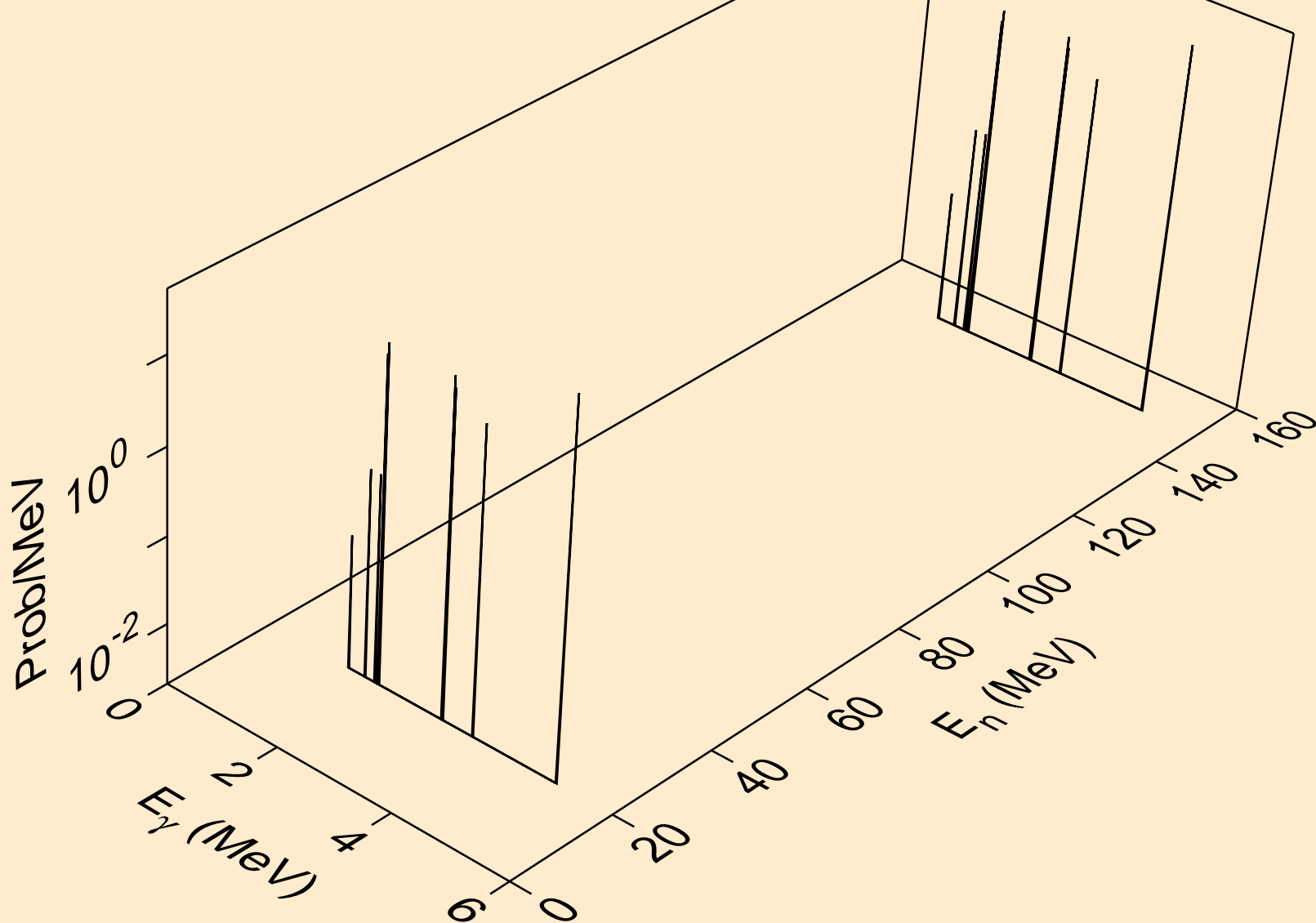

17-CL-37 FOR FENDL-3.2 FROM FENDL-3.2 BY NJOY2016.60+ OI
Photon emission for (n,n*27)

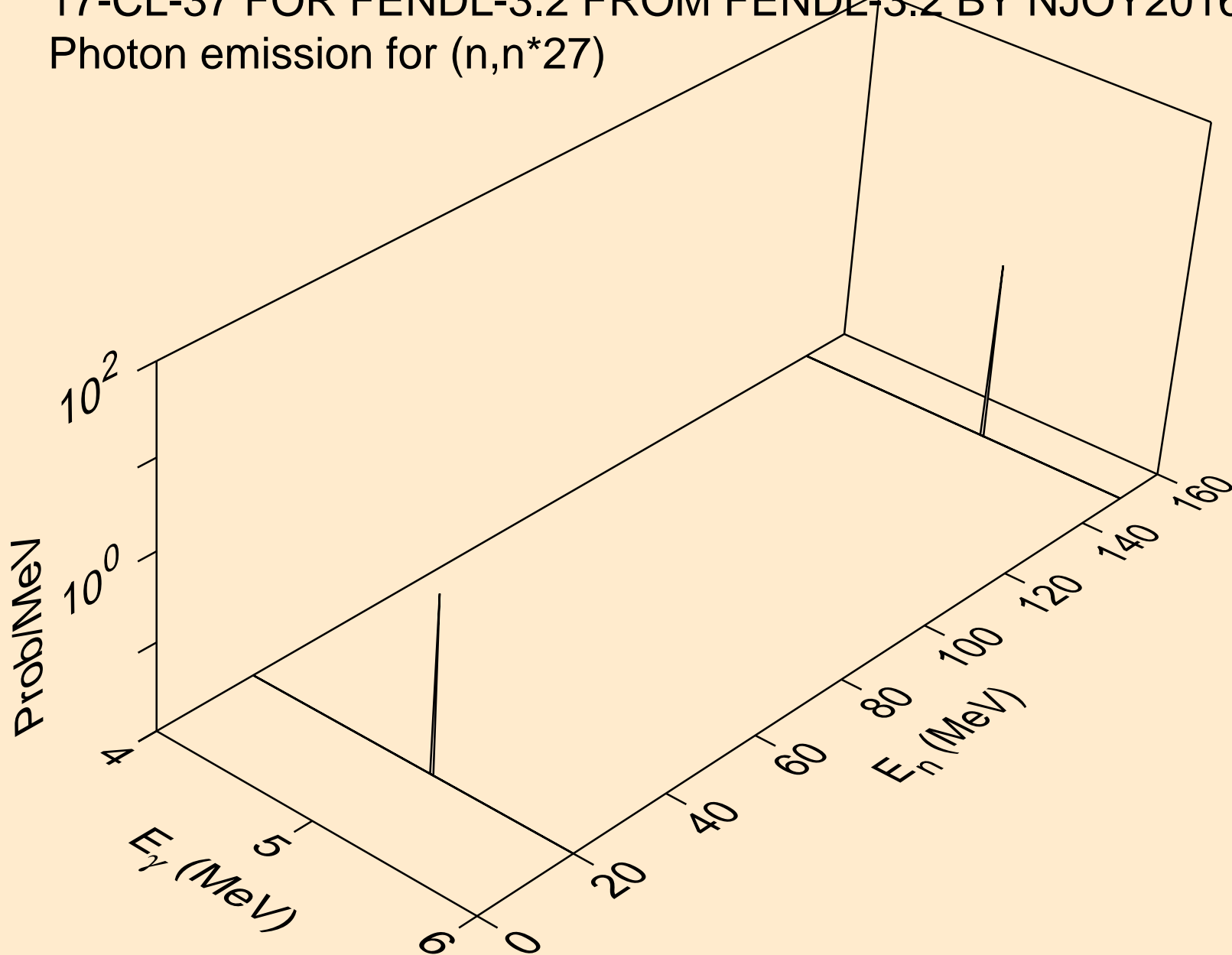

17-CL-37 FOR FENDL-3.2 FROM FENDL-3.2 BY NJOY2016.60+ OI
Photon emission for (n,n*c)

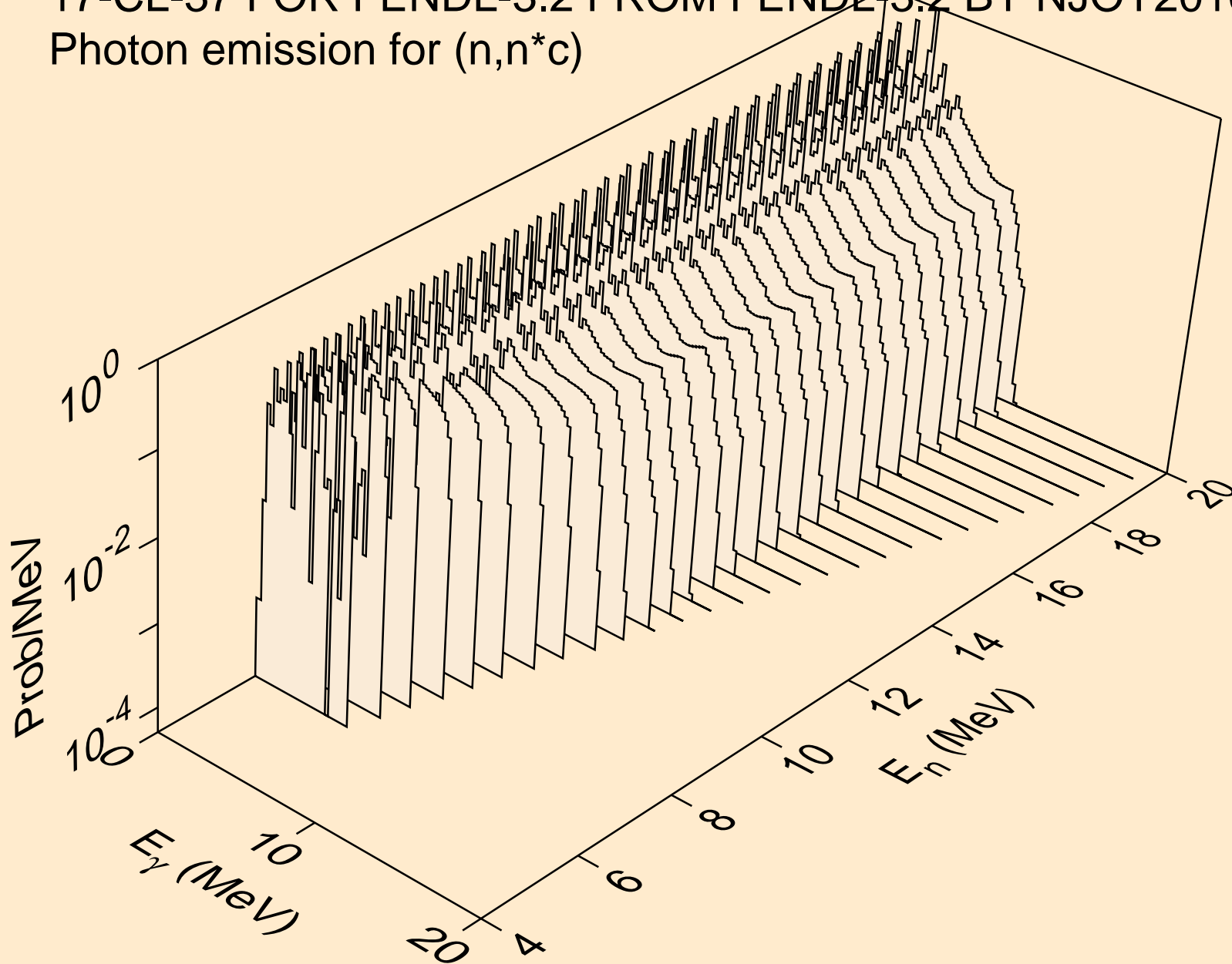

17-CL-37 FOR FENDL-3.2 FROM FENDL-3.2 BY NJOY2016.60+ OI
Photon emission for (n,p*c)

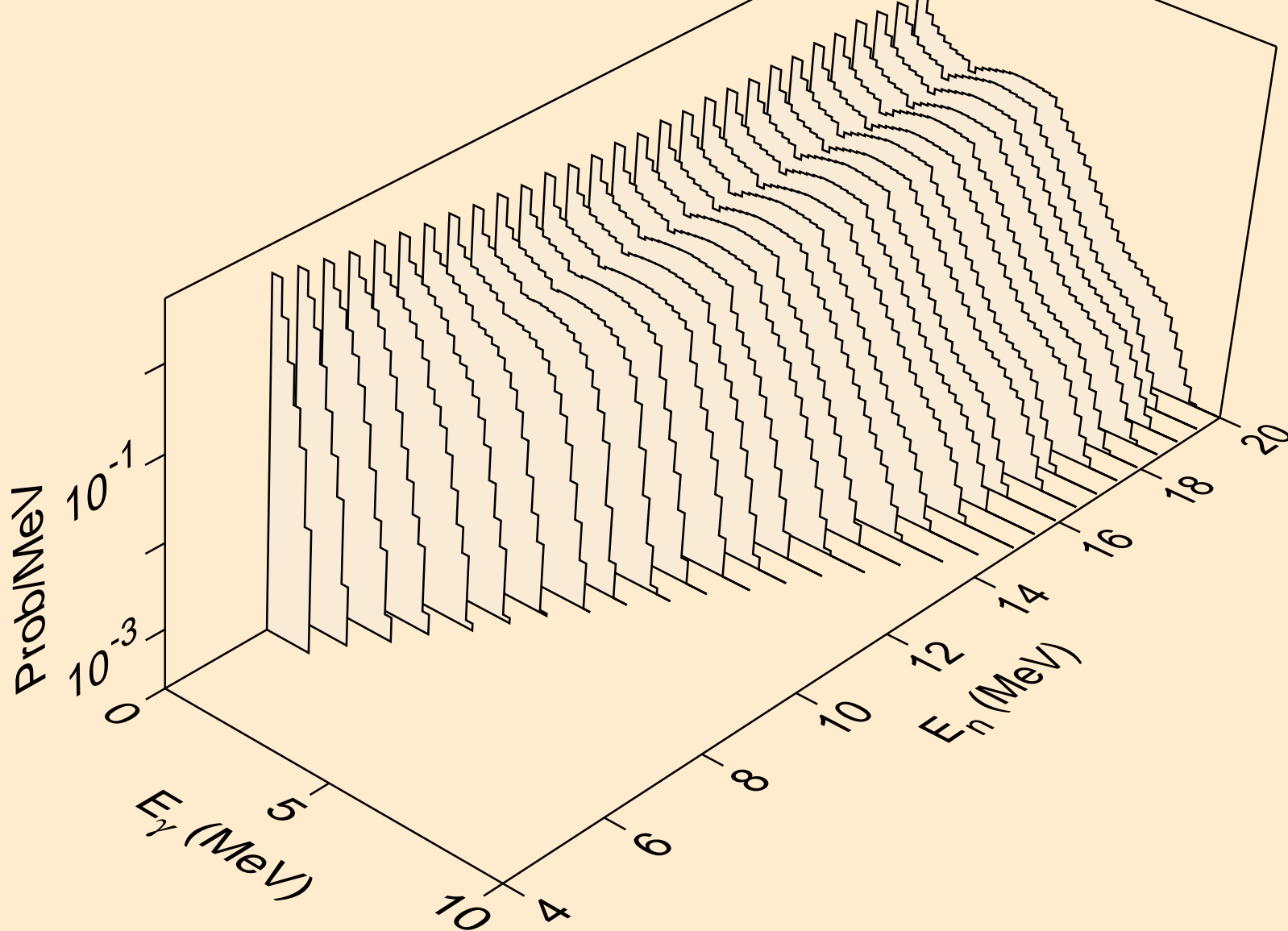

17-CL-37 FOR FENDL-3.2 FROM FENDL-3.2 BY NJOY2016.60+ OI
Photon emission for (n,d*1)

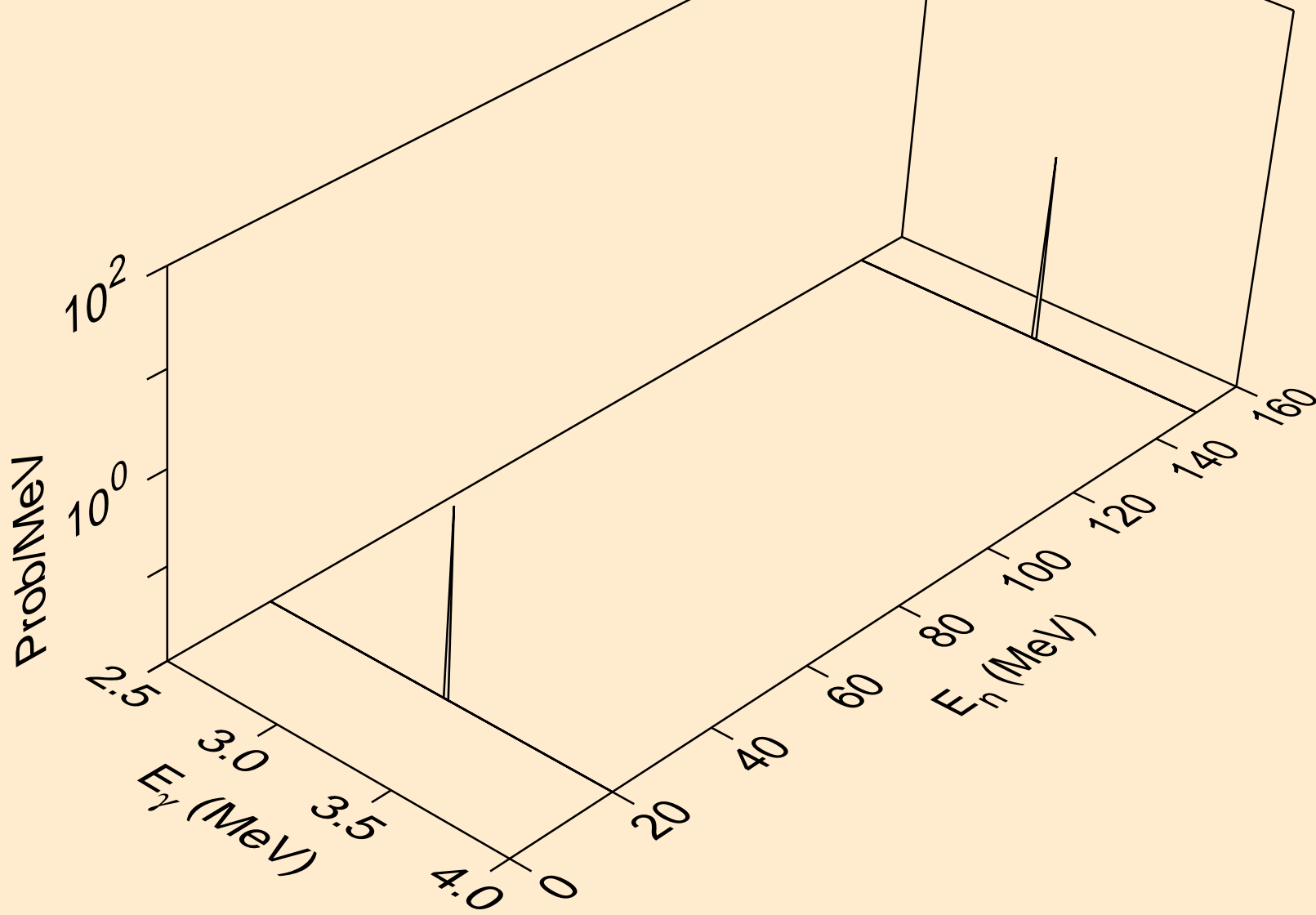

17-CL-37 FOR FENDL-3.2 FROM FENDL-3.2 BY NJOY2016.60+ OI
Photon emission for (n,d*2)

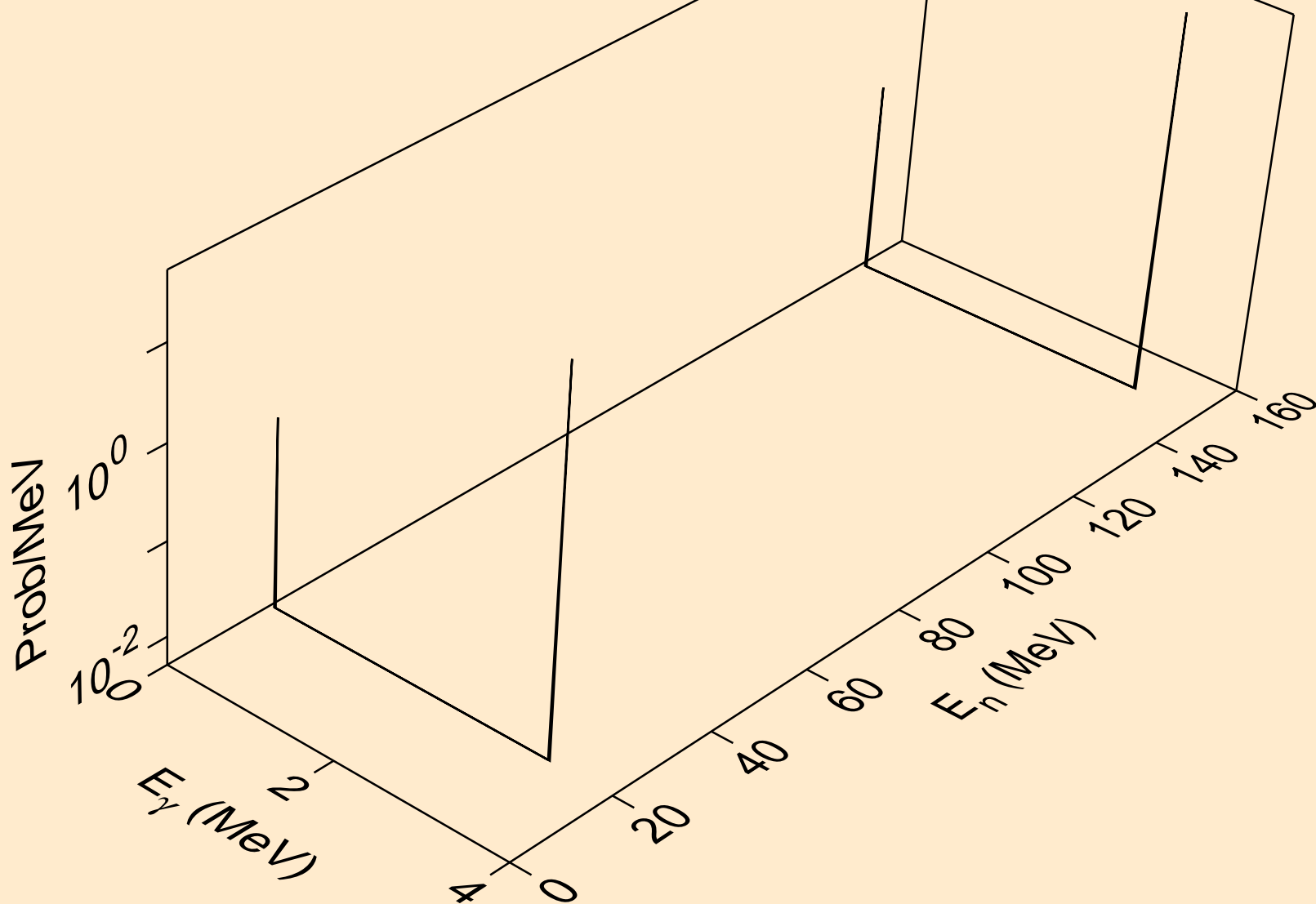

17-CL-37 FOR FENDL-3.2 FROM FENDL-3.2 BY NJOY2016.60+ OI
Photon emission for (n,d*3)

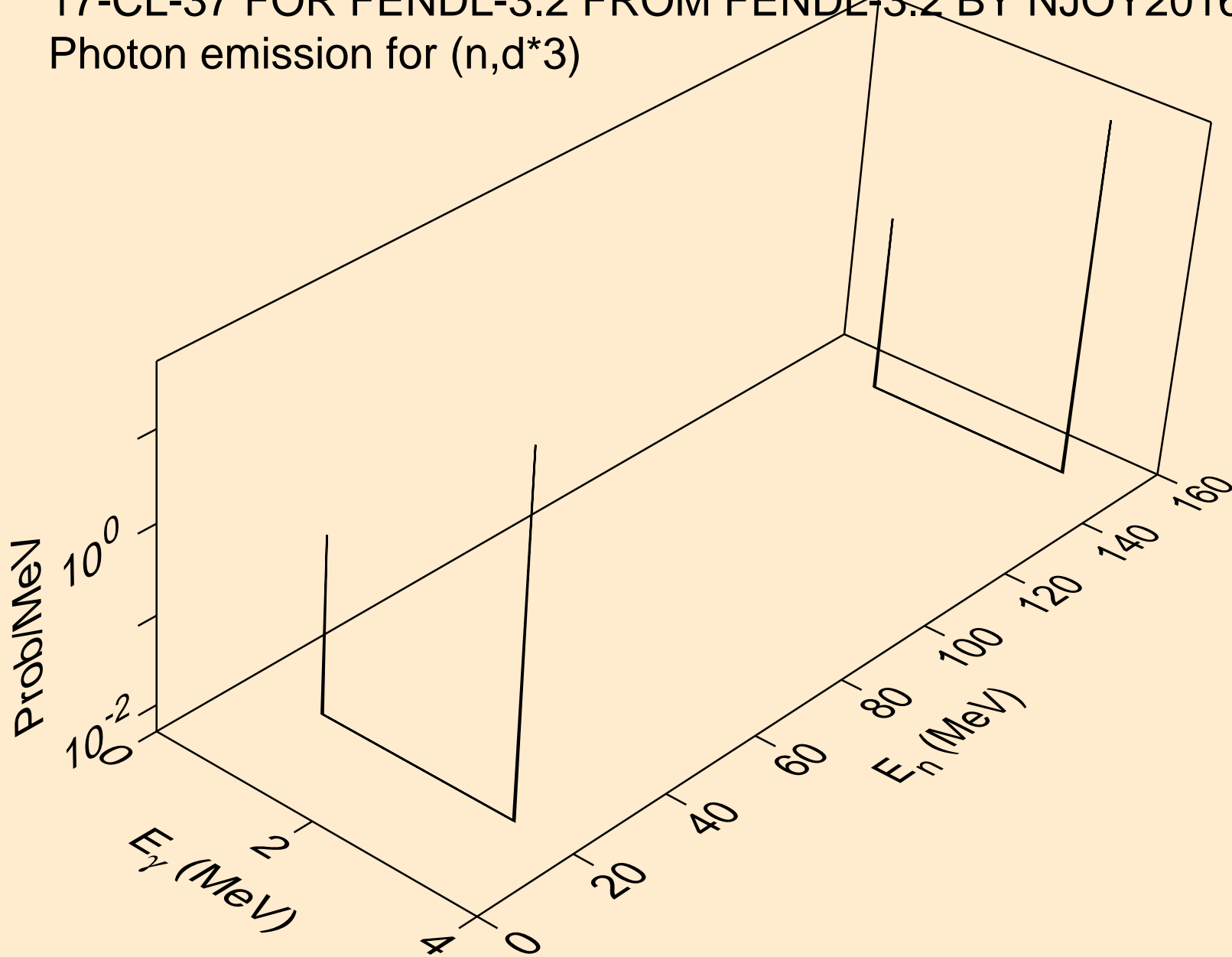

17-CL-37 FOR FENDL-3.2 FROM FENDL-3.2 BY NJOY2016.60+ OI
Photon emission for (n,d*4)

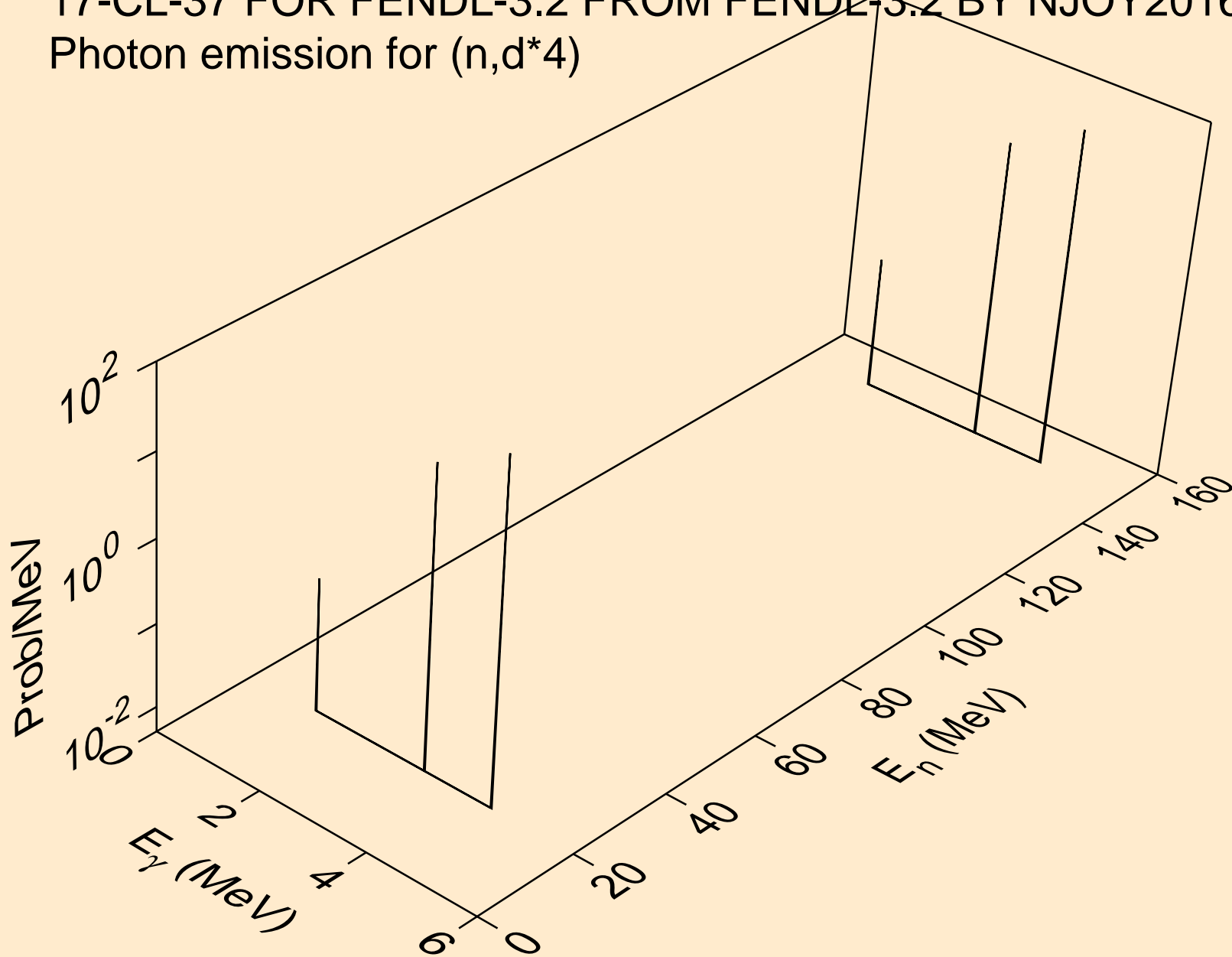

17-CL-37 FOR FENDL-3.2 FROM FENDL-3.2 BY NJOY2016.60+ OI
Photon emission for (n,d*5)

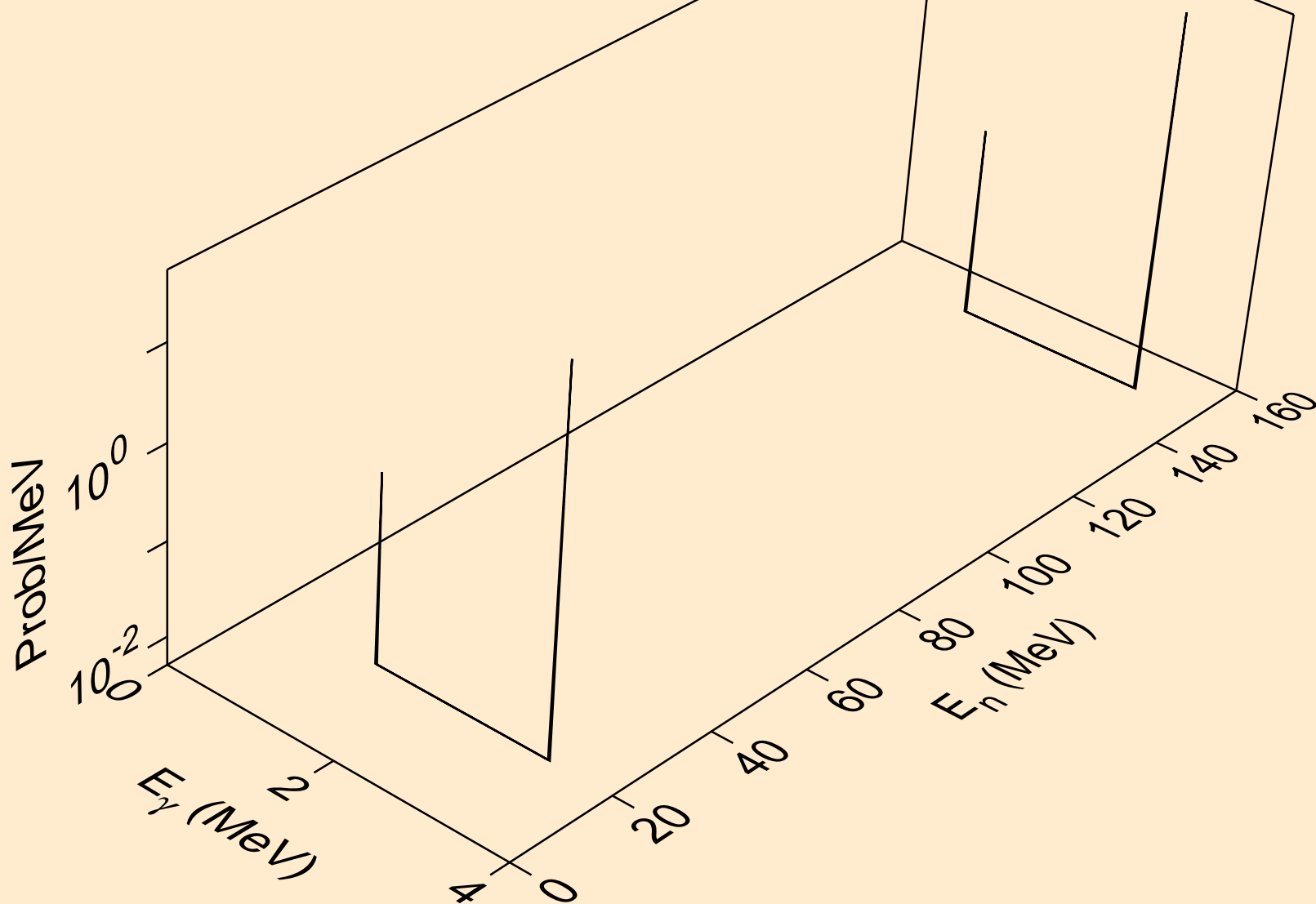

17-CL-37 FOR FENDL-3.2 FROM FENDL-3.2 BY NJOY2016.60+ OI
Photon emission for (n,d*6)

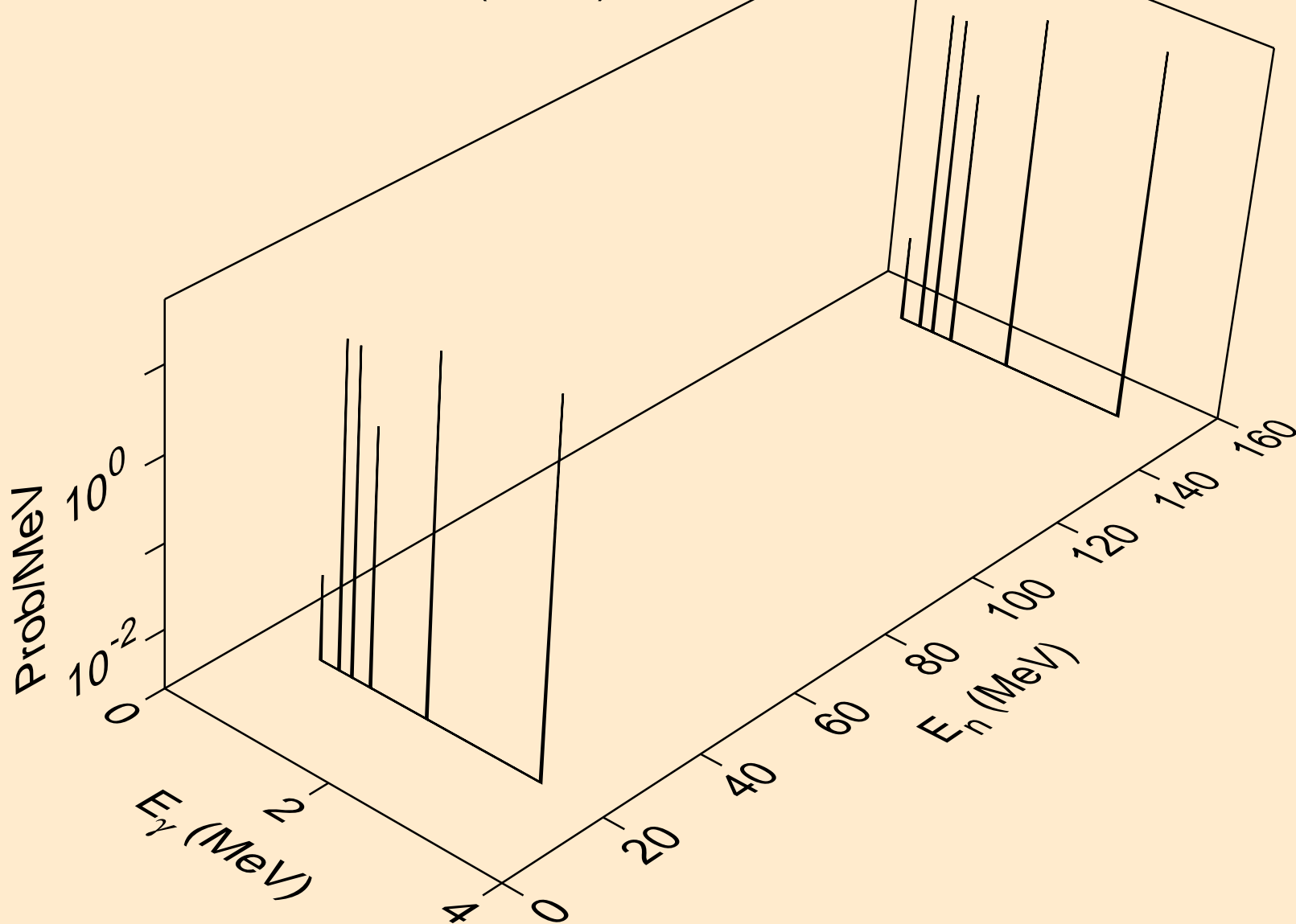

17-CL-37 FOR FENDL-3.2 FROM FENDL-3.2 BY NJOY2016.60+ OI
Photon emission for (n,d*7)

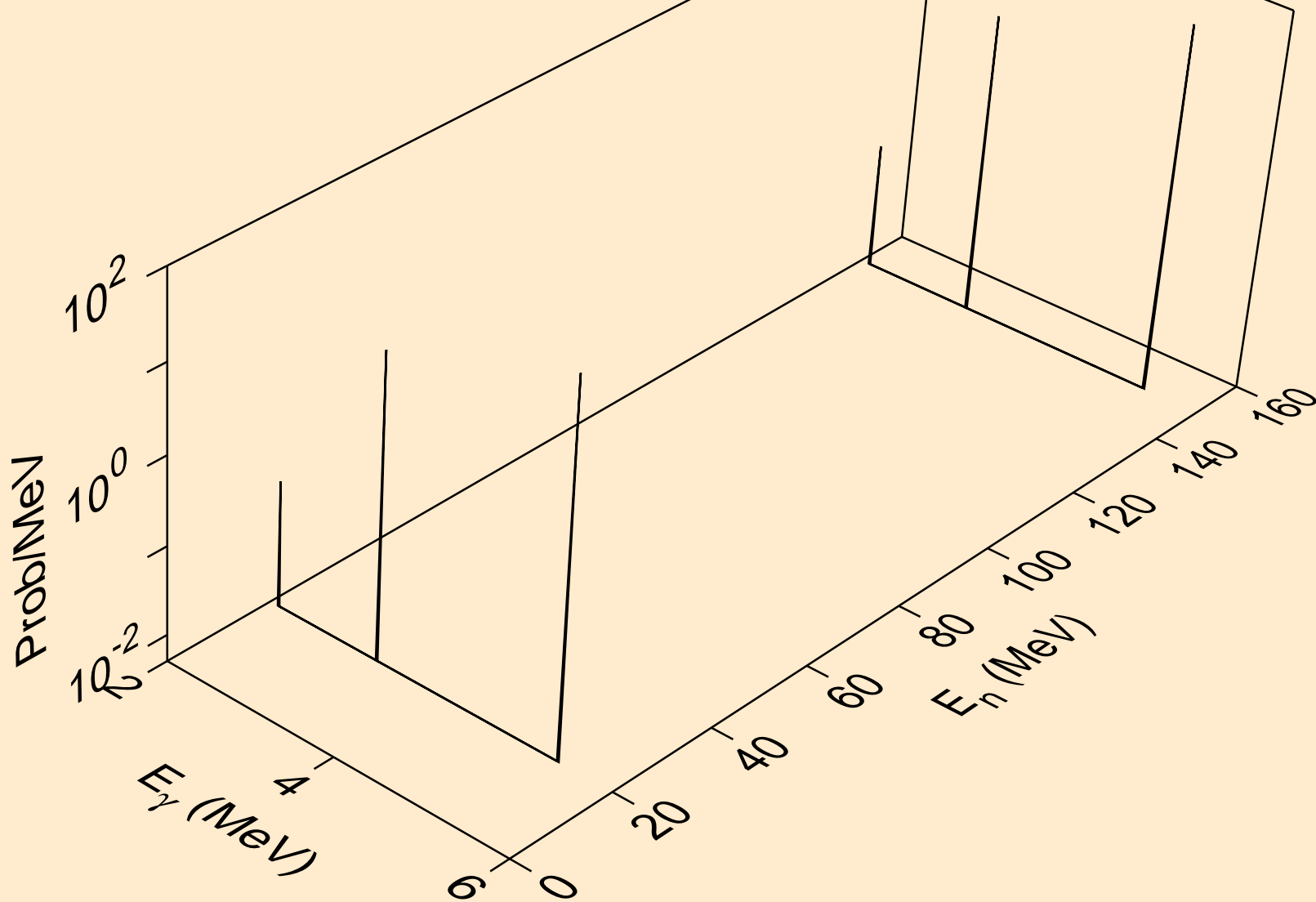

17-CL-37 FOR FENDL-3.2 FROM FENDL-3.2 BY NJOY2016.60+ OI
Photon emission for (n,d*8)

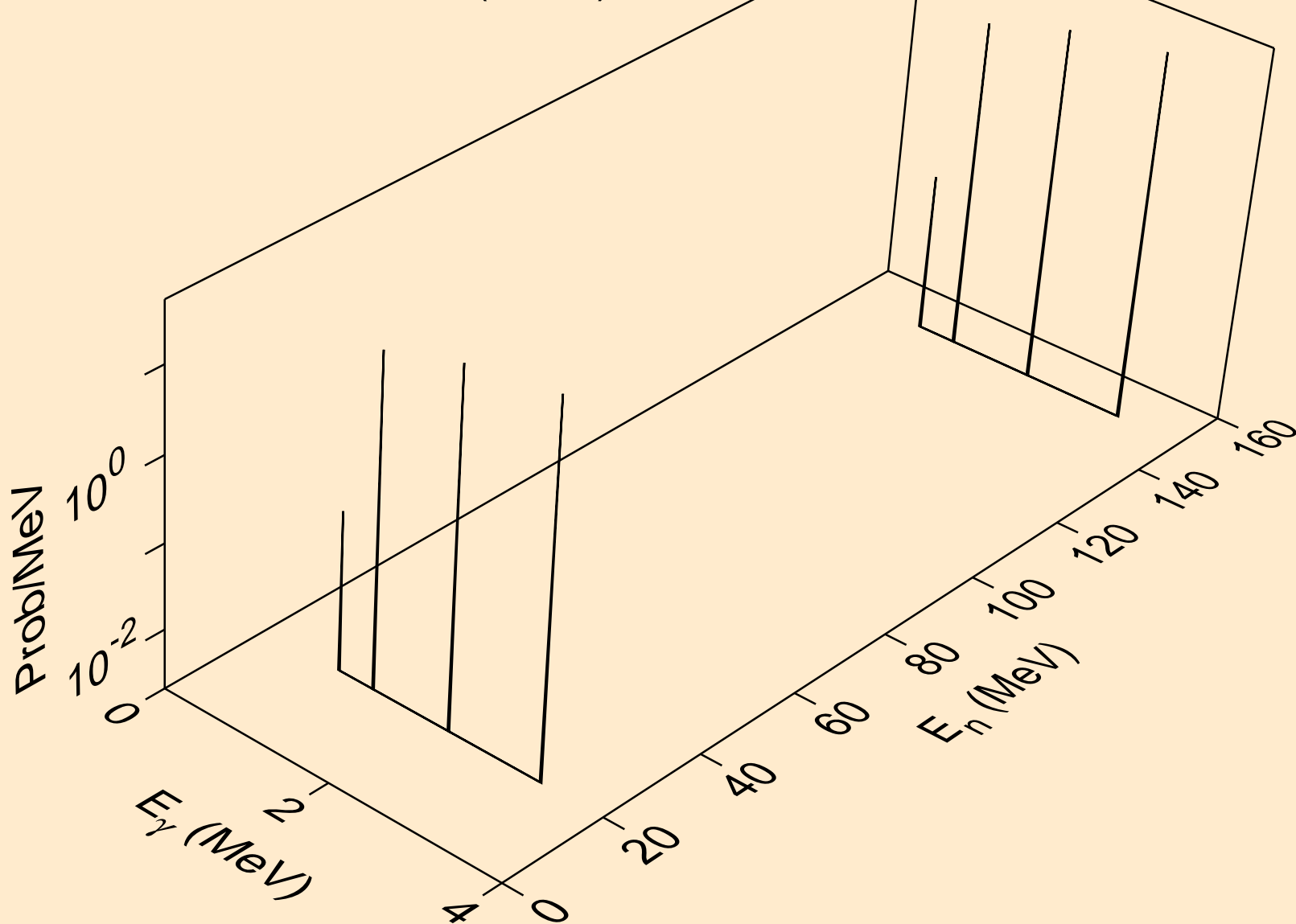

17-CL-37 FOR FENDL-3.2 FROM FENDL-3.2 BY NJOY2016.60+ OI
Photon emission for (n,d*9)

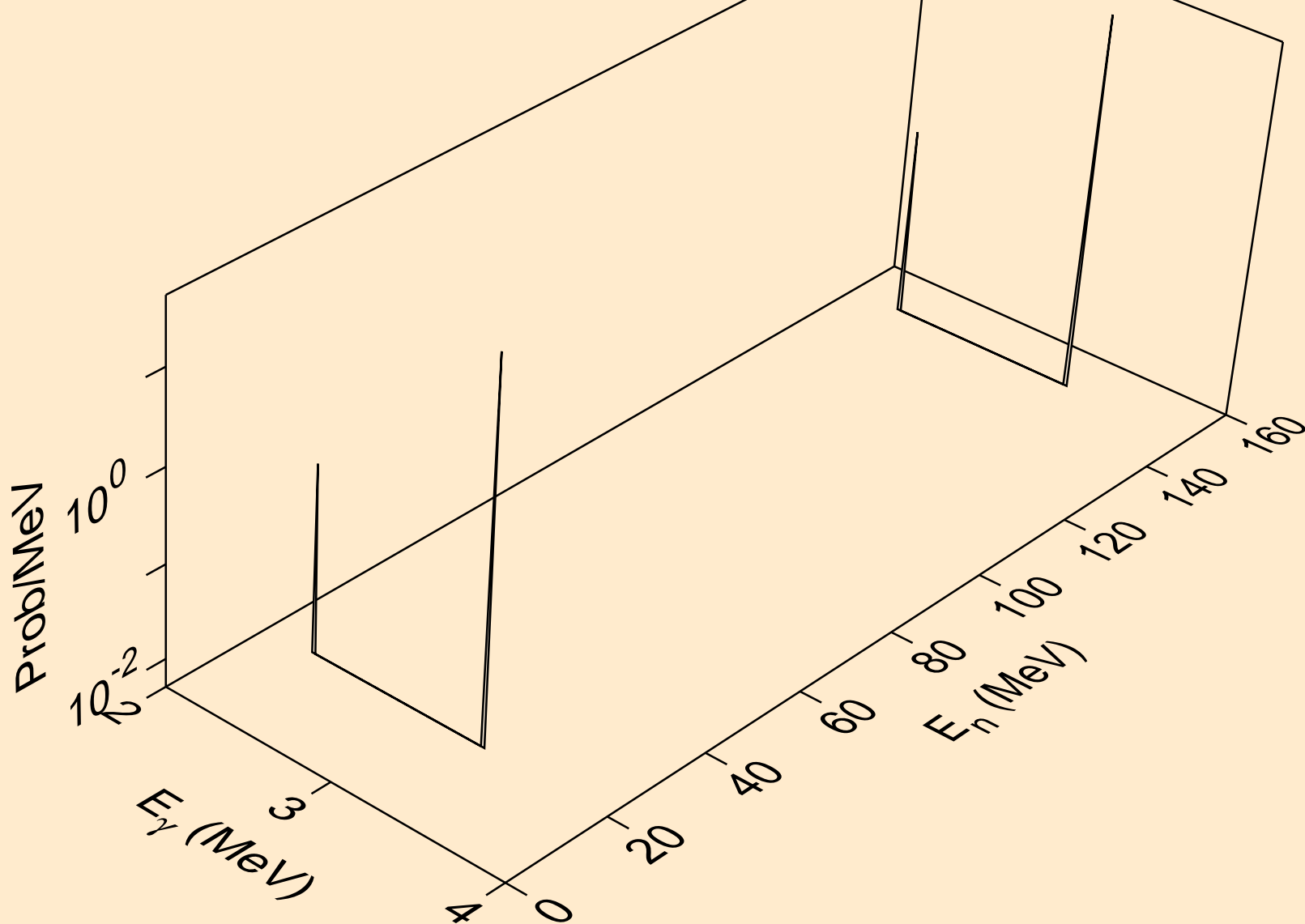

17-CL-37 FOR FENDL-3.2 FROM FENDL-3.2 BY NJOY2016.60+ OI
Photon emission for (n,d*10)

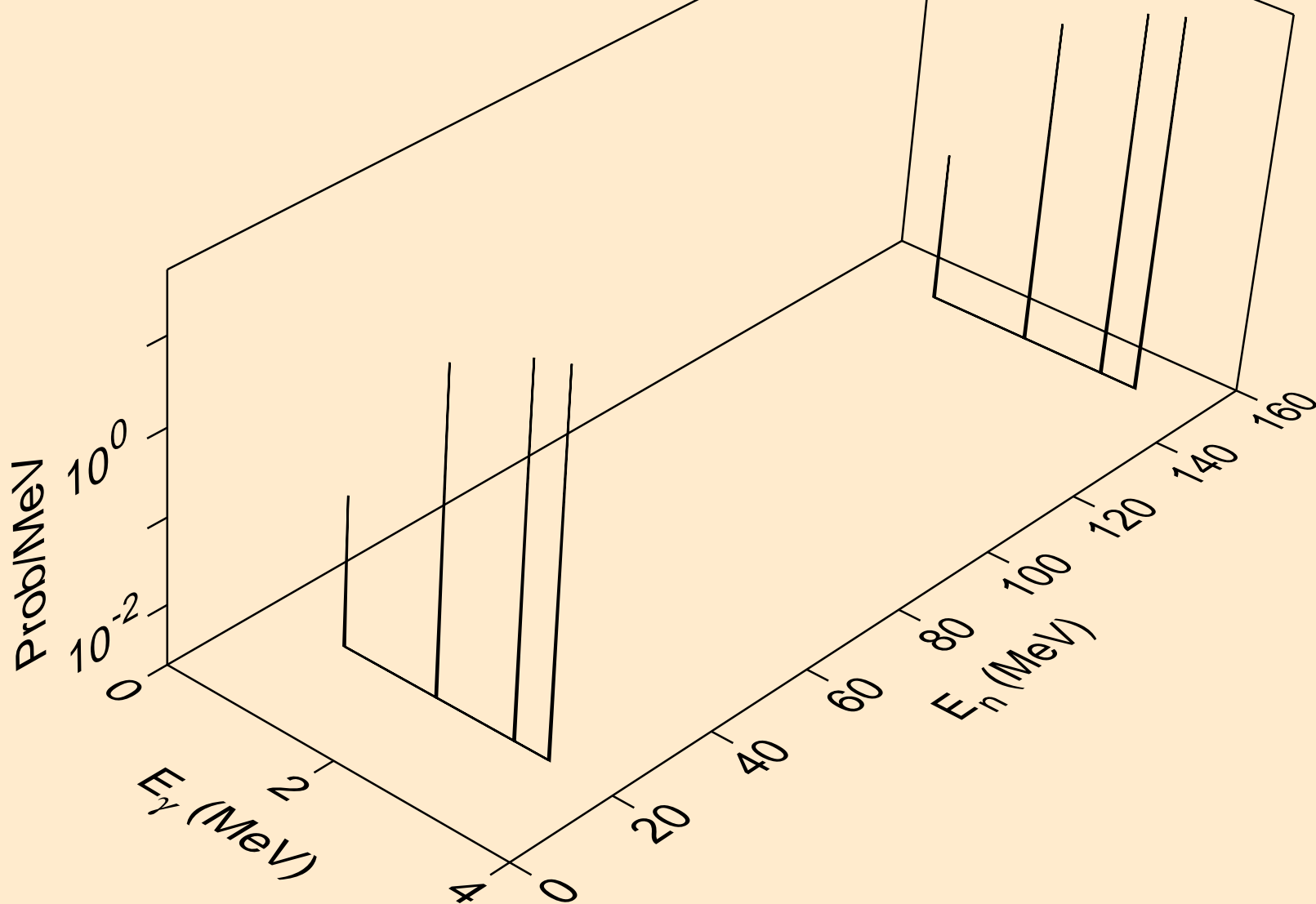

17-CL-37 FOR FENDL-3.2 FROM FENDL-3.2 BY NJOY2016.60+ OI
Photon emission for (n,d*11)

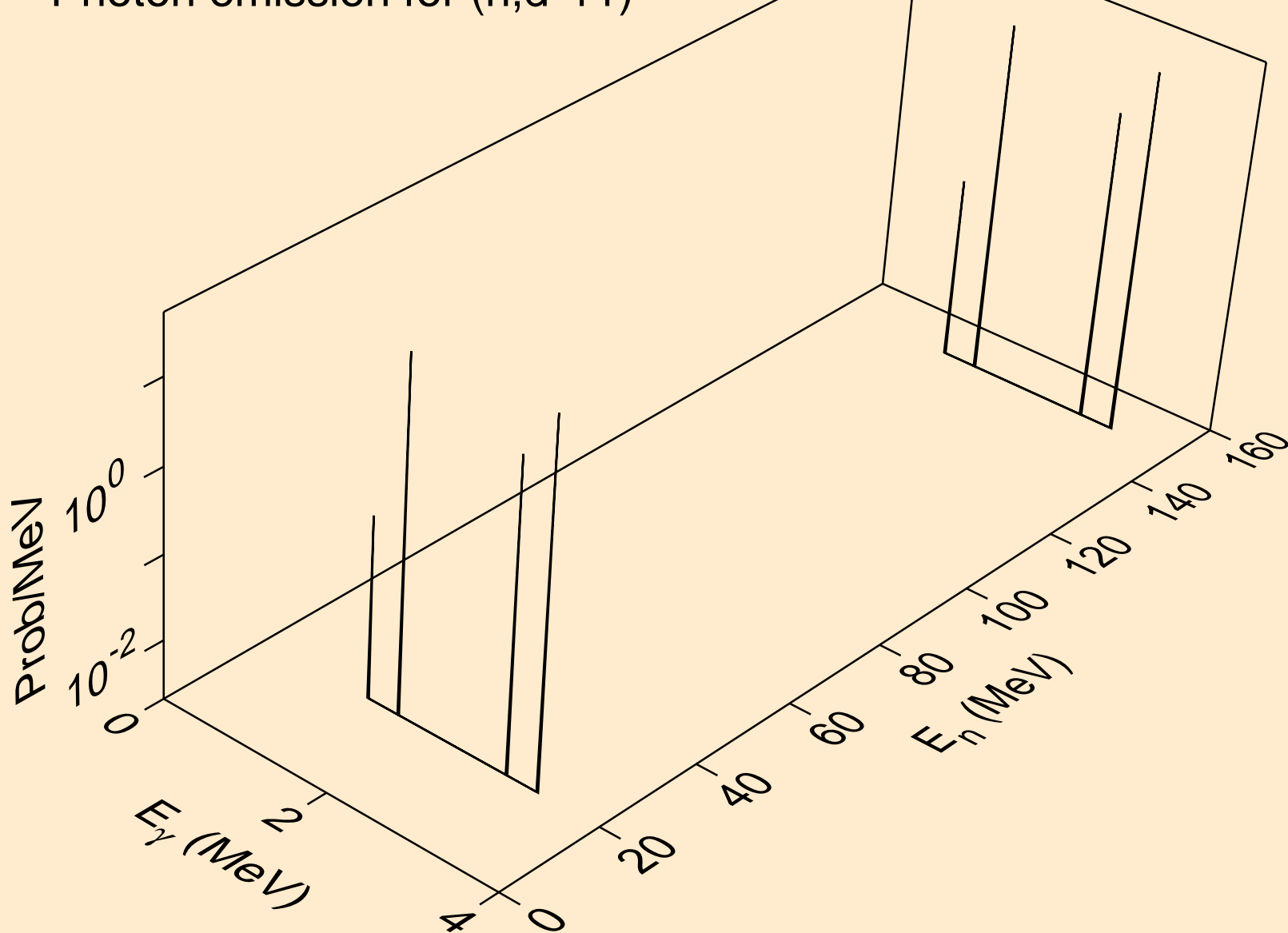

17-CL-37 FOR FENDL-3.2 FROM FENDL-3.2 BY NJOY2016.60+ OI
Photon emission for (n,d*c)

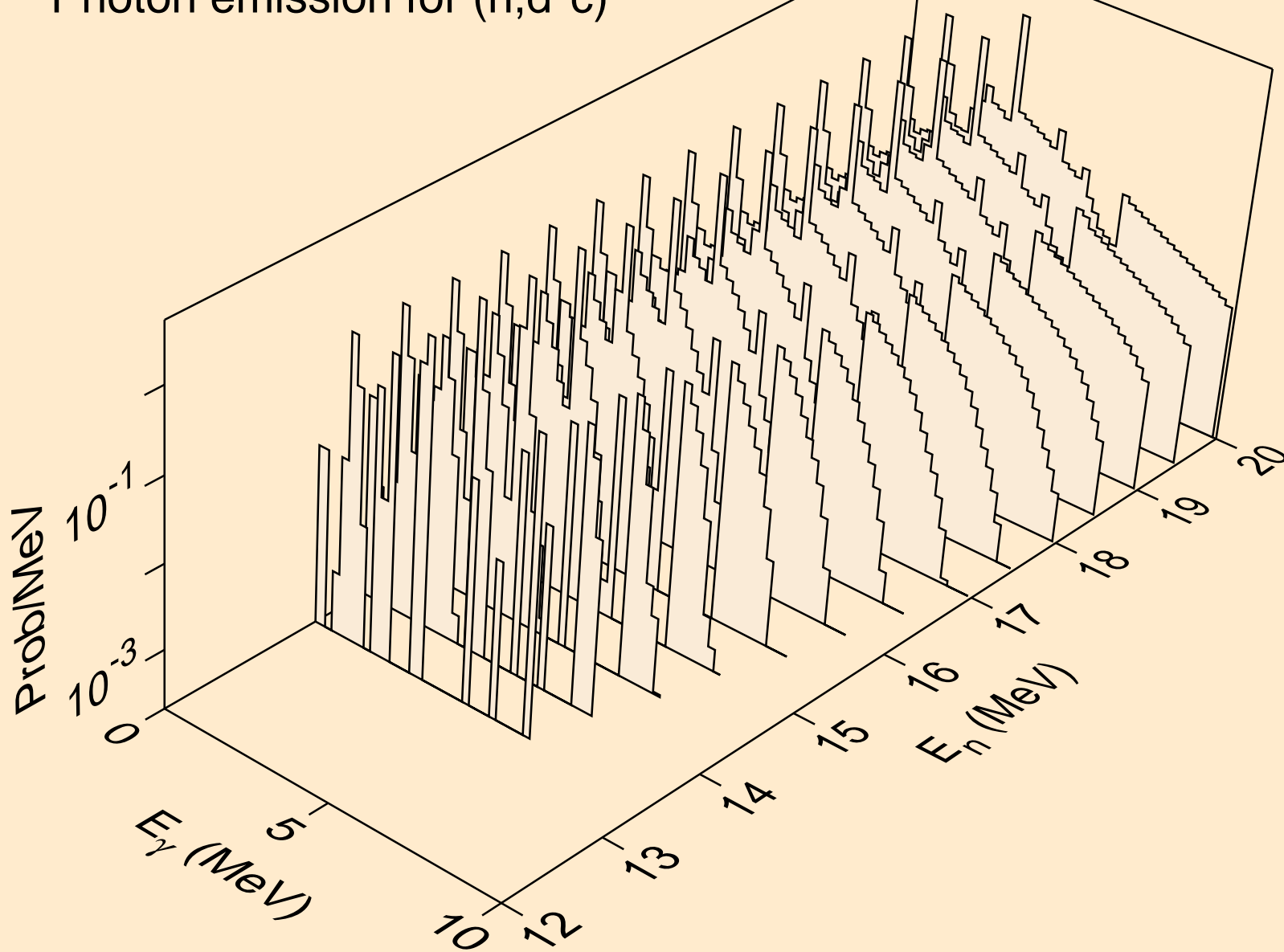

17-CL-37 FOR FENDL-3.2 FROM FENDL-3.2 BY NJOY2016.60+ OI
Photon emission for (n,t*1)

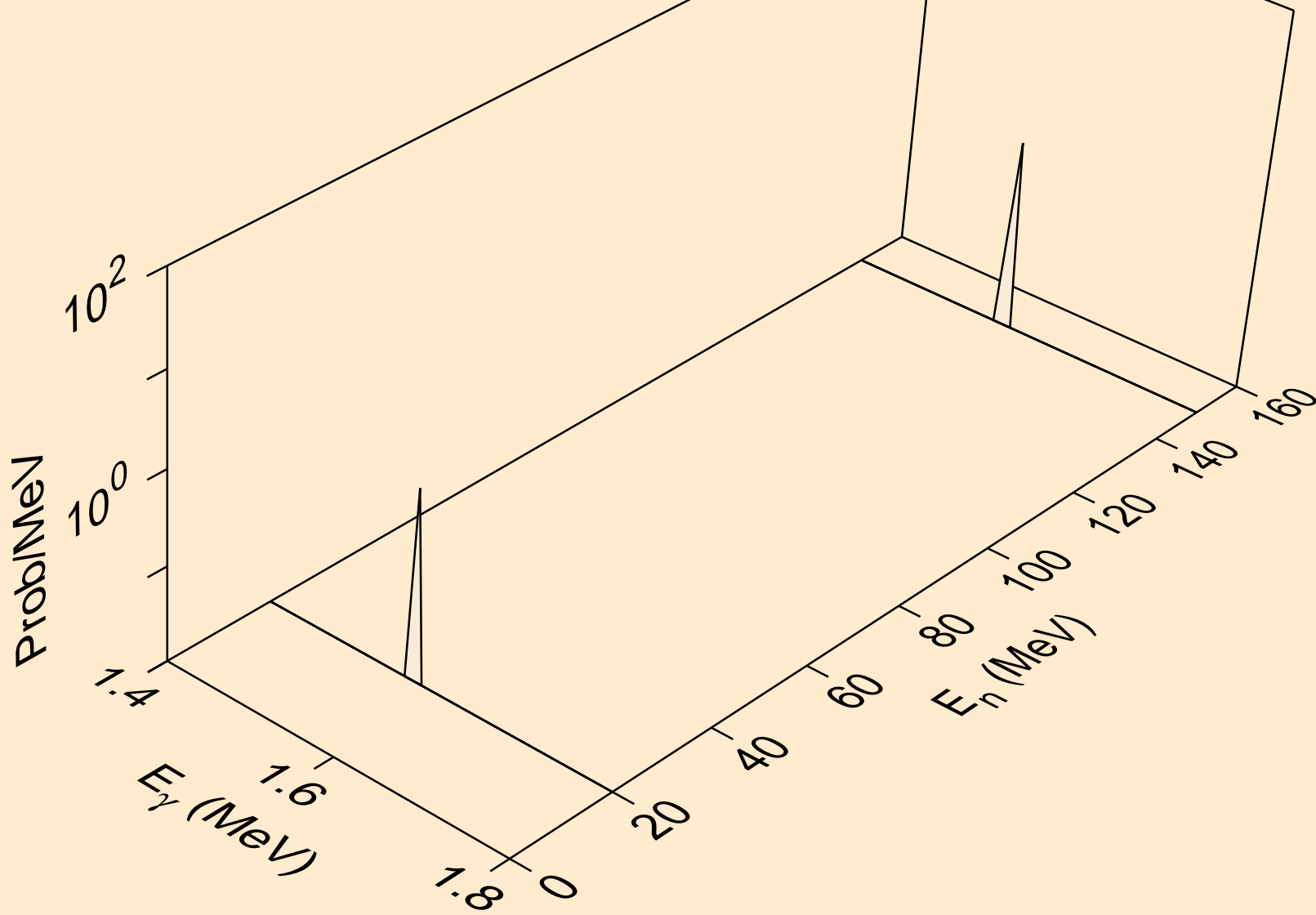

17-CL-37 FOR FENDL-3.2 FROM FENDL-3.2 BY NJOY2016.60+ OI
Photon emission for (n,t*2)

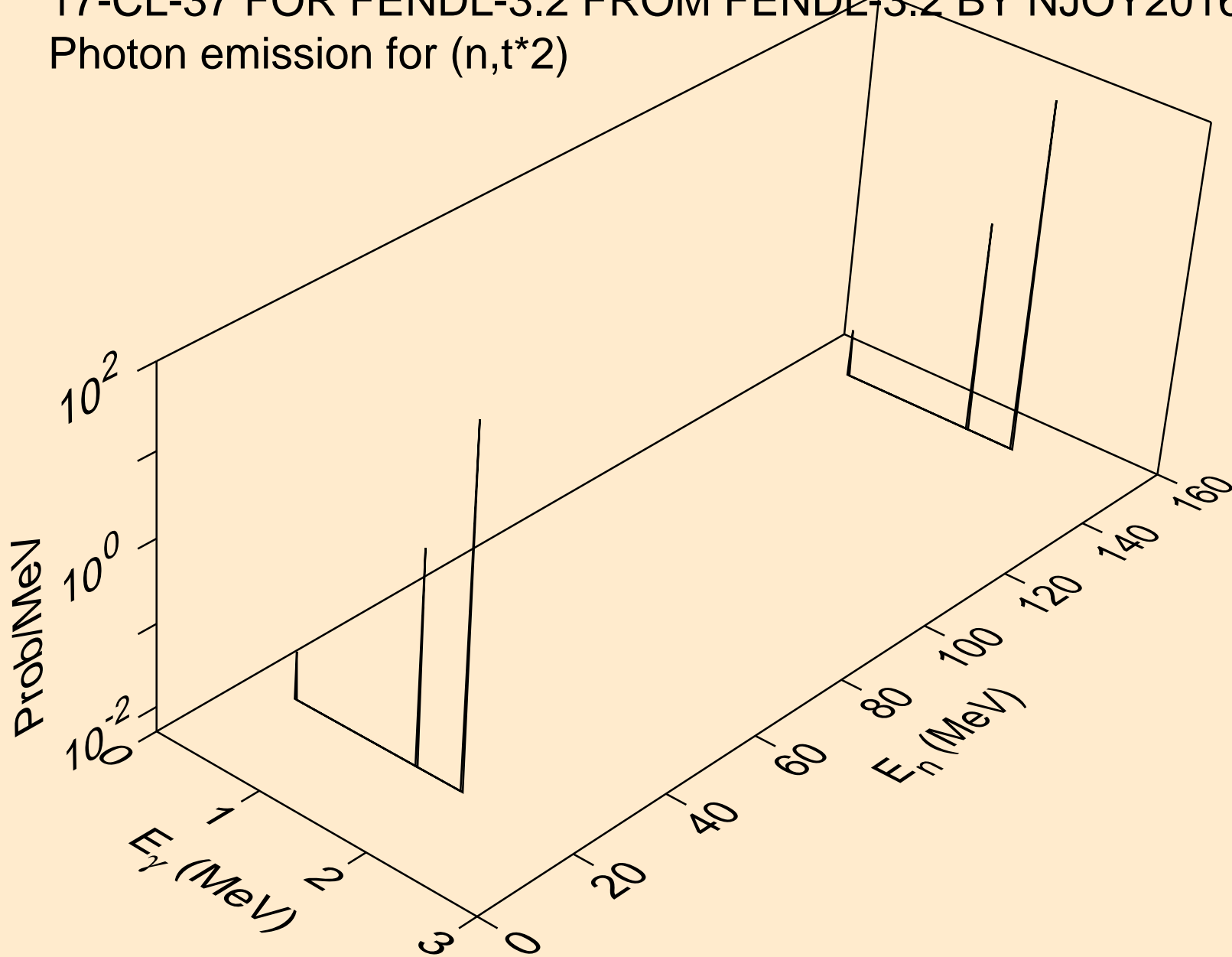

17-CL-37 FOR FENDL-3.2 FROM FENDL-3.2 BY NJOY2016.60+ OI
Photon emission for (n,t*3)

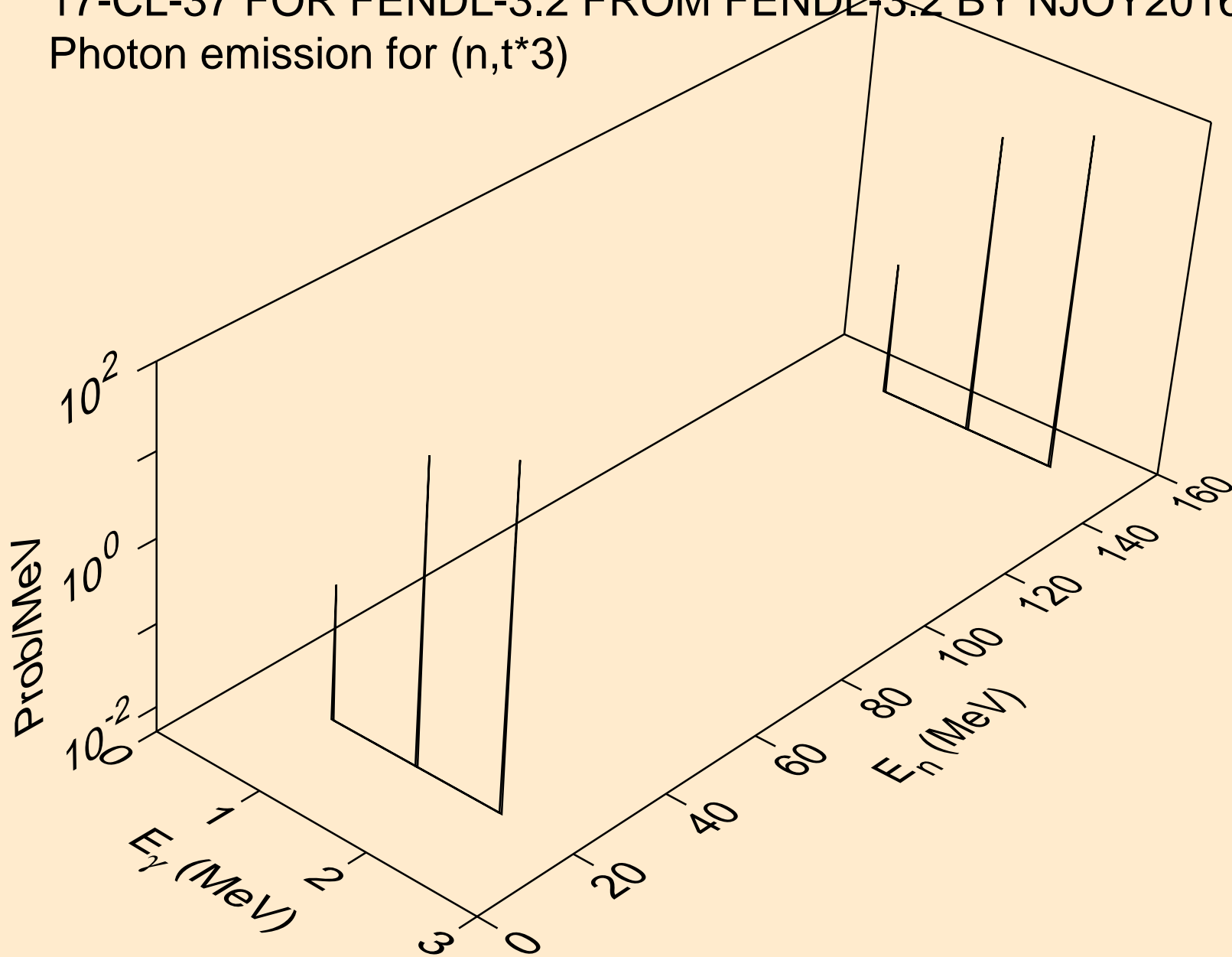

17-CL-37 FOR FENDL-3.2 FROM FENDL-3.2 BY NJOY2016.60+ OI
Photon emission for (n,t*4)

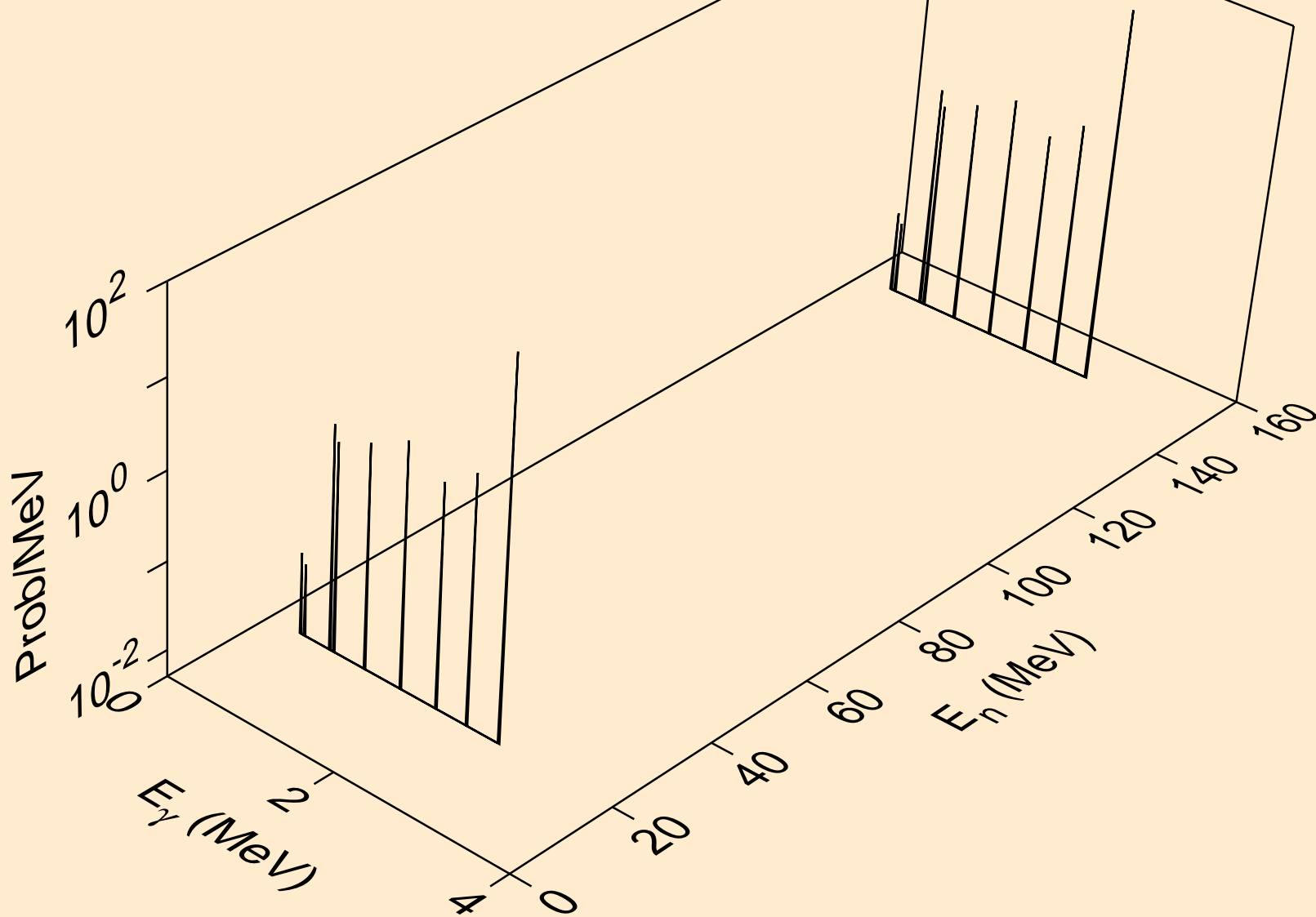

17-CL-37 FOR FENDL-3.2 FROM FENDL-3.2 BY NJOY2016.60+ OI
Photon emission for (n,t*5)

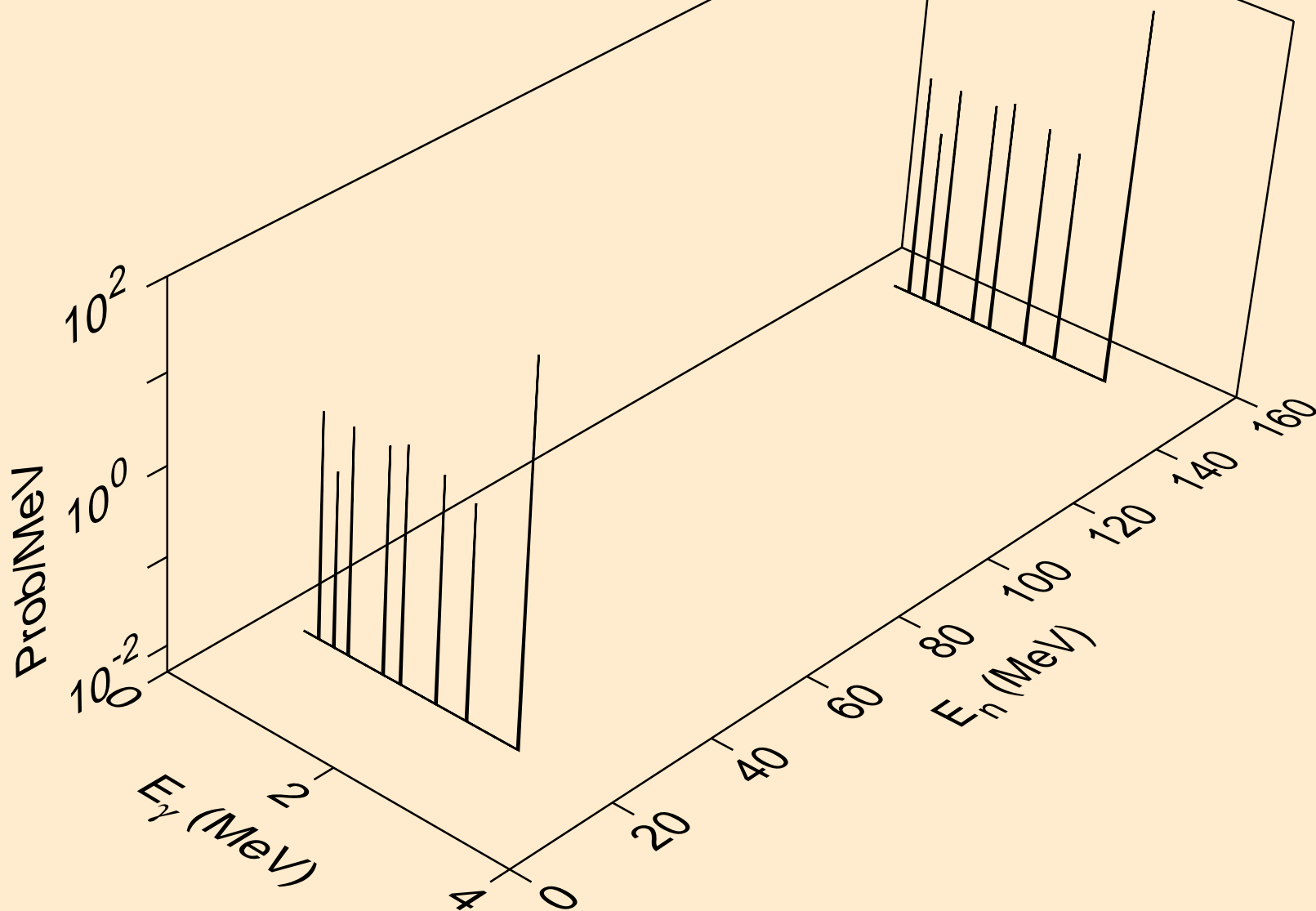

17-CL-37 FOR FENDL-3.2 FROM FENDL-3.2 BY NJOY2016.60+ OI
Photon emission for (n,t*6)

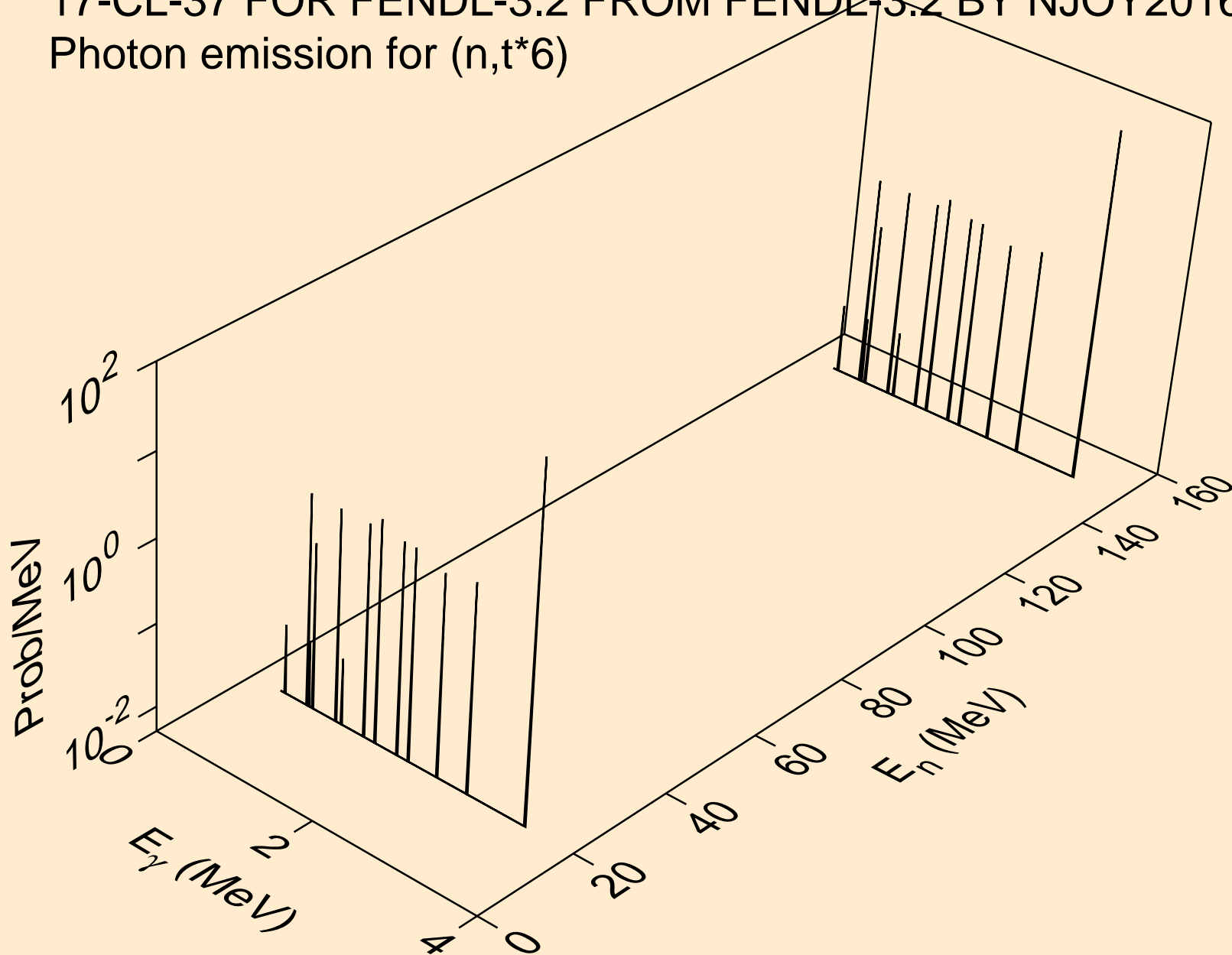

17-CL-37 FOR FENDL-3.2 FROM FENDL-3.2 BY NJOY2016.60+ OI
Photon emission for (n,t*7)

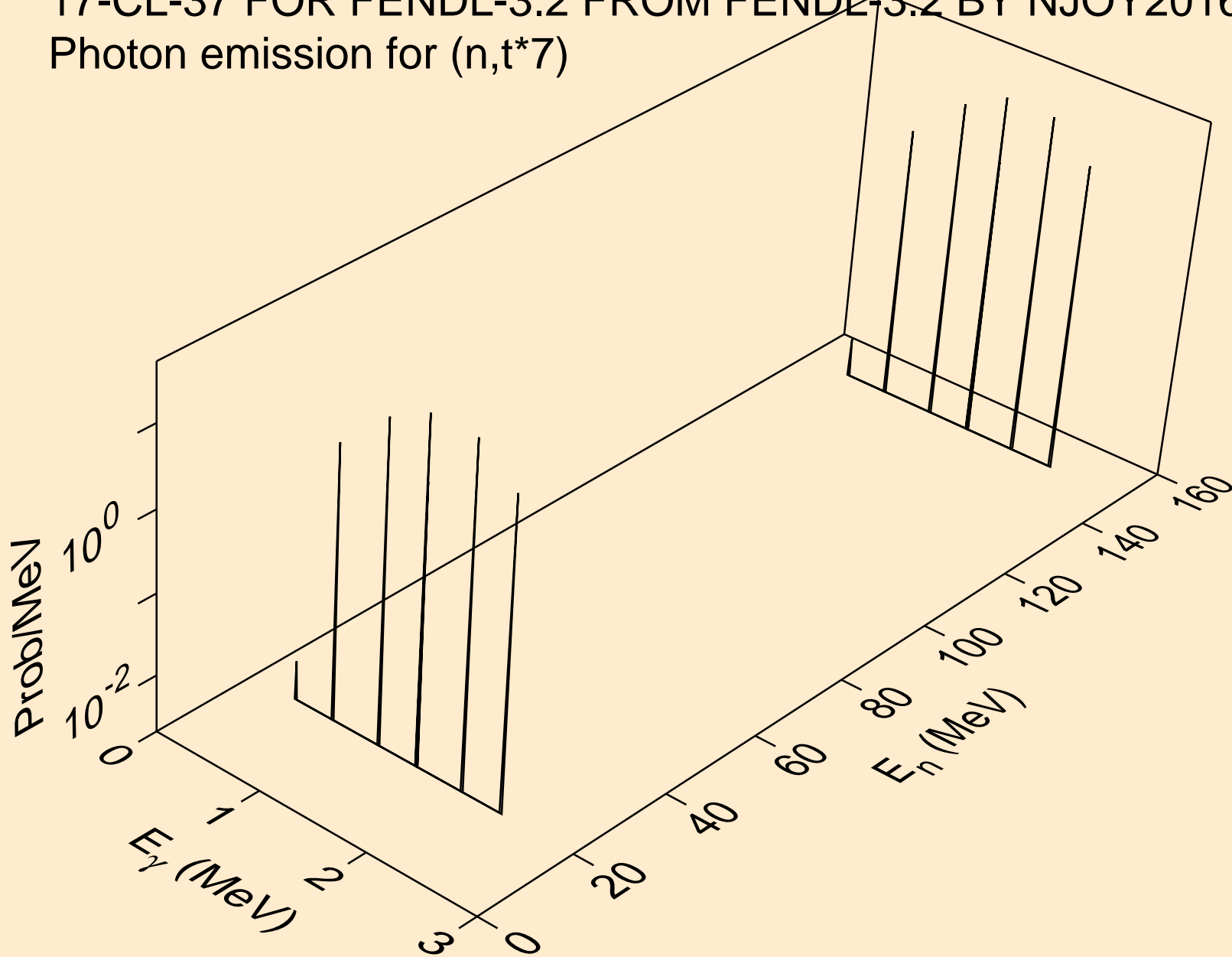

17-CL-37 FOR FENDL-3.2 FROM FENDL-3.2 BY NJOY2016.60+ OI
Photon emission for (n,t*8)

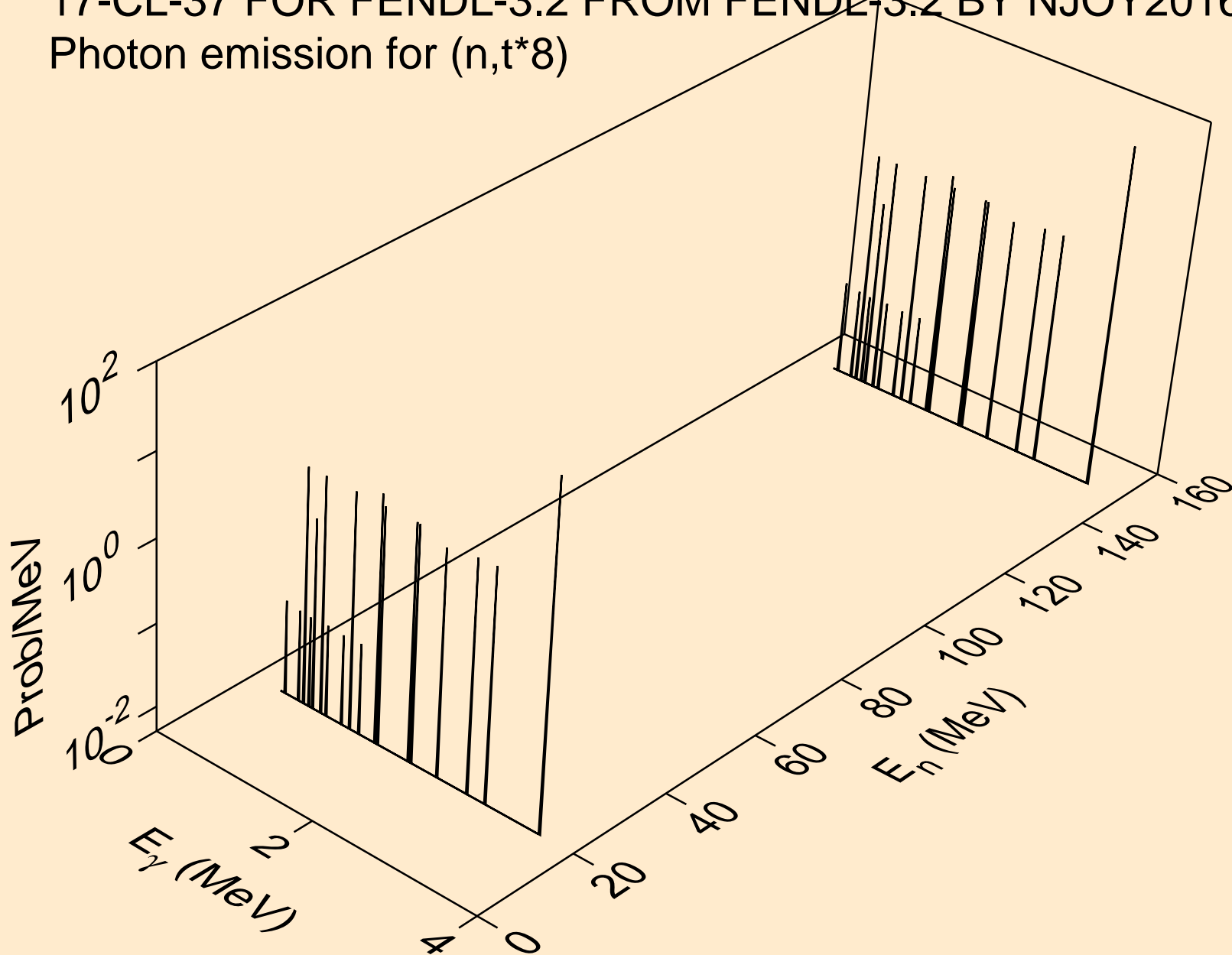

17-CL-37 FOR FENDL-3.2 FROM FENDL-3.2 BY NJOY2016.60+ OI
Photon emission for (n,t*9)

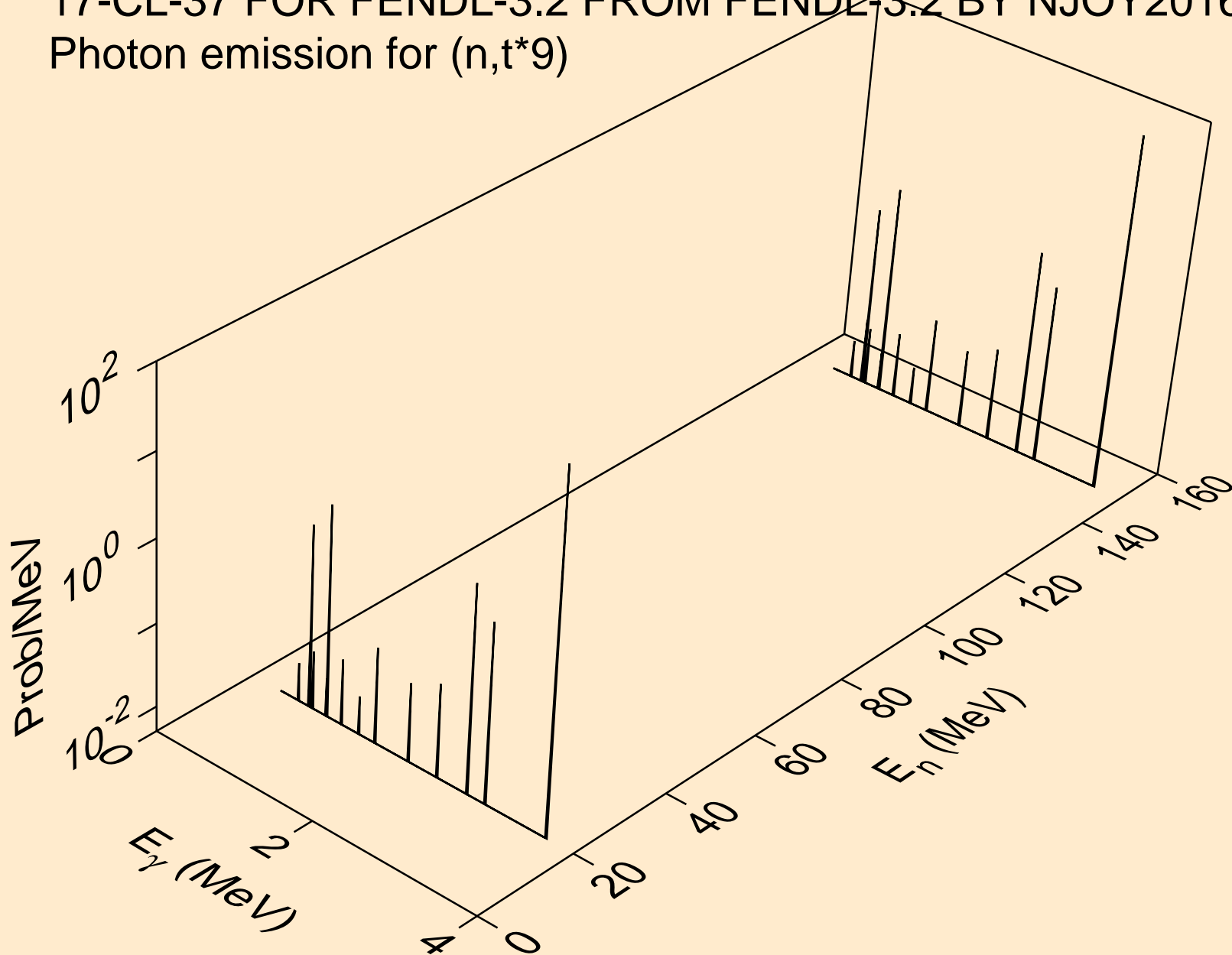

17-CL-37 FOR FENDL-3.2 FROM FENDL-3.2 BY NJOY2016.60+ OI
Photon emission for (n,t*10)

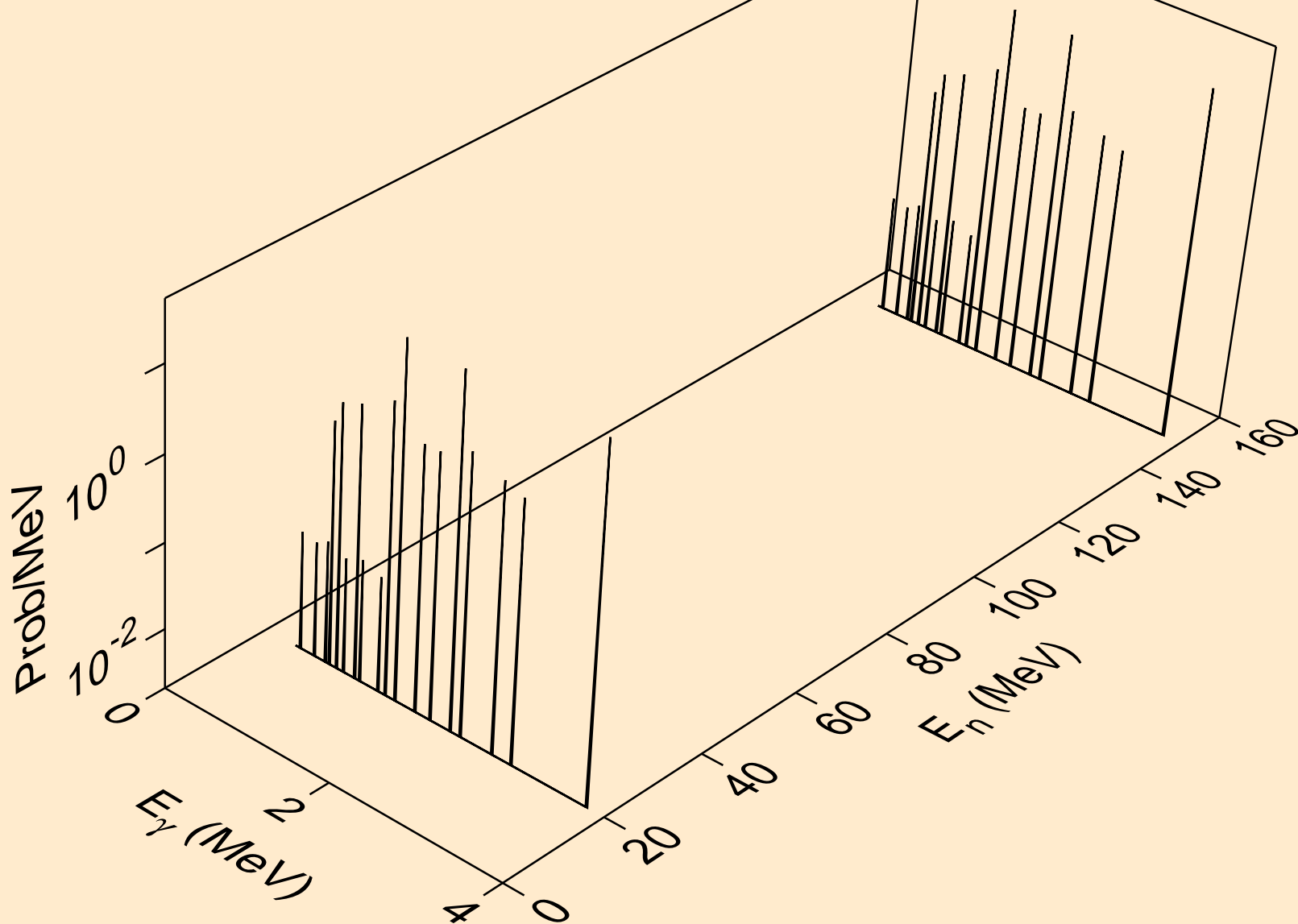

17-CL-37 FOR FENDL-3.2 FROM FENDL-3.2 BY NJOY2016.60+ OI
Photon emission for (n,t*11)

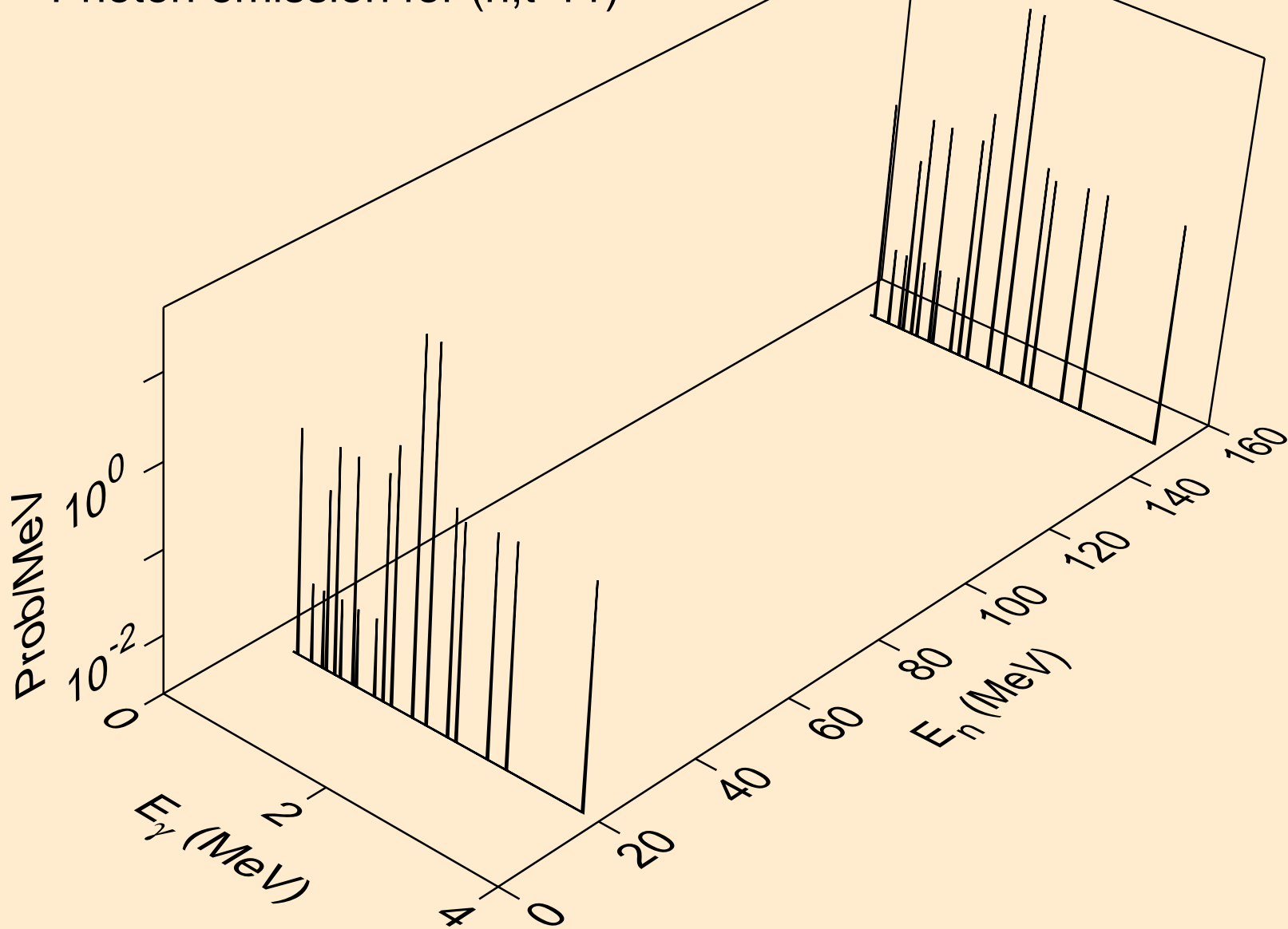

17-CL-37 FOR FENDL-3.2 FROM FENDL-3.2 BY NJOY2016.60+ OI
Photon emission for (n,t*12)

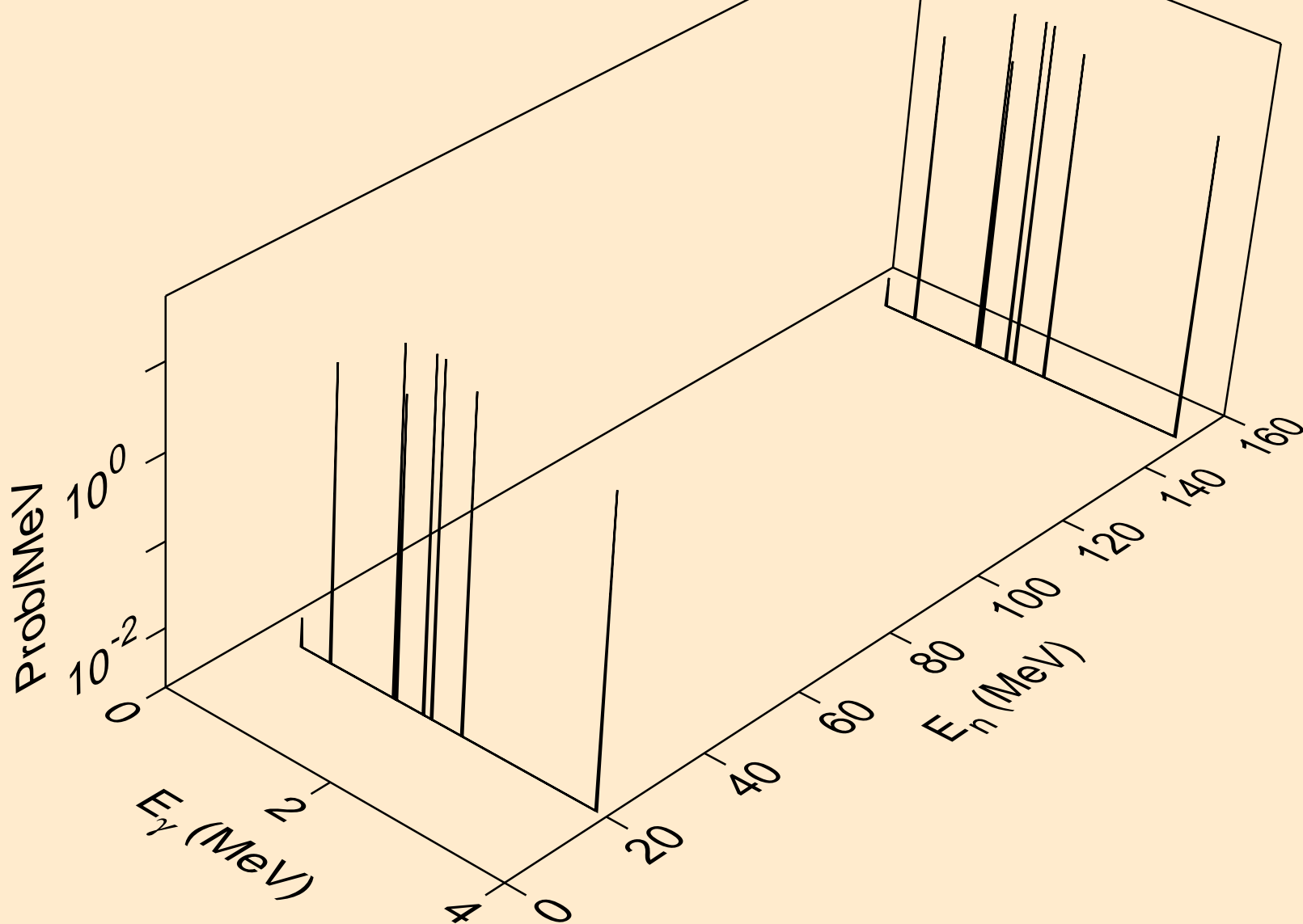

17-CL-37 FOR FENDL-3.2 FROM FENDL-3.2 BY NJOY2016.60+ OI
Photon emission for (n,t*13)

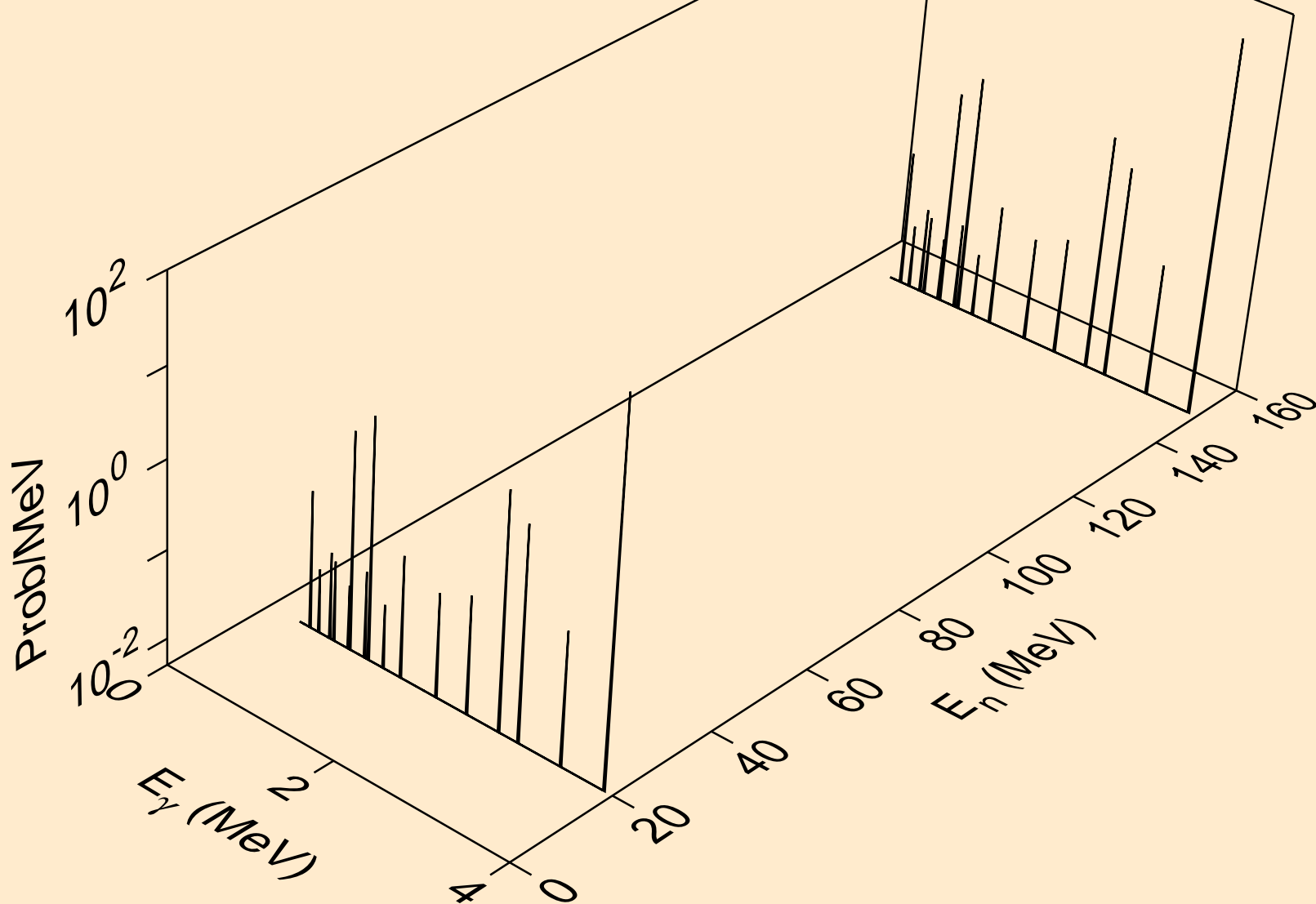

17-CL-37 FOR FENDL-3.2 FROM FENDL-3.2 BY NJOY2016.60+ OI
Photon emission for (n,t*14)

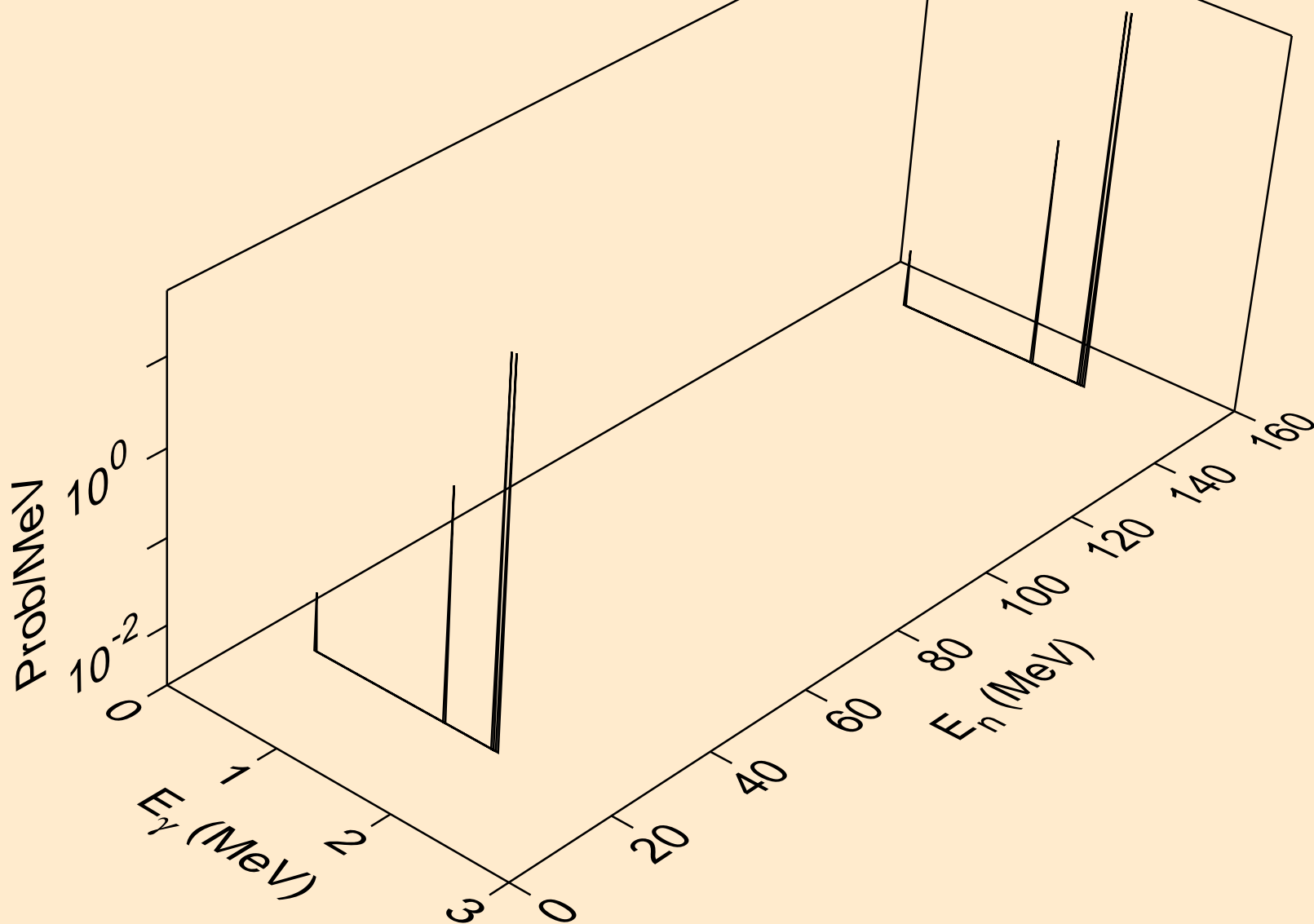

17-CL-37 FOR FENDL-3.2 FROM FENDL-3.2 BY NJOY2016.60+ OI
Photon emission for (n,t*15)

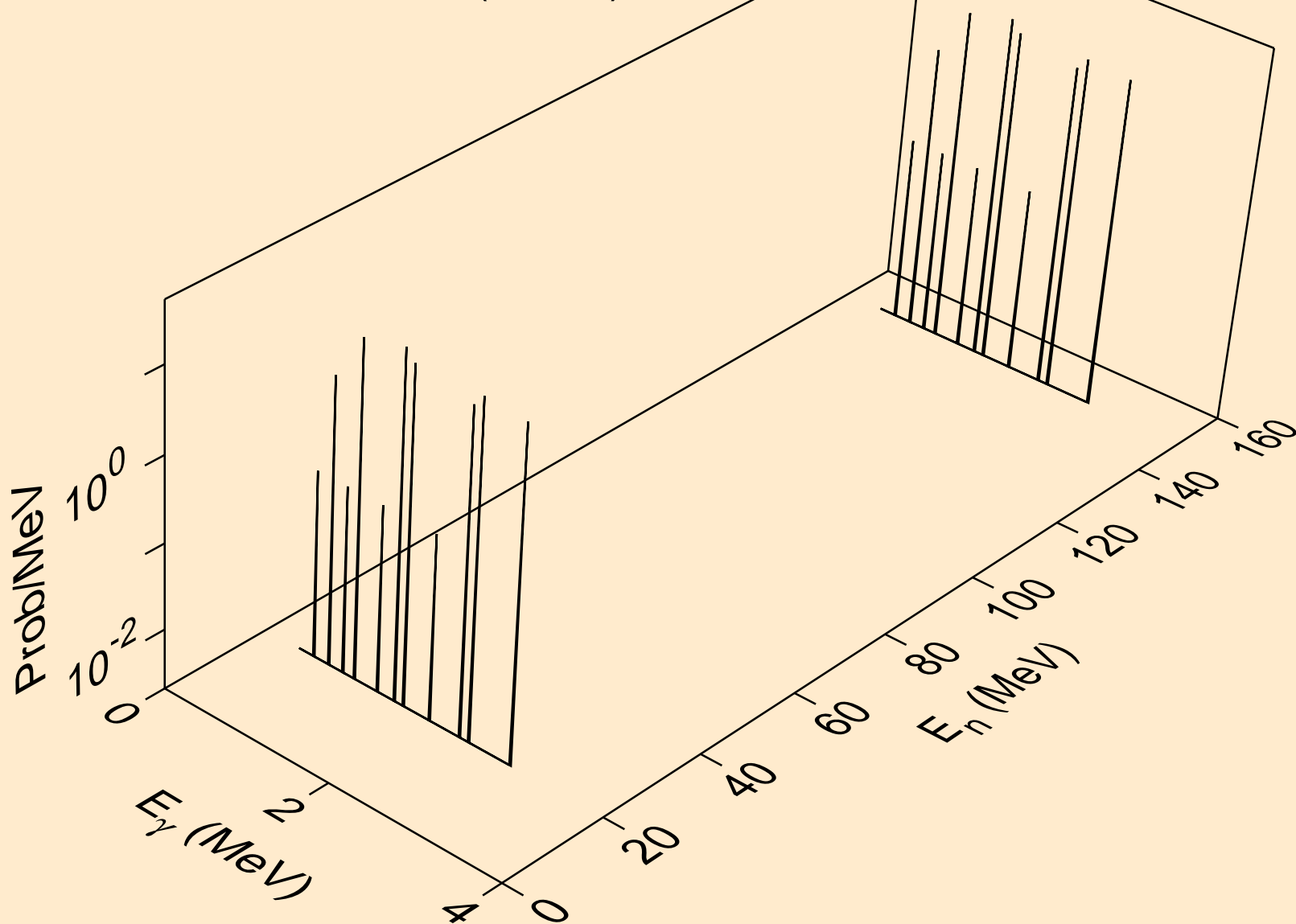

17-CL-37 FOR FENDL-3.2 FROM FENDL-3.2 BY NJOY2016.60+ OI
Photon emission for (n,t*c)

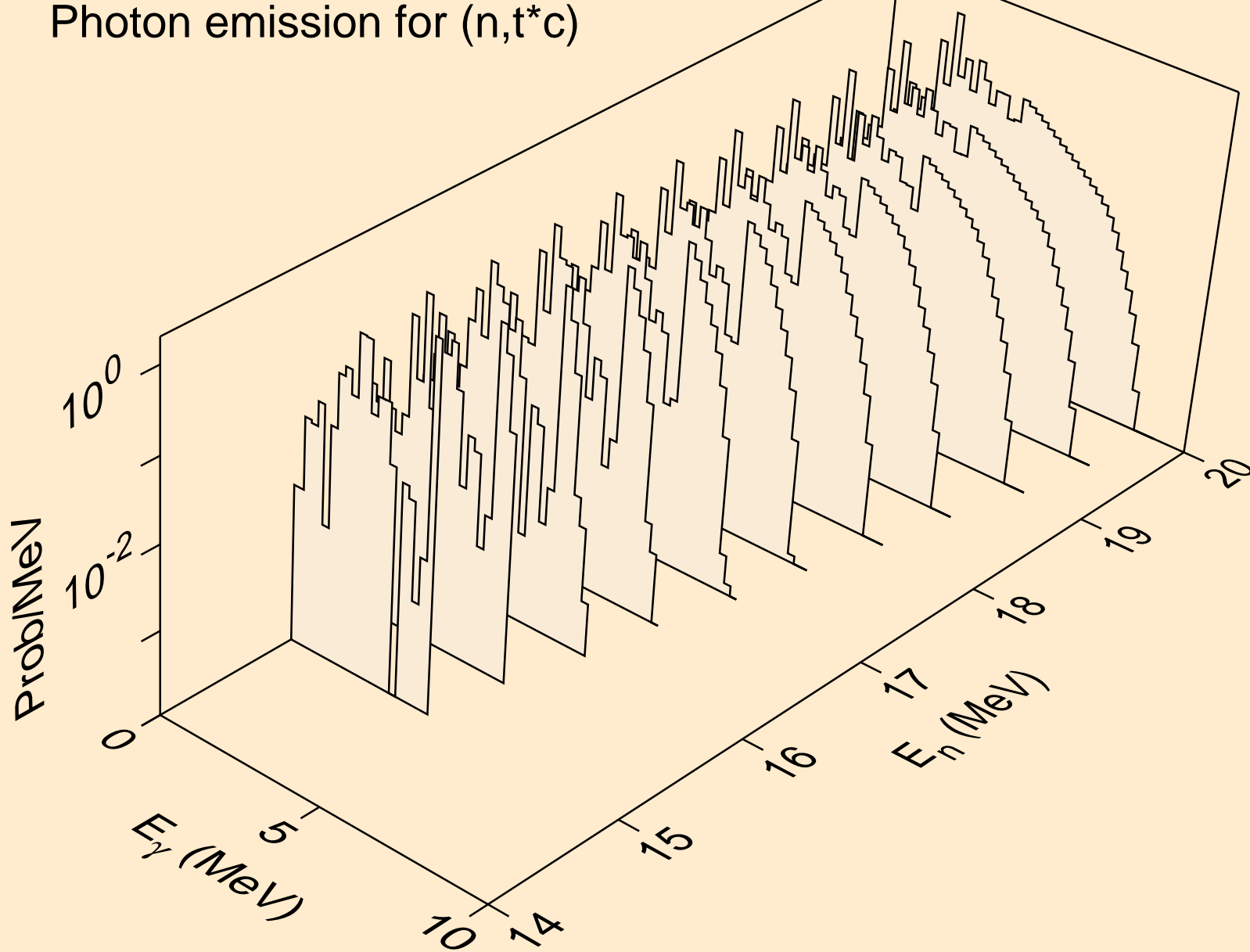

17-CL-37 FOR FENDL-3.2 FROM FENDL-3.2 BY NJOY2016.60+ OI
Photon emission for (n,a*1)

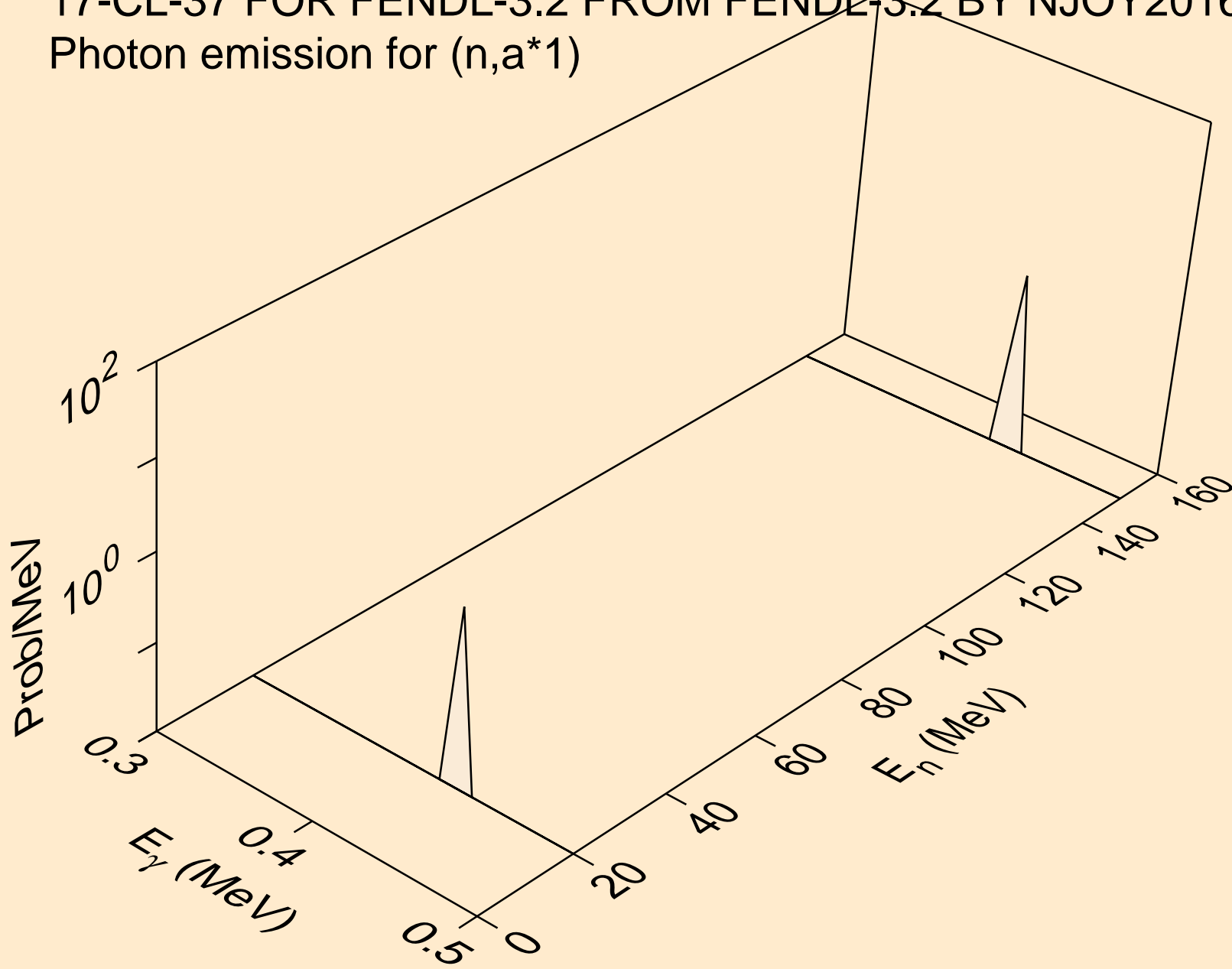

17-CL-37 FOR FENDL-3.2 FROM FENDL-3.2 BY NJOY2016.60+ OI
Photon emission for (n,a*2)

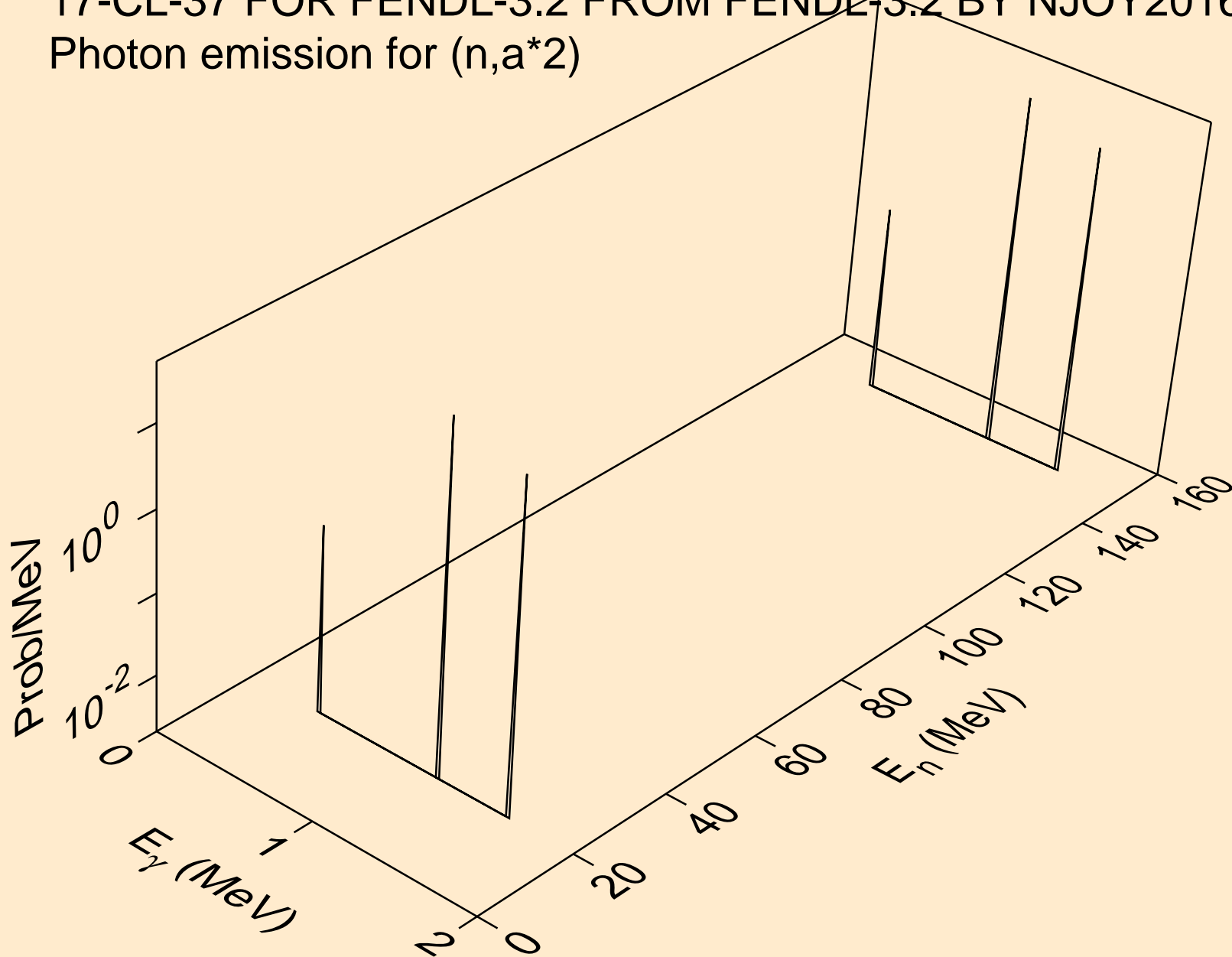

17-CL-37 FOR FENDL-3.2 FROM FENDL-3.2 BY NJOY2016.60+ OI
Photon emission for (n,a*3)

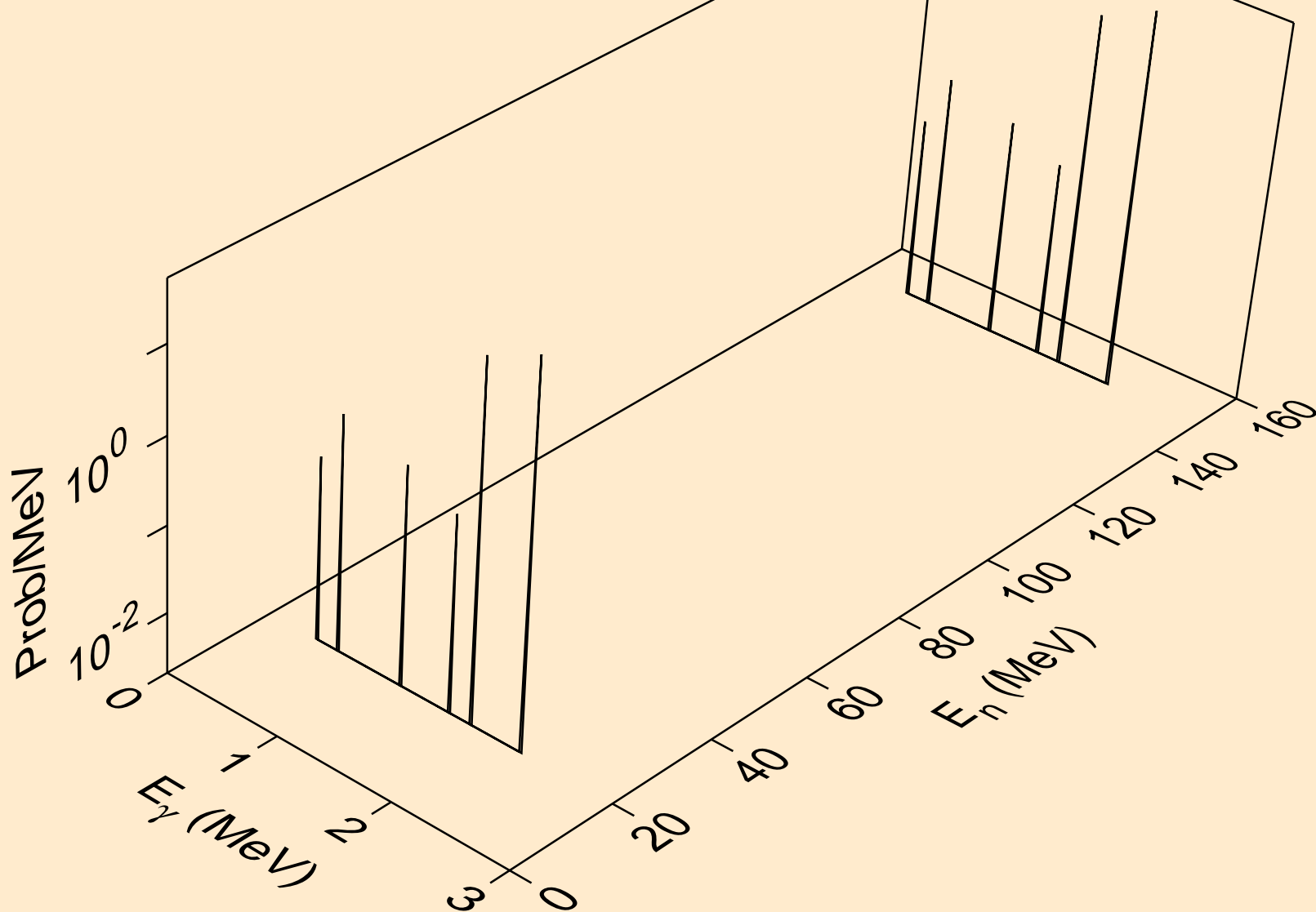

17-CL-37 FOR FENDL-3.2 FROM FENDL-3.2 BY NJOY2016.60+ OI
Photon emission for (n,a*4)

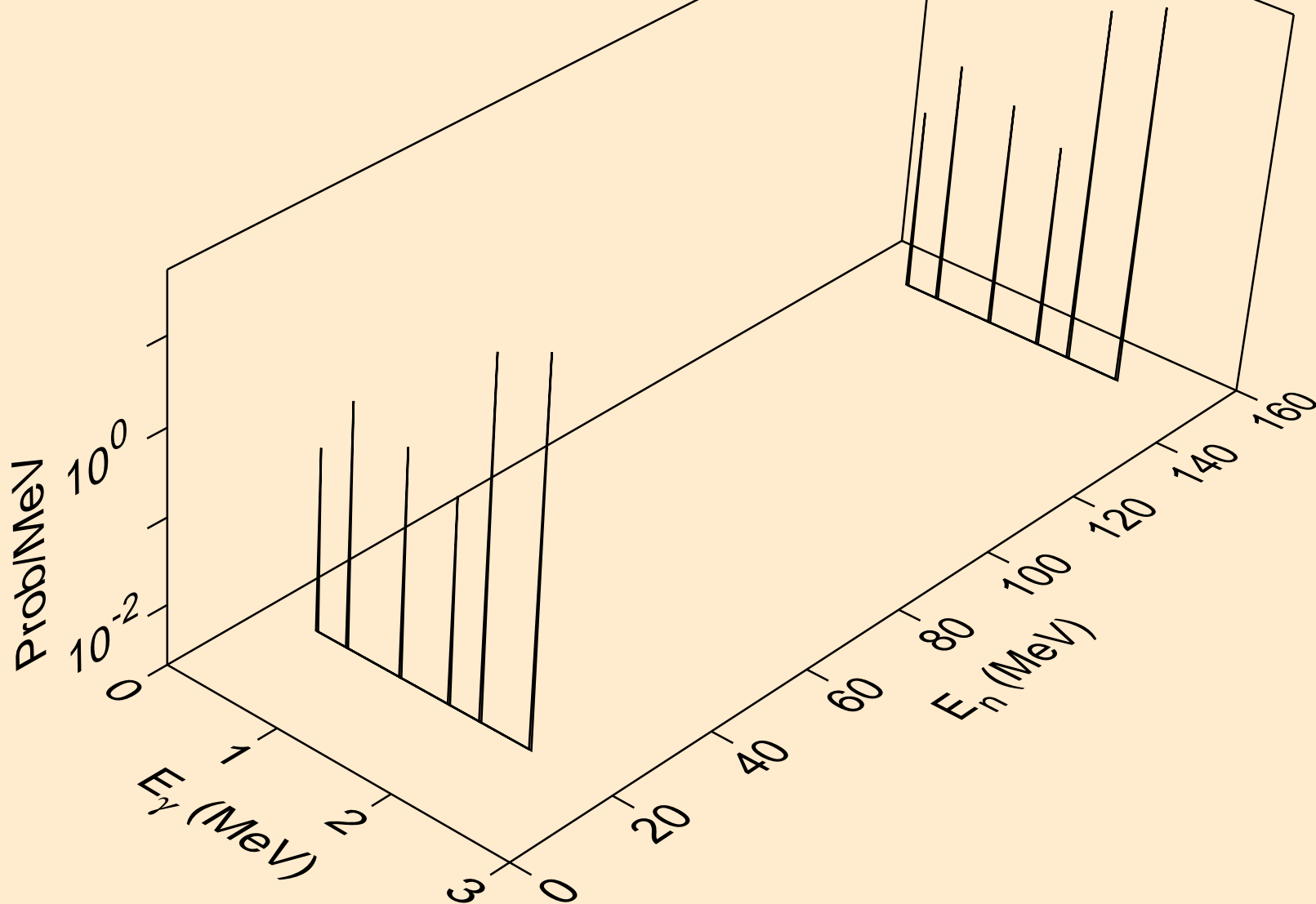

17-CL-37 FOR FENDL-3.2 FROM FENDL-3.2 BY NJOY2016.60+ OI
Photon emission for (n,a*5)

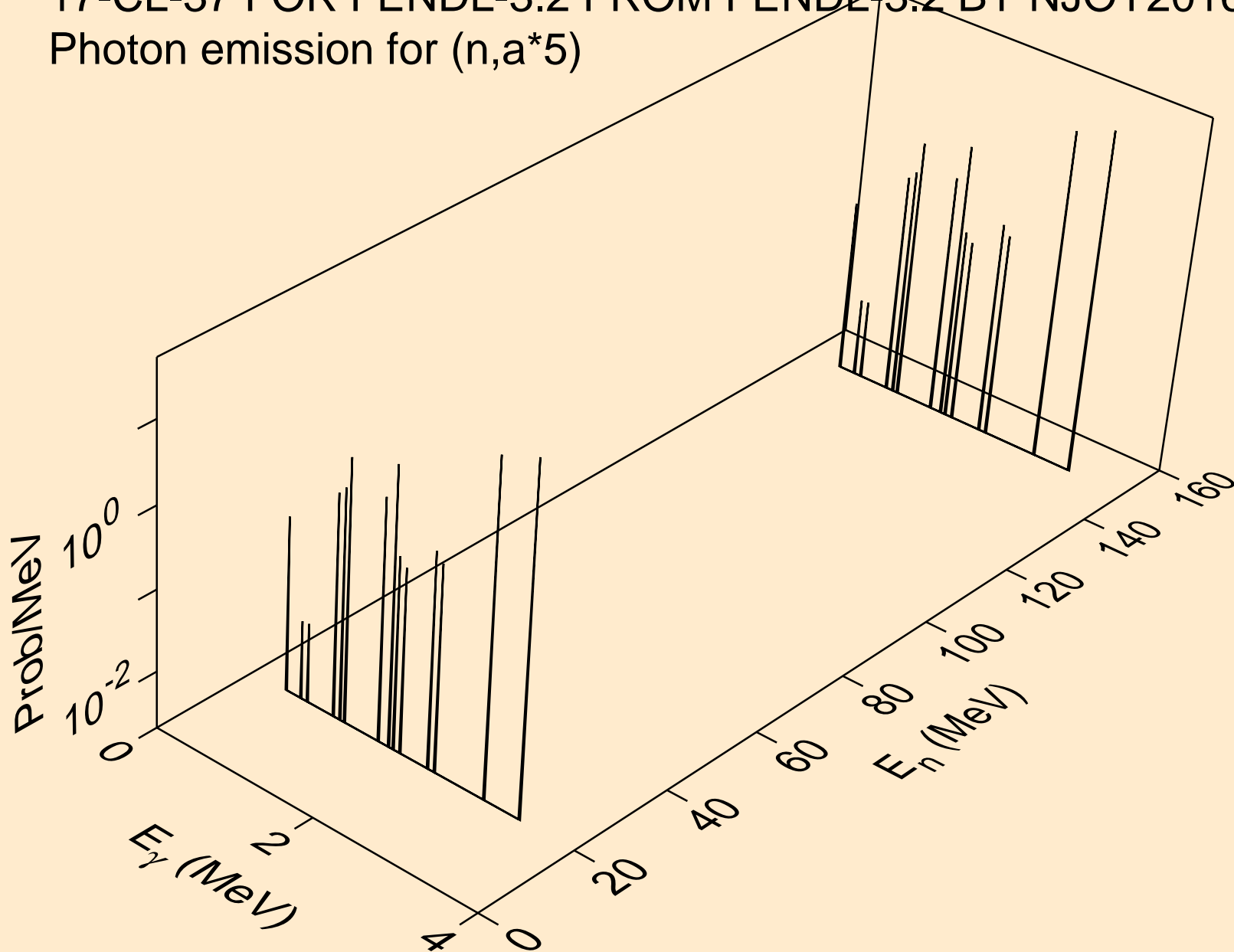

17-CL-37 FOR FENDL-3.2 FROM FENDL-3.2 BY NJOY2016.60+ OI
Photon emission for (n,a*c)

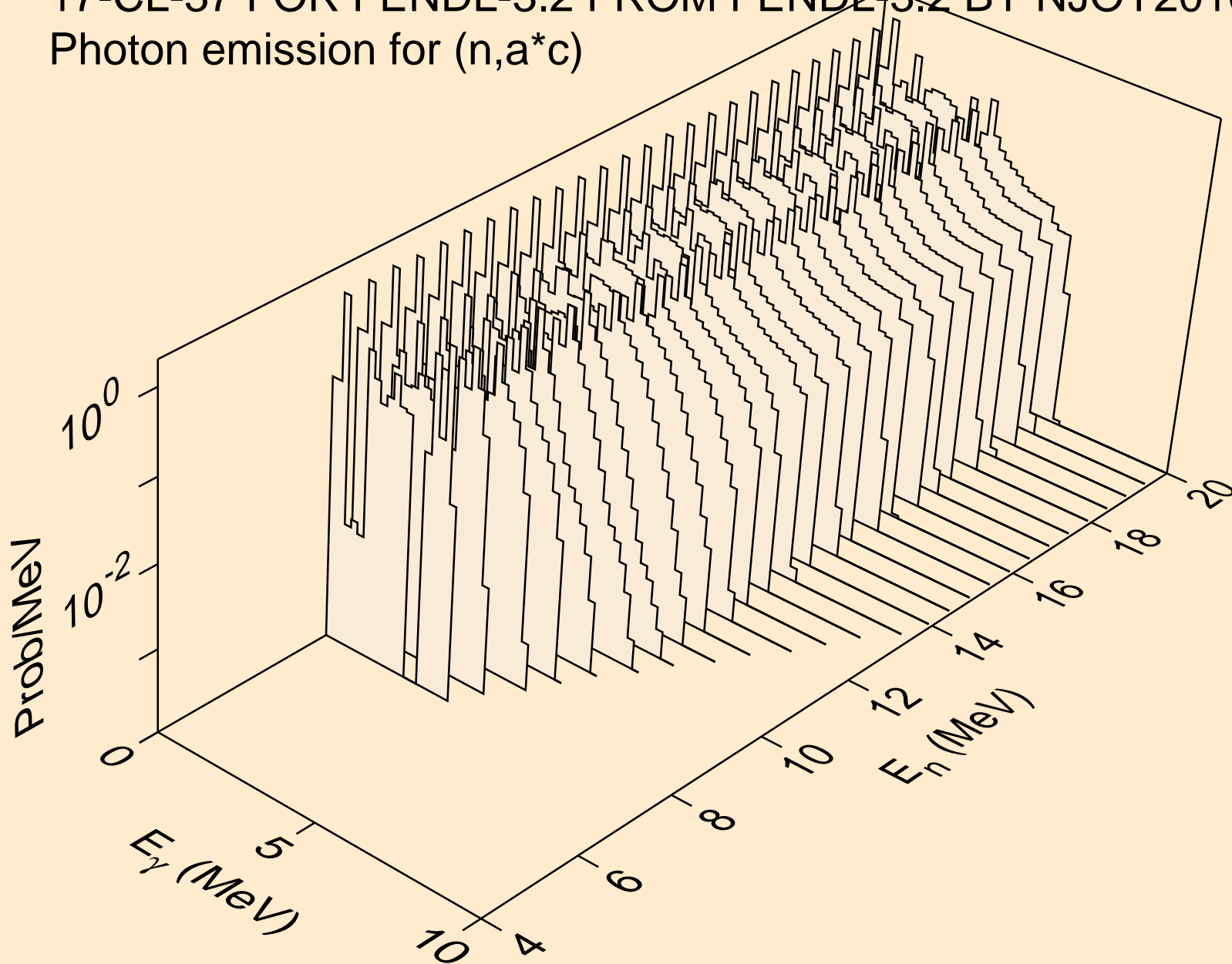

17-CL-37 FOR FENDL-3.2 FROM FENDL-3.2 BY NJOY2016.60+ OI
thermal capture photon spectrum

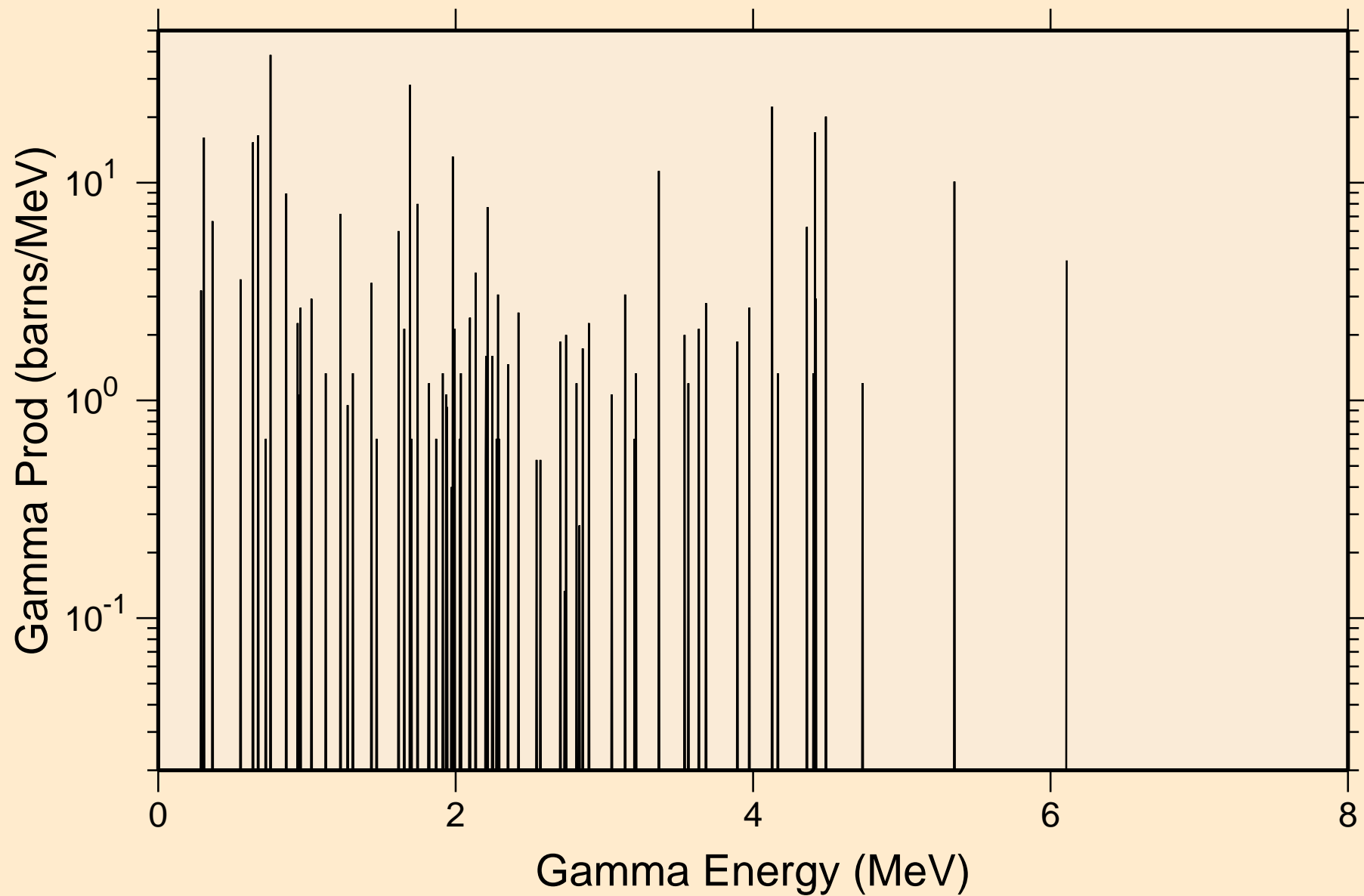

17-CL-37 FOR FENDL-3.2 FROM FENDL-3.2 BY NJOY2016.60+ OI
14 MeV photon spectrum

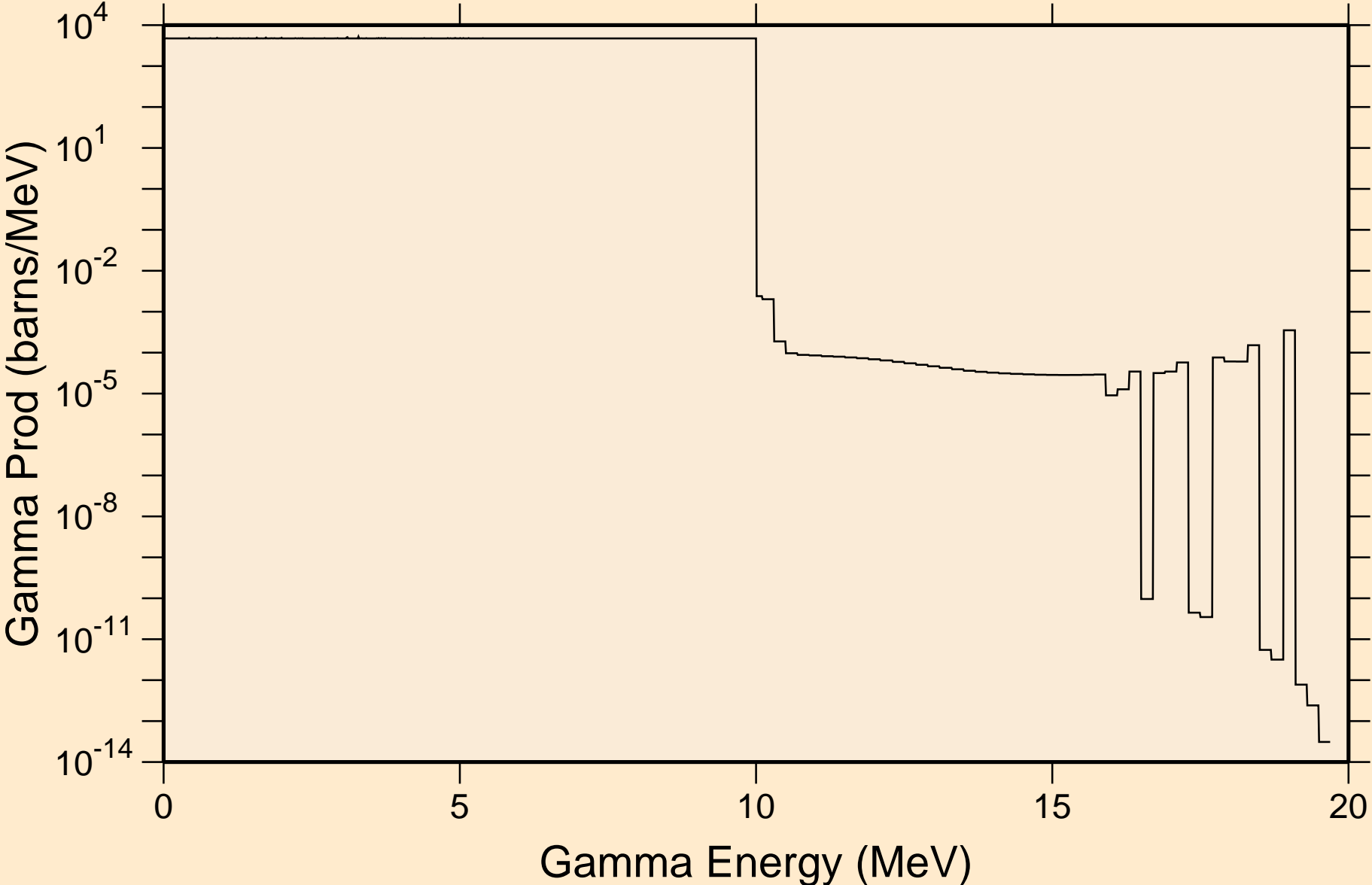

17-CL-37 FOR FENDL-3.2 FROM FENDL-3.2 BY NJOY2016.60+ OI

Particle heating contributions

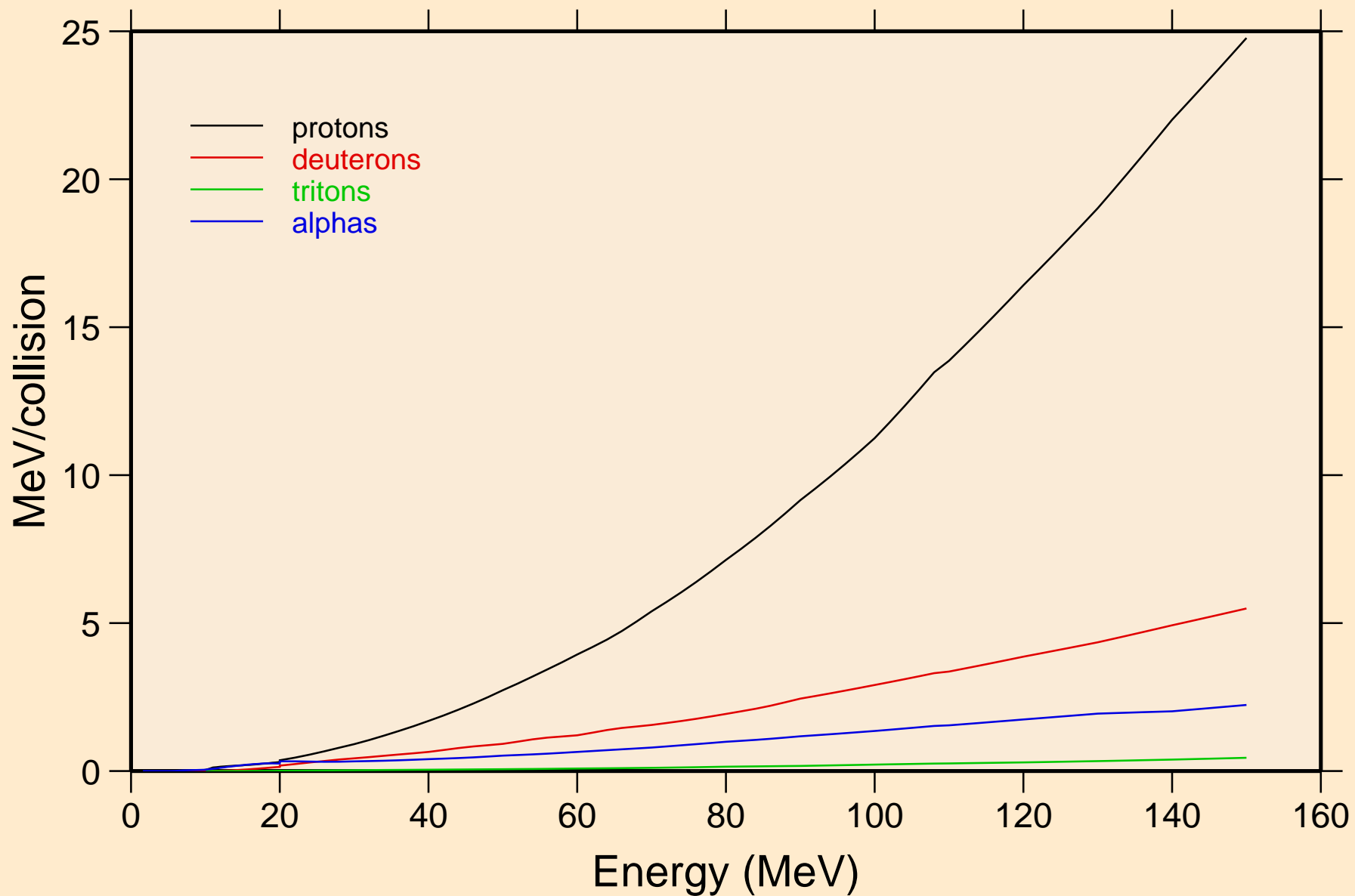

17-CL-37 FOR FENDL-3.2 FROM FENDL-3.2 BY NJOY2016.60+ OI Recoil Heating

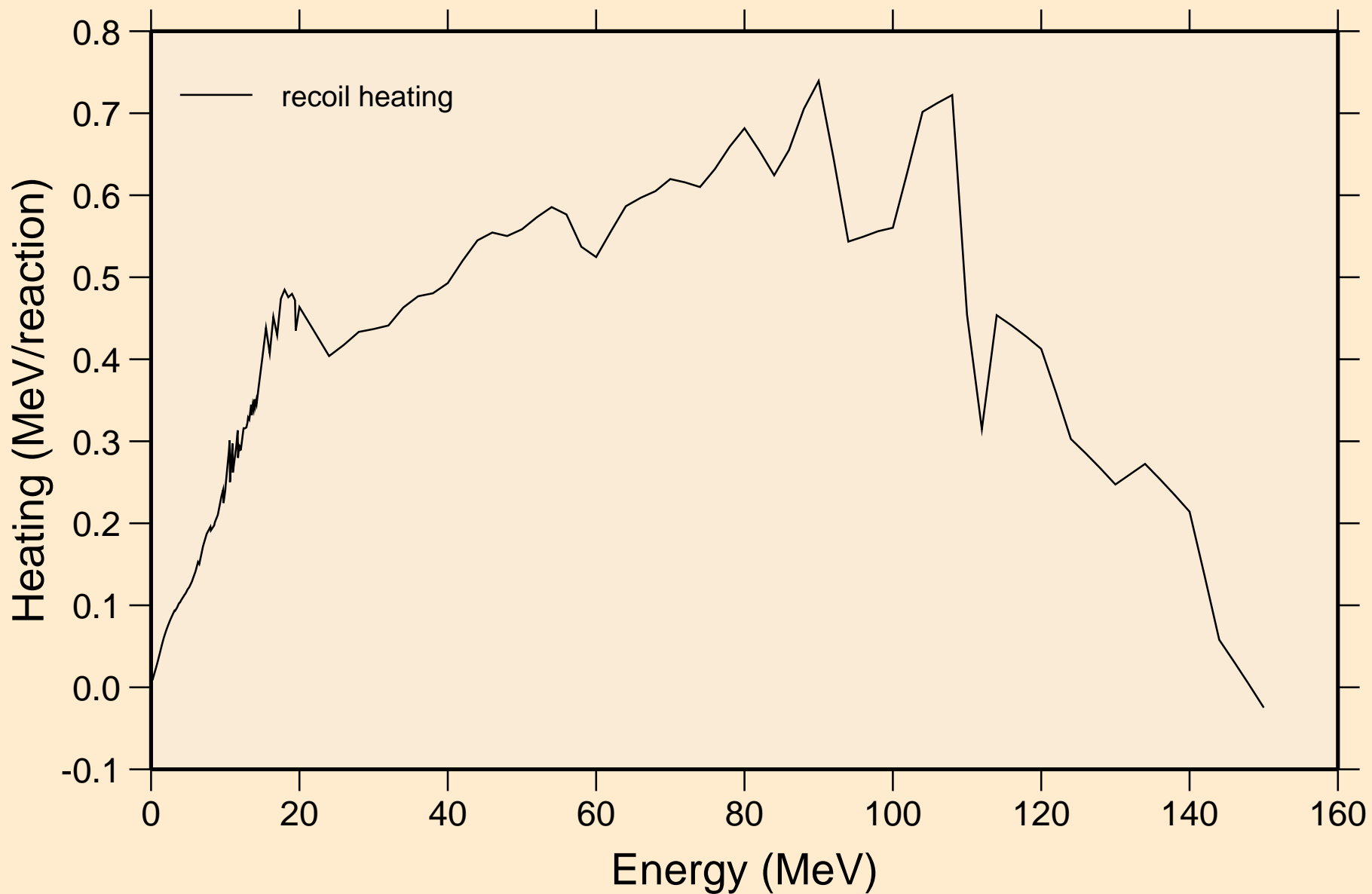

17-CL-37 FOR FENDL-3.2 FROM FENDL-3.2 BY NJOY2016.60+ OI

Particle production cross sections

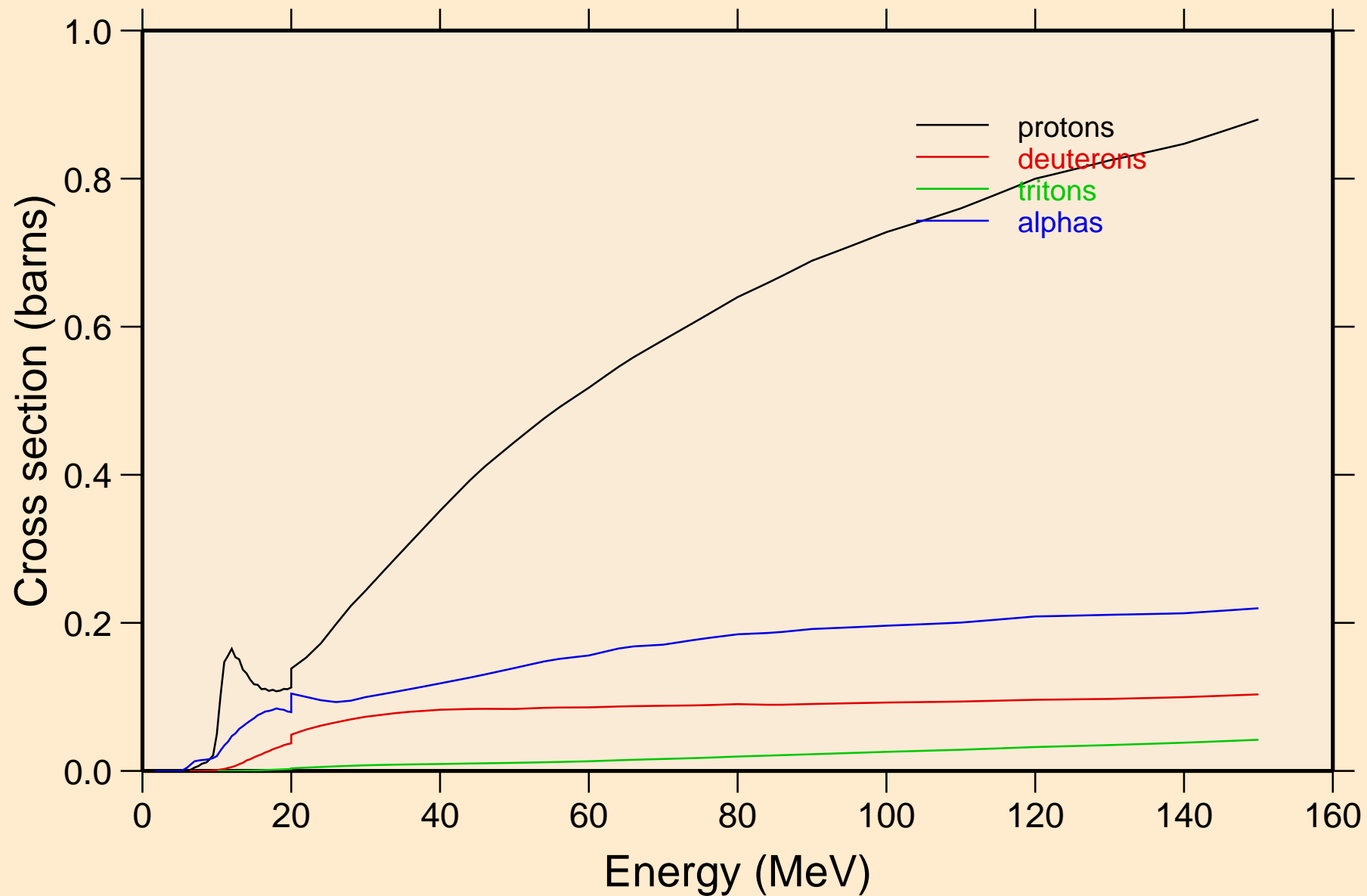

17-CL-37 FOR FENDL-3.2 FROM FENDL-3.2 BY NJOY2016.60+ OI
protons from (n,x)

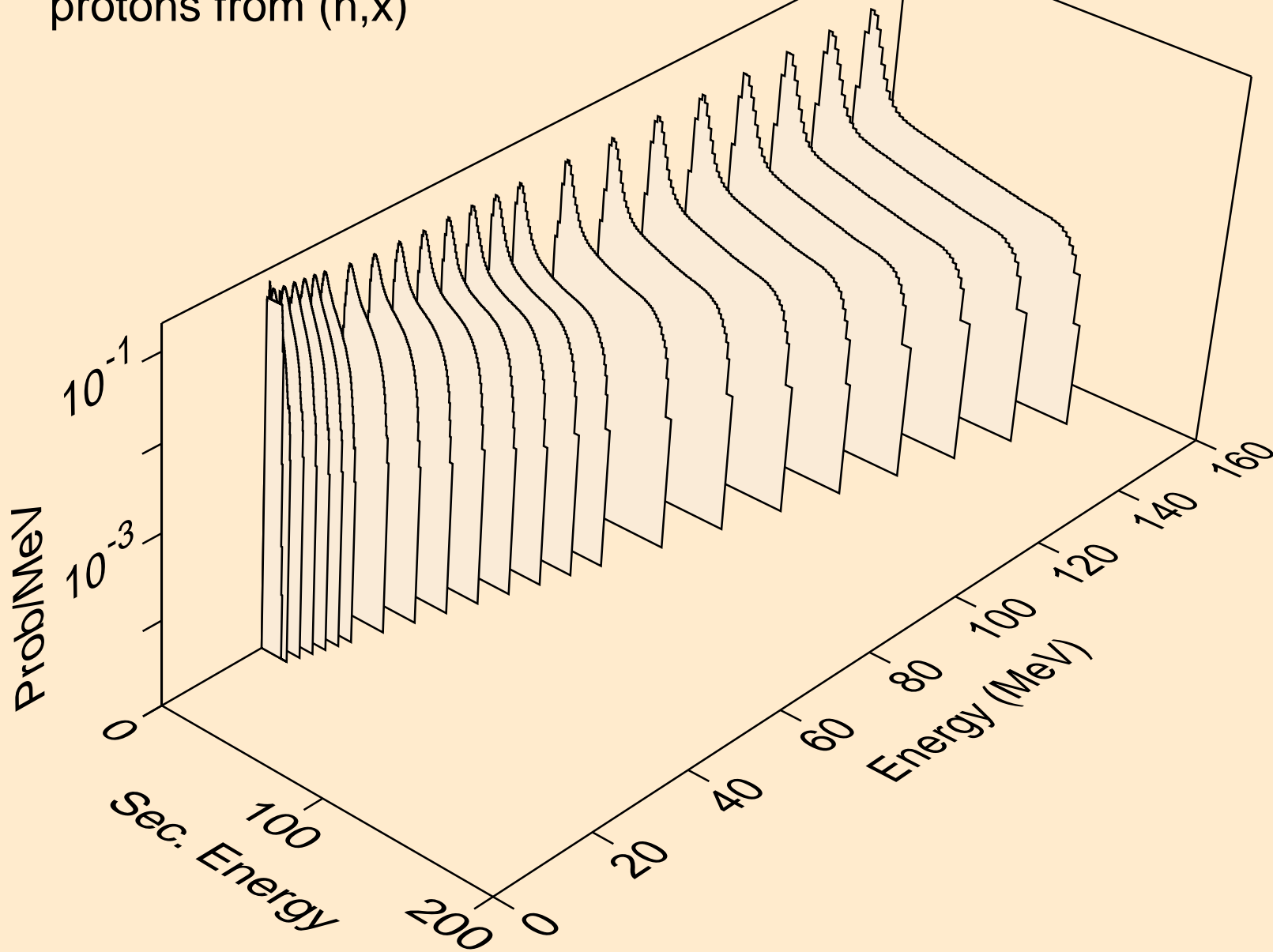

17-CL-37 FOR FENDL-3.2 FROM FENDL-3.2 BY NJOY2016.60+ OI
protons from (n,n*)p

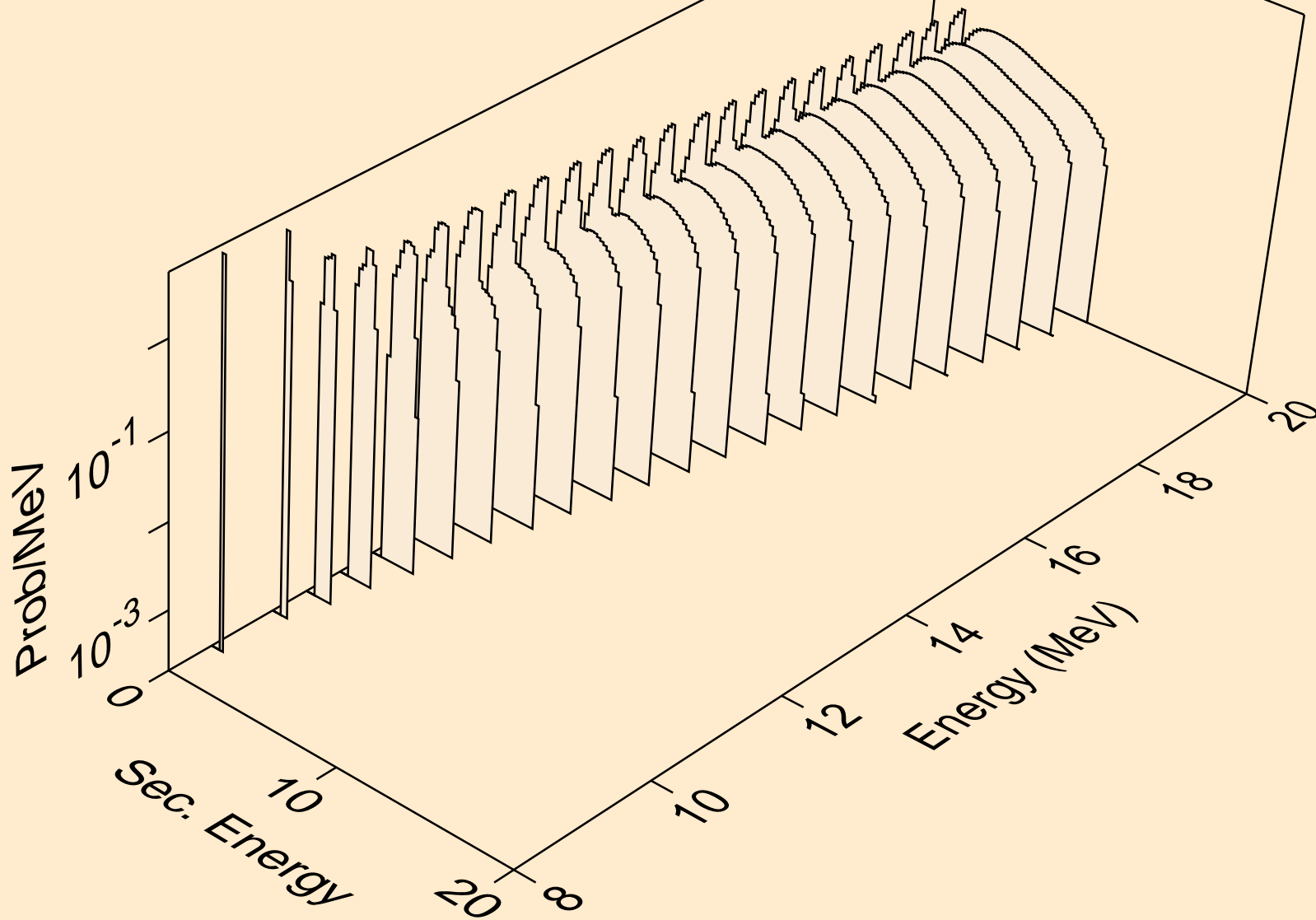

17-CL-37 FOR FENDL-3.2 FROM FENDL-3.2 BY NJOY2016.60+ OI
protons from (n,p*c)

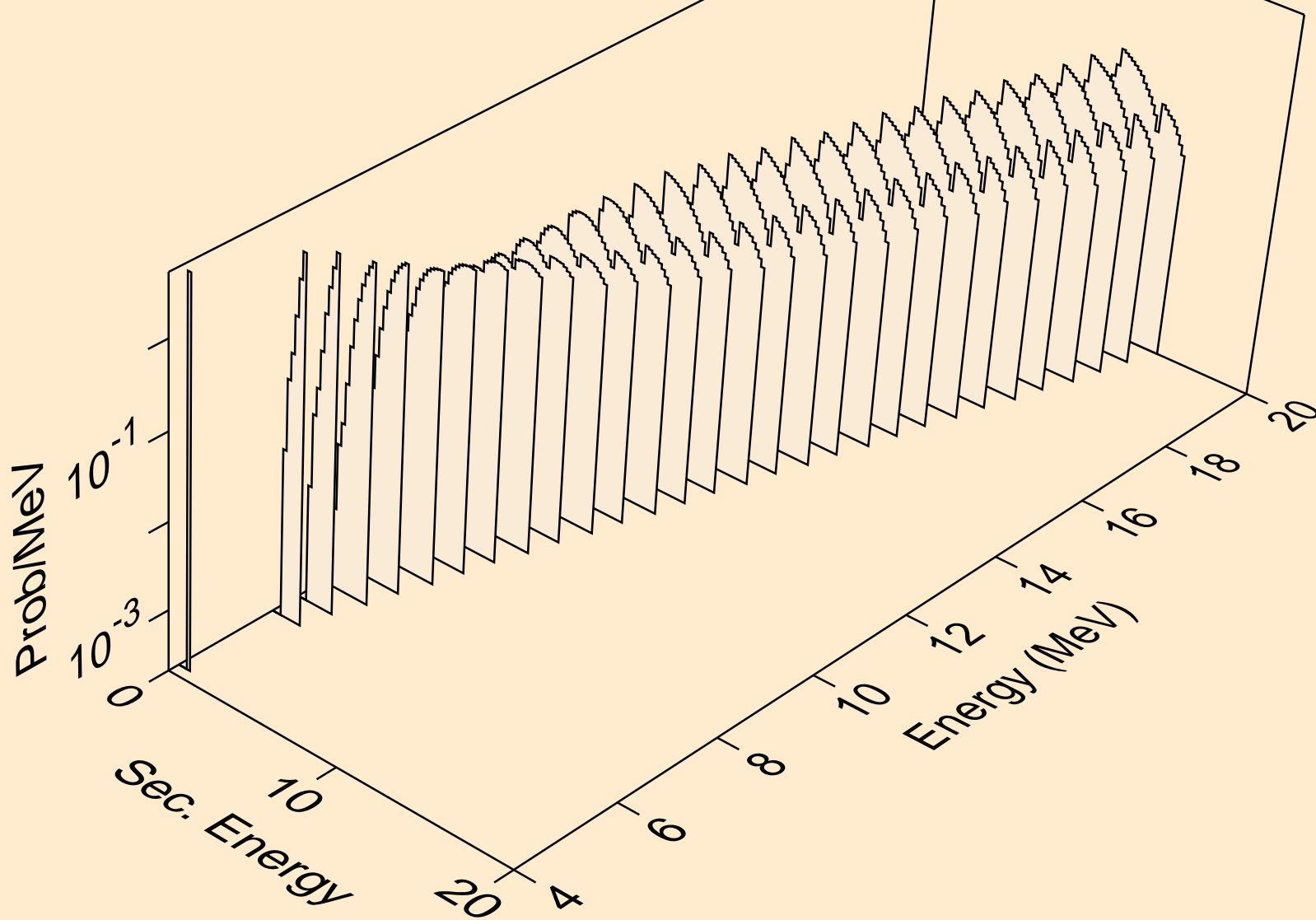

17-CL-37 FOR FENDL-3.2 FROM FENDL-3.2 BY NJOY2016.60+ OI
deuterons from (n,x)

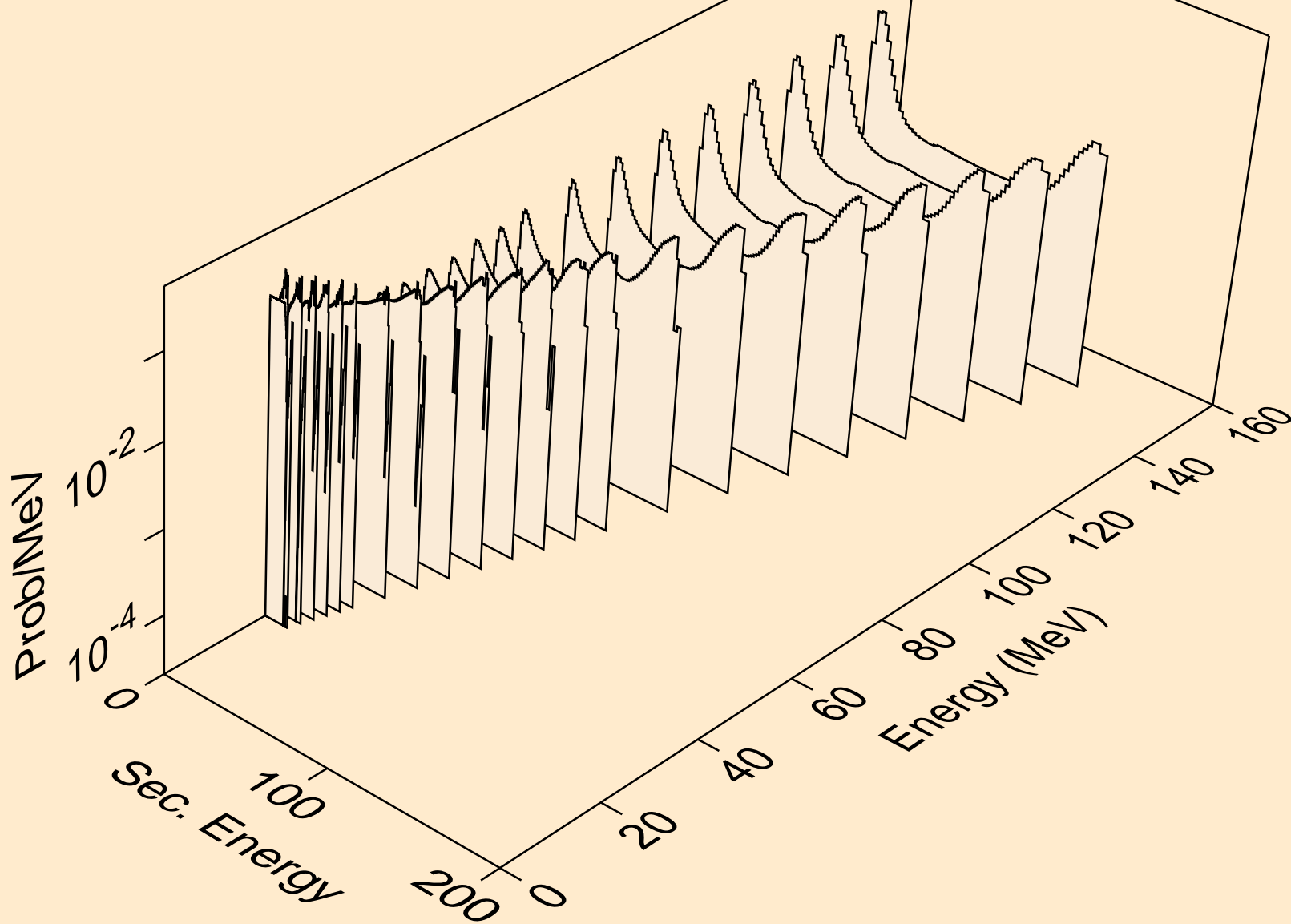

17-CL-37 FOR FENDL-3.2 FROM FENDL-3.2 BY NJOY2016.60+ OI
deuterons from (n,n*)d

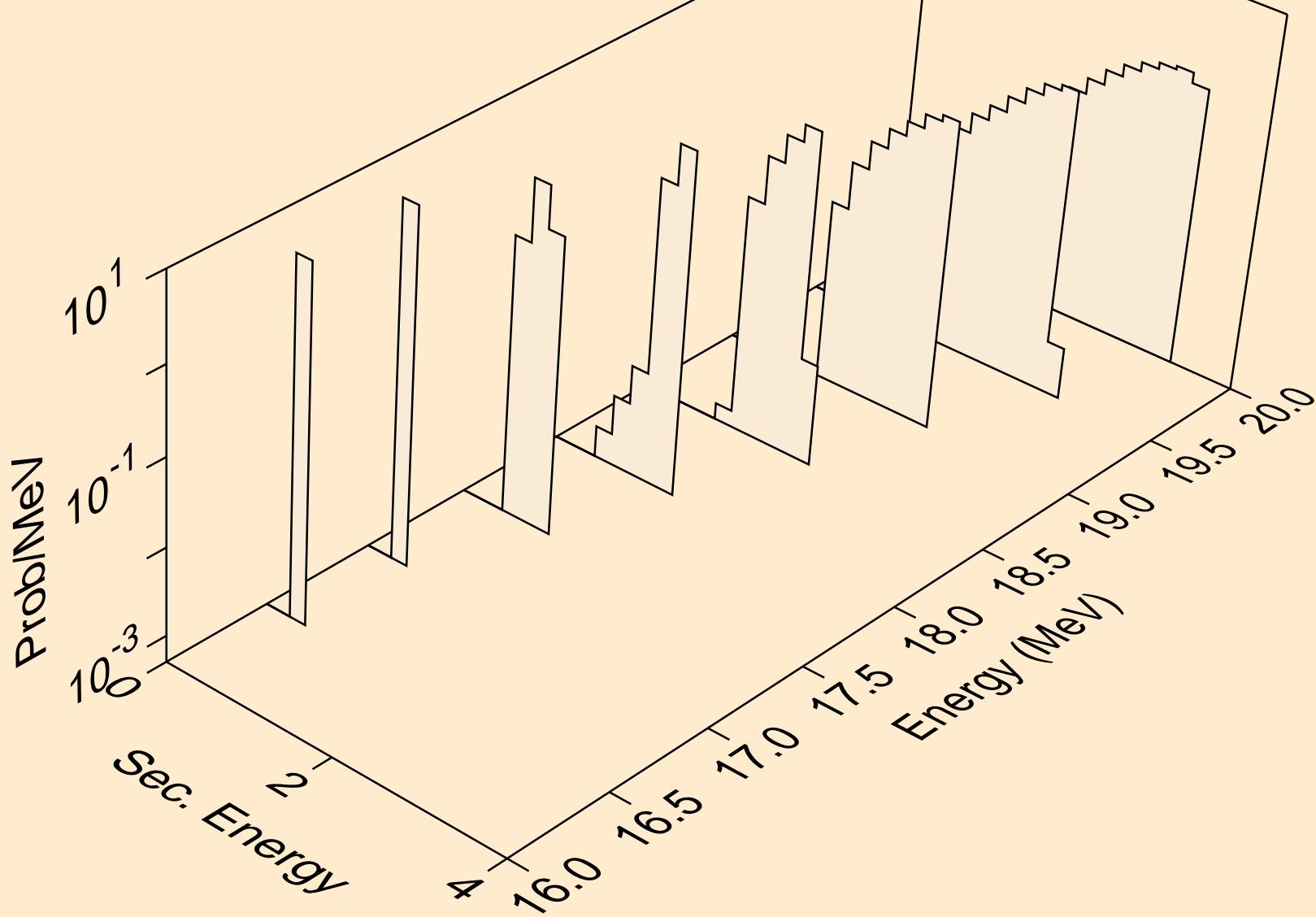

17-CL-37 FOR FENDL-3.2 FROM FENDL-3.2 BY NJOY2016.60+ OI
angular distribution for (n,d*0) deuteron

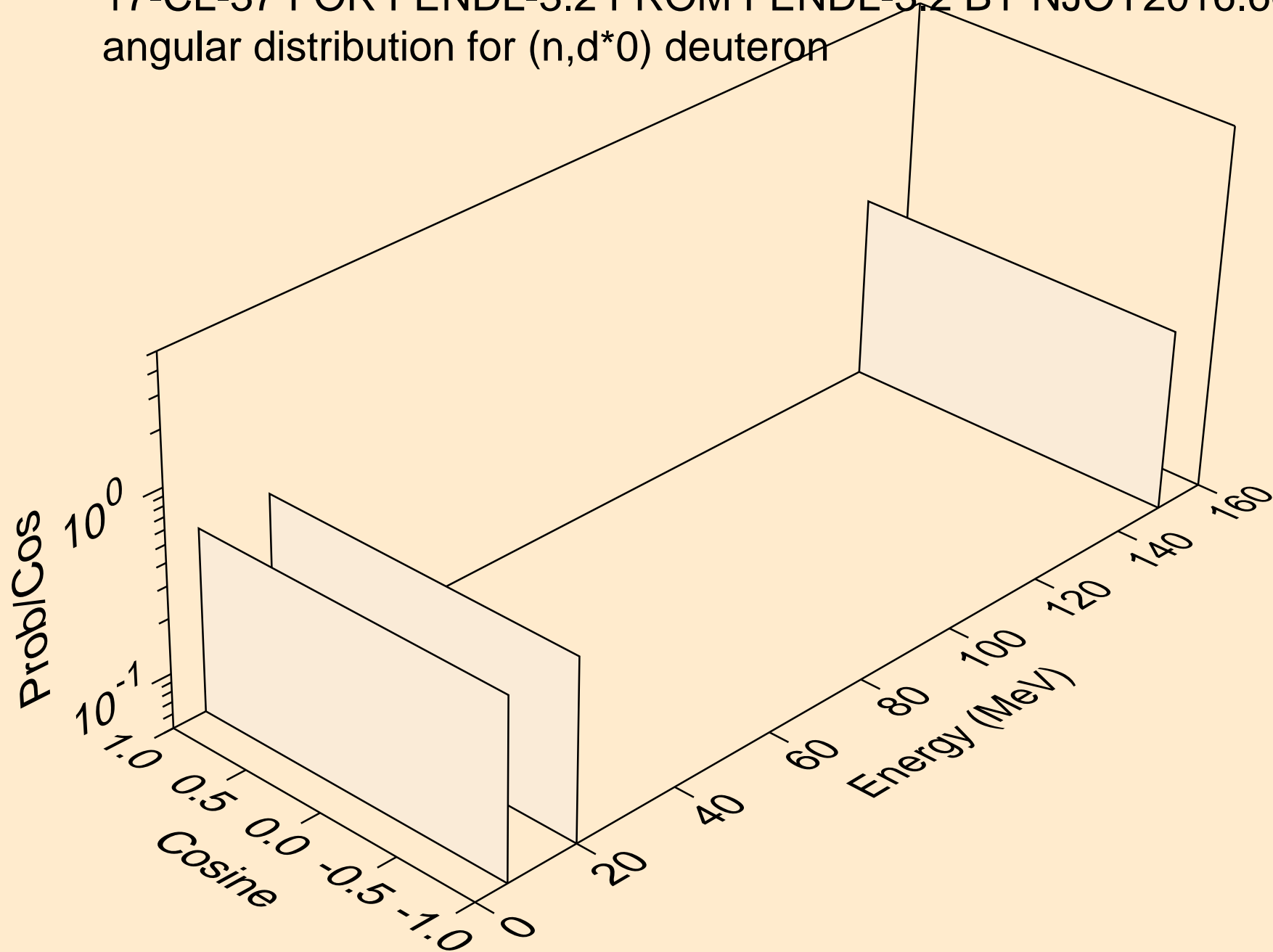

17-CL-37 FOR FENDL-3.2 FROM FENDL-3.2 BY NJOY2016.60+ OI
angular distribution for (n,d*1) deuteron

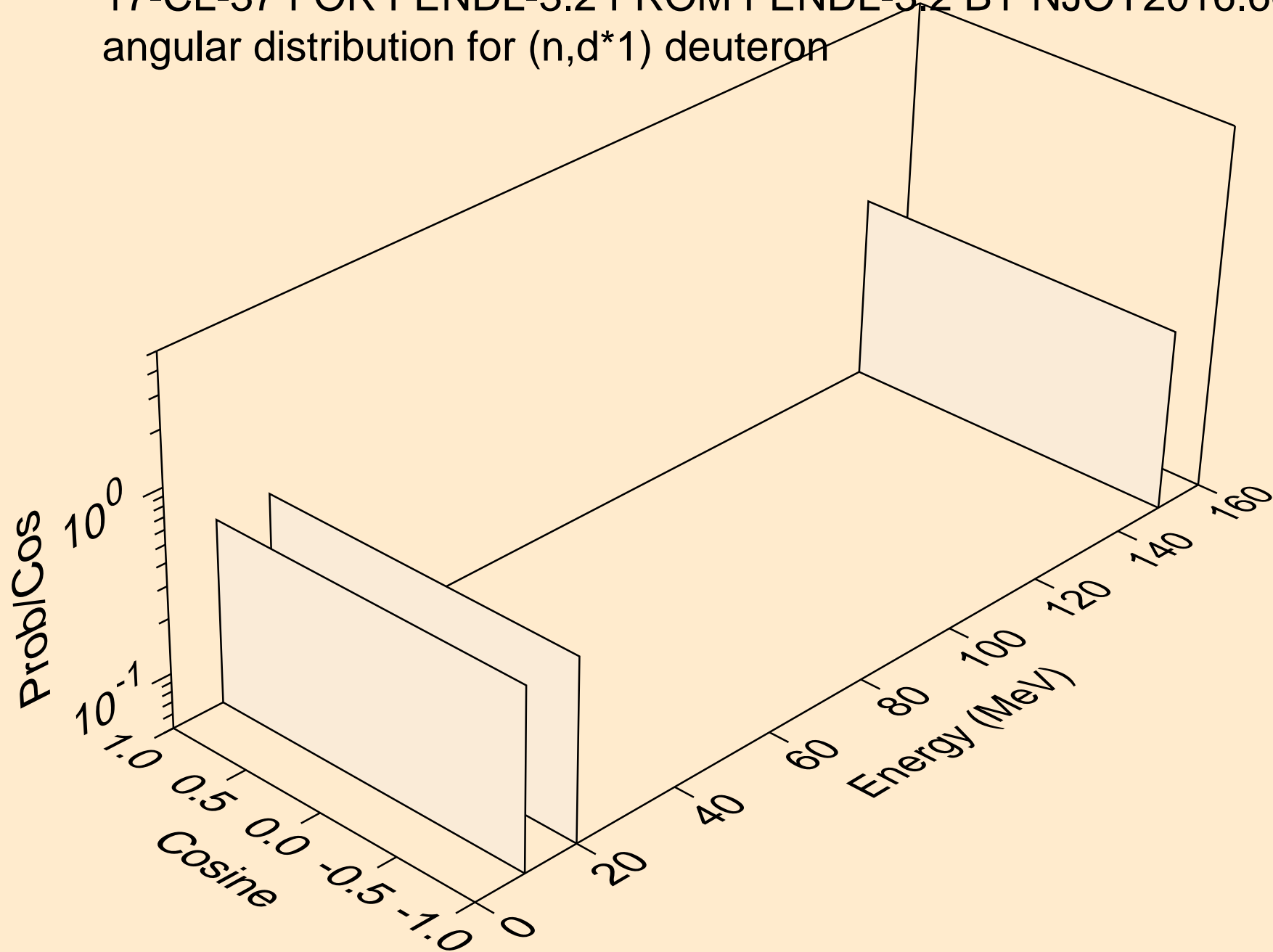

17-CL-37 FOR FENDL-3.2 FROM FENDL-3.2 BY NJOY2016.60+ OI
angular distribution for (n,d*2) deuteron

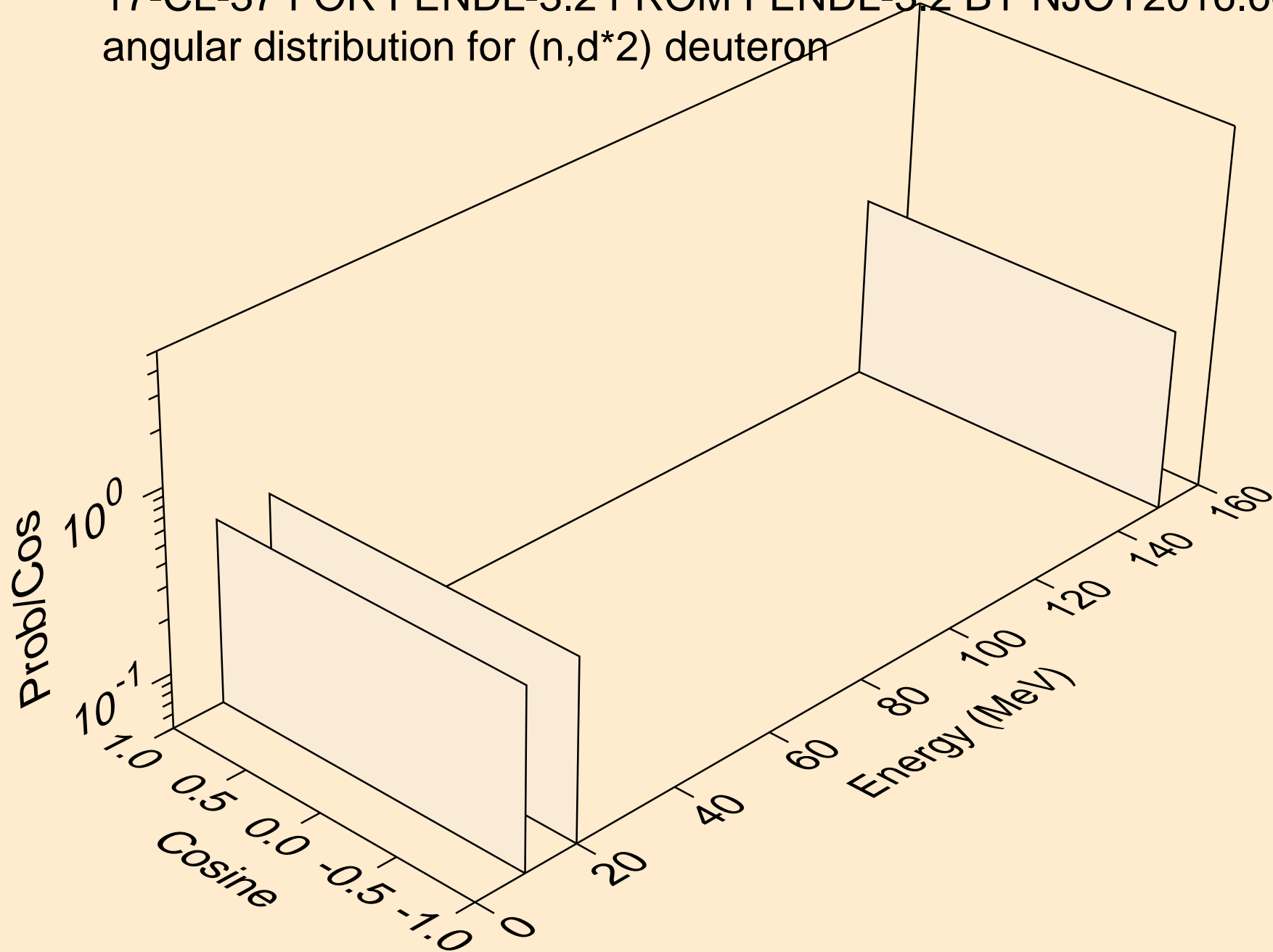

17-CL-37 FOR FENDL-3.2 FROM FENDL-3.2 BY NJOY2016.60+ OI
angular distribution for (n,d*3) deuteron

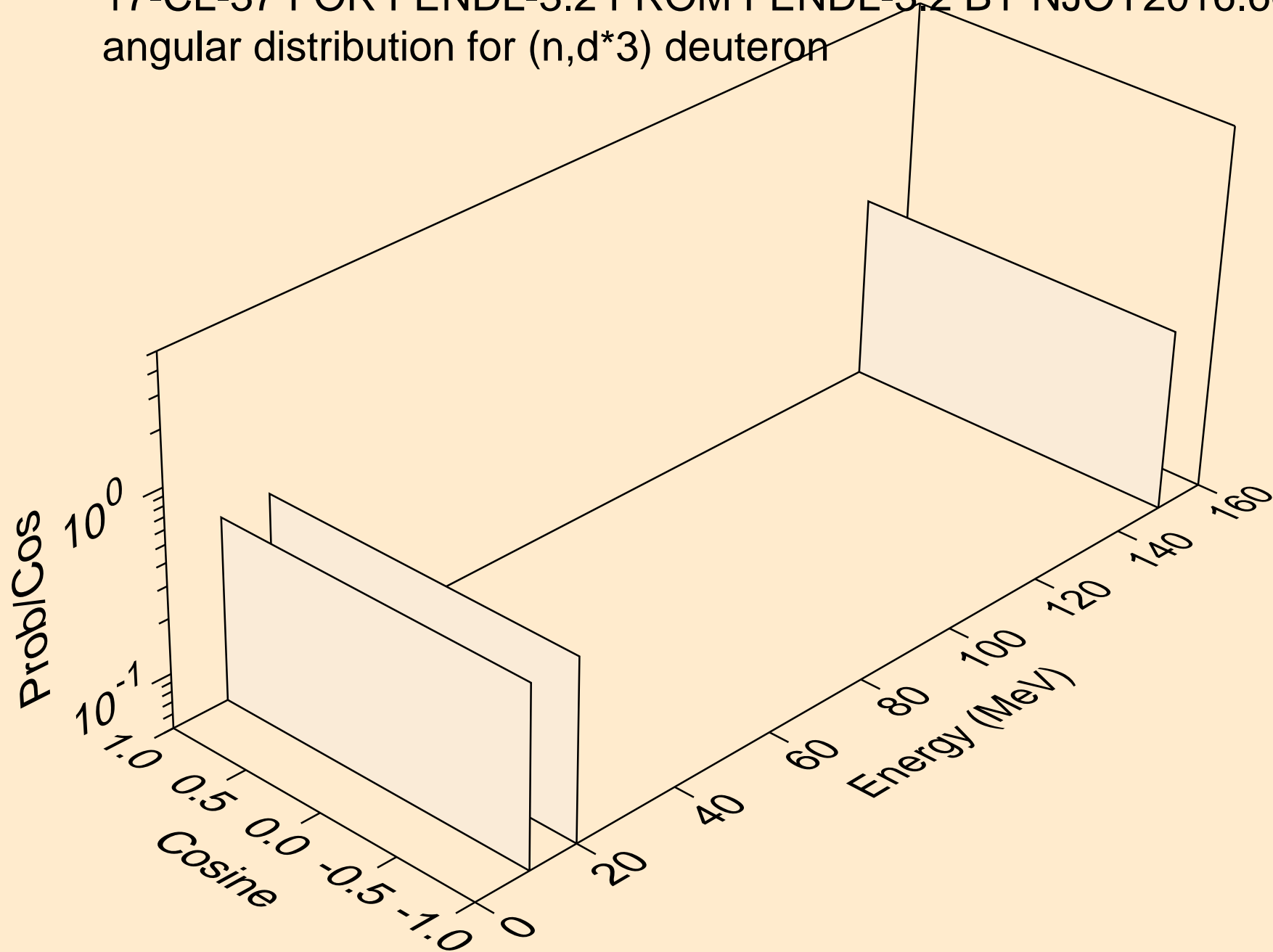

17-CL-37 FOR FENDL-3.2 FROM FENDL-3.2 BY NJOY2016.60+ OI
angular distribution for (n,d*4) deuteron

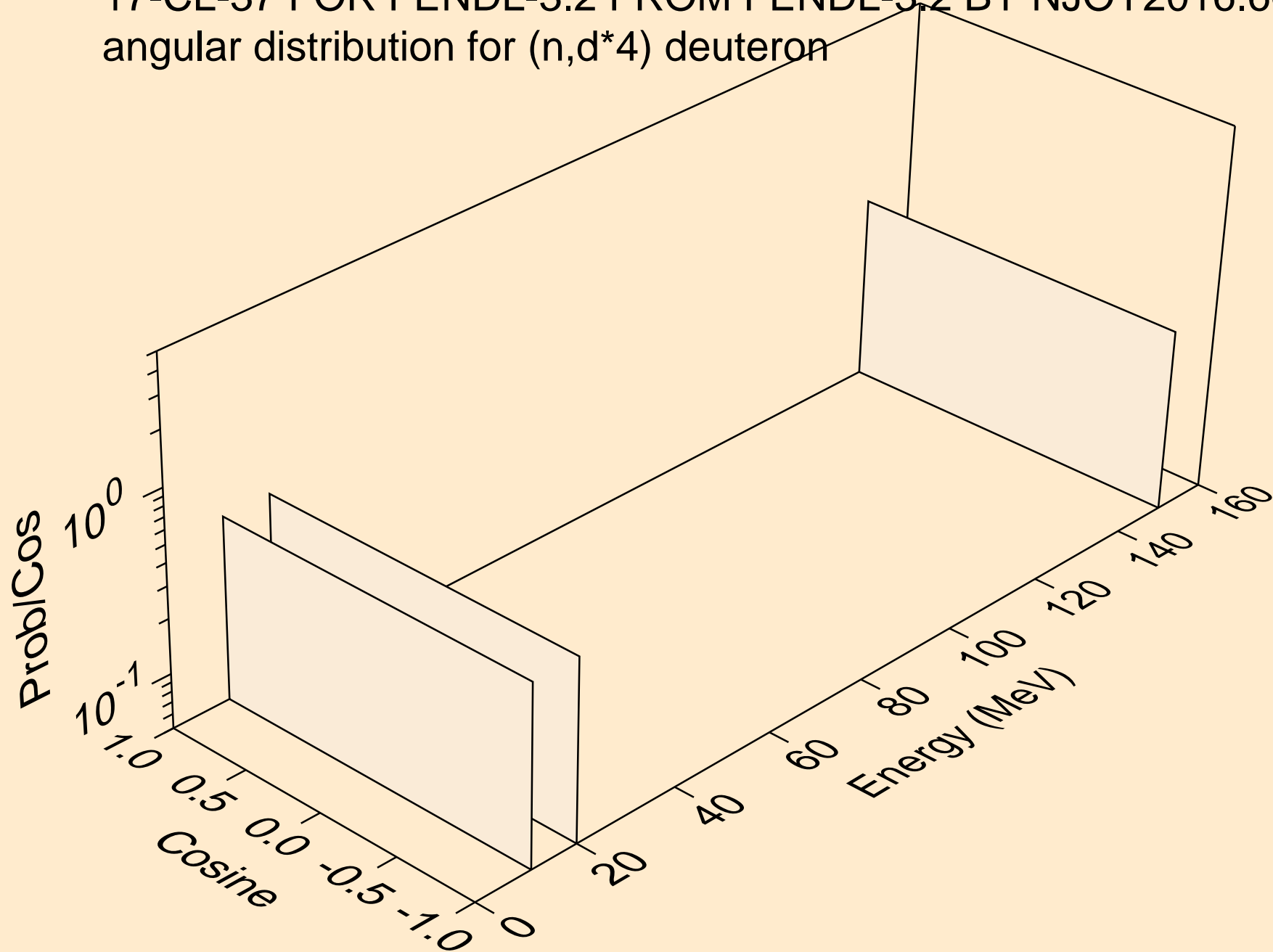

17-CL-37 FOR FENDL-3.2 FROM FENDL-3.2 BY NJOY2016.60+ OI
angular distribution for (n,d*5) deuteron

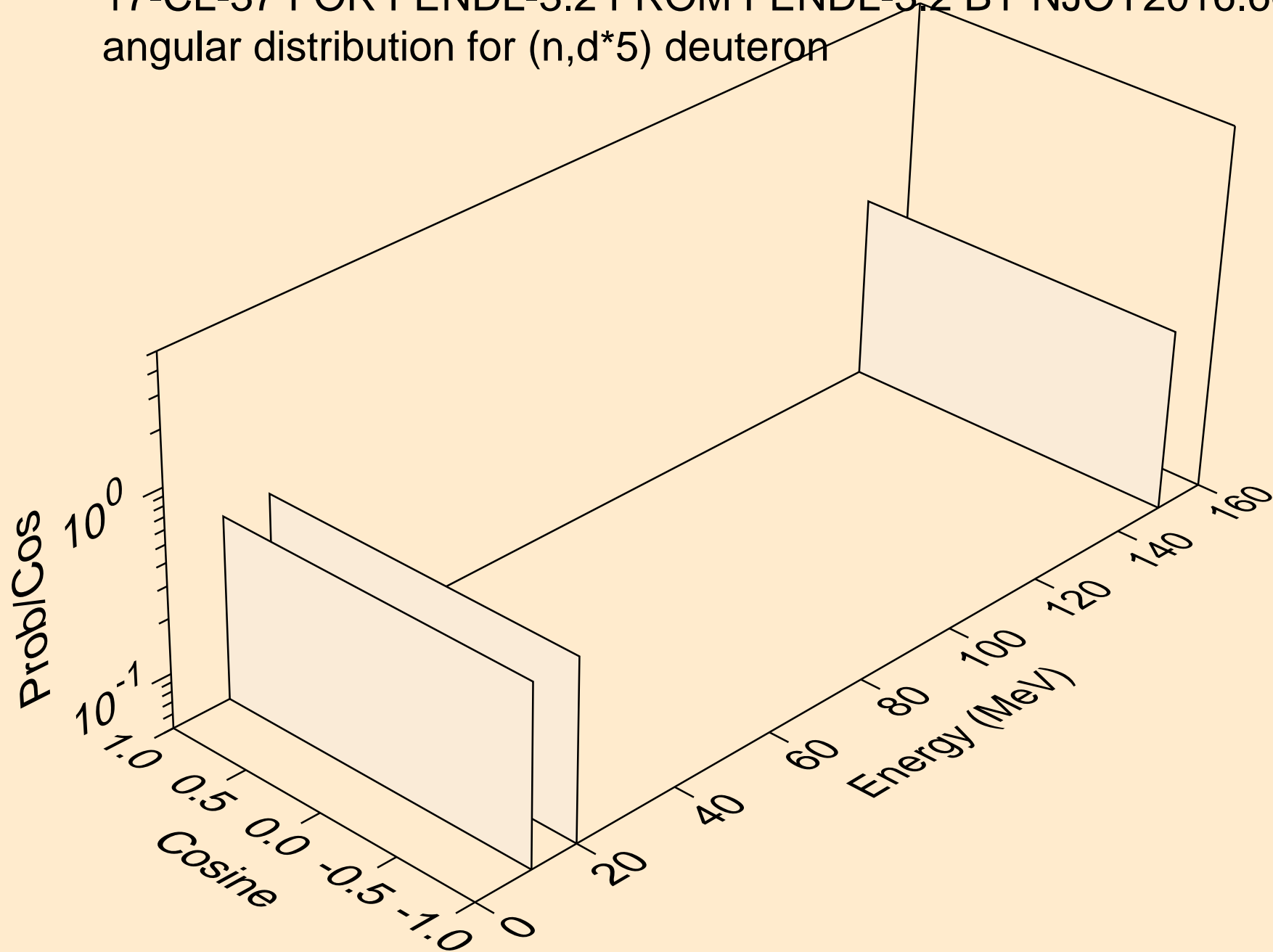

17-CL-37 FOR FENDL-3.2 FROM FENDL-3.2 BY NJOY2016.60+ OI
angular distribution for (n,d*6) deuteron

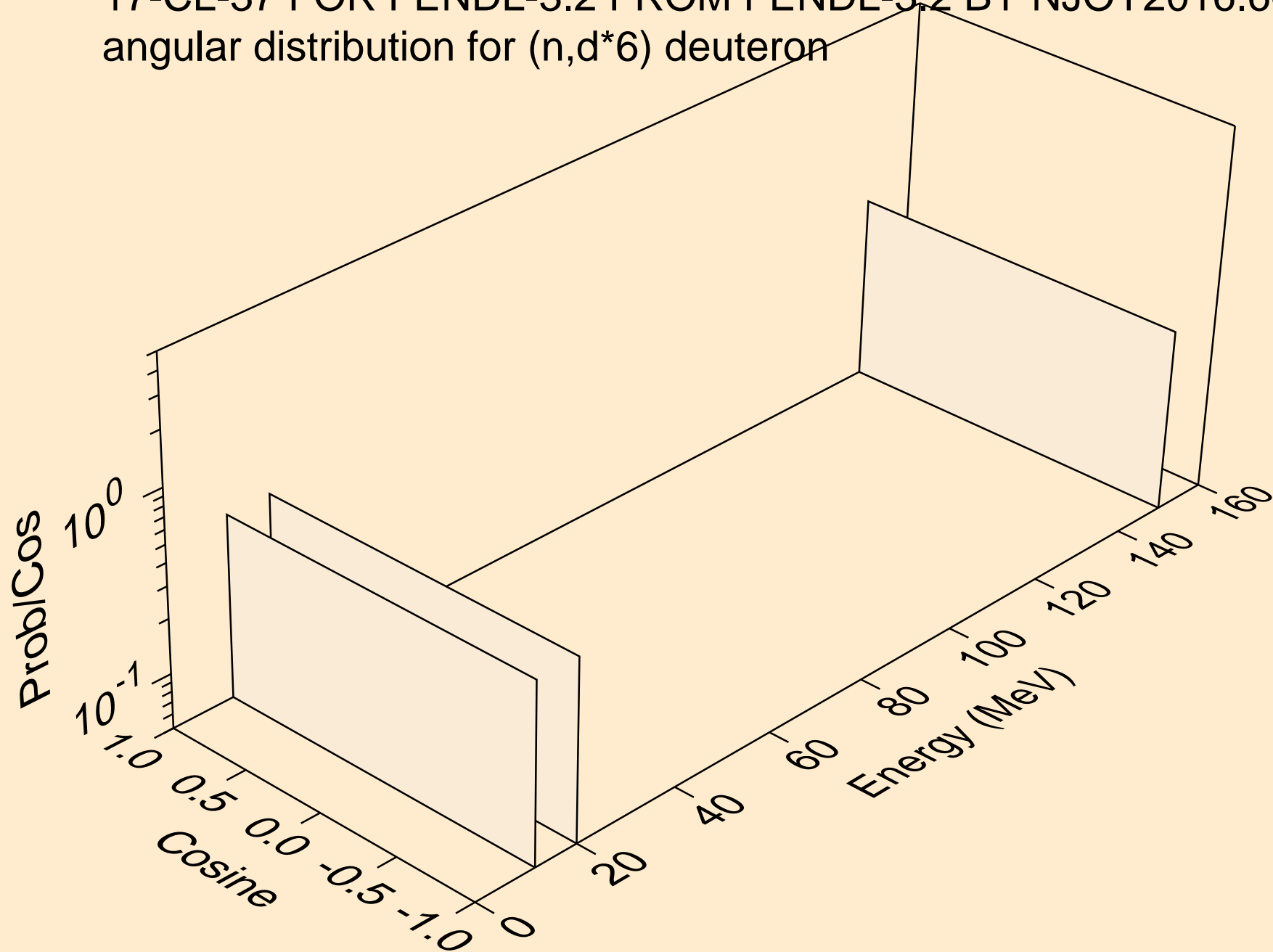

17-CL-37 FOR FENDL-3.2 FROM FENDL-3.2 BY NJOY2016.60+ OI
angular distribution for (n,d*7) deuteron

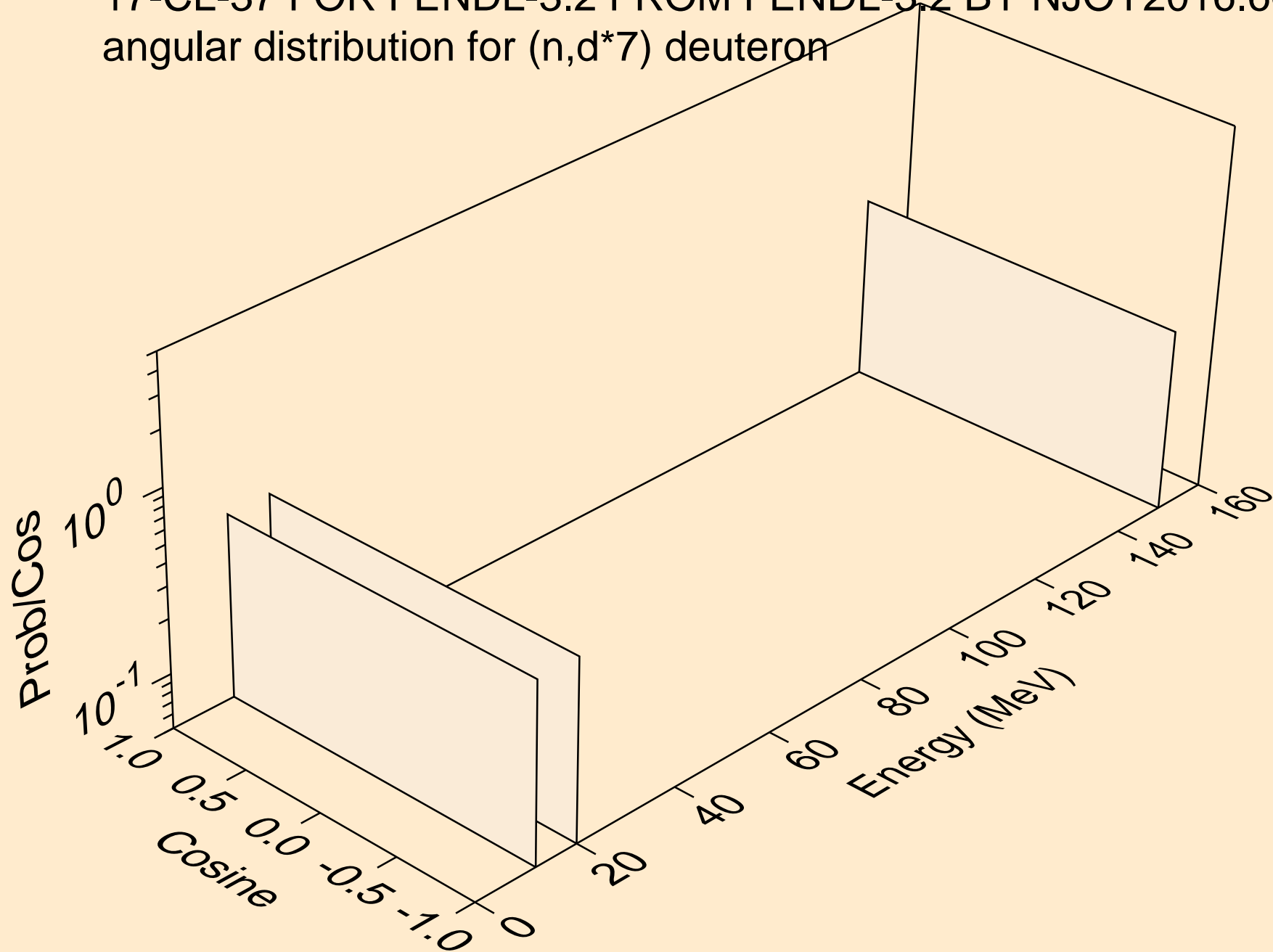

17-CL-37 FOR FENDL-3.2 FROM FENDL-3.2 BY NJOY2016.60+ OI
angular distribution for (n,d*8) deuteron

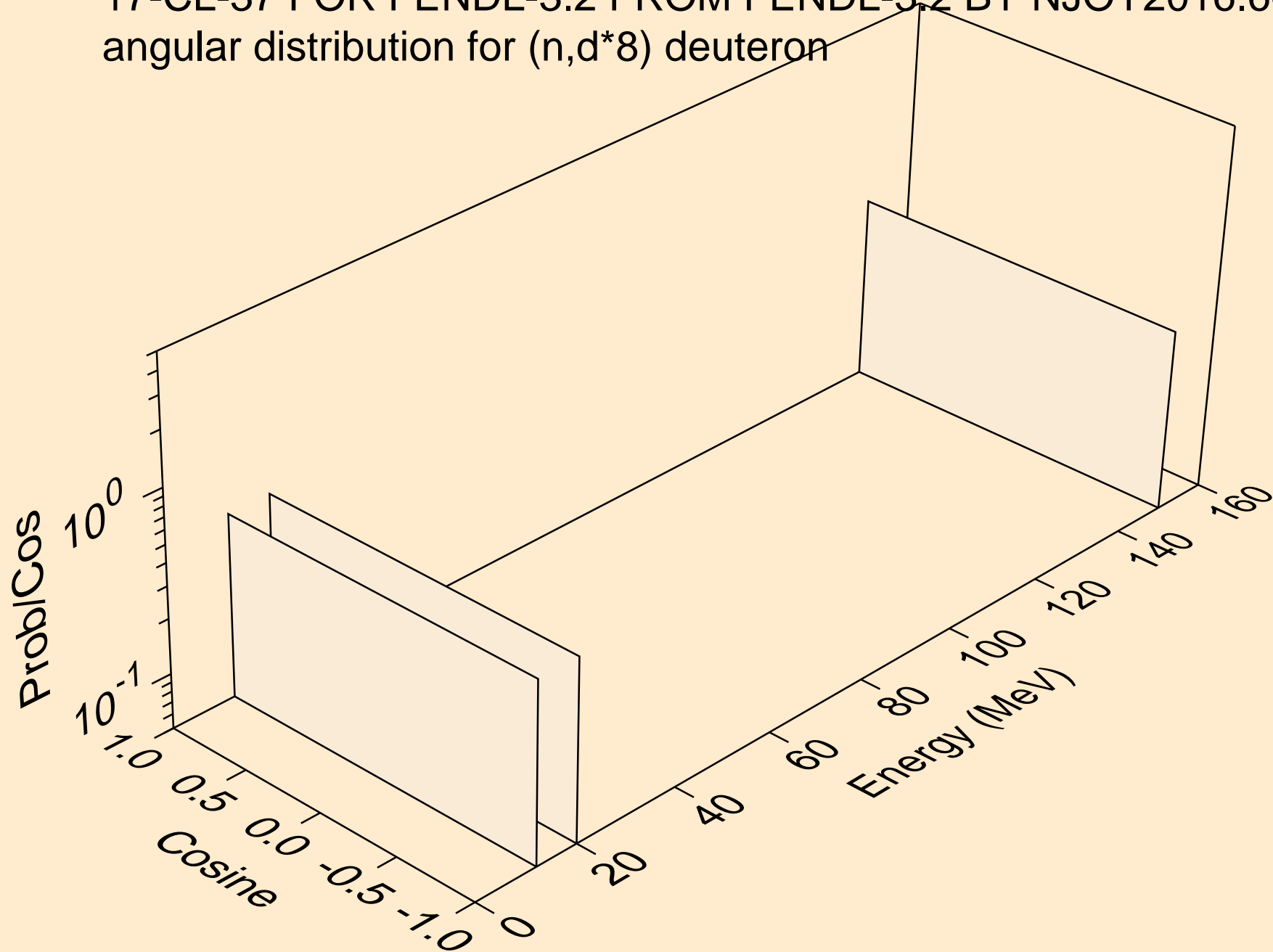

17-CL-37 FOR FENDL-3.2 FROM FENDL-3.2 BY NJOY2016.60+ OI
angular distribution for (n,d*9) deuteron

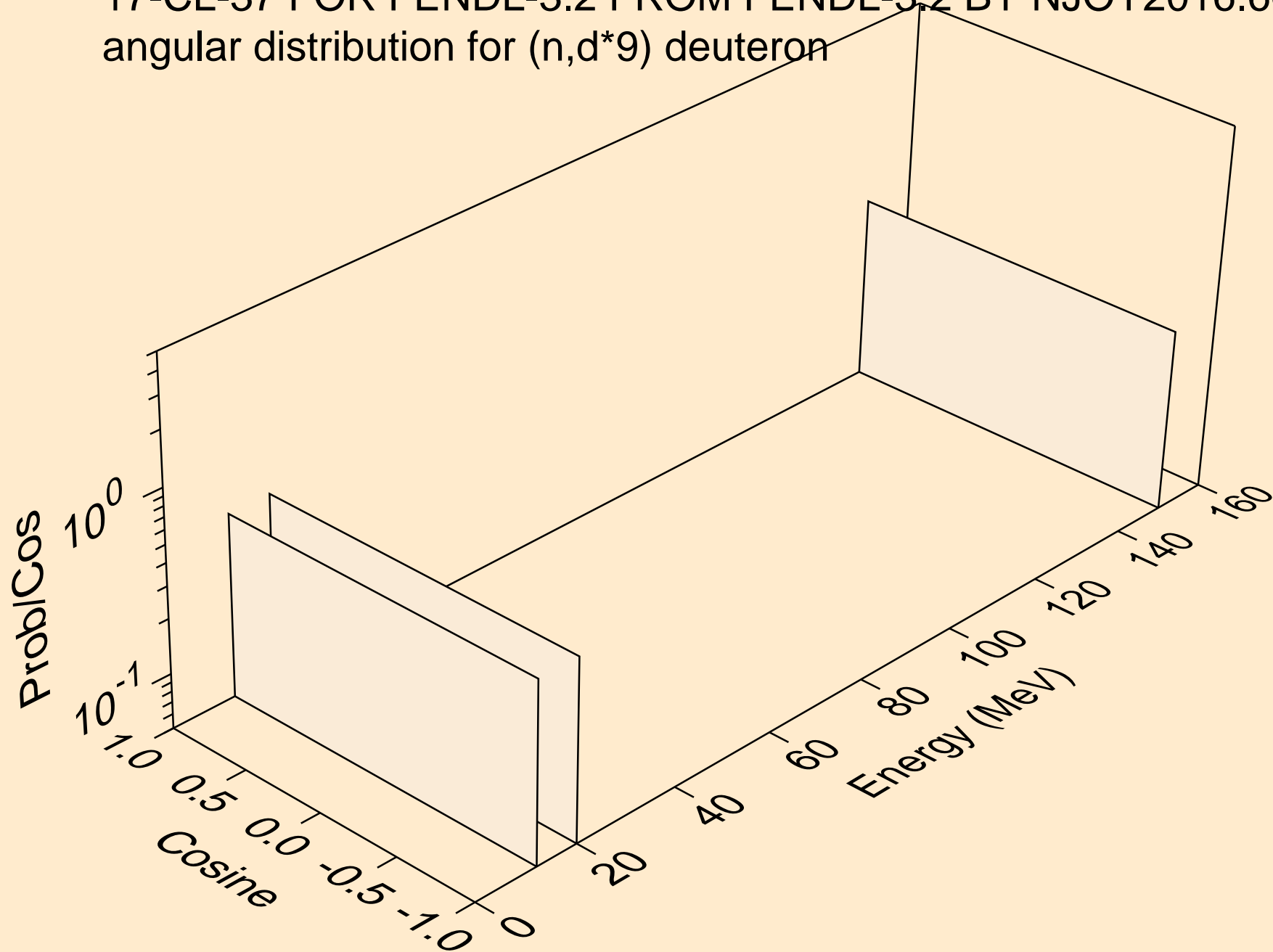

17-CL-37 FOR FENDL-3.2 FROM FENDL-3.2 BY NJOY2016.60+ OI
angular distribution for (n,d*10) deuteron

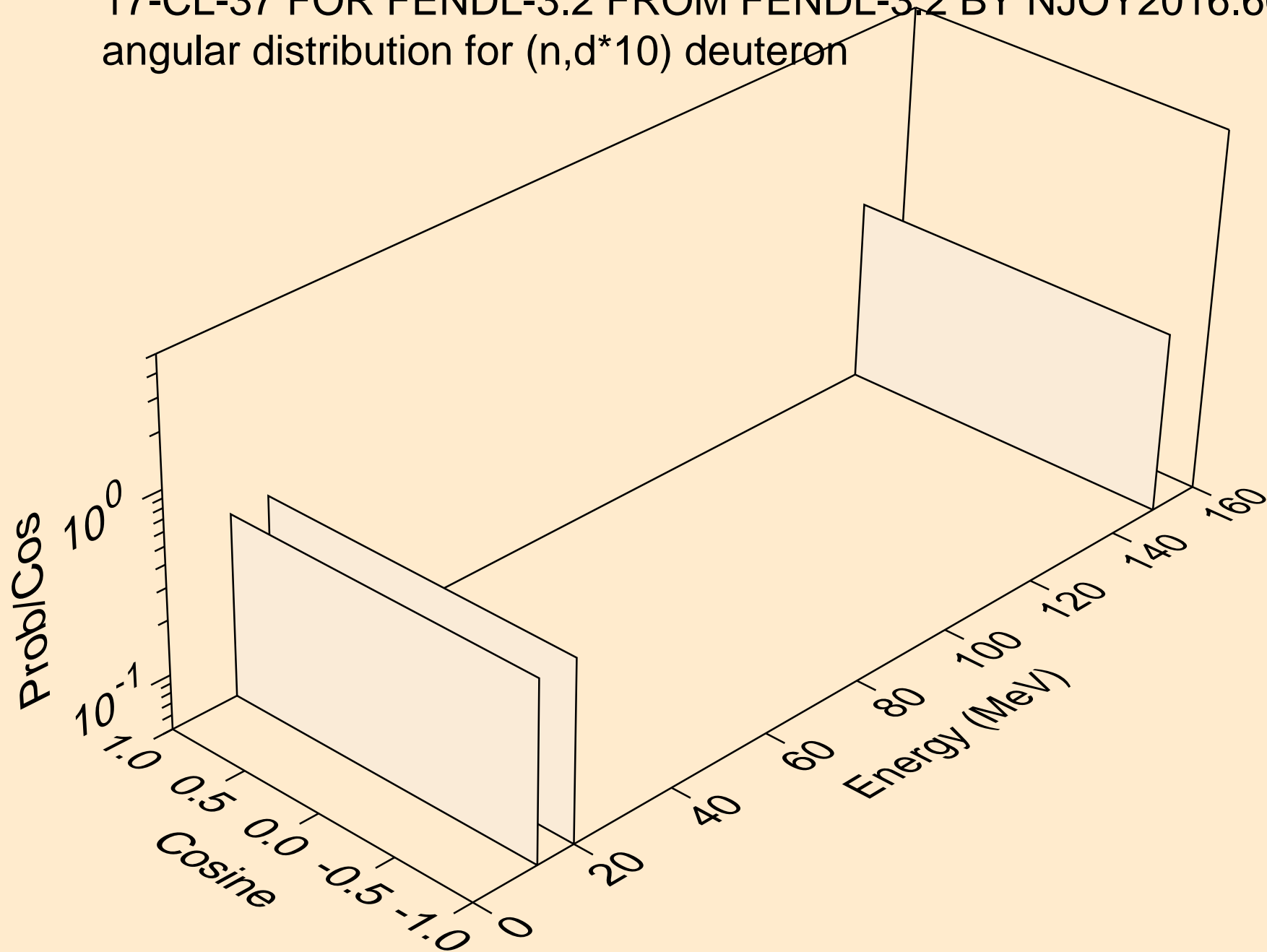

17-CL-37 FOR FENDL-3.2 FROM FENDL-3.2 BY NJOY2016.60+ OI
angular distribution for (n,d*11) deuteron

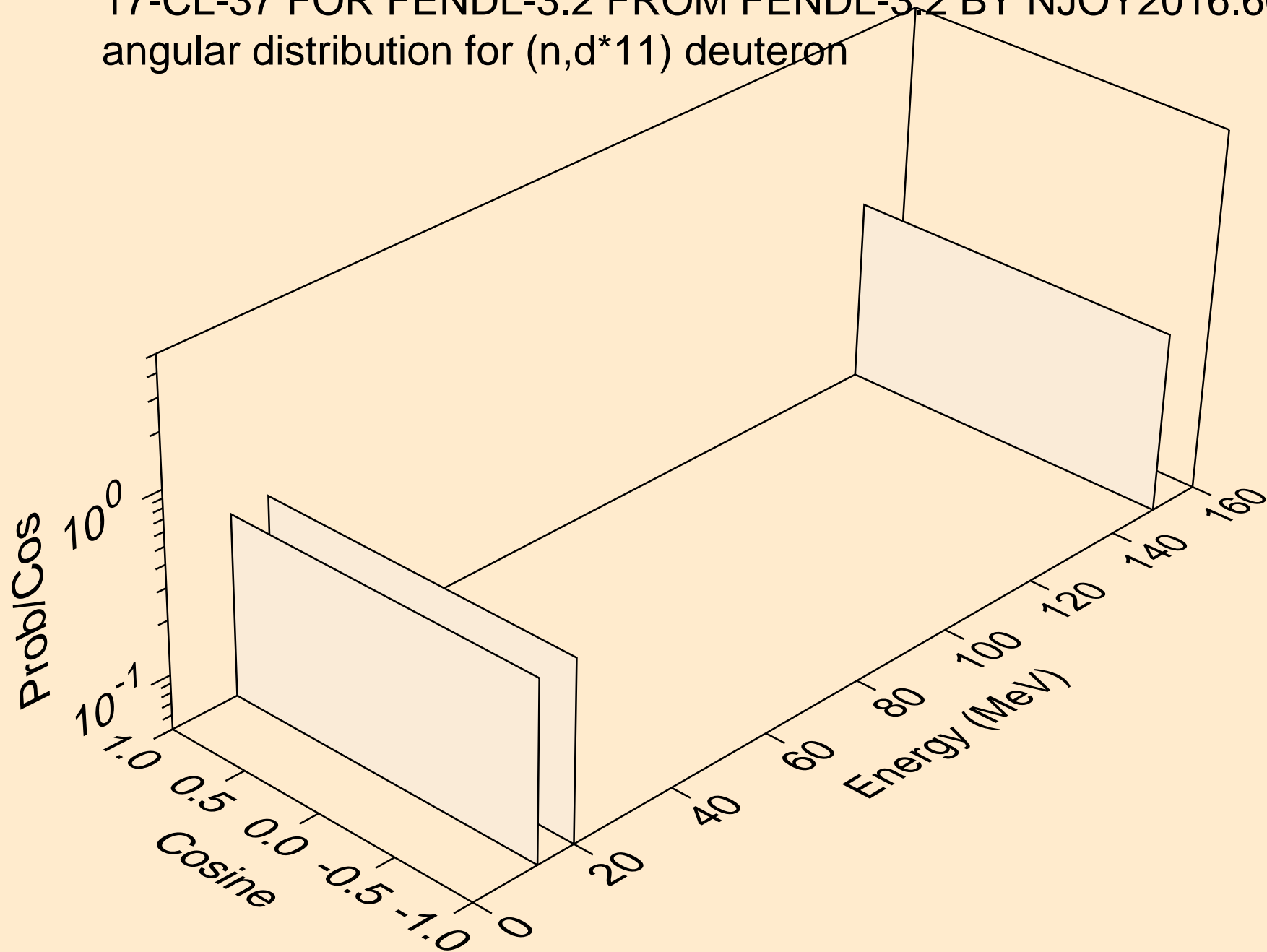

17-CL-37 FOR FENDL-3.2 FROM FENDL-3.2 BY NJOY2016.60+ OI
deuterons from (n,d*c)

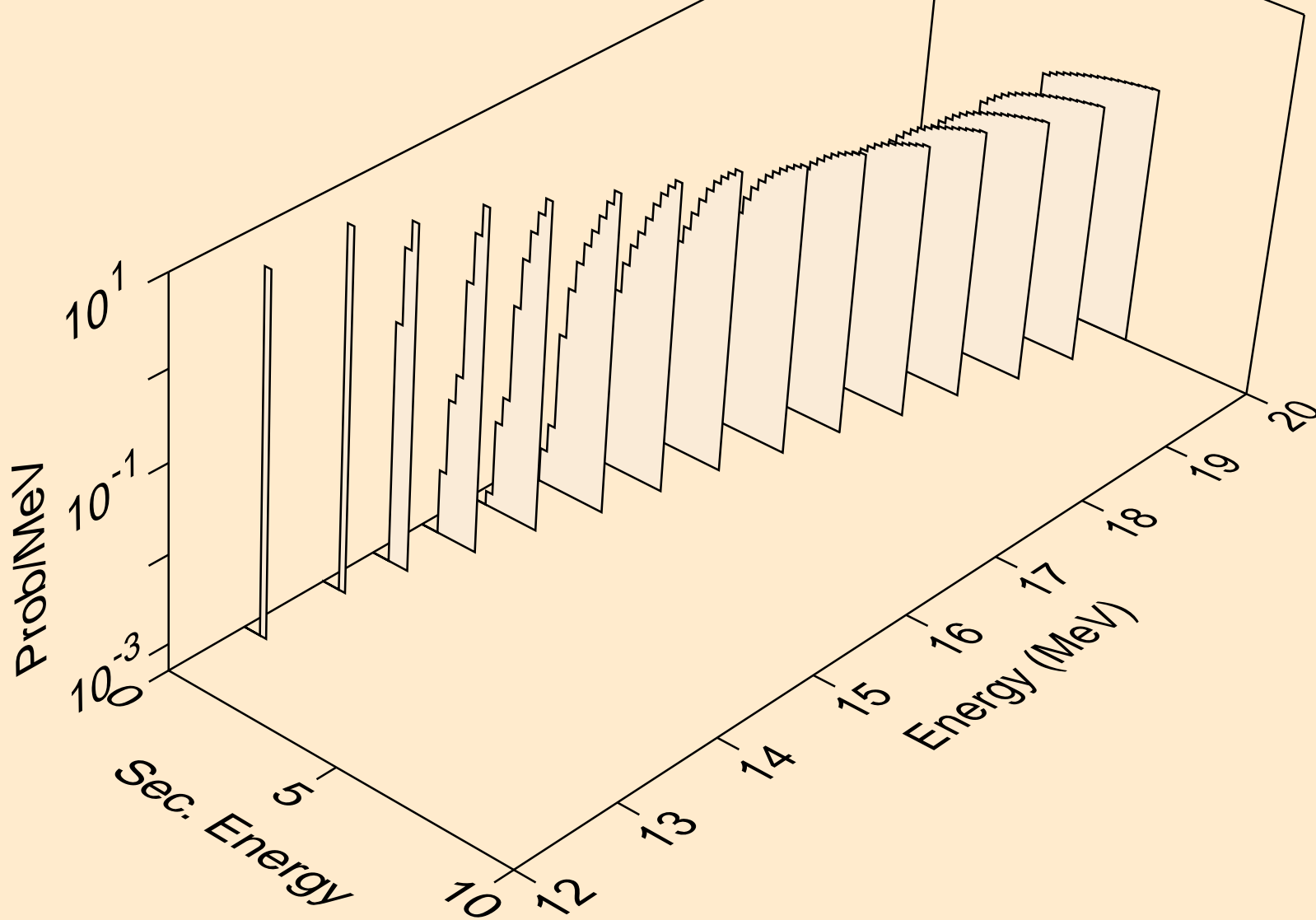

17-CL-37 FOR FENDL-3.2 FROM FENDL-3.2 BY NJOY2016.60+ OI
tritons from (n,x)

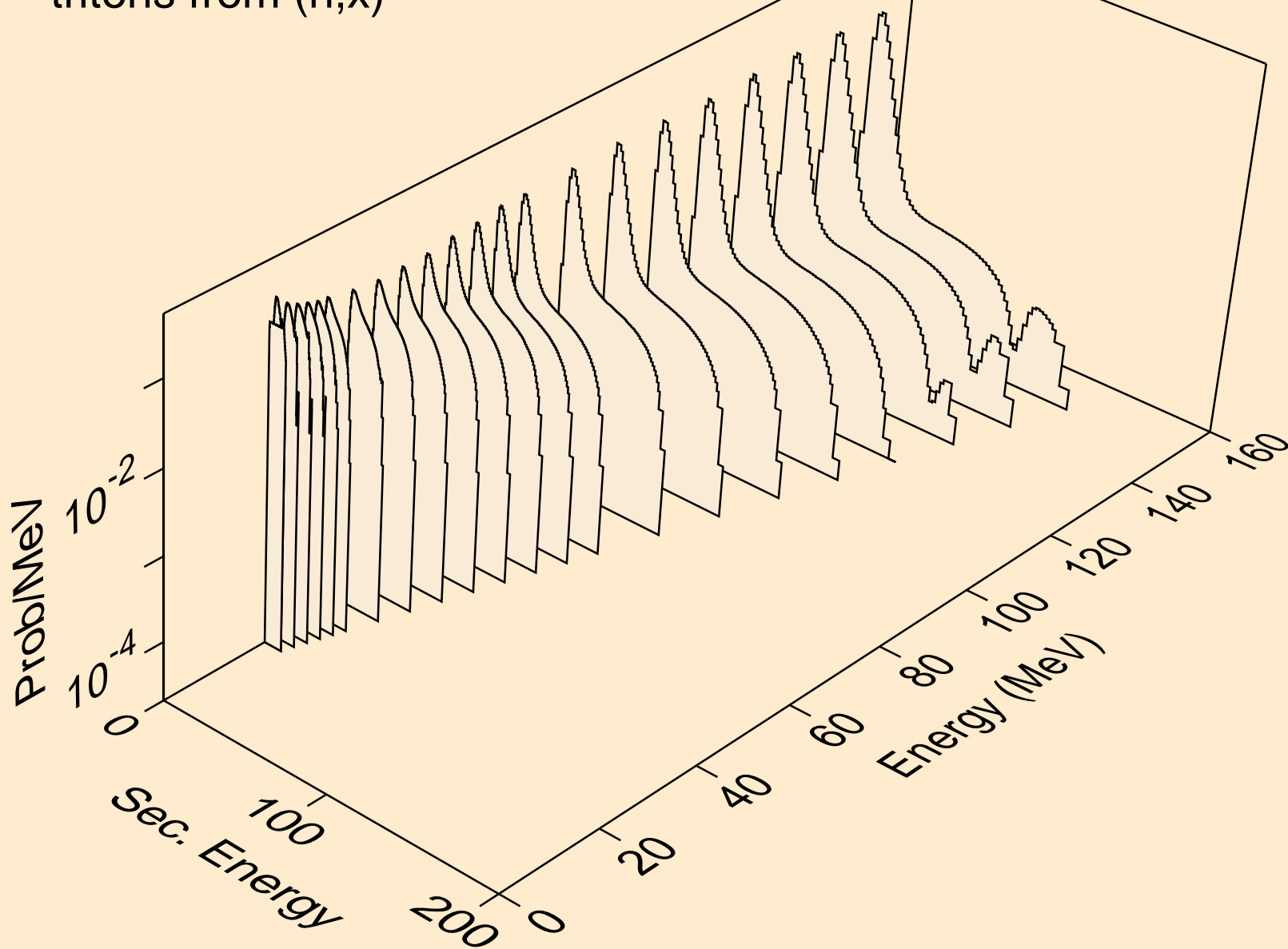

17-CL-37 FOR FENDL-3.2 FROM FENDL-3.2 BY NJOY2016.60+ OI
angular distribution for (n,t*0) triton

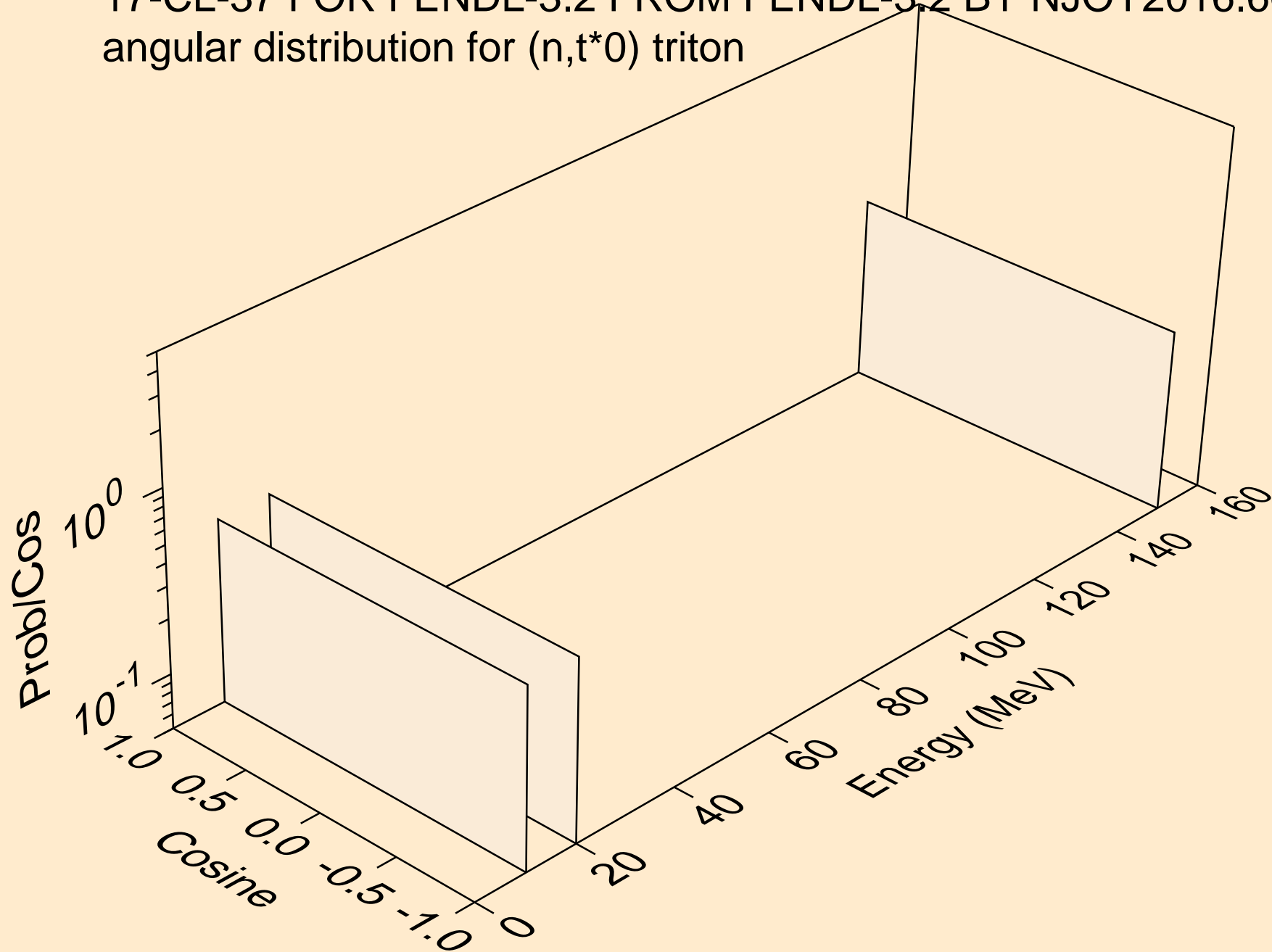

17-CL-37 FOR FENDL-3.2 FROM FENDL-3.2 BY NJOY2016.60+ OI
angular distribution for (n,t*1) triton

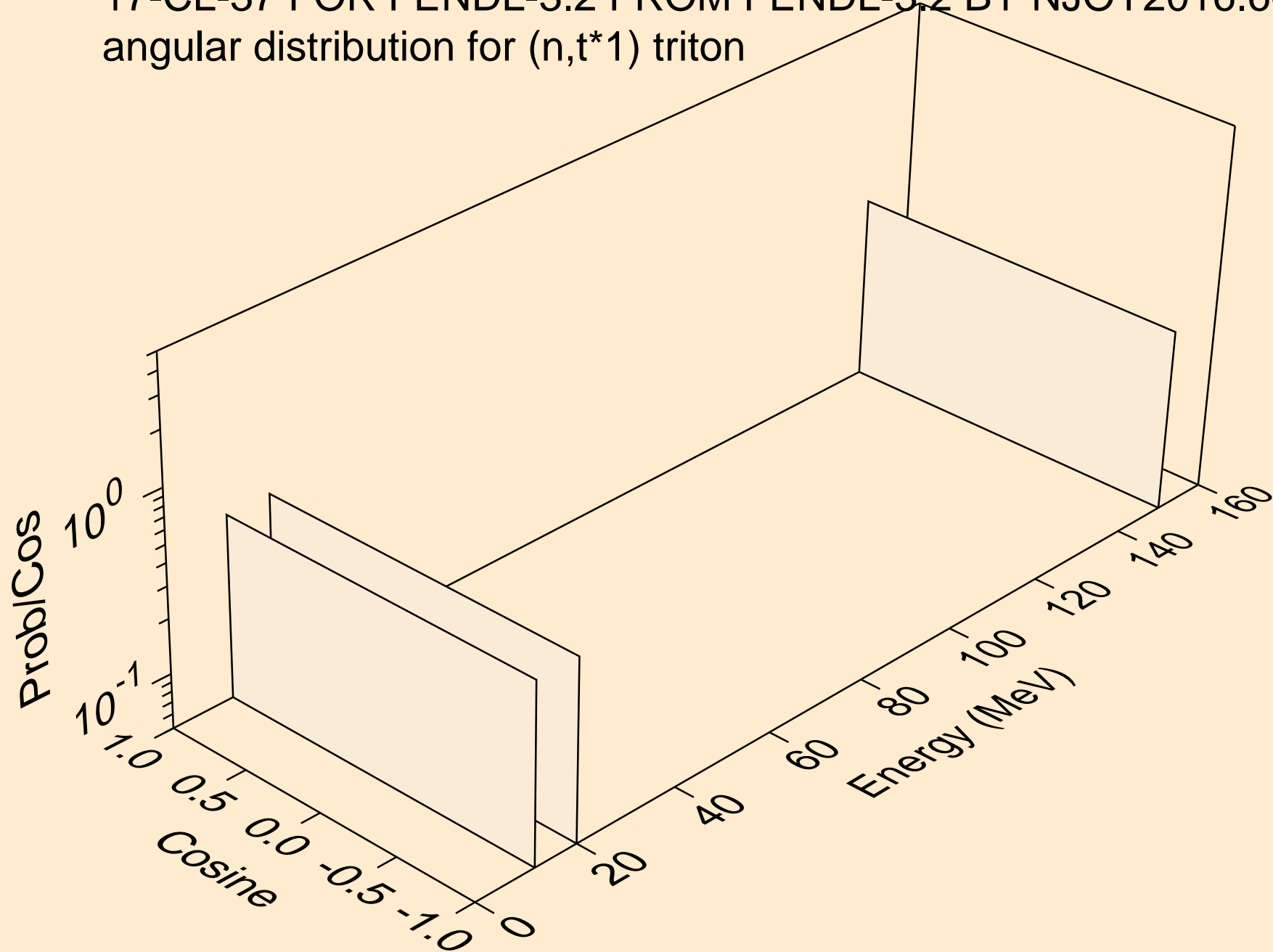

17-CL-37 FOR FENDL-3.2 FROM FENDL-3.2 BY NJOY2016.60+ OI
angular distribution for (n,t*2) triton

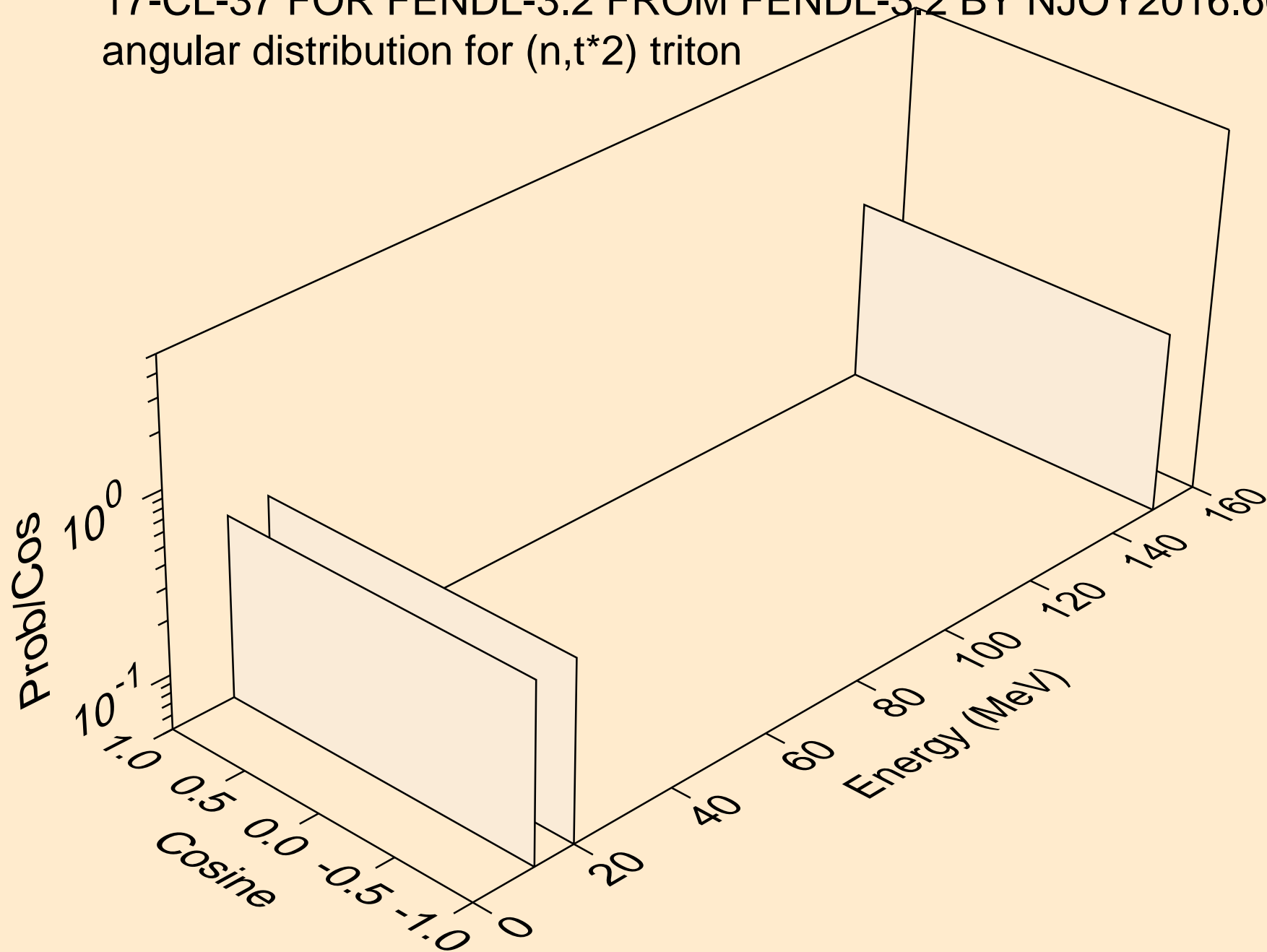

17-CL-37 FOR FENDL-3.2 FROM FENDL-3.2 BY NJOY2016.60+ OI
angular distribution for (n,t*3) triton

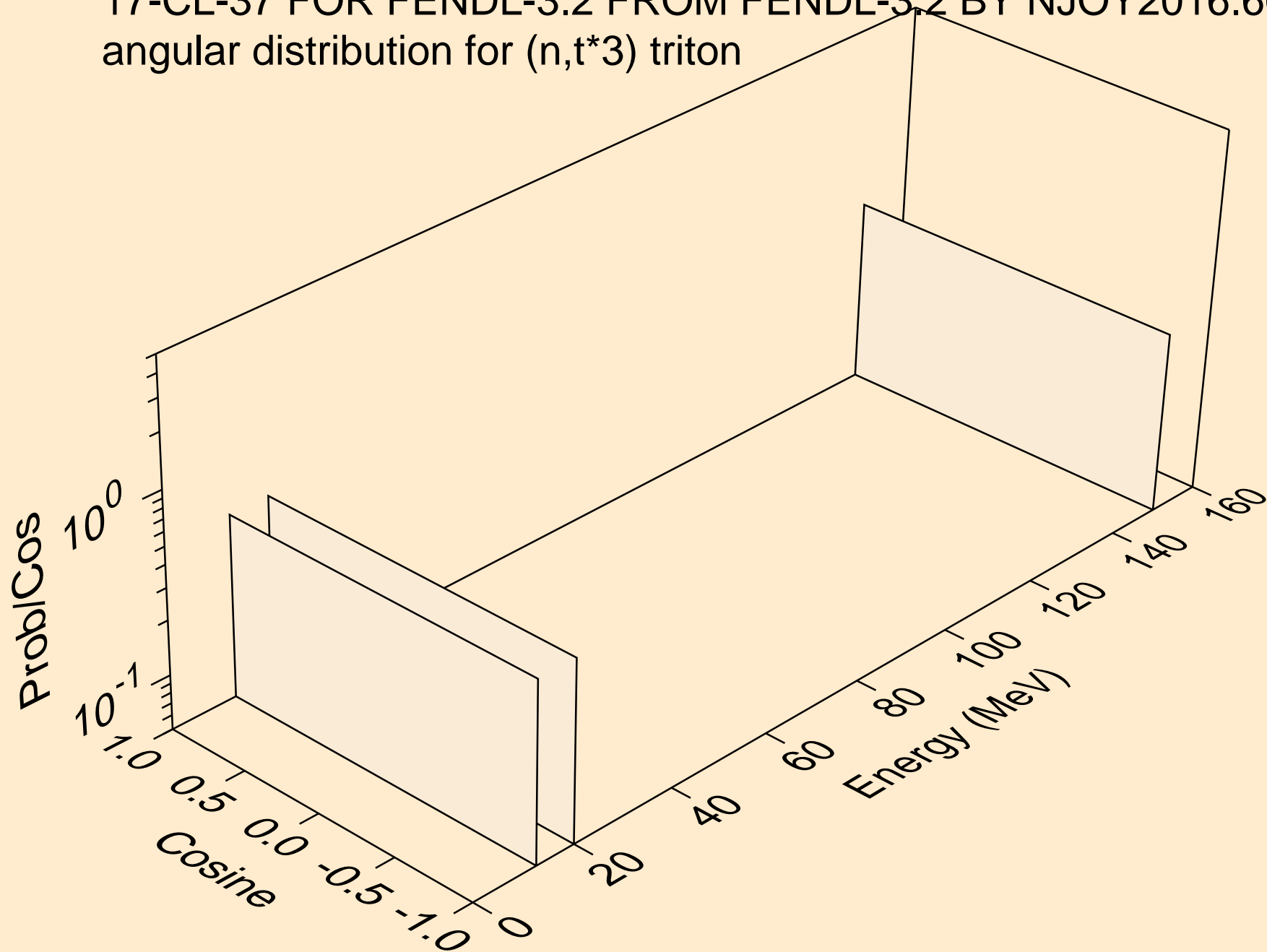

17-CL-37 FOR FENDL-3.2 FROM FENDL-3.2 BY NJOY2016.60+ OI
angular distribution for (n,t*4) triton

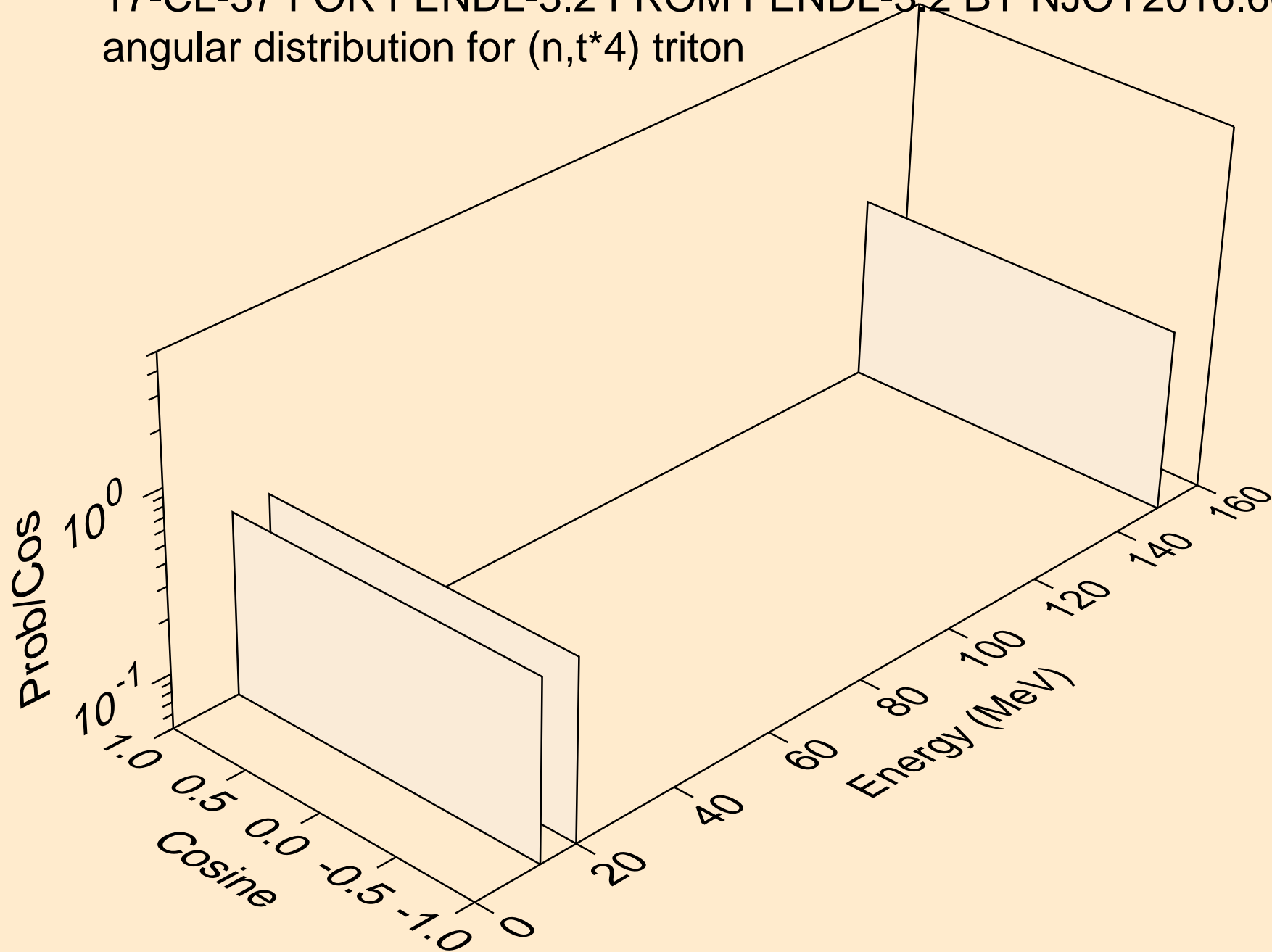

17-CL-37 FOR FENDL-3.2 FROM FENDL-3.2 BY NJOY2016.60+ OI
angular distribution for (n,t*5) triton

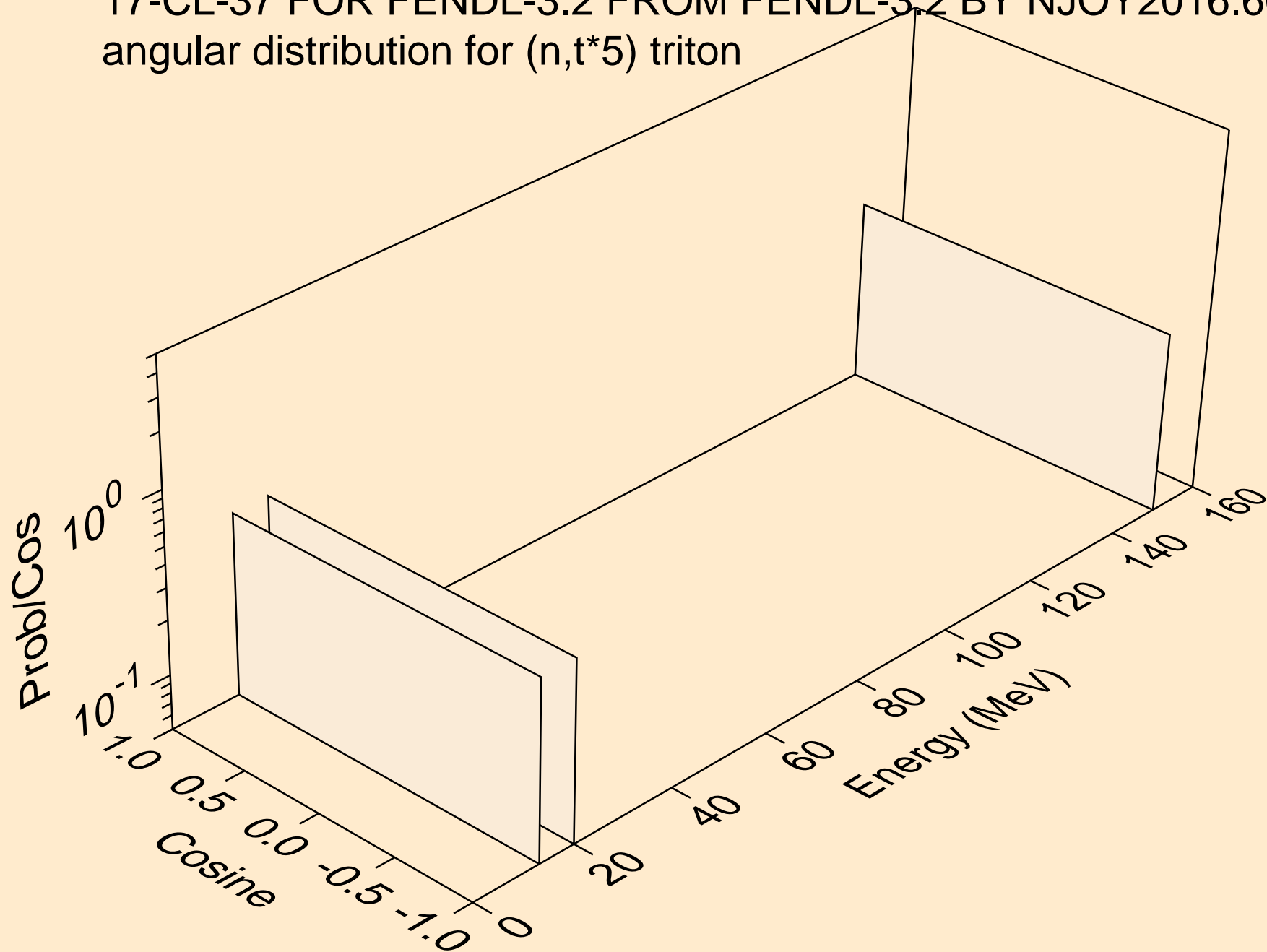

17-CL-37 FOR FENDL-3.2 FROM FENDL-3.2 BY NJOY2016.60+ OI
angular distribution for (n,t*6) triton

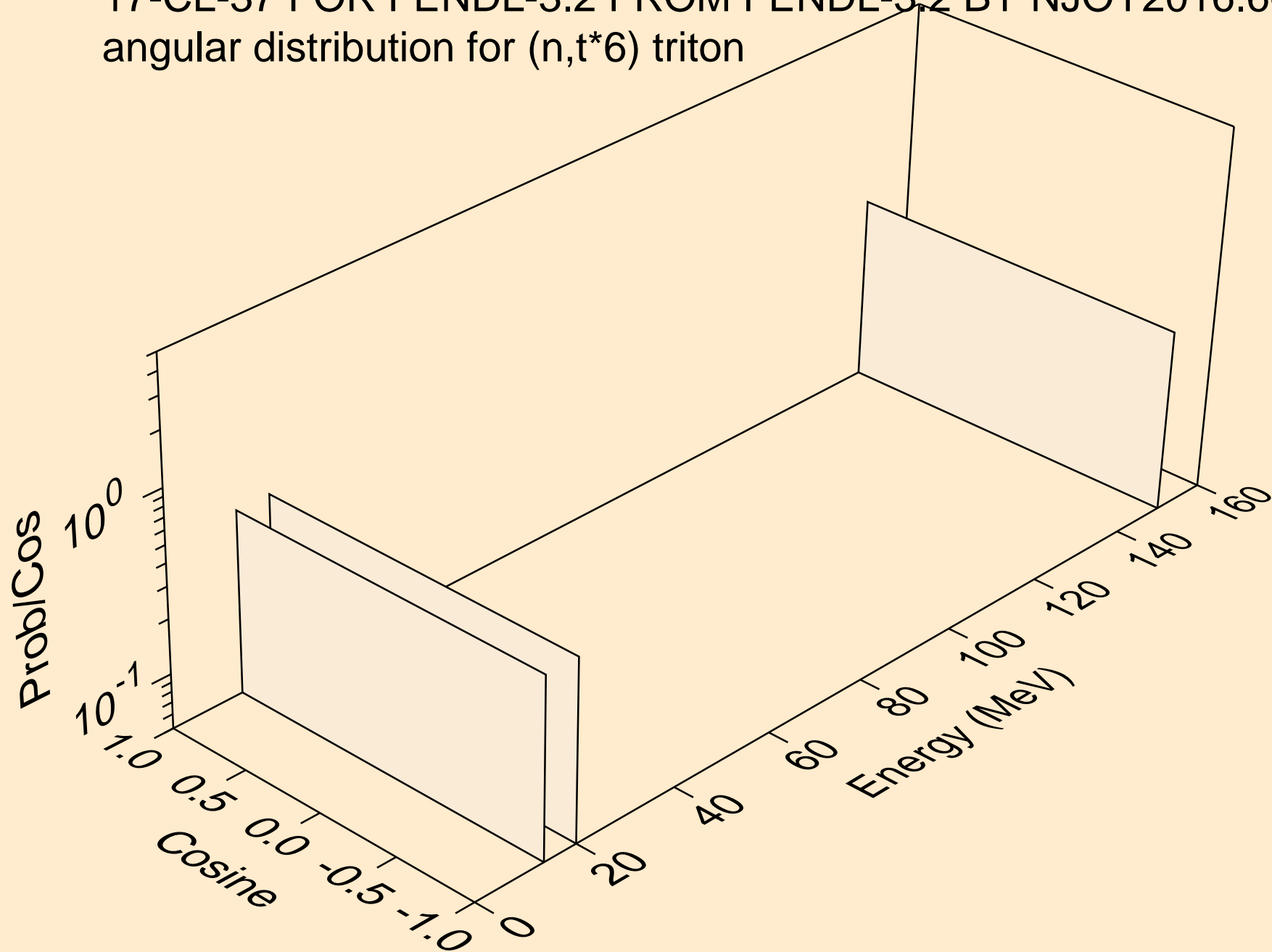

17-CL-37 FOR FENDL-3.2 FROM FENDL-3.2 BY NJOY2016.60+ OI
angular distribution for (n,t*7) triton

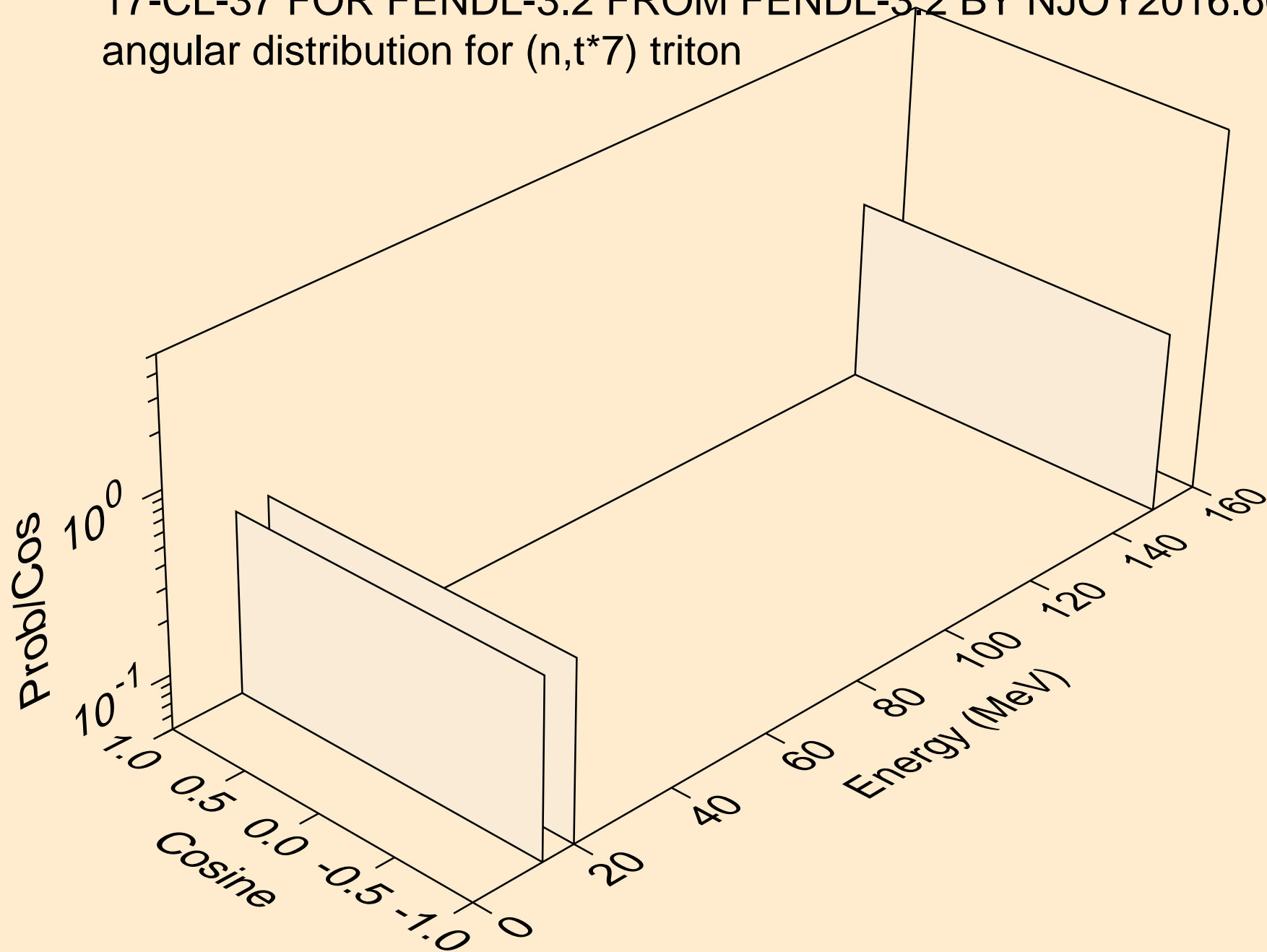

17-CL-37 FOR FENDL-3.2 FROM FENDL-3.2 BY NJOY2016.60+ OI
angular distribution for (n,t*8) triton

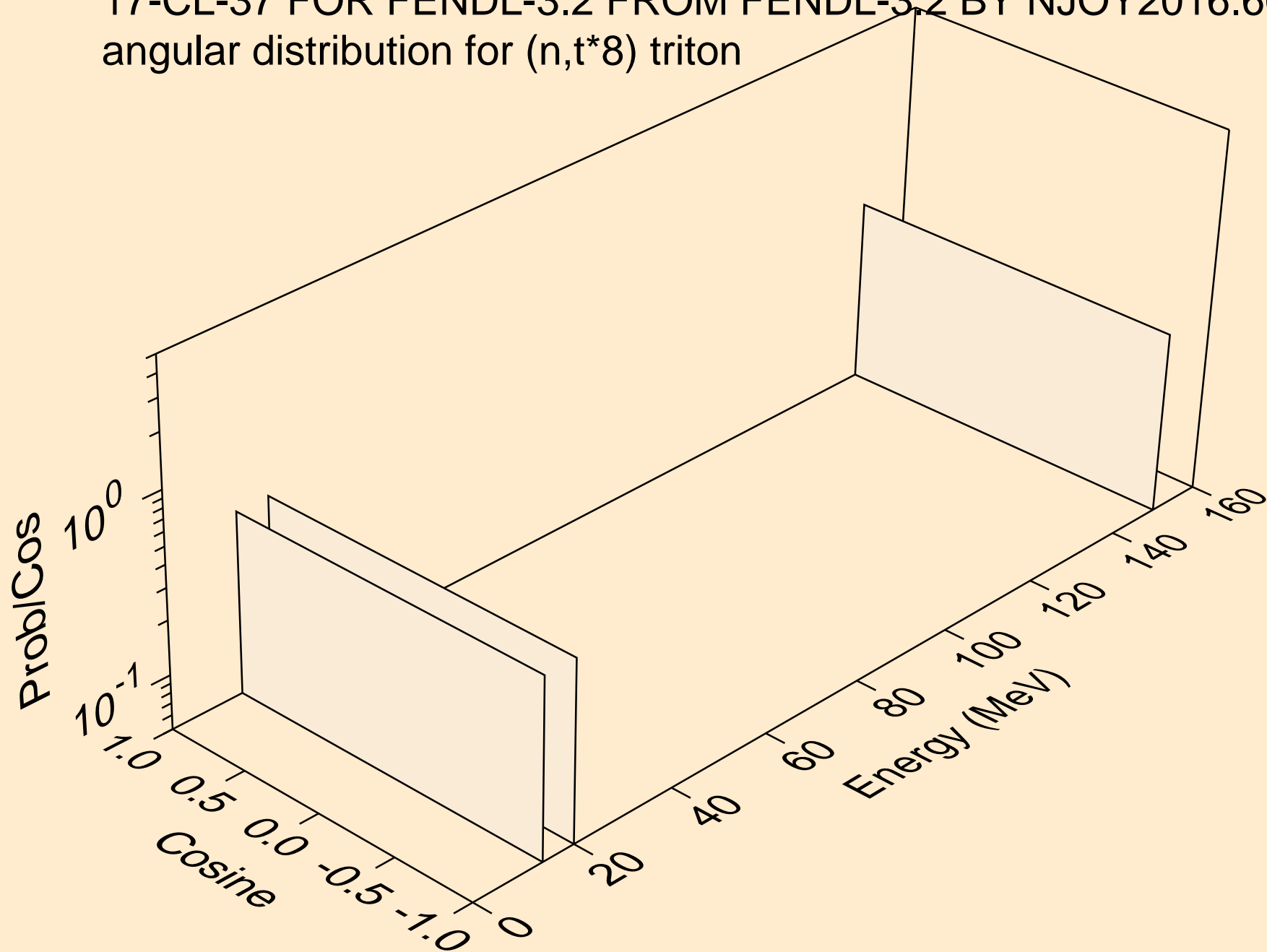

17-CL-37 FOR FENDL-3.2 FROM FENDL-3.2 BY NJOY2016.60+ OI
angular distribution for (n,t*9) triton

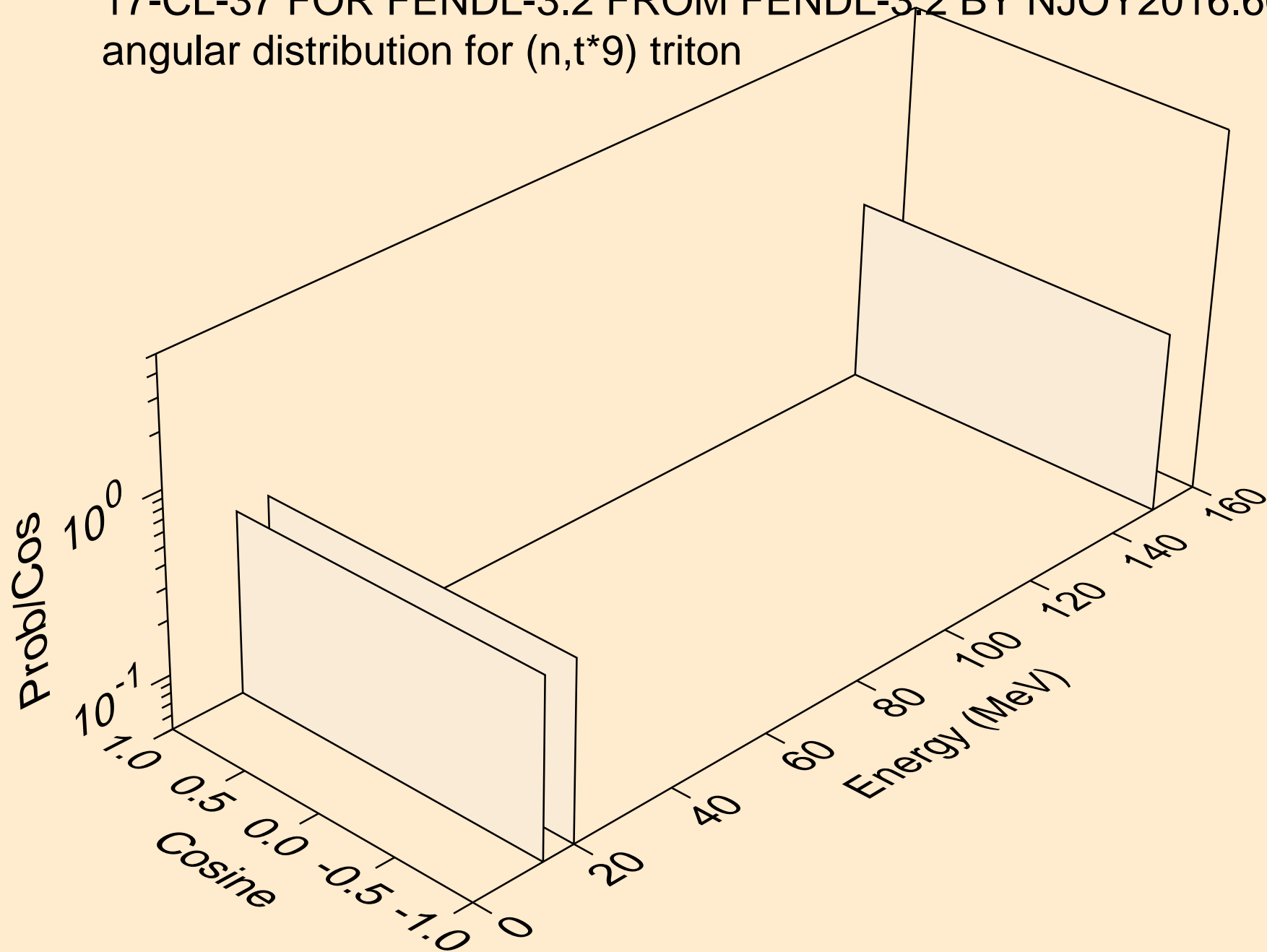

17-CL-37 FOR FENDL-3.2 FROM FENDL-3.2 BY NJOY2016.60+ OI
angular distribution for (n,t*10) triton

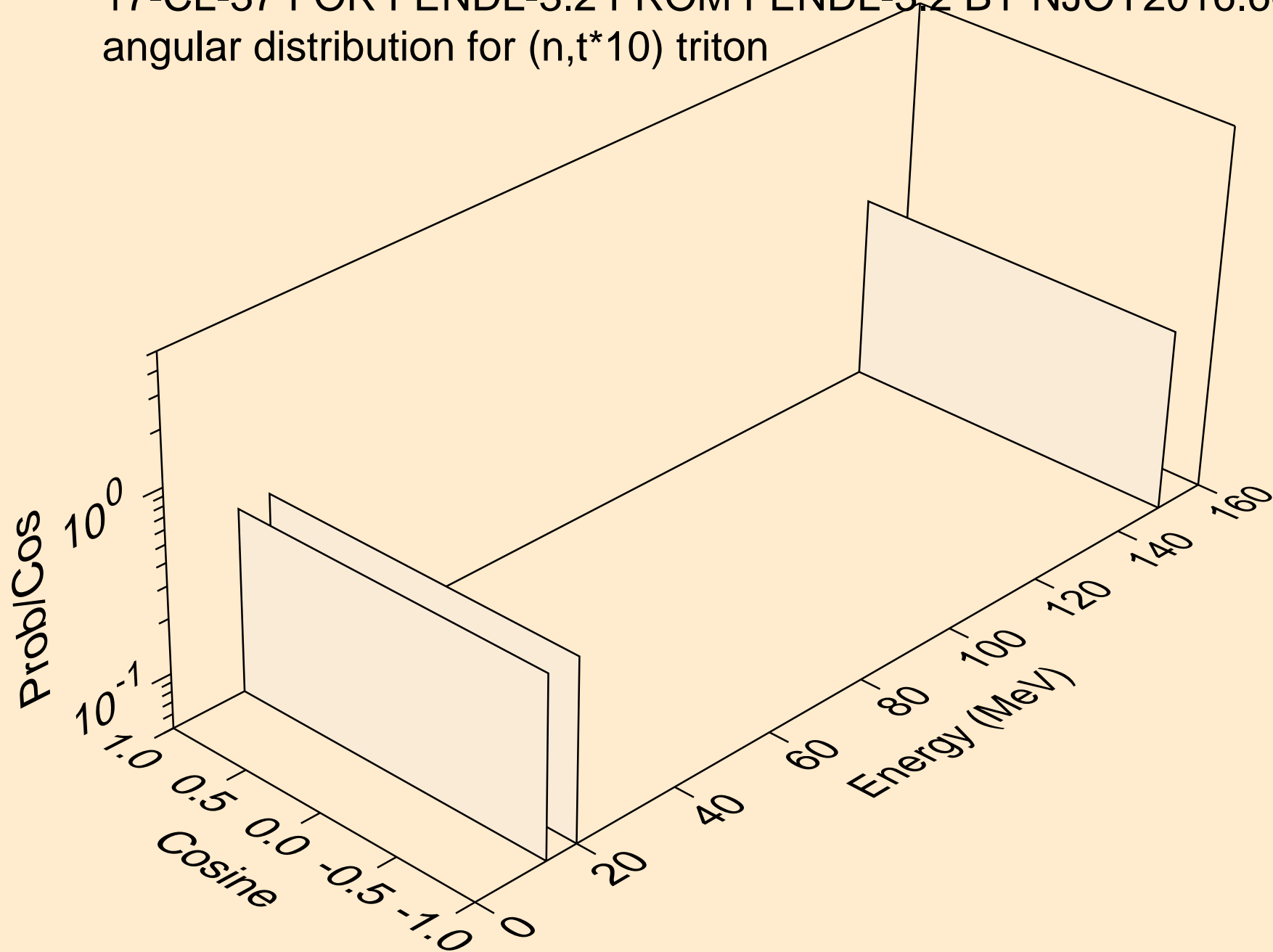

17-CL-37 FOR FENDL-3.2 FROM FENDL-3.2 BY NJOY2016.60+ OI
angular distribution for (n,t*11) triton

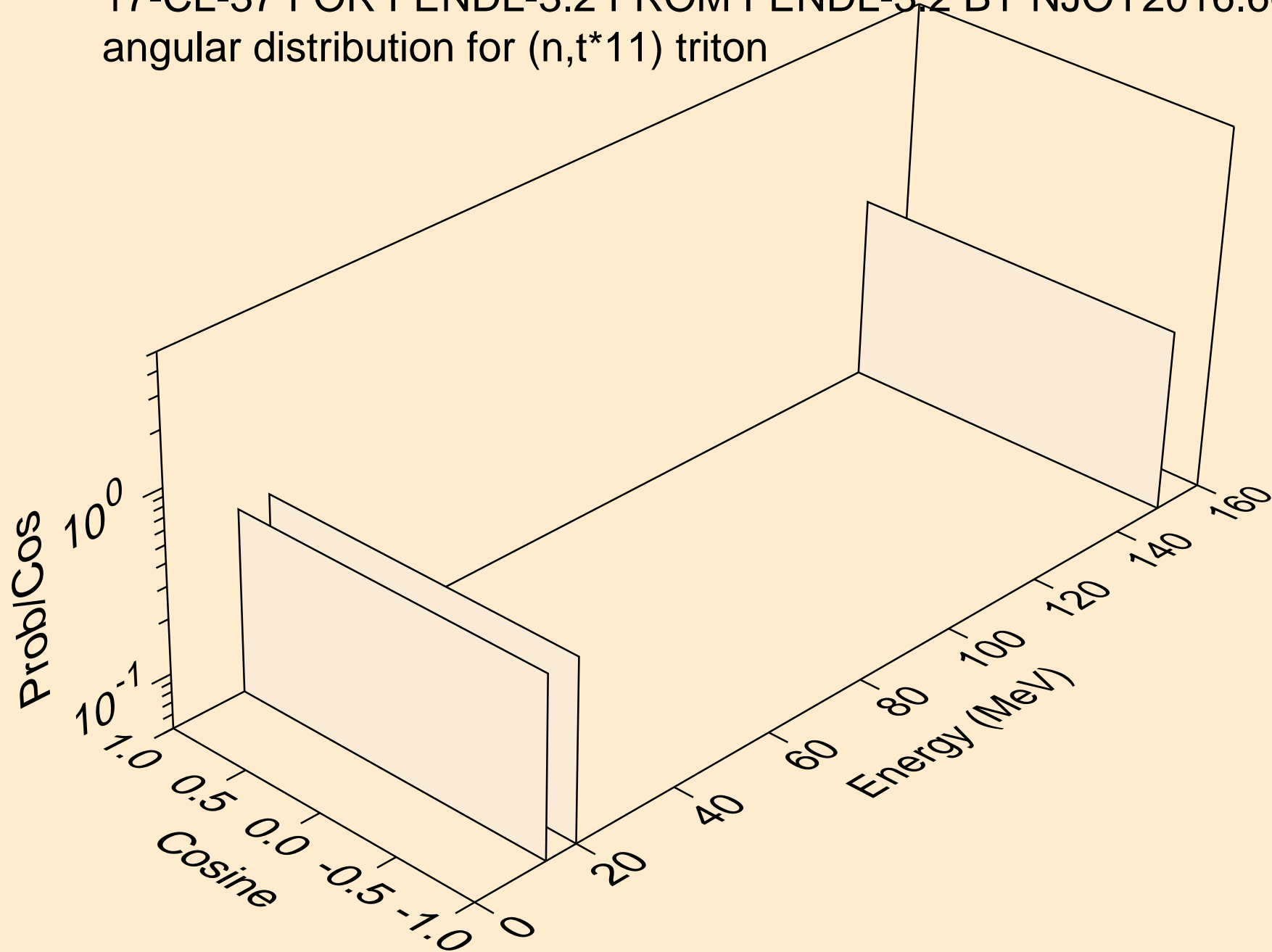

17-CL-37 FOR FENDL-3.2 FROM FENDL-3.2 BY NJOY2016.60+ OI
angular distribution for (n,t*12) triton

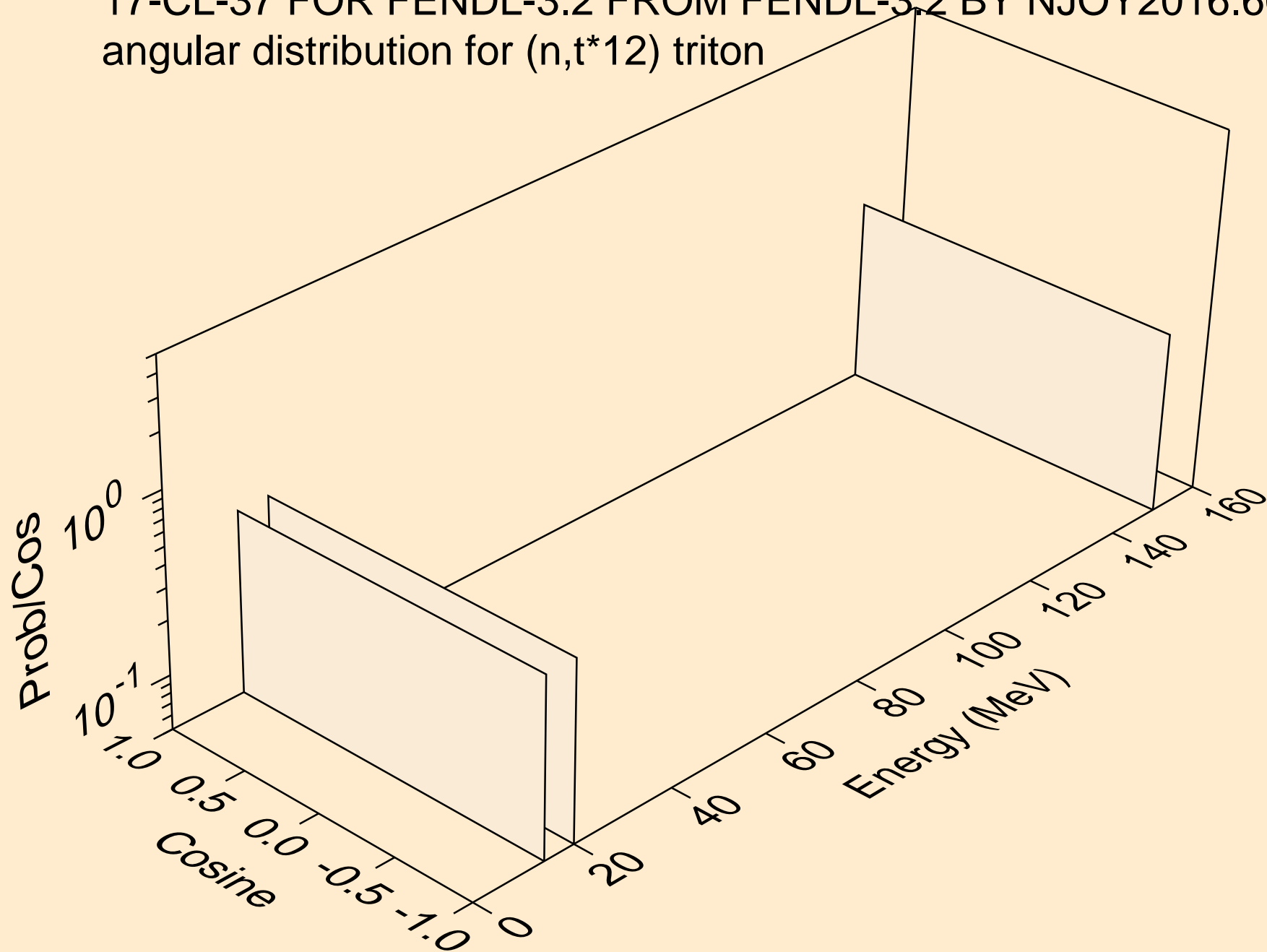

17-CL-37 FOR FENDL-3.2 FROM FENDL-3.2 BY NJOY2016.60+ OI
angular distribution for (n,t*13) triton

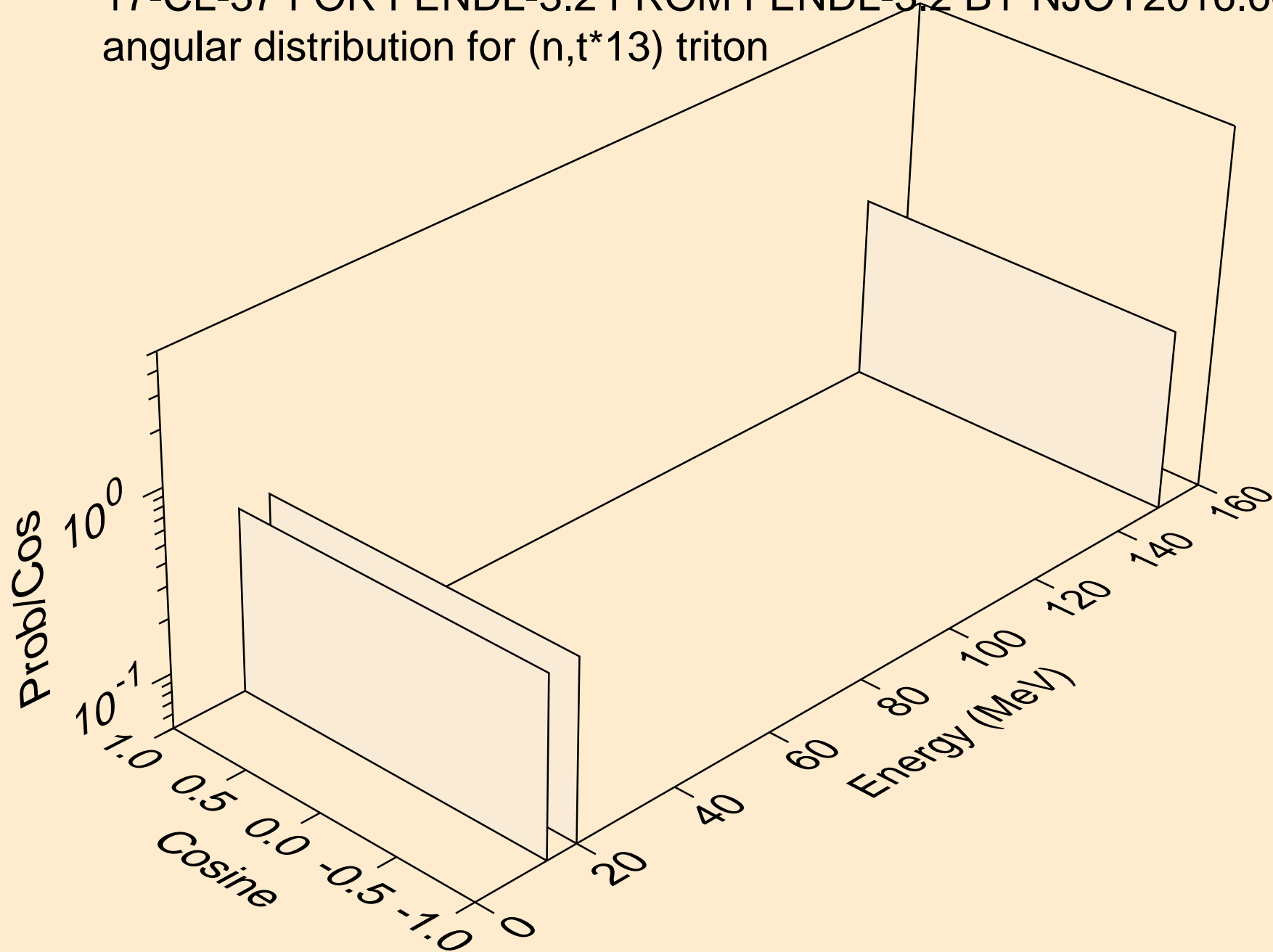

17-CL-37 FOR FENDL-3.2 FROM FENDL-3.2 BY NJOY2016.60+ OI
angular distribution for (n,t*14) triton

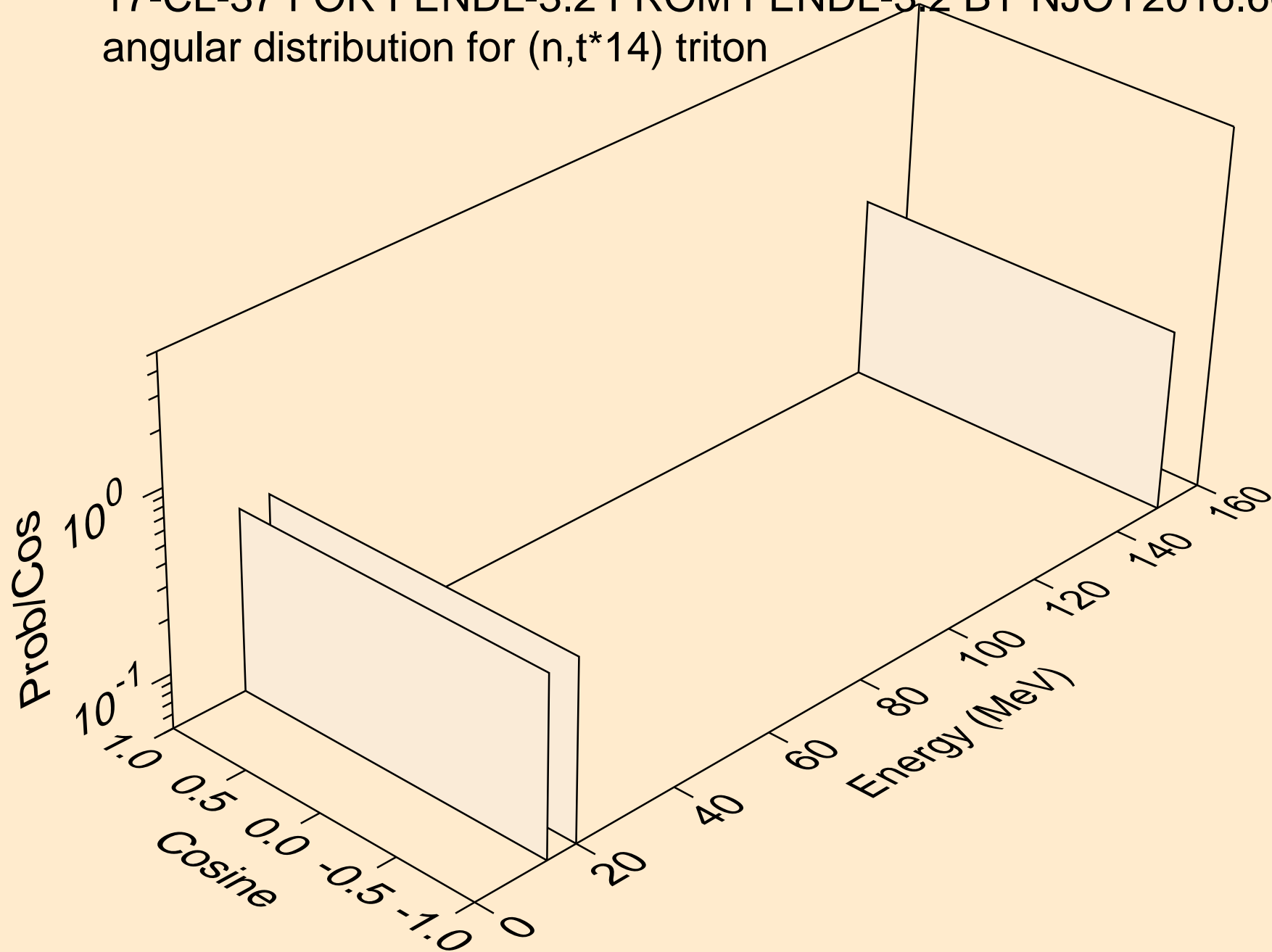

17-CL-37 FOR FENDL-3.2 FROM FENDL-3.2 BY NJOY2016.60+ OI
angular distribution for (n,t*15) triton

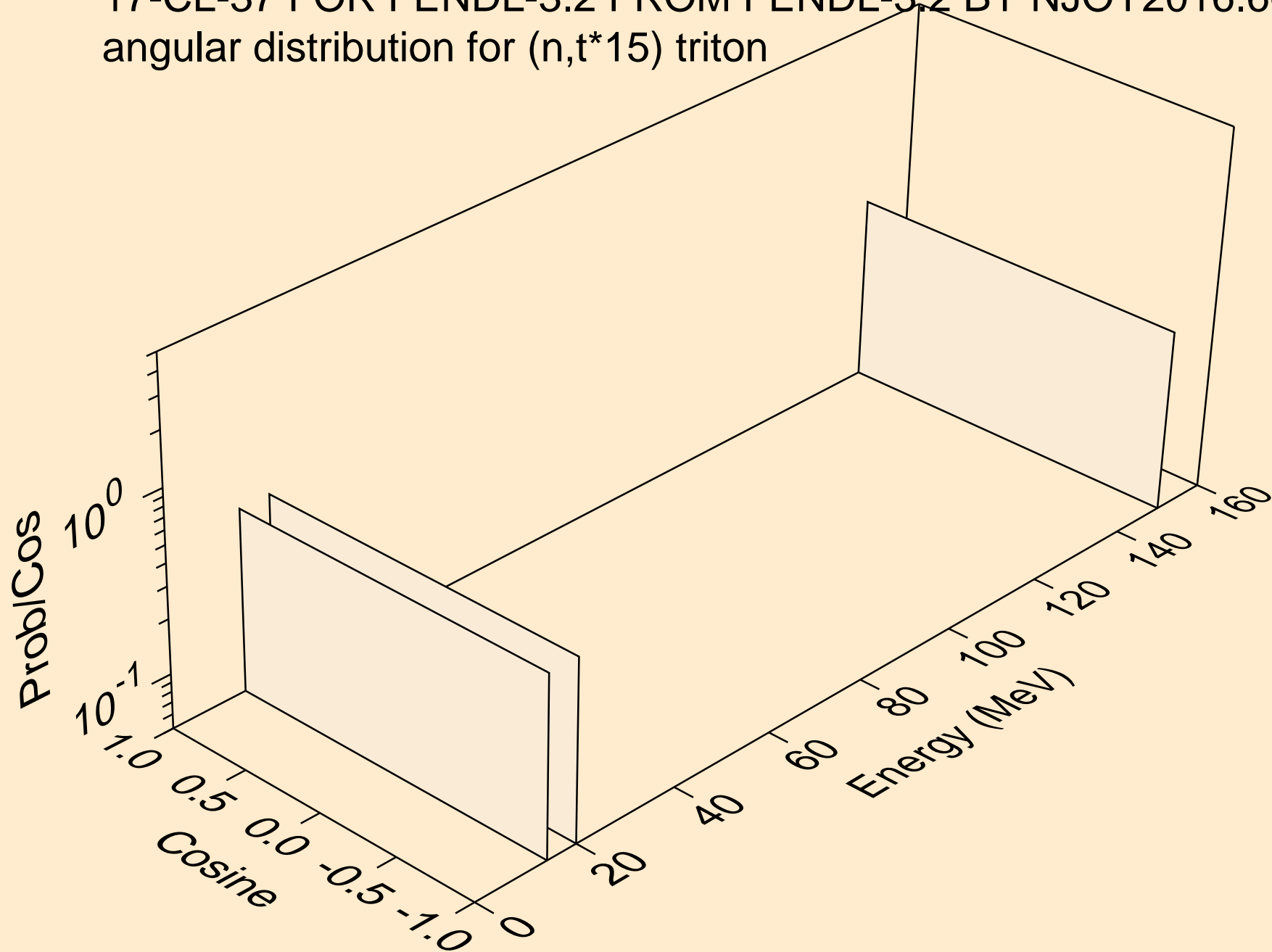

17-CL-37 FOR FENDL-3.2 FROM FENDL-3.2 BY NJOY2016.60+ OI
tritons from (n,t*c)

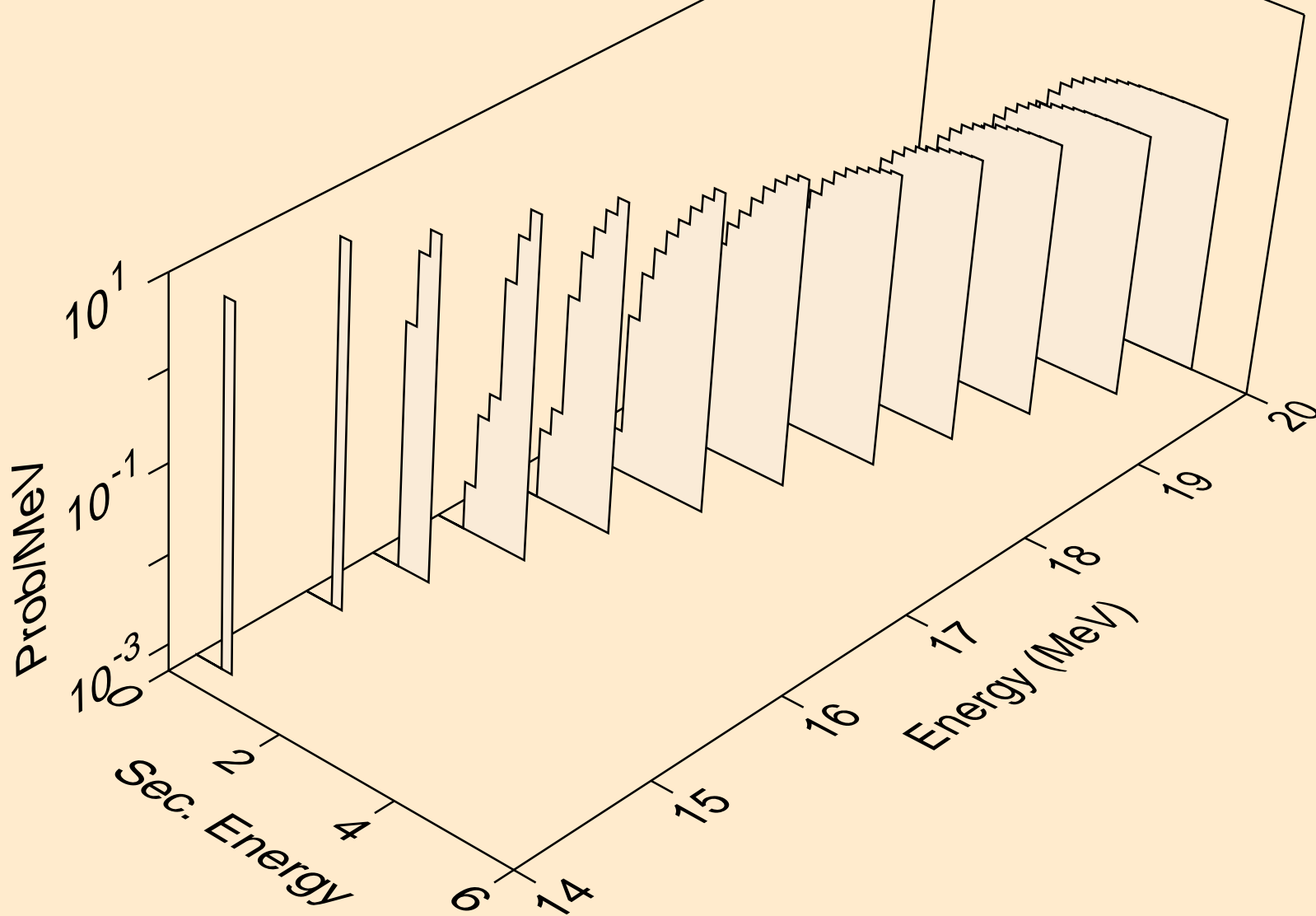

17-CL-37 FOR FENDL-3.2 FROM FENDL-3.2 BY NJOY2016.60+ OI
alphas from (n,x)

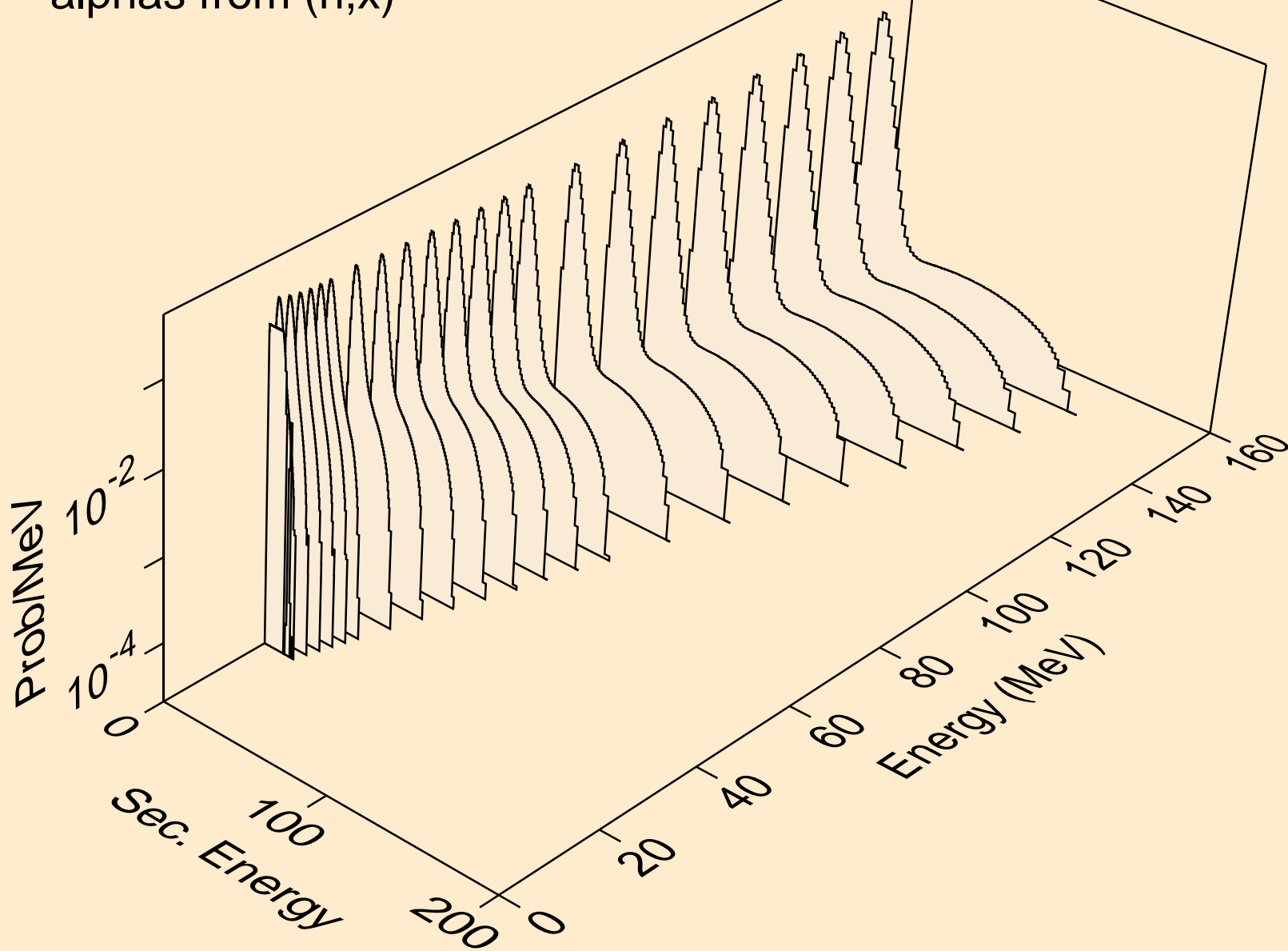

17-CL-37 FOR FENDL-3.2 FROM FENDL-3.2 BY NJOY2016.60+ OI
alphas from (n,n*)a

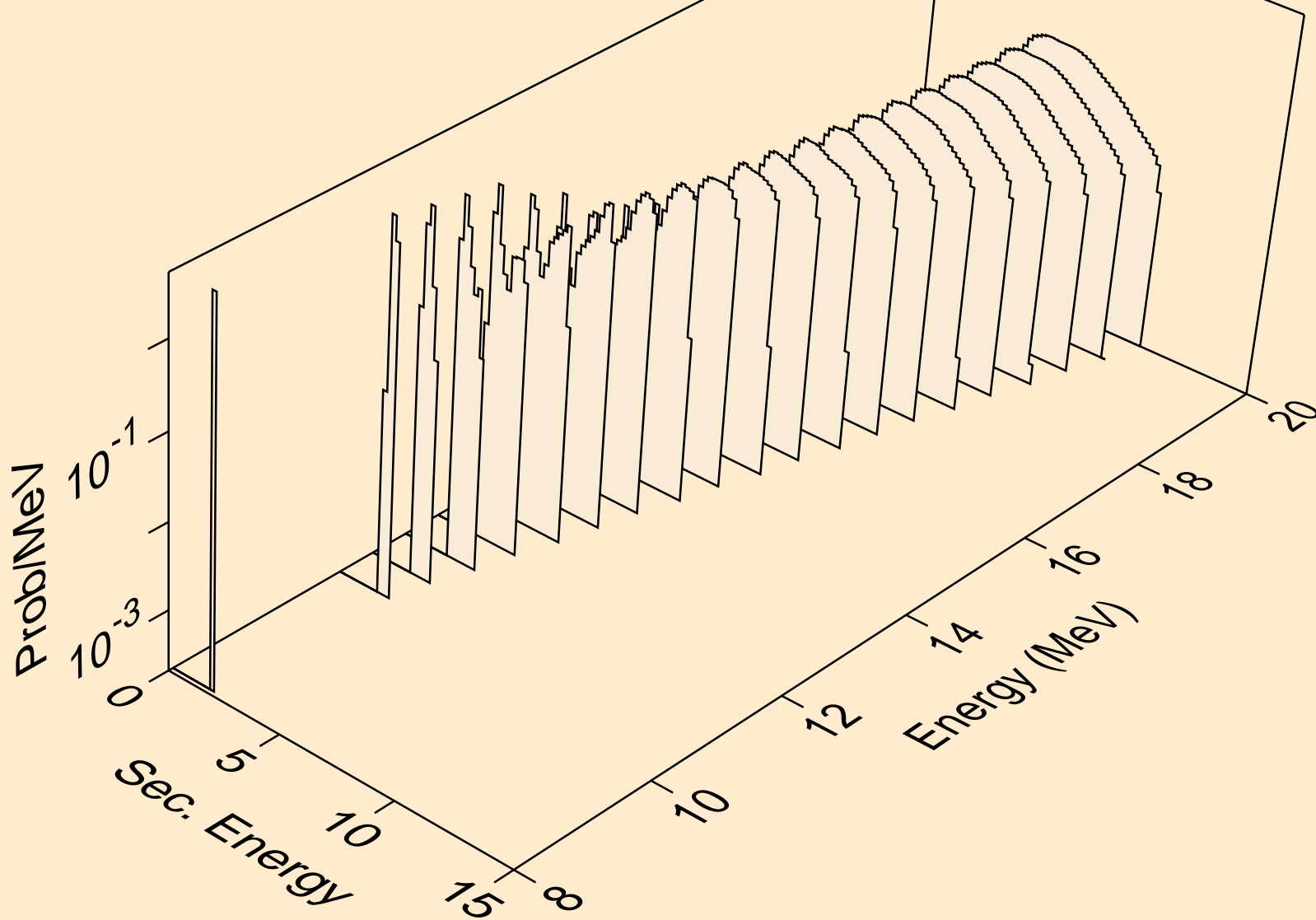

17-CL-37 FOR FENDL-3.2 FROM FENDL-3.2 BY NJOY2016.60+ OI
angular distribution for (n,a*0) alpha

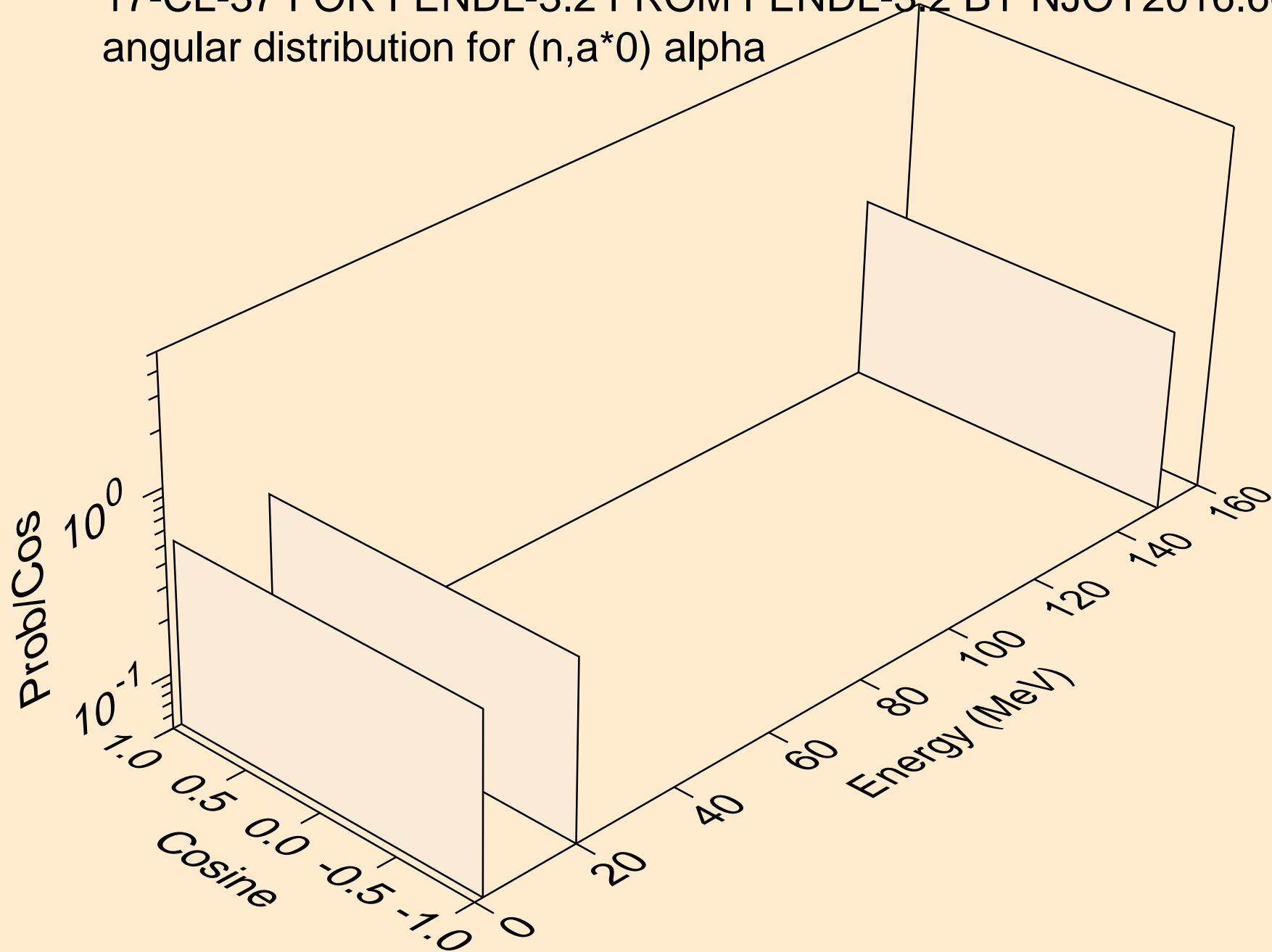

17-CL-37 FOR FENDL-3.2 FROM FENDL-3.2 BY NJOY2016.60+ OI
angular distribution for (n,a*1) alpha

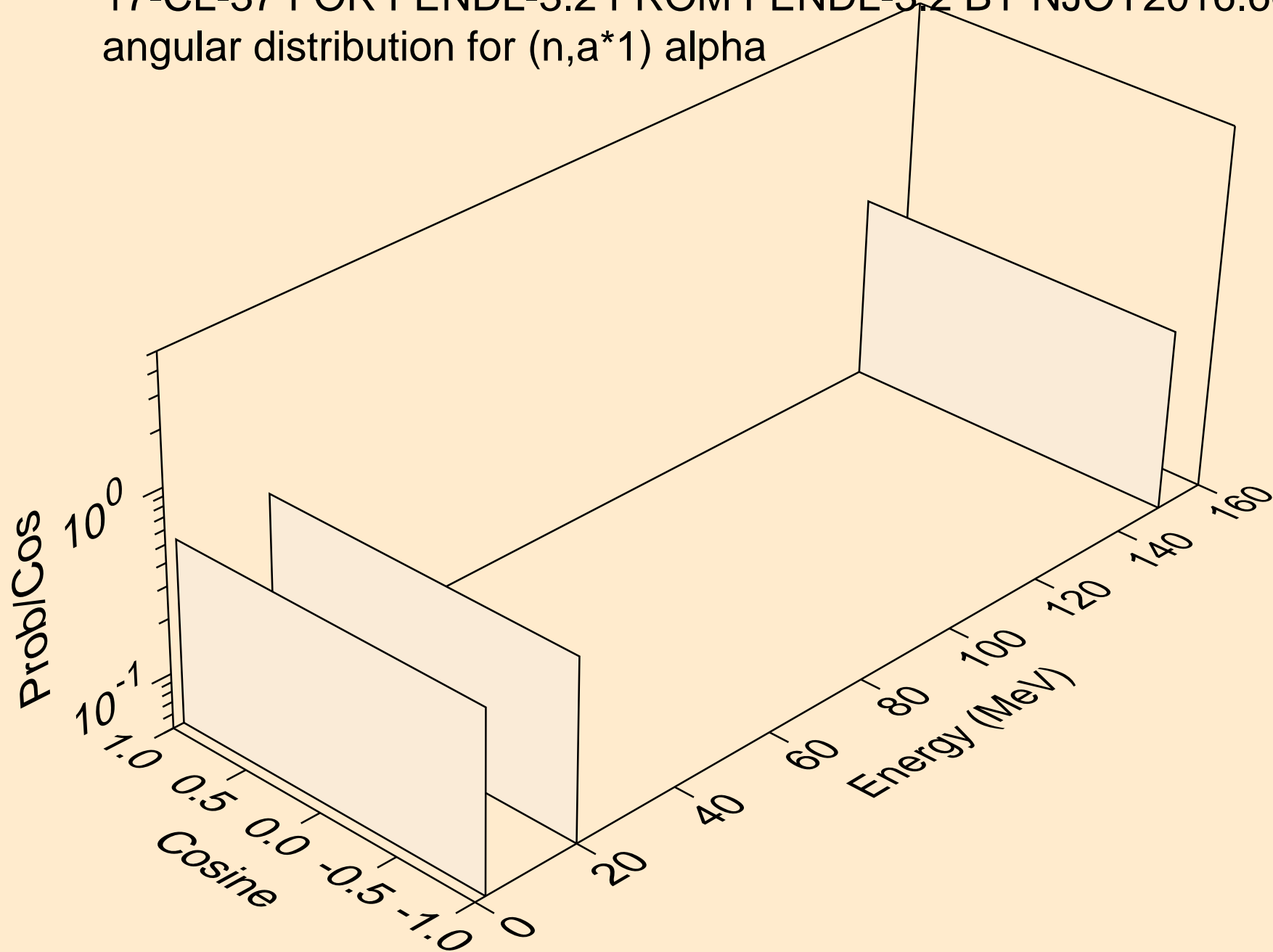

17-CL-37 FOR FENDL-3.2 FROM FENDL-3.2 BY NJOY2016.60+ OI
angular distribution for (n,a*2) alpha

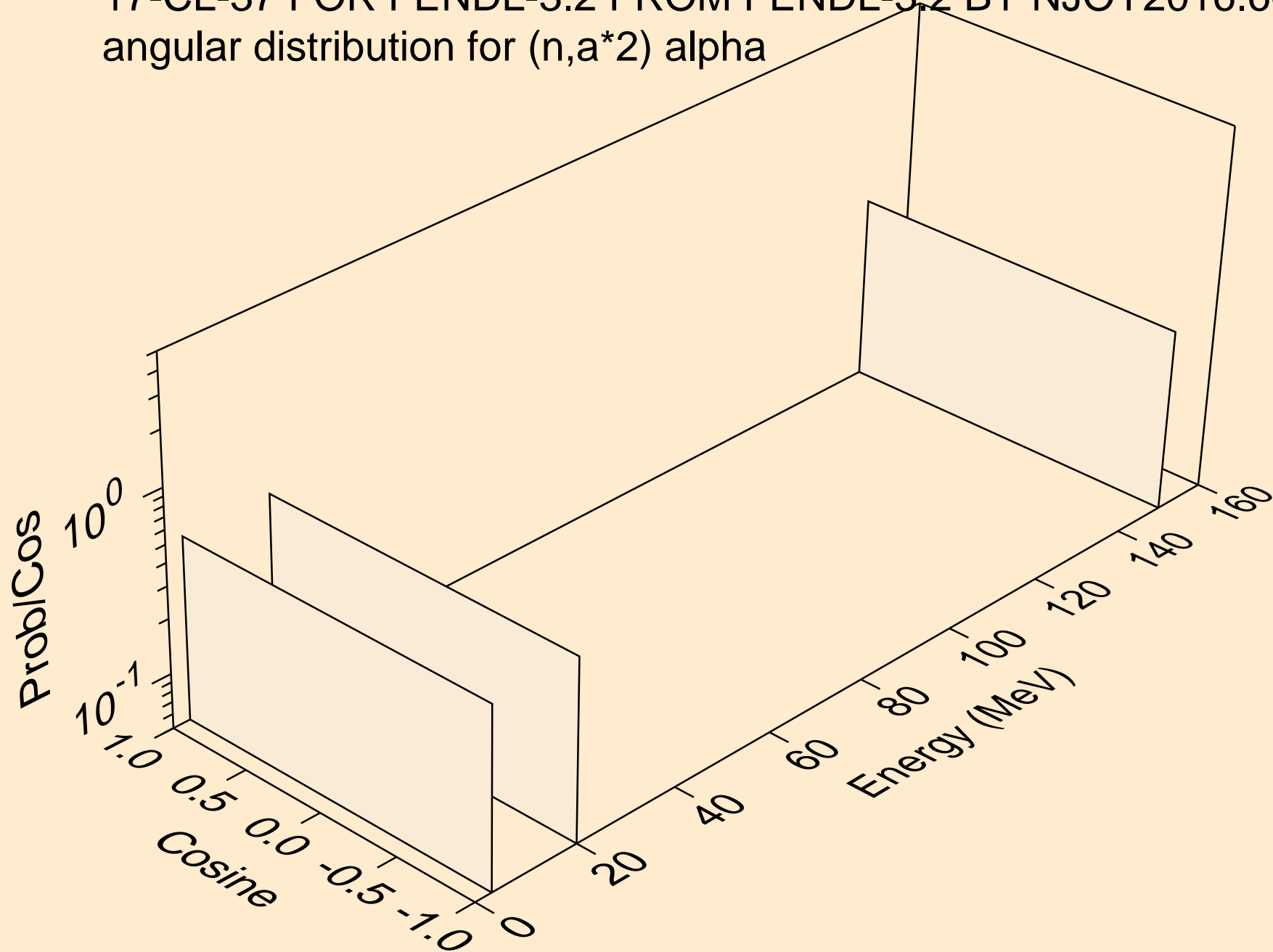

17-CL-37 FOR FENDL-3.2 FROM FENDL-3.2 BY NJOY2016.60+ OI
angular distribution for (n,a*3) alpha

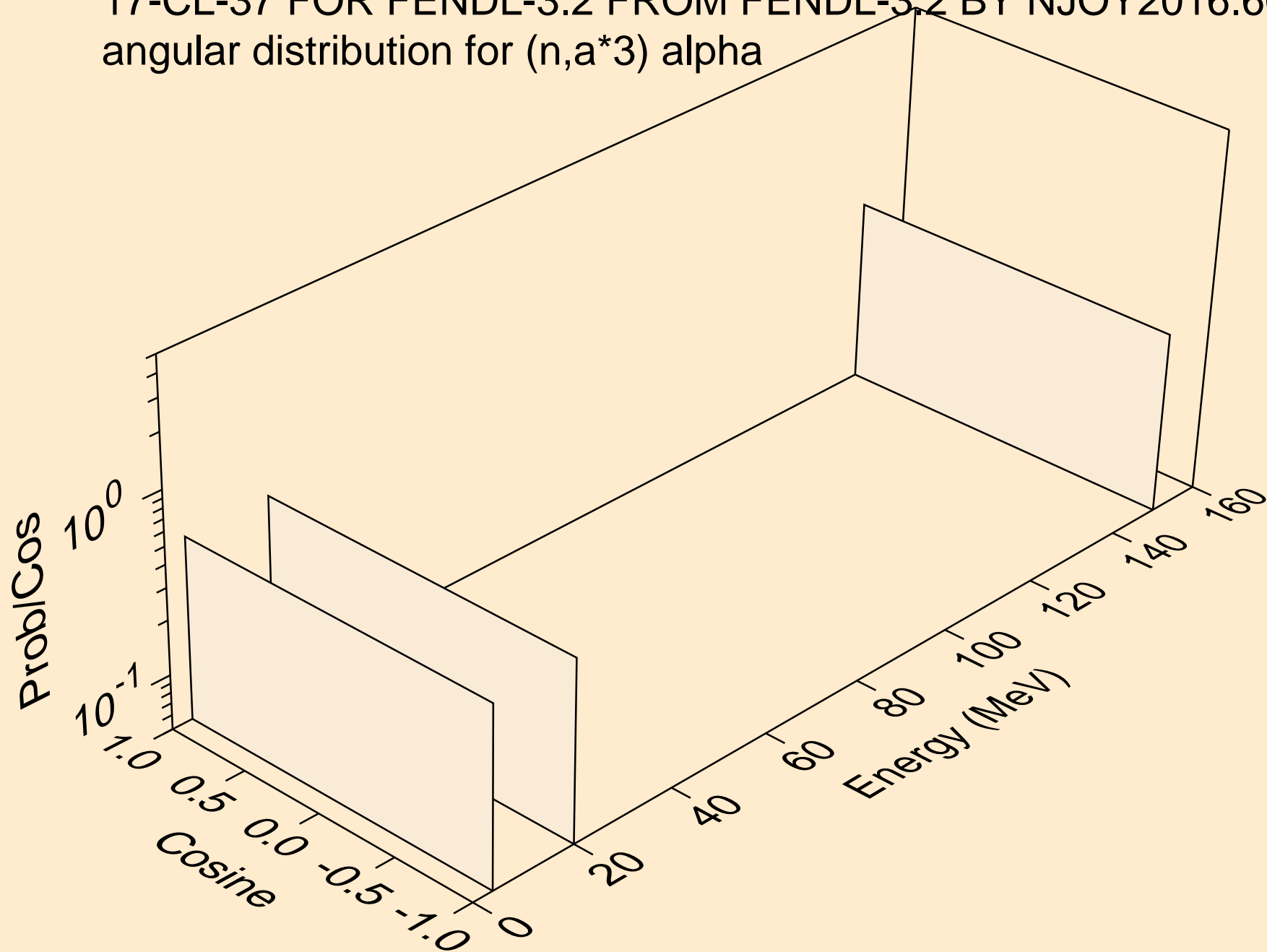

17-CL-37 FOR FENDL-3.2 FROM FENDL-3.2 BY NJOY2016.60+ OI
angular distribution for (n,a*4) alpha

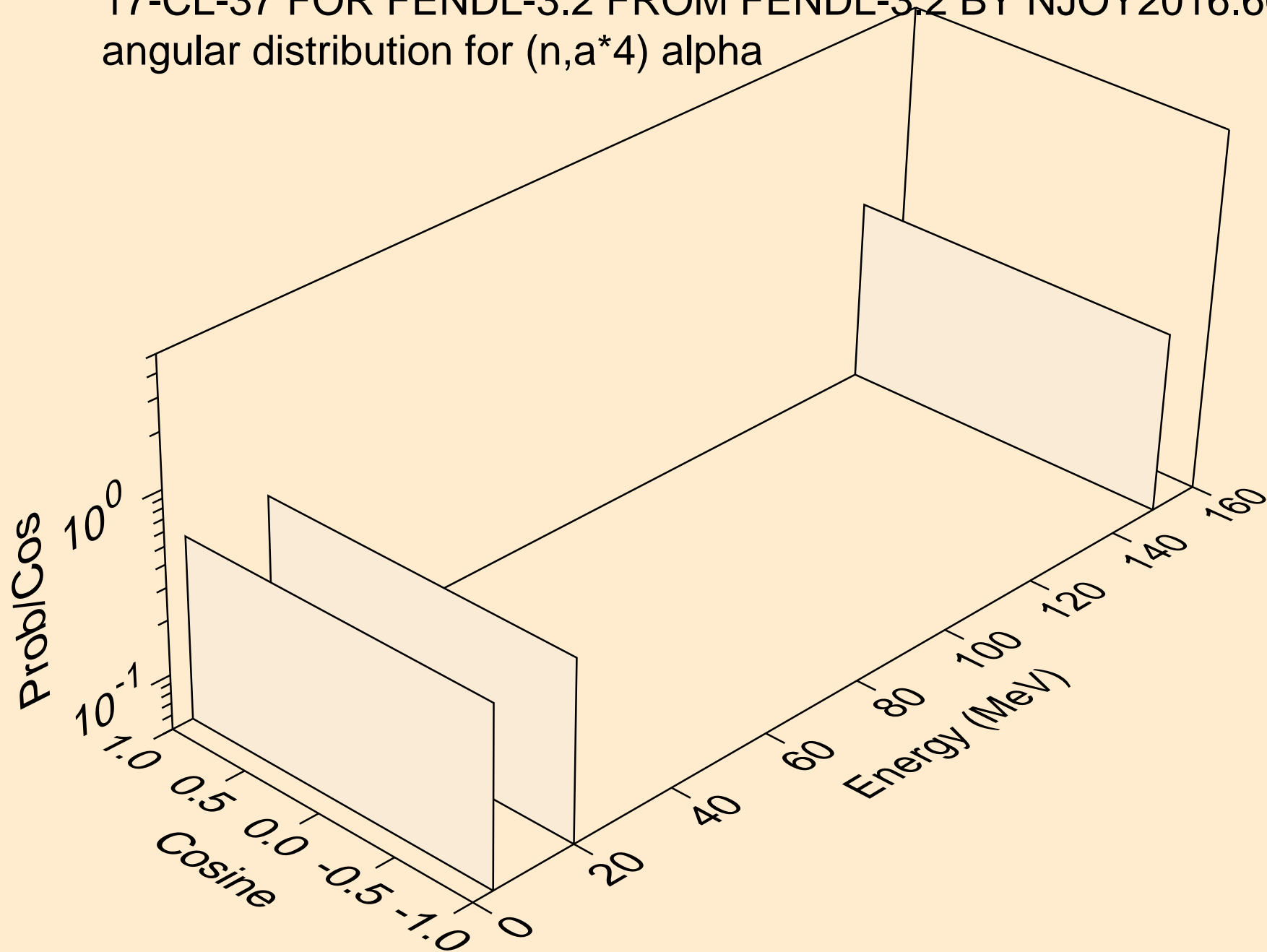

17-CL-37 FOR FENDL-3.2 FROM FENDL-3.2 BY NJOY2016.60+ OI
angular distribution for (n,a*5) alpha

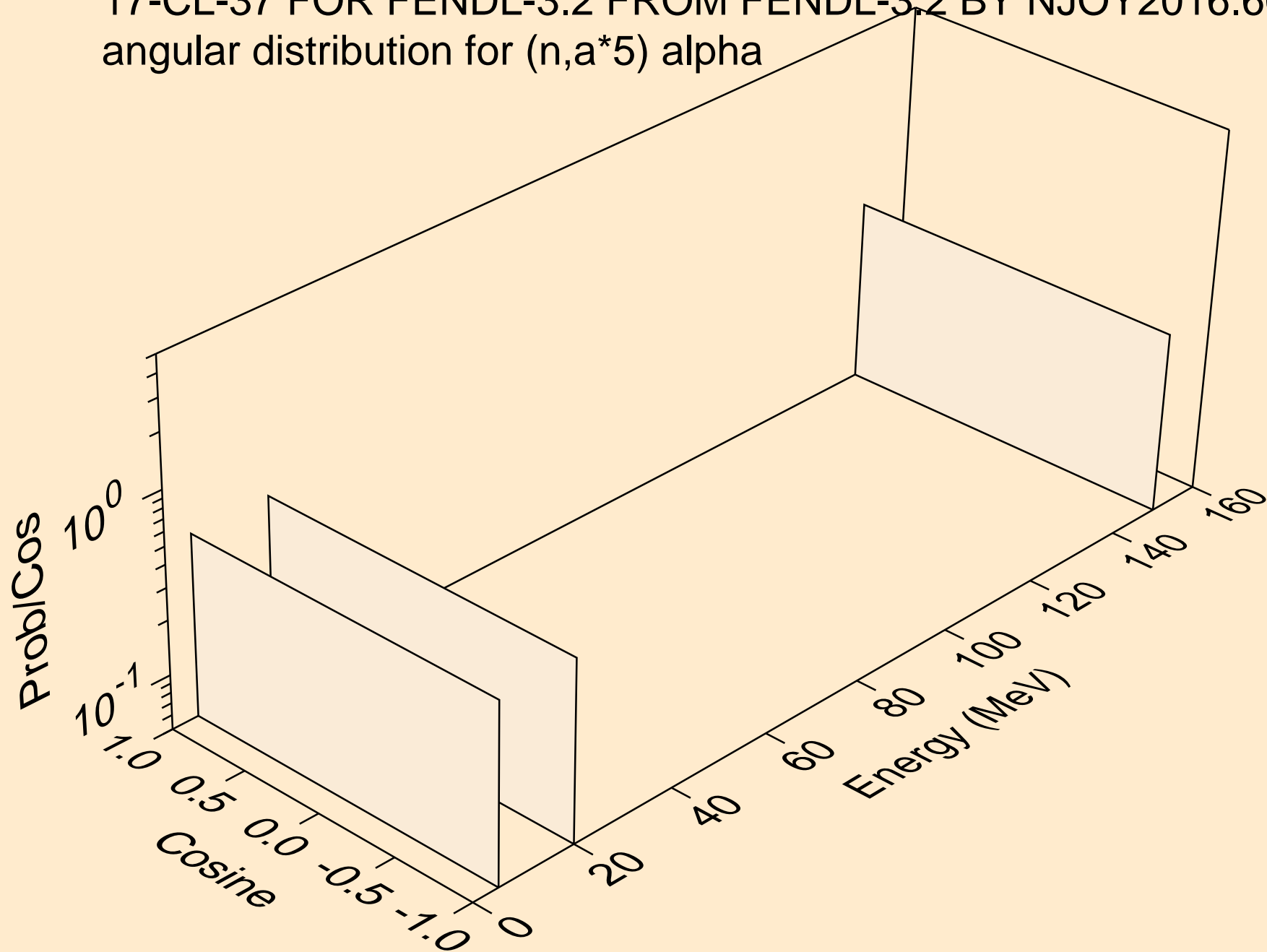

17-CL-37 FOR FENDL-3.2 FROM FENDL-3.2 BY NJOY2016.60+ OI
alphas from (n,a*c)

