

19-K-41 FOR FENDL-3.2 FROM TENDL-2015 BY NJOY2016.60+ O
Principal cross sections

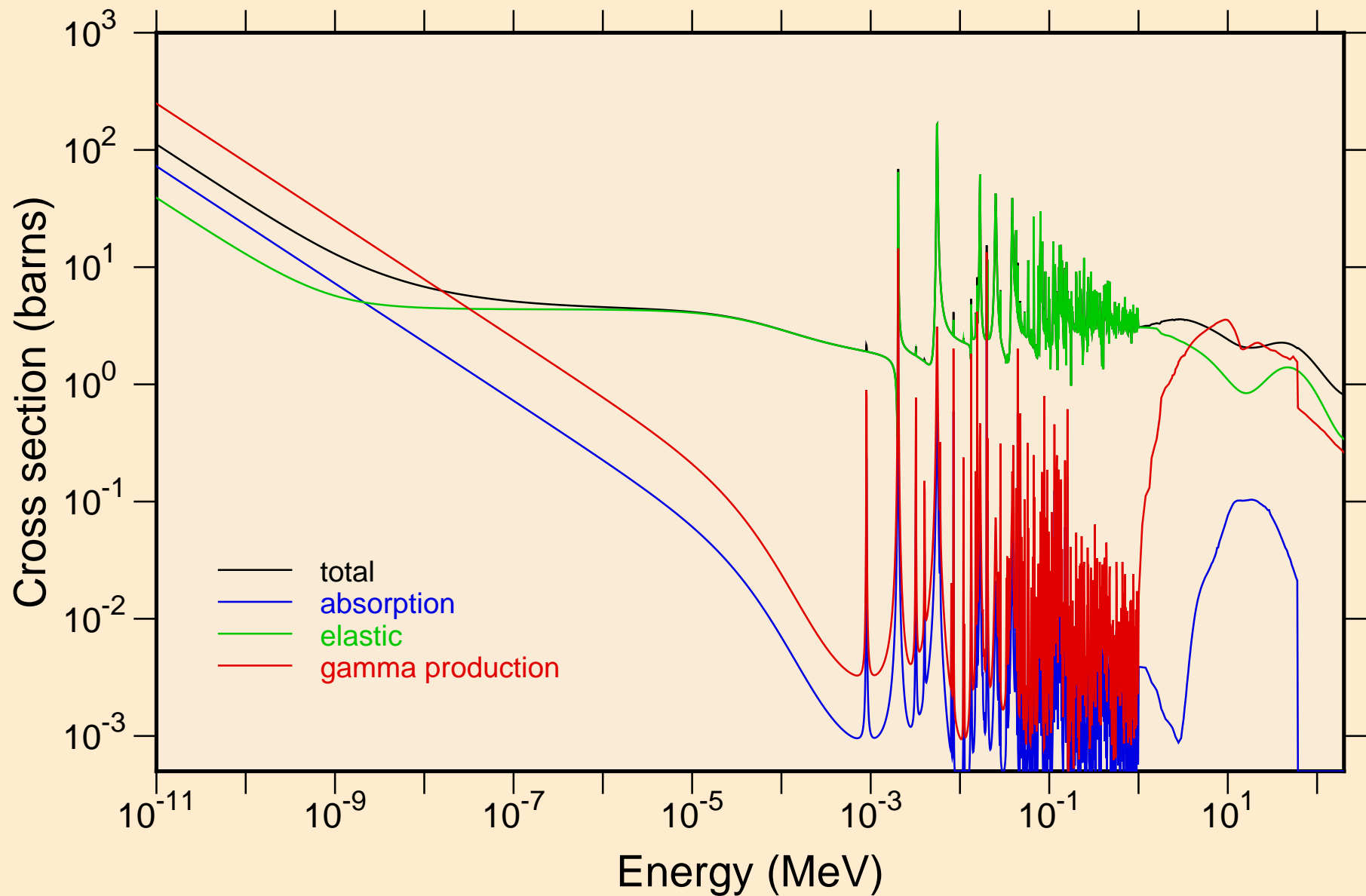

19-K-41 FOR FENDL-3.2 FROM TENDL-2015 BY NJOY2016.60+ O
resonance total cross section

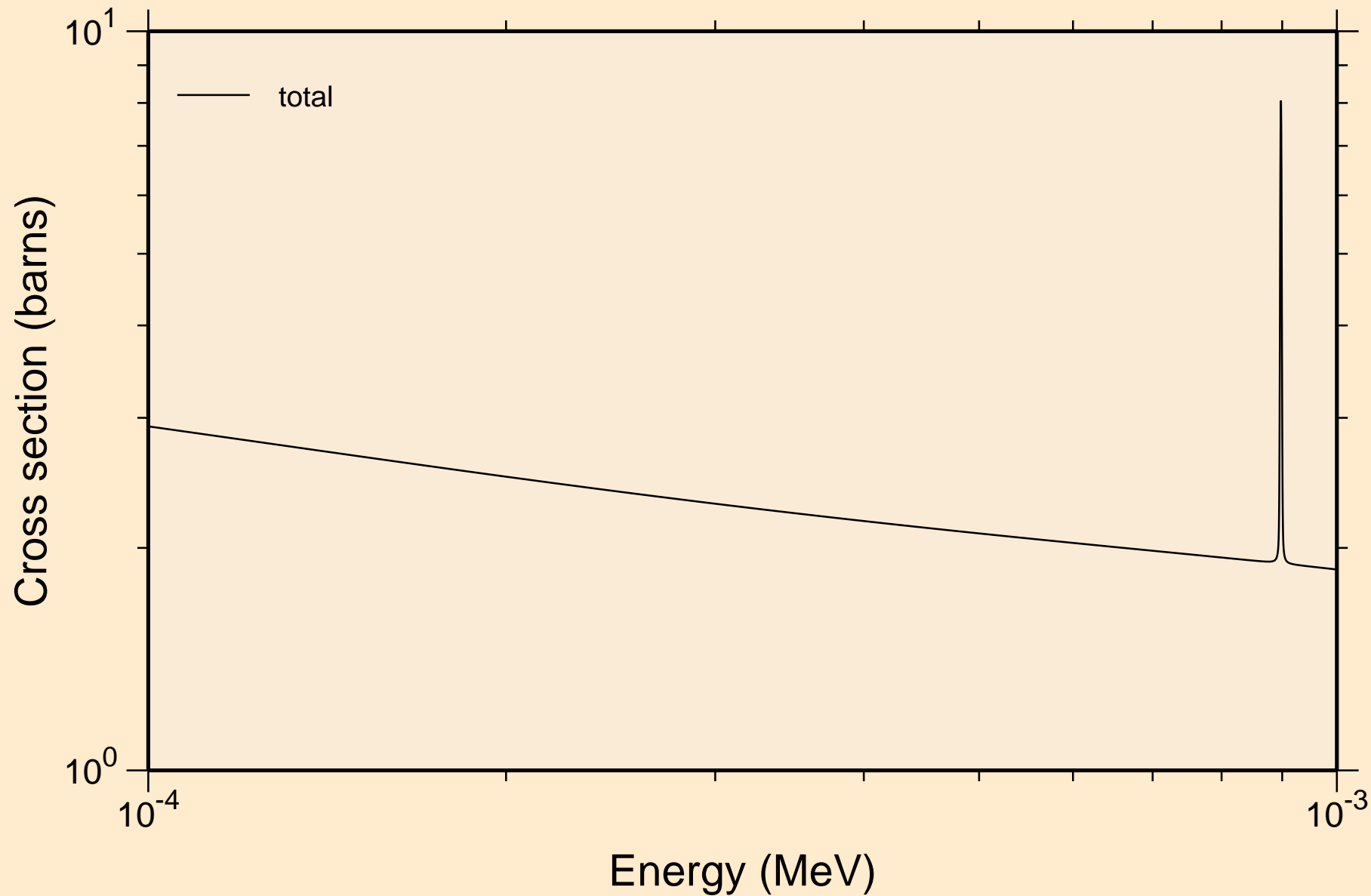

19-K-41 FOR FENDL-3.2 FROM TENDL-2015 BY NJOY2016.60+ O
resonance total cross section

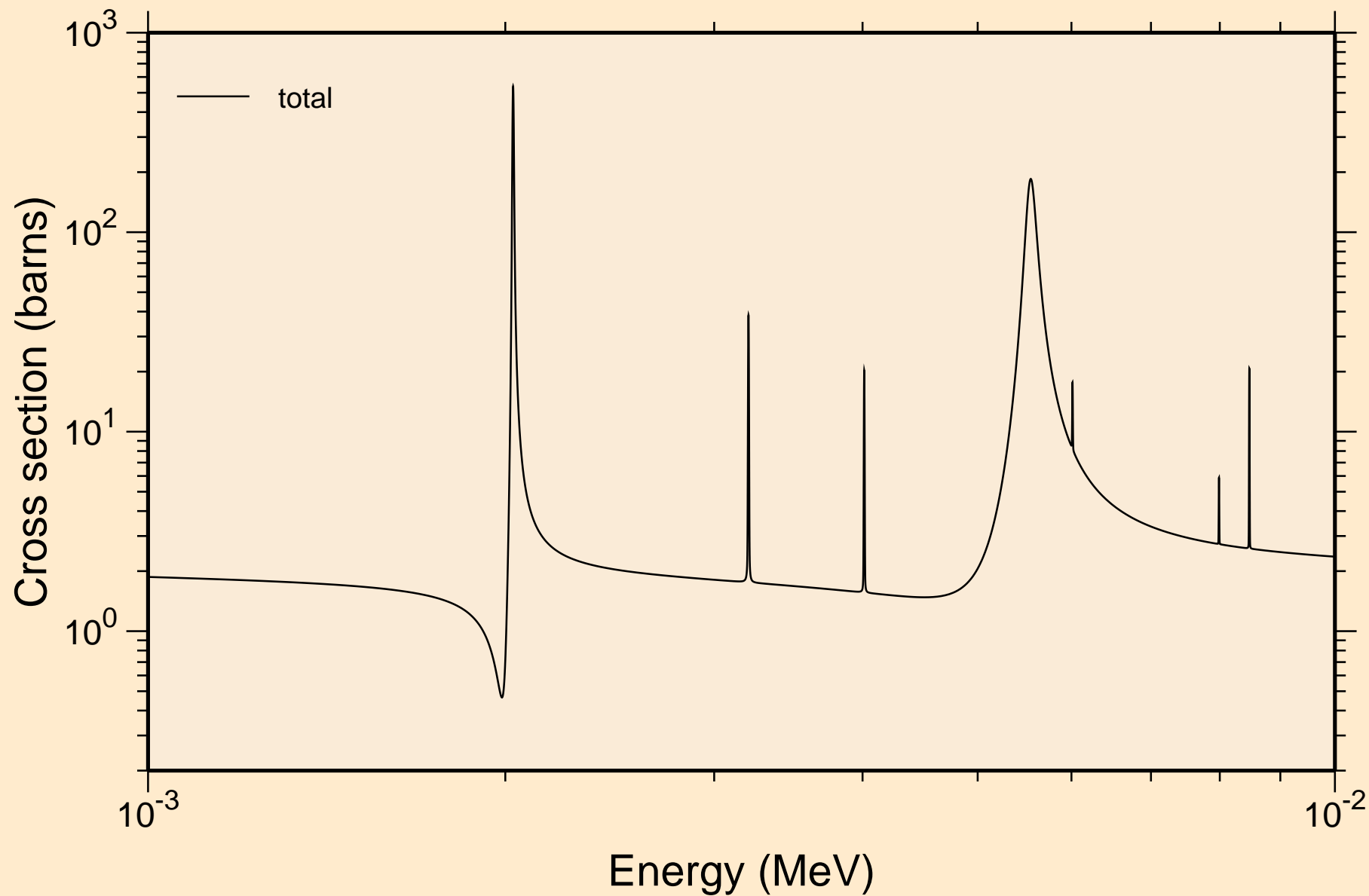

19-K-41 FOR FENDL-3.2 FROM TENDL-2015 BY NJOY2016.60+ O
resonance total cross section

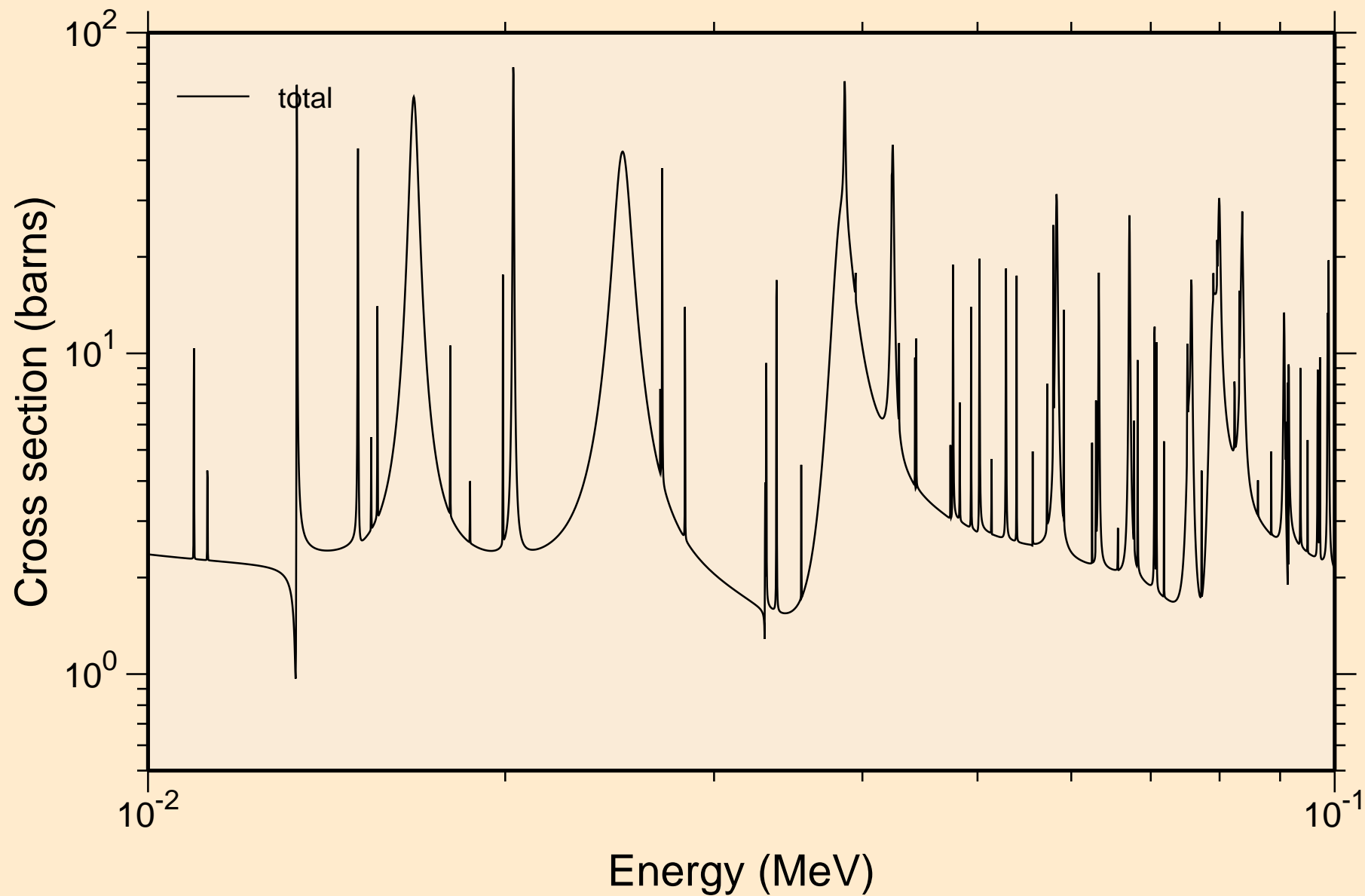

19-K-41 FOR FENDL-3.2 FROM TENDL-2015 BY NJOY2016.60+ O
resonance total cross section

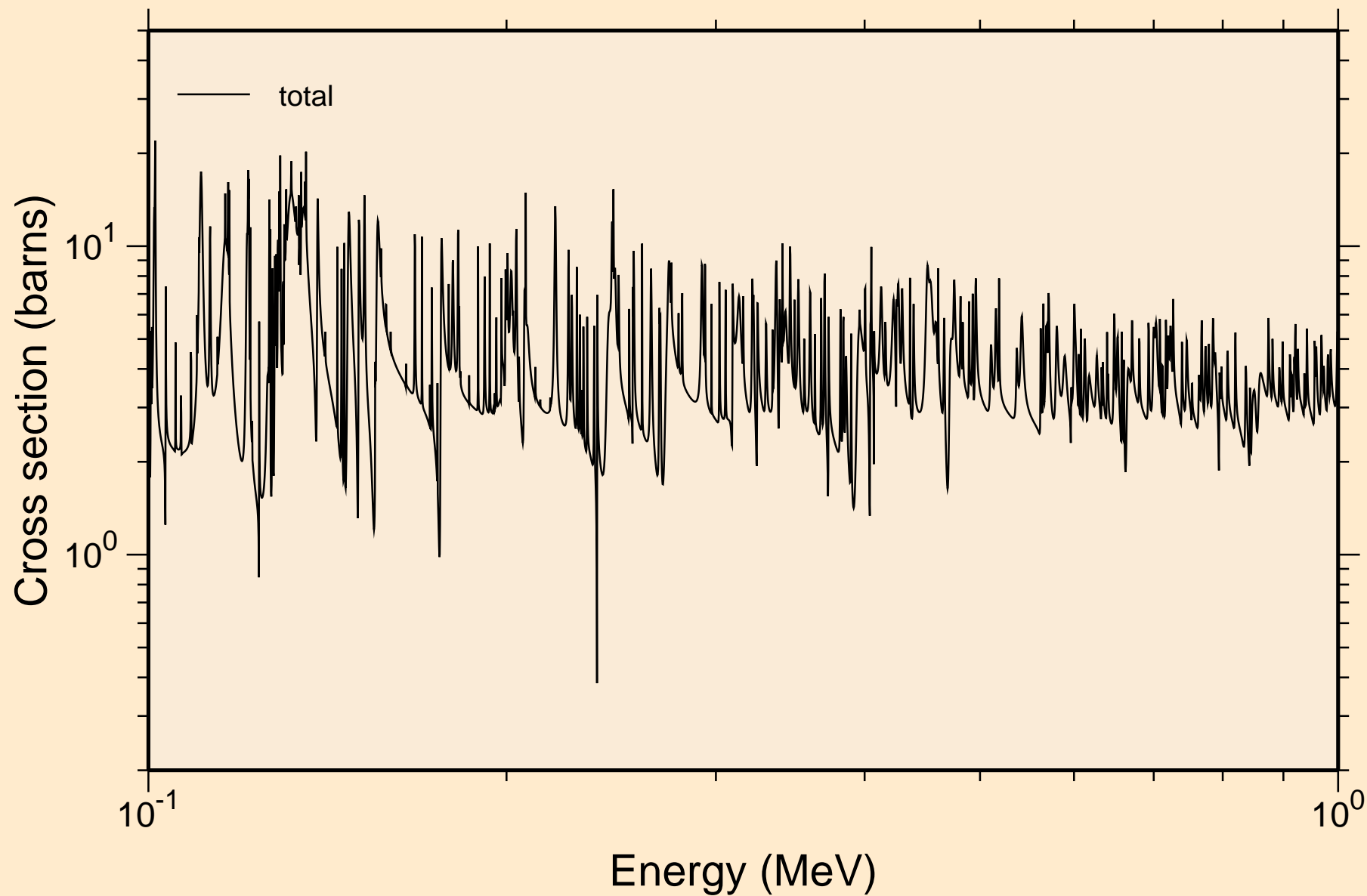

19-K-41 FOR FENDL-3.2 FROM TENDL-2015 BY NJOY2016.60+ O
resonance total cross section

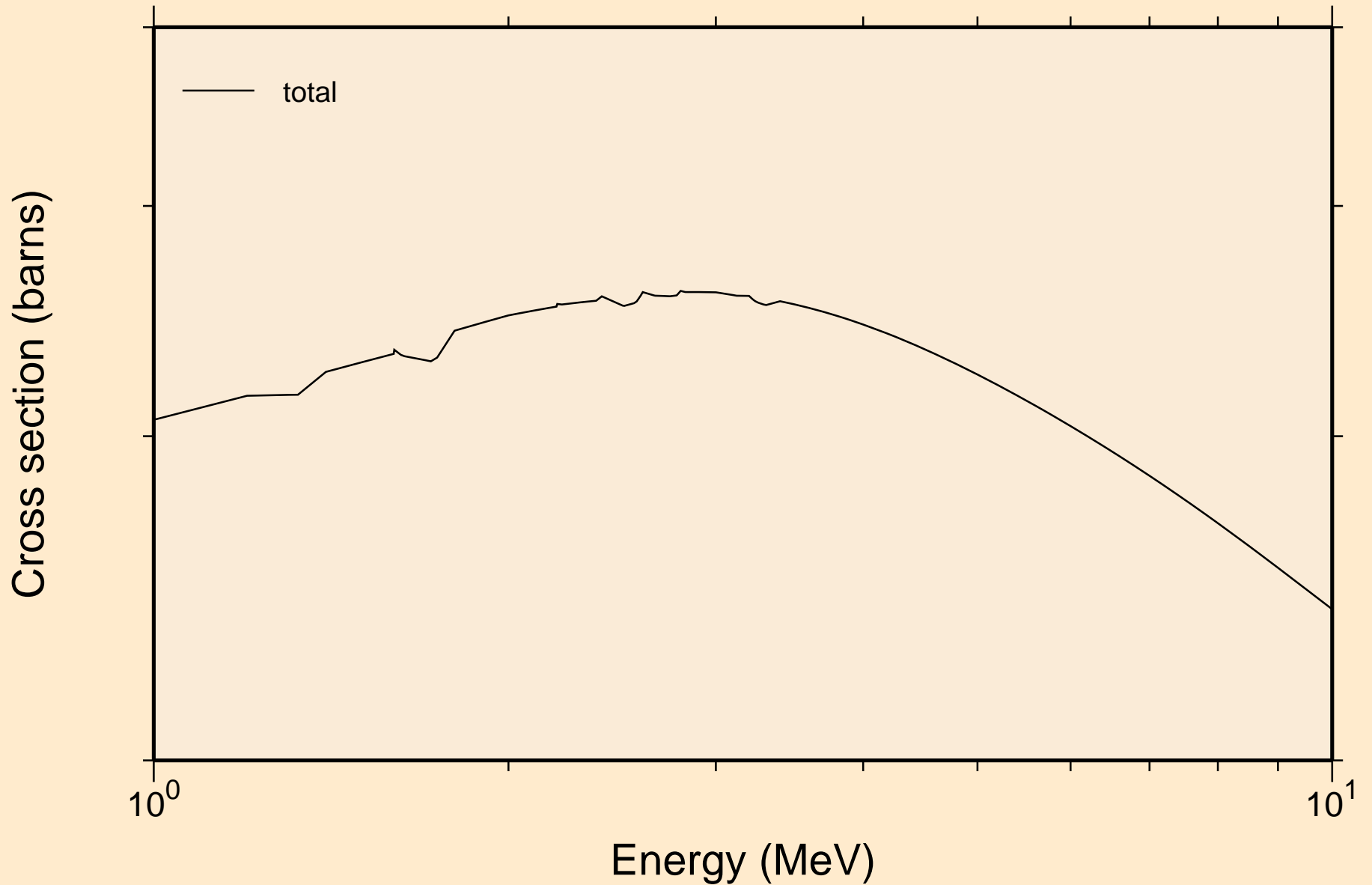

19-K-41 FOR FENDL-3.2 FROM TENDL-2015 BY NJOY2016.60+ O
resonance absorption cross sections

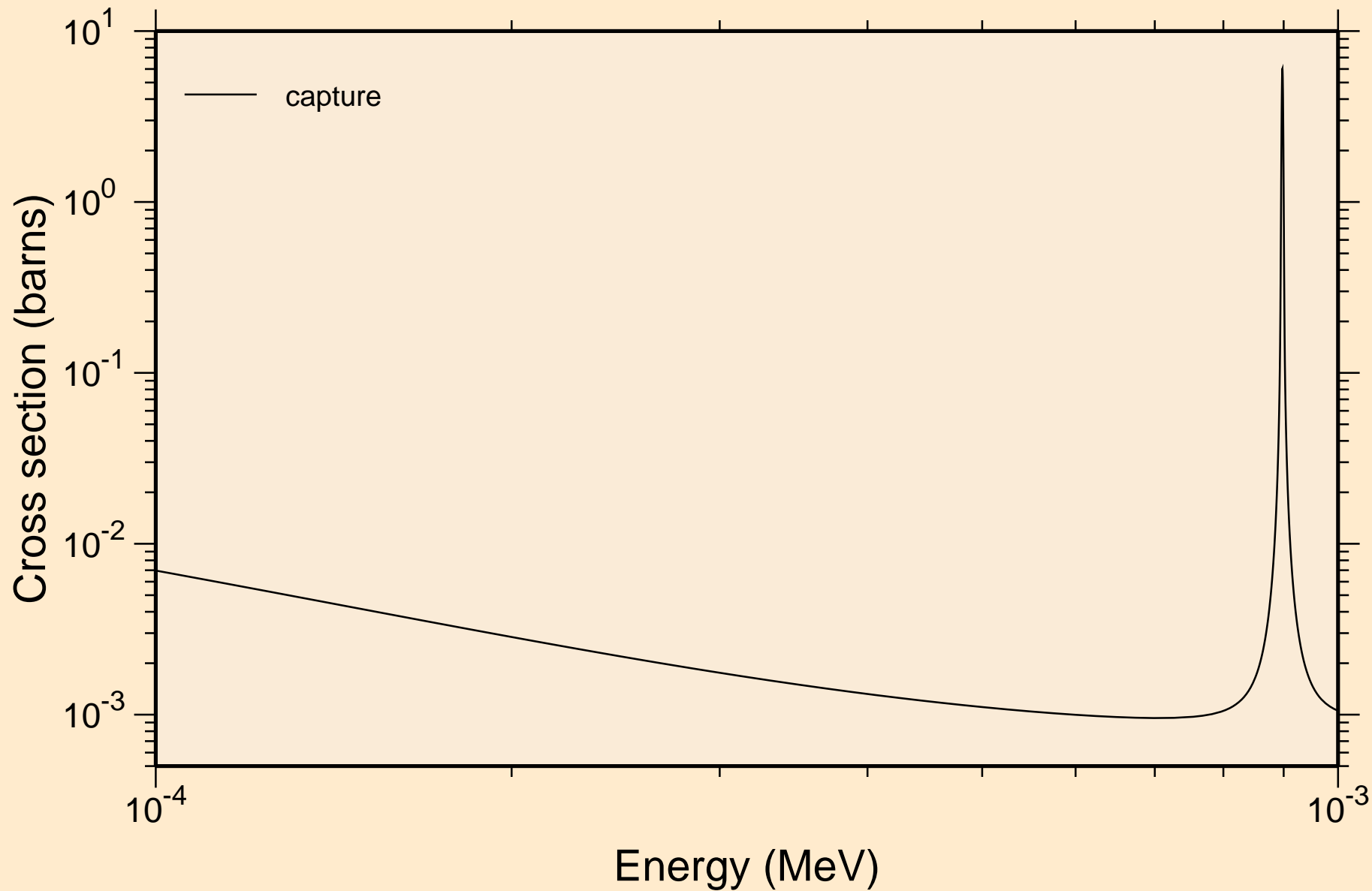

19-K-41 FOR FENDL-3.2 FROM TENDL-2015 BY NJOY2016.60+ O
resonance absorption cross sections

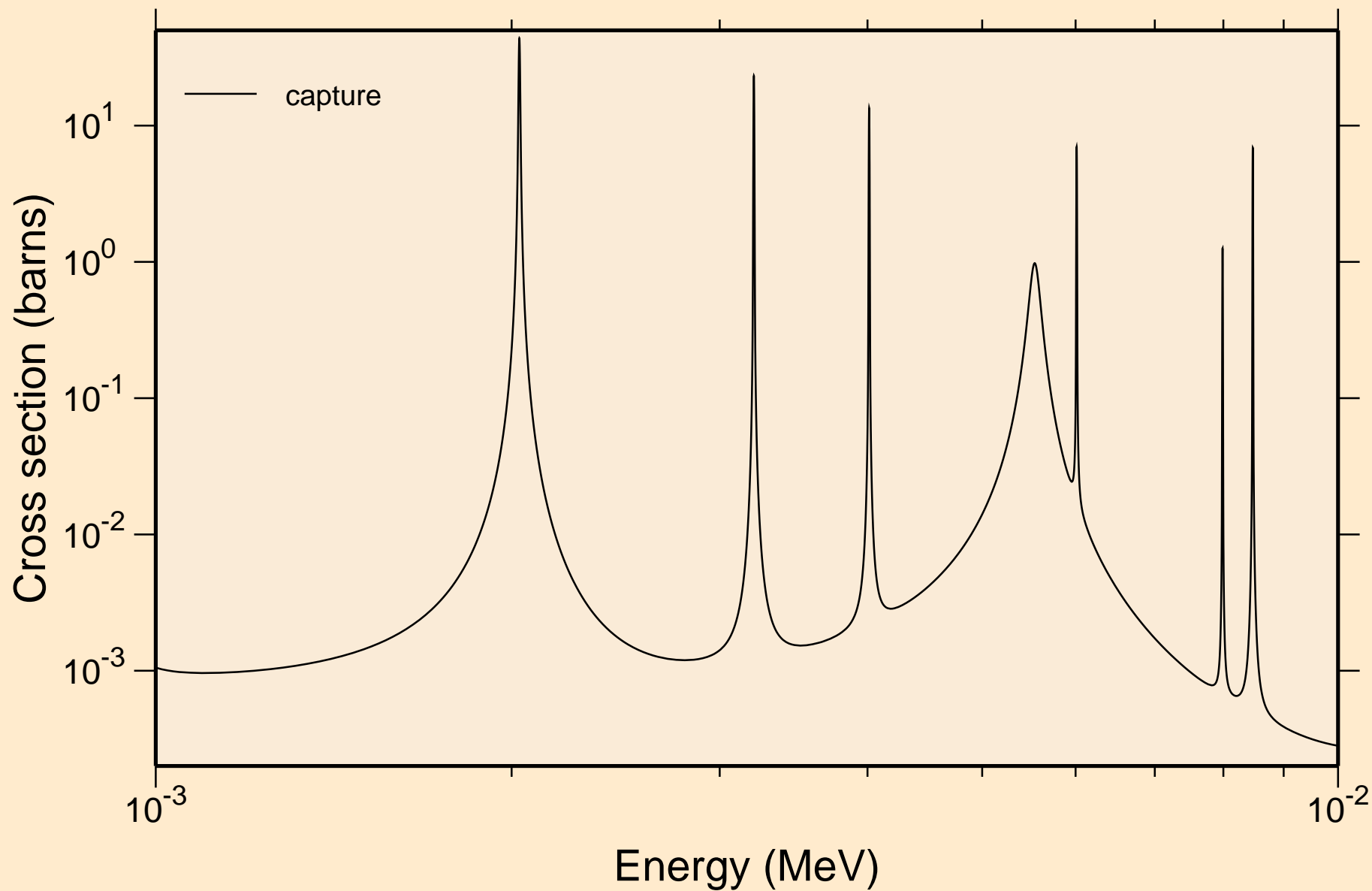

19-K-41 FOR FENDL-3.2 FROM TENDL-2015 BY NJOY2016.60+ O
resonance absorption cross sections

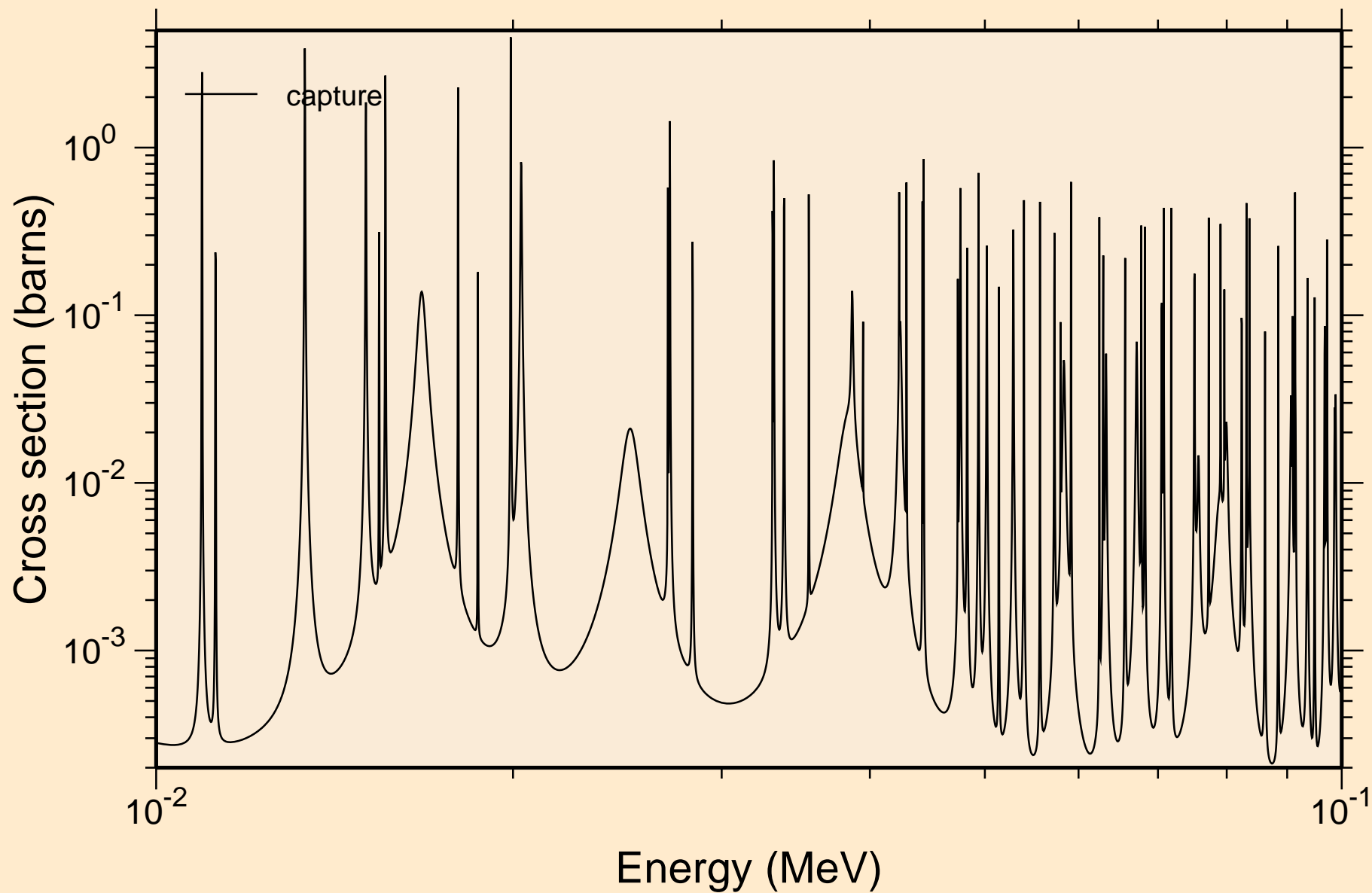

19-K-41 FOR FENDL-3.2 FROM TENDL-2015 BY NJOY2016.60+ O
resonance absorption cross sections

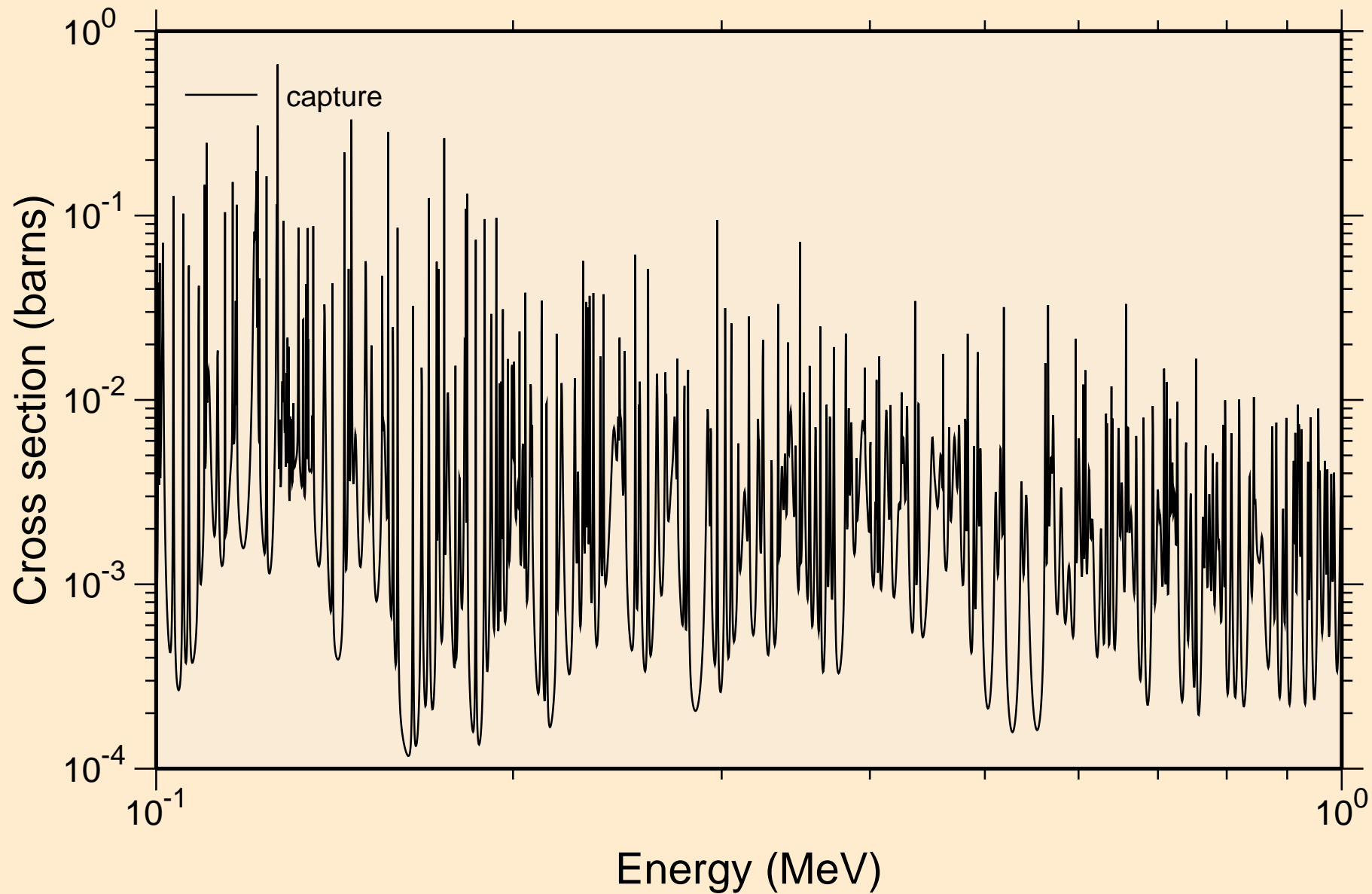

19-K-41 FOR FENDL-3.2 FROM TENDL-2015 BY NJOY2016.60+ O
resonance absorption cross sections

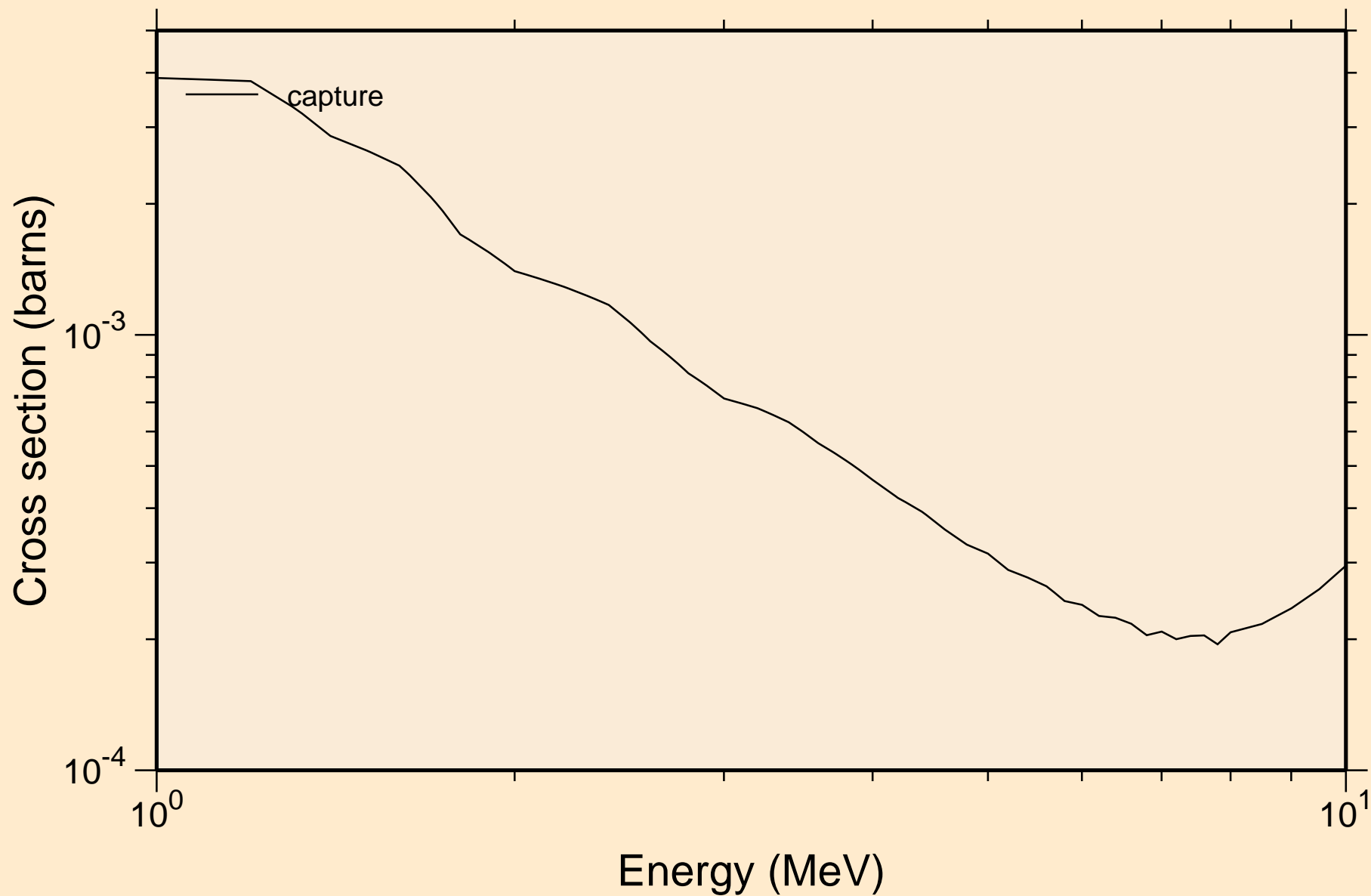

19-K-41 FOR FENDL-3.2 FROM TENDL-2015 BY NJOY2016.60+ O
Heating

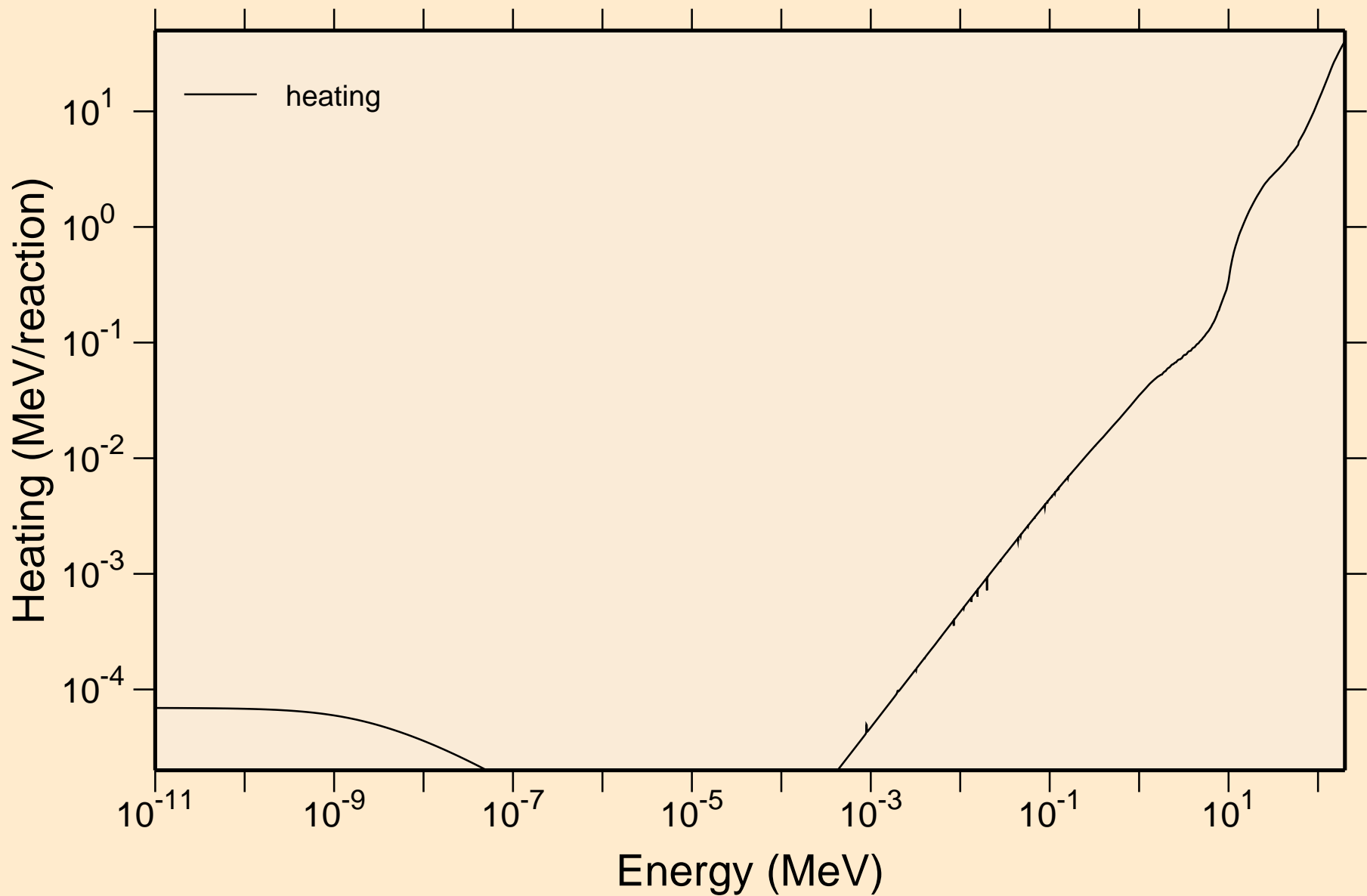

19-K-41 FOR FENDL-3.2 FROM TENDL-2015 BY NJOY2016.60+ O
Damage

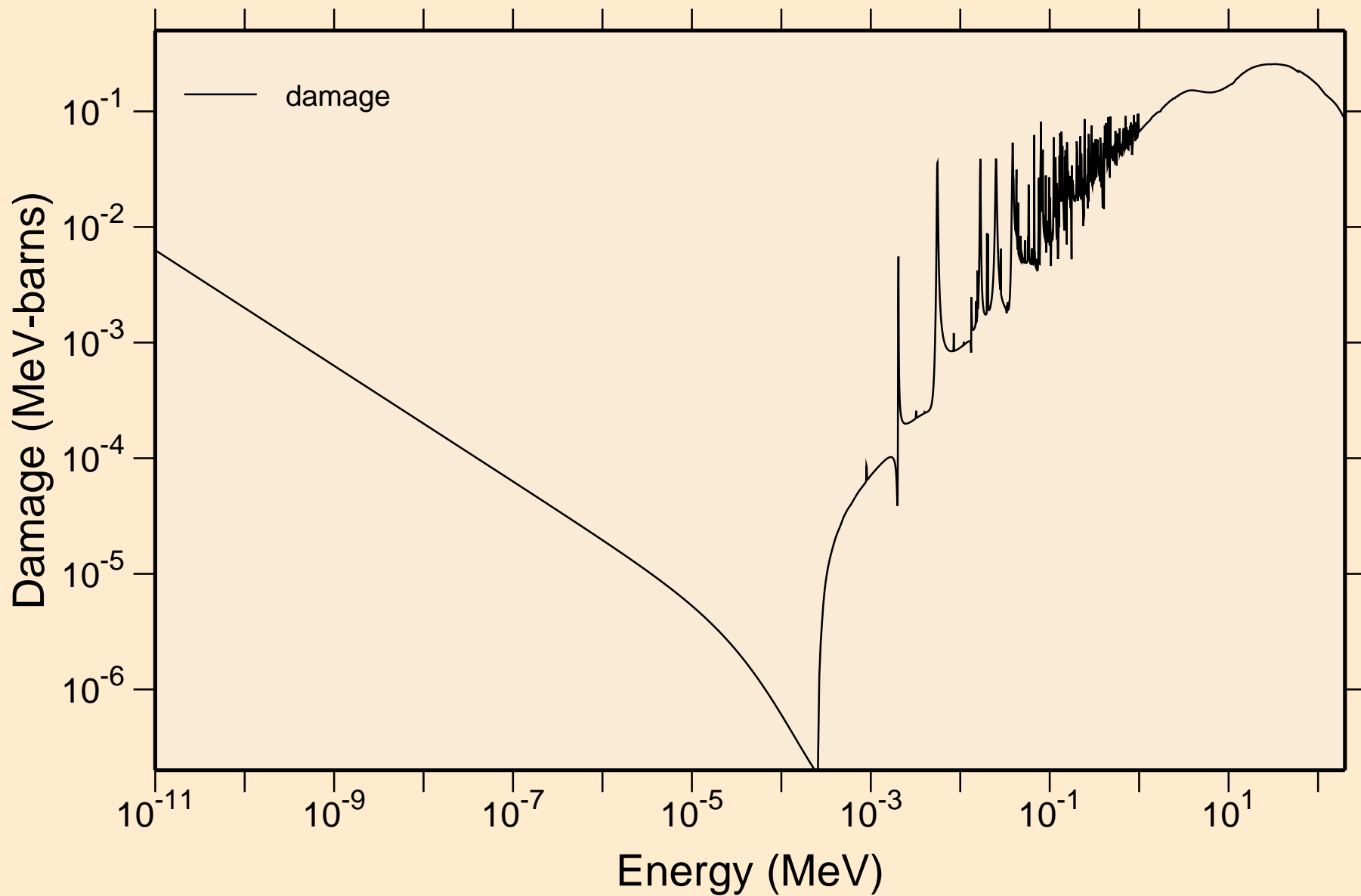

19-K-41 FOR FENDL-3.2 FROM TENDL-2015 BY NJOY2016.60+ O
Non-threshold reactions

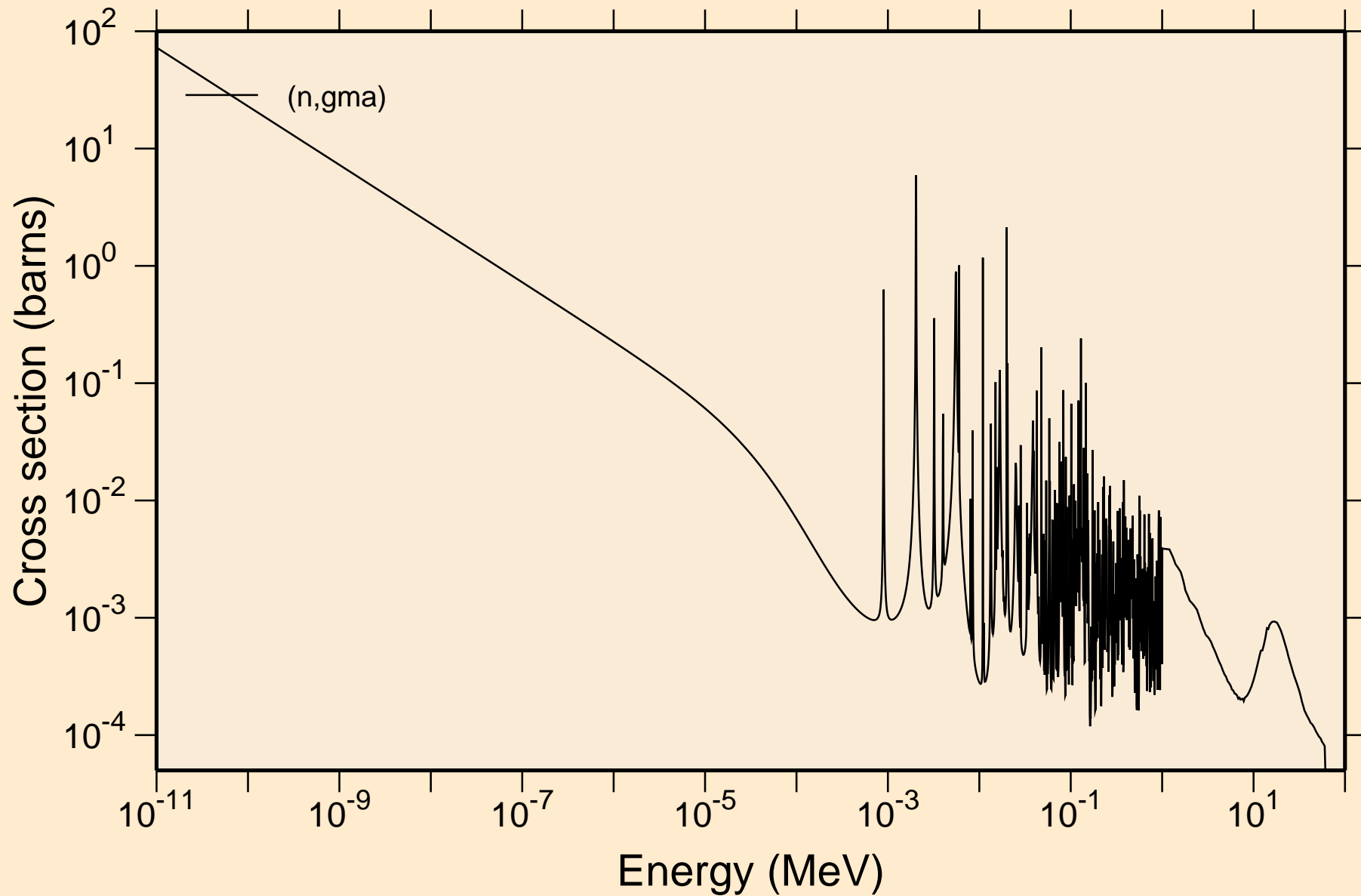

19-K-41 FOR FENDL-3.2 FROM TENDL-2015 BY NJOY2016.60+ O

Principal cross sections

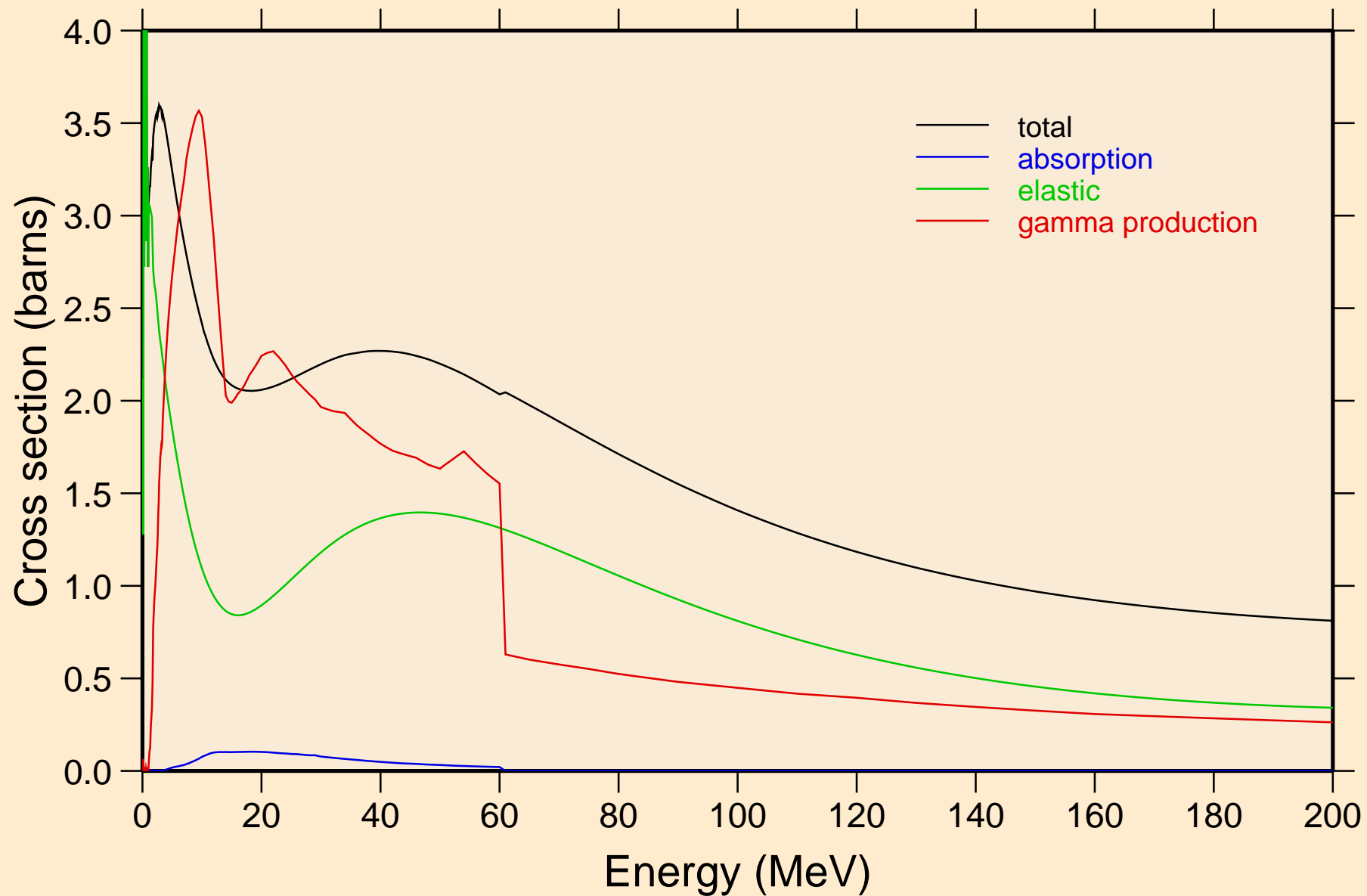

19-K-41 FOR FENDL-3.2 FROM TENDL-2015 BY NJOY2016.60+ O Heating

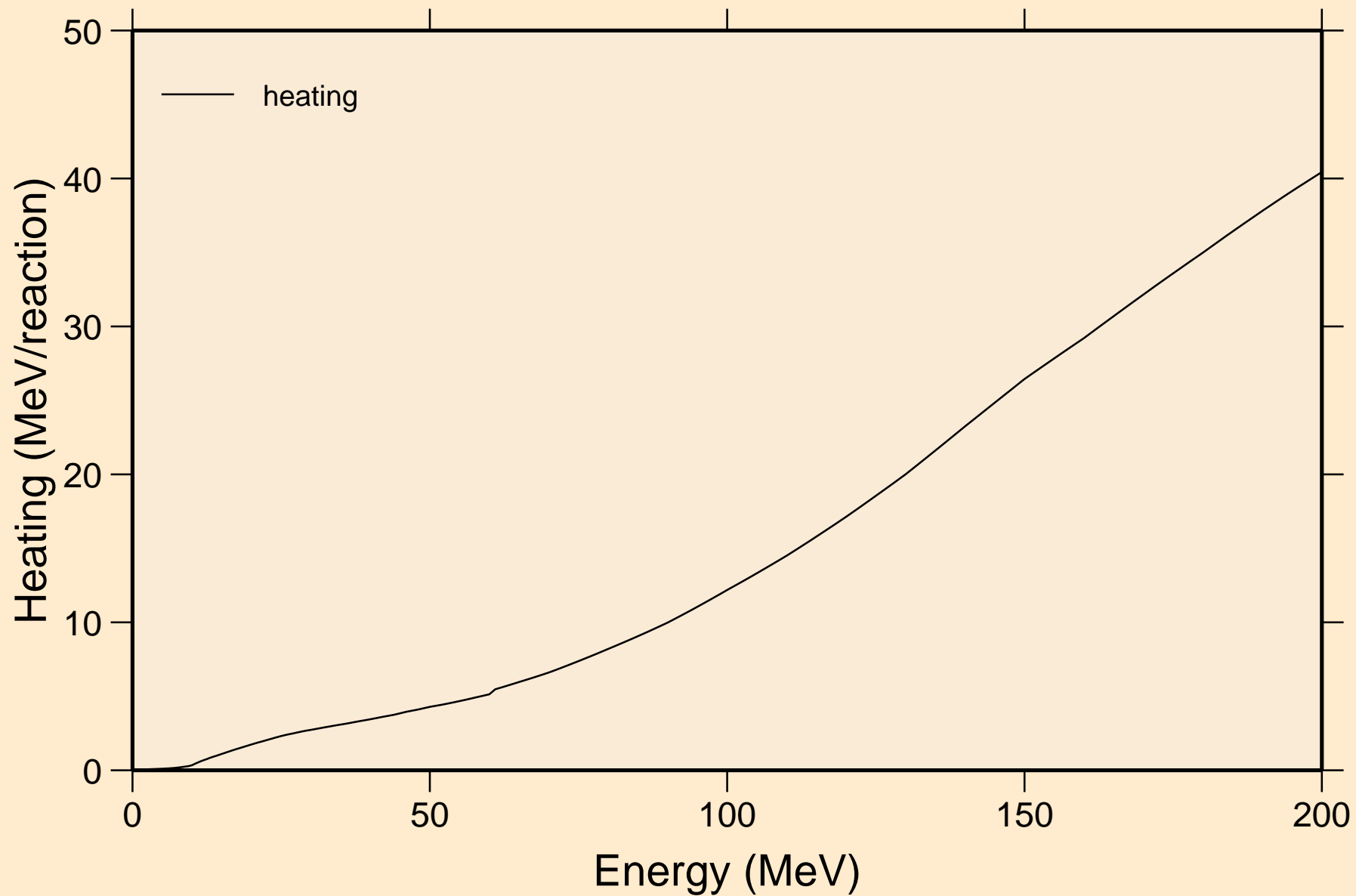

19-K-41 FOR FENDL-3.2 FROM TENDL-2015 BY NJOY2016.60+ O Damage

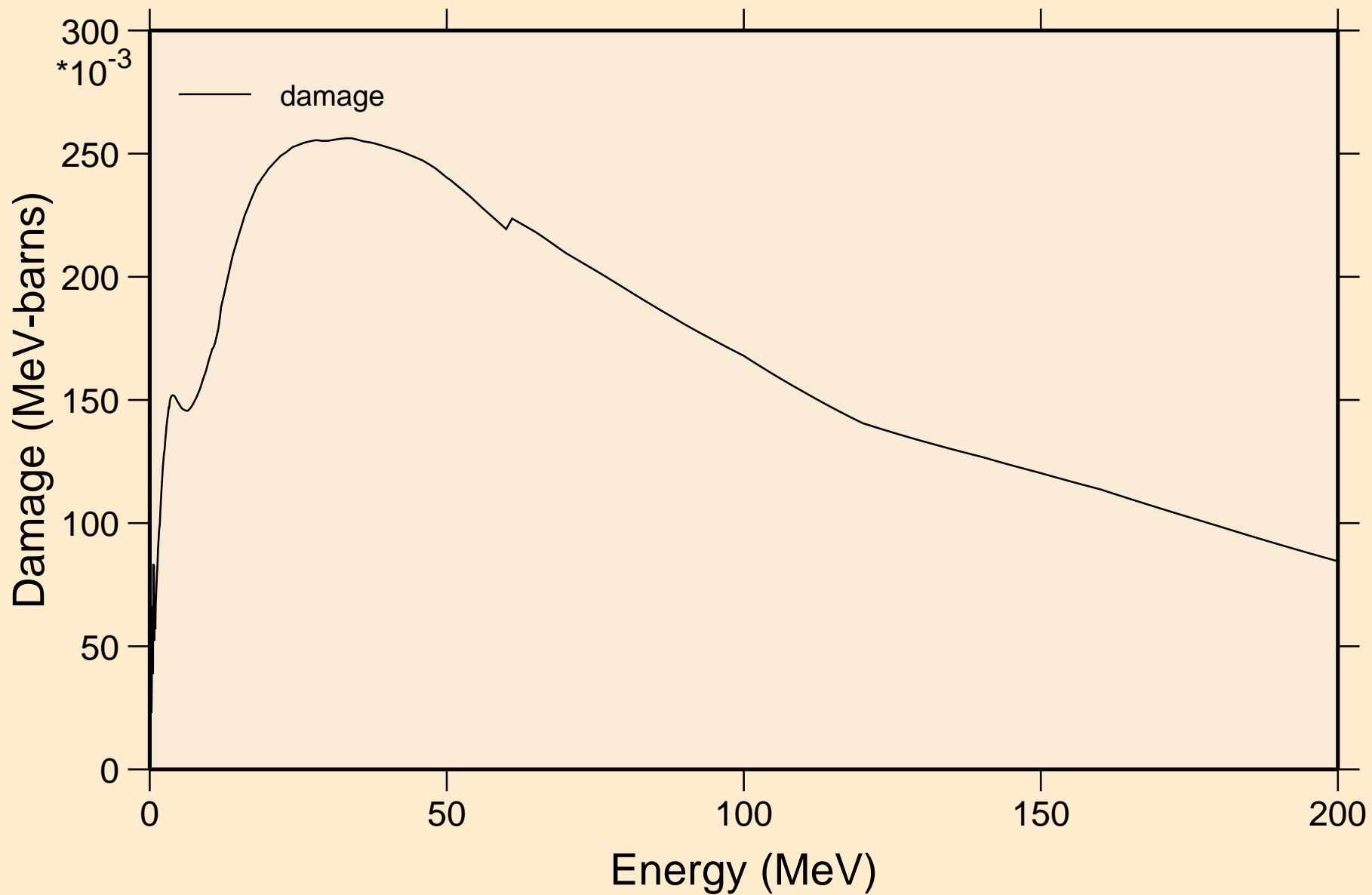

19-K-41 FOR FENDL-3.2 FROM TENDL-2015 BY NJOY2016.60+ O
Non-threshold reactions

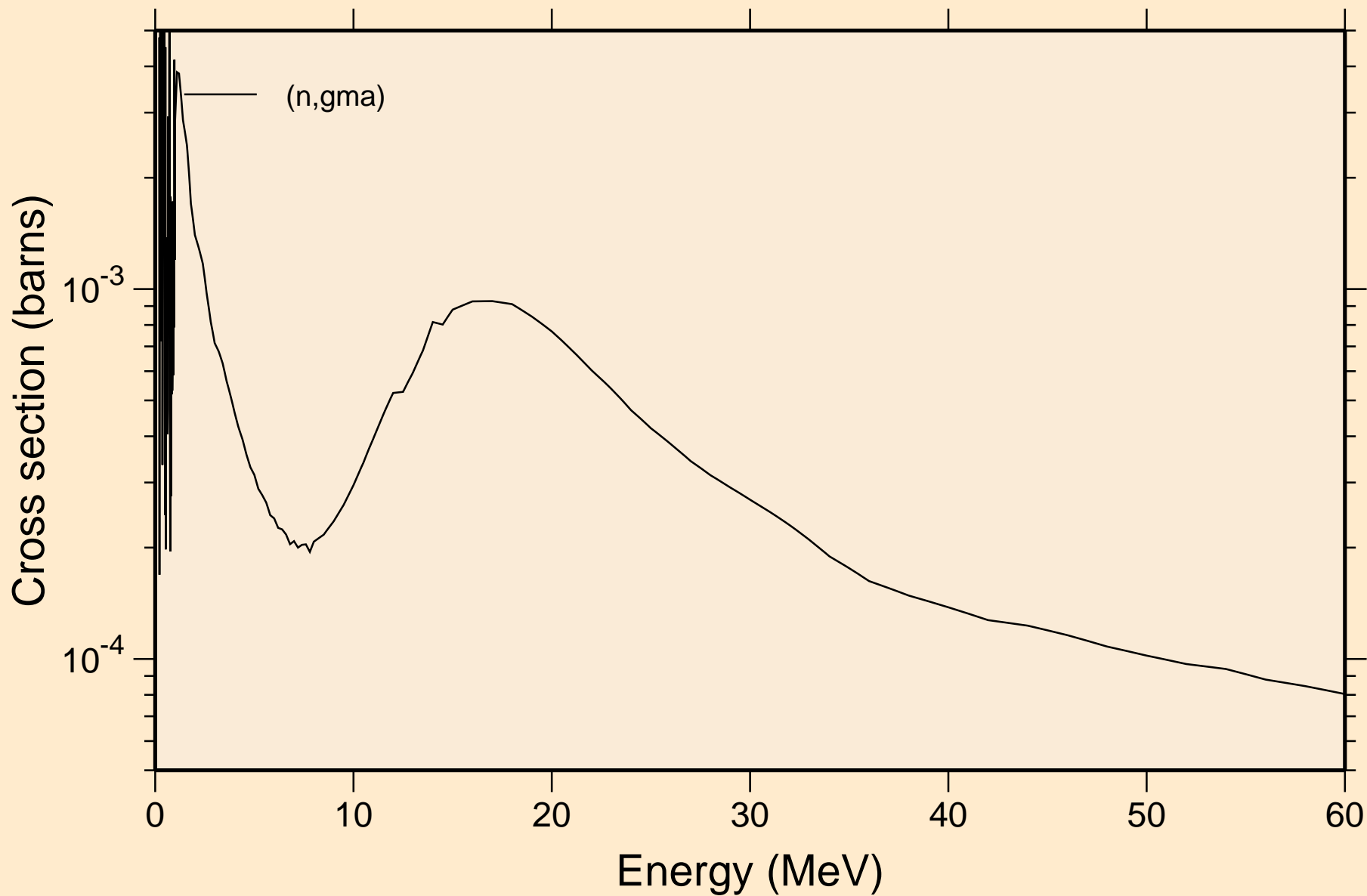

19-K-41 FOR FENDL-3.2 FROM TENDL-2015 BY NJOY2016.60+ O
Inelastic levels

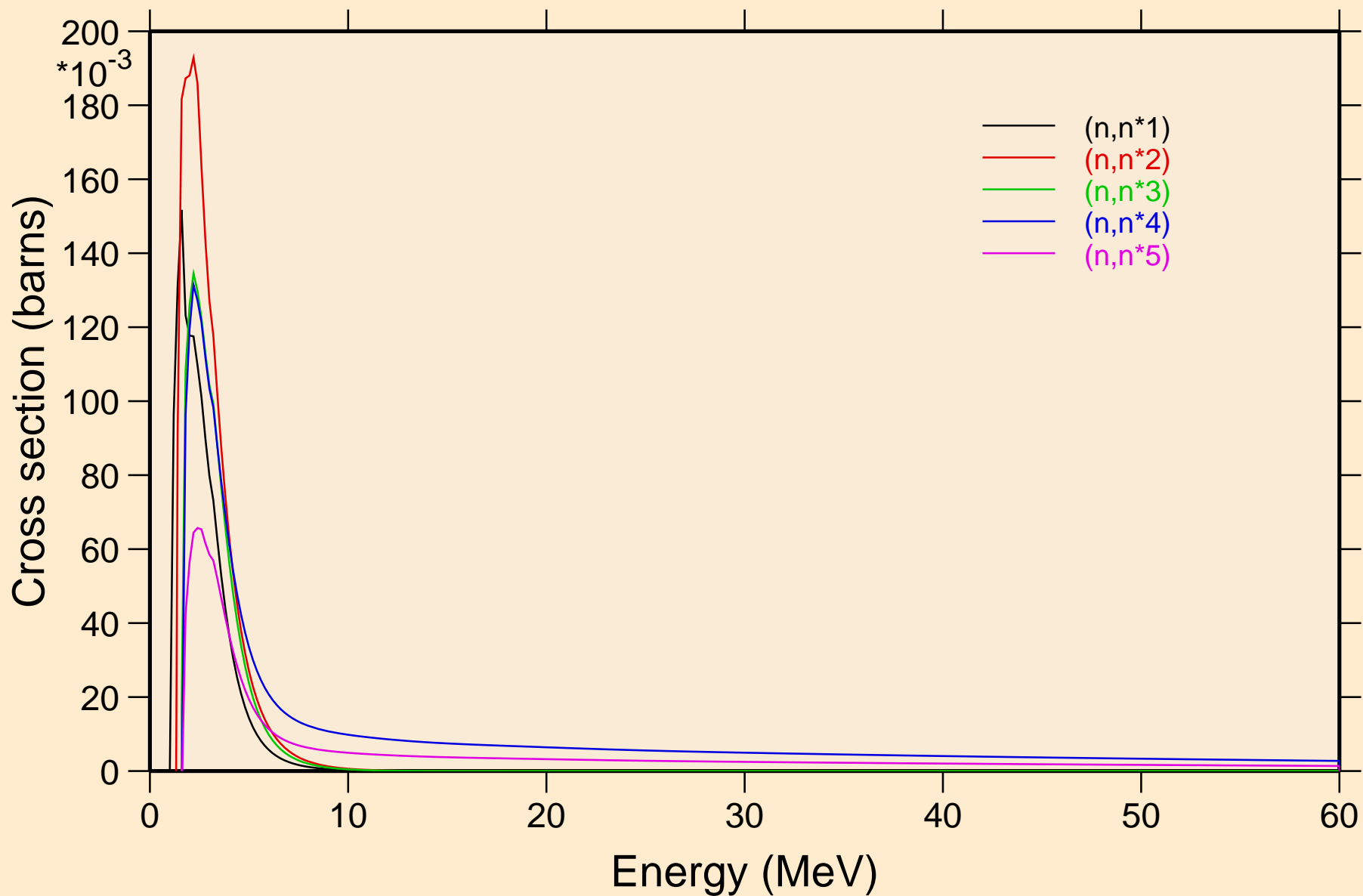

19-K-41 FOR FENDL-3.2 FROM TENDL-2015 BY NJOY2016.60+ O
Inelastic levels

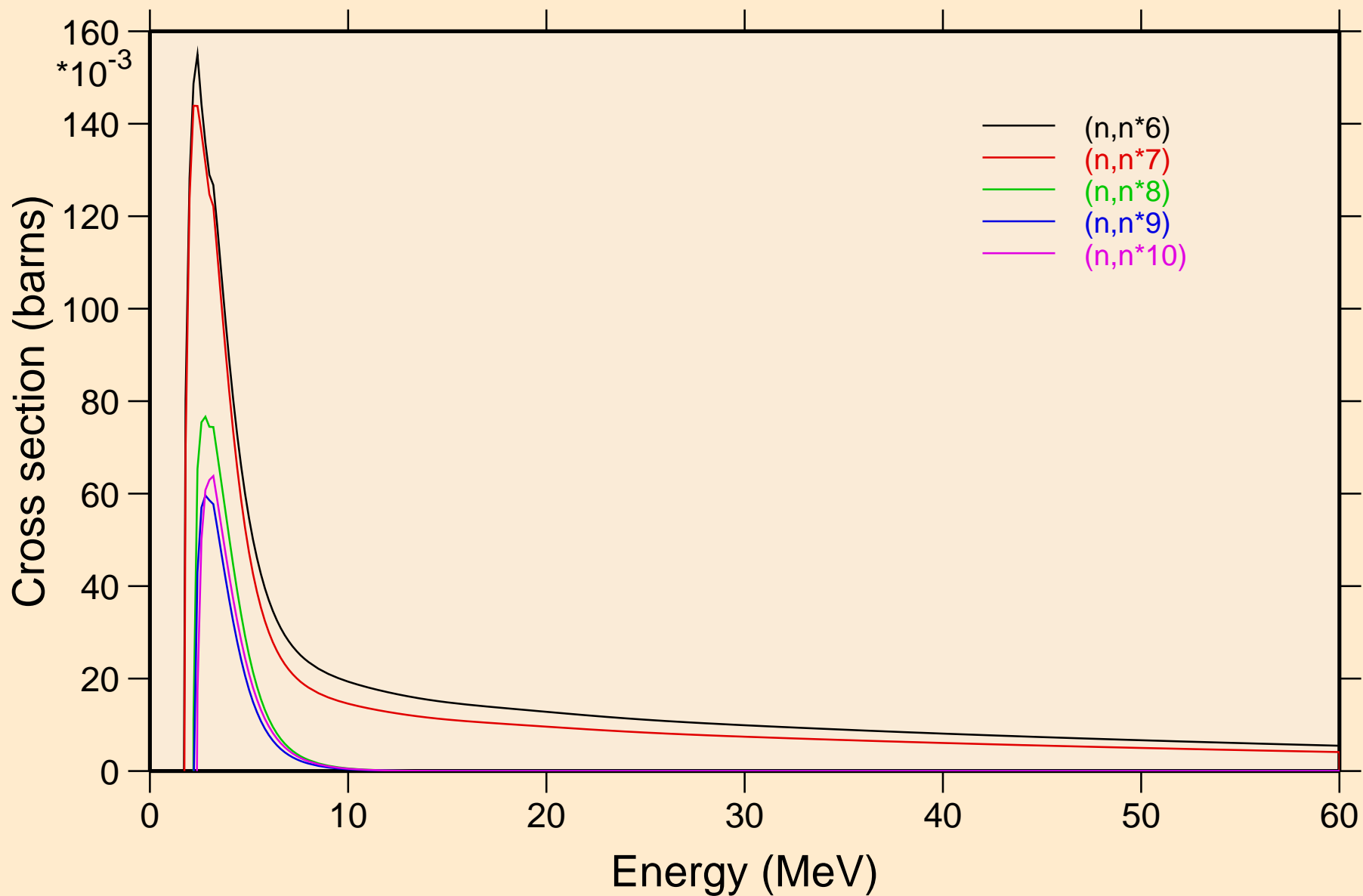

19-K-41 FOR FENDL-3.2 FROM TENDL-2015 BY NJOY2016.60+ O
Inelastic levels

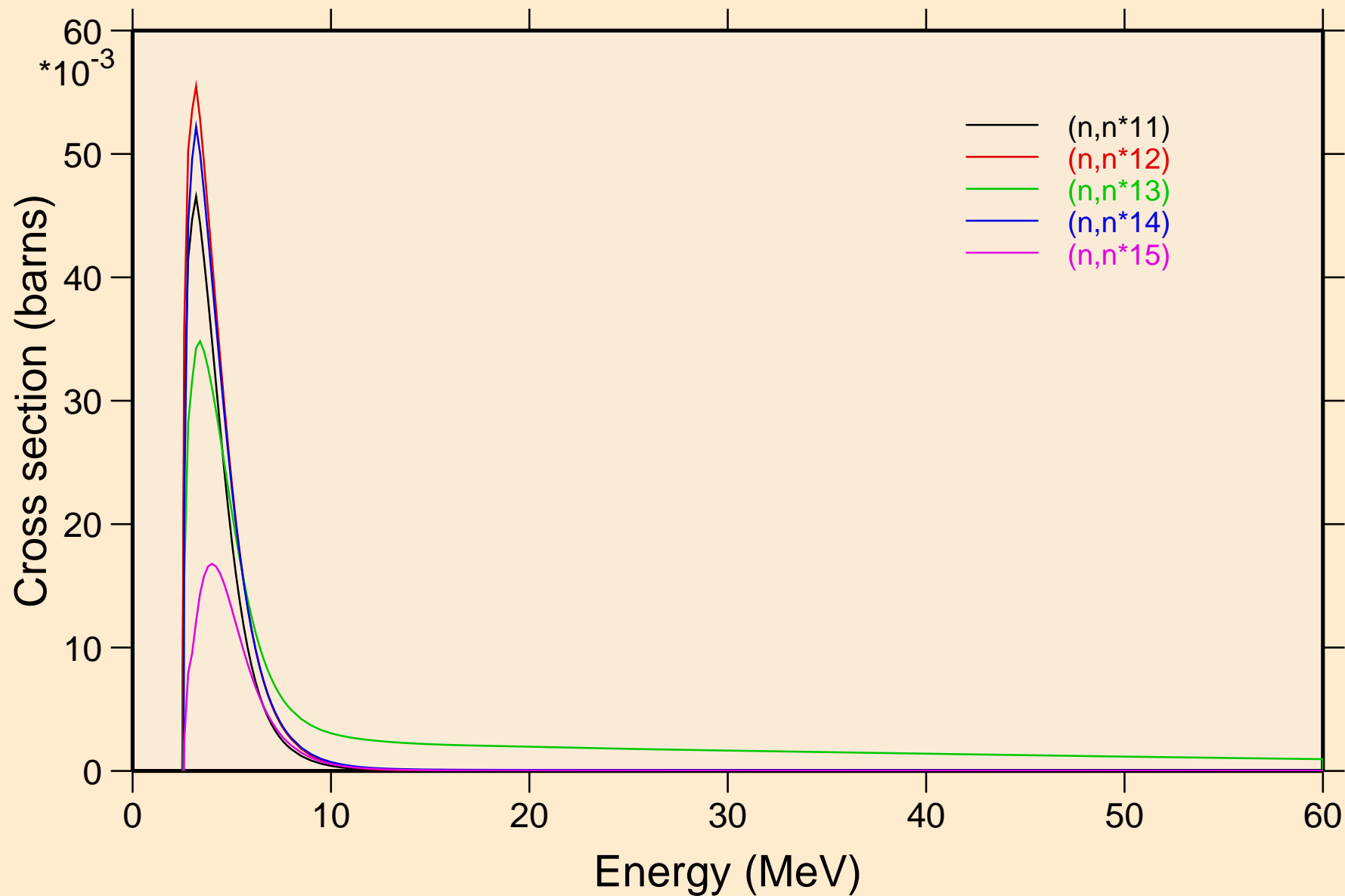

19-K-41 FOR FENDL-3.2 FROM TENDL-2015 BY NJOY2016.60+ O Inelastic levels

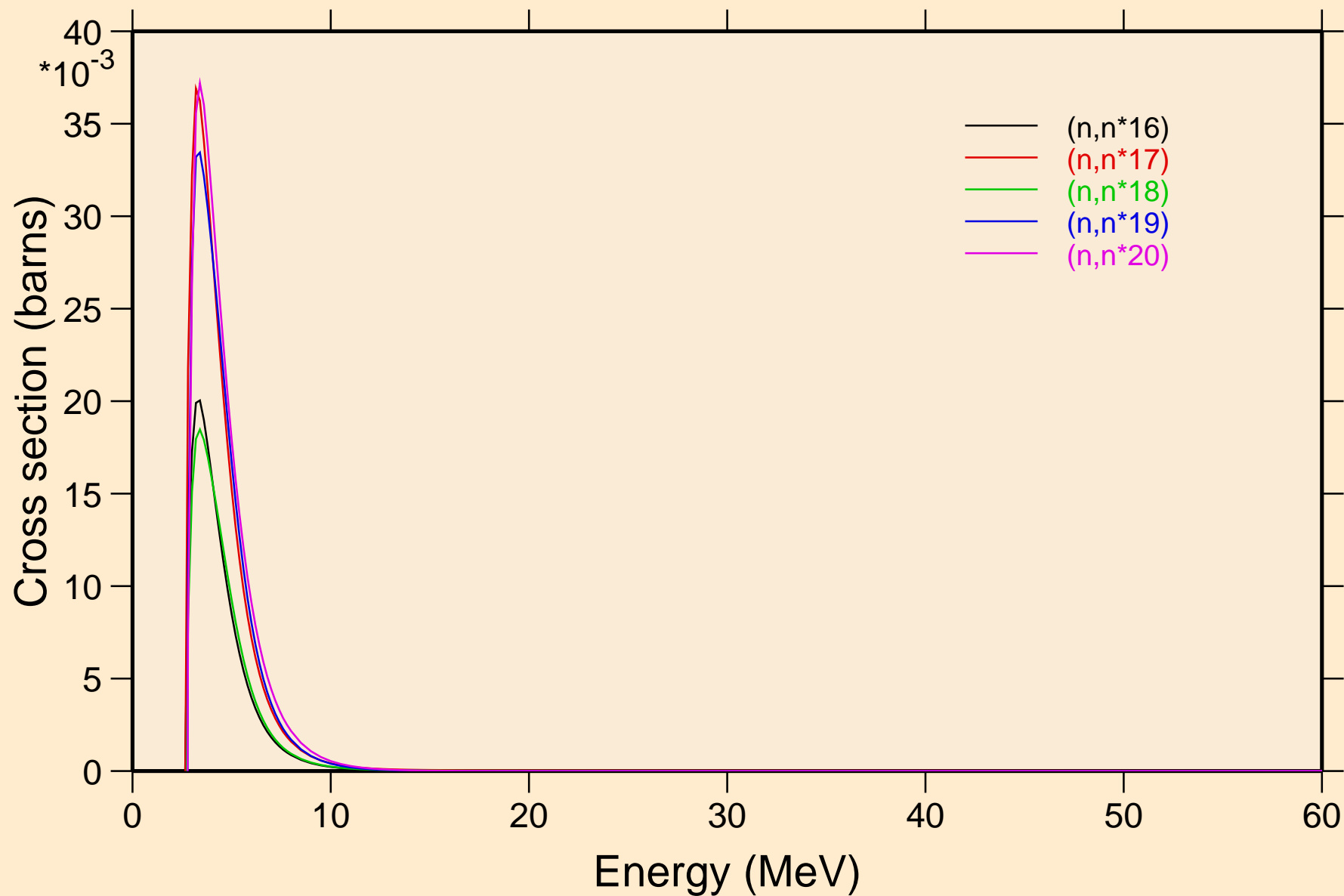

19-K-41 FOR FENDL-3.2 FROM TENDL-2015 BY NJOY2016.60+ O Inelastic levels

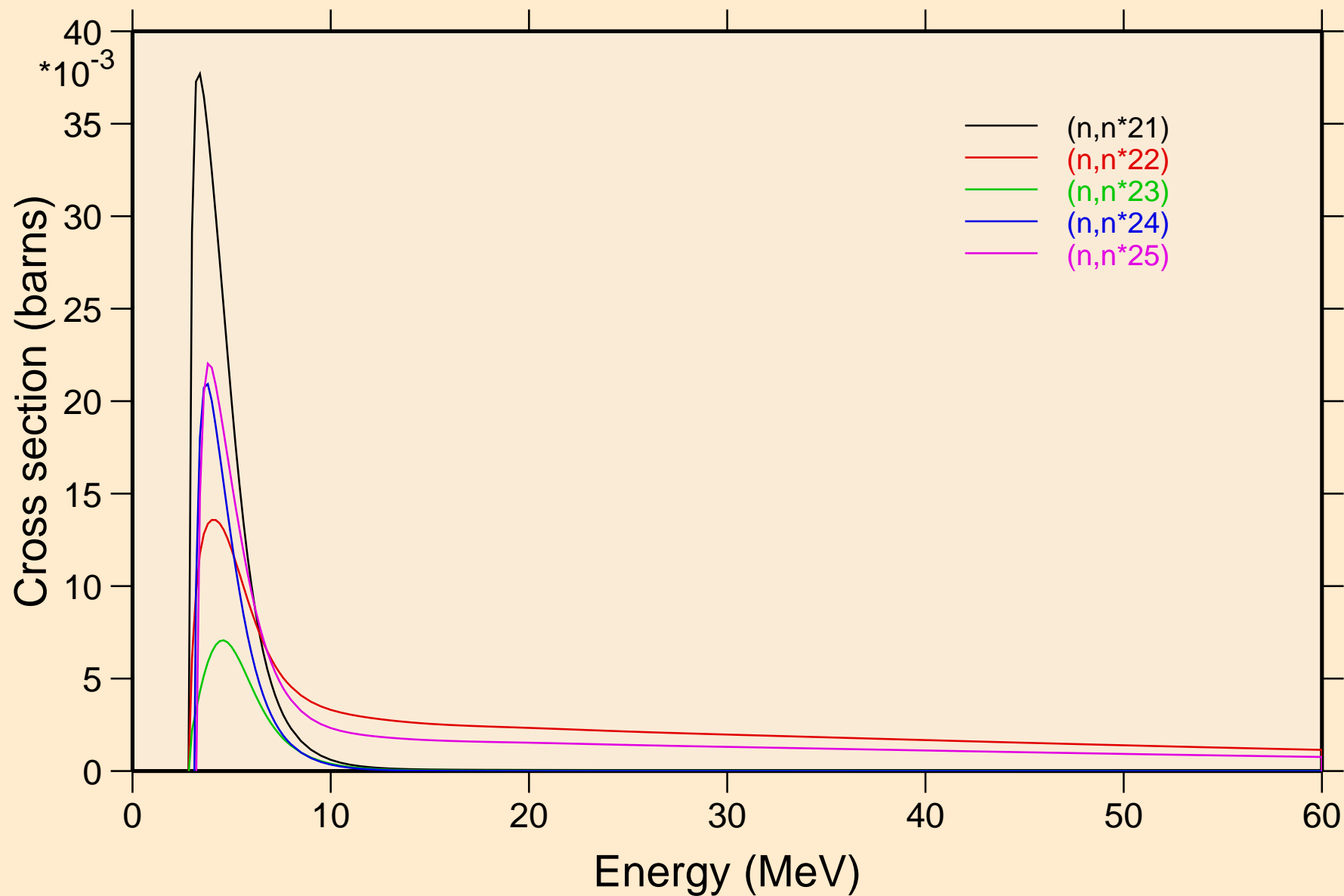

19-K-41 FOR FENDL-3.2 FROM TENDL-2015 BY NJOY2016.60+ O
Inelastic levels

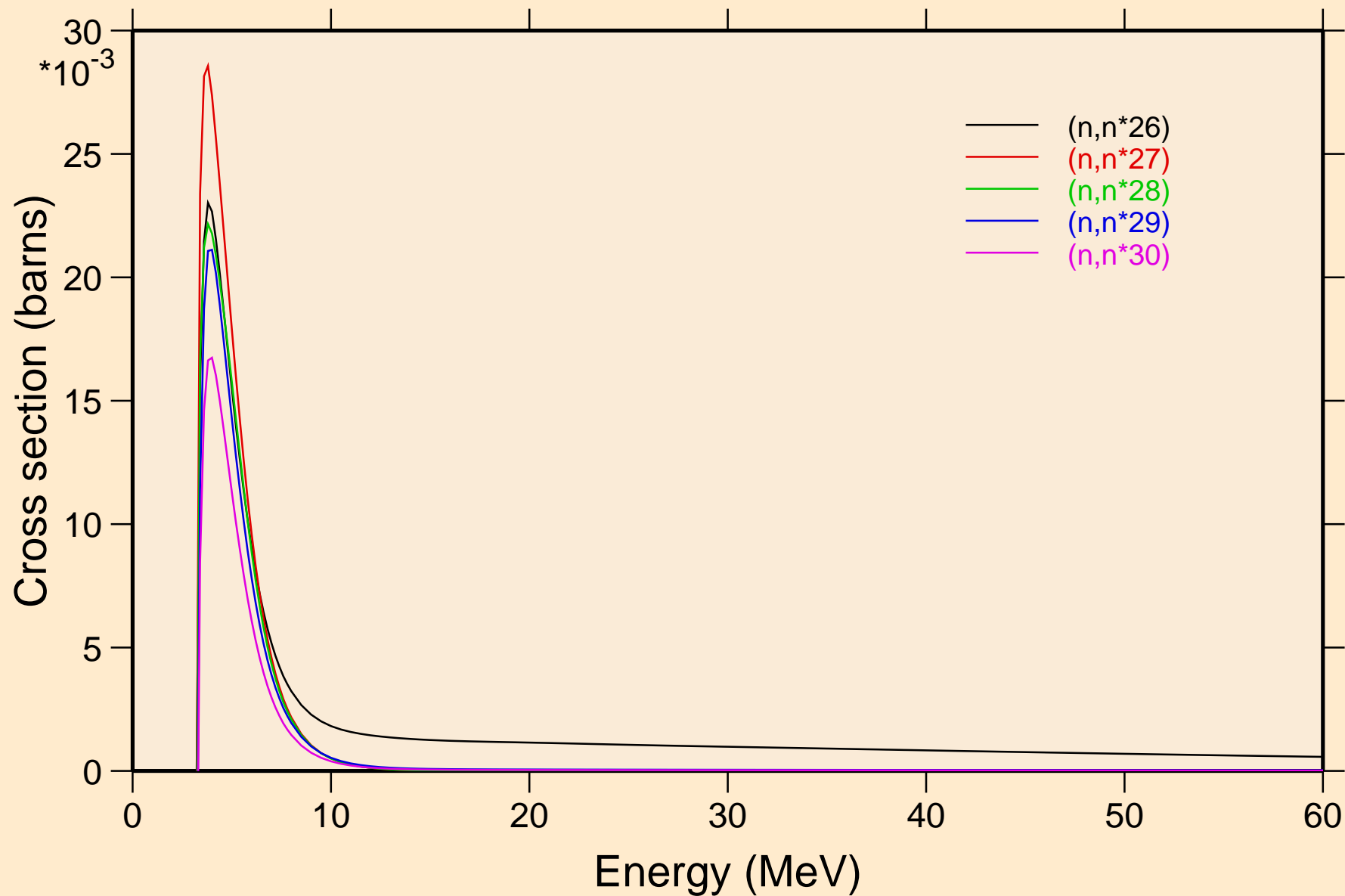

19-K-41 FOR FENDL-3.2 FROM TENDL-2015 BY NJOY2016.60+ O
Threshold reactions

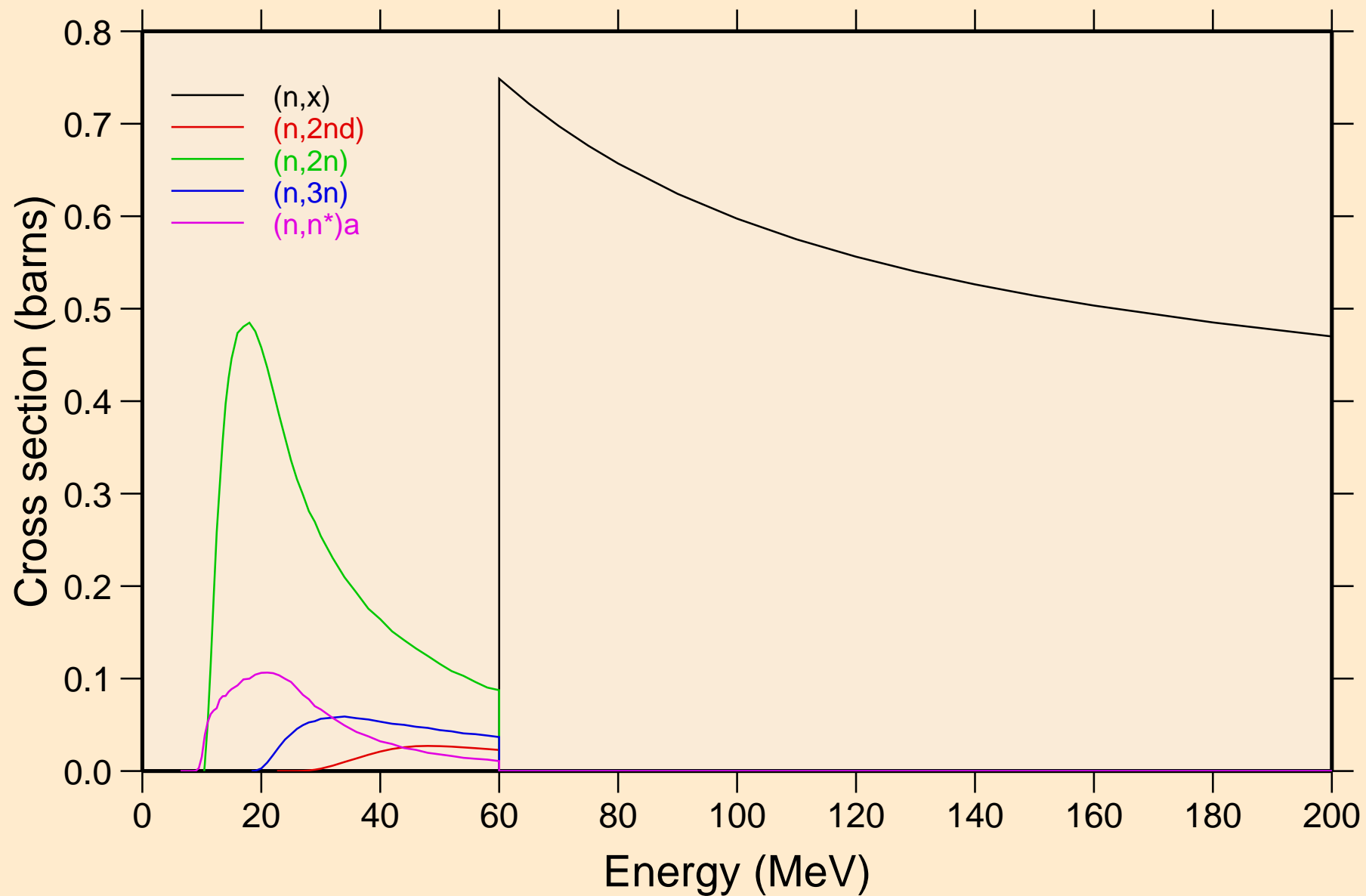

19-K-41 FOR FENDL-3.2 FROM TENDL-2015 BY NJOY2016.60+ O
Threshold reactions

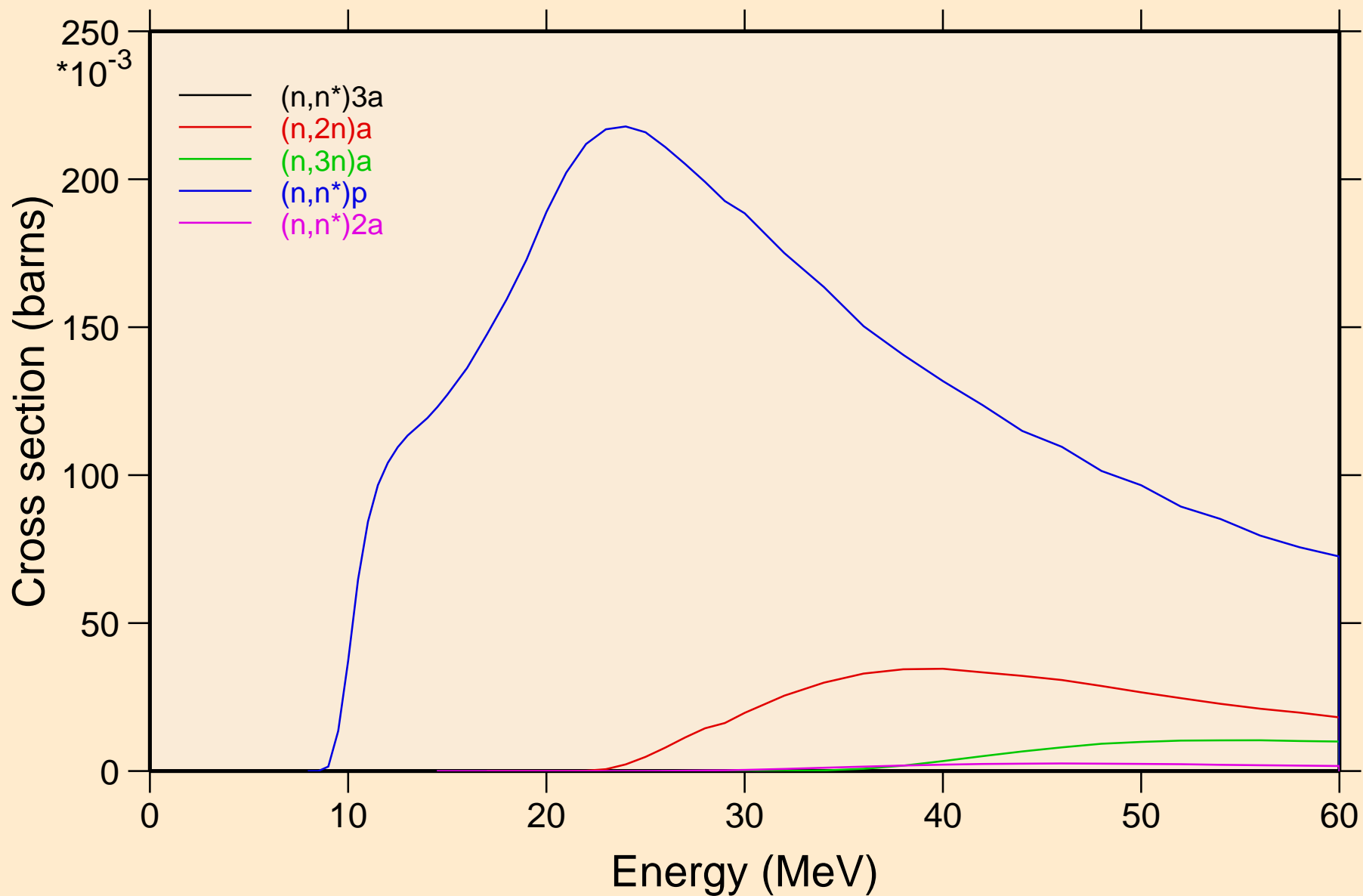

19-K-41 FOR FENDL-3.2 FROM TENDL-2015 BY NJOY2016.60+ O
Threshold reactions

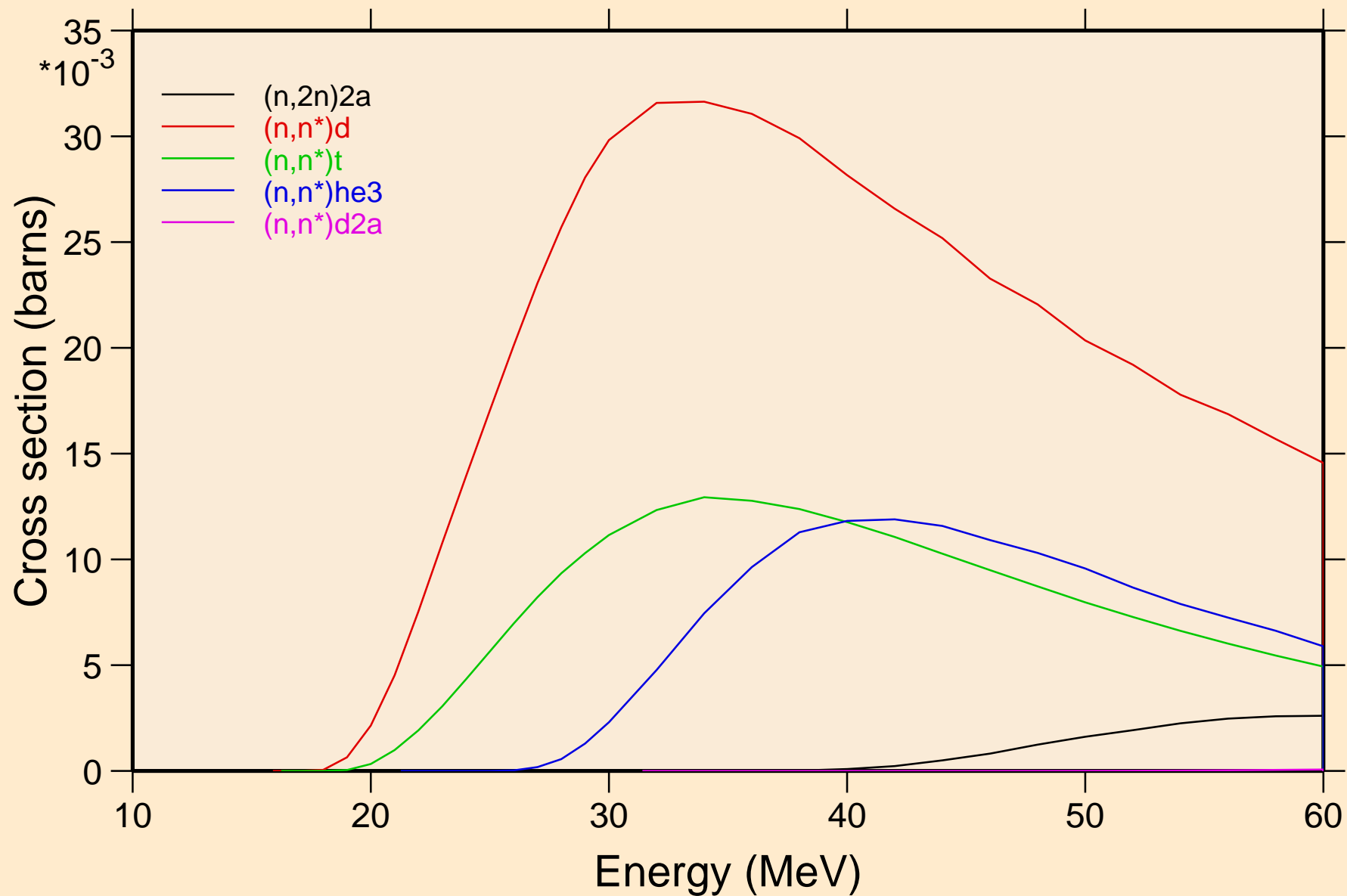

19-K-41 FOR FENDL-3.2 FROM TENDL-2015 BY NJOY2016.60+ O
Threshold reactions

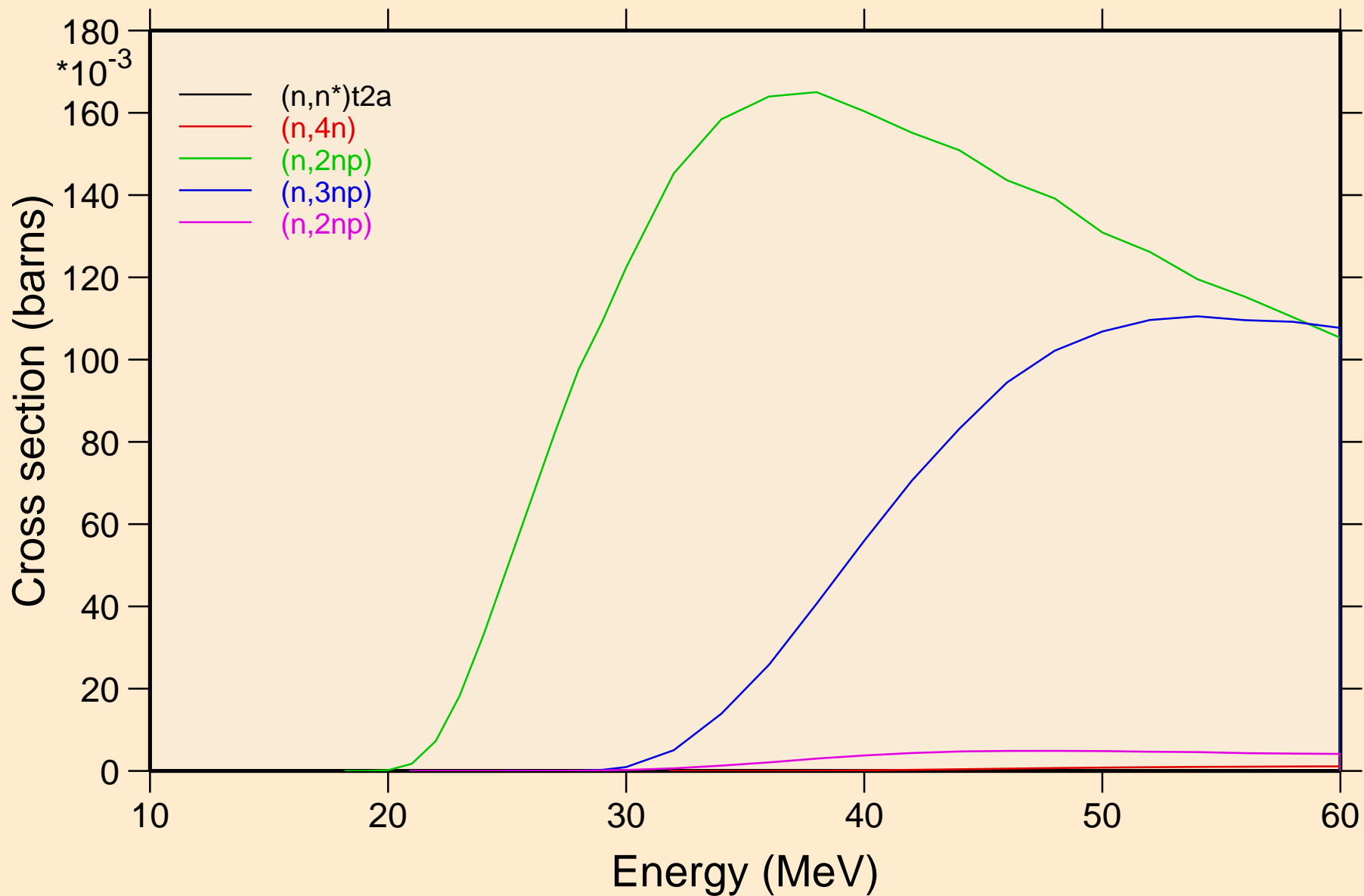

19-K-41 FOR FENDL-3.2 FROM TENDL-2015 BY NJOY2016.60+ O
Threshold reactions

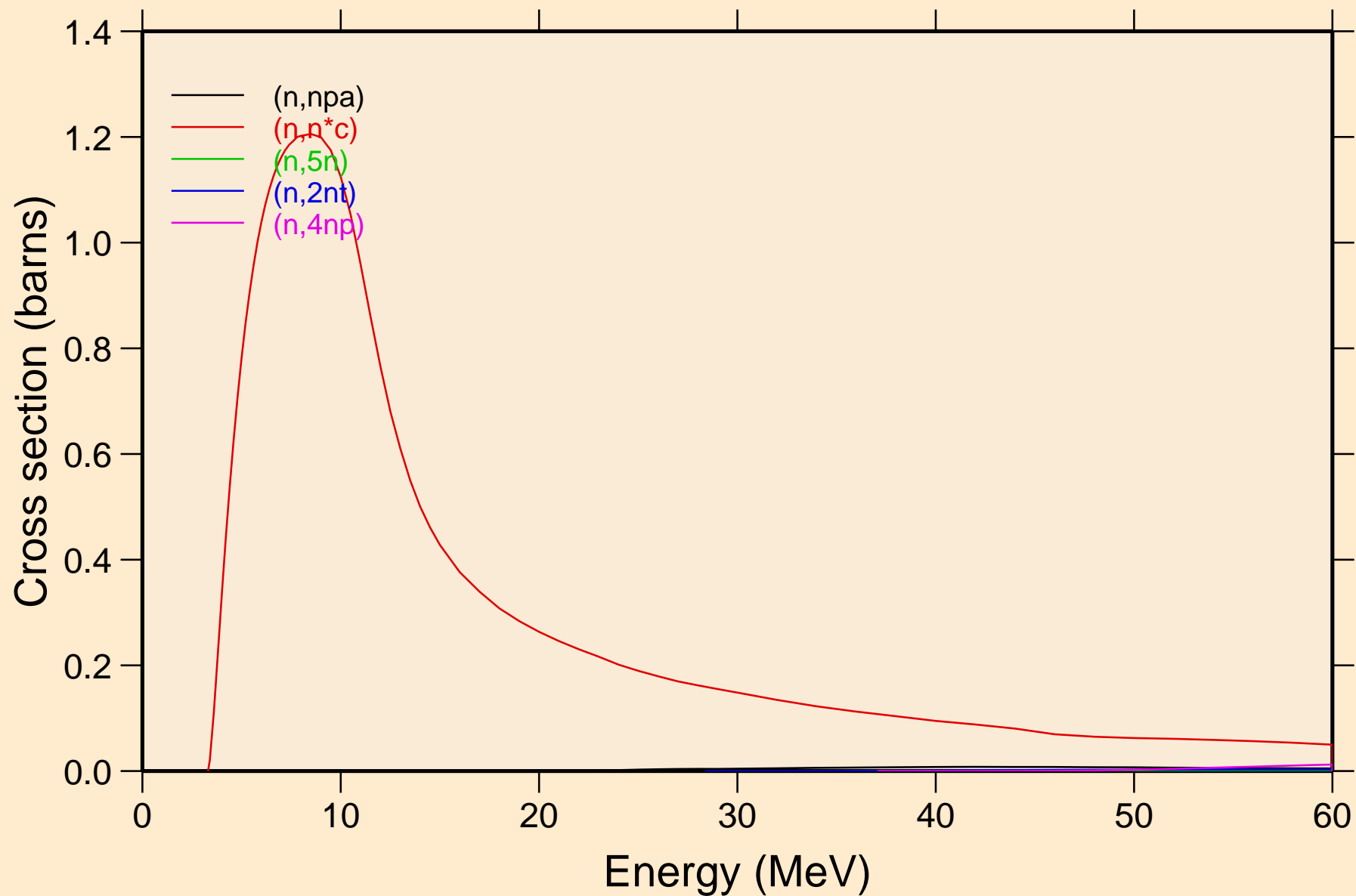

19-K-41 FOR FENDL-3.2 FROM TENDL-2015 BY NJOY2016.60+ O

Threshold reactions

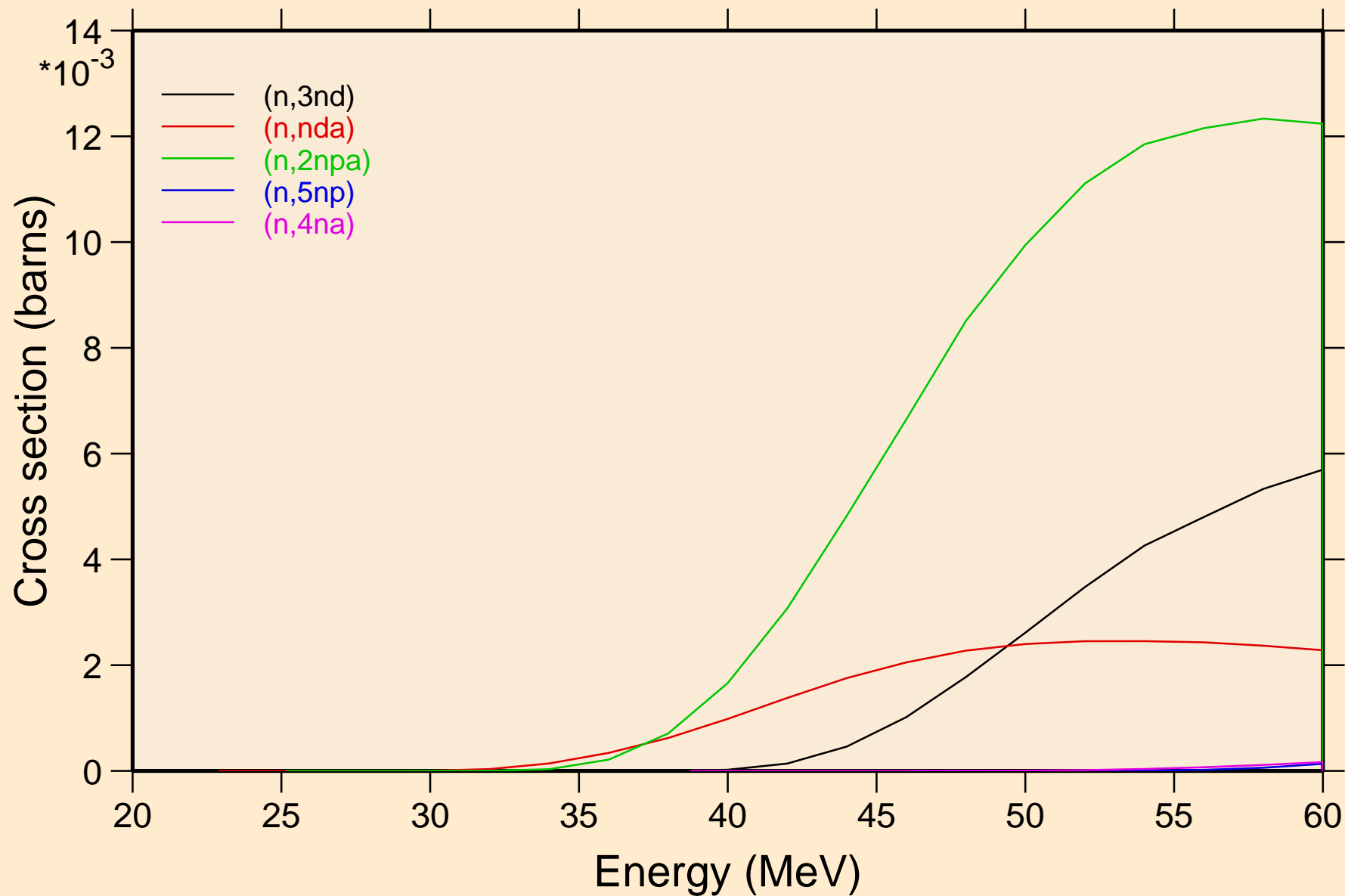

19-K-41 FOR FENDL-3.2 FROM TENDL-2015 BY NJOY2016.60+ O
Threshold reactions

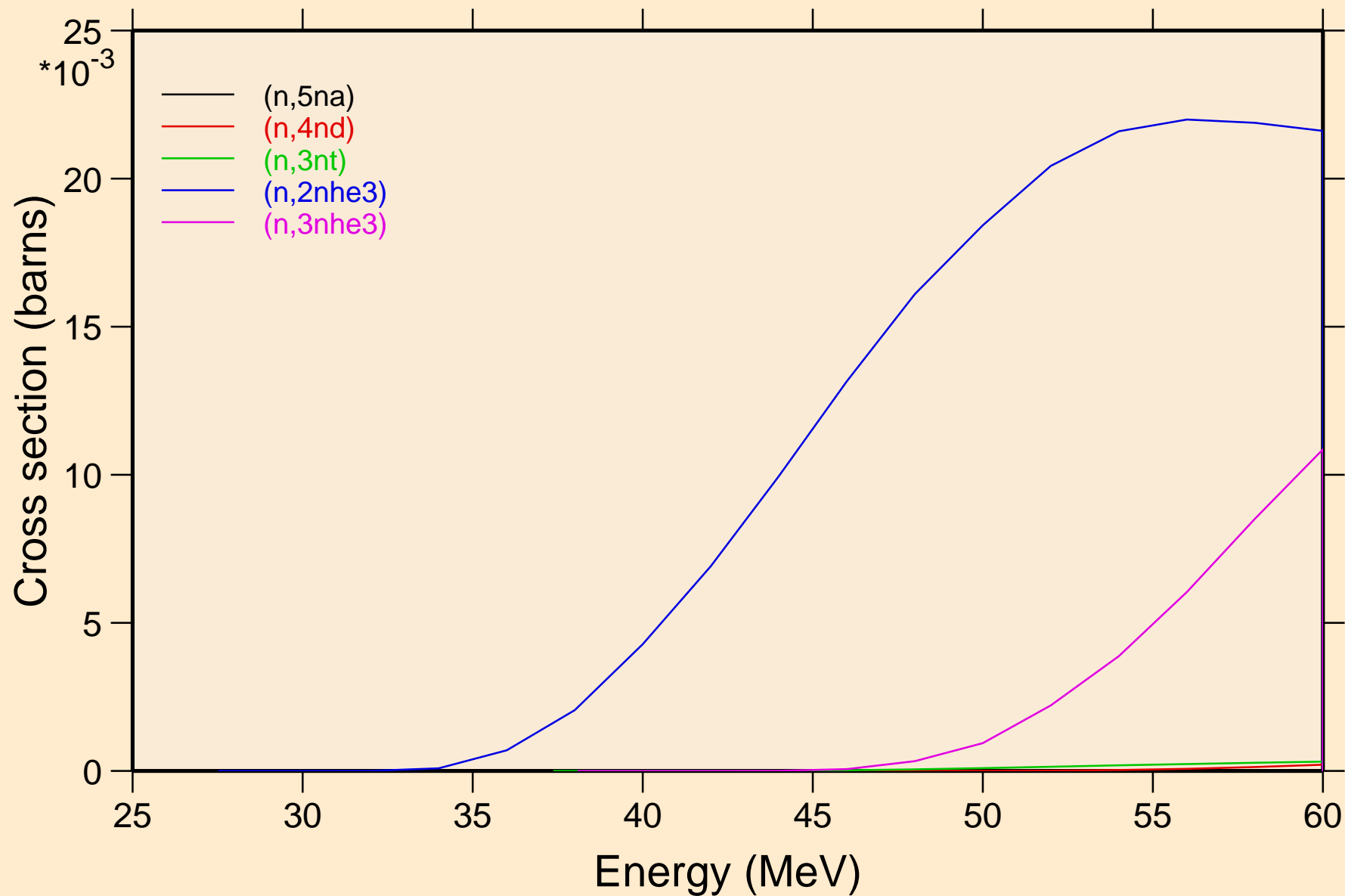

19-K-41 FOR FENDL-3.2 FROM TENDL-2015 BY NJOY2016.60+ O

Threshold reactions

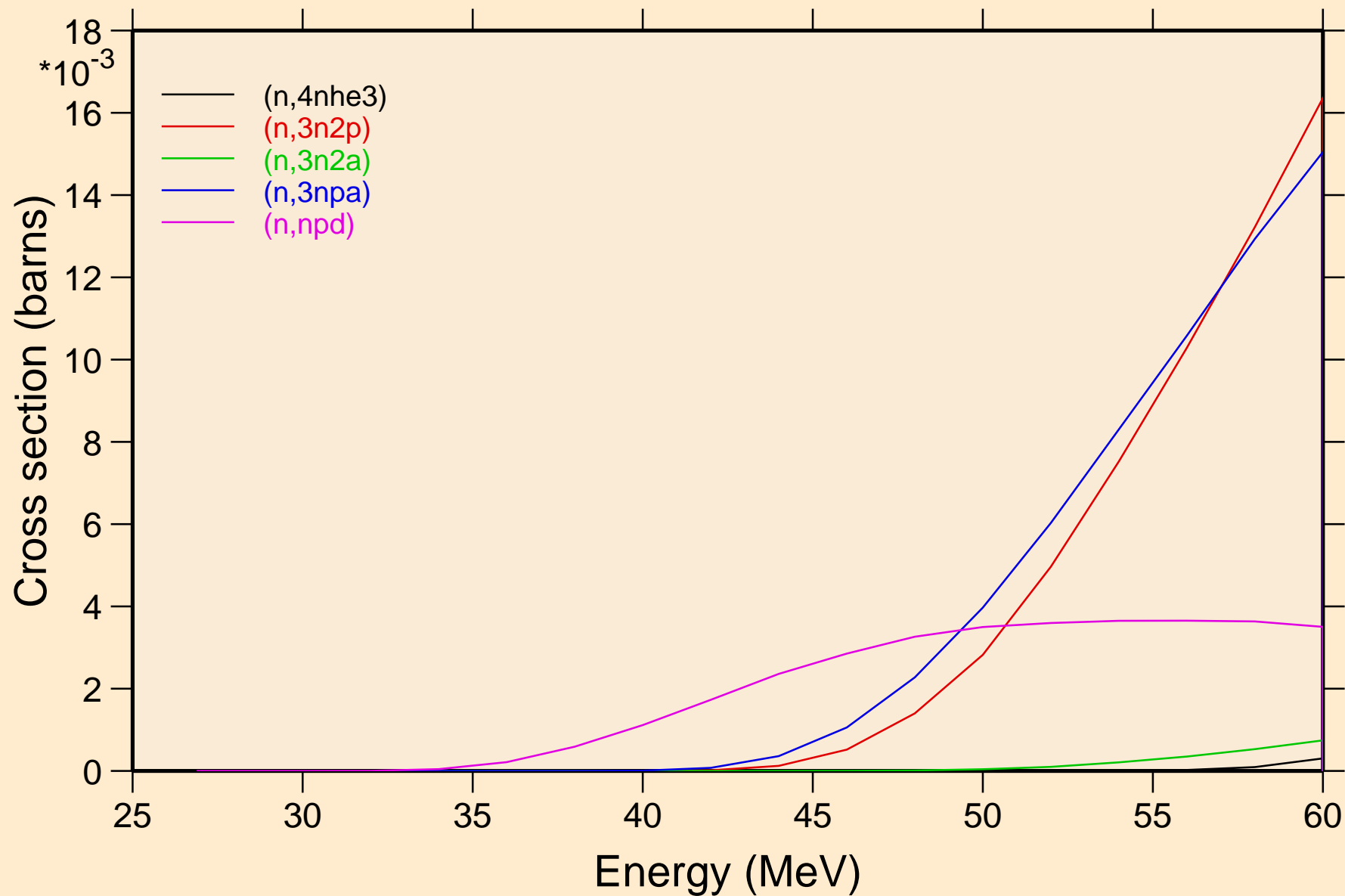

19-K-41 FOR FENDL-3.2 FROM TENDL-2015 BY NJOY2016.60+ O

Threshold reactions

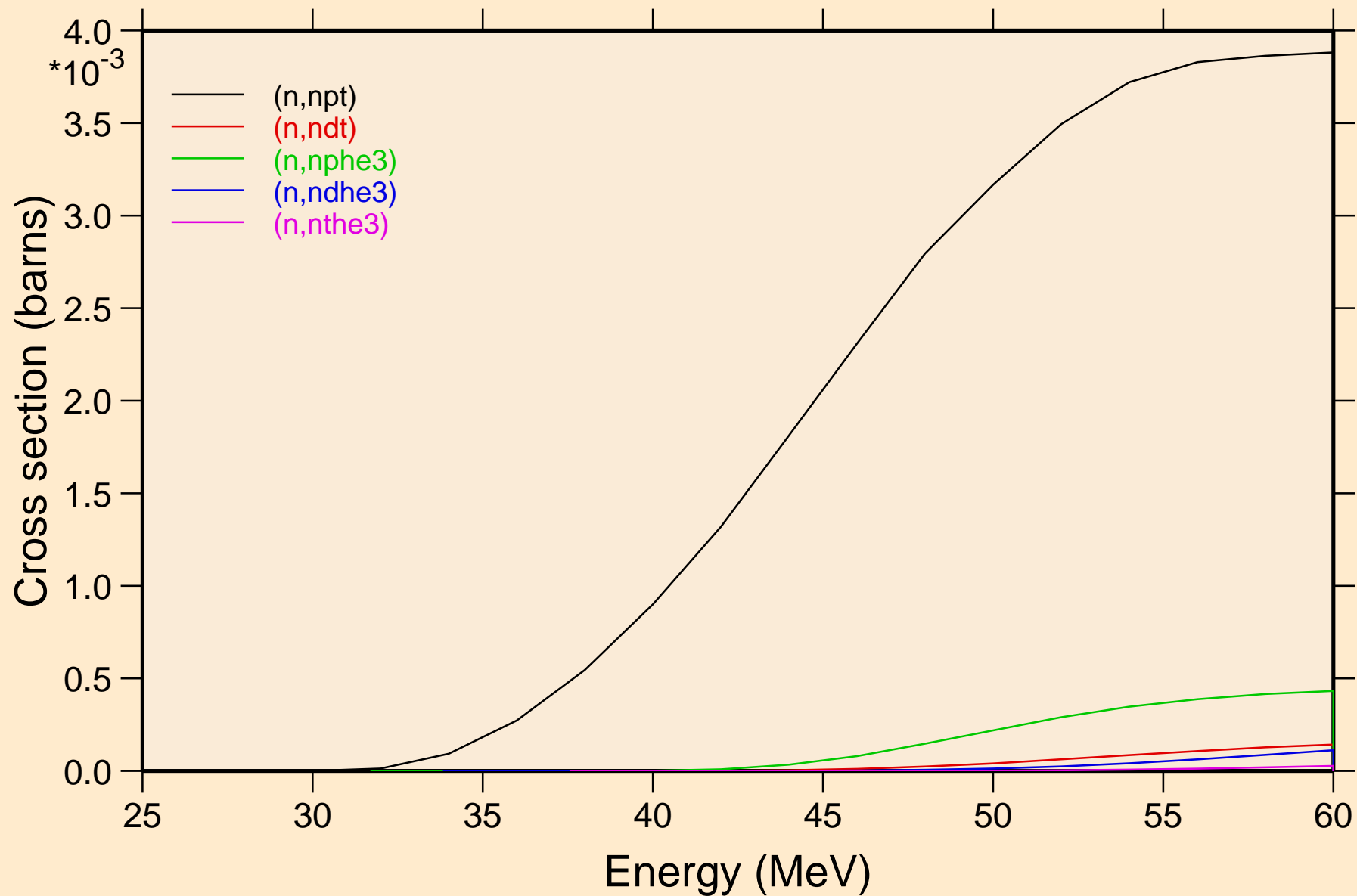

19-K-41 FOR FENDL-3.2 FROM TENDL-2015 BY NJOY2016.60+ O
Threshold reactions

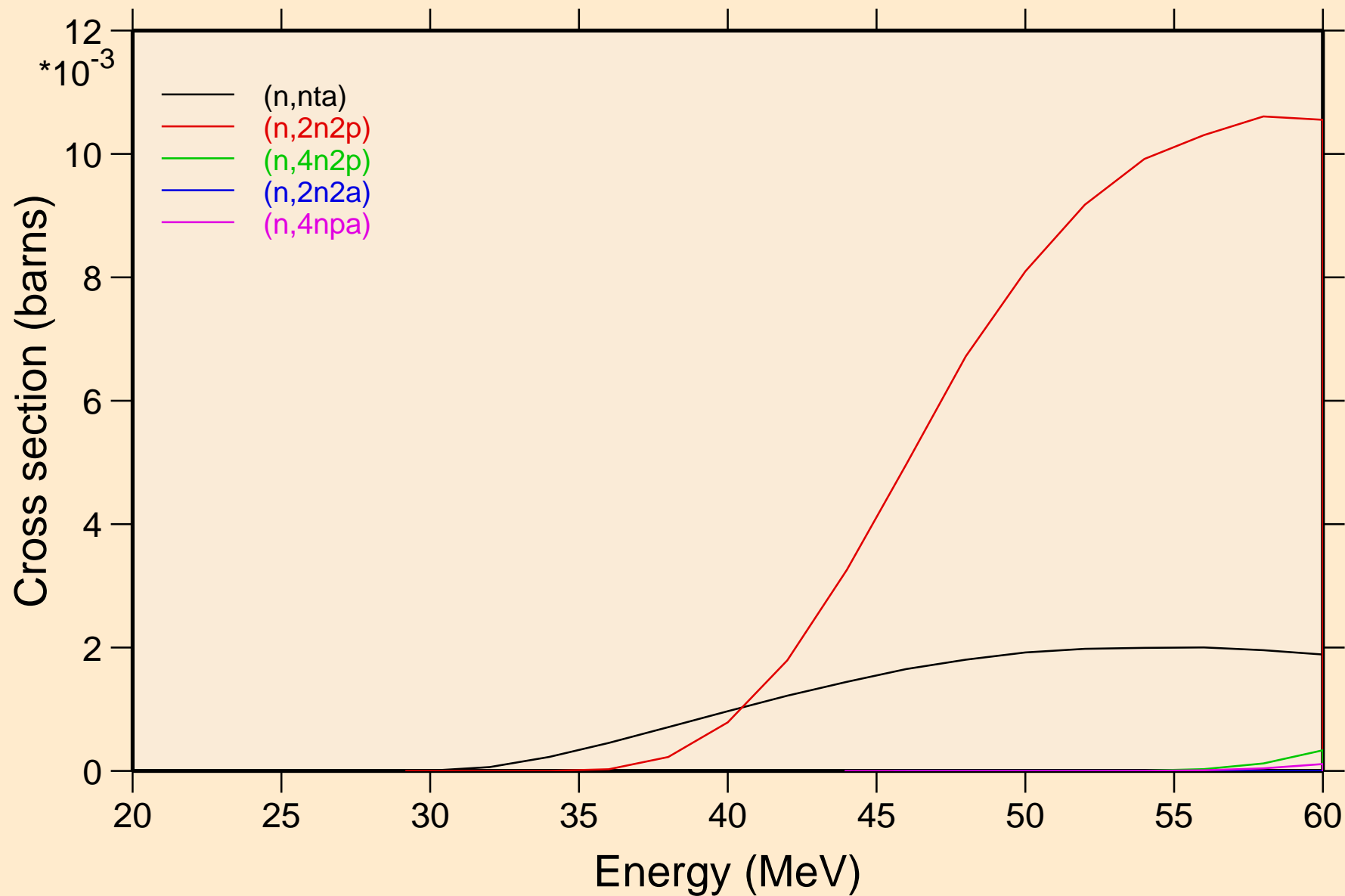

19-K-41 FOR FENDL-3.2 FROM TENDL-2015 BY NJOY2016.60+ O
Threshold reactions

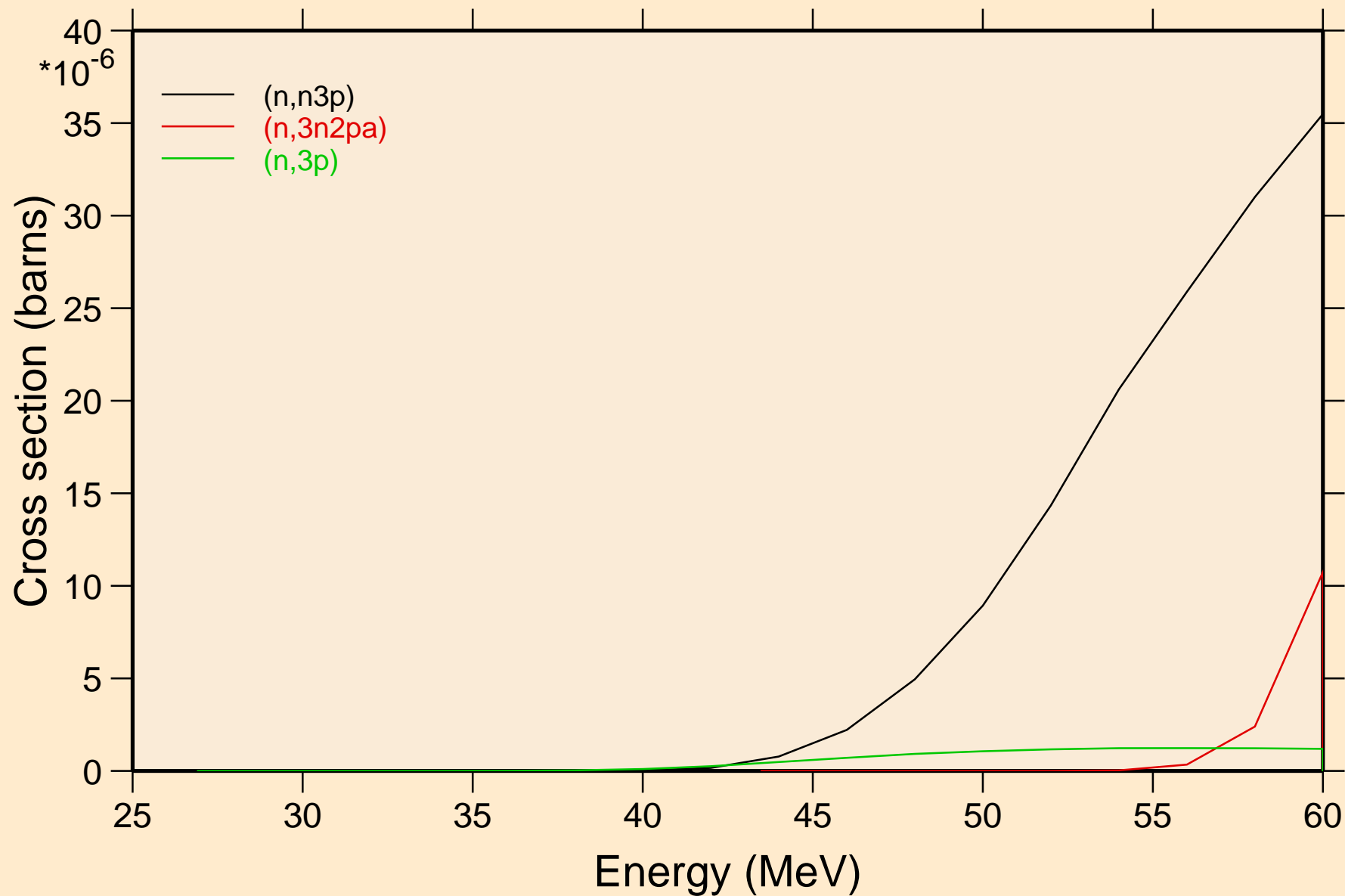

19-K-41 FOR FENDL-3.2 FROM TENDL-2015 BY NJOY2016.60+ O
Threshold reactions

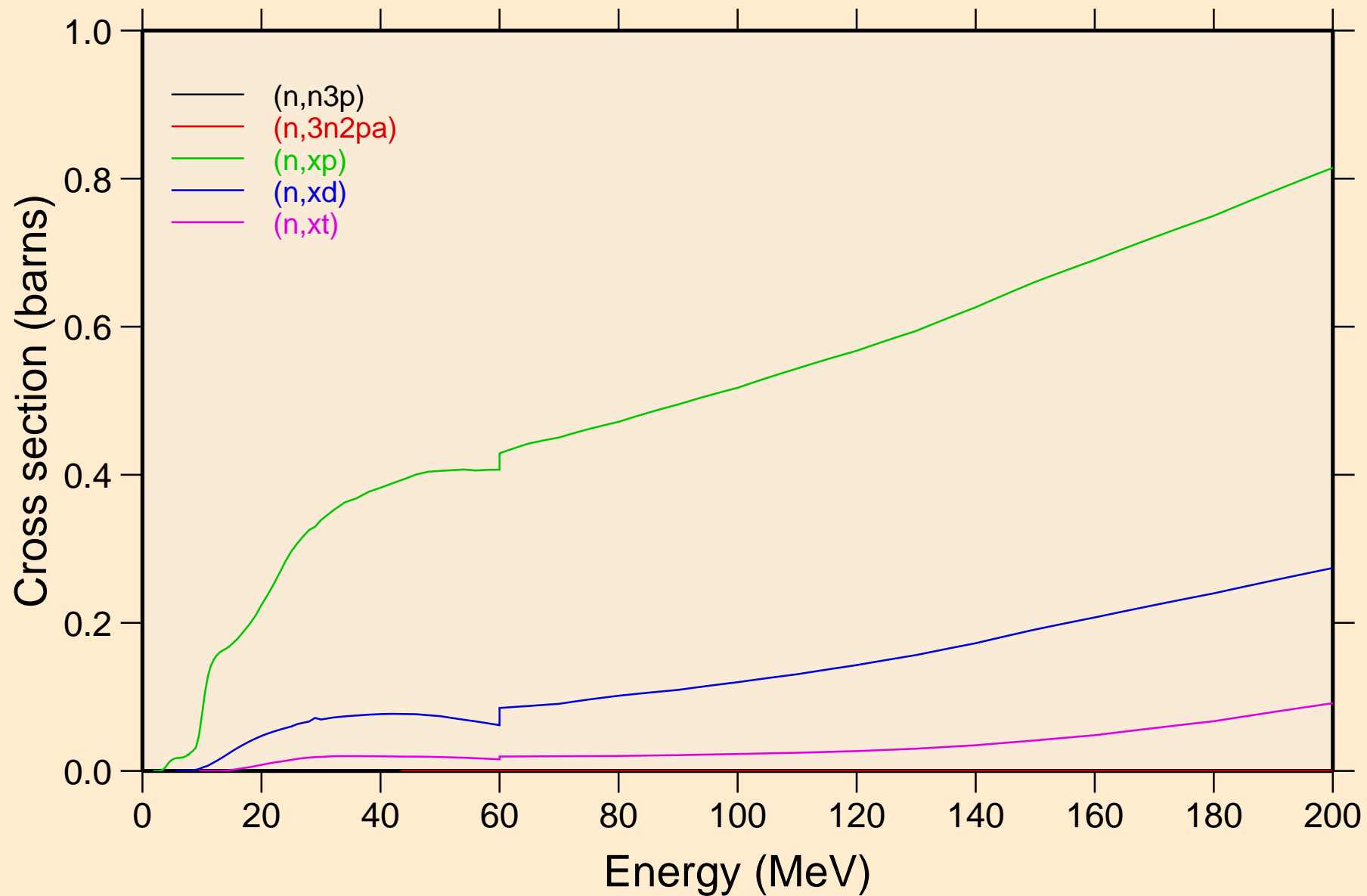

19-K-41 FOR FENDL-3.2 FROM TENDL-2015 BY NJOY2016.60+ O
Threshold reactions

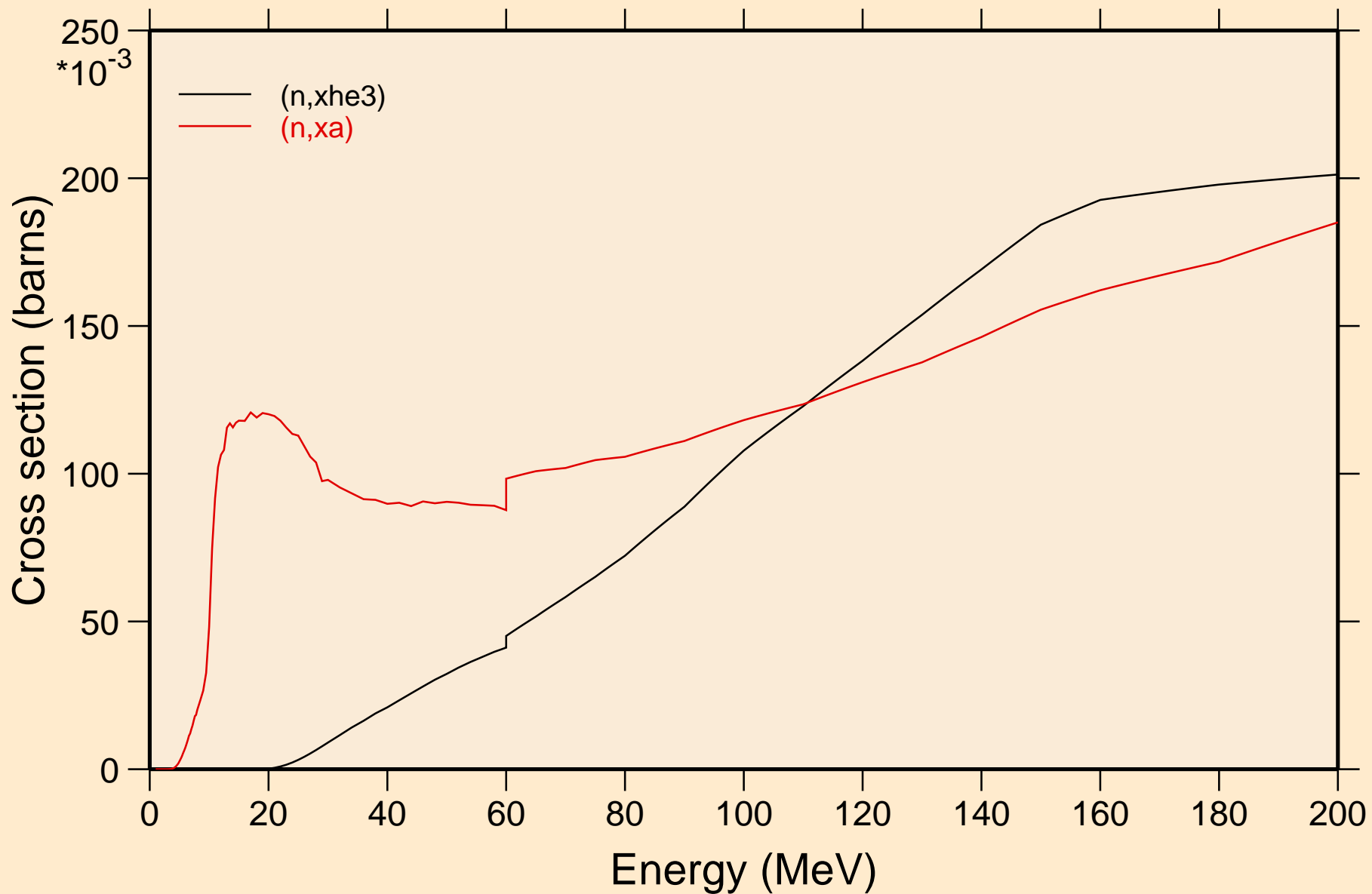

19-K-41 FOR FENDL-3.2 FROM TENDL-2015 BY NJOY2016.60+ O
angular distribution for elastic

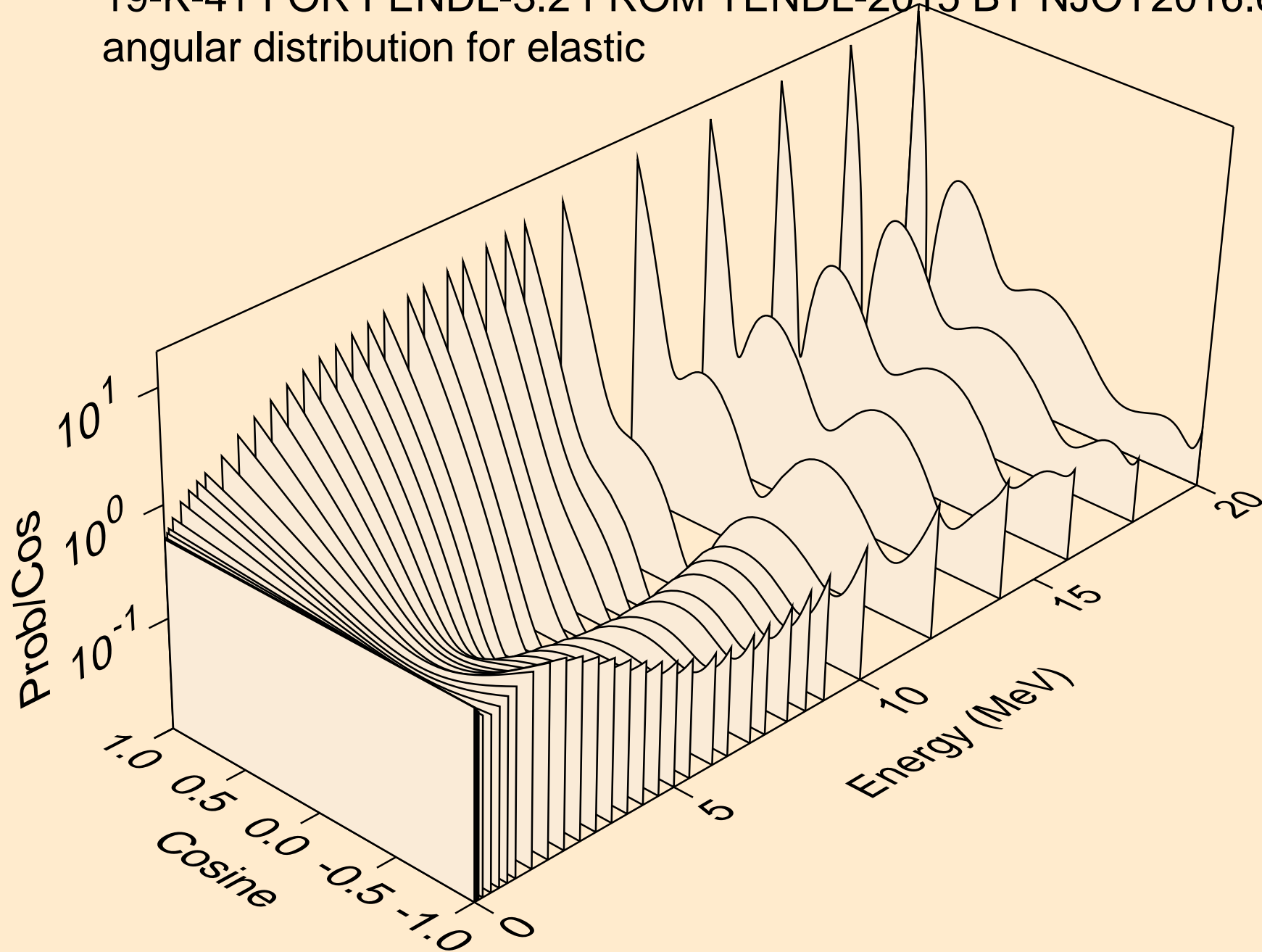

19-K-41 FOR FENDL-3.2 FROM TENDL-2015 BY NJOY2016.60+ O
angular distribution for elastic

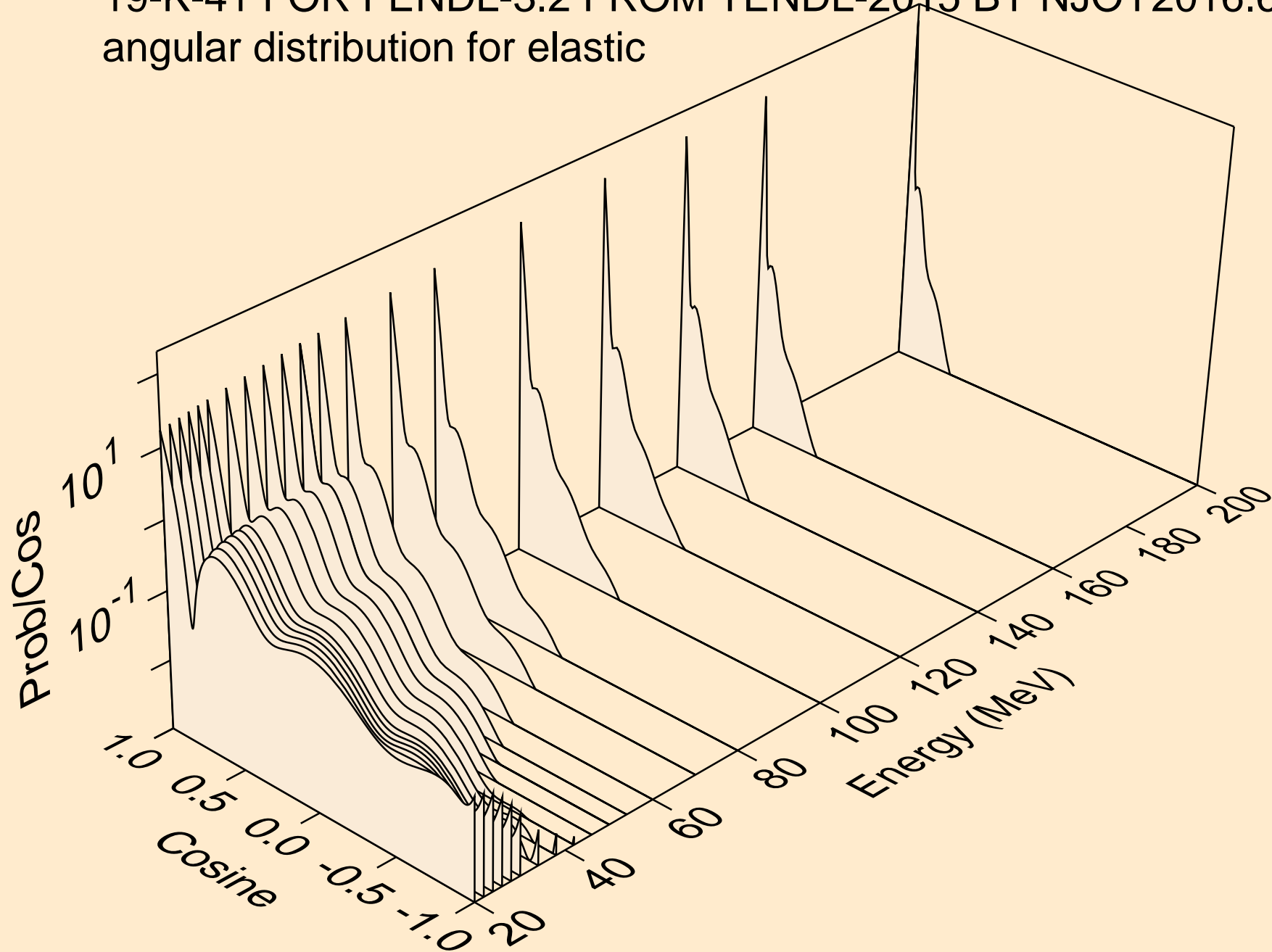

19-K-41 FOR FENDL-3.2 FROM TENDL-2015 BY NJOY2016.60+ O
angular distribution for (n,n*1)

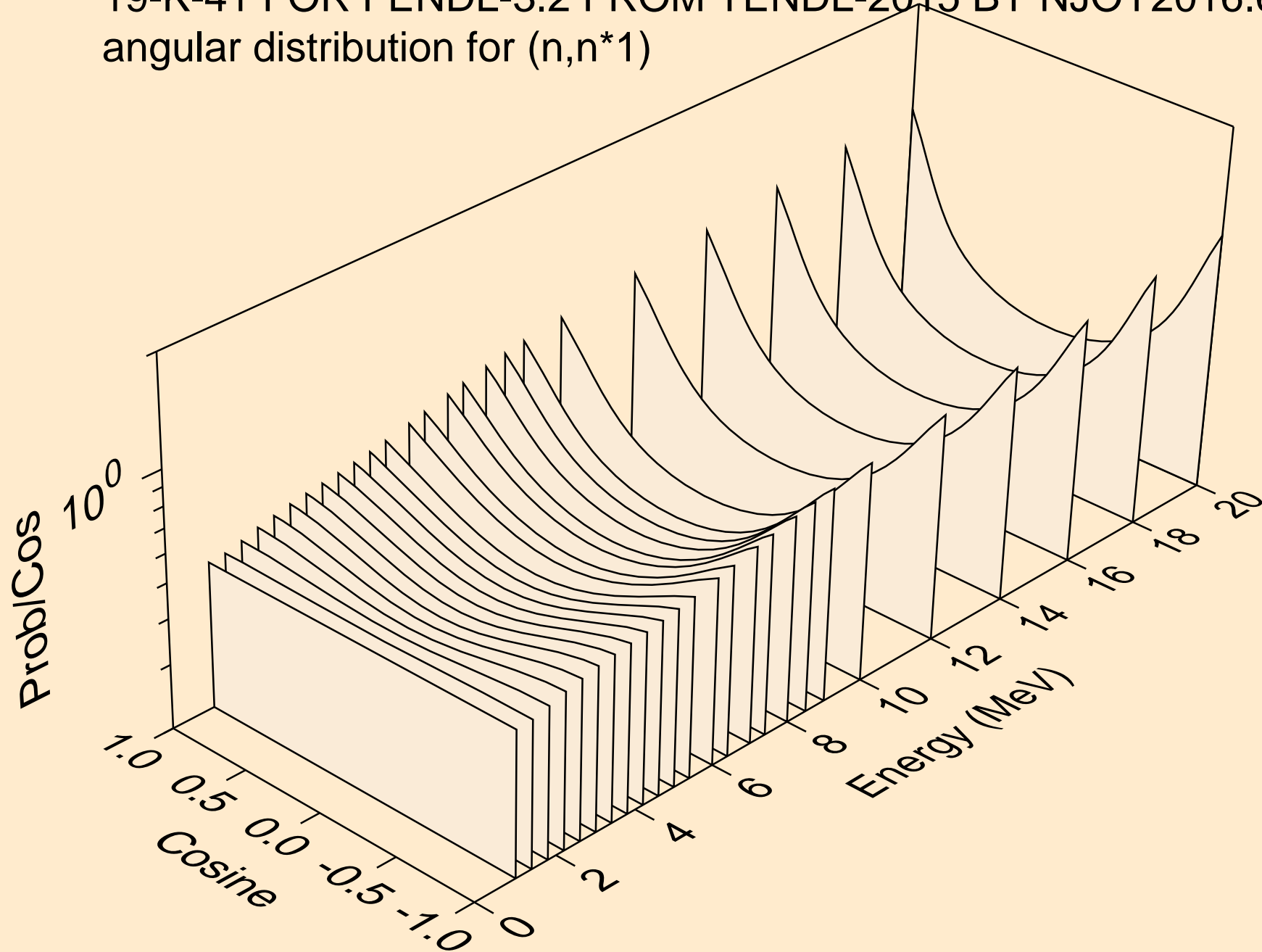

19-K-41 FOR FENDL-3.2 FROM TENDL-2015 BY NJOY2016.60+ O
angular distribution for (n,n*1)

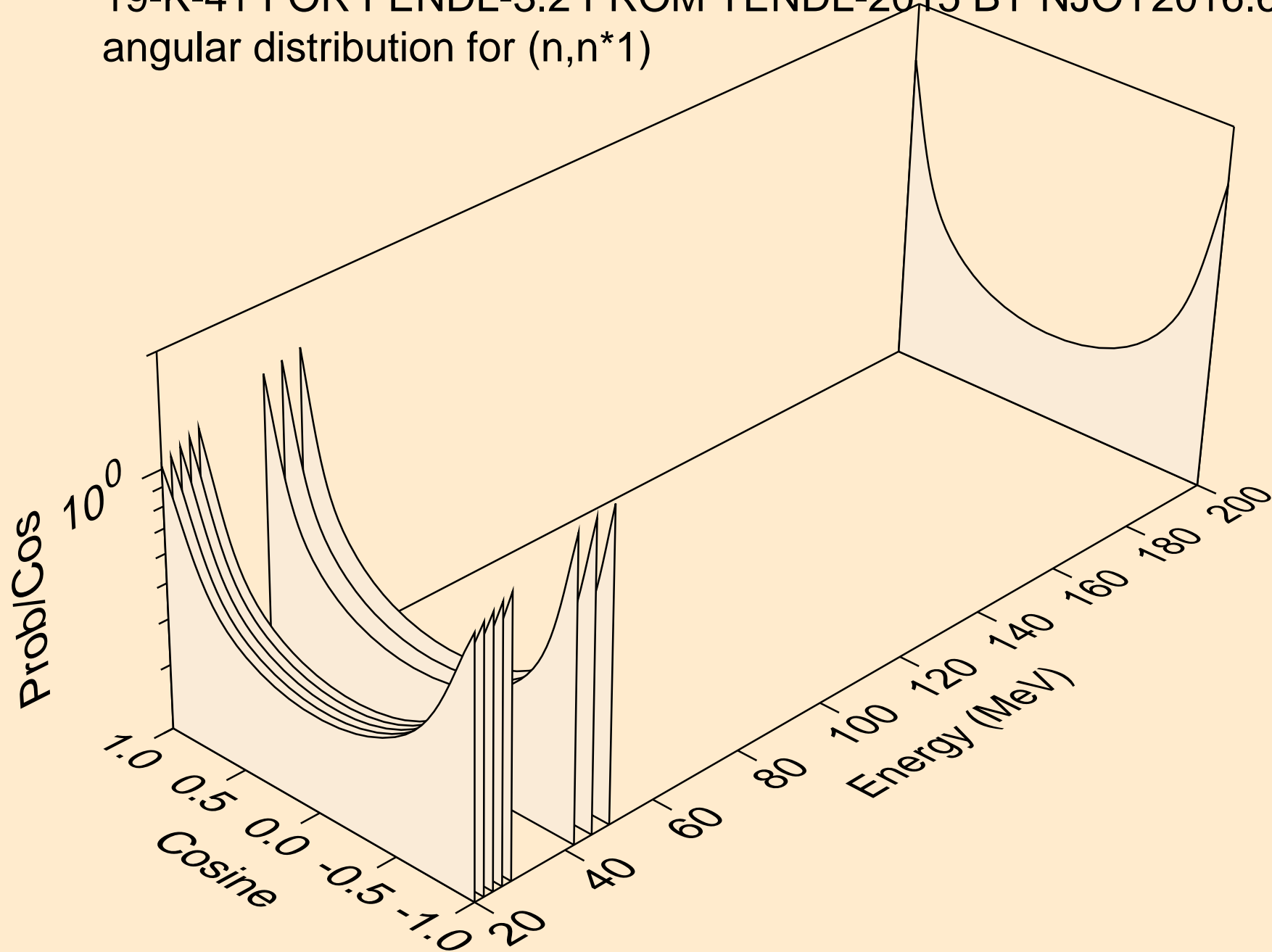

19-K-41 FOR FENDL-3.2 FROM TENDL-2015 BY NJOY2016.60+ O
angular distribution for (n,n*2)

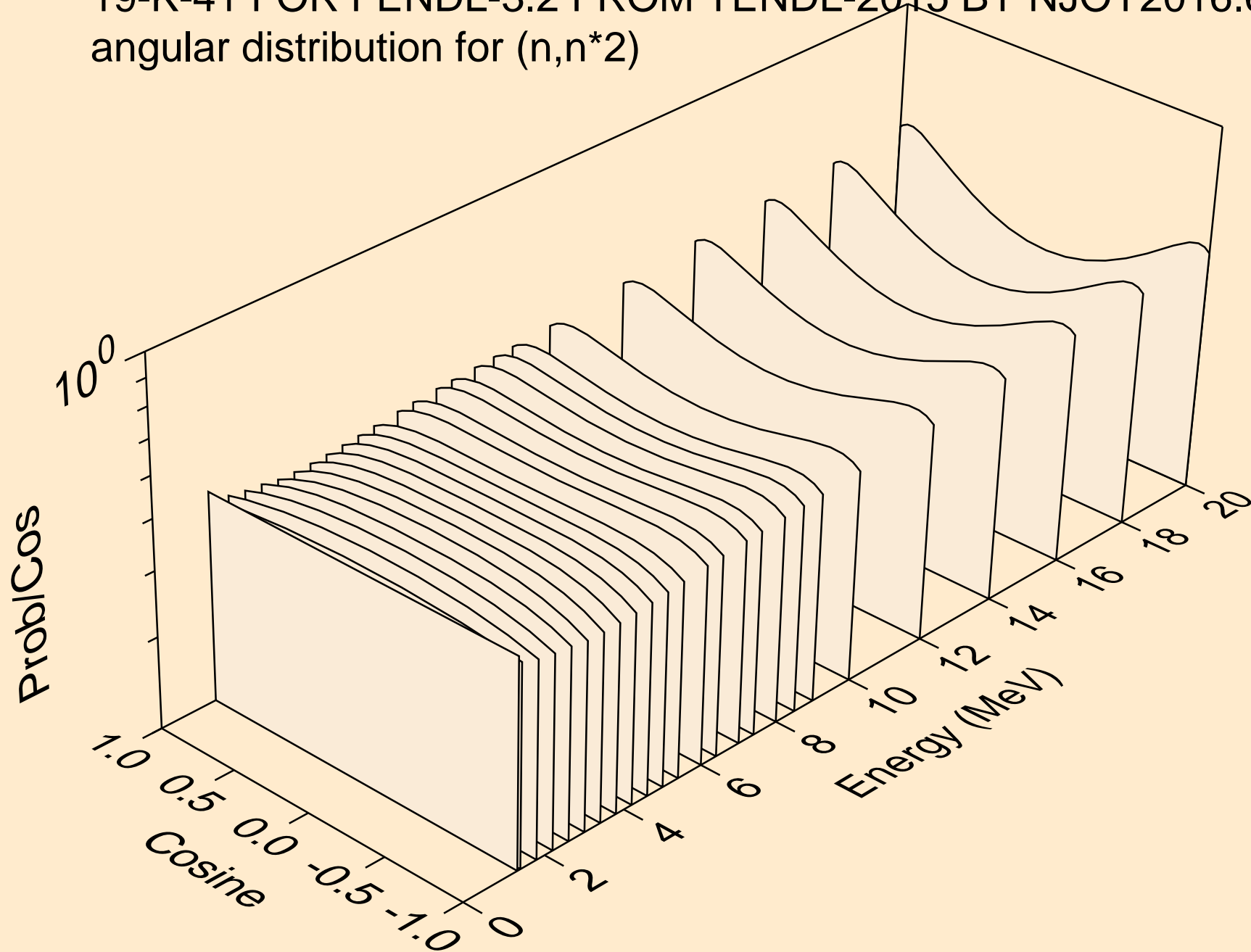

19-K-41 FOR FENDL-3.2 FROM TENDL-2015 BY NJOY2016.60+ O
angular distribution for (n,n*2)

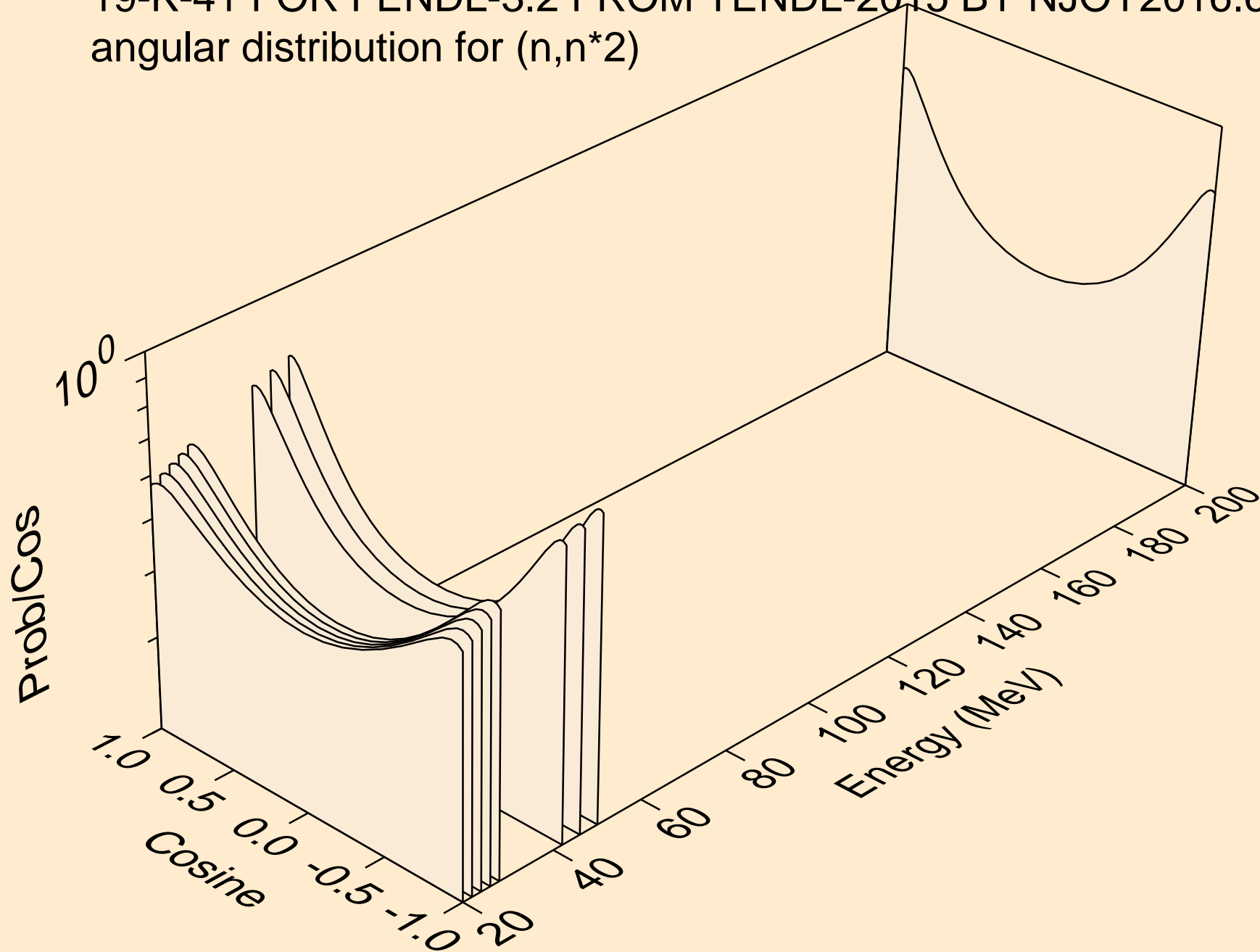

19-K-41 FOR FENDL-3.2 FROM TENDL-2015 BY NJOY2016.60+ O
angular distribution for (n,n*3)

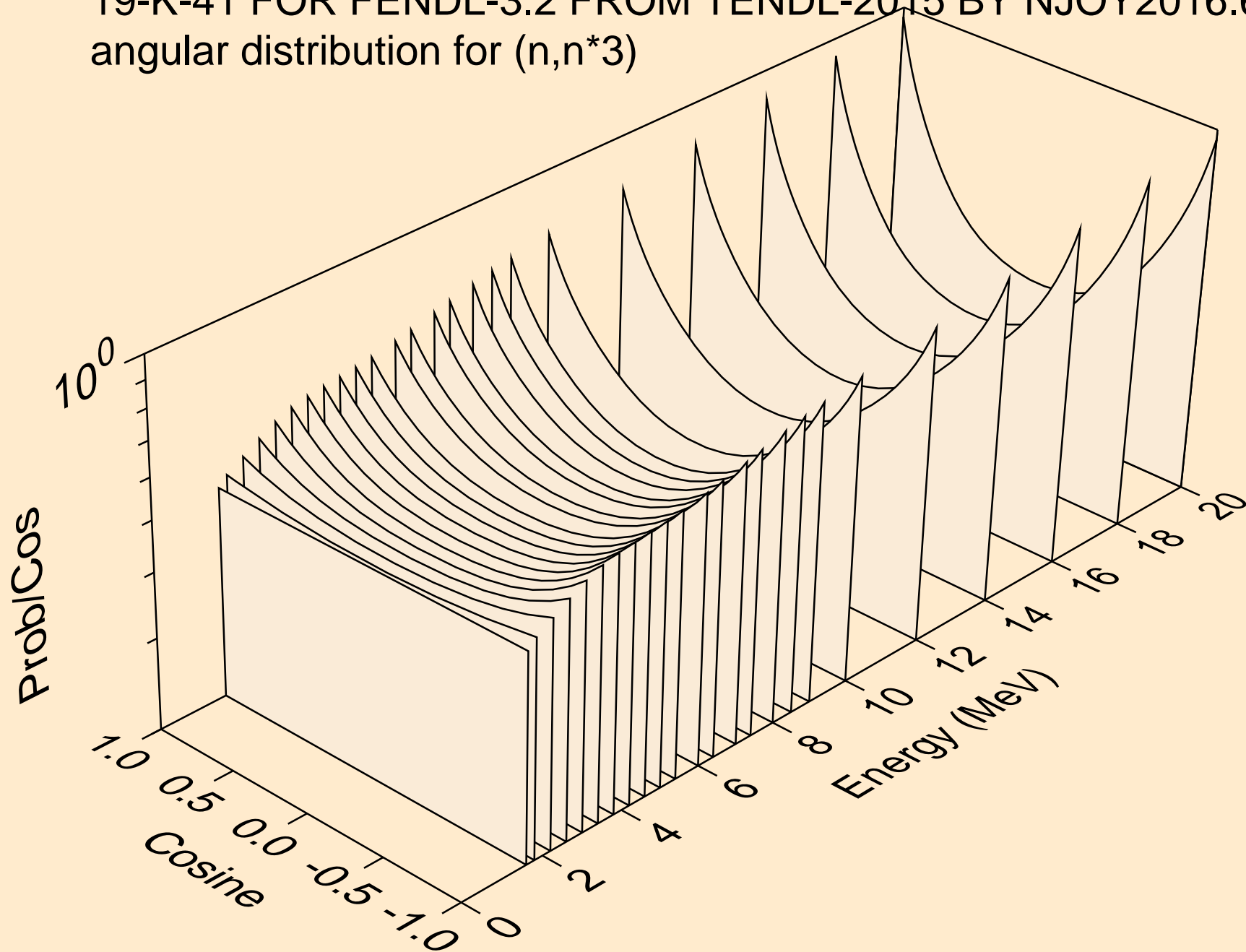

19-K-41 FOR FENDL-3.2 FROM TENDL-2015 BY NJOY2016.60+ O
angular distribution for (n,n*3)

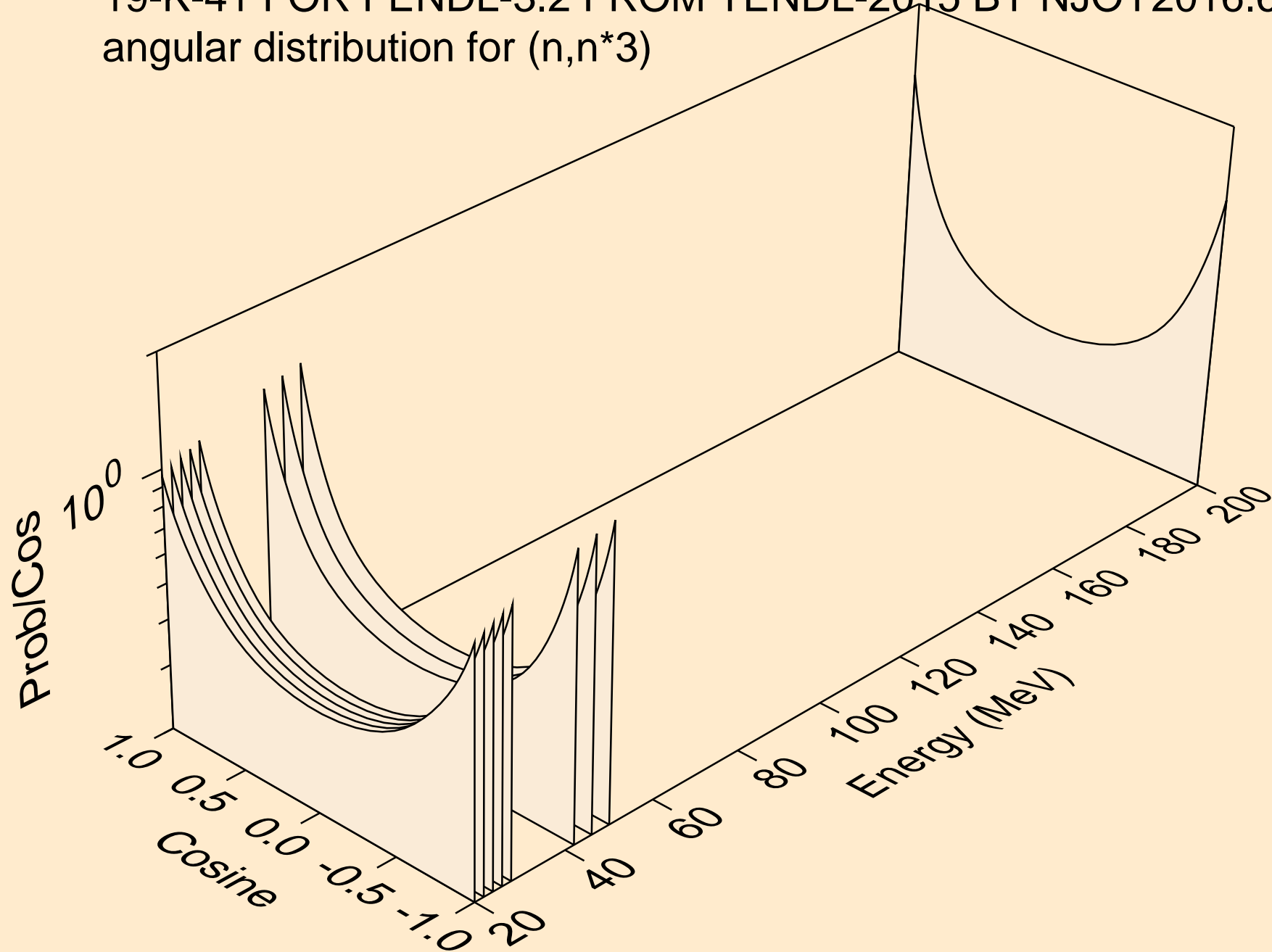

19-K-41 FOR FENDL-3.2 FROM TENDL-2015 BY NJOY2016.60+ O
angular distribution for (n,n*4)

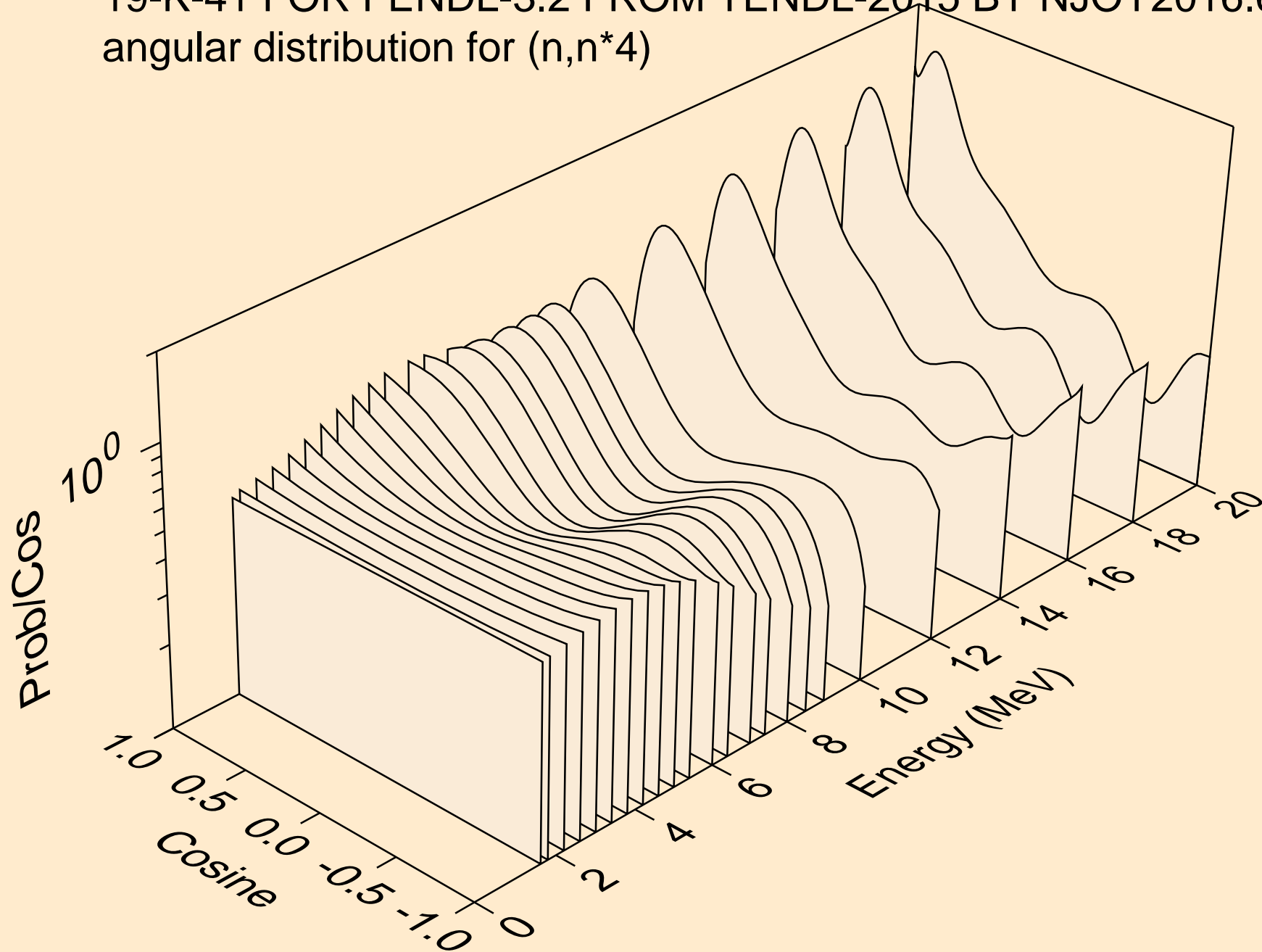

19-K-41 FOR FENDL-3.2 FROM TENDL-2015 BY NJOY2016.60+ O
angular distribution for (n,n*4)

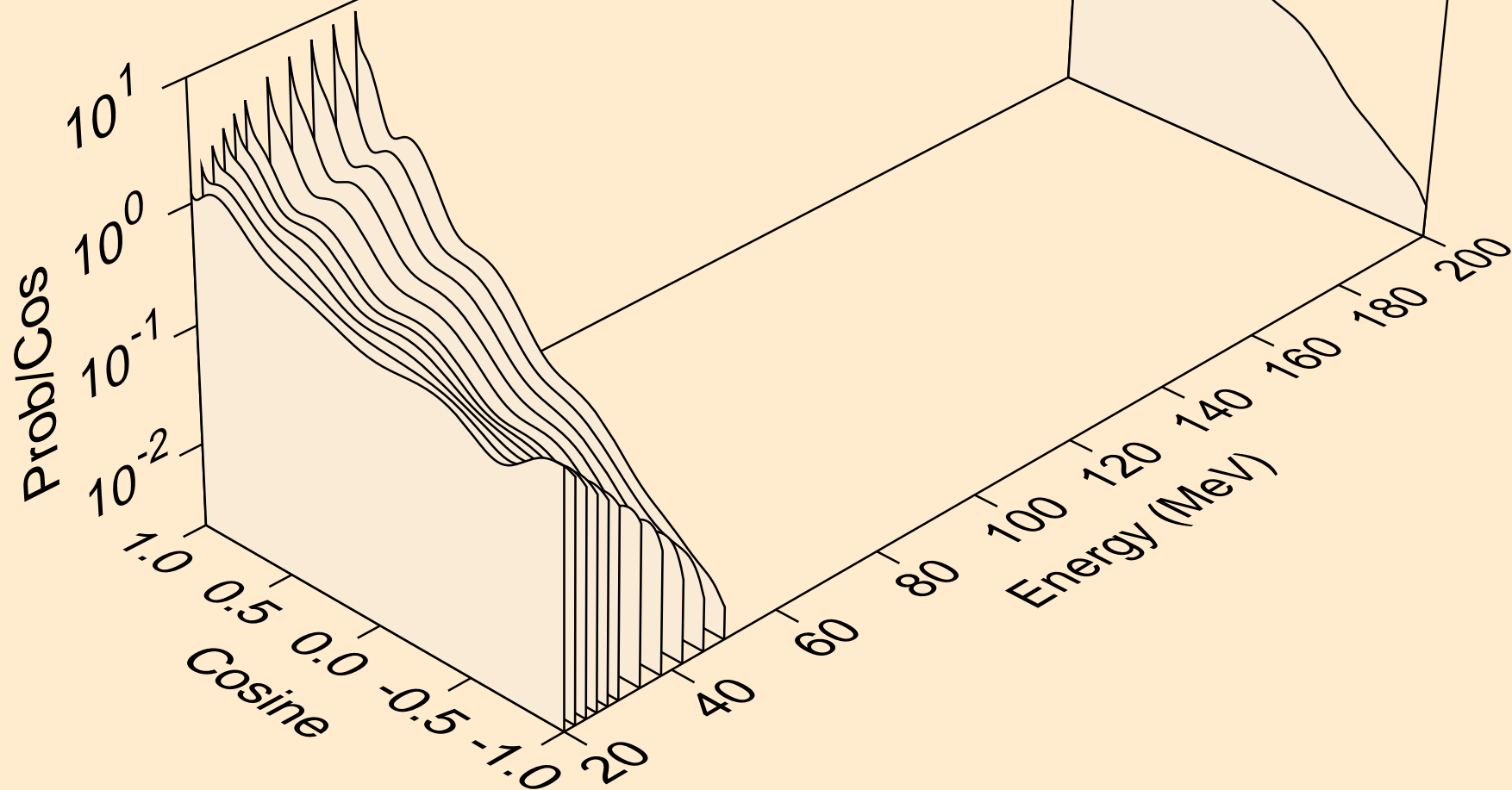

19-K-41 FOR FENDL-3.2 FROM TENDL-2015 BY NJOY2016.60+ O
angular distribution for (n,n*5)

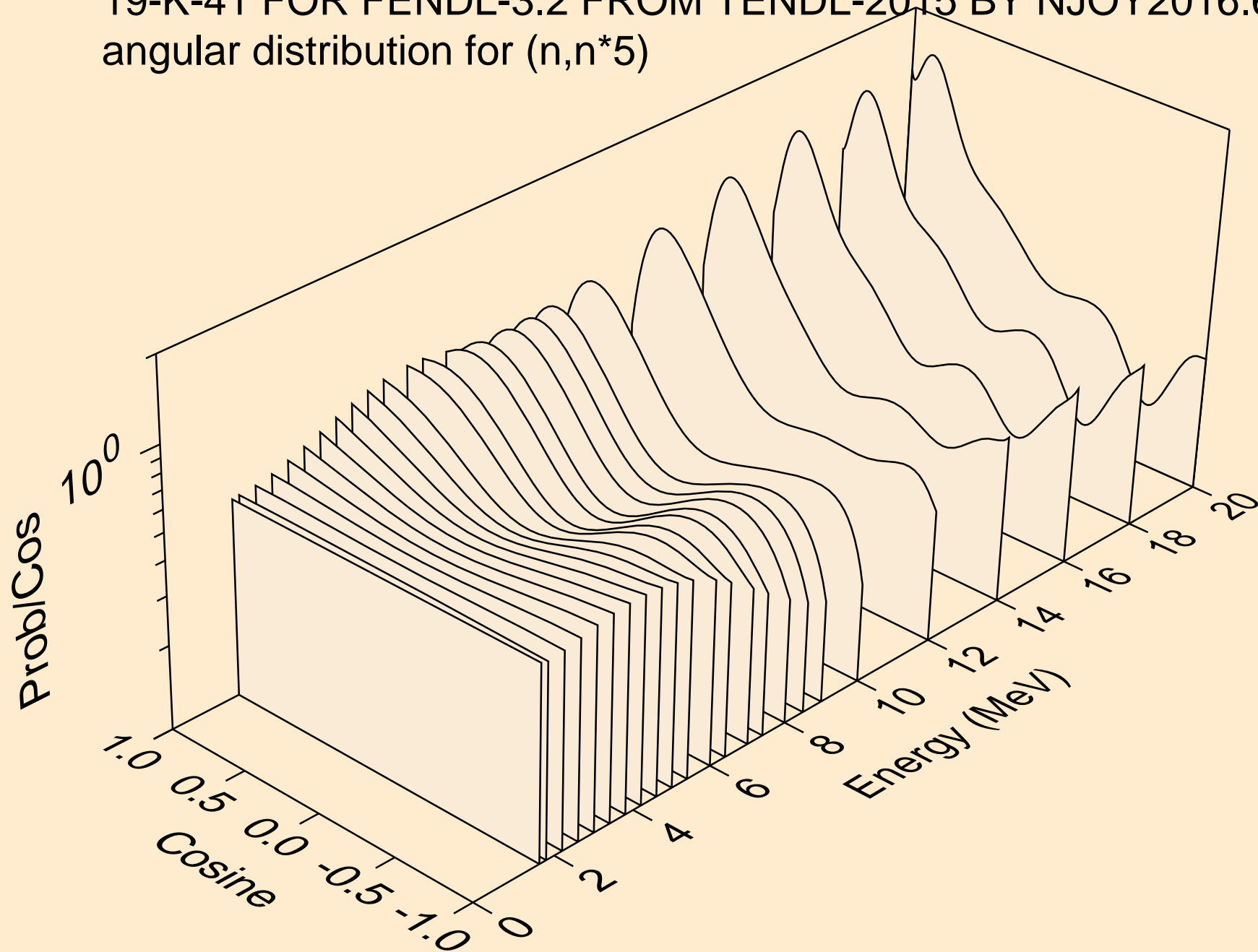

19-K-41 FOR FENDL-3.2 FROM TENDL-2015 BY NJOY2016.60+ O
angular distribution for (n,n*5)

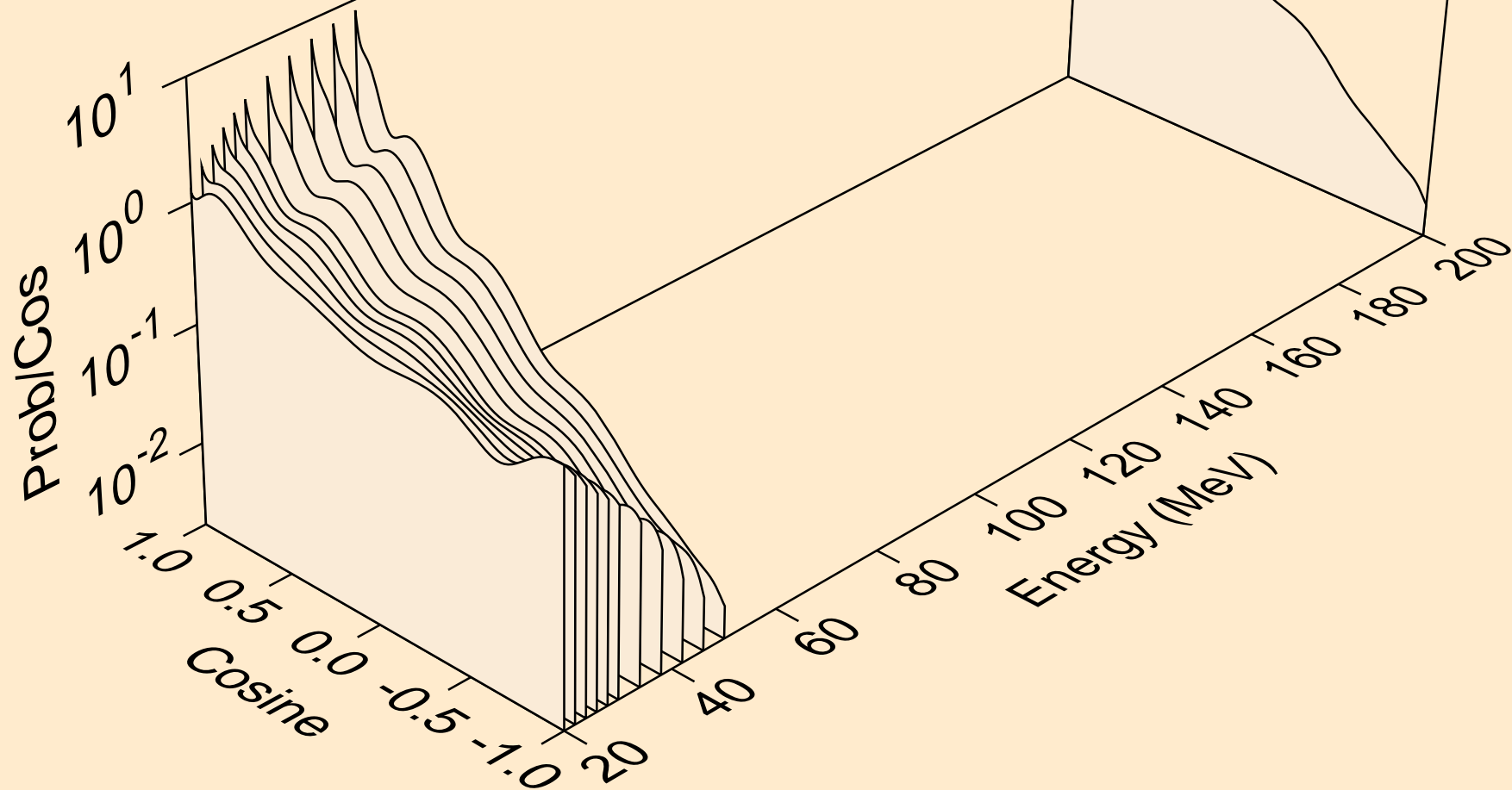

19-K-41 FOR FENDL-3.2 FROM TENDL-2015 BY NJOY2016.60+ O
angular distribution for (n,n*6)

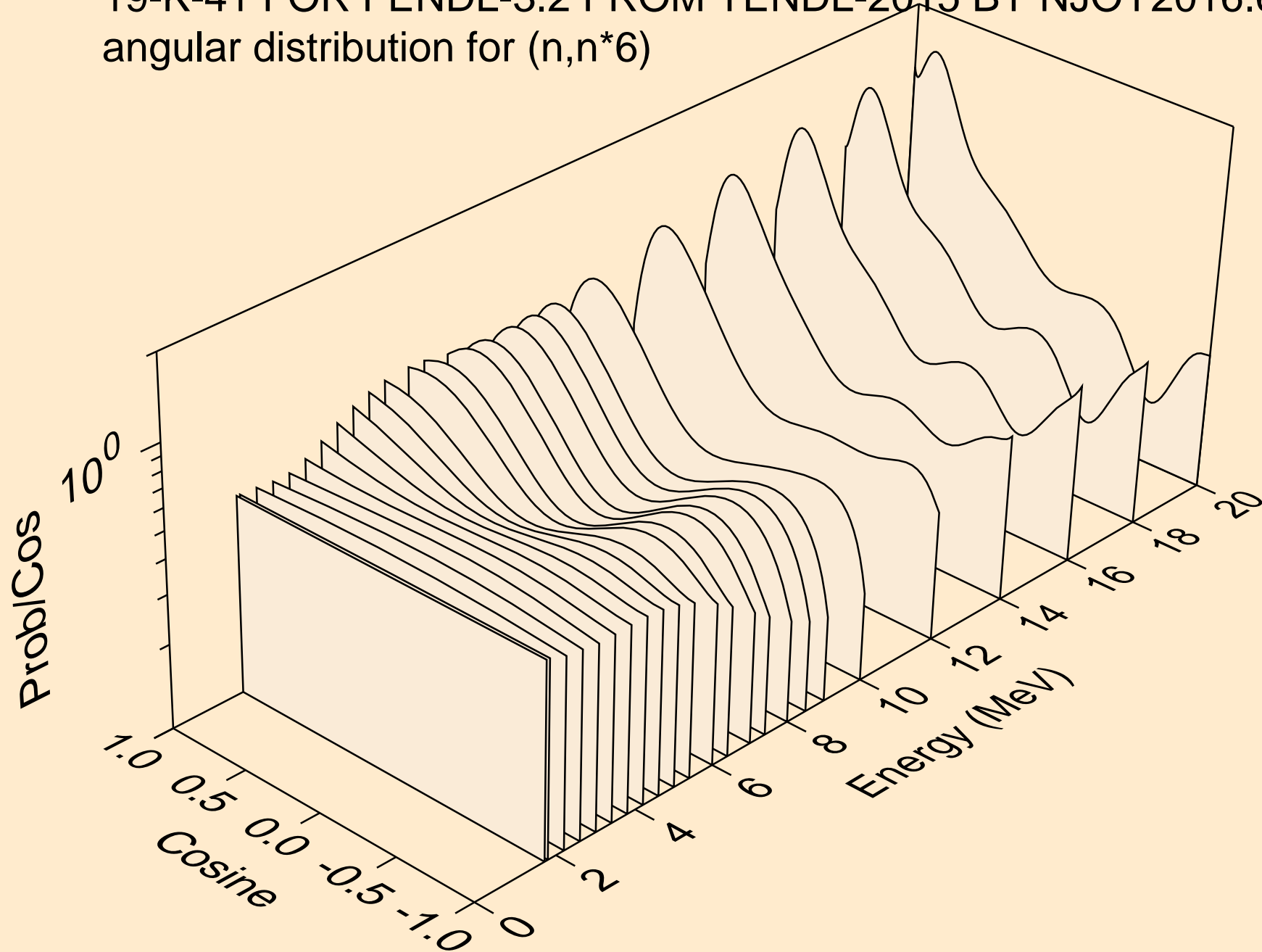

19-K-41 FOR FENDL-3.2 FROM TENDL-2015 BY NJOY2016.60+ O
angular distribution for (n,n*6)

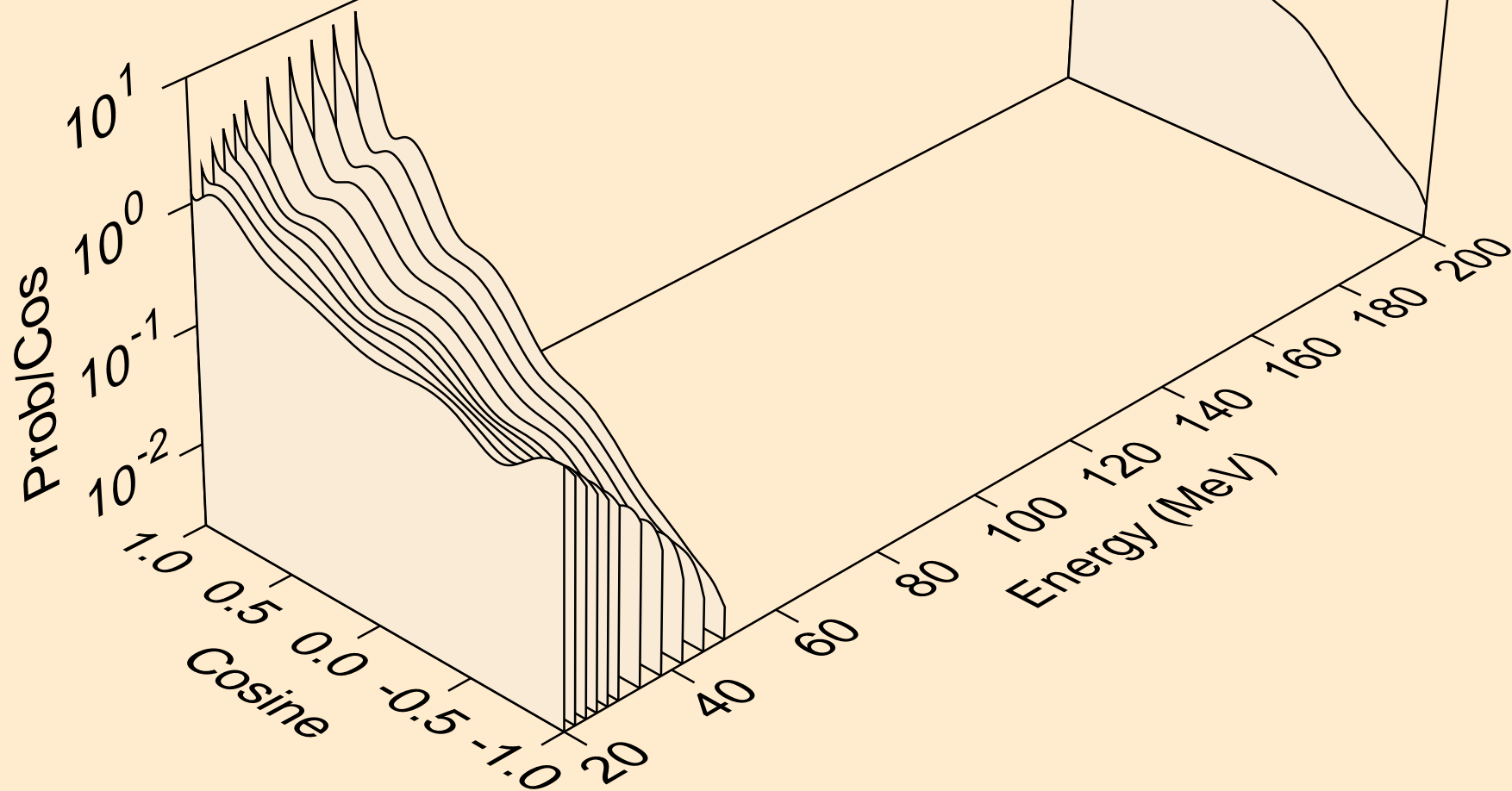

19-K-41 FOR FENDL-3.2 FROM TENDL-2015 BY NJOY2016.60+ O
angular distribution for (n,n*7)

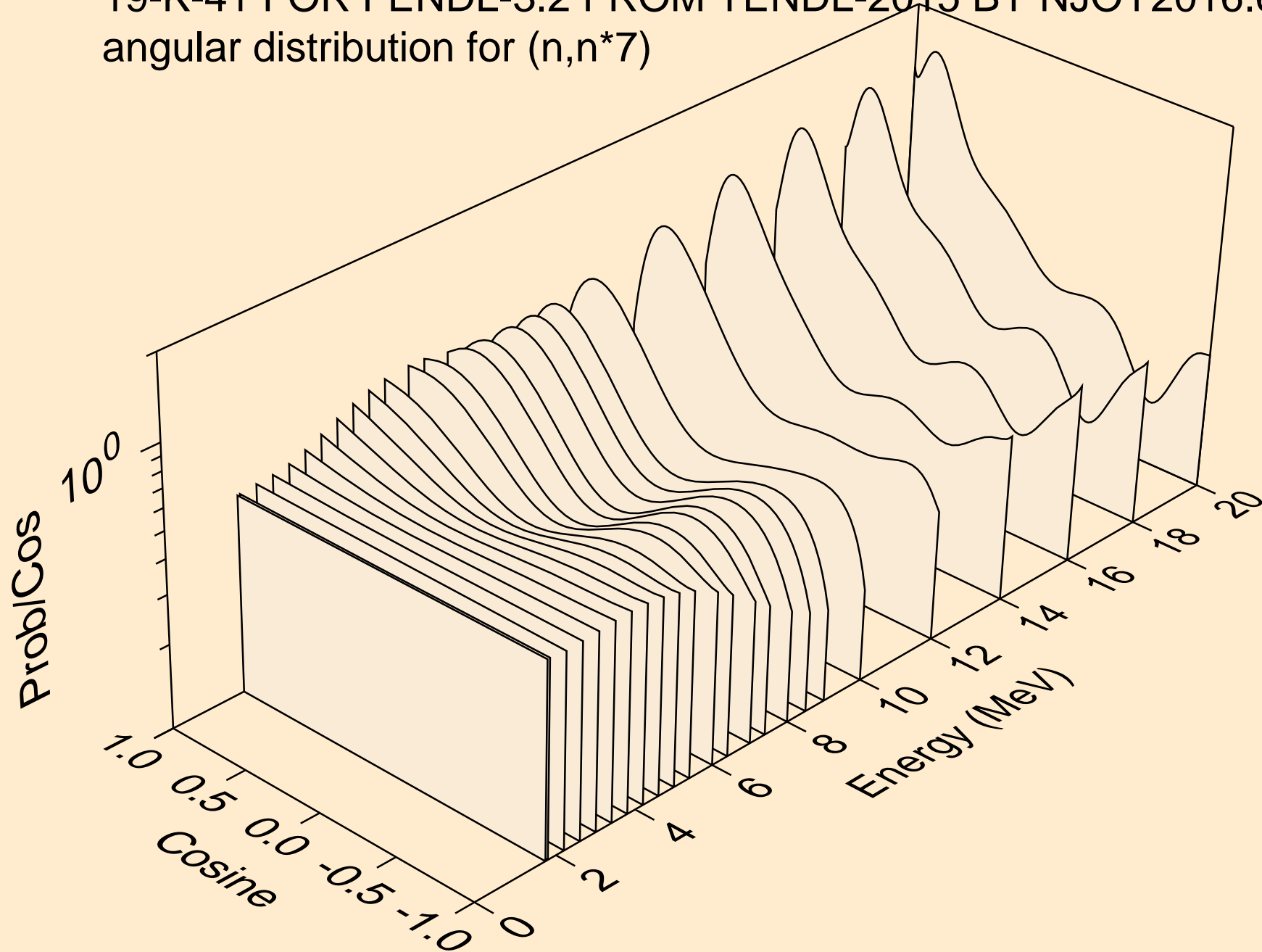

19-K-41 FOR FENDL-3.2 FROM TENDL-2015 BY NJOY2016.60+ O
angular distribution for (n,n*7)

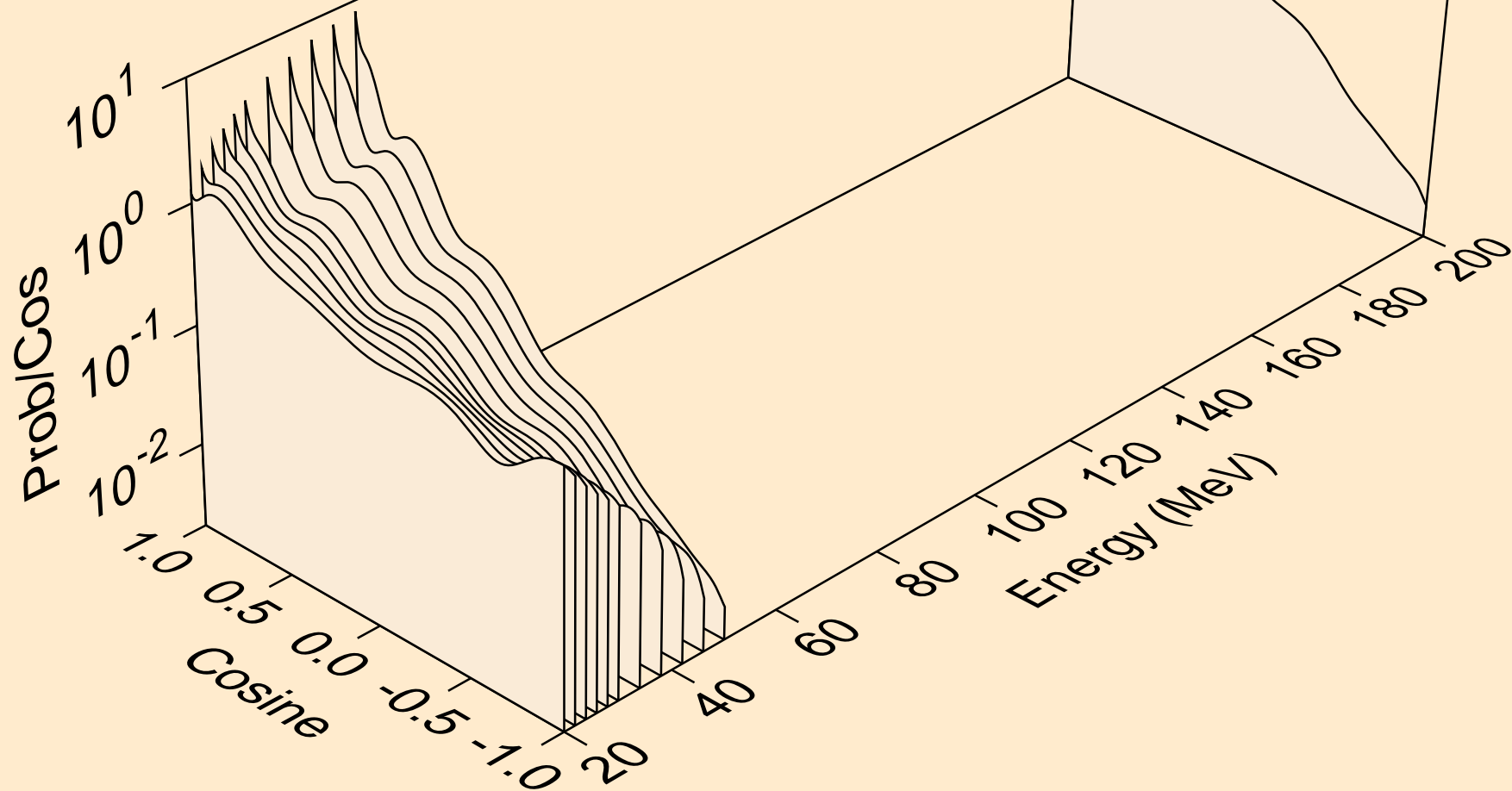

19-K-41 FOR FENDL-3.2 FROM TENDL-2015 BY NJOY2016.60+ O
angular distribution for (n,n*8)

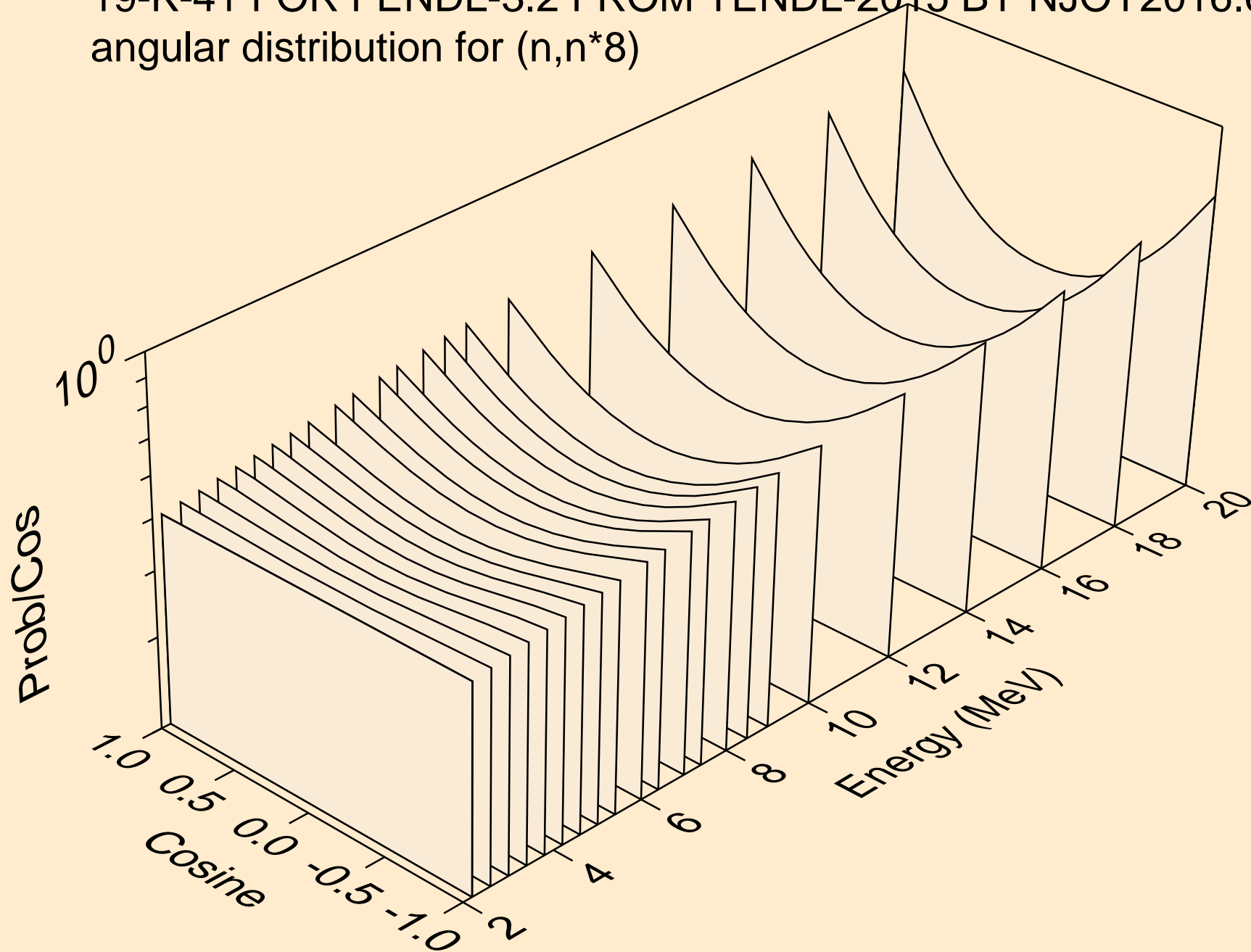

19-K-41 FOR FENDL-3.2 FROM TENDL-2015 BY NJOY2016.60+ O
angular distribution for (n,n*8)

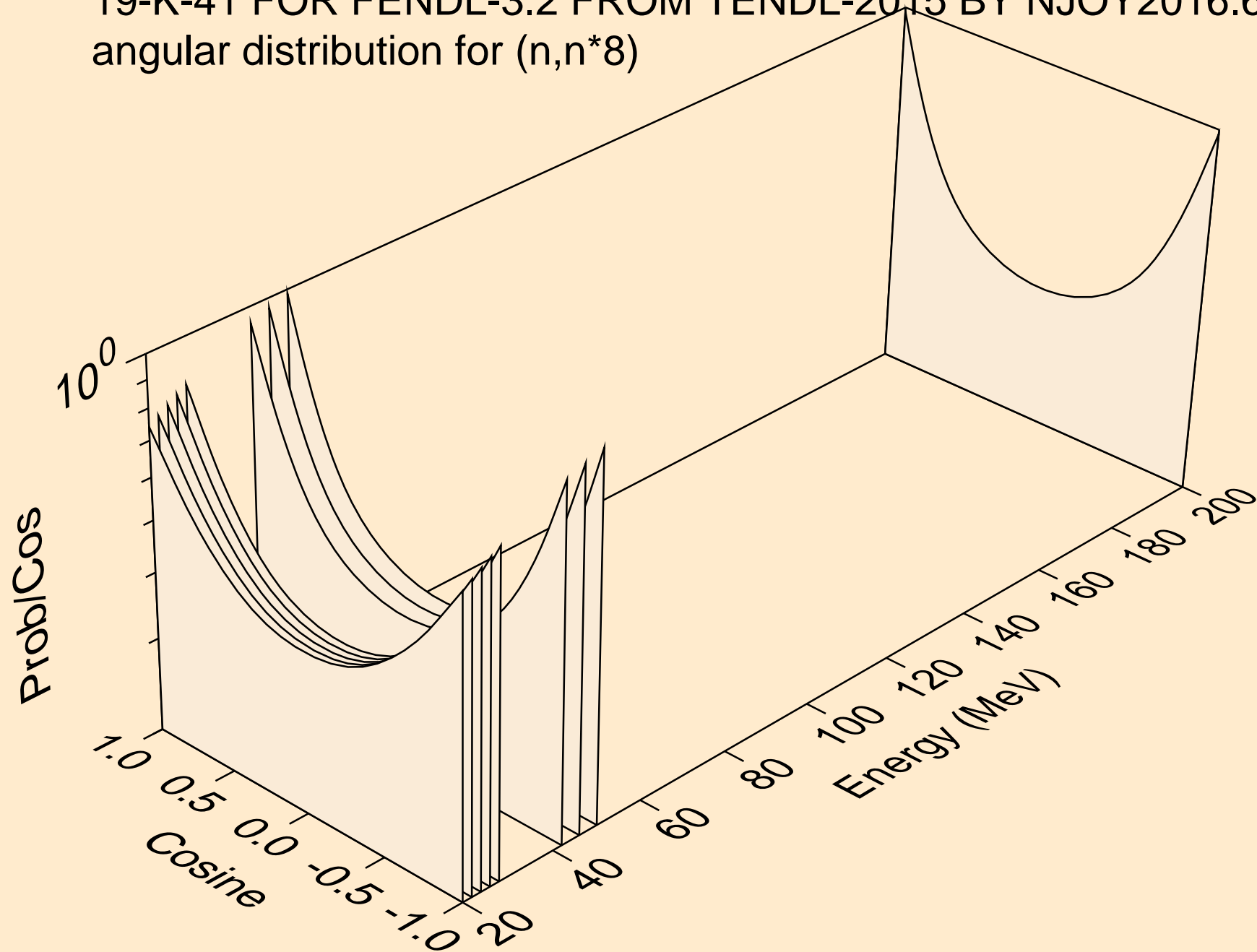

19-K-41 FOR FENDL-3.2 FROM TENDL-2015 BY NJOY2016.60+ O
angular distribution for (n,n*9)

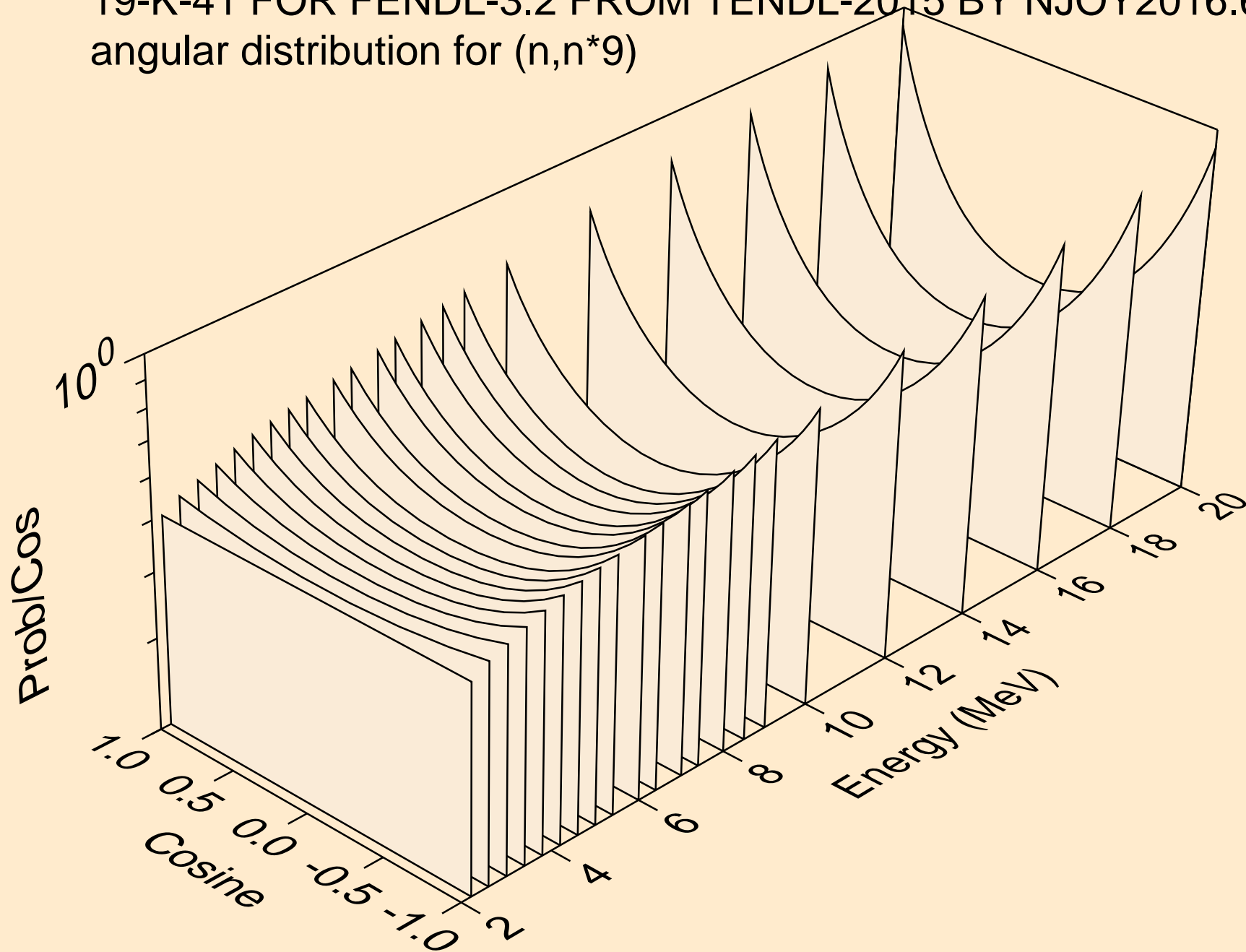

19-K-41 FOR FENDL-3.2 FROM TENDL-2015 BY NJOY2016.60+ O
angular distribution for (n,n*9)

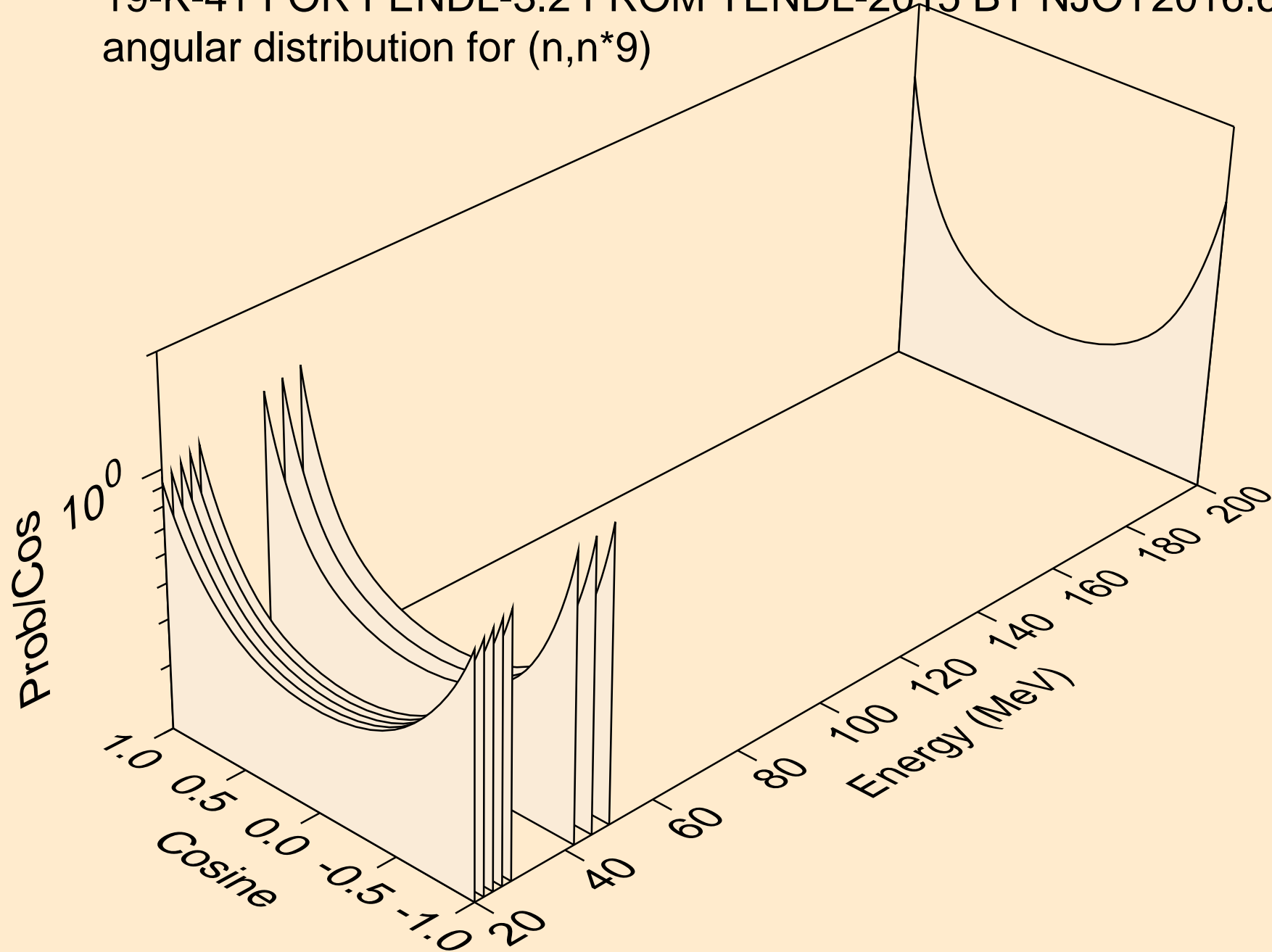

19-K-41 FOR FENDL-3.2 FROM TENDL-2015 BY NJOY2016.60+ O
angular distribution for (n,n*10)

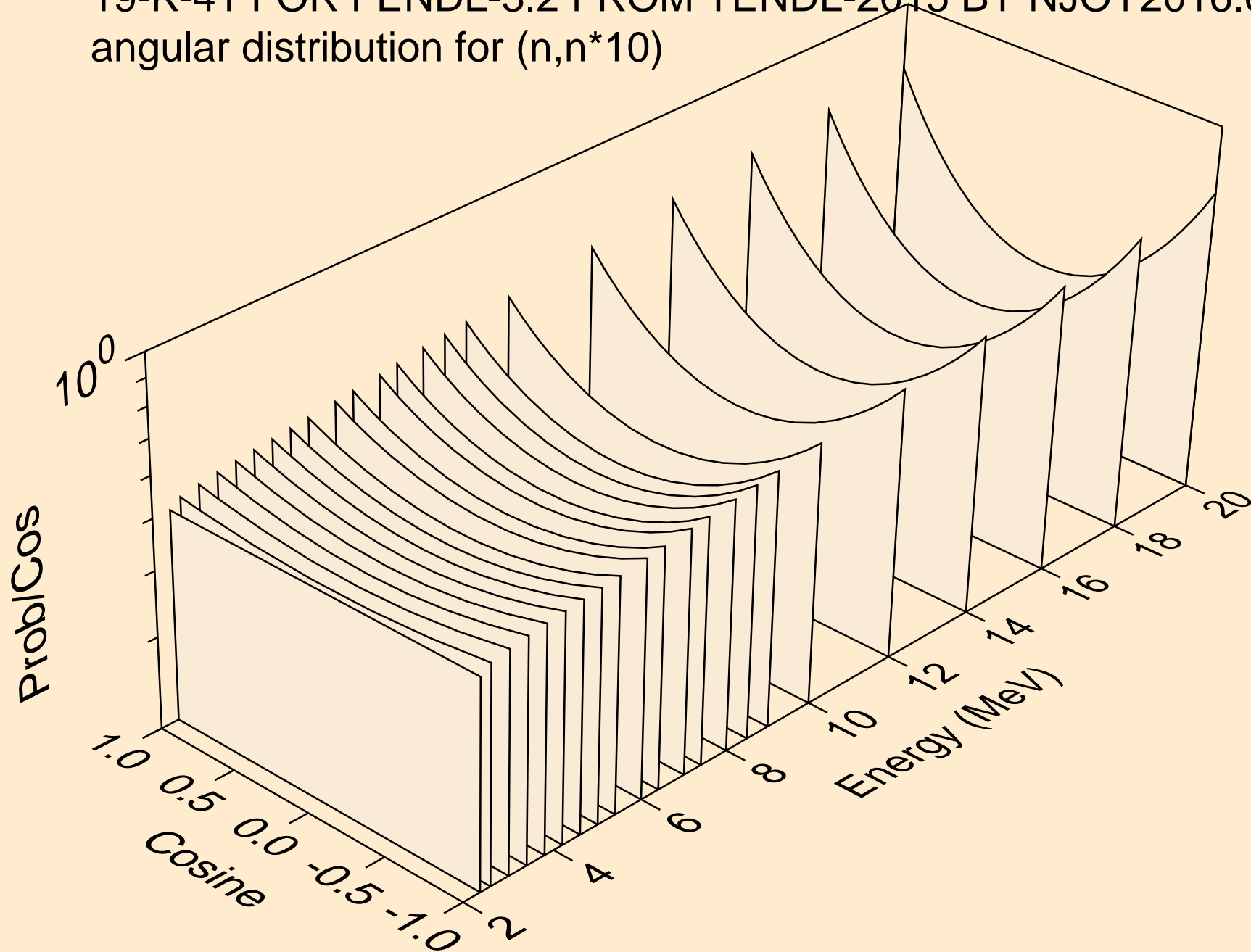

19-K-41 FOR FENDL-3.2 FROM TENDL-2015 BY NJOY2016.60+ O
angular distribution for (n,n*10)

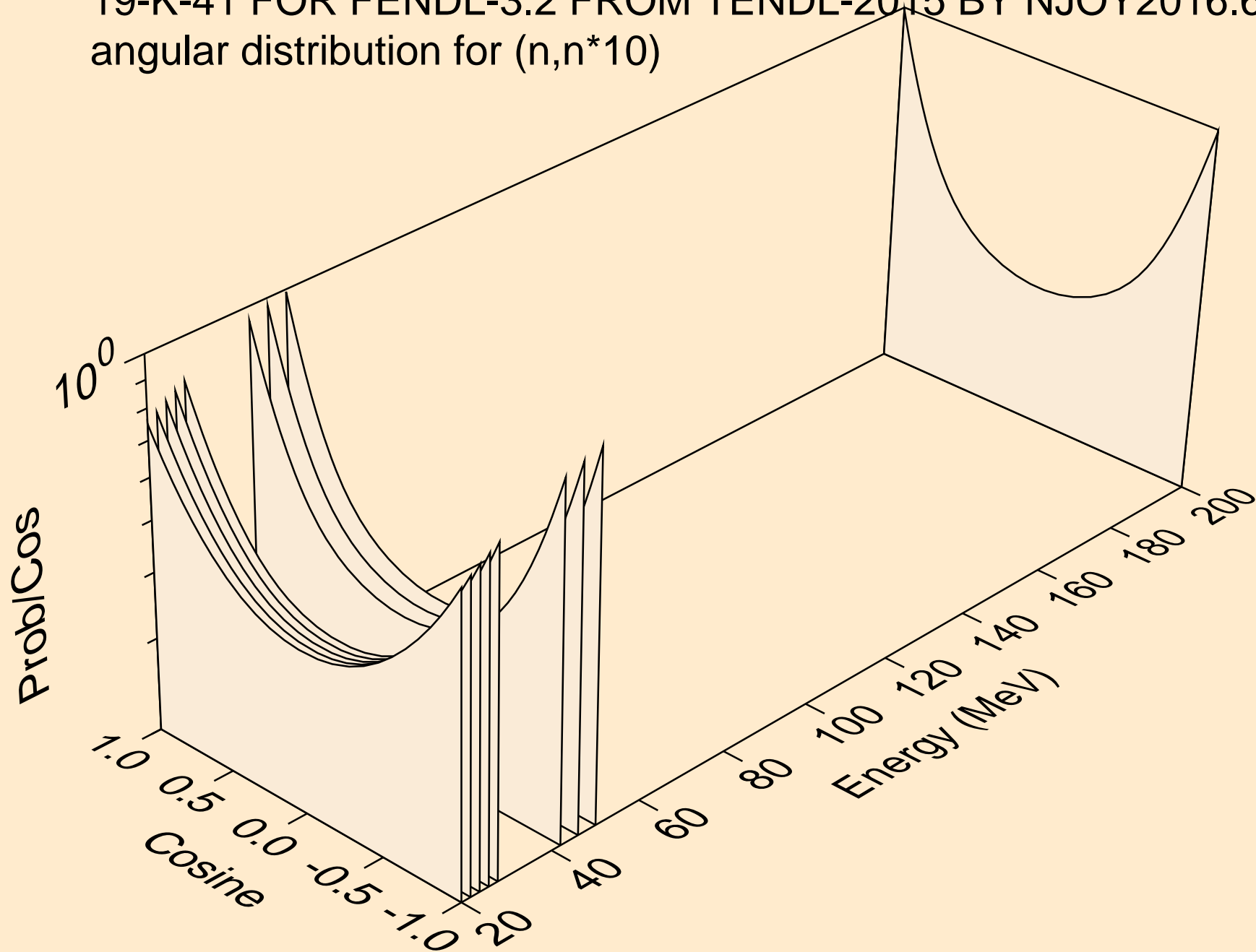

19-K-41 FOR FENDL-3.2 FROM TENDL-2015 BY NJOY2016.60+ O
angular distribution for (n,n*11)

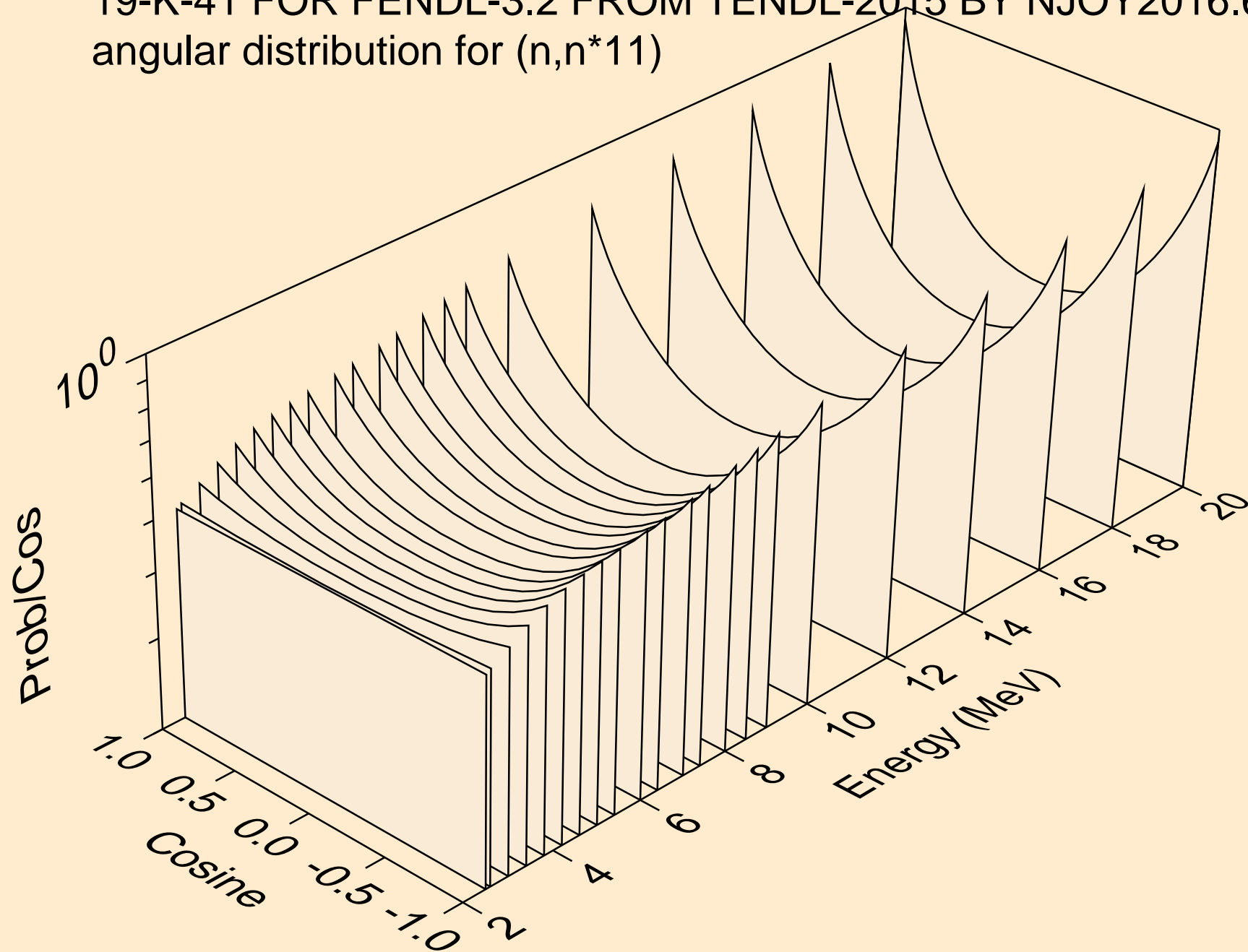

19-K-41 FOR FENDL-3.2 FROM TENDL-2015 BY NJOY2016.60+ O
angular distribution for (n,n*11)

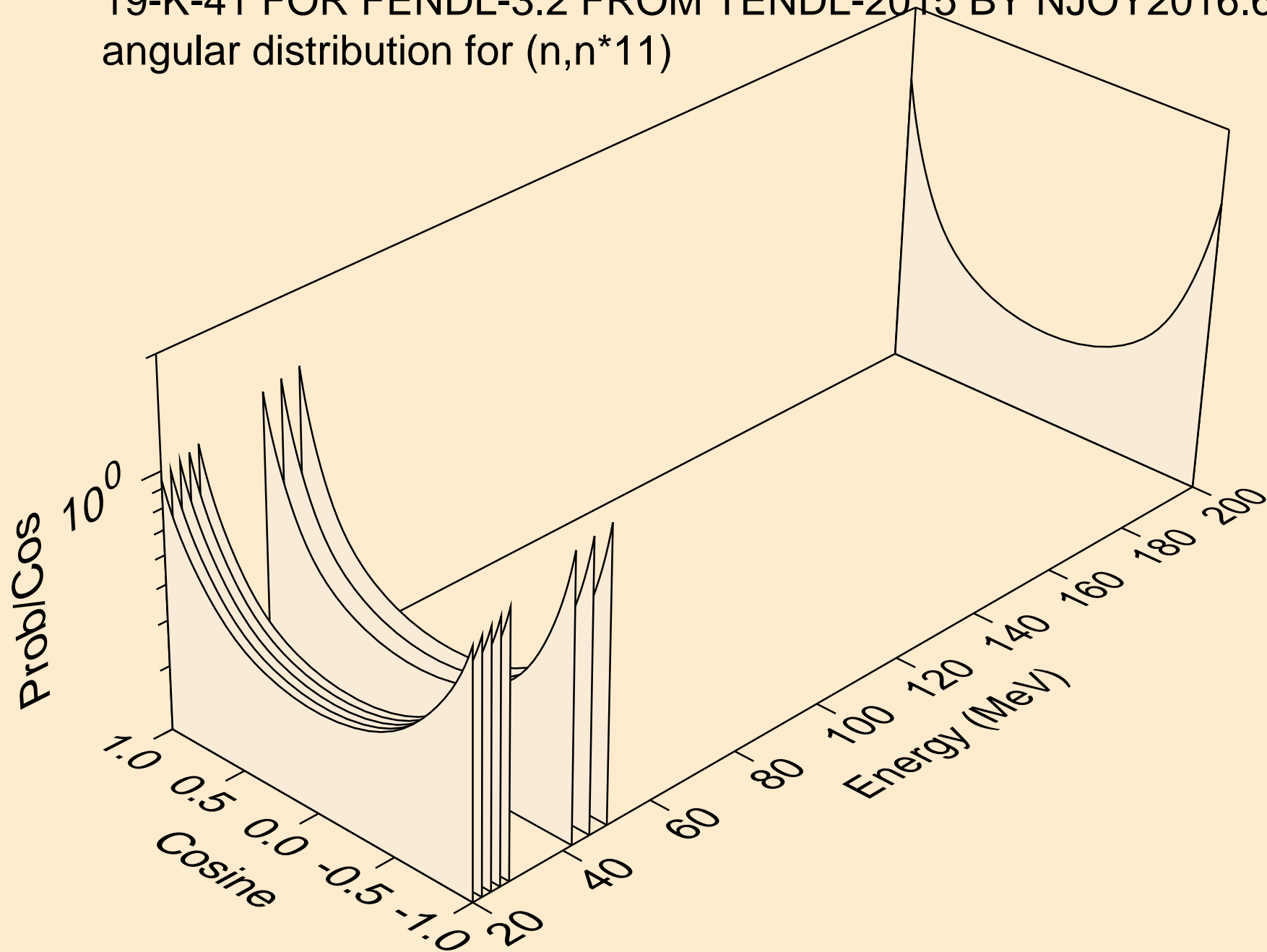

19-K-41 FOR FENDL-3.2 FROM TENDL-2015 BY NJOY2016.60+ O
angular distribution for (n,n*12)

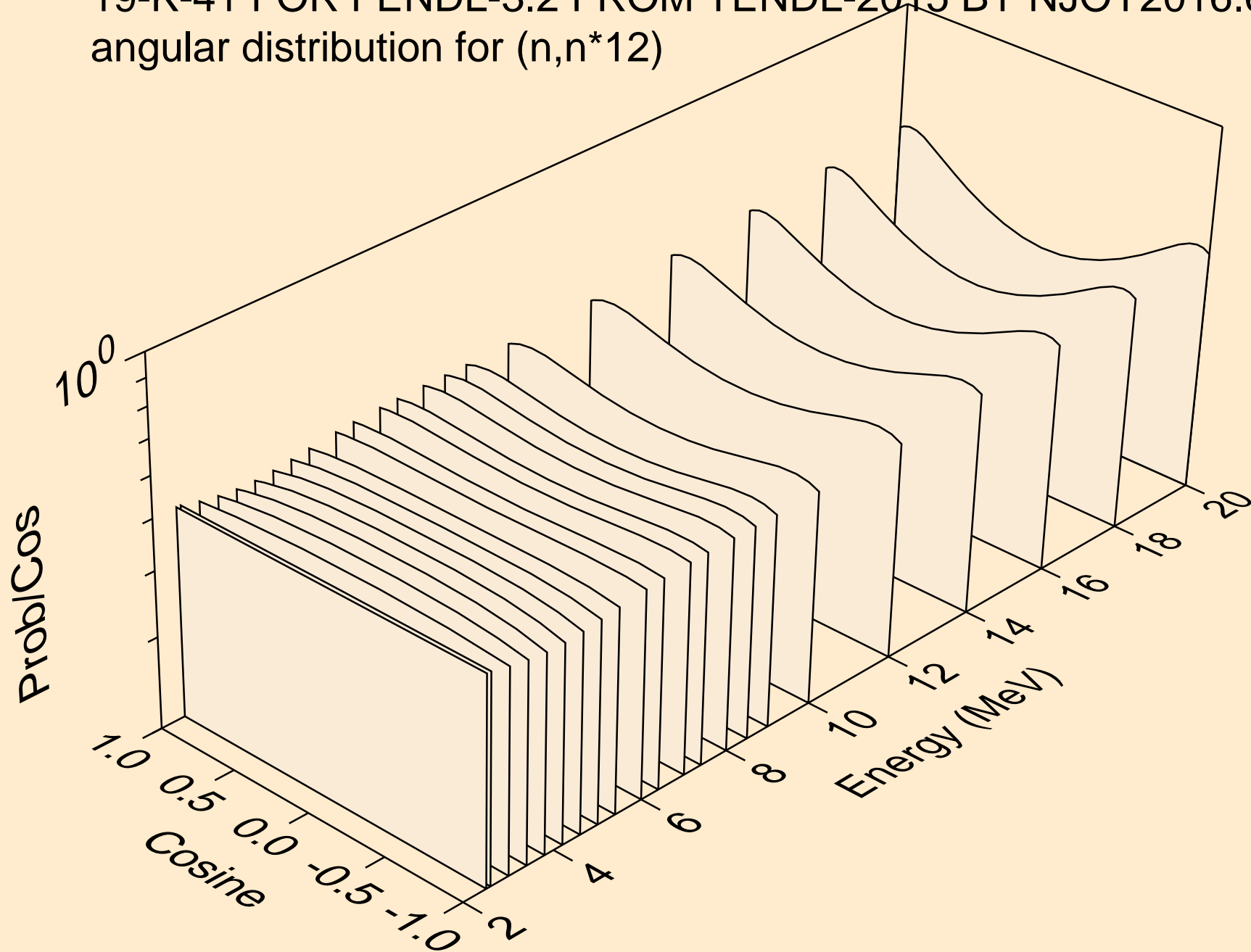

19-K-41 FOR FENDL-3.2 FROM TENDL-2015 BY NJOY2016.60+ O
angular distribution for (n,n*12)

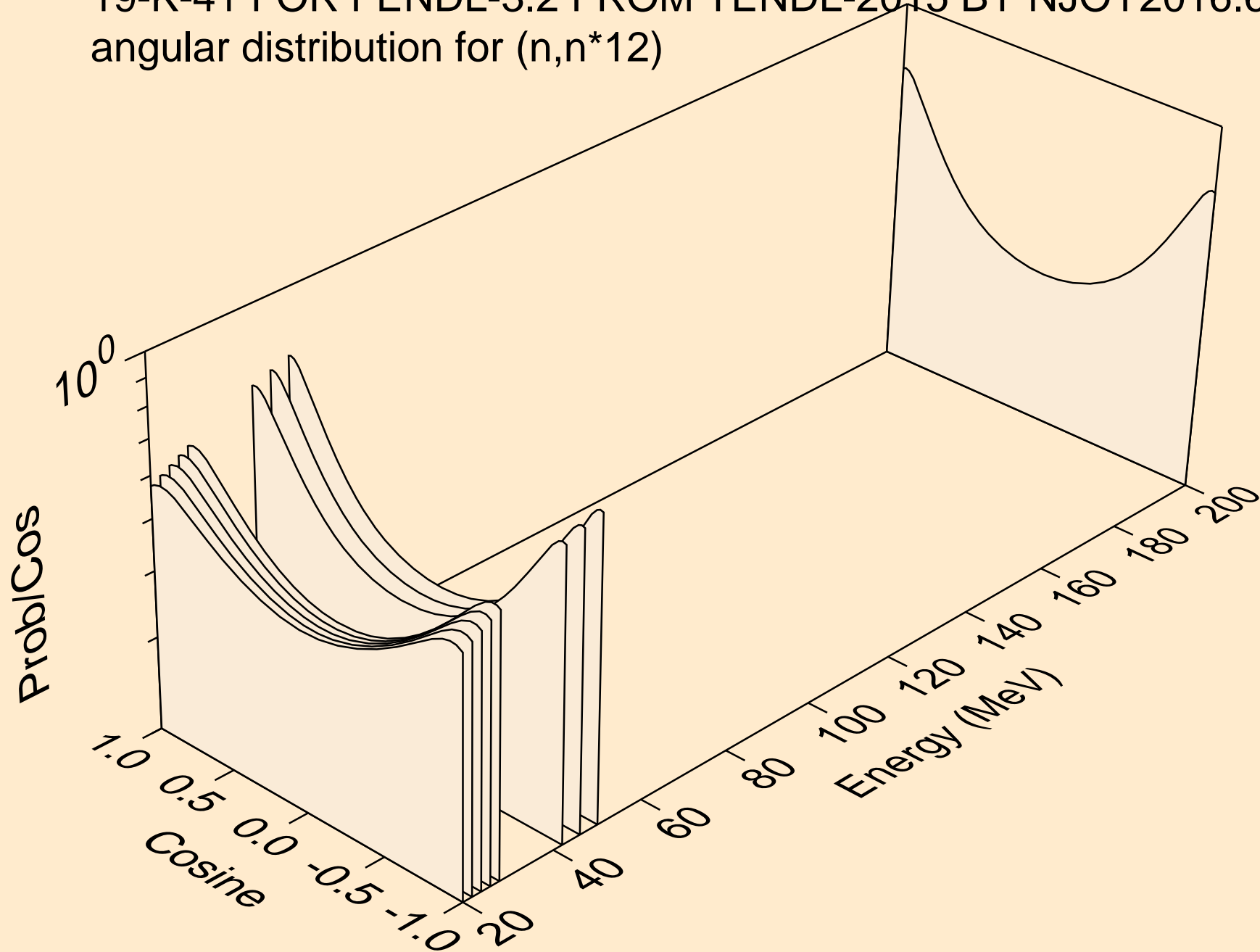

19-K-41 FOR FENDL-3.2 FROM TENDL-2015 BY NJOY2016.60+ O
angular distribution for (n,n*13)

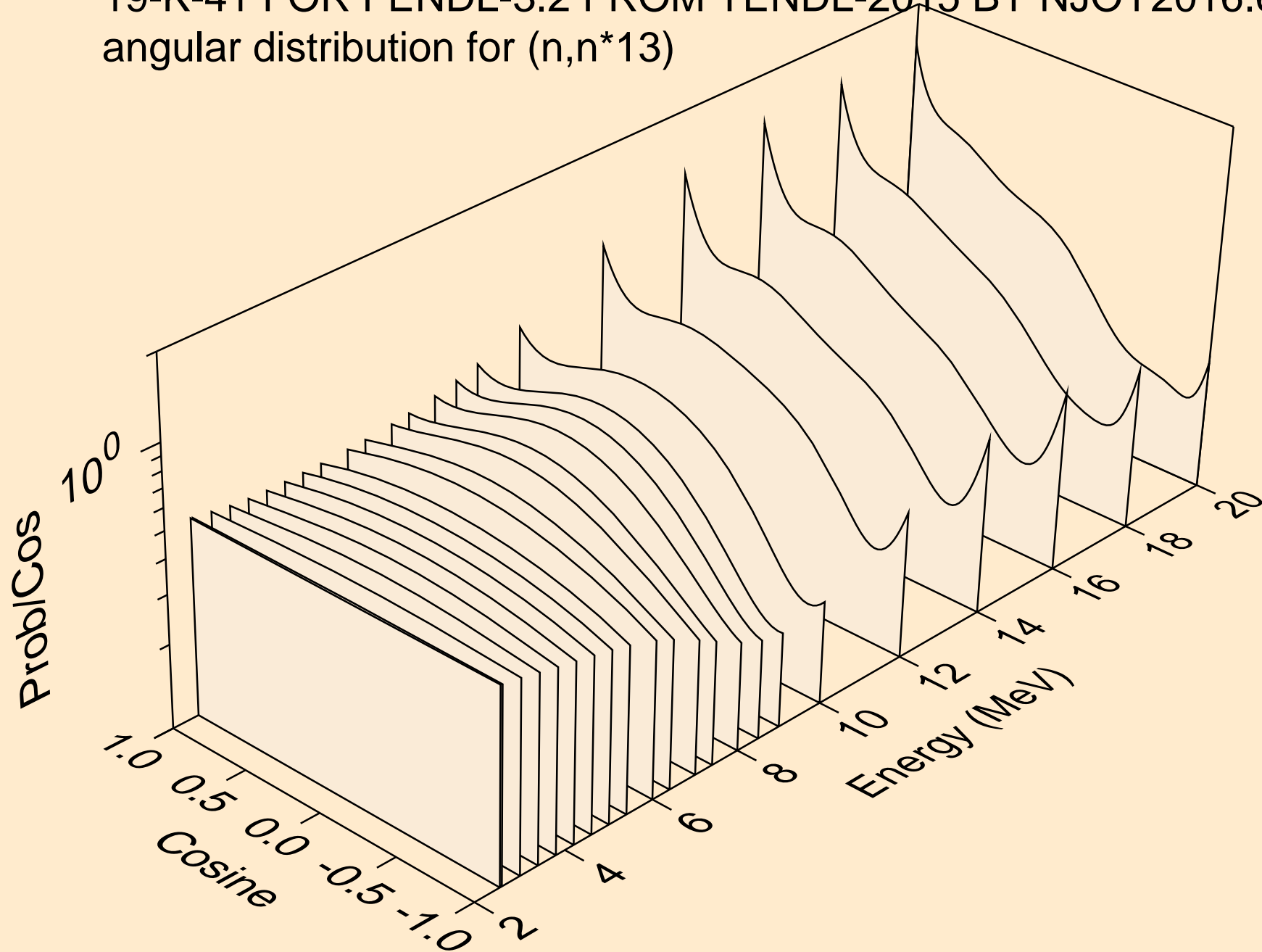

19-K-41 FOR FENDL-3.2 FROM TENDL-2015 BY NJOY2016.60+ O
angular distribution for (n,n*13)

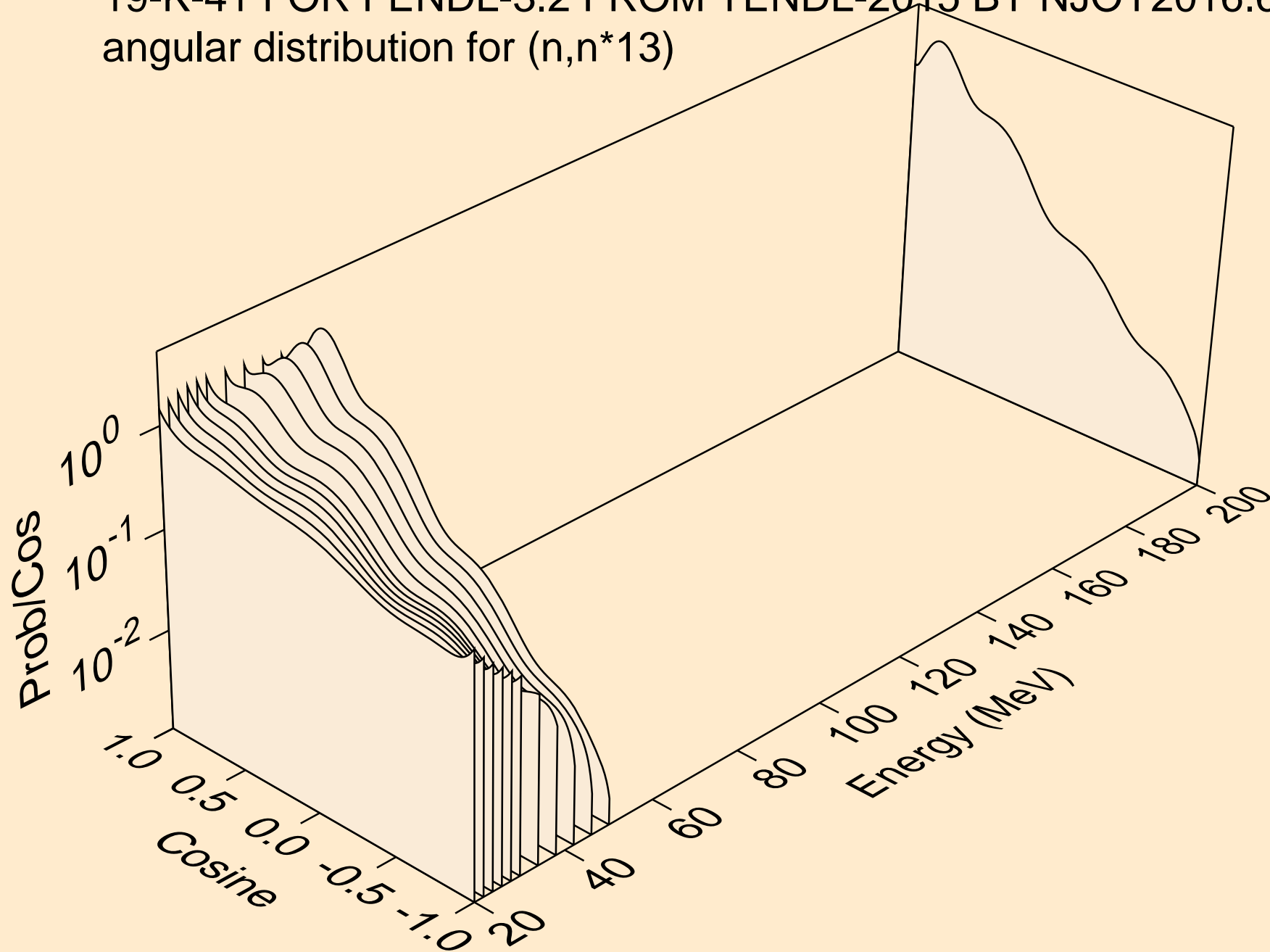

19-K-41 FOR FENDL-3.2 FROM TENDL-2015 BY NJOY2016.60+ O
angular distribution for (n,n*14)

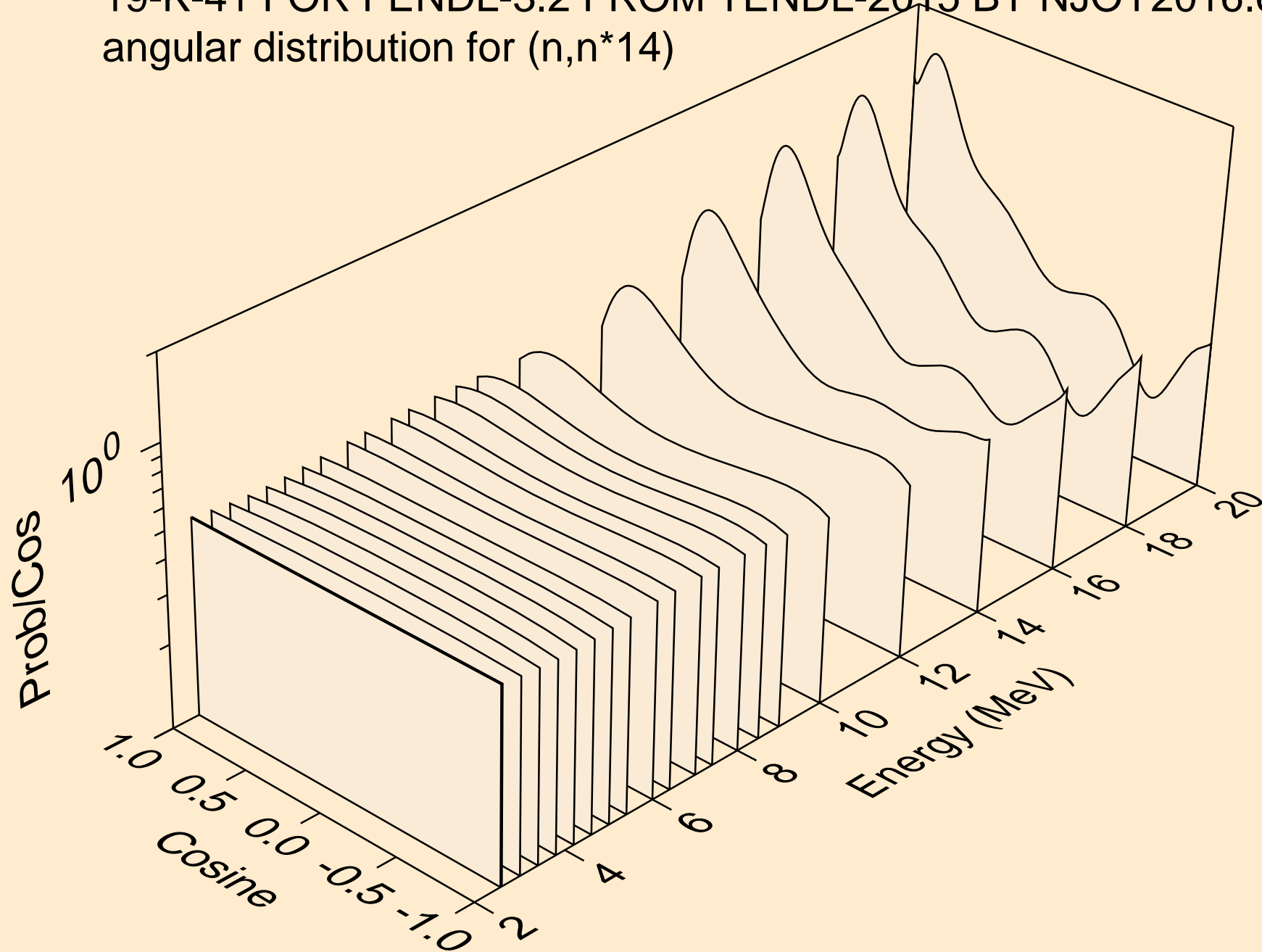

19-K-41 FOR FENDL-3.2 FROM TENDL-2015 BY NJOY2016.60+ O
angular distribution for (n,n*14)

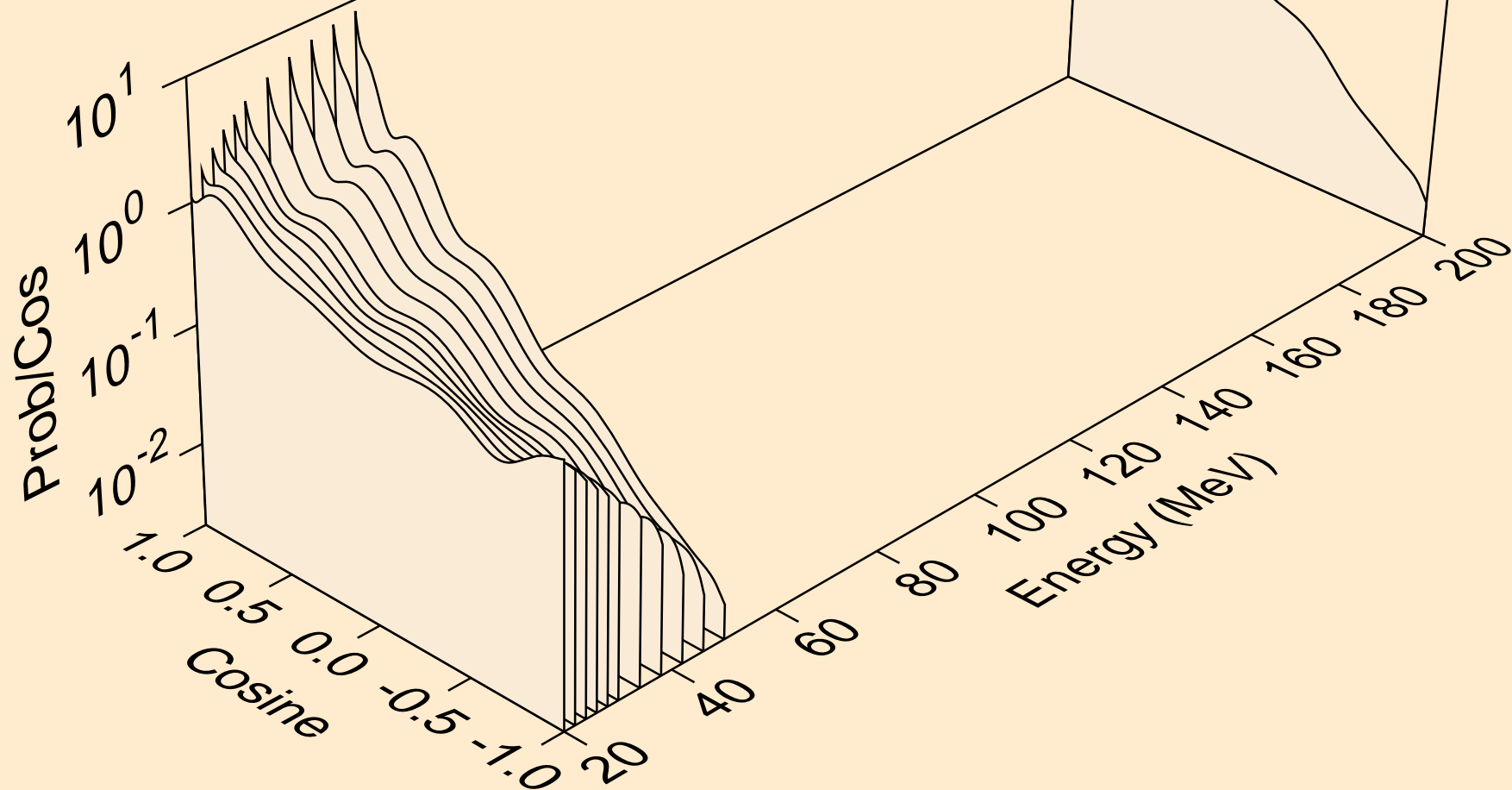

19-K-41 FOR FENDL-3.2 FROM TENDL-2015 BY NJOY2016.60+ O
angular distribution for (n,n*15)

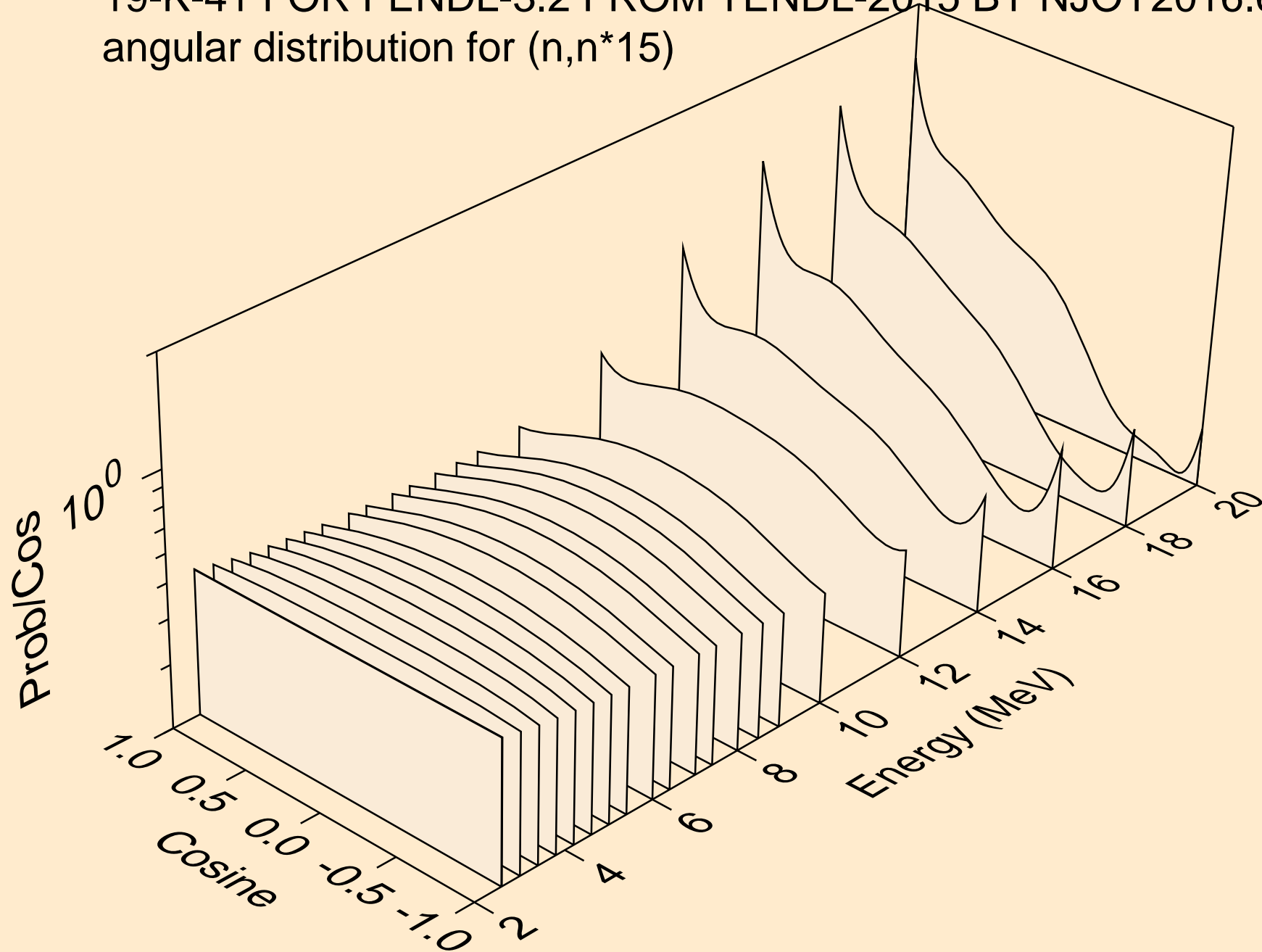

19-K-41 FOR FENDL-3.2 FROM TENDL-2015 BY NJOY2016.60+ O
angular distribution for (n,n*15)

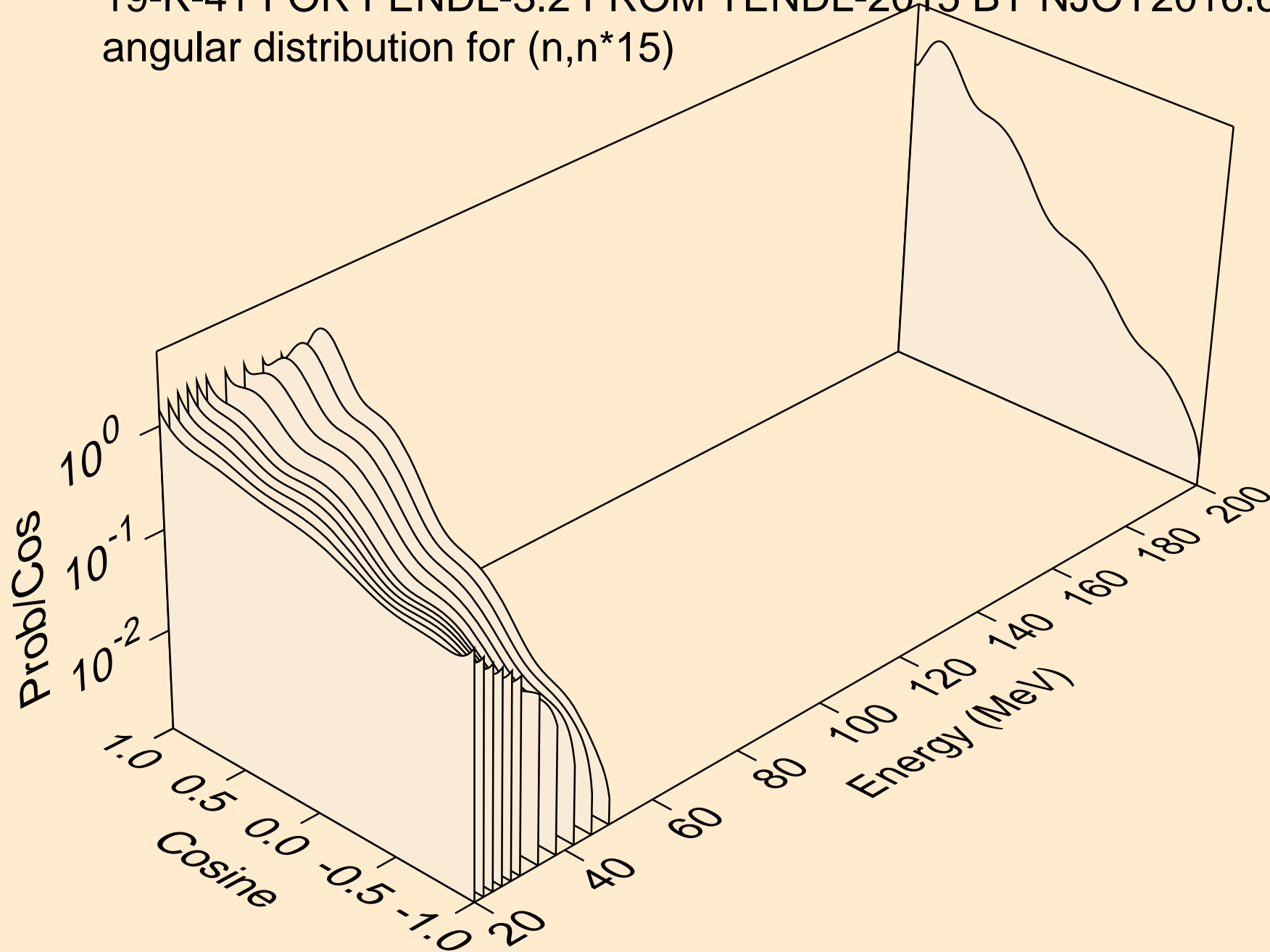

19-K-41 FOR FENDL-3.2 FROM TENDL-2015 BY NJOY2016.60+ O
angular distribution for (n,n*16)

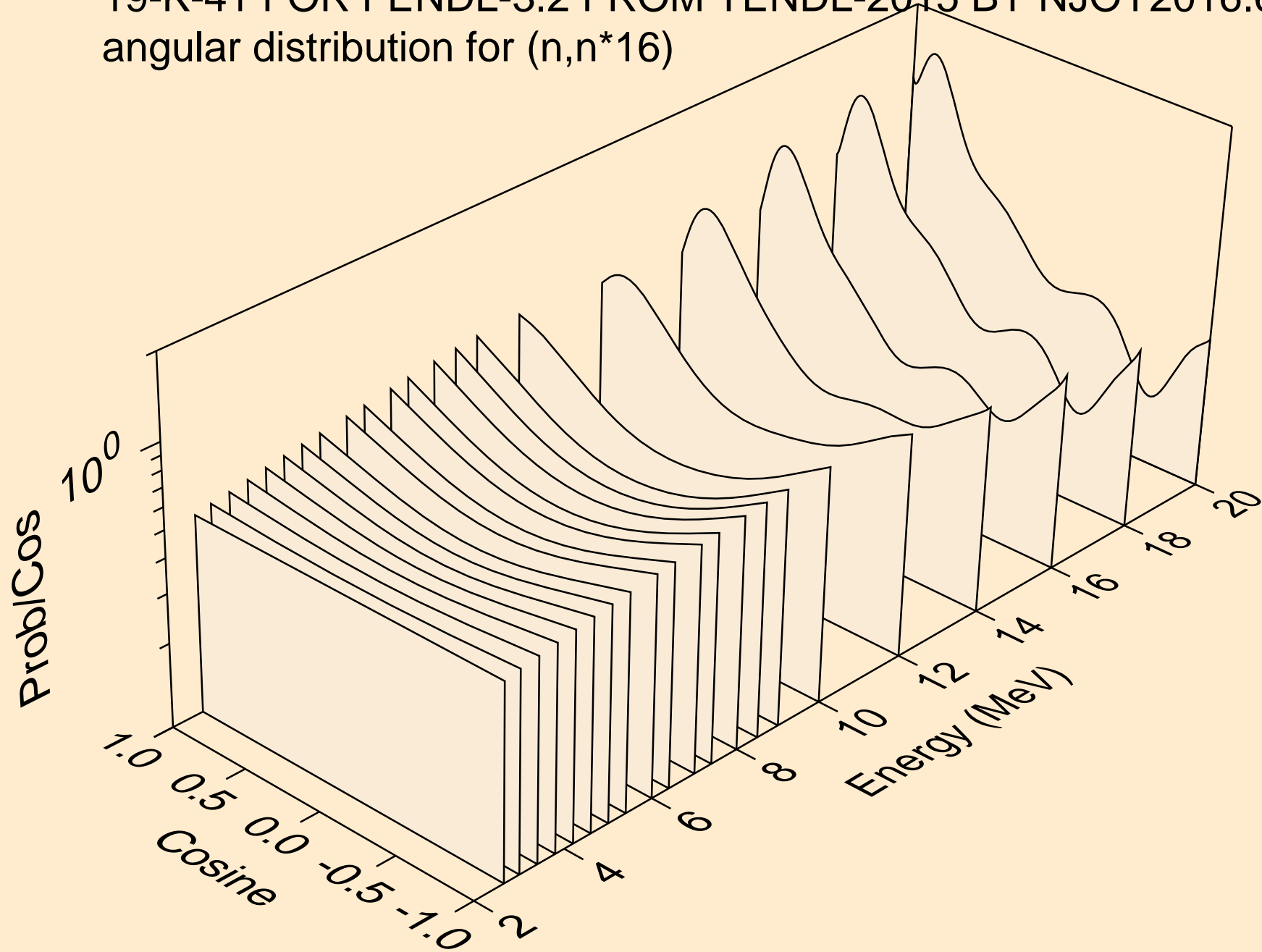

19-K-41 FOR FENDL-3.2 FROM TENDL-2015 BY NJOY2016.60+ O
angular distribution for (n,n*16)

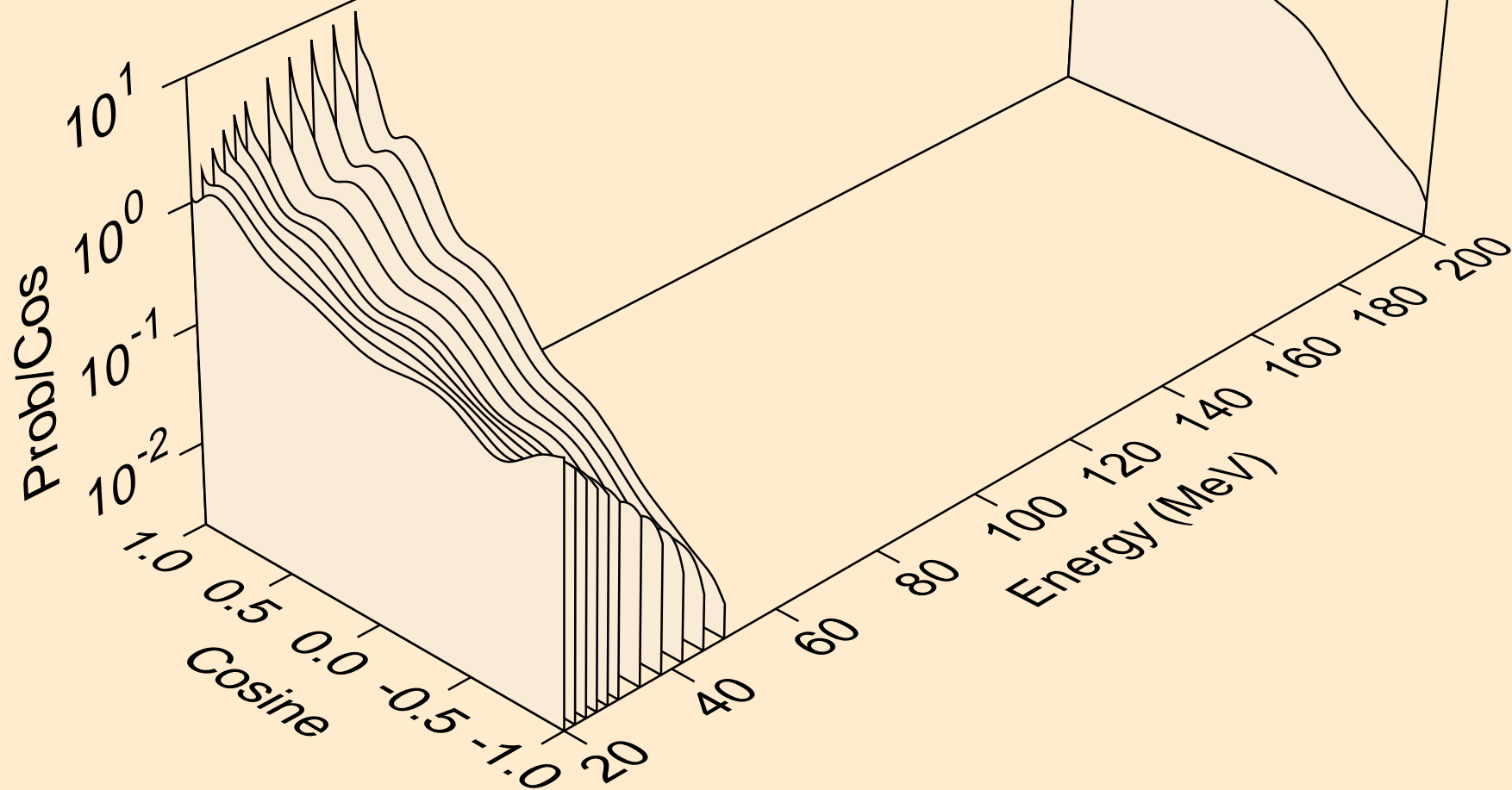

19-K-41 FOR FENDL-3.2 FROM TENDL-2015 BY NJOY2016.60+ O
angular distribution for (n,n*17)

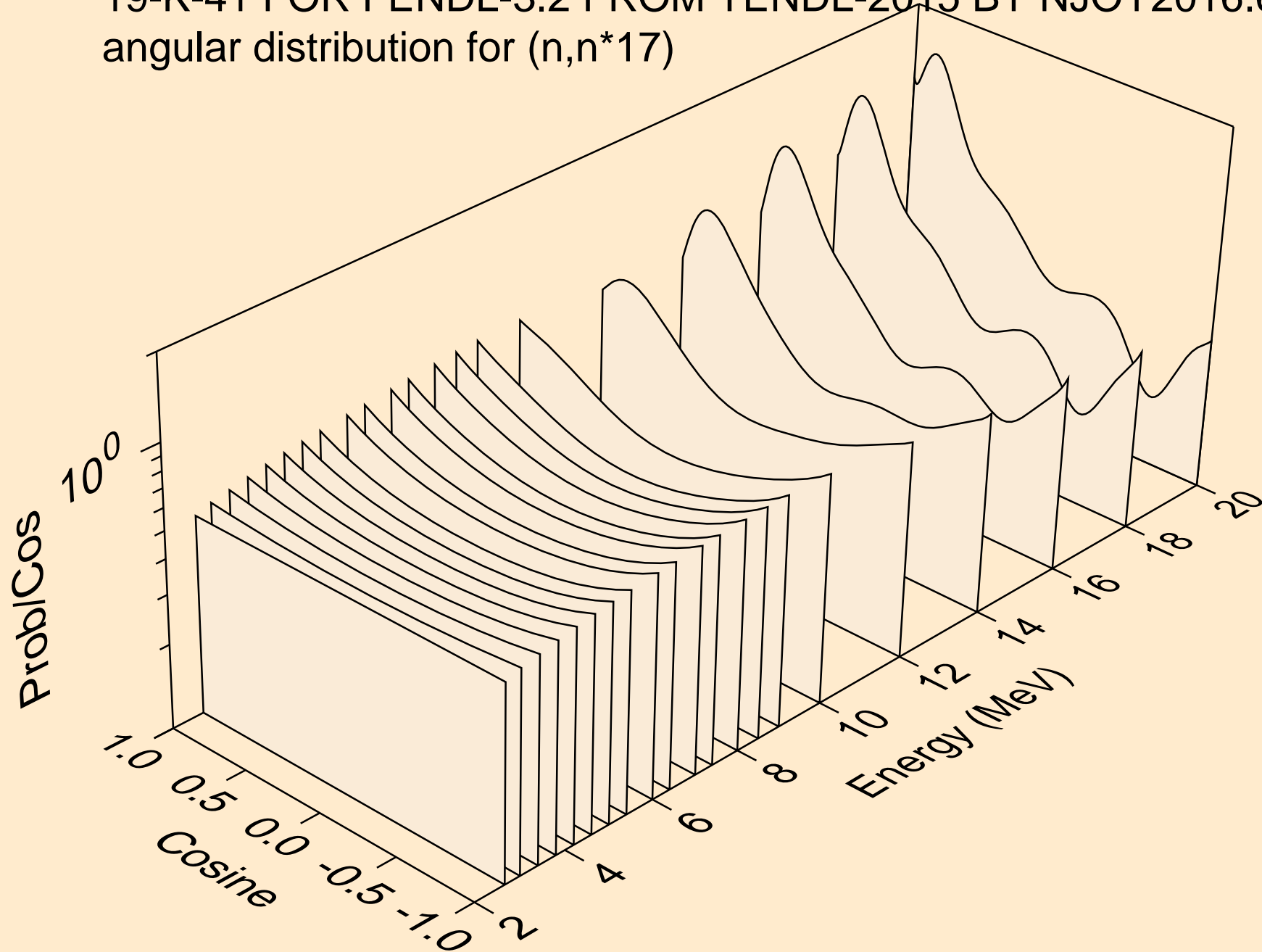

19-K-41 FOR FENDL-3.2 FROM TENDL-2015 BY NJOY2016.60+ O
angular distribution for (n,n*17)

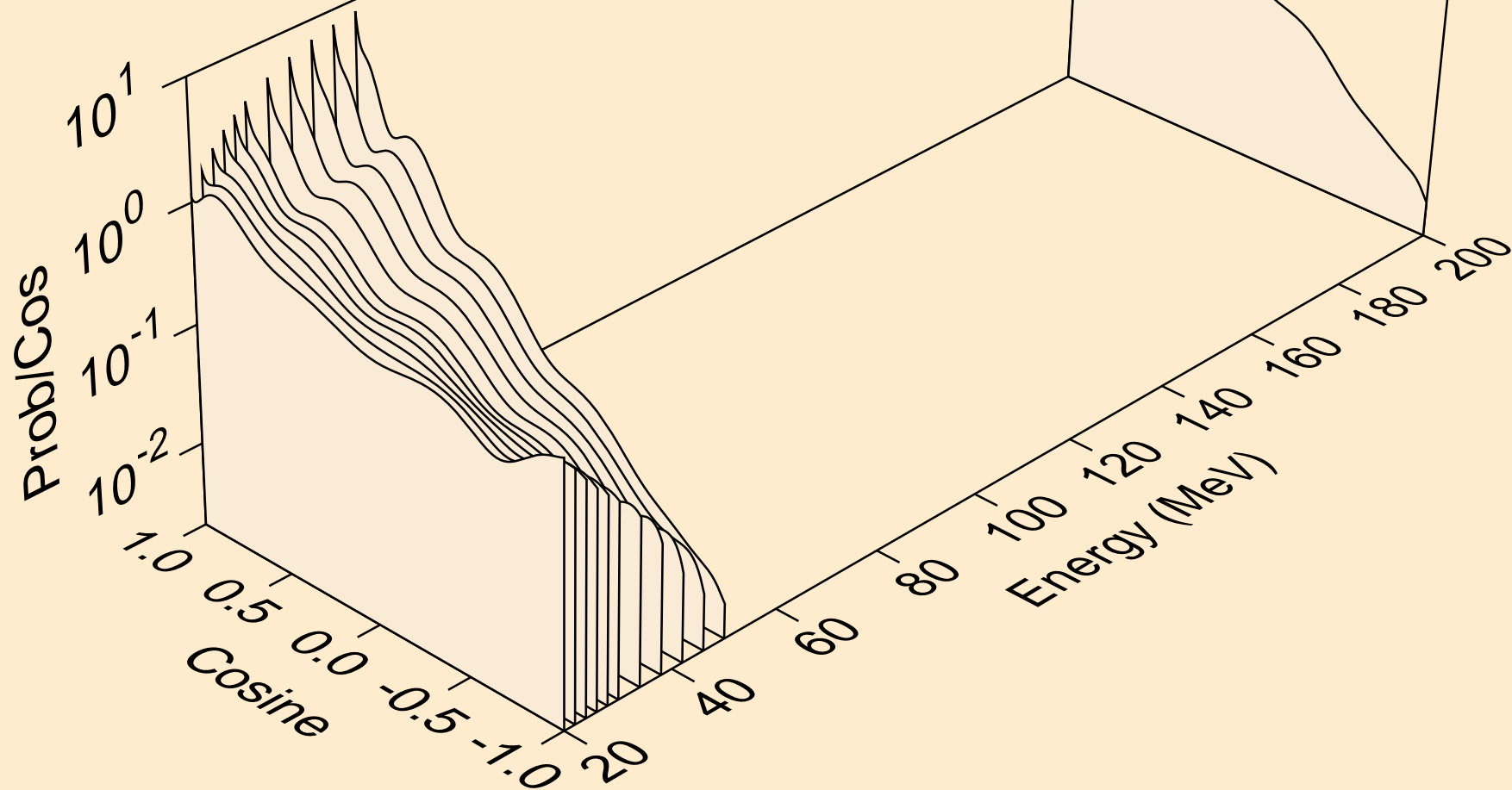

19-K-41 FOR FENDL-3.2 FROM TENDL-2015 BY NJOY2016.60+ O
angular distribution for (n,n*18)

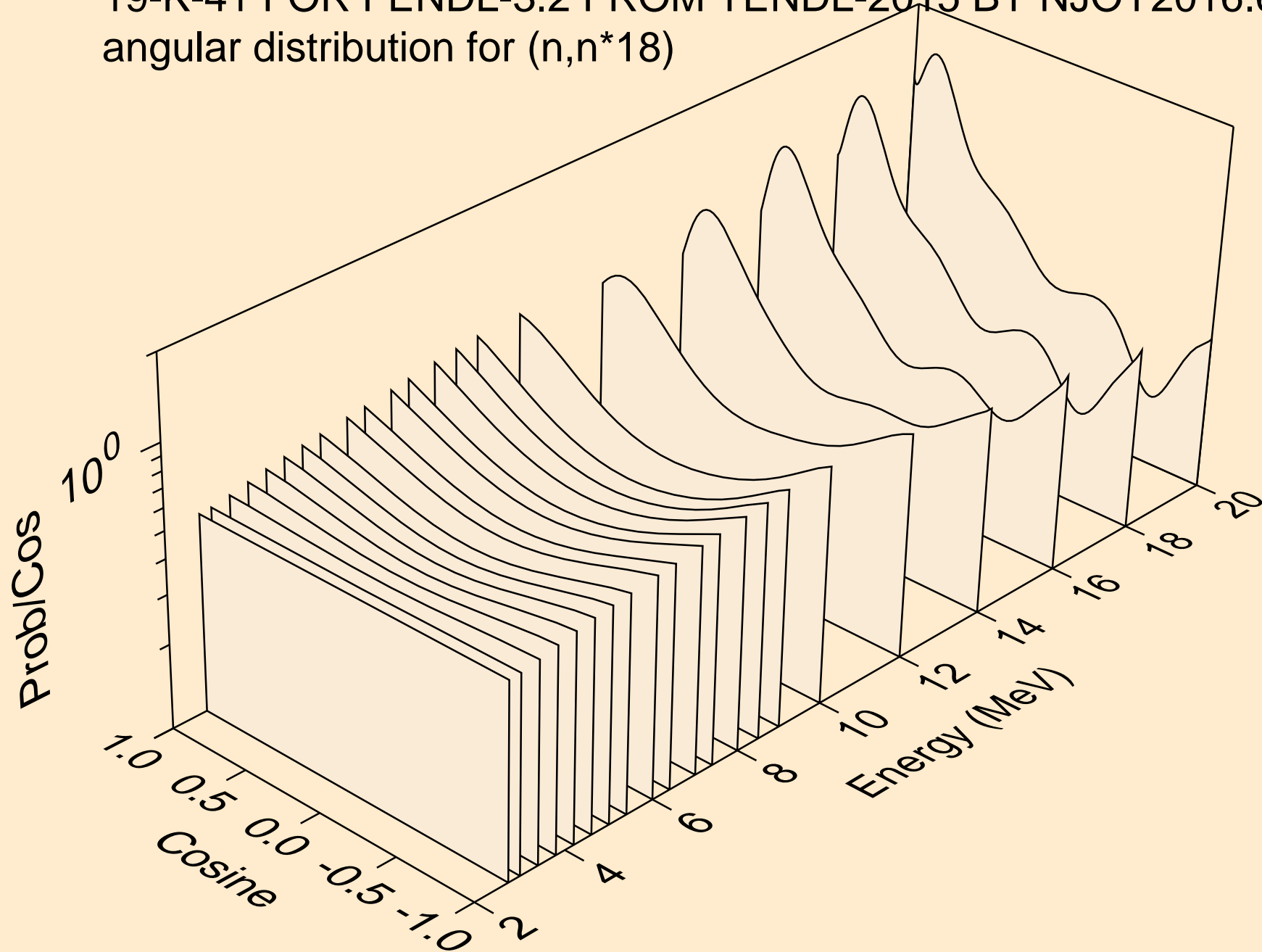

19-K-41 FOR FENDL-3.2 FROM TENDL-2015 BY NJOY2016.60+ O
angular distribution for (n,n*18)

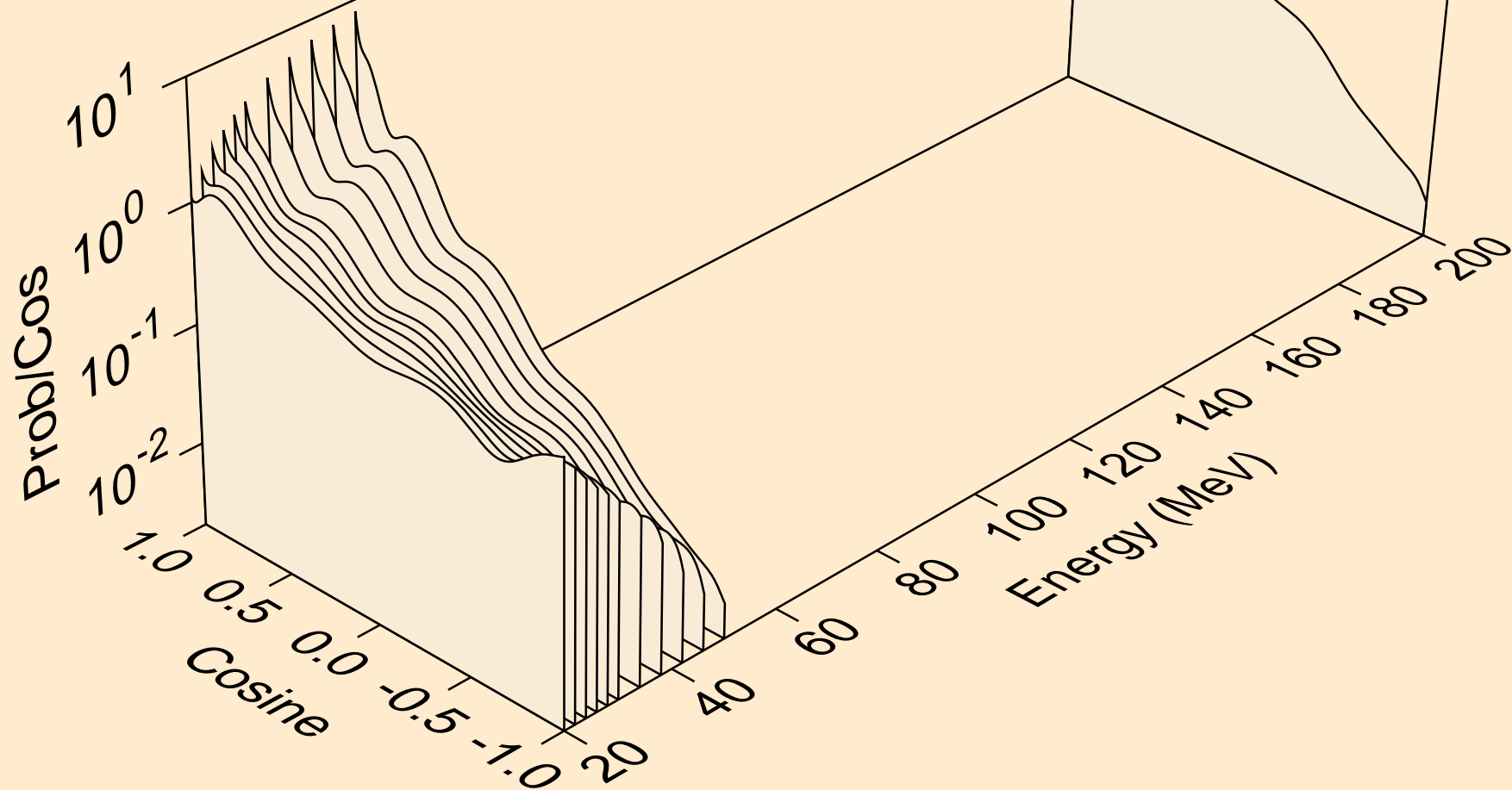

19-K-41 FOR FENDL-3.2 FROM TENDL-2015 BY NJOY2016.60+ O
angular distribution for (n,n*19)

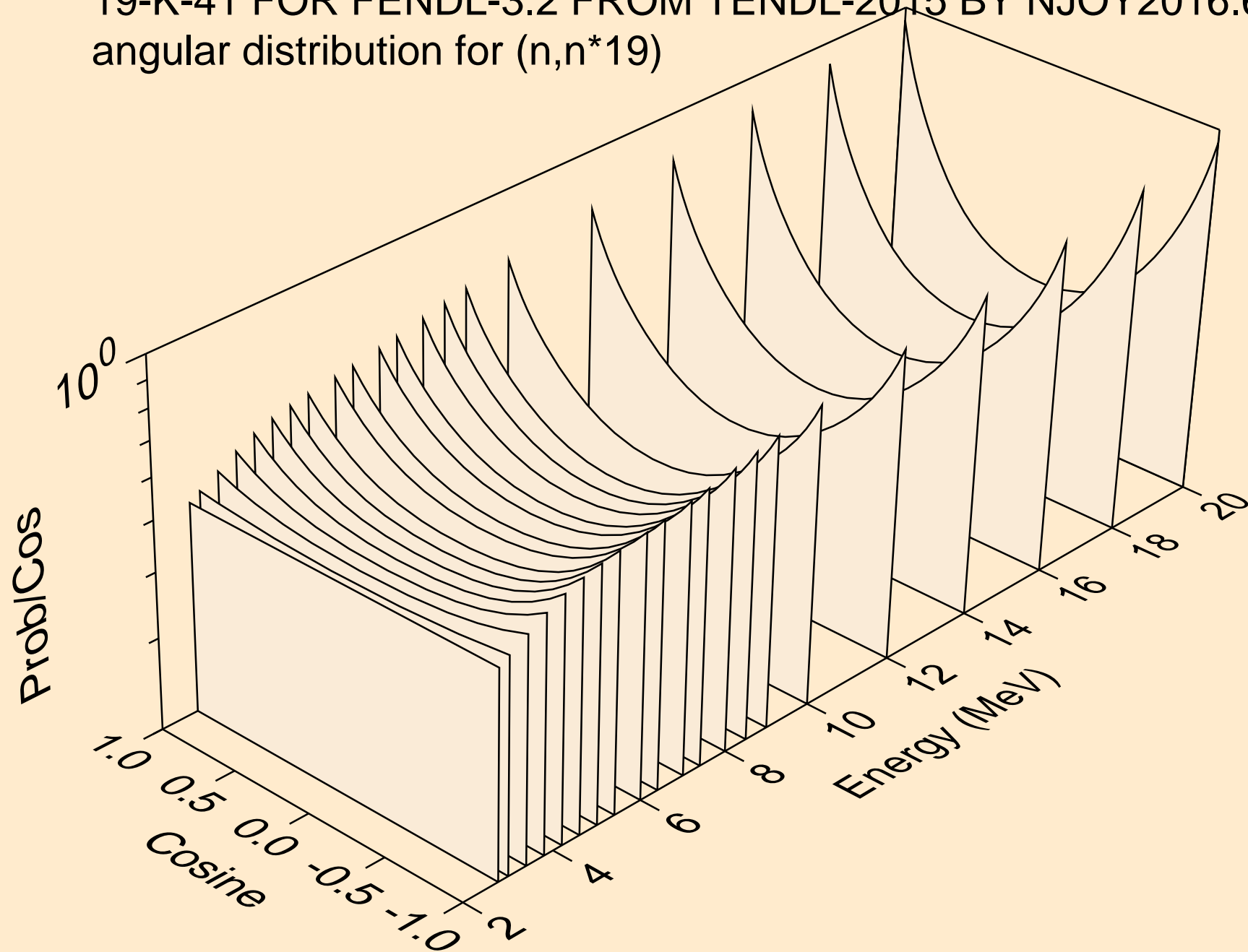

19-K-41 FOR FENDL-3.2 FROM TENDL-2015 BY NJOY2016.60+ O
angular distribution for (n,n*19)

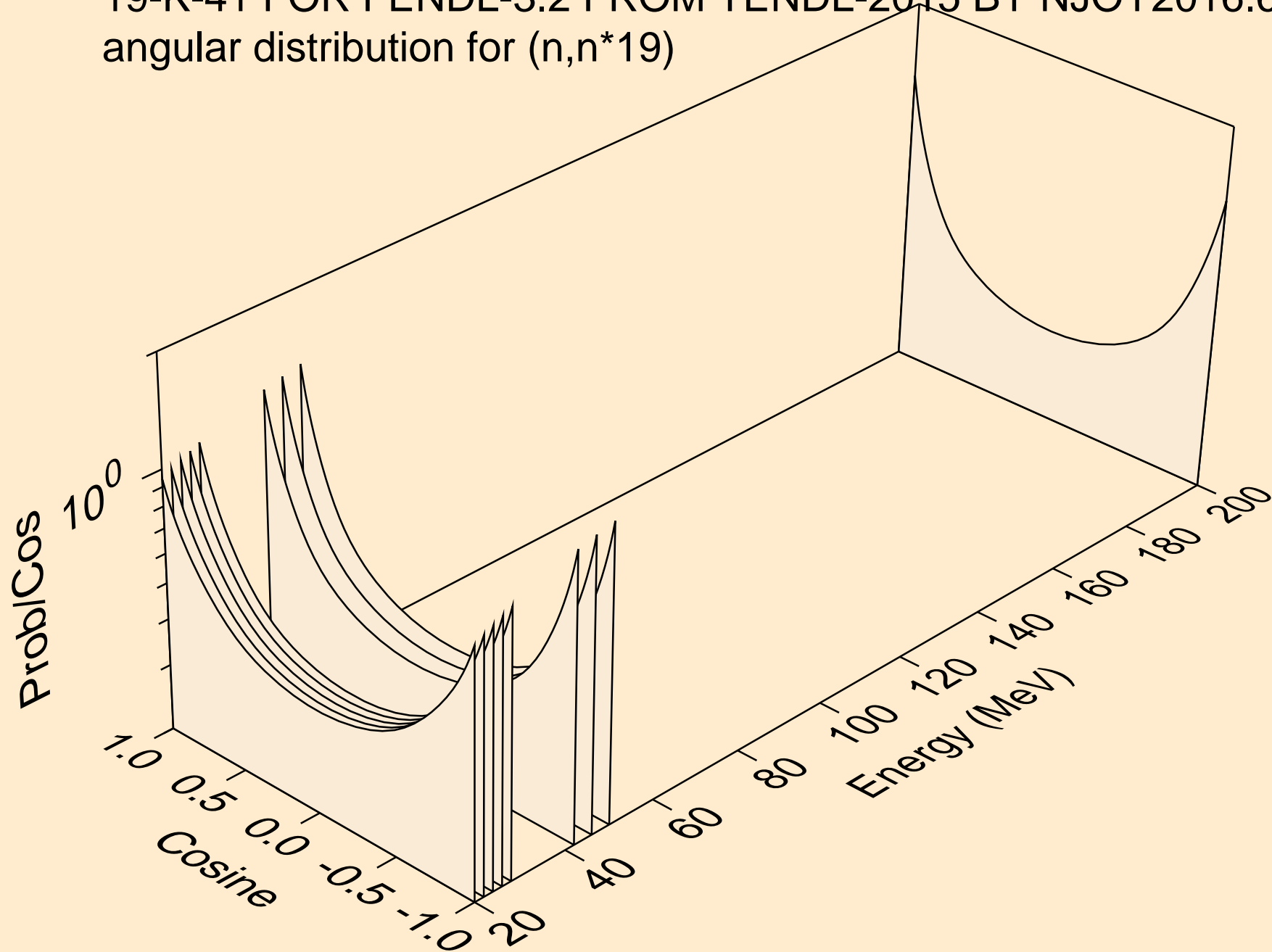

19-K-41 FOR FENDL-3.2 FROM TENDL-2015 BY NJOY2016.60+ O
angular distribution for (n,n*20)

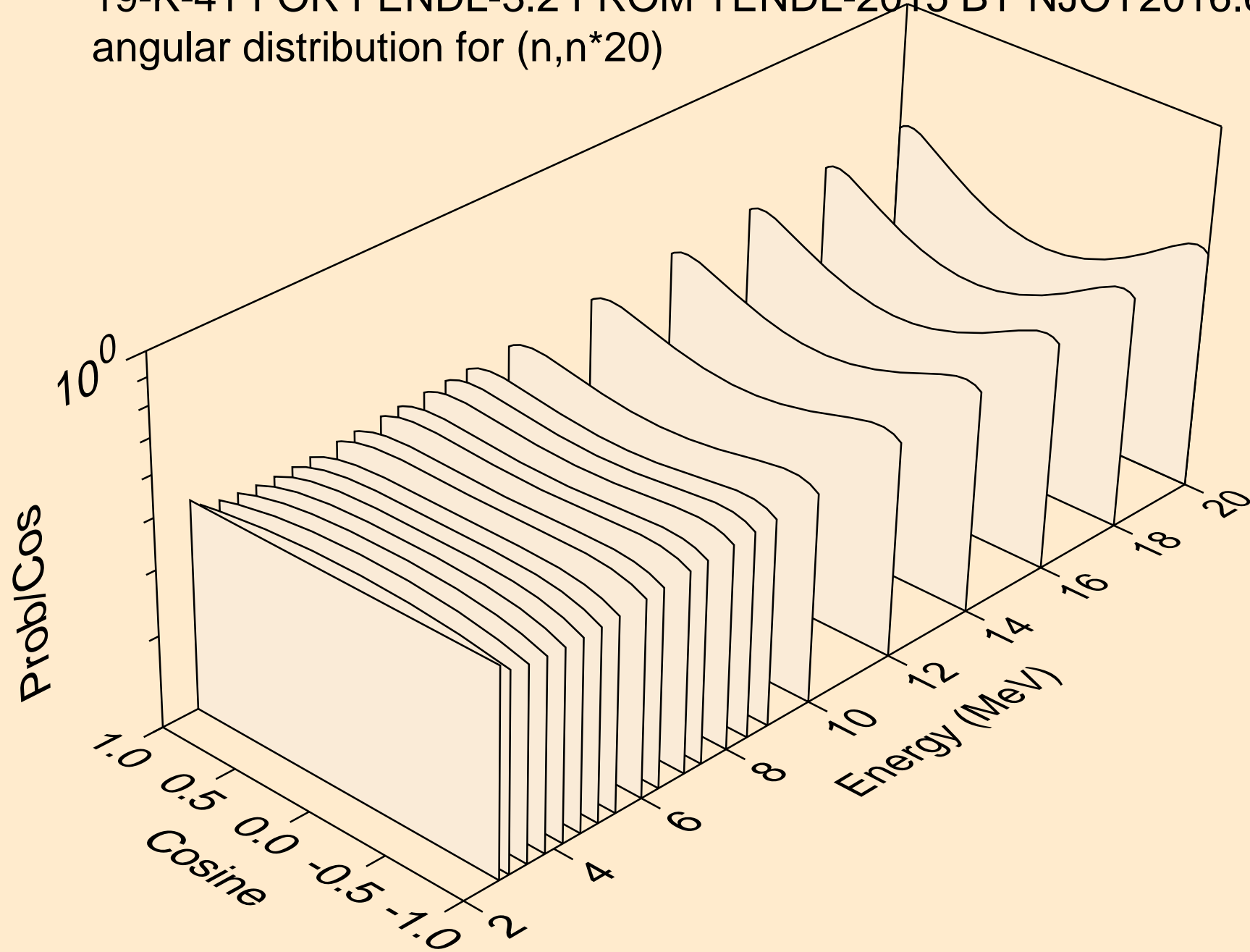

19-K-41 FOR FENDL-3.2 FROM TENDL-2015 BY NJOY2016.60+ O
angular distribution for (n,n*20)

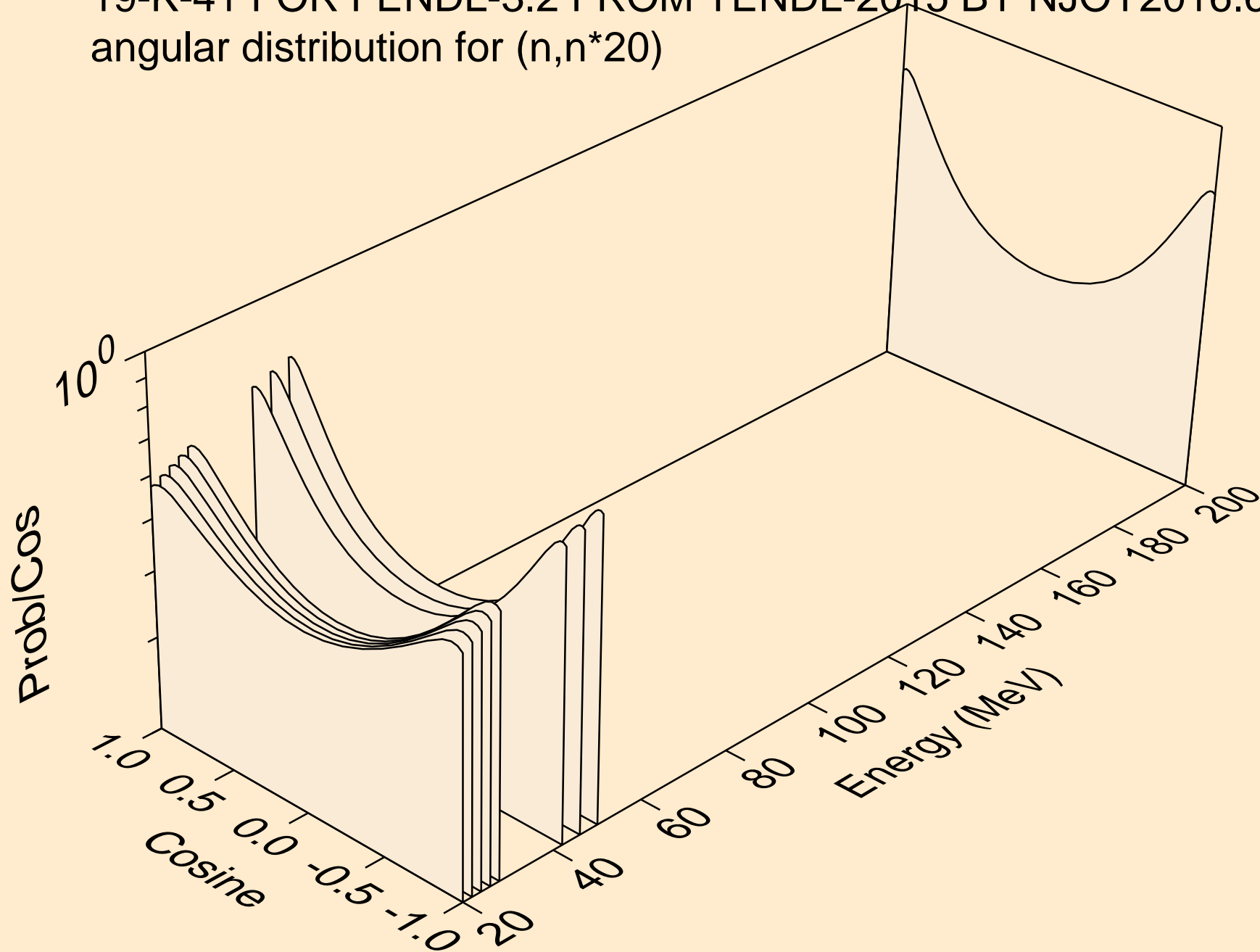

19-K-41 FOR FENDL-3.2 FROM TENDL-2015 BY NJOY2016.60+ O
angular distribution for (n,n*21)

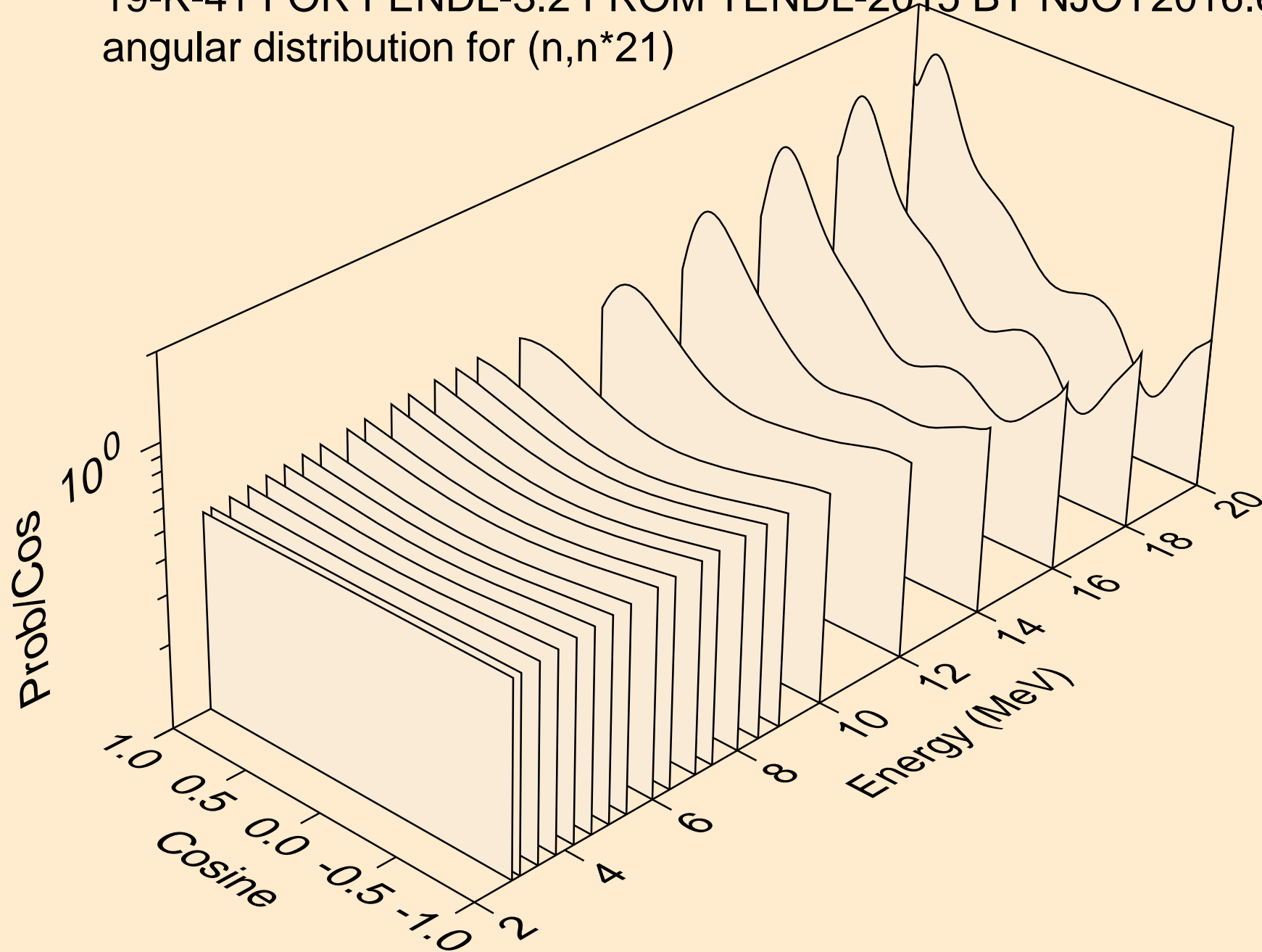

19-K-41 FOR FENDL-3.2 FROM TENDL-2015 BY NJOY2016.60+ O
angular distribution for (n,n*21)

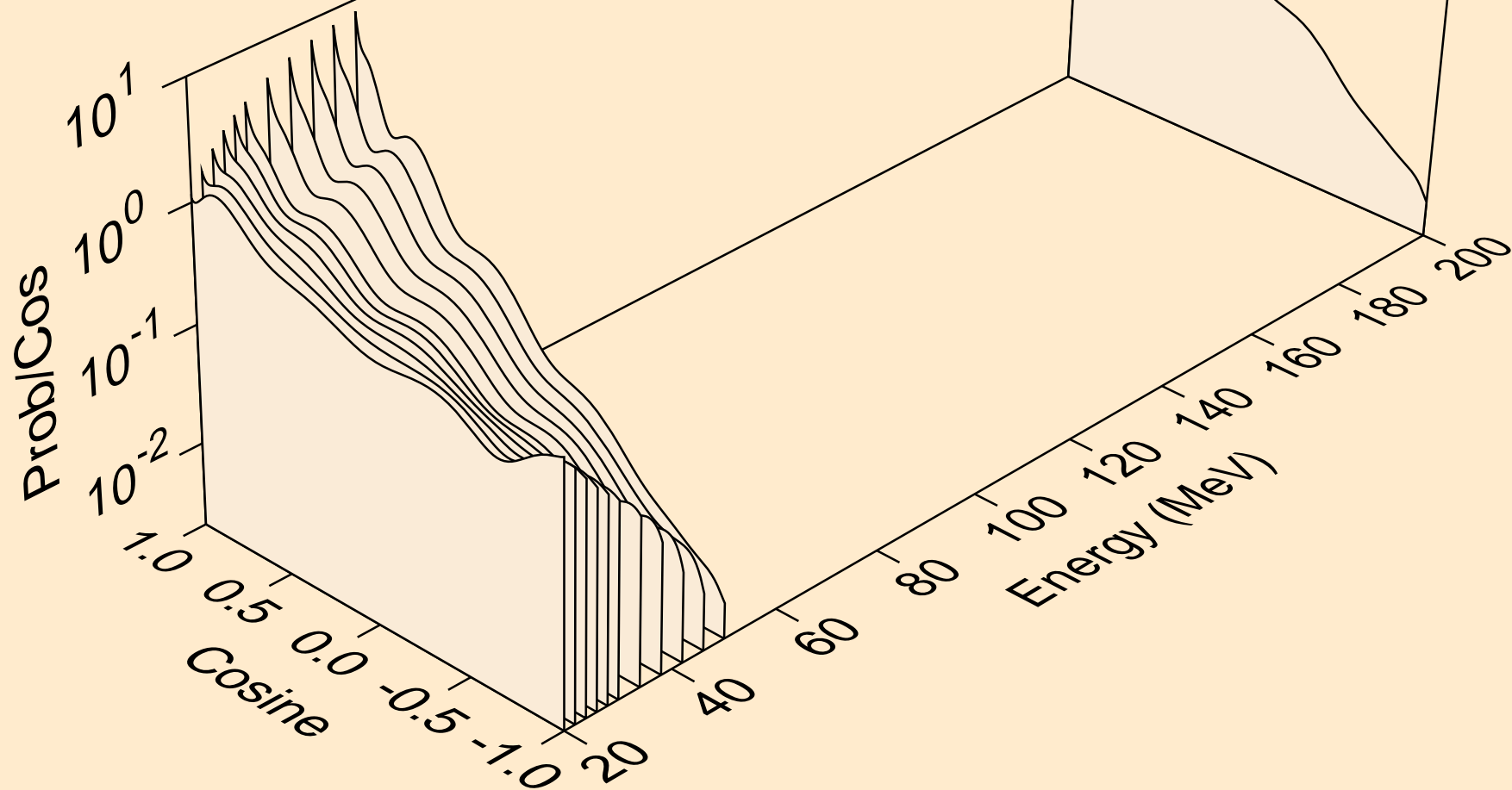

19-K-41 FOR FENDL-3.2 FROM TENDL-2015 BY NJOY2016.60+ O
angular distribution for (n,n*22)

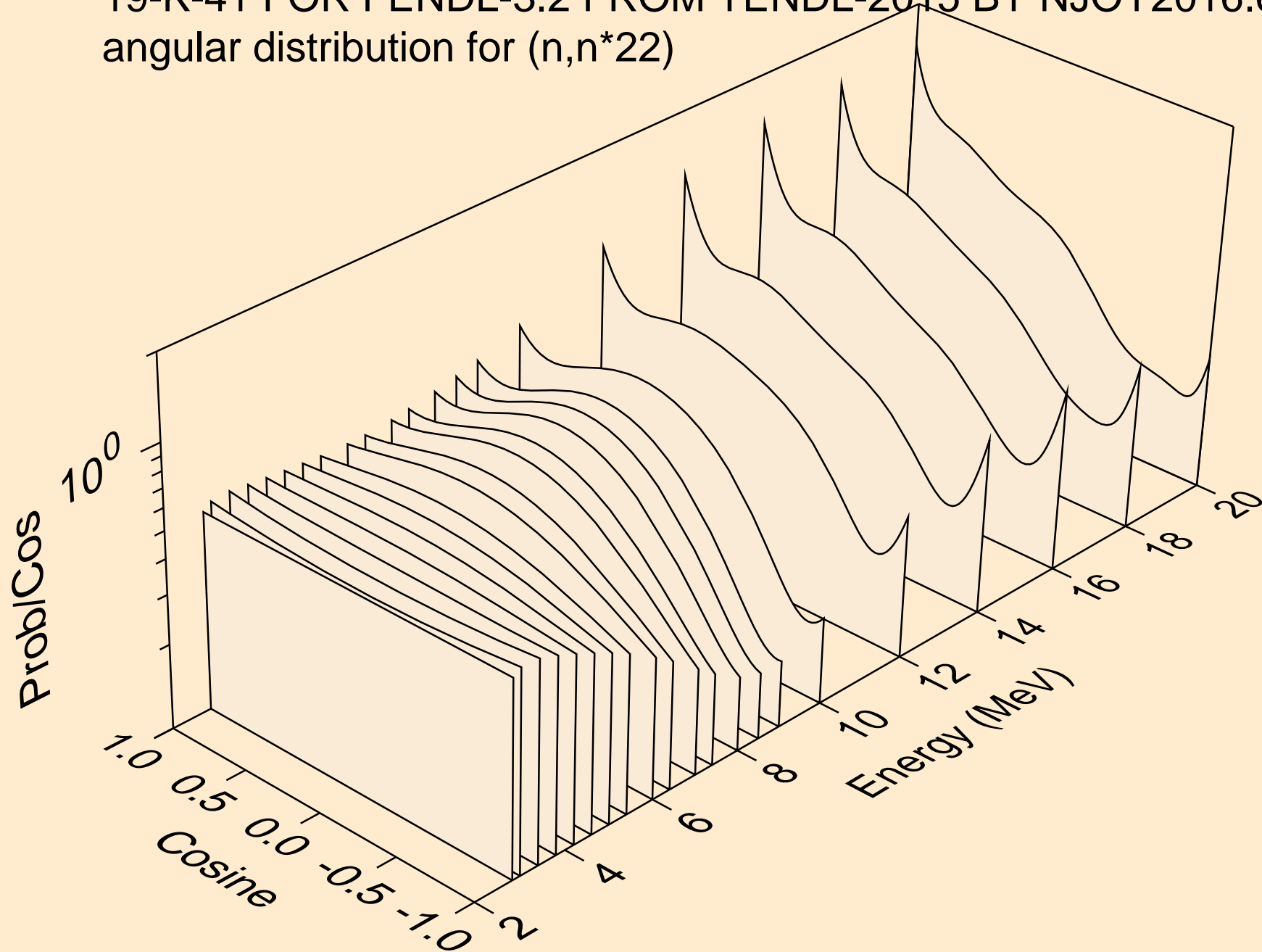

19-K-41 FOR FENDL-3.2 FROM TENDL-2015 BY NJOY2016.60+ O
angular distribution for (n,n*22)

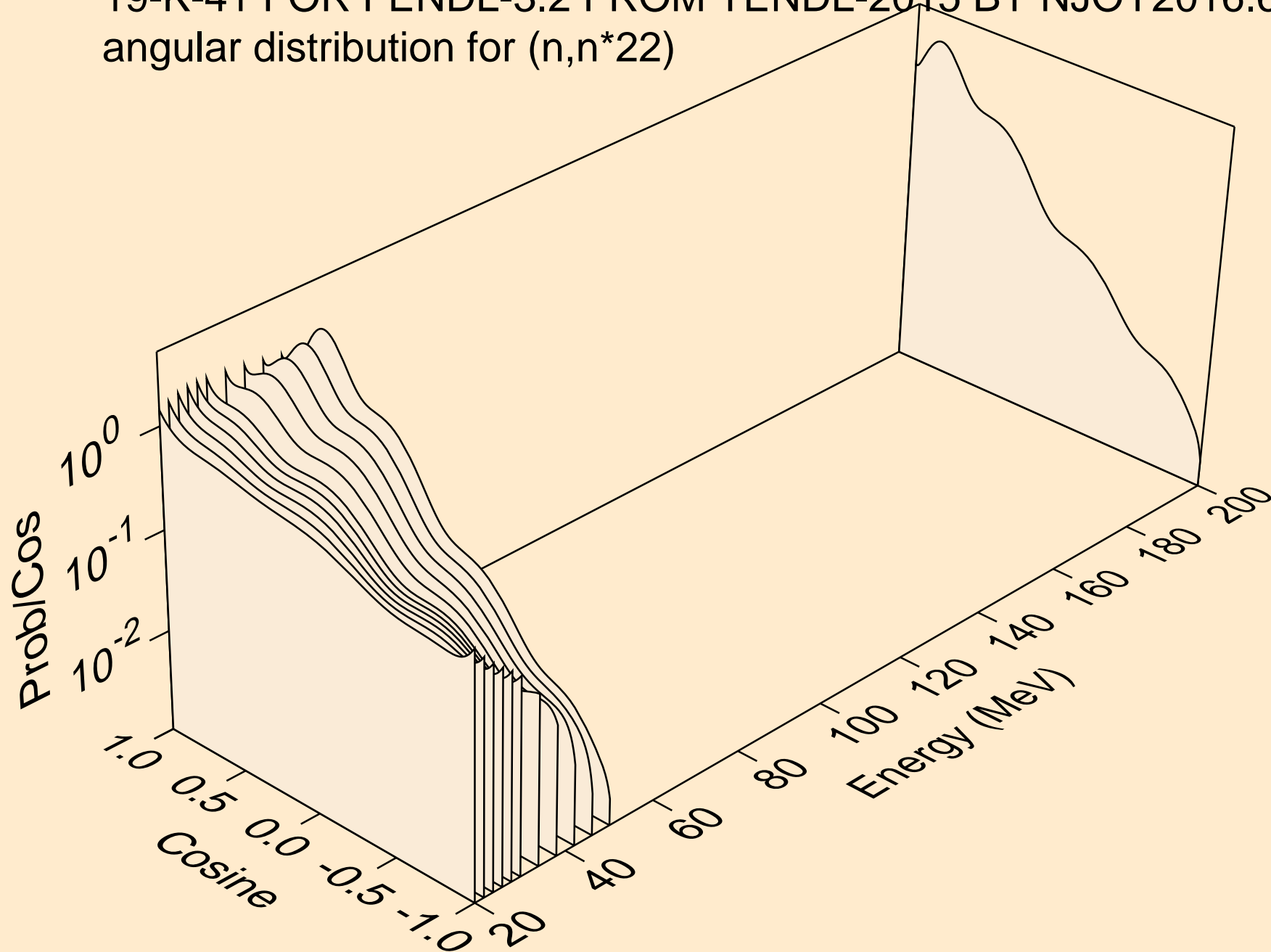

19-K-41 FOR FENDL-3.2 FROM TENDL-2015 BY NJOY2016.60+ O
angular distribution for (n,n*23)

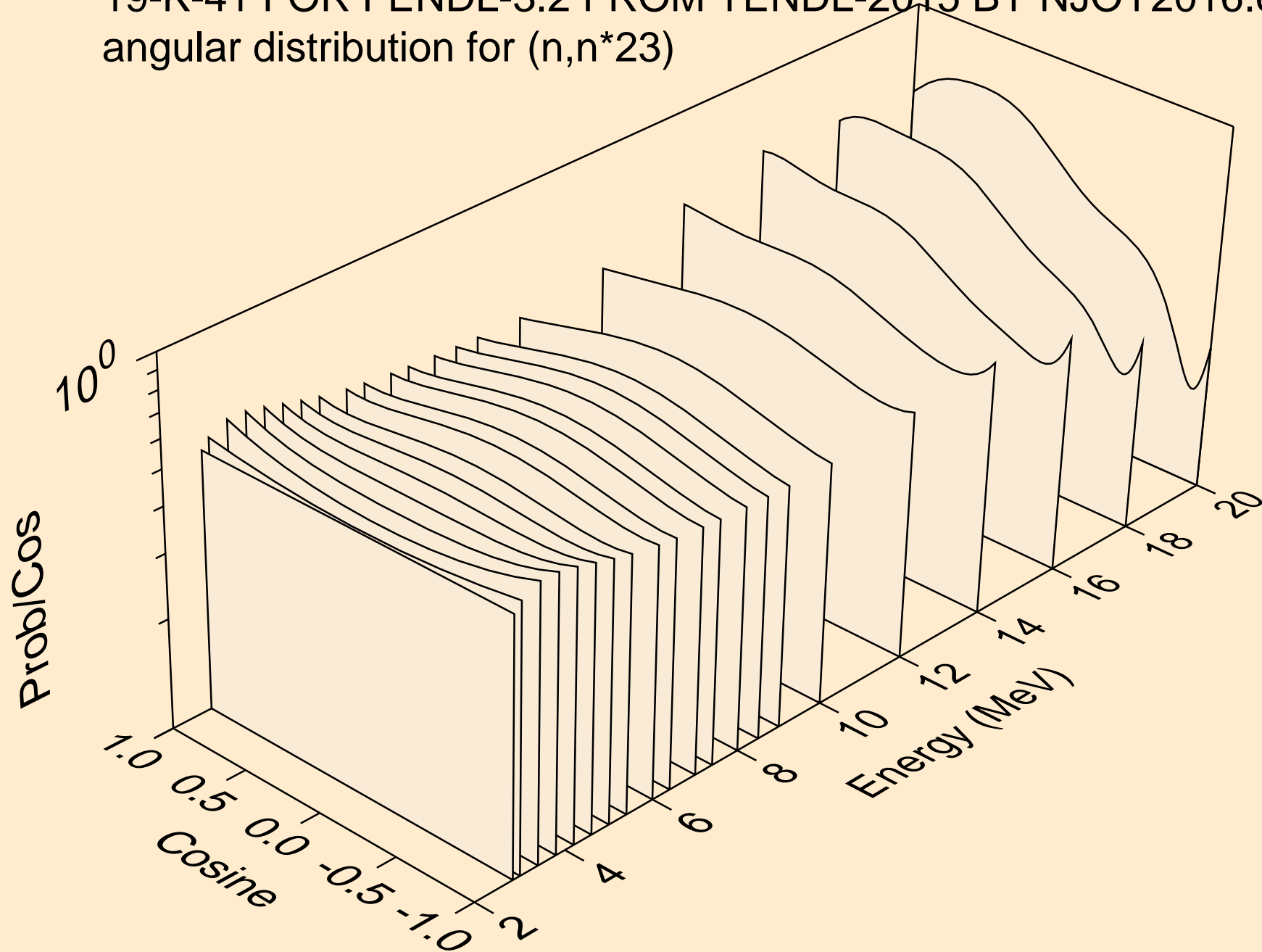

19-K-41 FOR FENDL-3.2 FROM TENDL-2015 BY NJOY2016.60+ O
angular distribution for (n,n*23)

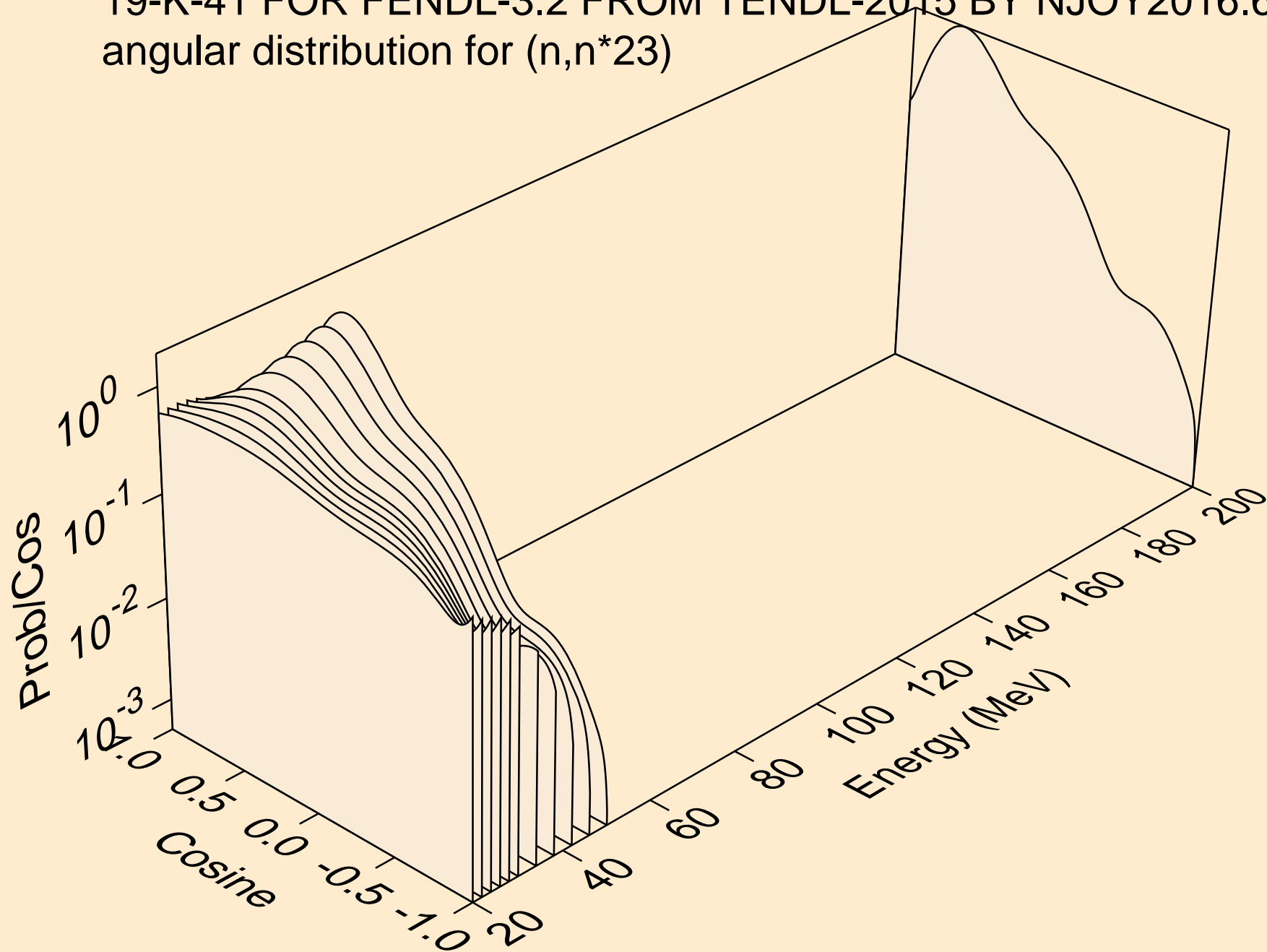

19-K-41 FOR FENDL-3.2 FROM TENDL-2015 BY NJOY2016.60+ O
angular distribution for (n,n*24)

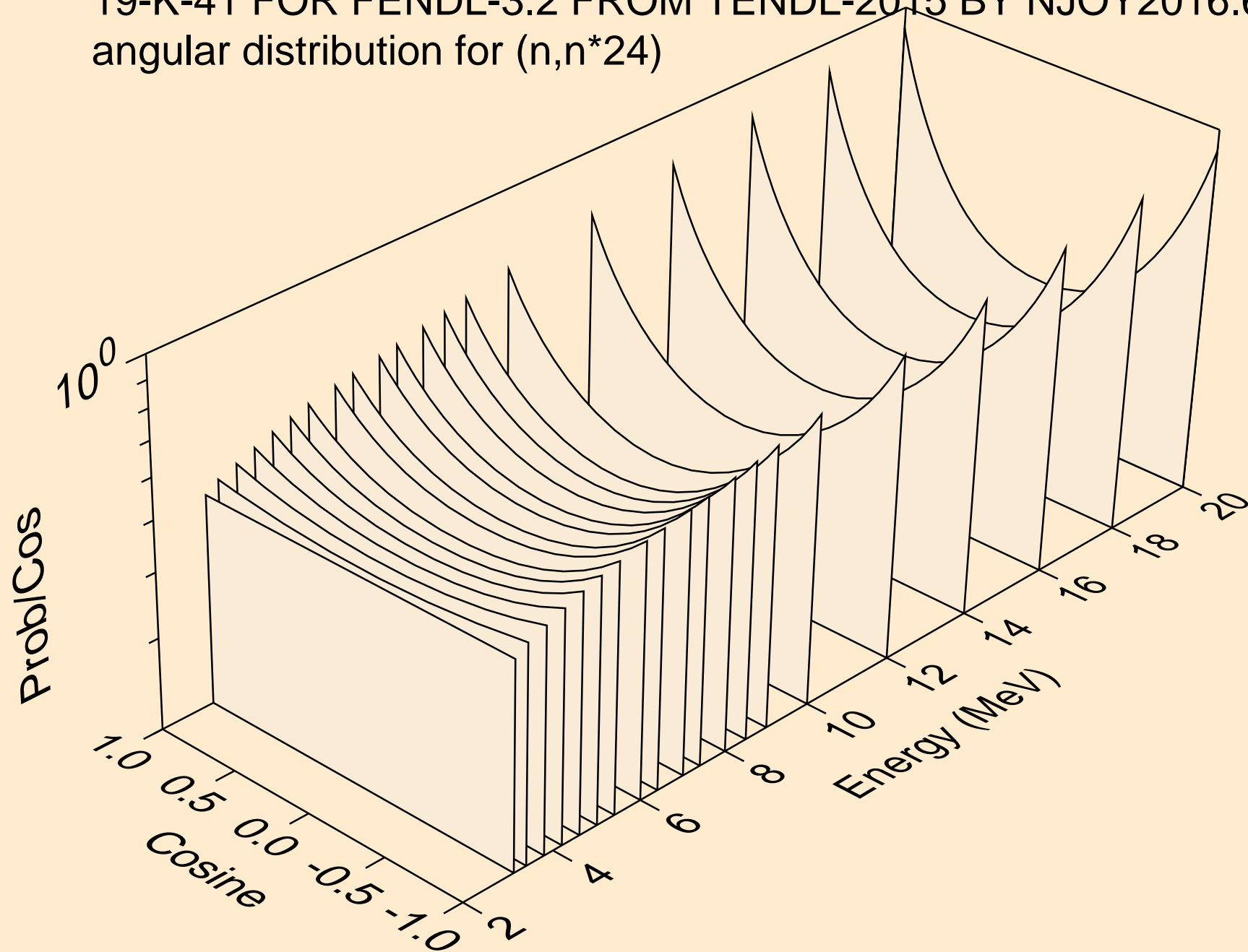

19-K-41 FOR FENDL-3.2 FROM TENDL-2015 BY NJOY2016.60+ O
angular distribution for (n,n*24)

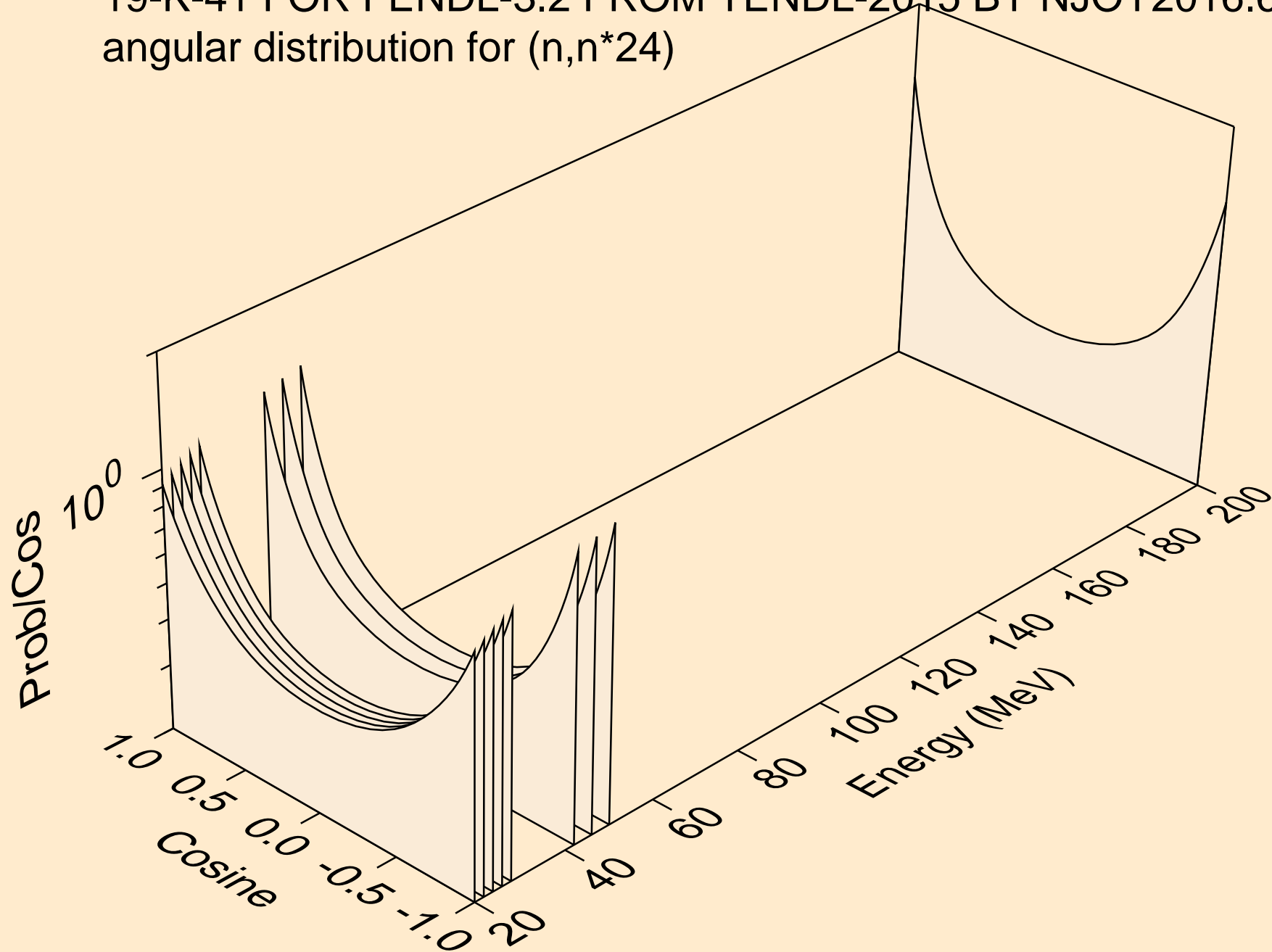

19-K-41 FOR FENDL-3.2 FROM TENDL-2015 BY NJOY2016.60+ O
angular distribution for (n,n*25)

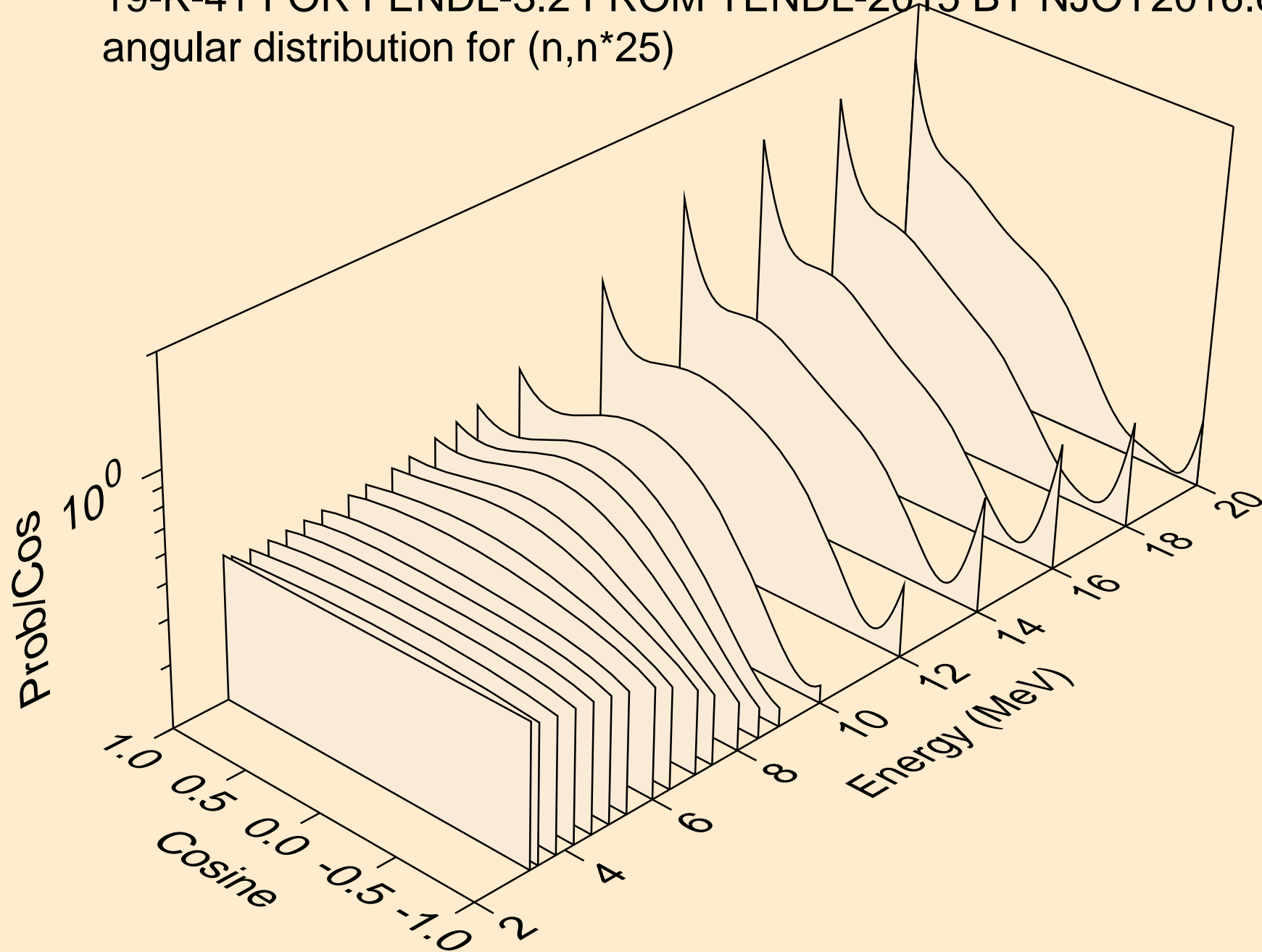

19-K-41 FOR FENDL-3.2 FROM TENDL-2015 BY NJOY2016.60+ O
angular distribution for (n,n*25)

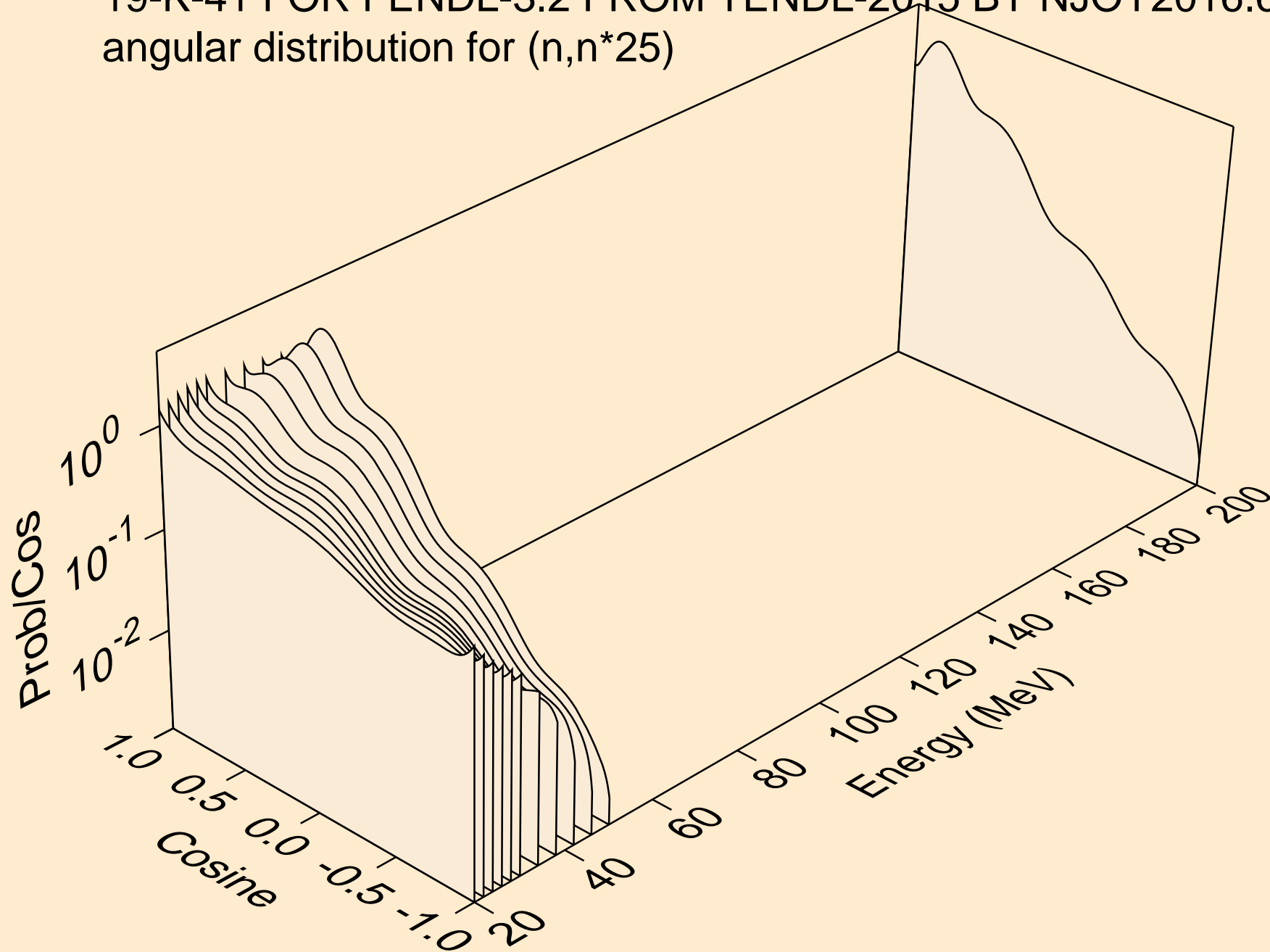

19-K-41 FOR FENDL-3.2 FROM TENDL-2015 BY NJOY2016.60+ O
angular distribution for (n,n*26)

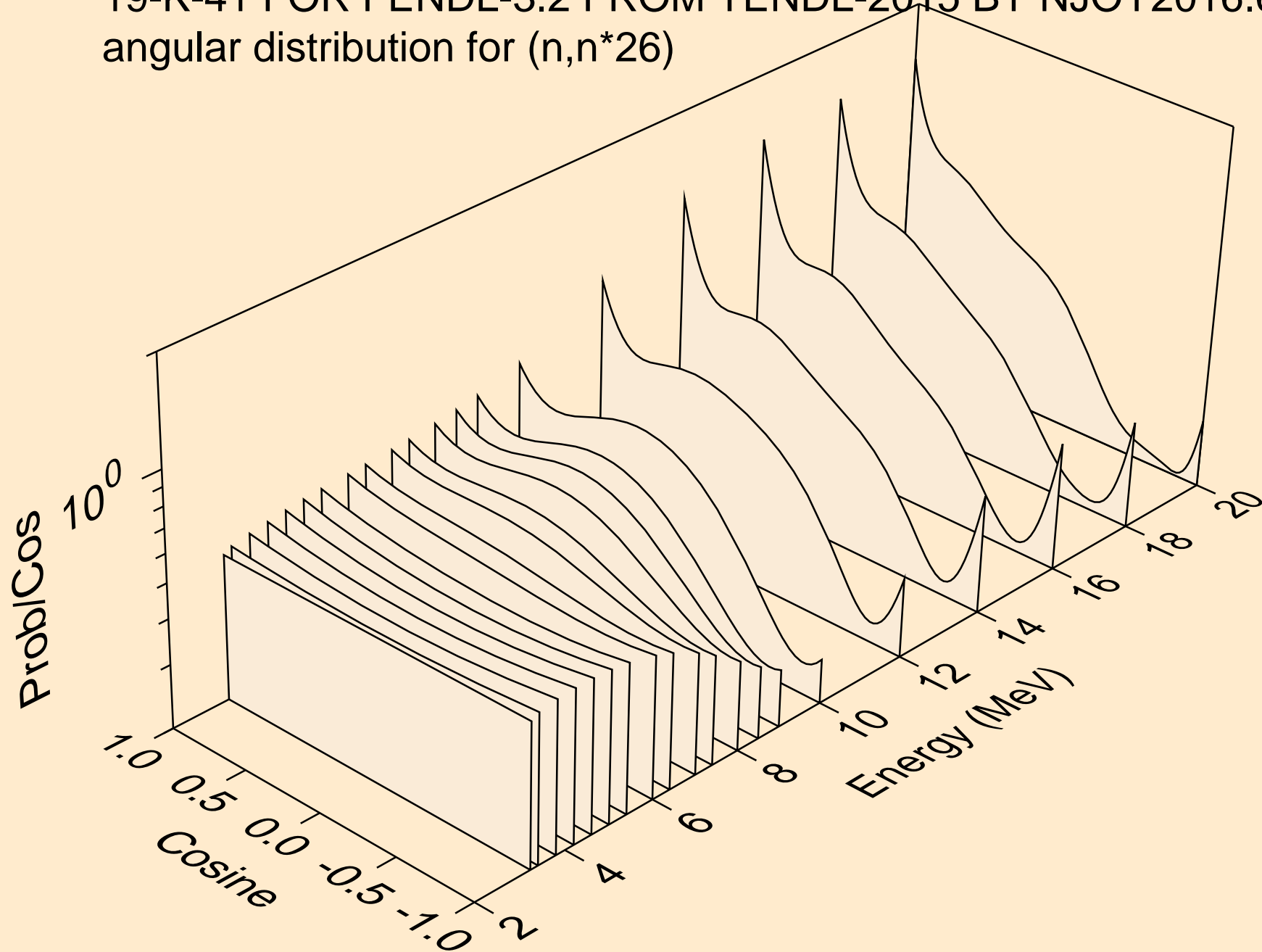

19-K-41 FOR FENDL-3.2 FROM TENDL-2015 BY NJOY2016.60+ O
angular distribution for (n,n*26)

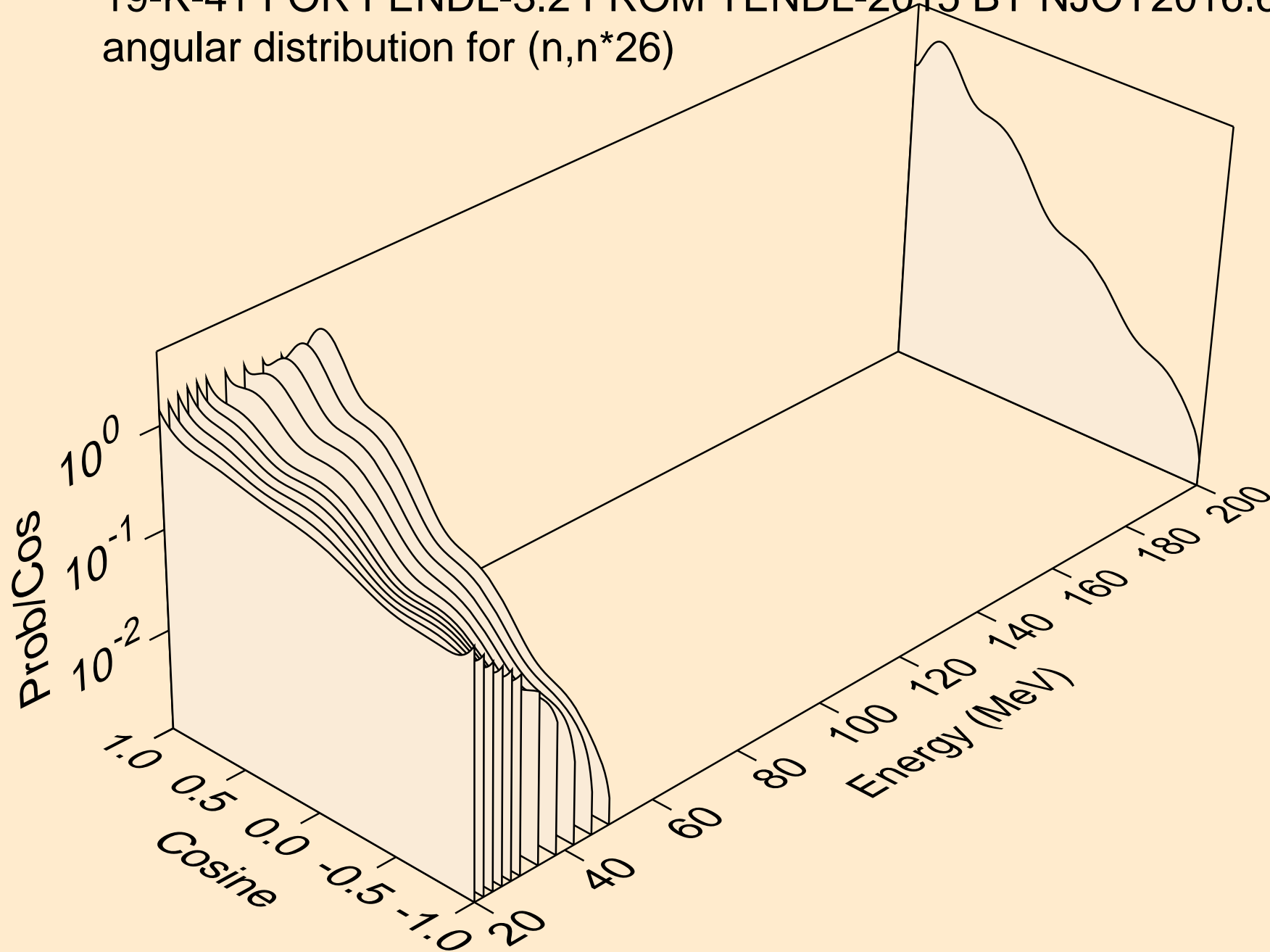

19-K-41 FOR FENDL-3.2 FROM TENDL-2015 BY NJOY2016.60+ O
angular distribution for (n,n*27)

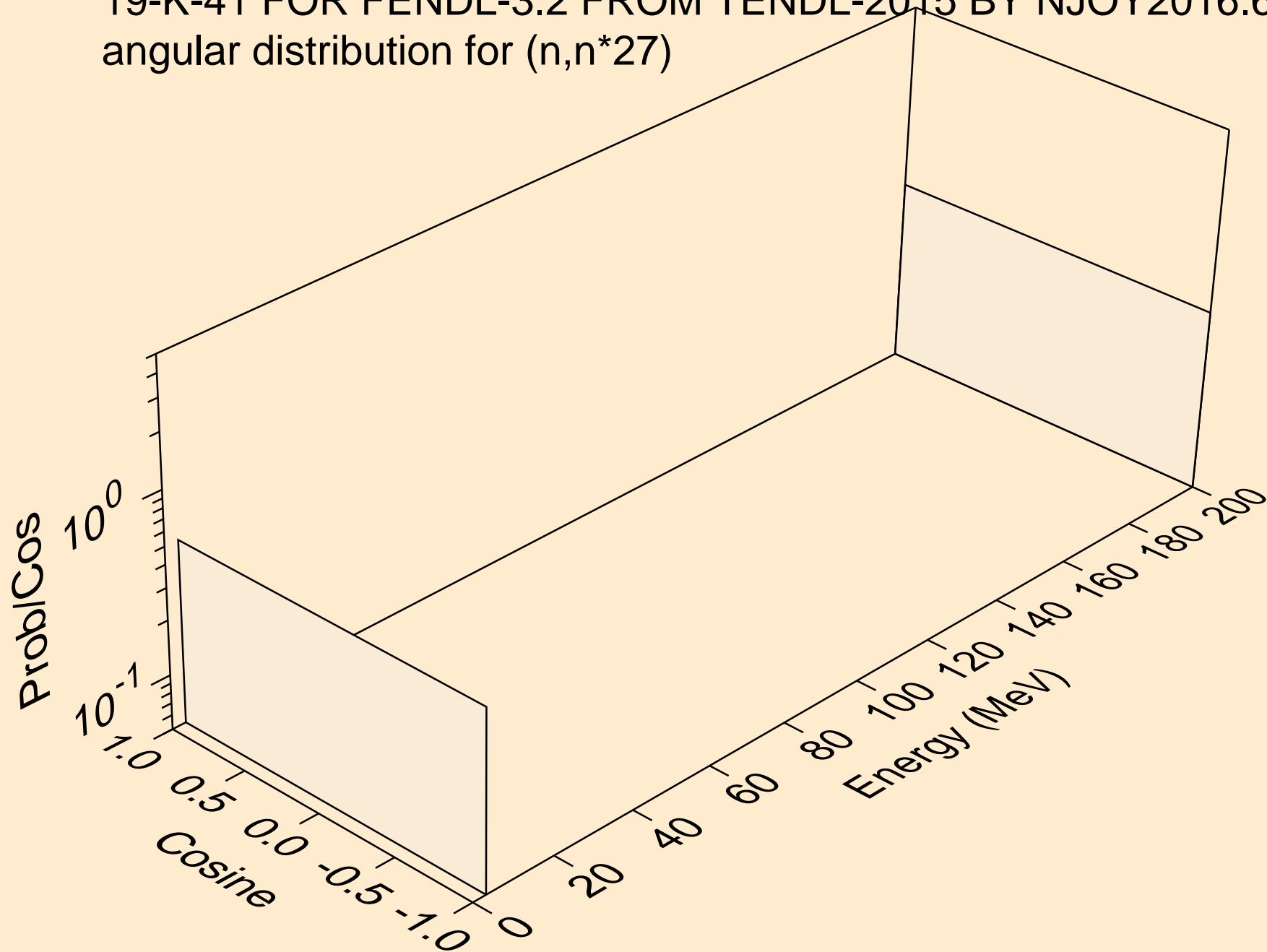

19-K-41 FOR FENDL-3.2 FROM TENDL-2015 BY NJOY2016.60+ O
angular distribution for (n,n*28)

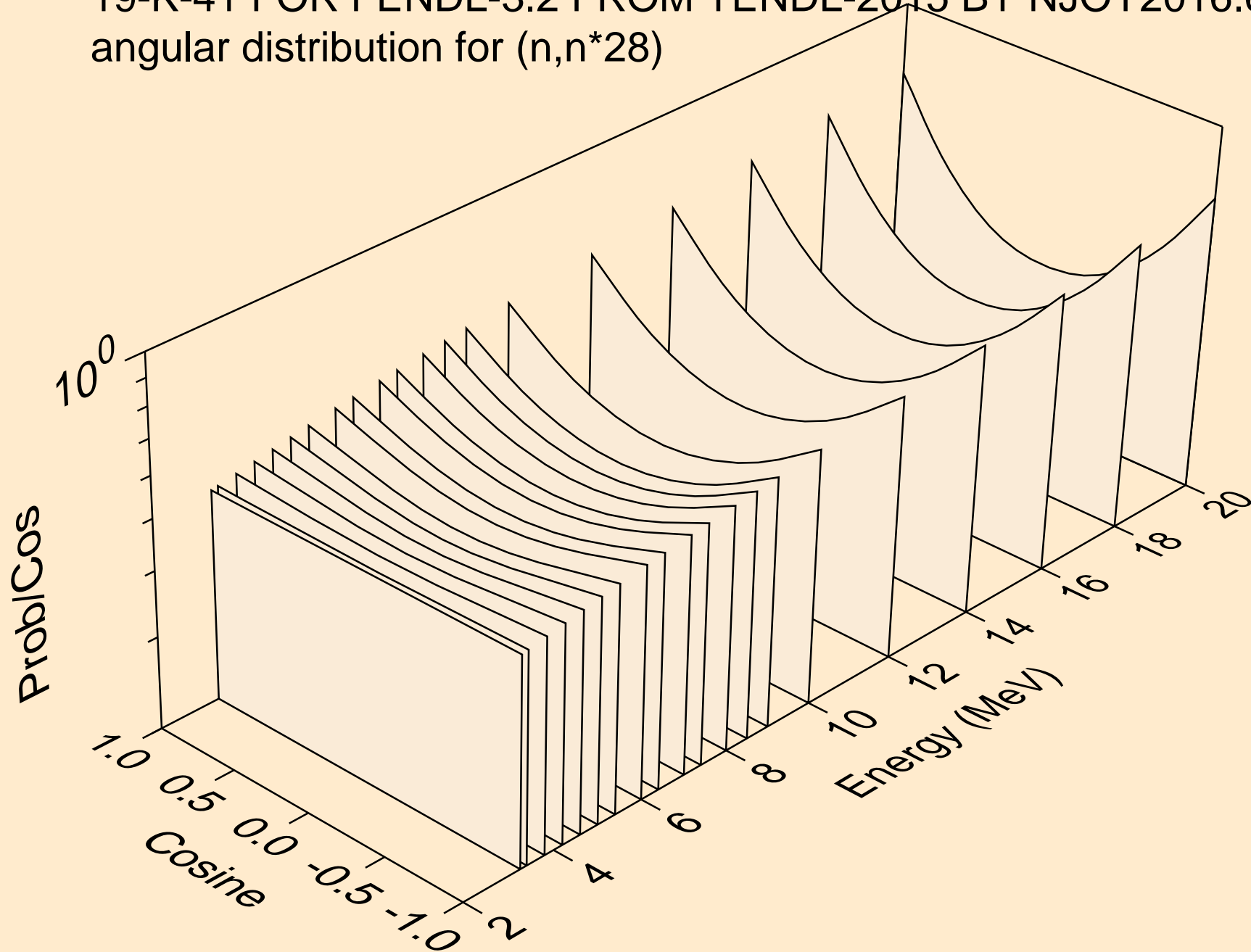

19-K-41 FOR FENDL-3.2 FROM TENDL-2015 BY NJOY2016.60+ O
angular distribution for (n,n*28)

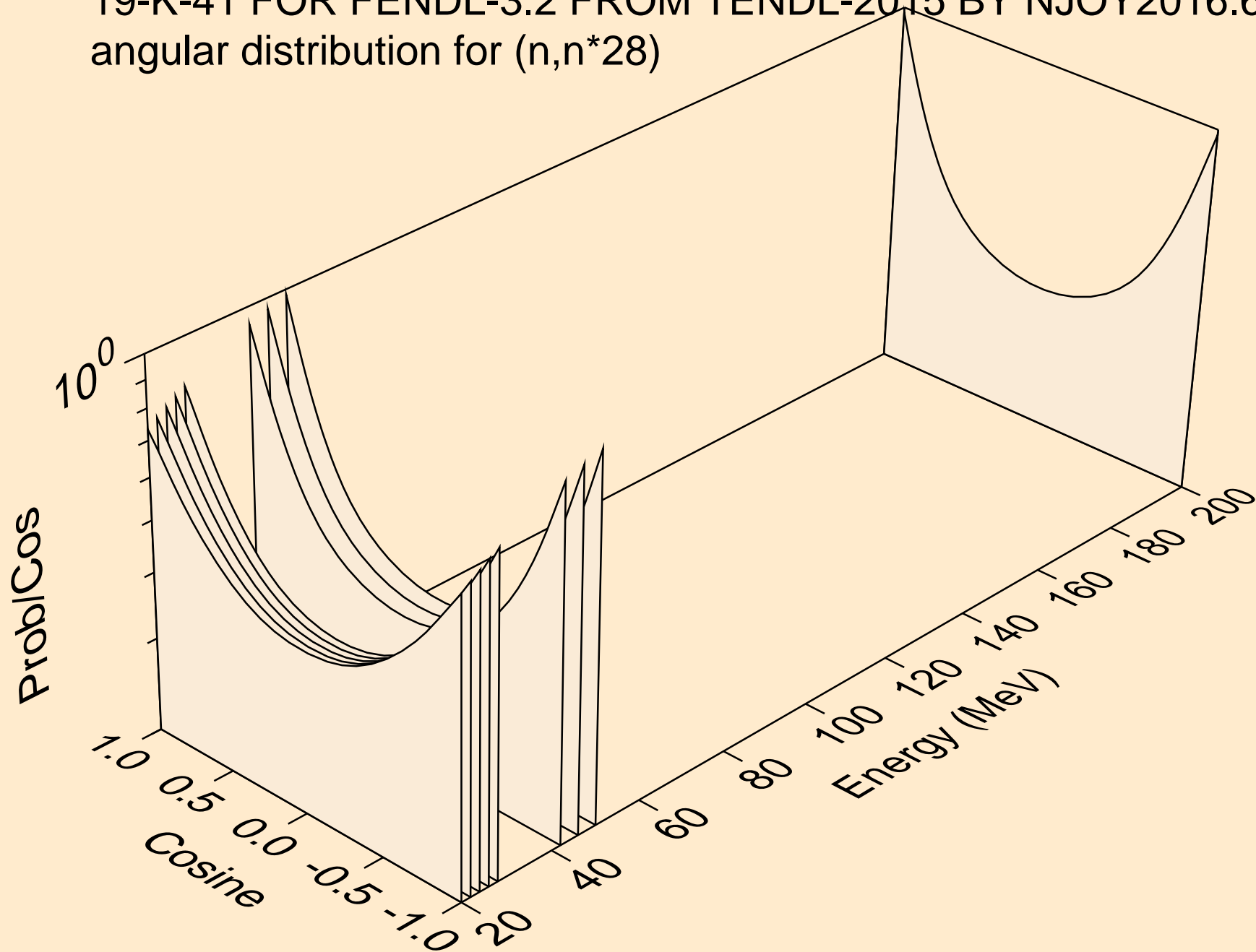

19-K-41 FOR FENDL-3.2 FROM TENDL-2015 BY NJOY2016.60+ O
angular distribution for (n,n*29)

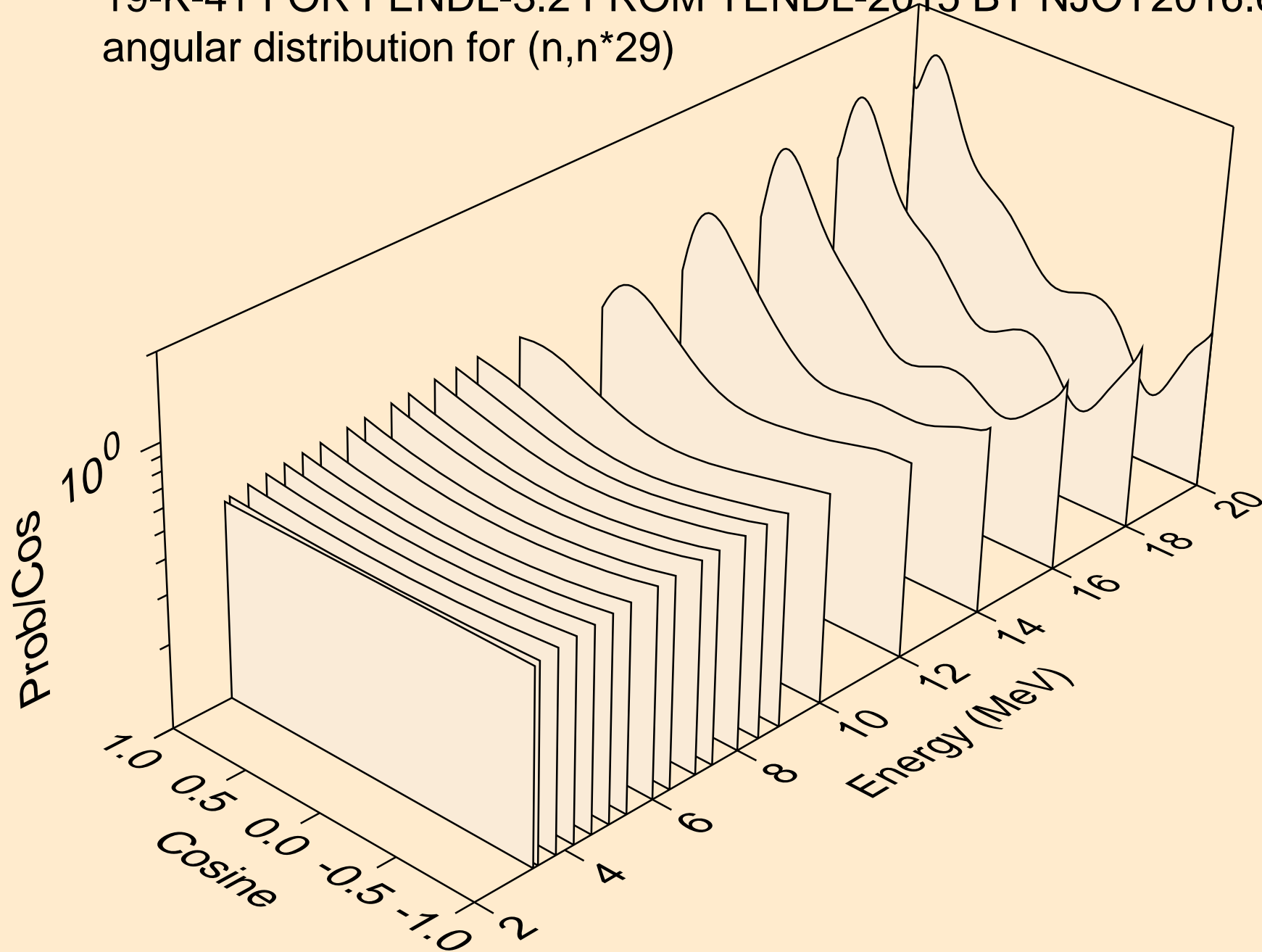

19-K-41 FOR FENDL-3.2 FROM TENDL-2015 BY NJOY2016.60+ O
angular distribution for (n,n*29)

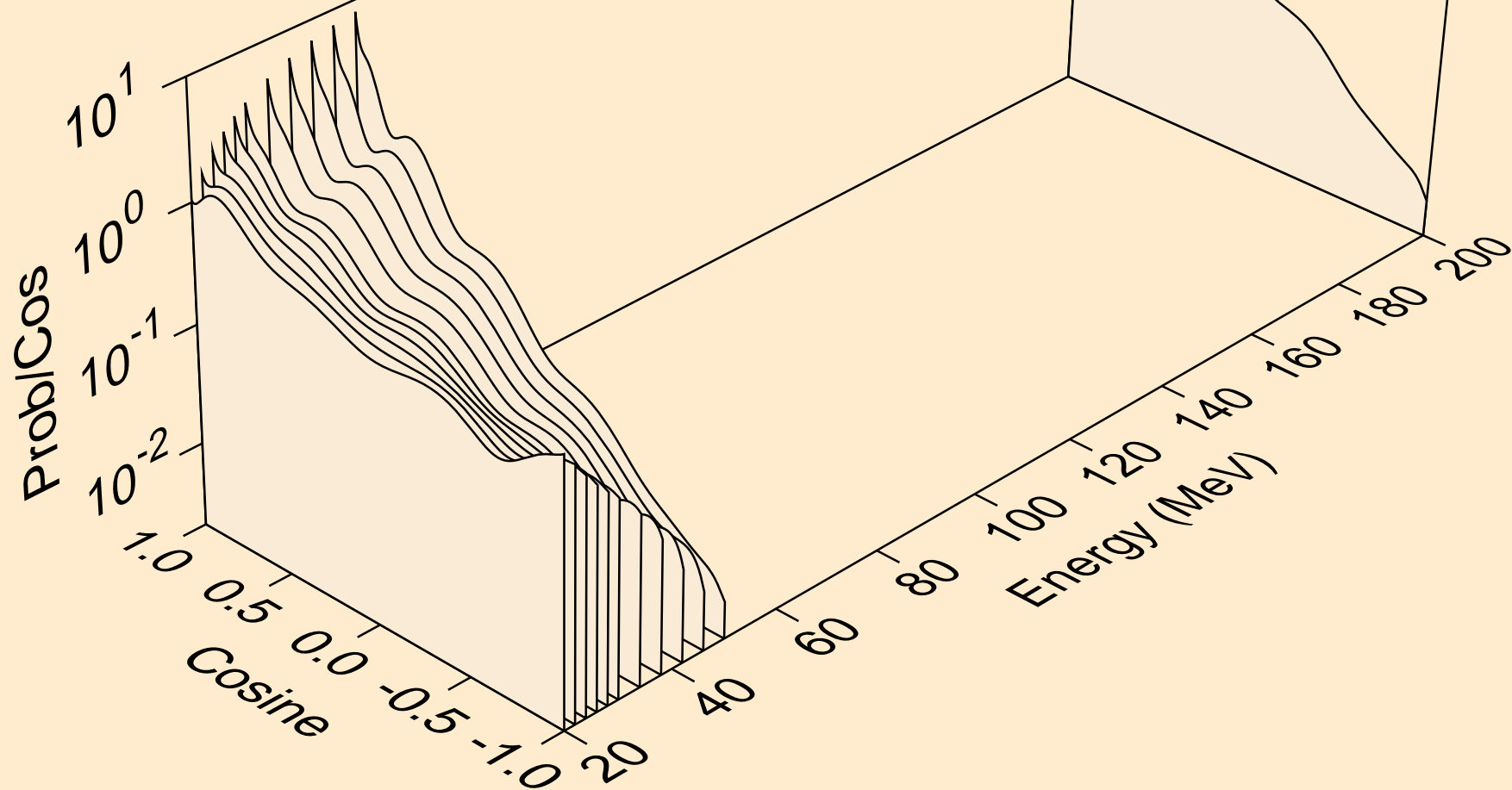

19-K-41 FOR FENDL-3.2 FROM TENDL-2015 BY NJOY2016.60+ O
angular distribution for (n,n*30)

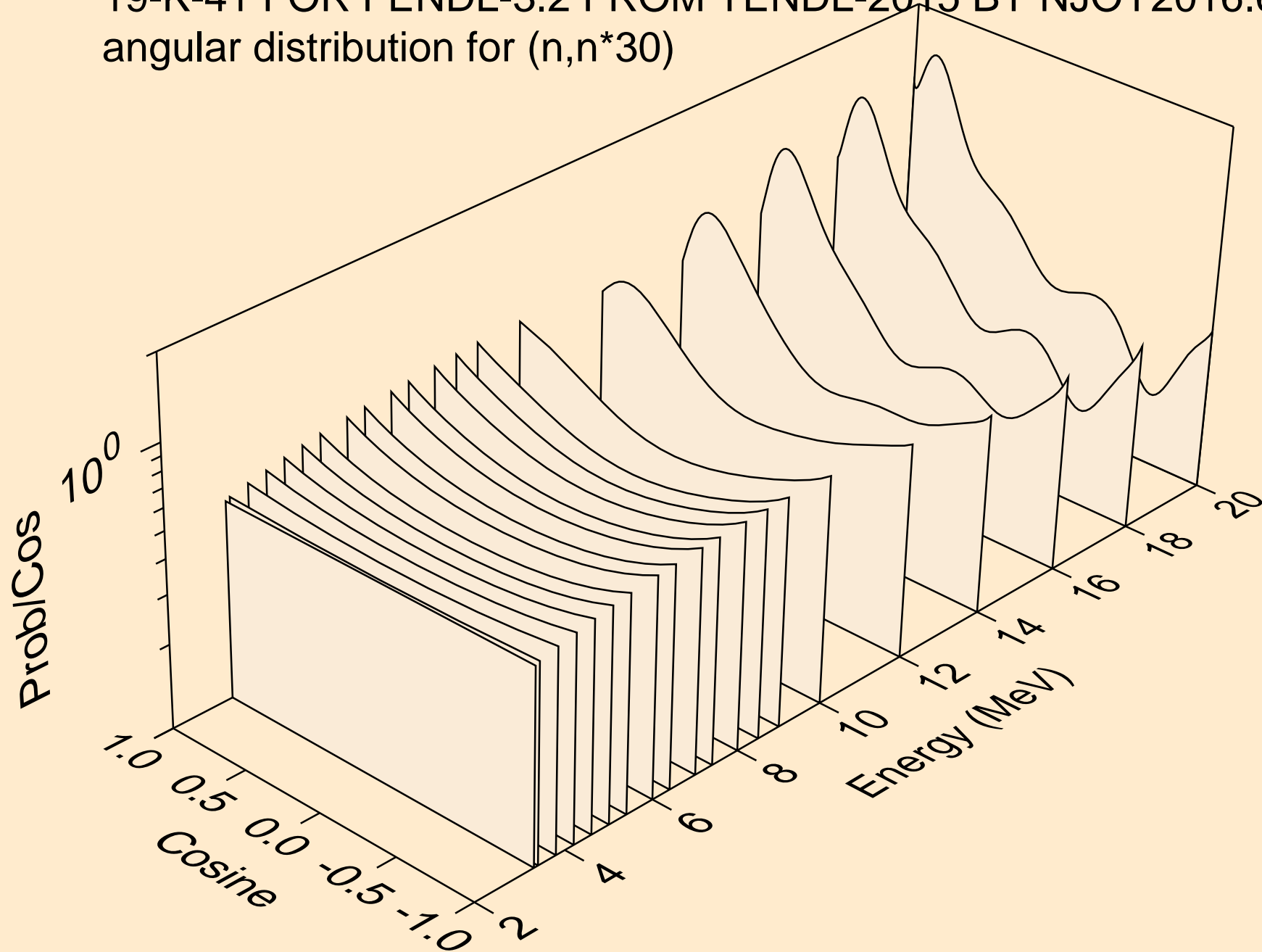

19-K-41 FOR FENDL-3.2 FROM TENDL-2015 BY NJOY2016.60+ O
angular distribution for (n,n*30)

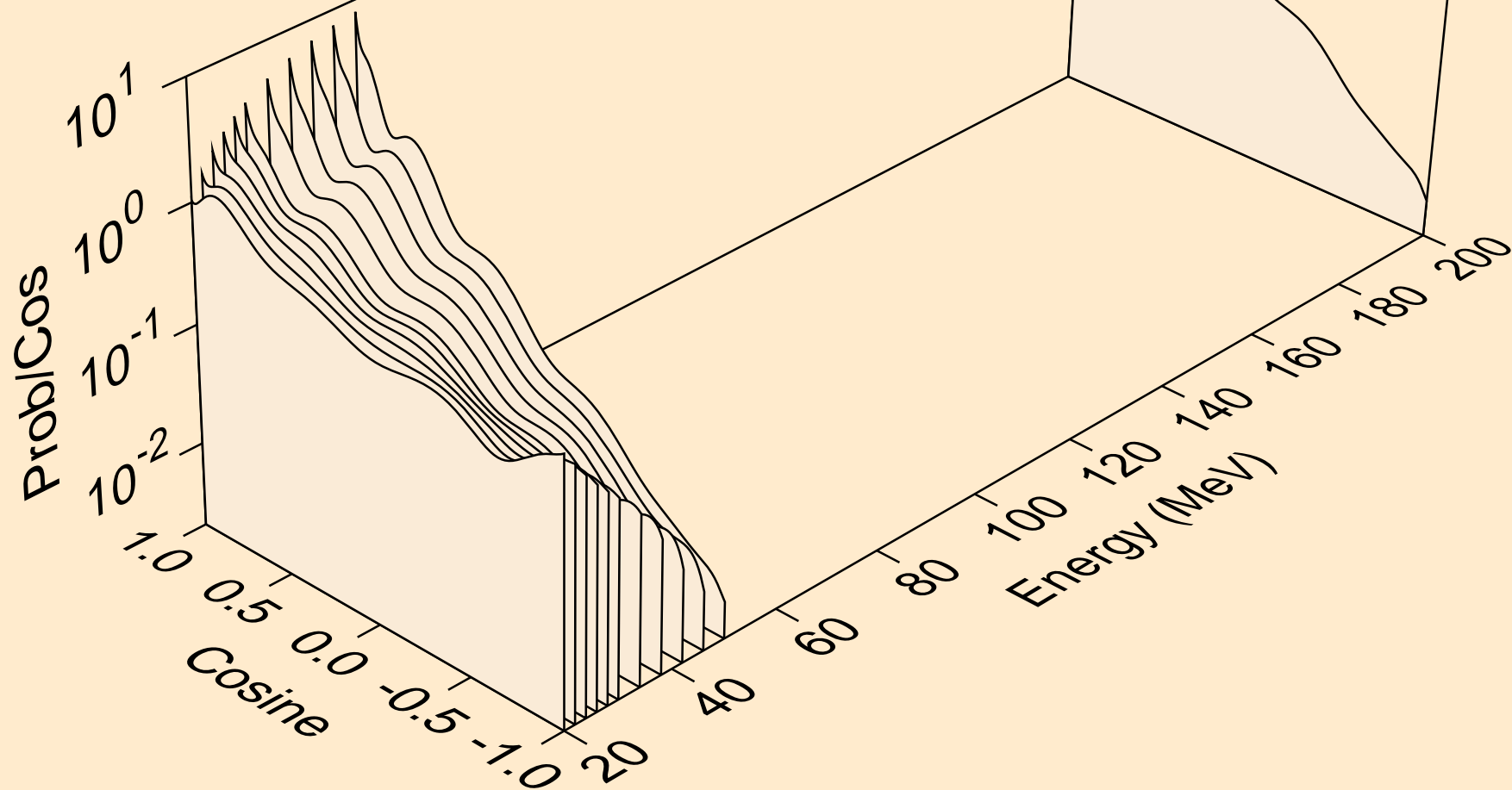

19-K-41 FOR FENDL-3.2 FROM TENDL-2015 BY NJOY2016.60+ O
Neutron emission for (n,x)

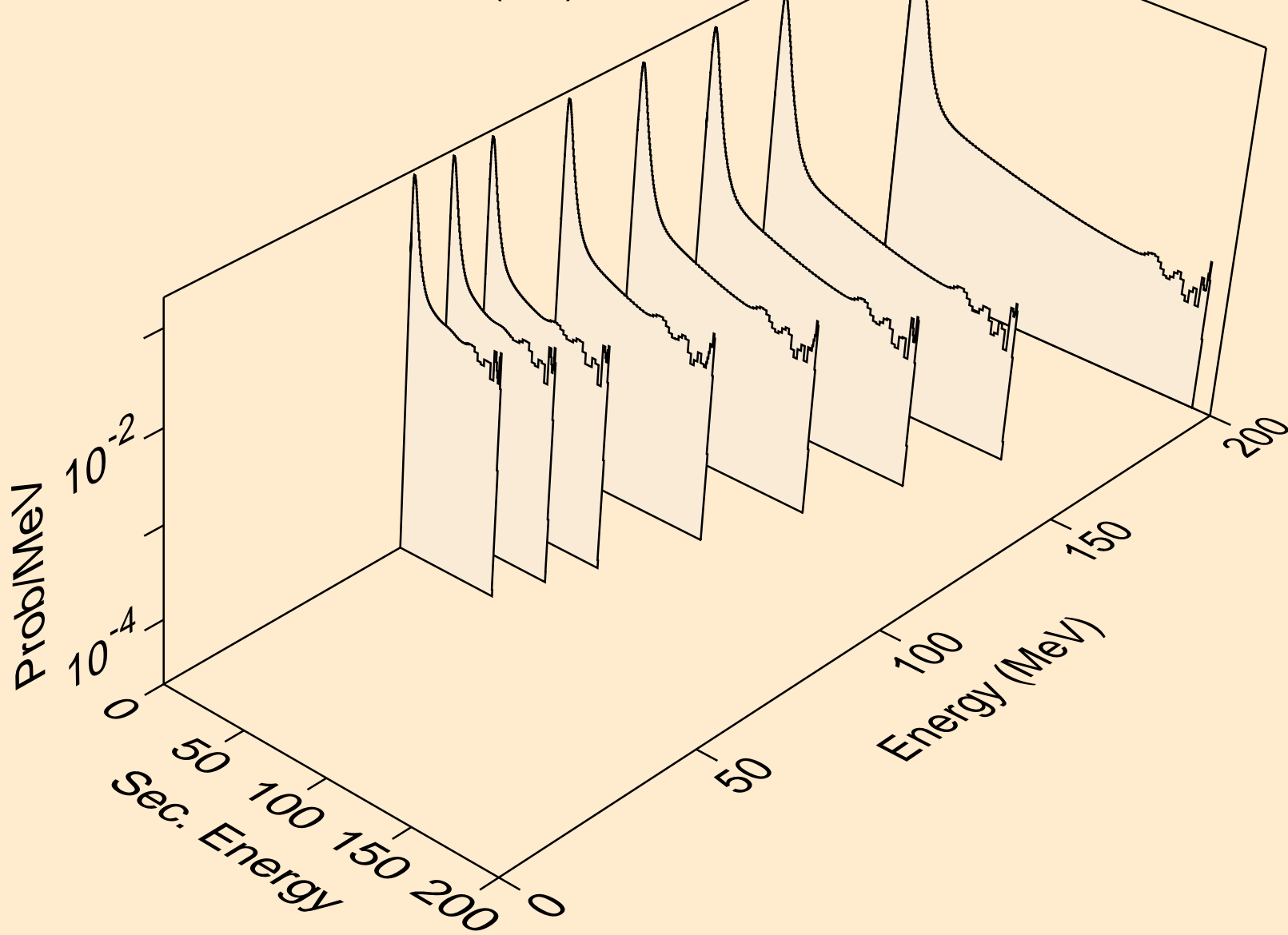

19-K-41 FOR FENDL-3.2 FROM TENDL-2015 BY NJOY2016.60+ O
Neutron emission for (n,2nd)

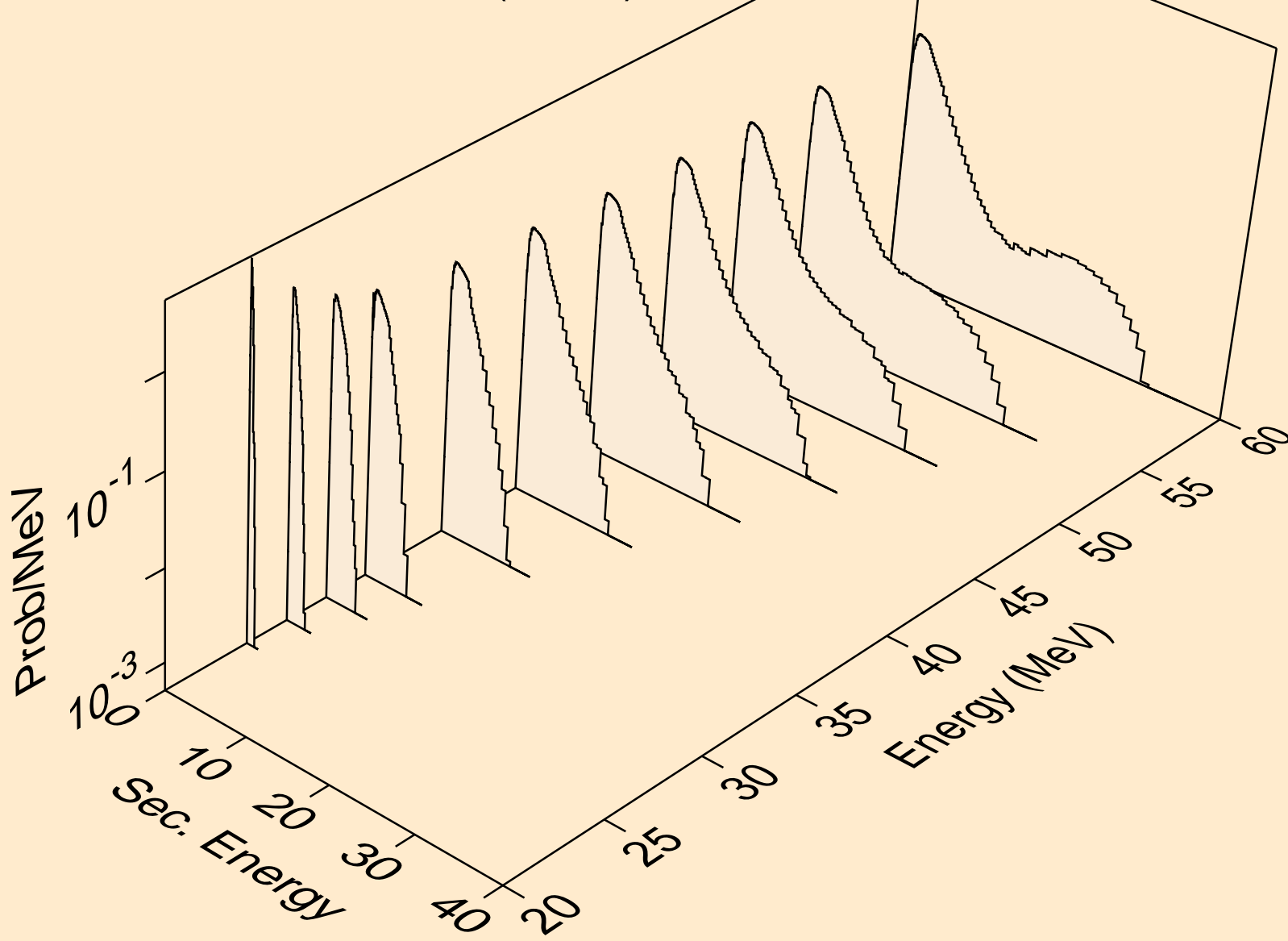

19-K-41 FOR FENDL-3.2 FROM TENDL-2015 BY NJOY2016.60+ O
Neutron emission for (n,2n)

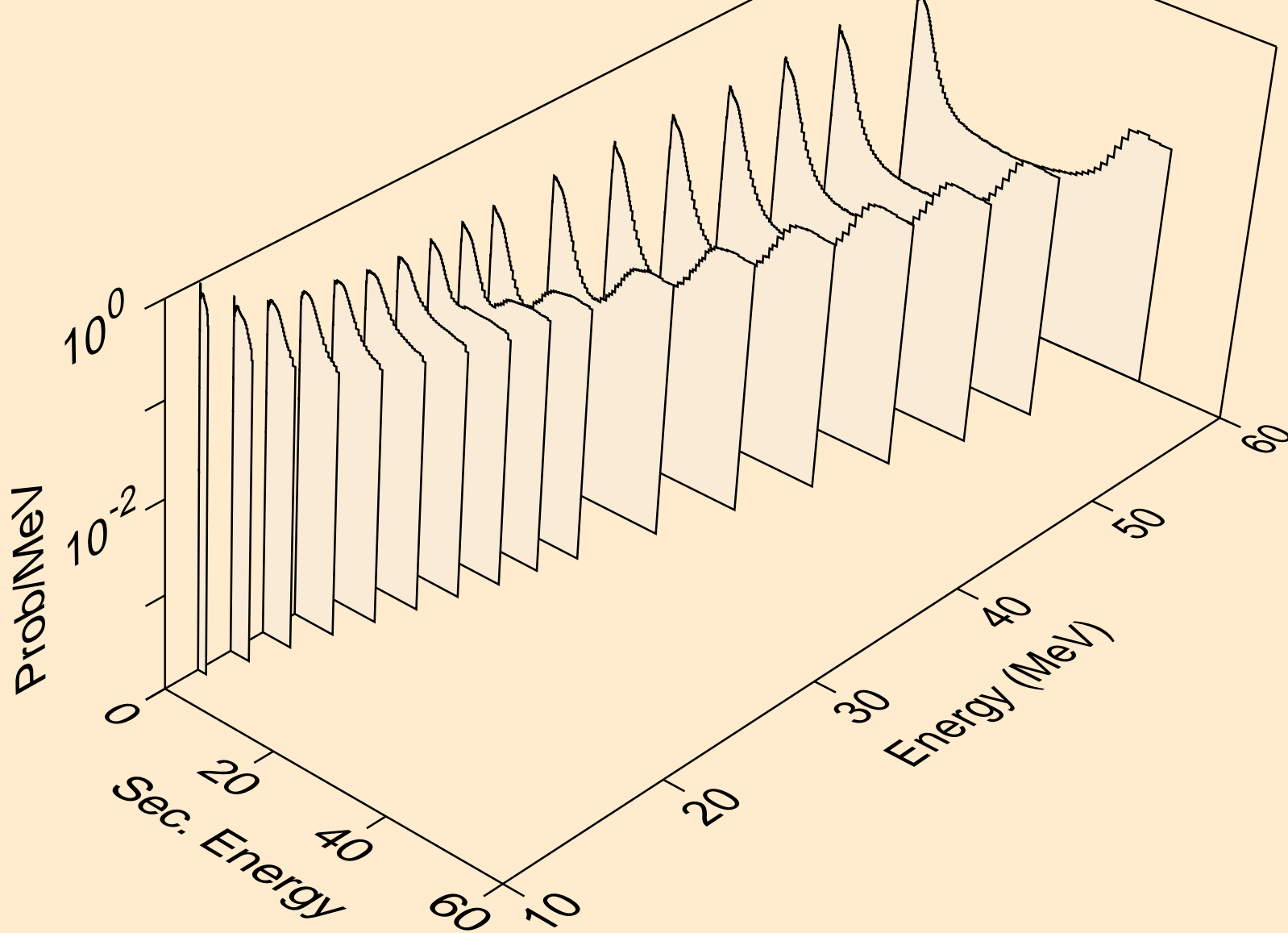

19-K-41 FOR FENDL-3.2 FROM TENDL-2015 BY NJOY2016.60+ O
Neutron emission for (n,3n)

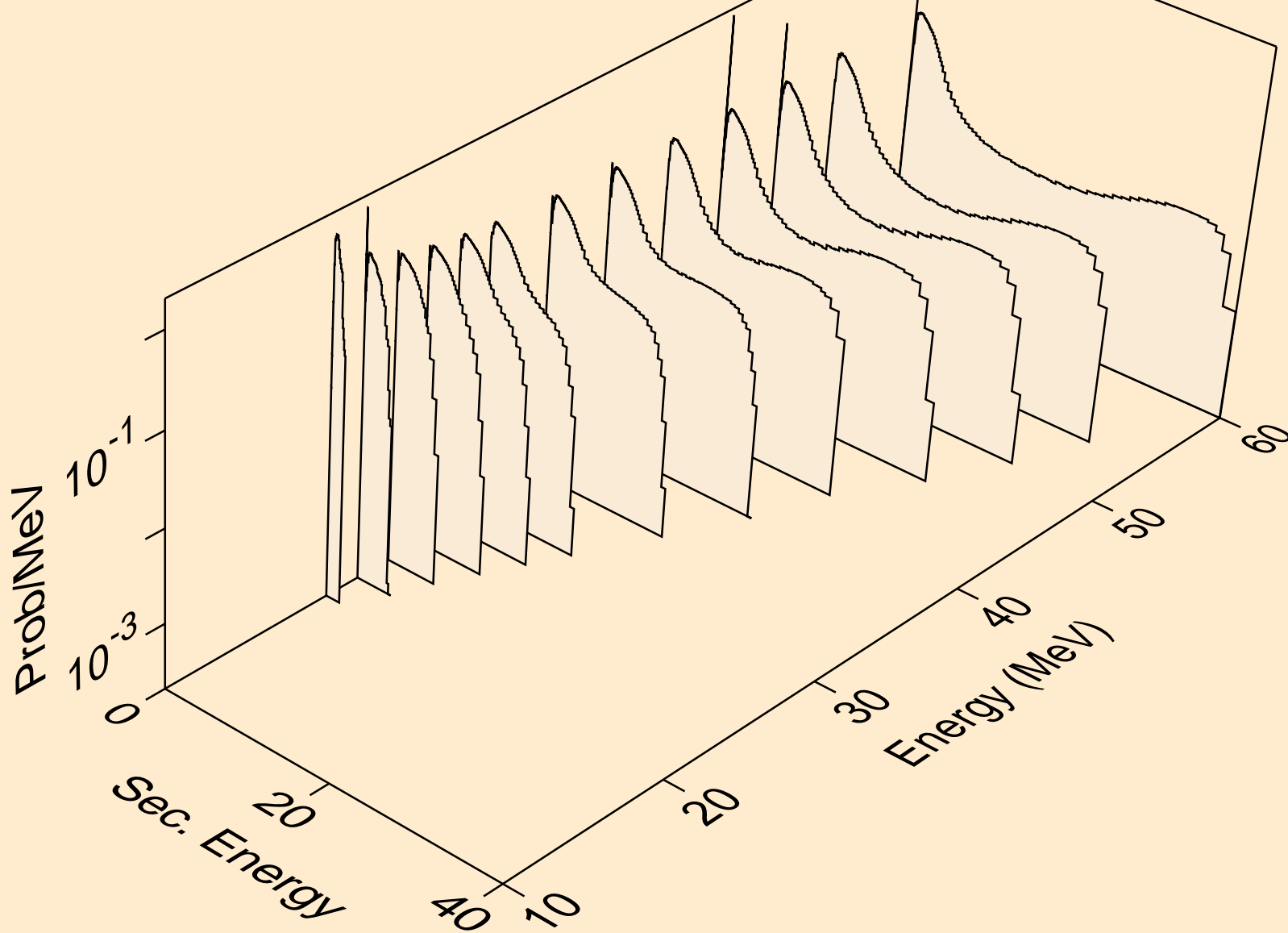

19-K-41 FOR FENDL-3.2 FROM TENDL-2015 BY NJOY2016.60+ O
Neutron emission for (n,n*)a

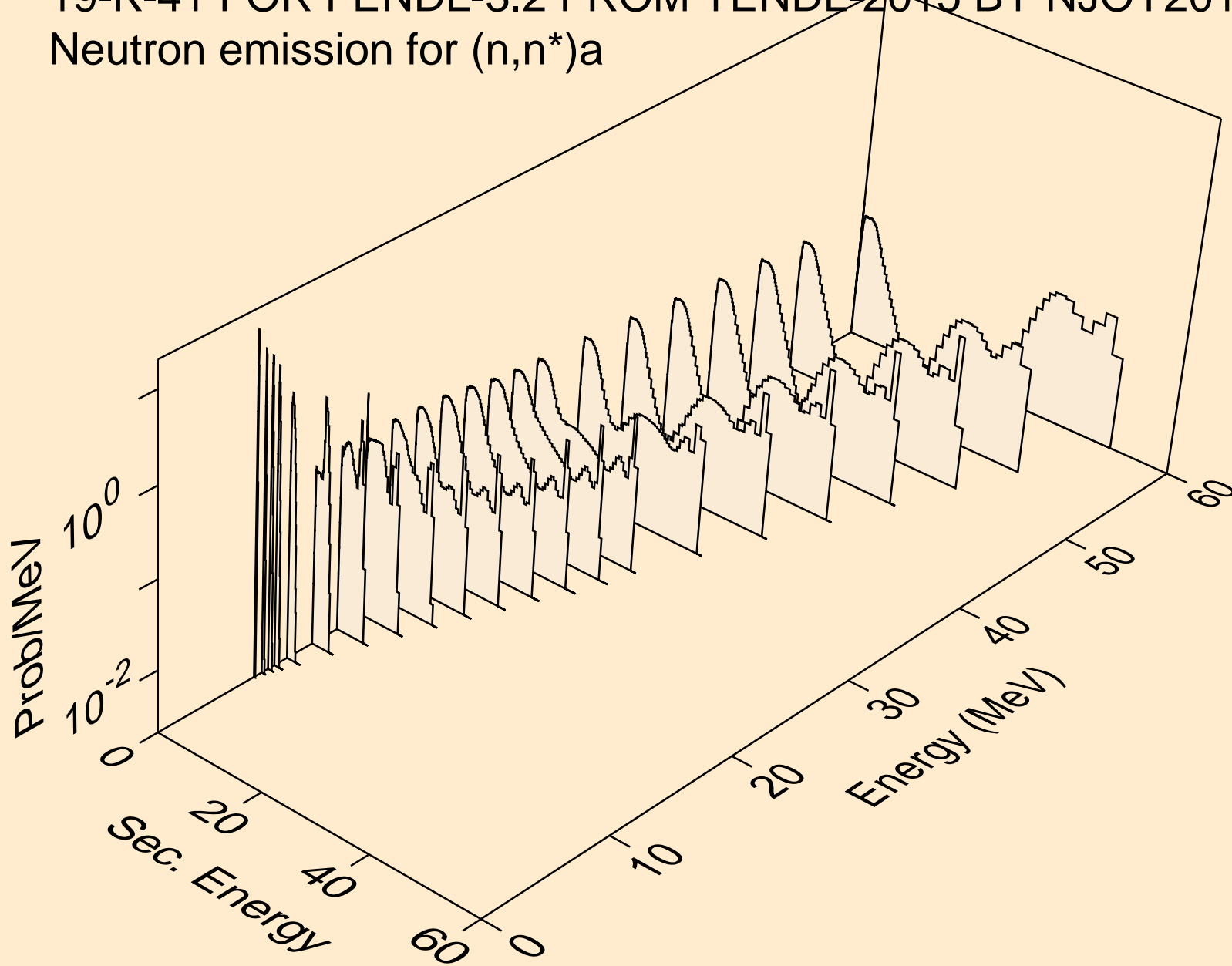

19-K-41 FOR FENDL-3.2 FROM TENDL-2015 BY NJOY2016.60+ O
Neutron emission for (n,n*)3a

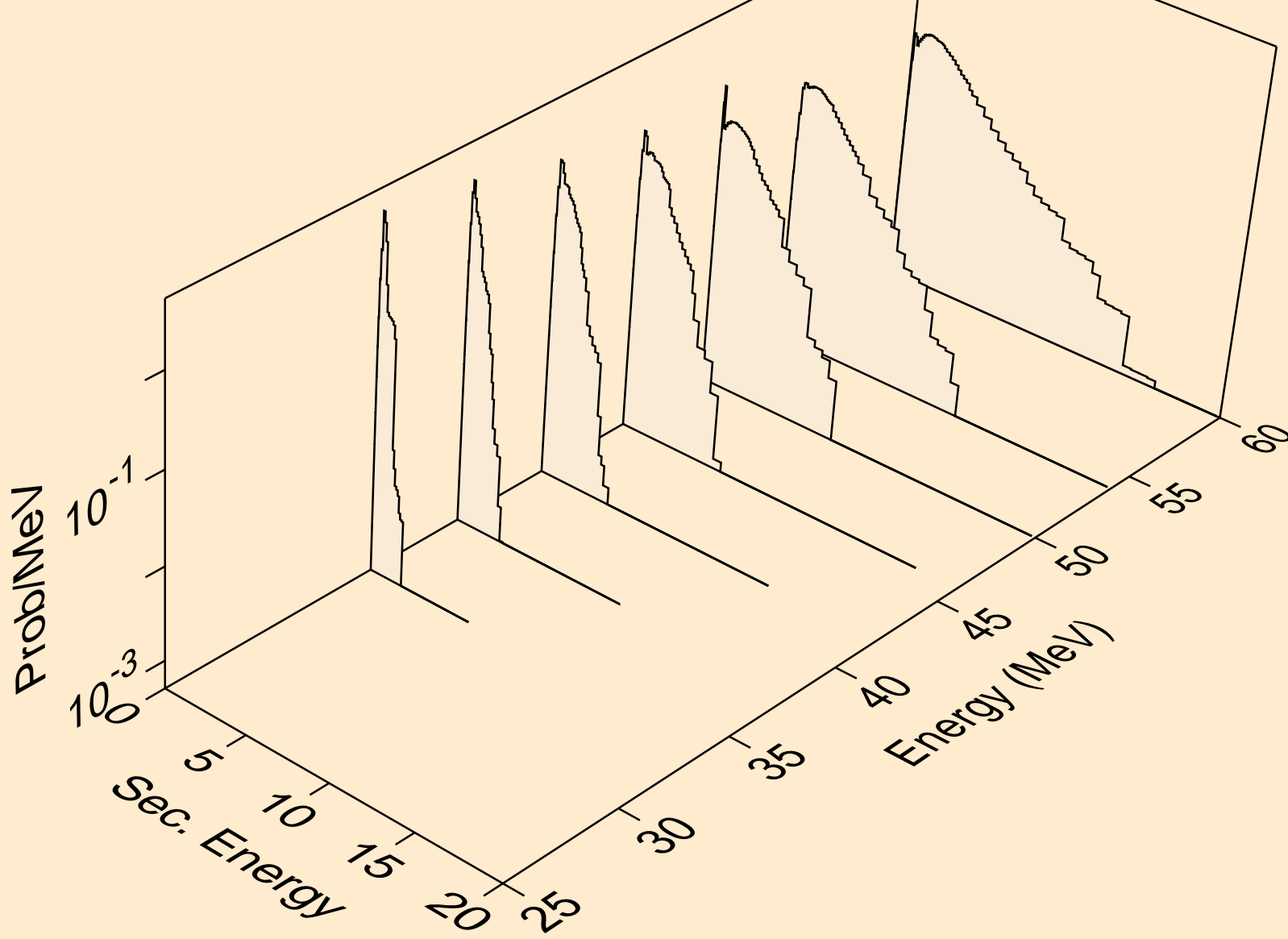

19-K-41 FOR FENDL-3.2 FROM TENDL-2015 BY NJOY2016.60+ O
Neutron emission for (n,2n)a

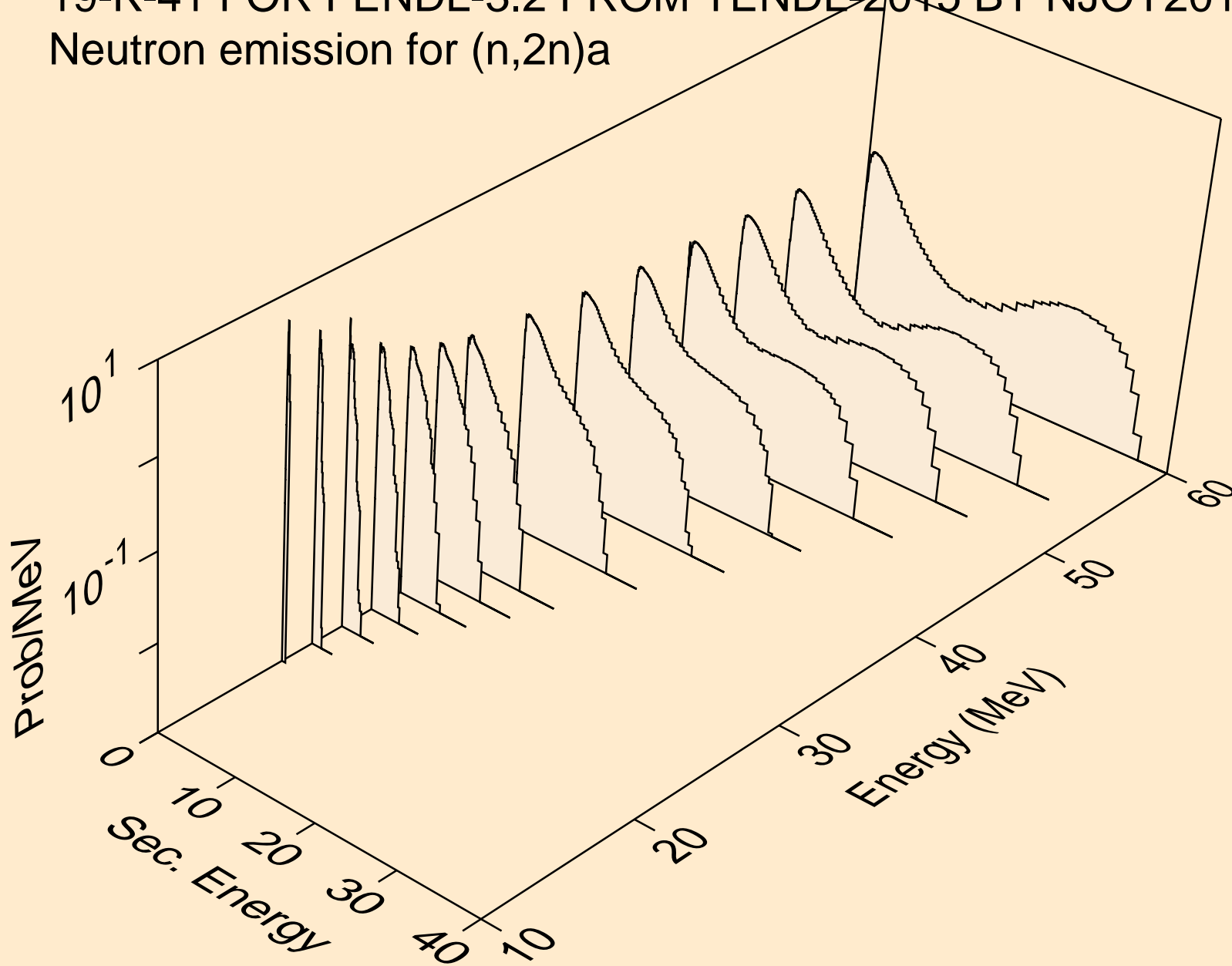

19-K-41 FOR FENDL-3.2 FROM TENDL-2015 BY NJOY2016.60+ O
Neutron emission for (n,3n)a

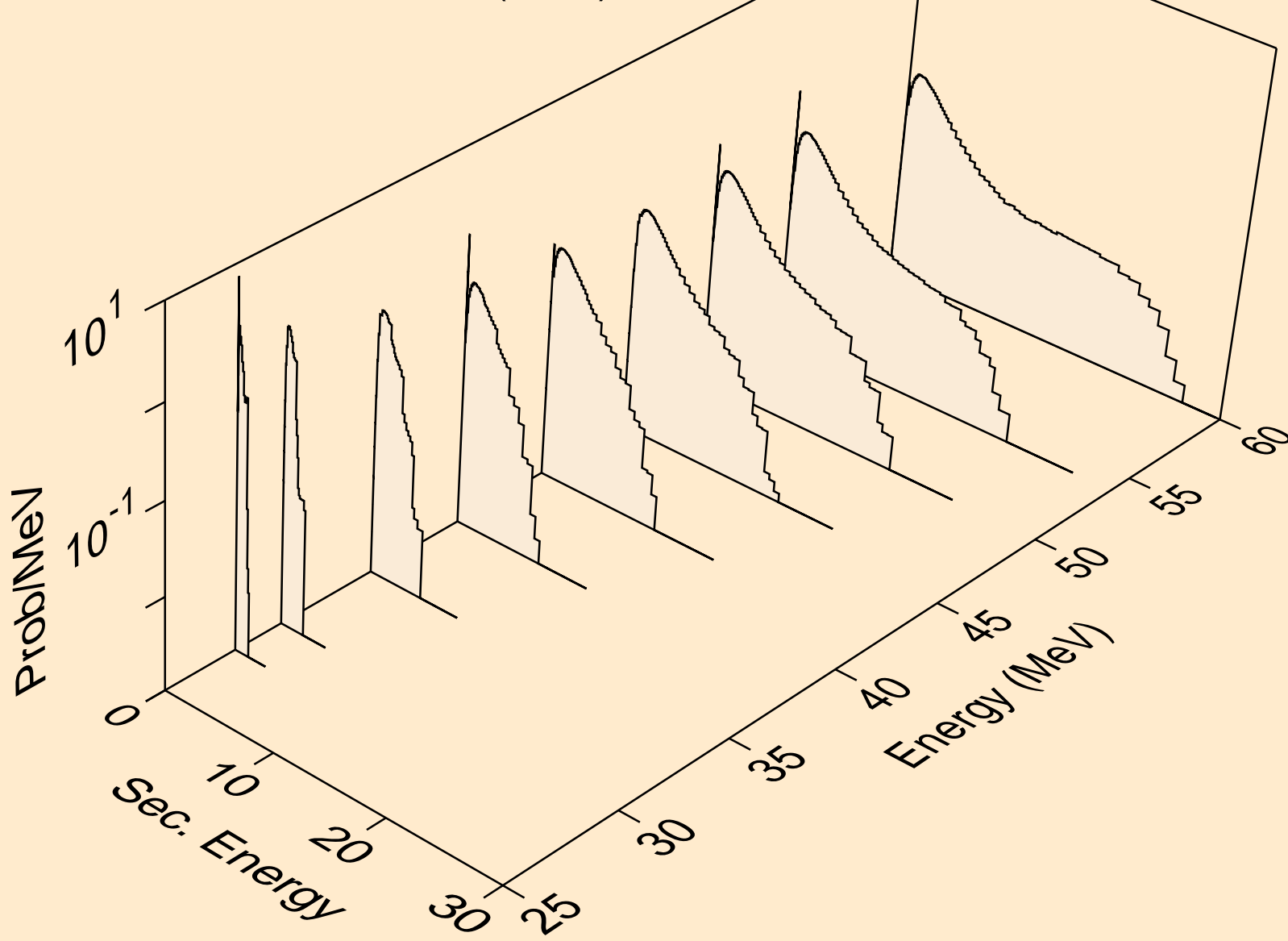

19-K-41 FOR FENDL-3.2 FROM TENDL-2015 BY NJOY2016.60+ O
Neutron emission for (n,n*)p

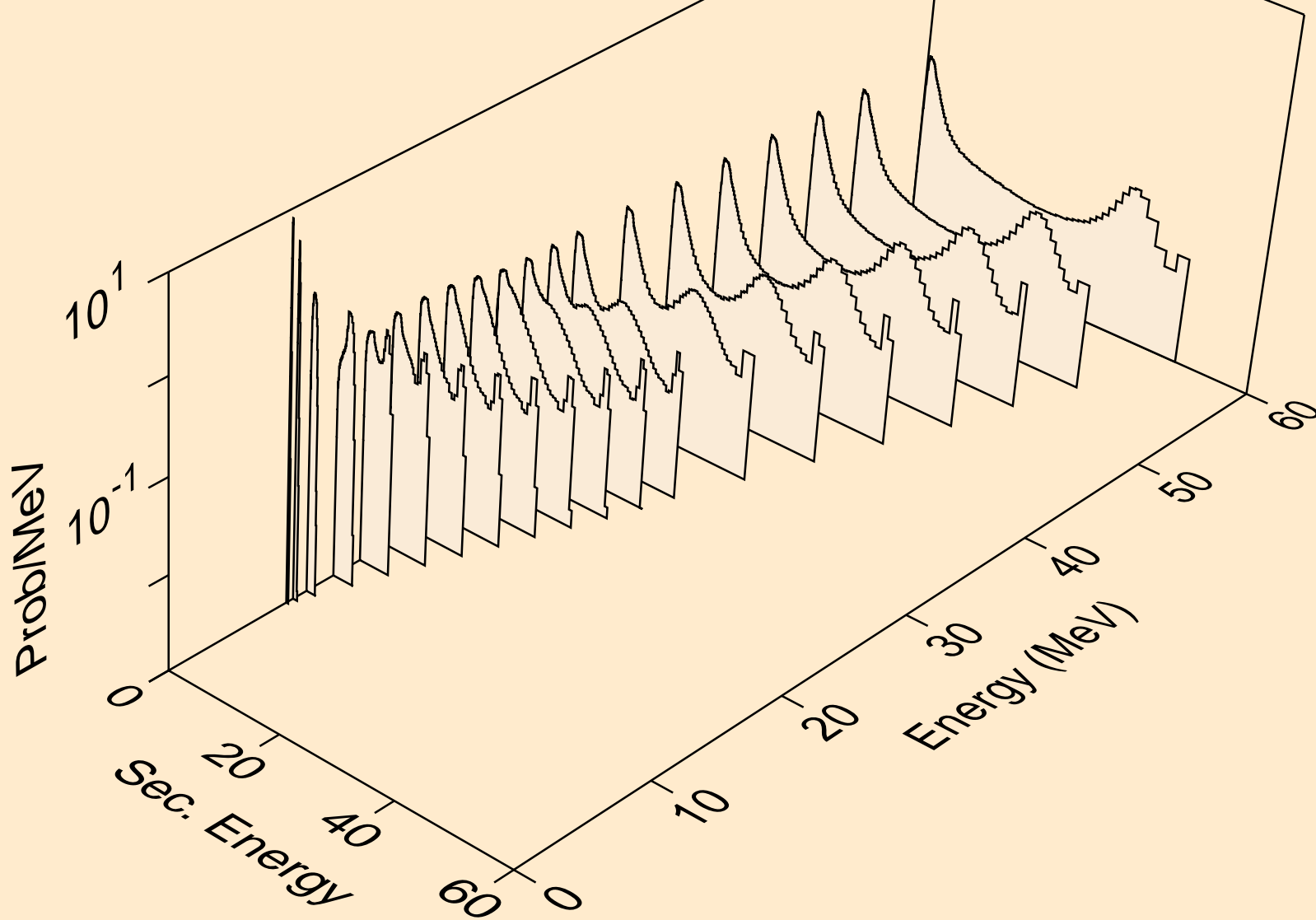

19-K-41 FOR FENDL-3.2 FROM TENDL-2015 BY NJOY2016.60+ O
Neutron emission for (n,n*)2a

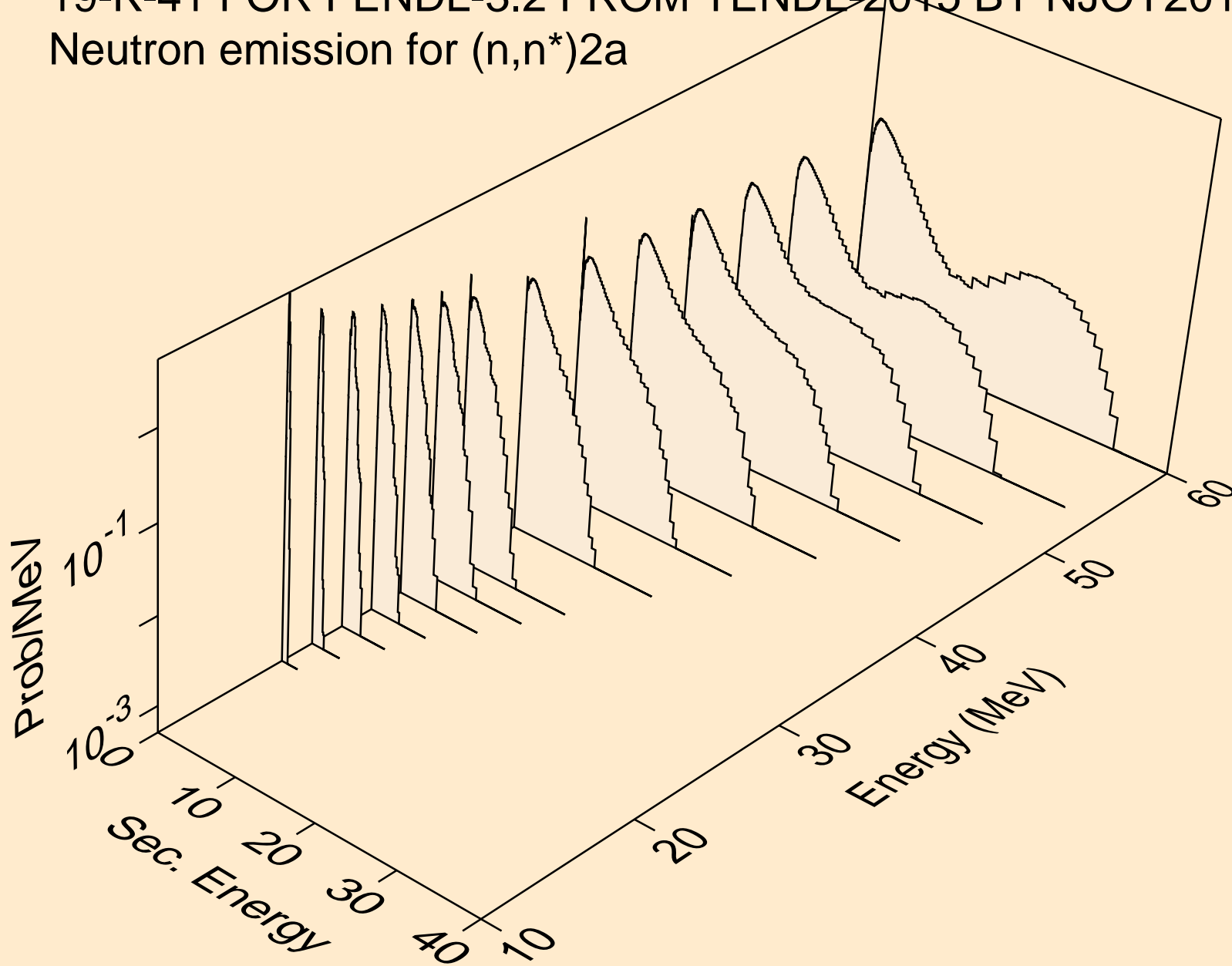

19-K-41 FOR FENDL-3.2 FROM TENDL-2015 BY NJOY2016.60+ O
Neutron emission for (n,2n)2a

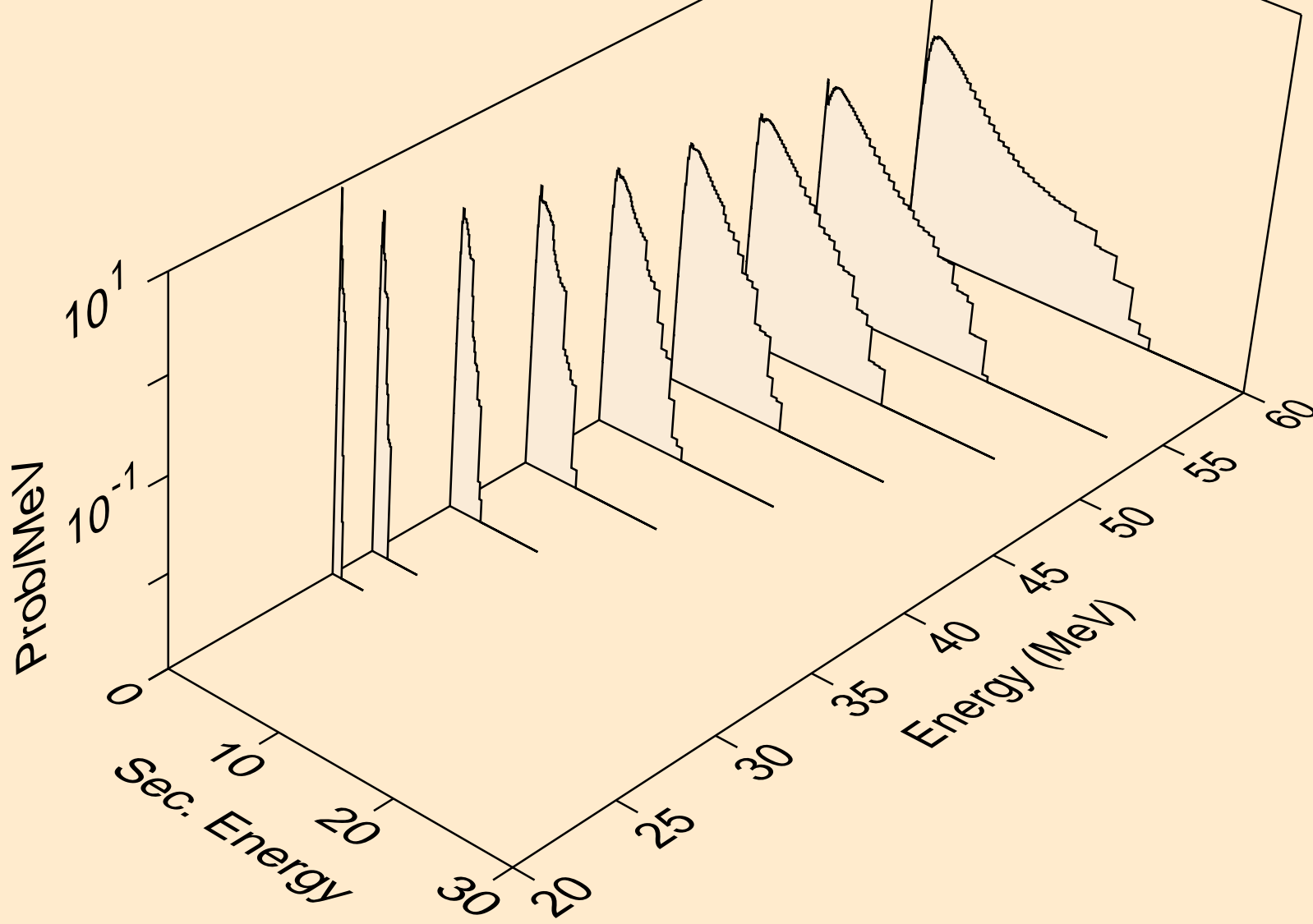

19-K-41 FOR FENDL-3.2 FROM TENDL-2015 BY NJOY2016.60+ O
Neutron emission for (n,n*)d

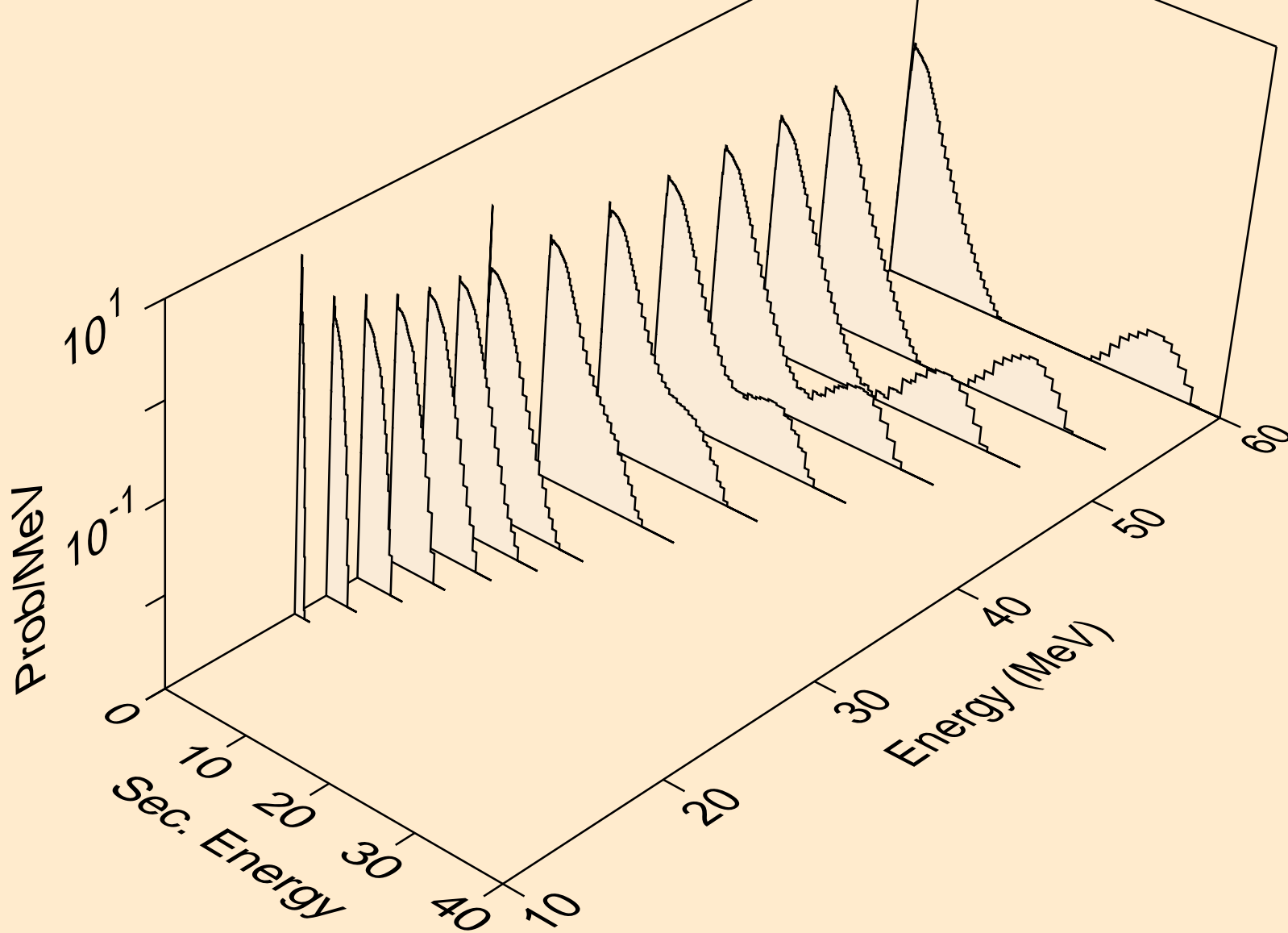

19-K-41 FOR FENDL-3.2 FROM TENDL-2015 BY NJOY2016.60+ O
Neutron emission for (n,n*)t

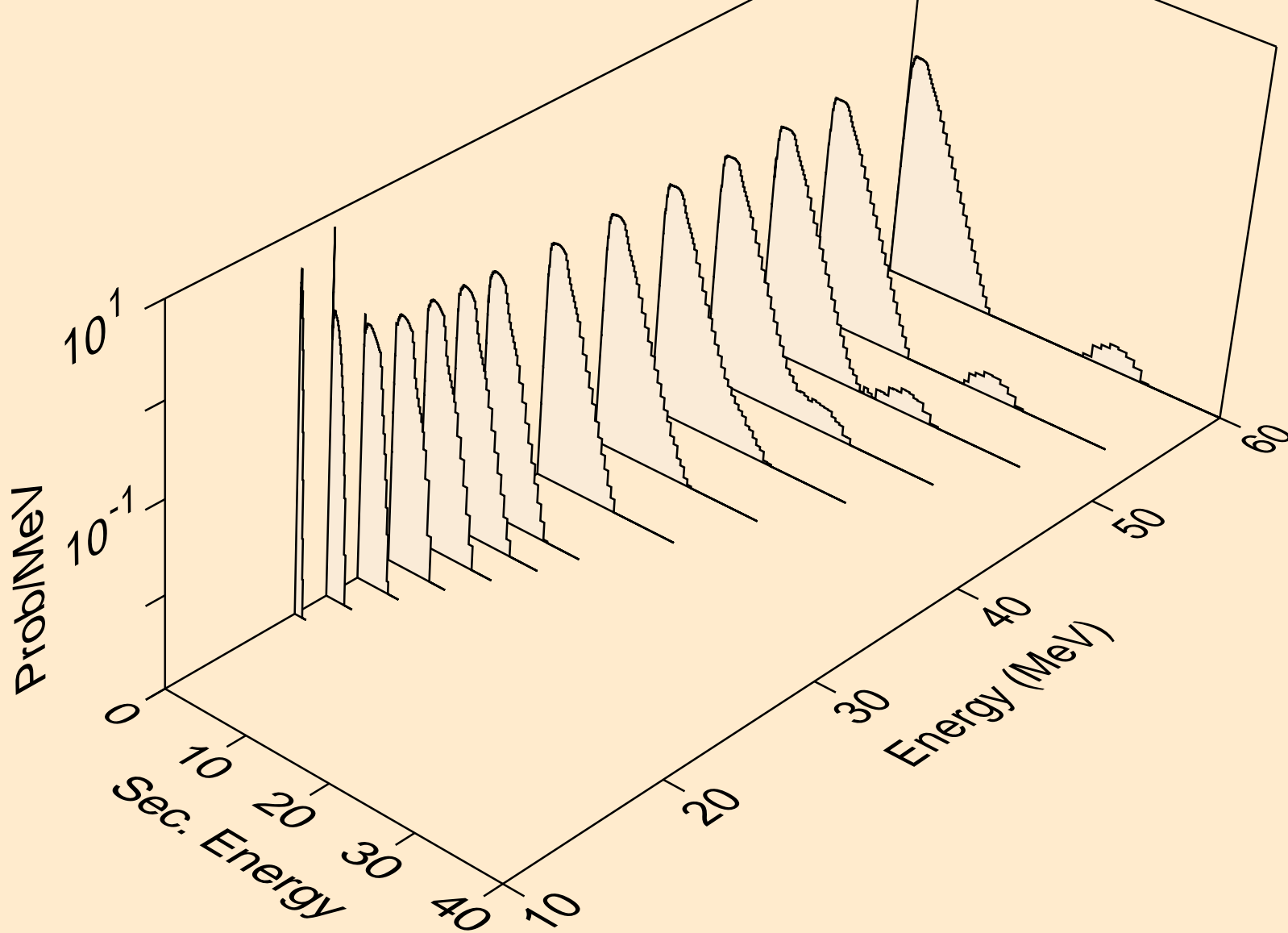

19-K-41 FOR FENDL-3.2 FROM TENDL-2015 BY NJOY2016.60+ O
Neutron emission for (n,n*)he3

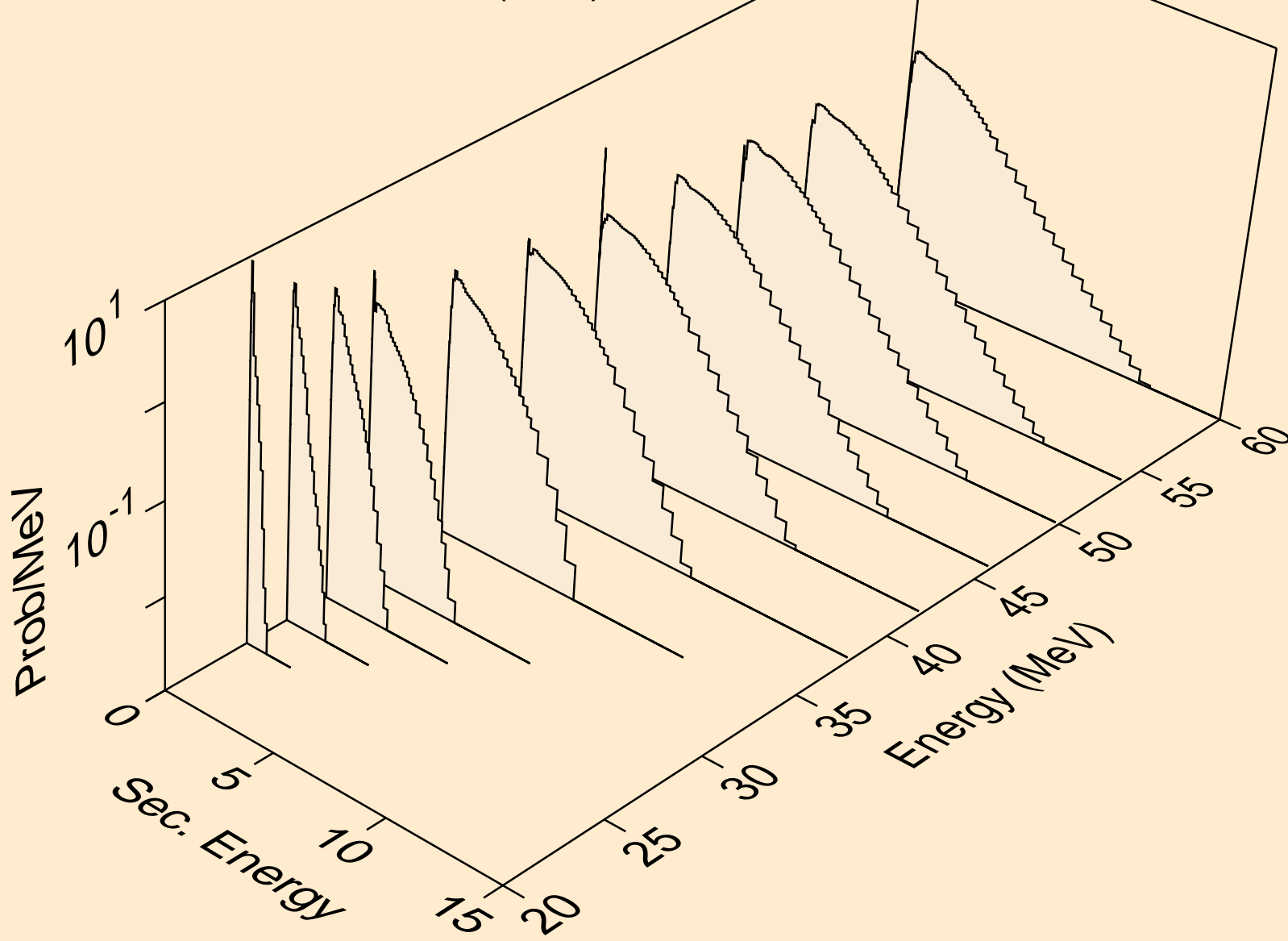

19-K-41 FOR FENDL-3.2 FROM TENDL-2015 BY NJOY2016.60+ O
Neutron emission for (n,n*)d2a

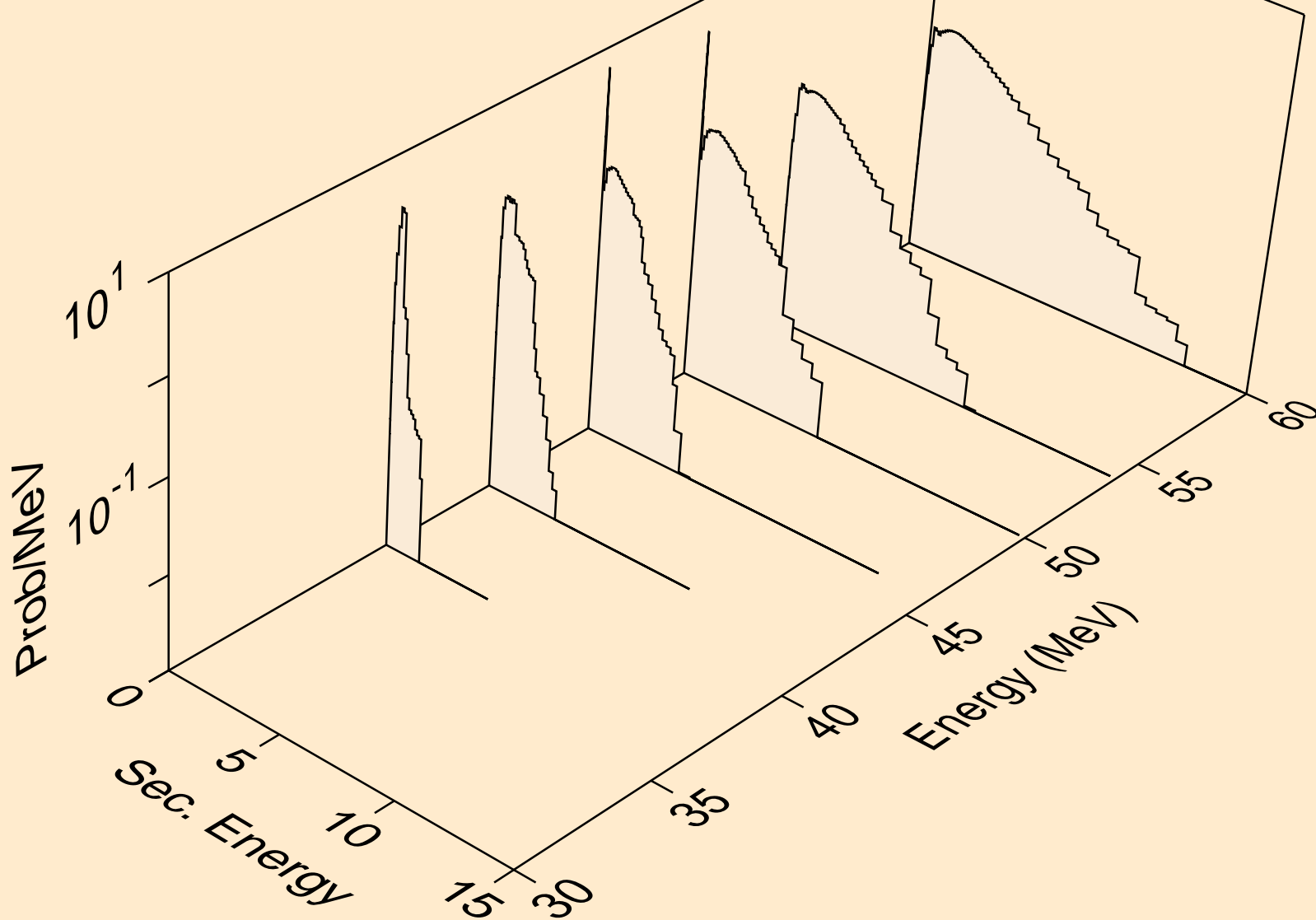

19-K-41 FOR FENDL-3.2 FROM TENDL-2015 BY NJOY2016.60+ O
Neutron emission for (n,n*)t2a

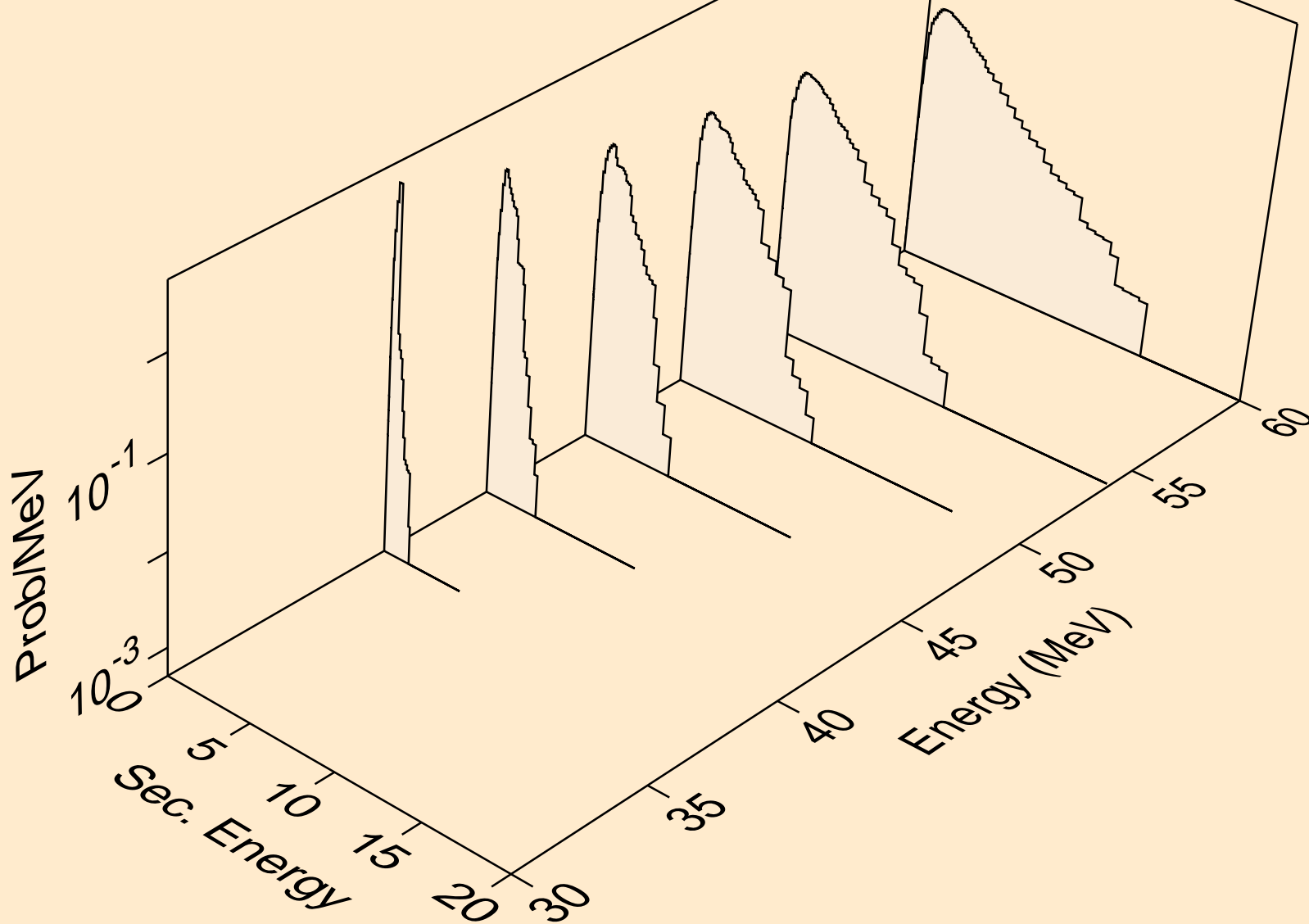

19-K-41 FOR FENDL-3.2 FROM TENDL-2015 BY NJOY2016.60+ O
Neutron emission for (n,4n)

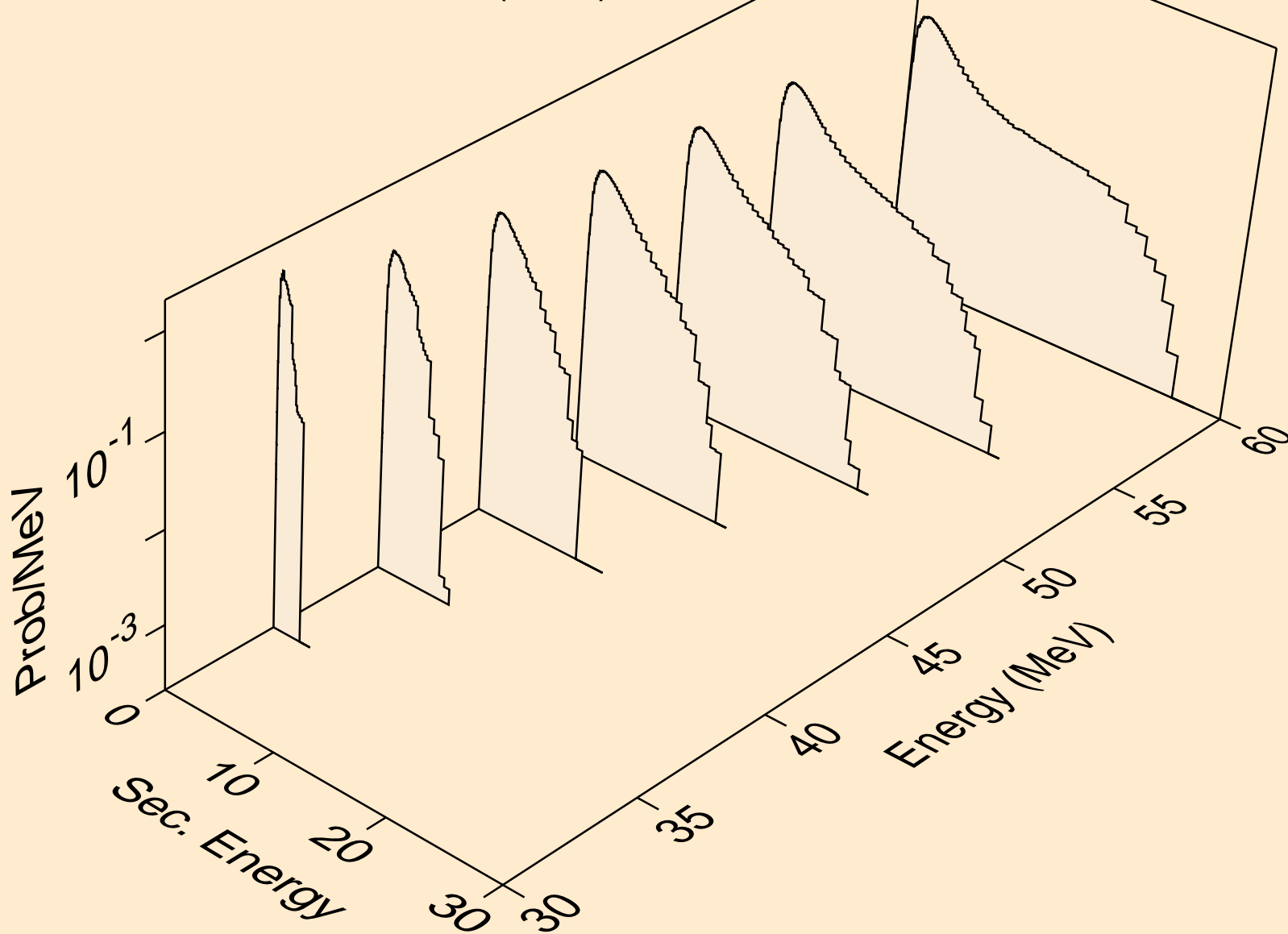

19-K-41 FOR FENDL-3.2 FROM TENDL-2015 BY NJOY2016.60+ O
Neutron emission for (n,2np)

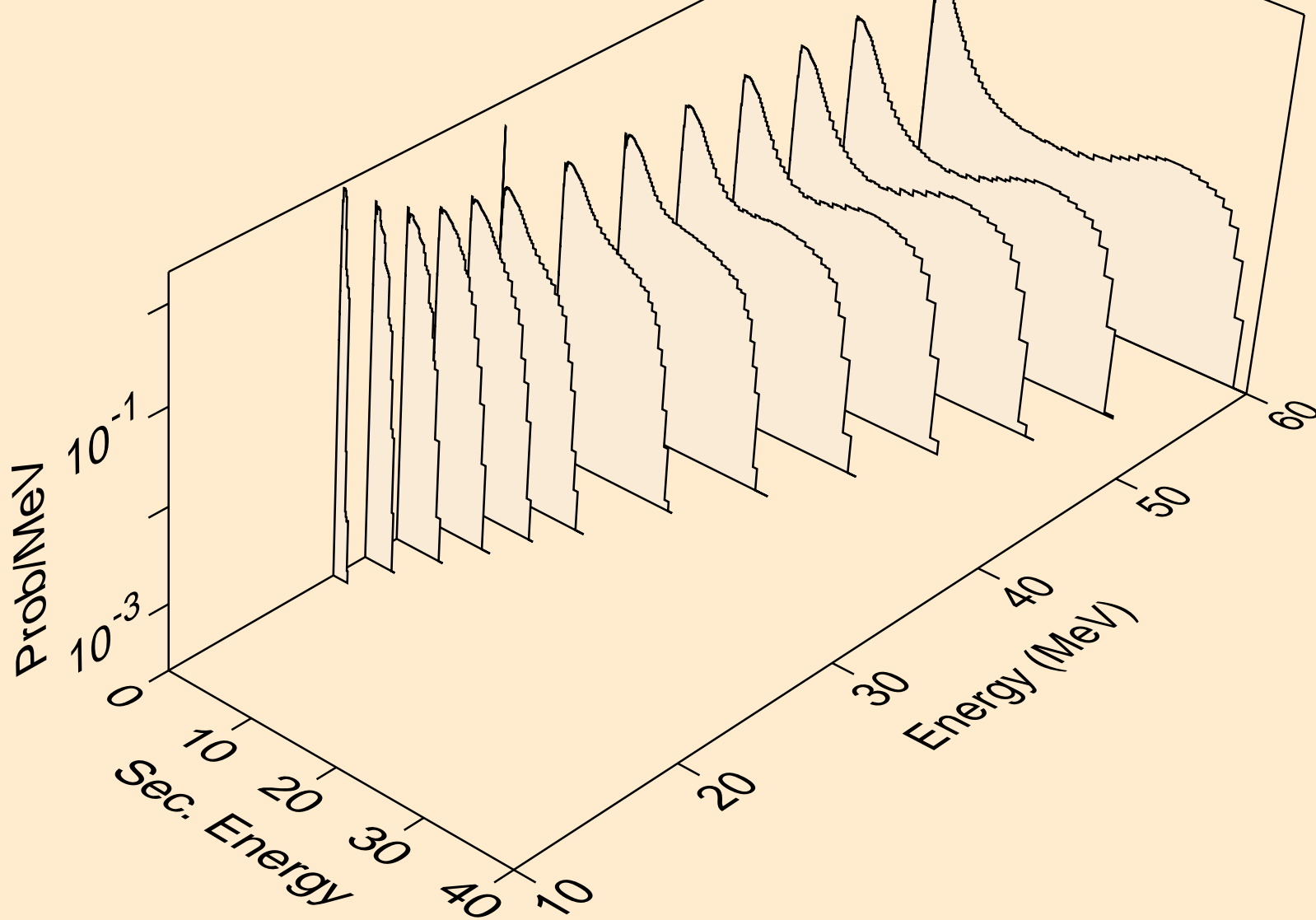

19-K-41 FOR FENDL-3.2 FROM TENDL-2015 BY NJOY2016.60+ O
Neutron emission for (n,3np)

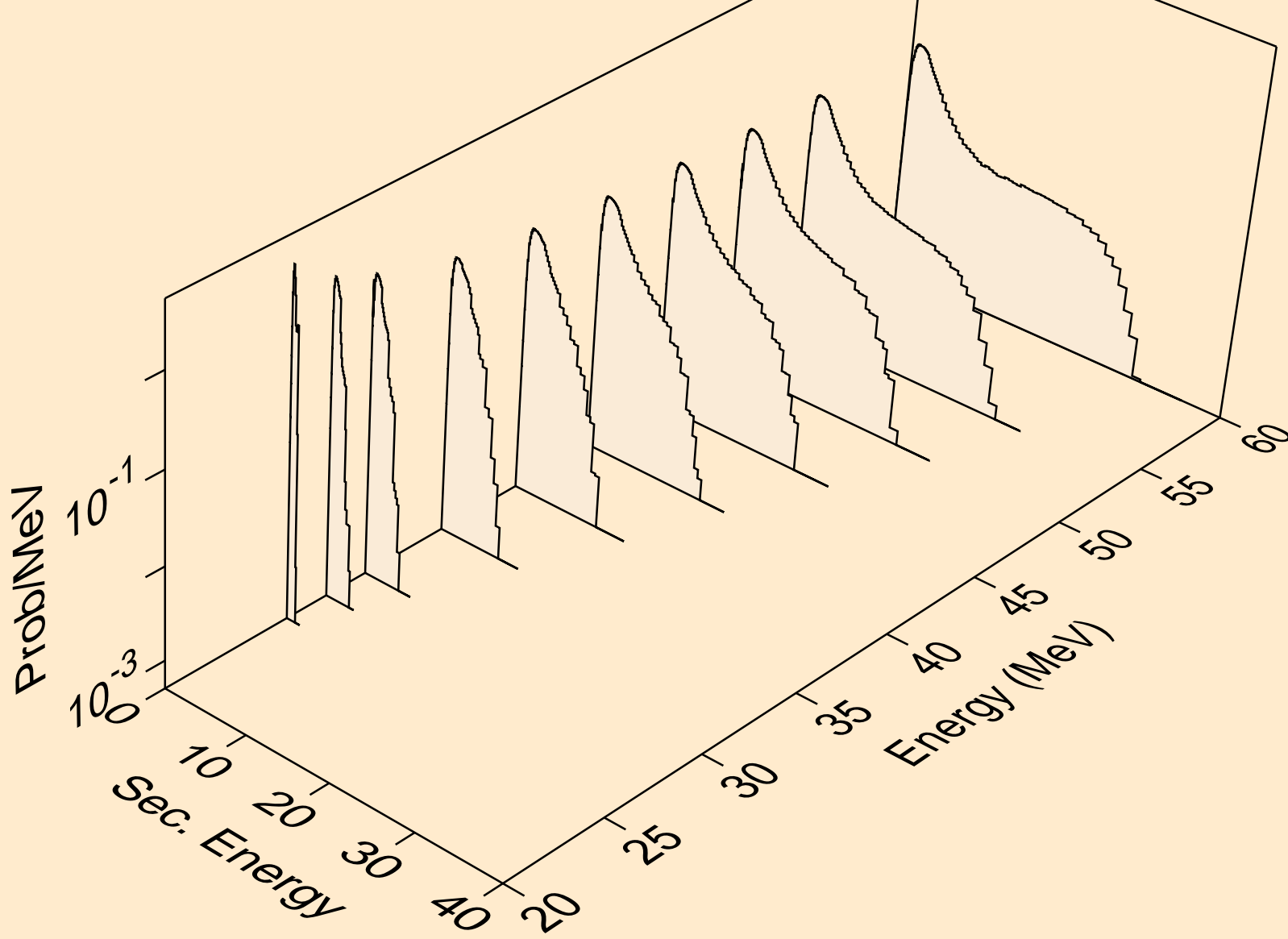

19-K-41 FOR FENDL-3.2 FROM TENDL-2015 BY NJOY2016.60+ O
Neutron emission for (n,2np)

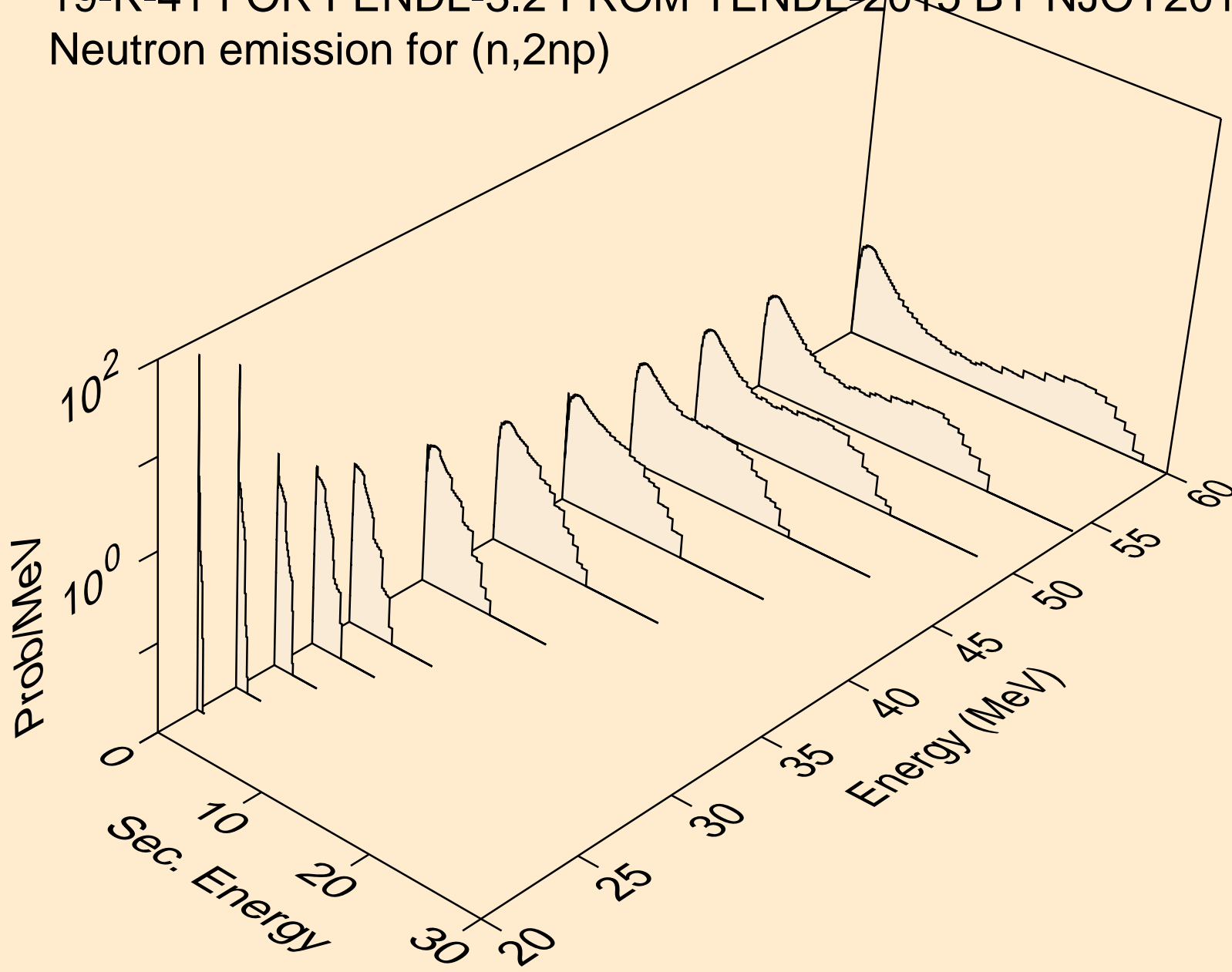

19-K-41 FOR FENDL-3.2 FROM TENDL-2015 BY NJOY2016.60+ O
Neutron emission for (n,npa)

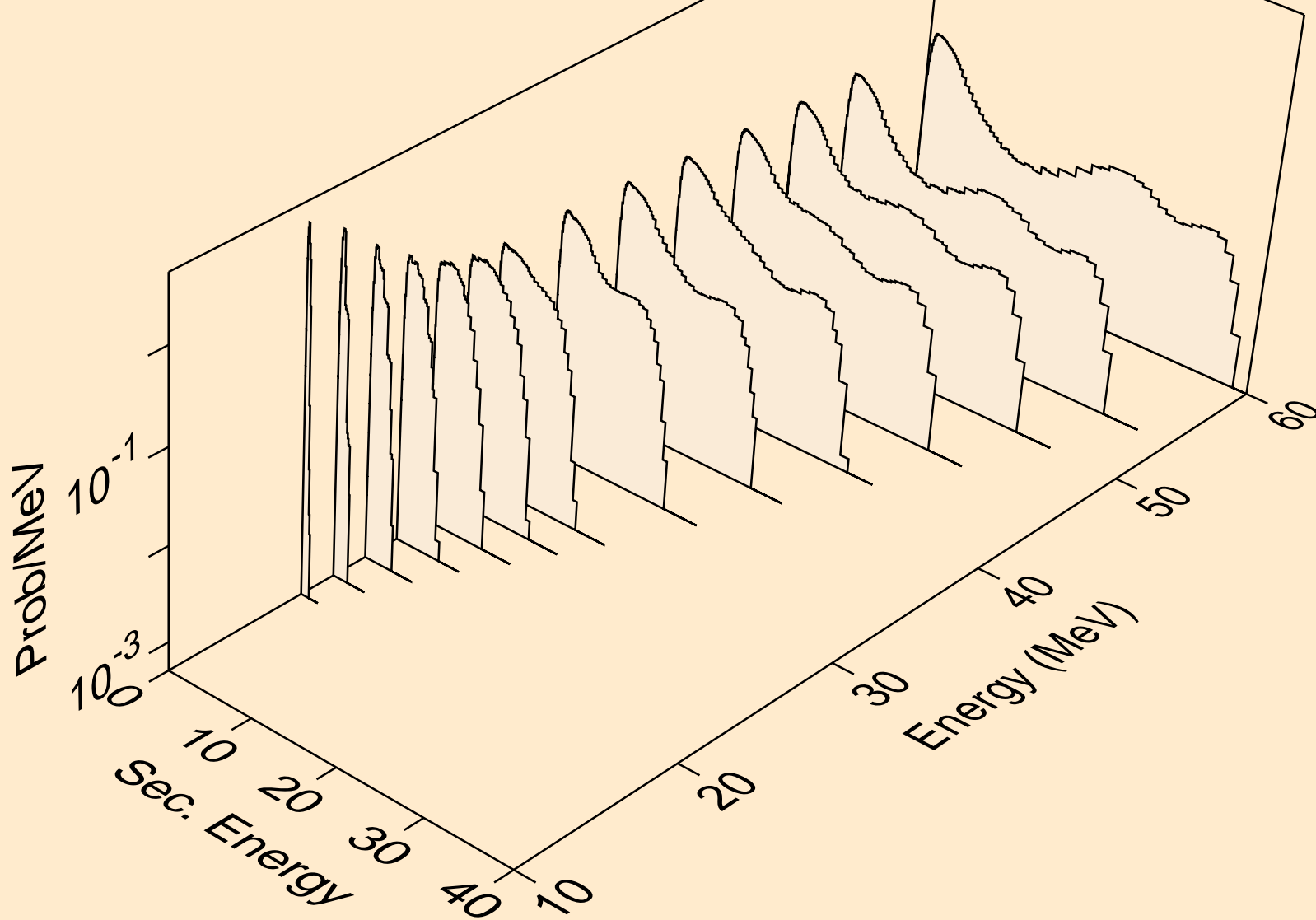

19-K-41 FOR FENDL-3.2 FROM TENDL-2015 BY NJOY2016.60+ O
Neutron emission for (n,n*c)

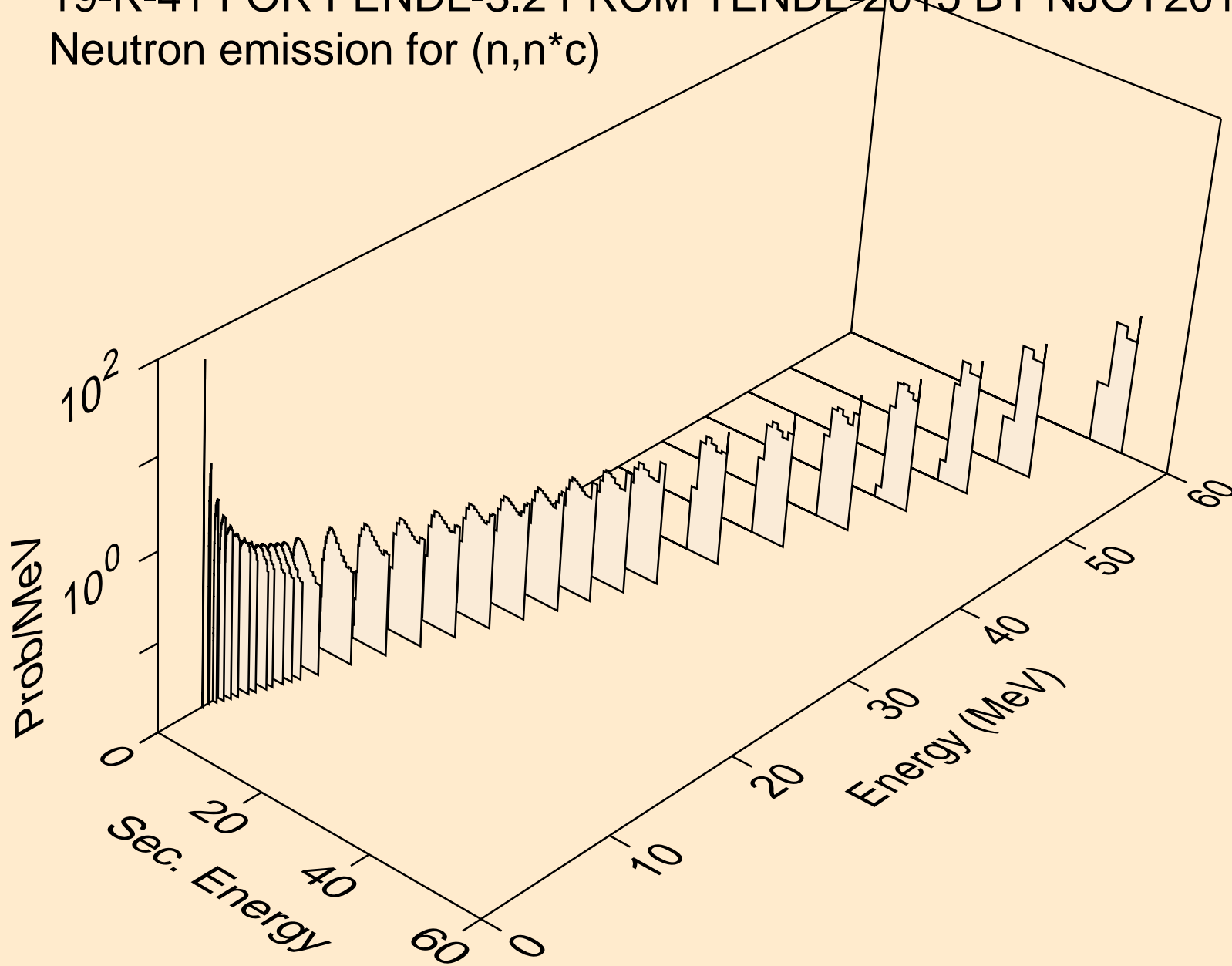

19-K-41 FOR FENDL-3.2 FROM TENDL-2015 BY NJOY2016.60+ O
Neutron emission for (n,5n)

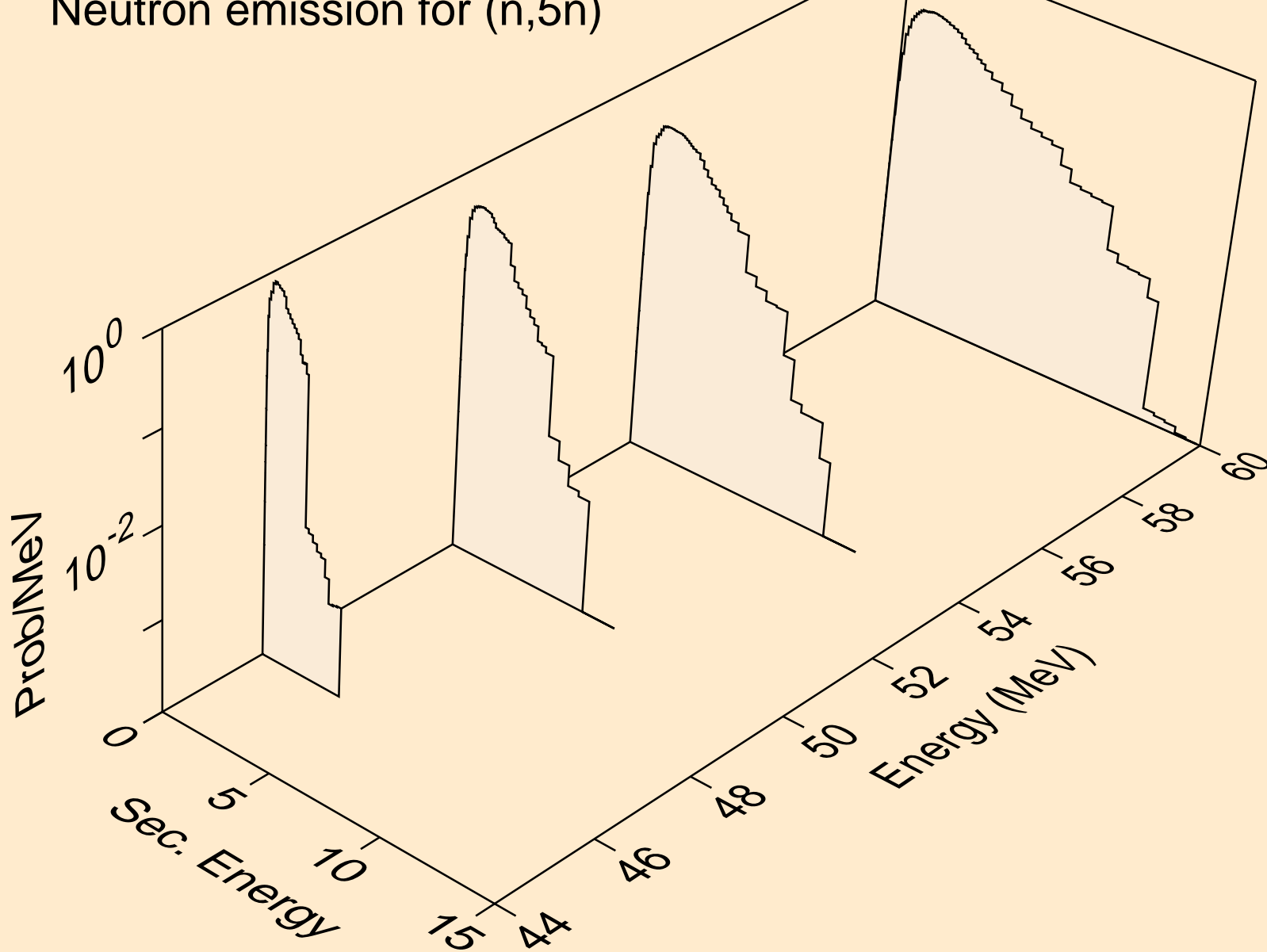

19-K-41 FOR FENDL-3.2 FROM TENDL-2015 BY NJOY2016.60+ O
Neutron emission for (n,2nt)

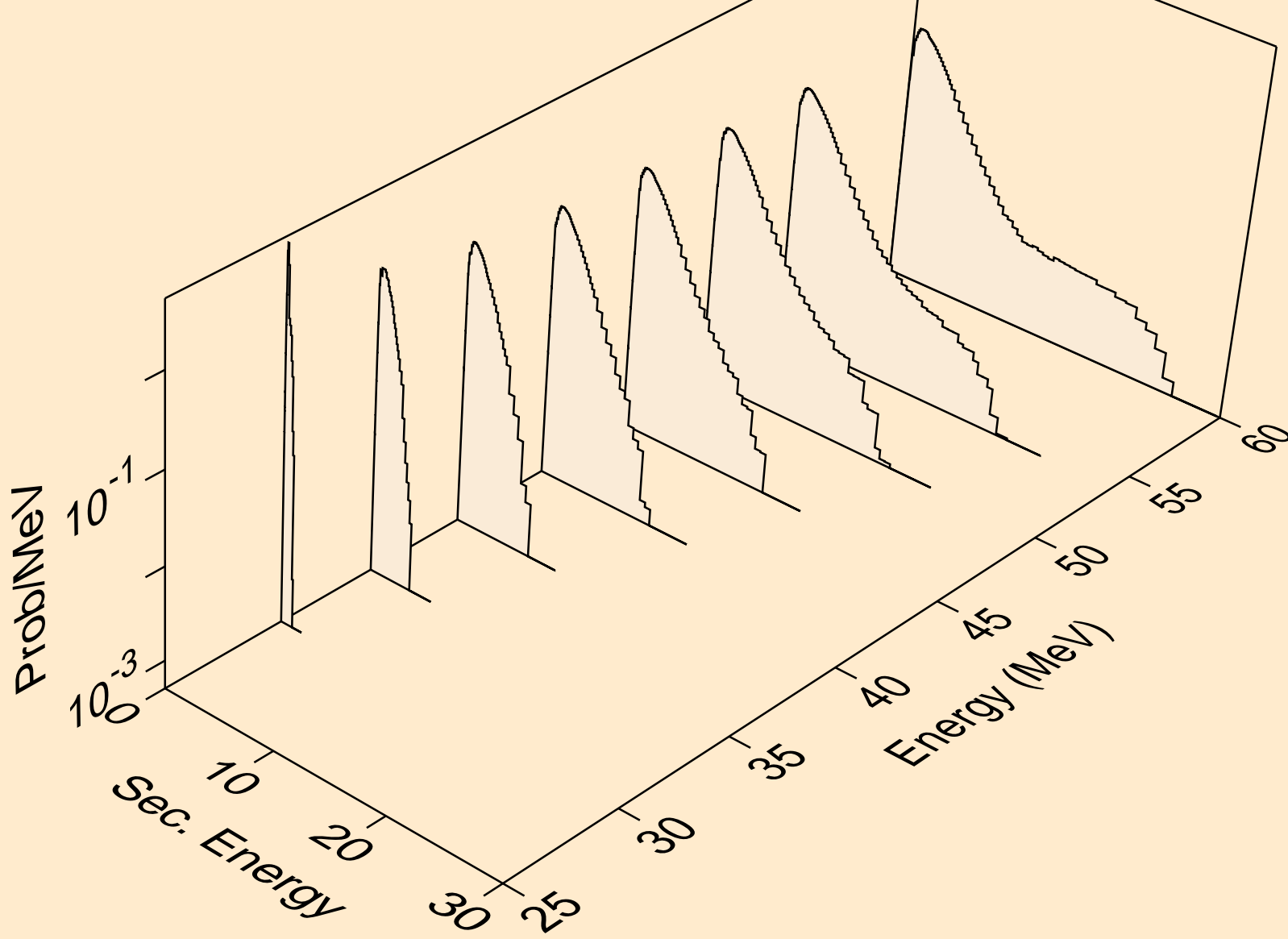

19-K-41 FOR FENDL-3.2 FROM TENDL-2015 BY NJOY2016.60+ O
Neutron emission for (n,4np)

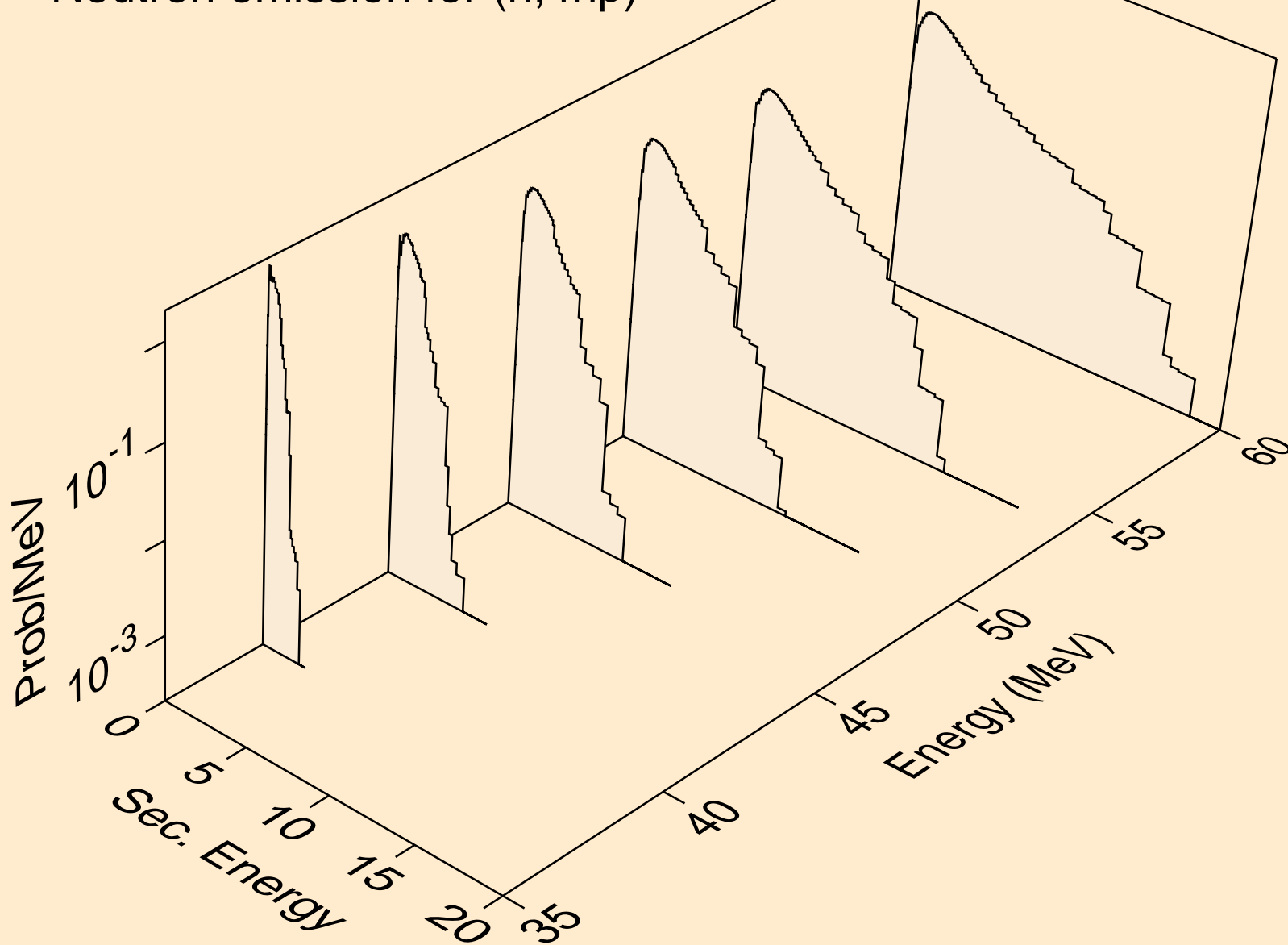

19-K-41 FOR FENDL-3.2 FROM TENDL-2015 BY NJOY2016.60+ O
Neutron emission for (n,3nd)

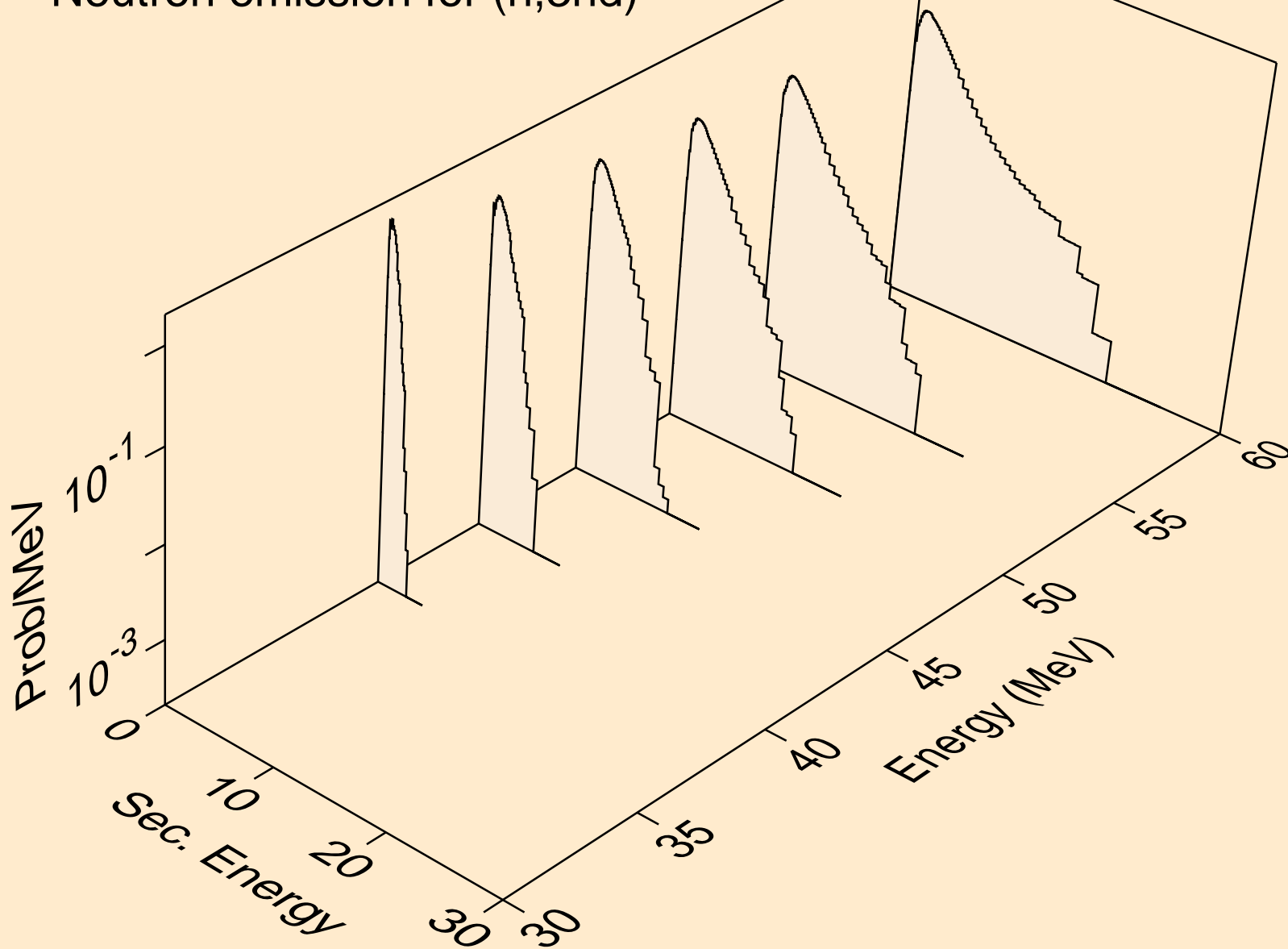

19-K-41 FOR FENDL-3.2 FROM TENDL-2015 BY NJOY2016.60+ O
Neutron emission for (n,nda)

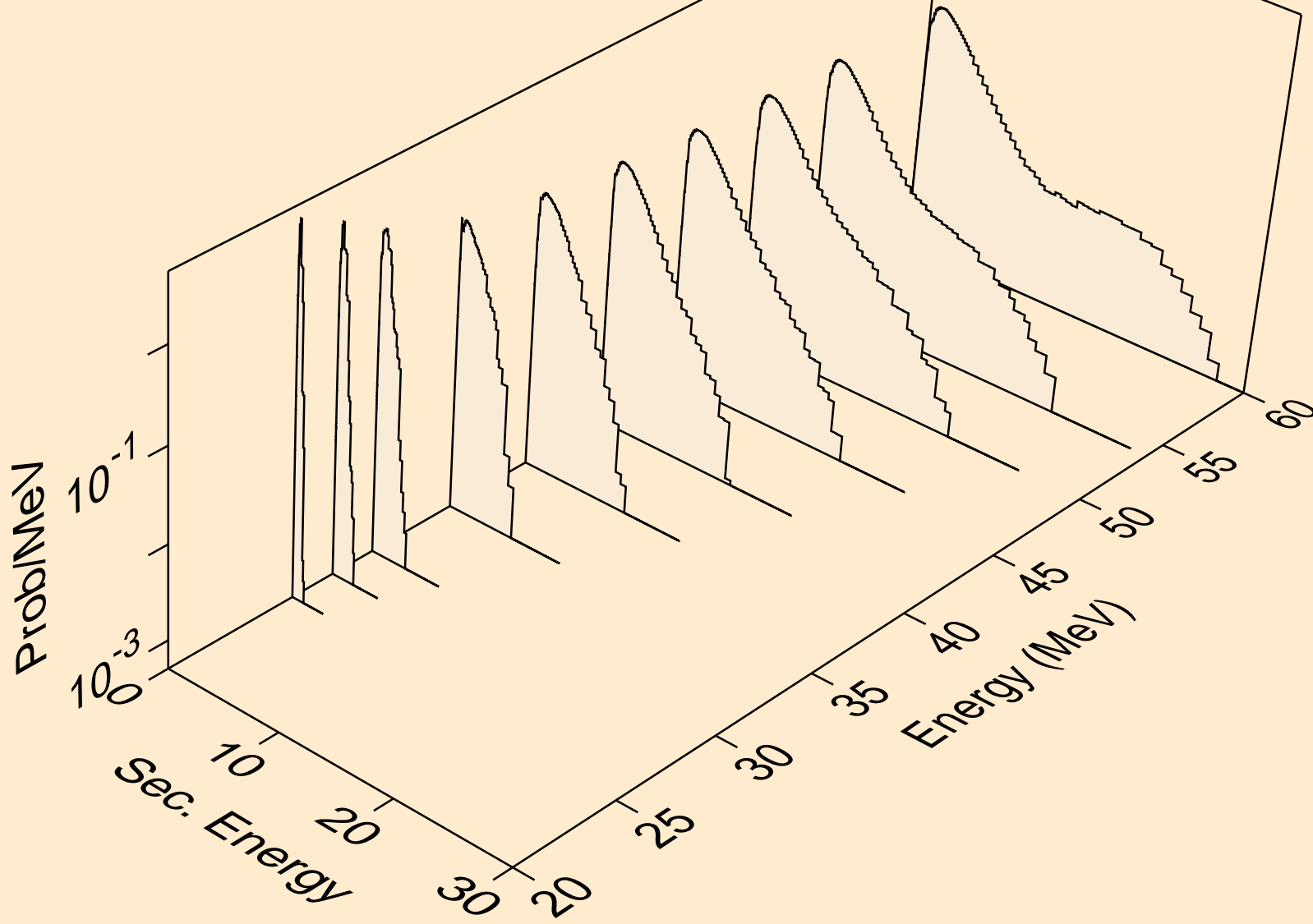

19-K-41 FOR FENDL-3.2 FROM TENDL-2015 BY NJOY2016.60+ O
Neutron emission for (n,2npa)

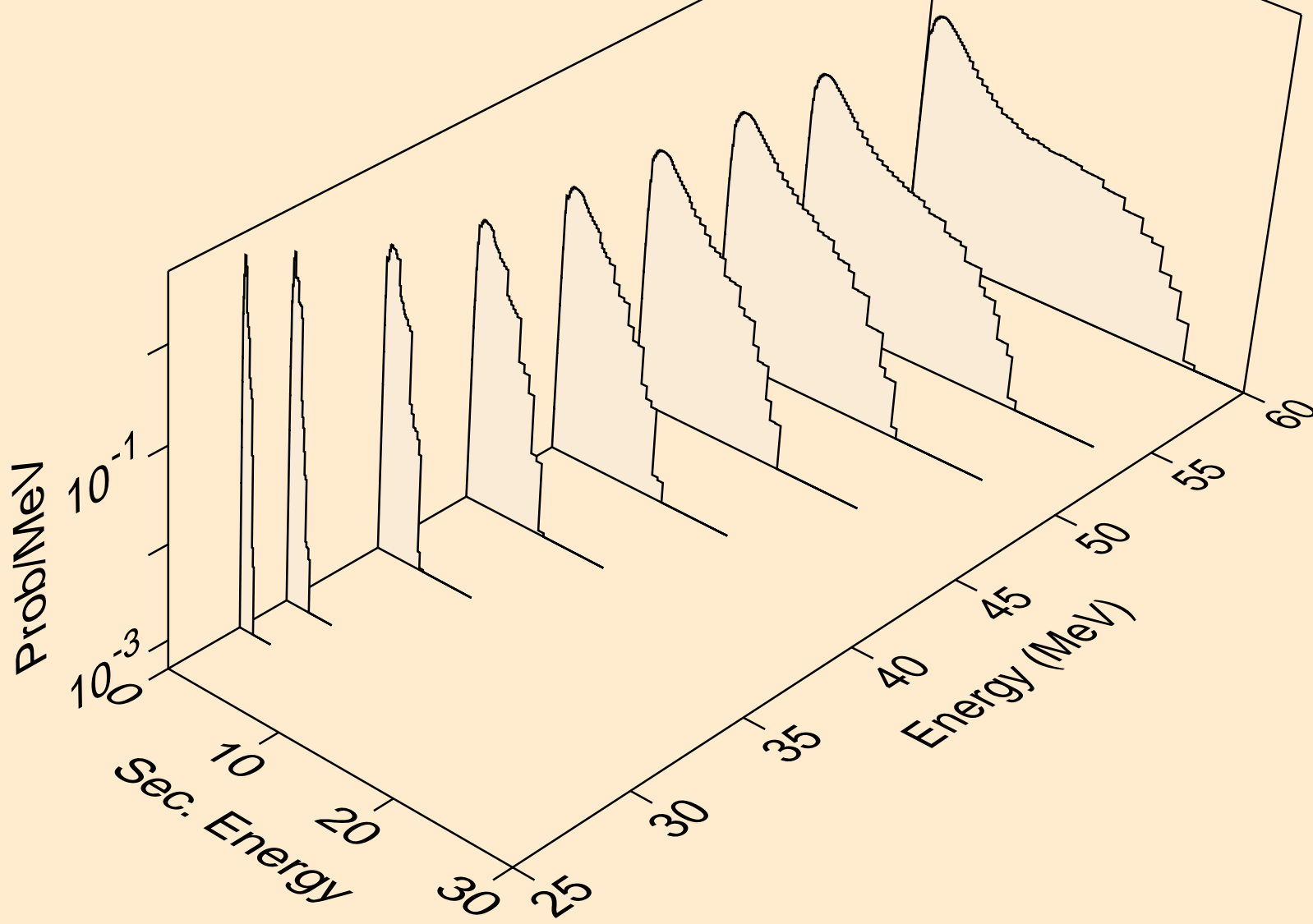

19-K-41 FOR FENDL-3.2 FROM TENDL-2015 BY NJOY2016.60+ O
Neutron emission for (n,5np)

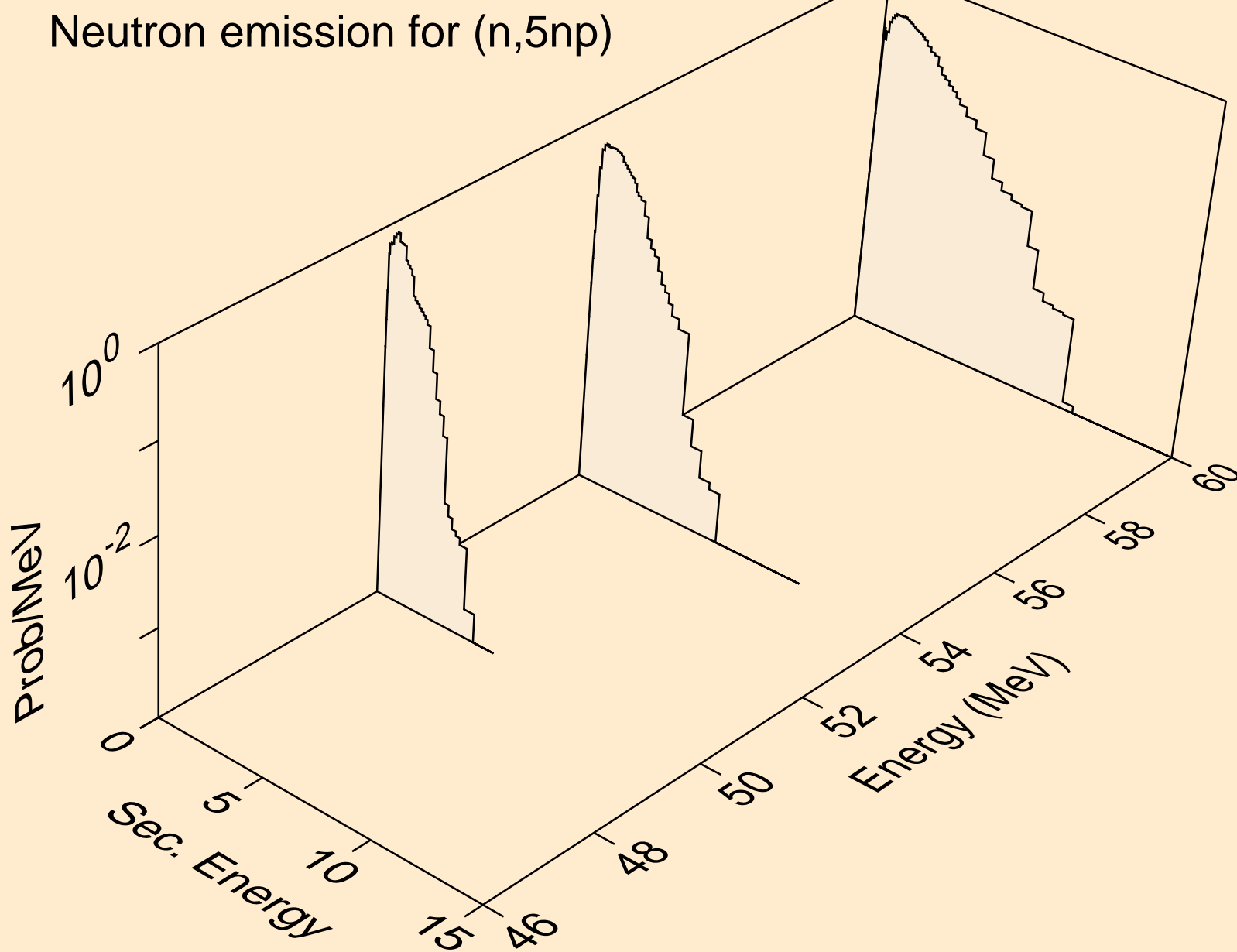

19-K-41 FOR FENDL-3.2 FROM TENDL-2015 BY NJOY2016.60+ O
Neutron emission for (n,4na)

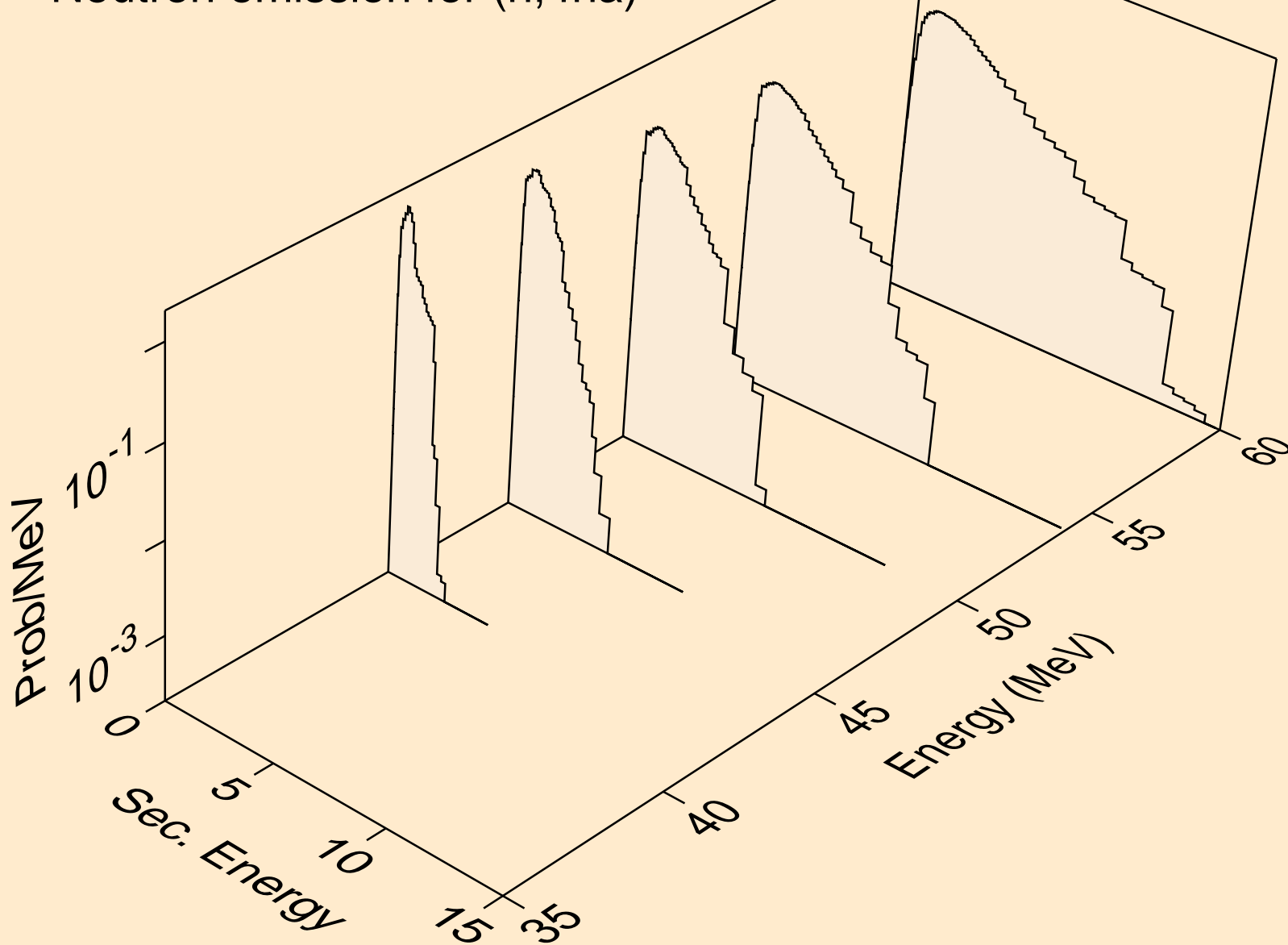

19-K-41 FOR FENDL-3.2 FROM TENDL-2015 BY NJOY2016.60+ O
Neutron emission for (n,5na)

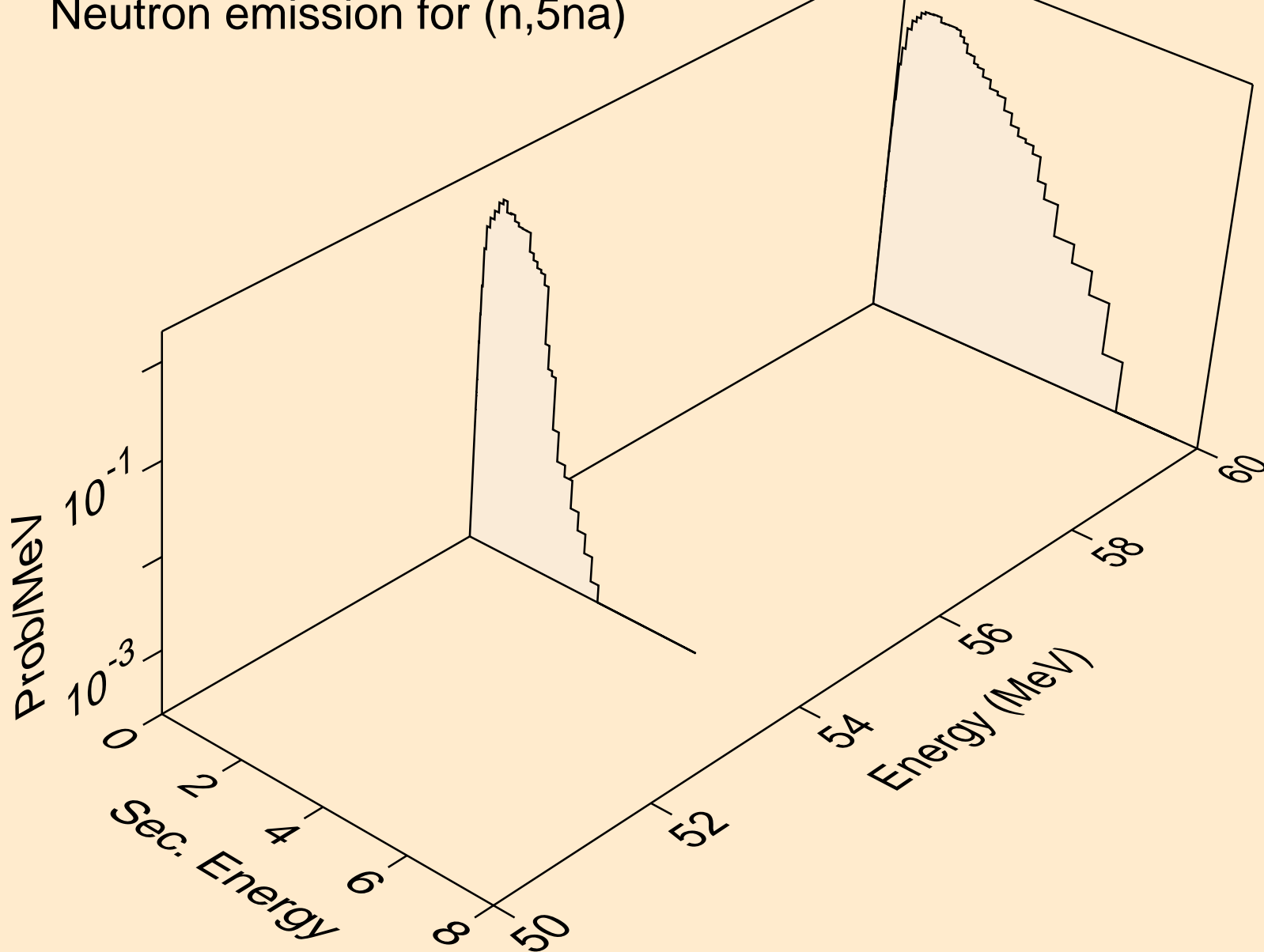

19-K-41 FOR FENDL-3.2 FROM TENDL-2015 BY NJOY2016.60+ O
Neutron emission for (n,4nd)

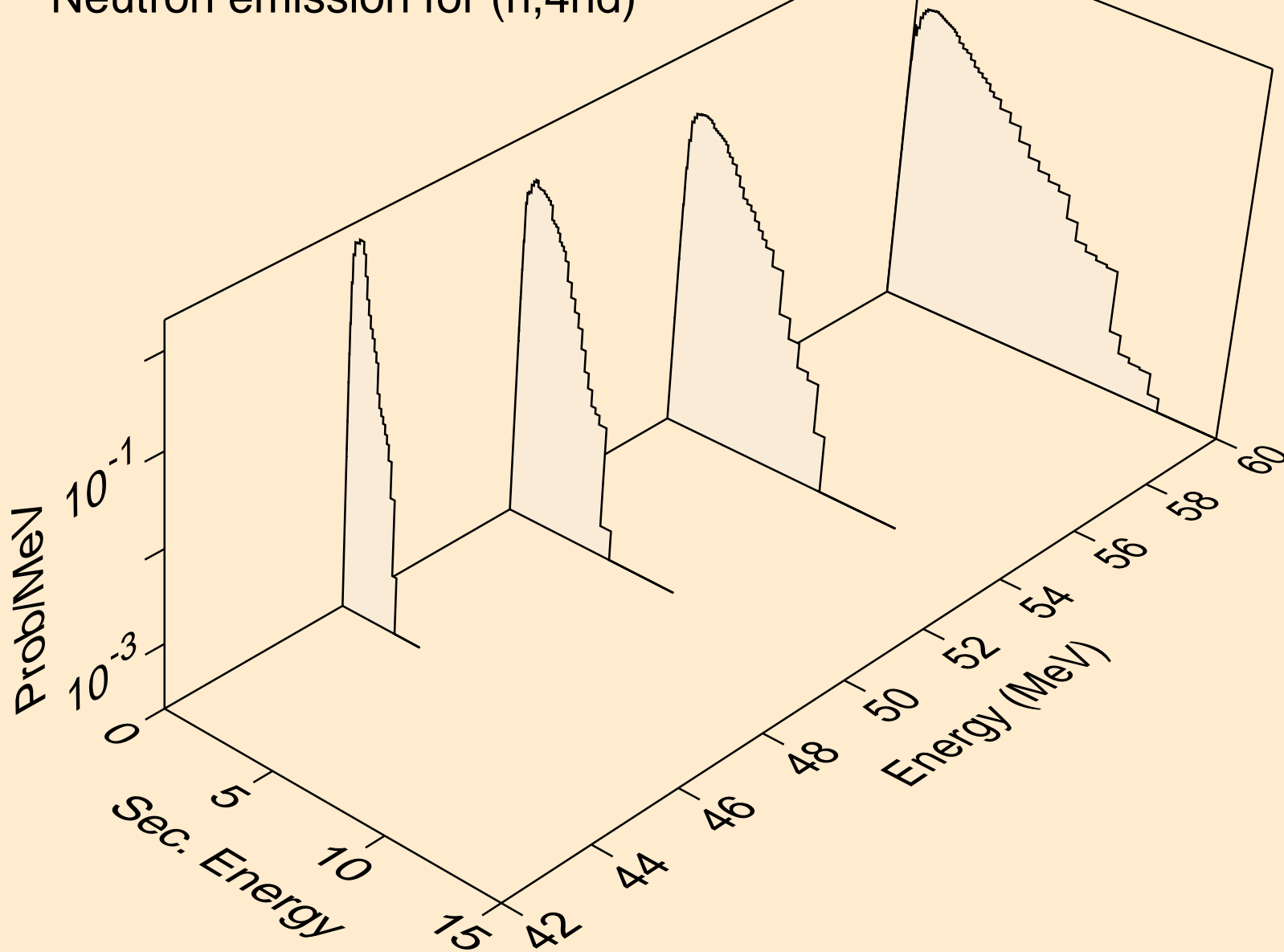

19-K-41 FOR FENDL-3.2 FROM TENDL-2015 BY NJOY2016.60+ O
Neutron emission for (n,3nt)

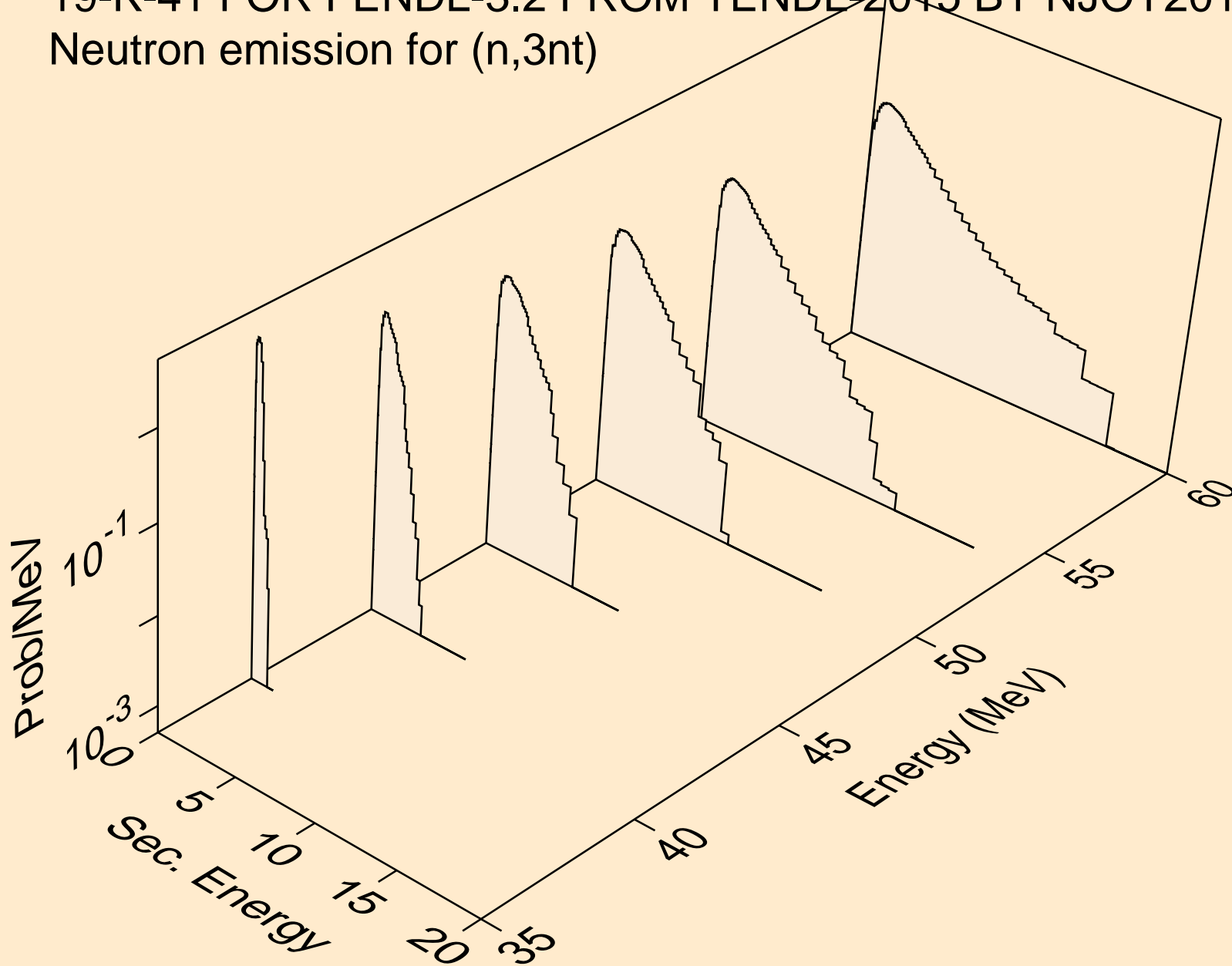

19-K-41 FOR FENDL-3.2 FROM TENDL-2015 BY NJOY2016.60+ O
Neutron emission for (n,2n)he3

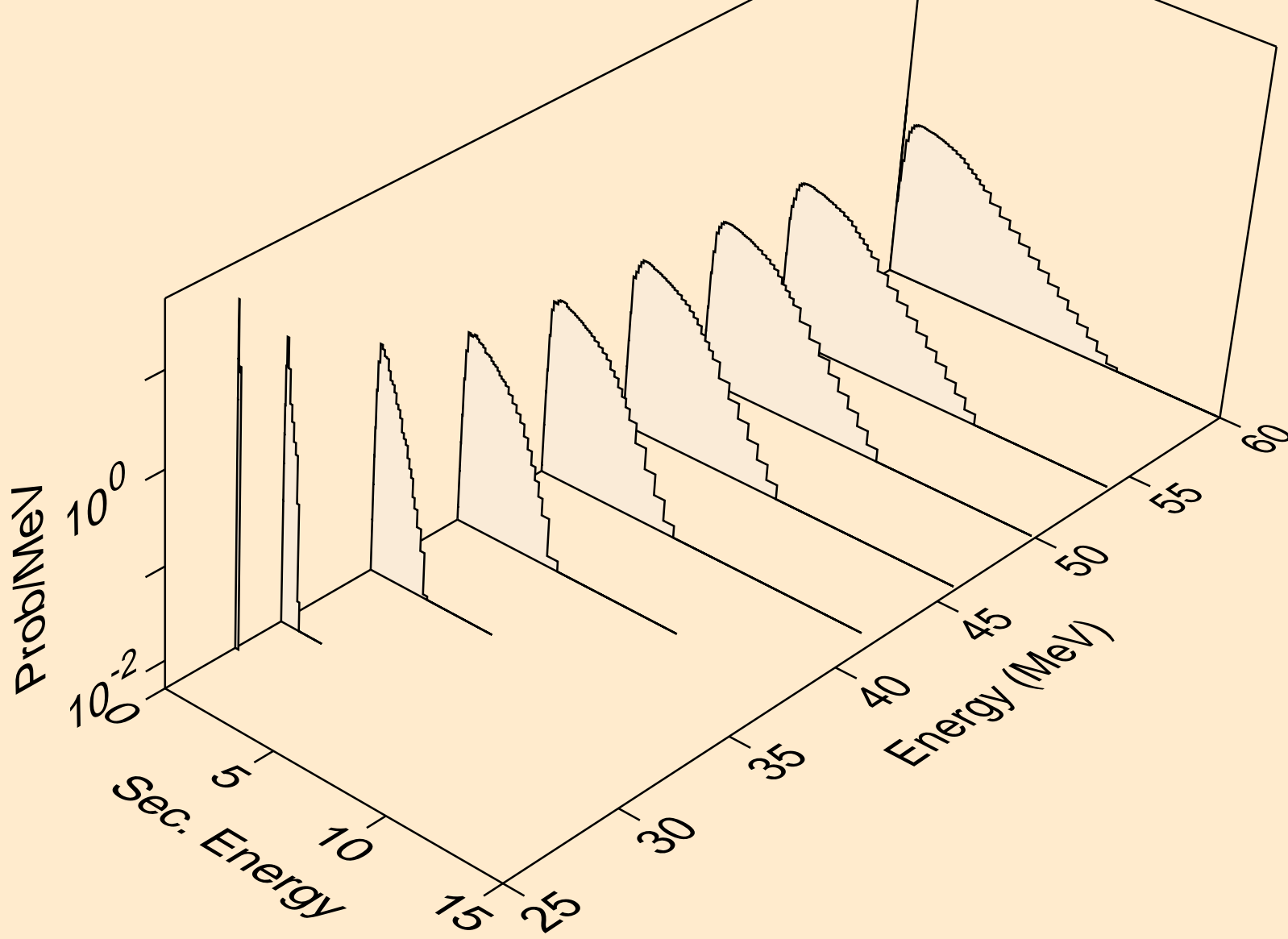

19-K-41 FOR FENDL-3.2 FROM TENDL-2015 BY NJOY2016.60+ O
Neutron emission for (n,3n)he3)

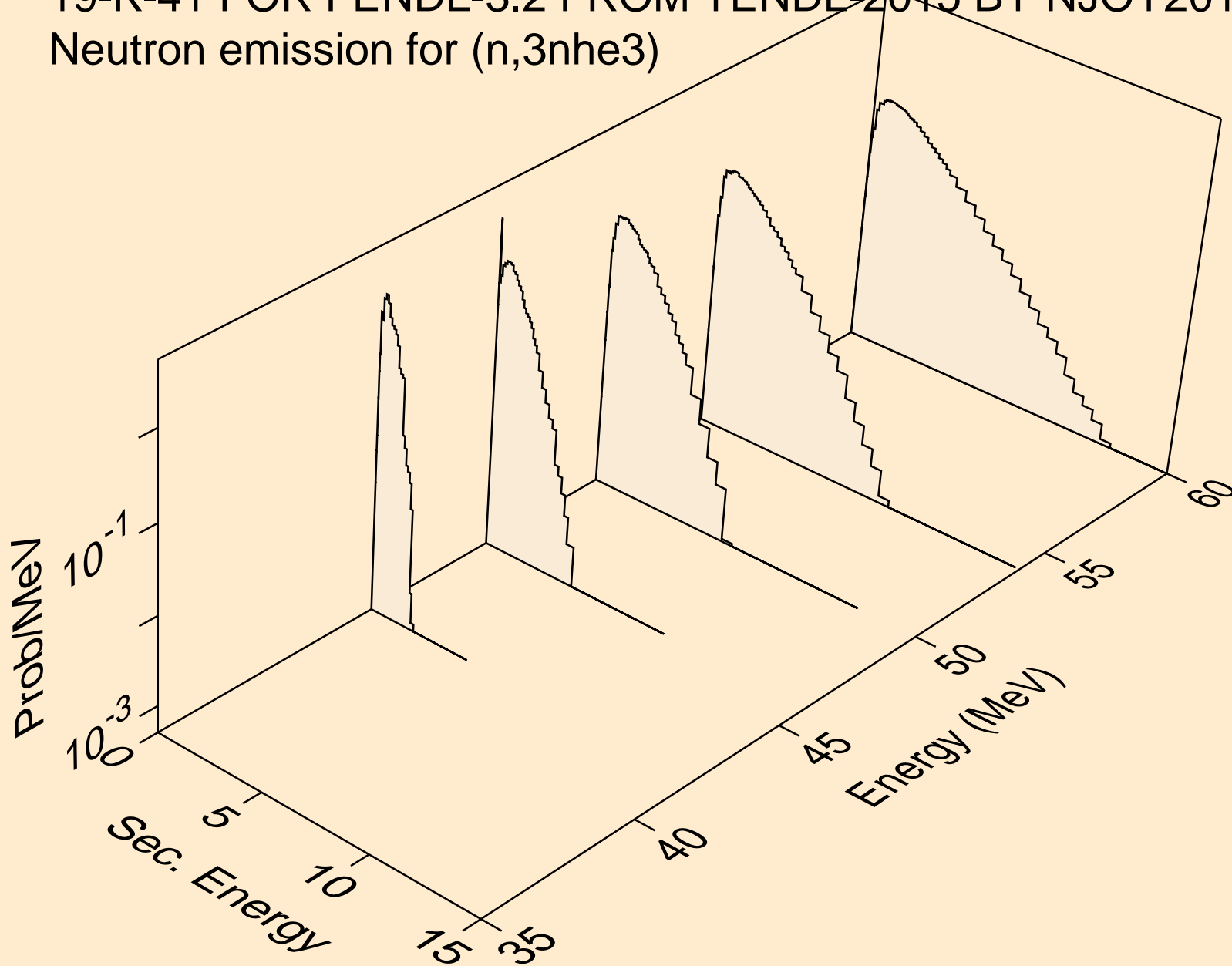

19-K-41 FOR FENDL-3.2 FROM TENDL-2015 BY NJOY2016.60+ O
Neutron emission for (n,4nhe3)

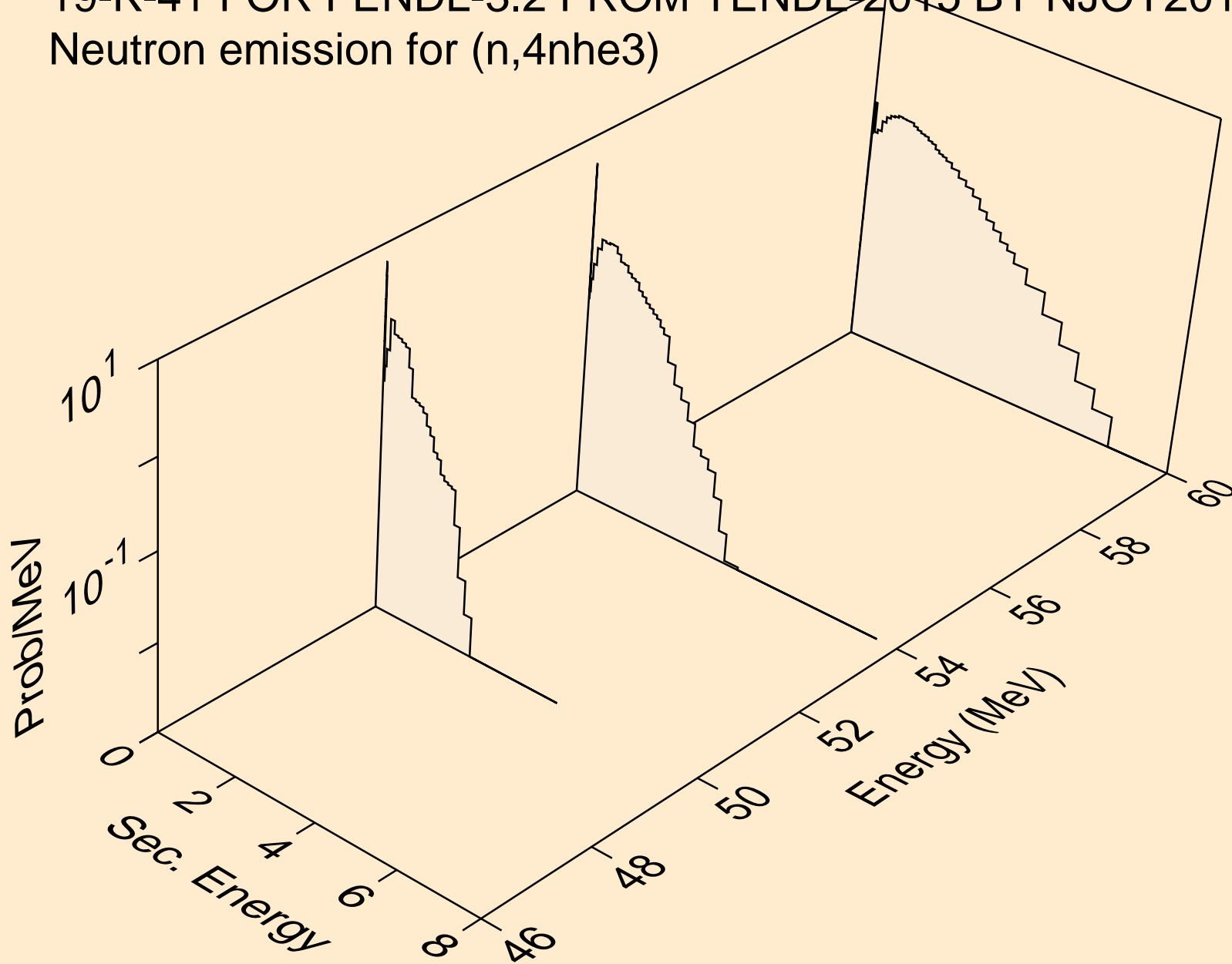

19-K-41 FOR FENDL-3.2 FROM TENDL-2015 BY NJOY2016.60+ O
Neutron emission for (n,3n2p)

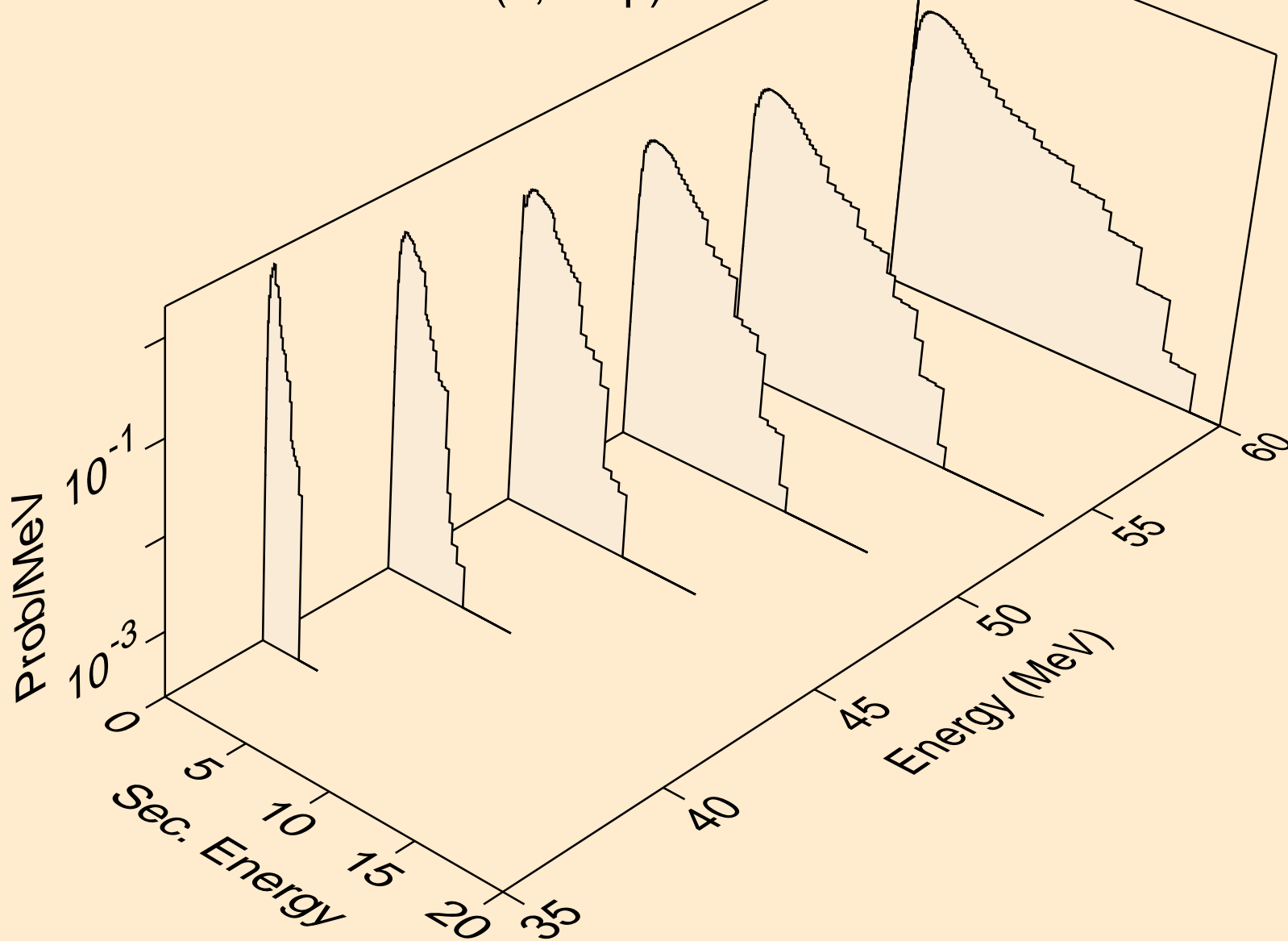

19-K-41 FOR FENDL-3.2 FROM TENDL-2015 BY NJOY2016.60+ O
Neutron emission for (n,3n2a)

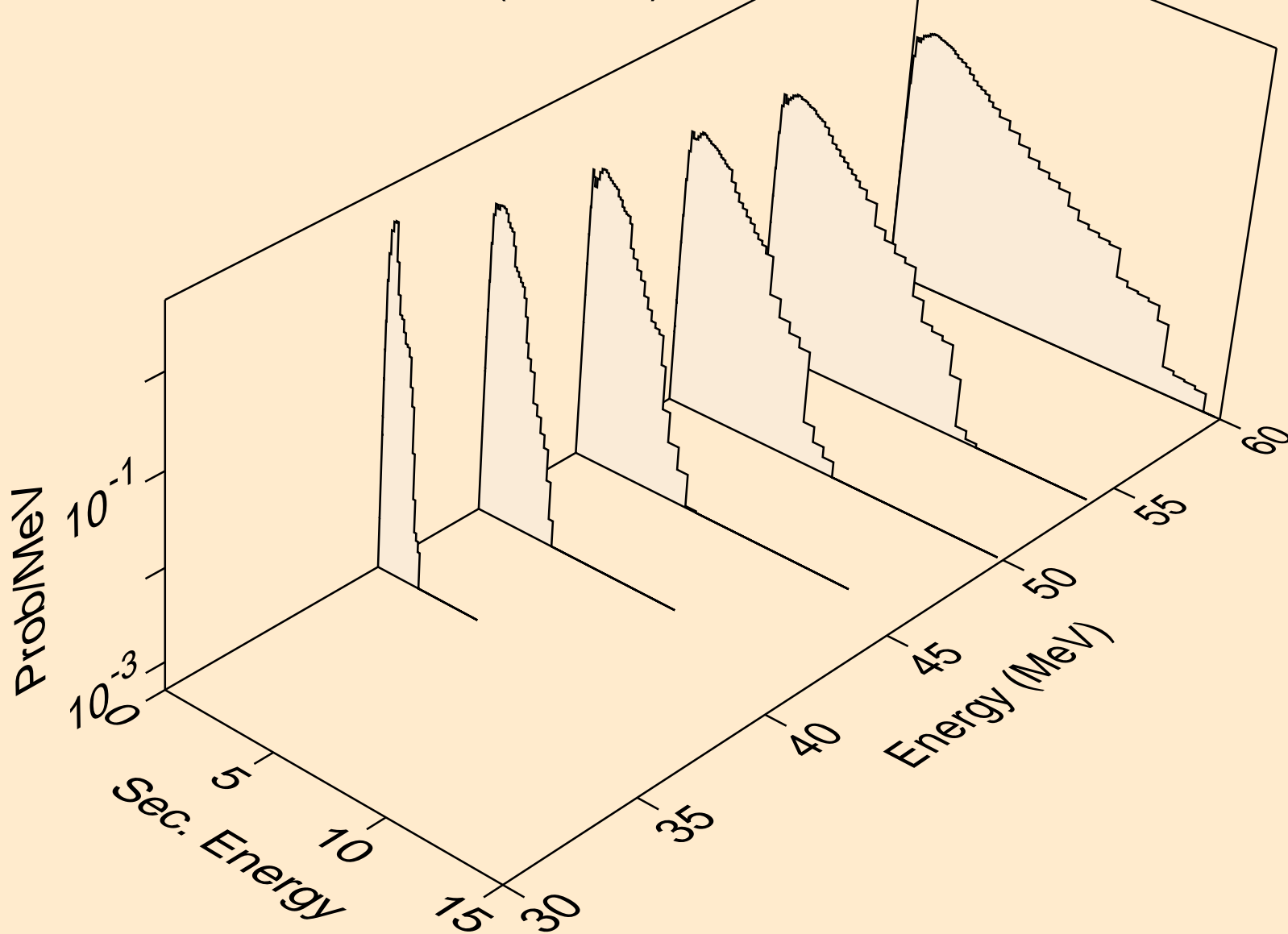

19-K-41 FOR FENDL-3.2 FROM TENDL-2015 BY NJOY2016.60+ O
Neutron emission for (n,3npa)

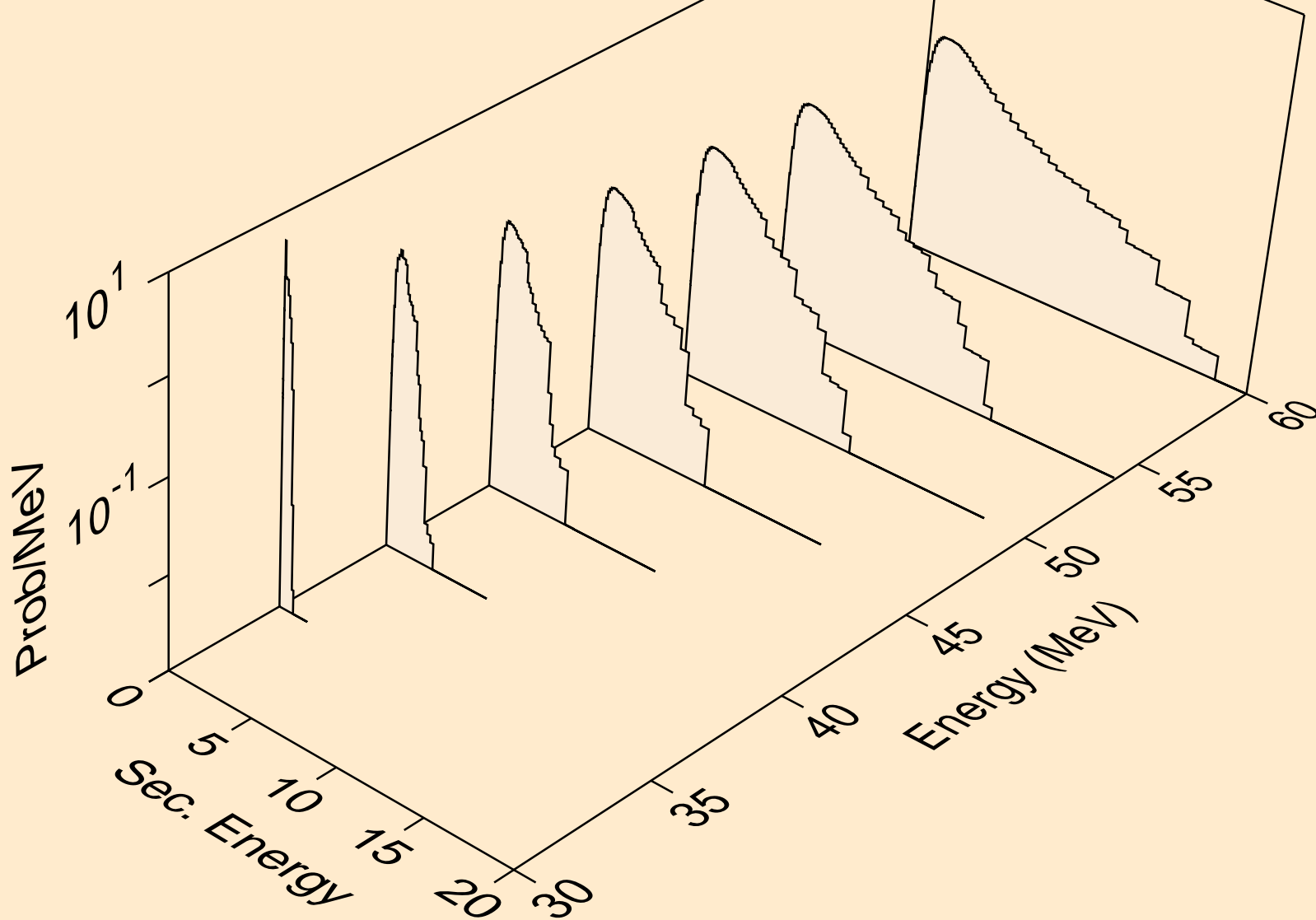

19-K-41 FOR FENDL-3.2 FROM TENDL-2015 BY NJOY2016.60+ O
Neutron emission for (n,npd)

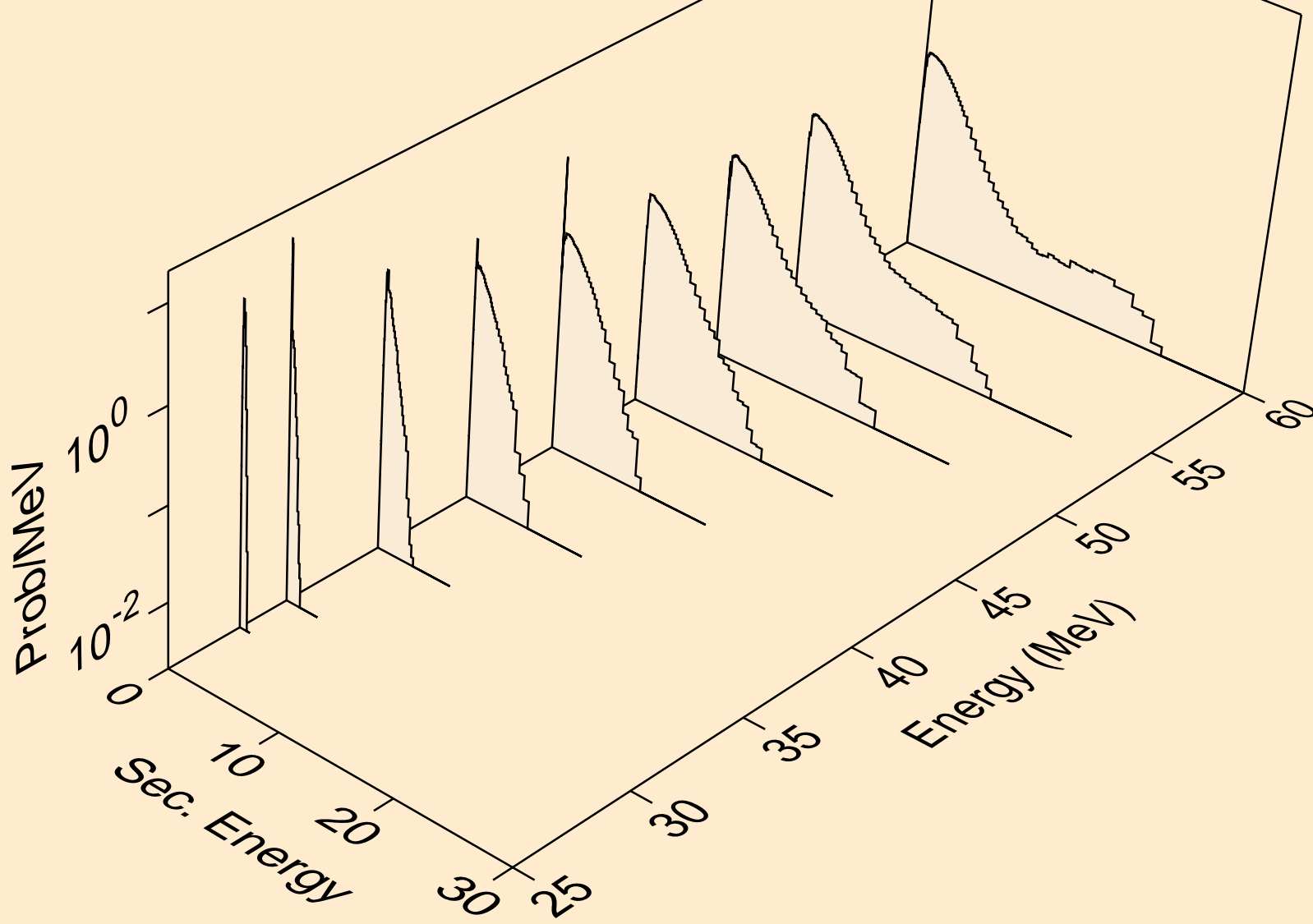

19-K-41 FOR FENDL-3.2 FROM TENDL-2015 BY NJOY2016.60+ O
Neutron emission for (n,npt)

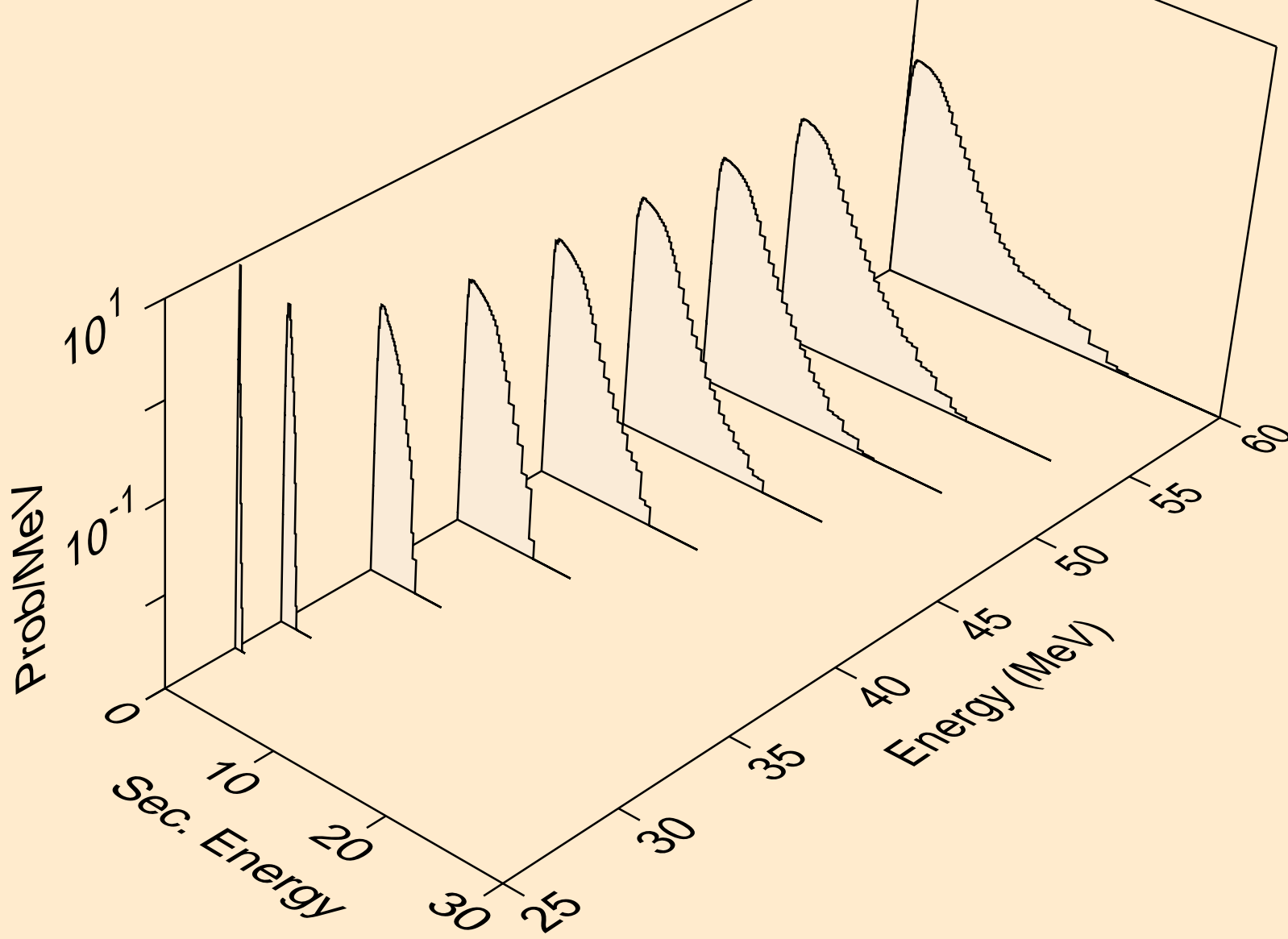

19-K-41 FOR FENDL-3.2 FROM TENDL-2015 BY NJOY2016.60+ O
Neutron emission for (n,ndt)

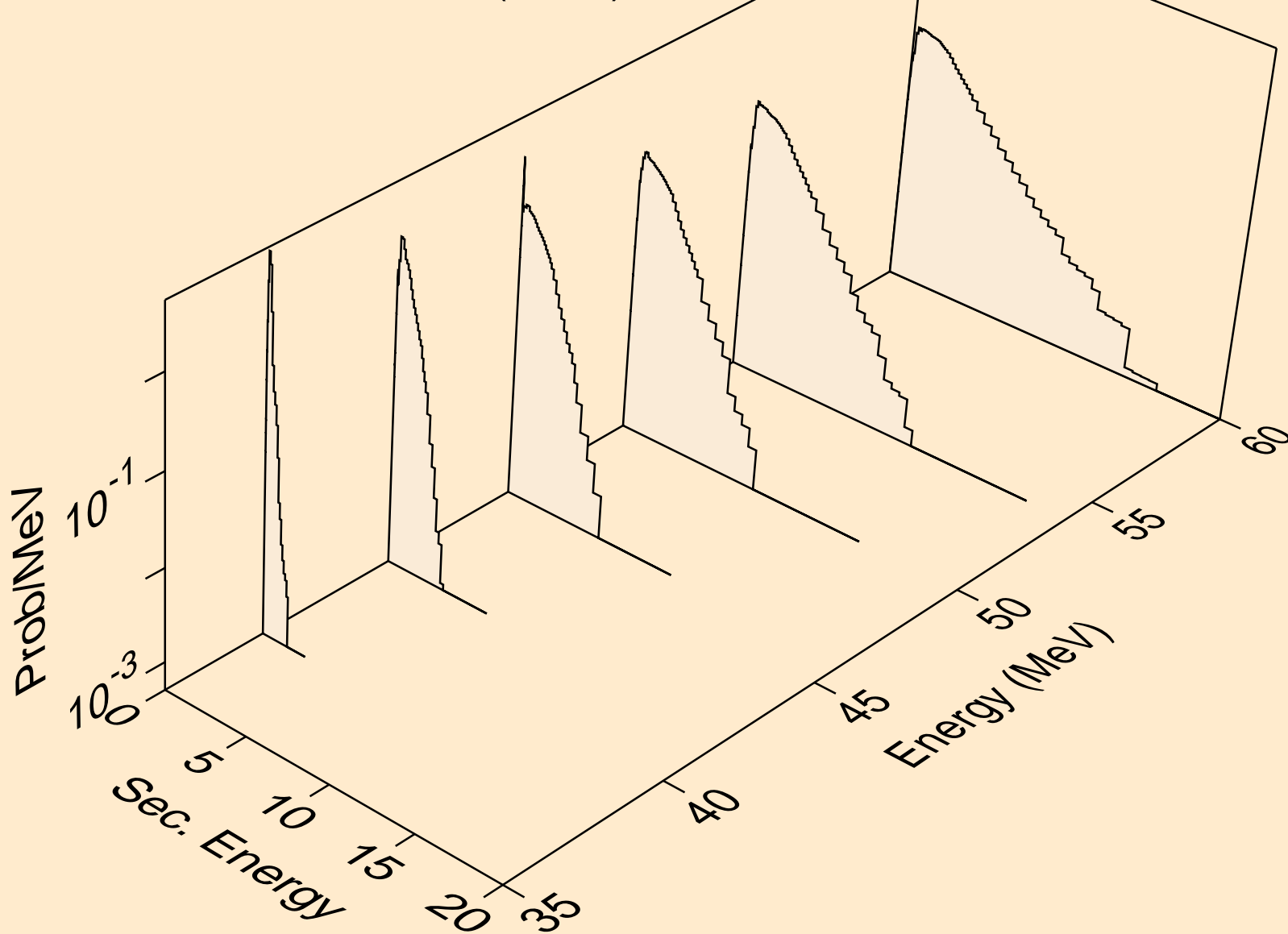

19-K-41 FOR FENDL-3.2 FROM TENDL-2015 BY NJOY2016.60+ O
Neutron emission for (n,nphe3)

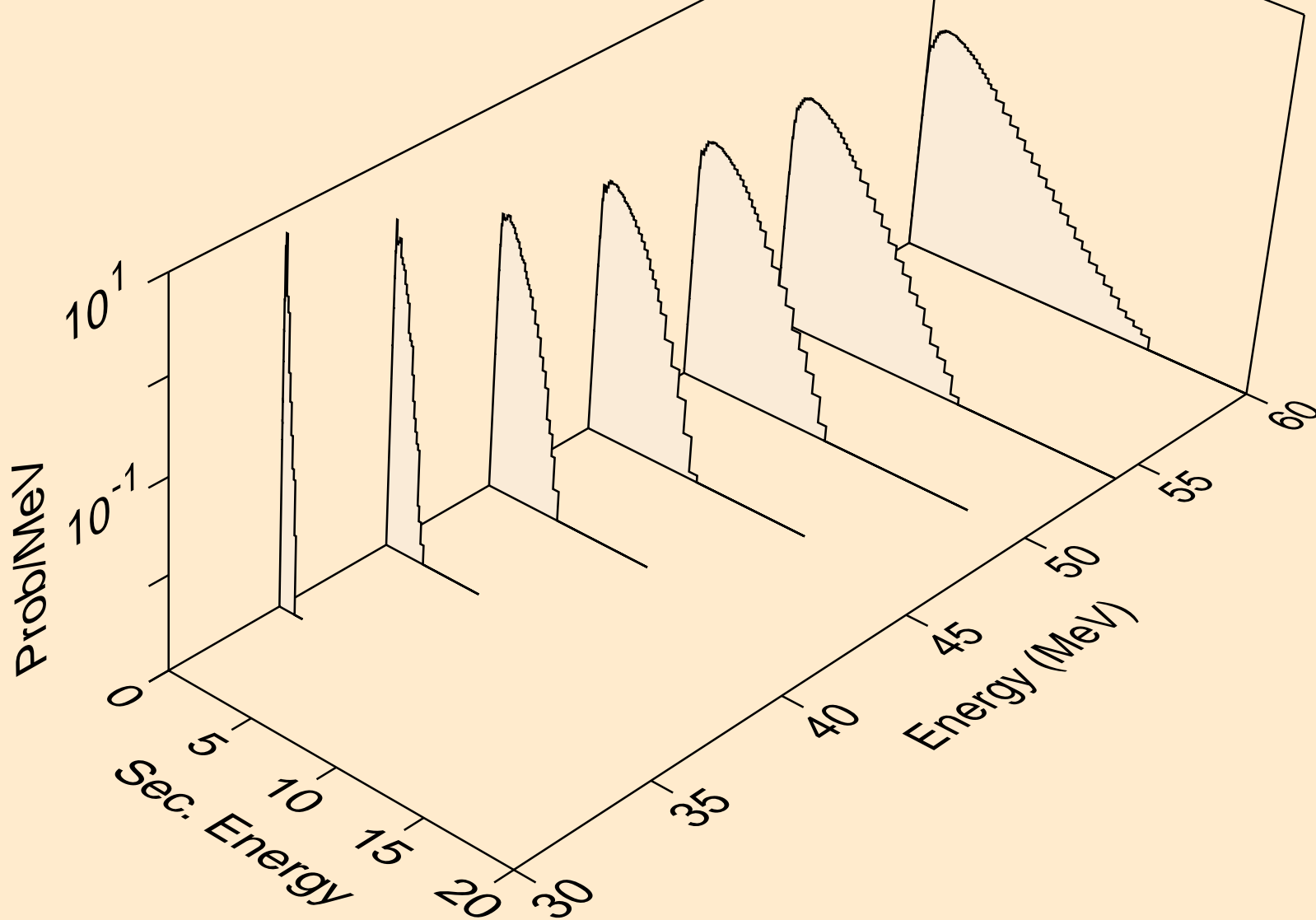

19-K-41 FOR FENDL-3.2 FROM TENDL-2015 BY NJOY2016.60+ O
Neutron emission for (n,ndhe3)

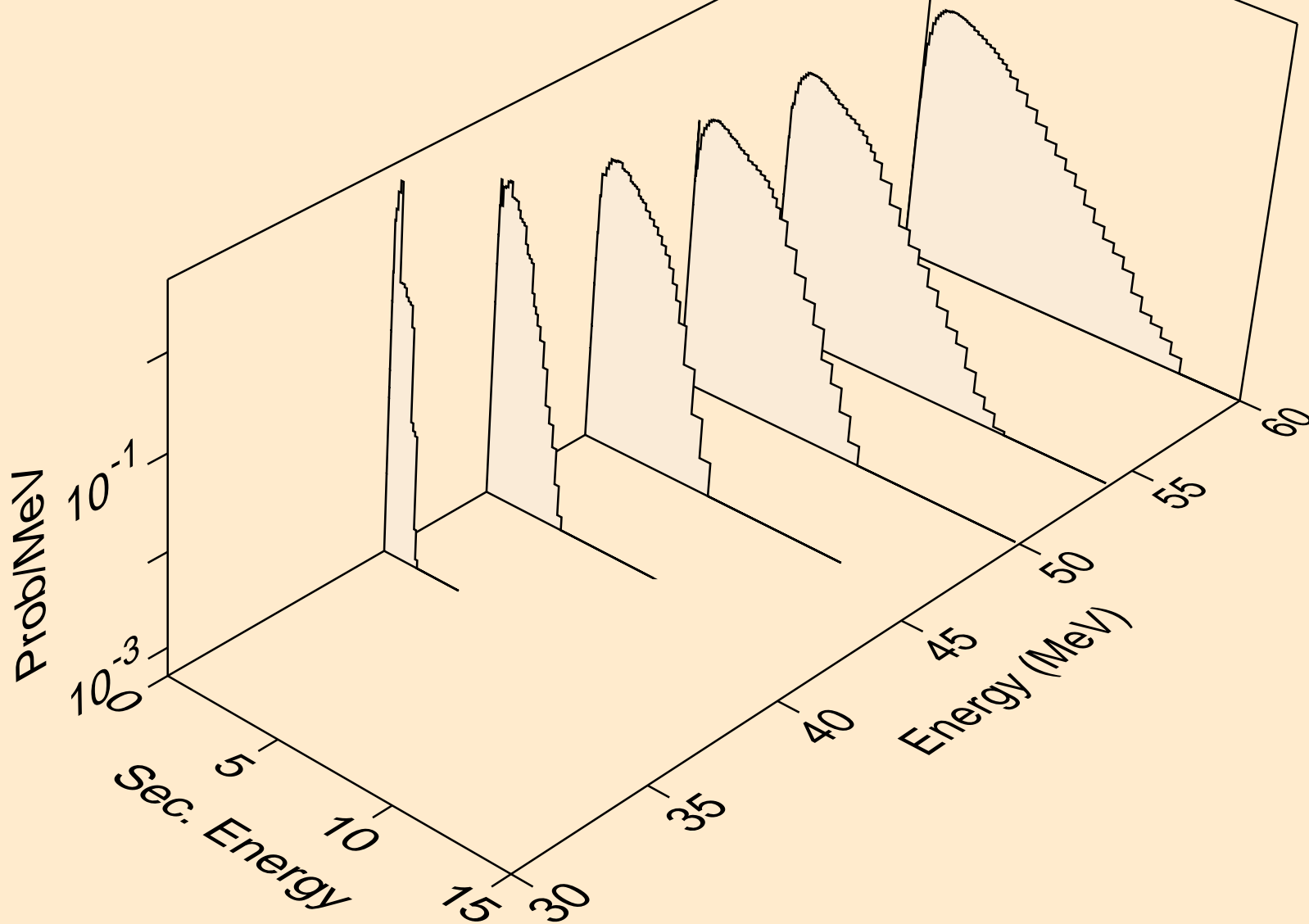

19-K-41 FOR FENDL-3.2 FROM TENDL-2015 BY NJOY2016.60+ O
Neutron emission for (n,nthe3)

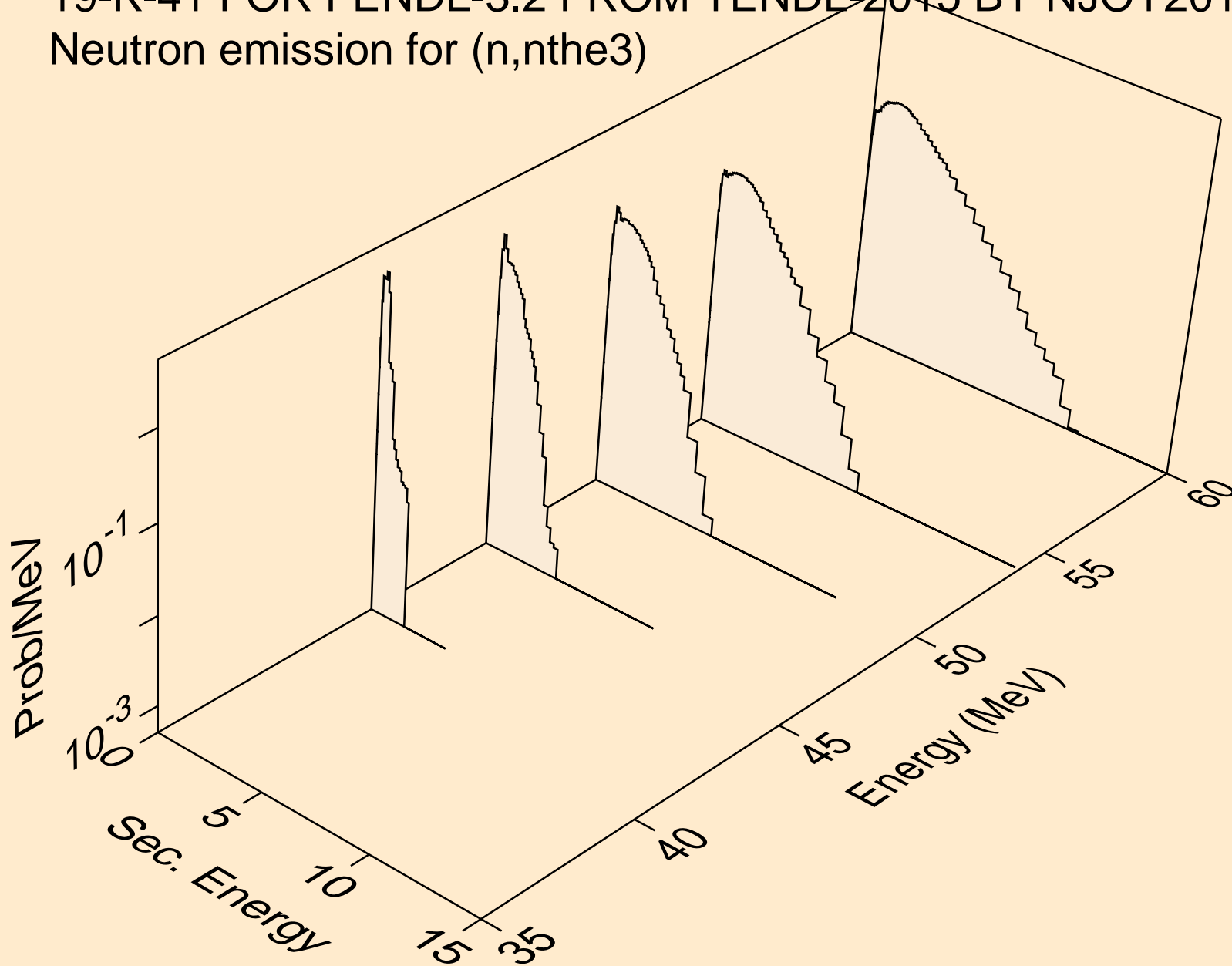

19-K-41 FOR FENDL-3.2 FROM TENDL-2015 BY NJOY2016.60+ O
Neutron emission for (n,nta)

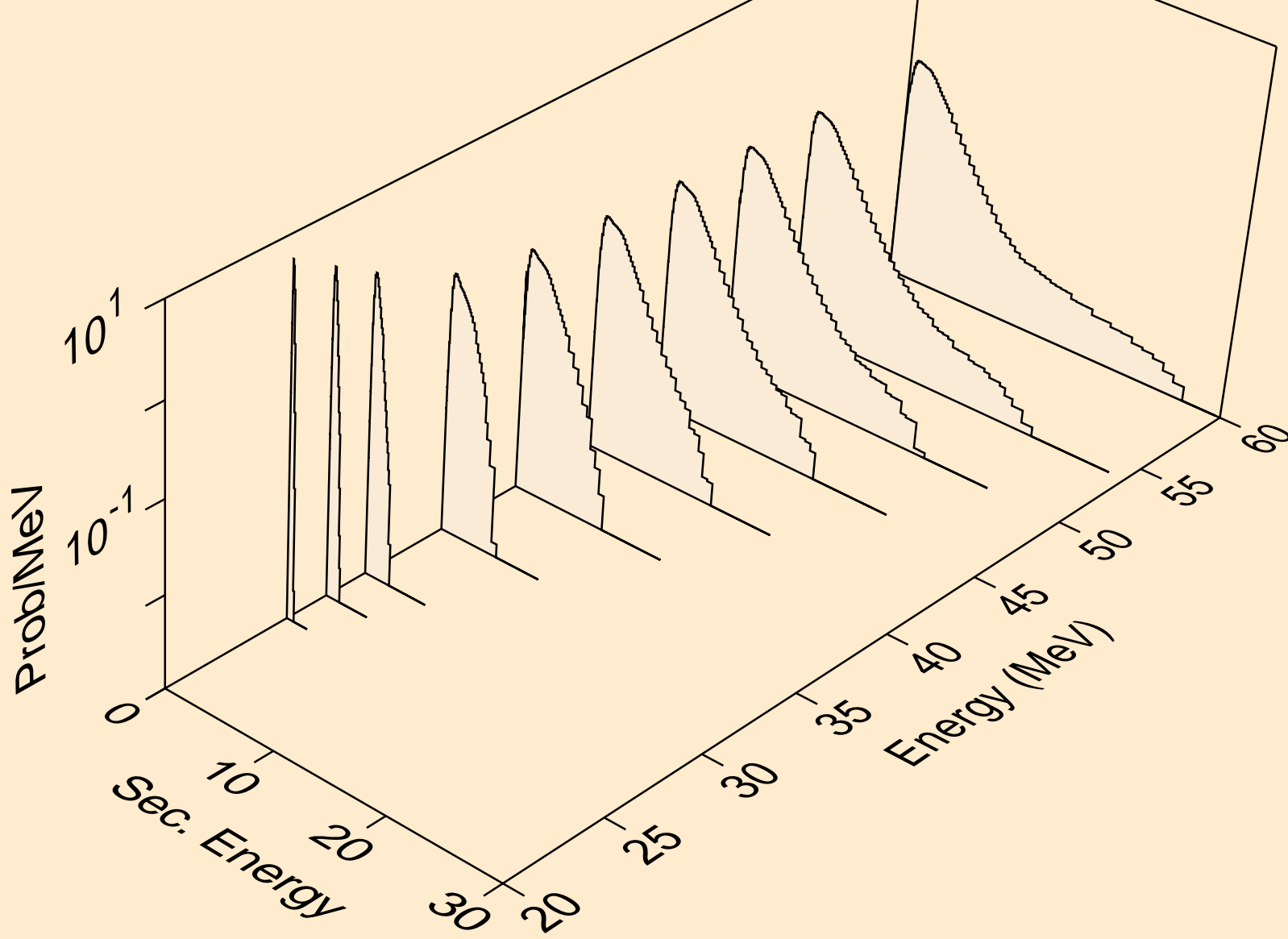

19-K-41 FOR FENDL-3.2 FROM TENDL-2015 BY NJOY2016.60+ O
Neutron emission for (n,2n2p)

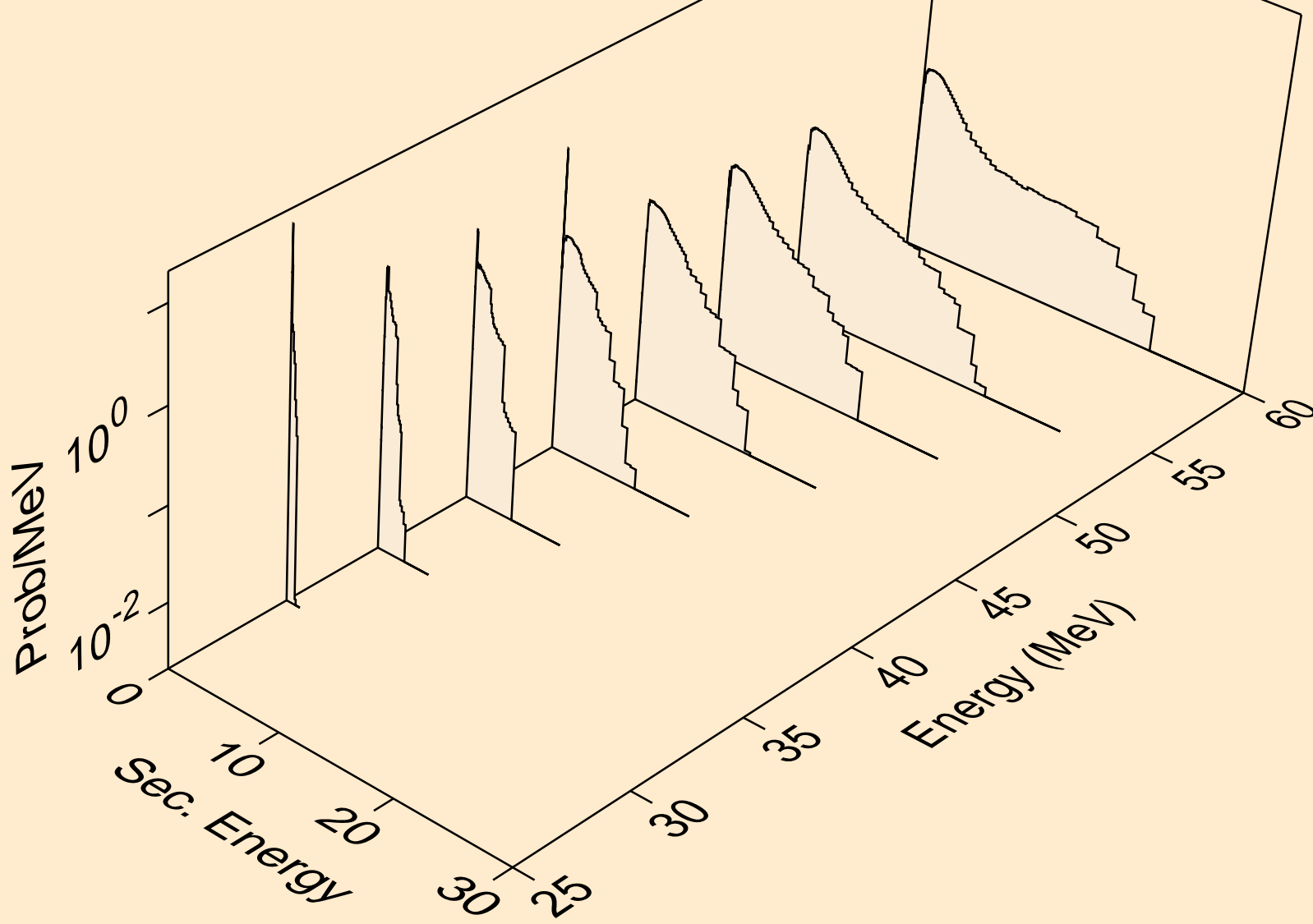

19-K-41 FOR FENDL-3.2 FROM TENDL-2015 BY NJOY2016.60+ O
Neutron emission for (n,4n2p)

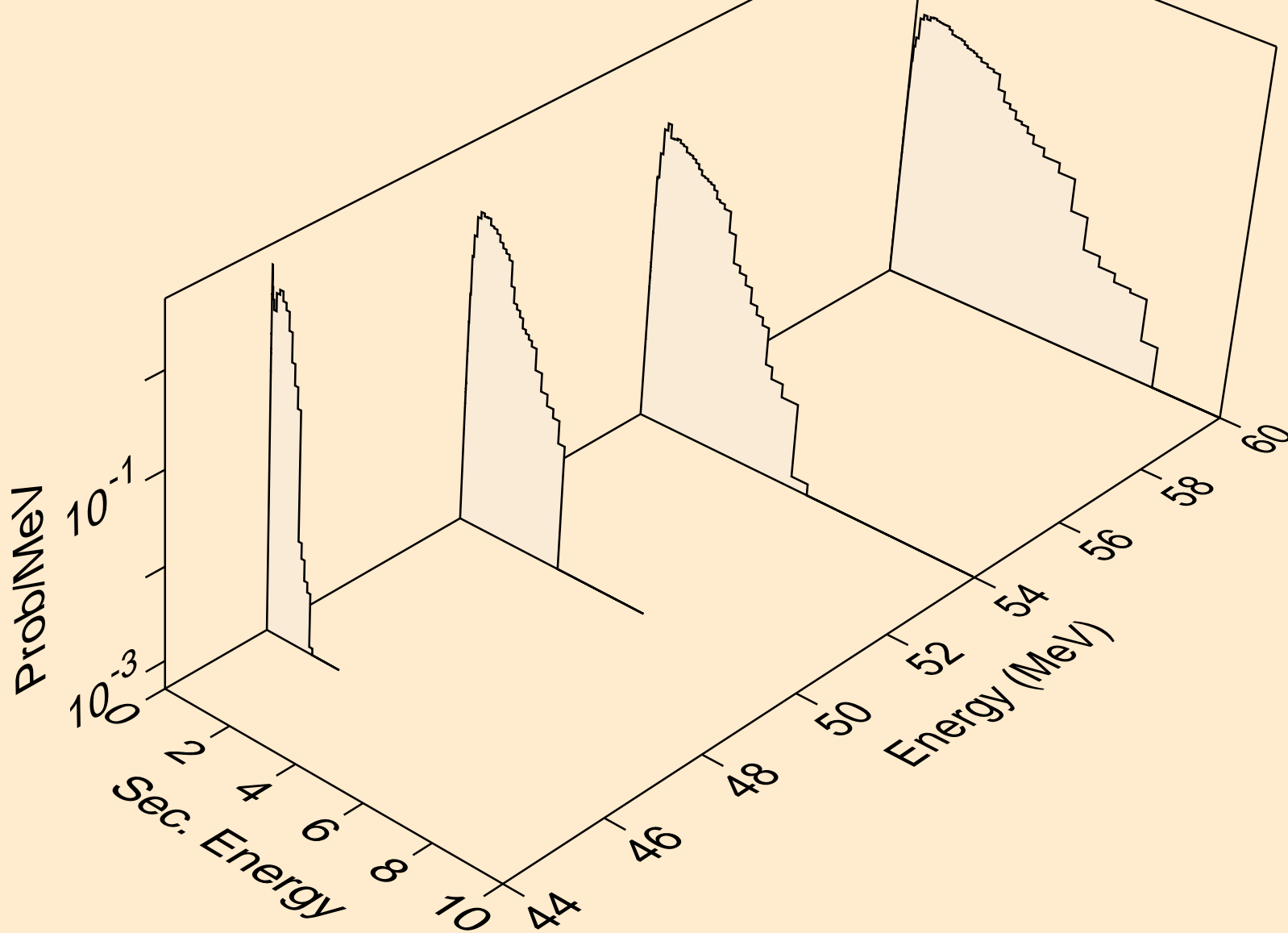

19-K-41 FOR FENDL-3.2 FROM TENDL-2015 BY NJOY2016.60+ O
Neutron emission for (n,2n2a)

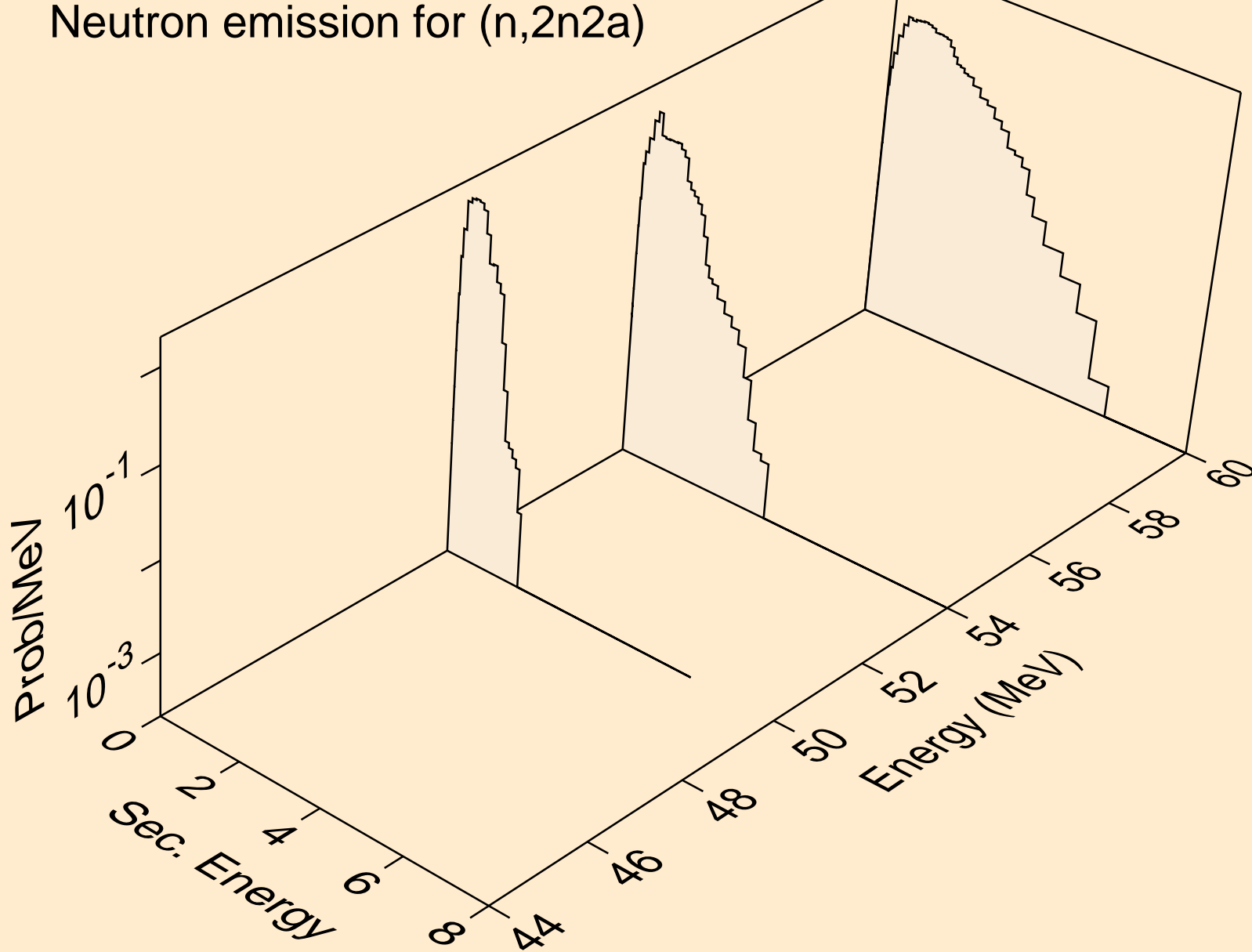

19-K-41 FOR FENDL-3.2 FROM TENDL-2015 BY NJOY2016.60+ O
Neutron emission for (n,4npa)

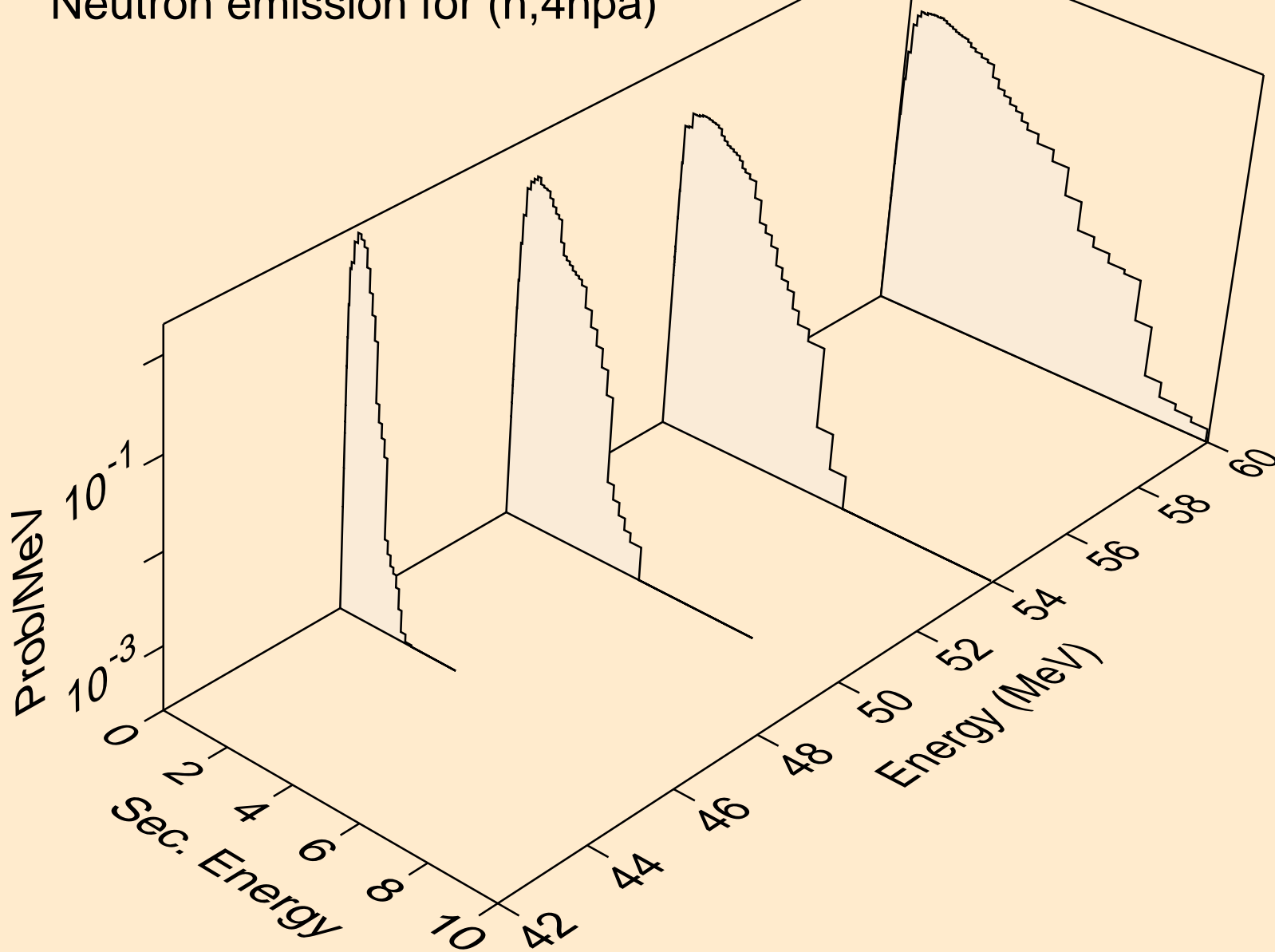

19-K-41 FOR FENDL-3.2 FROM TENDL-2015 BY NJOY2016.60+ O
Neutron emission for (n,n3p)

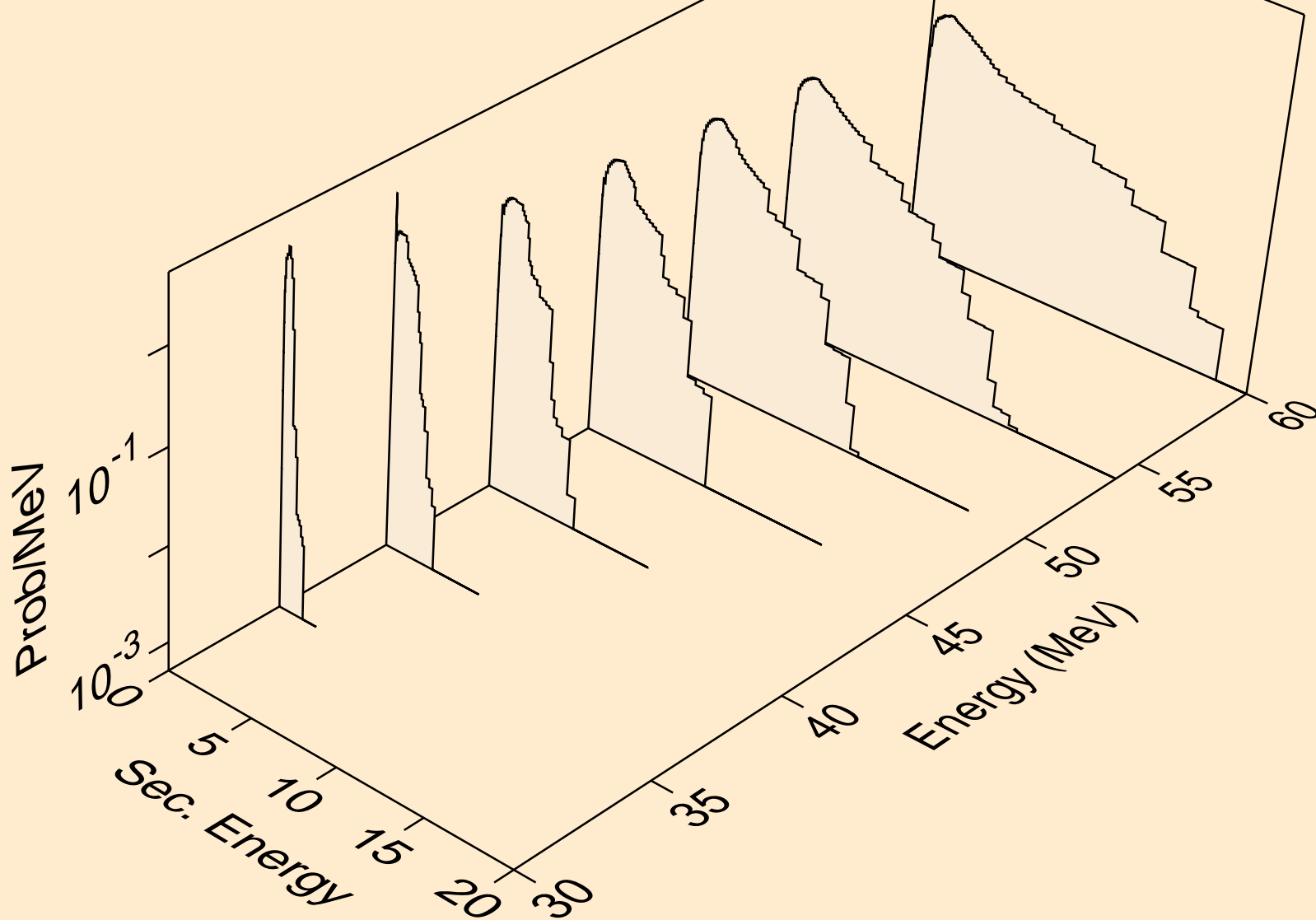

19-K-41 FOR FENDL-3.2 FROM TENDL-2015 BY NJOY2016.60+ O
Neutron emission for (n,3n2pa)

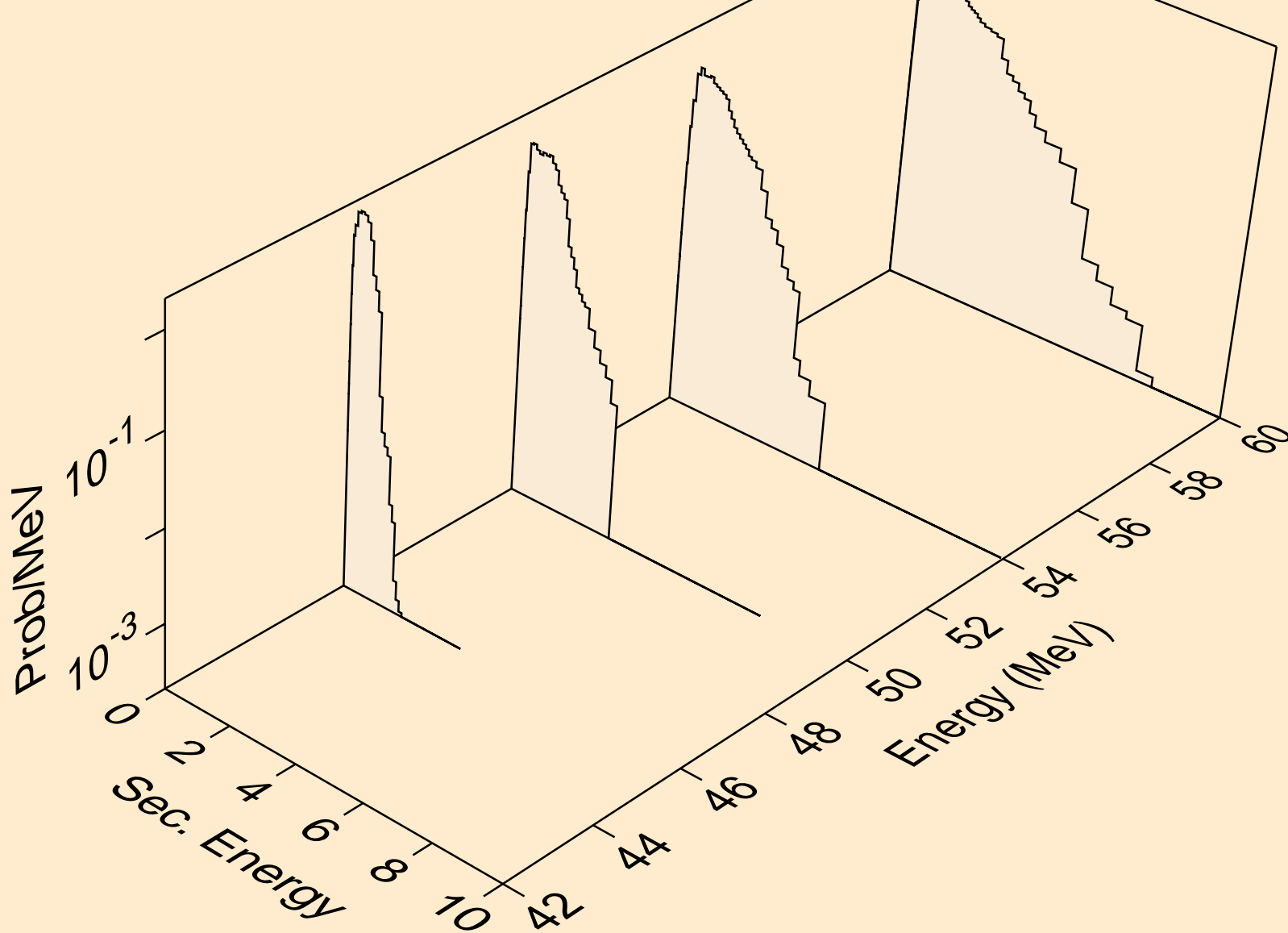

19-K-41 FOR FENDL-3.2 FROM TENDL-2015 BY NJOY2016.60+ O
Photon emission for (n,x)

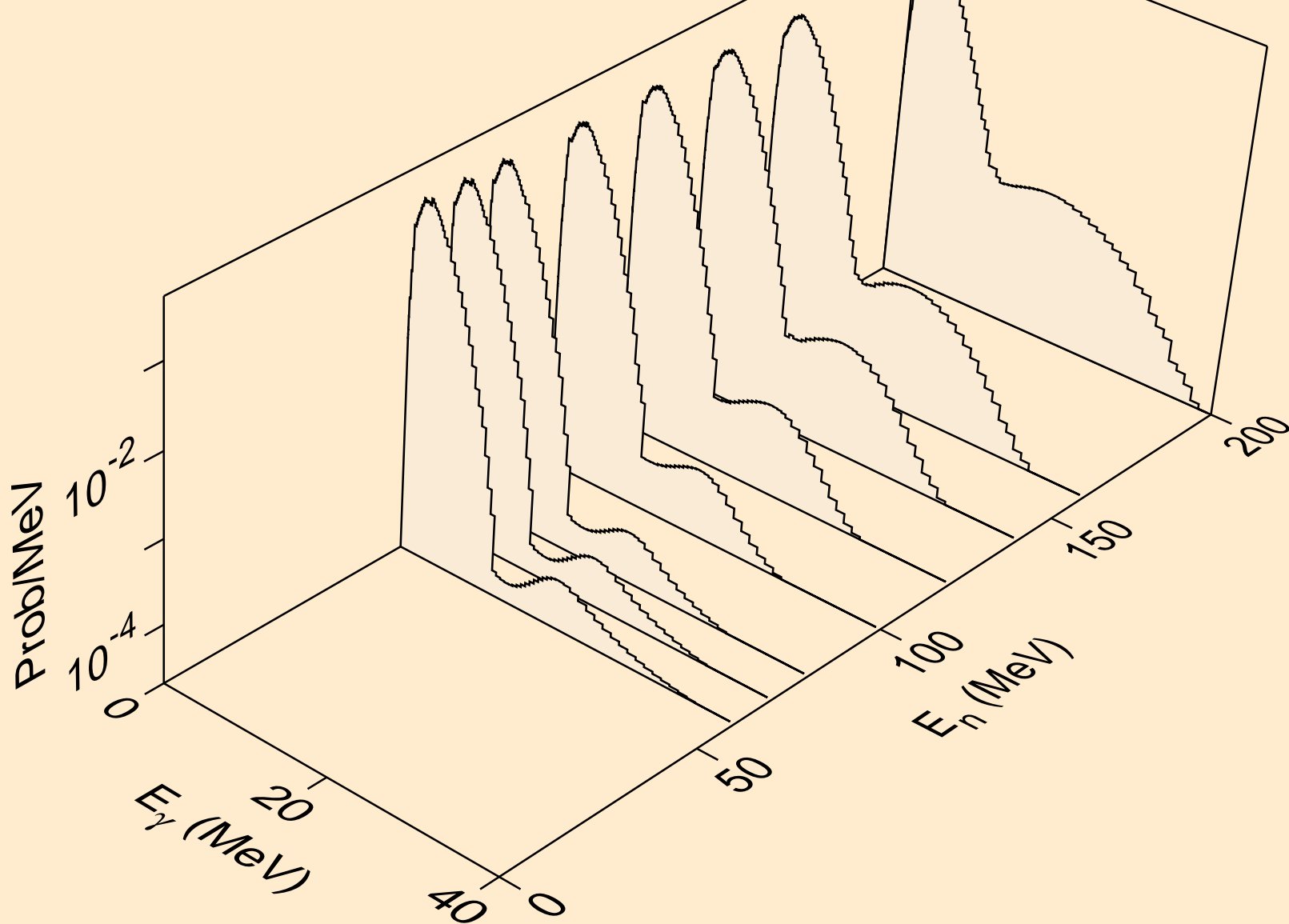

19-K-41 FOR FENDL-3.2 FROM TENDL-2015 BY NJOY2016.60+ O
Photon emission for (n,2nd)

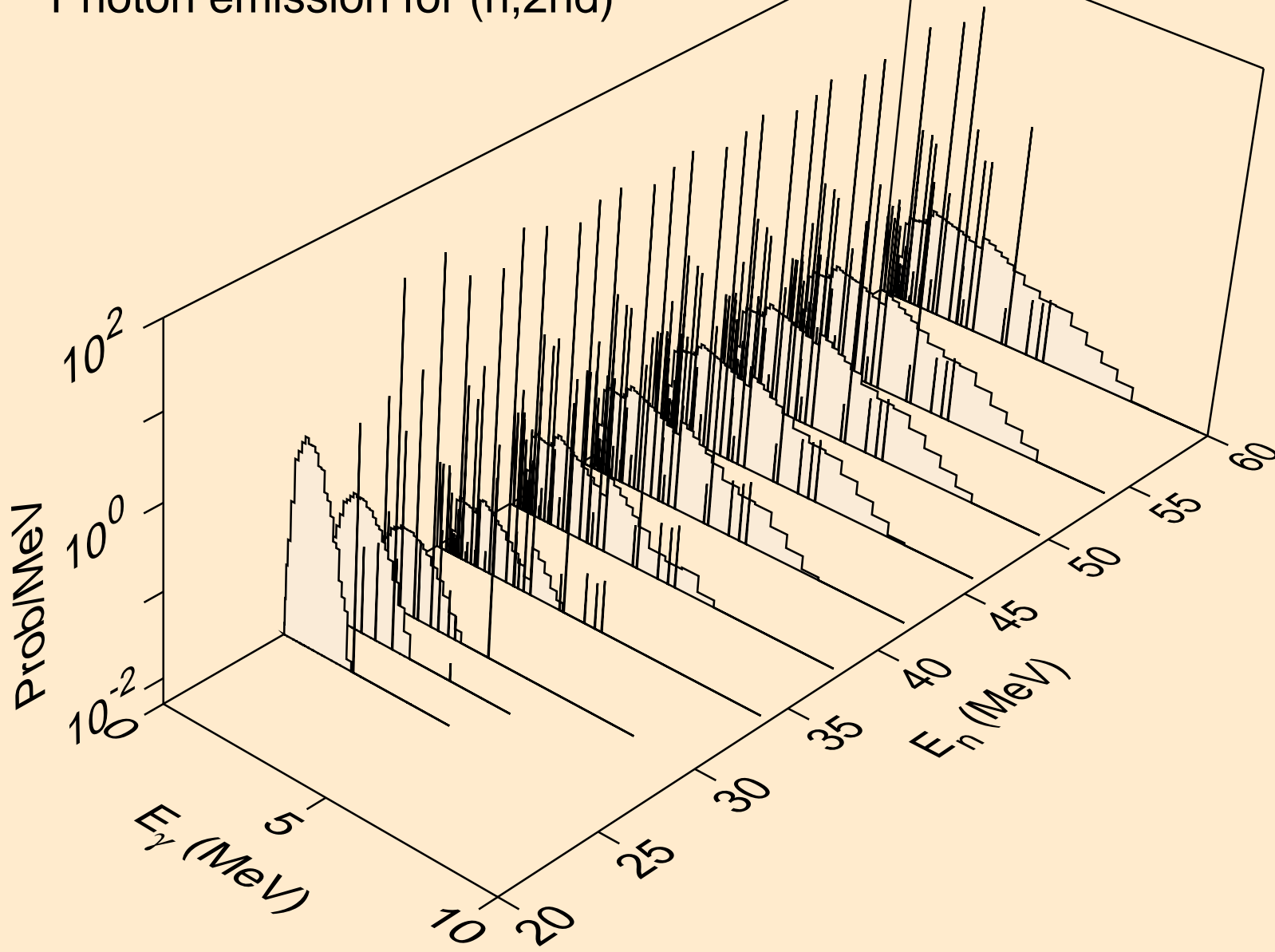

19-K-41 FOR FENDL-3.2 FROM TENDL-2015 BY NJOY2016.60+ O
Photon emission for (n,2n)

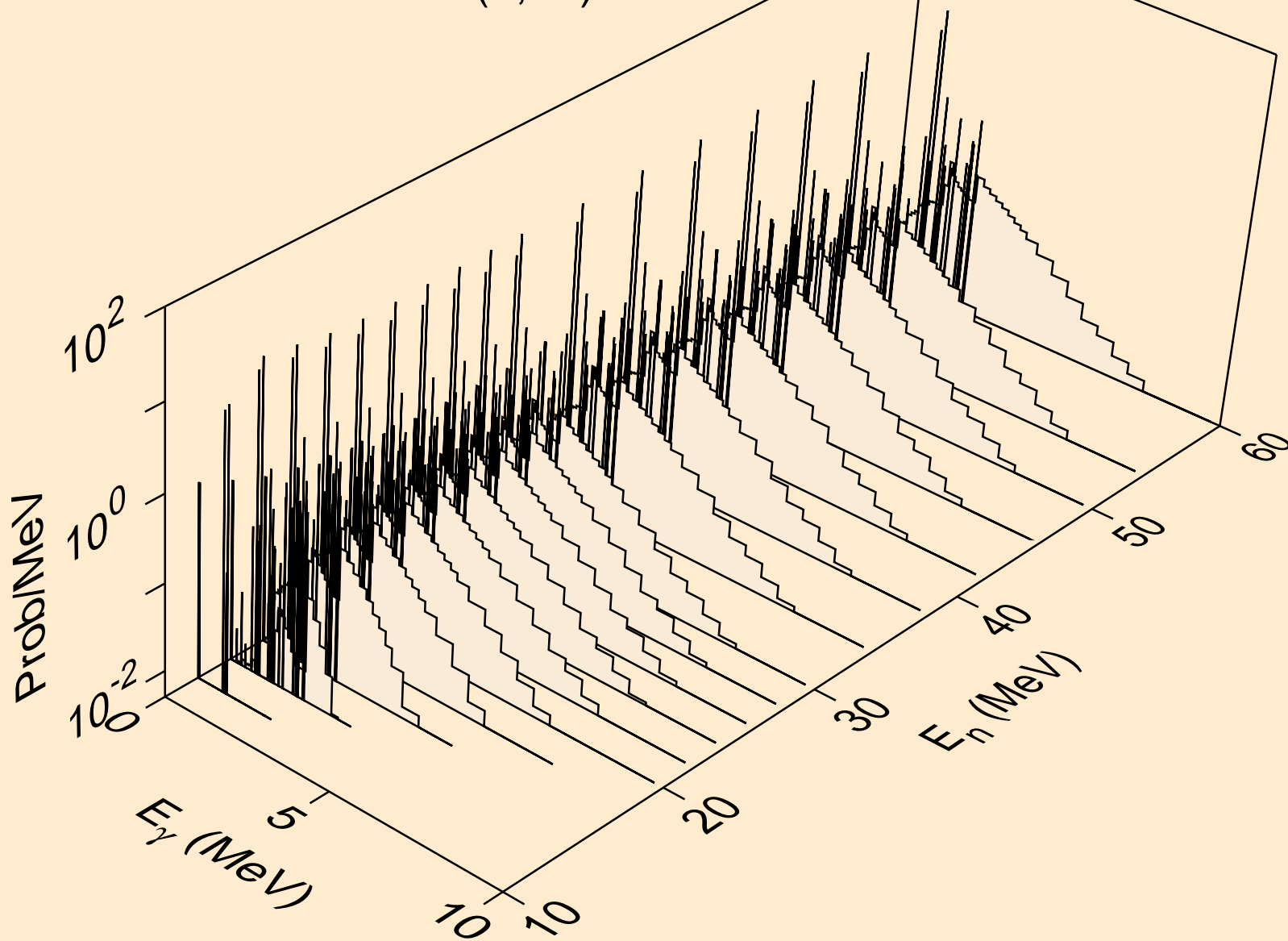

19-K-41 FOR FENDL-3.2 FROM TENDL-2015 BY NJOY2016.60+ O
Photon emission for (n,3n)

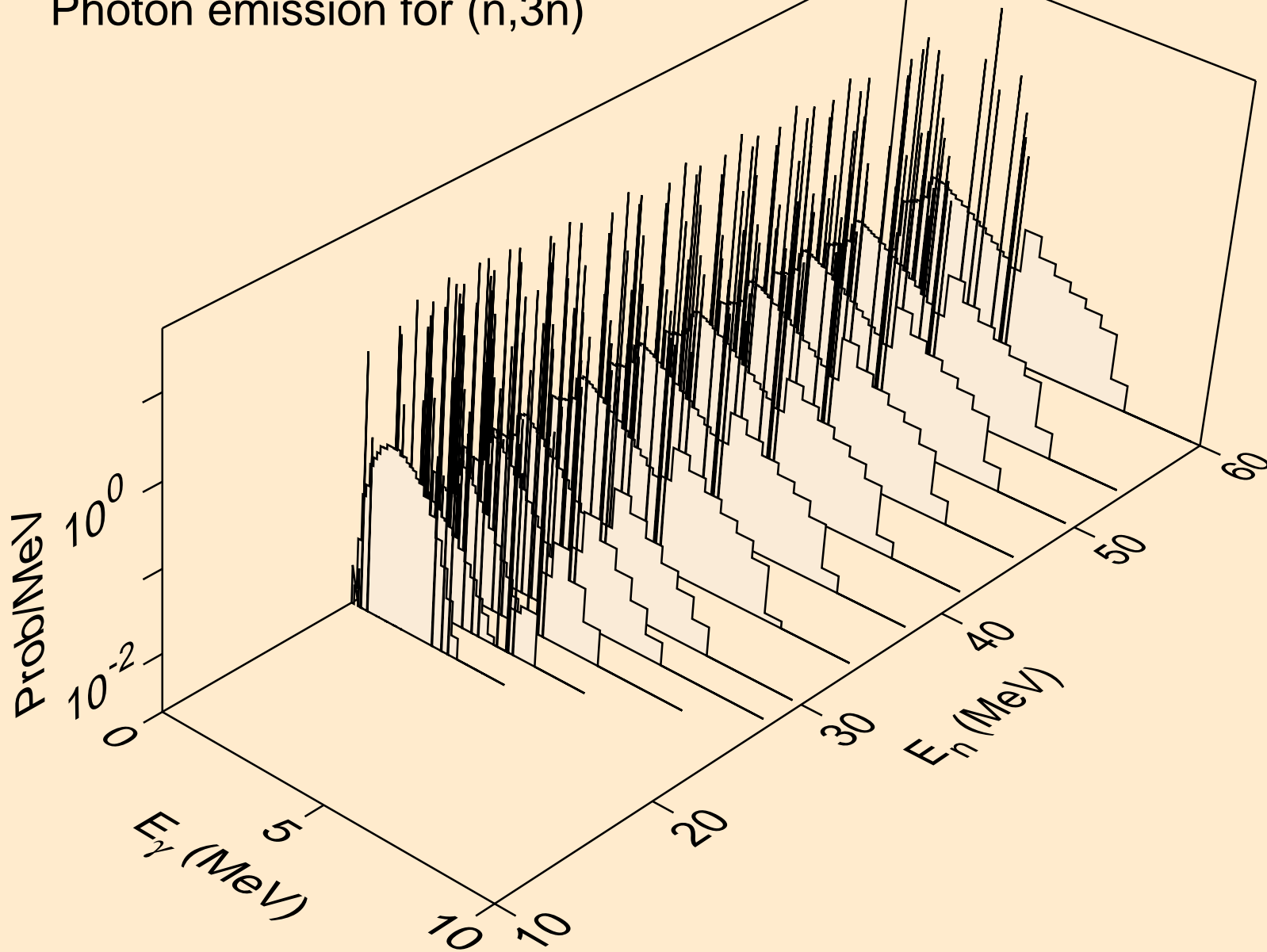

19-K-41 FOR FENDL-3.2 FROM TENDL-2015 BY NJOY2016.60+ O
Photon emission for (n,n*)a

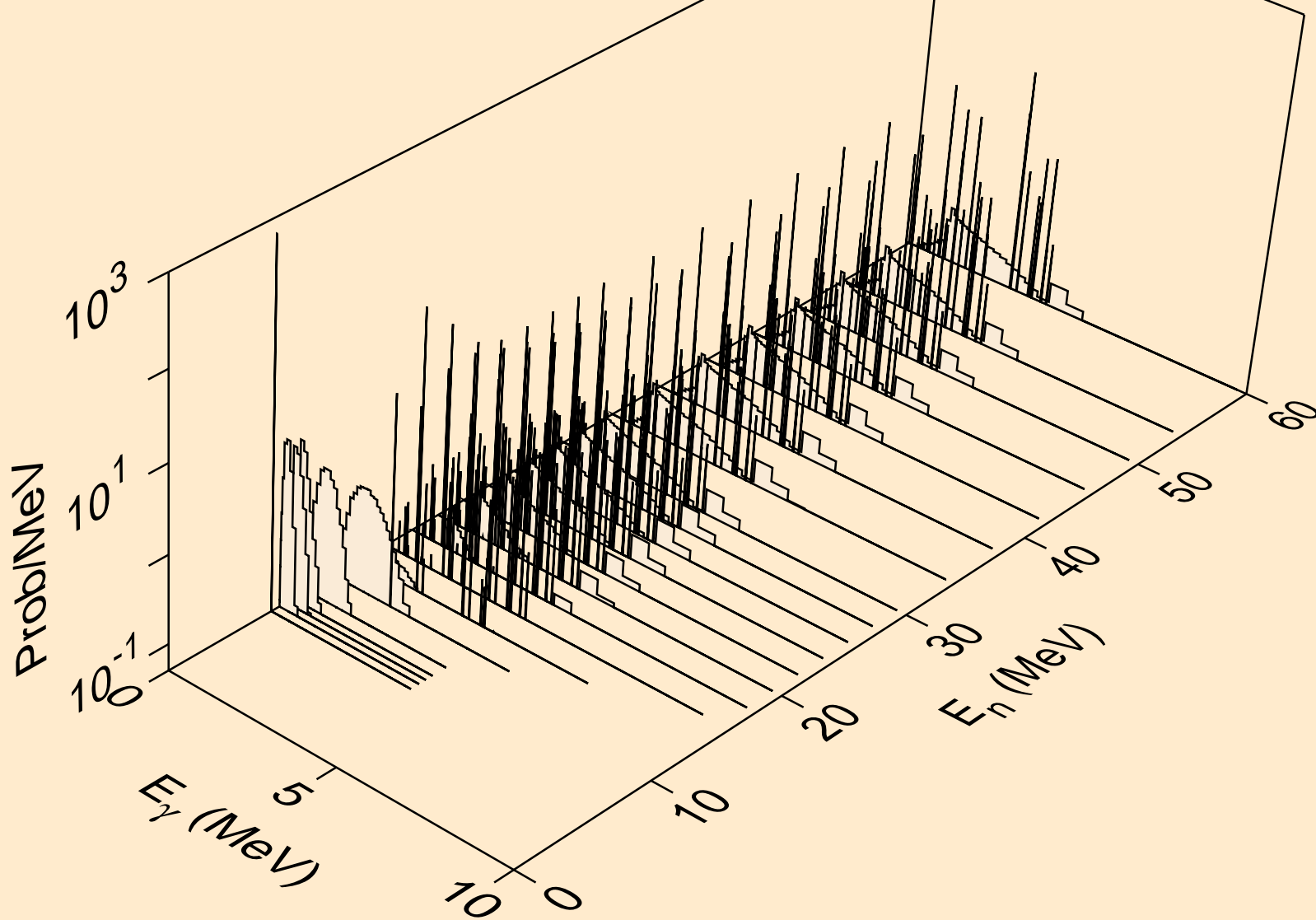

19-K-41 FOR FENDL-3.2 FROM TENDL-2015 BY NJOY2016.60+ O
Photon emission for (n,n*)3a

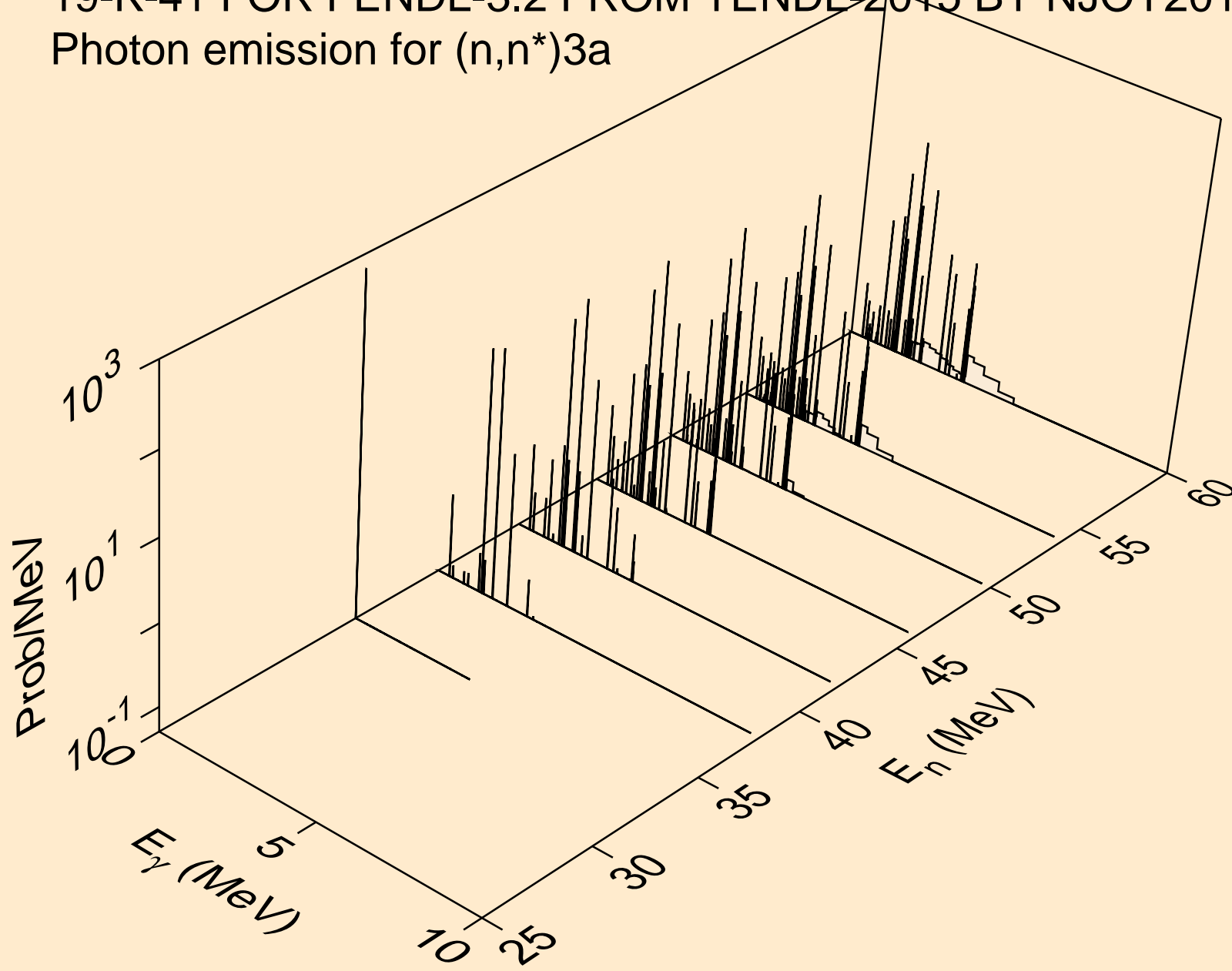

19-K-41 FOR FENDL-3.2 FROM TENDL-2015 BY NJOY2016.60+ O
Photon emission for (n,2n)a

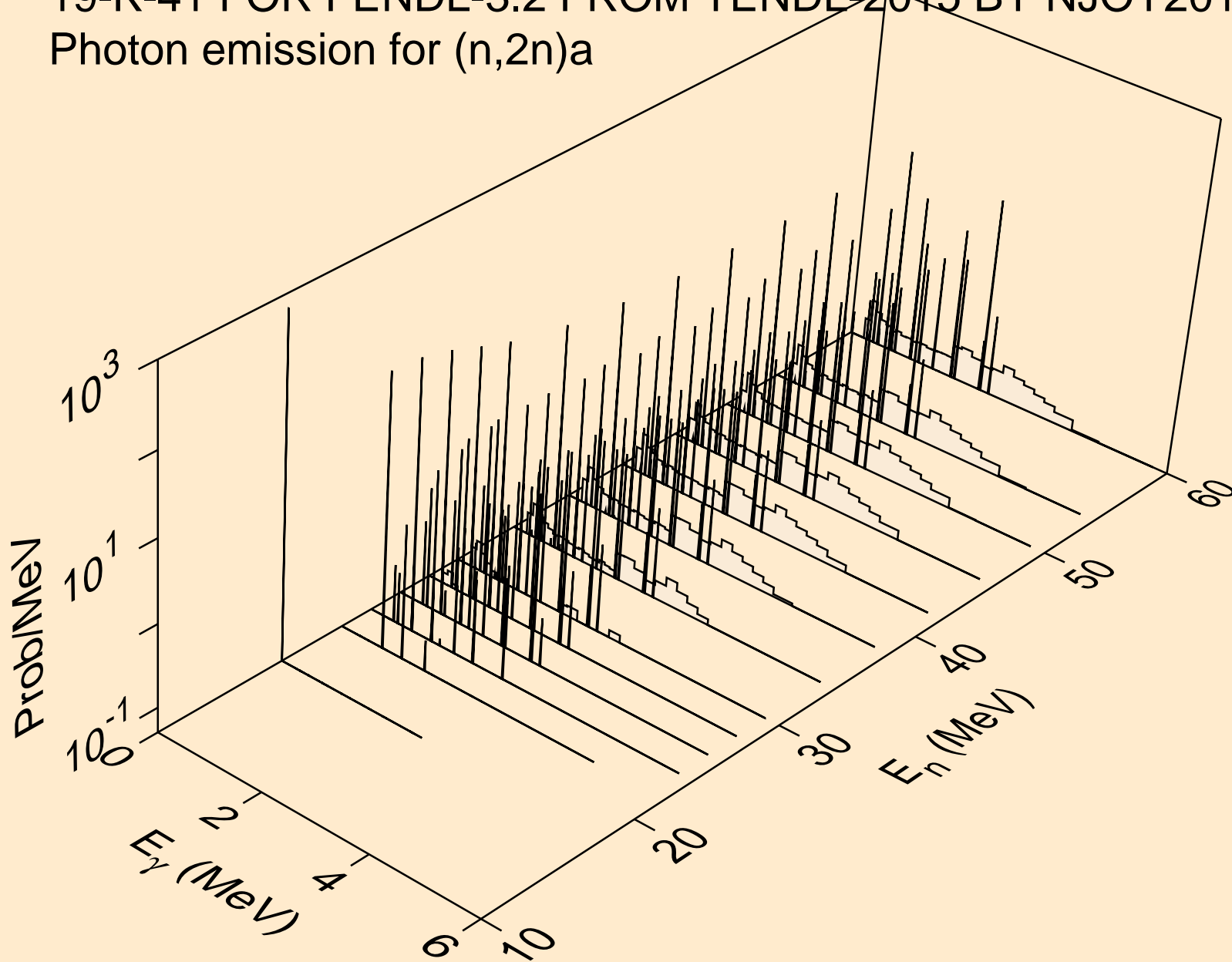

19-K-41 FOR FENDL-3.2 FROM TENDL-2015 BY NJOY2016.60+ O
Photon emission for (n,3n)a

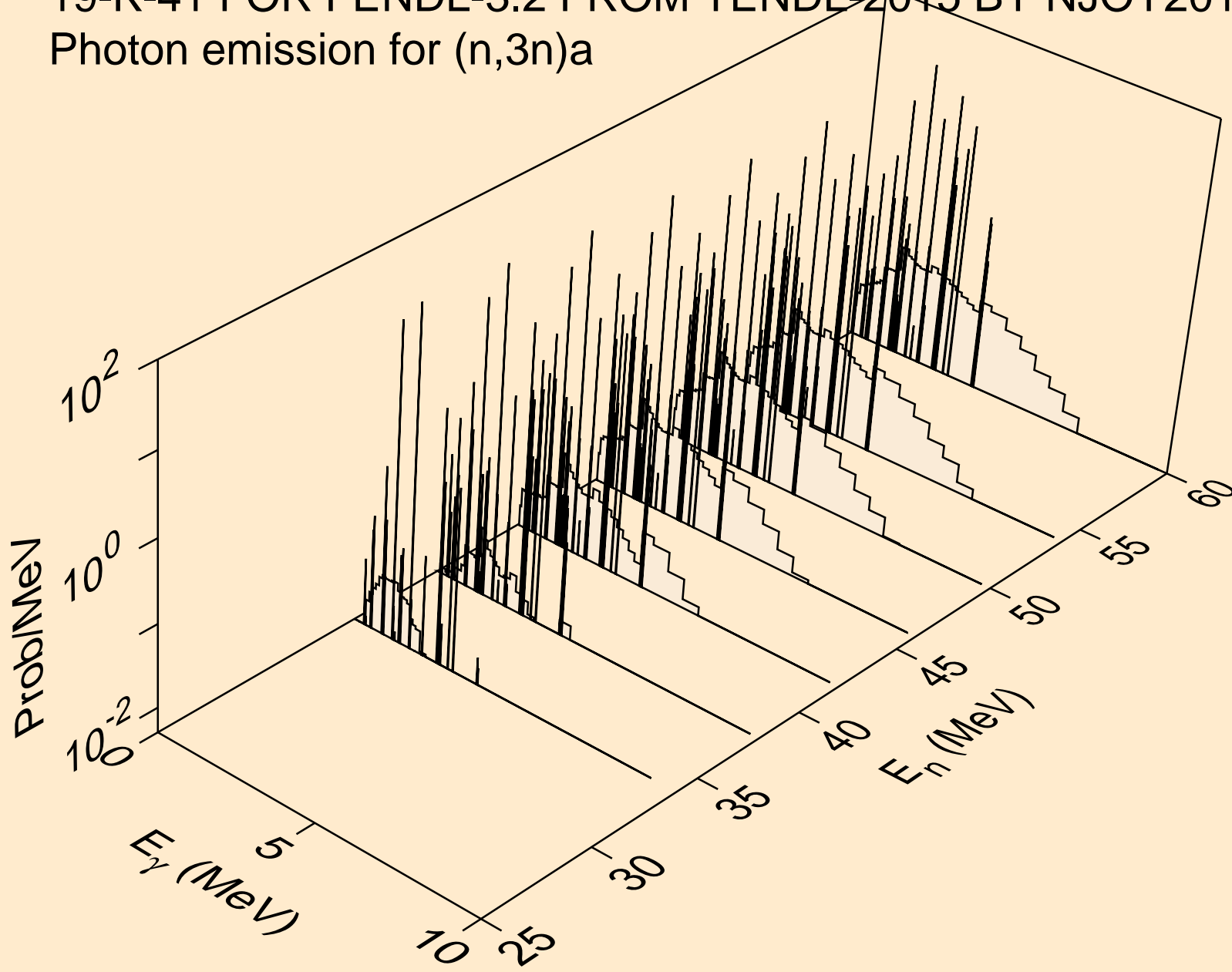

19-K-41 FOR FENDL-3.2 FROM TENDL-2015 BY NJOY2016.60+ O
Photon emission for (n,n*)p

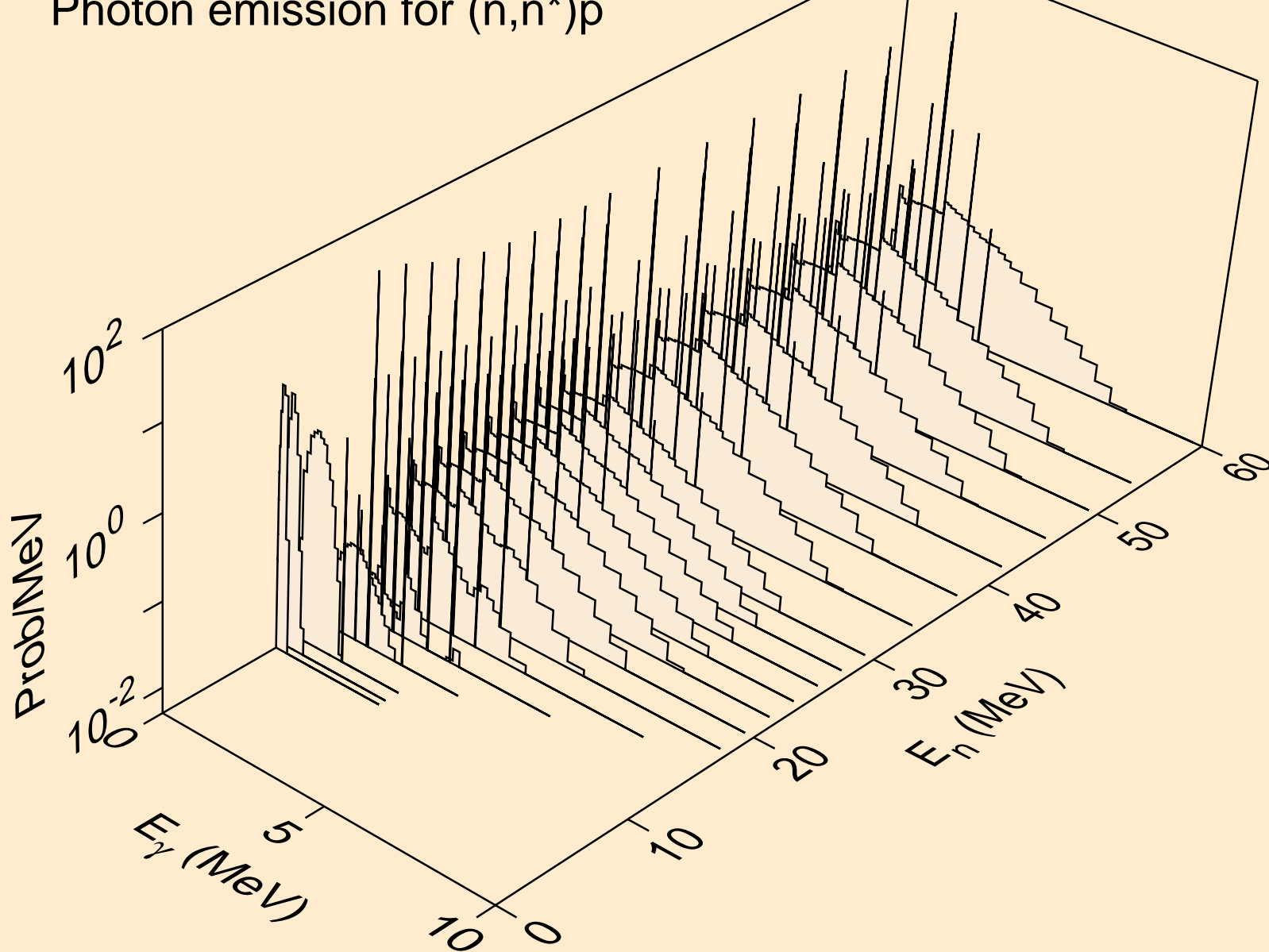

19-K-41 FOR FENDL-3.2 FROM TENDL-2015 BY NJOY2016.60+ O
Photon emission for (n,n*)2a

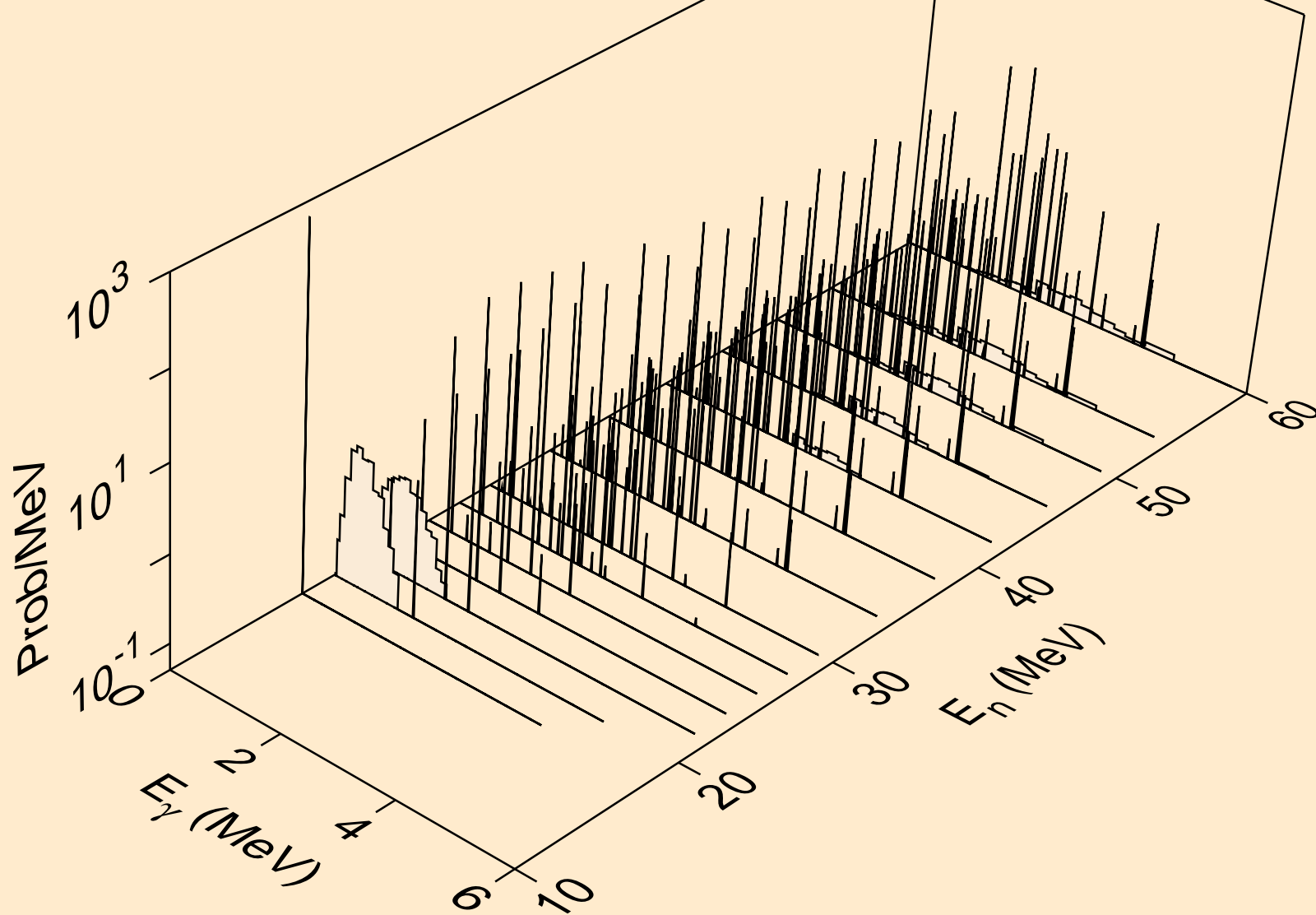

19-K-41 FOR FENDL-3.2 FROM TENDL-2015 BY NJOY2016.60+ O
Photon emission for (n,2n)2a

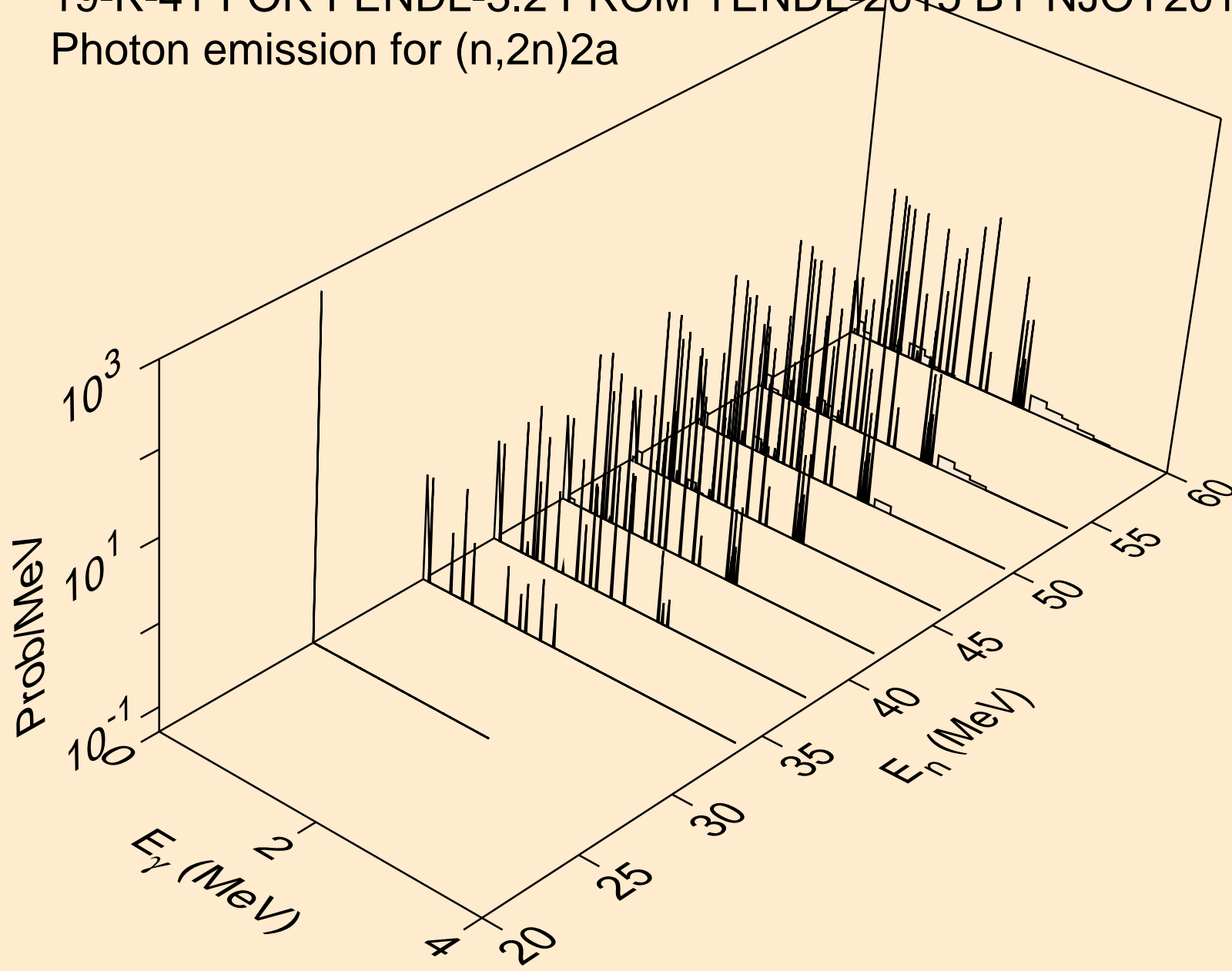

19-K-41 FOR FENDL-3.2 FROM TENDL-2015 BY NJOY2016.60+ O
Photon emission for (n,n*)d

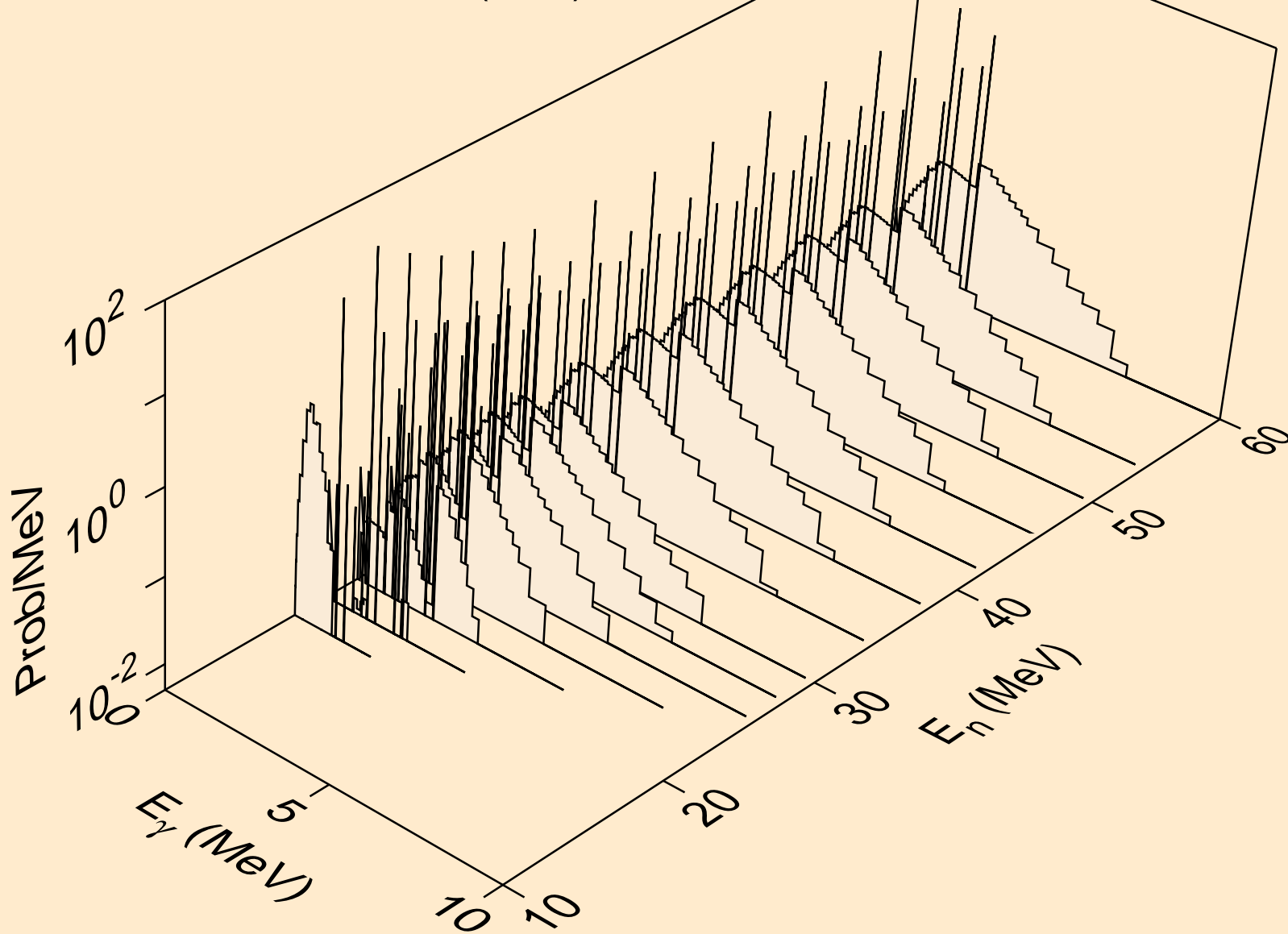

19-K-41 FOR FENDL-3.2 FROM TENDL-2015 BY NJOY2016.60+ O
Photon emission for (n,n*)t

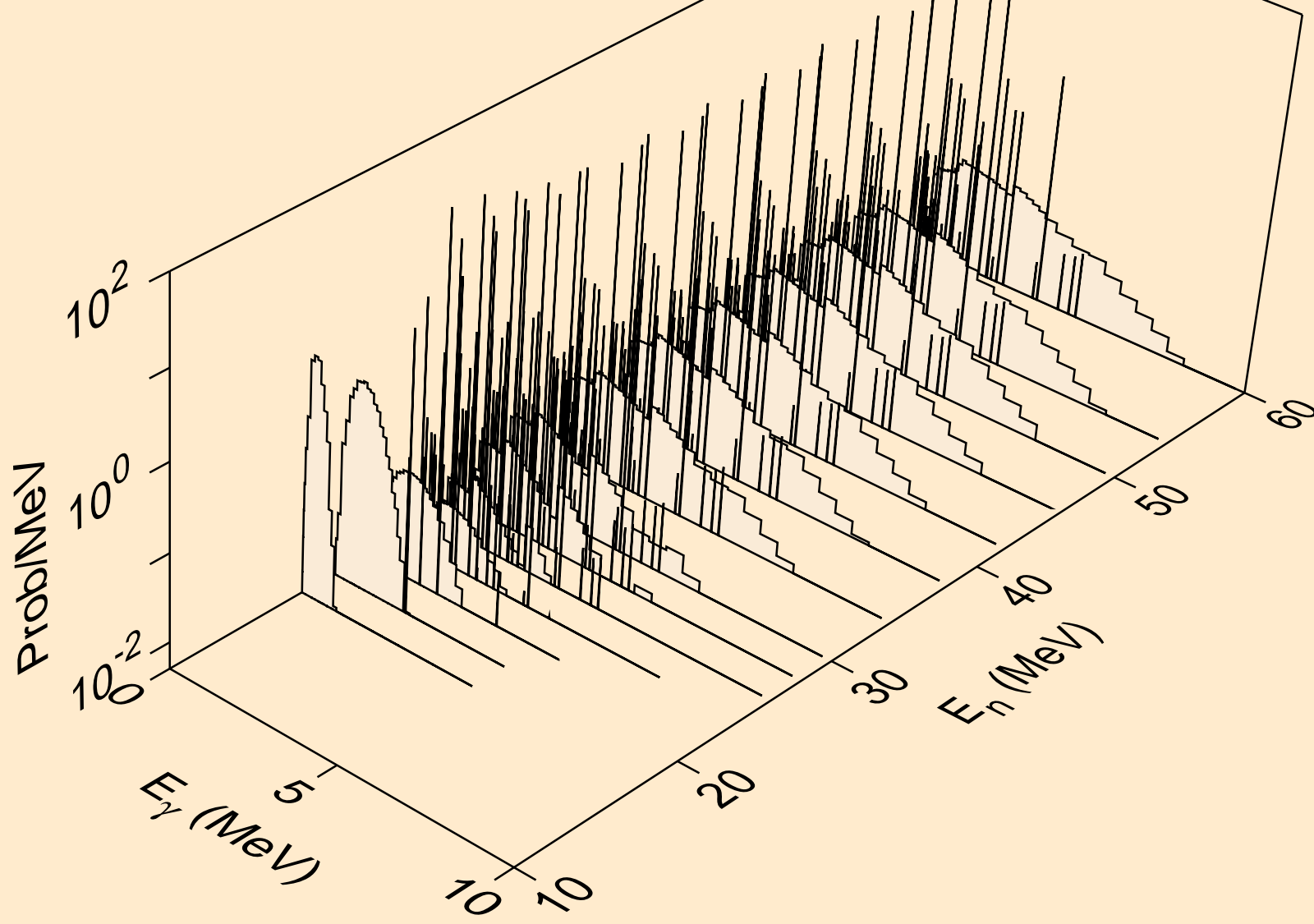

19-K-41 FOR FENDL-3.2 FROM TENDL-2015 BY NJOY2016.60+ O
Photon emission for (n,n*)he3

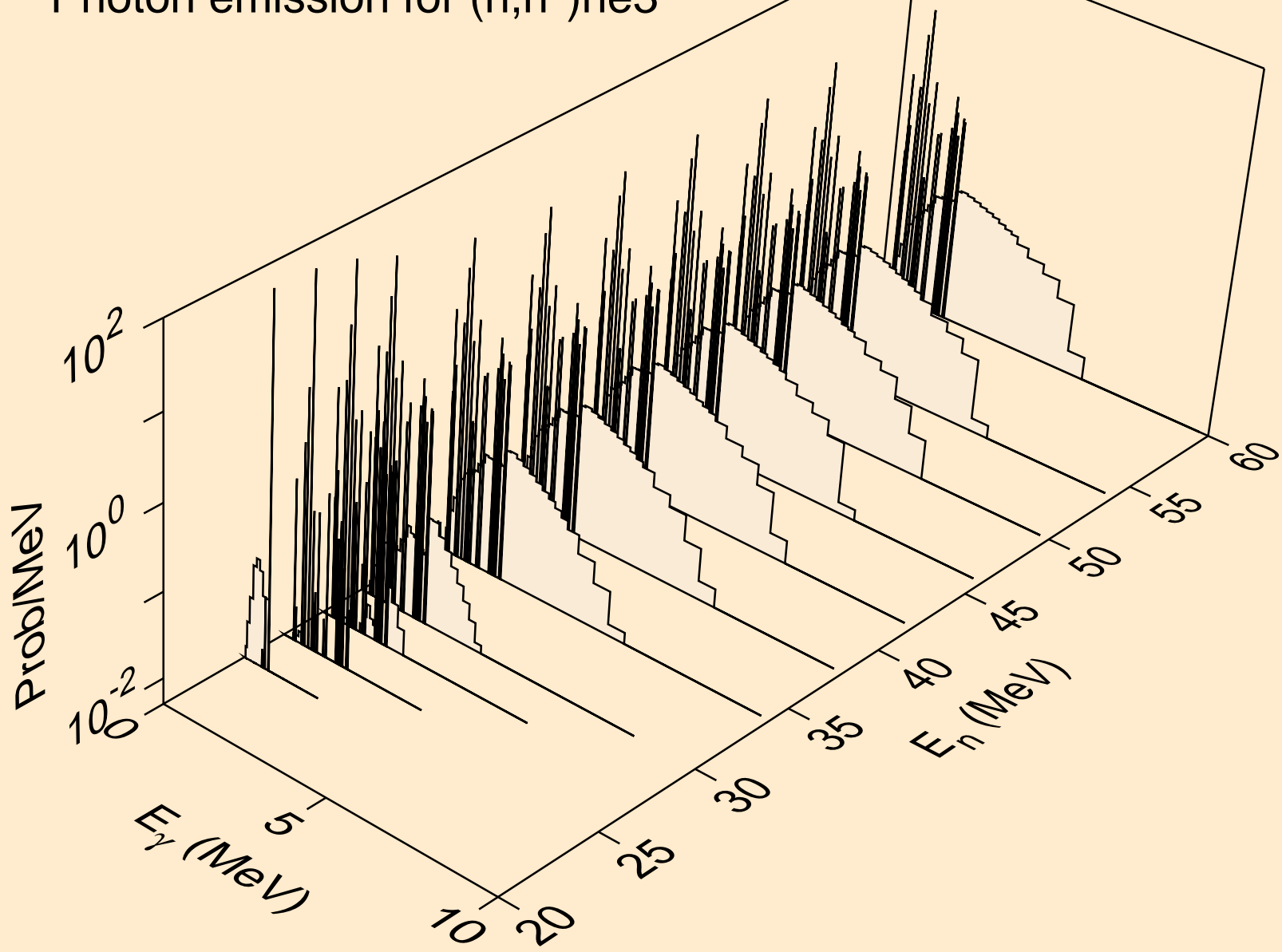

19-K-41 FOR FENDL-3.2 FROM TENDL-2015 BY NJOY2016.60+ O
Photon emission for (n,n*)d2a

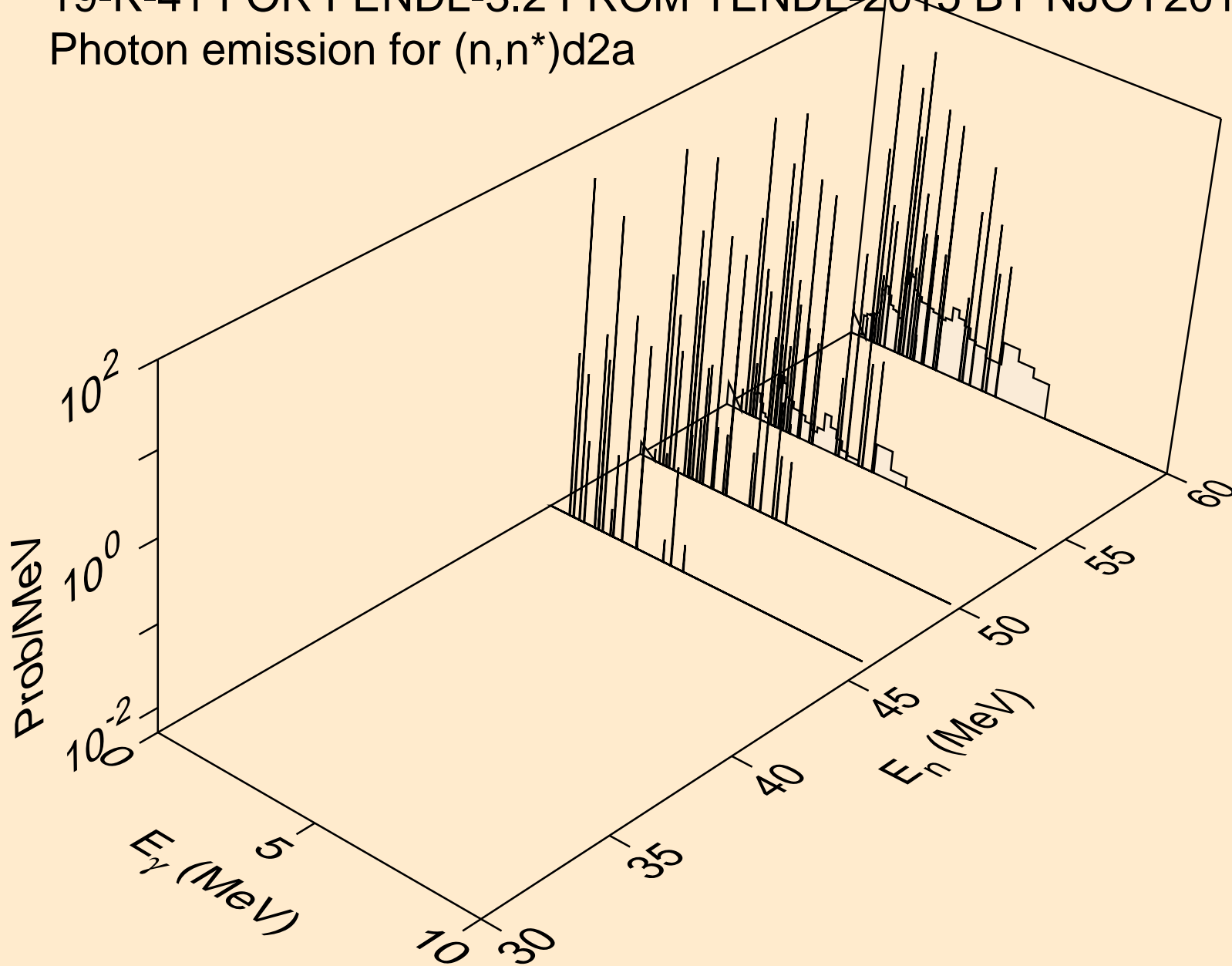

19-K-41 FOR FENDL-3.2 FROM TENDL-2015 BY NJOY2016.60+ O
Photon emission for (n,n*)t2a

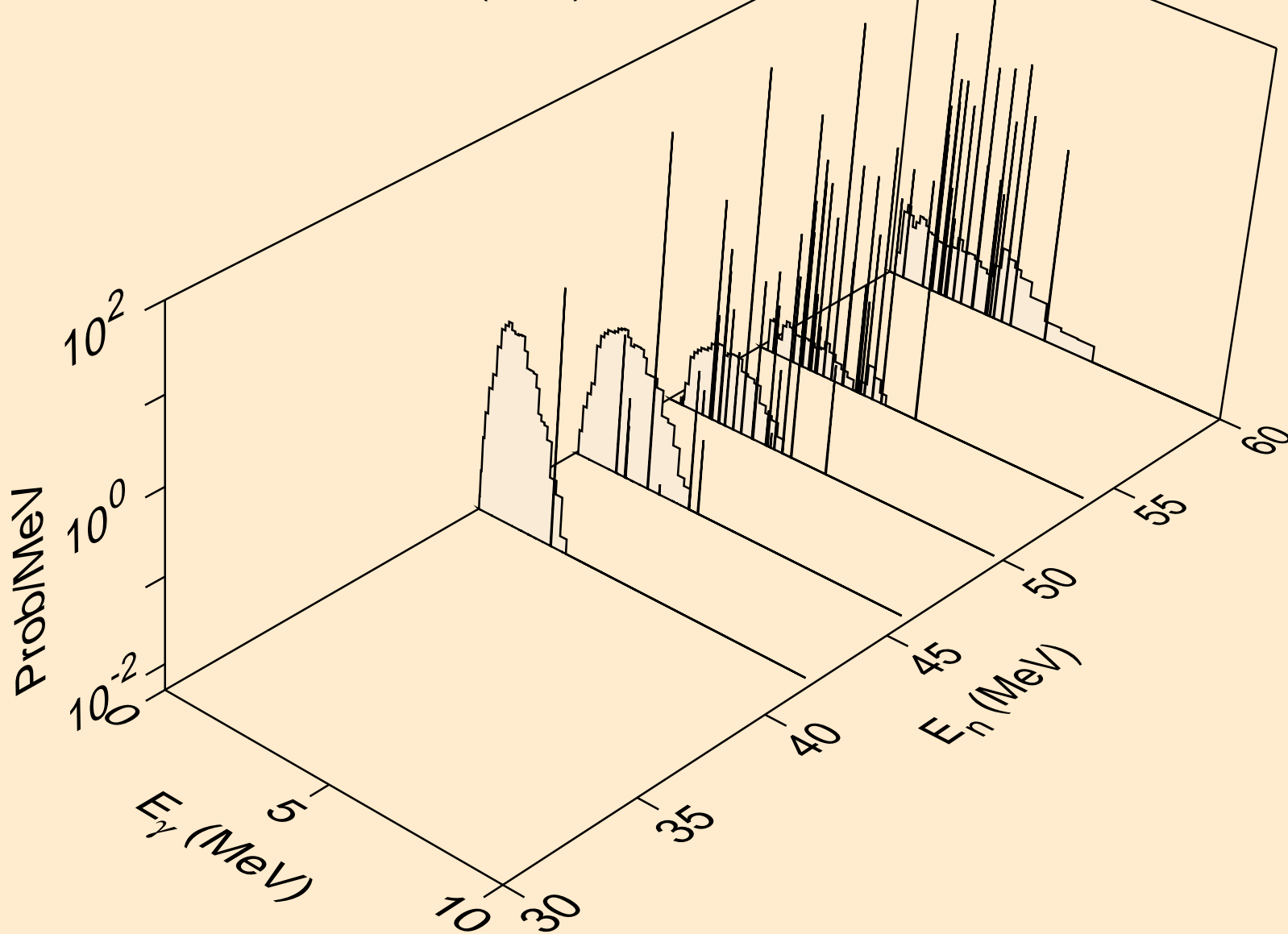

19-K-41 FOR FENDL-3.2 FROM TENDL-2015 BY NJOY2016.60+ O
Photon emission for (n,4n)

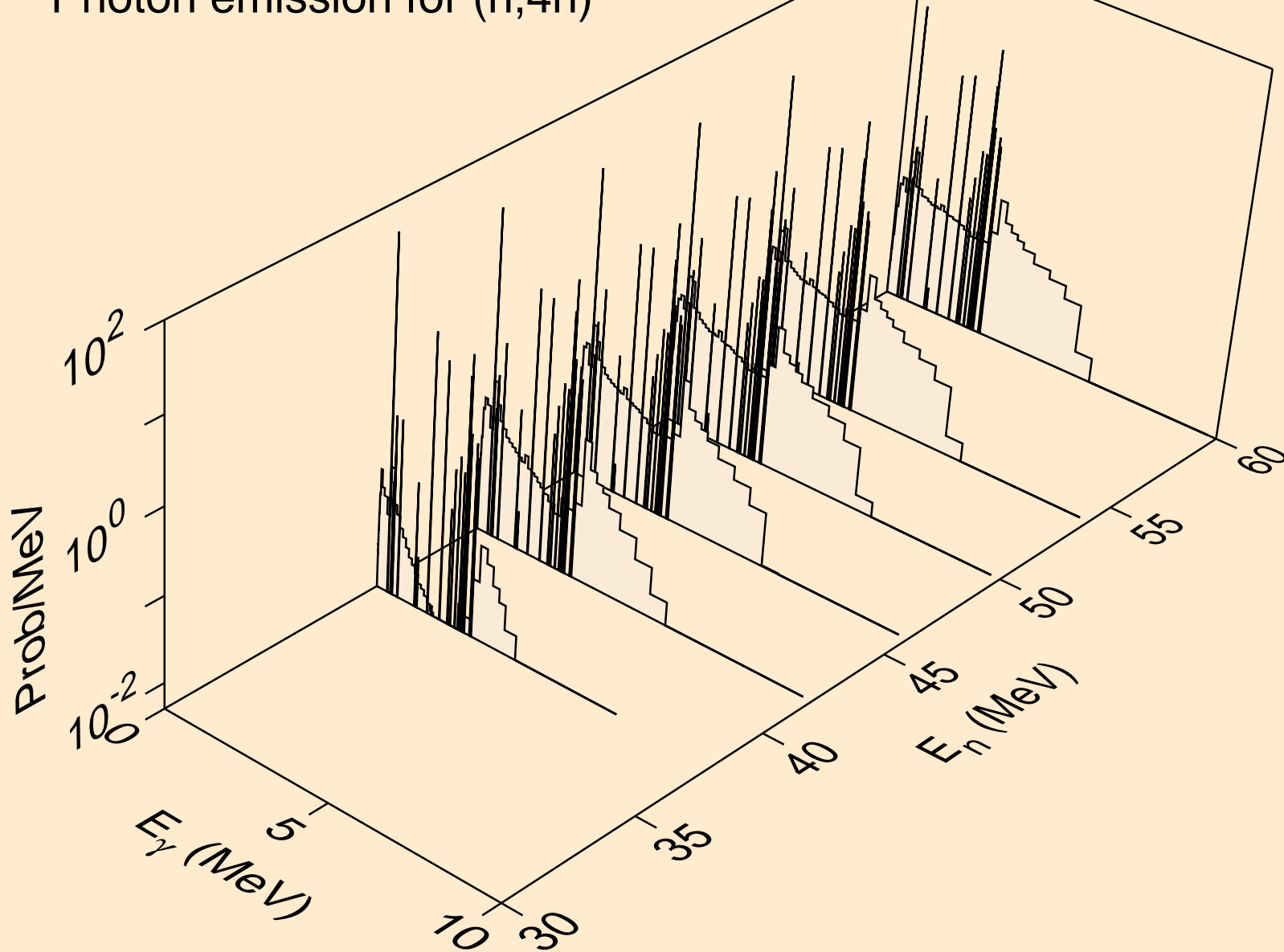

19-K-41 FOR FENDL-3.2 FROM TENDL-2015 BY NJOY2016.60+ O
Photon emission for (n,2np)

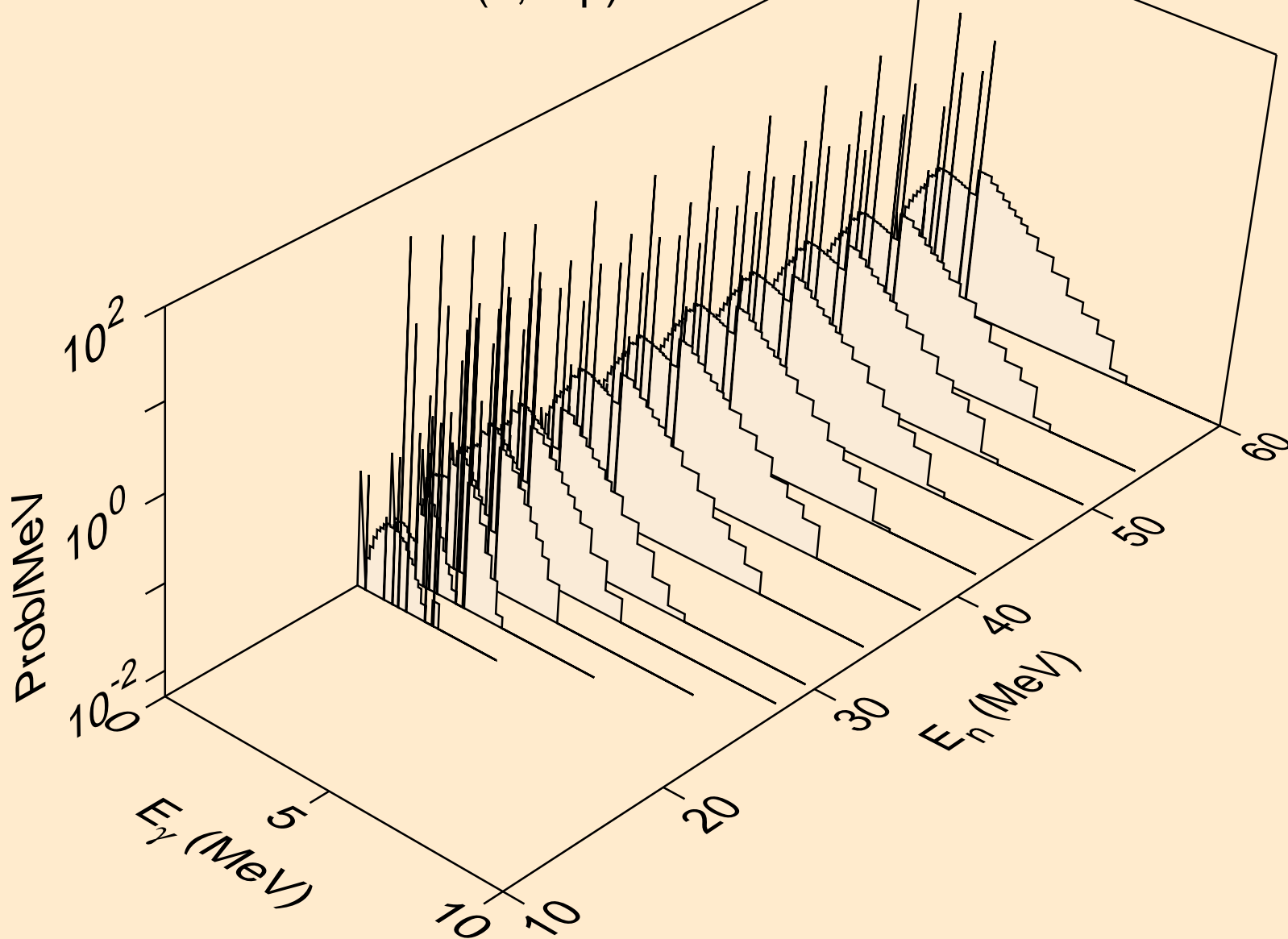

19-K-41 FOR FENDL-3.2 FROM TENDL-2015 BY NJOY2016.60+ O
Photon emission for (n,3np)

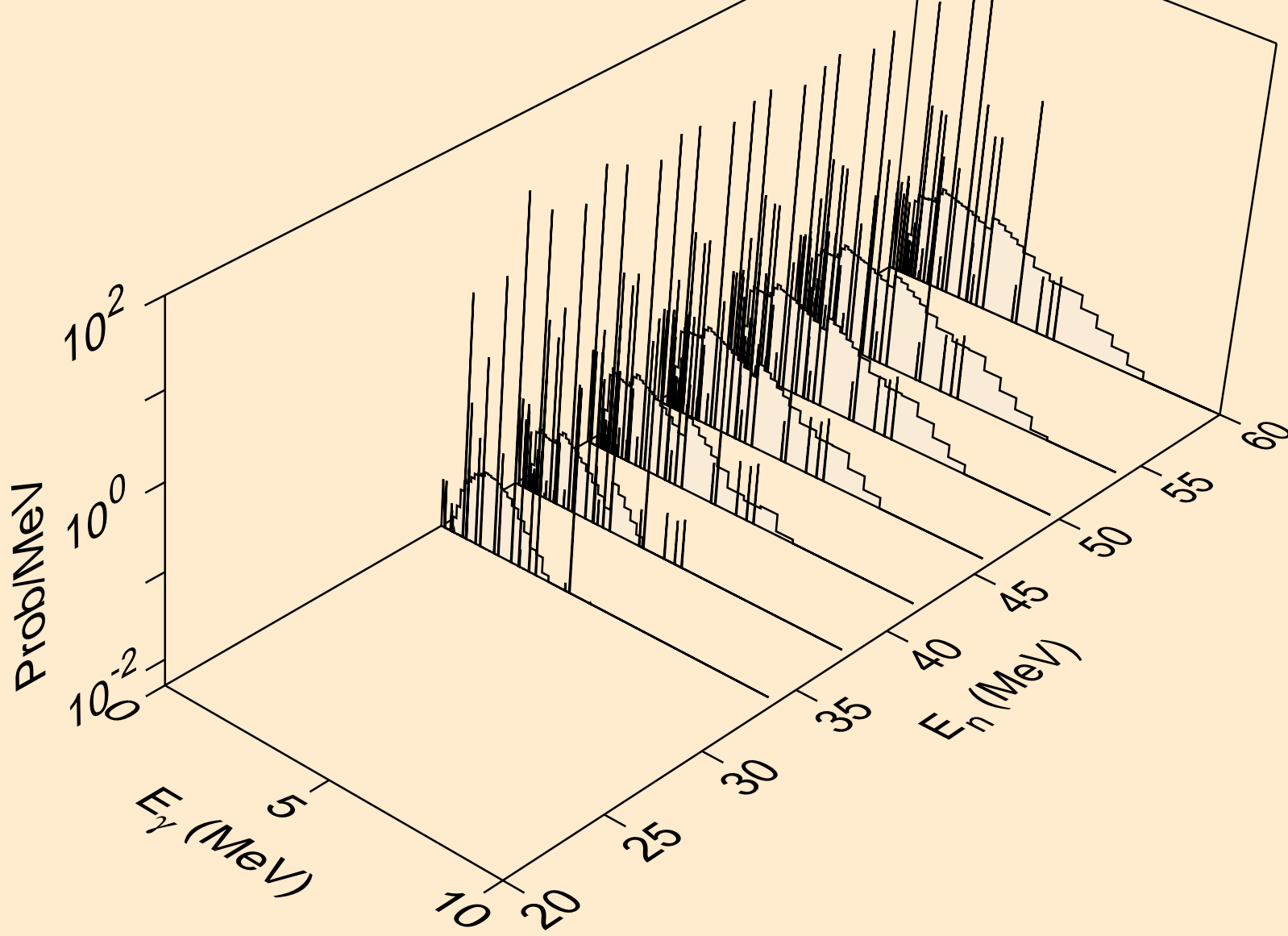

19-K-41 FOR FENDL-3.2 FROM TENDL-2015 BY NJOY2016.60+ O
Photon emission for (n,2np)

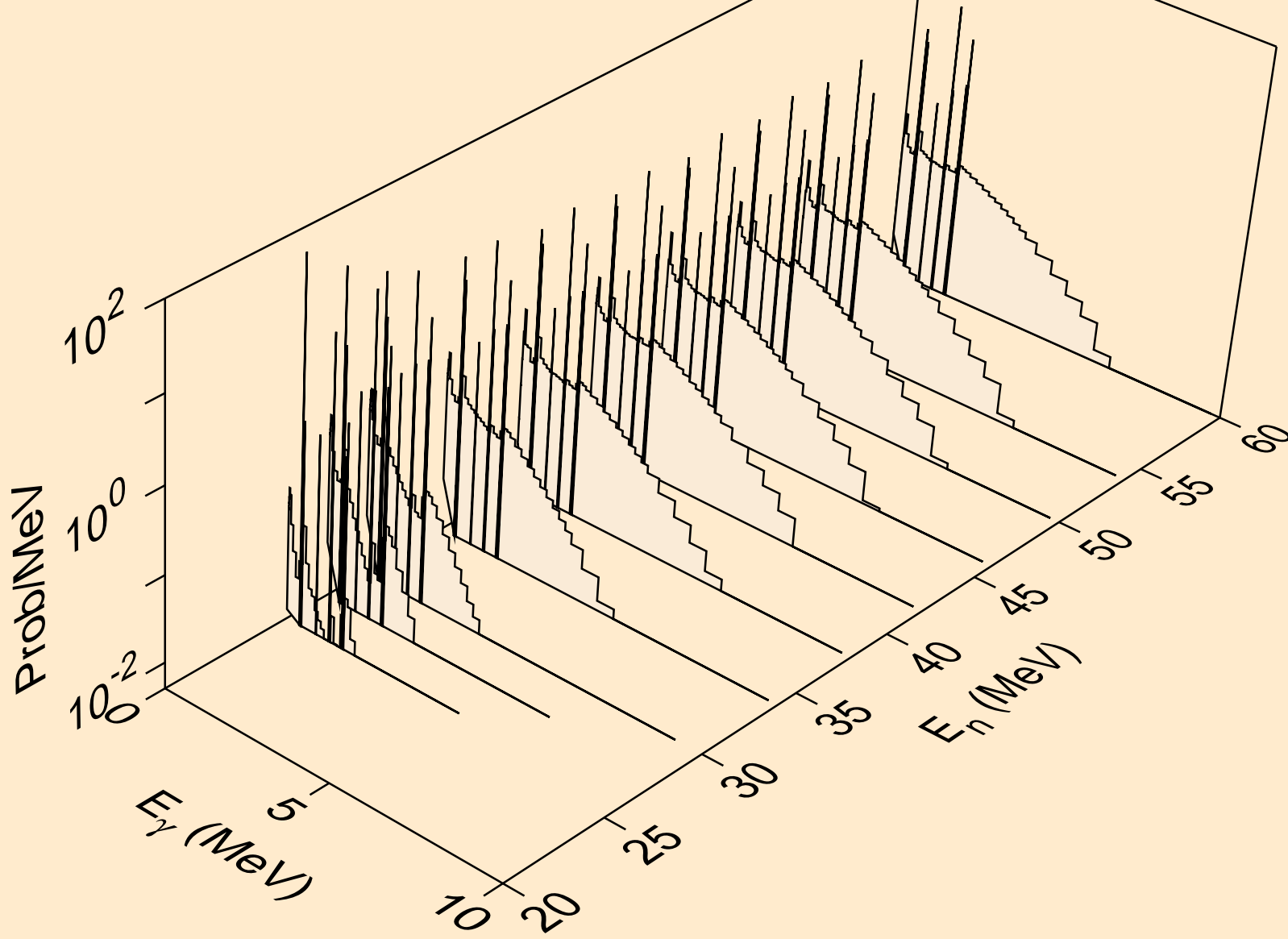

19-K-41 FOR FENDL-3.2 FROM TENDL-2015 BY NJOY2016.60+ O
Photon emission for (n,npa)

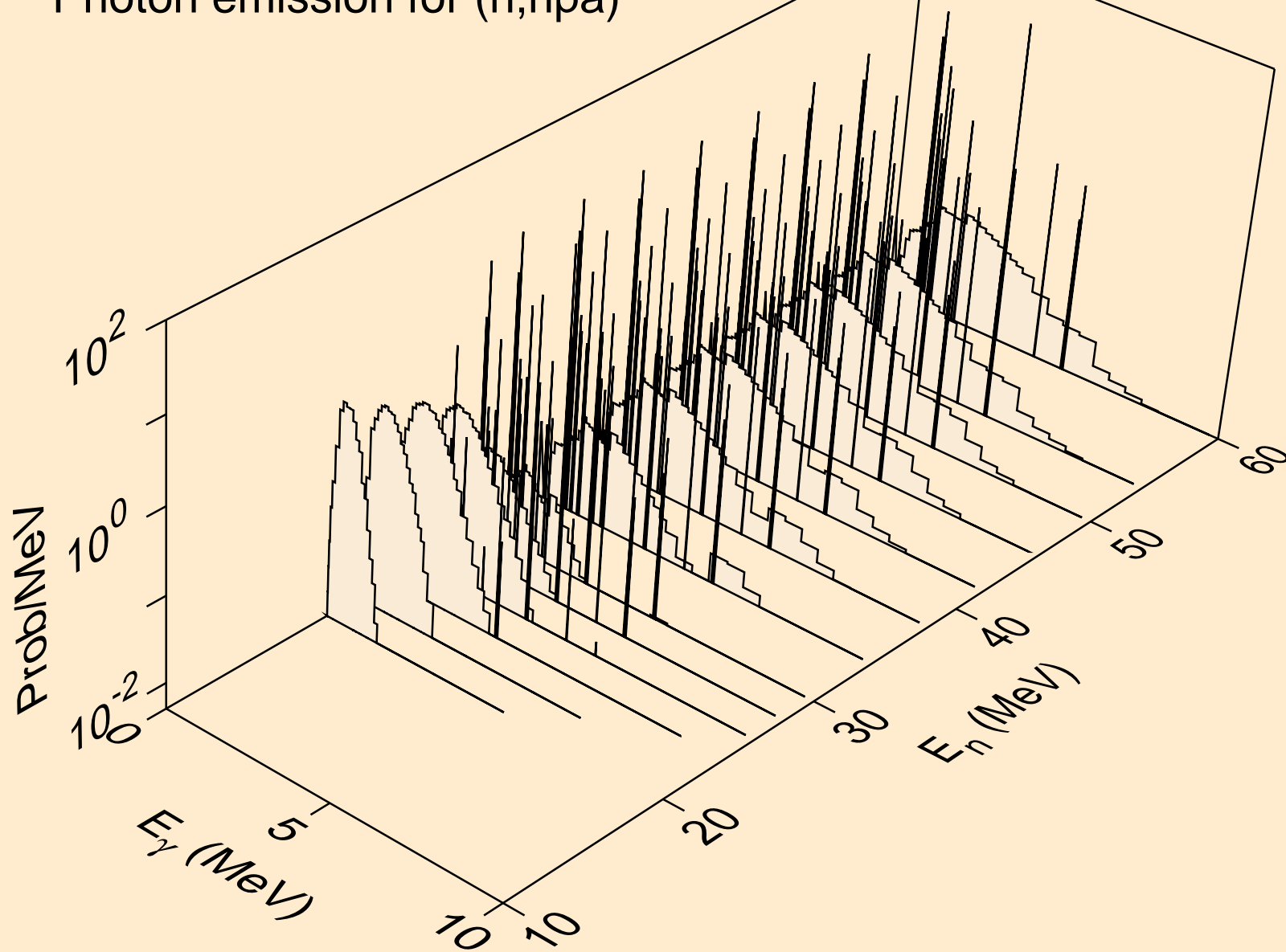

19-K-41 FOR FENDL-3.2 FROM TENDL-2015 BY NJOY2016.60+ O
Photon emission for (n,n*c)

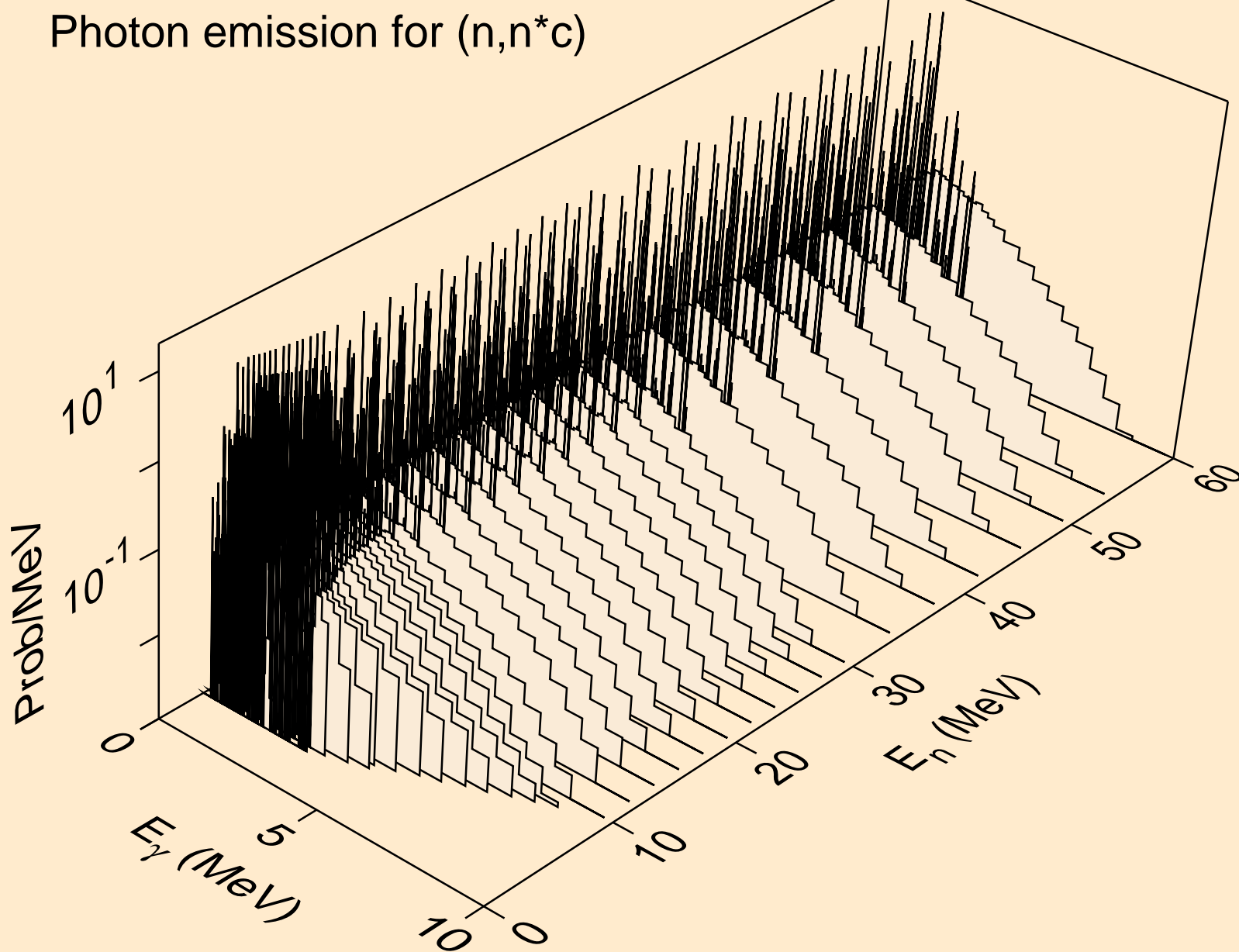

19-K-41 FOR FENDL-3.2 FROM TENDL-2015 BY NJOY2016.60+ O
Photon emission for (n,gma)

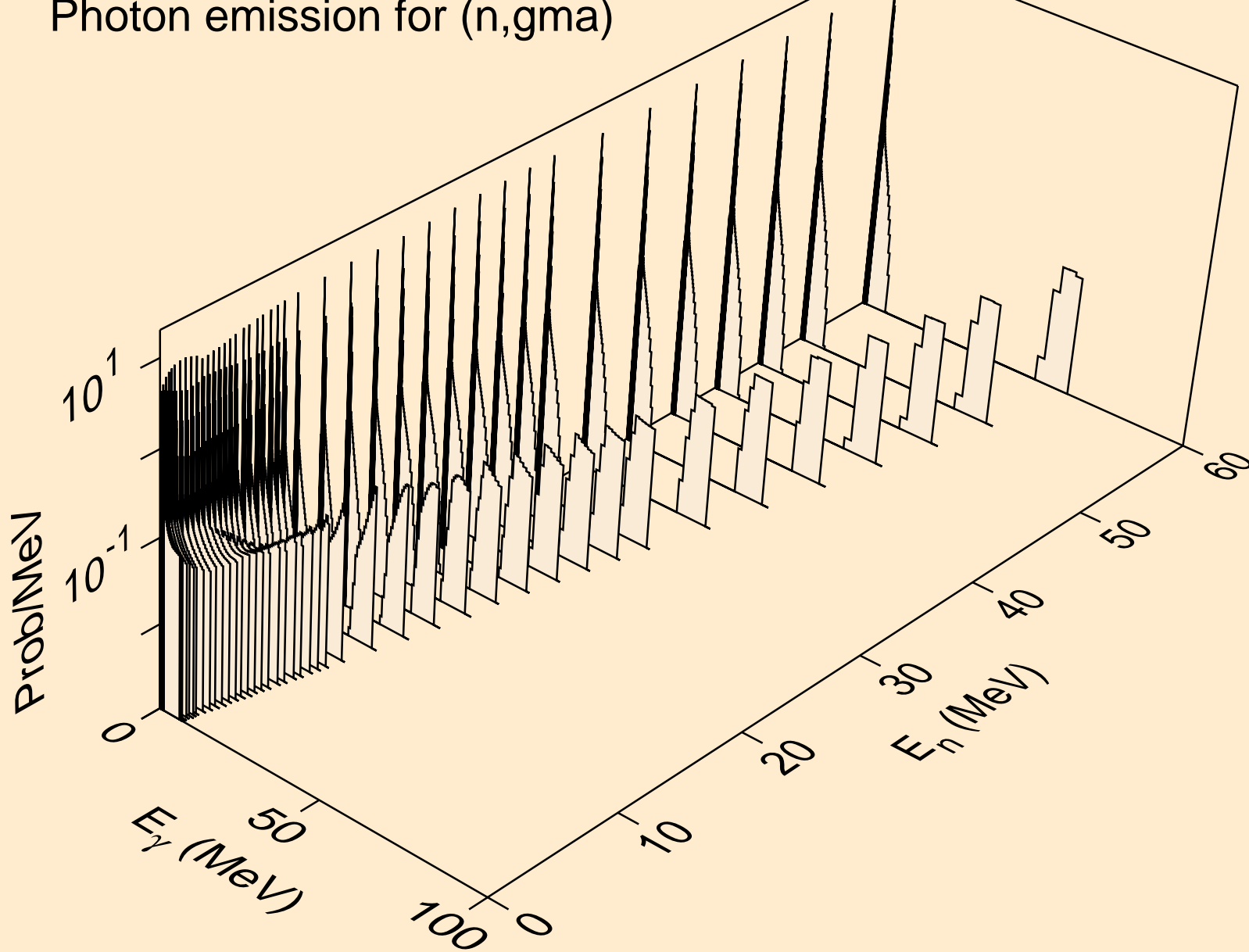

19-K-41 FOR FENDL-3.2 FROM TENDL-2015 BY NJOY2016.60+ O
Photon emission for (n,p)

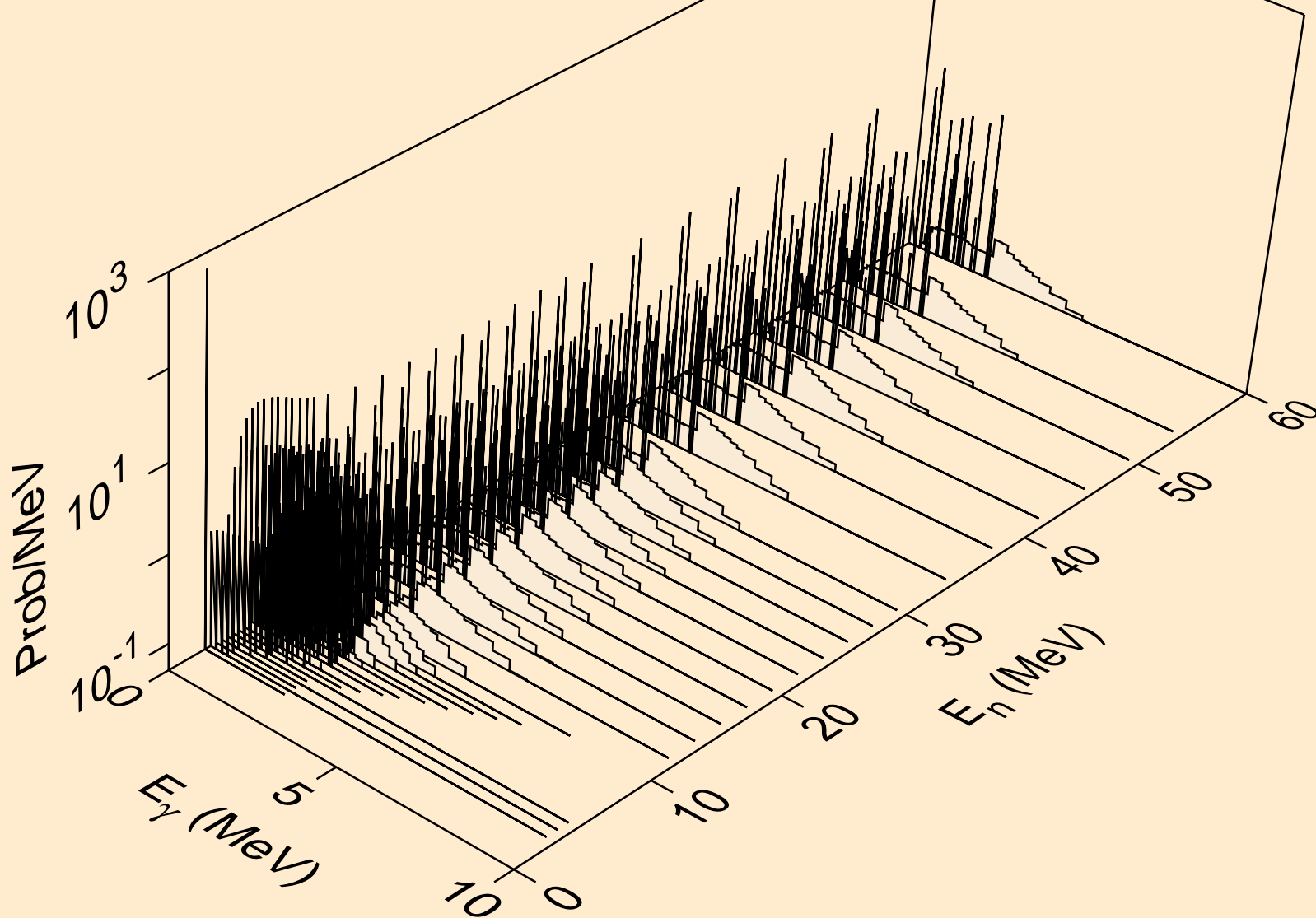

19-K-41 FOR FENDL-3.2 FROM TENDL-2015 BY NJOY2016.60+ O
Photon emission for (n,d)

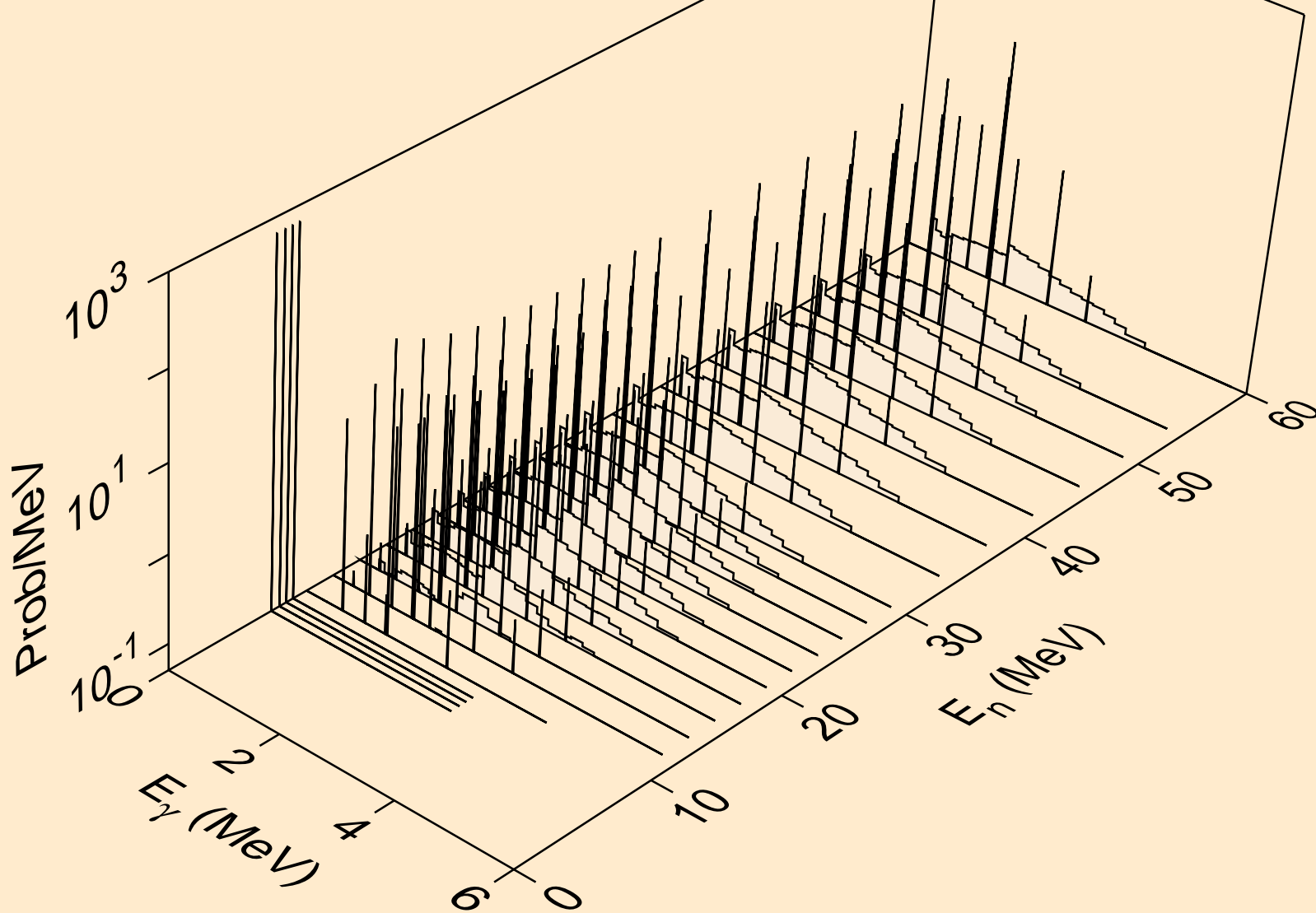

19-K-41 FOR FENDL-3.2 FROM TENDL-2015 BY NJOY2016.60+ O
Photon emission for (n,t)

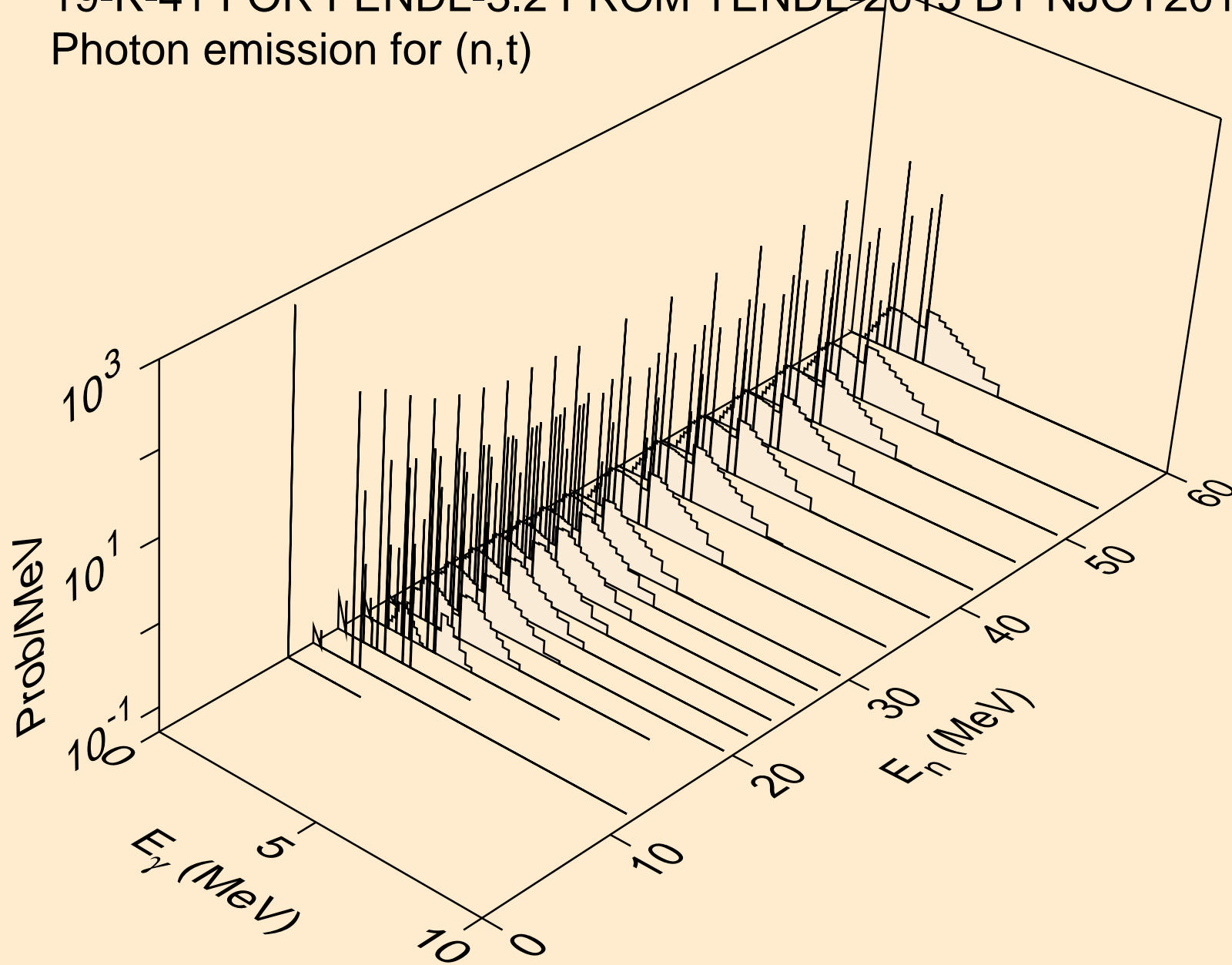

19-K-41 FOR FENDL-3.2 FROM TENDL-2015 BY NJOY2016.60+ O
Photon emission for (n,he3)

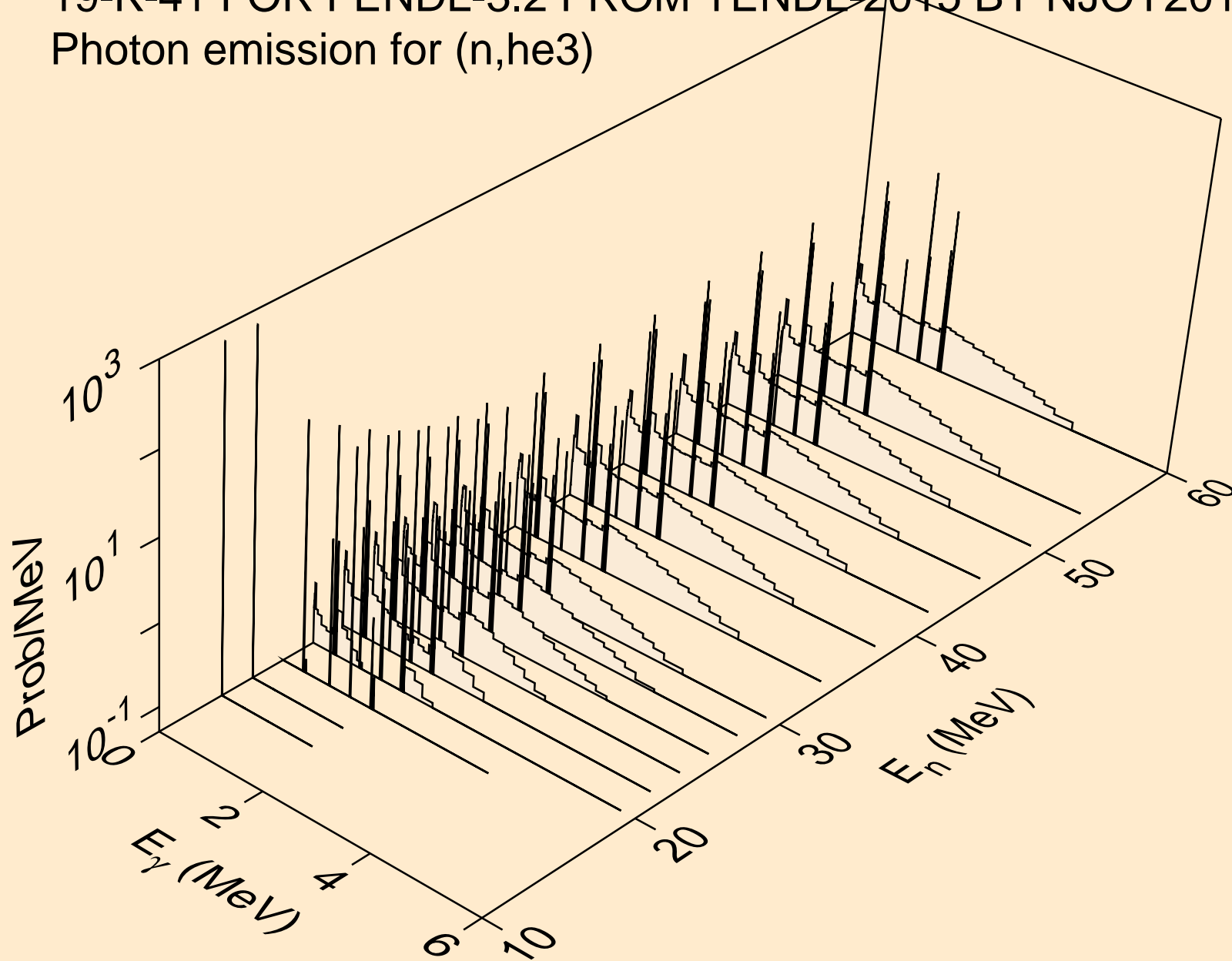

19-K-41 FOR FENDL-3.2 FROM TENDL-2015 BY NJOY2016.60+ O
Photon emission for (n,a)

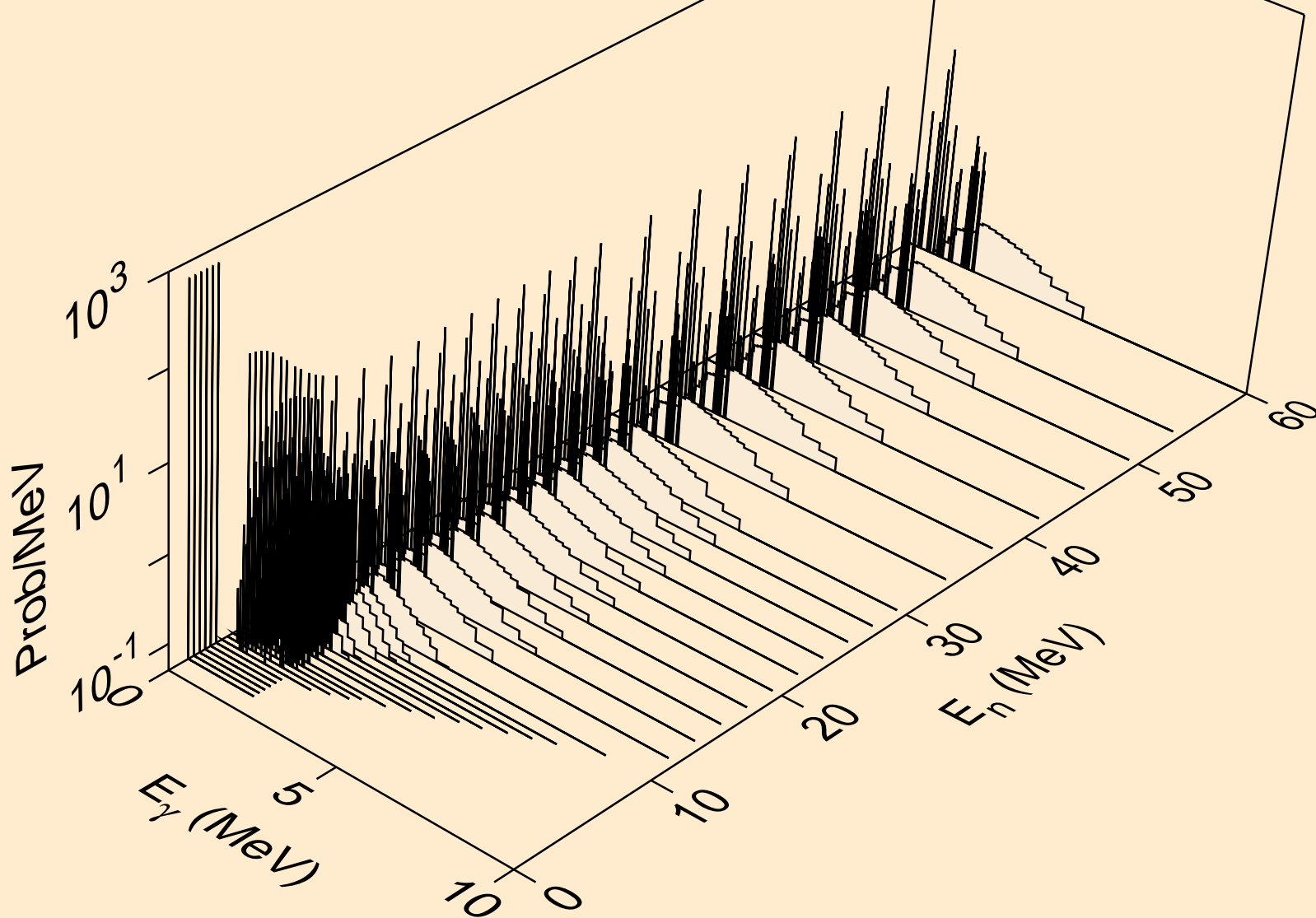

19-K-41 FOR FENDL-3.2 FROM TENDL-2015 BY NJOY2016.60+ O
Photon emission for (n,2a)

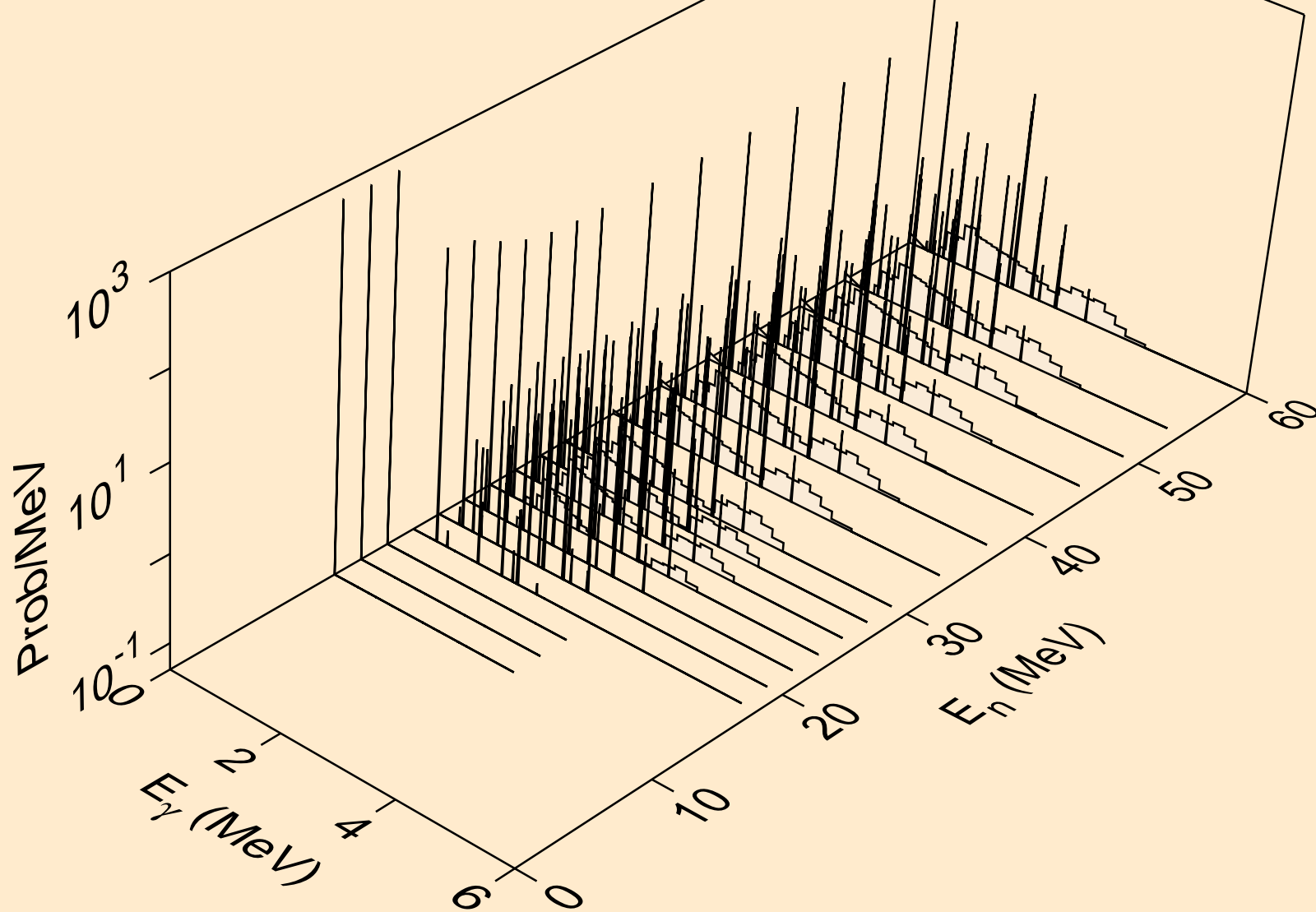

19-K-41 FOR FENDL-3.2 FROM TENDL-2015 BY NJOY2016.60+ O
Photon emission for (n,3a)

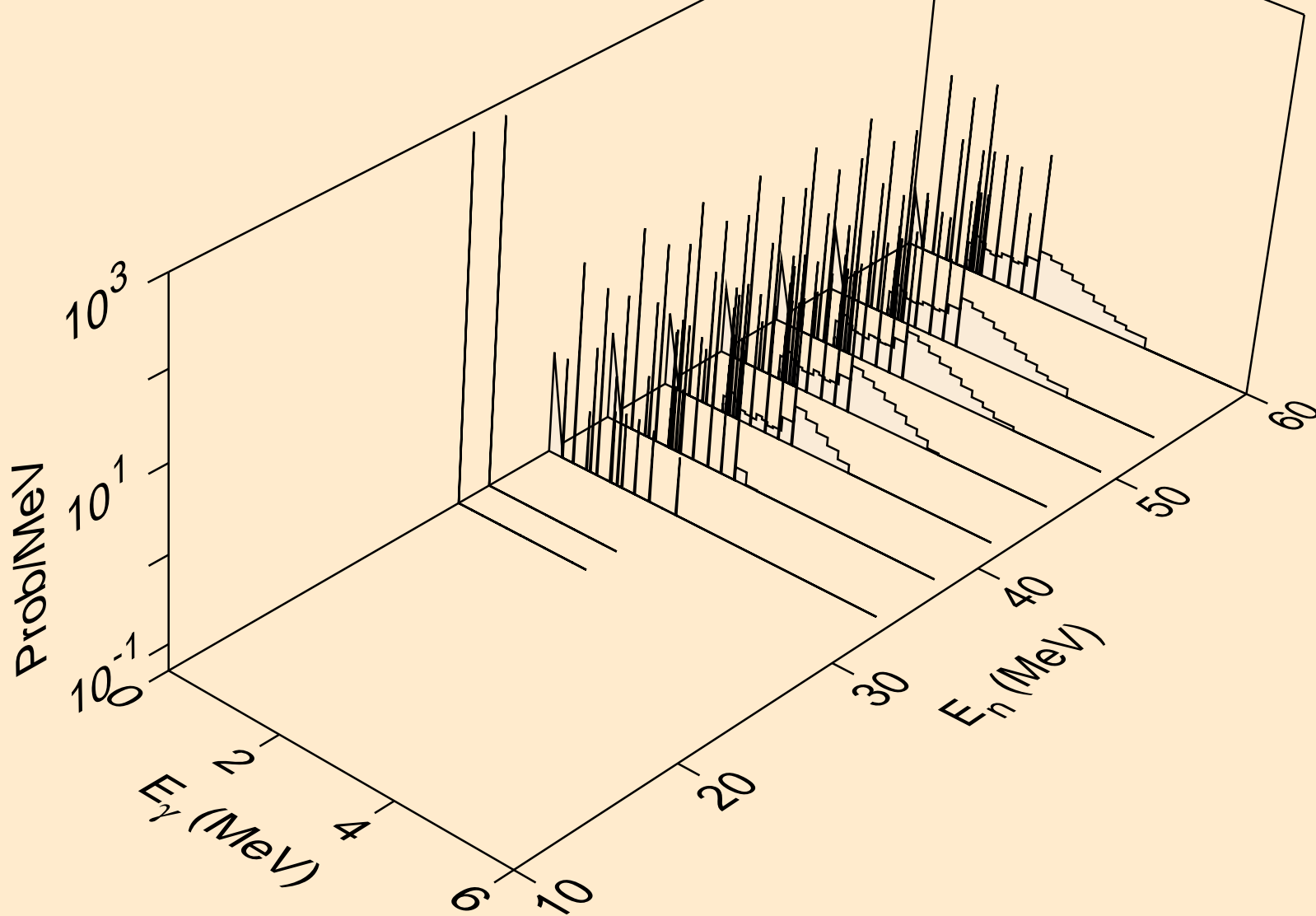

19-K-41 FOR FENDL-3.2 FROM TENDL-2015 BY NJOY2016.60+ O
Photon emission for (n,2p)

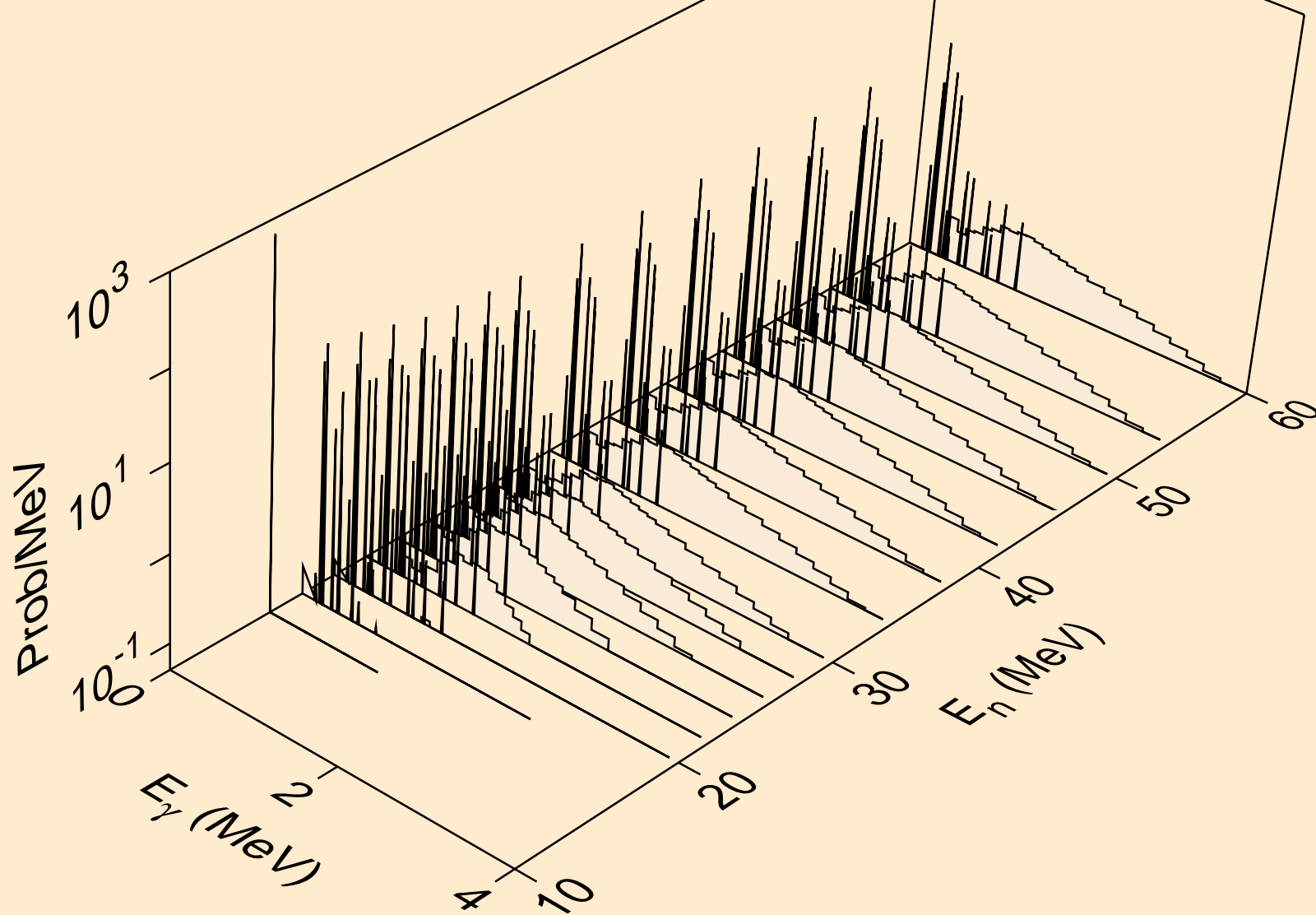

19-K-41 FOR FENDL-3.2 FROM TENDL-2015 BY NJOY2016.60+ O
Photon emission for (n,pa)

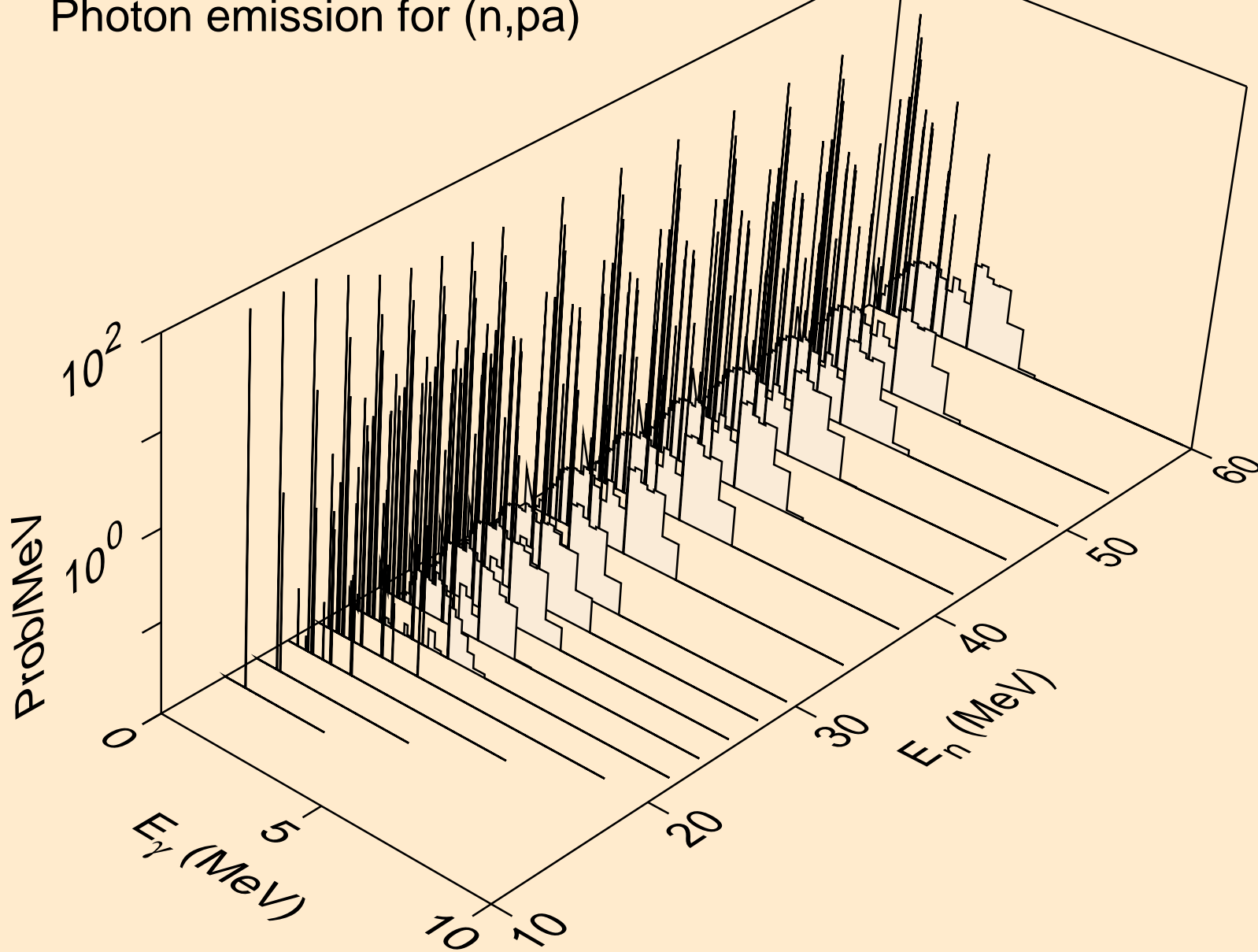

19-K-41 FOR FENDL-3.2 FROM TENDL-2015 BY NJOY2016.60+ O
Photon emission for (n,t2a)

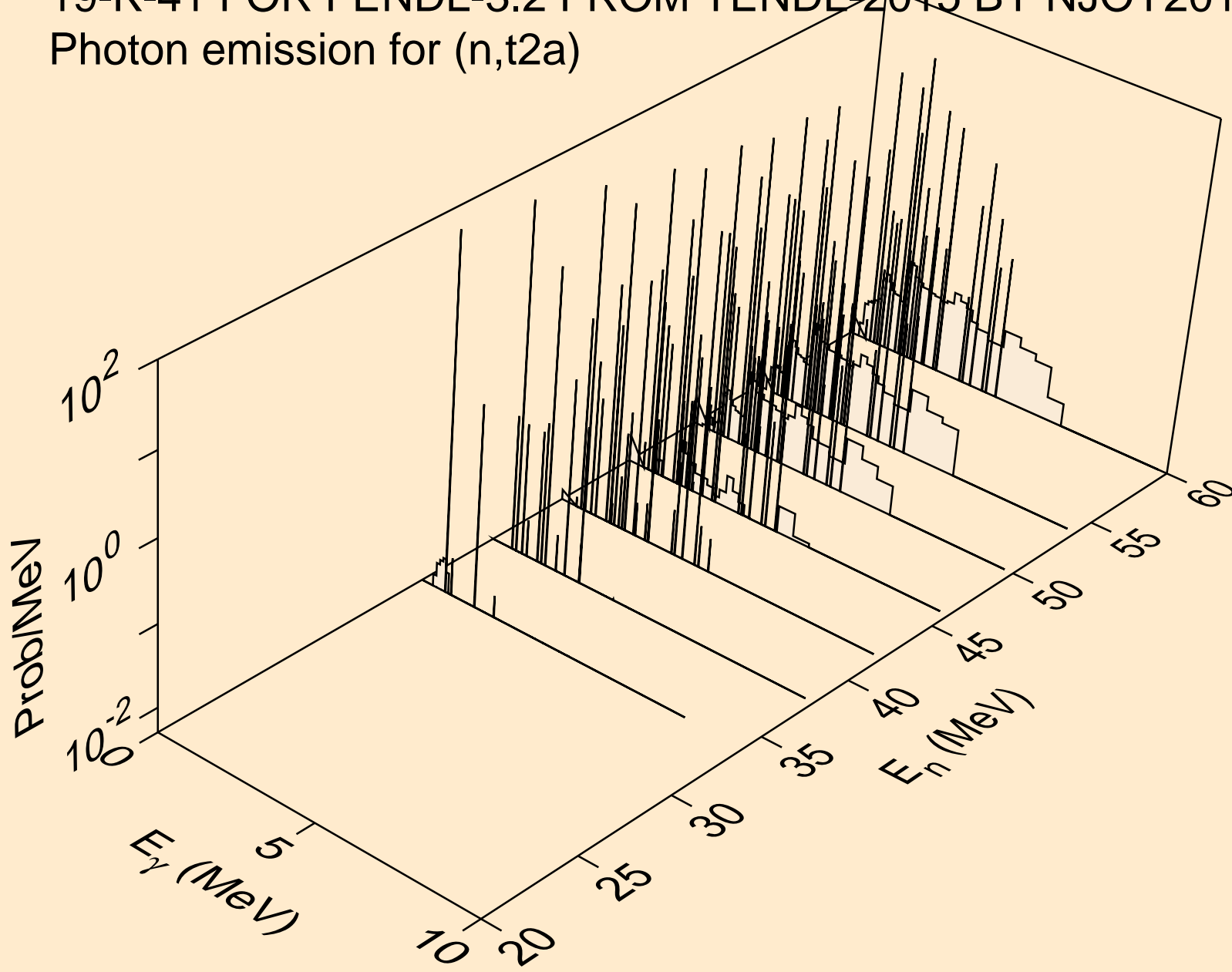

19-K-41 FOR FENDL-3.2 FROM TENDL-2015 BY NJOY2016.60+ O
Photon emission for (n,d2a)

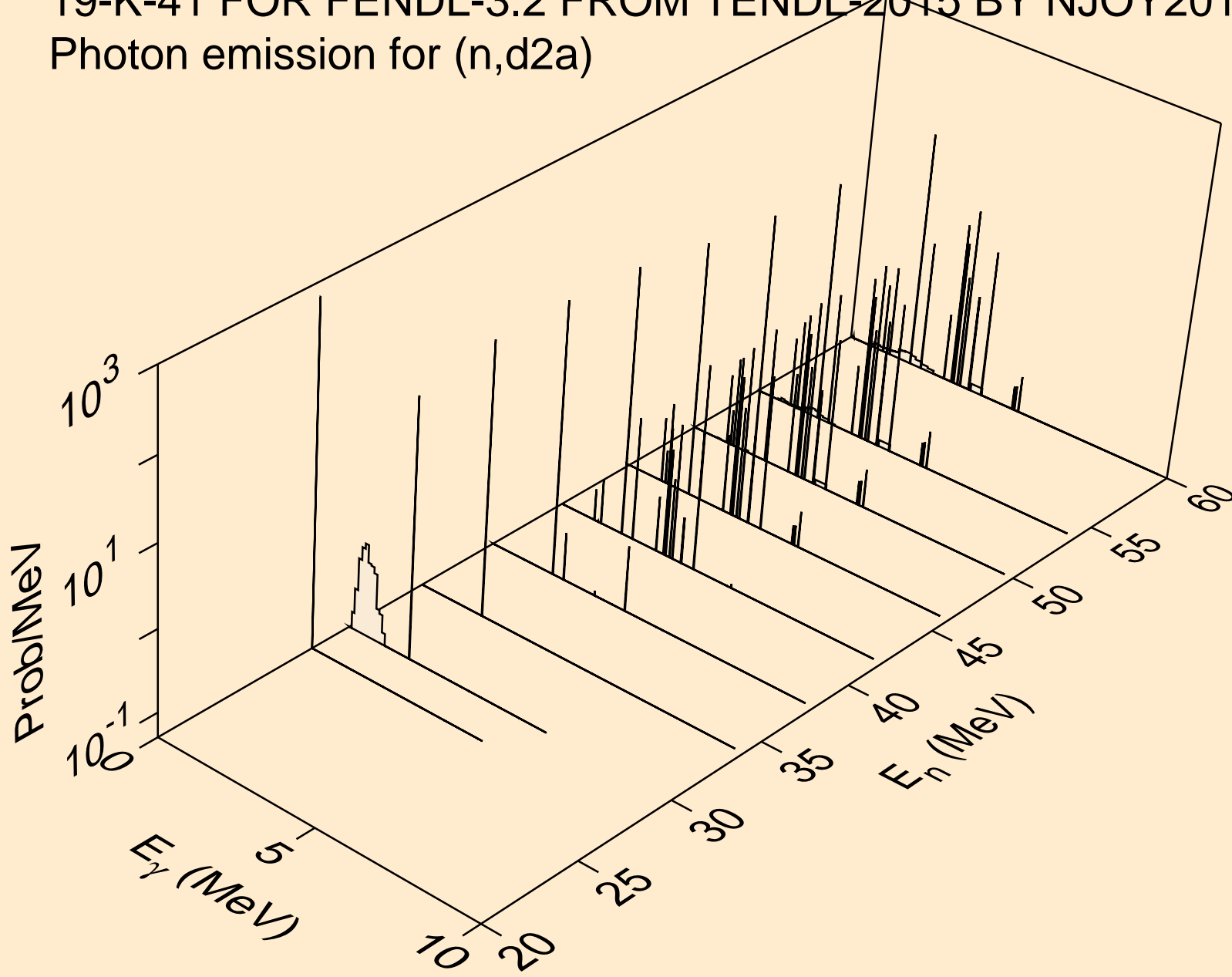

19-K-41 FOR FENDL-3.2 FROM TENDL-2015 BY NJOY2016.60+ O
Photon emission for (n,pd)

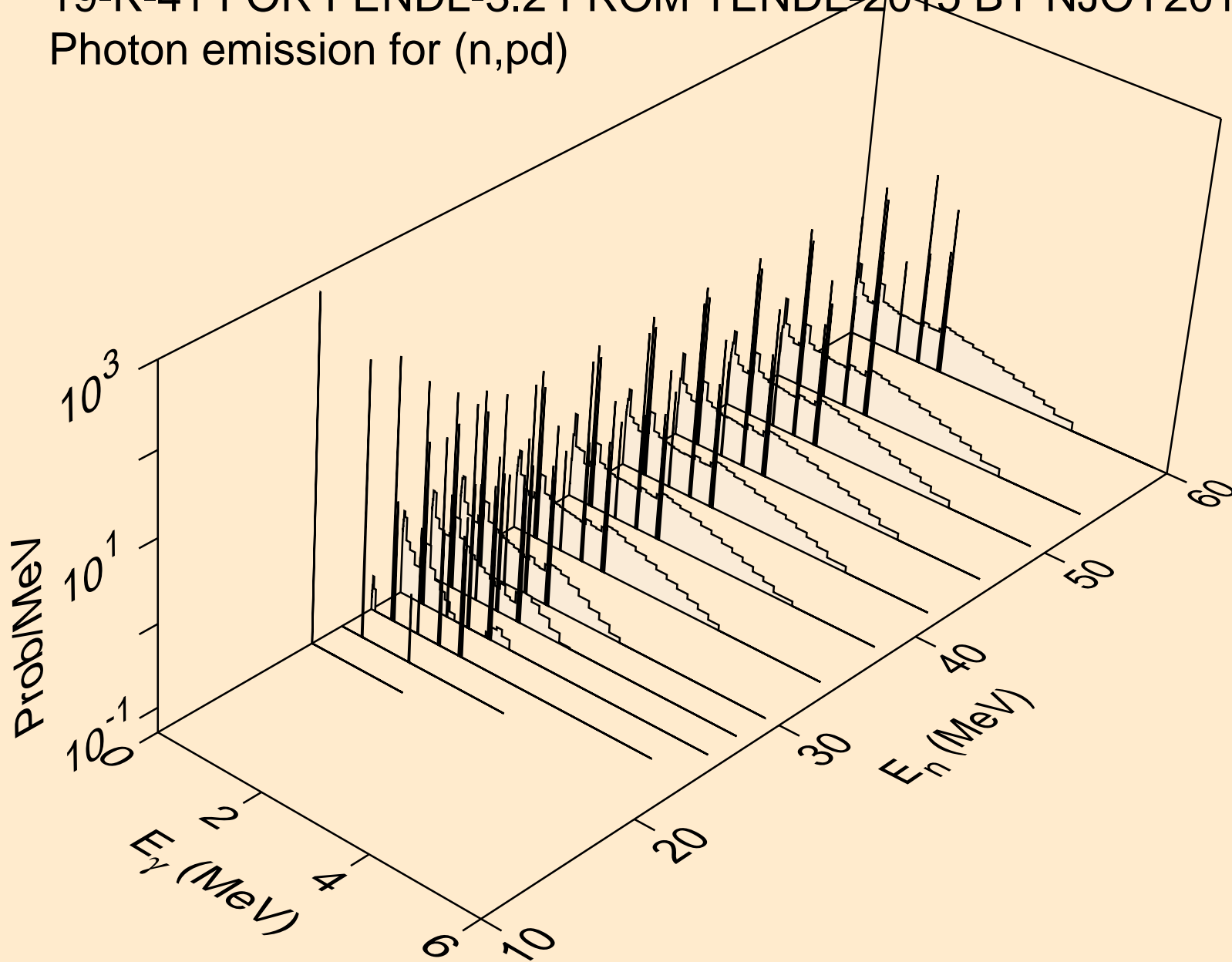

19-K-41 FOR FENDL-3.2 FROM TENDL-2015 BY NJOY2016.60+ O
Photon emission for (n,pt)

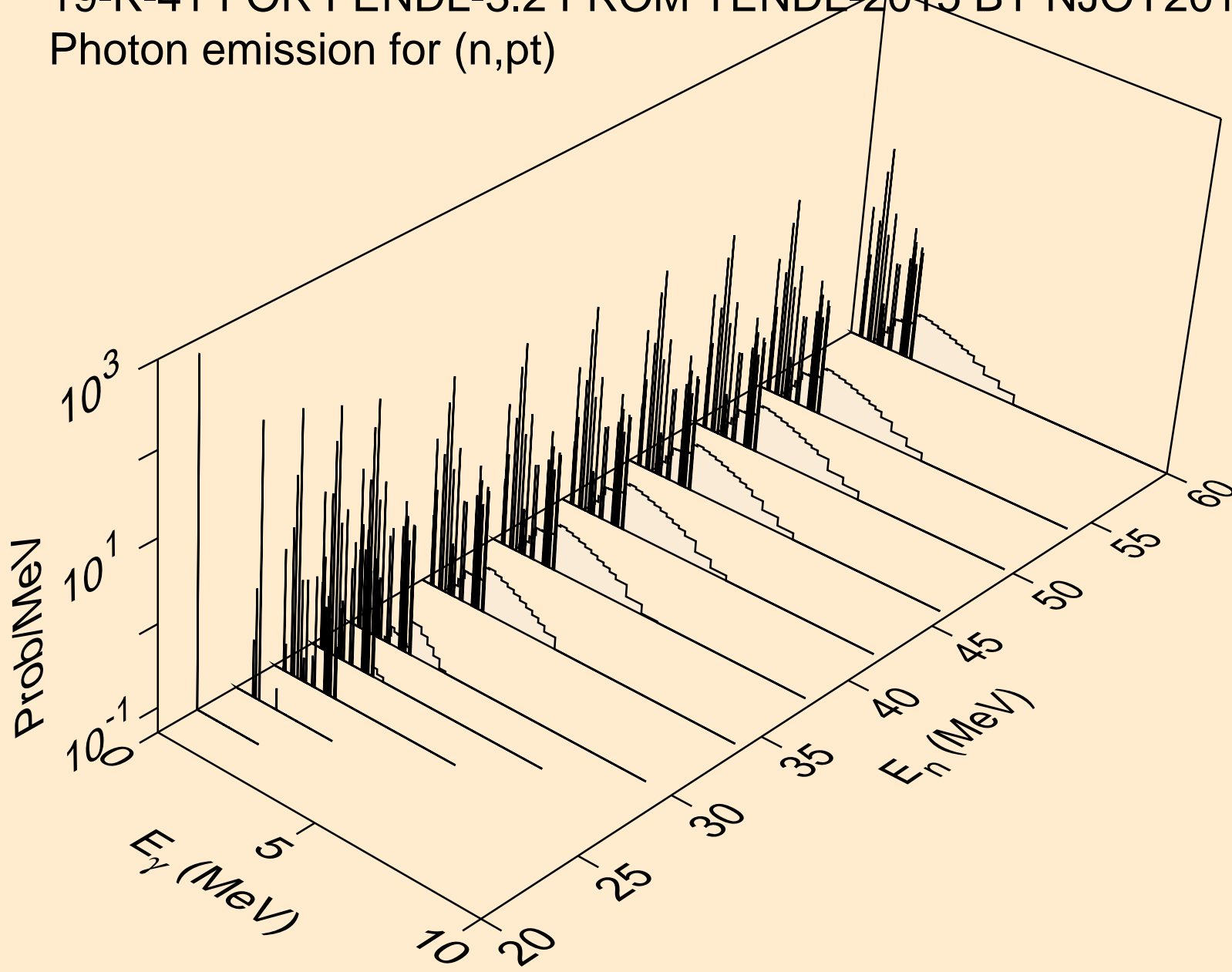

19-K-41 FOR FENDL-3.2 FROM TENDL-2015 BY NJOY2016.60+ O
Photon emission for (n,da)

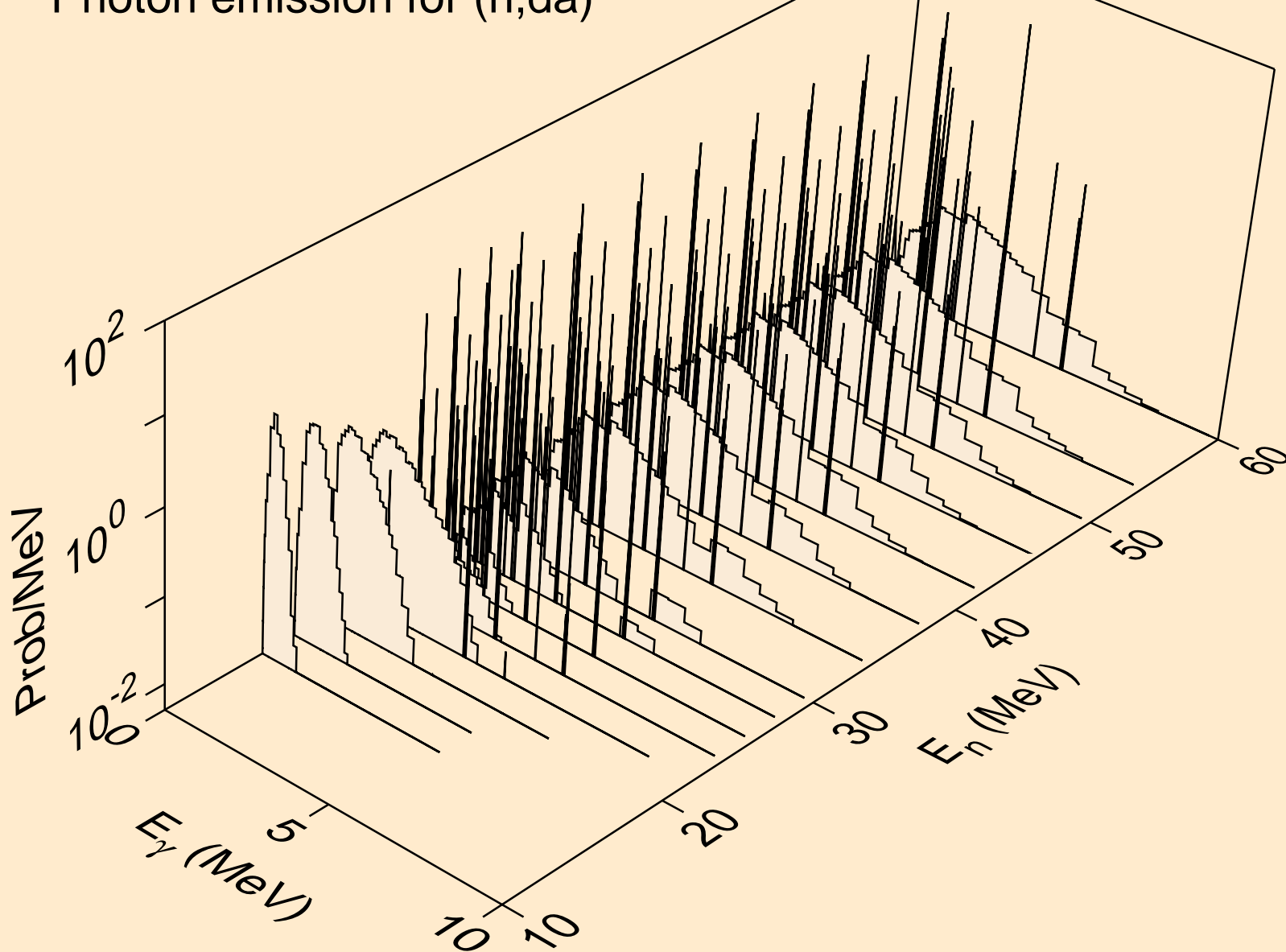

19-K-41 FOR FENDL-3.2 FROM TENDL-2015 BY NJOY2016.60+ O
Photon emission for (n,5n)

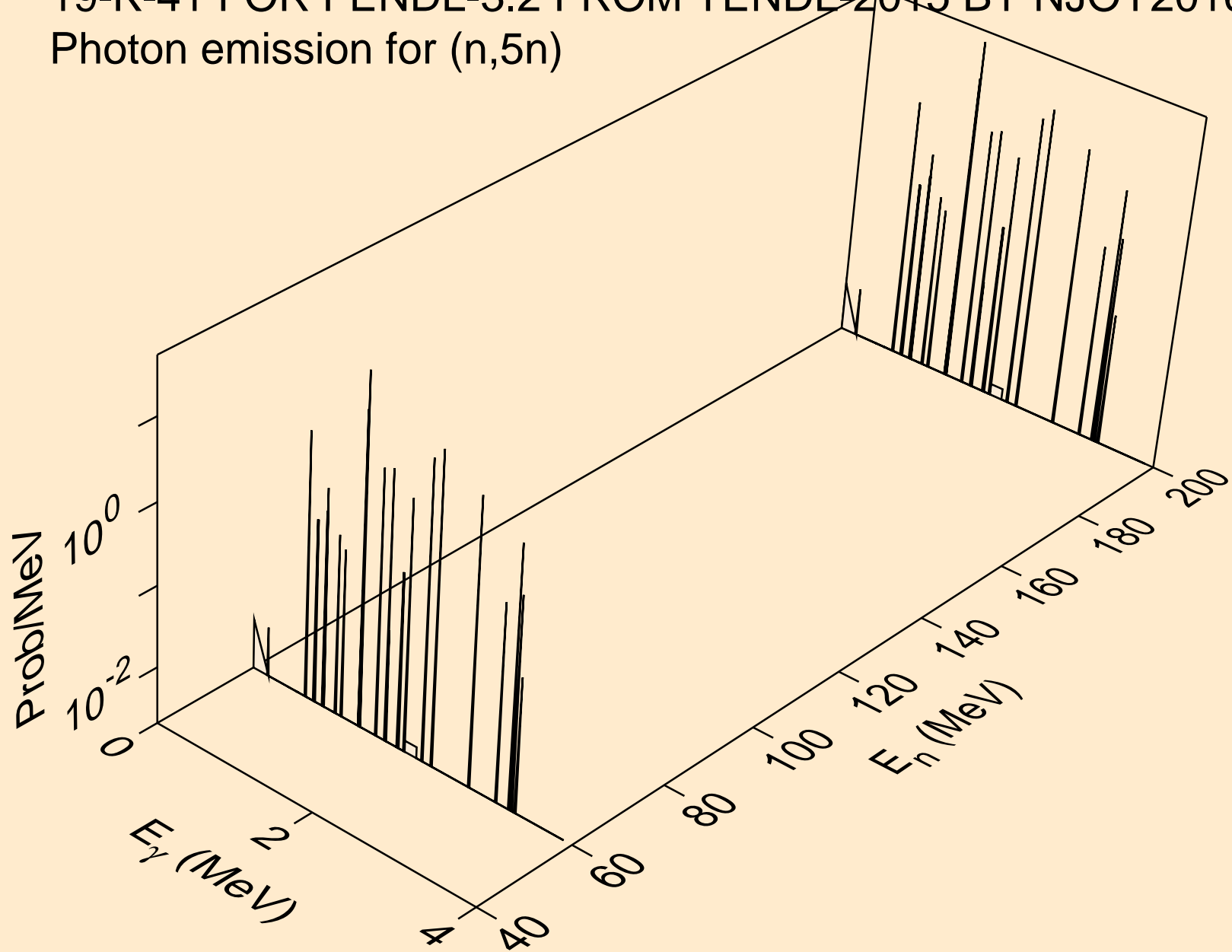

19-K-41 FOR FENDL-3.2 FROM TENDL-2015 BY NJOY2016.60+ O
Photon emission for (n,2nt)

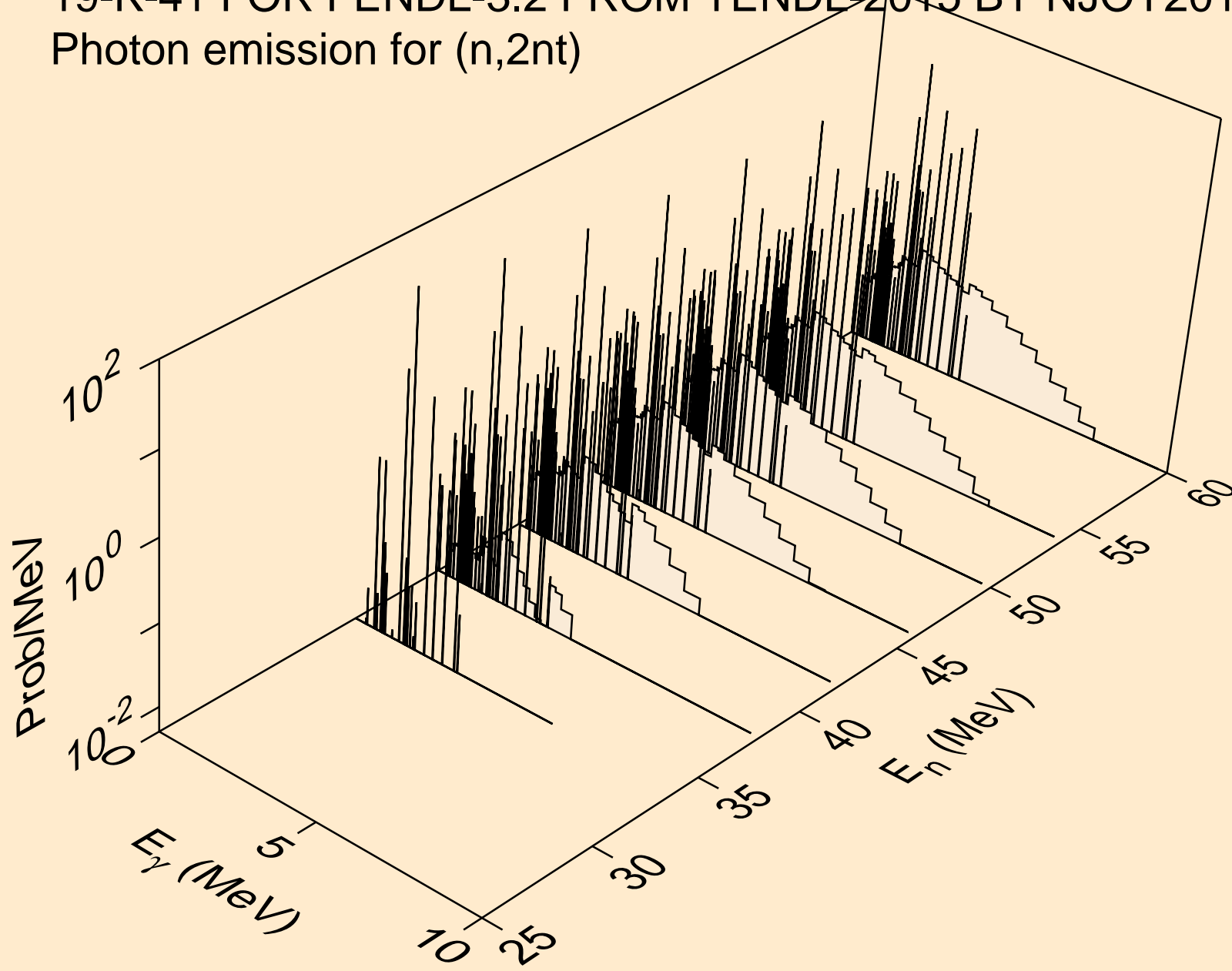

19-K-41 FOR FENDL-3.2 FROM TENDL-2015 BY NJOY2016.60+ O
Photon emission for (n,ta)

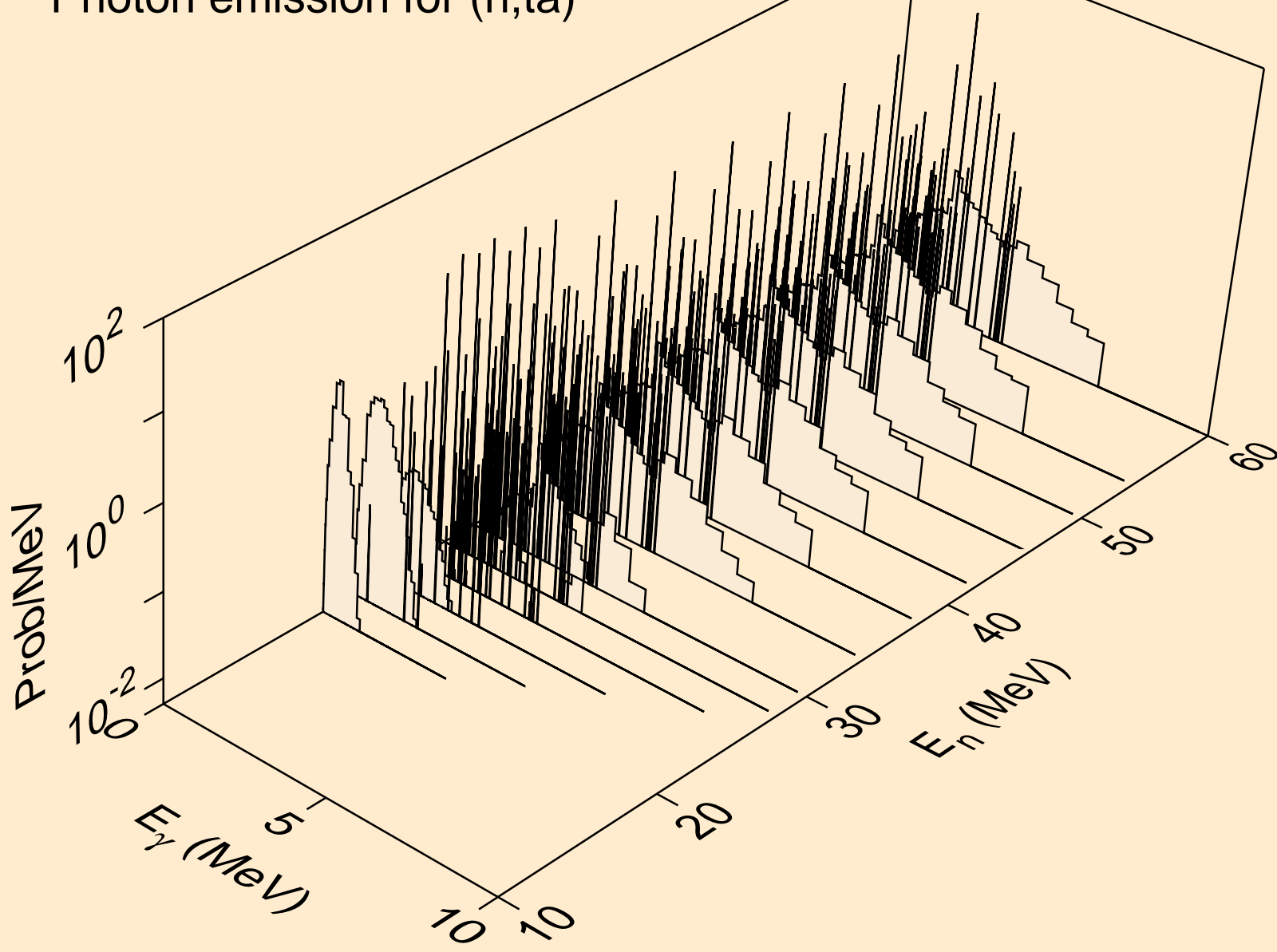

19-K-41 FOR FENDL-3.2 FROM TENDL-2015 BY NJOY2016.60+ O
Photon emission for (n,4np)

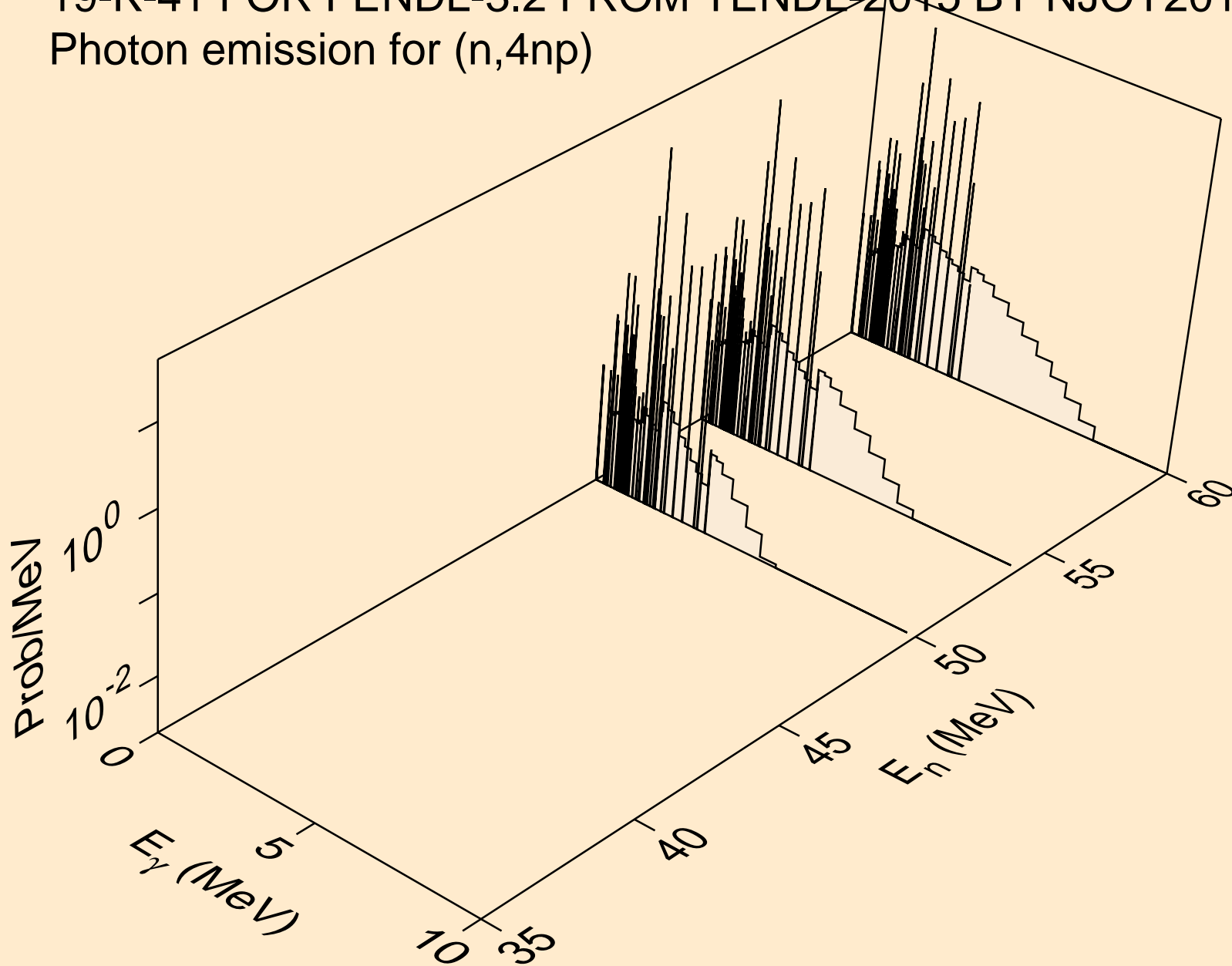

19-K-41 FOR FENDL-3.2 FROM TENDL-2015 BY NJOY2016.60+ O
Photon emission for (n,3nd)

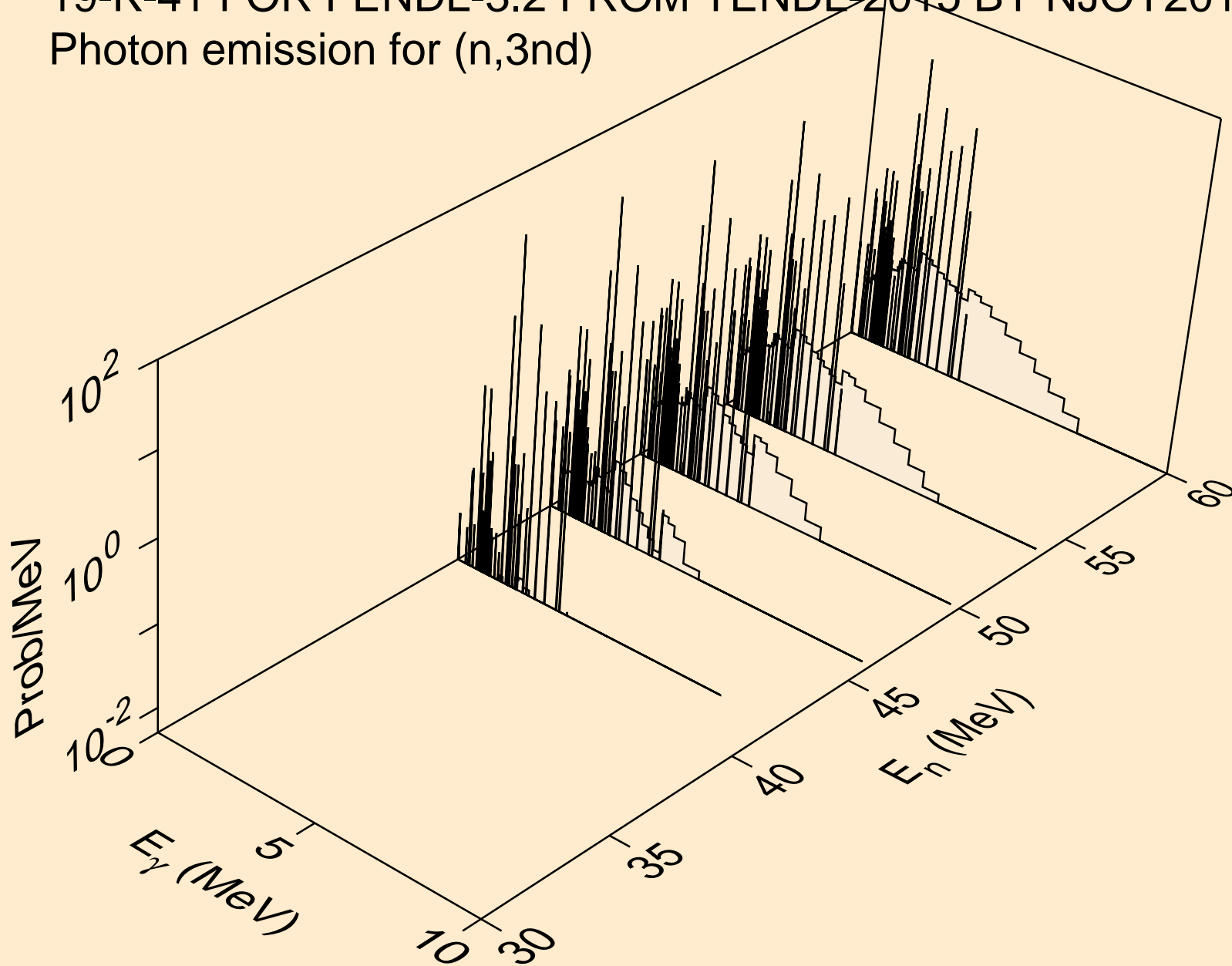

19-K-41 FOR FENDL-3.2 FROM TENDL-2015 BY NJOY2016.60+ O
Photon emission for (n,nda)

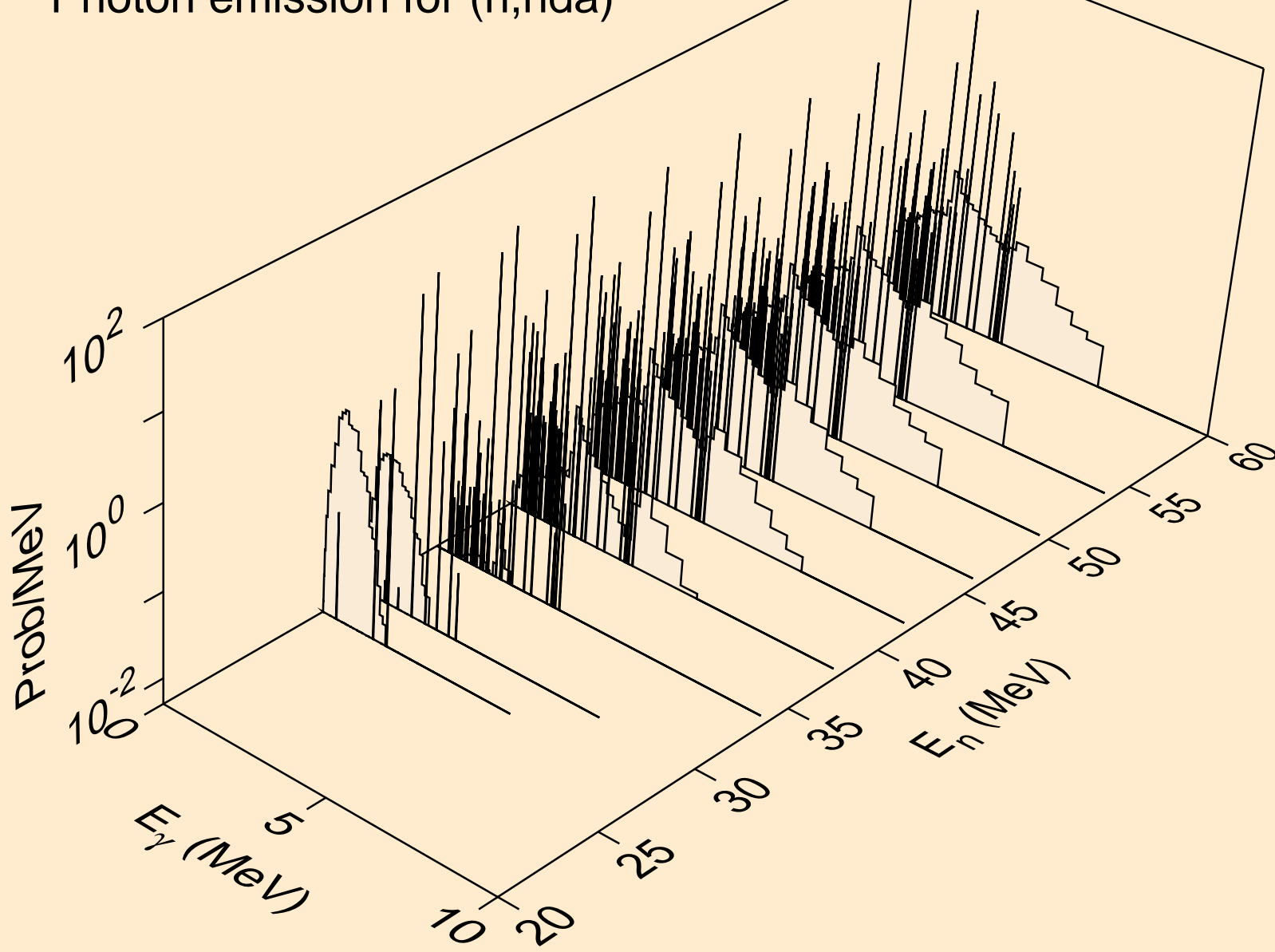

19-K-41 FOR FENDL-3.2 FROM TENDL-2015 BY NJOY2016.60+ O
Photon emission for (n,2npa)

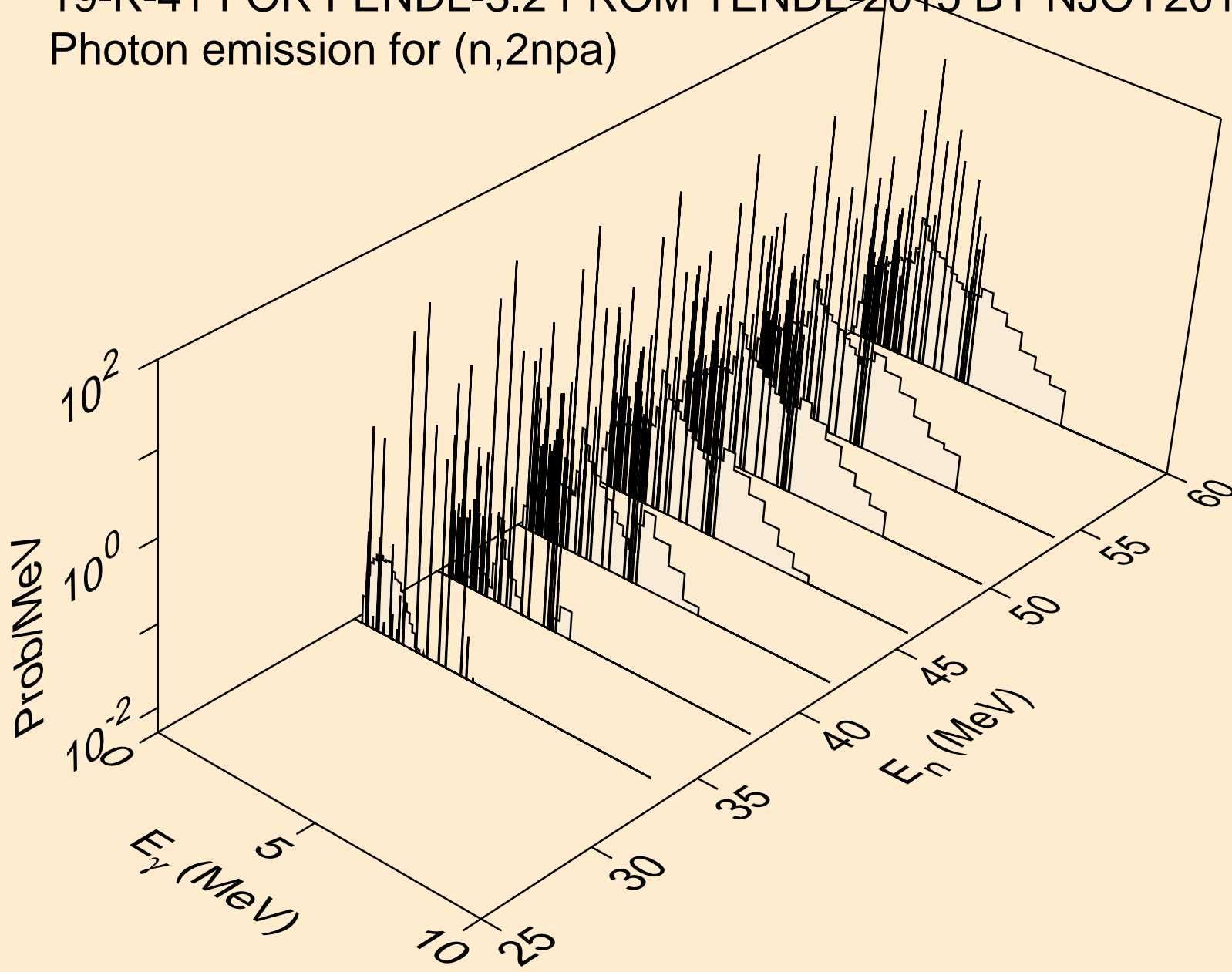

19-K-41 FOR FENDL-3.2 FROM TENDL-2015 BY NJOY2016.60+ O
Photon emission for (n,5np)

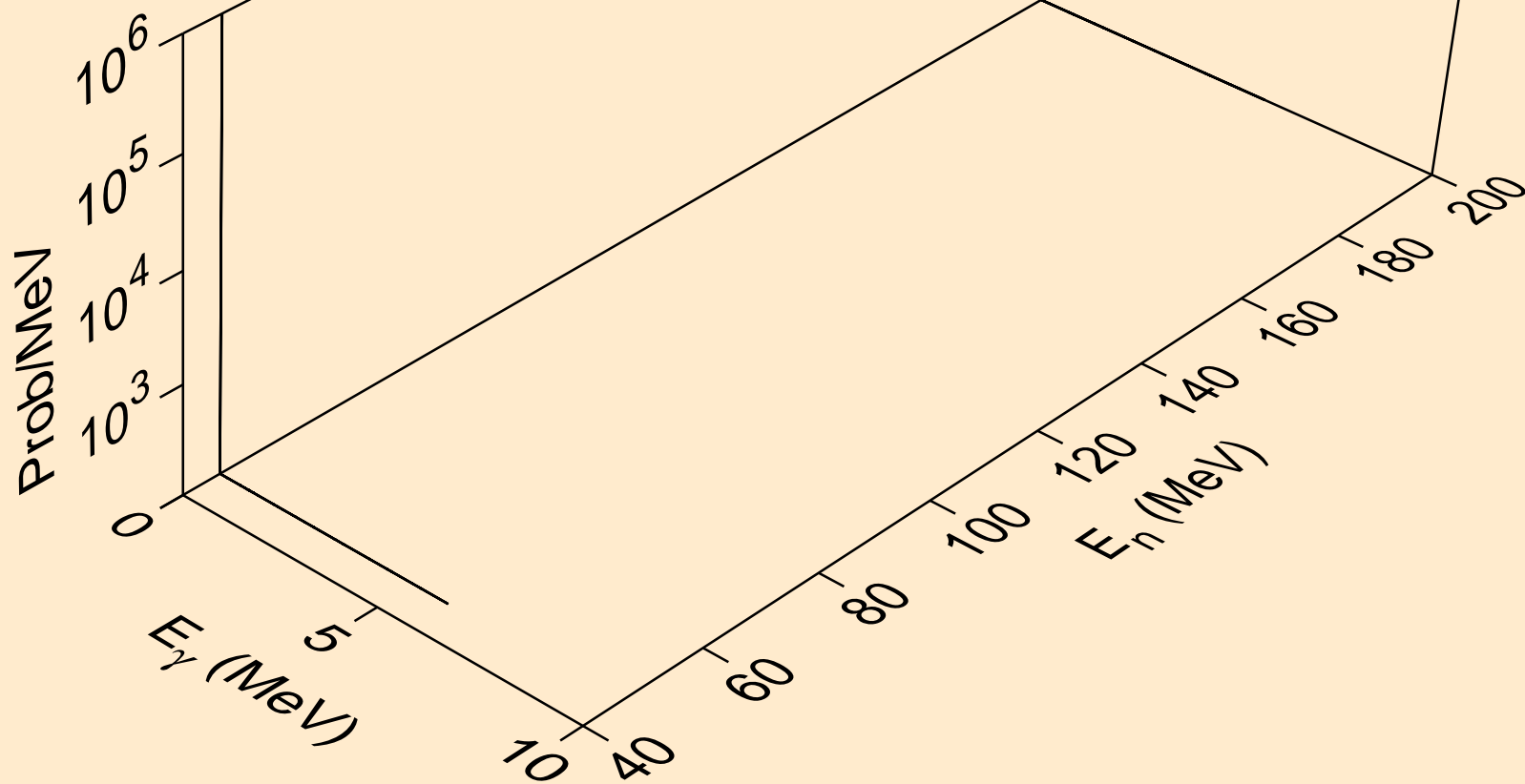

19-K-41 FOR FENDL-3.2 FROM TENDL-2015 BY NJOY2016.60+ O
Photon emission for (n,4na)

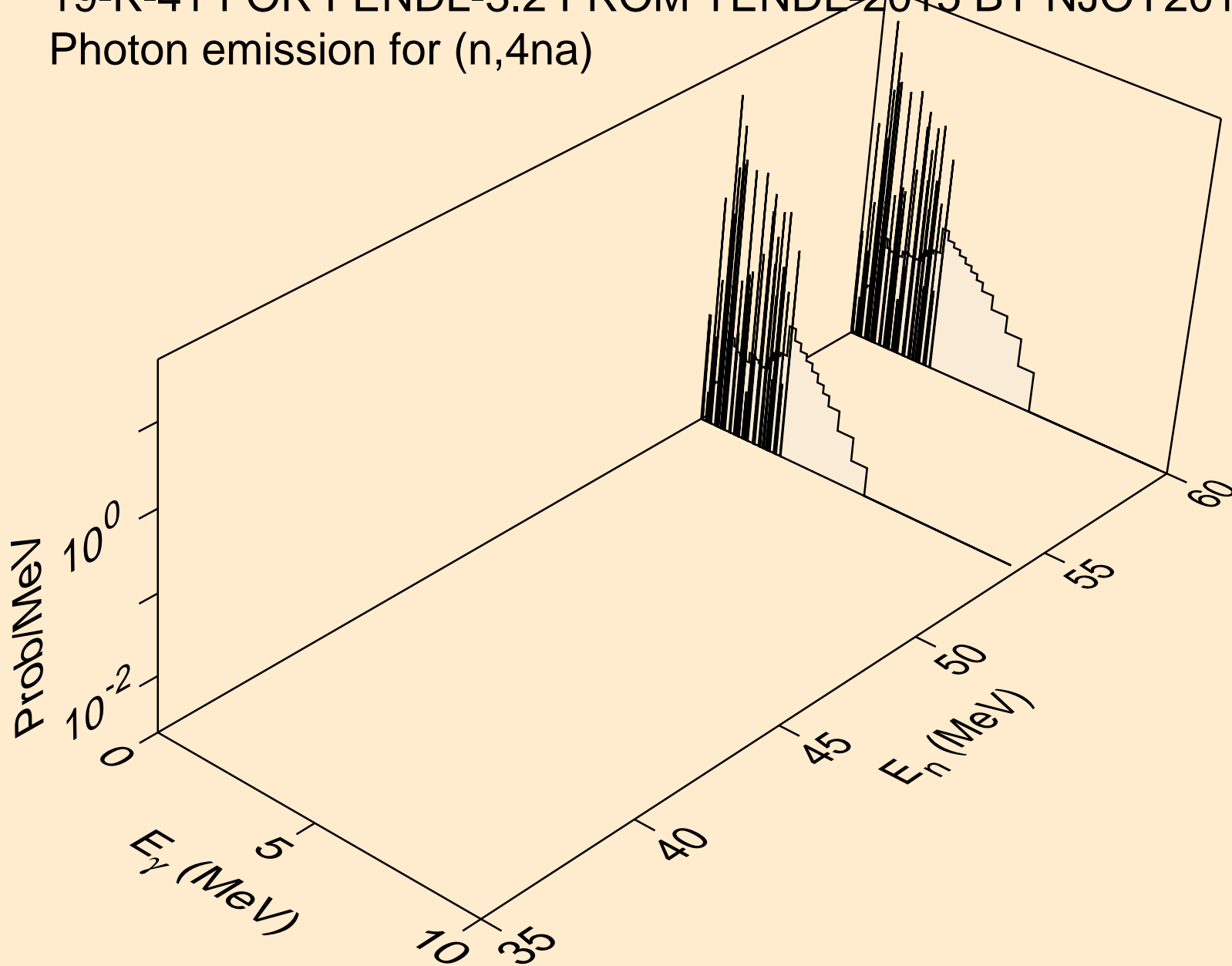

19-K-41 FOR FENDL-3.2 FROM TENDL-2015 BY NJOY2016.60+ O
Photon emission for (n,5na)

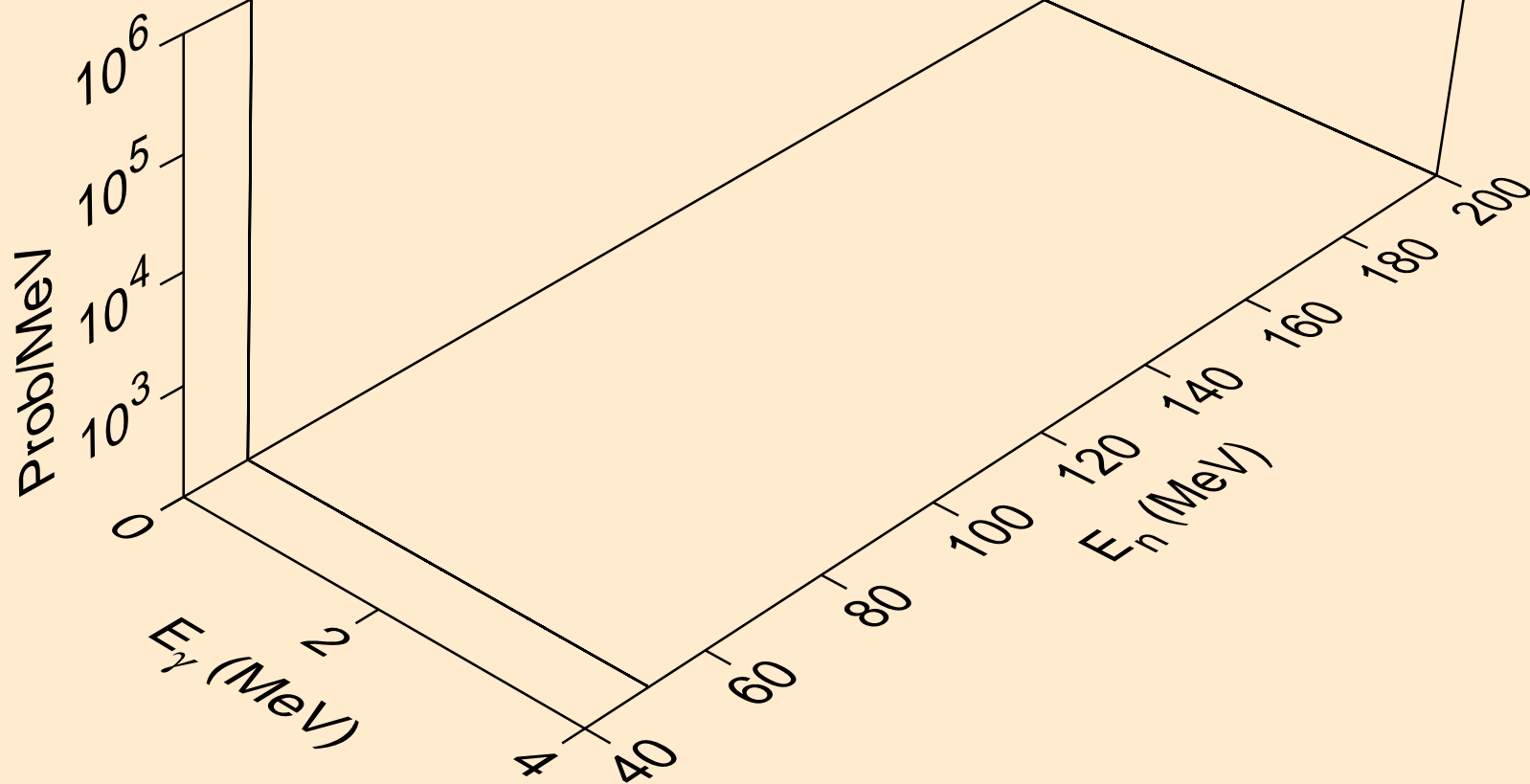

19-K-41 FOR FENDL-3.2 FROM TENDL-2015 BY NJOY2016.60+ O
Photon emission for (n,4nd)

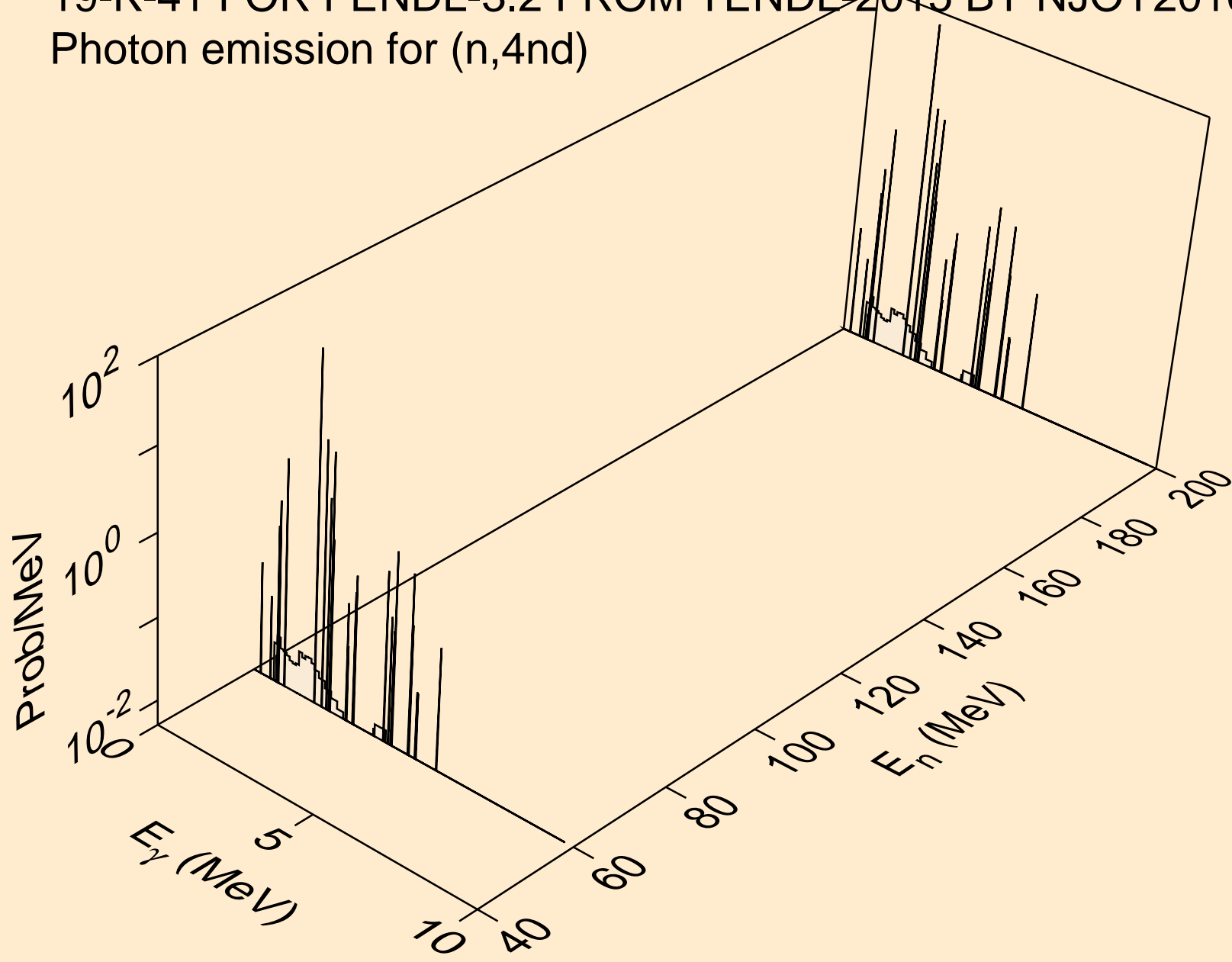

19-K-41 FOR FENDL-3.2 FROM TENDL-2015 BY NJOY2016.60+ O
Photon emission for (n,3nt)

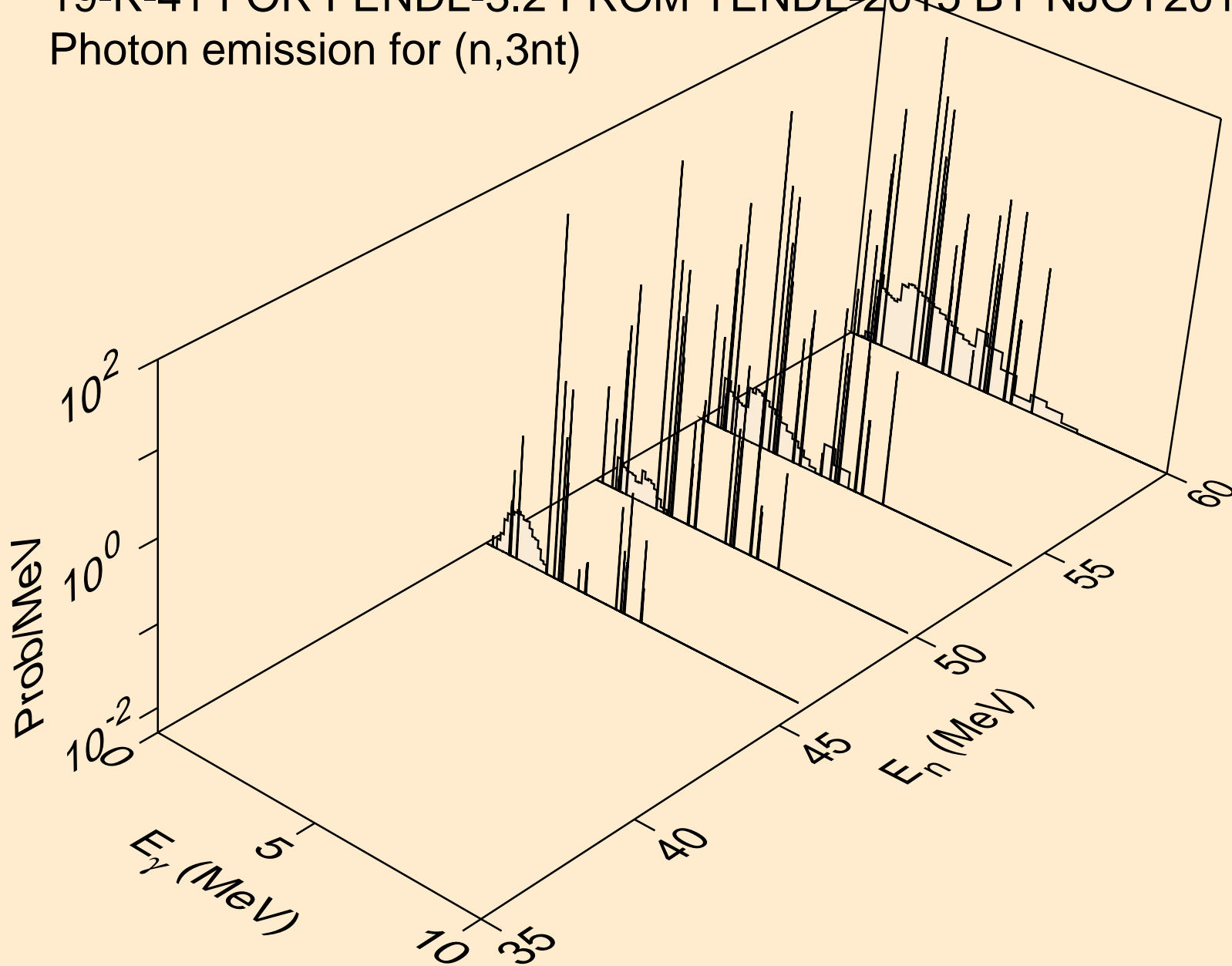

19-K-41 FOR FENDL-3.2 FROM TENDL-2015 BY NJOY2016.60+ O
Photon emission for (n,2n)he3

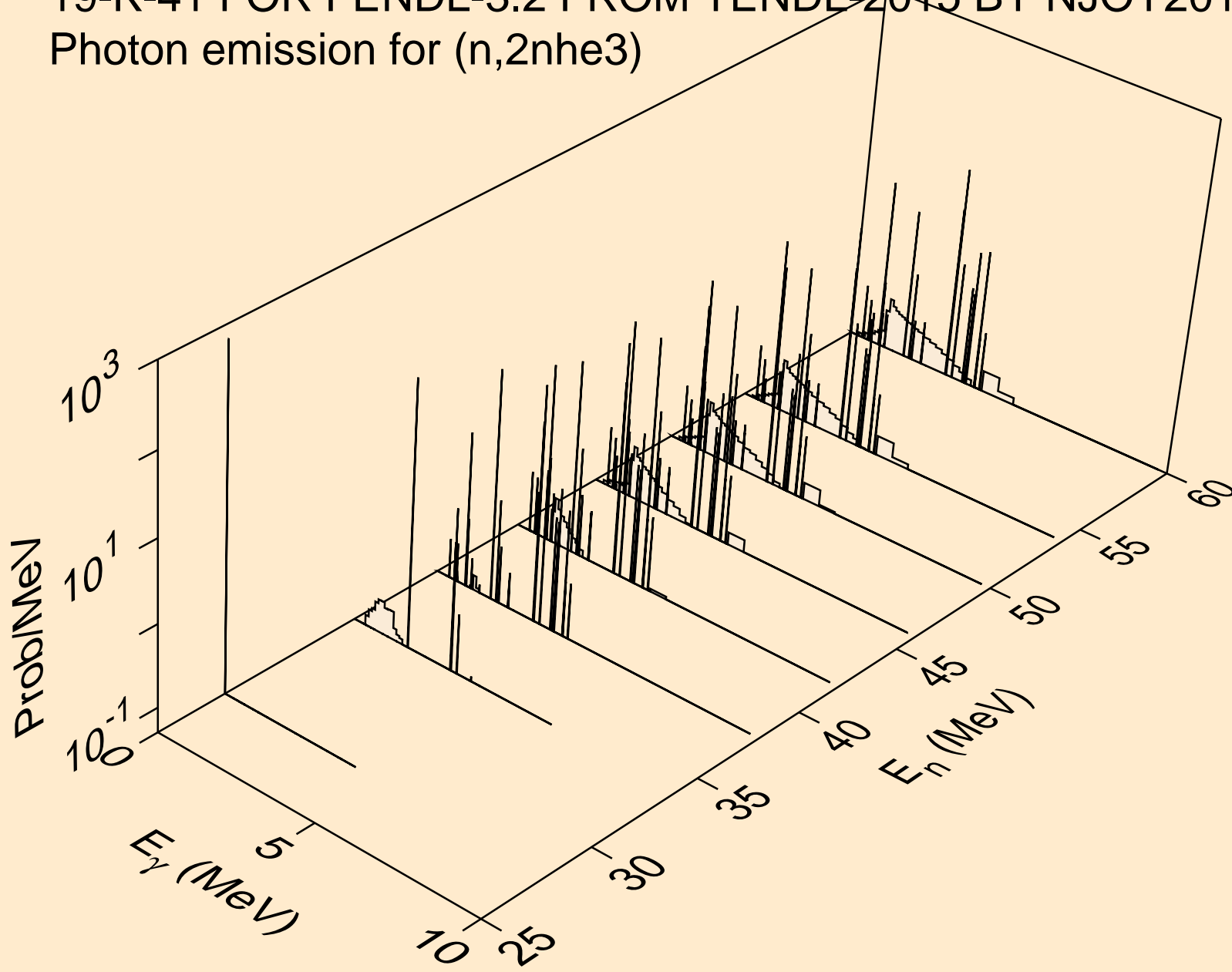

19-K-41 FOR FENDL-3.2 FROM TENDL-2015 BY NJOY2016.60+ O
Photon emission for (n,3n)he3

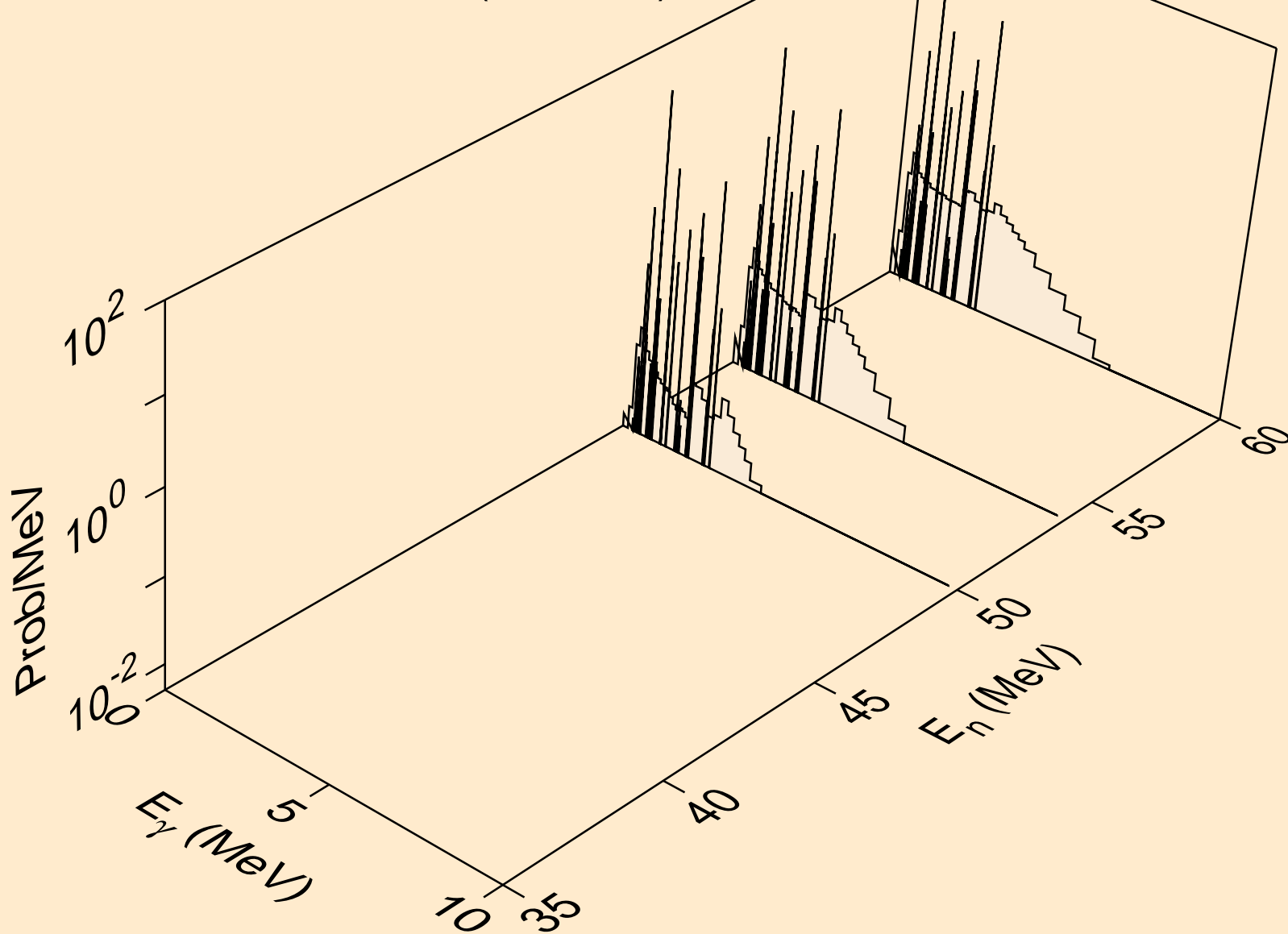

19-K-41 FOR FENDL-3.2 FROM TENDL-2015 BY NJOY2016.60+ O
Photon emission for (n,4n)he3

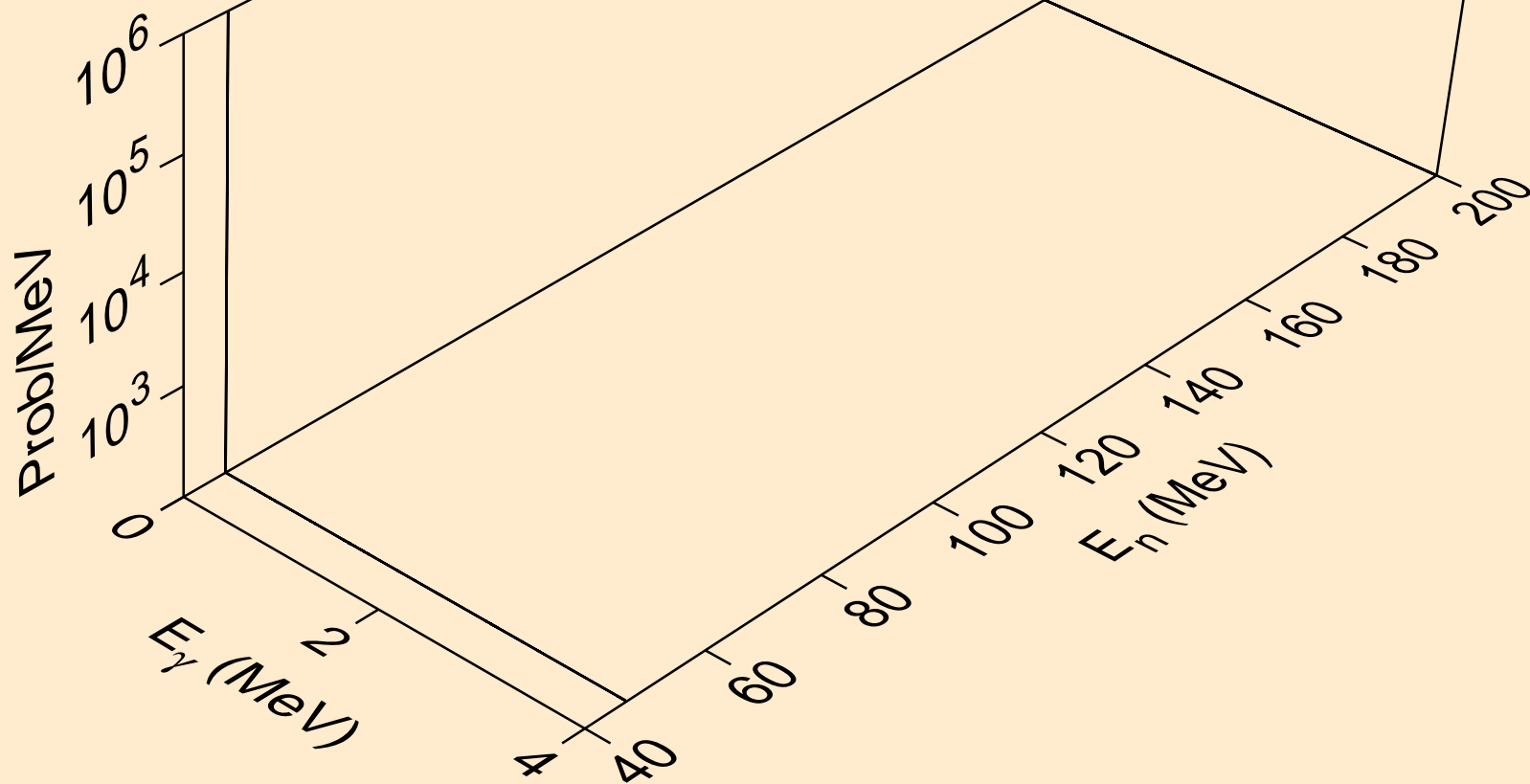

19-K-41 FOR FENDL-3.2 FROM TENDL-2015 BY NJOY2016.60+ O
Photon emission for (n,3n2p)

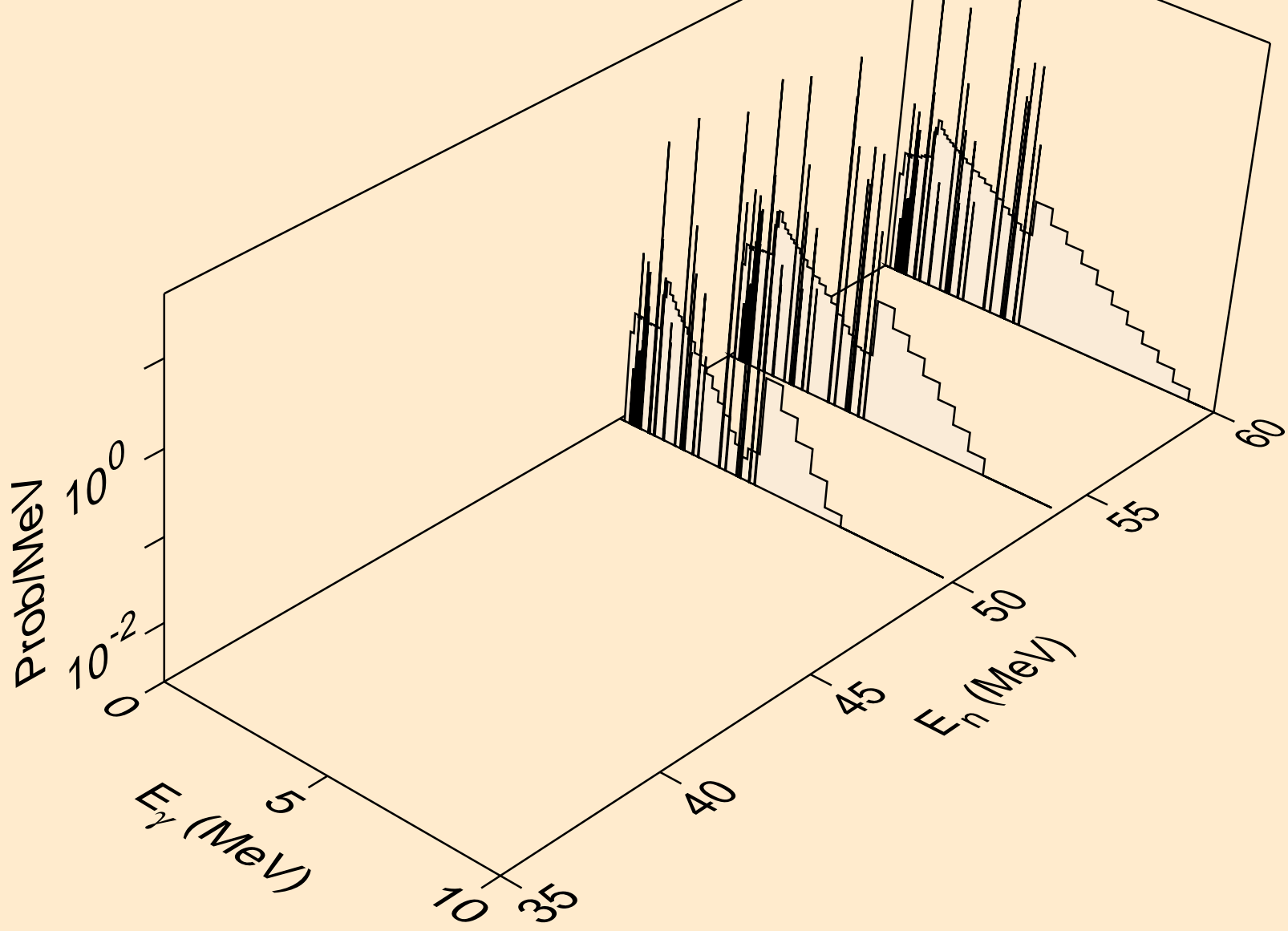

19-K-41 FOR FENDL-3.2 FROM TENDL-2015 BY NJOY2016.60+ O
Photon emission for (n,3n2a)

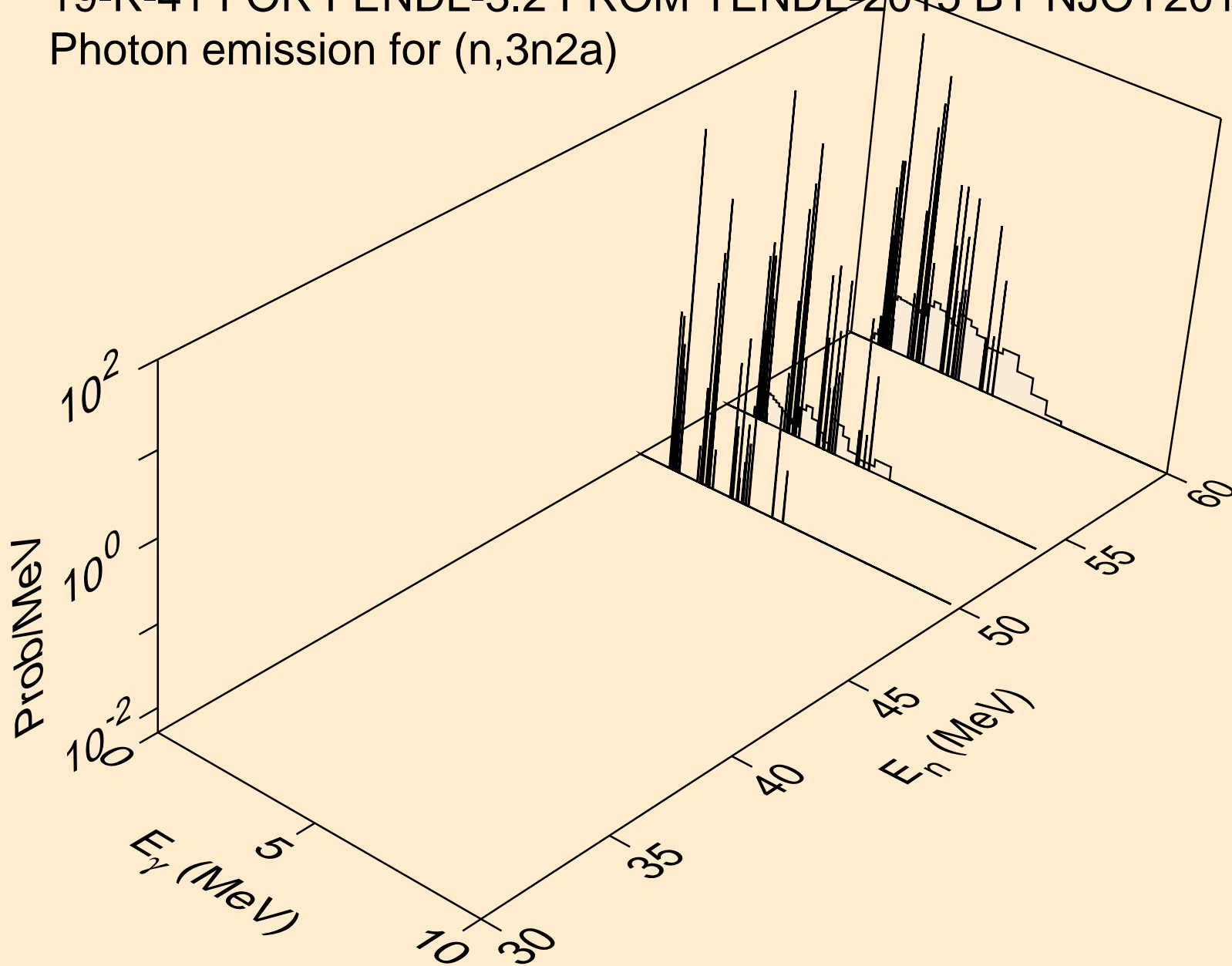

19-K-41 FOR FENDL-3.2 FROM TENDL-2015 BY NJOY2016.60+ O
Photon emission for (n,3npa)

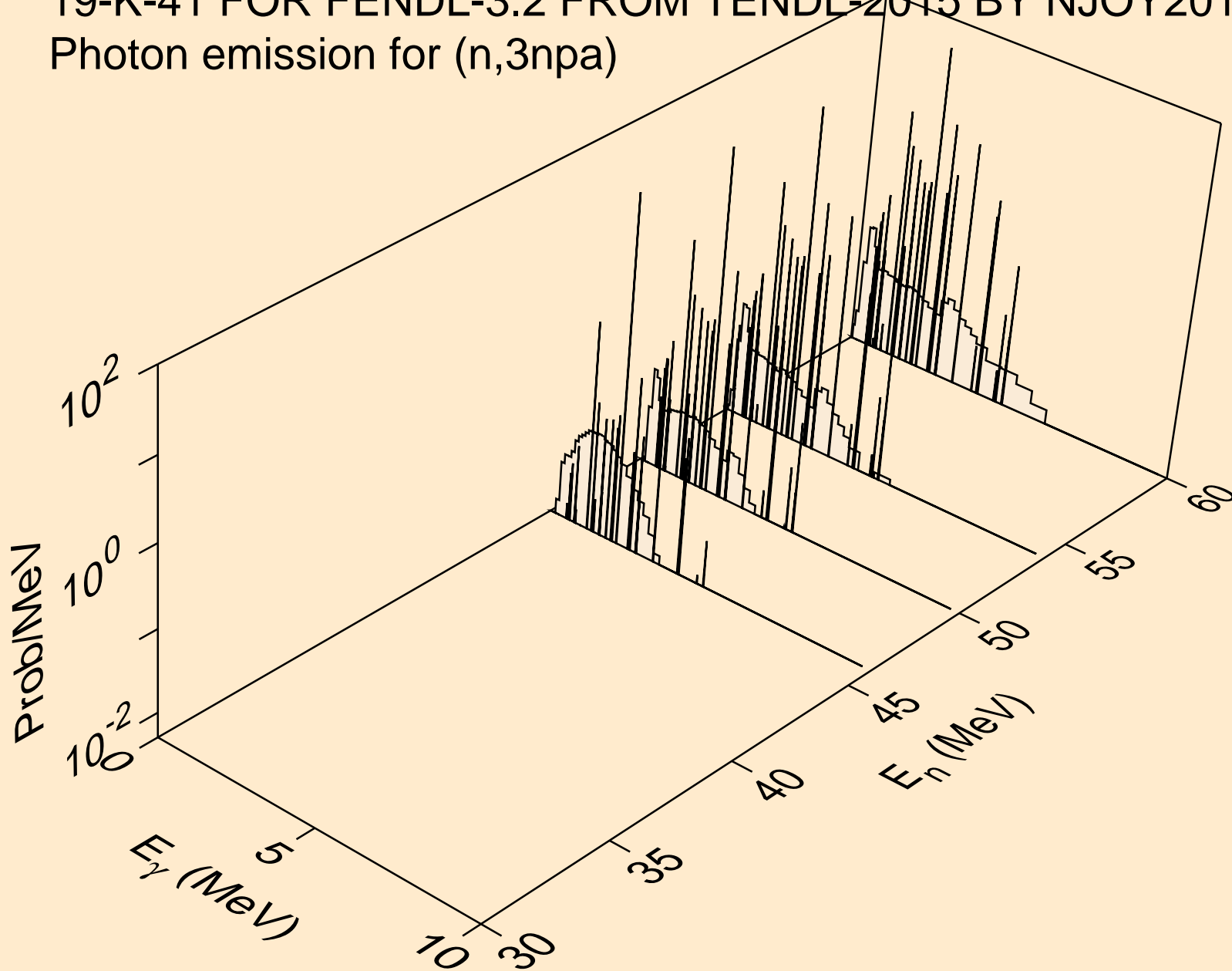

19-K-41 FOR FENDL-3.2 FROM TENDL-2015 BY NJOY2016.60+ O
Photon emission for (n,dt)

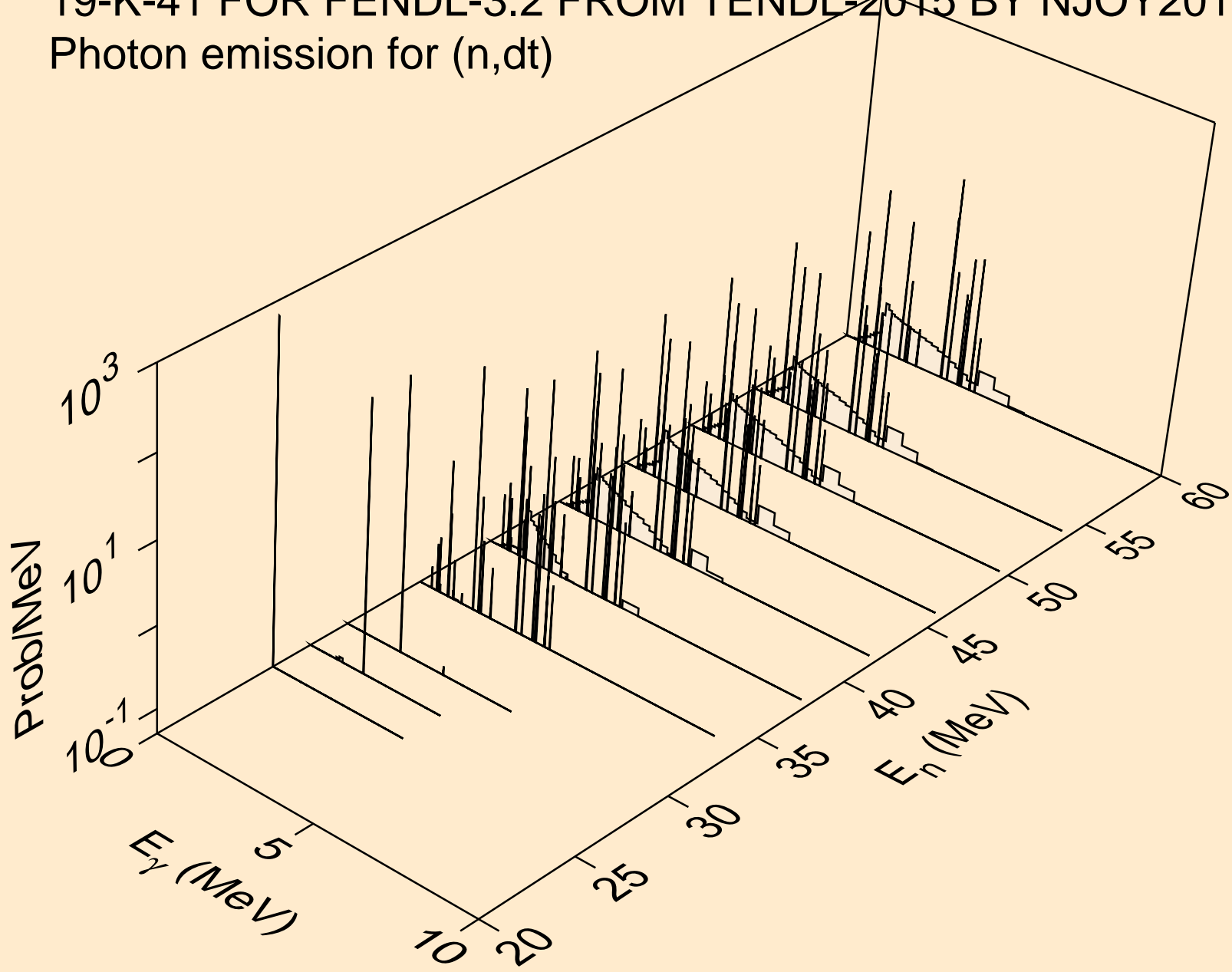

19-K-41 FOR FENDL-3.2 FROM TENDL-2015 BY NJOY2016.60+ O
Photon emission for (n,npd)

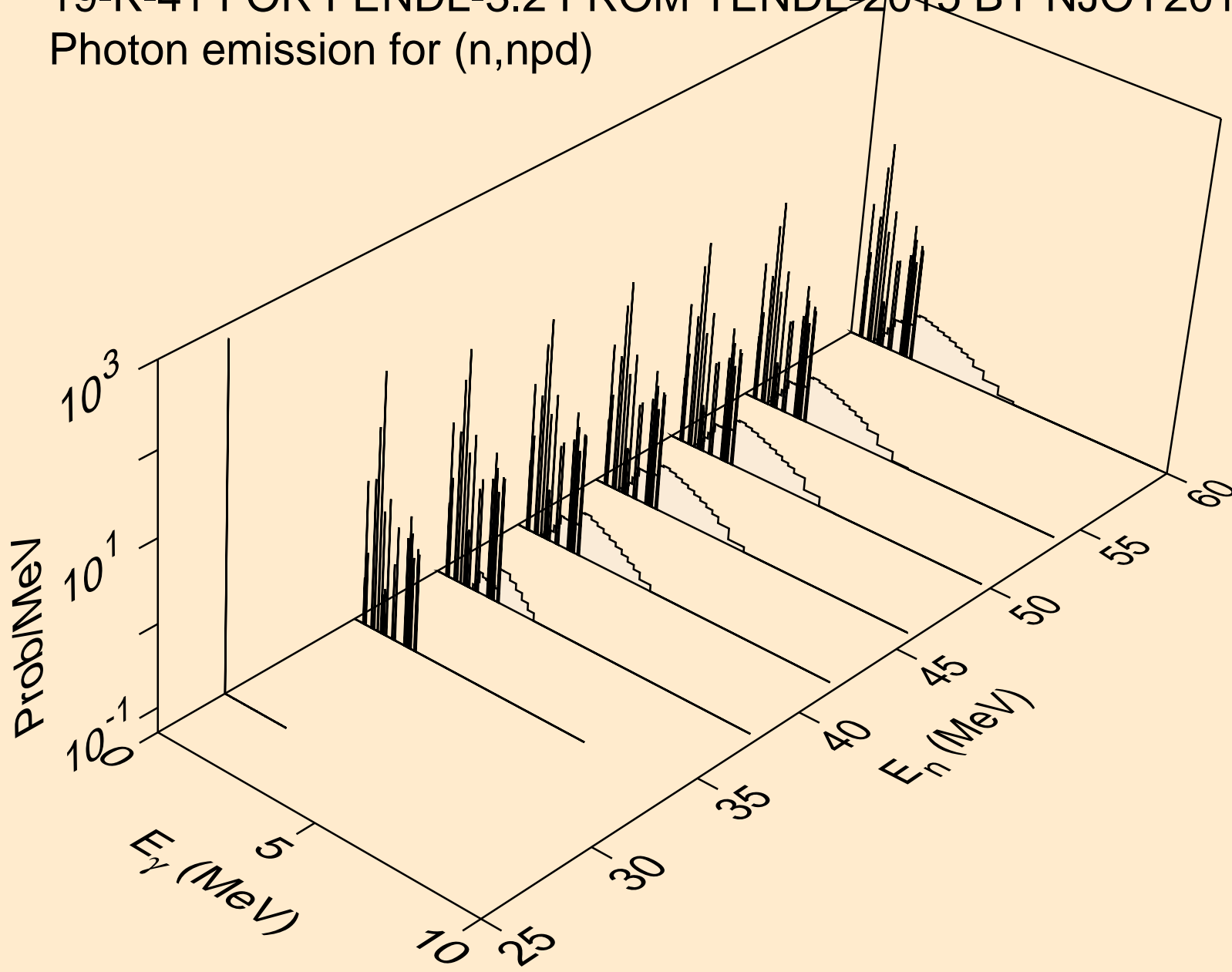

19-K-41 FOR FENDL-3.2 FROM TENDL-2015 BY NJOY2016.60+ O
Photon emission for (n,npt)

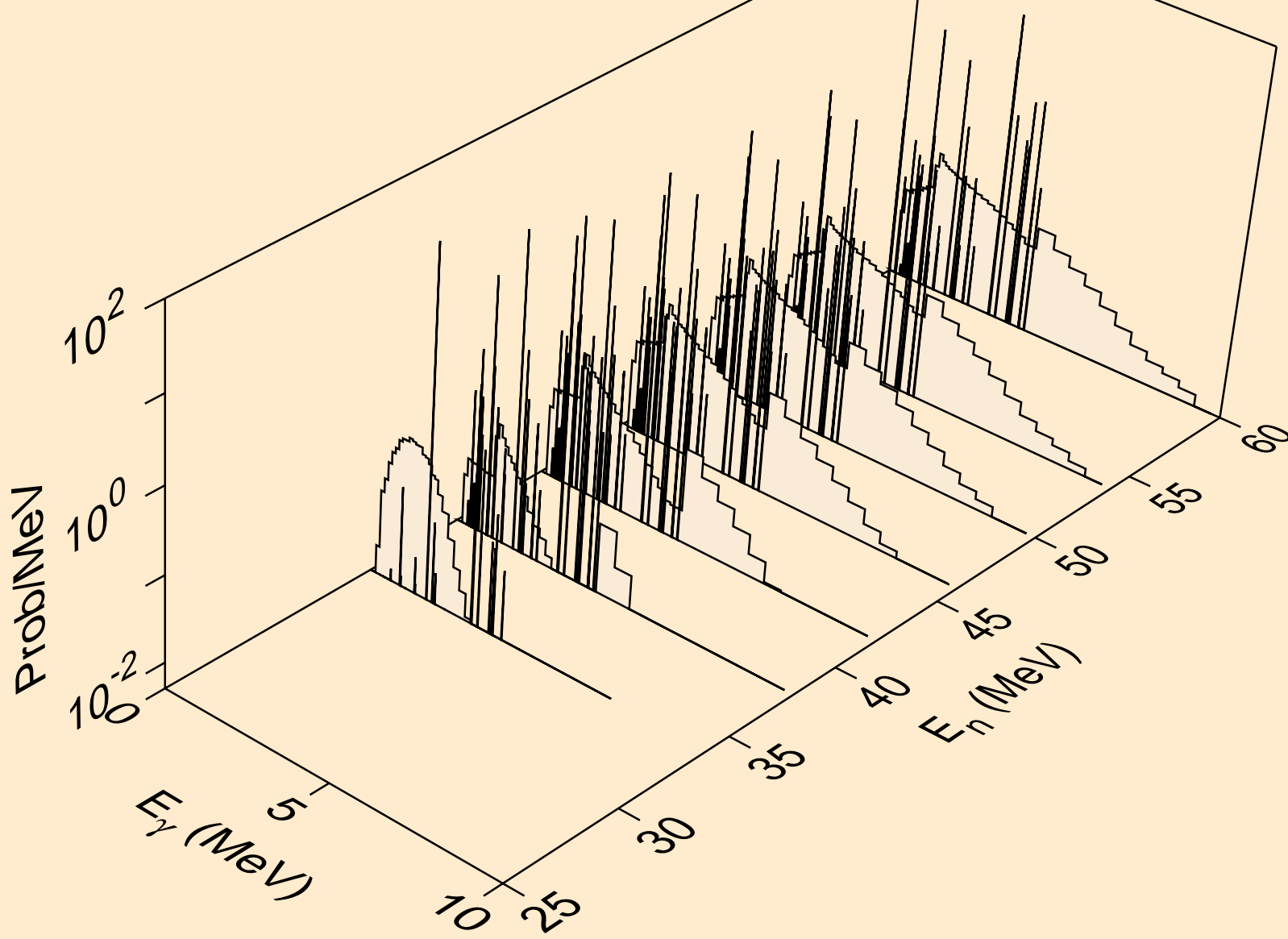

19-K-41 FOR FENDL-3.2 FROM TENDL-2015 BY NJOY2016.60+ O
Photon emission for (n,ndt)

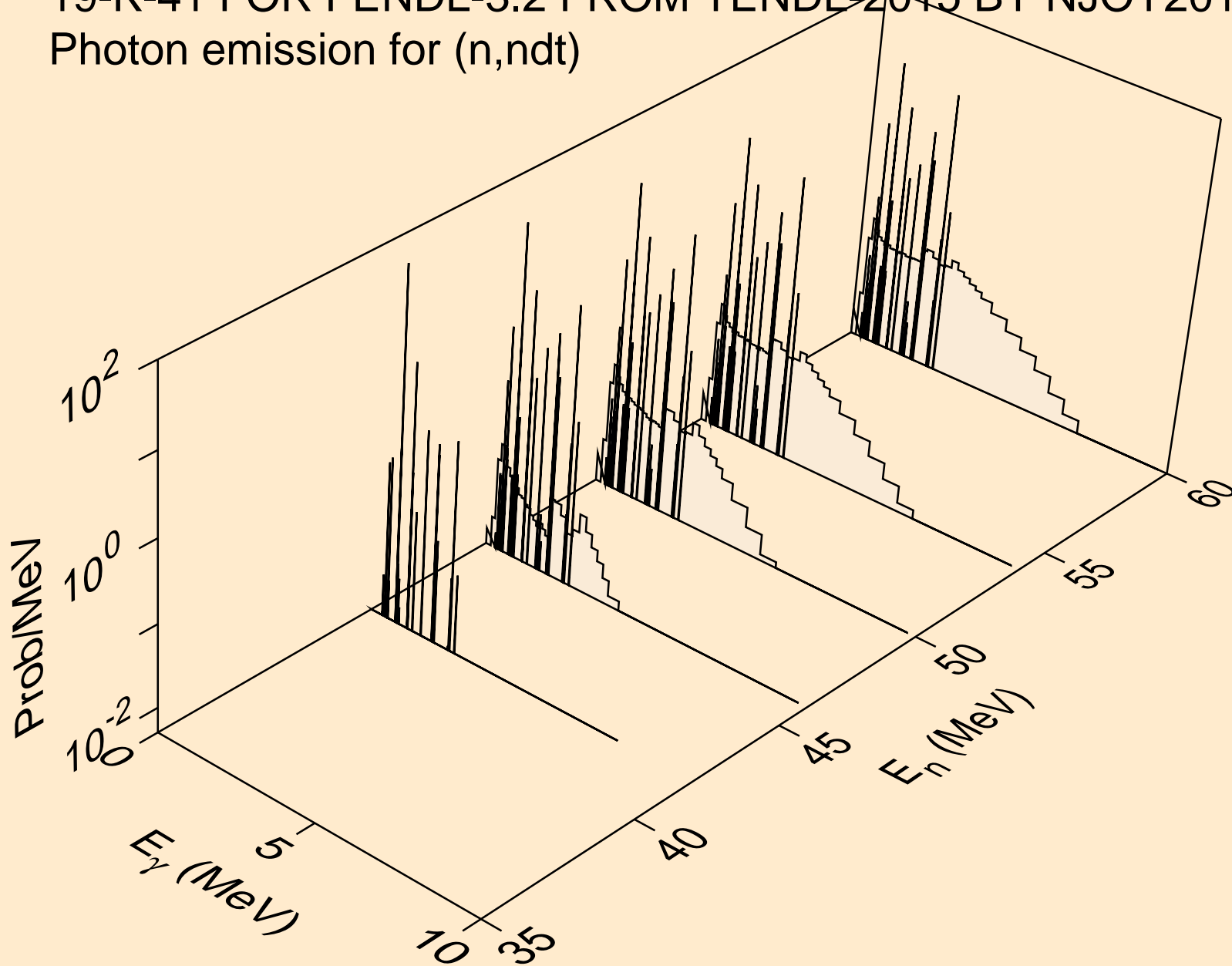

19-K-41 FOR FENDL-3.2 FROM TENDL-2015 BY NJOY2016.60+ O
Photon emission for (n,nphe3)

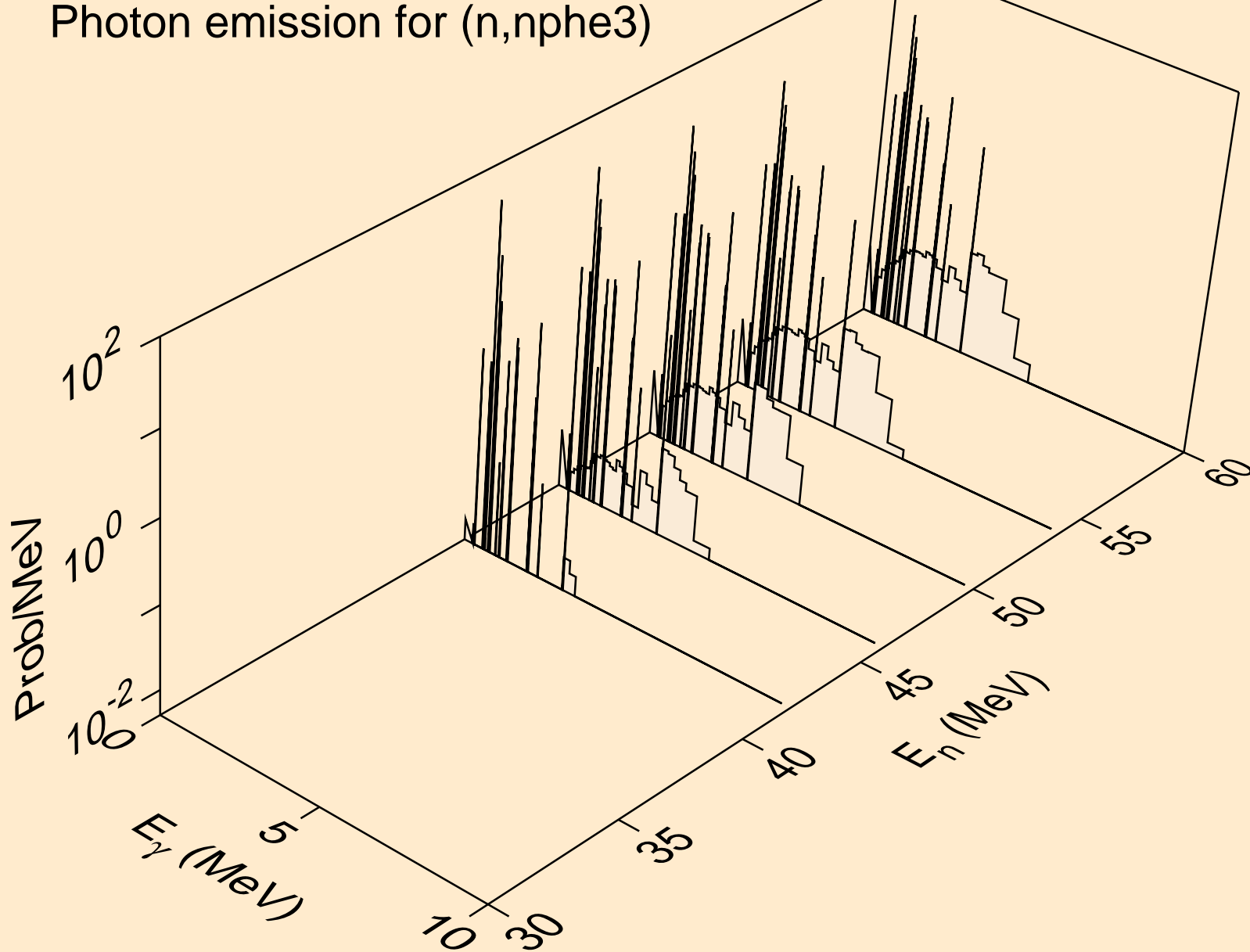

19-K-41 FOR FENDL-3.2 FROM TENDL-2015 BY NJOY2016.60+ O
Photon emission for (n,ndhe3)

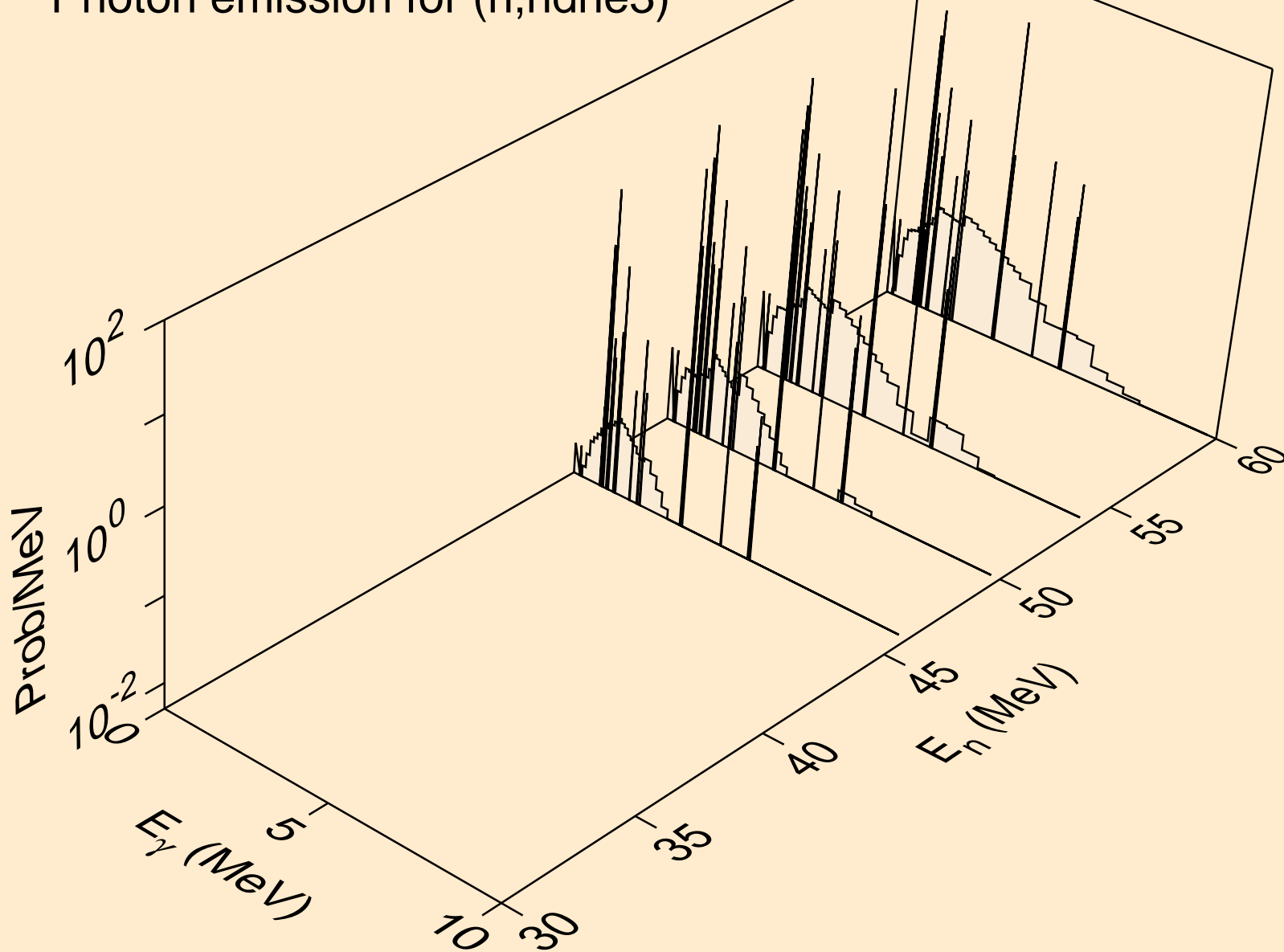

19-K-41 FOR FENDL-3.2 FROM TENDL-2015 BY NJOY2016.60+ O
Photon emission for (n,nthe3)

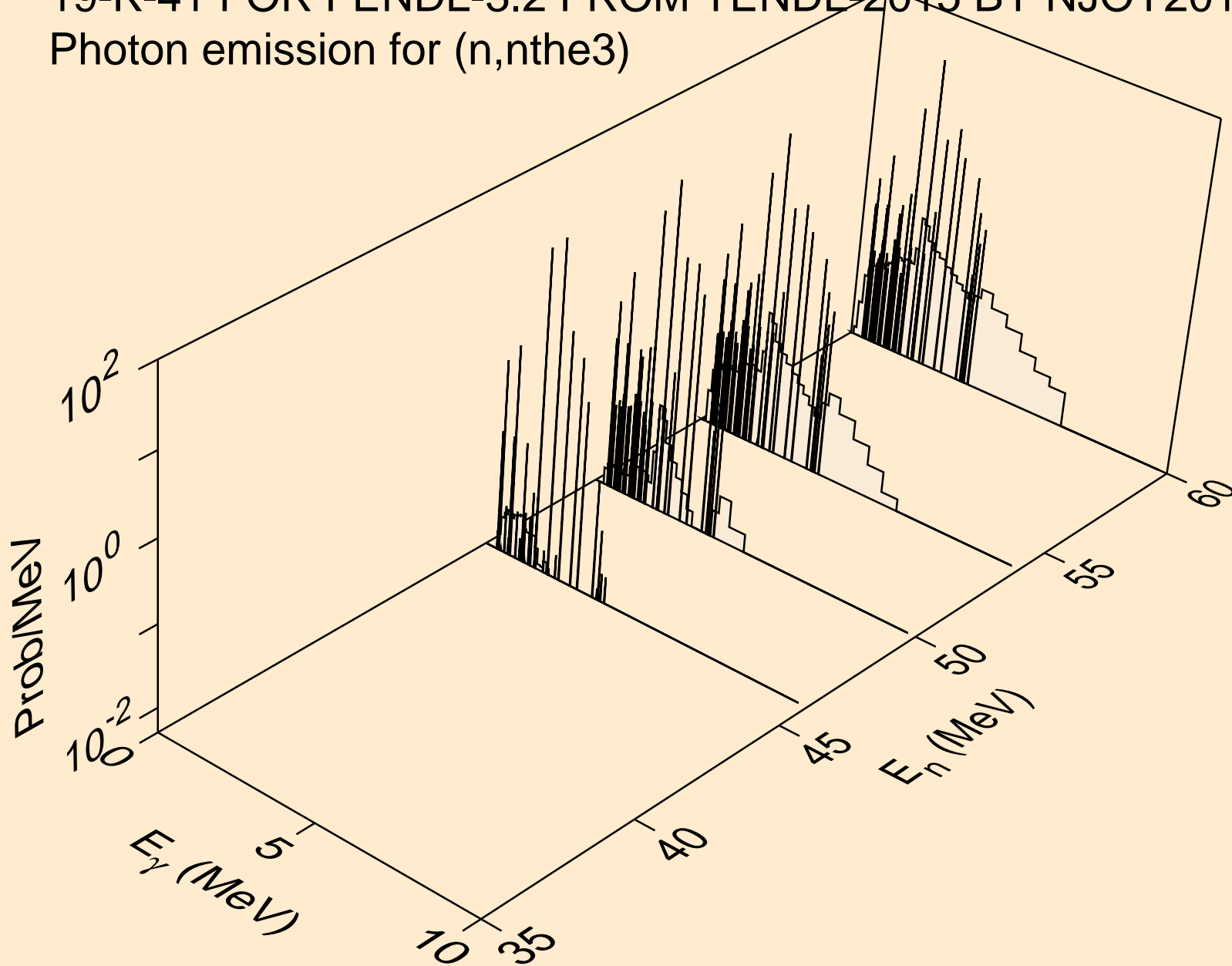

19-K-41 FOR FENDL-3.2 FROM TENDL-2015 BY NJOY2016.60+ O
Photon emission for (n,nta)

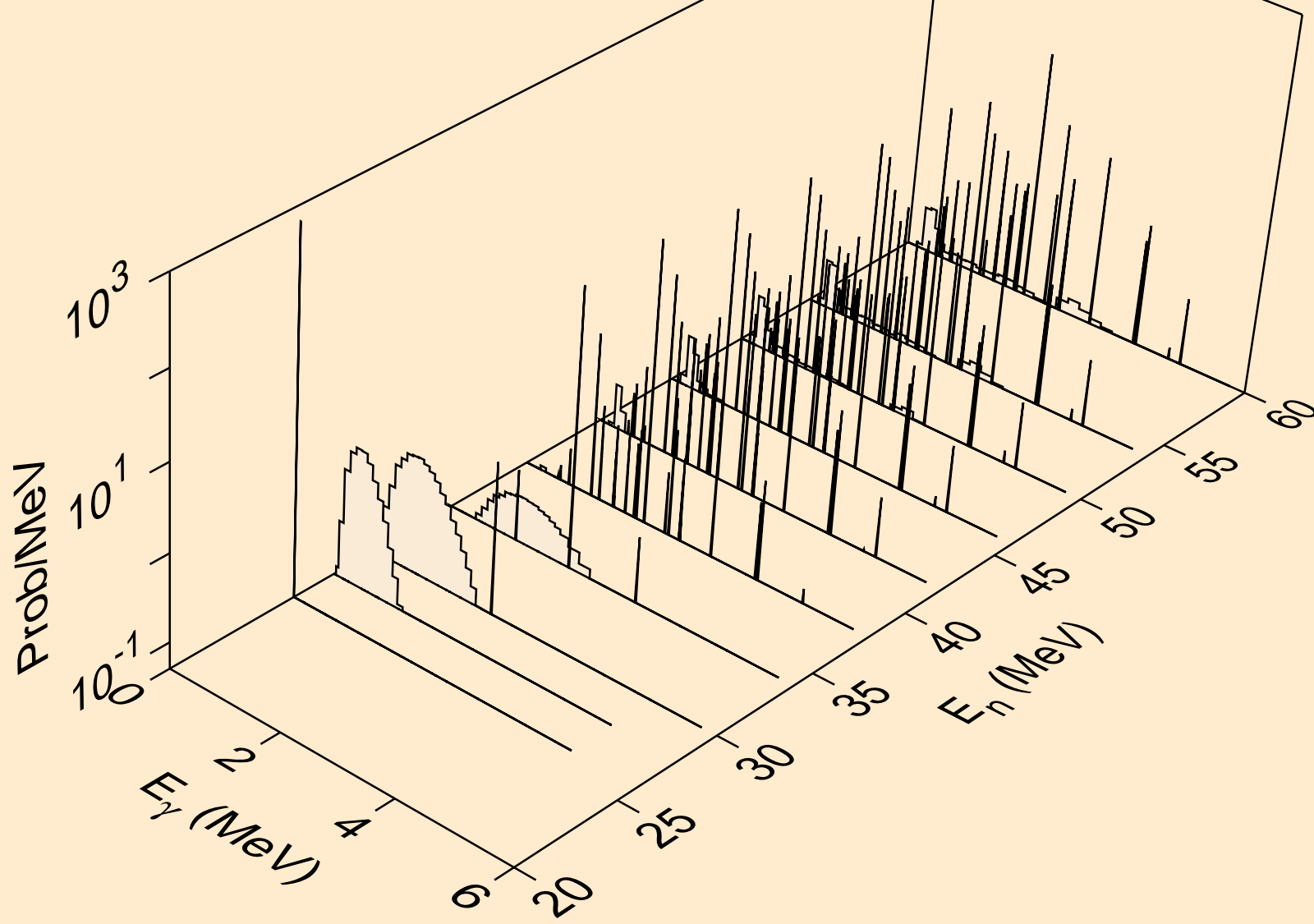

19-K-41 FOR FENDL-3.2 FROM TENDL-2015 BY NJOY2016.60+ O
Photon emission for (n,2n2p)

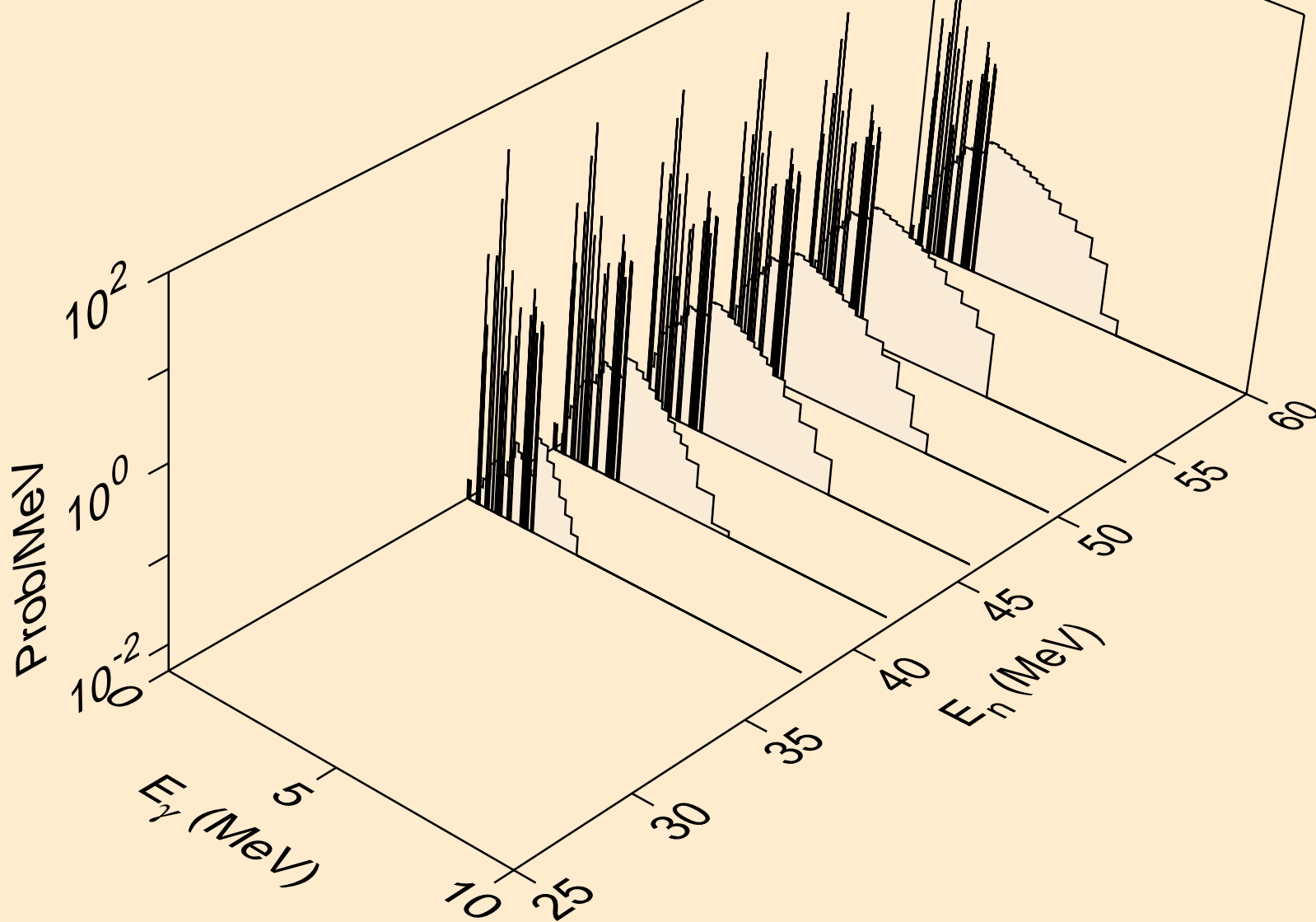

19-K-41 FOR FENDL-3.2 FROM TENDL-2015 BY NJOY2016.60+ O
Photon emission for (n,phe3)

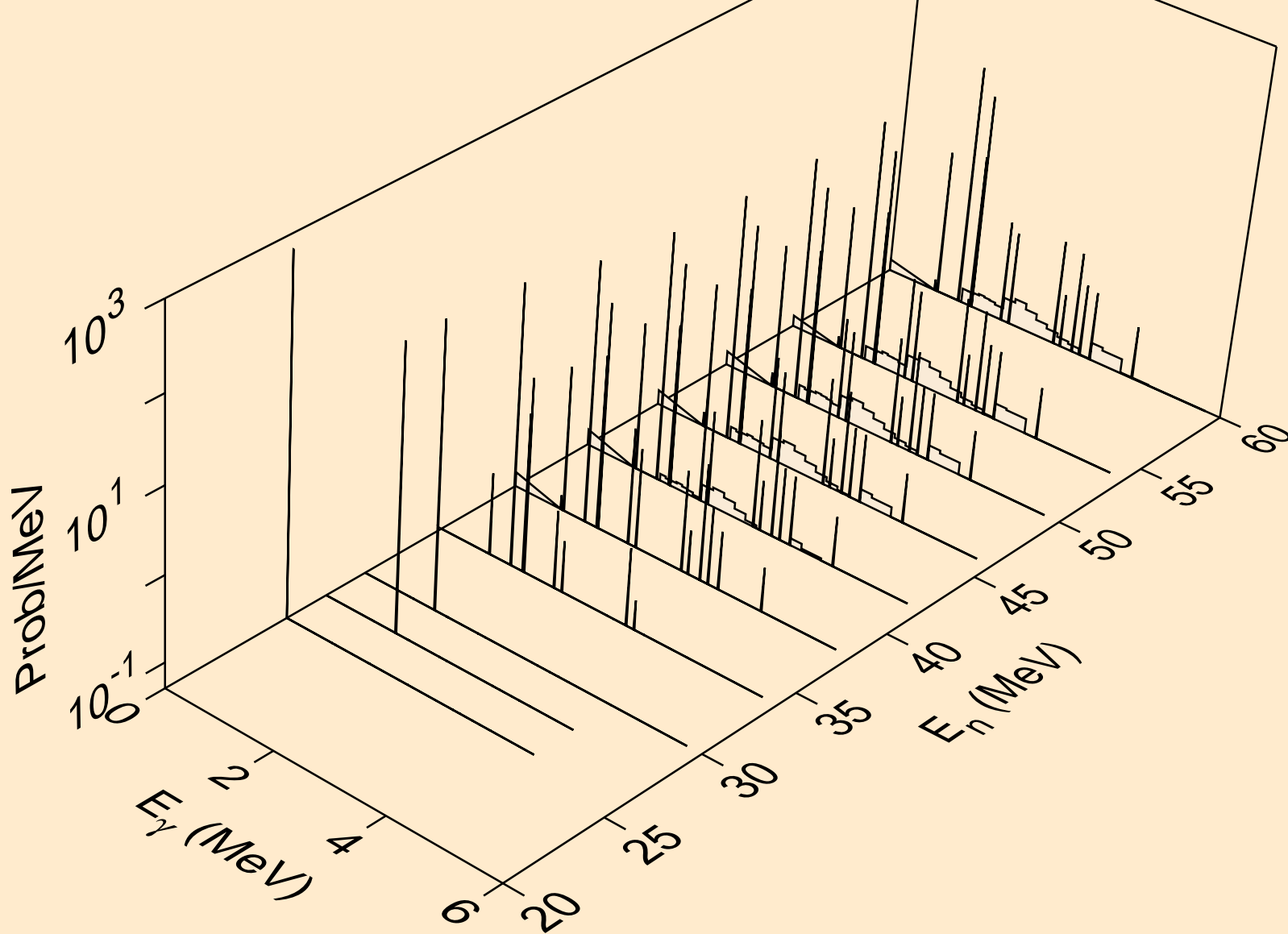

19-K-41 FOR FENDL-3.2 FROM TENDL-2015 BY NJOY2016.60+ O
Photon emission for (n,dhe3)

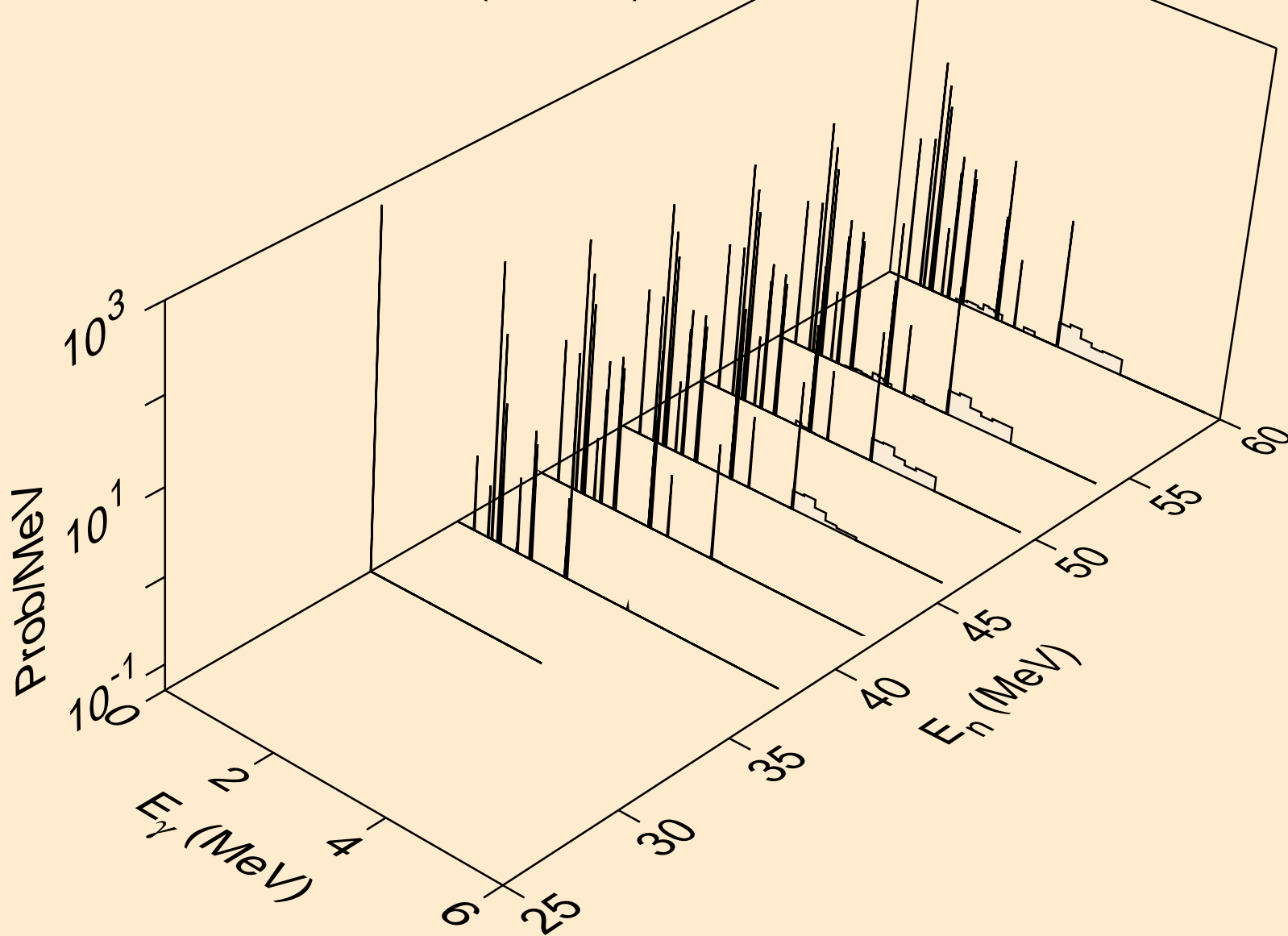

19-K-41 FOR FENDL-3.2 FROM TENDL-2015 BY NJOY2016.60+ O
Photon emission for (n,he3a)

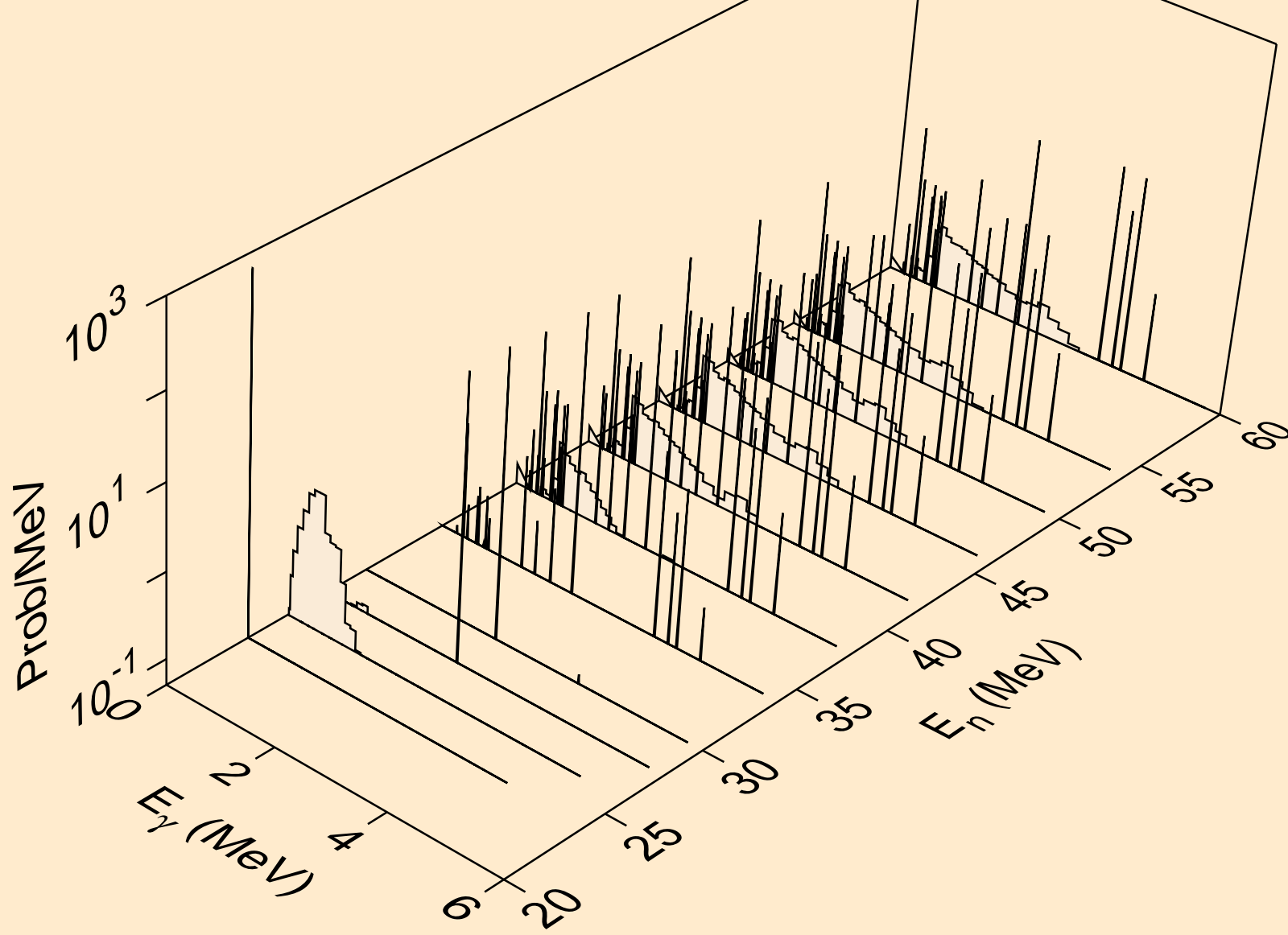

19-K-41 FOR FENDL-3.2 FROM TENDL-2015 BY NJOY2016.60+ O
Photon emission for (n,4n2p)

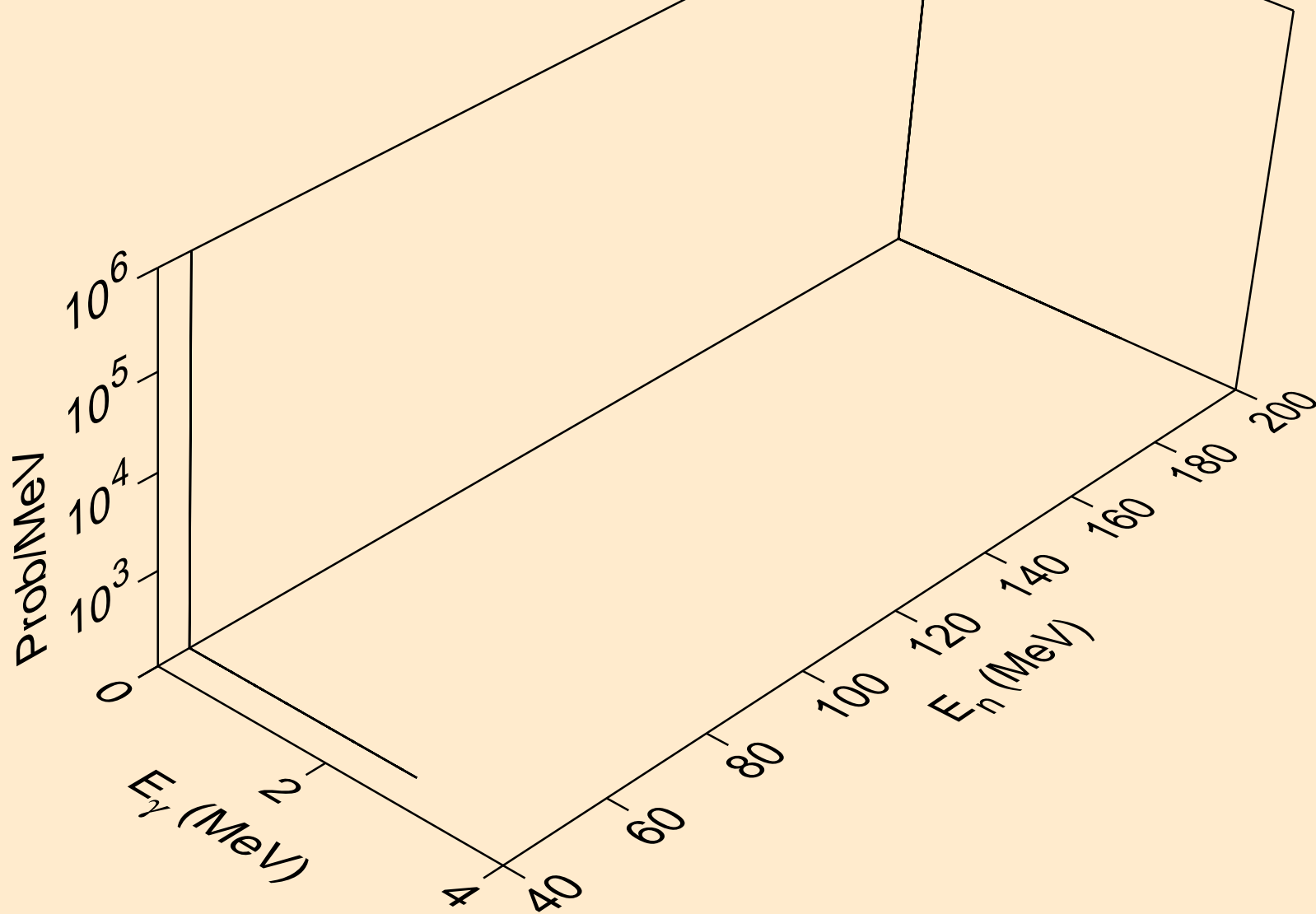

19-K-41 FOR FENDL-3.2 FROM TENDL-2015 BY NJOY2016.60+ O
Photon emission for (n,2n2a)

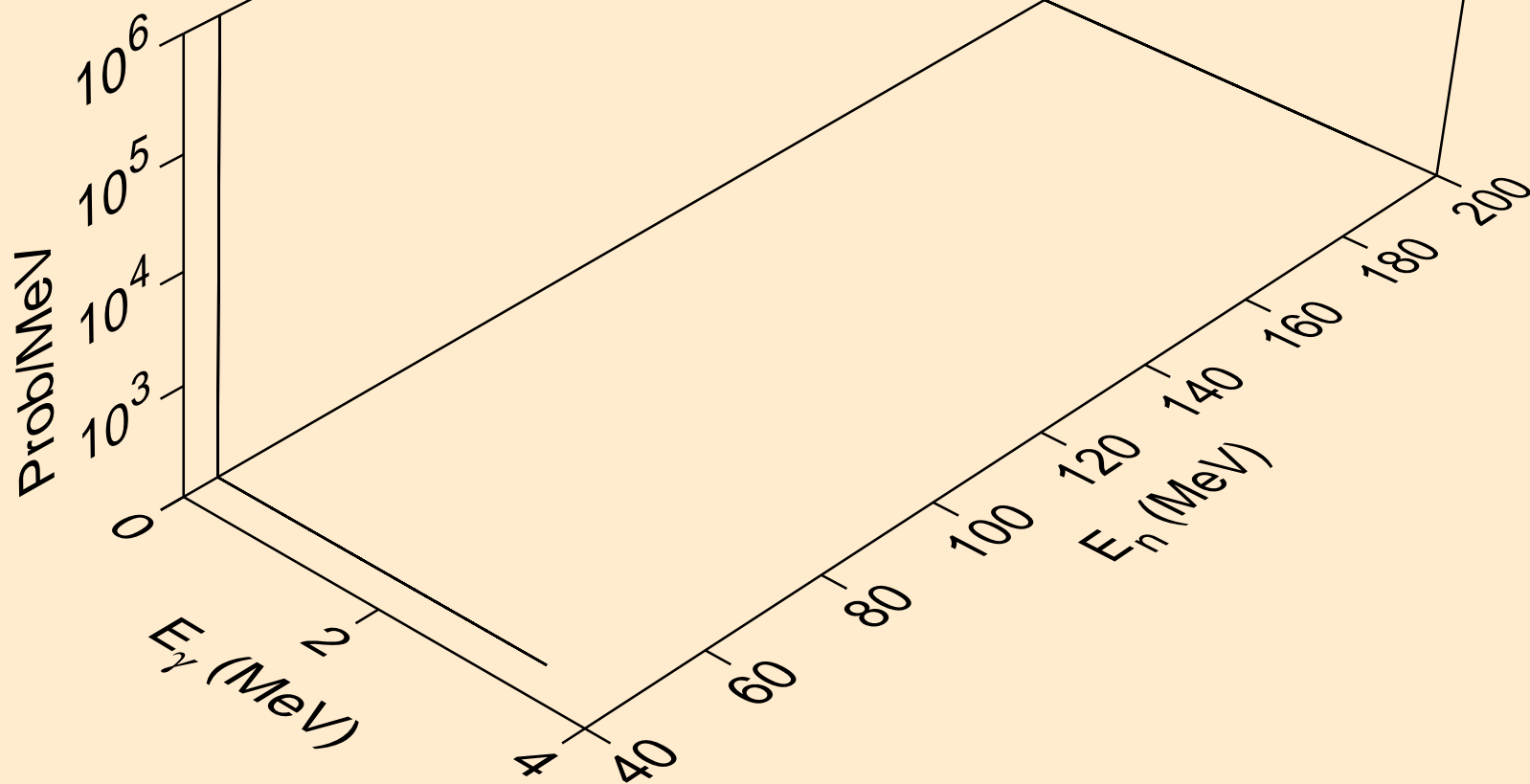

19-K-41 FOR FENDL-3.2 FROM TENDL-2015 BY NJOY2016.60+ O
Photon emission for (n,4npa)

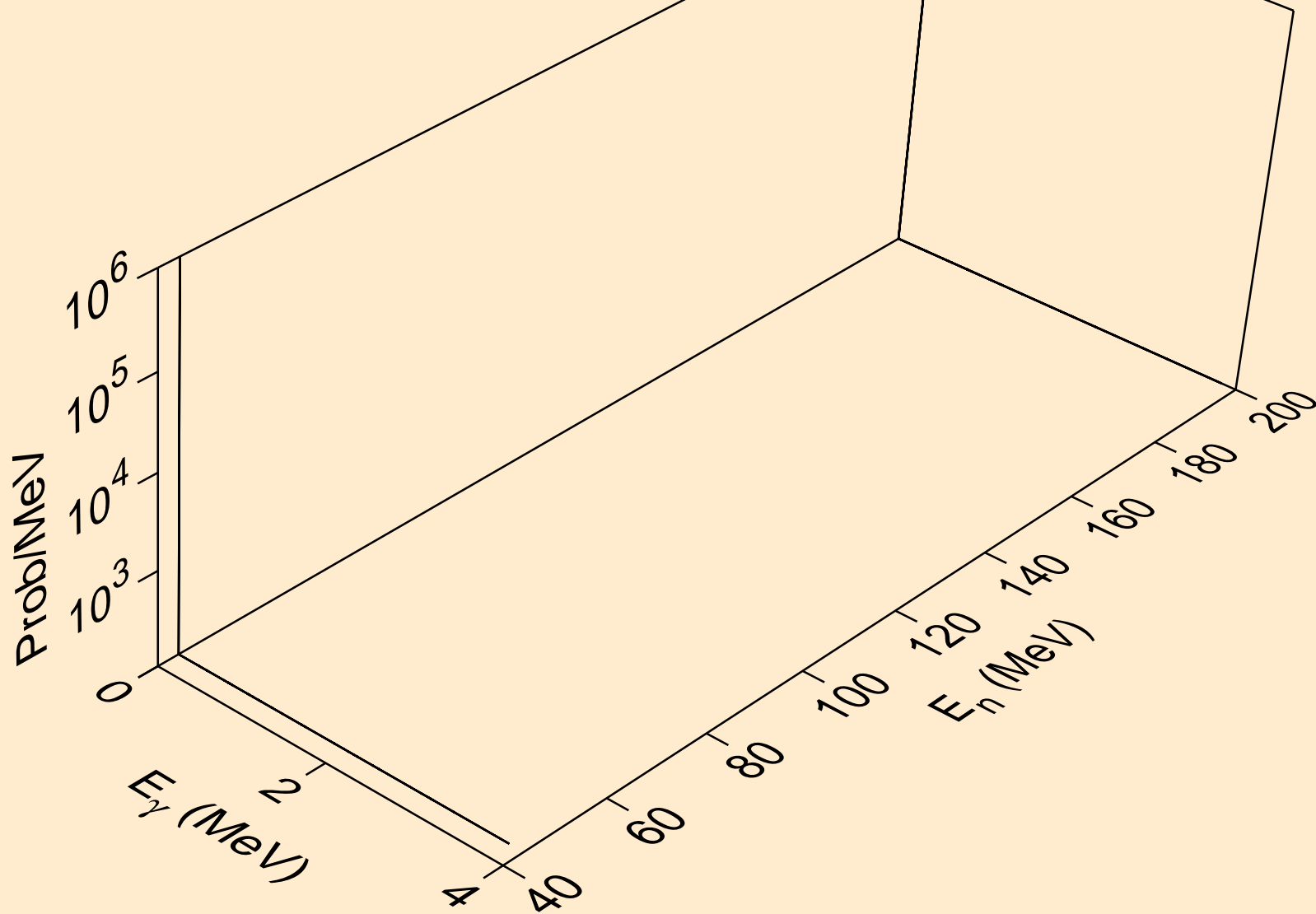

19-K-41 FOR FENDL-3.2 FROM TENDL-2015 BY NJOY2016.60+ O
Photon emission for (n,3p)

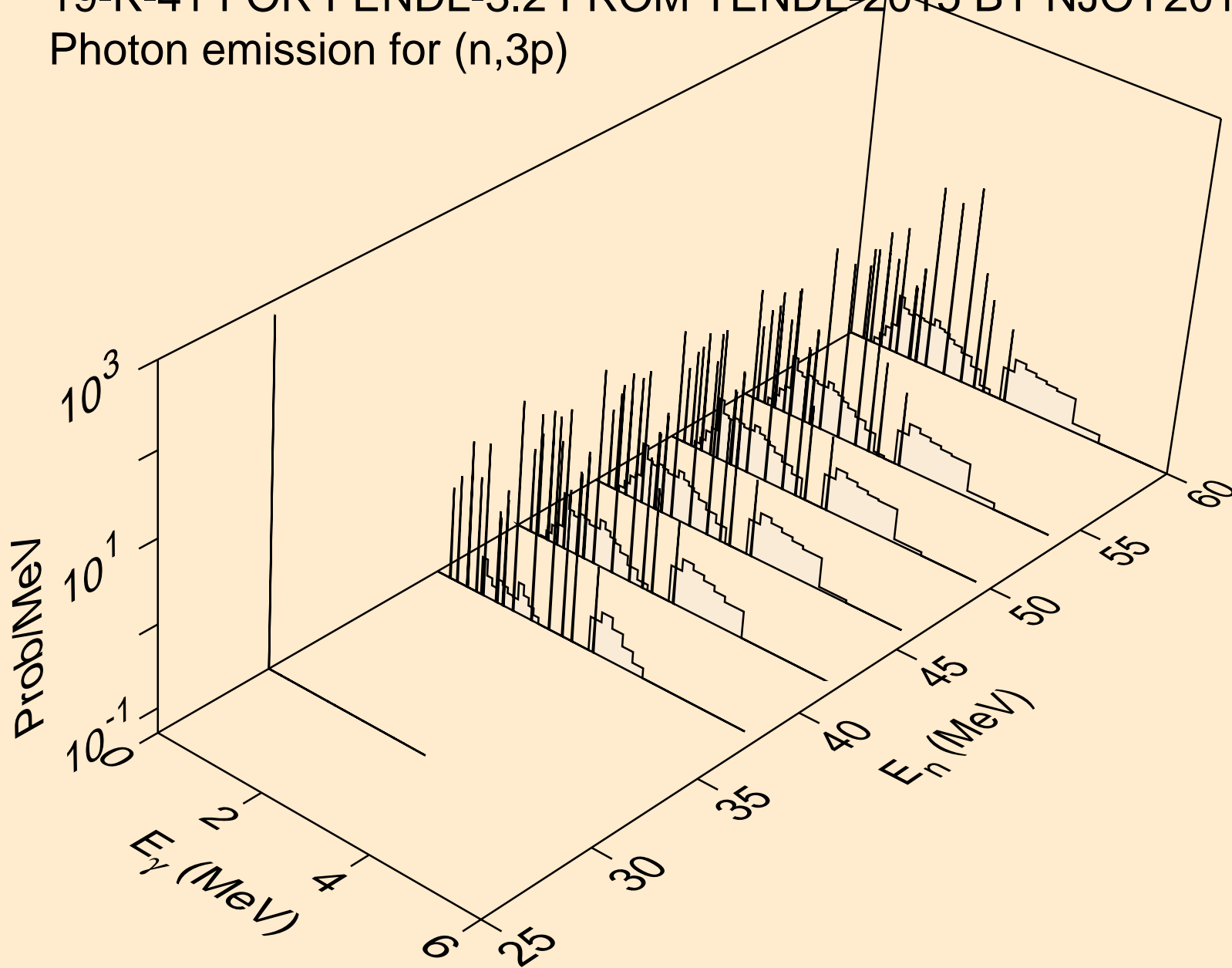

19-K-41 FOR FENDL-3.2 FROM TENDL-2015 BY NJOY2016.60+ O
Photon emission for (n,n3p)

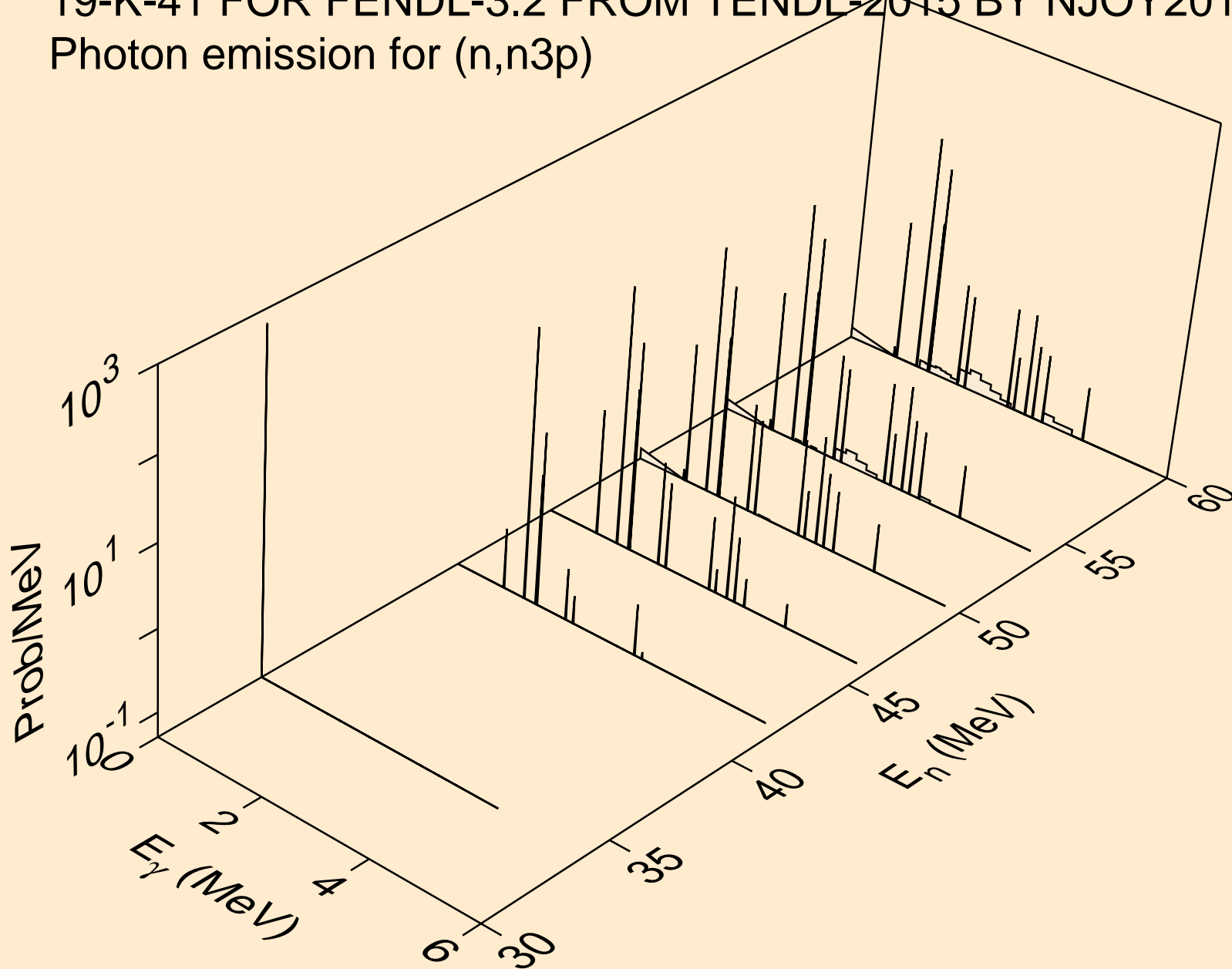

19-K-41 FOR FENDL-3.2 FROM TENDL-2015 BY NJOY2016.60+ O
Photon emission for (n,3n2pa)

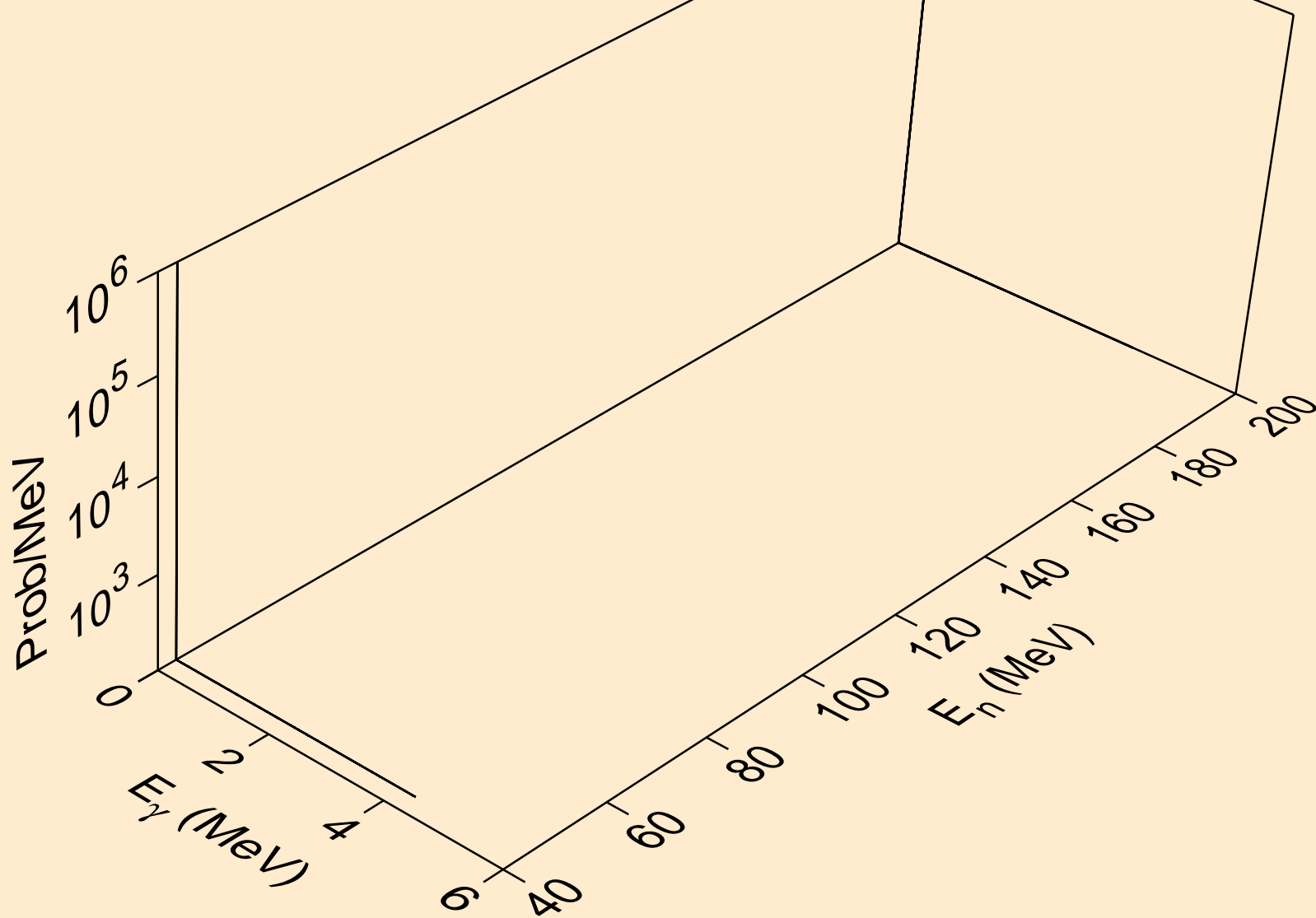

19-K-41 FOR FENDL-3.2 FROM TENDL-2015 BY NJOY2016.60+ O
thermal capture photon spectrum

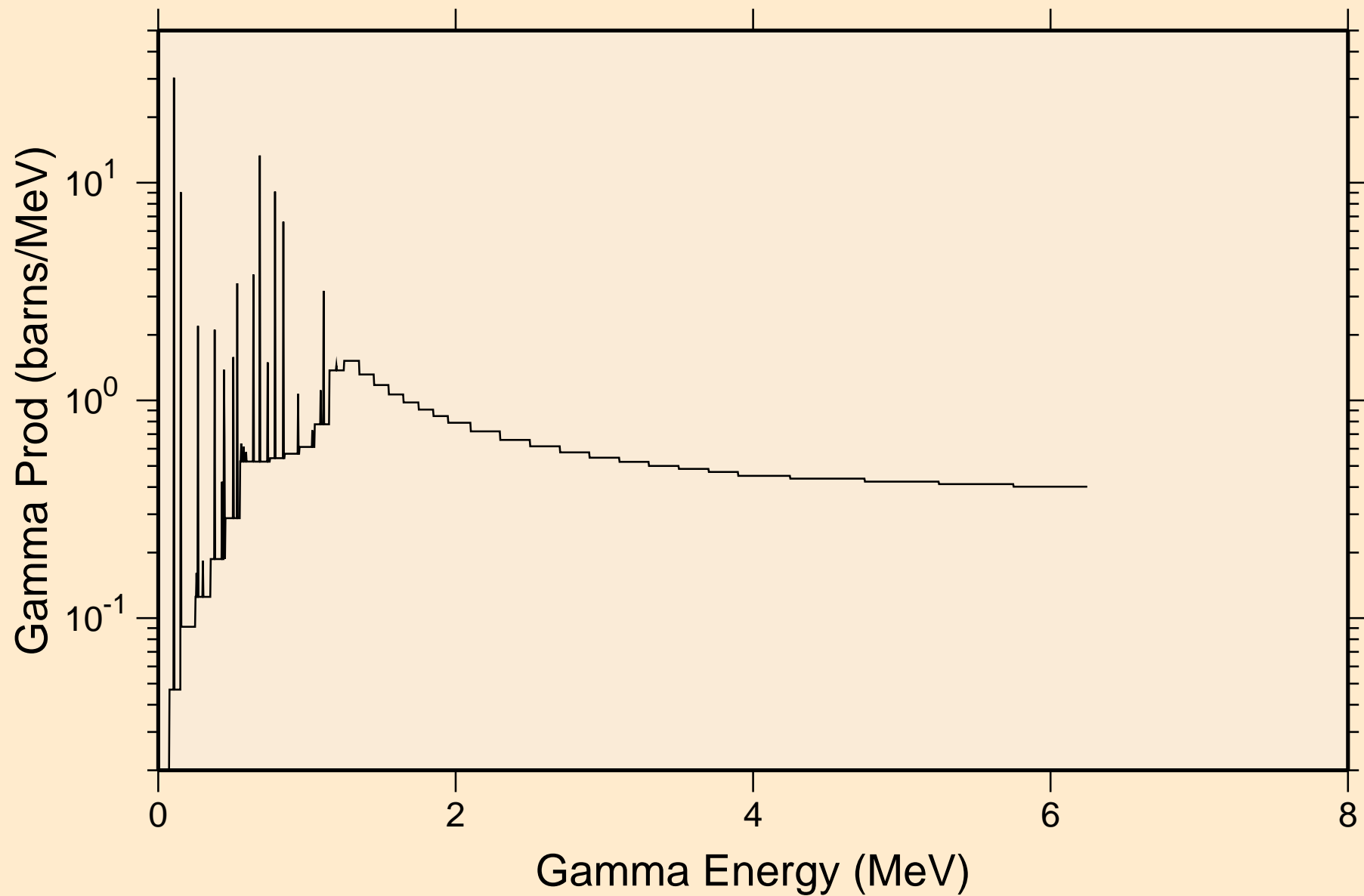

19-K-41 FOR FENDL-3.2 FROM TENDL-2015 BY NJOY2016.60+ O
14 MeV photon spectrum

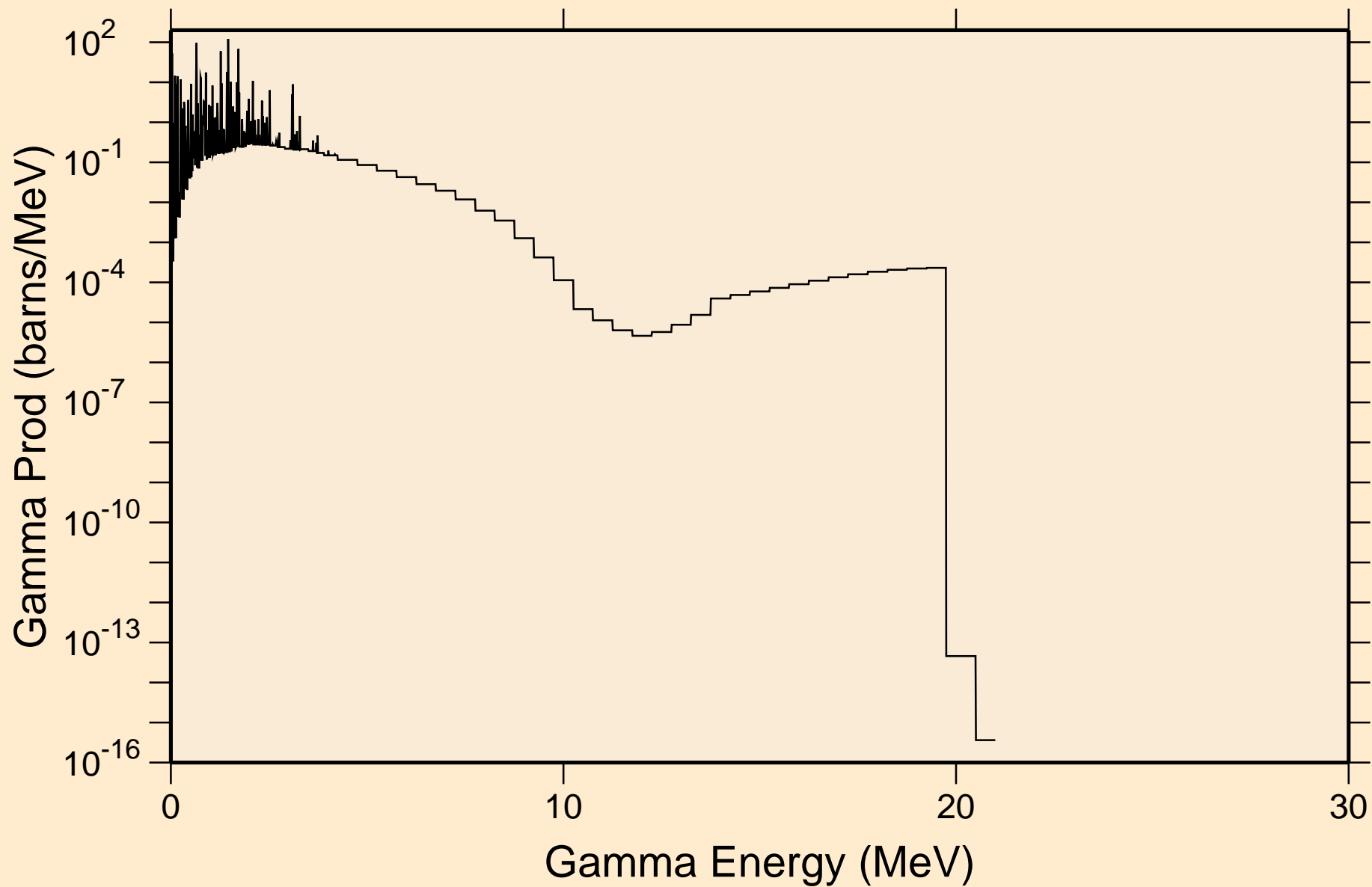

19-K-41 FOR FENDL-3.2 FROM TENDL-2015 BY NJOY2016.60+ O

Particle heating contributions

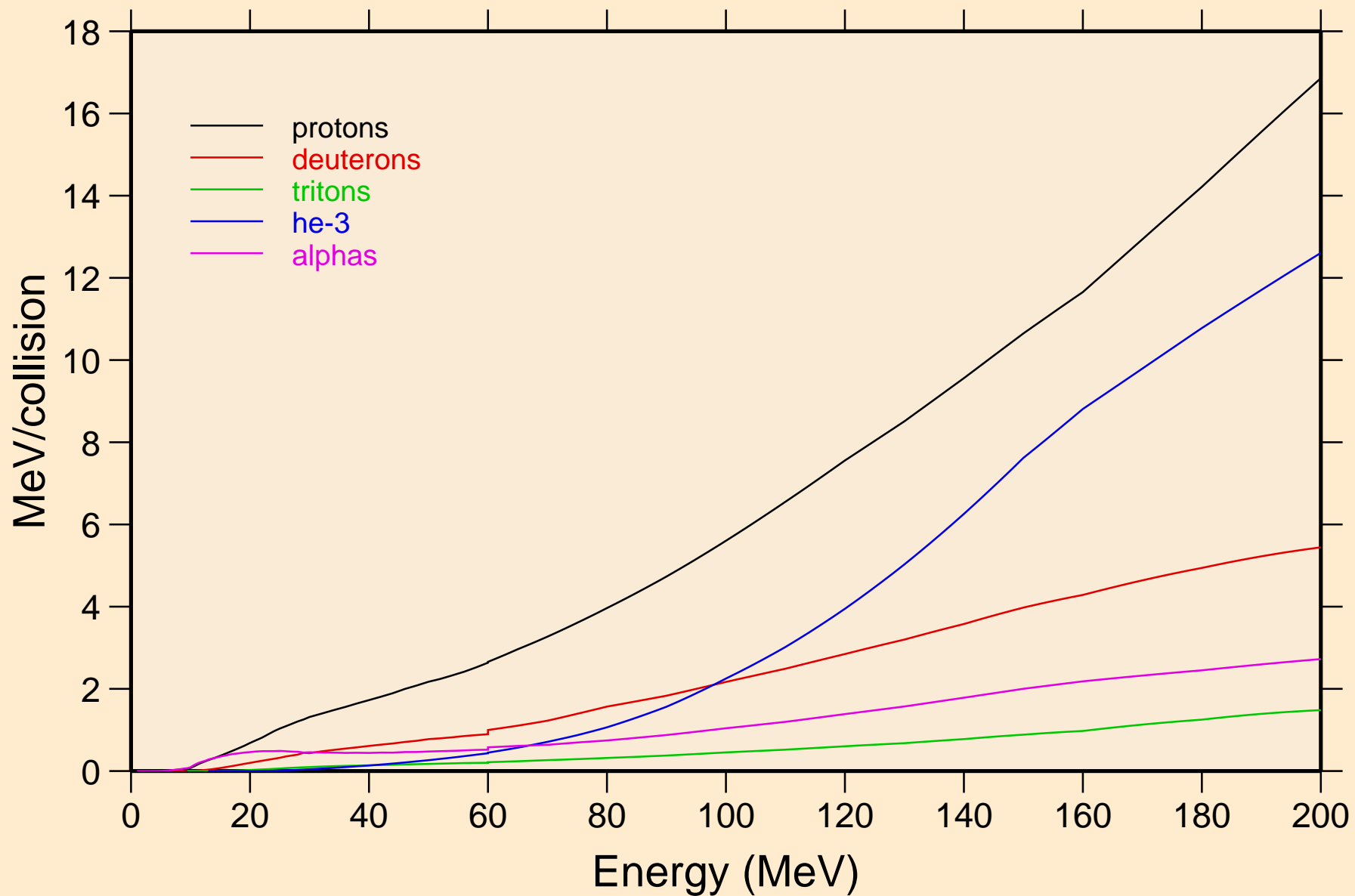

19-K-41 FOR FENDL-3.2 FROM TENDL-2015 BY NJOY2016.60+ O Recoil Heating

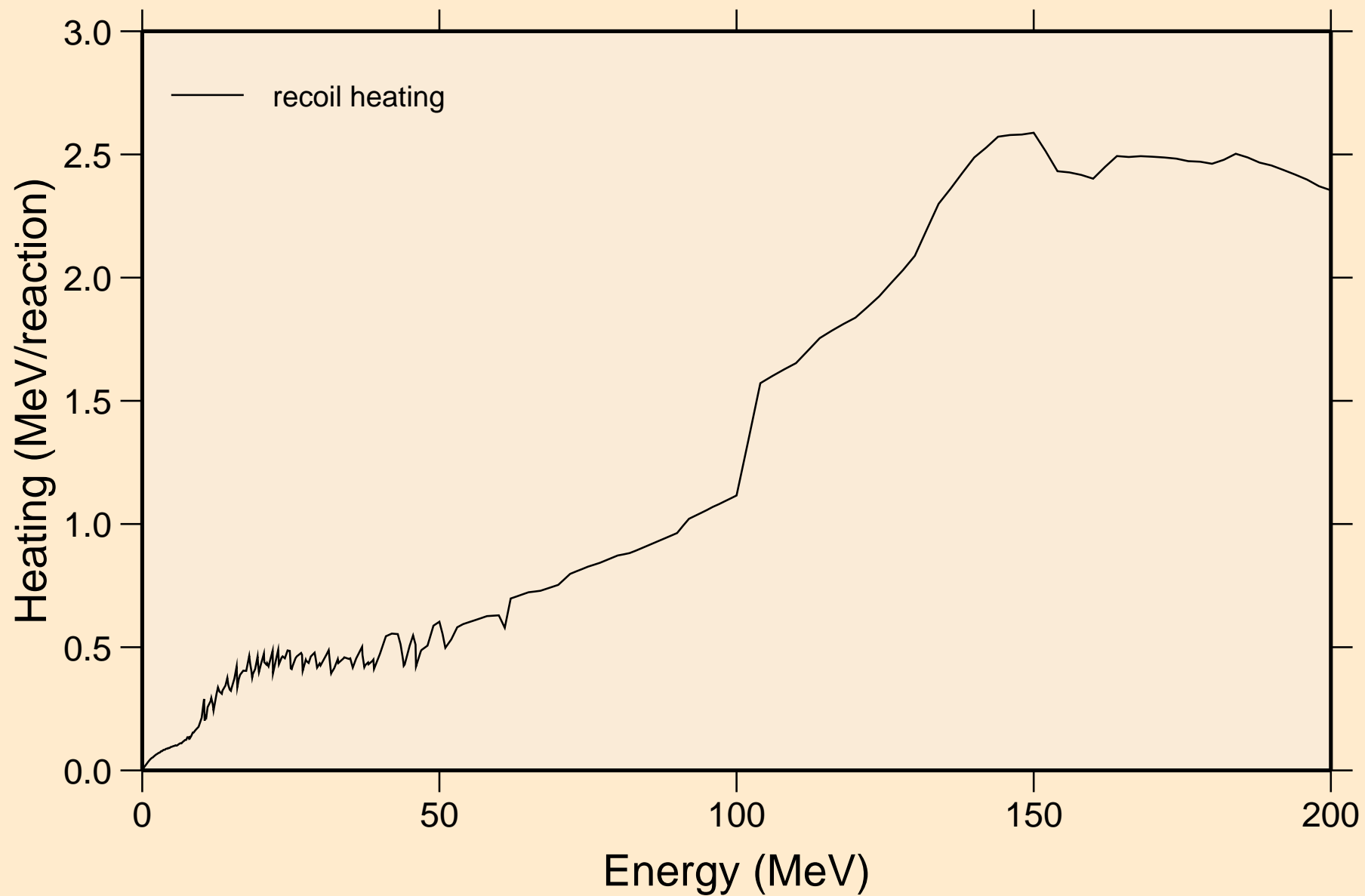

19-K-41 FOR FENDL-3.2 FROM TENDL-2015 BY NJOY2016.60+ O

Particle production cross sections

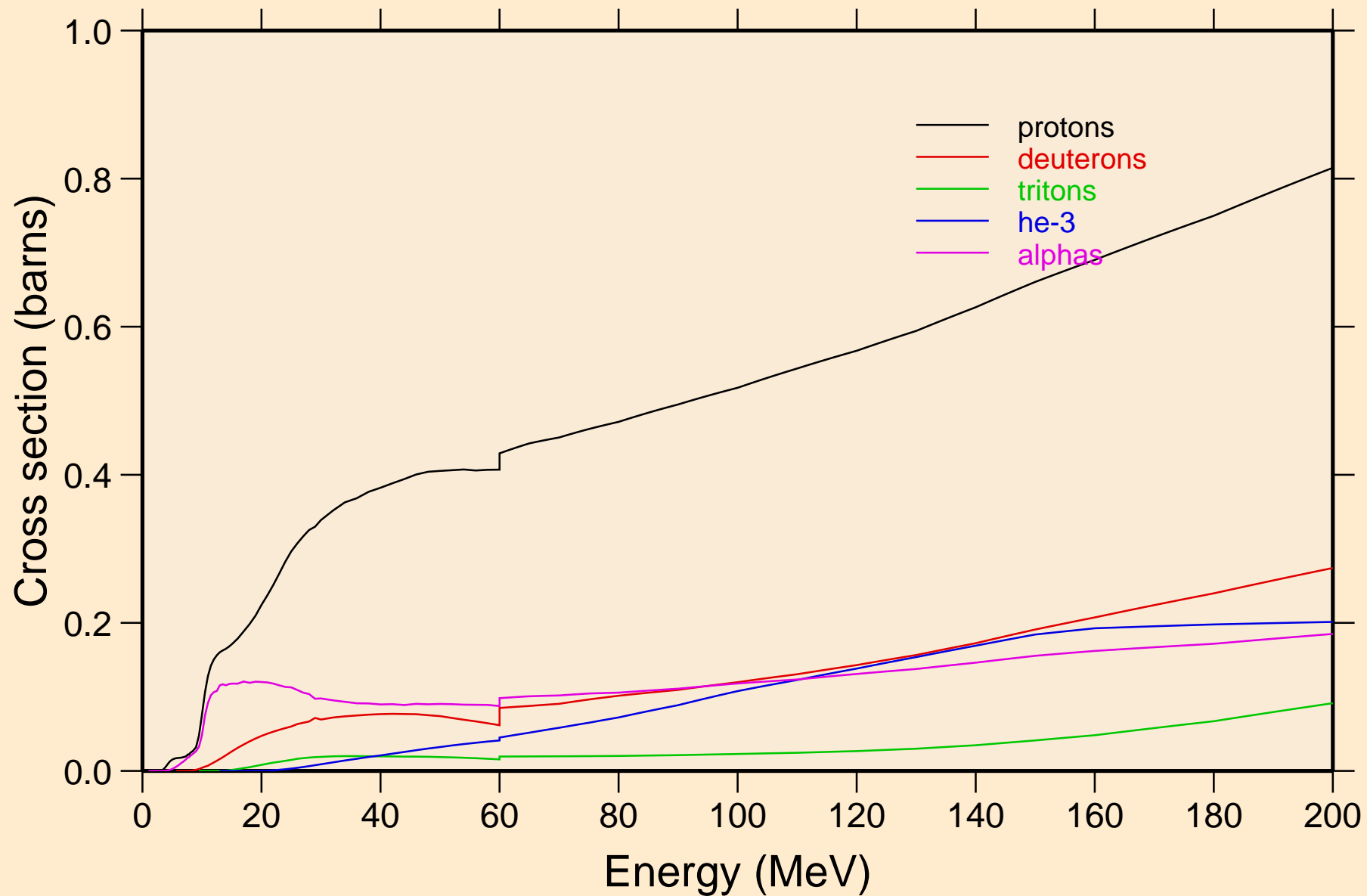

19-K-41 FOR FENDL-3.2 FROM TENDL-2015 BY NJOY2016.60+ O
protons from (n,x)

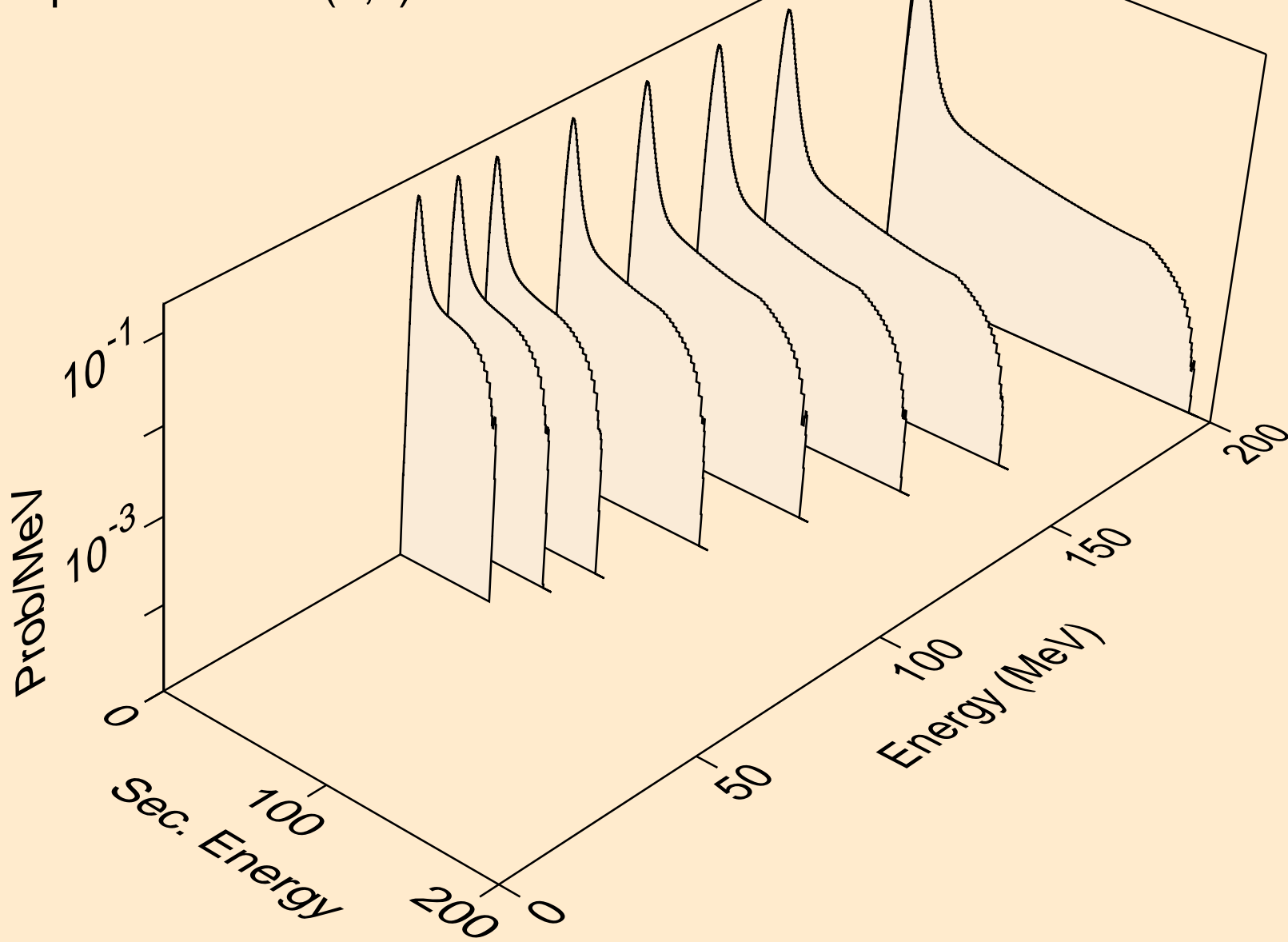

19-K-41 FOR FENDL-3.2 FROM TENDL-2015 BY NJOY2016.60+ O
protons from (n,n*)p

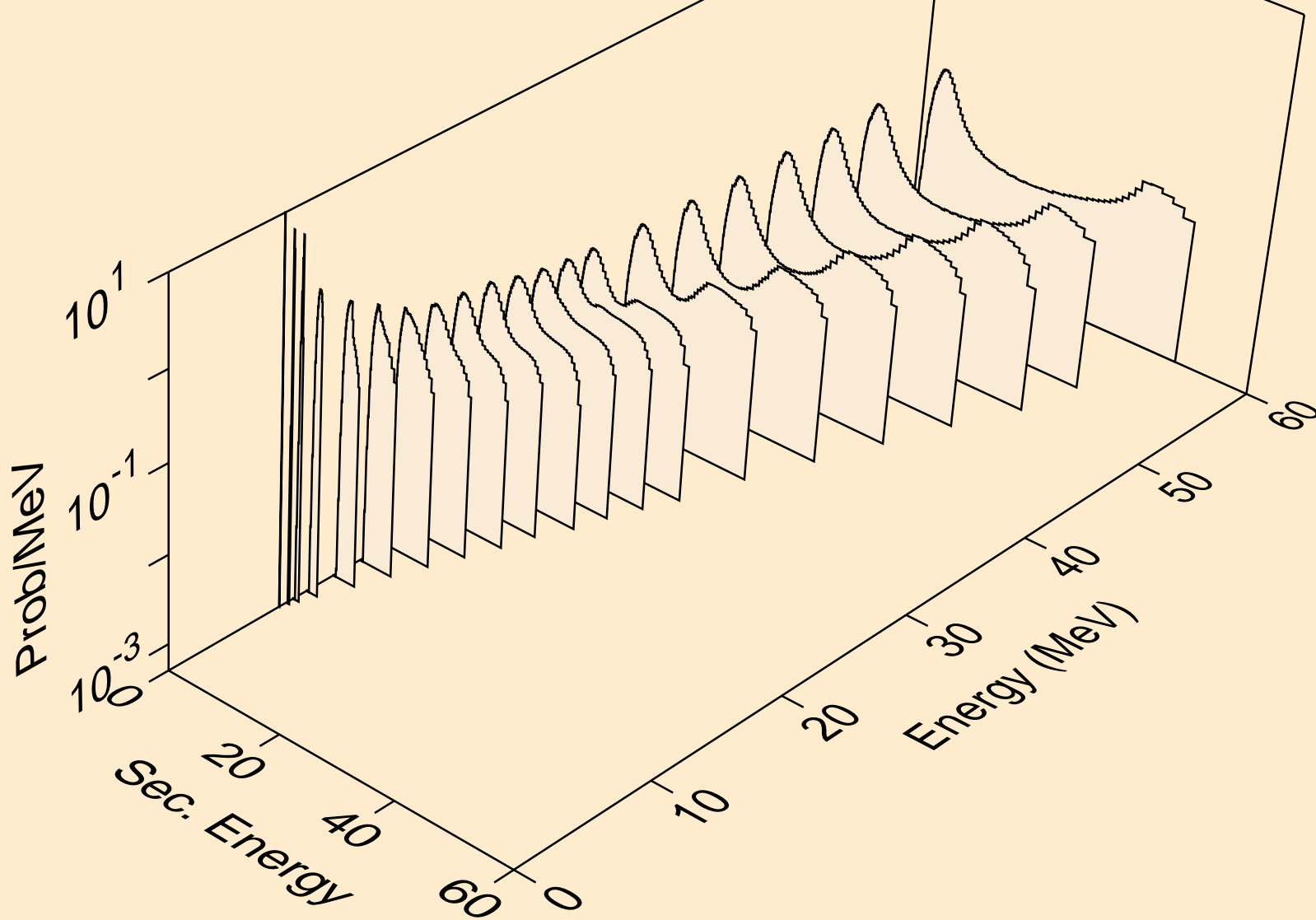

19-K-41 FOR FENDL-3.2 FROM TENDL-2015 BY NJOY2016.60+ O
protons from (n,2np)

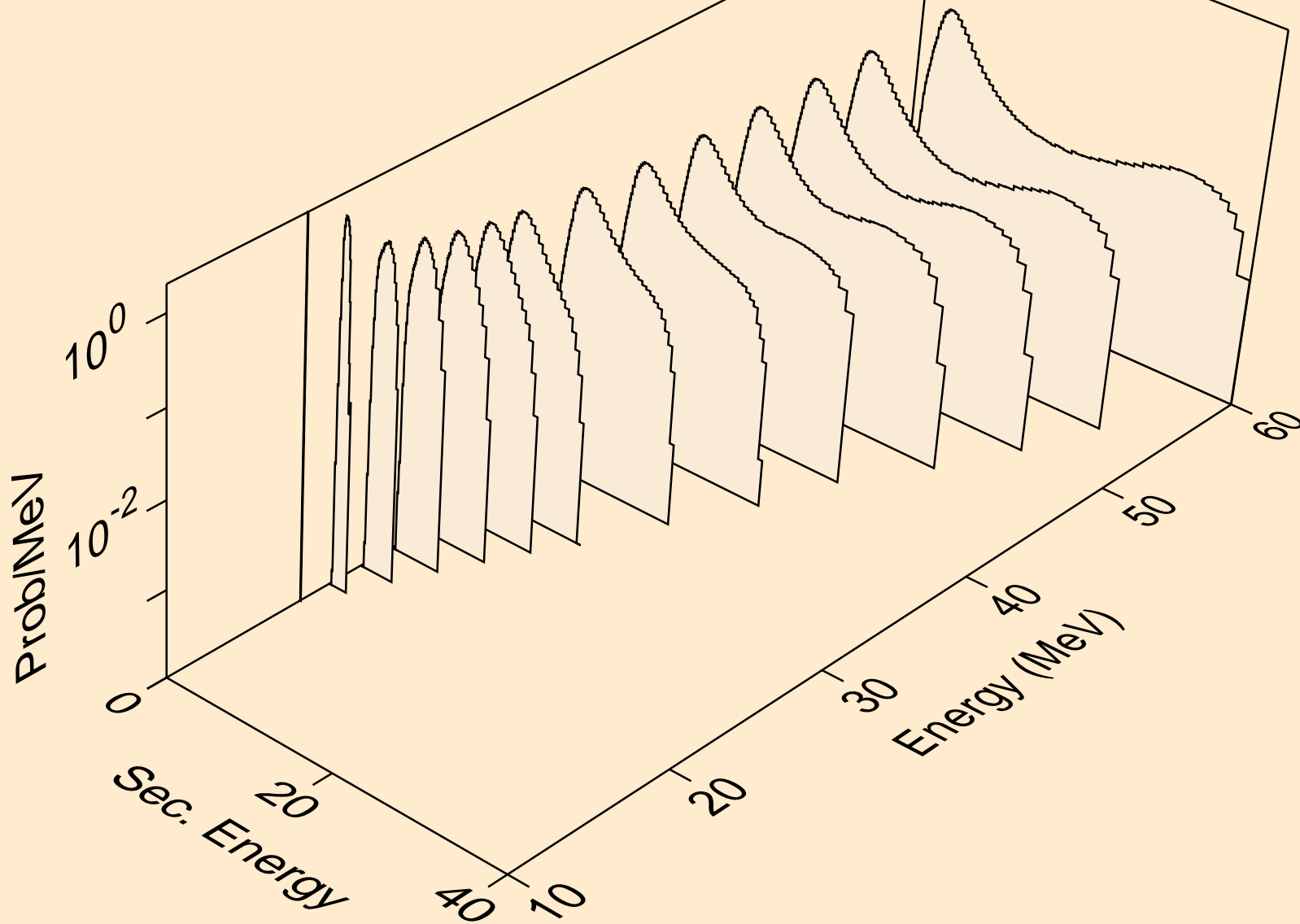

19-K-41 FOR FENDL-3.2 FROM TENDL-2015 BY NJOY2016.60+ O
protons from (n,3np)

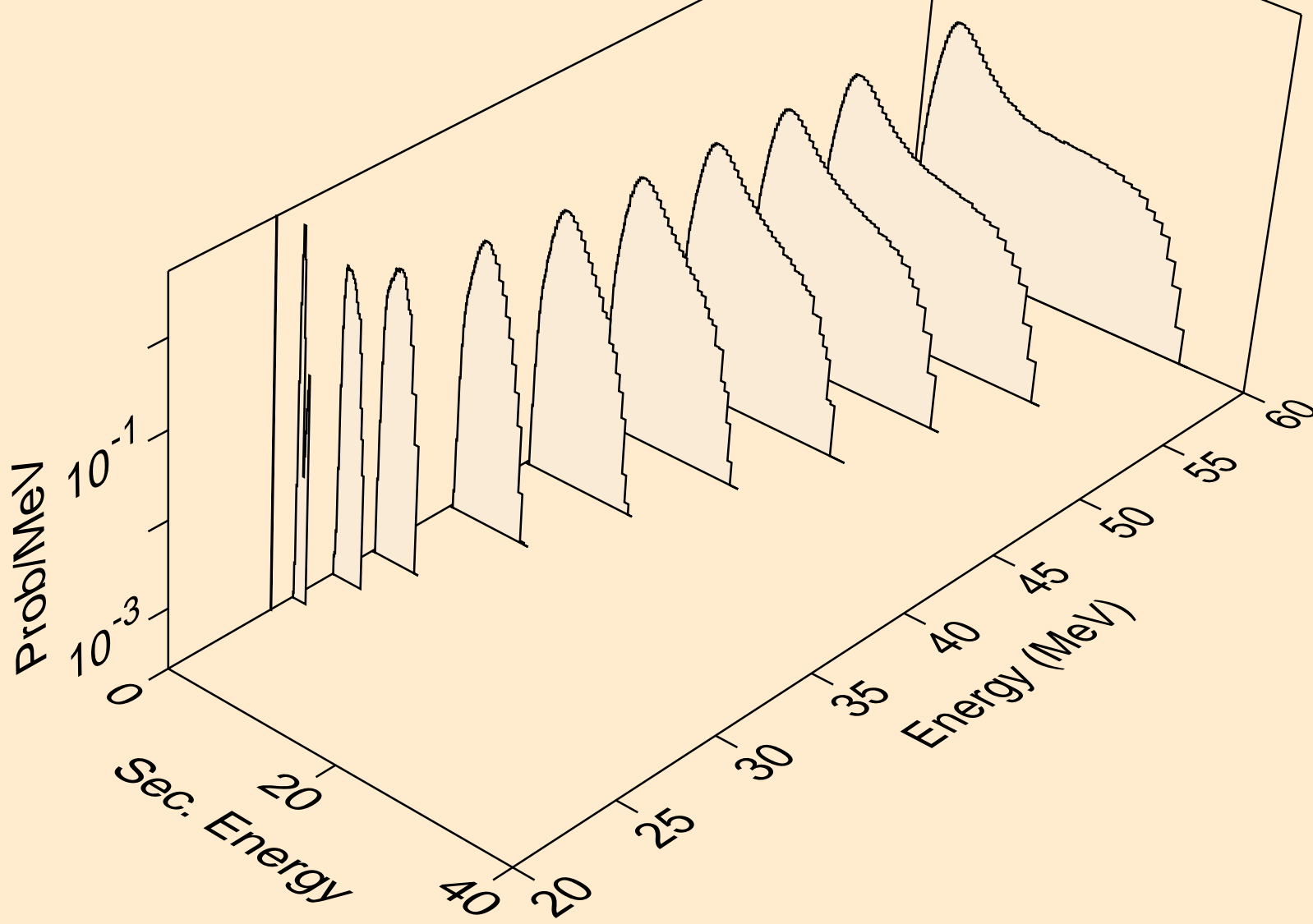

19-K-41 FOR FENDL-3.2 FROM TENDL-2015 BY NJOY2016.60+ O
protons from (n,2np)

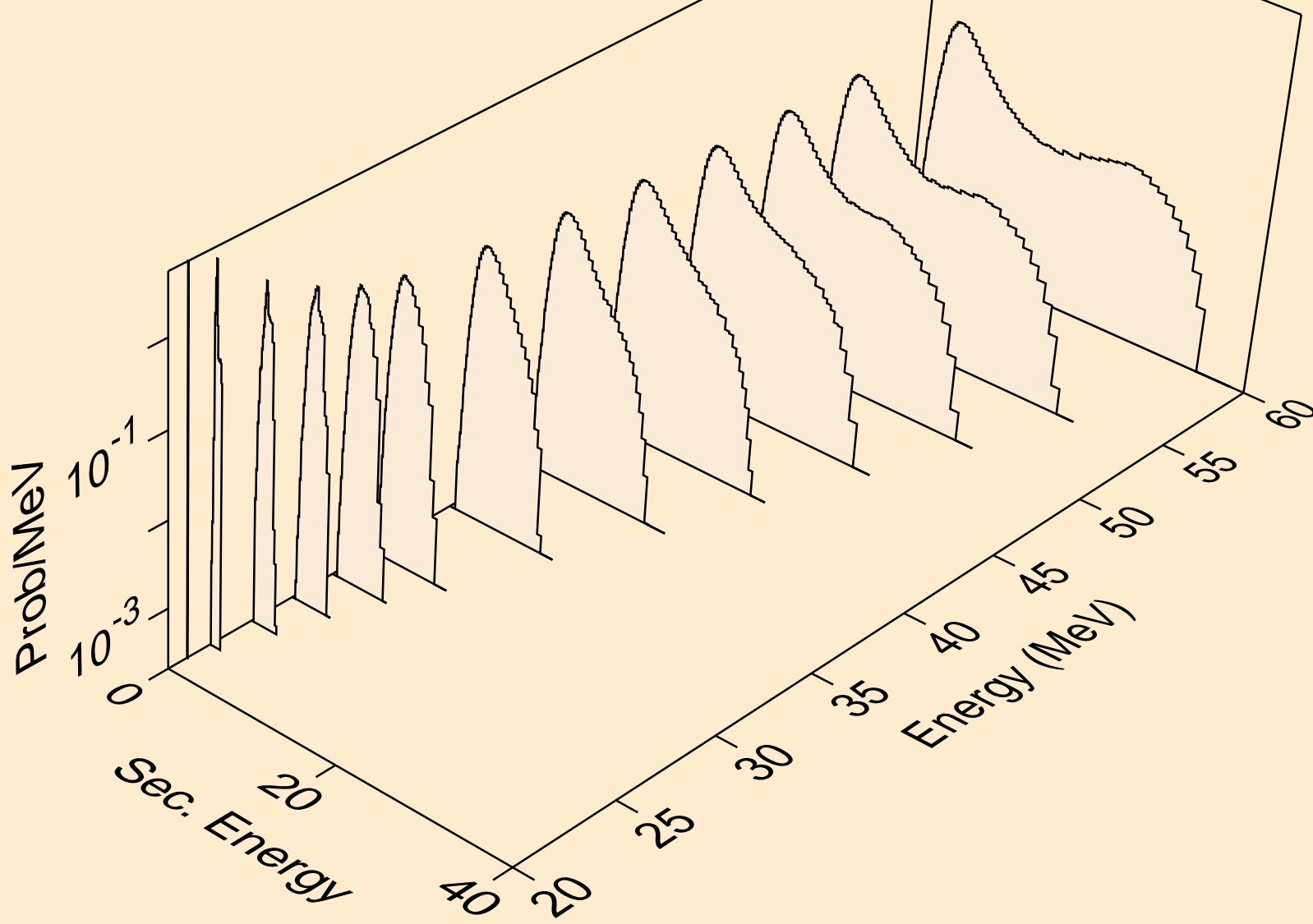

19-K-41 FOR FENDL-3.2 FROM TENDL-2015 BY NJOY2016.60+ O
protons from (n,npa)

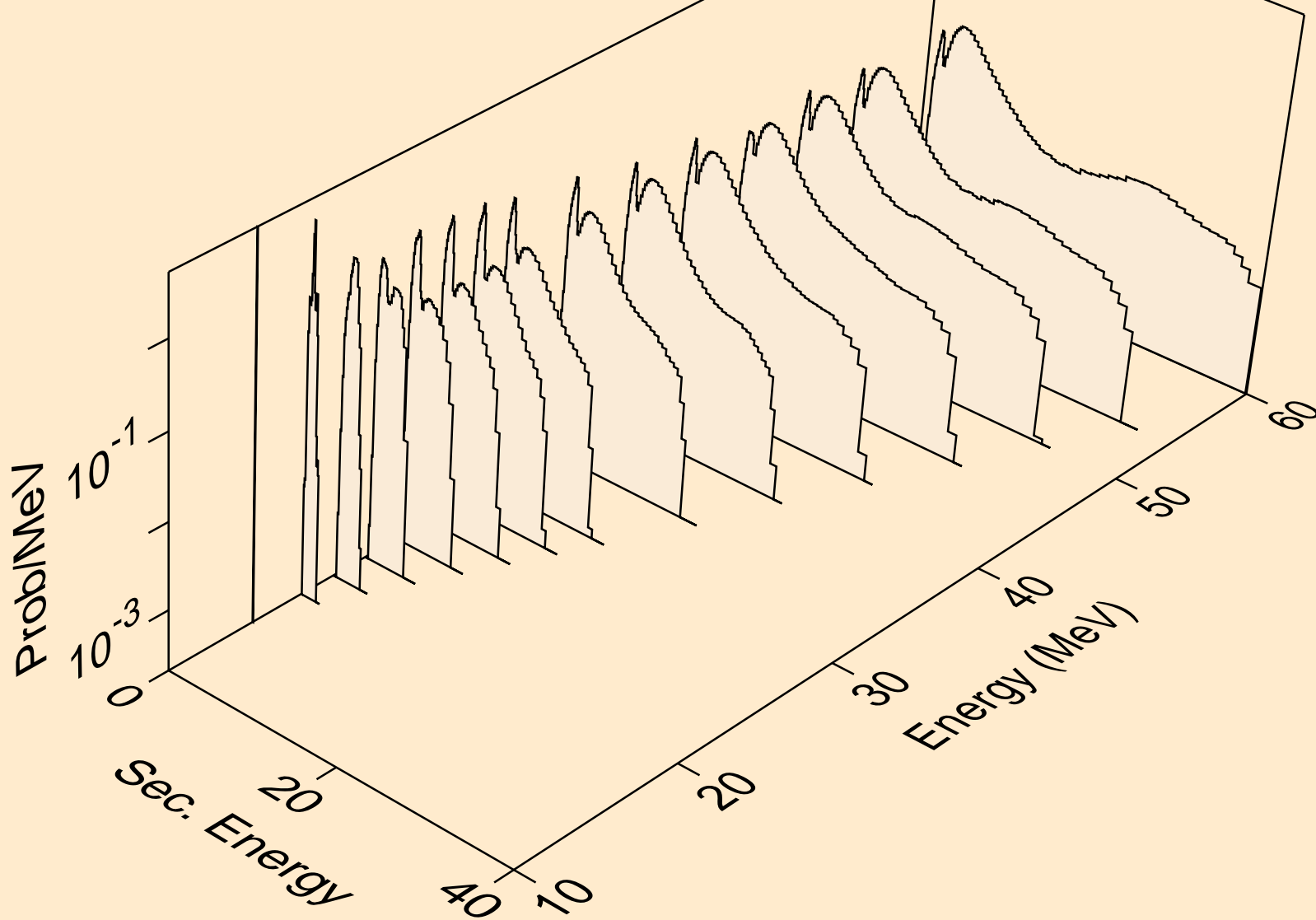

19-K-41 FOR FENDL-3.2 FROM TENDL-2015 BY NJOY2016.60+ O
protons from (n,p)

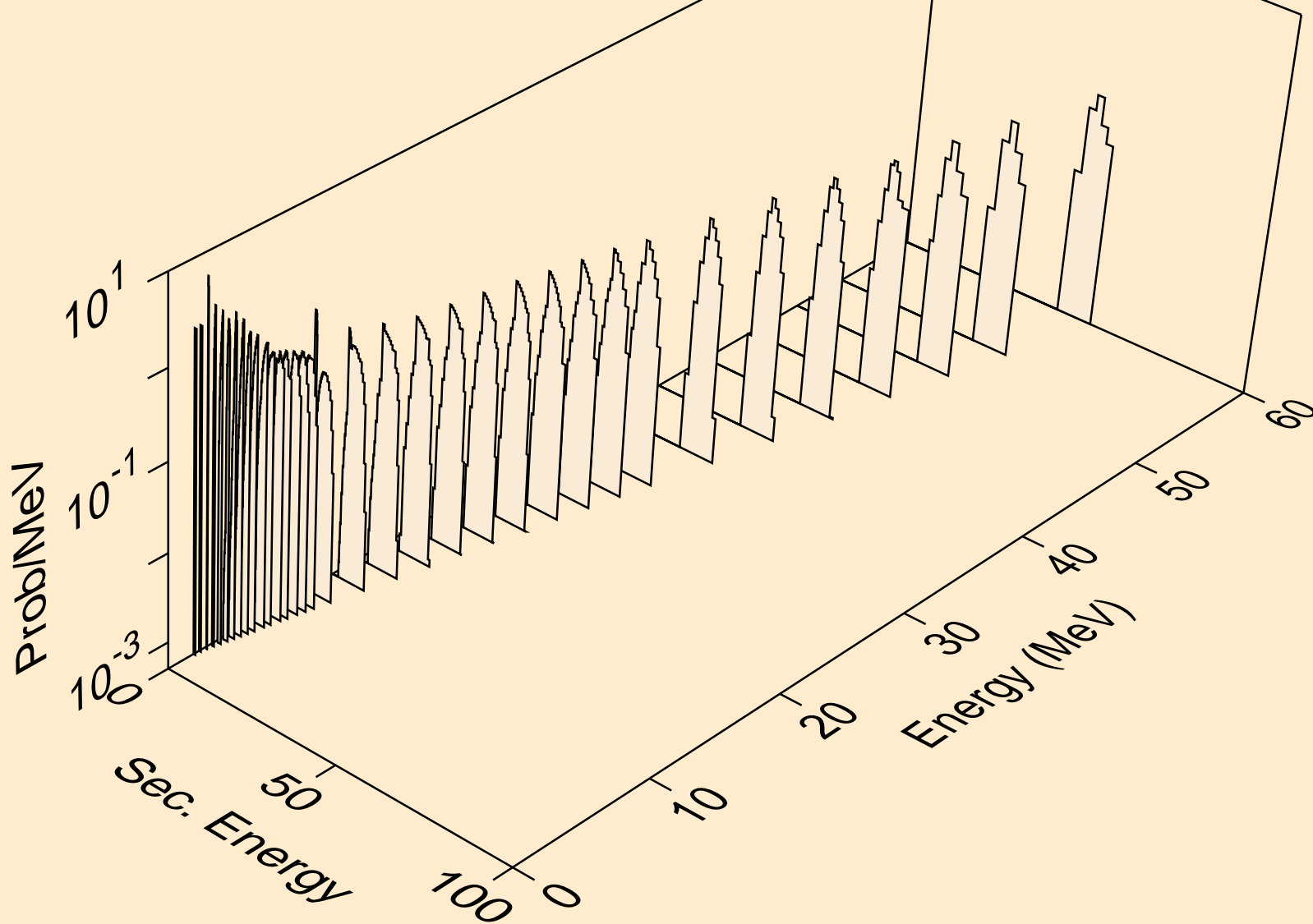

19-K-41 FOR FENDL-3.2 FROM TENDL-2015 BY NJOY2016.60+ O
protons from (n,2p)

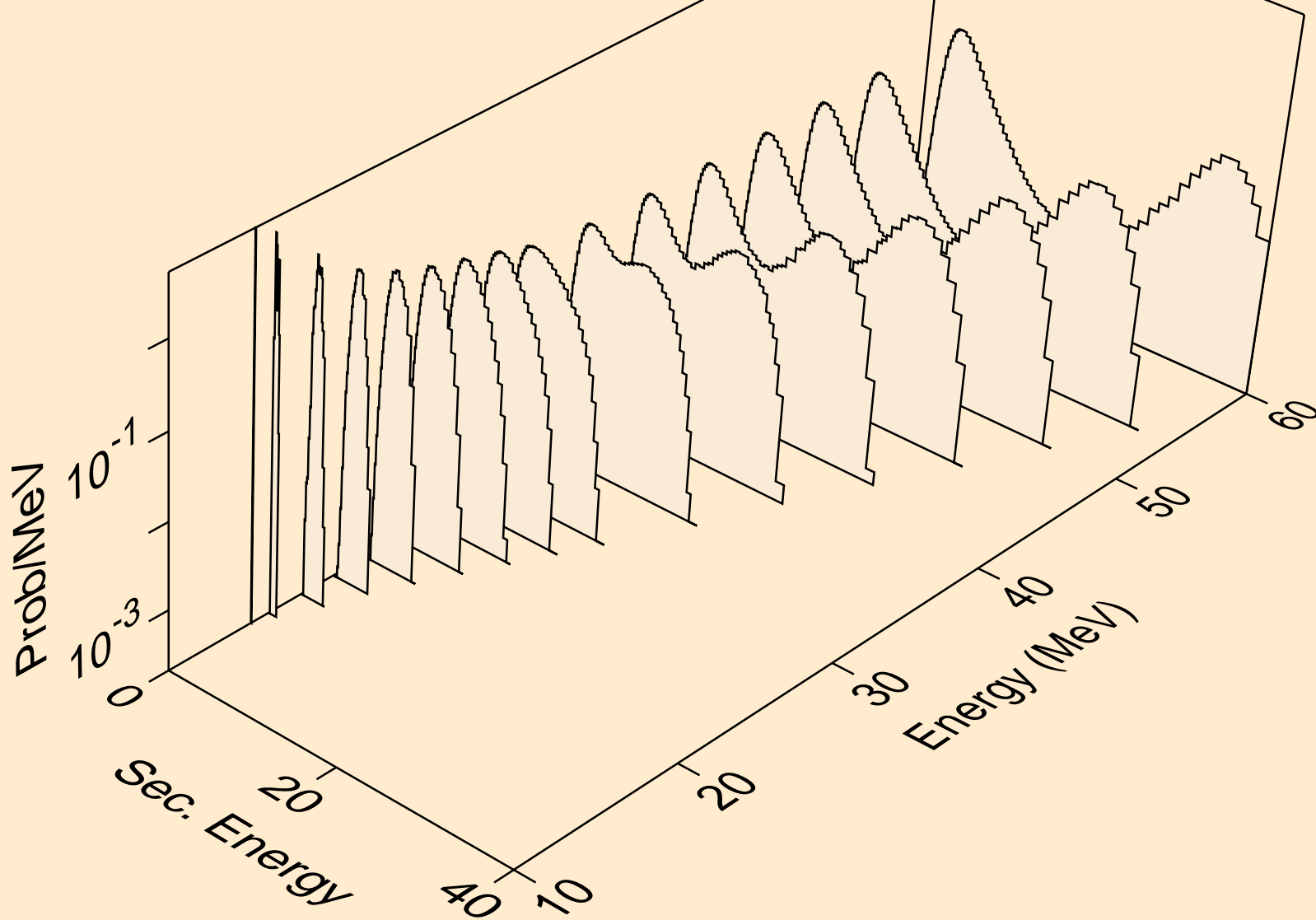

19-K-41 FOR FENDL-3.2 FROM TENDL-2015 BY NJOY2016.60+ O
protons from (n,pa)

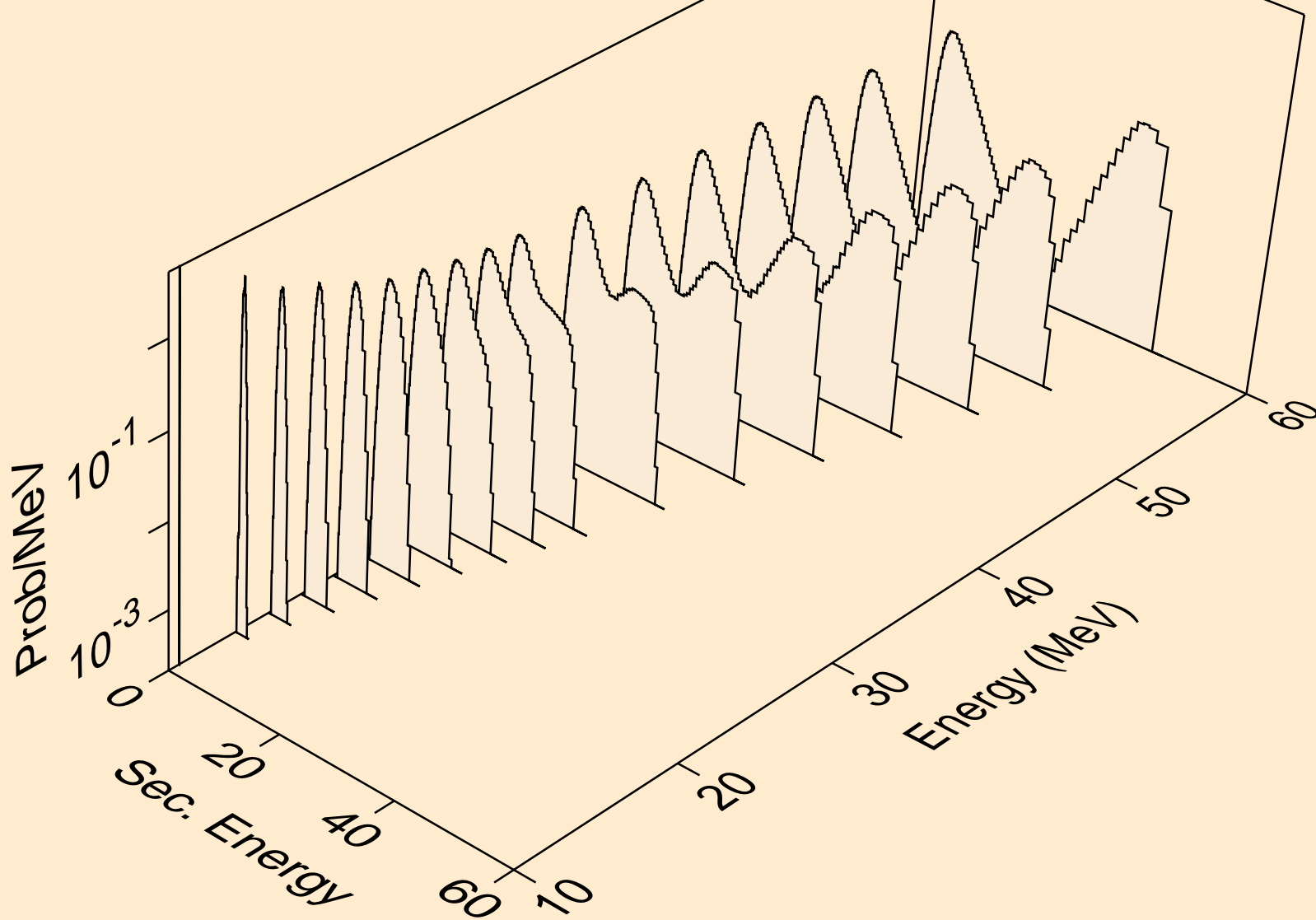

19-K-41 FOR FENDL-3.2 FROM TENDL-2015 BY NJOY2016.60+ O
protons from (n,pd)

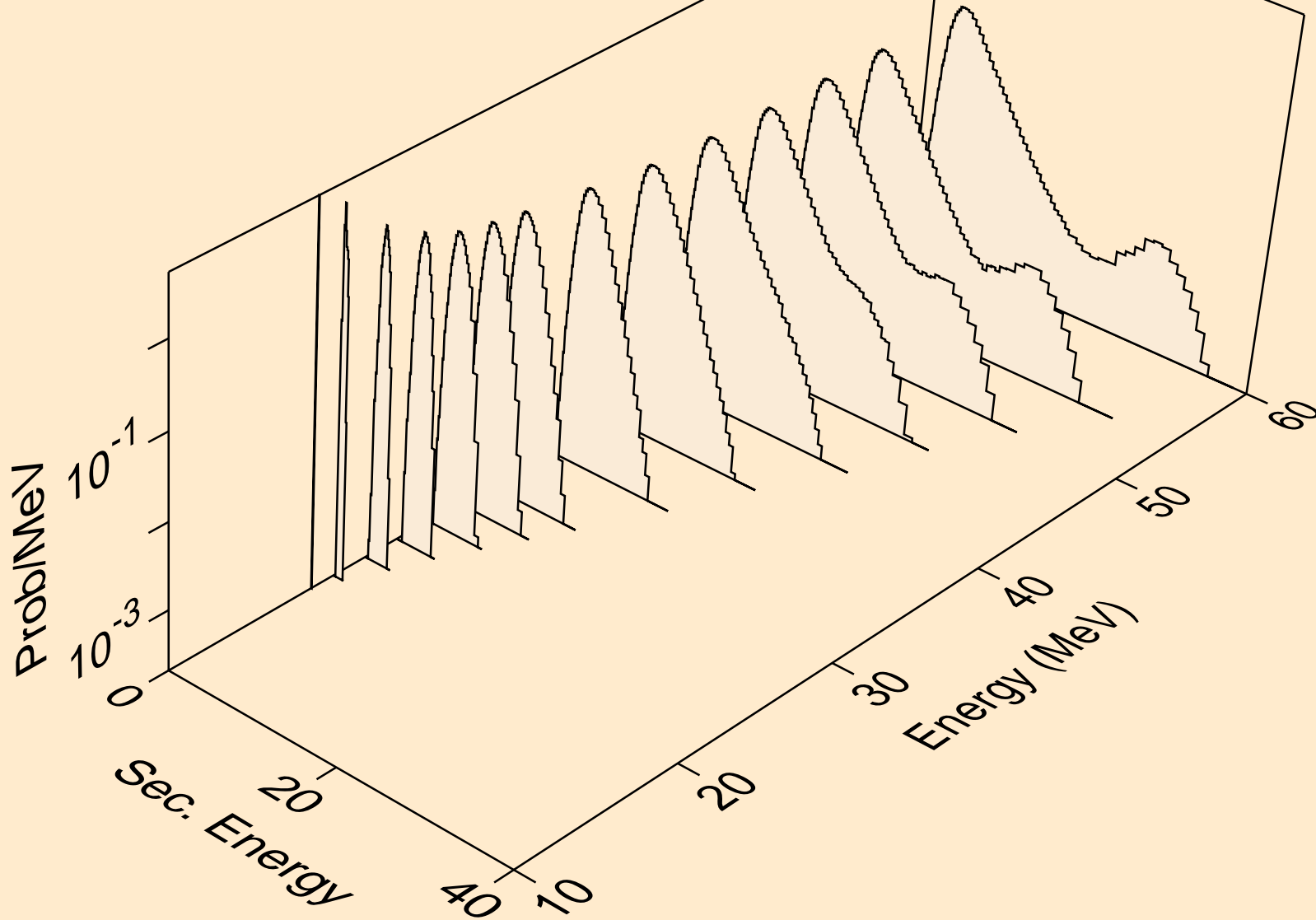

19-K-41 FOR FENDL-3.2 FROM TENDL-2015 BY NJOY2016.60+ O
protons from (n,pt)

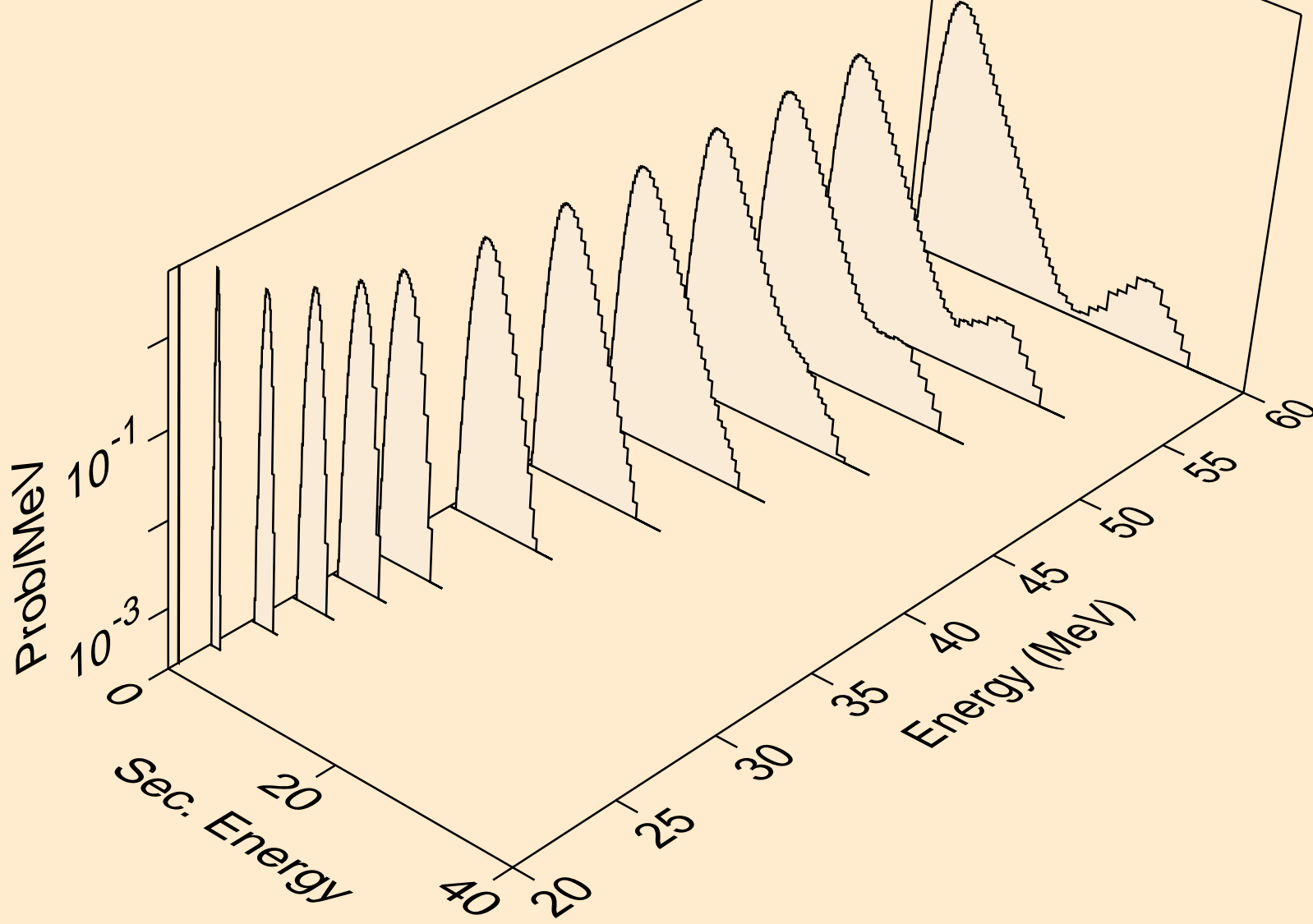

19-K-41 FOR FENDL-3.2 FROM TENDL-2015 BY NJOY2016.60+ O
protons from (n,4np)

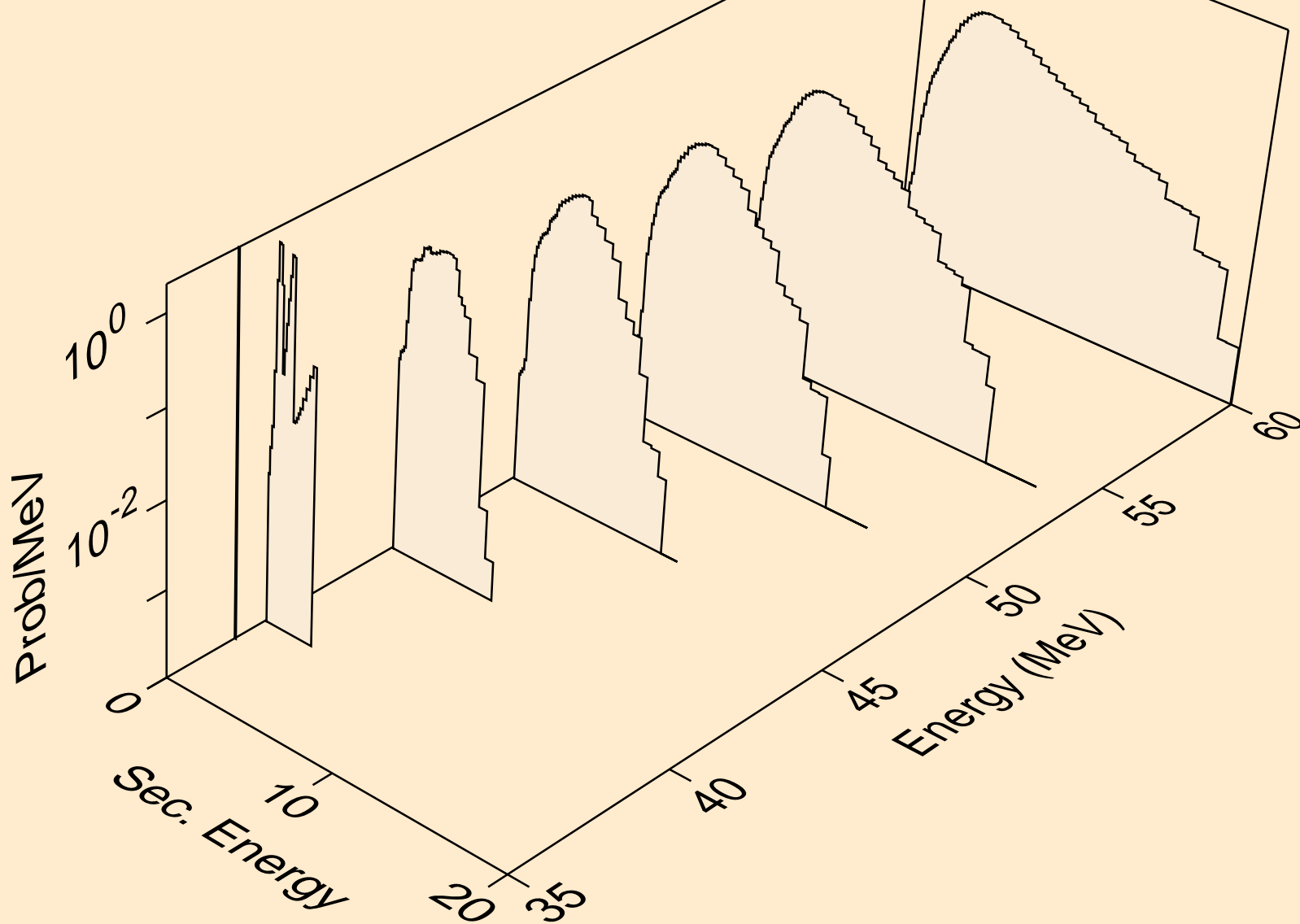

19-K-41 FOR FENDL-3.2 FROM TENDL-2015 BY NJOY2016.60+ O
protons from (n,2npa)

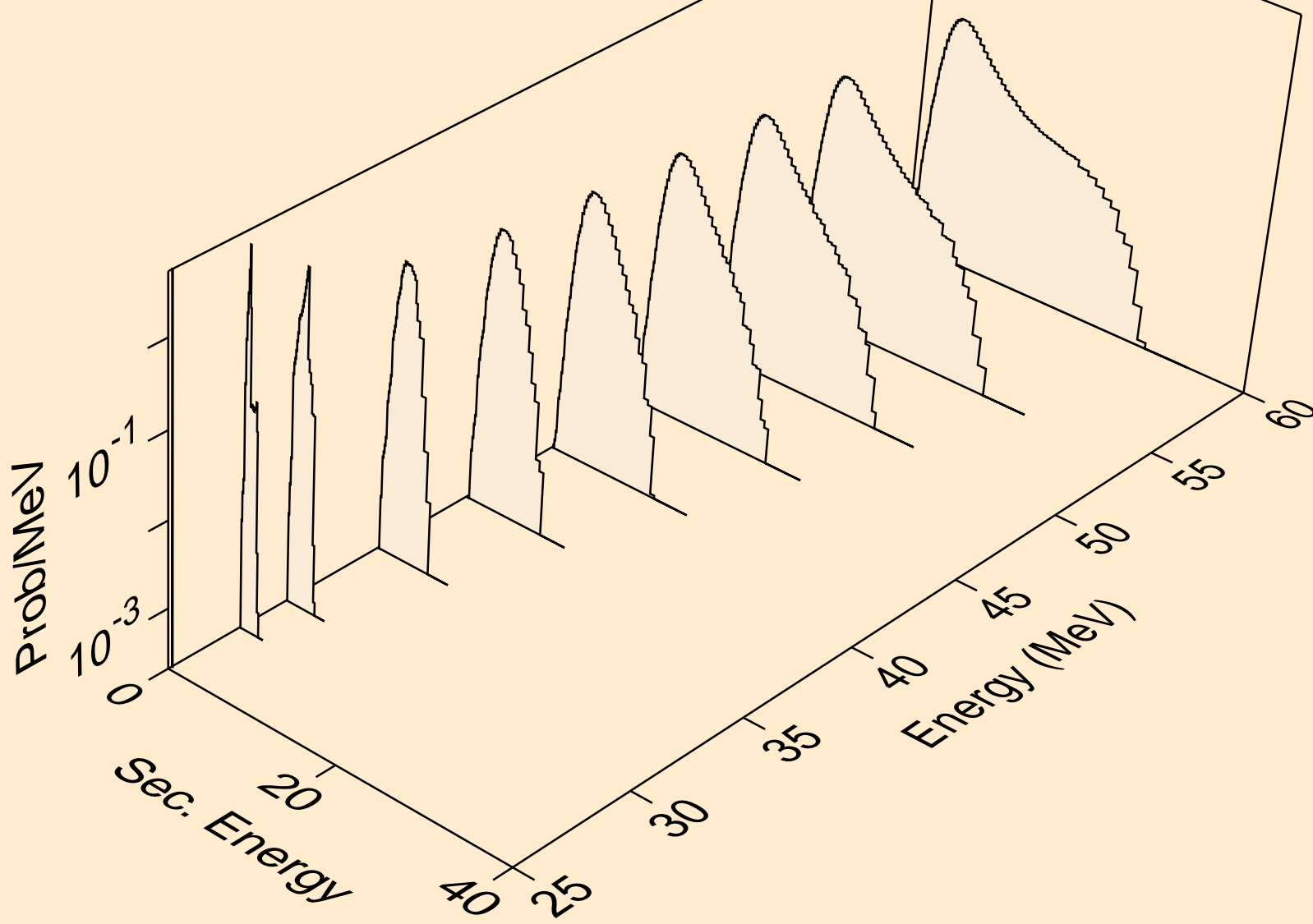

19-K-41 FOR FENDL-3.2 FROM TENDL-2015 BY NJOY2016.60+ O
protons from (n,5np)

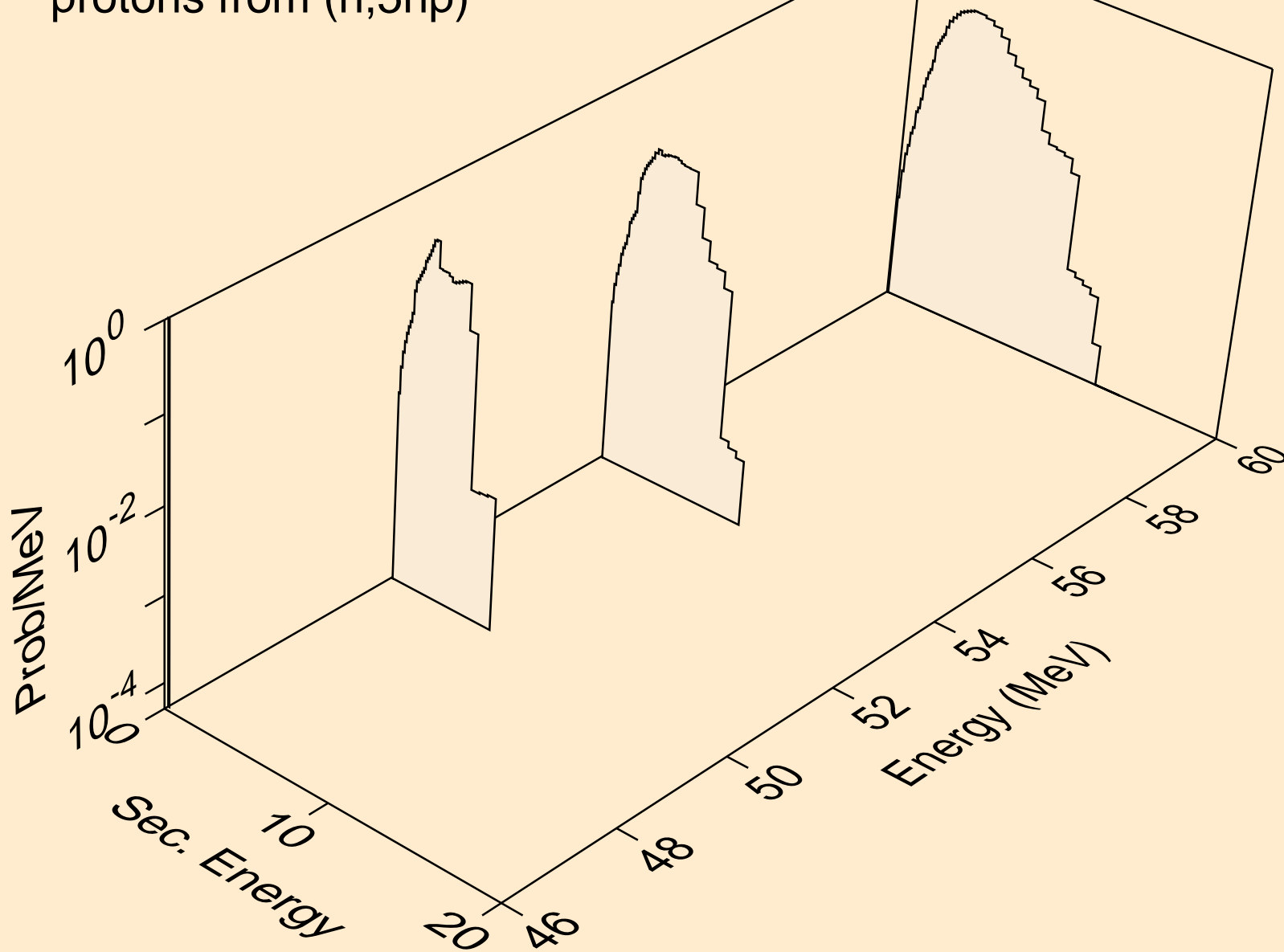

19-K-41 FOR FENDL-3.2 FROM TENDL-2015 BY NJOY2016.60+ O
protons from (n,3n2p)

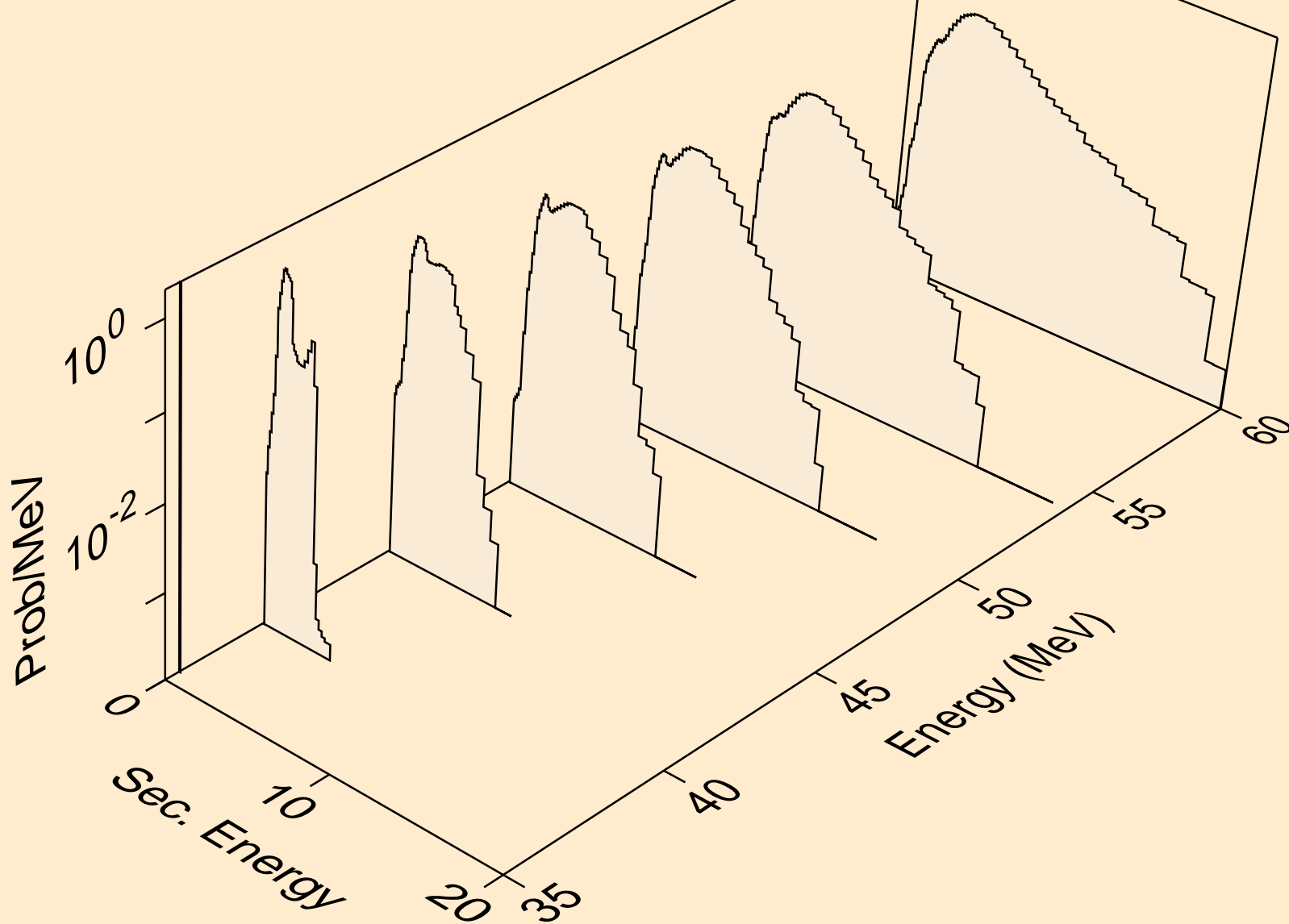

19-K-41 FOR FENDL-3.2 FROM TENDL-2015 BY NJOY2016.60+ O
protons from (n,3npa)

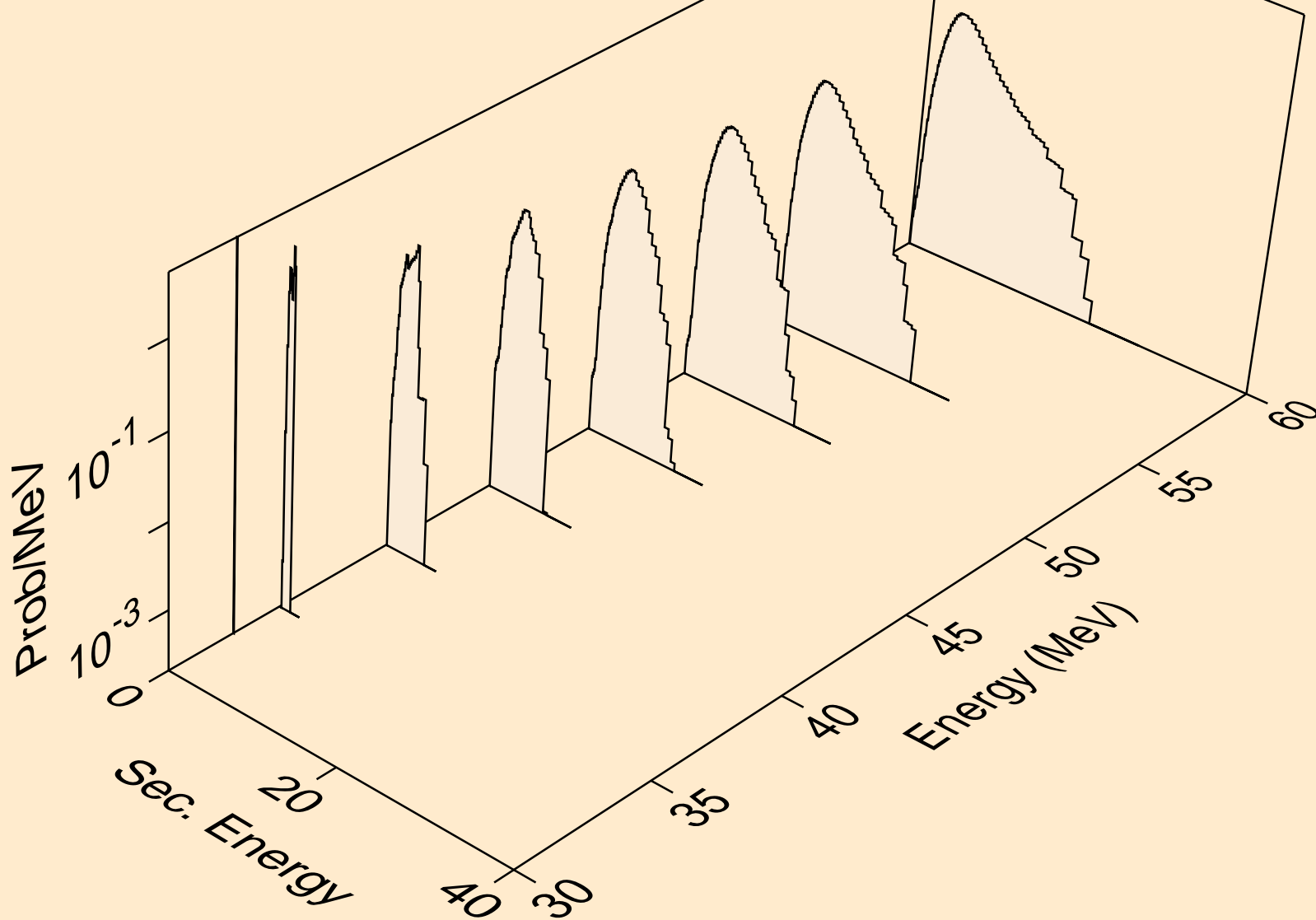

19-K-41 FOR FENDL-3.2 FROM TENDL-2015 BY NJOY2016.60+ O
protons from (n,npd)

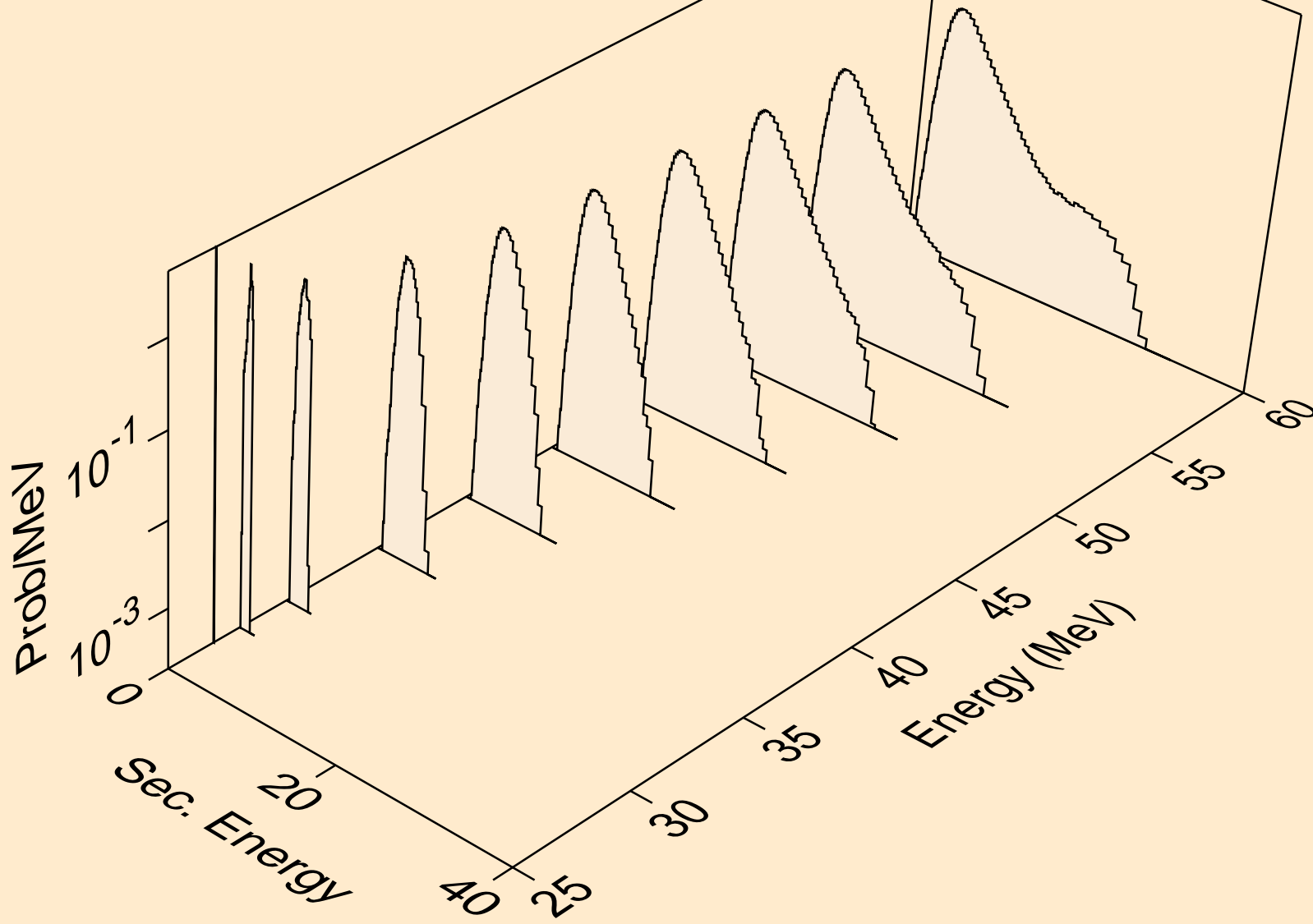

19-K-41 FOR FENDL-3.2 FROM TENDL-2015 BY NJOY2016.60+ O
protons from (n,npt)

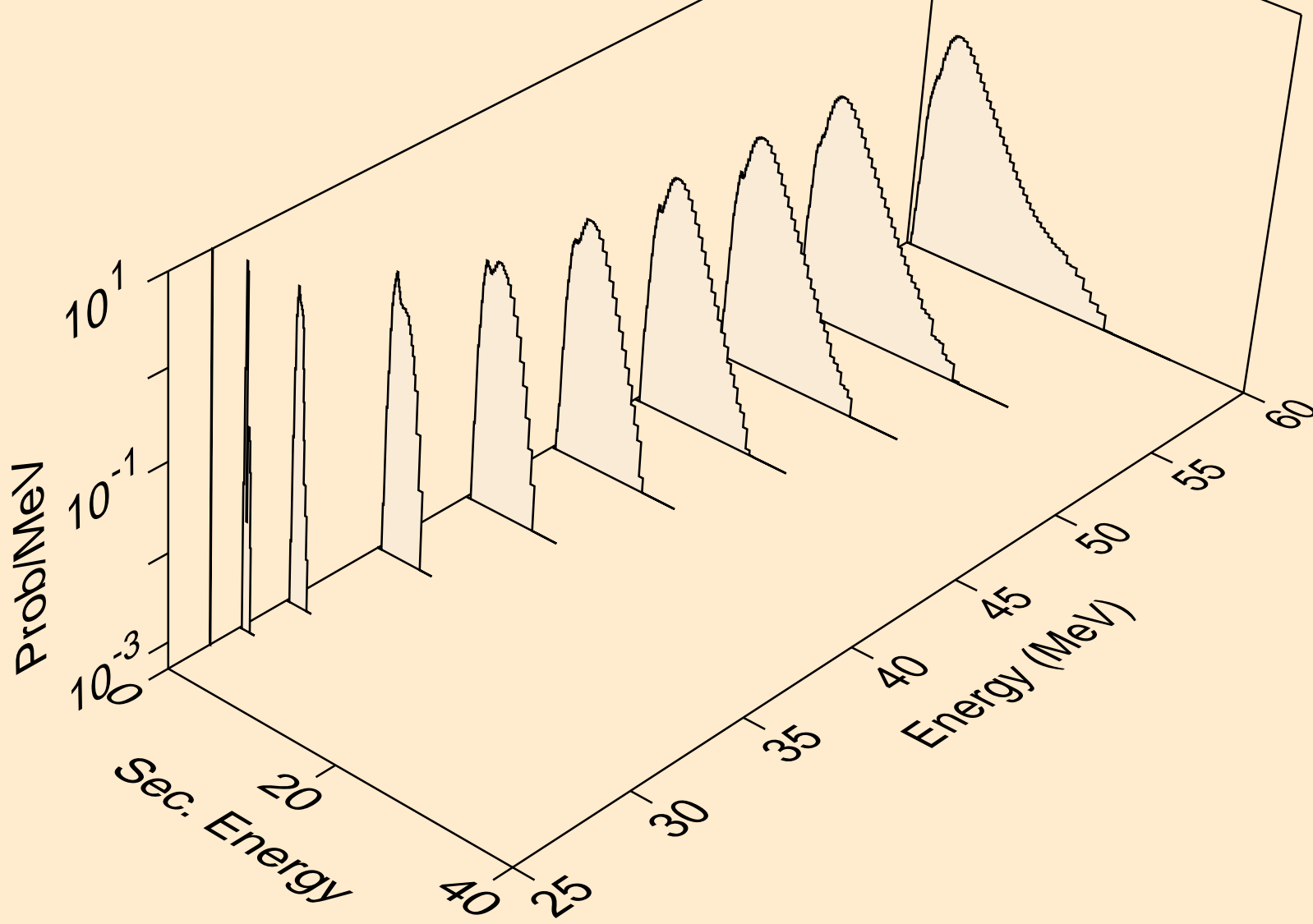

19-K-41 FOR FENDL-3.2 FROM TENDL-2015 BY NJOY2016.60+ O
protons from (n,nphe3)

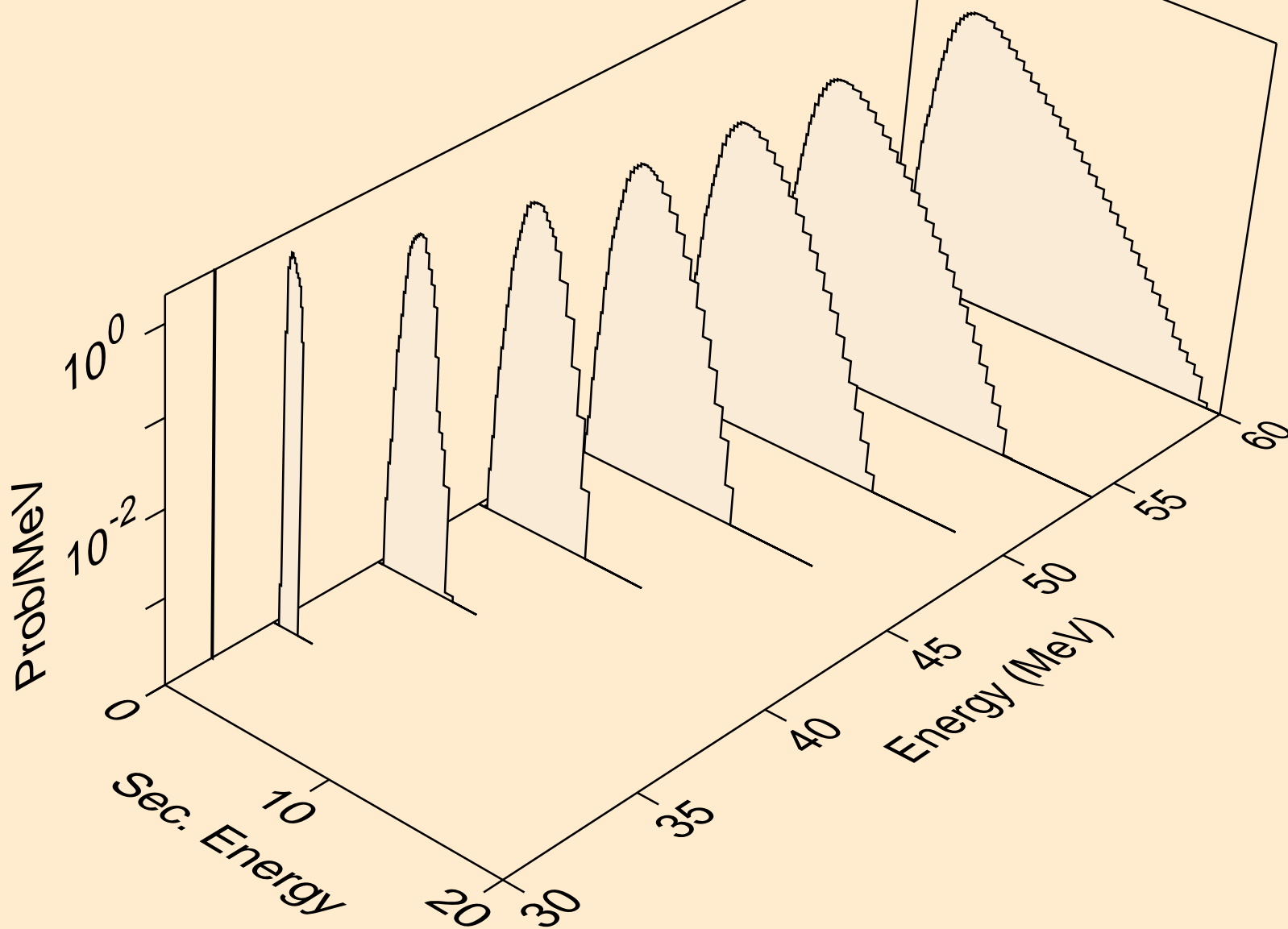

19-K-41 FOR FENDL-3.2 FROM TENDL-2015 BY NJOY2016.60+ O
protons from (n,2n2p)

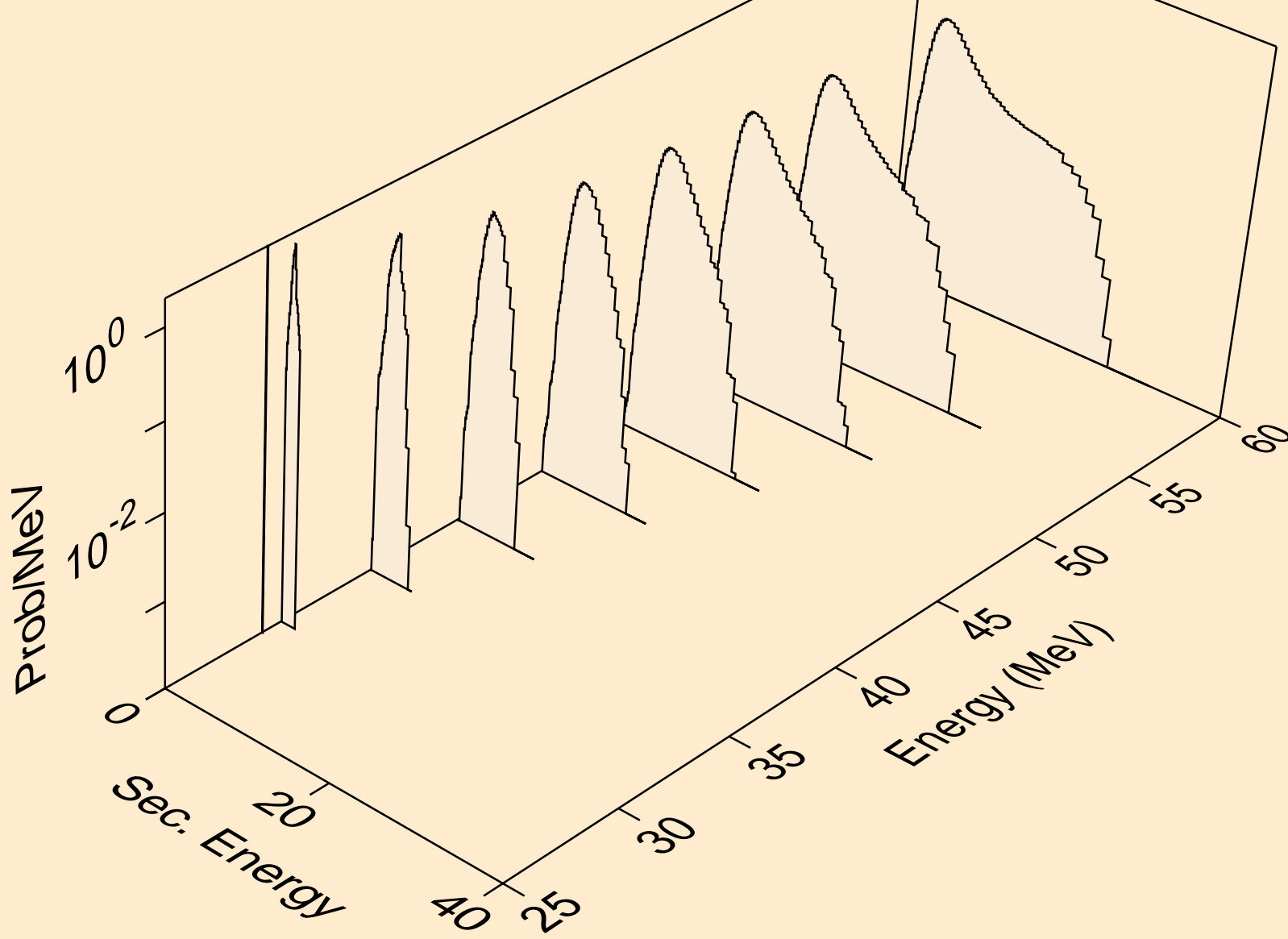

19-K-41 FOR FENDL-3.2 FROM TENDL-2015 BY NJOY2016.60+ O
protons from (n,phe3)

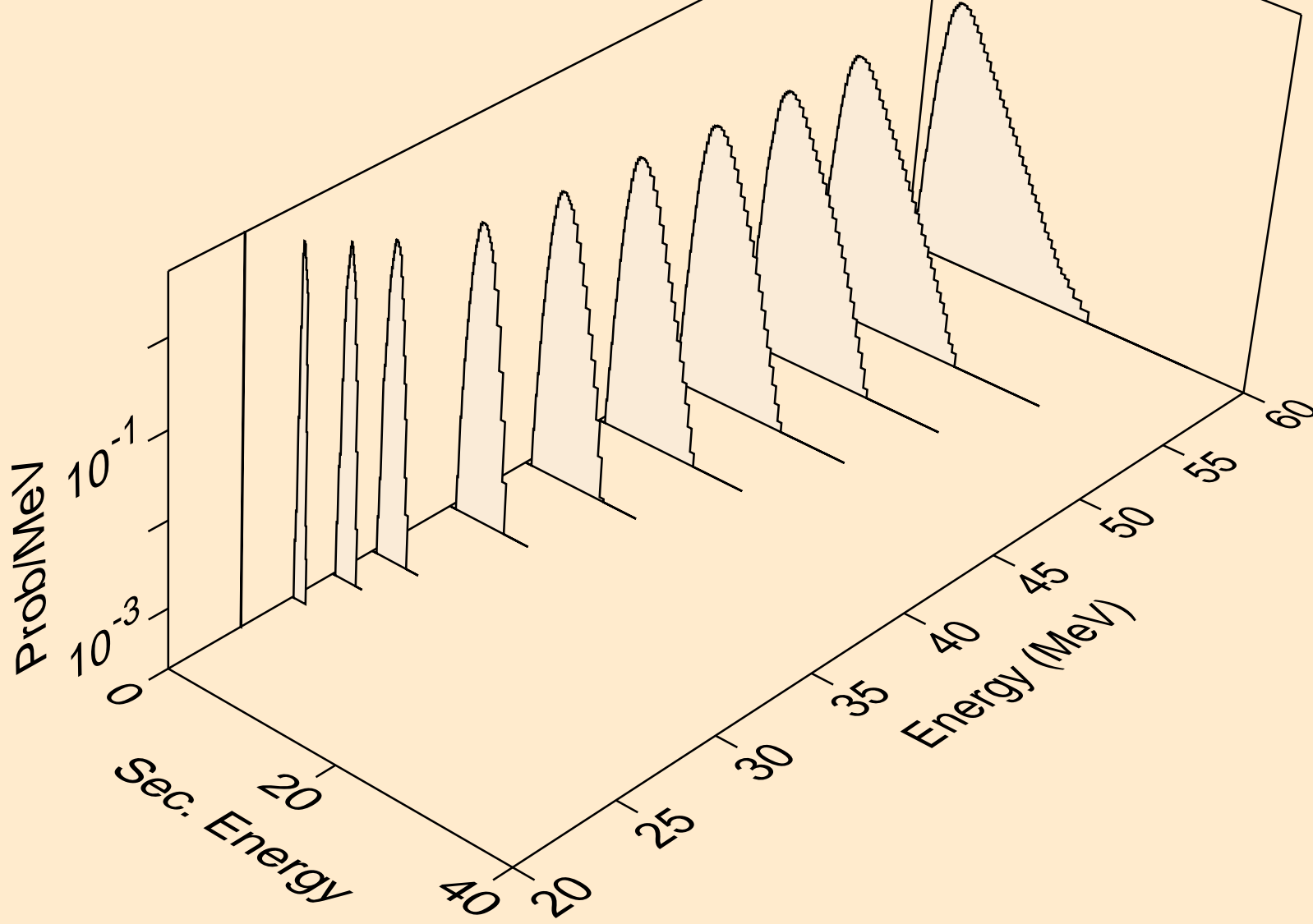

19-K-41 FOR FENDL-3.2 FROM TENDL-2015 BY NJOY2016.60+ O
protons from (n,4n2p)

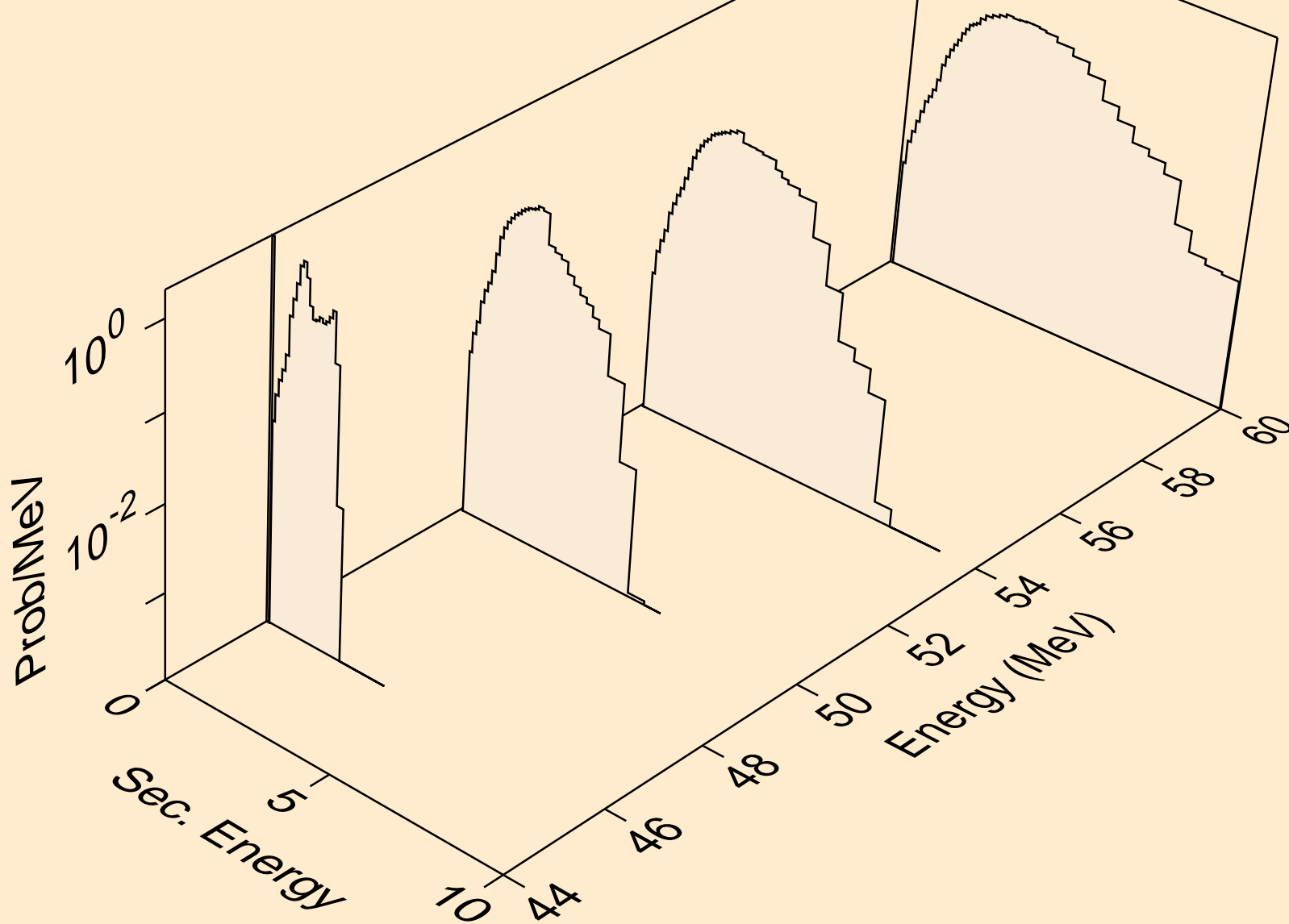

19-K-41 FOR FENDL-3.2 FROM TENDL-2015 BY NJOY2016.60+ O
protons from (n,4npa)

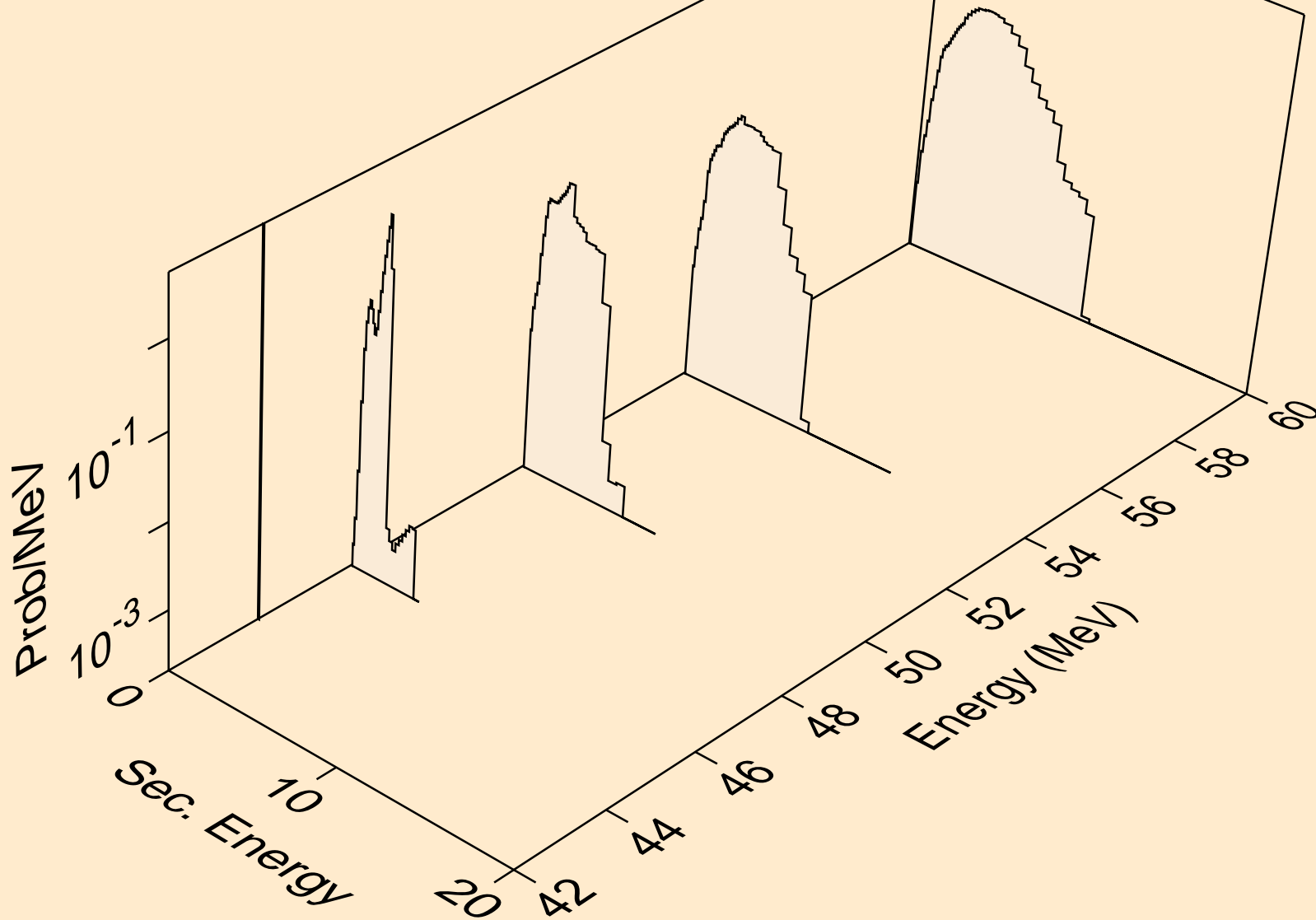

19-K-41 FOR FENDL-3.2 FROM TENDL-2015 BY NJOY2016.60+ O
protons from (n,3p)

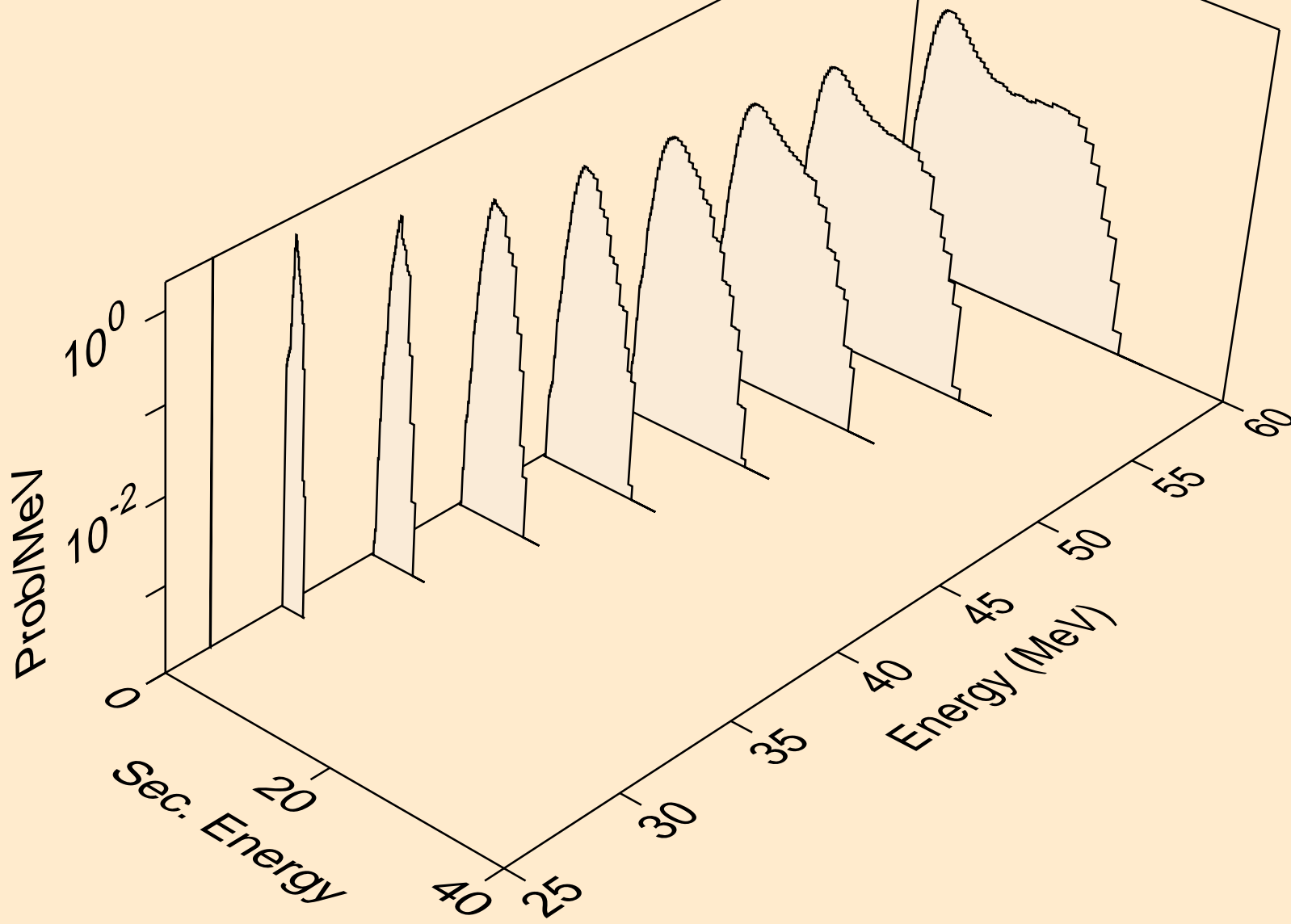

19-K-41 FOR FENDL-3.2 FROM TENDL-2015 BY NJOY2016.60+ O
protons from (n,n3p)

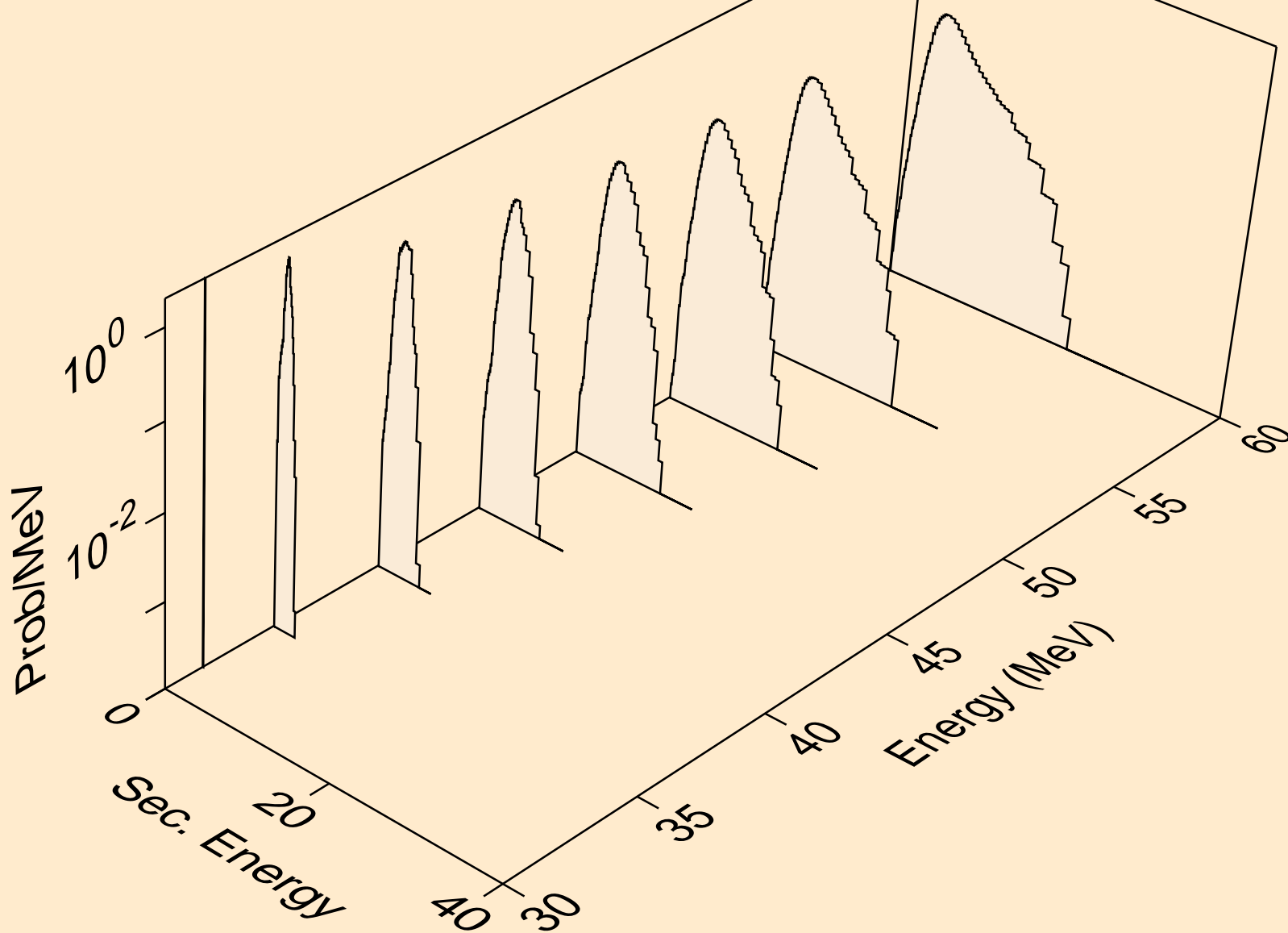

19-K-41 FOR FENDL-3.2 FROM TENDL-2015 BY NJOY2016.60+ O
protons from (n,3n2pa)

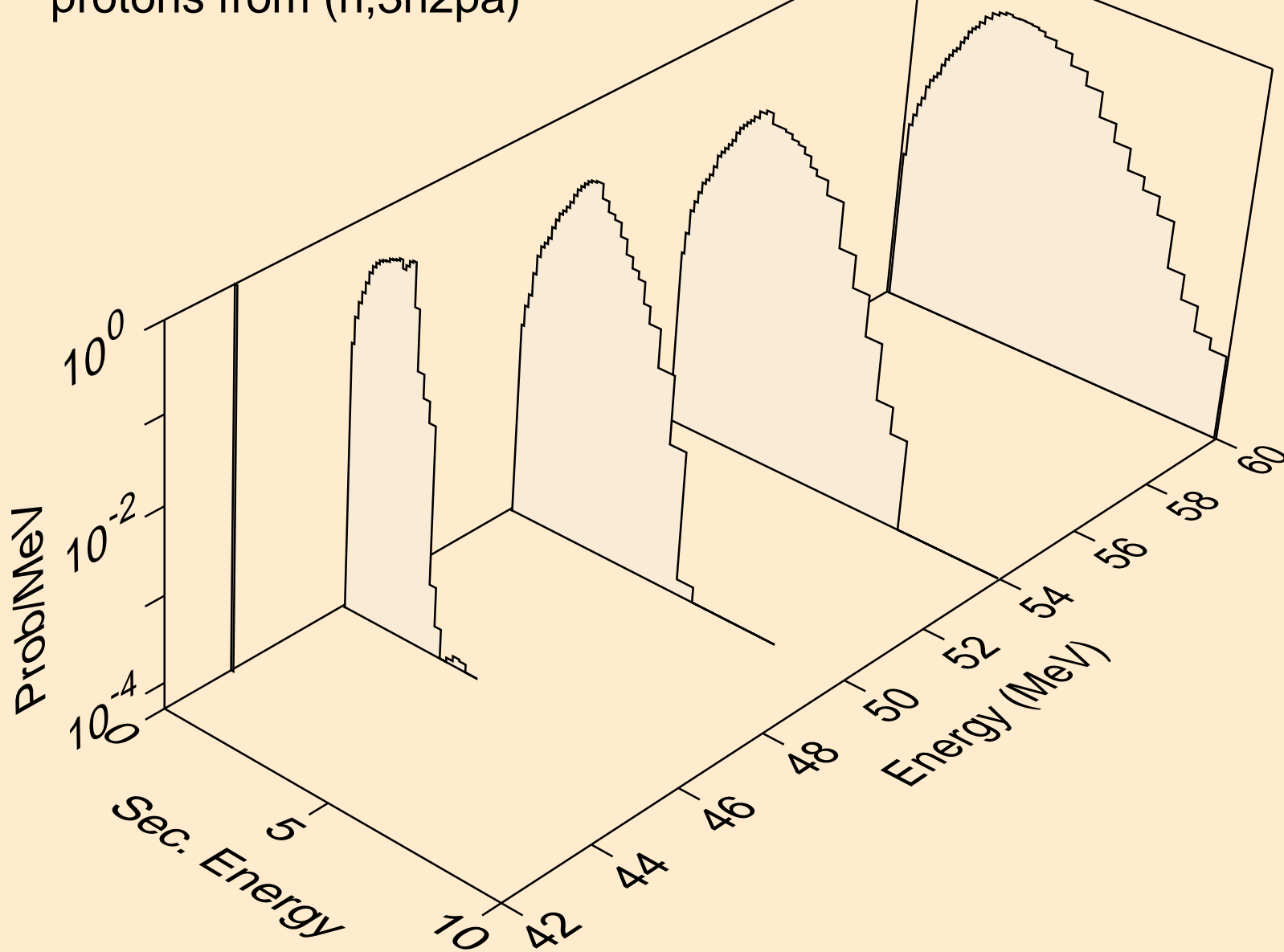

19-K-41 FOR FENDL-3.2 FROM TENDL-2015 BY NJOY2016.60+ O
deuterons from (n,x)

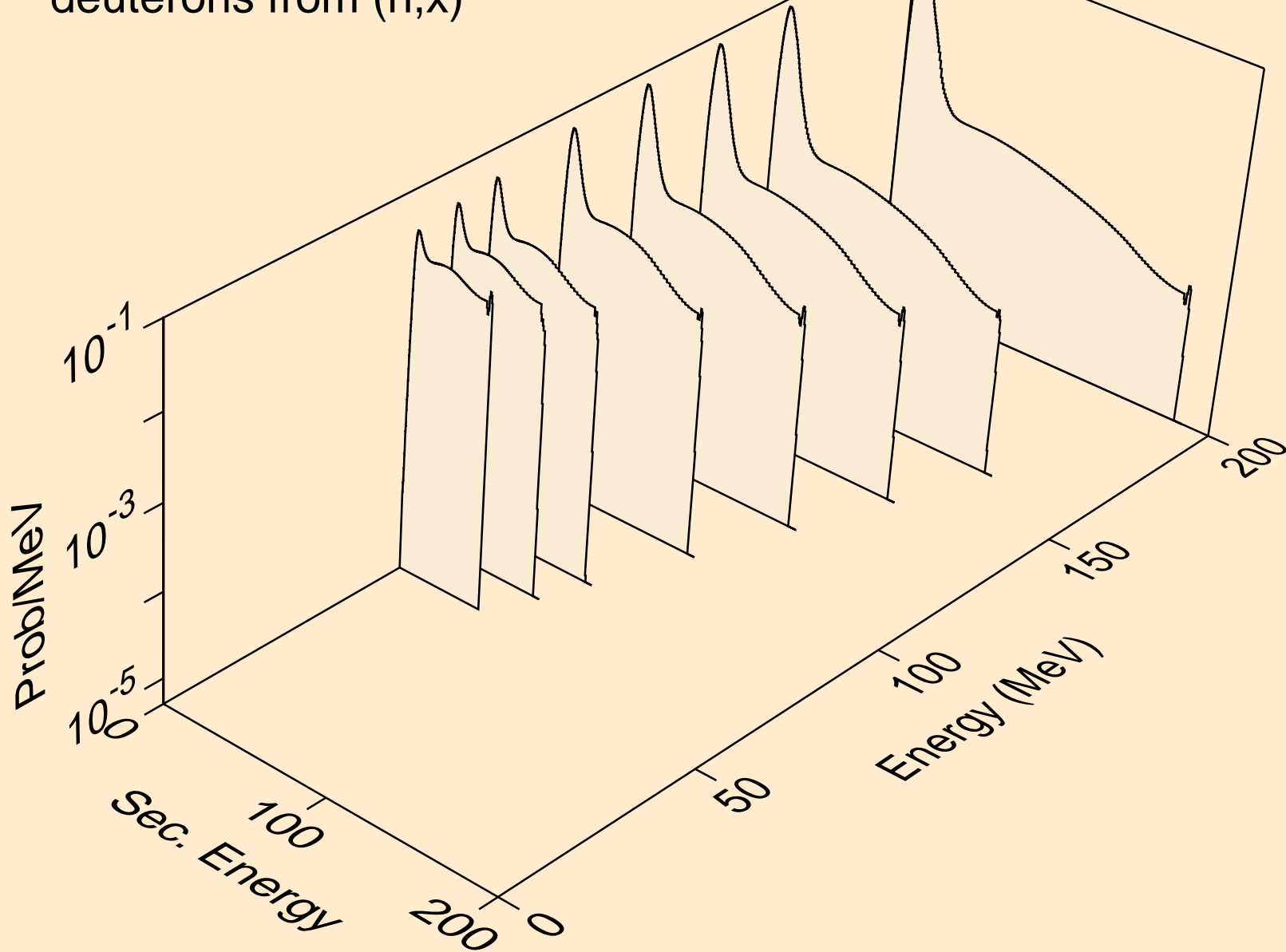

19-K-41 FOR FENDL-3.2 FROM TENDL-2015 BY NJOY2016.60+ O
deuterons from (n,2nd)

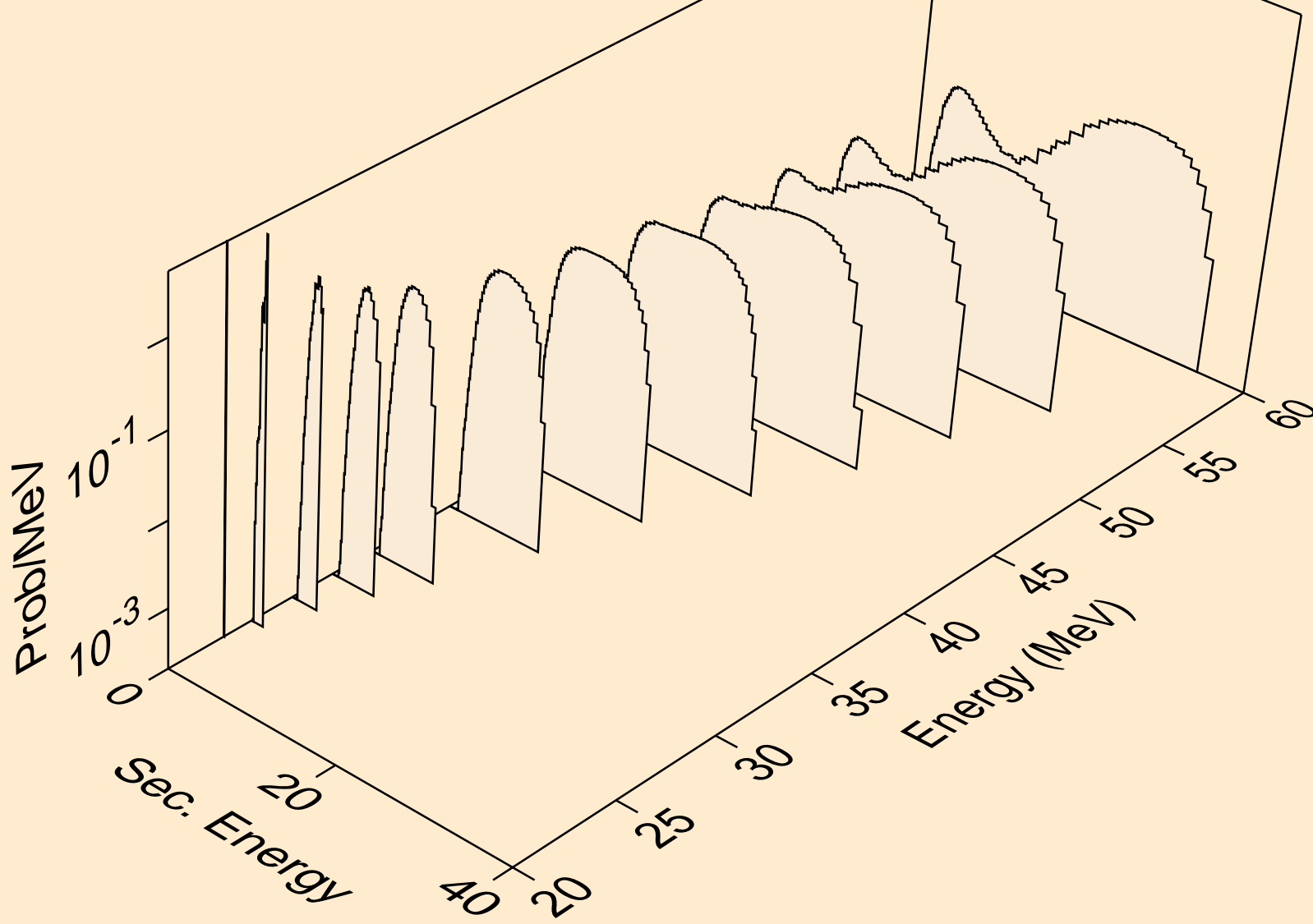

19-K-41 FOR FENDL-3.2 FROM TENDL-2015 BY NJOY2016.60+ O
deuterons from (n,n*)d

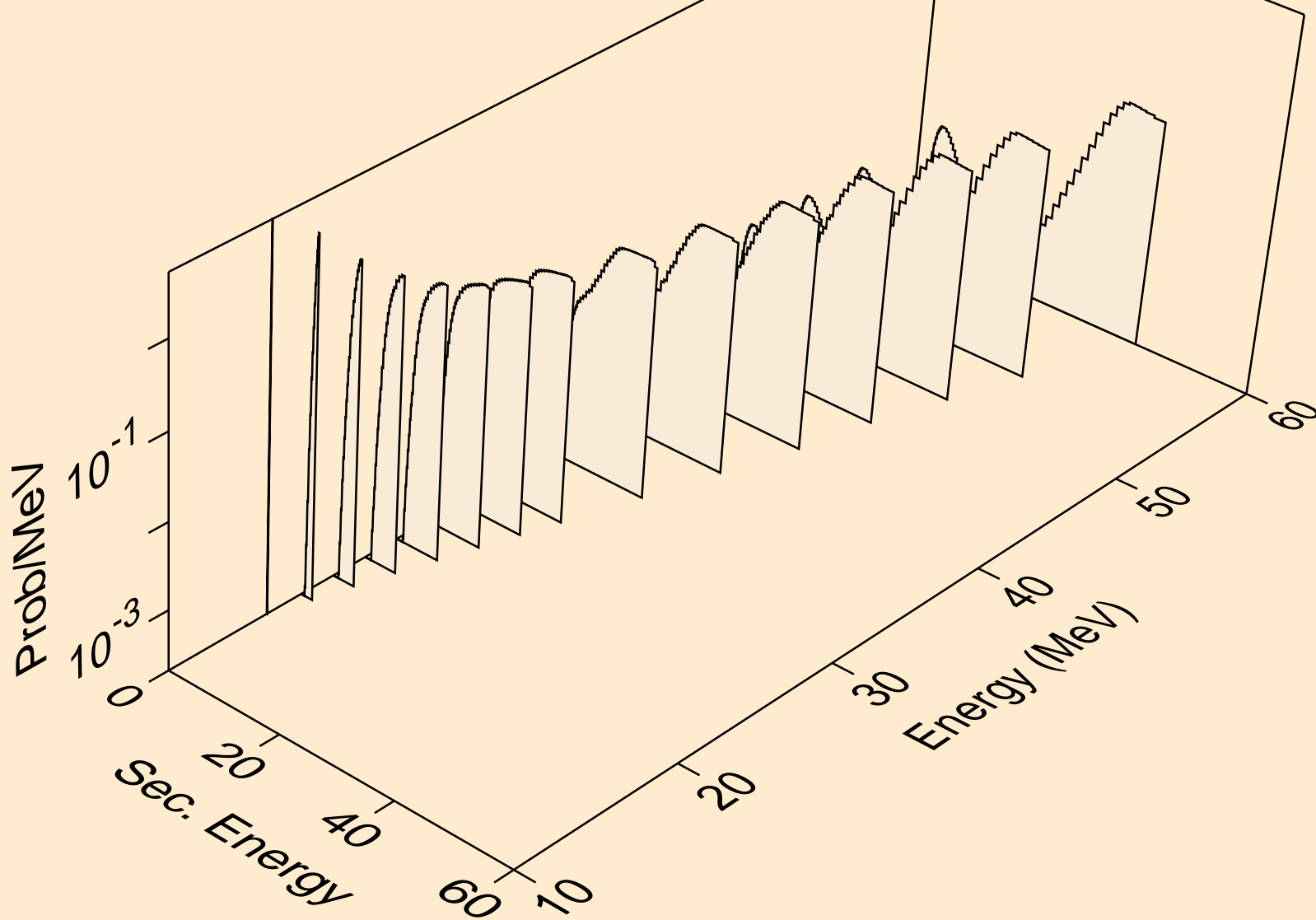

19-K-41 FOR FENDL-3.2 FROM TENDL-2015 BY NJOY2016.60+ O
deuterons from (n,n*)d2a

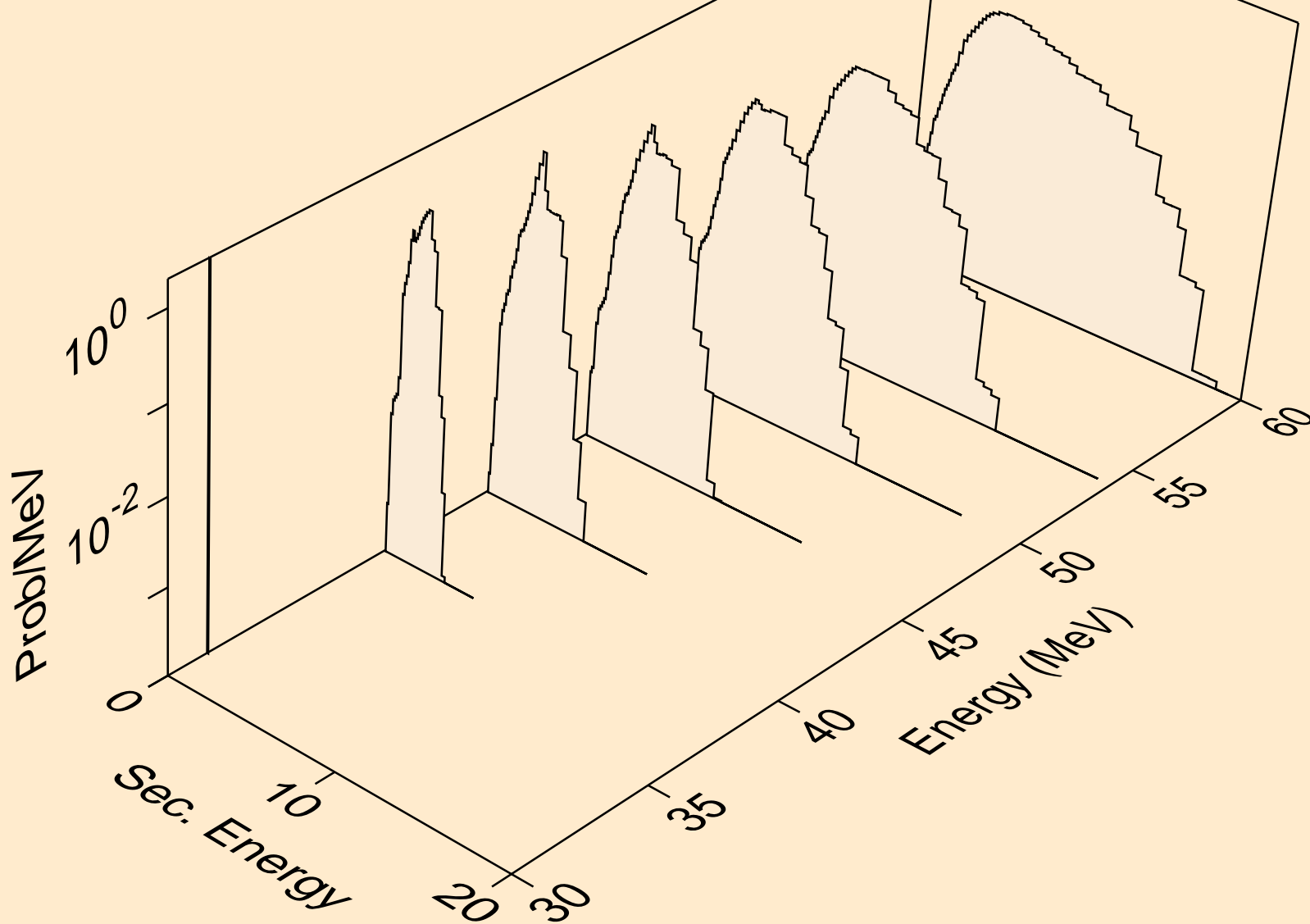

19-K-41 FOR FENDL-3.2 FROM TENDL-2015 BY NJOY2016.60+ O
deuterons from (n,d)

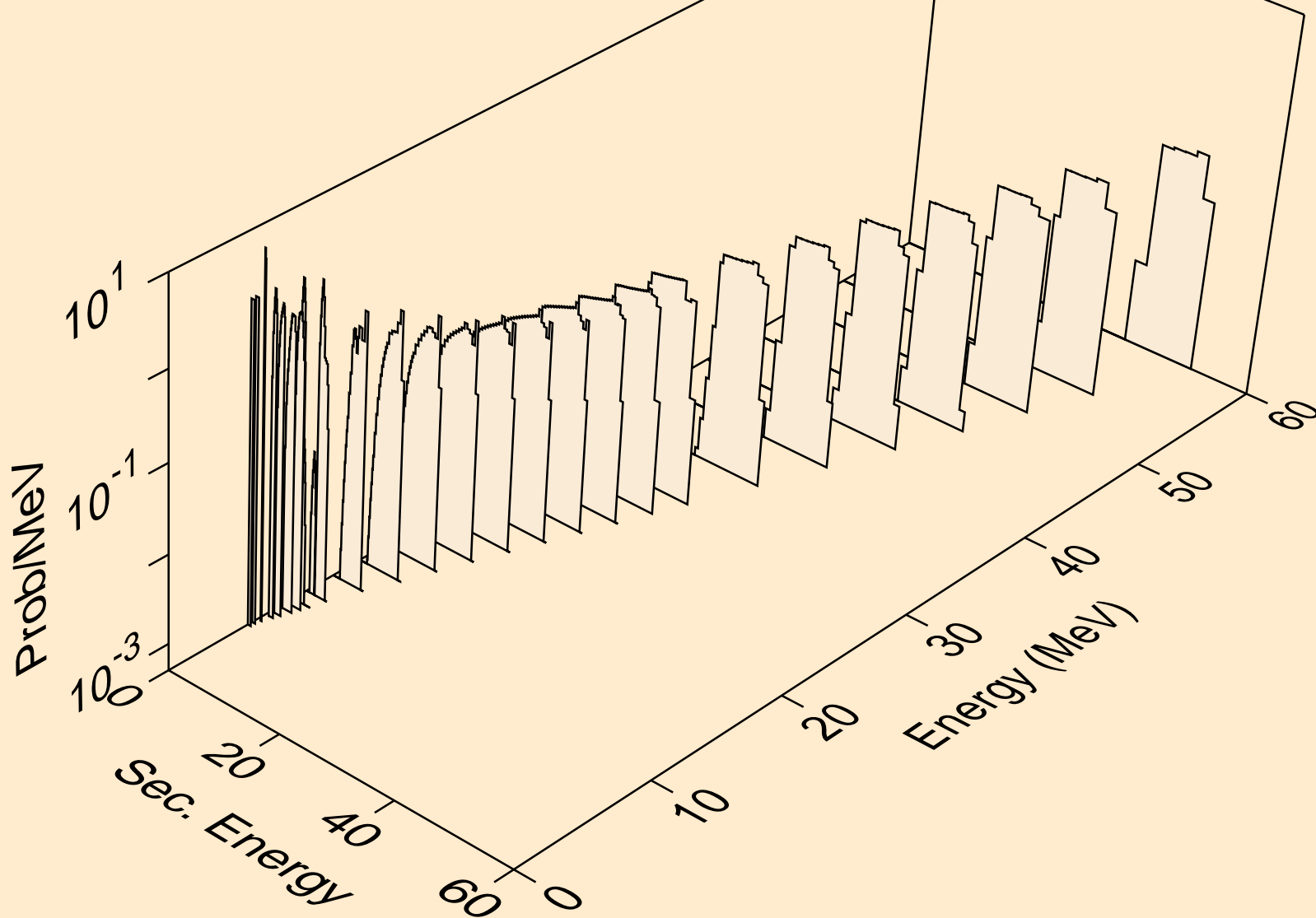

19-K-41 FOR FENDL-3.2 FROM TENDL-2015 BY NJOY2016.60+ O
deuterons from (n,d2a)

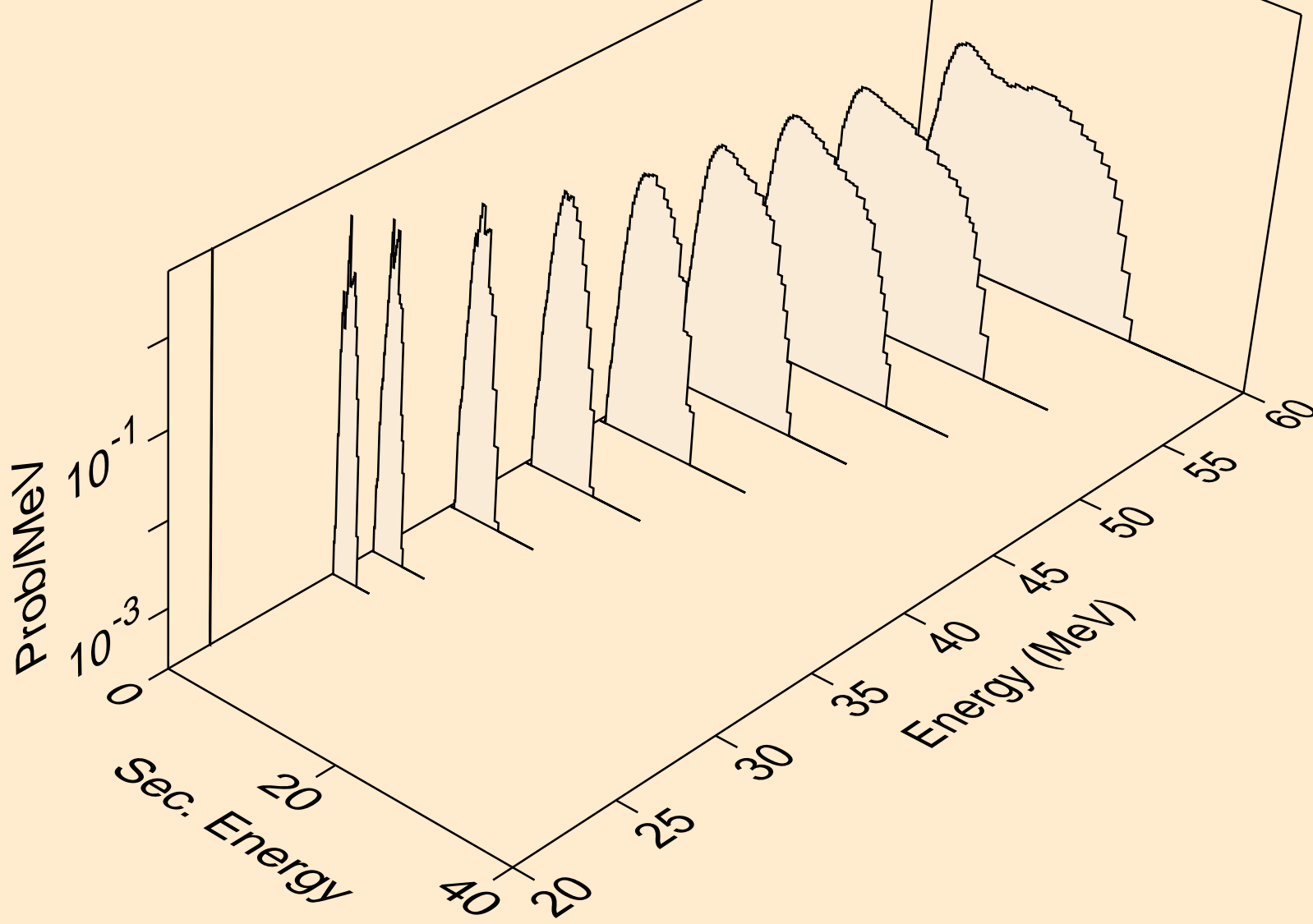

19-K-41 FOR FENDL-3.2 FROM TENDL-2015 BY NJOY2016.60+ O
deuterons from (n,pd)

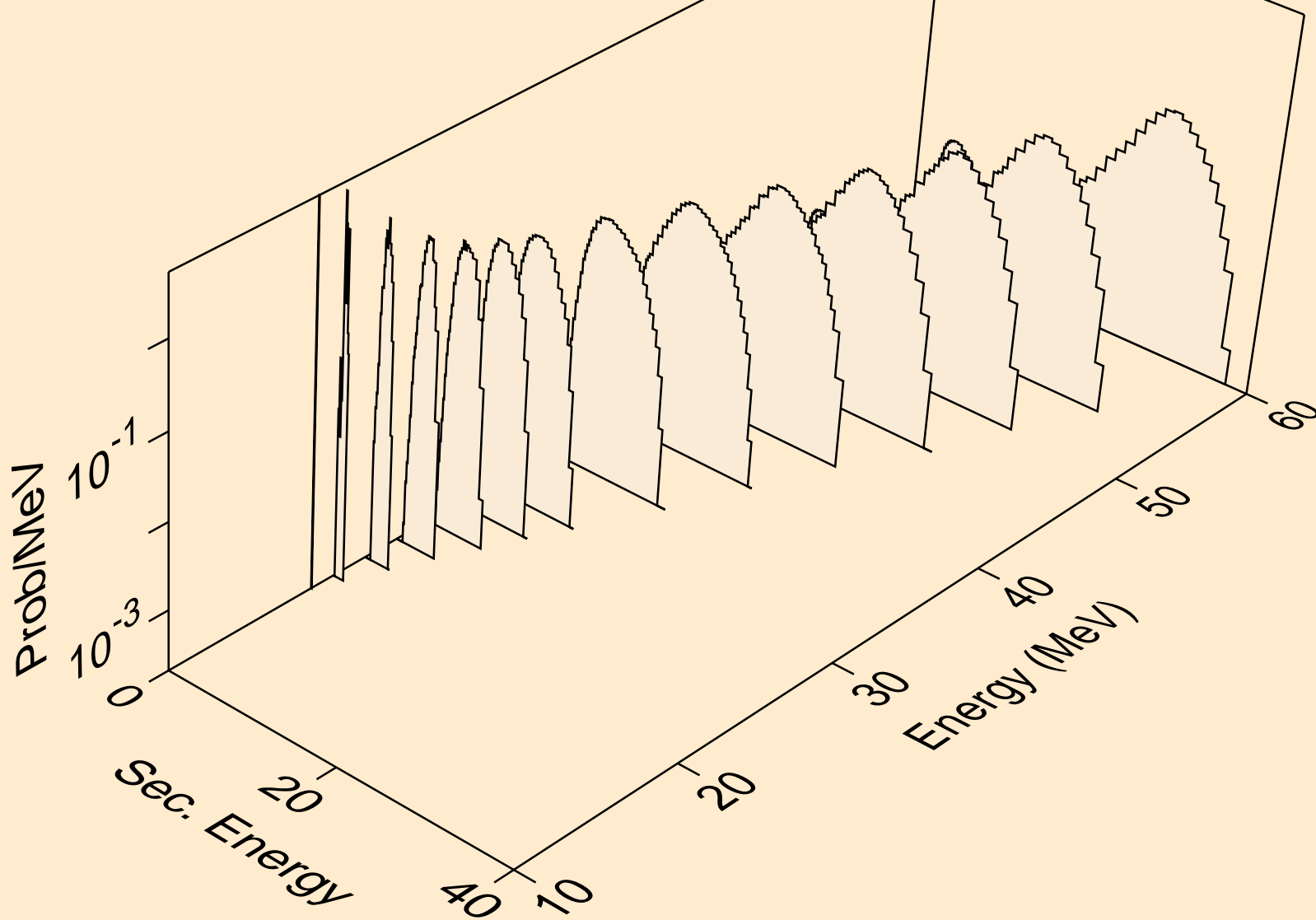

19-K-41 FOR FENDL-3.2 FROM TENDL-2015 BY NJOY2016.60+ O
deuterons from (n,da)

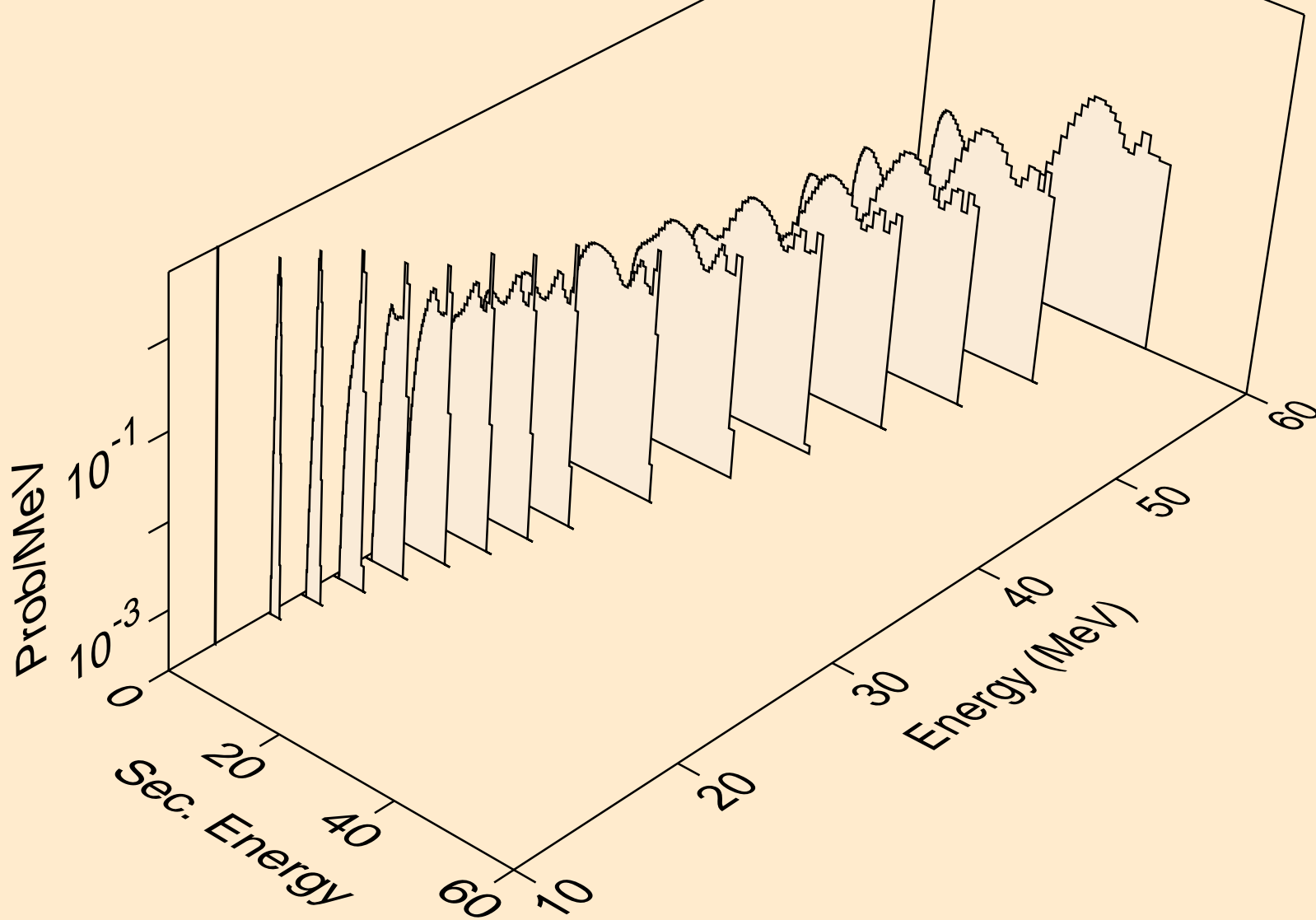

19-K-41 FOR FENDL-3.2 FROM TENDL-2015 BY NJOY2016.60+ O
deuterons from (n,3nd)

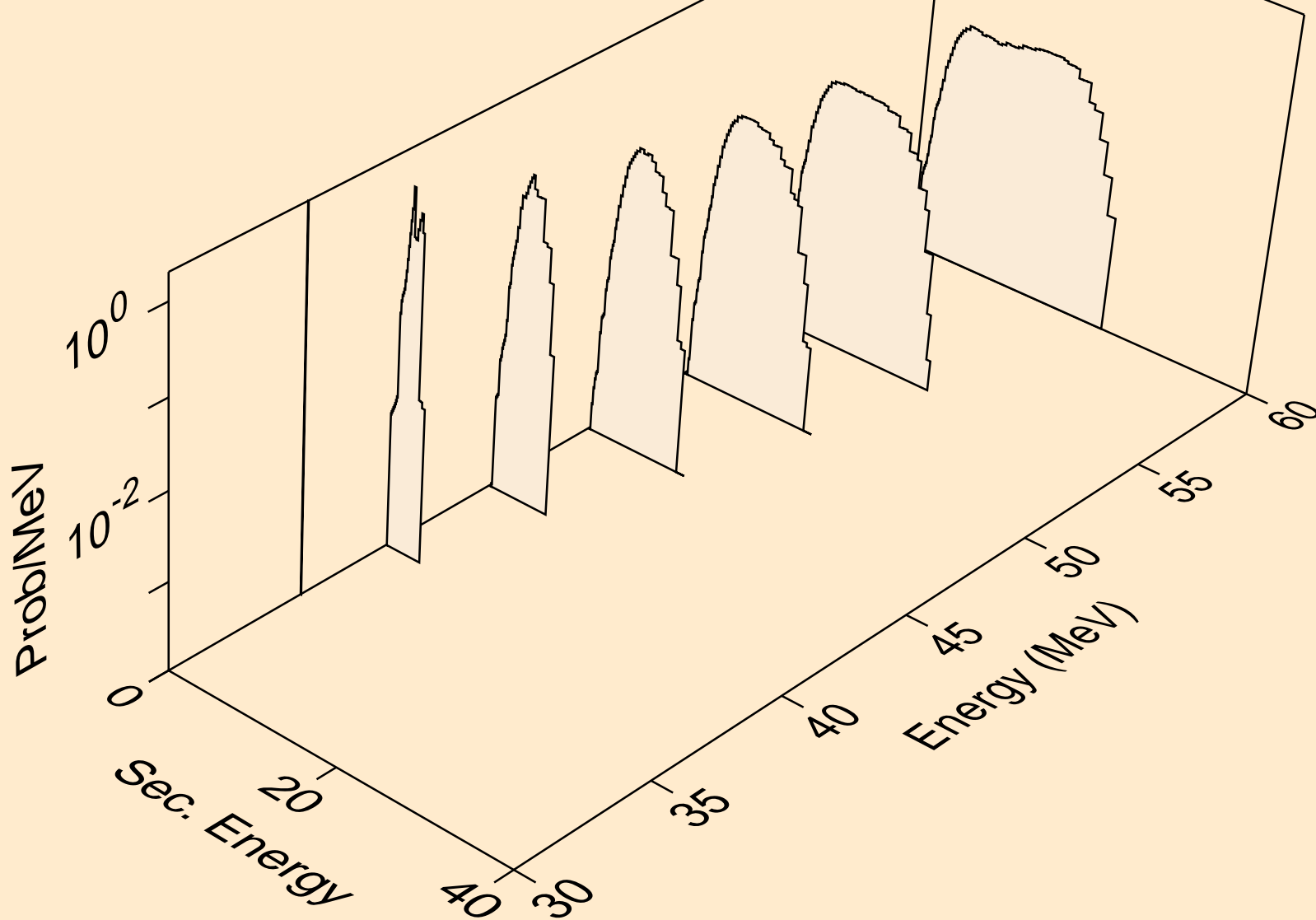

19-K-41 FOR FENDL-3.2 FROM TENDL-2015 BY NJOY2016.60+ O
deuterons from (n,nda)

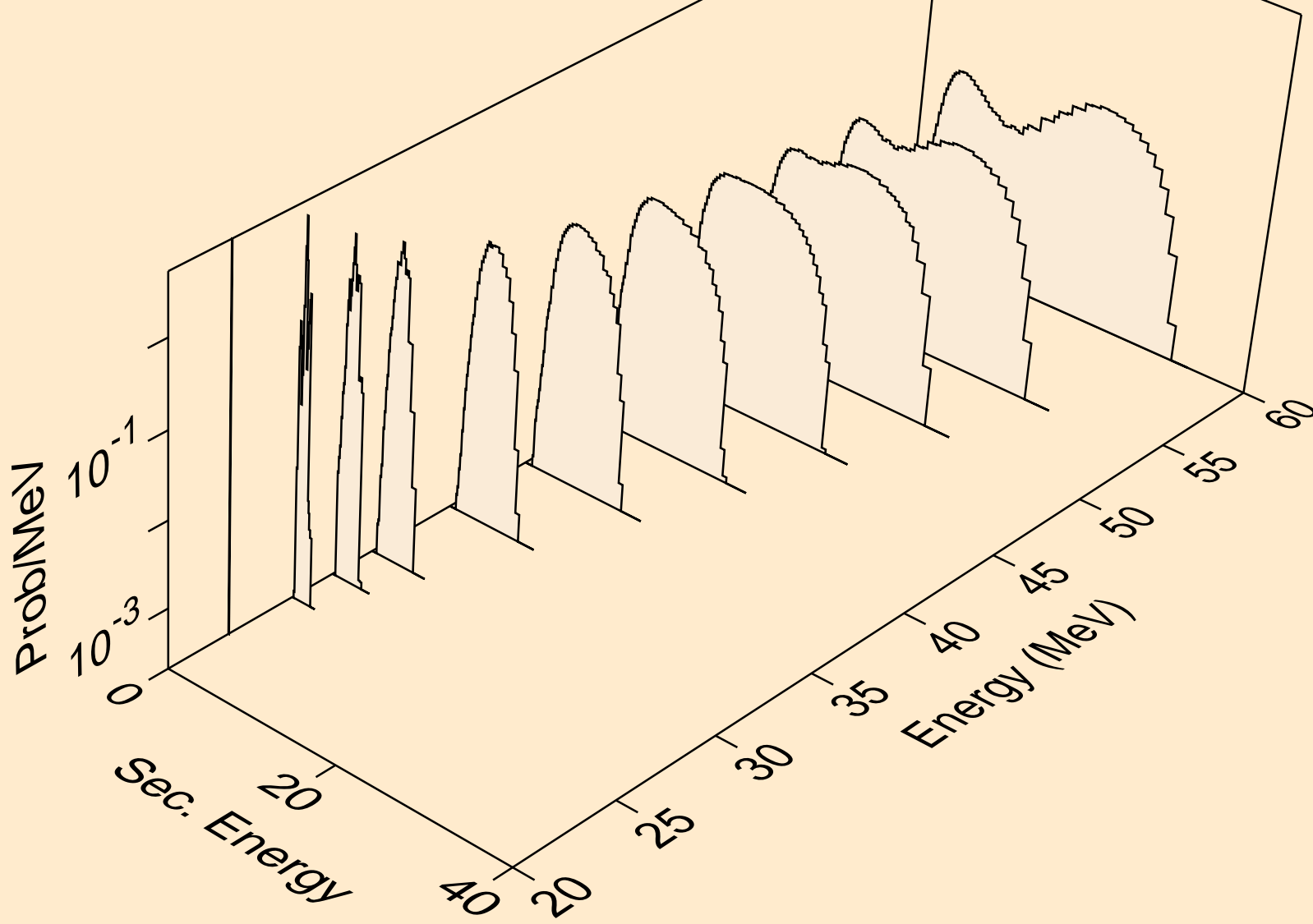

19-K-41 FOR FENDL-3.2 FROM TENDL-2015 BY NJOY2016.60+ O
deuterons from (n,4nd)

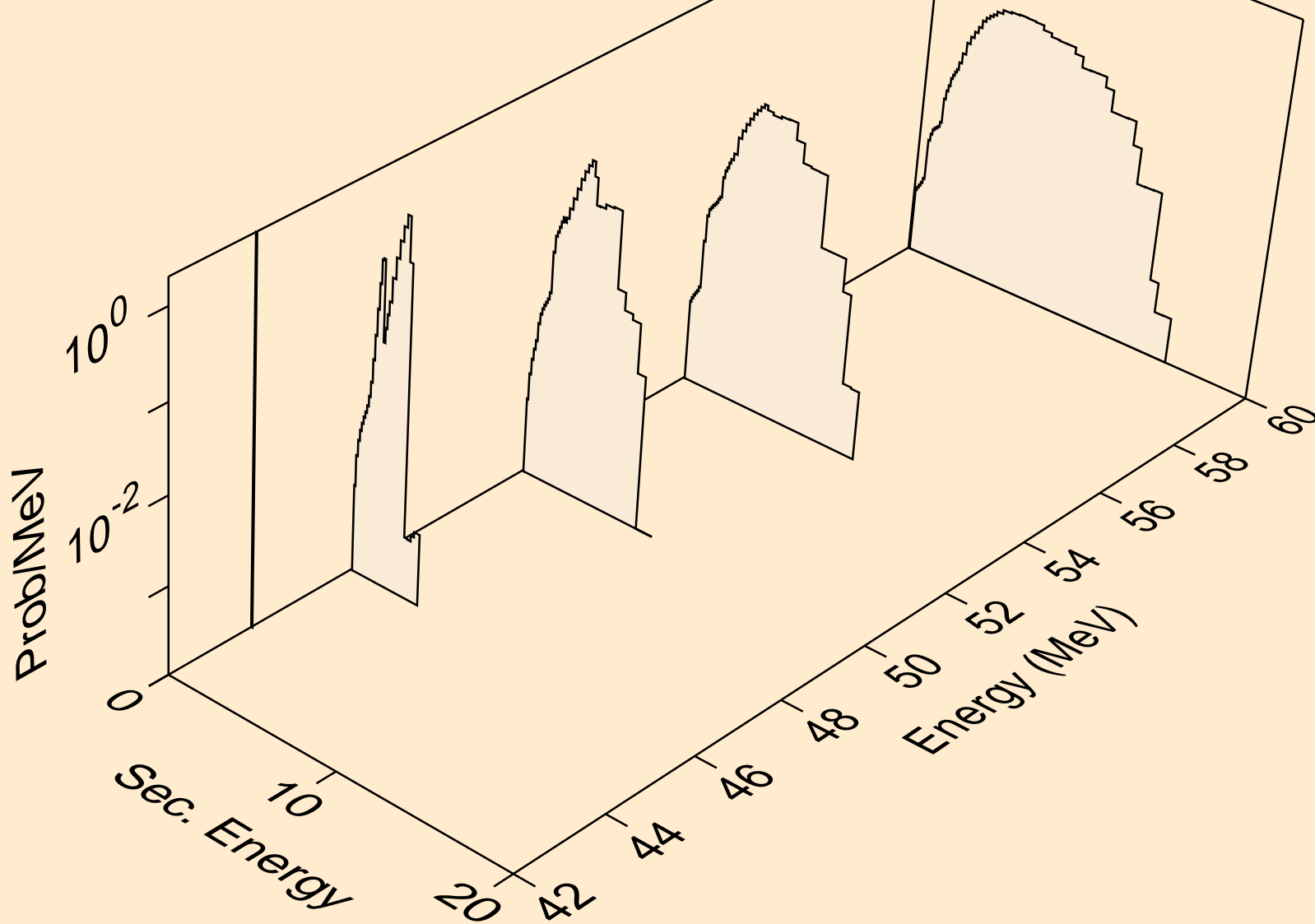

19-K-41 FOR FENDL-3.2 FROM TENDL-2015 BY NJOY2016.60+ O
deuterons from (n,dt)

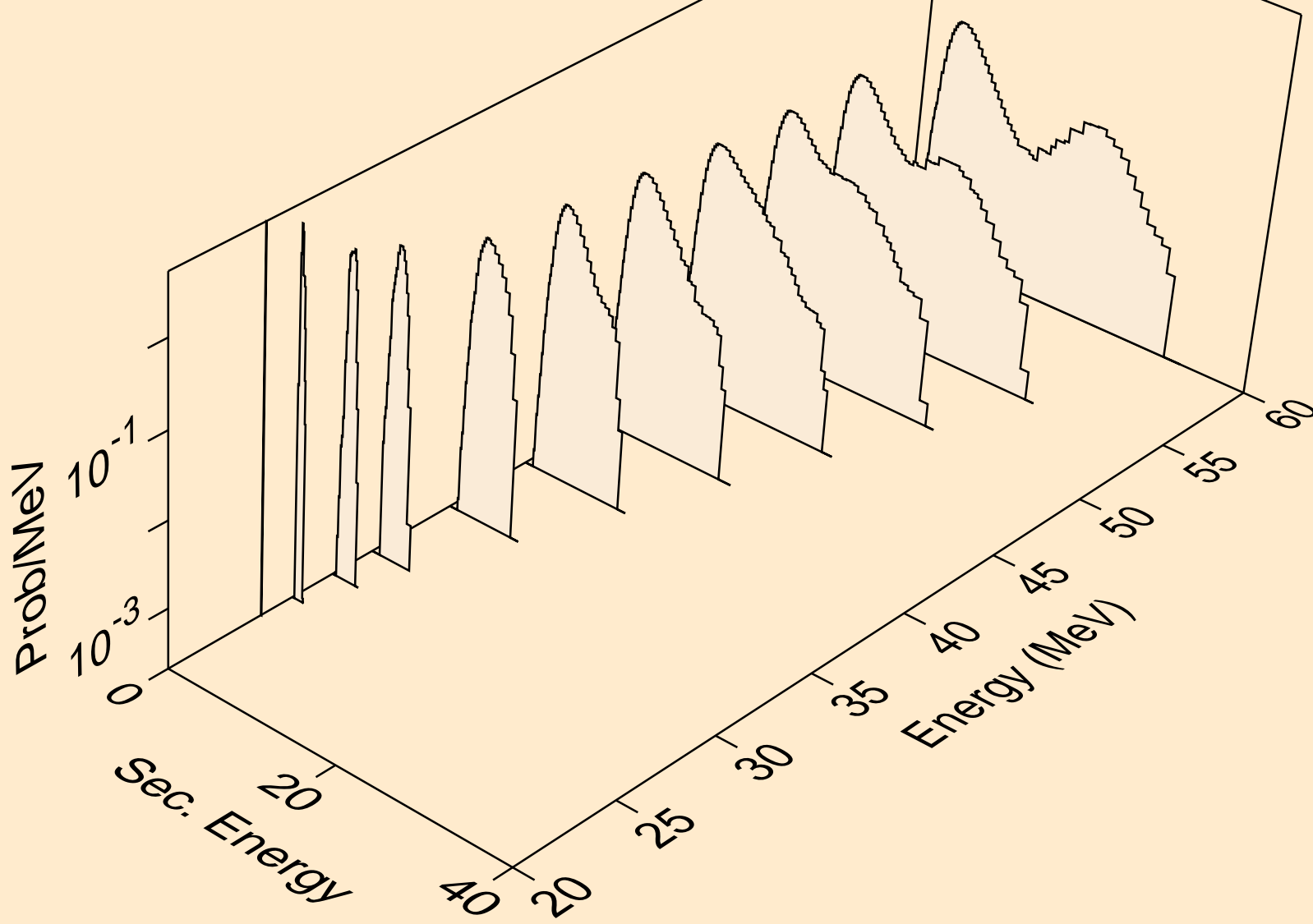

19-K-41 FOR FENDL-3.2 FROM TENDL-2015 BY NJOY2016.60+ O
deuterons from (n,npd)

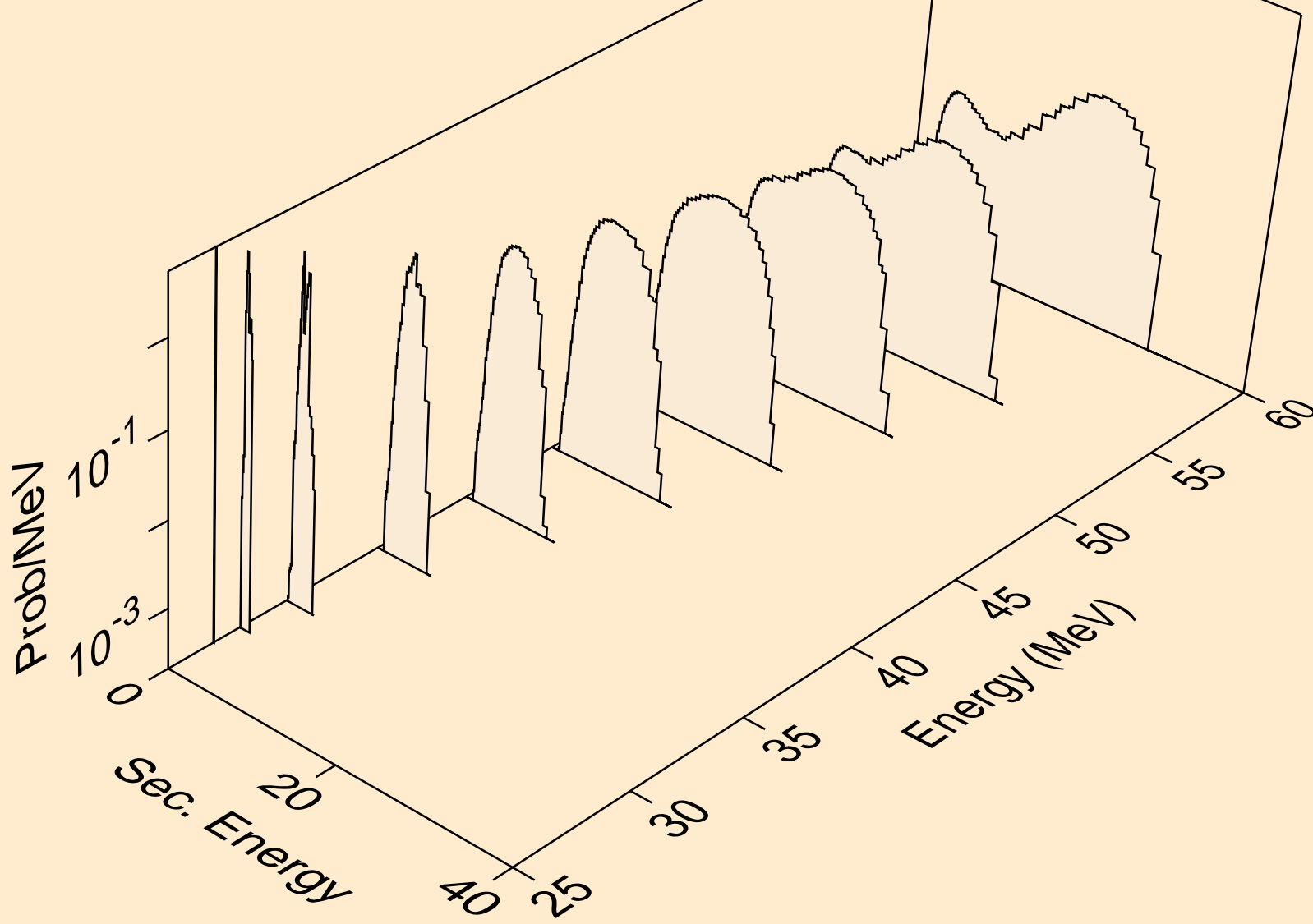

19-K-41 FOR FENDL-3.2 FROM TENDL-2015 BY NJOY2016.60+ O
deuterons from (n,ndt)

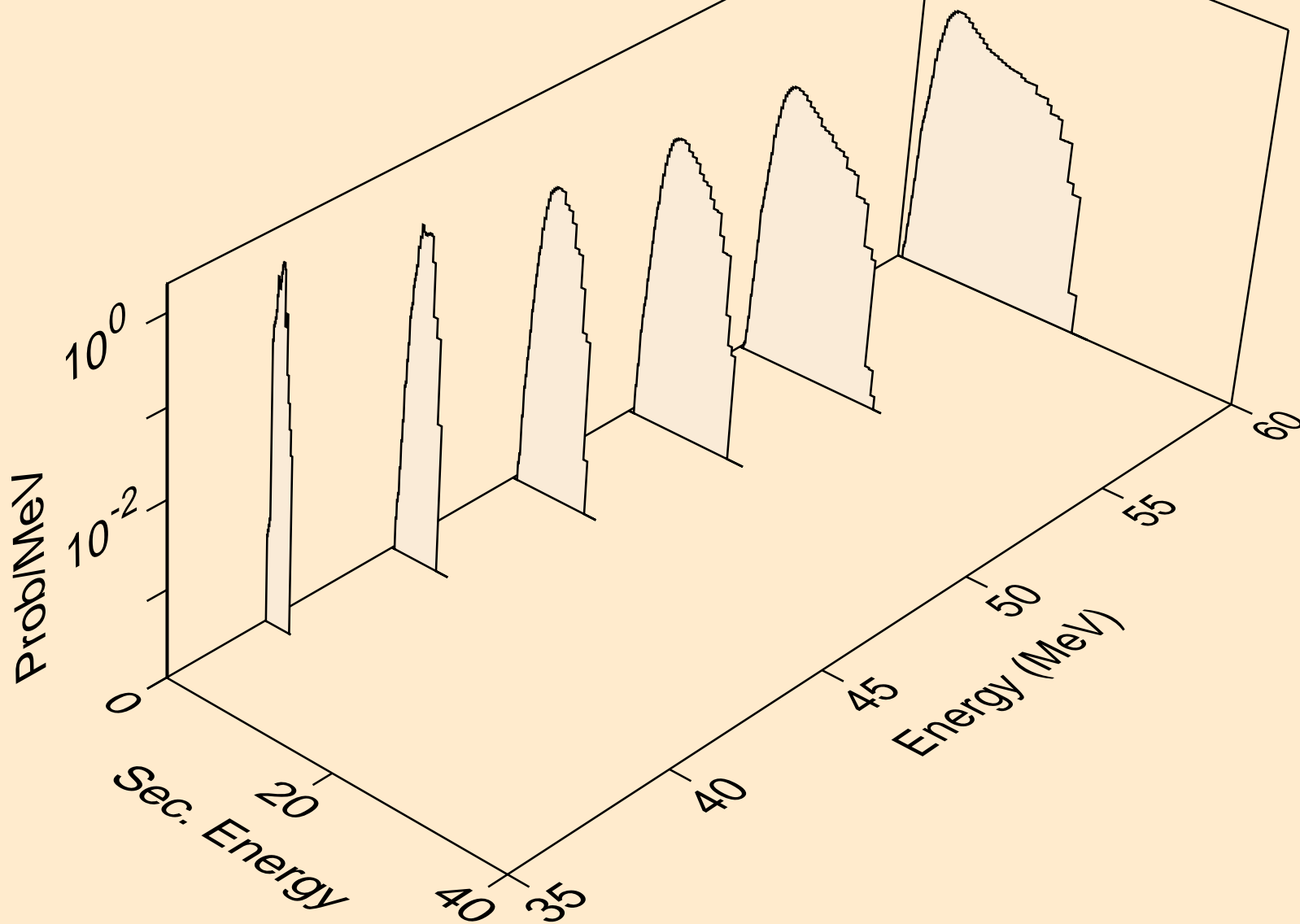

19-K-41 FOR FENDL-3.2 FROM TENDL-2015 BY NJOY2016.60+ O
deuterons from (n,ndhe3)

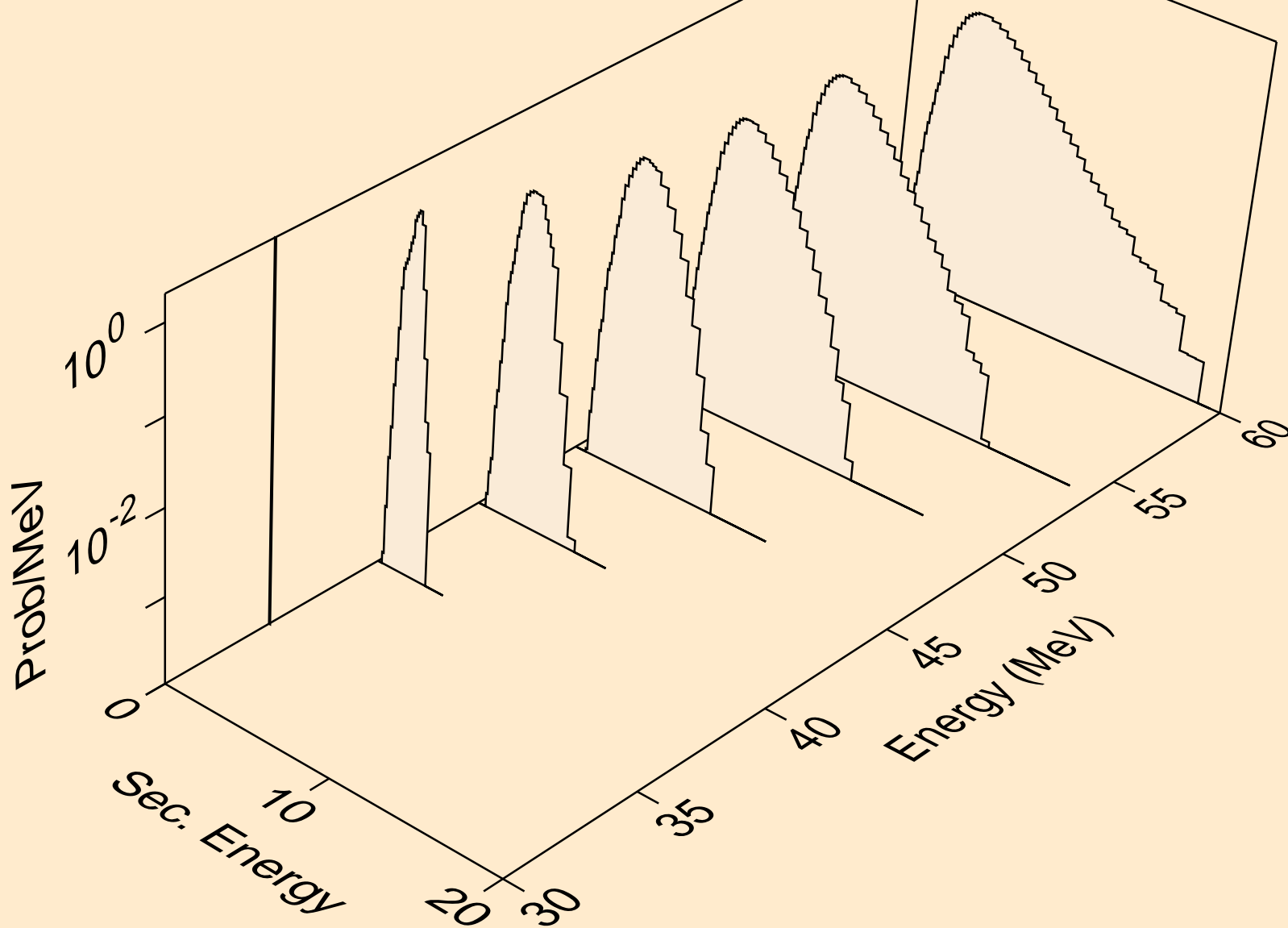

19-K-41 FOR FENDL-3.2 FROM TENDL-2015 BY NJOY2016.60+ O
deuterons from (n,dhe3)

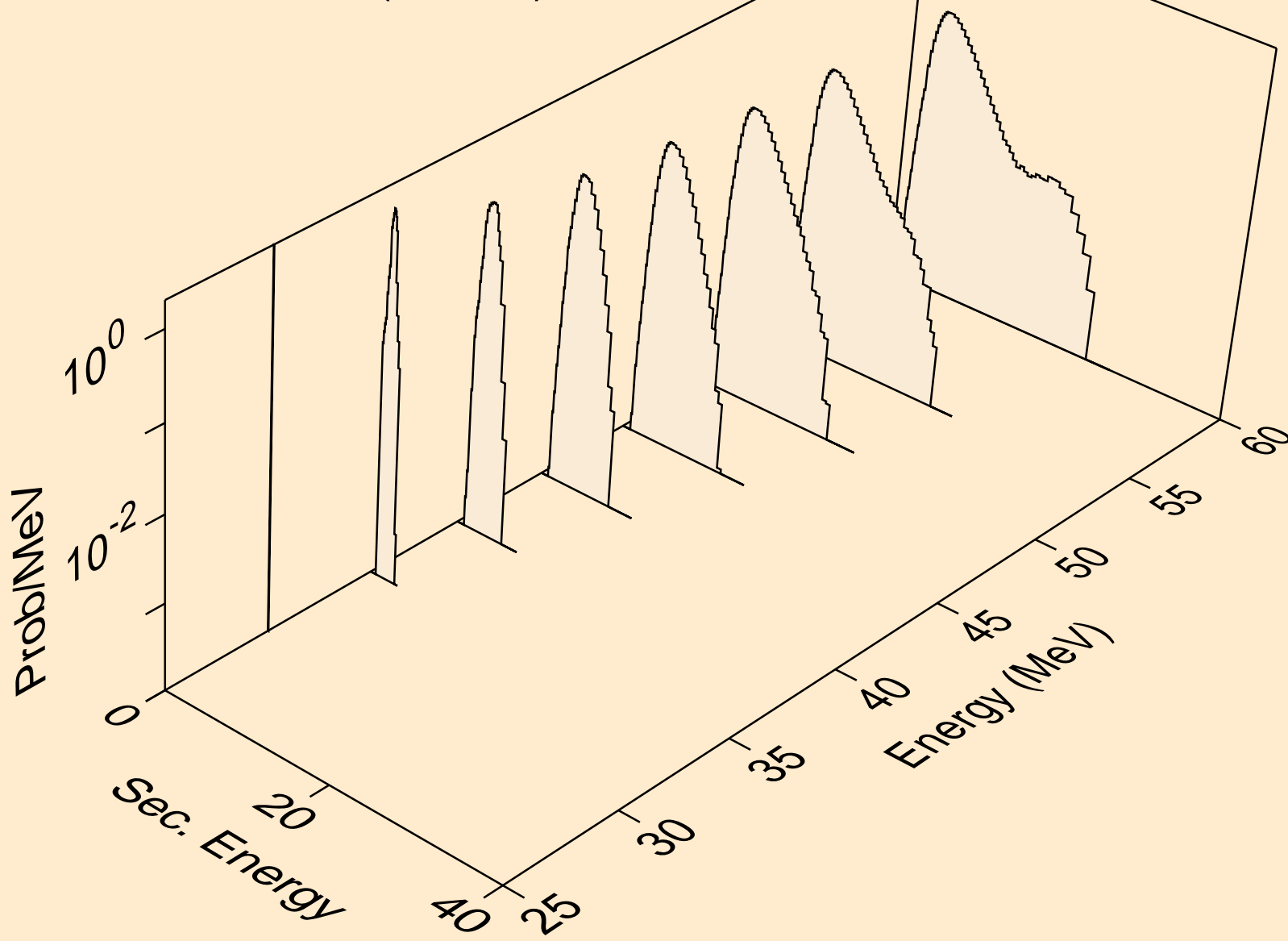

19-K-41 FOR FENDL-3.2 FROM TENDL-2015 BY NJOY2016.60+ O
tritons from (n,x)

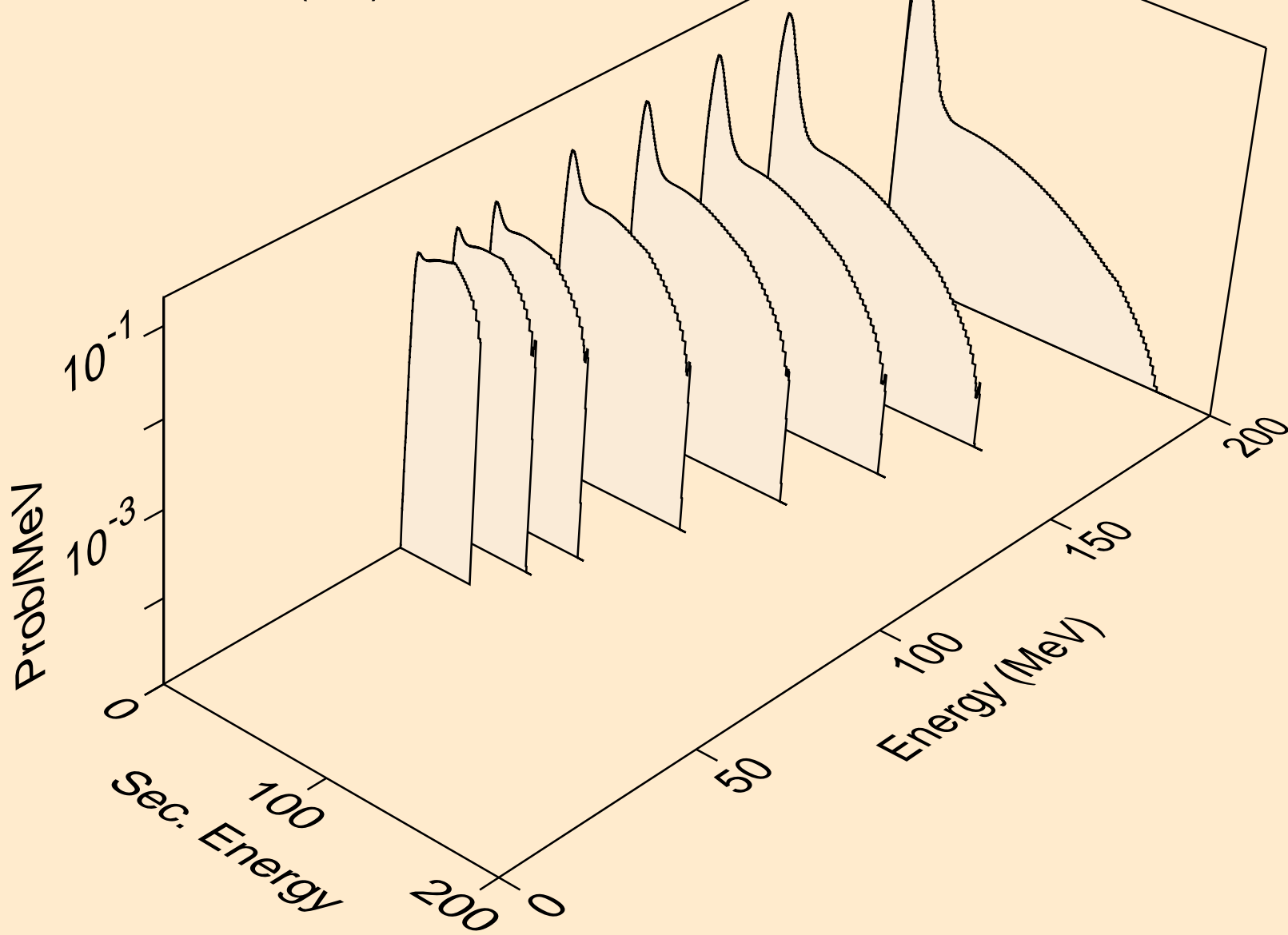

19-K-41 FOR FENDL-3.2 FROM TENDL-2015 BY NJOY2016.60+ O
tritons from (n,n*)t

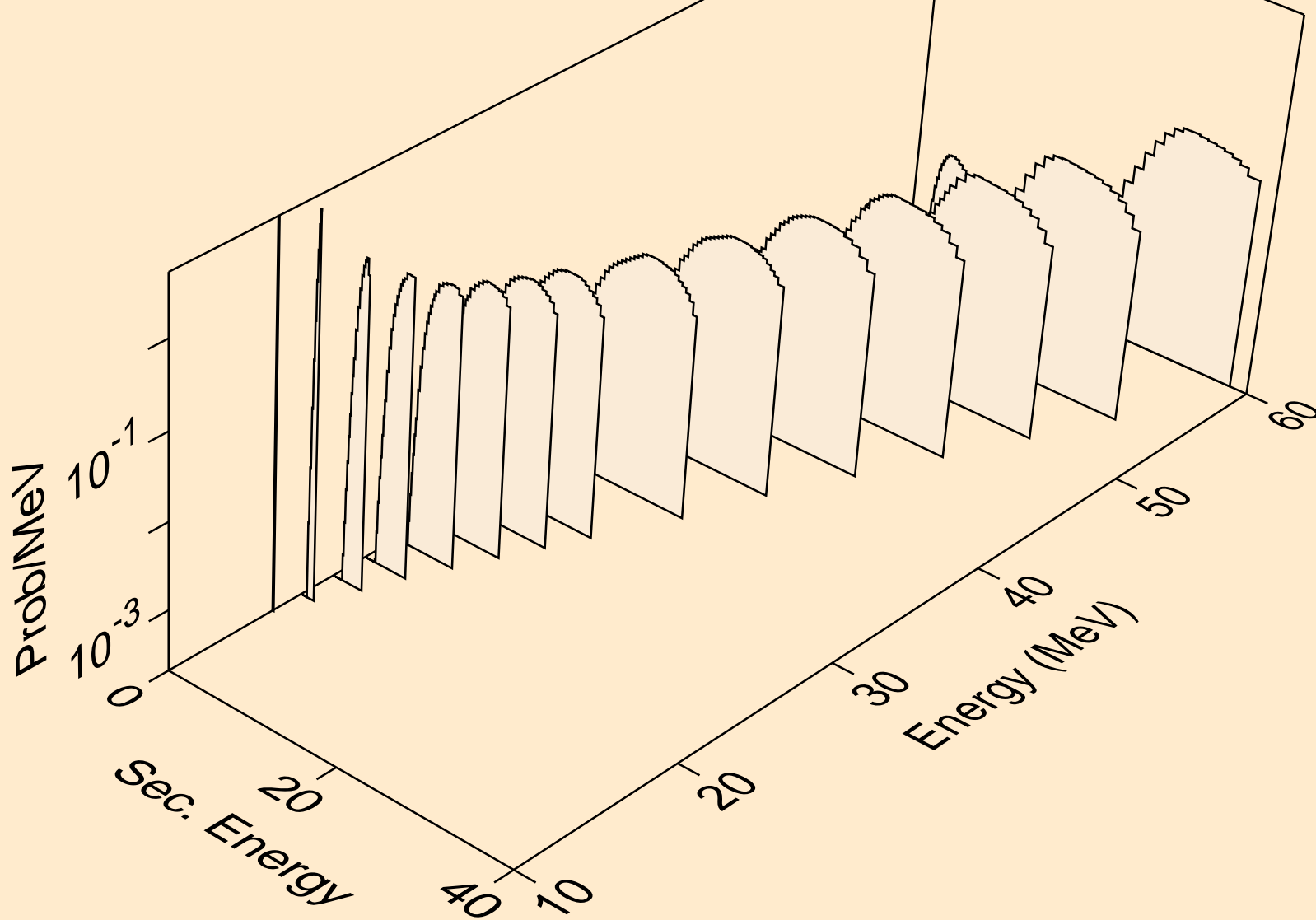

19-K-41 FOR FENDL-3.2 FROM TENDL-2015 BY NJOY2016.60+ O
tritons from (n,n*)t2a

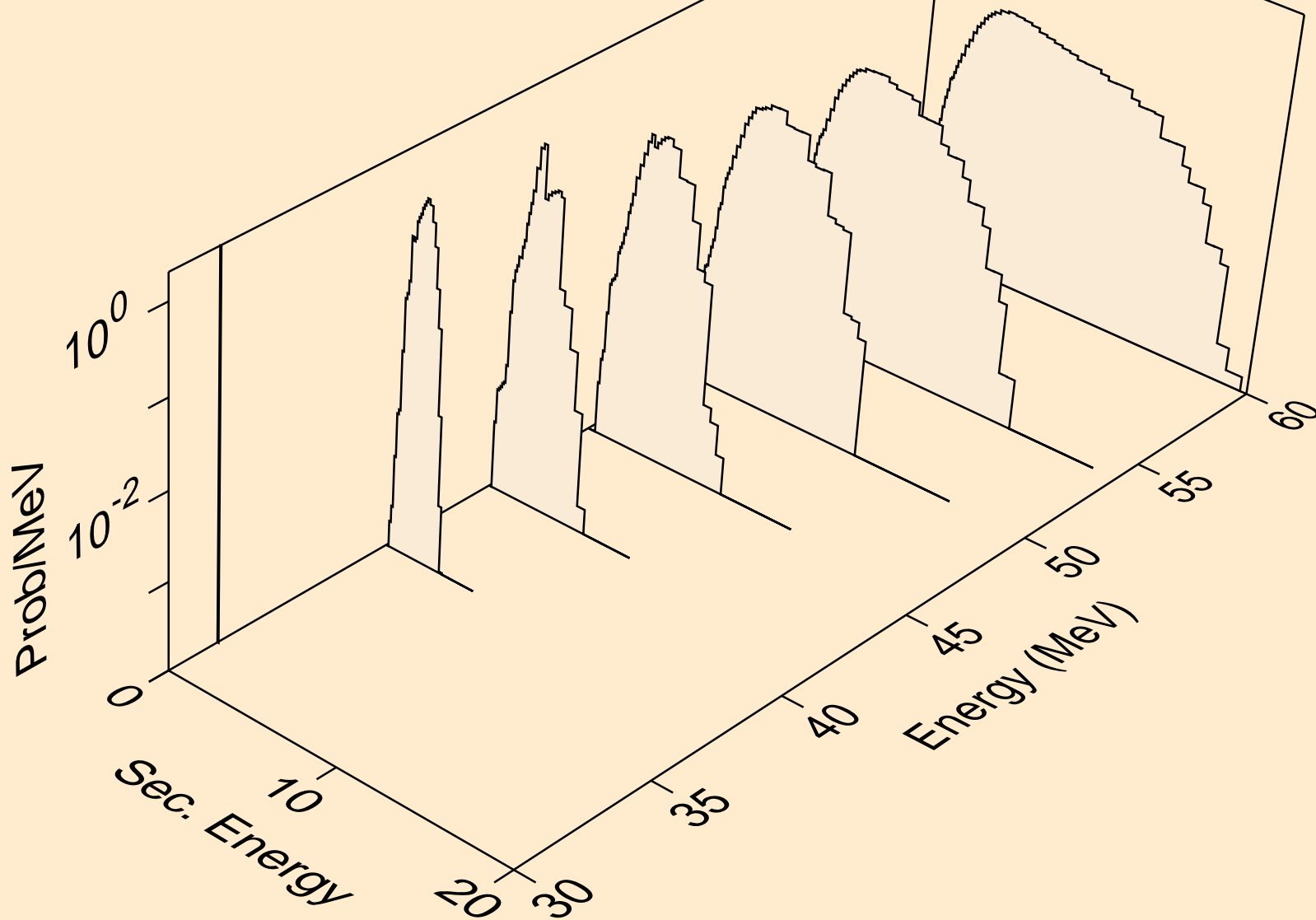

19-K-41 FOR FENDL-3.2 FROM TENDL-2015 BY NJOY2016.60+ O
tritons from (n,t)

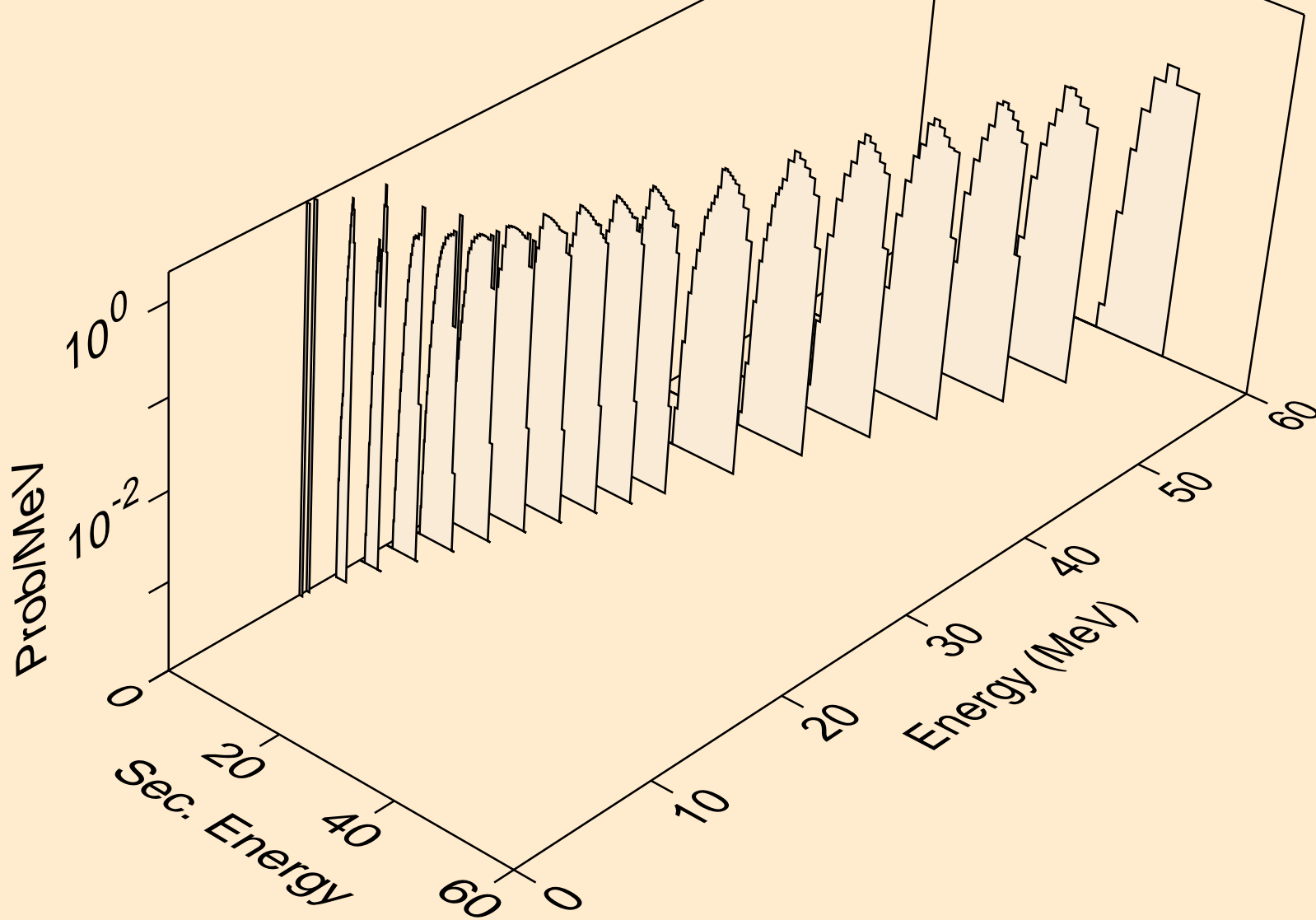

19-K-41 FOR FENDL-3.2 FROM TENDL-2015 BY NJOY2016.60+ O
tritons from (n,t2a)

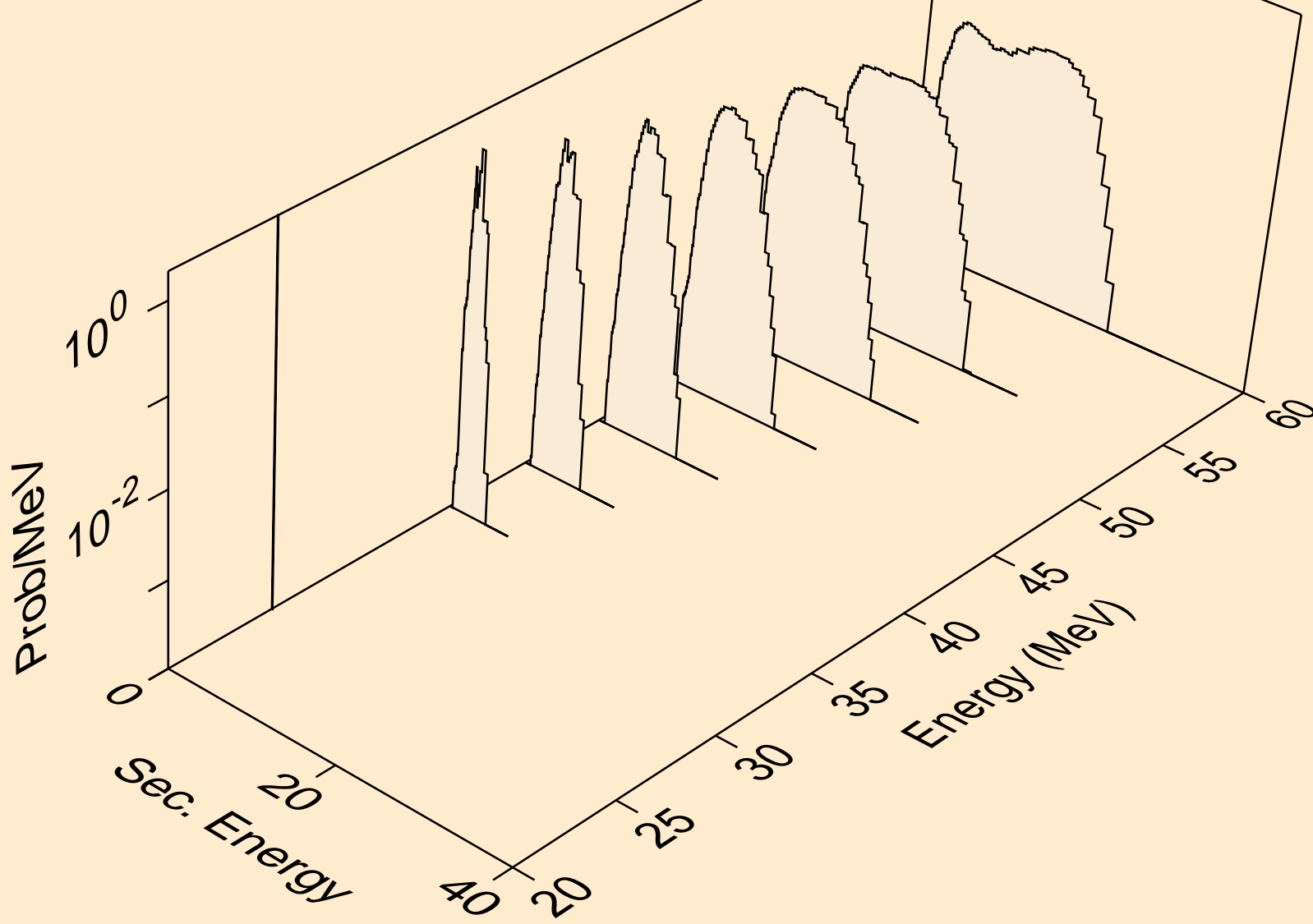

19-K-41 FOR FENDL-3.2 FROM TENDL-2015 BY NJOY2016.60+ O
tritons from (n,pt)

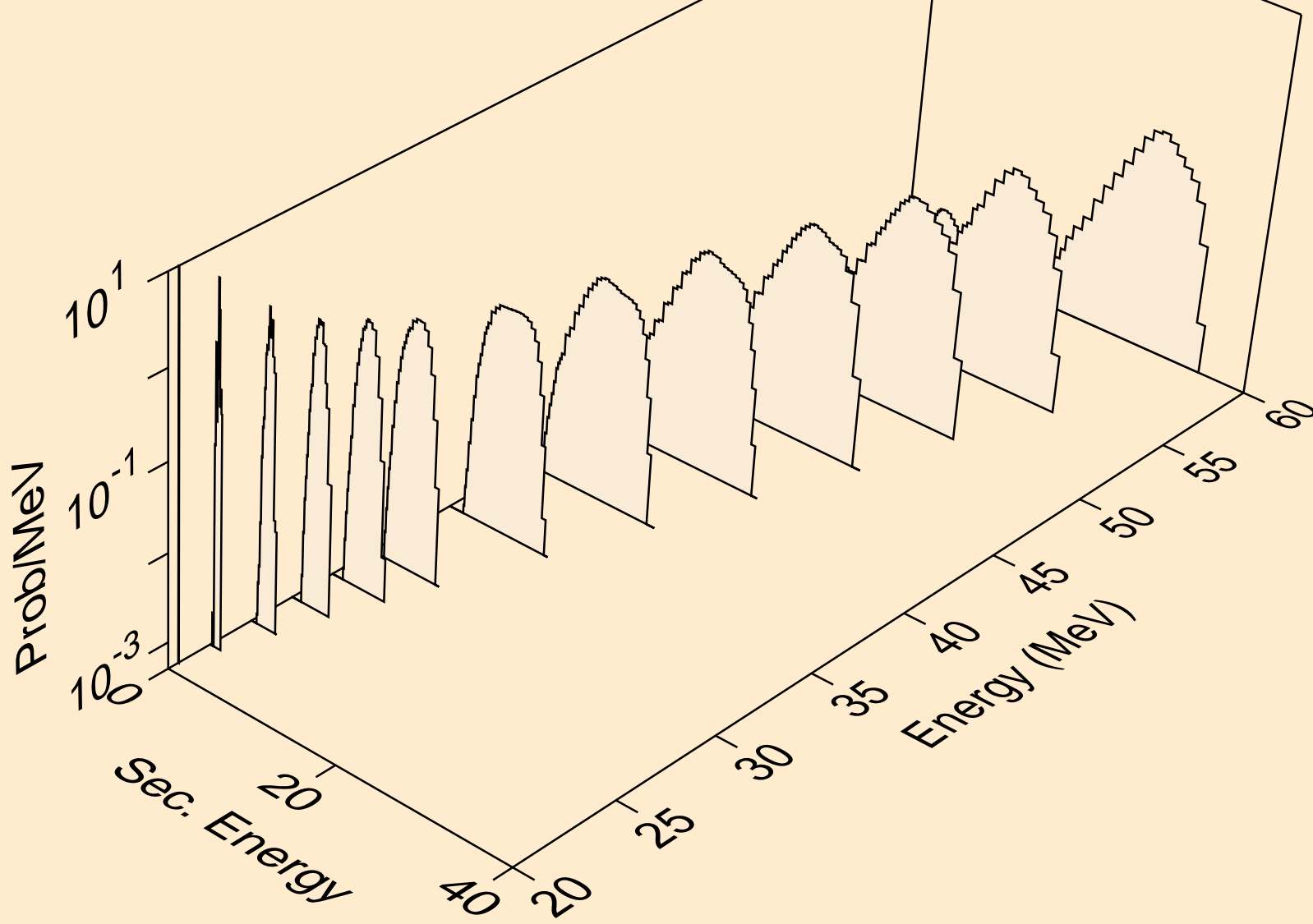

19-K-41 FOR FENDL-3.2 FROM TENDL-2015 BY NJOY2016.60+ O
tritons from (n,2nt)

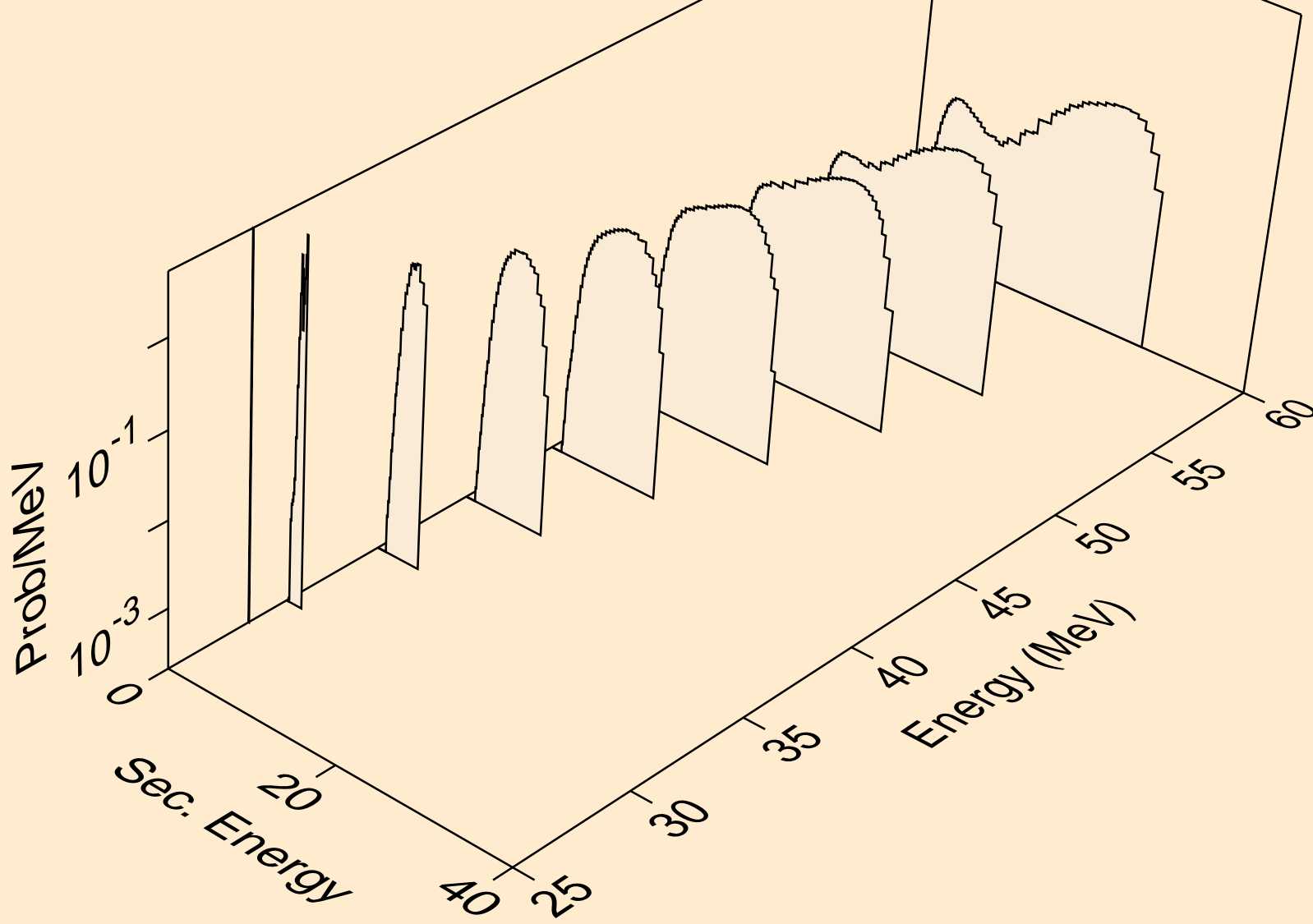

19-K-41 FOR FENDL-3.2 FROM TENDL-2015 BY NJOY2016.60+ O
tritons from (n,ta)

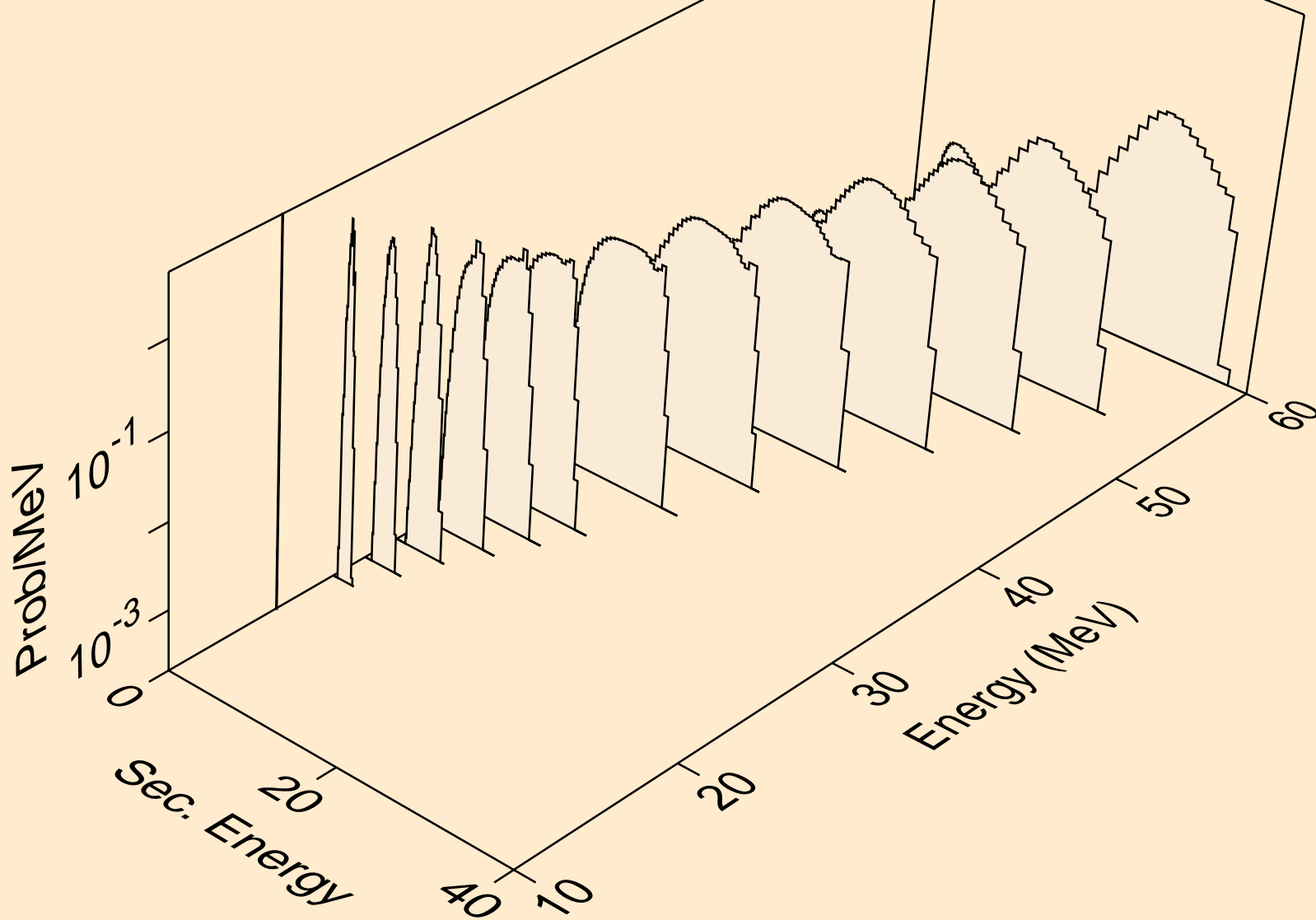

19-K-41 FOR FENDL-3.2 FROM TENDL-2015 BY NJOY2016.60+ O
tritons from (n,3nt)

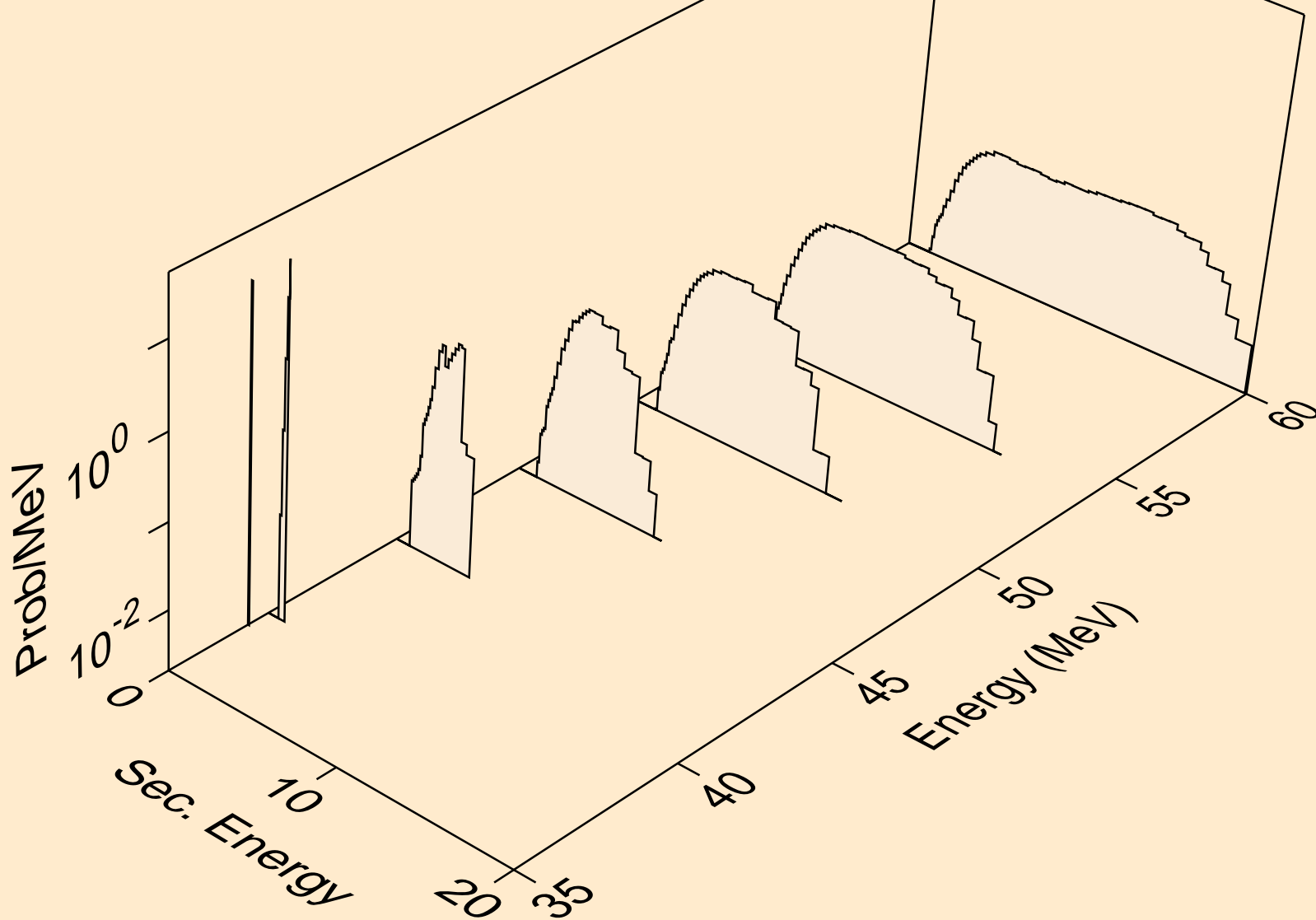

19-K-41 FOR FENDL-3.2 FROM TENDL-2015 BY NJOY2016.60+ O
tritons from (n,dt)

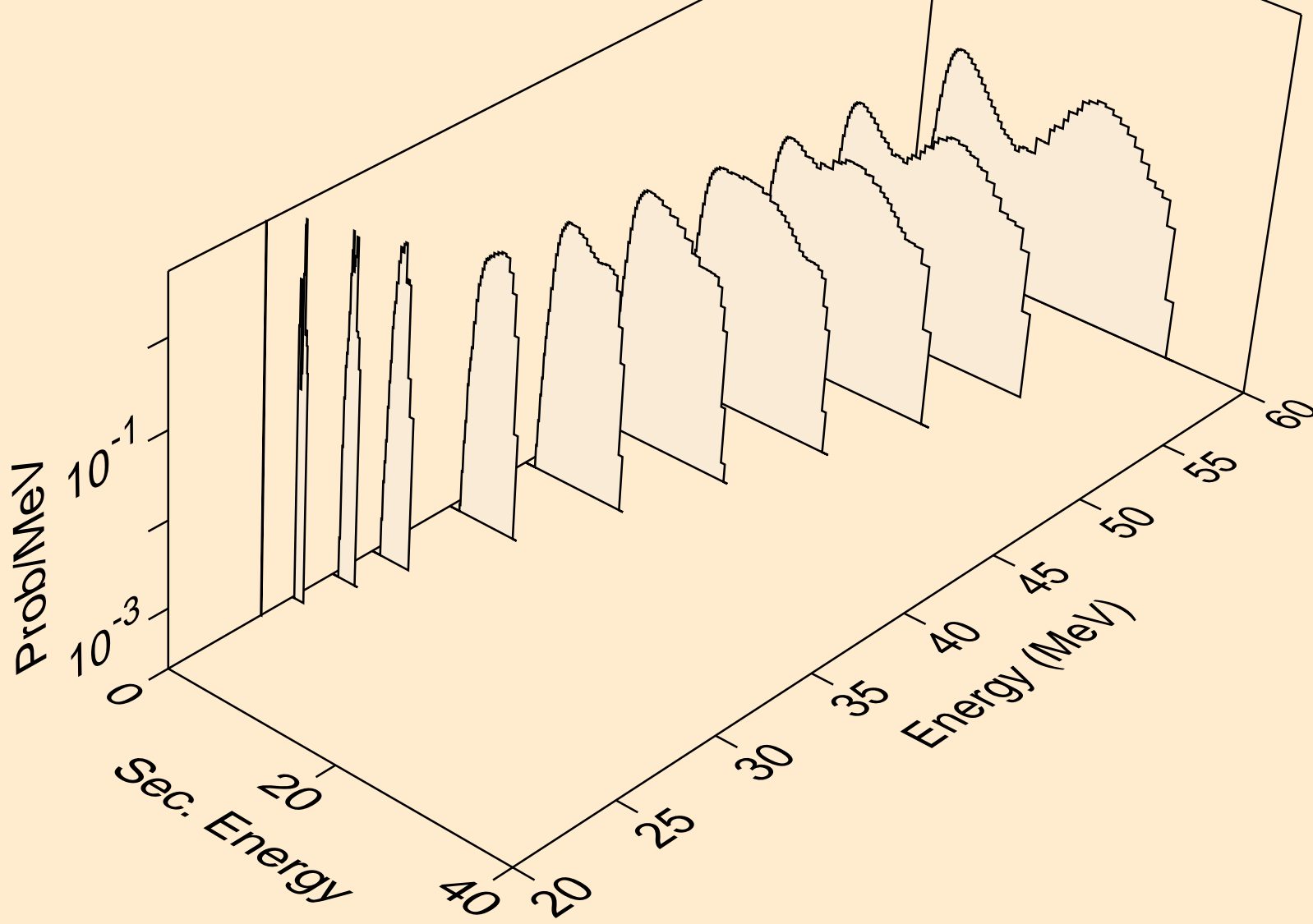

19-K-41 FOR FENDL-3.2 FROM TENDL-2015 BY NJOY2016.60+ O
tritons from (n,npt)

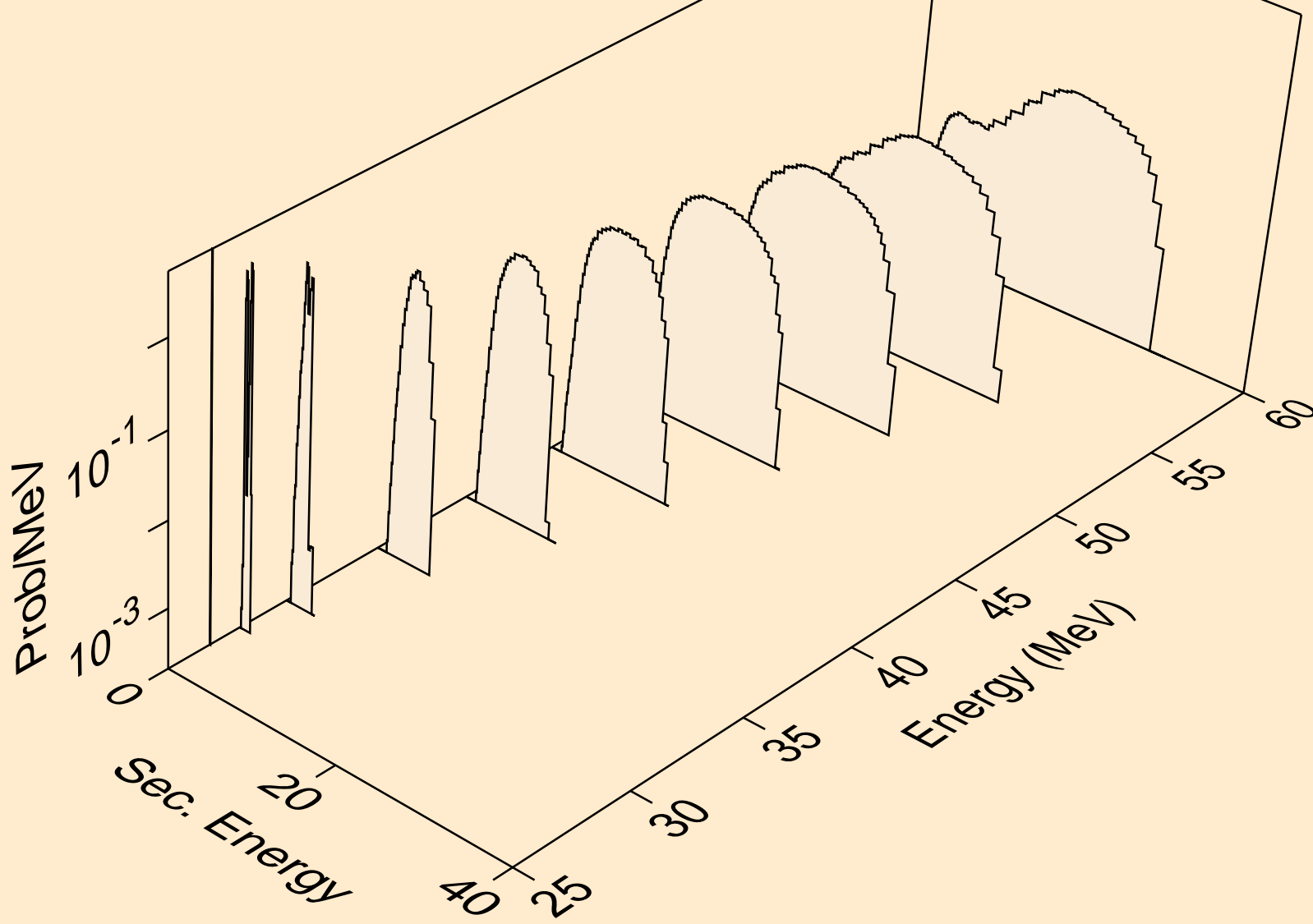

19-K-41 FOR FENDL-3.2 FROM TENDL-2015 BY NJOY2016.60+ O
tritons from (n,ndt)

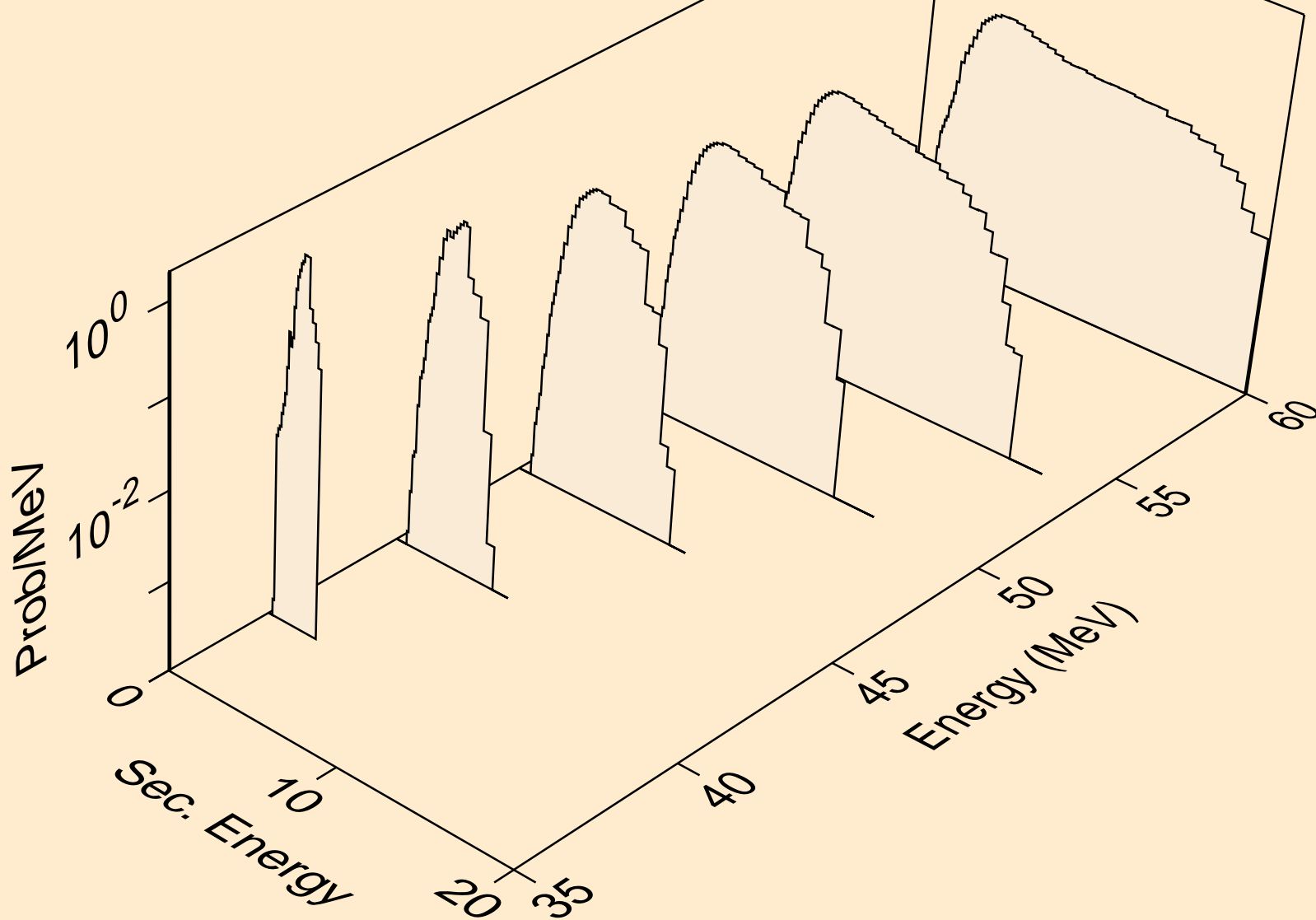

19-K-41 FOR FENDL-3.2 FROM TENDL-2015 BY NJOY2016.60+ O
tritons from (n,nthe3)

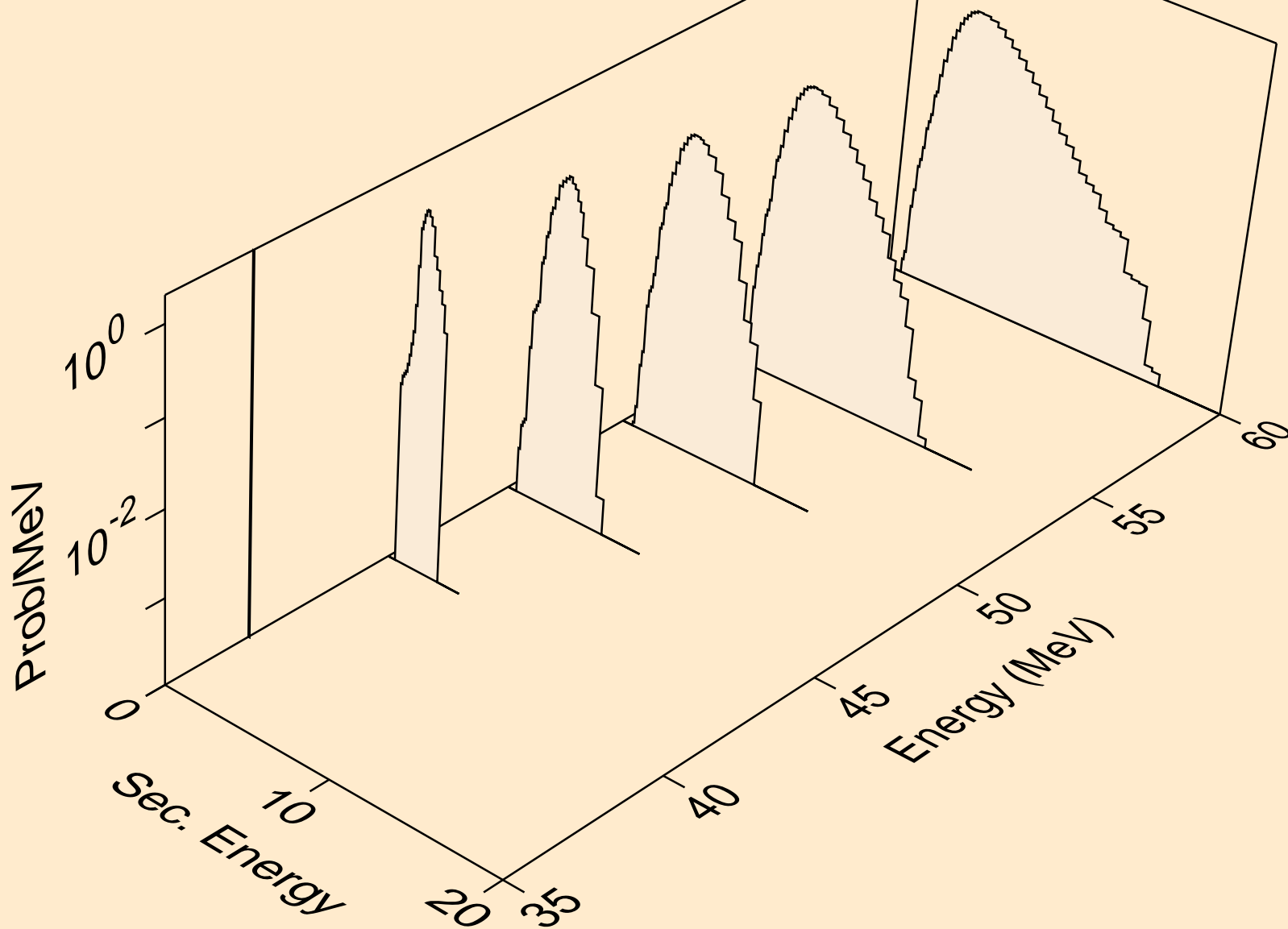

19-K-41 FOR FENDL-3.2 FROM TENDL-2015 BY NJOY2016.60+ O
tritons from (n,nta)

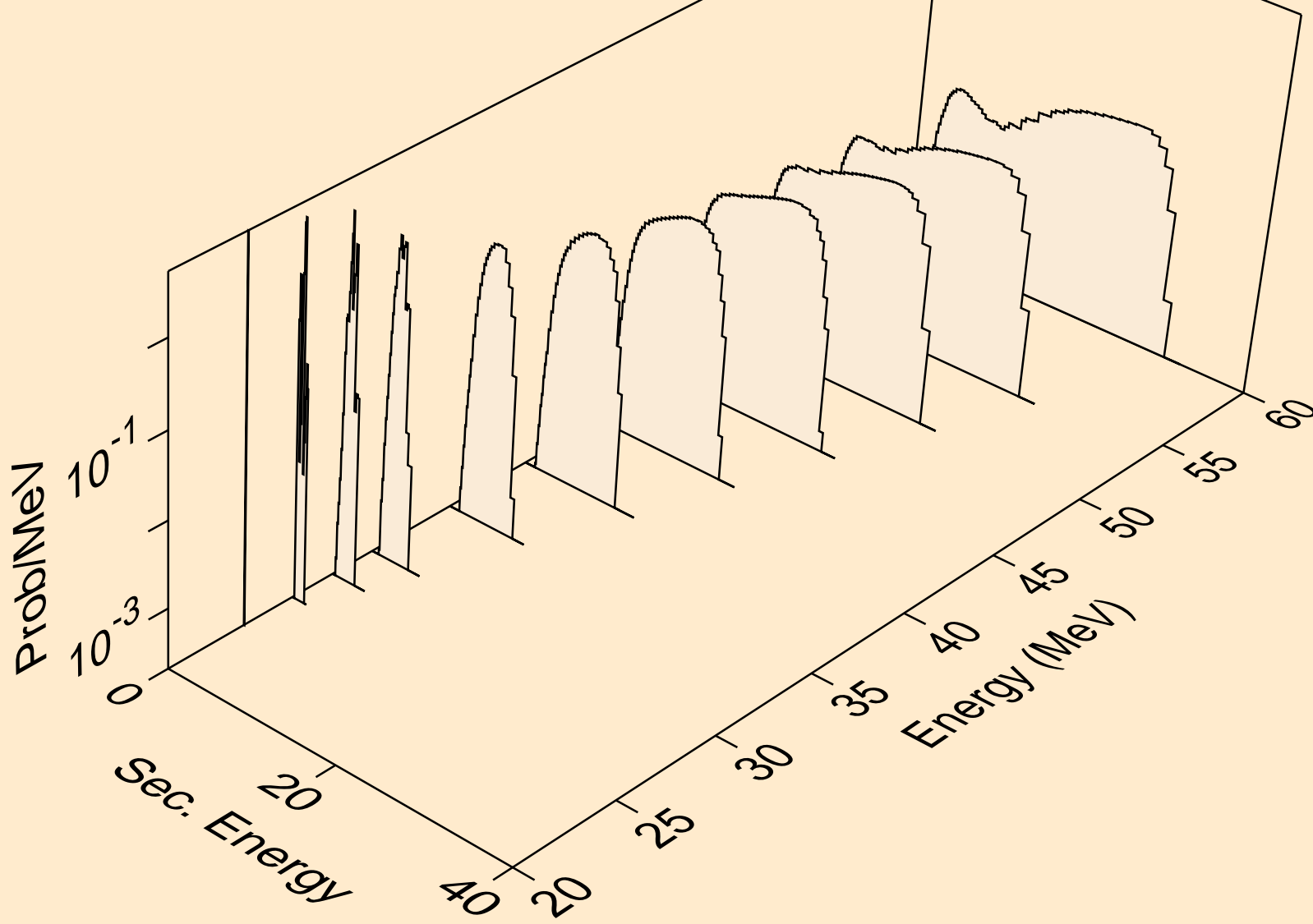

19-K-41 FOR FENDL-3.2 FROM TENDL-2015 BY NJOY2016.60+ O
he3s from (n,x)

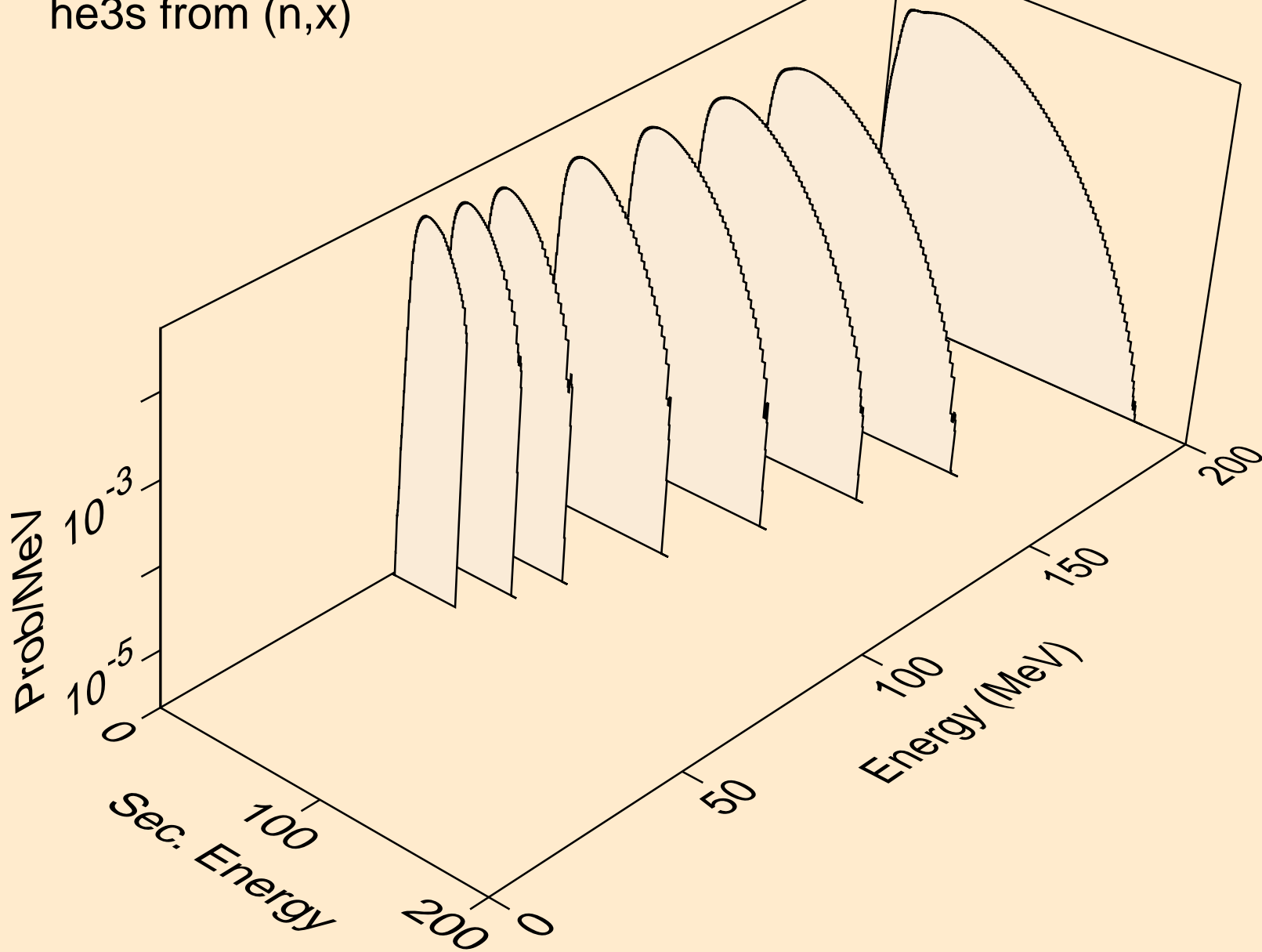

19-K-41 FOR FENDL-3.2 FROM TENDL-2015 BY NJOY2016.60+ O
he3s from (n,n*)he3

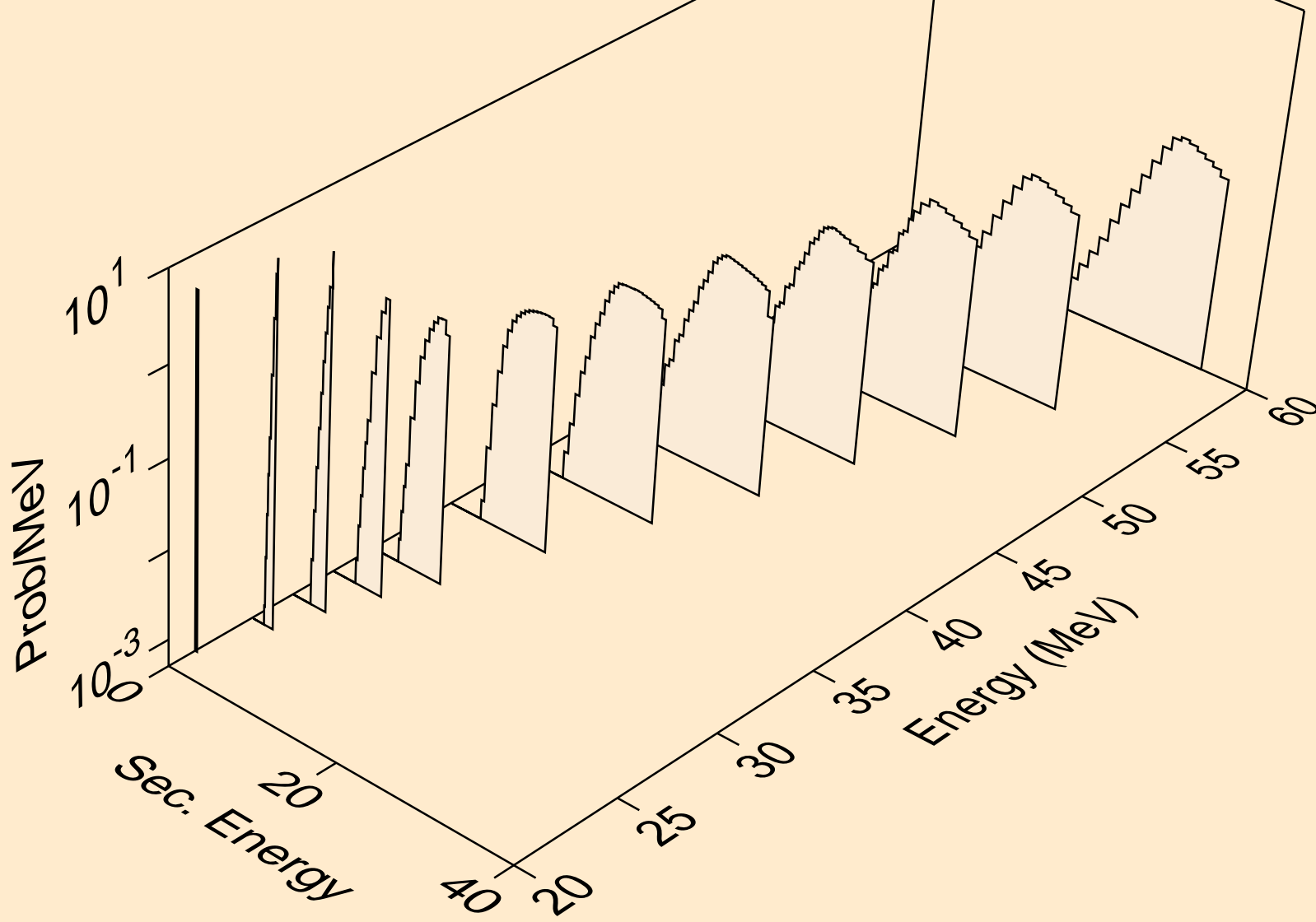

19-K-41 FOR FENDL-3.2 FROM TENDL-2015 BY NJOY2016.60+ O
he3s from (n,he3)

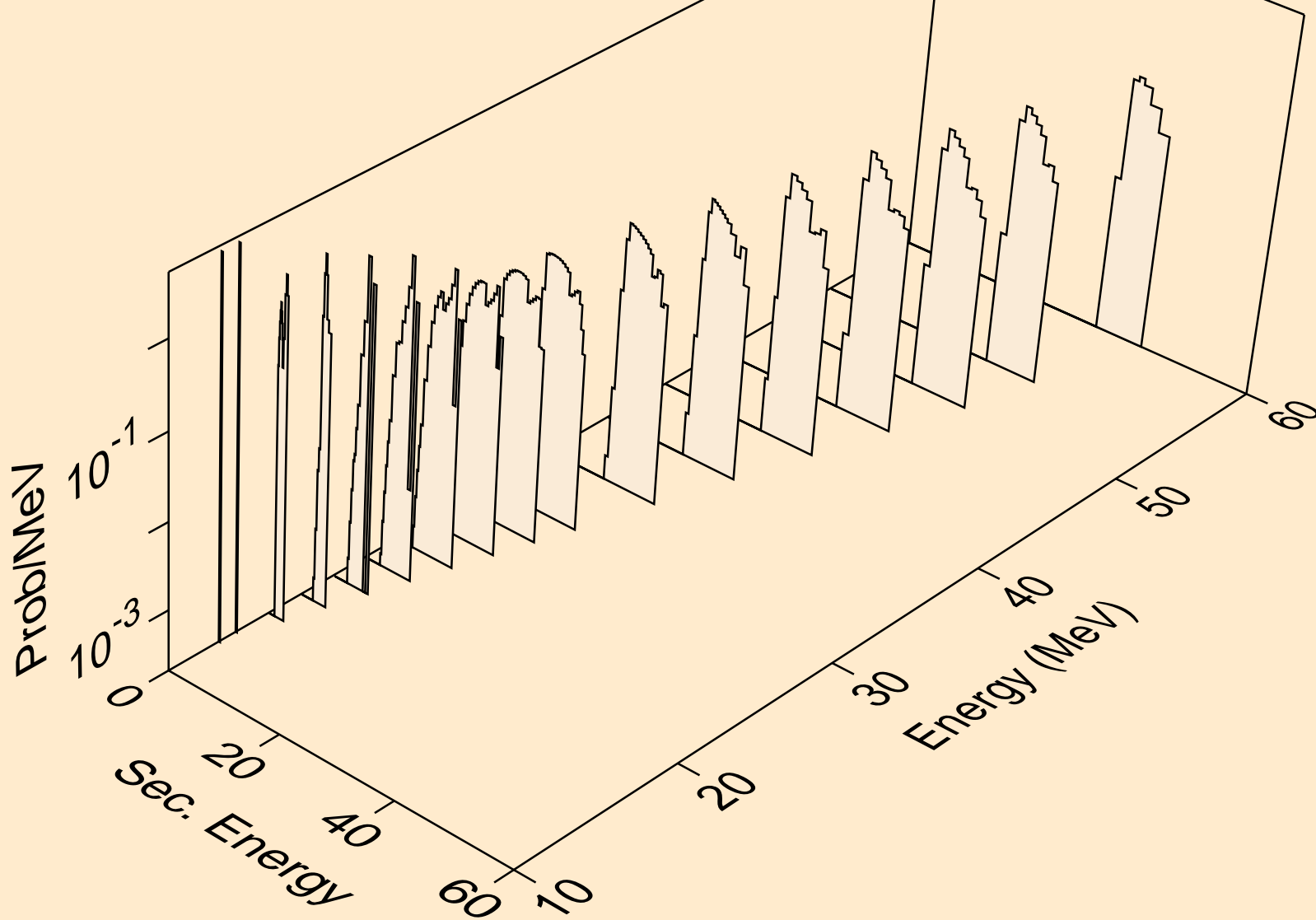

19-K-41 FOR FENDL-3.2 FROM TENDL-2015 BY NJOY2016.60+ O
he3s from (n,2n)he3)

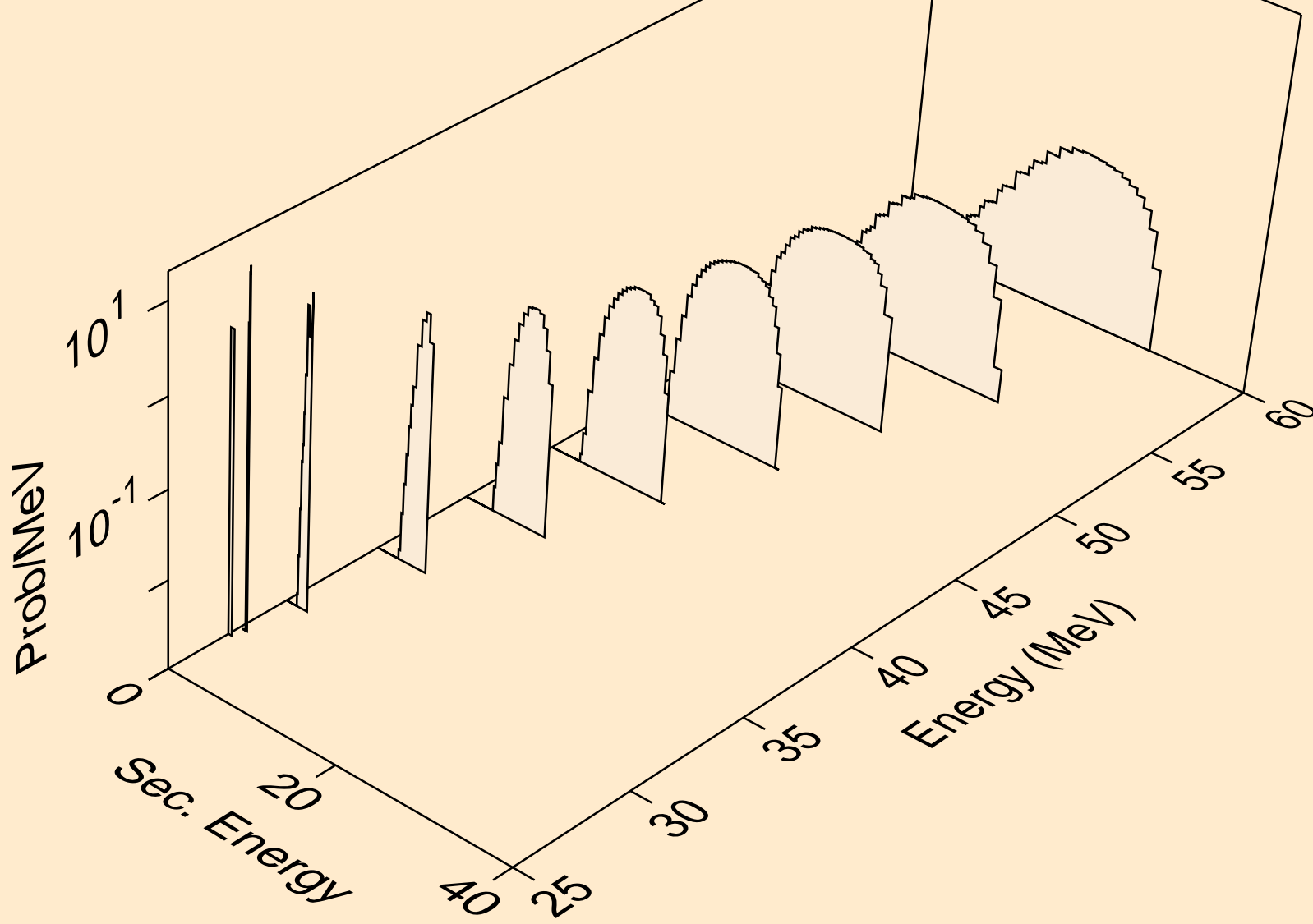

19-K-41 FOR FENDL-3.2 FROM TENDL-2015 BY NJOY2016.60+ O
he3s from (n,3n)he3)

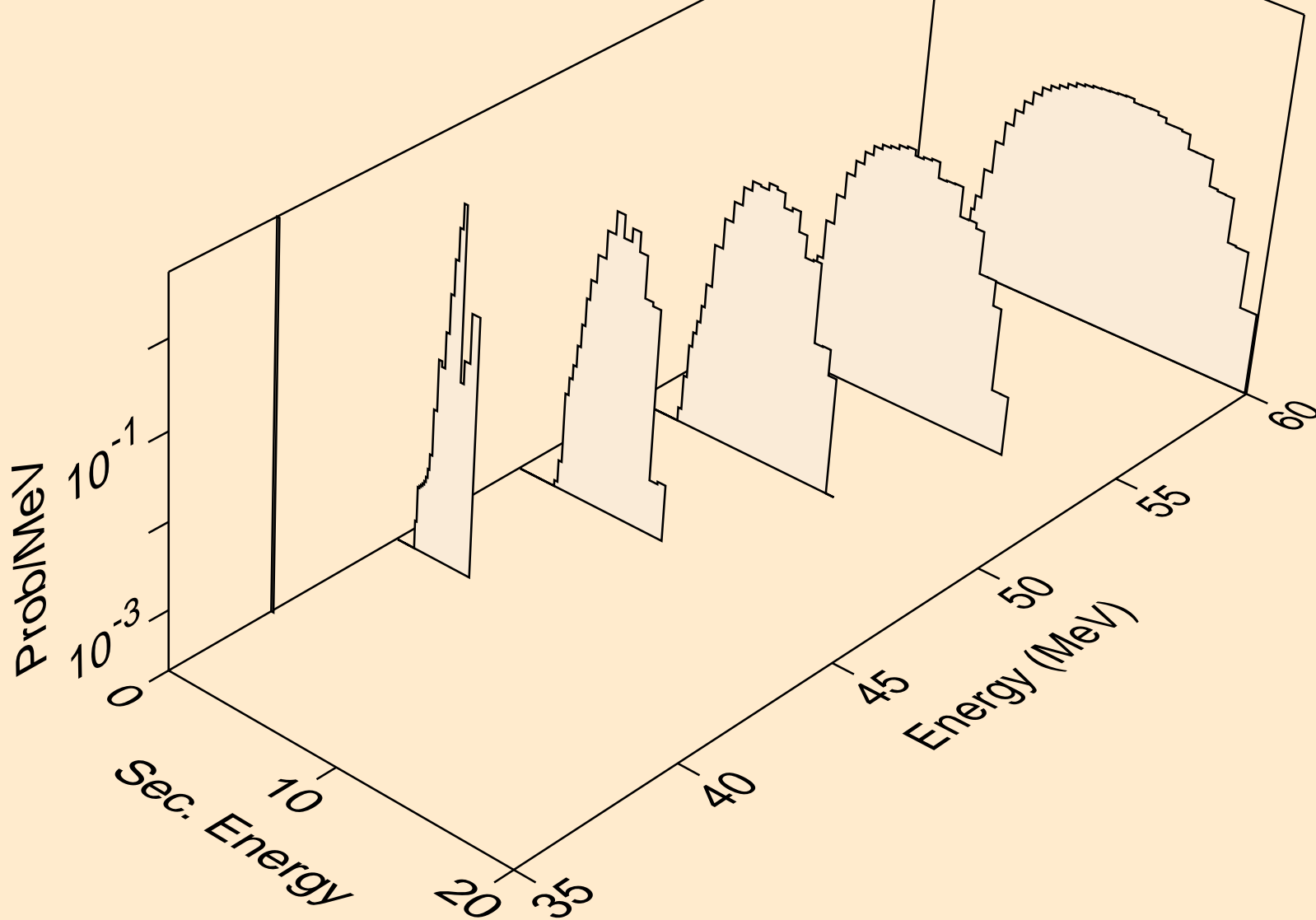

19-K-41 FOR FENDL-3.2 FROM TENDL-2015 BY NJOY2016.60+ O
he3s from (n,4n)he3)

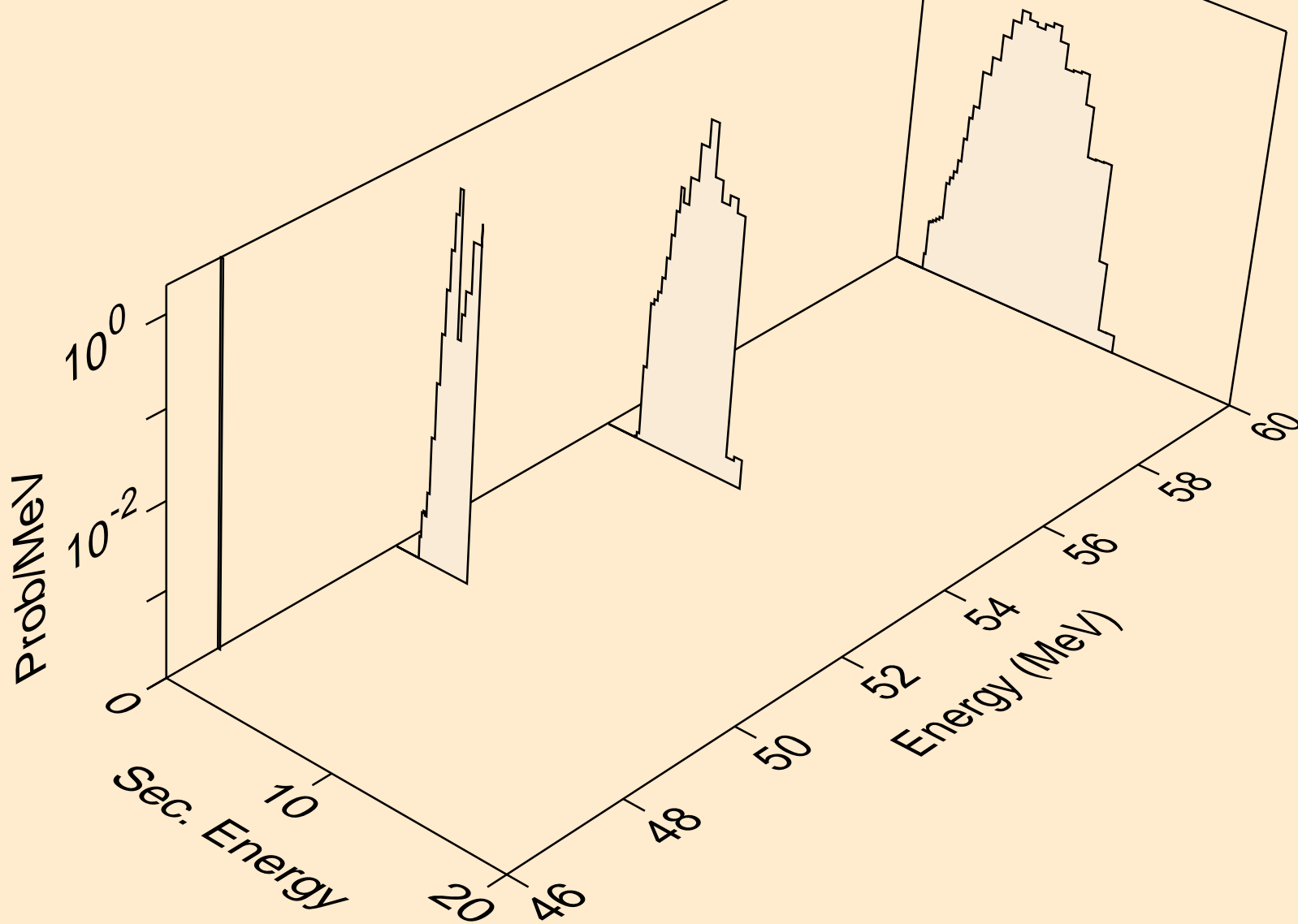

19-K-41 FOR FENDL-3.2 FROM TENDL-2015 BY NJOY2016.60+ O
he3s from (n,nphe3)

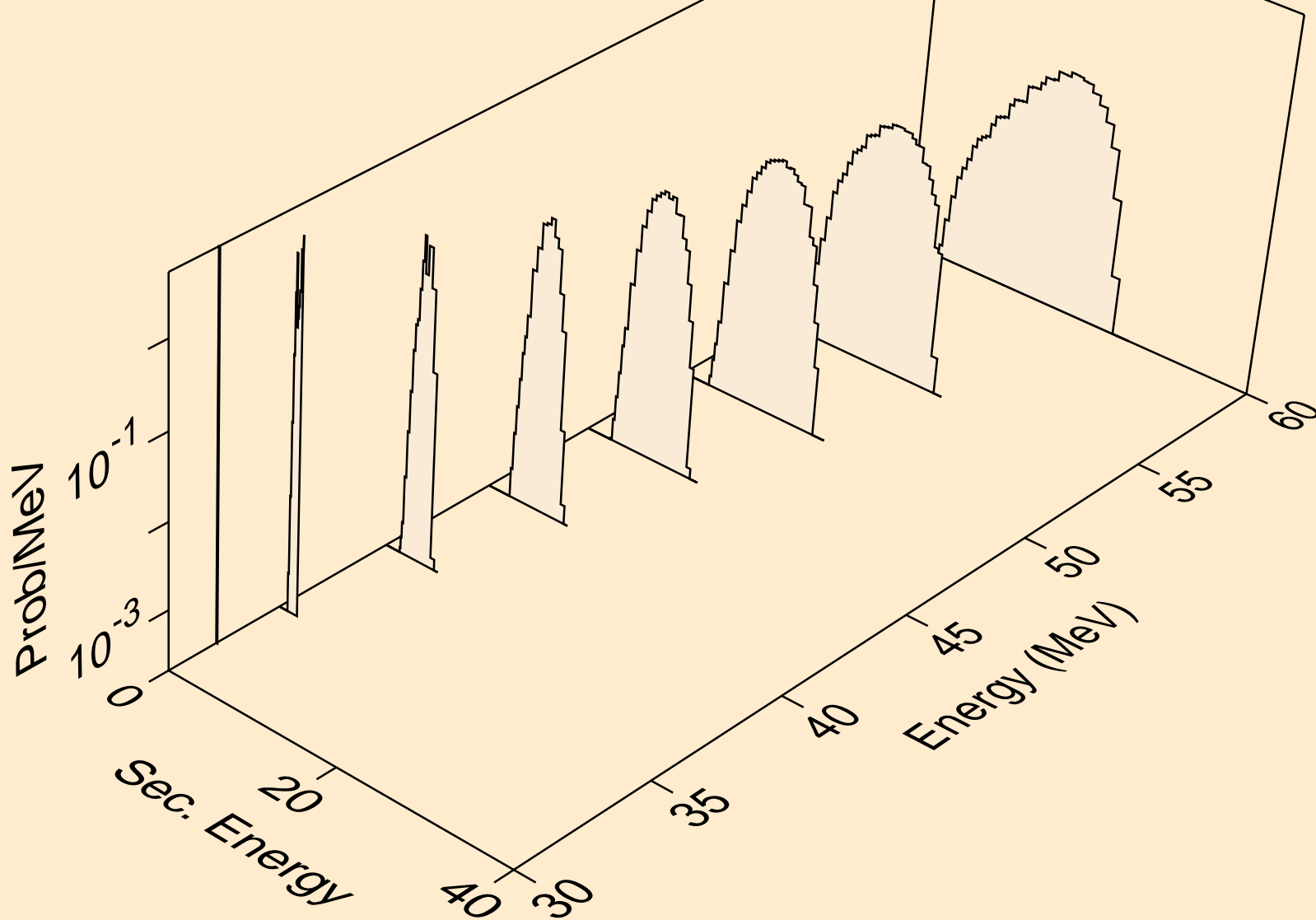

19-K-41 FOR FENDL-3.2 FROM TENDL-2015 BY NJOY2016.60+ O
he3s from (n,ndhe3)

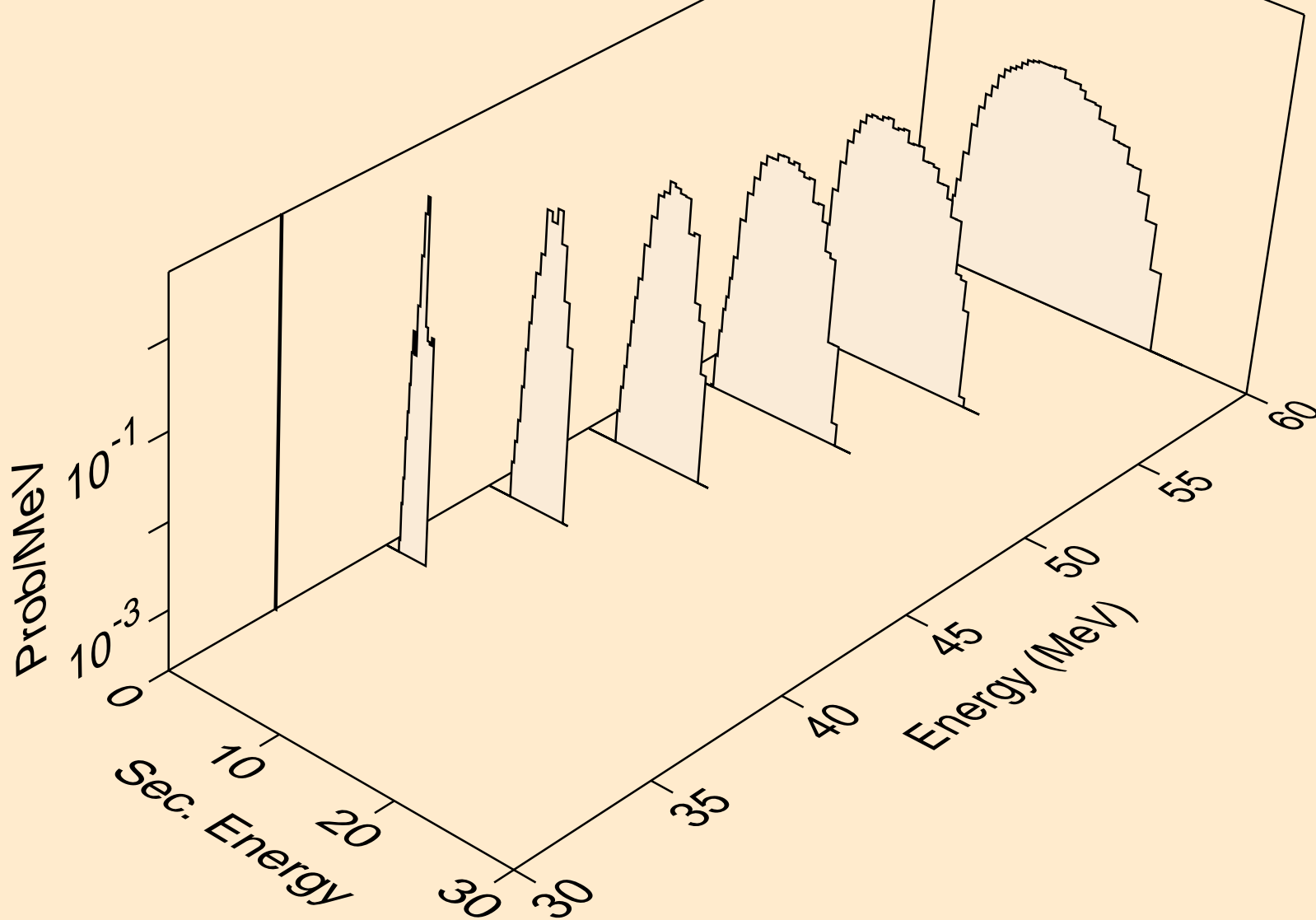

19-K-41 FOR FENDL-3.2 FROM TENDL-2015 BY NJOY2016.60+ O
he3s from (n,nthe3)

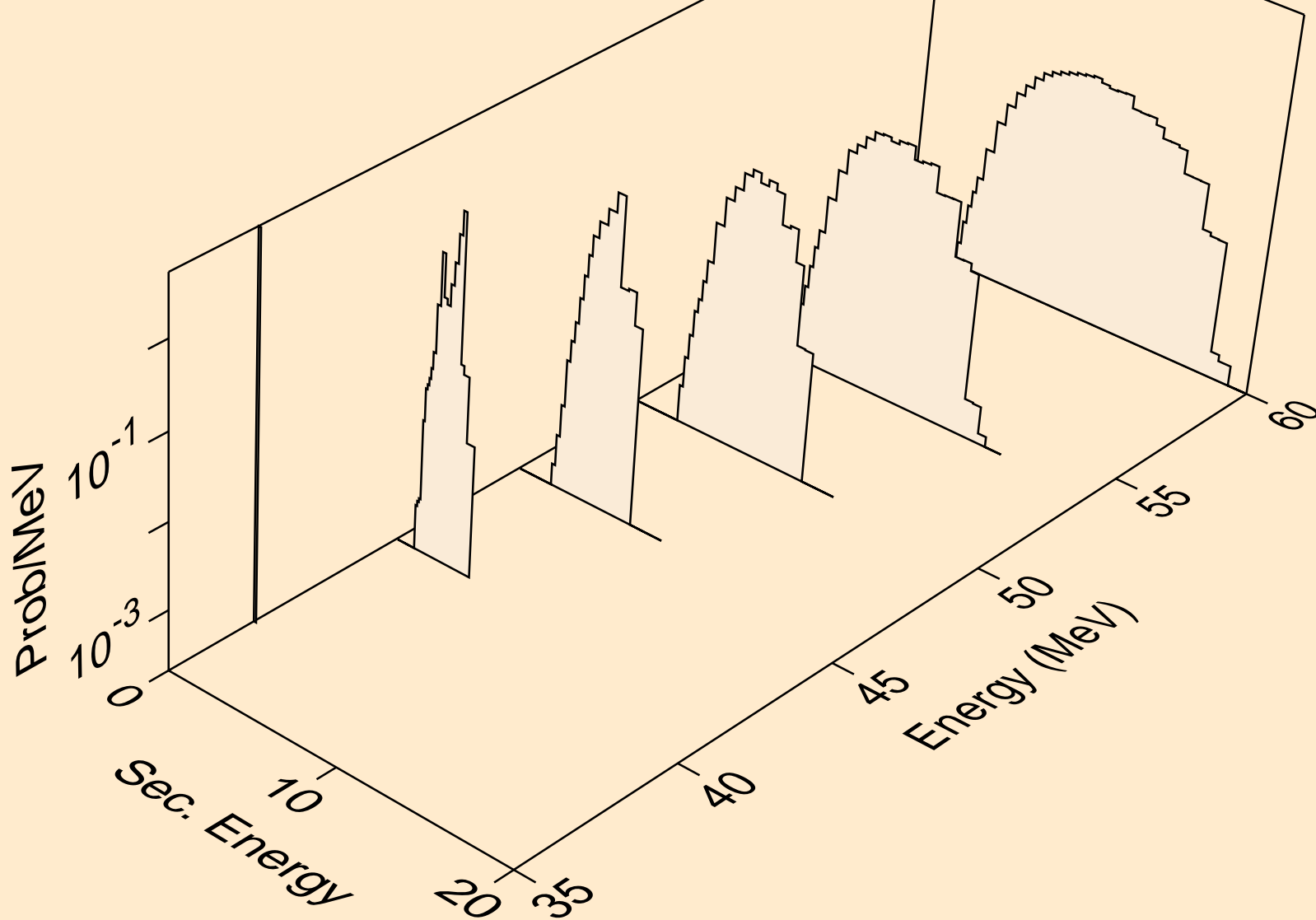

19-K-41 FOR FENDL-3.2 FROM TENDL-2015 BY NJOY2016.60+ O
he3s from (n,phe3)

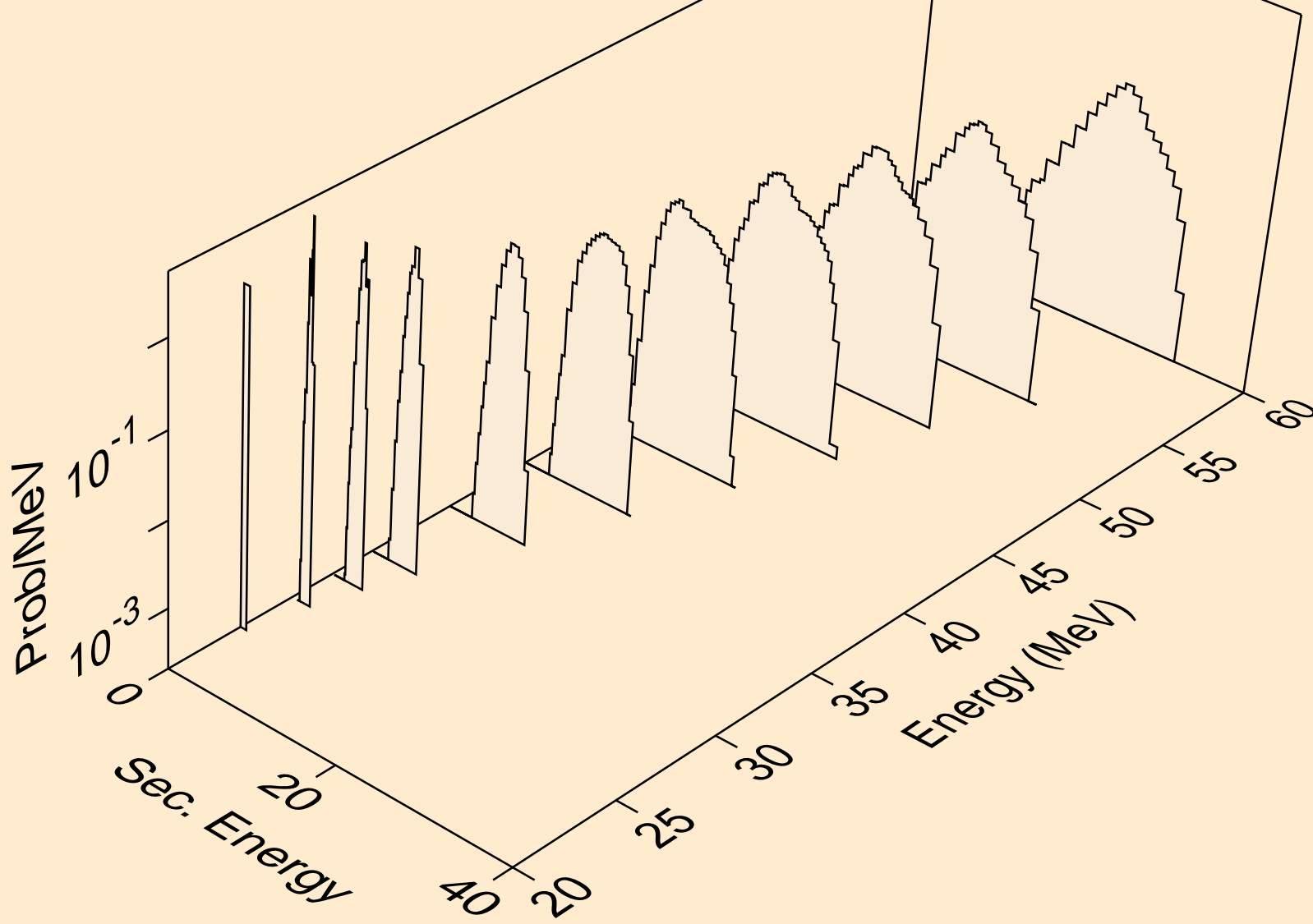

19-K-41 FOR FENDL-3.2 FROM TENDL-2015 BY NJOY2016.60+ O
he3s from (n,d)he3)

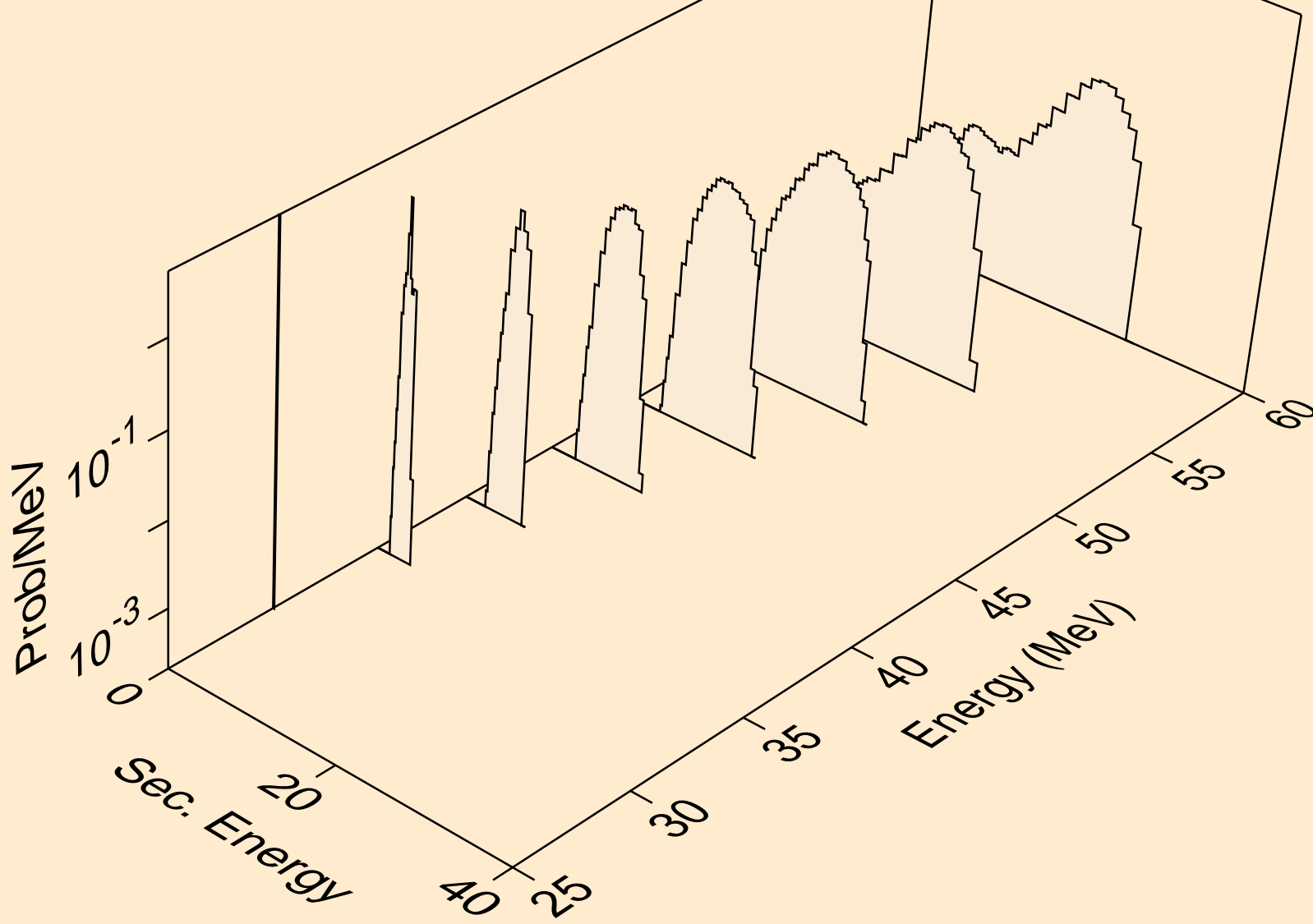

19-K-41 FOR FENDL-3.2 FROM TENDL-2015 BY NJOY2016.60+ O
he3s from (n,he3a)

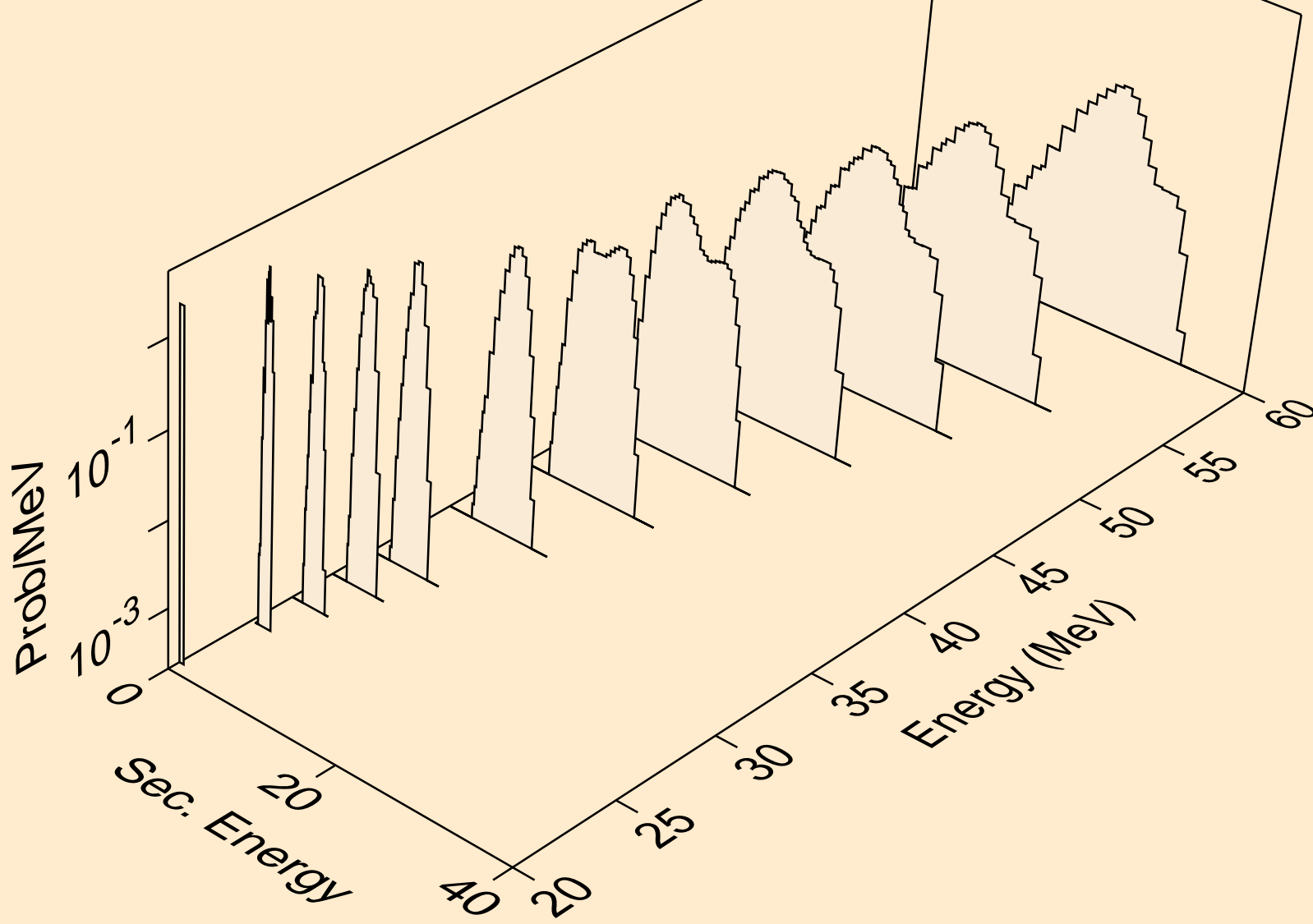

19-K-41 FOR FENDL-3.2 FROM TENDL-2015 BY NJOY2016.60+ O
alphas from (n,x)

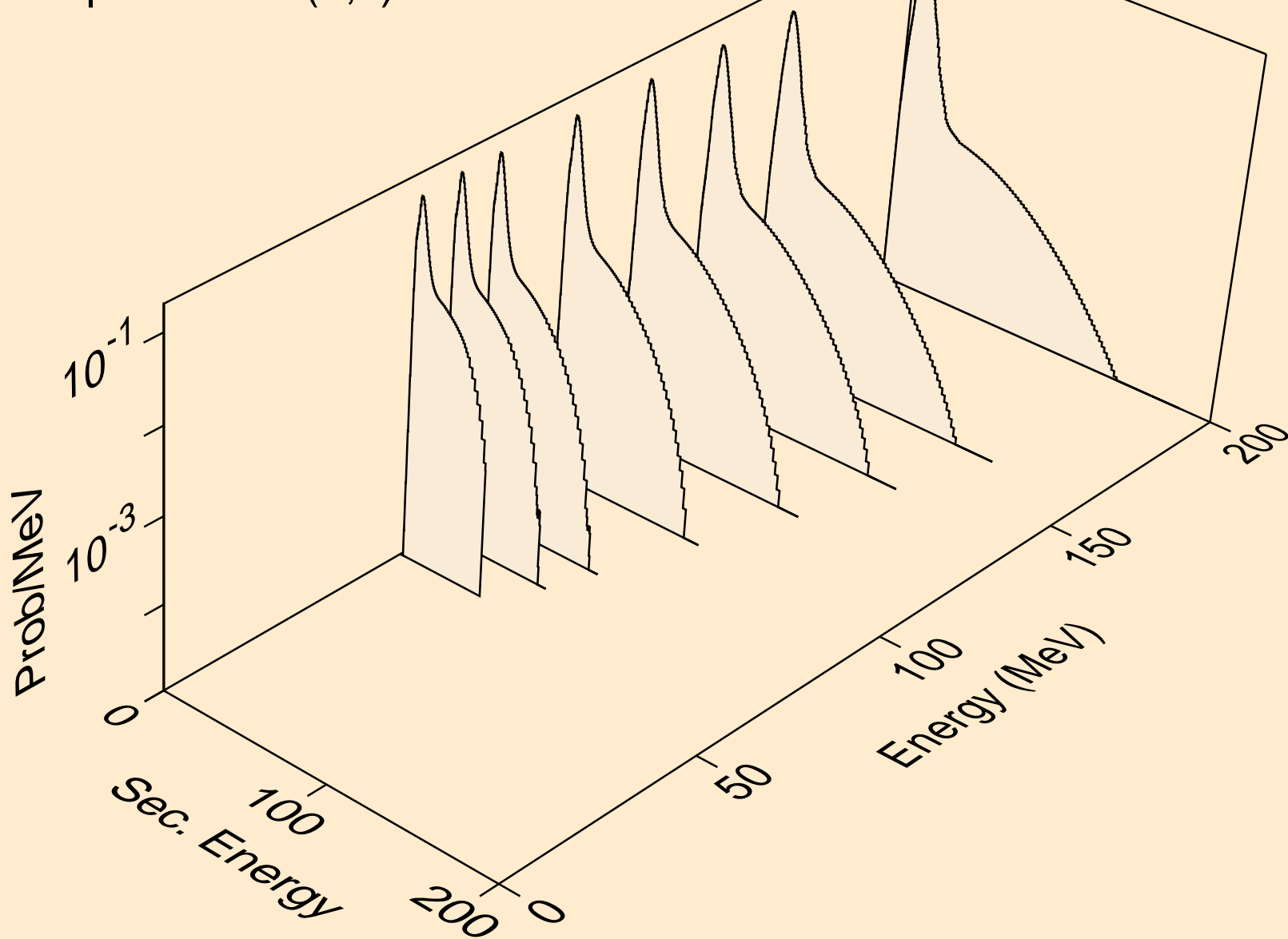

19-K-41 FOR FENDL-3.2 FROM TENDL-2015 BY NJOY2016.60+ O
alphas from (n,n*)a

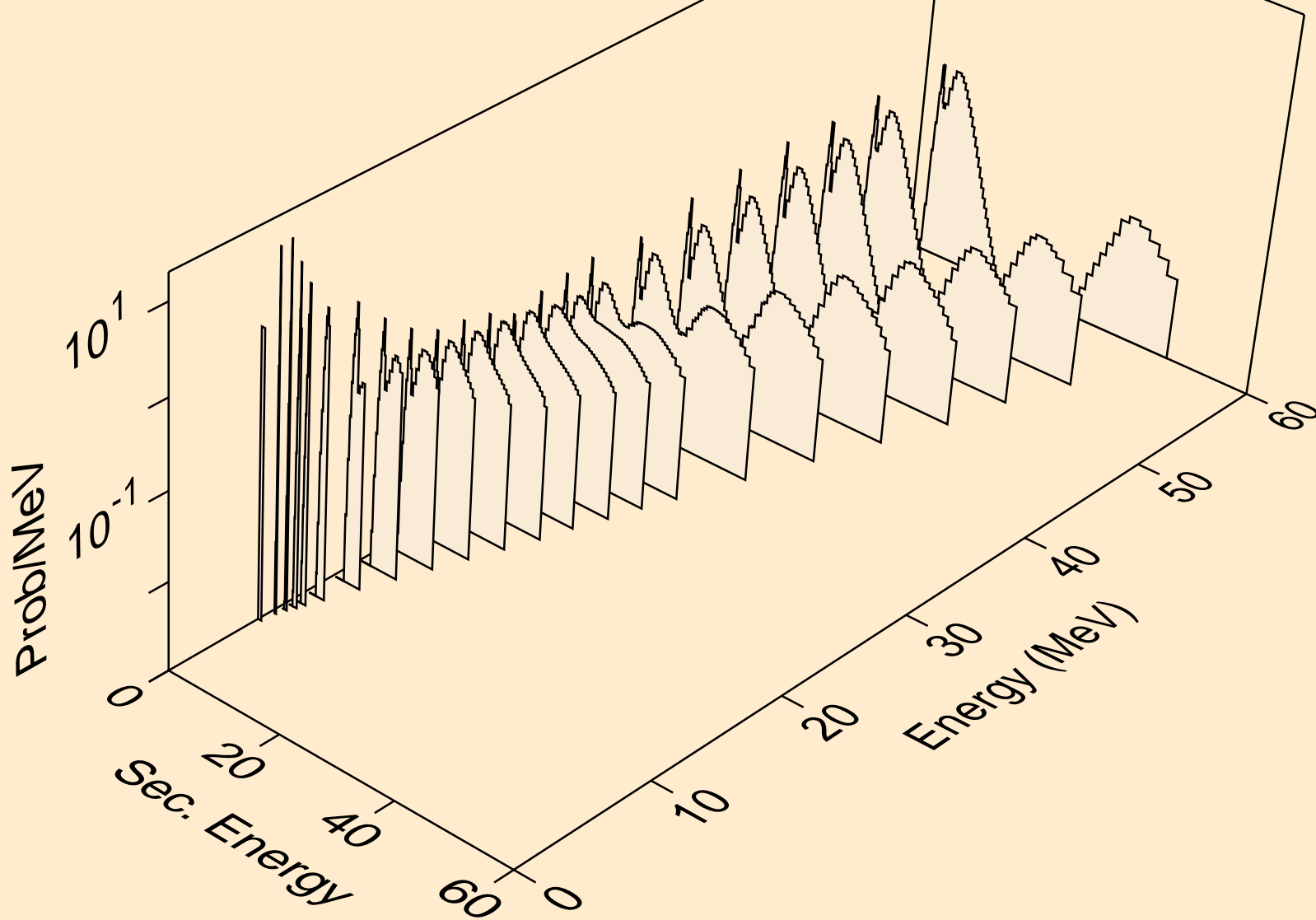

19-K-41 FOR FENDL-3.2 FROM TENDL-2015 BY NJOY2016.60+ O
alphas from (n,n*)3a

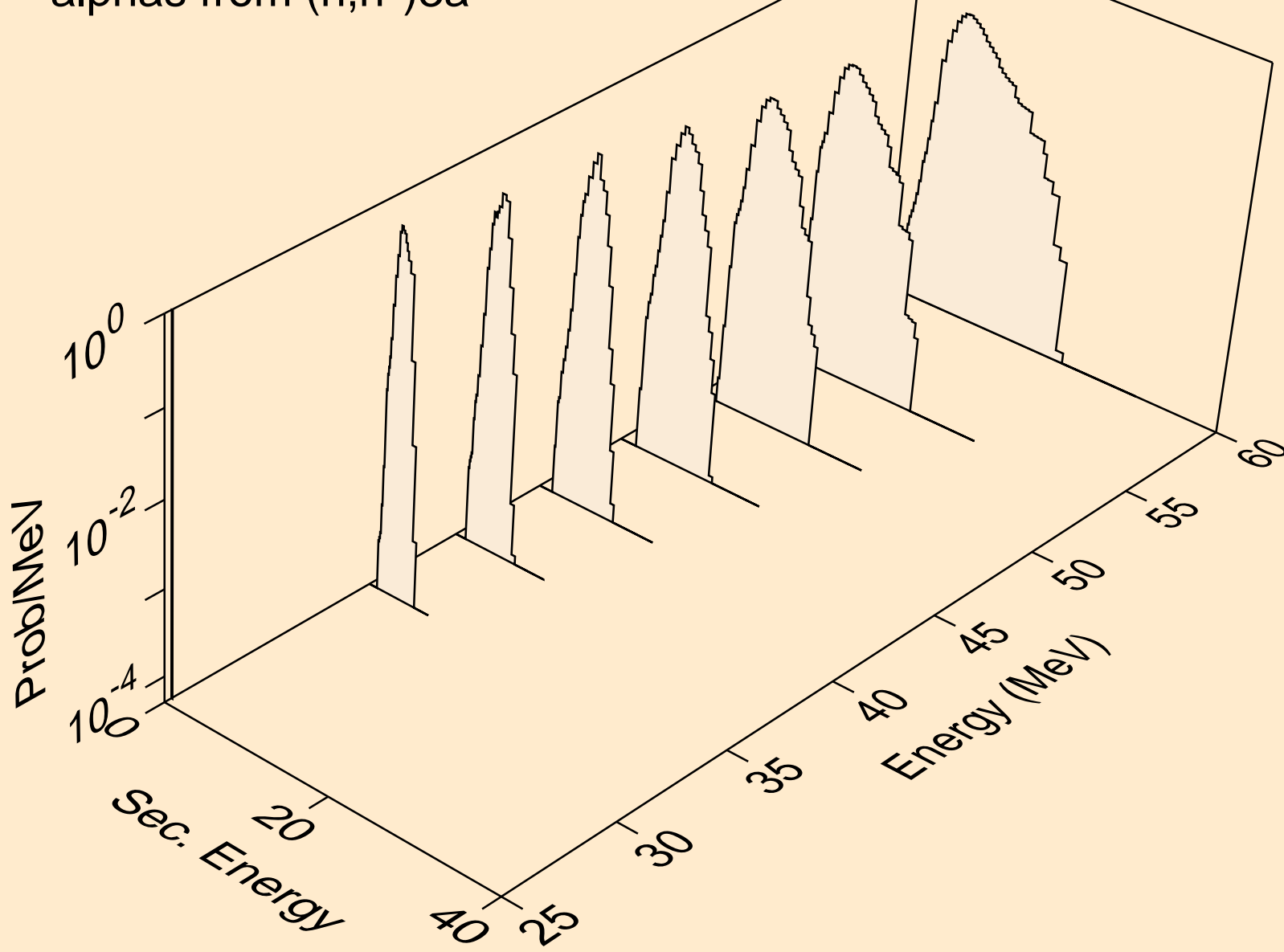

19-K-41 FOR FENDL-3.2 FROM TENDL-2015 BY NJOY2016.60+ O
alphas from (n,2n)a

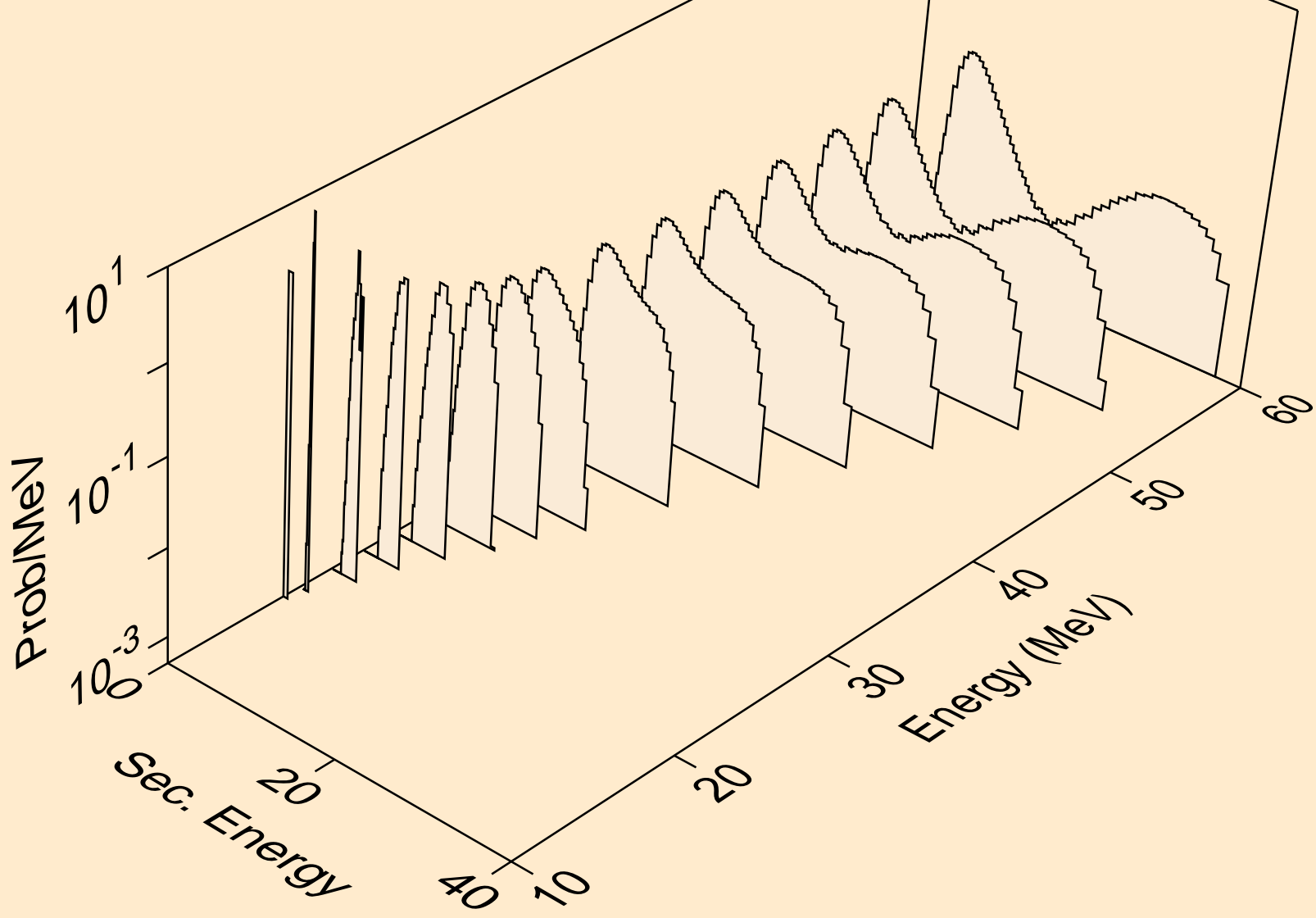

19-K-41 FOR FENDL-3.2 FROM TENDL-2015 BY NJOY2016.60+ O
alphas from (n,3n)a

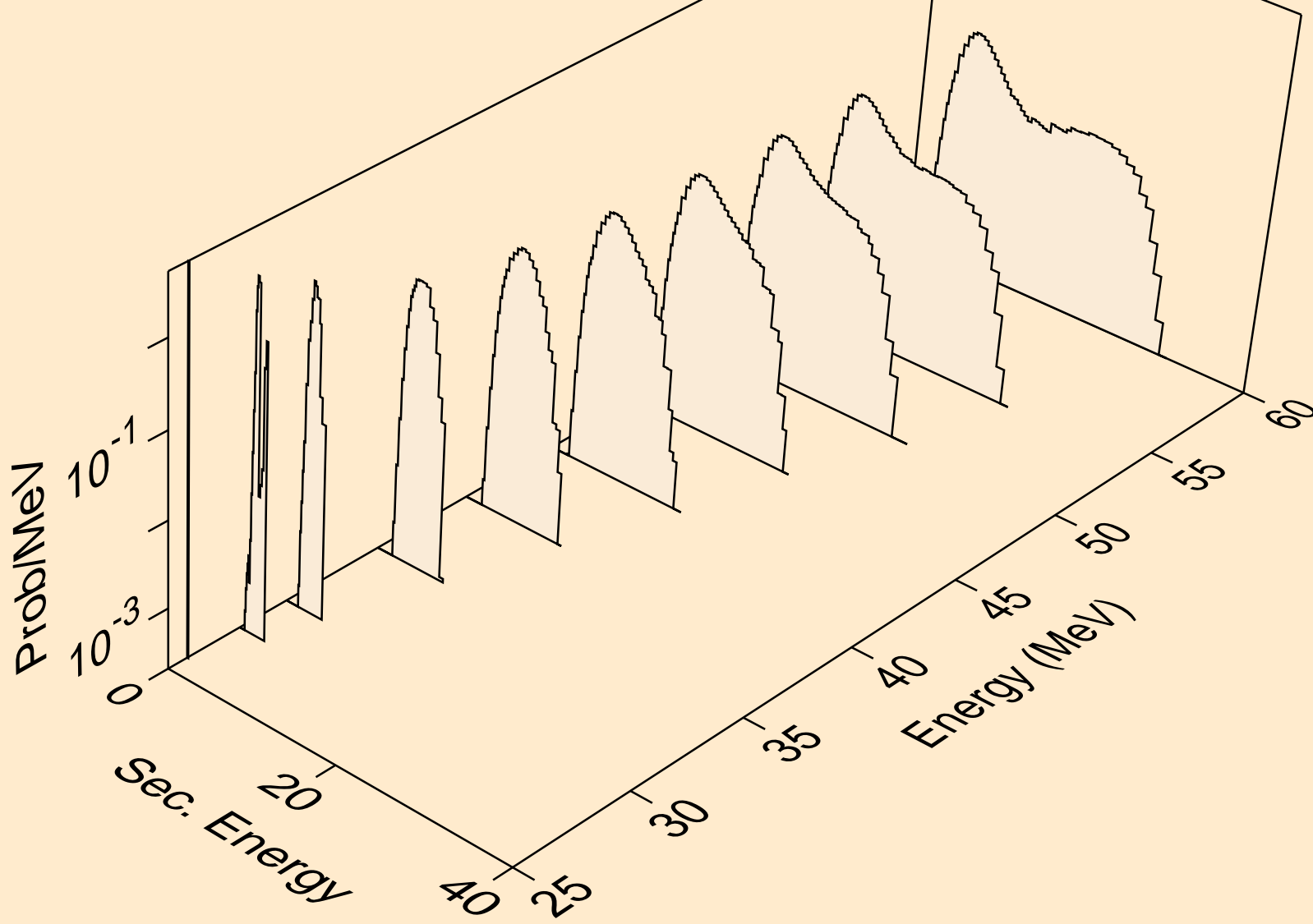

19-K-41 FOR FENDL-3.2 FROM TENDL-2015 BY NJOY2016.60+ O
alphas from (n,n*)2a

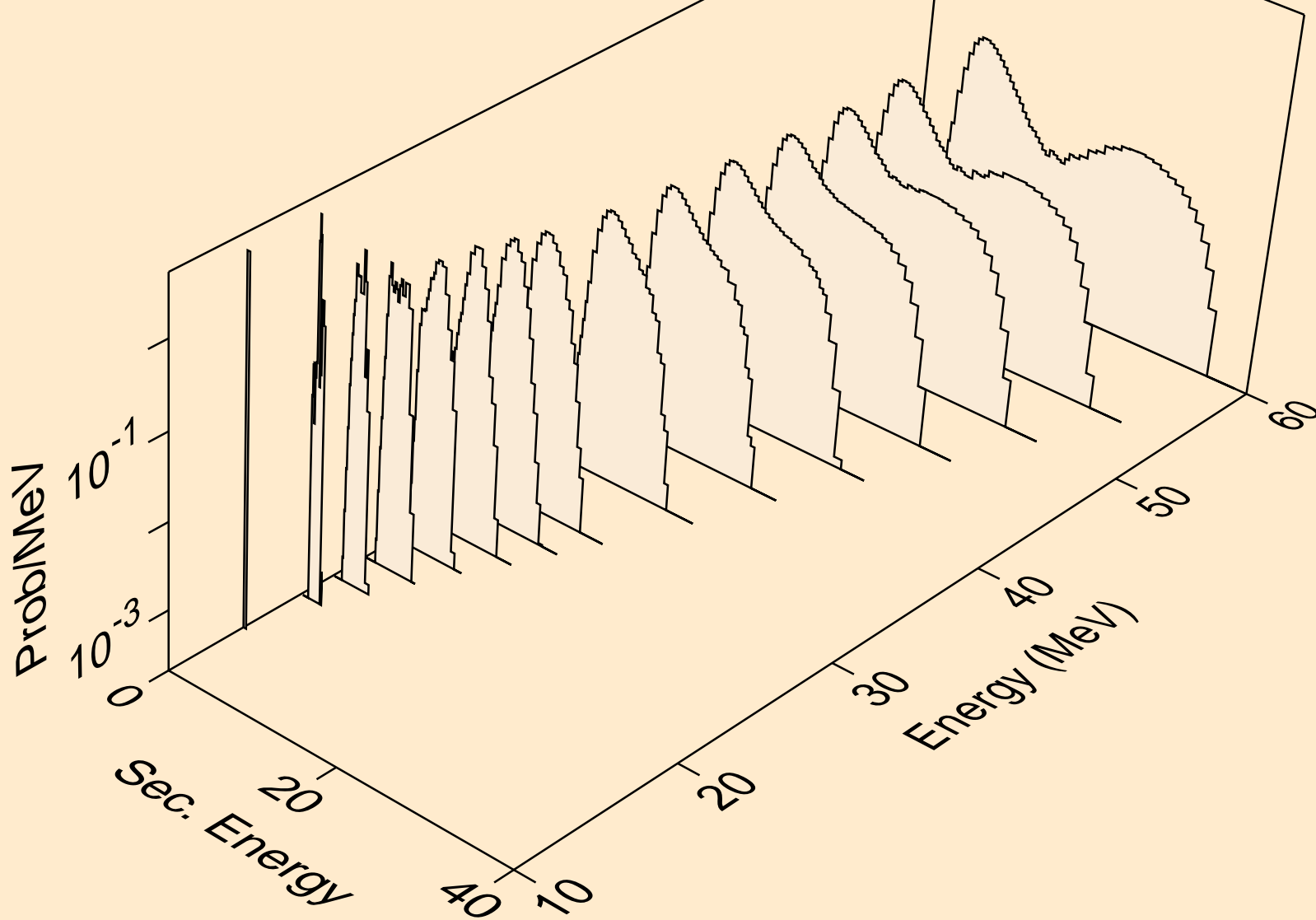

19-K-41 FOR FENDL-3.2 FROM TENDL-2015 BY NJOY2016.60+ O
alphas from (n,2n)2a

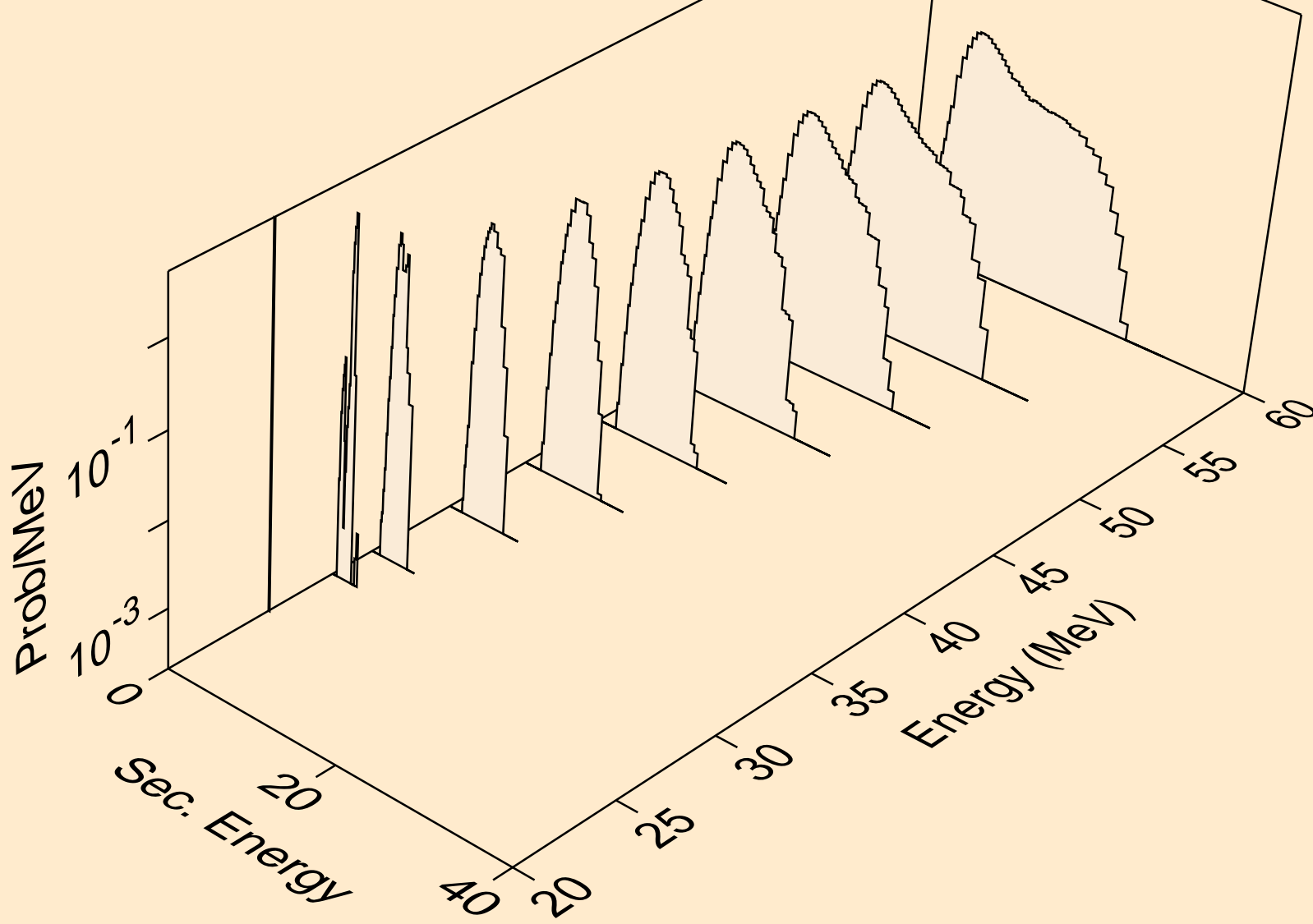

19-K-41 FOR FENDL-3.2 FROM TENDL-2015 BY NJOY2016.60+ O
alphas from (n,n*)d2a

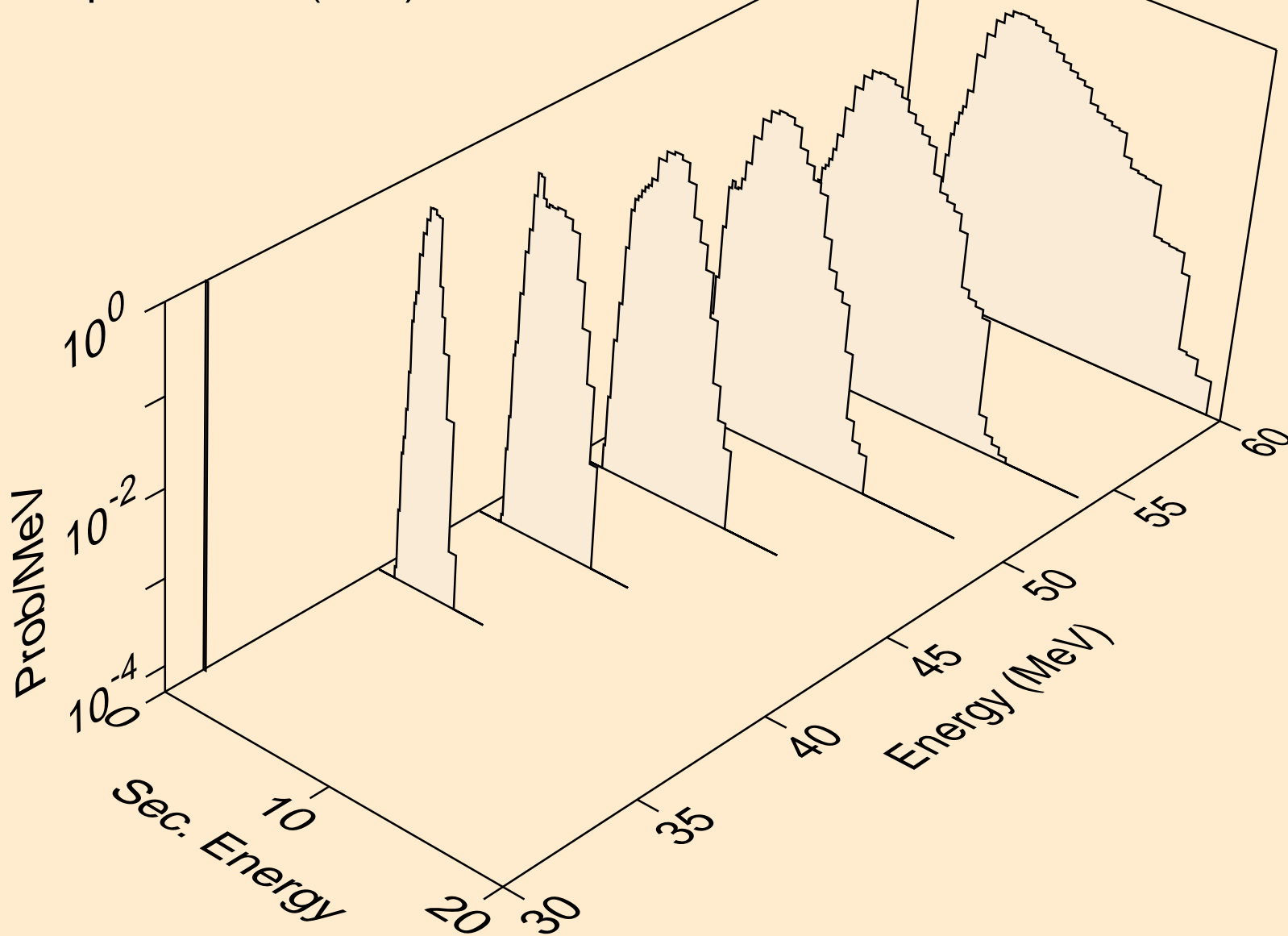

19-K-41 FOR FENDL-3.2 FROM TENDL-2015 BY NJOY2016.60+ O
alphas from (n,n*)t2a

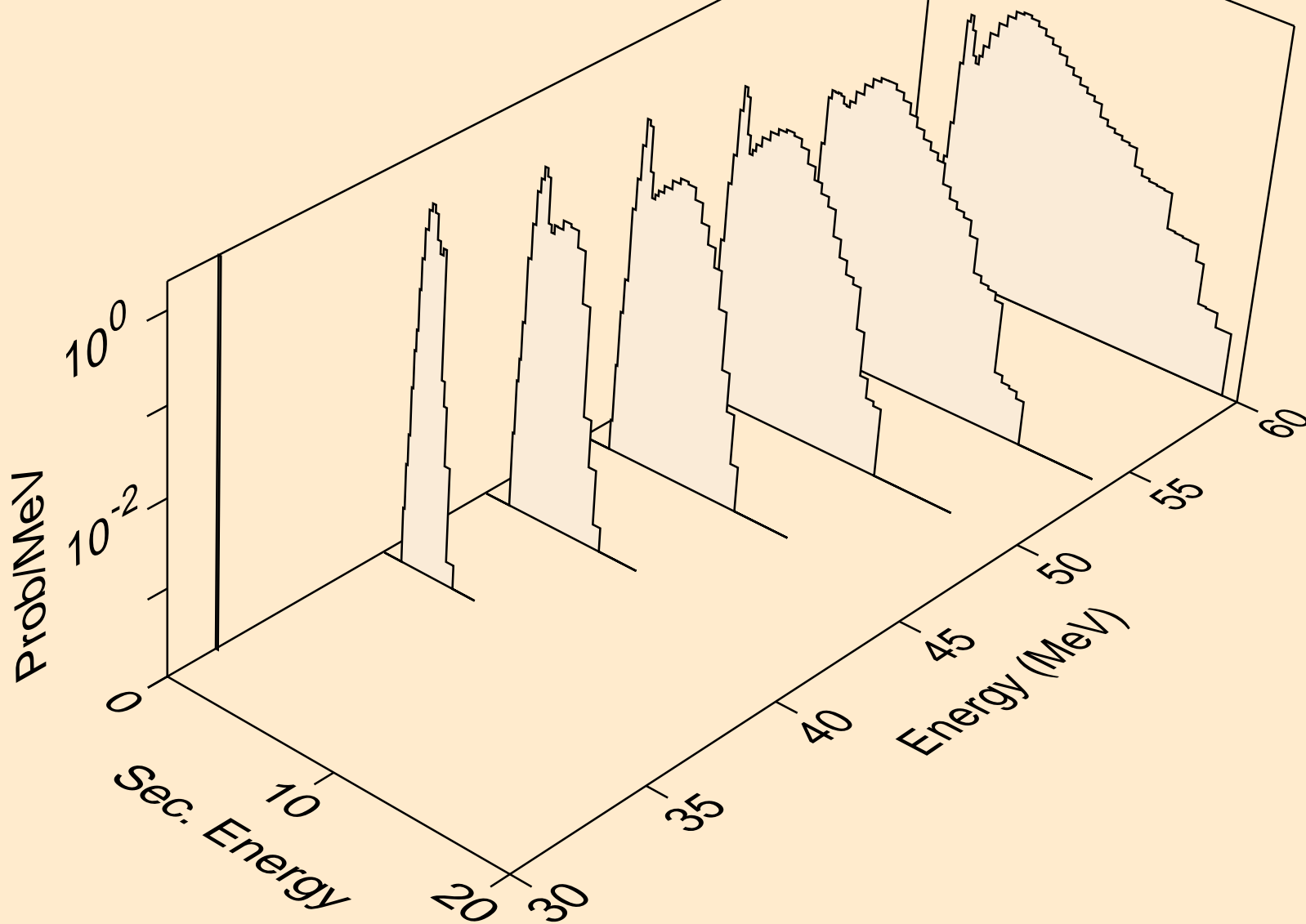

19-K-41 FOR FENDL-3.2 FROM TENDL-2015 BY NJOY2016.60+ O
alphas from (n,npa)

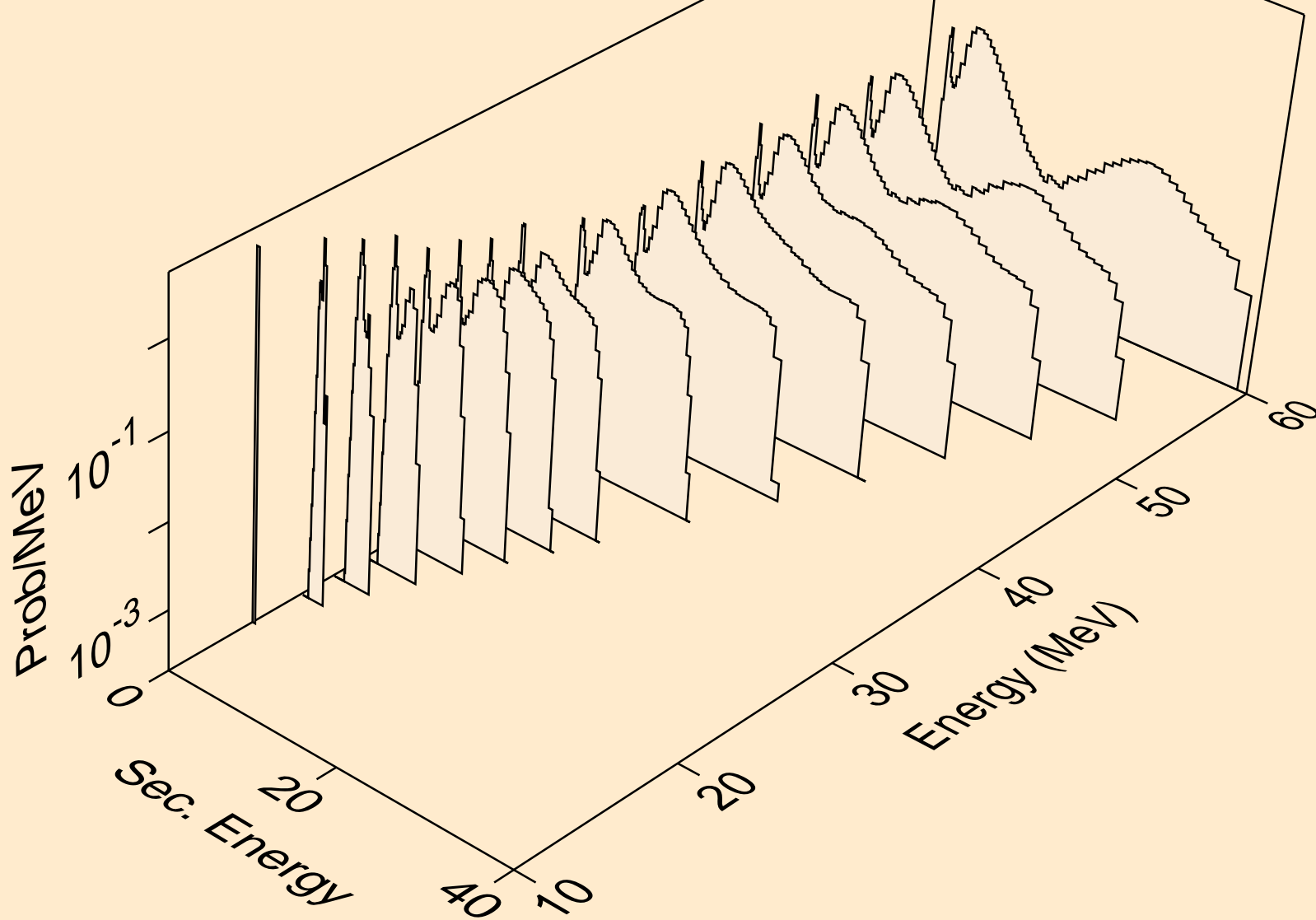

19-K-41 FOR FENDL-3.2 FROM TENDL-2015 BY NJOY2016.60+ O
alphas from (n,a)

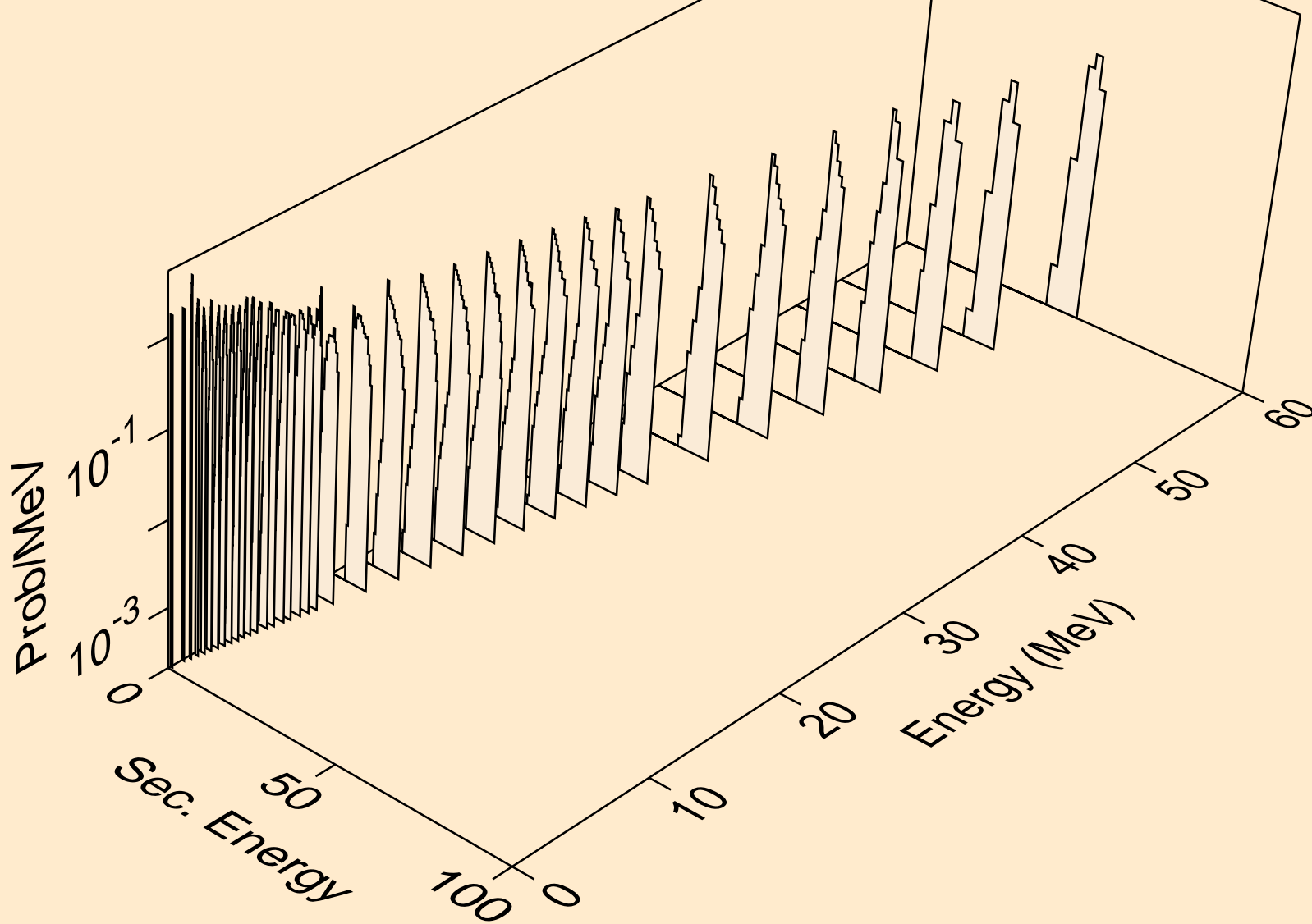

19-K-41 FOR FENDL-3.2 FROM TENDL-2015 BY NJOY2016.60+ O
alphas from (n,2a)

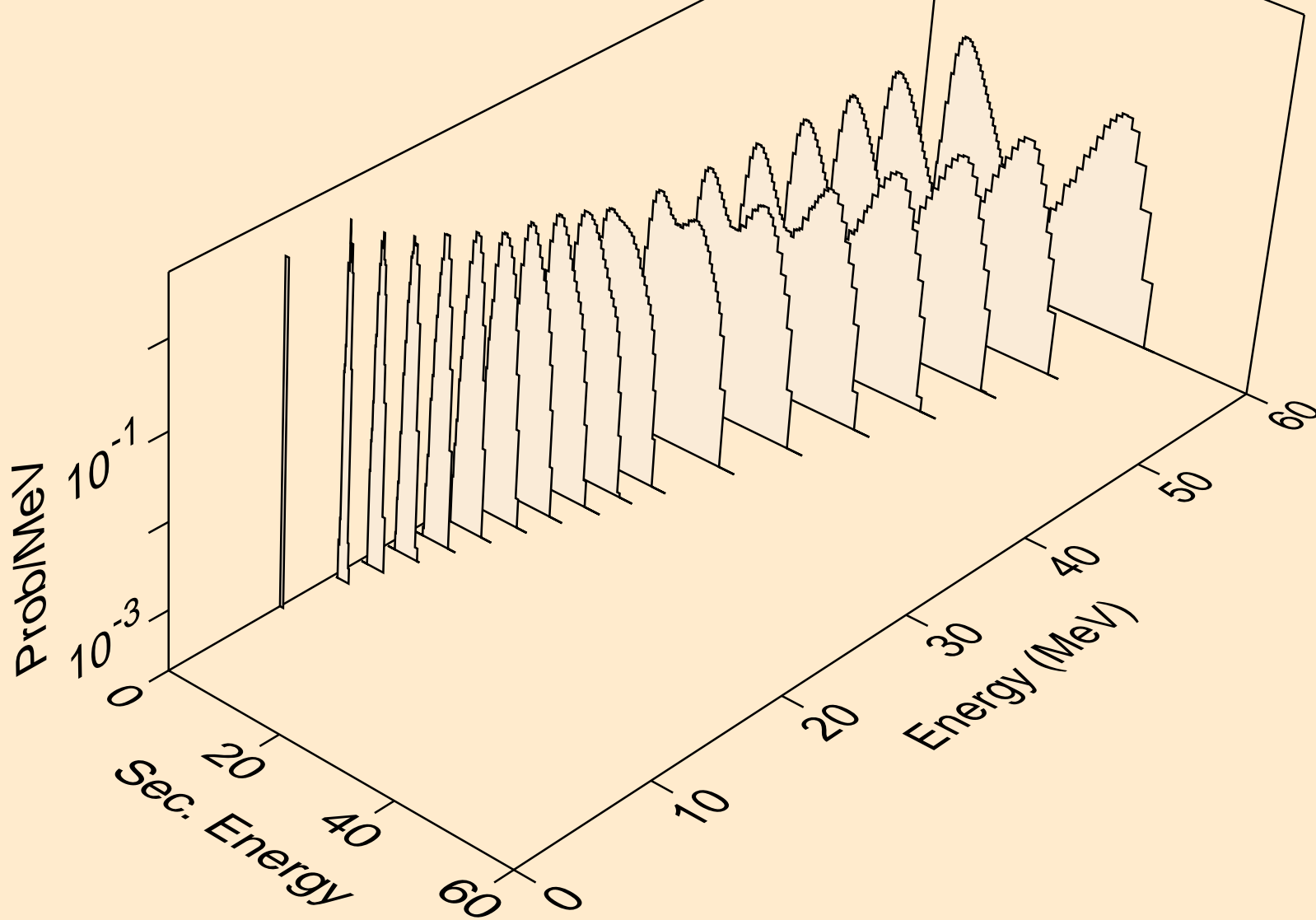

19-K-41 FOR FENDL-3.2 FROM TENDL-2015 BY NJOY2016.60+ O
alphas from (n,3a)

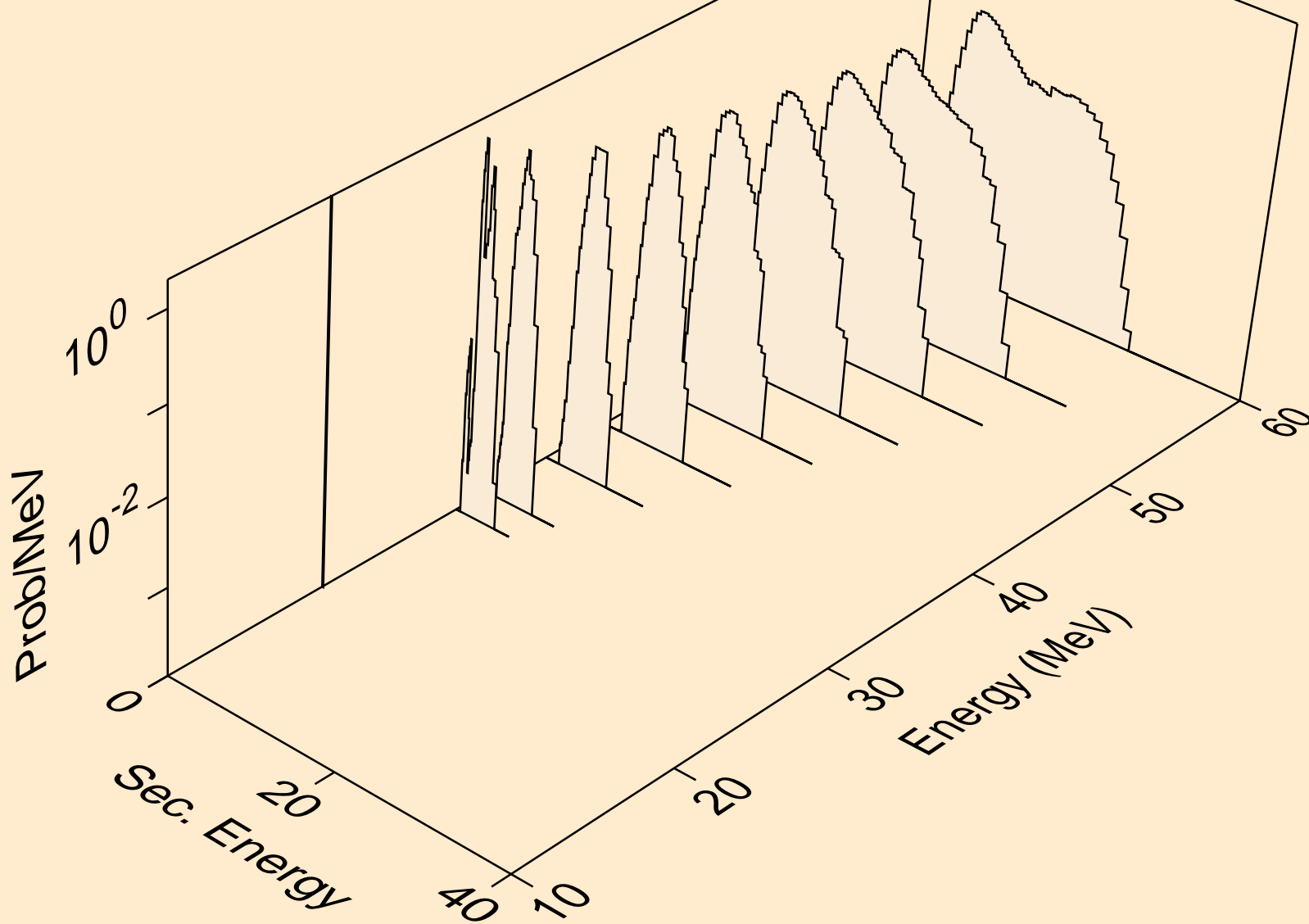

19-K-41 FOR FENDL-3.2 FROM TENDL-2015 BY NJOY2016.60+ O
alphas from (n,pa)

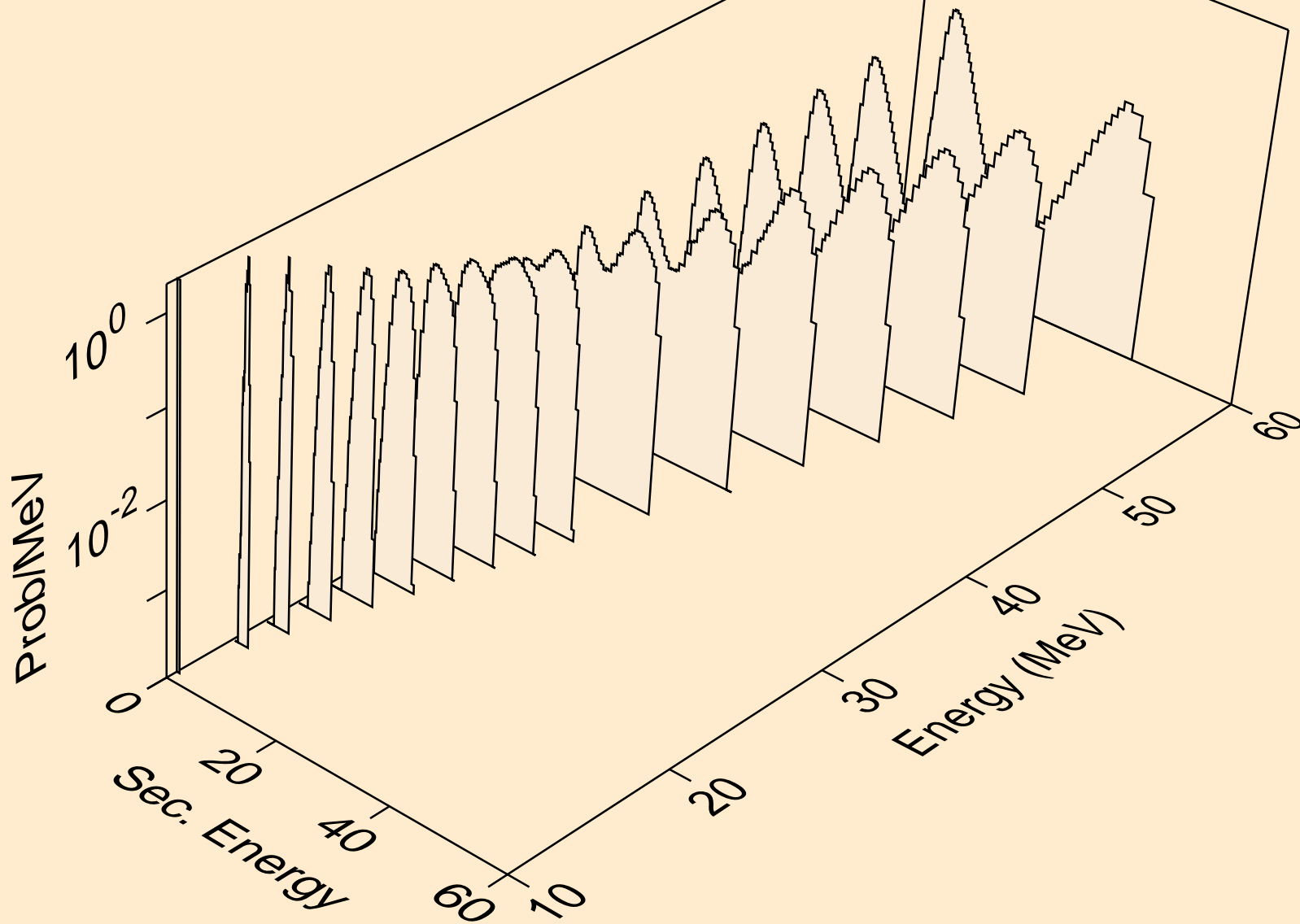

19-K-41 FOR FENDL-3.2 FROM TENDL-2015 BY NJOY2016.60+ O
alphas from (n,t2a)

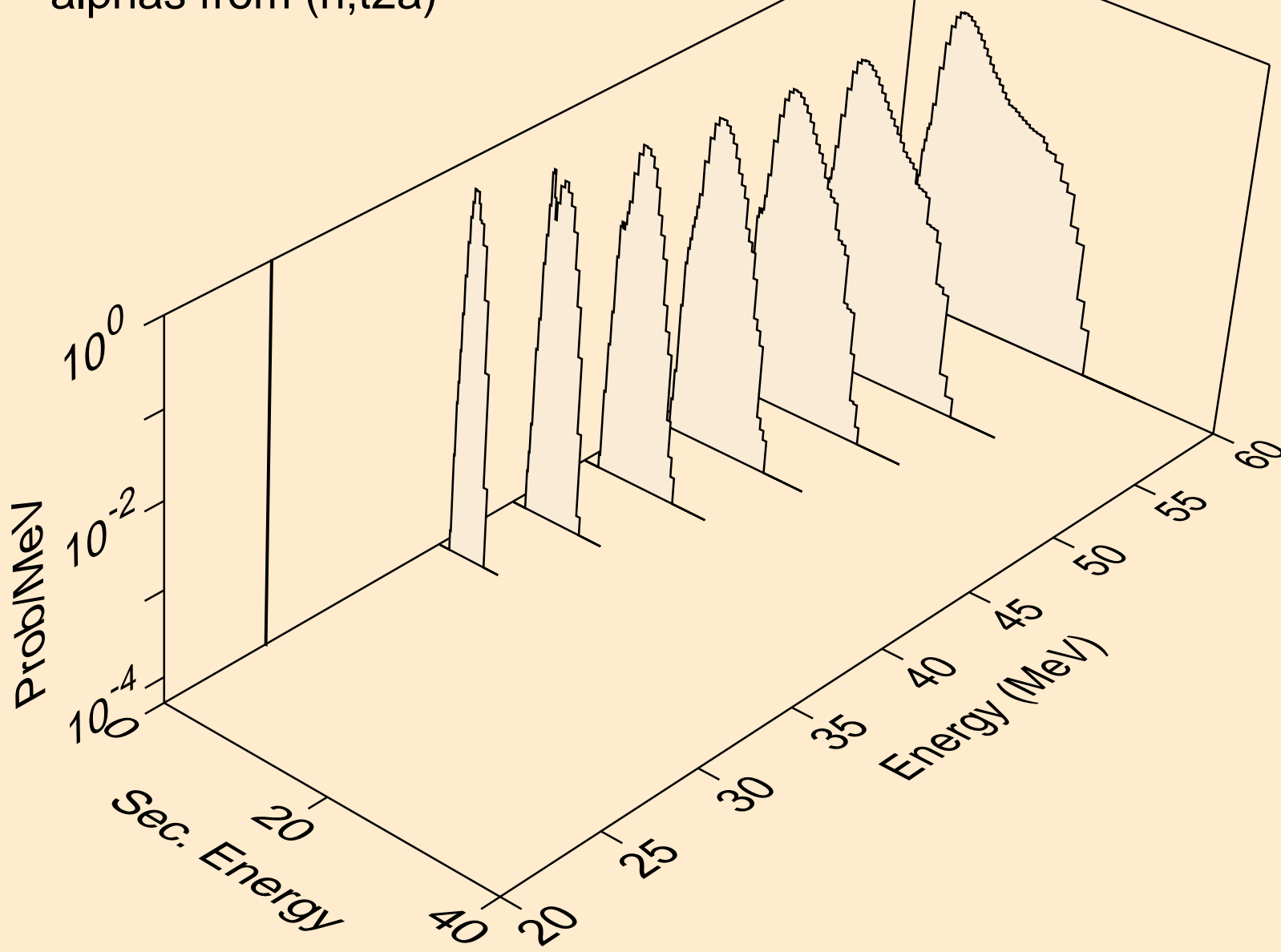

19-K-41 FOR FENDL-3.2 FROM TENDL-2015 BY NJOY2016.60+ O
alphas from (n,d2a)

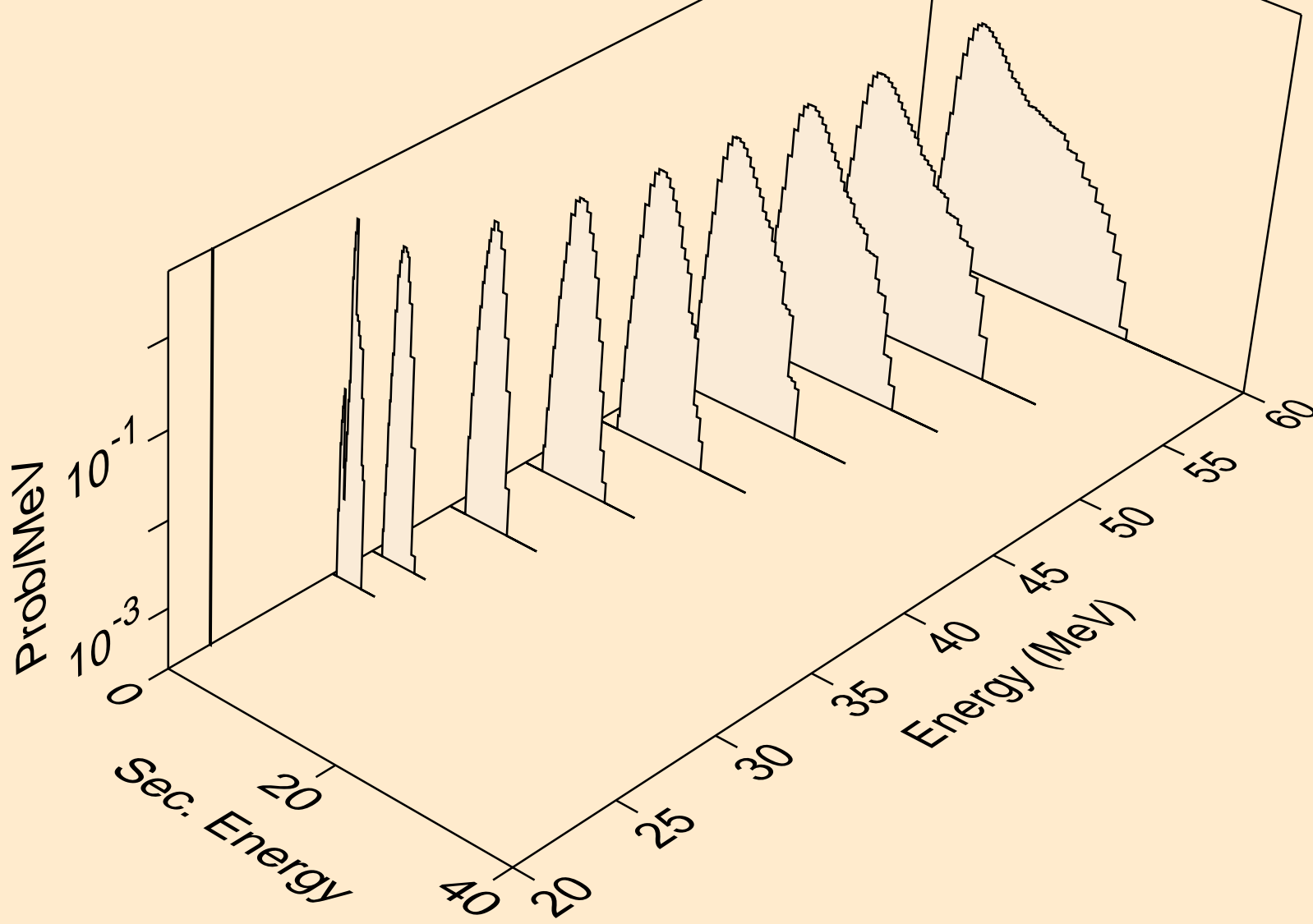

19-K-41 FOR FENDL-3.2 FROM TENDL-2015 BY NJOY2016.60+ O
alphas from (n,da)

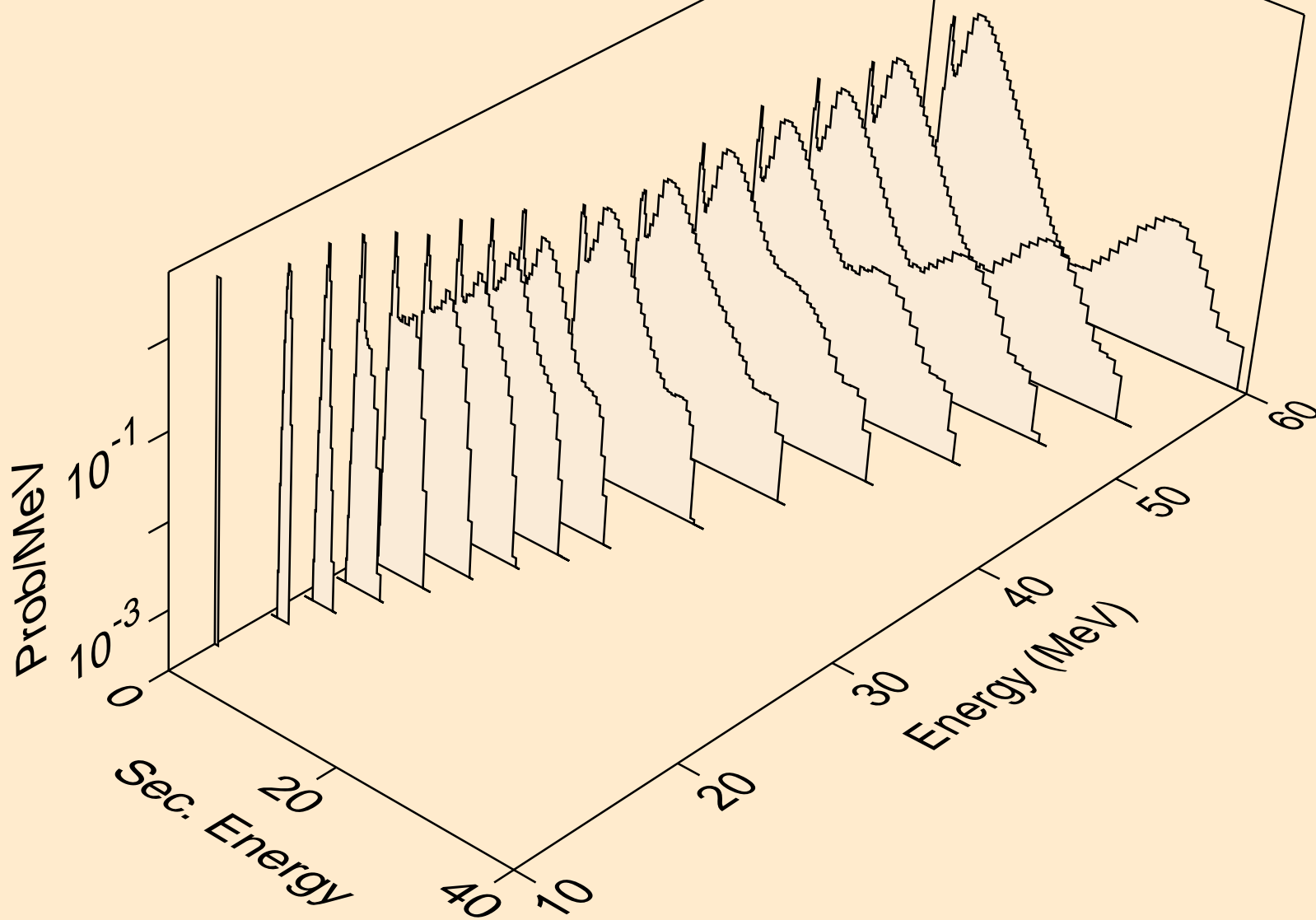

19-K-41 FOR FENDL-3.2 FROM TENDL-2015 BY NJOY2016.60+ O
alphas from (n,ta)

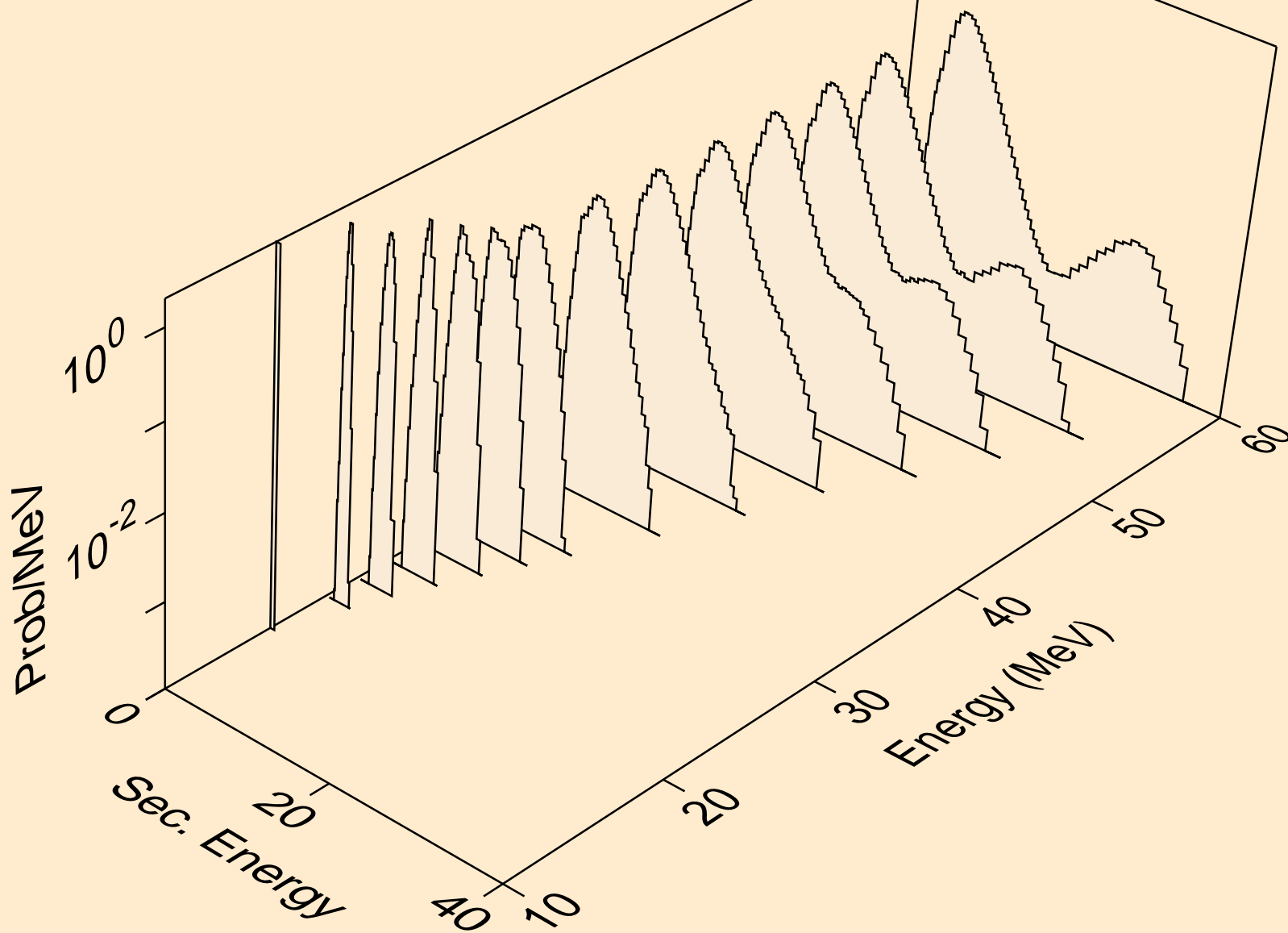

19-K-41 FOR FENDL-3.2 FROM TENDL-2015 BY NJOY2016.60+ O
alphas from (n,nda)

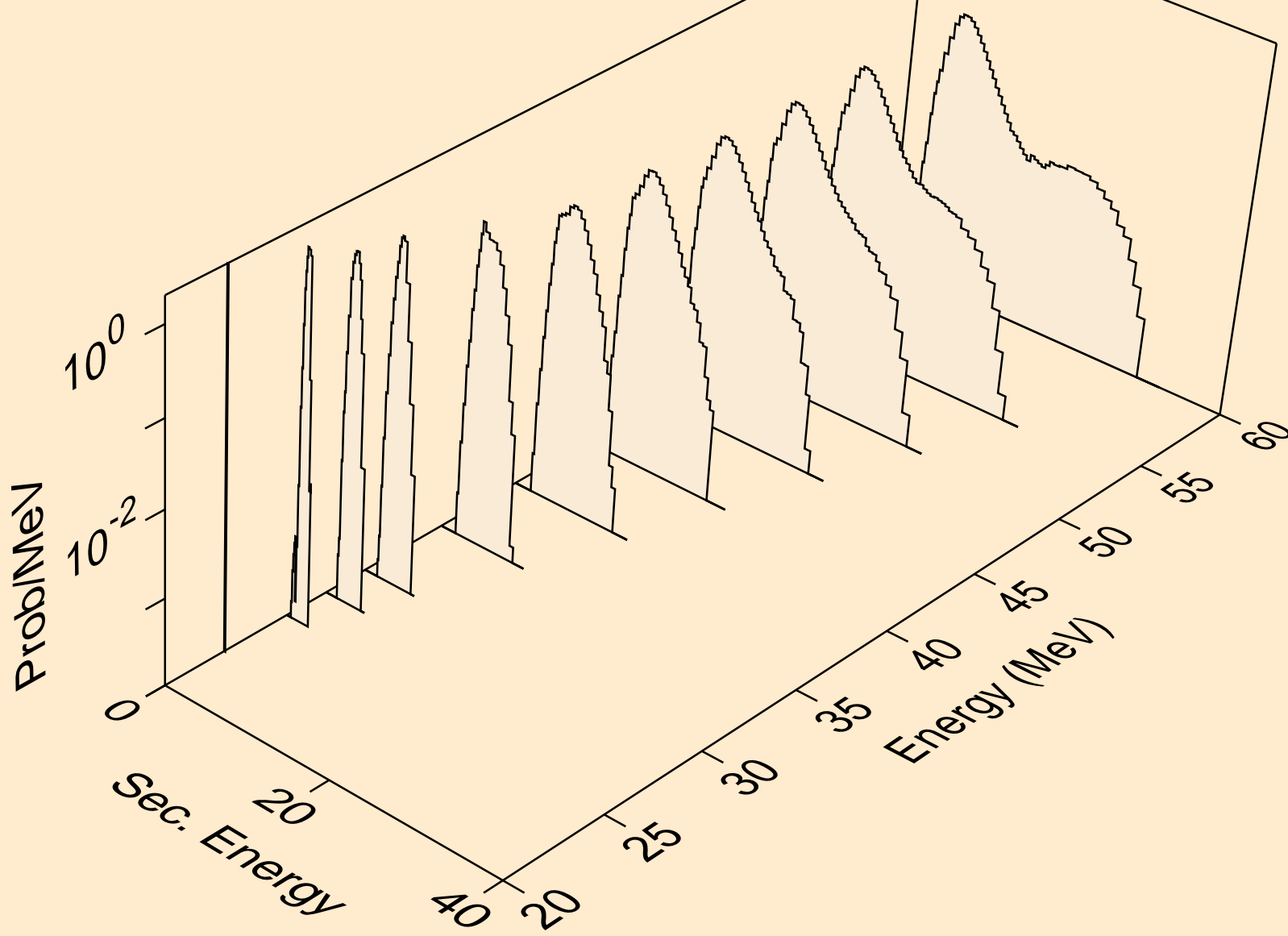

19-K-41 FOR FENDL-3.2 FROM TENDL-2015 BY NJOY2016.60+ O
alphas from (n,2npa)

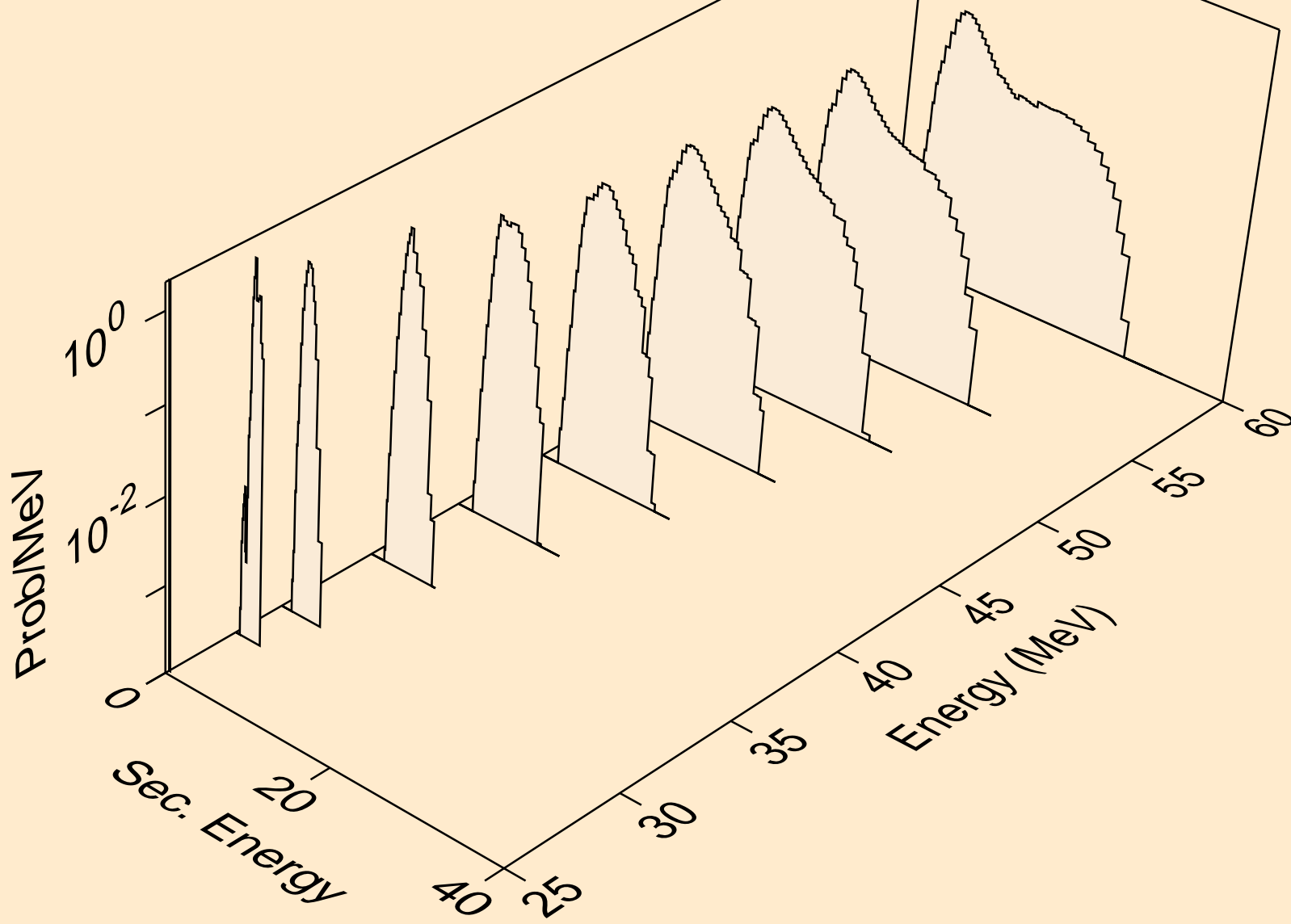

19-K-41 FOR FENDL-3.2 FROM TENDL-2015 BY NJOY2016.60+ O
alphas from (n,4na)

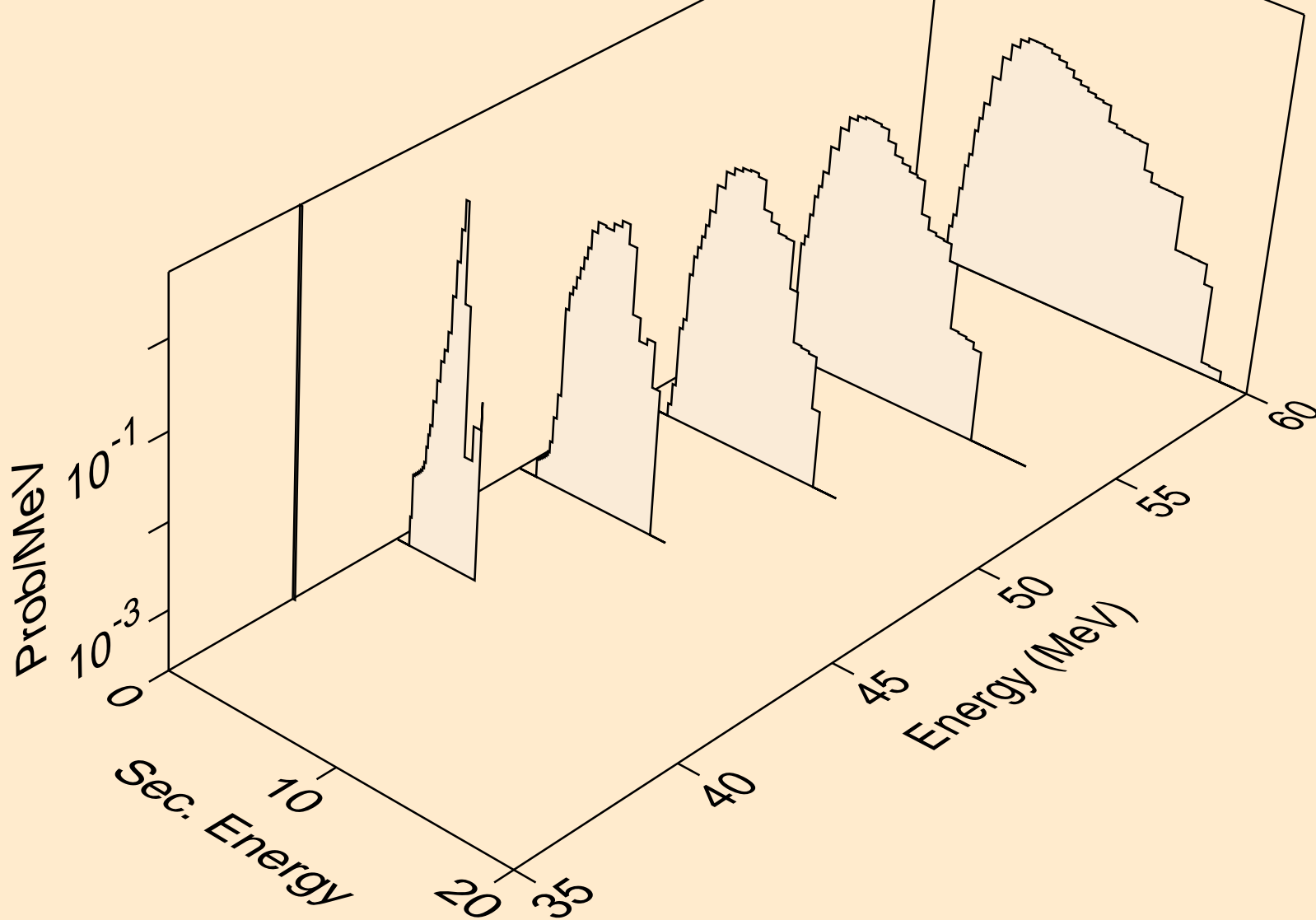

19-K-41 FOR FENDL-3.2 FROM TENDL-2015 BY NJOY2016.60+ O
alphas from (n,5na)

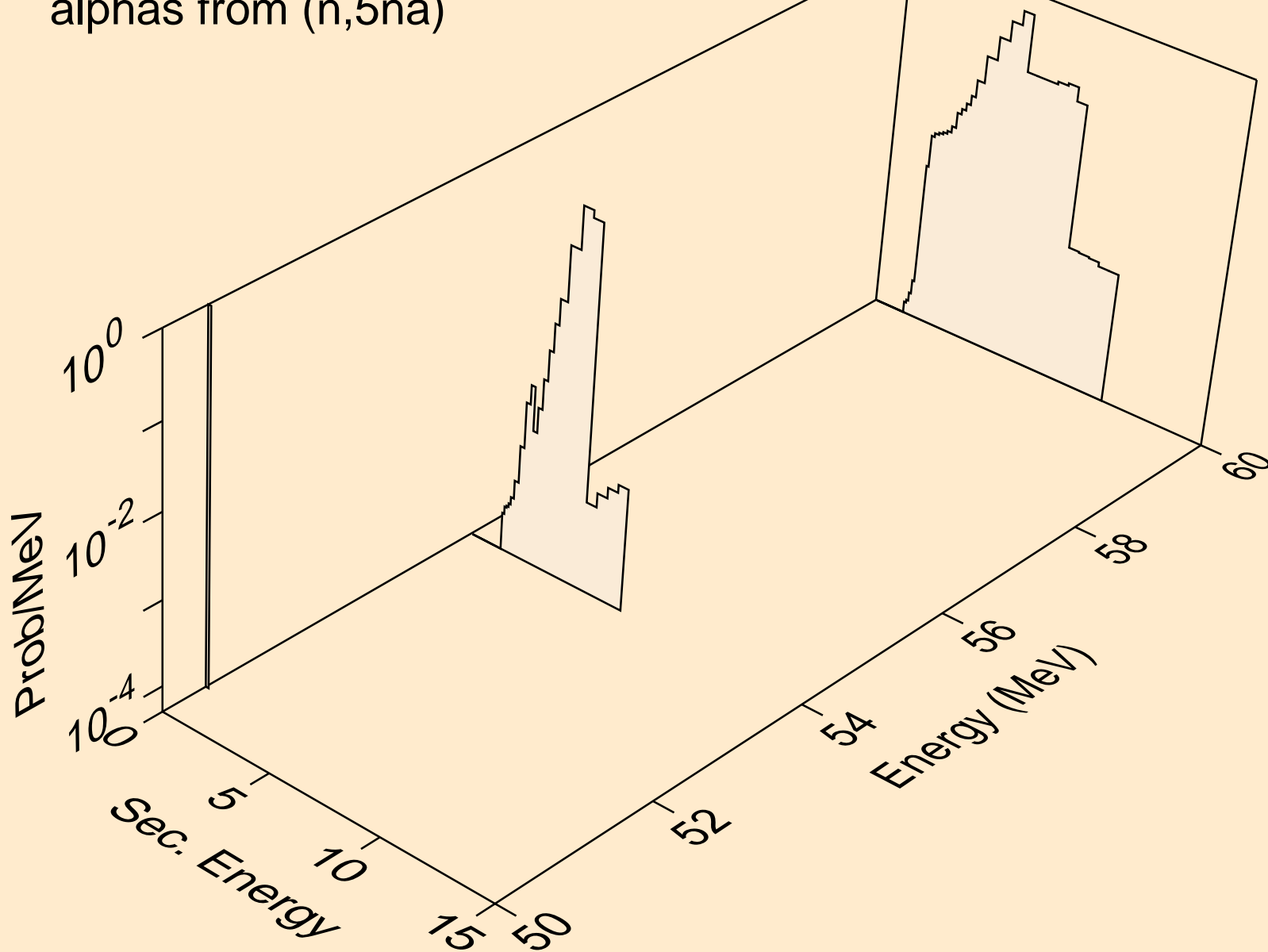

19-K-41 FOR FENDL-3.2 FROM TENDL-2015 BY NJOY2016.60+ O
alphas from (n,3n2a)

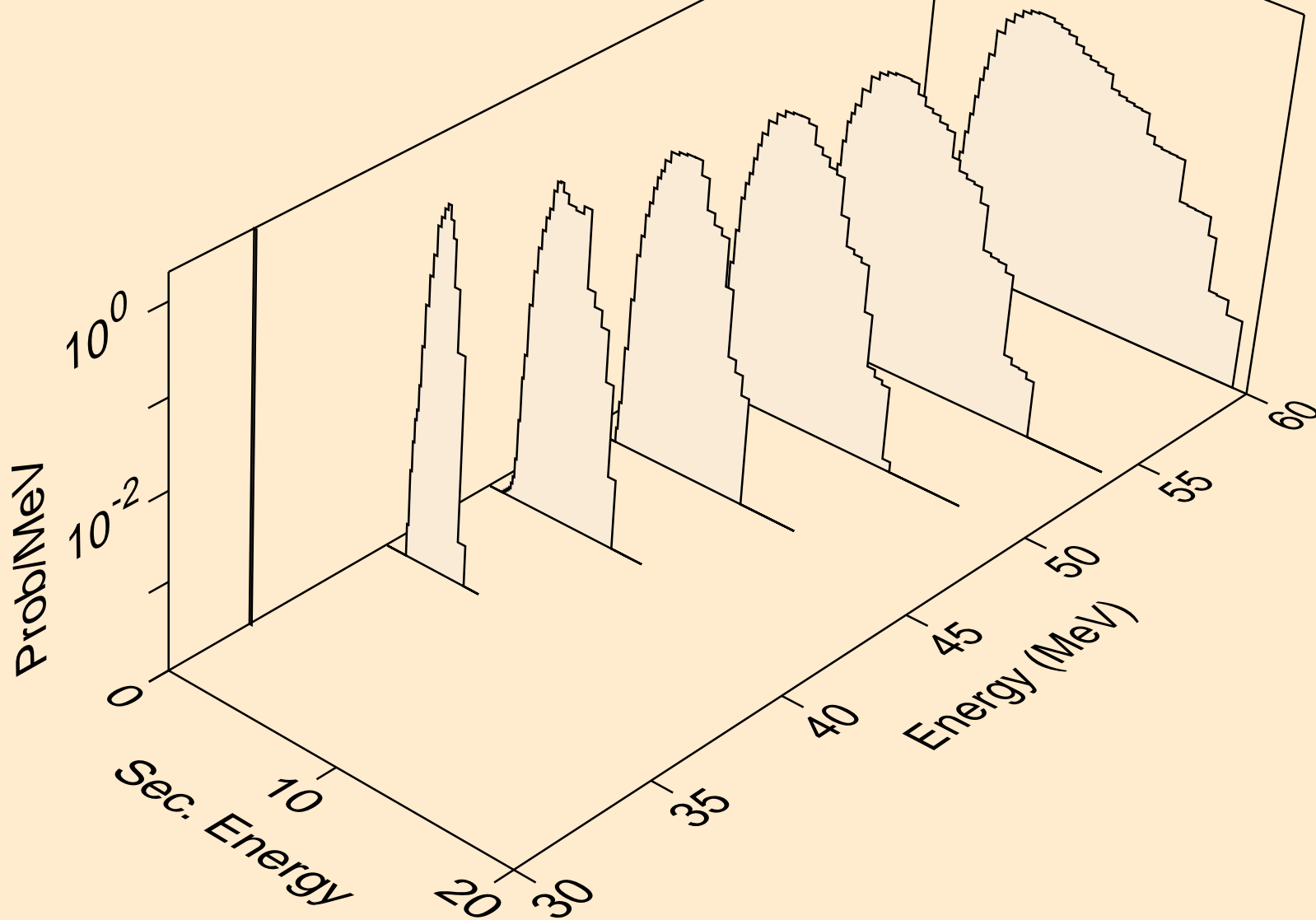

19-K-41 FOR FENDL-3.2 FROM TENDL-2015 BY NJOY2016.60+ O
alphas from (n,3npa)

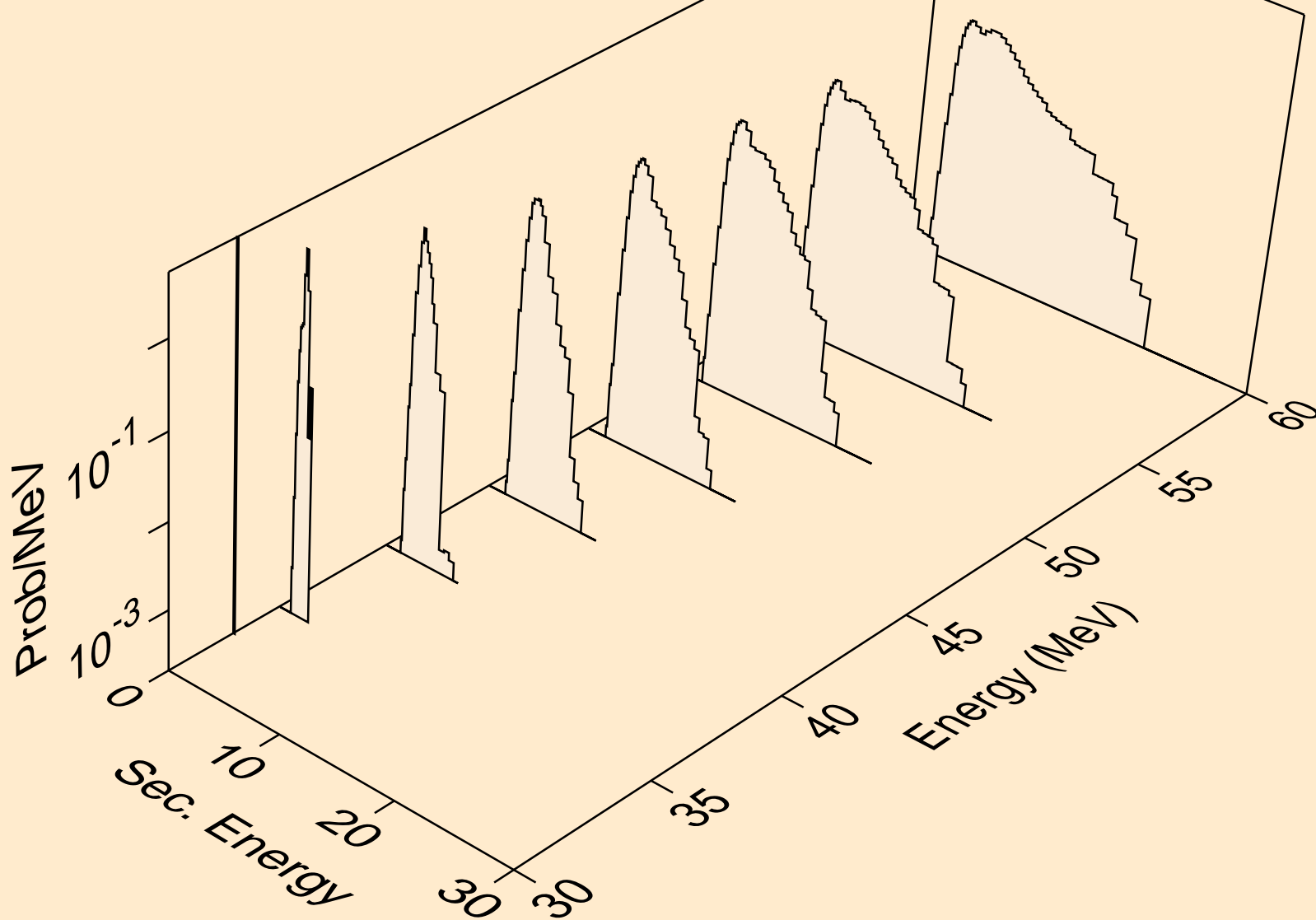

19-K-41 FOR FENDL-3.2 FROM TENDL-2015 BY NJOY2016.60+ O
alphas from (n,nta)

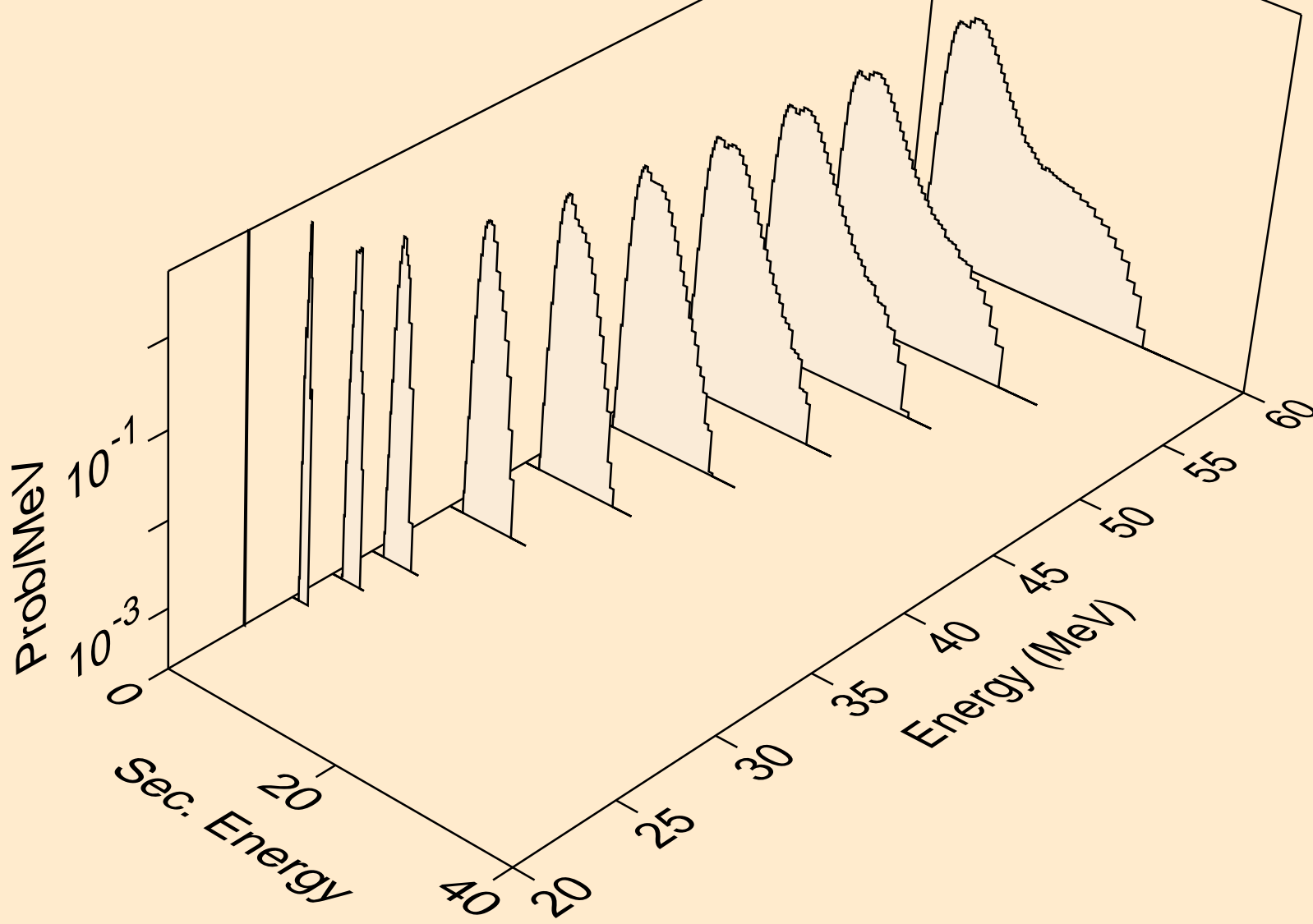

19-K-41 FOR FENDL-3.2 FROM TENDL-2015 BY NJOY2016.60+ O
alphas from (n,he3a)

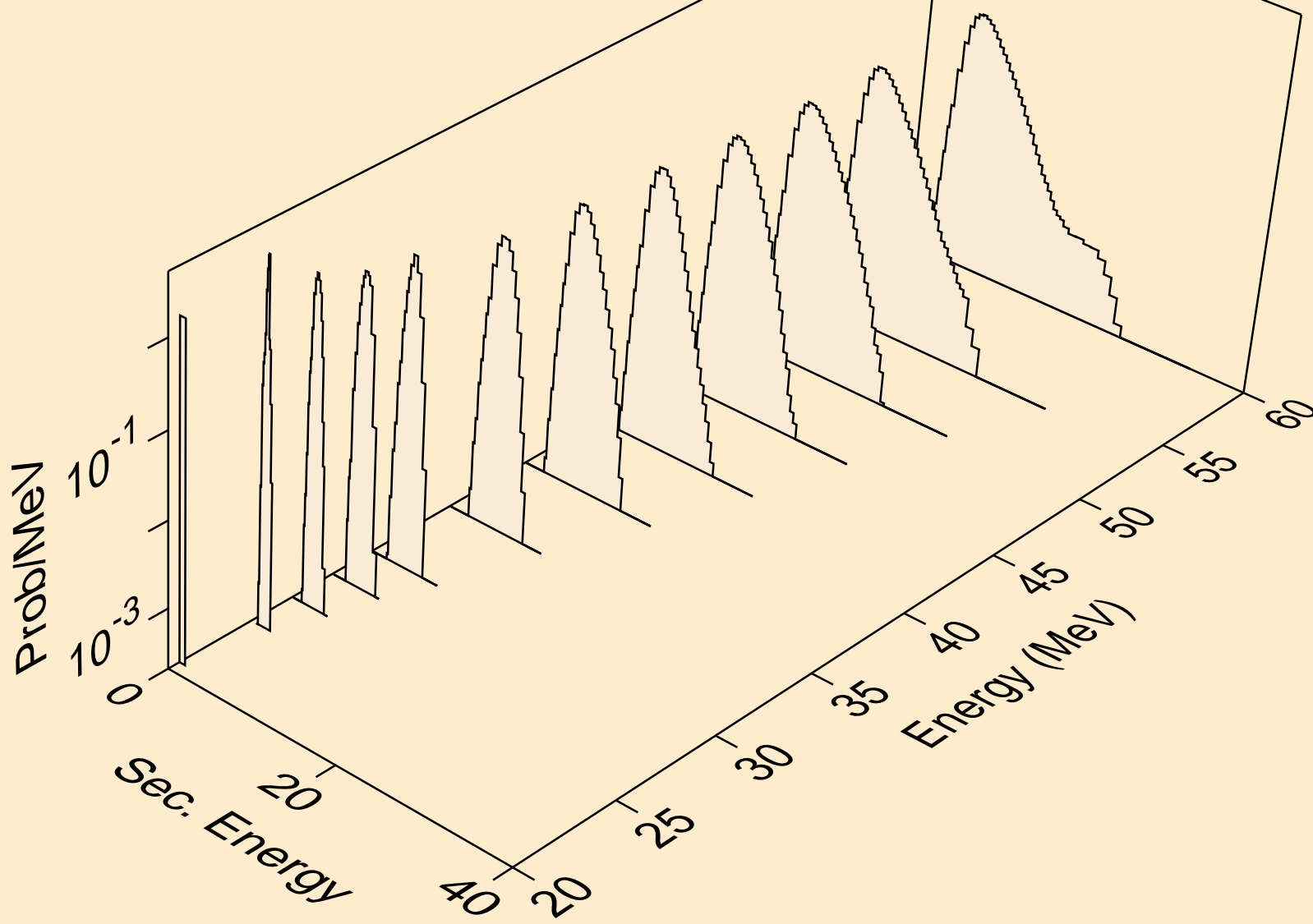

19-K-41 FOR FENDL-3.2 FROM TENDL-2015 BY NJOY2016.60+ O
alphas from (n,2n2a)

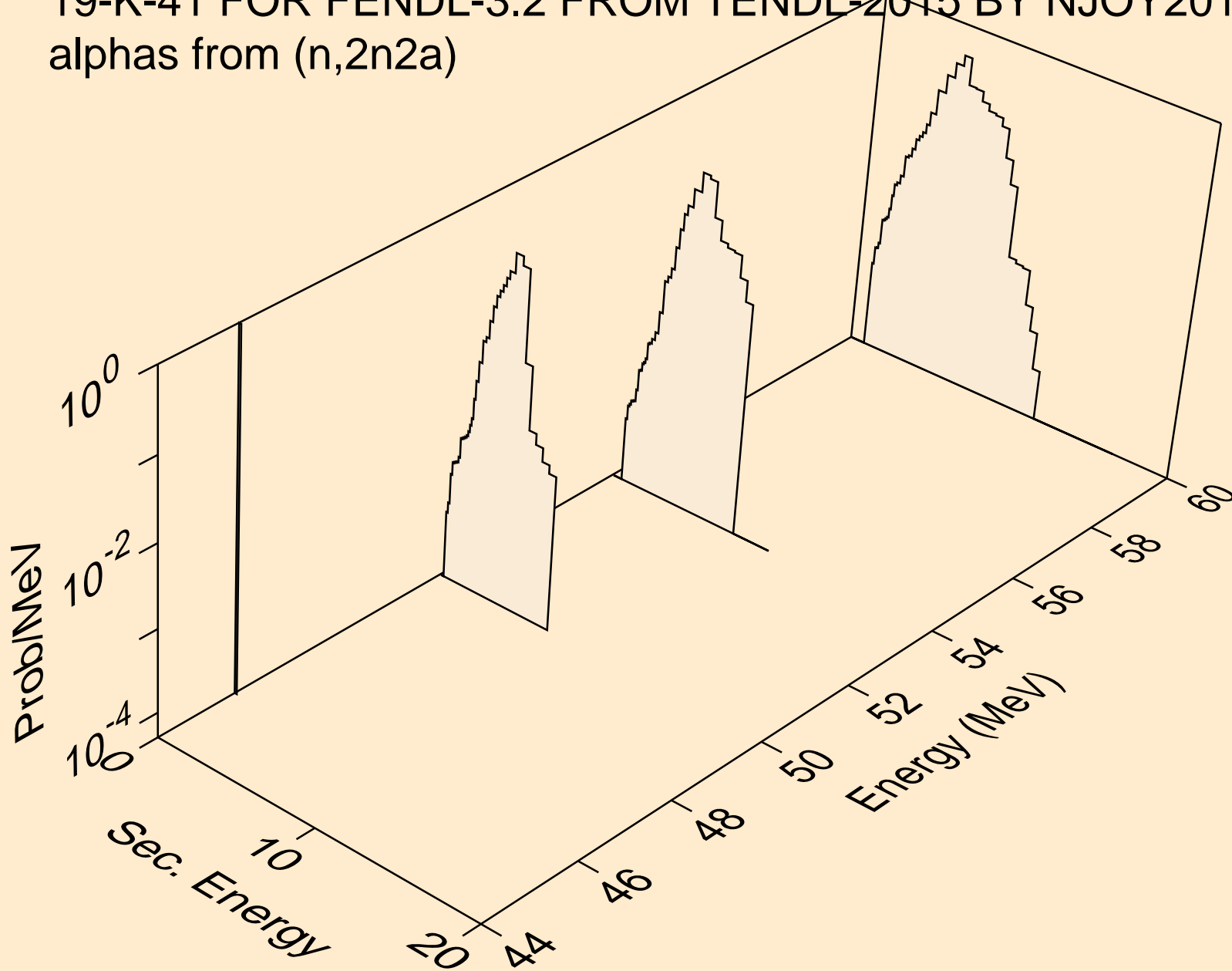

19-K-41 FOR FENDL-3.2 FROM TENDL-2015 BY NJOY2016.60+ O
alphas from (n,4npa)

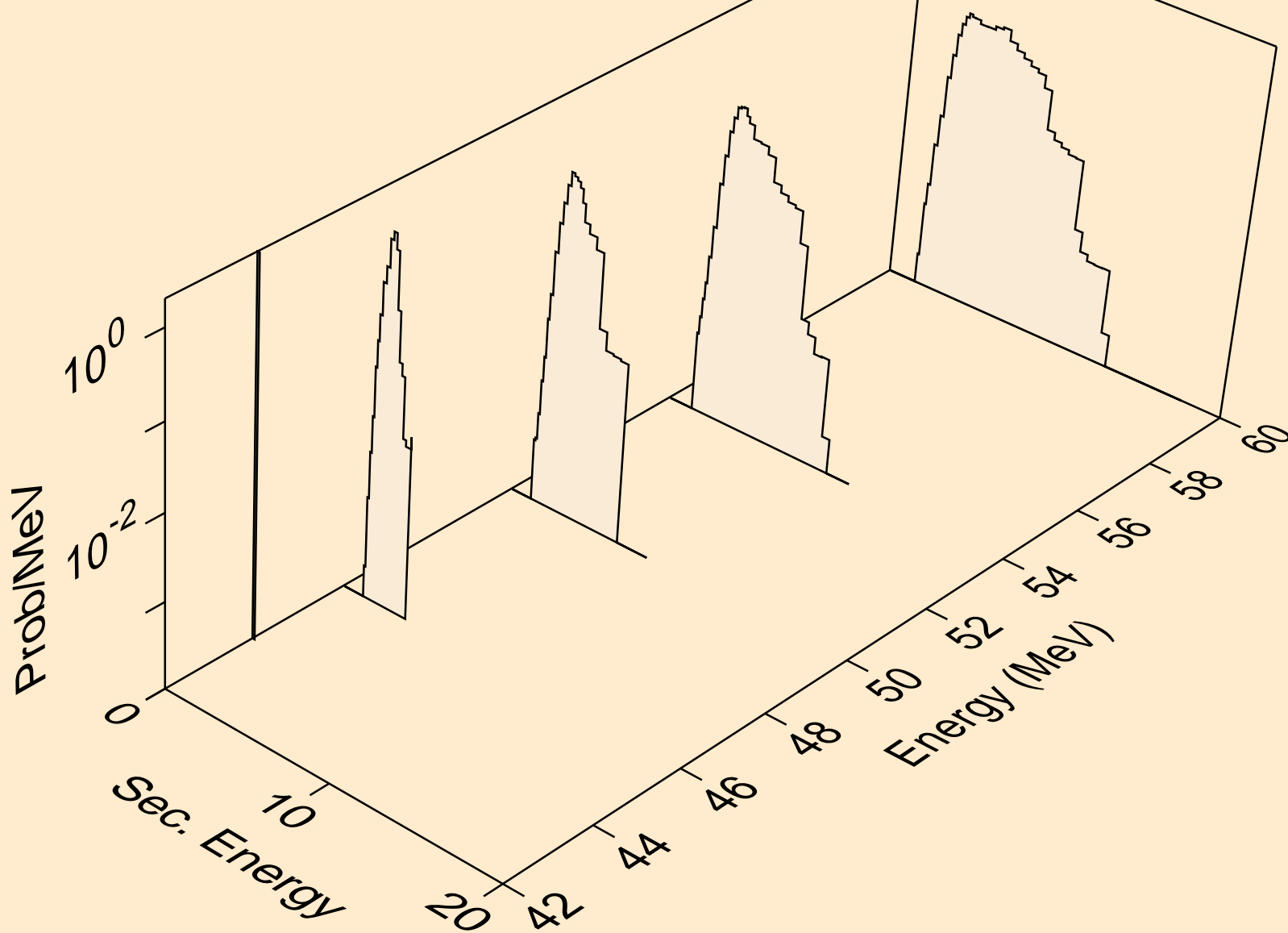

19-K-41 FOR FENDL-3.2 FROM TENDL-2015 BY NJOY2016.60+ O
alphas from (n,3n2pa)

