

20-CA-43 FOR FENDL-3.2 FROM FENDL-3.2 BY NJOY2016.60+ O
Principal cross sections

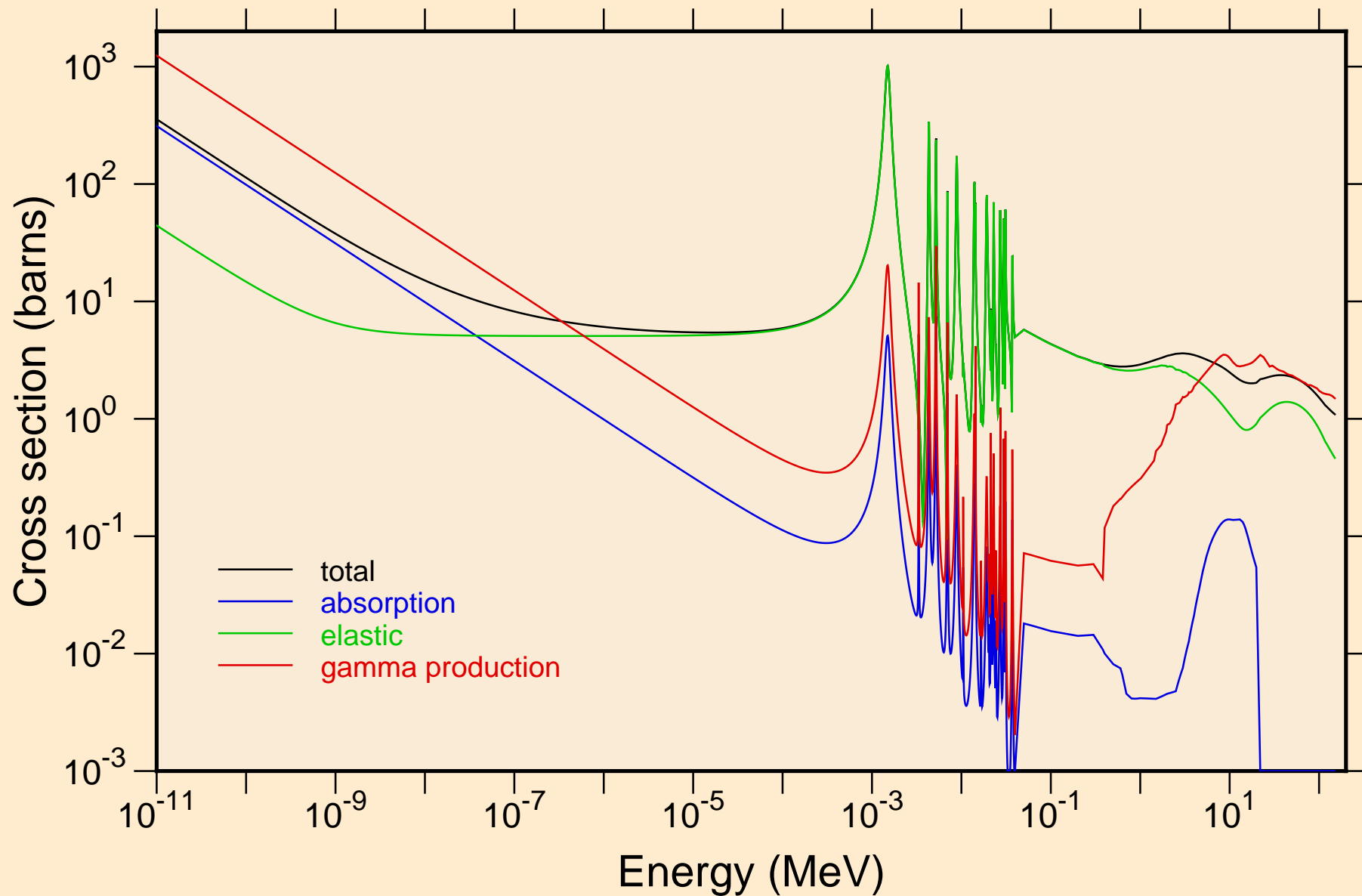

20-CA-43 FOR FENDL-3.2 FROM FENDL-3.2 BY NJOY2016.60+ O
resonance total cross section

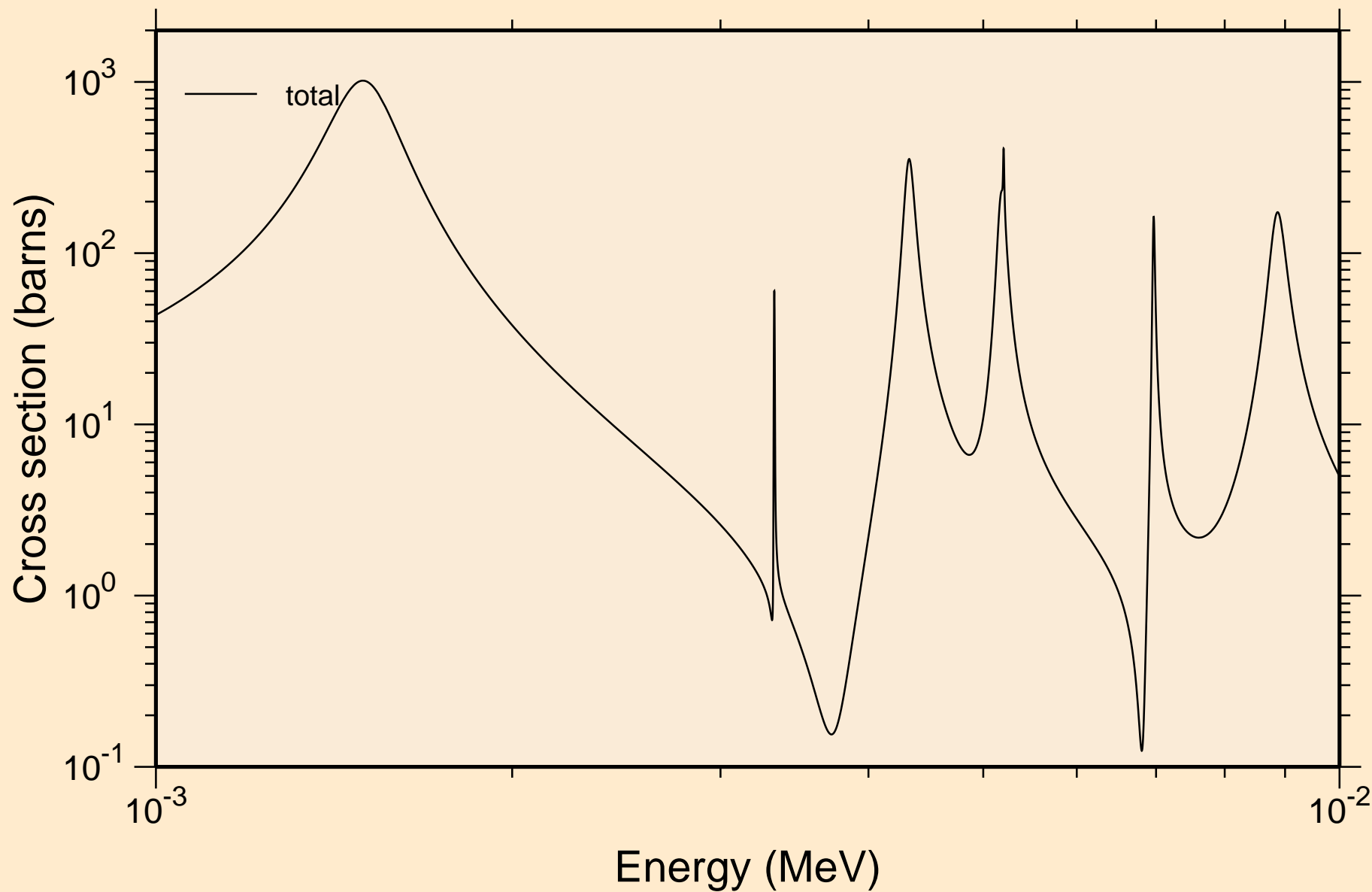

20-CA-43 FOR FENDL-3.2 FROM FENDL-3.2 BY NJOY2016.60+ O
resonance total cross section

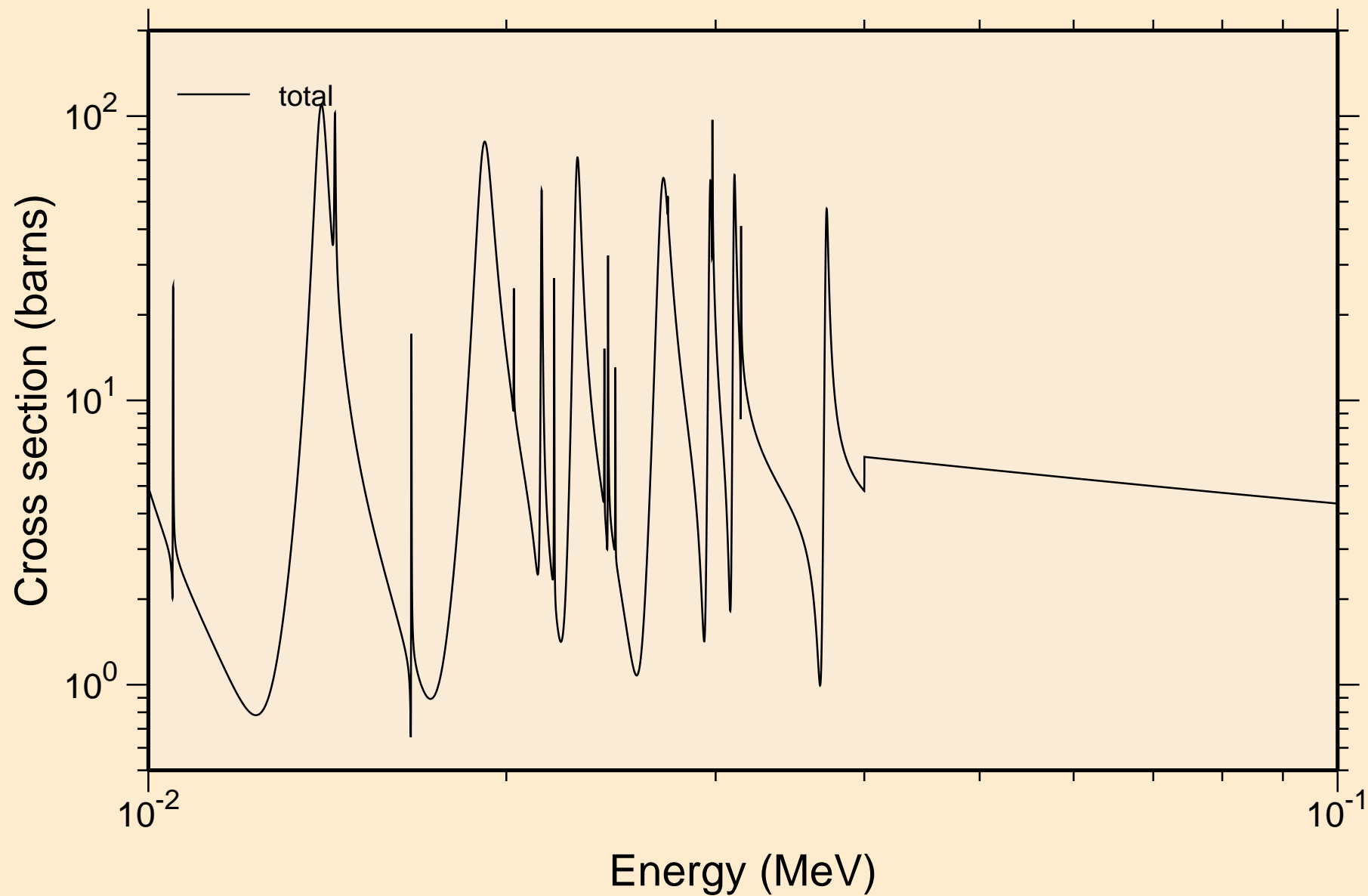

20-CA-43 FOR FENDL-3.2 FROM FENDL-3.2 BY NJOY2016.60+ O
resonance total cross section

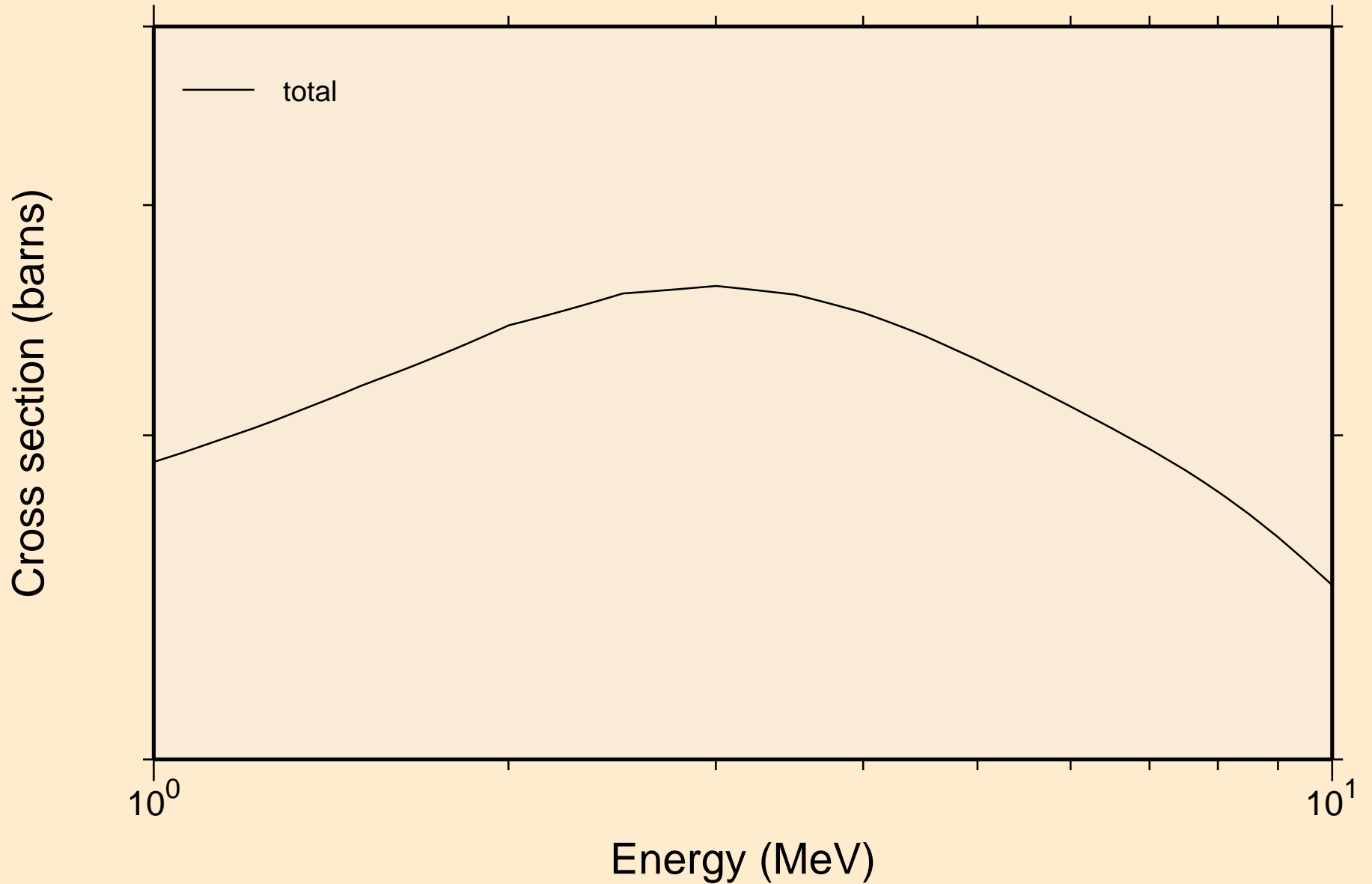

20-CA-43 FOR FENDL-3.2 FROM FENDL-3.2 BY NJOY2016.60+ O
resonance absorption cross sections

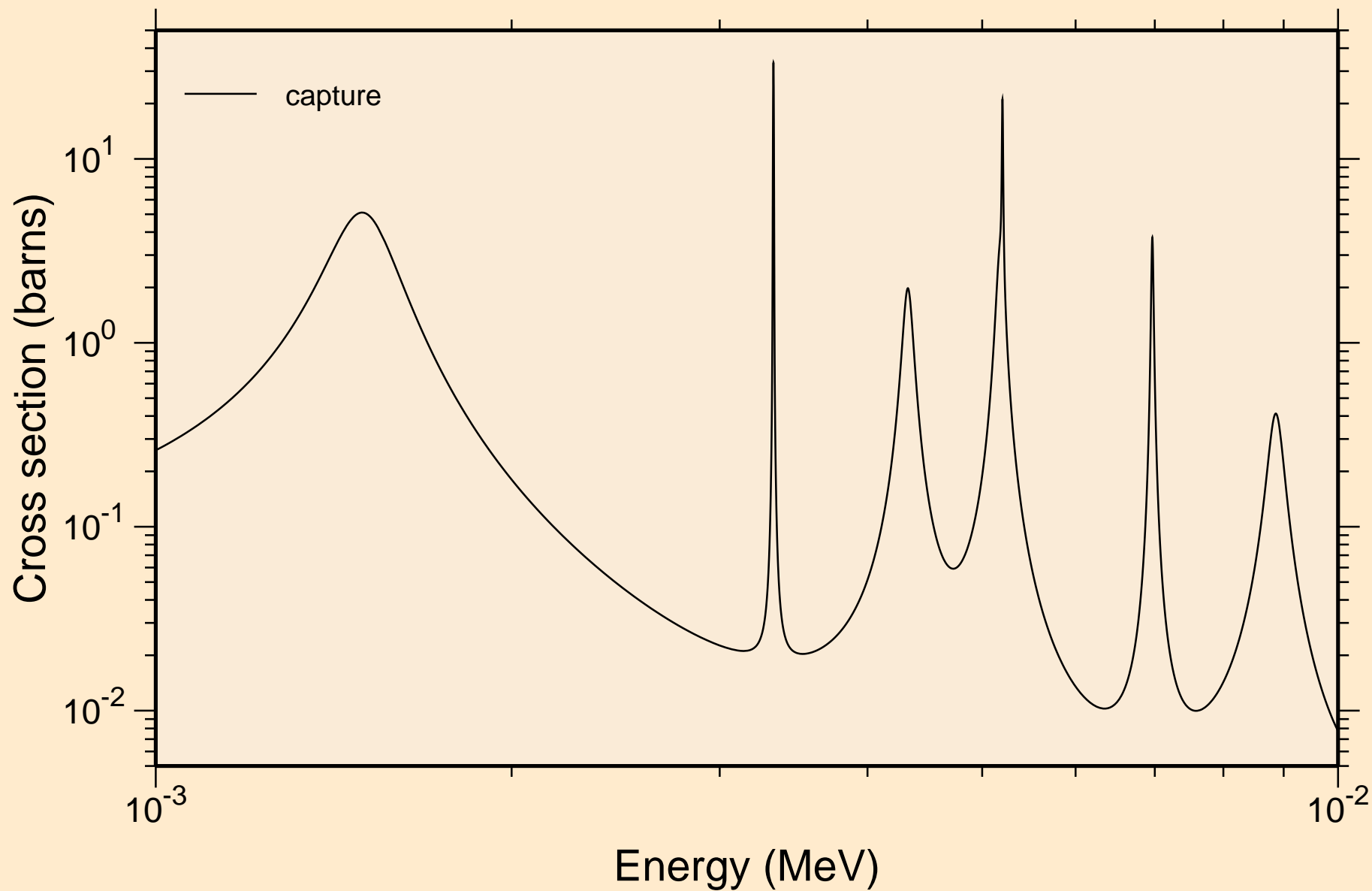

20-CA-43 FOR FENDL-3.2 FROM FENDL-3.2 BY NJOY2016.60+ O
resonance absorption cross sections

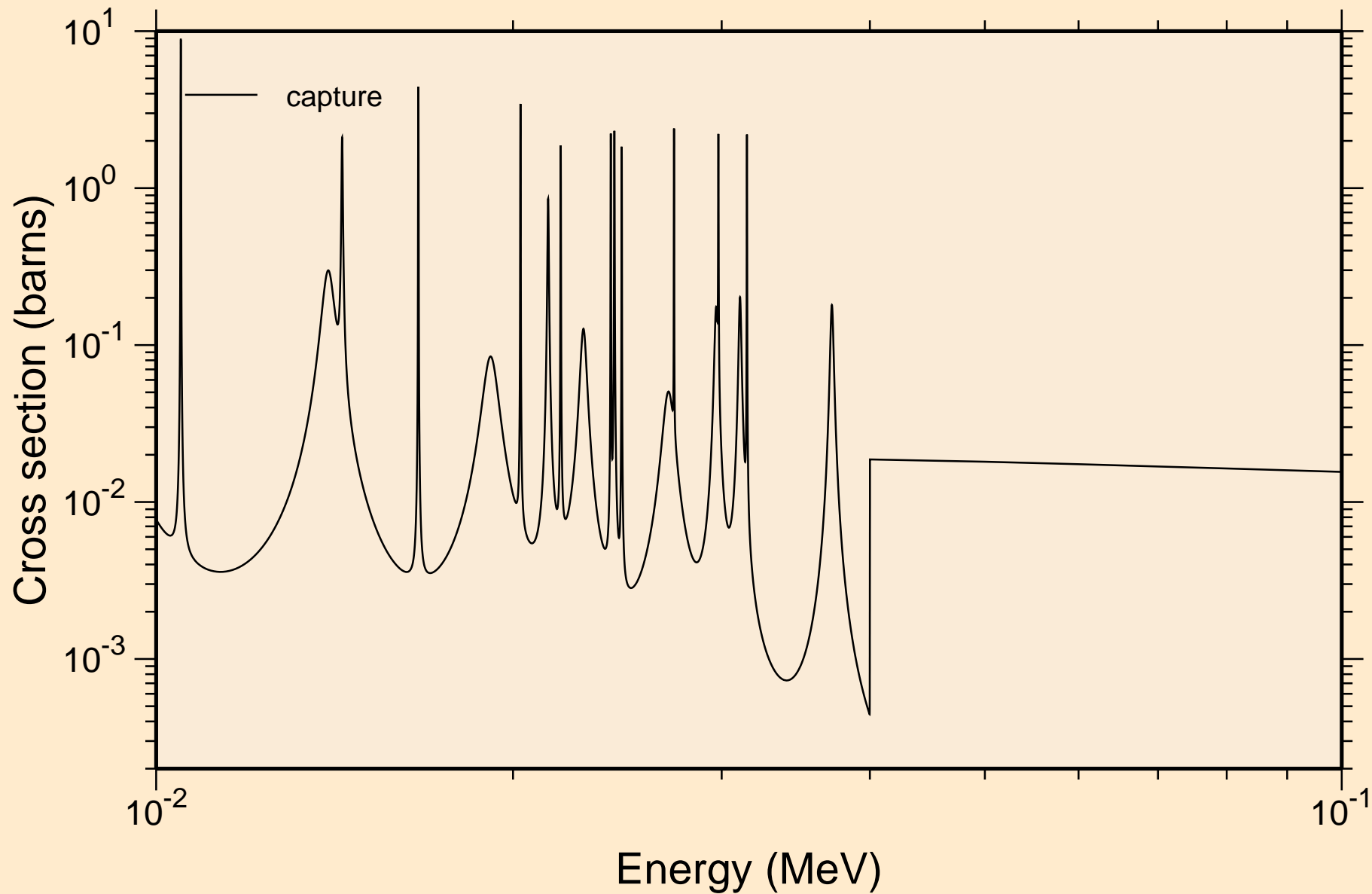

20-CA-43 FOR FENDL-3.2 FROM FENDL-3.2 BY NJOY2016.60+ O
resonance absorption cross sections

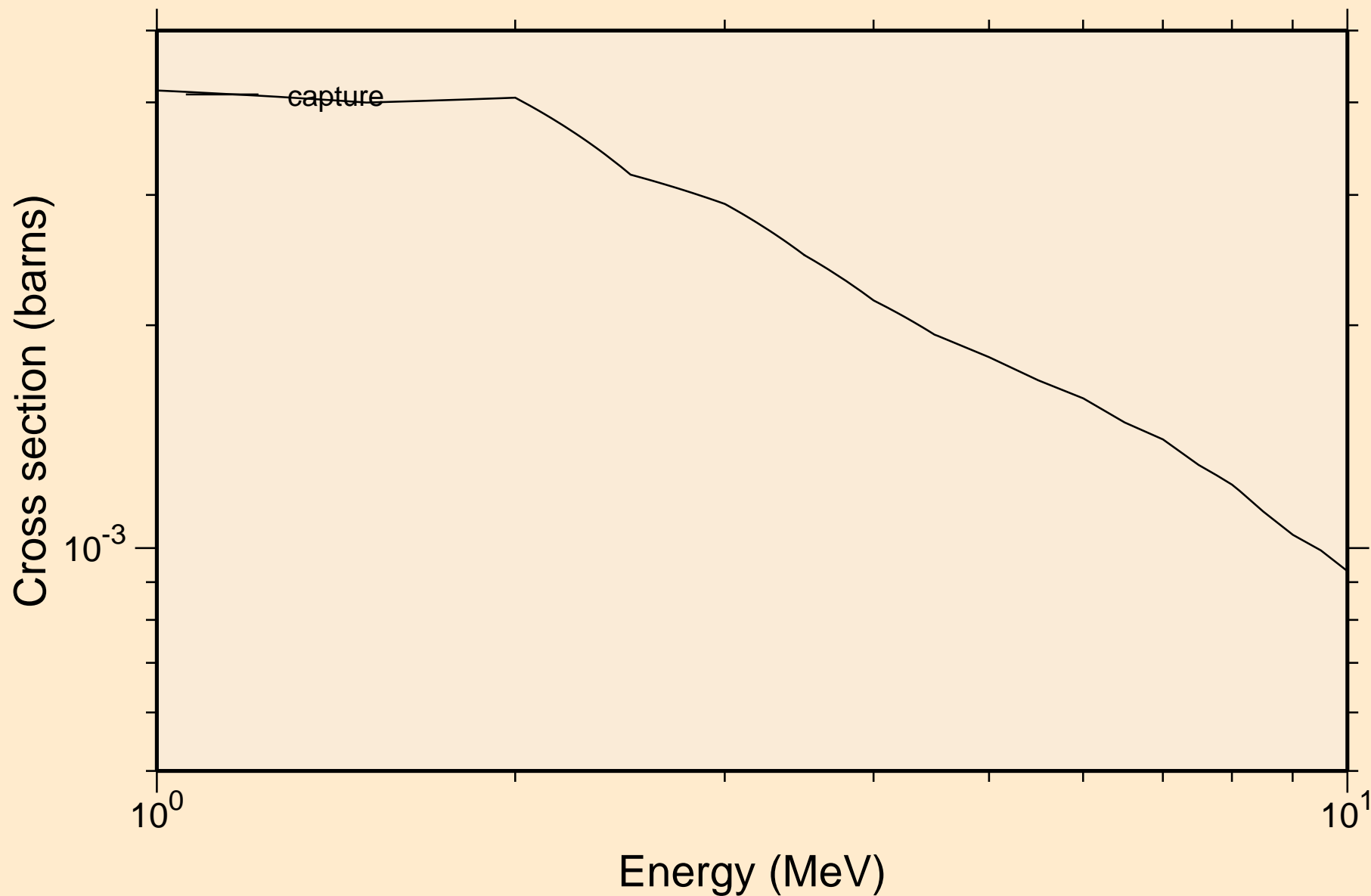

20-CA-43 FOR FENDL-3.2 FROM FENDL-3.2 BY NJOY2016.60+ O Heating

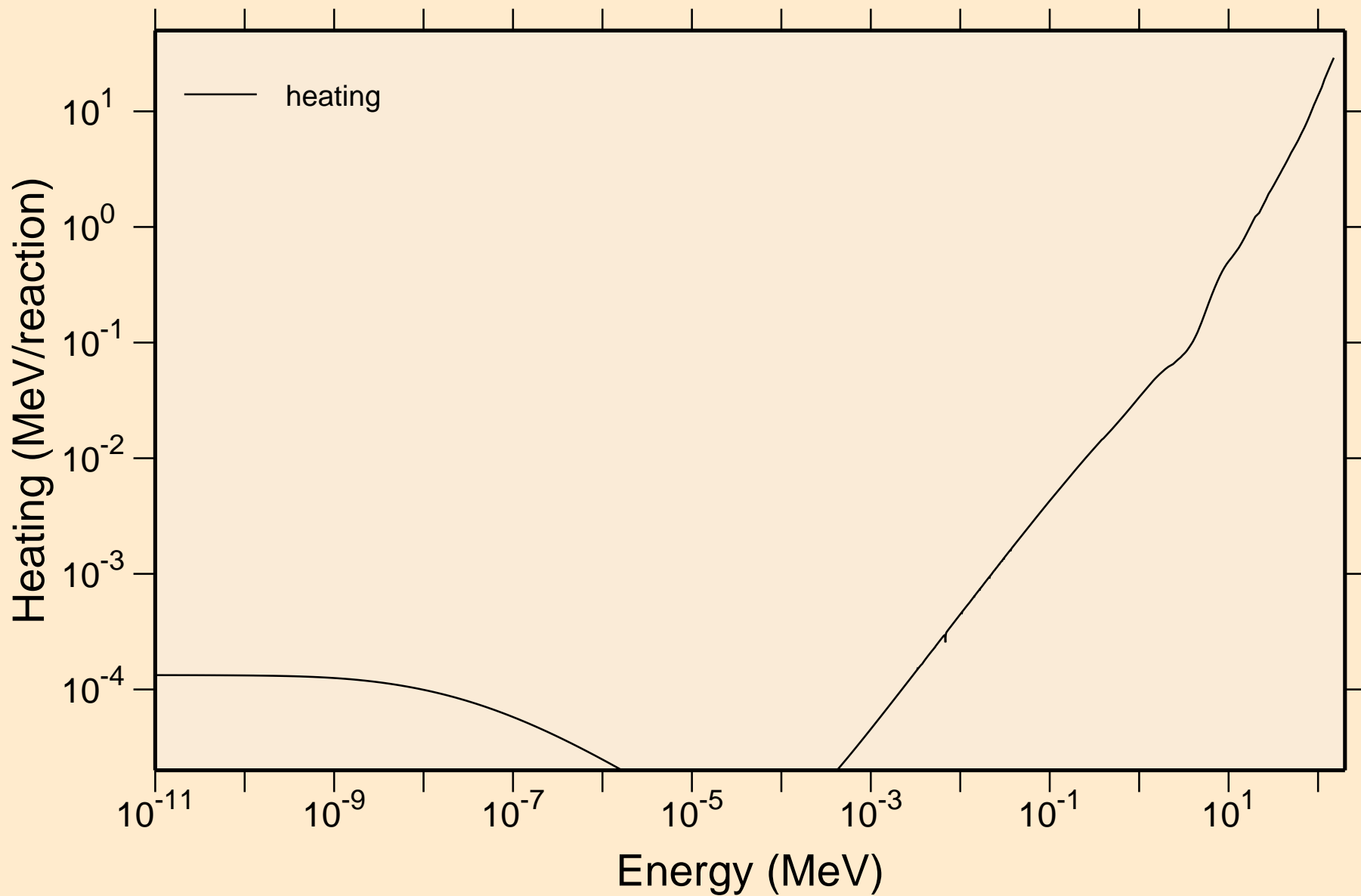

20-CA-43 FOR FENDL-3.2 FROM FENDL-3.2 BY NJOY2016.60+ O Damage

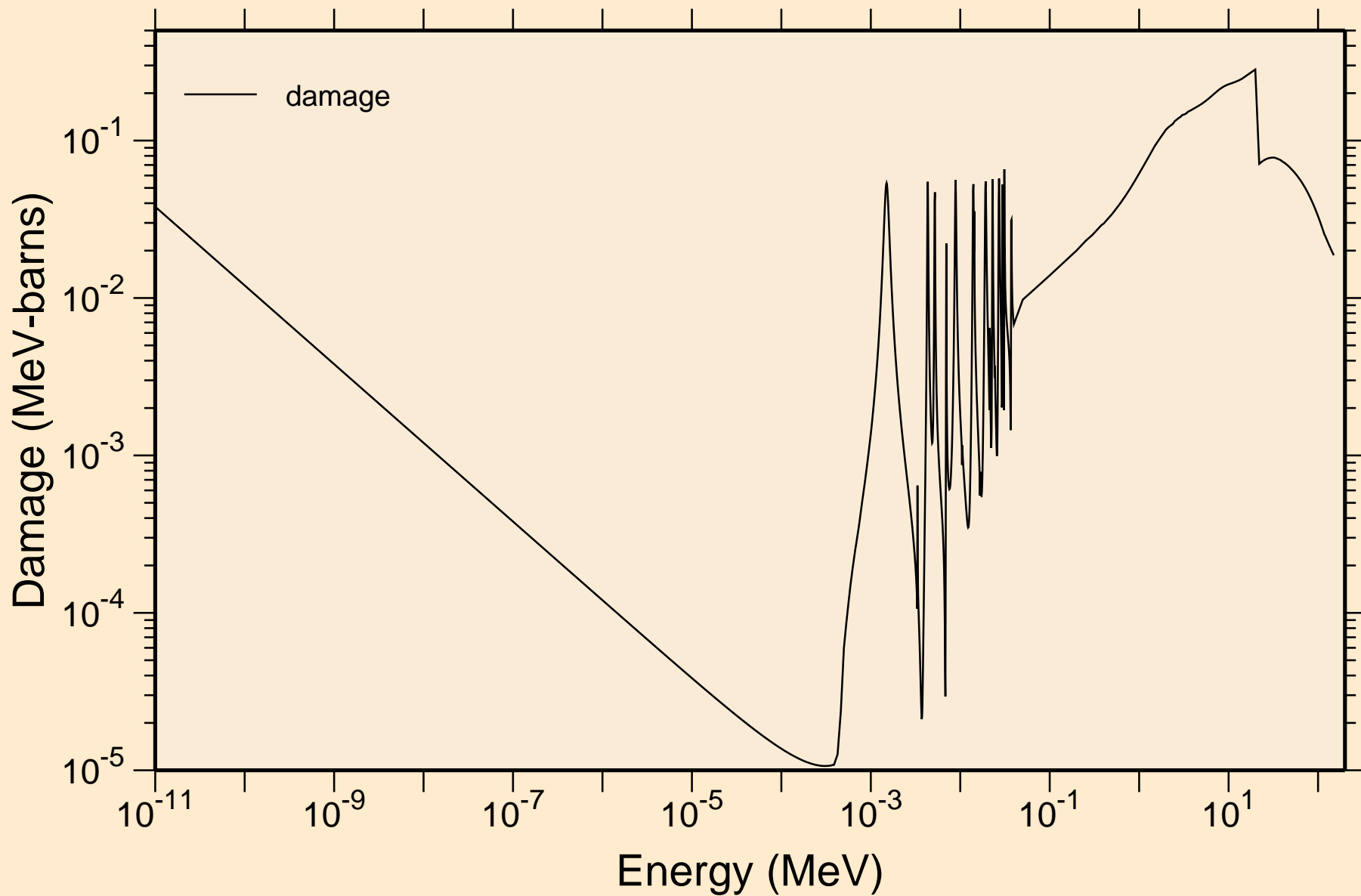

20-CA-43 FOR FENDL-3.2 FROM FENDL-3.2 BY NJOY2016.60+ O
Non-threshold reactions

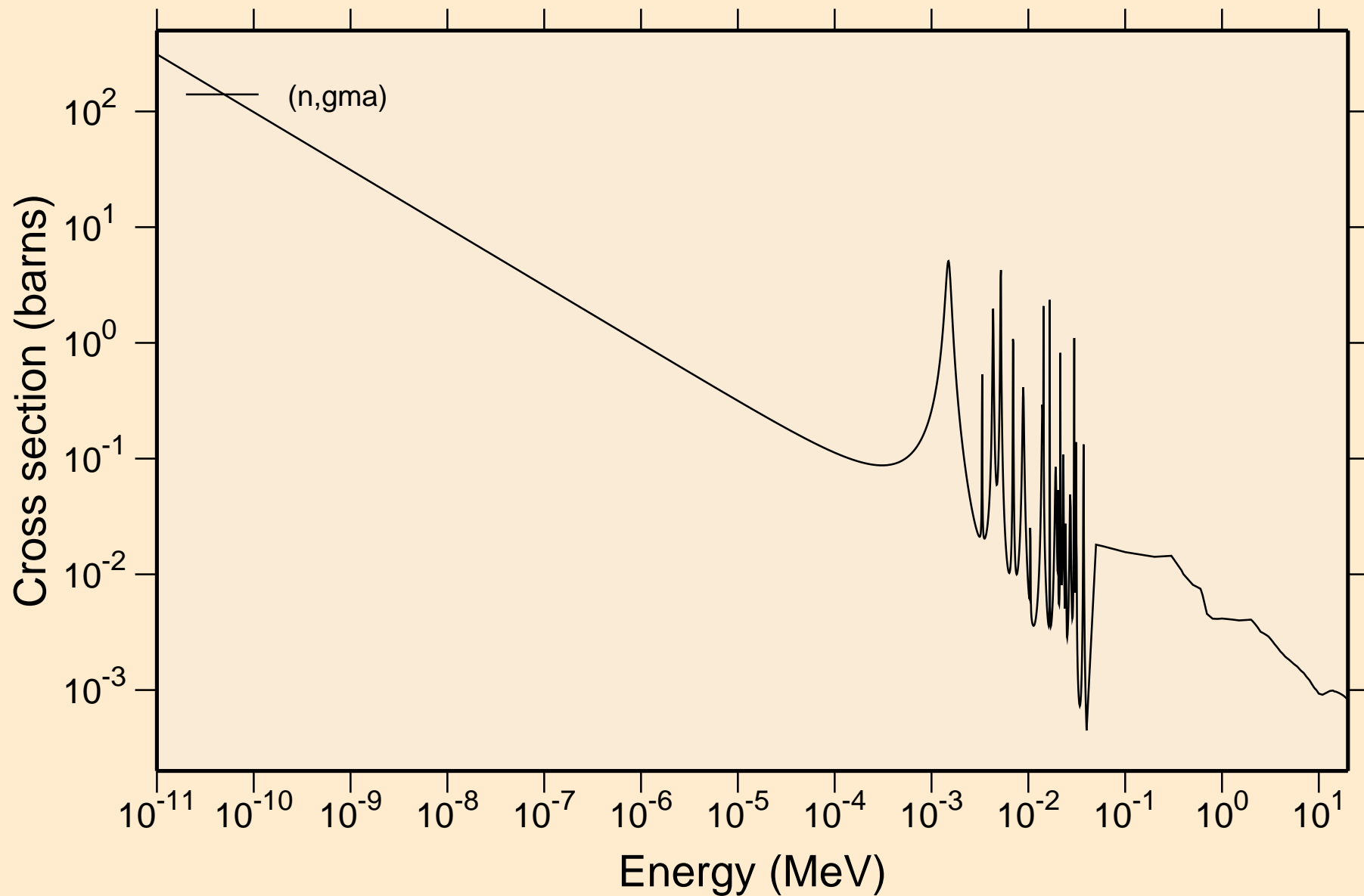

20-CA-43 FOR FENDL-3.2 FROM FENDL-3.2 BY NJOY2016.60+ O

Principal cross sections

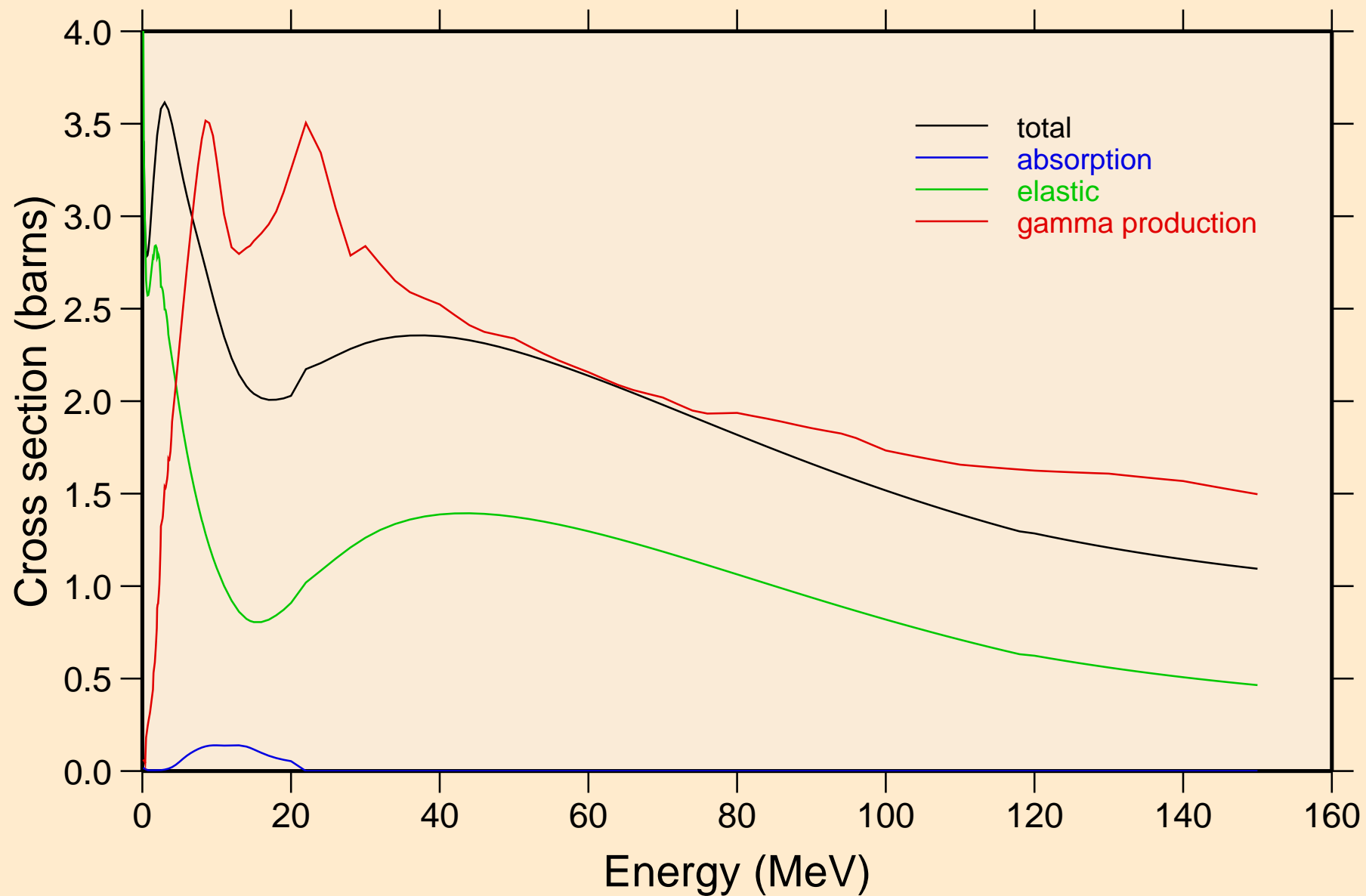

20-CA-43 FOR FENDL-3.2 FROM FENDL-3.2 BY NJOY2016.60+ O Heating

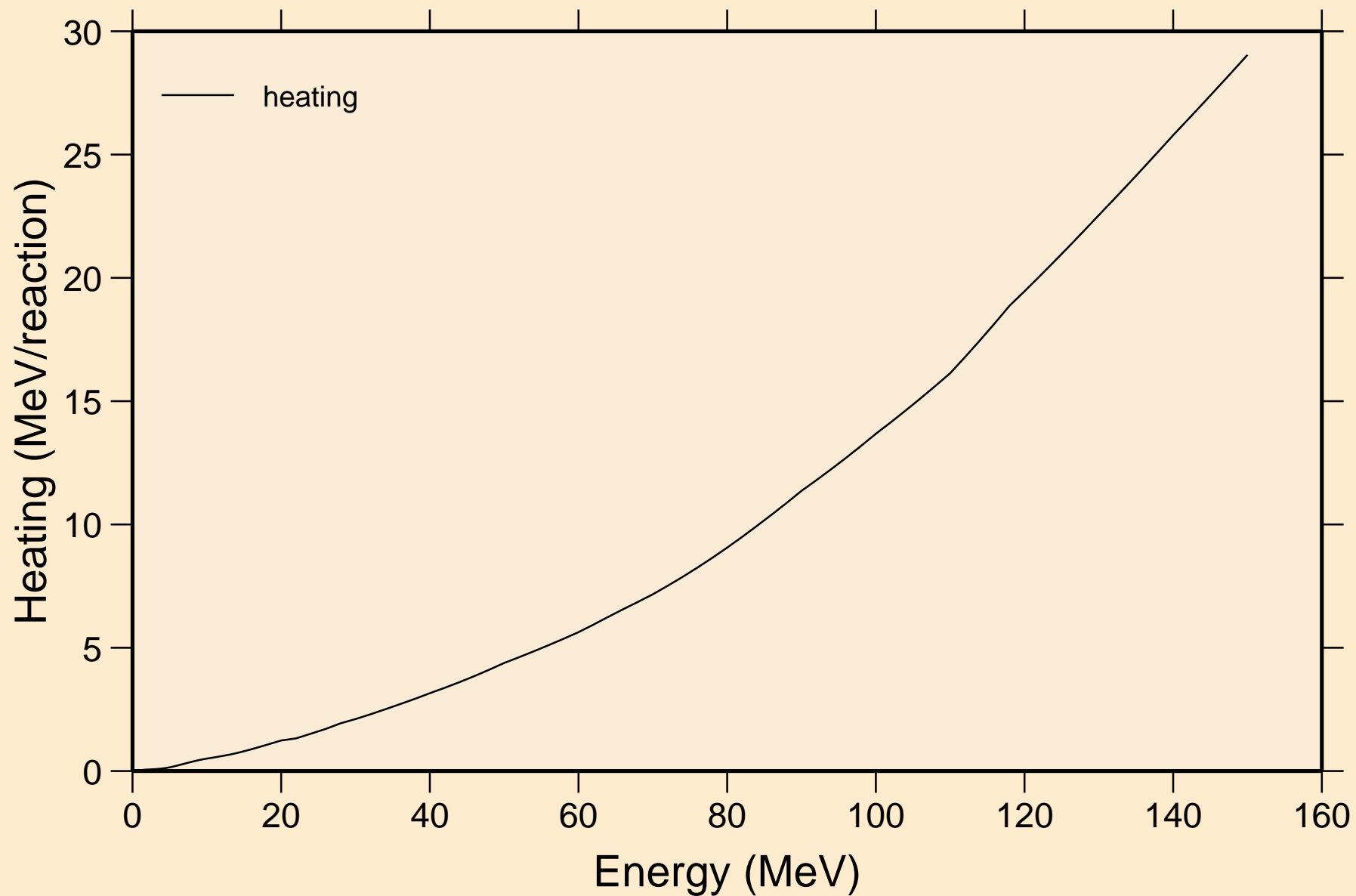

20-CA-43 FOR FENDL-3.2 FROM FENDL-3.2 BY NJOY2016.60+ O Damage

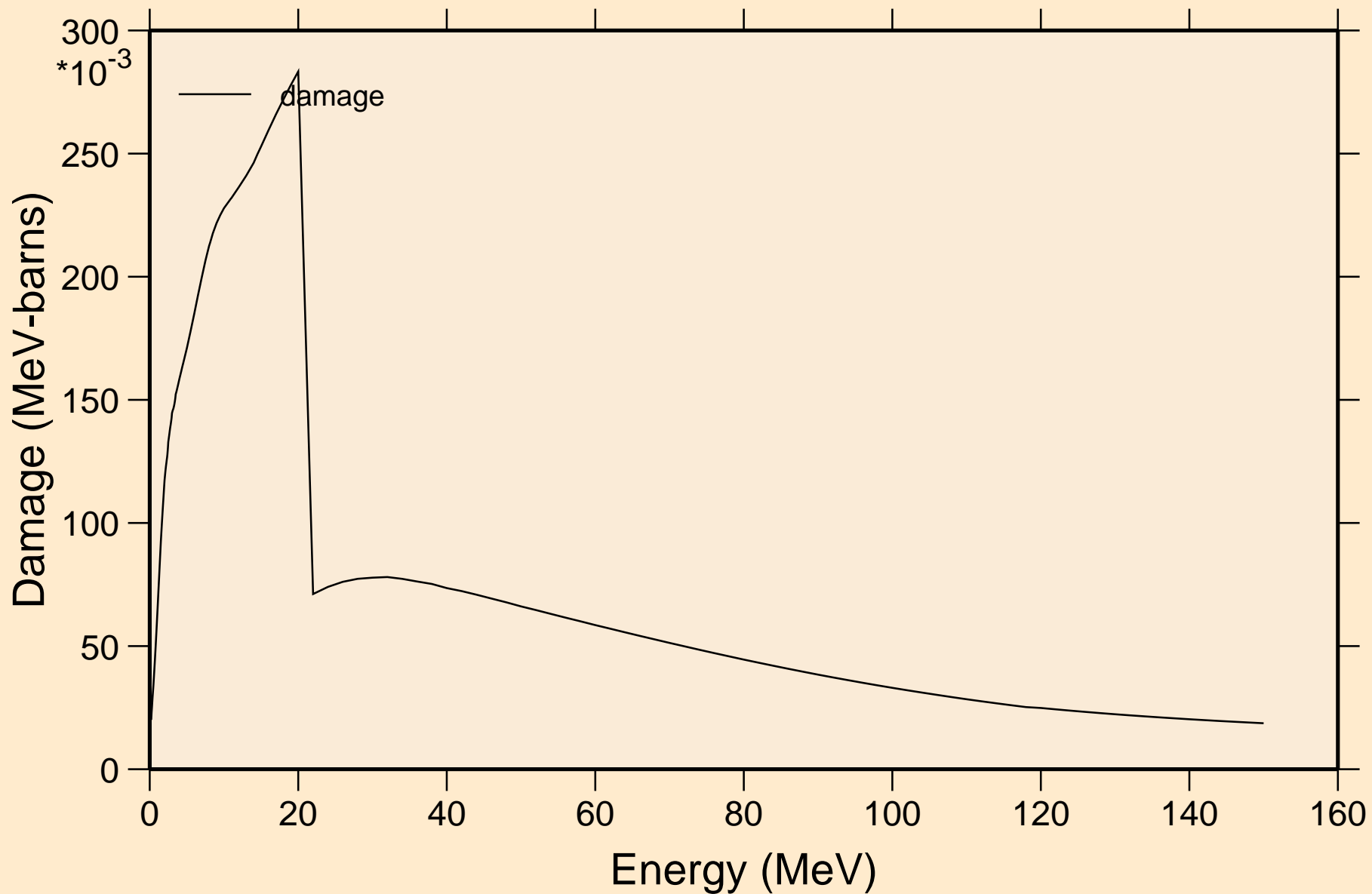

20-CA-43 FOR FENDL-3.2 FROM FENDL-3.2 BY NJOY2016.60+ O
Non-threshold reactions

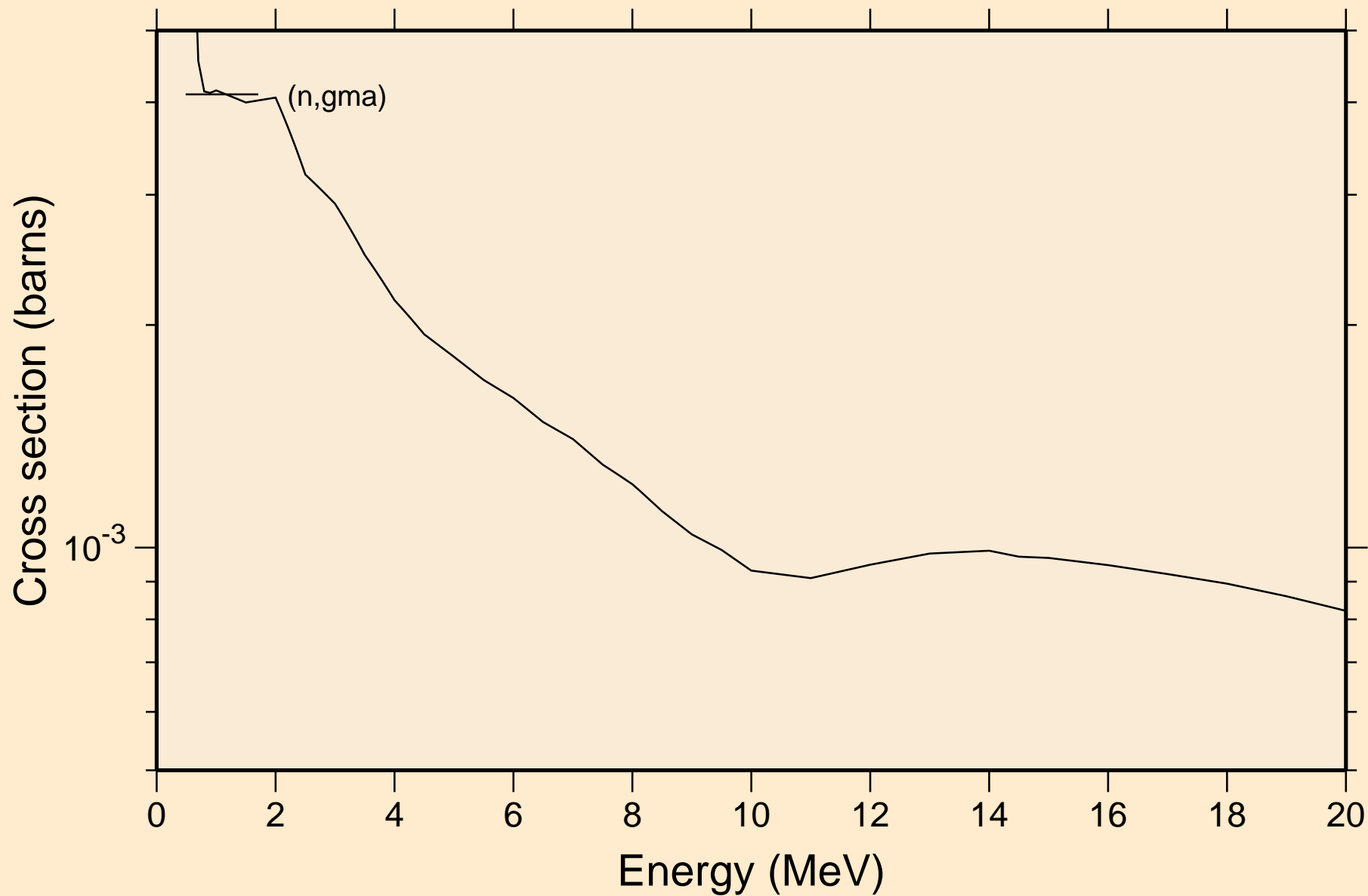

20-CA-43 FOR FENDL-3.2 FROM FENDL-3.2 BY NJOY2016.60+ O
Inelastic levels

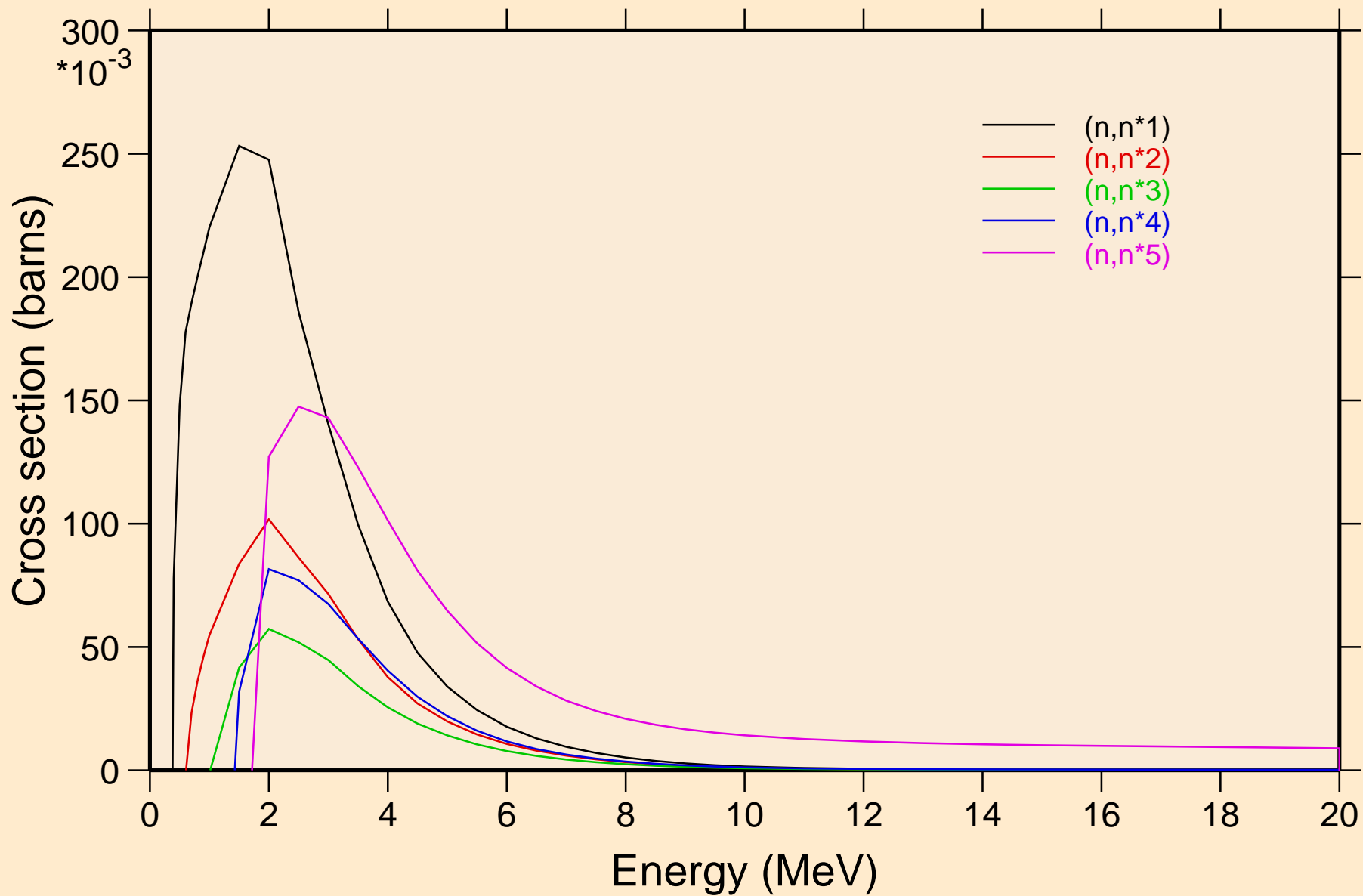

20-CA-43 FOR FENDL-3.2 FROM FENDL-3.2 BY NJOY2016.60+ O Inelastic levels

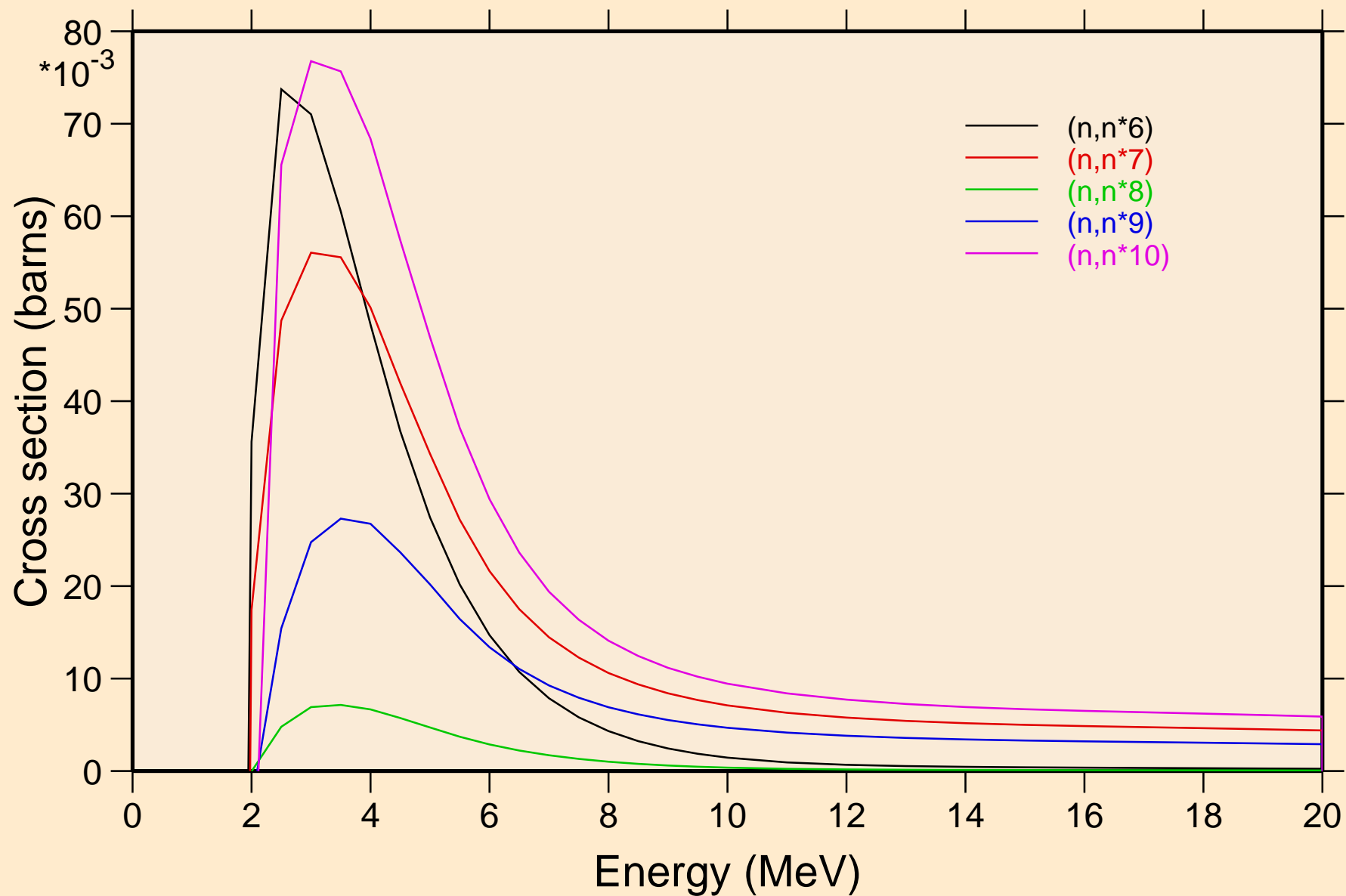

20-CA-43 FOR FENDL-3.2 FROM FENDL-3.2 BY NJOY2016.60+ O
Inelastic levels

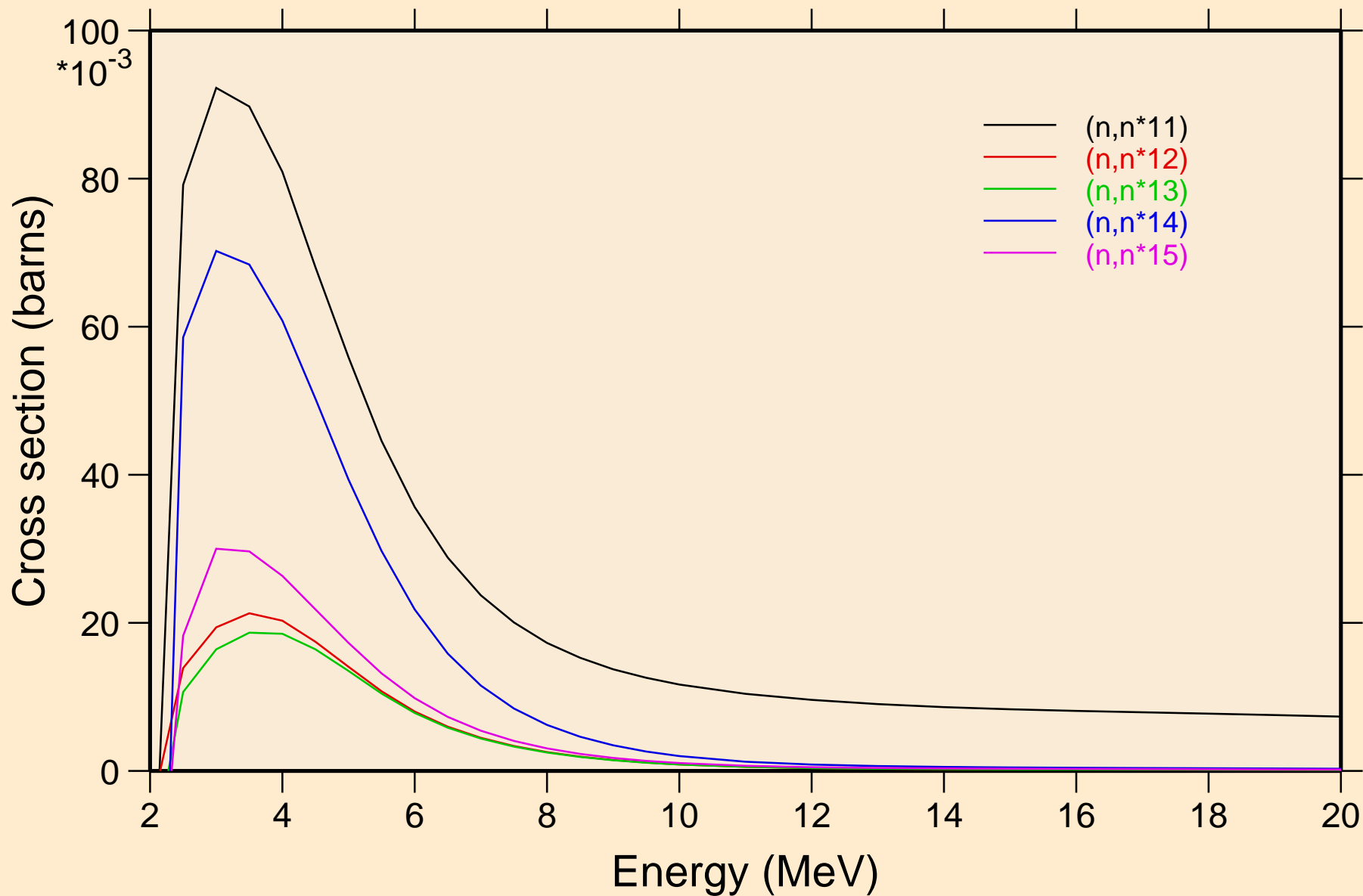

20-CA-43 FOR FENDL-3.2 FROM FENDL-3.2 BY NJOY2016.60+ O Inelastic levels

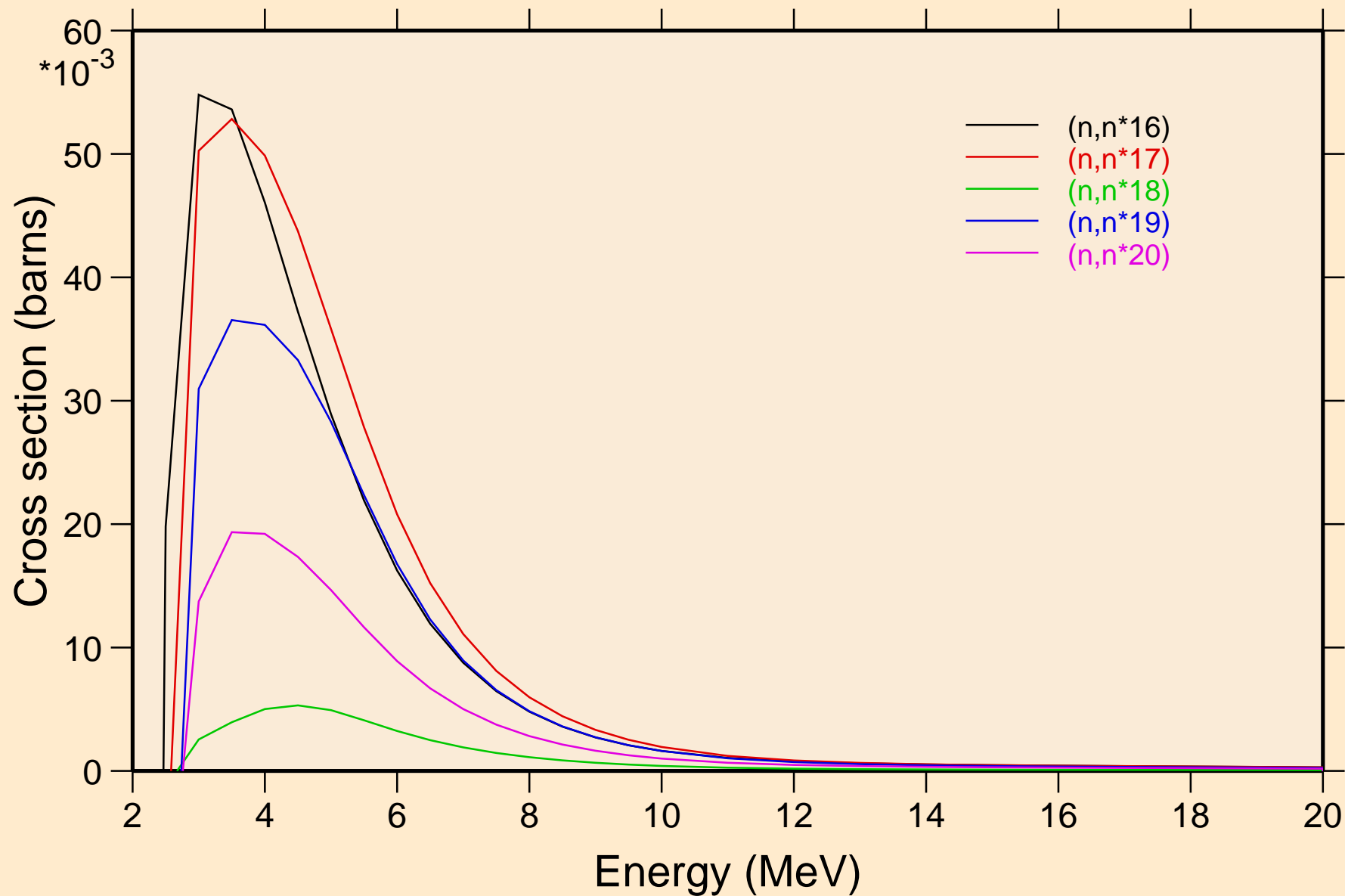

20-CA-43 FOR FENDL-3.2 FROM FENDL-3.2 BY NJOY2016.60+ O Inelastic levels

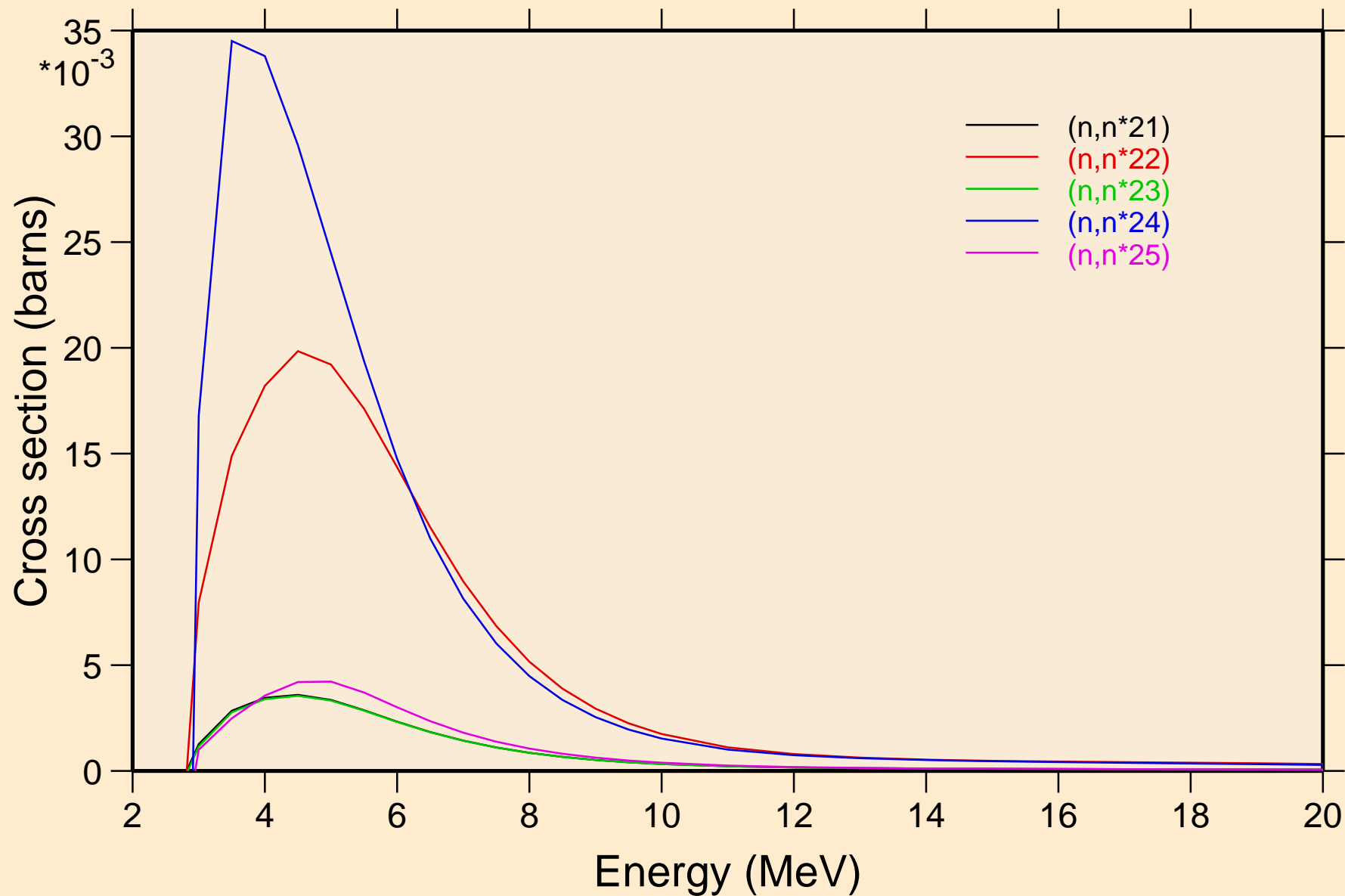

20-CA-43 FOR FENDL-3.2 FROM FENDL-3.2 BY NJOY2016.60+ O
Inelastic levels

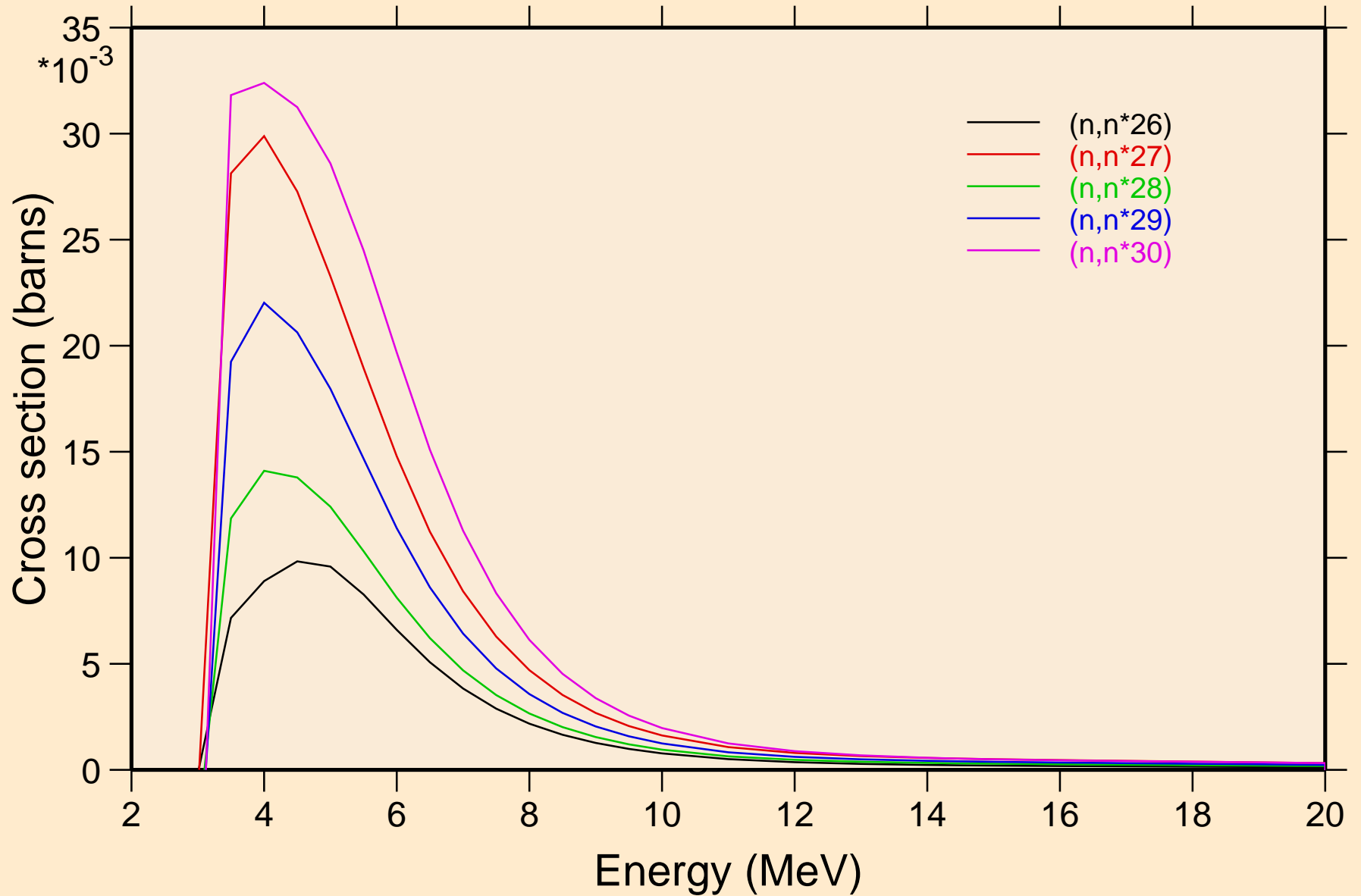

20-CA-43 FOR FENDL-3.2 FROM FENDL-3.2 BY NJOY2016.60+ O
Inelastic levels

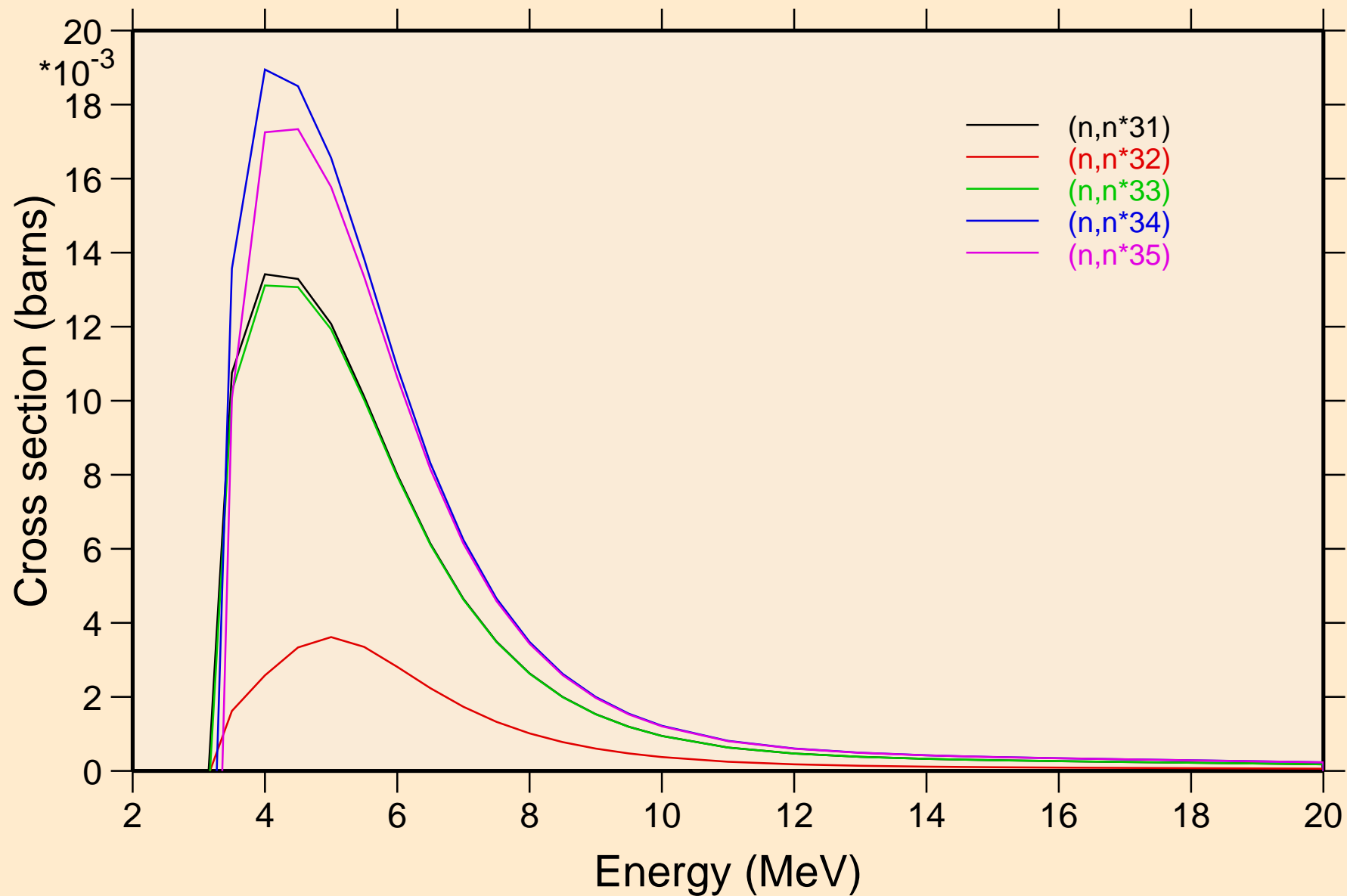

20-CA-43 FOR FENDL-3.2 FROM FENDL-3.2 BY NJOY2016.60+ O
Inelastic levels

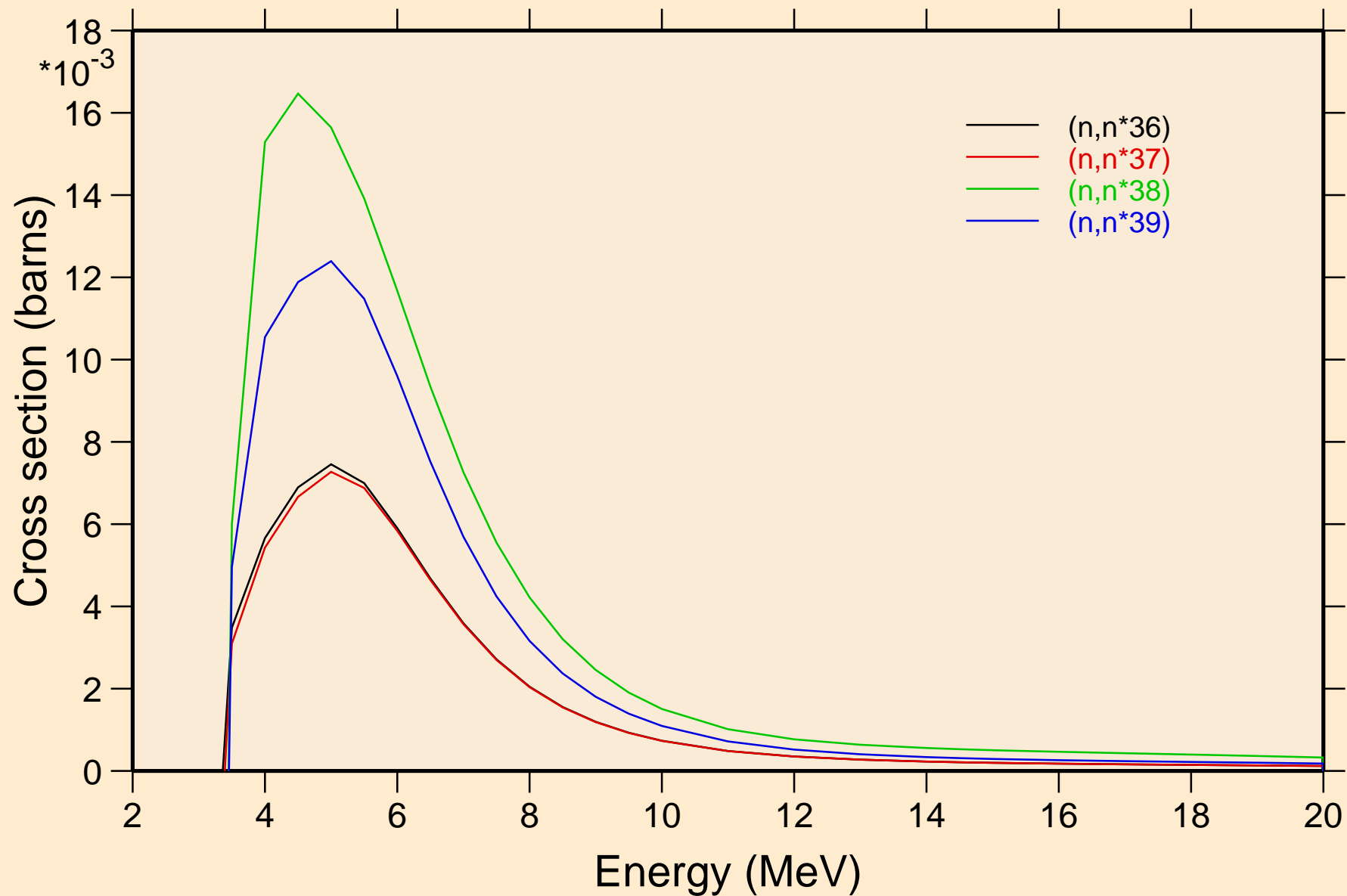

20-CA-43 FOR FENDL-3.2 FROM FENDL-3.2 BY NJOY2016.60+ O Threshold reactions

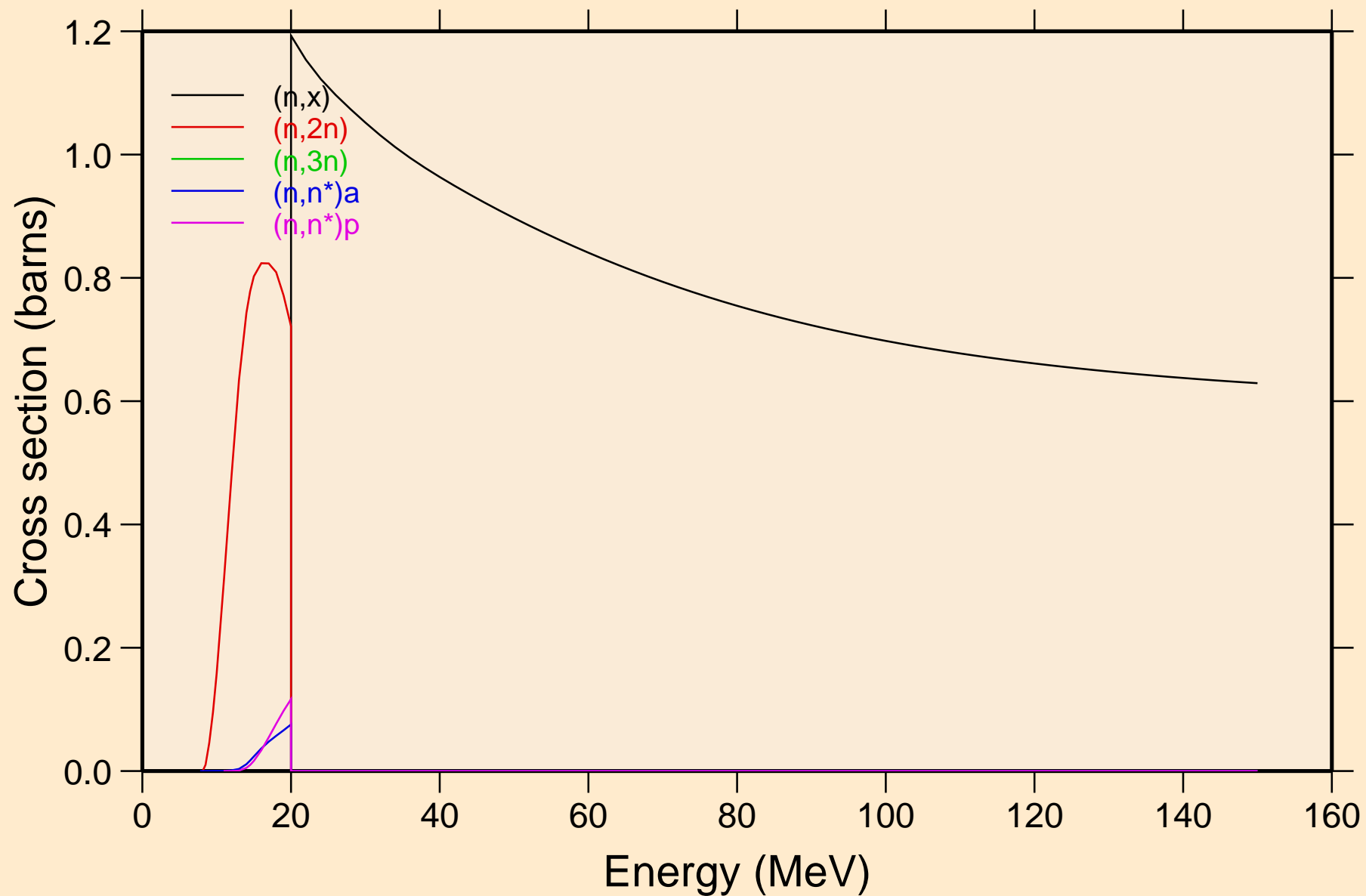

20-CA-43 FOR FENDL-3.2 FROM FENDL-3.2 BY NJOY2016.60+ O
Threshold reactions

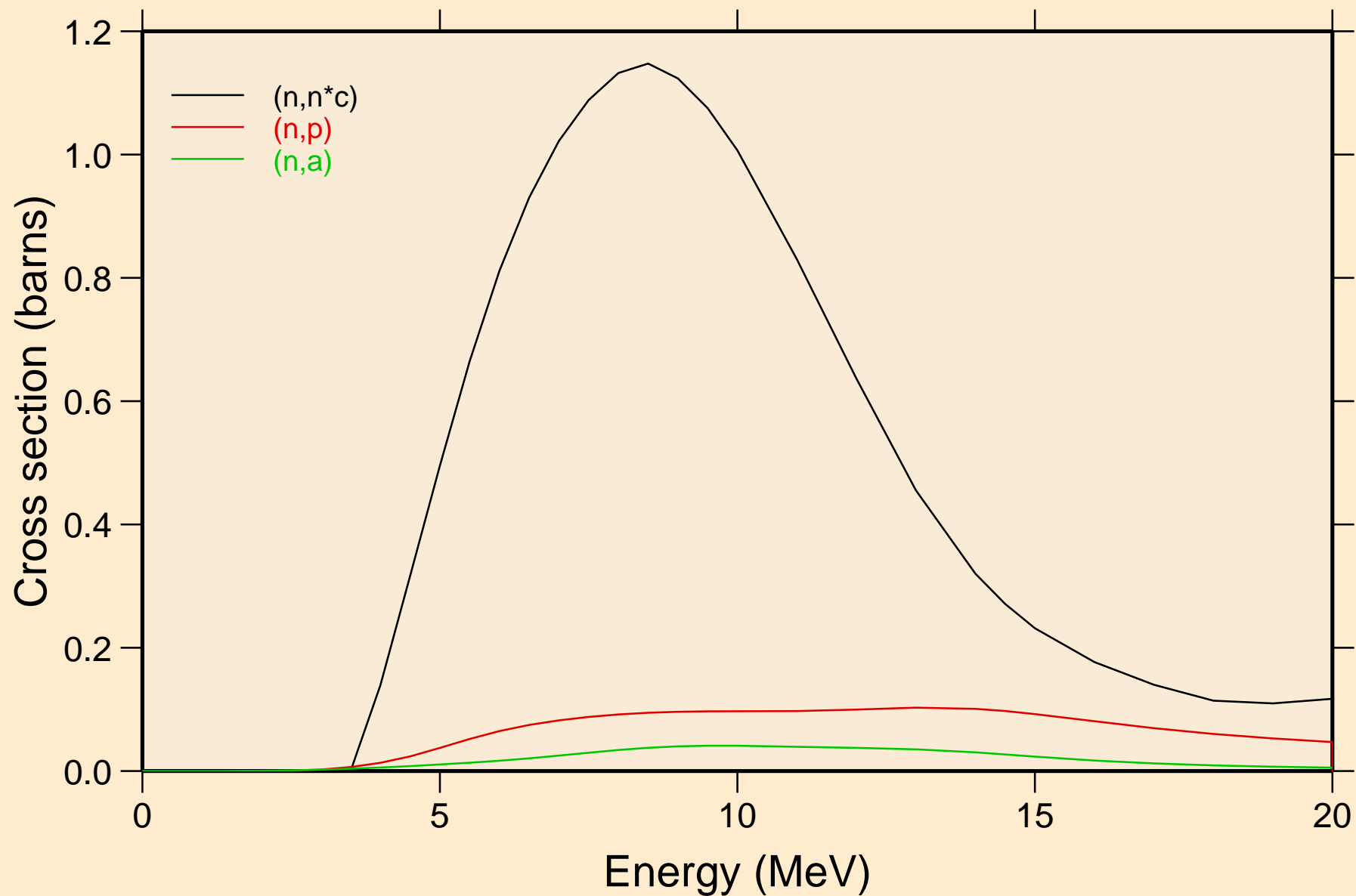

20-CA-43 FOR FENDL-3.2 FROM FENDL-3.2 BY NJOY2016.60+ O
Threshold reactions

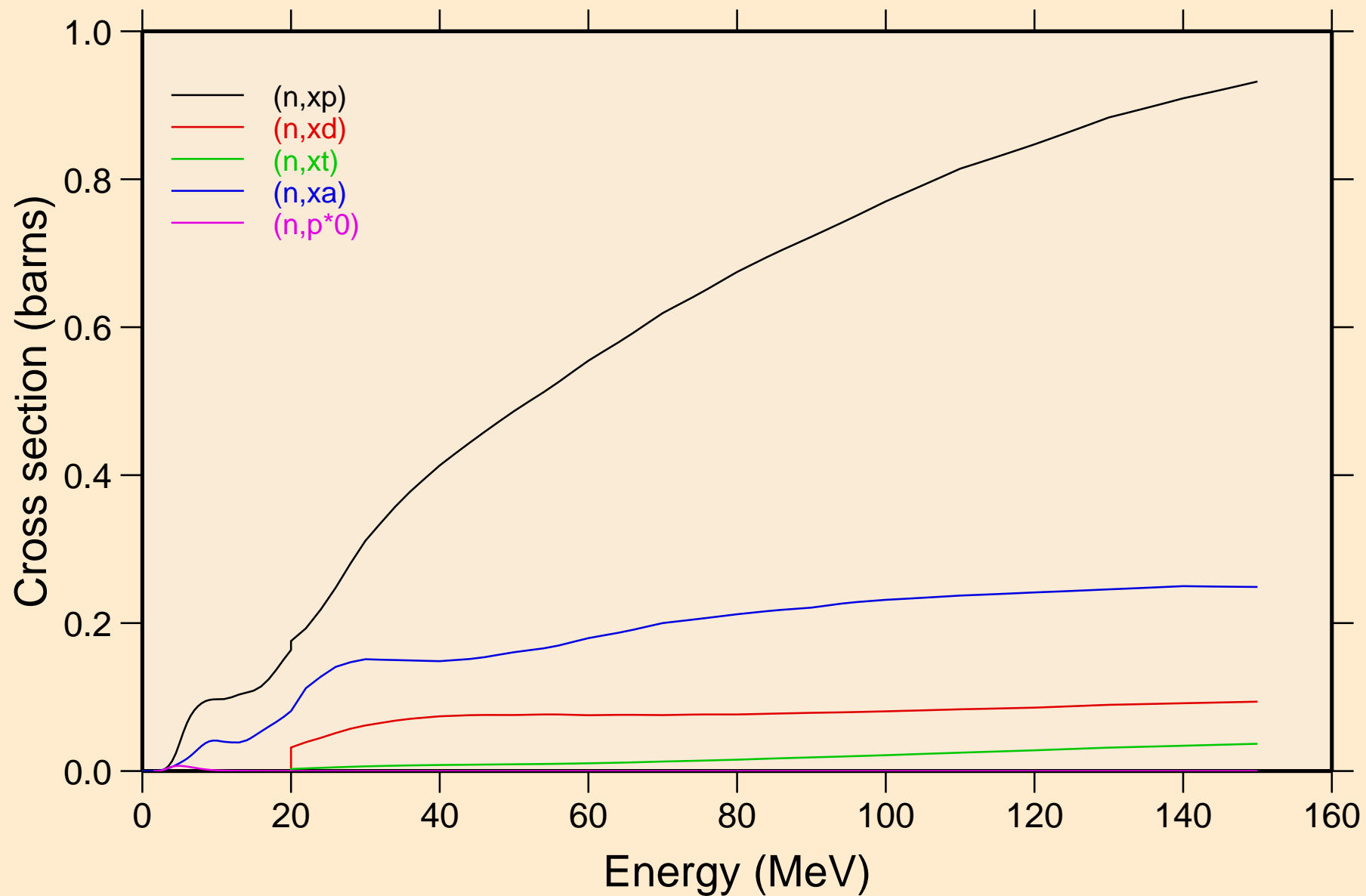

20-CA-43 FOR FENDL-3.2 FROM FENDL-3.2 BY NJOY2016.60+ O
Threshold reactions

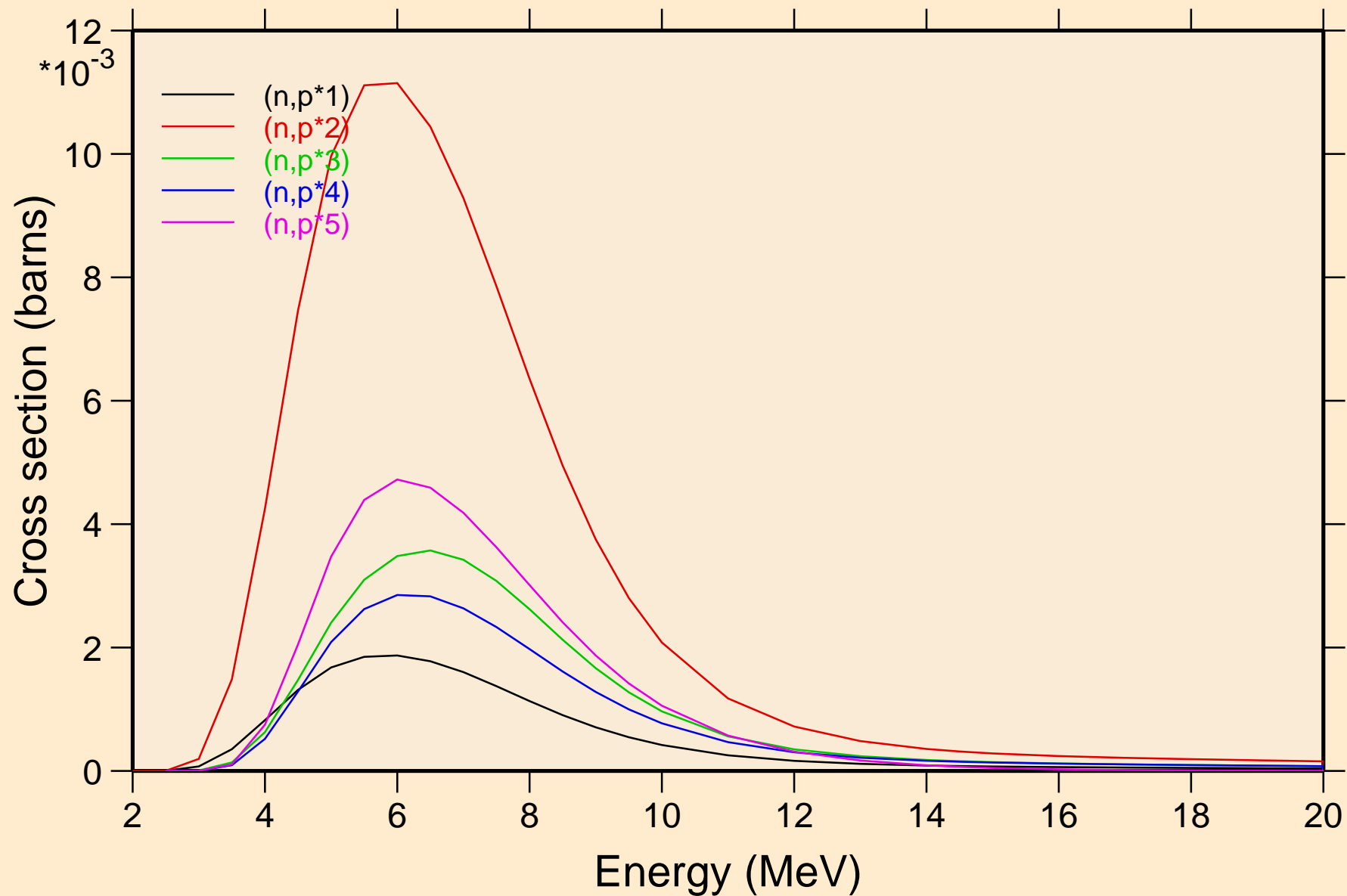

20-CA-43 FOR FENDL-3.2 FROM FENDL-3.2 BY NJOY2016.60+ O
Threshold reactions

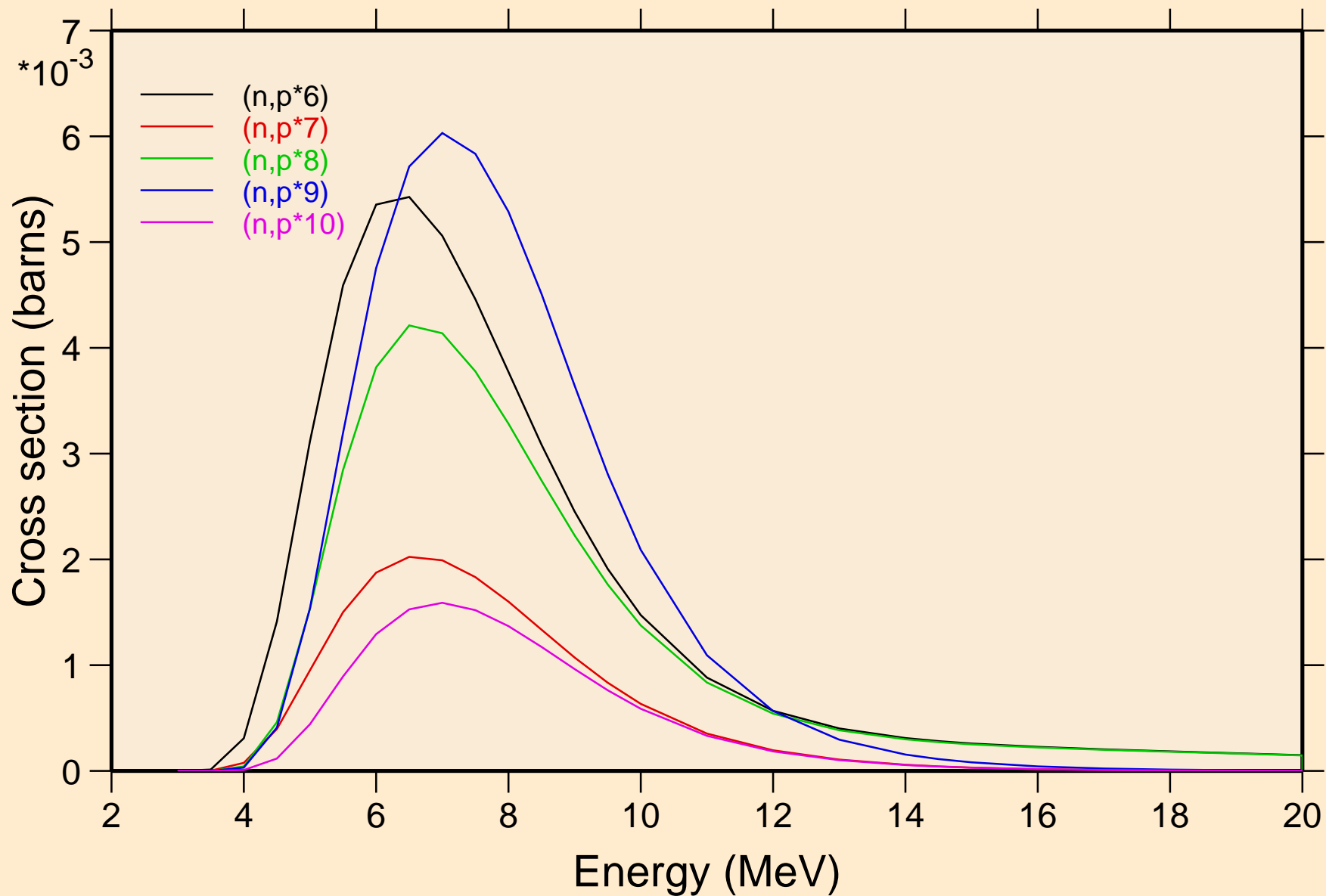

20-CA-43 FOR FENDL-3.2 FROM FENDL-3.2 BY NJOY2016.60+ O
Threshold reactions

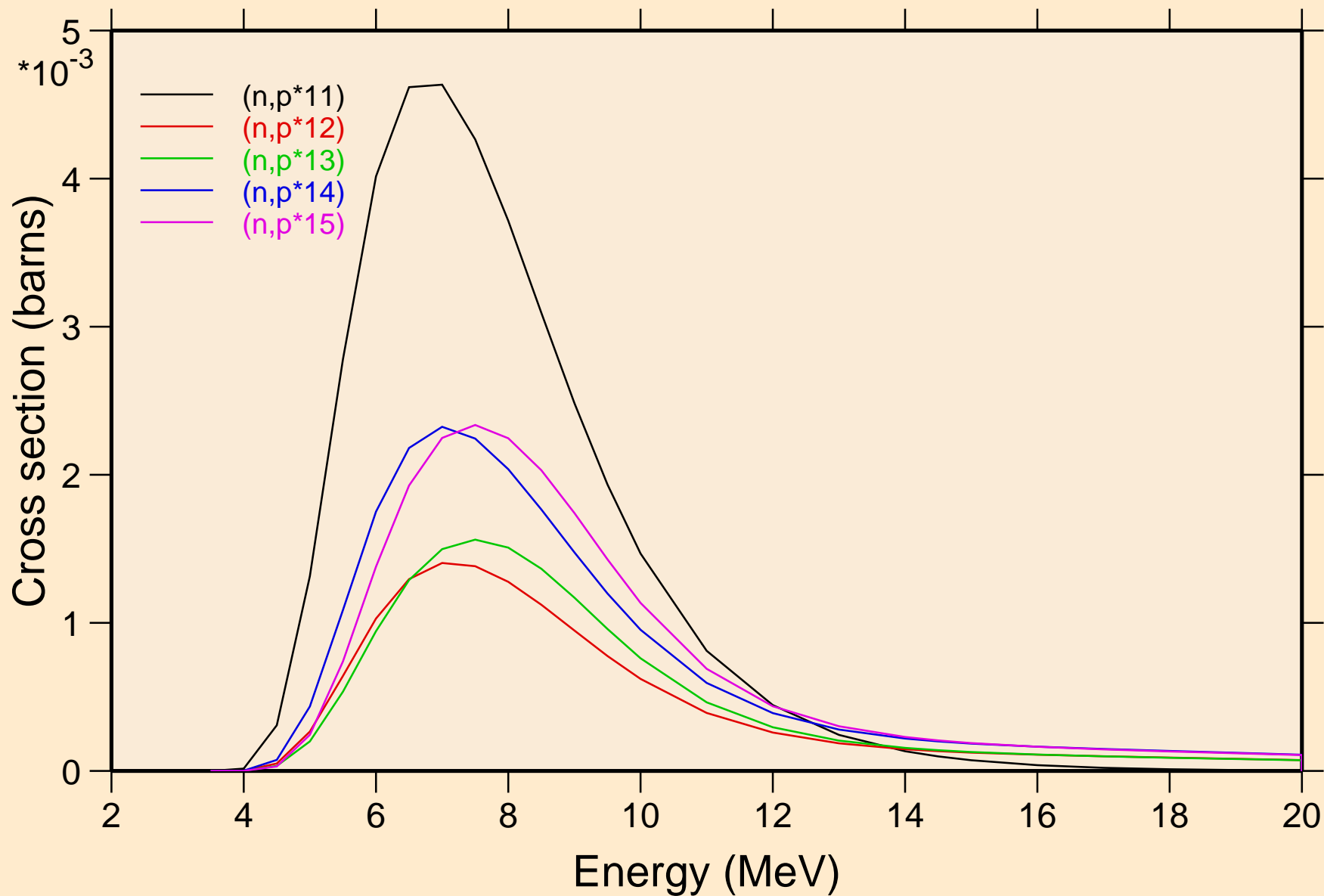

20-CA-43 FOR FENDL-3.2 FROM FENDL-3.2 BY NJOY2016.60+ O Threshold reactions

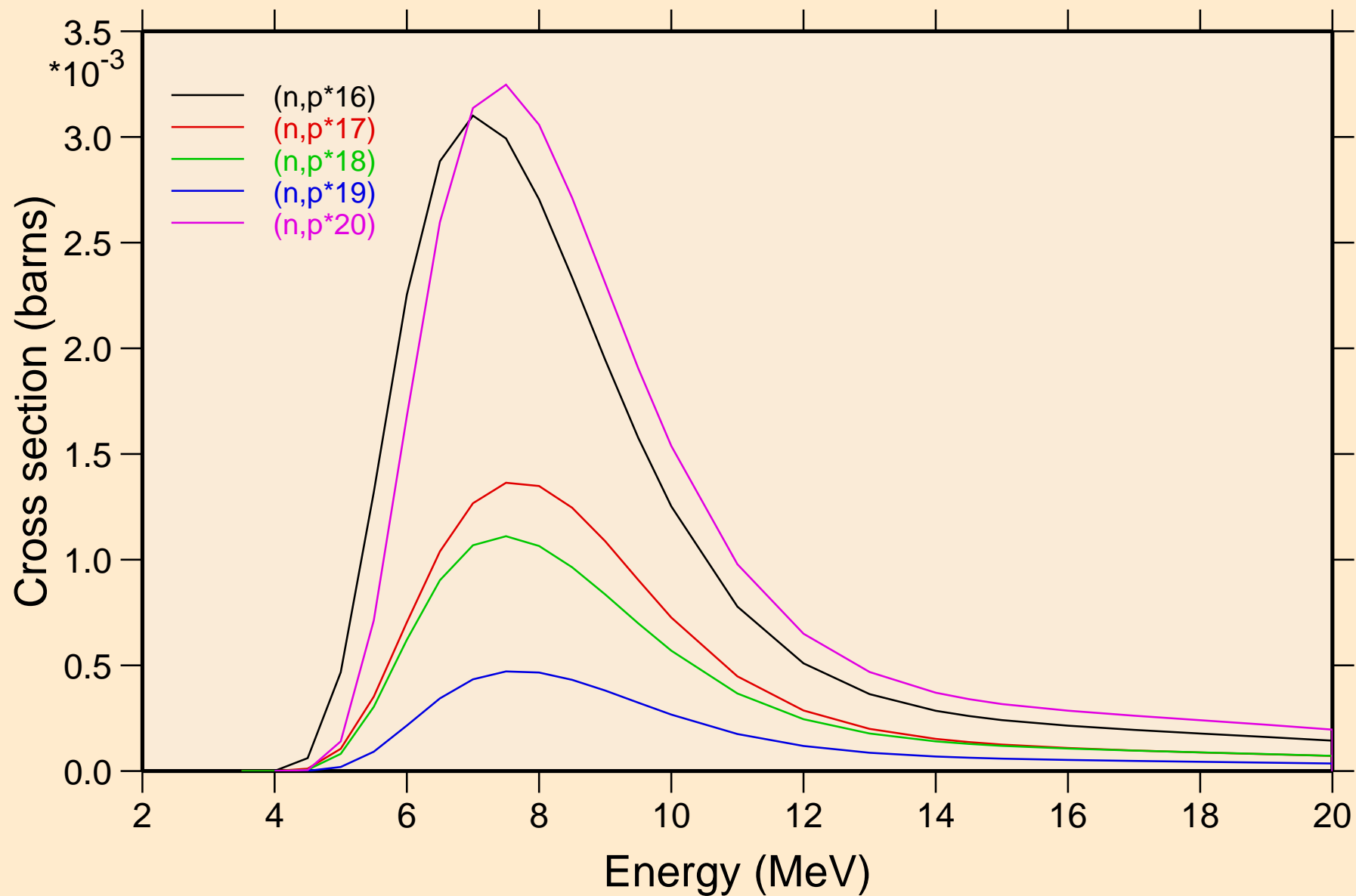

20-CA-43 FOR FENDL-3.2 FROM FENDL-3.2 BY NJOY2016.60+ O
Threshold reactions

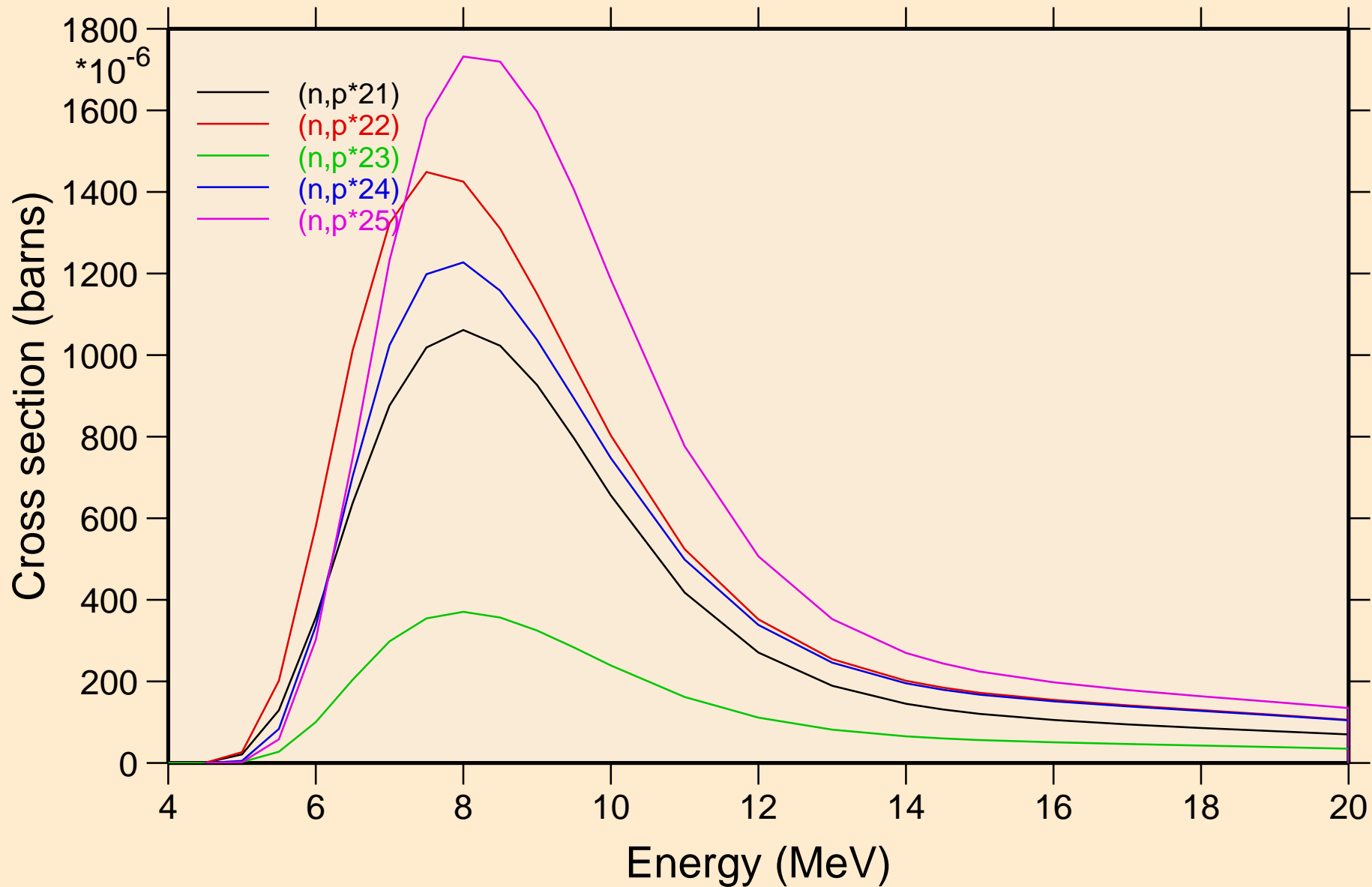

20-CA-43 FOR FENDL-3.2 FROM FENDL-3.2 BY NJOY2016.60+ O
Threshold reactions

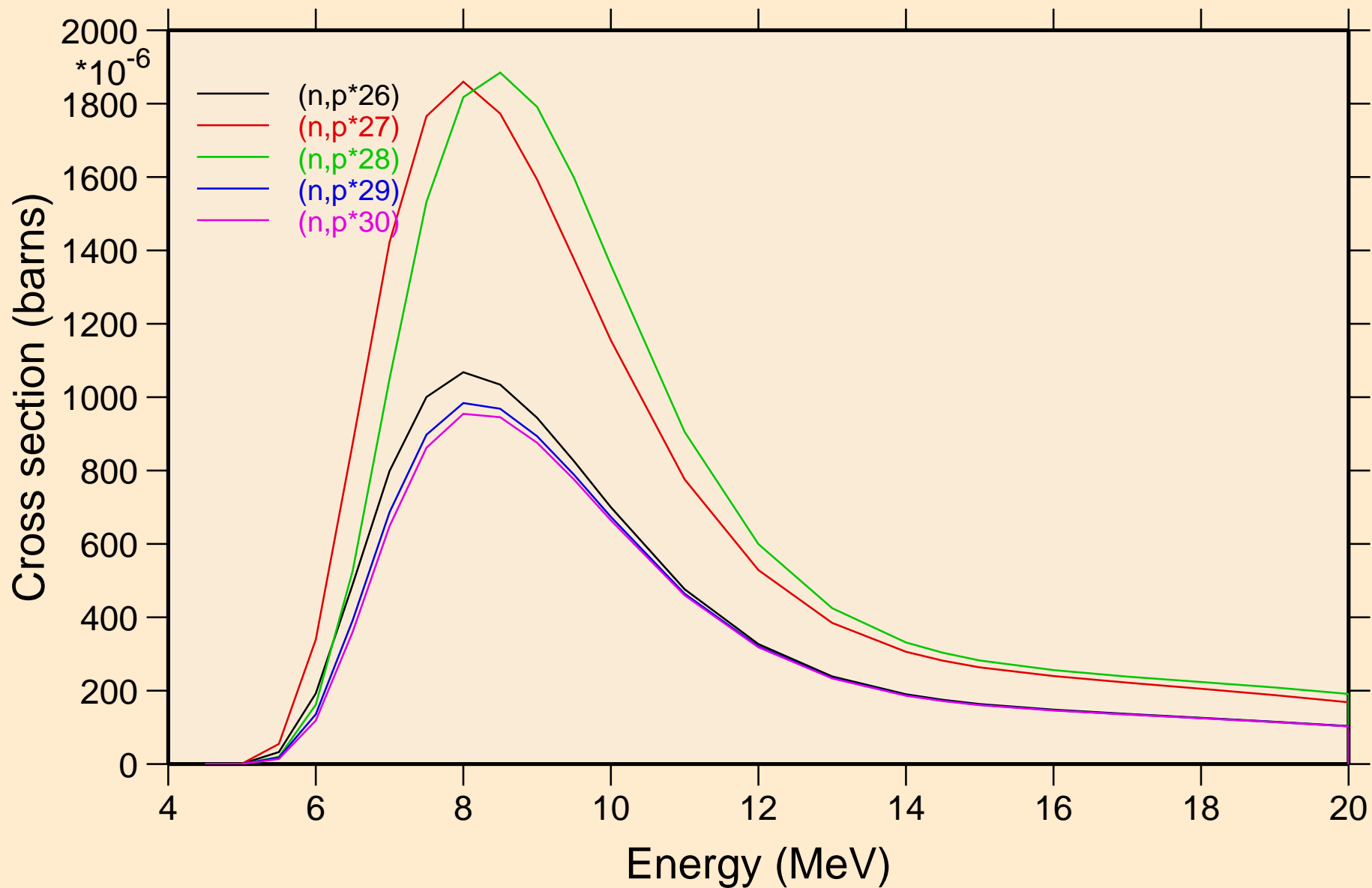

20-CA-43 FOR FENDL-3.2 FROM FENDL-3.2 BY NJOY2016.60+ O
Threshold reactions

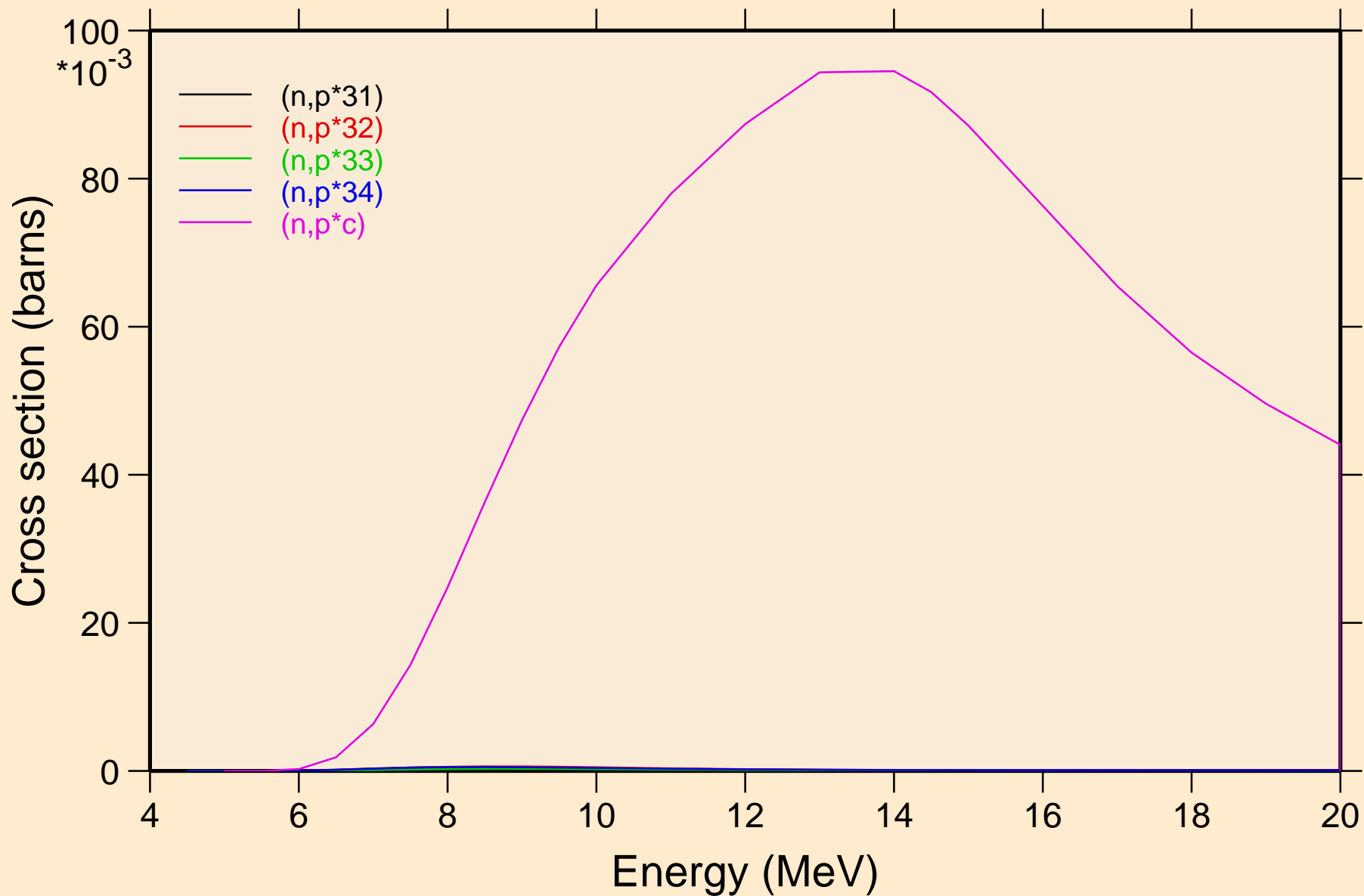

20-CA-43 FOR FENDL-3.2 FROM FENDL-3.2 BY NJOY2016.60+ O
Threshold reactions

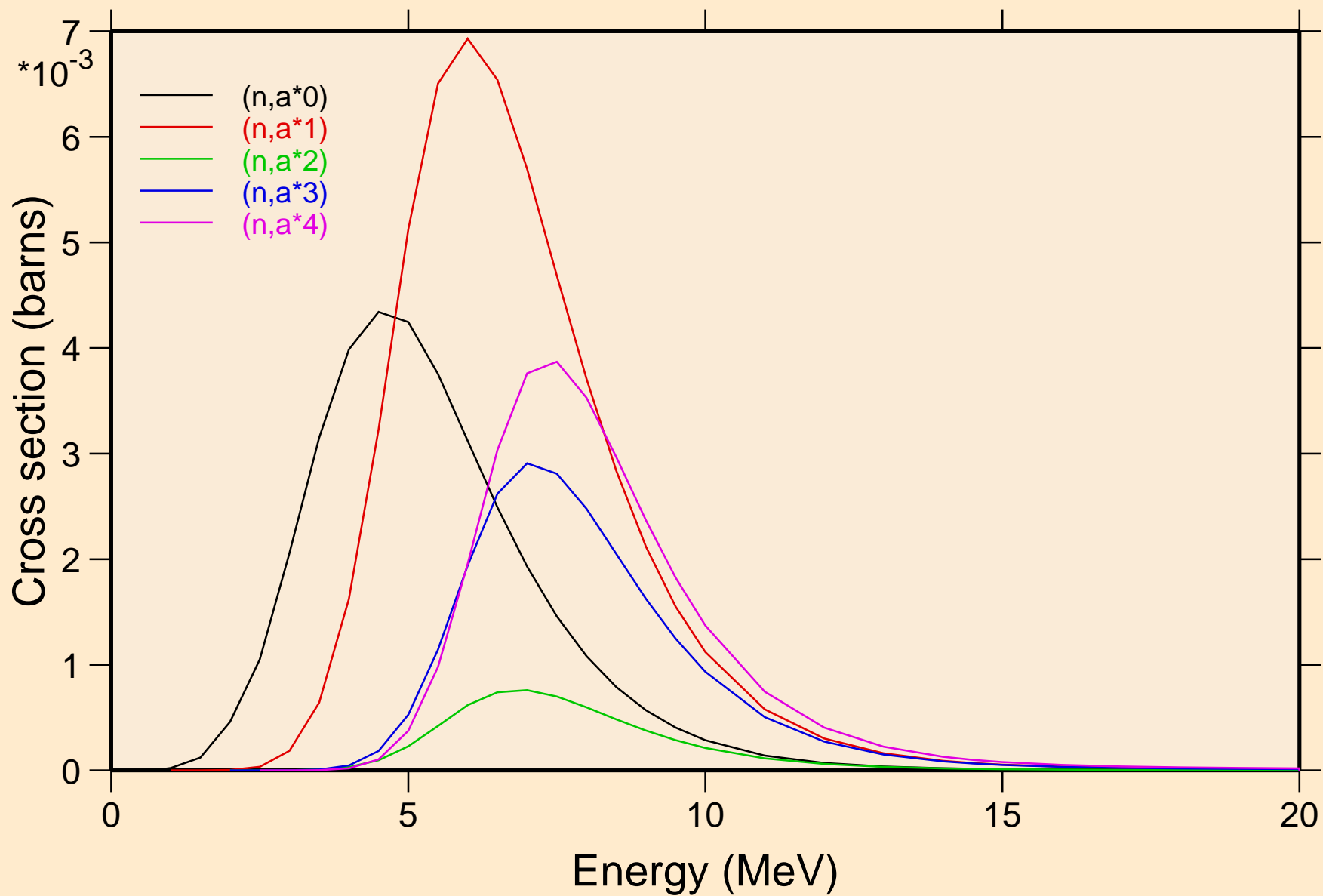

20-CA-43 FOR FENDL-3.2 FROM FENDL-3.2 BY NJOY2016.60+ O
Threshold reactions

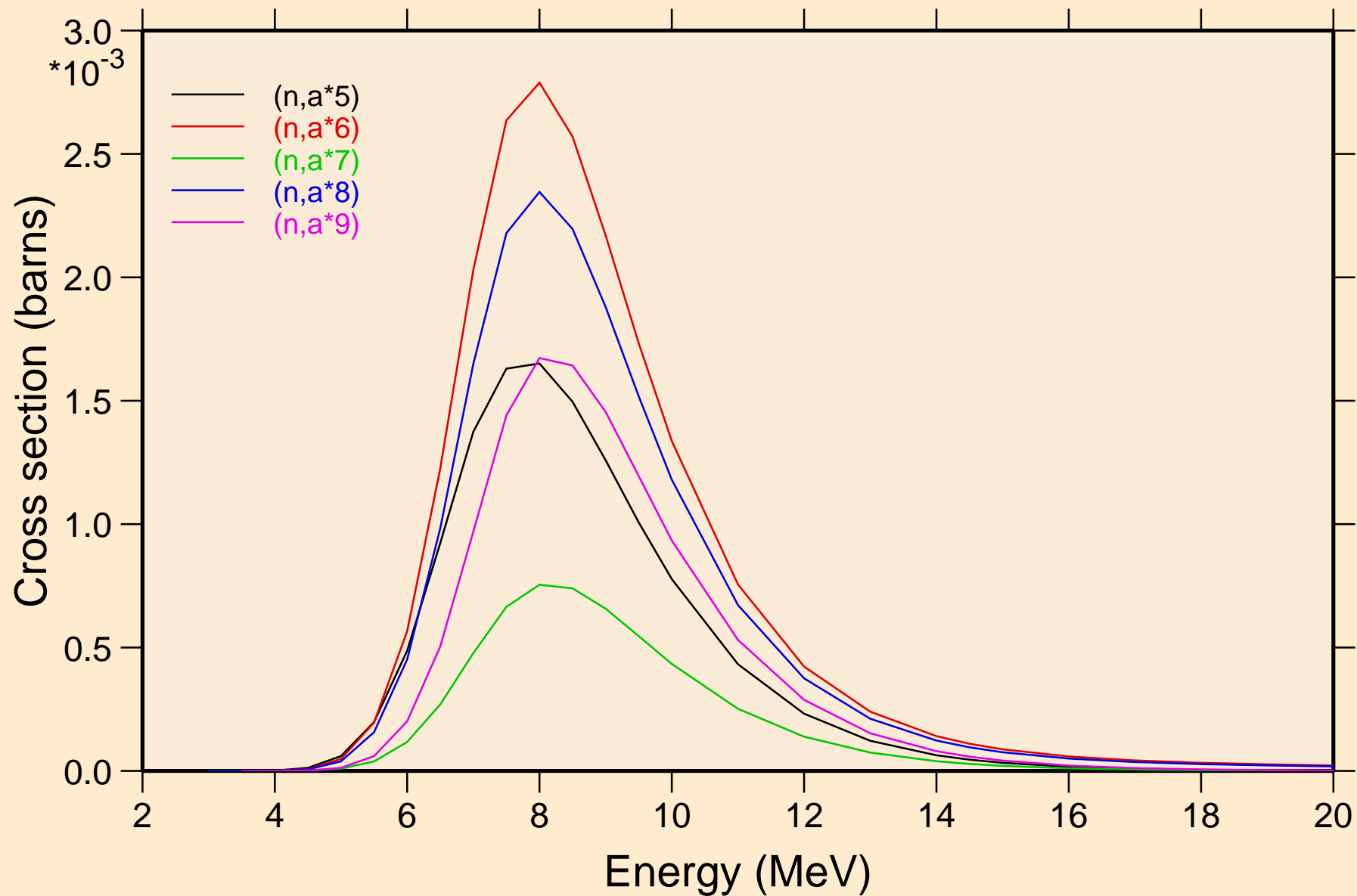

20-CA-43 FOR FENDL-3.2 FROM FENDL-3.2 BY NJOY2016.60+ O Threshold reactions

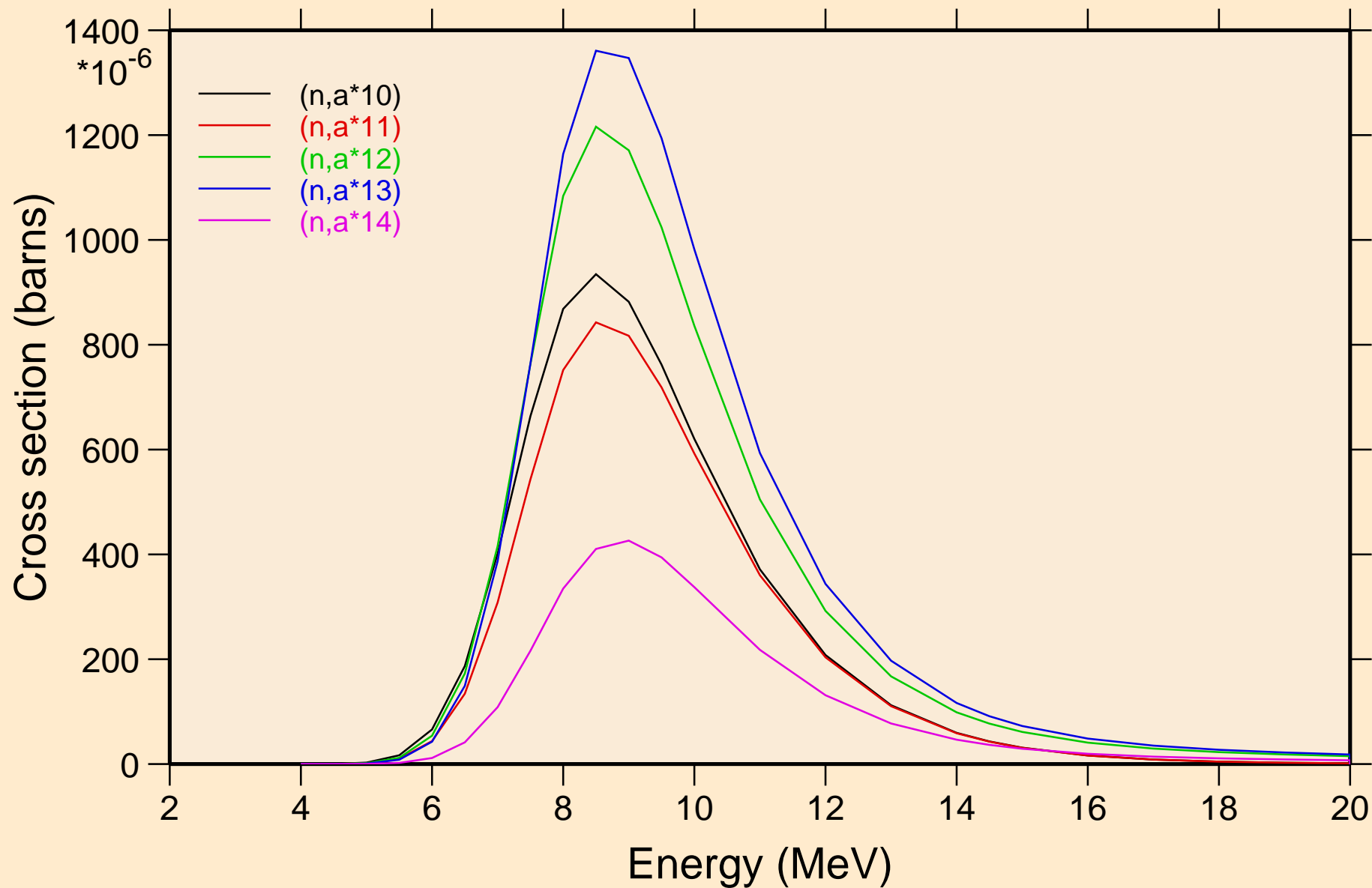

20-CA-43 FOR FENDL-3.2 FROM FENDL-3.2 BY NJOY2016.60+ O
Threshold reactions

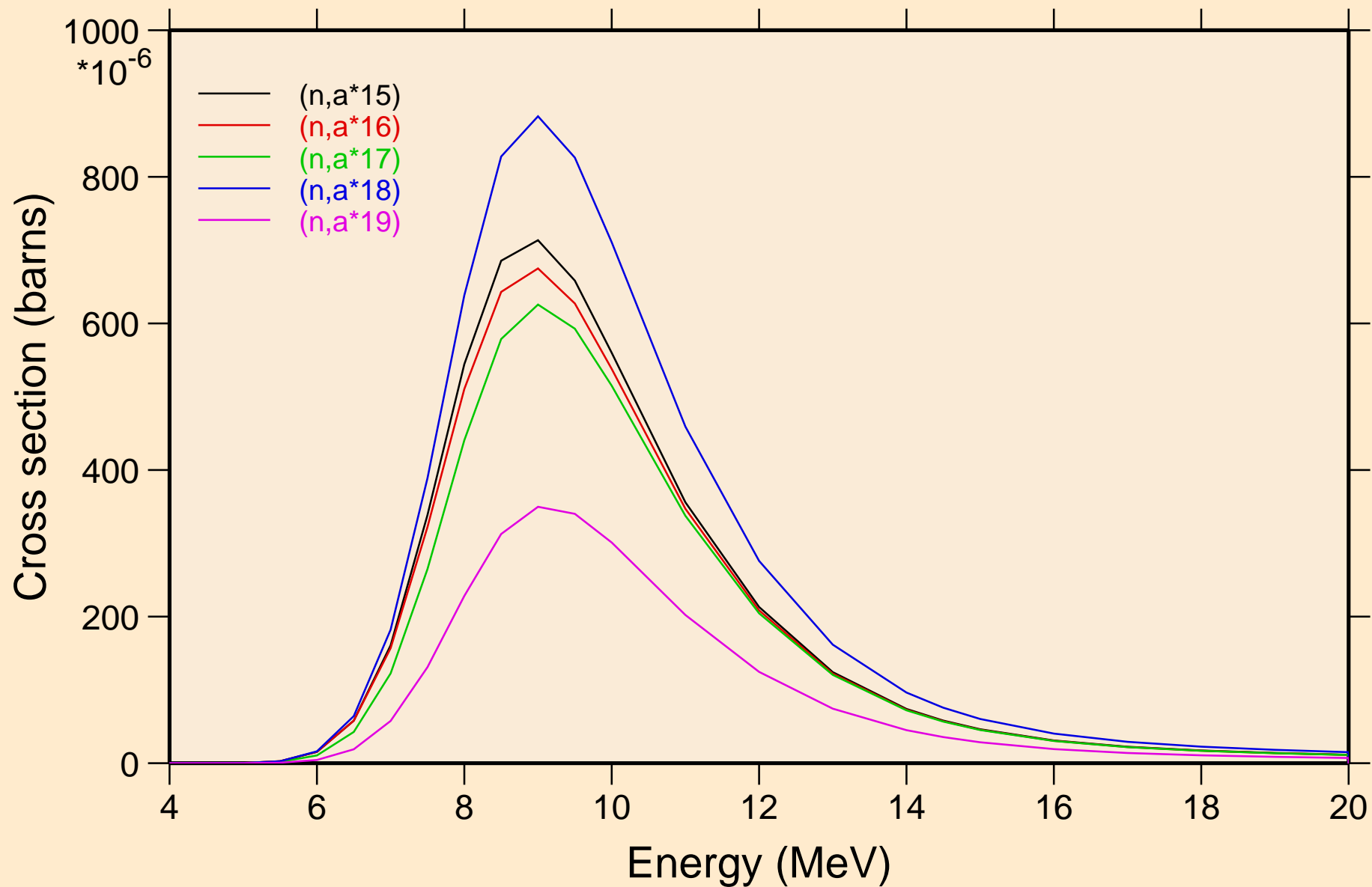

20-CA-43 FOR FENDL-3.2 FROM FENDL-3.2 BY NJOY2016.60+ O
Threshold reactions

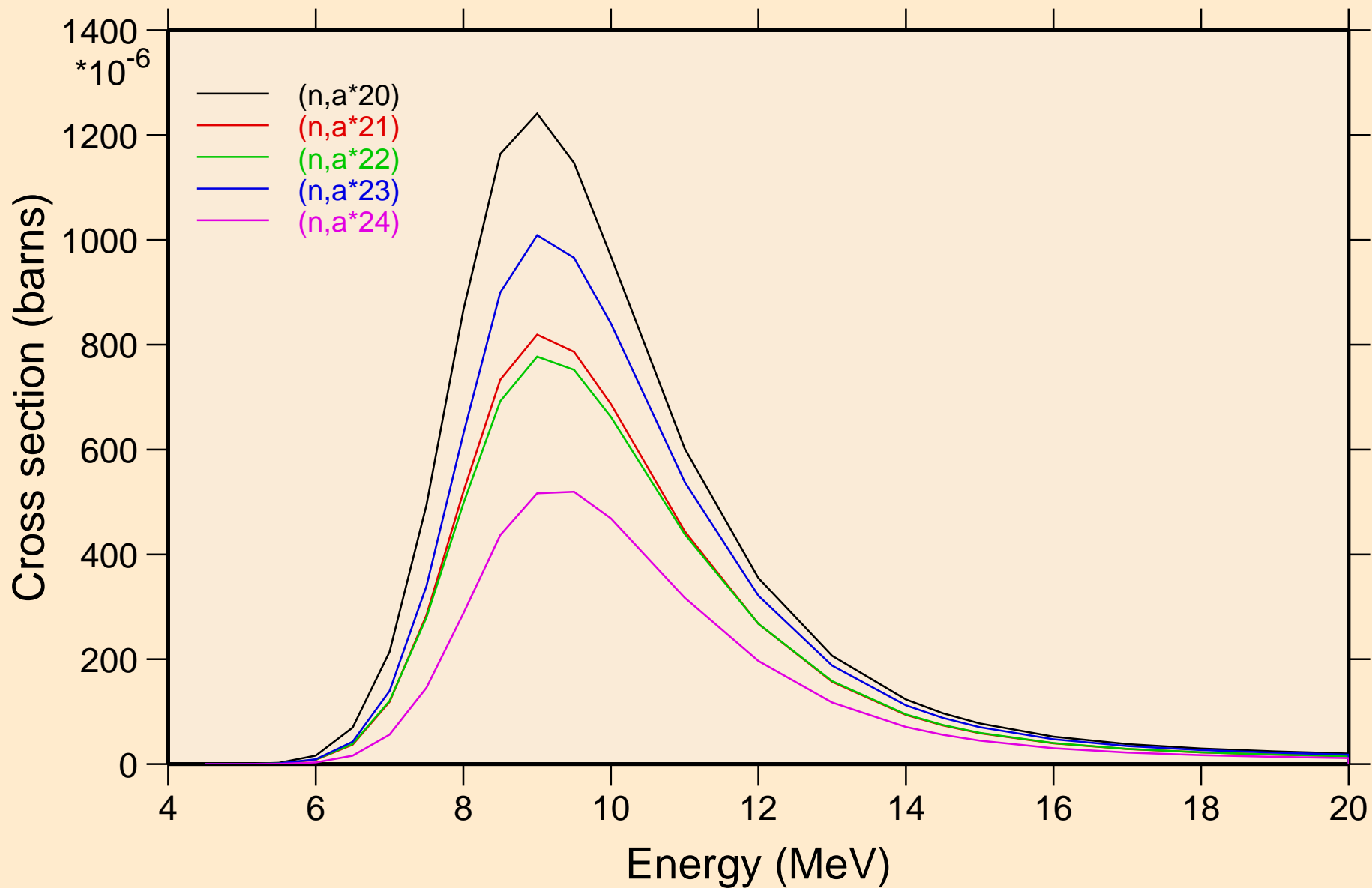

20-CA-43 FOR FENDL-3.2 FROM FENDL-3.2 BY NJOY2016.60+ O
Threshold reactions

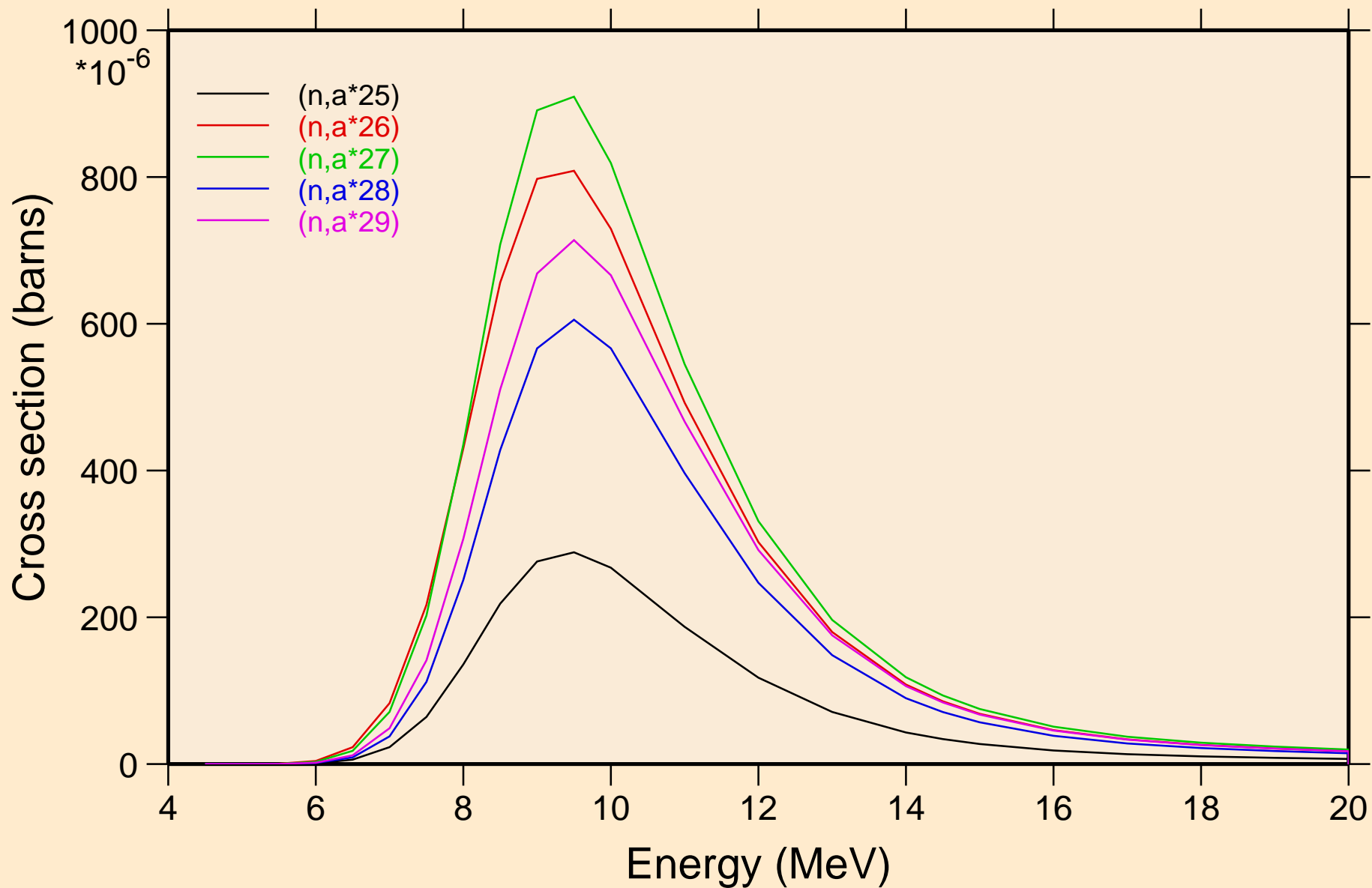

20-CA-43 FOR FENDL-3.2 FROM FENDL-3.2 BY NJOY2016.60+ O
Threshold reactions

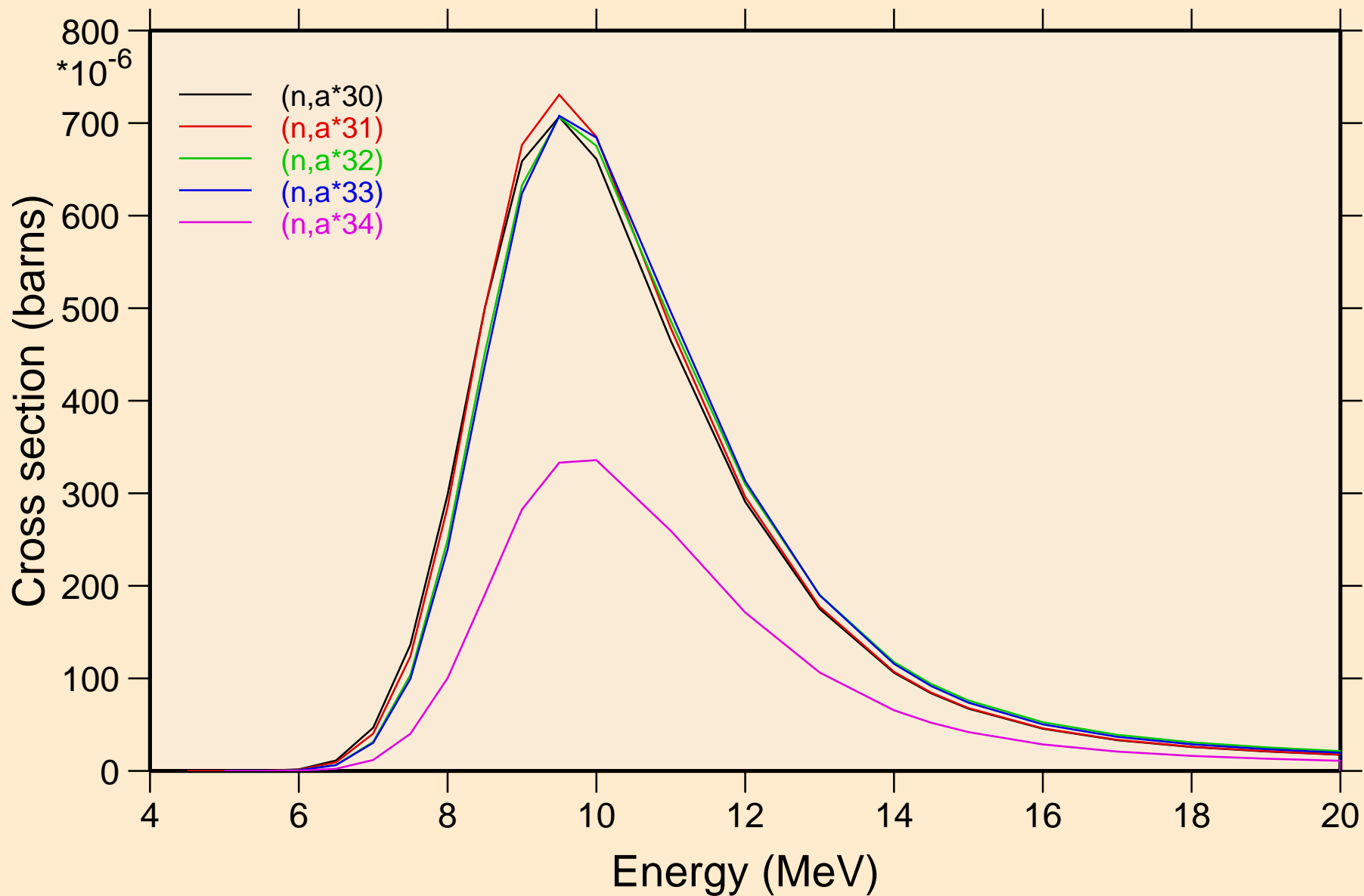

20-CA-43 FOR FENDL-3.2 FROM FENDL-3.2 BY NJOY2016.60+ O
Threshold reactions

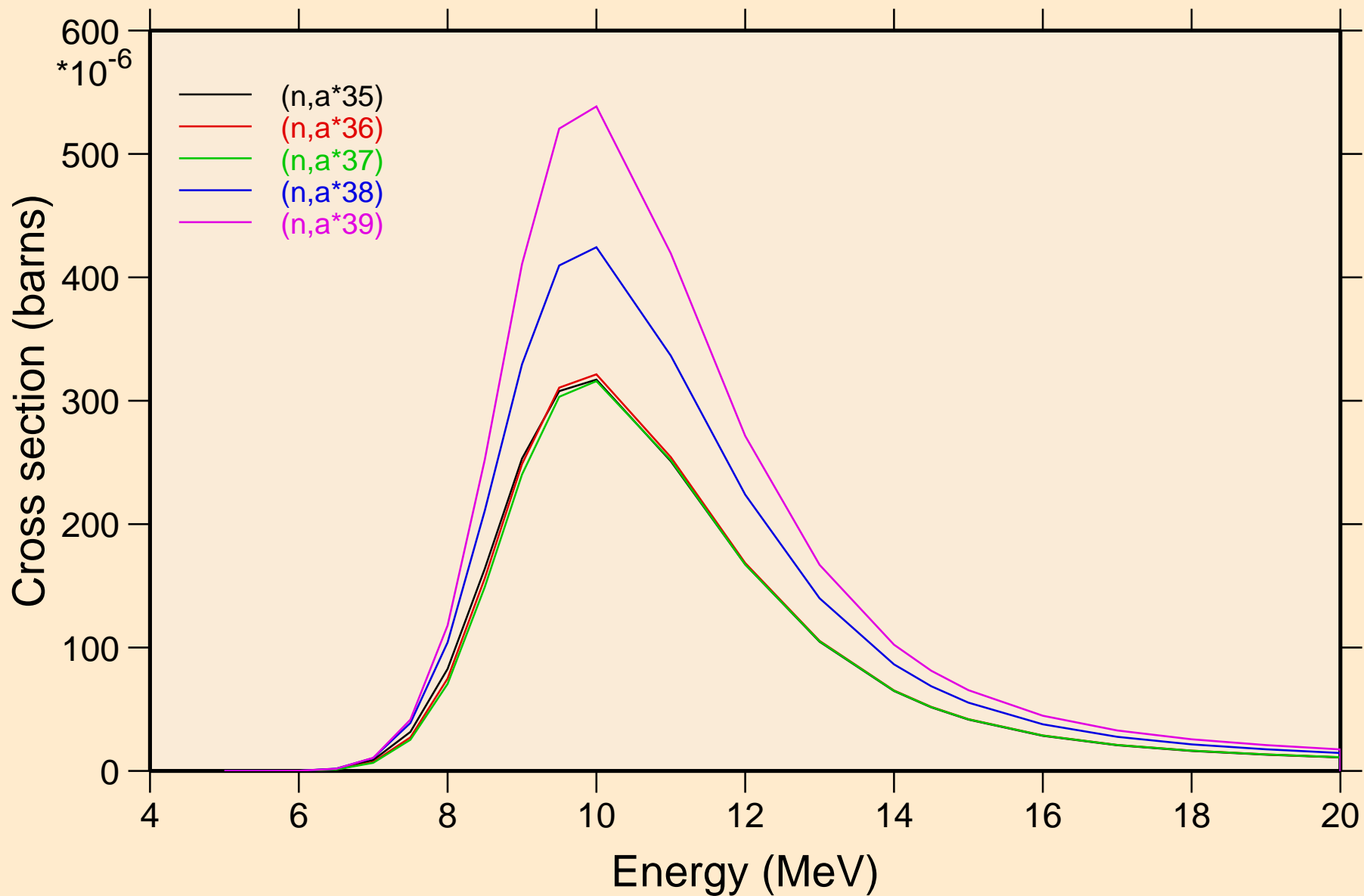

20-CA-43 FOR FENDL-3.2 FROM FENDL-3.2 BY NJOY2016.60+ O
Threshold reactions

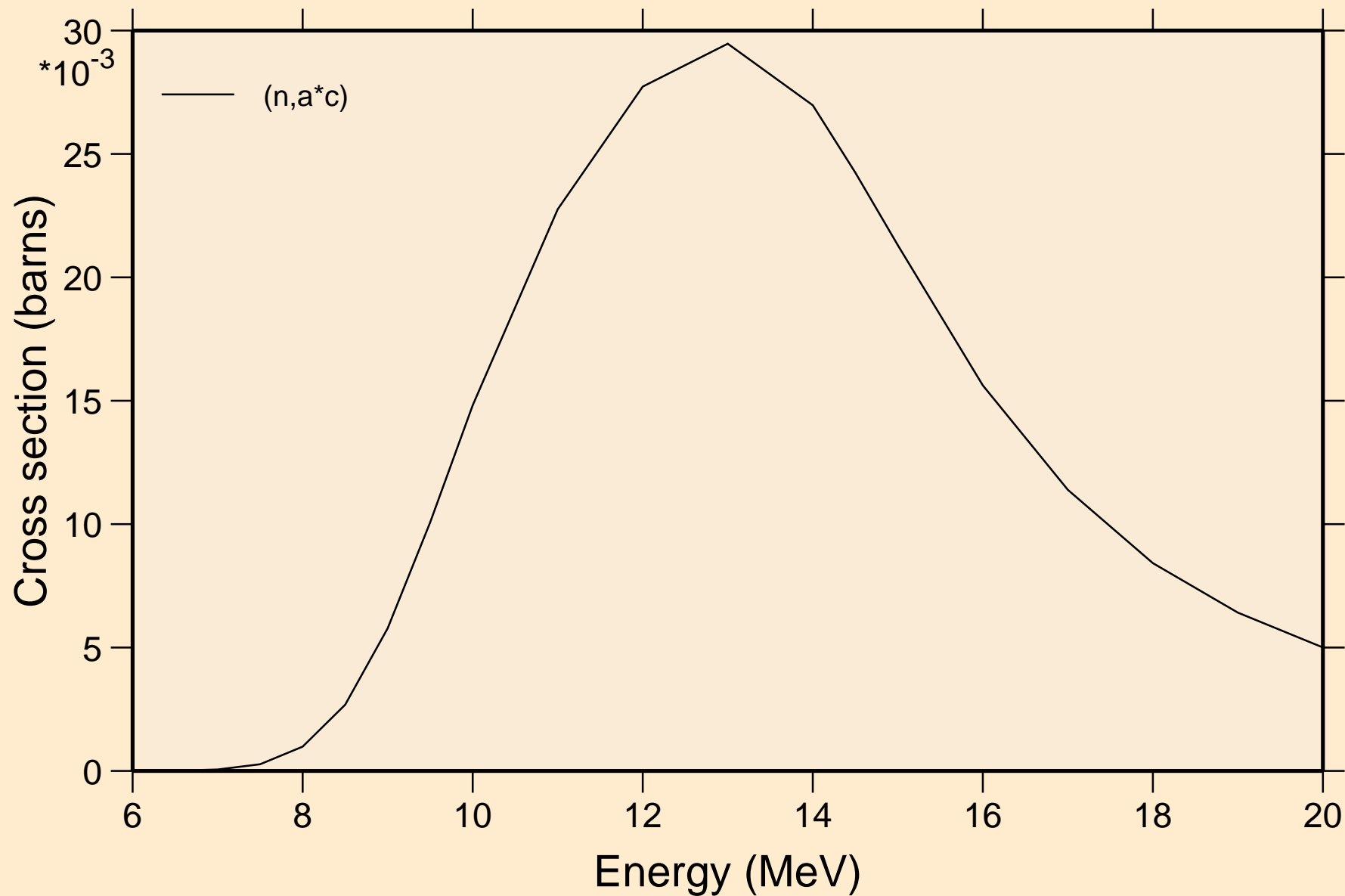

20-CA-43 FOR FENDL-3.2 FROM FENDL-3.2 BY NJOY2016.60+ O
angular distribution for elastic

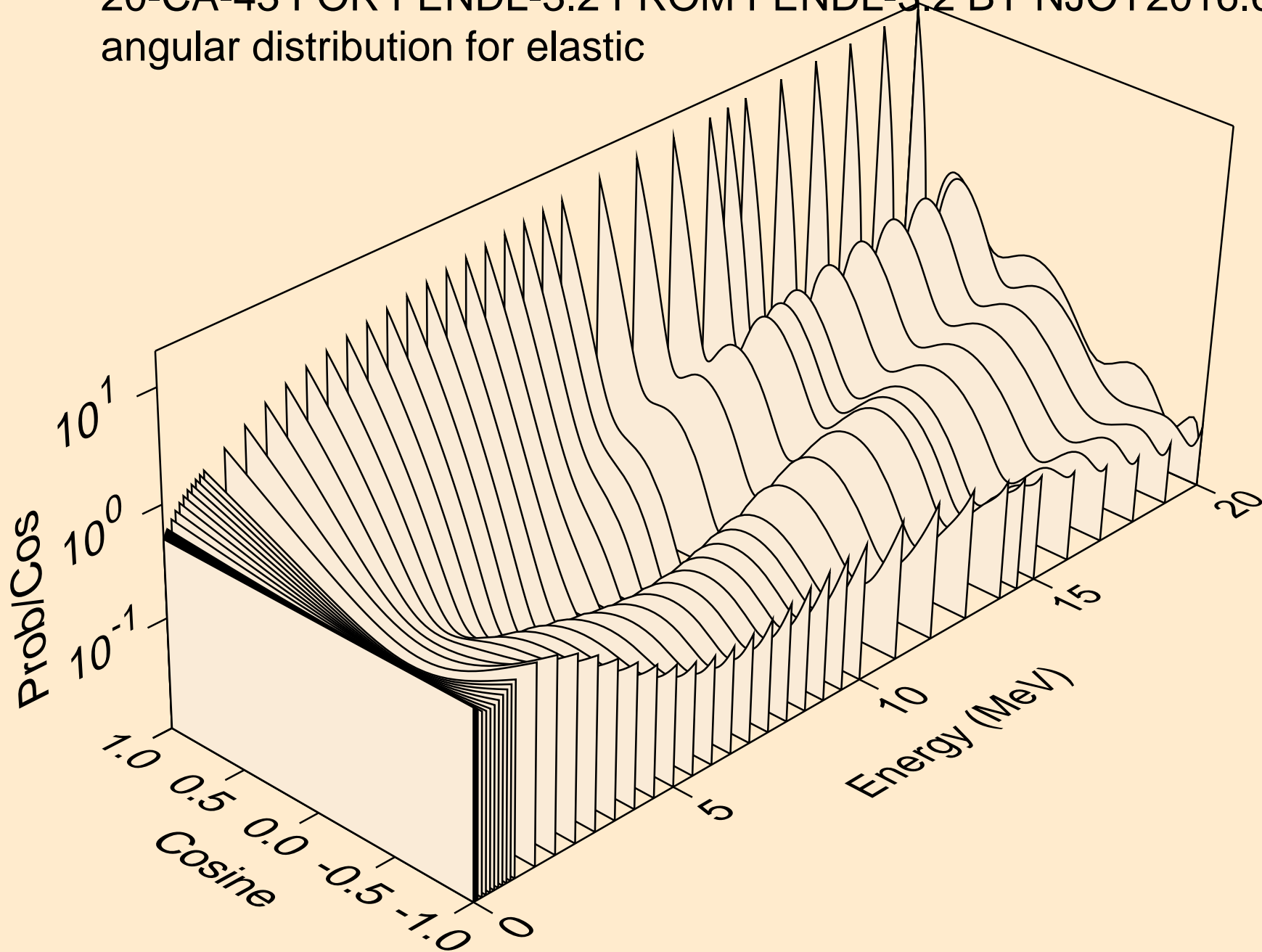

20-CA-43 FOR FENDL-3.2 FROM FENDL-3.2 BY NJOY2016.60+ O
angular distribution for elastic

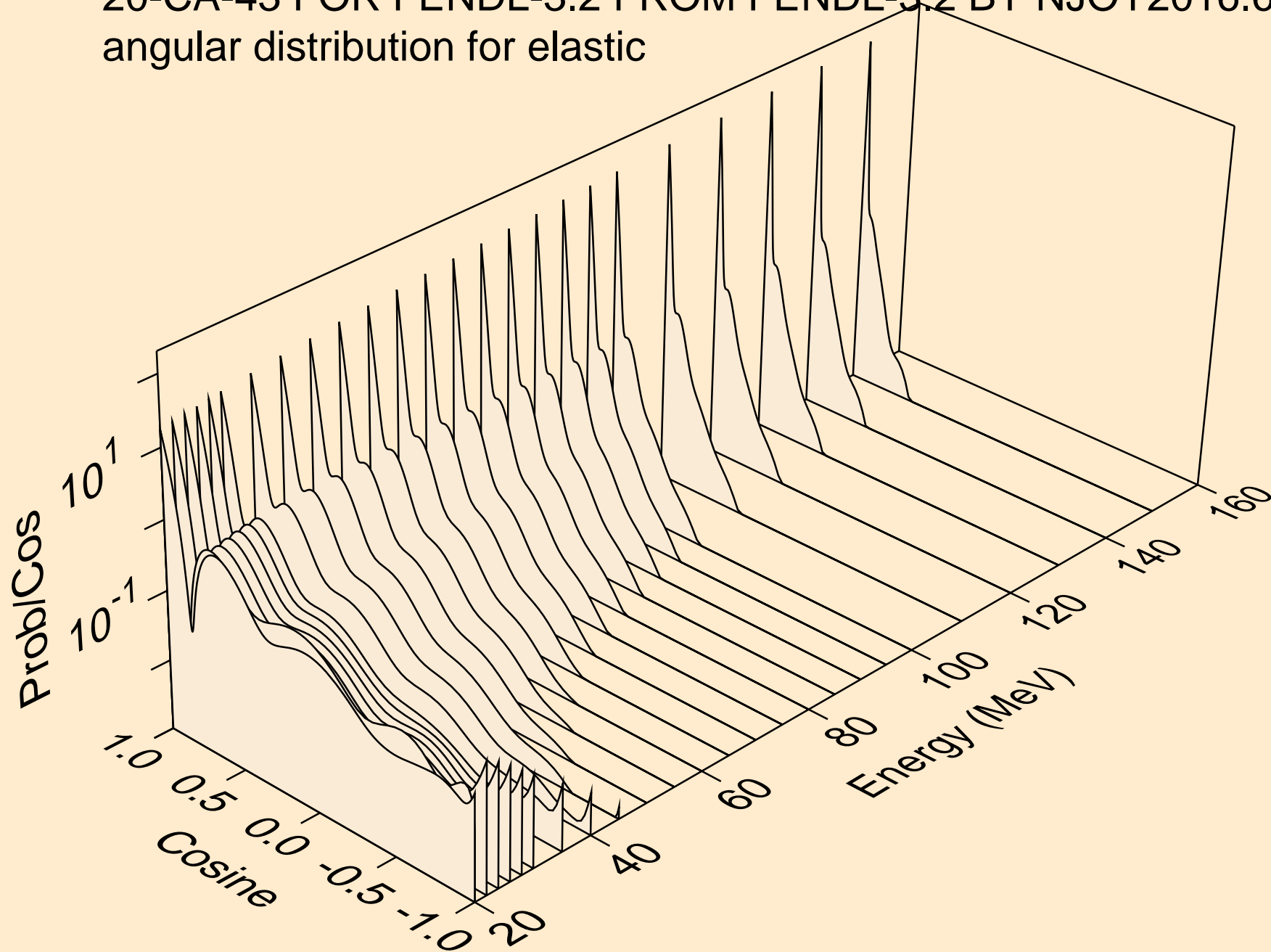

20-CA-43 FOR FENDL-3.2 FROM FENDL-3.2 BY NJOY2016.60+ O
angular distribution for (n,n*1)

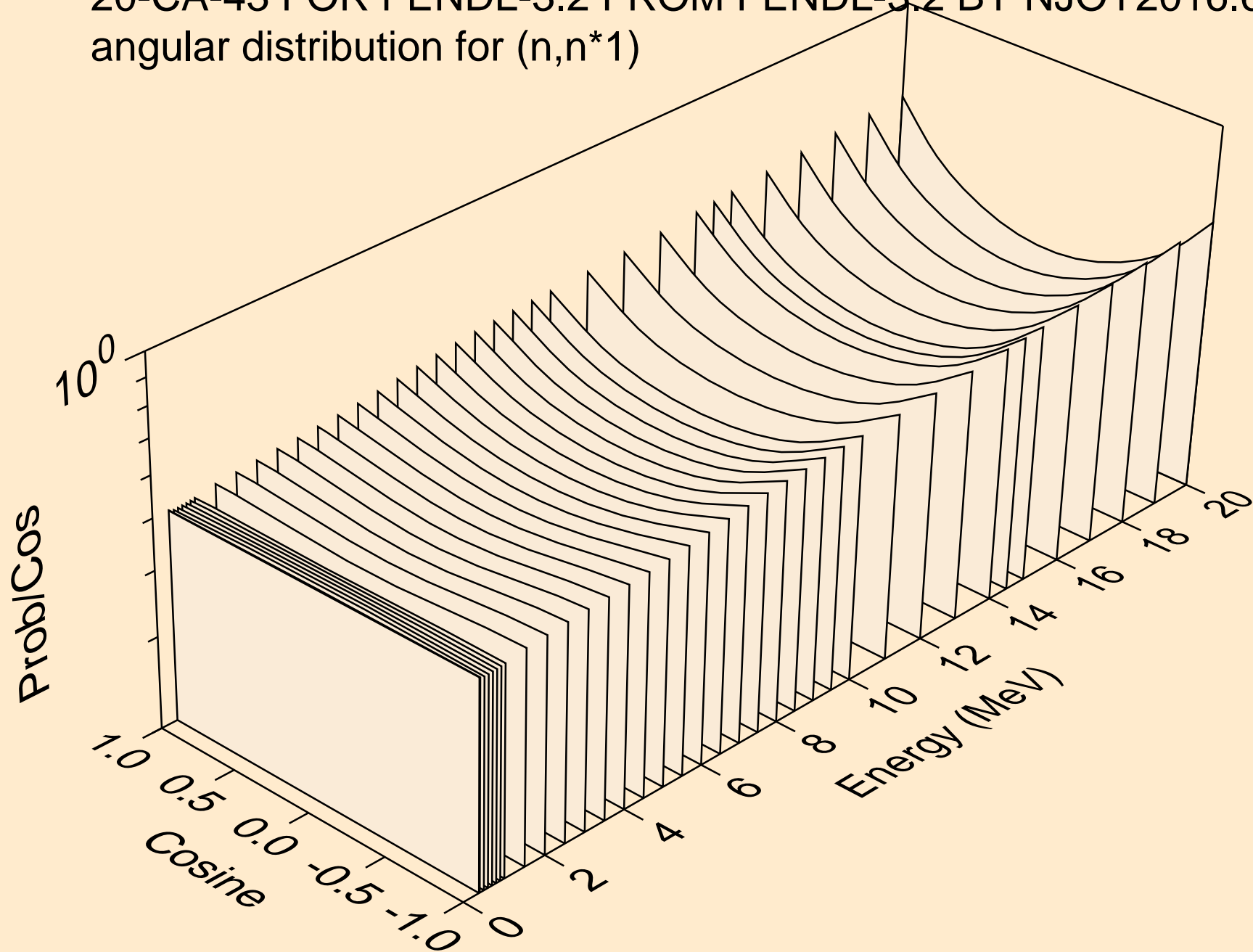

20-CA-43 FOR FENDL-3.2 FROM FENDL-3.2 BY NJOY2016.60+ O
angular distribution for (n,n*2)

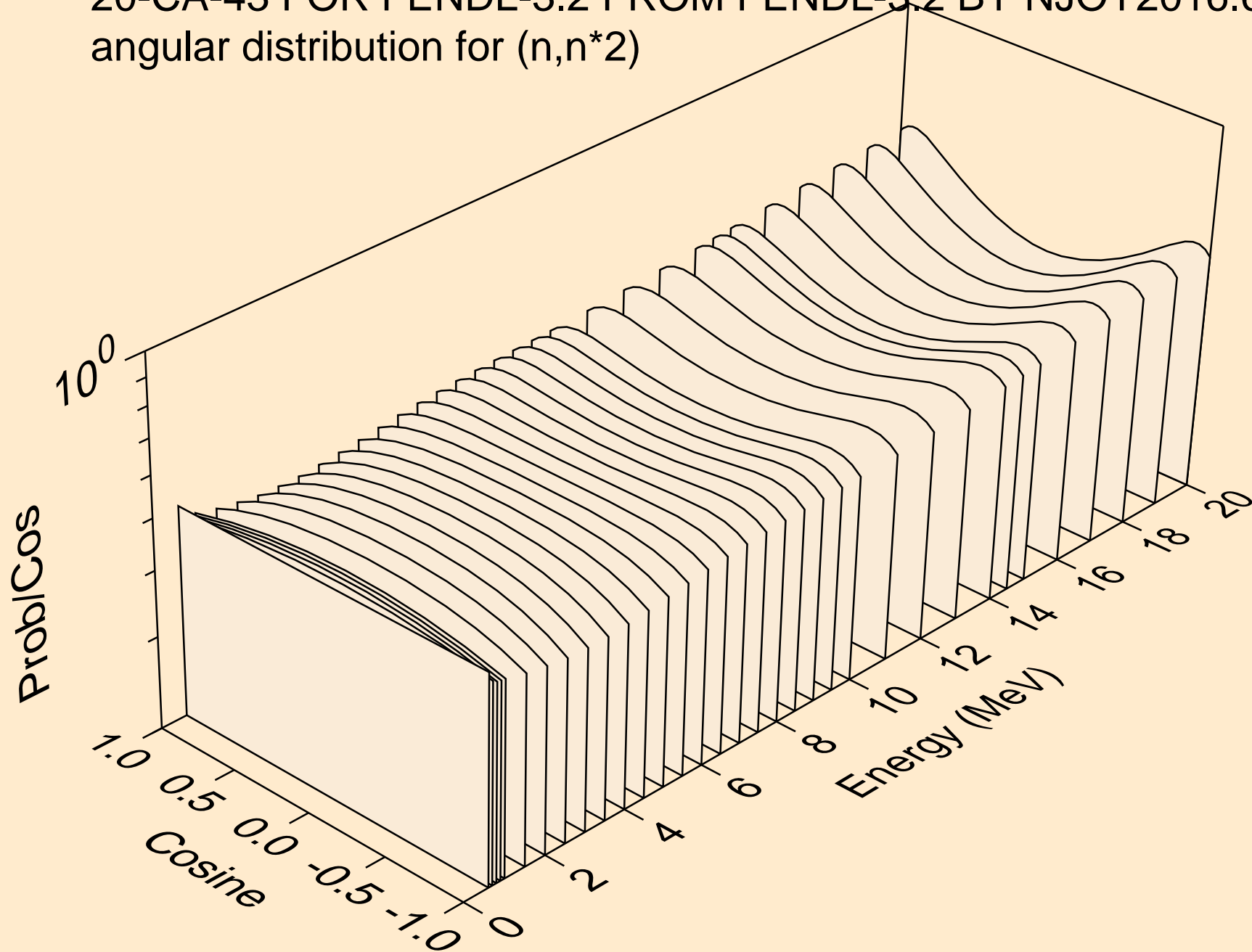

20-CA-43 FOR FENDL-3.2 FROM FENDL-3.2 BY NJOY2016.60+ O
angular distribution for (n,n*3)

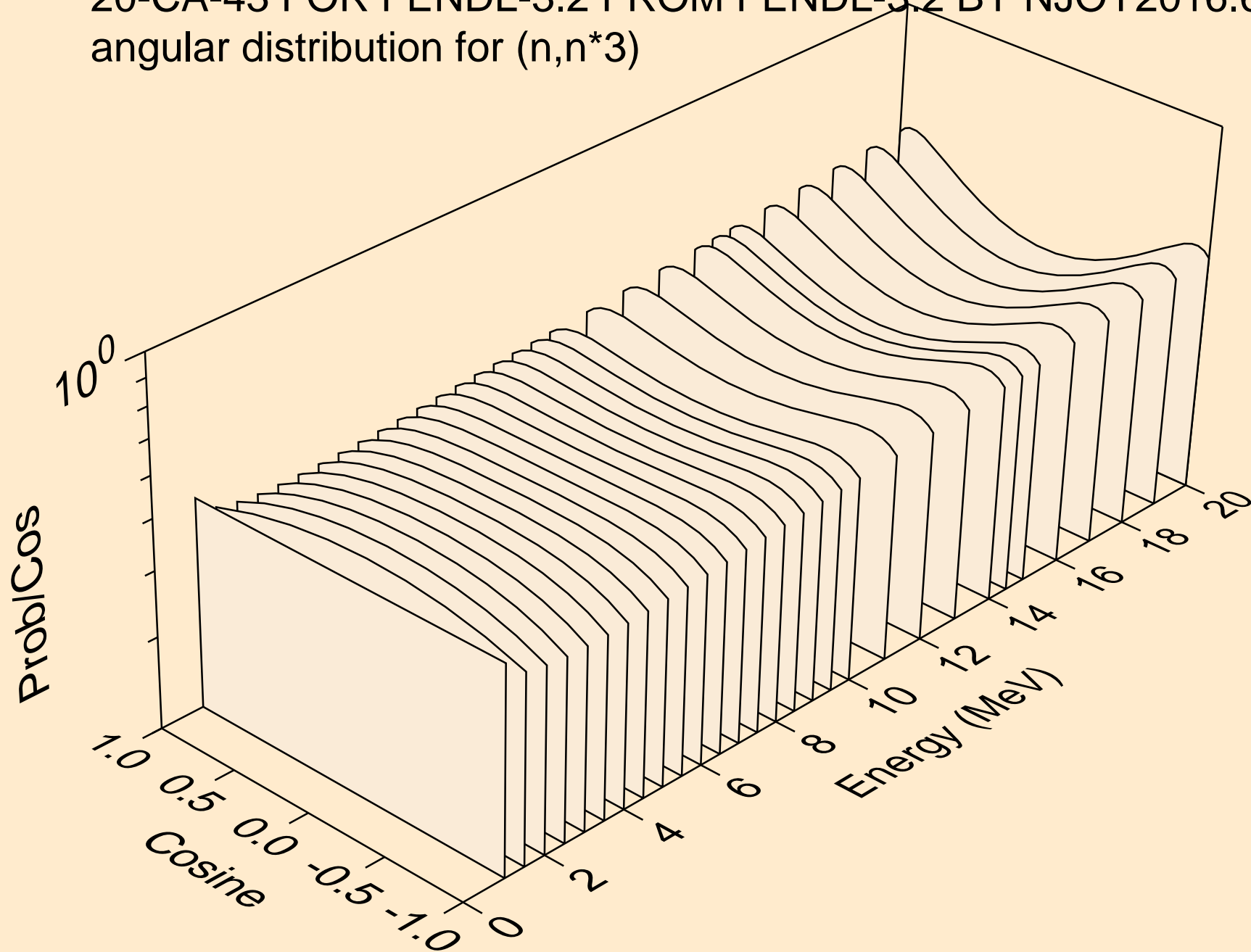

20-CA-43 FOR FENDL-3.2 FROM FENDL-3.2 BY NJOY2016.60+ O
angular distribution for (n,n*4)

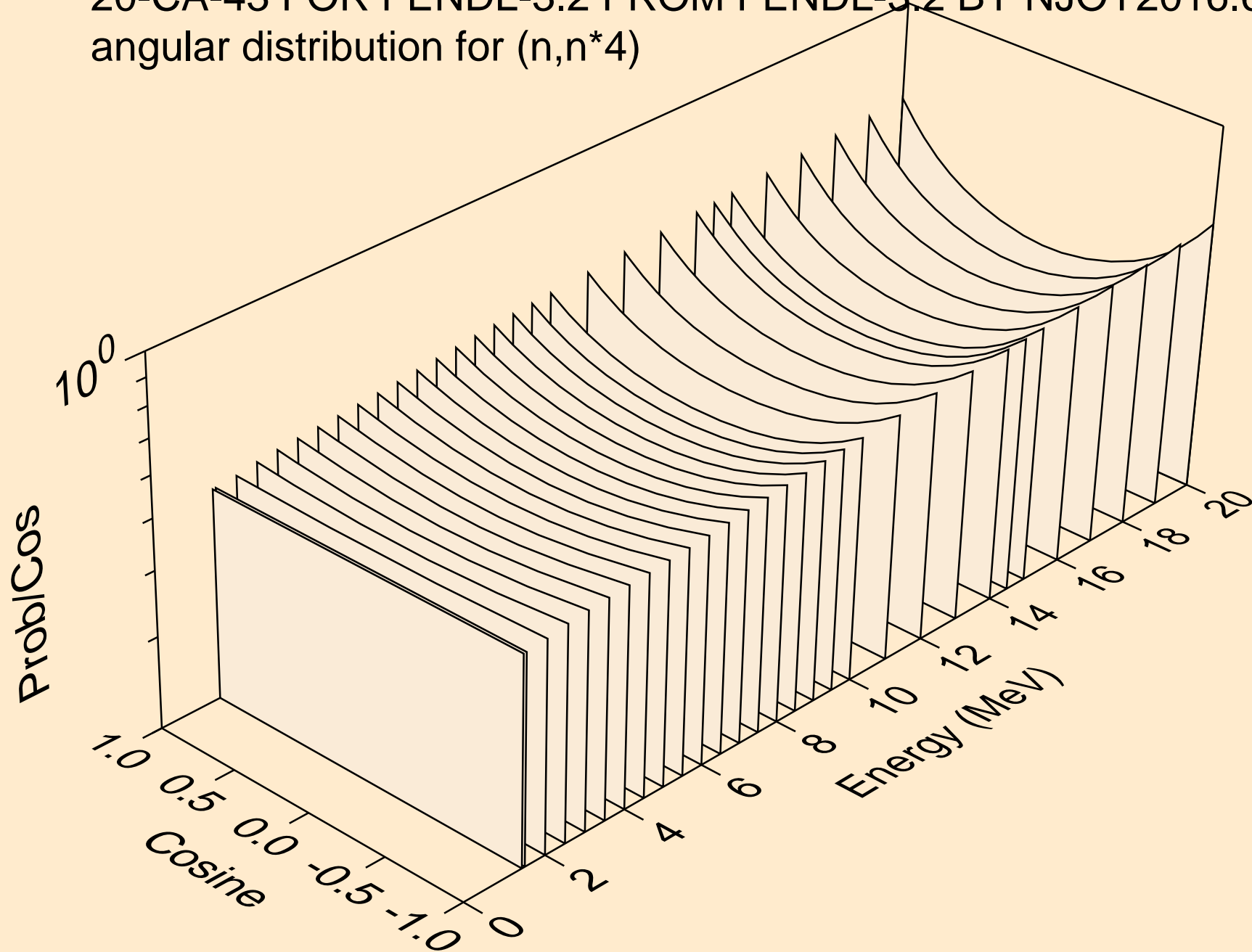

20-CA-43 FOR FENDL-3.2 FROM FENDL-3.2 BY NJOY2016.60+ O
angular distribution for (n,n*5)

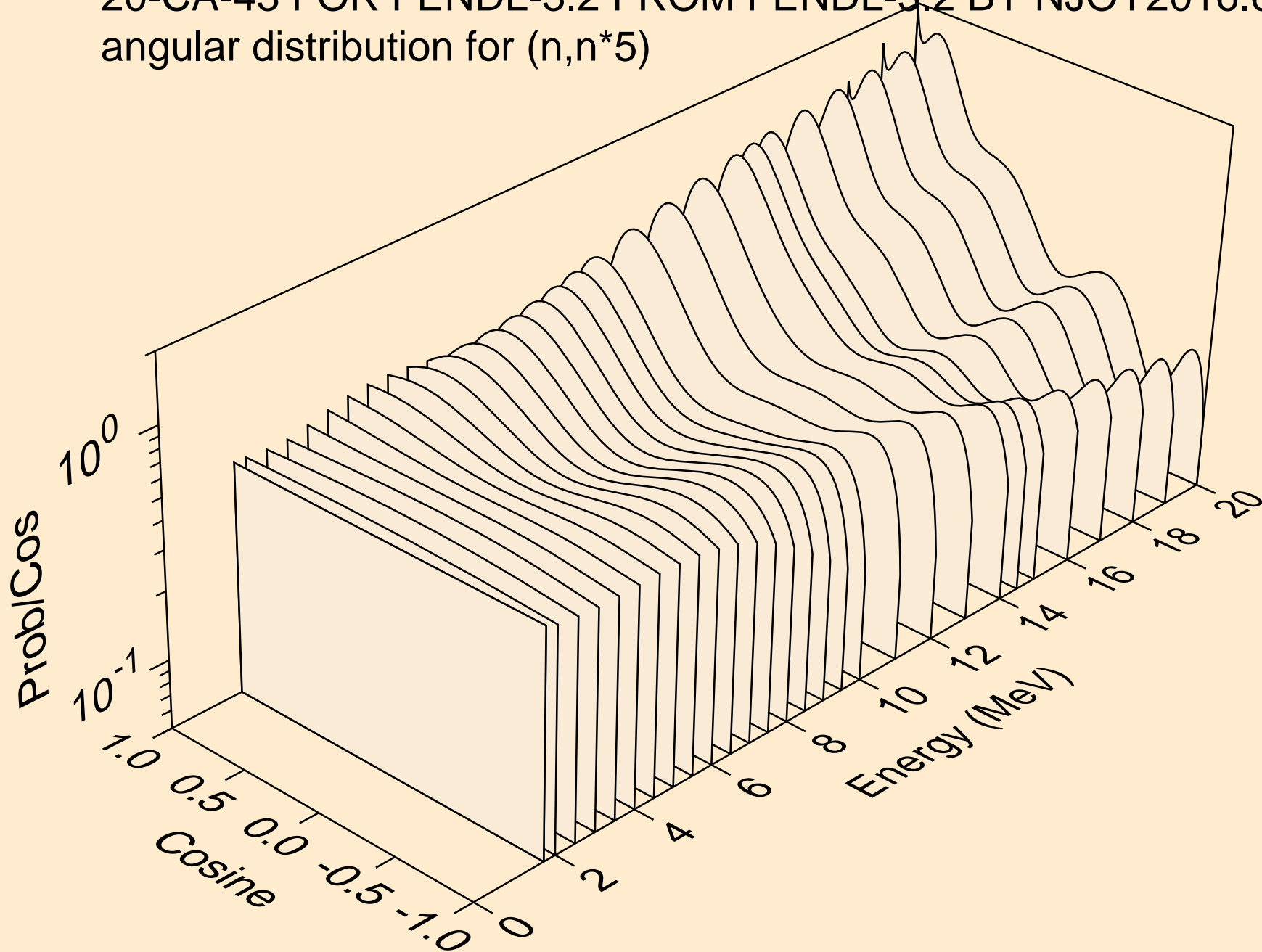

20-CA-43 FOR FENDL-3.2 FROM FENDL-3.2 BY NJOY2016.60+ O
angular distribution for (n,n*6)

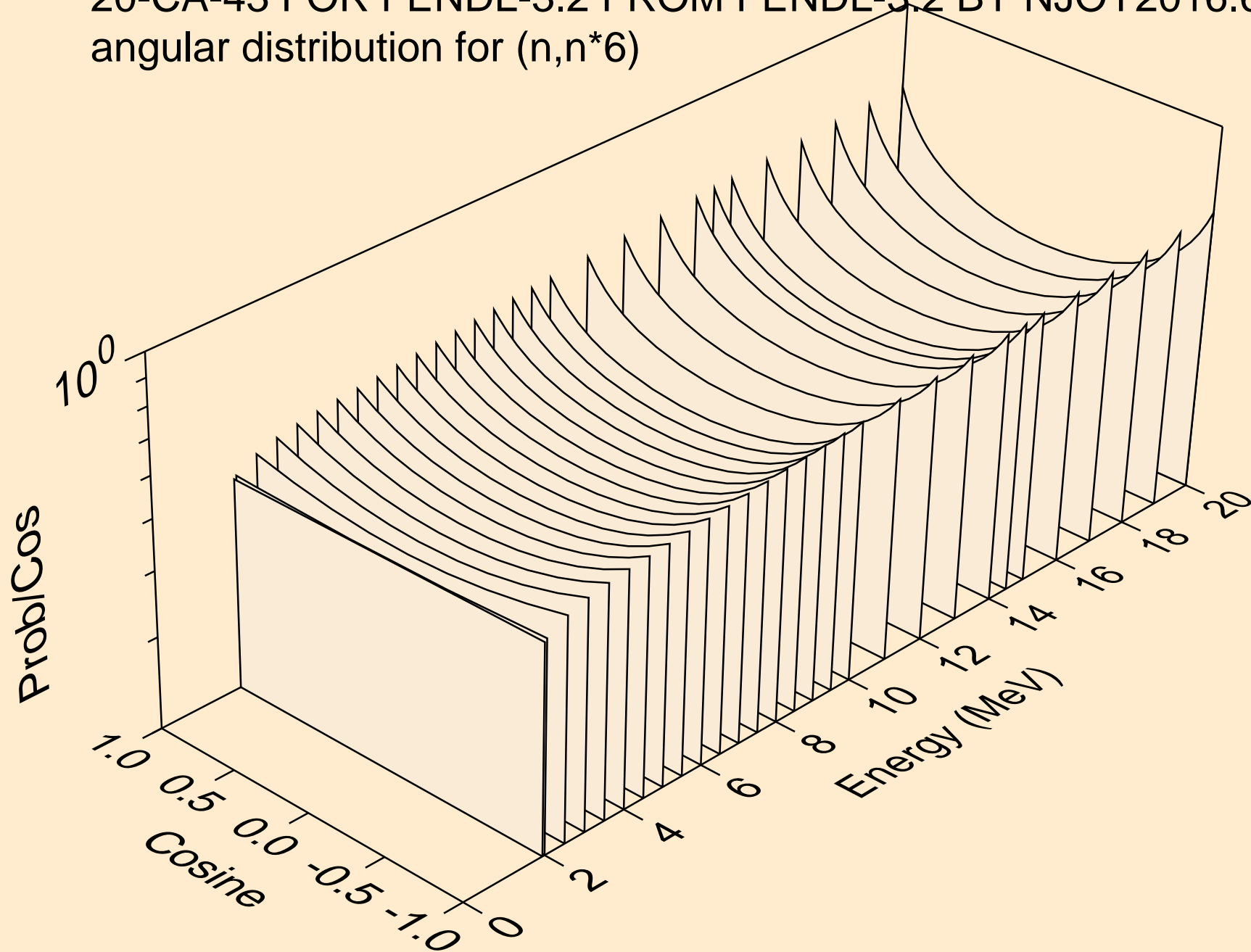

20-CA-43 FOR FENDL-3.2 FROM FENDL-3.2 BY NJOY2016.60+ O
angular distribution for (n,n*7)

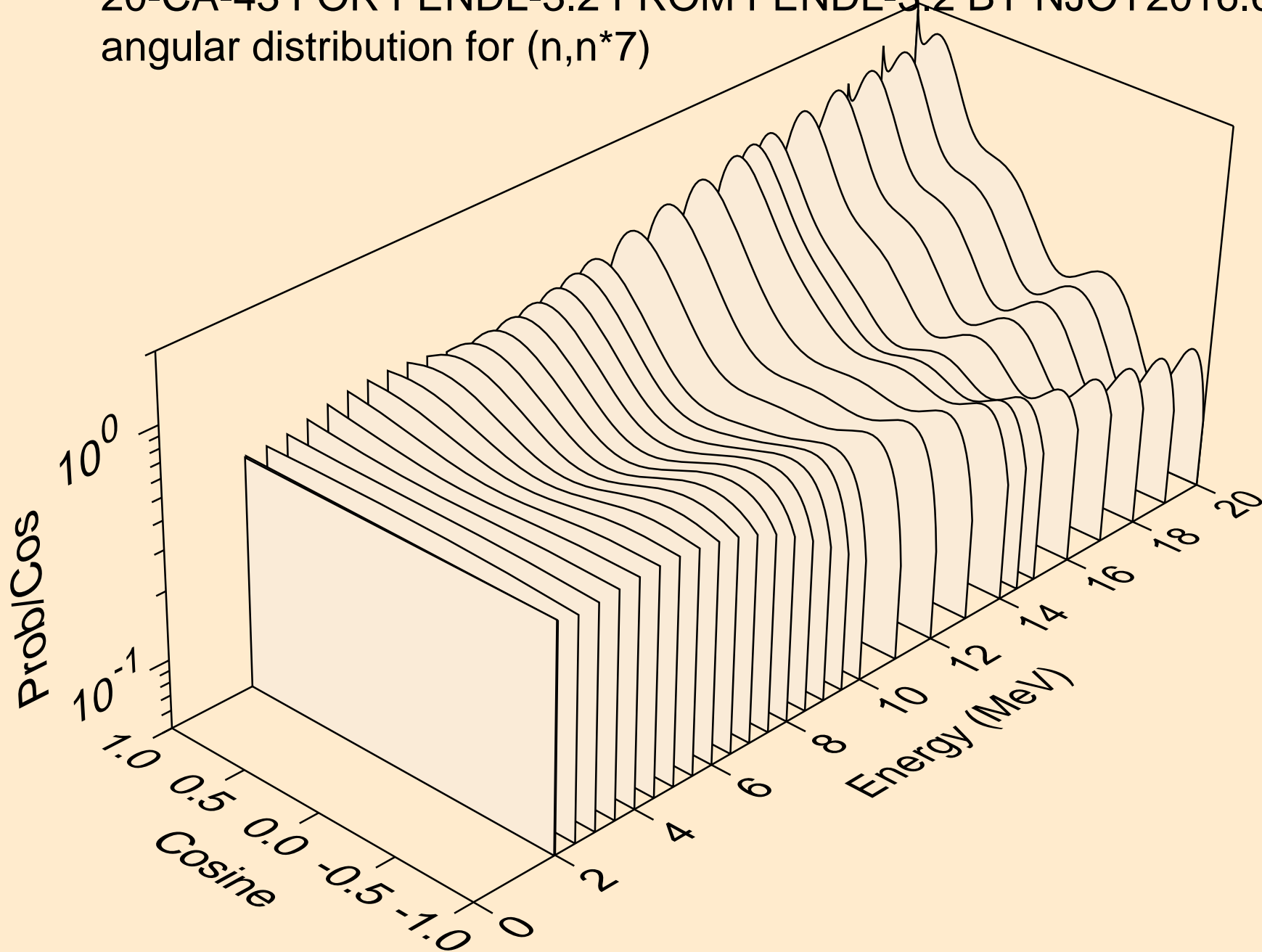

20-CA-43 FOR FENDL-3.2 FROM FENDL-3.2 BY NJOY2016.60+ O
angular distribution for (n,n*8)

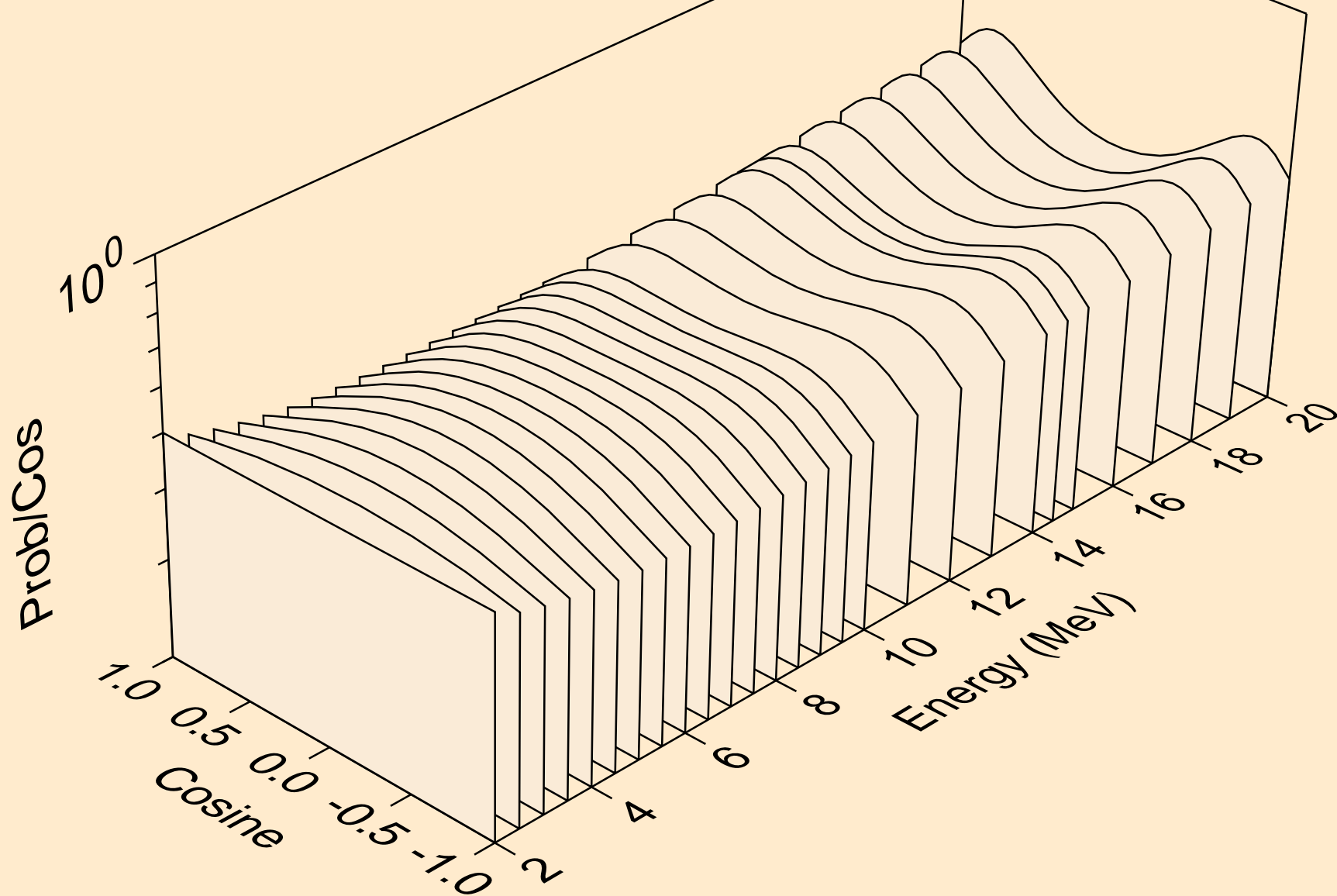

20-CA-43 FOR FENDL-3.2 FROM FENDL-3.2 BY NJOY2016.60+ O
angular distribution for (n,n*9)

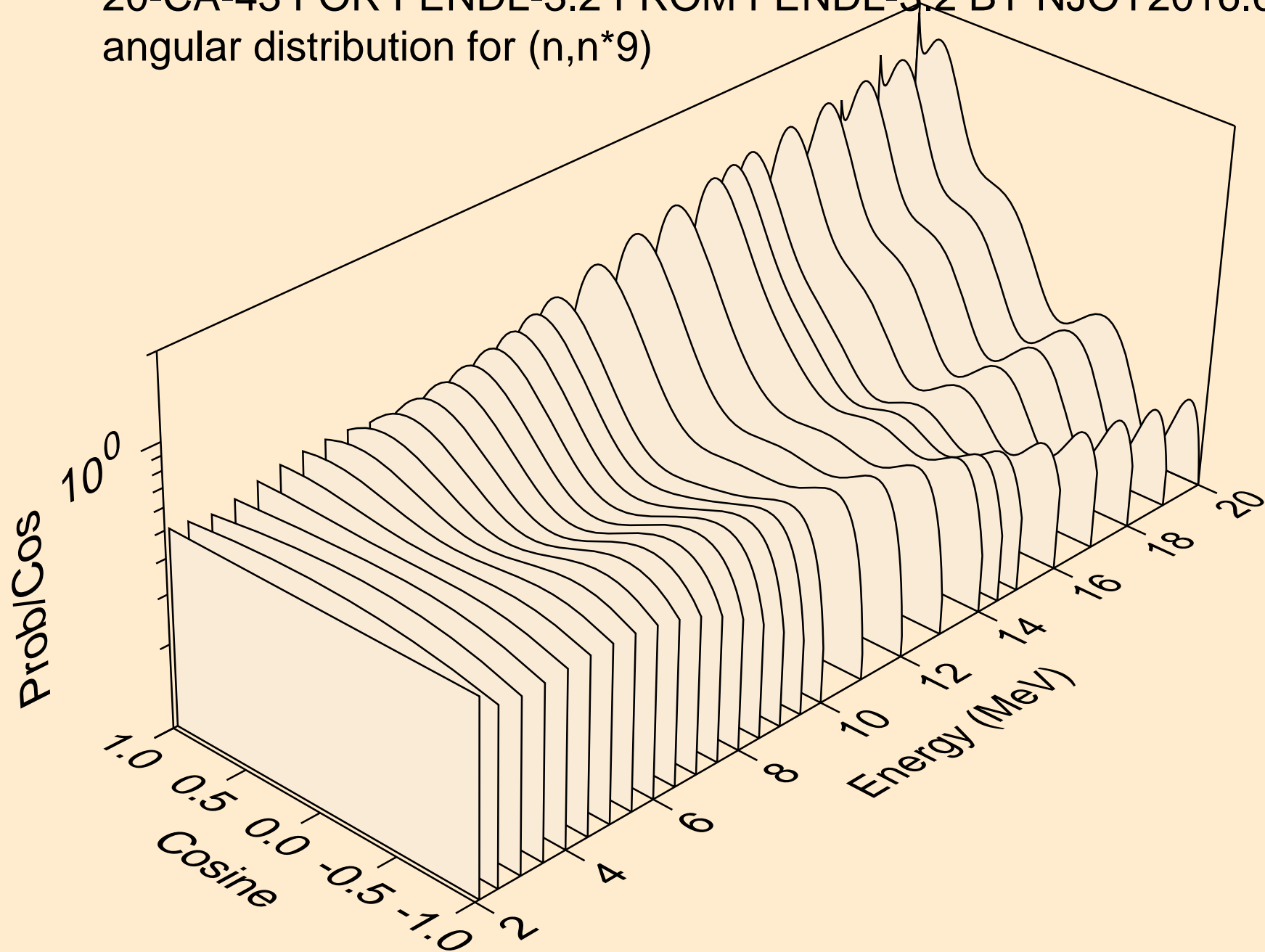

20-CA-43 FOR FENDL-3.2 FROM FENDL-3.2 BY NJOY2016.60+ O
angular distribution for (n,n*10)

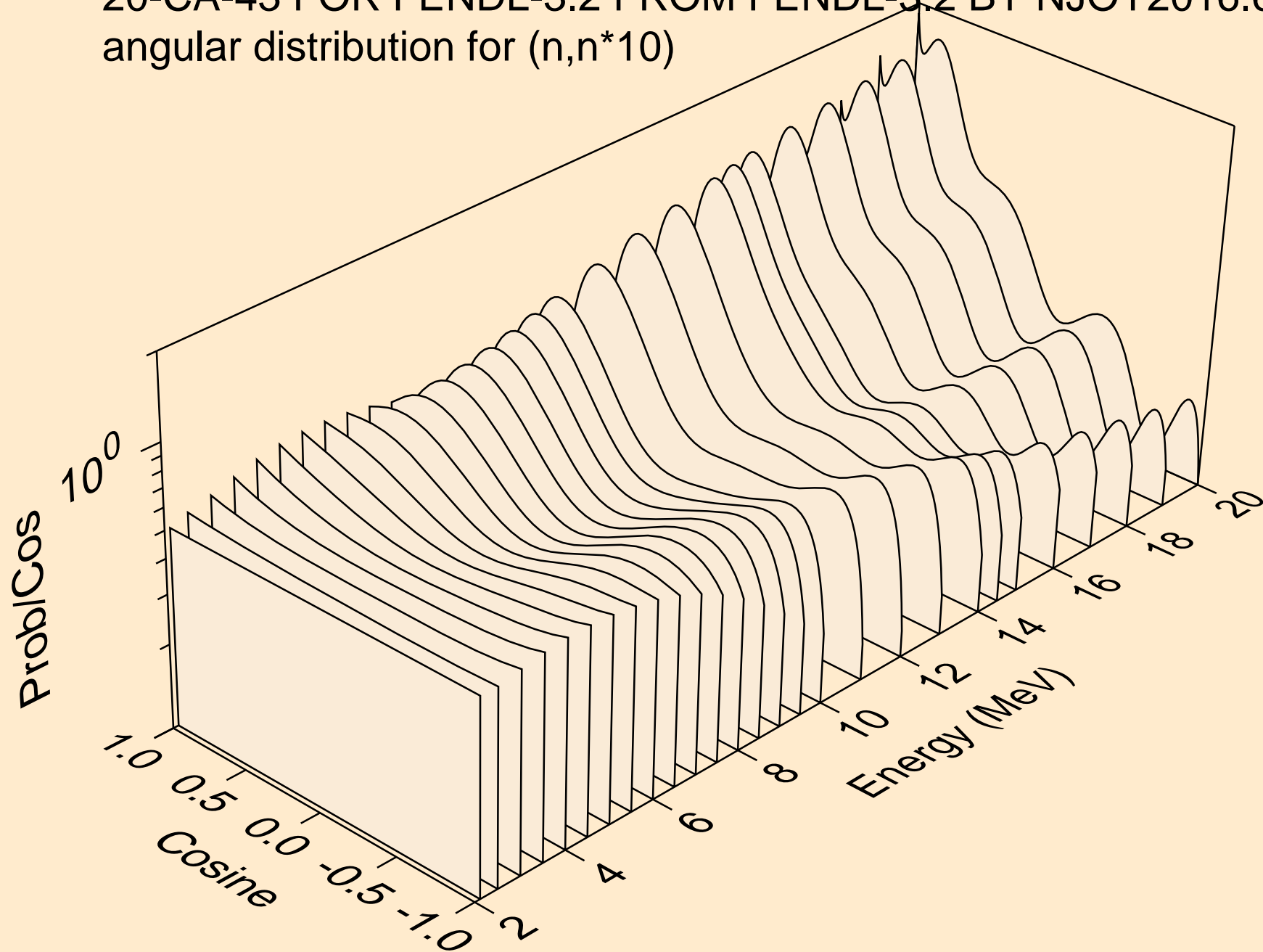

20-CA-43 FOR FENDL-3.2 FROM FENDL-3.2 BY NJOY2016.60+ O
angular distribution for (n,n*11)

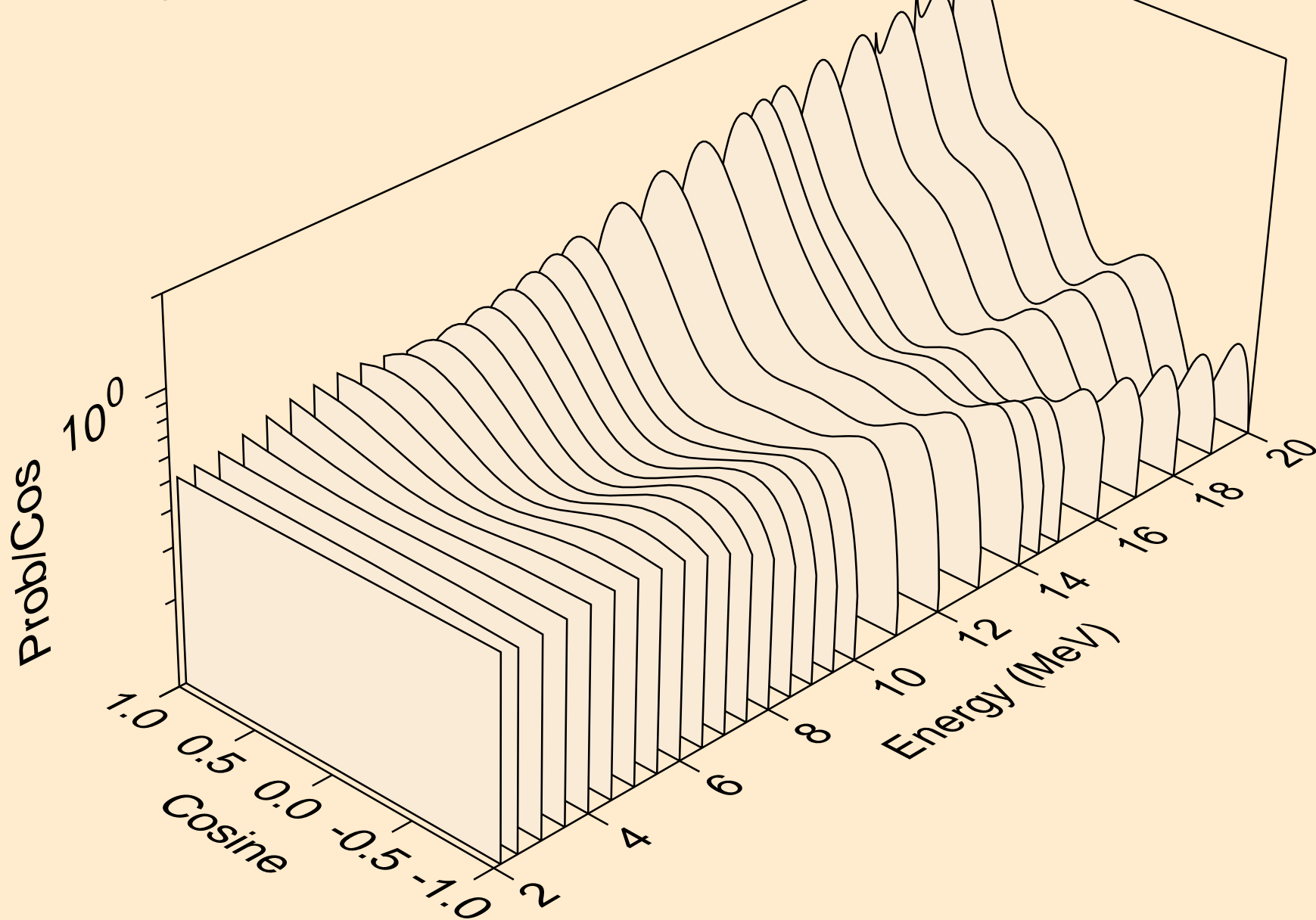

20-CA-43 FOR FENDL-3.2 FROM FENDL-3.2 BY NJOY2016.60+ O
angular distribution for (n,n*12)

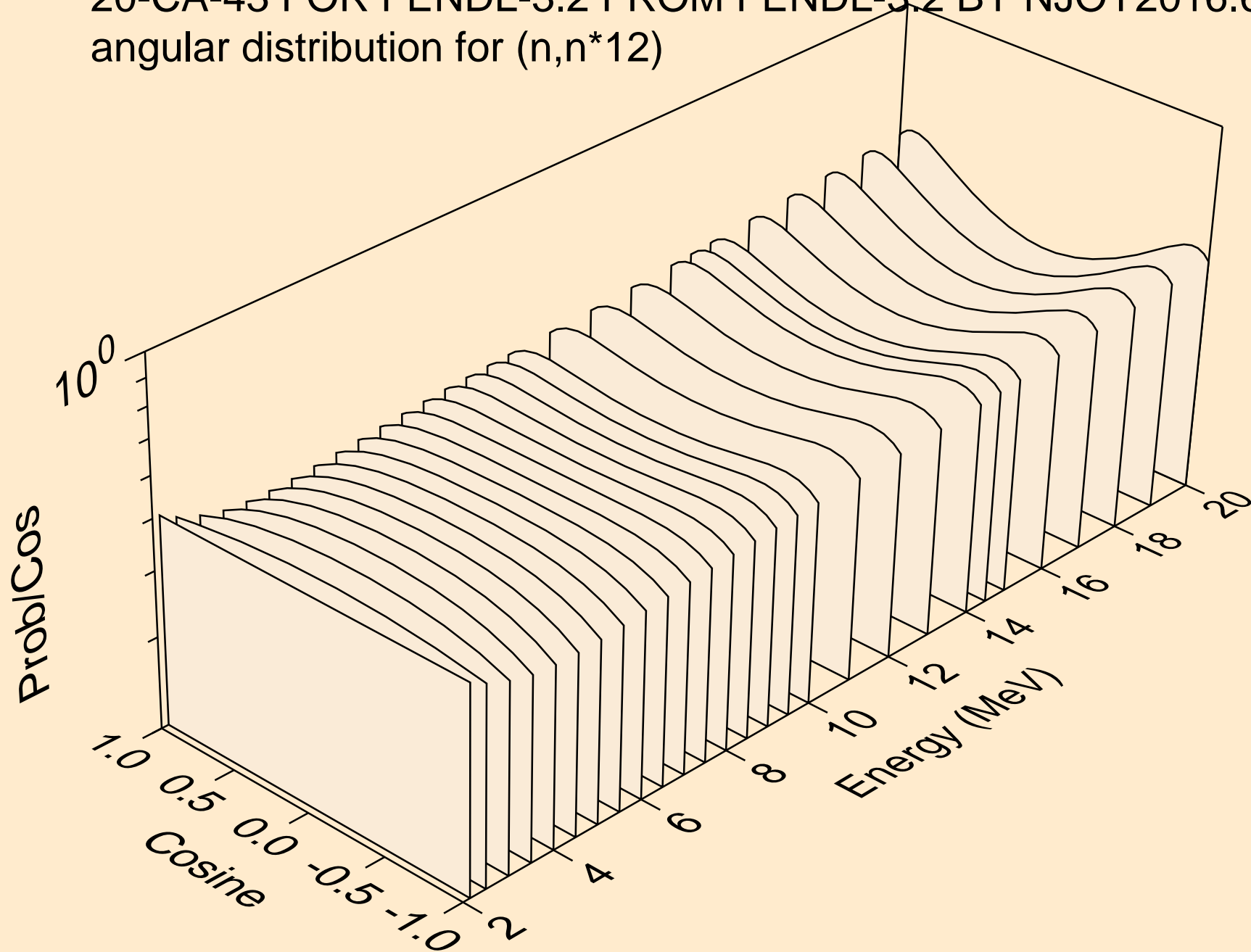

20-CA-43 FOR FENDL-3.2 FROM FENDL-3.2 BY NJOY2016.60+ O
angular distribution for (n,n*13)

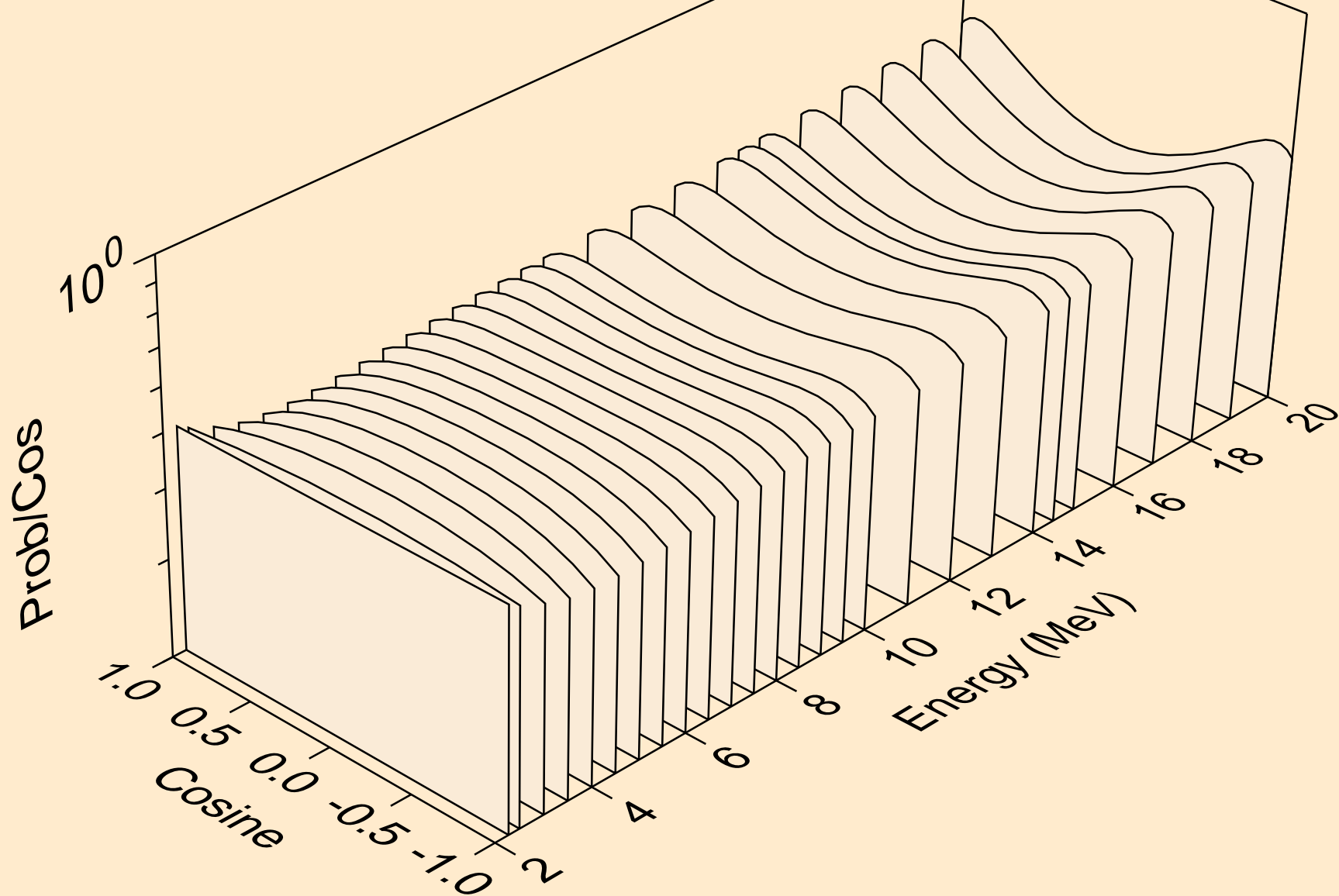

20-CA-43 FOR FENDL-3.2 FROM FENDL-3.2 BY NJOY2016.60+ O
angular distribution for (n,n*14)

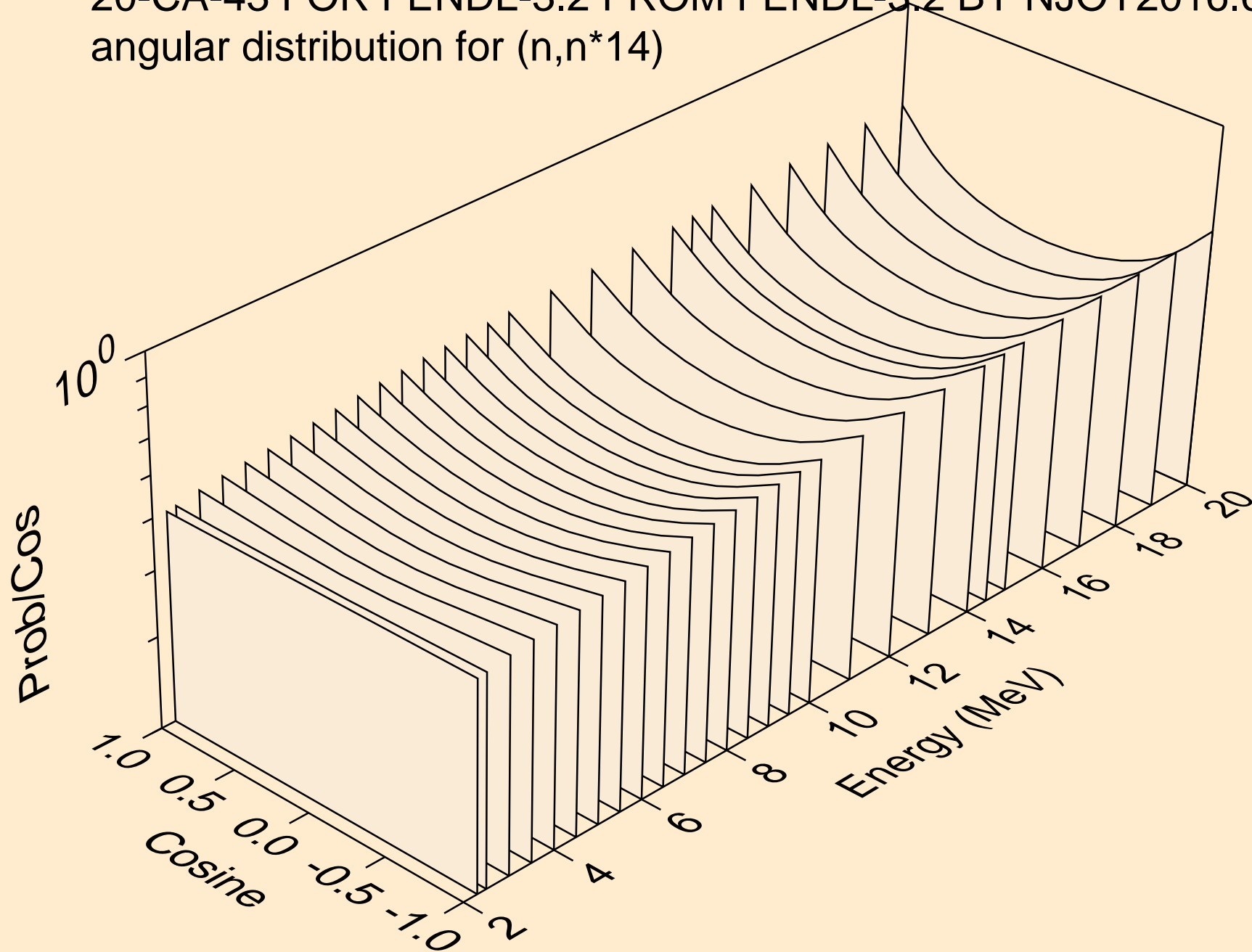

20-CA-43 FOR FENDL-3.2 FROM FENDL-3.2 BY NJOY2016.60+ O
angular distribution for (n,n*15)

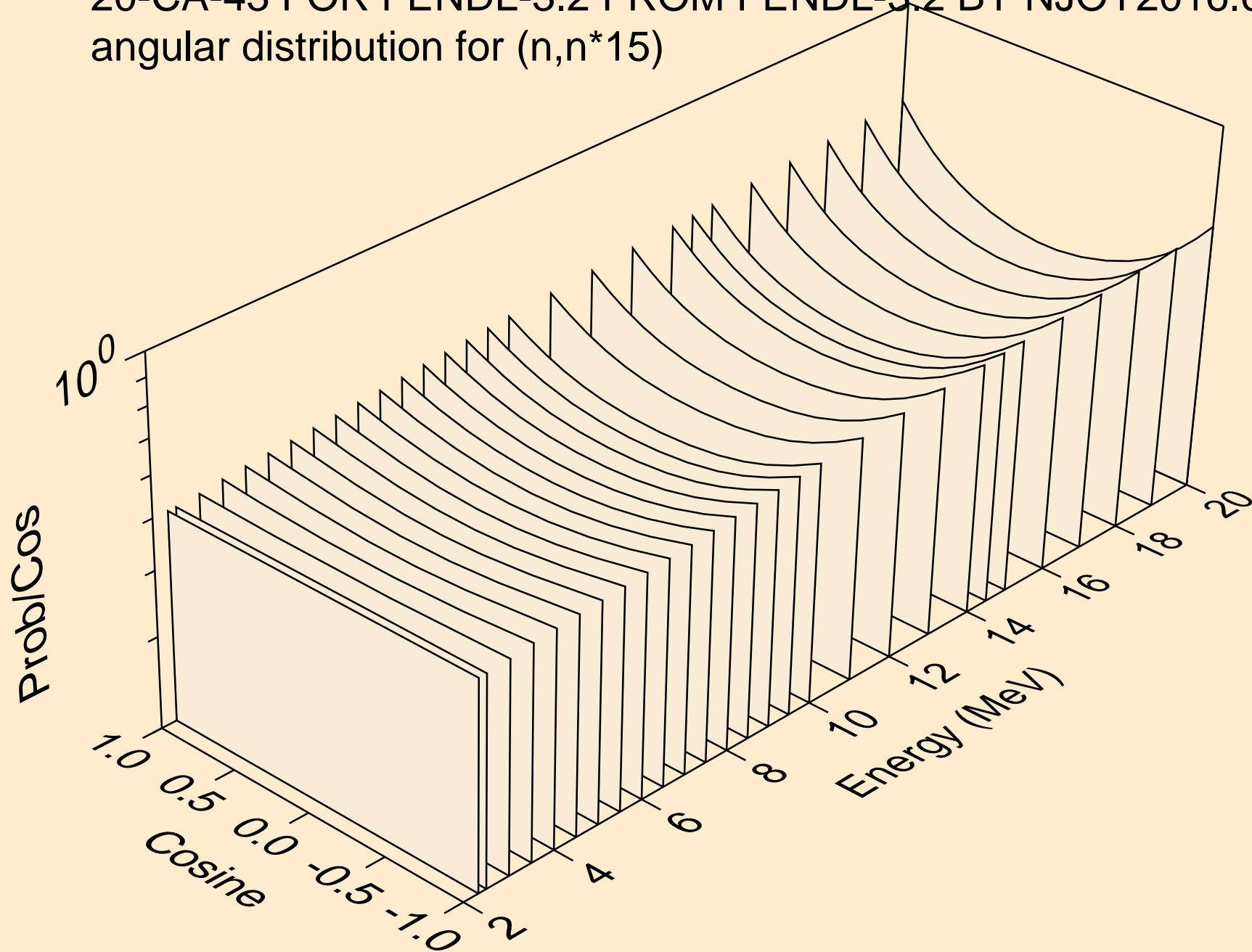

20-CA-43 FOR FENDL-3.2 FROM FENDL-3.2 BY NJOY2016.60+ O
angular distribution for (n,n*16)

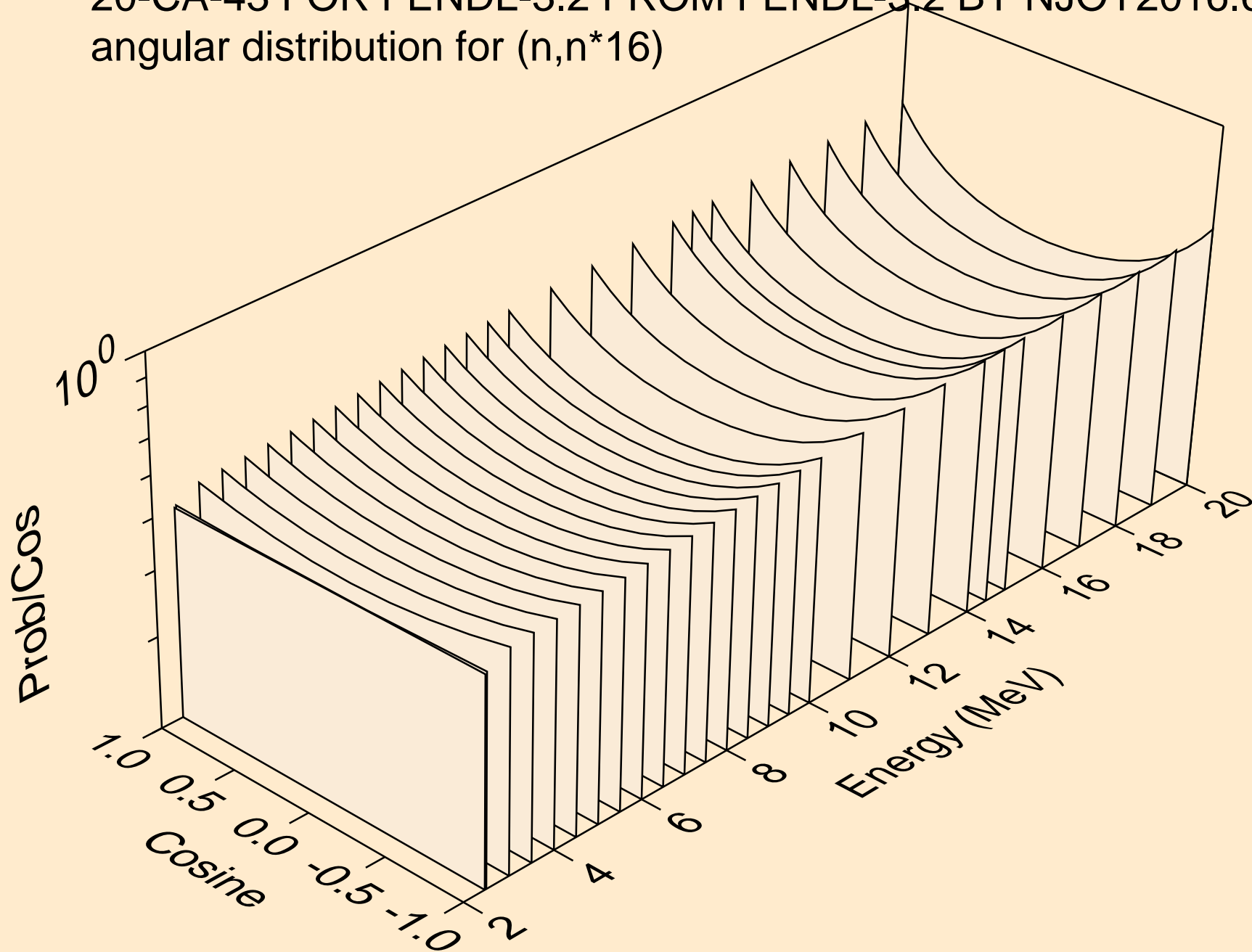

20-CA-43 FOR FENDL-3.2 FROM FENDL-3.2 BY NJOY2016.60+ O
angular distribution for (n,n*17)

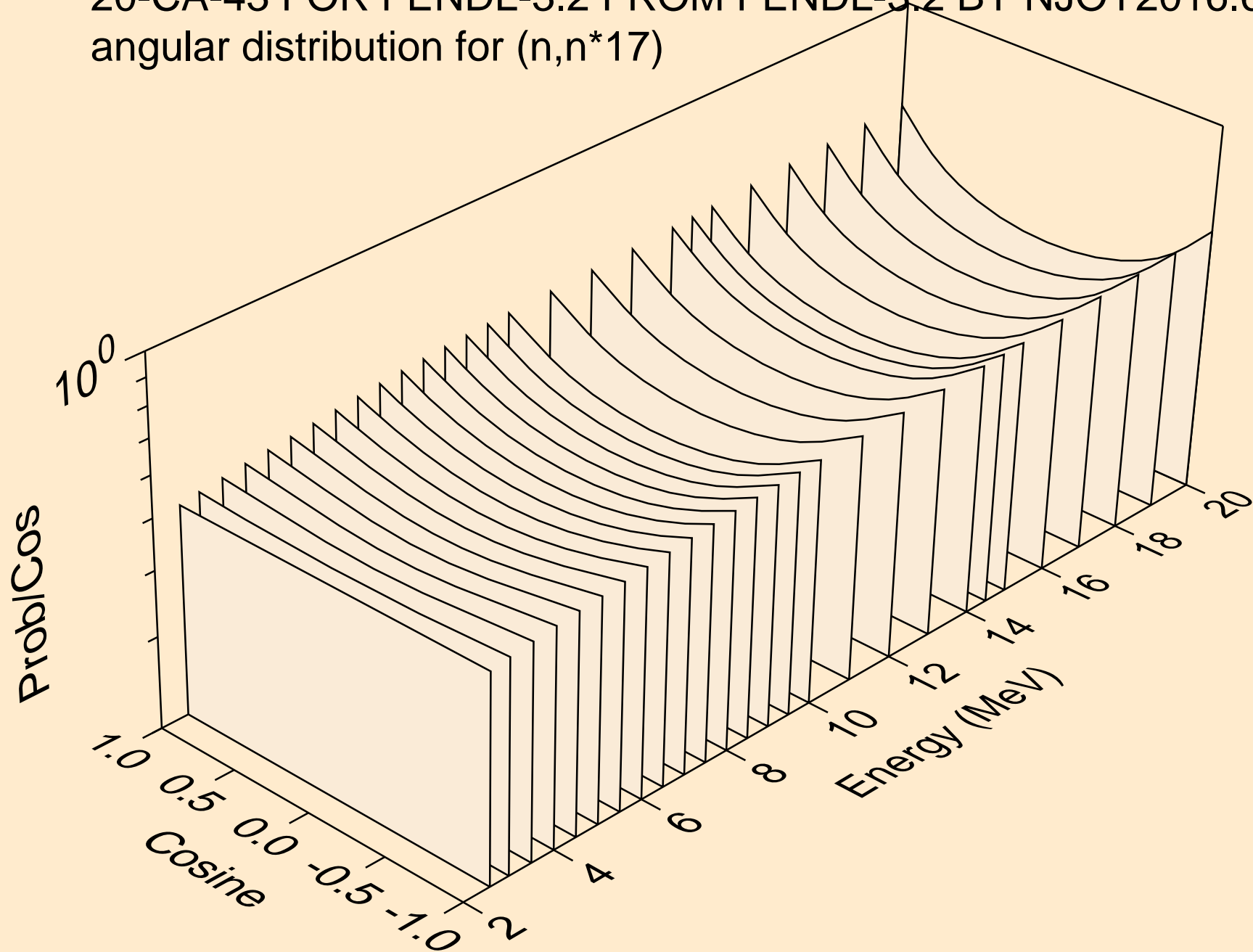

20-CA-43 FOR FENDL-3.2 FROM FENDL-3.2 BY NJOY2016.60+ O
angular distribution for (n,n*18)

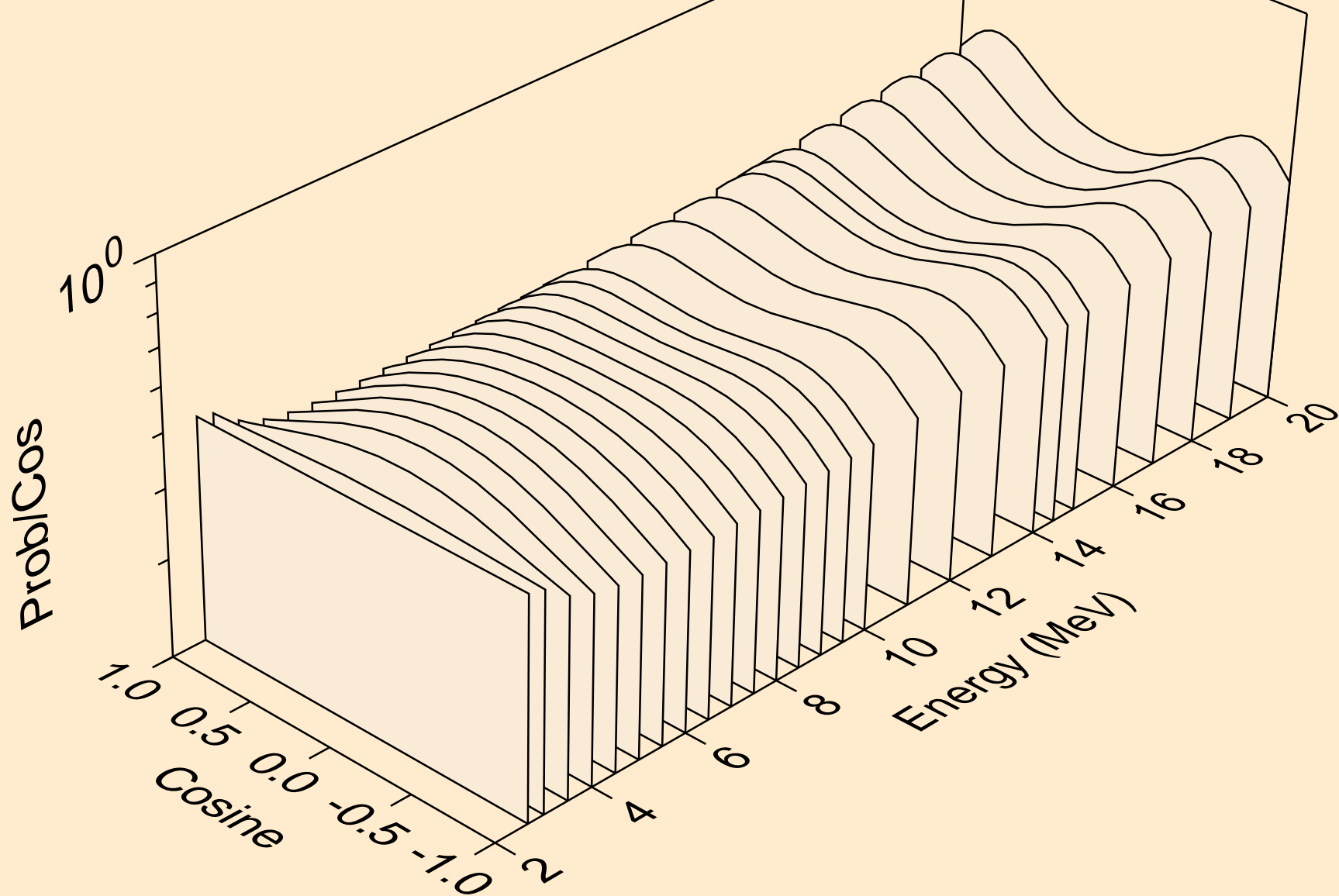

20-CA-43 FOR FENDL-3.2 FROM FENDL-3.2 BY NJOY2016.60+ O
angular distribution for (n,n*19)

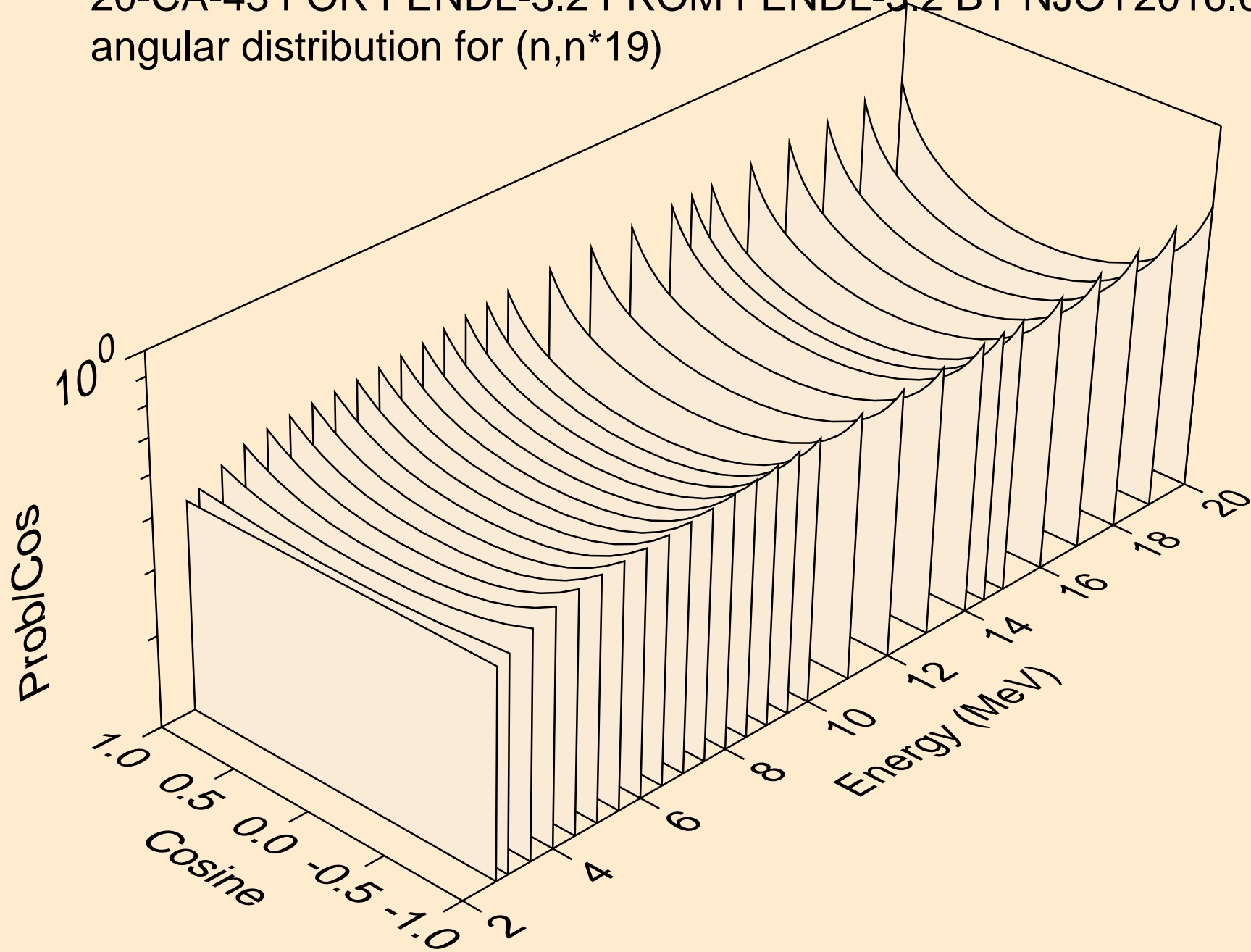

20-CA-43 FOR FENDL-3.2 FROM FENDL-3.2 BY NJOY2016.60+ O
angular distribution for (n,n*20)

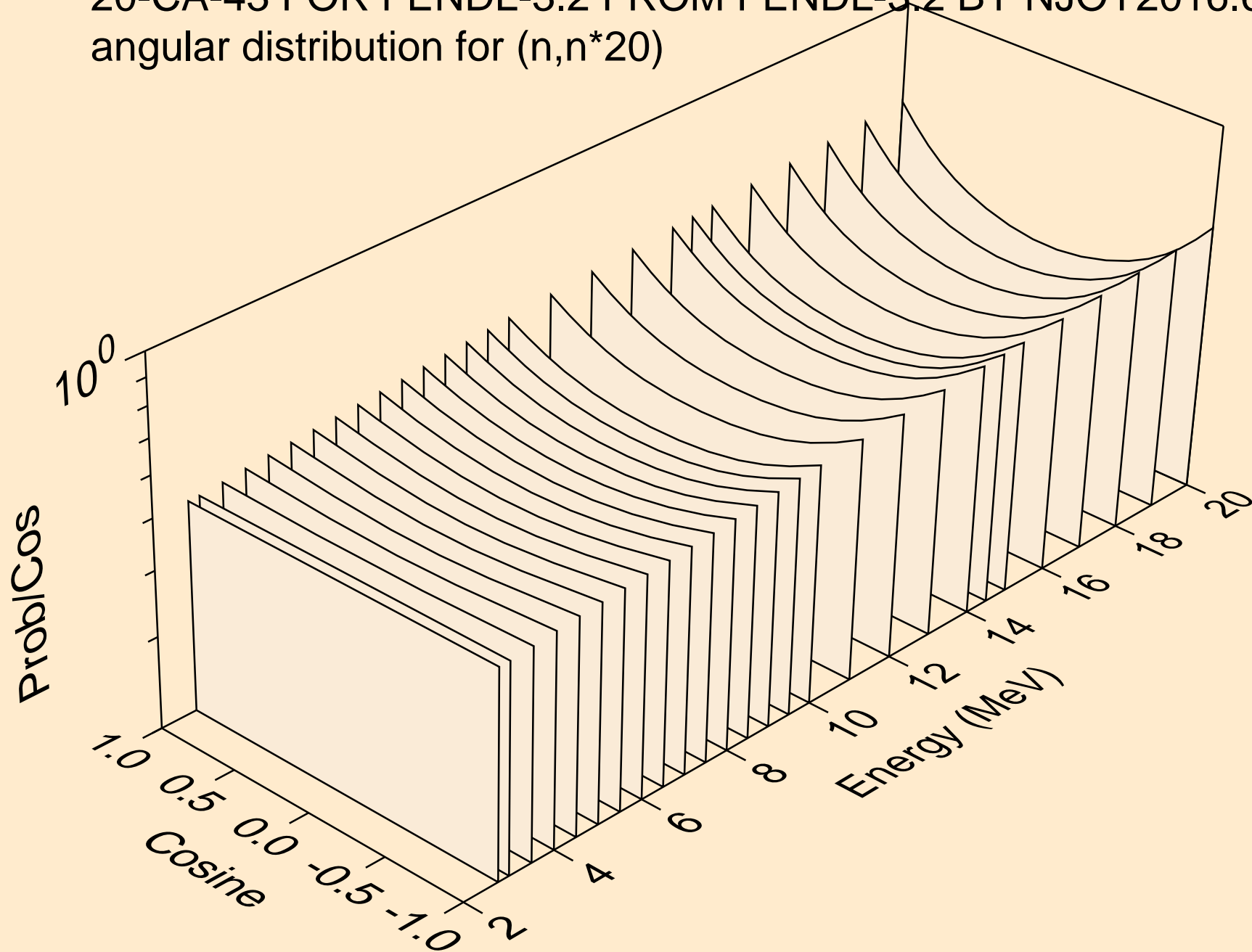

20-CA-43 FOR FENDL-3.2 FROM FENDL-3.2 BY NJOY2016.60+ O
angular distribution for (n,n*21)

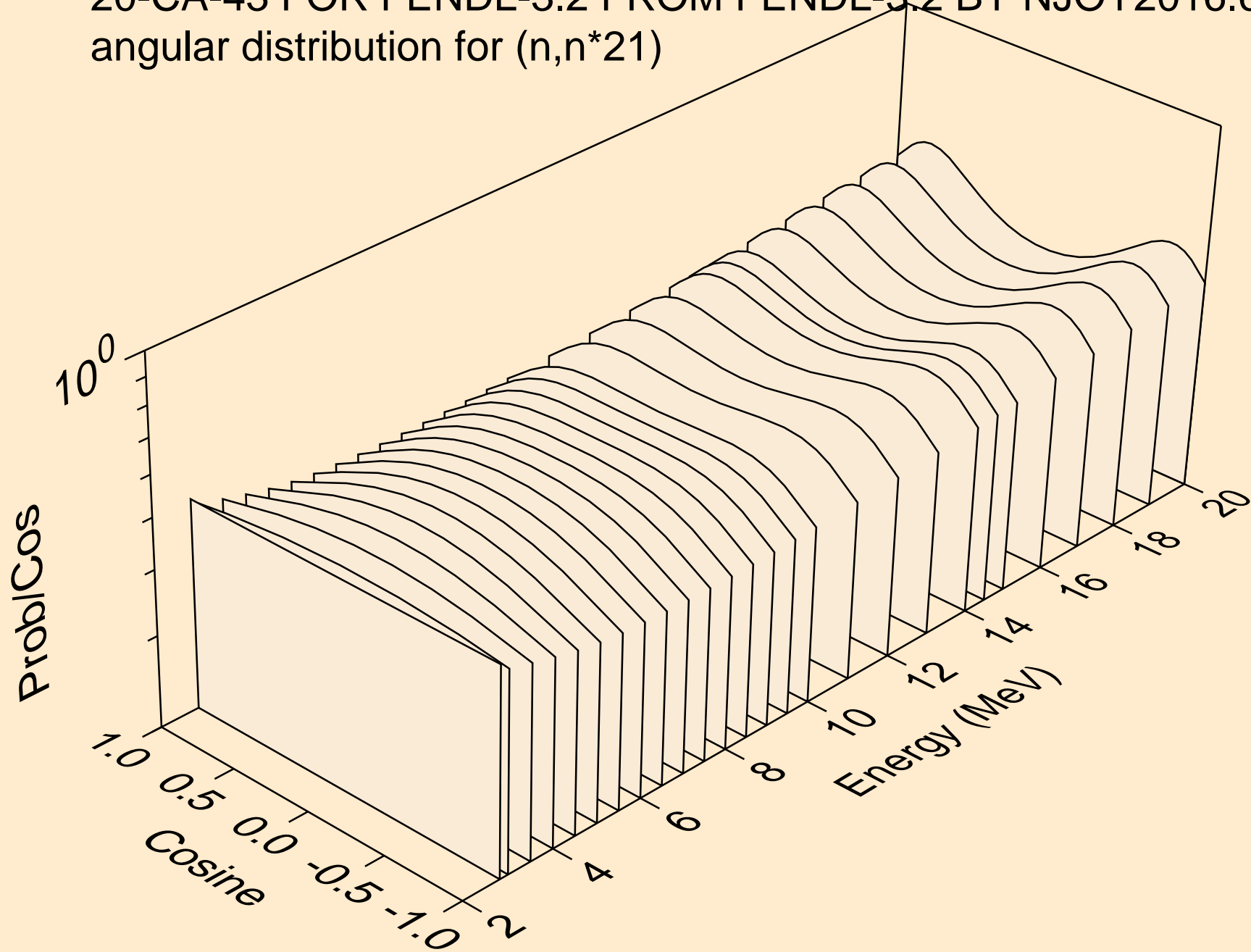

20-CA-43 FOR FENDL-3.2 FROM FENDL-3.2 BY NJOY2016.60+ O
angular distribution for (n,n*22)

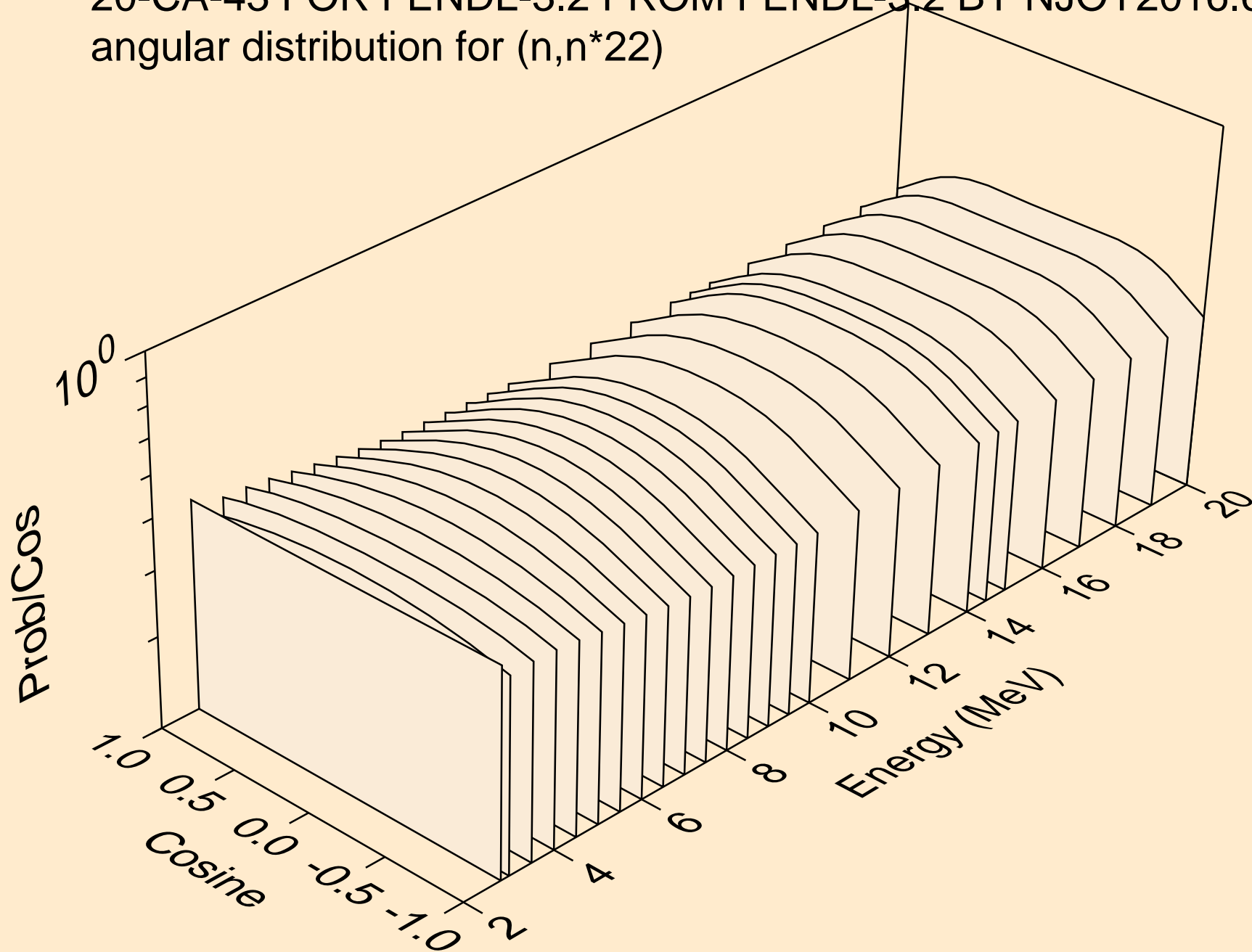

20-CA-43 FOR FENDL-3.2 FROM FENDL-3.2 BY NJOY2016.60+ O
angular distribution for (n,n*23)

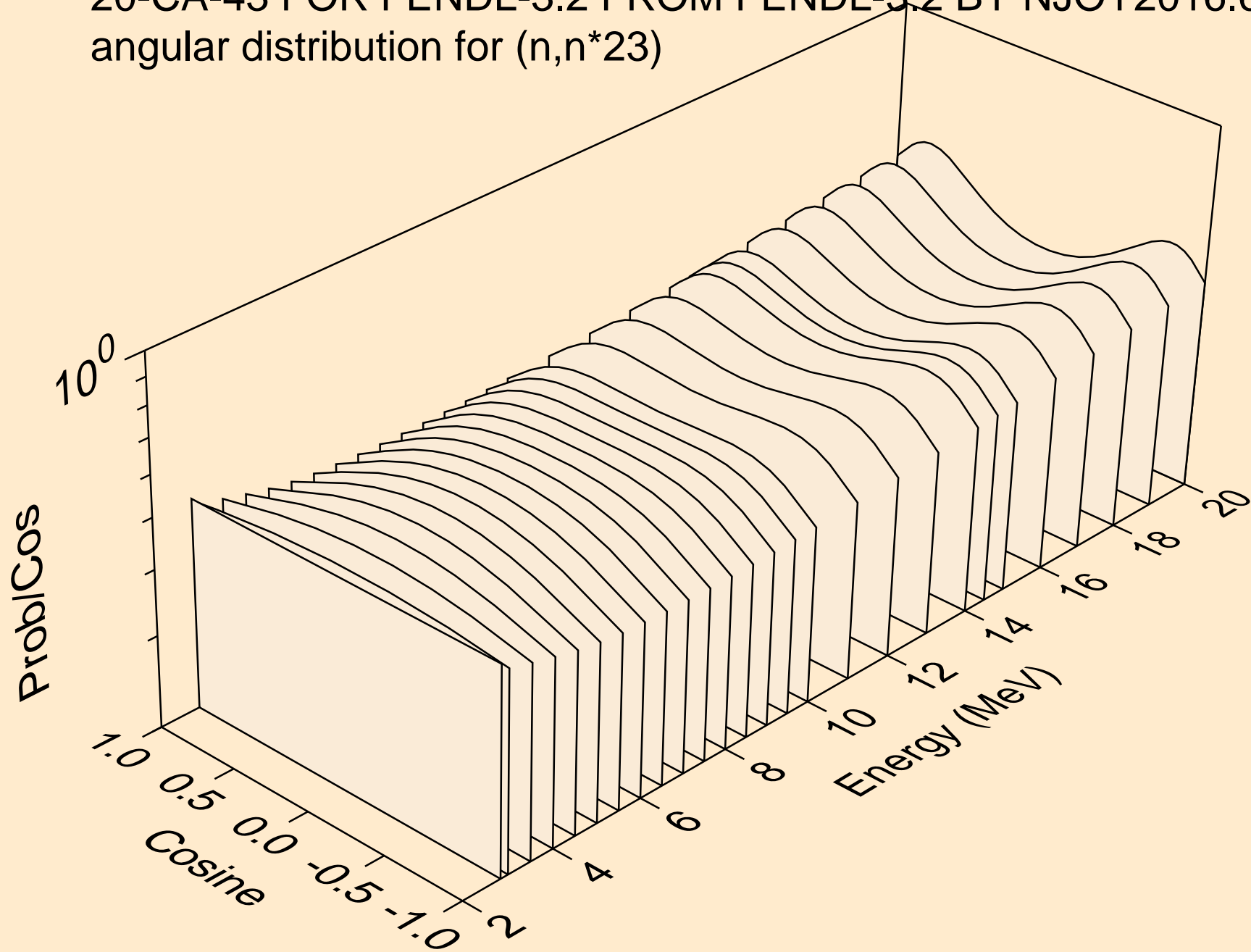

20-CA-43 FOR FENDL-3.2 FROM FENDL-3.2 BY NJOY2016.60+ O
angular distribution for (n,n*24)

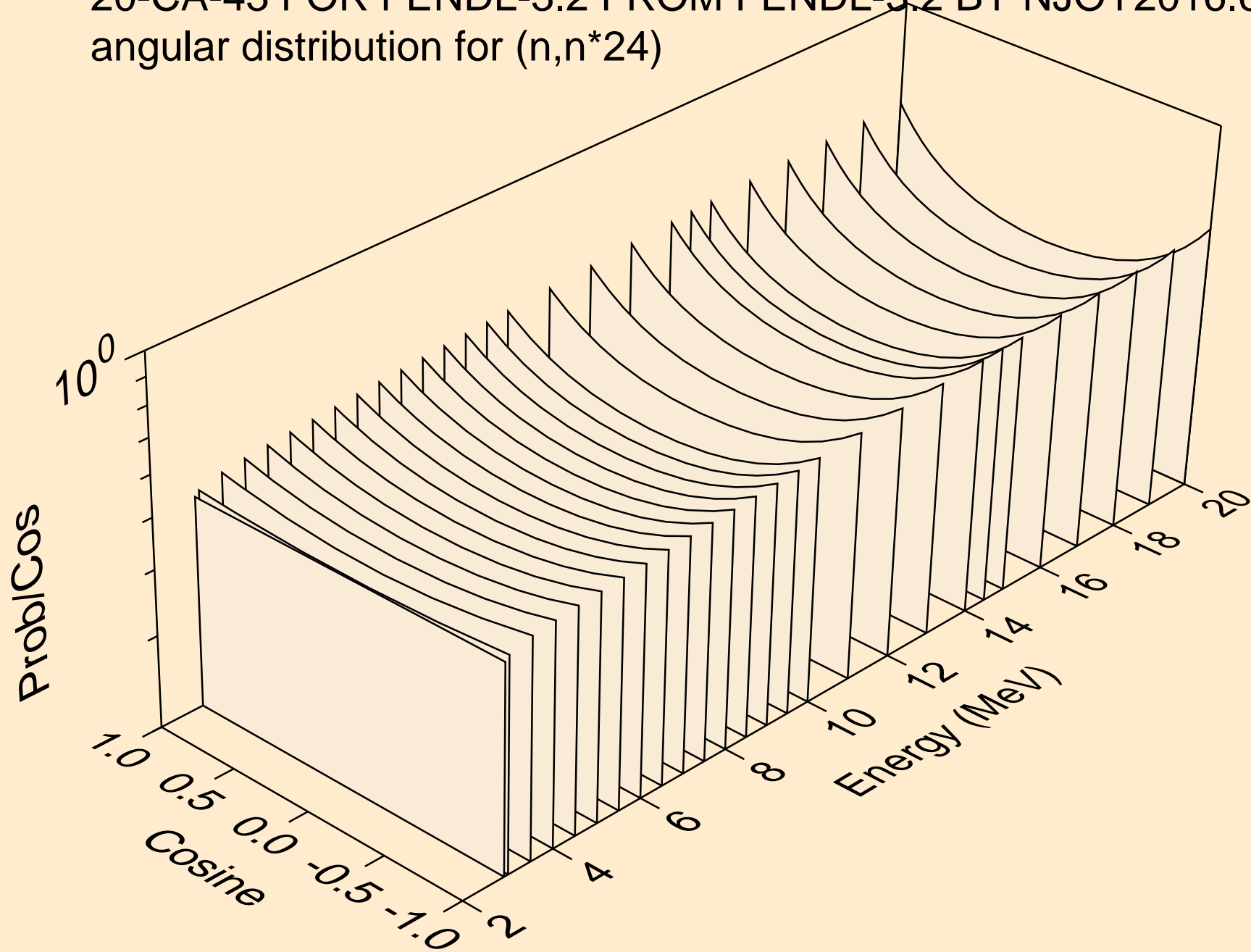

20-CA-43 FOR FENDL-3.2 FROM FENDL-3.2 BY NJOY2016.60+ O
angular distribution for (n,n*25)

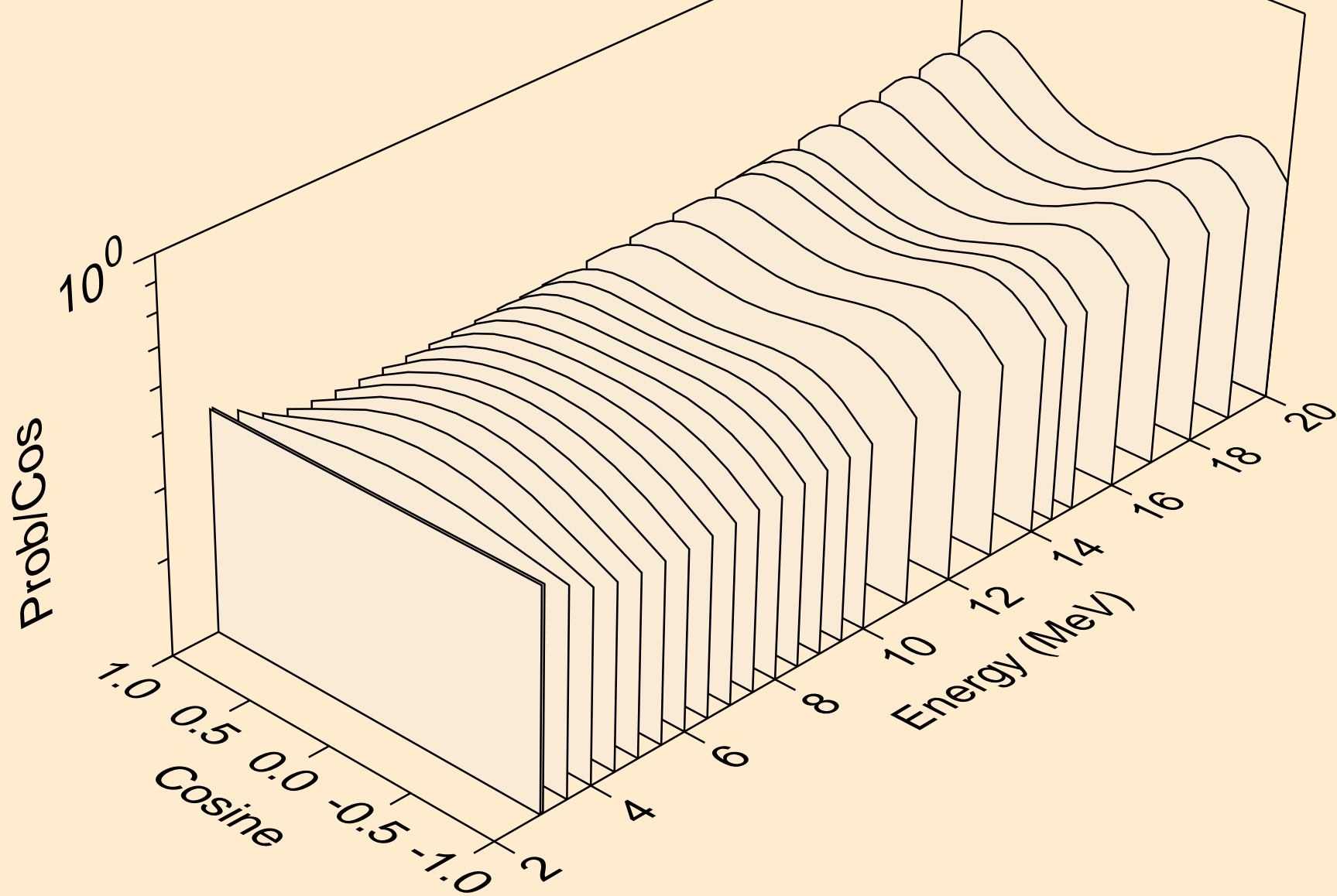

20-CA-43 FOR FENDL-3.2 FROM FENDL-3.2 BY NJOY2016.60+ O
angular distribution for (n,n*26)

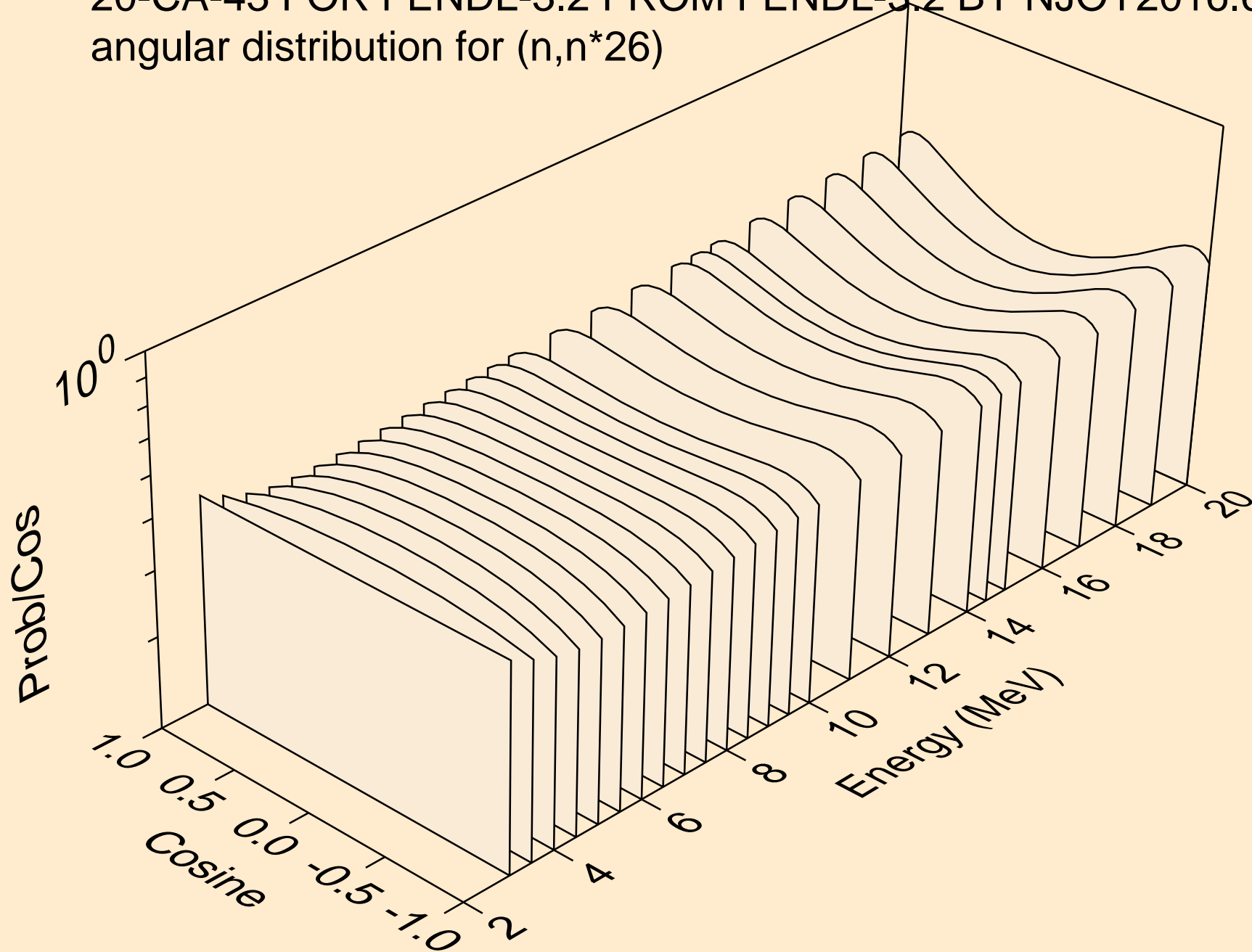

20-CA-43 FOR FENDL-3.2 FROM FENDL-3.2 BY NJOY2016.60+ O
angular distribution for (n,n*27)

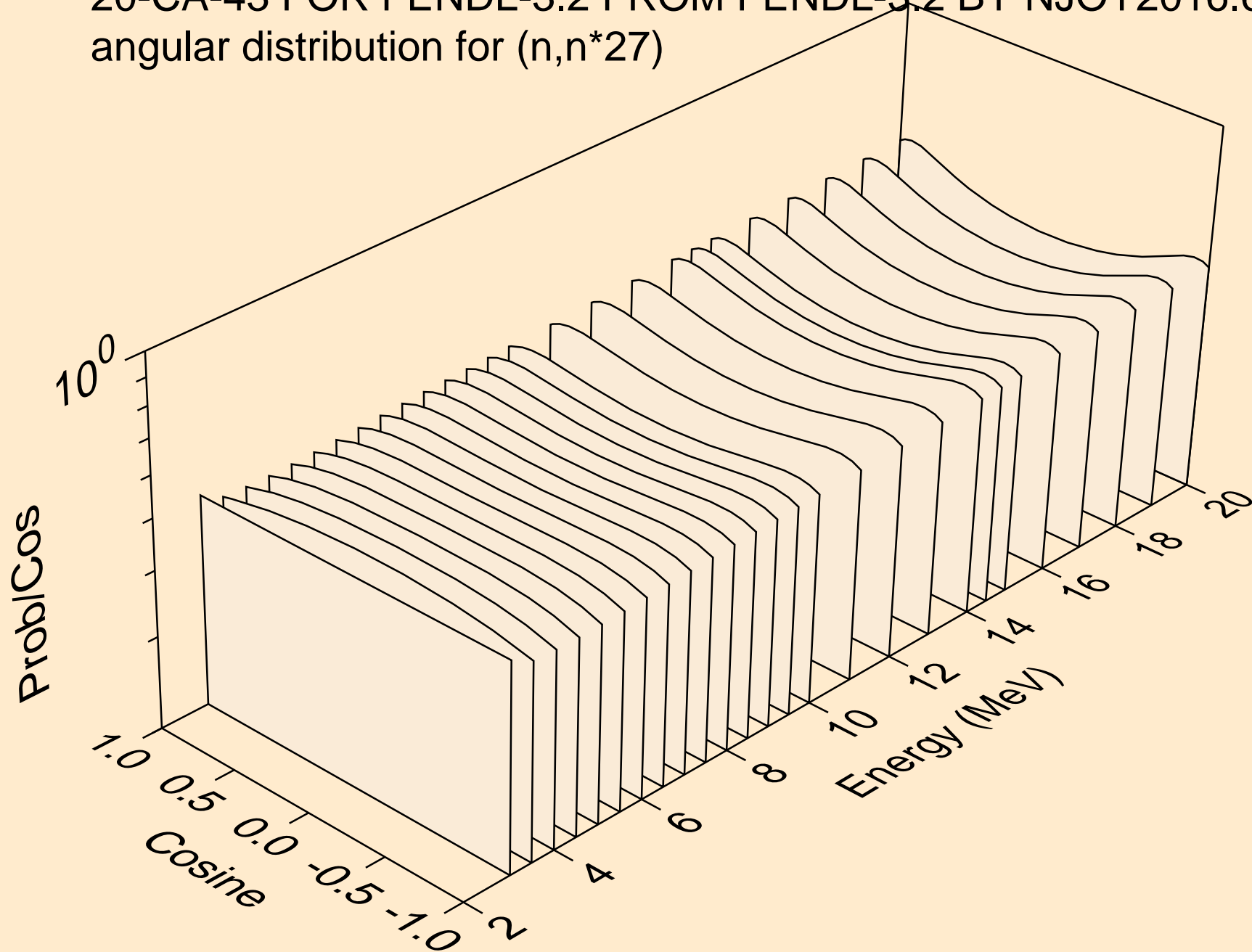

20-CA-43 FOR FENDL-3.2 FROM FENDL-3.2 BY NJOY2016.60+ O
angular distribution for (n,n*28)

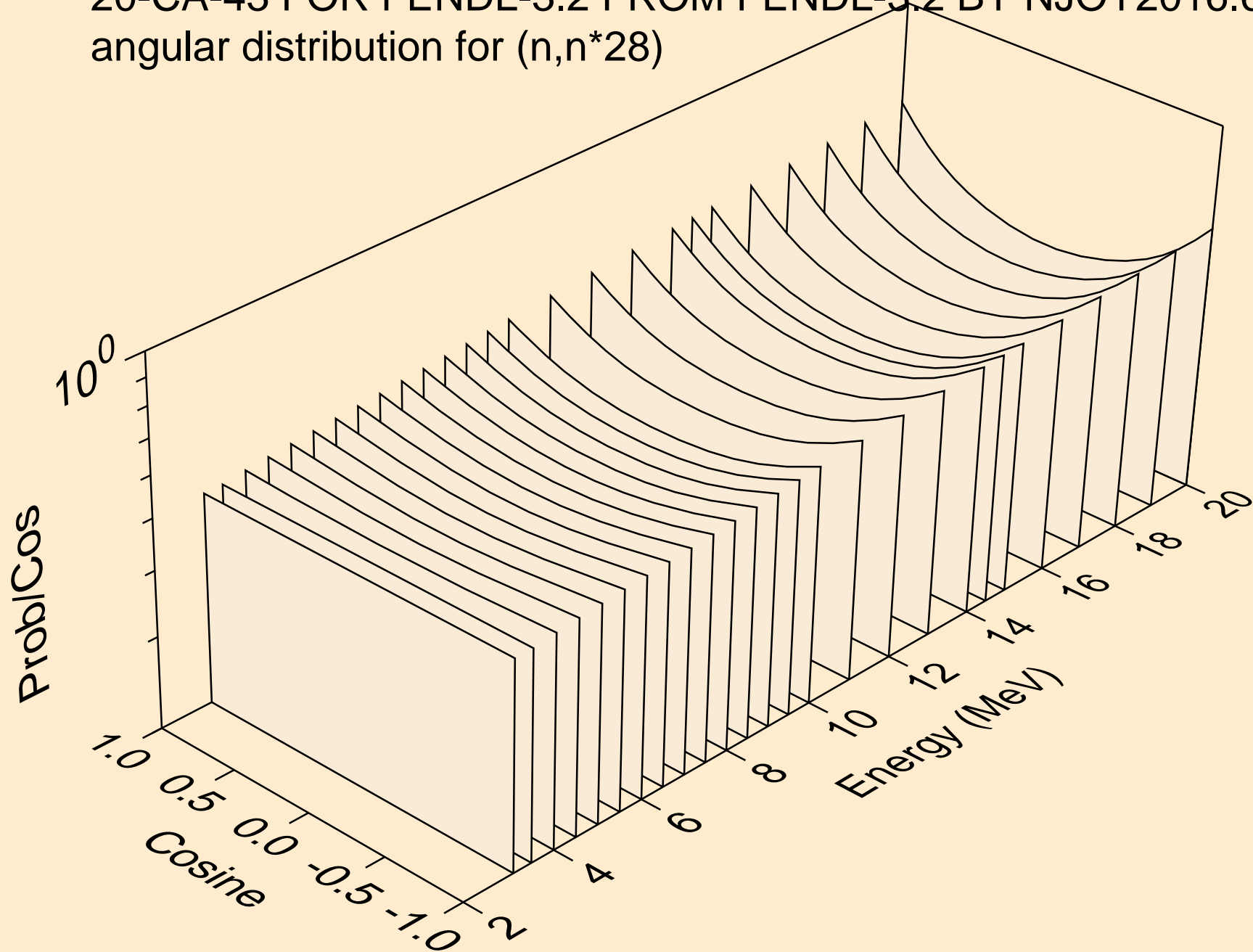

20-CA-43 FOR FENDL-3.2 FROM FENDL-3.2 BY NJOY2016.60+ O
angular distribution for (n,n*29)

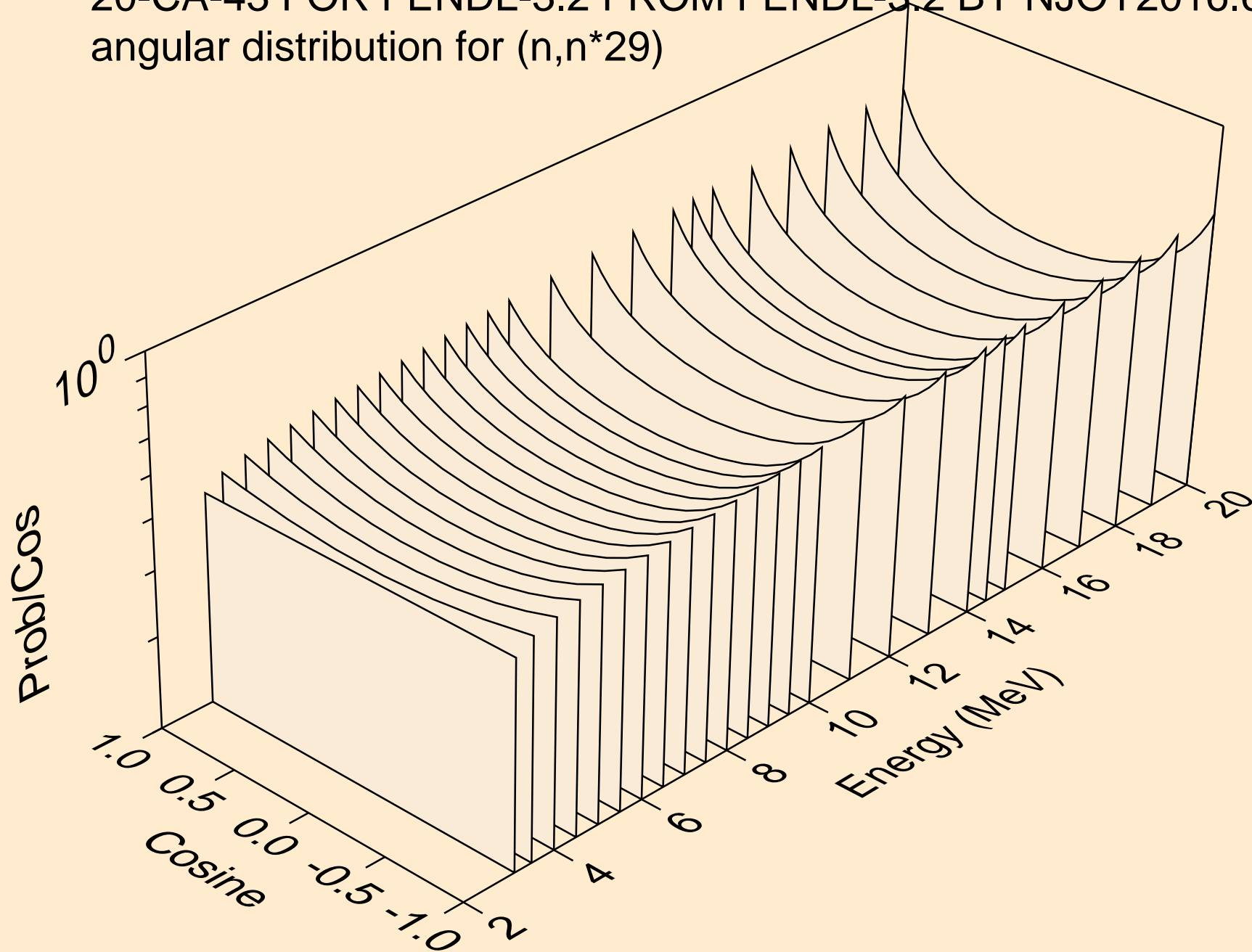

20-CA-43 FOR FENDL-3.2 FROM FENDL-3.2 BY NJOY2016.60+ O
angular distribution for (n,n*30)

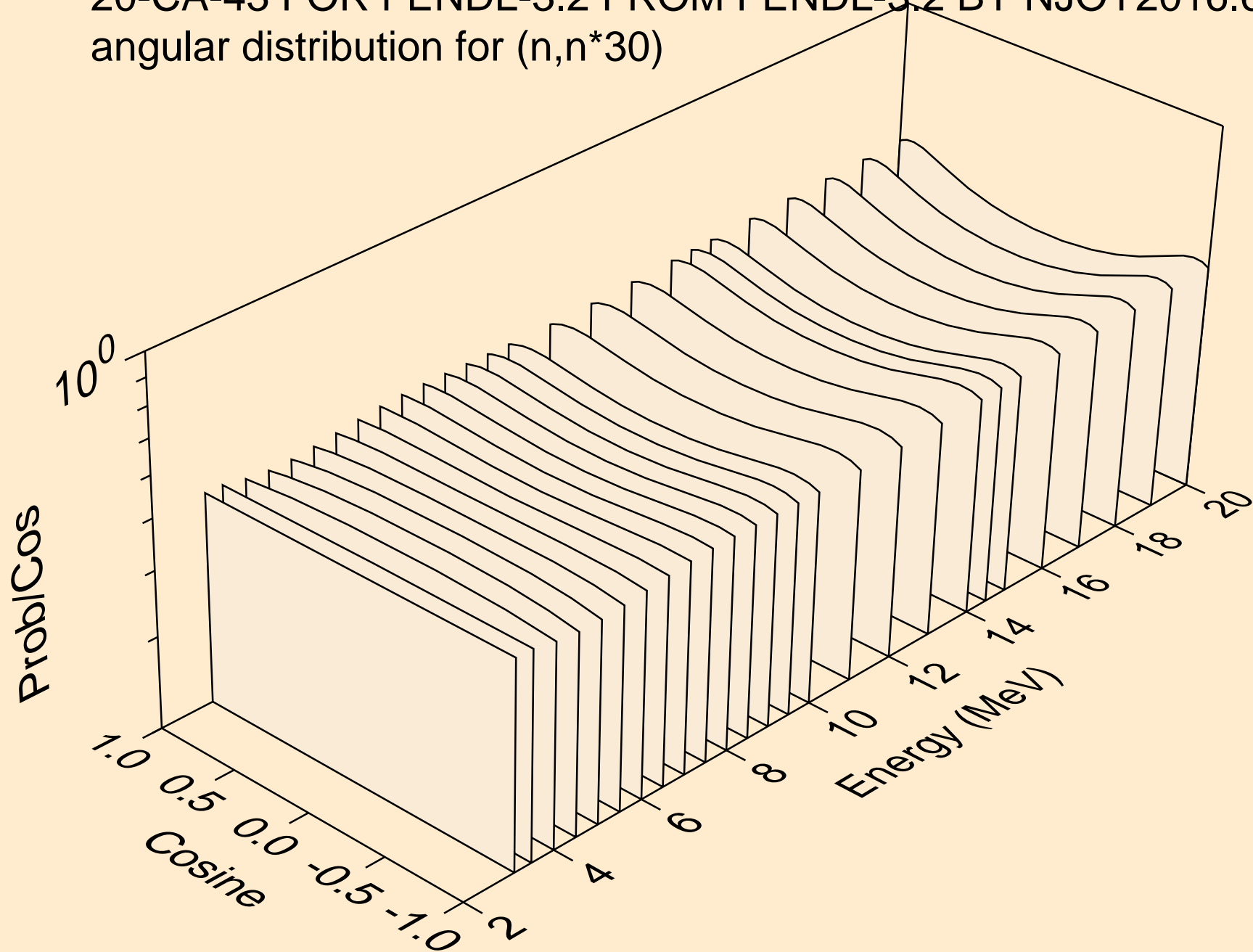

20-CA-43 FOR FENDL-3.2 FROM FENDL-3.2 BY NJOY2016.60+ O
angular distribution for (n,n*31)

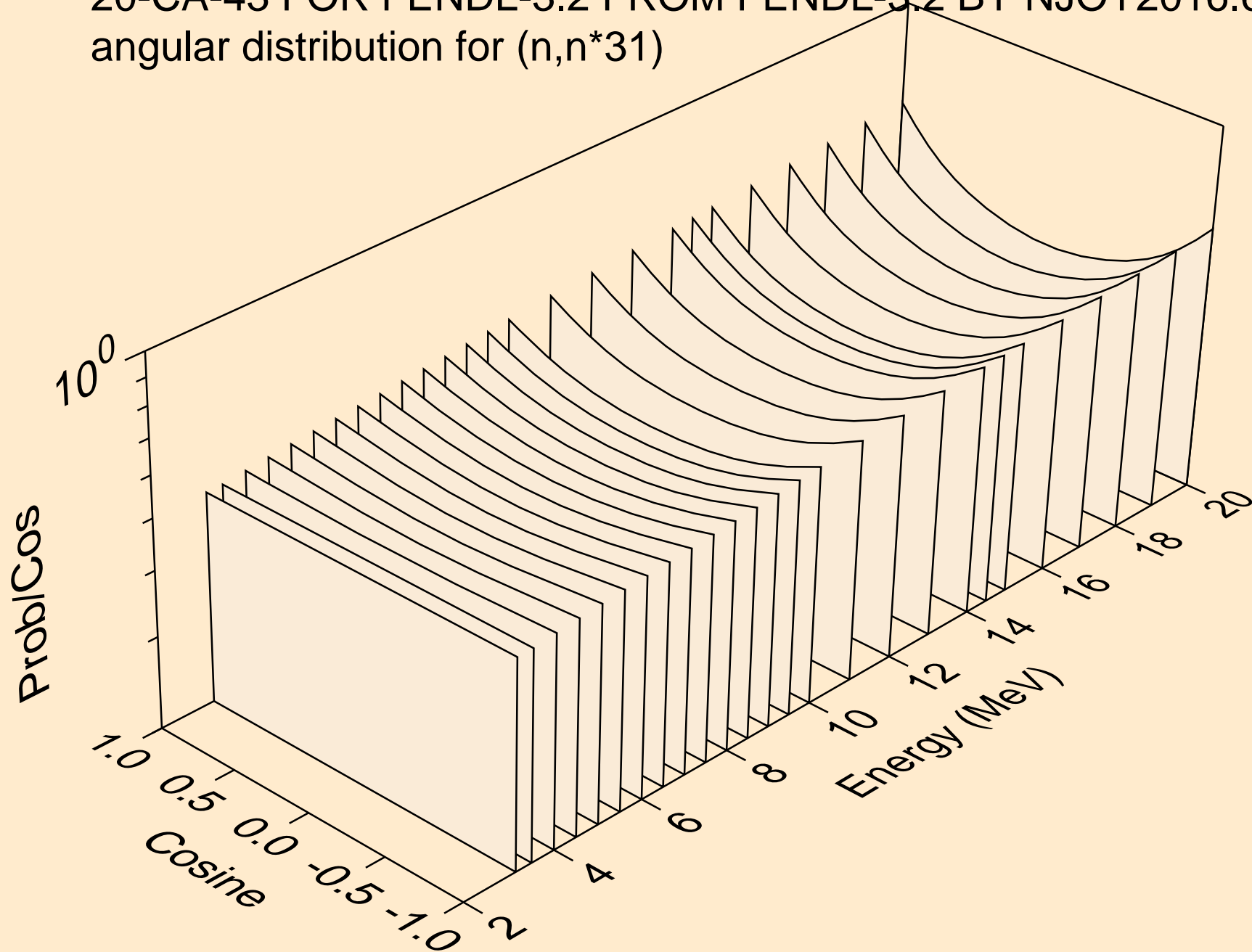

20-CA-43 FOR FENDL-3.2 FROM FENDL-3.2 BY NJOY2016.60+ O
angular distribution for (n,n*32)

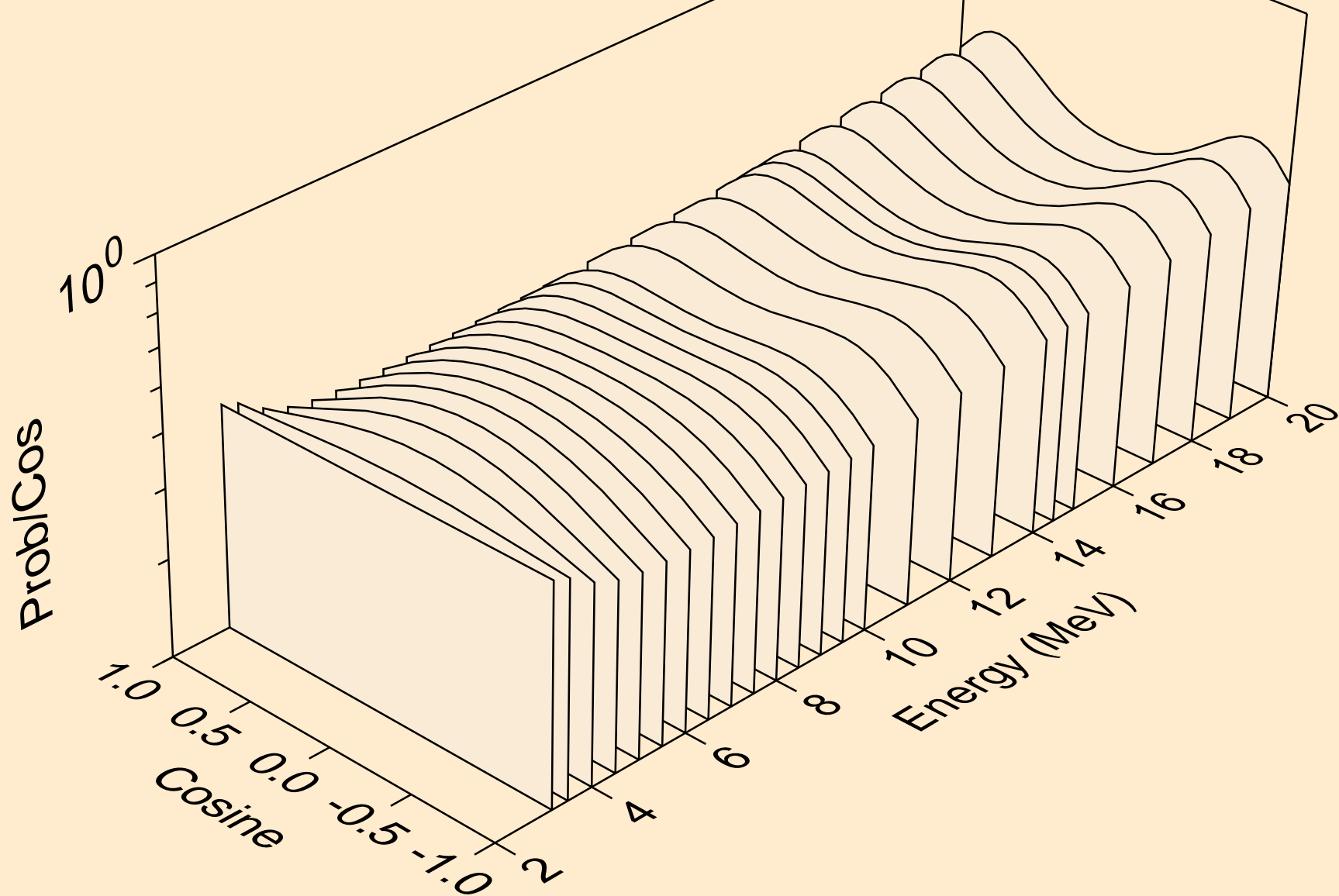

20-CA-43 FOR FENDL-3.2 FROM FENDL-3.2 BY NJOY2016.60+ O
angular distribution for (n,n*33)

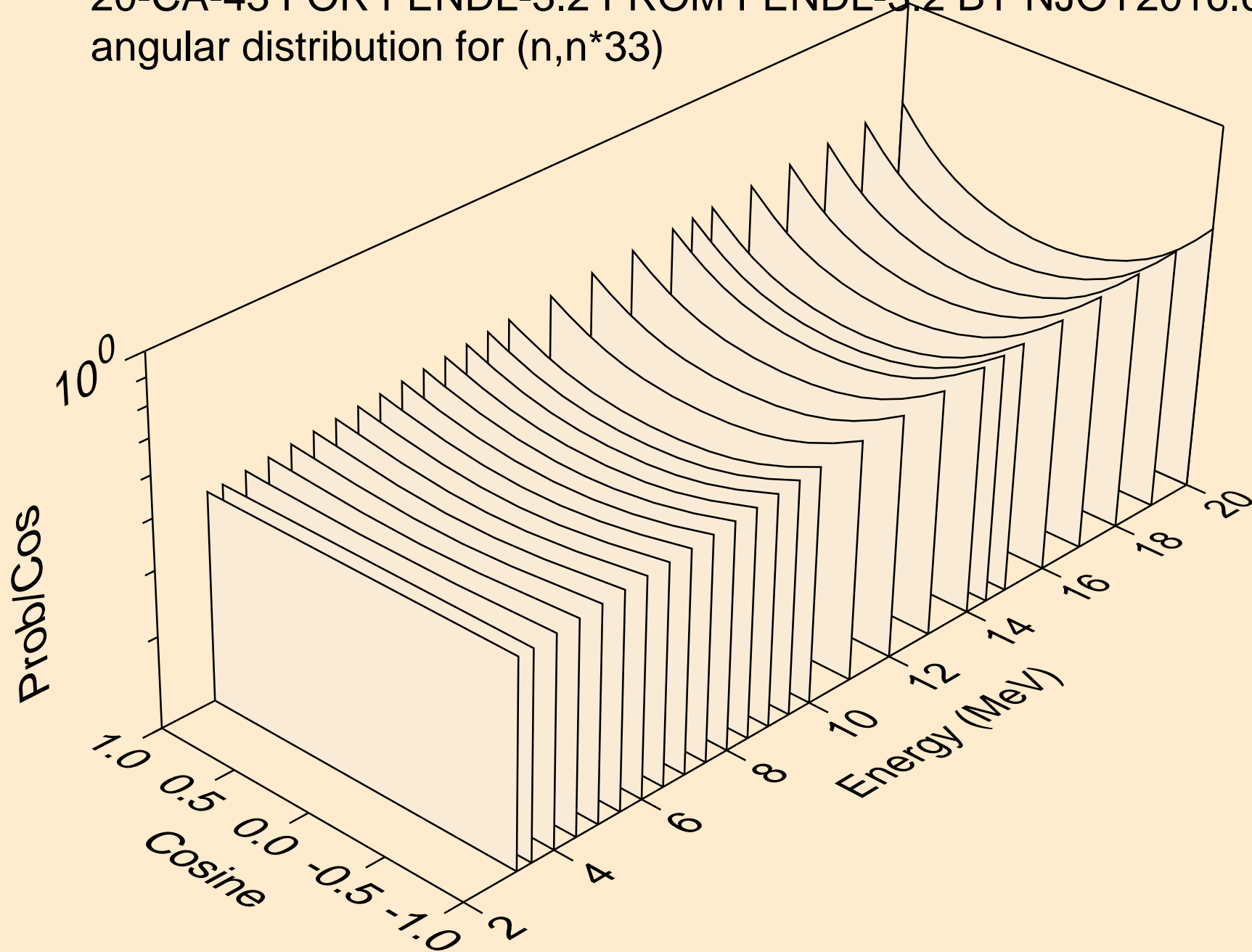

20-CA-43 FOR FENDL-3.2 FROM FENDL-3.2 BY NJOY2016.60+ O
angular distribution for (n,n*34)

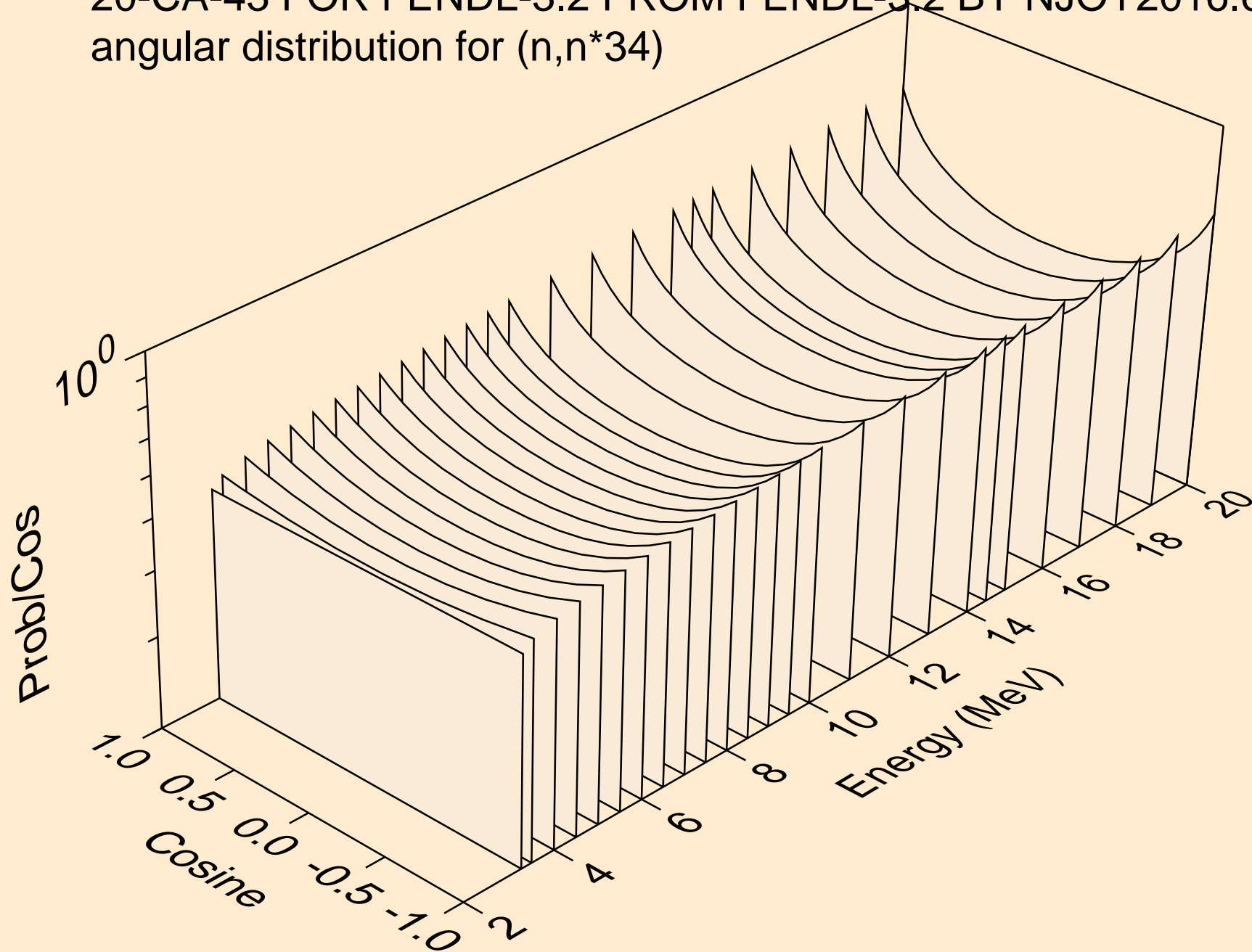

20-CA-43 FOR FENDL-3.2 FROM FENDL-3.2 BY NJOY2016.60+ O
angular distribution for (n,n*35)

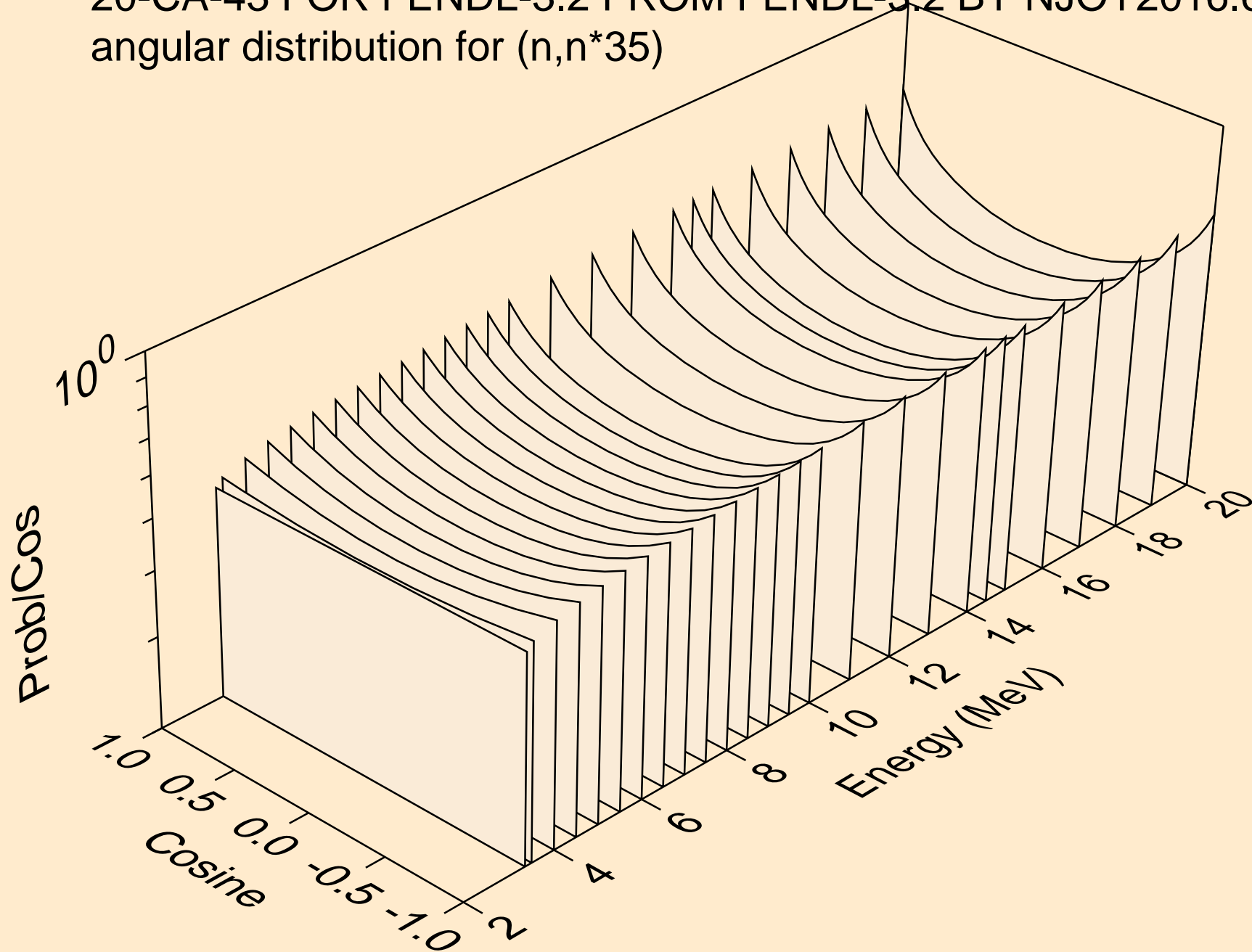

20-CA-43 FOR FENDL-3.2 FROM FENDL-3.2 BY NJOY2016.60+ O
angular distribution for (n,n*36)

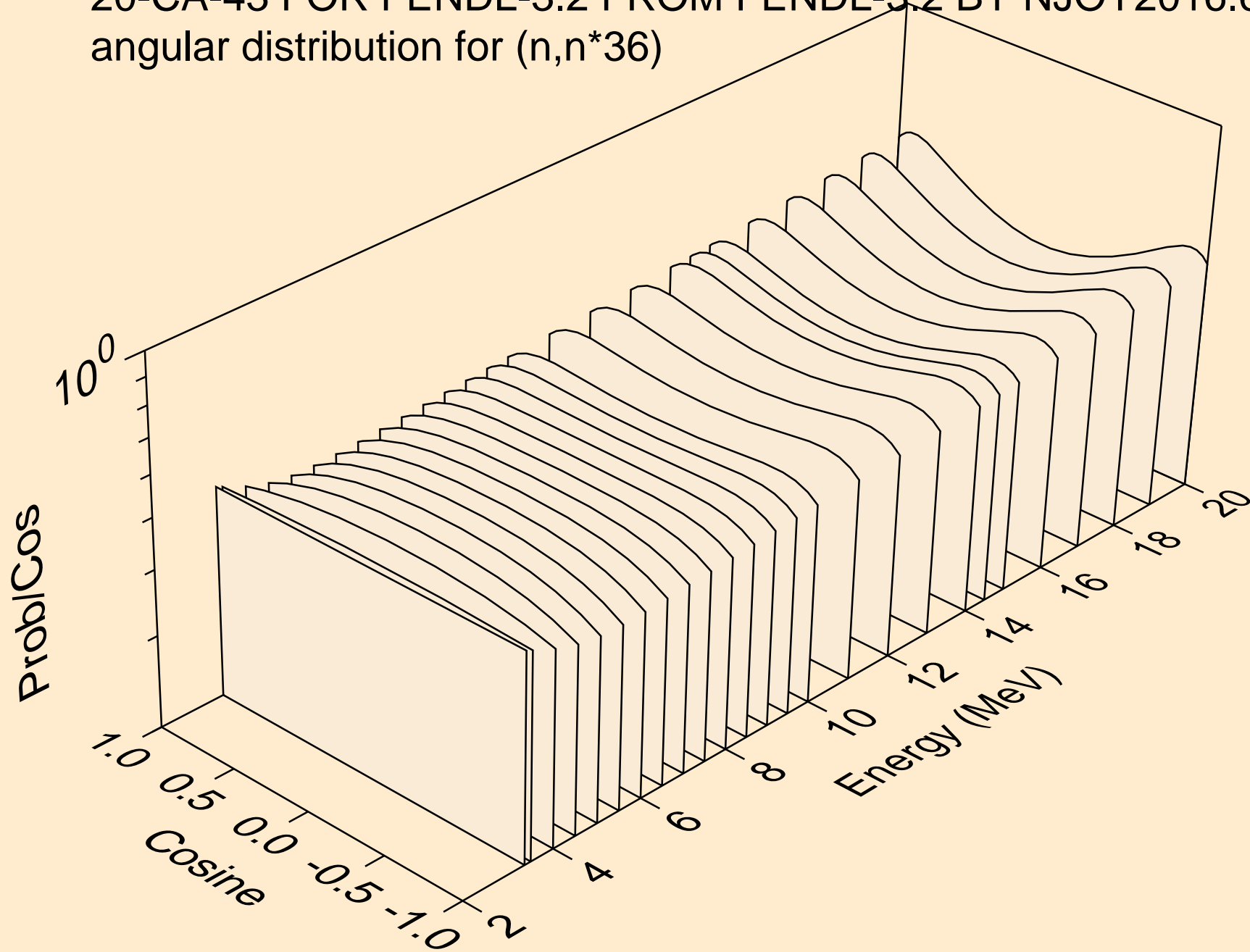

20-CA-43 FOR FENDL-3.2 FROM FENDL-3.2 BY NJOY2016.60+ O
angular distribution for (n,n*37)

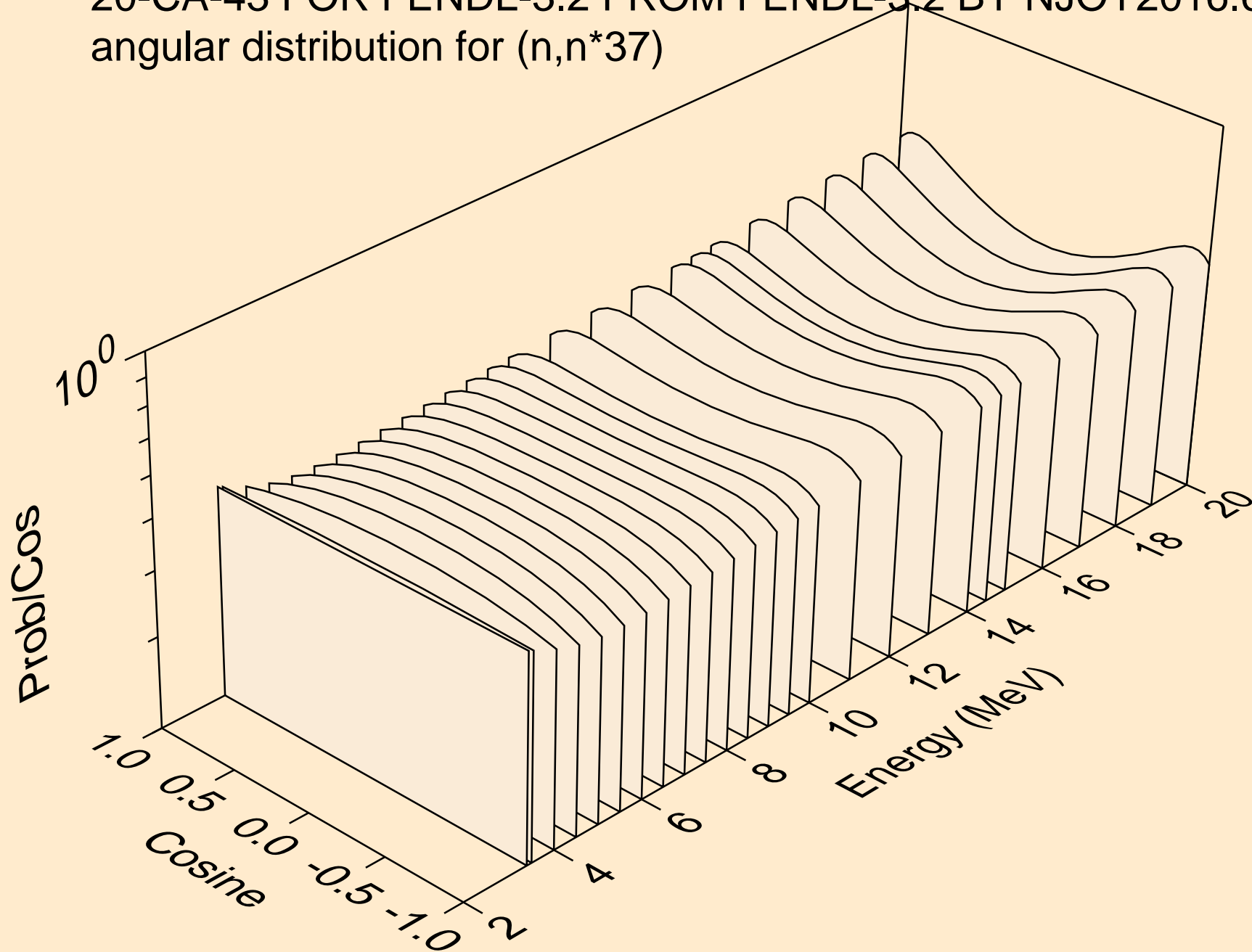

20-CA-43 FOR FENDL-3.2 FROM FENDL-3.2 BY NJOY2016.60+ O
angular distribution for (n,n*38)

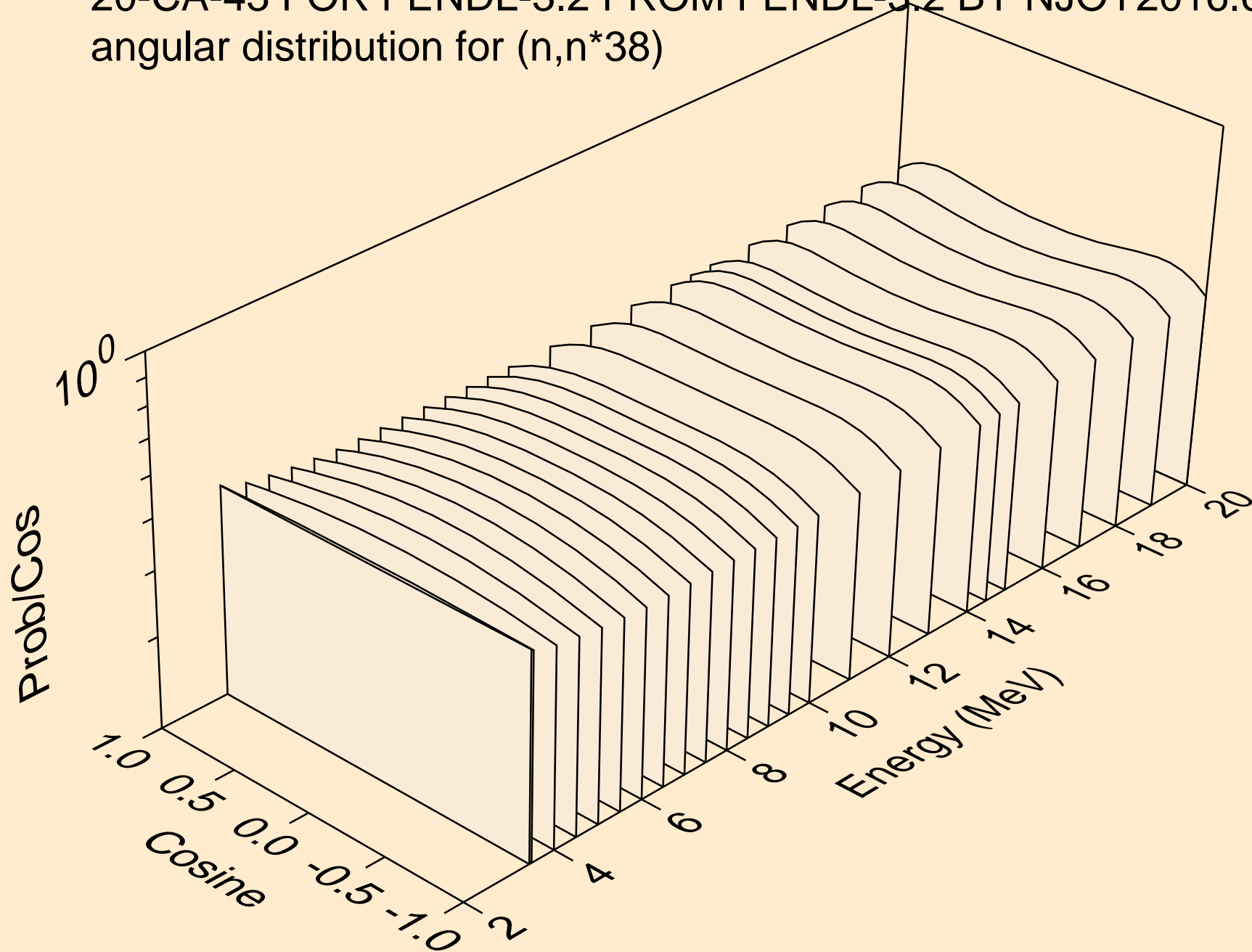

20-CA-43 FOR FENDL-3.2 FROM FENDL-3.2 BY NJOY2016.60+ O
angular distribution for (n,n*39)

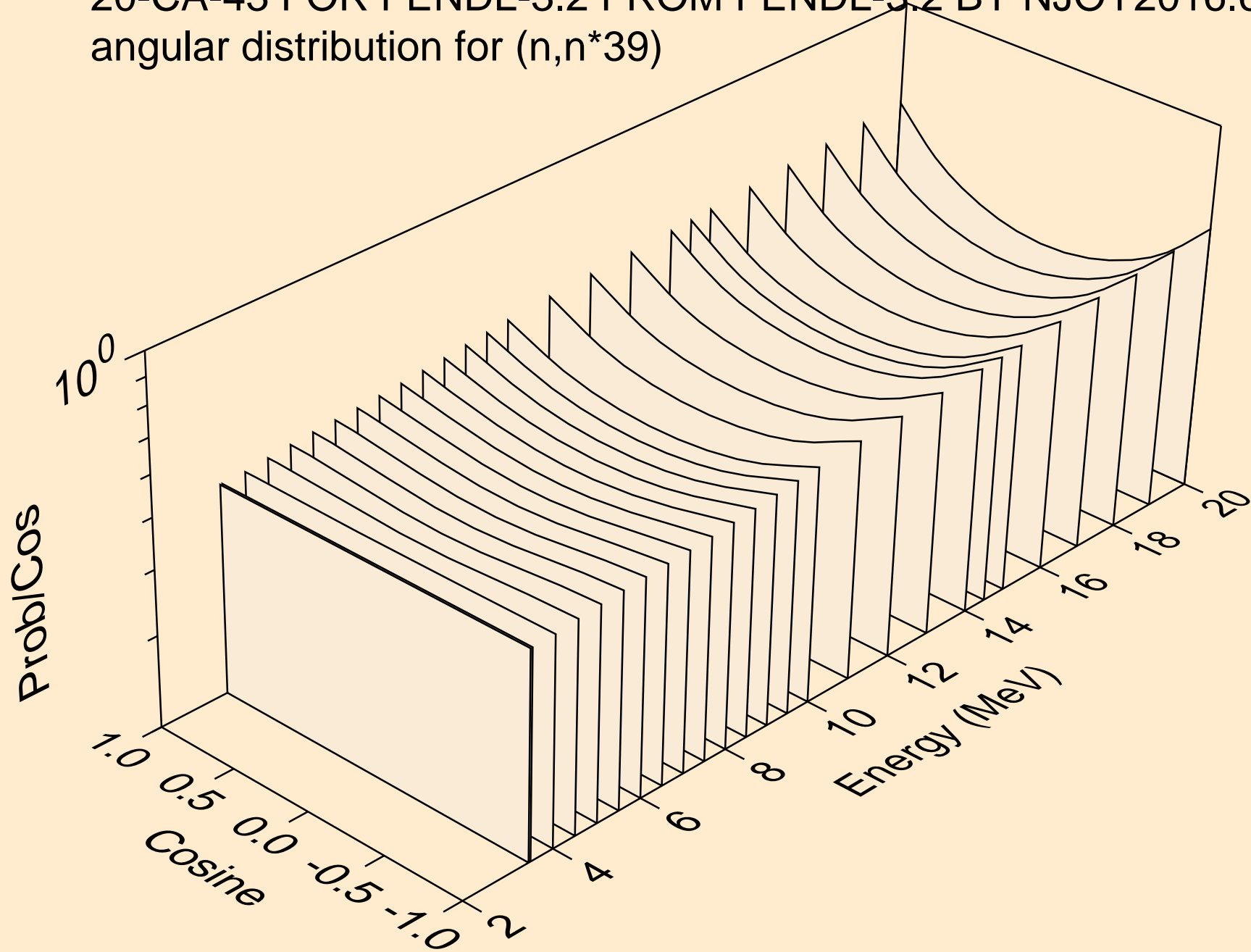

20-CA-43 FOR FENDL-3.2 FROM FENDL-3.2 BY NJOY2016.60+ O
Neutron emission for (n,x)

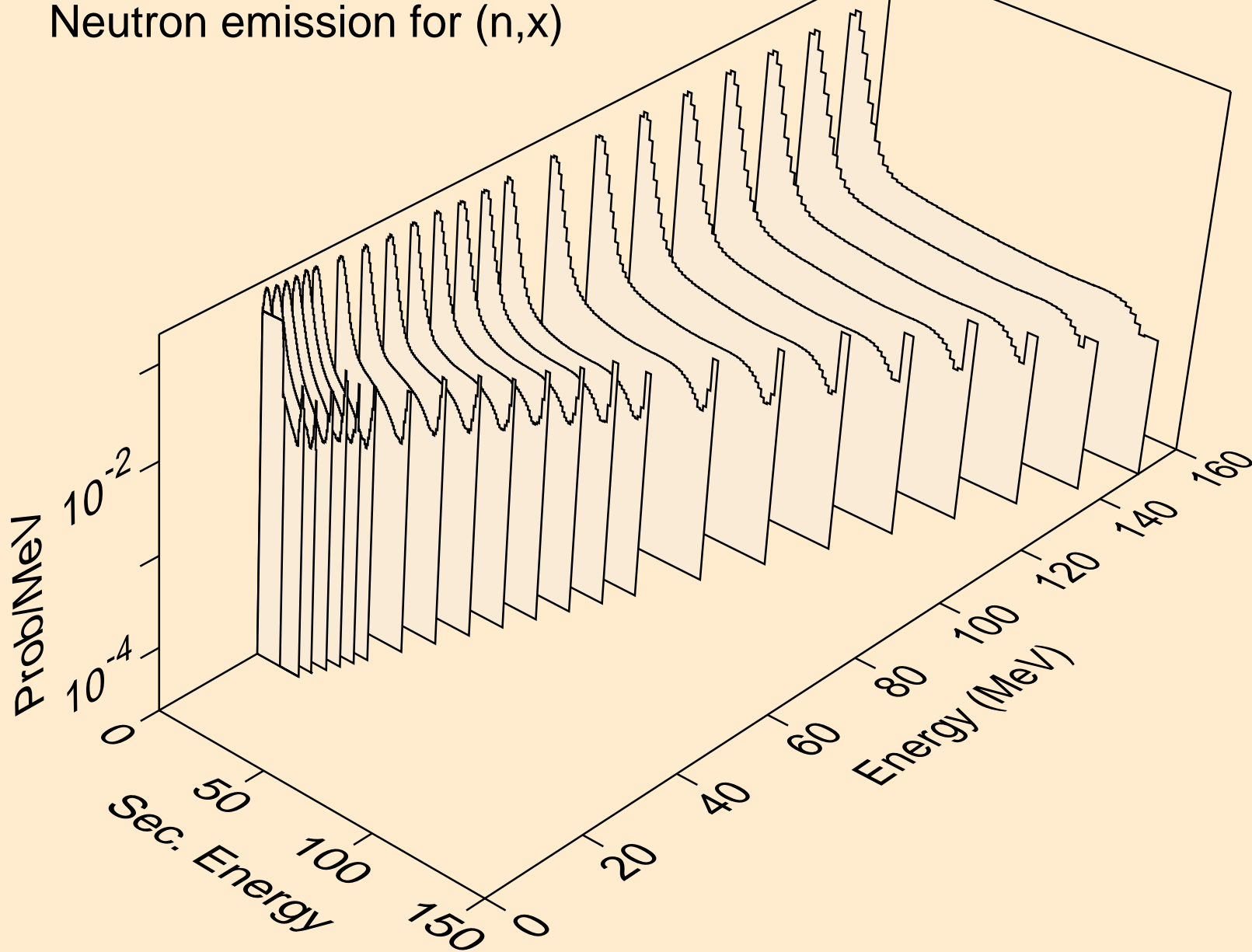

20-CA-43 FOR FENDL-3.2 FROM FENDL-3.2 BY NJOY2016.60+ O
Neutron emission for (n,2n)

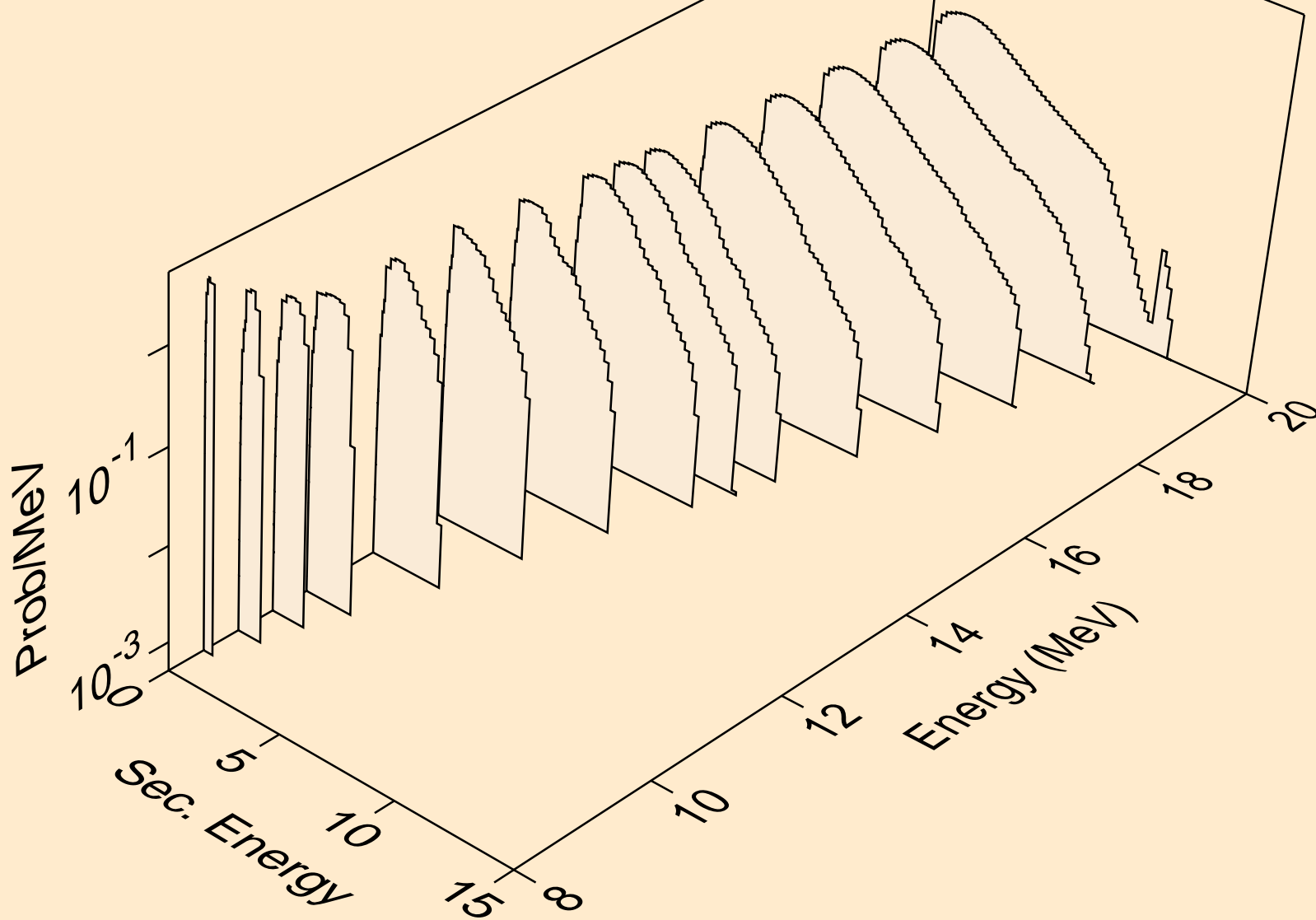

20-CA-43 FOR FENDL-3.2 FROM FENDL-3.2 BY NJOY2016.60+ O
Neutron emission for (n,3n)

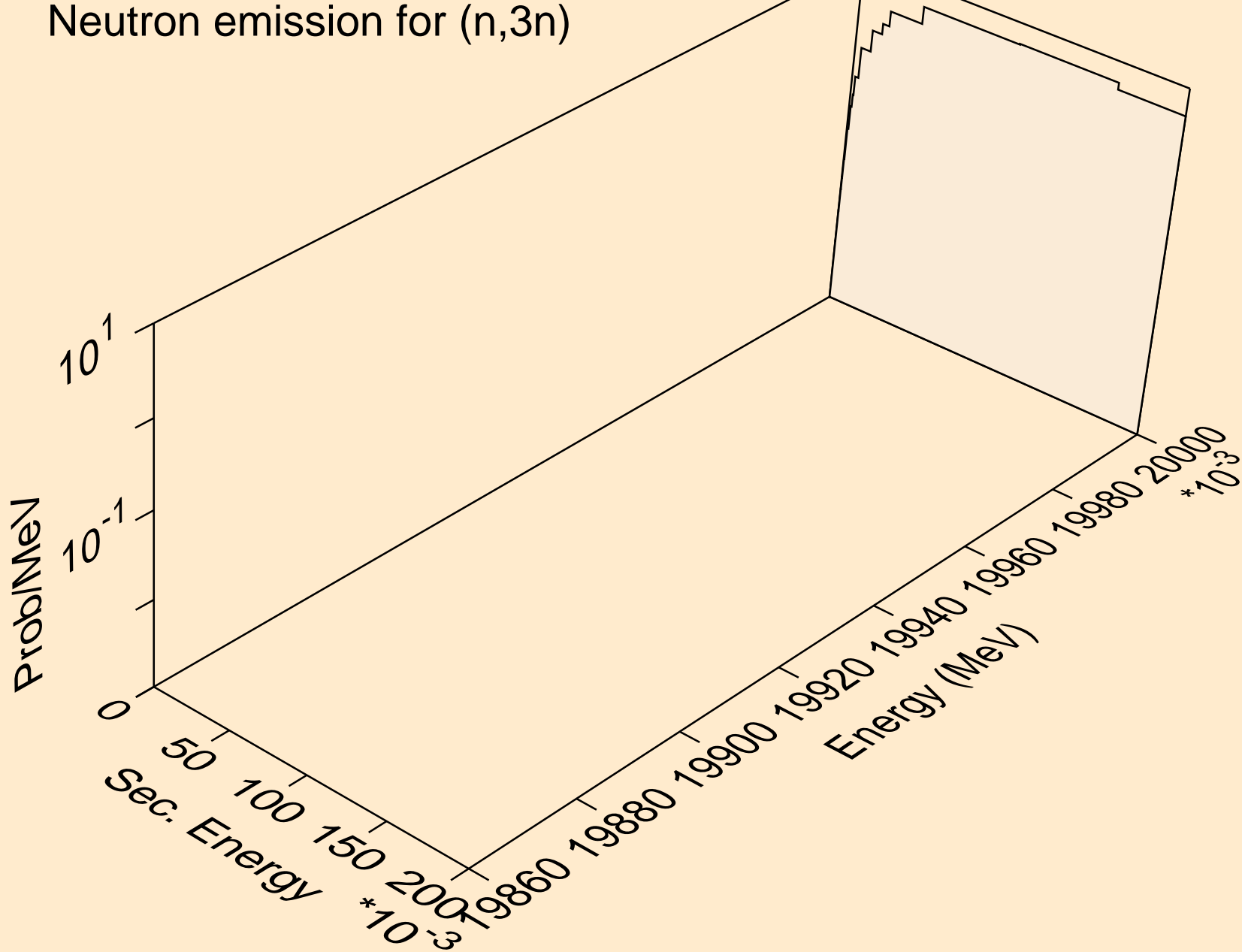

20-CA-43 FOR FENDL-3.2 FROM FENDL-3.2 BY NJOY2016.60+ O
Neutron emission for (n,n*)a

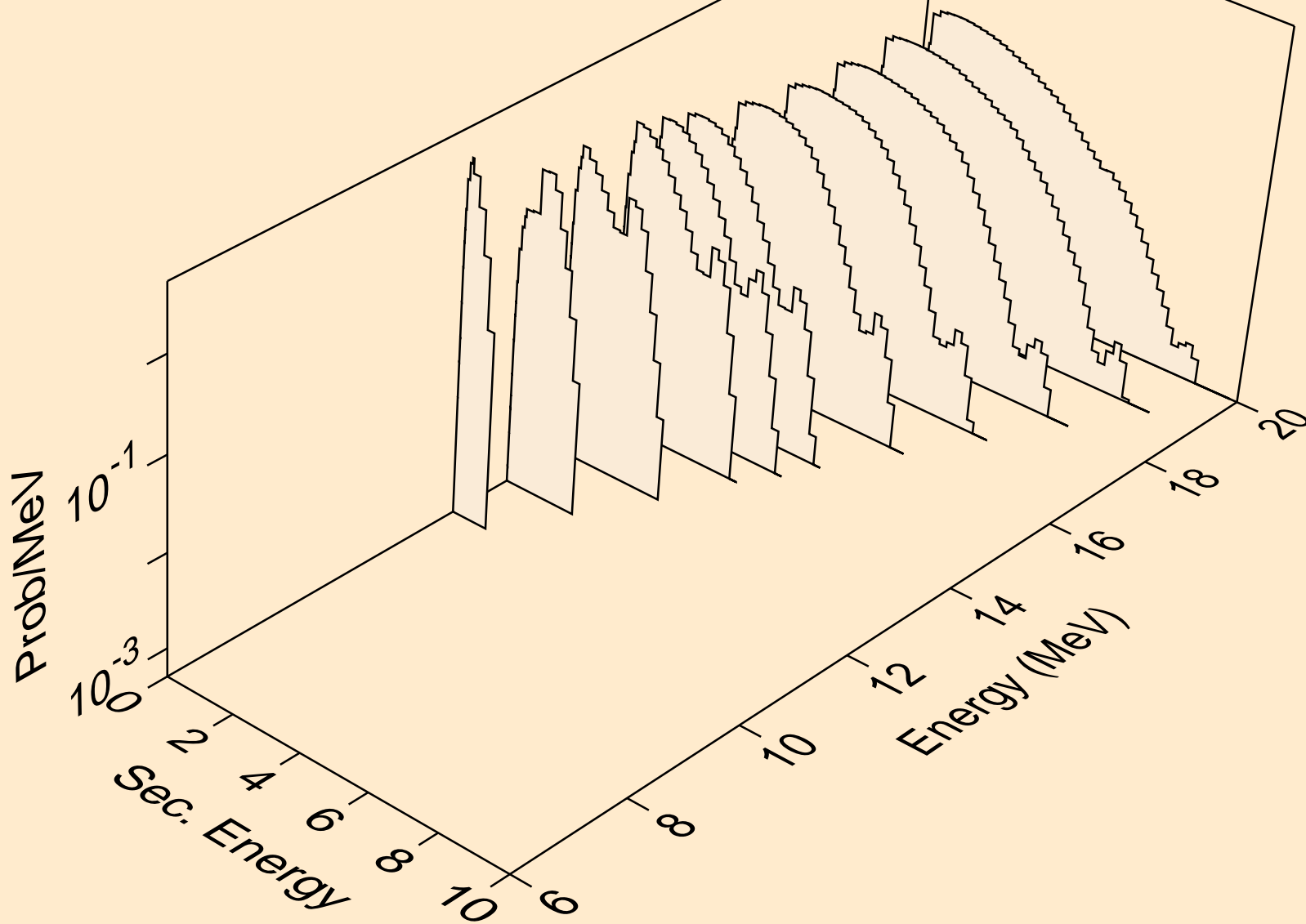

20-CA-43 FOR FENDL-3.2 FROM FENDL-3.2 BY NJOY2016.60+ O
Neutron emission for (n,n*)p

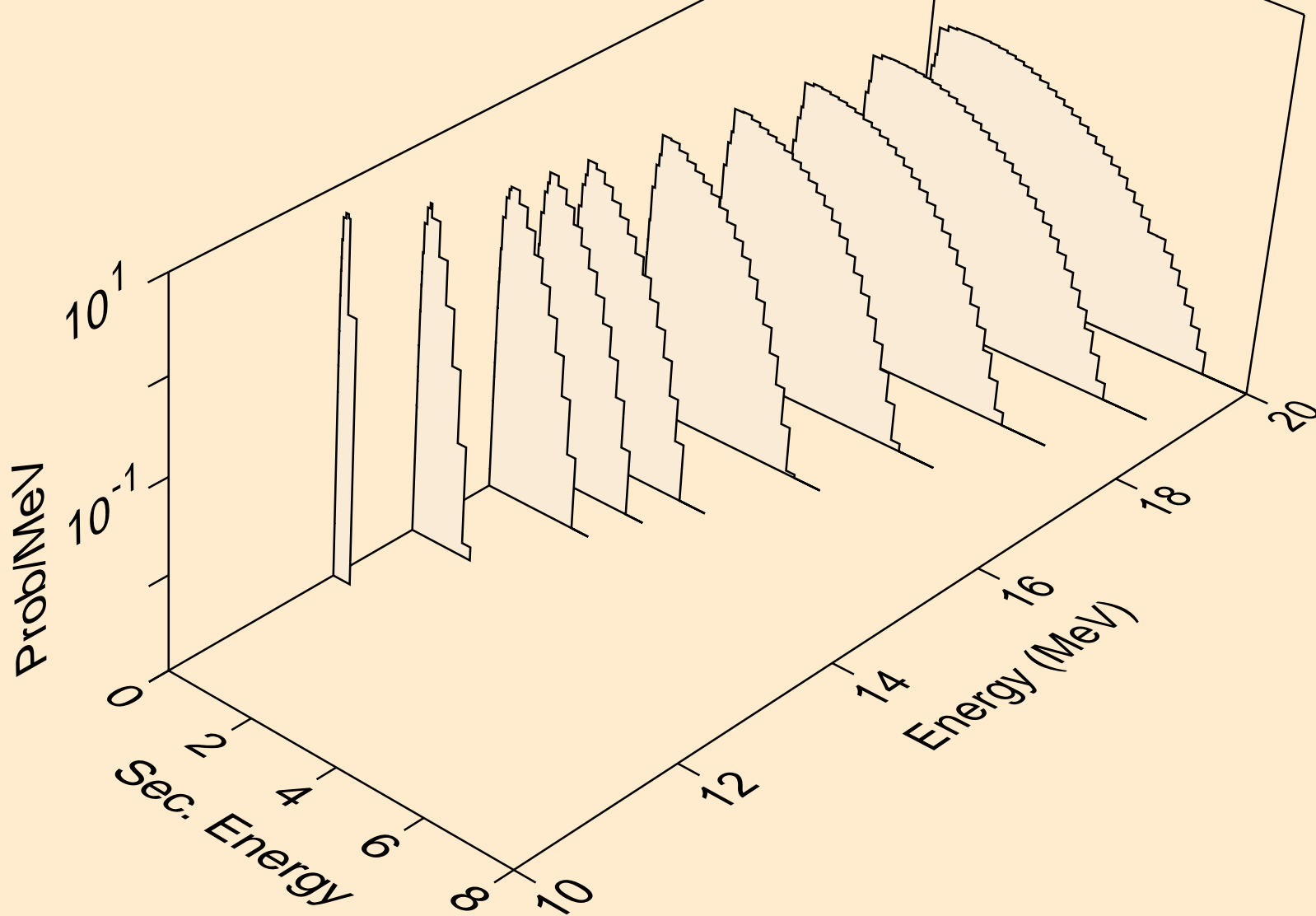

20-CA-43 FOR FENDL-3.2 FROM FENDL-3.2 BY NJOY2016.60+ O
Neutron emission for (n,n*c)

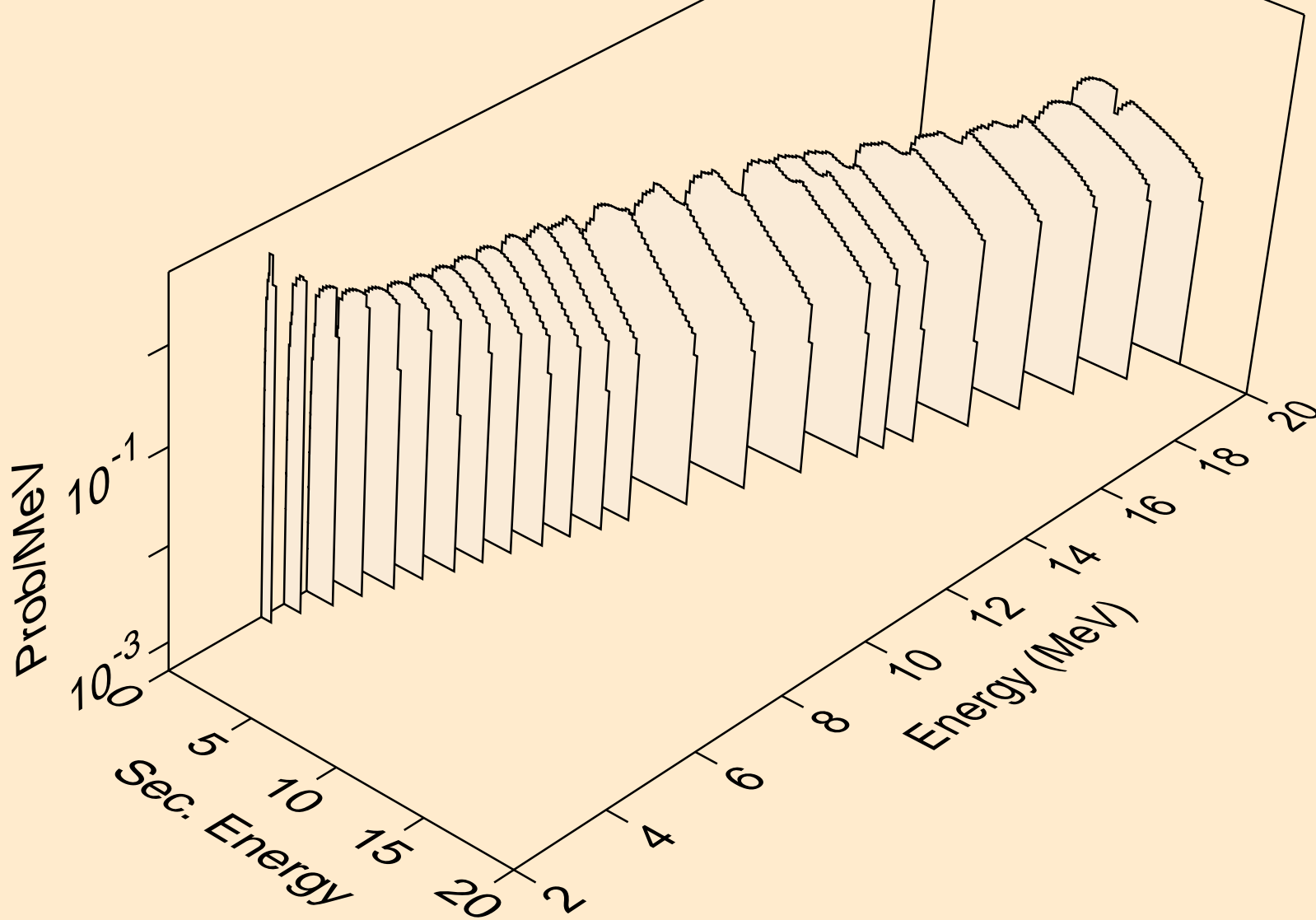

20-CA-43 FOR FENDL-3.2 FROM FENDL-3.2 BY NJOY2016.60+ O
Photon emission for (n,x)

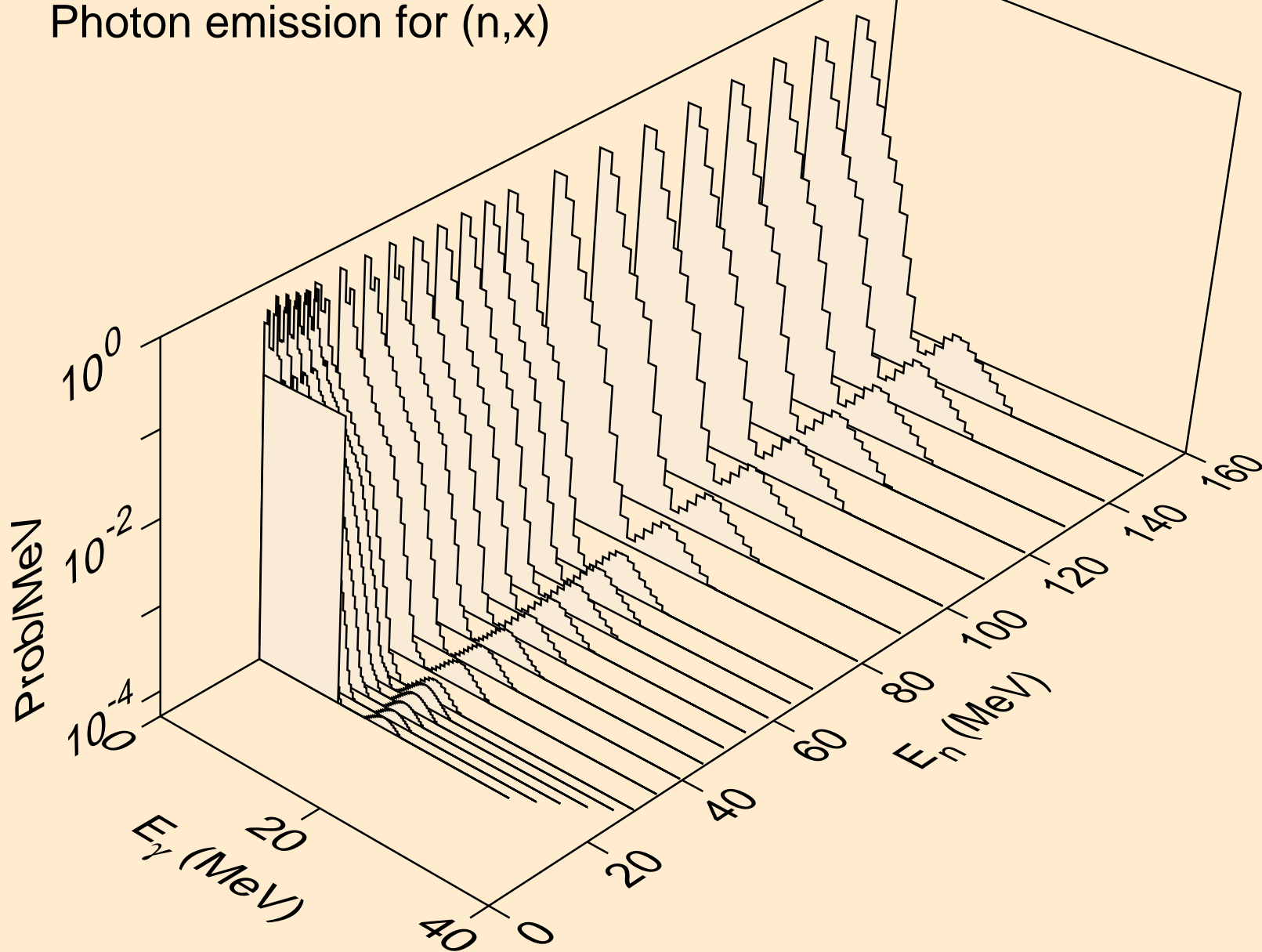

20-CA-43 FOR FENDL-3.2 FROM FENDL-3.2 BY NJOY2016.60+ O
Photon emission for (n,2n)

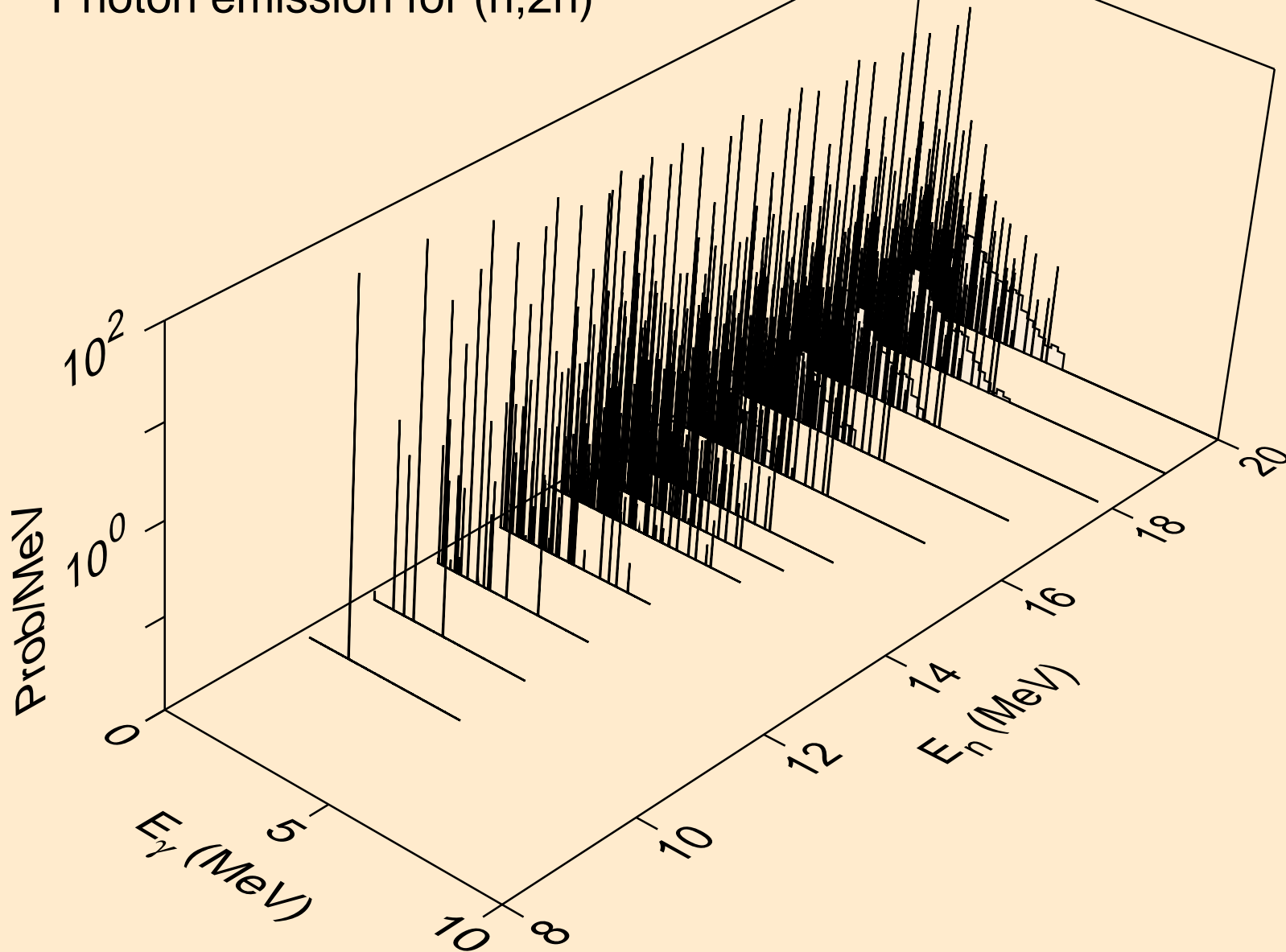

20-CA-43 FOR FENDL-3.2 FROM FENDL-3.2 BY NJOY2016.60+ O
Photon emission for (n,n*)a

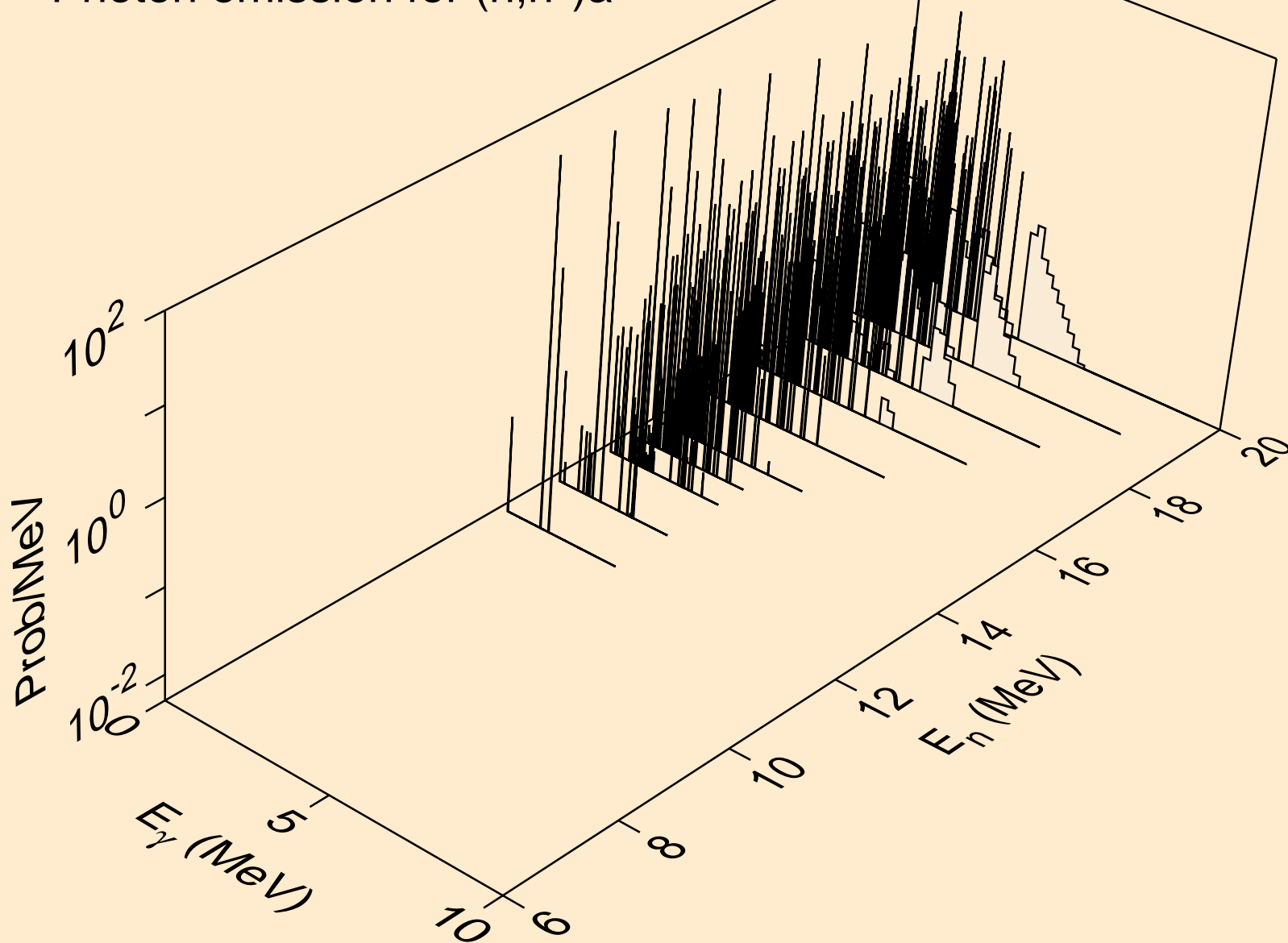

20-CA-43 FOR FENDL-3.2 FROM FENDL-3.2 BY NJOY2016.60+ O
Photon emission for (n,n*)p

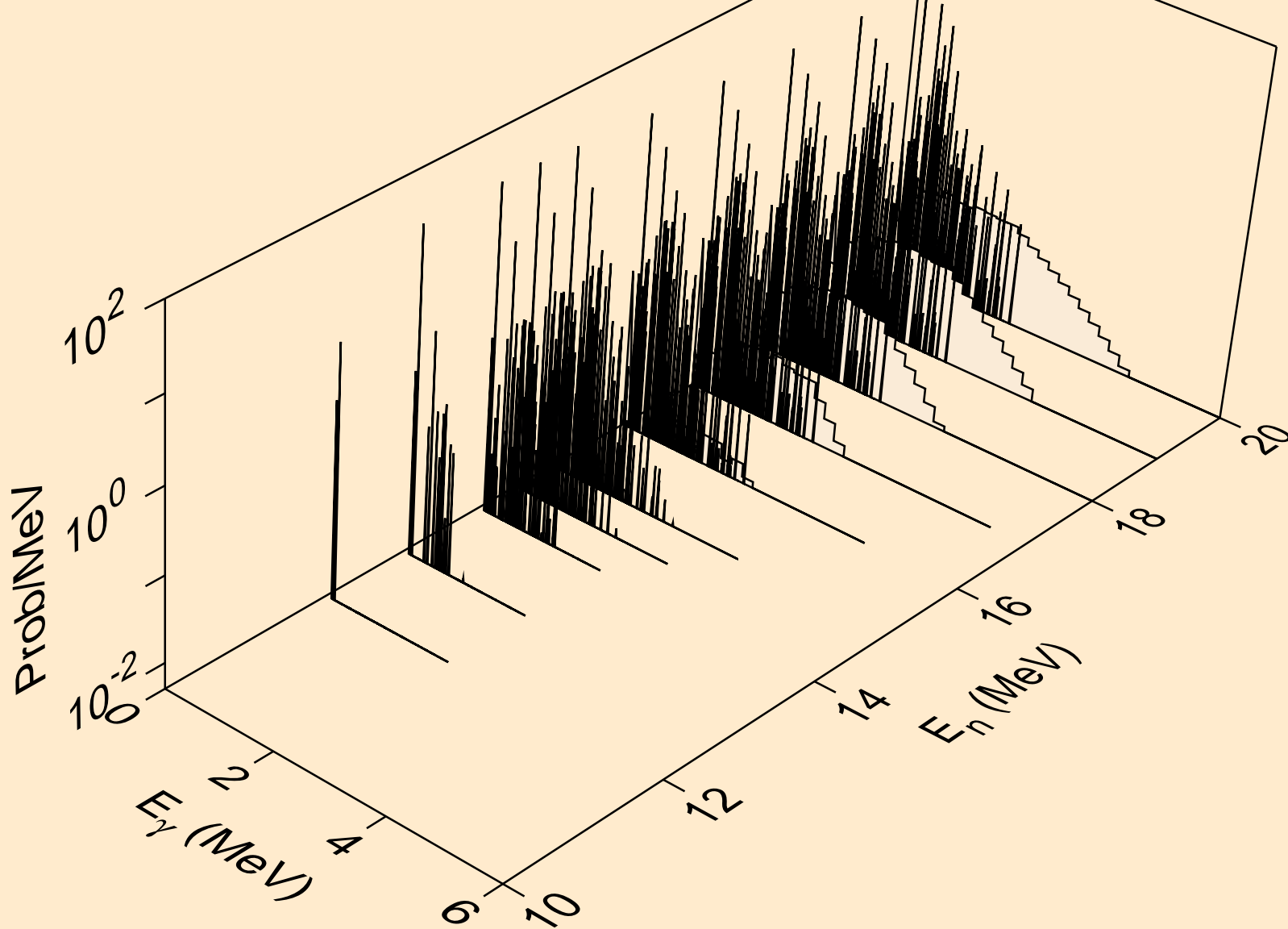

20-CA-43 FOR FENDL-3.2 FROM FENDL-3.2 BY NJOY2016.60+ O
Photon emission for (n,n*1)

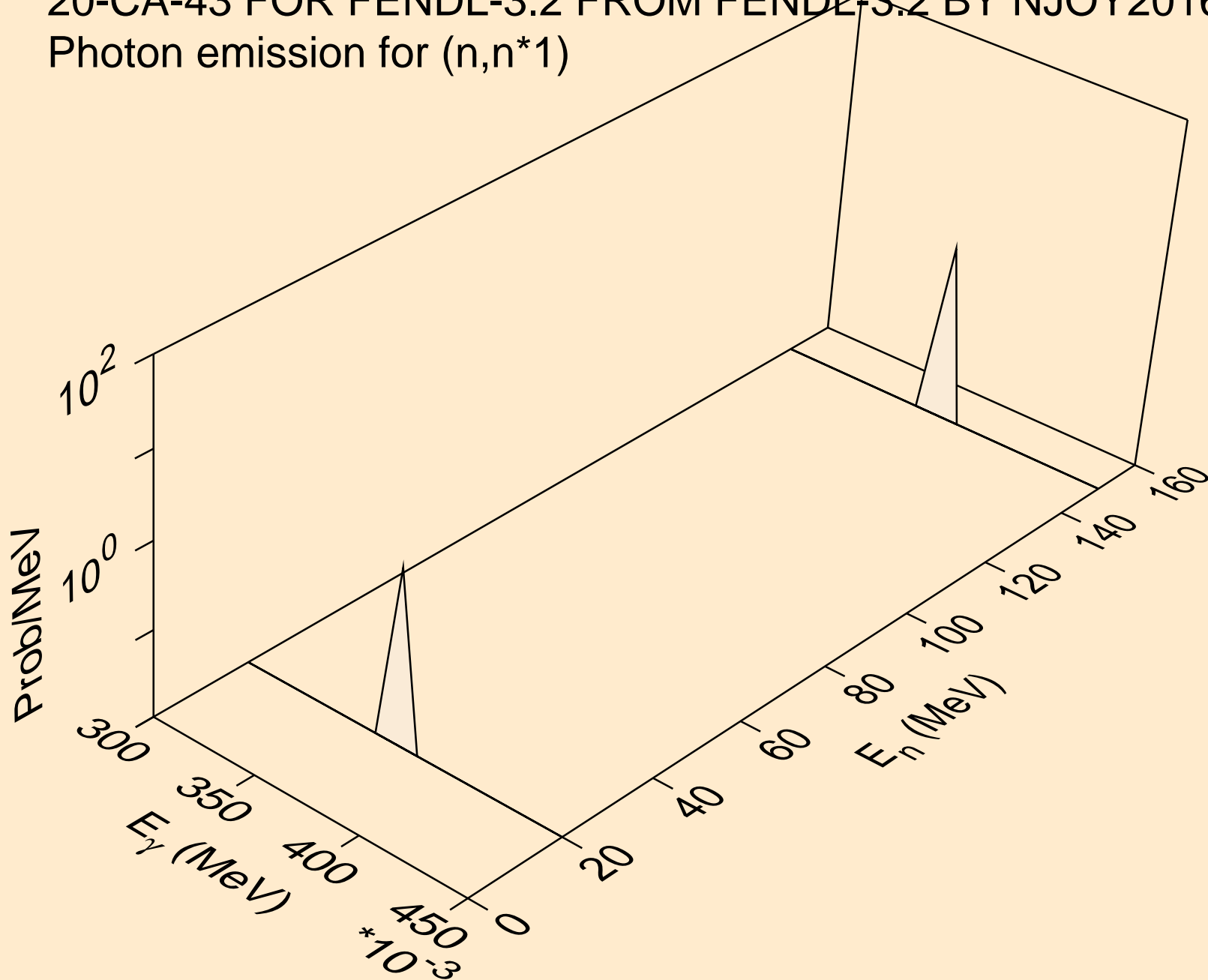

20-CA-43 FOR FENDL-3.2 FROM FENDL-3.2 BY NJOY2016.60+ O
Photon emission for (n,n*2)

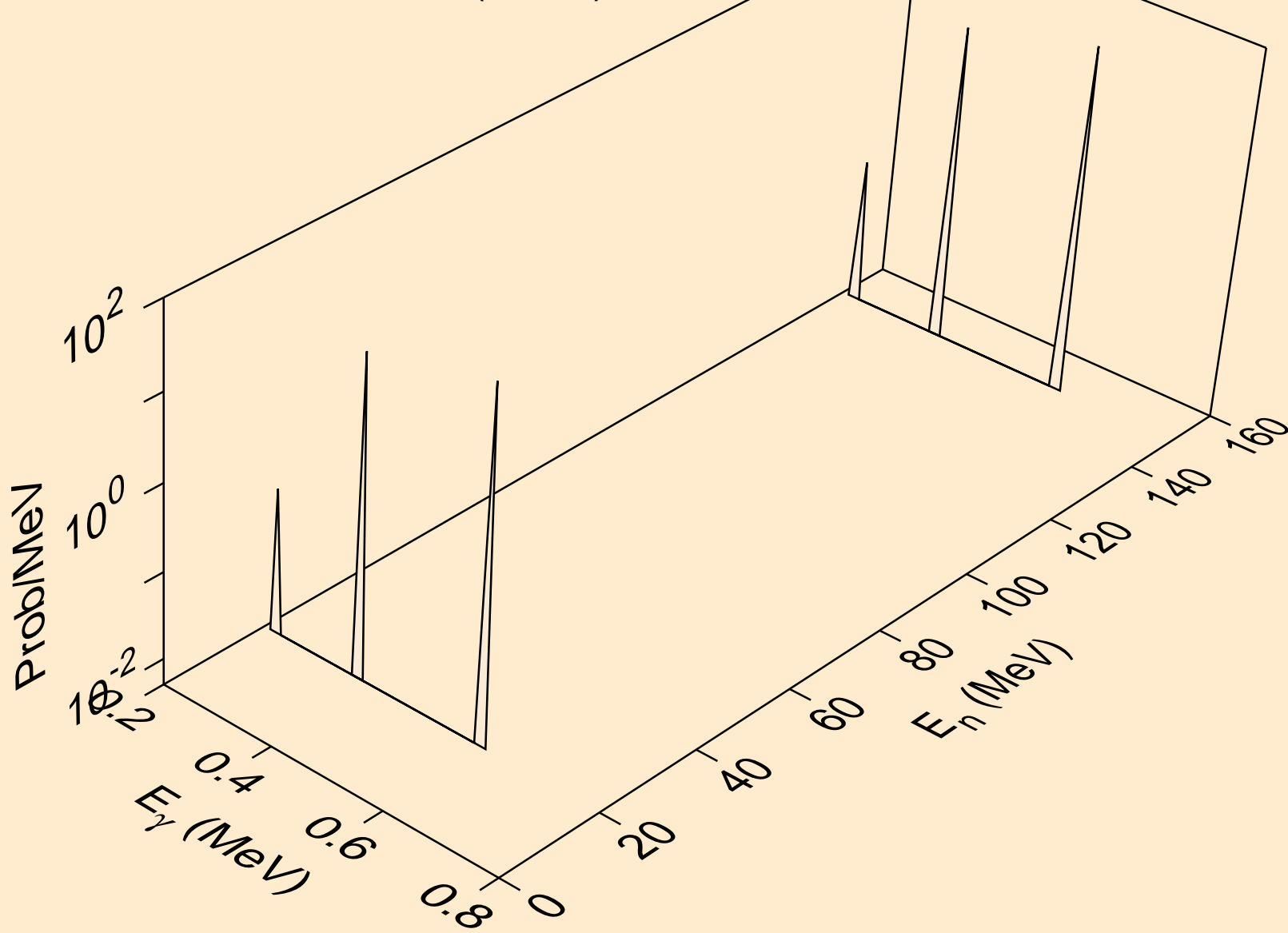

20-CA-43 FOR FENDL-3.2 FROM FENDL-3.2 BY NJOY2016.60+ O
Photon emission for (n,n*3)

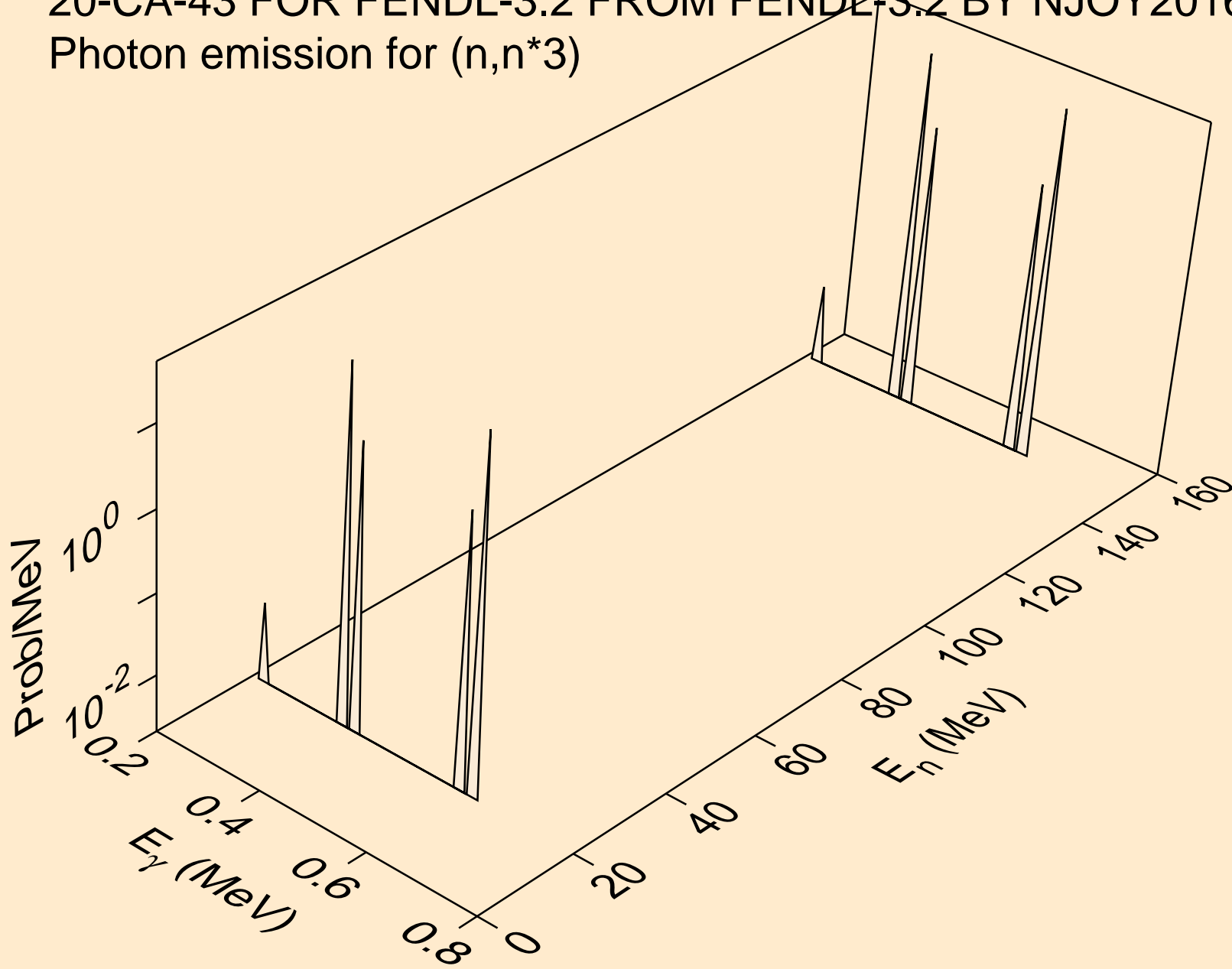

20-CA-43 FOR FENDL-3.2 FROM FENDL-3.2 BY NJOY2016.60+ O
Photon emission for (n,n*4)

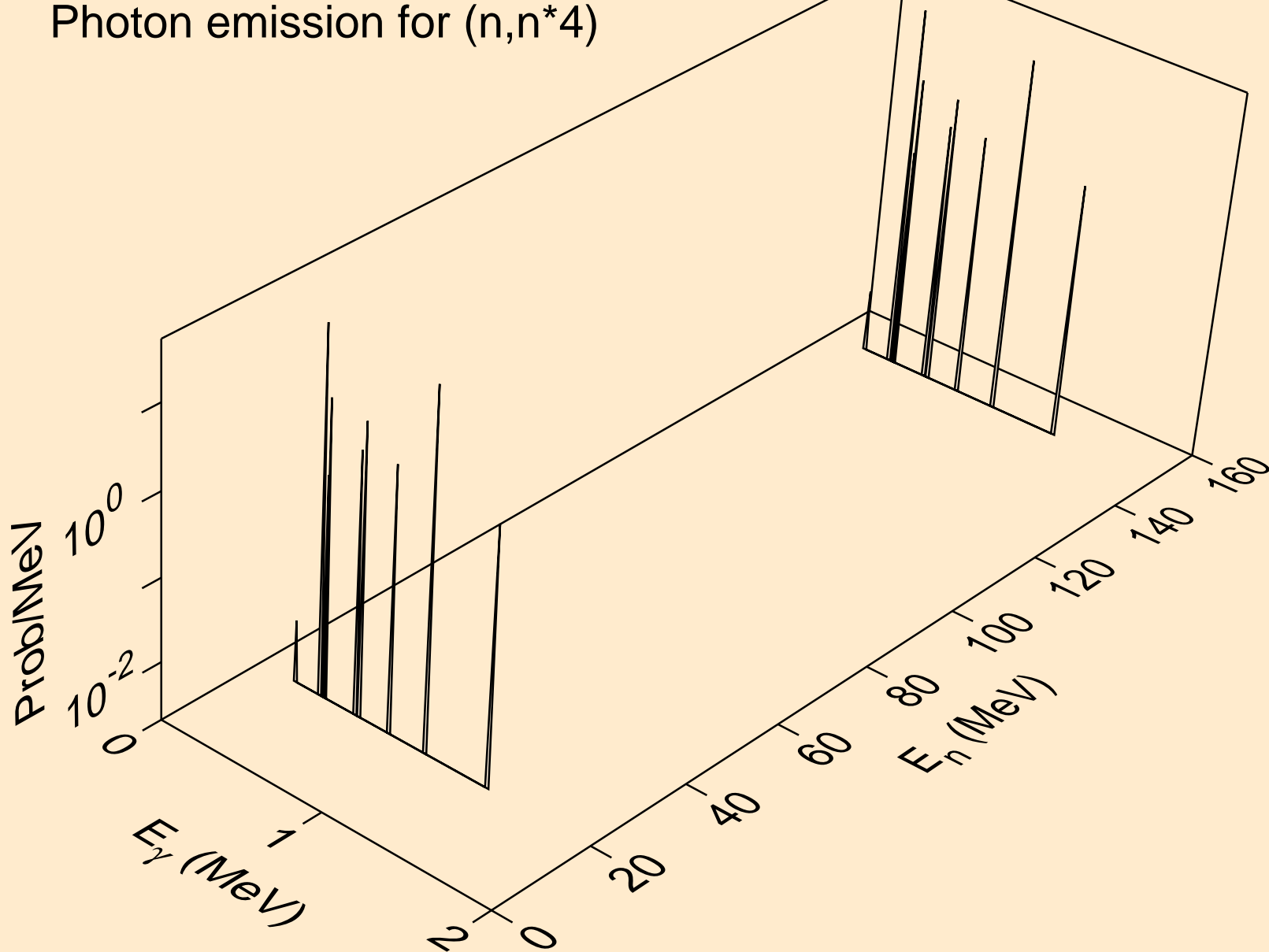

20-CA-43 FOR FENDL-3.2 FROM FENDL-3.2 BY NJOY2016.60+ O
Photon emission for (n,n*5)

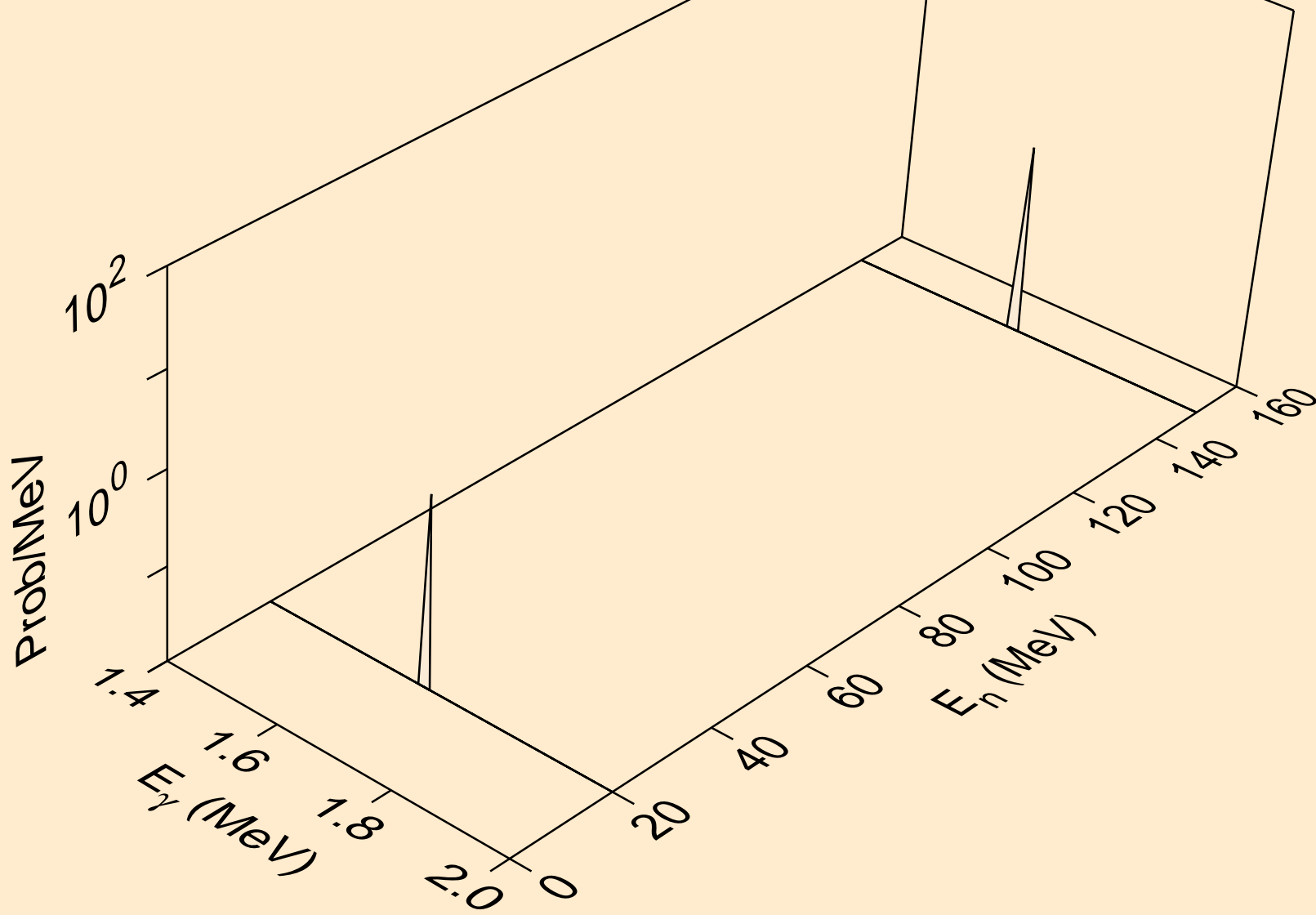

20-CA-43 FOR FENDL-3.2 FROM FENDL-3.2 BY NJOY2016.60+ O
Photon emission for (n,n*6)

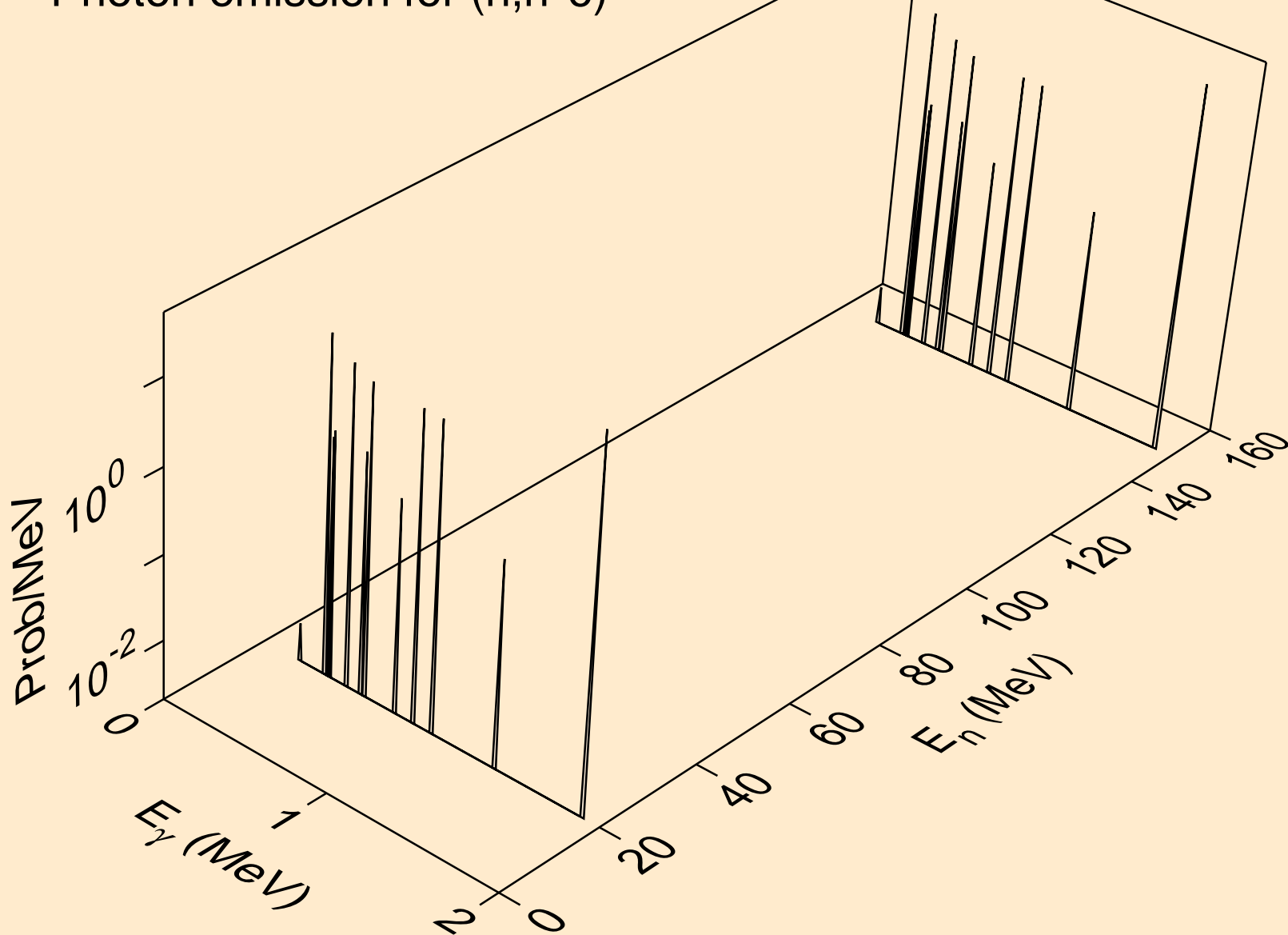

20-CA-43 FOR FENDL-3.2 FROM FENDL-3.2 BY NJOY2016.60+ O
Photon emission for (n,n*7)

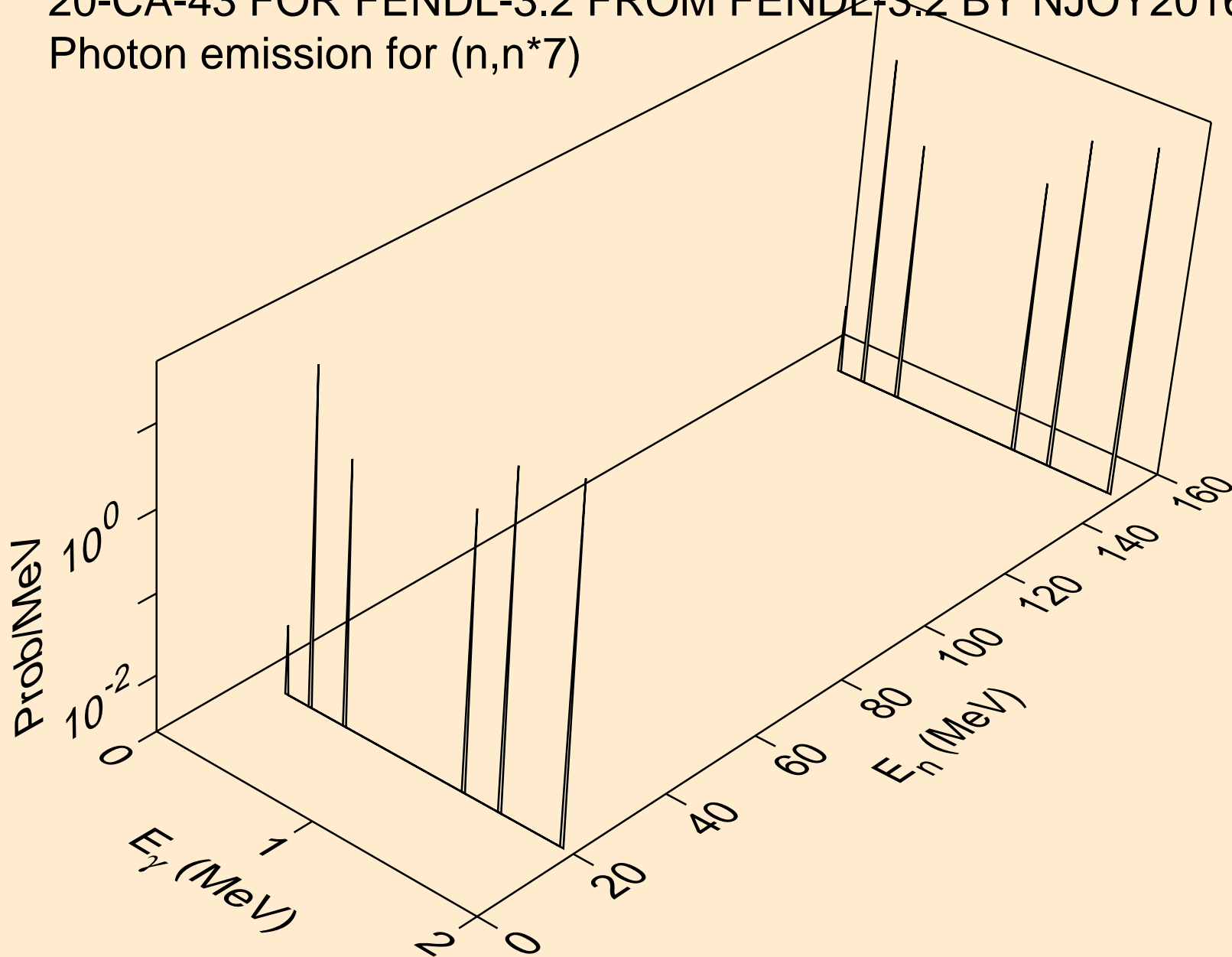

20-CA-43 FOR FENDL-3.2 FROM FENDL-3.2 BY NJOY2016.60+ O
Photon emission for (n,n*8)

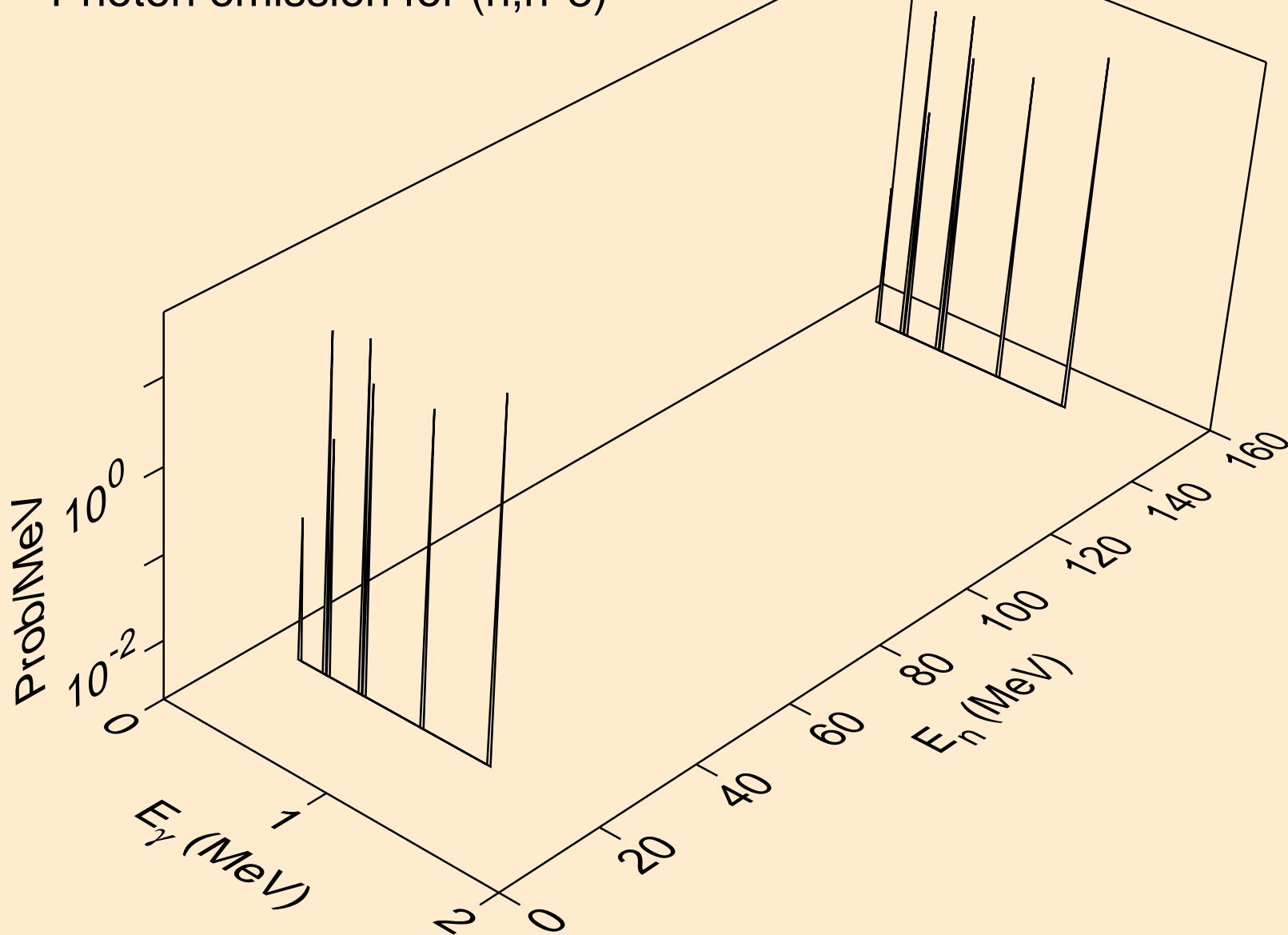

20-CA-43 FOR FENDL-3.2 FROM FENDL-3.2 BY NJOY2016.60+ O
Photon emission for (n,n*9)

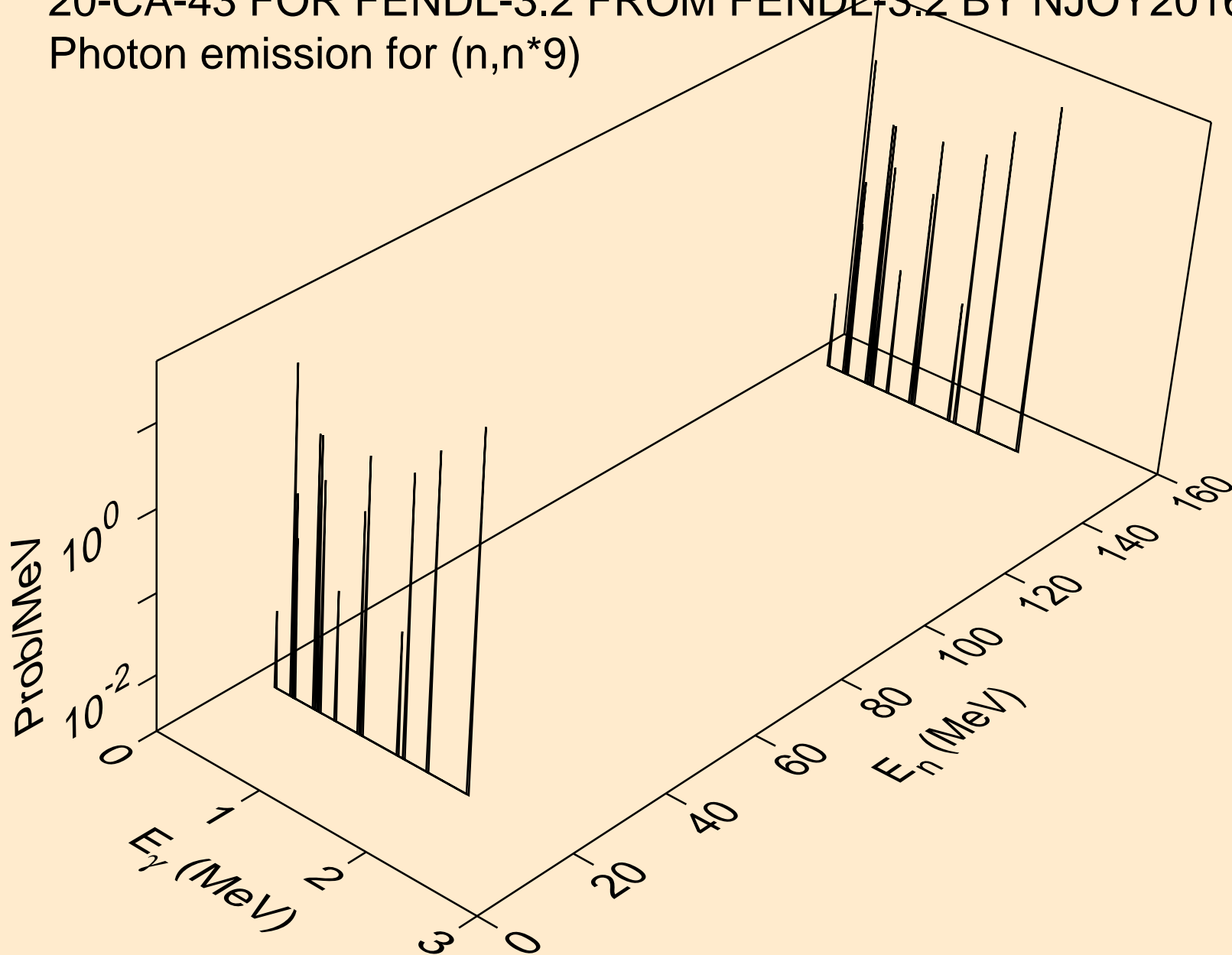

20-CA-43 FOR FENDL-3.2 FROM FENDL-3.2 BY NJOY2016.60+ O
Photon emission for (n,n*10)

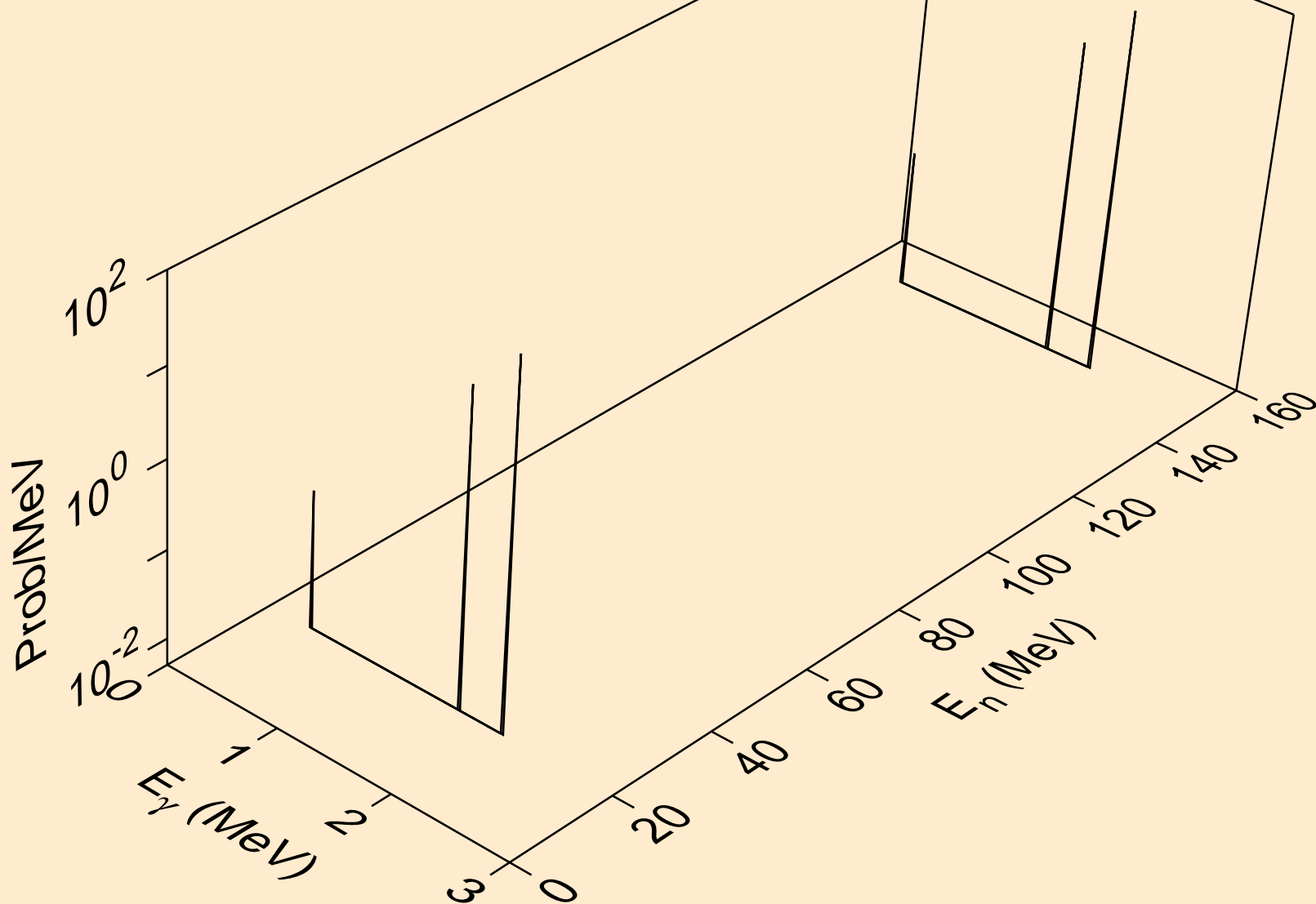

20-CA-43 FOR FENDL-3.2 FROM FENDL-3.2 BY NJOY2016.60+ O
Photon emission for (n,n*11)

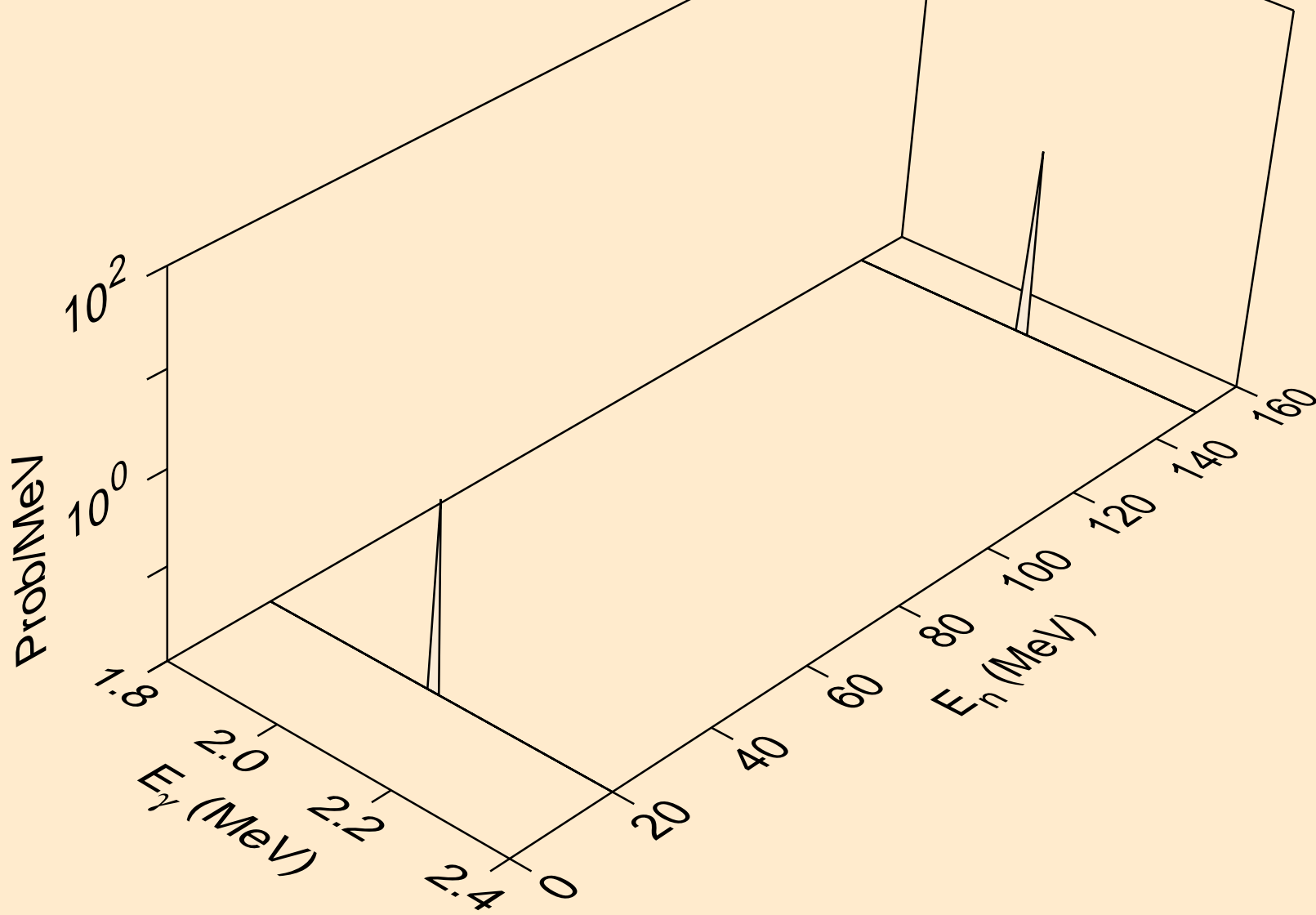

20-CA-43 FOR FENDL-3.2 FROM FENDL-3.2 BY NJOY2016.60+ O
Photon emission for (n,n*12)

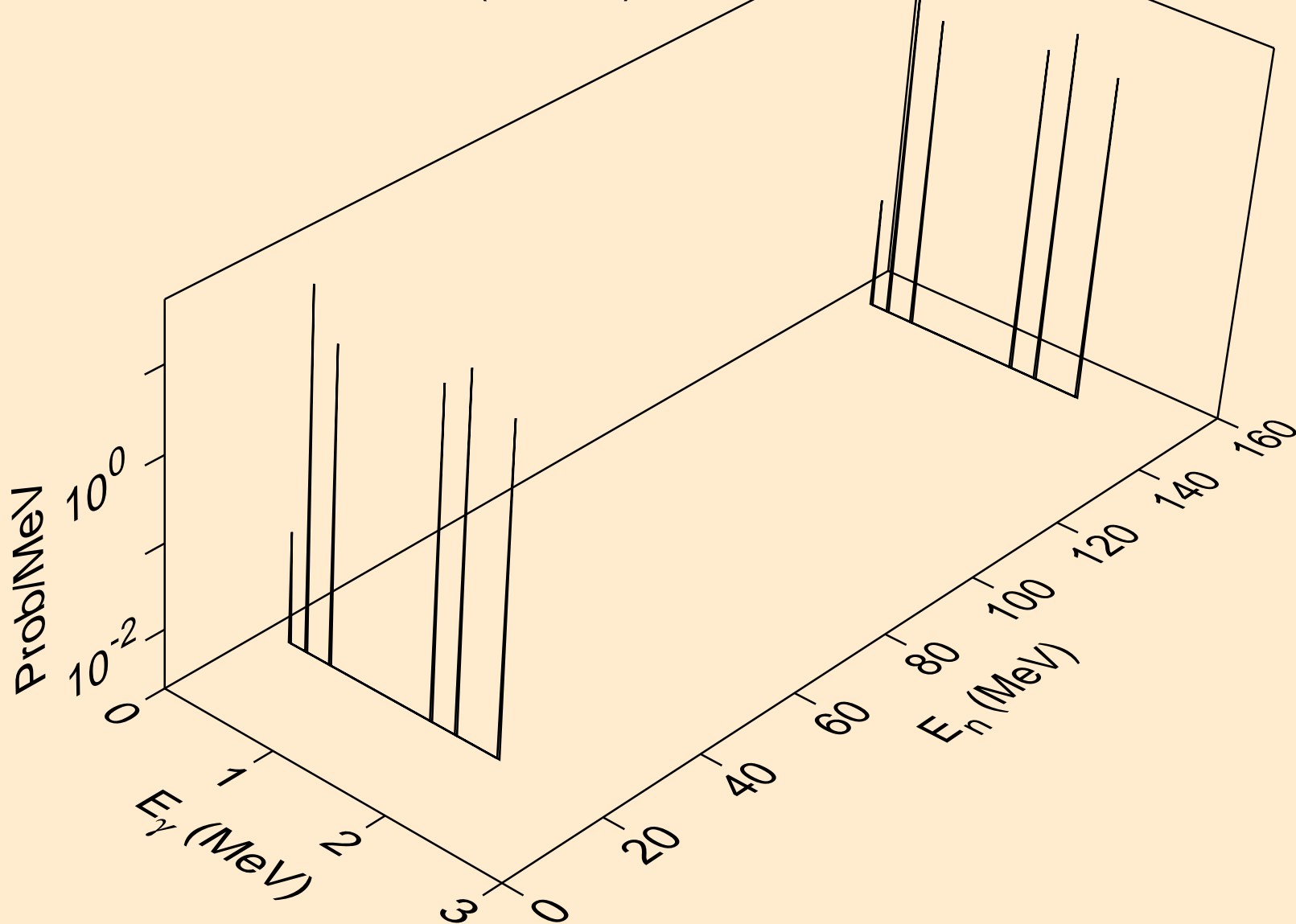

20-CA-43 FOR FENDL-3.2 FROM FENDL-3.2 BY NJOY2016.60+ O
Photon emission for (n,n*13)

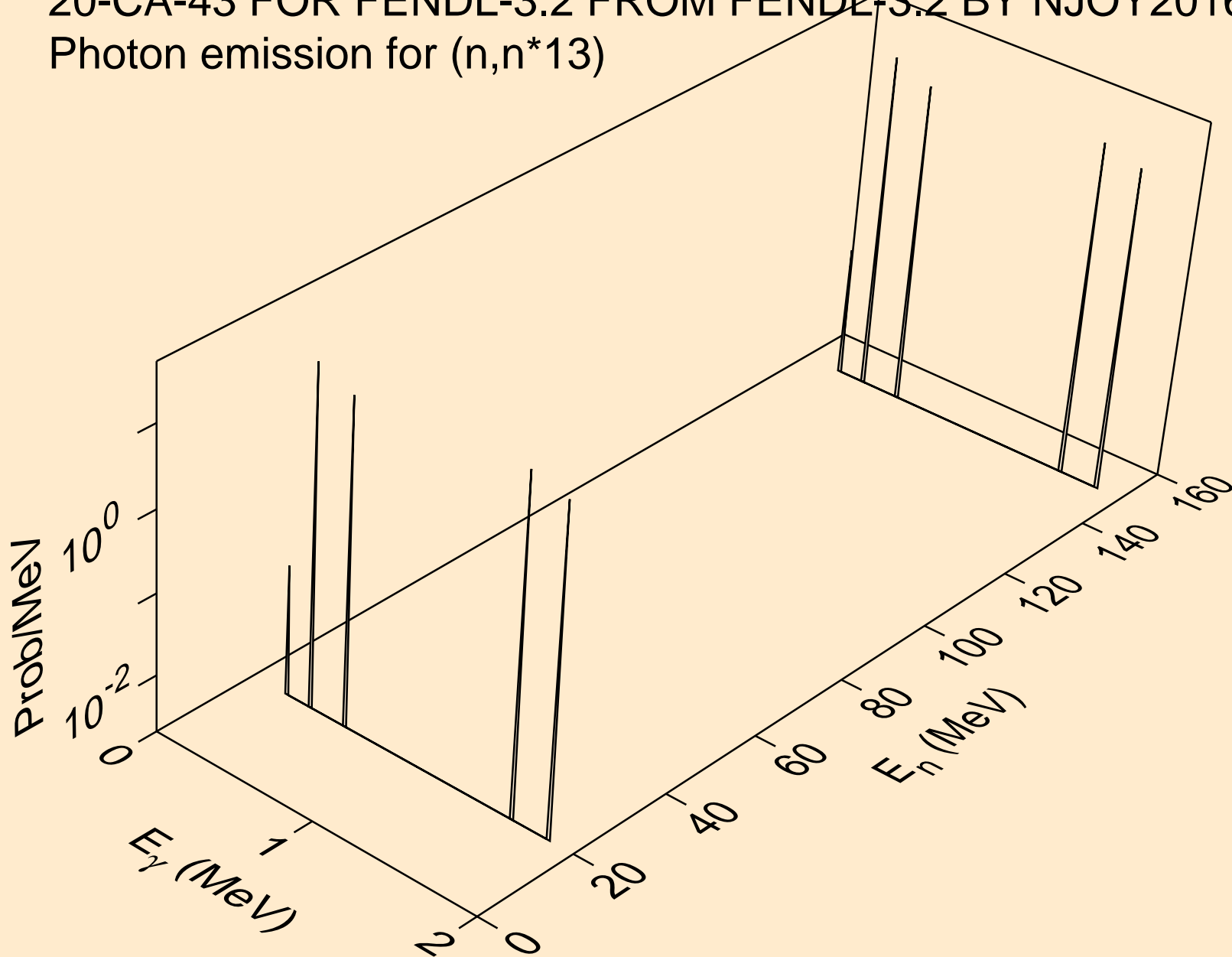

20-CA-43 FOR FENDL-3.2 FROM FENDL-3.2 BY NJOY2016.60+ O
Photon emission for (n,n*14)

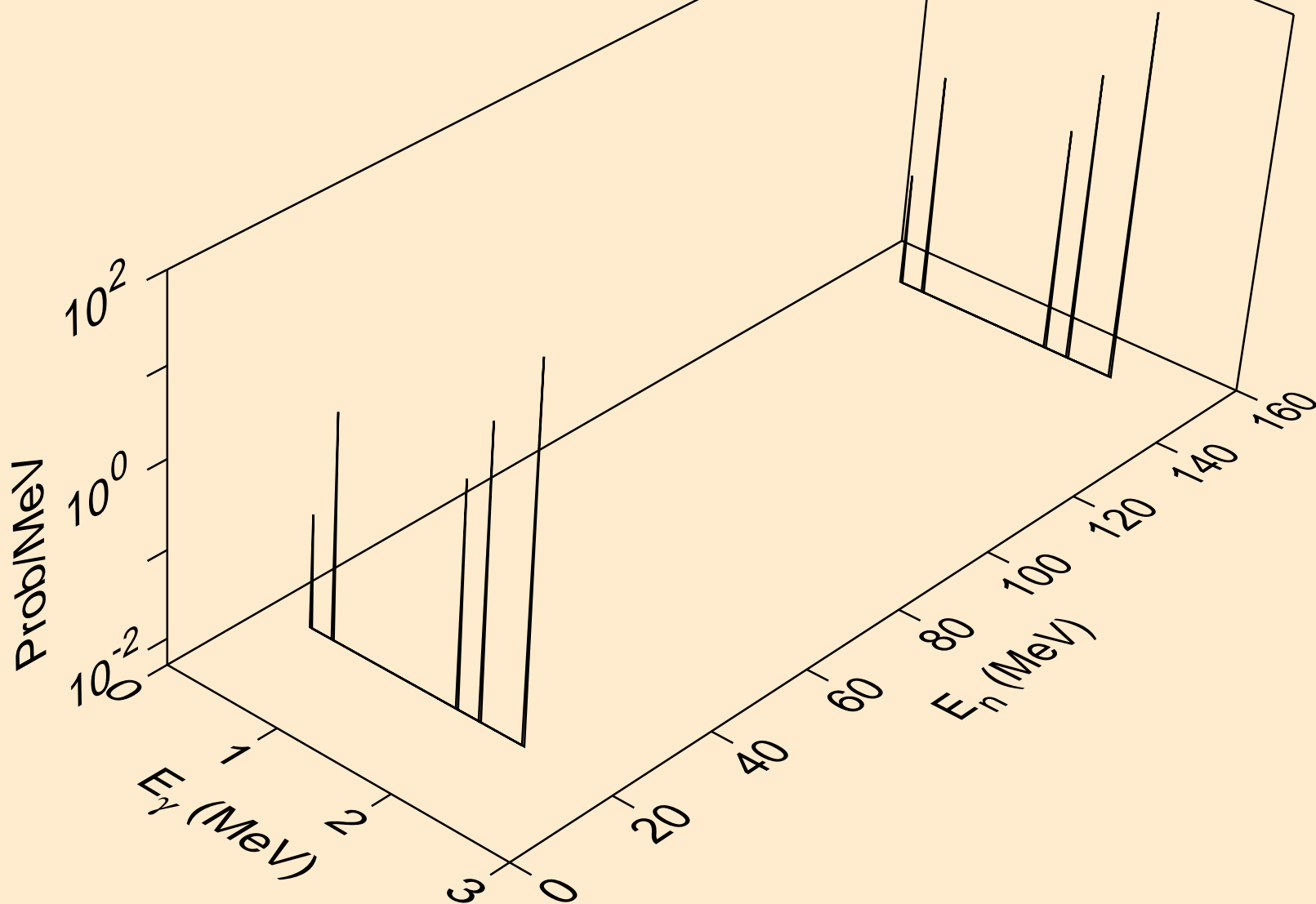

20-CA-43 FOR FENDL-3.2 FROM FENDL-3.2 BY NJOY2016.60+ O
Photon emission for (n,n*15)

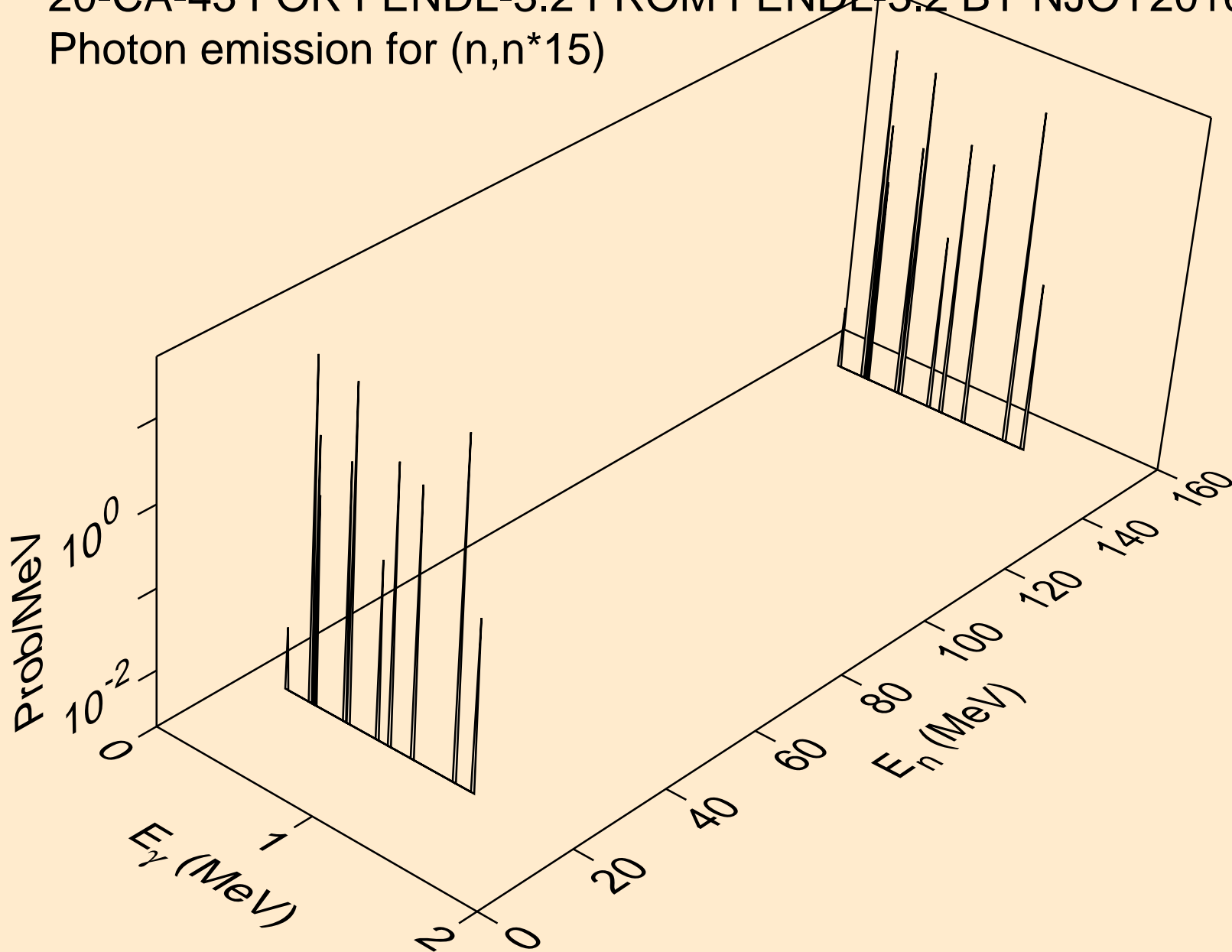

20-CA-43 FOR FENDL-3.2 FROM FENDL-3.2 BY NJOY2016.60+ O
Photon emission for (n,n*16)

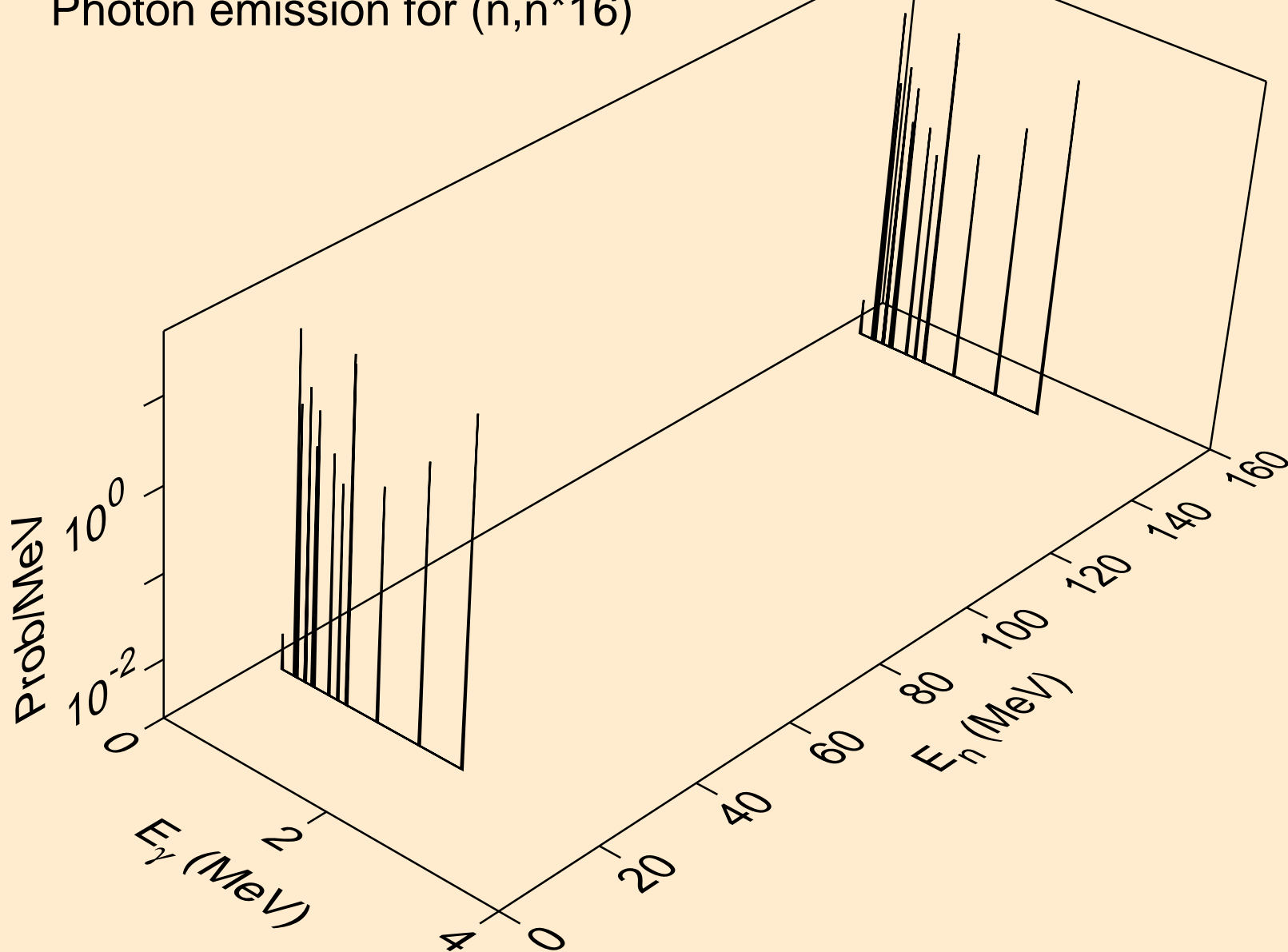

20-CA-43 FOR FENDL-3.2 FROM FENDL-3.2 BY NJOY2016.60+ O
Photon emission for (n,n*18)

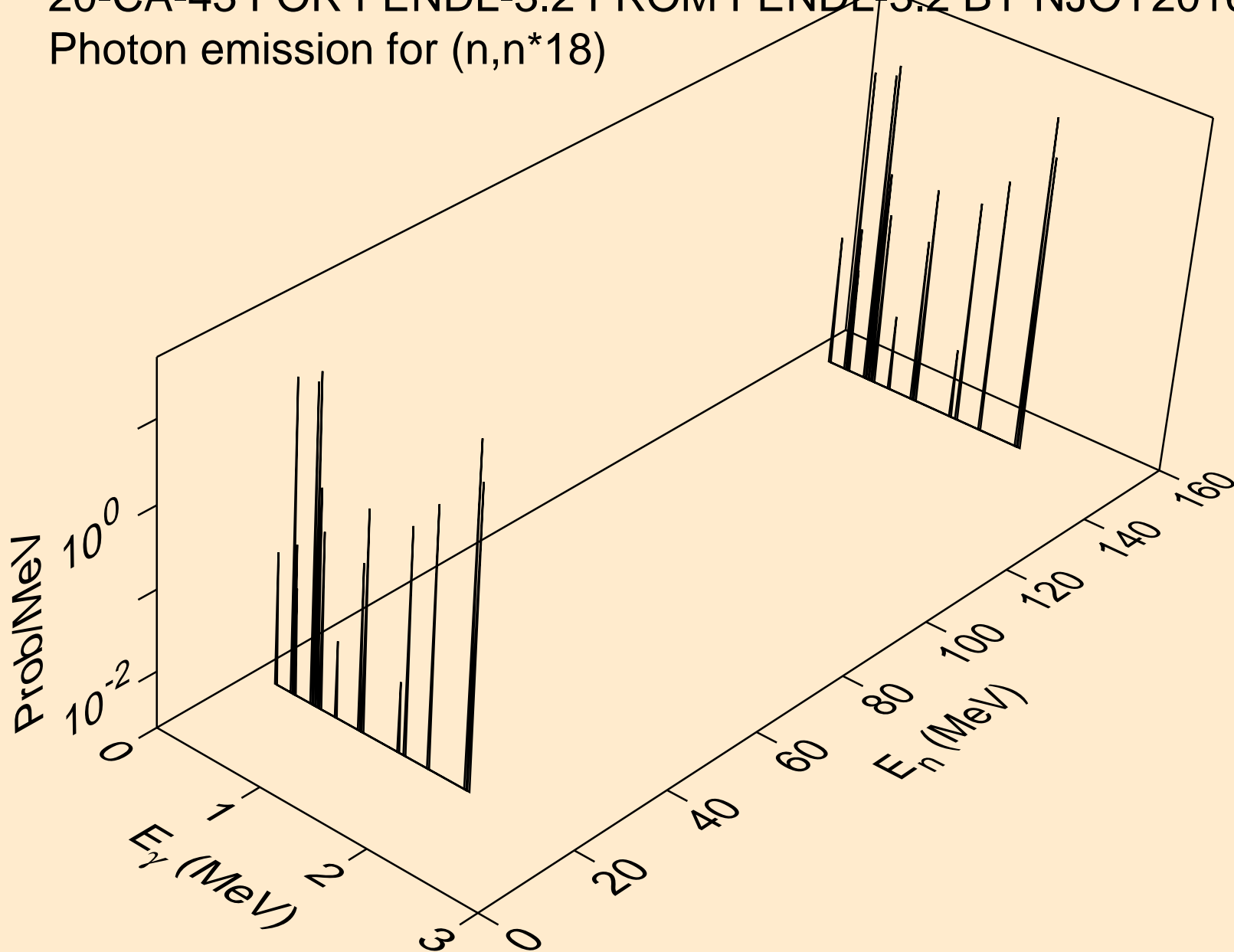

20-CA-43 FOR FENDL-3.2 FROM FENDL-3.2 BY NJOY2016.60+ O
Photon emission for (n,n*19)

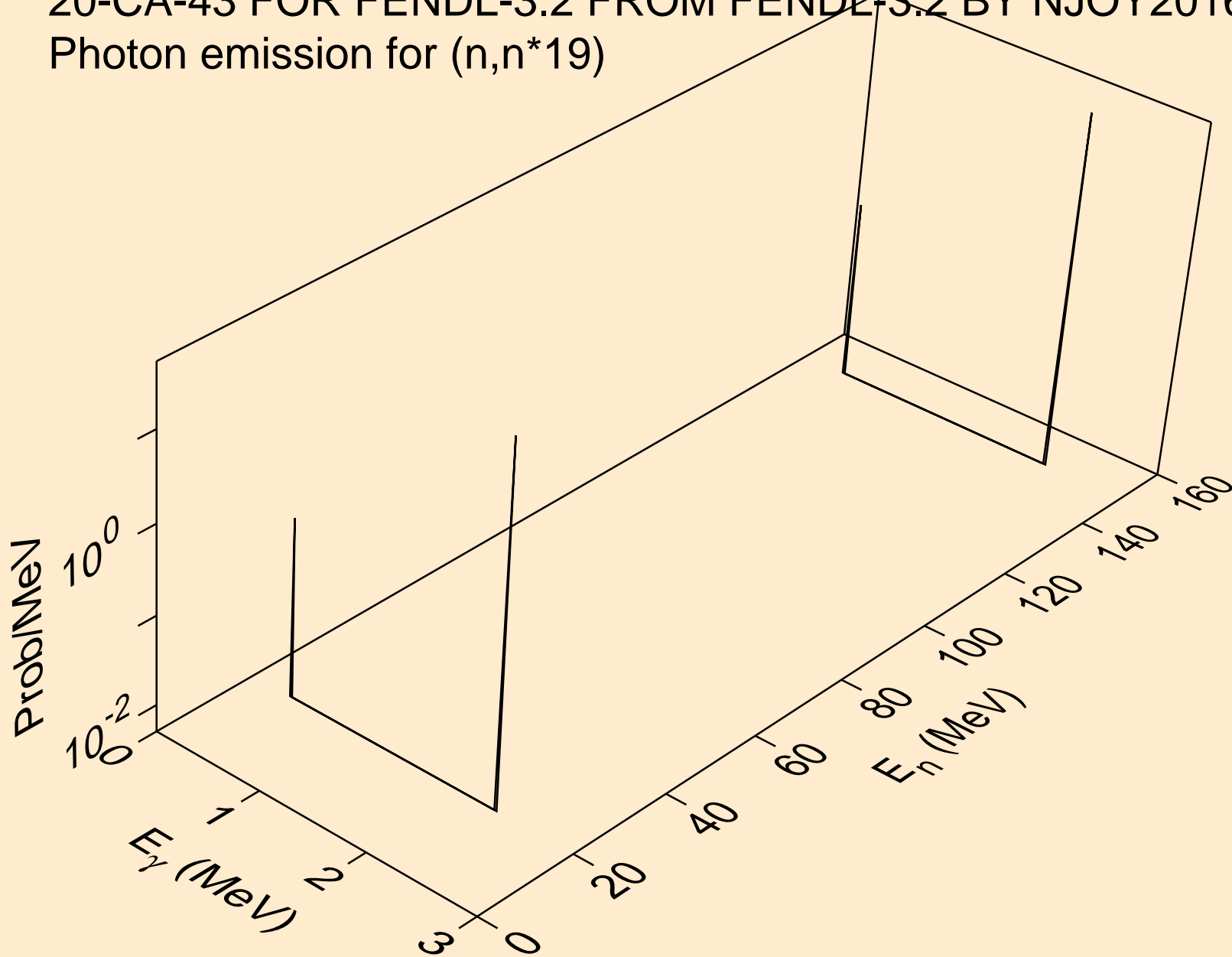

20-CA-43 FOR FENDL-3.2 FROM FENDL-3.2 BY NJOY2016.60+ O
Photon emission for (n,n*20)

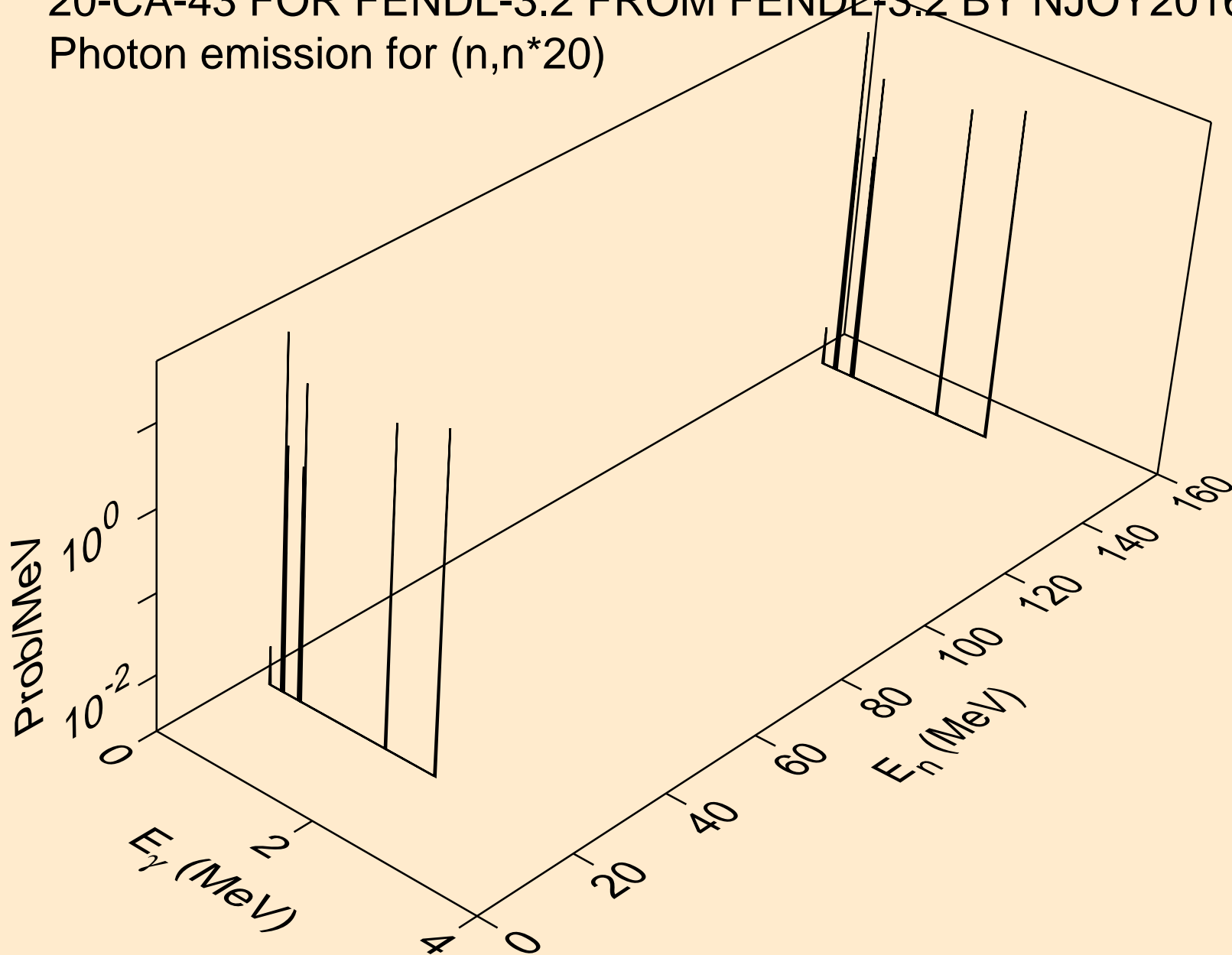

20-CA-43 FOR FENDL-3.2 FROM FENDL-3.2 BY NJOY2016.60+ O
Photon emission for (n,n*22)

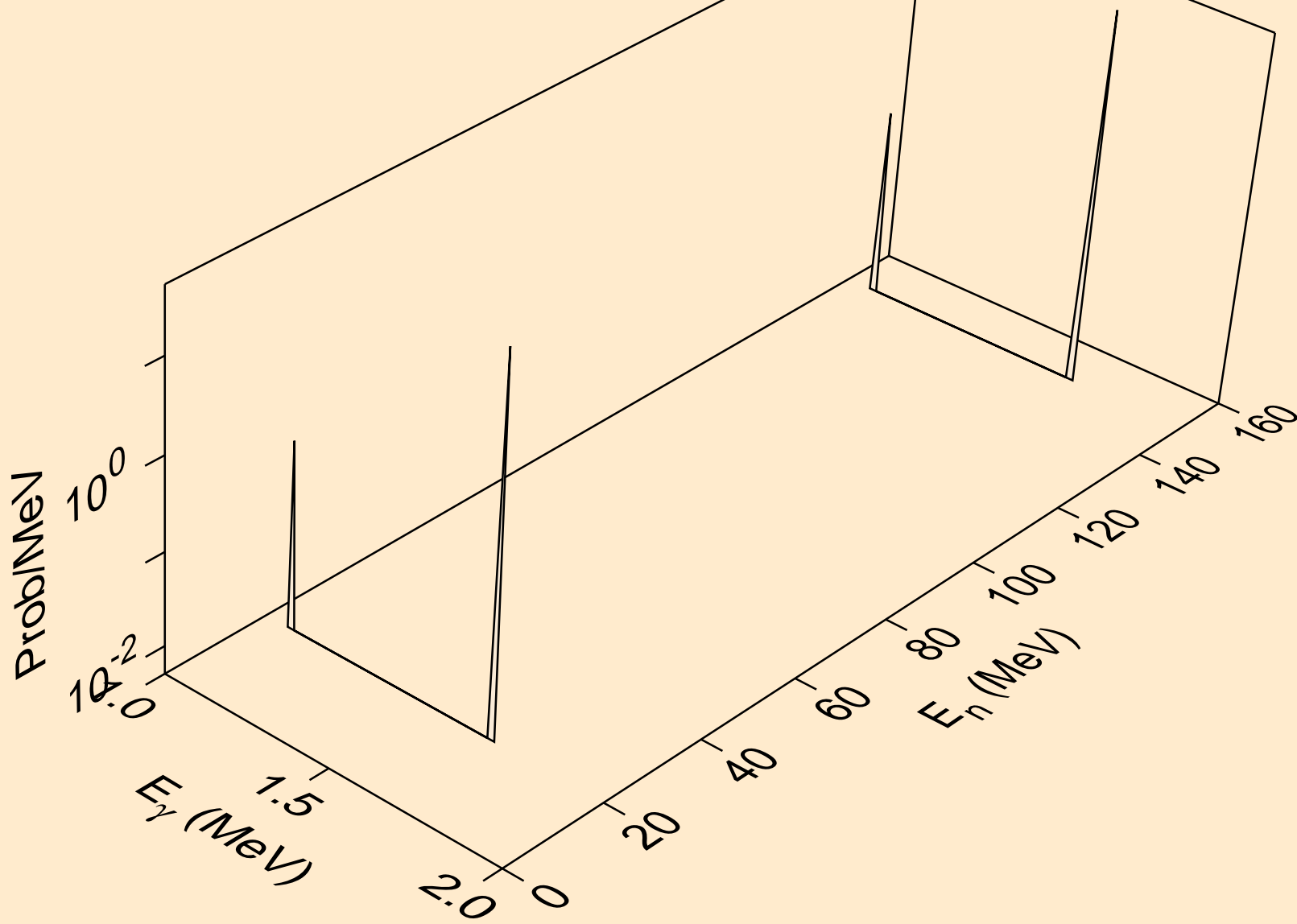

20-CA-43 FOR FENDL-3.2 FROM FENDL-3.2 BY NJOY2016.60+ O
Photon emission for (n,n*25)

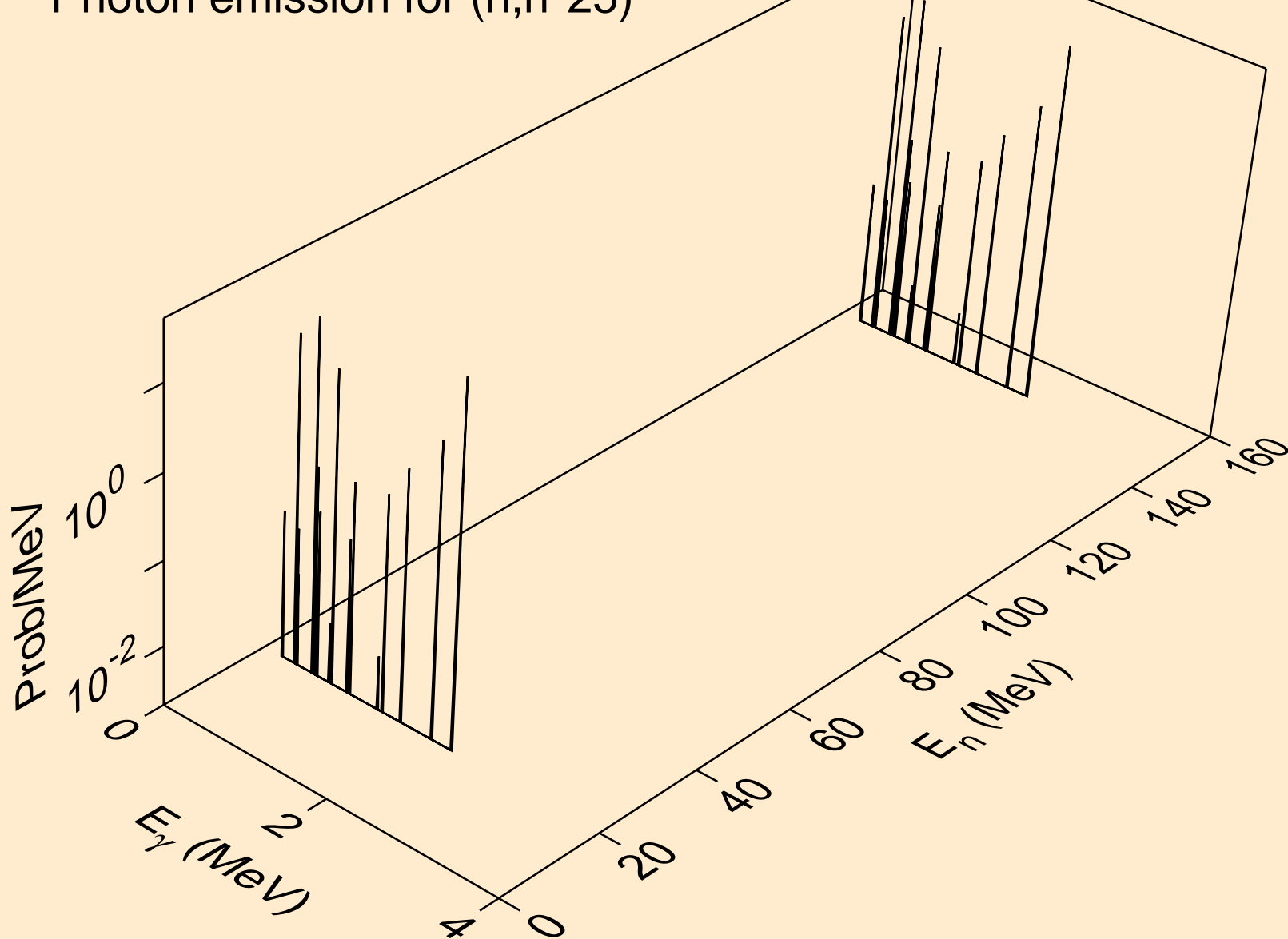

20-CA-43 FOR FENDL-3.2 FROM FENDL-3.2 BY NJOY2016.60+ O
Photon emission for (n,n*26)

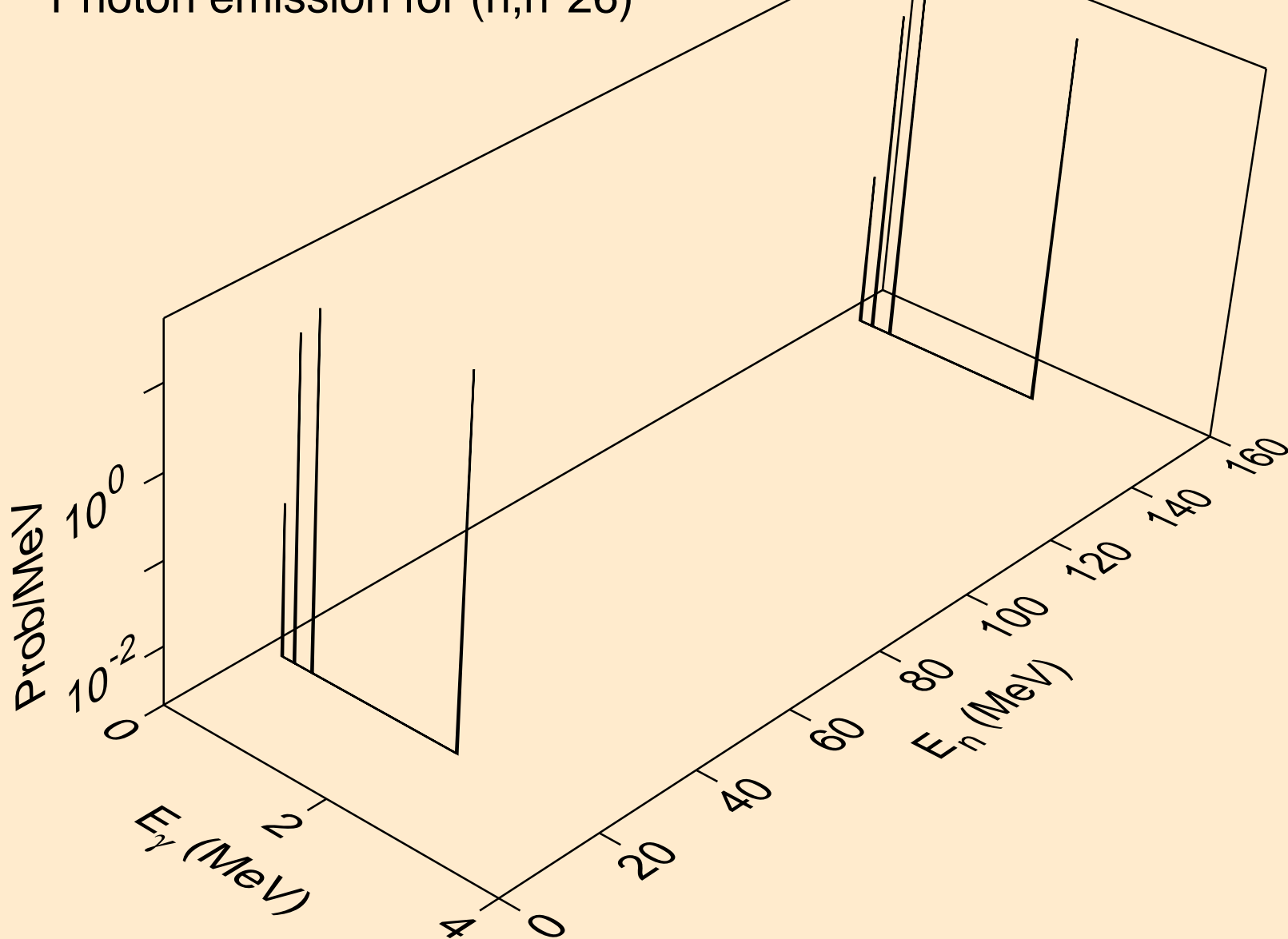

20-CA-43 FOR FENDL-3.2 FROM FENDL-3.2 BY NJOY2016.60+ O
Photon emission for (n,n*27)

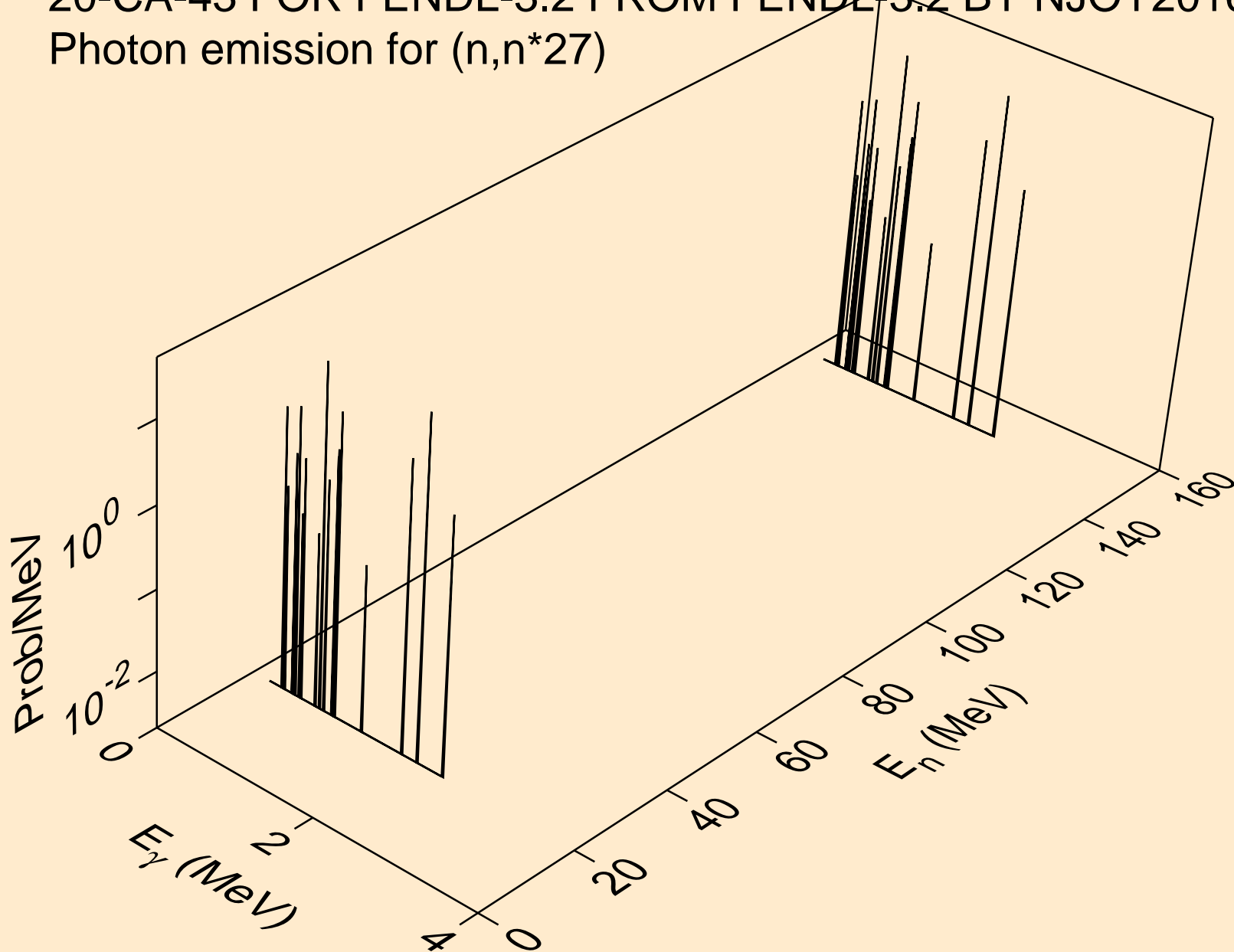

20-CA-43 FOR FENDL-3.2 FROM FENDL-3.2 BY NJOY2016.60+ O
Photon emission for (n,n*28)

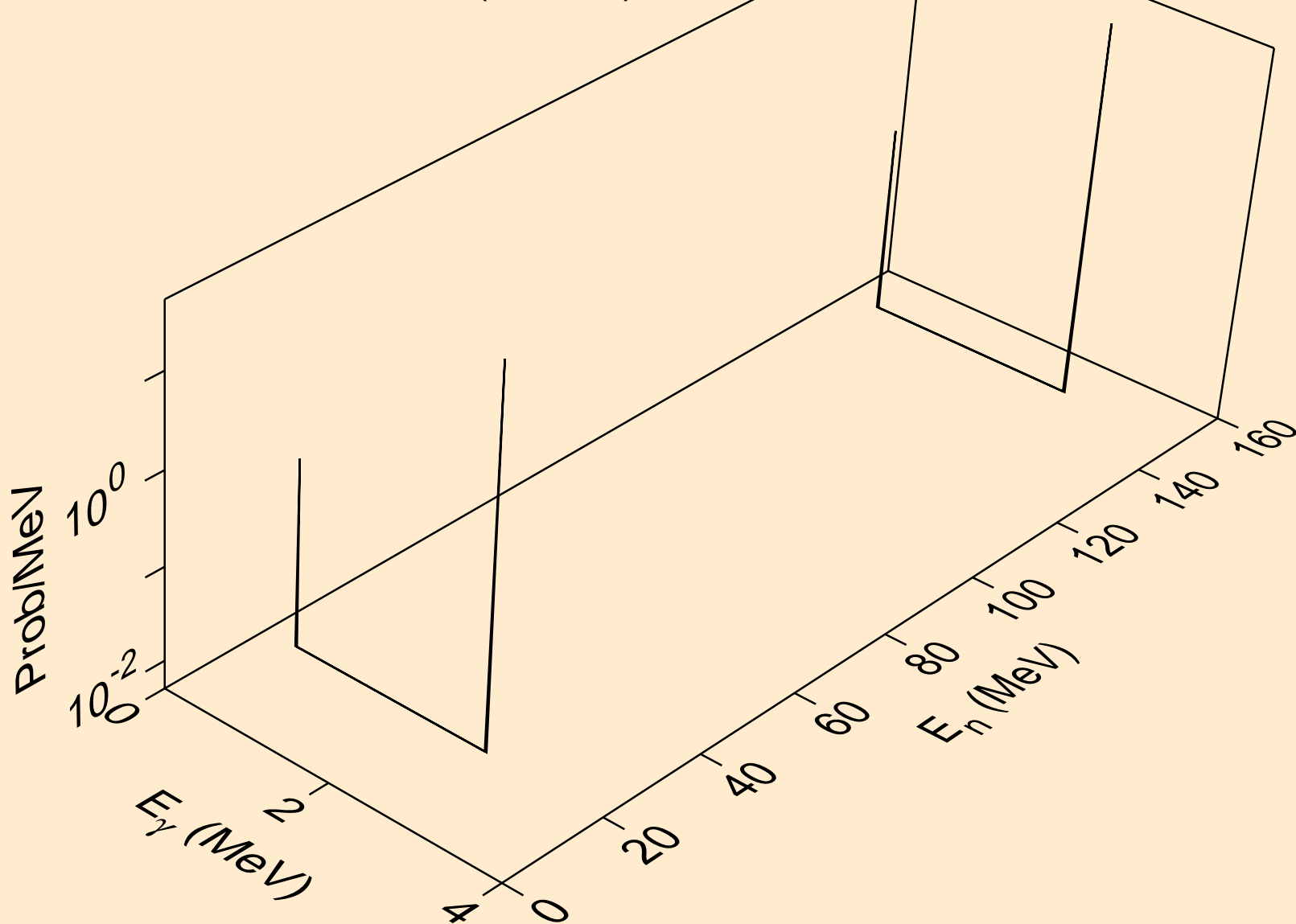

20-CA-43 FOR FENDL-3.2 FROM FENDL-3.2 BY NJOY2016.60+ O
Photon emission for (n,n*29)

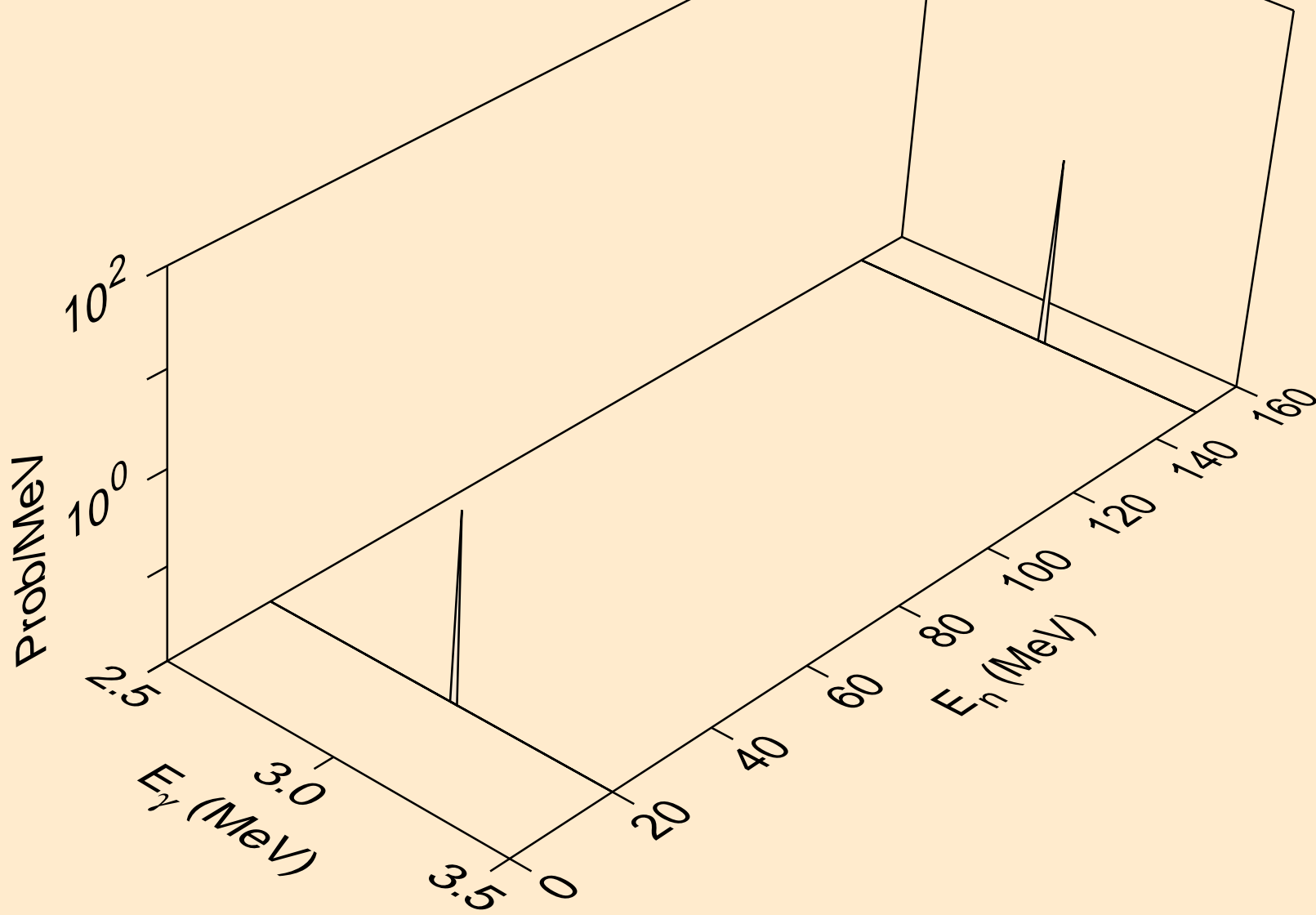

20-CA-43 FOR FENDL-3.2 FROM FENDL-3.2 BY NJOY2016.60+ O
Photon emission for (n,n*30)

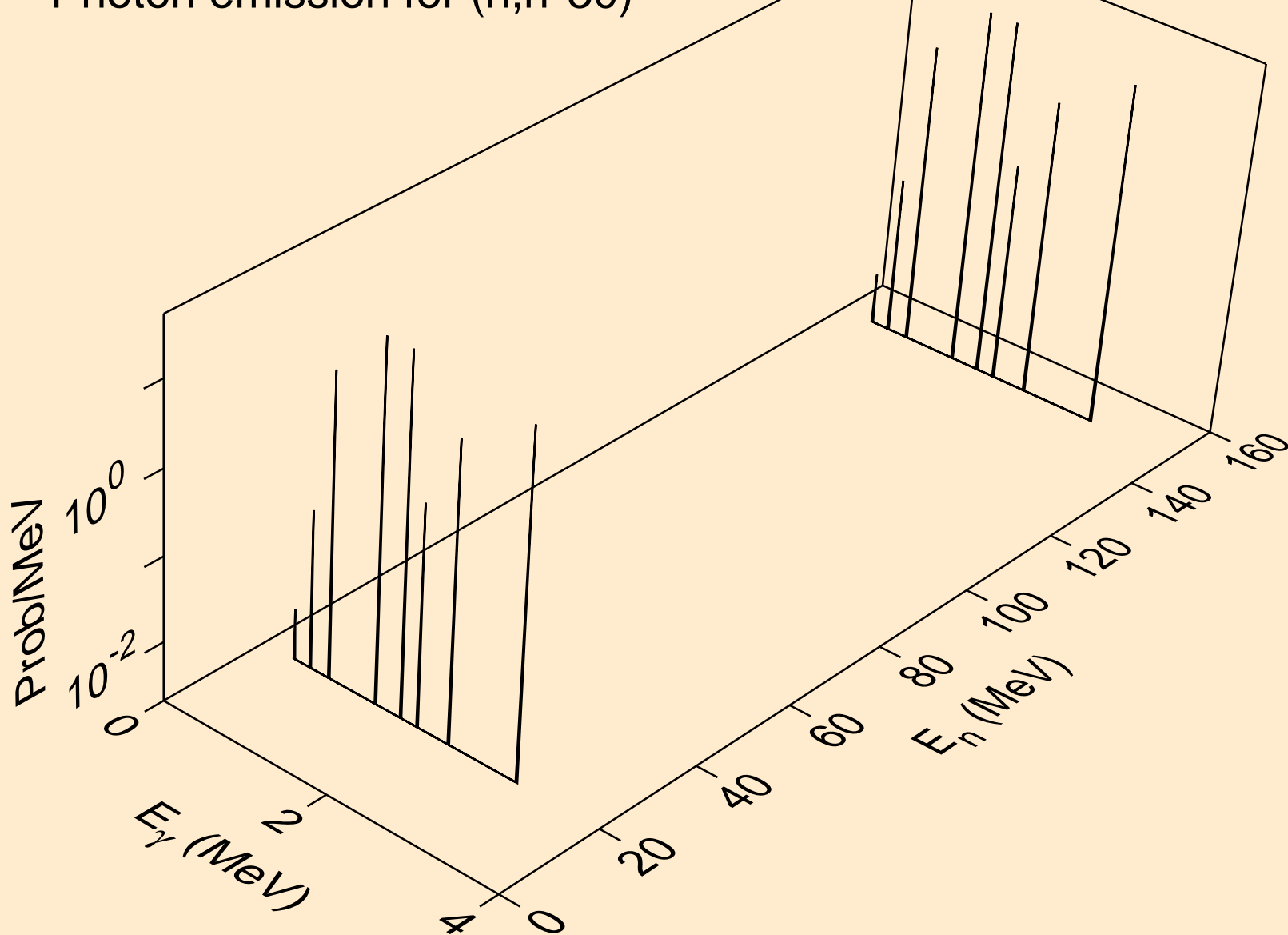

20-CA-43 FOR FENDL-3.2 FROM FENDL-3.2 BY NJOY2016.60+ O
Photon emission for (n,n*31)

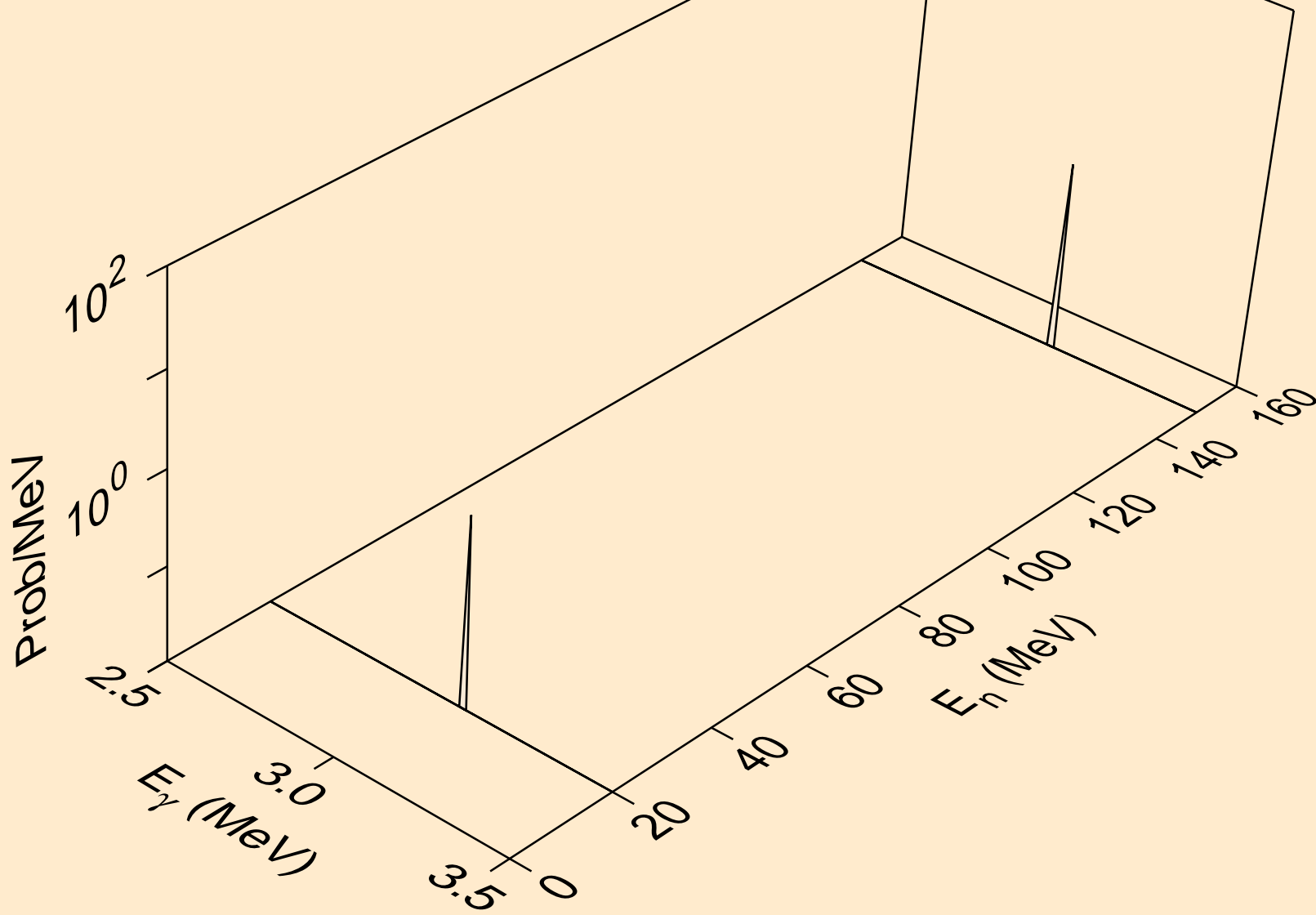

20-CA-43 FOR FENDL-3.2 FROM FENDL-3.2 BY NJOY2016.60+ O
Photon emission for (n,n*35)

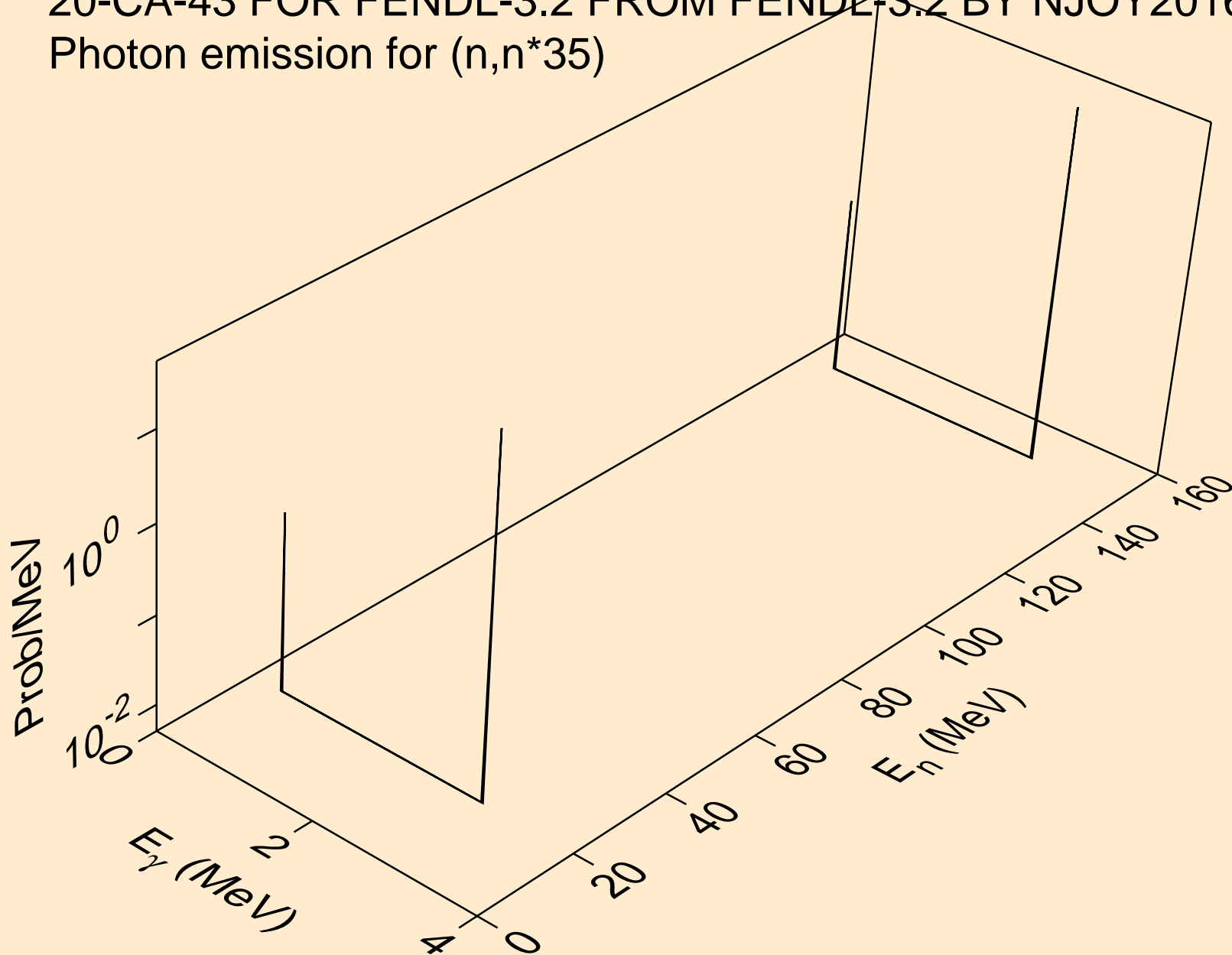

20-CA-43 FOR FENDL-3.2 FROM FENDL-3.2 BY NJOY2016.60+ O
Photon emission for (n,n*36)

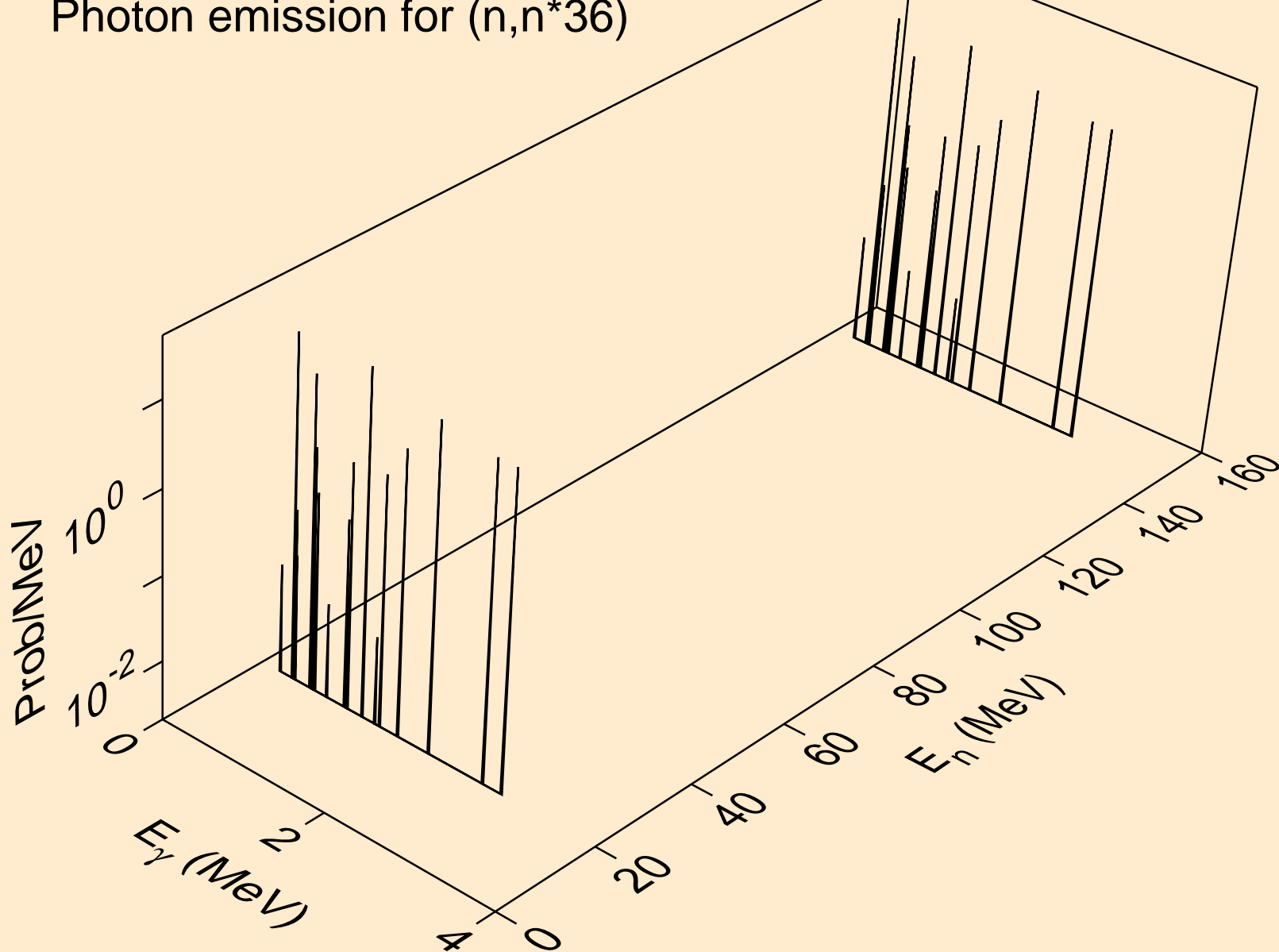

20-CA-43 FOR FENDL-3.2 FROM FENDL-3.2 BY NJOY2016.60+ O
Photon emission for (n,n*37)

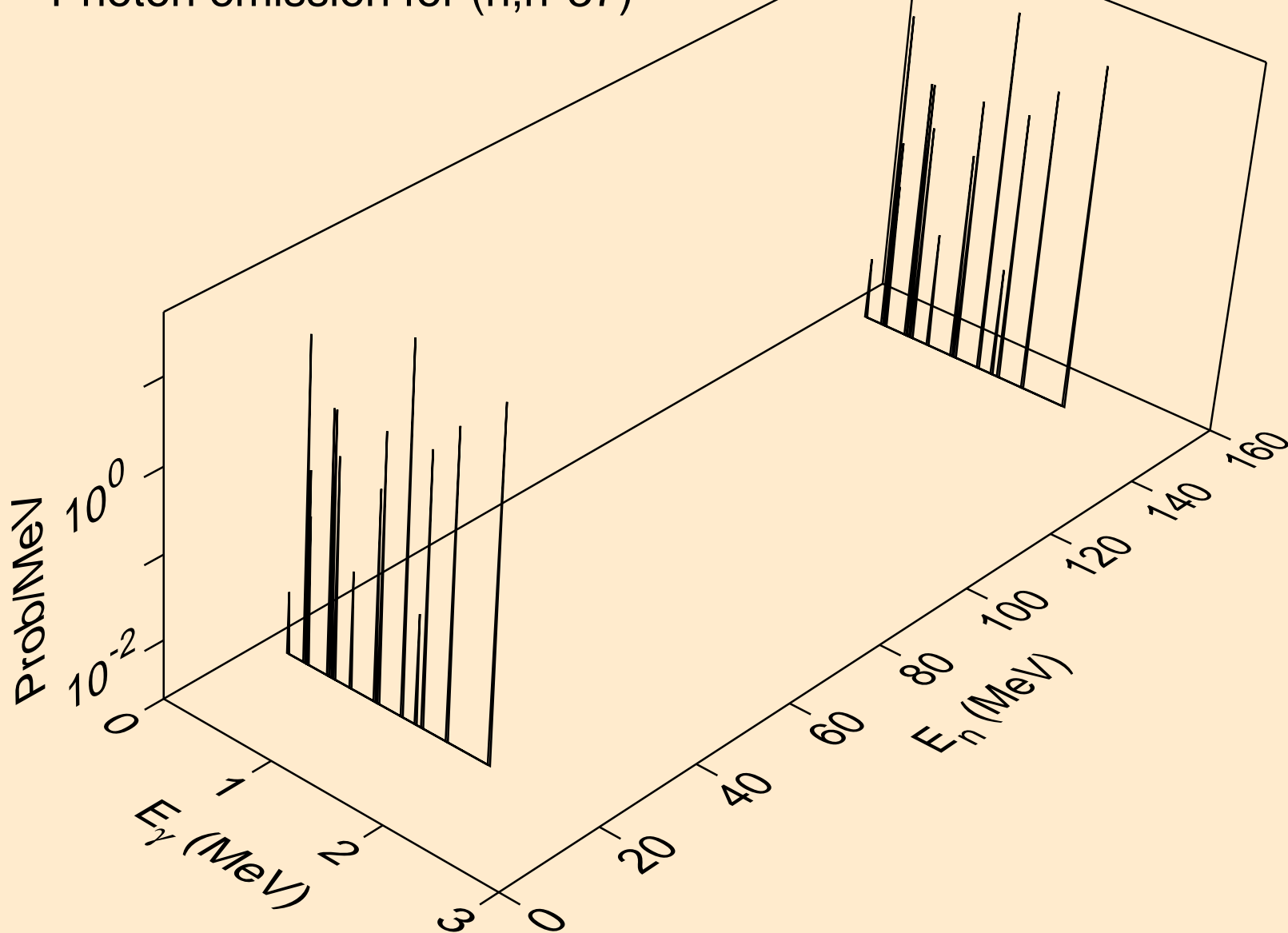

20-CA-43 FOR FENDL-3.2 FROM FENDL-3.2 BY NJOY2016.60+ O
Photon emission for (n,n*38)

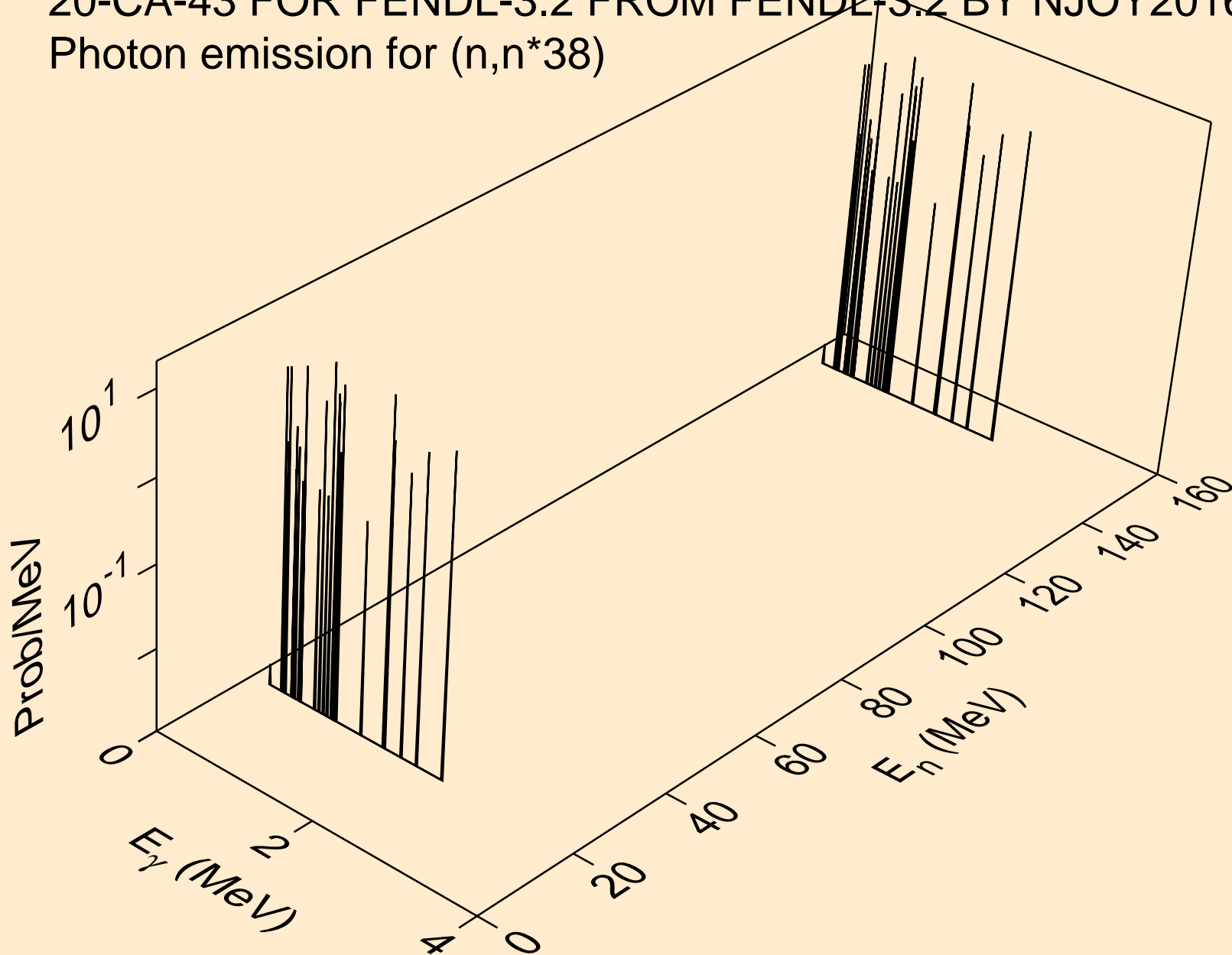

20-CA-43 FOR FENDL-3.2 FROM FENDL-3.2 BY NJOY2016.60+ O
Photon emission for (n,n*39)

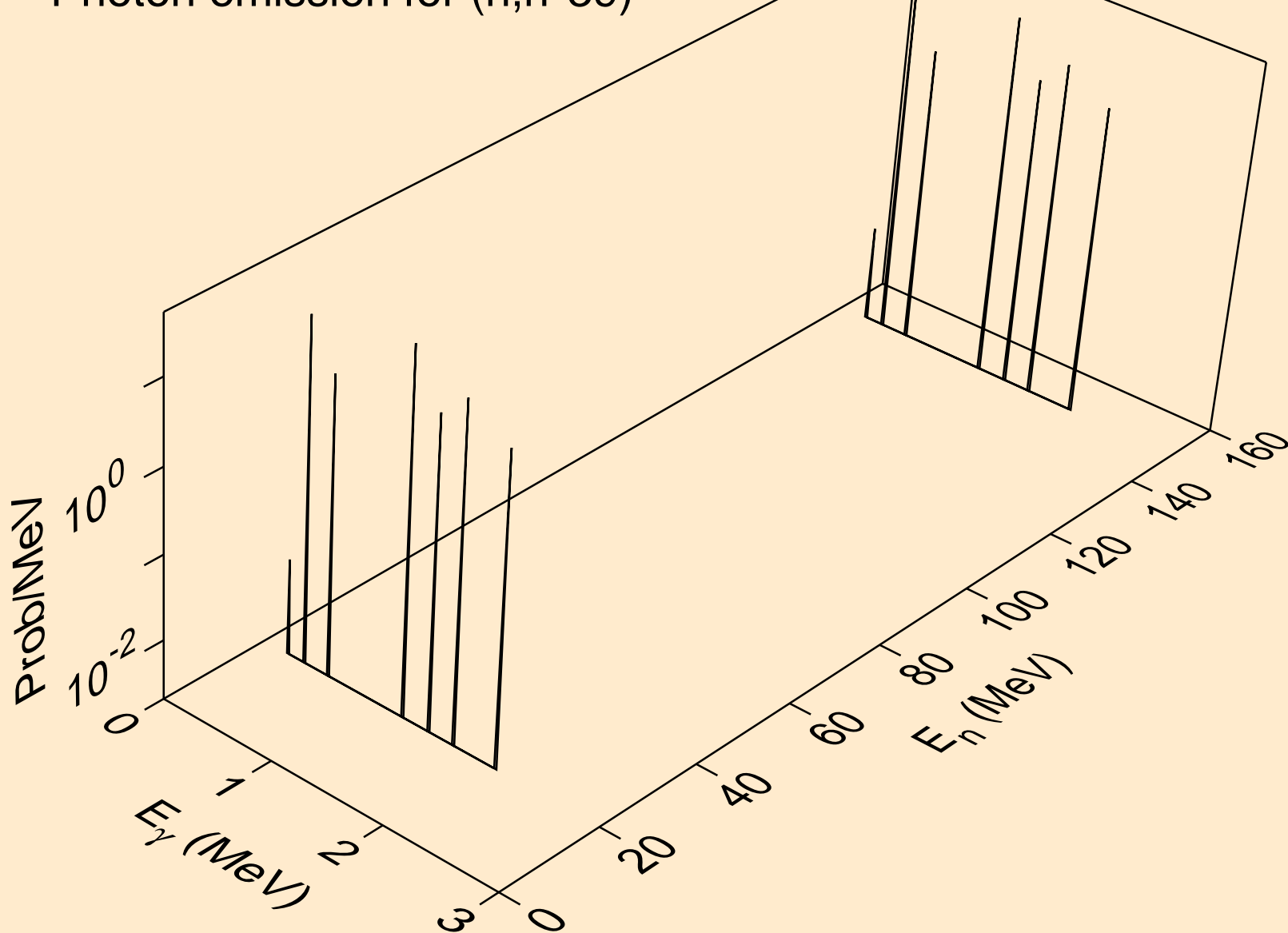

20-CA-43 FOR FENDL-3.2 FROM FENDL-3.2 BY NJOY2016.60+ O
Photon emission for (n,n*c)

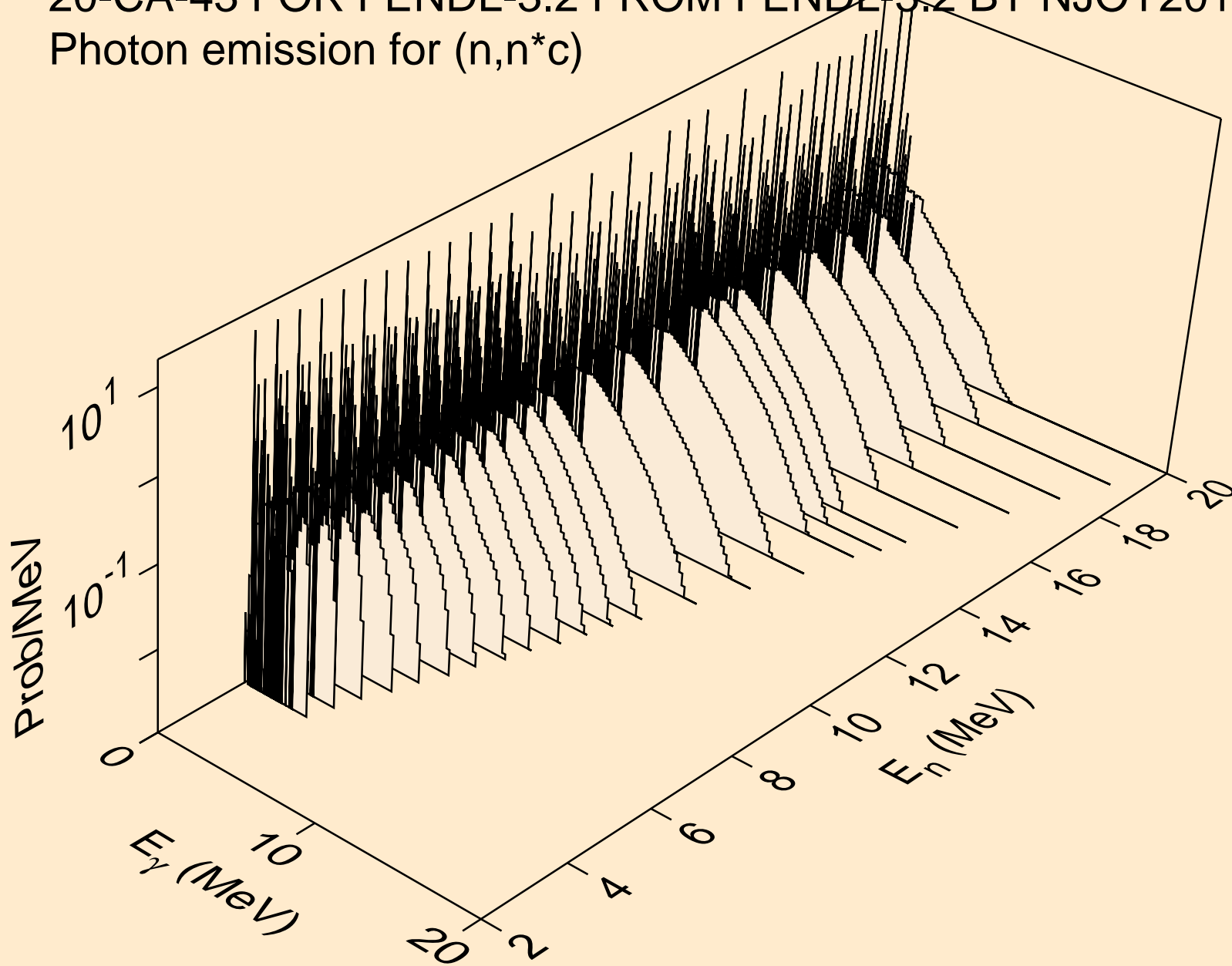

20-CA-43 FOR FENDL-3.2 FROM FENDL-3.2 BY NJOY2016.60+ O
Photon emission for (n,gma)

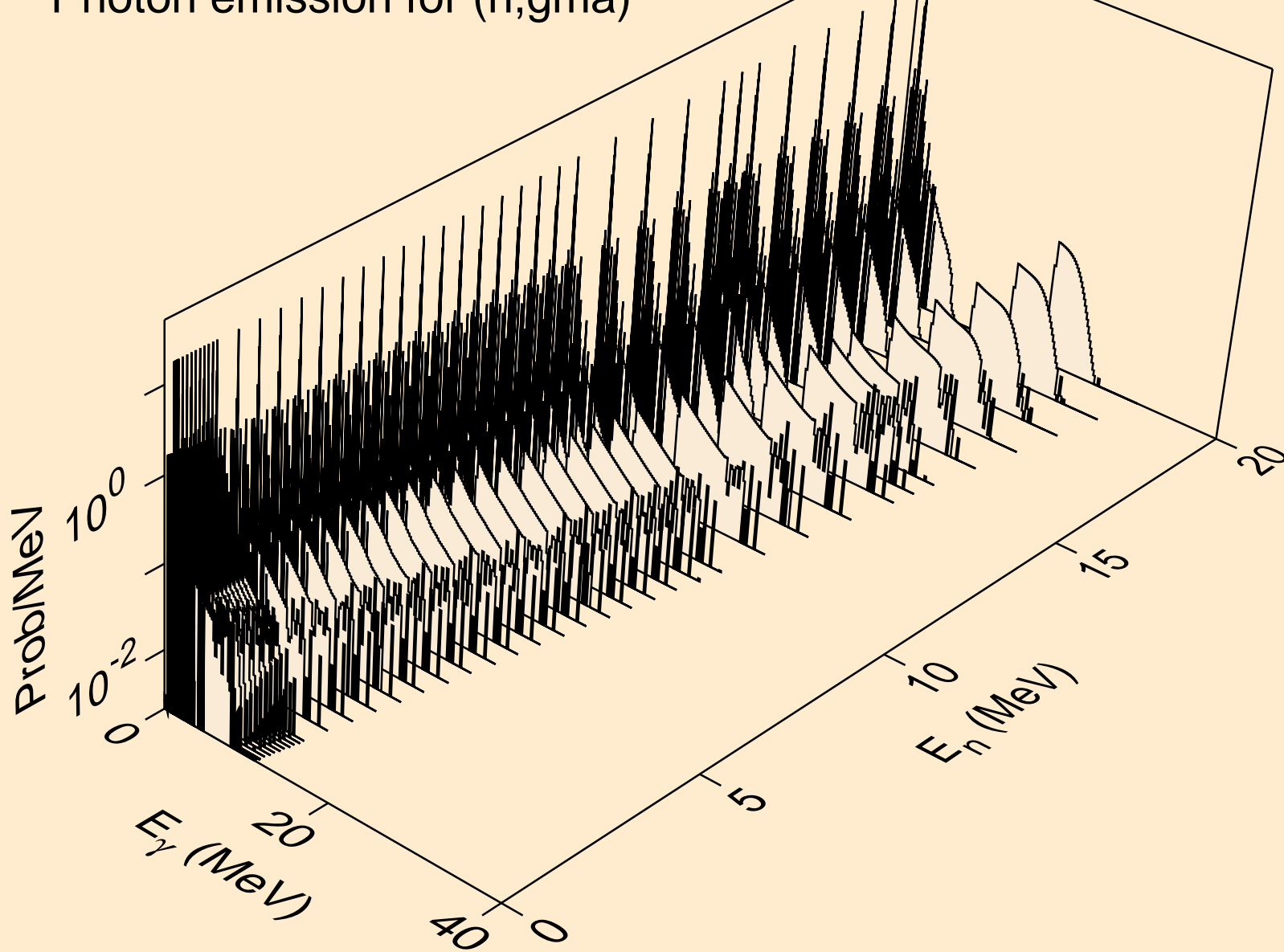

20-CA-43 FOR FENDL-3.2 FROM FENDL-3.2 BY NJOY2016.60+ O
Photon emission for (n,p*1)

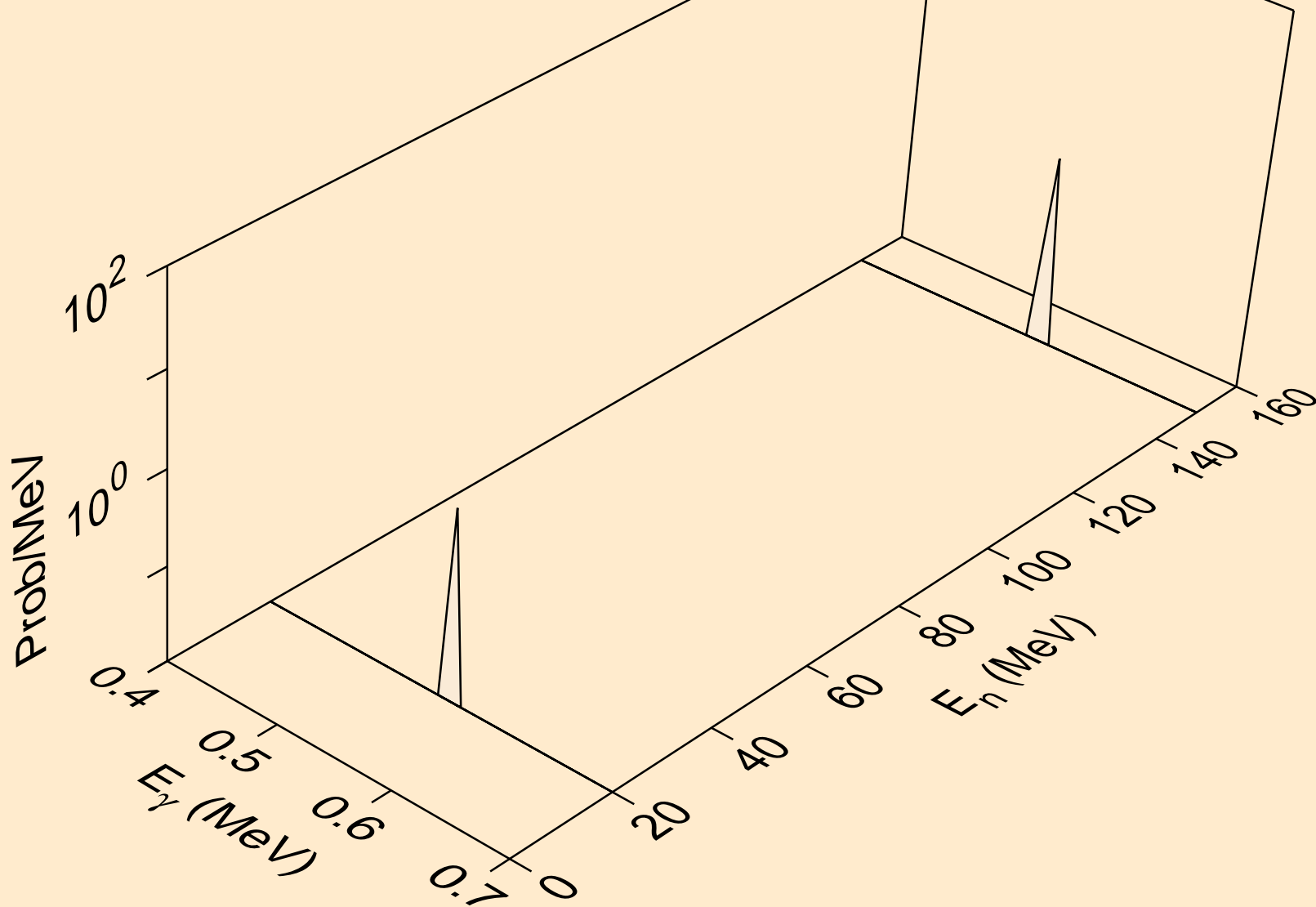

20-CA-43 FOR FENDL-3.2 FROM FENDL-3.2 BY NJOY2016.60+ O
Photon emission for (n,p*2)

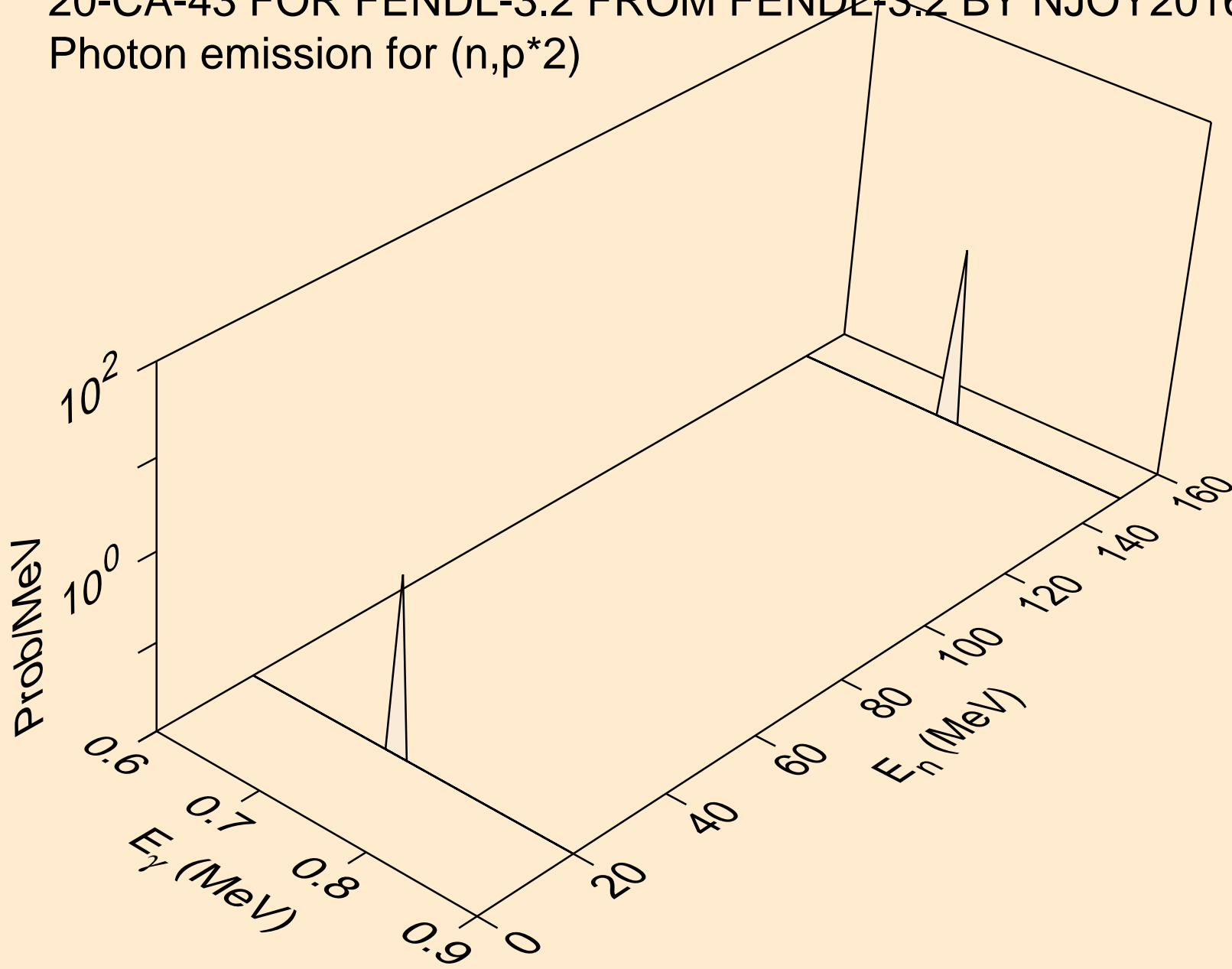

20-CA-43 FOR FENDL-3.2 FROM FENDL-3.2 BY NJOY2016.60+ O
Photon emission for (n,p*3)

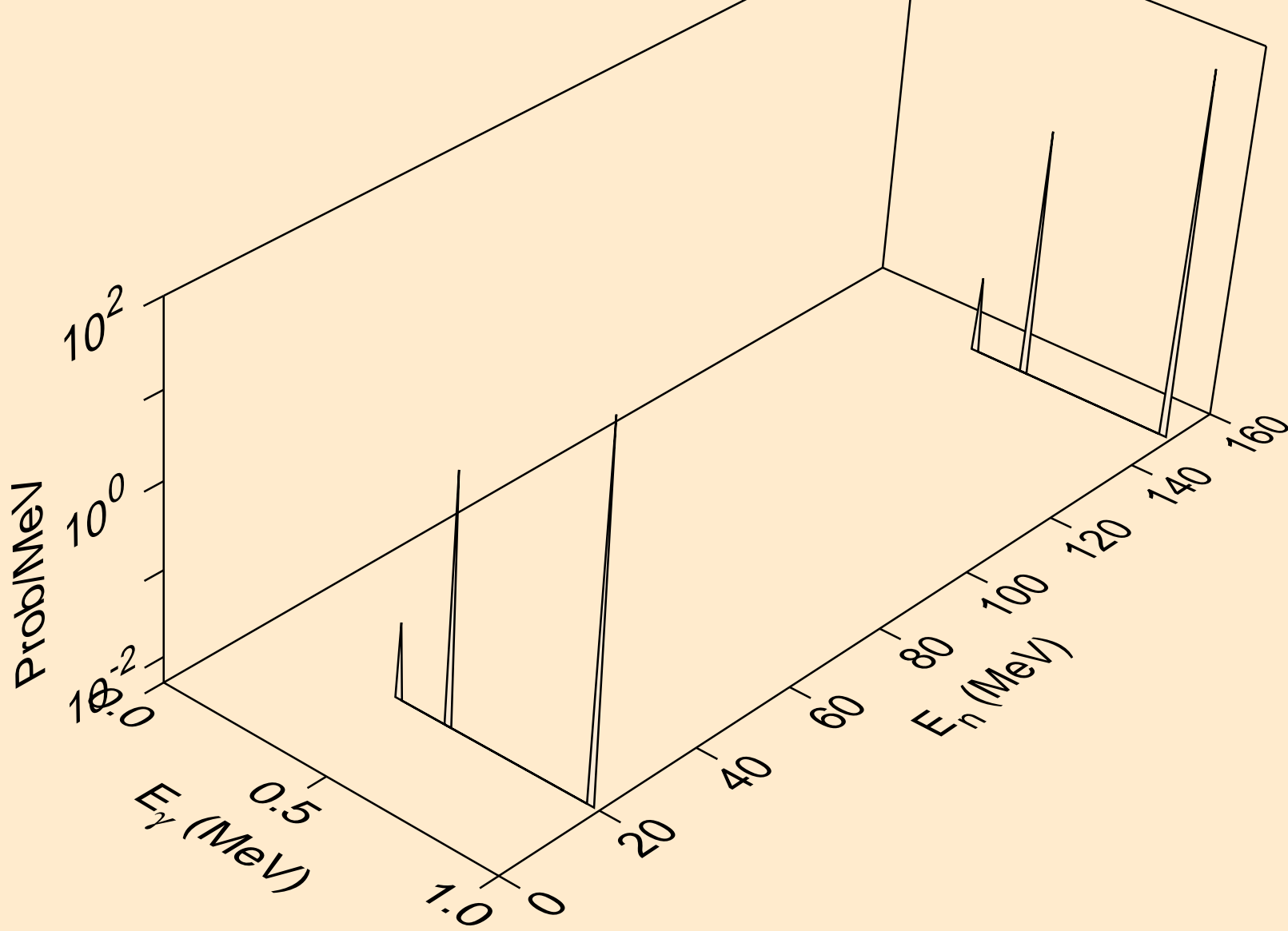

20-CA-43 FOR FENDL-3.2 FROM FENDL-3.2 BY NJOY2016.60+ O
Photon emission for (n,p*4)

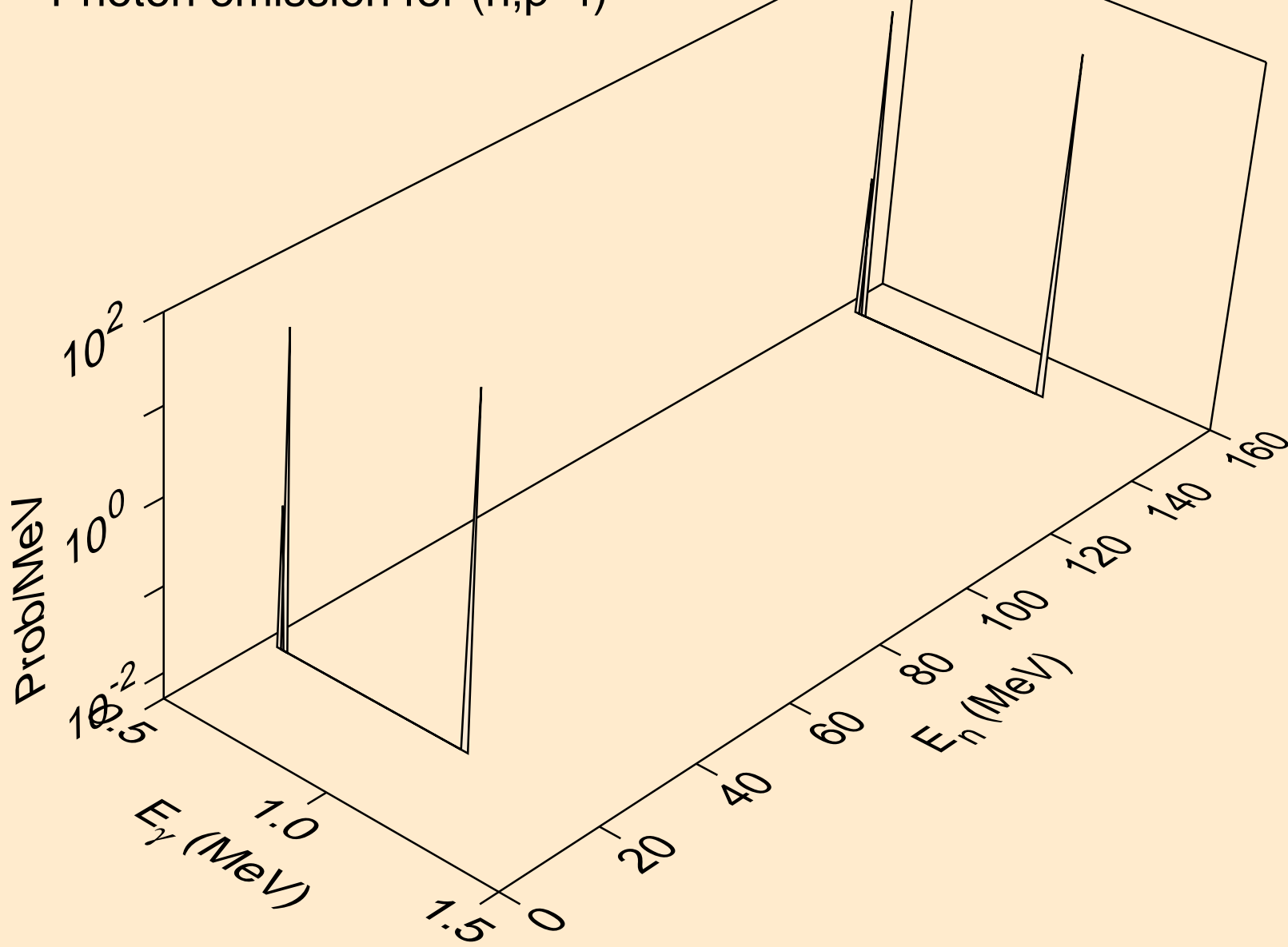

20-CA-43 FOR FENDL-3.2 FROM FENDL-3.2 BY NJOY2016.60+ O
Photon emission for (n,p*5)

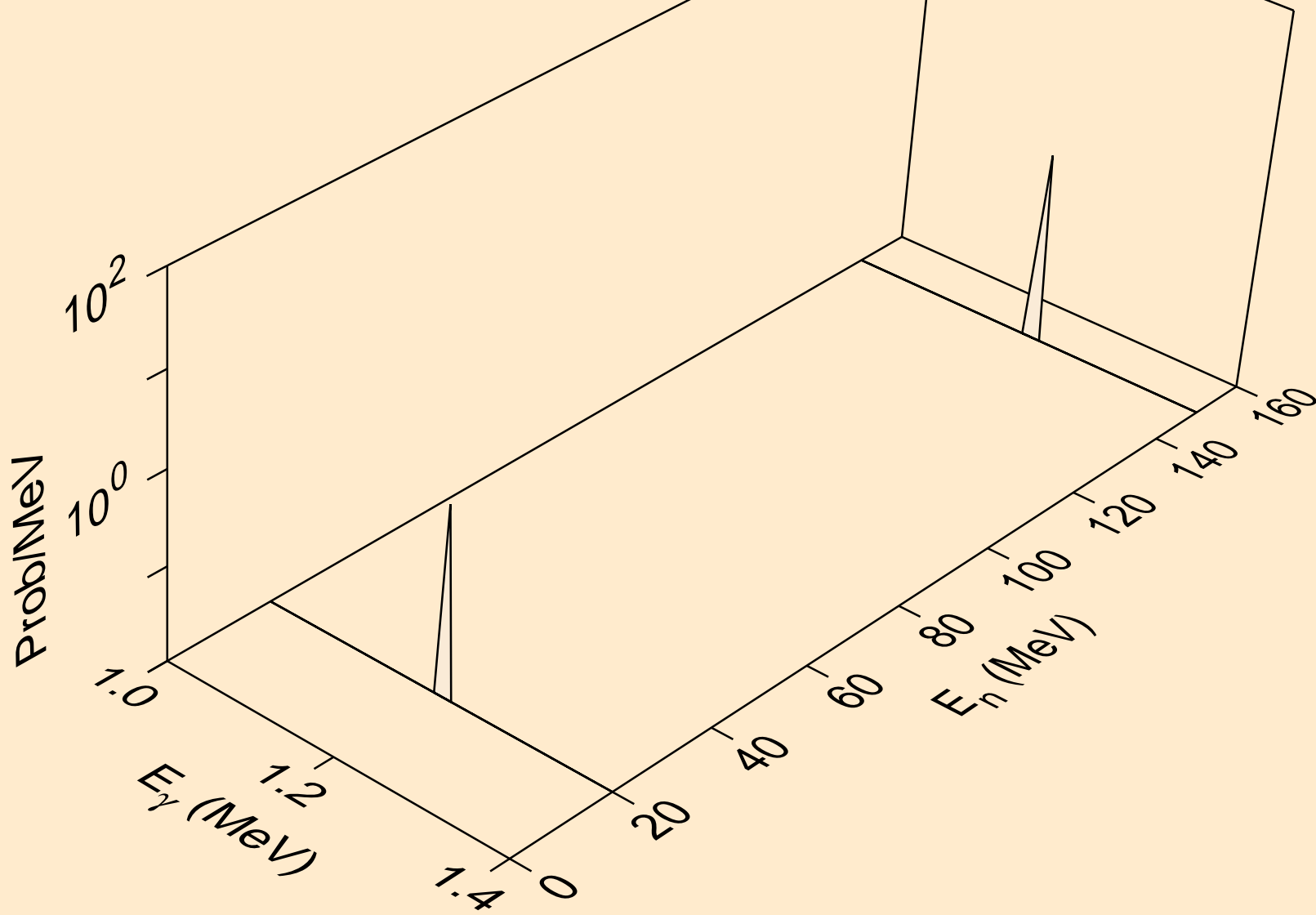

20-CA-43 FOR FENDL-3.2 FROM FENDL-3.2 BY NJOY2016.60+ O
Photon emission for (n,p*6)

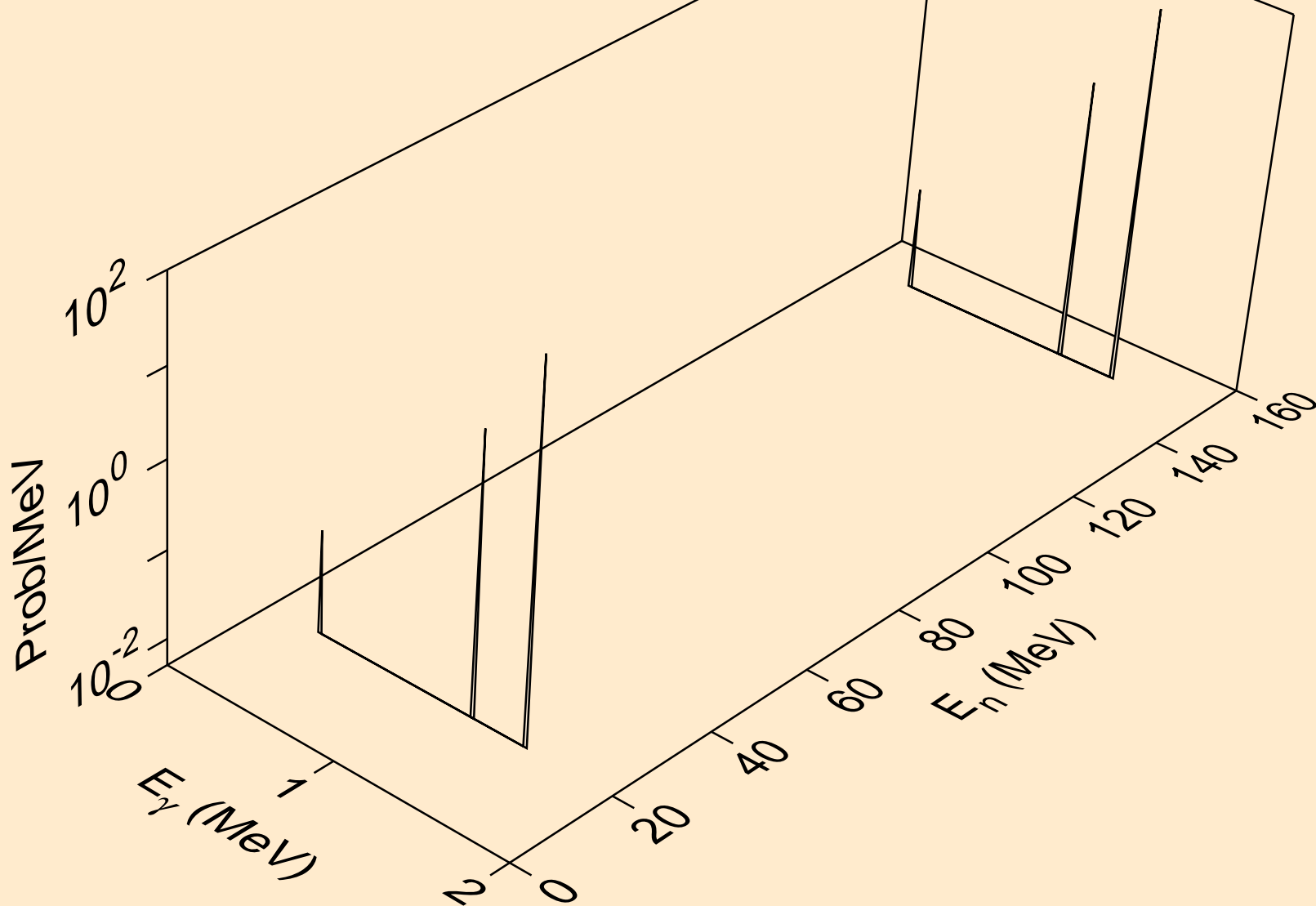

20-CA-43 FOR FENDL-3.2 FROM FENDL-3.2 BY NJOY2016.60+ O
Photon emission for (n,p*7)

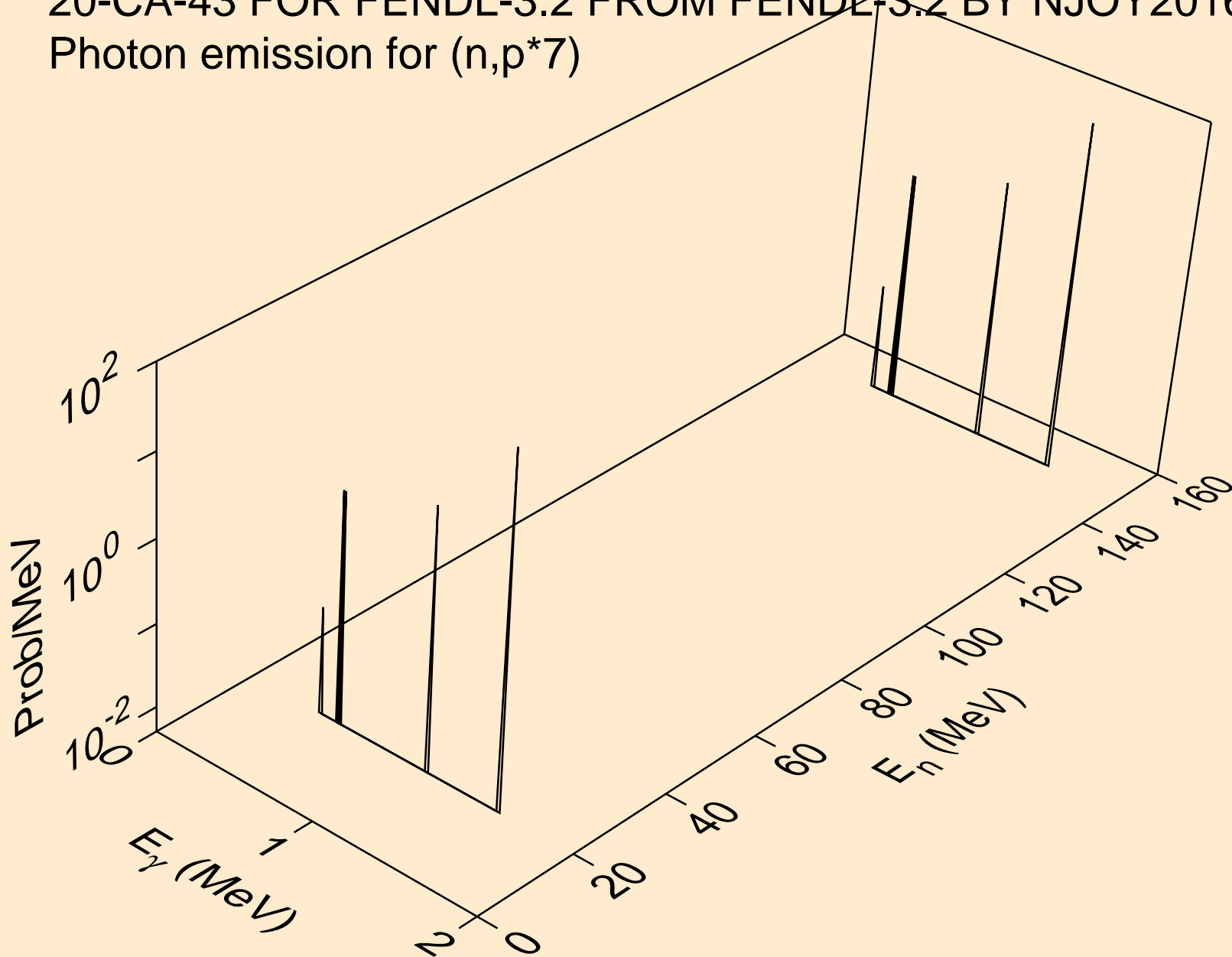

20-CA-43 FOR FENDL-3.2 FROM FENDL-3.2 BY NJOY2016.60+ O
Photon emission for (n,p*9)

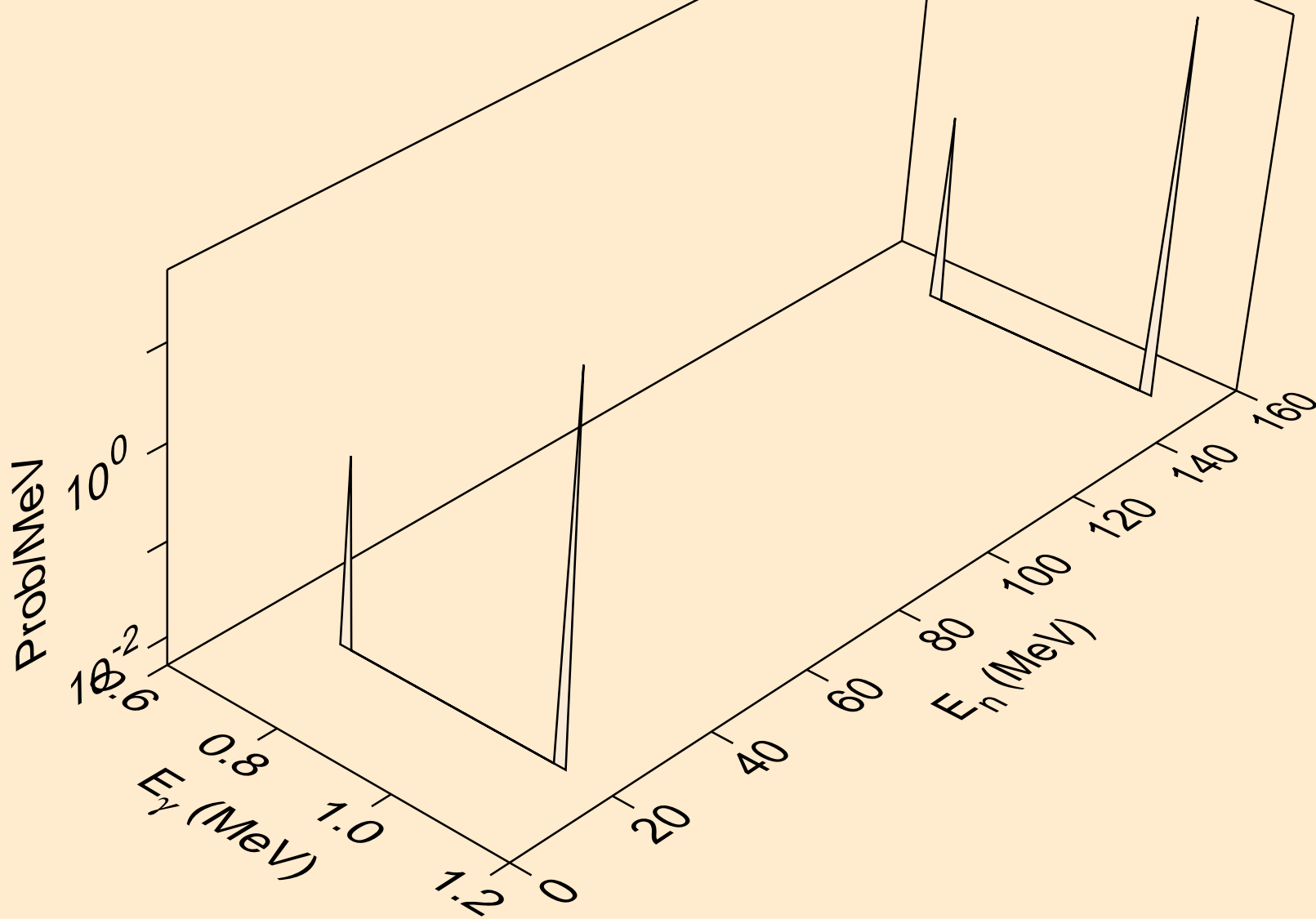

20-CA-43 FOR FENDL-3.2 FROM FENDL-3.2 BY NJOY2016.60+ O
Photon emission for (n,p*10)

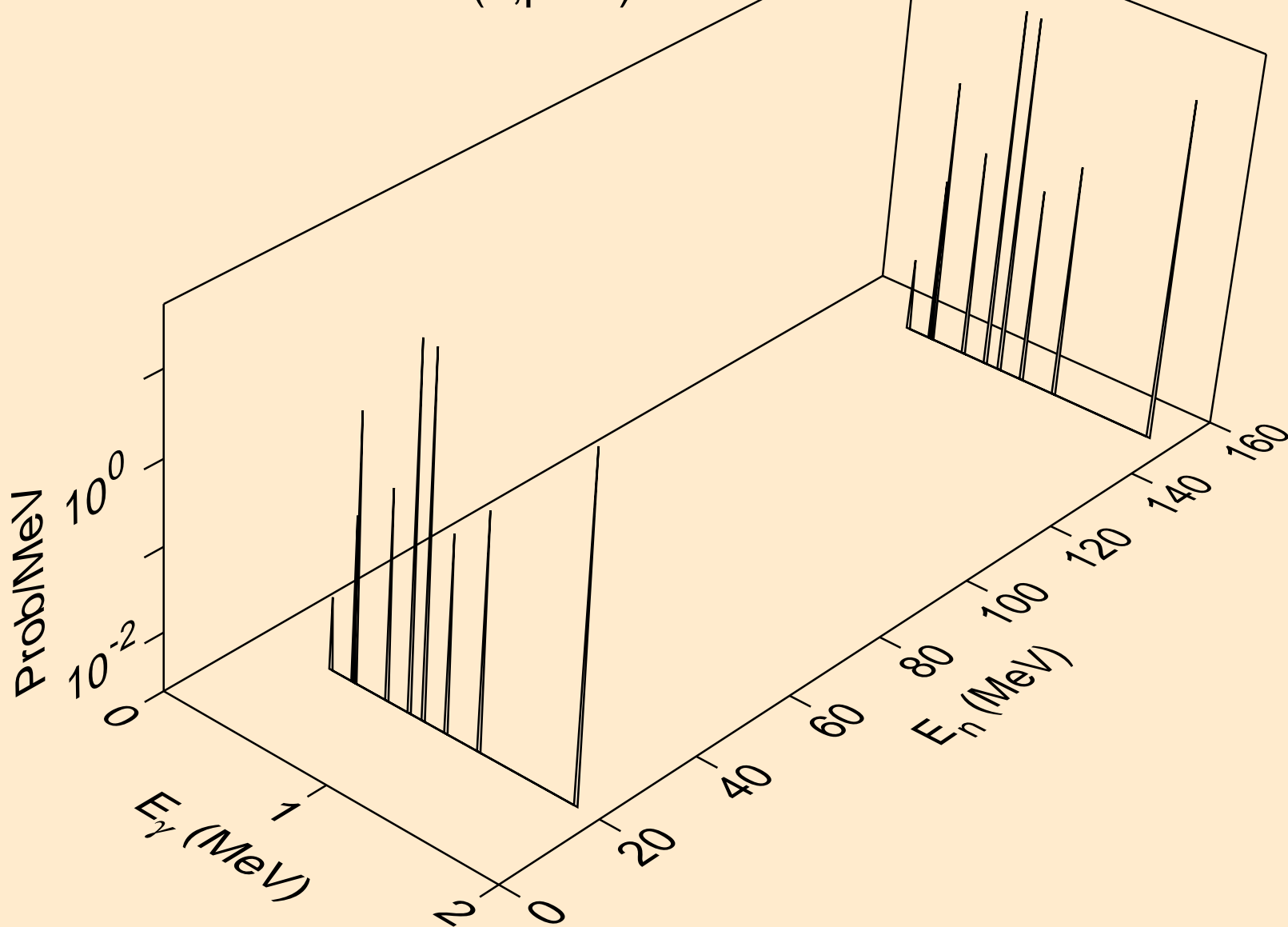

20-CA-43 FOR FENDL-3.2 FROM FENDL-3.2 BY NJOY2016.60+ O
Photon emission for (n,p*13)

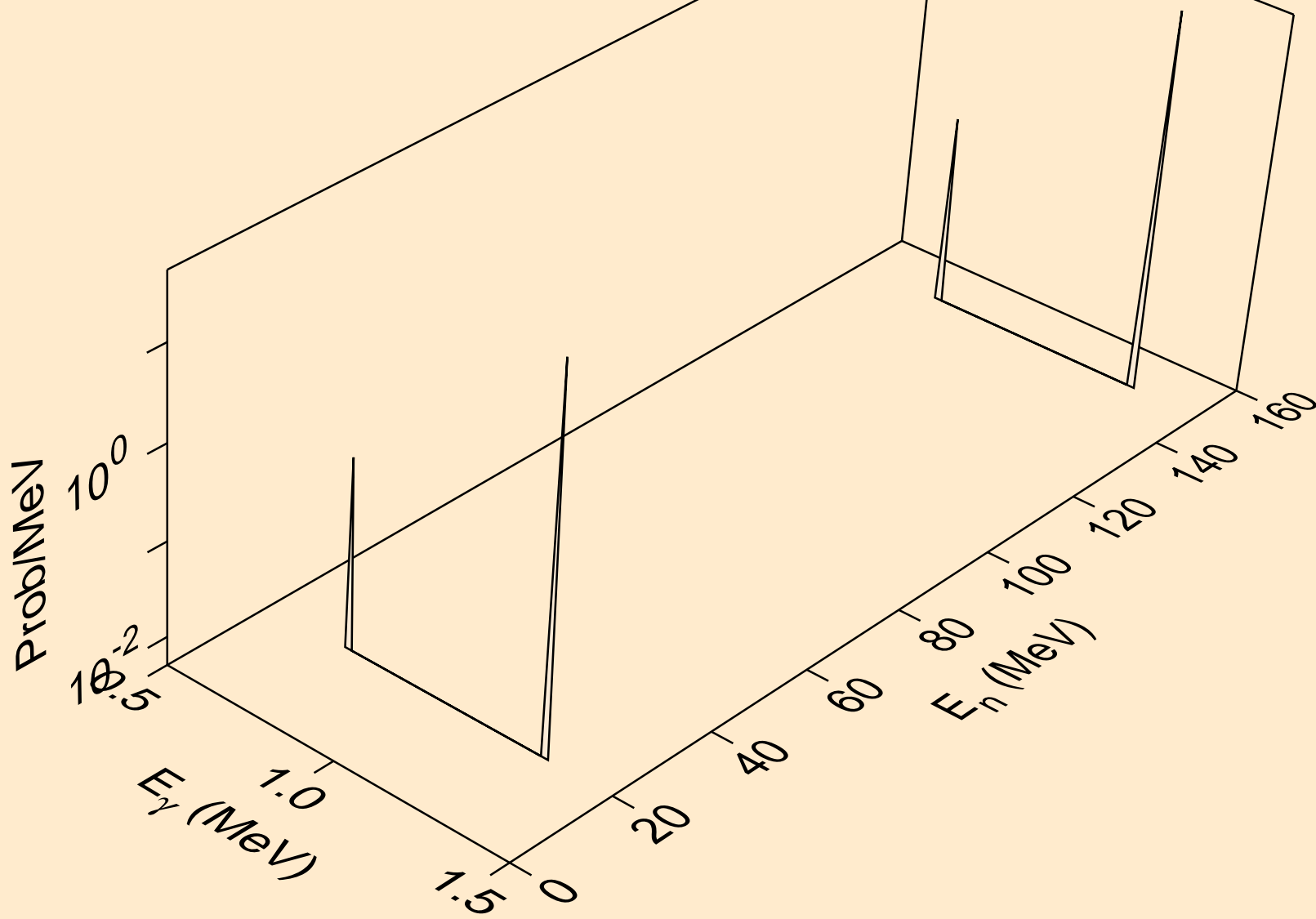

20-CA-43 FOR FENDL-3.2 FROM FENDL-3.2 BY NJOY2016.60+ O
Photon emission for (n,p*15)

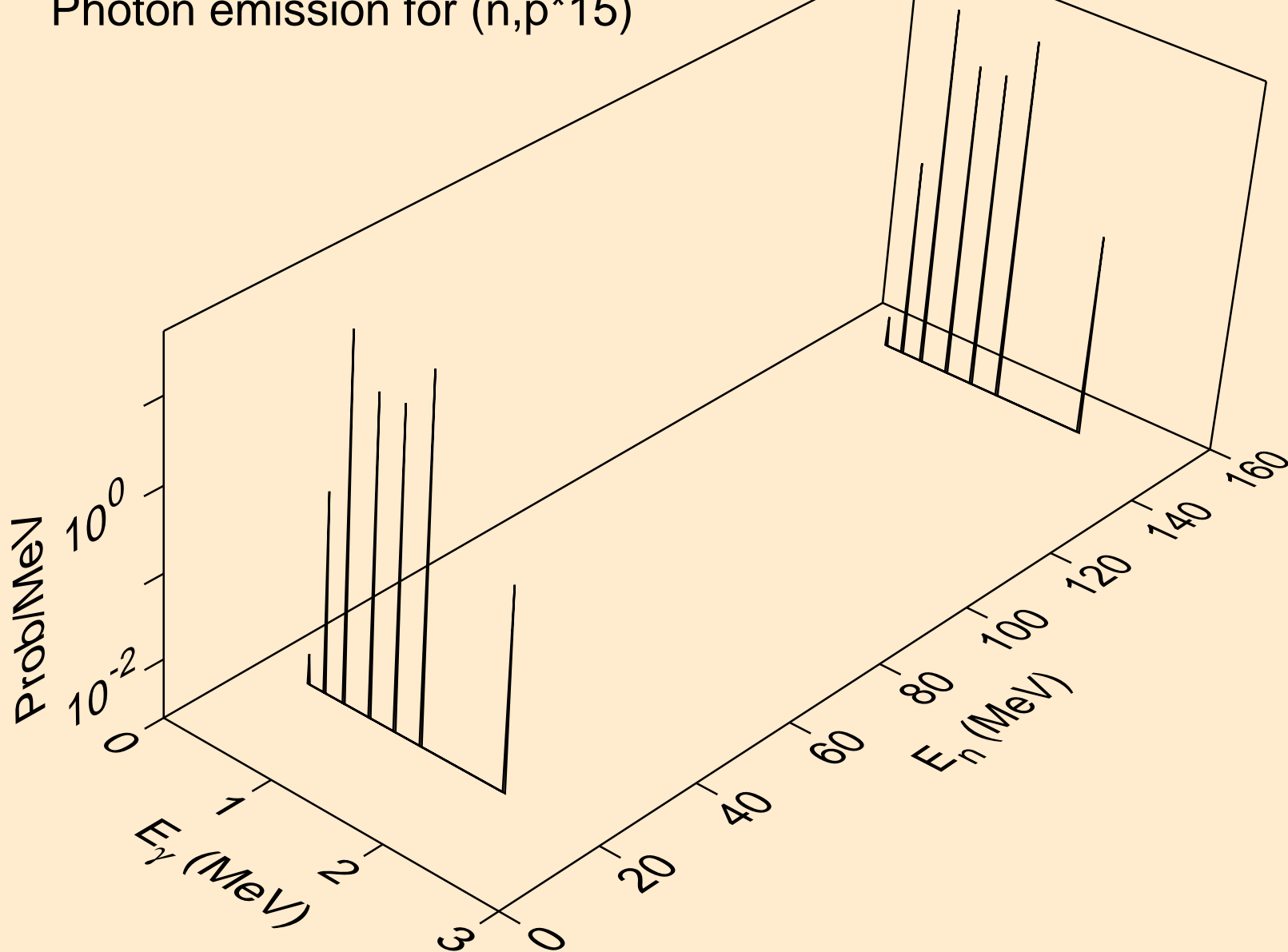

20-CA-43 FOR FENDL-3.2 FROM FENDL-3.2 BY NJOY2016.60+ O
Photon emission for (n,p*16)

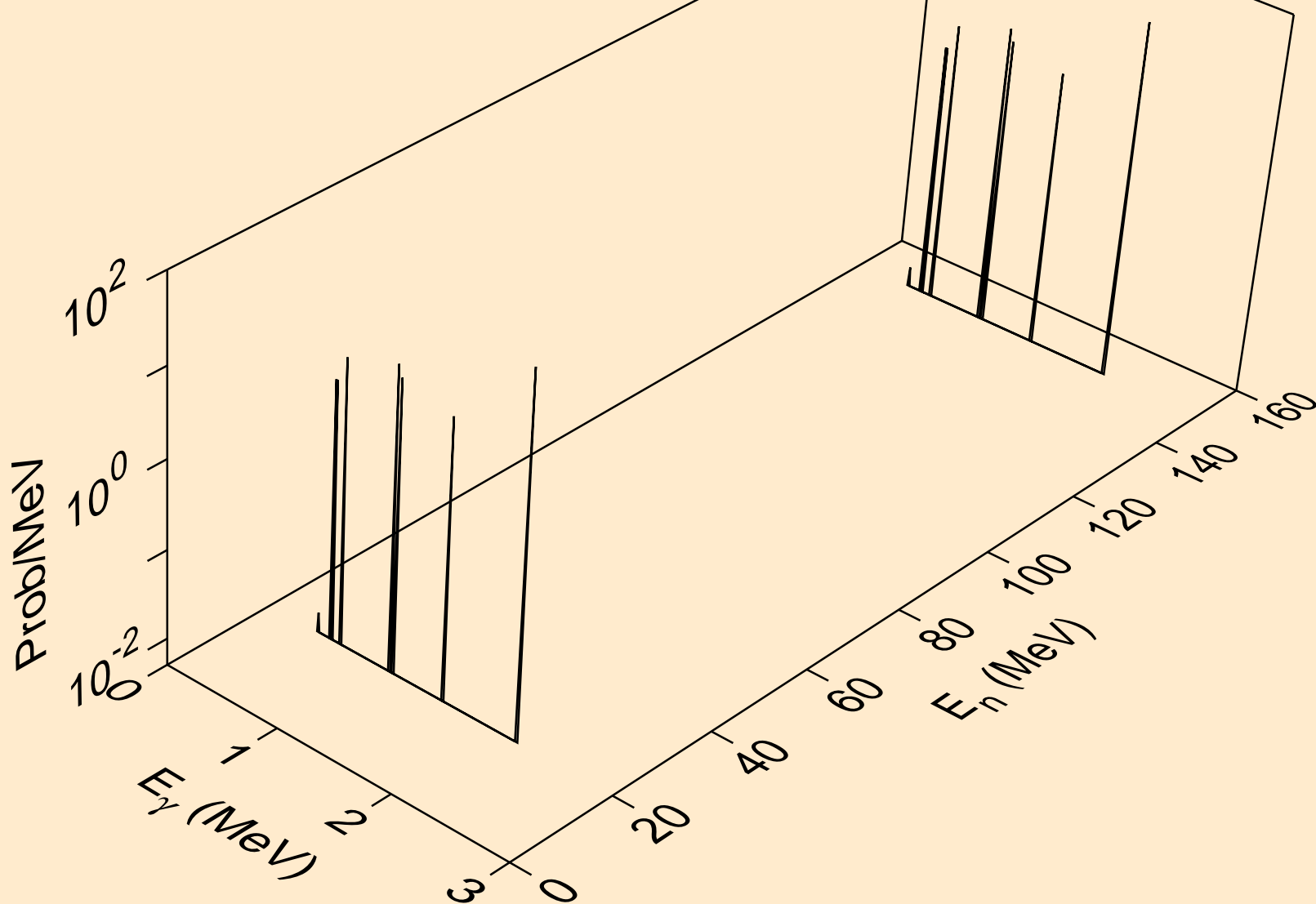

20-CA-43 FOR FENDL-3.2 FROM FENDL-3.2 BY NJOY2016.60+ O
Photon emission for (n,p*18)

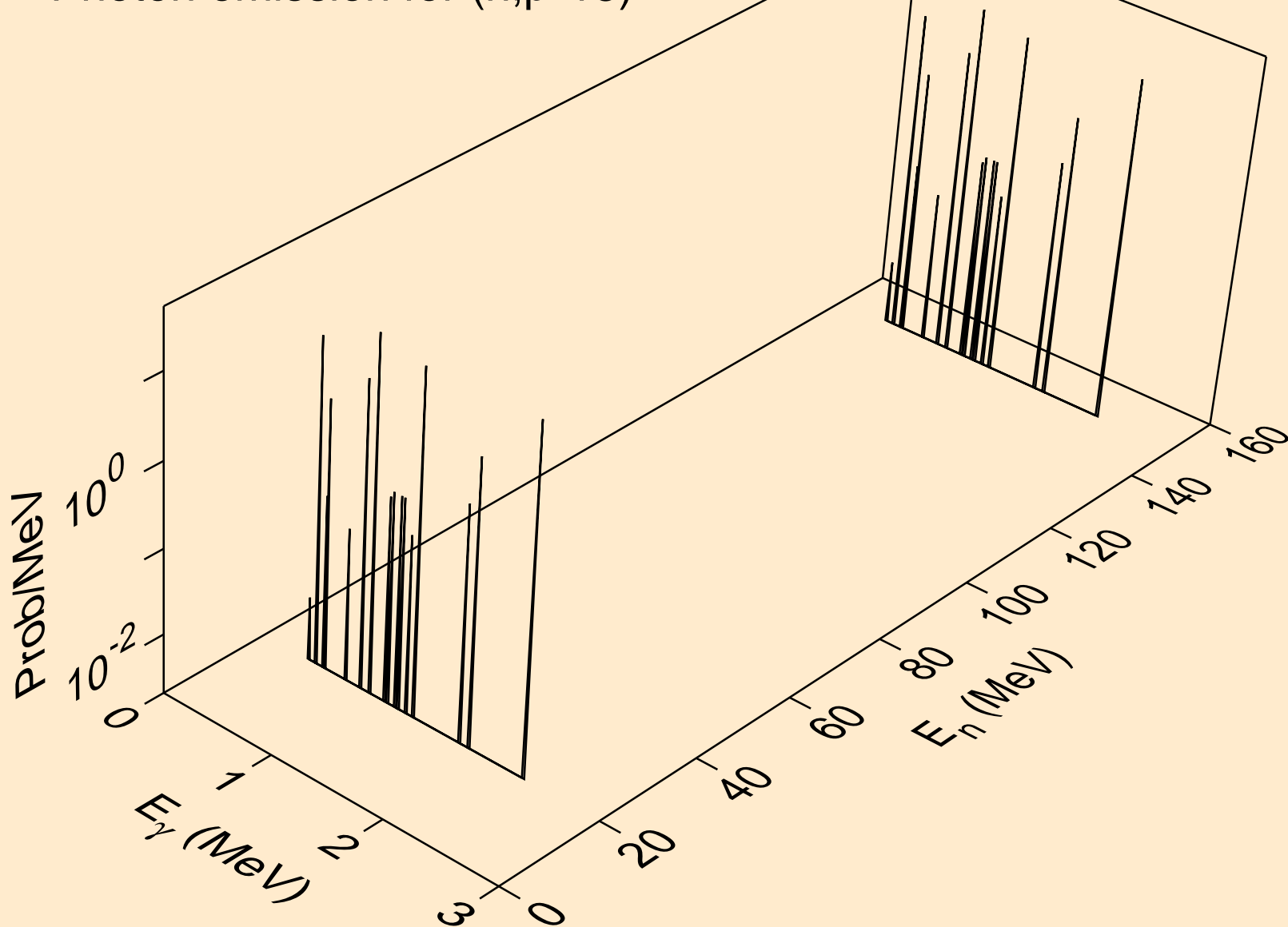

20-CA-43 FOR FENDL-3.2 FROM FENDL-3.2 BY NJOY2016.60+ O
Photon emission for (n,p*26)

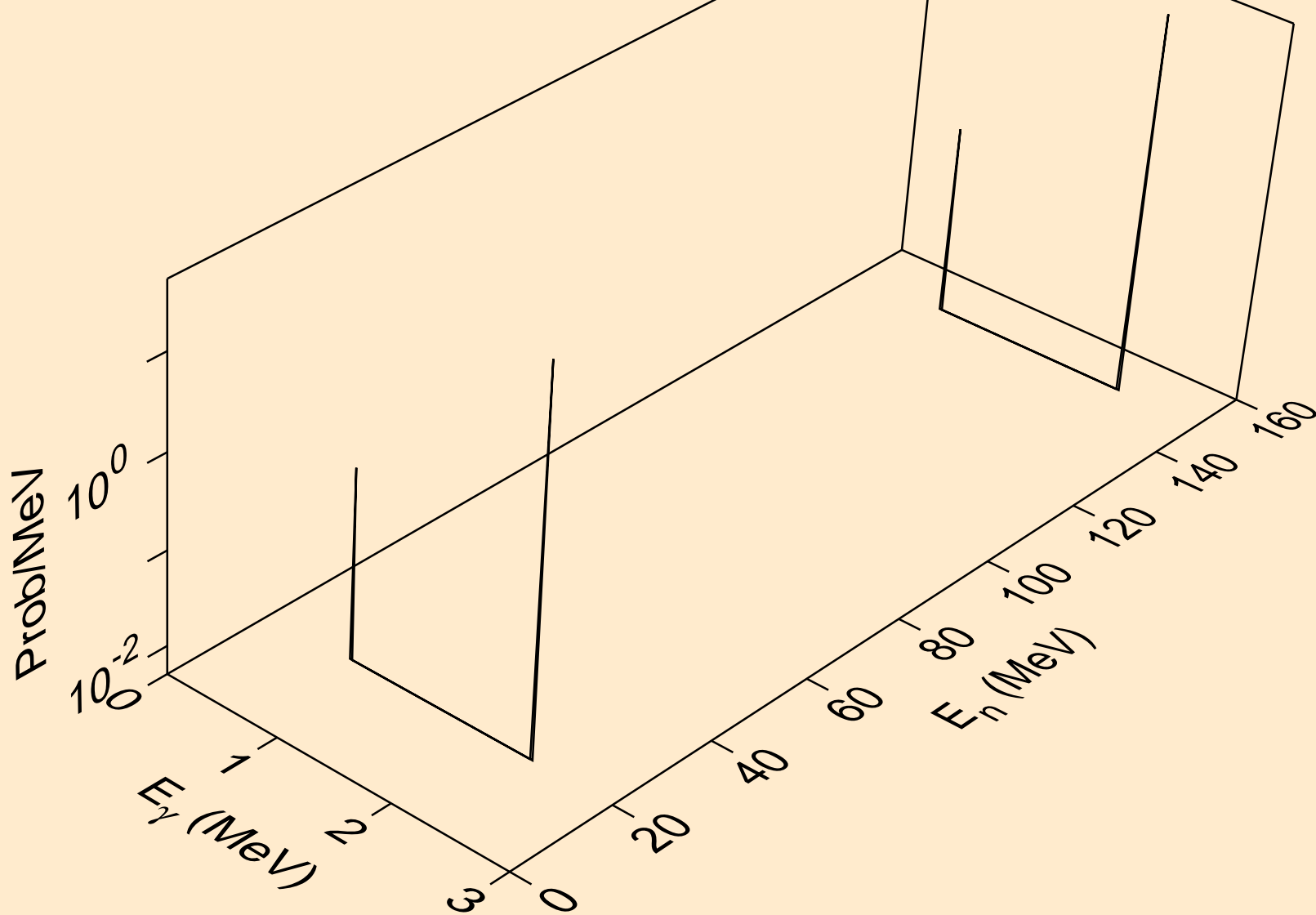

20-CA-43 FOR FENDL-3.2 FROM FENDL-3.2 BY NJOY2016.60+ O
Photon emission for (n,p*28)

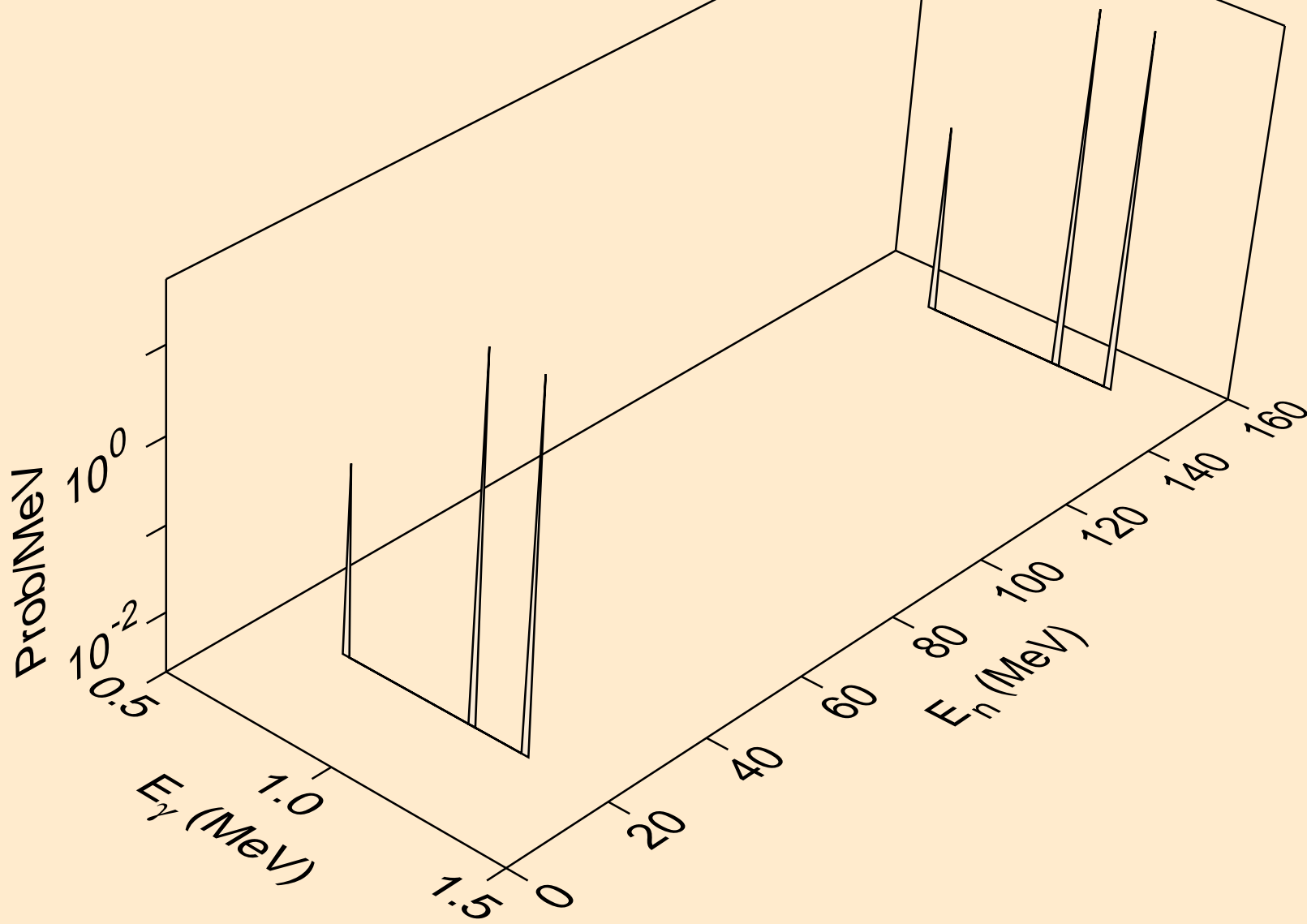

20-CA-43 FOR FENDL-3.2 FROM FENDL-3.2 BY NJOY2016.60+ O
Photon emission for (n,p*32)

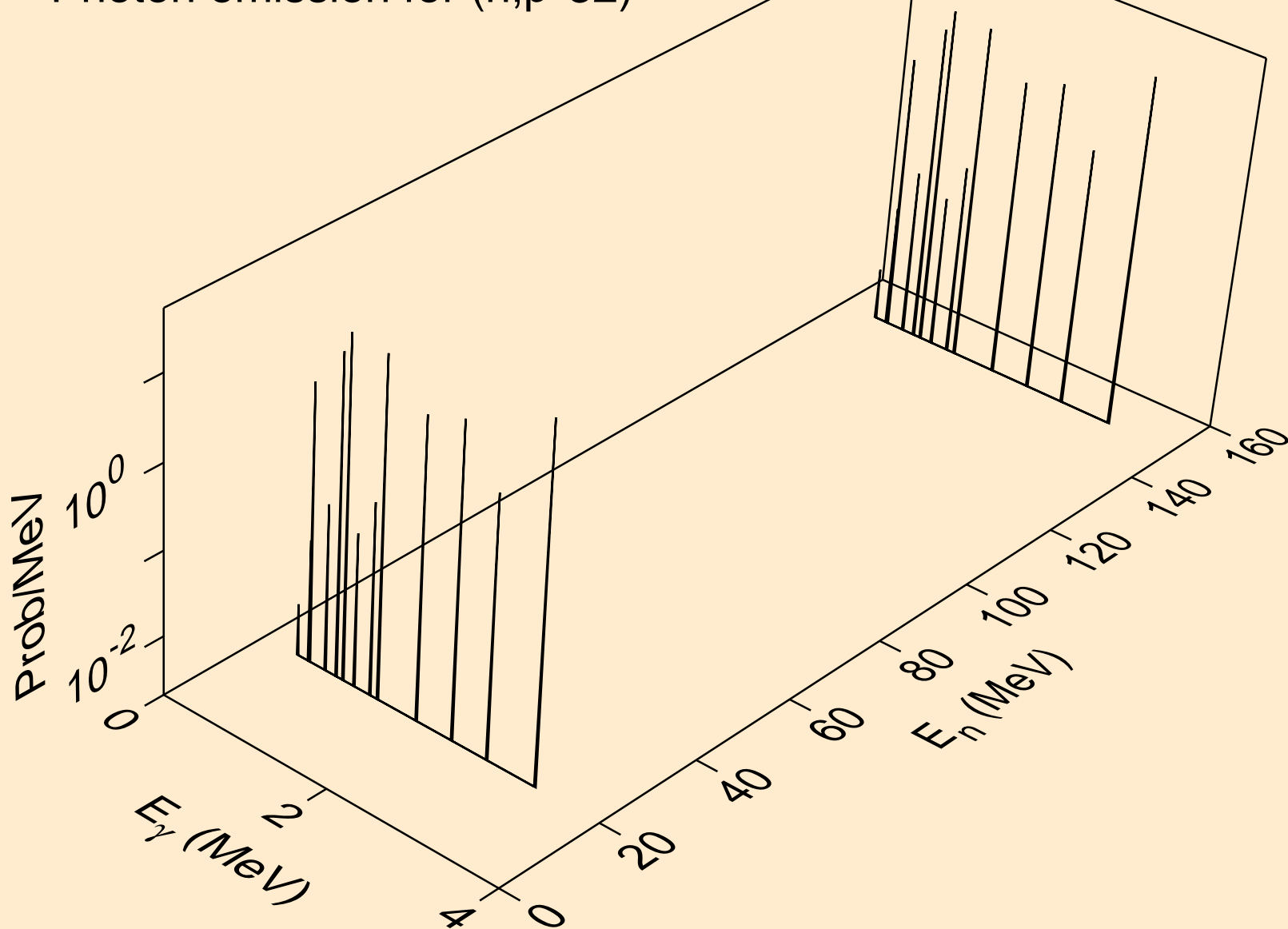

20-CA-43 FOR FENDL-3.2 FROM FENDL-3.2 BY NJOY2016.60+ O
Photon emission for (n,p*33)

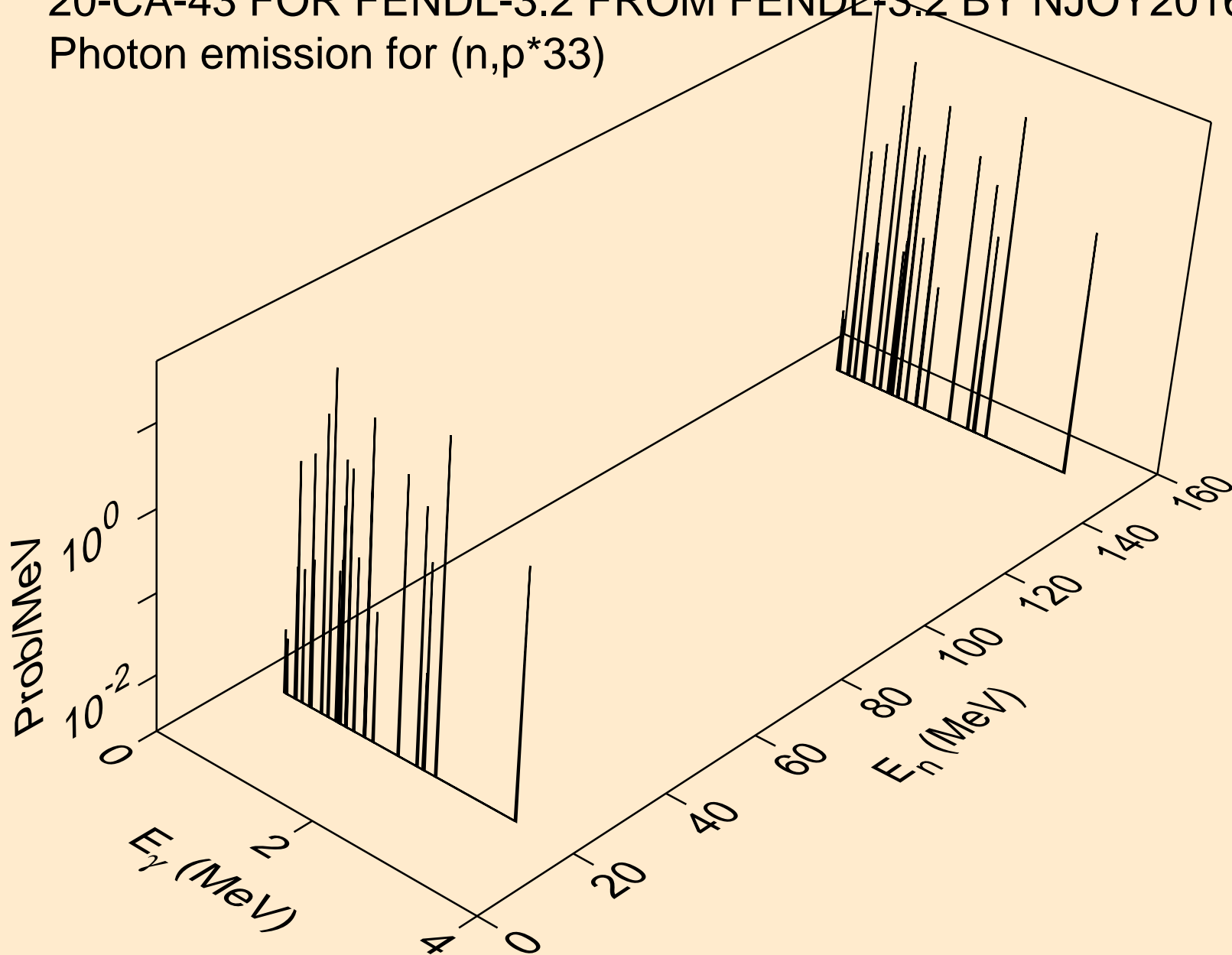

20-CA-43 FOR FENDL-3.2 FROM FENDL-3.2 BY NJOY2016.60+ O
Photon emission for (n,p*c)

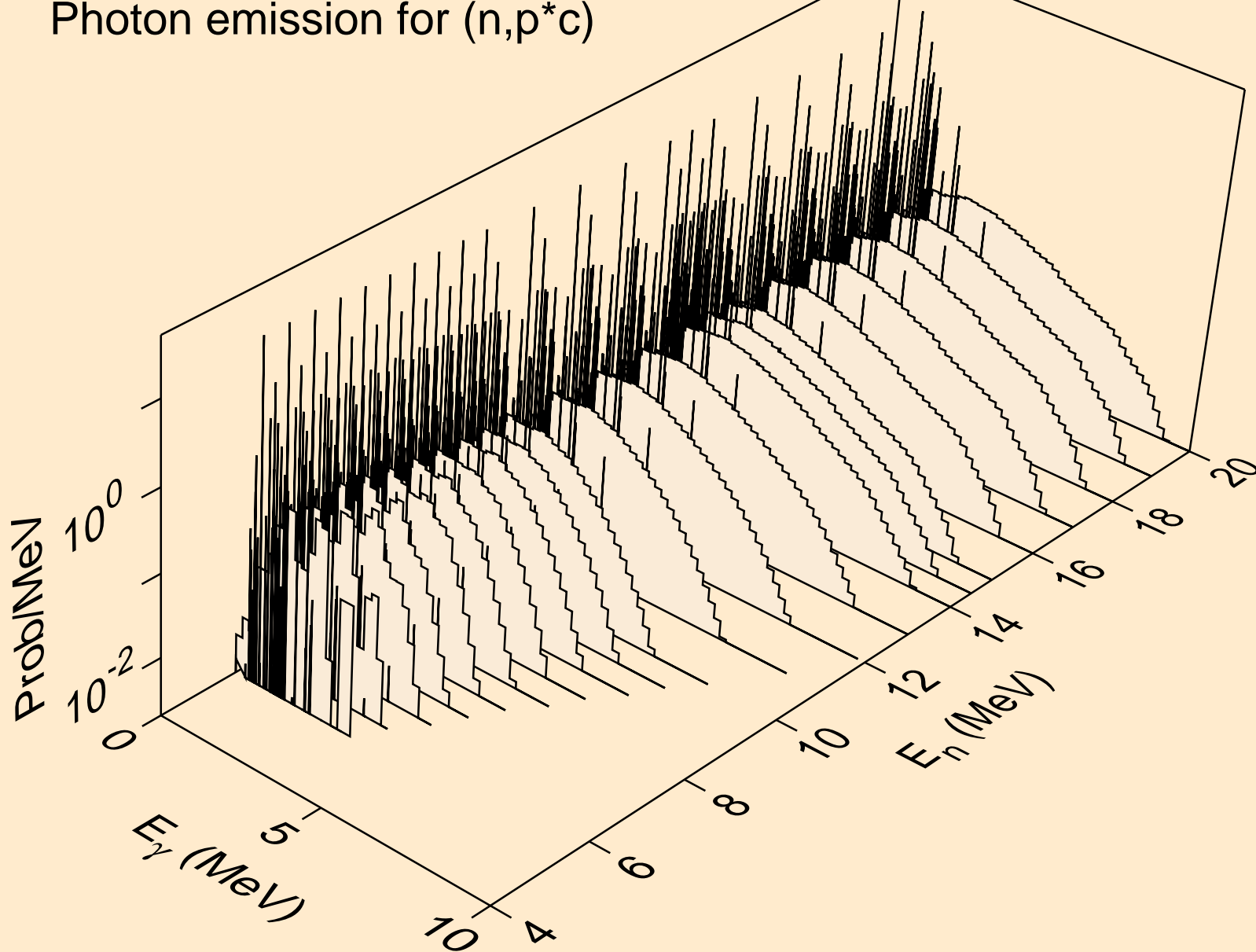

20-CA-43 FOR FENDL-3.2 FROM FENDL-3.2 BY NJOY2016.60+ O
Photon emission for (n,a*1)

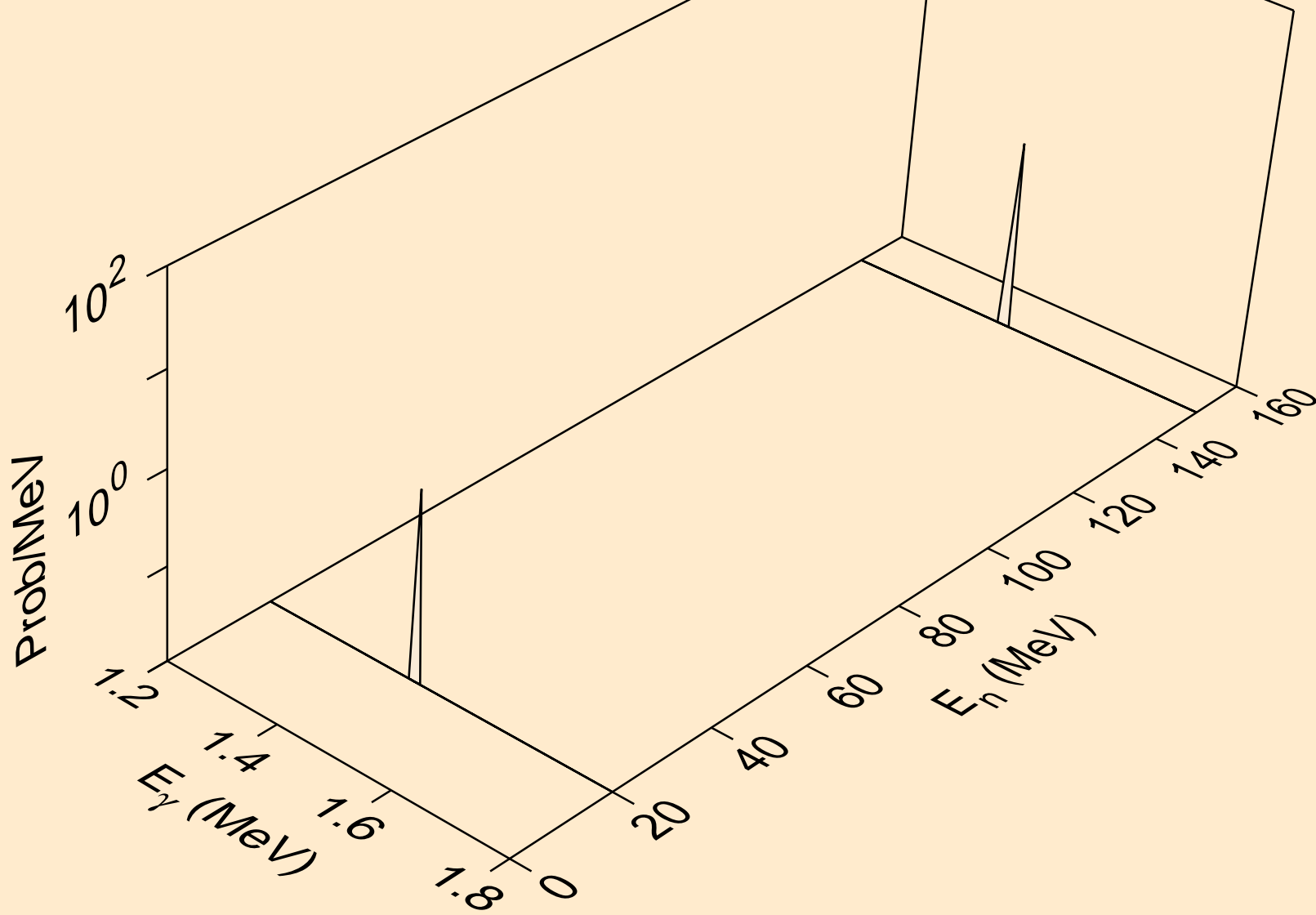

20-CA-43 FOR FENDL-3.2 FROM FENDL-3.2 BY NJOY2016.60+ O
Photon emission for (n,a*2)

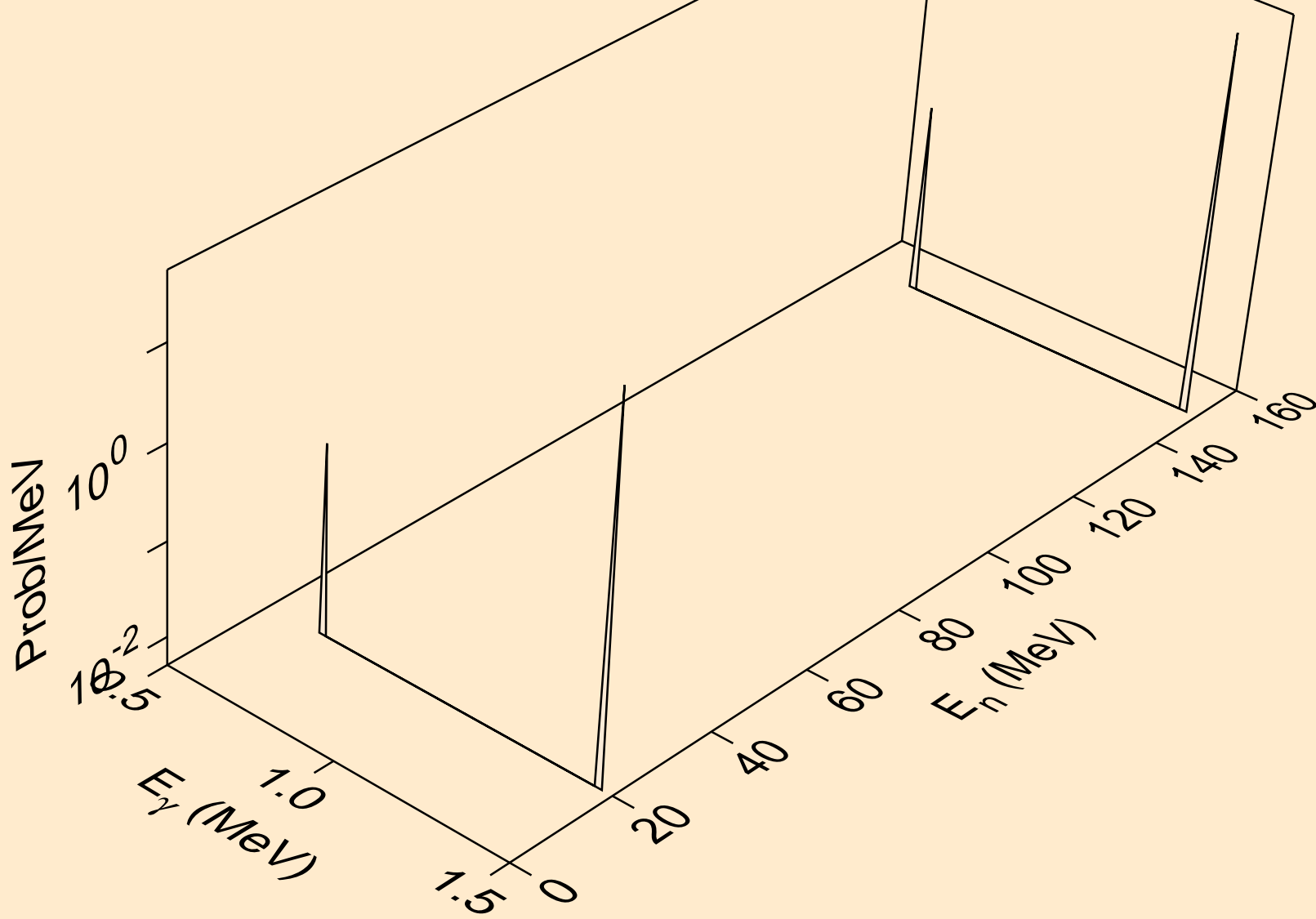

20-CA-43 FOR FENDL-3.2 FROM FENDL-3.2 BY NJOY2016.60+ O
Photon emission for (n,a*3)

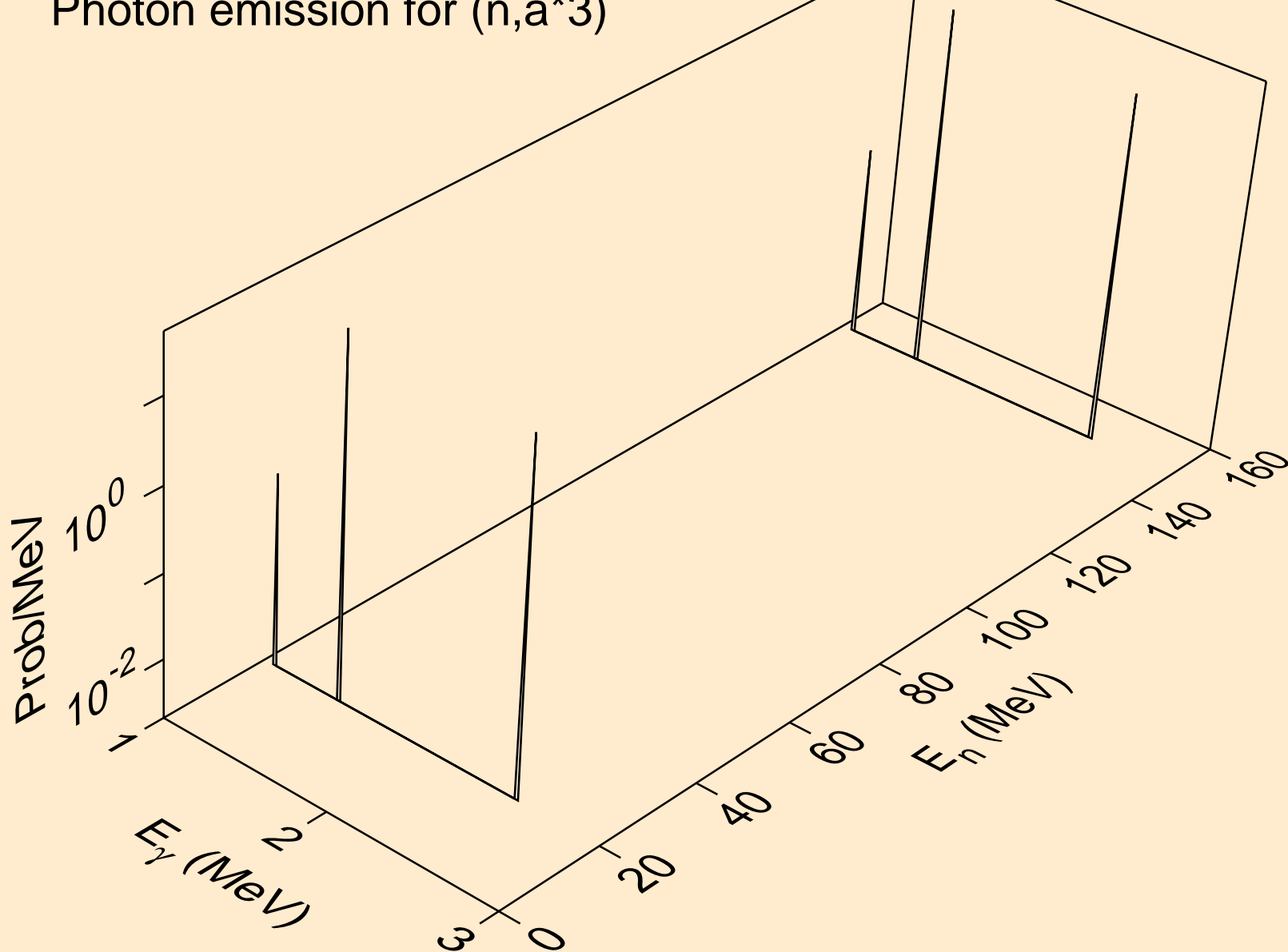

20-CA-43 FOR FENDL-3.2 FROM FENDL-3.2 BY NJOY2016.60+ O
Photon emission for (n,a*4)

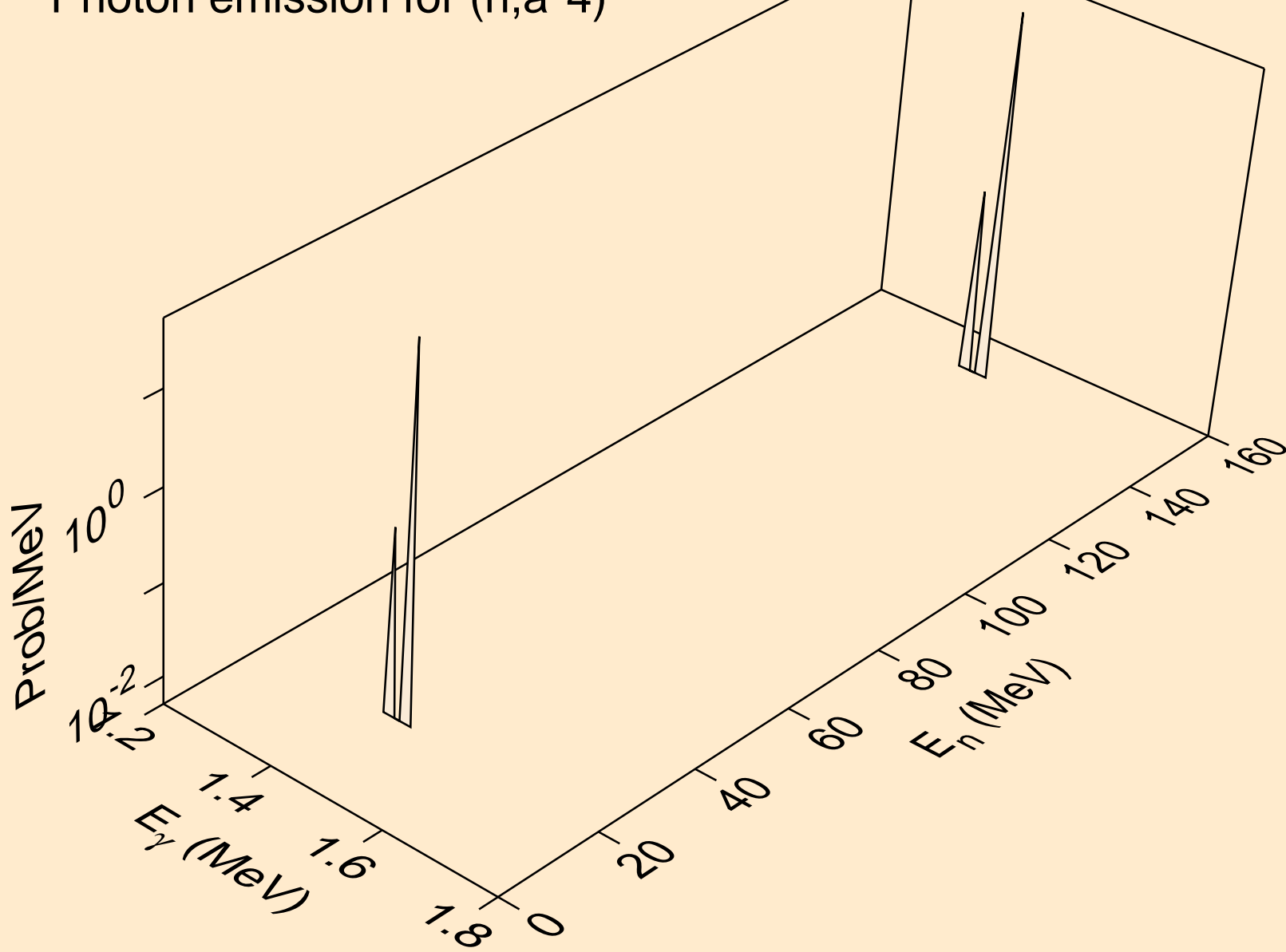

20-CA-43 FOR FENDL-3.2 FROM FENDL-3.2 BY NJOY2016.60+ O
Photon emission for (n,a*5)

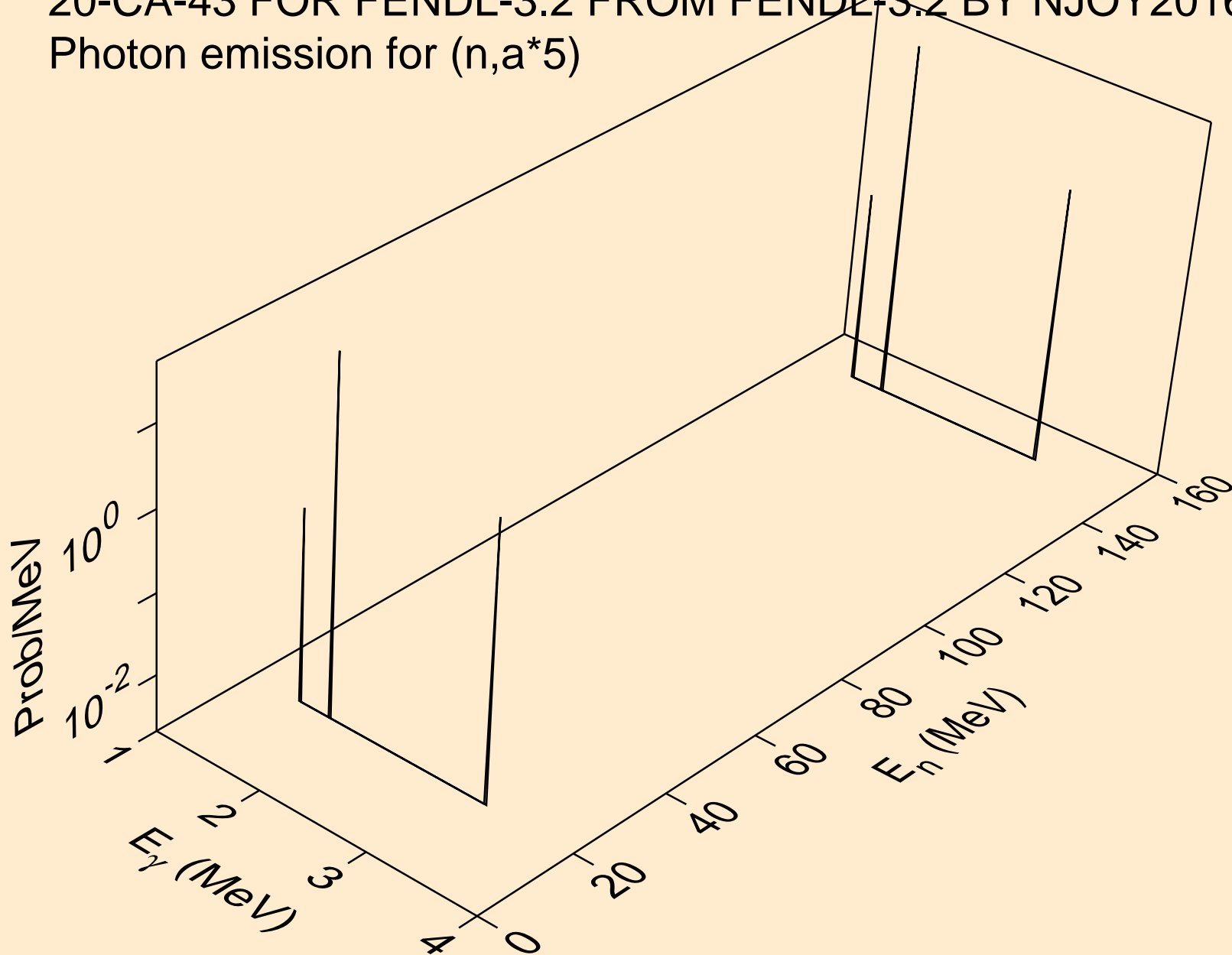

20-CA-43 FOR FENDL-3.2 FROM FENDL-3.2 BY NJOY2016.60+ O
Photon emission for (n,a*6)

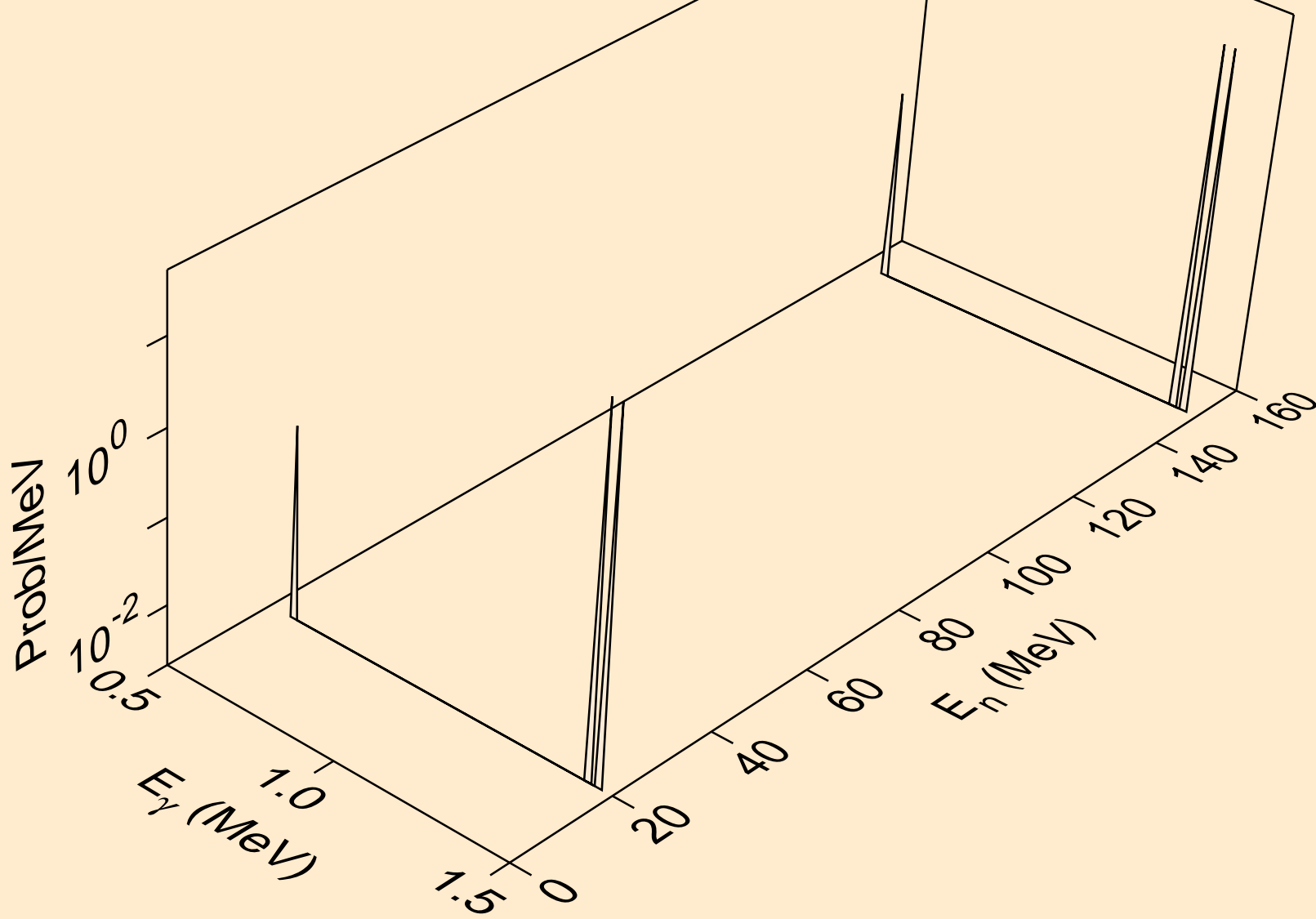

20-CA-43 FOR FENDL-3.2 FROM FENDL-3.2 BY NJOY2016.60+ O
Photon emission for (n,a*7)

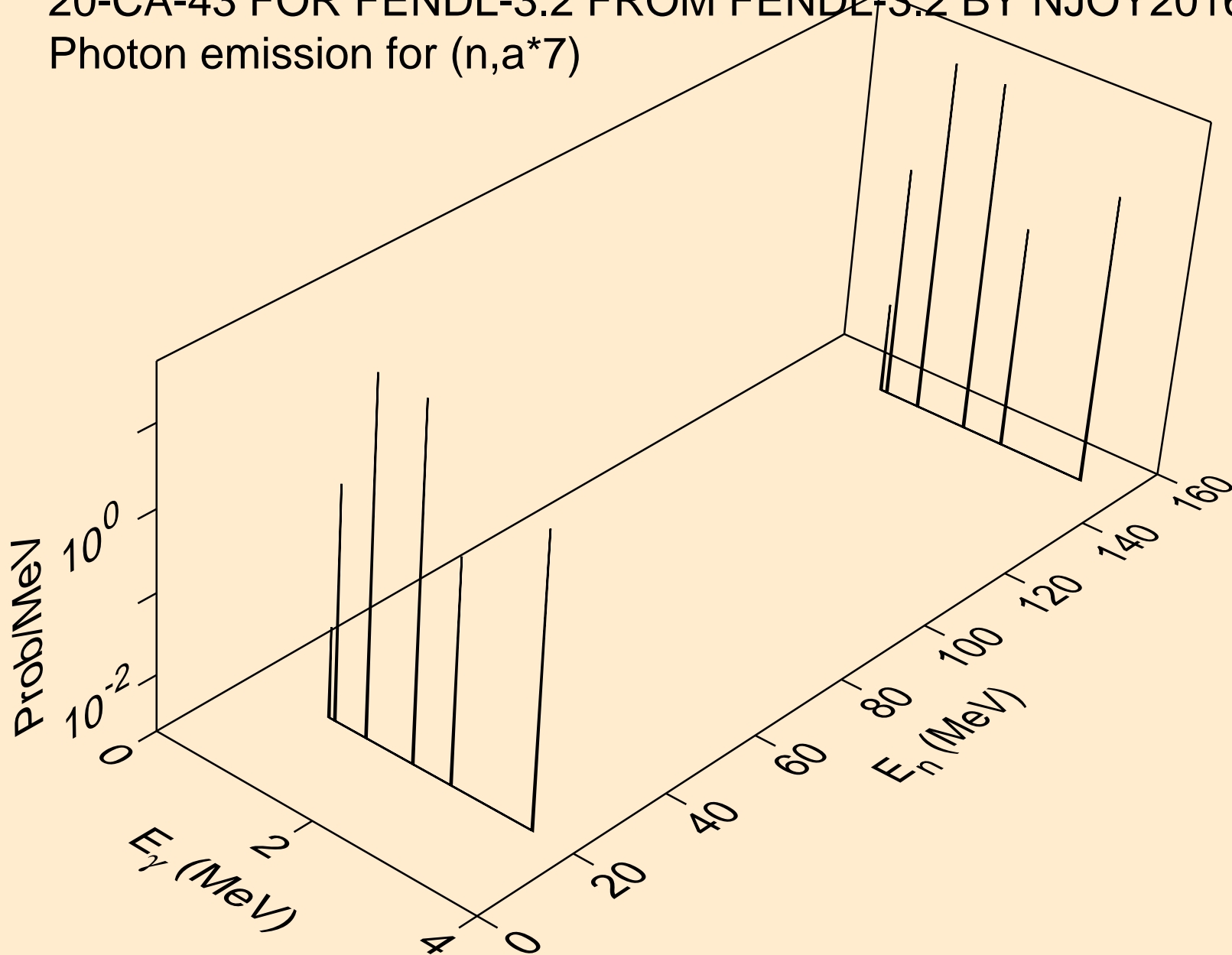

20-CA-43 FOR FENDL-3.2 FROM FENDL-3.2 BY NJOY2016.60+ O
Photon emission for (n,a*8)

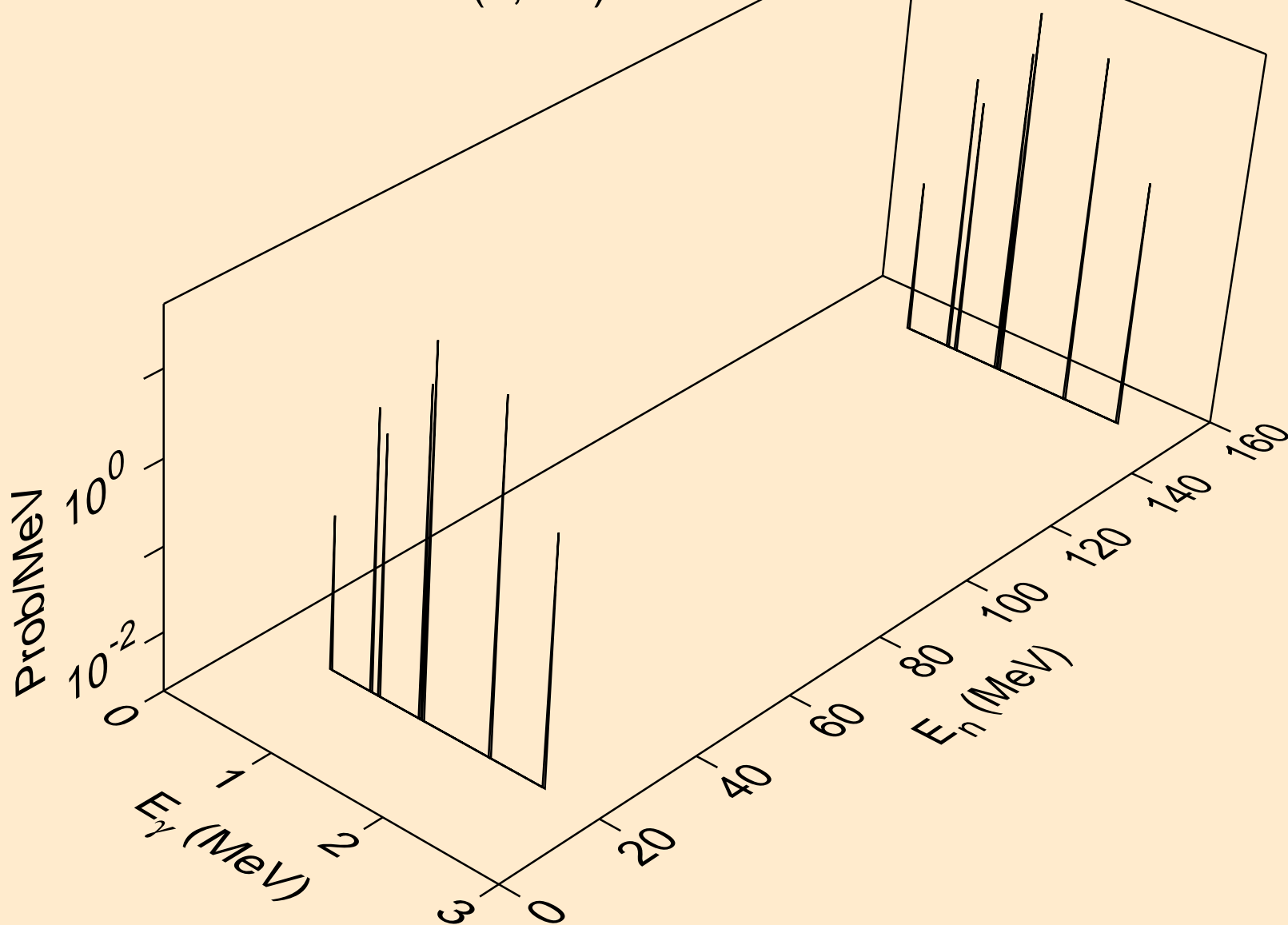

20-CA-43 FOR FENDL-3.2 FROM FENDL-3.2 BY NJOY2016.60+ O
Photon emission for (n,a*9)

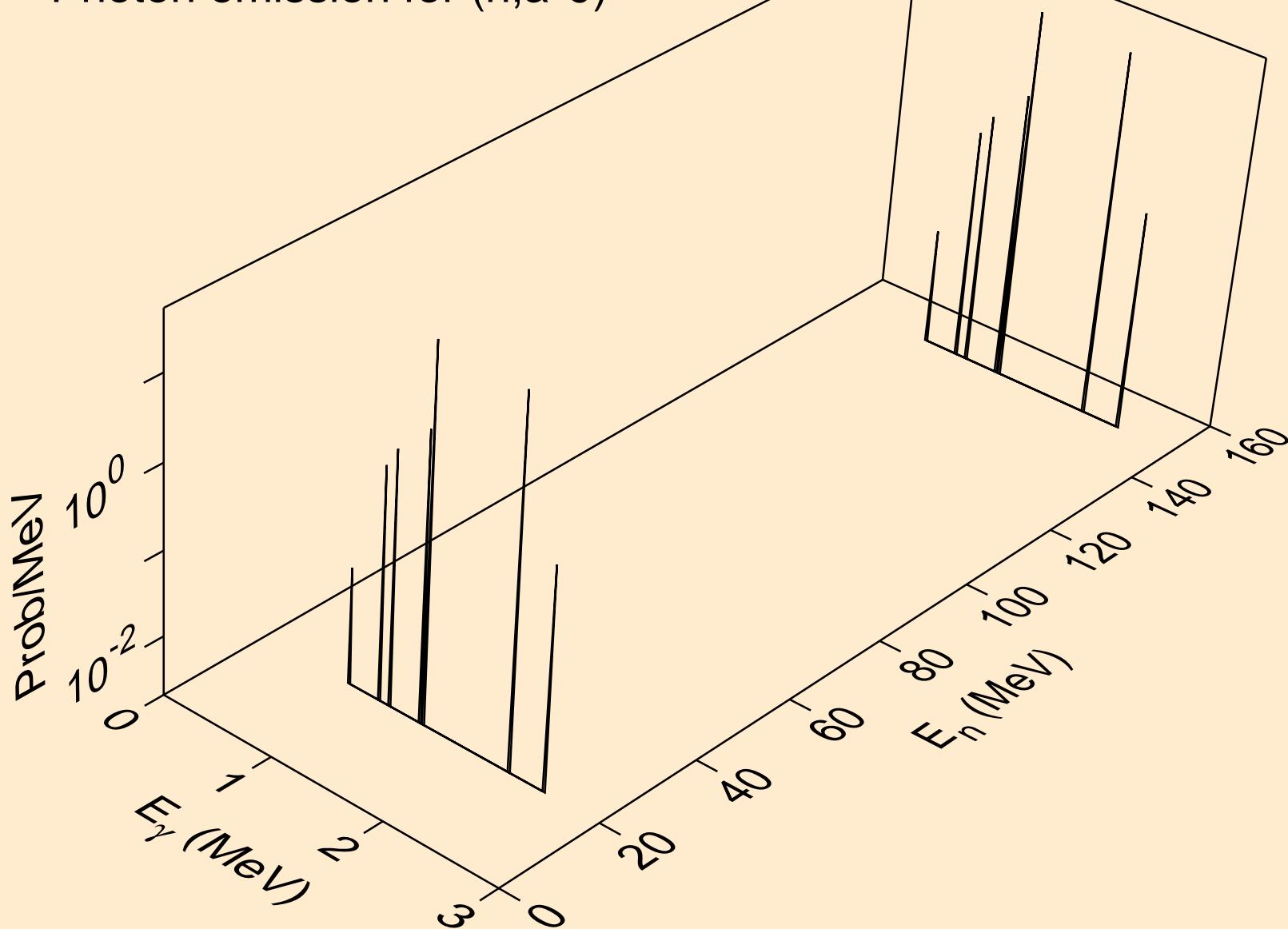

20-CA-43 FOR FENDL-3.2 FROM FENDL-3.2 BY NJOY2016.60+ O
Photon emission for (n,a*10)

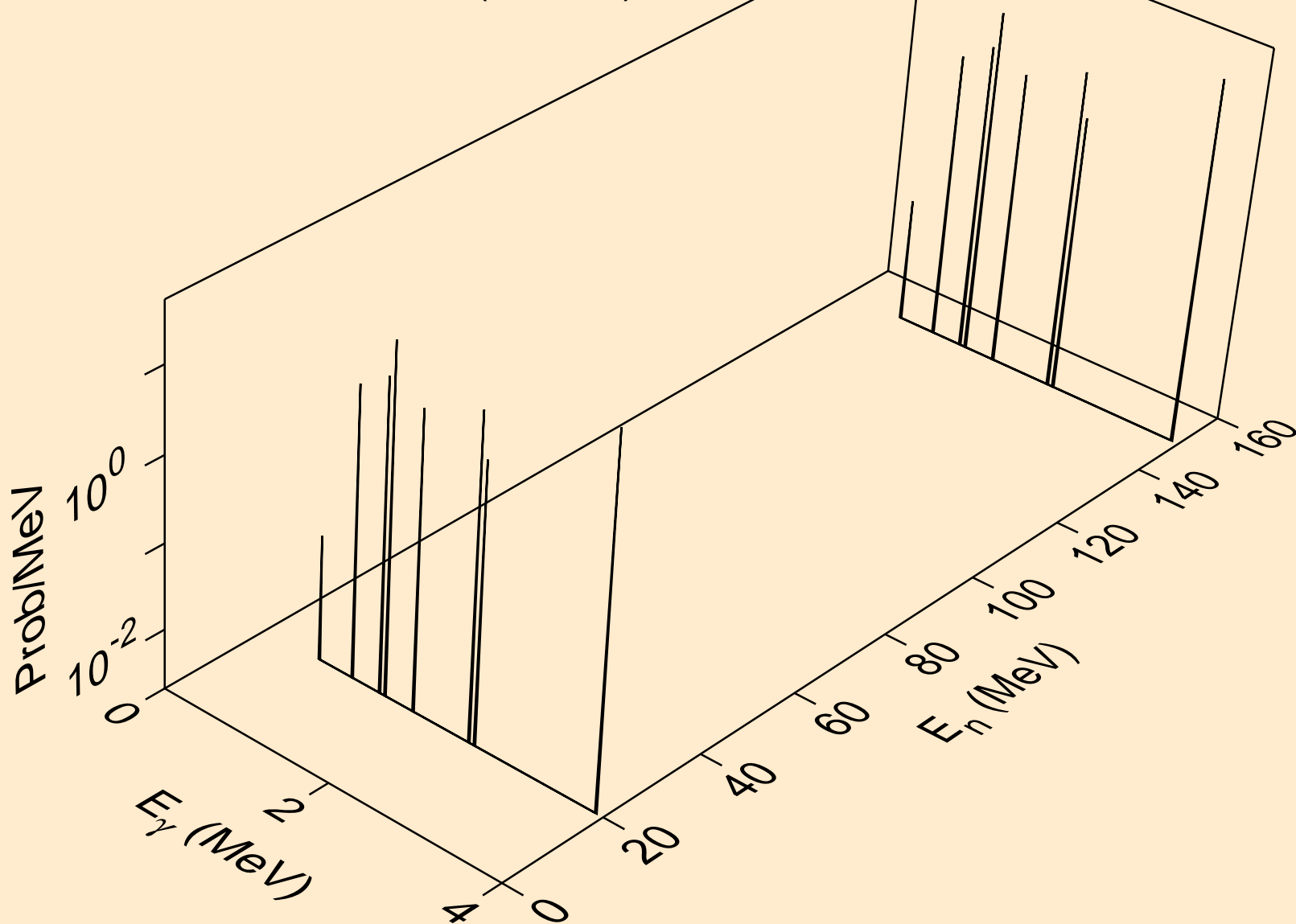

20-CA-43 FOR FENDL-3.2 FROM FENDL-3.2 BY NJOY2016.60+ O
Photon emission for (n,a*11)

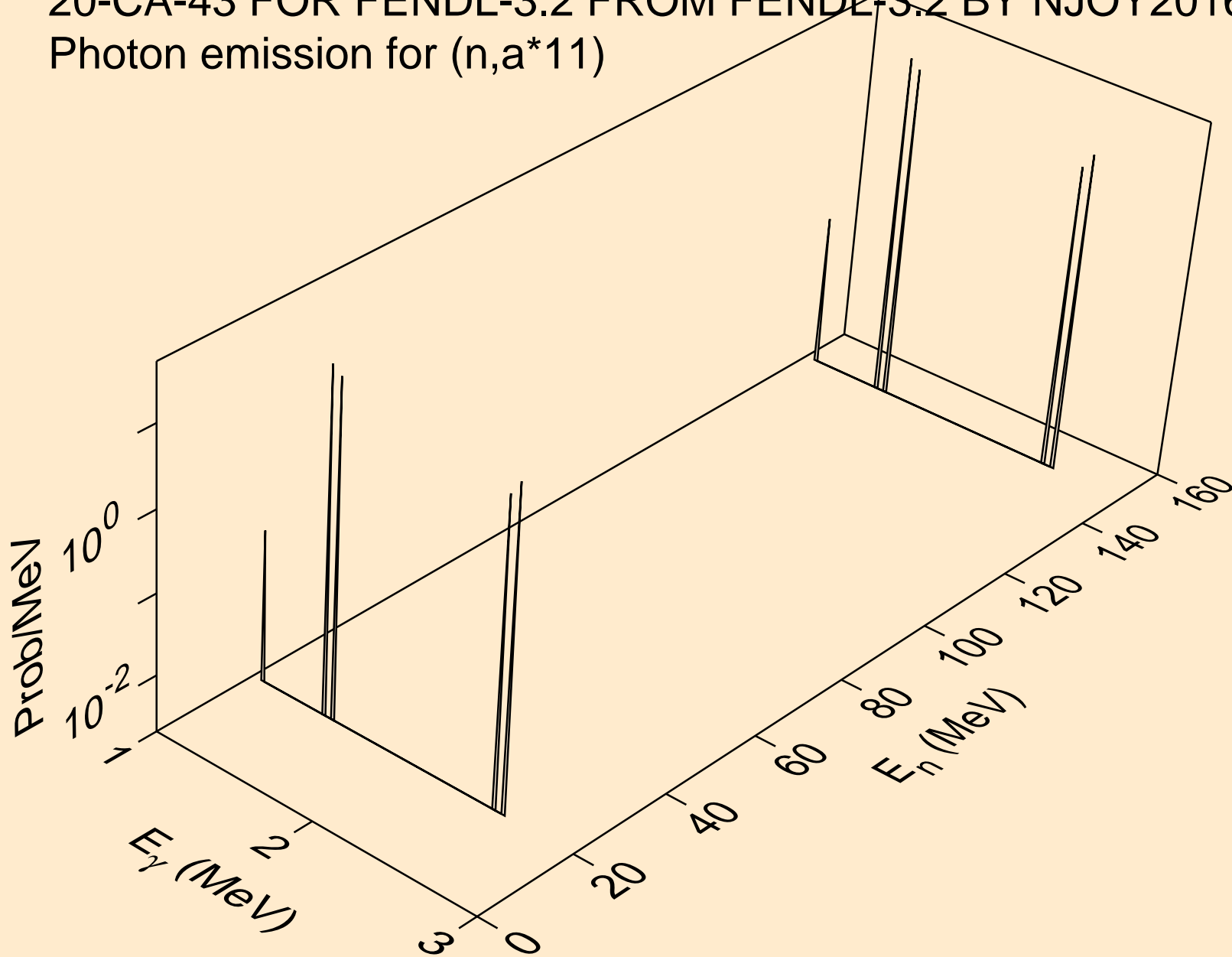

20-CA-43 FOR FENDL-3.2 FROM FENDL-3.2 BY NJOY2016.60+ O
Photon emission for (n,a*12)

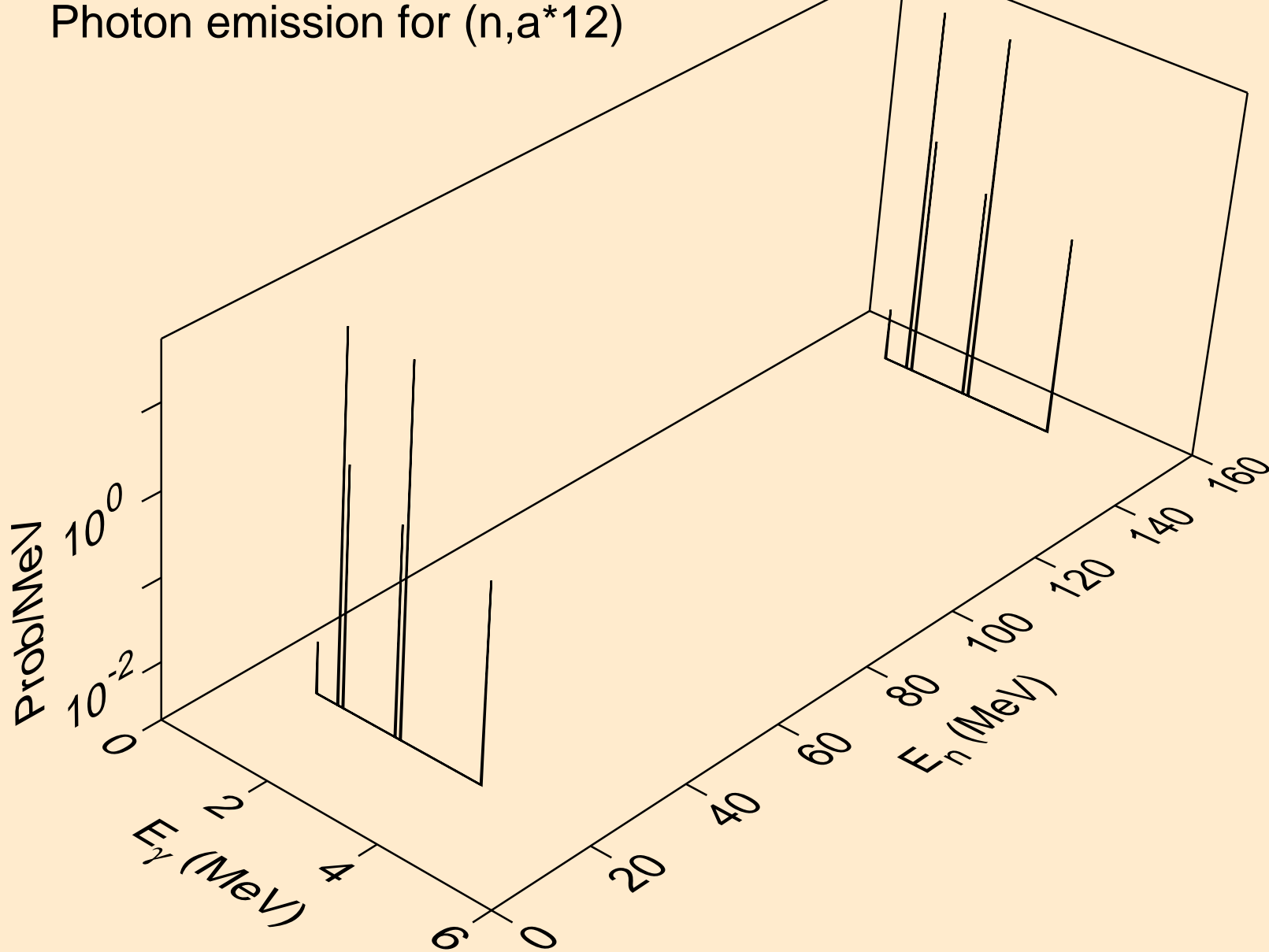

20-CA-43 FOR FENDL-3.2 FROM FENDL-3.2 BY NJOY2016.60+ O
Photon emission for (n,a*13)

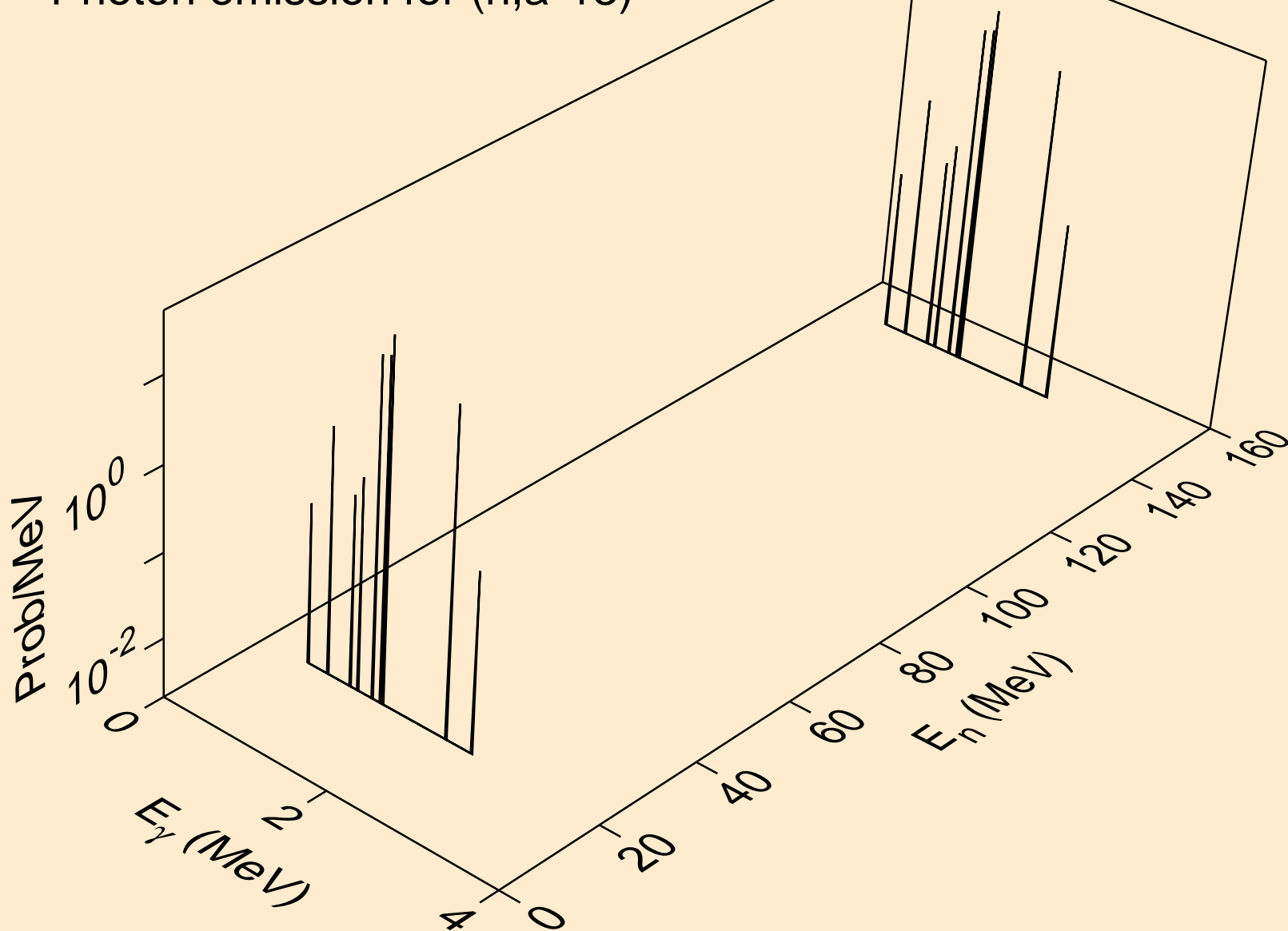

20-CA-43 FOR FENDL-3.2 FROM FENDL-3.2 BY NJOY2016.60+ O
Photon emission for (n,a*14)

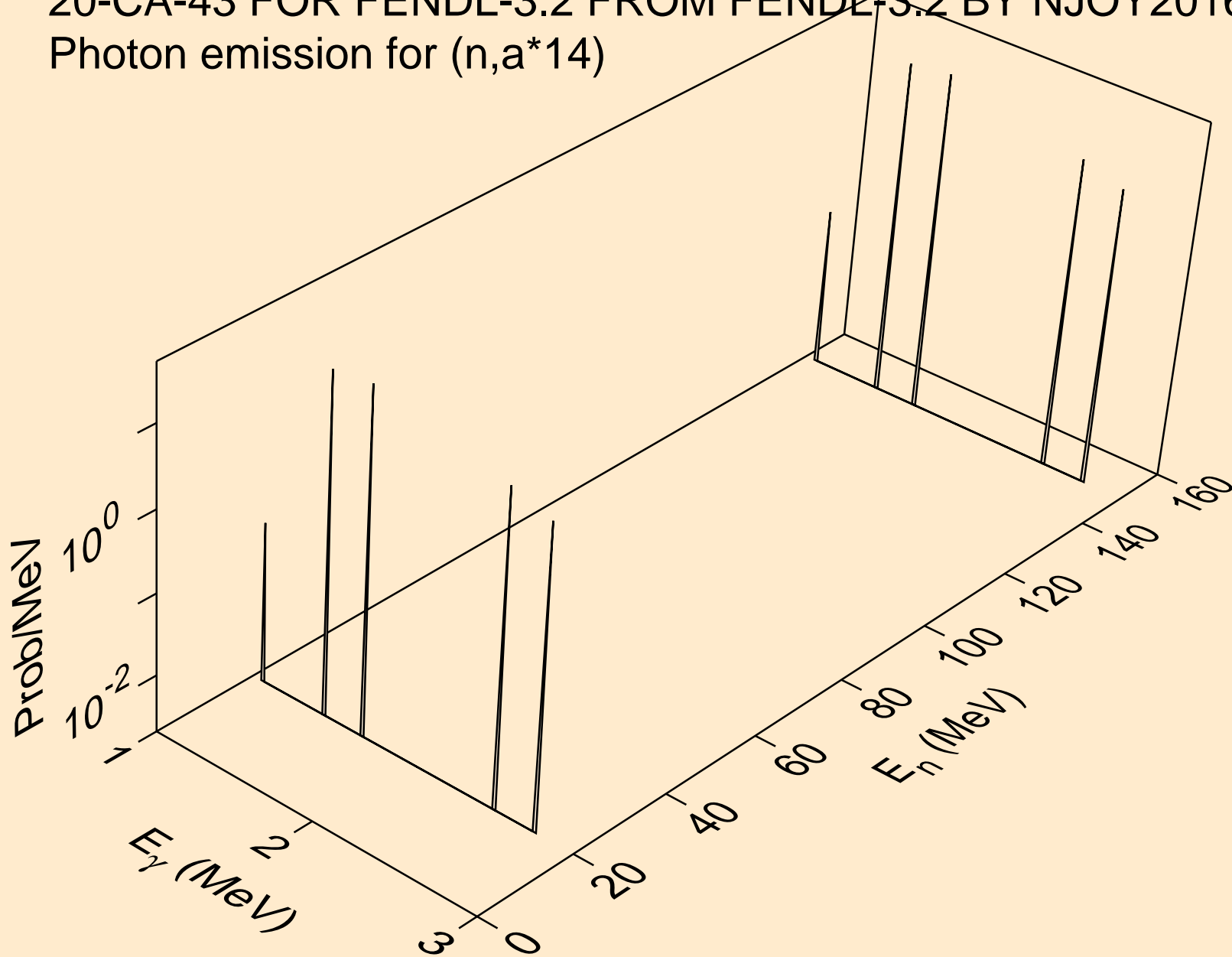

20-CA-43 FOR FENDL-3.2 FROM FENDL-3.2 BY NJOY2016.60+ O
Photon emission for (n,a*15)

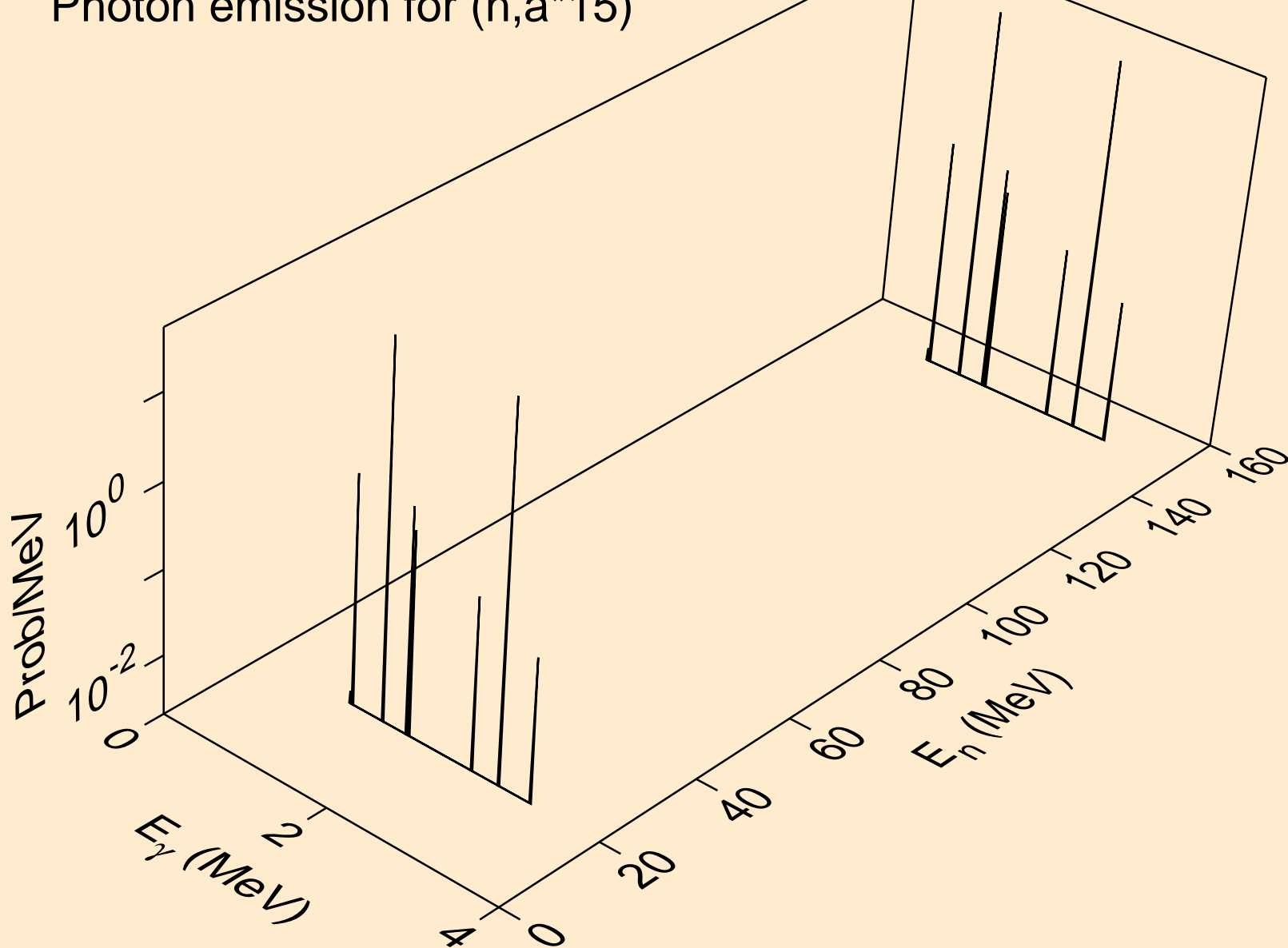

20-CA-43 FOR FENDL-3.2 FROM FENDL-3.2 BY NJOY2016.60+ O
Photon emission for (n,a*16)

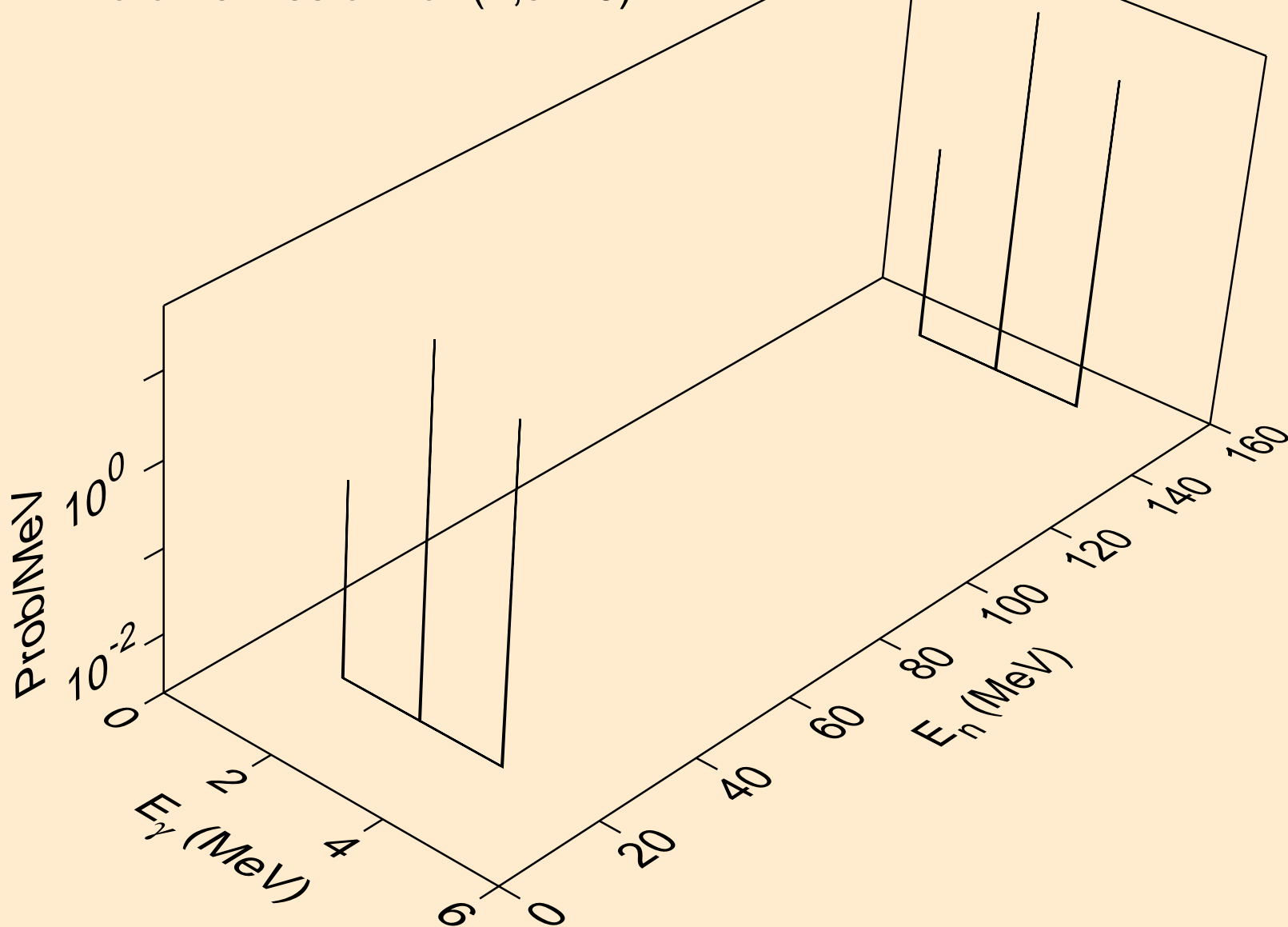

20-CA-43 FOR FENDL-3.2 FROM FENDL-3.2 BY NJOY2016.60+ O
Photon emission for (n,a*17)

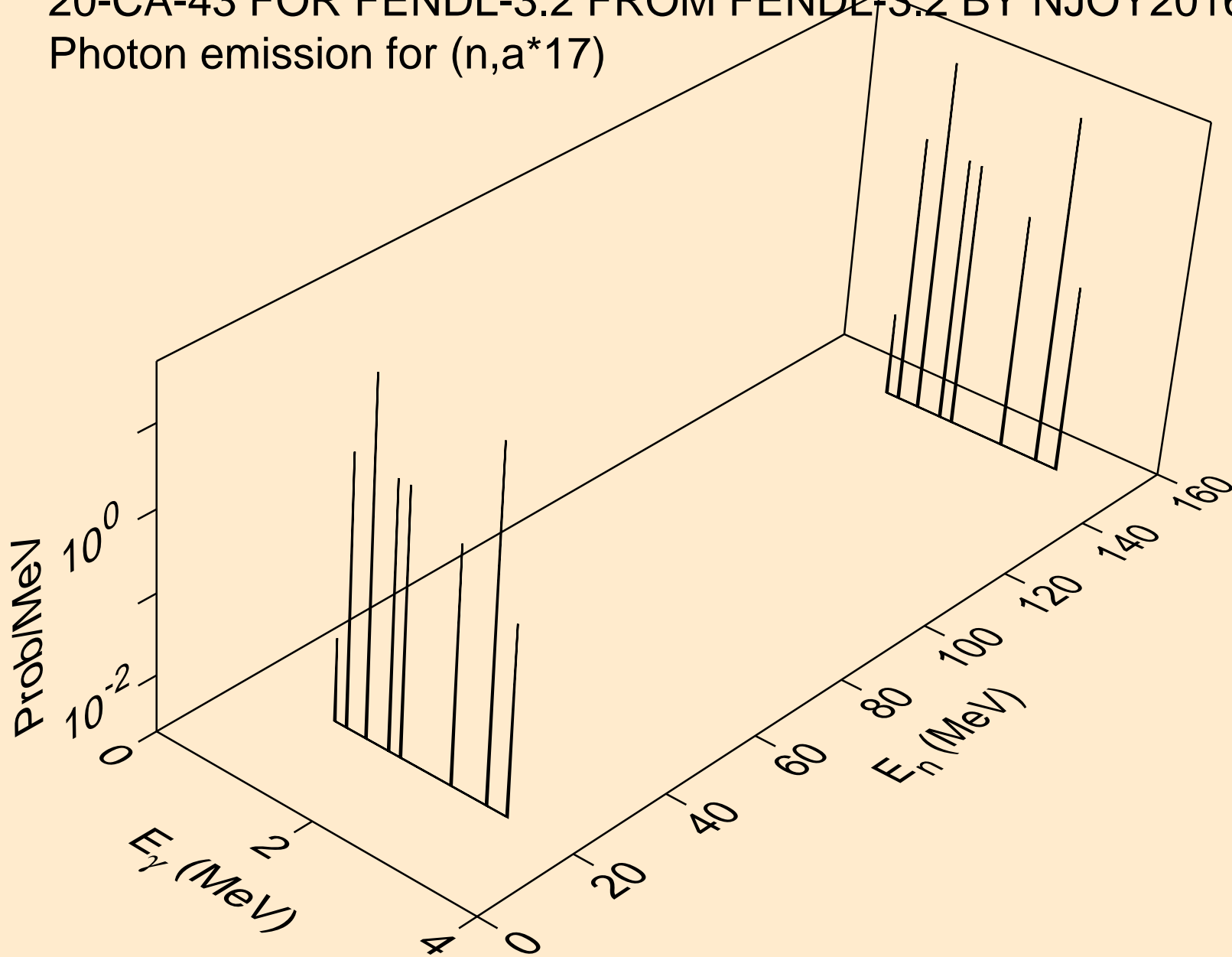

20-CA-43 FOR FENDL-3.2 FROM FENDL-3.2 BY NJOY2016.60+ O
Photon emission for (n,a*18)

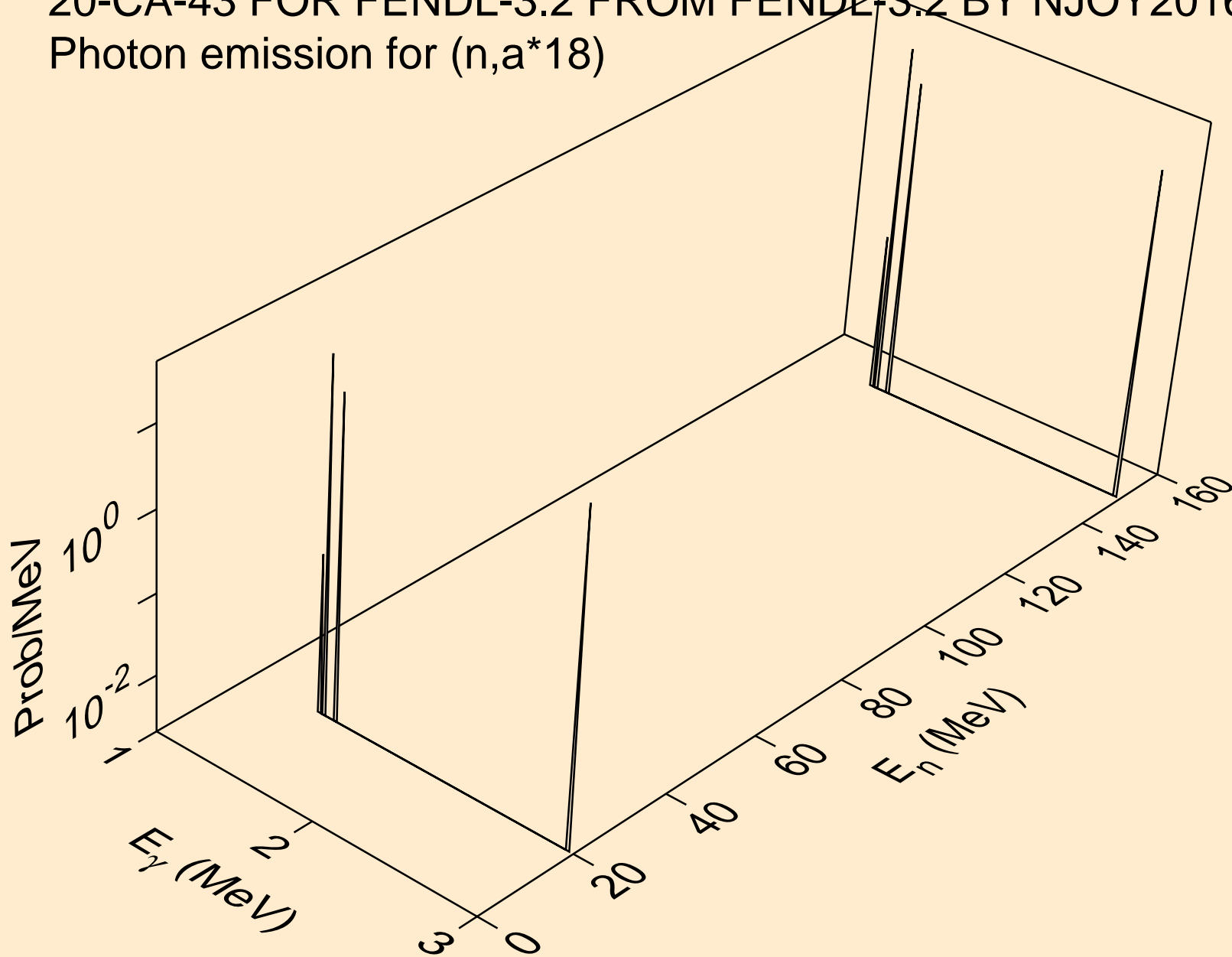

20-CA-43 FOR FENDL-3.2 FROM FENDL-3.2 BY NJOY2016.60+ O
Photon emission for (n,a*19)

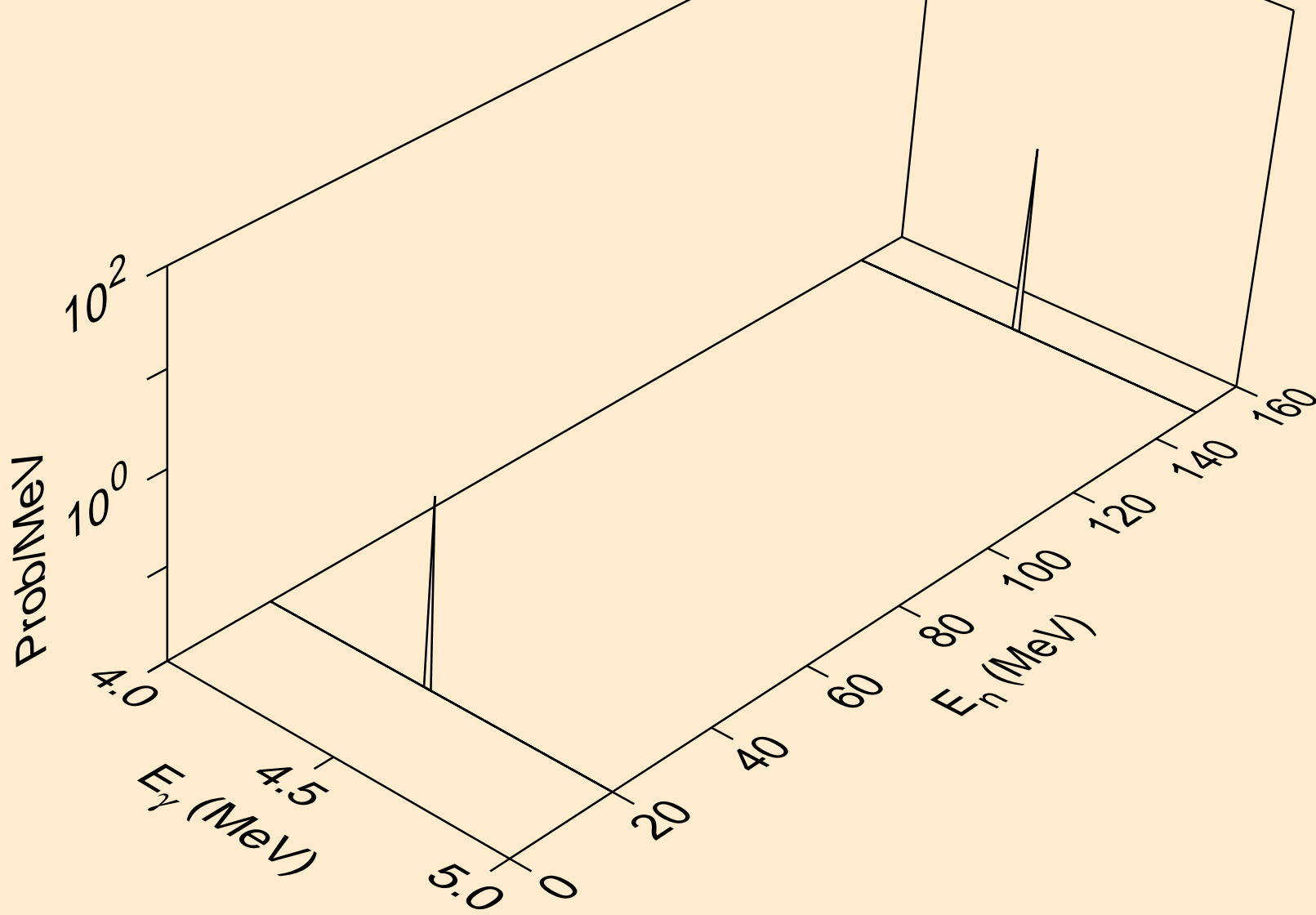

20-CA-43 FOR FENDL-3.2 FROM FENDL-3.2 BY NJOY2016.60+ O
Photon emission for (n,a*20)

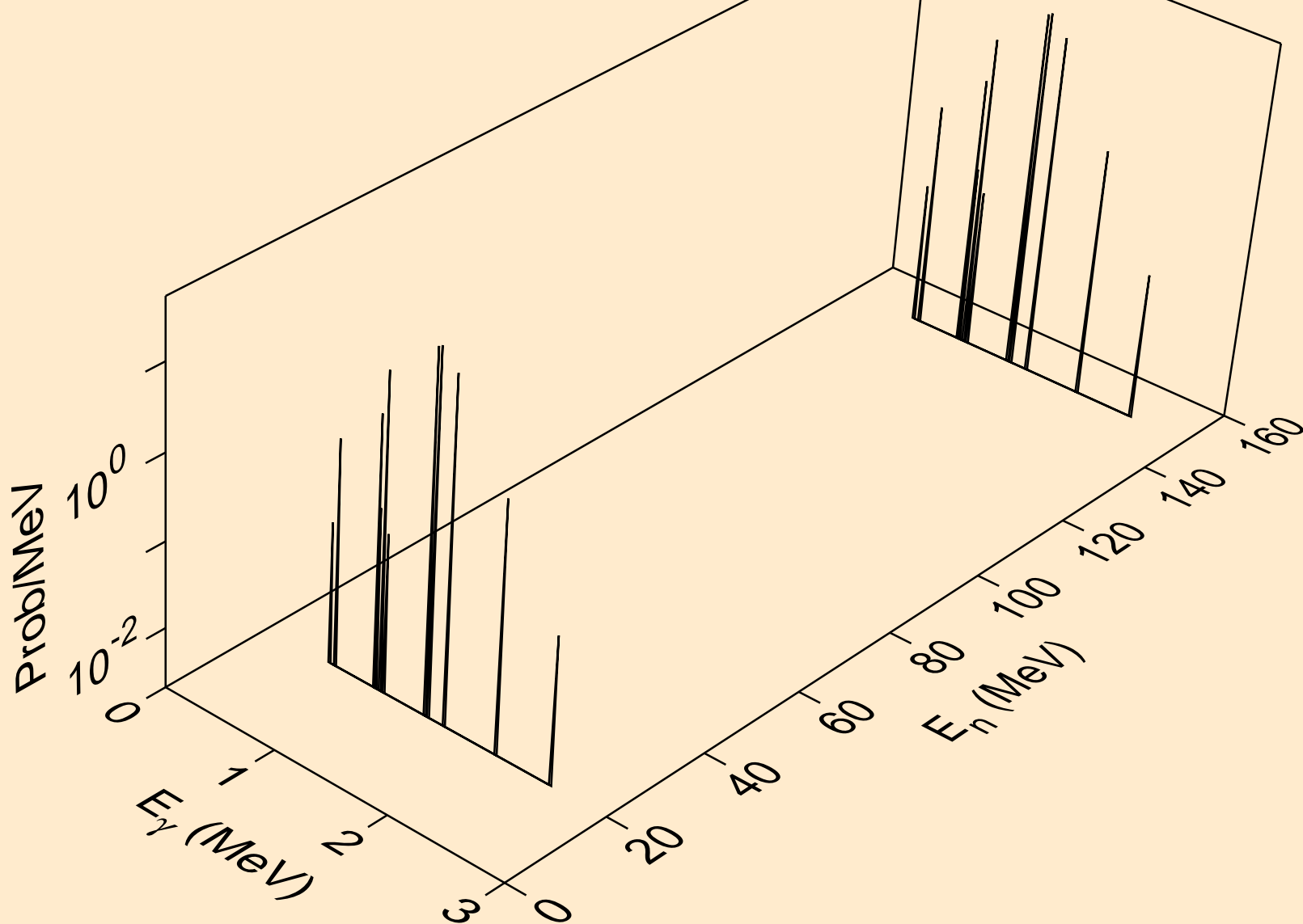

20-CA-43 FOR FENDL-3.2 FROM FENDL-3.2 BY NJOY2016.60+ O
Photon emission for (n,a*21)

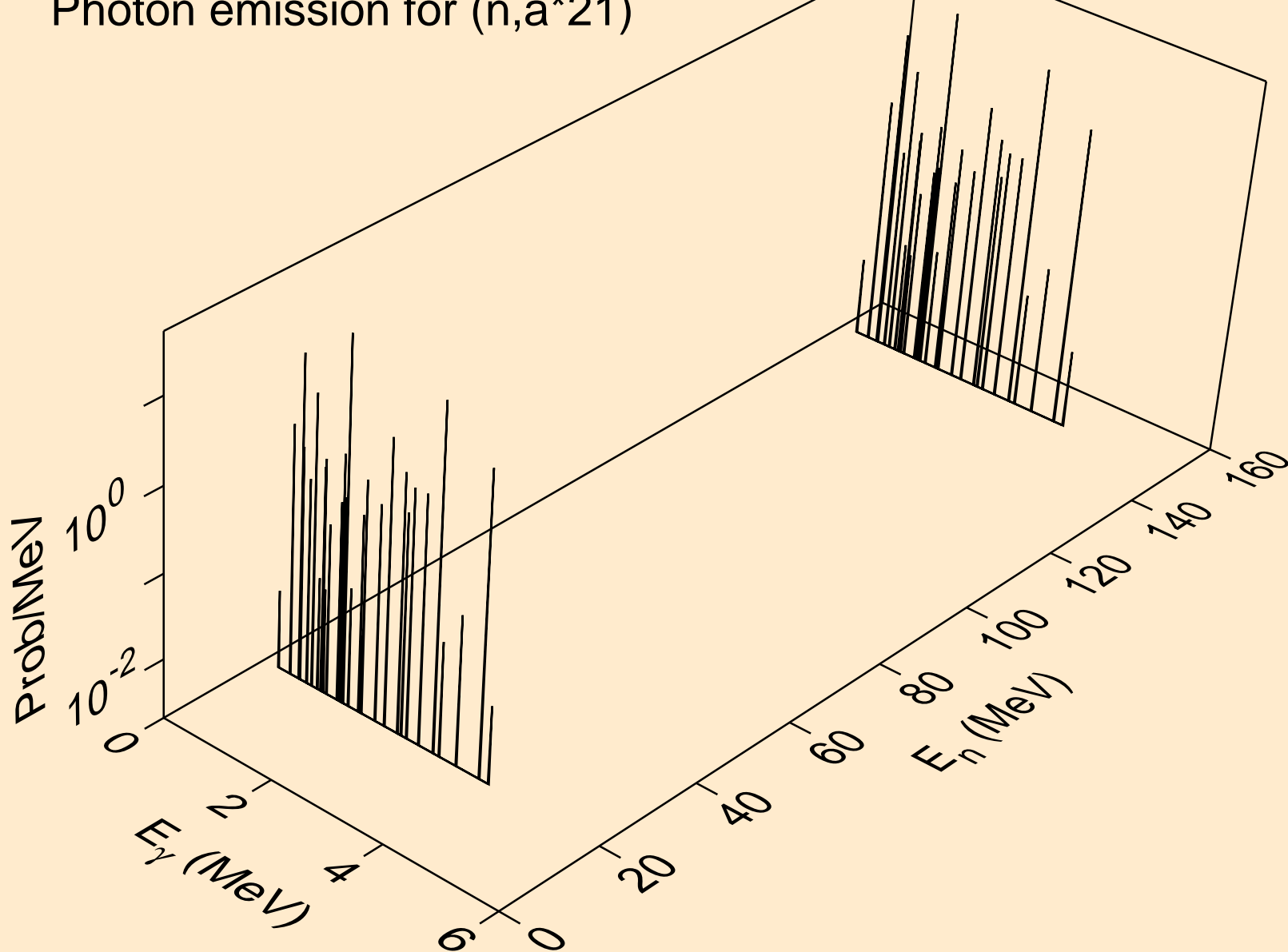

20-CA-43 FOR FENDL-3.2 FROM FENDL-3.2 BY NJOY2016.60+ O
Photon emission for (n,a*22)

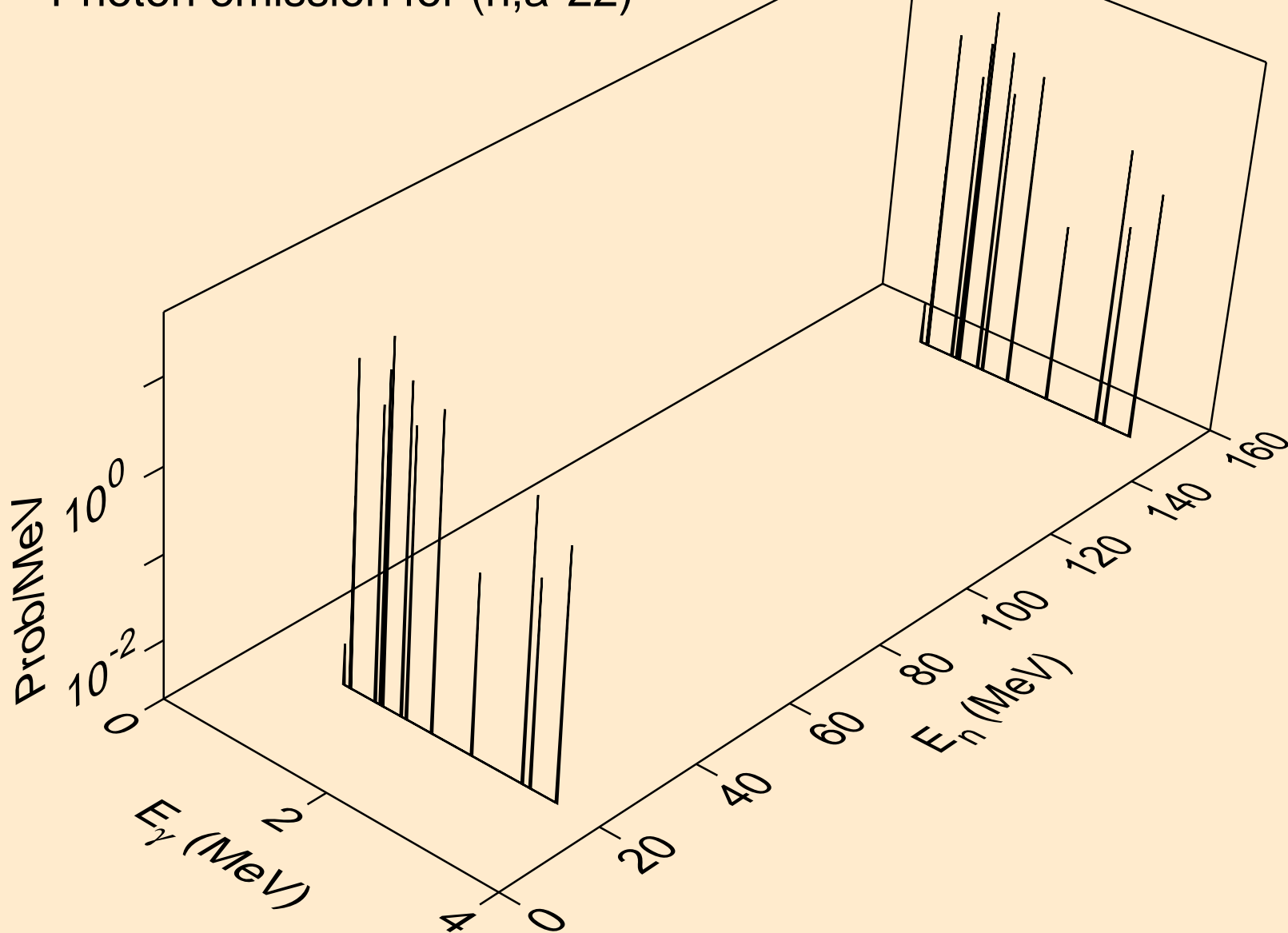

20-CA-43 FOR FENDL-3.2 FROM FENDL-3.2 BY NJOY2016.60+ O
Photon emission for (n,a*23)

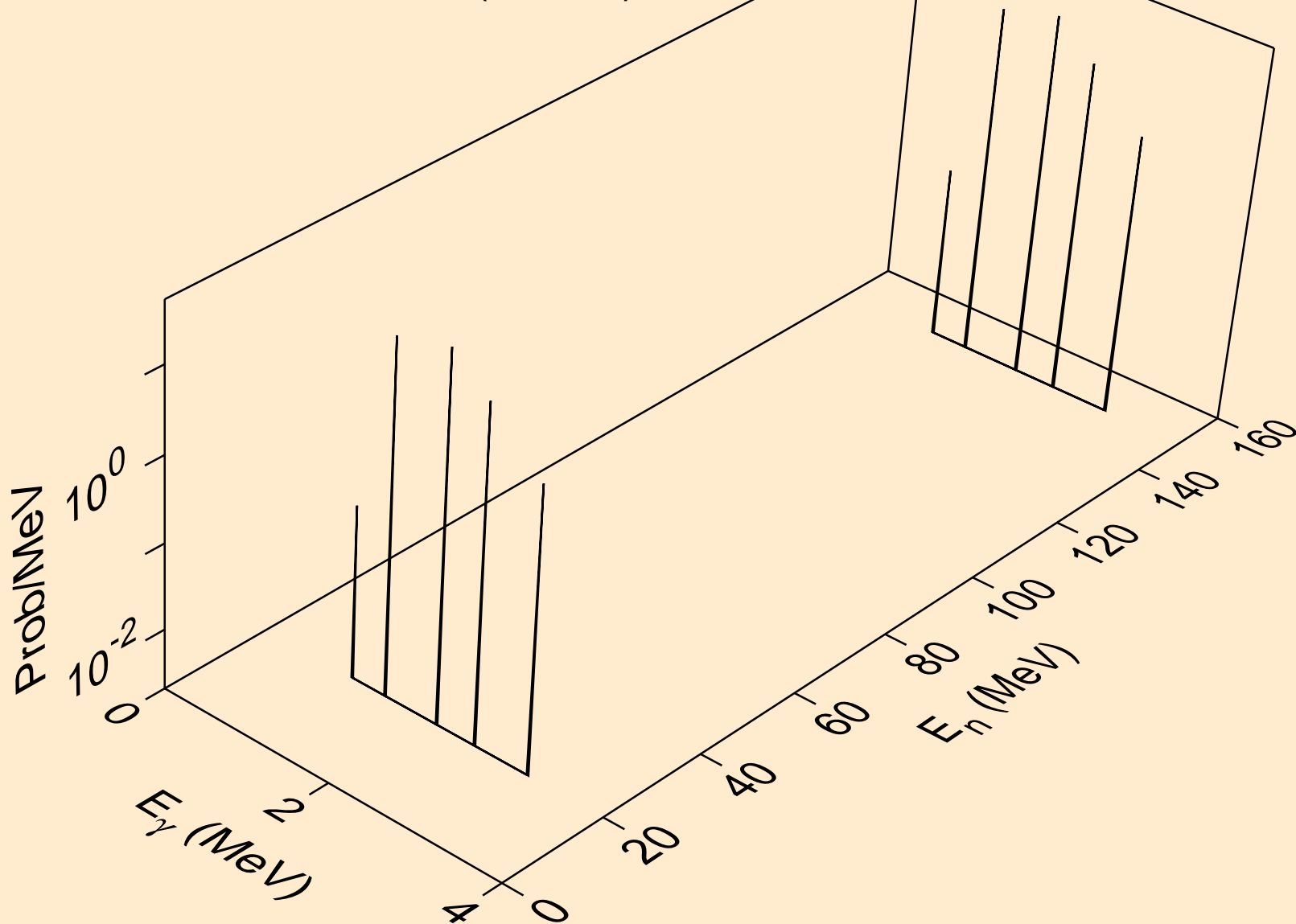

20-CA-43 FOR FENDL-3.2 FROM FENDL-3.2 BY NJOY2016.60+ O
Photon emission for (n,a*24)

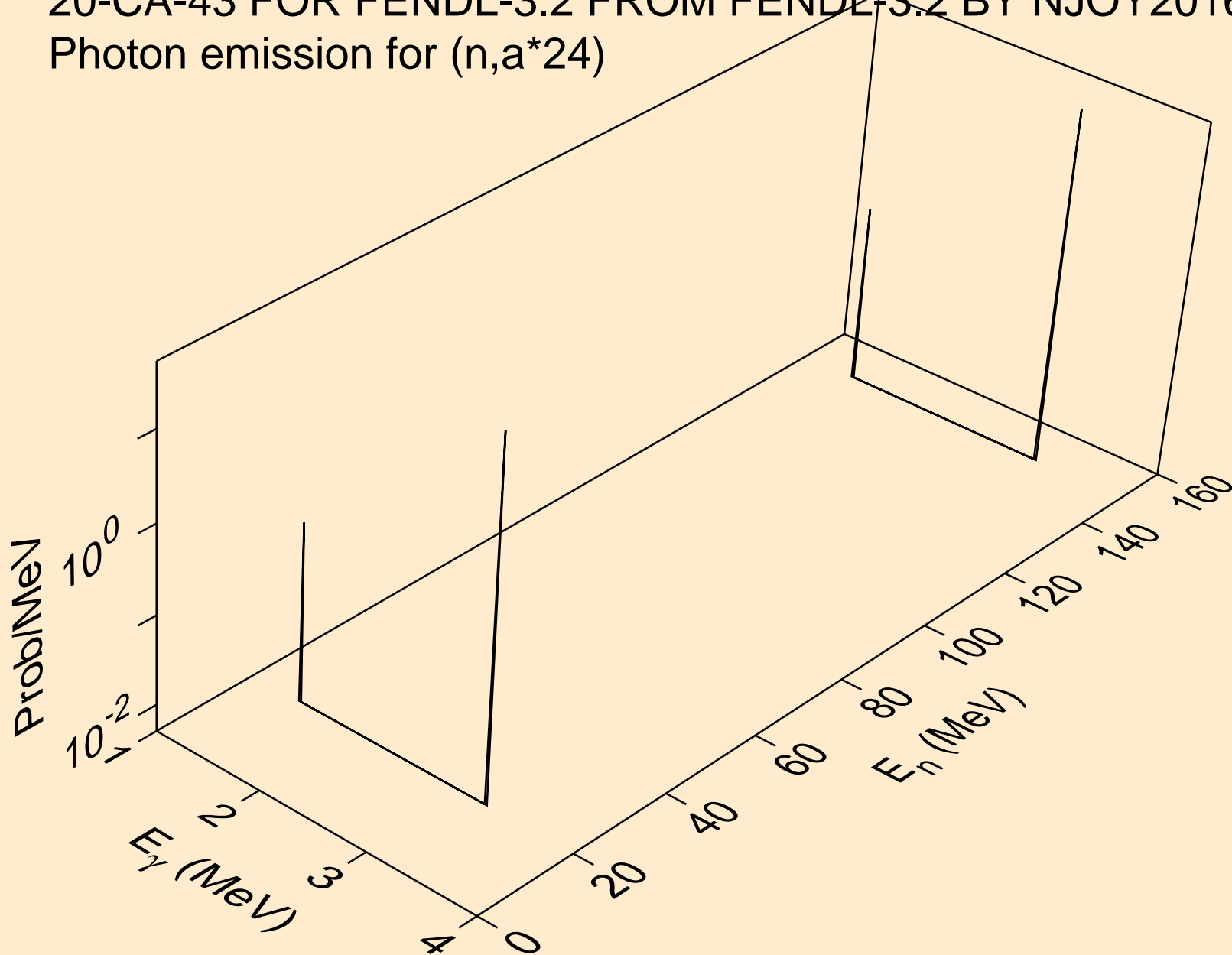

20-CA-43 FOR FENDL-3.2 FROM FENDL-3.2 BY NJOY2016.60+ O
Photon emission for (n,a*25)

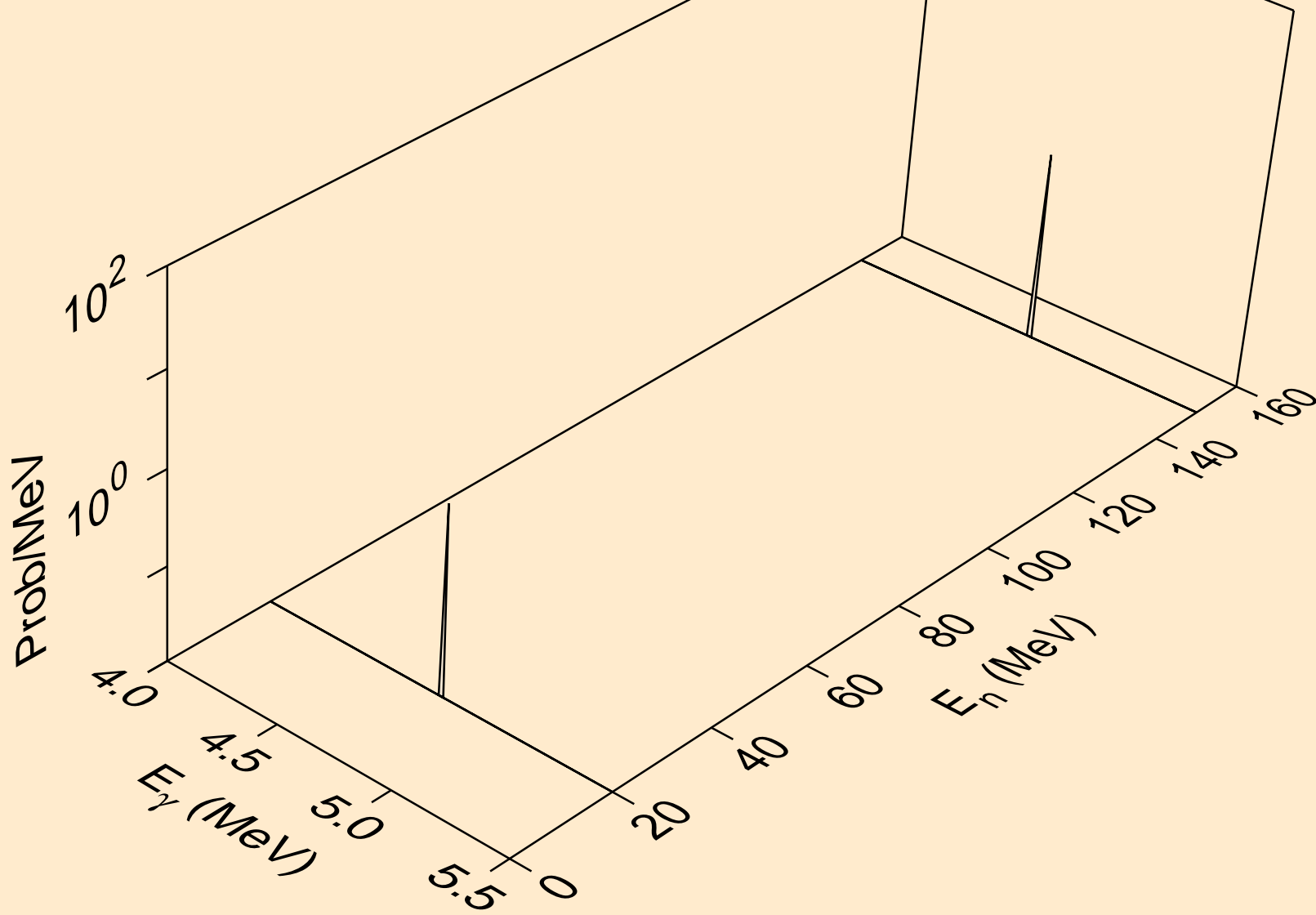

20-CA-43 FOR FENDL-3.2 FROM FENDL-3.2 BY NJOY2016.60+ O
Photon emission for (n,a*26)

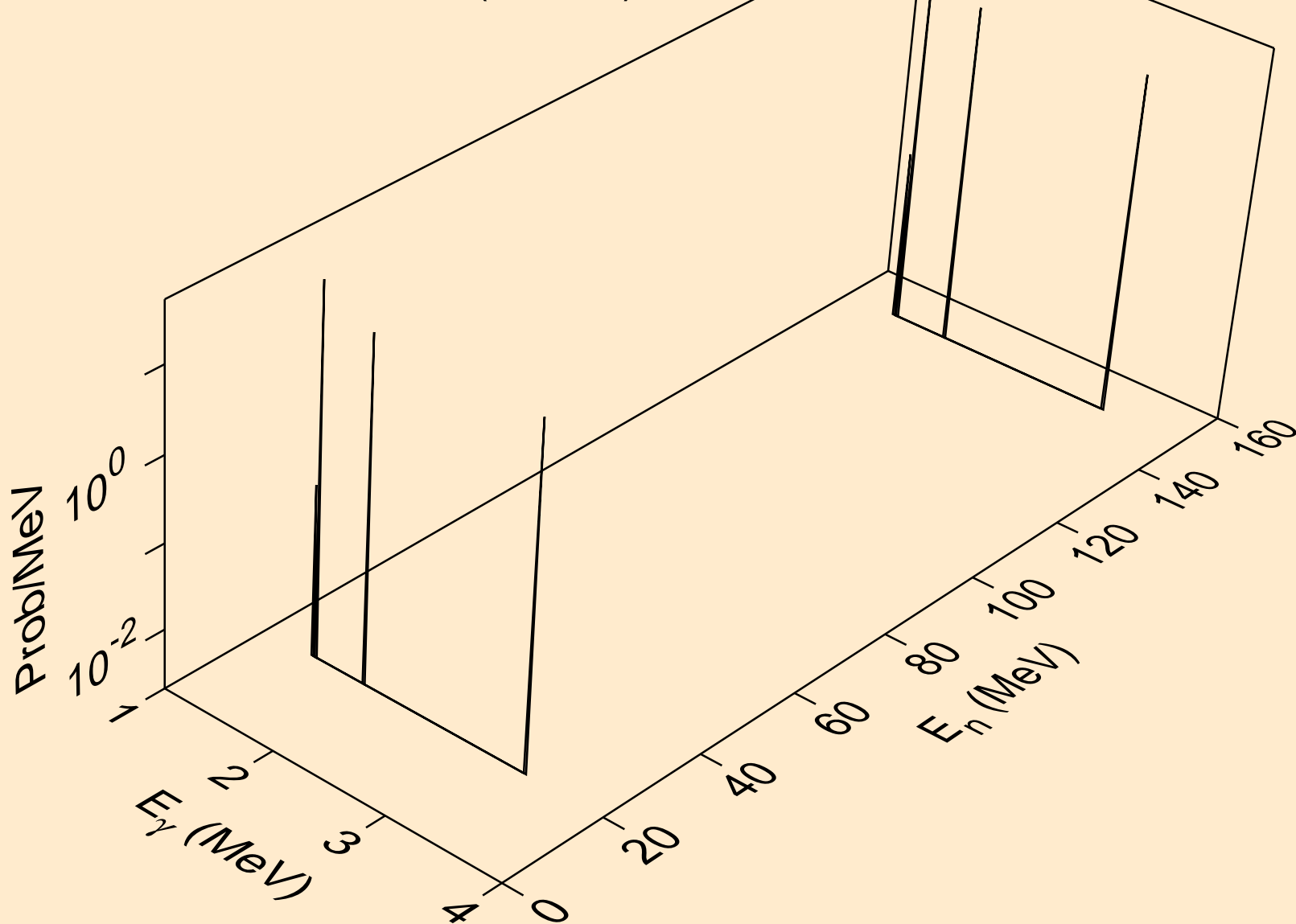

20-CA-43 FOR FENDL-3.2 FROM FENDL-3.2 BY NJOY2016.60+ O
Photon emission for (n,a*27)

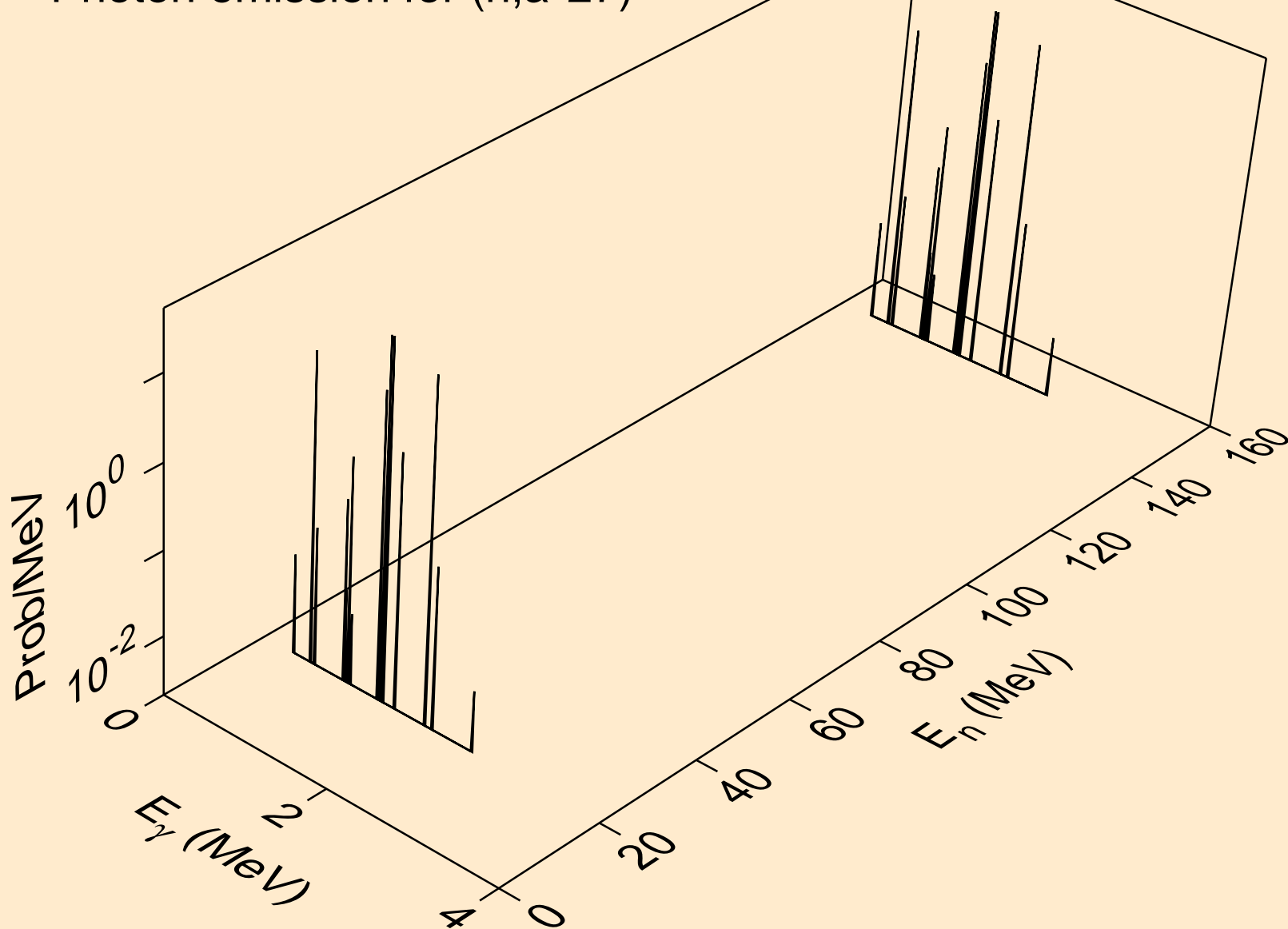

20-CA-43 FOR FENDL-3.2 FROM FENDL-3.2 BY NJOY2016.60+ O
Photon emission for (n,a*28)

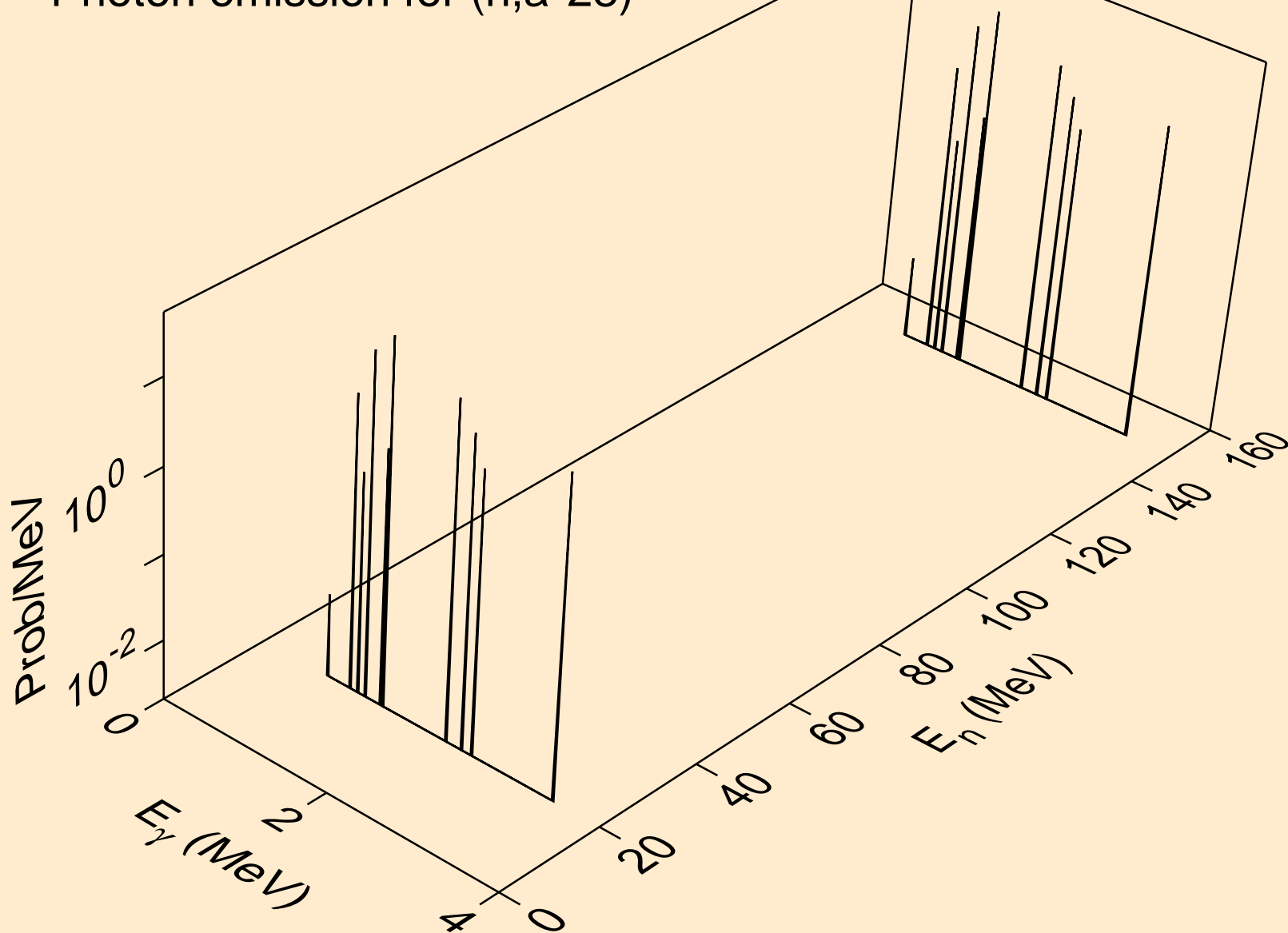

20-CA-43 FOR FENDL-3.2 FROM FENDL-3.2 BY NJOY2016.60+ O
Photon emission for (n,a*29)

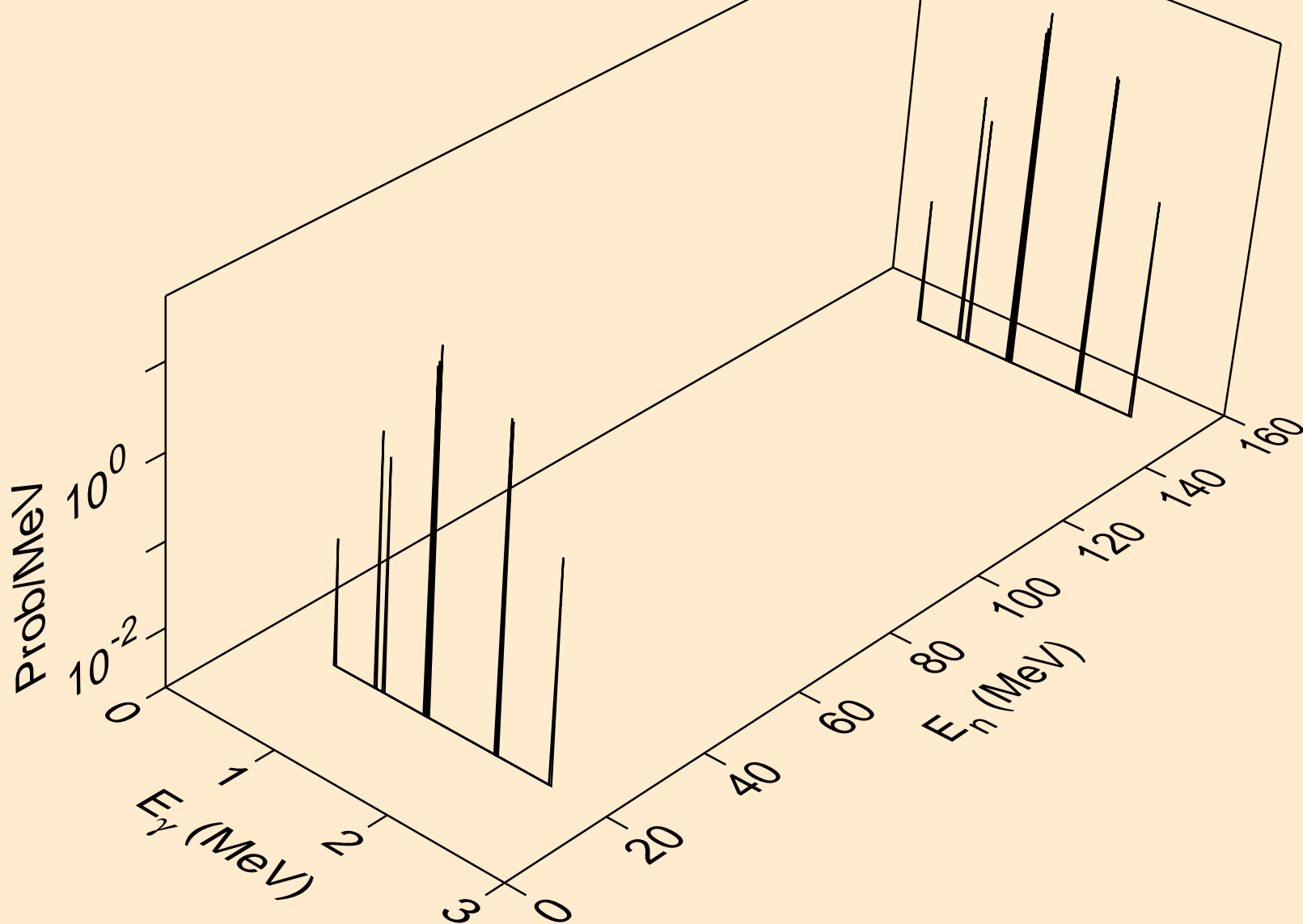

20-CA-43 FOR FENDL-3.2 FROM FENDL-3.2 BY NJOY2016.60+ O
Photon emission for (n,a*30)

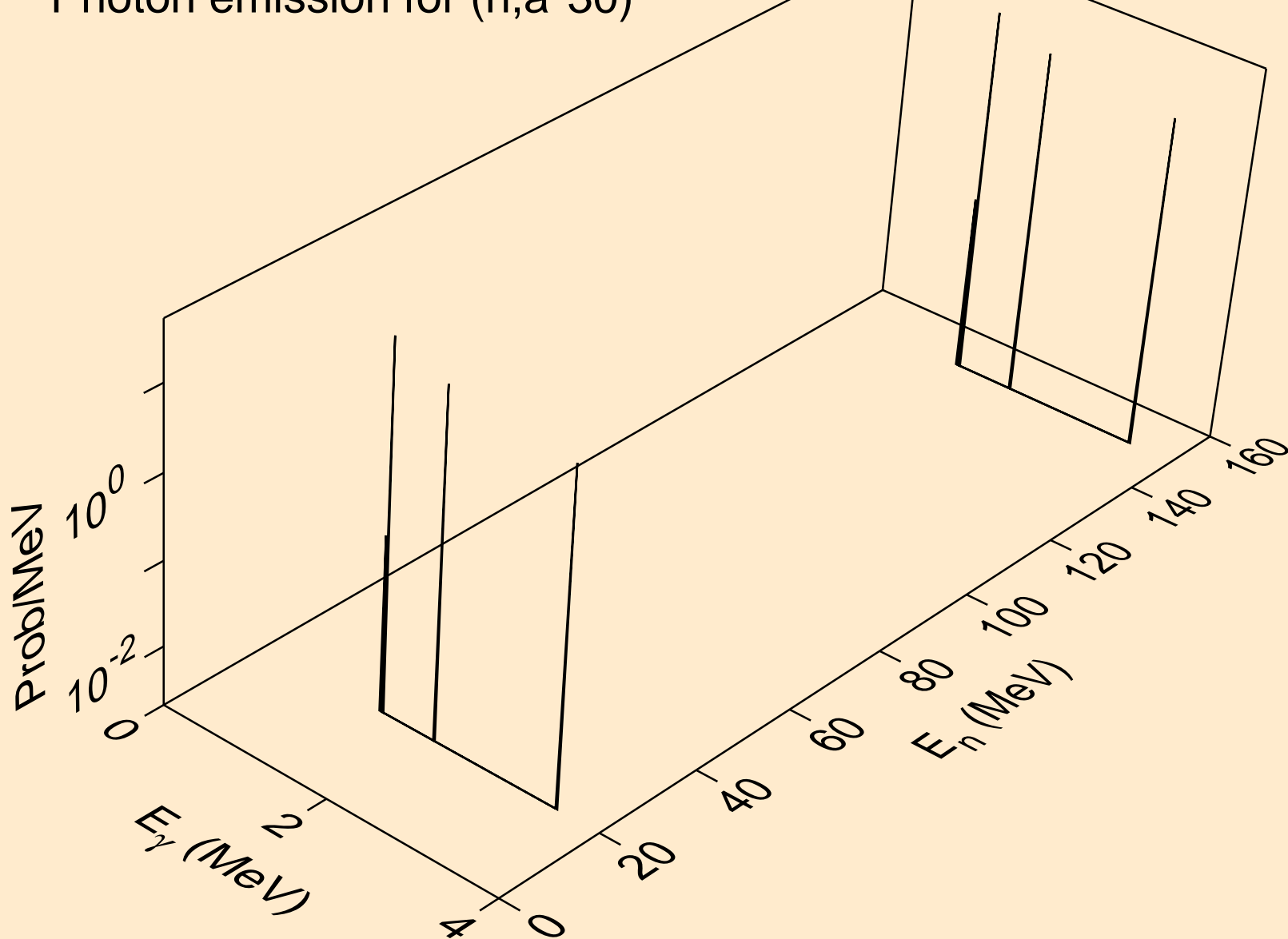

20-CA-43 FOR FENDL-3.2 FROM FENDL-3.2 BY NJOY2016.60+ O
Photon emission for (n,a*31)

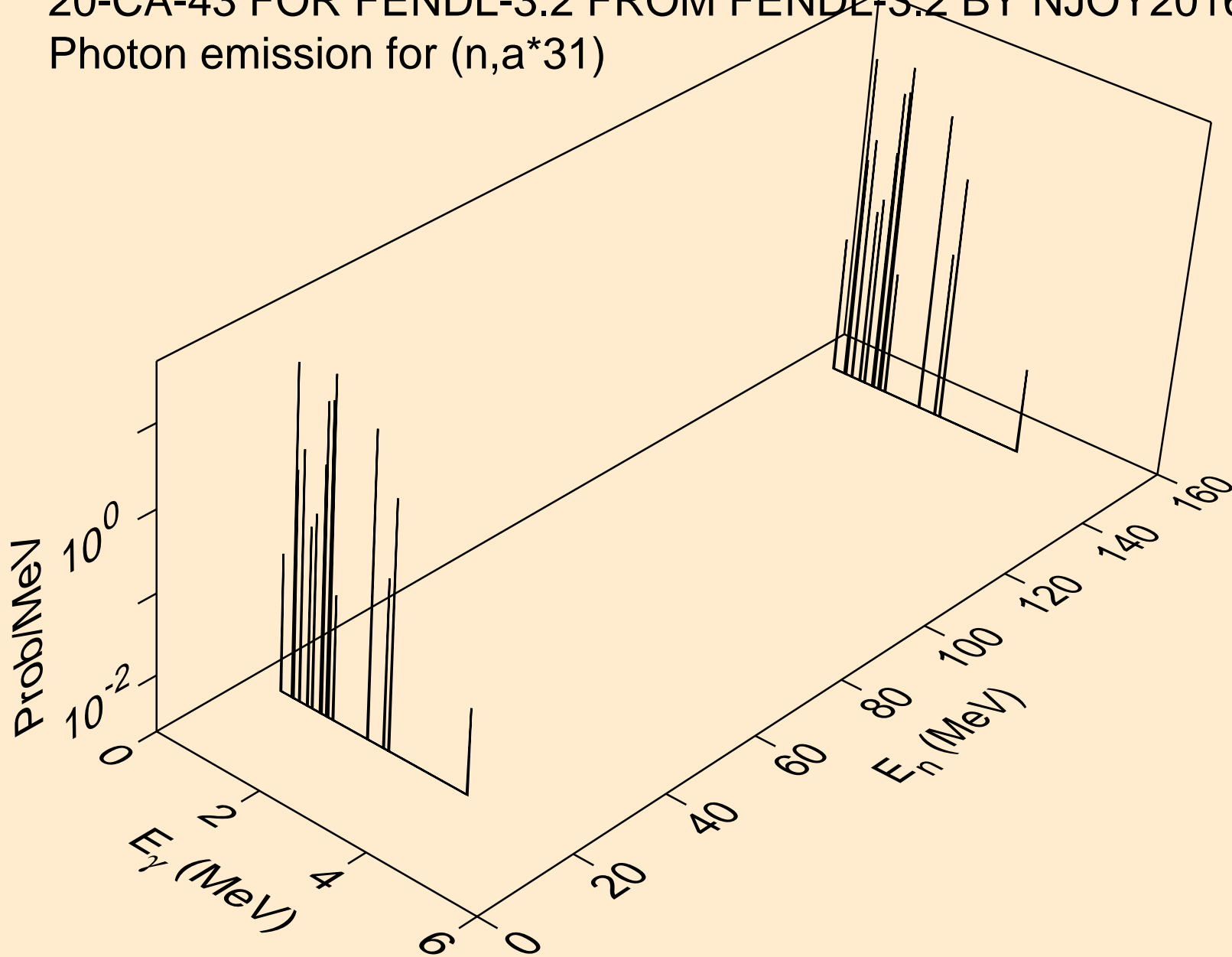

20-CA-43 FOR FENDL-3.2 FROM FENDL-3.2 BY NJOY2016.60+ O
Photon emission for (n,a*32)

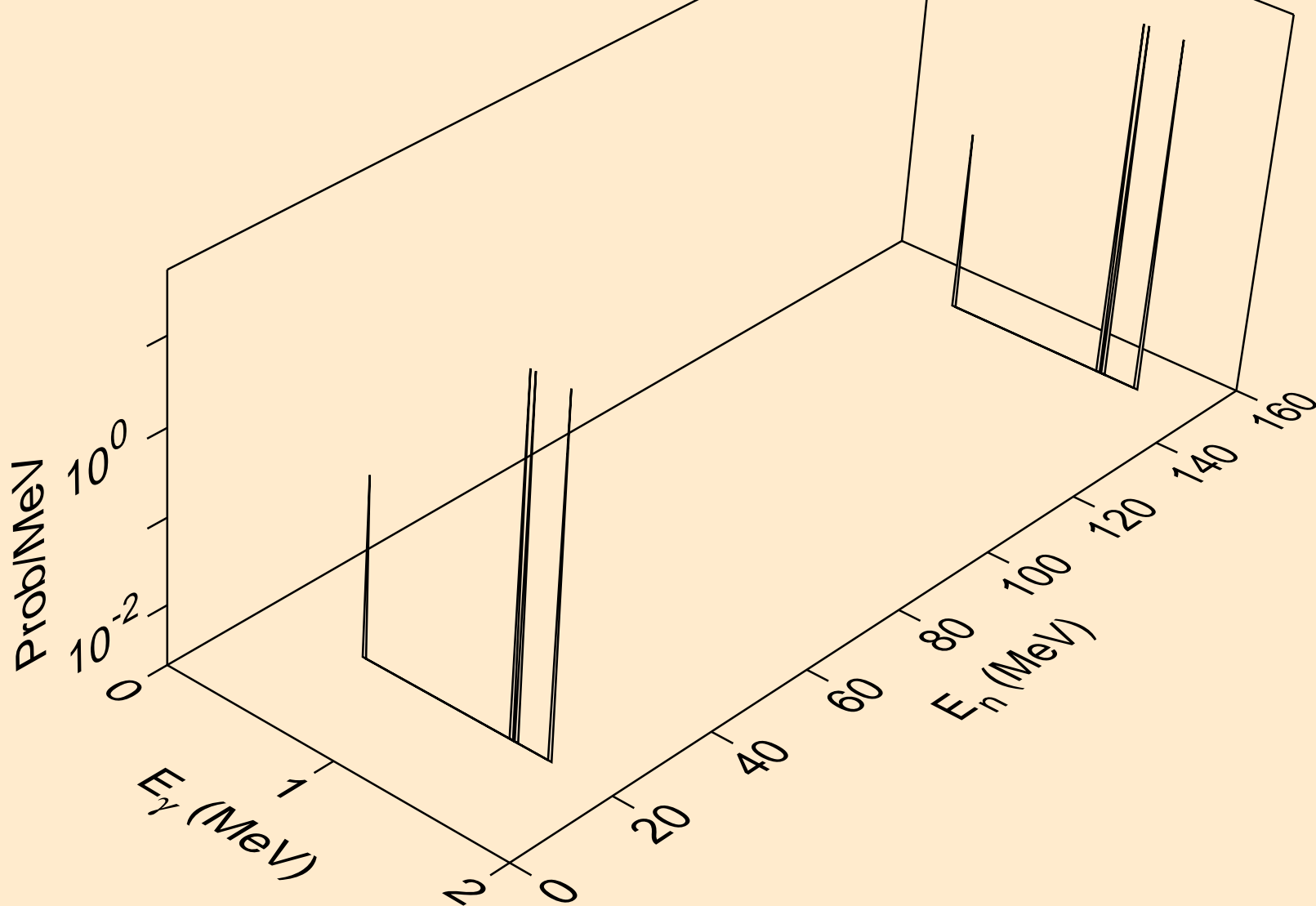

20-CA-43 FOR FENDL-3.2 FROM FENDL-3.2 BY NJOY2016.60+ O
Photon emission for (n,a*33)

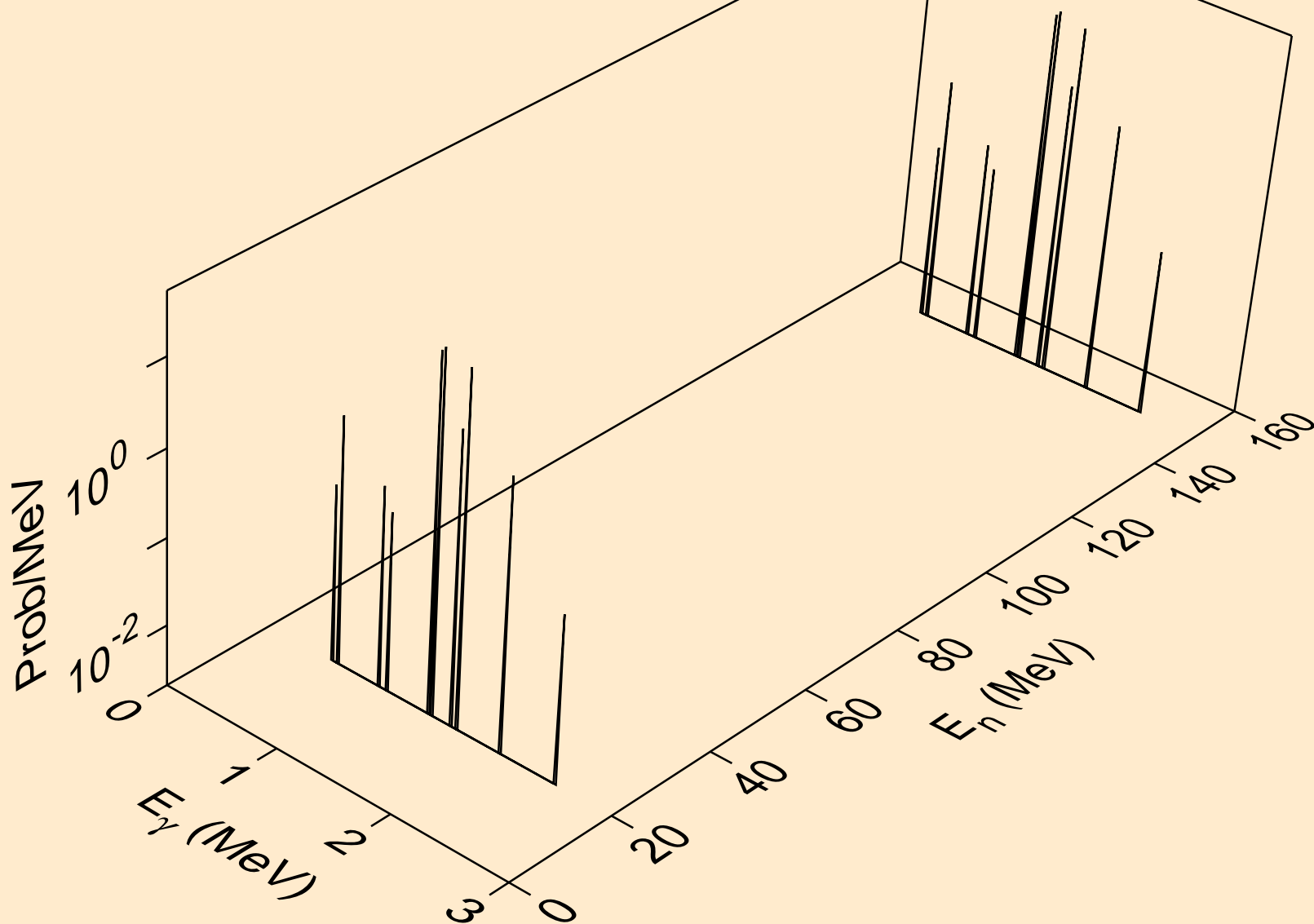

20-CA-43 FOR FENDL-3.2 FROM FENDL-3.2 BY NJOY2016.60+ O
Photon emission for (n,a*34)

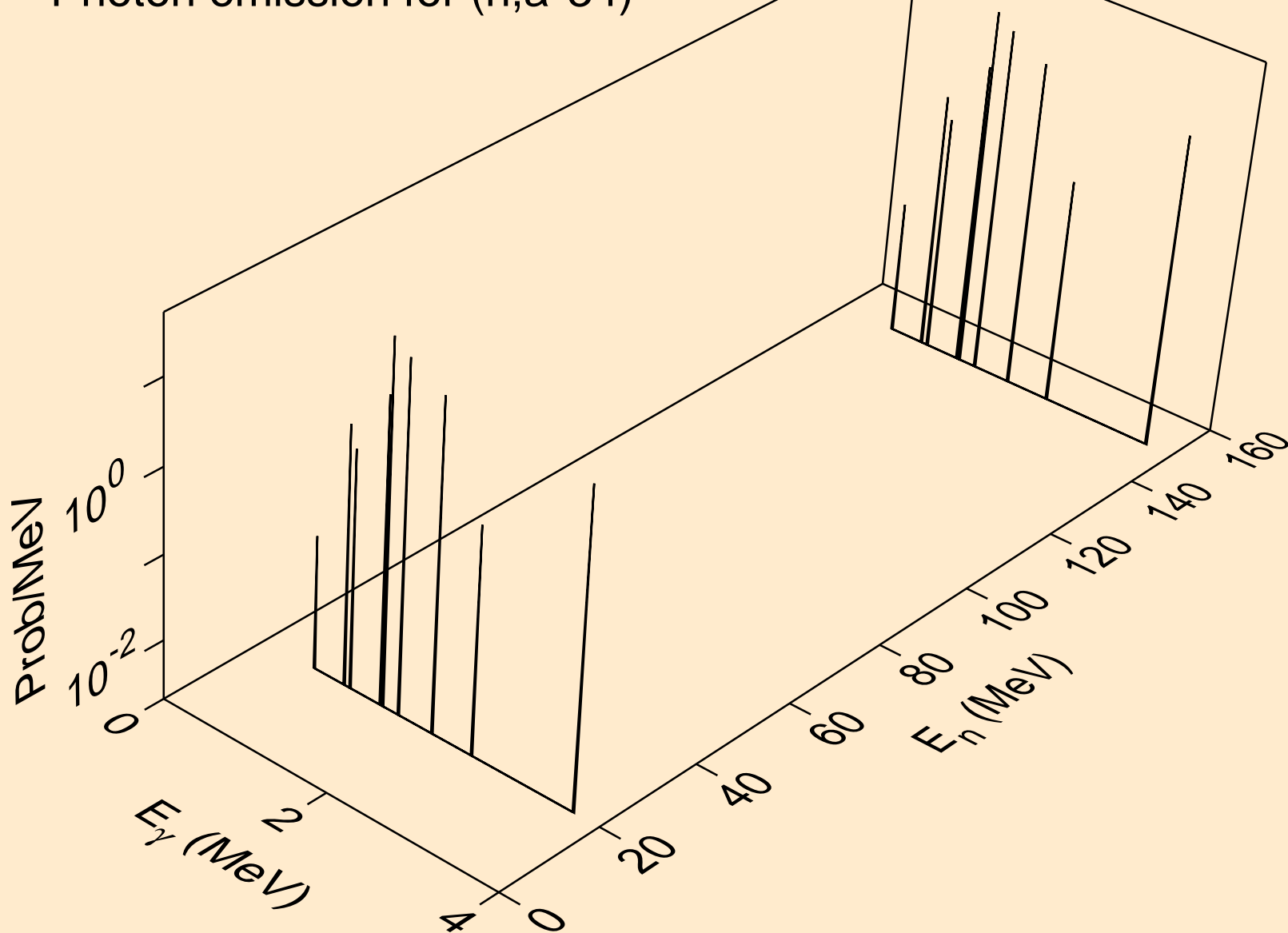

20-CA-43 FOR FENDL-3.2 FROM FENDL-3.2 BY NJOY2016.60+ O
Photon emission for (n,a*35)

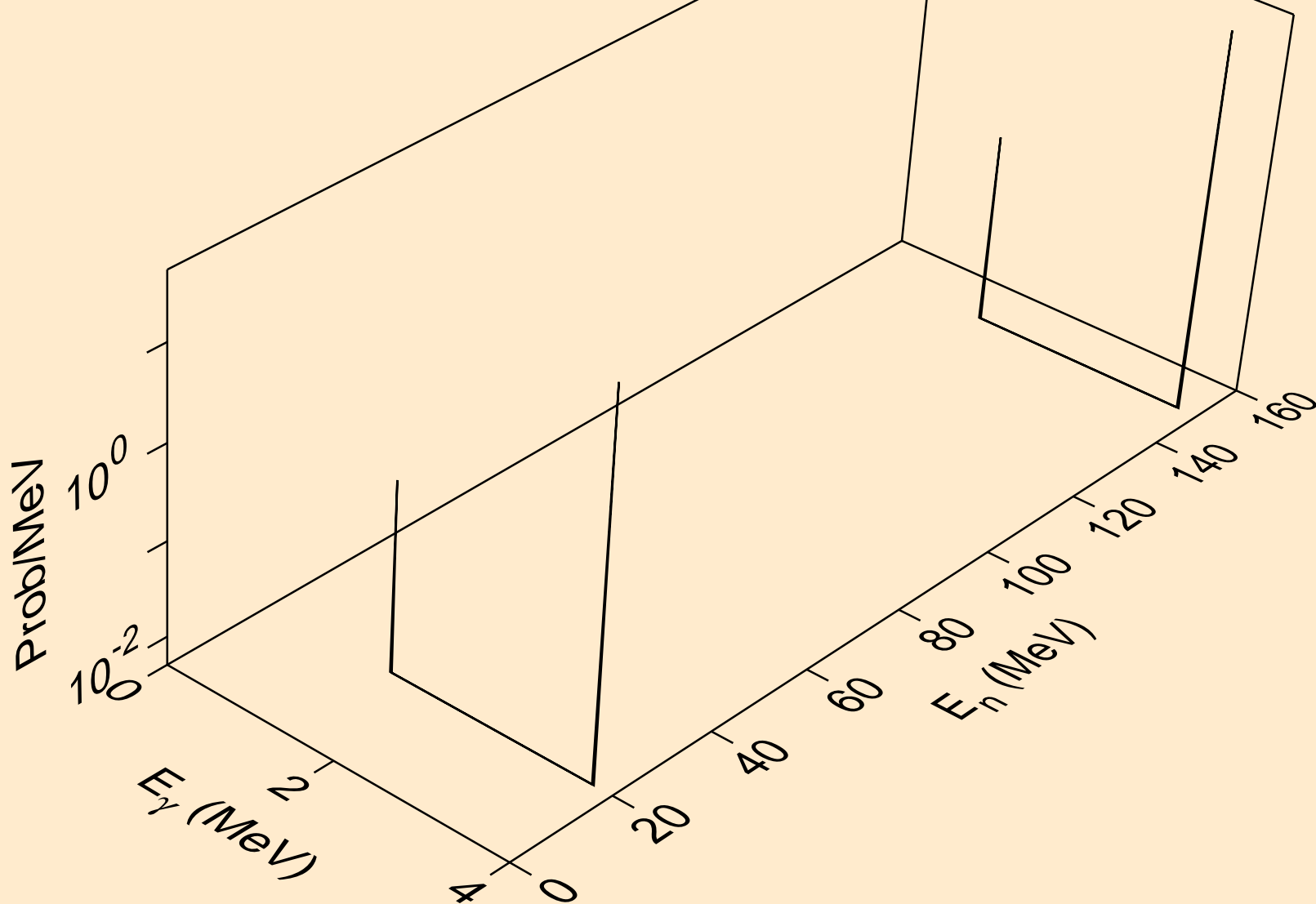

20-CA-43 FOR FENDL-3.2 FROM FENDL-3.2 BY NJOY2016.60+ O
Photon emission for (n,a*36)

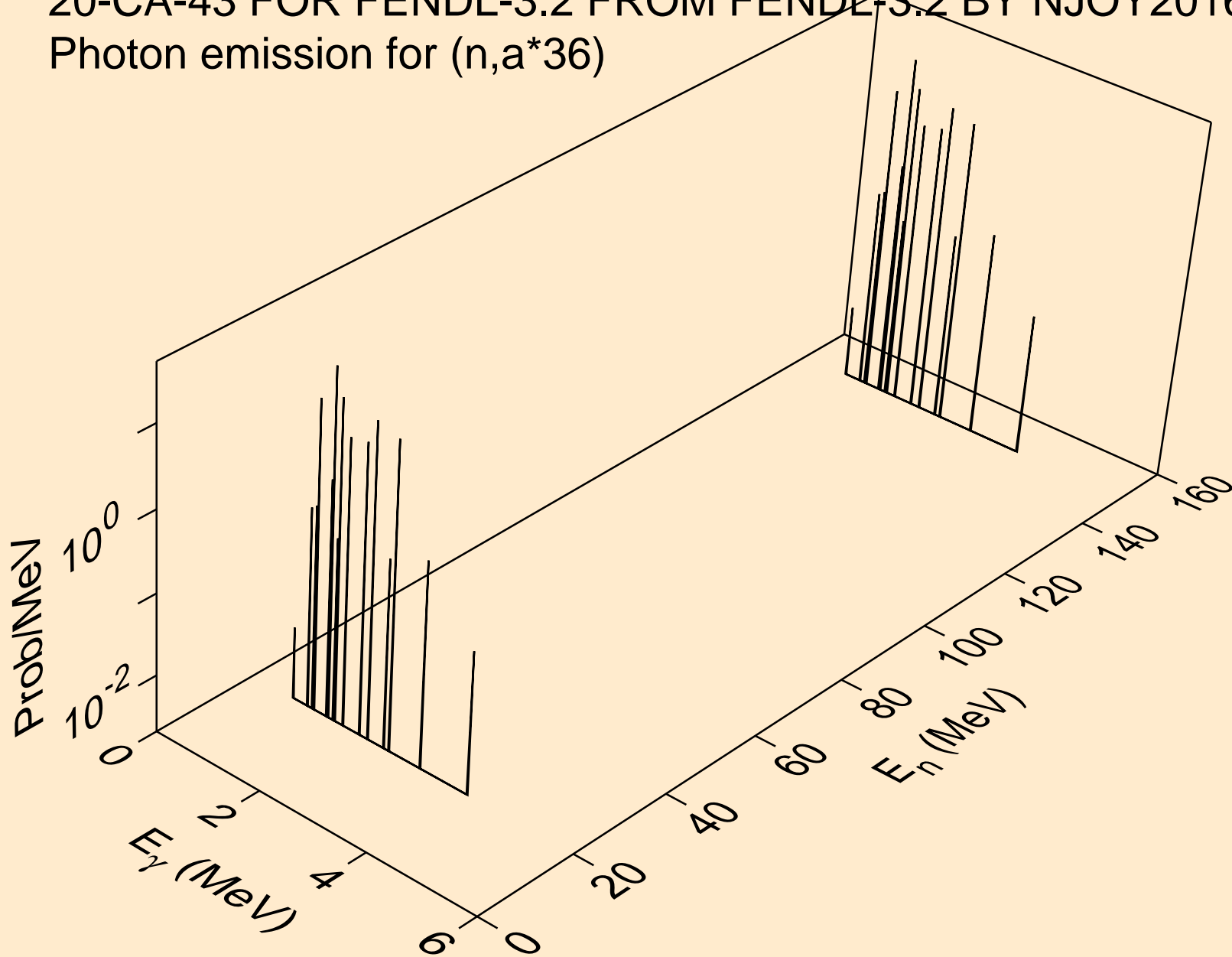

20-CA-43 FOR FENDL-3.2 FROM FENDL-3.2 BY NJOY2016.60+ O
Photon emission for (n,a*37)

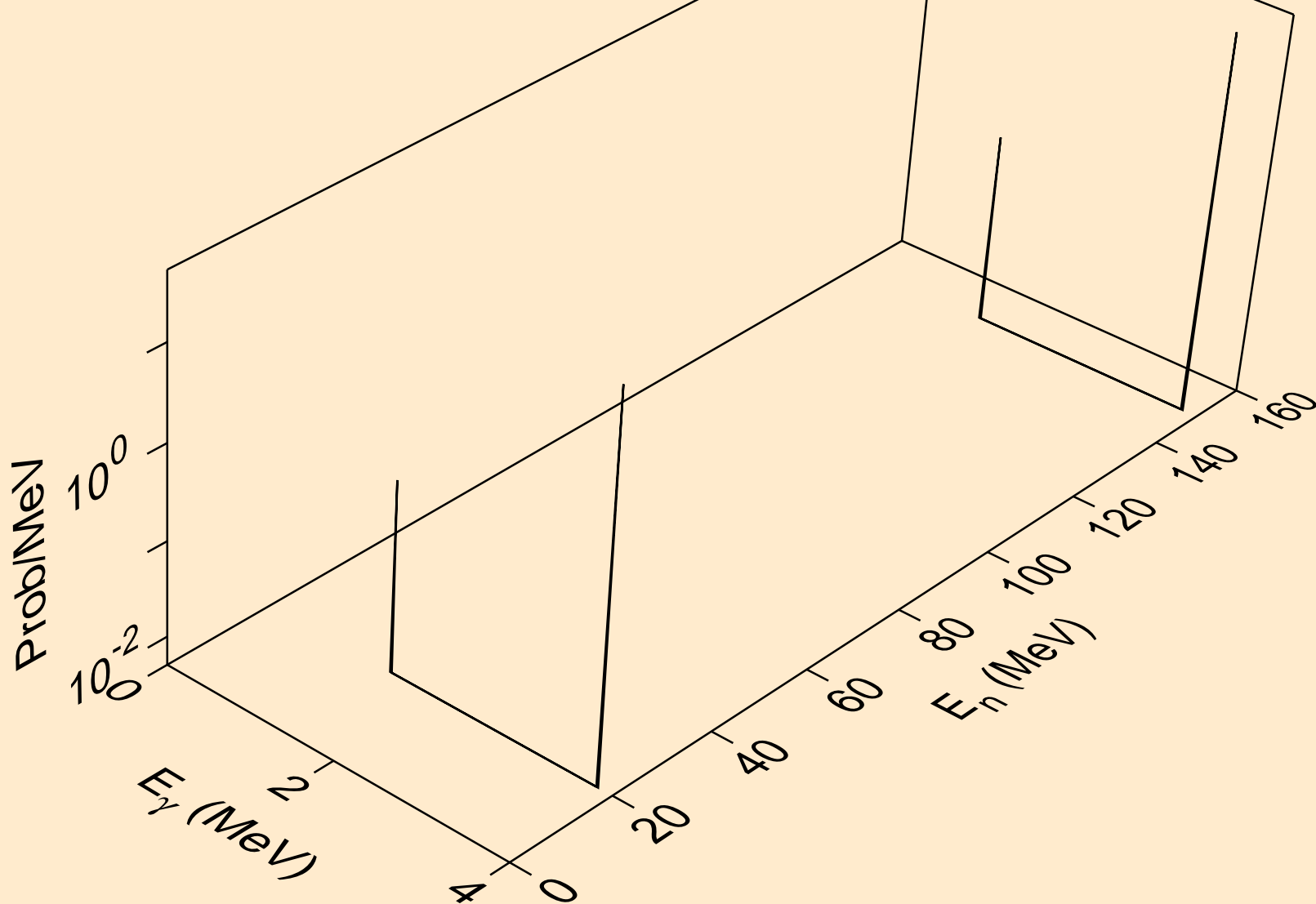

20-CA-43 FOR FENDL-3.2 FROM FENDL-3.2 BY NJOY2016.60+ O
Photon emission for (n,a*38)

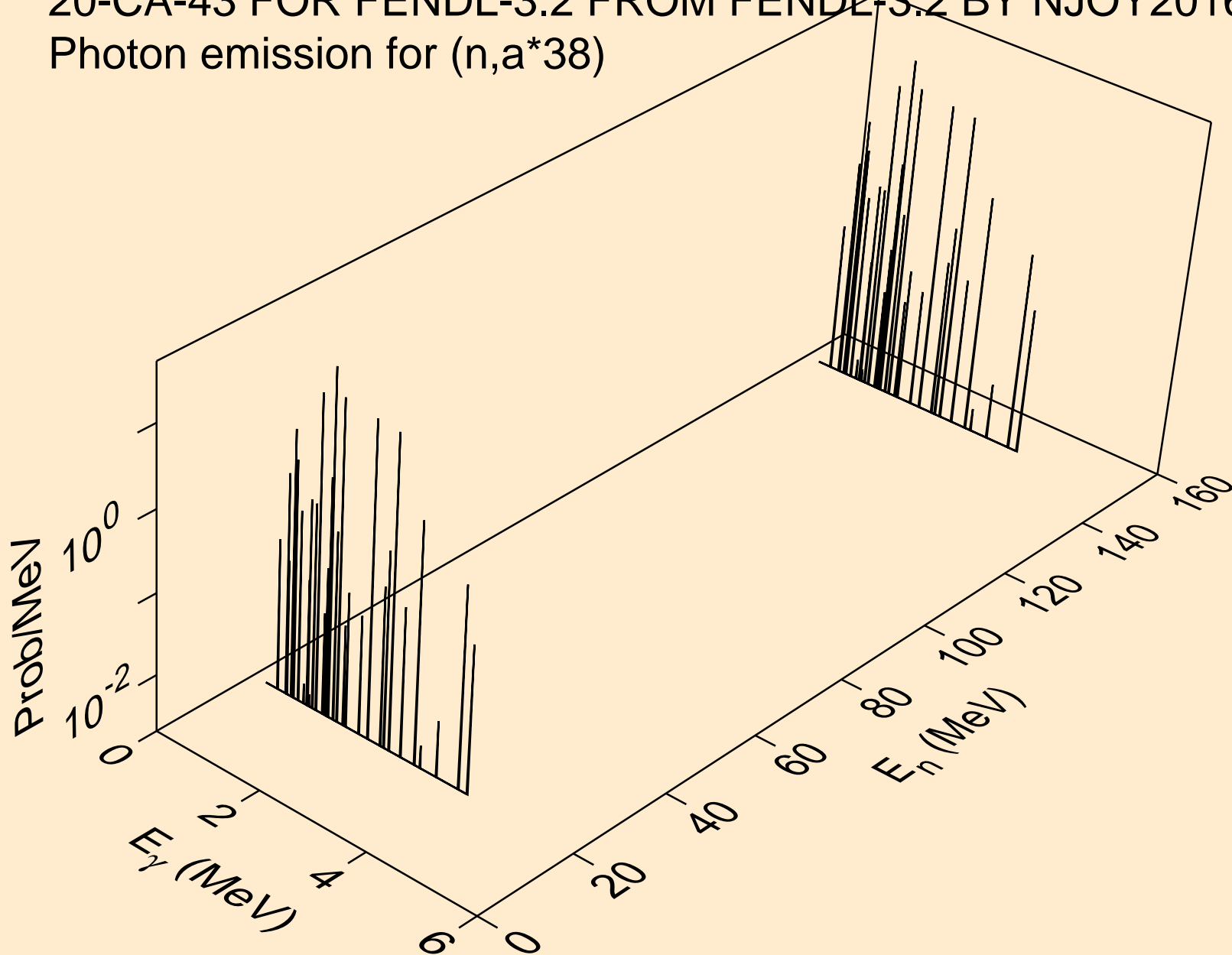

20-CA-43 FOR FENDL-3.2 FROM FENDL-3.2 BY NJOY2016.60+ O
Photon emission for (n,a*39)

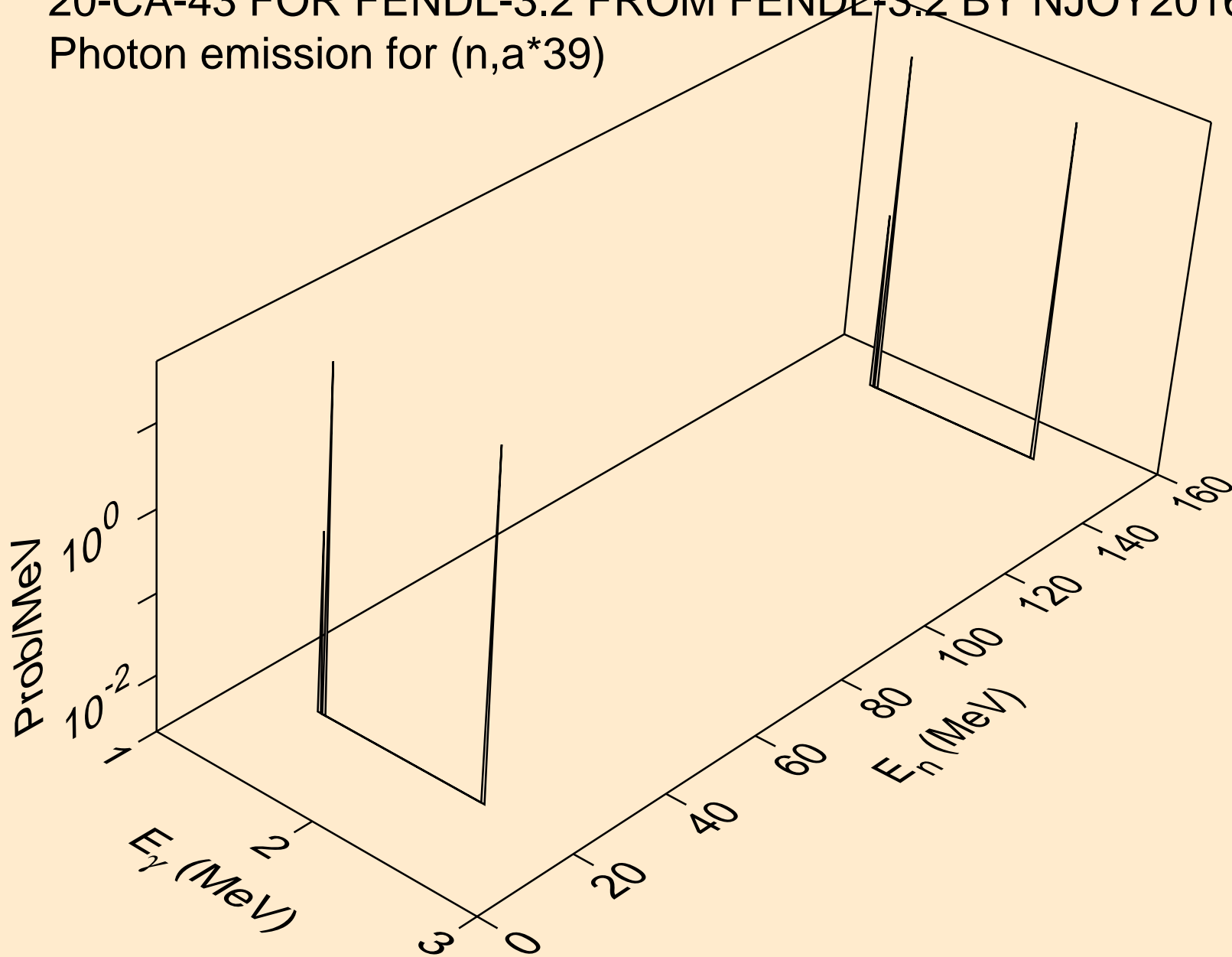

20-CA-43 FOR FENDL-3.2 FROM FENDL-3.2 BY NJOY2016.60+ O
Photon emission for (n,a*c)

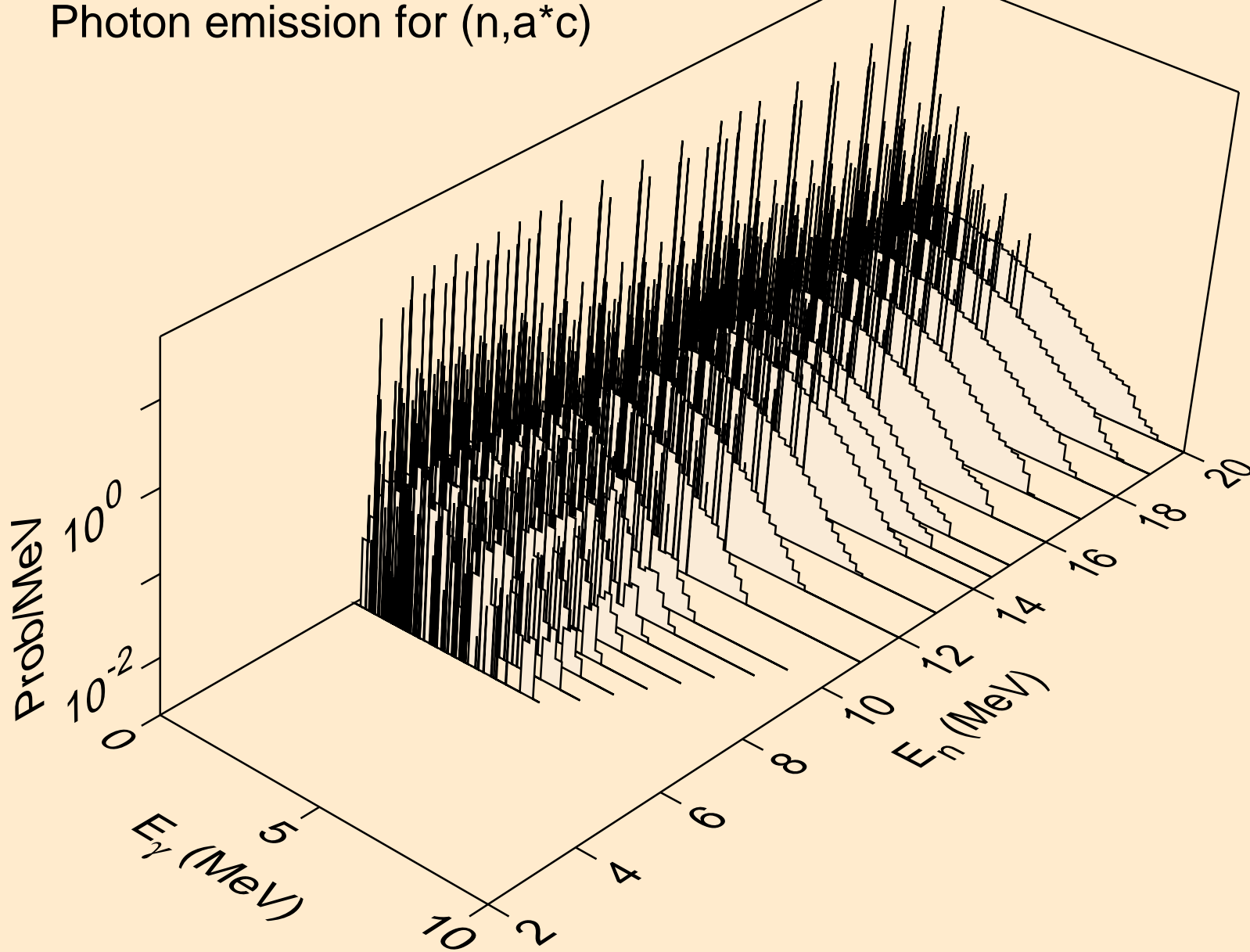

20-CA-43 FOR FENDL-3.2 FROM FENDL-3.2 BY NJOY2016.60+ O
thermal capture photon spectrum

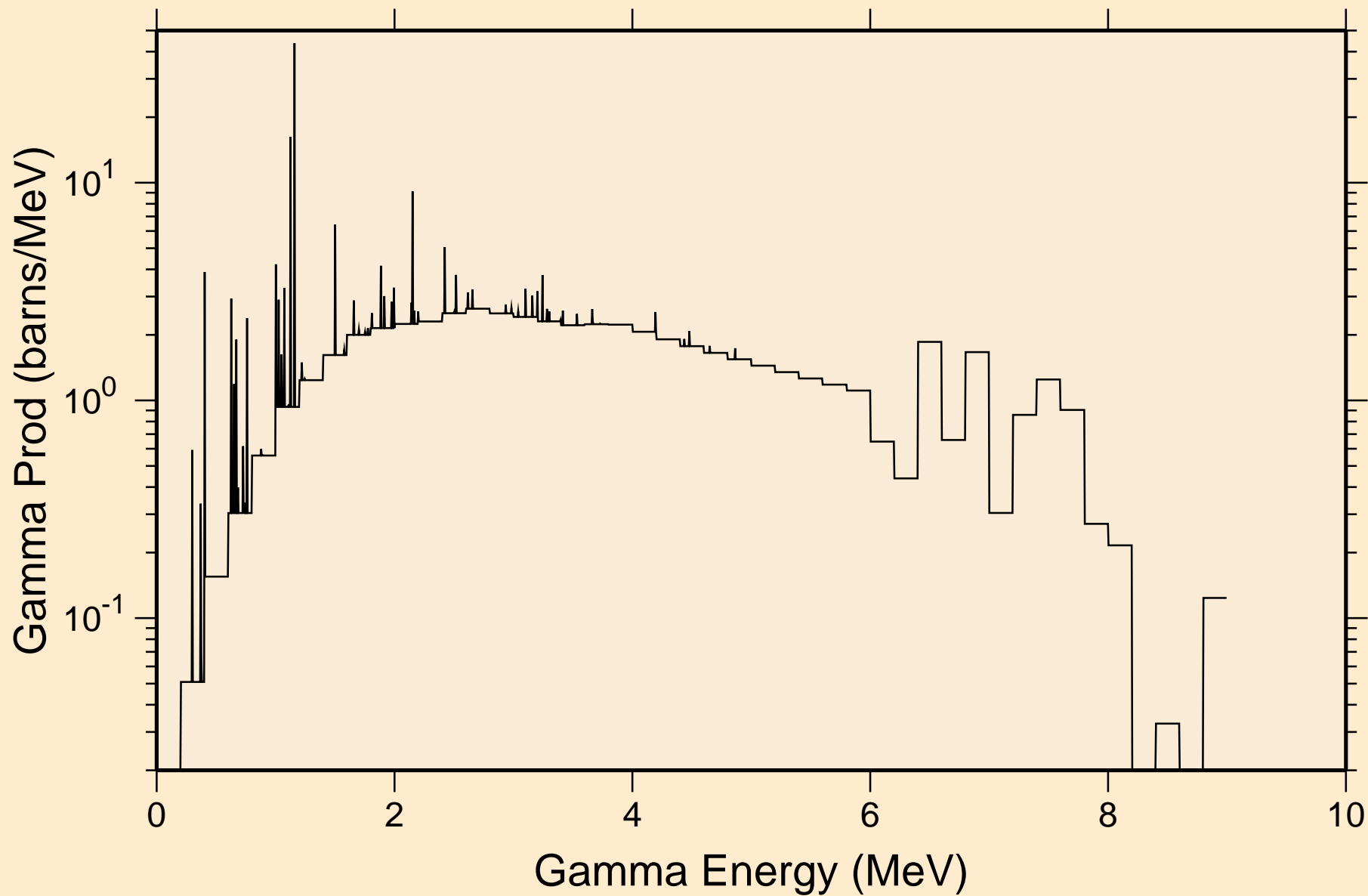

20-CA-43 FOR FENDL-3.2 FROM FENDL-3.2 BY NJOY2016.60+ O
14 MeV photon spectrum

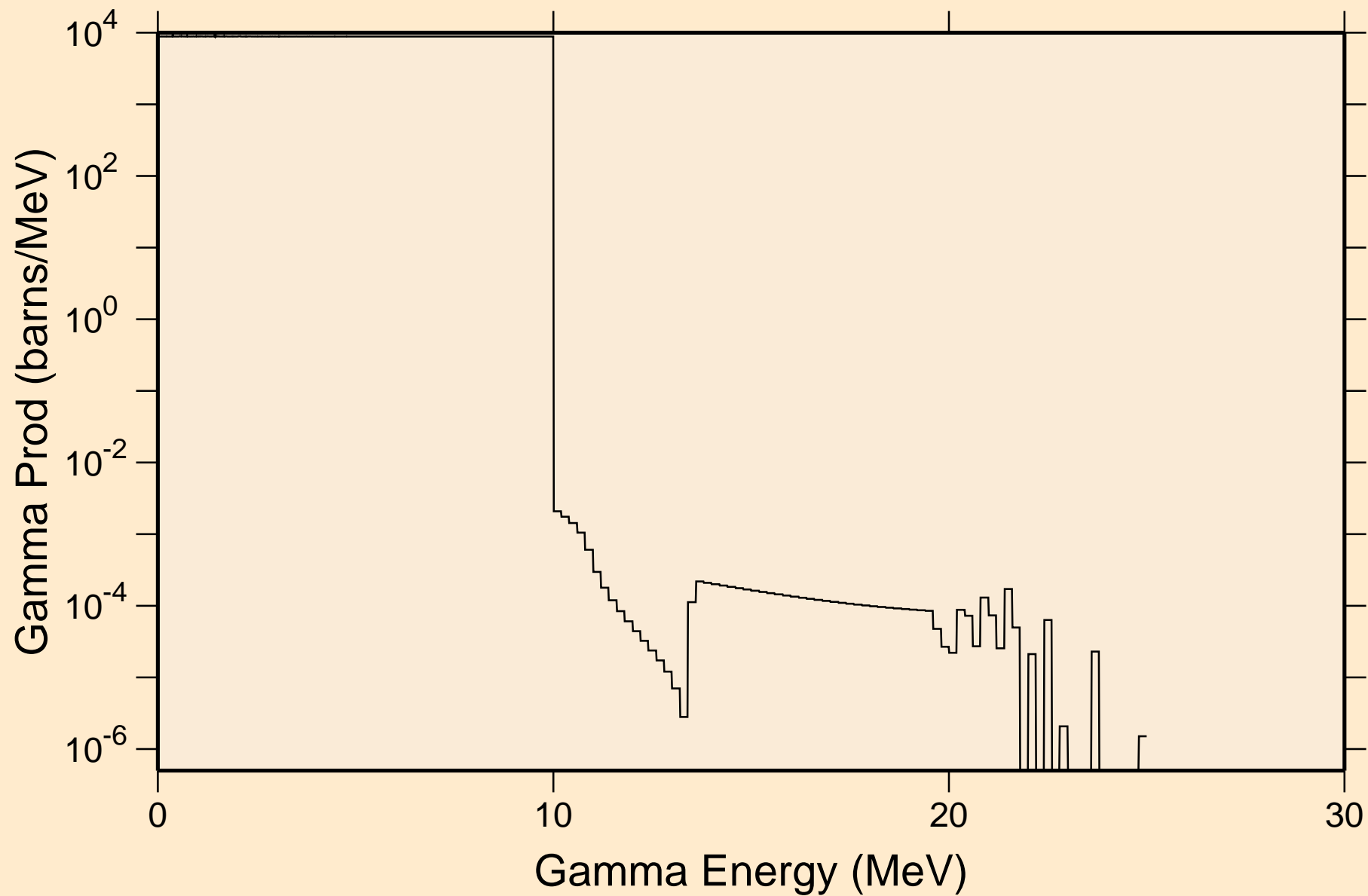

20-CA-43 FOR FENDL-3.2 FROM FENDL-3.2 BY NJOY2016.60+ O

Particle heating contributions

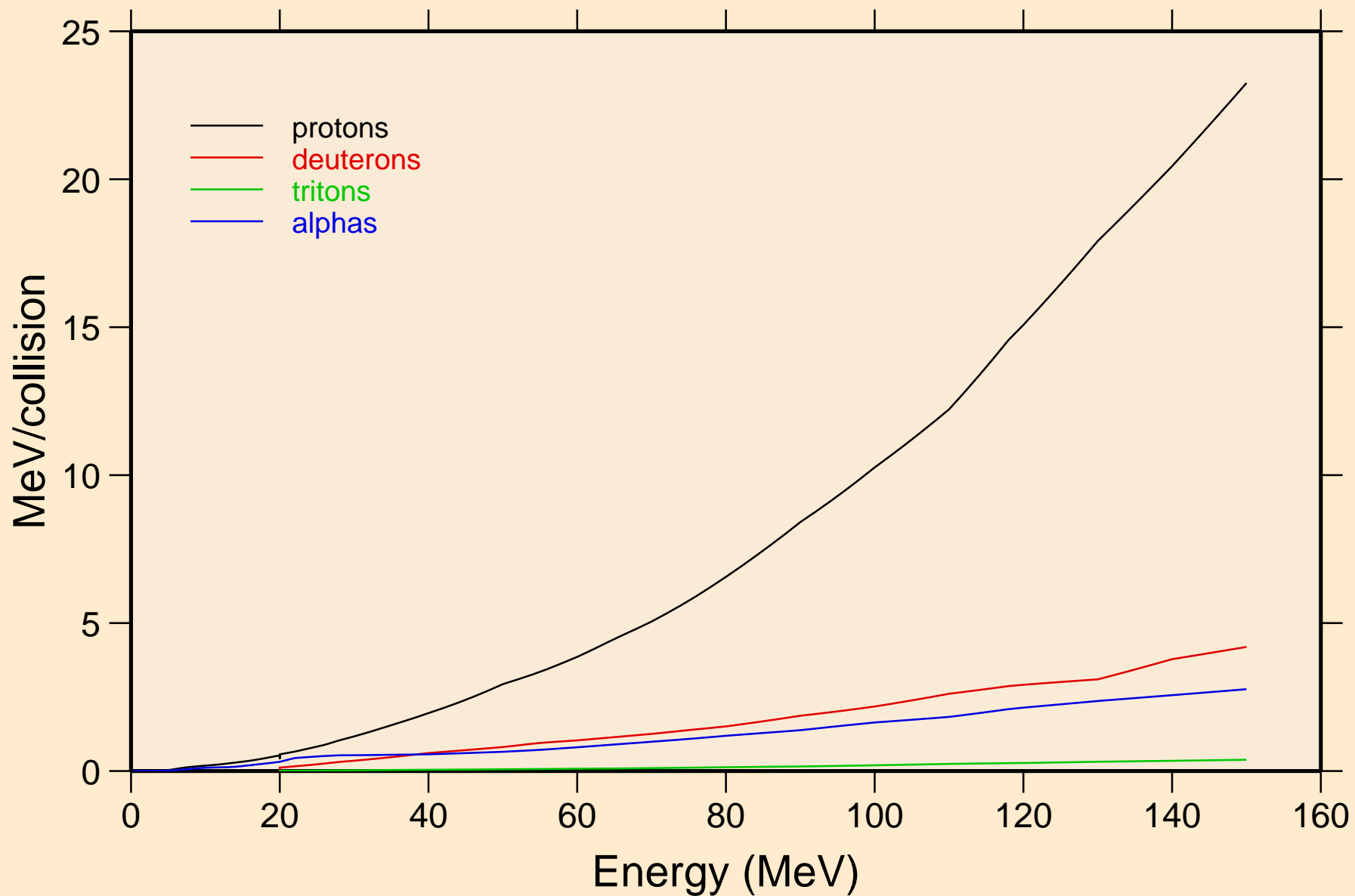

20-CA-43 FOR FENDL-3.2 FROM FENDL-3.2 BY NJOY2016.60+ O
Recoil Heating

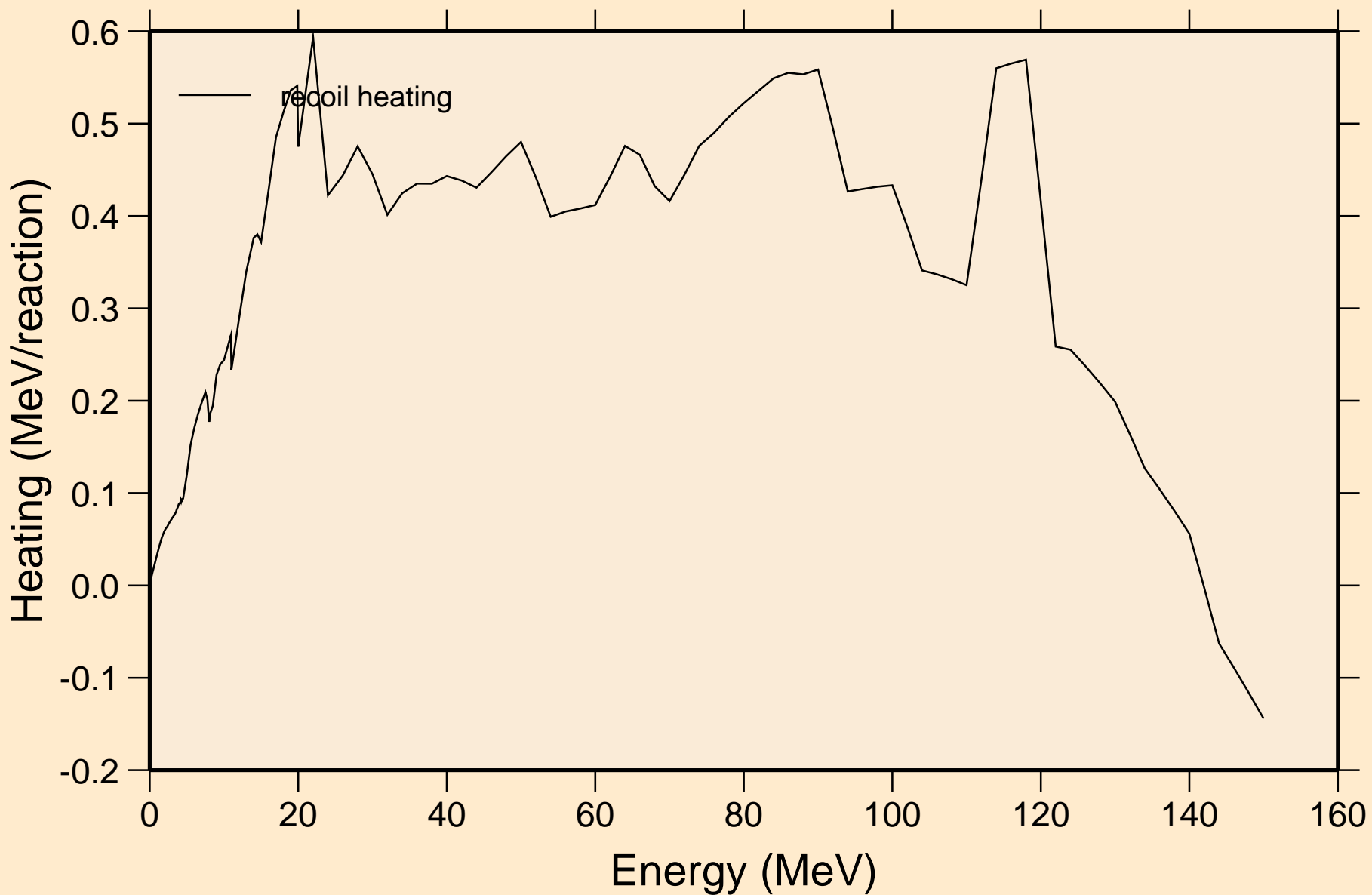

20-CA-43 FOR FENDL-3.2 FROM FENDL-3.2 BY NJOY2016.60+ O

Particle production cross sections

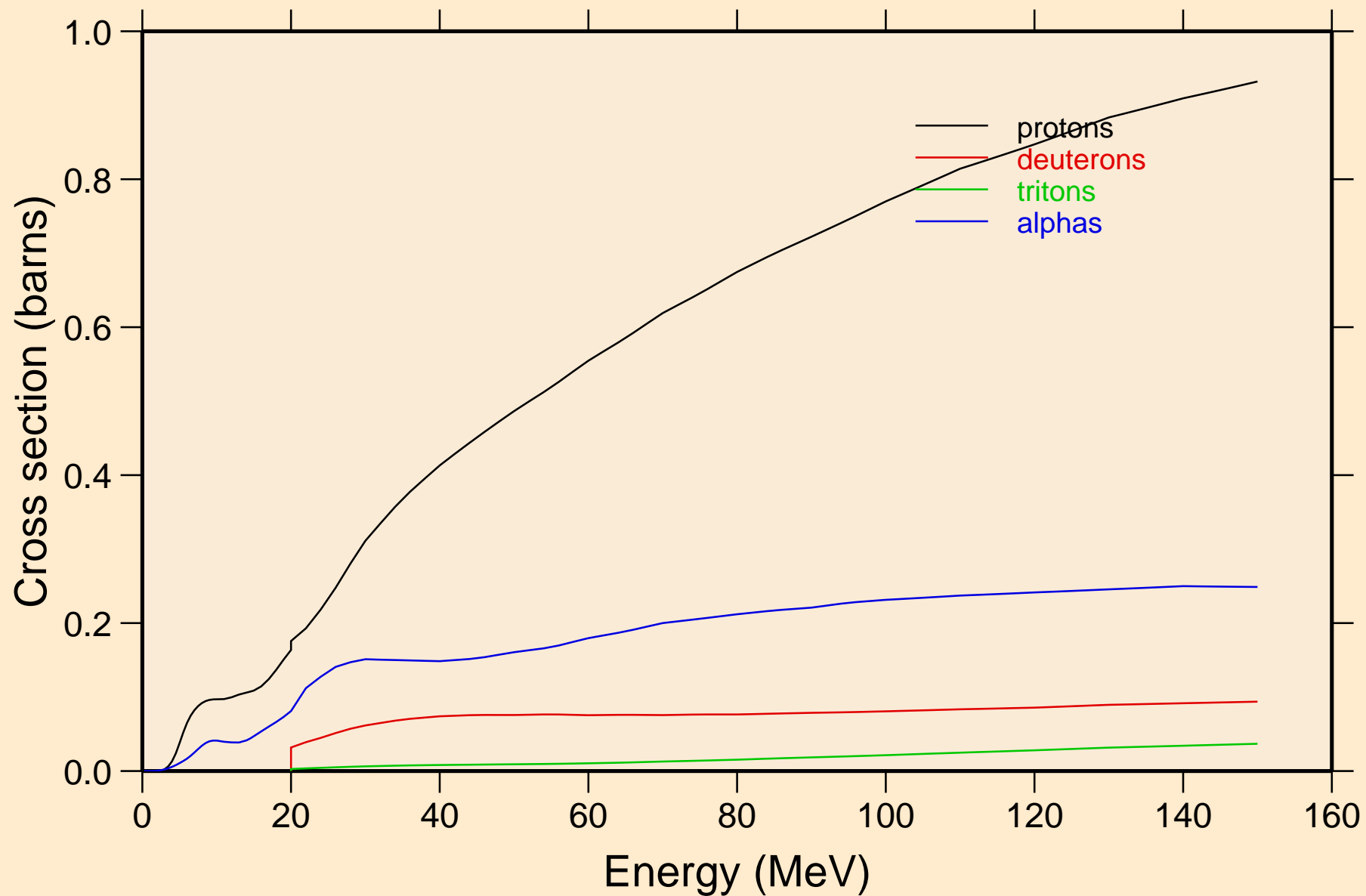

20-CA-43 FOR FENDL-3.2 FROM FENDL-3.2 BY NJOY2016.60+ O
protons from (n,x)

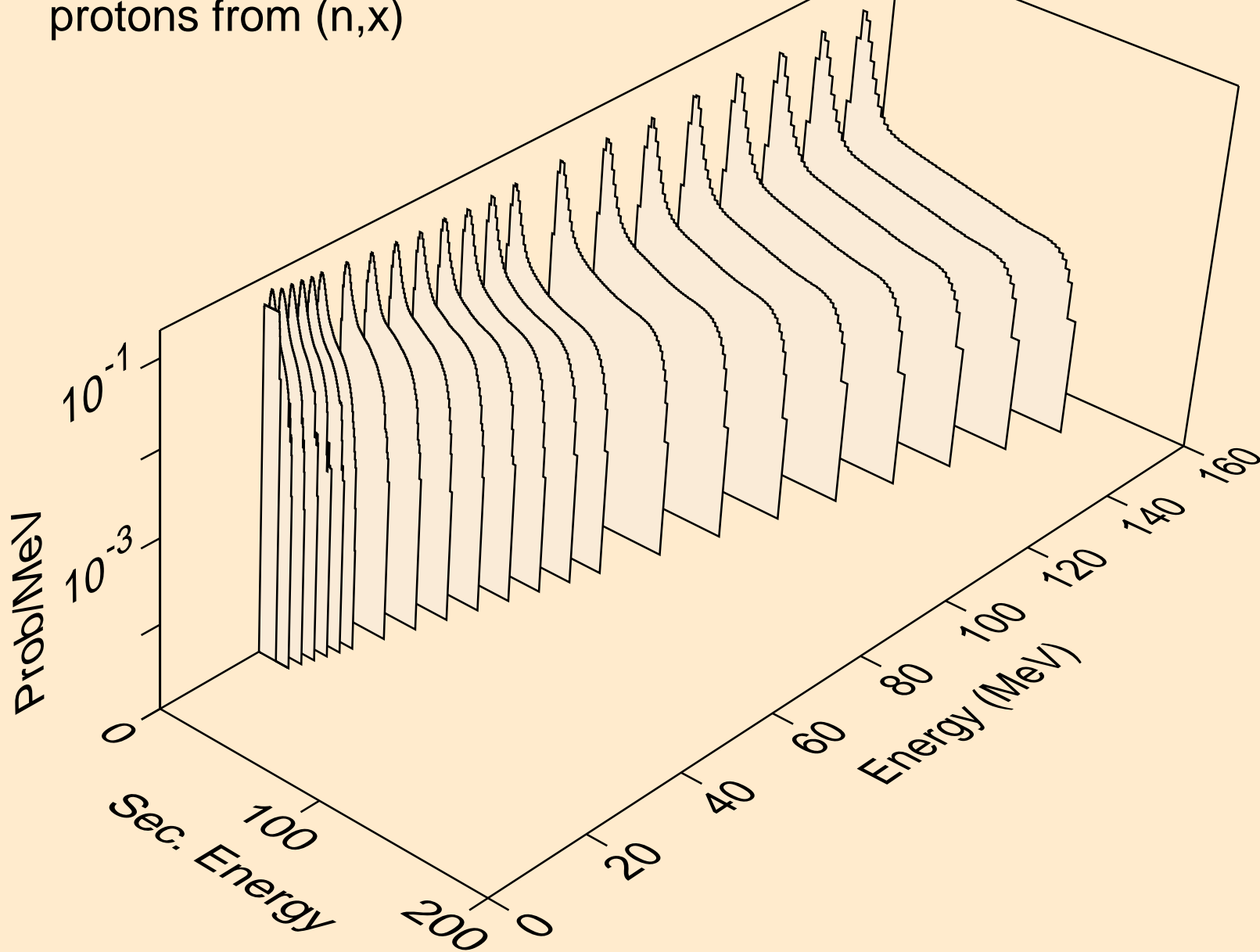

20-CA-43 FOR FENDL-3.2 FROM FENDL-3.2 BY NJOY2016.60+ O
protons from (n,n*)p

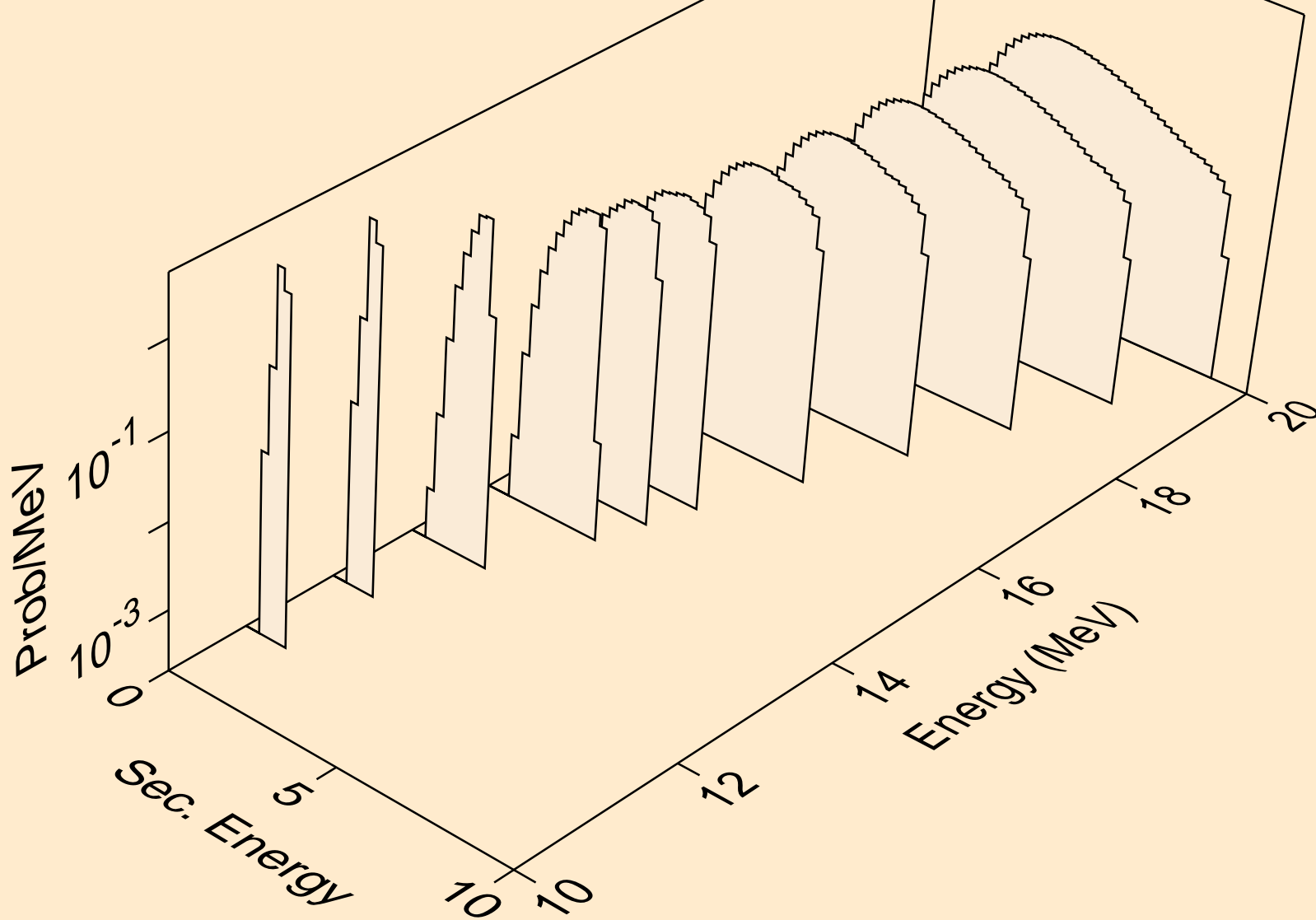

20-CA-43 FOR FENDL-3.2 FROM FENDL-3.2 BY NJOY2016.60+ O
protons from (n,p*c)

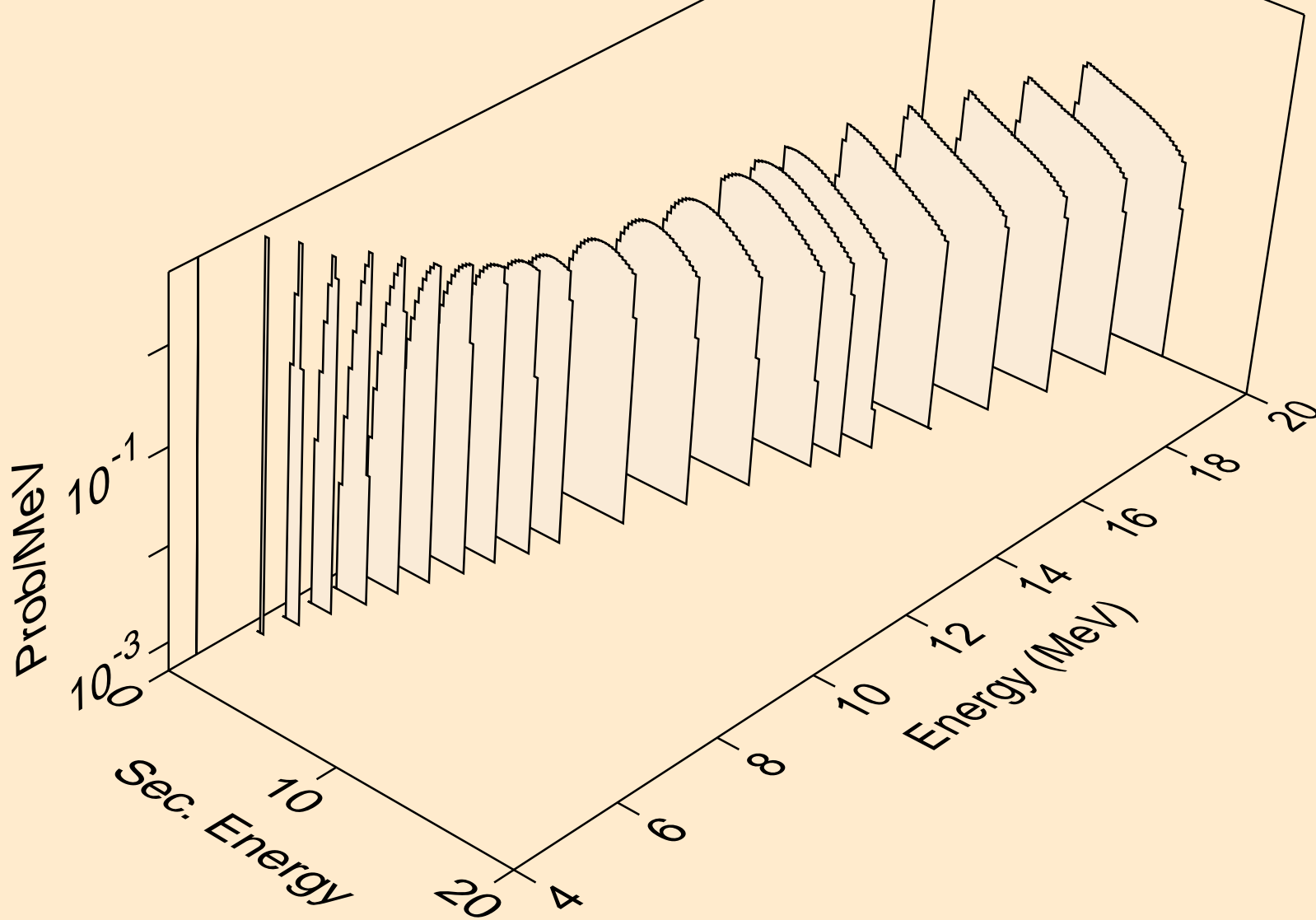

20-CA-43 FOR FENDL-3.2 FROM FENDL-3.2 BY NJOY2016.60+ O
deuterons from (n,x)

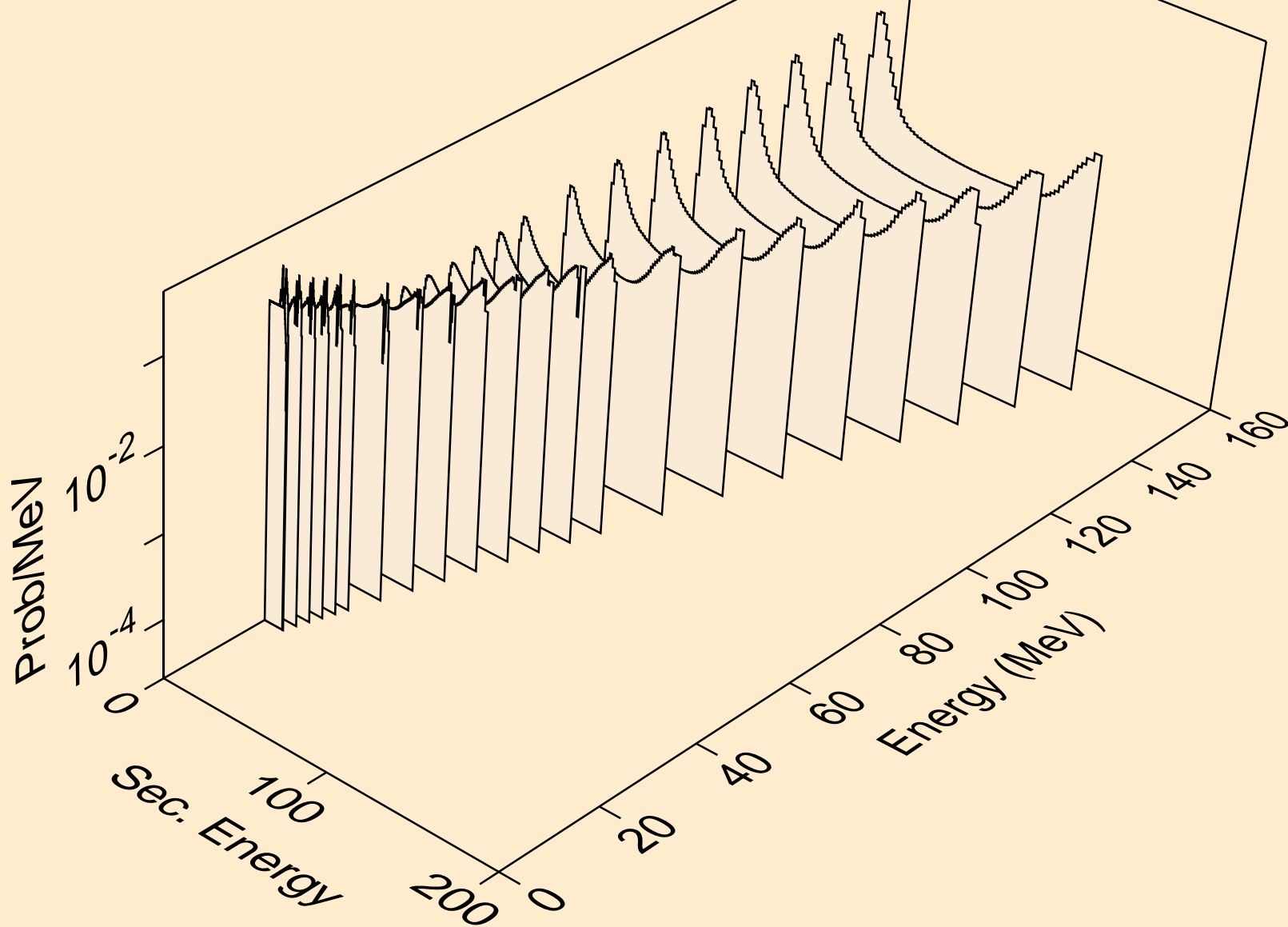

20-CA-43 FOR FENDL-3.2 FROM FENDL-3.2 BY NJOY2016.60+ O
tritons from (n,x)

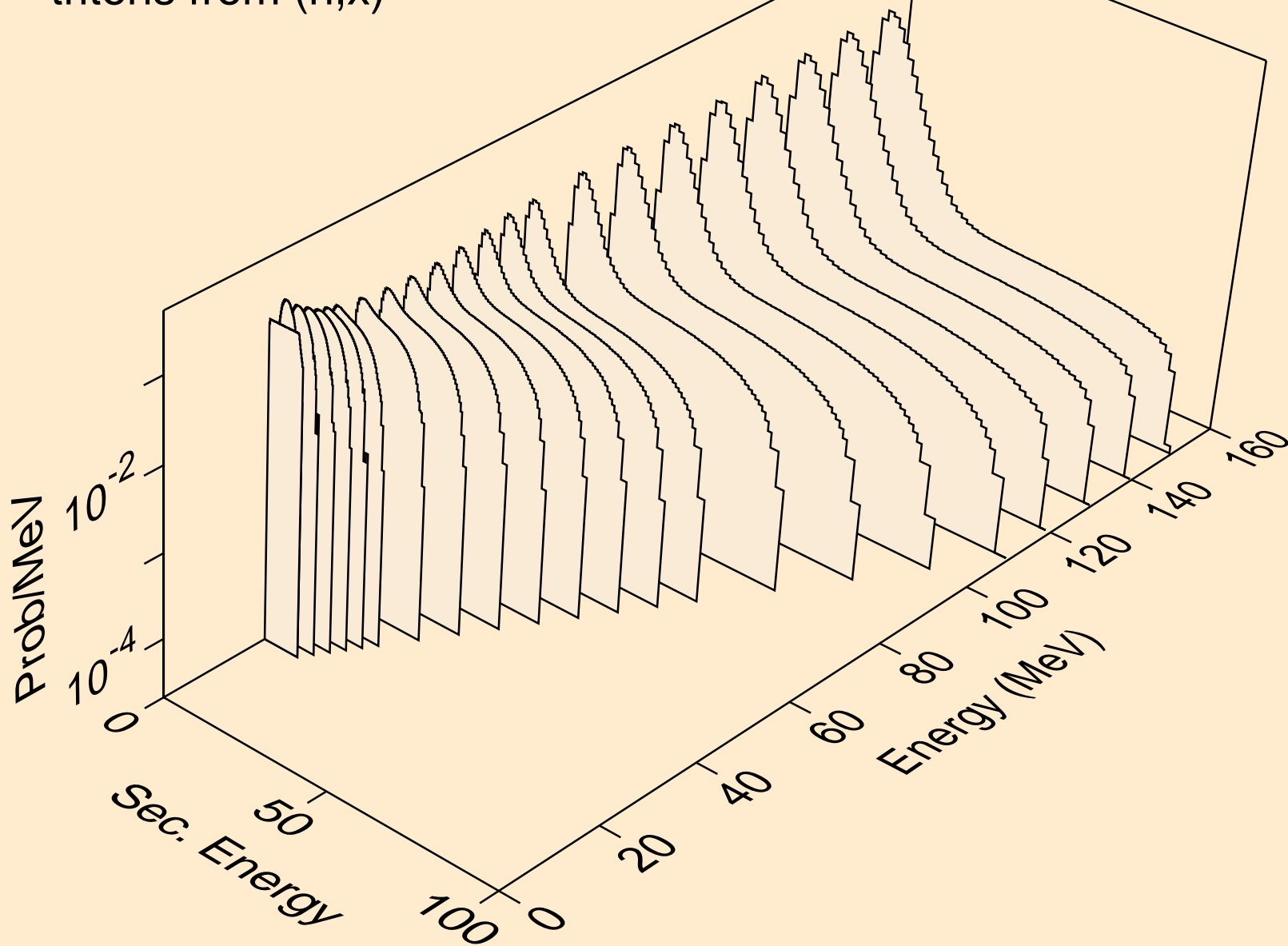

20-CA-43 FOR FENDL-3.2 FROM FENDL-3.2 BY NJOY2016.60+ O
alphas from (n,x)

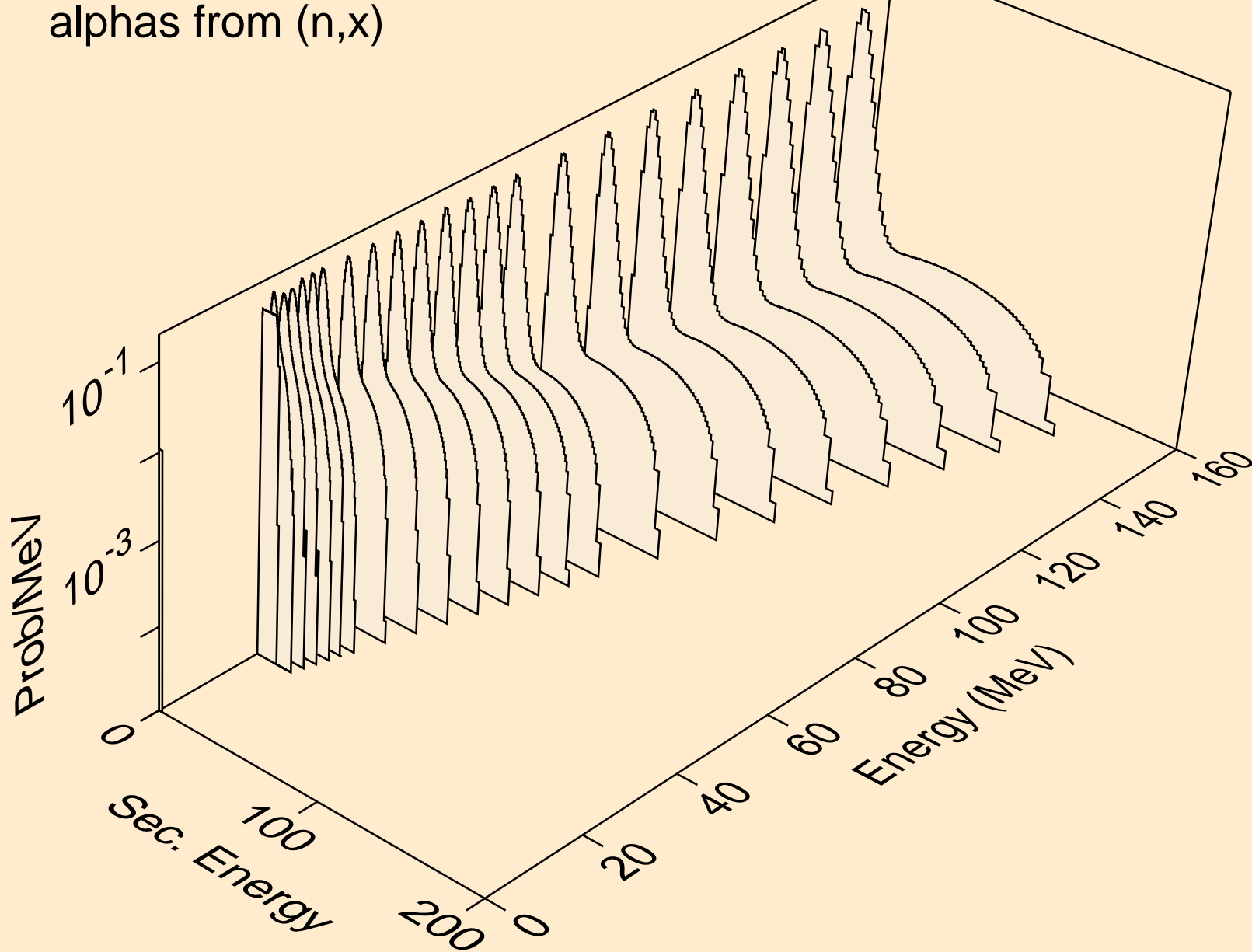

20-CA-43 FOR FENDL-3.2 FROM FENDL-3.2 BY NJOY2016.60+ O
alphas from (n,n*)a

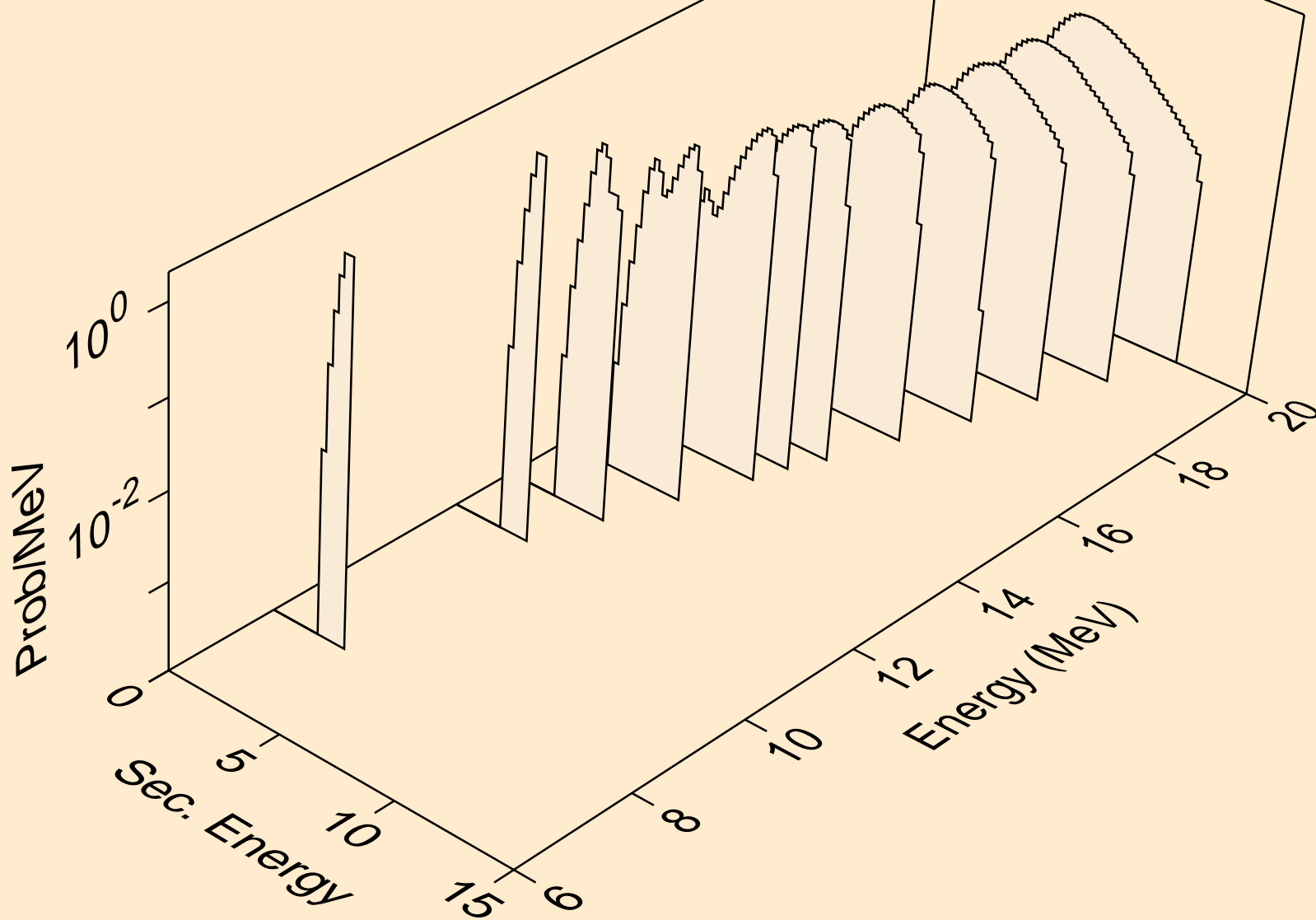

20-CA-43 FOR FENDL-3.2 FROM FENDL-3.2 BY NJOY2016.60+ O
alphas from (n,a*c)

