

25-MN-55 FOR FENDL-3.2 FROM INDL/V-3 BY NJOY2016.60+ ON  
Principal cross sections

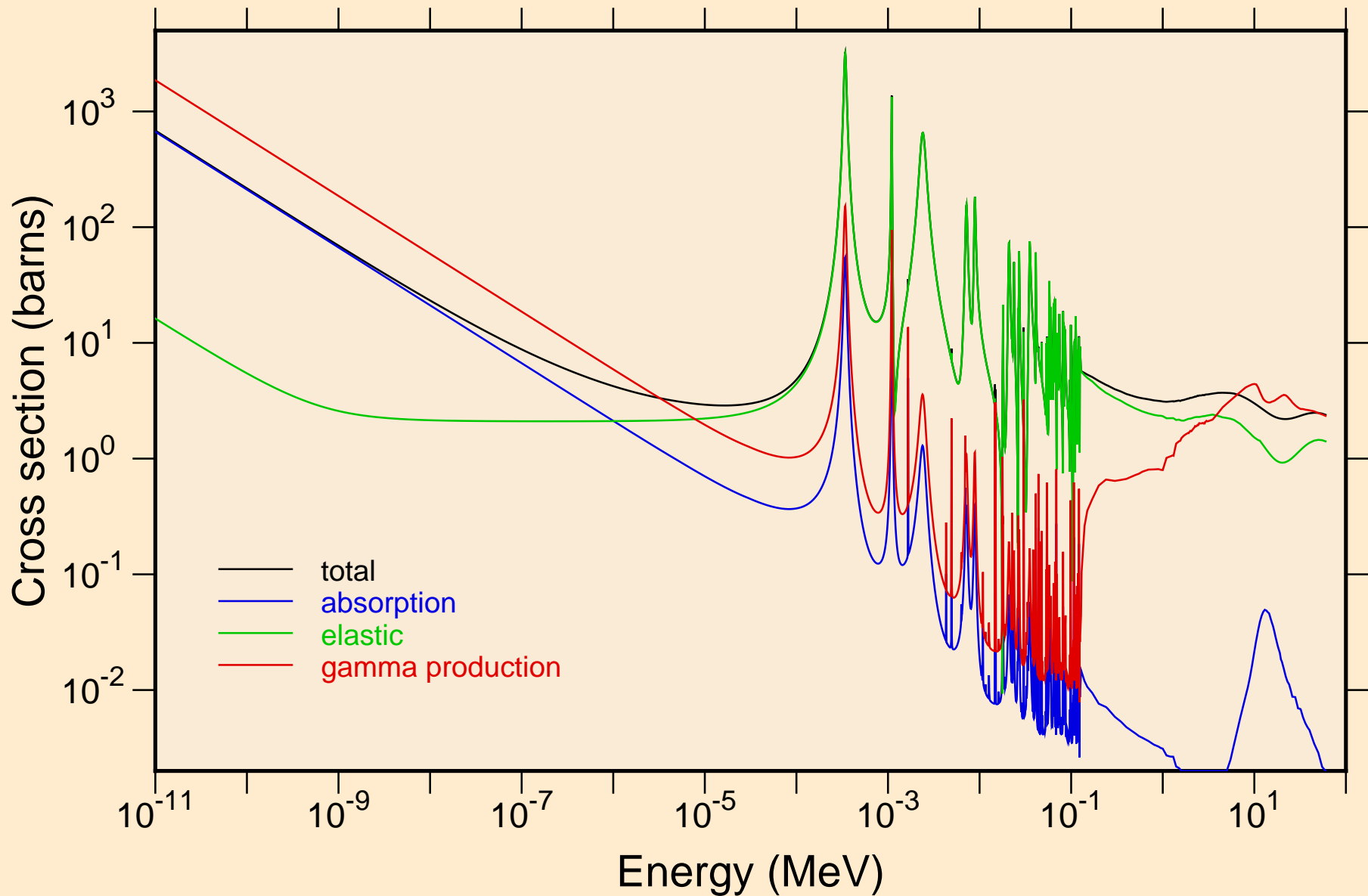

25-MN-55 FOR FENDL-3.2 FROM INDL/V-3 BY NJOY2016.60+ ON  
resonance total cross section

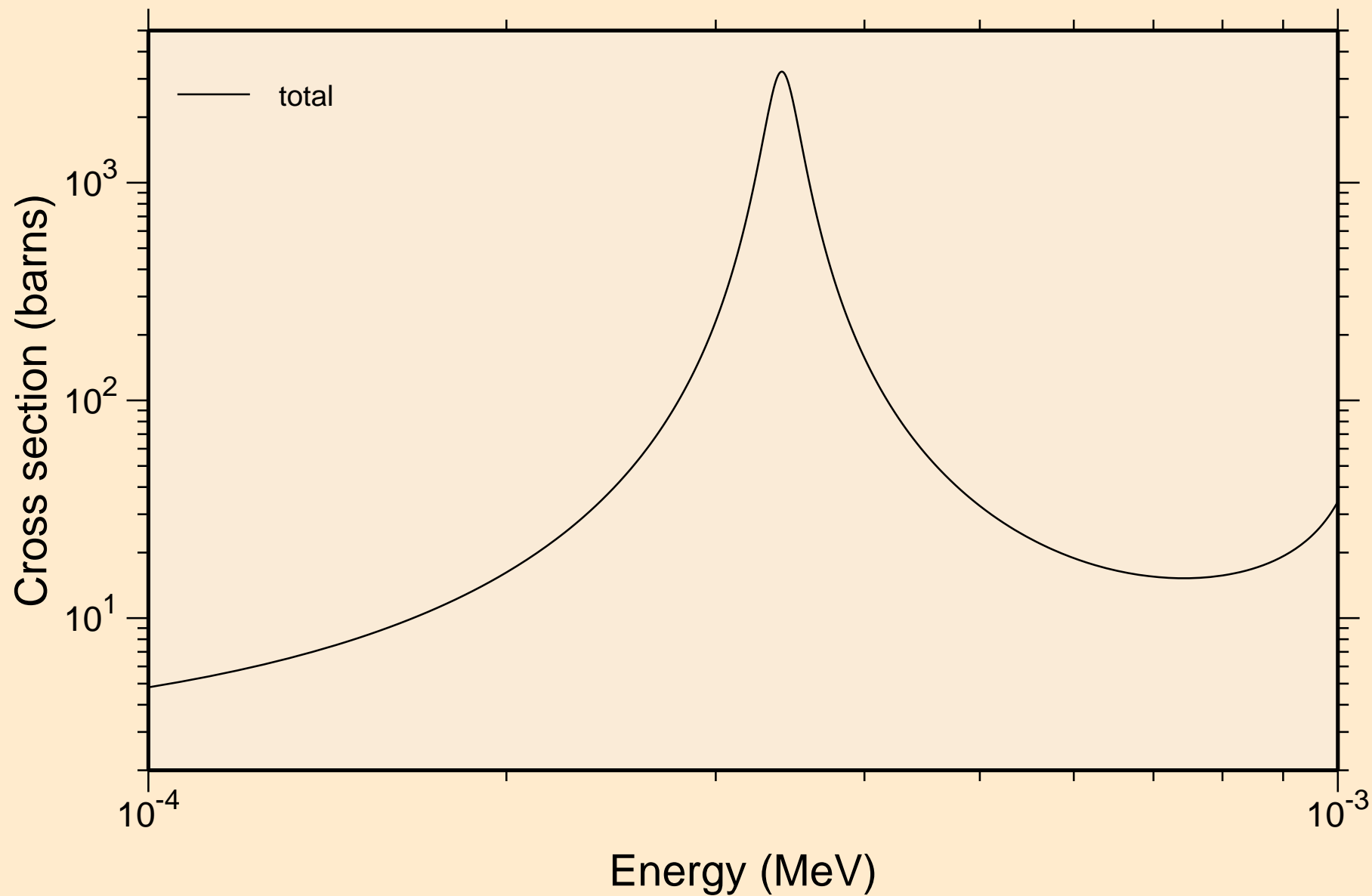

25-MN-55 FOR FENDL-3.2 FROM INDL/V-3 BY NJOY2016.60+ ON  
resonance total cross section

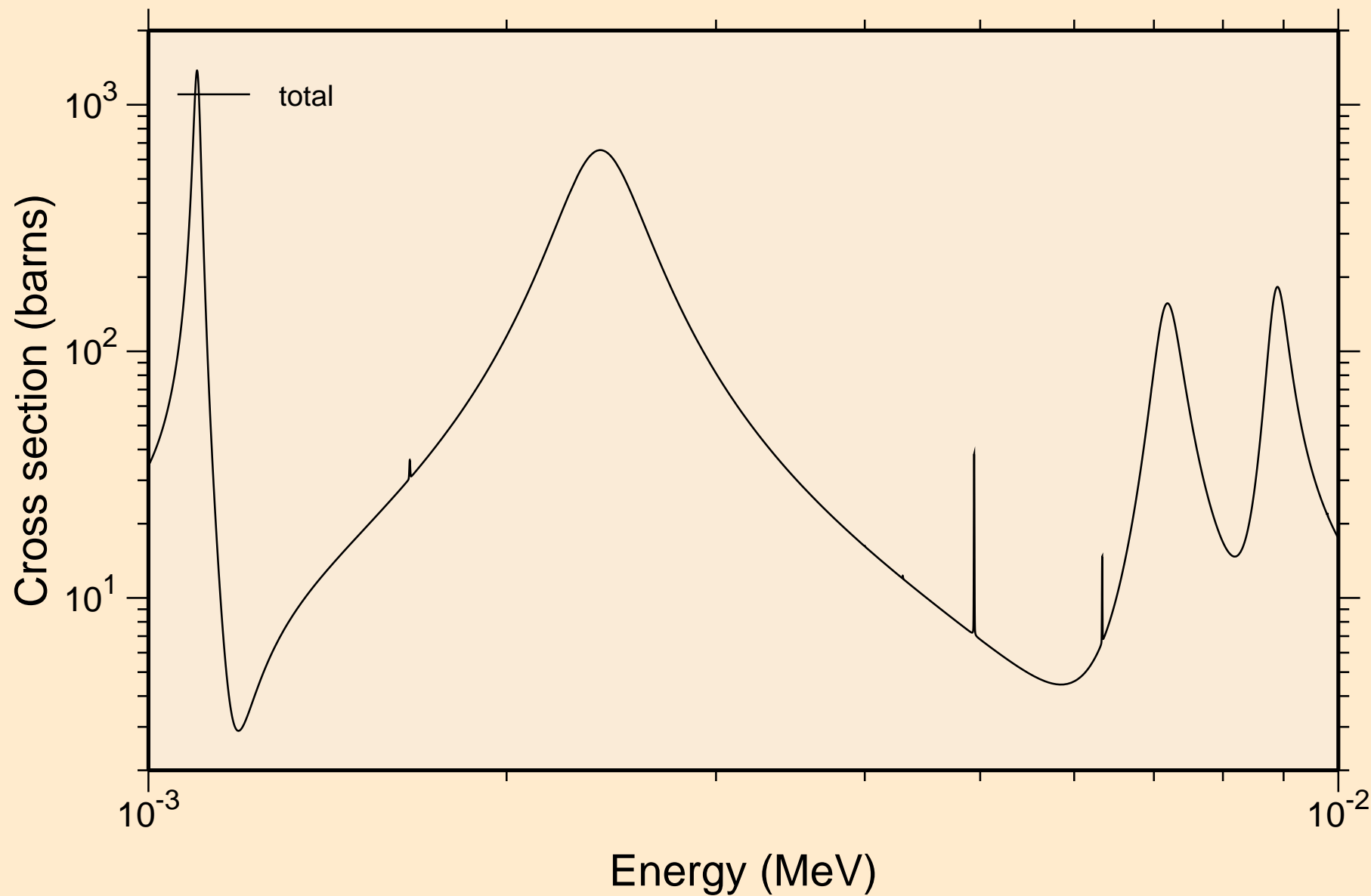

25-MN-55 FOR FENDL-3.2 FROM INDL/V-3 BY NJOY2016.60+ ON  
resonance total cross section

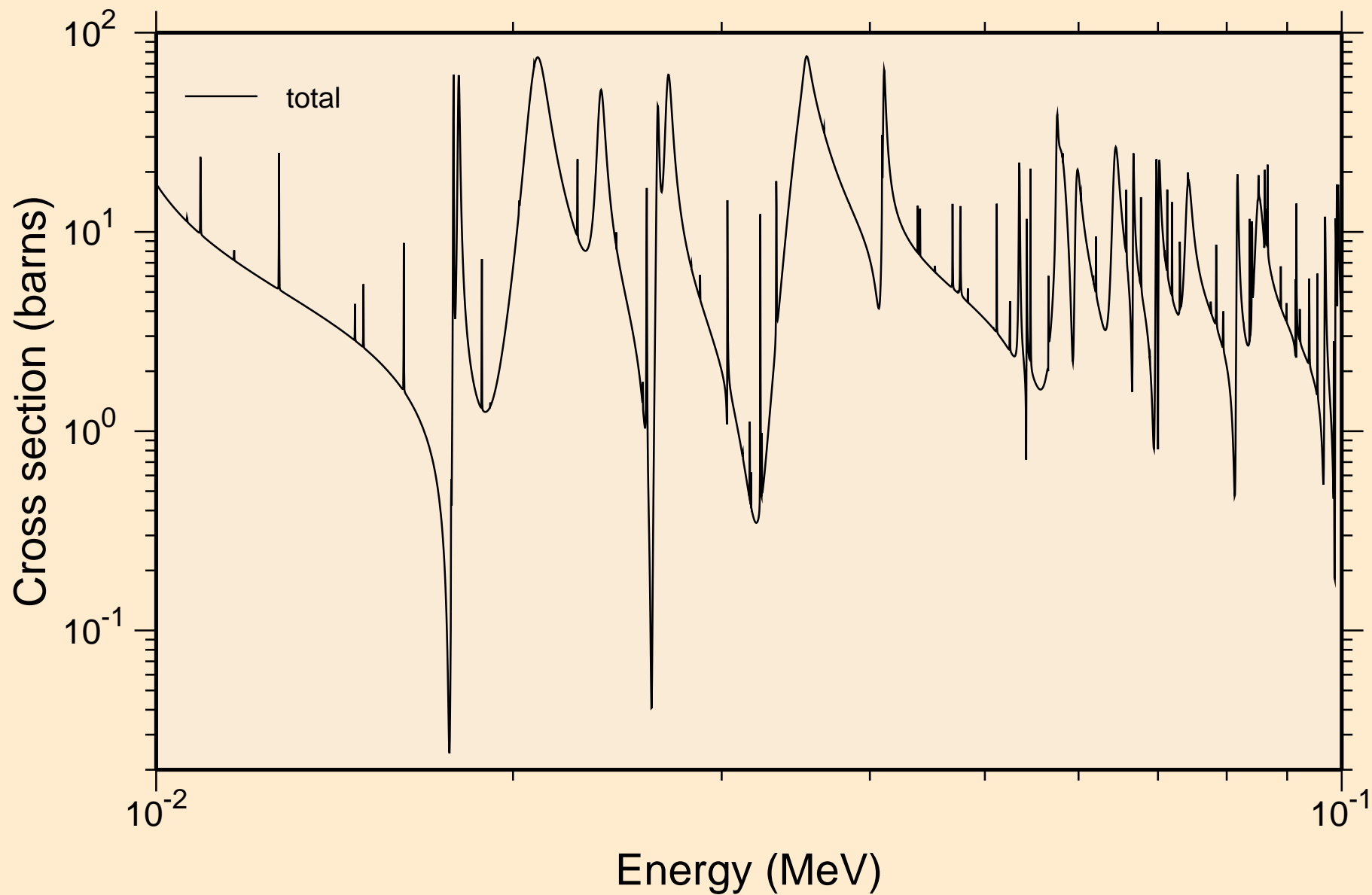

25-MN-55 FOR FENDL-3.2 FROM INDL/V-3 BY NJOY2016.60+ ON  
resonance total cross section

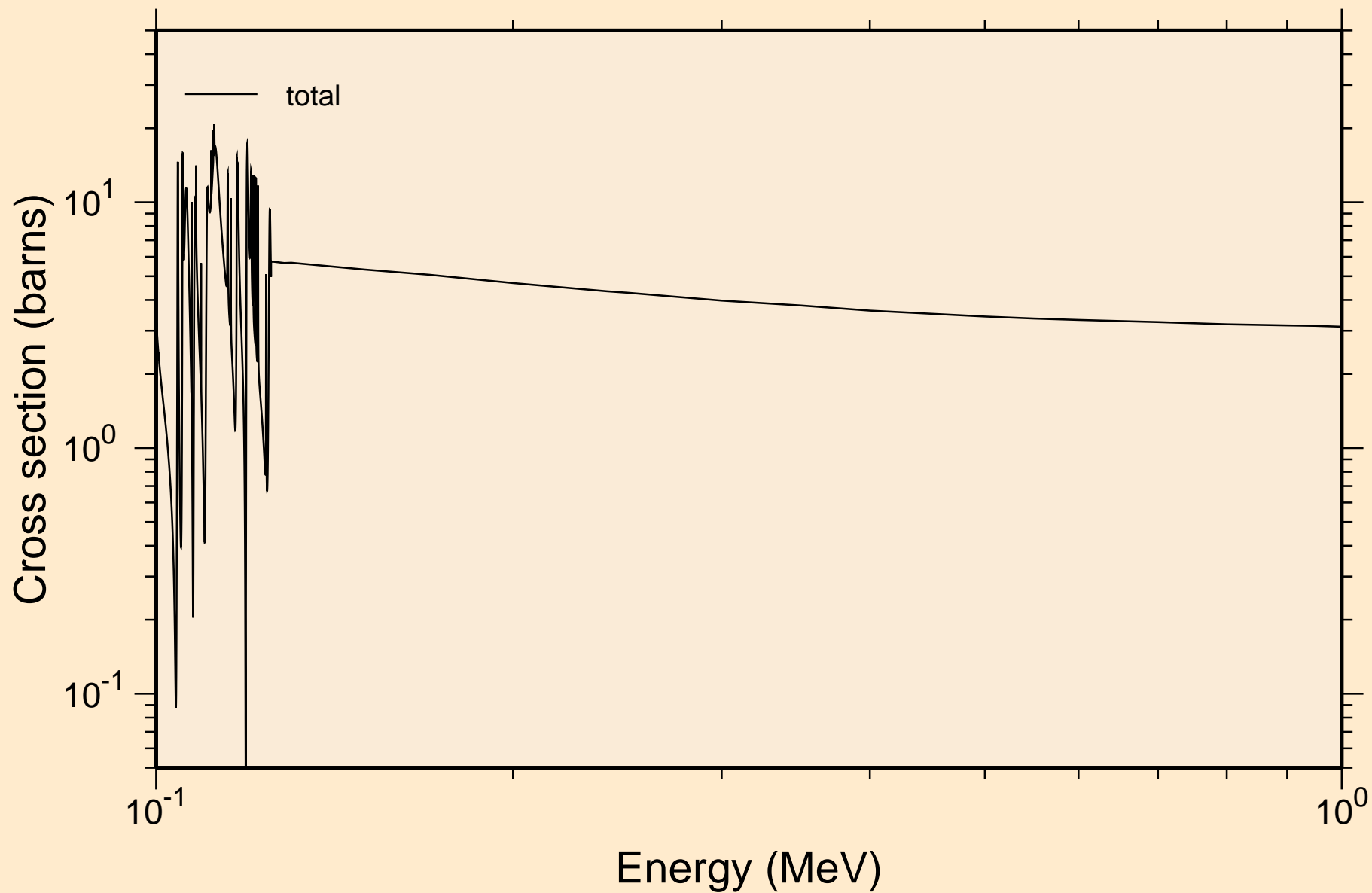

25-MN-55 FOR FENDL-3.2 FROM INDL/V-3 BY NJOY2016.60+ ON  
resonance absorption cross sections

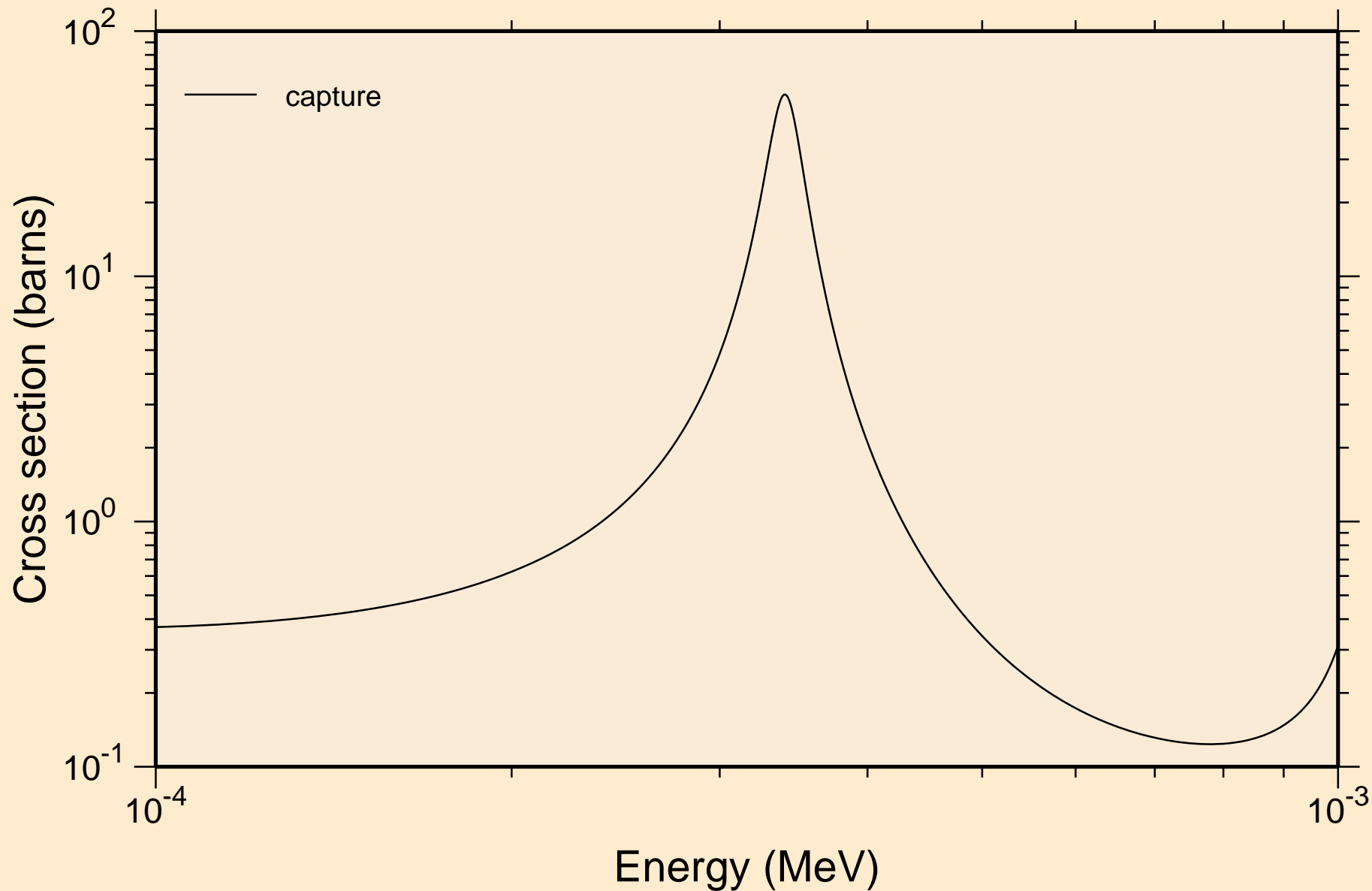

25-MN-55 FOR FENDL-3.2 FROM INDL/V-3 BY NJOY2016.60+ ON  
resonance absorption cross sections

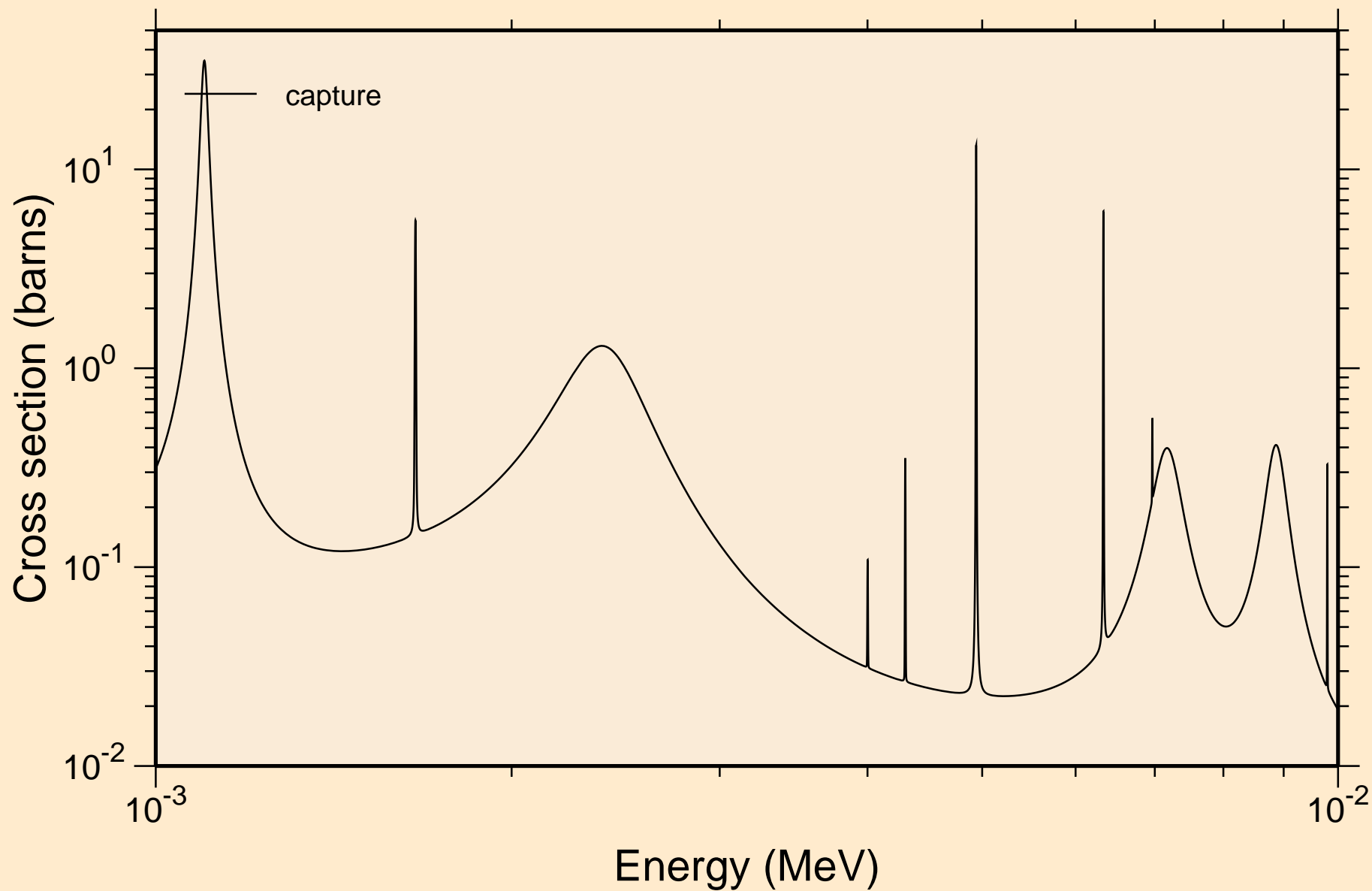

25-MN-55 FOR FENDL-3.2 FROM INDL/V-3 BY NJOY2016.60+ ON  
resonance absorption cross sections

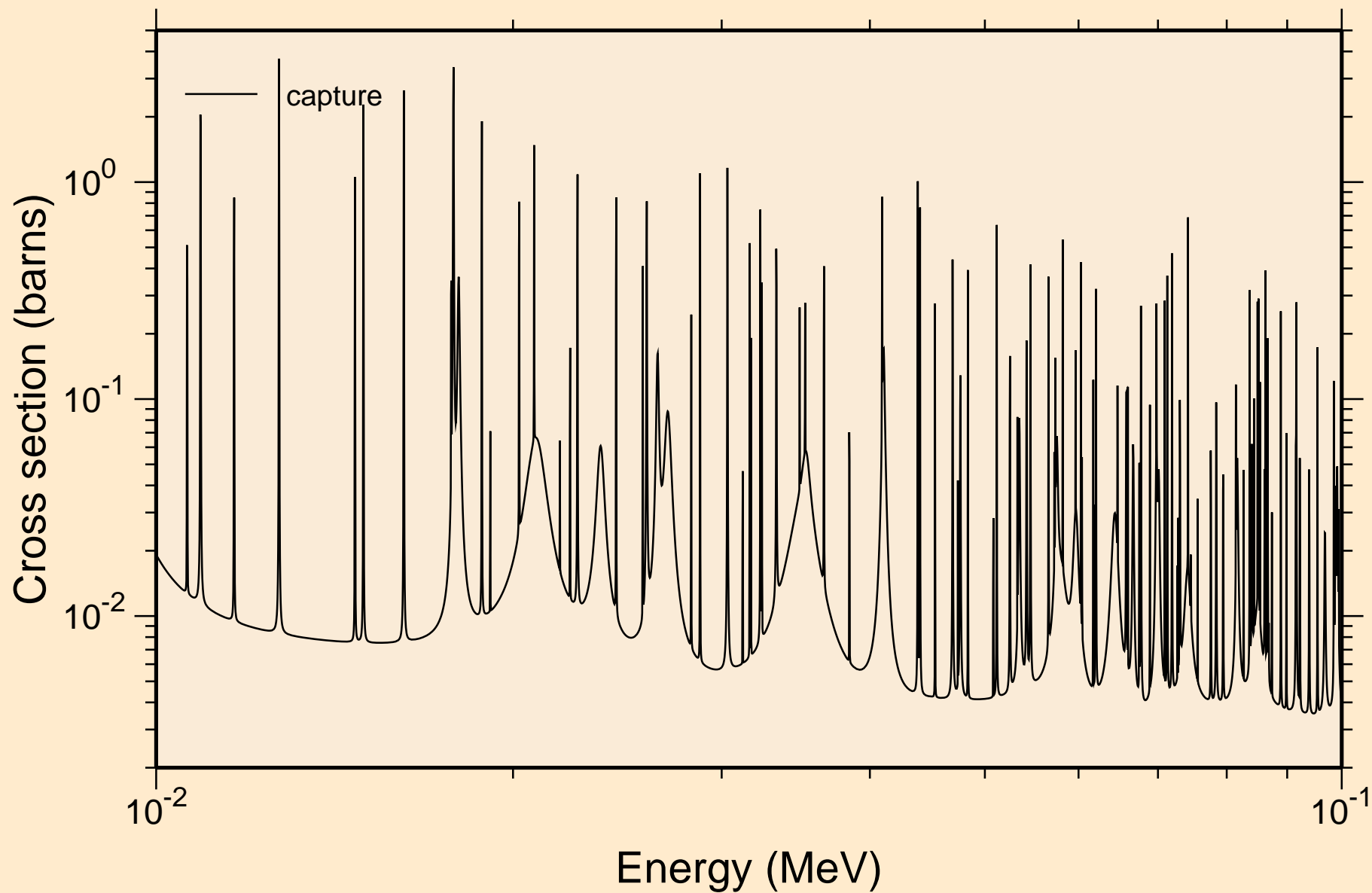



25-MN-55 FOR FENDL-3.2 FROM INDL/V-3 BY NJOY2016.60+ ON  
resonance absorption cross sections

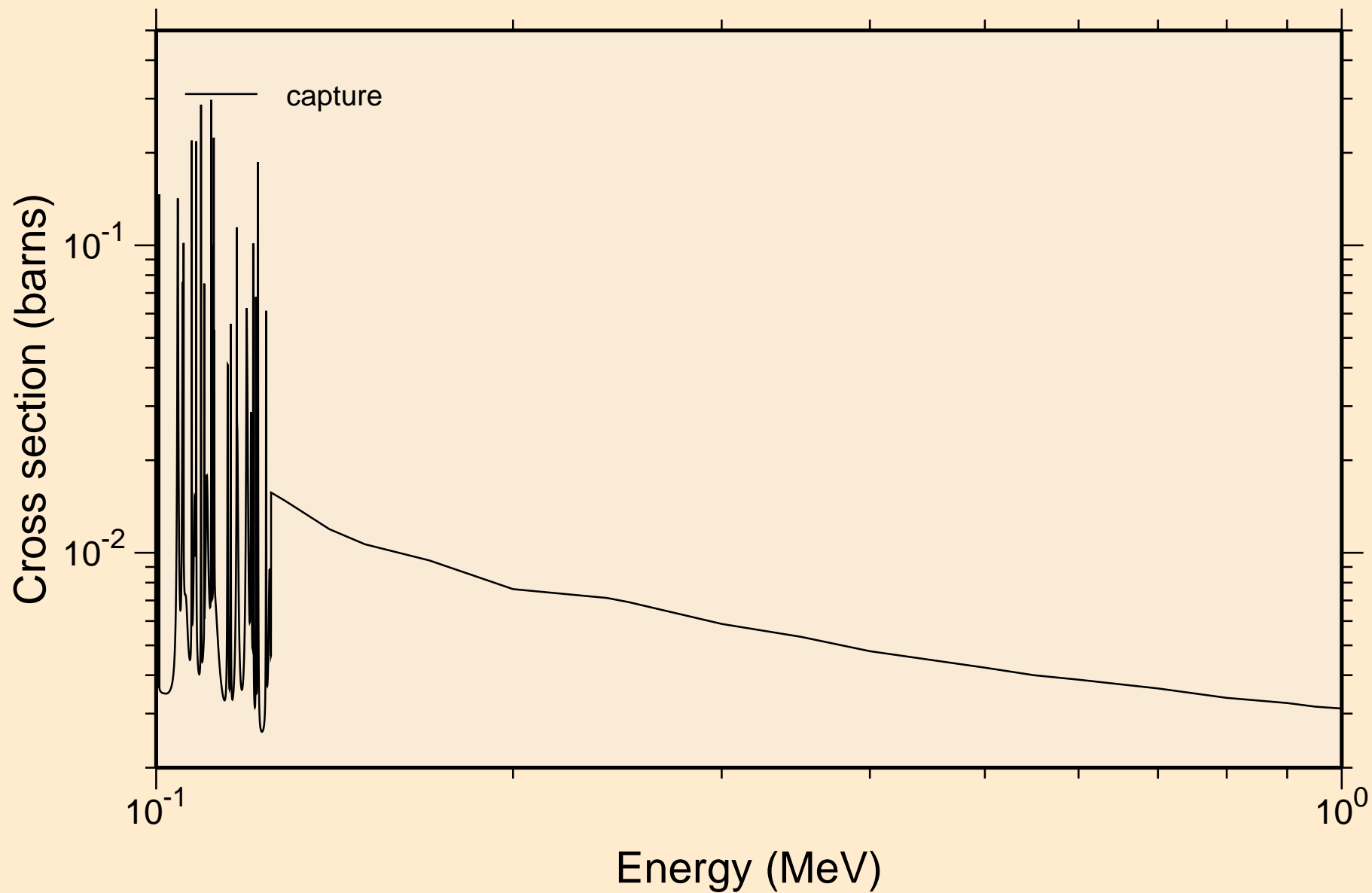

25-MN-55 FOR FENDL-3.2 FROM INDL/V-3 BY NJOY2016.60+ ON  
UR total cross section

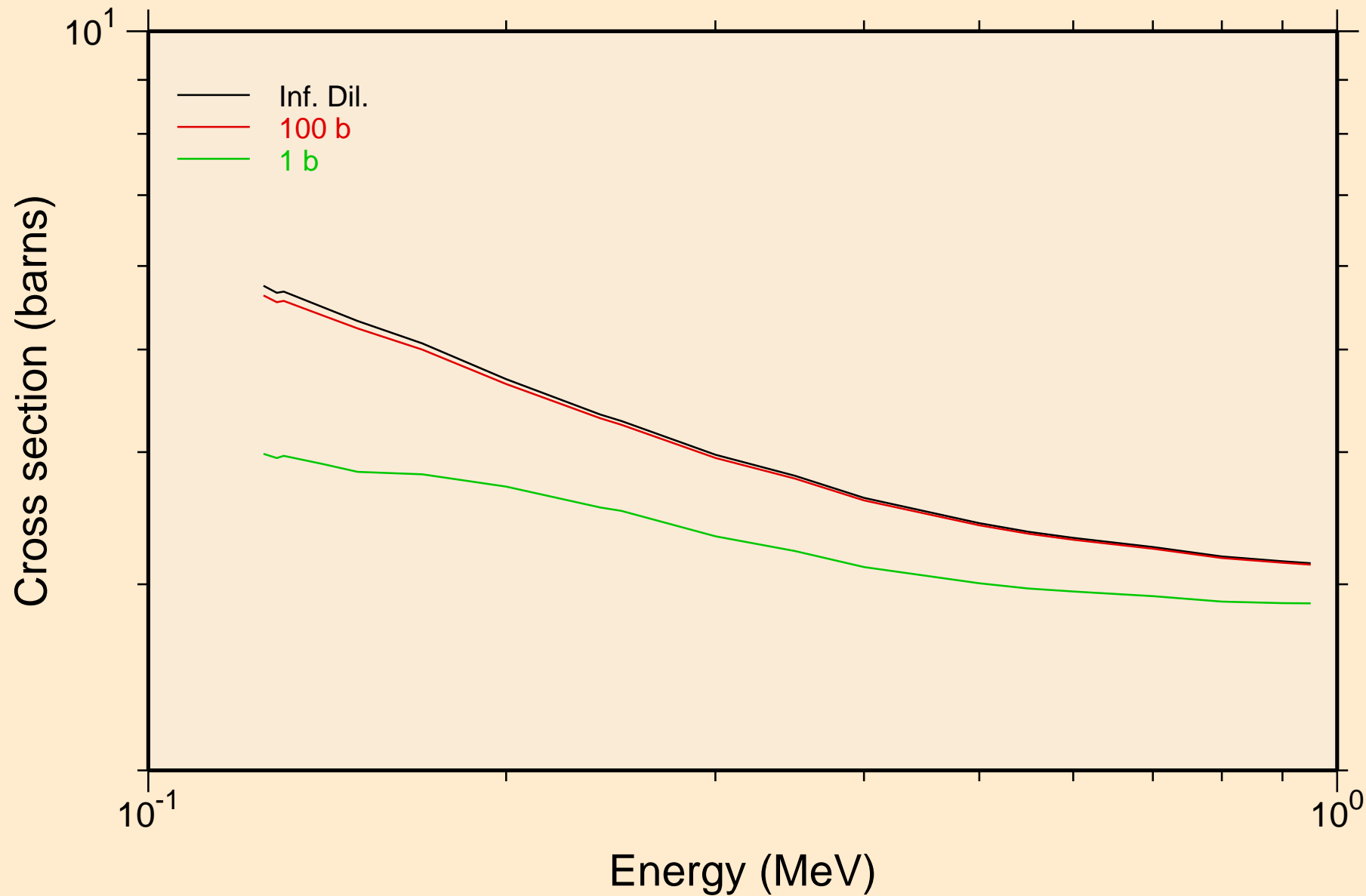

25-MN-55 FOR FENDL-3.2 FROM INDL/V-3 BY NJOY2016.60+ ON  
UR elastic cross section

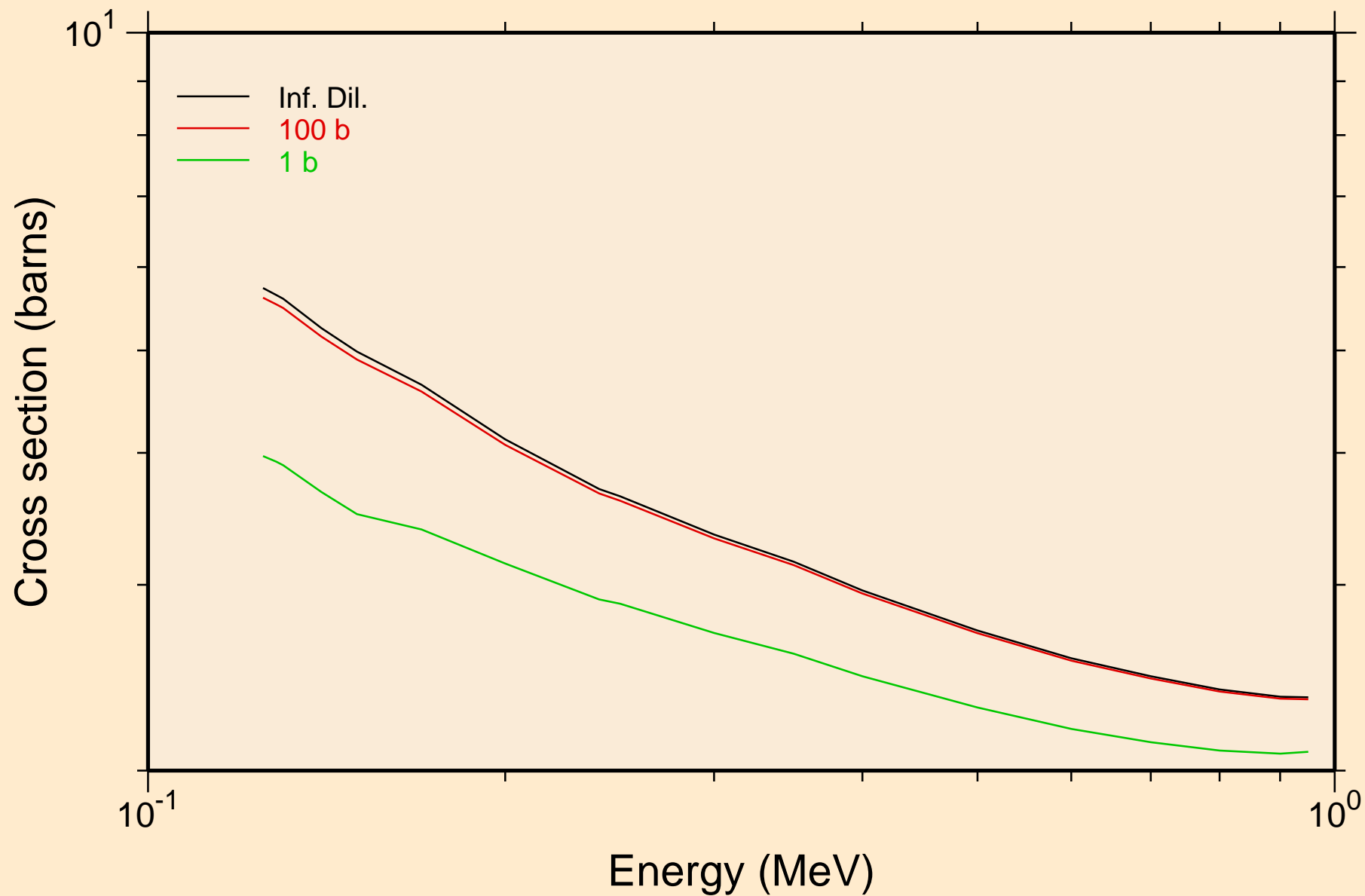

25-MN-55 FOR FENDL-3.2 FROM INDL/V-3 BY NJOY2016.60+ ON  
UR capture cross section

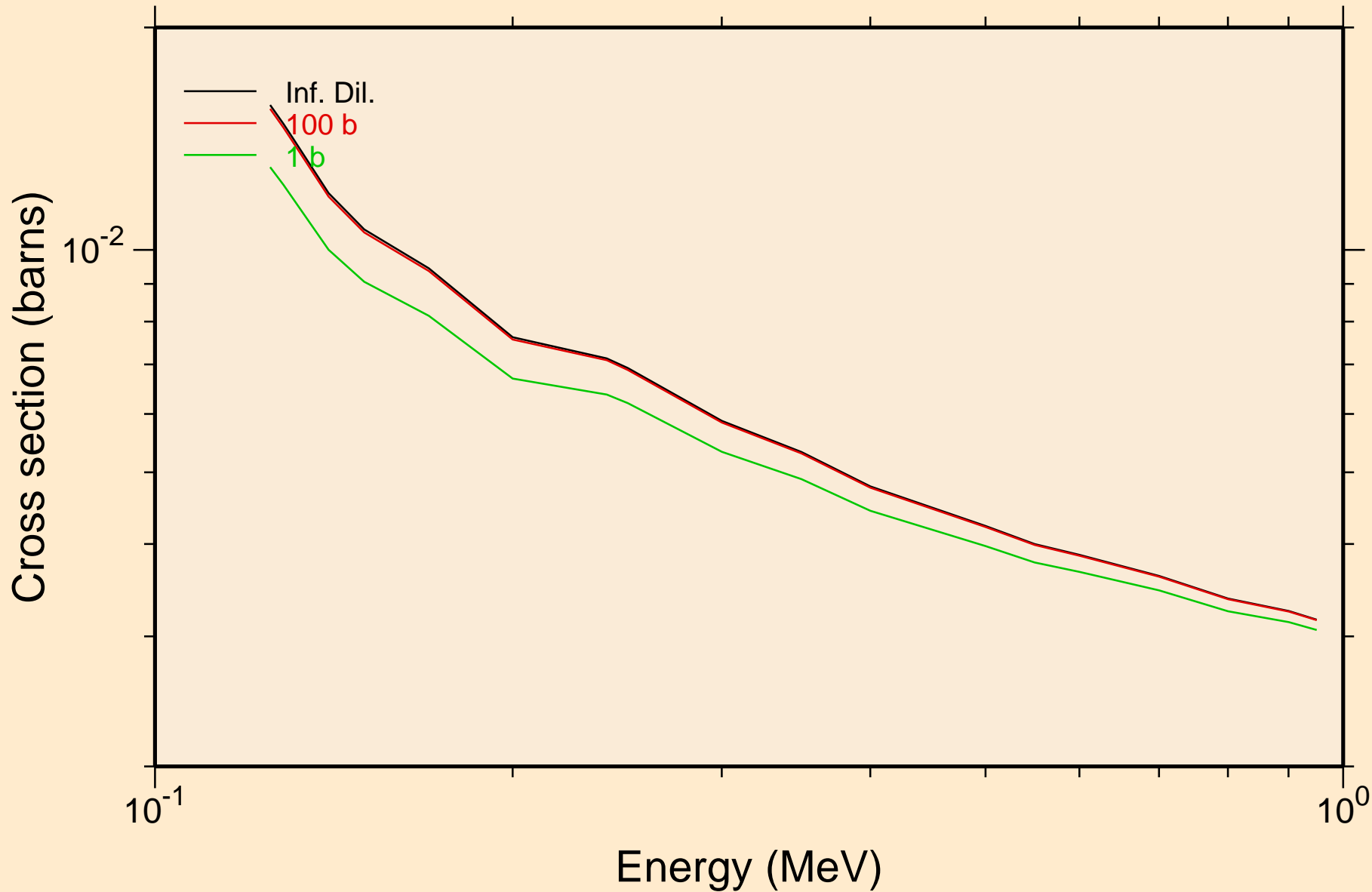

# 25-MN-55 FOR FENDL-3.2 FROM INDL/V-3 BY NJOY2016.60+ ON Heating

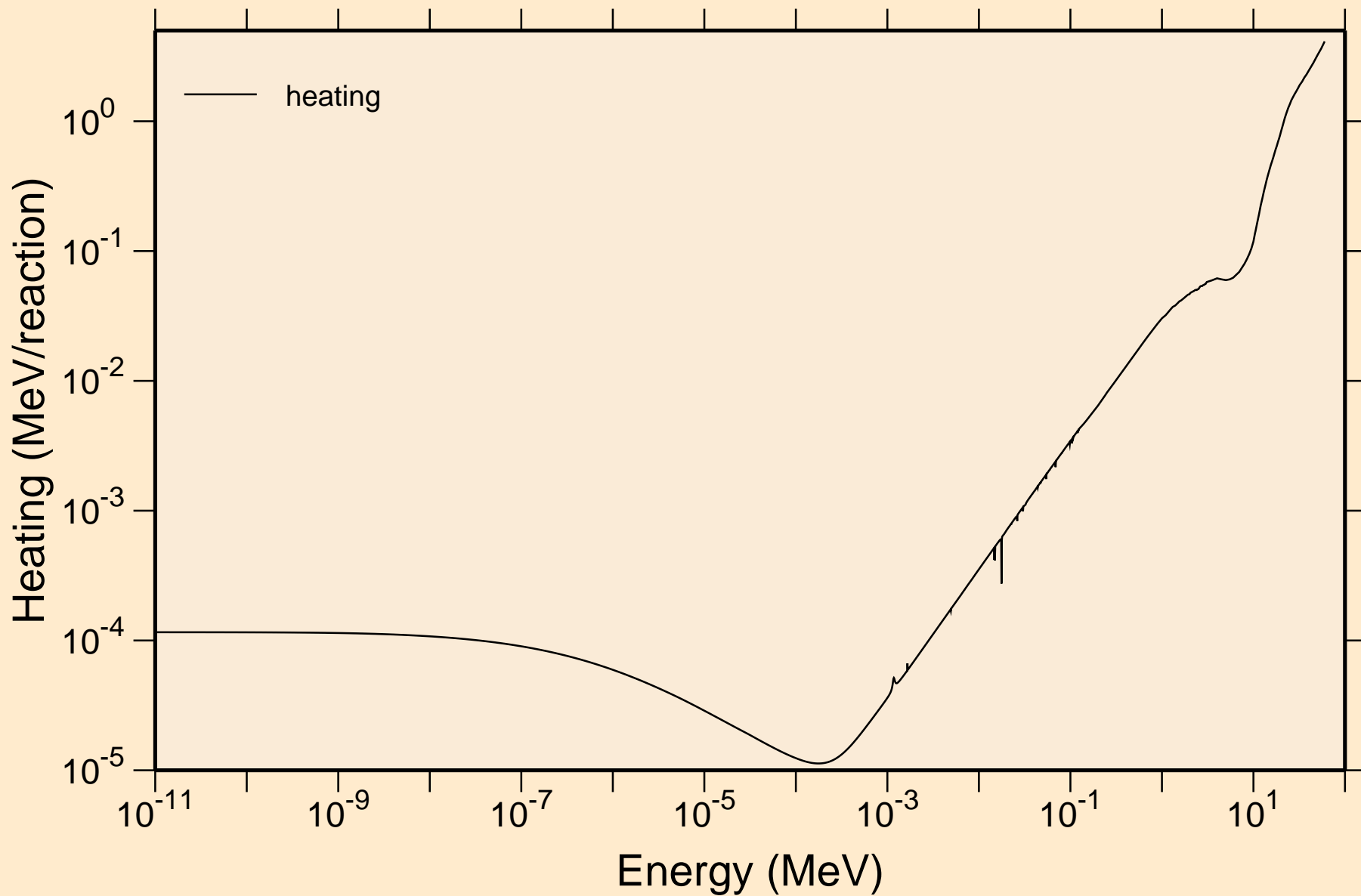

# 25-MN-55 FOR FENDL-3.2 FROM INDL/V-3 BY NJOY2016.60+ ON Damage

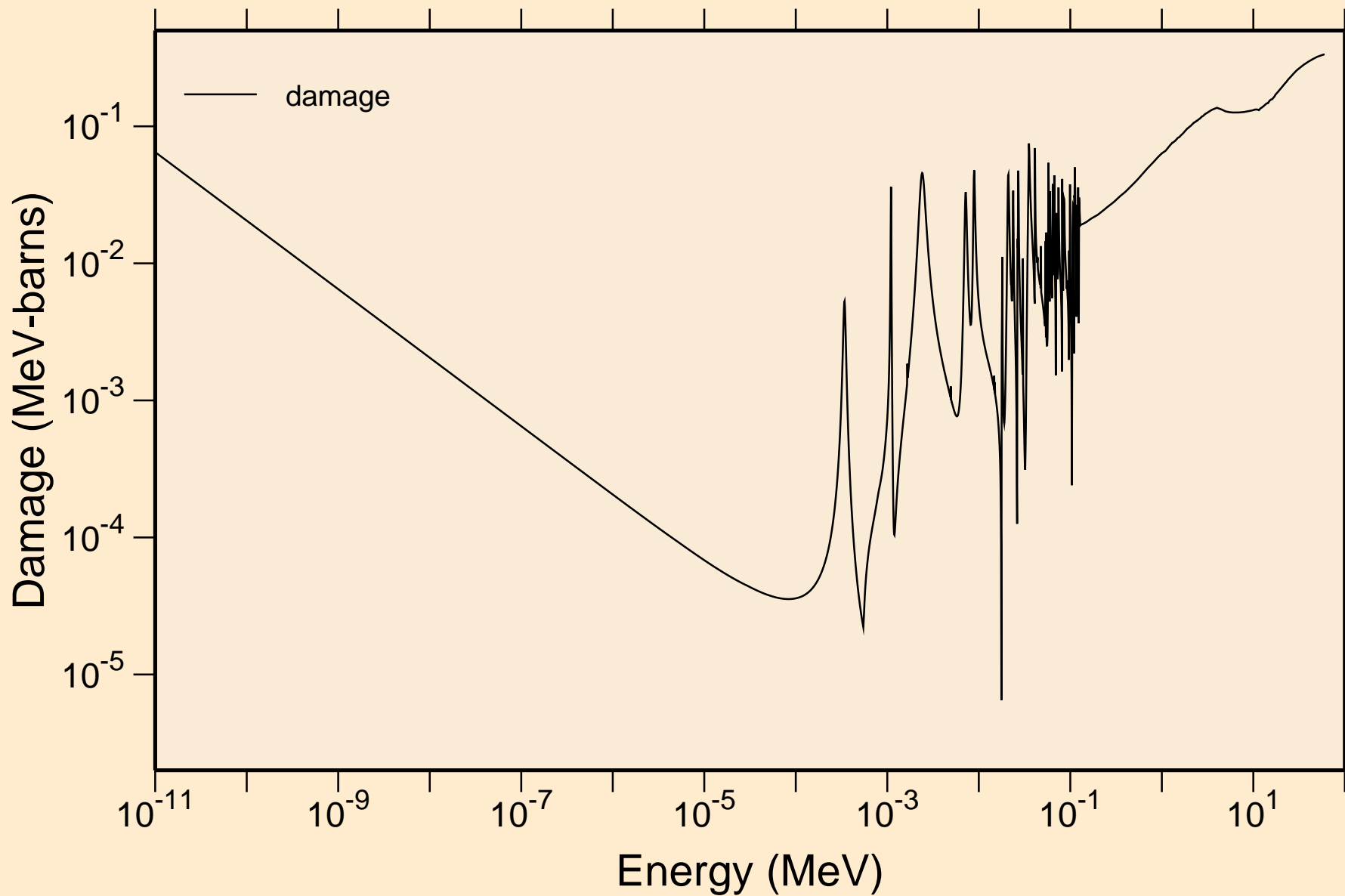

25-MN-55 FOR FENDL-3.2 FROM INDL/V-3 BY NJOY2016.60+ ON  
Non-threshold reactions

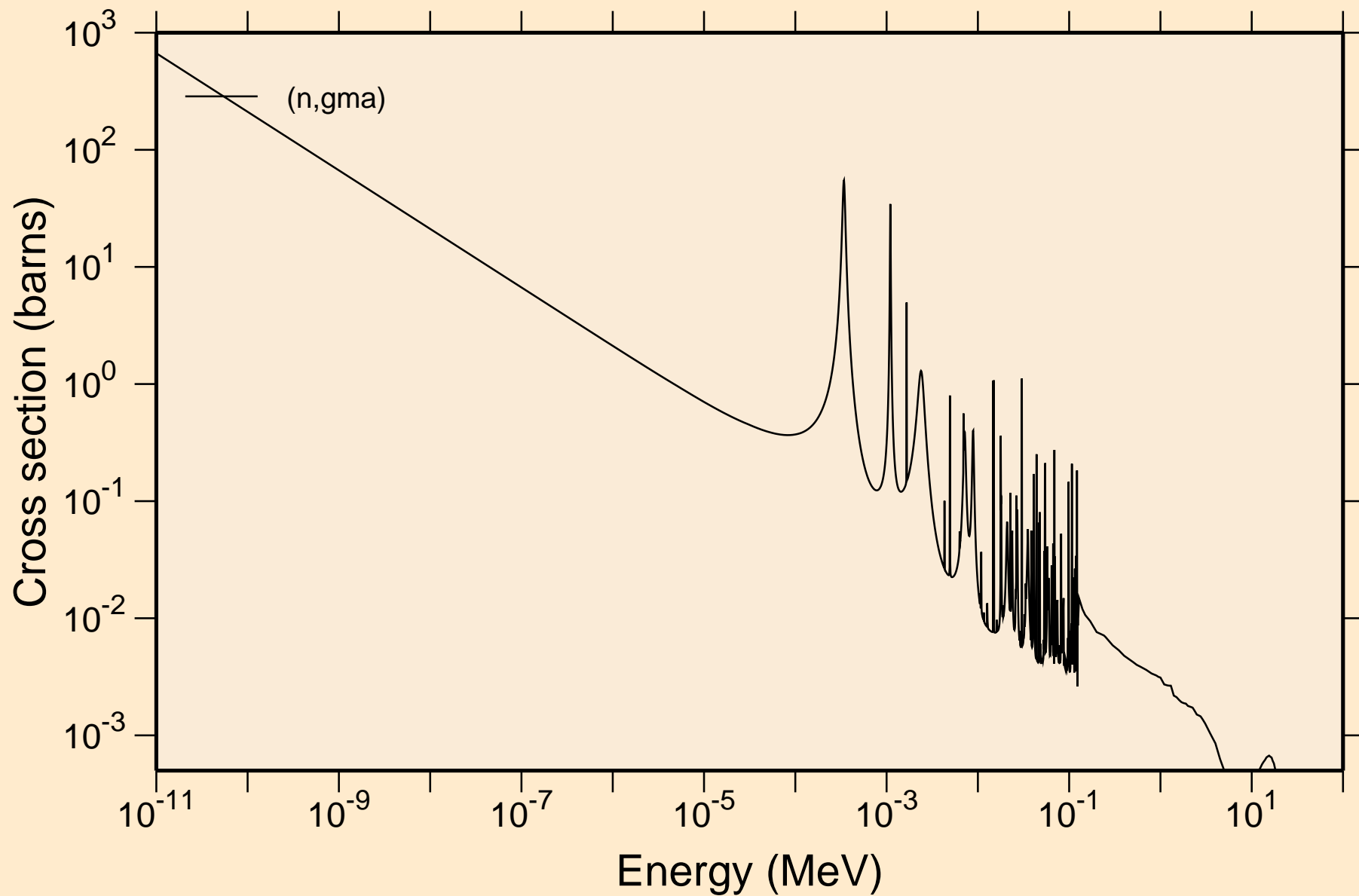

25-MN-55 FOR FENDL-3.2 FROM INDL/V-3 BY NJOY2016.60+ ON  
Principal cross sections

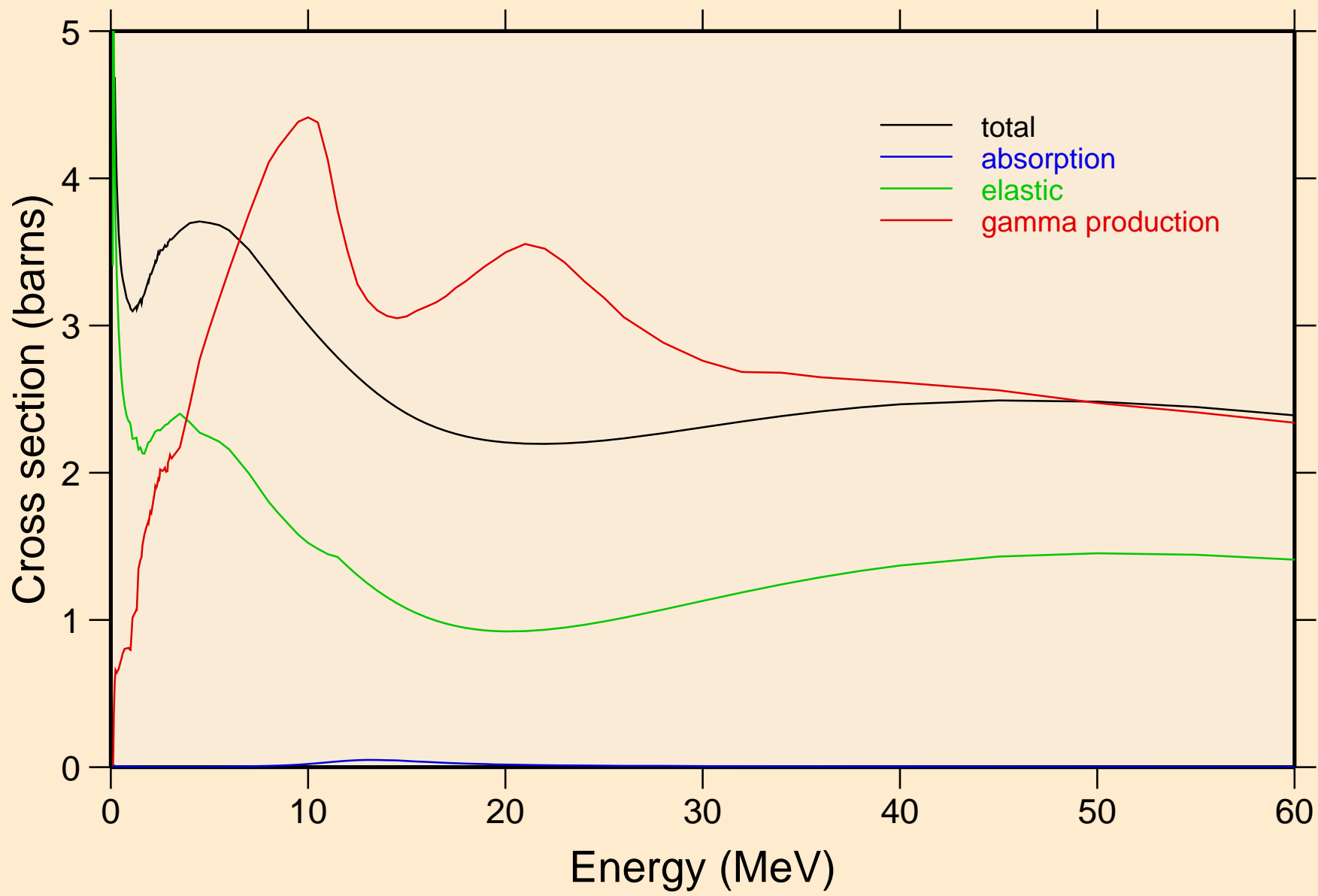



# 25-MN-55 FOR FENDL-3.2 FROM INDL/V-3 BY NJOY2016.60+ ON Heating

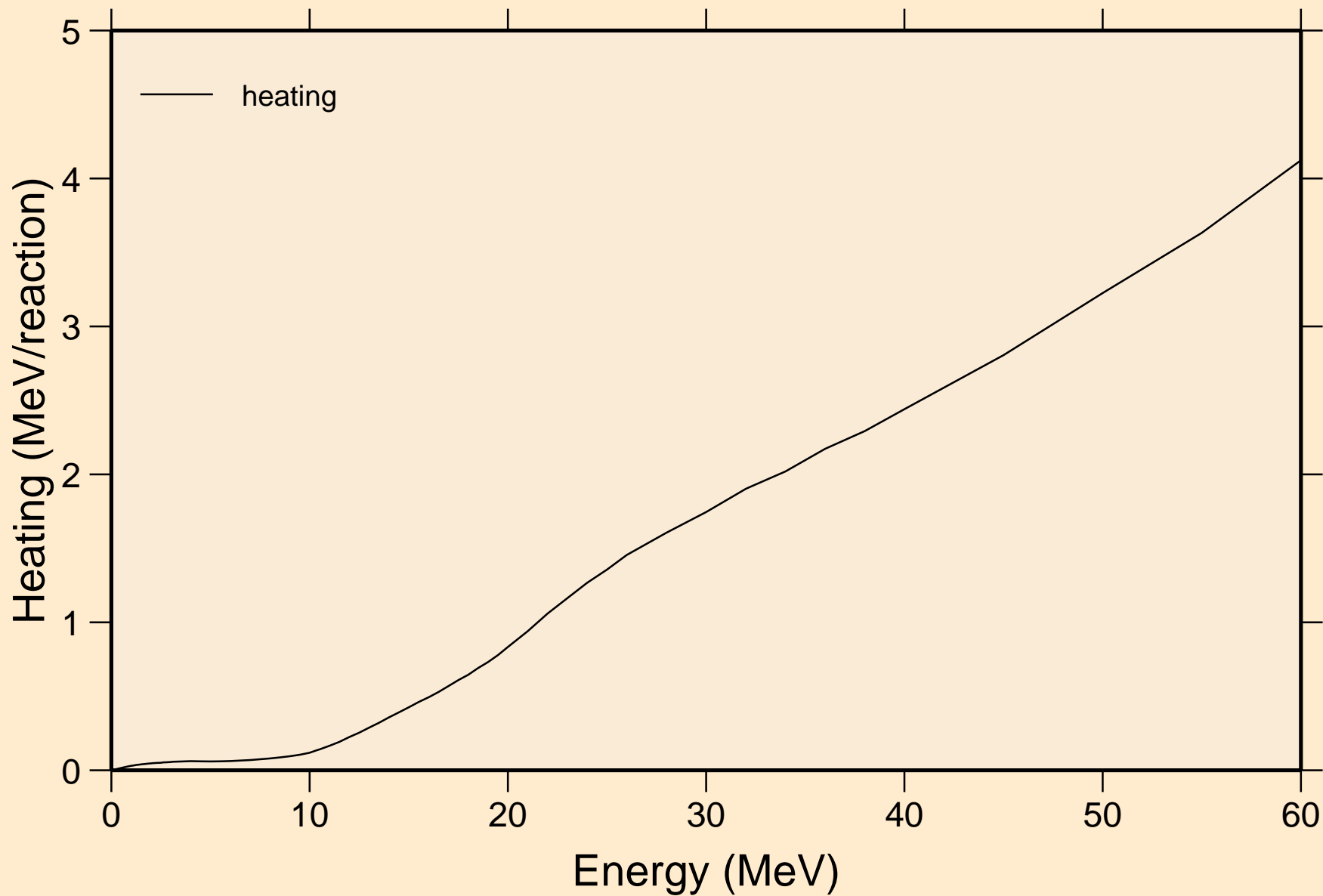

# 25-MN-55 FOR FENDL-3.2 FROM INDL/V-3 BY NJOY2016.60+ ON Damage

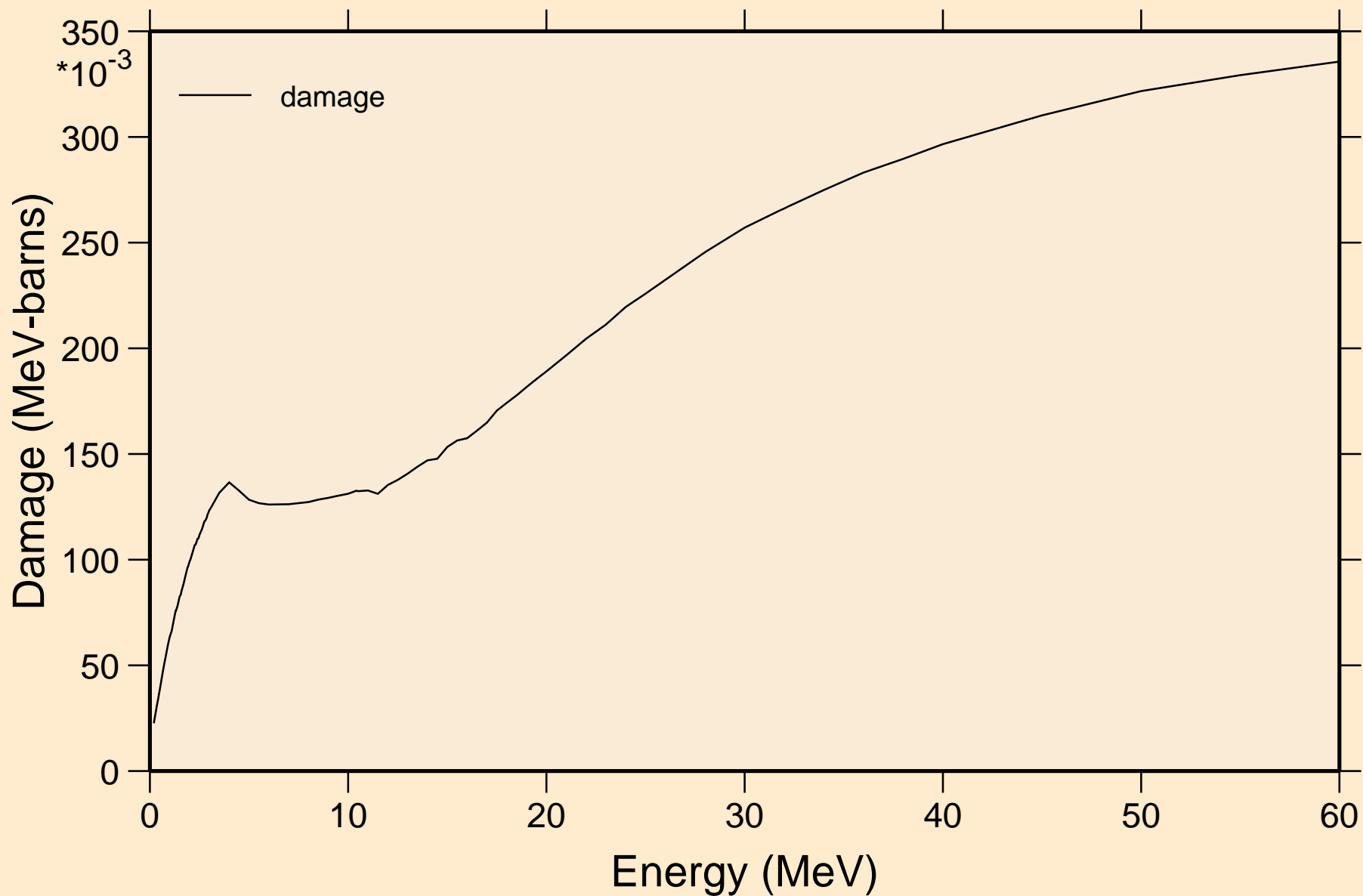

25-MN-55 FOR FENDL-3.2 FROM INDL/V-3 BY NJOY2016.60+ ON  
Non-threshold reactions

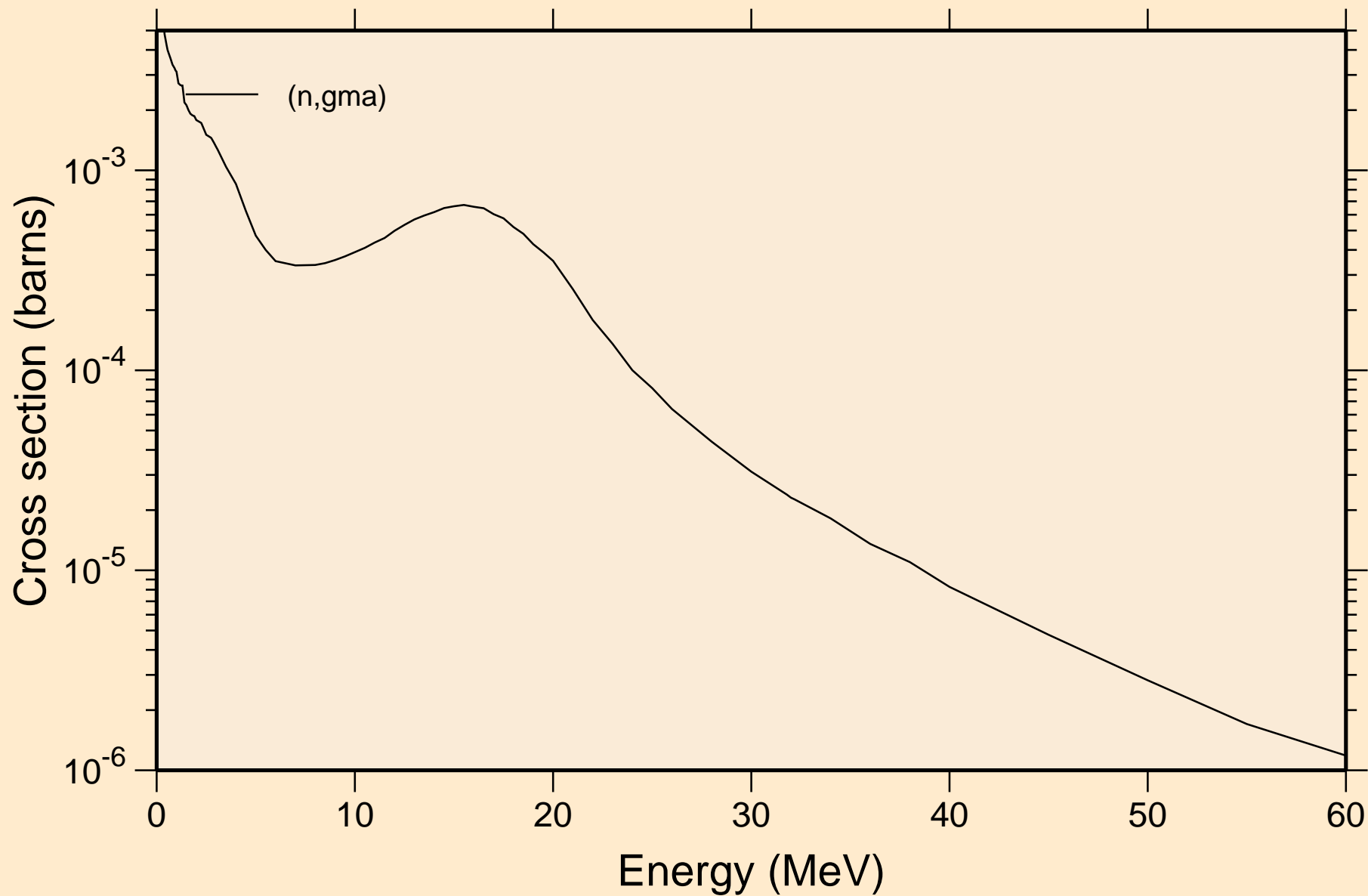

25-MN-55 FOR FENDL-3.2 FROM INDL/V-3 BY NJOY2016.60+ ON  
Inelastic levels

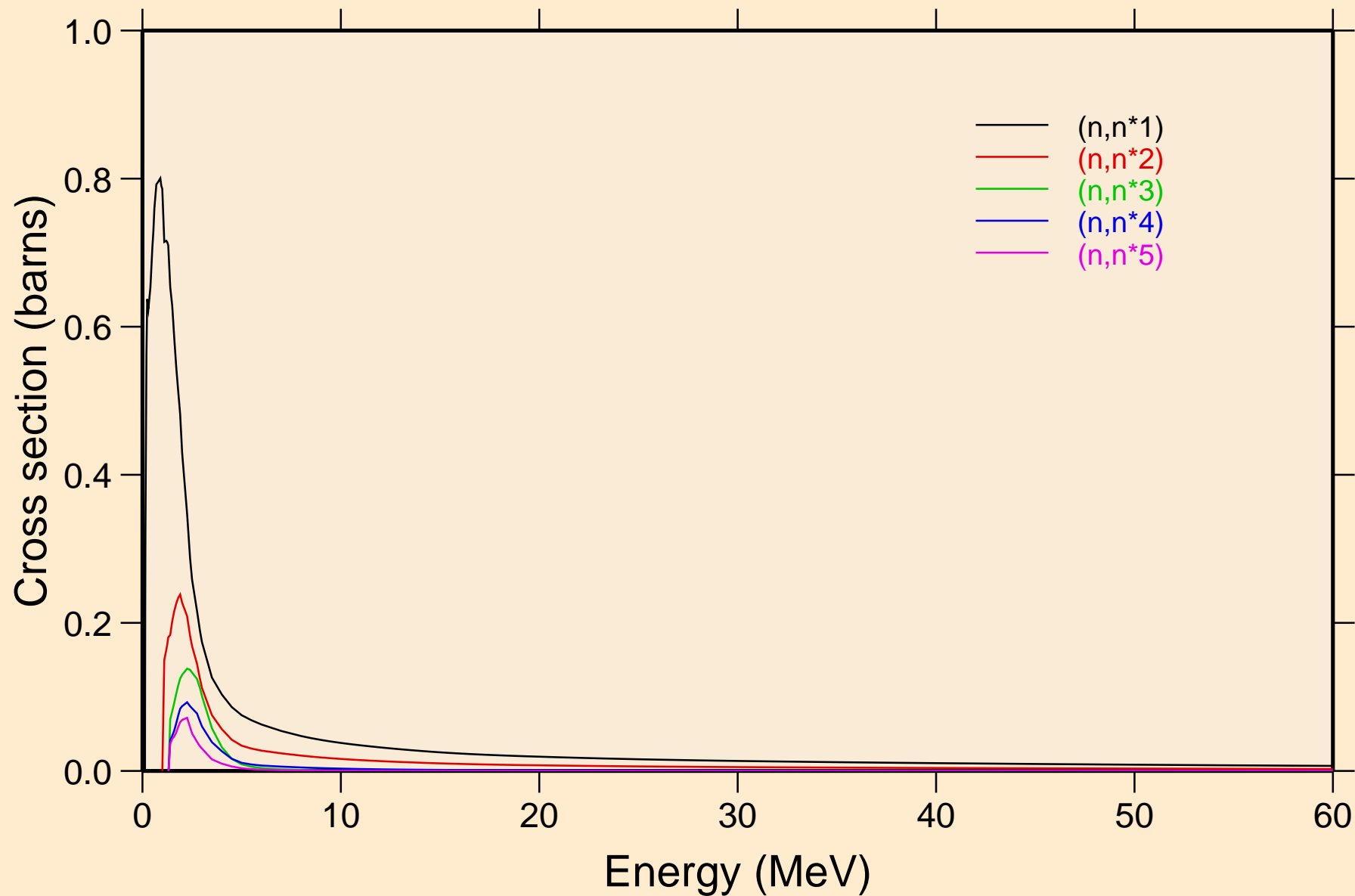

# 25-MN-55 FOR FENDL-3.2 FROM INDL/V-3 BY NJOY2016.60+ ON Inelastic levels

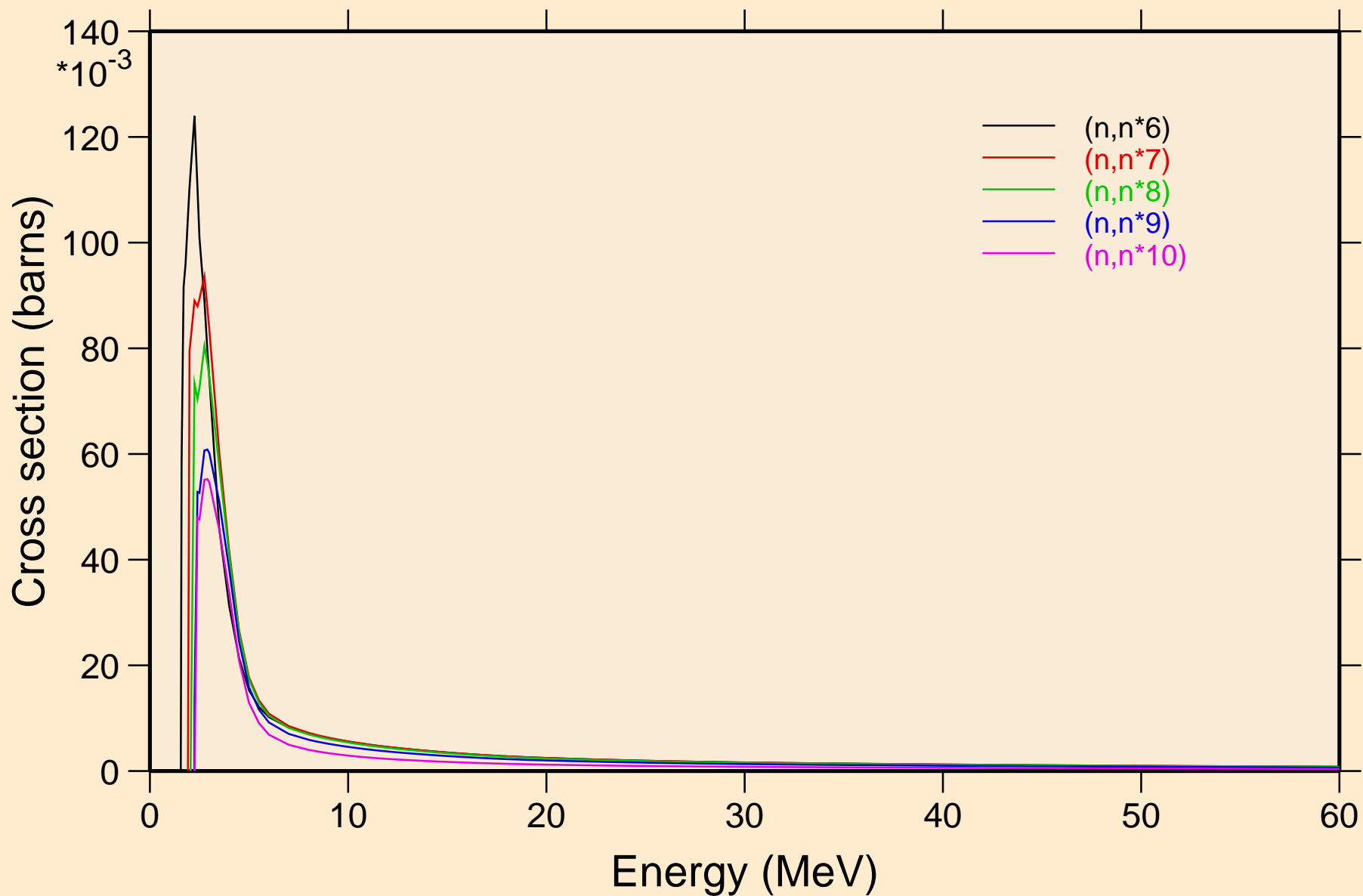

# 25-MN-55 FOR FENDL-3.2 FROM INDL/V-3 BY NJOY2016.60+ ON Inelastic levels

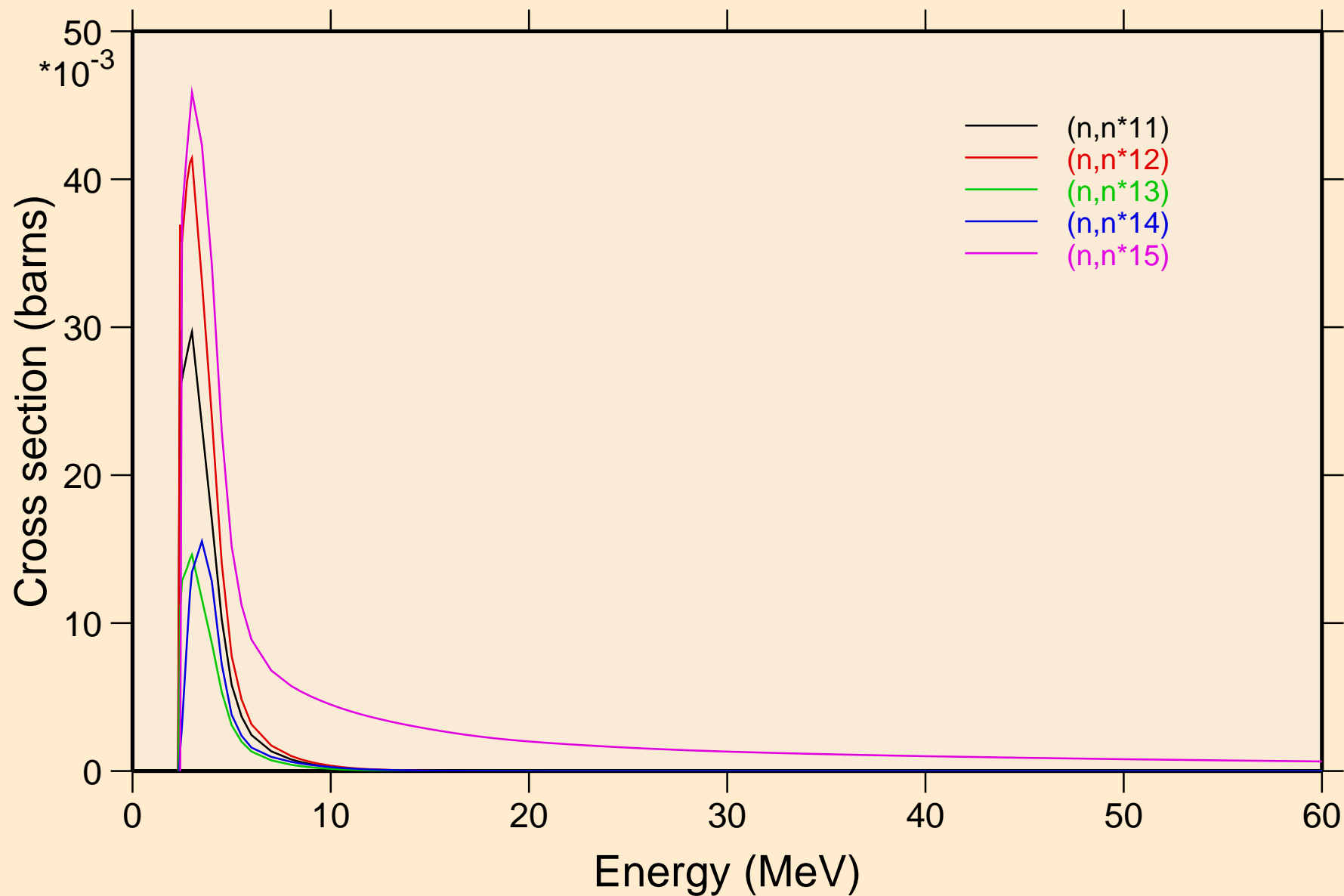

# 25-MN-55 FOR FENDL-3.2 FROM INDL/V-3 BY NJOY2016.60+ ON Inelastic levels

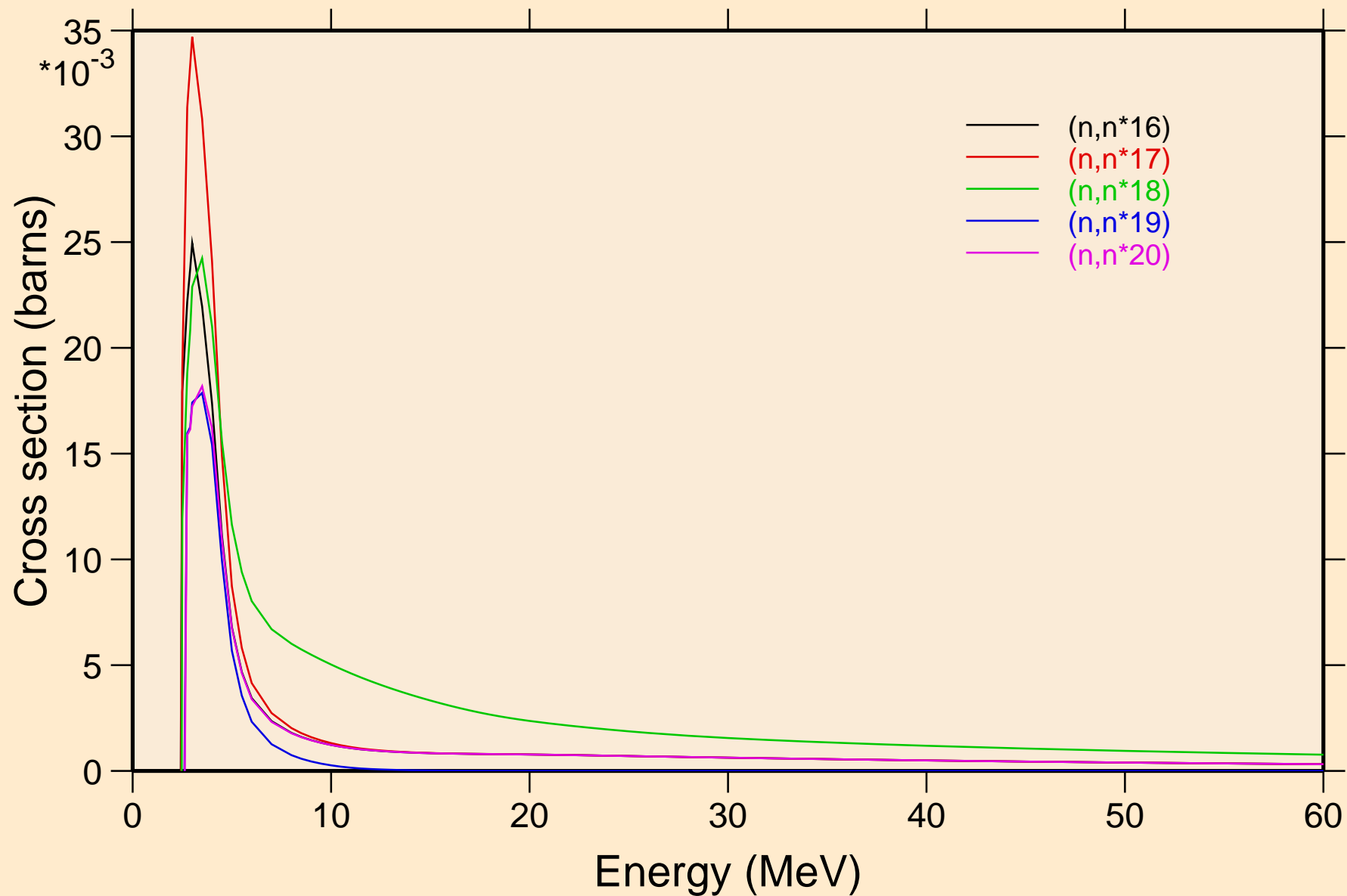

# 25-MN-55 FOR FENDL-3.2 FROM INDL/V-3 BY NJOY2016.60+ ON Inelastic levels

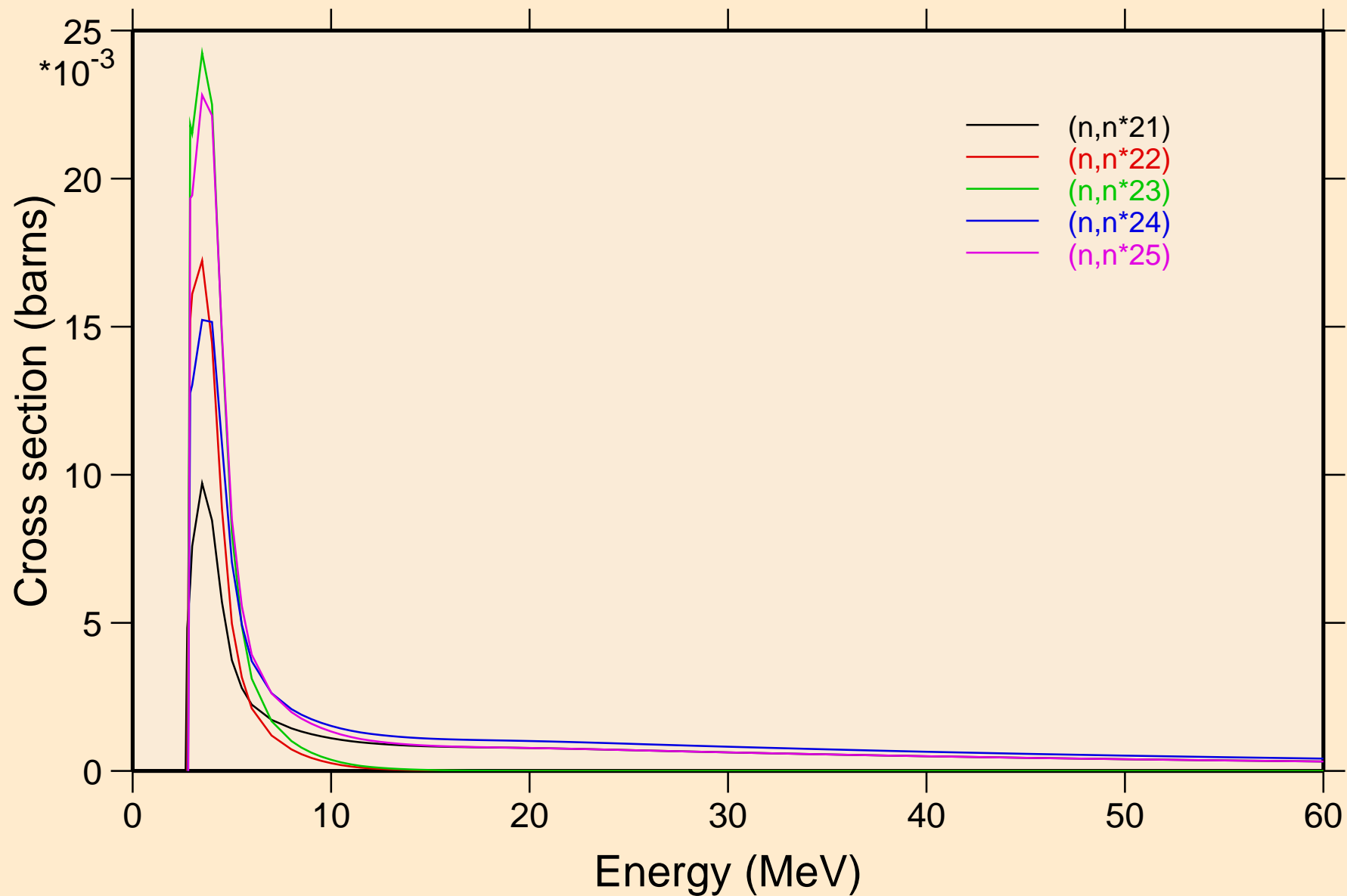



# 25-MN-55 FOR FENDL-3.2 FROM INDL/V-3 BY NJOY2016.60+ ON Inelastic levels

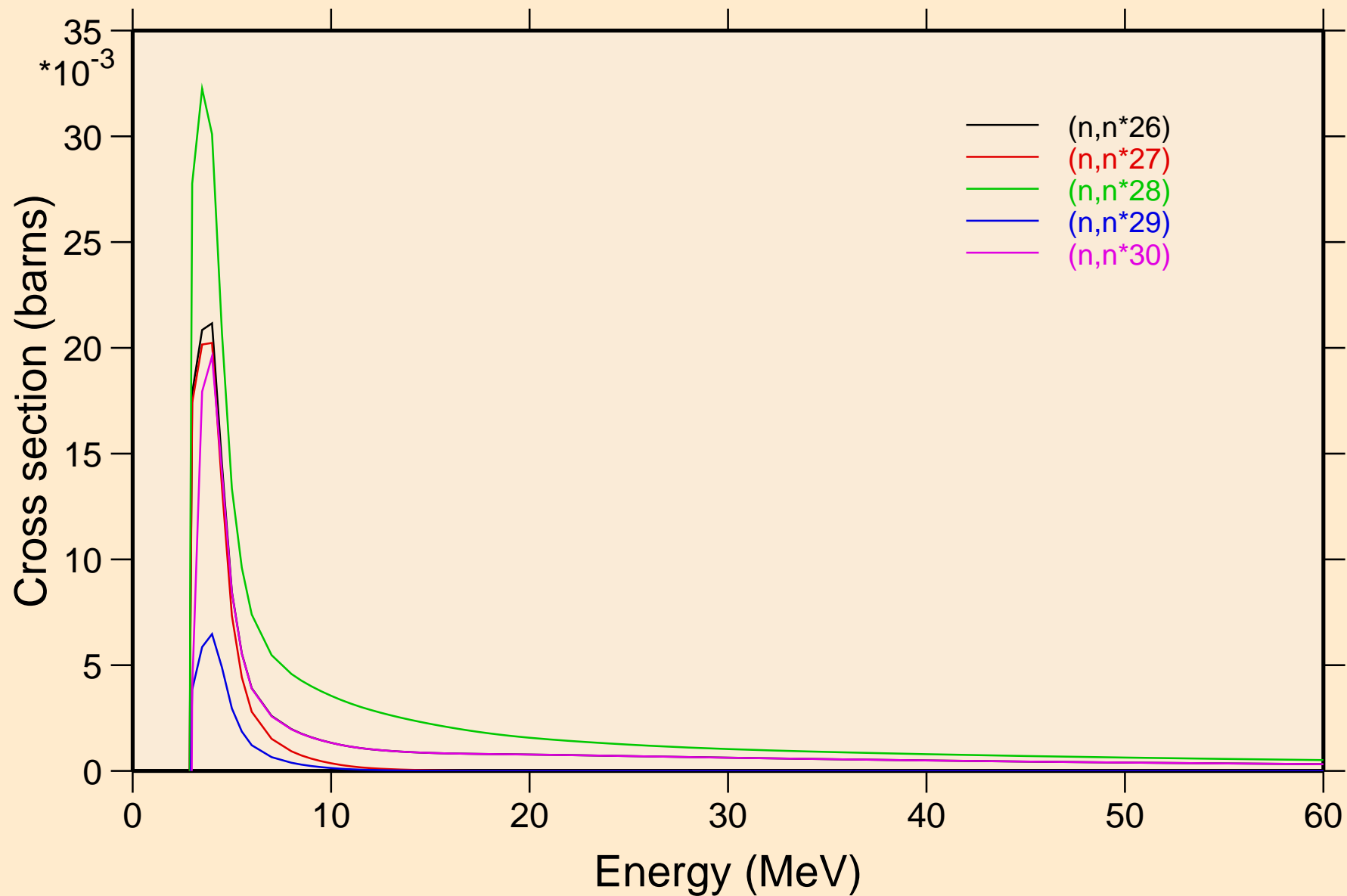

# 25-MN-55 FOR FENDL-3.2 FROM INDL/V-3 BY NJOY2016.60+ ON Inelastic levels

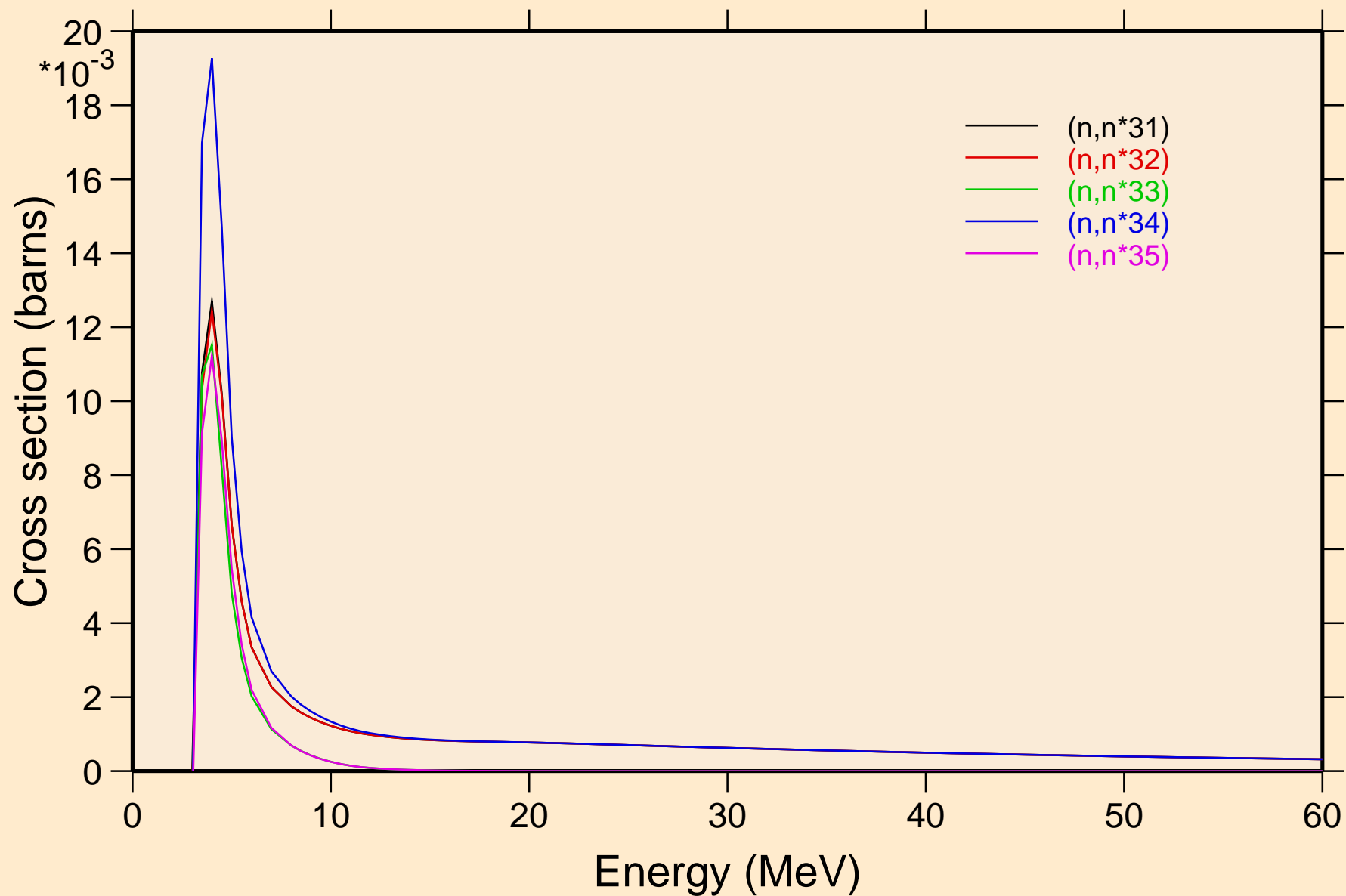

# 25-MN-55 FOR FENDL-3.2 FROM INDL/V-3 BY NJOY2016.60+ ON Inelastic levels

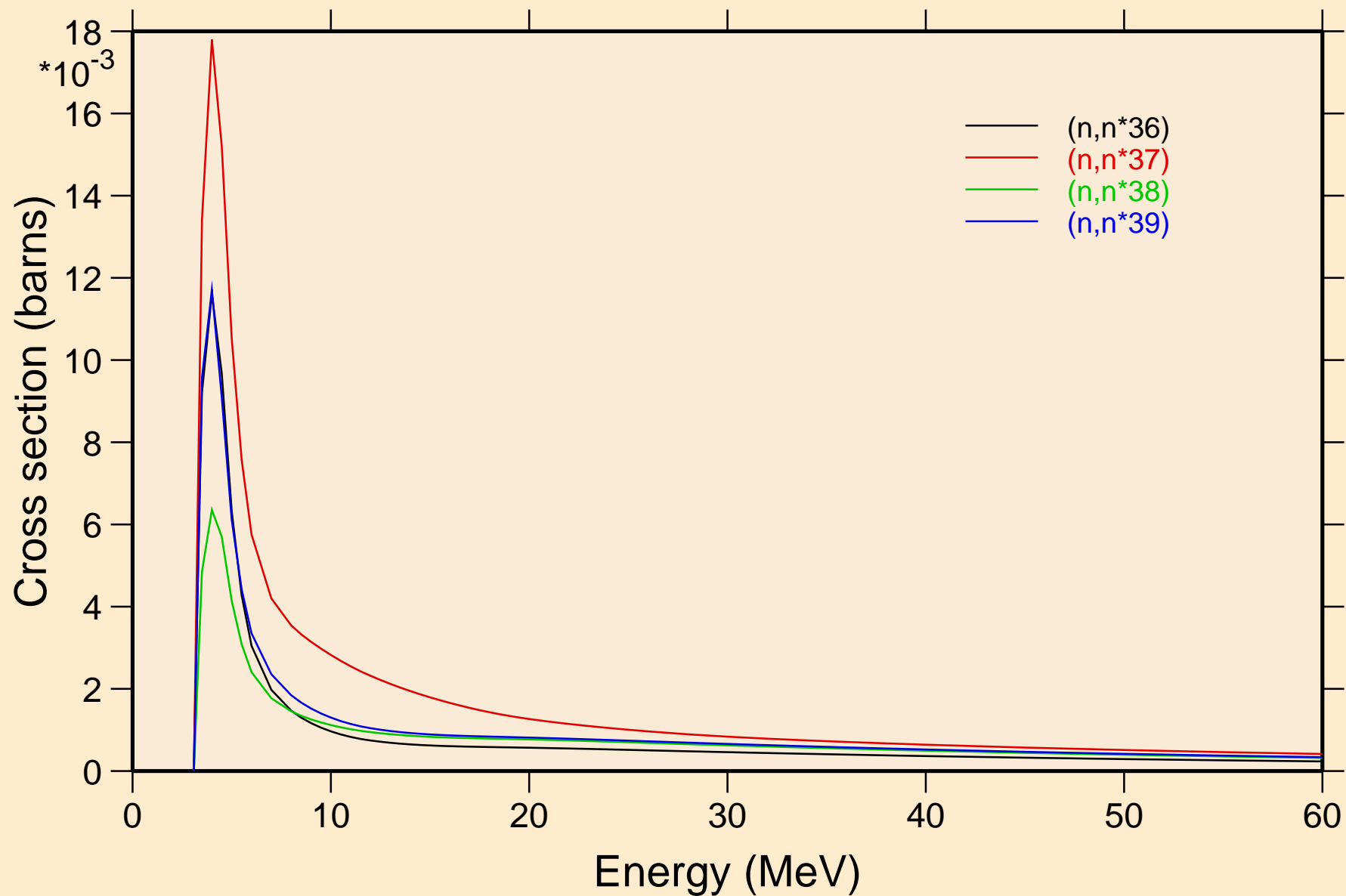

# 25-MN-55 FOR FENDL-3.2 FROM INDL/V-3 BY NJOY2016.60+ ON Threshold reactions

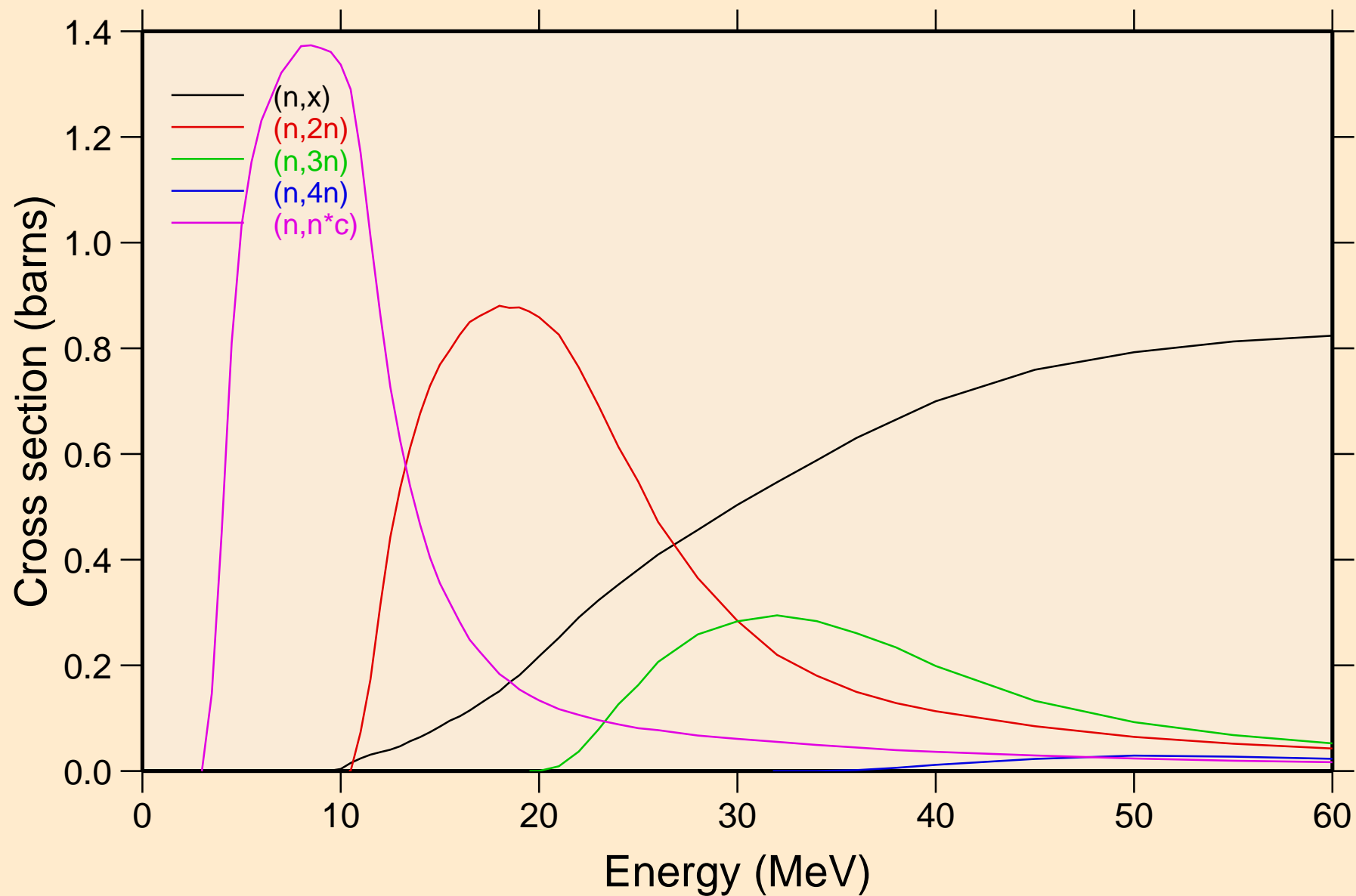

# 25-MN-55 FOR FENDL-3.2 FROM INDL/V-3 BY NJOY2016.60+ ON Threshold reactions

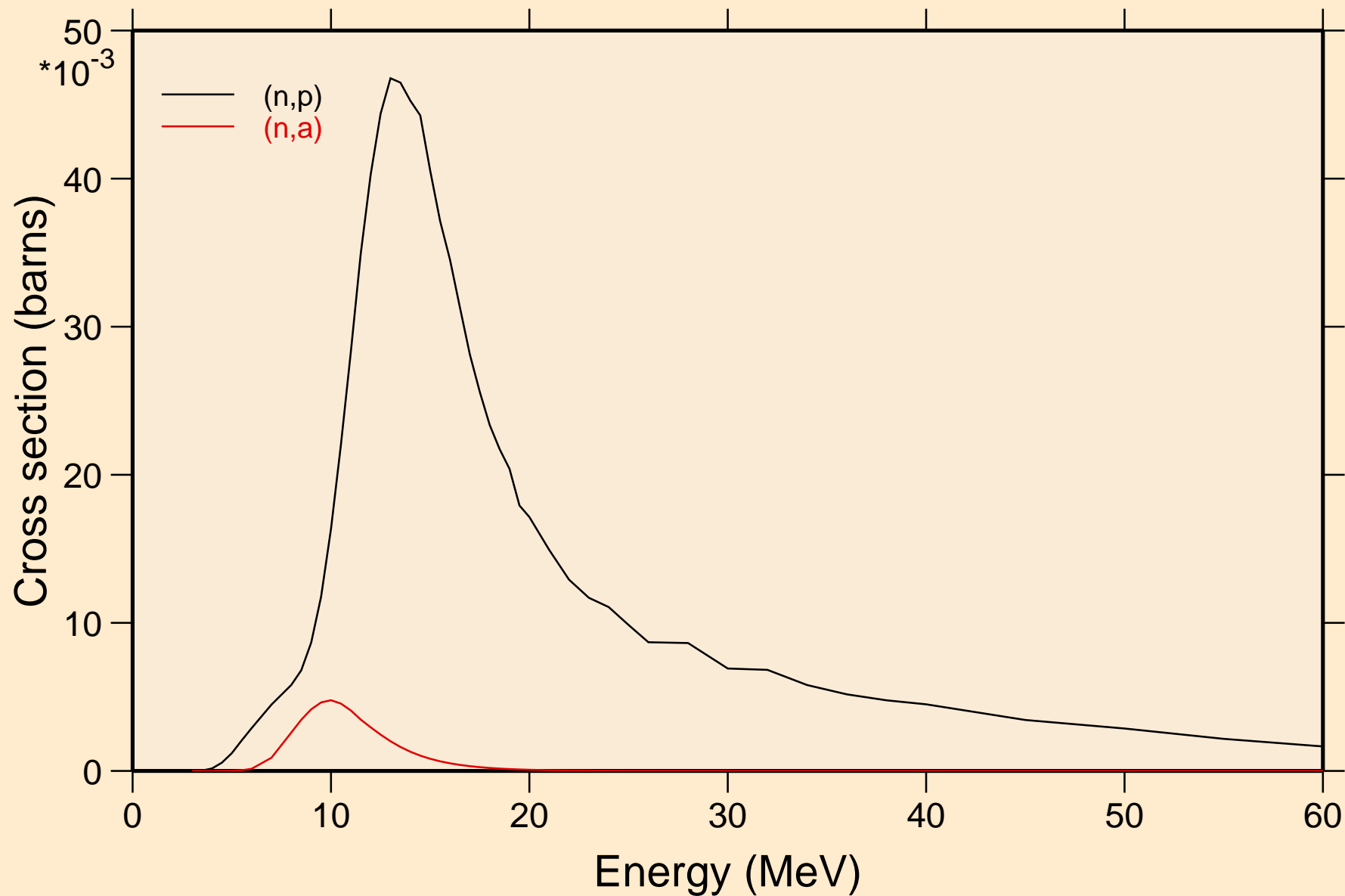

# 25-MN-55 FOR FENDL-3.2 FROM INDL/V-3 BY NJOY2016.60+ ON Threshold reactions

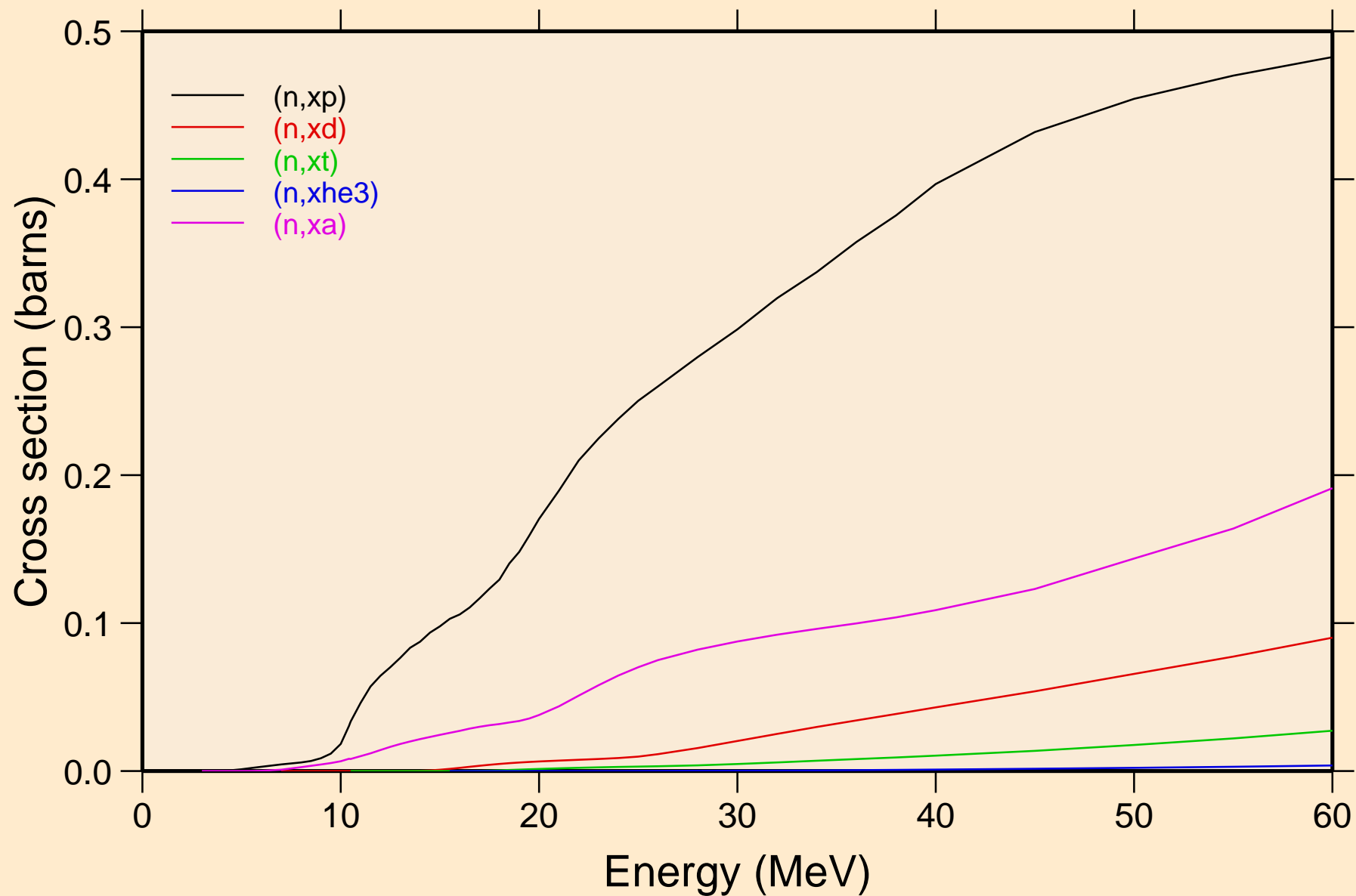

# 25-MN-55 FOR FENDL-3.2 FROM INDL/V-3 BY NJOY2016.60+ ON Threshold reactions

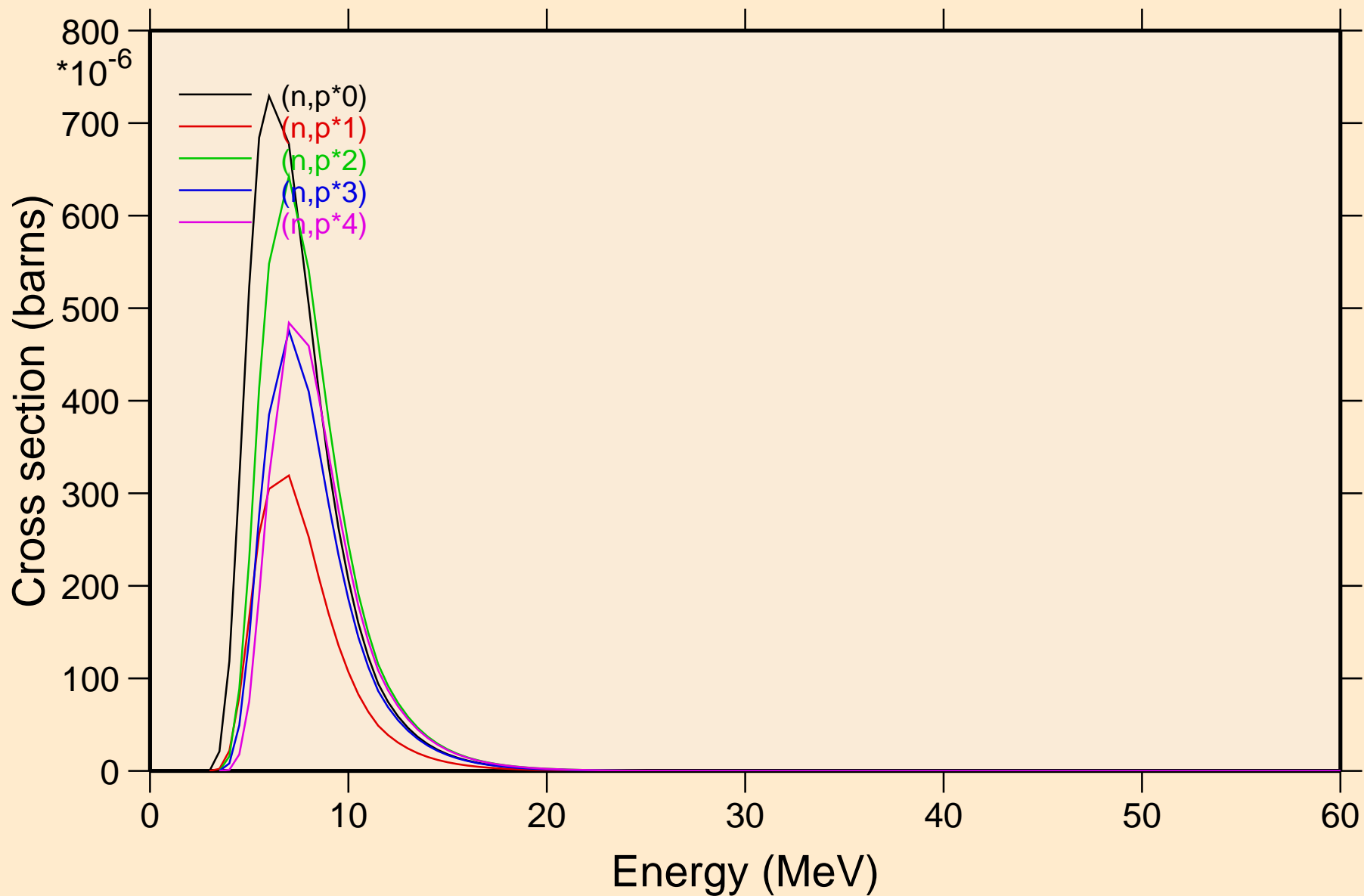

# 25-MN-55 FOR FENDL-3.2 FROM INDL/V-3 BY NJOY2016.60+ ON Threshold reactions

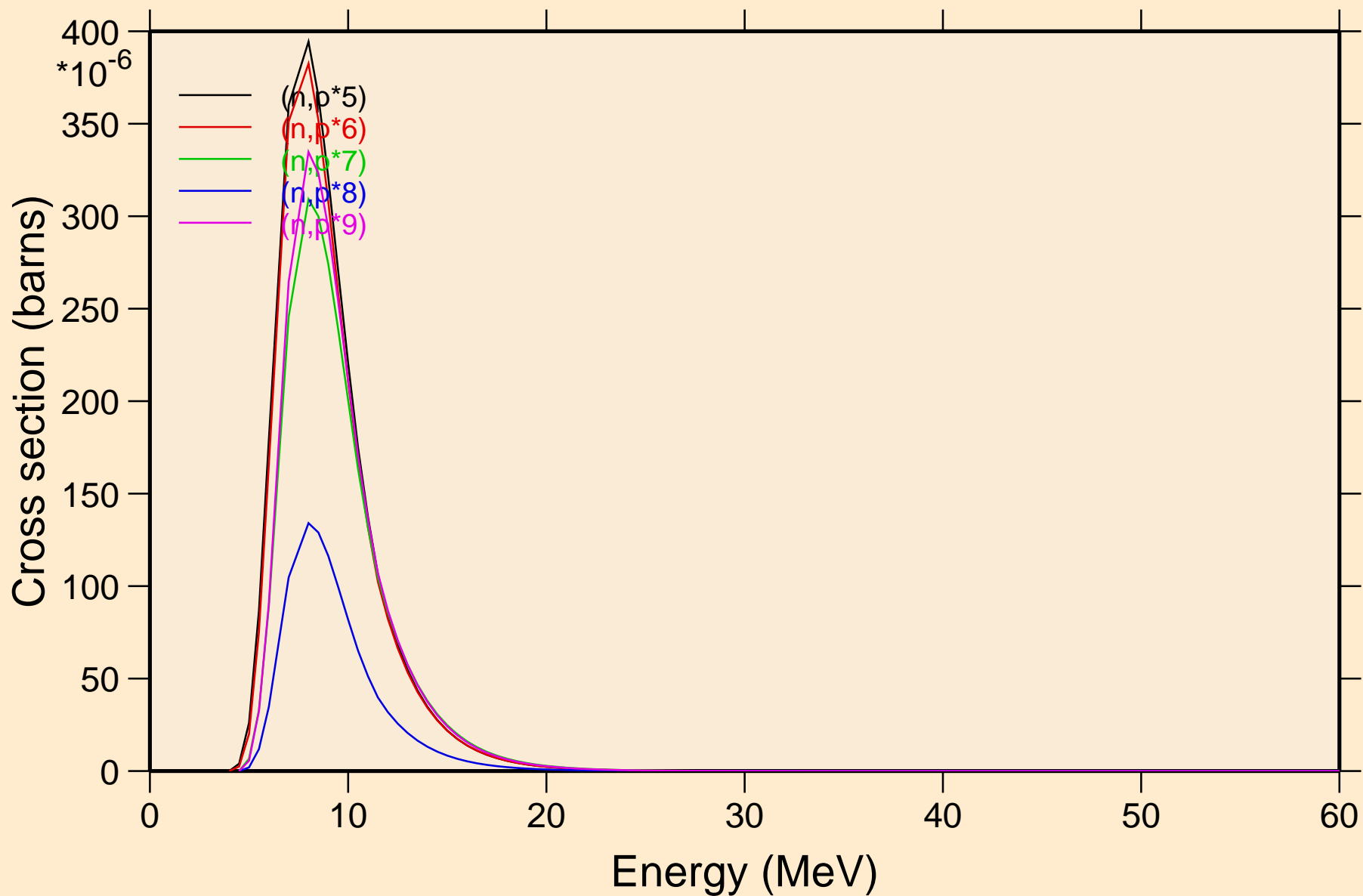



# 25-MN-55 FOR FENDL-3.2 FROM INDL/V-3 BY NJOY2016.60+ ON Threshold reactions

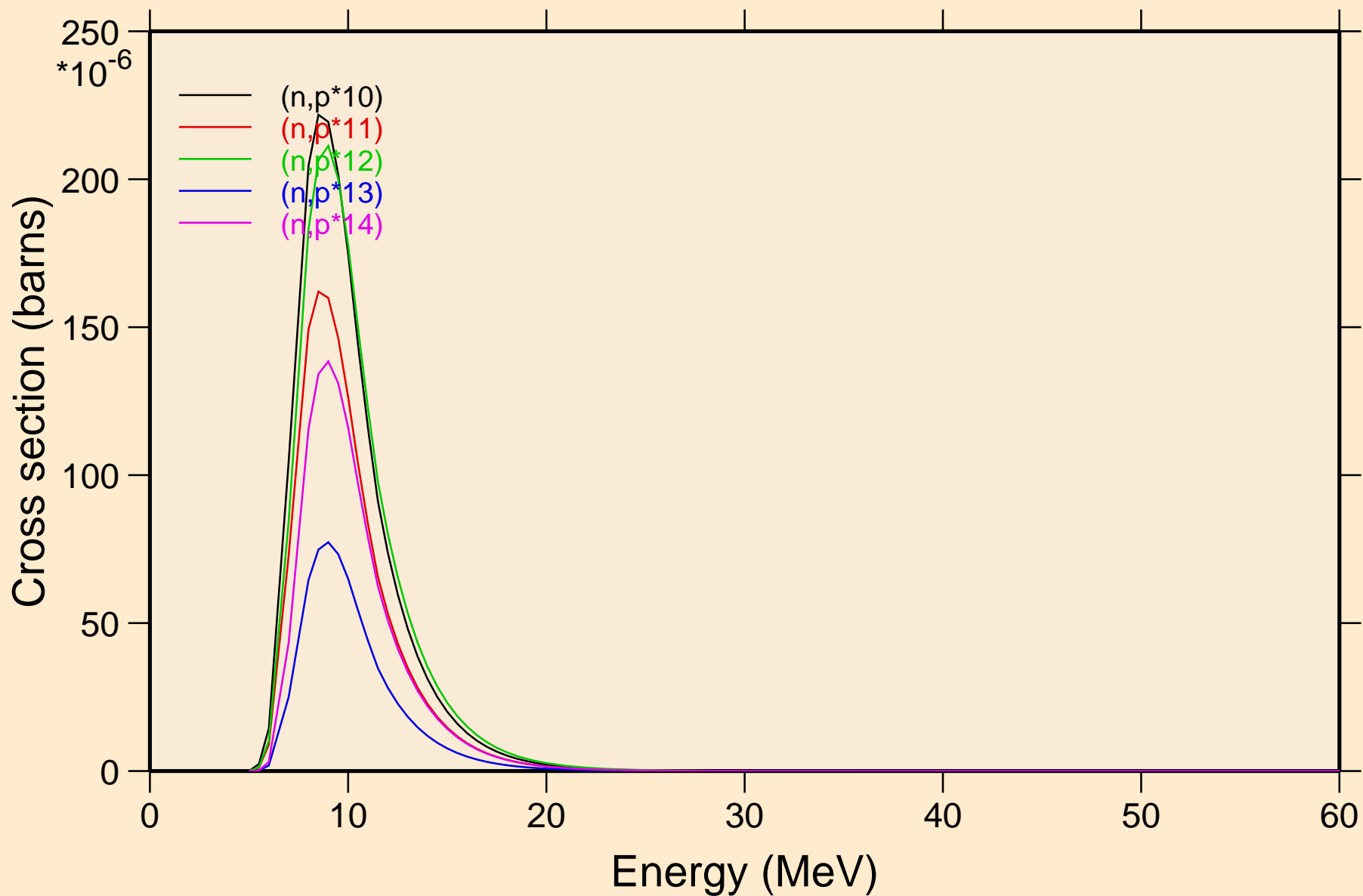

# 25-MN-55 FOR FENDL-3.2 FROM INDL/V-3 BY NJOY2016.60+ ON Threshold reactions

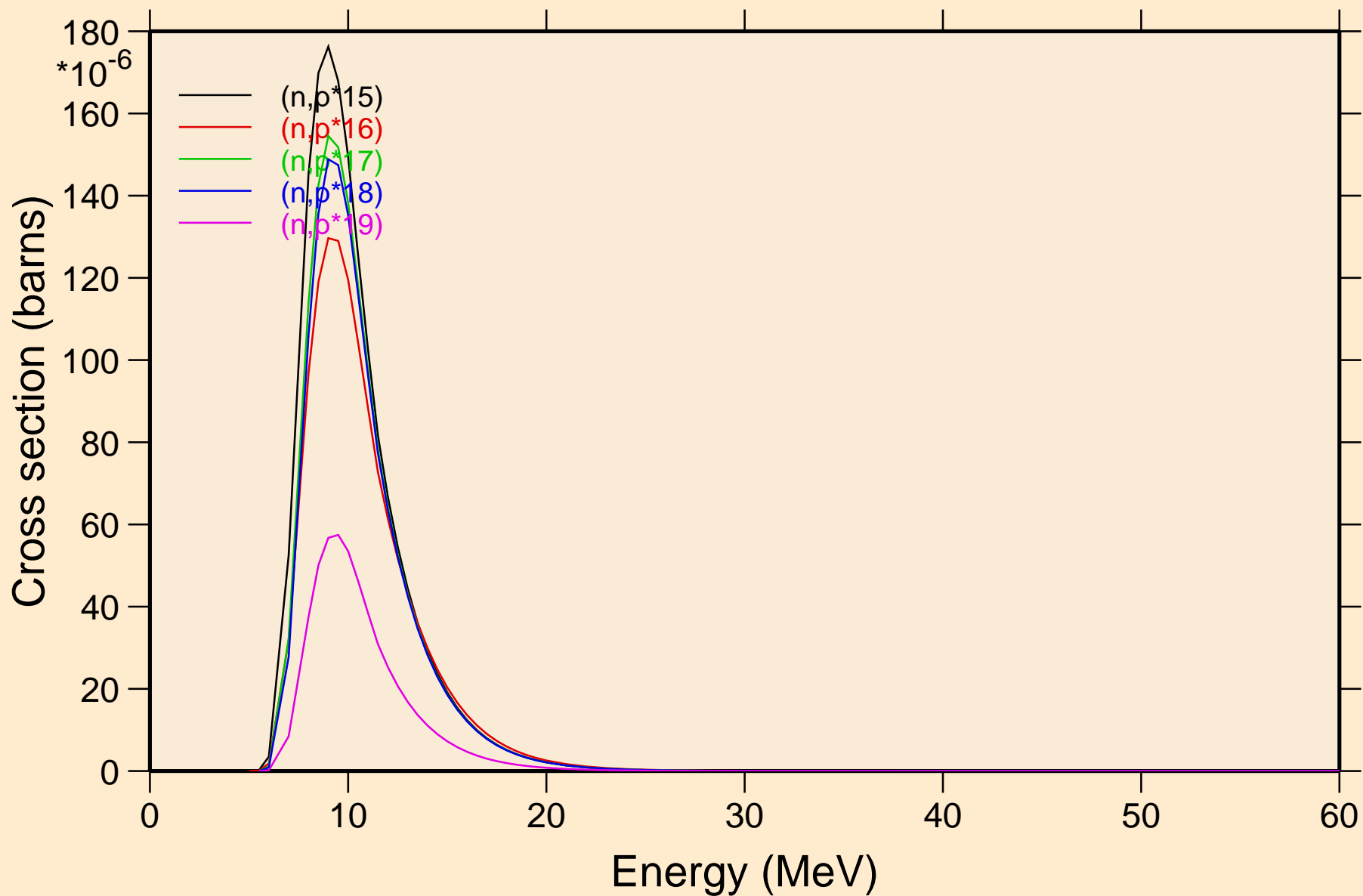

# 25-MN-55 FOR FENDL-3.2 FROM INDL/V-3 BY NJOY2016.60+ ON Threshold reactions

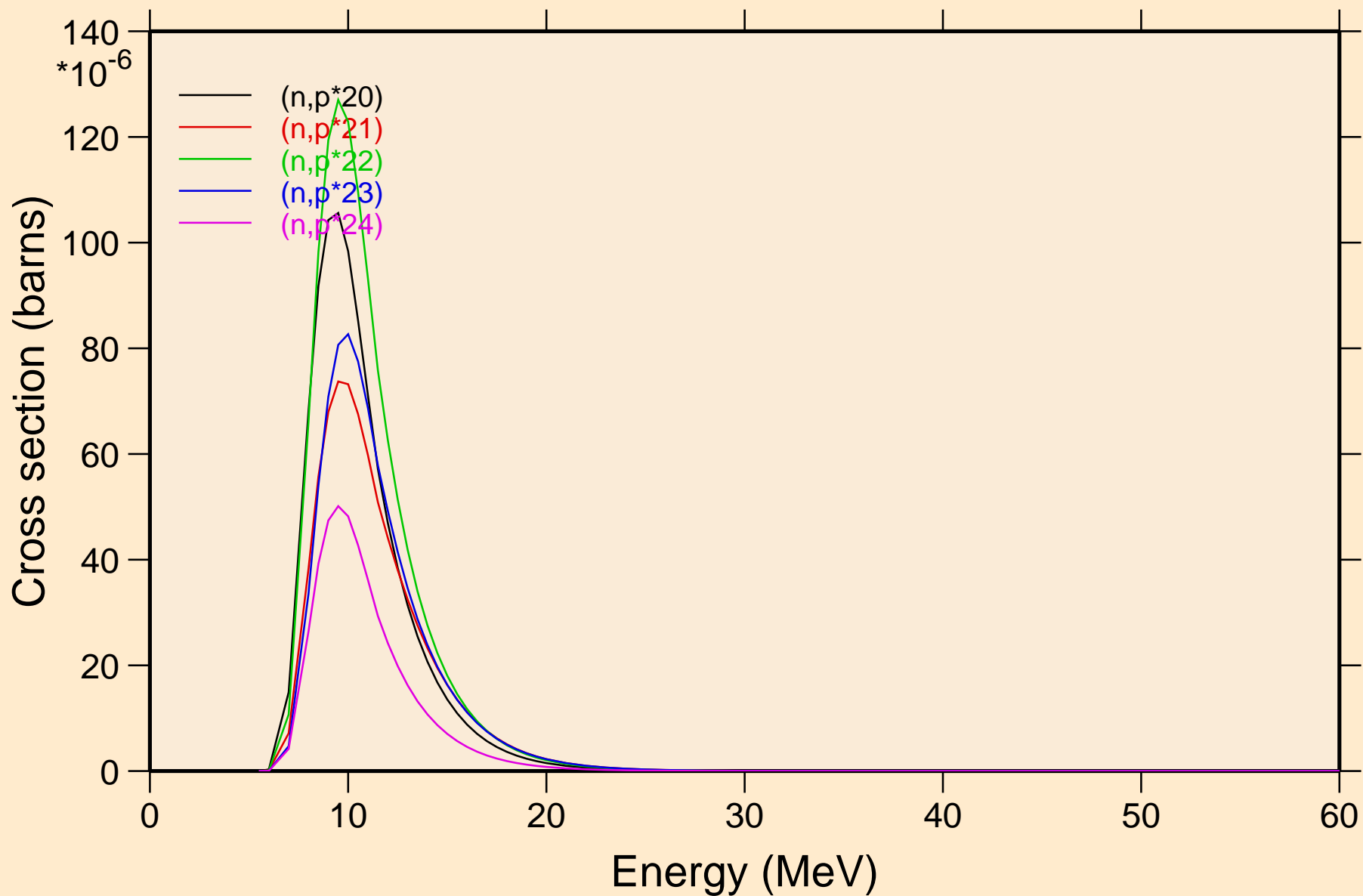

# 25-MN-55 FOR FENDL-3.2 FROM INDL/V-3 BY NJOY2016.60+ ON Threshold reactions

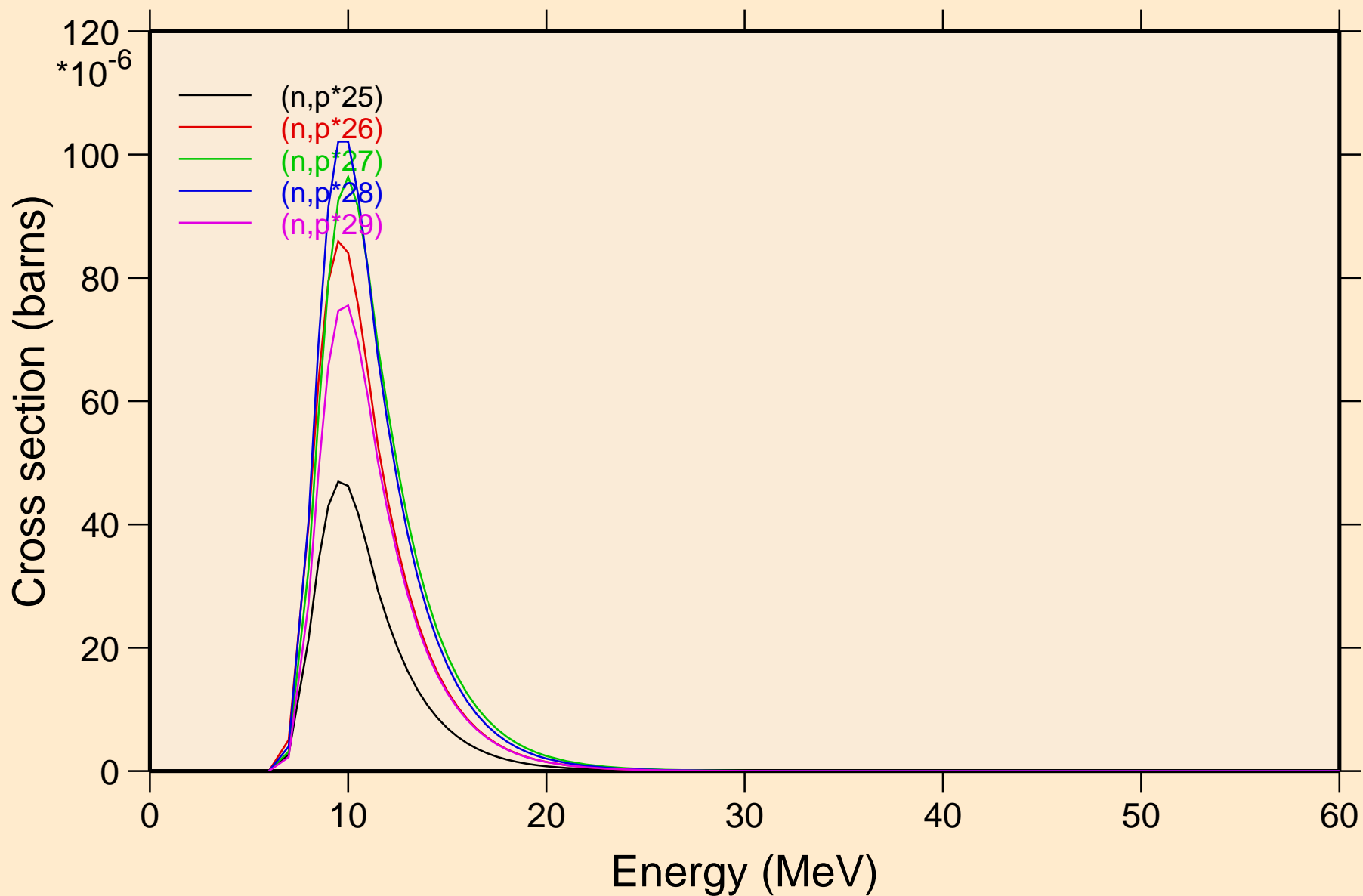

# 25-MN-55 FOR FENDL-3.2 FROM INDL/V-3 BY NJOY2016.60+ ON Threshold reactions

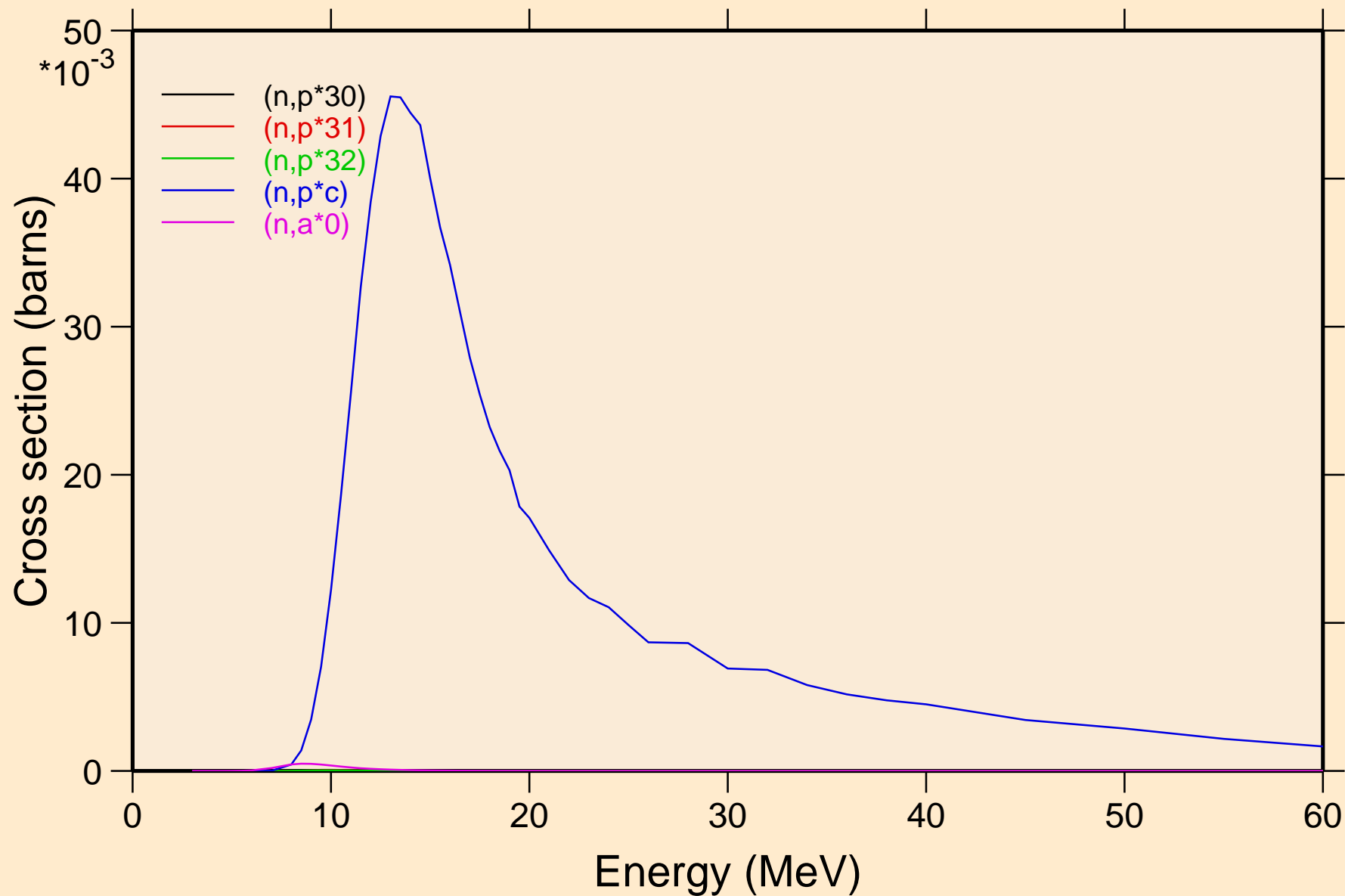

# 25-MN-55 FOR FENDL-3.2 FROM INDL/V-3 BY NJOY2016.60+ ON Threshold reactions

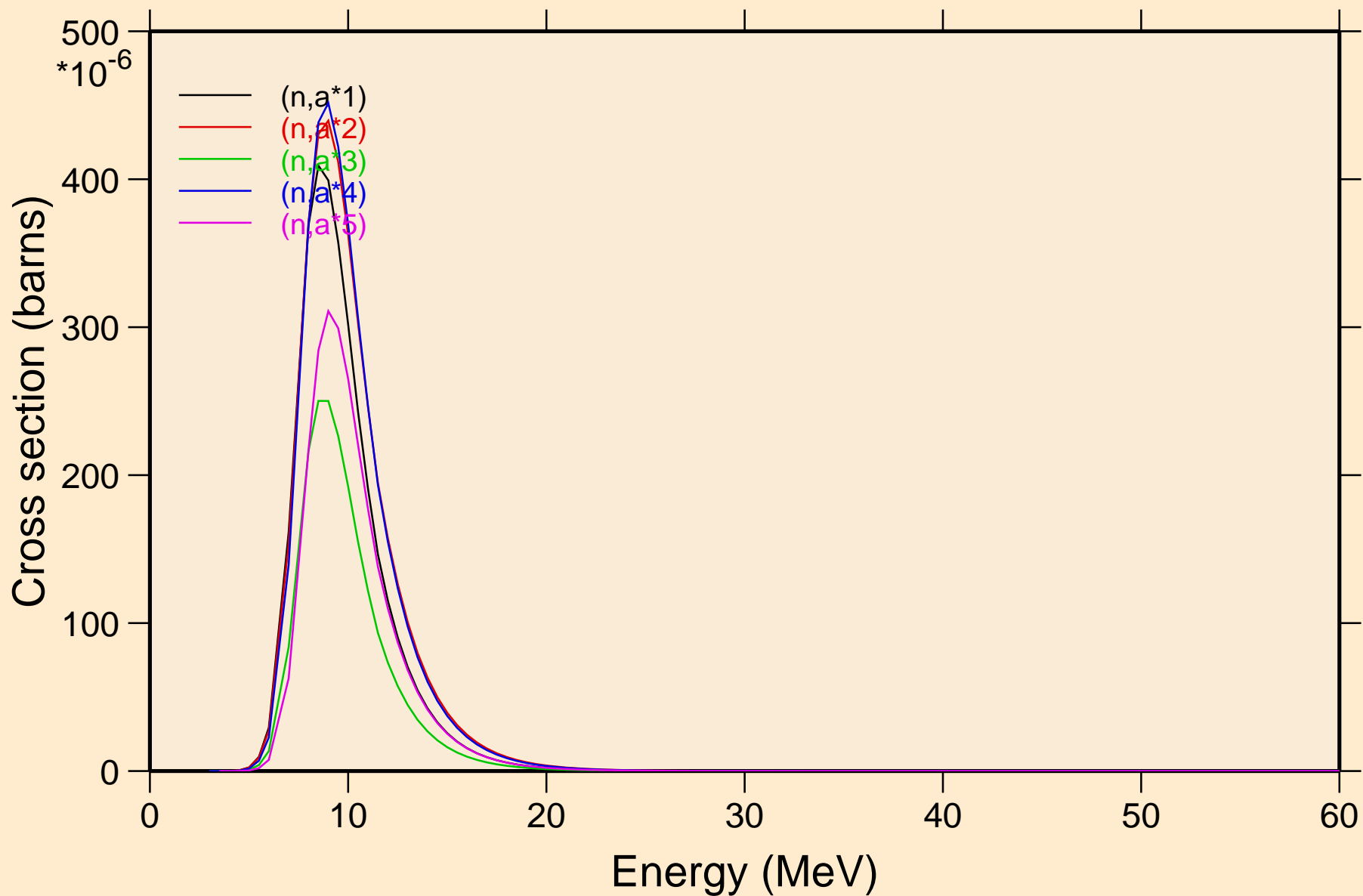

# 25-MN-55 FOR FENDL-3.2 FROM INDL/V-3 BY NJOY2016.60+ ON Threshold reactions

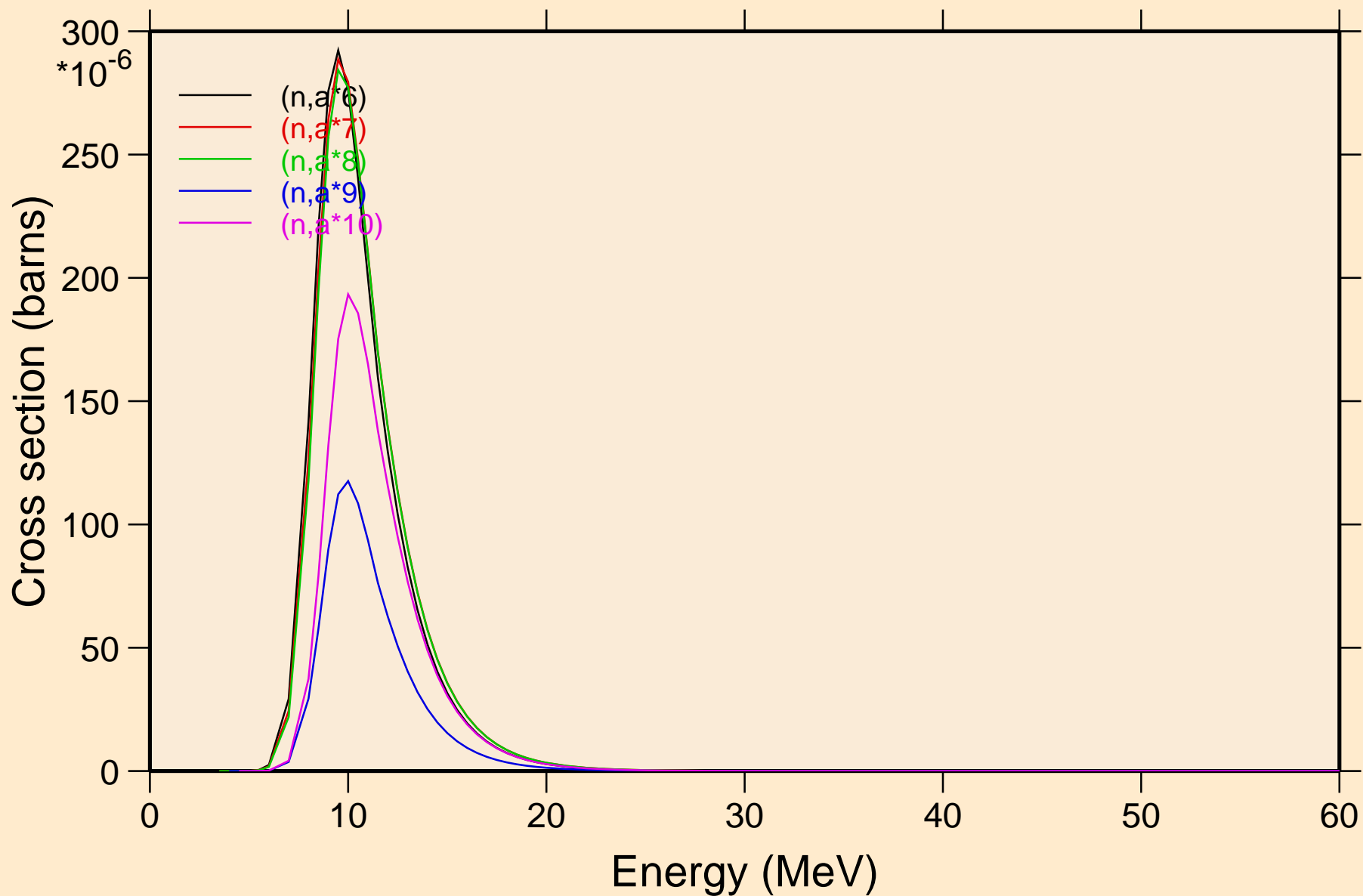

# 25-MN-55 FOR FENDL-3.2 FROM INDL/V-3 BY NJOY2016.60+ ON Threshold reactions

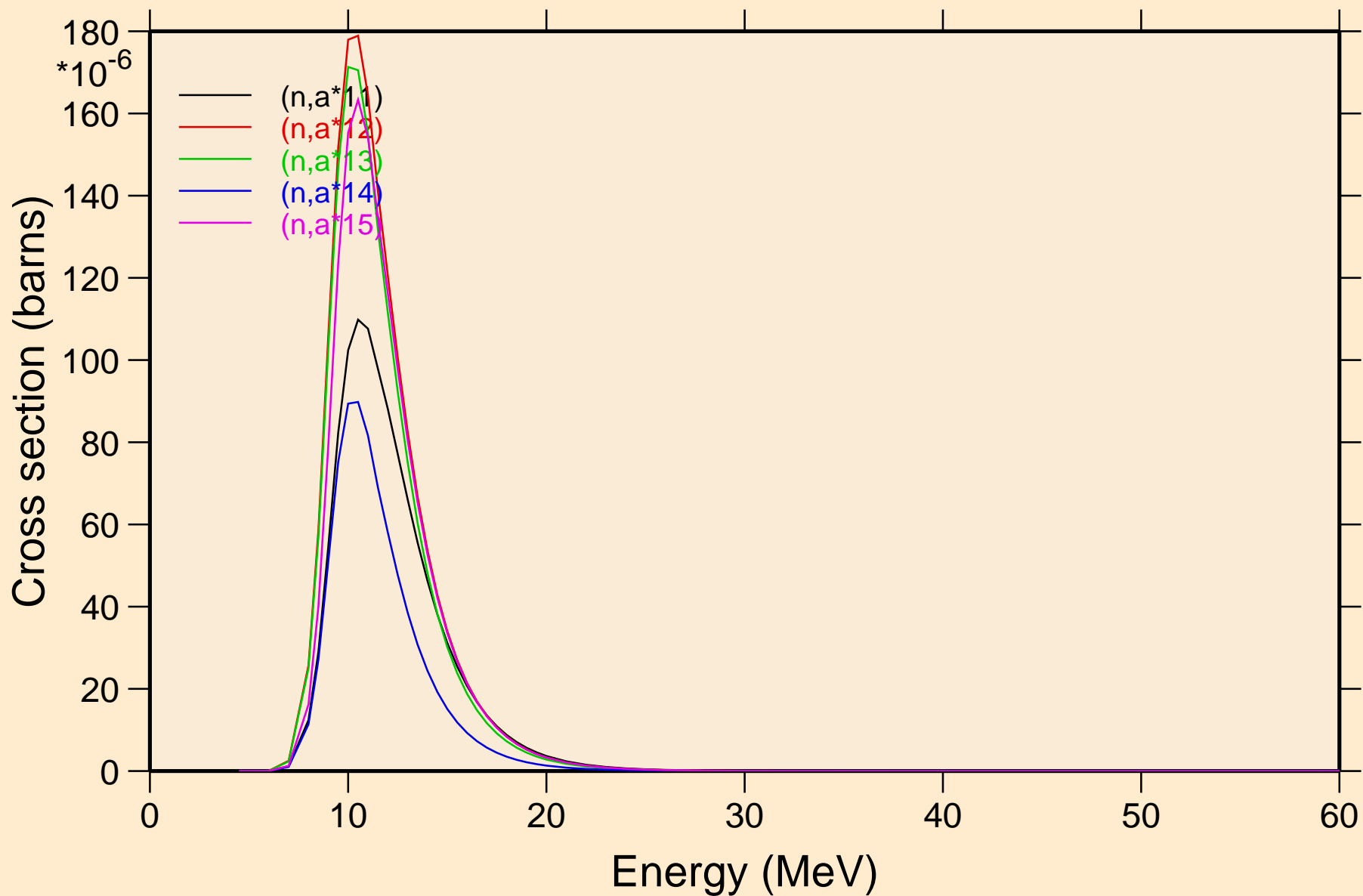



# 25-MN-55 FOR FENDL-3.2 FROM INDL/V-3 BY NJOY2016.60+ ON Threshold reactions

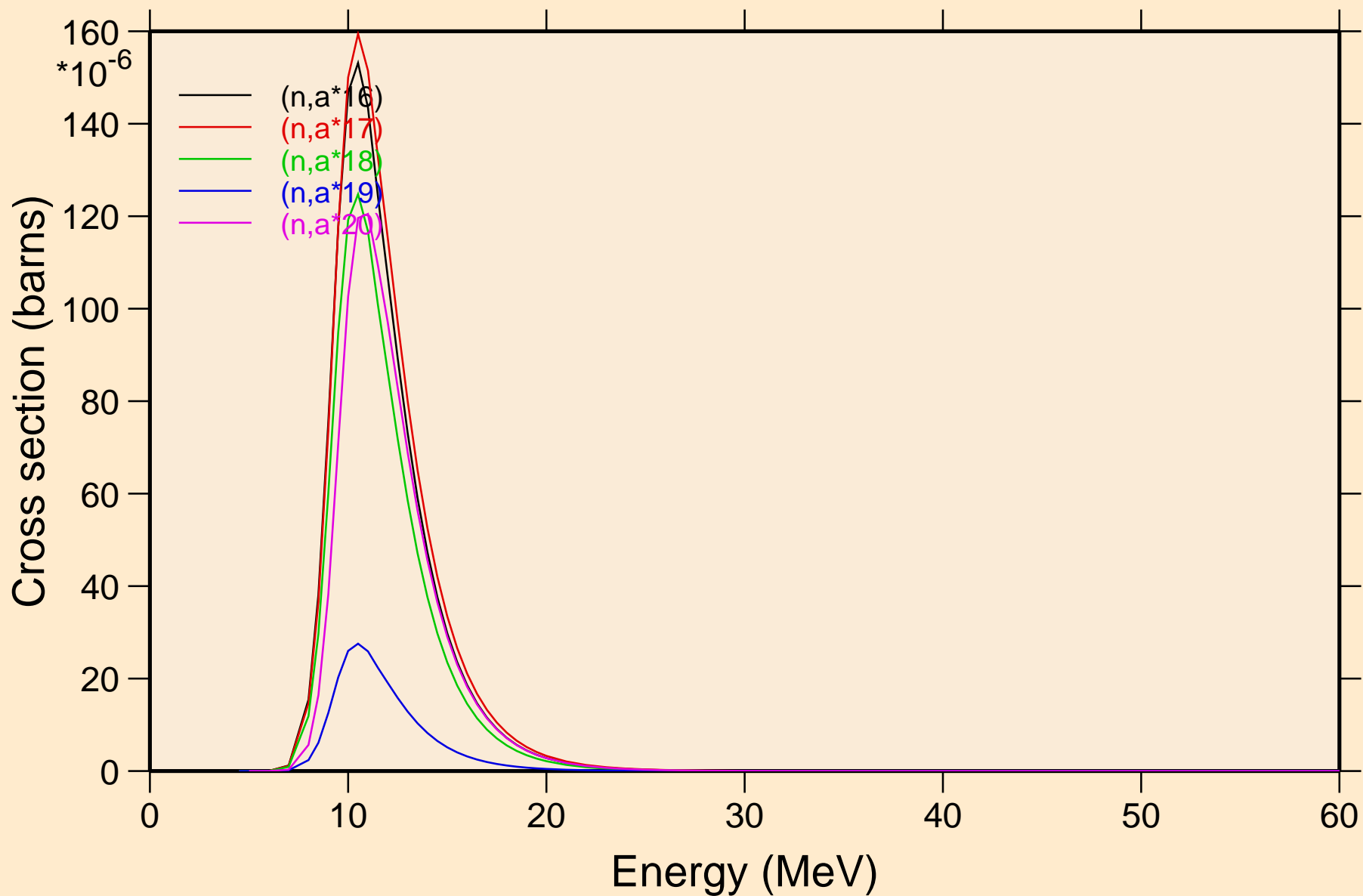

# 25-MN-55 FOR FENDL-3.2 FROM INDL/V-3 BY NJOY2016.60+ ON Threshold reactions

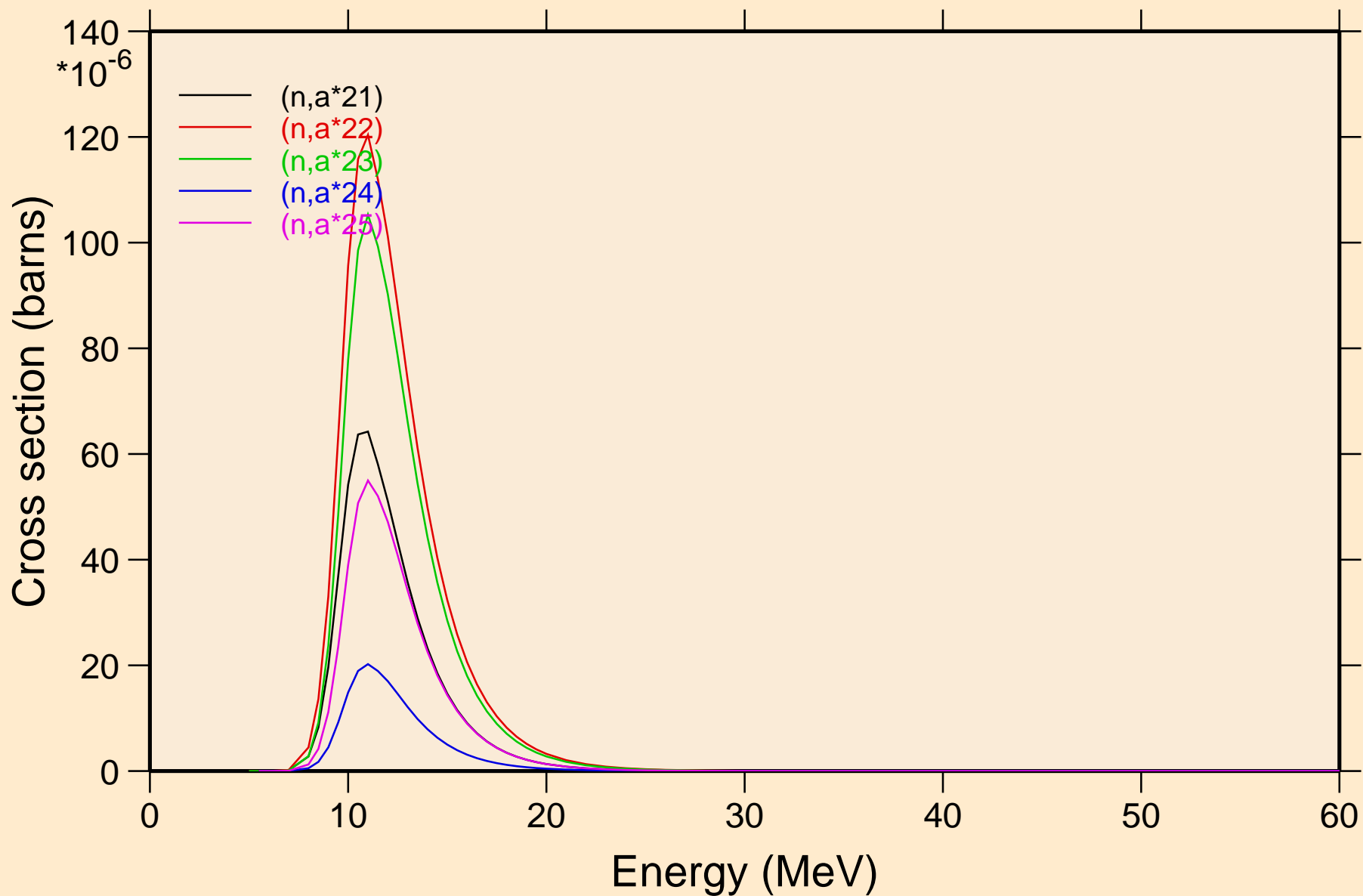

# 25-MN-55 FOR FENDL-3.2 FROM INDL/V-3 BY NJOY2016.60+ ON Threshold reactions

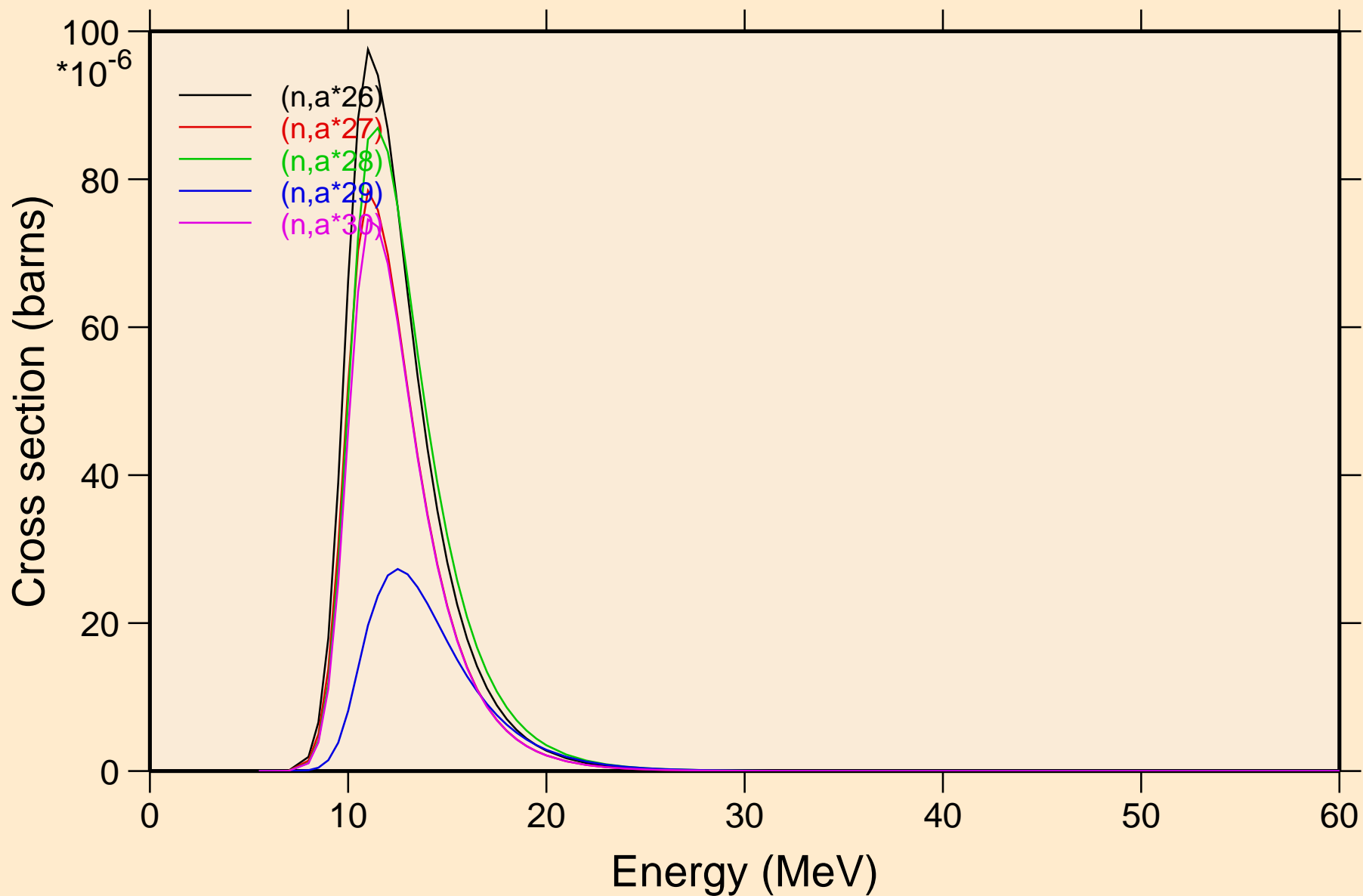

25-MN-55 FOR FENDL-3.2 FROM INDL/V-3 BY NJOY2016.60+ ON  
Threshold reactions

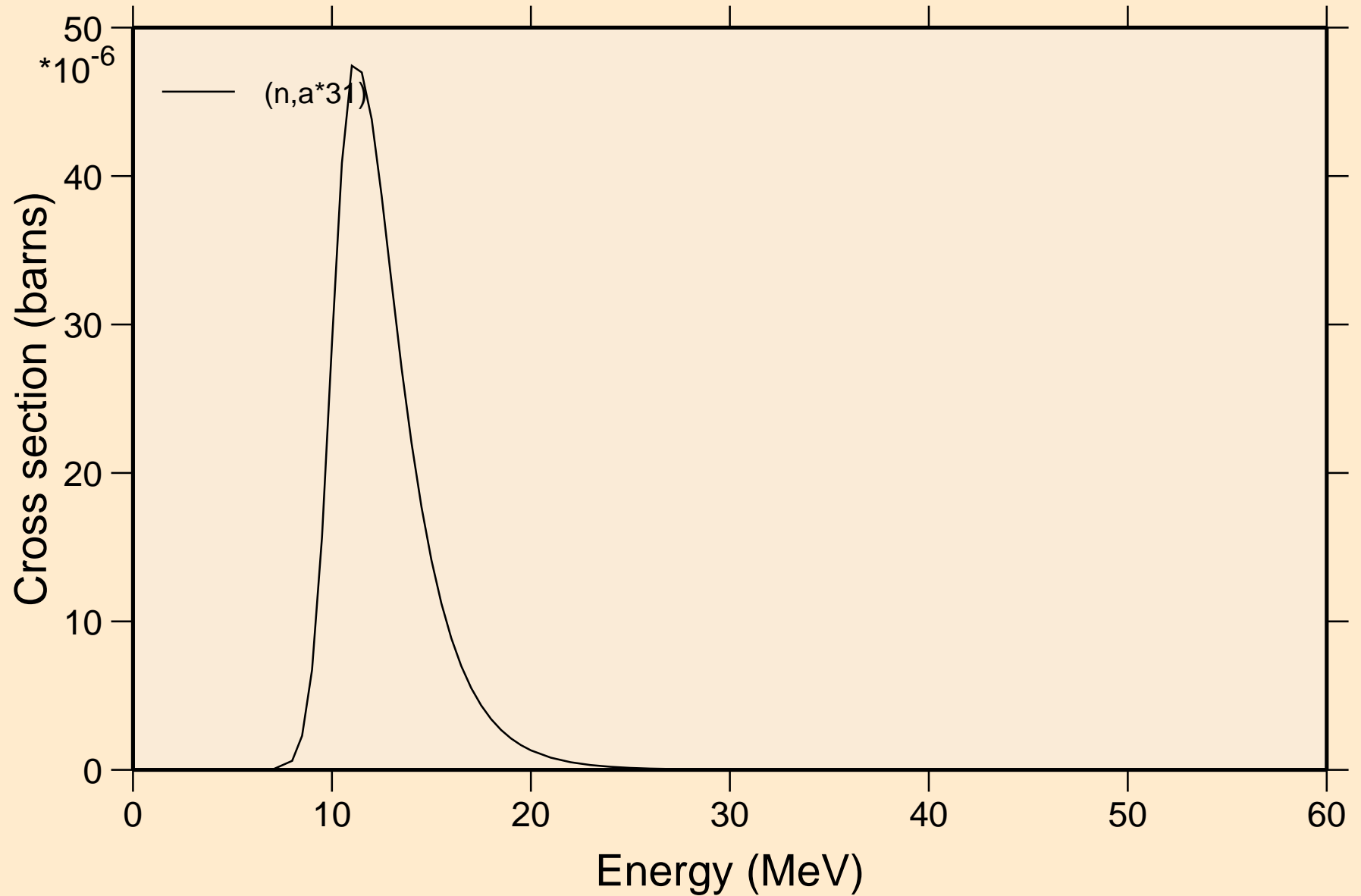

25-MN-55 FOR FENDL-3.2 FROM INDL/V-3 BY NJOY2016.60+ ON  
angular distribution for elastic

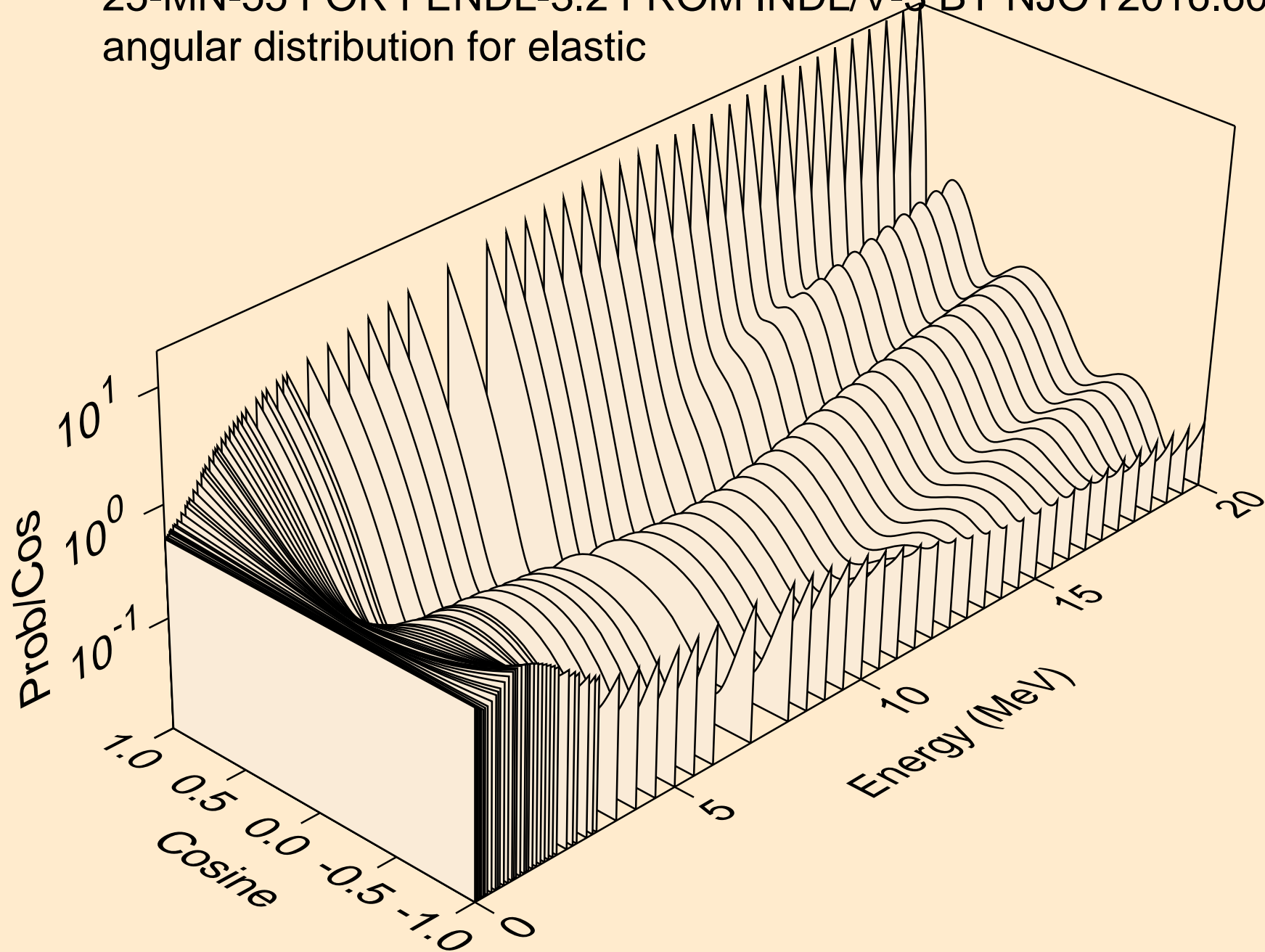

25-MN-55 FOR FENDL-3.2 FROM INDL/V-3 BY NJOY2016.60+ ON  
angular distribution for elastic

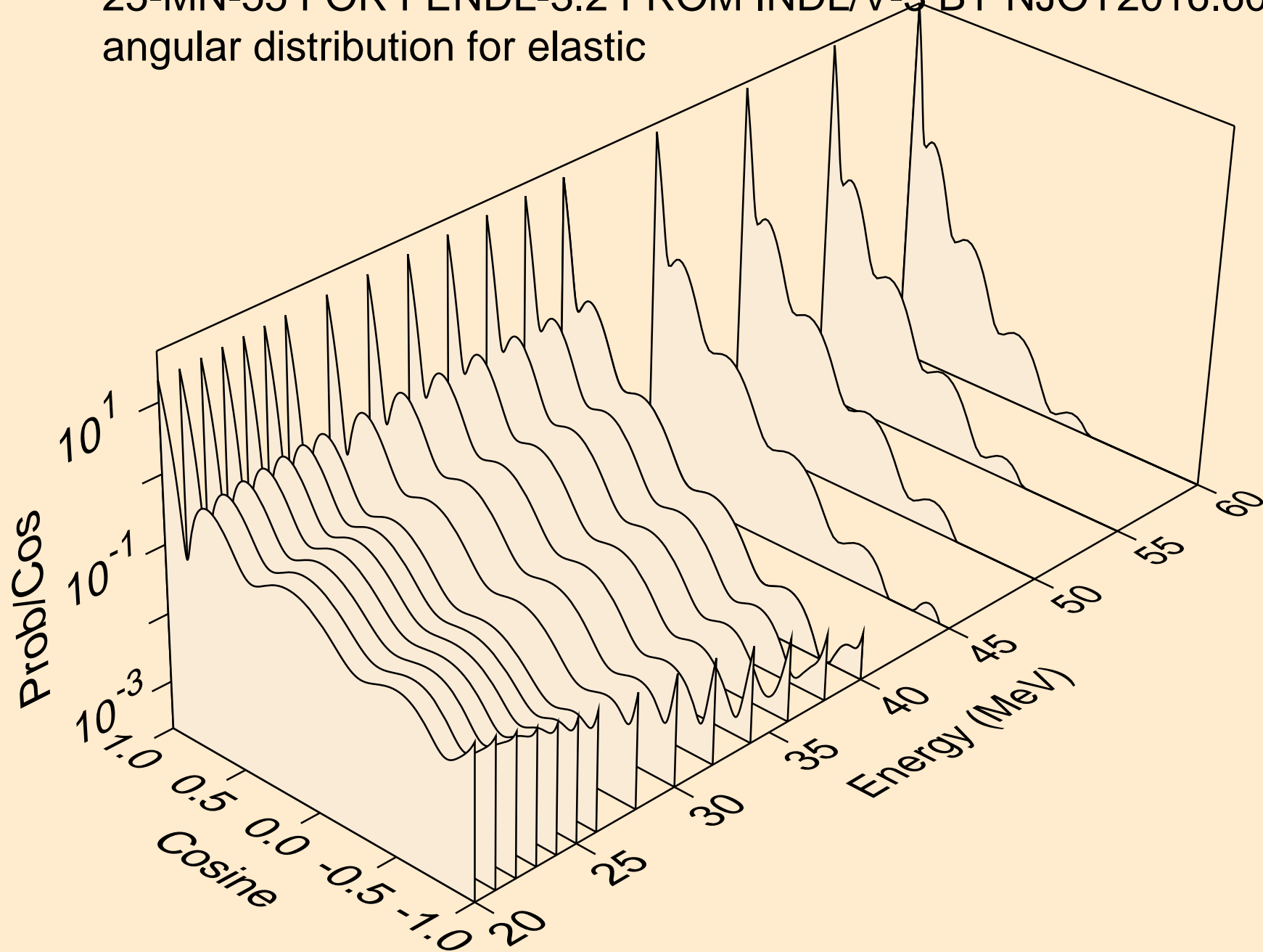

25-MN-55 FOR FENDL-3.2 FROM INDL/V-3 BY NJOY2016.60+ ON  
angular distribution for (n,n\*1)

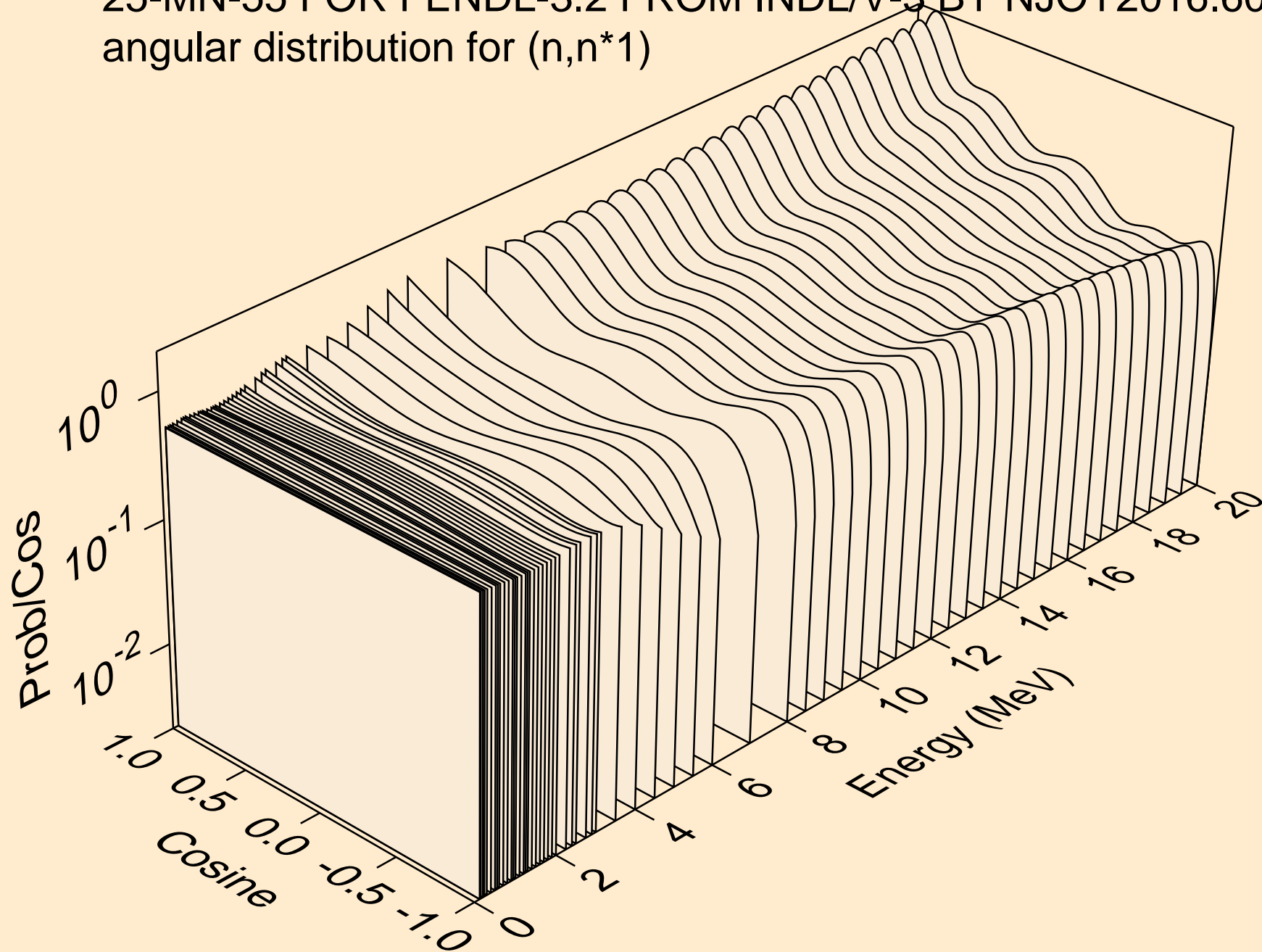

25-MN-55 FOR FENDL-3.2 FROM INDL/V-3 BY NJOY2016.60+ ON  
angular distribution for (n,n\*1)

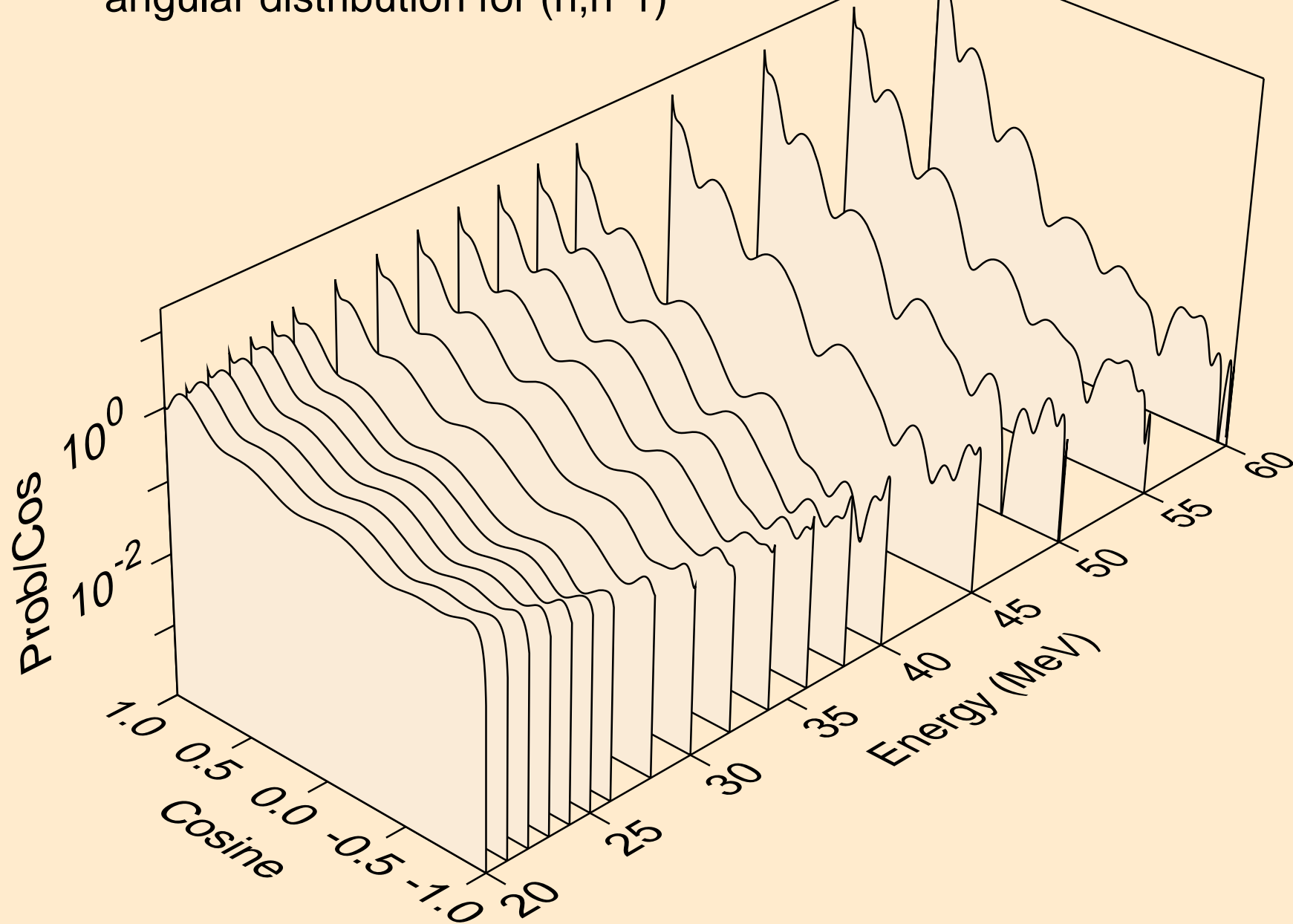



25-MN-55 FOR FENDL-3.2 FROM INDL/V-3 BY NJOY2016.60+ ON  
angular distribution for (n,n\*2)

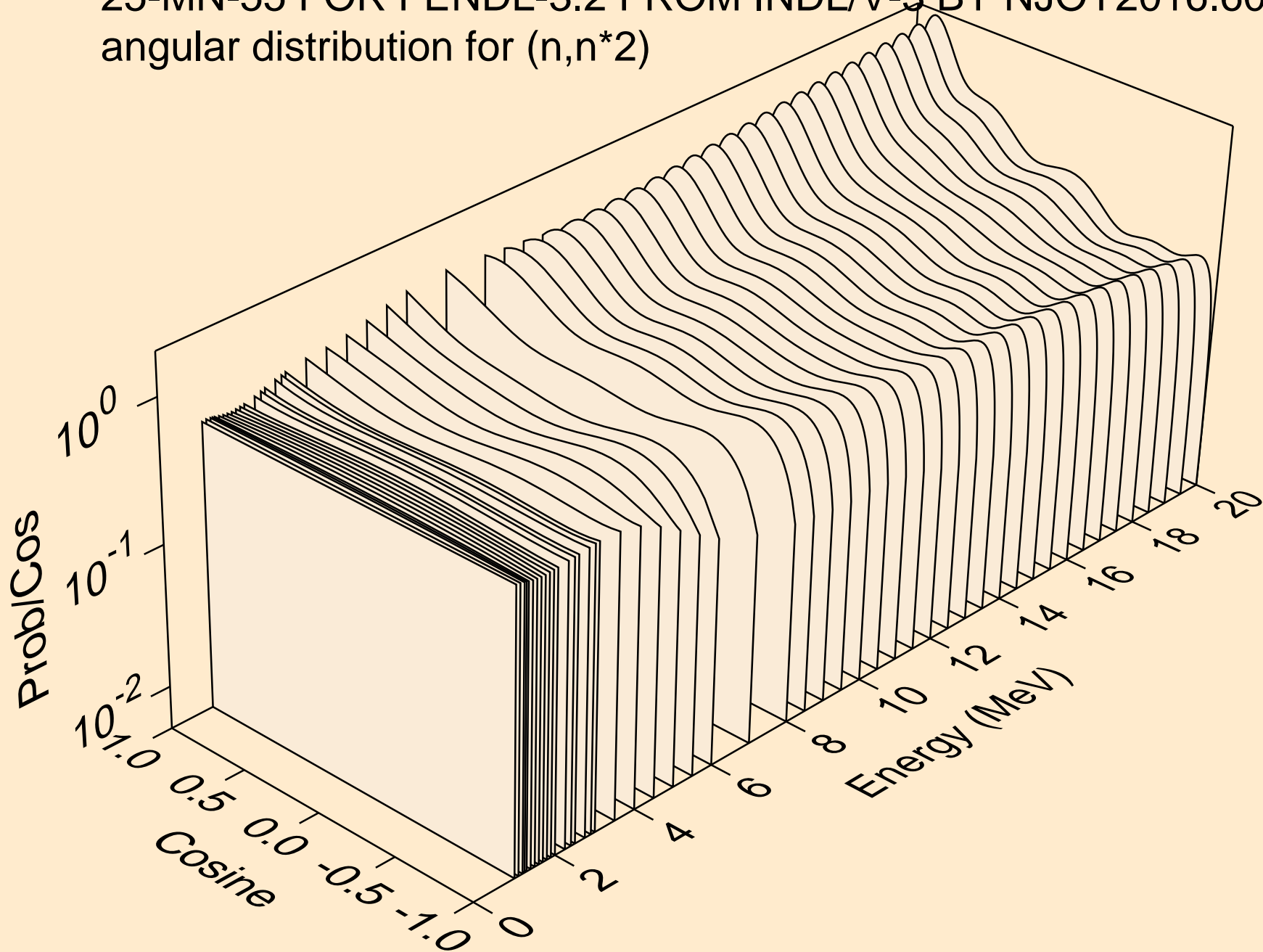

25-MN-55 FOR FENDL-3.2 FROM INDL/V-3 BY NJOY2016.60+ ON  
angular distribution for (n,n\*2)

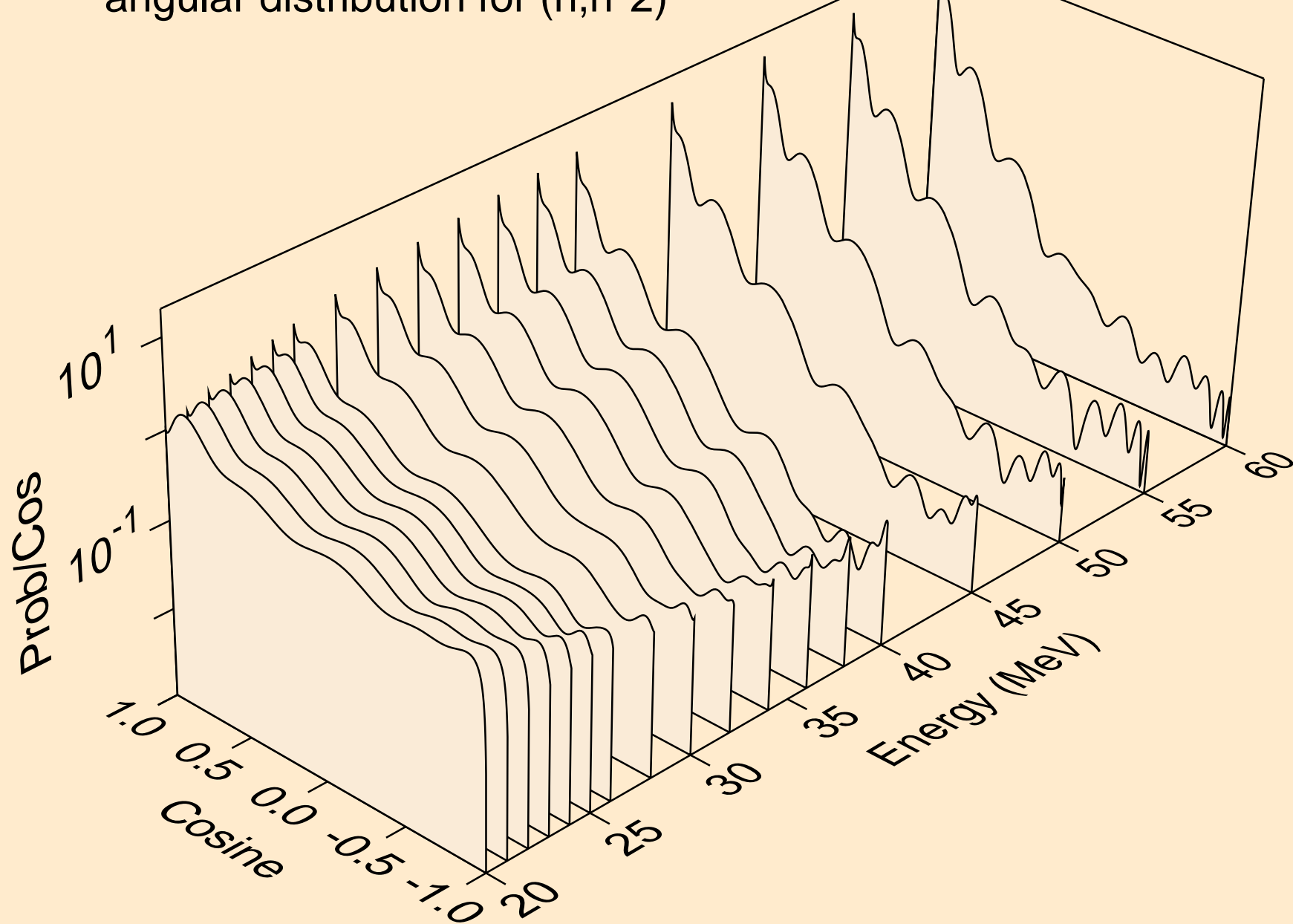

25-MN-55 FOR FENDL-3.2 FROM INDL/V-3 BY NJOY2016.60+ ON  
angular distribution for (n,n\*3)

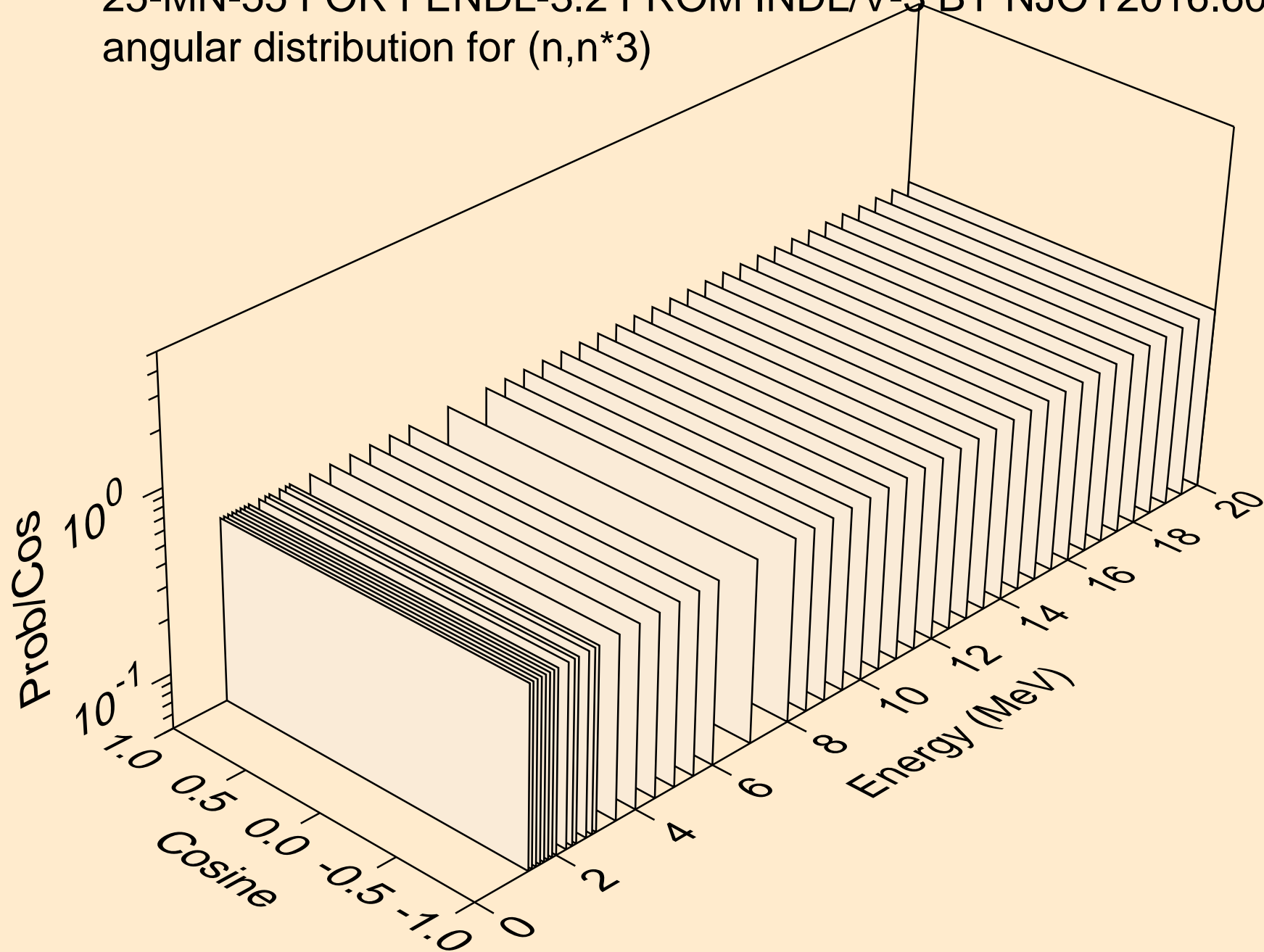

25-MN-55 FOR FENDL-3.2 FROM INDL/V-3 BY NJOY2016.60+ ON  
angular distribution for (n,n\*3)

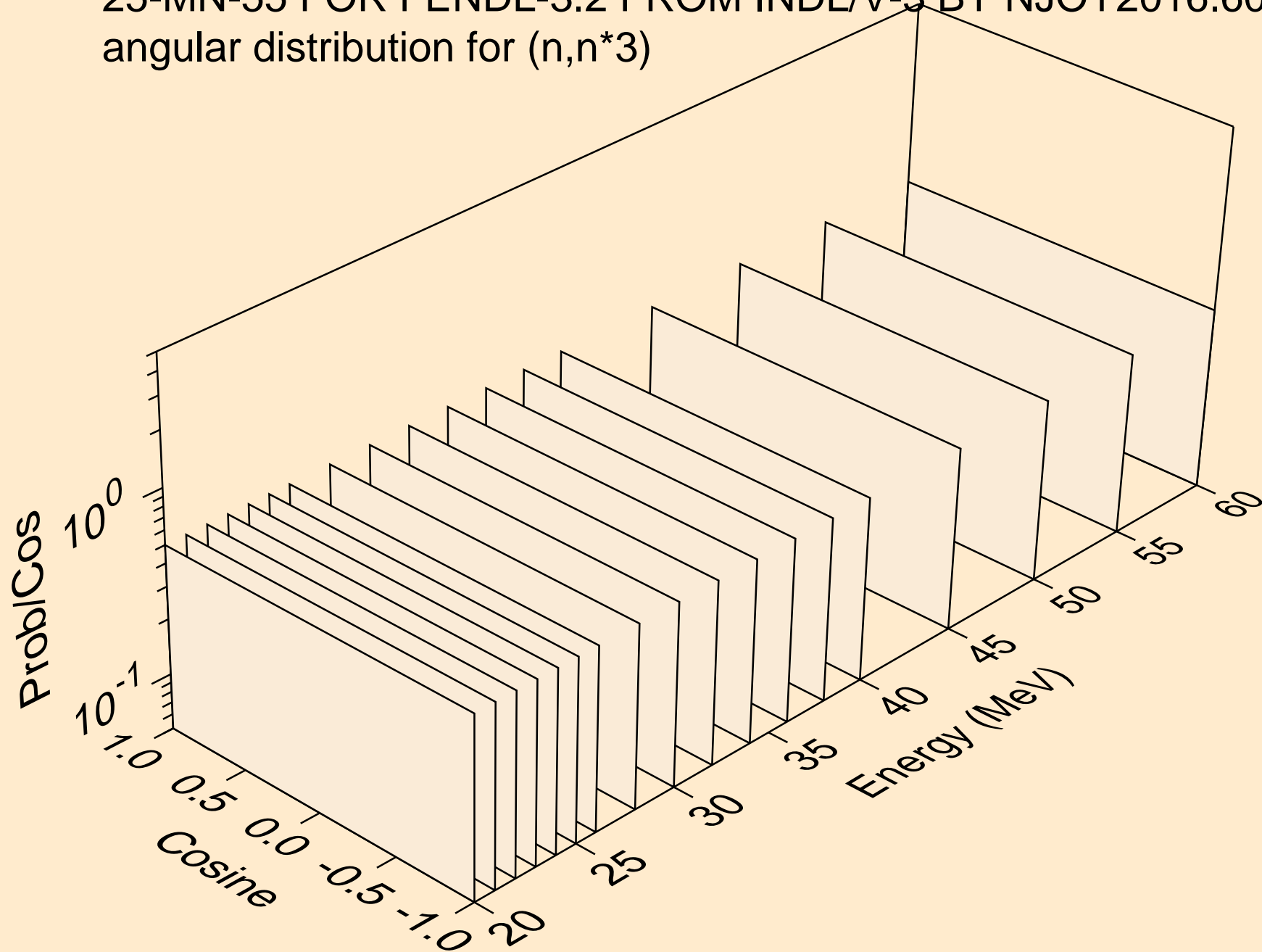

25-MN-55 FOR FENDL-3.2 FROM INDL/V-3 BY NJOY2016.60+ ON  
angular distribution for (n,n\*4)

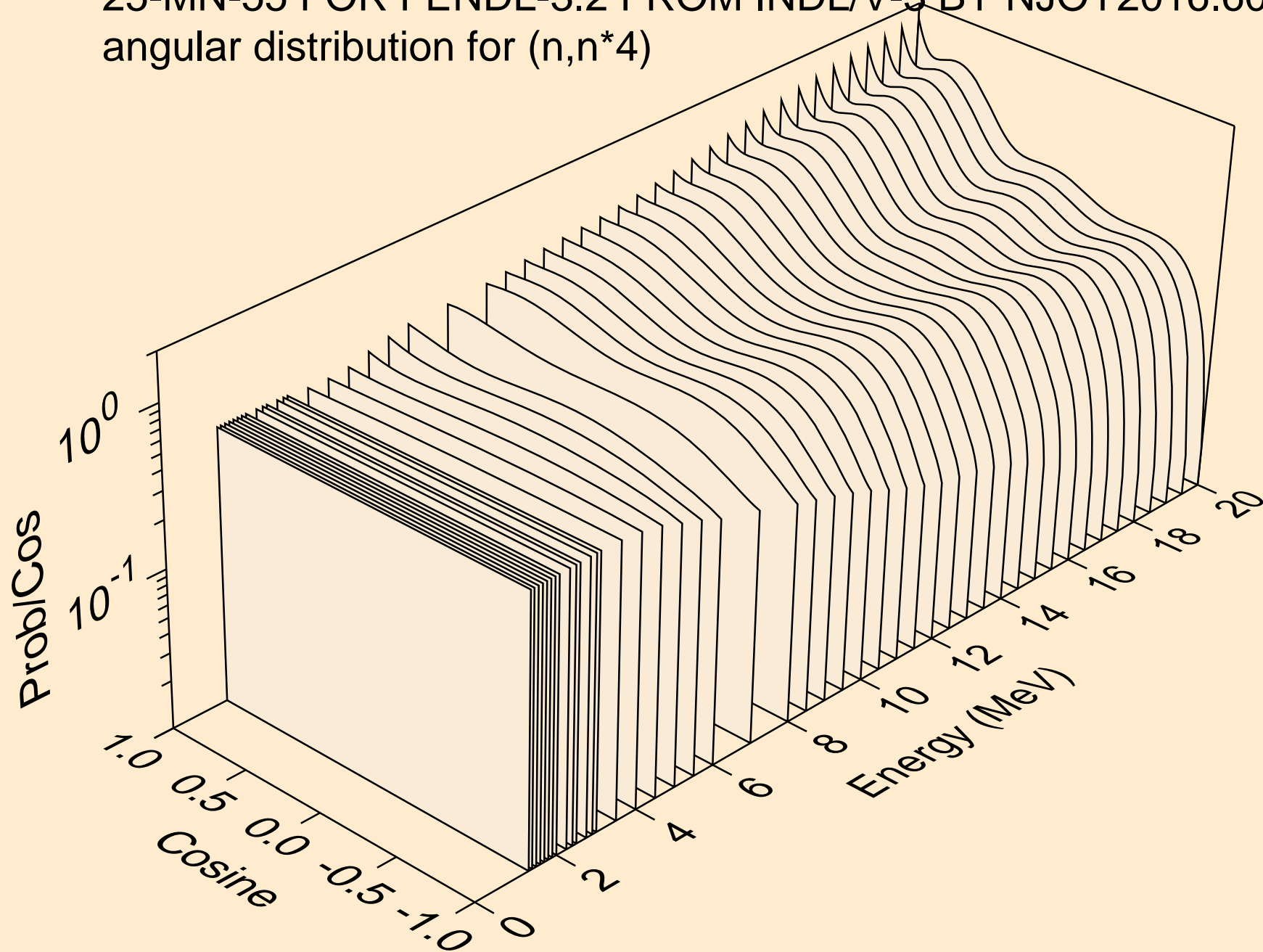

25-MN-55 FOR FENDL-3.2 FROM INDL/V-3 BY NJOY2016.60+ ON  
angular distribution for (n,n\*4)

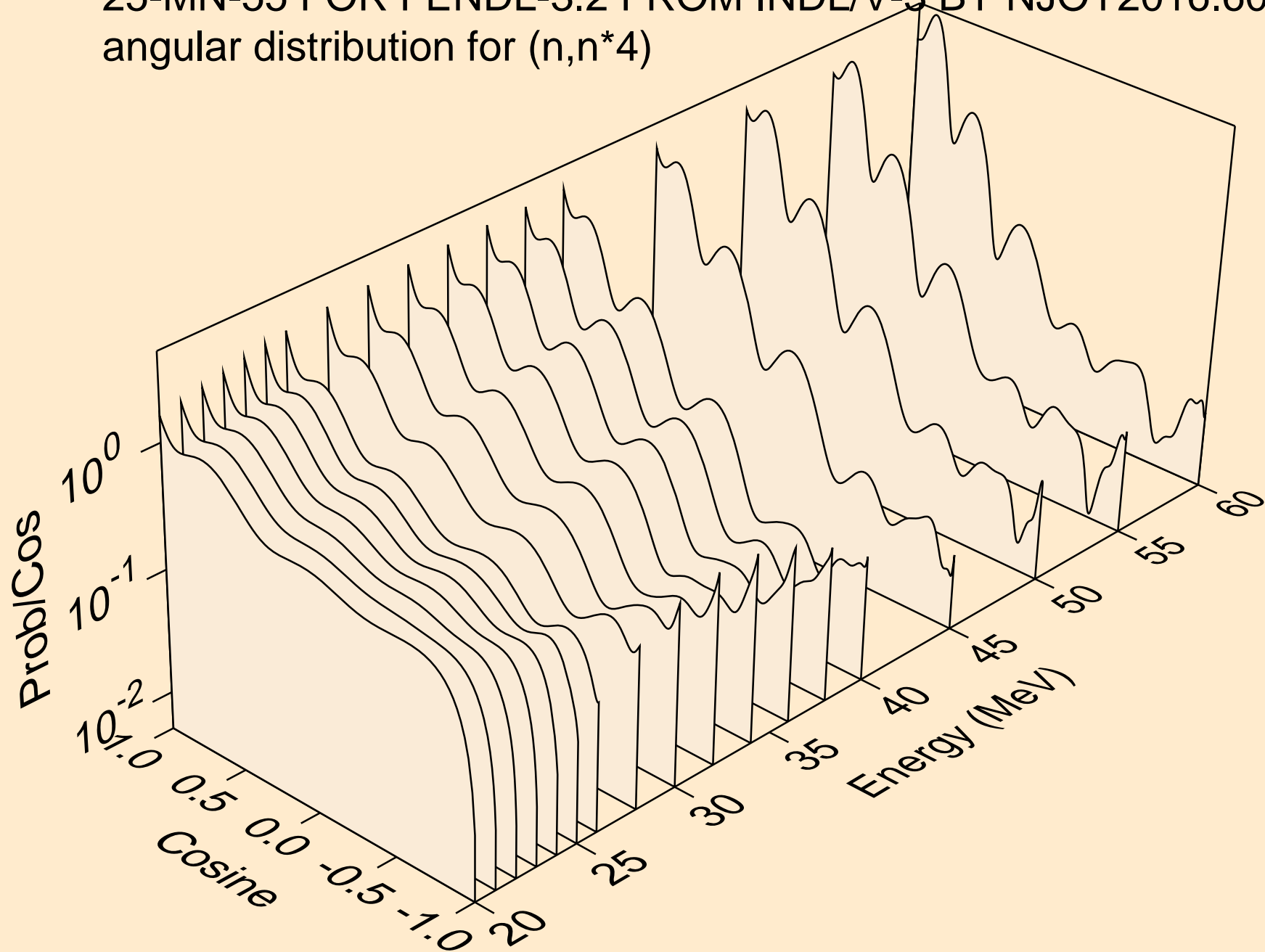

25-MN-55 FOR FENDL-3.2 FROM INDL/V-3 BY NJOY2016.60+ ON  
angular distribution for (n,n\*5)

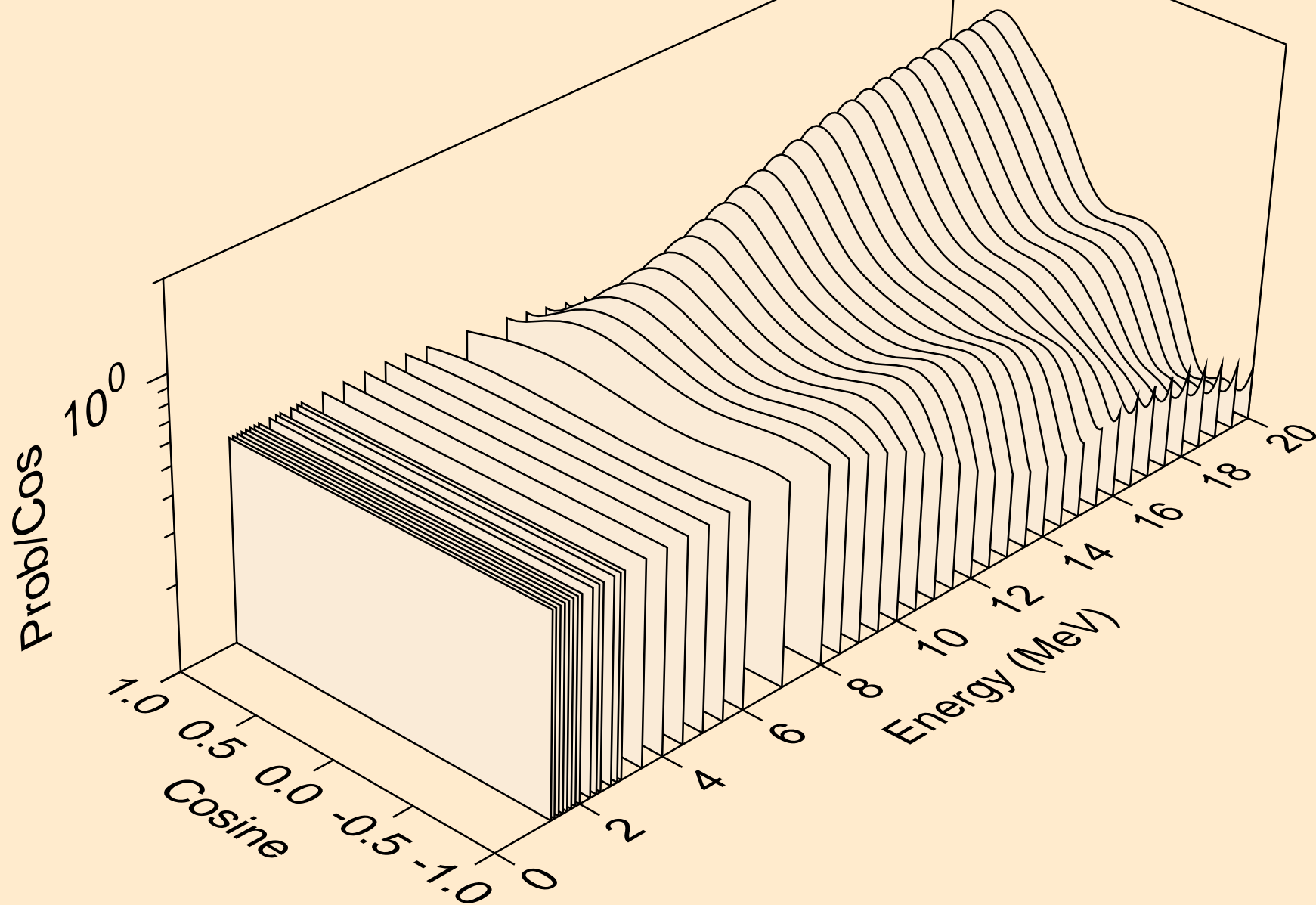

25-MN-55 FOR FENDL-3.2 FROM INDL/V-3 BY NJOY2016.60+ ON  
angular distribution for (n,n\*5)

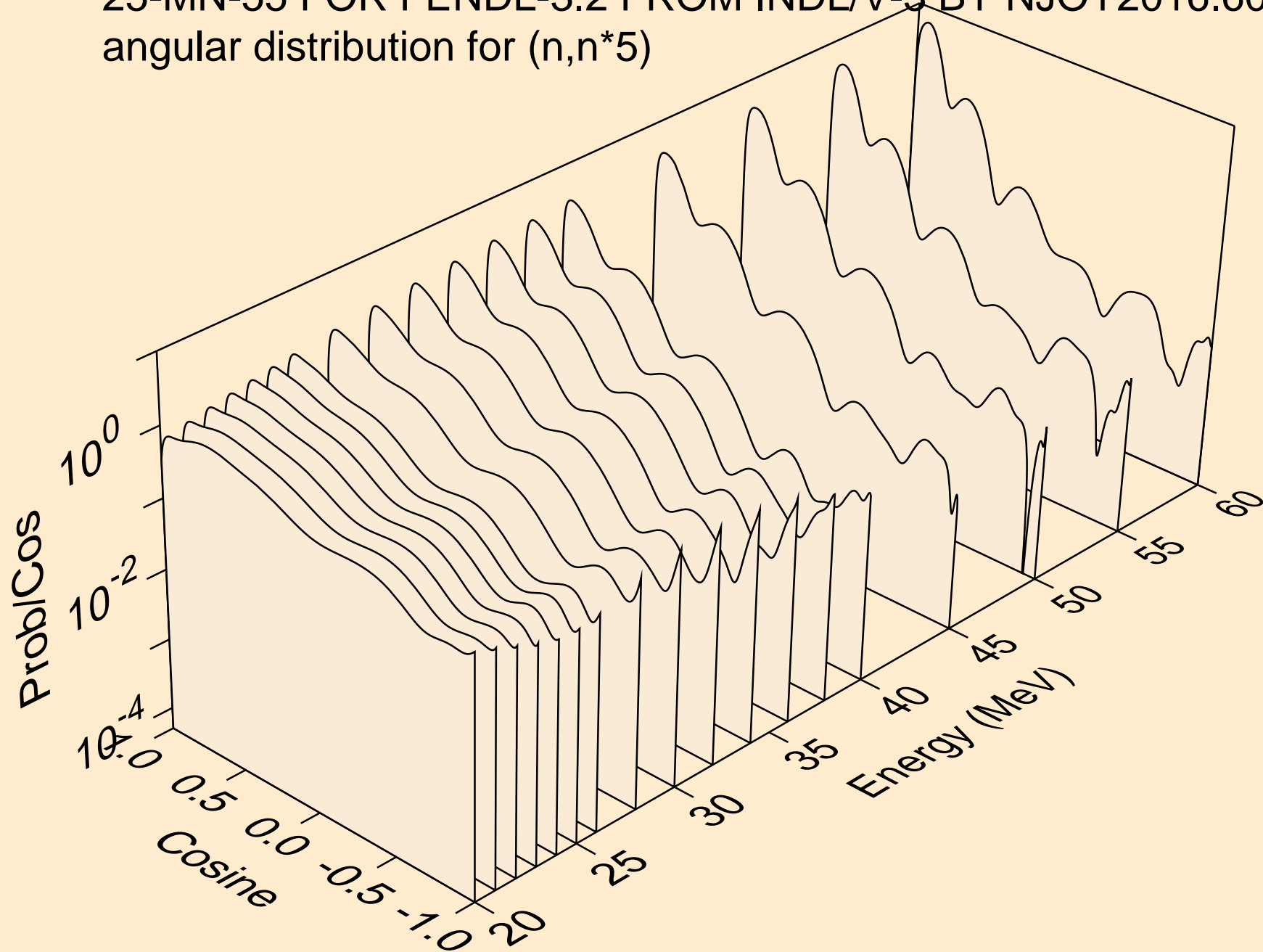



25-MN-55 FOR FENDL-3.2 FROM INDL/V-3 BY NJOY2016.60+ ON  
angular distribution for (n,n\*6)

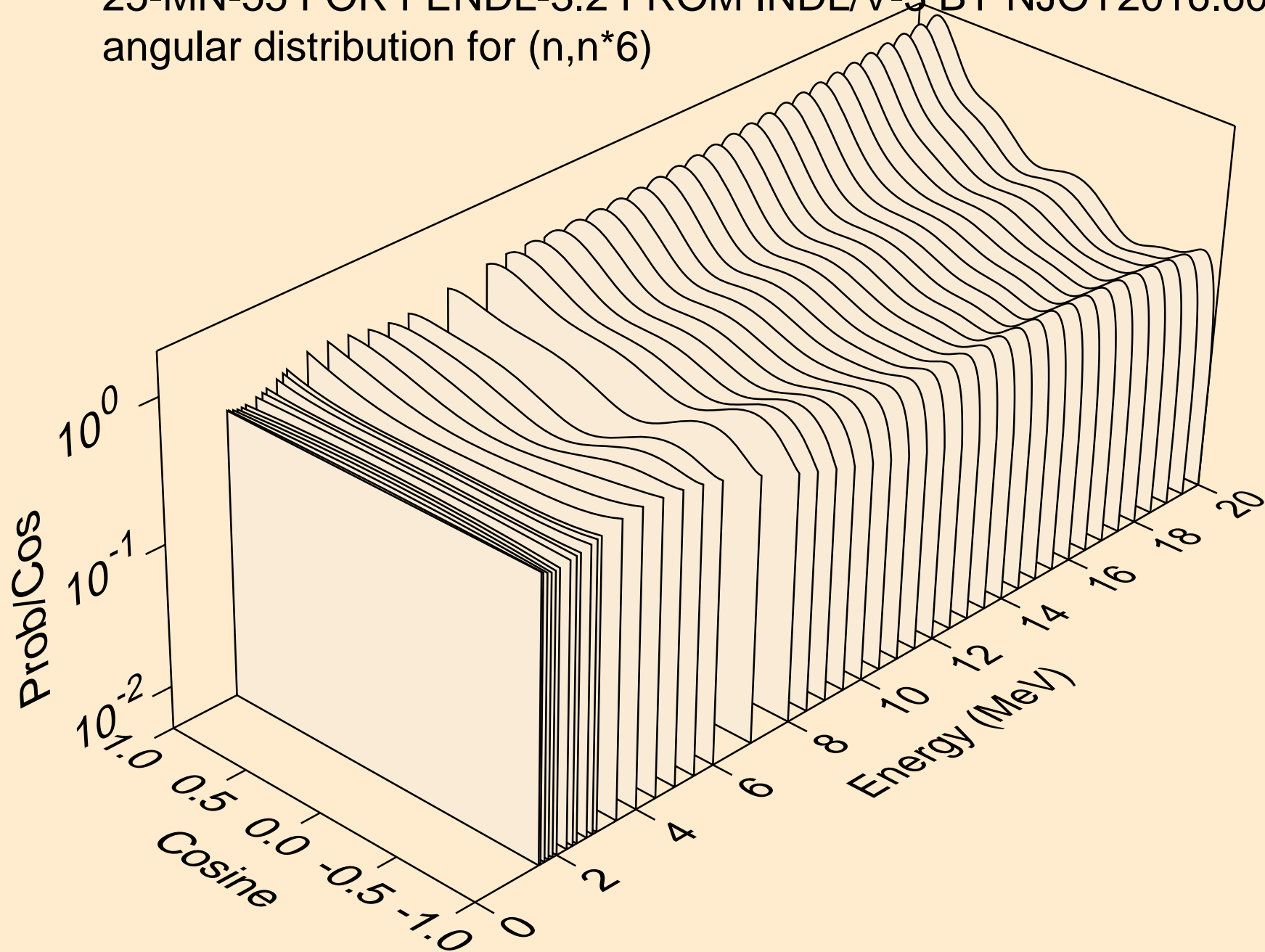

25-MN-55 FOR FENDL-3.2 FROM INDL/V-3 BY NJOY2016.60+ ON  
angular distribution for (n,n\*6)

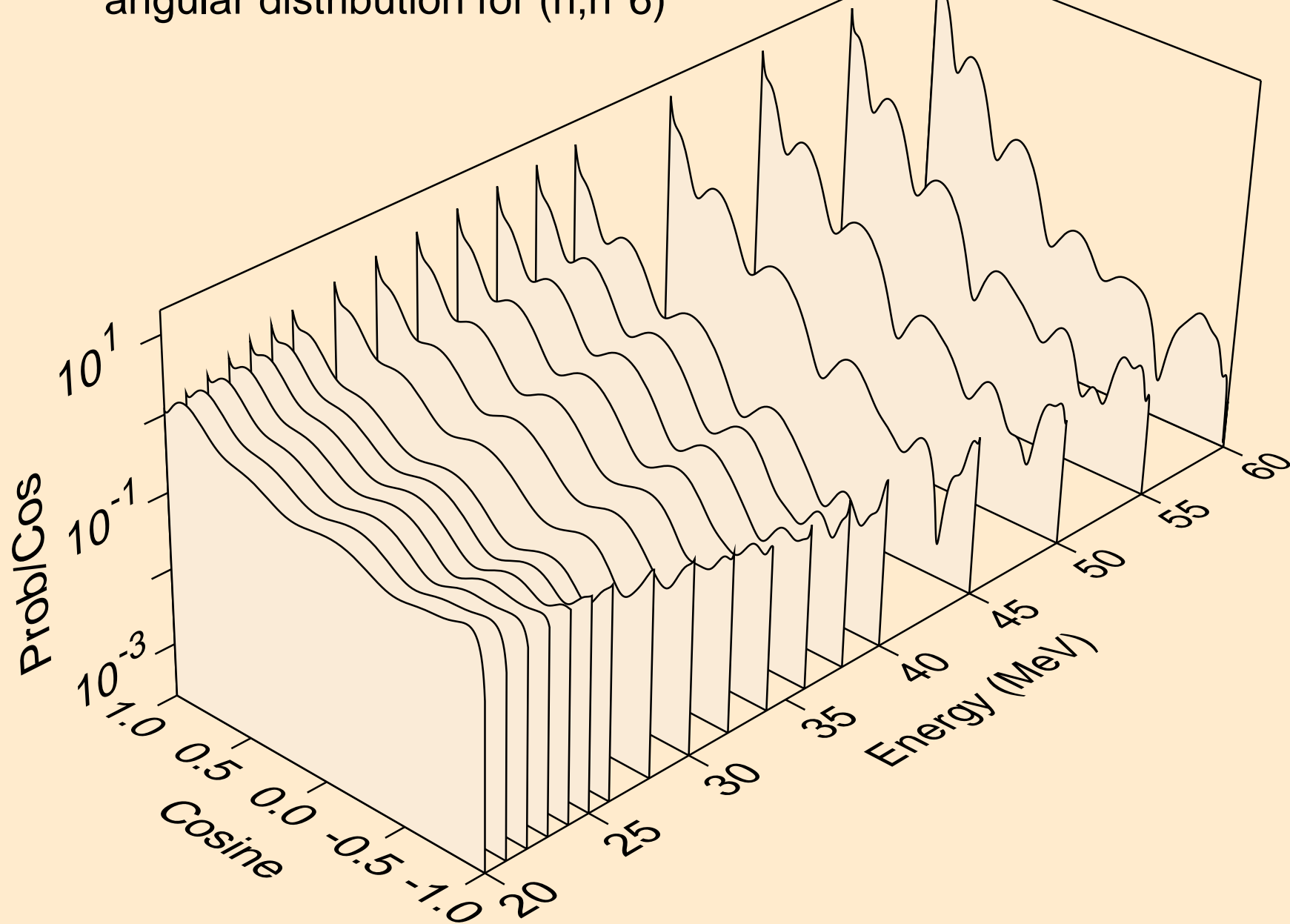

25-MN-55 FOR FENDL-3.2 FROM INDL/V-3 BY NJOY2016.60+ ON  
angular distribution for (n,n\*7)

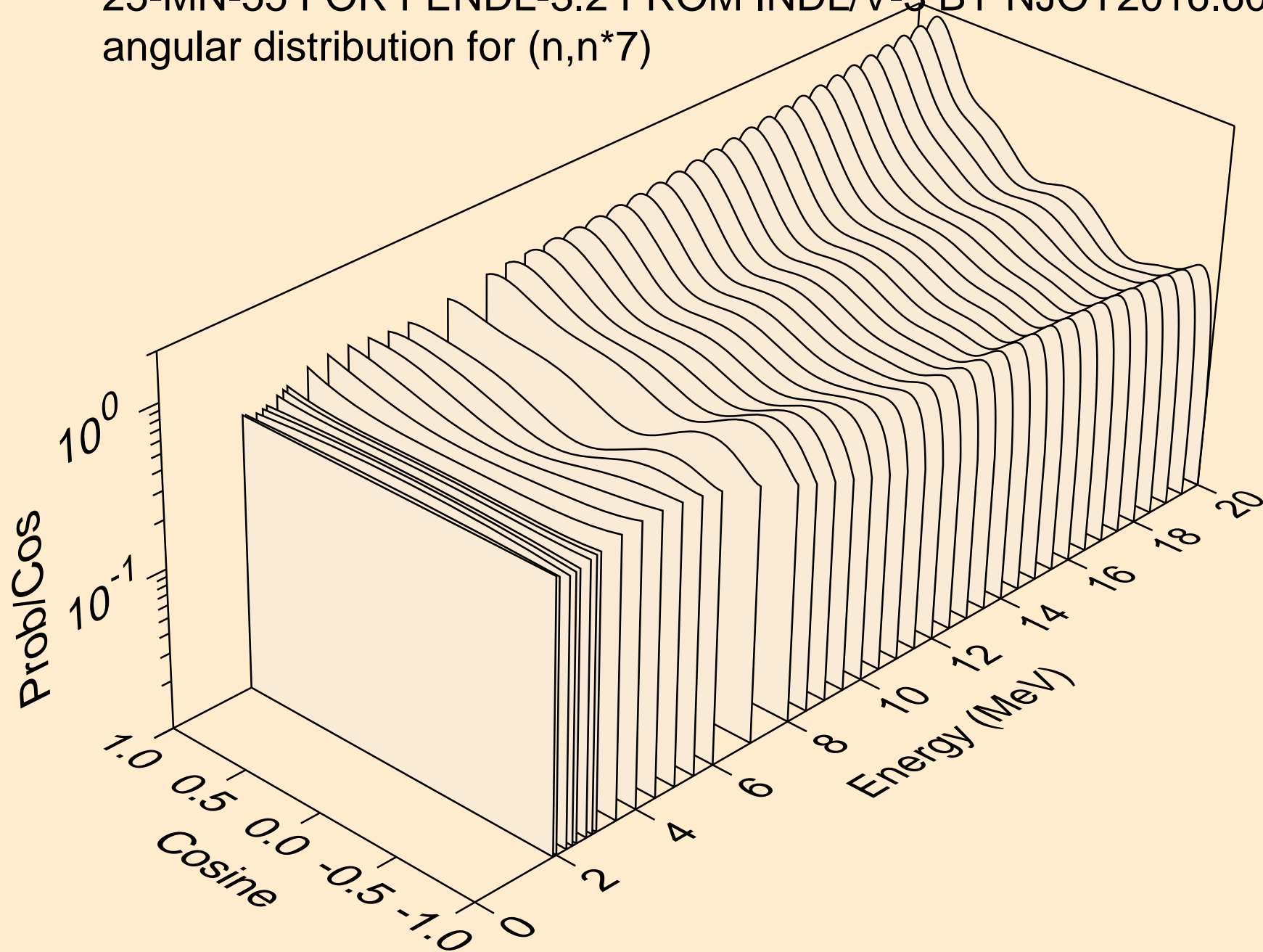

25-MN-55 FOR FENDL-3.2 FROM INDL/V-3 BY NJOY2016.60+ ON  
angular distribution for (n,n\*7)

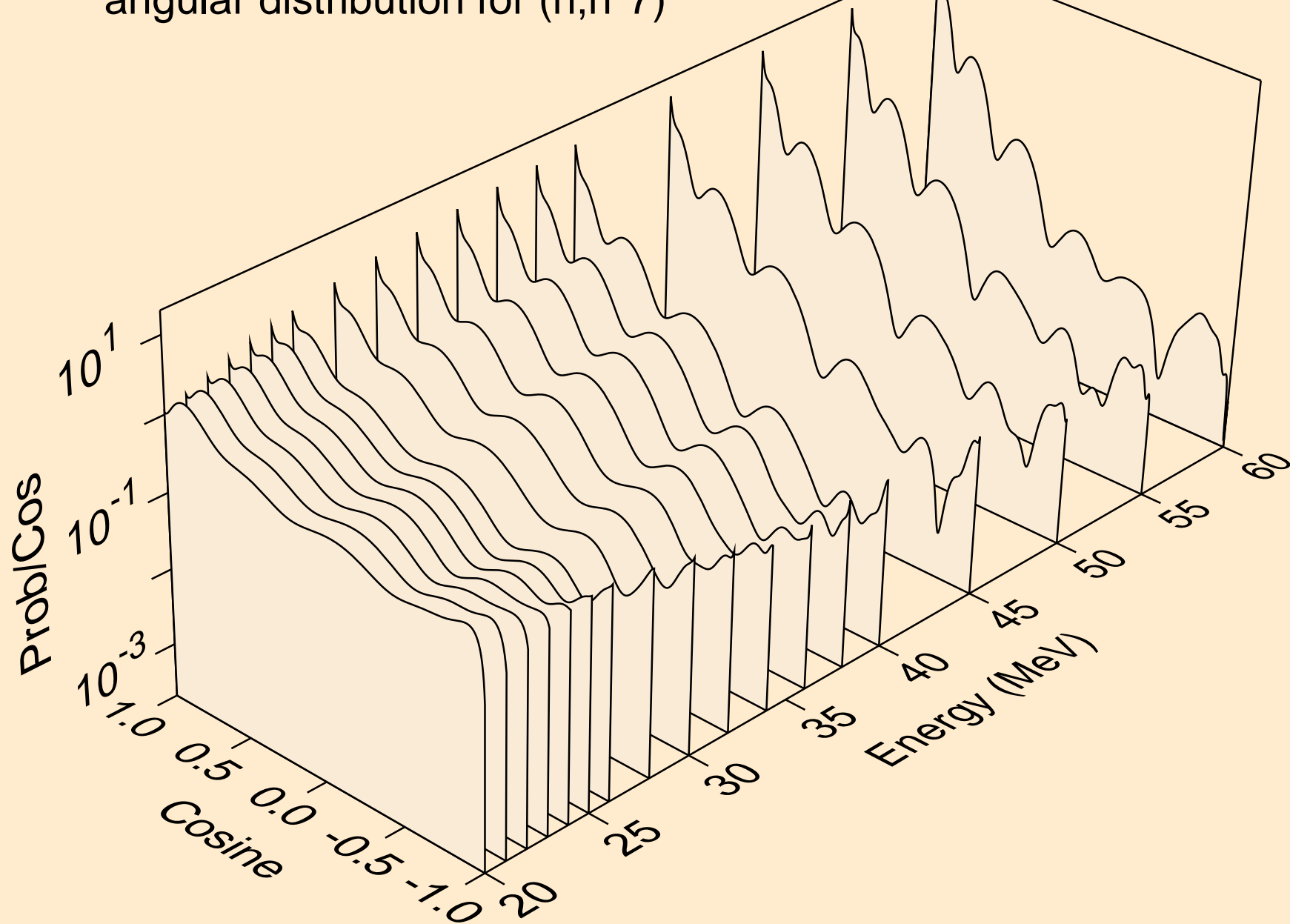

25-MN-55 FOR FENDL-3.2 FROM INDL/V-3 BY NJOY2016.60+ ON  
angular distribution for (n,n\*8)

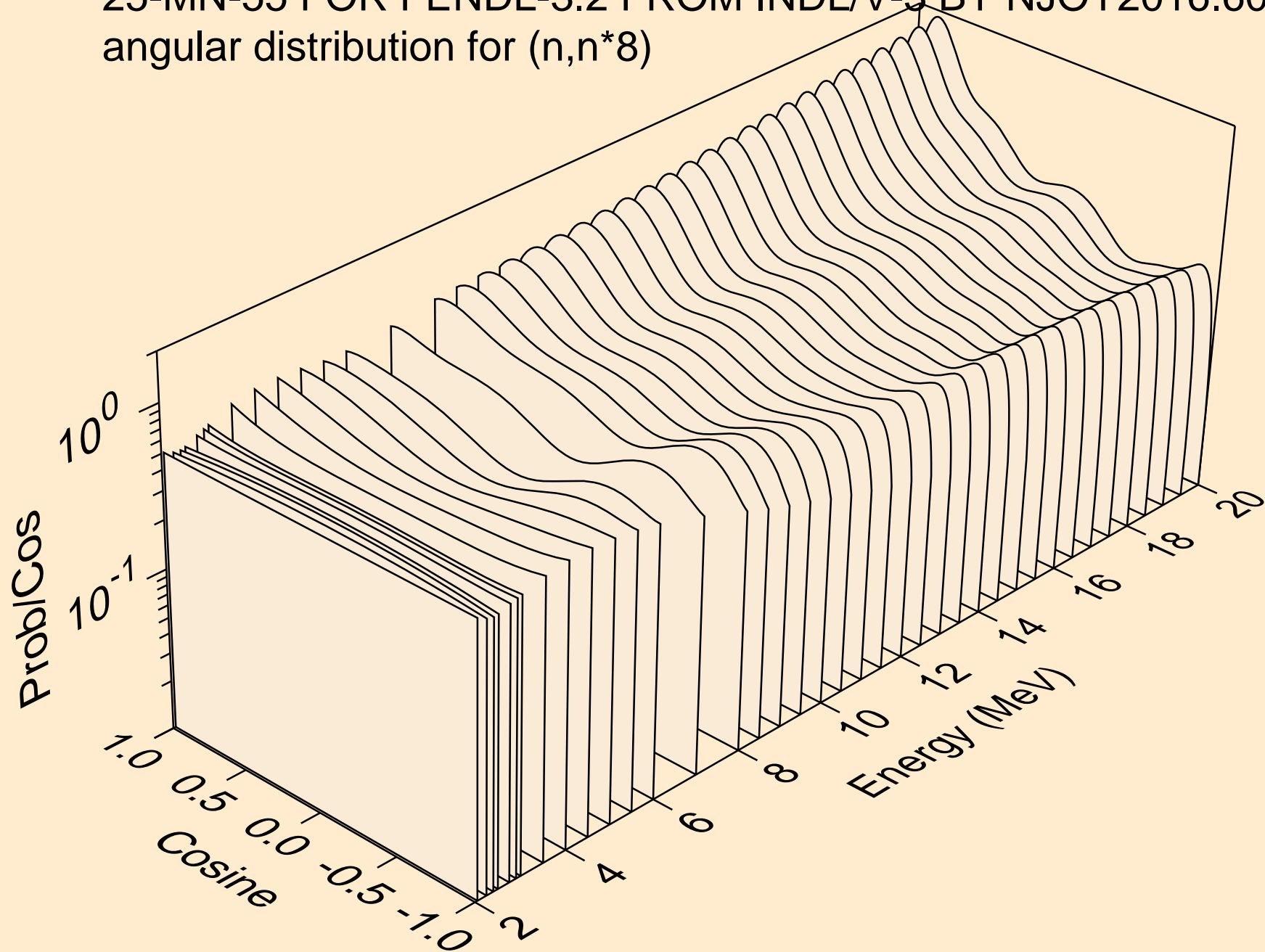

25-MN-55 FOR FENDL-3.2 FROM INDL/V-3 BY NJOY2016.60+ ON  
angular distribution for (n,n\*8)

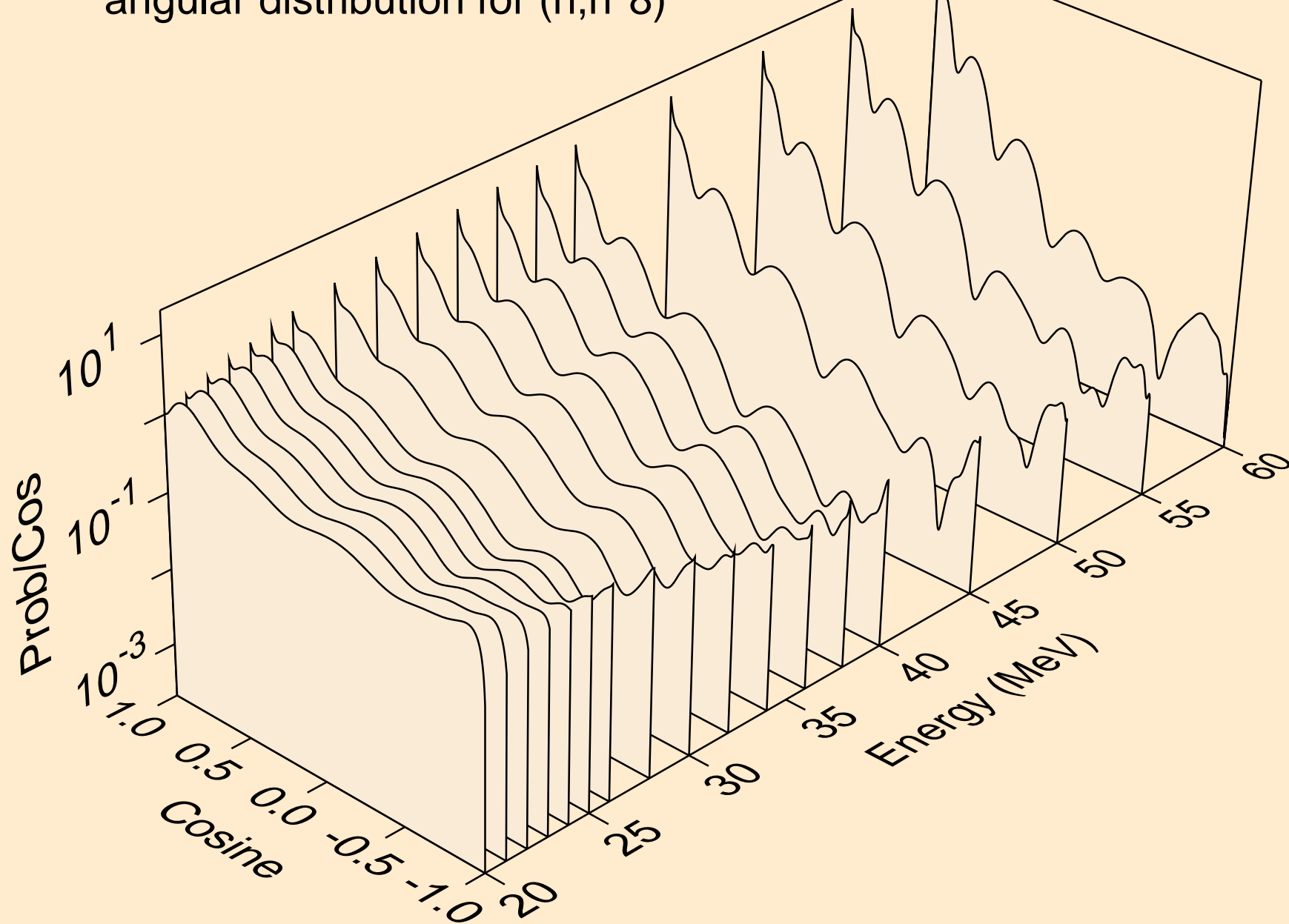

25-MN-55 FOR FENDL-3.2 FROM INDL/V-3 BY NJOY2016.60+ ON  
angular distribution for (n,n\*9)

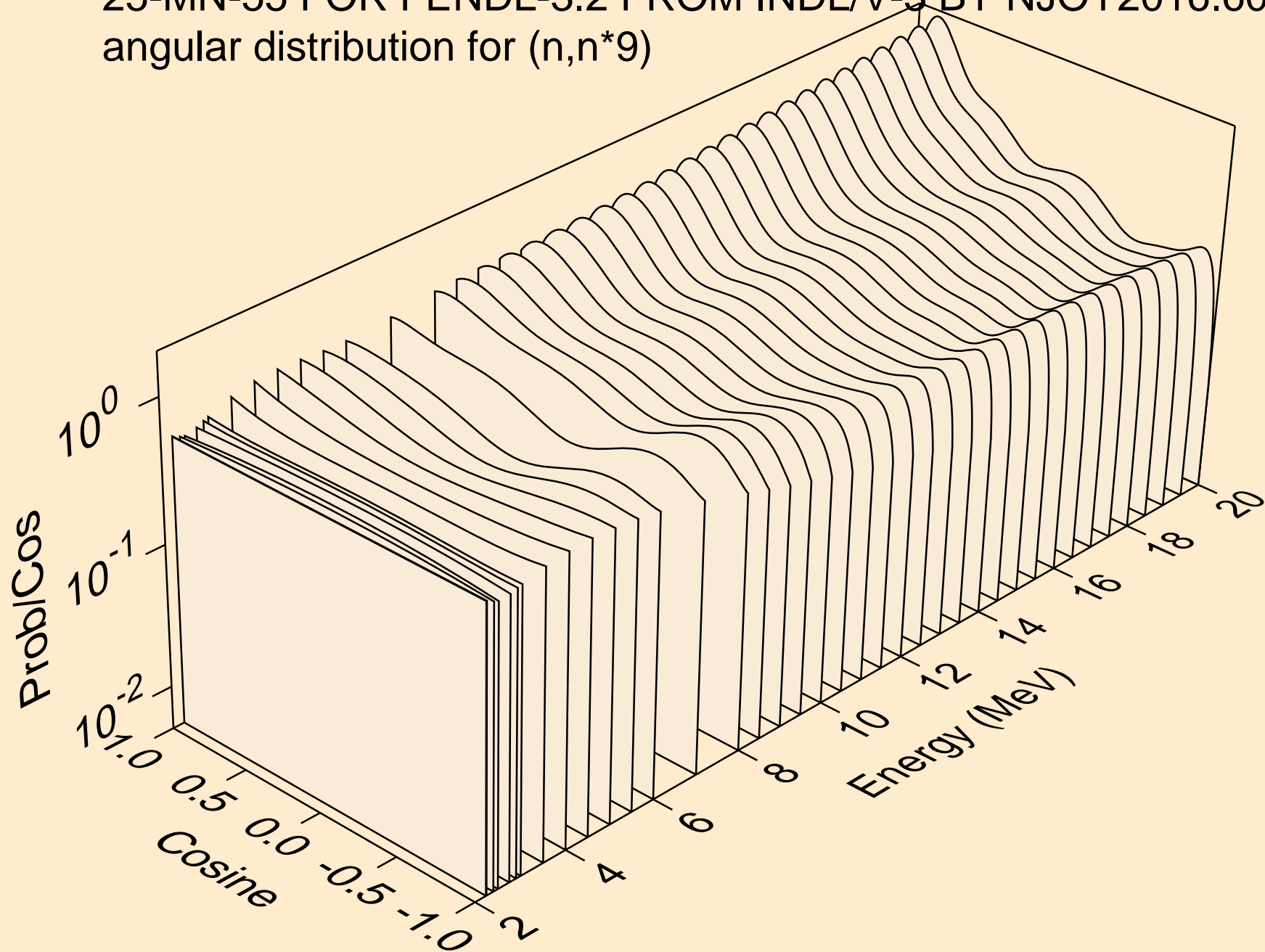

25-MN-55 FOR FENDL-3.2 FROM INDL/V-3 BY NJOY2016.60+ ON  
angular distribution for (n,n\*9)

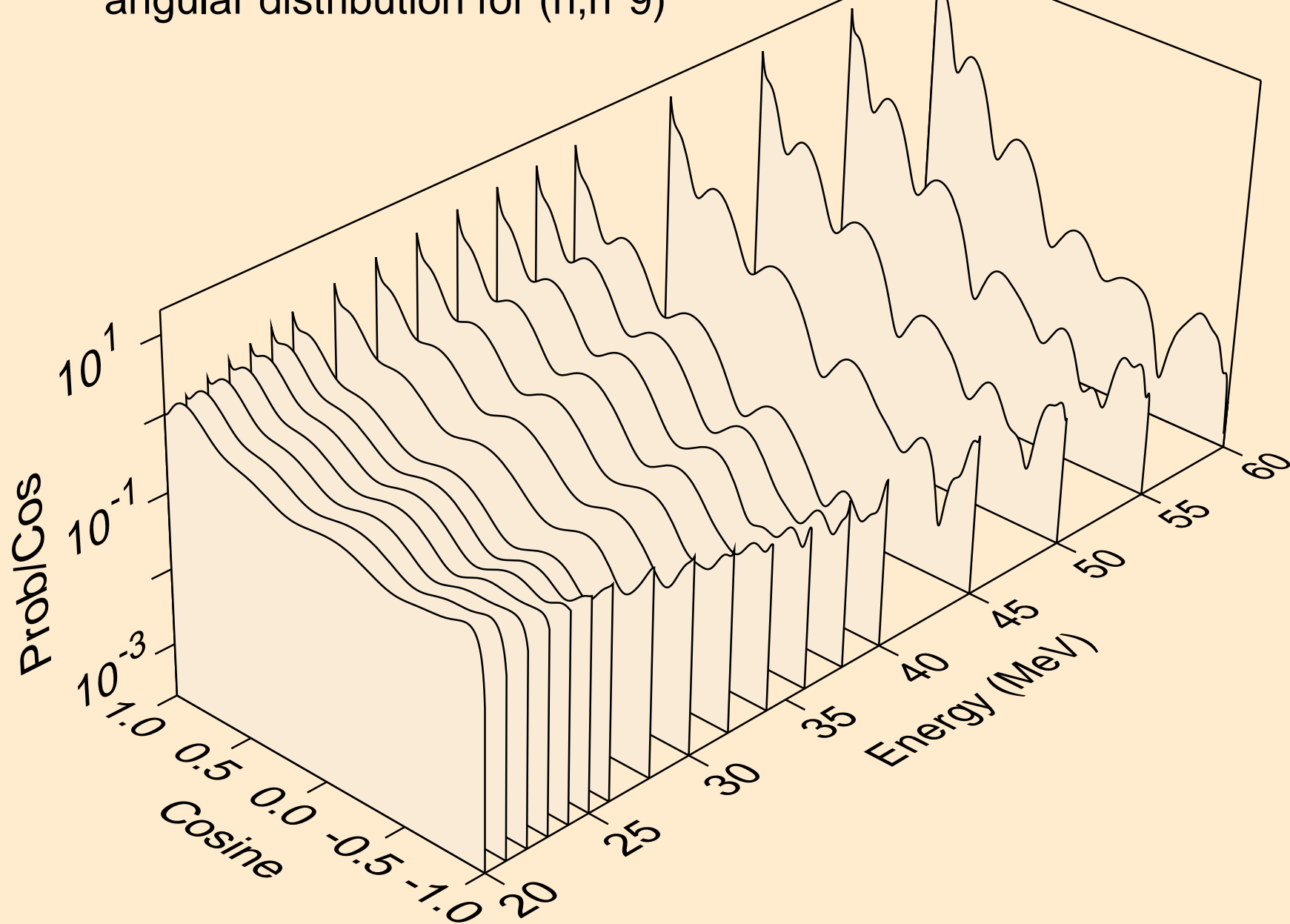



25-MN-55 FOR FENDL-3.2 FROM INDL/V-3 BY NJOY2016.60+ ON  
angular distribution for (n,n\*10)

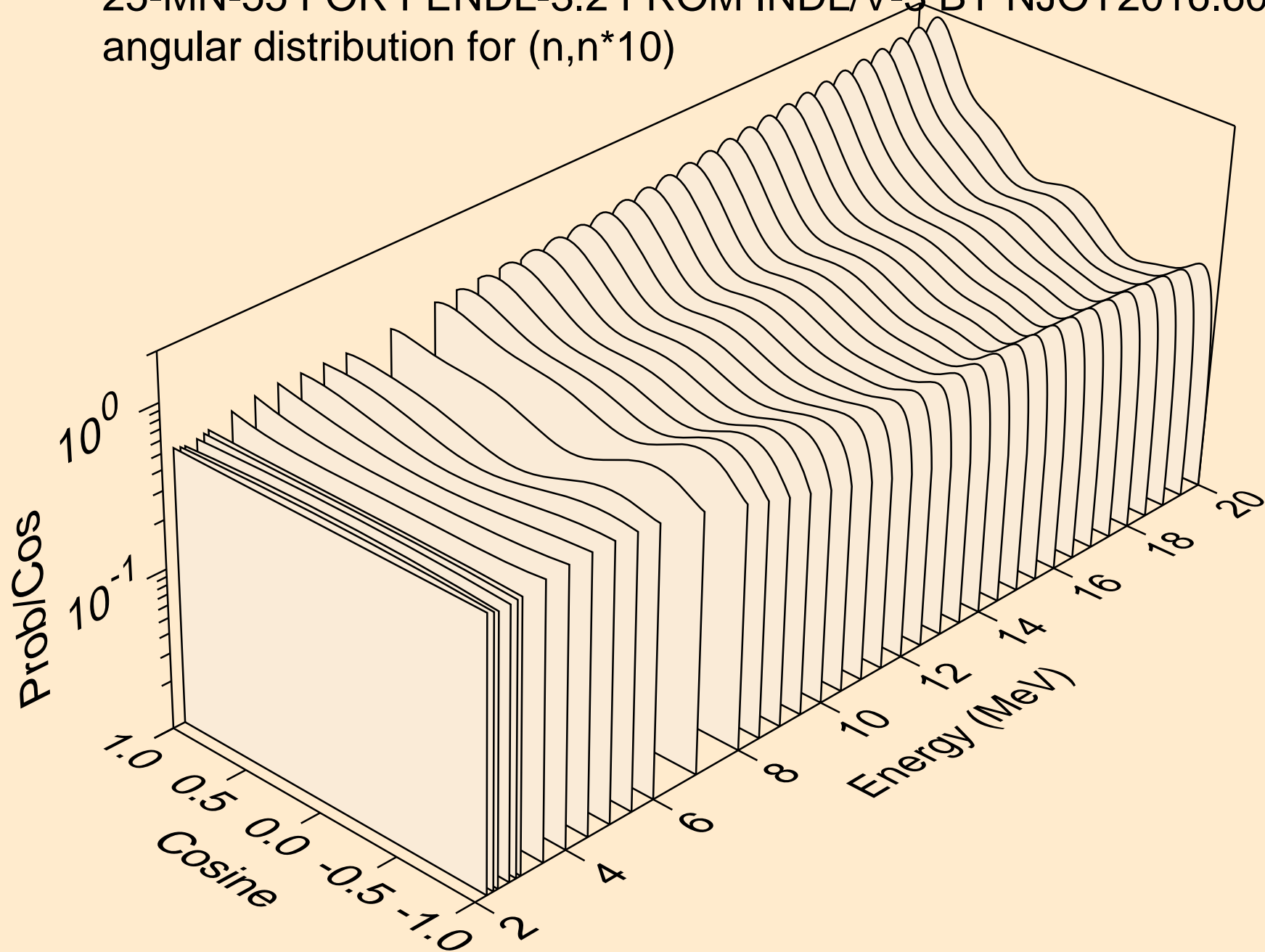

25-MN-55 FOR FENDL-3.2 FROM INDL/V-3 BY NJOY2016.60+ ON  
angular distribution for (n,n\*10)

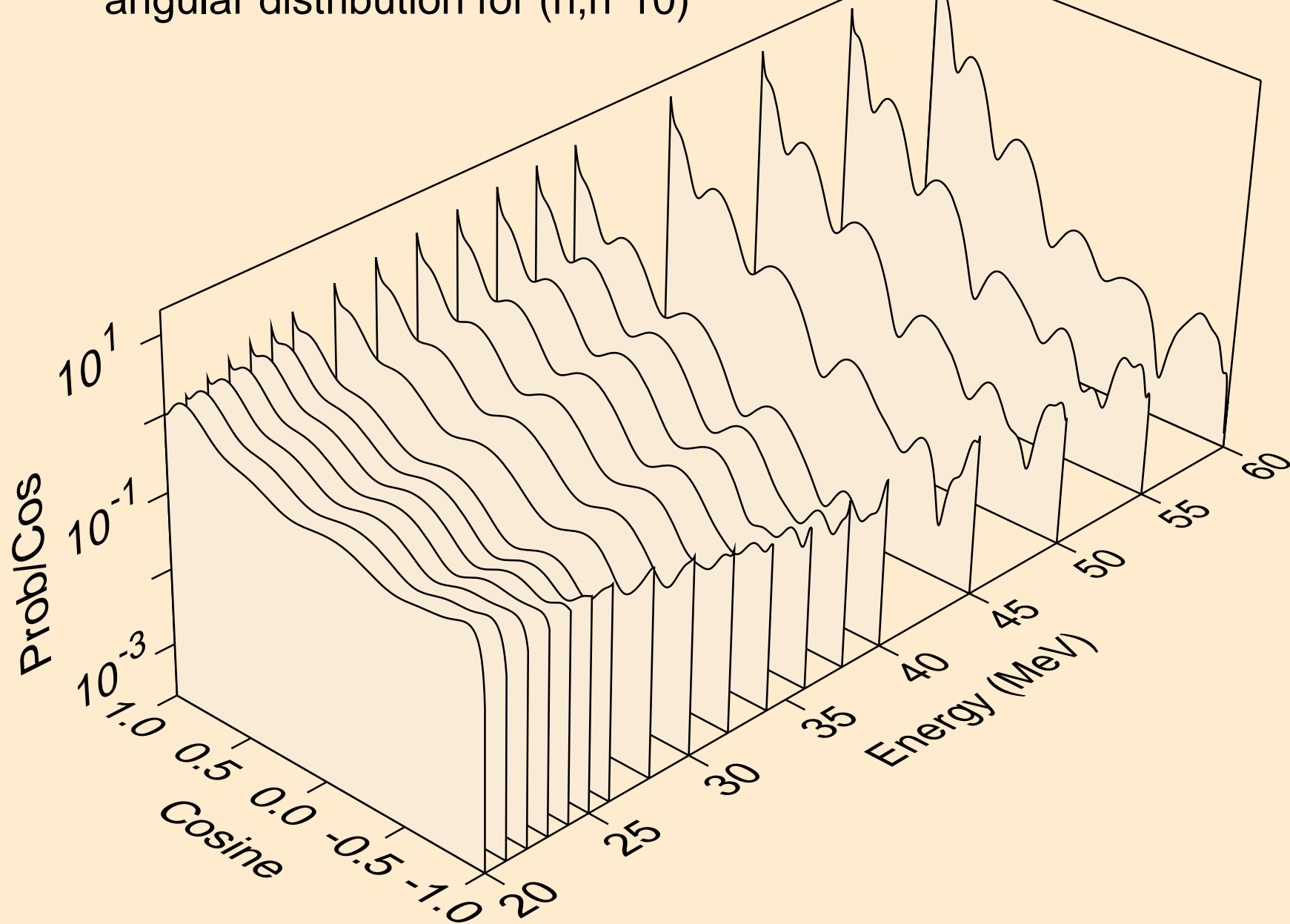

25-MN-55 FOR FENDL-3.2 FROM INDL/V-3 BY NJOY2016.60+ ON  
angular distribution for (n,n\*11)

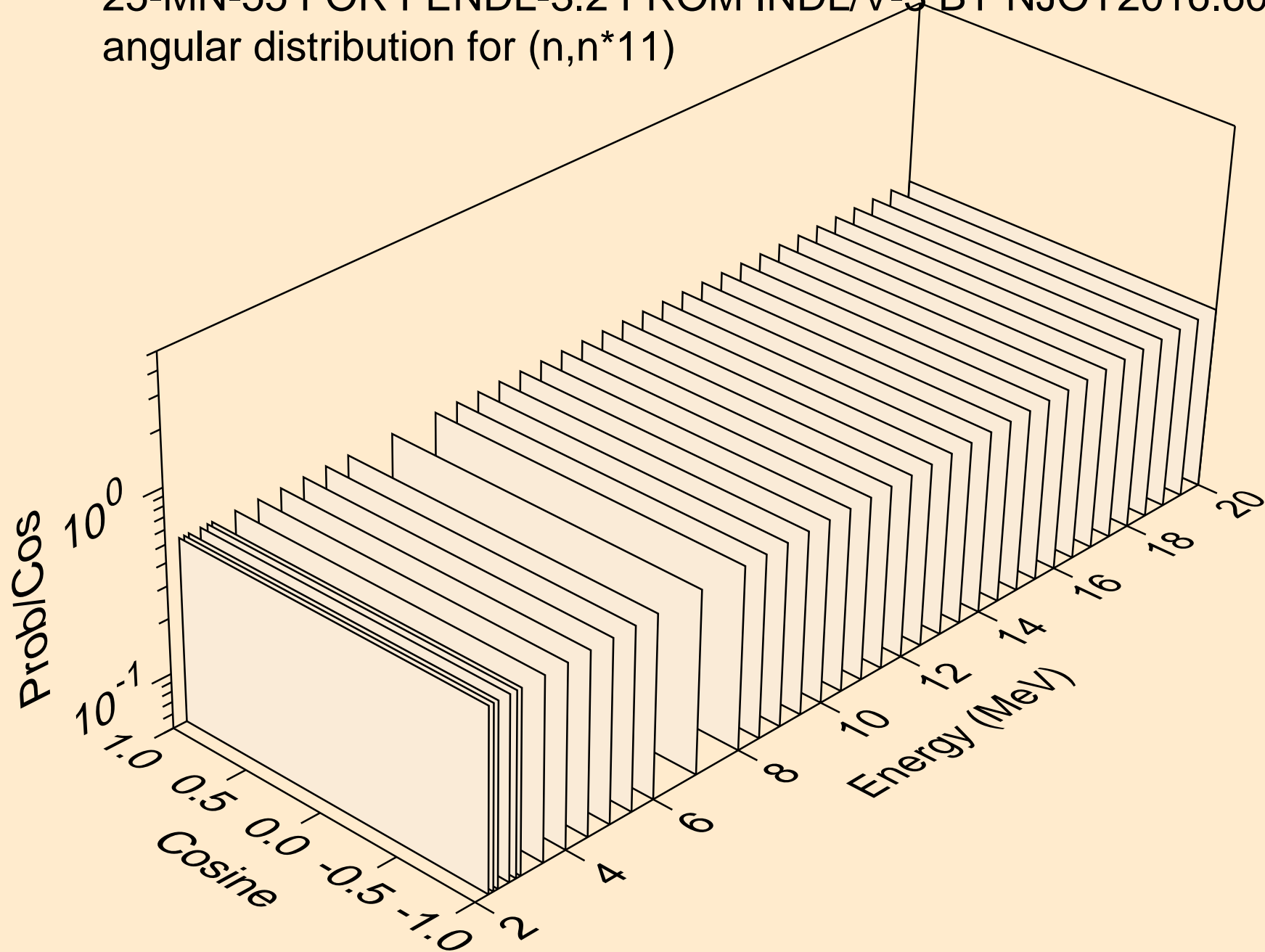

25-MN-55 FOR FENDL-3.2 FROM INDL/V-3 BY NJOY2016.60+ ON  
angular distribution for (n,n\*11)

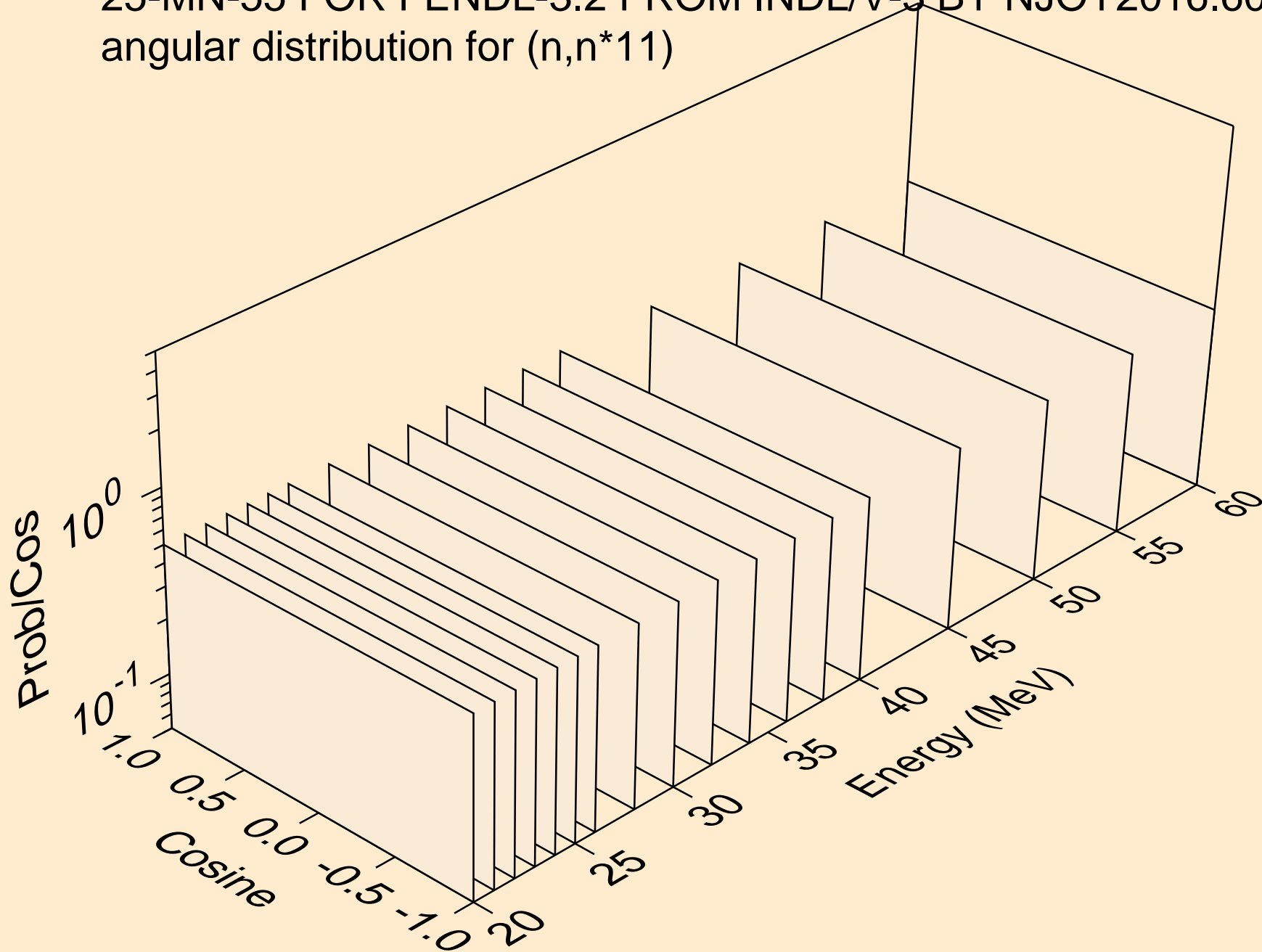

25-MN-55 FOR FENDL-3.2 FROM INDL/V-3 BY NJOY2016.60+ ON  
angular distribution for (n,n\*12)

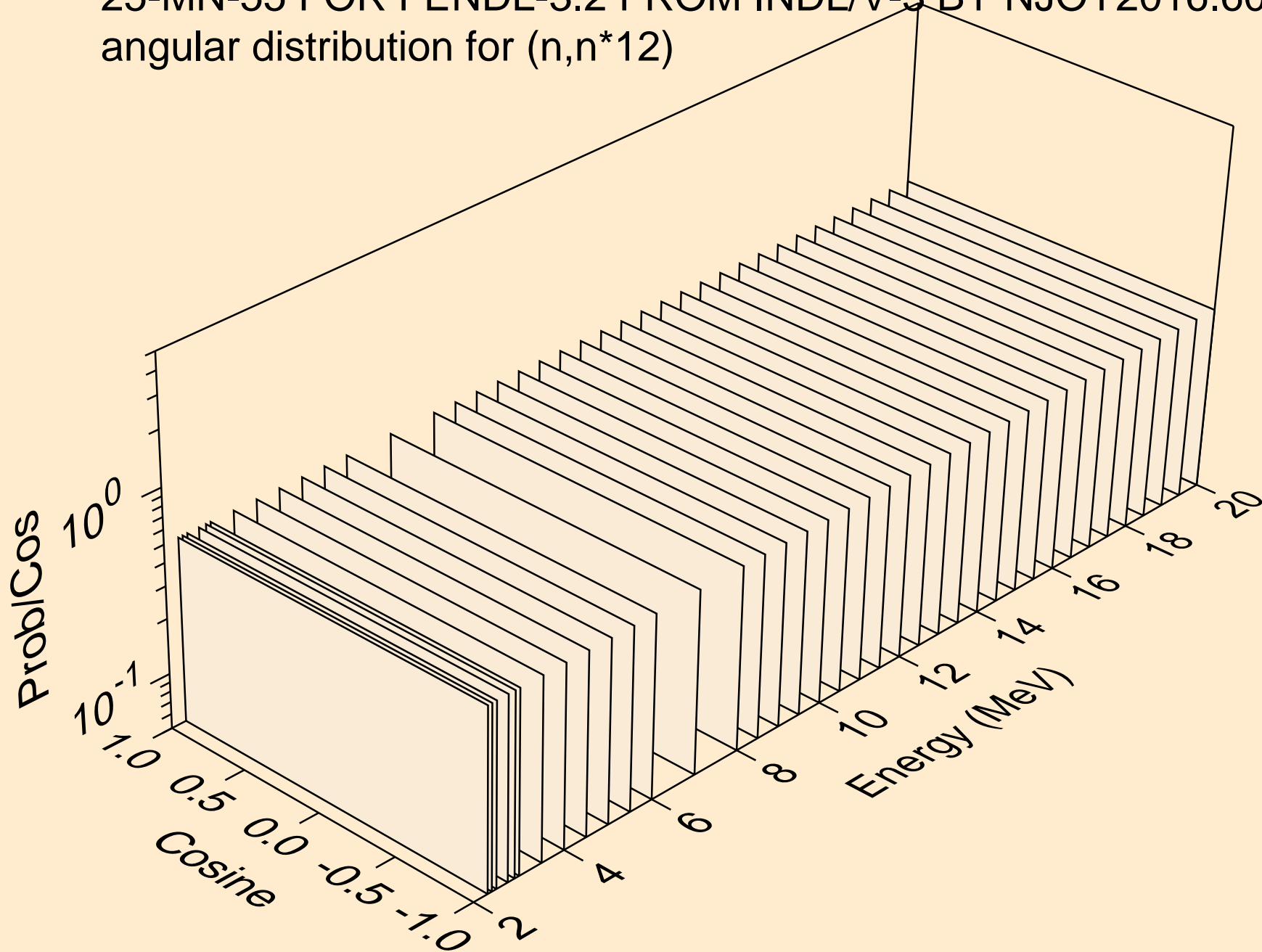

25-MN-55 FOR FENDL-3.2 FROM INDL/V-3 BY NJOY2016.60+ ON  
angular distribution for (n,n\*12)

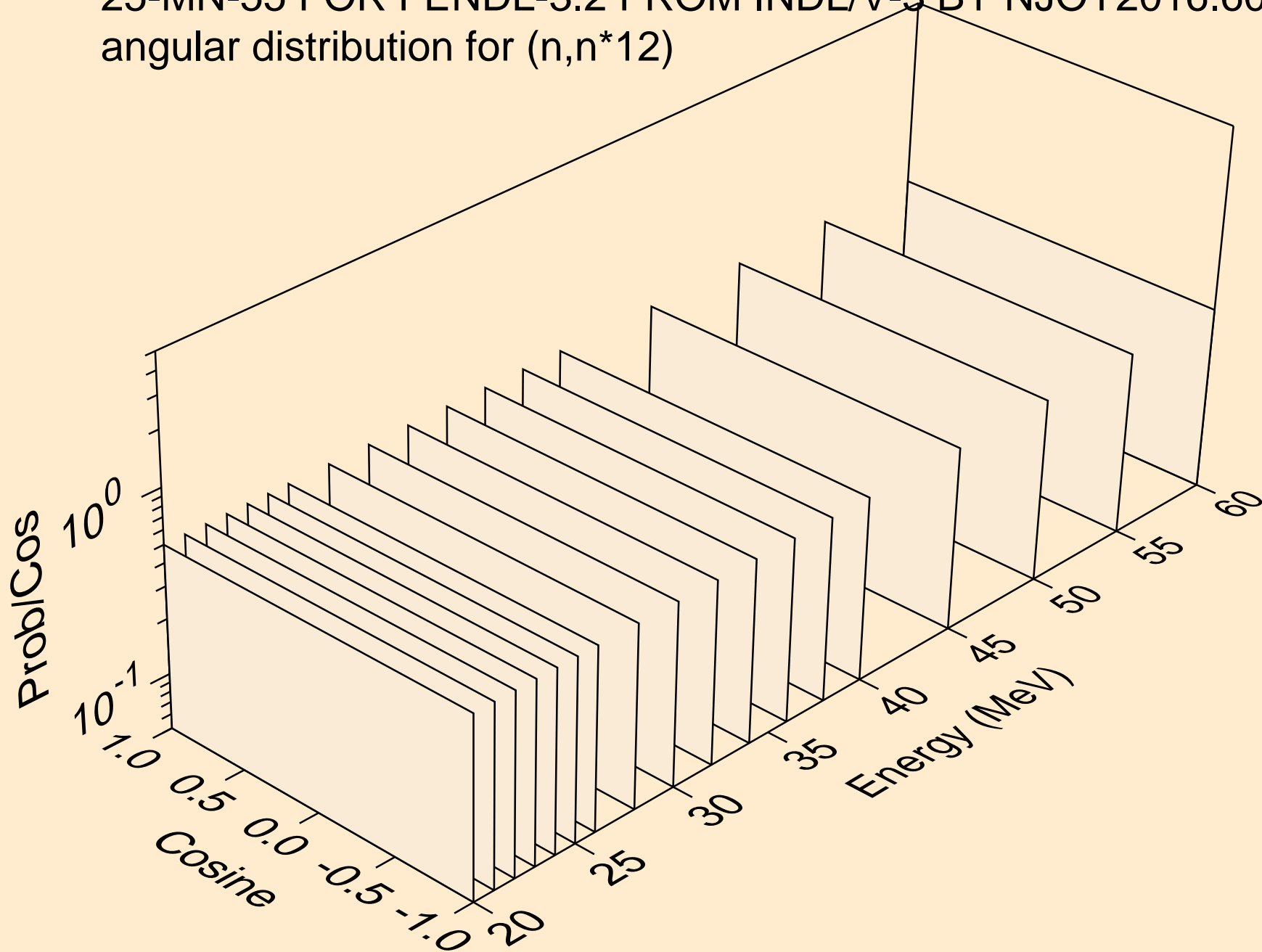

25-MN-55 FOR FENDL-3.2 FROM INDL/V-3 BY NJOY2016.60+ ON  
angular distribution for (n,n\*13)

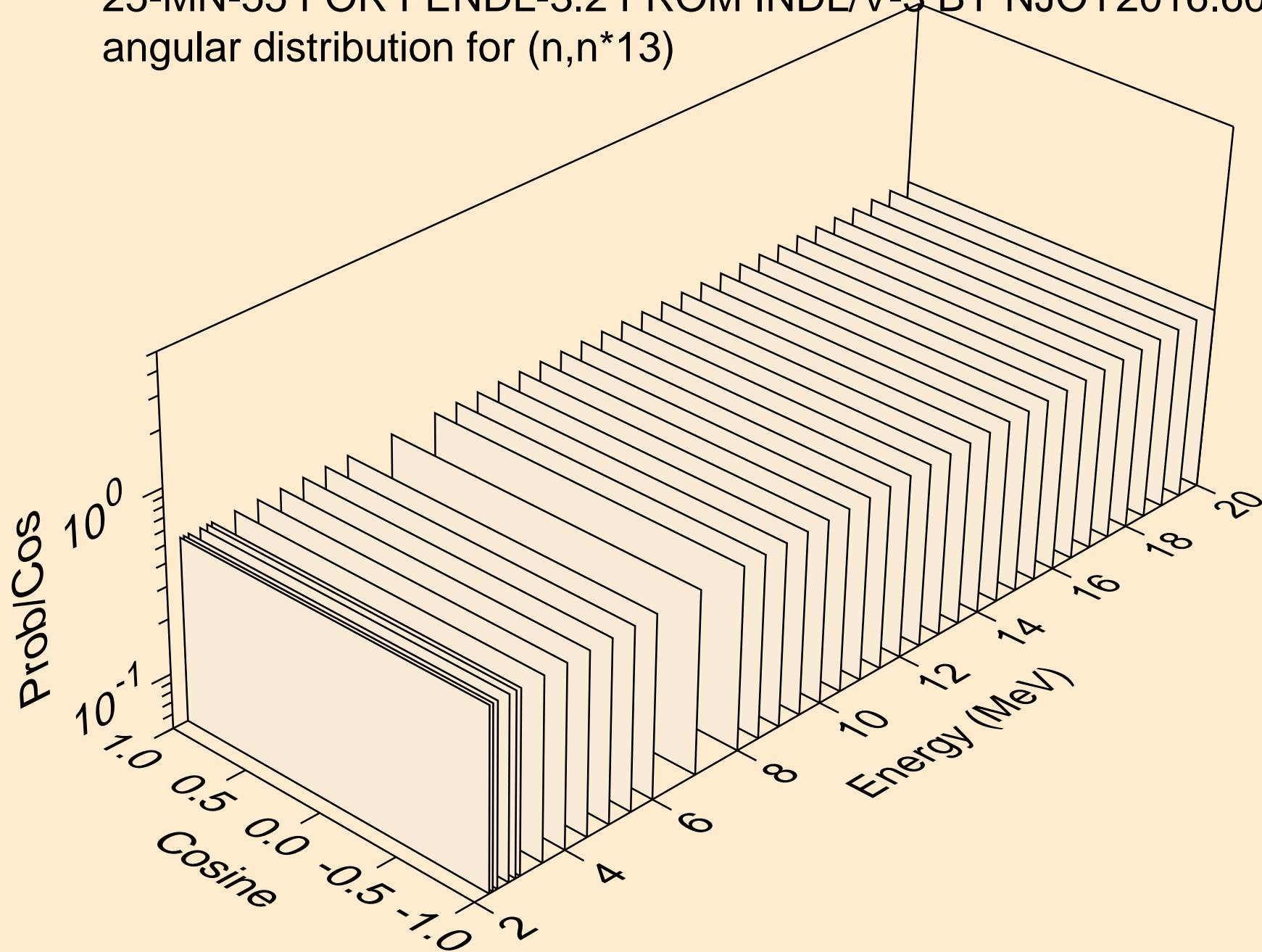

25-MN-55 FOR FENDL-3.2 FROM INDL/V-3 BY NJOY2016.60+ ON  
angular distribution for (n,n\*13)

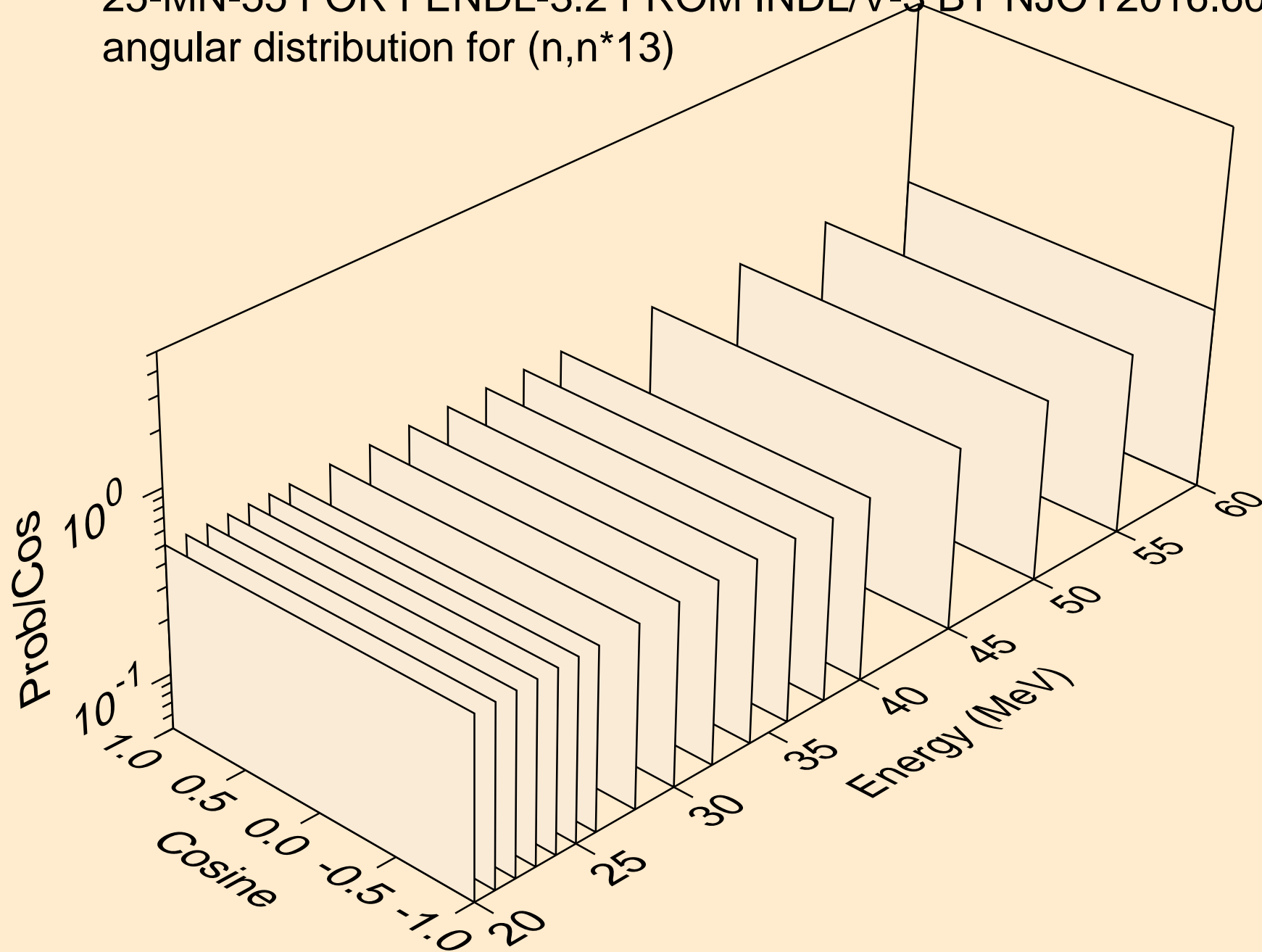



25-MN-55 FOR FENDL-3.2 FROM INDL/V-3 BY NJOY2016.60+ ON  
angular distribution for (n,n\*14)

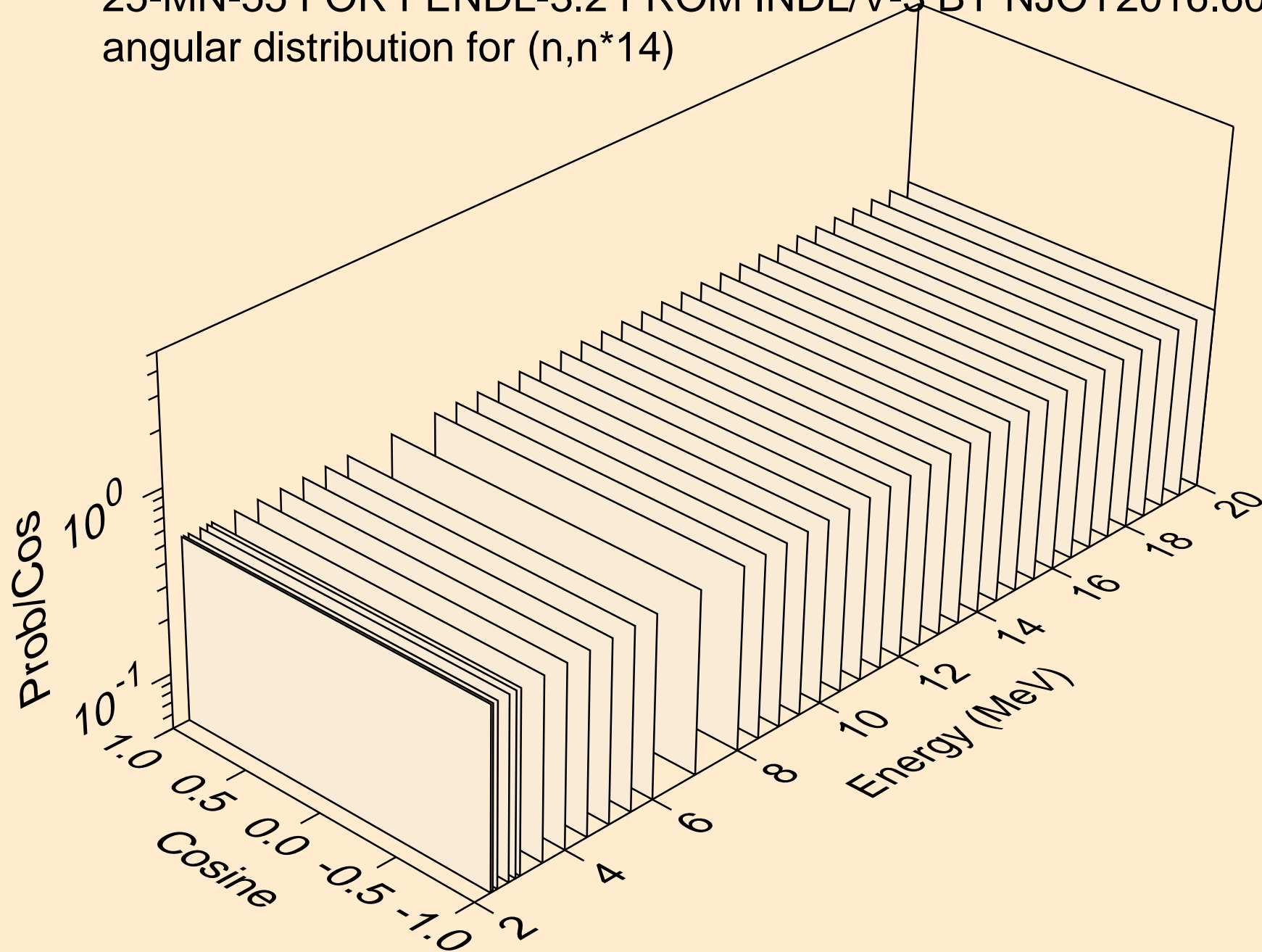

25-MN-55 FOR FENDL-3.2 FROM INDL/V-3 BY NJOY2016.60+ ON  
angular distribution for (n,n\*14)

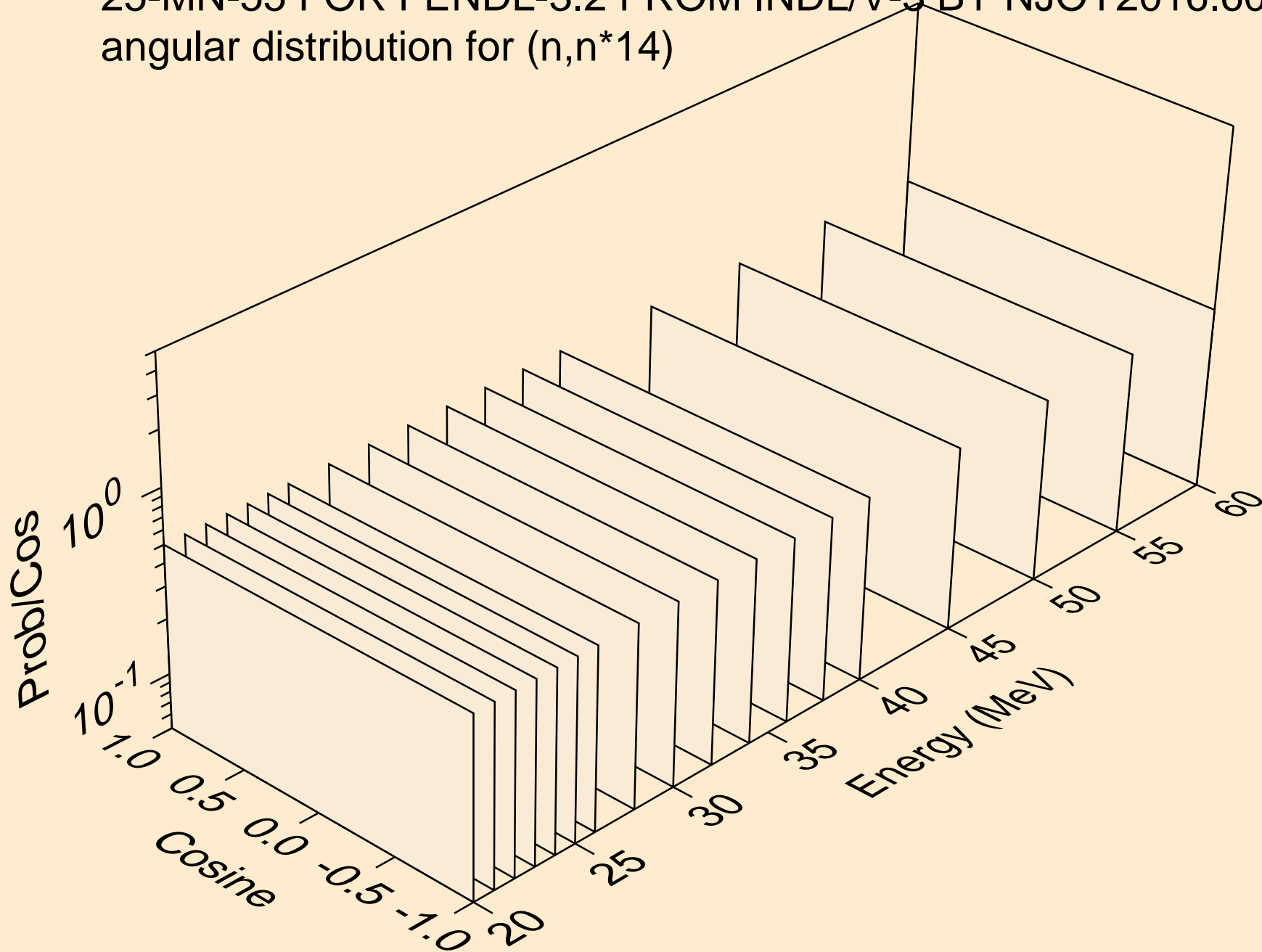

25-MN-55 FOR FENDL-3.2 FROM INDL/V-3 BY NJOY2016.60+ ON  
angular distribution for (n,n\*15)

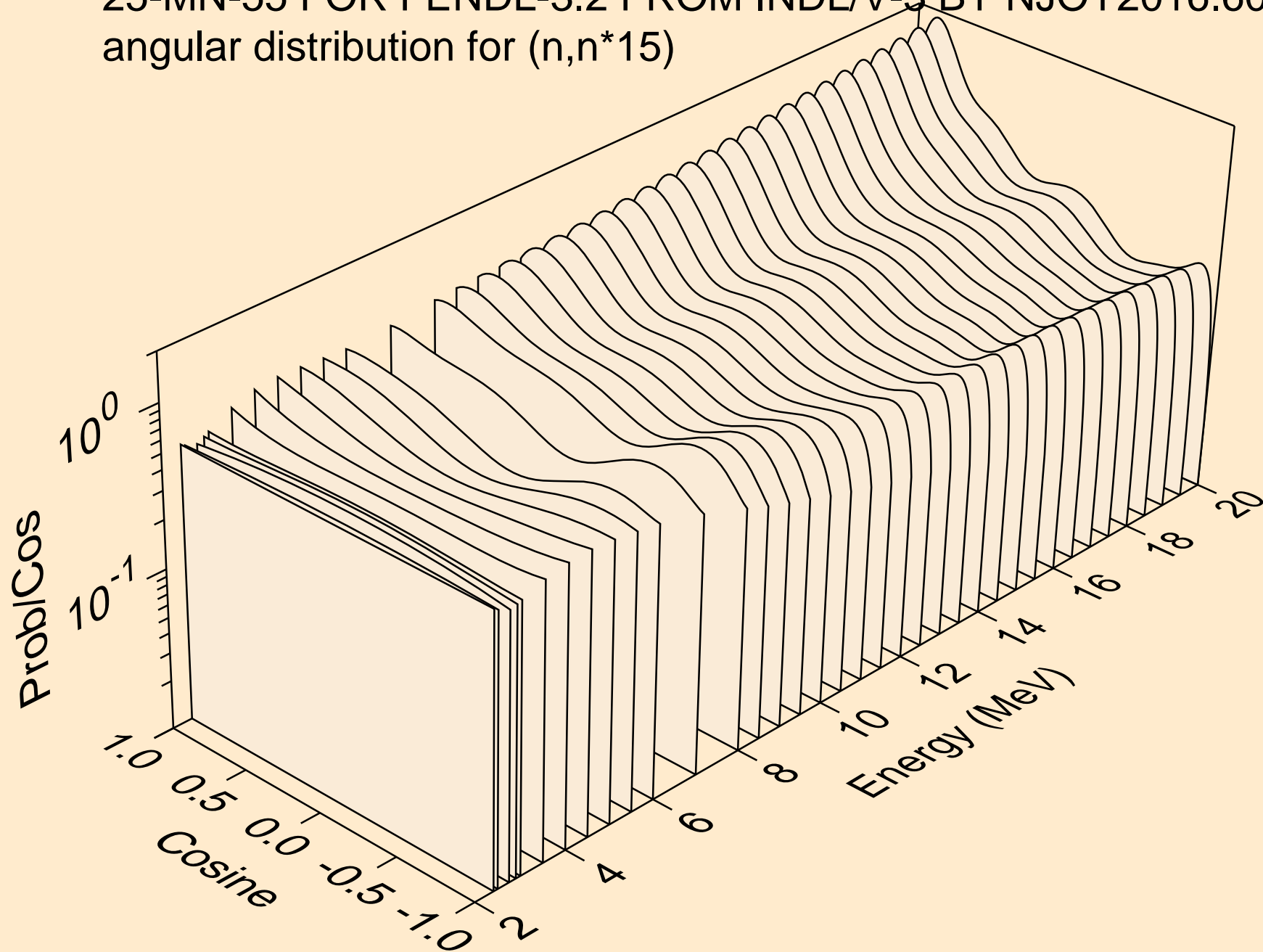

25-MN-55 FOR FENDL-3.2 FROM INDL/V-3 BY NJOY2016.60+ ON  
angular distribution for (n,n\*15)

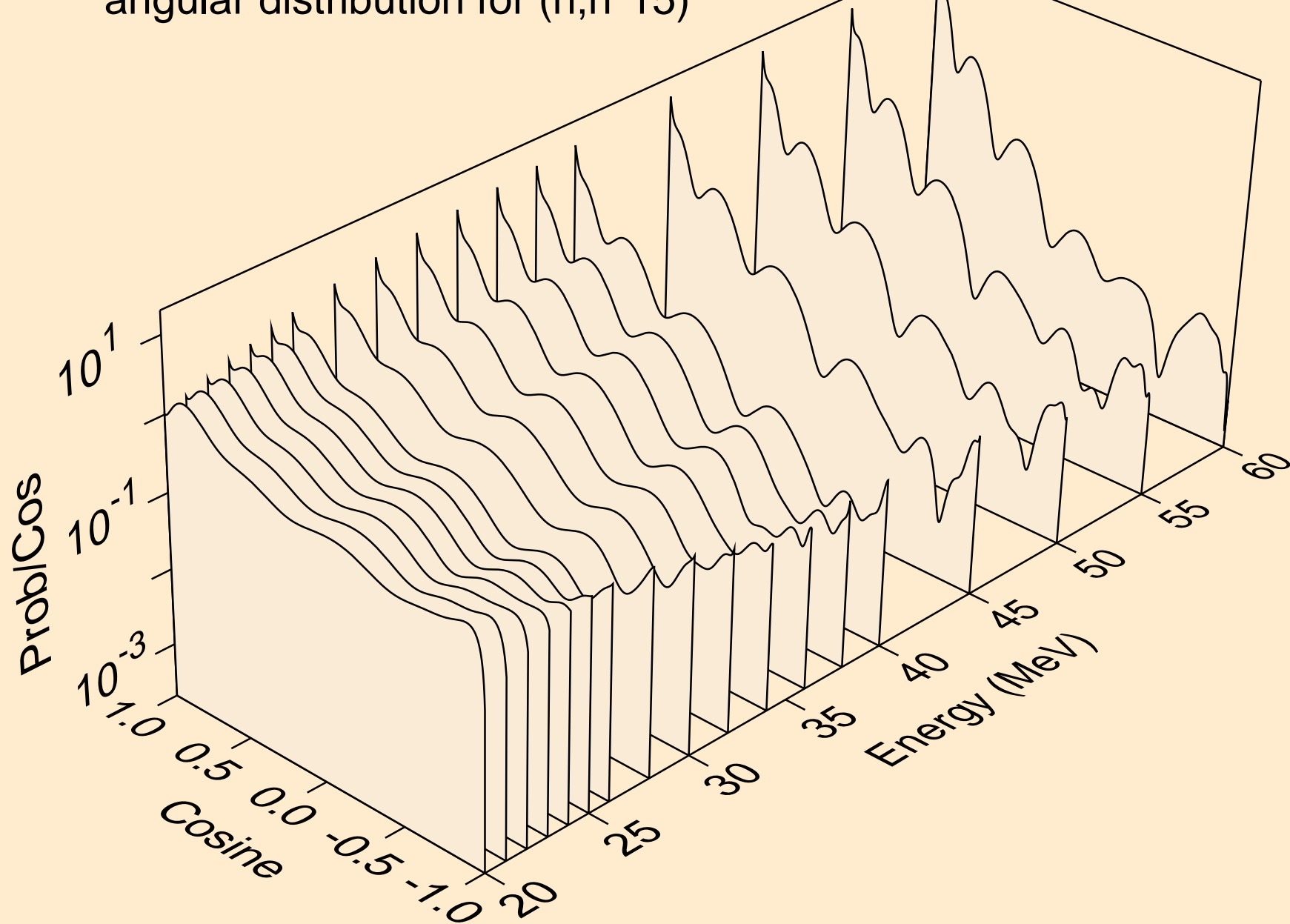

25-MN-55 FOR FENDL-3.2 FROM INDL/V-3 BY NJOY2016.60+ ON  
angular distribution for (n,n\*16)

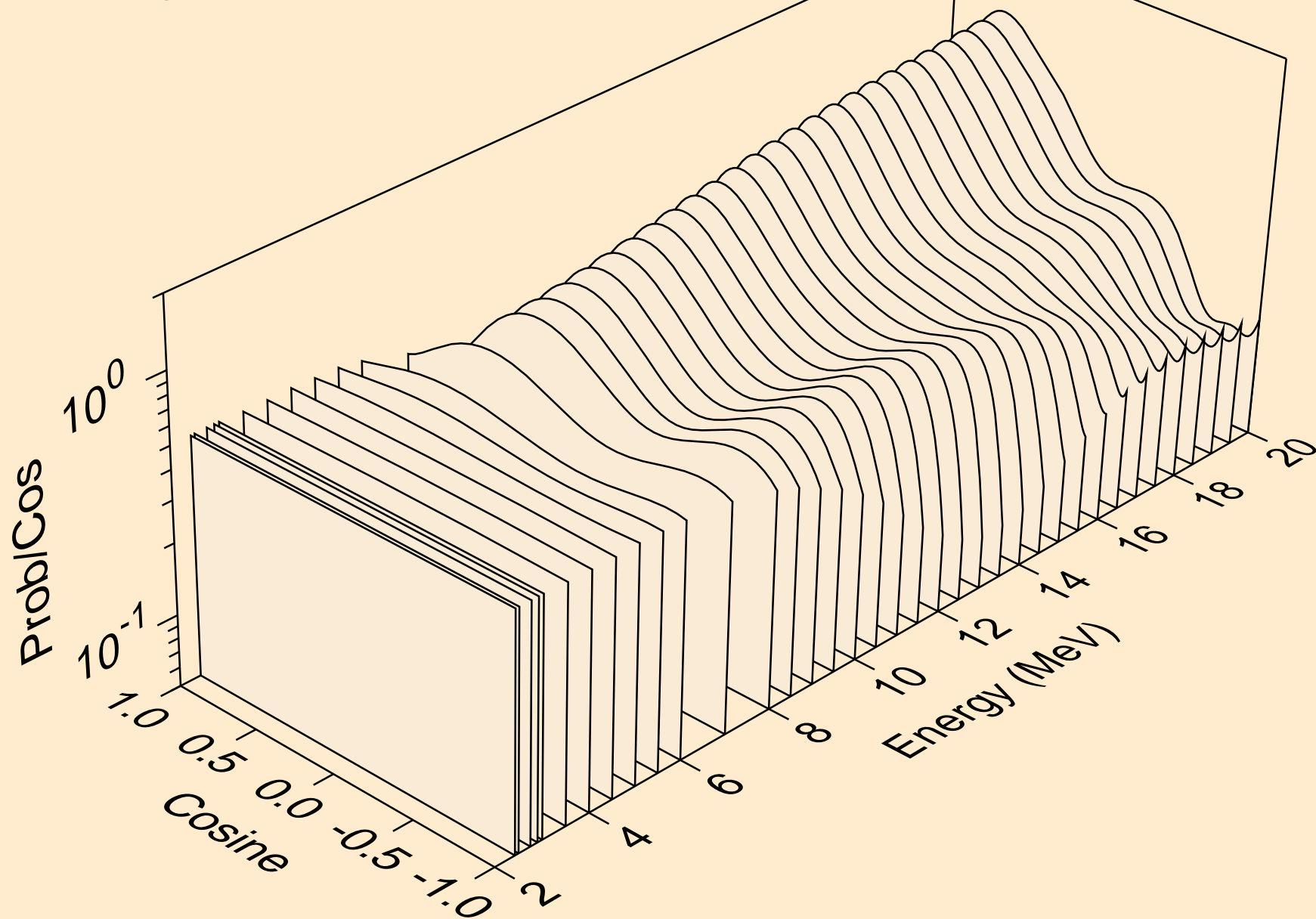

25-MN-55 FOR FENDL-3.2 FROM INDL/V-3 BY NJOY2016.60+ ON  
angular distribution for (n,n\*16)

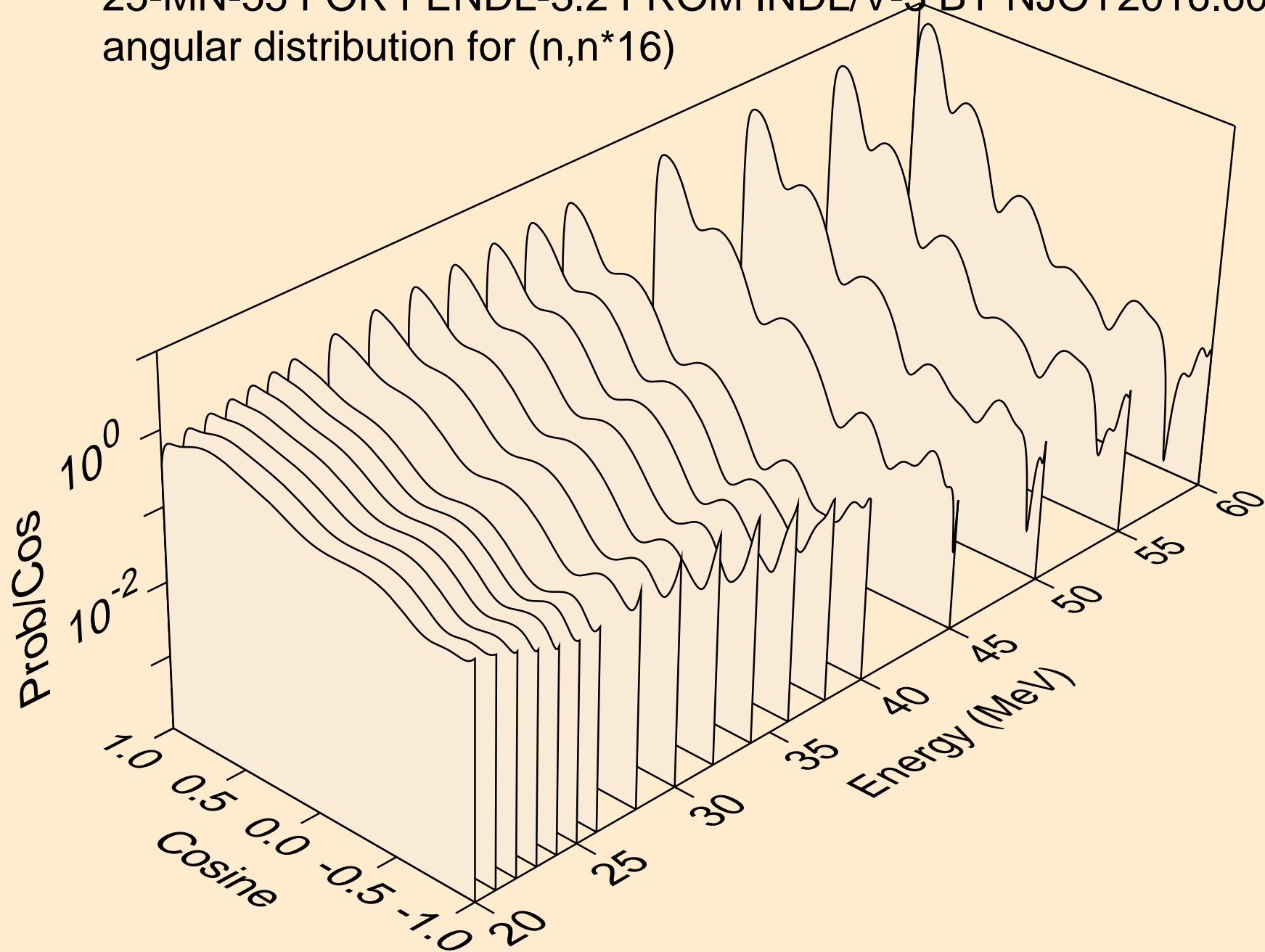

25-MN-55 FOR FENDL-3.2 FROM INDL/V-3 BY NJOY2016.60+ ON  
angular distribution for (n,n\*17)

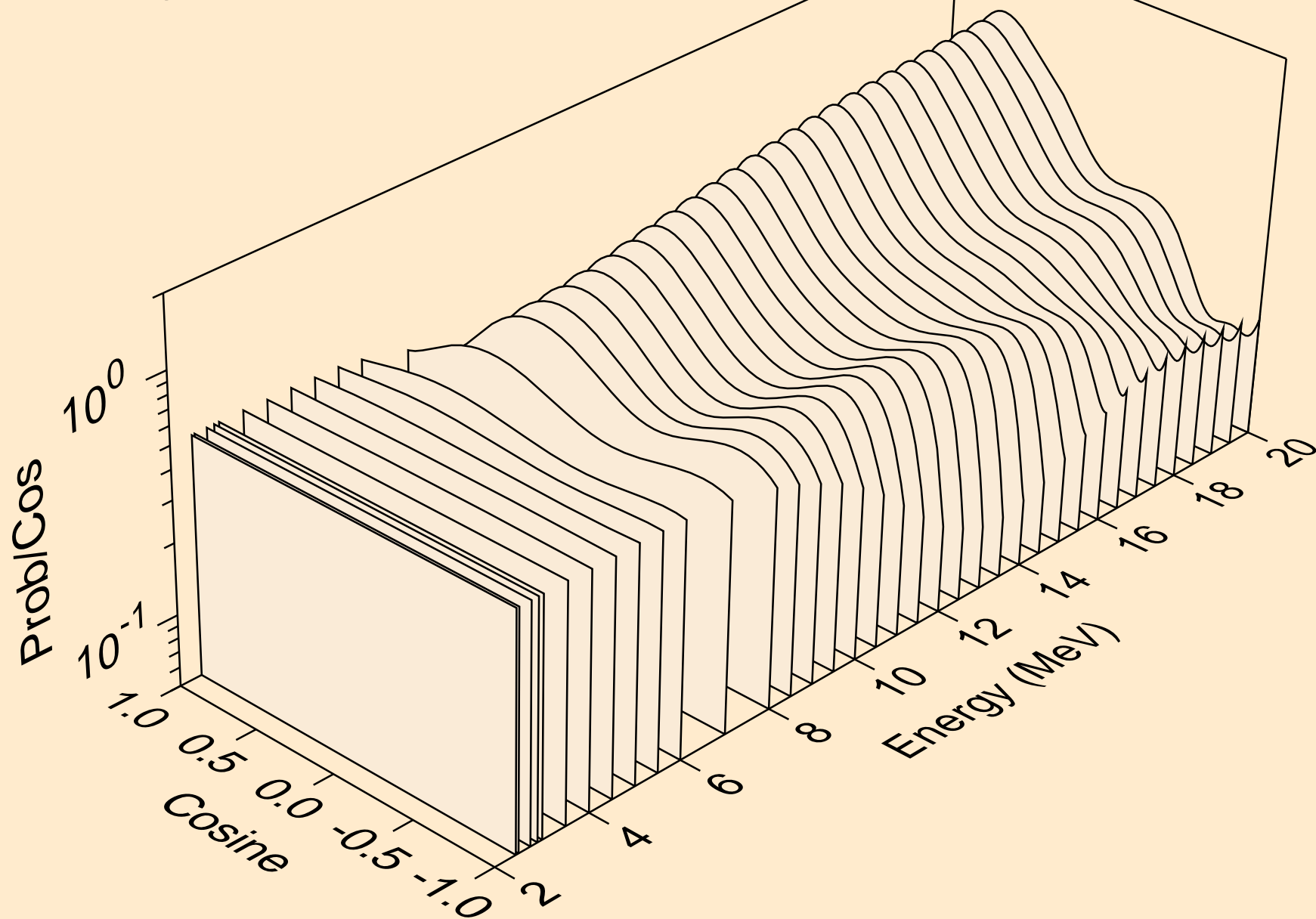

25-MN-55 FOR FENDL-3.2 FROM INDL/V-3 BY NJOY2016.60+ ON  
angular distribution for (n,n\*17)

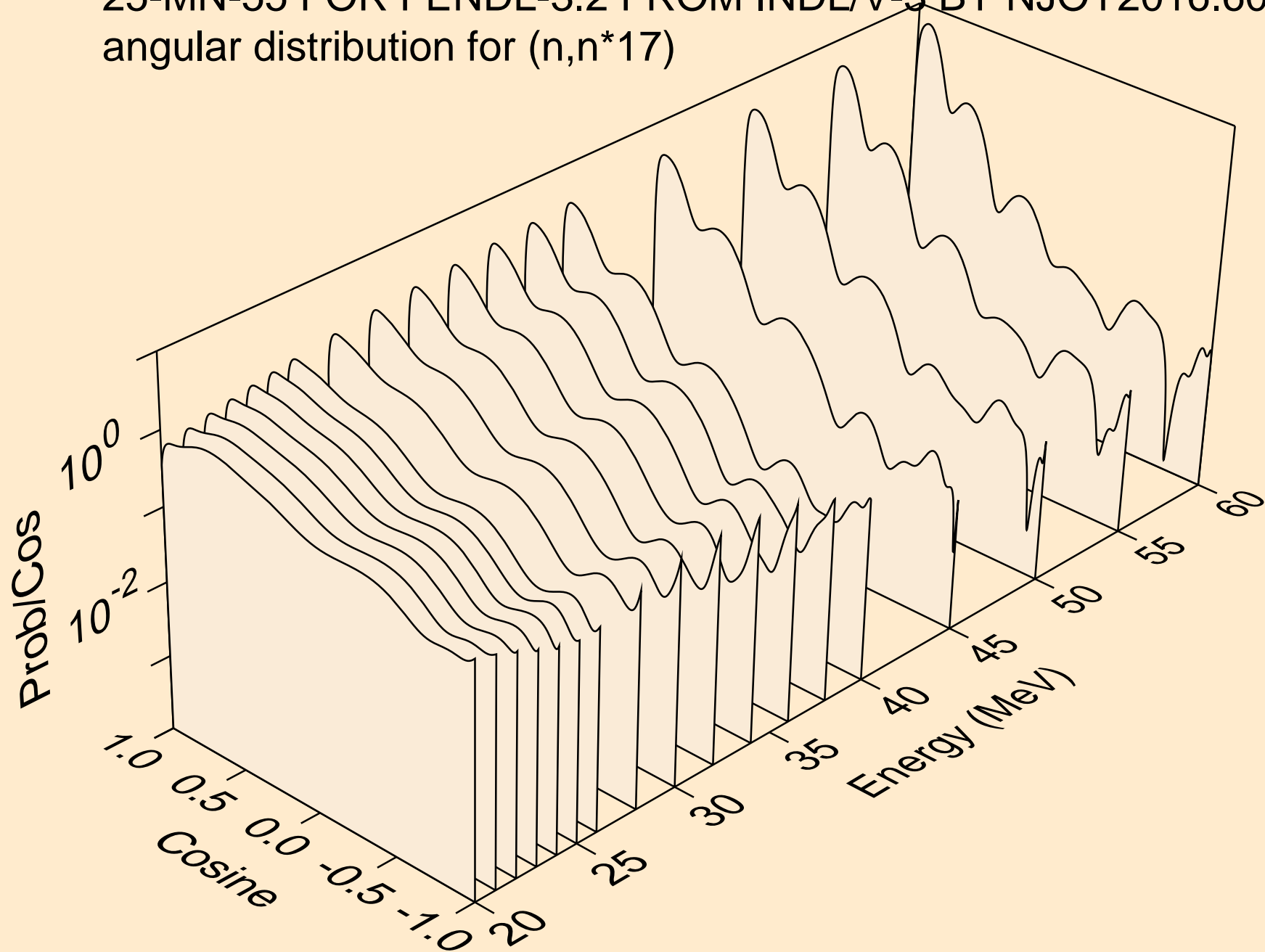



25-MN-55 FOR FENDL-3.2 FROM INDL/V-3 BY NJOY2016.60+ ON  
angular distribution for (n,n\*18)

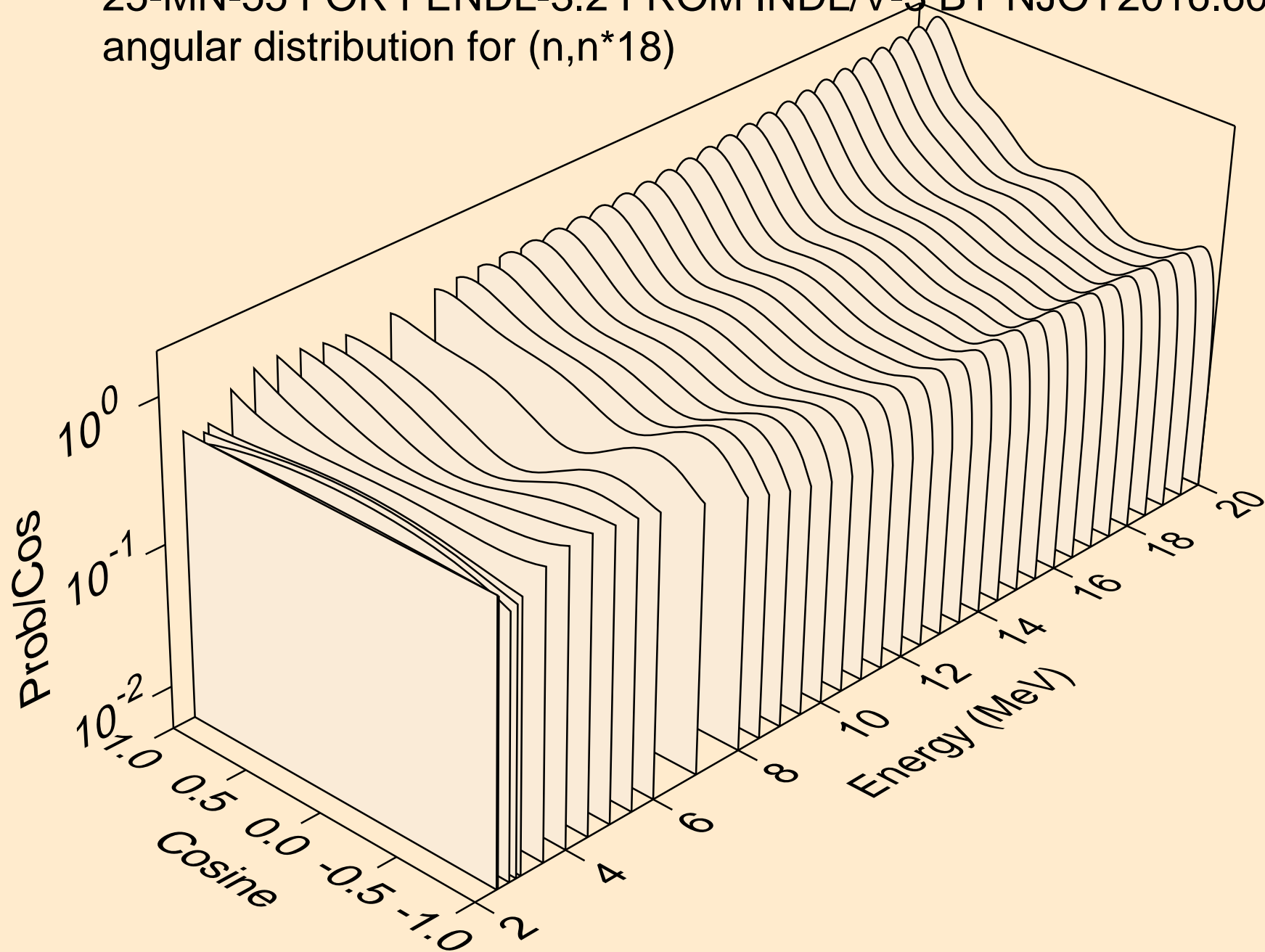

25-MN-55 FOR FENDL-3.2 FROM INDL/V-3 BY NJOY2016.60+ ON  
angular distribution for (n,n\*18)

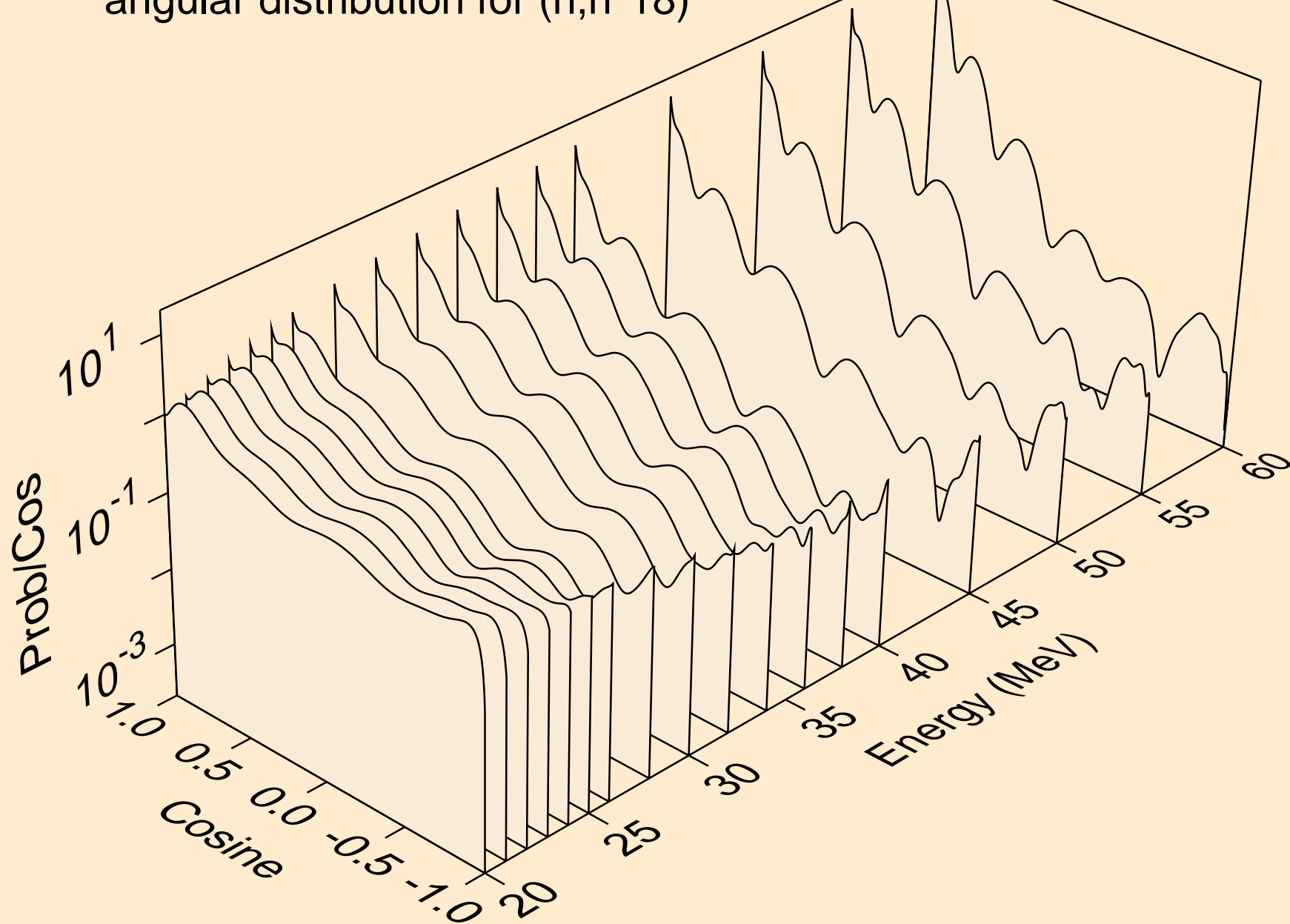

25-MN-55 FOR FENDL-3.2 FROM INDL/V-3 BY NJOY2016.60+ ON  
angular distribution for (n,n\*19)

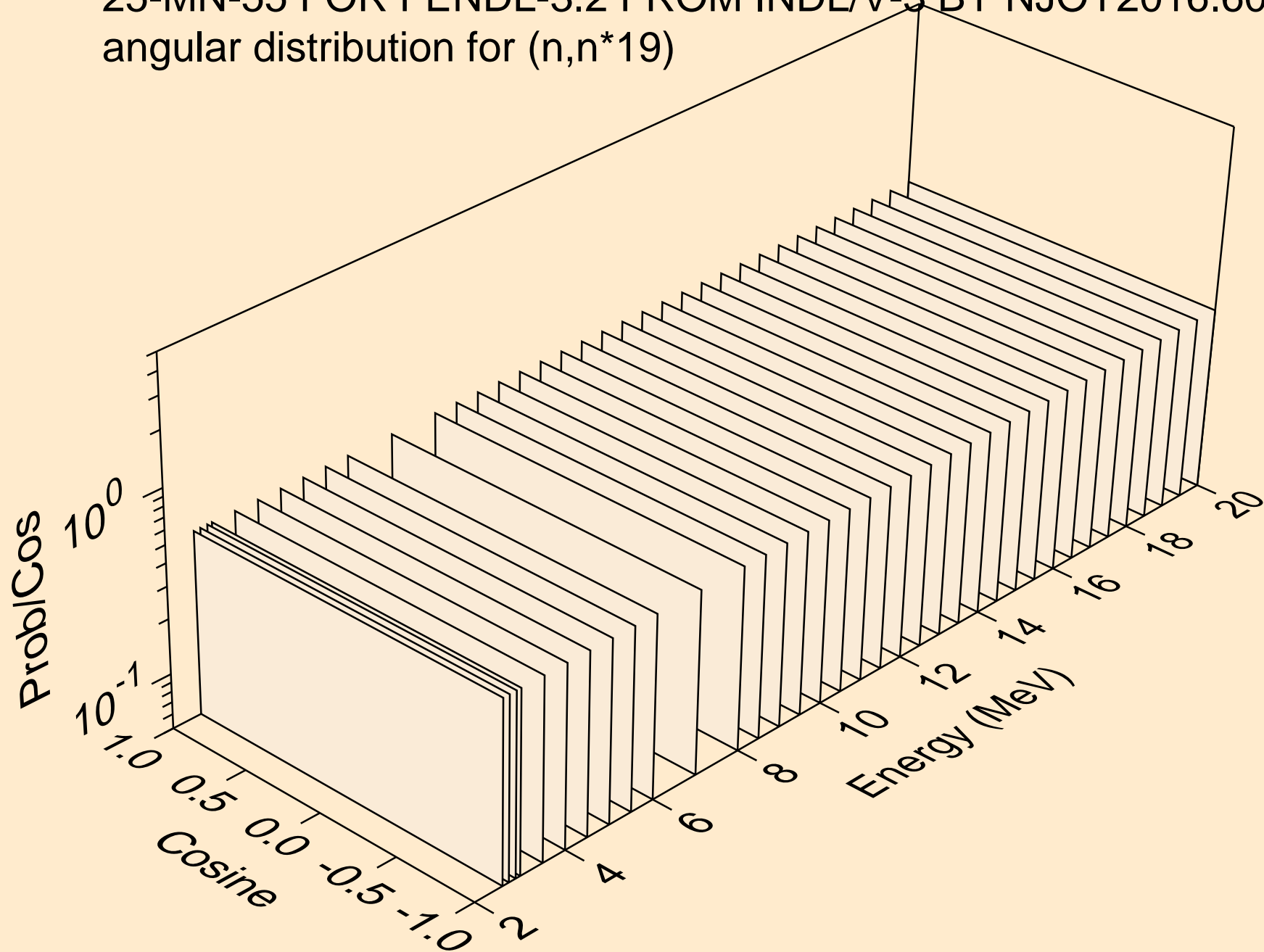

25-MN-55 FOR FENDL-3.2 FROM INDL/V-3 BY NJOY2016.60+ ON  
angular distribution for (n,n\*19)

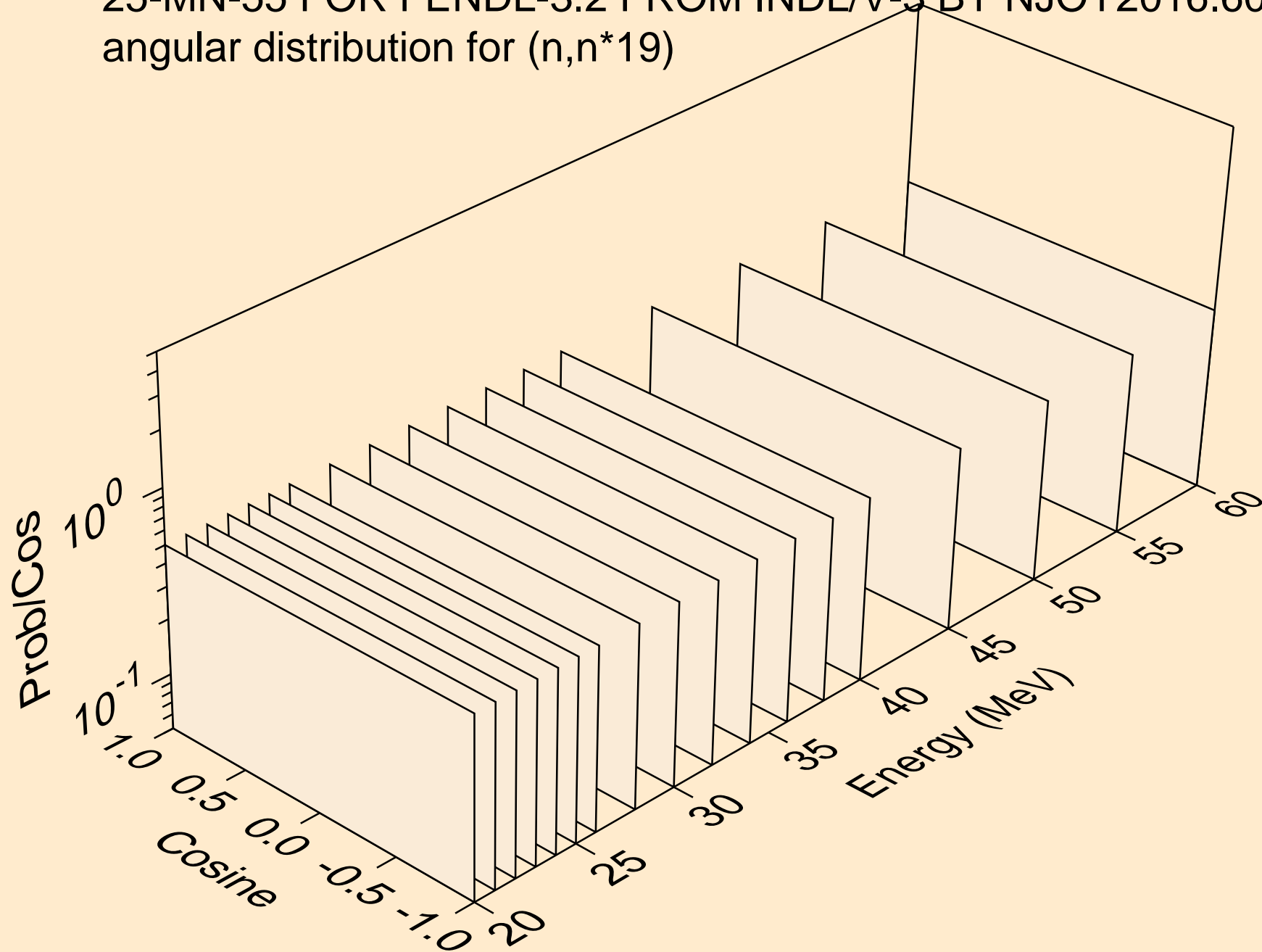

25-MN-55 FOR FENDL-3.2 FROM INDL/V-3 BY NJOY2016.60+ ON  
angular distribution for (n,n\*20)

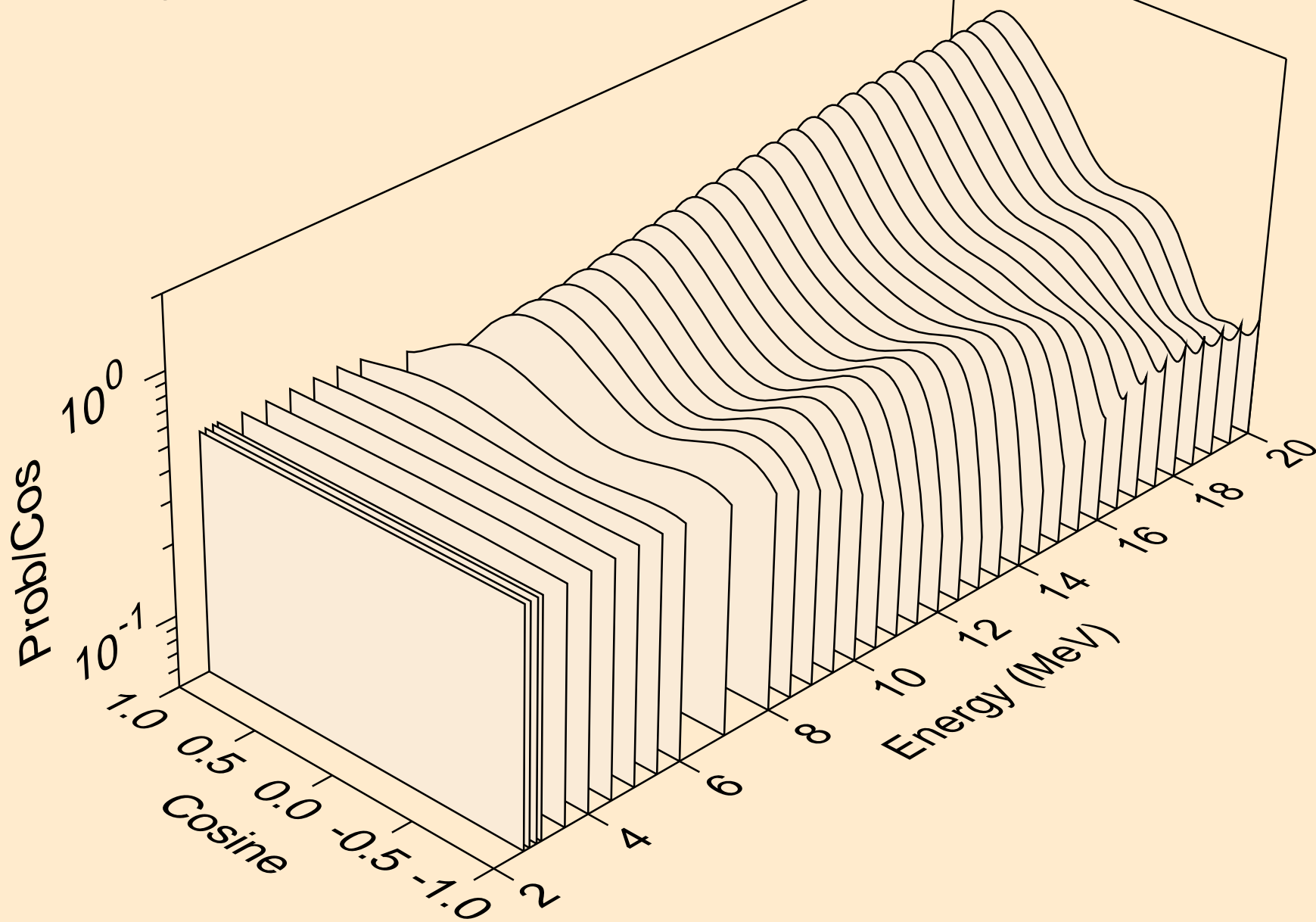

25-MN-55 FOR FENDL-3.2 FROM INDL/V-3 BY NJOY2016.60+ ON  
angular distribution for (n,n\*20)

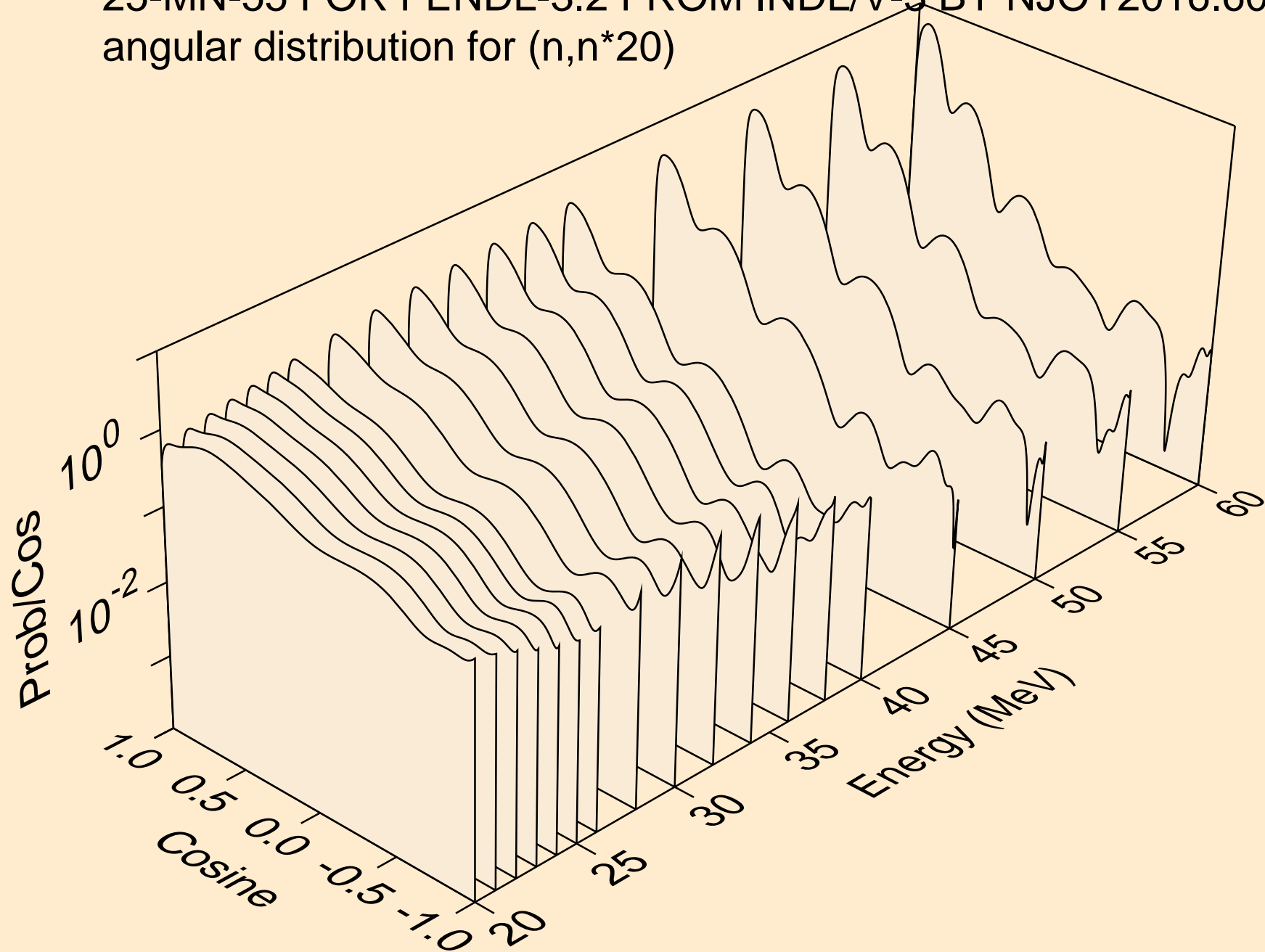

25-MN-55 FOR FENDL-3.2 FROM INDL/V-3 BY NJOY2016.60+ ON  
angular distribution for (n,n\*21)

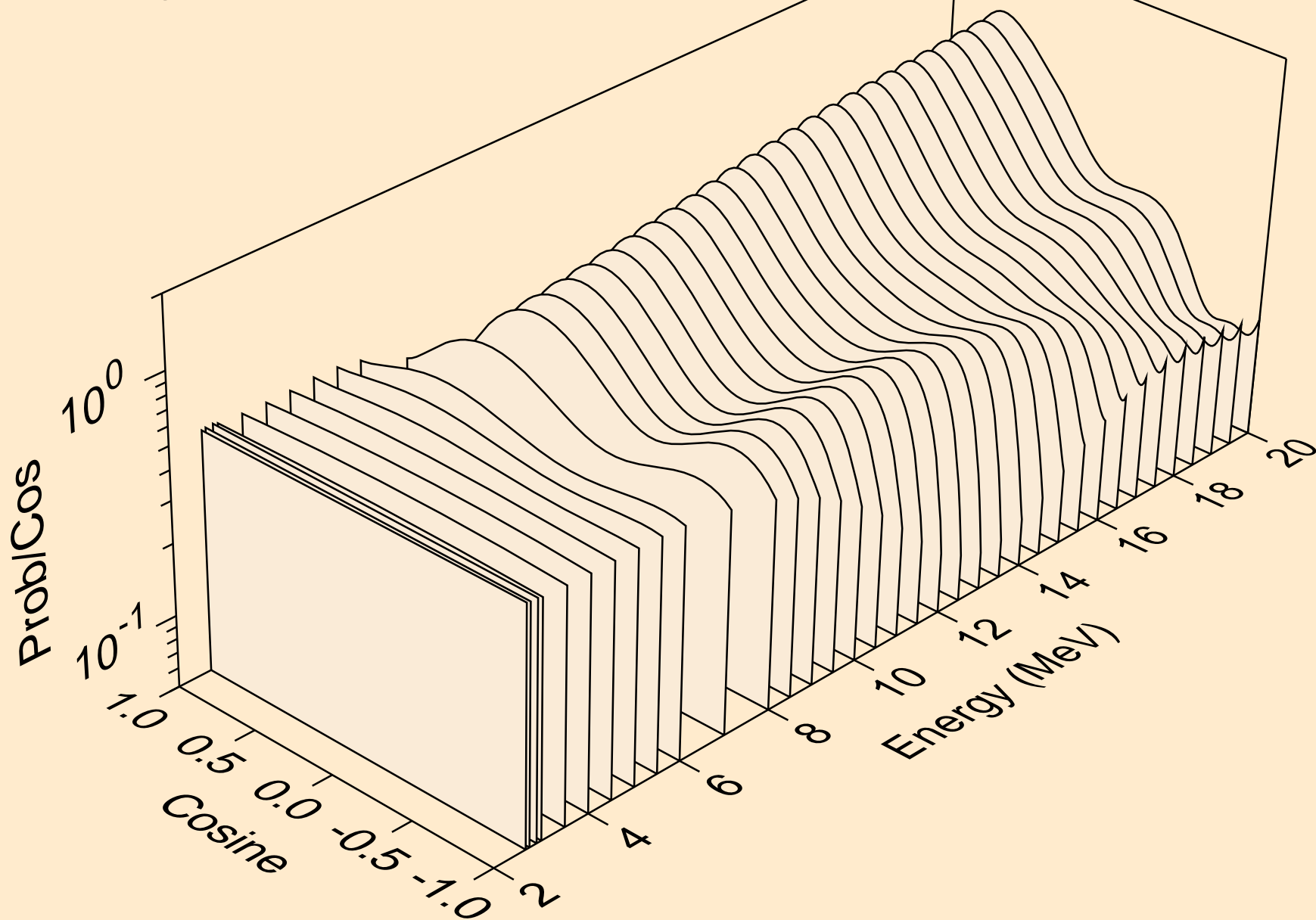

25-MN-55 FOR FENDL-3.2 FROM INDL/V-3 BY NJOY2016.60+ ON  
angular distribution for (n,n\*21)

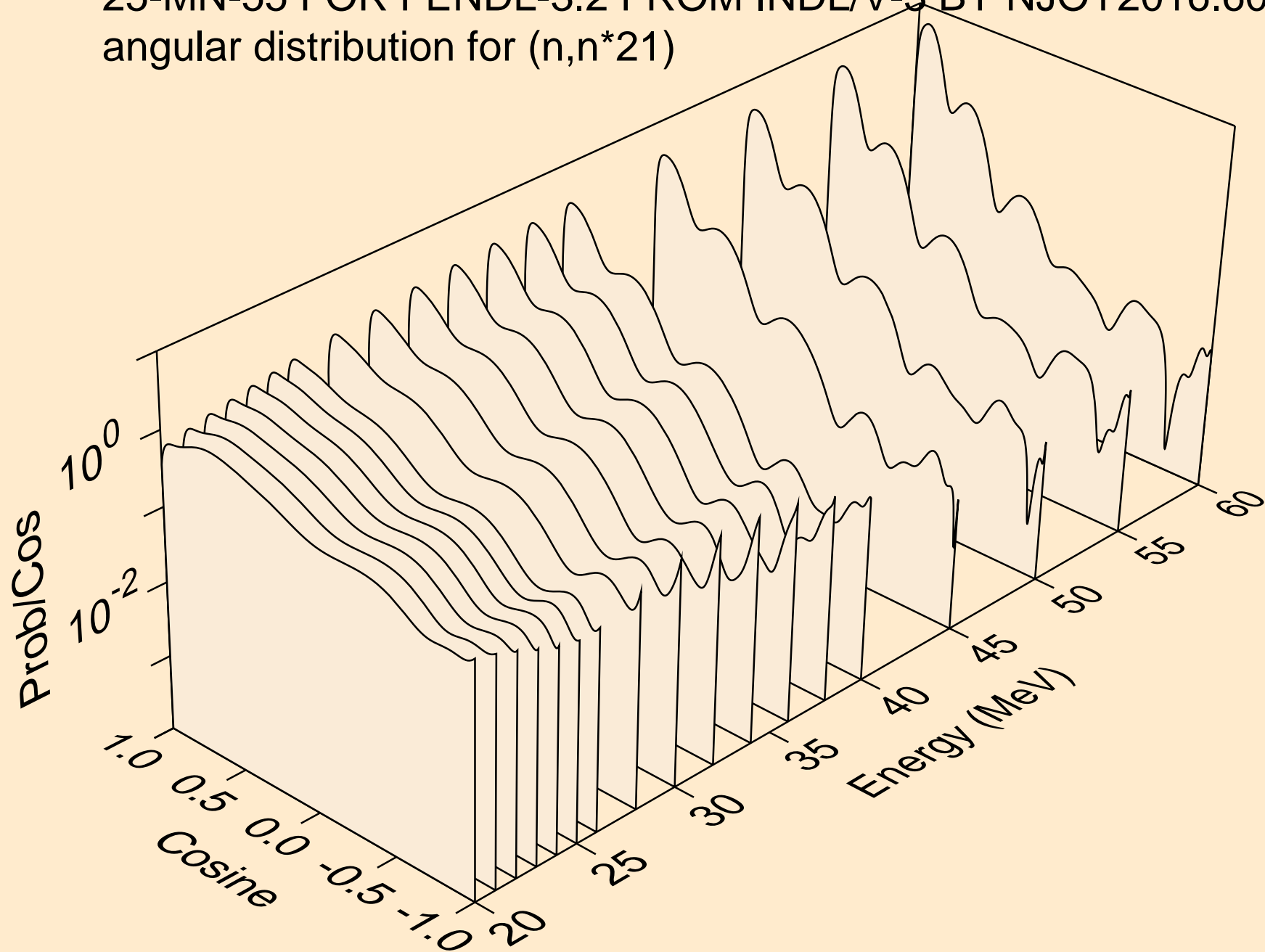



25-MN-55 FOR FENDL-3.2 FROM INDL/V-3 BY NJOY2016.60+ ON  
angular distribution for (n,n\*22)

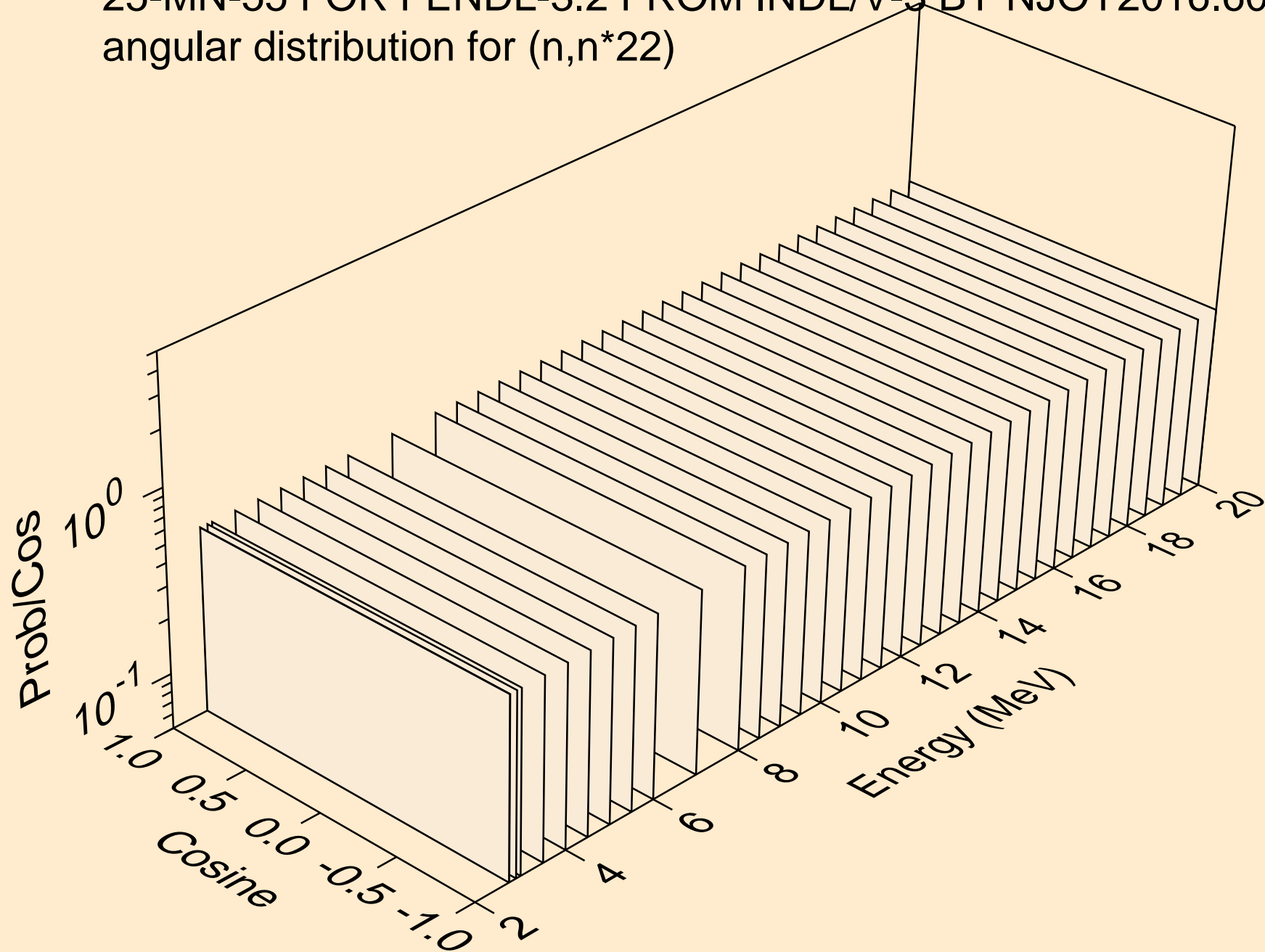

25-MN-55 FOR FENDL-3.2 FROM INDL/V-3 BY NJOY2016.60+ ON  
angular distribution for (n,n\*22)

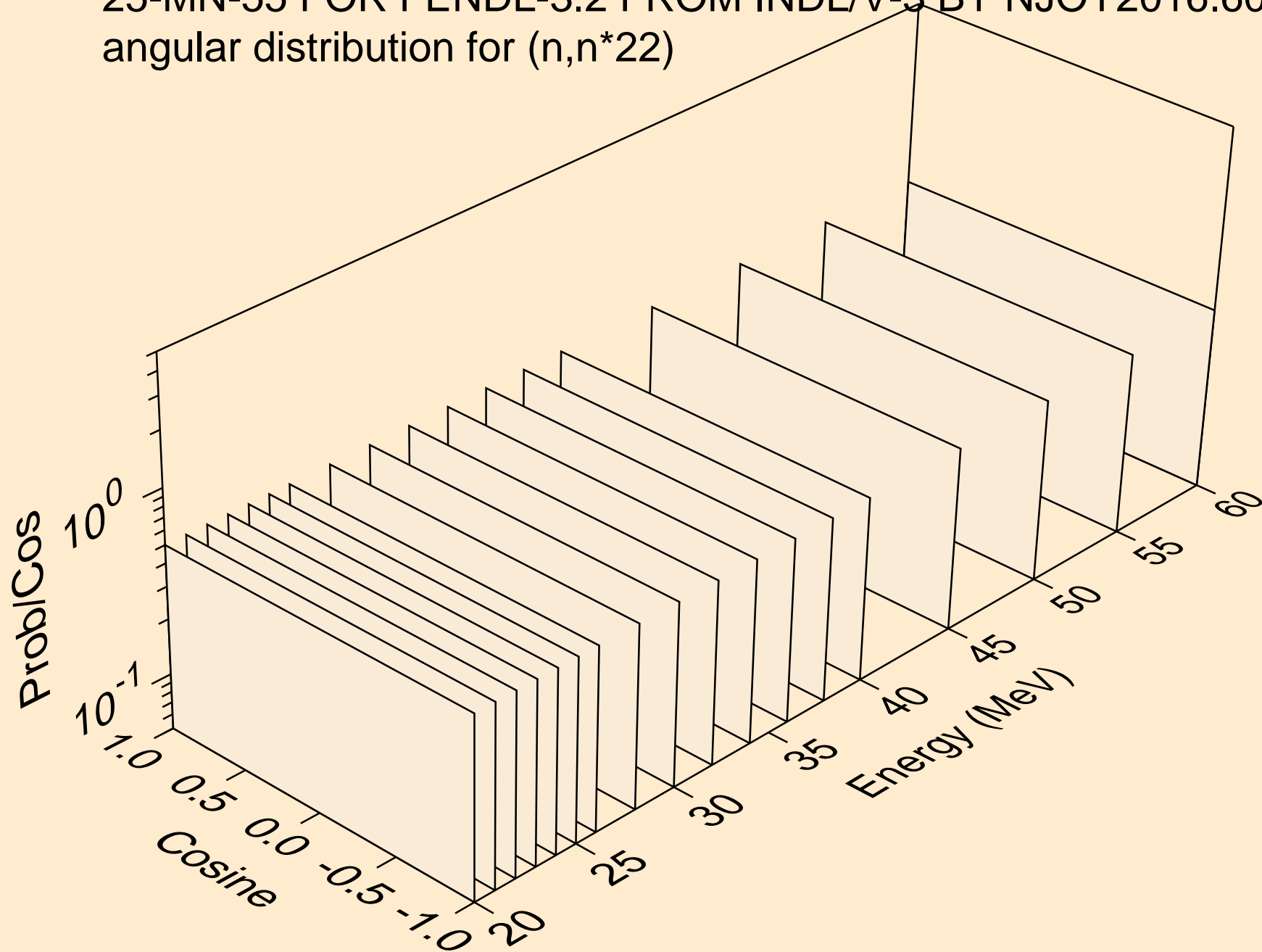

25-MN-55 FOR FENDL-3.2 FROM INDL/V-3 BY NJOY2016.60+ ON  
angular distribution for (n,n\*23)

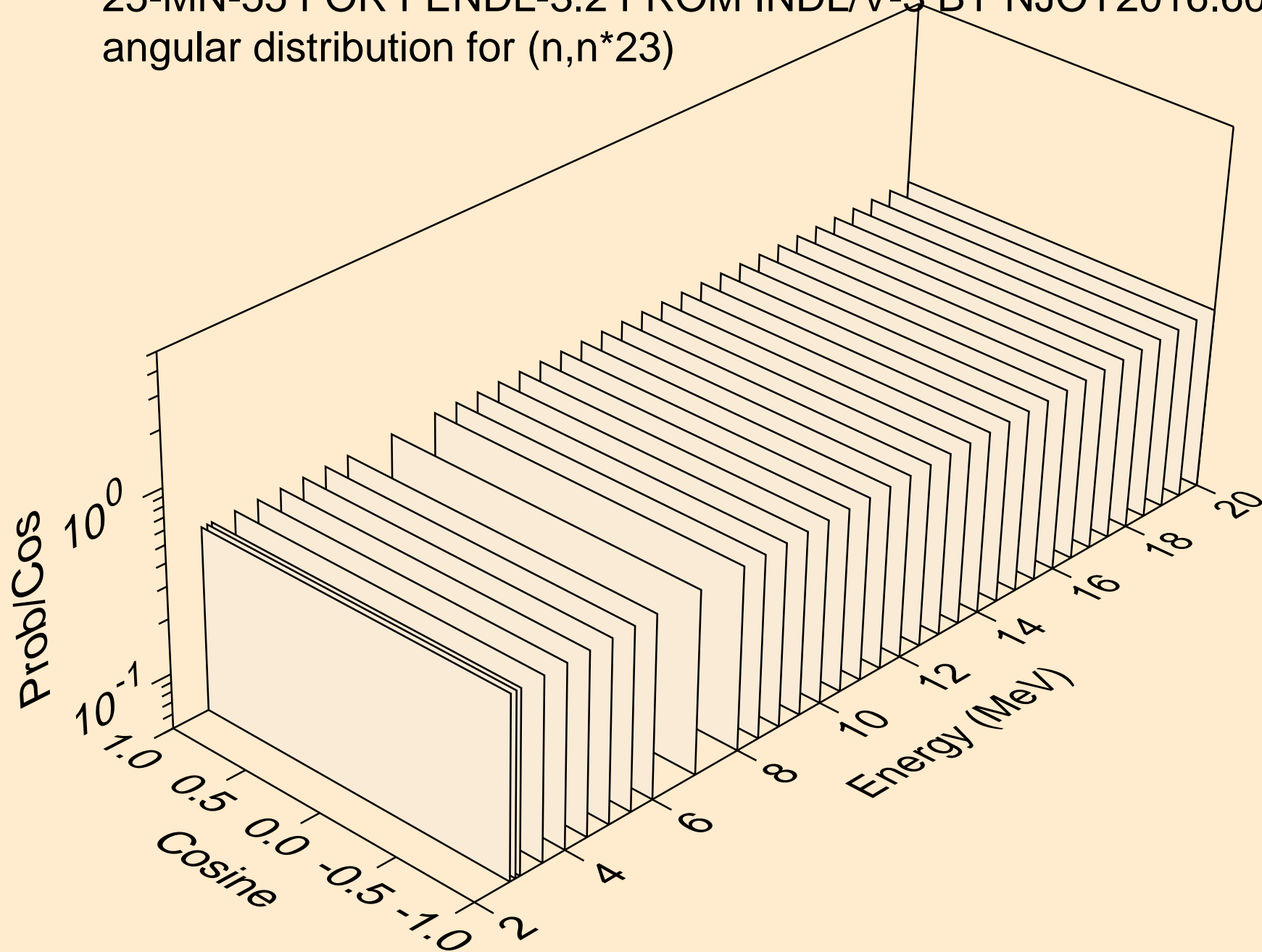

25-MN-55 FOR FENDL-3.2 FROM INDL/V-3 BY NJOY2016.60+ ON  
angular distribution for (n,n\*23)

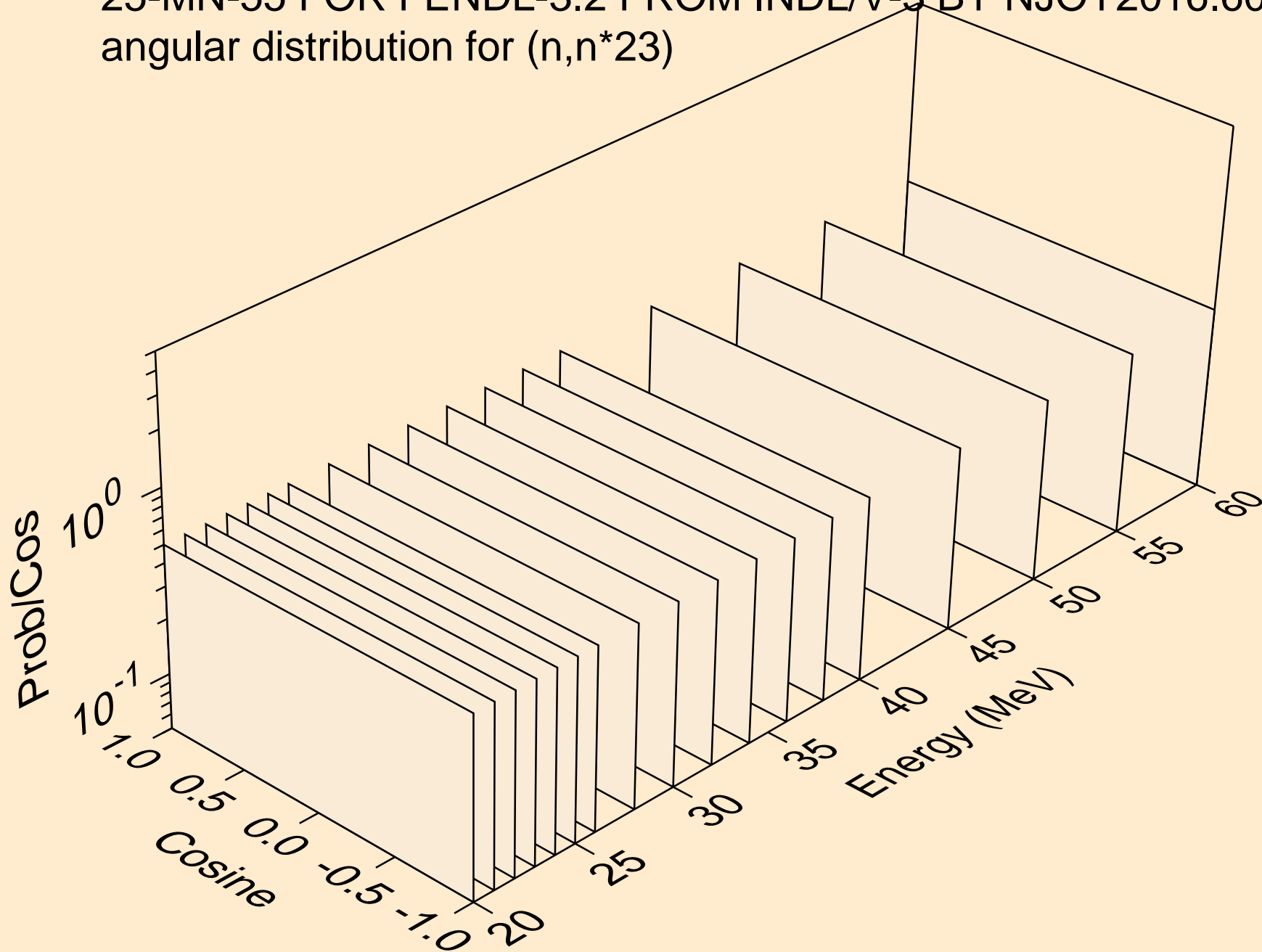

25-MN-55 FOR FENDL-3.2 FROM INDL/V-3 BY NJOY2016.60+ ON  
angular distribution for (n,n\*24)

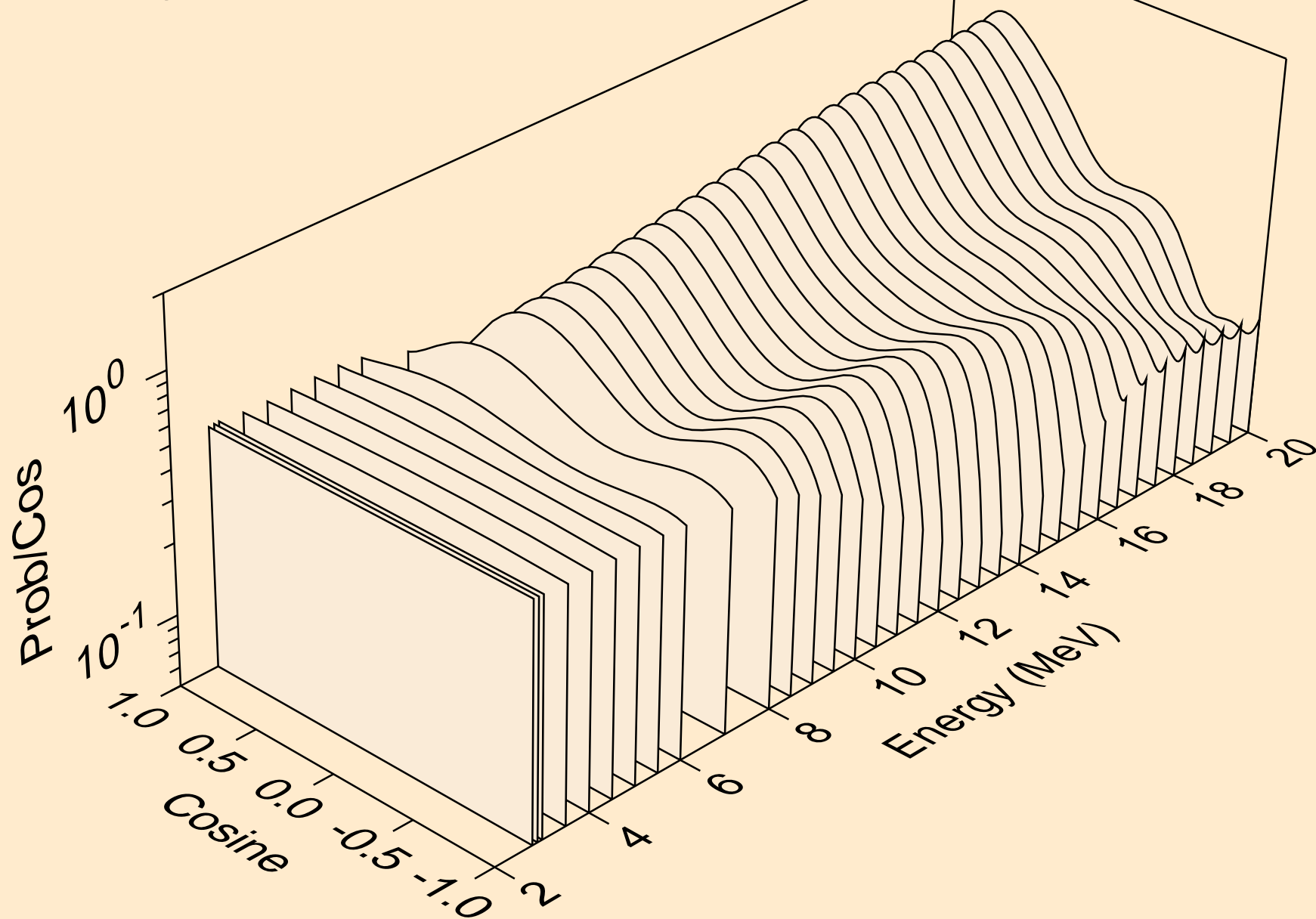

25-MN-55 FOR FENDL-3.2 FROM INDL/V-3 BY NJOY2016.60+ ON  
angular distribution for (n,n\*24)

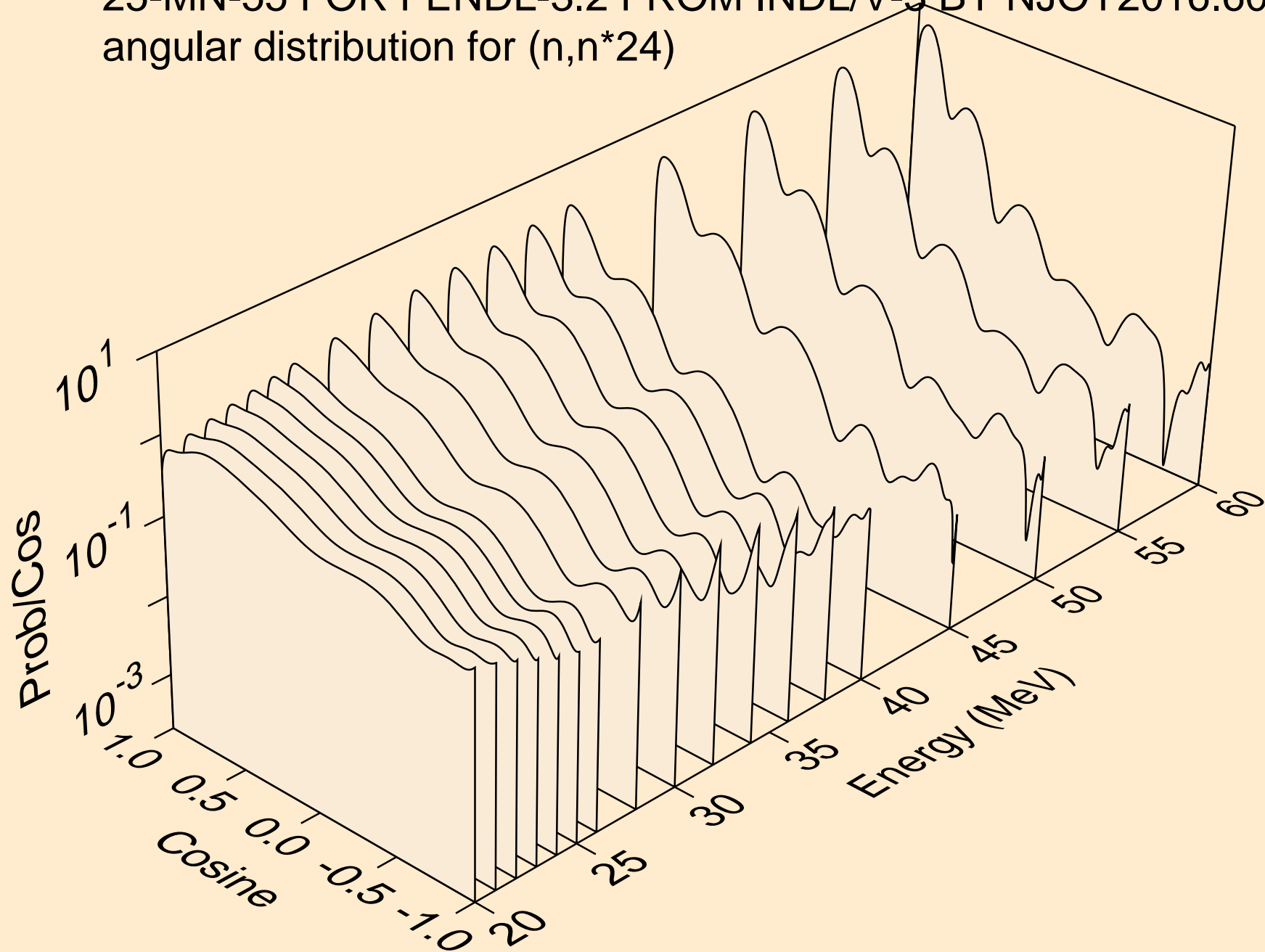

25-MN-55 FOR FENDL-3.2 FROM INDL/V-3 BY NJOY2016.60+ ON  
angular distribution for (n,n\*25)

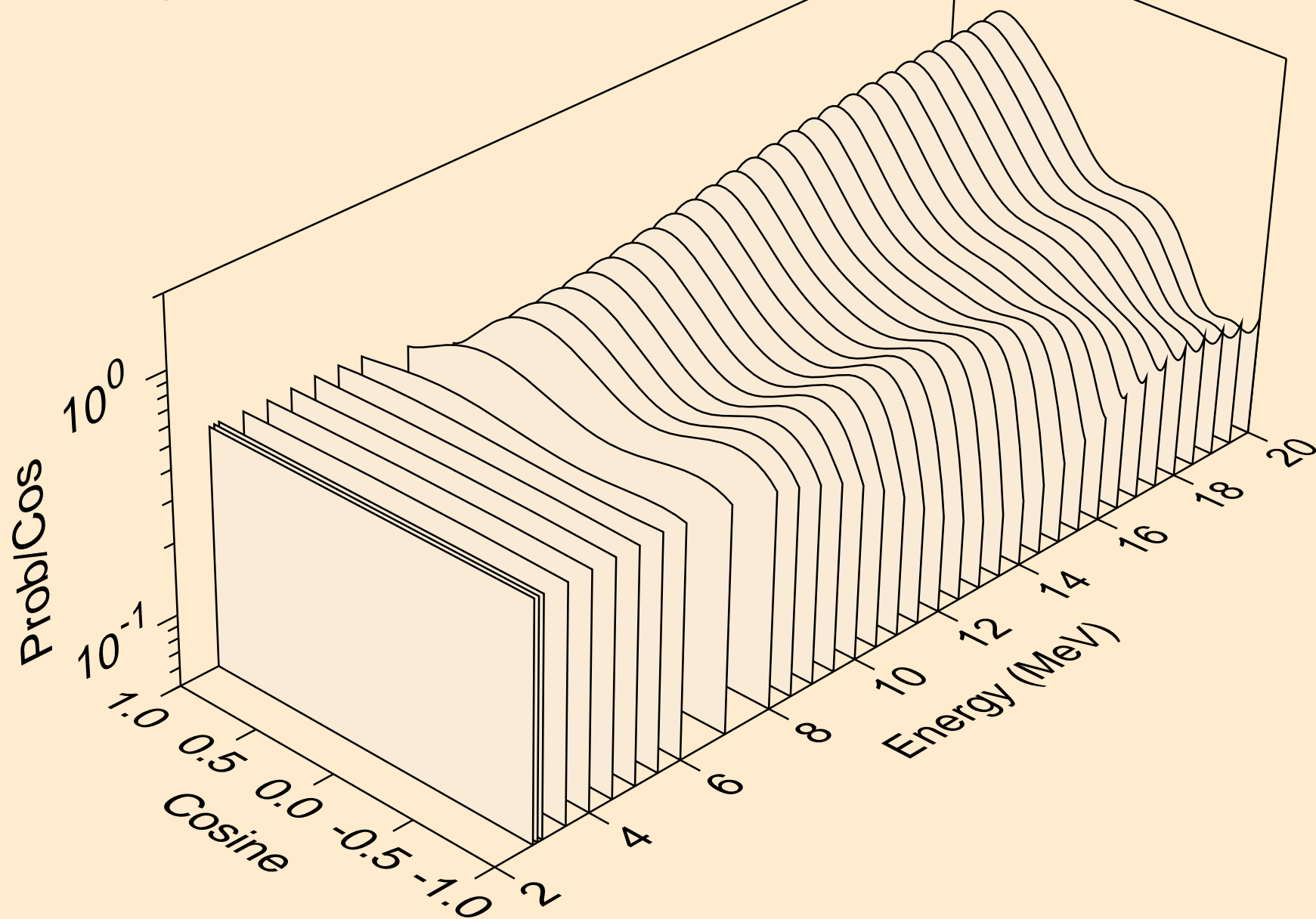

25-MN-55 FOR FENDL-3.2 FROM INDL/V-3 BY NJOY2016.60+ ON  
angular distribution for (n,n\*25)

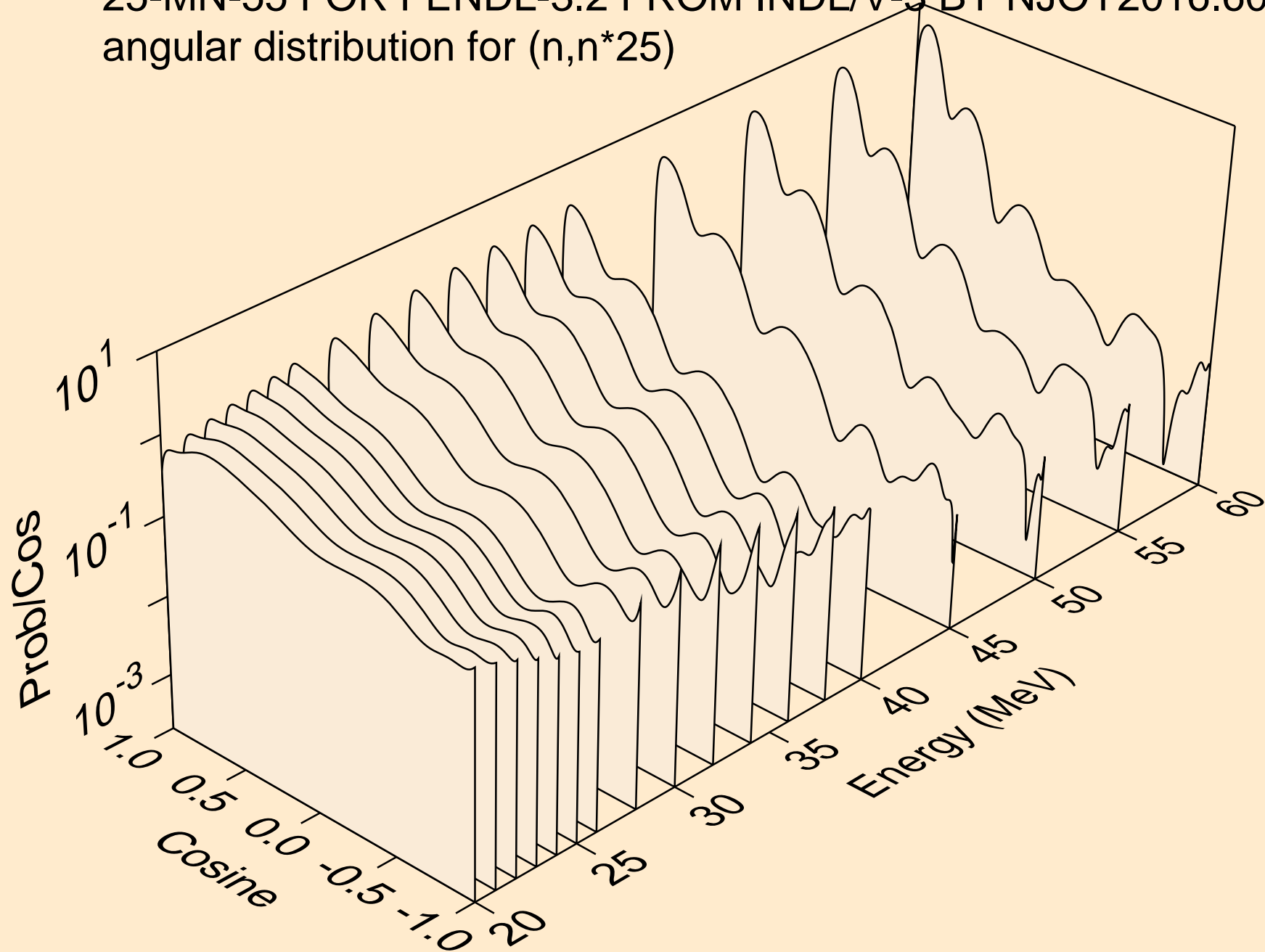



25-MN-55 FOR FENDL-3.2 FROM INDL/V-3 BY NJOY2016.60+ ON  
angular distribution for (n,n\*26)

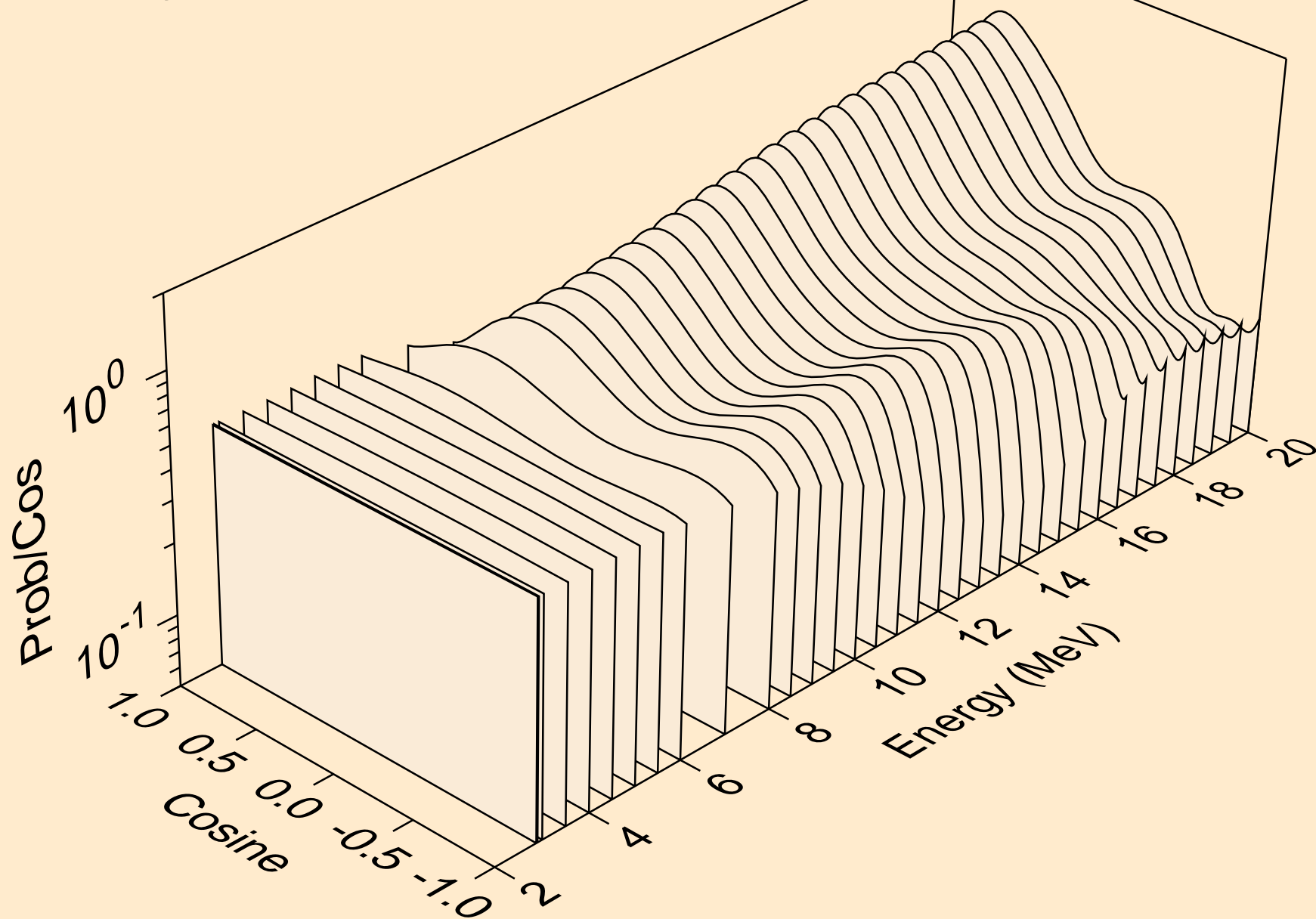

25-MN-55 FOR FENDL-3.2 FROM INDL/V-3 BY NJOY2016.60+ ON  
angular distribution for (n,n\*26)

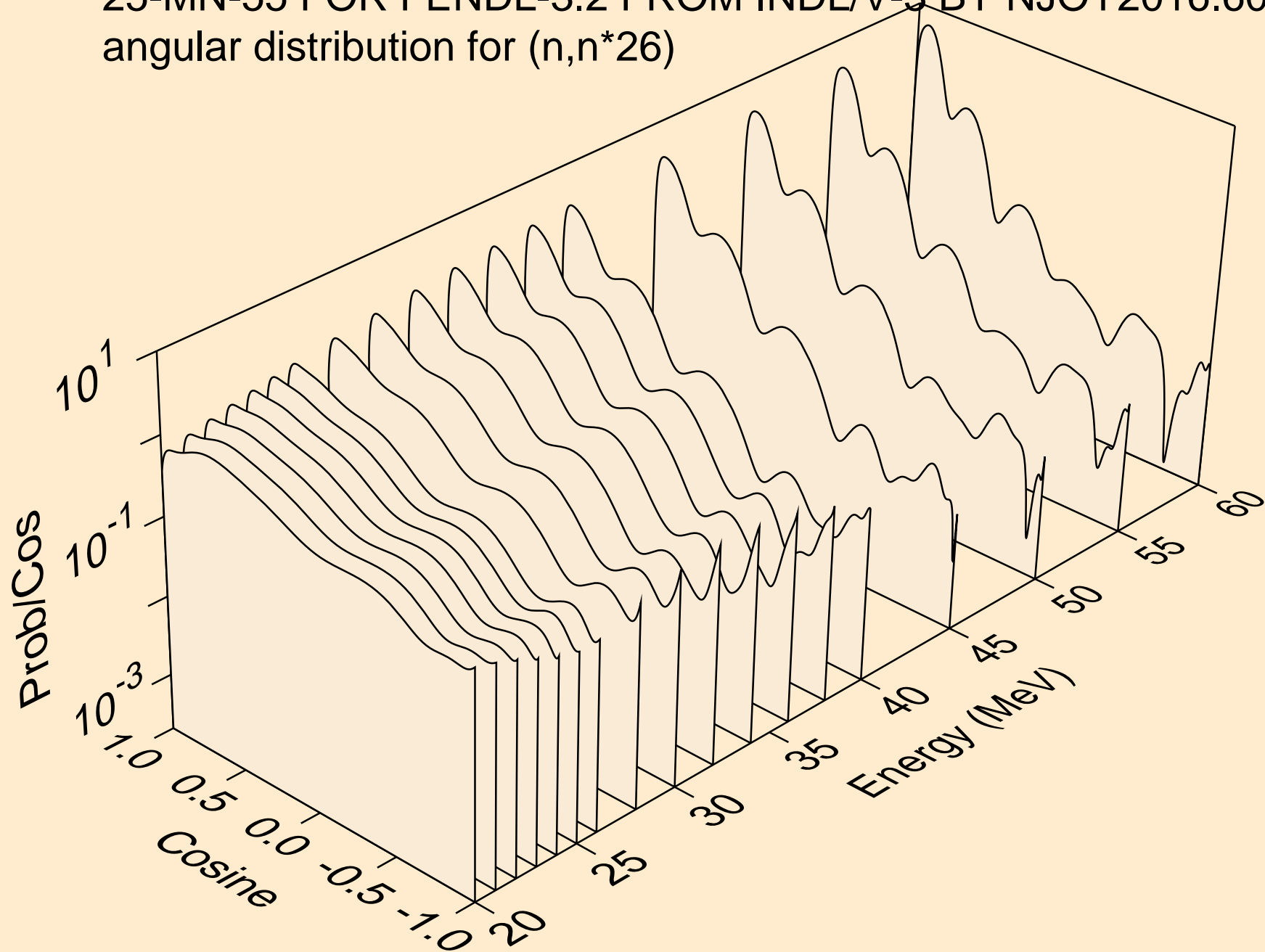

25-MN-55 FOR FENDL-3.2 FROM INDL/V-3 BY NJOY2016.60+ ON  
angular distribution for (n,n\*27)

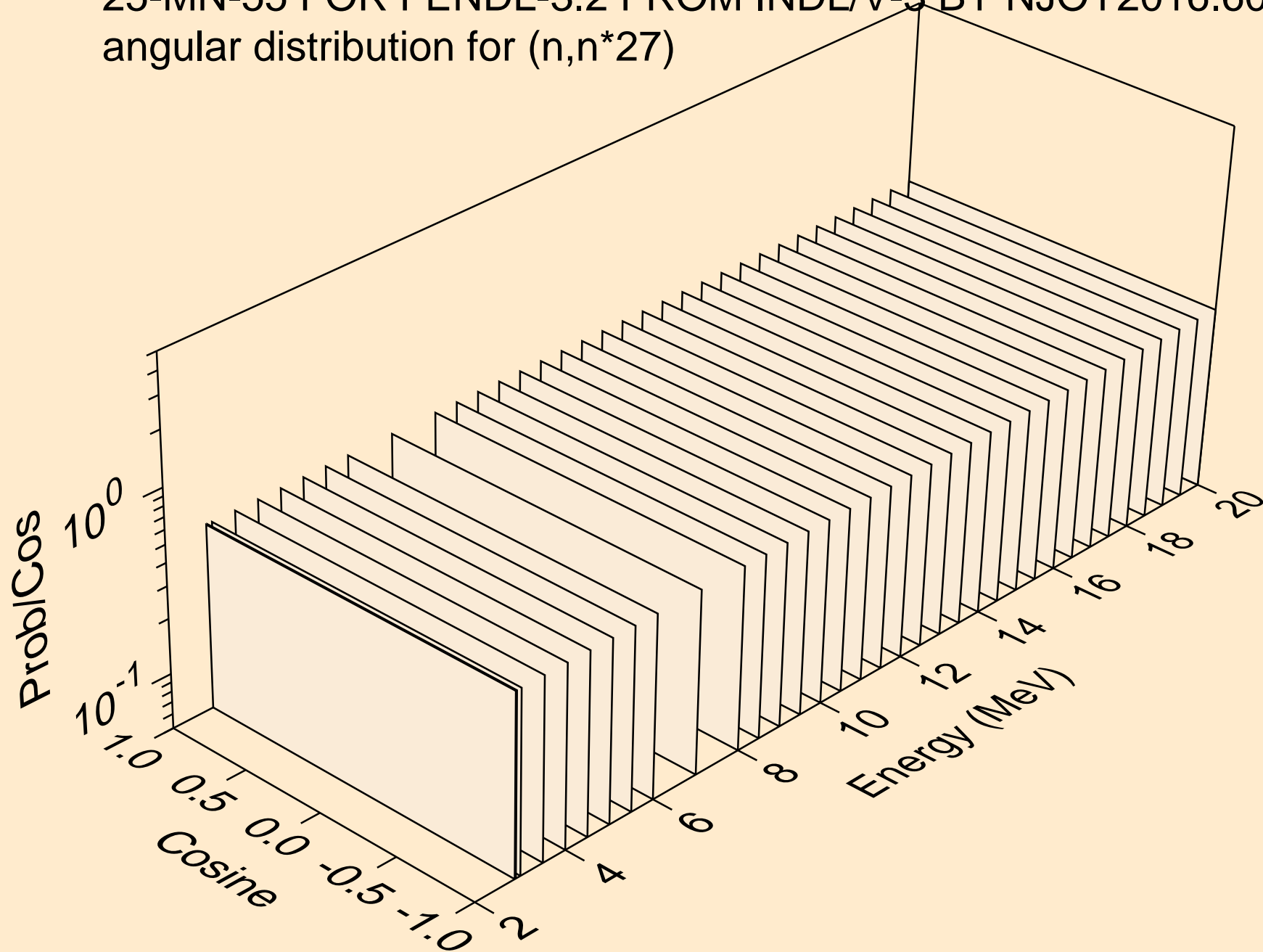

25-MN-55 FOR FENDL-3.2 FROM INDL/V-3 BY NJOY2016.60+ ON  
angular distribution for (n,n\*27)

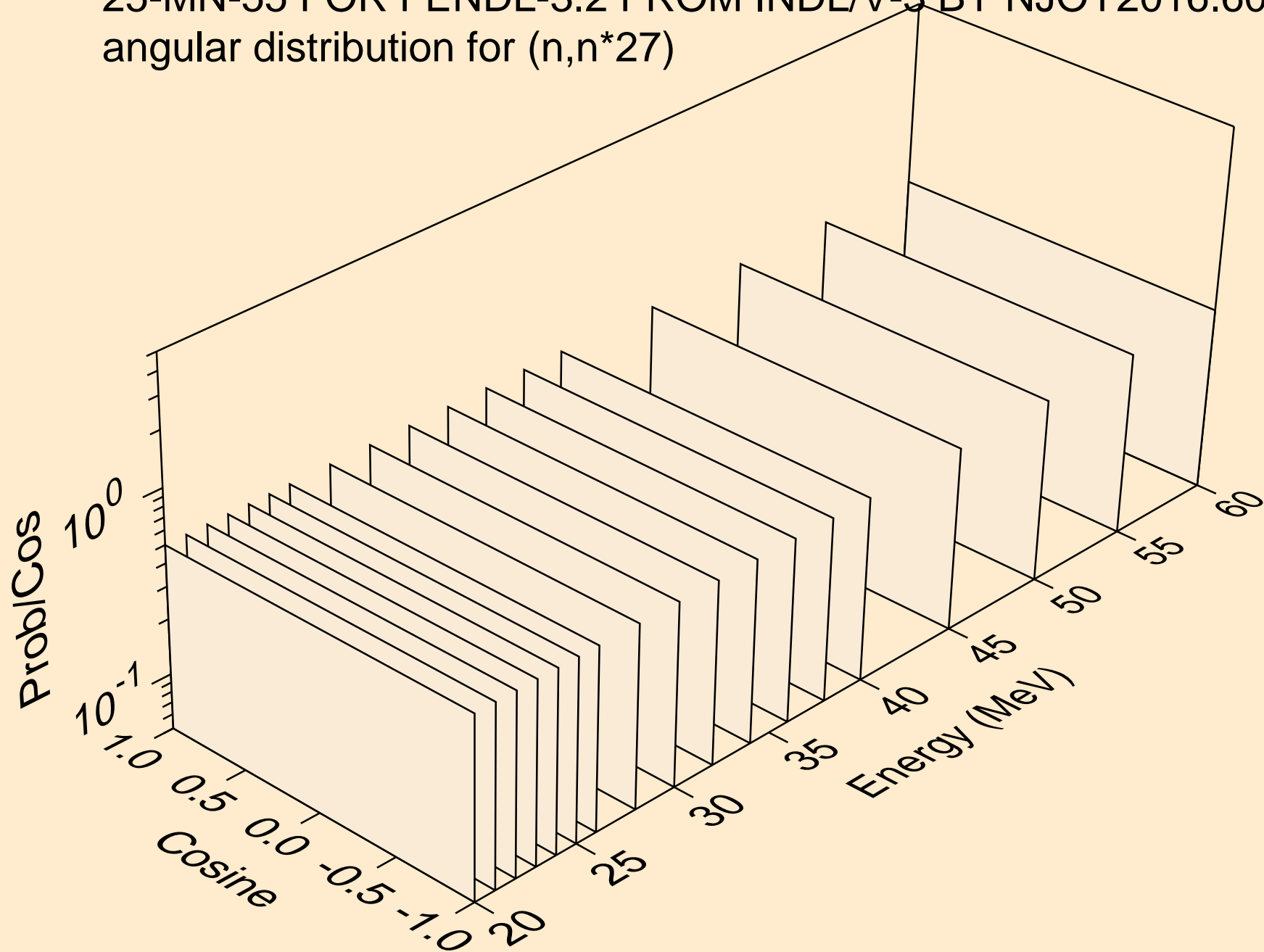

25-MN-55 FOR FENDL-3.2 FROM INDL/V-3 BY NJOY2016.60+ ON  
angular distribution for (n,n\*28)

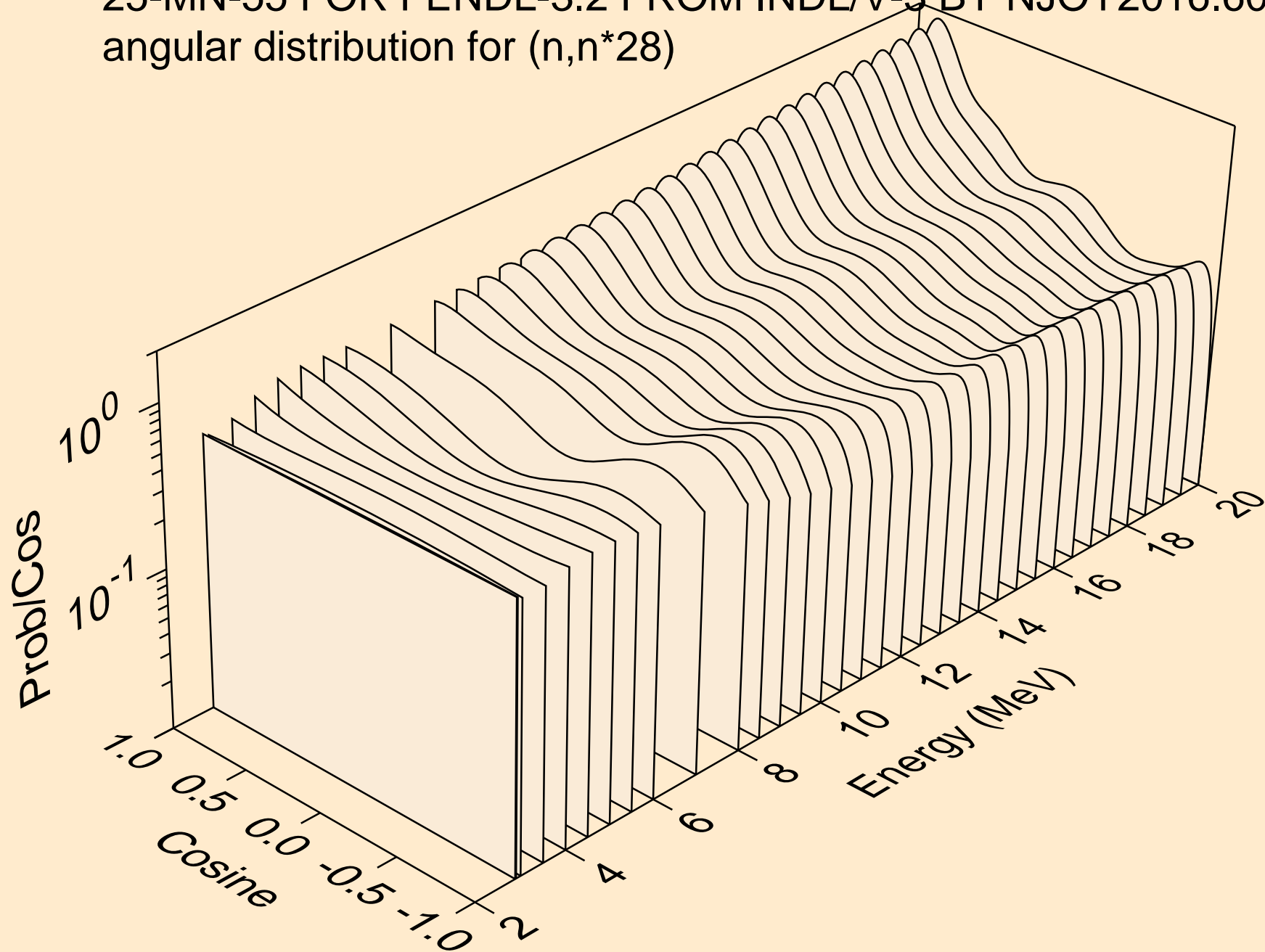

25-MN-55 FOR FENDL-3.2 FROM INDL/V-3 BY NJOY2016.60+ ON  
angular distribution for (n,n\*28)

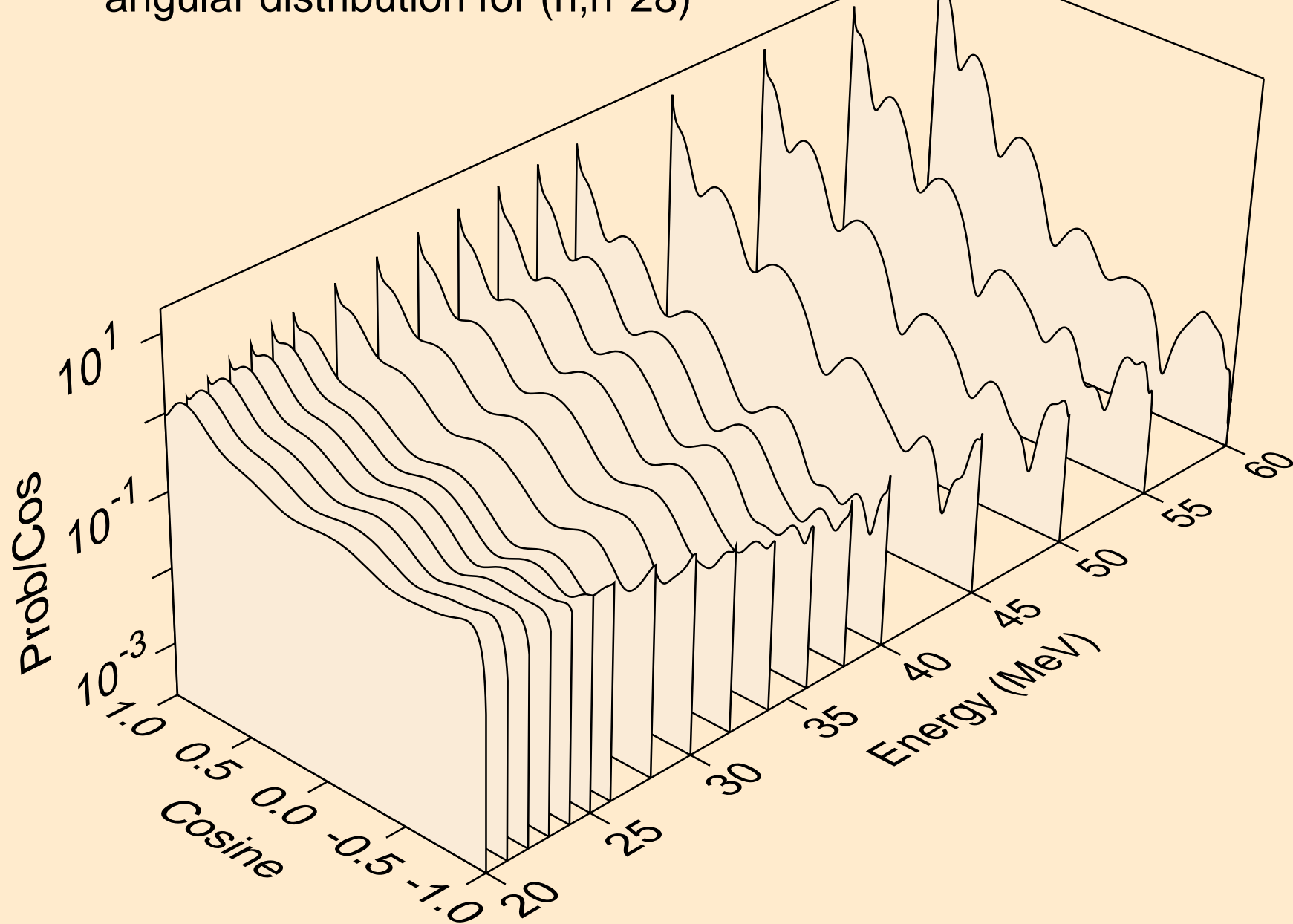

25-MN-55 FOR FENDL-3.2 FROM INDL/V-3 BY NJOY2016.60+ ON  
angular distribution for (n,n\*29)

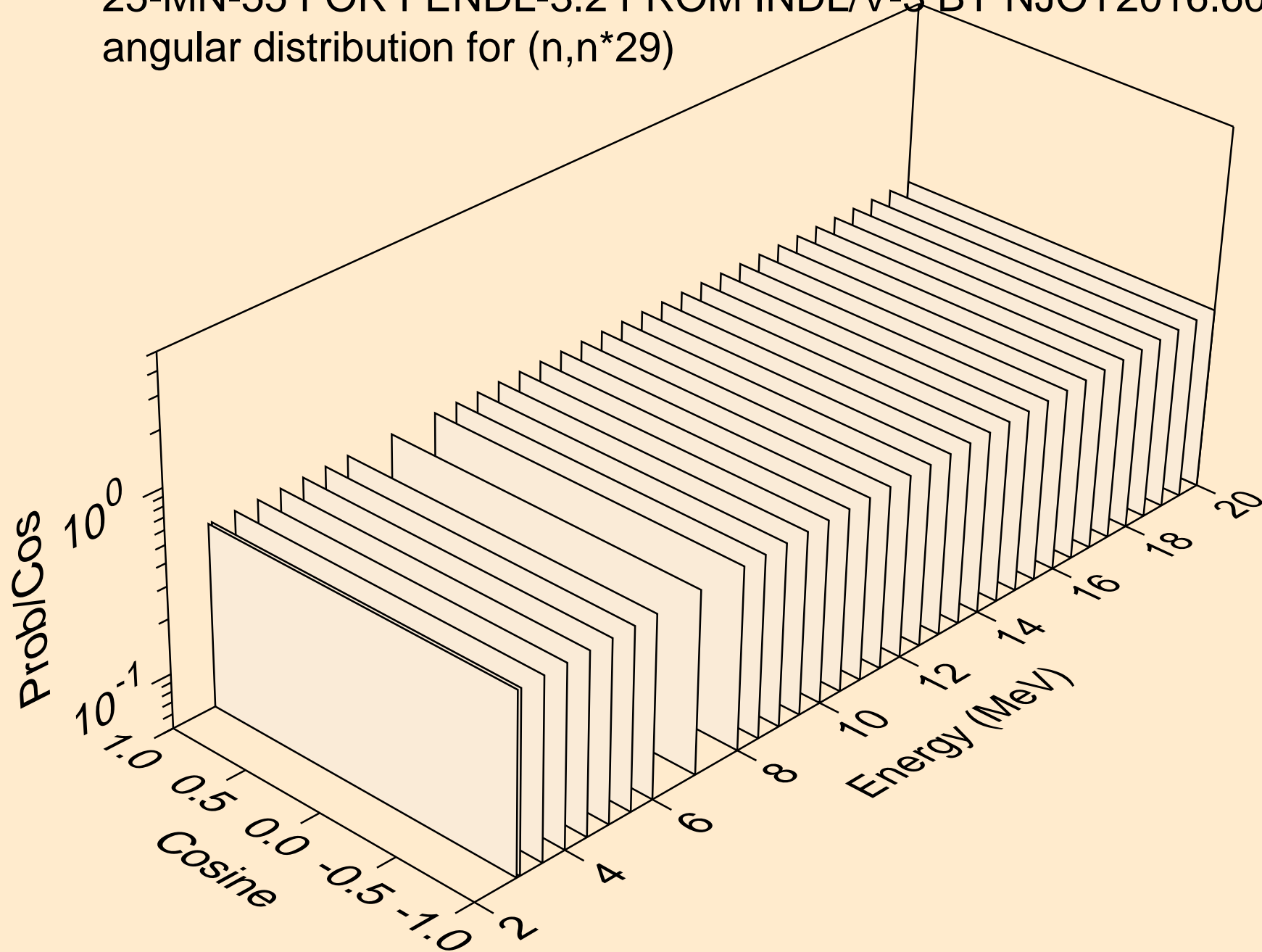

25-MN-55 FOR FENDL-3.2 FROM INDL/V-3 BY NJOY2016.60+ ON  
angular distribution for (n,n\*29)

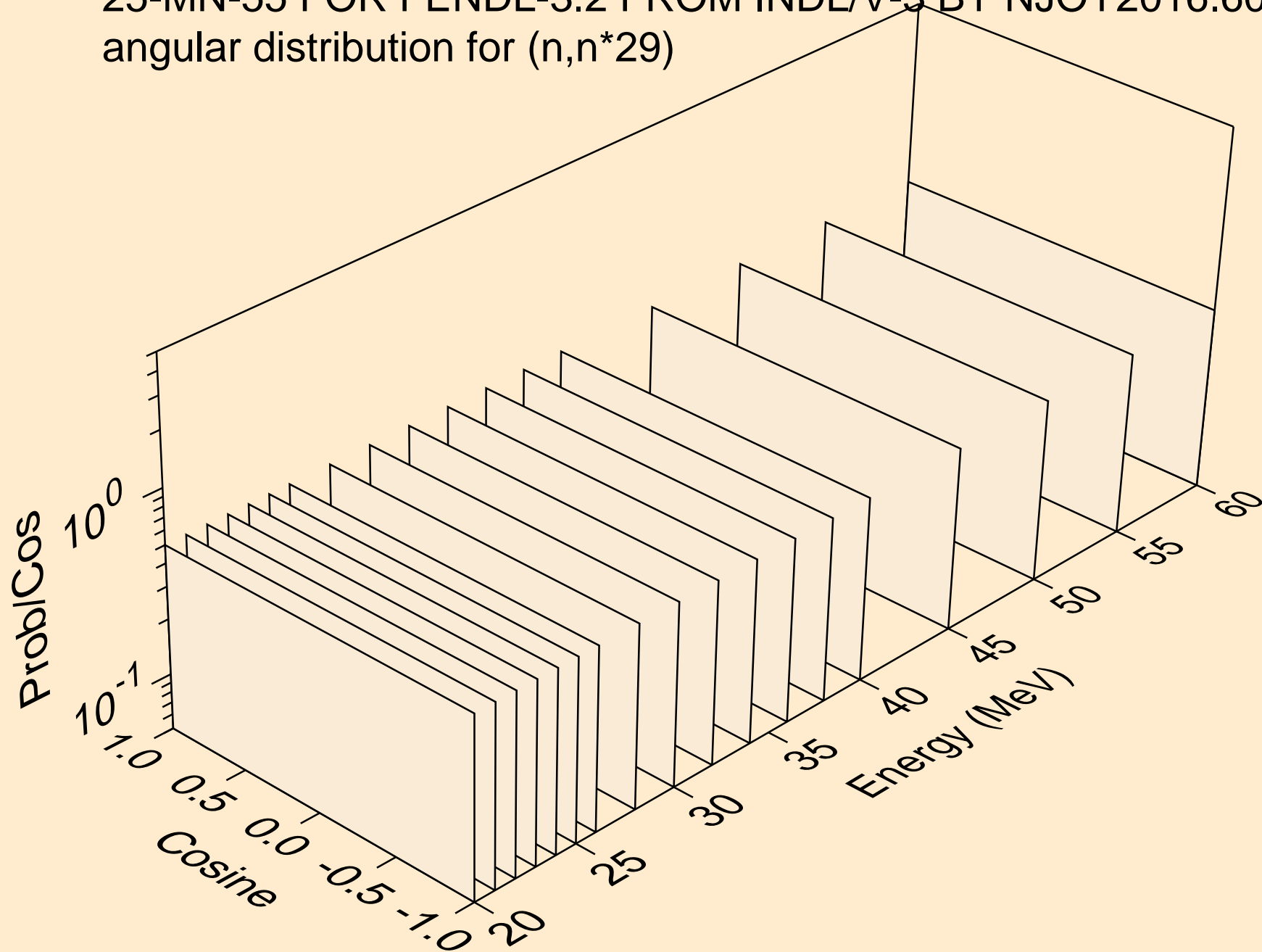



25-MN-55 FOR FENDL-3.2 FROM INDL/V-3 BY NJOY2016.60+ ON  
angular distribution for (n,n\*30)

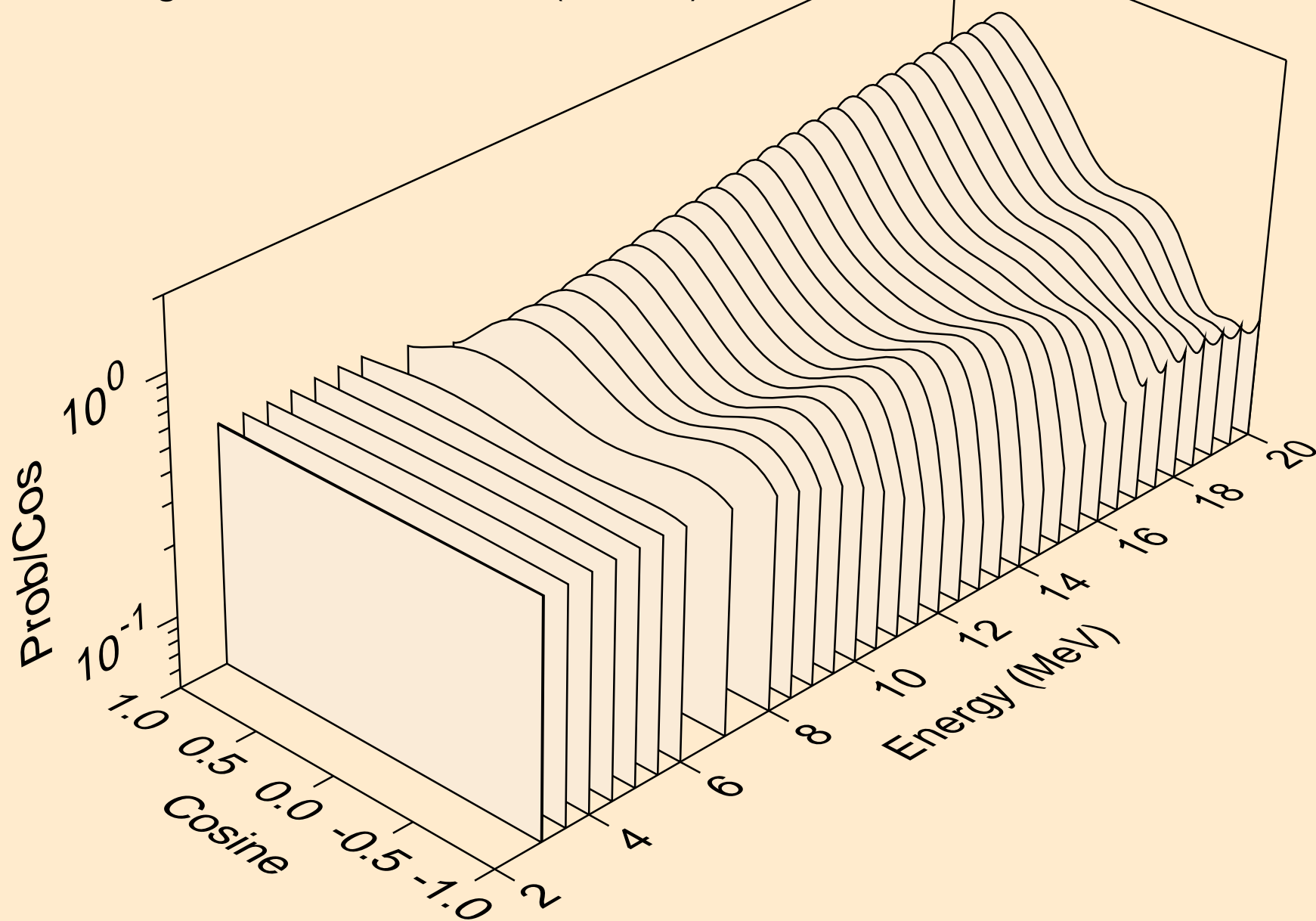

25-MN-55 FOR FENDL-3.2 FROM INDL/V-3 BY NJOY2016.60+ ON  
angular distribution for (n,n\*30)

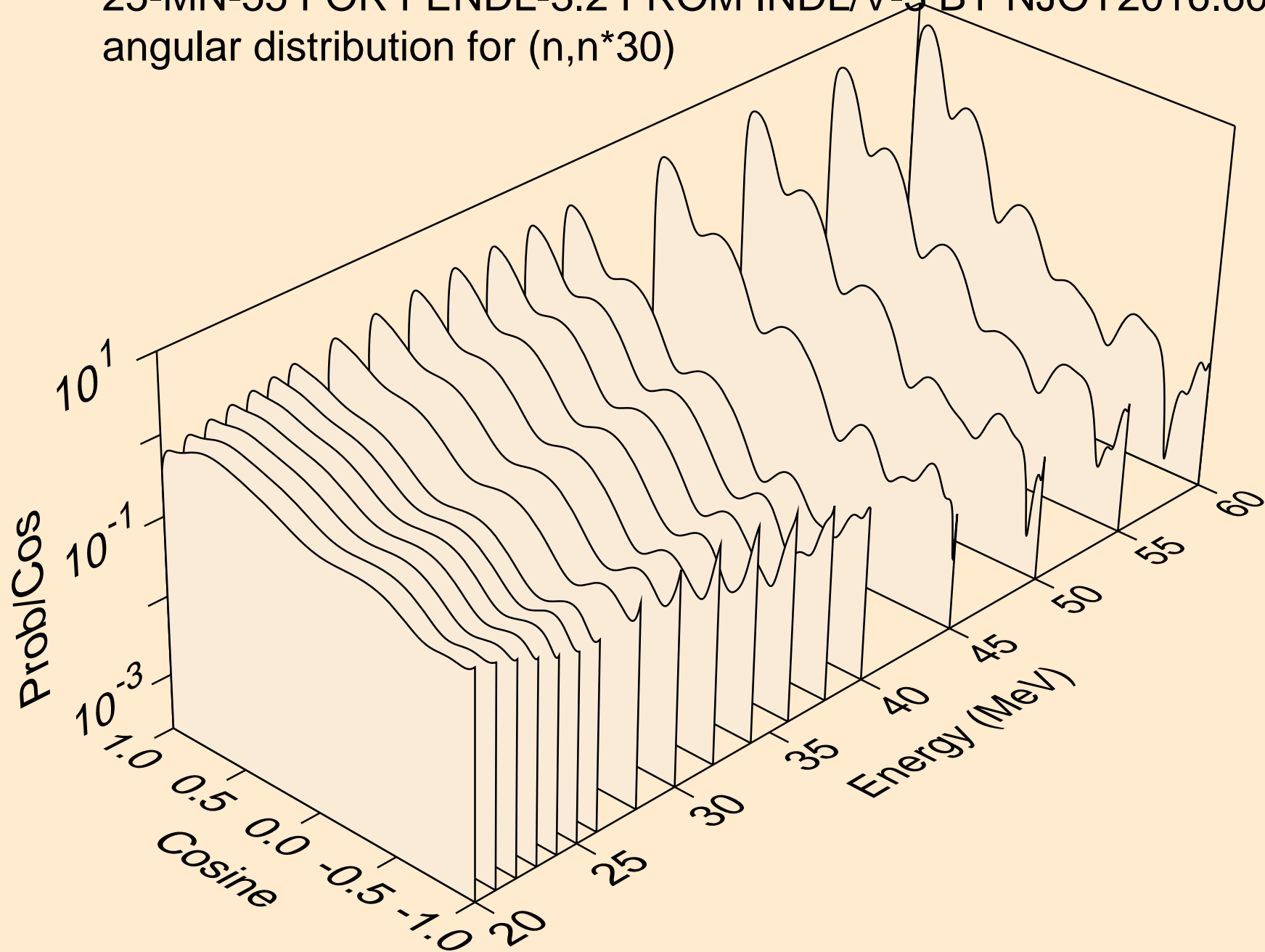

25-MN-55 FOR FENDL-3.2 FROM INDL/V-3 BY NJOY2016.60+ ON  
angular distribution for (n,n\*31)

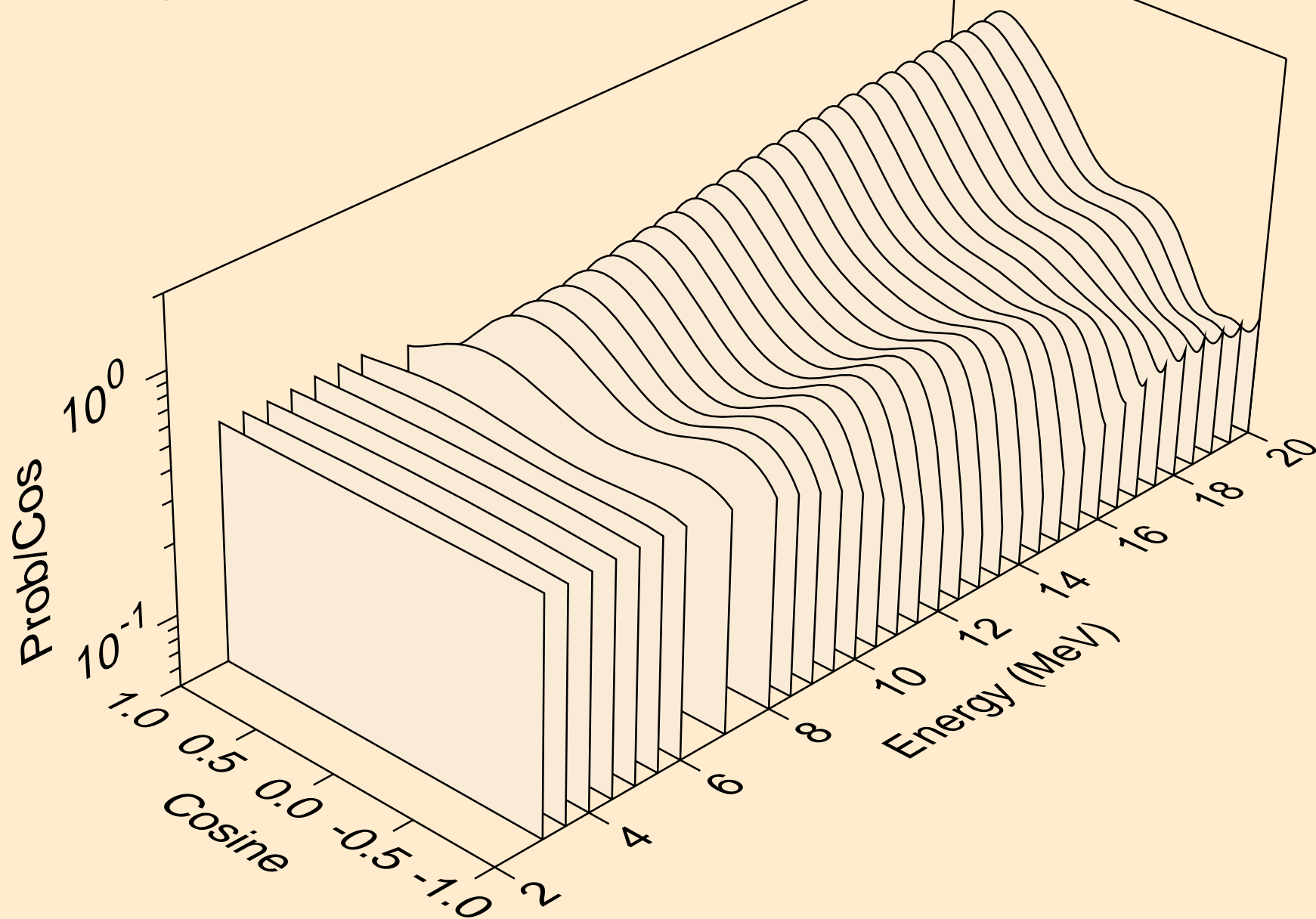

25-MN-55 FOR FENDL-3.2 FROM INDL/V-3 BY NJOY2016.60+ ON  
angular distribution for (n,n\*31)

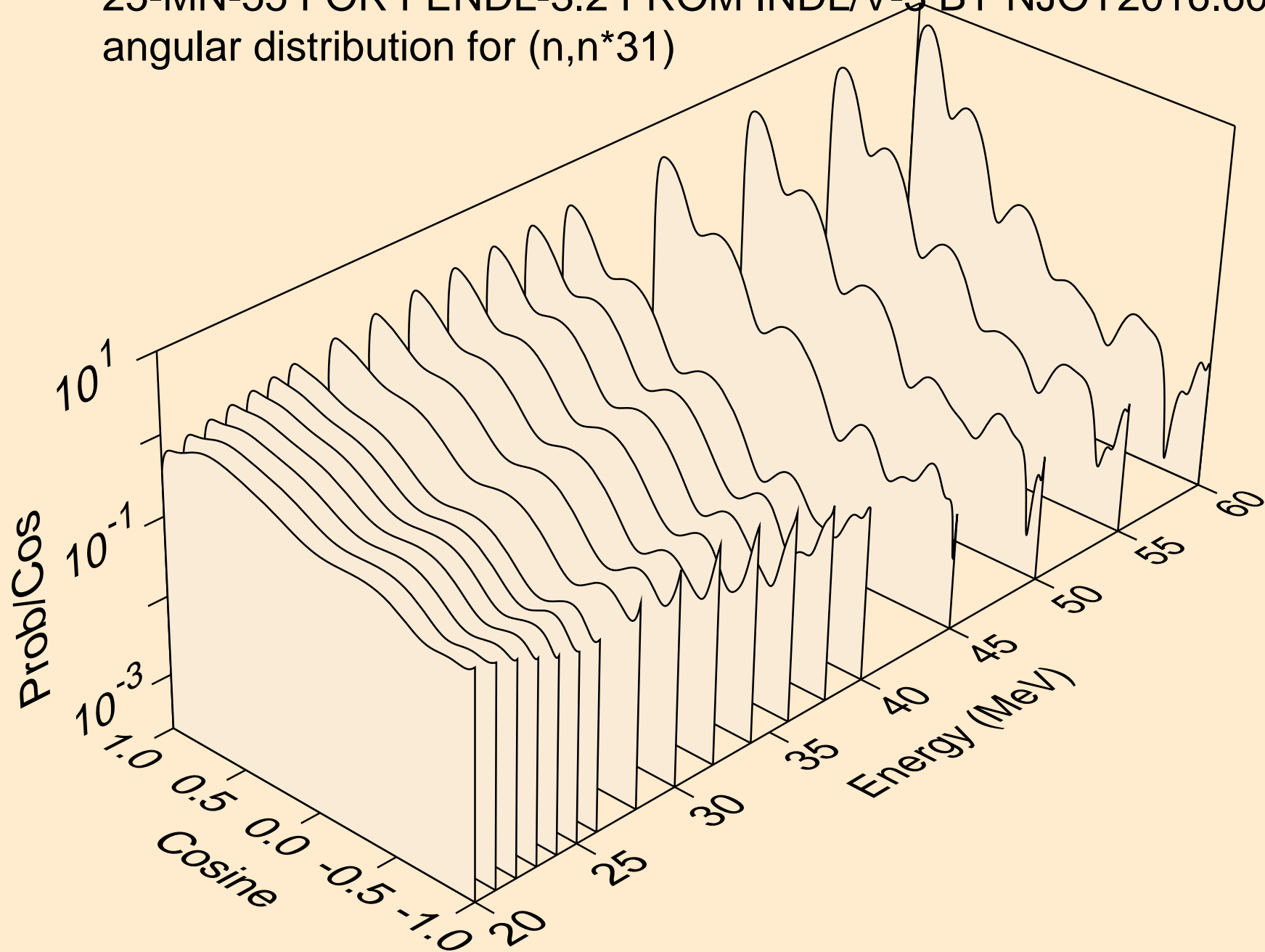

25-MN-55 FOR FENDL-3.2 FROM INDL/V-3 BY NJOY2016.60+ ON  
angular distribution for (n,n\*32)

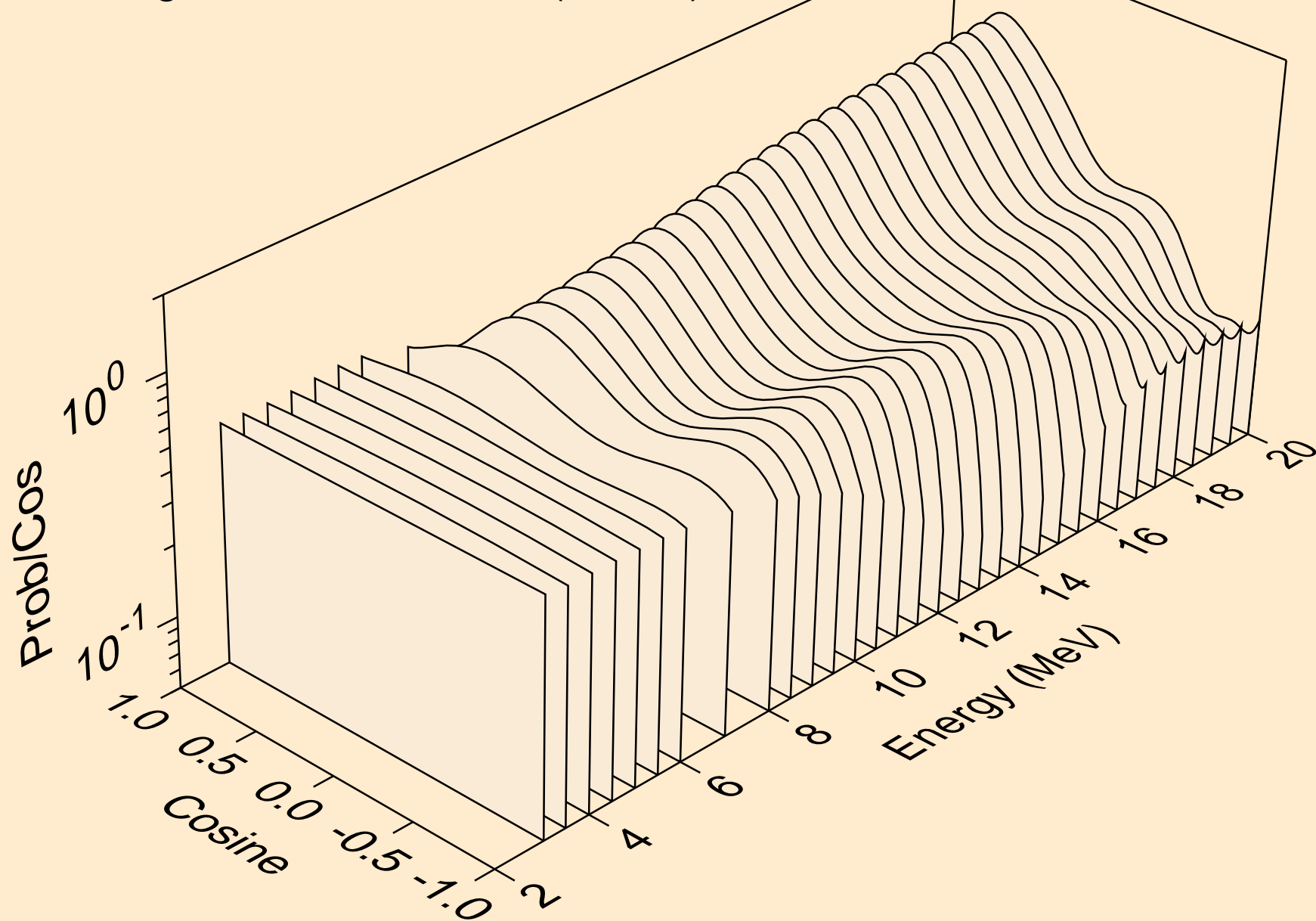

25-MN-55 FOR FENDL-3.2 FROM INDL/V-3 BY NJOY2016.60+ ON  
angular distribution for (n,n\*32)

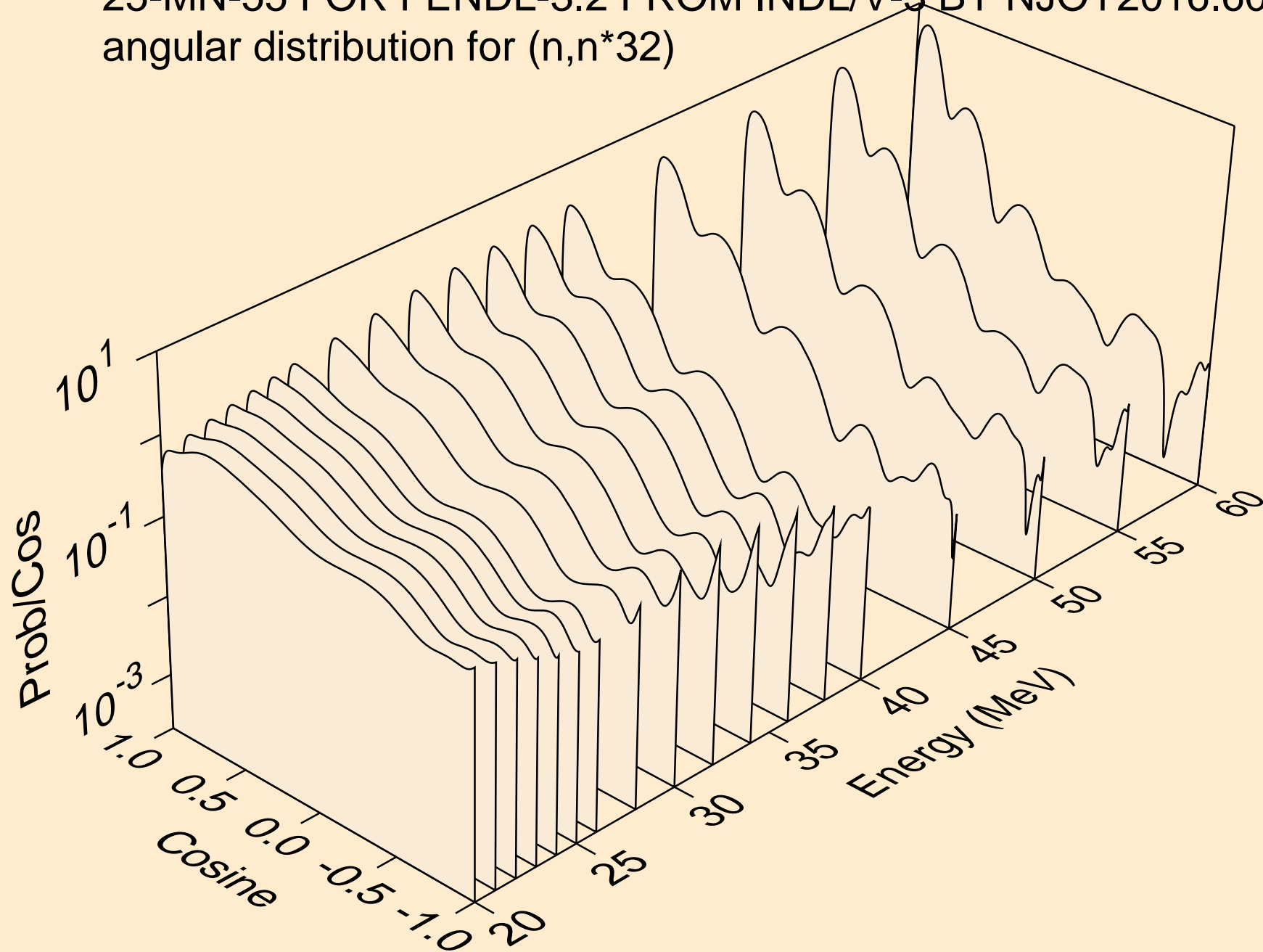

25-MN-55 FOR FENDL-3.2 FROM INDL/V-3 BY NJOY2016.60+ ON  
angular distribution for (n,n\*33)

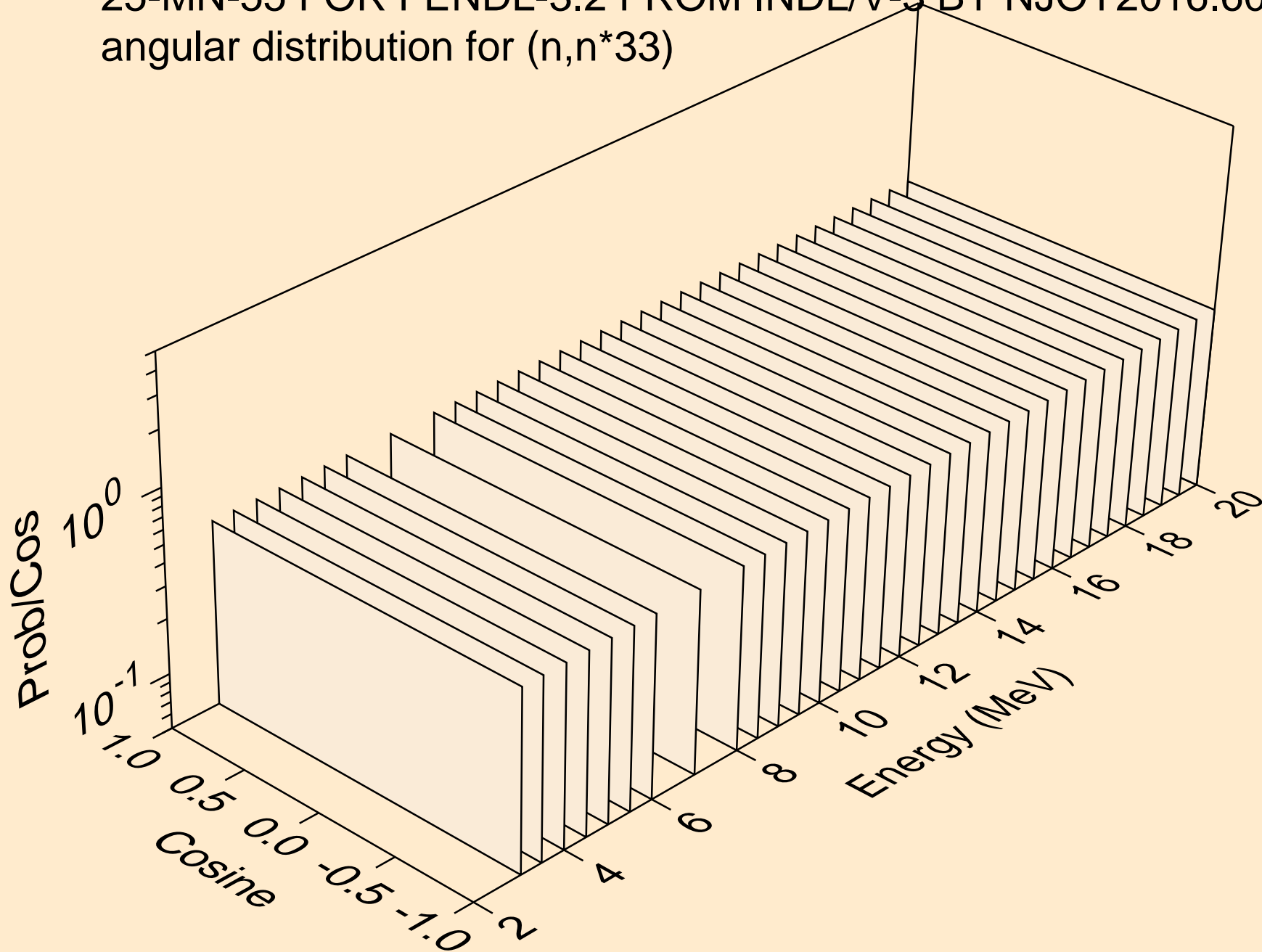

25-MN-55 FOR FENDL-3.2 FROM INDL/V-3 BY NJOY2016.60+ ON  
angular distribution for (n,n\*33)

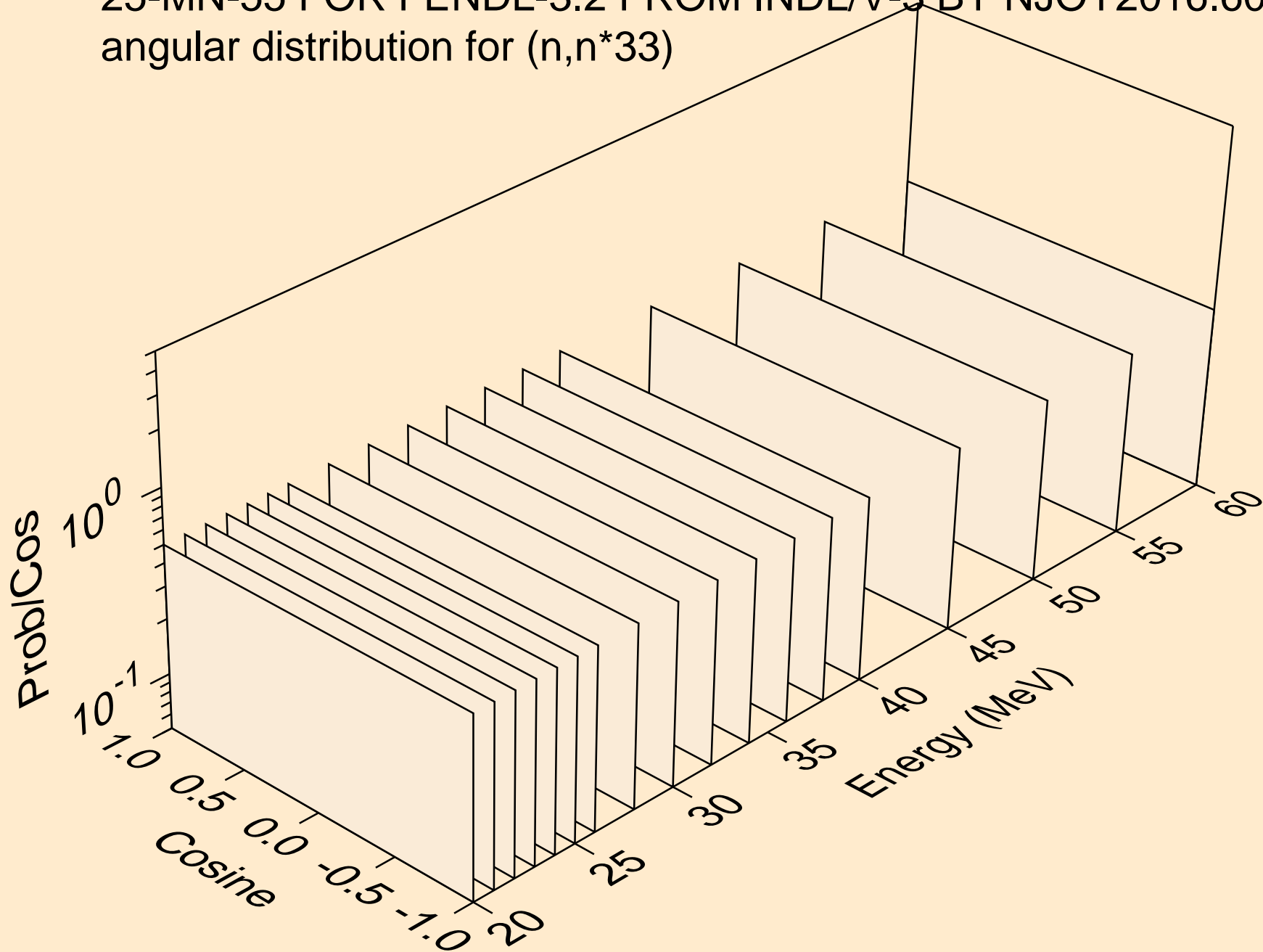



25-MN-55 FOR FENDL-3.2 FROM INDL/V-3 BY NJOY2016.60+ ON  
angular distribution for (n,n\*34)

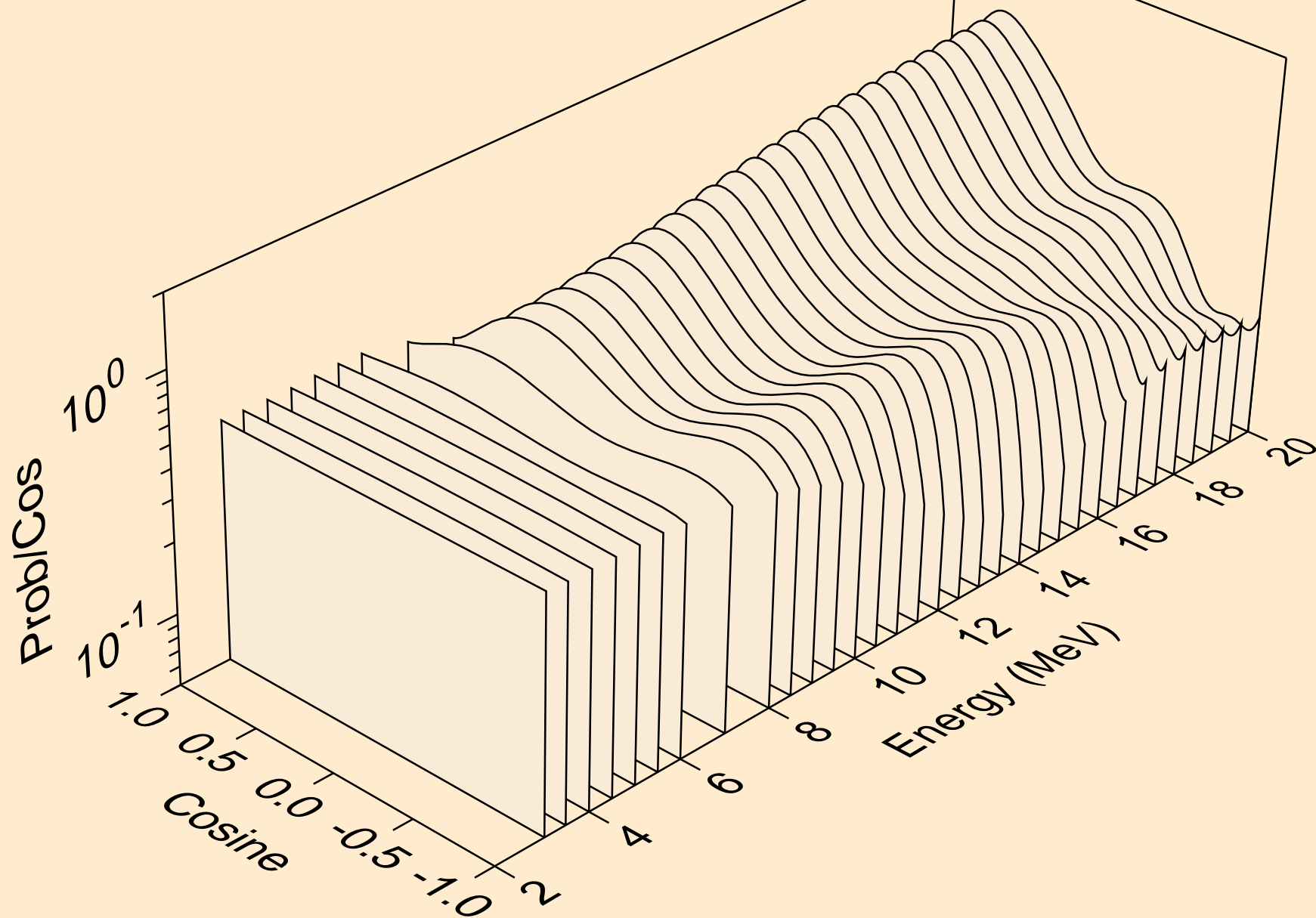

25-MN-55 FOR FENDL-3.2 FROM INDL/V-3 BY NJOY2016.60+ ON  
angular distribution for (n,n\*34)

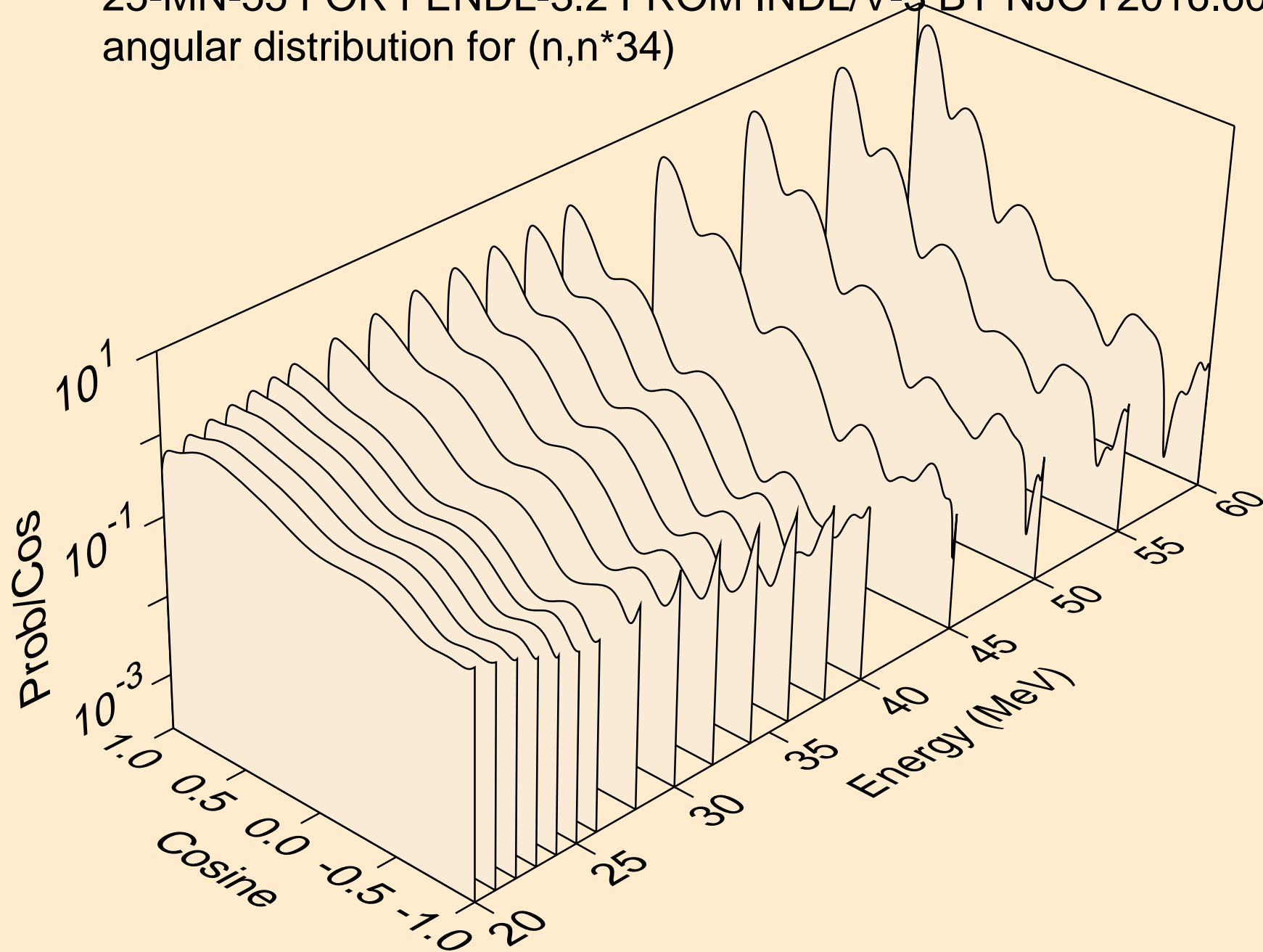

25-MN-55 FOR FENDL-3.2 FROM INDL/V-3 BY NJOY2016.60+ ON  
angular distribution for (n,n\*35)

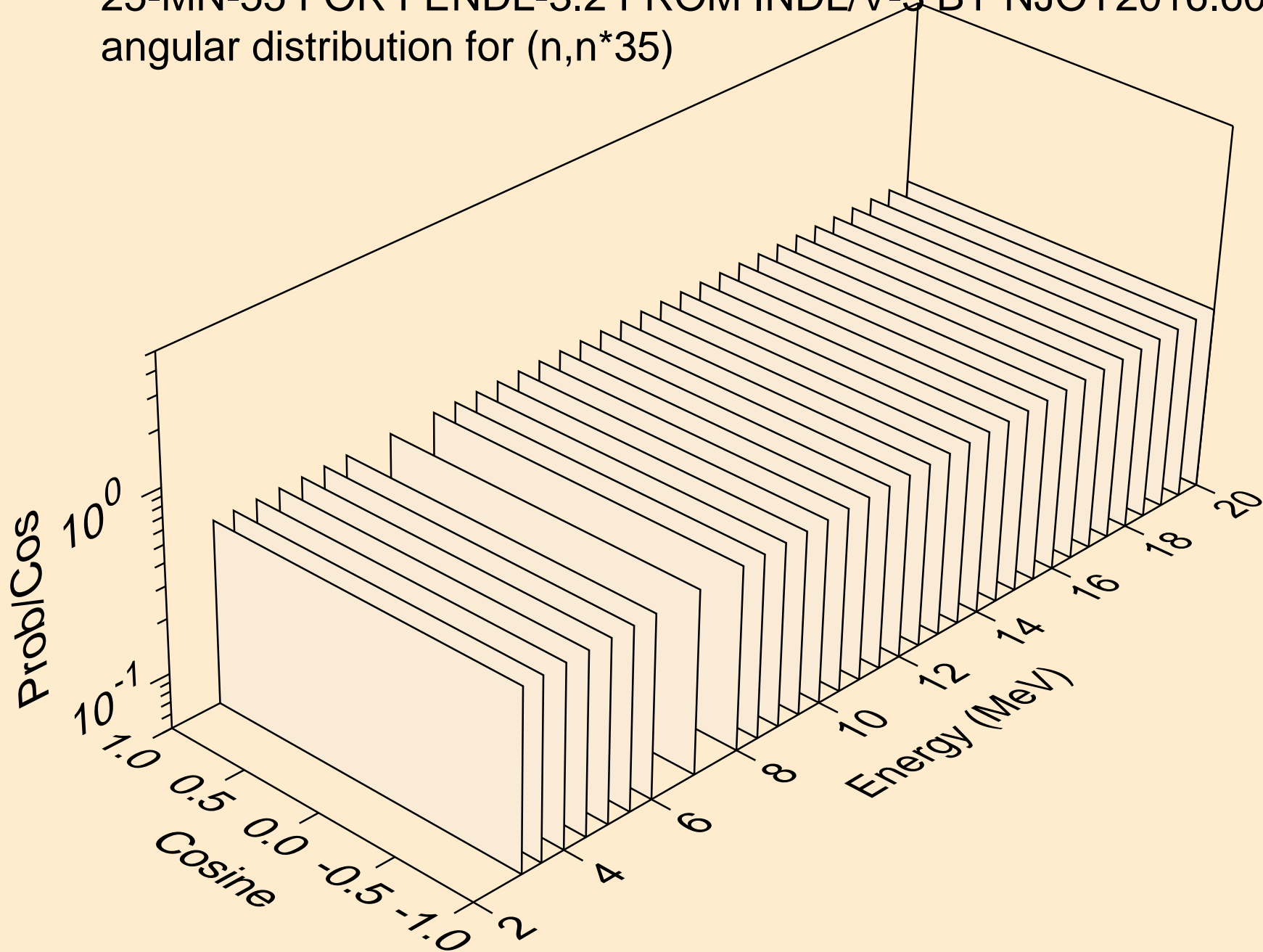

25-MN-55 FOR FENDL-3.2 FROM INDL/V-3 BY NJOY2016.60+ ON  
angular distribution for (n,n\*35)

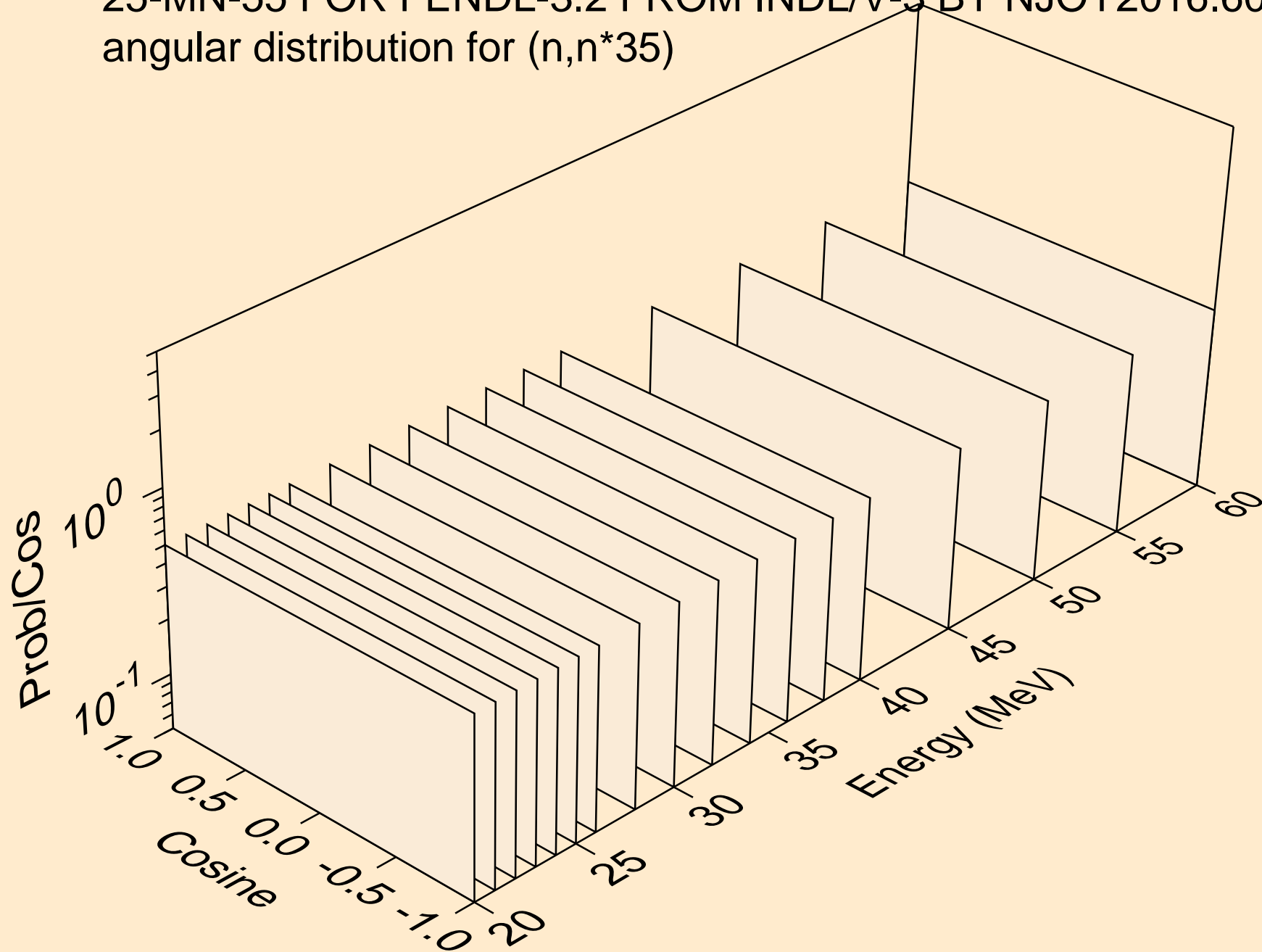

25-MN-55 FOR FENDL-3.2 FROM INDL/V-3 BY NJOY2016.60+ ON  
angular distribution for (n,n\*36)

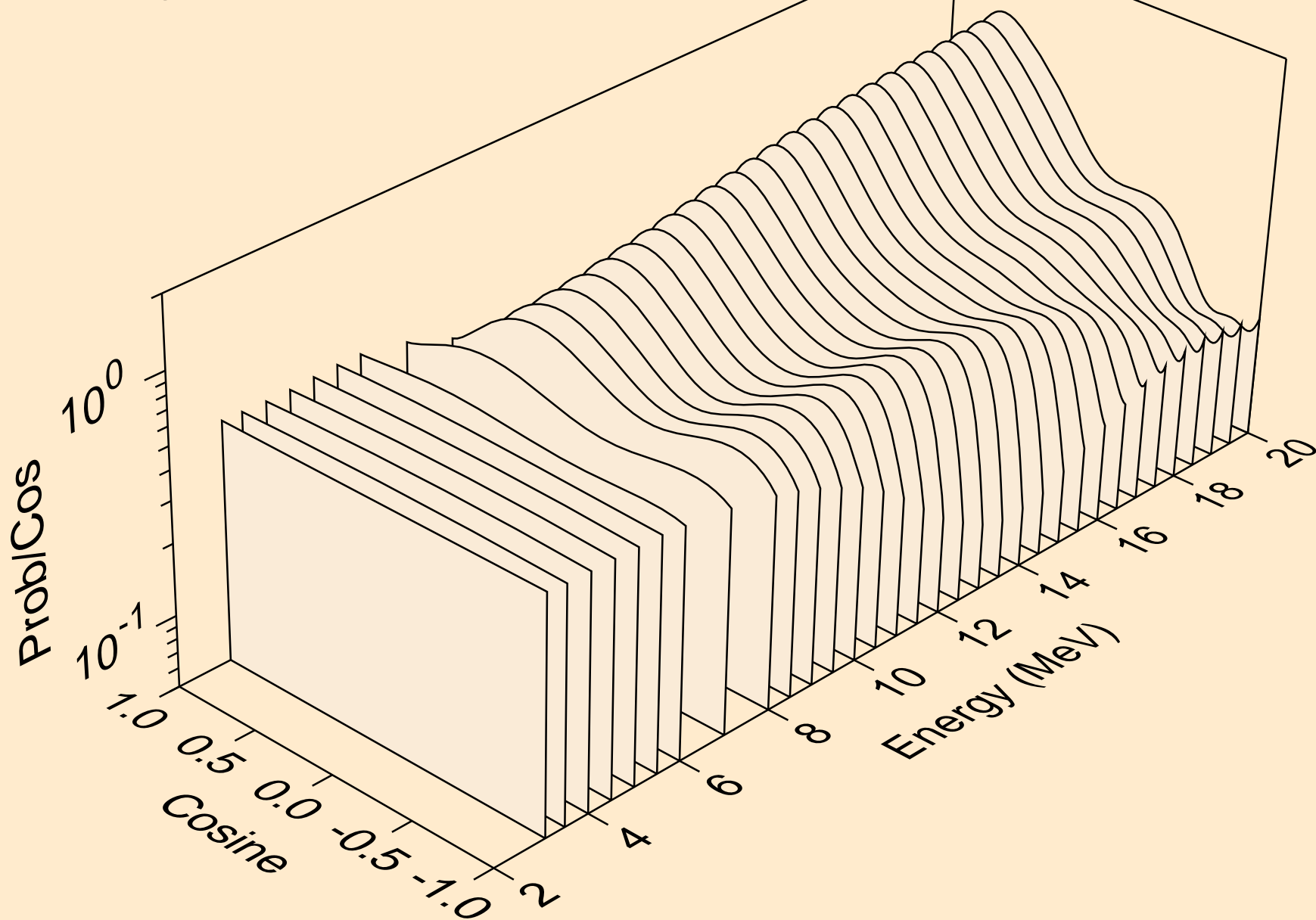

25-MN-55 FOR FENDL-3.2 FROM INDL/V-3 BY NJOY2016.60+ ON  
angular distribution for (n,n\*36)

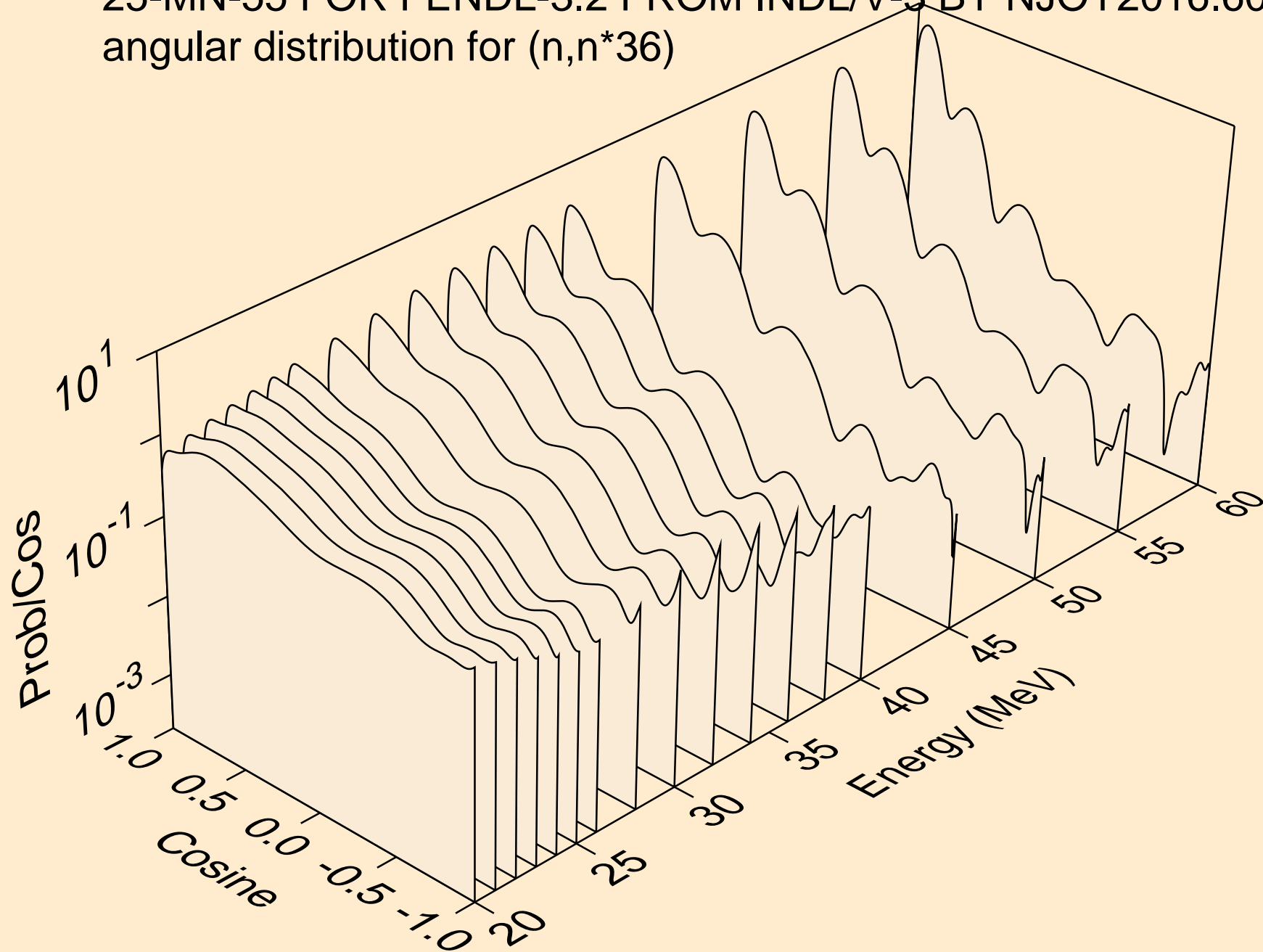

25-MN-55 FOR FENDL-3.2 FROM INDL/V-3 BY NJOY2016.60+ ON  
angular distribution for (n,n\*37)

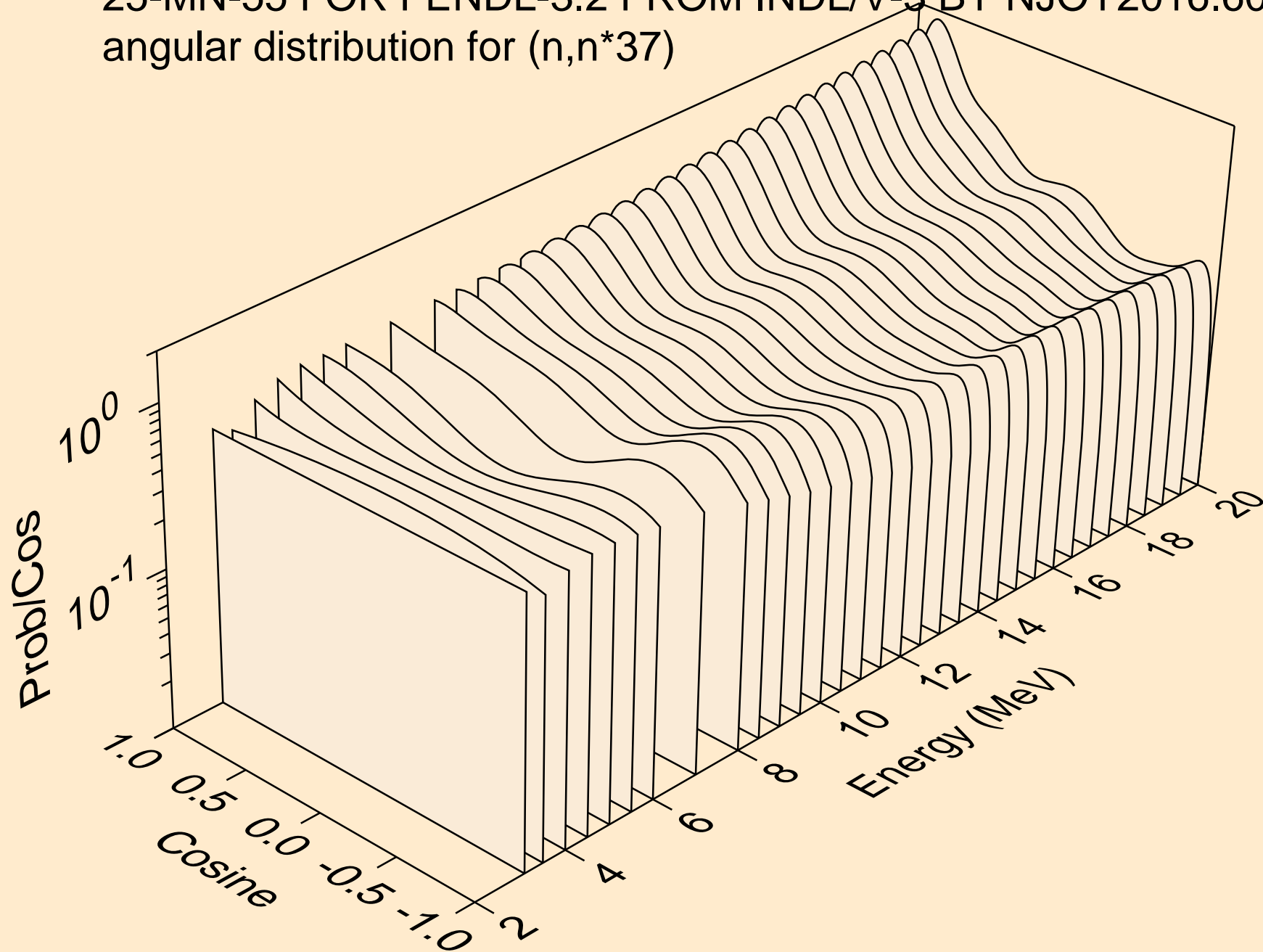

25-MN-55 FOR FENDL-3.2 FROM INDL/V-3 BY NJOY2016.60+ ON  
angular distribution for (n,n\*37)

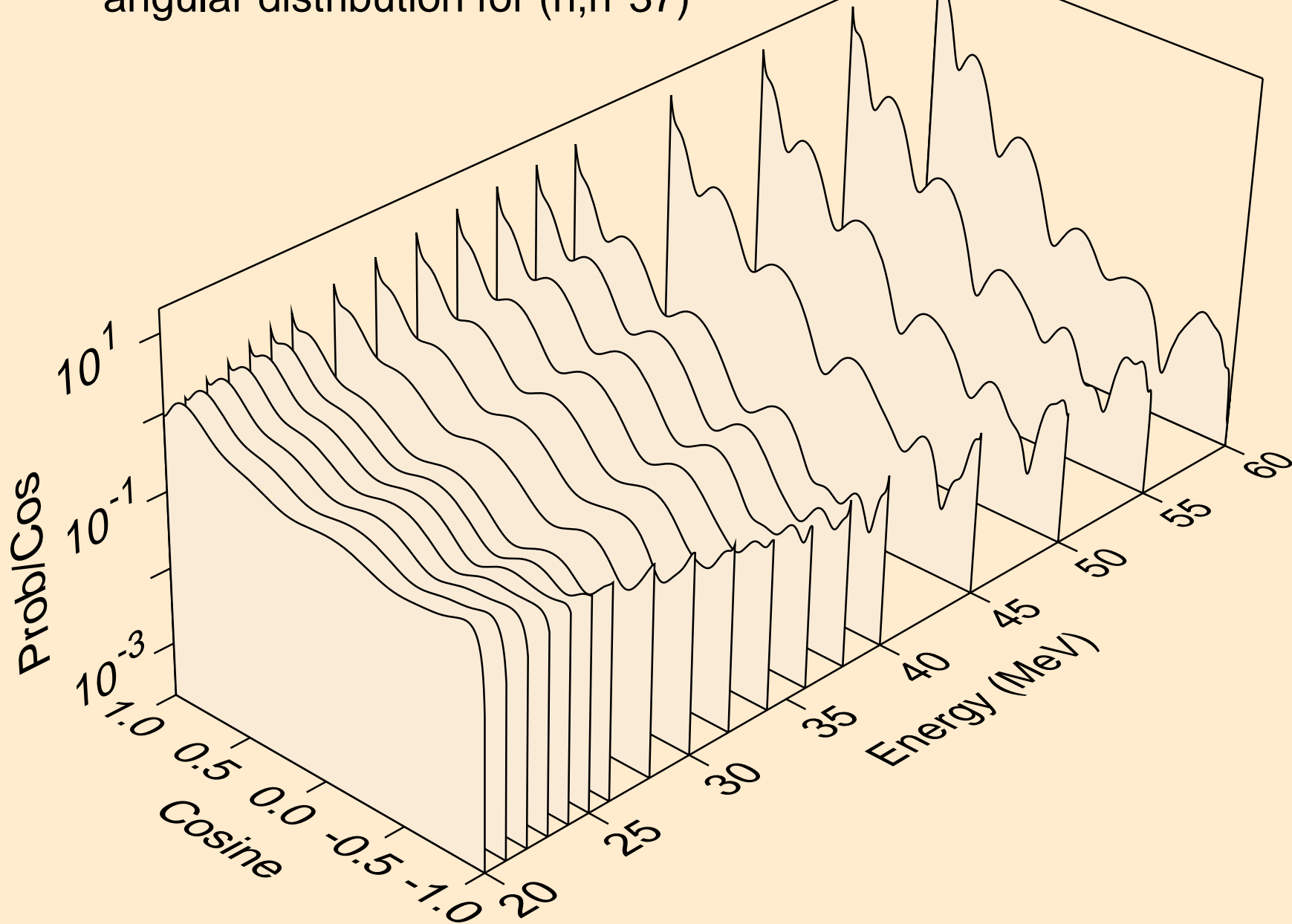



25-MN-55 FOR FENDL-3.2 FROM INDL/V-3 BY NJOY2016.60+ ON  
angular distribution for (n,n\*38)

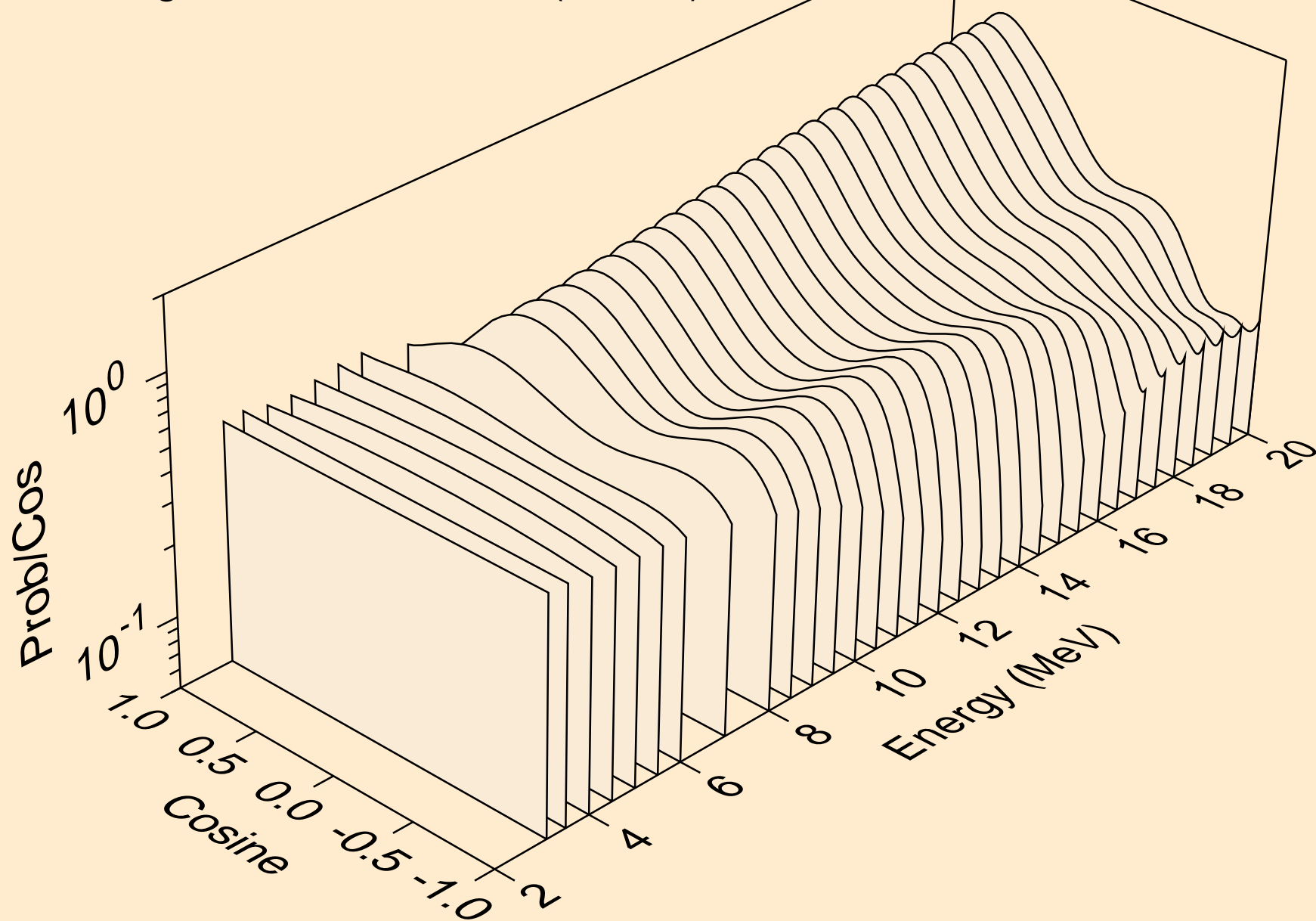

25-MN-55 FOR FENDL-3.2 FROM INDL/V-3 BY NJOY2016.60+ ON  
angular distribution for (n,n\*38)

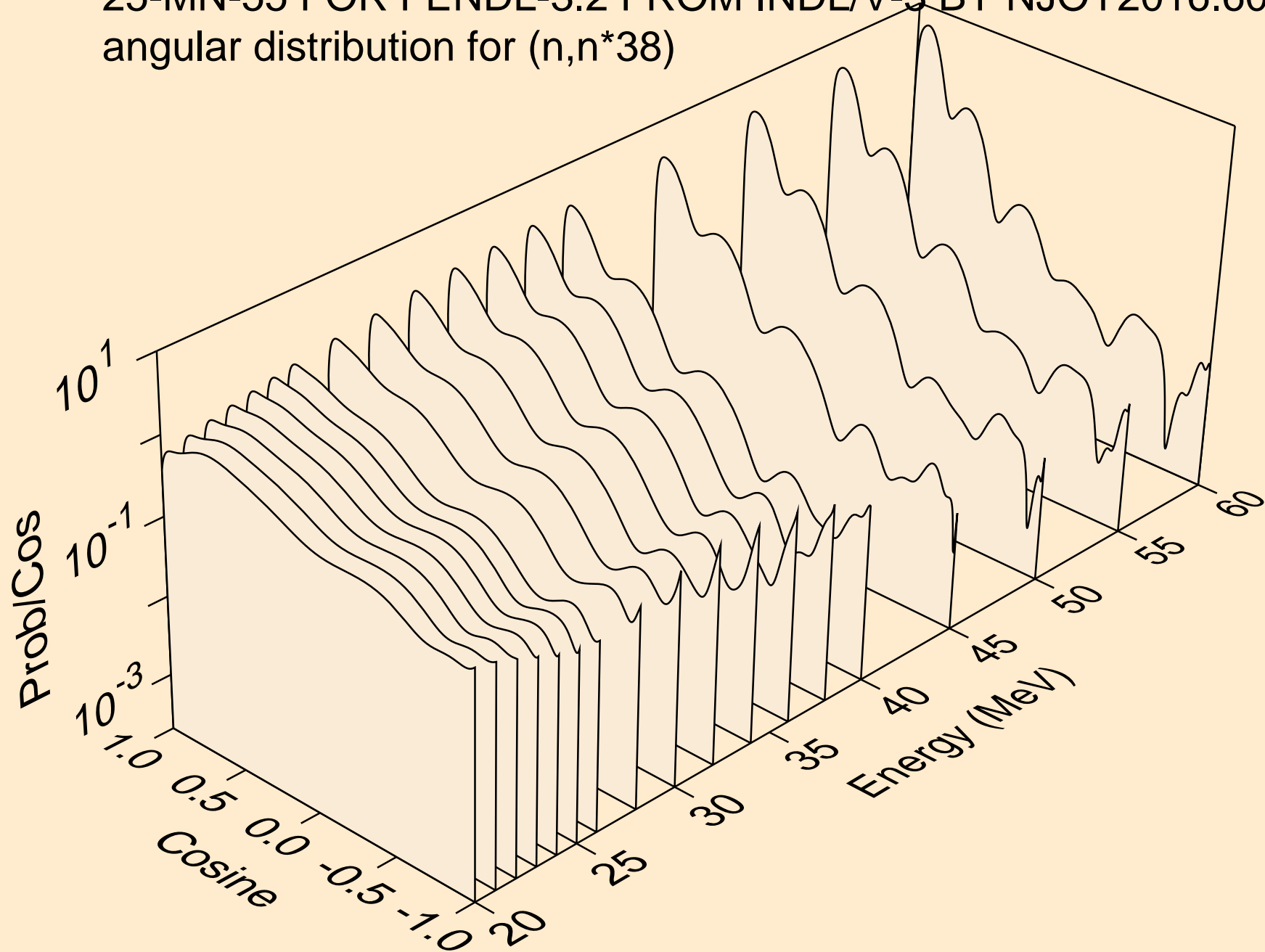

25-MN-55 FOR FENDL-3.2 FROM INDL/V-3 BY NJOY2016.60+ ON  
angular distribution for (n,n\*39)

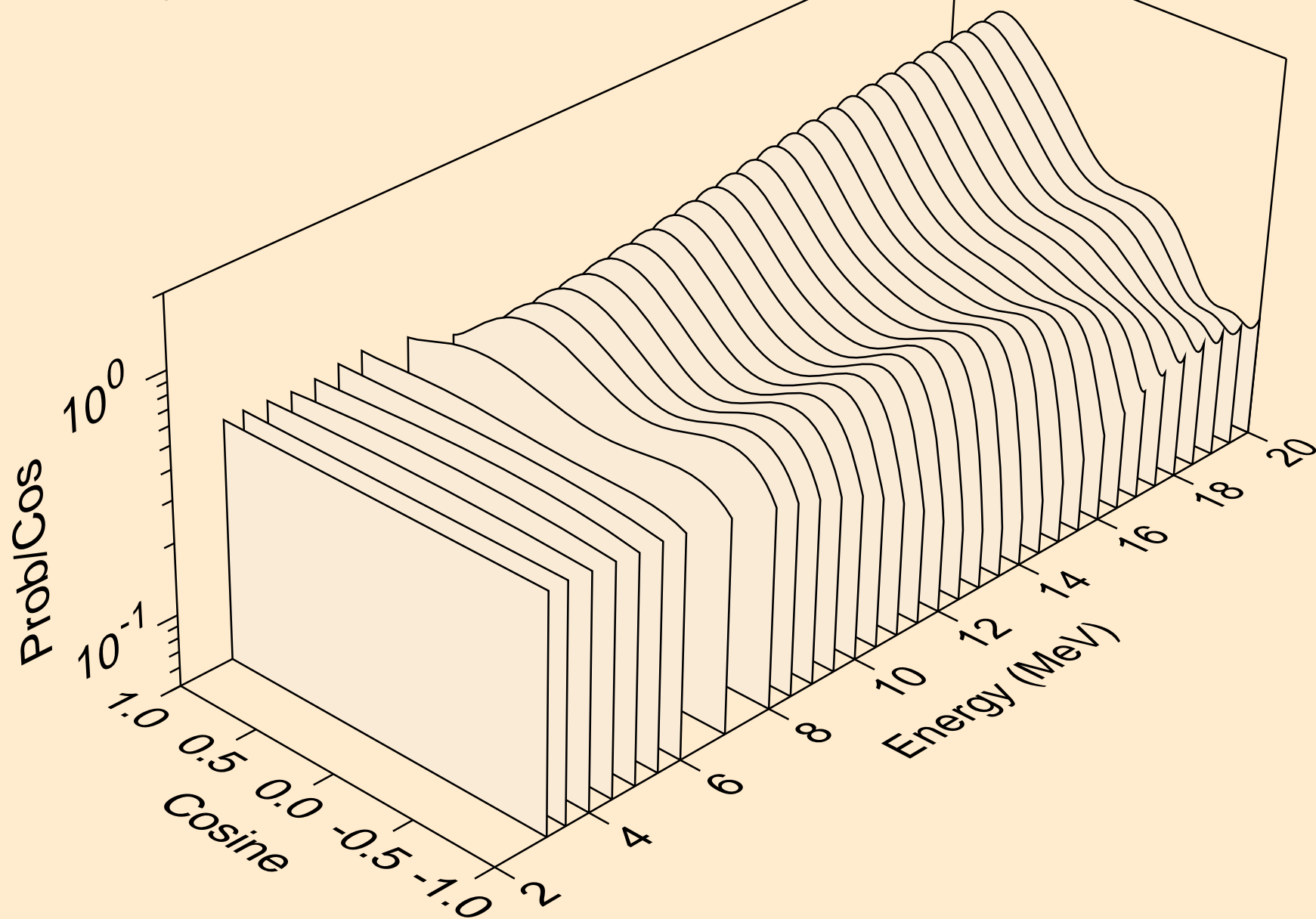

25-MN-55 FOR FENDL-3.2 FROM INDL/V-3 BY NJOY2016.60+ ON  
angular distribution for (n,n\*39)

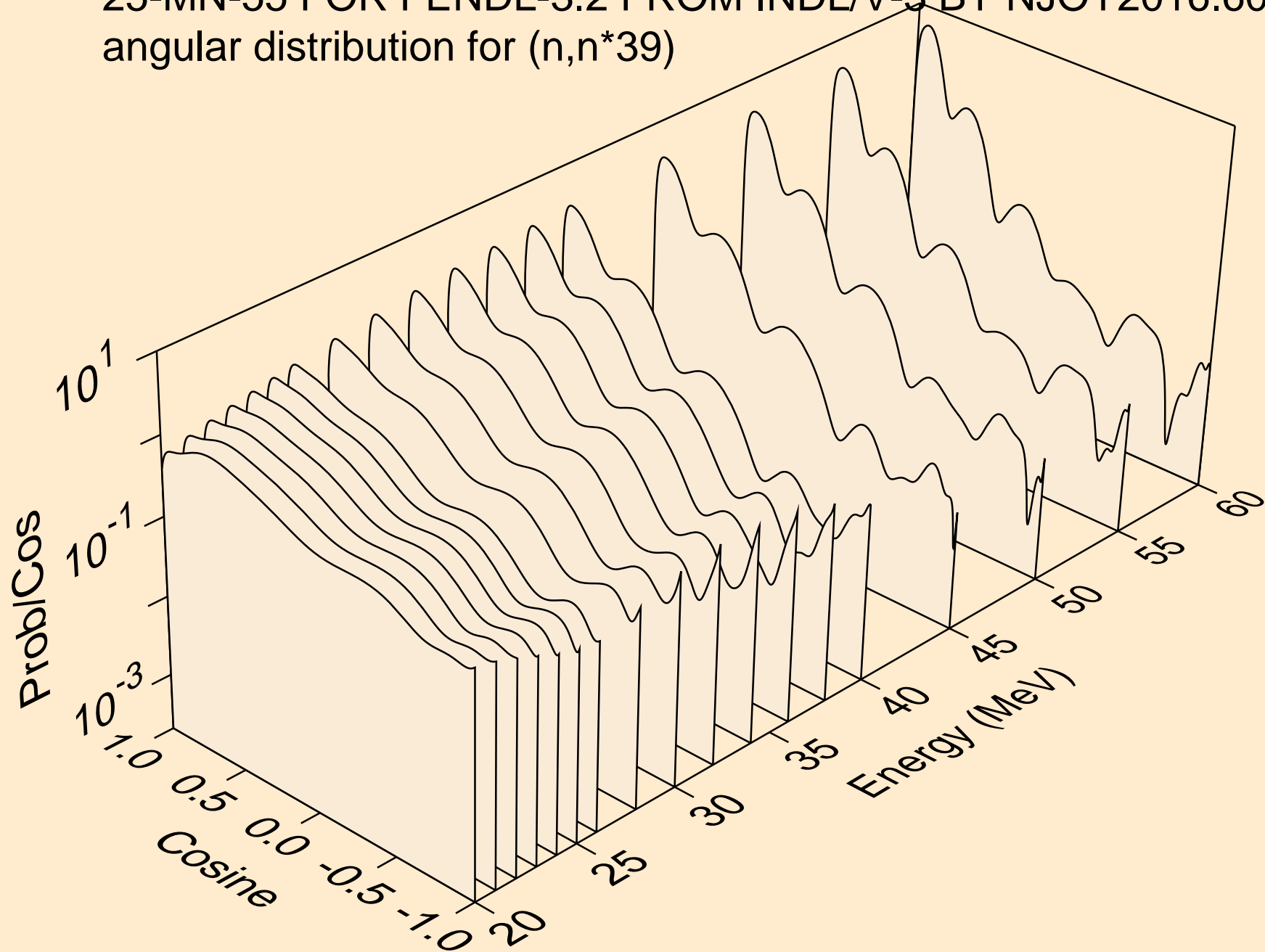

25-MN-55 FOR FENDL-3.2 FROM INDLV-3 BY NJOY2016.60+ ON  
Neutron emission for (n,x)

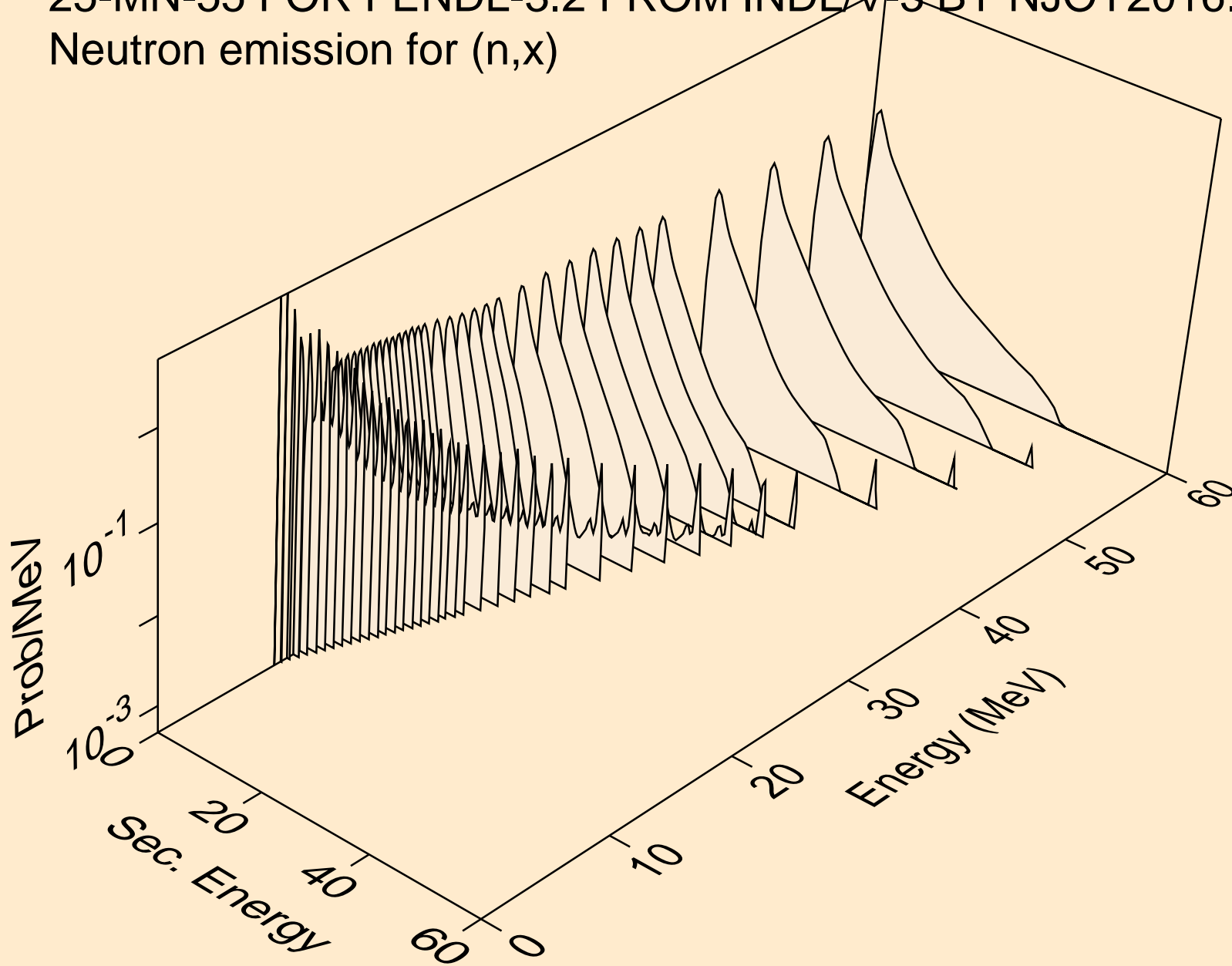

25-MN-55 FOR FENDL-3.2 FROM INDLV-3 BY NJOY2016.60+ ON  
Neutron emission for (n,2n)

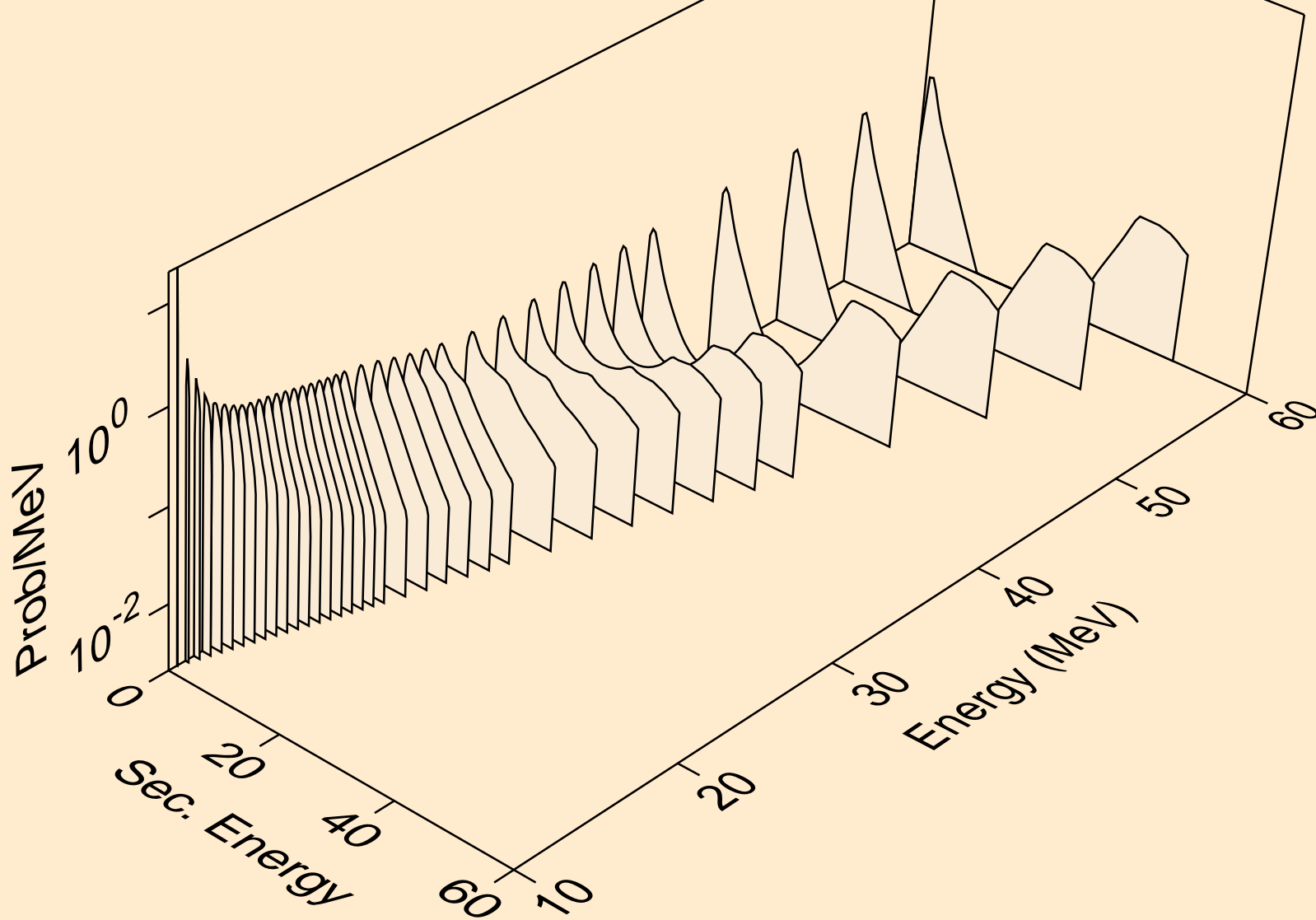

25-MN-55 FOR FENDL-3.2 FROM INDLV-3 BY NJOY2016.60+ ON  
Neutron emission for (n,3n)

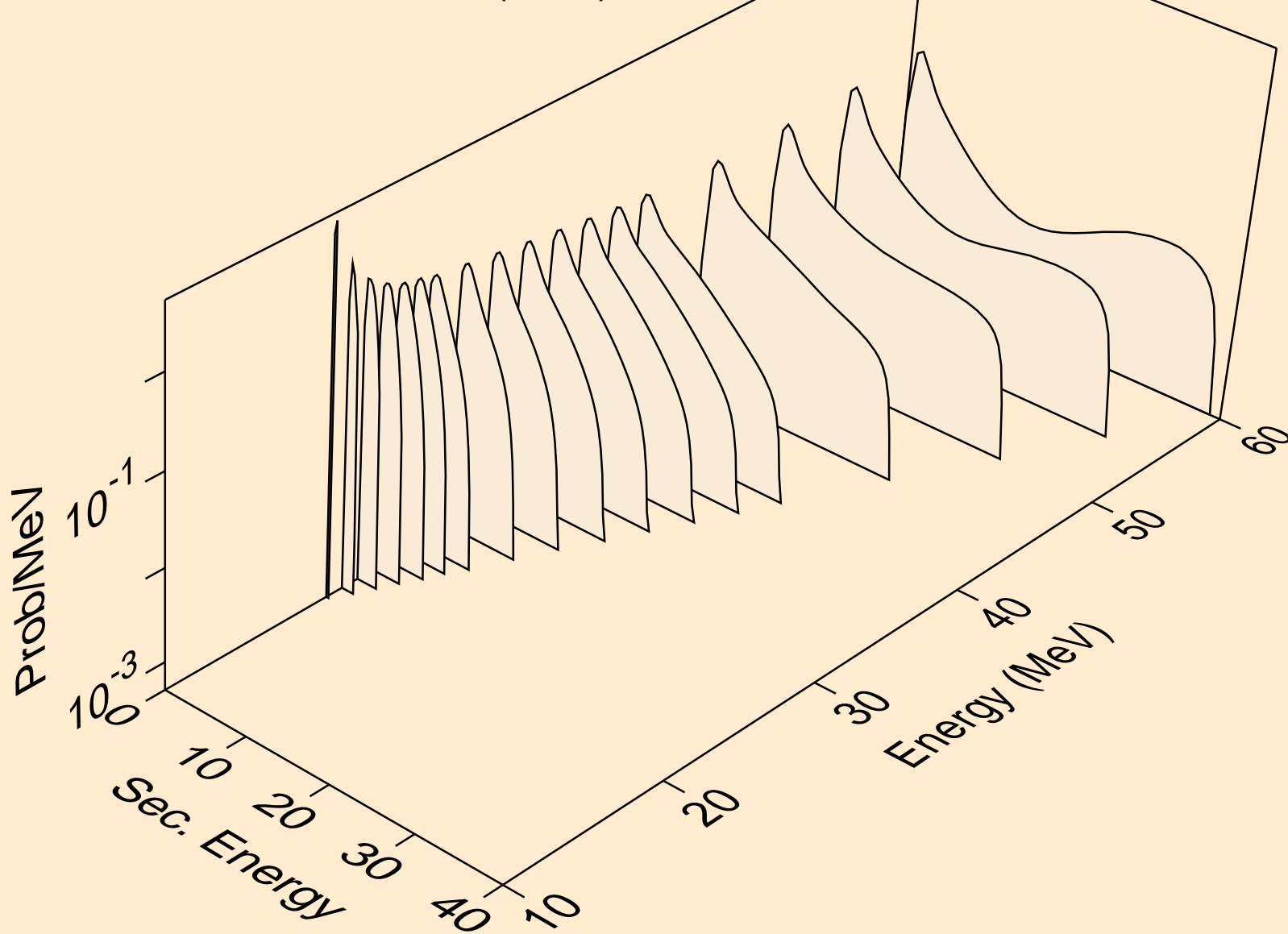

25-MN-55 FOR FENDL-3.2 FROM INDLV-3 BY NJOY2016.60+ ON  
Neutron emission for (n,4n)

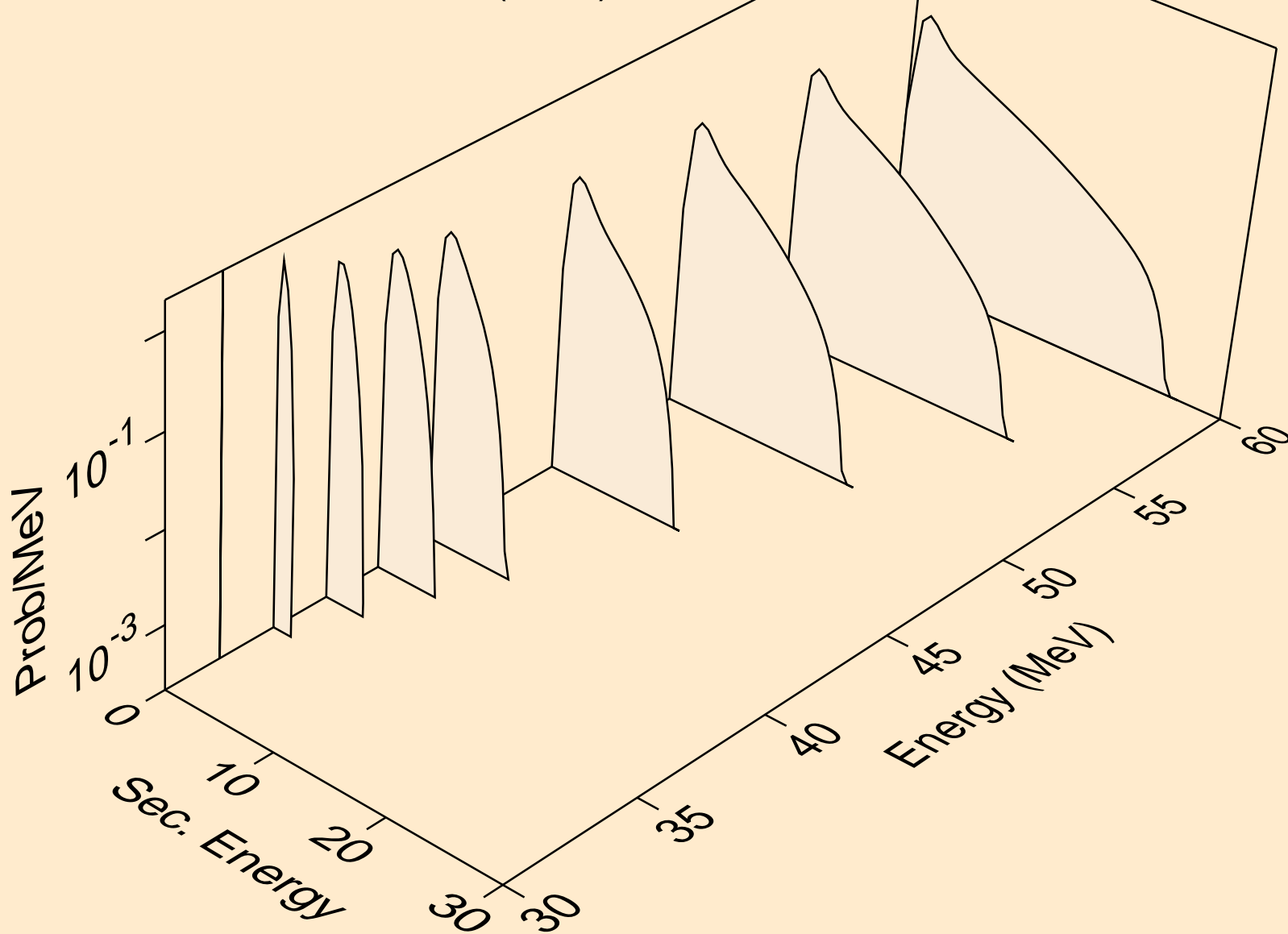



25-MN-55 FOR FENDL-3.2 FROM INDLV-3 BY NJOY2016.60+ ON  
Neutron emission for (n,n\*c)

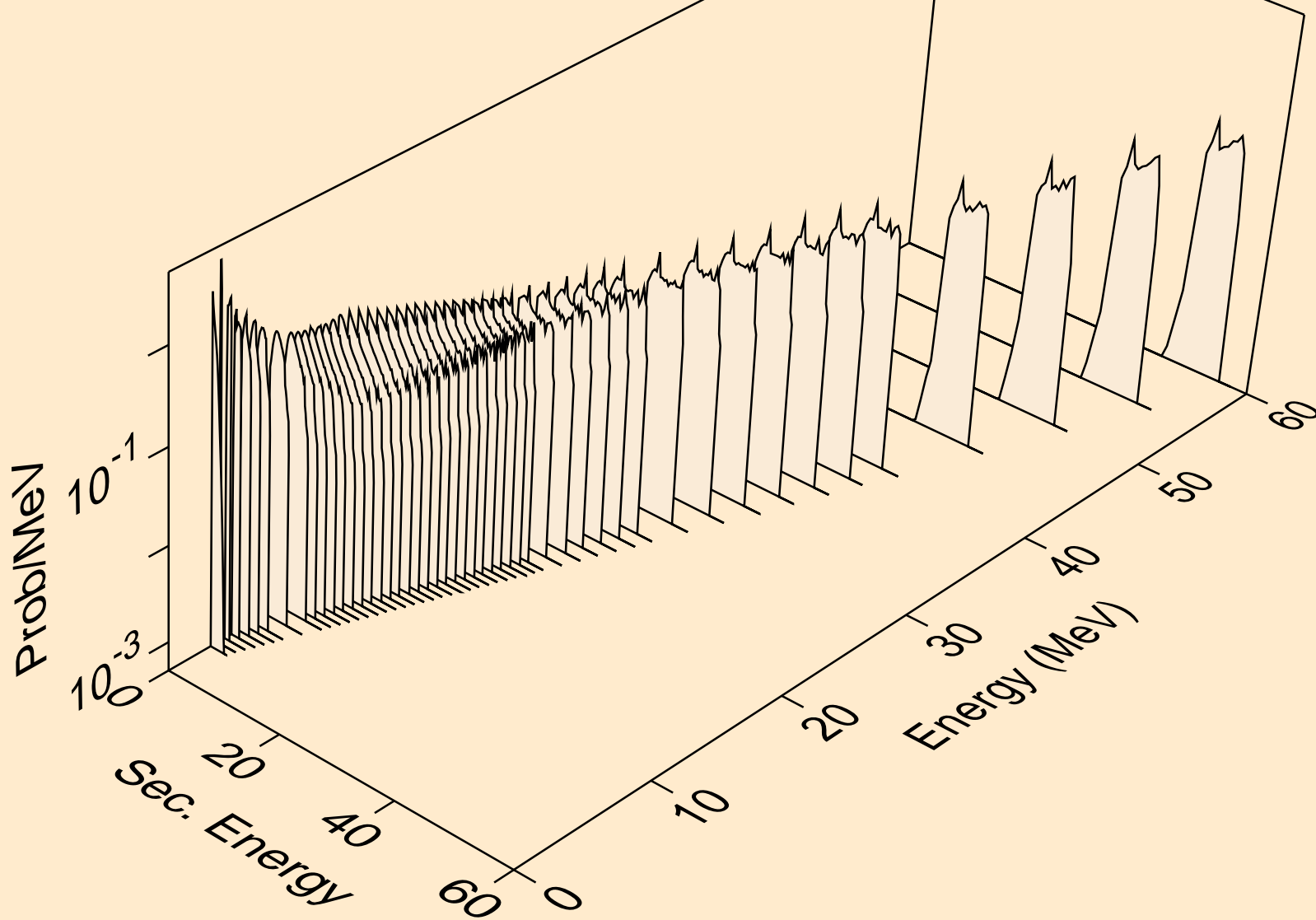

25-MN-55 FOR FENDL-3.2 FROM INDLV-3 BY NJOY2016.60+ ON  
Photon emission for (n,x)

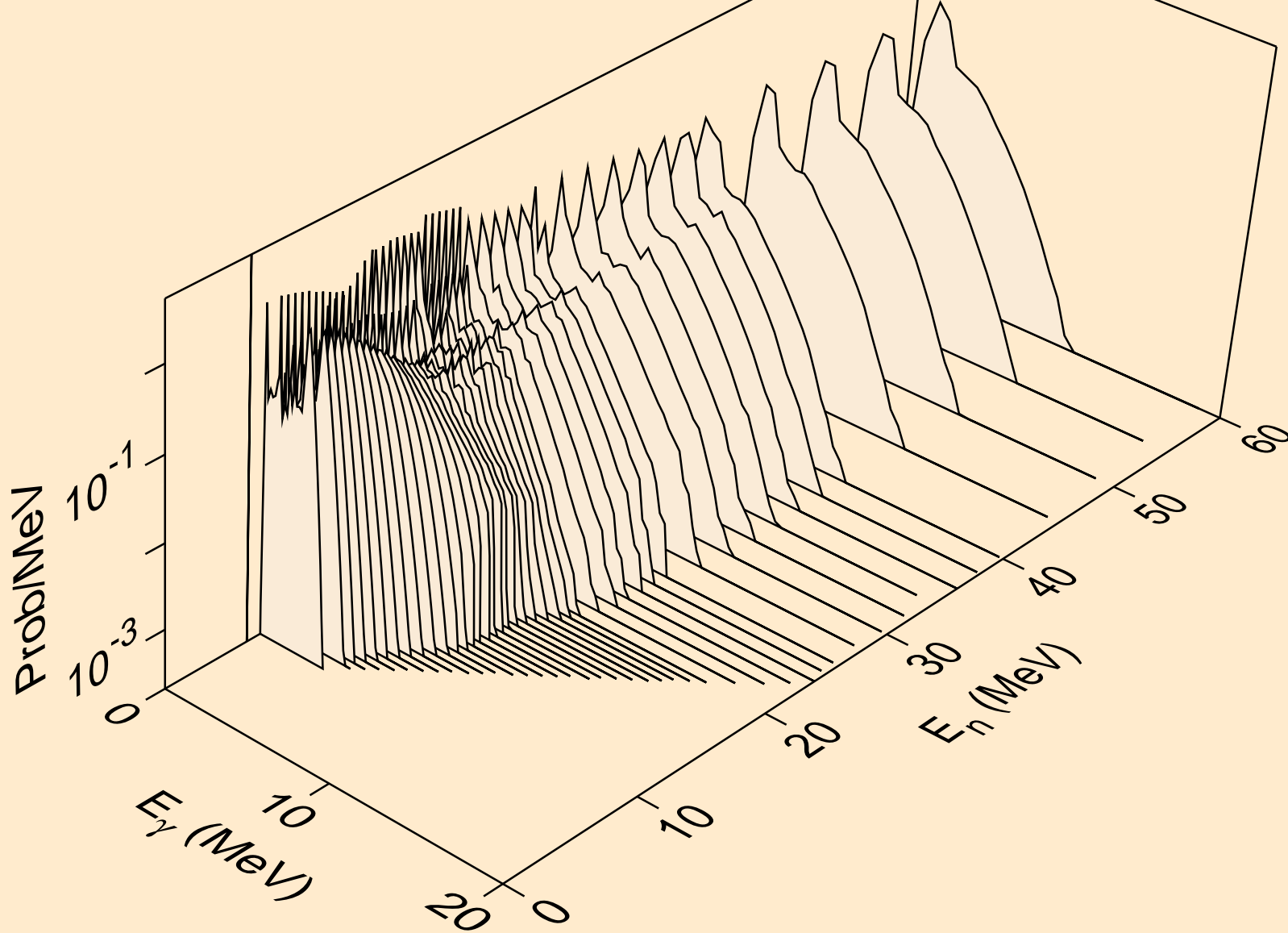

25-MN-55 FOR FENDL-3.2 FROM INDLV-3 BY NJOY2016.60+ ON  
Photon emission for (n,2n)

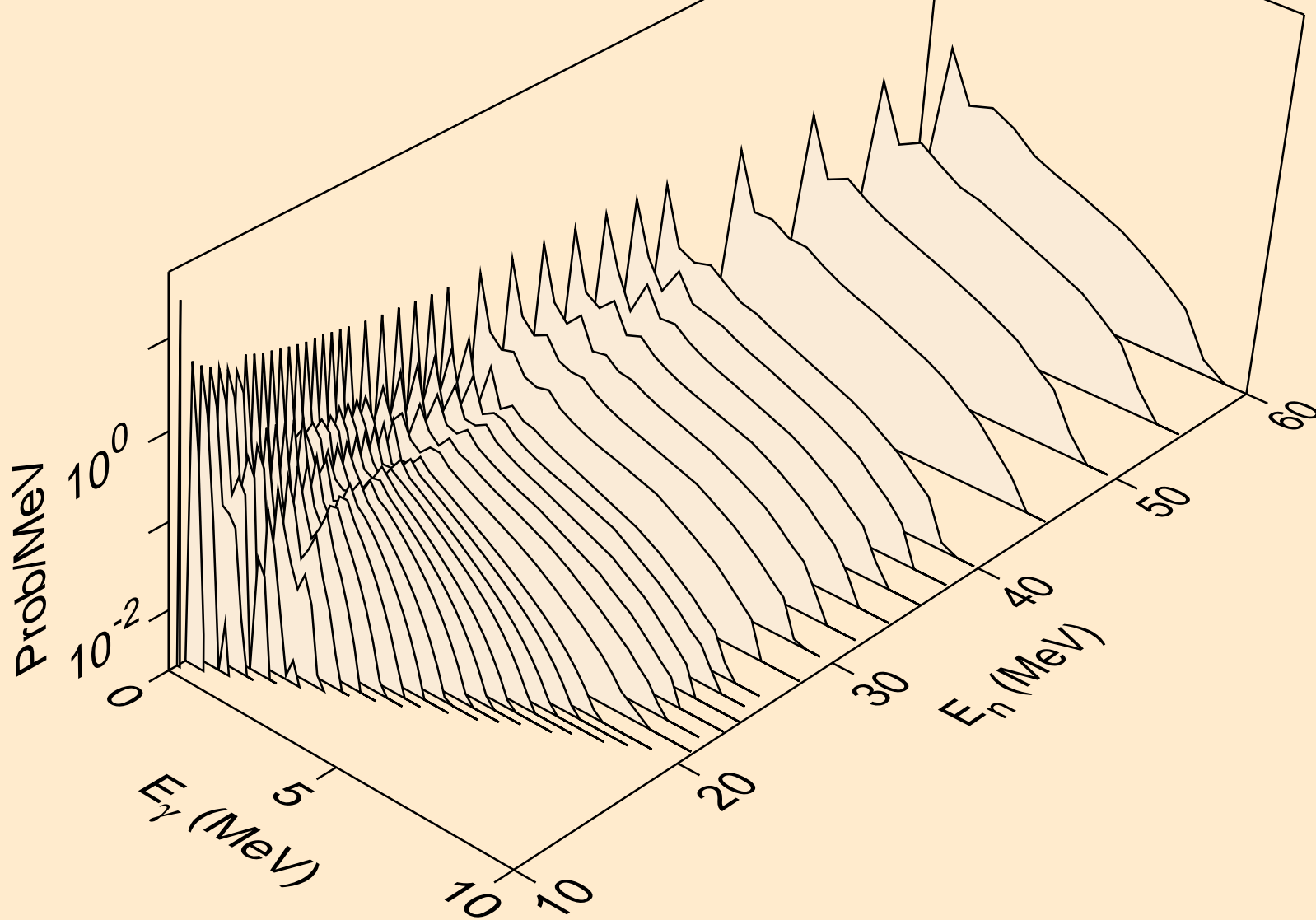

25-MN-55 FOR FENDL-3.2 FROM INDLV-3 BY NJOY2016.60+ ON  
Photon emission for (n,3n)

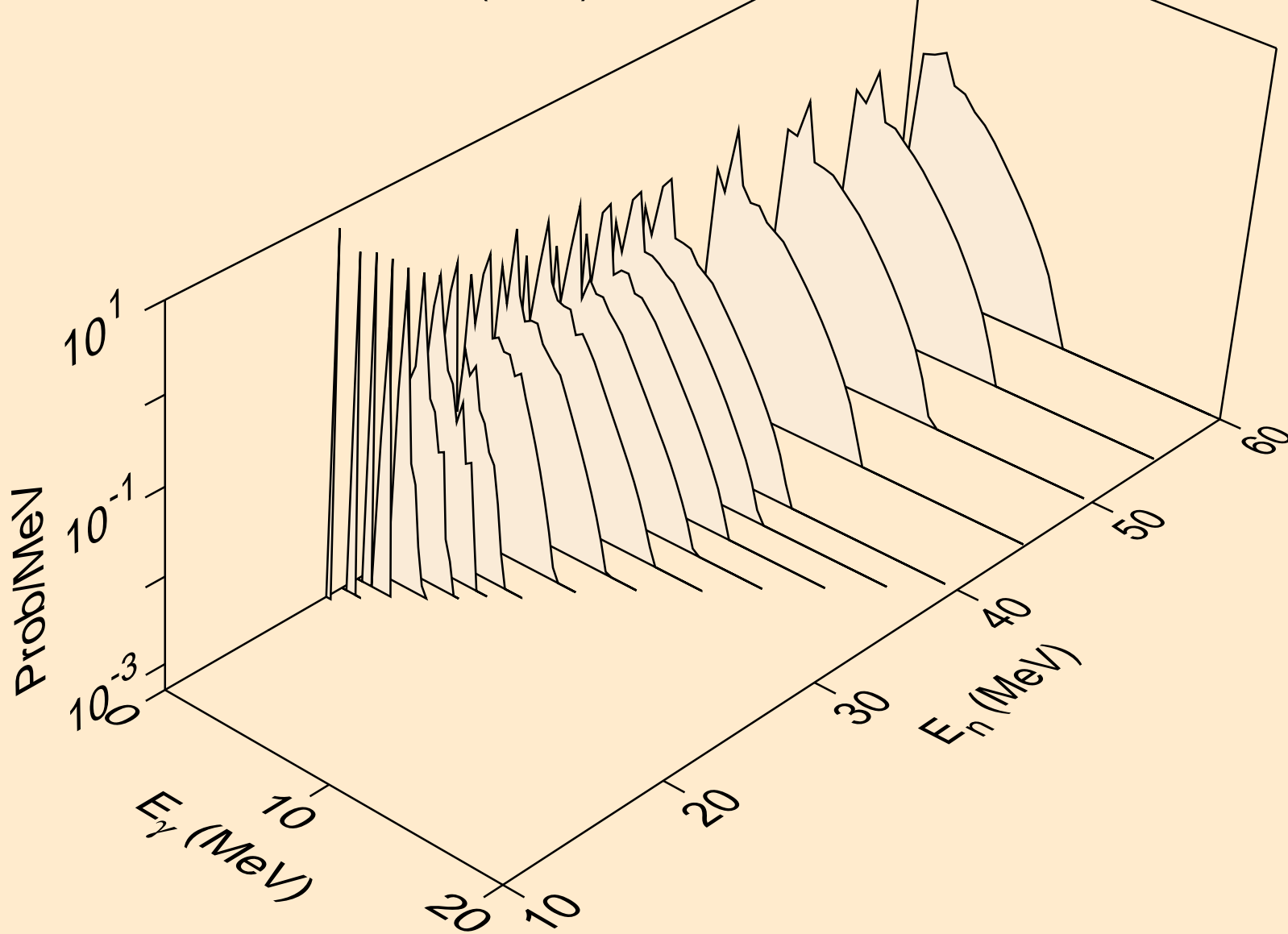

25-MN-55 FOR FENDL-3.2 FROM INDLV-3 BY NJOY2016.60+ ON  
Photon emission for (n,4n)

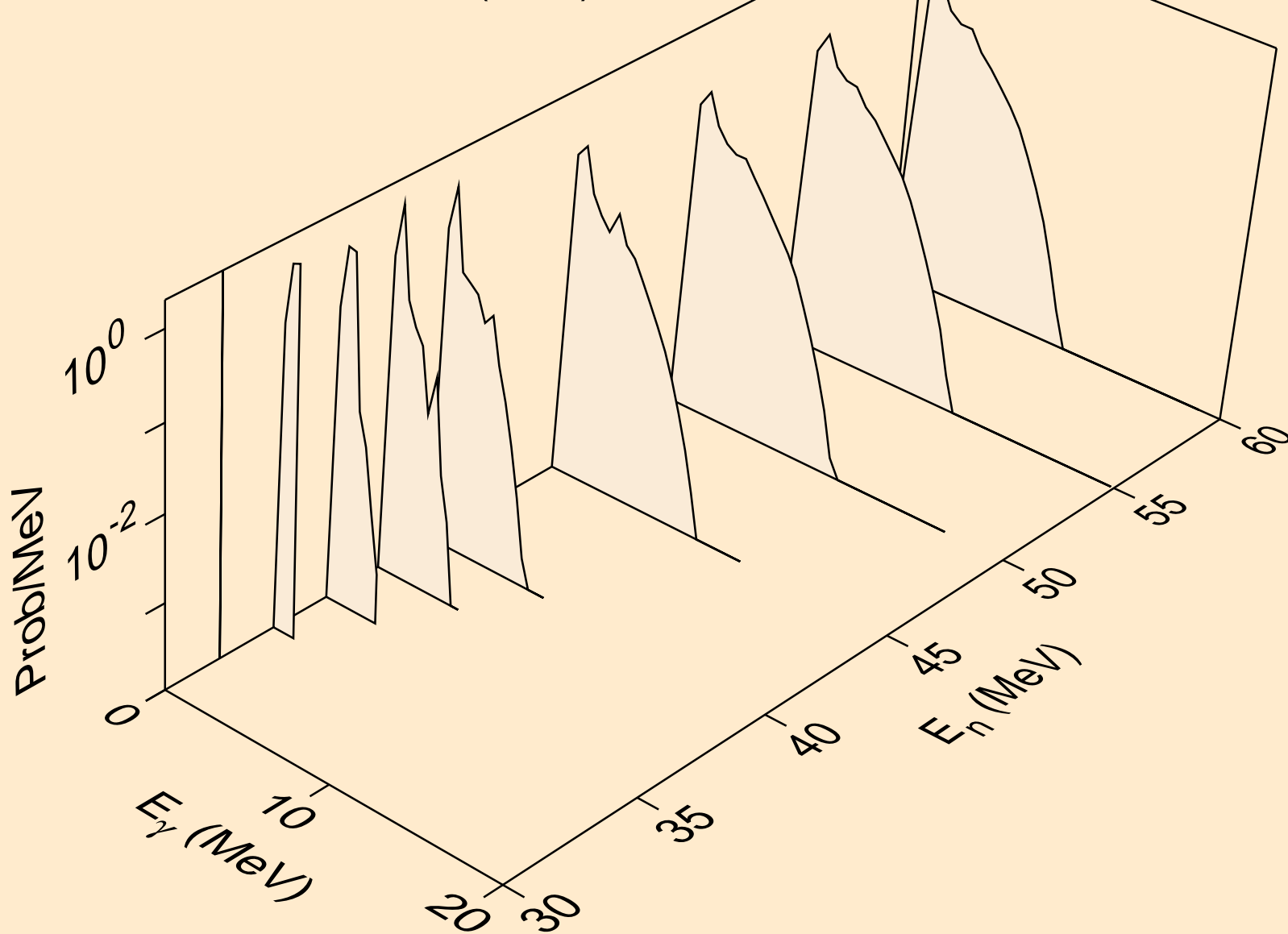

25-MN-55 FOR FENDL-3.2 FROM INDLV-3 BY NJOY2016.60+ ON  
Photon emission for (n,n\*c)

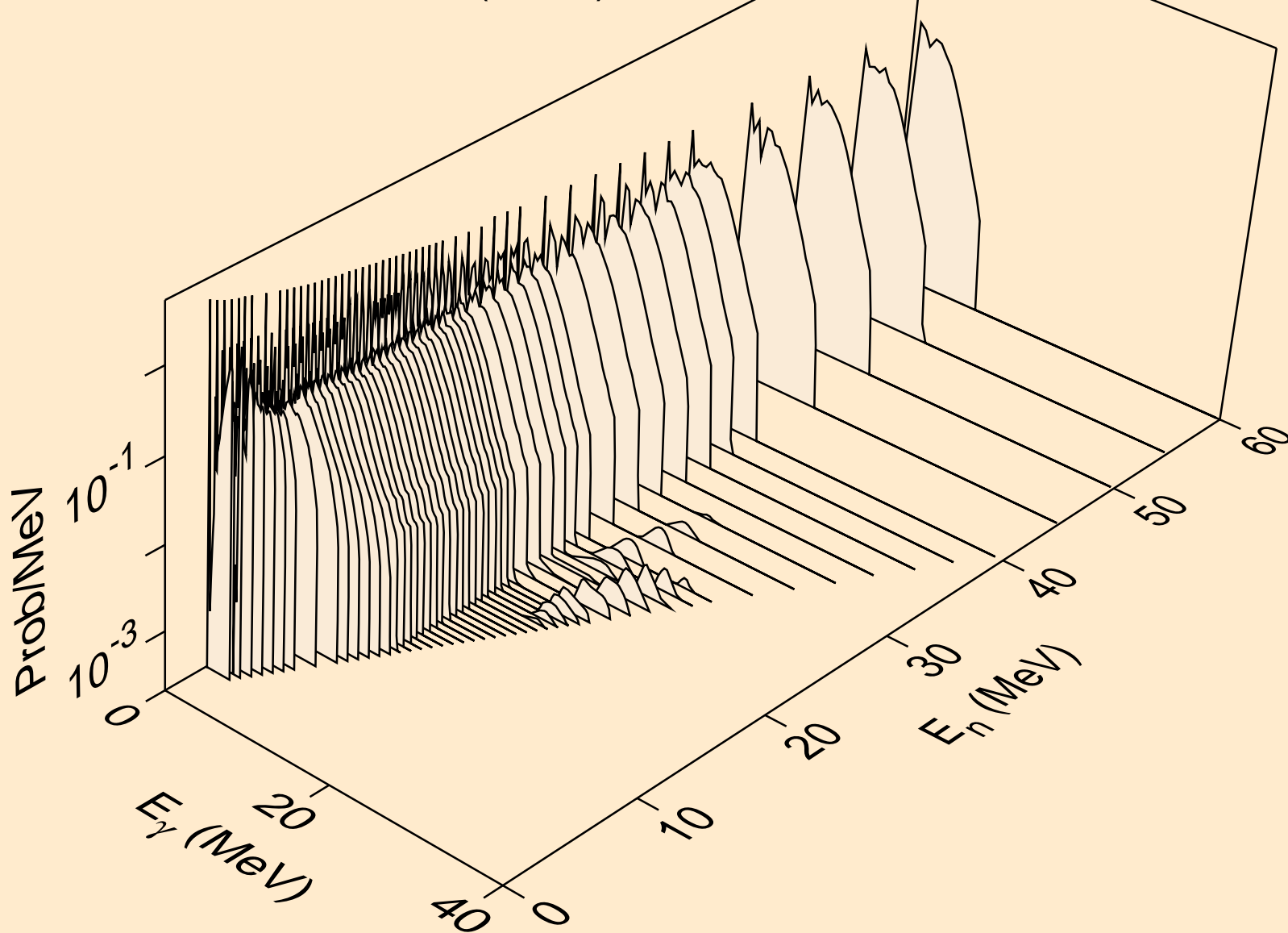

25-MN-55 FOR FENDL-3.2 FROM INDLV-3 BY NJOY2016.60+ ON  
Photon emission for (n,gma)

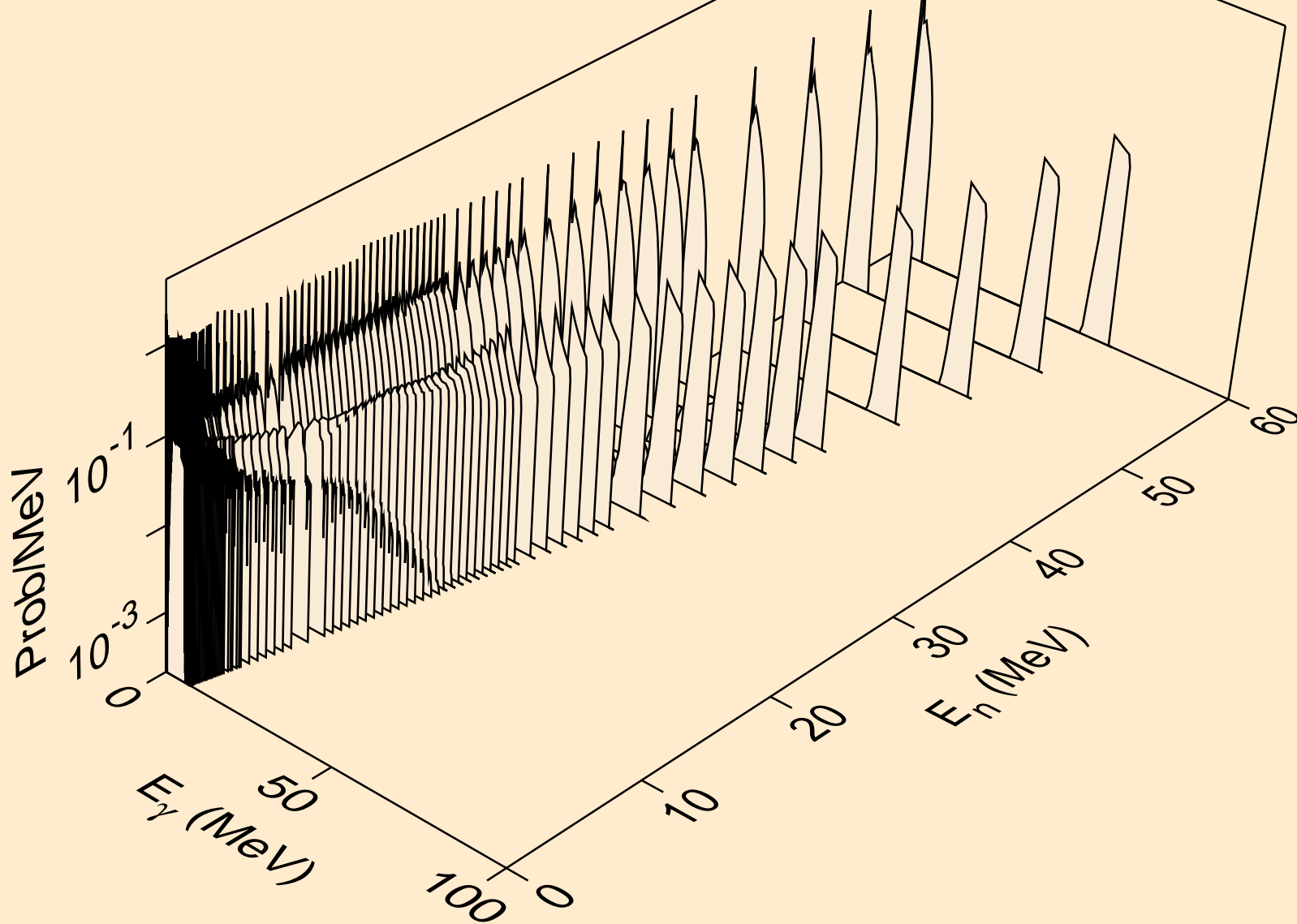

25-MN-55 FOR FENDL-3.2 FROM INDLV-3 BY NJOY2016.60+ ON  
Photon emission for (n,p\*c)

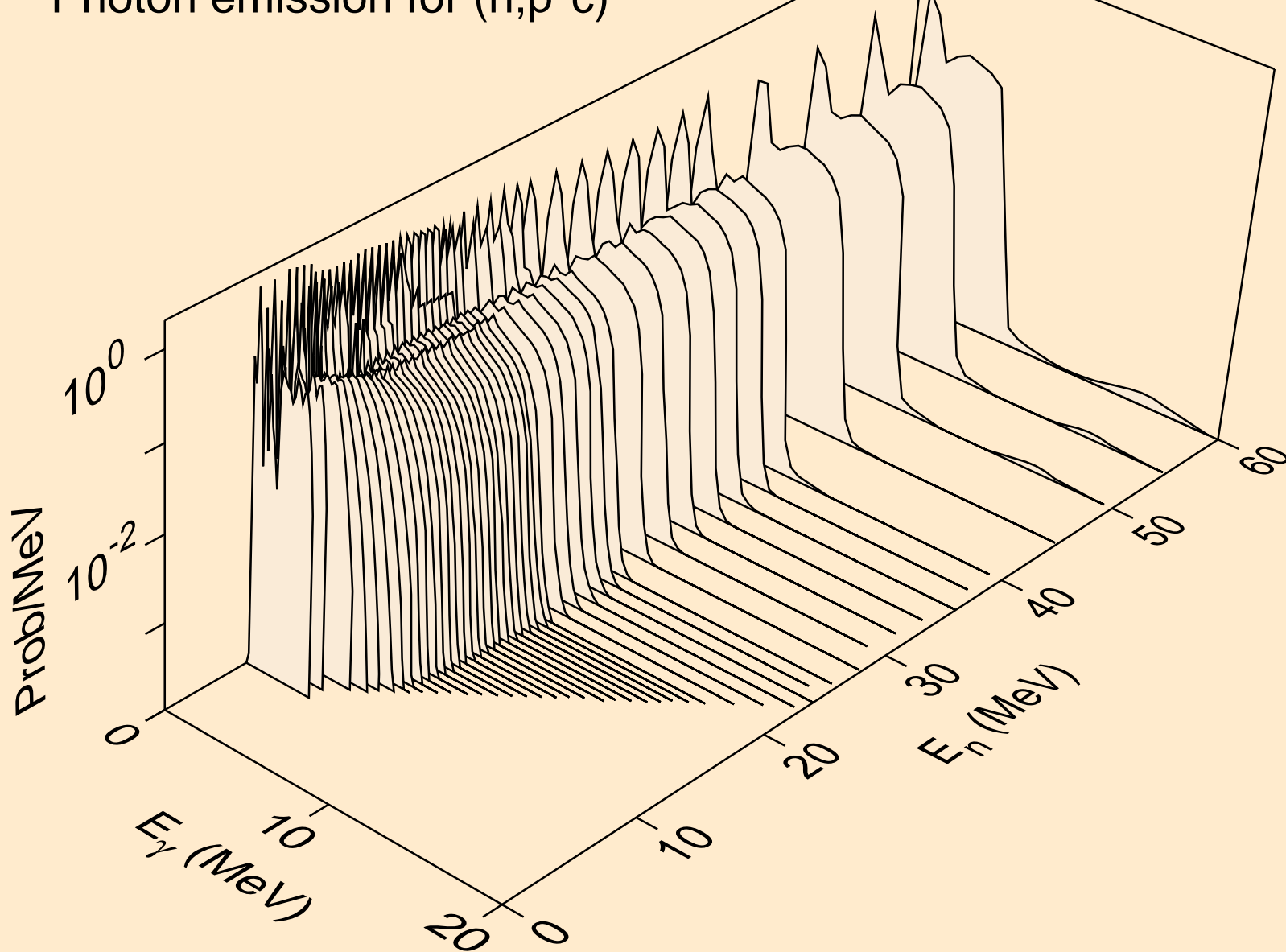



25-MN-55 FOR FENDL-3.2 FROM INDL/V-3 BY NJOY2016.60+ ON  
thermal capture photon spectrum

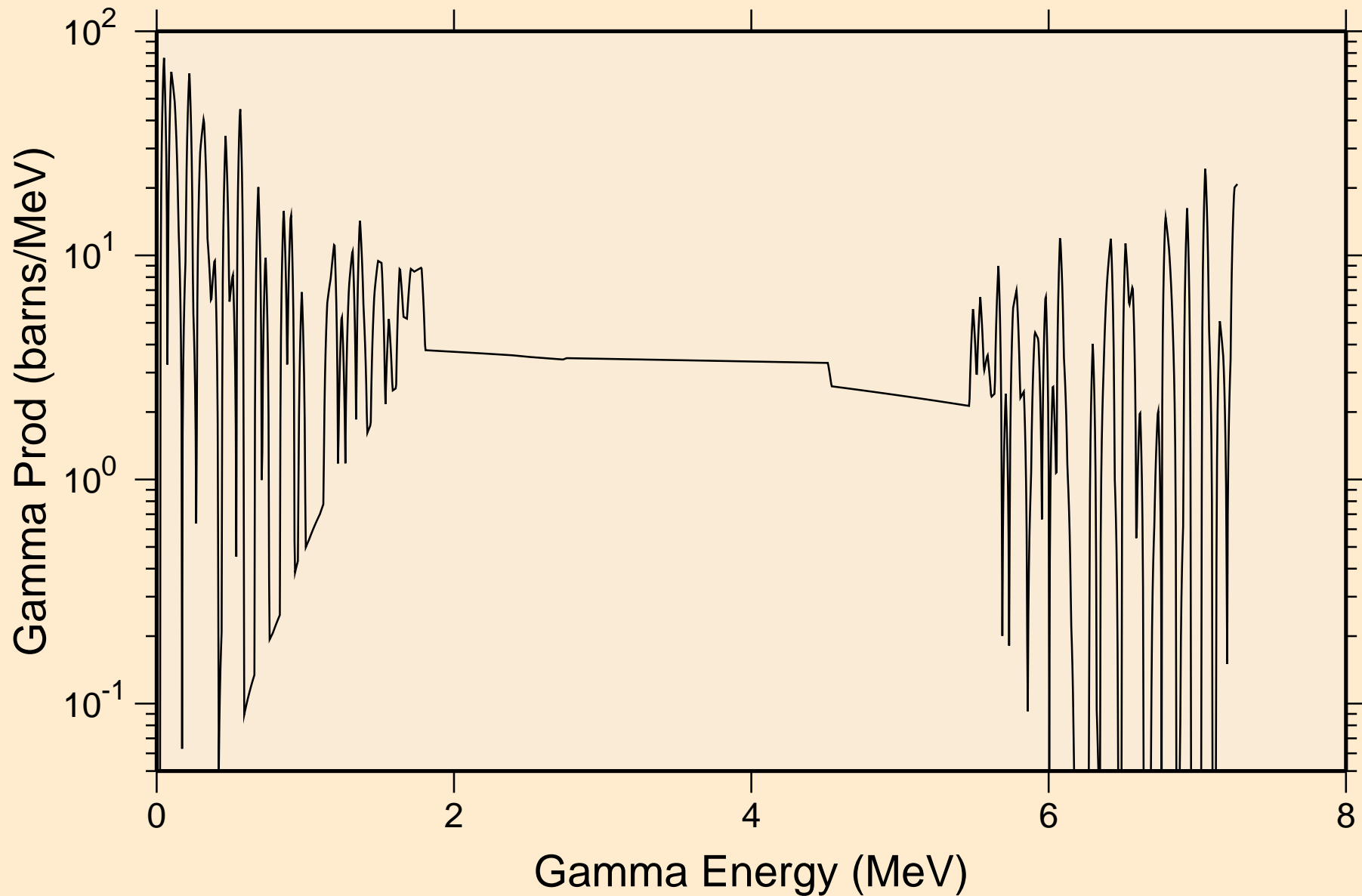

25-MN-55 FOR FENDL-3.2 FROM INDL/V-3 BY NJOY2016.60+ ON  
14 MeV photon spectrum

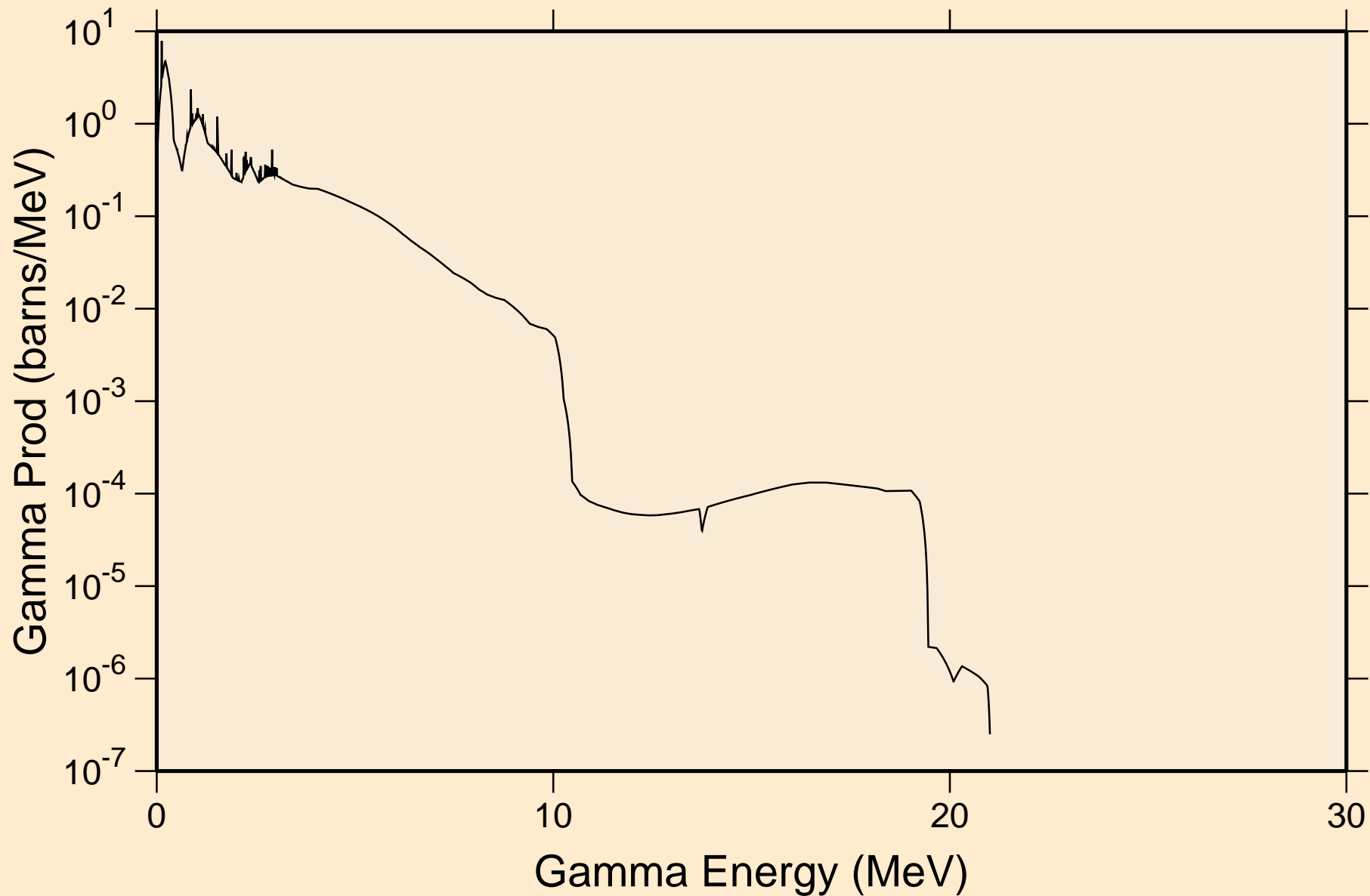

# 25-MN-55 FOR FENDL-3.2 FROM INDL/V-3 BY NJOY2016.60+ ON

## Particle heating contributions

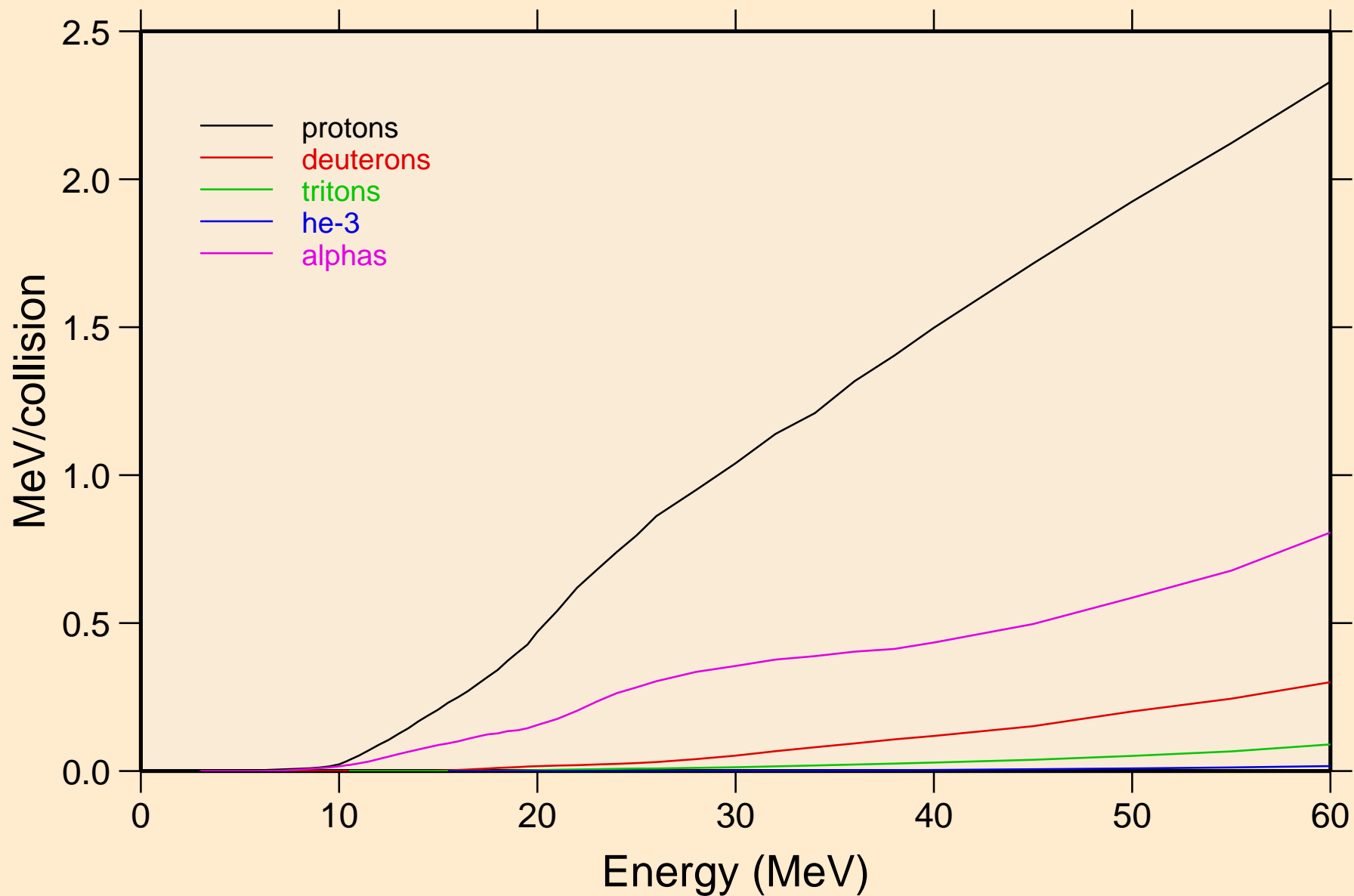

# 25-MN-55 FOR FENDL-3.2 FROM INDL/V-3 BY NJOY2016.60+ ON Recoil Heating

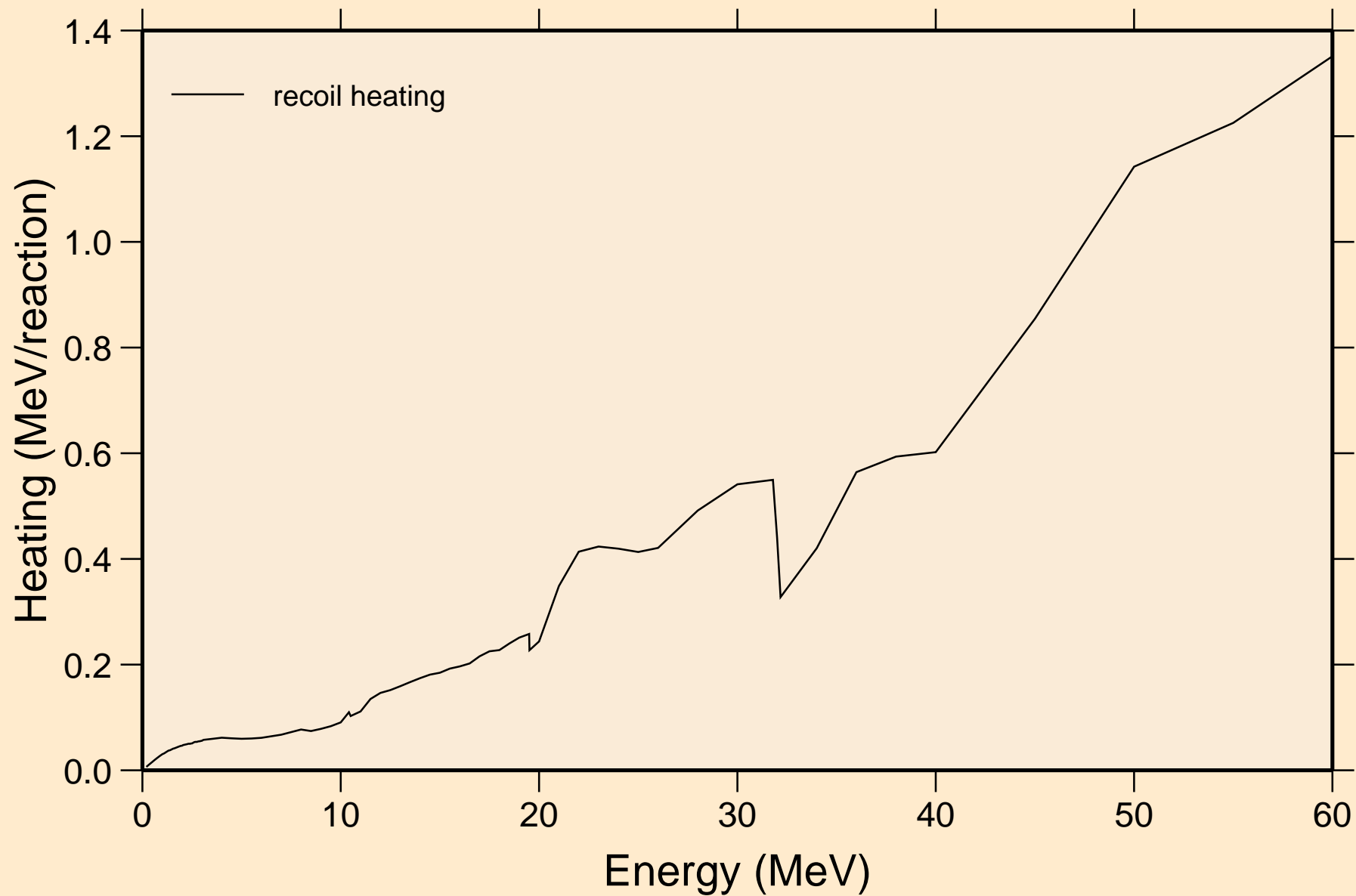

# 25-MN-55 FOR FENDL-3.2 FROM INDL/V-3 BY NJOY2016.60+ ON

## Particle production cross sections

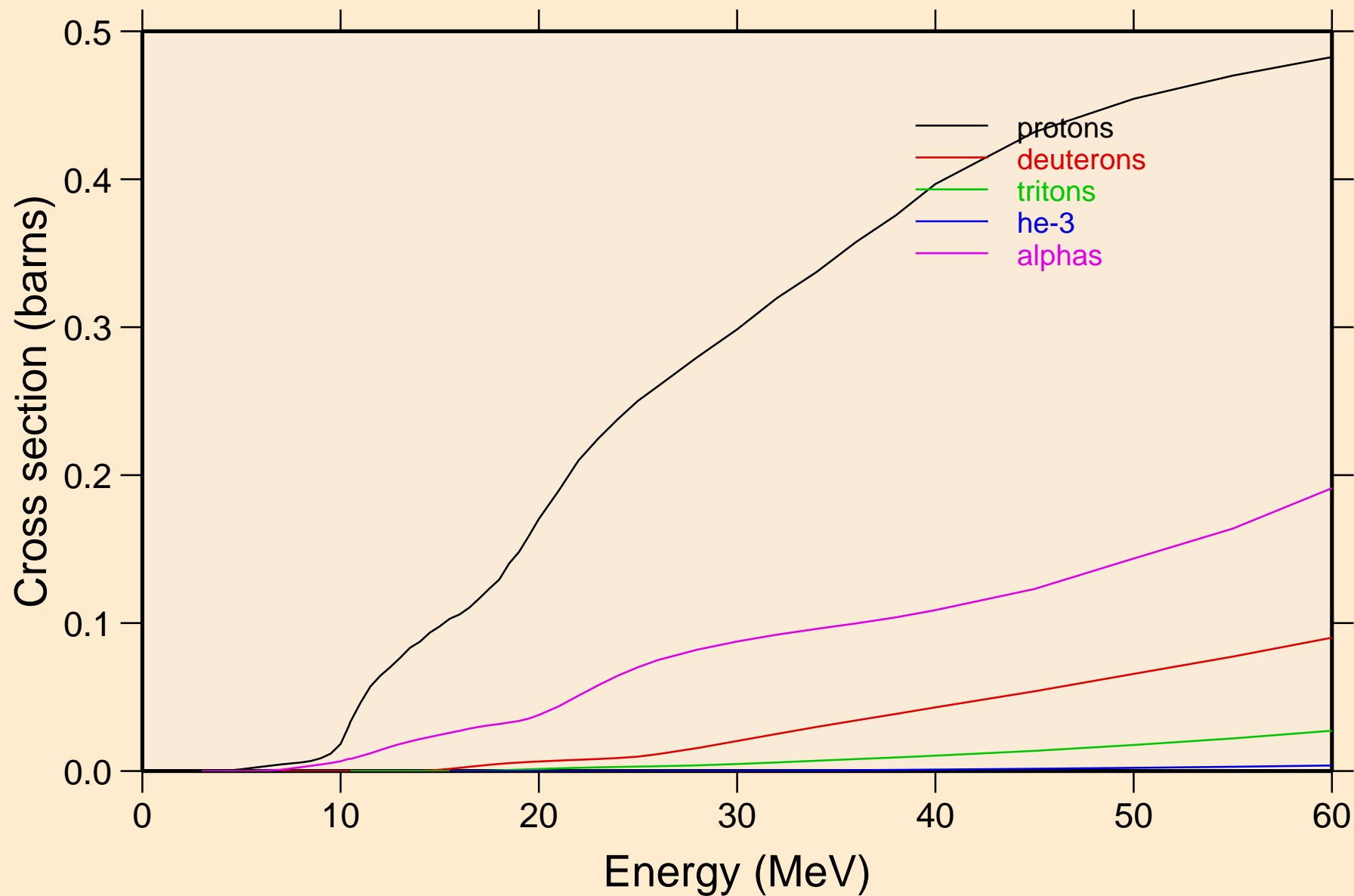

25-MN-55 FOR FENDL-3.2 FROM INDLV-3 BY NJOY2016.60+ ON  
protons from (n,x)

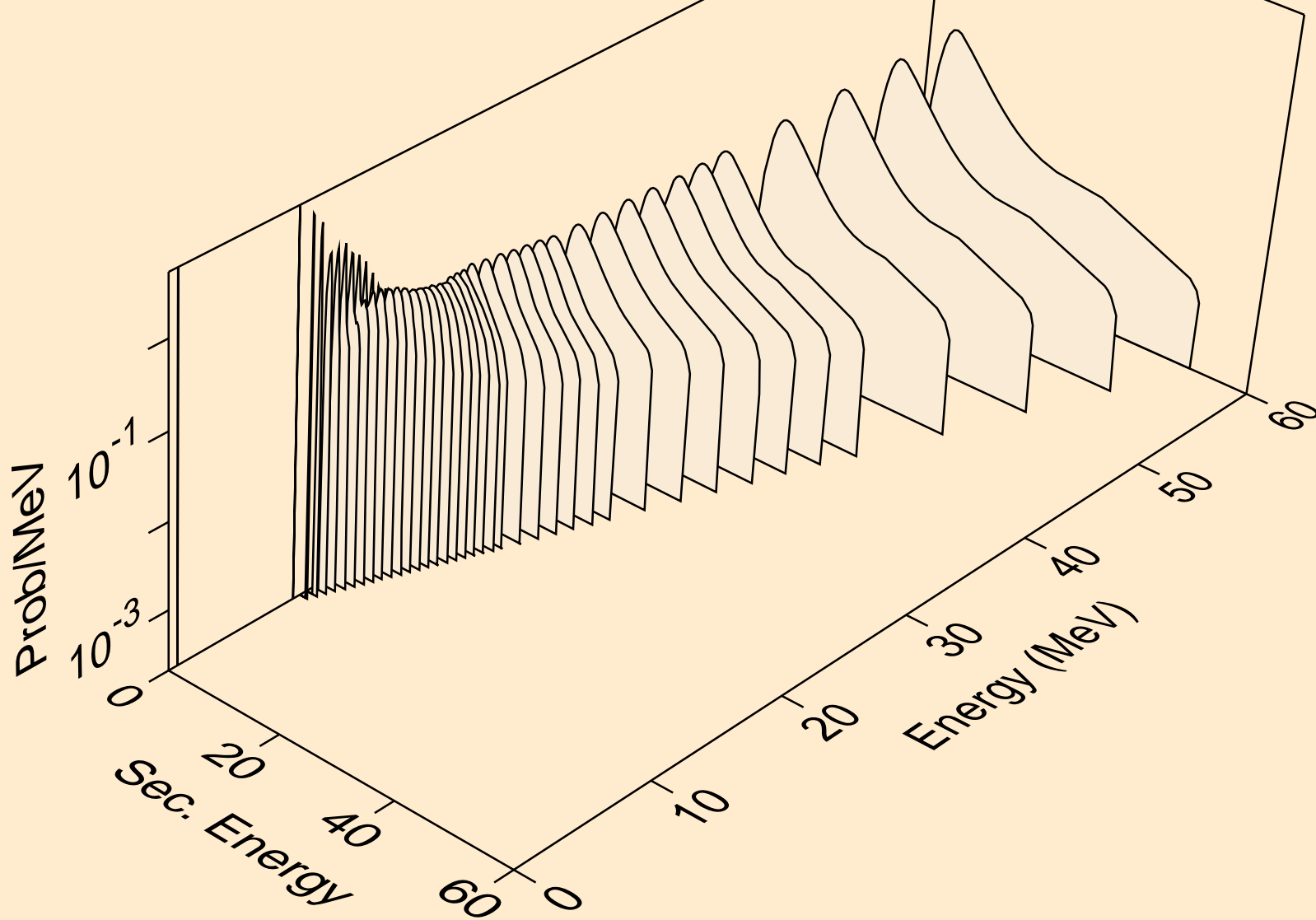

25-MN-55 FOR FENDL-3.2 FROM INDL/V-3 BY NJOY2016.60+ ON  
angular distribution for (n,p\*0) proton

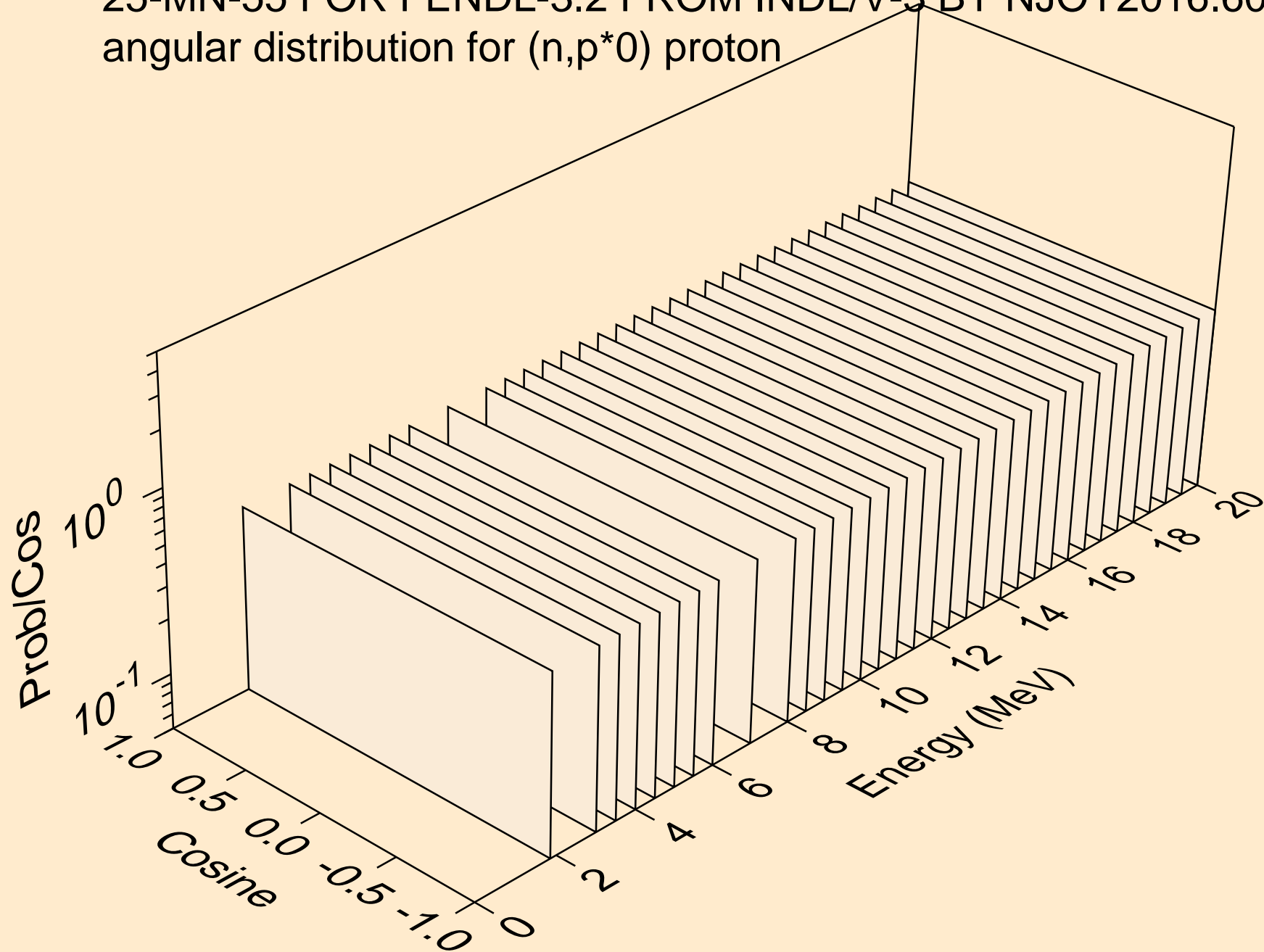

25-MN-55 FOR FENDL-3.2 FROM INDL/V-3 BY NJOY2016.60+ ON  
angular distribution for (n,p\*0) proton

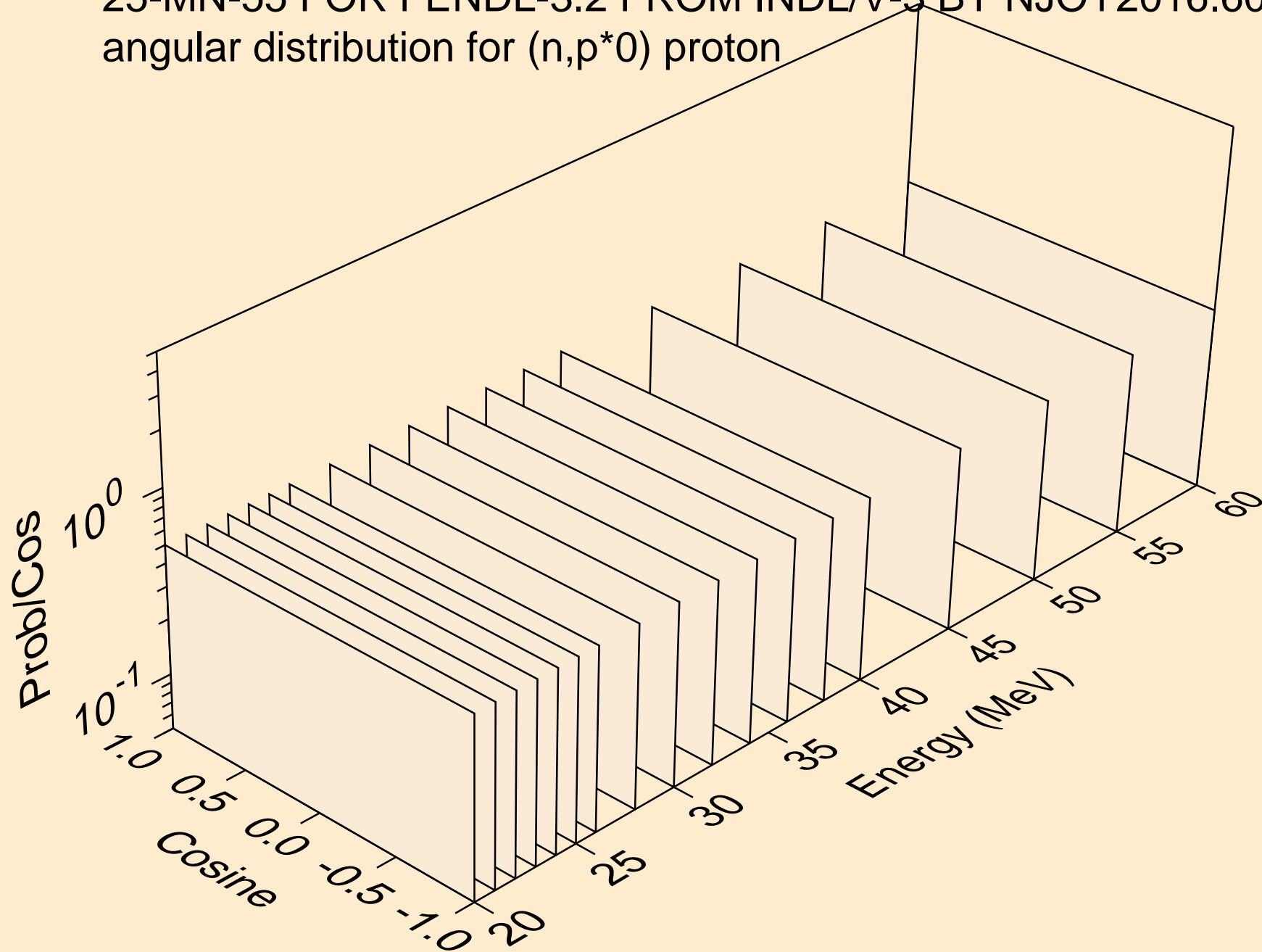



25-MN-55 FOR FENDL-3.2 FROM INDL/V-3 BY NJOY2016.60+ ON  
angular distribution for (n,p\*1) proton

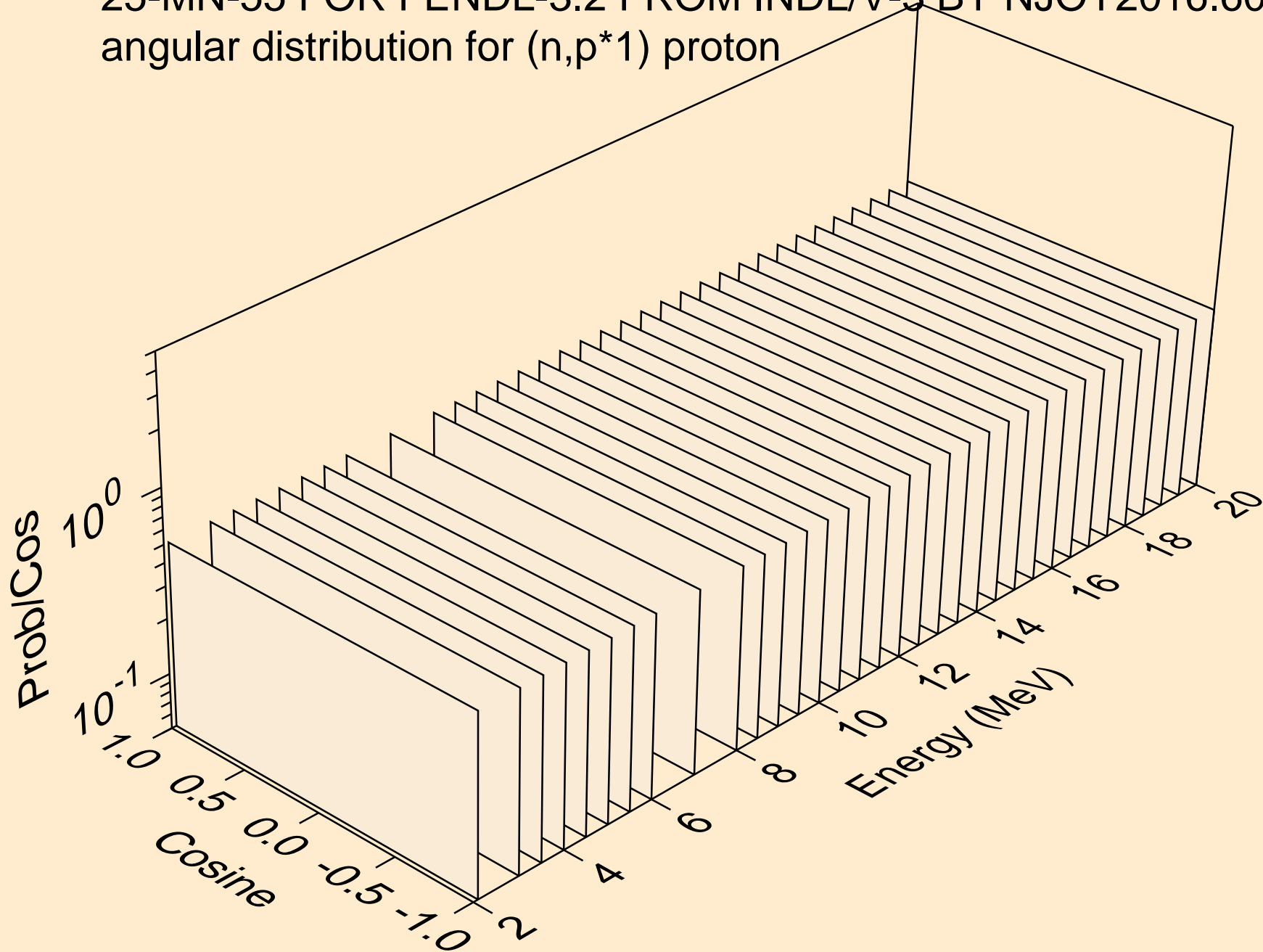

25-MN-55 FOR FENDL-3.2 FROM INDL/V-3 BY NJOY2016.60+ ON  
angular distribution for (n,p\*1) proton

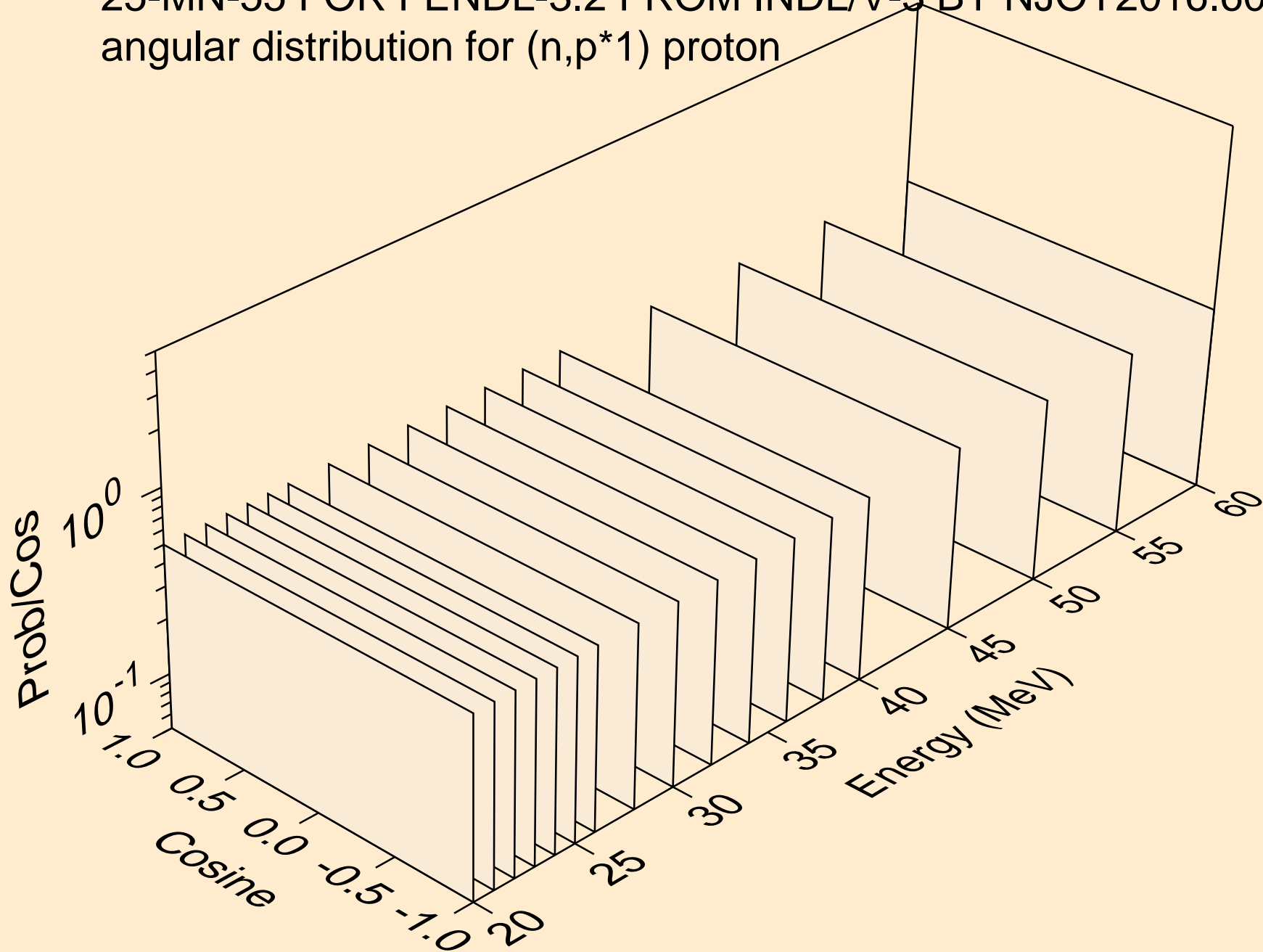

25-MN-55 FOR FENDL-3.2 FROM INDL/V-3 BY NJOY2016.60+ ON  
angular distribution for (n,p\*2) proton

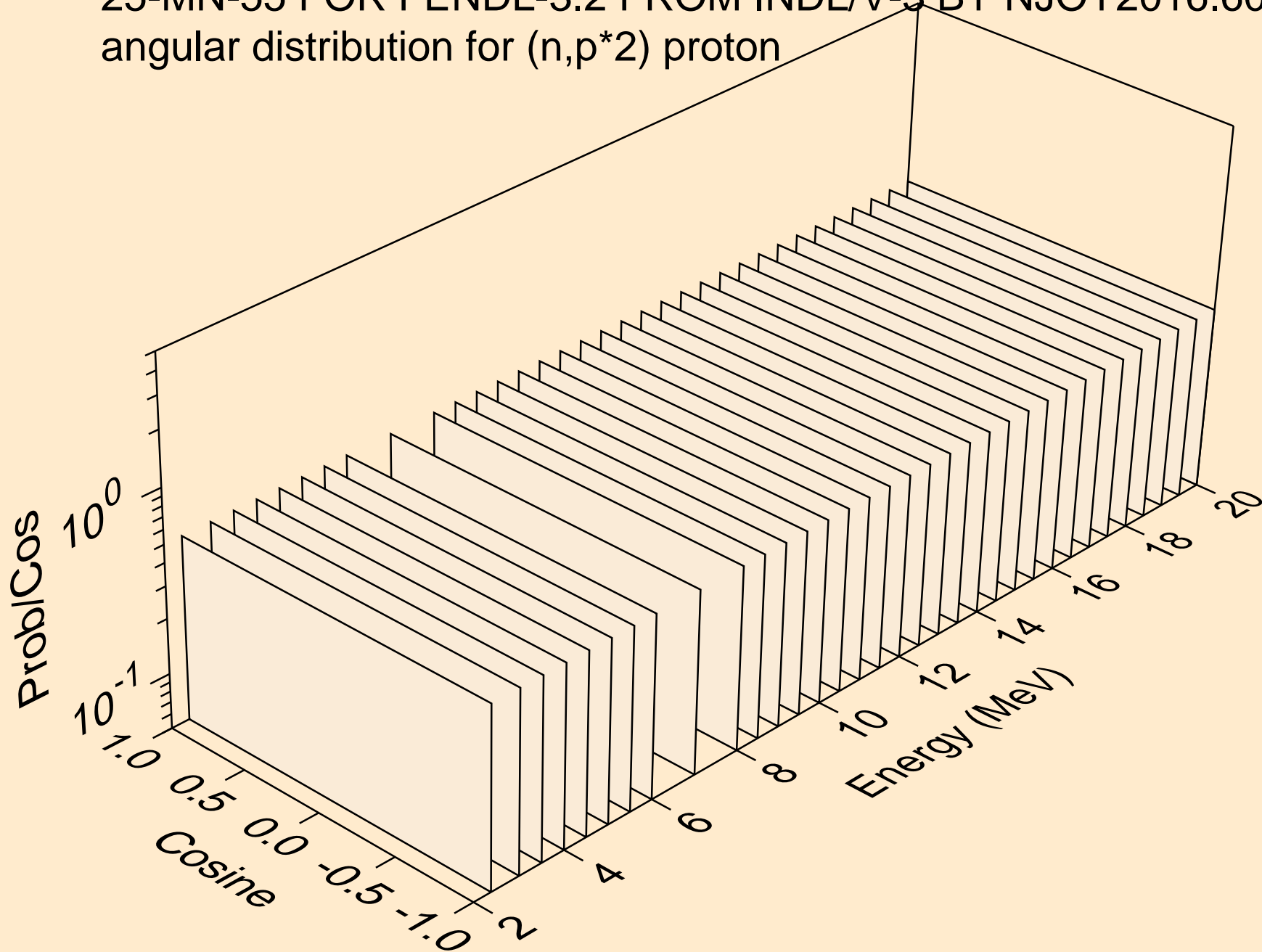

25-MN-55 FOR FENDL-3.2 FROM INDL/V-3 BY NJOY2016.60+ ON  
angular distribution for (n,p\*2) proton

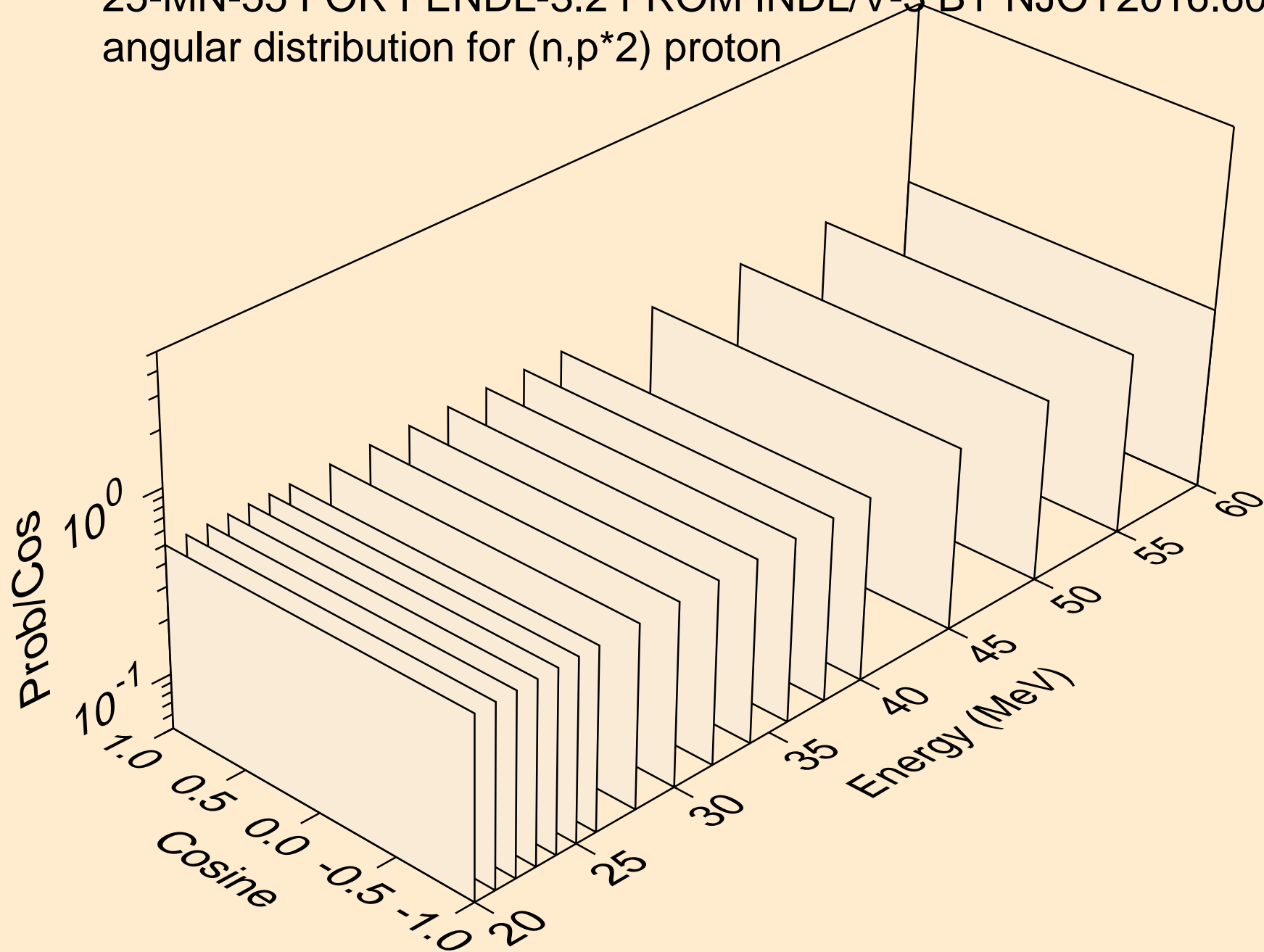

25-MN-55 FOR FENDL-3.2 FROM INDL/V-3 BY NJOY2016.60+ ON  
angular distribution for (n,p\*3) proton

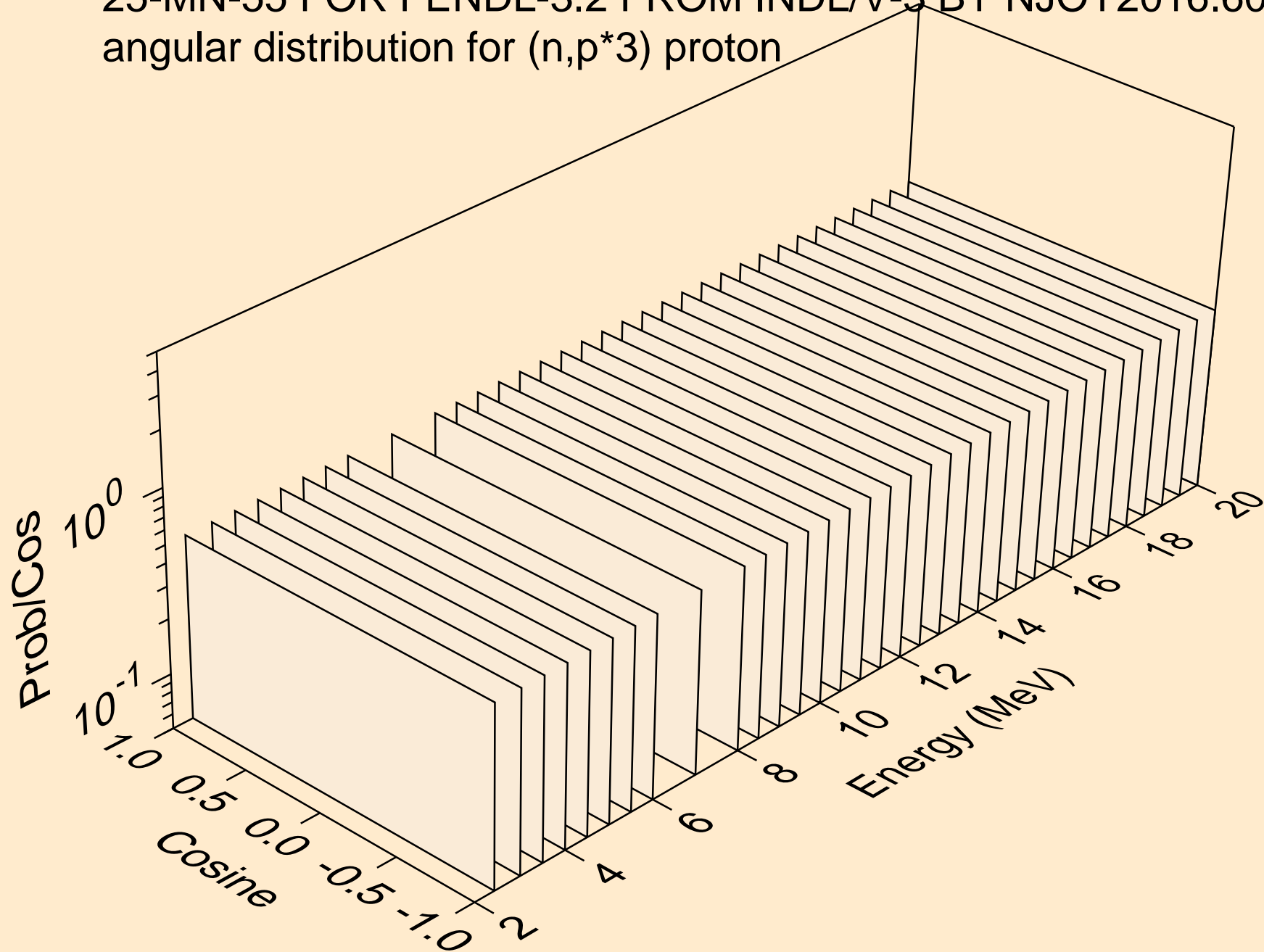

25-MN-55 FOR FENDL-3.2 FROM INDL/V-3 BY NJOY2016.60+ ON  
angular distribution for (n,p\*3) proton

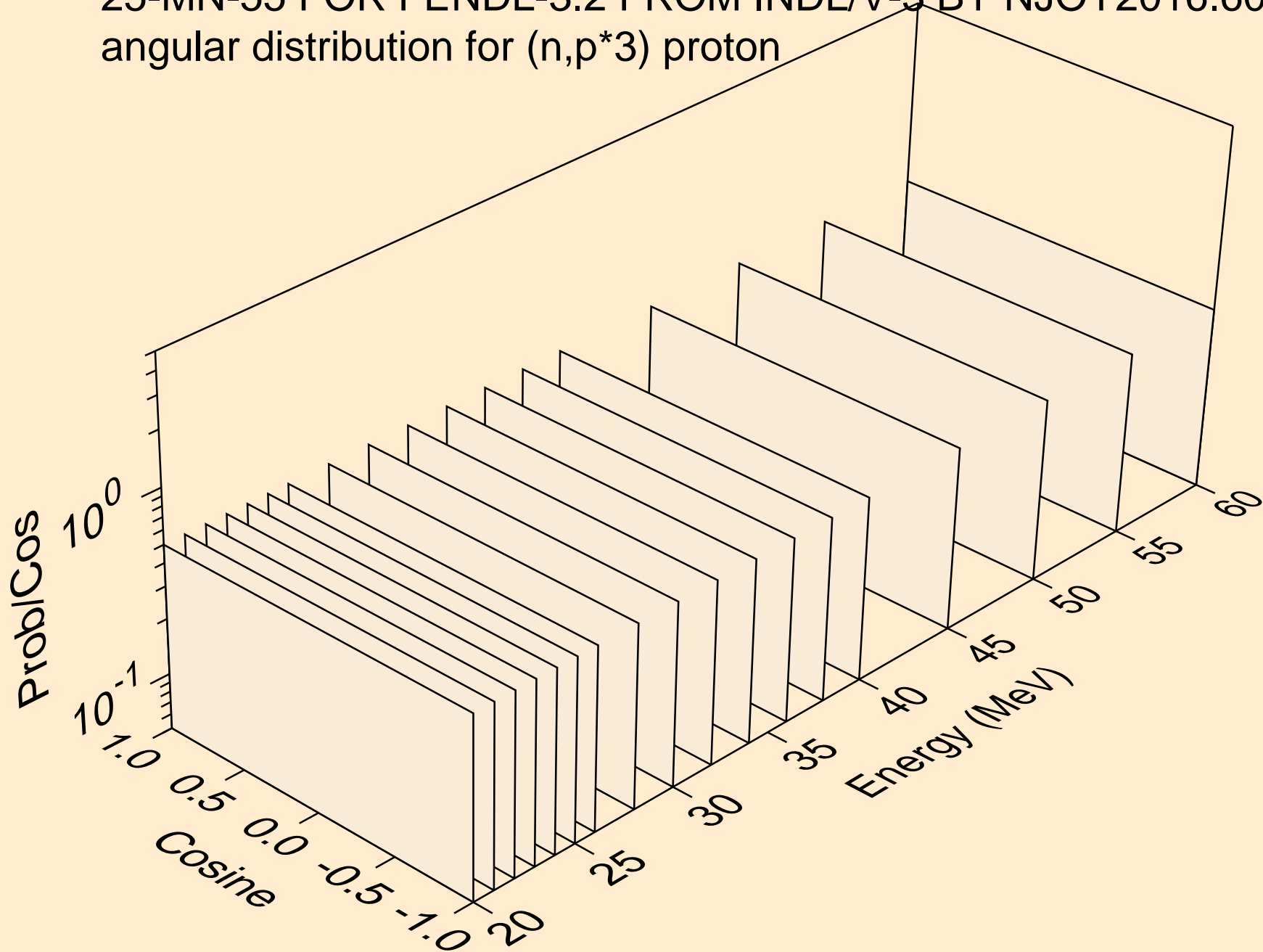

25-MN-55 FOR FENDL-3.2 FROM INDL/V-3 BY NJOY2016.60+ ON  
angular distribution for (n,p\*4) proton

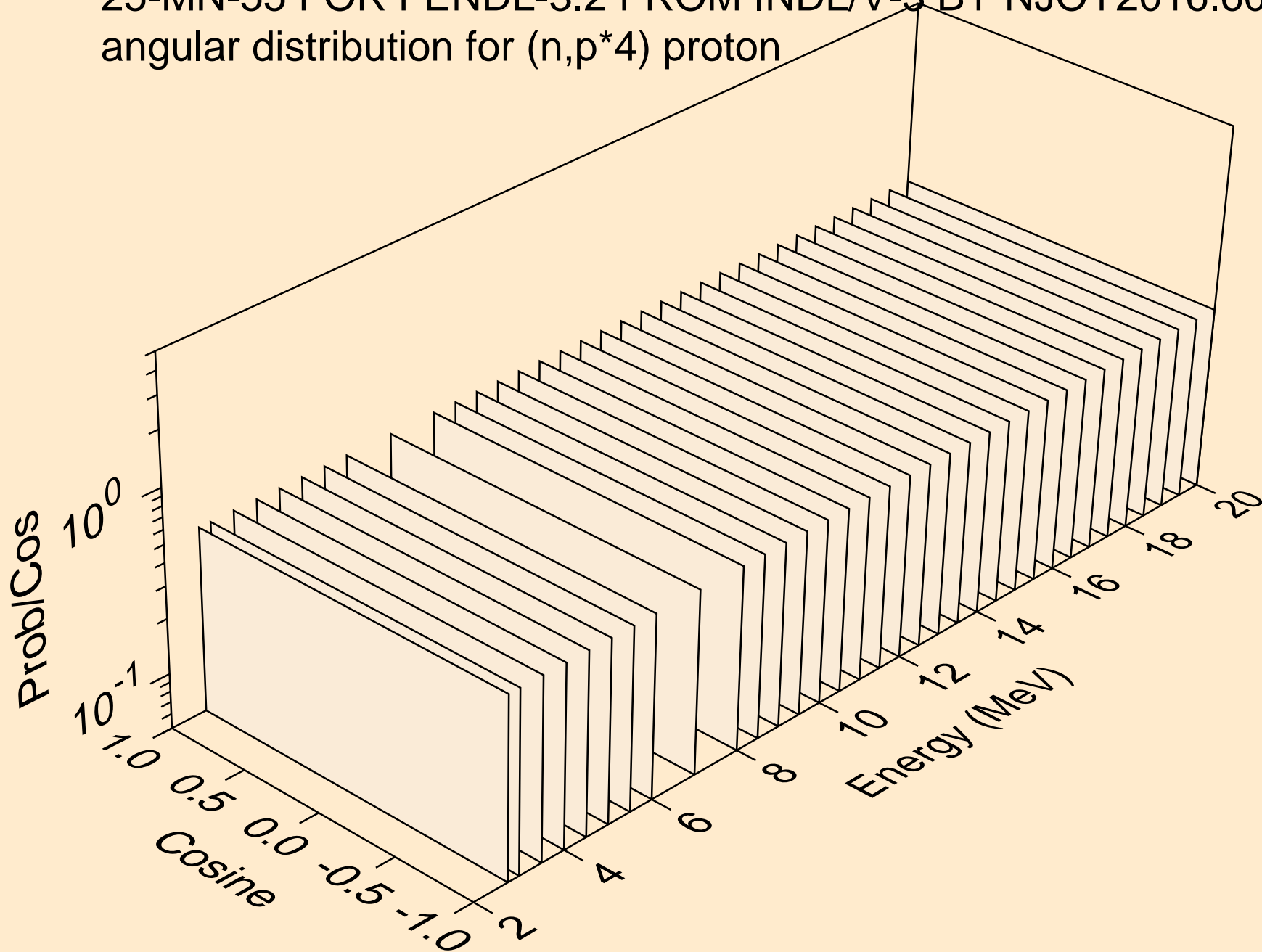

25-MN-55 FOR FENDL-3.2 FROM INDL/V-3 BY NJOY2016.60+ ON  
angular distribution for (n,p\*4) proton

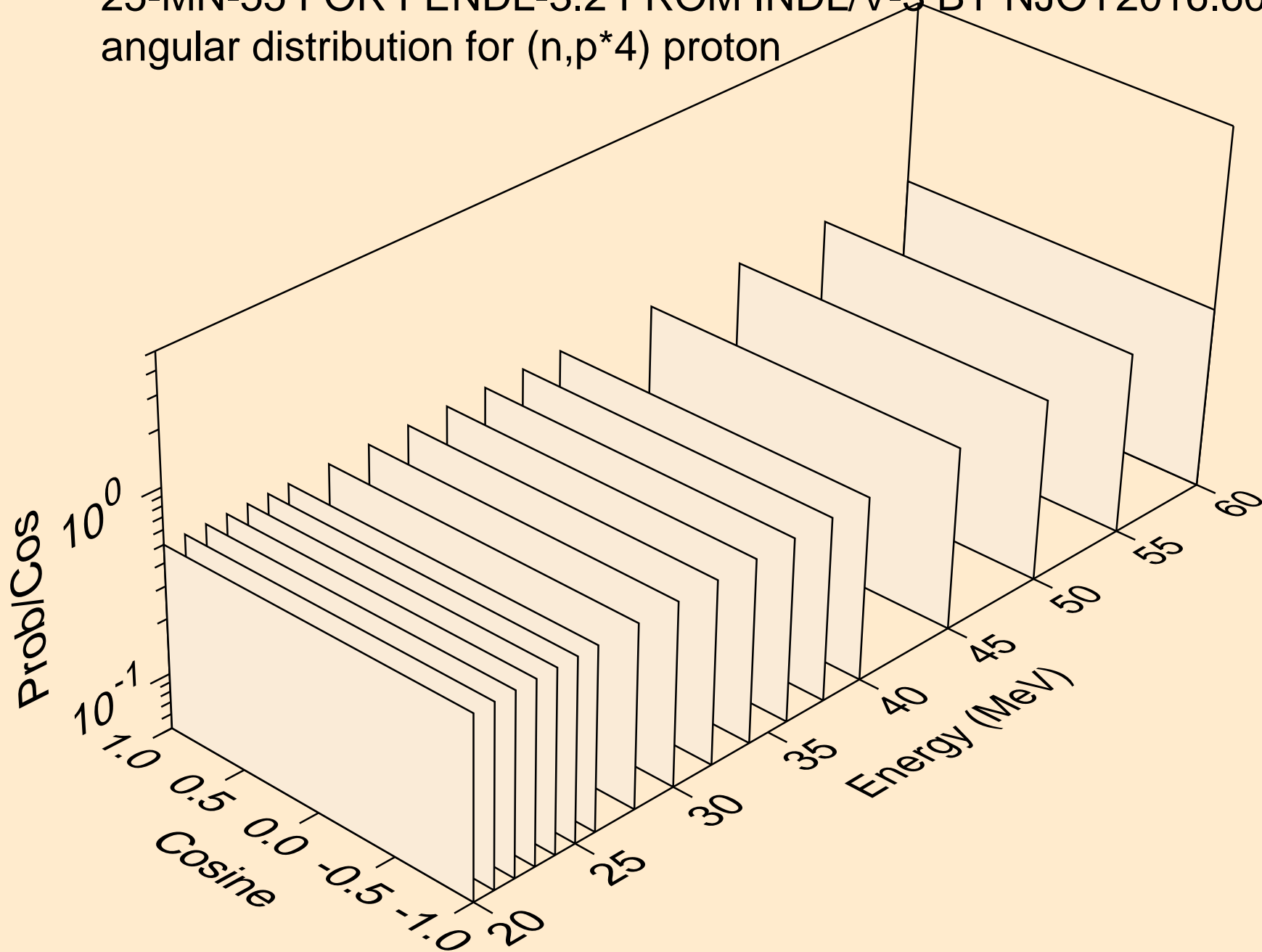



25-MN-55 FOR FENDL-3.2 FROM INDL/V-3 BY NJOY2016.60+ ON  
angular distribution for (n,p\*5) proton

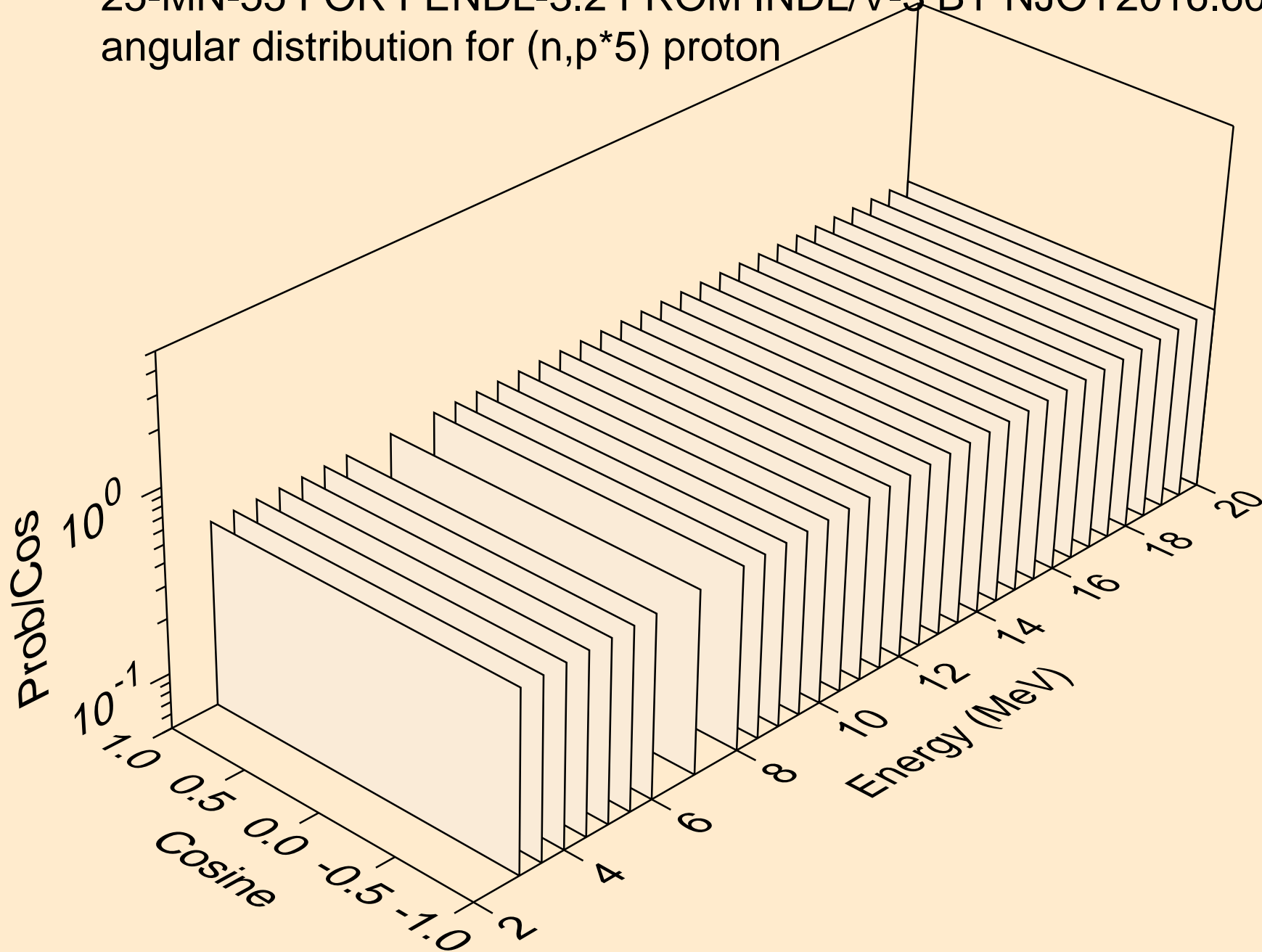

25-MN-55 FOR FENDL-3.2 FROM INDL/V-3 BY NJOY2016.60+ ON  
angular distribution for (n,p\*5) proton

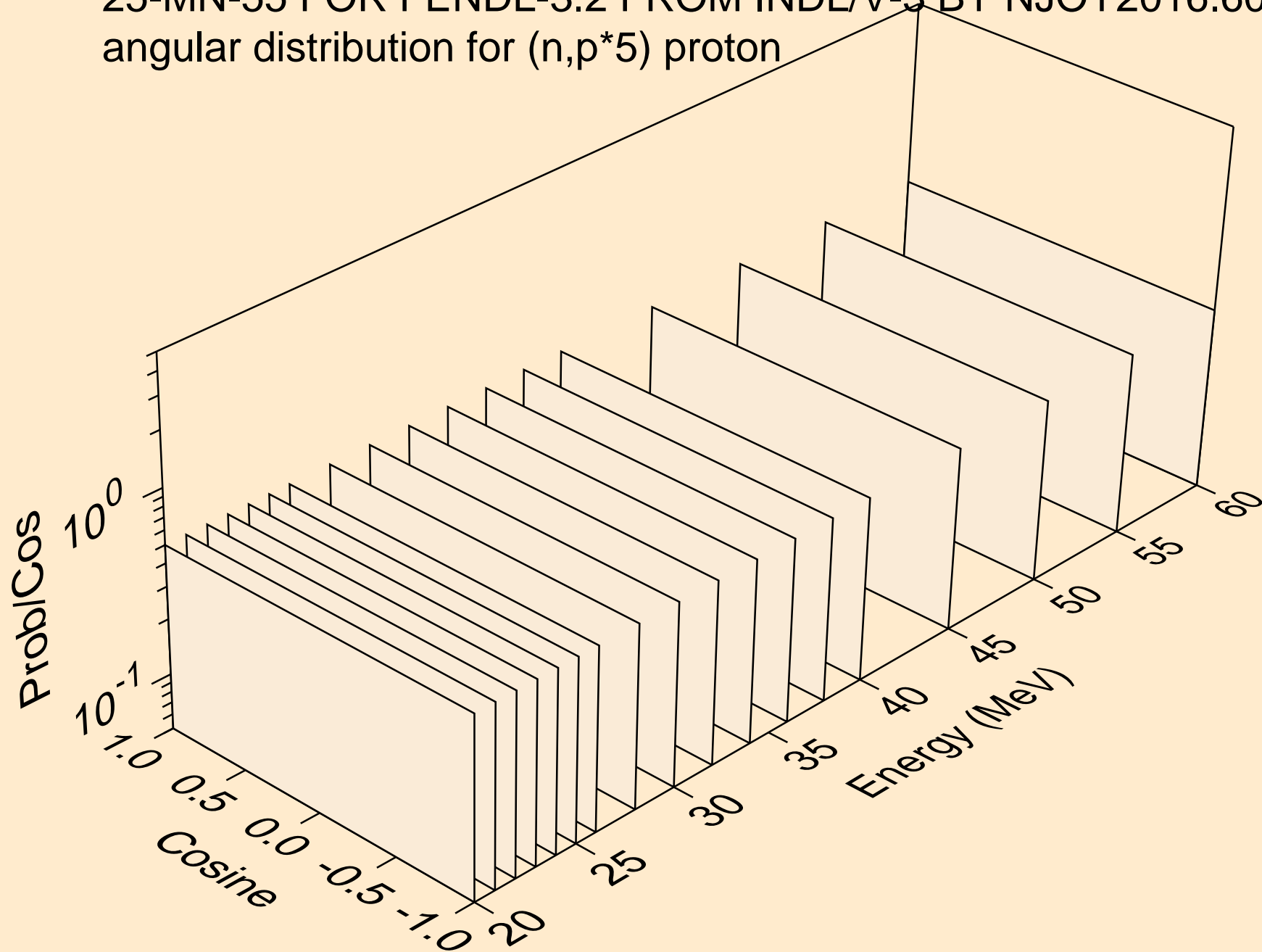

25-MN-55 FOR FENDL-3.2 FROM INDL/V-3 BY NJOY2016.60+ ON  
angular distribution for (n,p\*6) proton

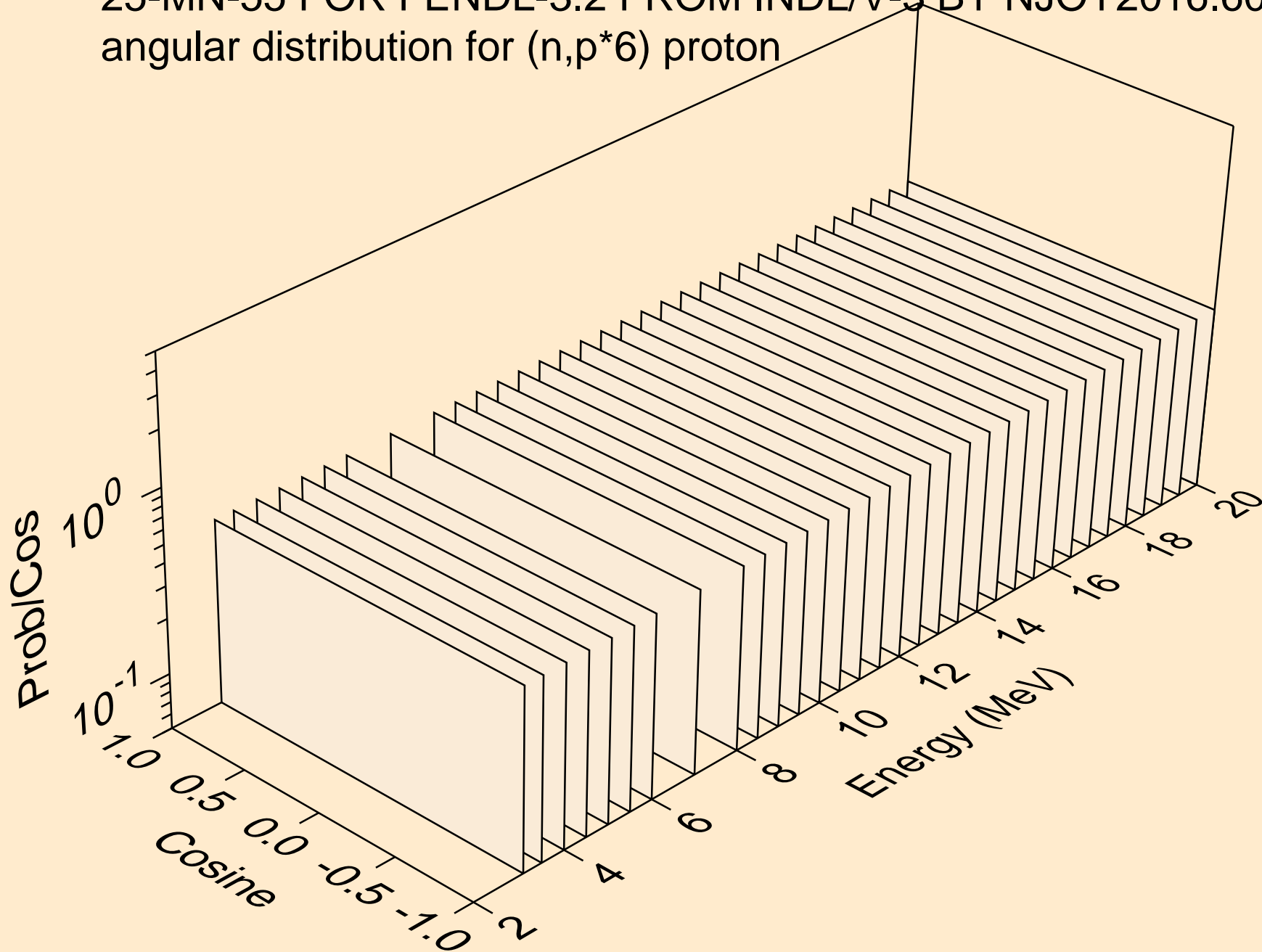

25-MN-55 FOR FENDL-3.2 FROM INDL/V-3 BY NJOY2016.60+ ON  
angular distribution for (n,p\*6) proton

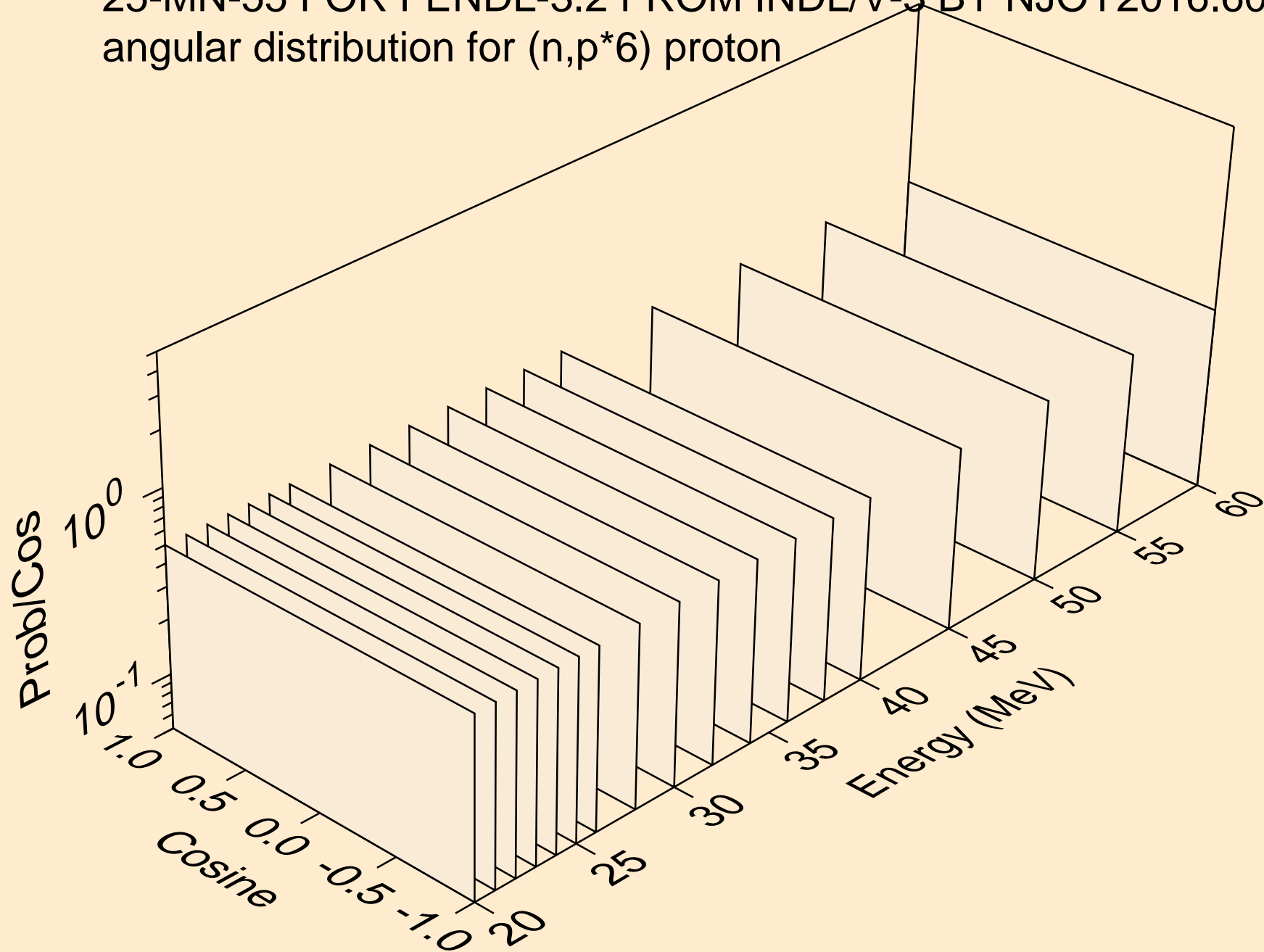

25-MN-55 FOR FENDL-3.2 FROM INDL/V-3 BY NJOY2016.60+ ON  
angular distribution for (n,p\*7) proton

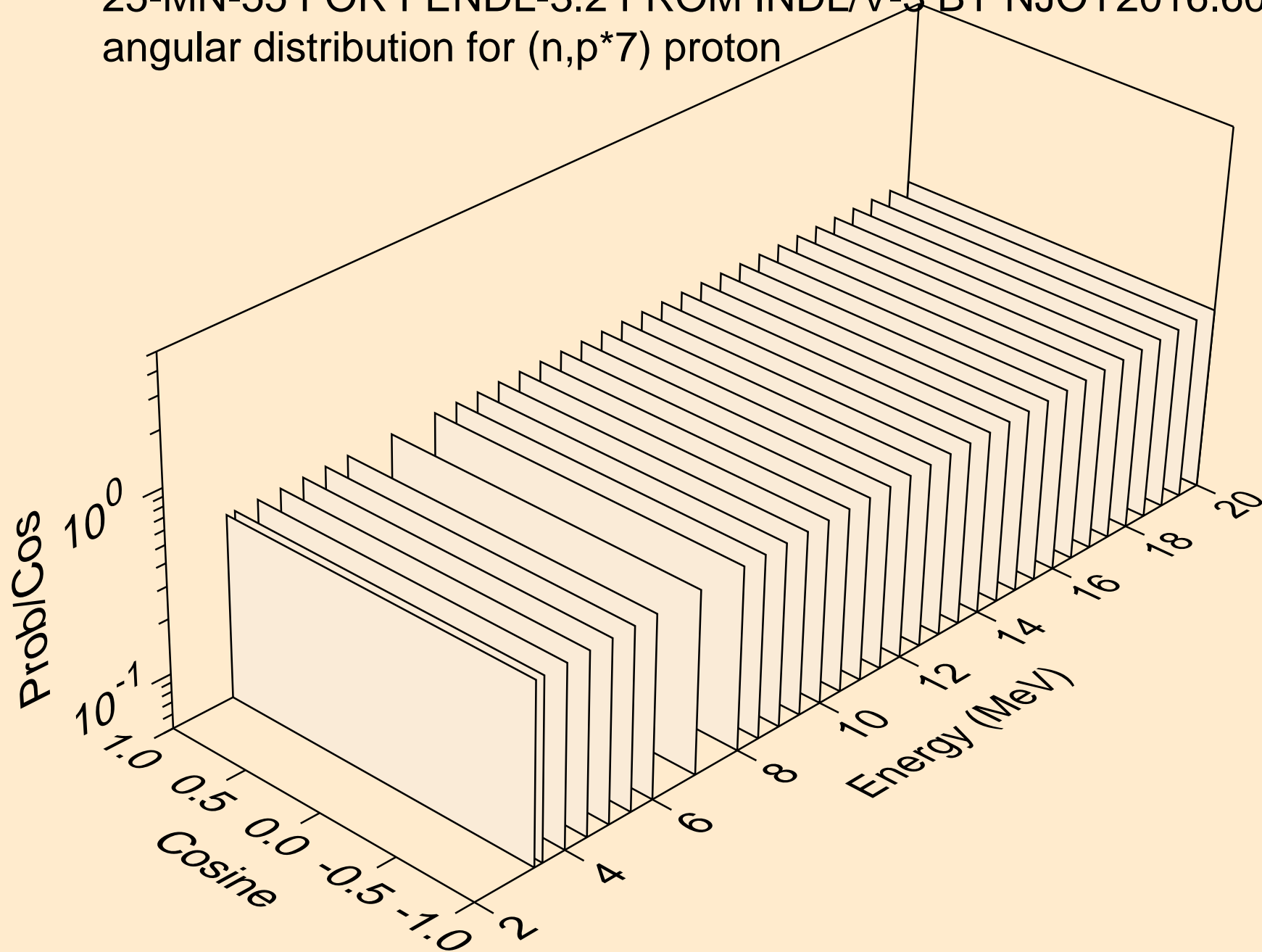

25-MN-55 FOR FENDL-3.2 FROM INDL/V-3 BY NJOY2016.60+ ON  
angular distribution for (n,p\*7) proton

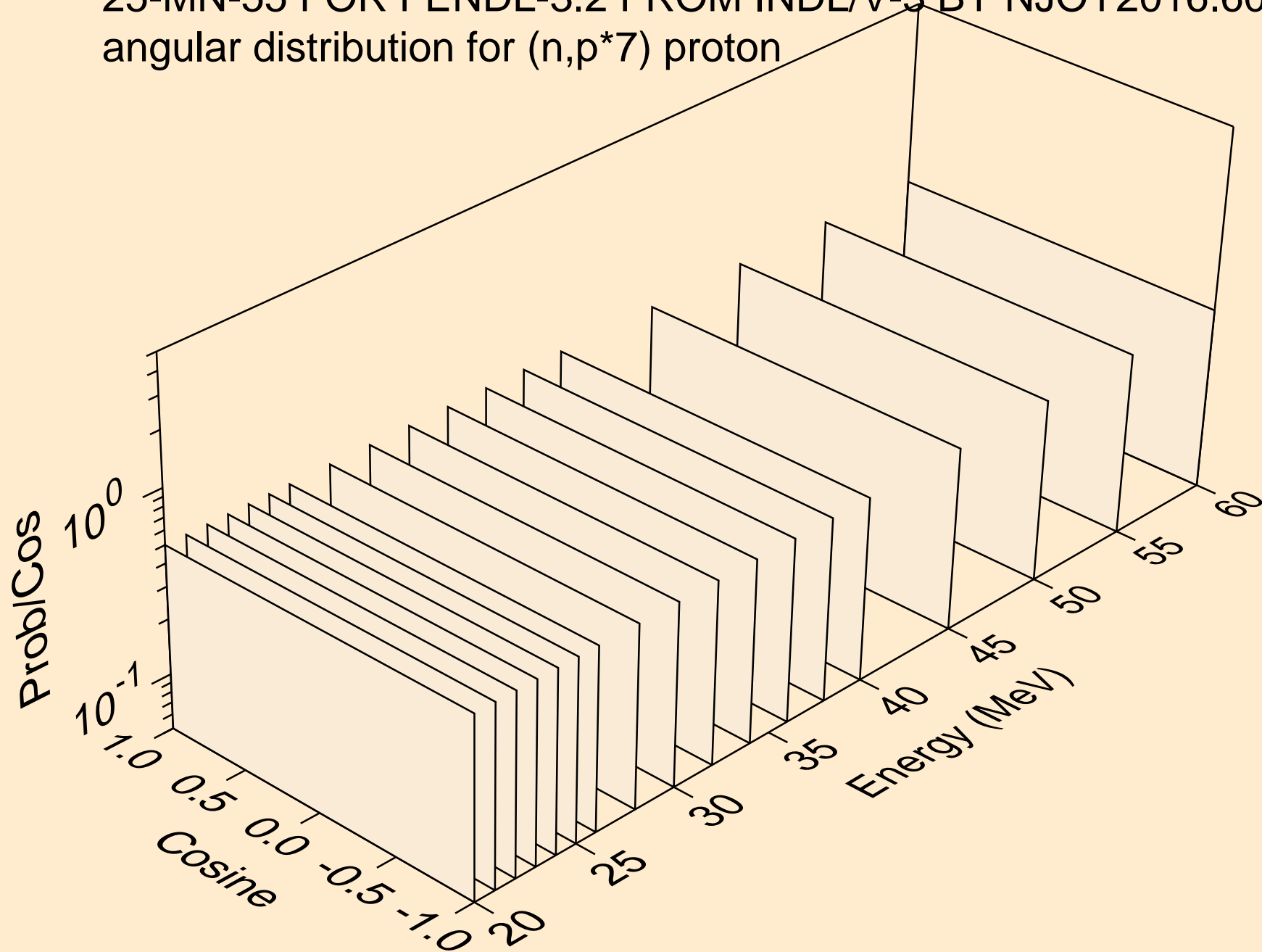

25-MN-55 FOR FENDL-3.2 FROM INDL/V-3 BY NJOY2016.60+ ON  
angular distribution for (n,p\*8) proton

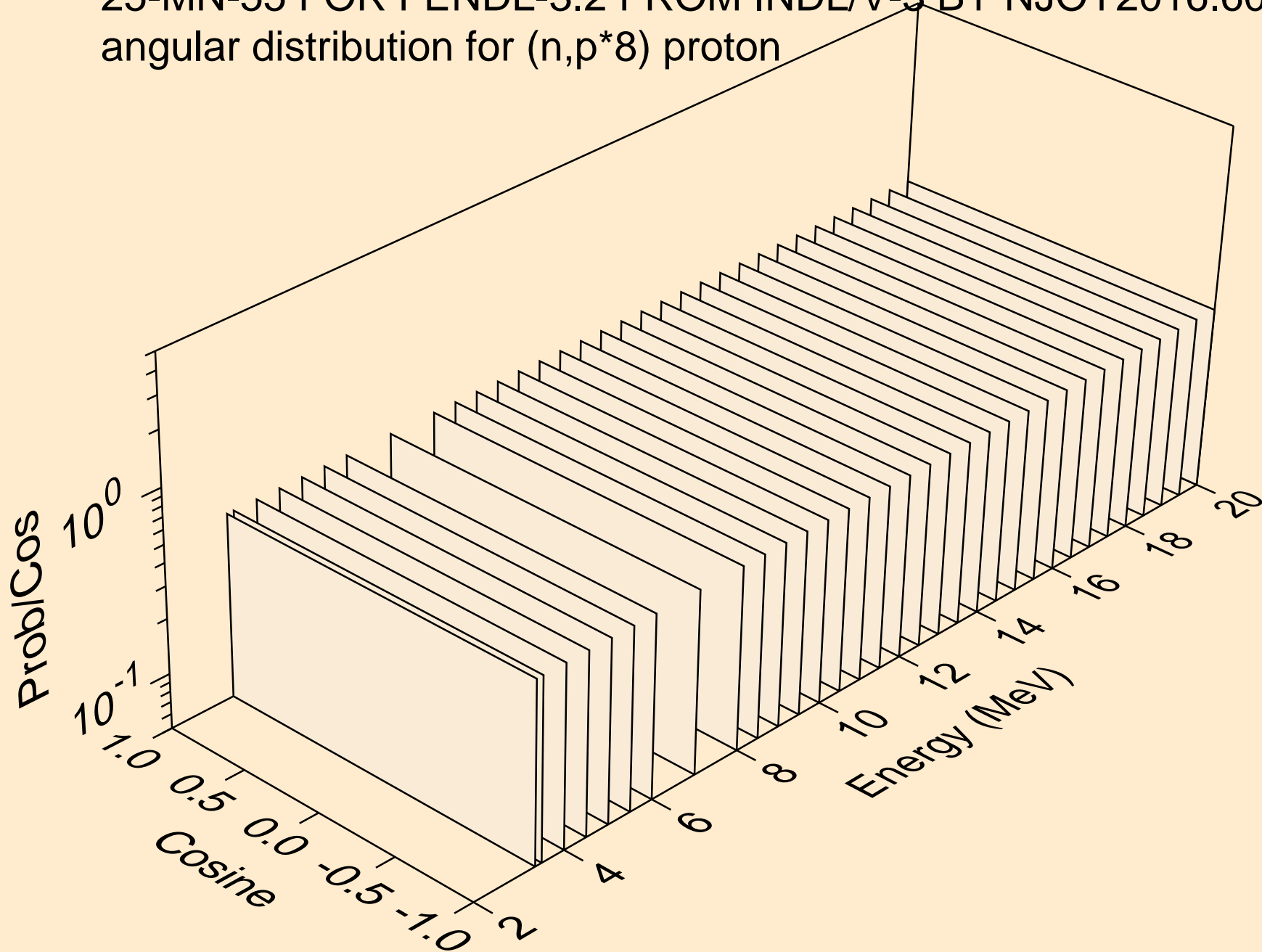

25-MN-55 FOR FENDL-3.2 FROM INDL/V-3 BY NJOY2016.60+ ON  
angular distribution for (n,p\*8) proton

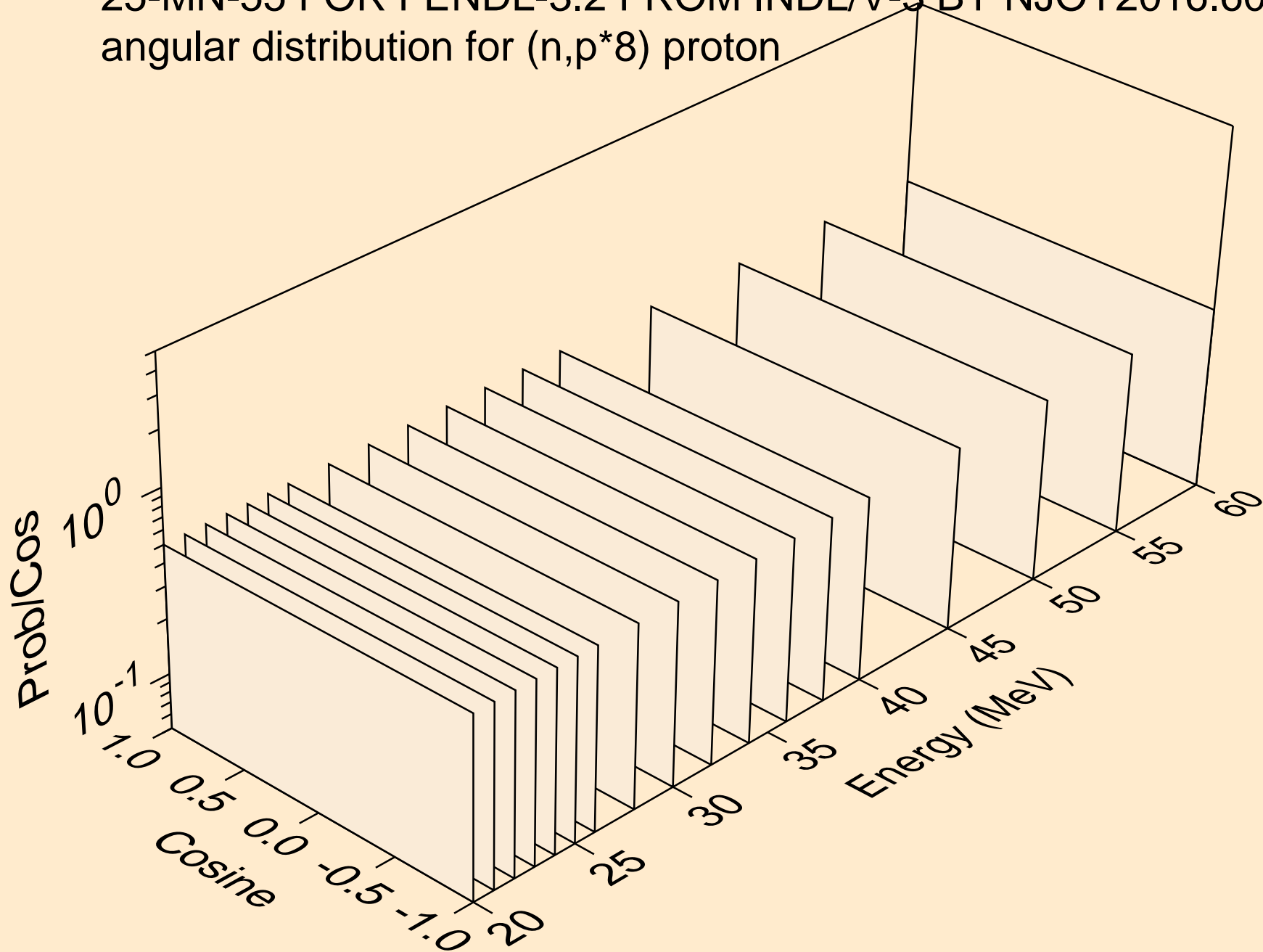



25-MN-55 FOR FENDL-3.2 FROM INDL/V-3 BY NJOY2016.60+ ON  
angular distribution for (n,p\*9) proton

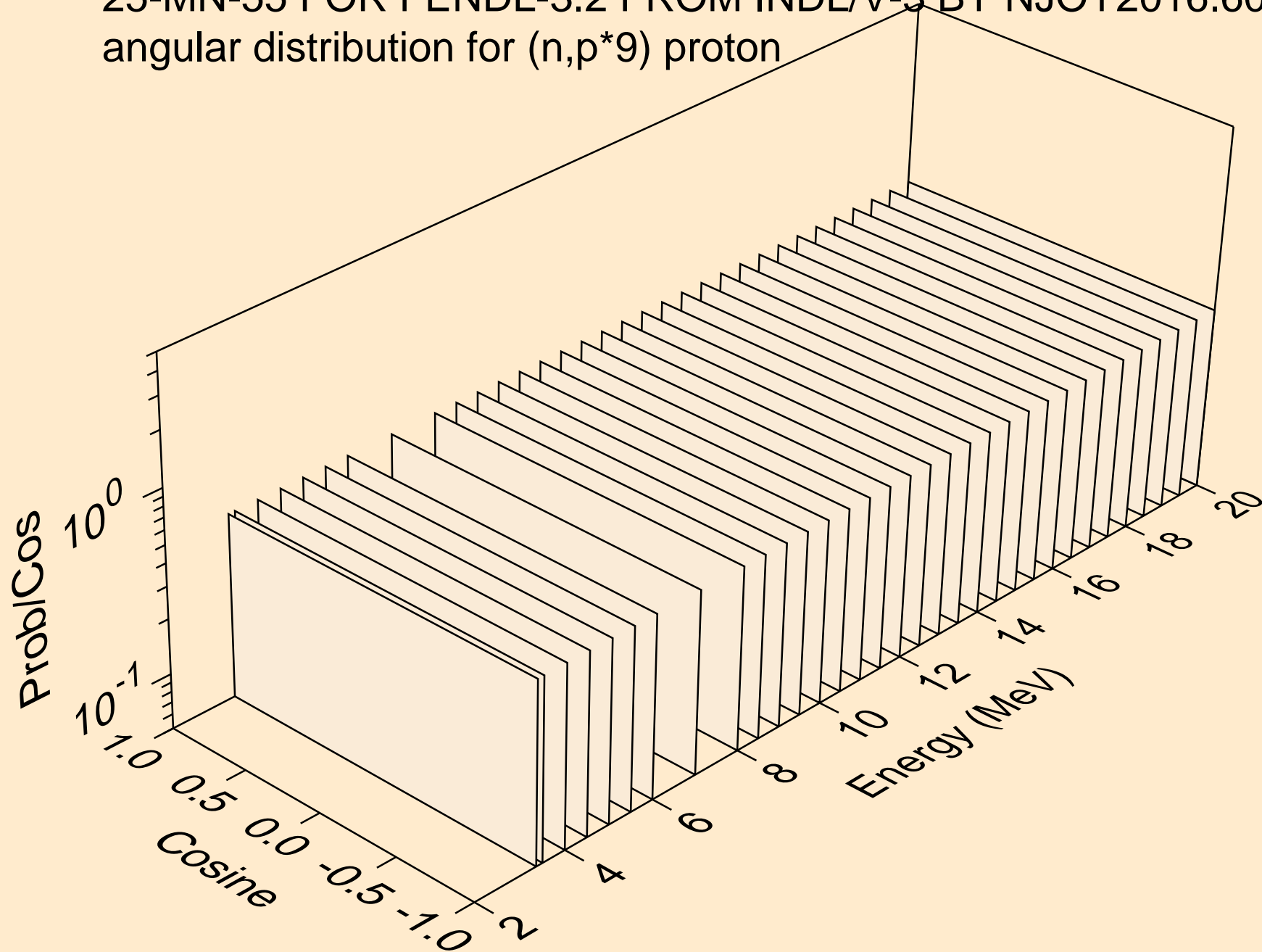

25-MN-55 FOR FENDL-3.2 FROM INDL/V-3 BY NJOY2016.60+ ON  
angular distribution for (n,p\*9) proton

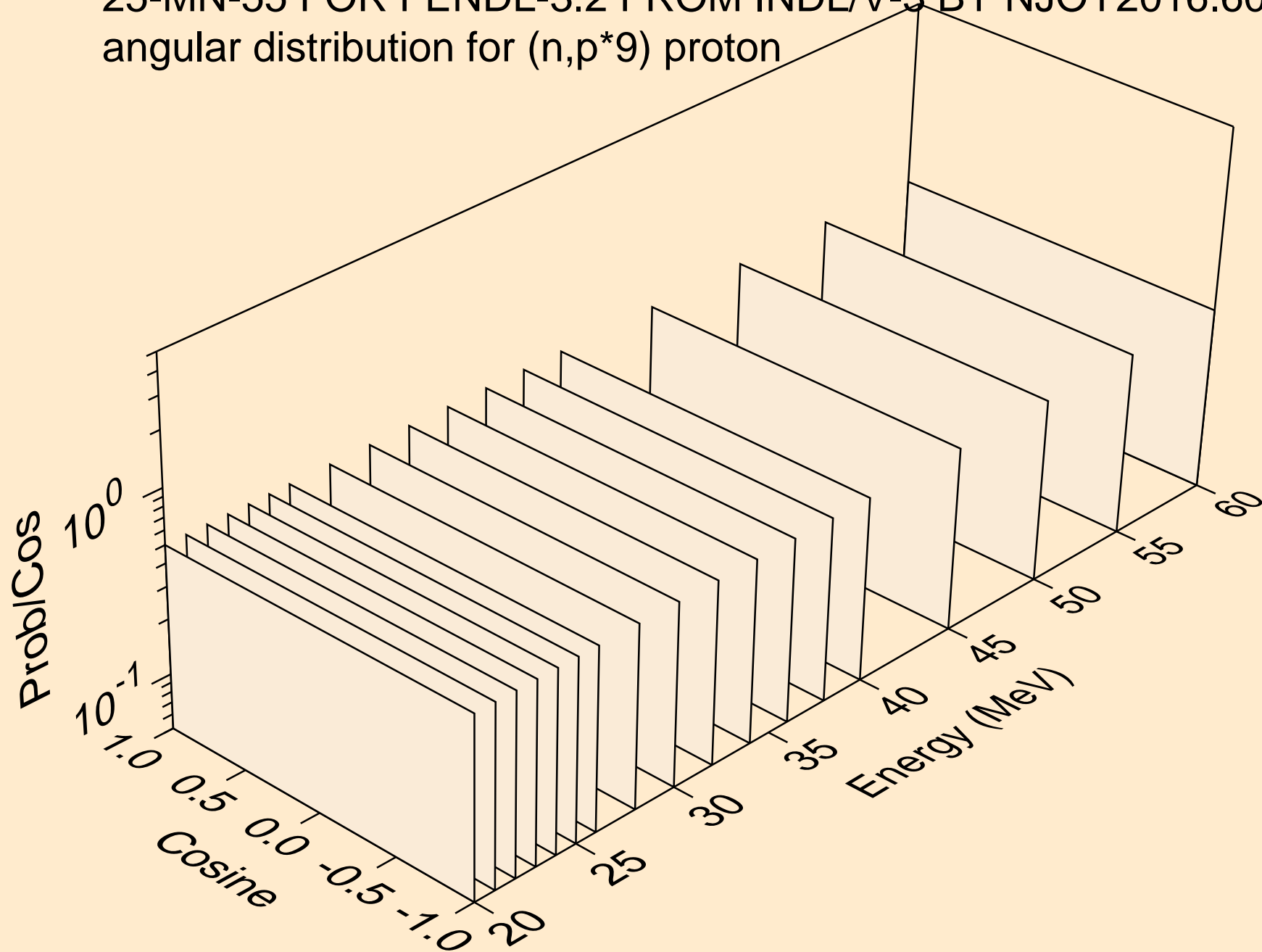

25-MN-55 FOR FENDL-3.2 FROM INDL/V-3 BY NJOY2016.60+ ON  
angular distribution for (n,p\*10) proton

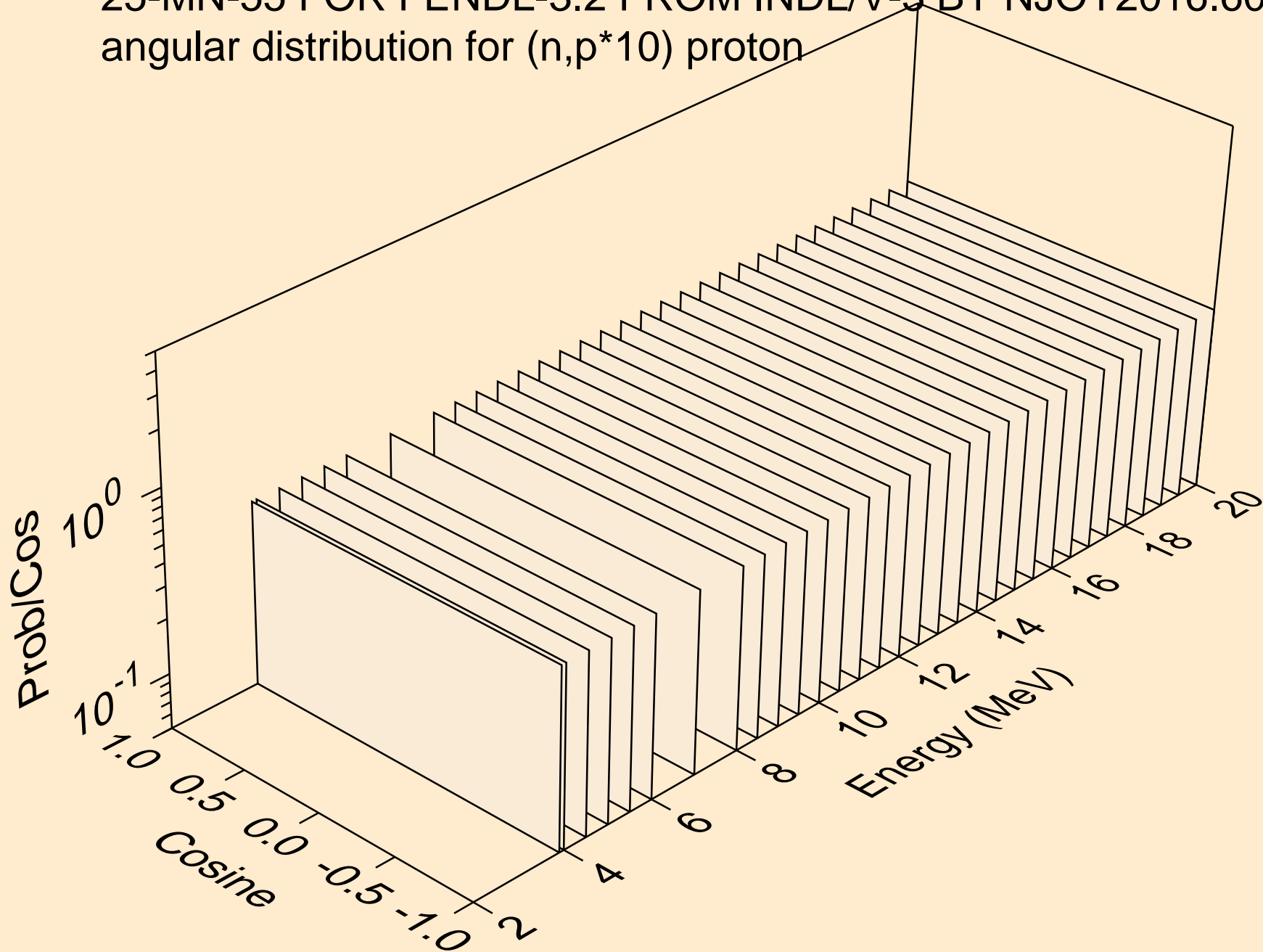

25-MN-55 FOR FENDL-3.2 FROM INDL/V-3 BY NJOY2016.60+ ON  
angular distribution for (n,p\*10) proton

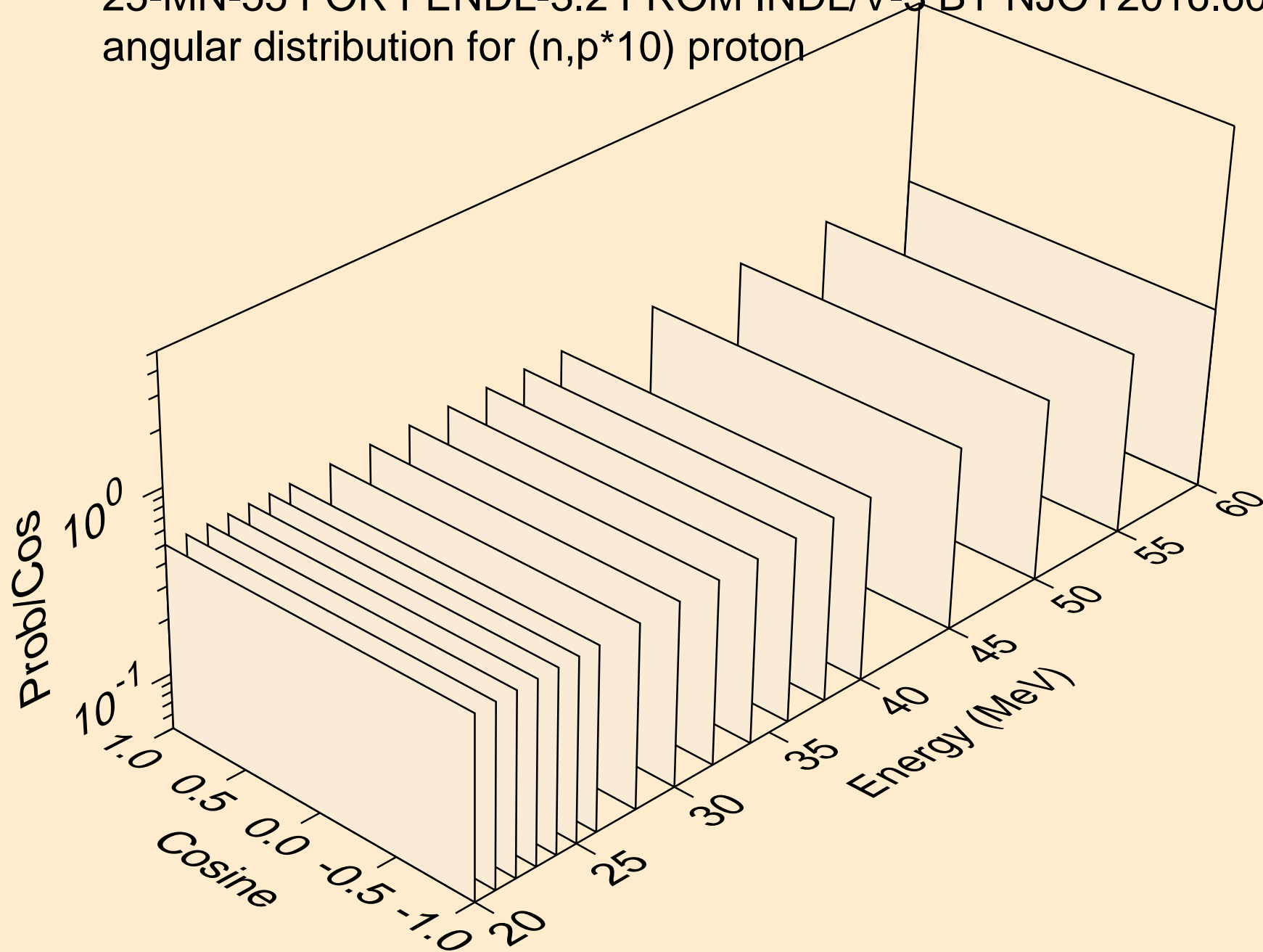

25-MN-55 FOR FENDL-3.2 FROM INDL/V-3 BY NJOY2016.60+ ON  
angular distribution for (n,p\*11) proton

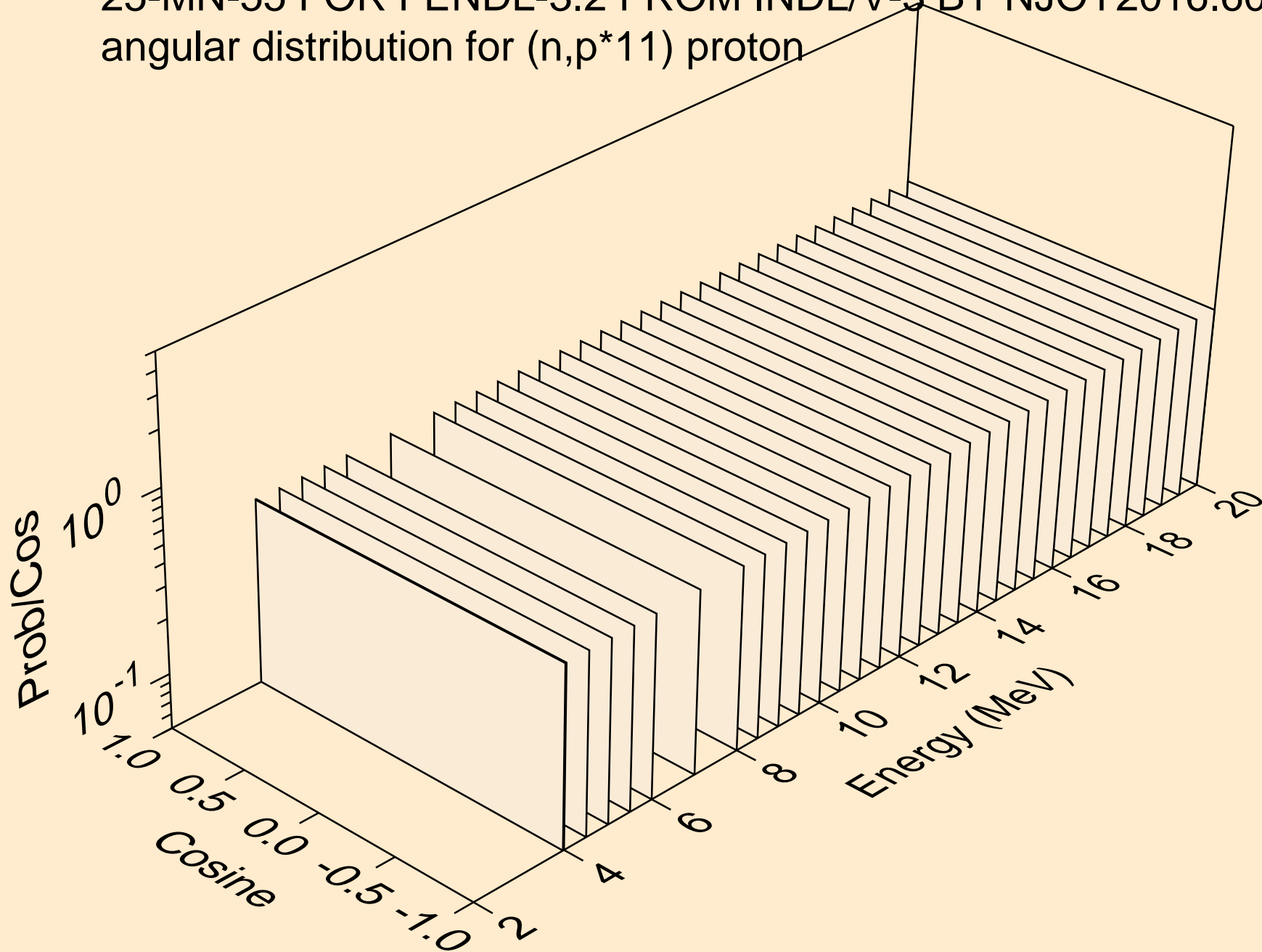

25-MN-55 FOR FENDL-3.2 FROM INDL/V-3 BY NJOY2016.60+ ON  
angular distribution for (n,p\*11) proton

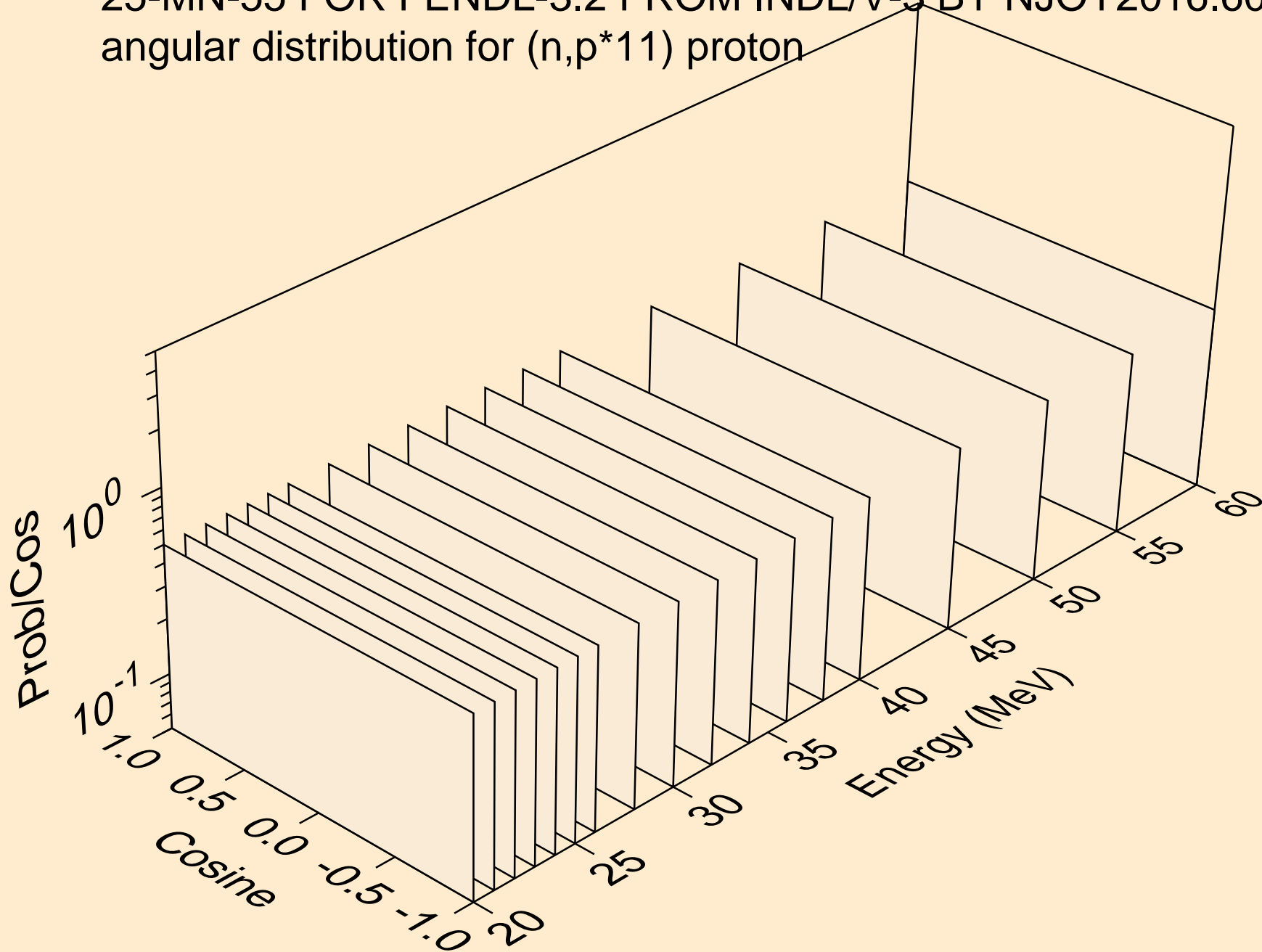

25-MN-55 FOR FENDL-3.2 FROM INDL/V-3 BY NJOY2016.60+ ON  
angular distribution for (n,p\*12) proton

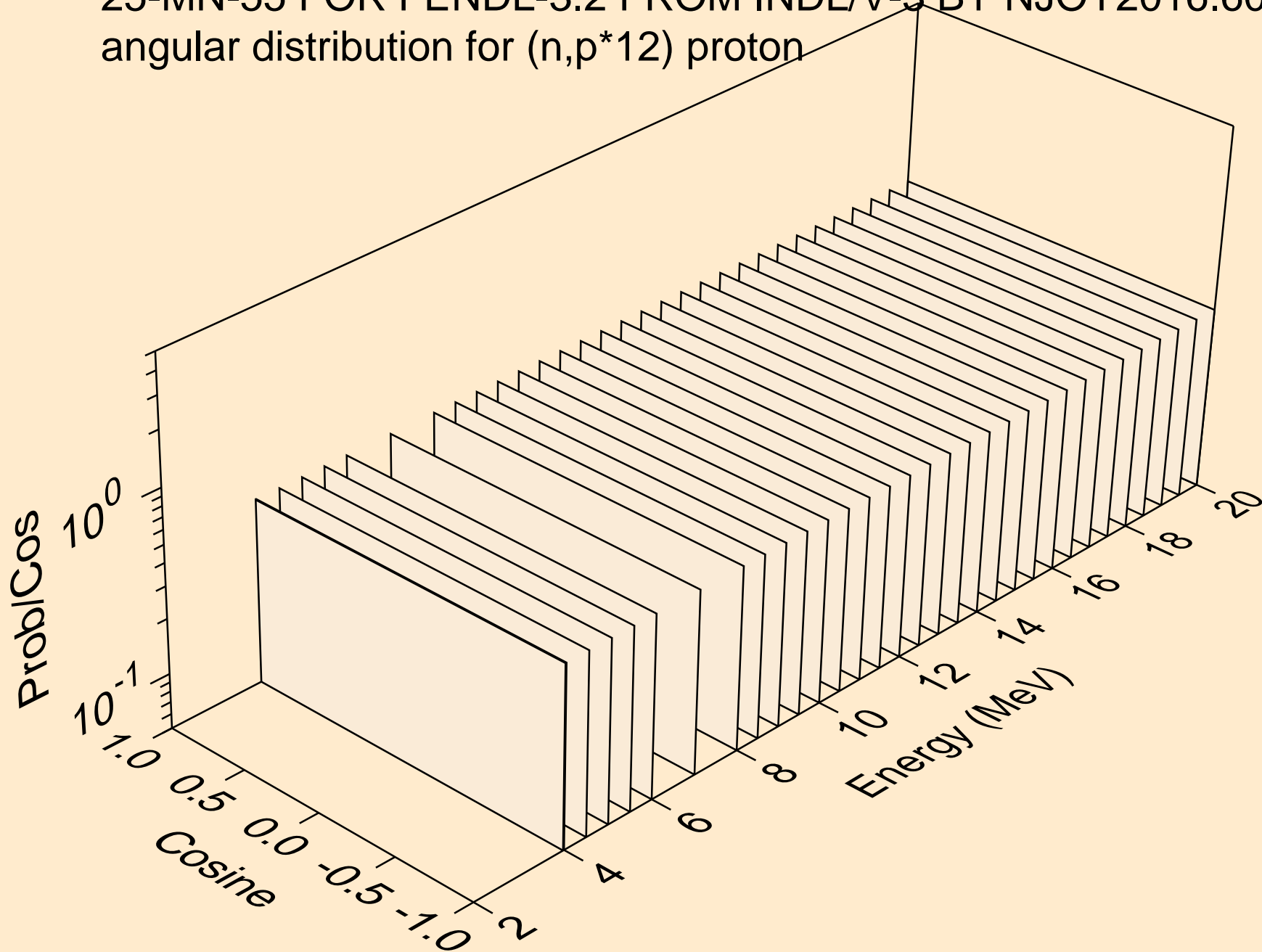

25-MN-55 FOR FENDL-3.2 FROM INDL/V-3 BY NJOY2016.60+ ON  
angular distribution for (n,p\*12) proton

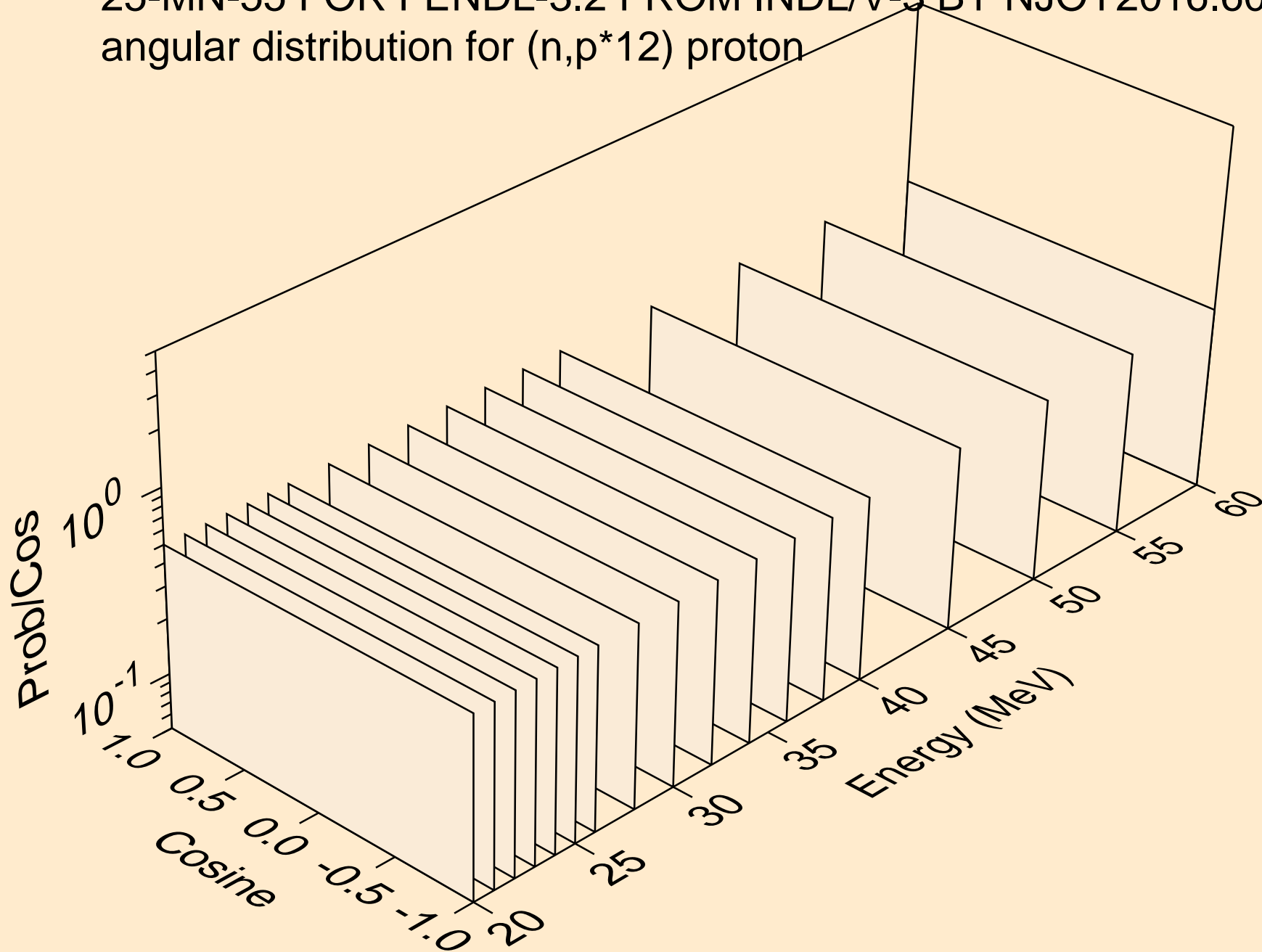



25-MN-55 FOR FENDL-3.2 FROM INDL/V-3 BY NJOY2016.60+ ON  
angular distribution for (n,p\*13) proton

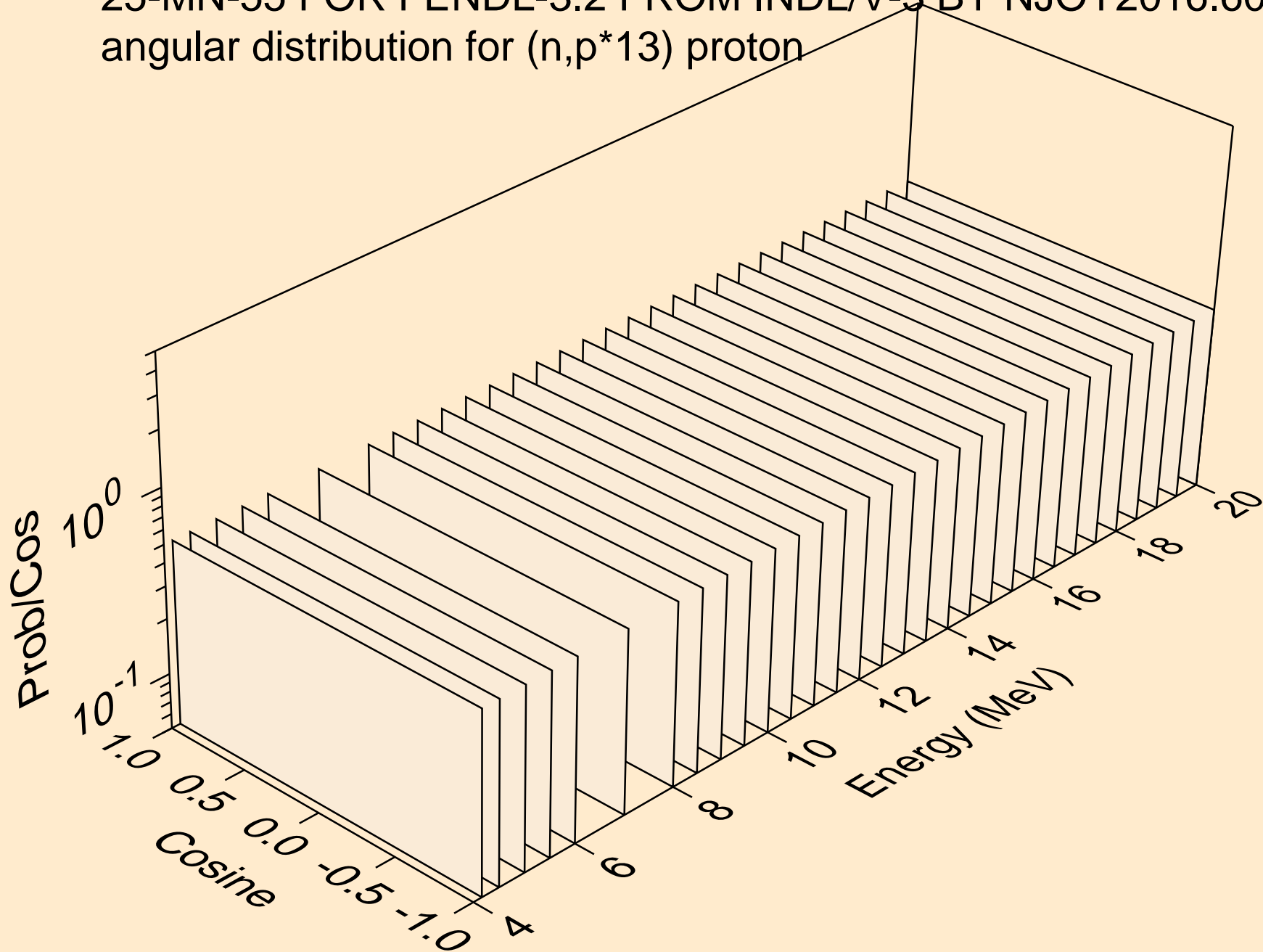

25-MN-55 FOR FENDL-3.2 FROM INDL/V-3 BY NJOY2016.60+ ON  
angular distribution for (n,p\*13) proton

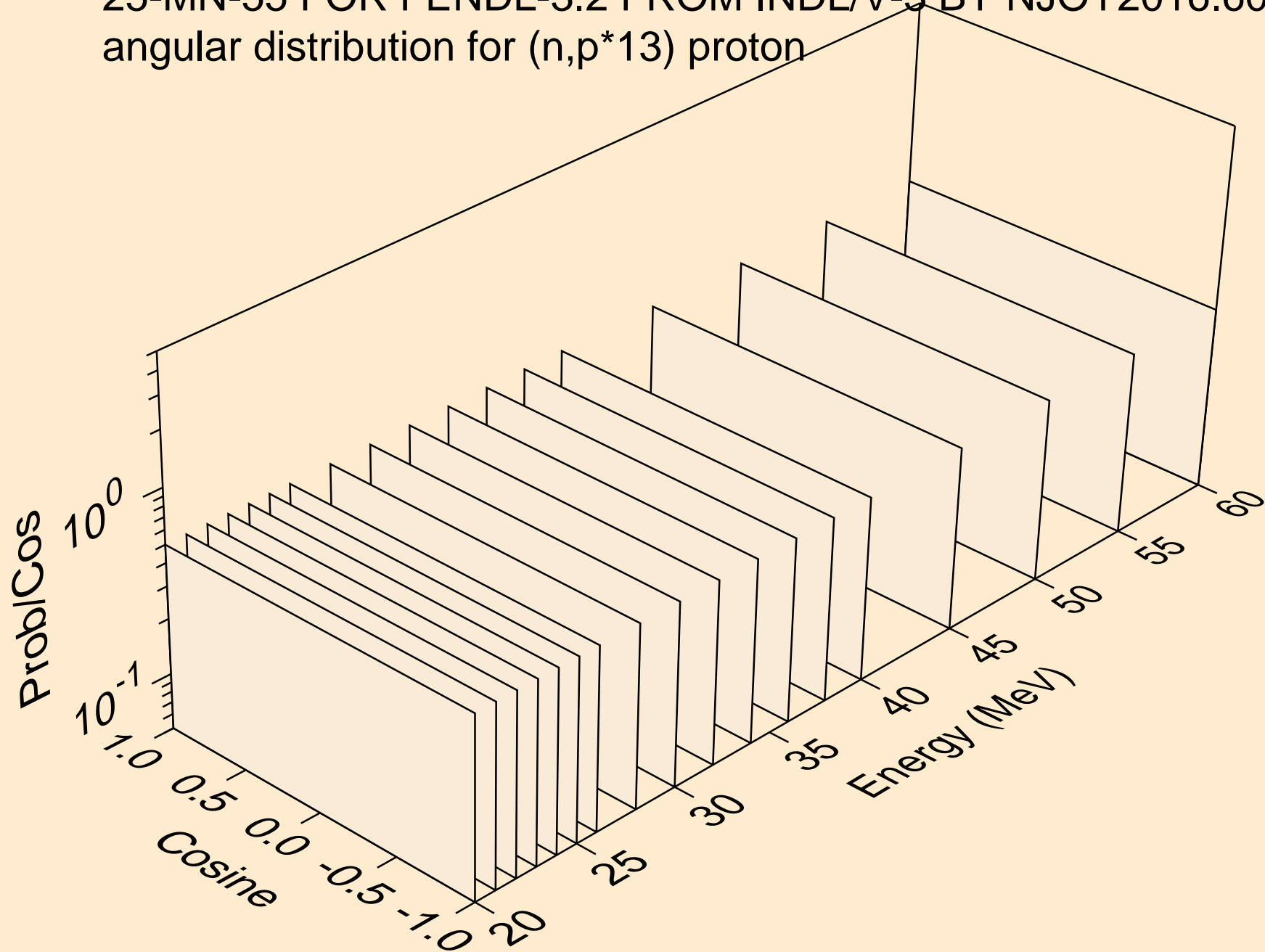

25-MN-55 FOR FENDL-3.2 FROM INDL/V-3 BY NJOY2016.60+ ON  
angular distribution for (n,p\*14) proton

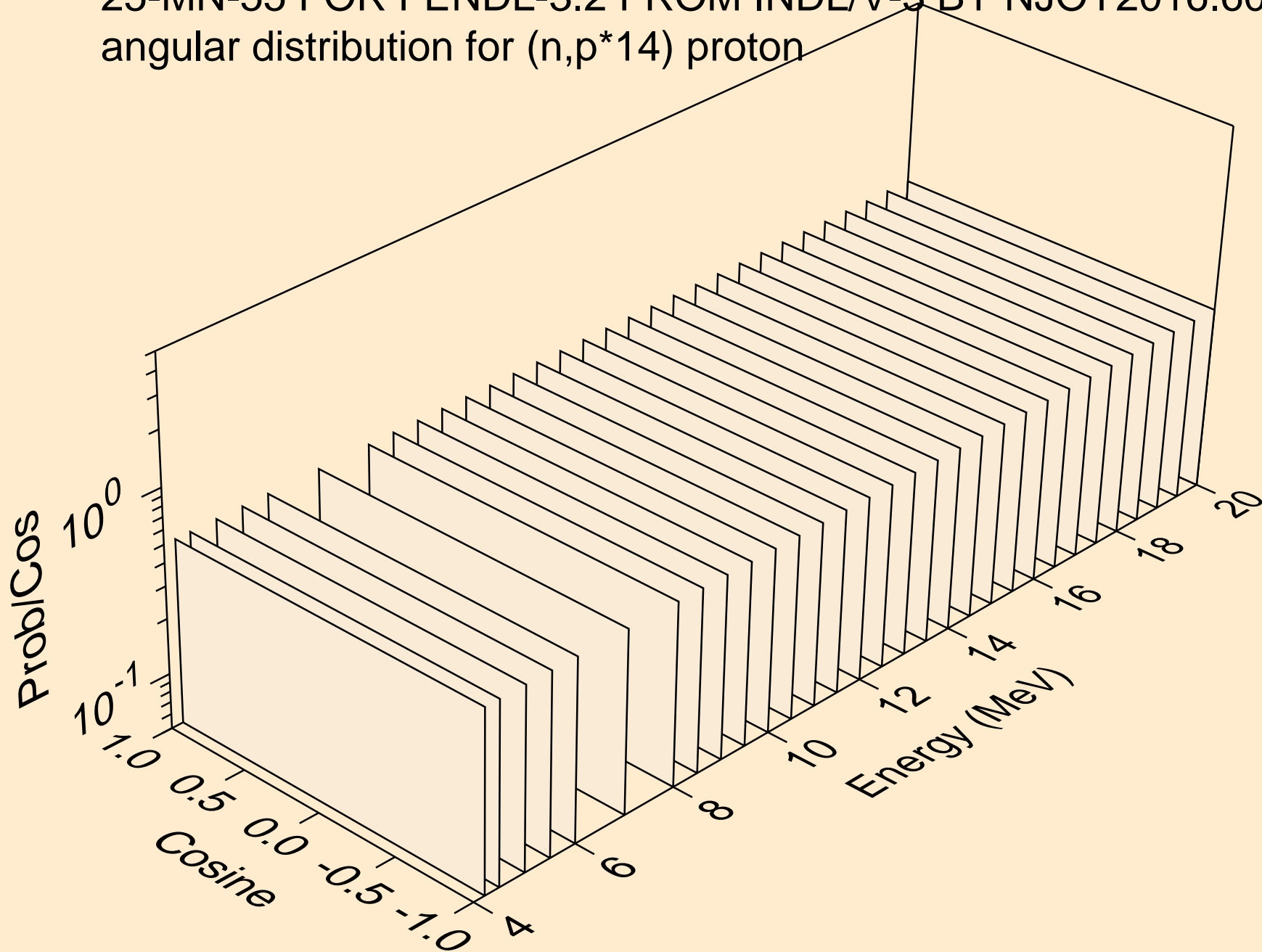

25-MN-55 FOR FENDL-3.2 FROM INDL/V-3 BY NJOY2016.60+ ON  
angular distribution for (n,p\*14) proton

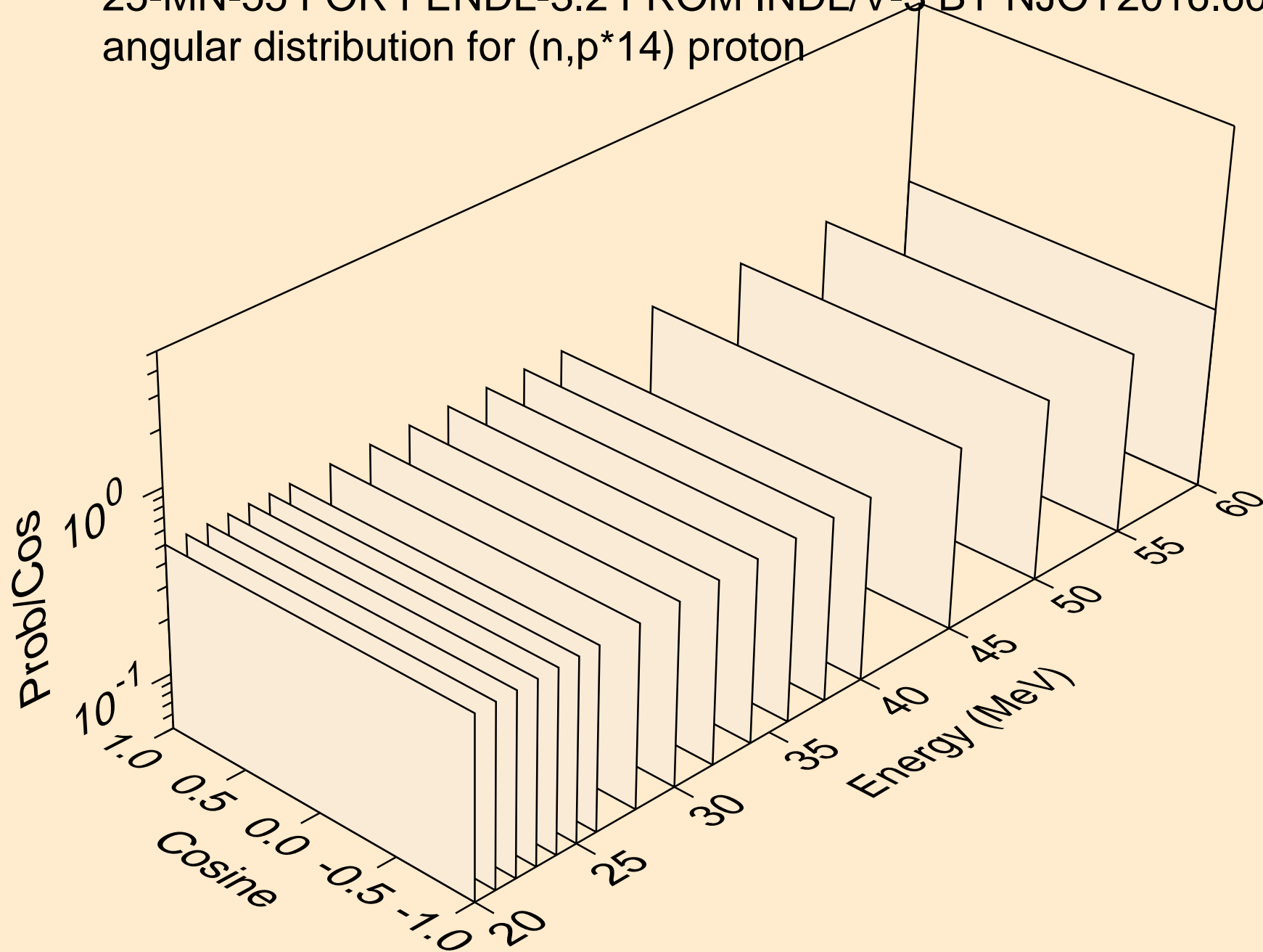

25-MN-55 FOR FENDL-3.2 FROM INDL/V-3 BY NJOY2016.60+ ON  
angular distribution for (n,p\*15) proton

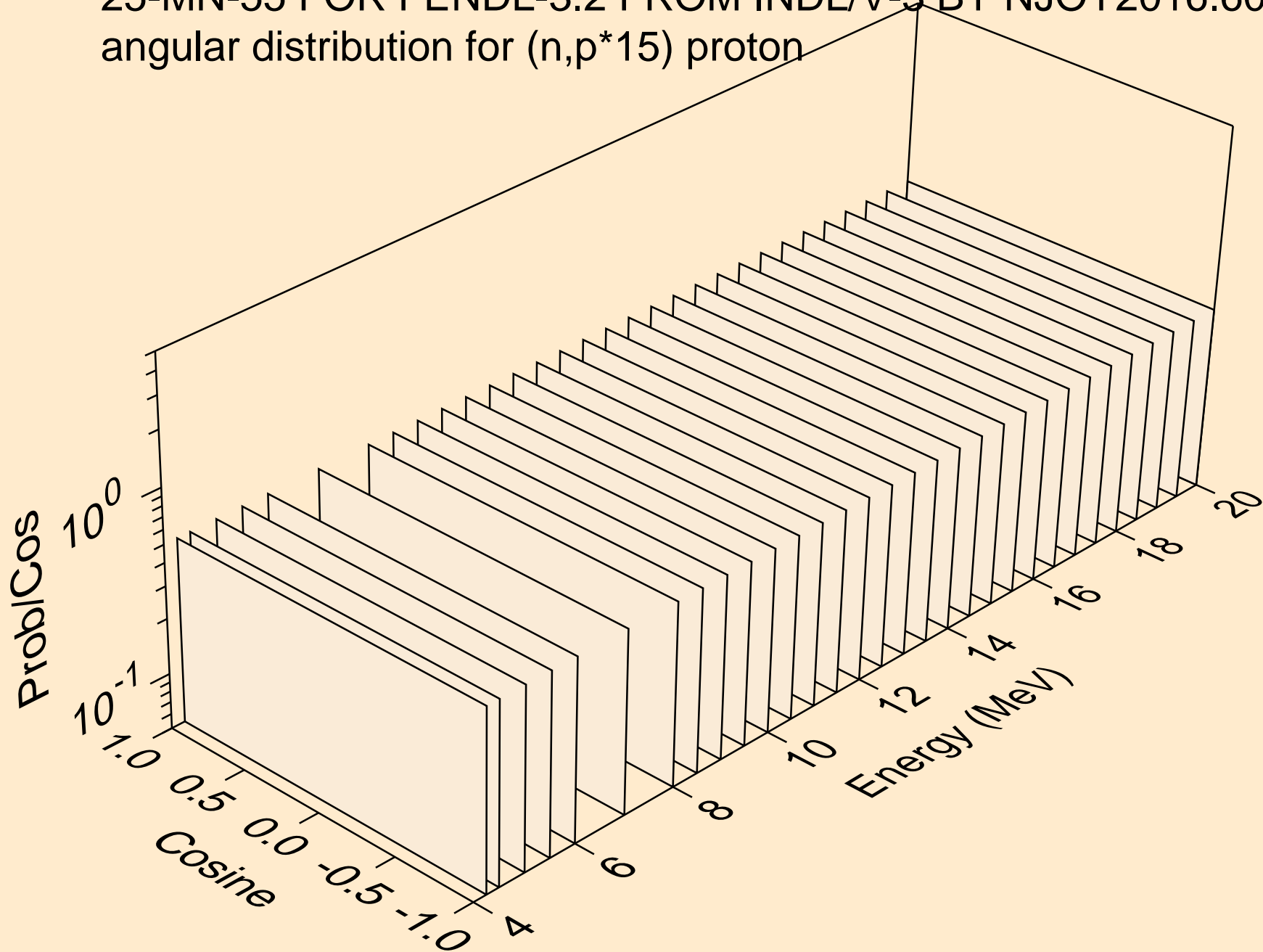

25-MN-55 FOR FENDL-3.2 FROM INDL/V-3 BY NJOY2016.60+ ON  
angular distribution for (n,p\*15) proton

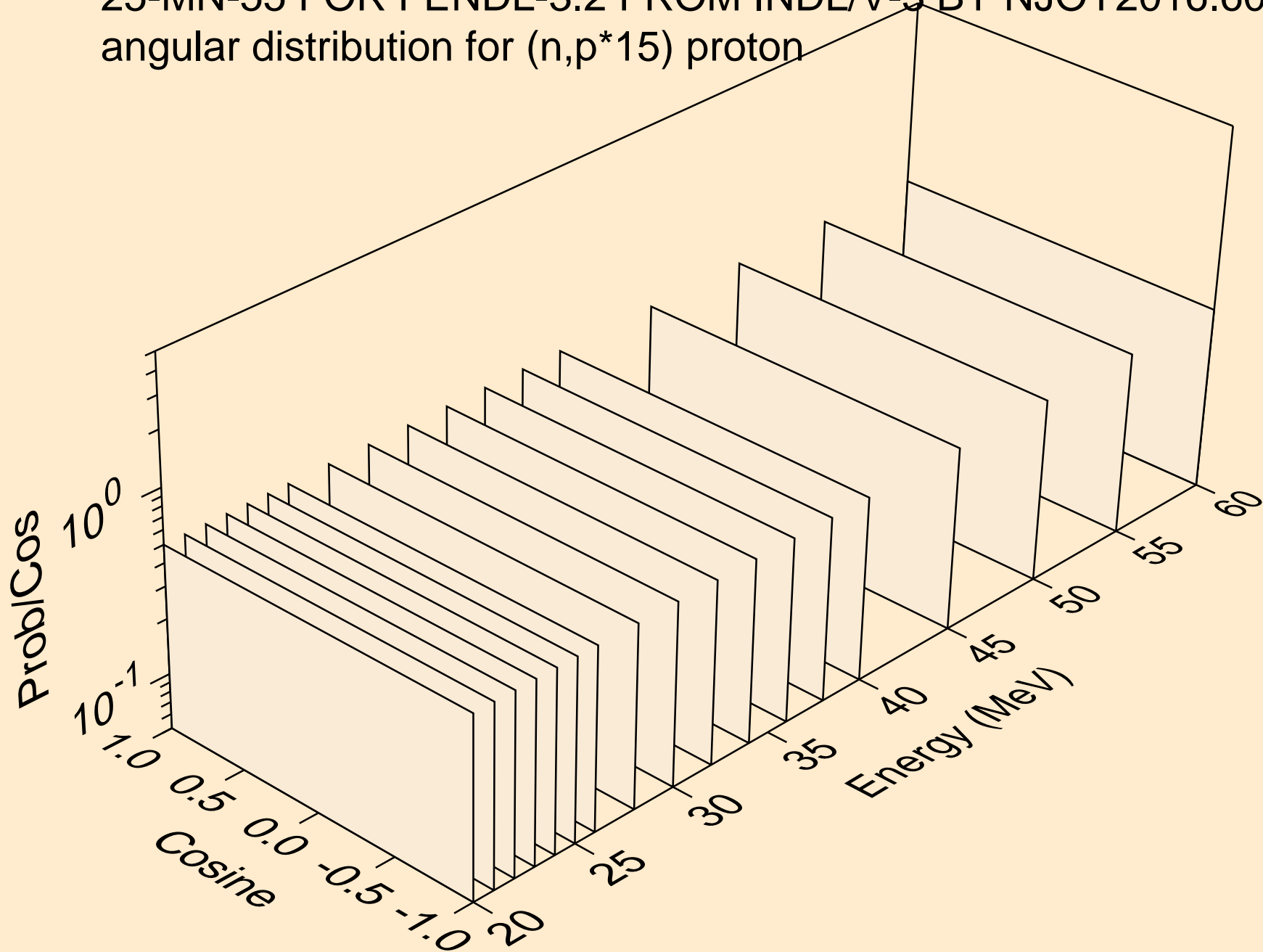

25-MN-55 FOR FENDL-3.2 FROM INDL/V-3 BY NJOY2016.60+ ON  
angular distribution for (n,p\*16) proton

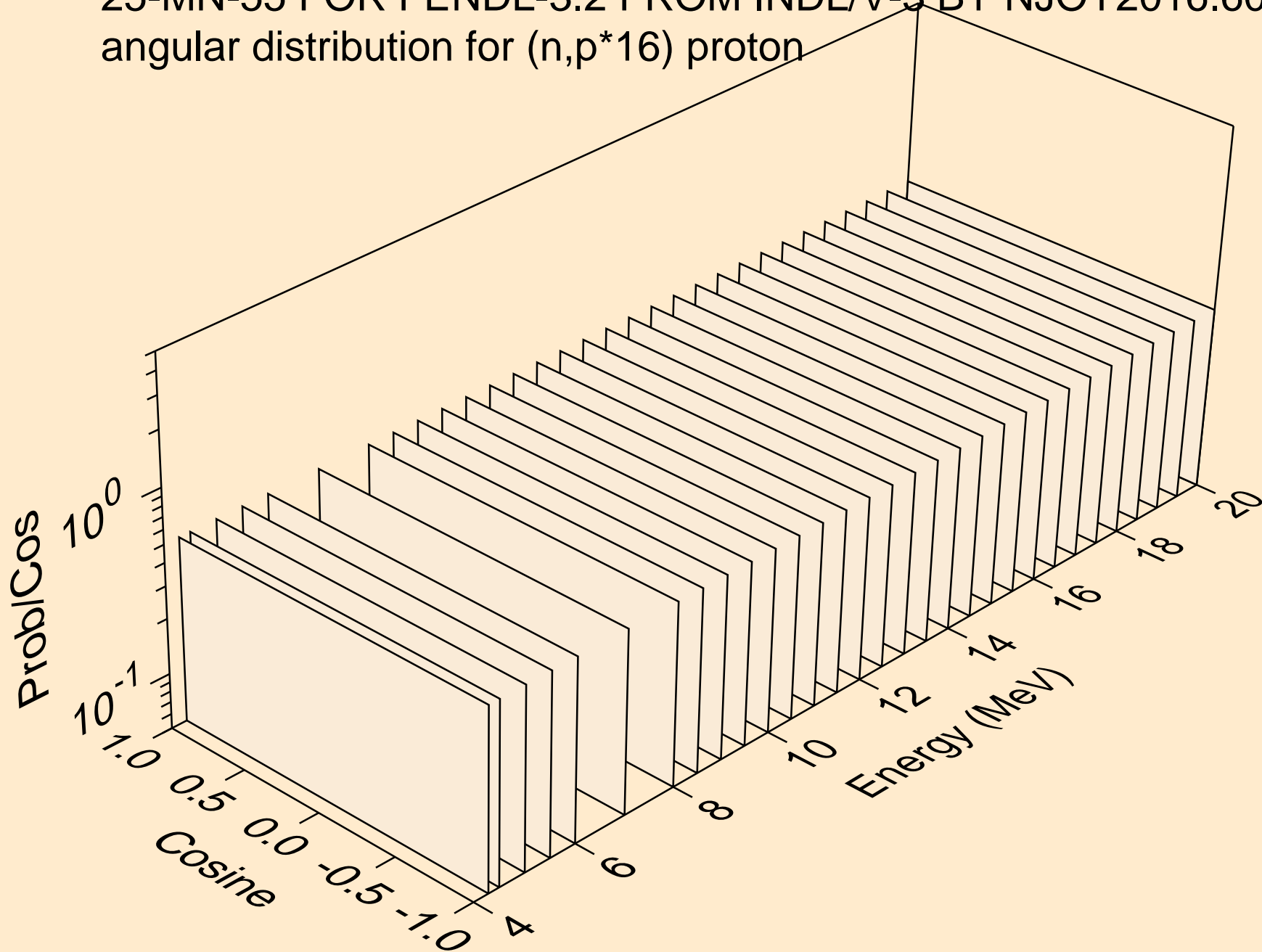

25-MN-55 FOR FENDL-3.2 FROM INDL/V-3 BY NJOY2016.60+ ON  
angular distribution for (n,p\*16) proton

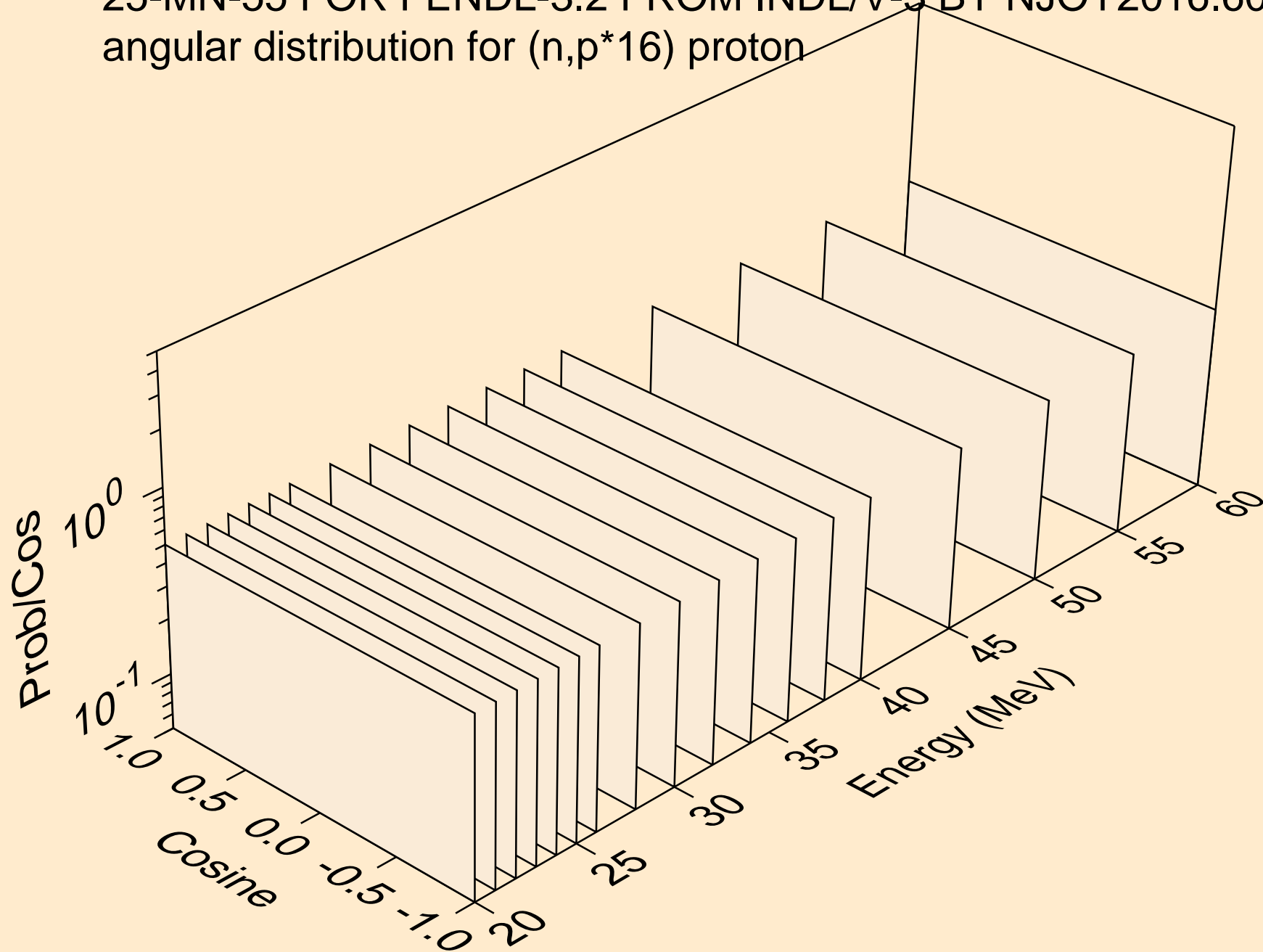



25-MN-55 FOR FENDL-3.2 FROM INDL/V-3 BY NJOY2016.60+ ON  
angular distribution for (n,p\*17) proton

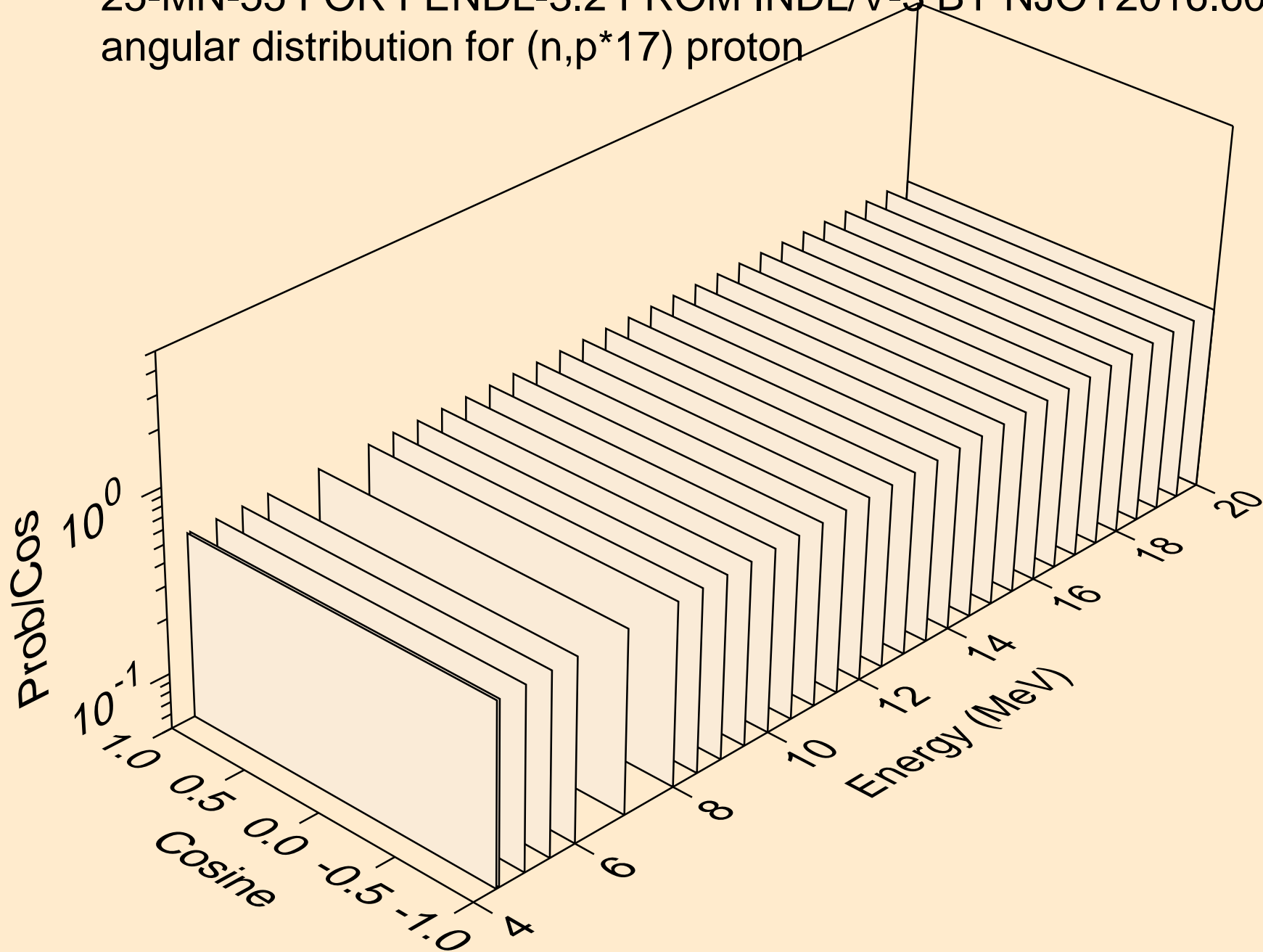

25-MN-55 FOR FENDL-3.2 FROM INDL/V-3 BY NJOY2016.60+ ON  
angular distribution for (n,p\*17) proton

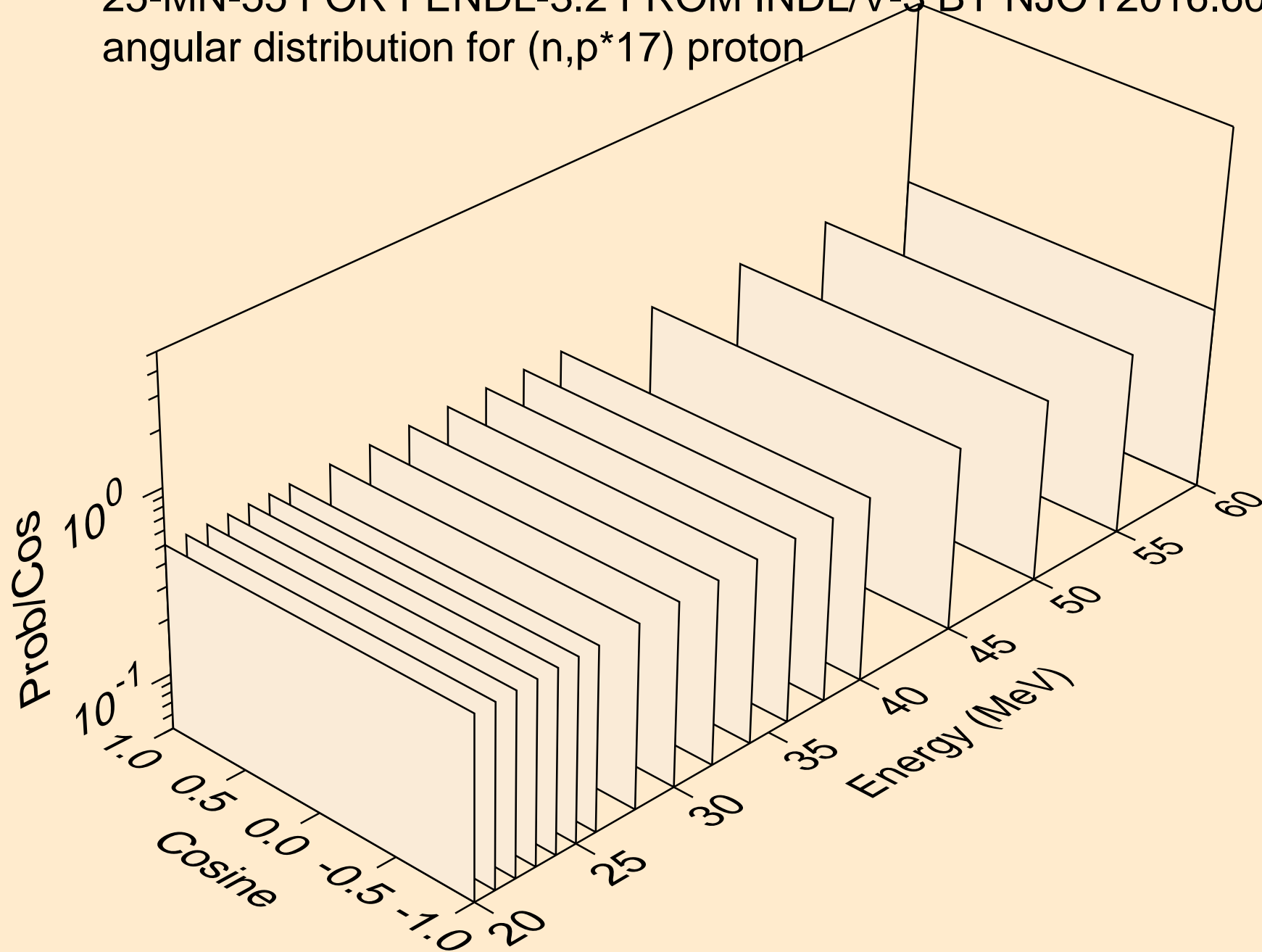

25-MN-55 FOR FENDL-3.2 FROM INDL/V-3 BY NJOY2016.60+ ON  
angular distribution for (n,p\*18) proton

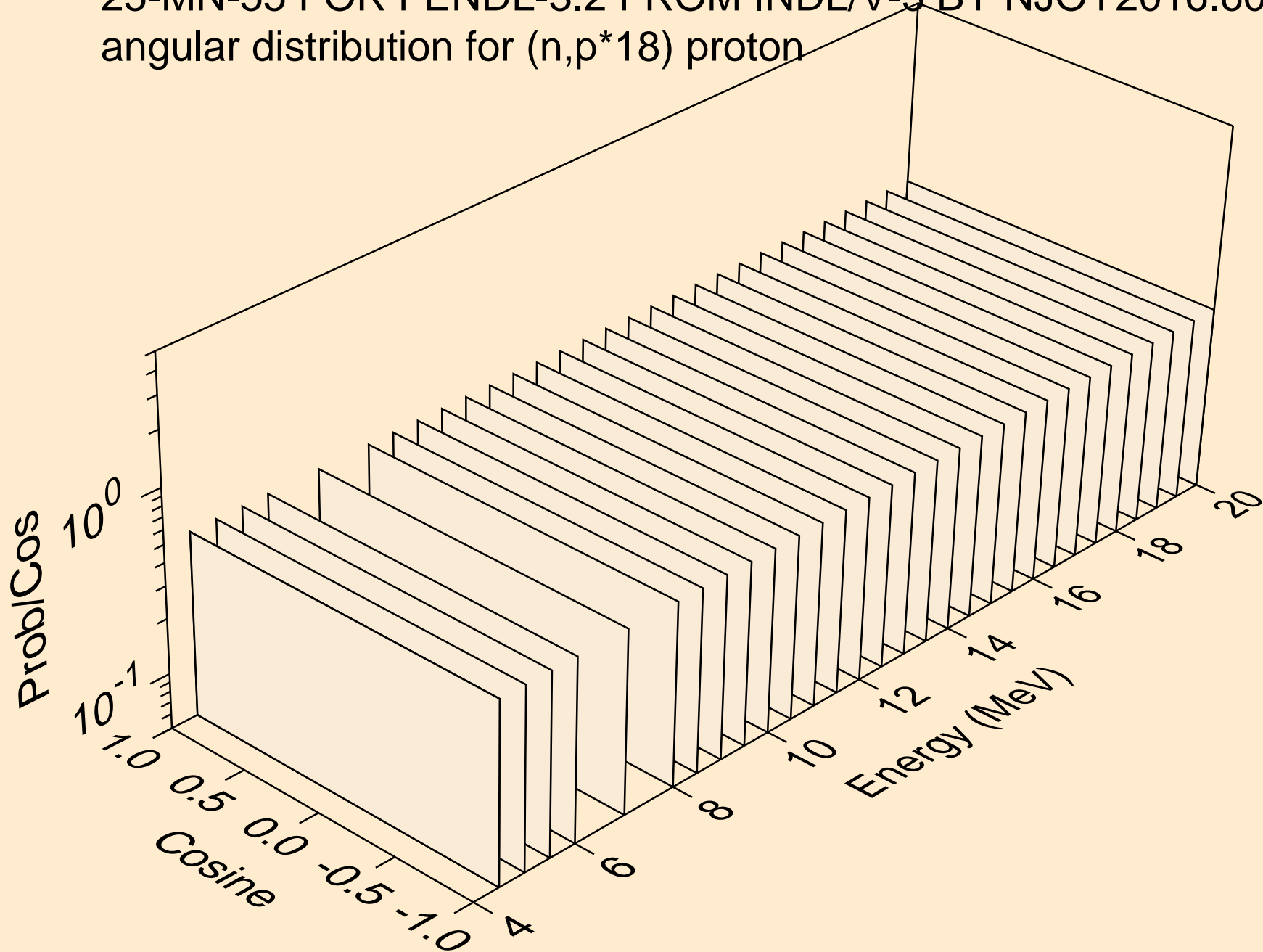

25-MN-55 FOR FENDL-3.2 FROM INDL/V-3 BY NJOY2016.60+ ON  
angular distribution for (n,p\*18) proton

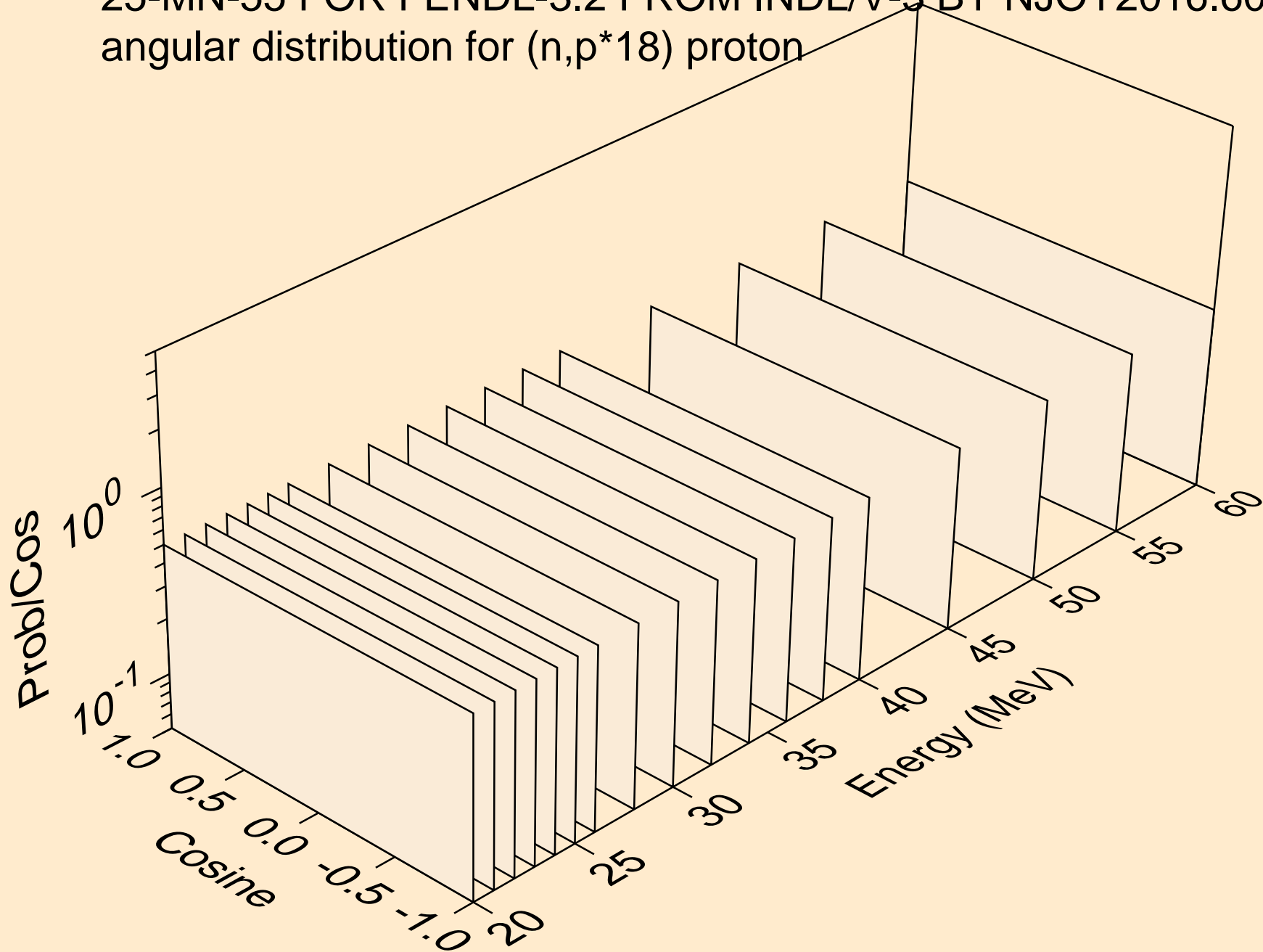

25-MN-55 FOR FENDL-3.2 FROM INDL/V-3 BY NJOY2016.60+ ON  
angular distribution for (n,p\*19) proton

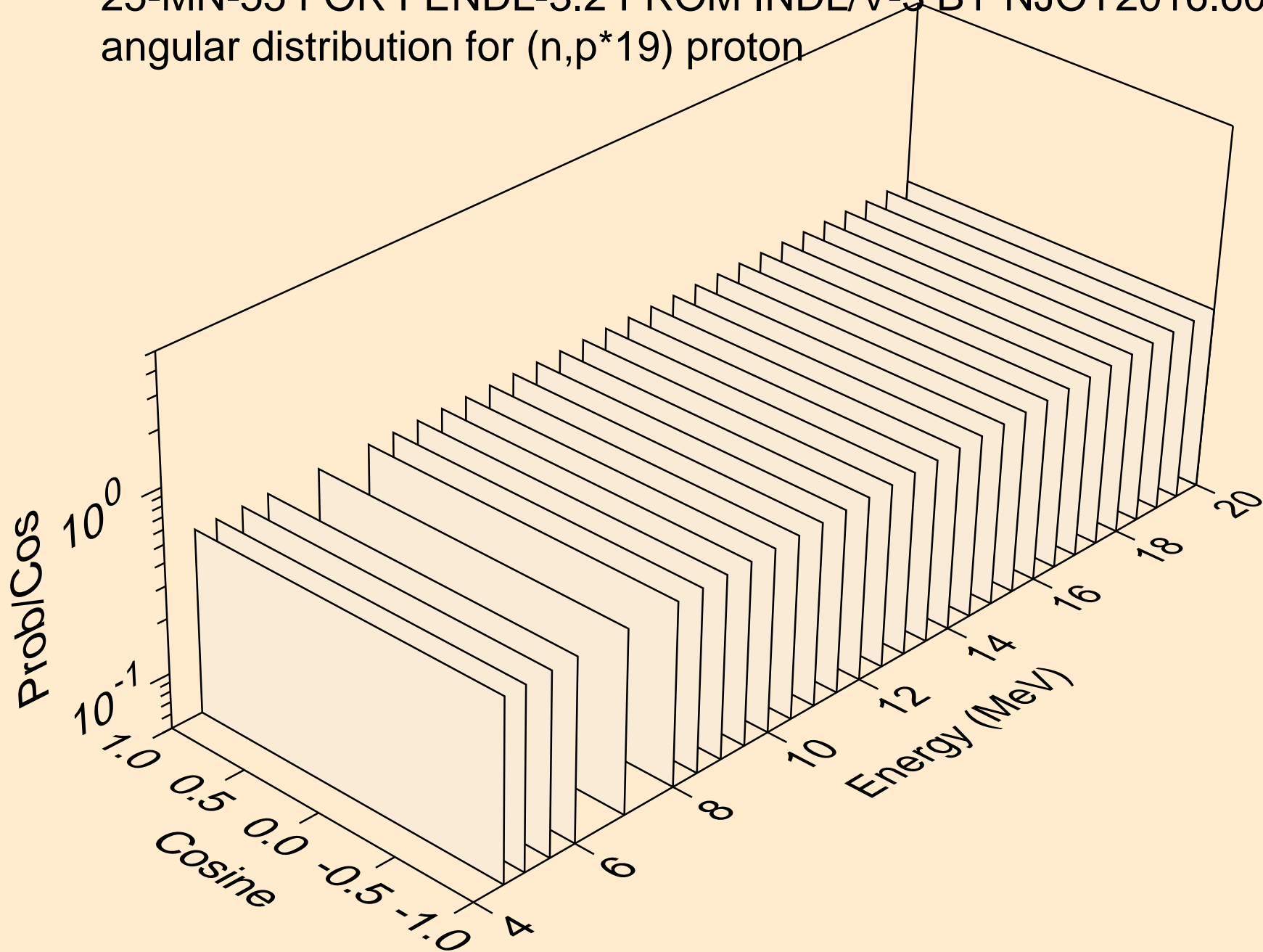

25-MN-55 FOR FENDL-3.2 FROM INDL/V-3 BY NJOY2016.60+ ON  
angular distribution for (n,p\*19) proton

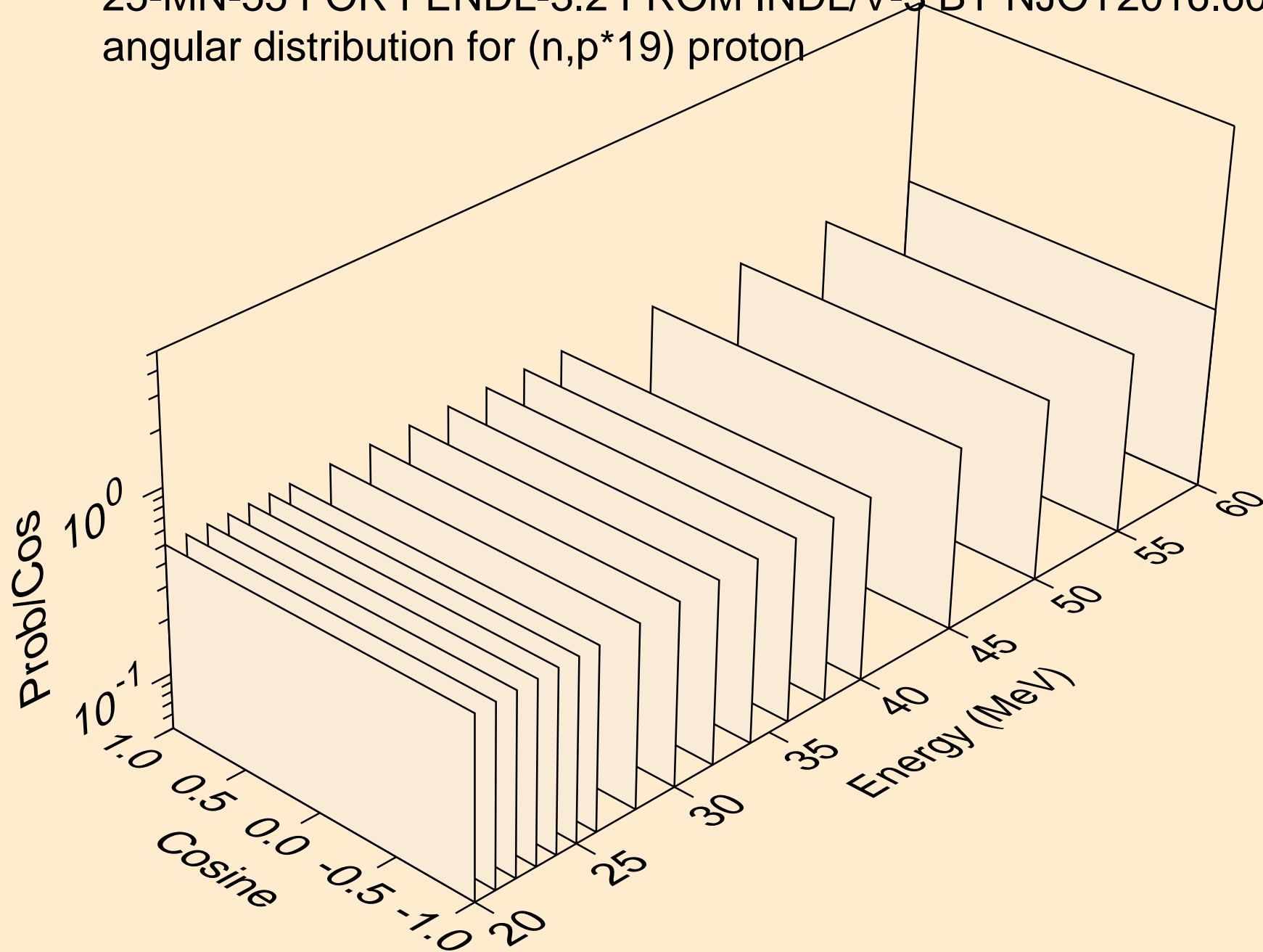

25-MN-55 FOR FENDL-3.2 FROM INDL/V-3 BY NJOY2016.60+ ON  
angular distribution for (n,p\*20) proton

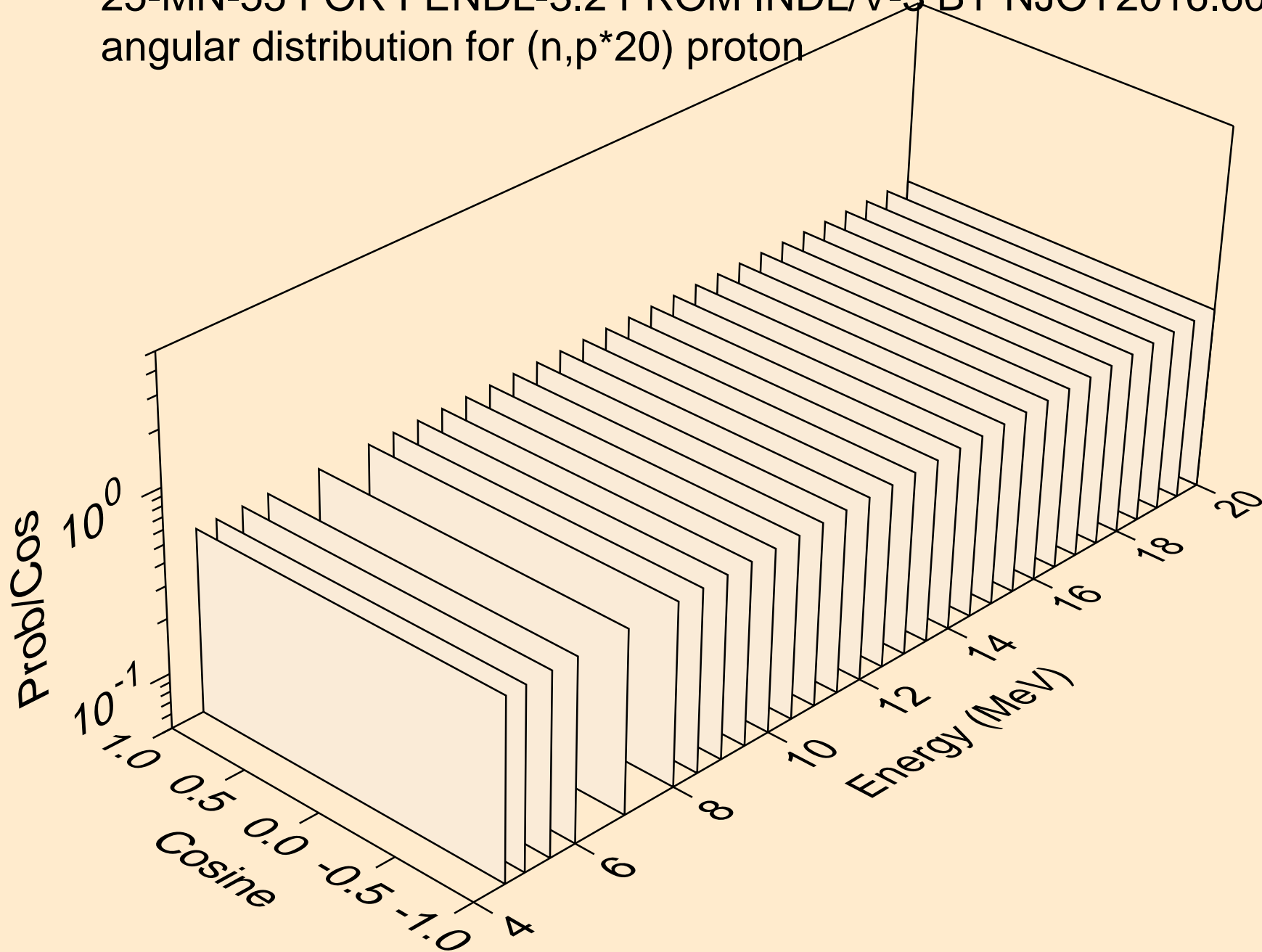

25-MN-55 FOR FENDL-3.2 FROM INDL/V-3 BY NJOY2016.60+ ON  
angular distribution for (n,p\*20) proton

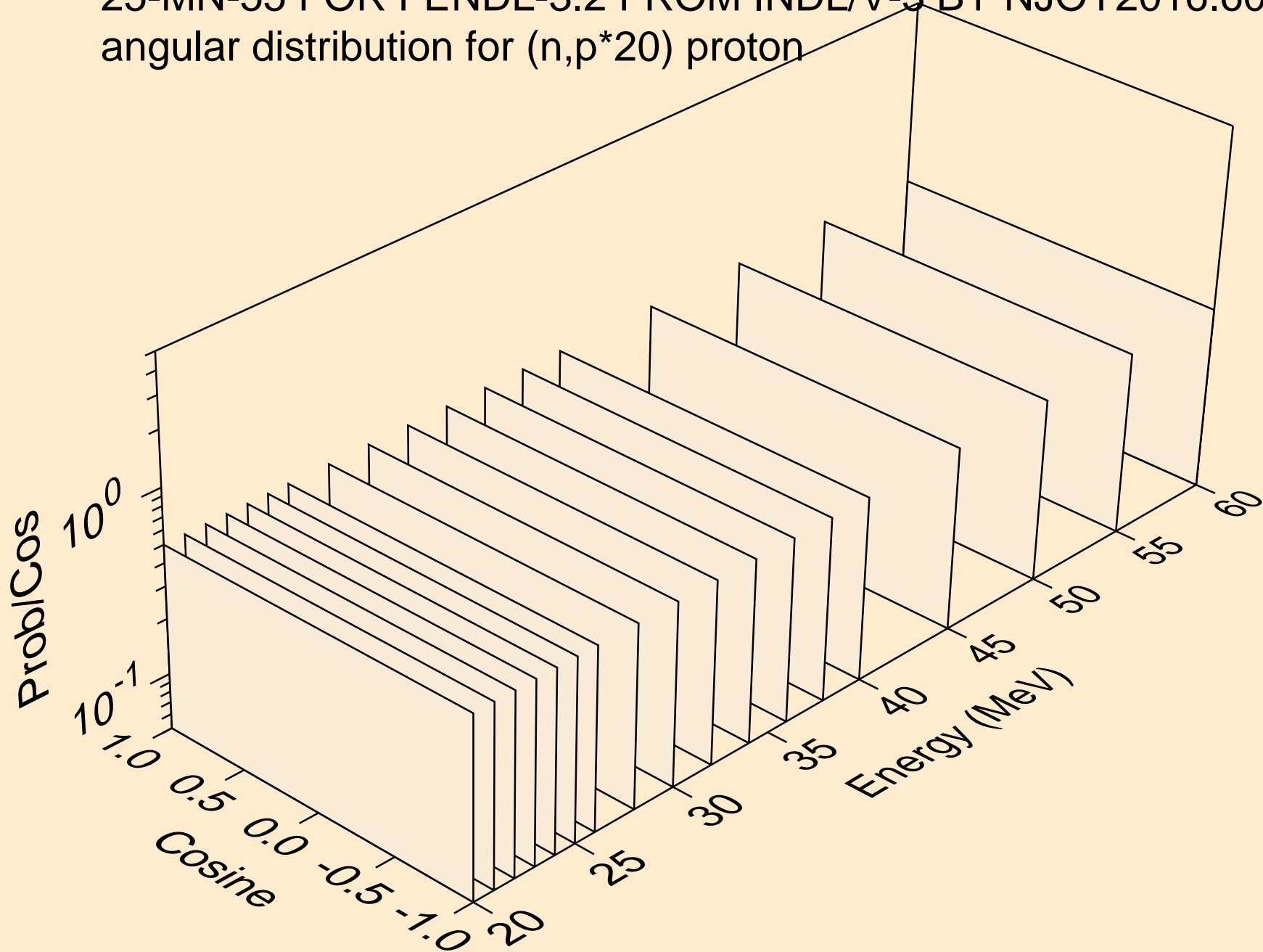



25-MN-55 FOR FENDL-3.2 FROM INDL/V-3 BY NJOY2016.60+ ON  
angular distribution for (n,p\*21) proton

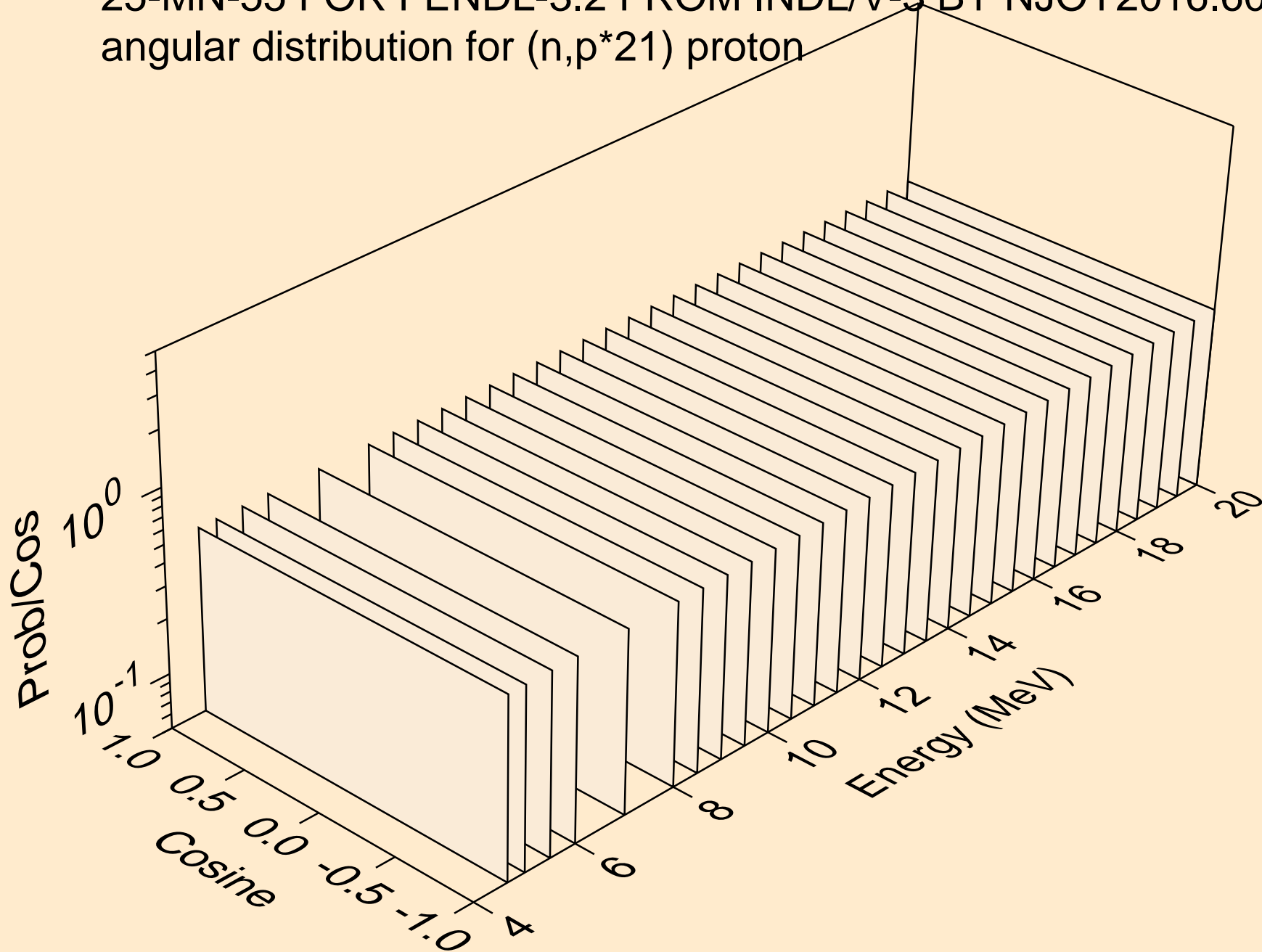

25-MN-55 FOR FENDL-3.2 FROM INDL/V-3 BY NJOY2016.60+ ON  
angular distribution for (n,p\*21) proton

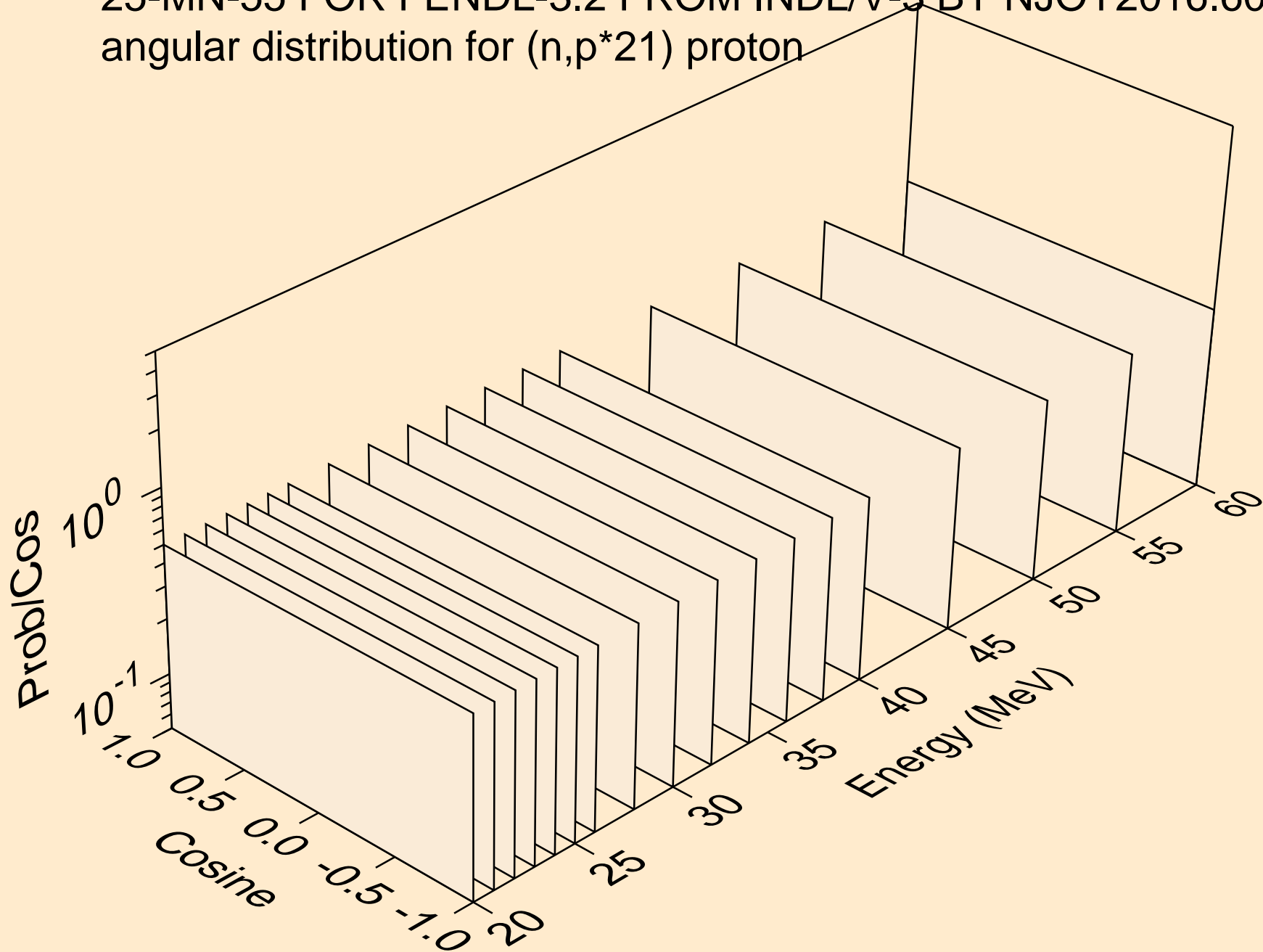

25-MN-55 FOR FENDL-3.2 FROM INDL/V-3 BY NJOY2016.60+ ON  
angular distribution for (n,p\*22) proton

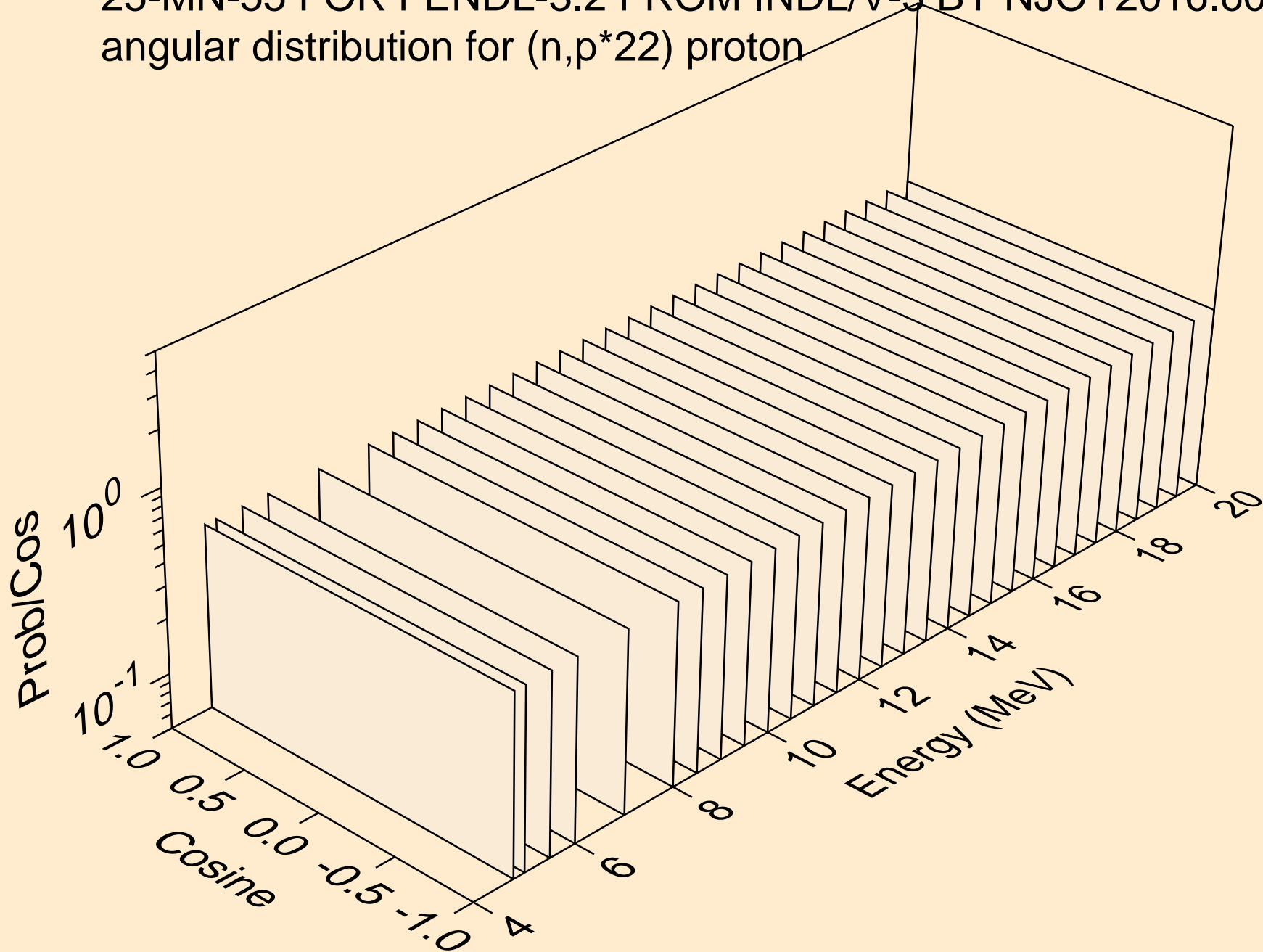

25-MN-55 FOR FENDL-3.2 FROM INDL/V-3 BY NJOY2016.60+ ON  
angular distribution for (n,p\*22) proton

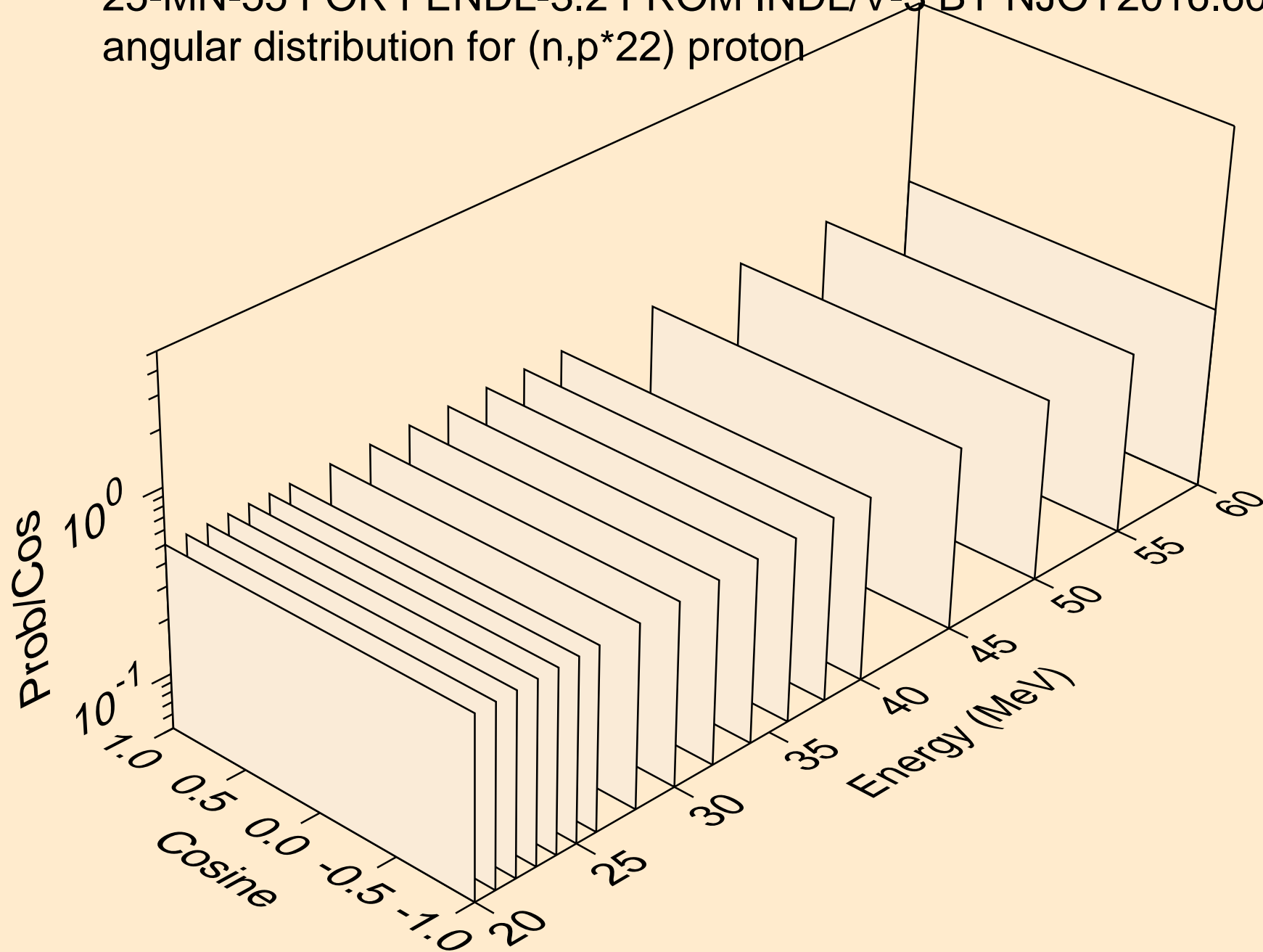

25-MN-55 FOR FENDL-3.2 FROM INDL/V-3 BY NJOY2016.60+ ON  
angular distribution for (n,p\*23) proton

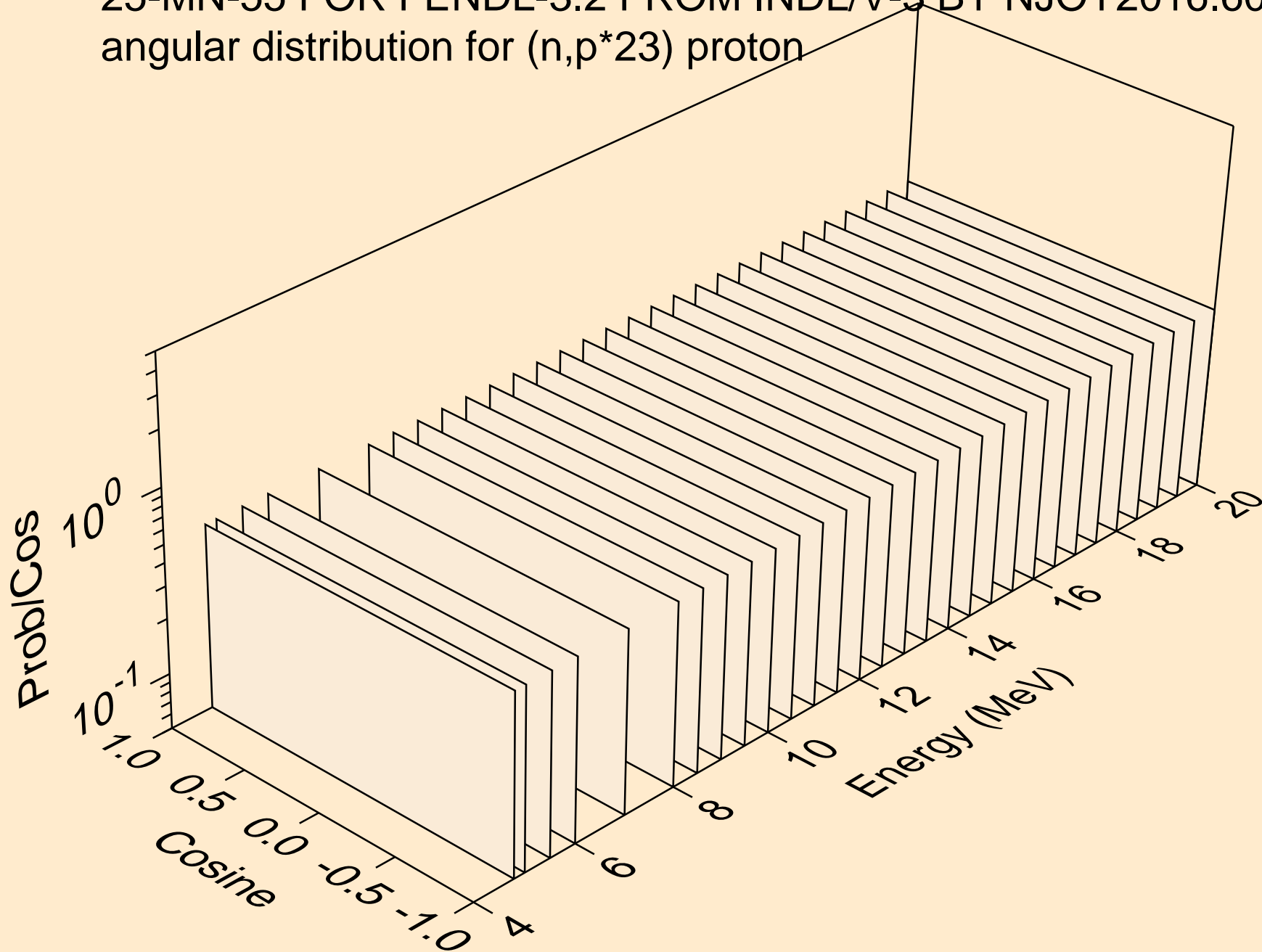

25-MN-55 FOR FENDL-3.2 FROM INDL/V-3 BY NJOY2016.60+ ON  
angular distribution for (n,p\*23) proton

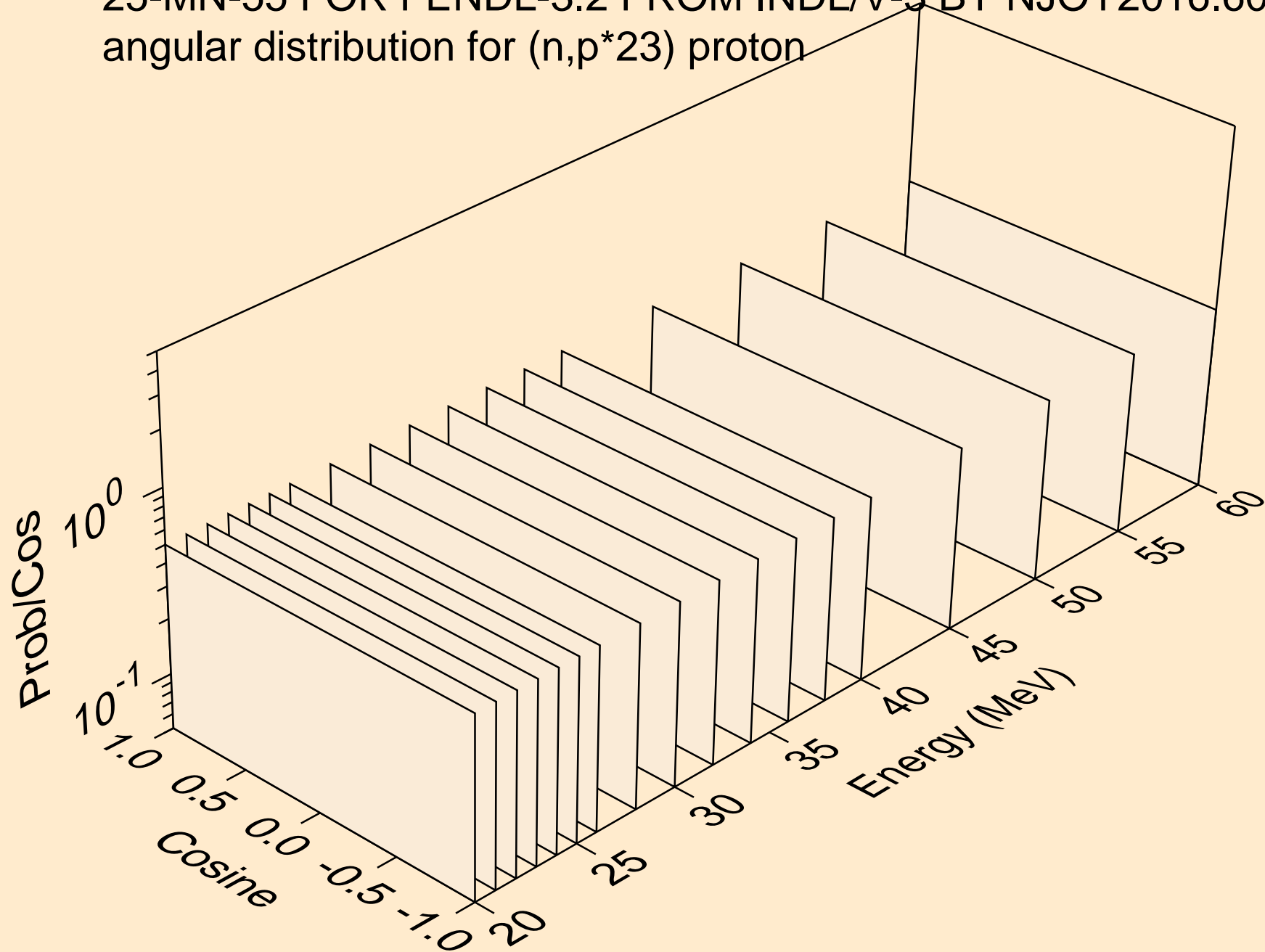

25-MN-55 FOR FENDL-3.2 FROM INDL/V-3 BY NJOY2016.60+ ON  
angular distribution for (n,p\*24) proton

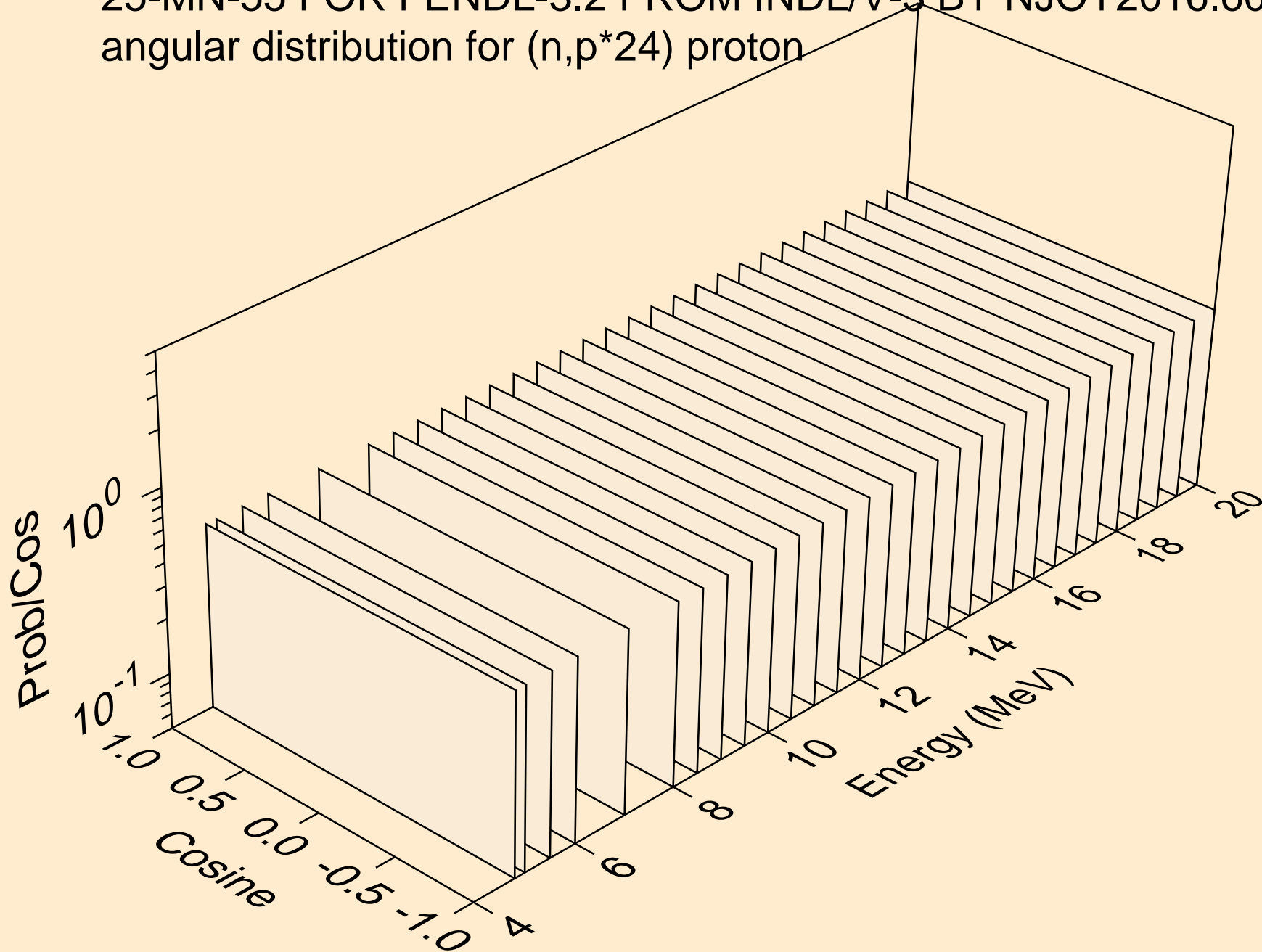

25-MN-55 FOR FENDL-3.2 FROM INDL/V-3 BY NJOY2016.60+ ON  
angular distribution for (n,p\*24) proton

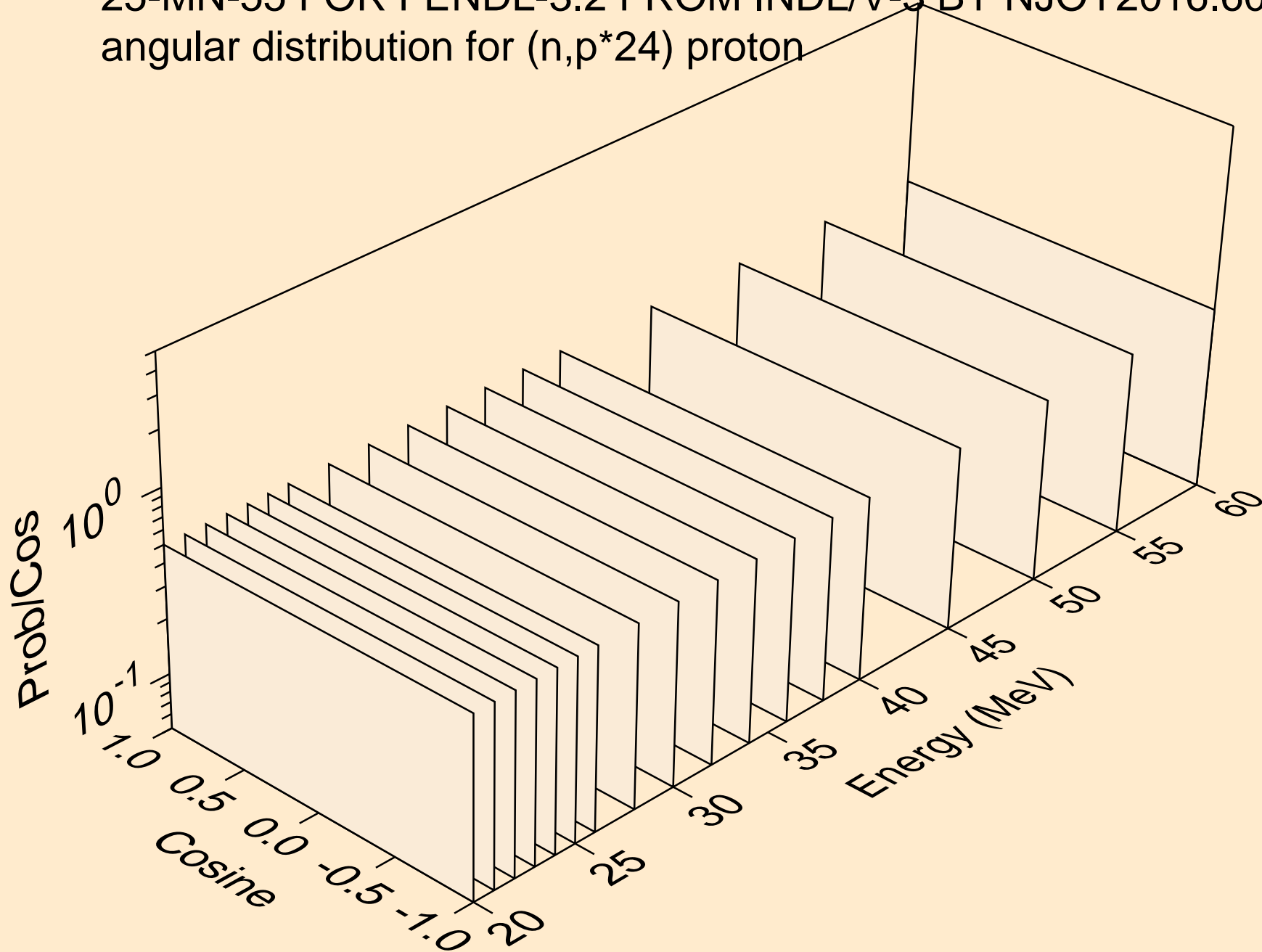



25-MN-55 FOR FENDL-3.2 FROM INDL/V-3 BY NJOY2016.60+ ON  
angular distribution for (n,p\*25) proton

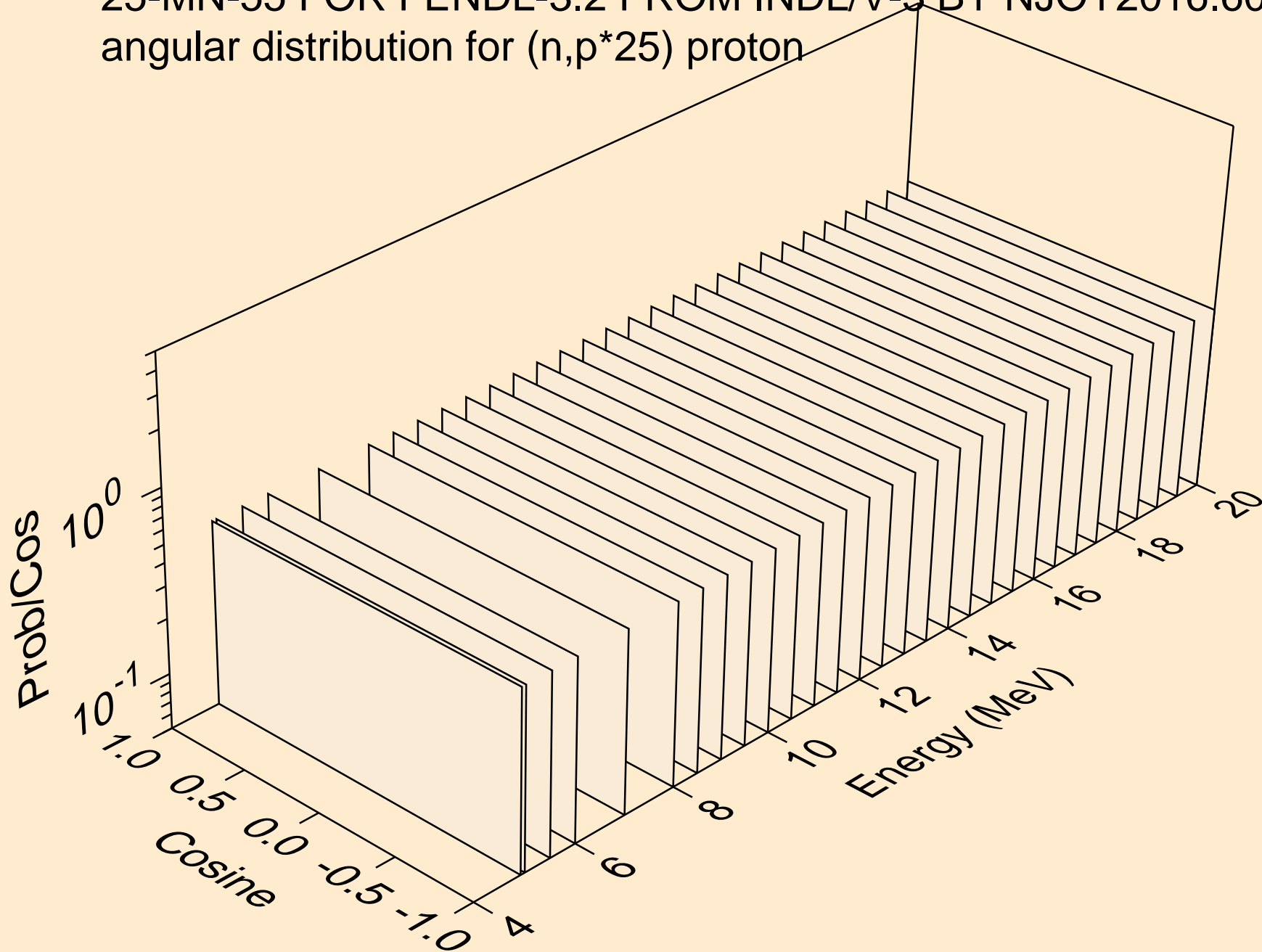

25-MN-55 FOR FENDL-3.2 FROM INDL/V-3 BY NJOY2016.60+ ON  
angular distribution for (n,p\*25) proton

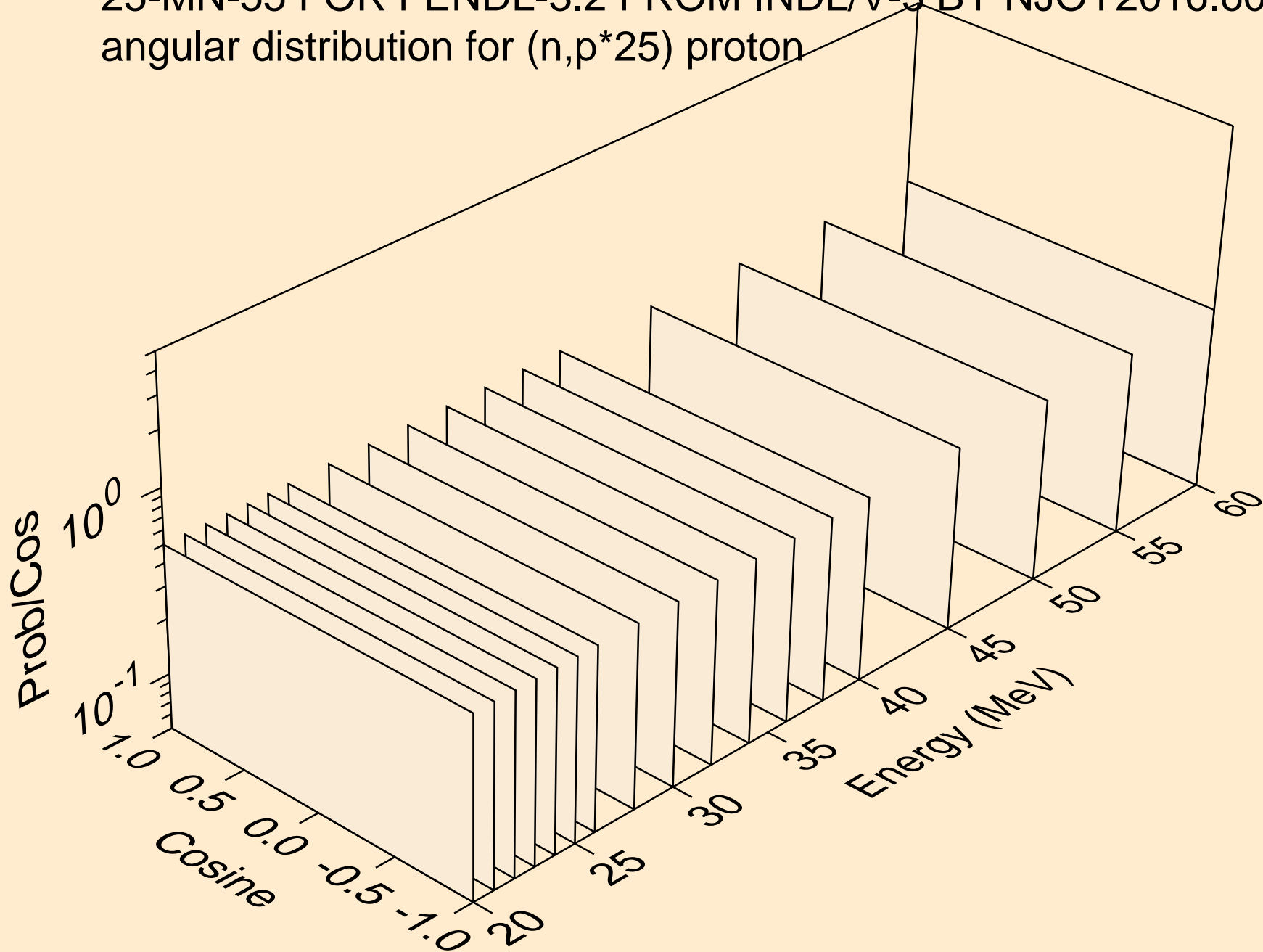

25-MN-55 FOR FENDL-3.2 FROM INDL/V-3 BY NJOY2016.60+ ON  
angular distribution for (n,p\*26) proton

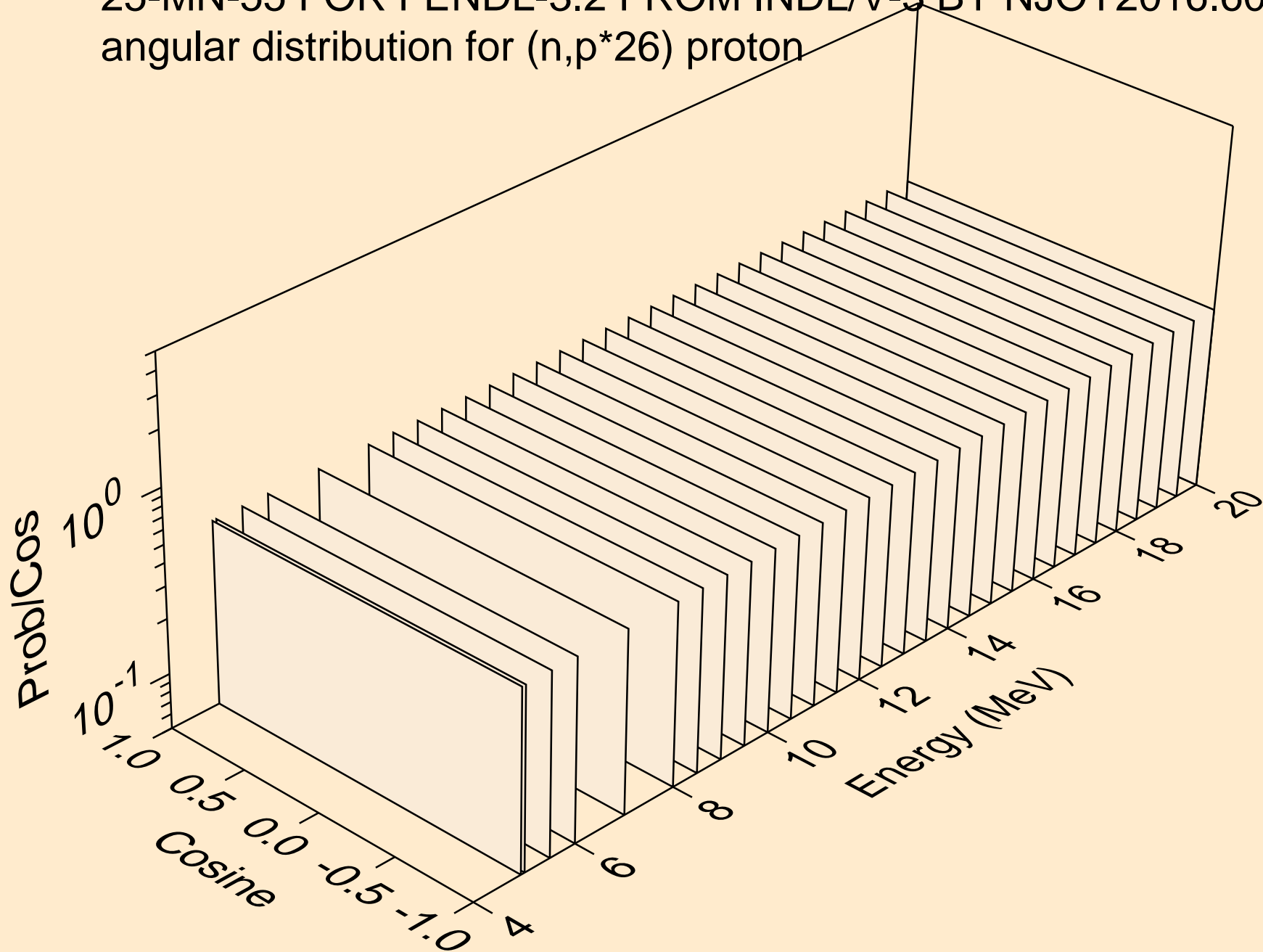

25-MN-55 FOR FENDL-3.2 FROM INDL/V-3 BY NJOY2016.60+ ON  
angular distribution for (n,p\*26) proton

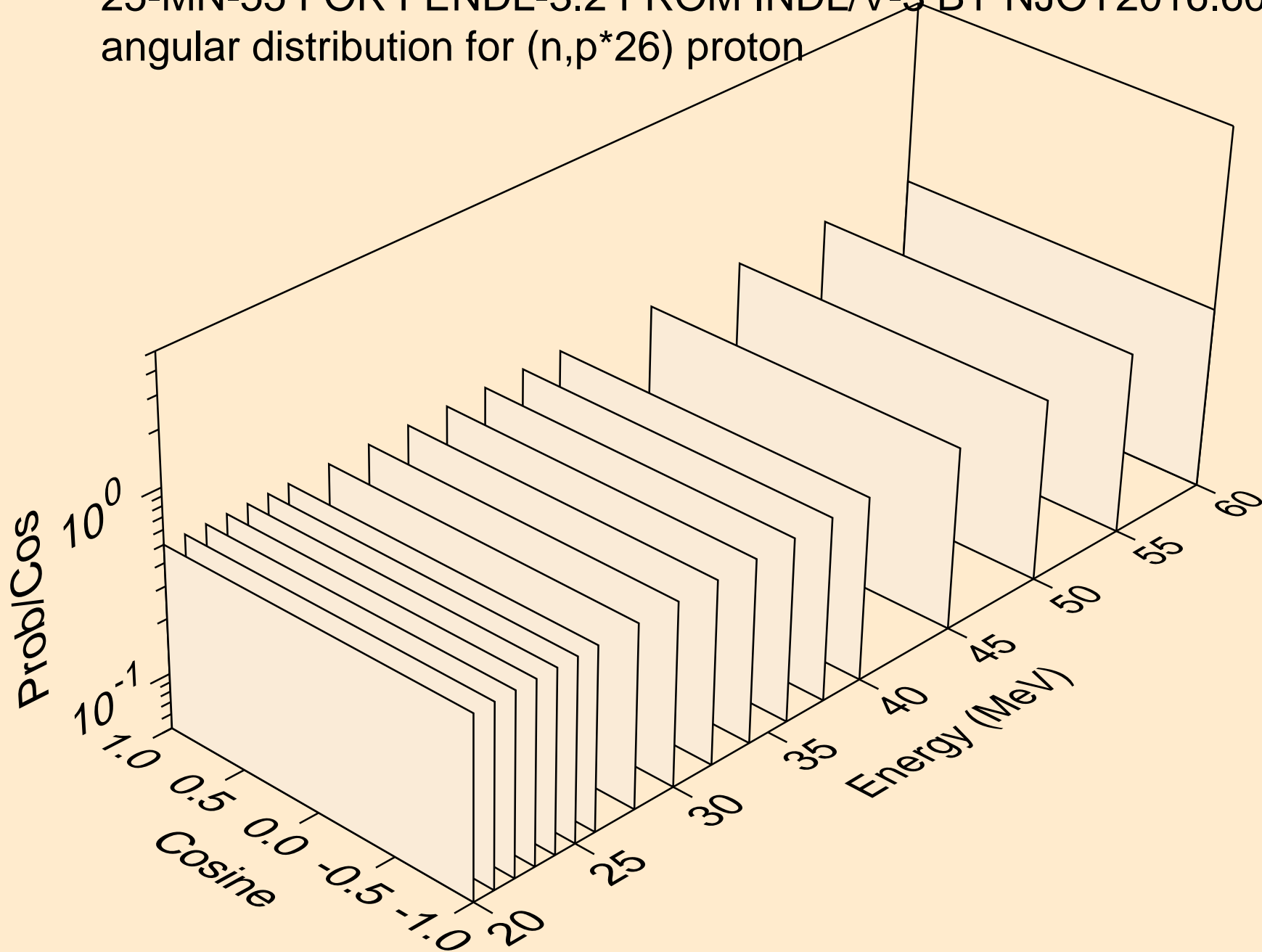

25-MN-55 FOR FENDL-3.2 FROM INDL/V-3 BY NJOY2016.60+ ON  
angular distribution for (n,p\*27) proton

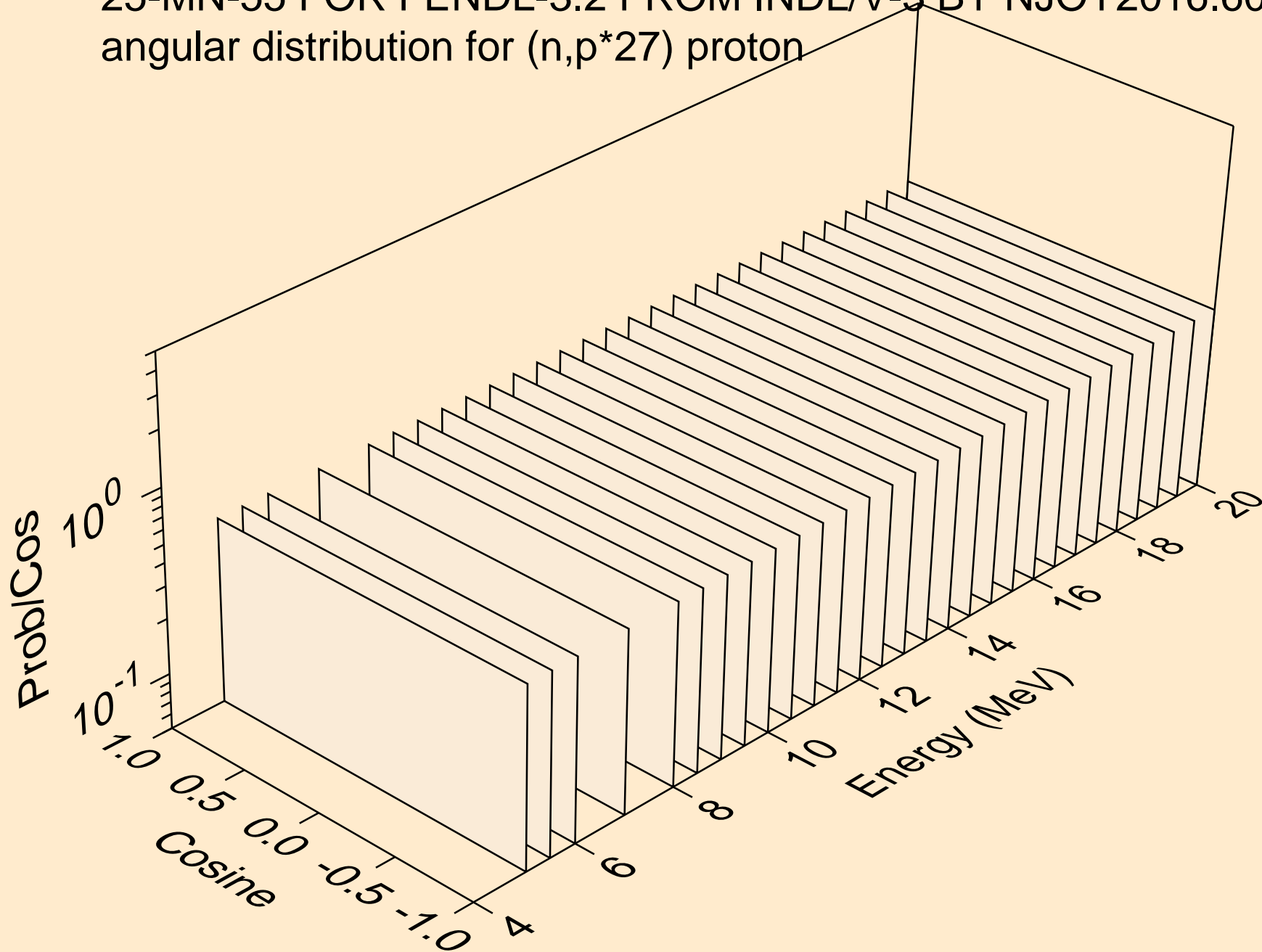

25-MN-55 FOR FENDL-3.2 FROM INDL/V-3 BY NJOY2016.60+ ON  
angular distribution for (n,p\*27) proton

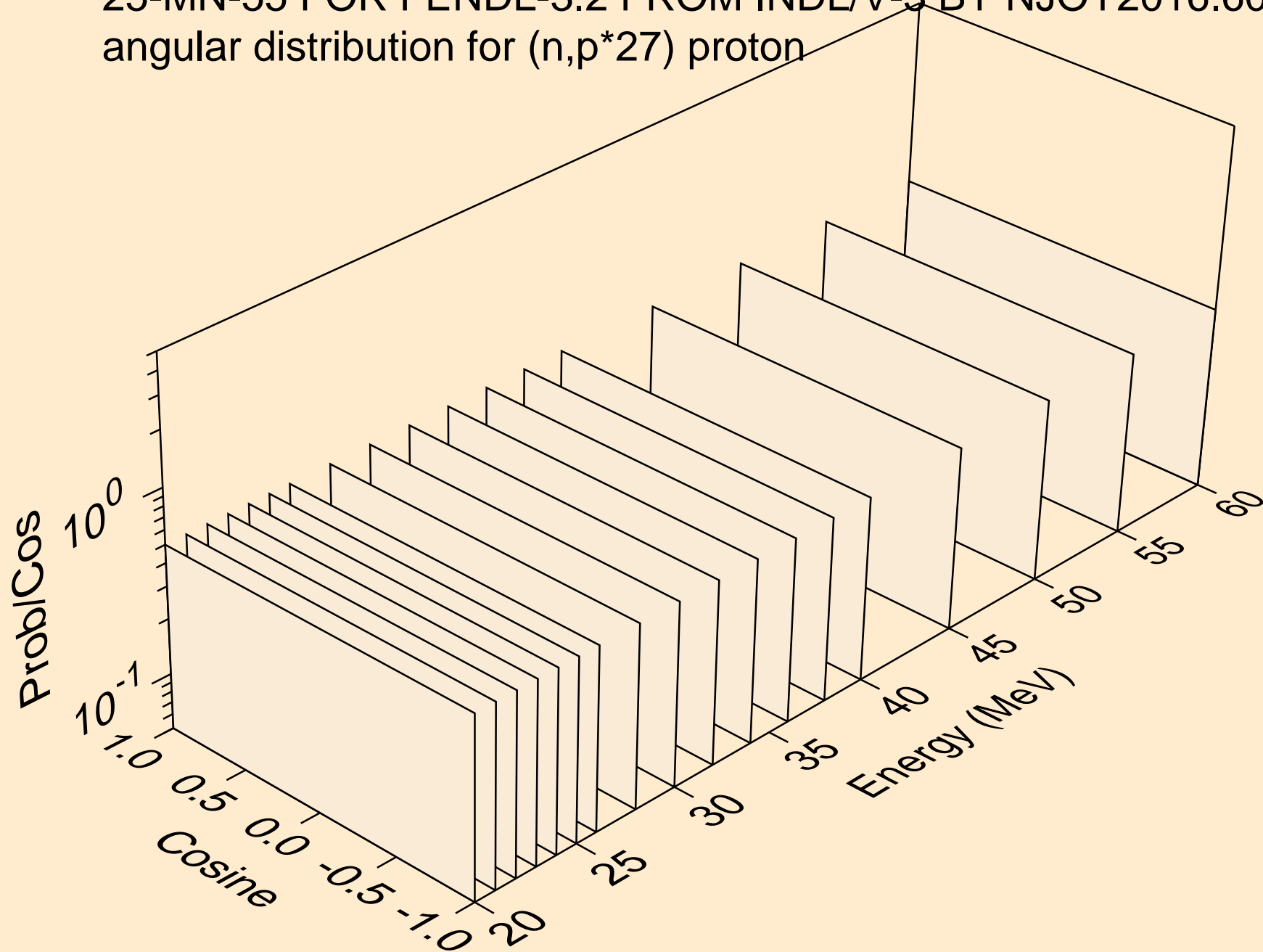

25-MN-55 FOR FENDL-3.2 FROM INDL/V-3 BY NJOY2016.60+ ON  
angular distribution for (n,p\*28) proton

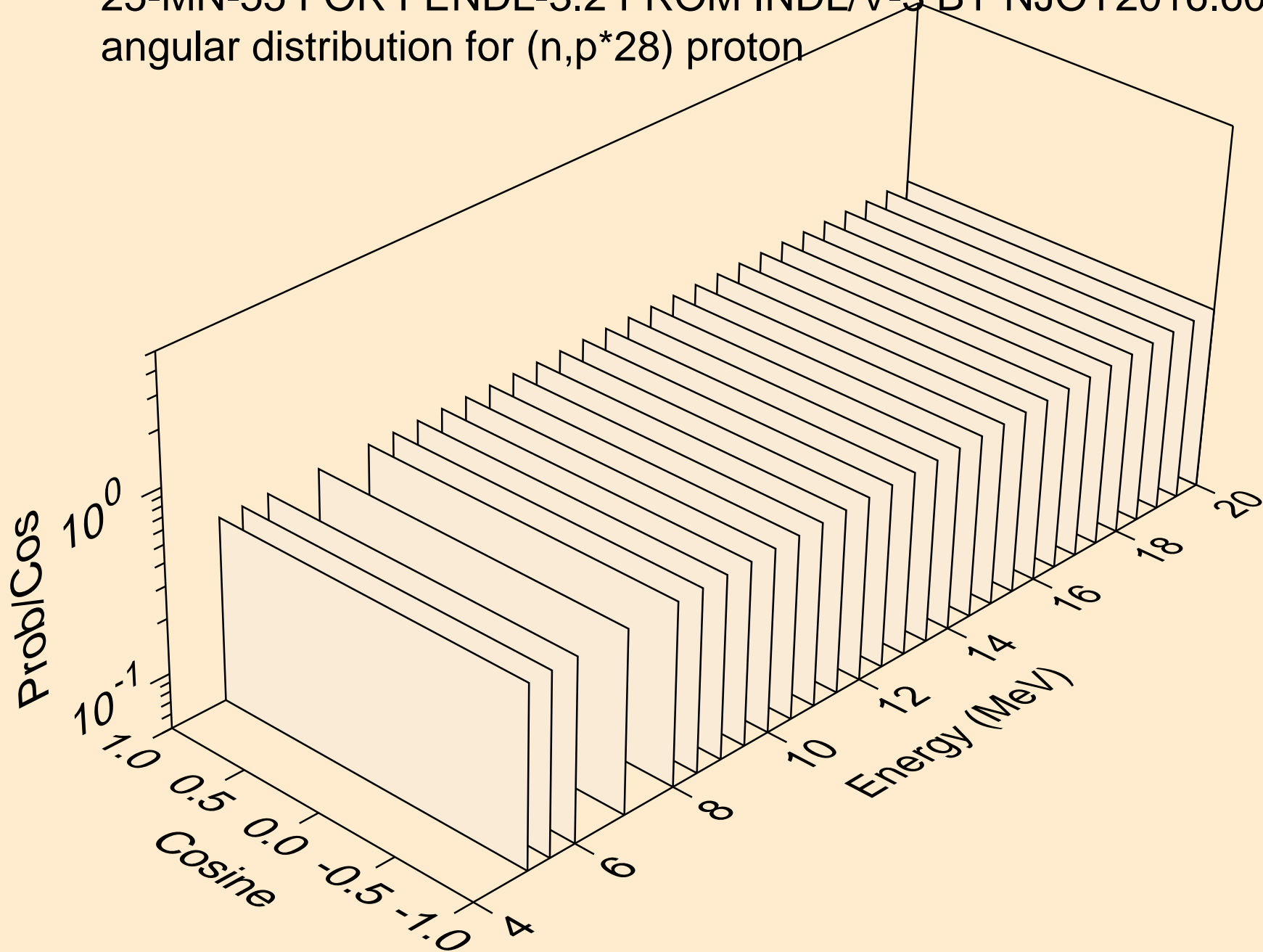

25-MN-55 FOR FENDL-3.2 FROM INDL/V-3 BY NJOY2016.60+ ON  
angular distribution for (n,p\*28) proton

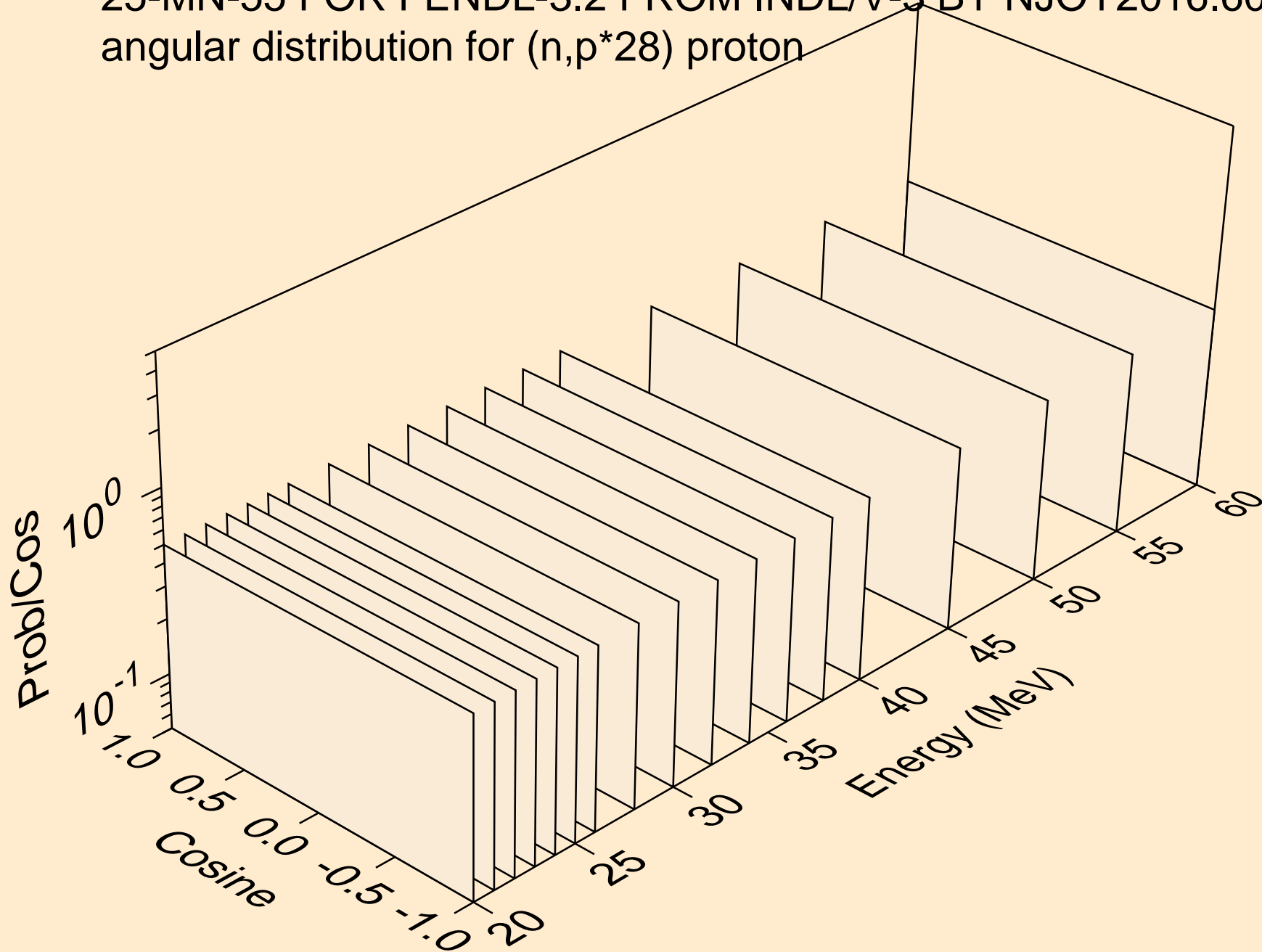



25-MN-55 FOR FENDL-3.2 FROM INDL/V-3 BY NJOY2016.60+ ON  
angular distribution for (n,p\*29) proton

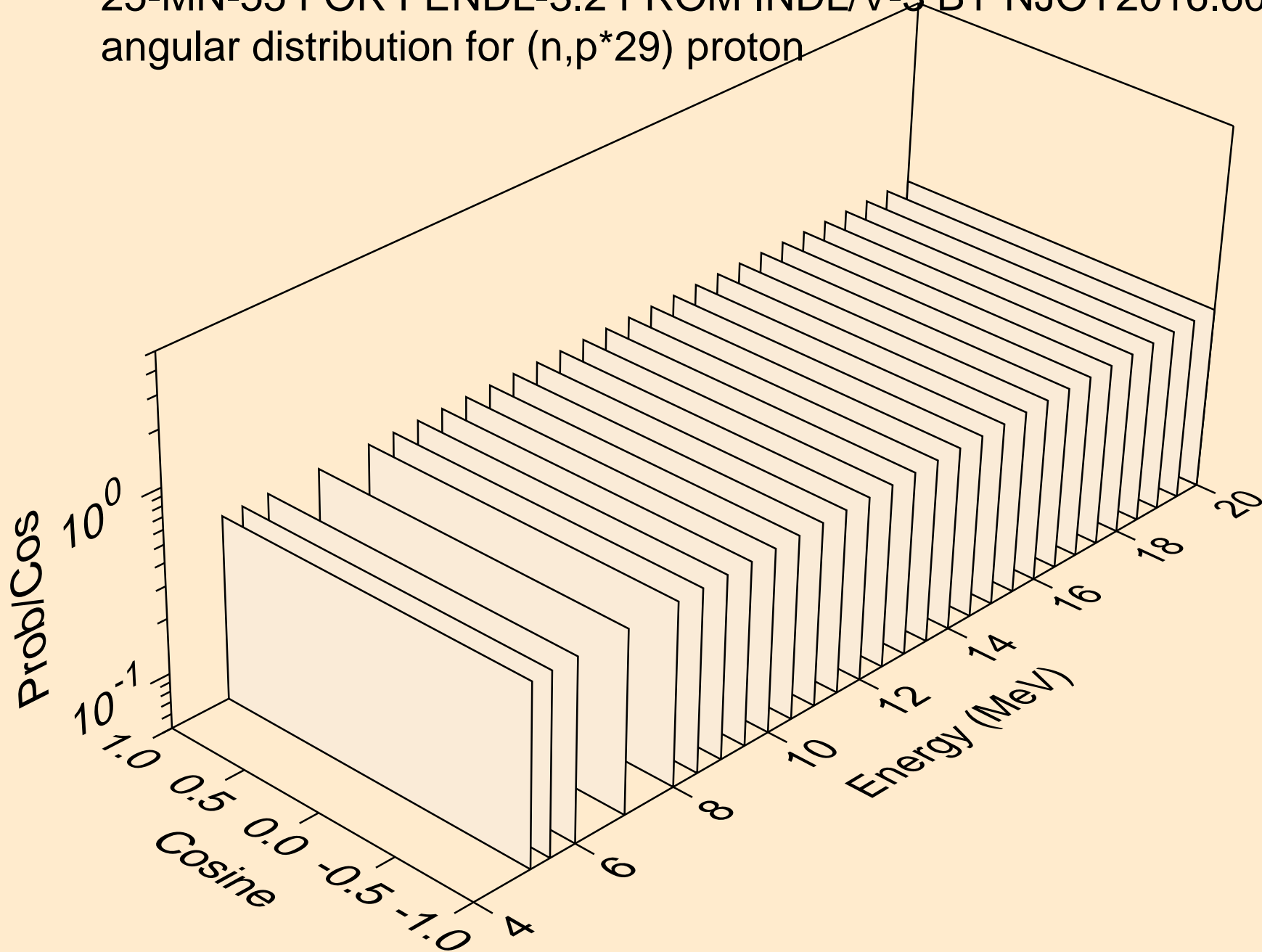

25-MN-55 FOR FENDL-3.2 FROM INDL/V-3 BY NJOY2016.60+ ON  
angular distribution for (n,p\*29) proton

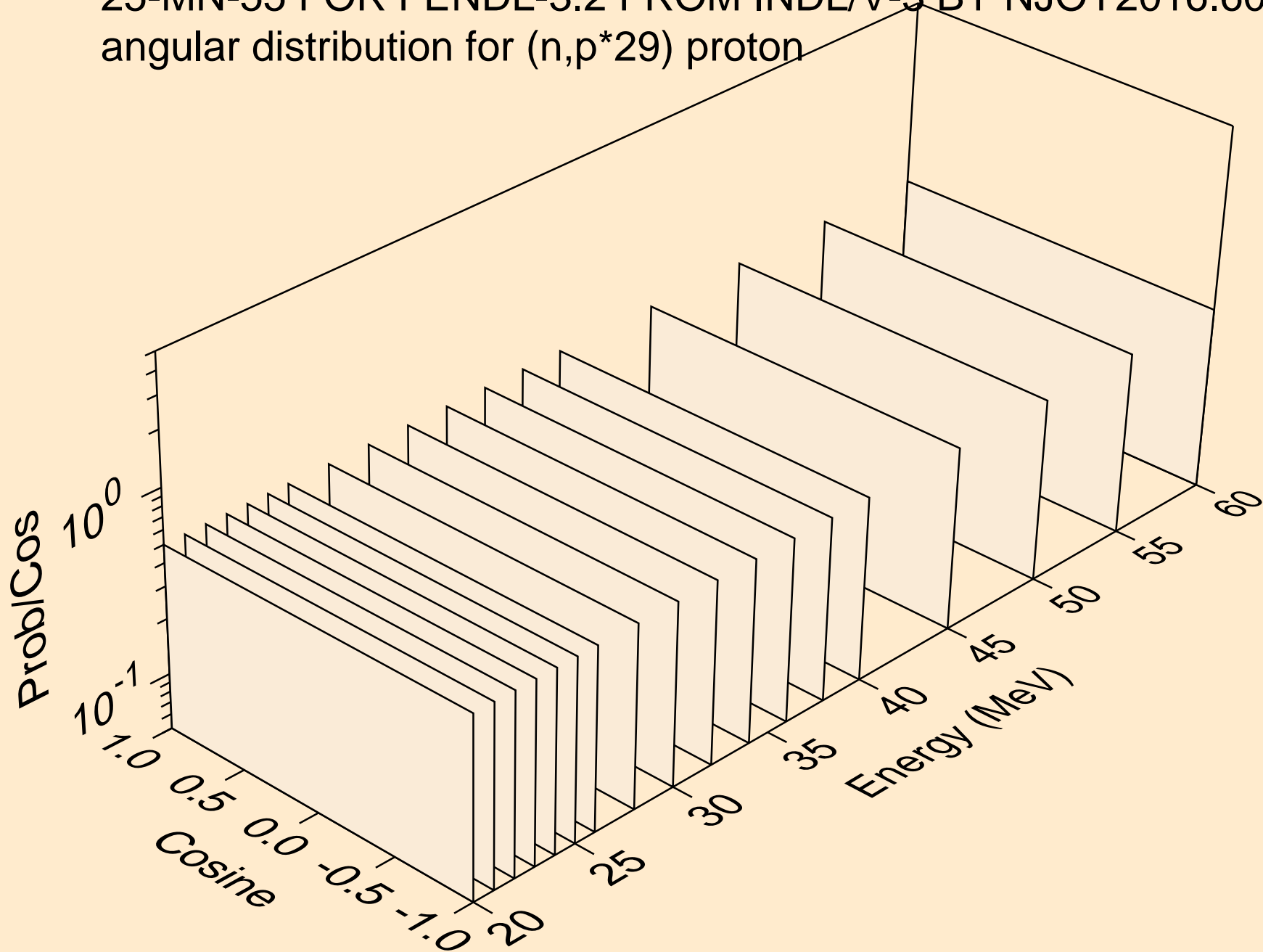

25-MN-55 FOR FENDL-3.2 FROM INDL/V-3 BY NJOY2016.60+ ON  
angular distribution for (n,p\*30) proton

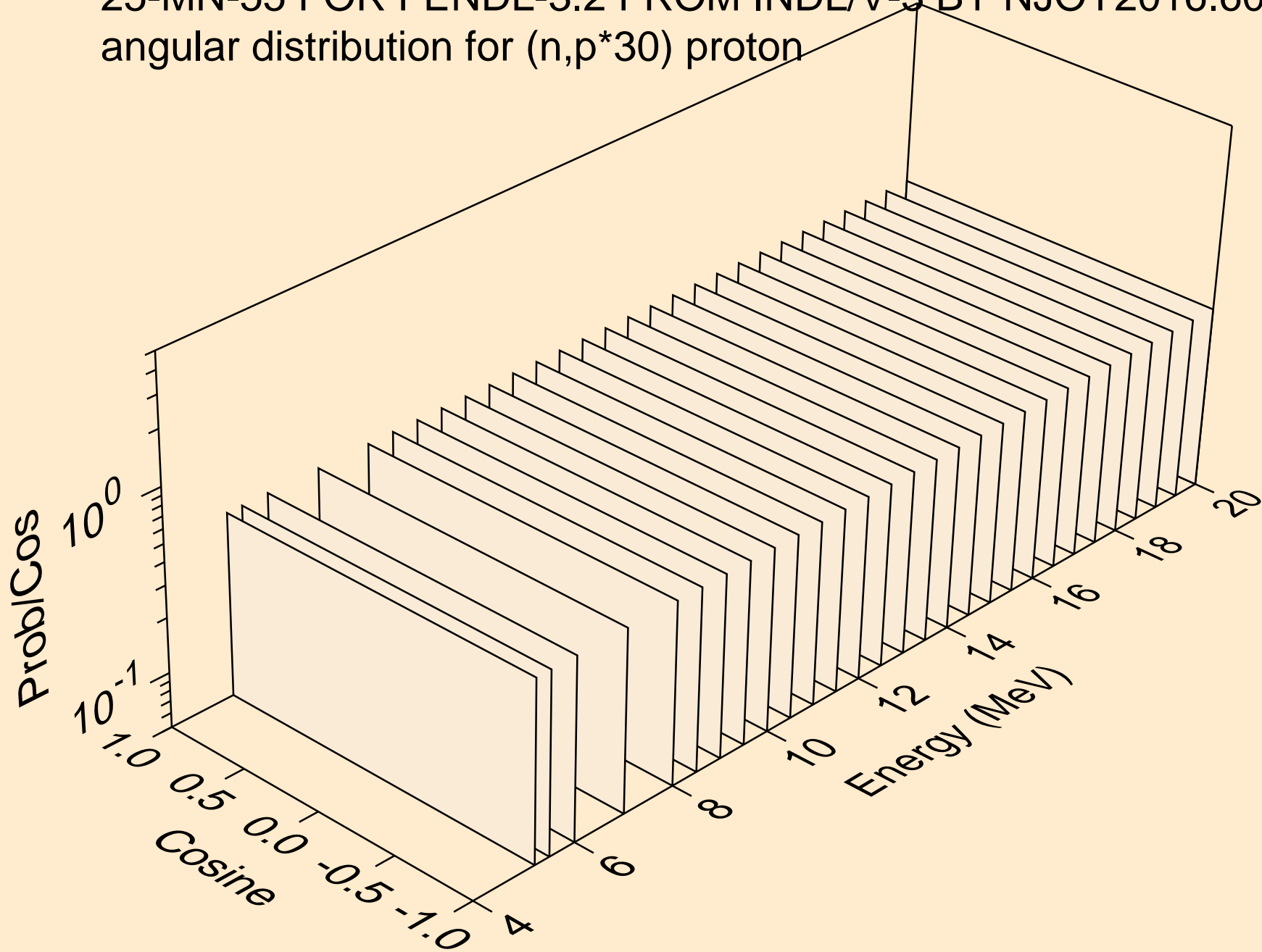

25-MN-55 FOR FENDL-3.2 FROM INDL/V-3 BY NJOY2016.60+ ON  
angular distribution for (n,p\*30) proton

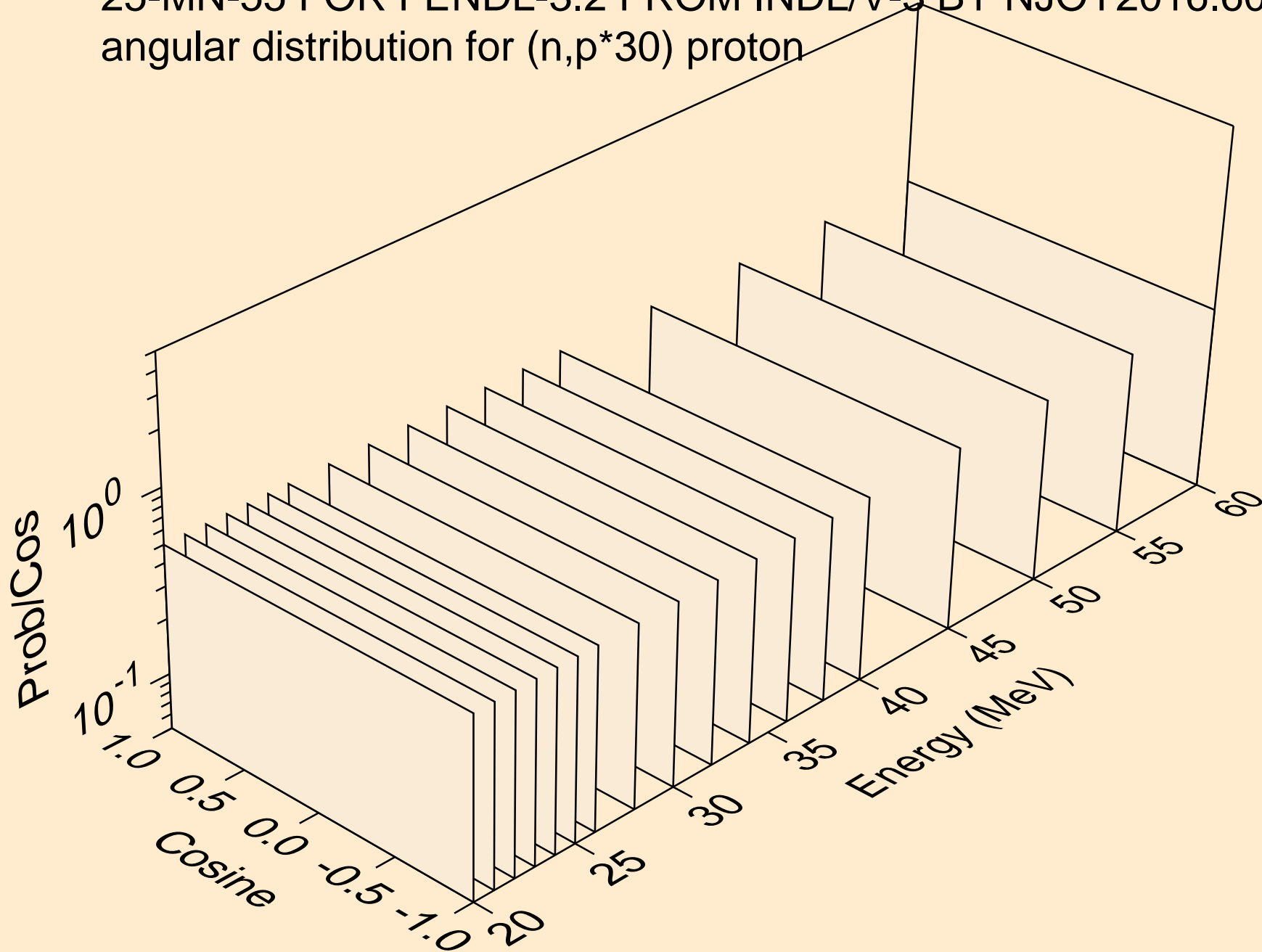

25-MN-55 FOR FENDL-3.2 FROM INDL/V-3 BY NJOY2016.60+ ON  
angular distribution for (n,p\*31) proton

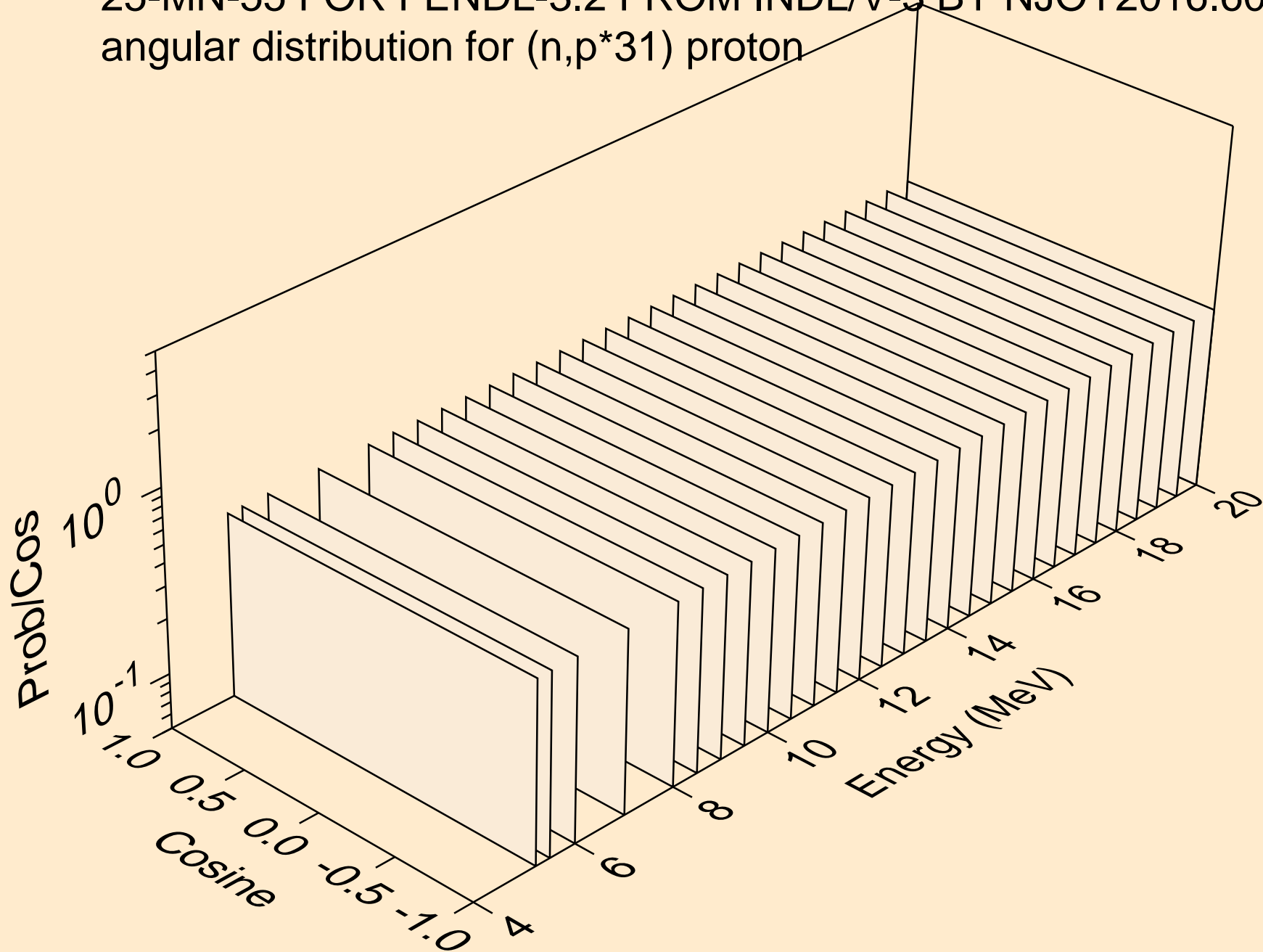

25-MN-55 FOR FENDL-3.2 FROM INDL/V-3 BY NJOY2016.60+ ON  
angular distribution for (n,p\*31) proton

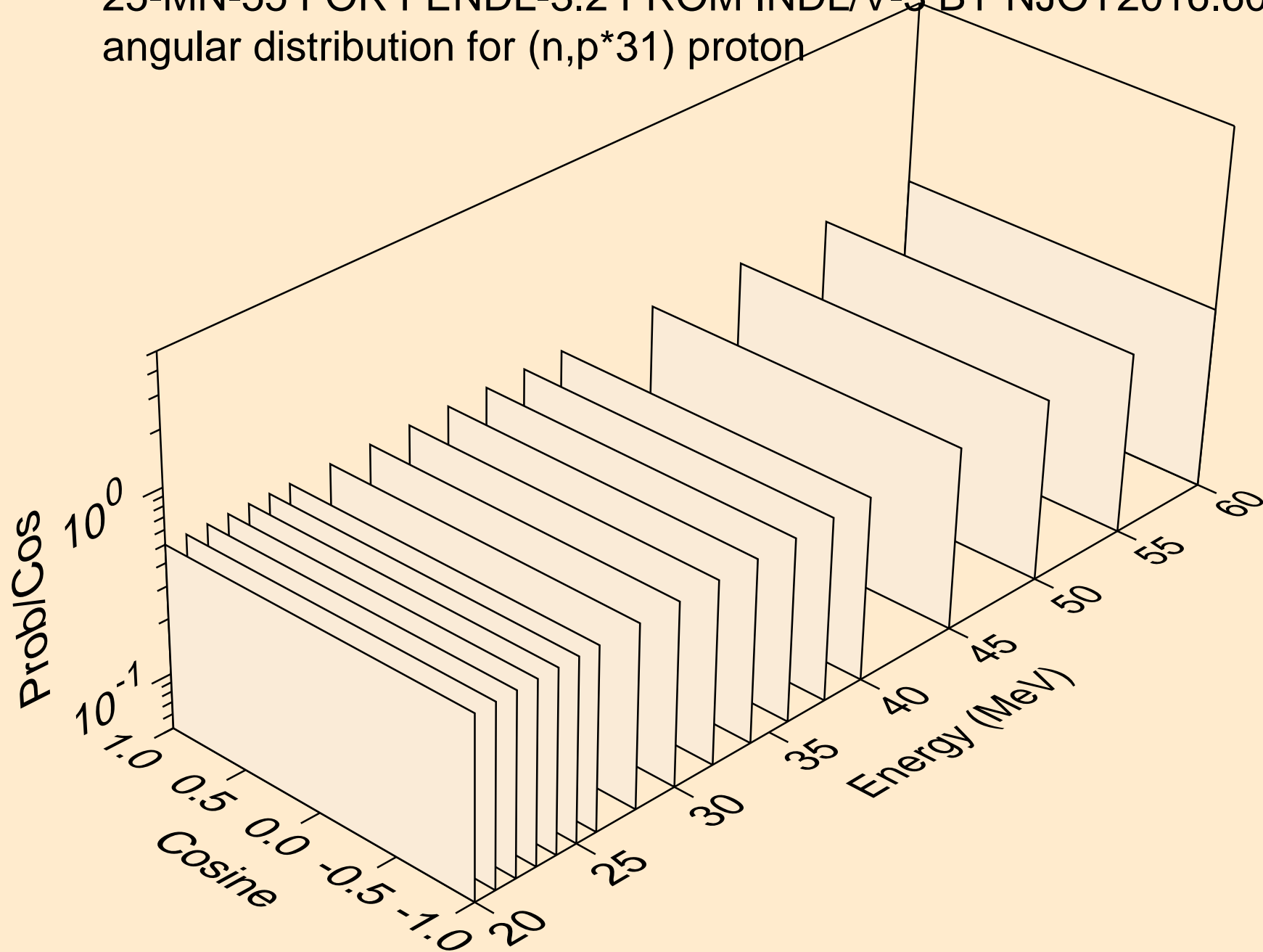

25-MN-55 FOR FENDL-3.2 FROM INDL/V-3 BY NJOY2016.60+ ON  
angular distribution for (n,p\*32) proton

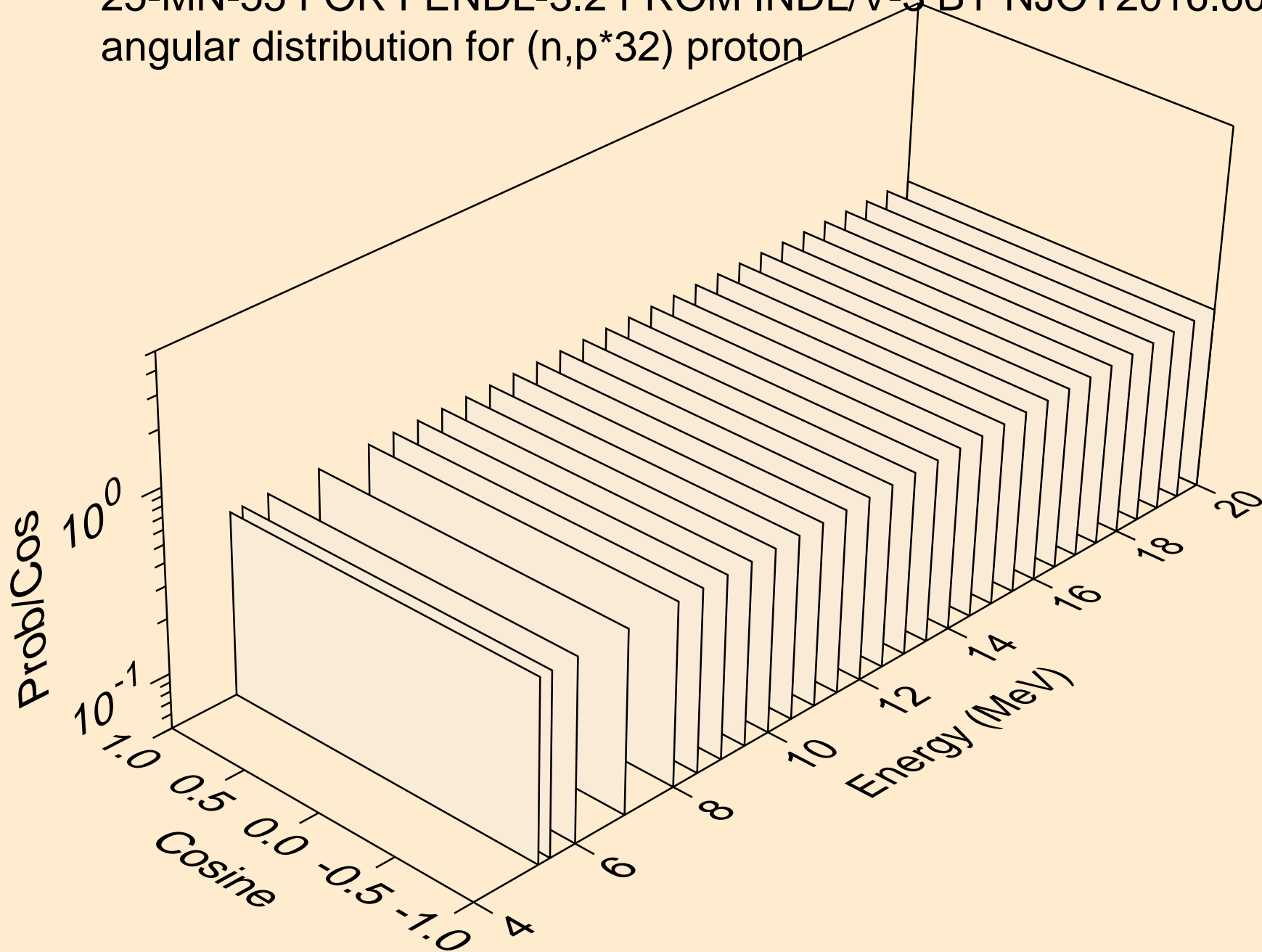

25-MN-55 FOR FENDL-3.2 FROM INDL/V-3 BY NJOY2016.60+ ON  
angular distribution for (n,p\*32) proton

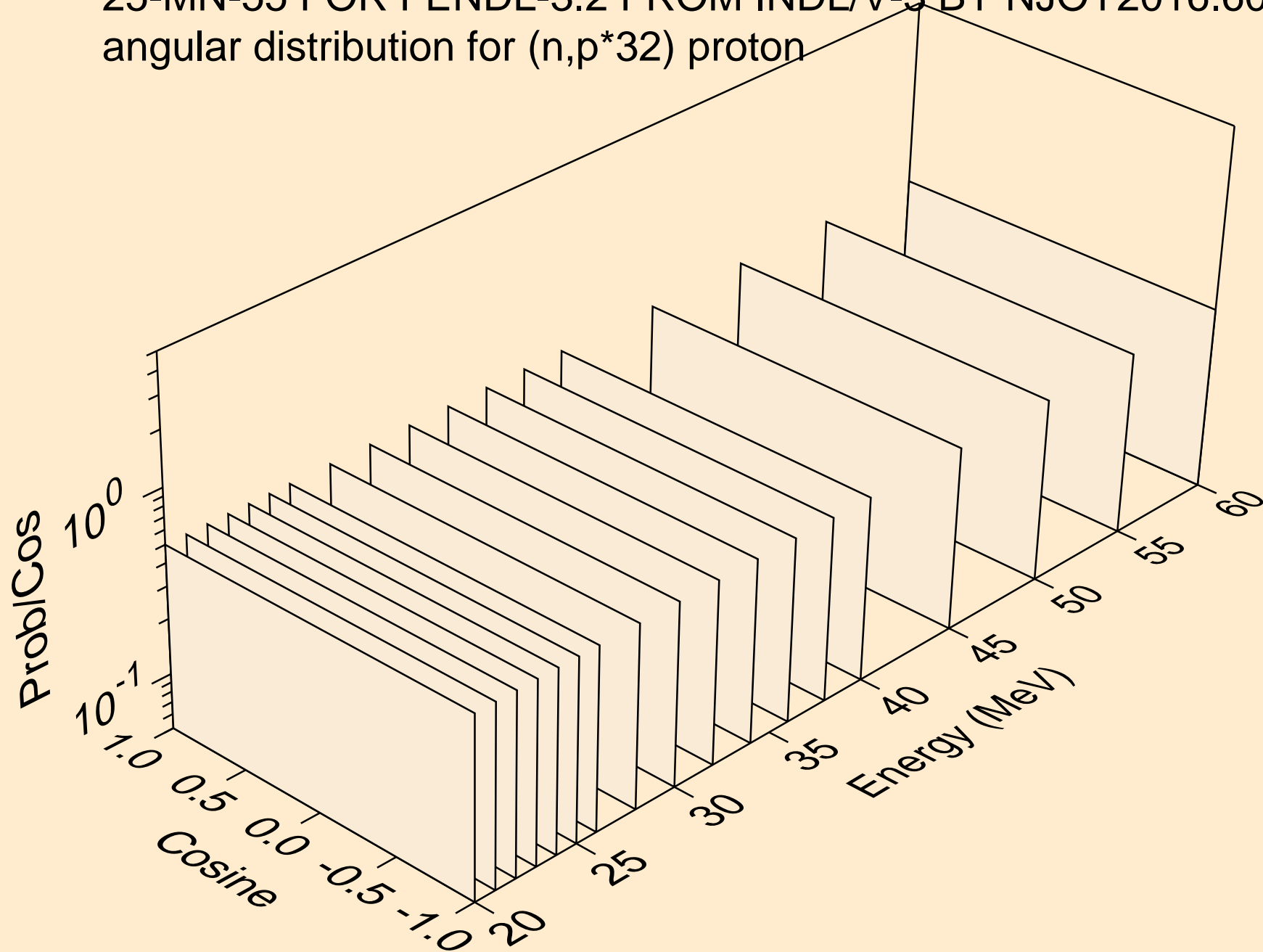



25-MN-55 FOR FENDL-3.2 FROM INDLV-3 BY NJOY2016.60+ ON  
protons from (n,p\*c)

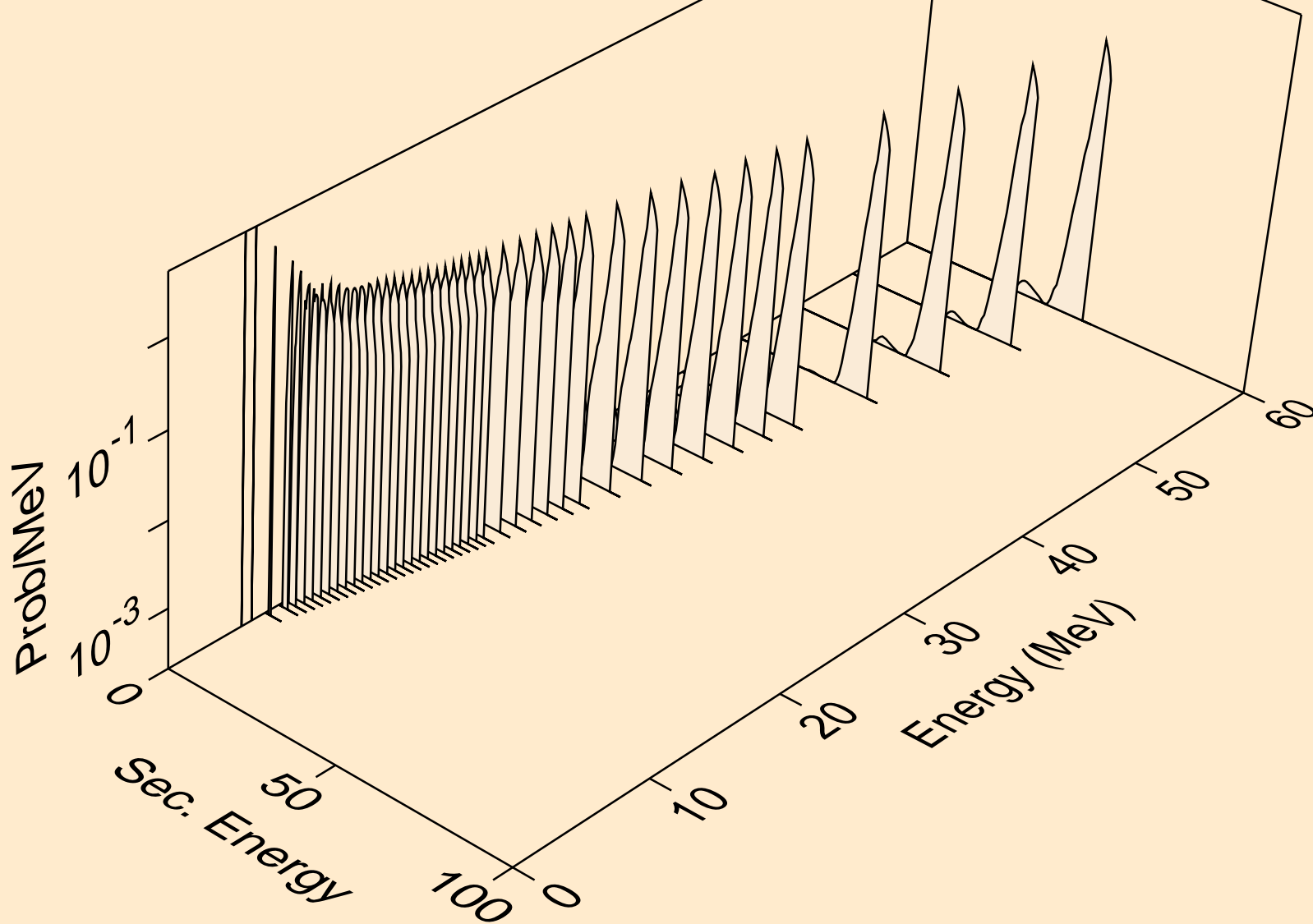

25-MN-55 FOR FENDL-3.2 FROM INDLV-3 BY NJOY2016.60+ ON  
deuterons from (n,x)

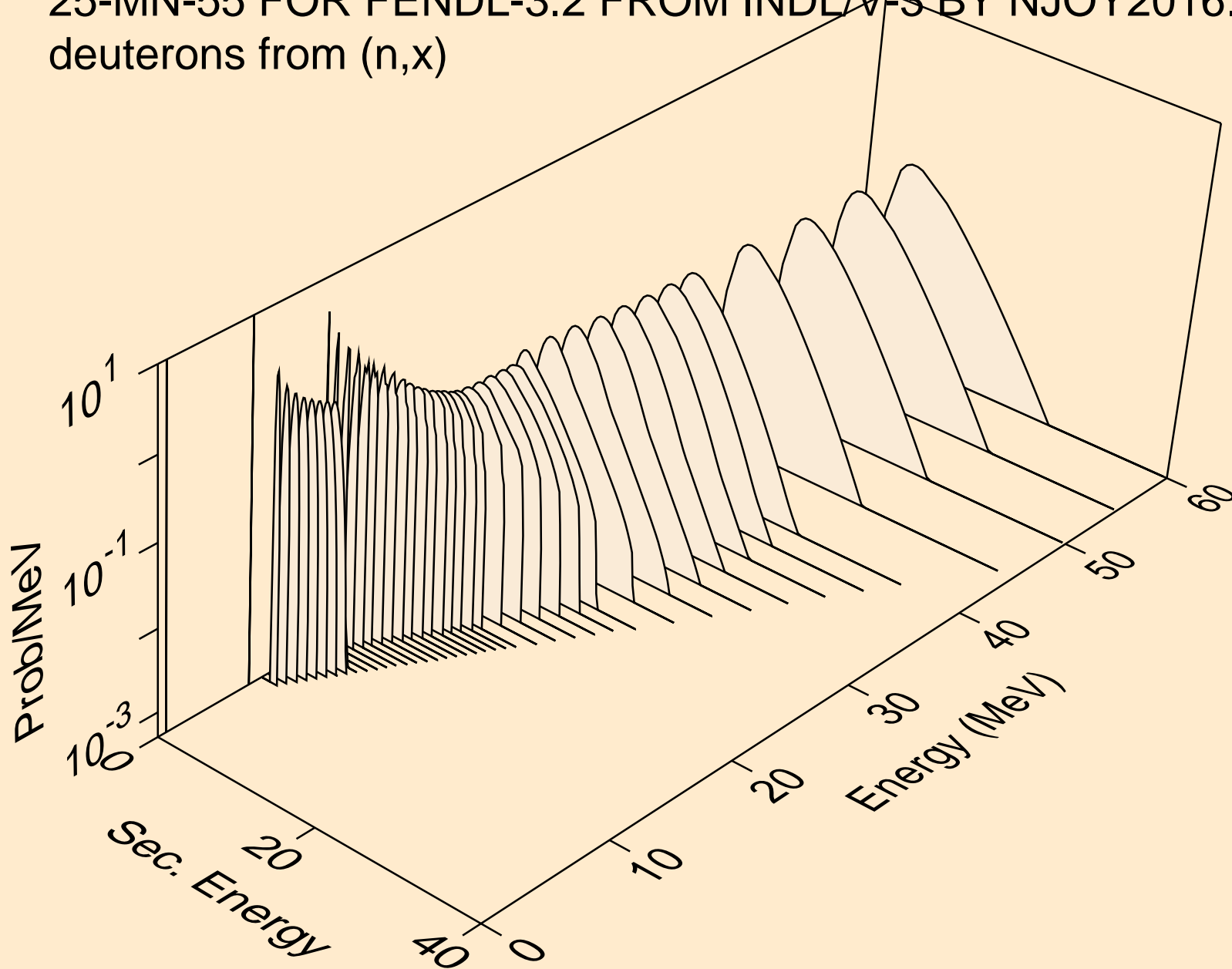

25-MN-55 FOR FENDL-3.2 FROM INDLV-3 BY NJOY2016.60+ ON  
tritons from (n,x)

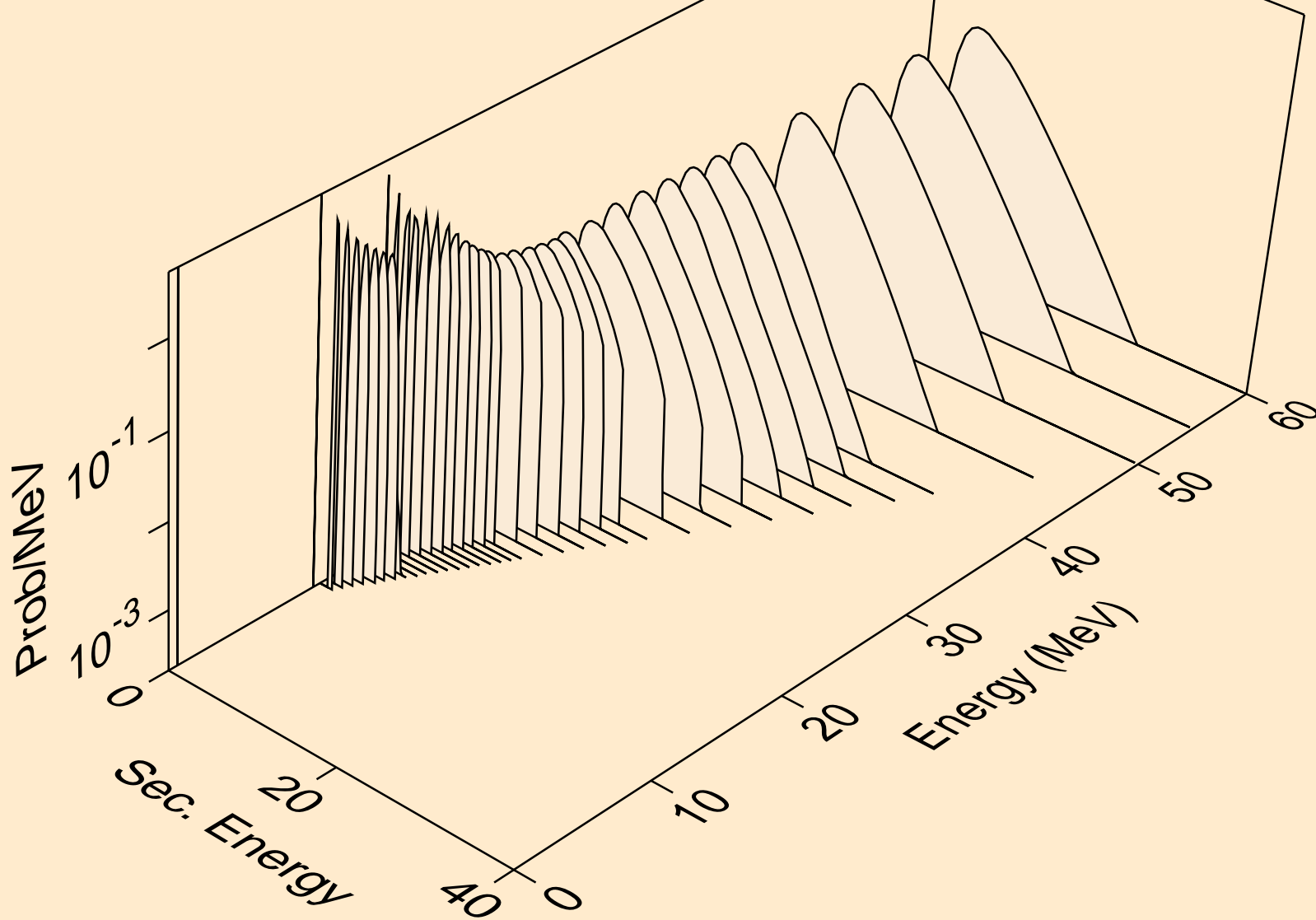

25-MN-55 FOR FENDL-3.2 FROM INDLV-3 BY NJOY2016.60+ ON  
he3s from (n,x)

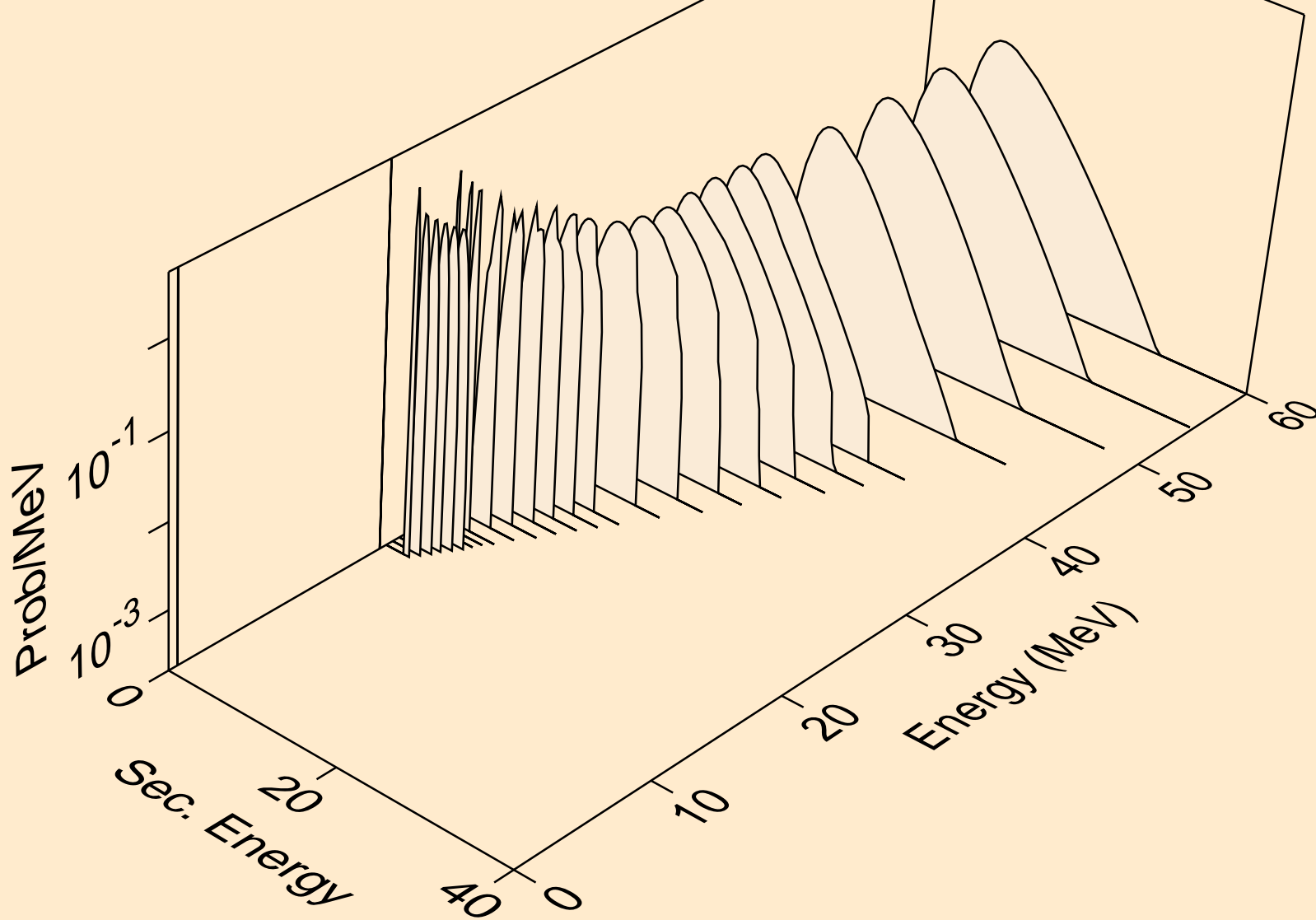

25-MN-55 FOR FENDL-3.2 FROM INDLV-3 BY NJOY2016.60+ ON  
alphas from (n,x)

