

26-FE-57 FOR FENDL-3.2 FROM INDEN-1.0 BY NJOY2016.60+ ON
Principal cross sections

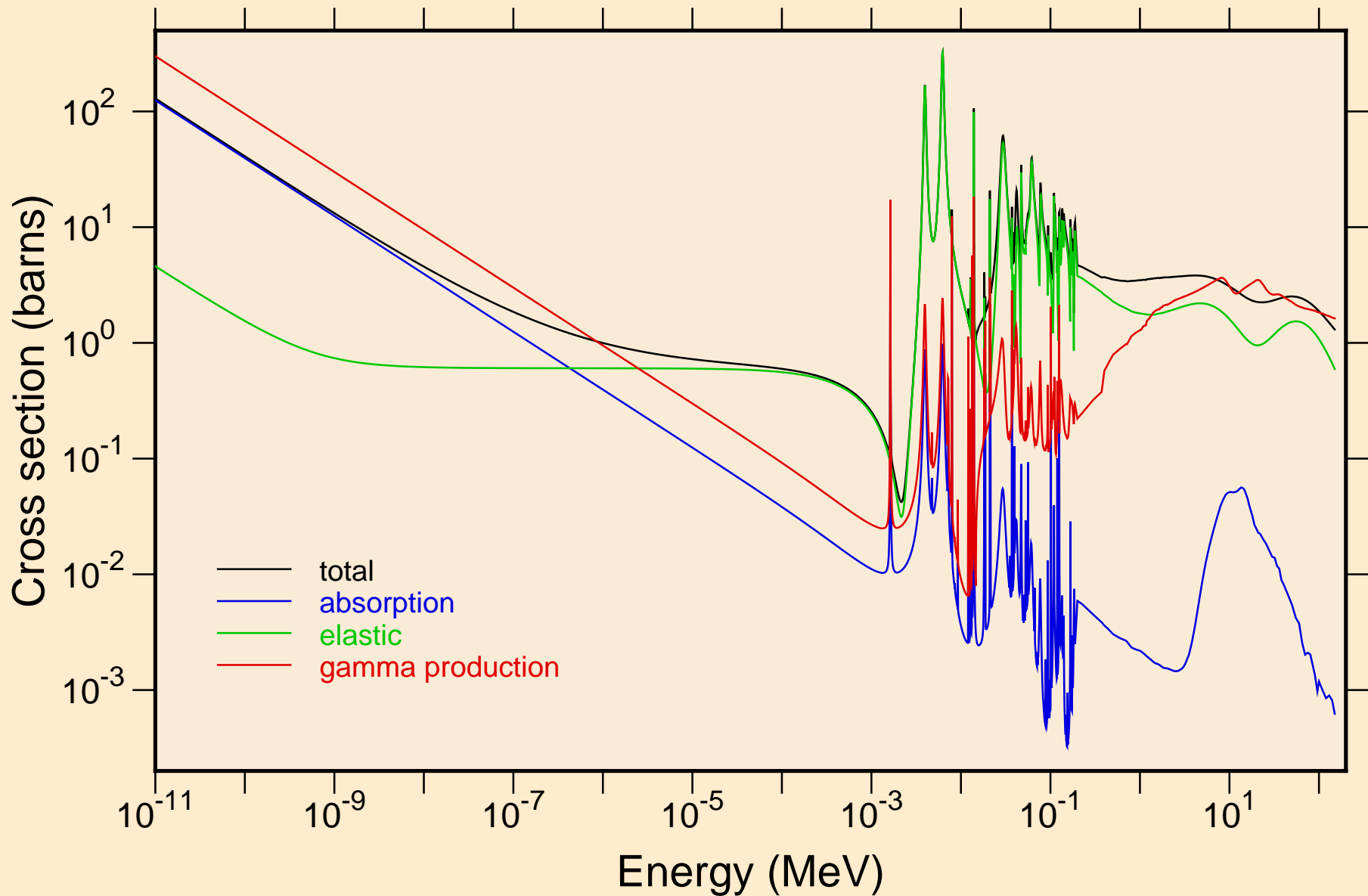

26-FE-57 FOR FENDL-3.2 FROM INDEN-1.0 BY NJOY2016.60+ ON
resonance total cross section

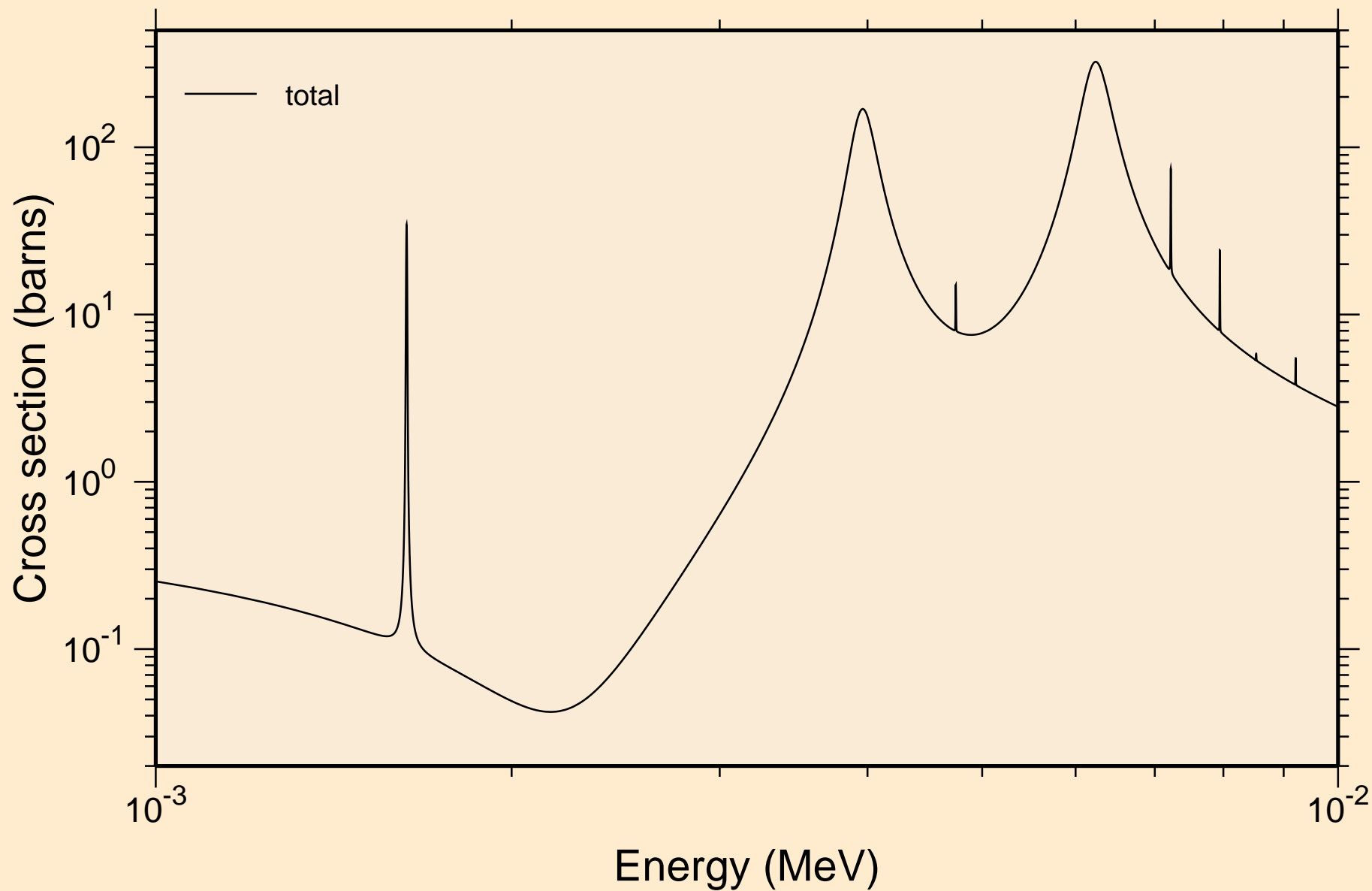

26-FE-57 FOR FENDL-3.2 FROM INDEN-1.0 BY NJOY2016.60+ ON
resonance total cross section

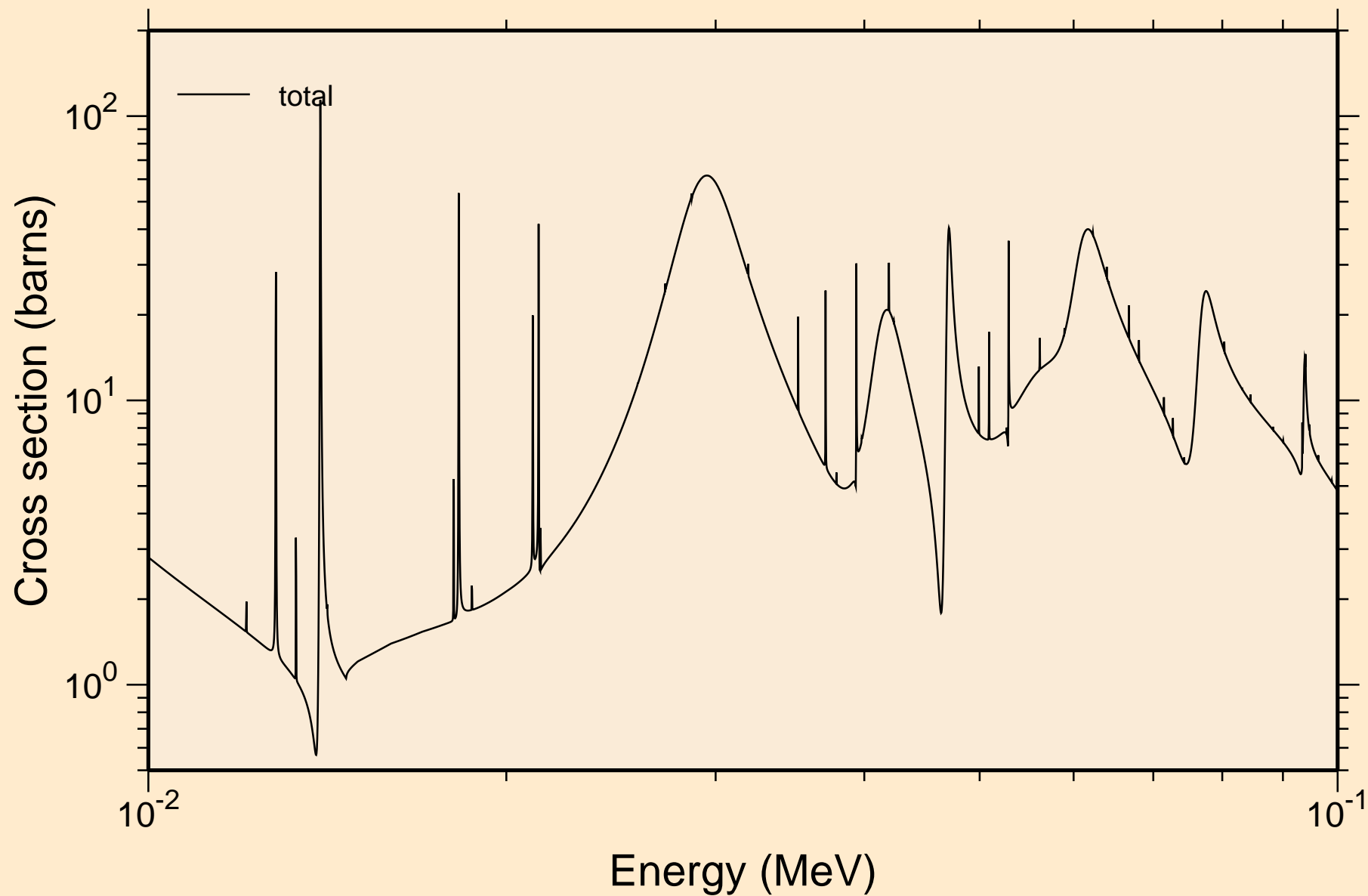

26-FE-57 FOR FENDL-3.2 FROM INDEN-1.0 BY NJOY2016.60+ ON
resonance total cross section

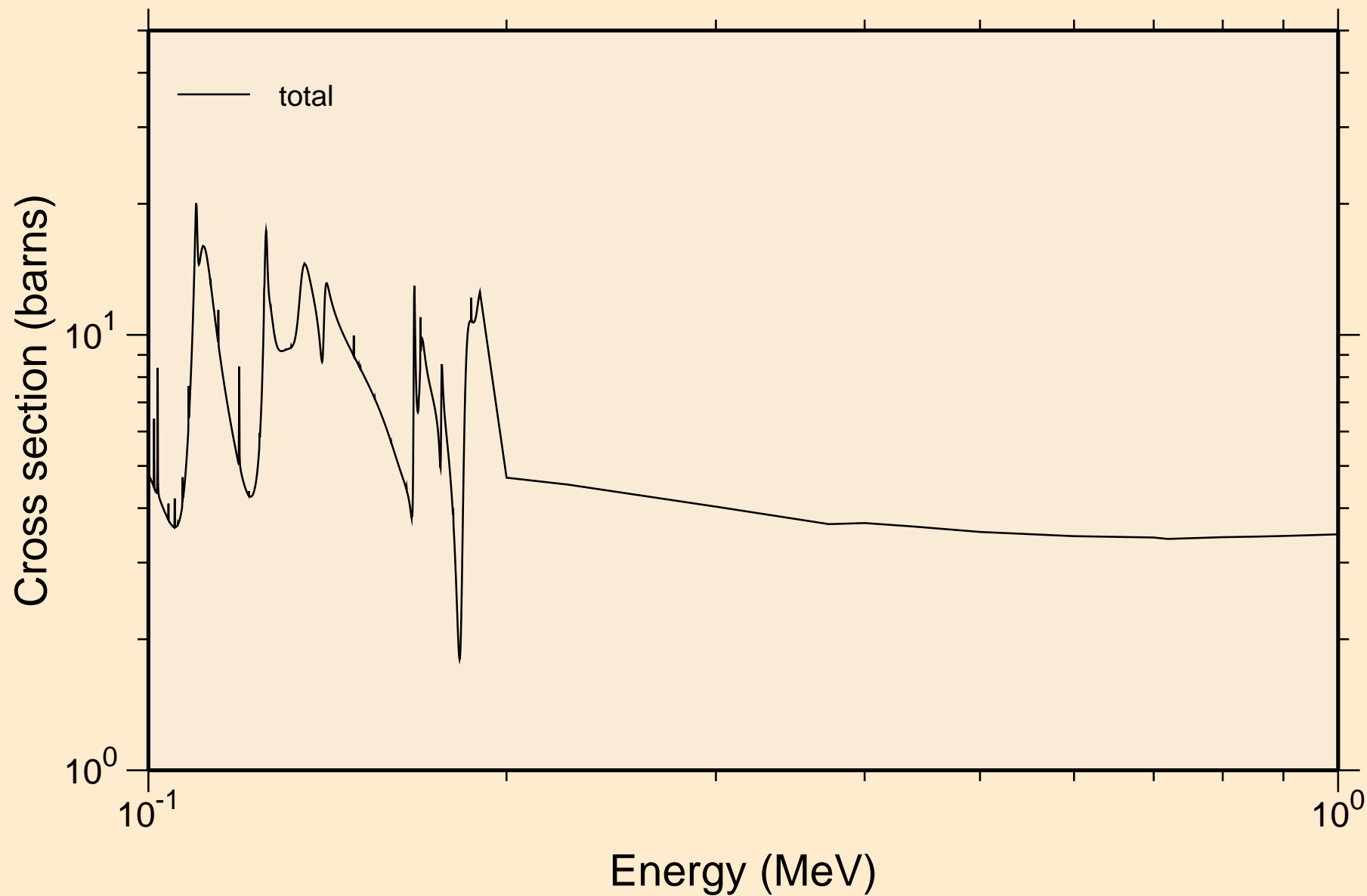

26-FE-57 FOR FENDL-3.2 FROM INDEN-1.0 BY NJOY2016.60+ ON
resonance absorption cross sections

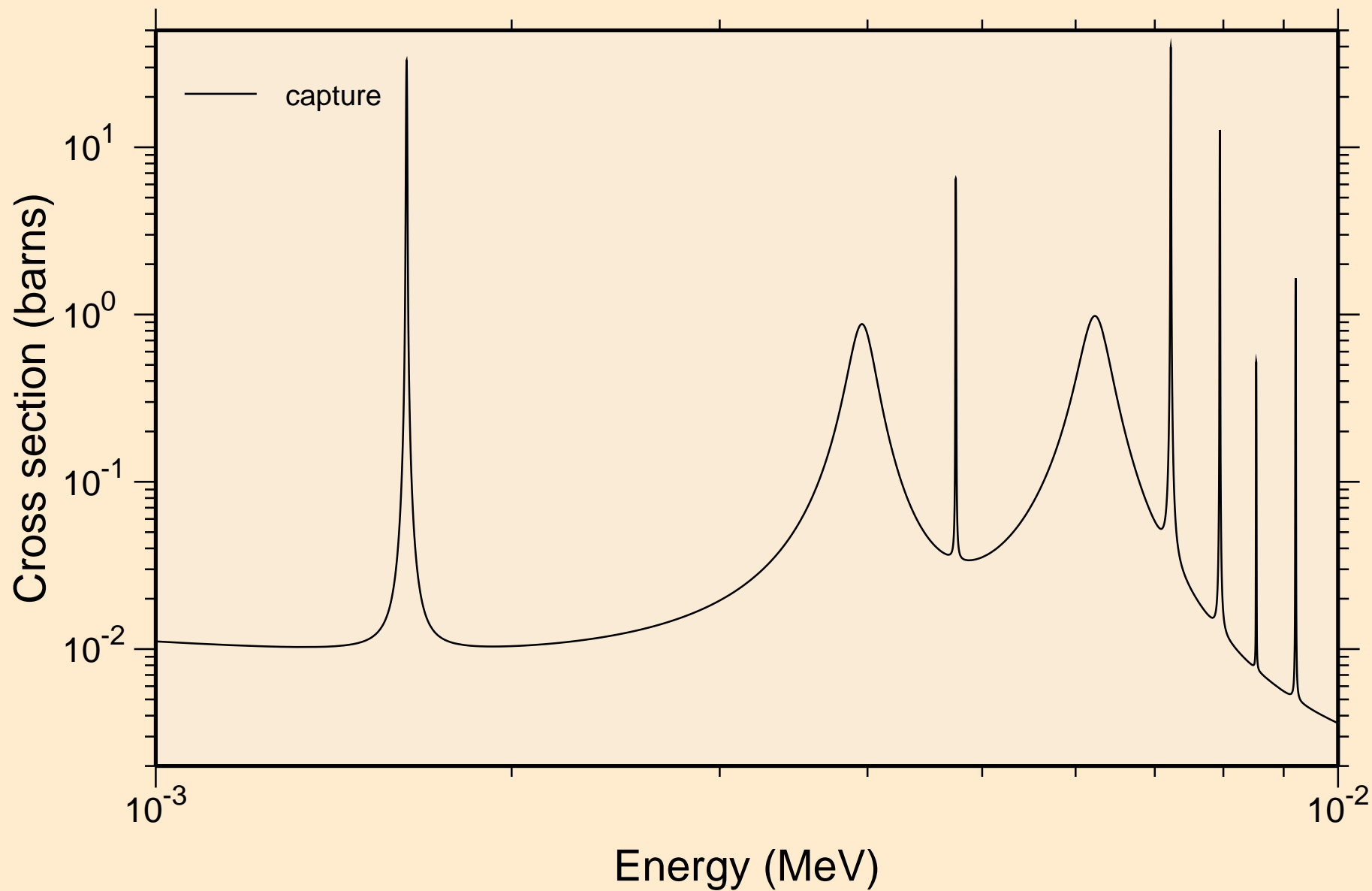

26-FE-57 FOR FENDL-3.2 FROM INDEN-1.0 BY NJOY2016.60+ ON
resonance absorption cross sections

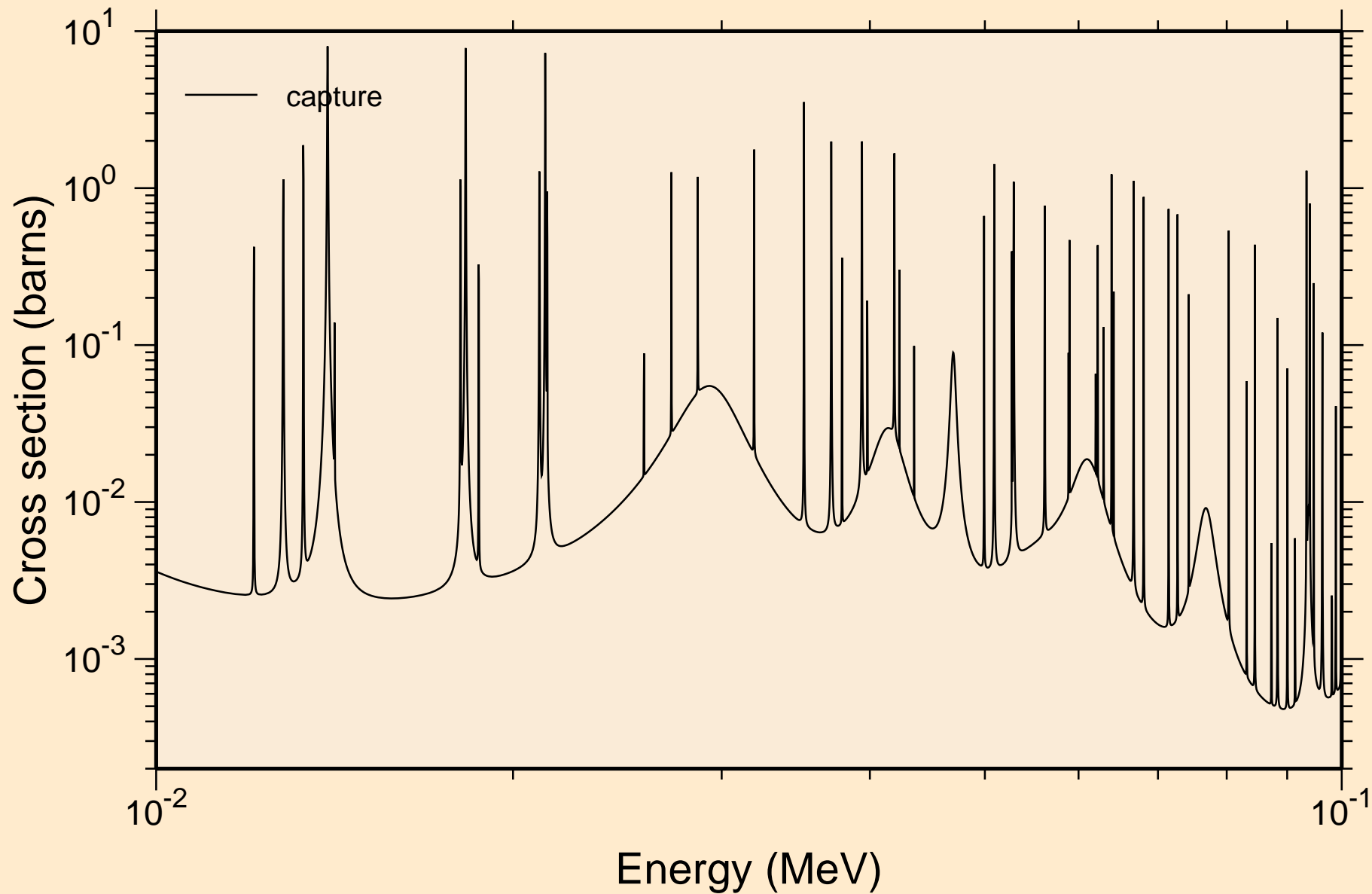

26-FE-57 FOR FENDL-3.2 FROM INDEN-1.0 BY NJOY2016.60+ ON
resonance absorption cross sections

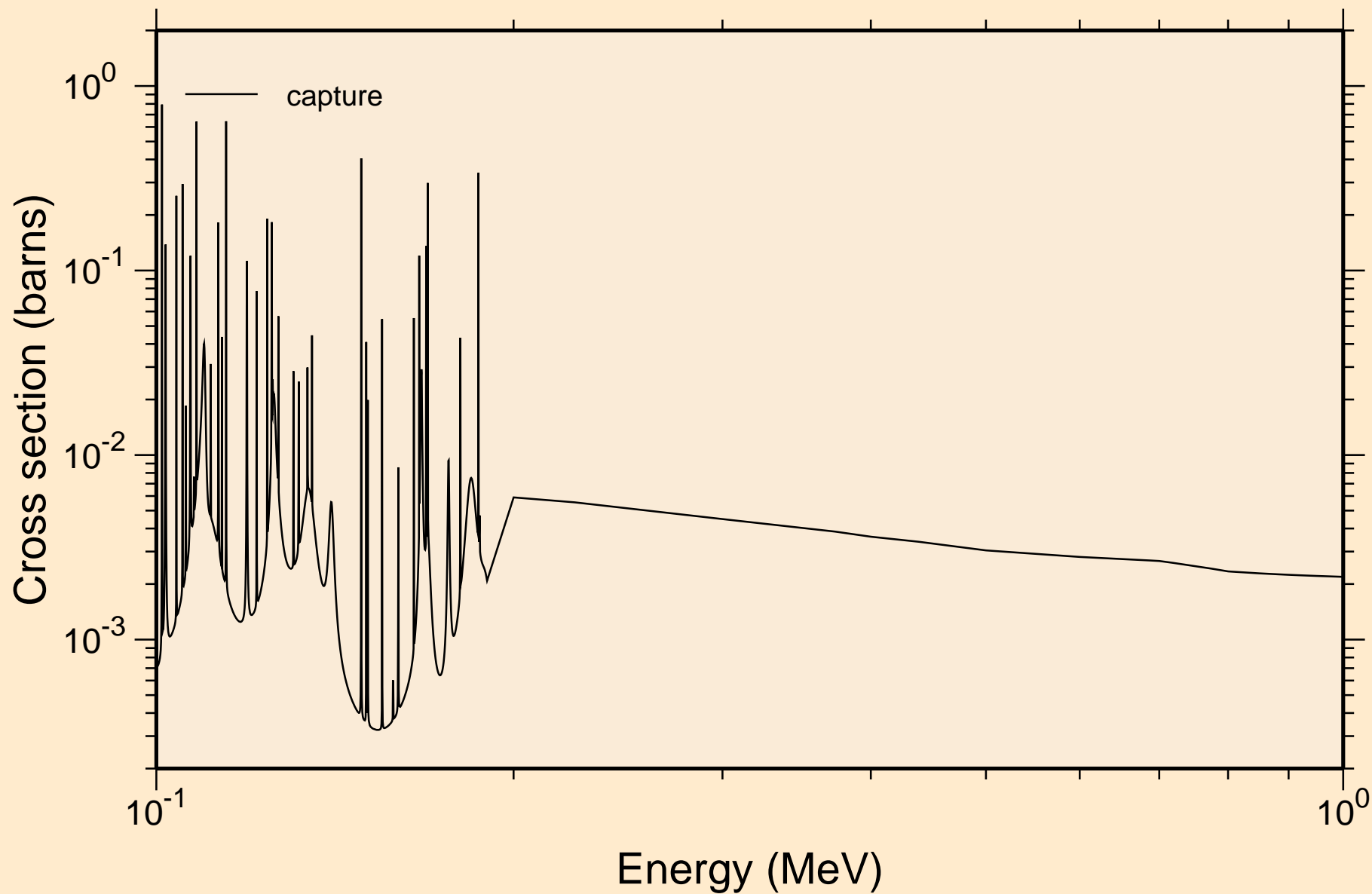

26-FE-57 FOR FENDL-3.2 FROM INDEN-1.0 BY NJOY2016.60+ ON Heating

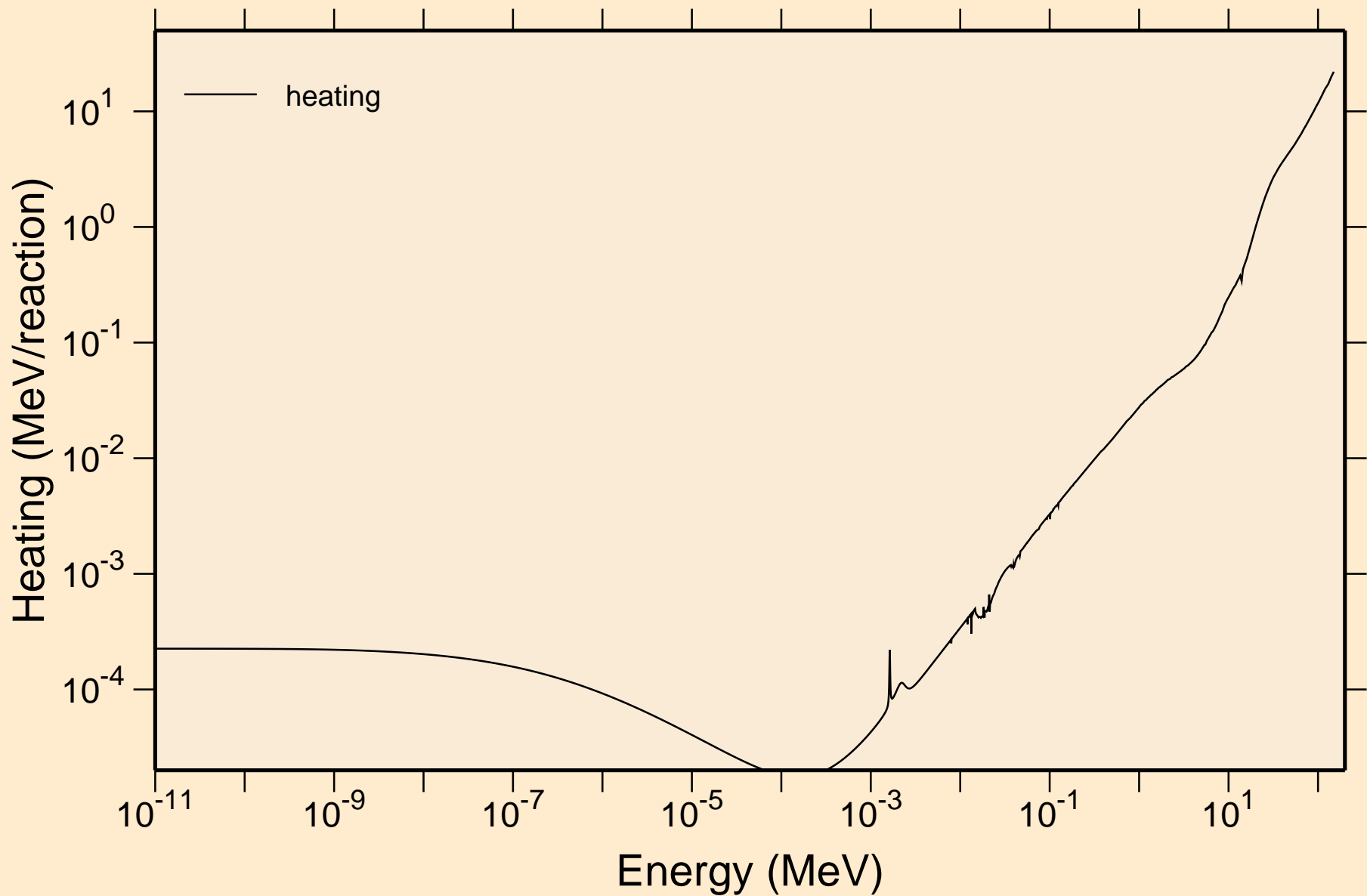

26-FE-57 FOR FENDL-3.2 FROM INDEN-1.0 BY NJOY2016.60+ ON Damage

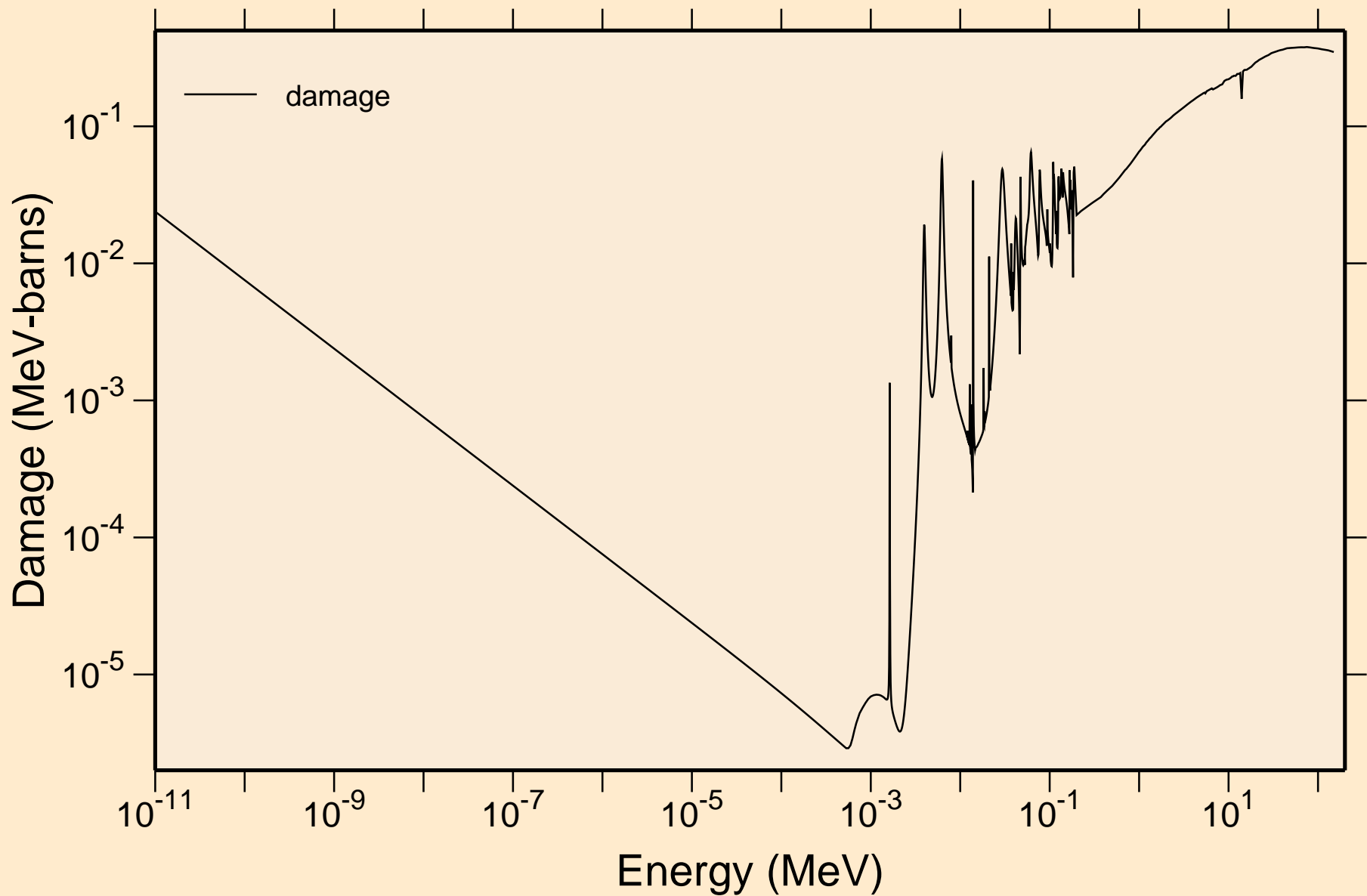

26-FE-57 FOR FENDL-3.2 FROM INDEN-1.0 BY NJOY2016.60+ ON
Non-threshold reactions

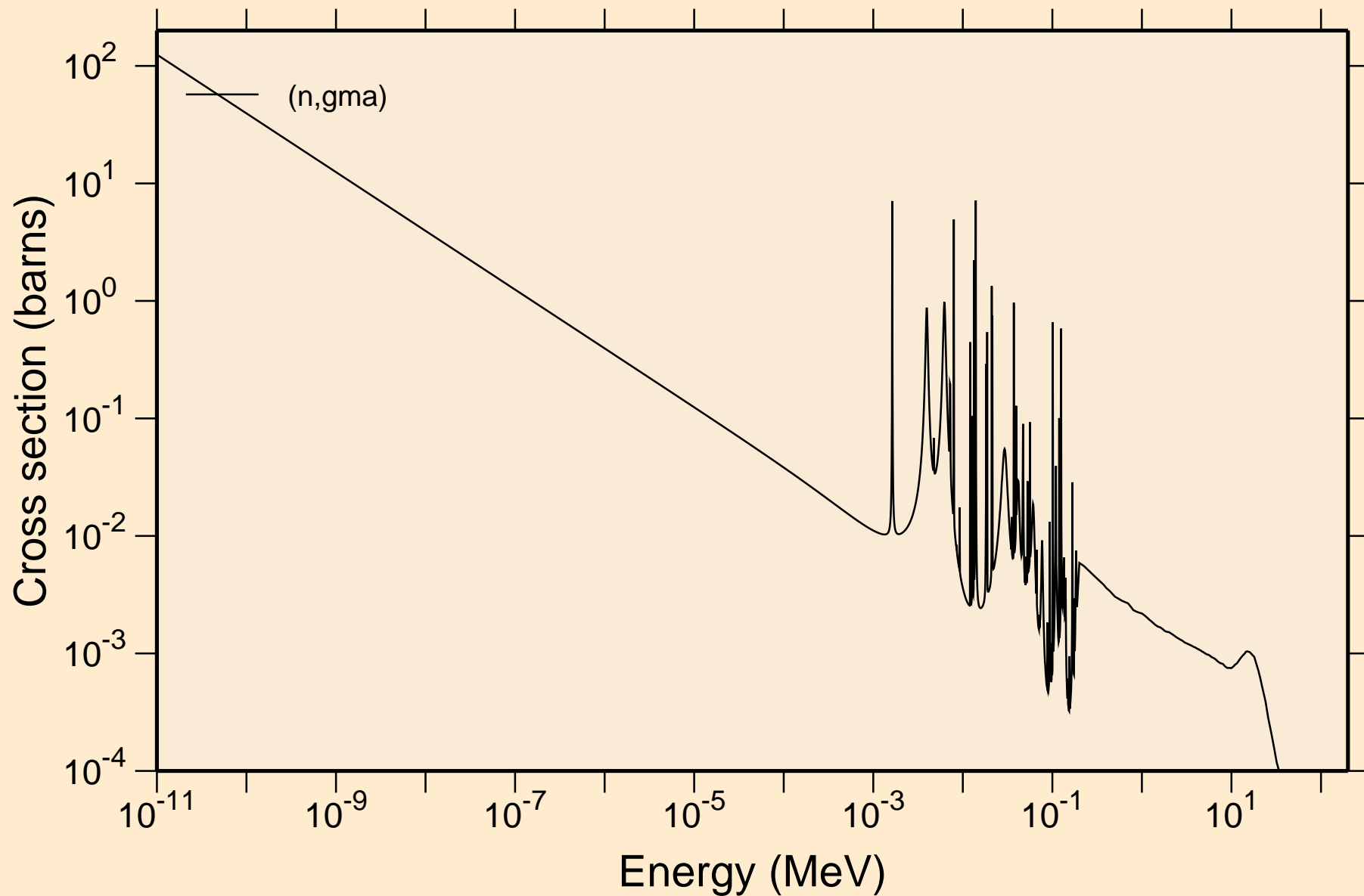

26-FE-57 FOR FENDL-3.2 FROM INDEN-1.0 BY NJOY2016.60+ ON
Principal cross sections

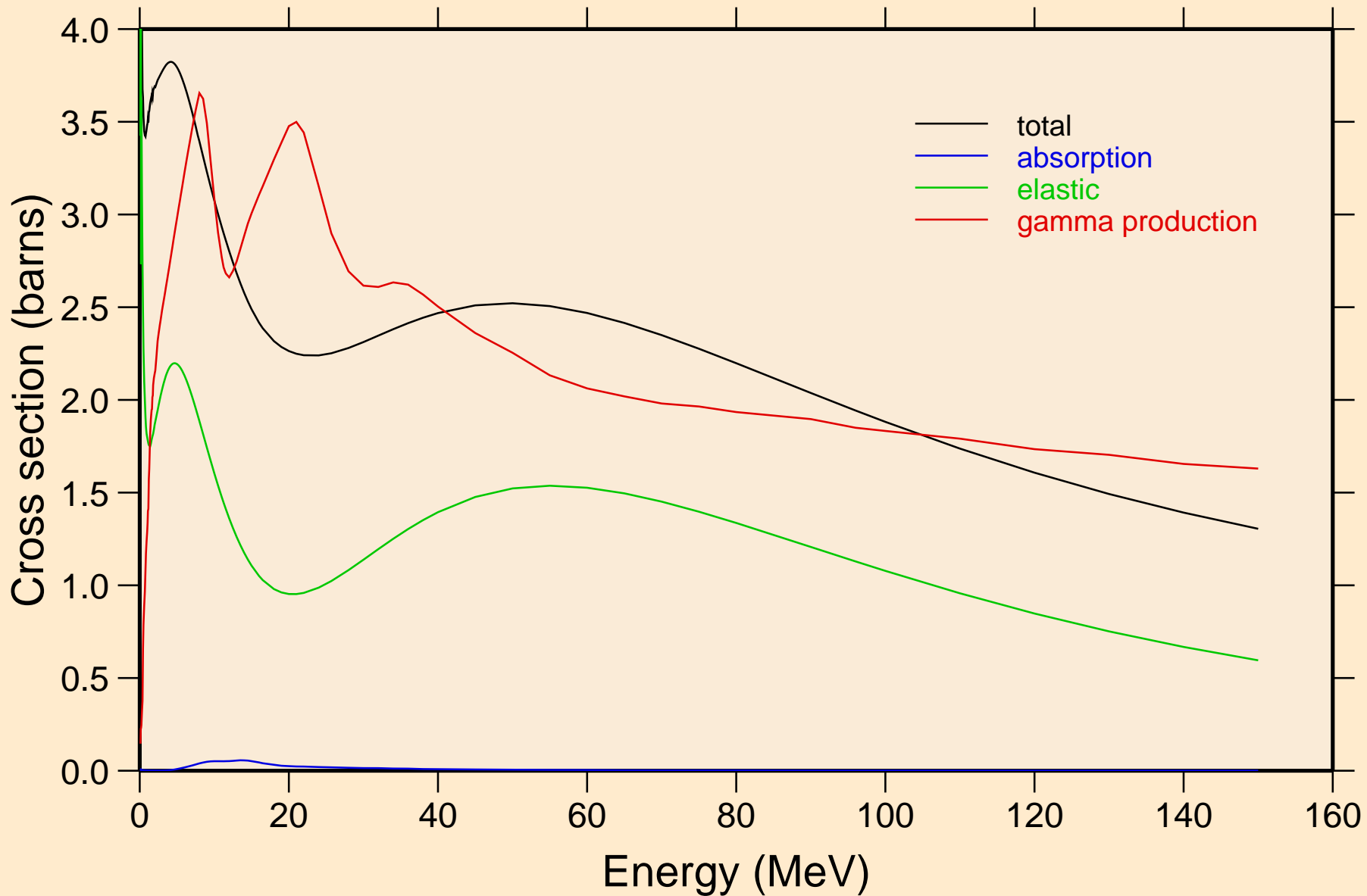

26-FE-57 FOR FENDL-3.2 FROM INDEN-1.0 BY NJOY2016.60+ ON Heating

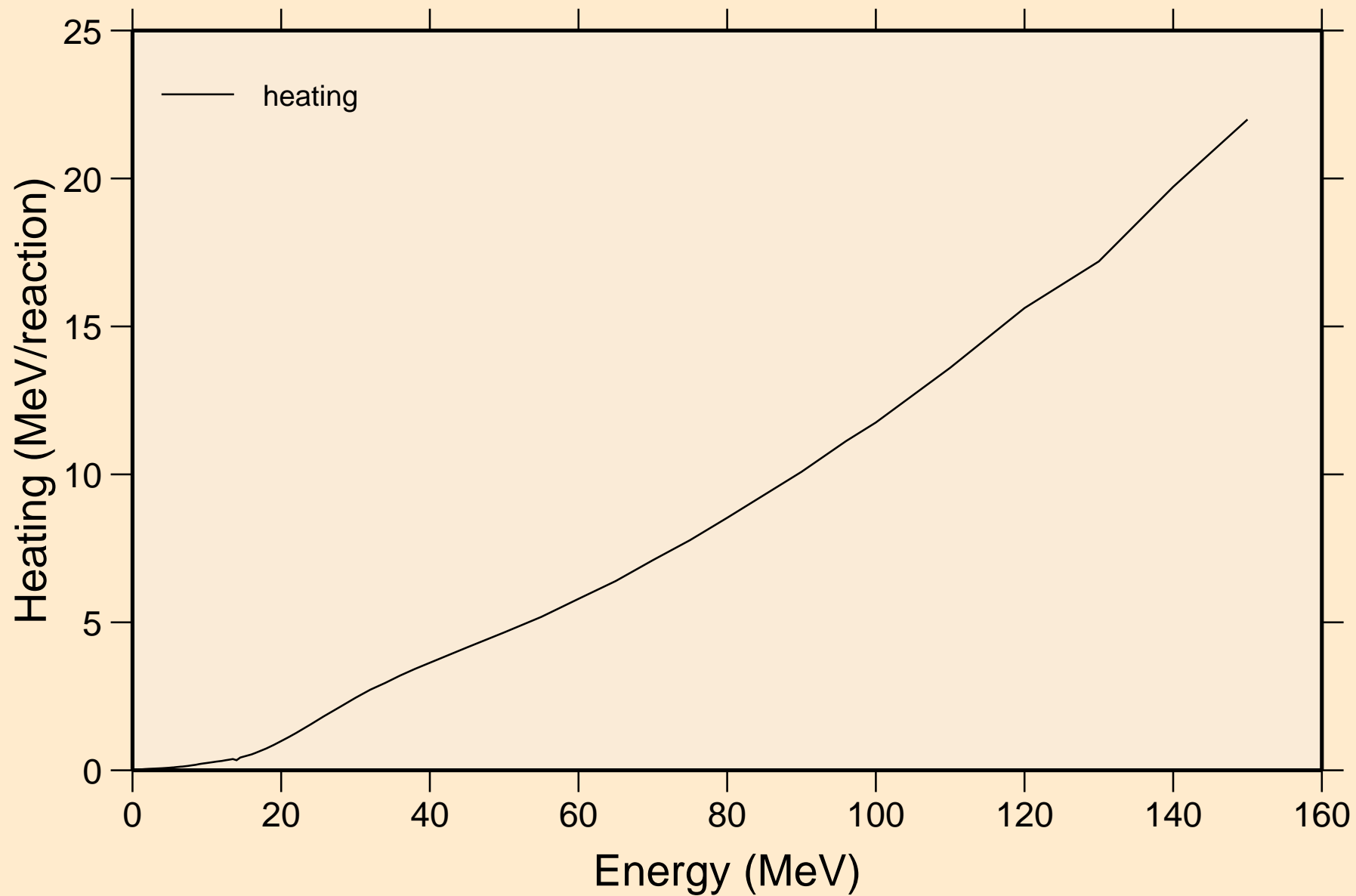

26-FE-57 FOR FENDL-3.2 FROM INDEN-1.0 BY NJOY2016.60+ ON
Damage

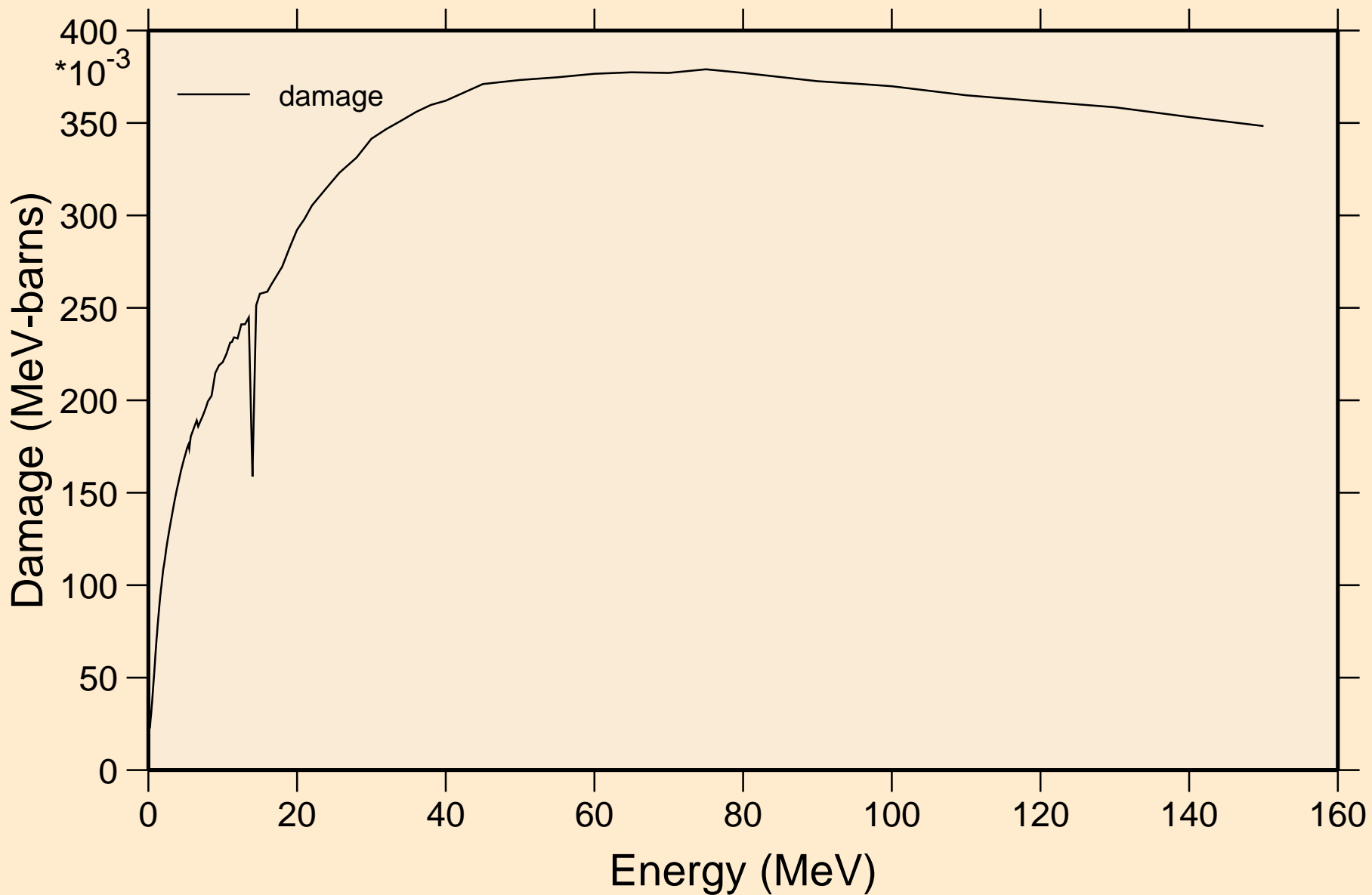

26-FE-57 FOR FENDL-3.2 FROM INDEN-1.0 BY NJOY2016.60+ ON
Non-threshold reactions

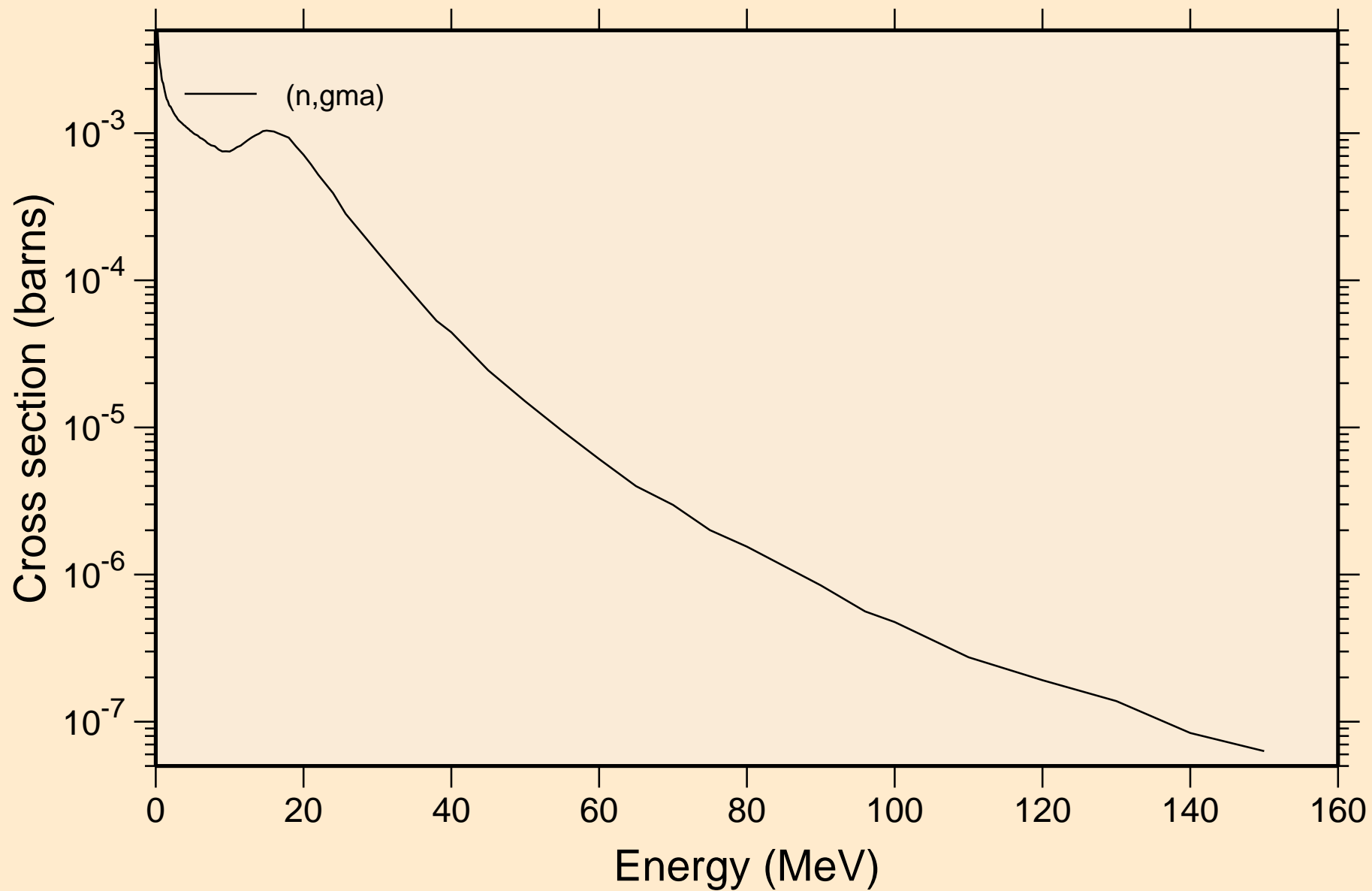

26-FE-57 FOR FENDL-3.2 FROM INDEN-1.0 BY NJOY2016.60+ ON
Inelastic levels

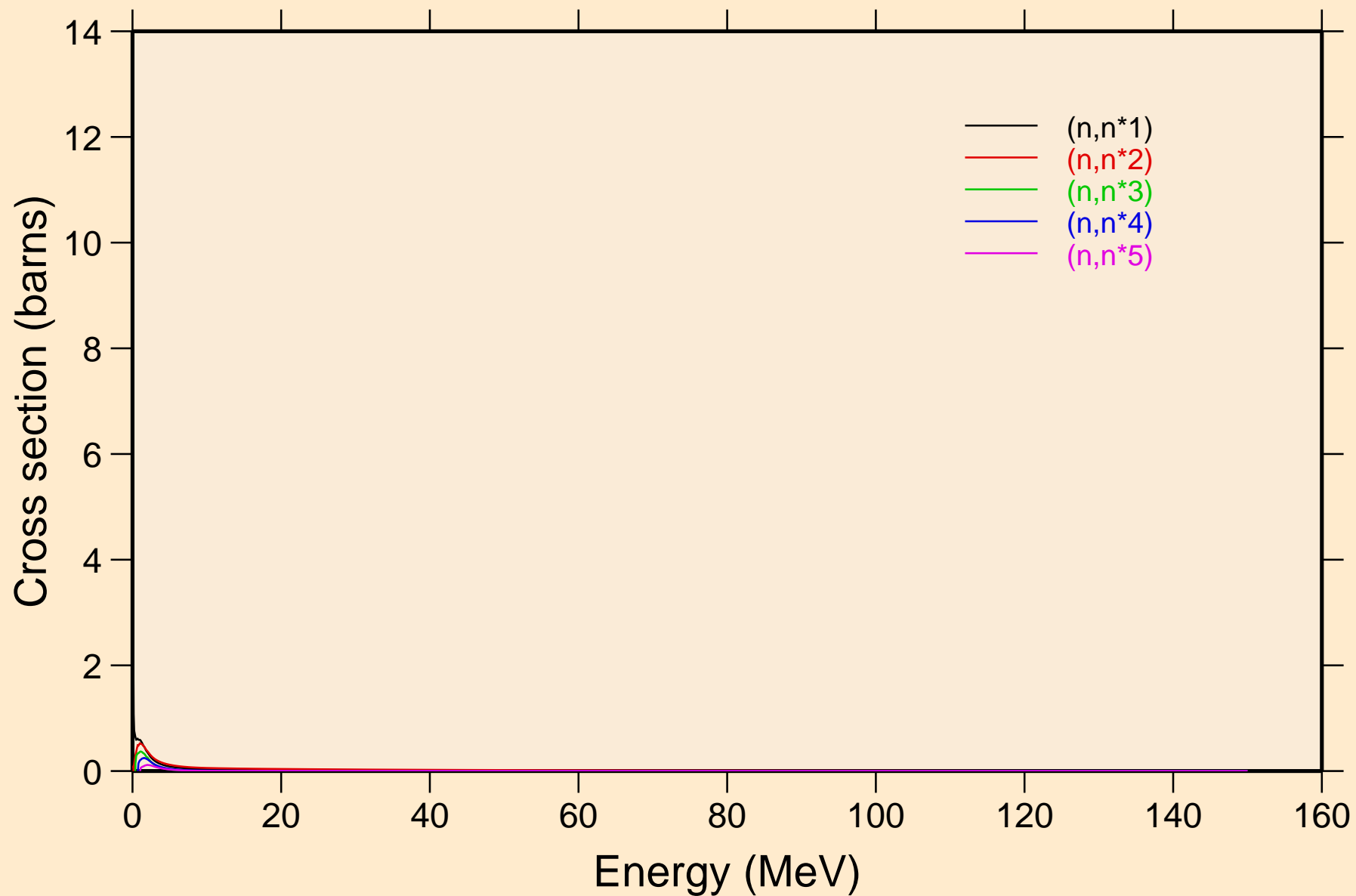

26-FE-57 FOR FENDL-3.2 FROM INDEN-1.0 BY NJOY2016.60+ ON
Inelastic levels

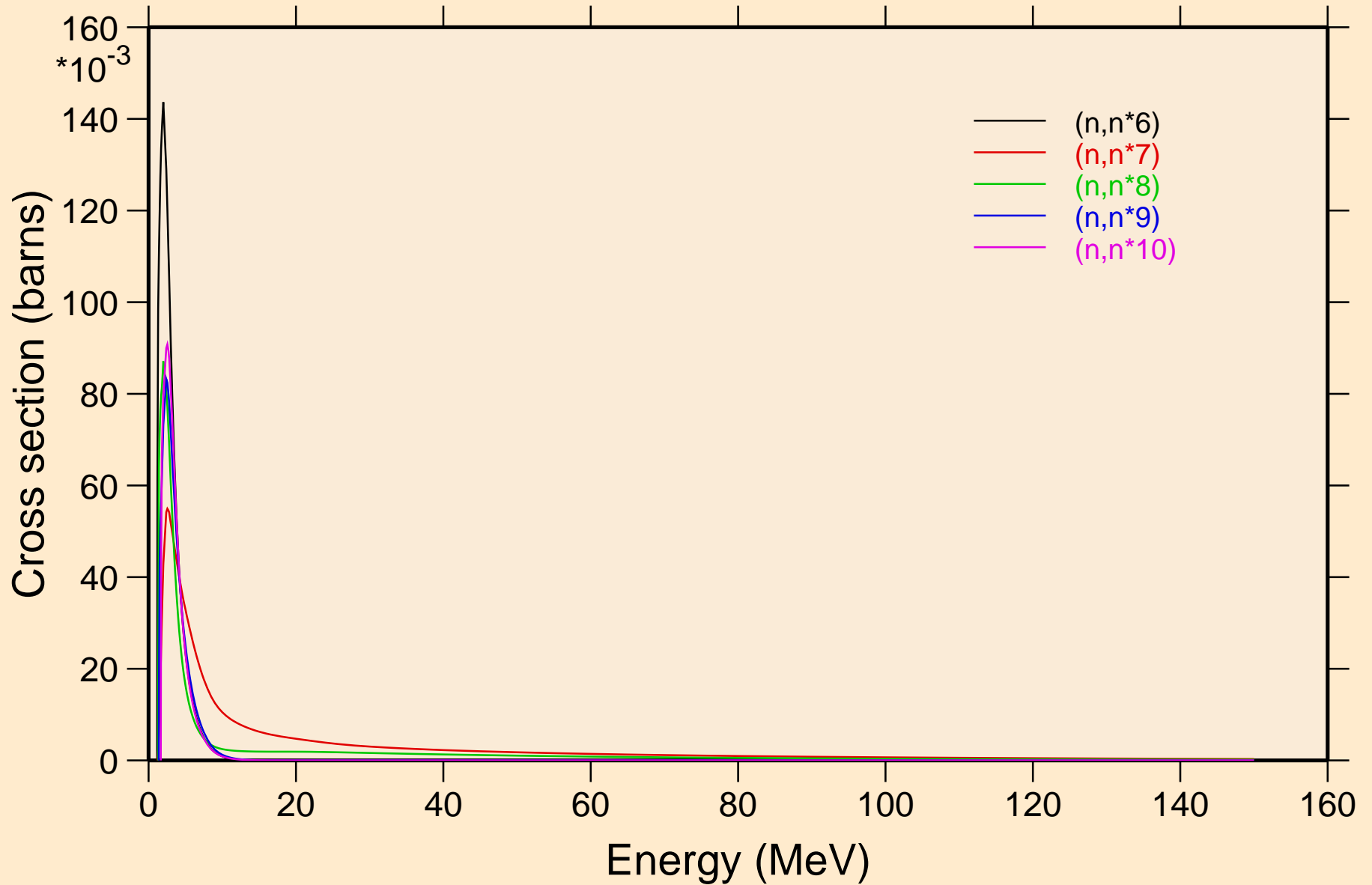

26-FE-57 FOR FENDL-3.2 FROM INDEN-1.0 BY NJOY2016.60+ ON
Inelastic levels

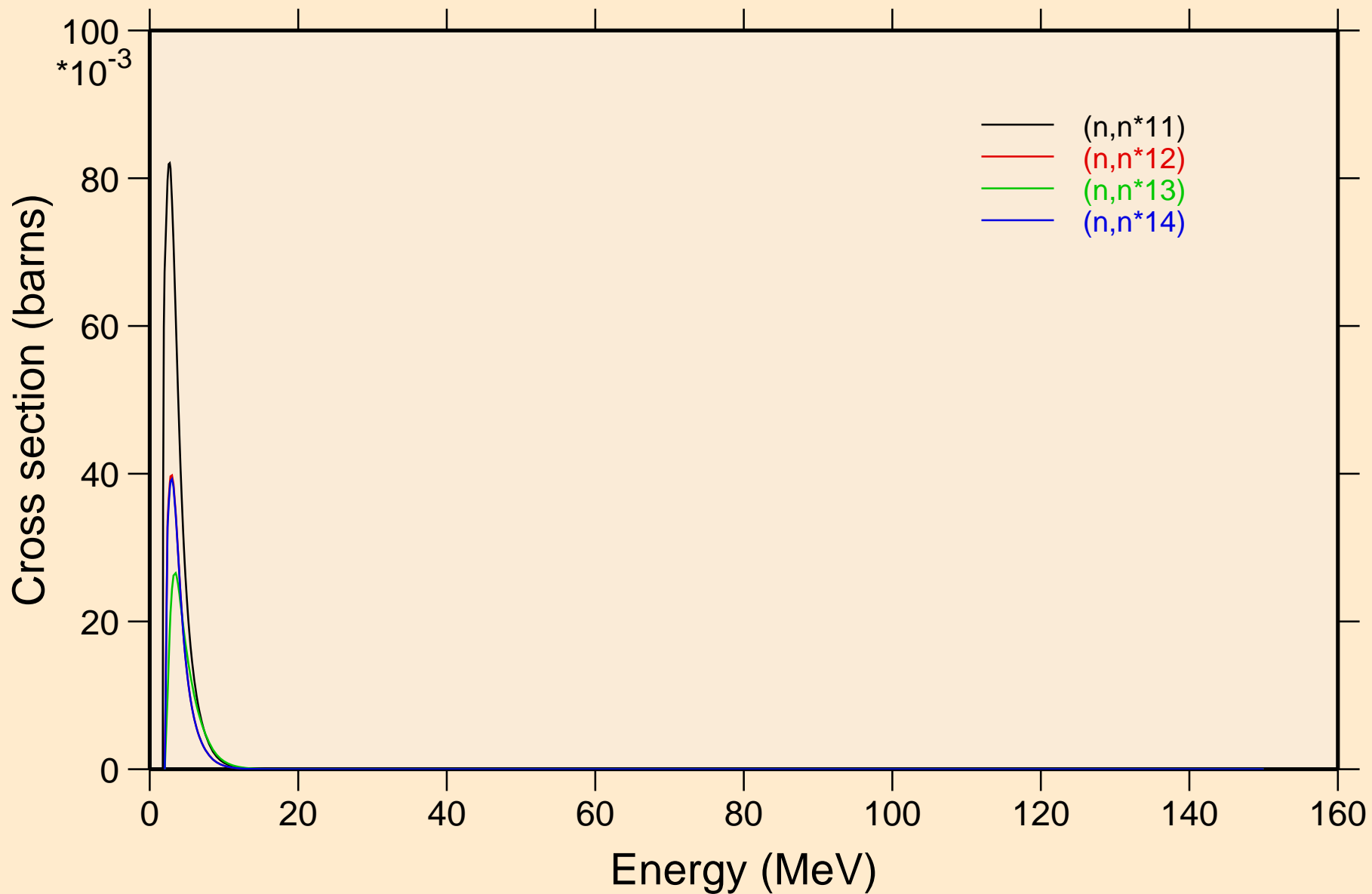

26-FE-57 FOR FENDL-3.2 FROM INDEN-1.0 BY NJOY2016.60+ ON
Threshold reactions

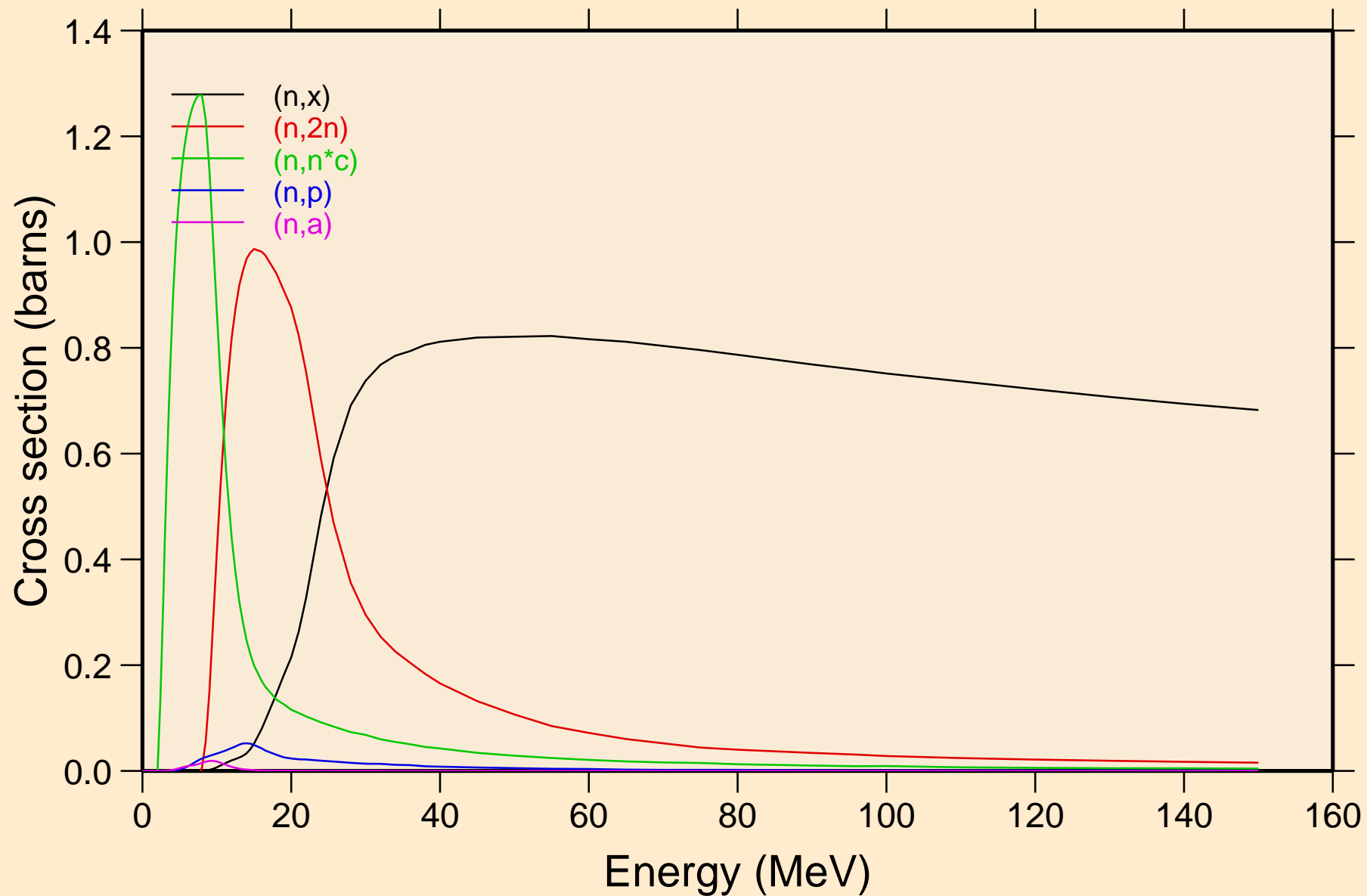

26-FE-57 FOR FENDL-3.2 FROM INDEN-1.0 BY NJOY2016.60+ ON
Threshold reactions

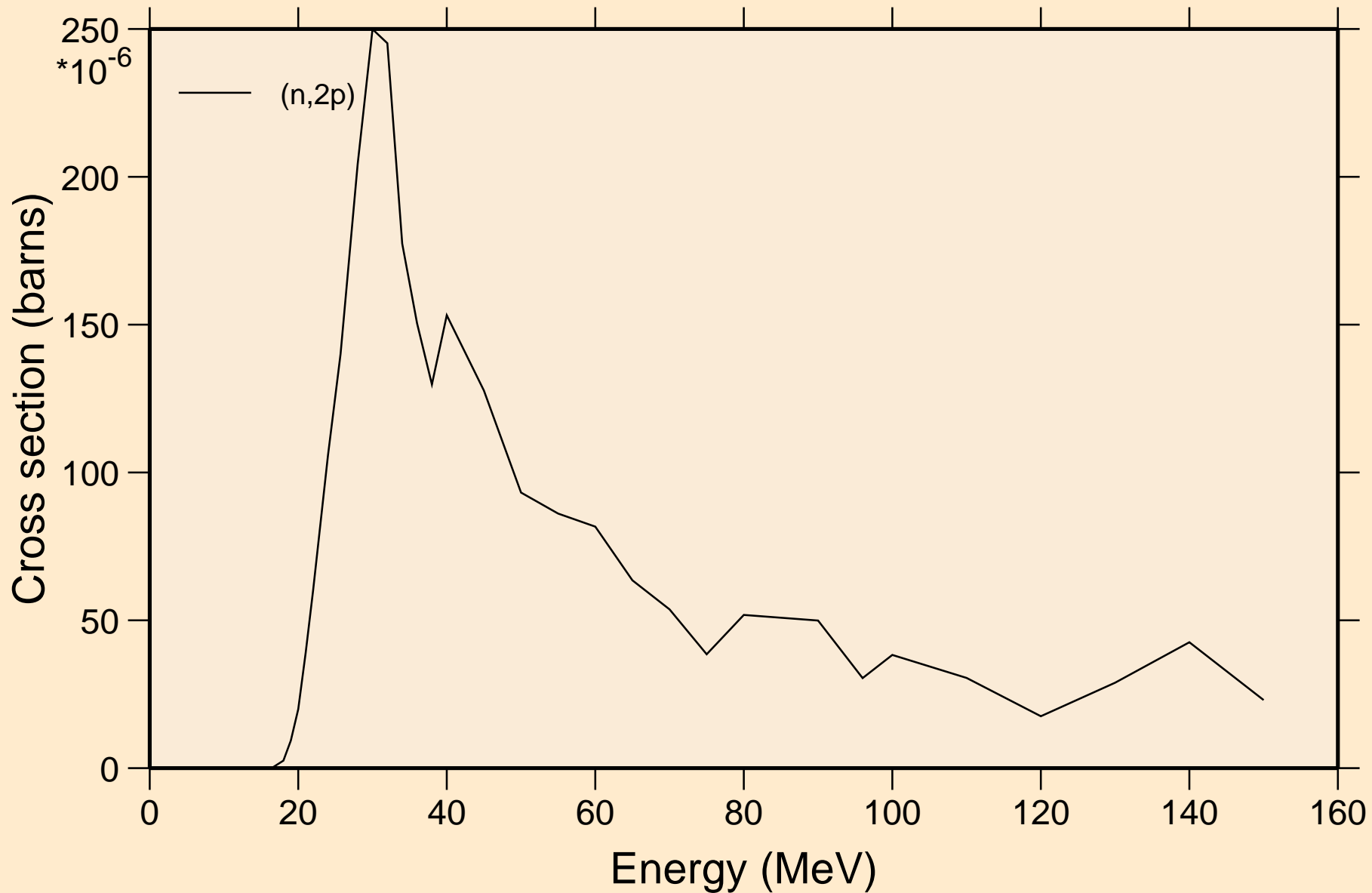

26-FE-57 FOR FENDL-3.2 FROM INDEN-1.0 BY NJOY2016.60+ ON
Threshold reactions

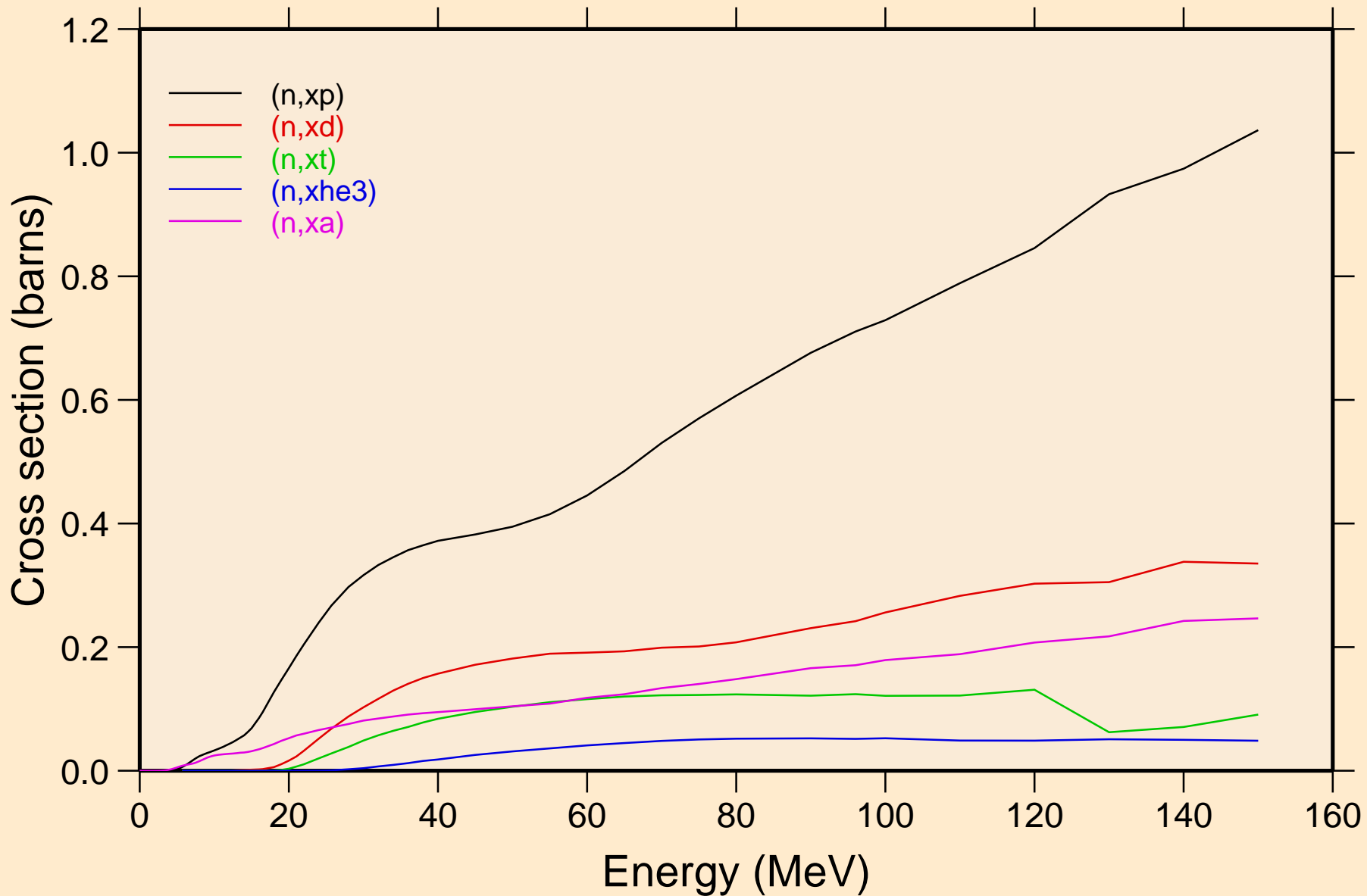

26-FE-57 FOR FENDL-3.2 FROM INDEN-1.0 BY NJOY2016.60+ ON
Threshold reactions

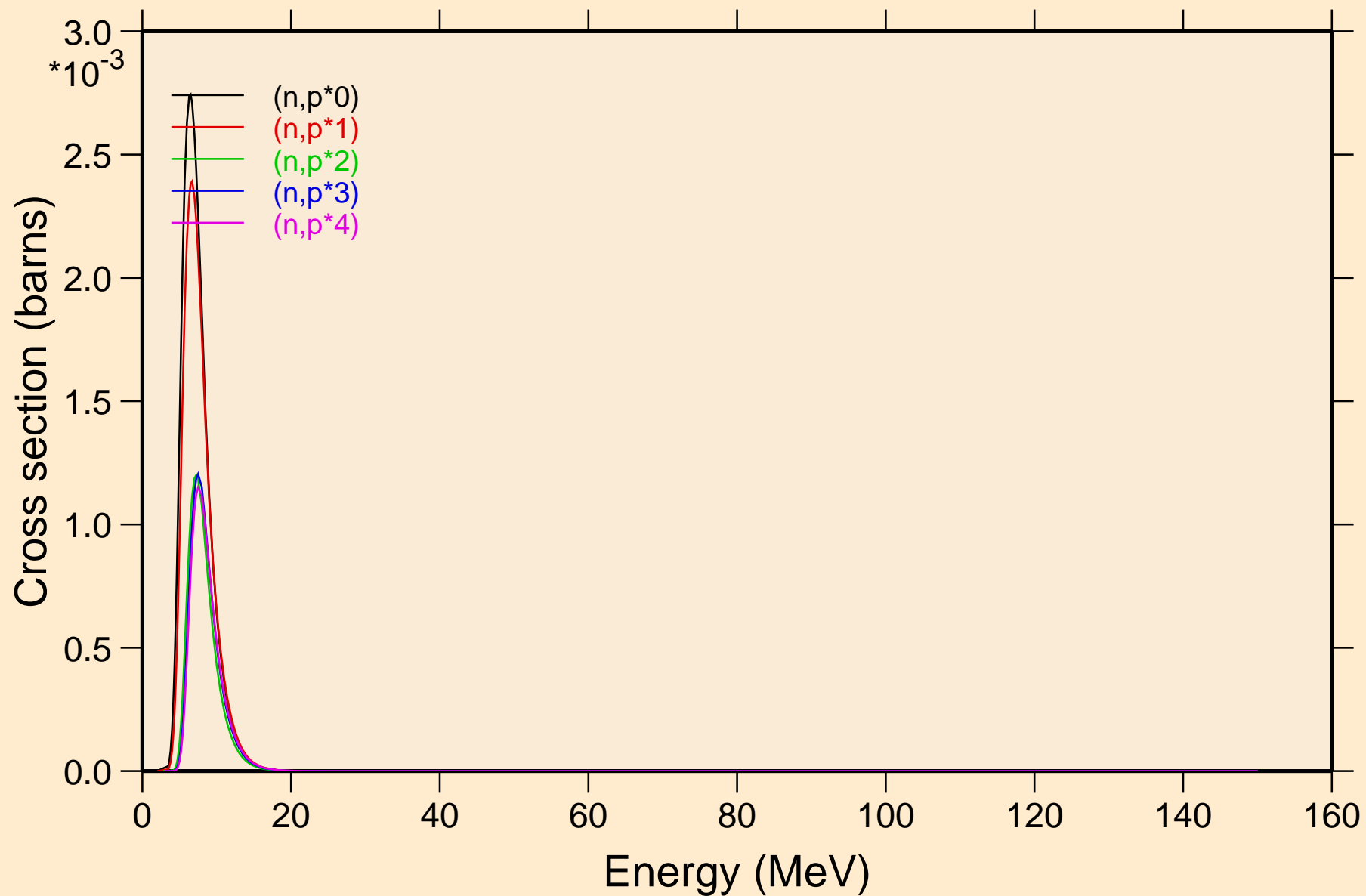

26-FE-57 FOR FENDL-3.2 FROM INDEN-1.0 BY NJOY2016.60+ ON
Threshold reactions

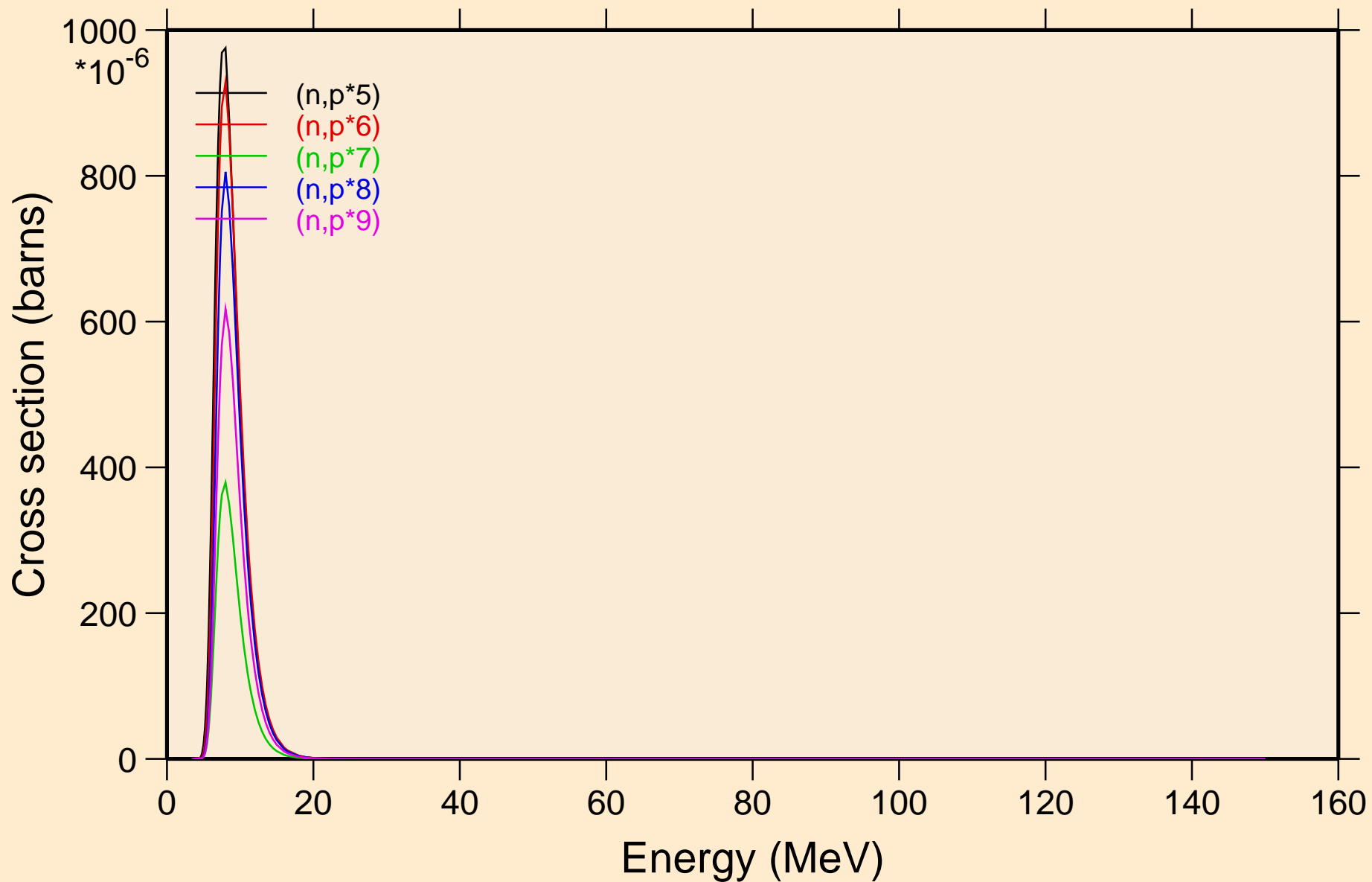

26-FE-57 FOR FENDL-3.2 FROM INDEN-1.0 BY NJOY2016.60+ ON
Threshold reactions

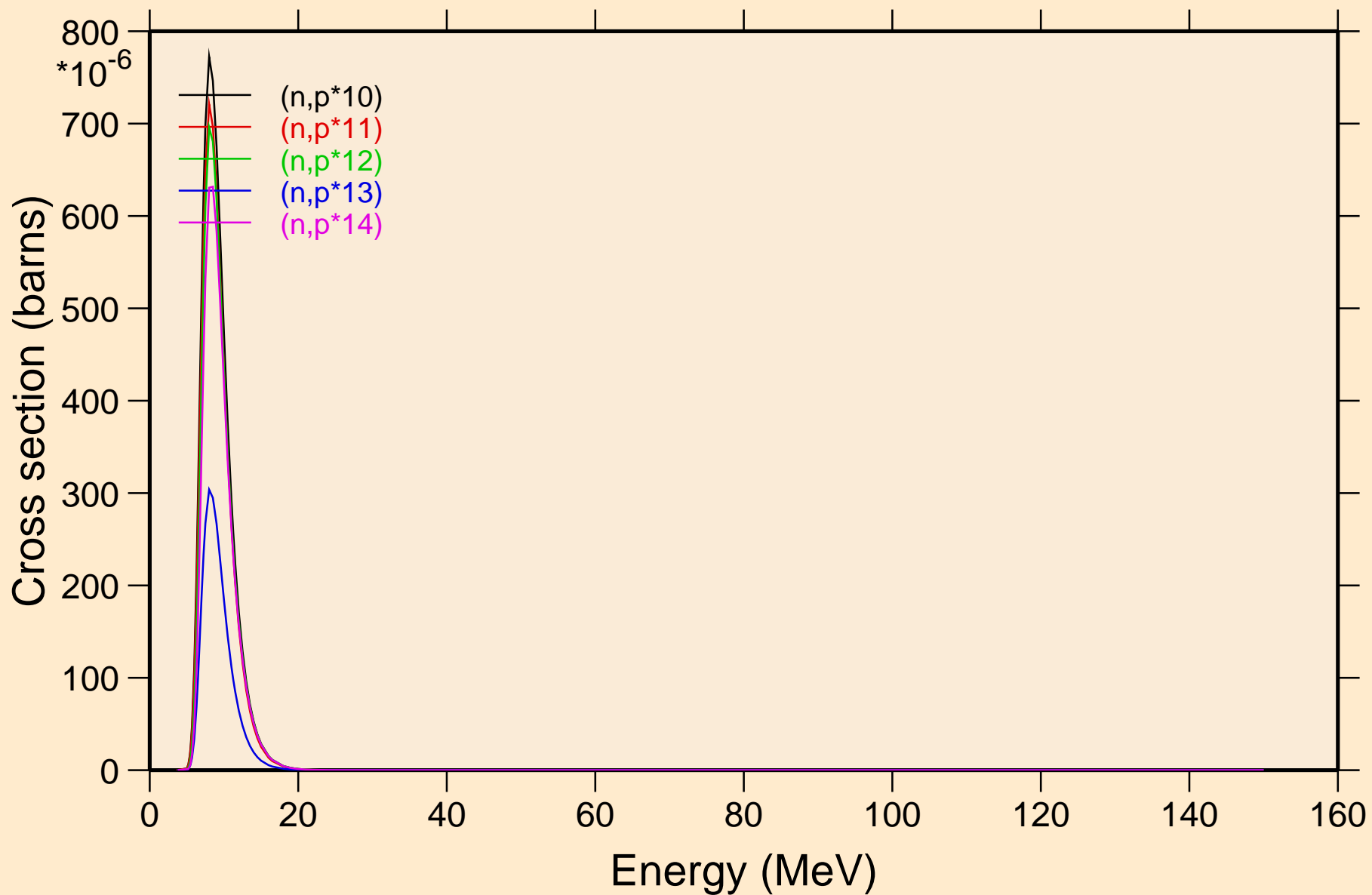

26-FE-57 FOR FENDL-3.2 FROM INDEN-1.0 BY NJOY2016.60+ ON
Threshold reactions

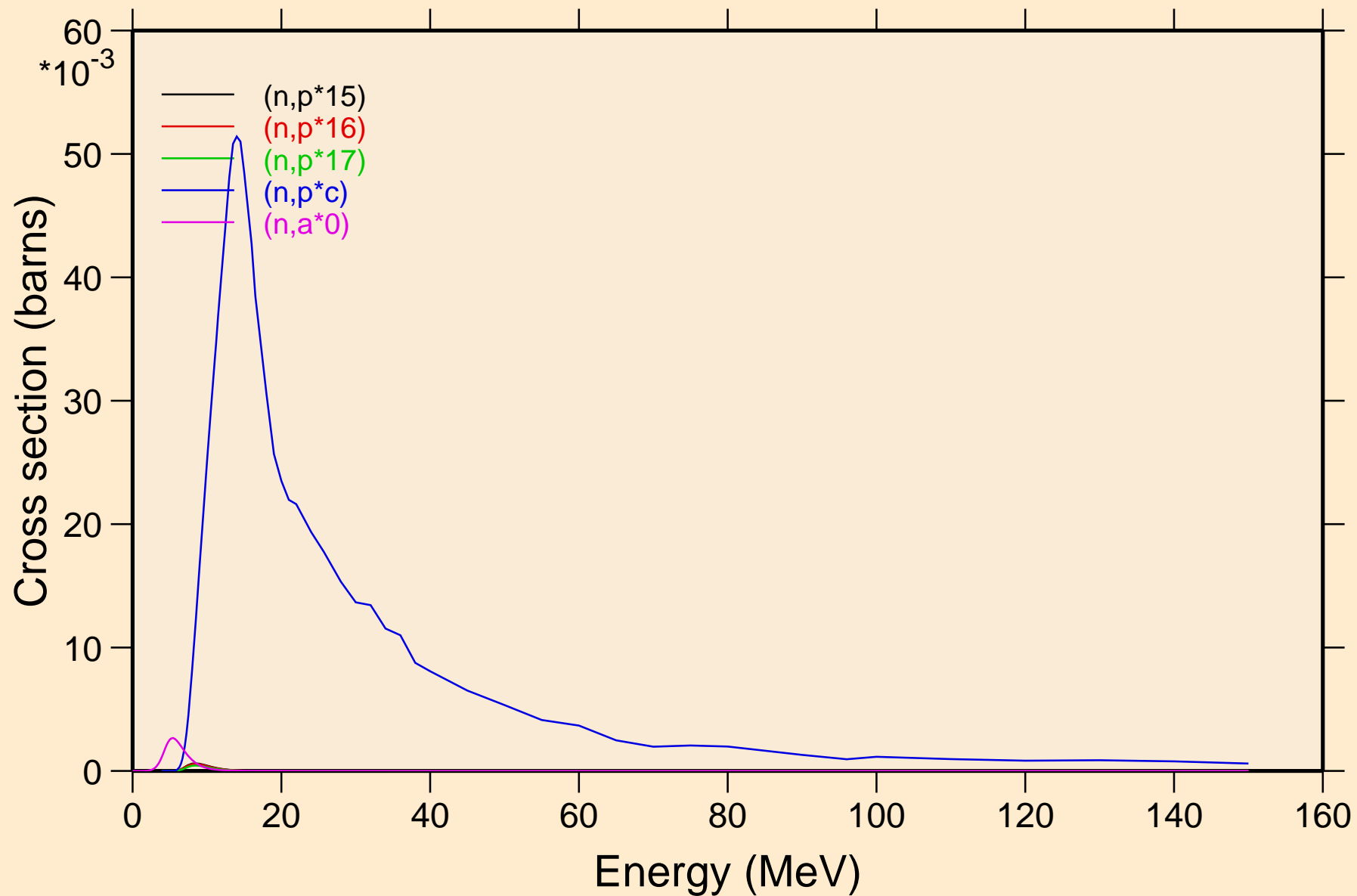

26-FE-57 FOR FENDL-3.2 FROM INDEN-1.0 BY NJOY2016.60+ ON
Threshold reactions

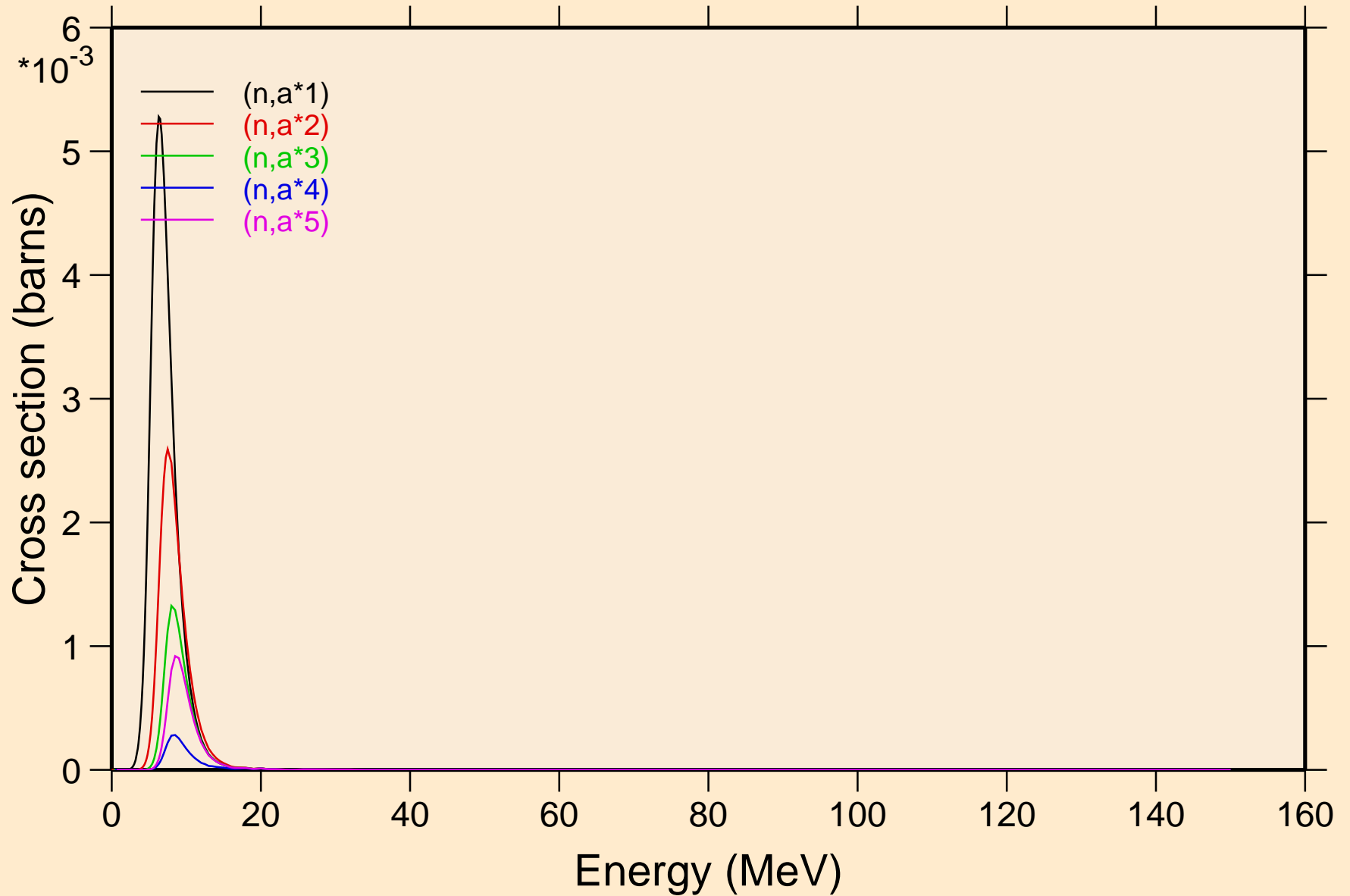

26-FE-57 FOR FENDL-3.2 FROM INDEN-1.0 BY NJOY2016.60+ ON
Threshold reactions

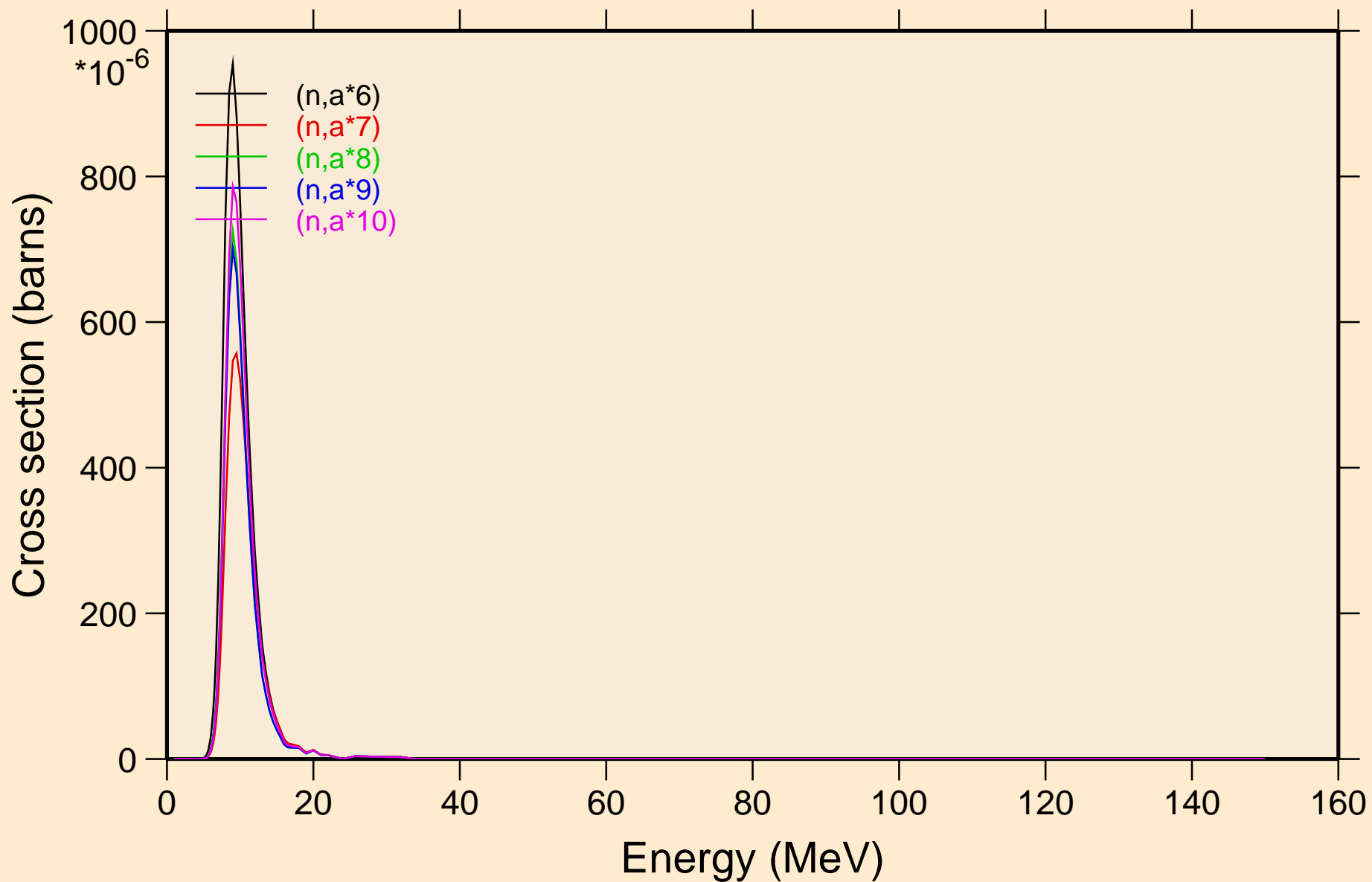

26-FE-57 FOR FENDL-3.2 FROM INDEN-1.0 BY NJOY2016.60+ ON
Threshold reactions

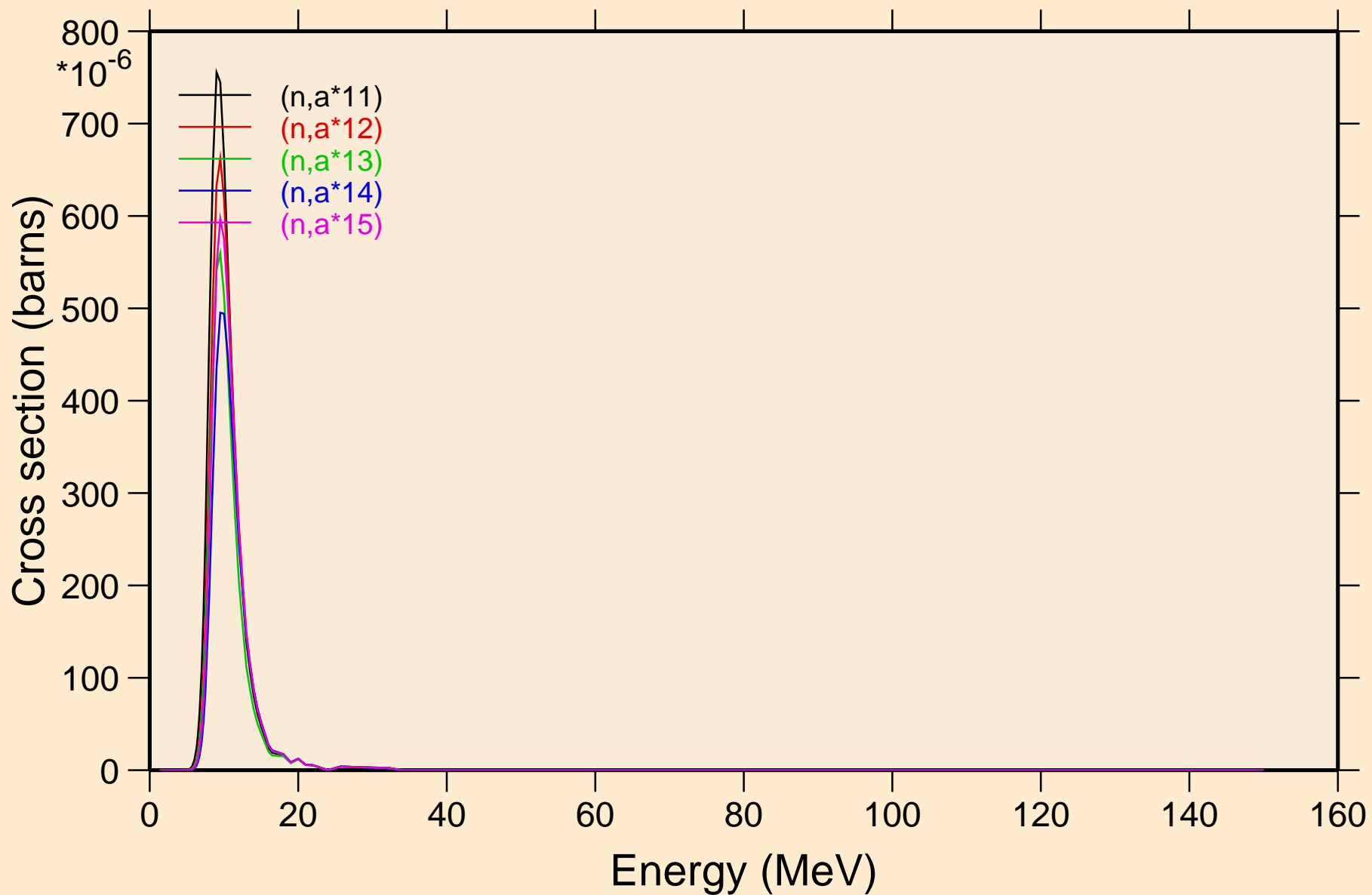

26-FE-57 FOR FENDL-3.2 FROM INDEN-1.0 BY NJOY2016.60+ ON
Threshold reactions

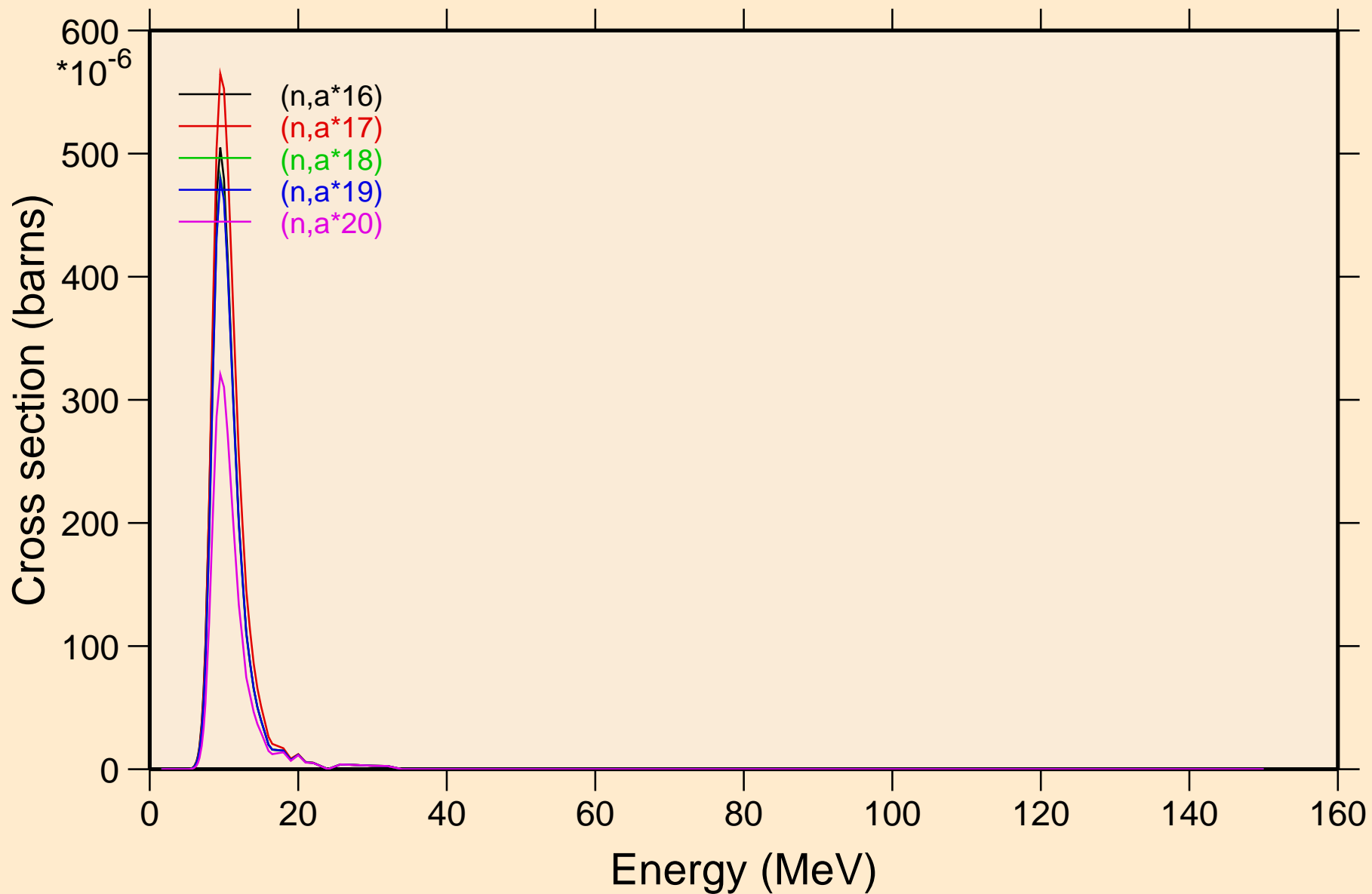

26-FE-57 FOR FENDL-3.2 FROM INDEN-1.0 BY NJOY2016.60+ ON
Threshold reactions

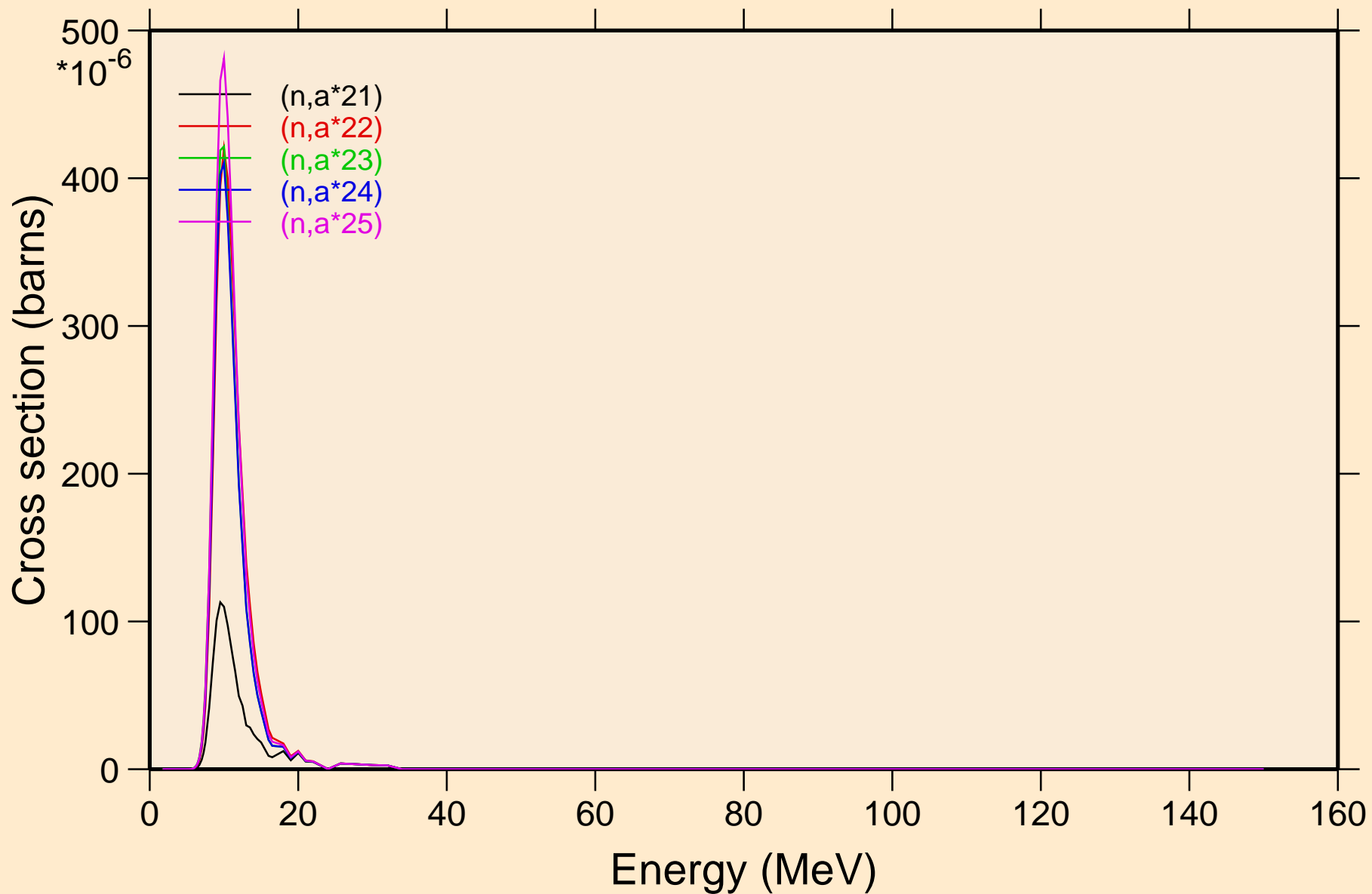

26-FE-57 FOR FENDL-3.2 FROM INDEN-1.0 BY NJOY2016.60+ ON
Threshold reactions

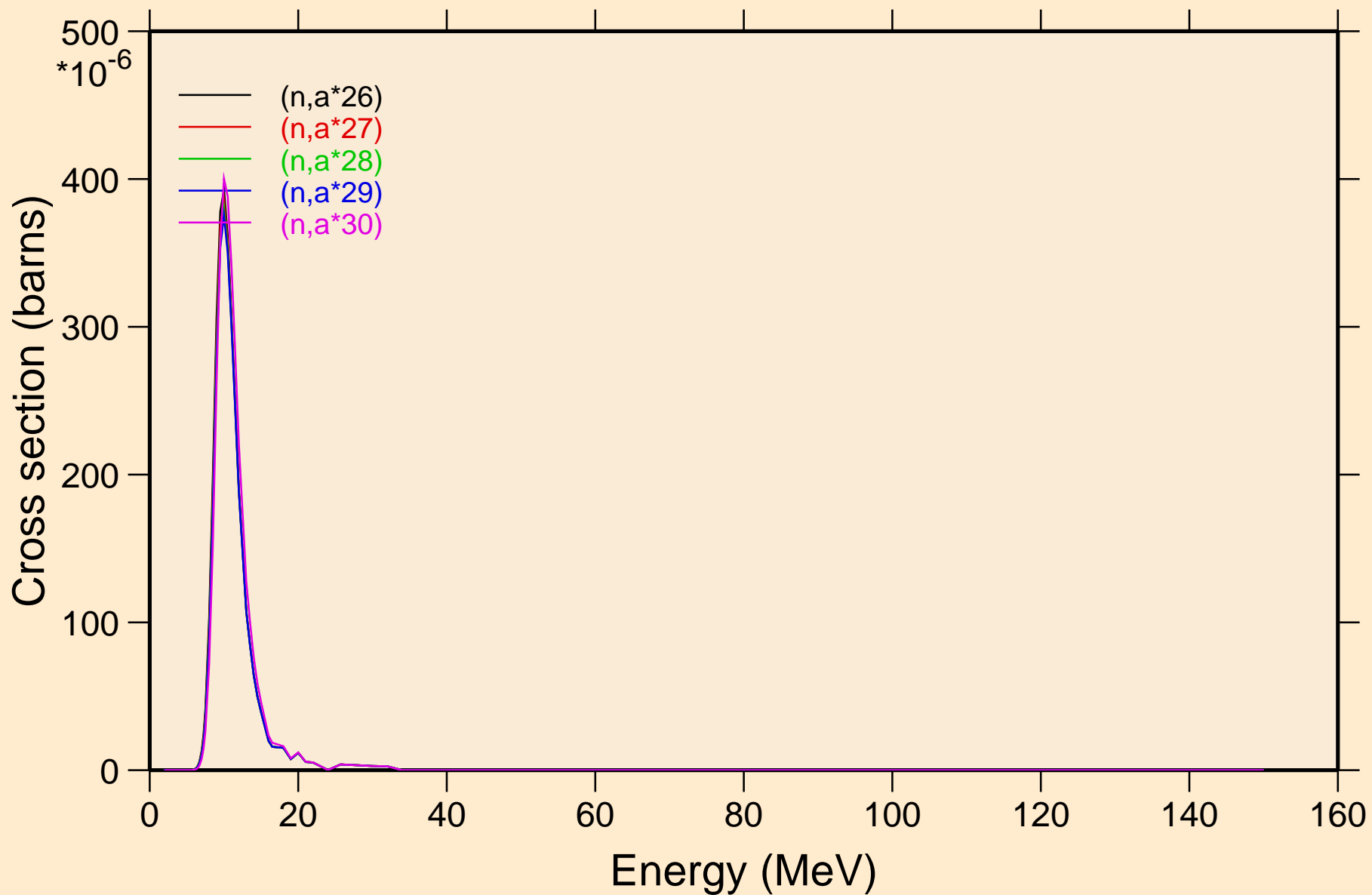

26-FE-57 FOR FENDL-3.2 FROM INDEN-1.0 BY NJOY2016.60+ ON
Threshold reactions

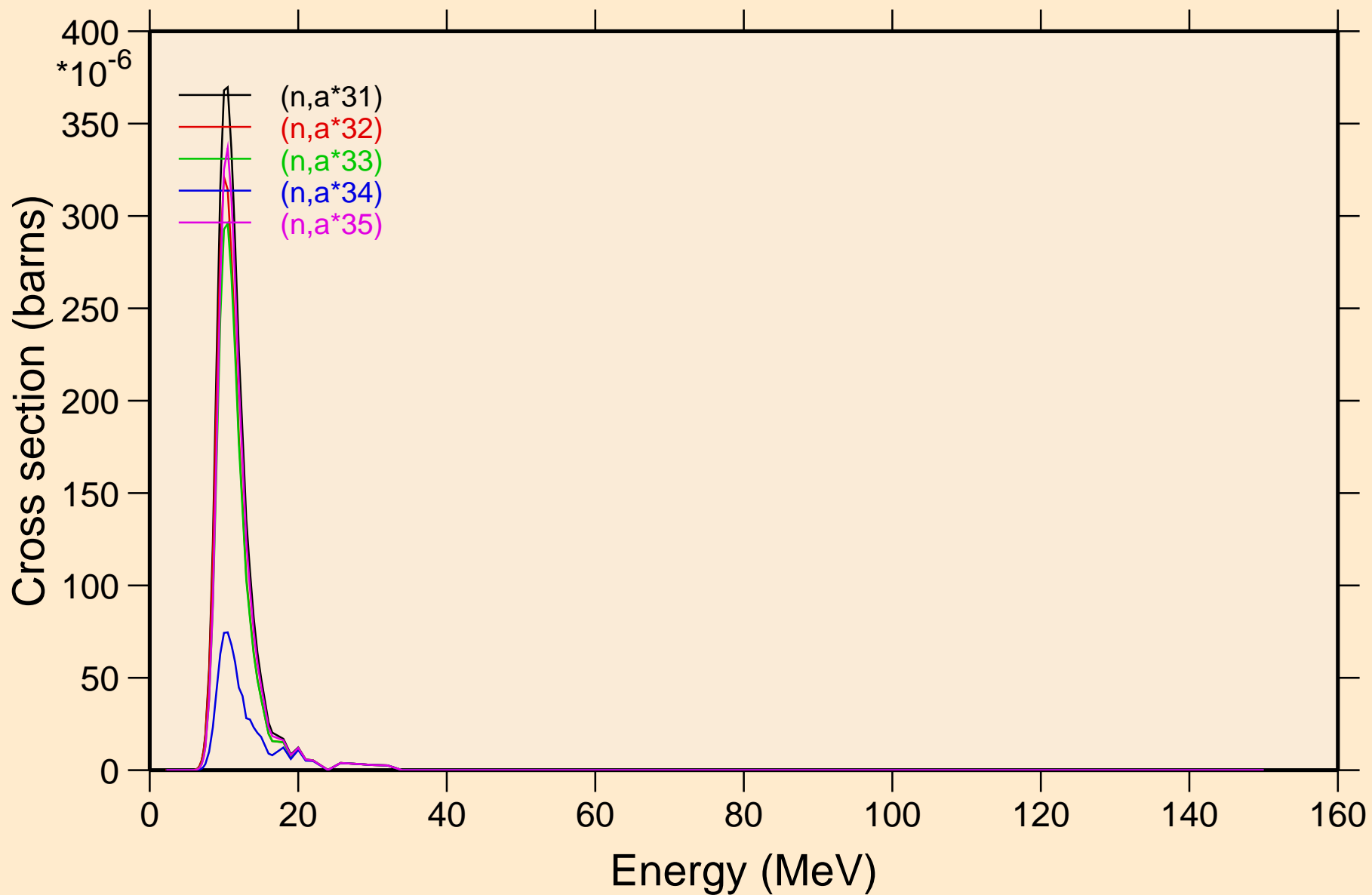

26-FE-57 FOR FENDL-3.2 FROM INDEN-1.0 BY NJOY2016.60+ ON
Threshold reactions

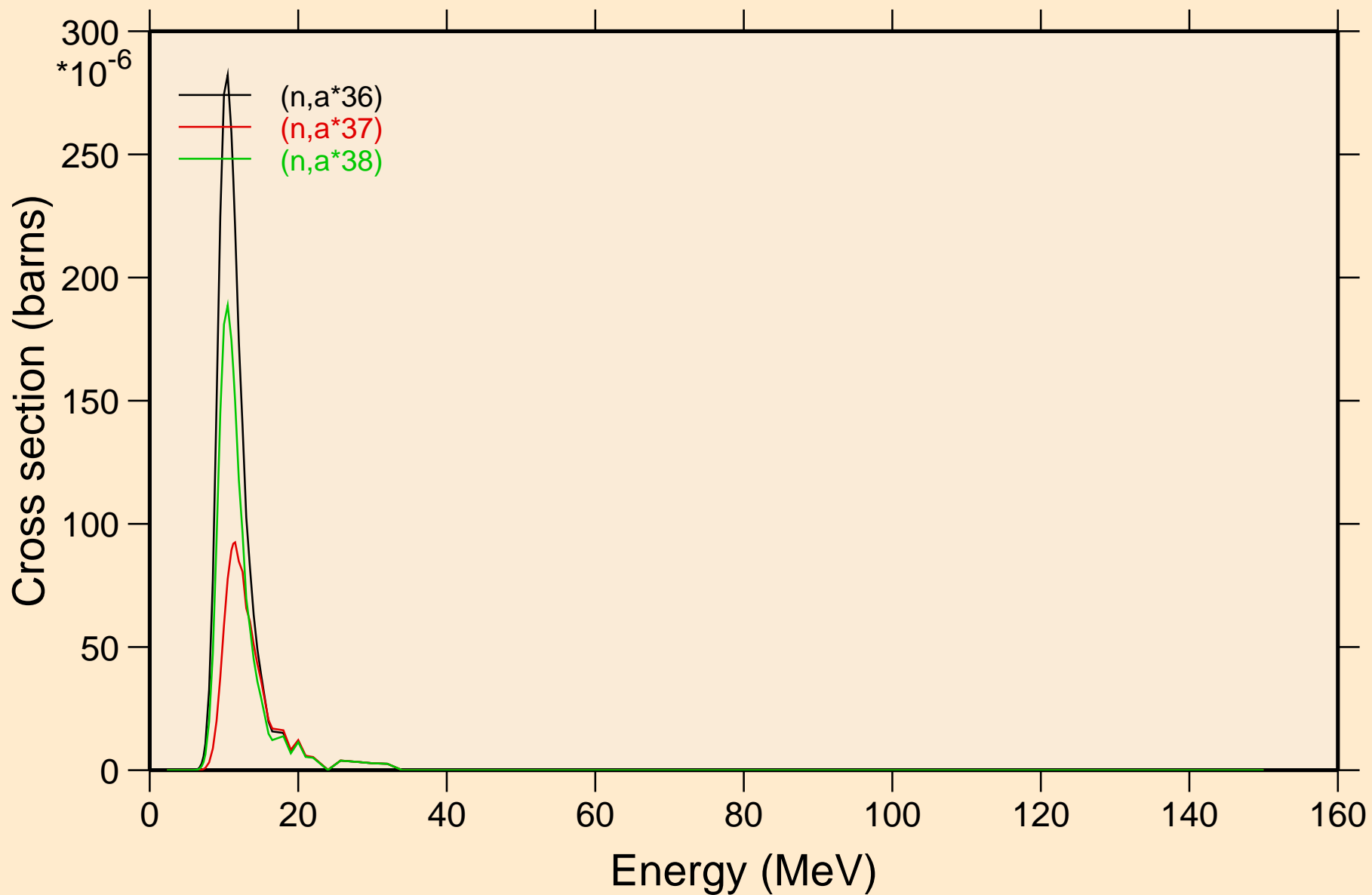

26-FE-57 FOR FENDL-3.2 FROM INDEN-1.0 BY NJOY2016.60+ ON
angular distribution for elastic

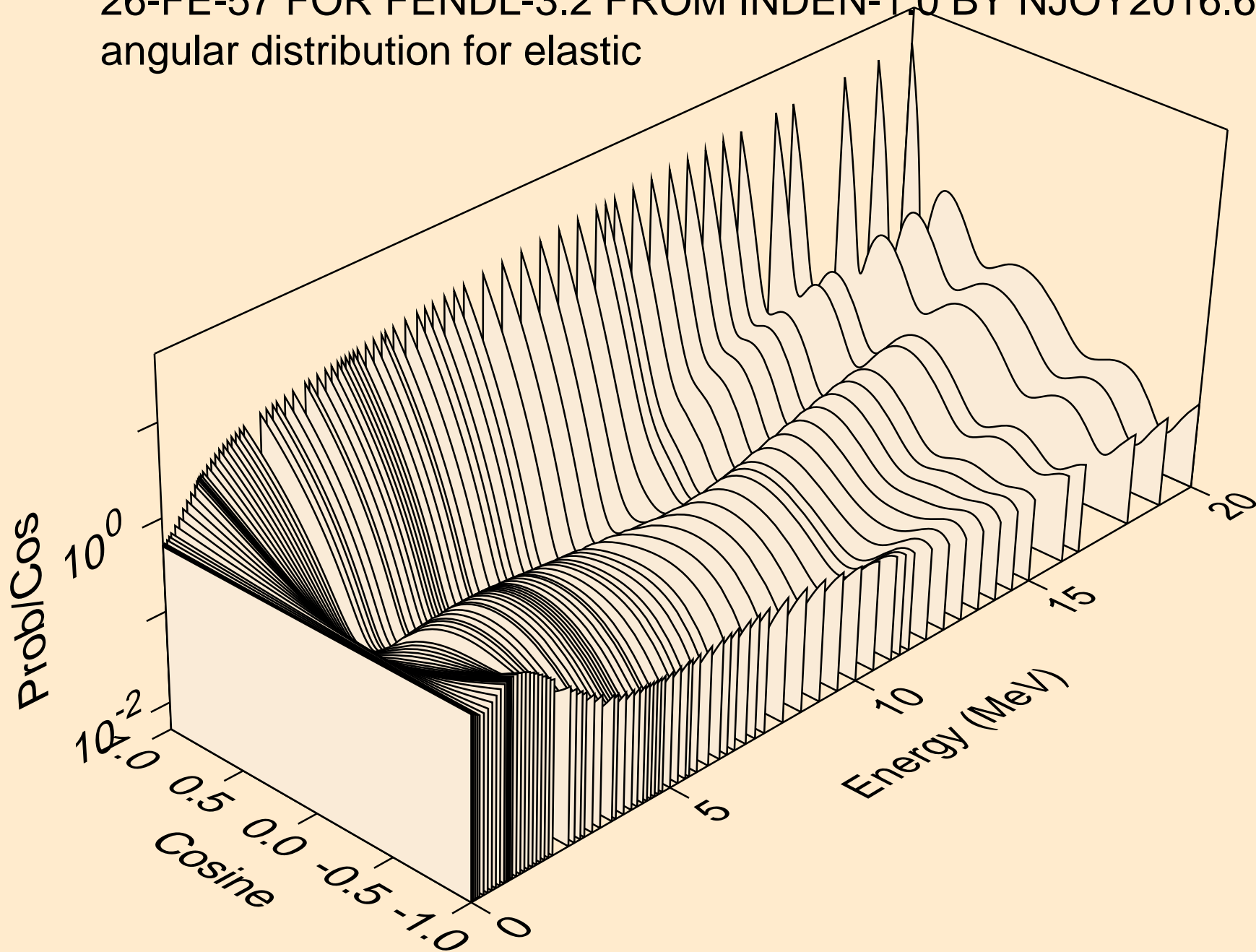

26-FE-57 FOR FENDL-3.2 FROM INDEN-1.0 BY NJOY2016.60+ ON
angular distribution for elastic

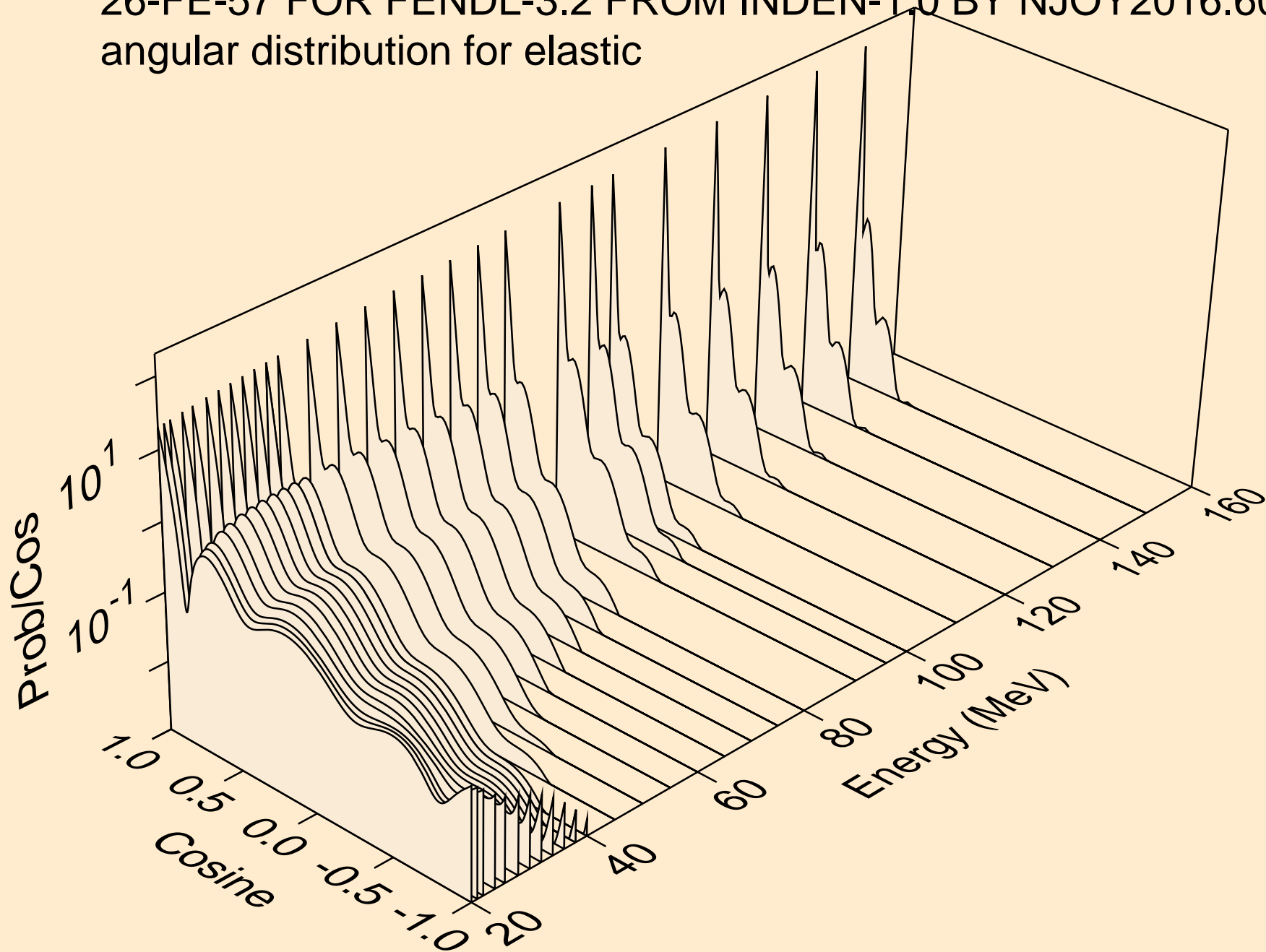

26-FE-57 FOR FENDL-3.2 FROM INDEN-1.0 BY NJOY2016.60+ ON
angular distribution for (n,n*1)

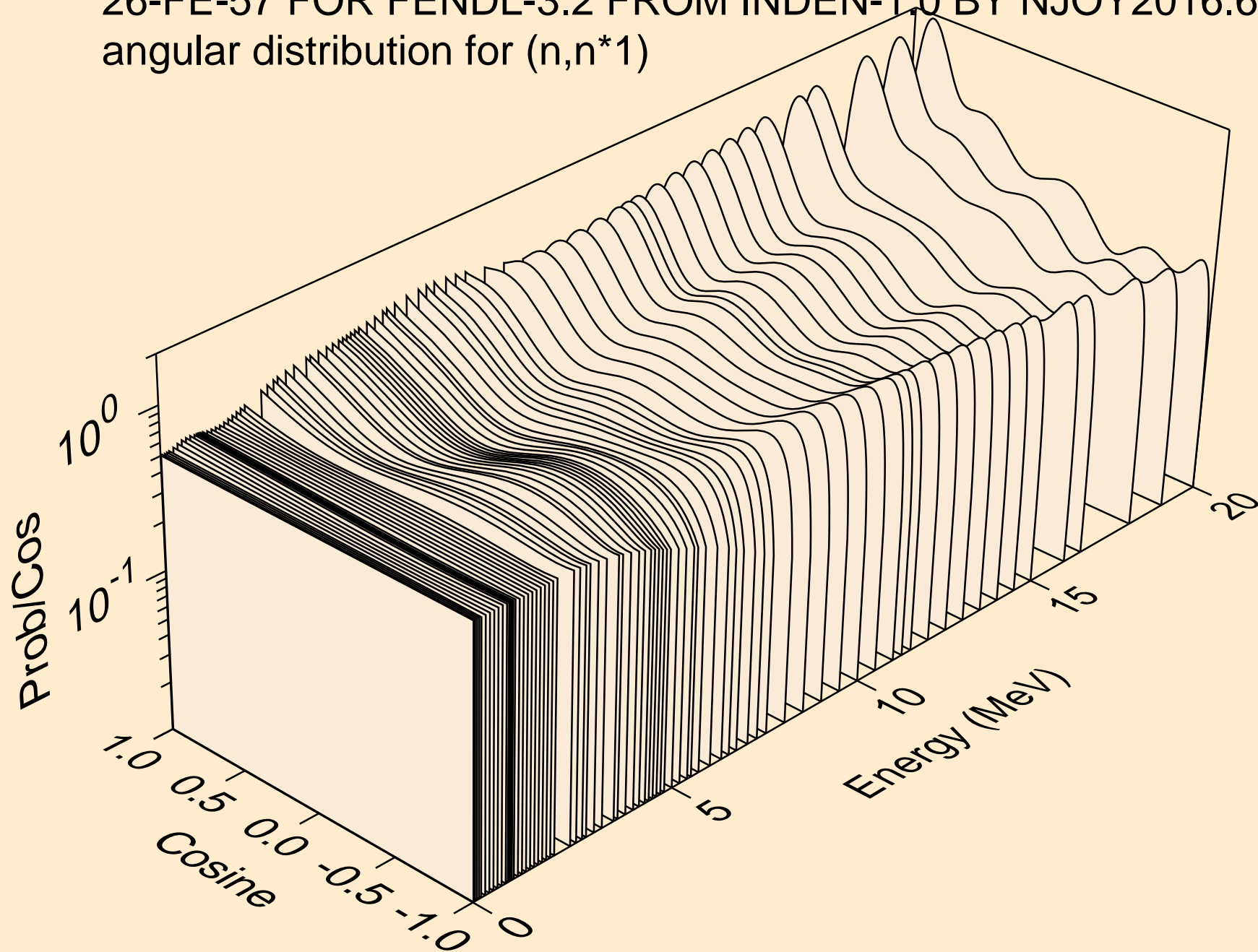

26-FE-57 FOR FENDL-3.2 FROM INDEN-1.0 BY NJOY2016.60+ ON
angular distribution for (n,n*1)

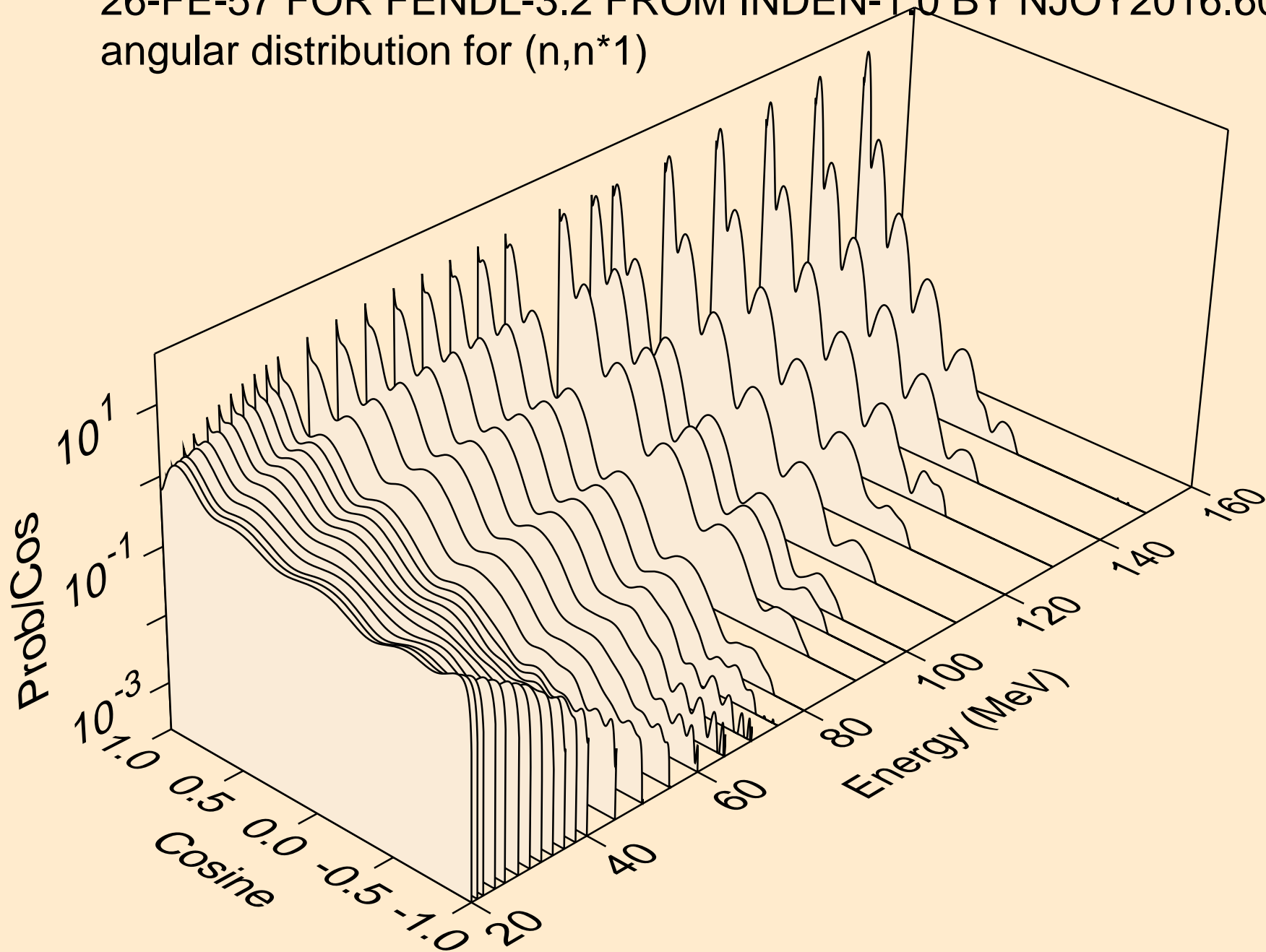

26-FE-57 FOR FENDL-3.2 FROM INDEN-1.0 BY NJOY2016.60+ ON
angular distribution for (n,n*2)

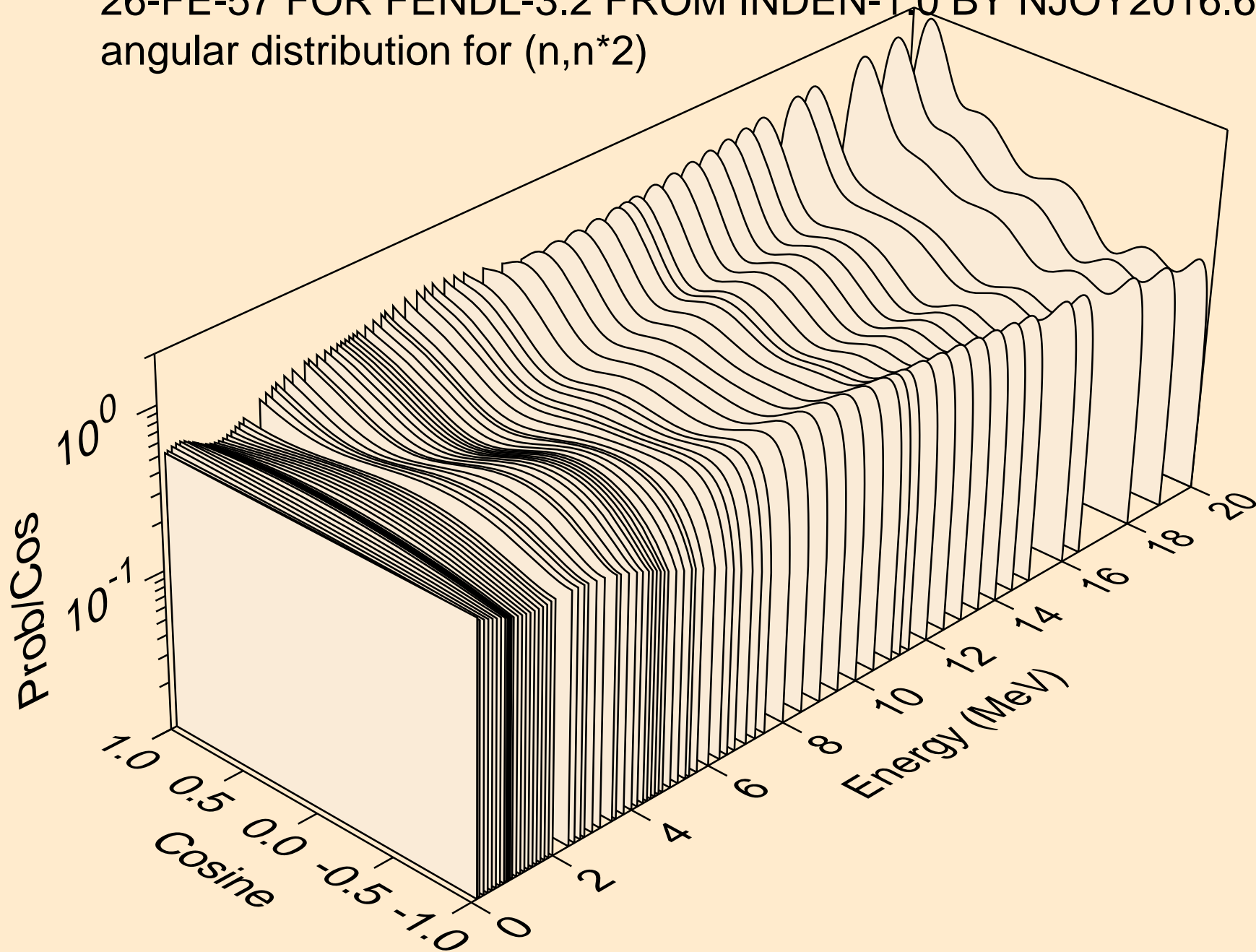

26-FE-57 FOR FENDL-3.2 FROM INDEN-1.0 BY NJOY2016.60+ ON
angular distribution for (n,n*2)

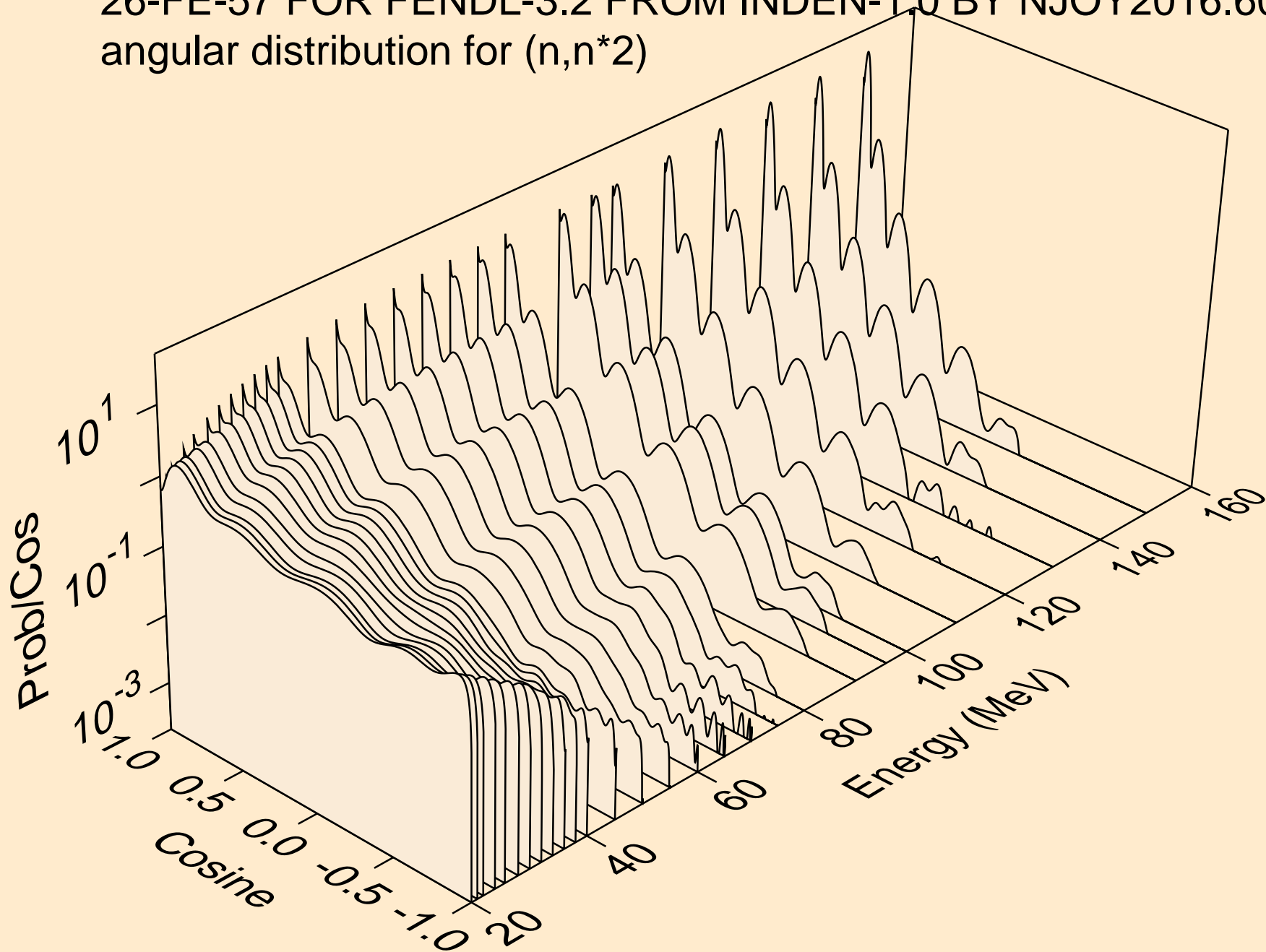

26-FE-57 FOR FENDL-3.2 FROM INDEN-1.0 BY NJOY2016.60+ ON
angular distribution for (n,n*3)

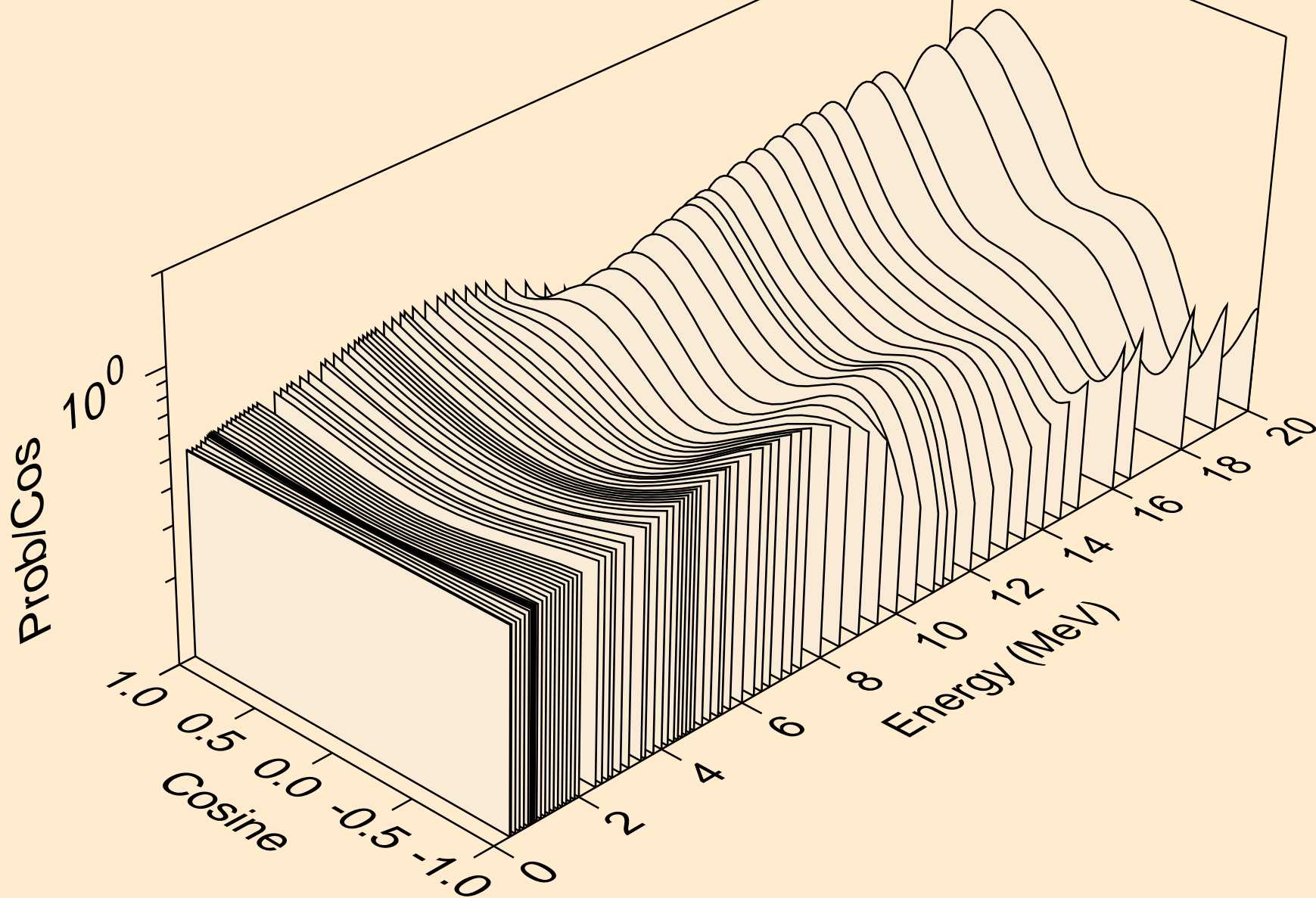

26-FE-57 FOR FENDL-3.2 FROM INDEN-1.0 BY NJOY2016.60+ ON
angular distribution for (n,n*3)

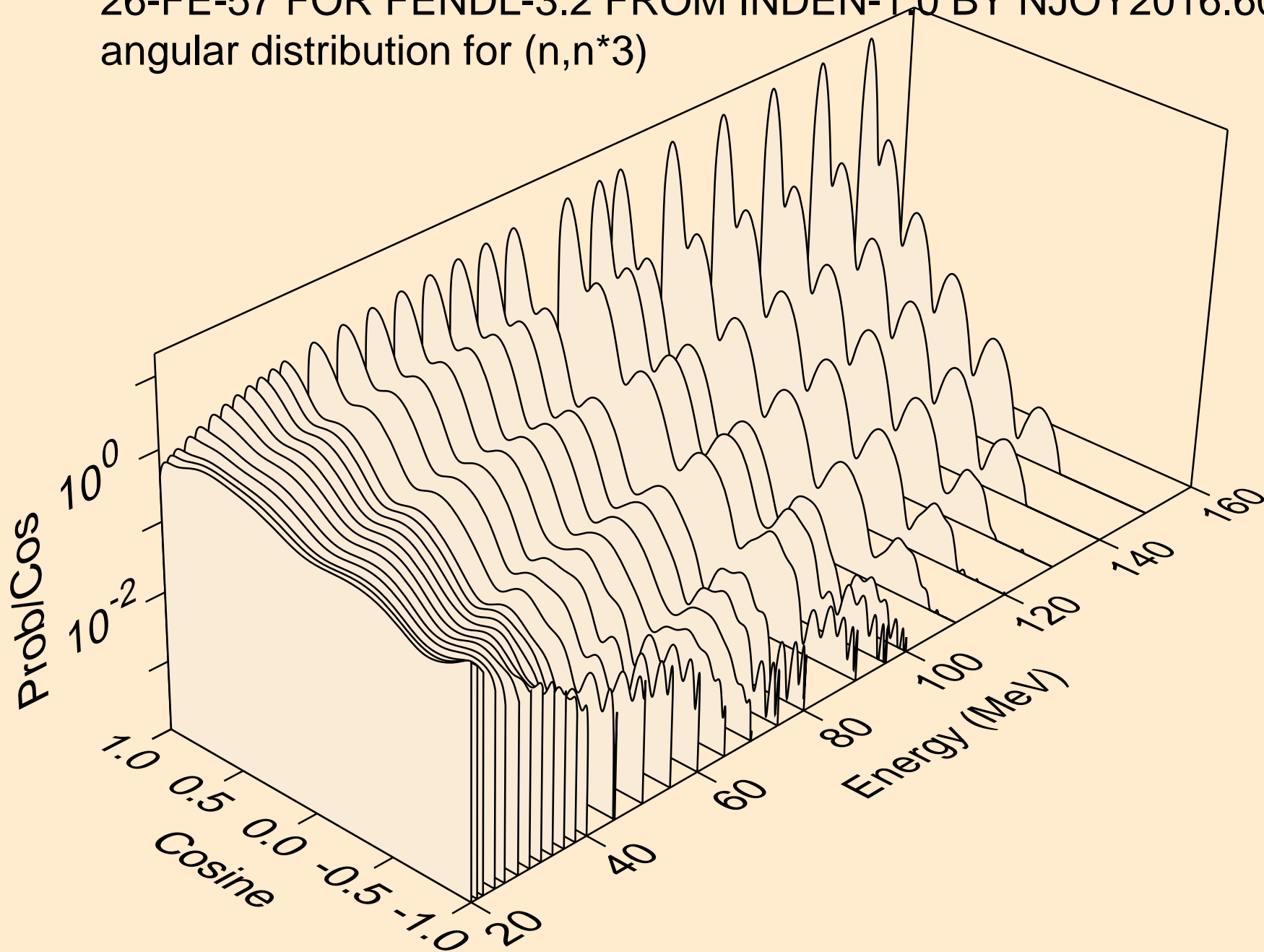

26-FE-57 FOR FENDL-3.2 FROM INDEN-1.0 BY NJOY2016.60+ ON
angular distribution for (n,n*4)

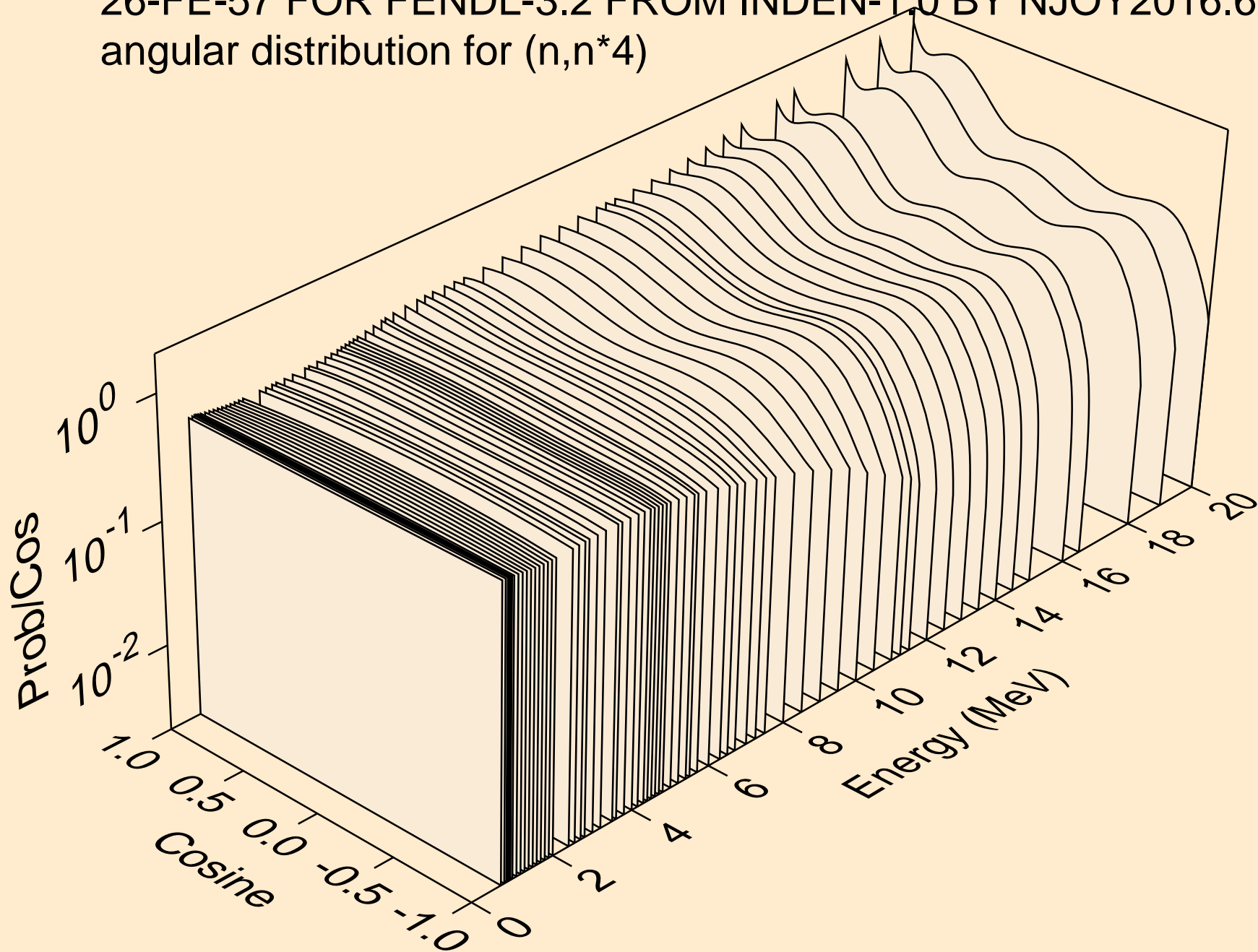

26-FE-57 FOR FENDL-3.2 FROM INDEN-1.0 BY NJOY2016.60+ ON
angular distribution for (n,n*4)

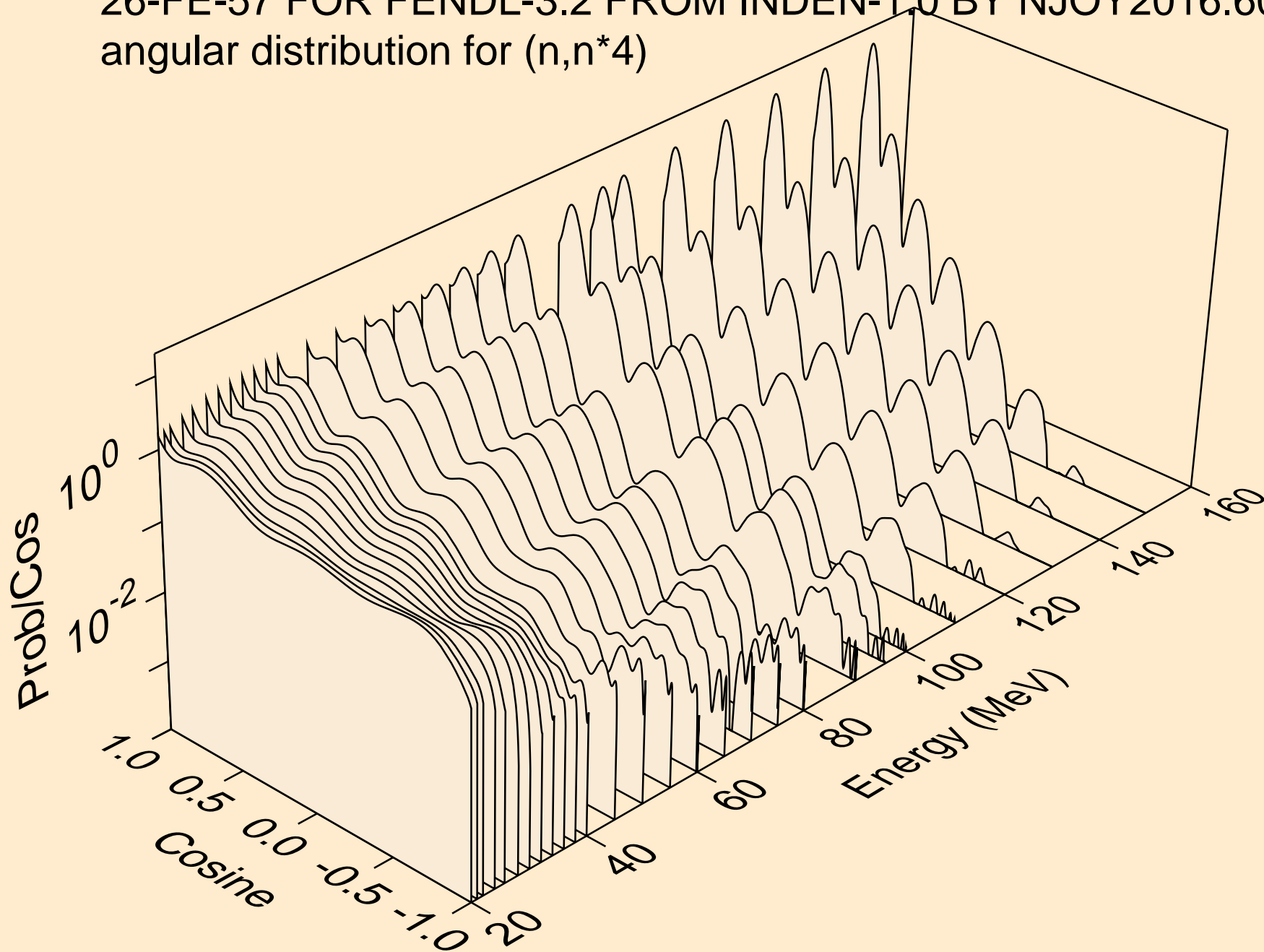

26-FE-57 FOR FENDL-3.2 FROM INDEN-1.0 BY NJOY2016.60+ ON
angular distribution for (n,n*5)

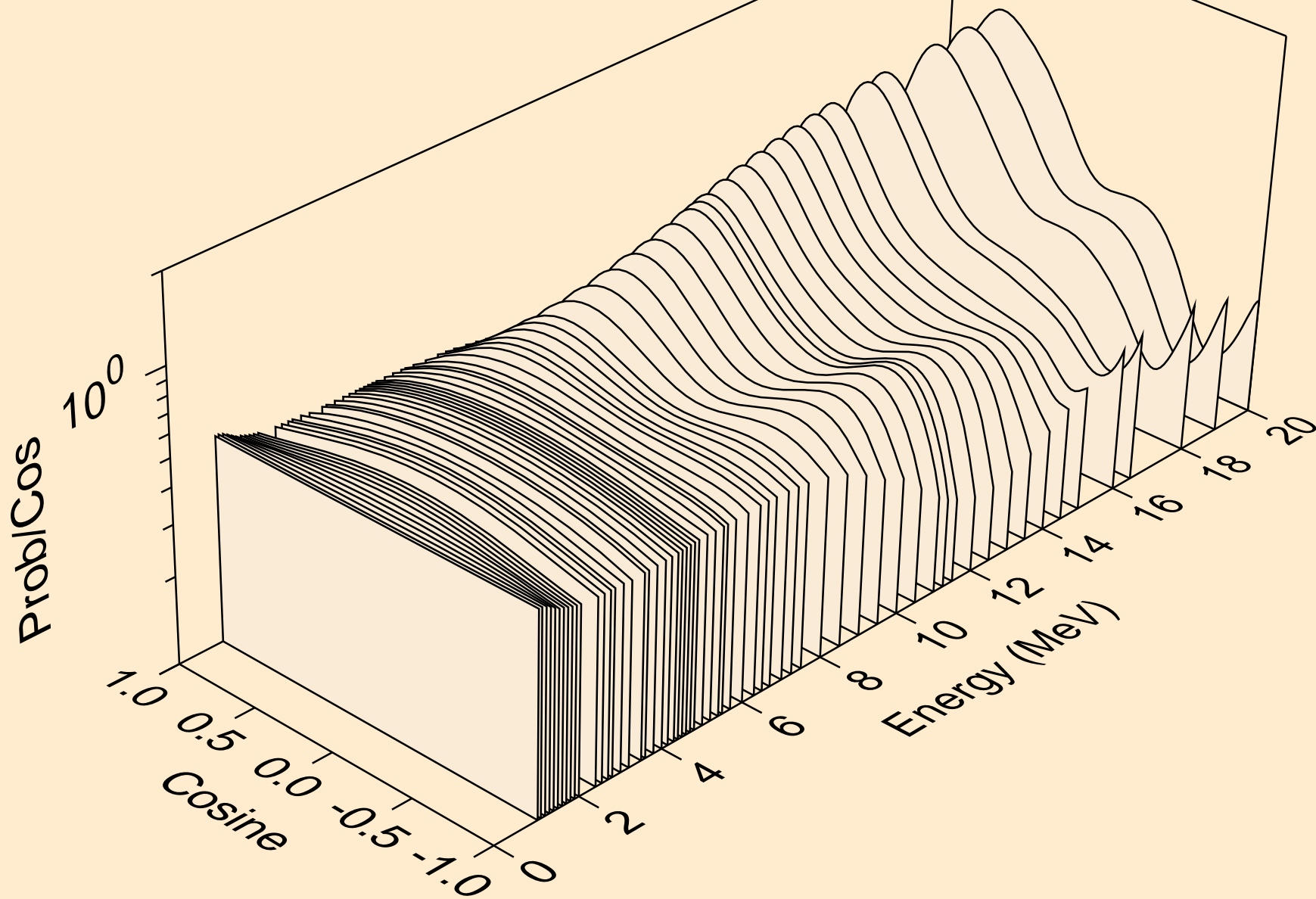

26-FE-57 FOR FENDL-3.2 FROM INDEN-1.0 BY NJOY2016.60+ ON
angular distribution for (n,n*5)

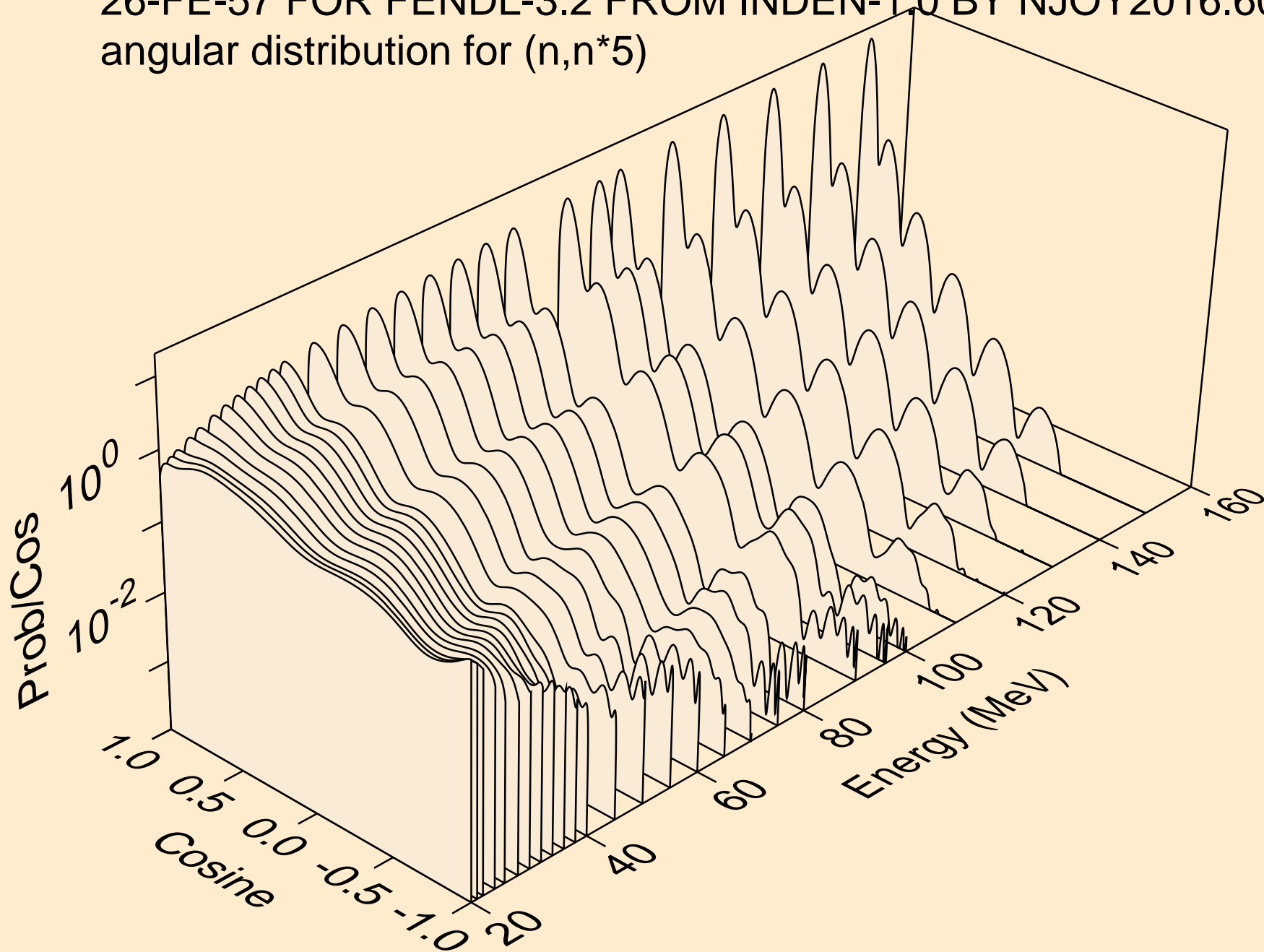

26-FE-57 FOR FENDL-3.2 FROM INDEN-1.0 BY NJOY2016.60+ ON
angular distribution for (n,n*6)

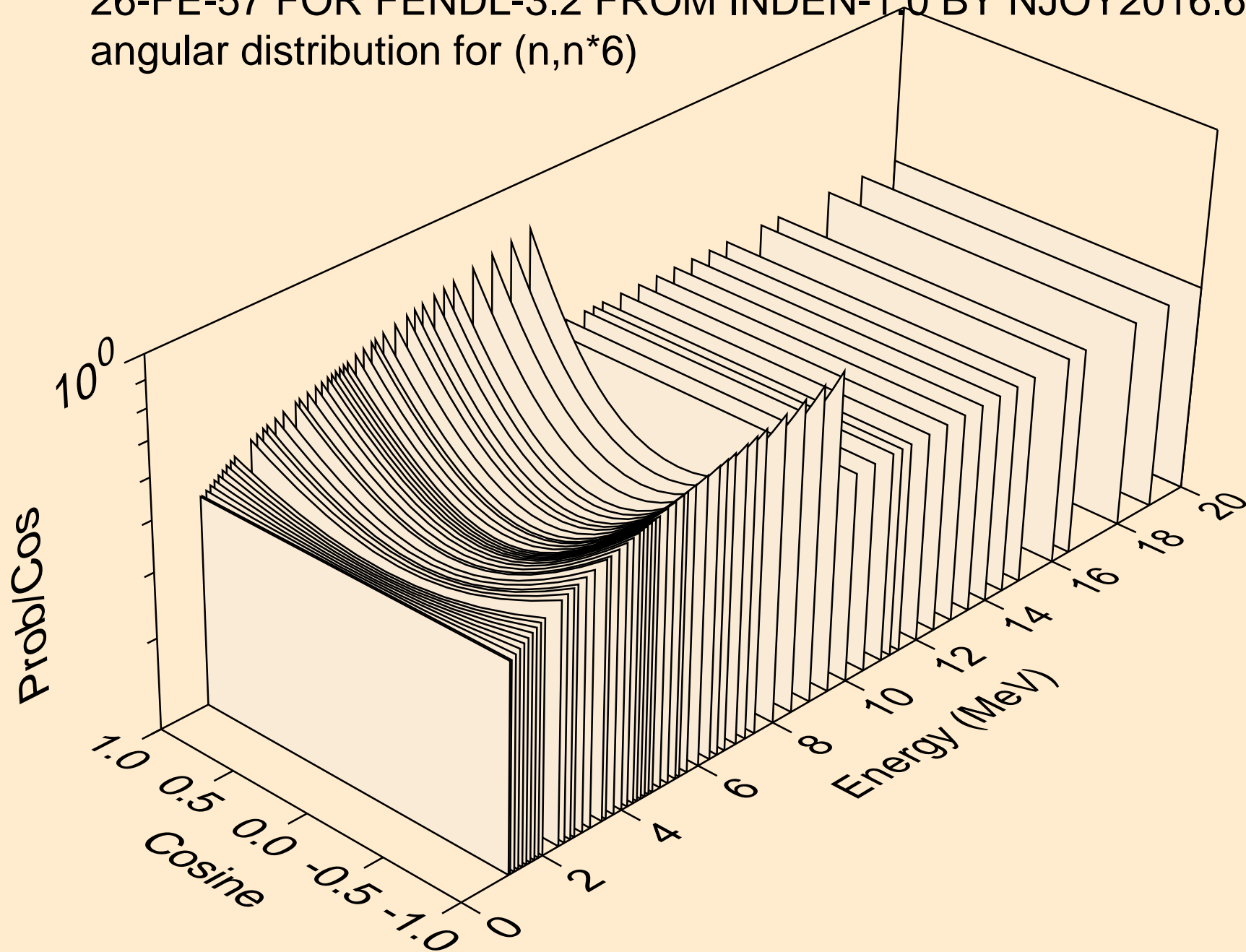

26-FE-57 FOR FENDL-3.2 FROM INDEN-1.0 BY NJOY2016.60+ ON
angular distribution for (n,n*6)

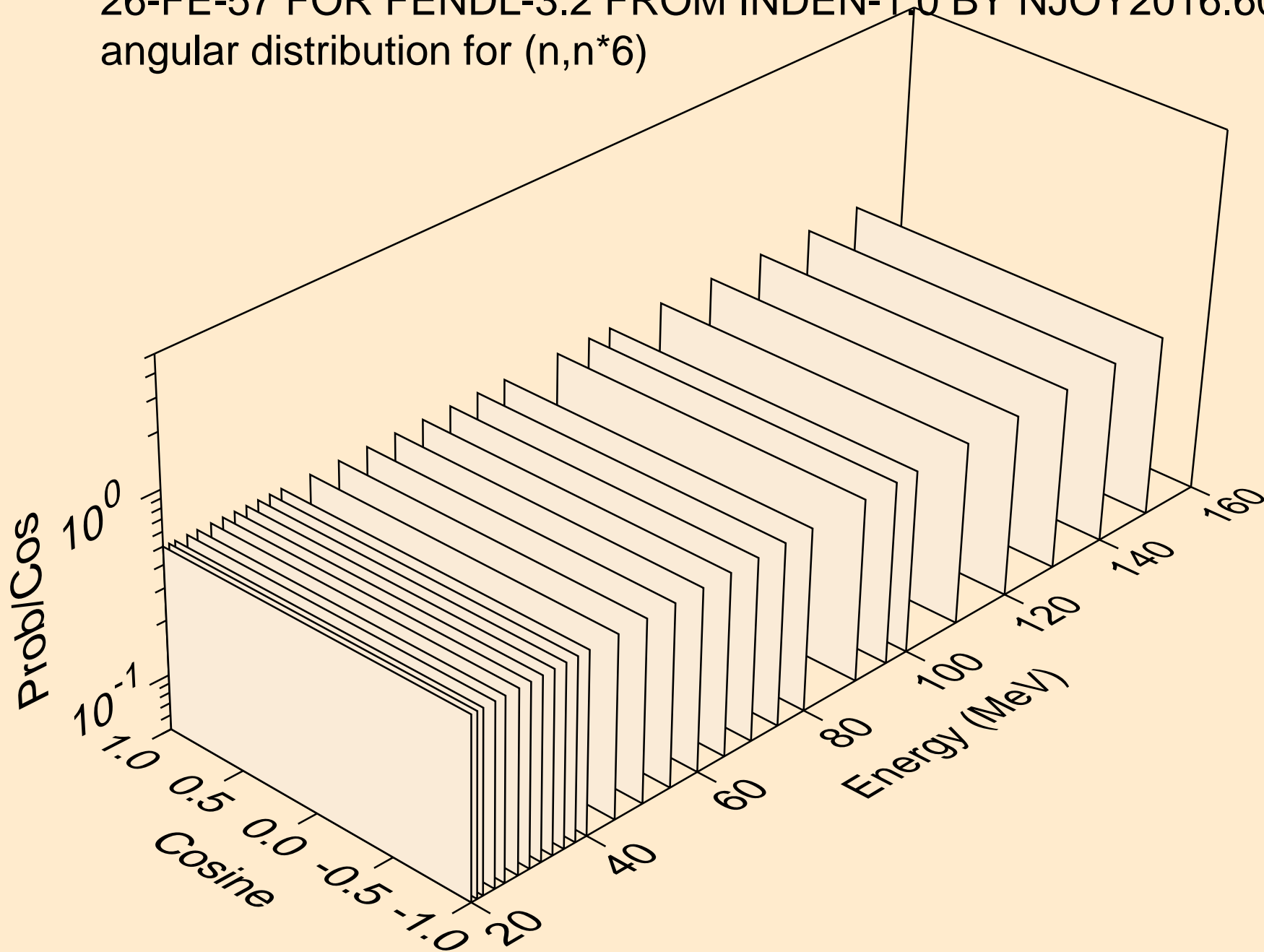

26-FE-57 FOR FENDL-3.2 FROM INDEN-1.0 BY NJOY2016.60+ ON
angular distribution for (n,n*7)

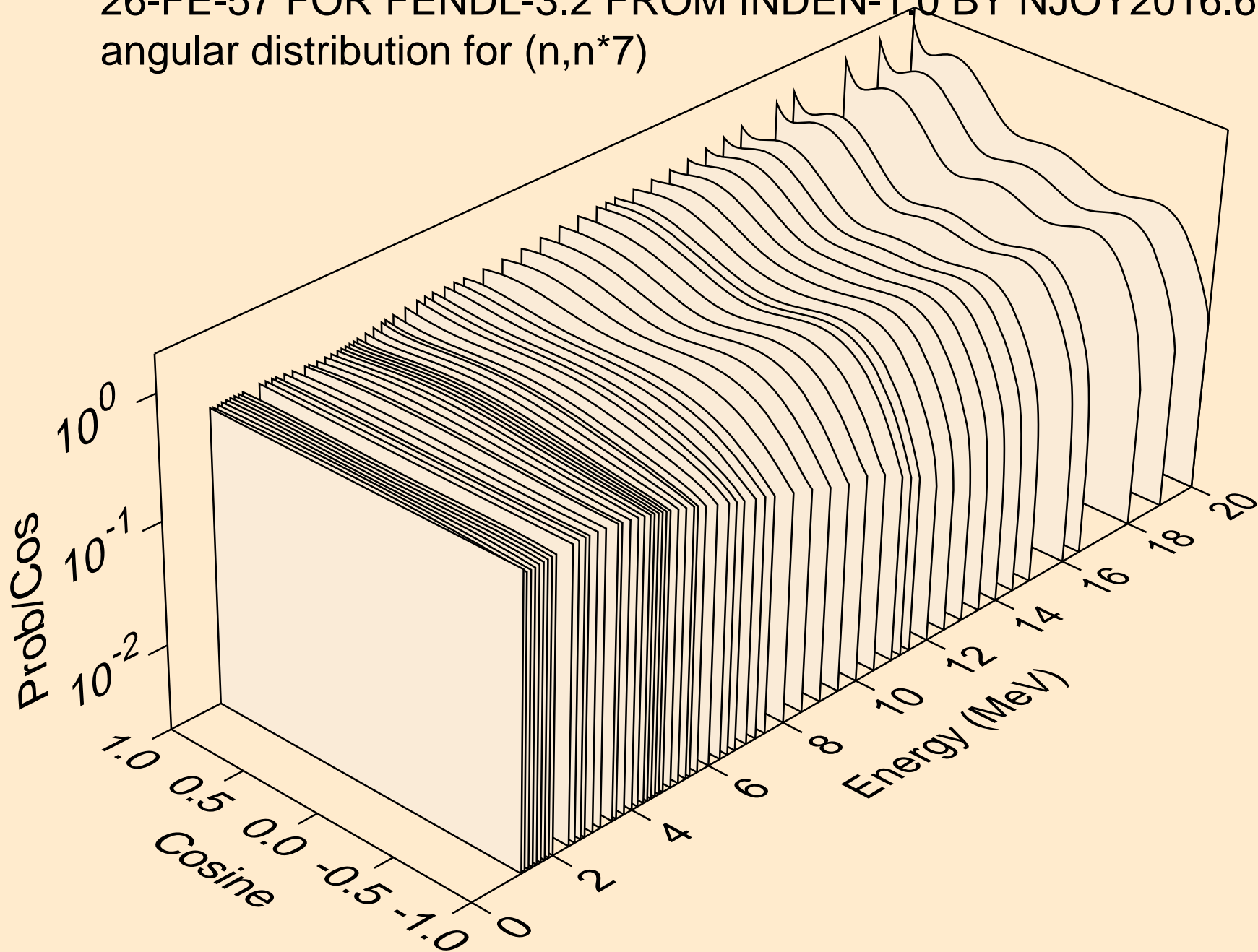

26-FE-57 FOR FENDL-3.2 FROM INDEN-1.0 BY NJOY2016.60+ ON
angular distribution for (n,n*7)

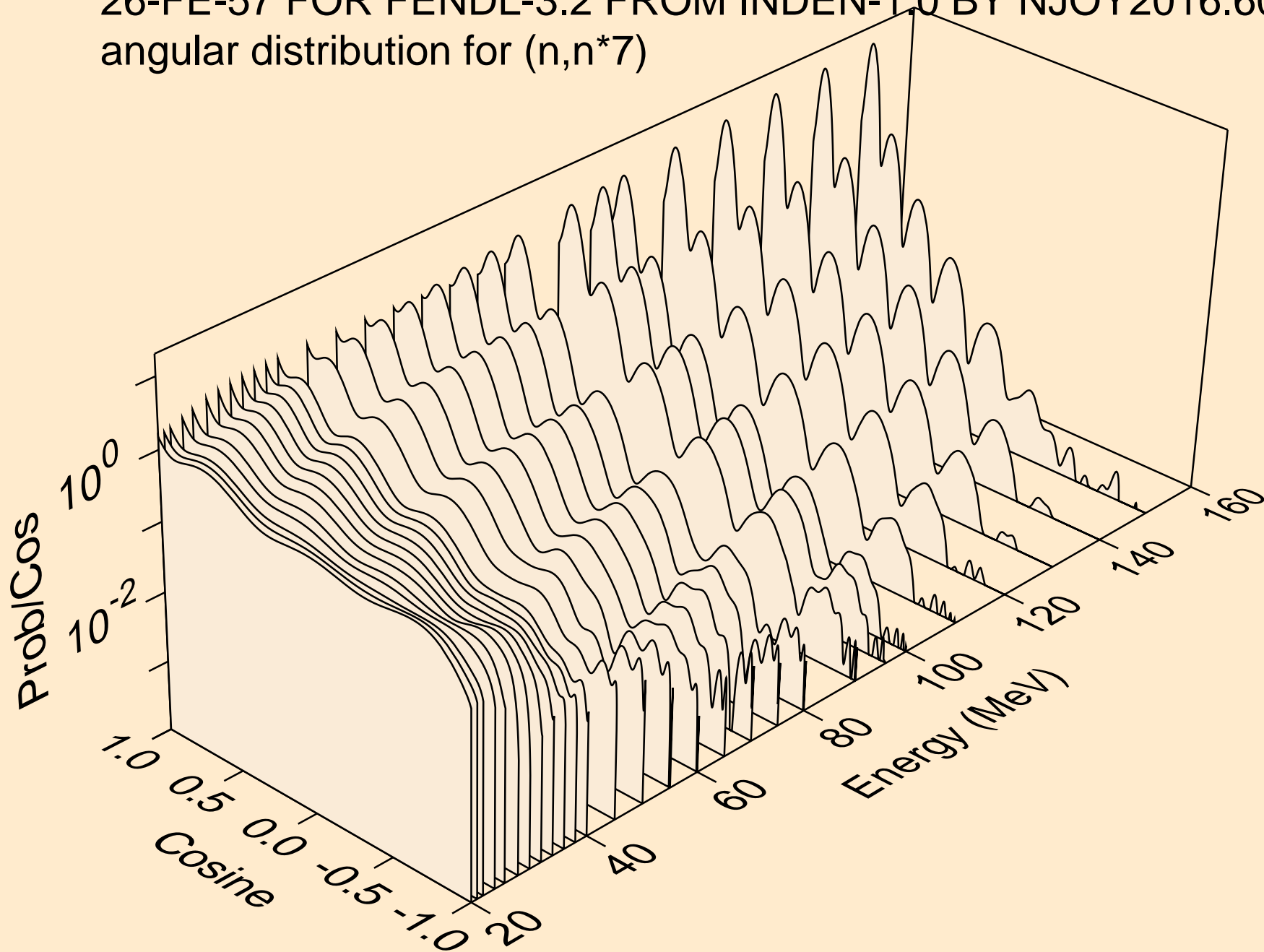

26-FE-57 FOR FENDL-3.2 FROM INDEN-1.0 BY NJOY2016.60+ ON
angular distribution for (n,n*8)

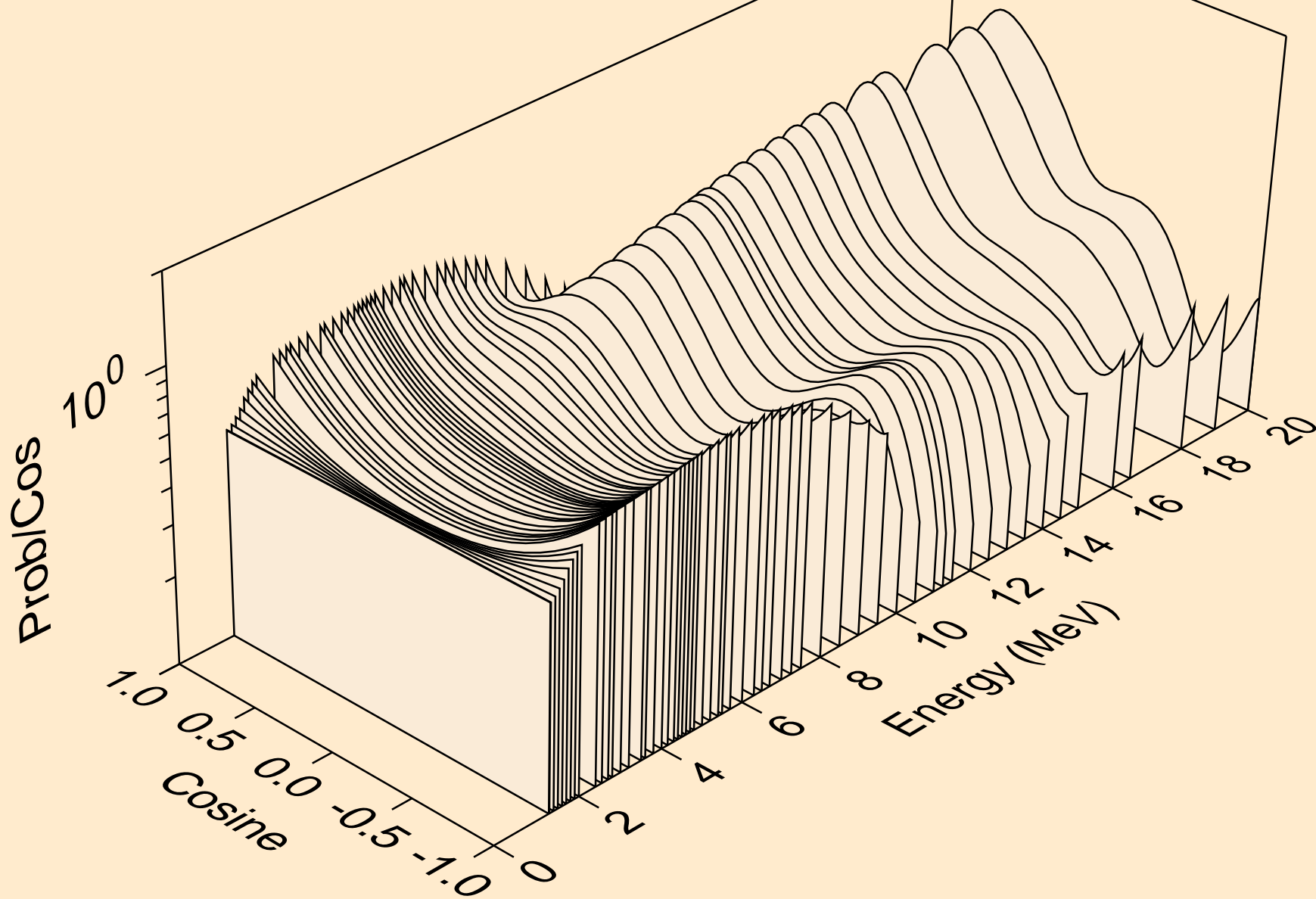

26-FE-57 FOR FENDL-3.2 FROM INDEN-1.0 BY NJOY2016.60+ ON
angular distribution for (n,n*8)

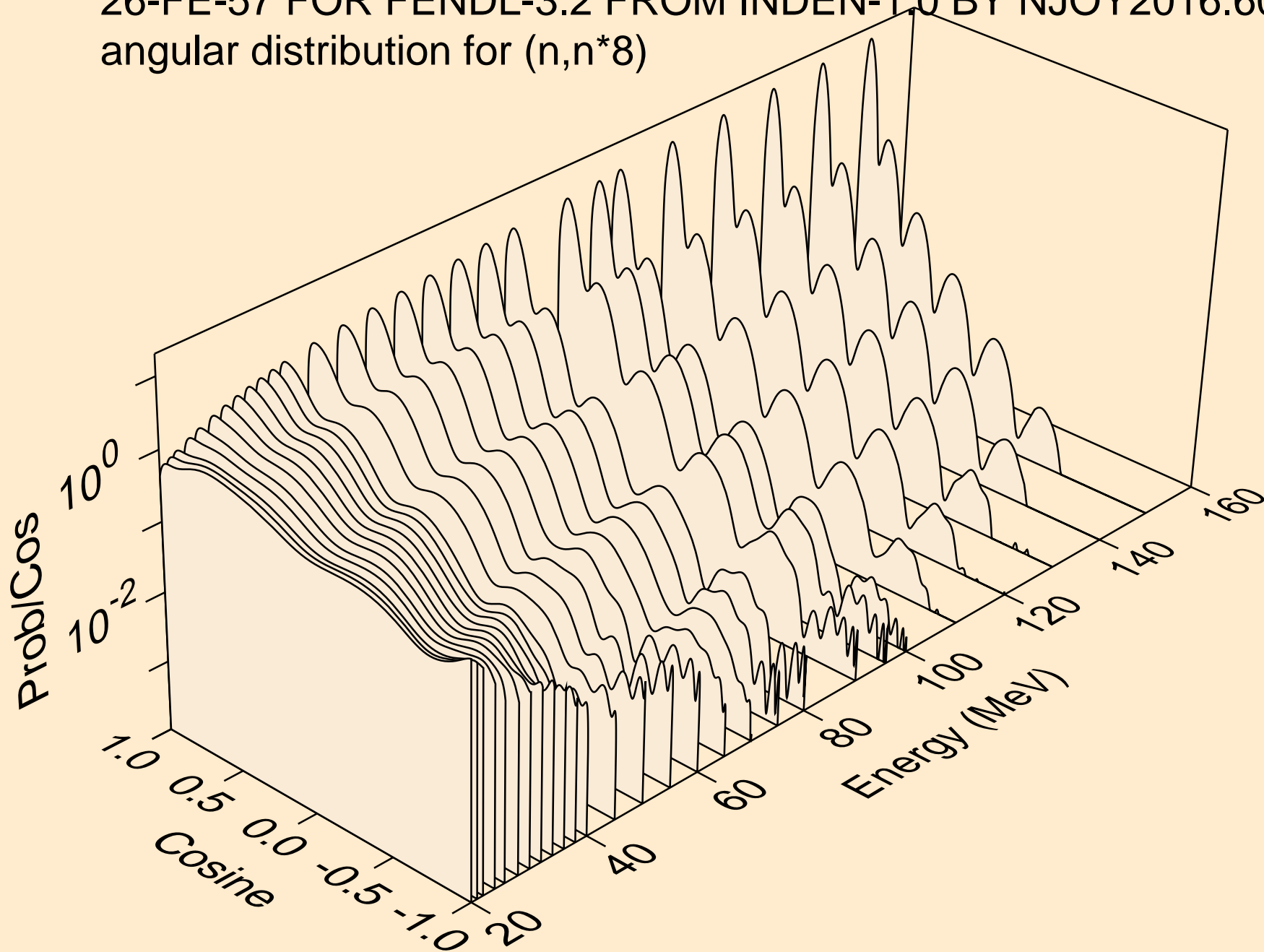

26-FE-57 FOR FENDL-3.2 FROM INDEN-1.0 BY NJOY2016.60+ ON
angular distribution for (n,n*9)

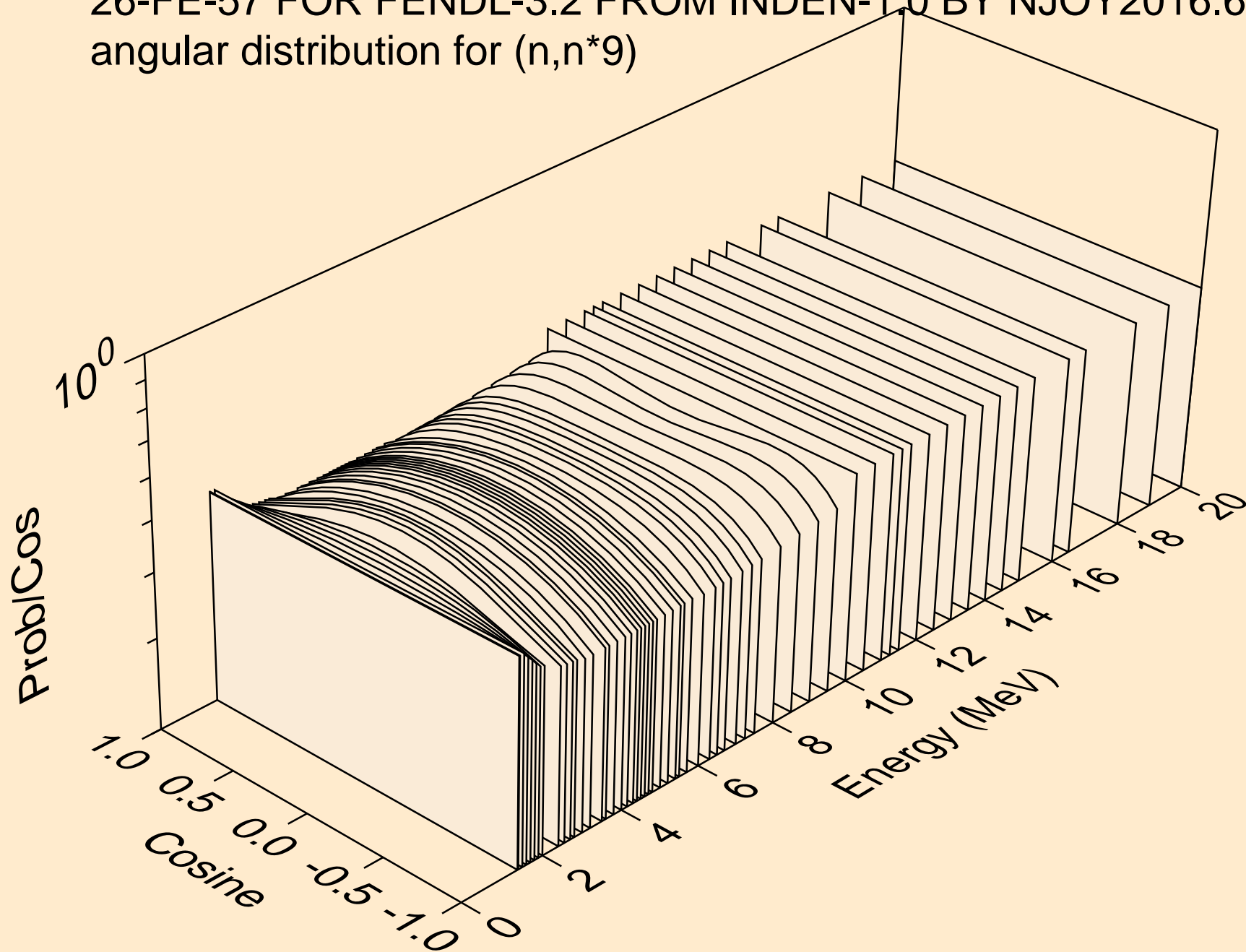

26-FE-57 FOR FENDL-3.2 FROM INDEN-1.0 BY NJOY2016.60+ ON
angular distribution for (n,n*9)

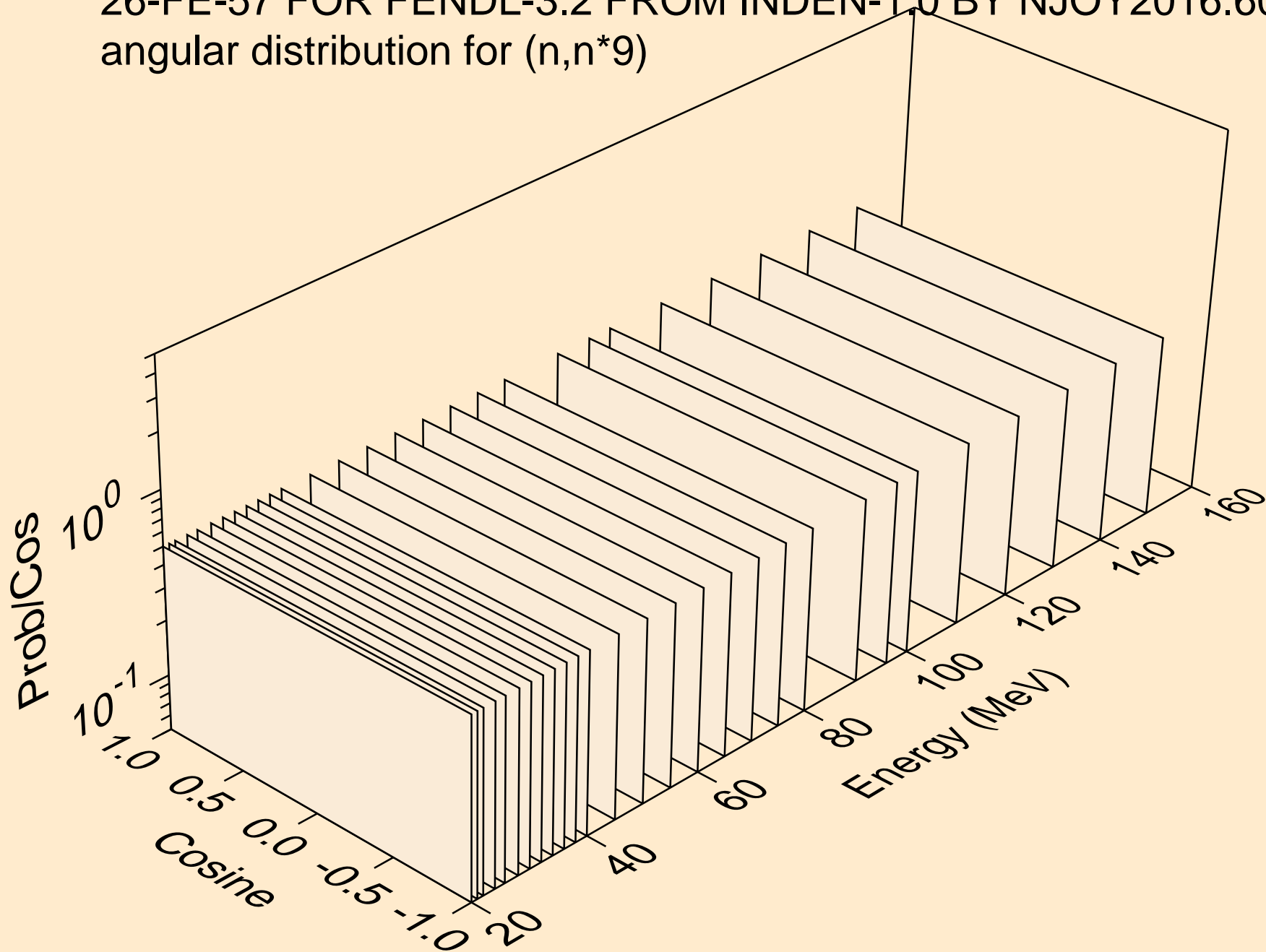

26-FE-57 FOR FENDL-3.2 FROM INDEN-1.0 BY NJOY2016.60+ ON
angular distribution for (n,n*10)

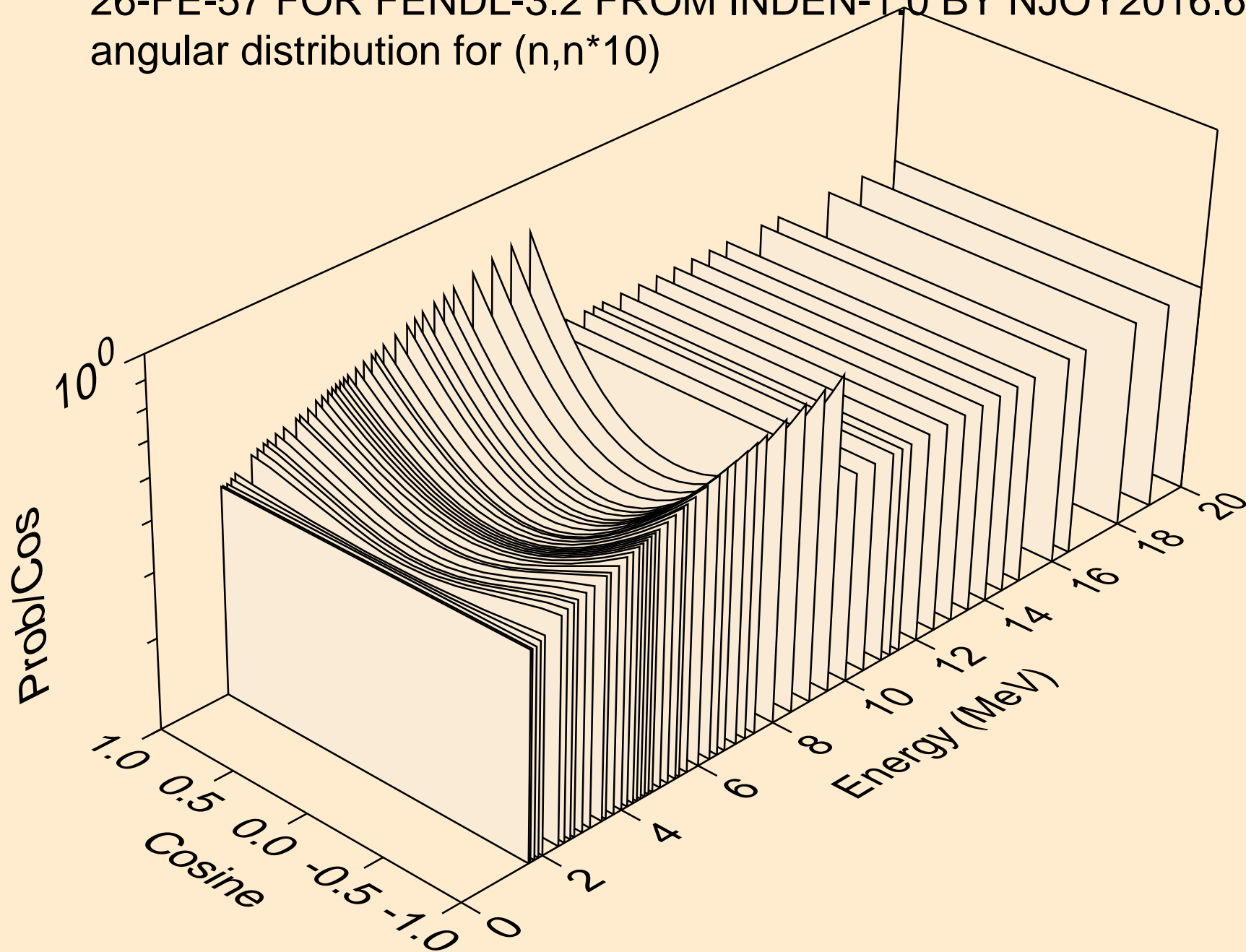

26-FE-57 FOR FENDL-3.2 FROM INDEN-1.0 BY NJOY2016.60+ ON
angular distribution for (n,n*10)

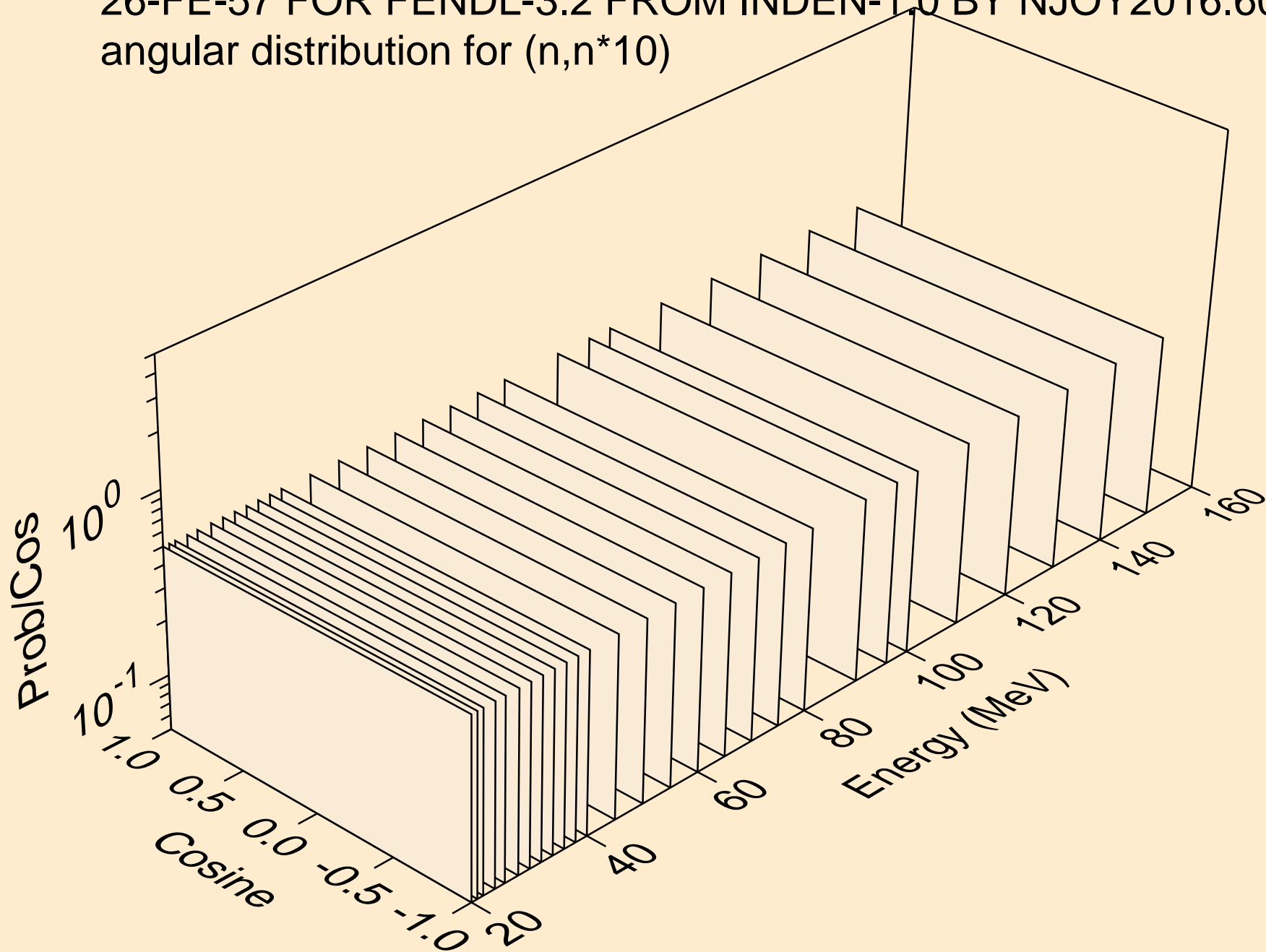

26-FE-57 FOR FENDL-3.2 FROM INDEN-1.0 BY NJOY2016.60+ ON
angular distribution for (n,n*11)

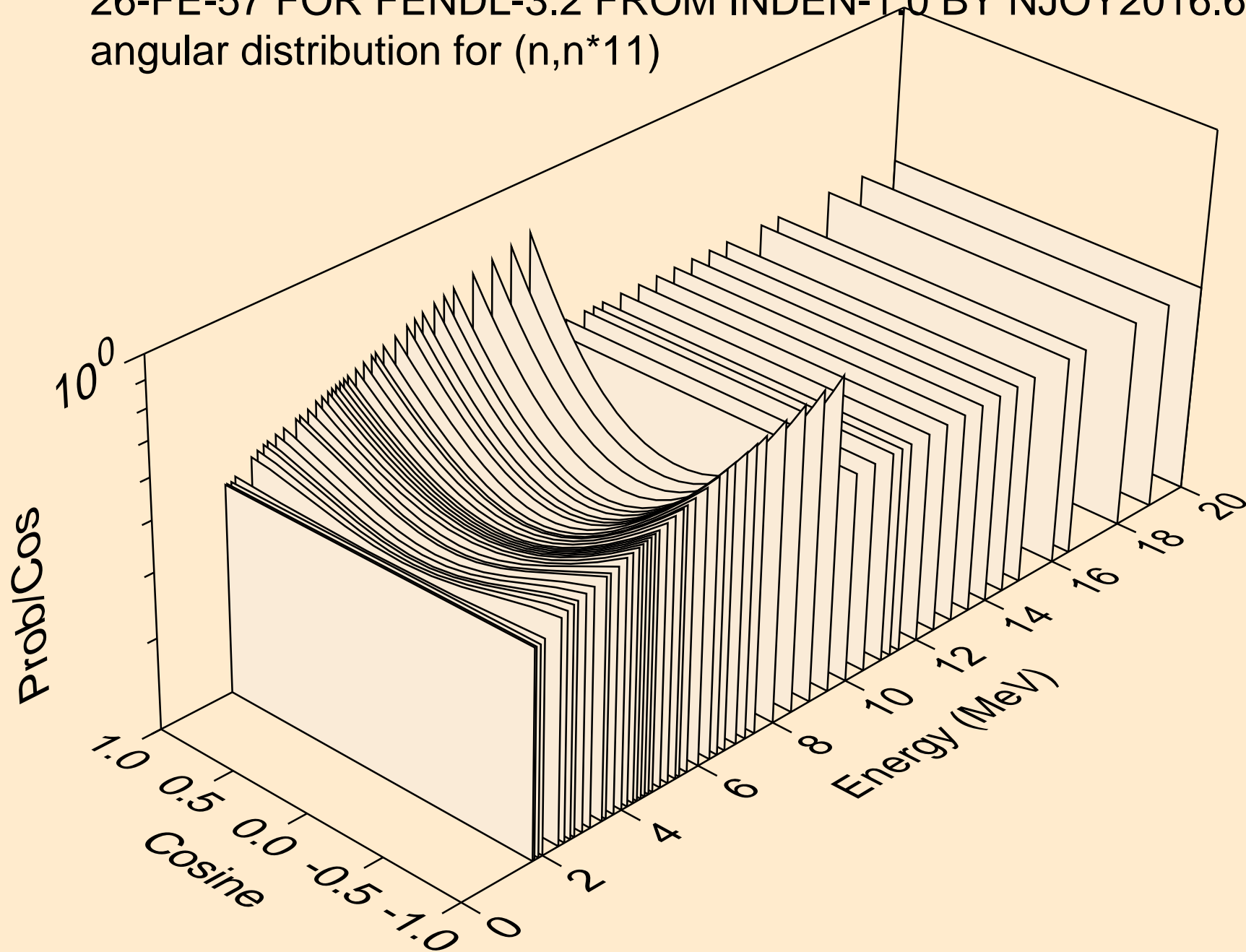

26-FE-57 FOR FENDL-3.2 FROM INDEN-1.0 BY NJOY2016.60+ ON
angular distribution for (n,n*11)

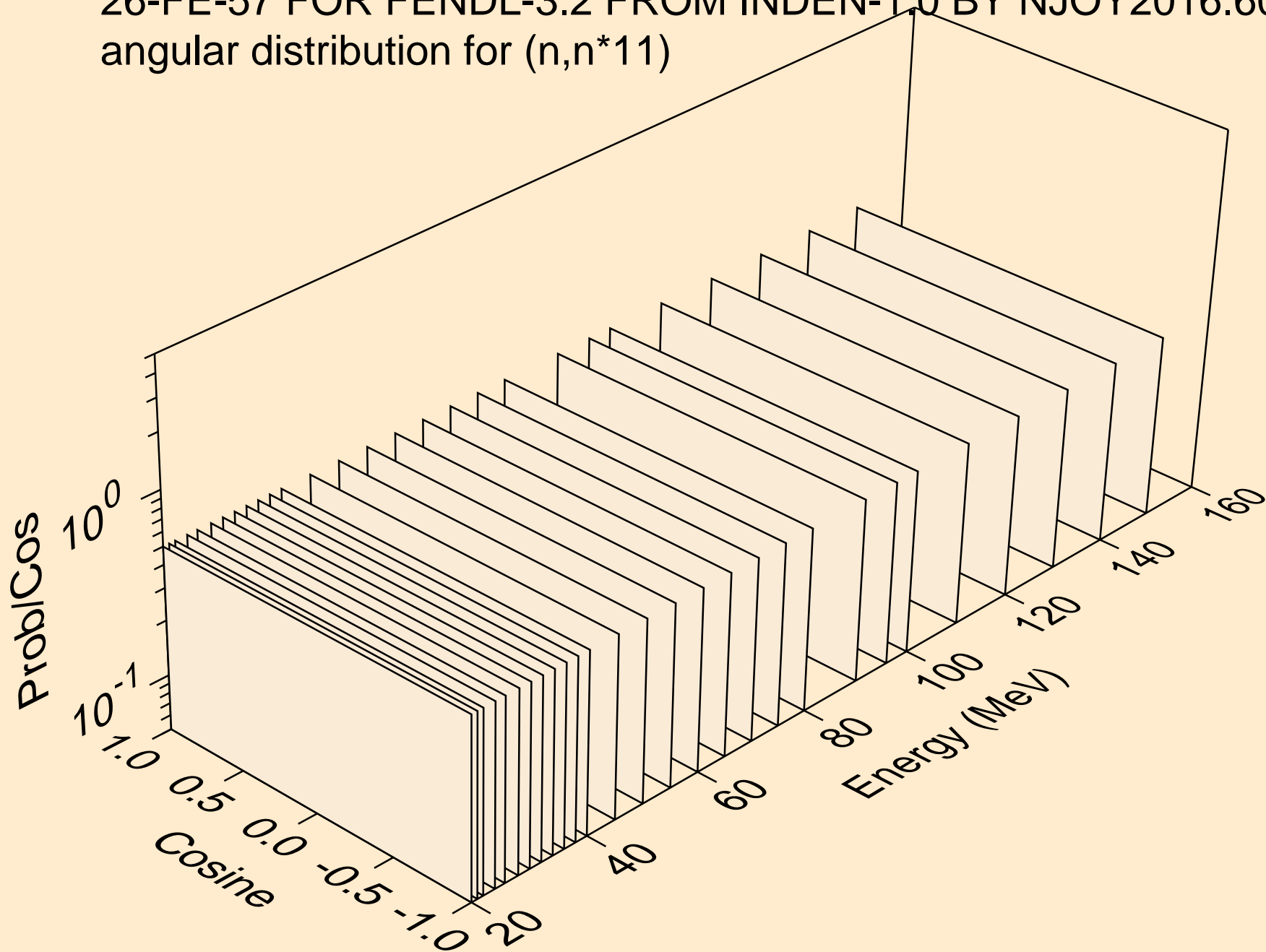

26-FE-57 FOR FENDL-3.2 FROM INDEN-1.0 BY NJOY2016.60+ ON
angular distribution for (n,n*12)

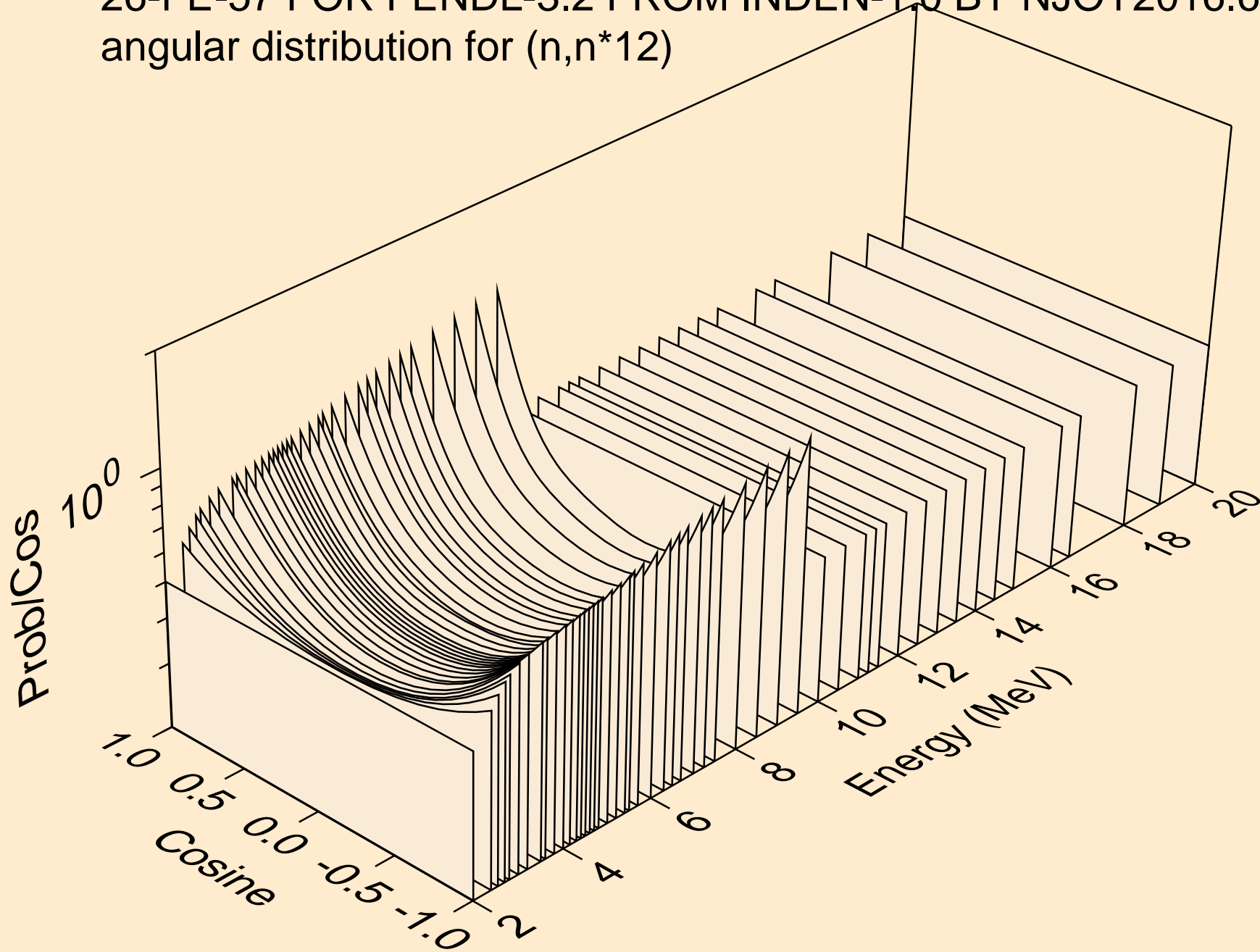

26-FE-57 FOR FENDL-3.2 FROM INDEN-1.0 BY NJOY2016.60+ ON
angular distribution for (n,n*12)

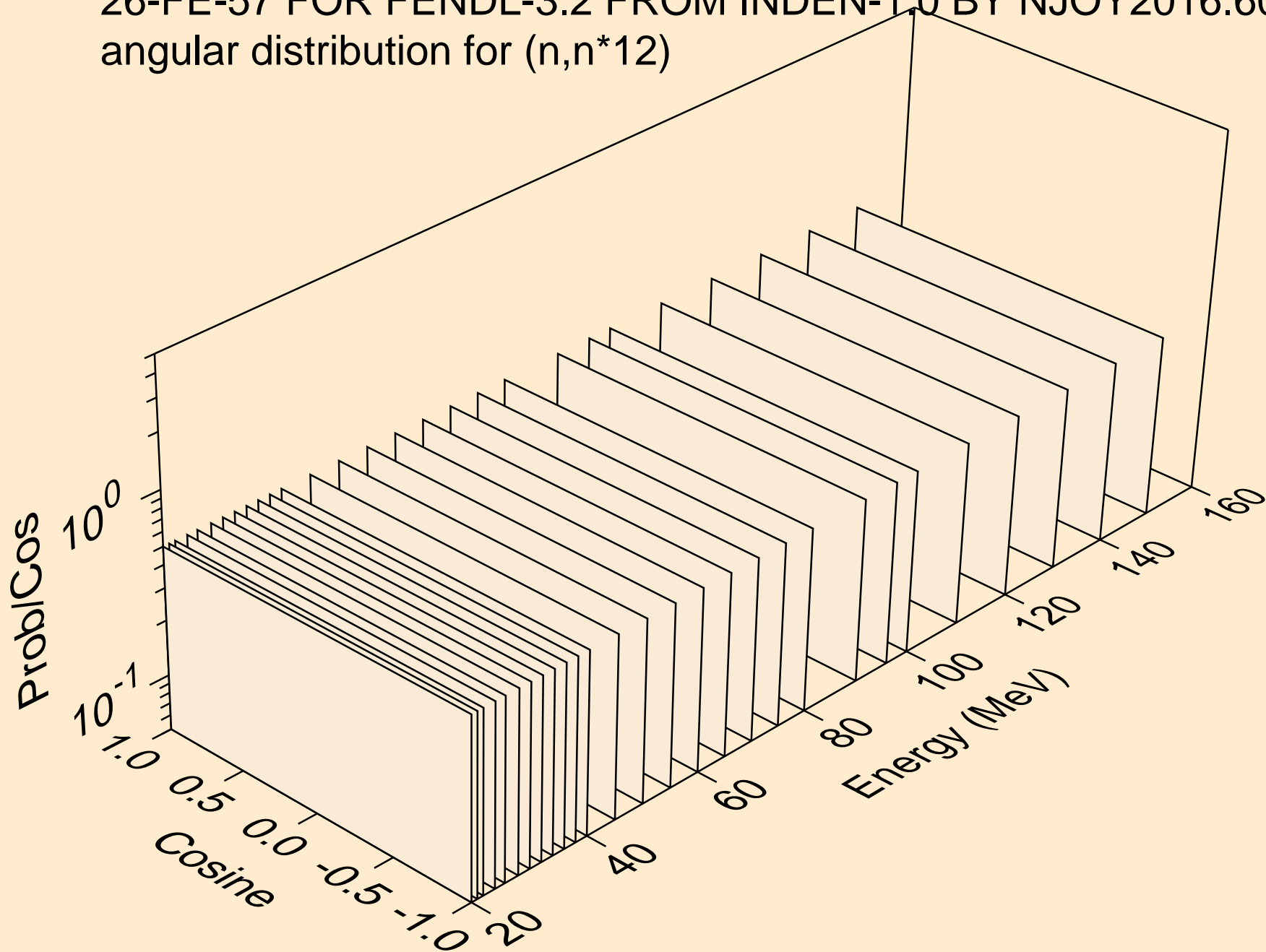

26-FE-57 FOR FENDL-3.2 FROM INDEN-1.0 BY NJOY2016.60+ ON
angular distribution for (n,n*13)

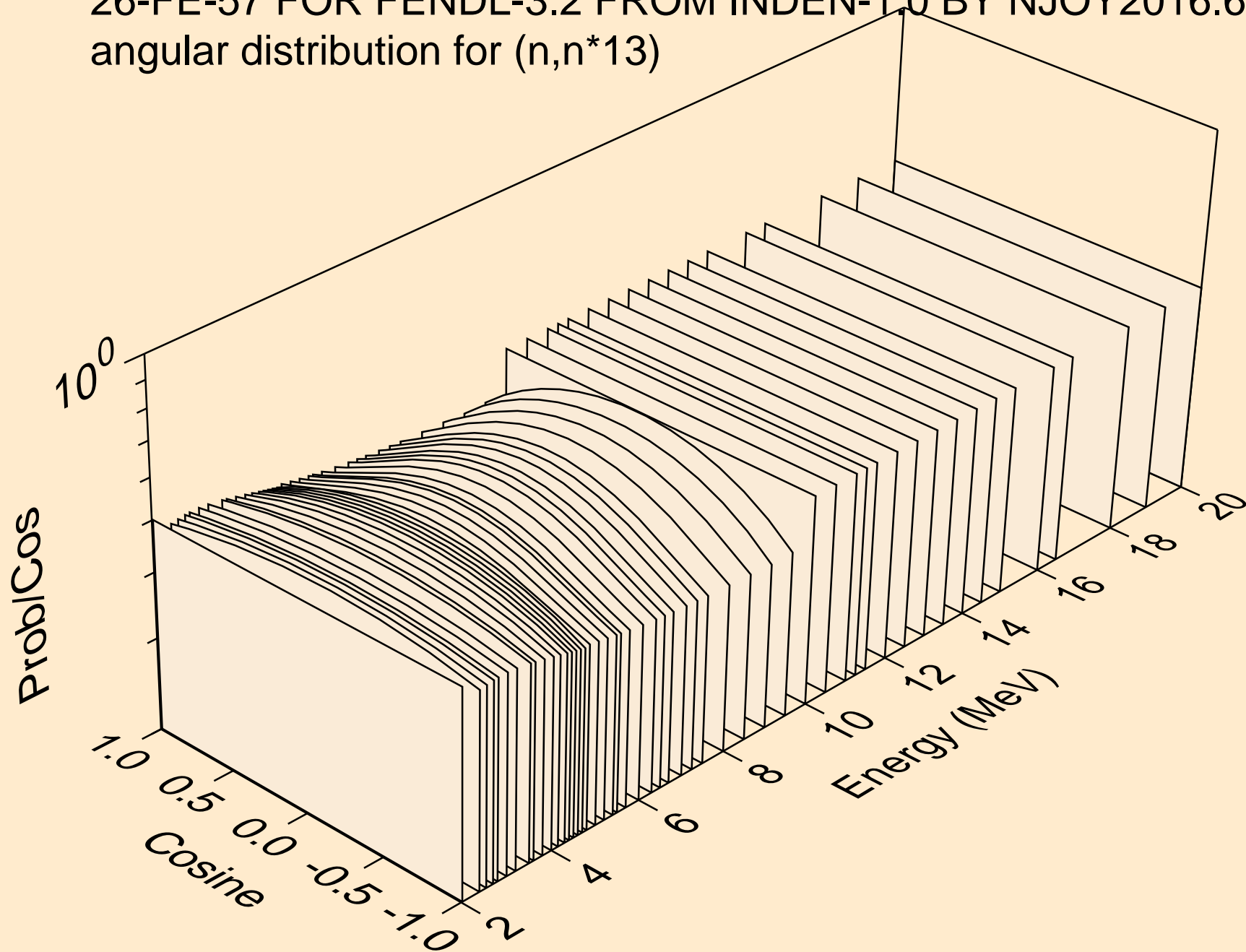

26-FE-57 FOR FENDL-3.2 FROM INDEN-1.0 BY NJOY2016.60+ ON
angular distribution for (n,n*13)

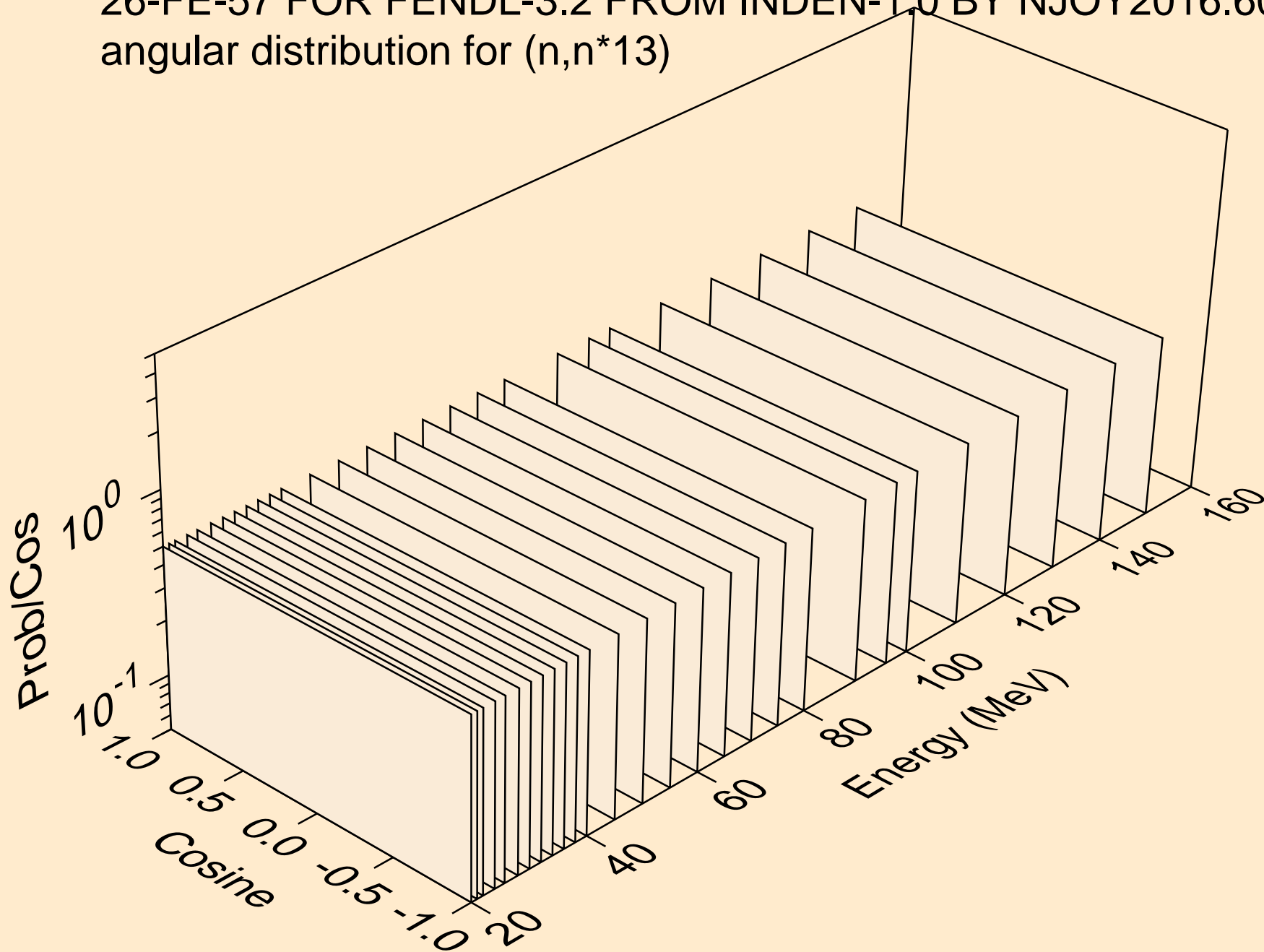

26-FE-57 FOR FENDL-3.2 FROM INDEN-1.0 BY NJOY2016.60+ ON
angular distribution for (n,n*14)

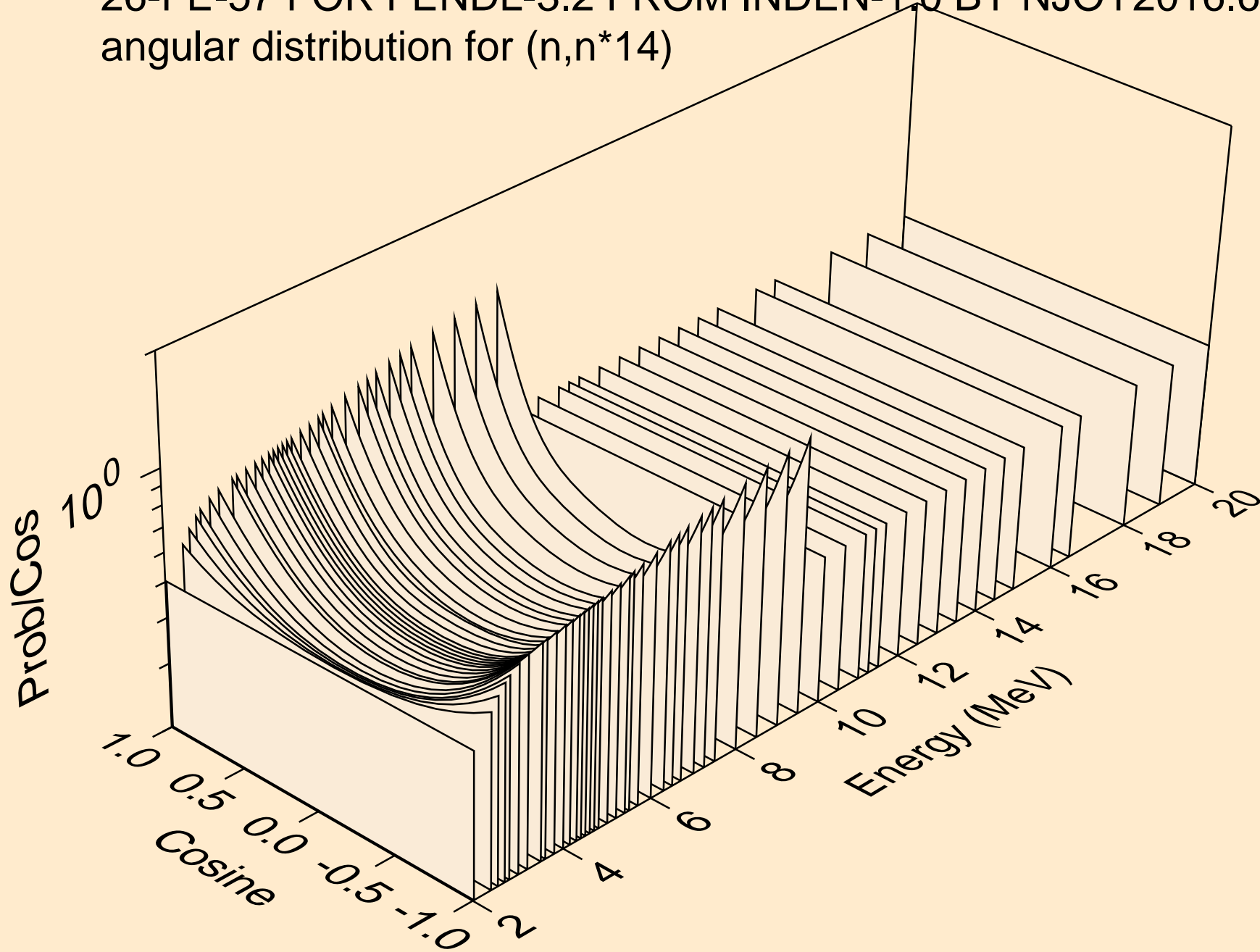

26-FE-57 FOR FENDL-3.2 FROM INDEN-1.0 BY NJOY2016.60+ ON
angular distribution for (n,n*14)

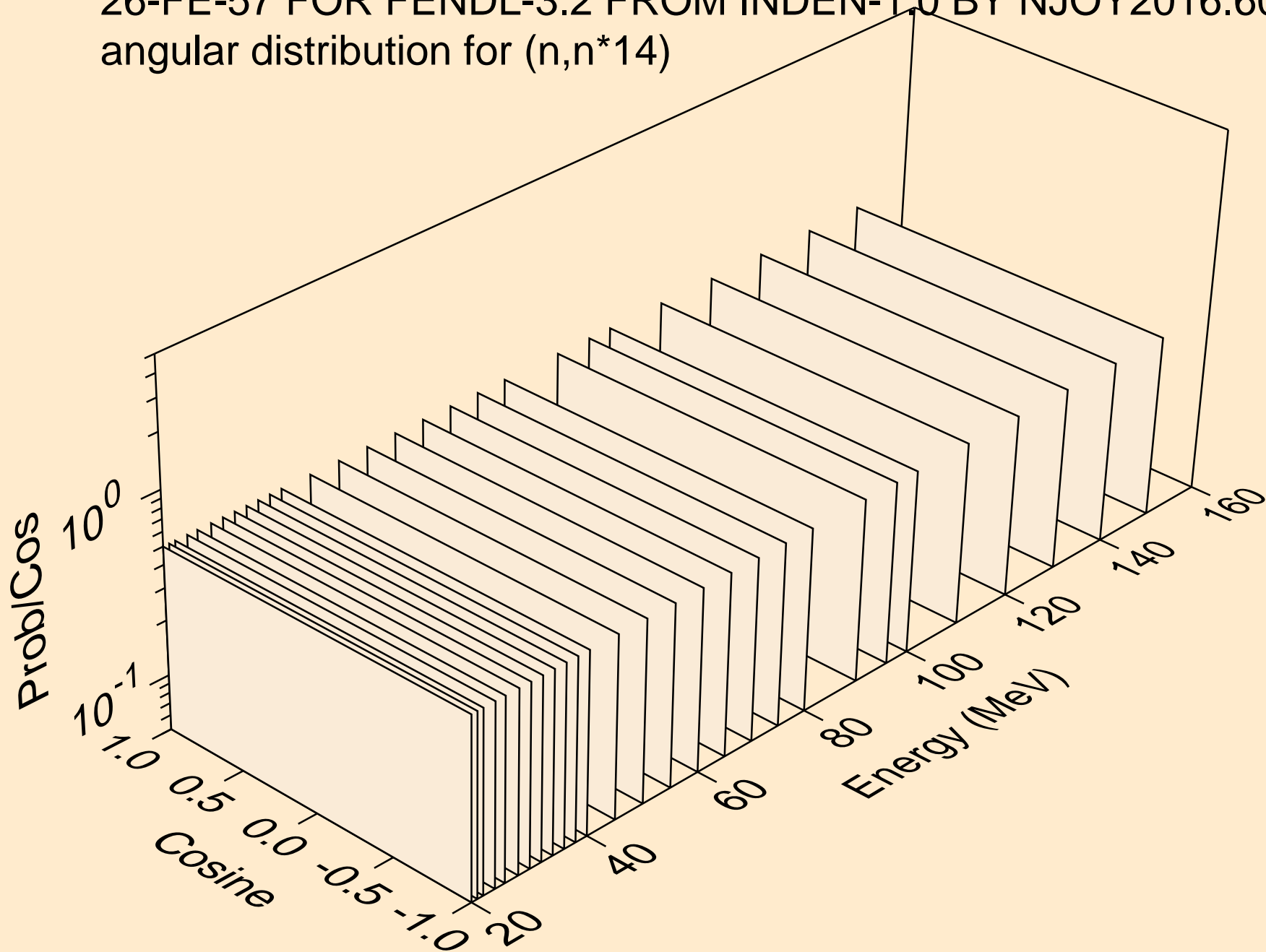

26-FE-57 FOR FENDL-3.2 FROM INDEN-1.0 BY NJOY2016.60+ ON
Neutron emission for (n,x)

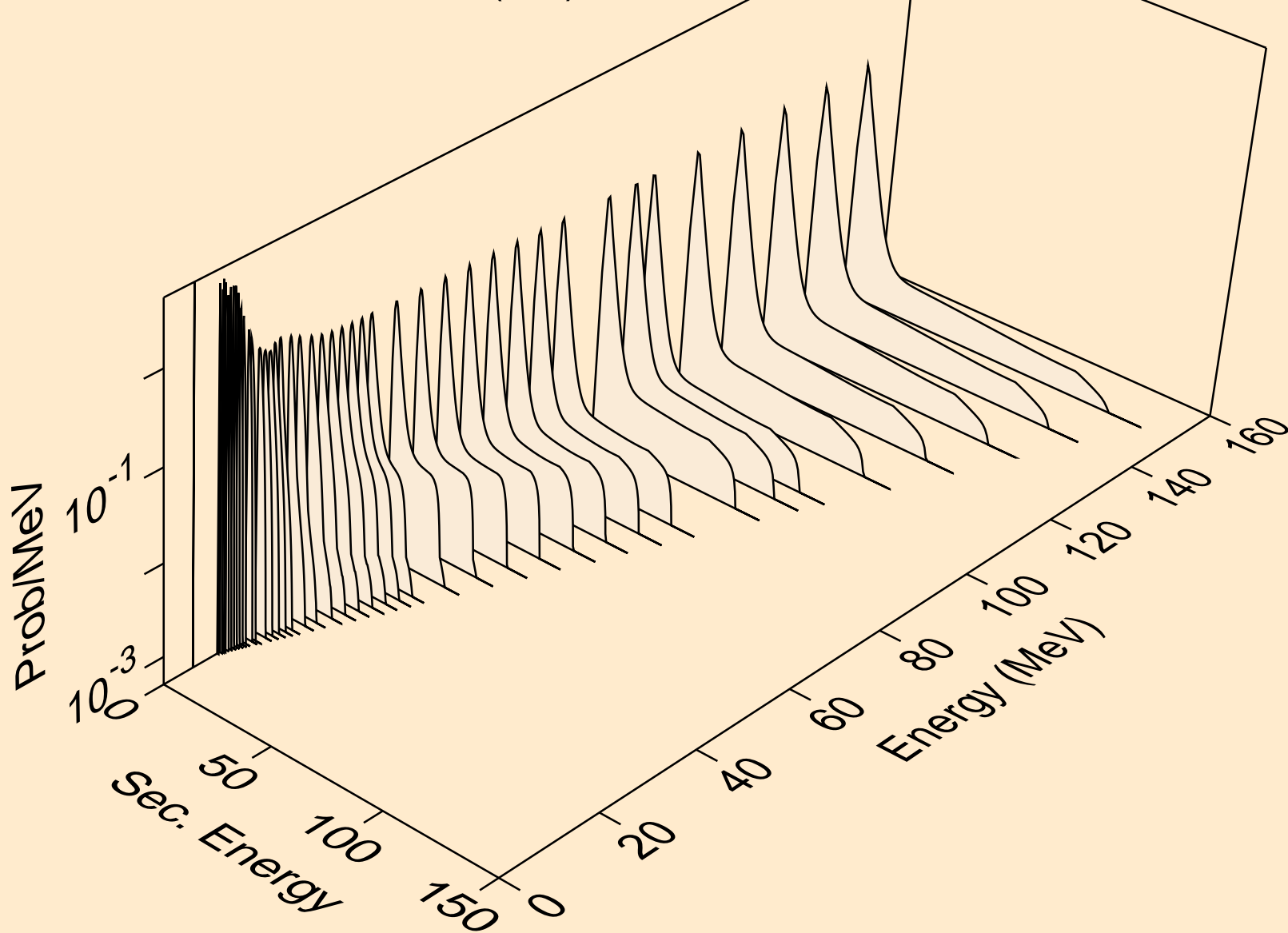

26-FE-57 FOR FENDL-3.2 FROM INDEN-1.0 BY NJOY2016.60+ ON
Neutron emission for (n,2n)

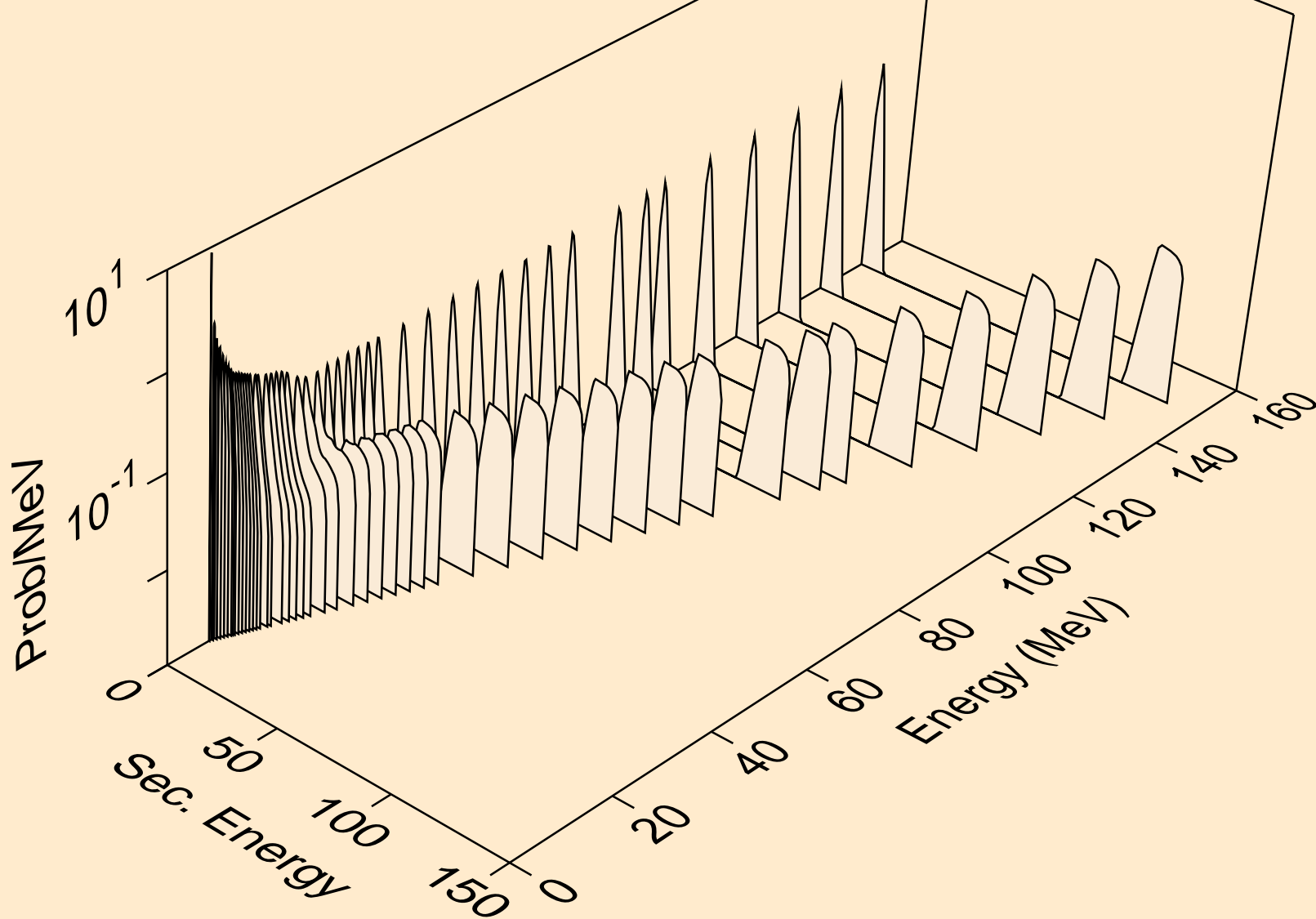

26-FE-57 FOR FENDL-3.2 FROM INDEN-1.0 BY NJOY2016.60+ ON
Neutron emission for (n,n*c)

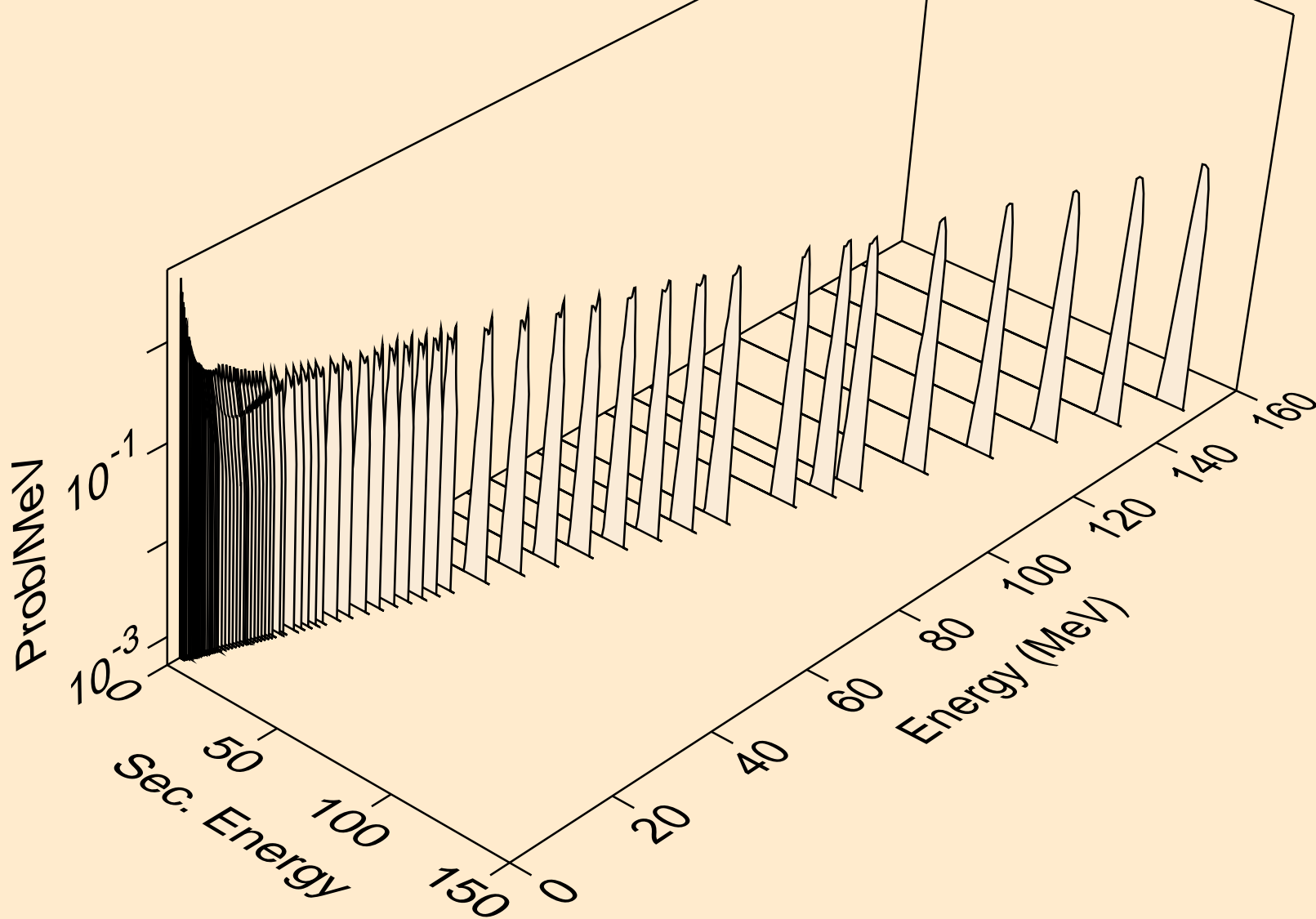

26-FE-57 FOR FENDL-3.2 FROM INDEN-1.0 BY NJOY2016.60+ ON
Photon emission for (n,x)

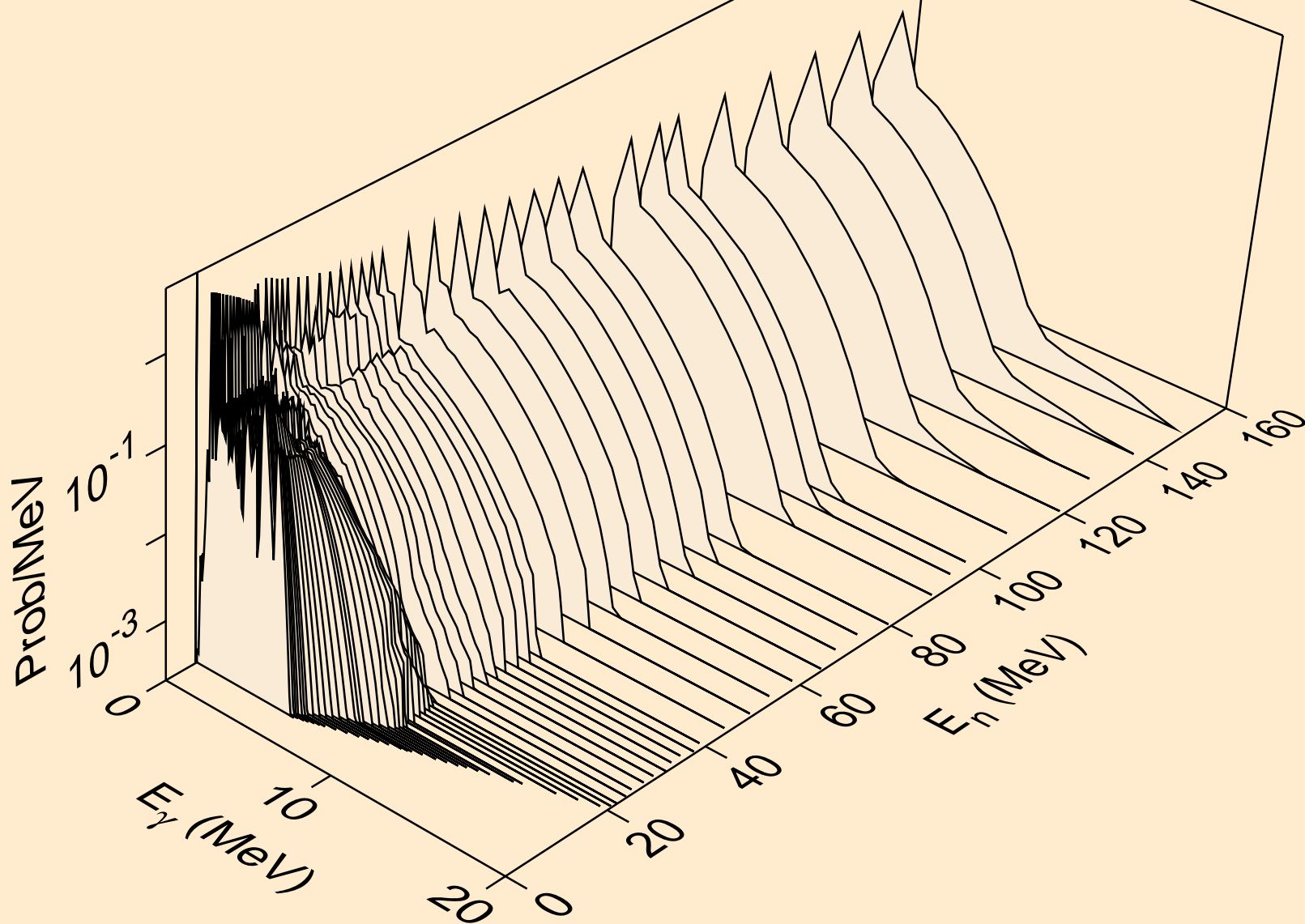

26-FE-57 FOR FENDL-3.2 FROM INDEN-1.0 BY NJOY2016.60+ ON
Photon emission for (n,2n)

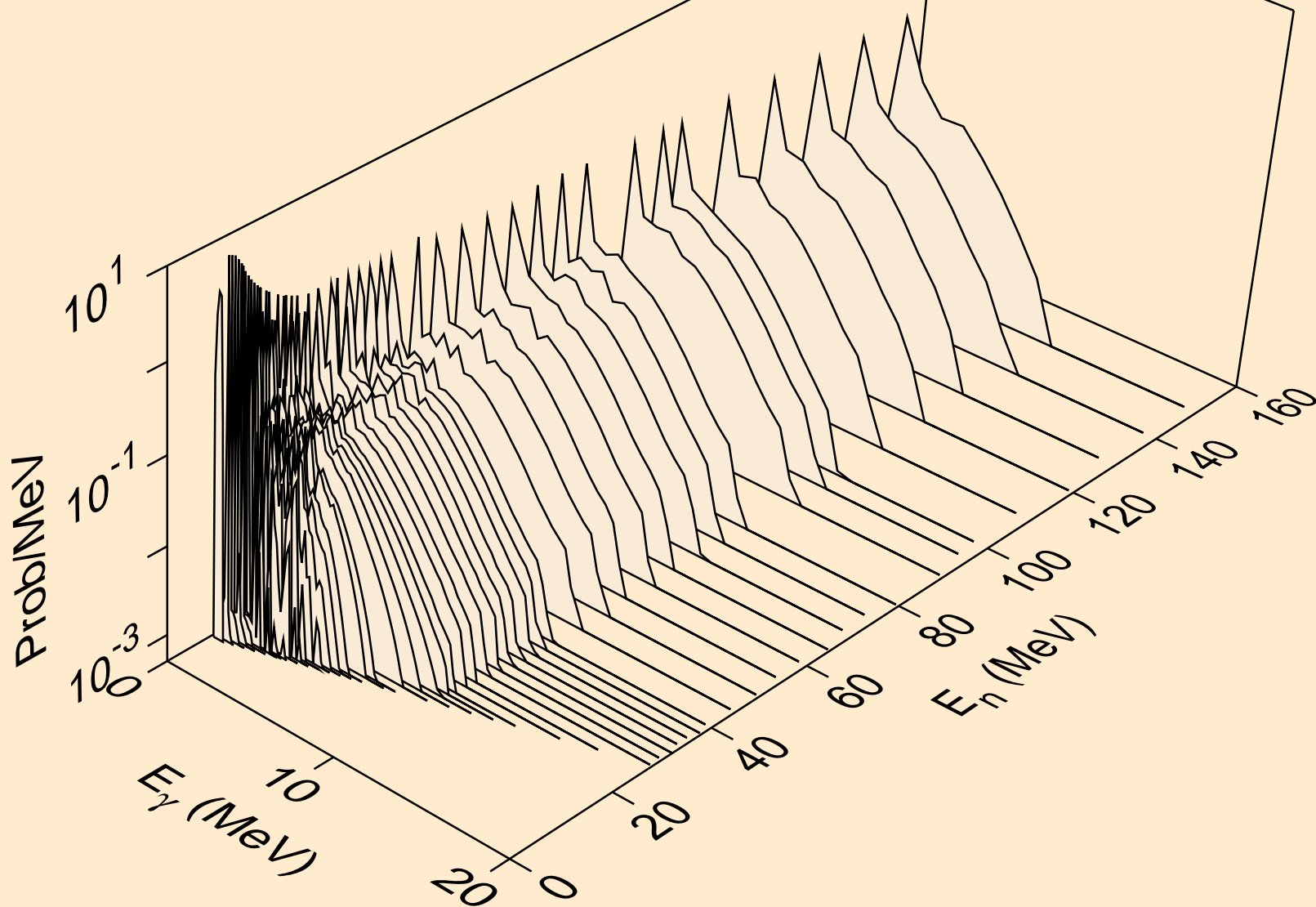

26-FE-57 FOR FENDL-3.2 FROM INDEN-1.0 BY NJOY2016.60+ ON
Photon emission for (n,n*c)

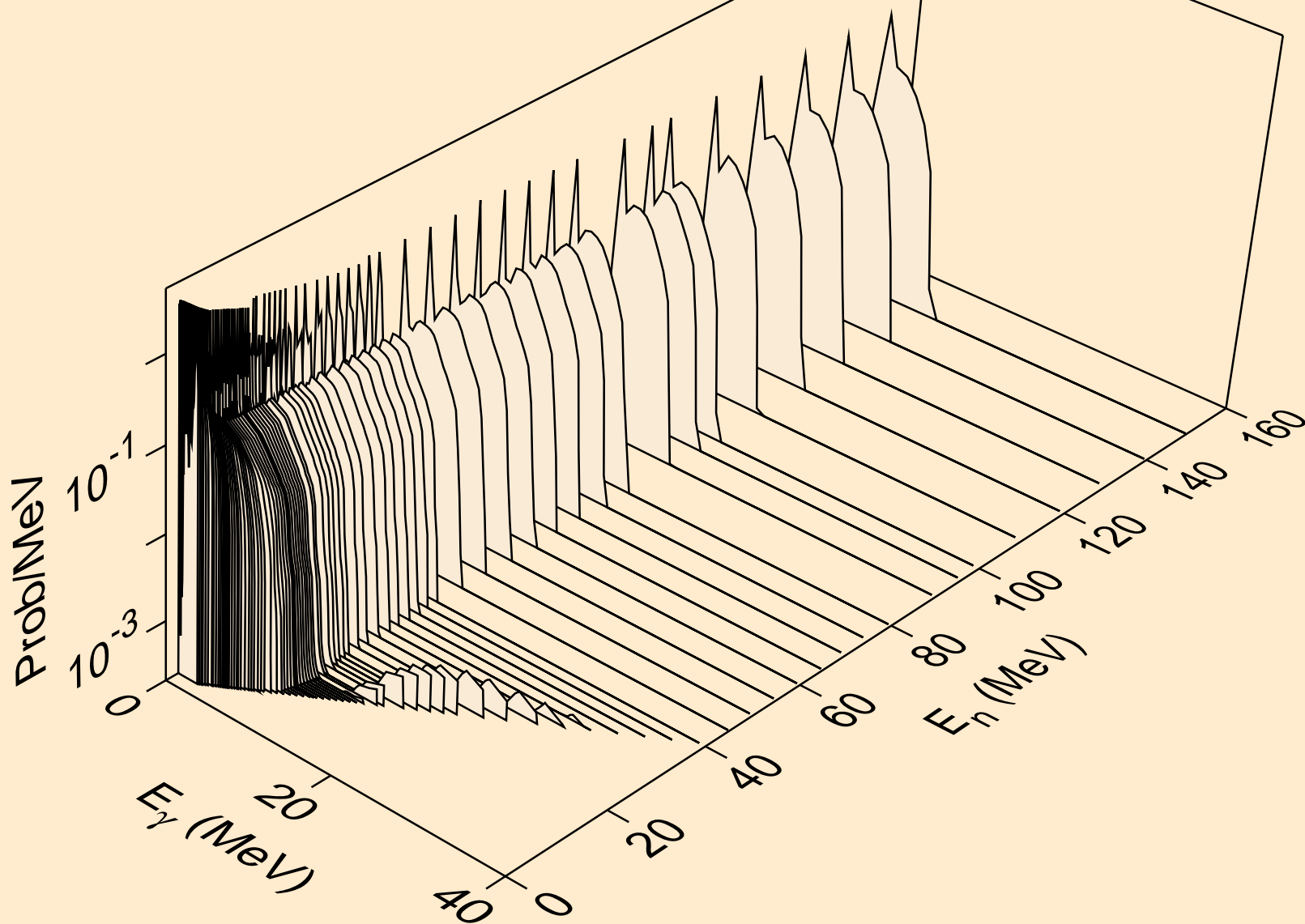

26-FE-57 FOR FENDL-3.2 FROM INDEN-1.0 BY NJOY2016.60+ ON
Photon emission for (n,gma)

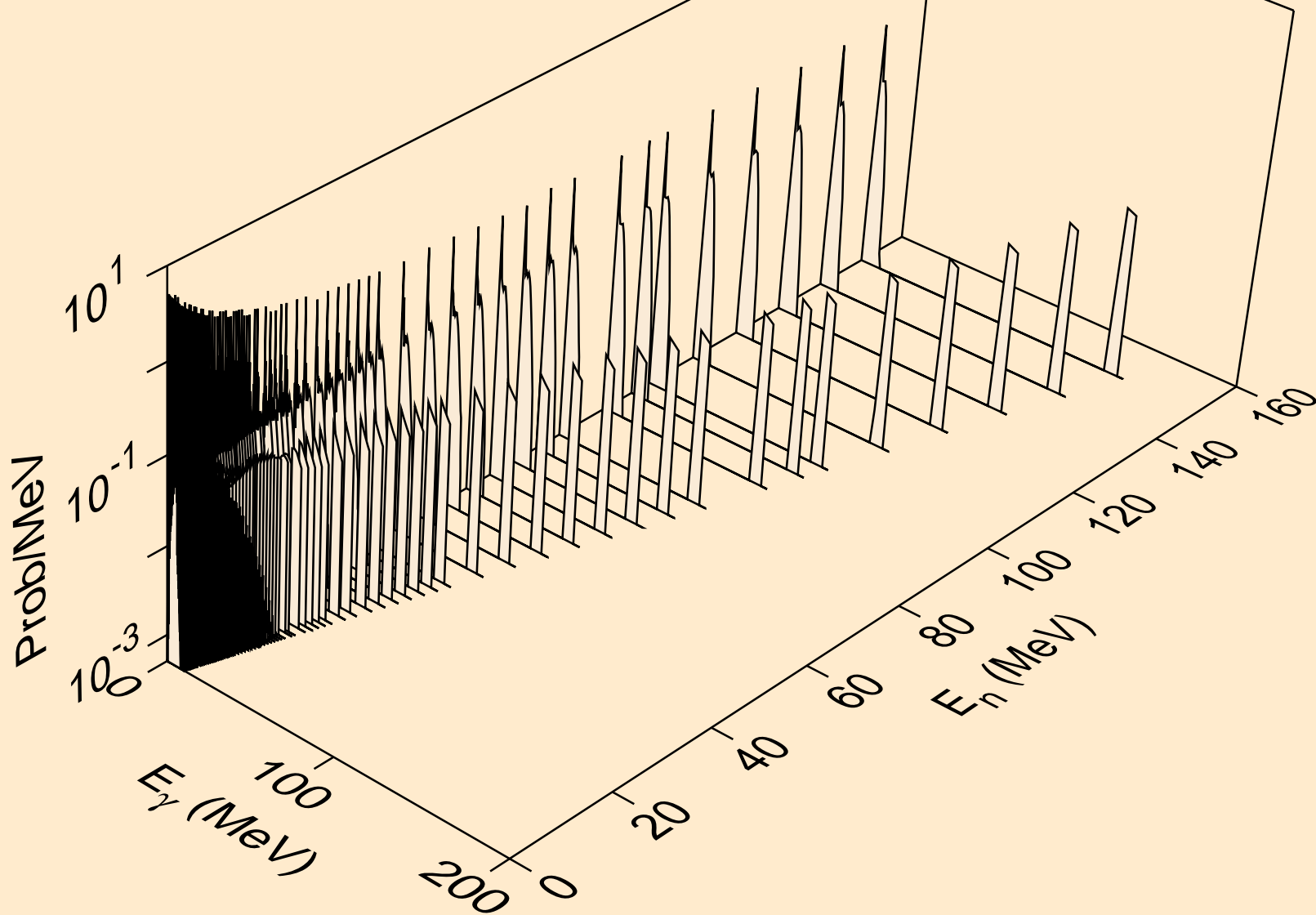

26-FE-57 FOR FENDL-3.2 FROM INDEN-1.0 BY NJOY2016.60+ ON
Photon emission for (n,2p)

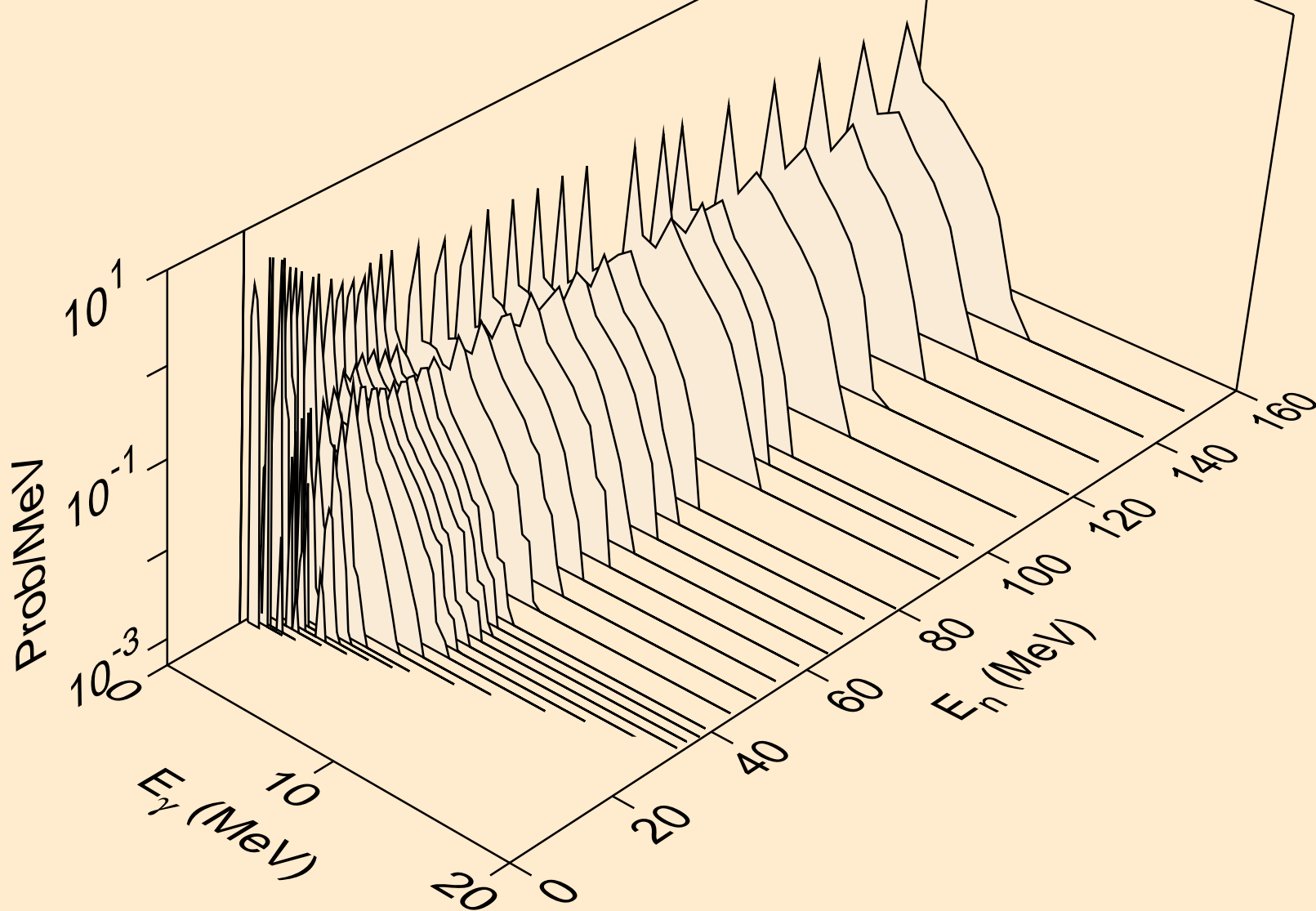

26-FE-57 FOR FENDL-3.2 FROM INDEN-1.0 BY NJOY2016.60+ ON
Photon emission for (n,p*c)

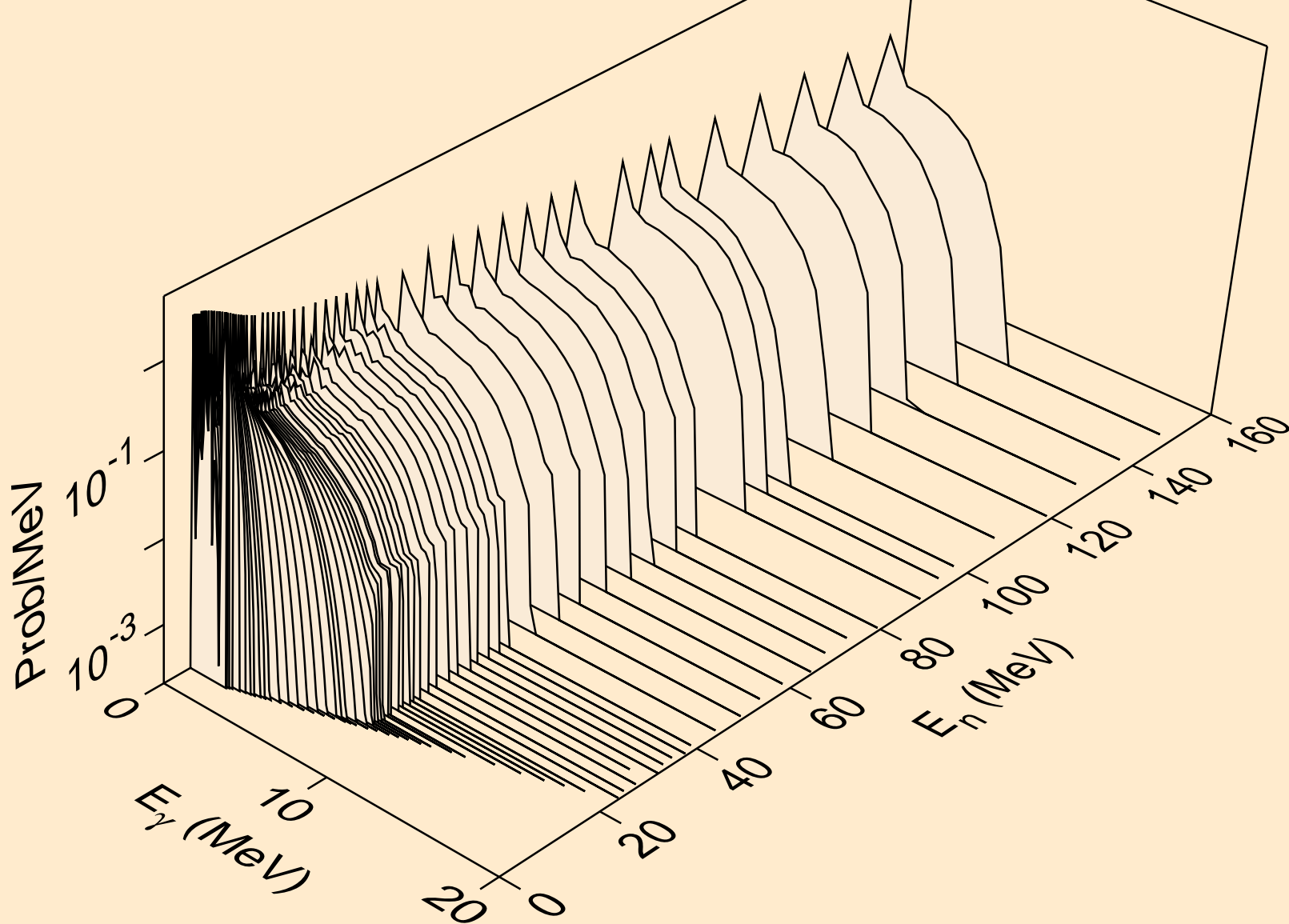

26-FE-57 FOR FENDL-3.2 FROM INDEN-1.0 BY NJOY2016.60+ ON
thermal capture photon spectrum

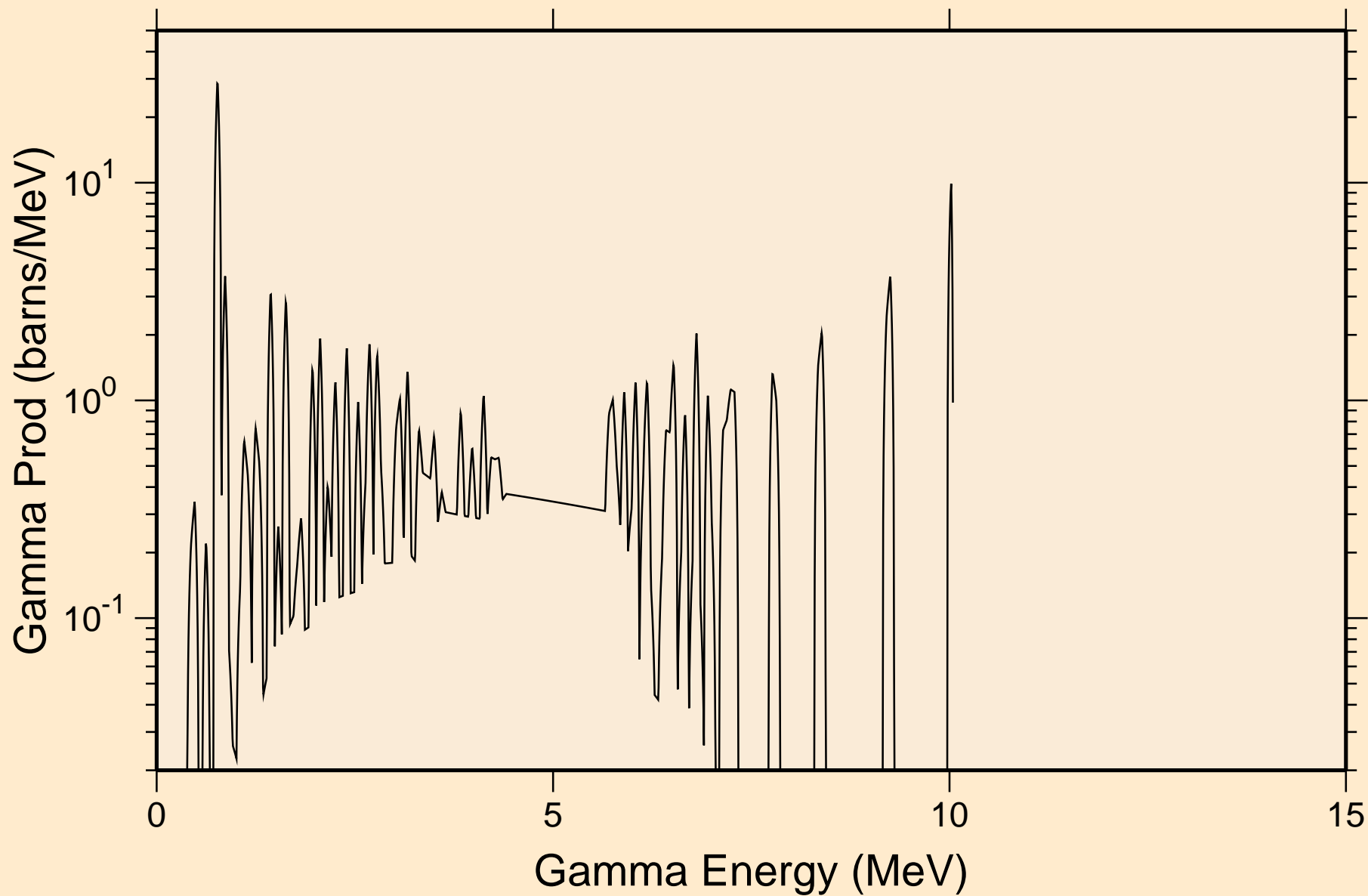

26-FE-57 FOR FENDL-3.2 FROM INDEN-1.0 BY NJOY2016.60+ ON
14 MeV photon spectrum

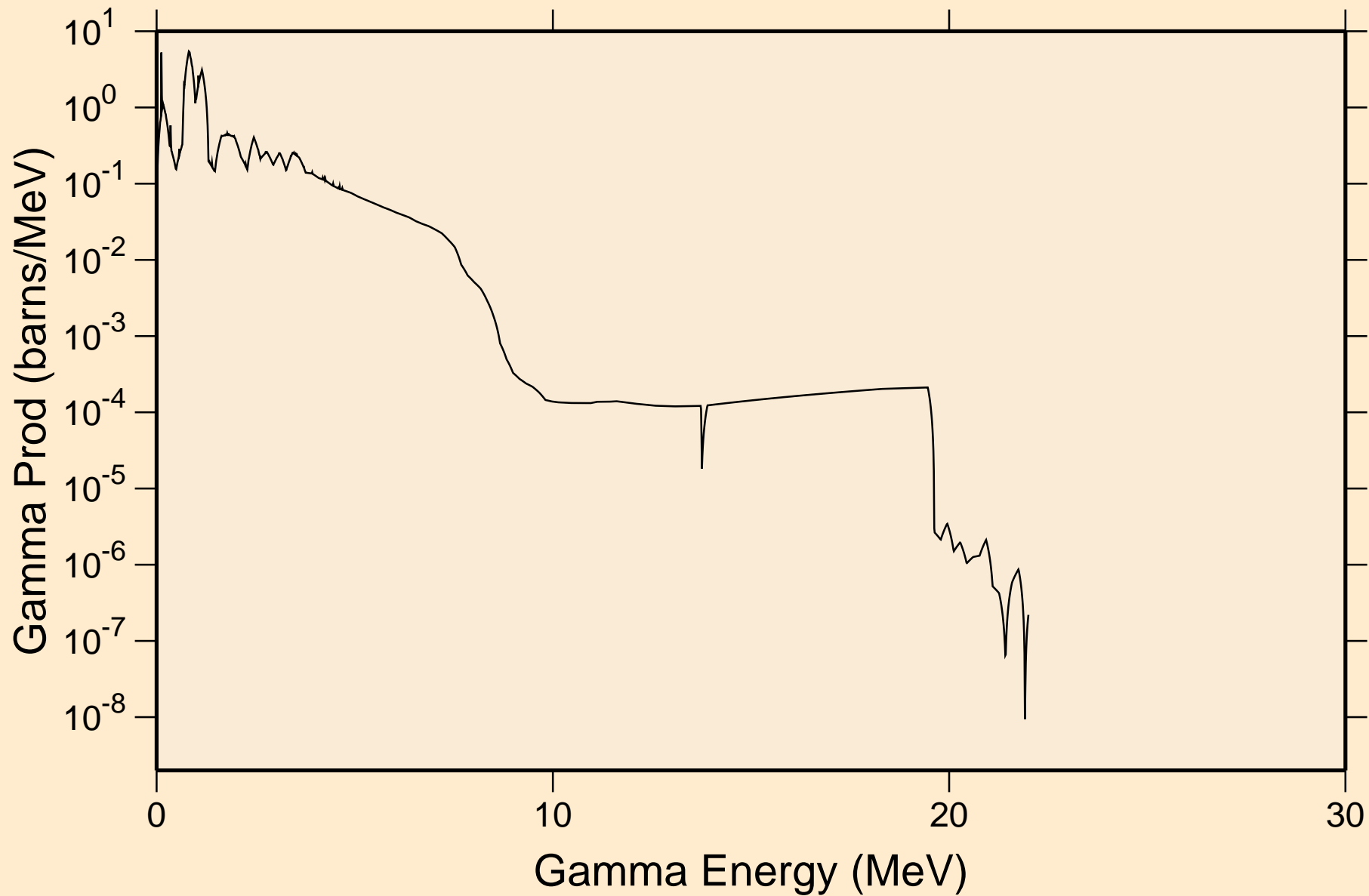

26-FE-57 FOR FENDL-3.2 FROM INDEN-1.0 BY NJOY2016.60+ ON Particle heating contributions

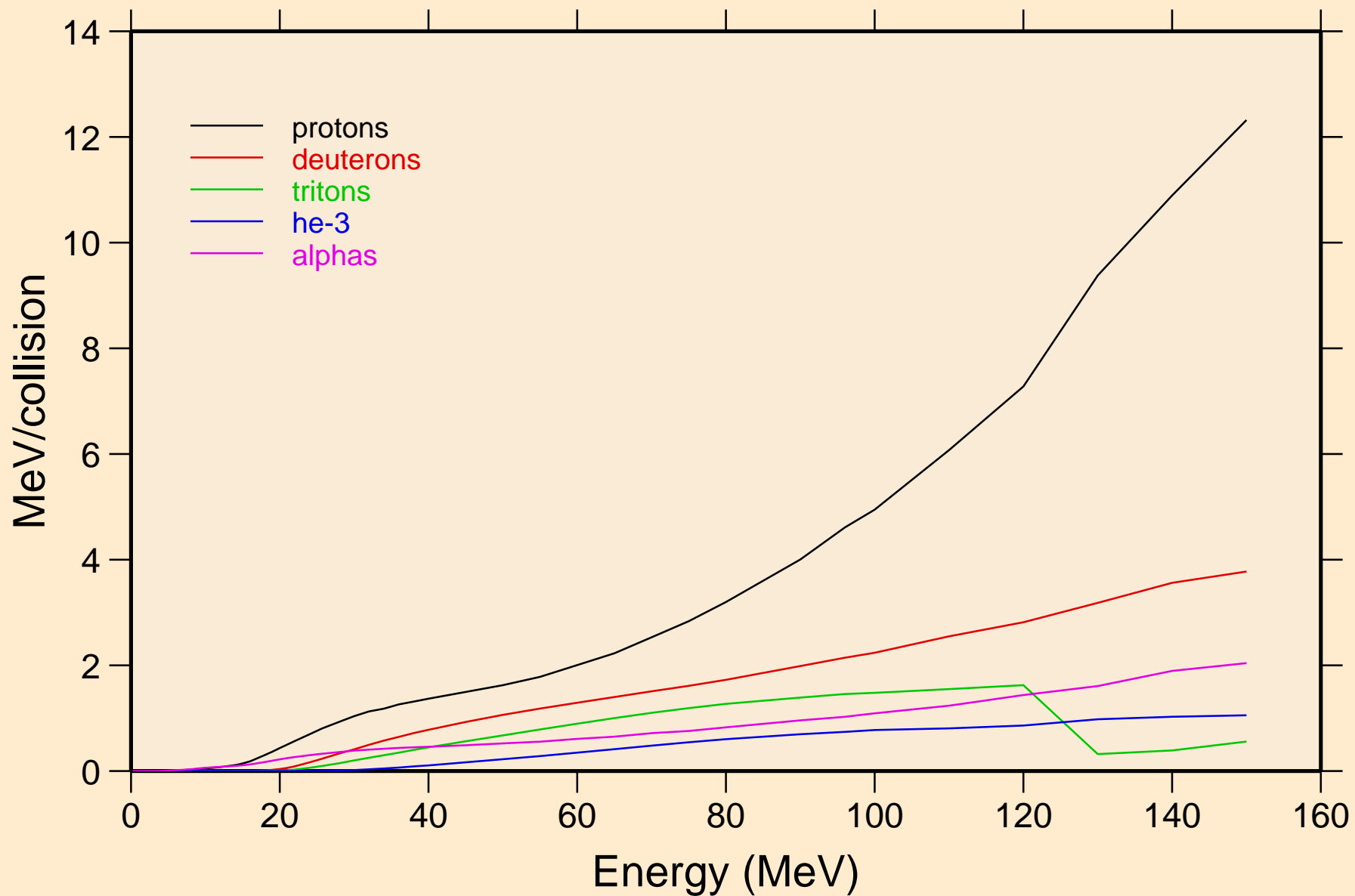

26-FE-57 FOR FENDL-3.2 FROM INDEN-1.0 BY NJOY2016.60+ ON
Recoil Heating

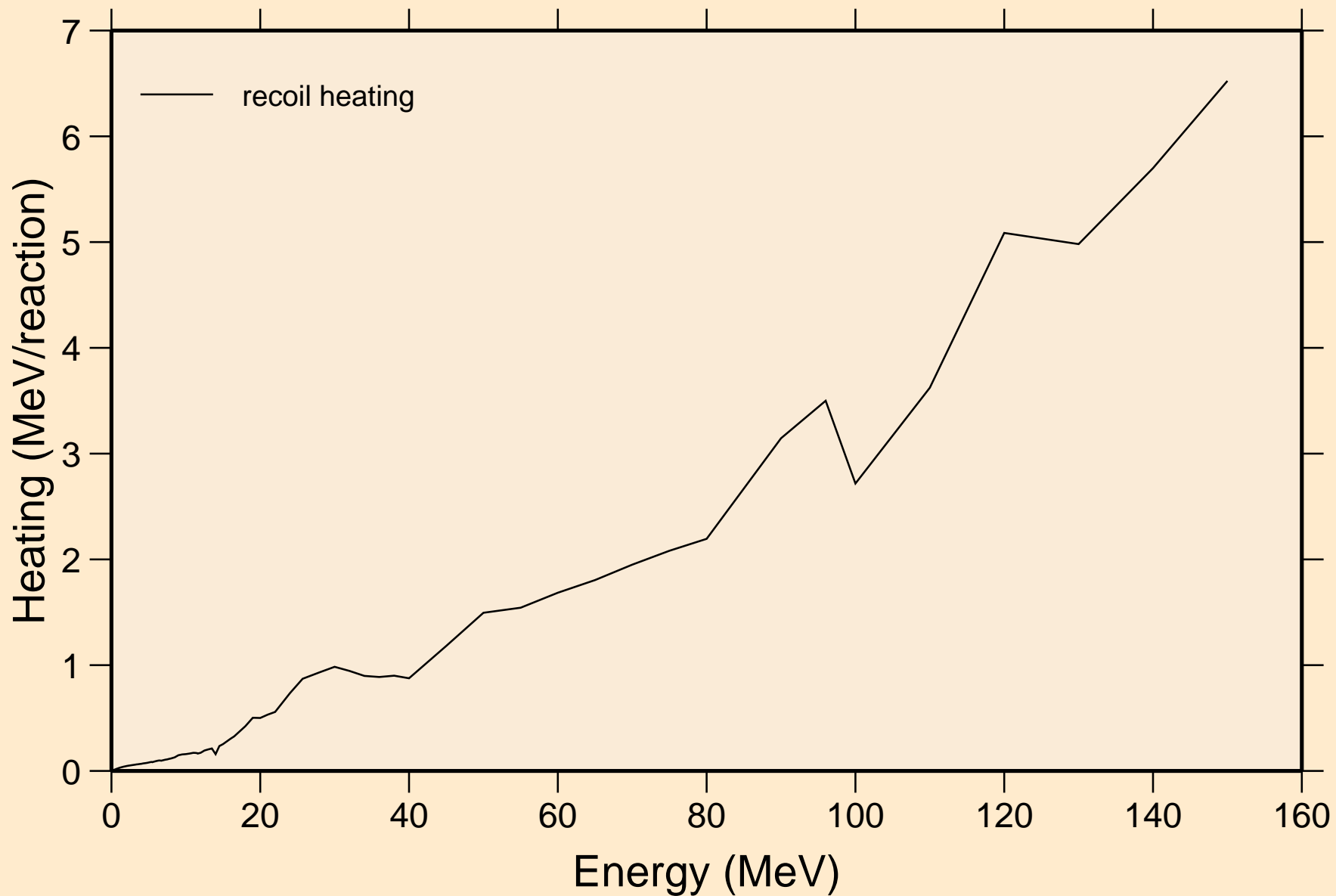

26-FE-57 FOR FENDL-3.2 FROM INDEN-1.0 BY NJOY2016.60+ ON
Particle production cross sections

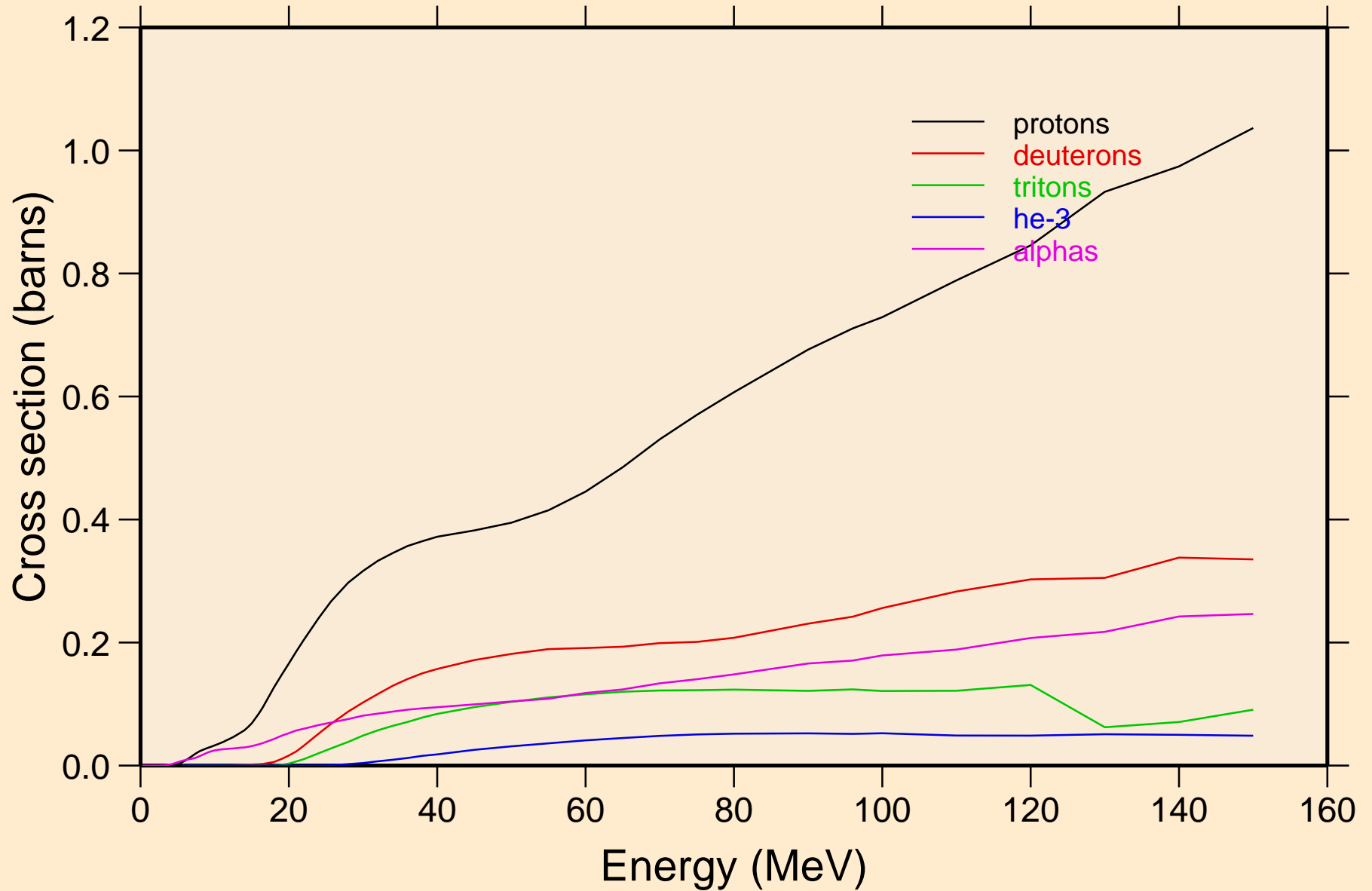

26-FE-57 FOR FENDL-3.2 FROM INDEN-1.0 BY NJOY2016.60+ ON
protons from (n,x)

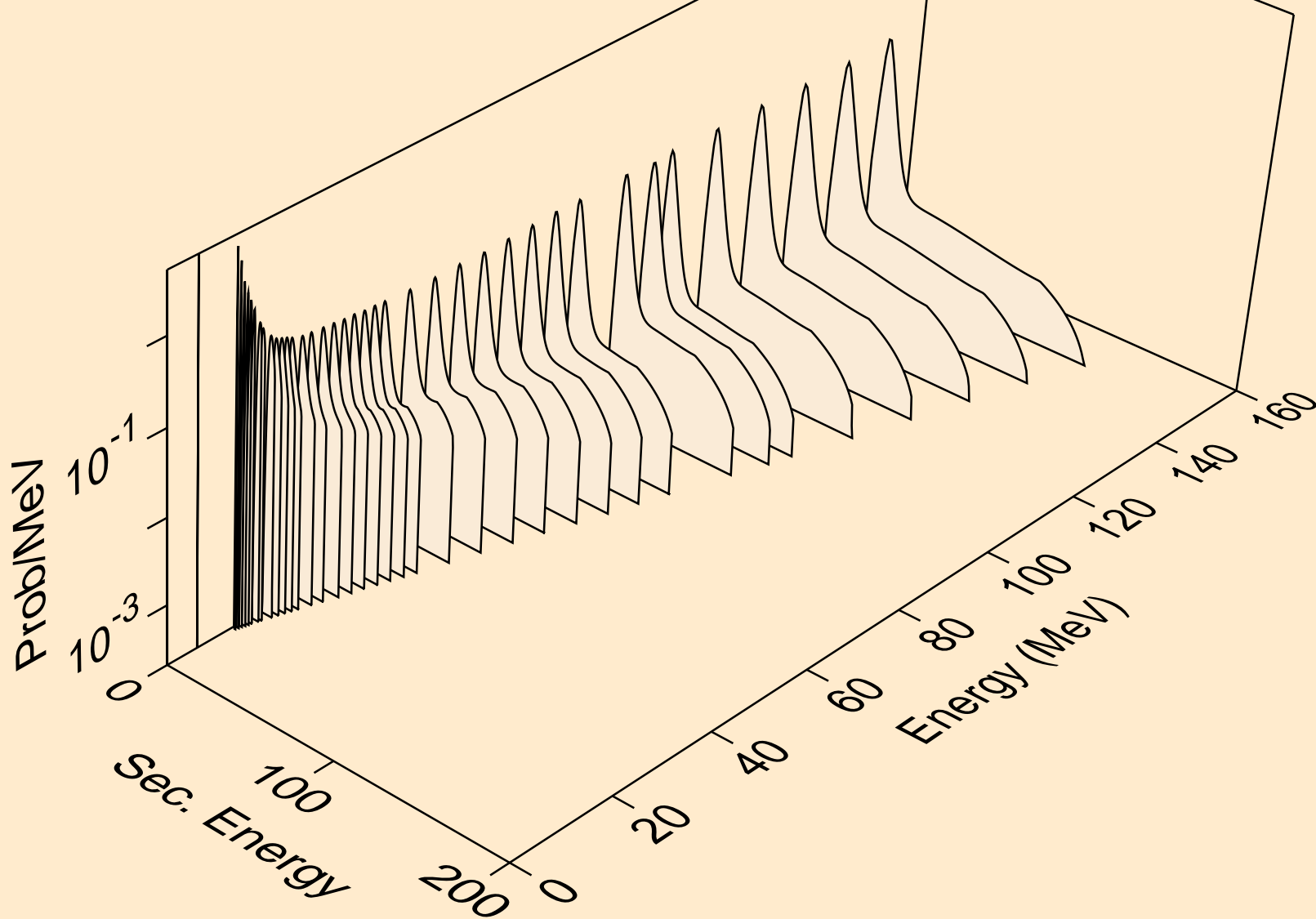

26-FE-57 FOR FENDL-3.2 FROM INDEN-1.0 BY NJOY2016.60+ ON
protons from (n,2p)

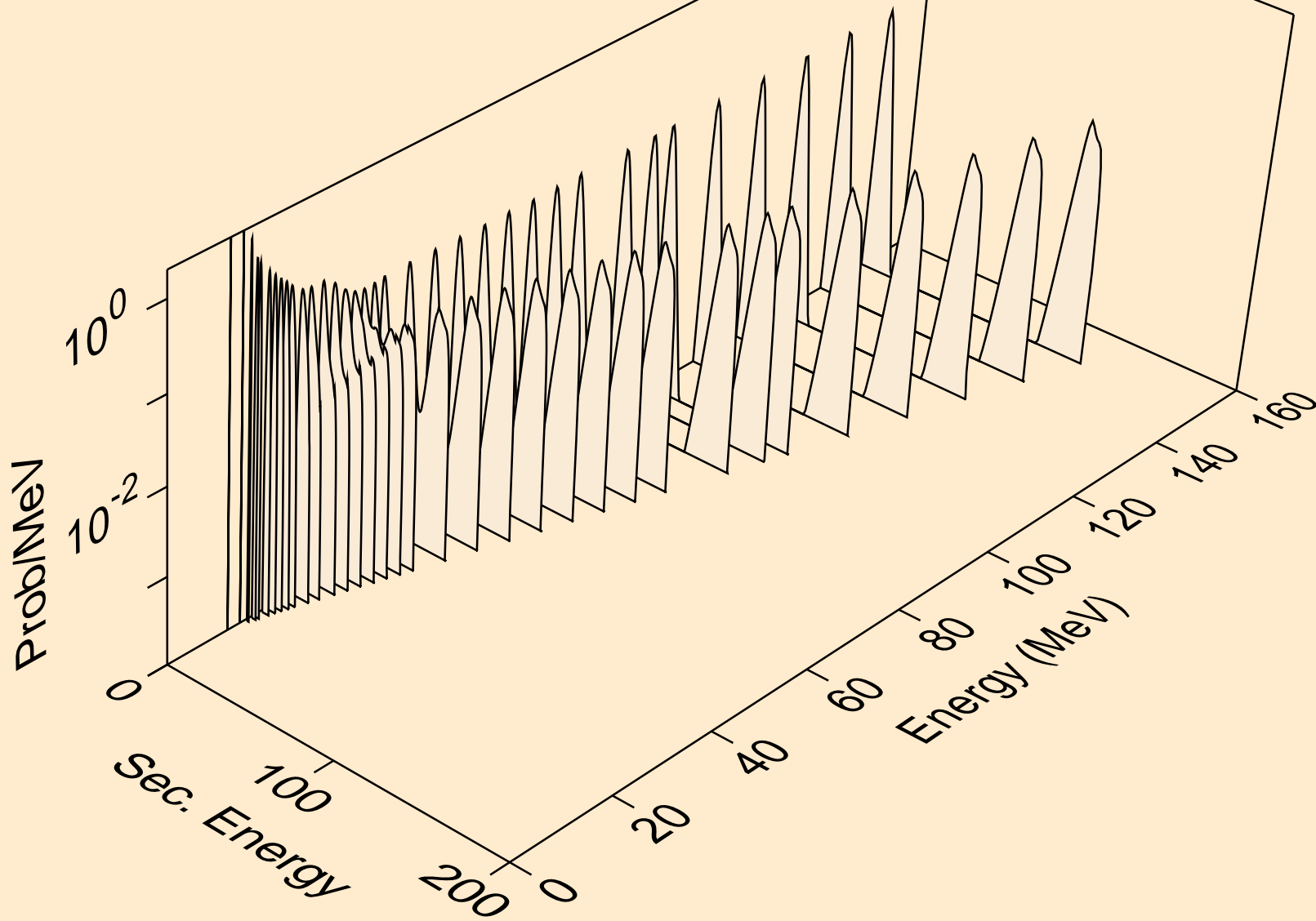

26-FE-57 FOR FENDL-3.2 FROM INDEN-1.0 BY NJOY2016.60+ ON
angular distribution for (n,p*0) proton

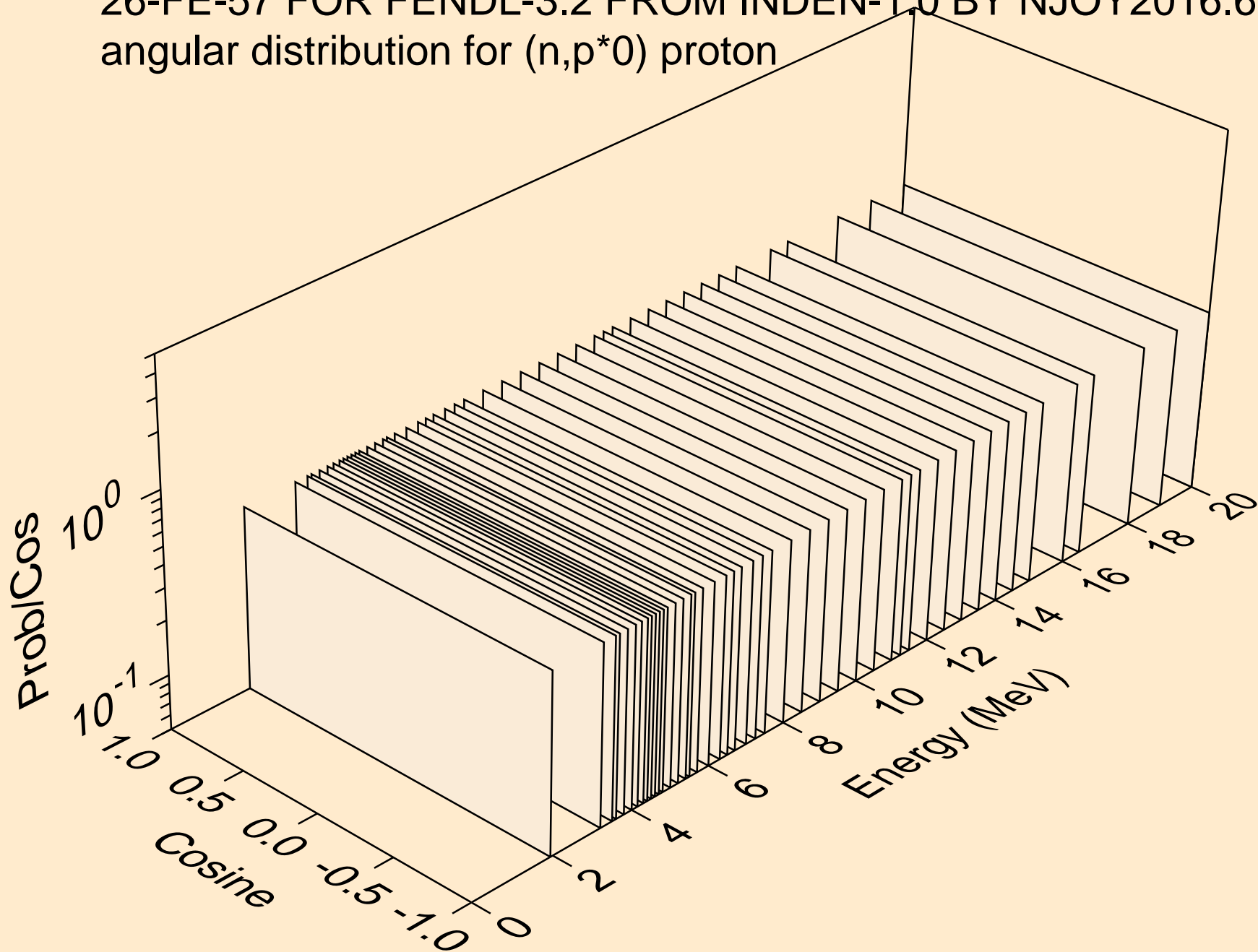

26-FE-57 FOR FENDL-3.2 FROM INDEN-1.0 BY NJOY2016.60+ ON
angular distribution for (n,p*0) proton

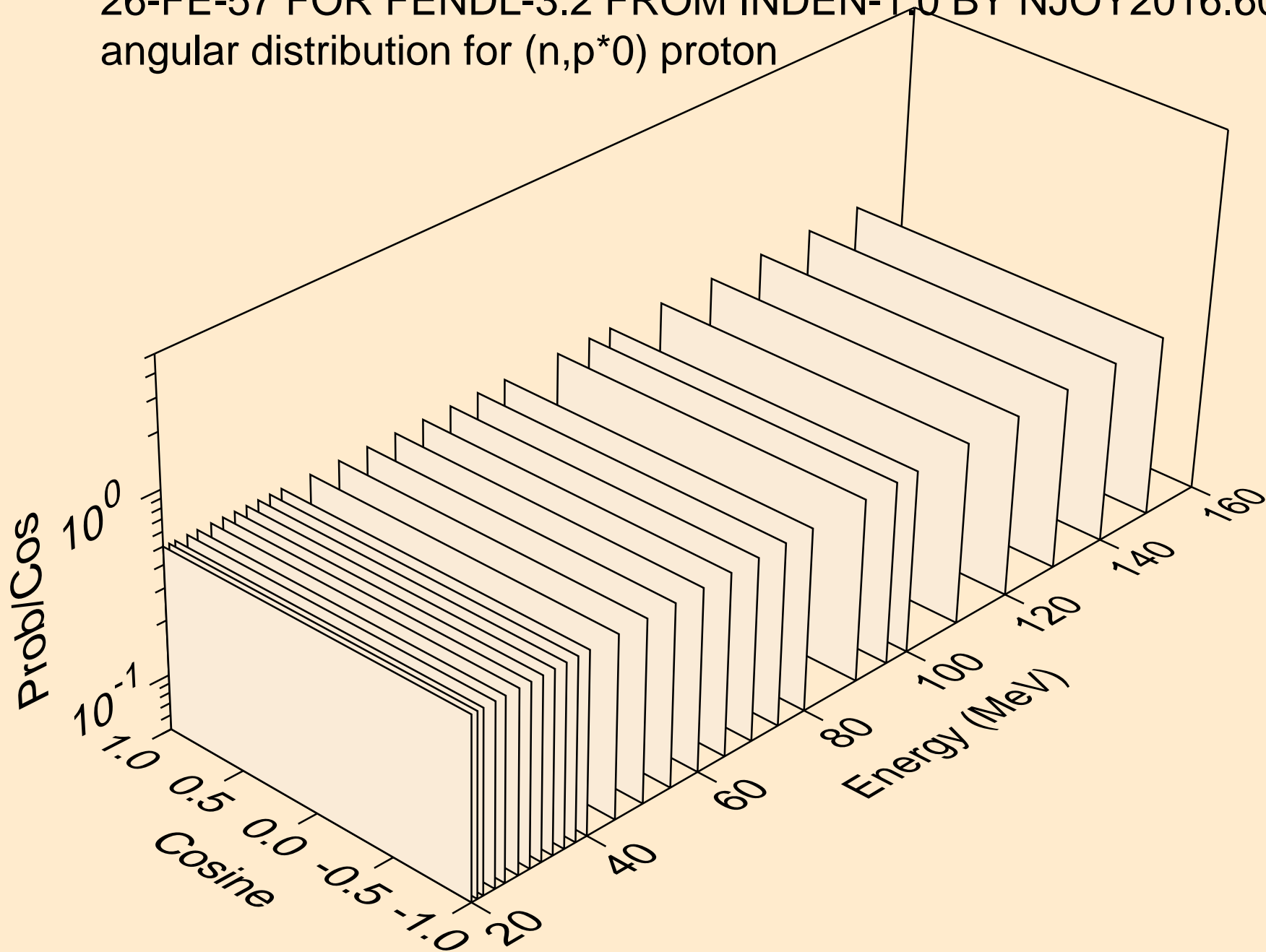

26-FE-57 FOR FENDL-3.2 FROM INDEN-1.0 BY NJOY2016.60+ ON
angular distribution for (n,p*1) proton

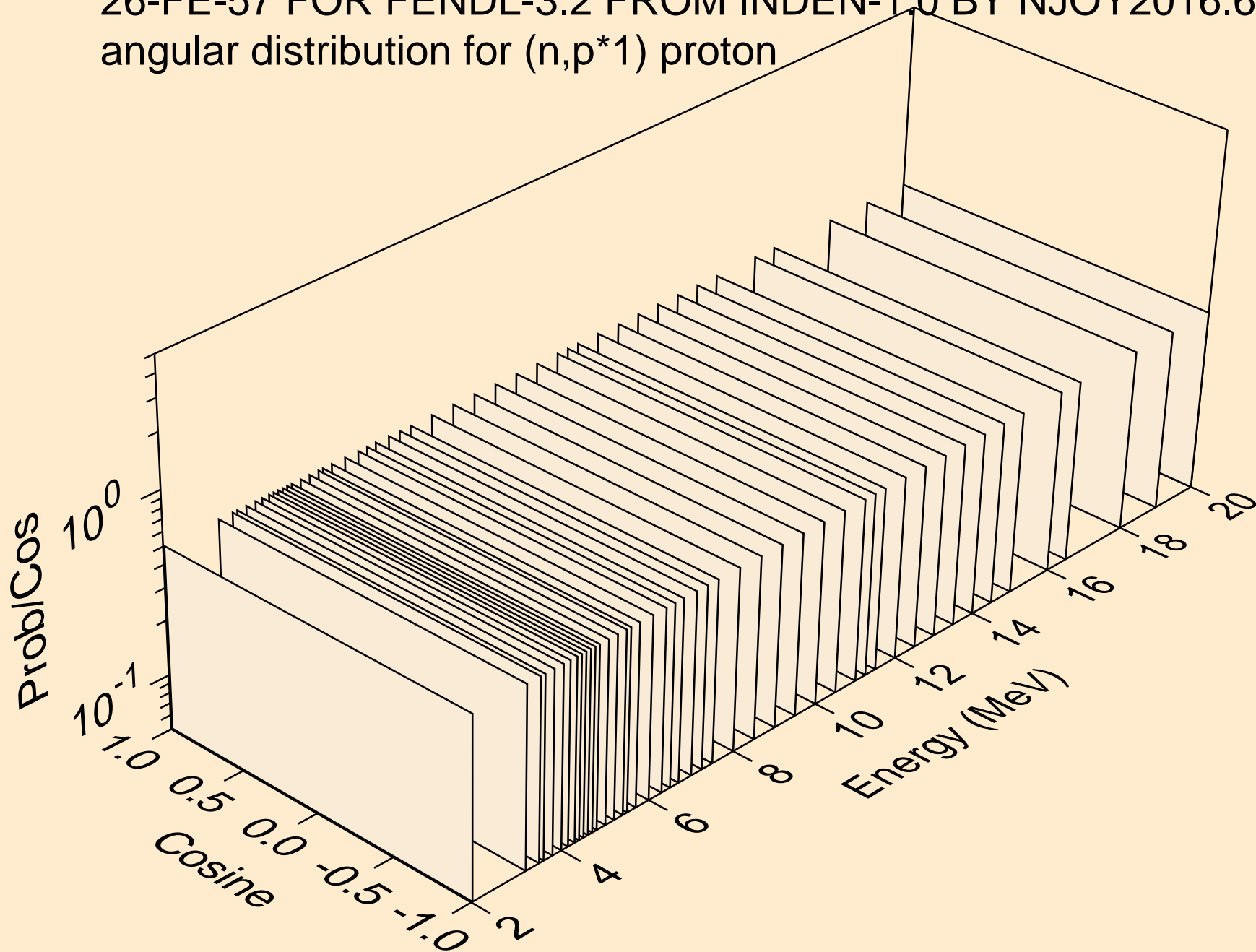

26-FE-57 FOR FENDL-3.2 FROM INDEN-1.0 BY NJOY2016.60+ ON
angular distribution for (n,p*1) proton

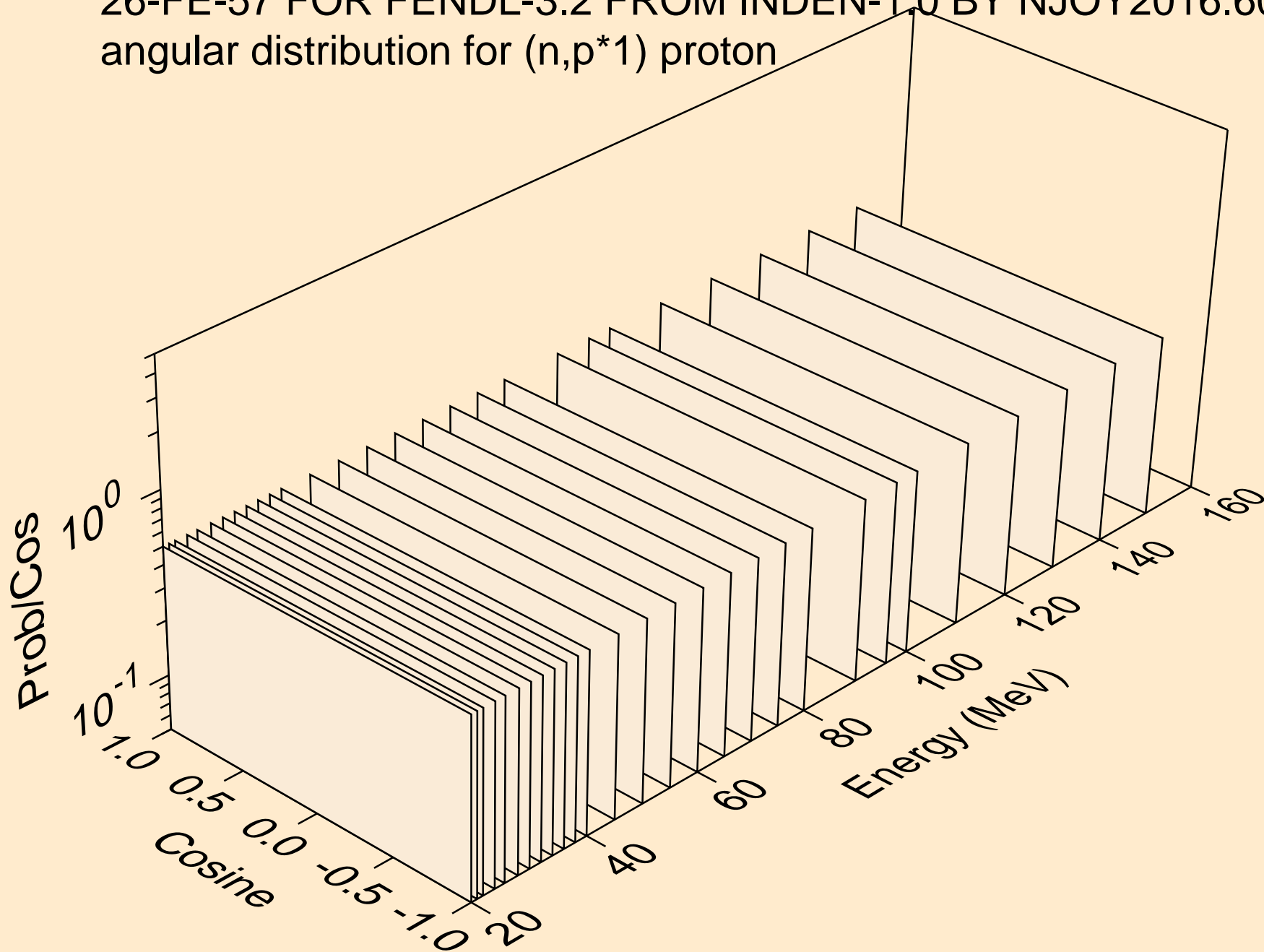

26-FE-57 FOR FENDL-3.2 FROM INDEN-1.0 BY NJOY2016.60+ ON
angular distribution for (n,p*2) proton

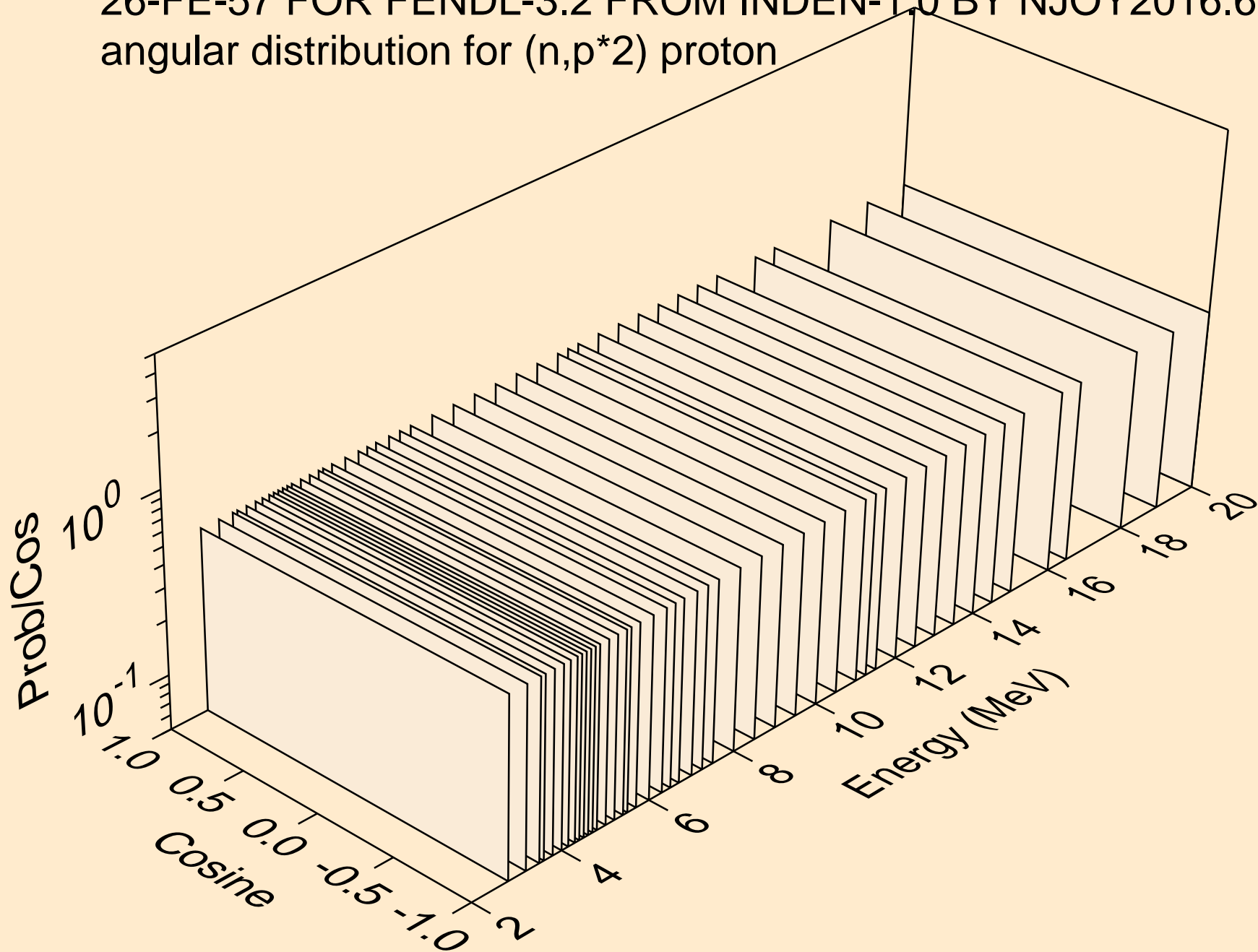

26-FE-57 FOR FENDL-3.2 FROM INDEN-1.0 BY NJOY2016.60+ ON
angular distribution for (n,p*2) proton

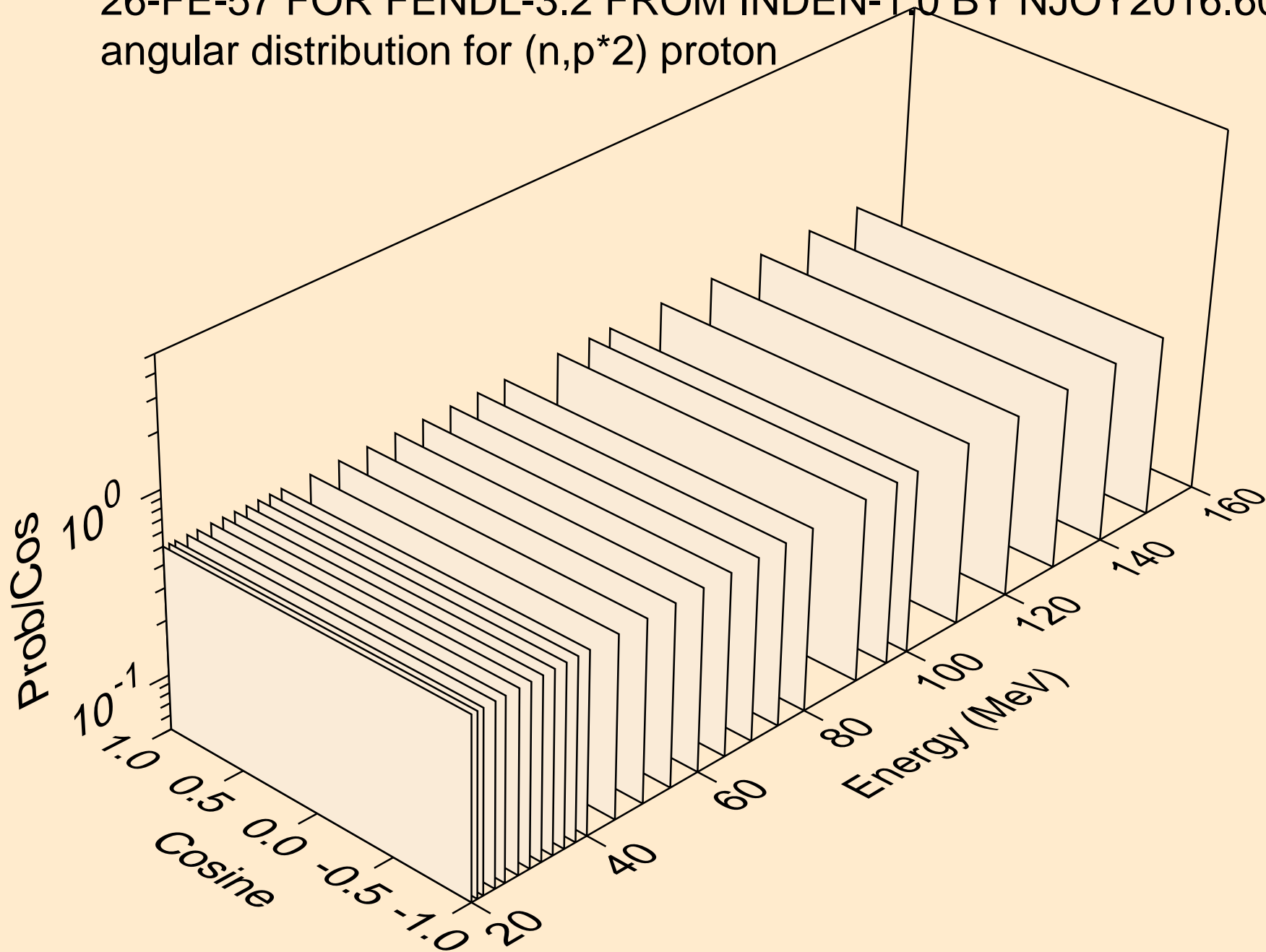

26-FE-57 FOR FENDL-3.2 FROM INDEN-1.0 BY NJOY2016.60+ ON
angular distribution for (n,p*3) proton

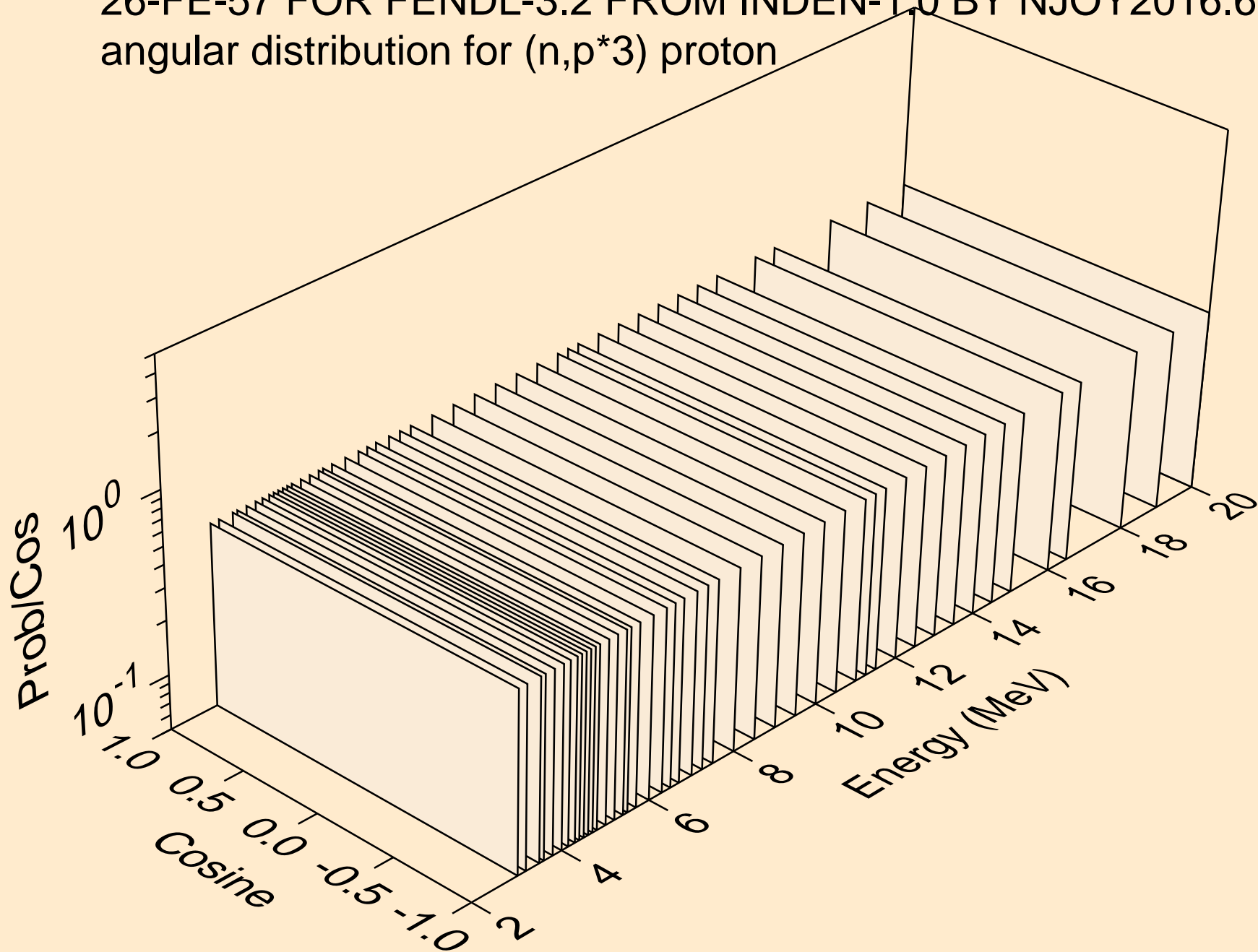

26-FE-57 FOR FENDL-3.2 FROM INDEN-1.0 BY NJOY2016.60+ ON
angular distribution for (n,p*3) proton

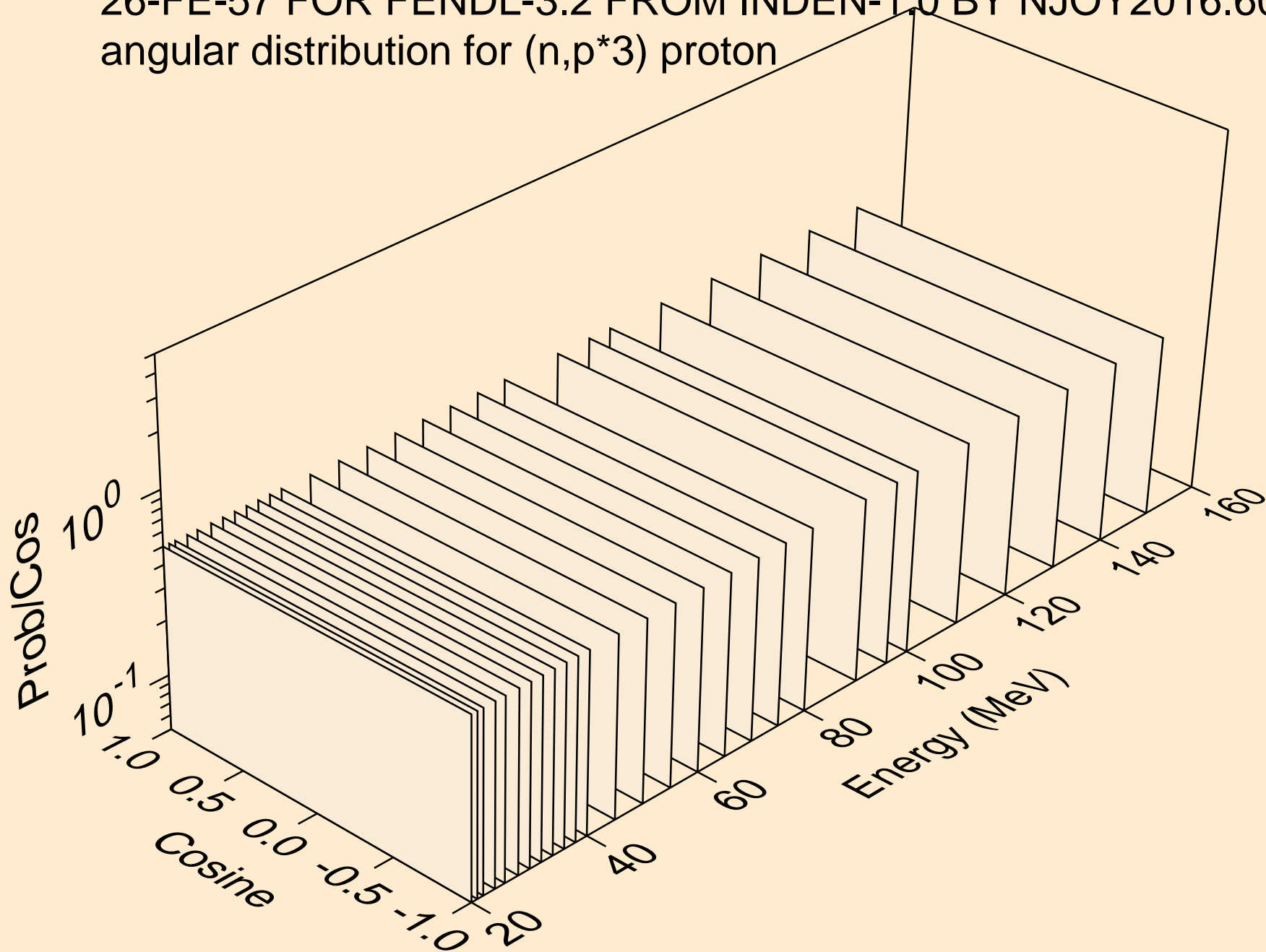

26-FE-57 FOR FENDL-3.2 FROM INDEN-1.0 BY NJOY2016.60+ ON
angular distribution for (n,p*4) proton

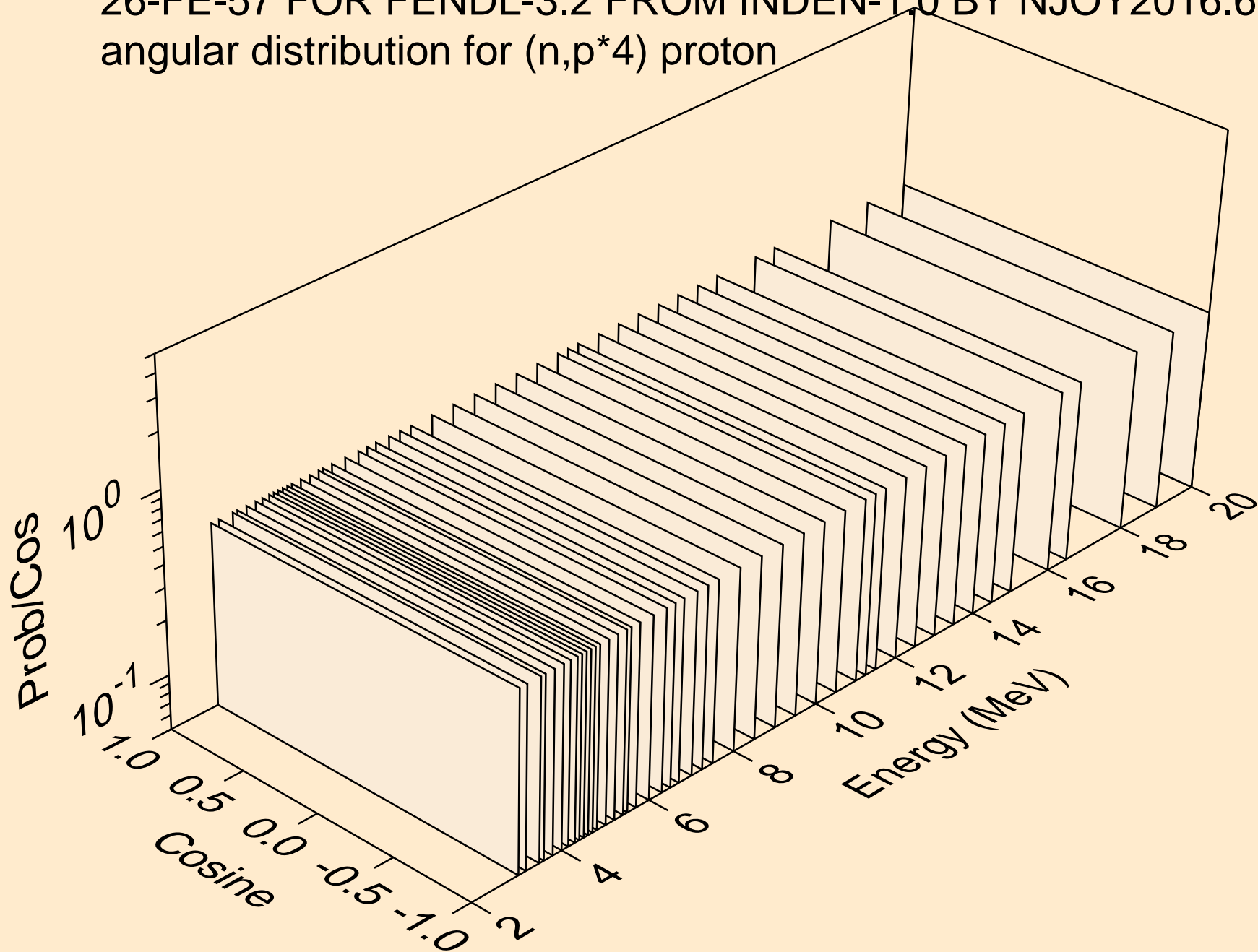

26-FE-57 FOR FENDL-3.2 FROM INDEN-1.0 BY NJOY2016.60+ ON
angular distribution for (n,p*4) proton

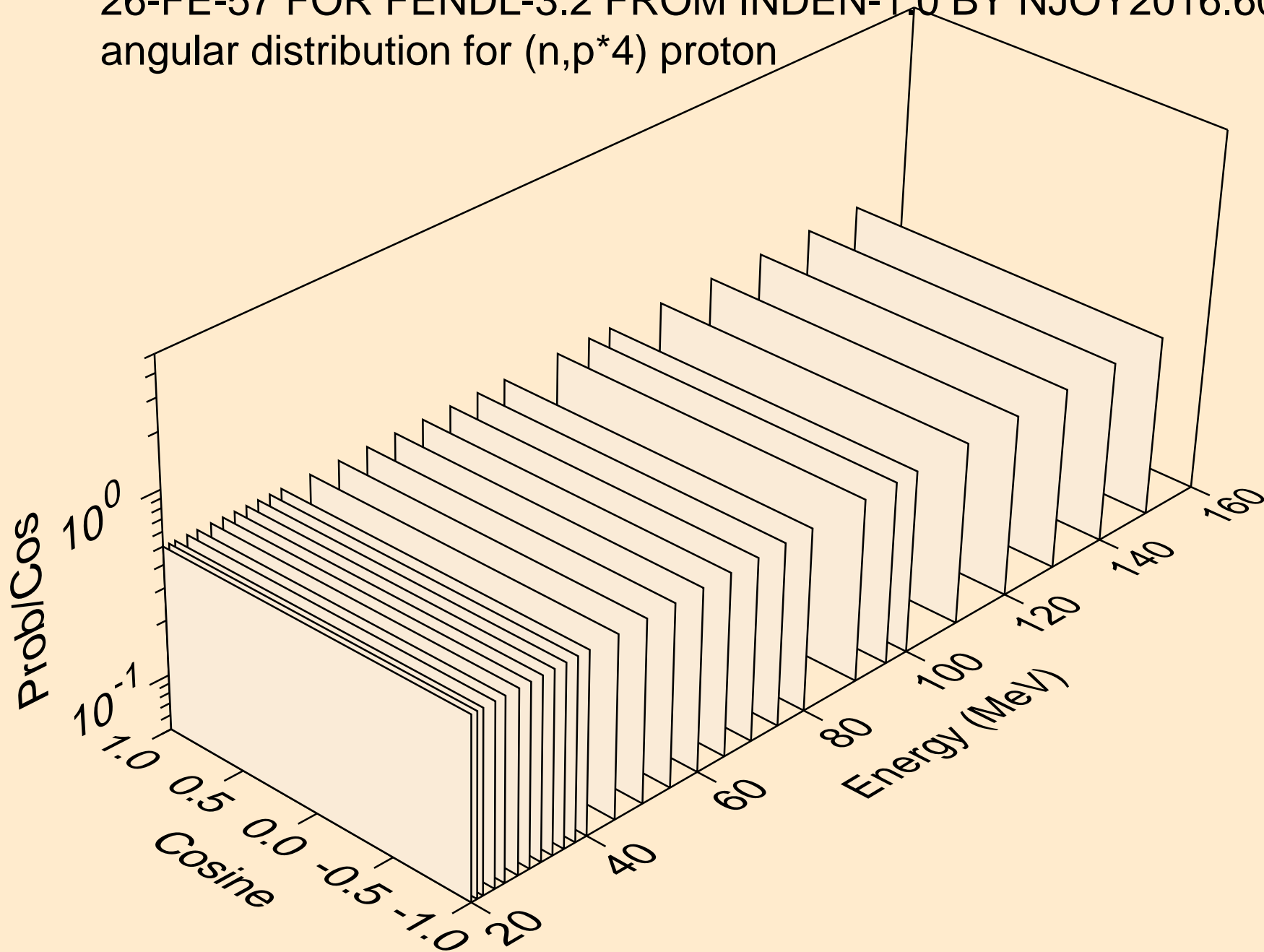

26-FE-57 FOR FENDL-3.2 FROM INDEN-1.0 BY NJOY2016.60+ ON
angular distribution for (n,p*5) proton

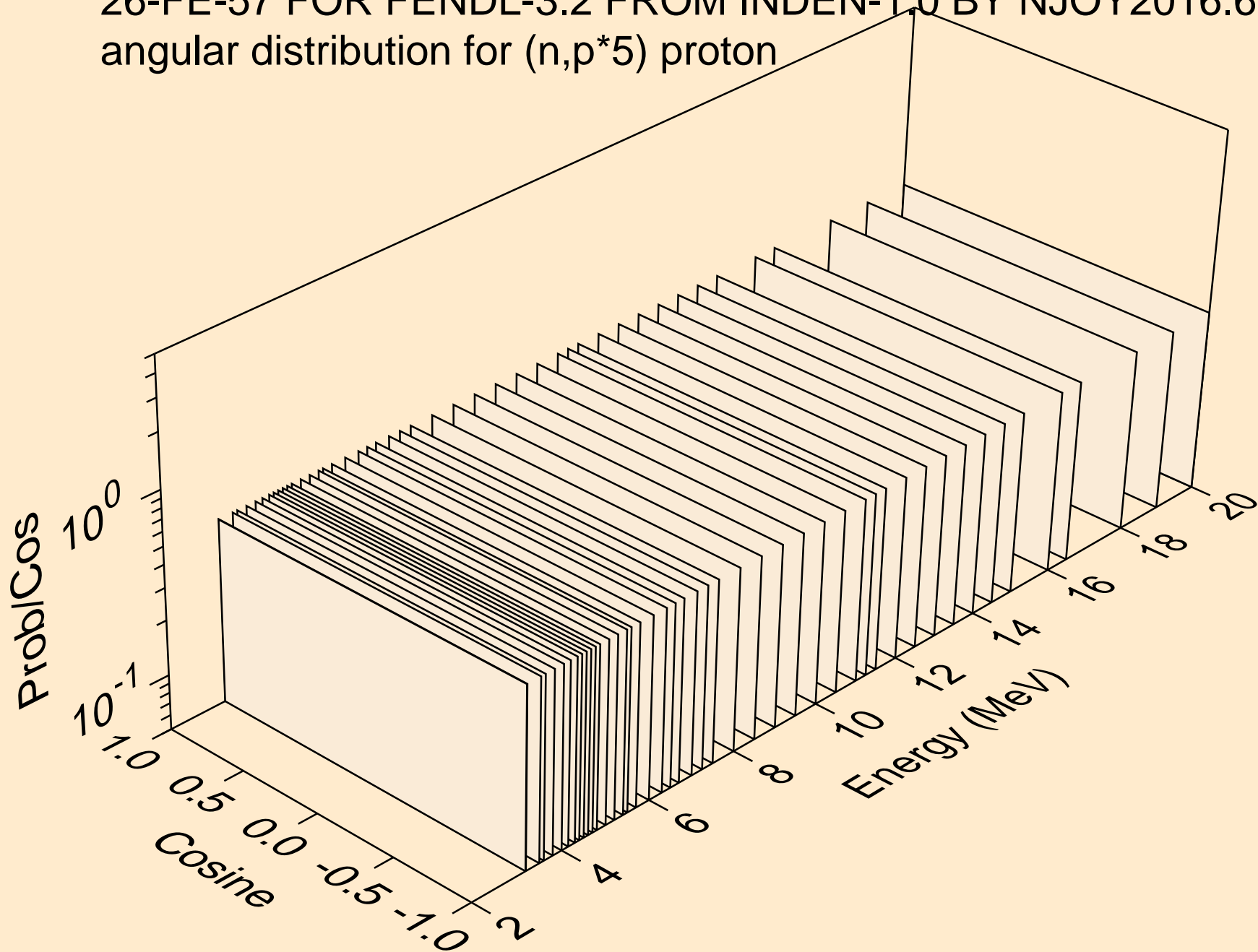

26-FE-57 FOR FENDL-3.2 FROM INDEN-1.0 BY NJOY2016.60+ ON
angular distribution for (n,p*5) proton

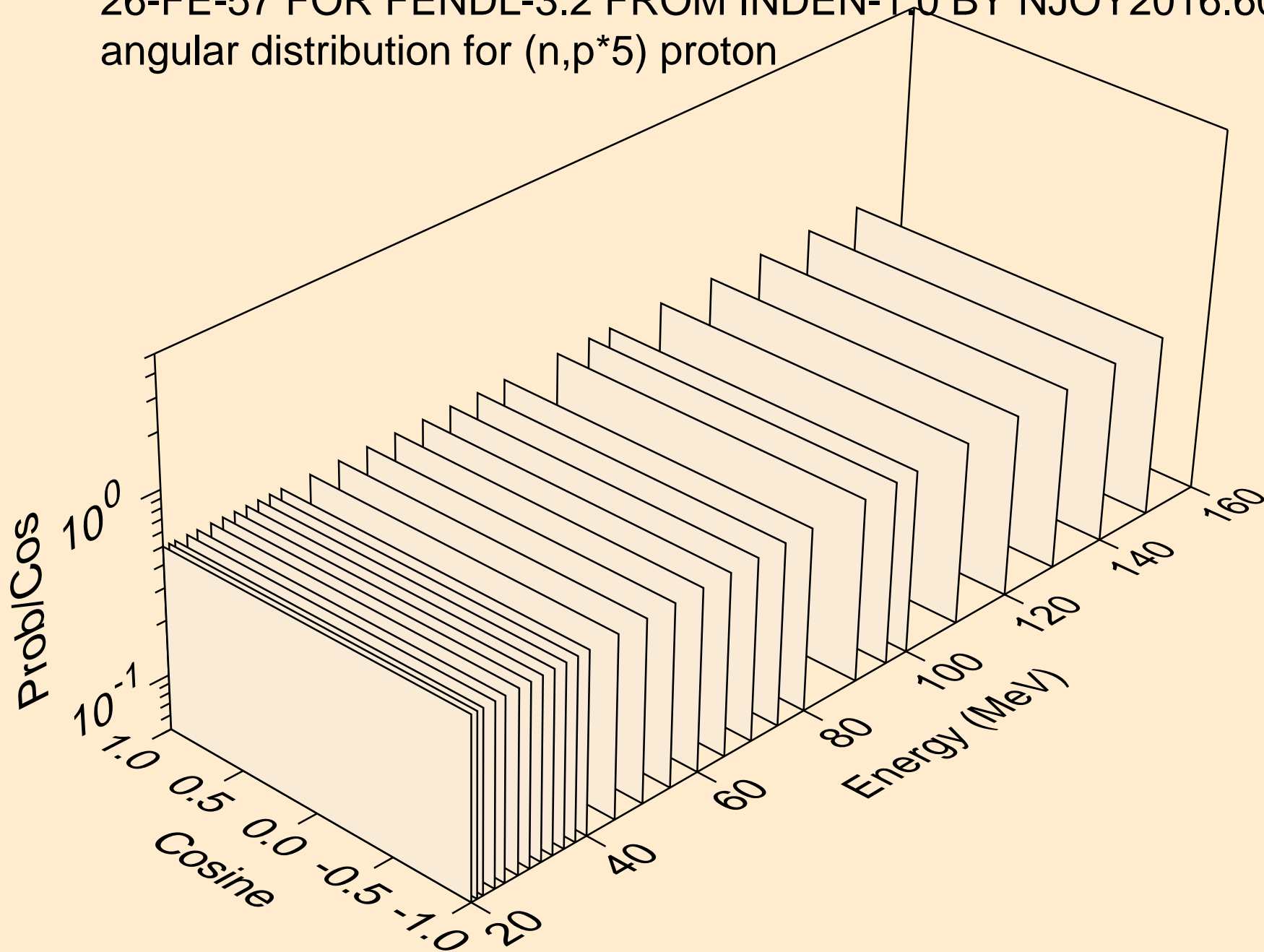

26-FE-57 FOR FENDL-3.2 FROM INDEN-1.0 BY NJOY2016.60+ ON
angular distribution for (n,p*6) proton

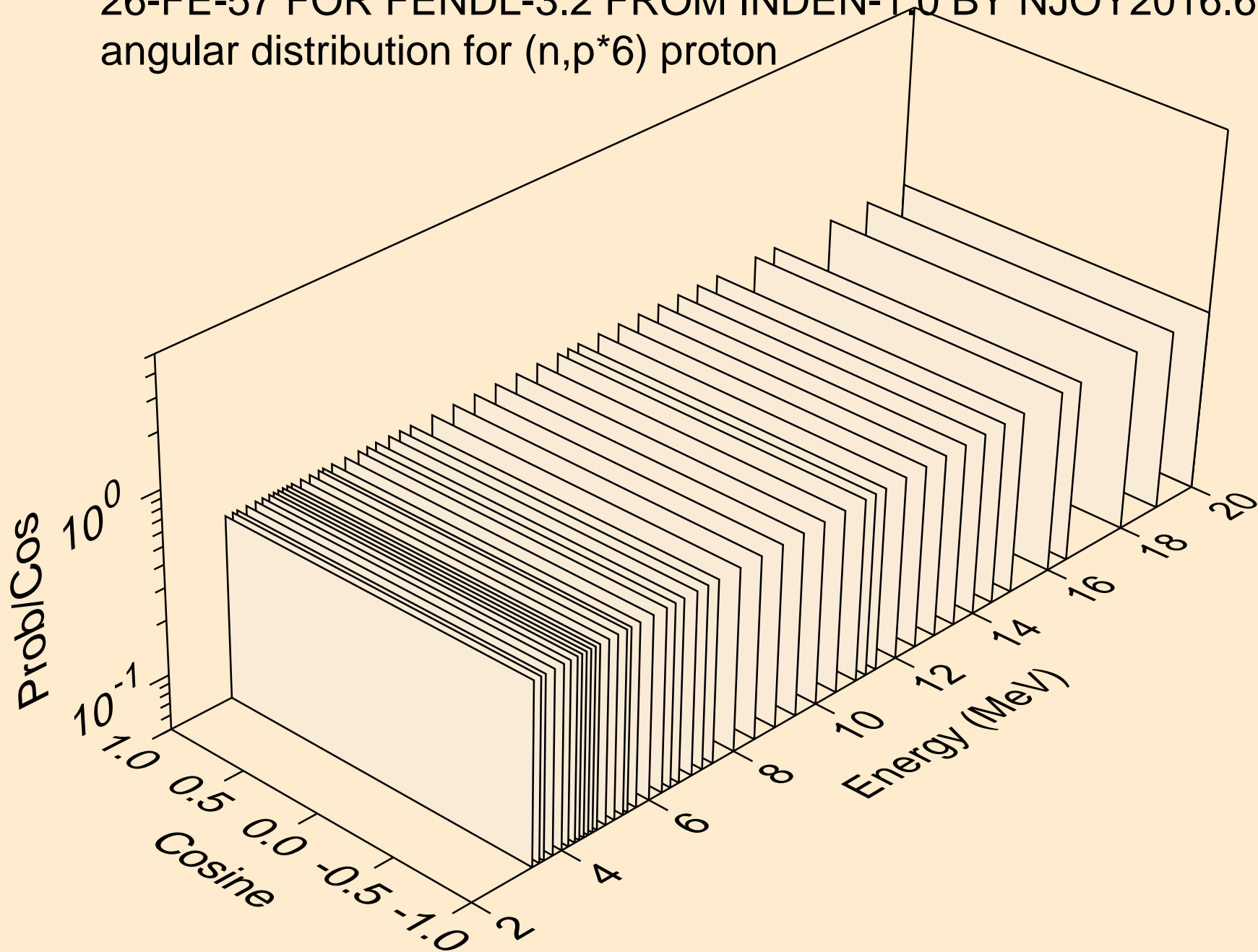

26-FE-57 FOR FENDL-3.2 FROM INDEN-1.0 BY NJOY2016.60+ ON
angular distribution for (n,p*6) proton

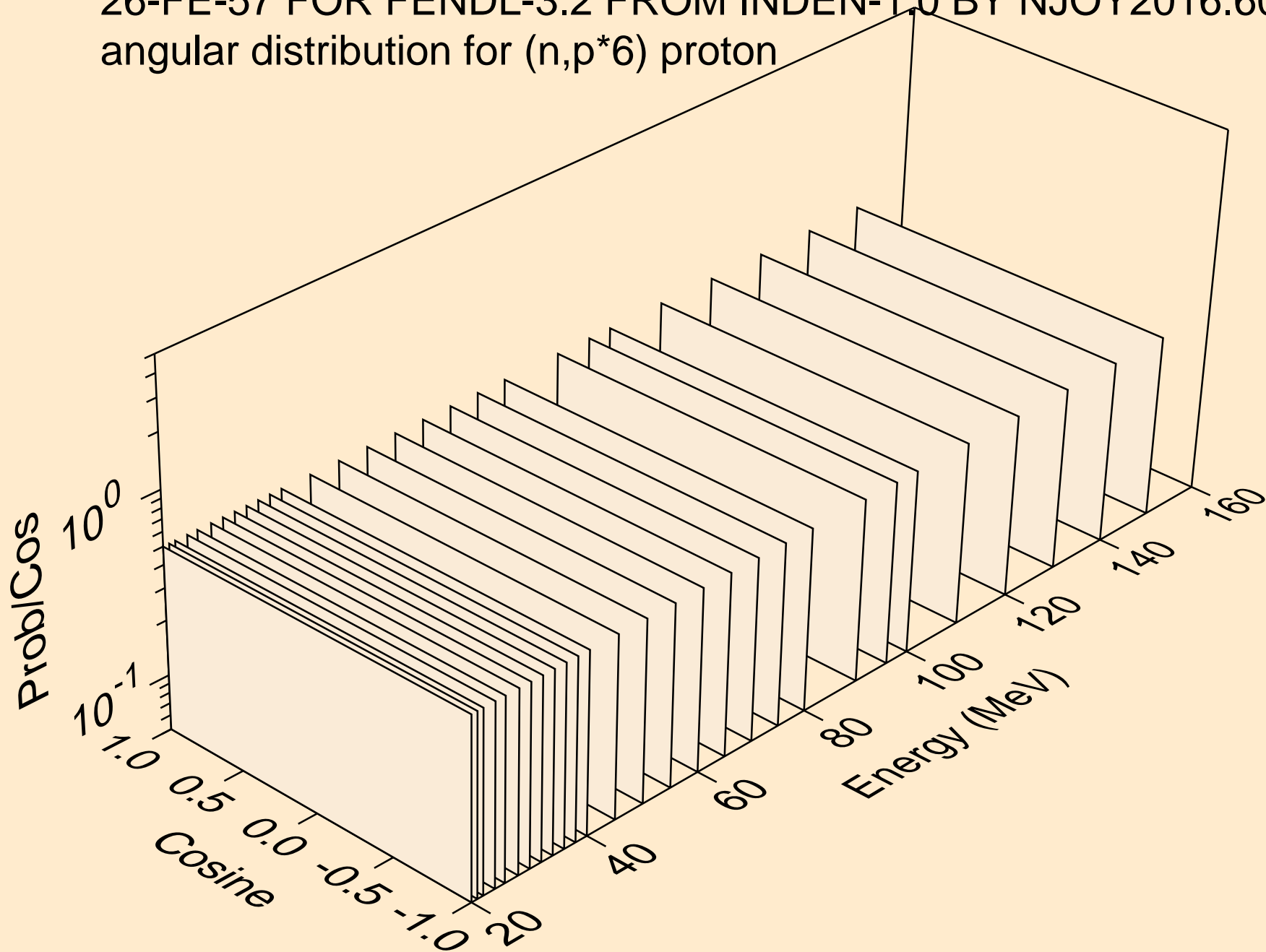

26-FE-57 FOR FENDL-3.2 FROM INDEN-1.0 BY NJOY2016.60+ ON
angular distribution for (n,p*7) proton

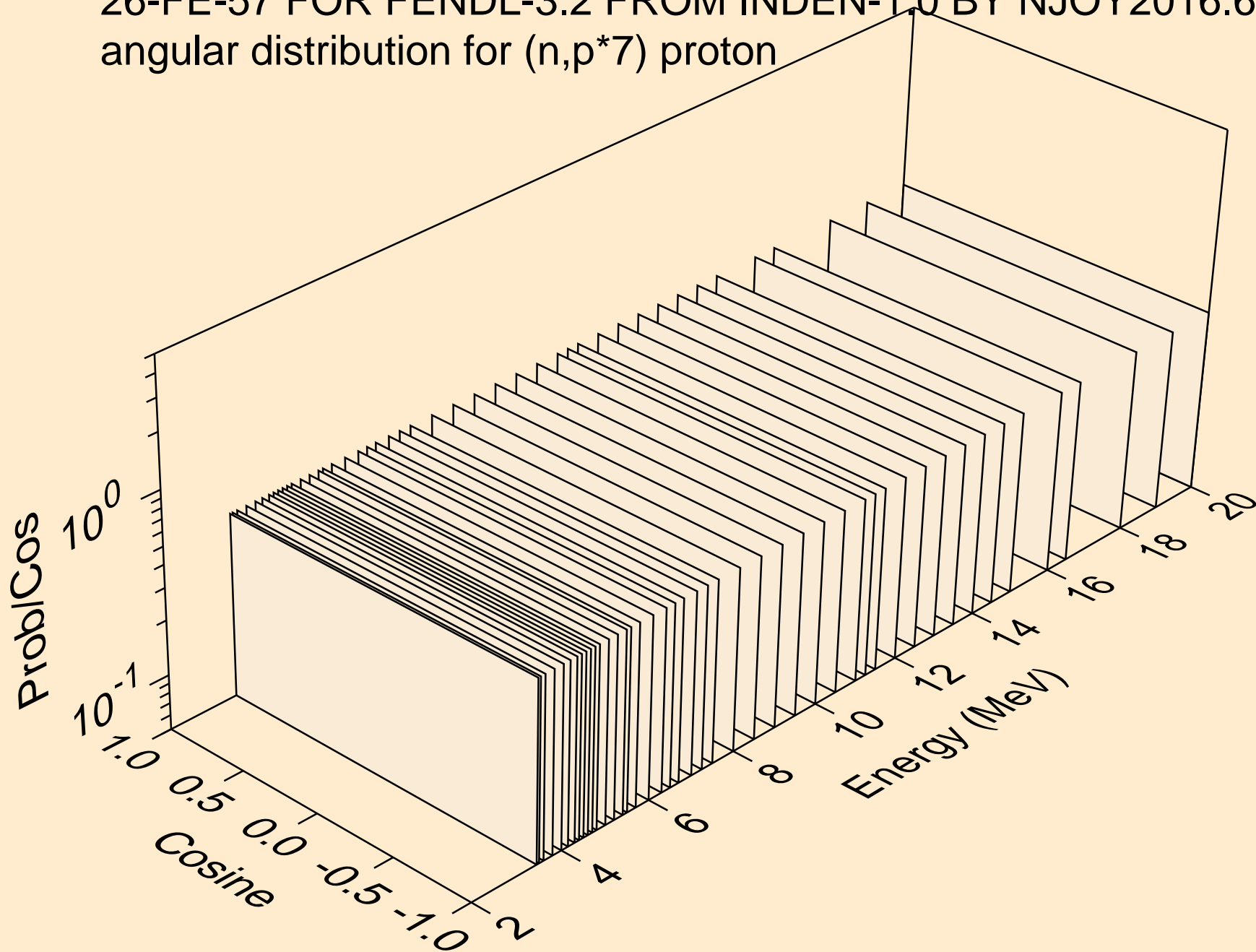

26-FE-57 FOR FENDL-3.2 FROM INDEN-1.0 BY NJOY2016.60+ ON
angular distribution for (n,p*7) proton

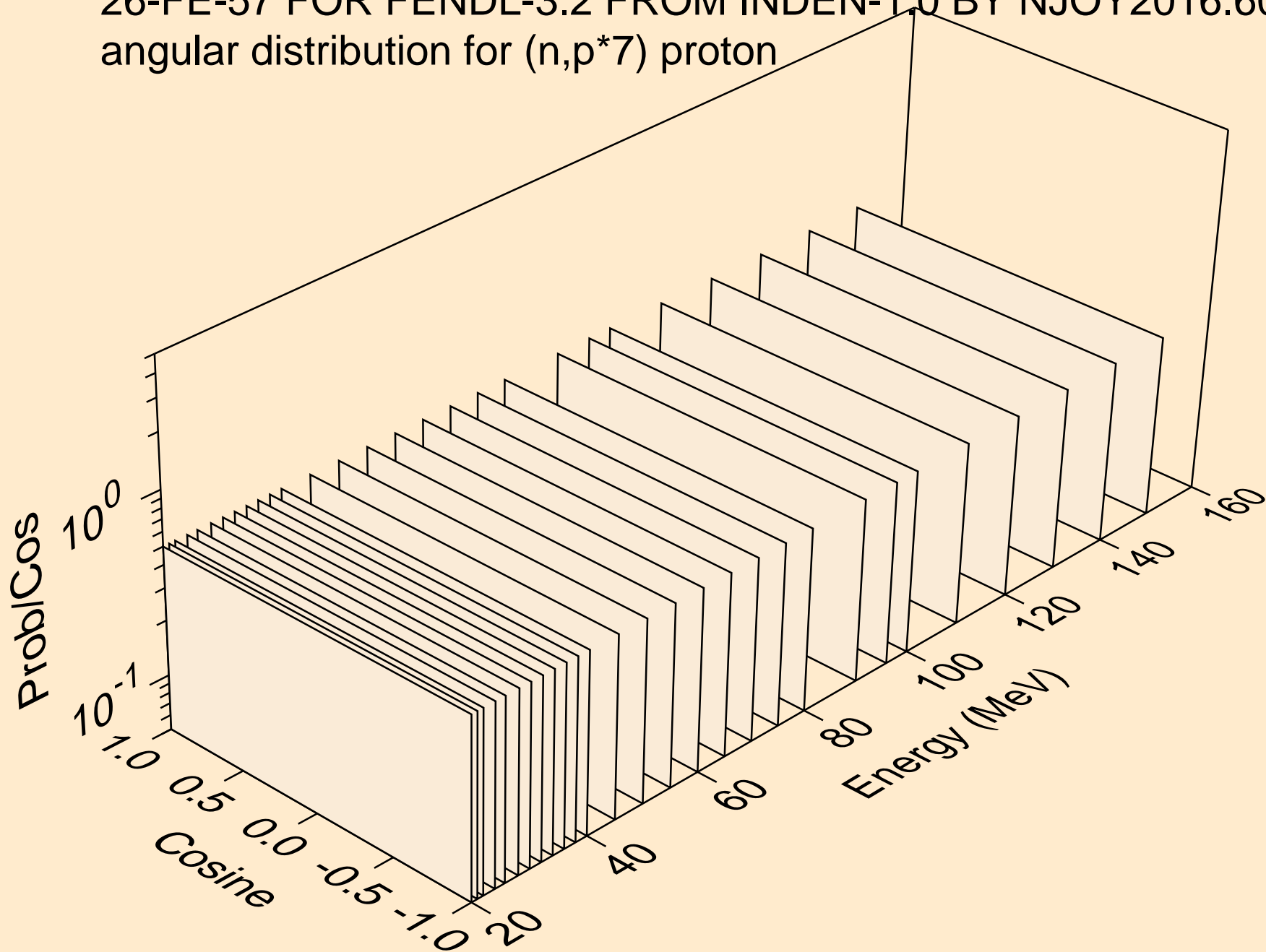

26-FE-57 FOR FENDL-3.2 FROM INDEN-1.0 BY NJOY2016.60+ ON
angular distribution for (n,p*8) proton

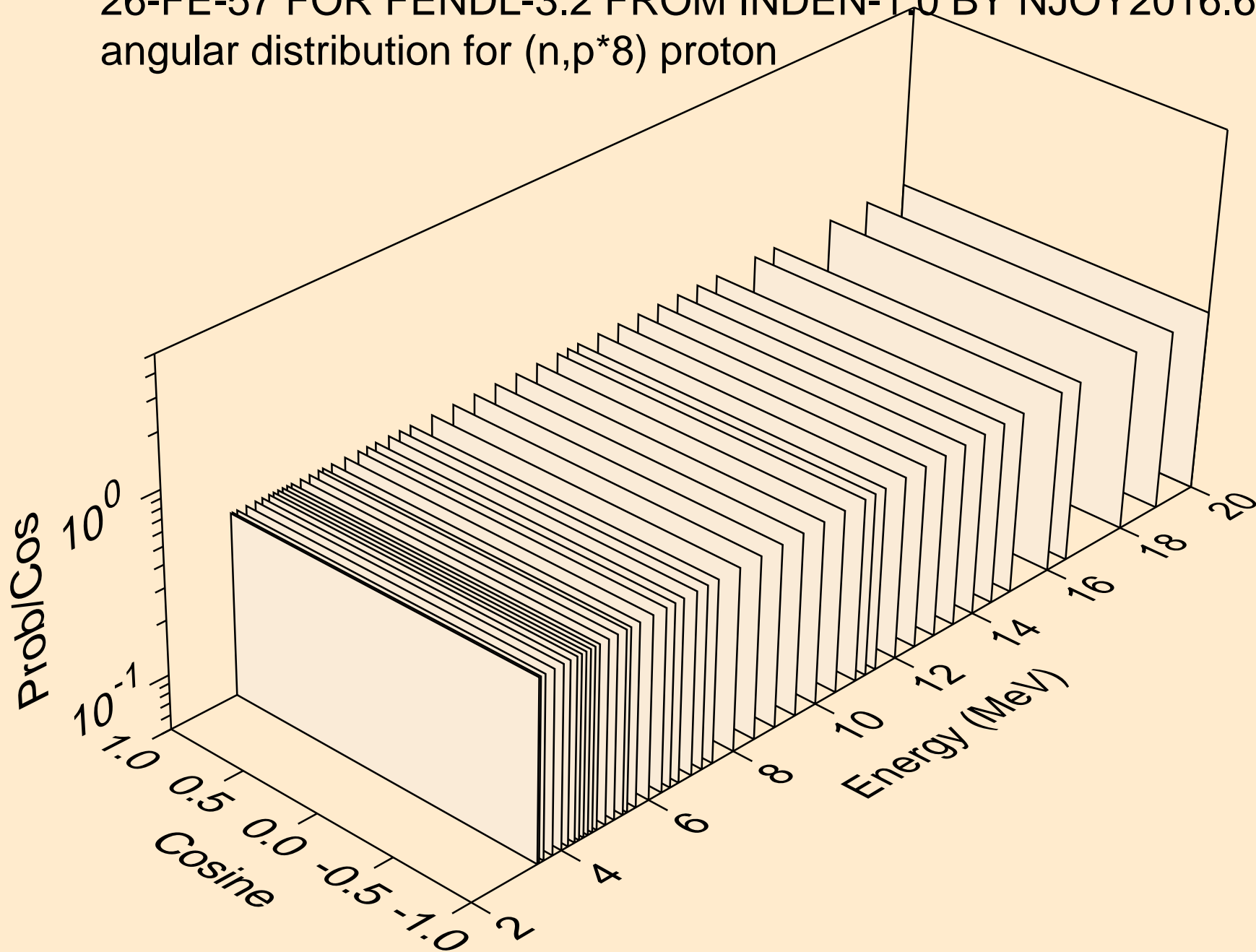

26-FE-57 FOR FENDL-3.2 FROM INDEN-1.0 BY NJOY2016.60+ ON
angular distribution for (n,p*8) proton

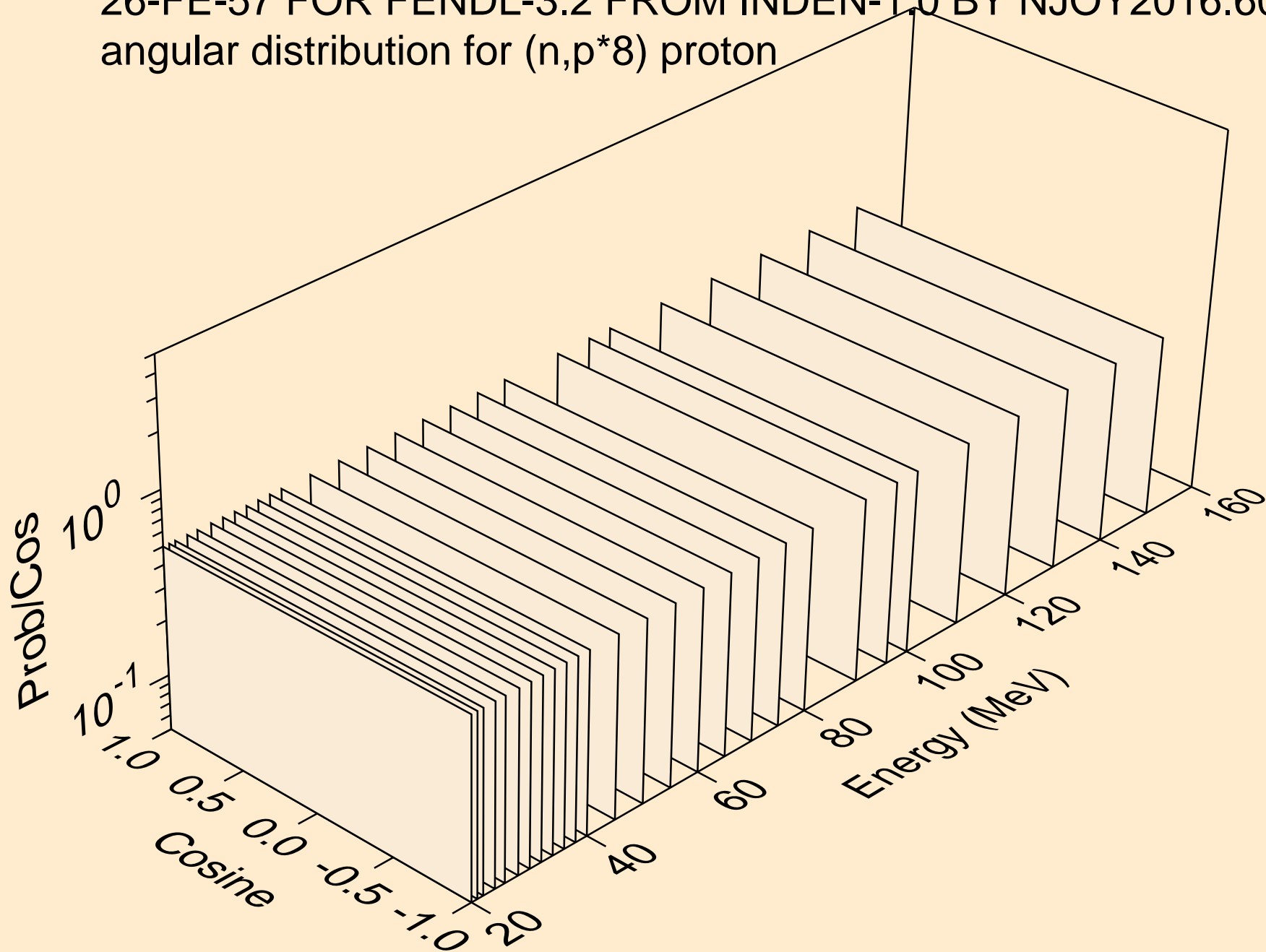

26-FE-57 FOR FENDL-3.2 FROM INDEN-1.0 BY NJOY2016.60+ ON
angular distribution for (n,p*9) proton

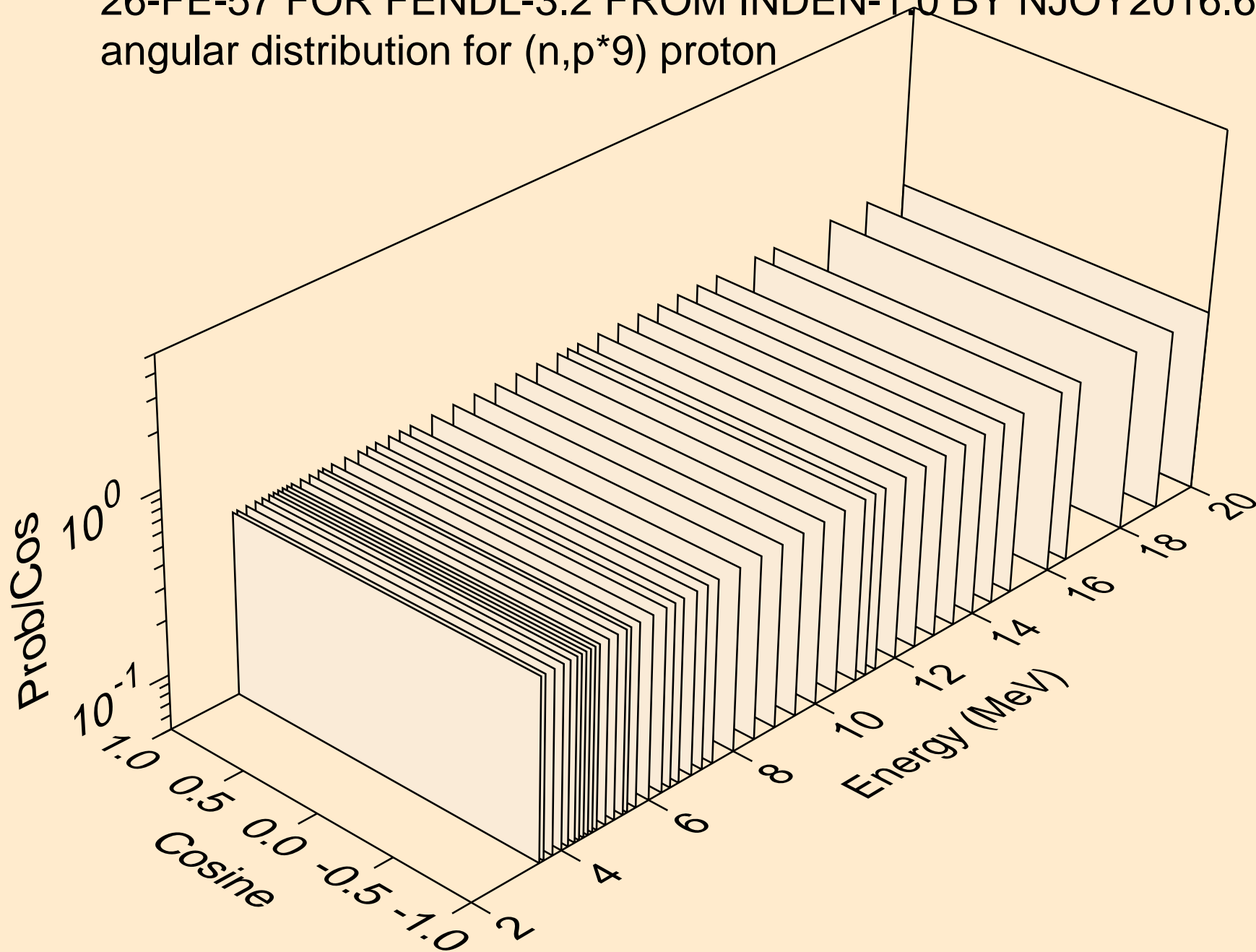

26-FE-57 FOR FENDL-3.2 FROM INDEN-1.0 BY NJOY2016.60+ ON
angular distribution for (n,p*9) proton

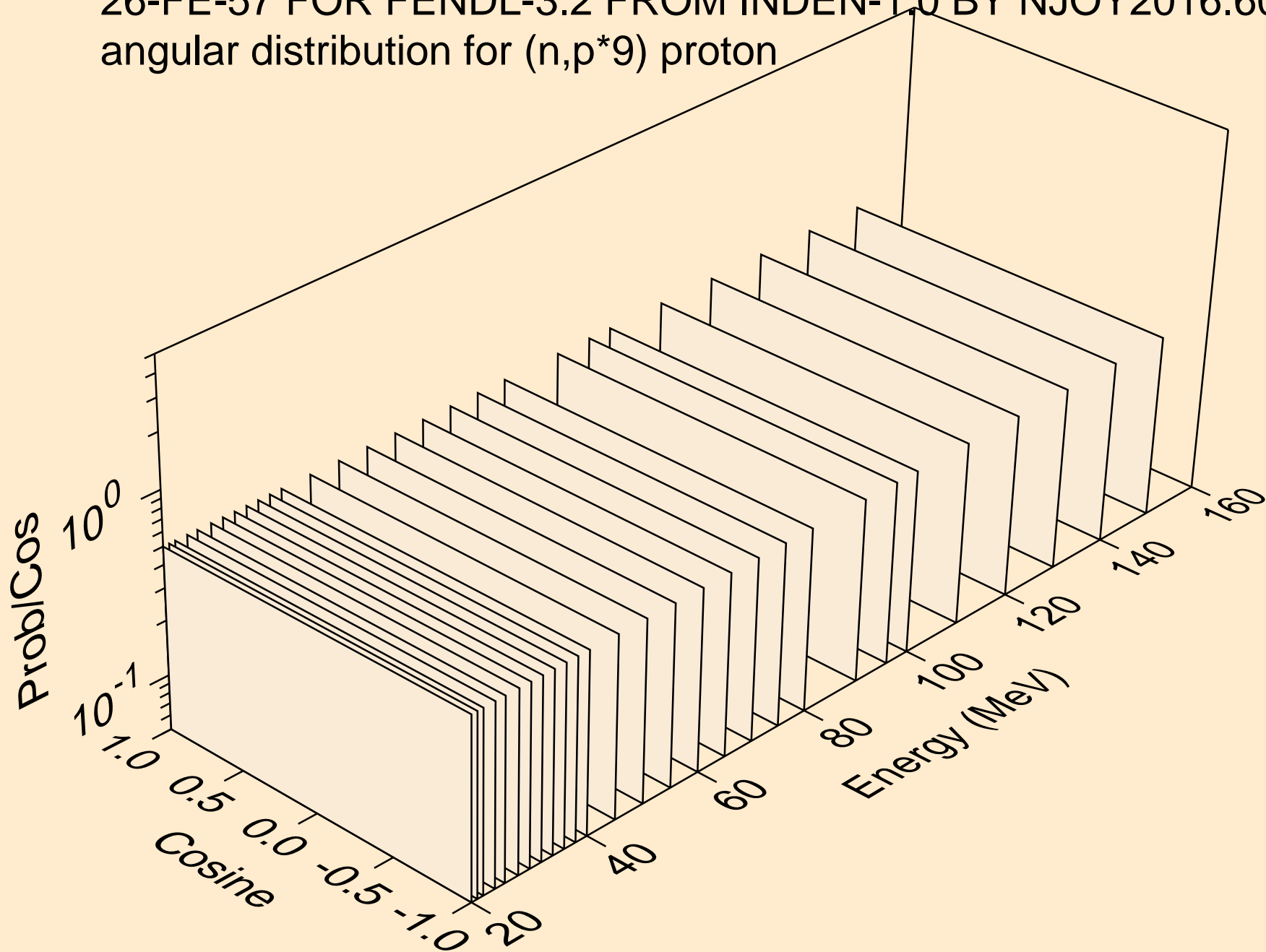

26-FE-57 FOR FENDL-3.2 FROM INDEN-1.0 BY NJOY2016.60+ ON
angular distribution for (n,p*10) proton

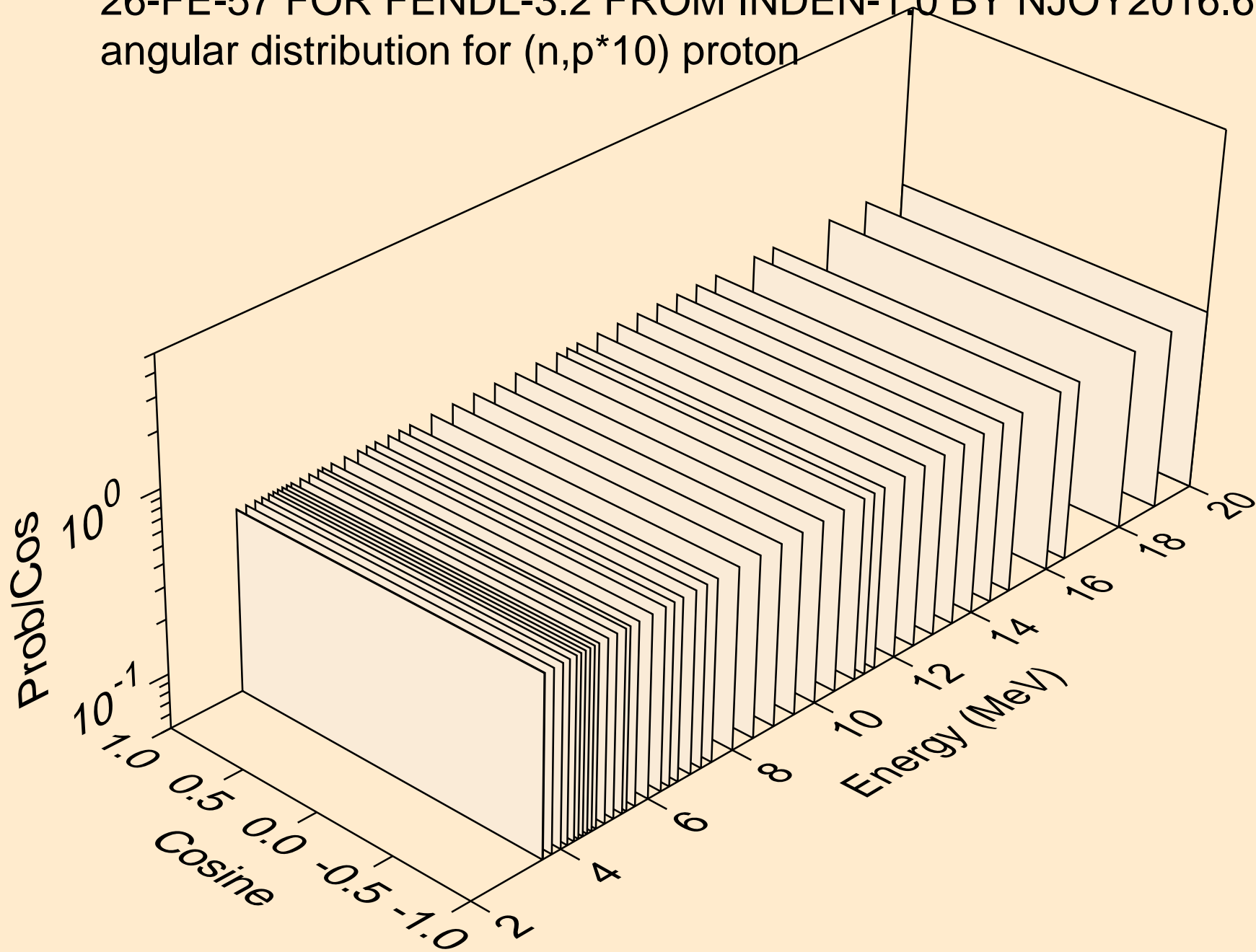

26-FE-57 FOR FENDL-3.2 FROM INDEN-1.0 BY NJOY2016.60+ ON
angular distribution for (n,p*10) proton

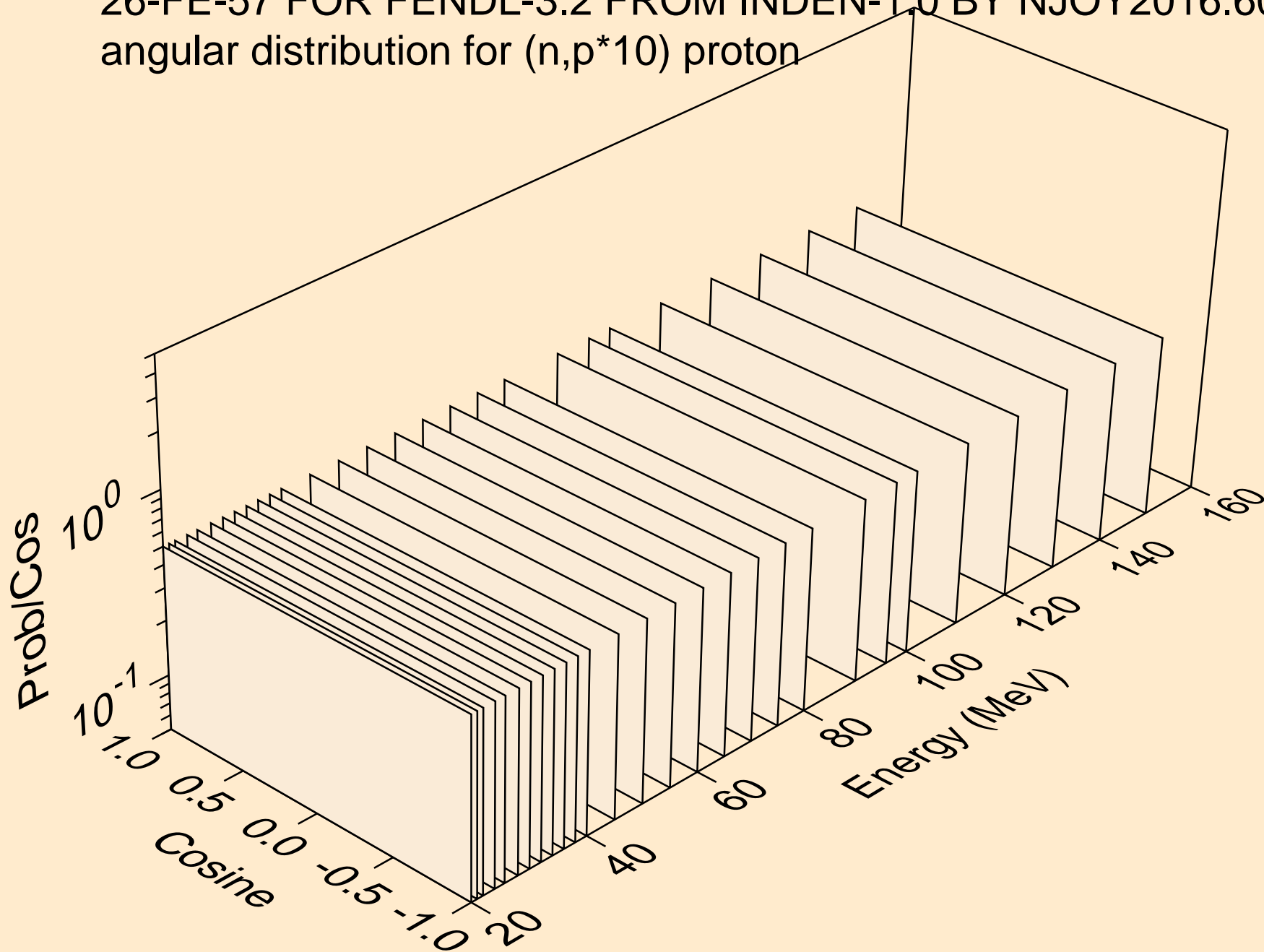

26-FE-57 FOR FENDL-3.2 FROM INDEN-1.0 BY NJOY2016.60+ ON
angular distribution for (n,p*11) proton

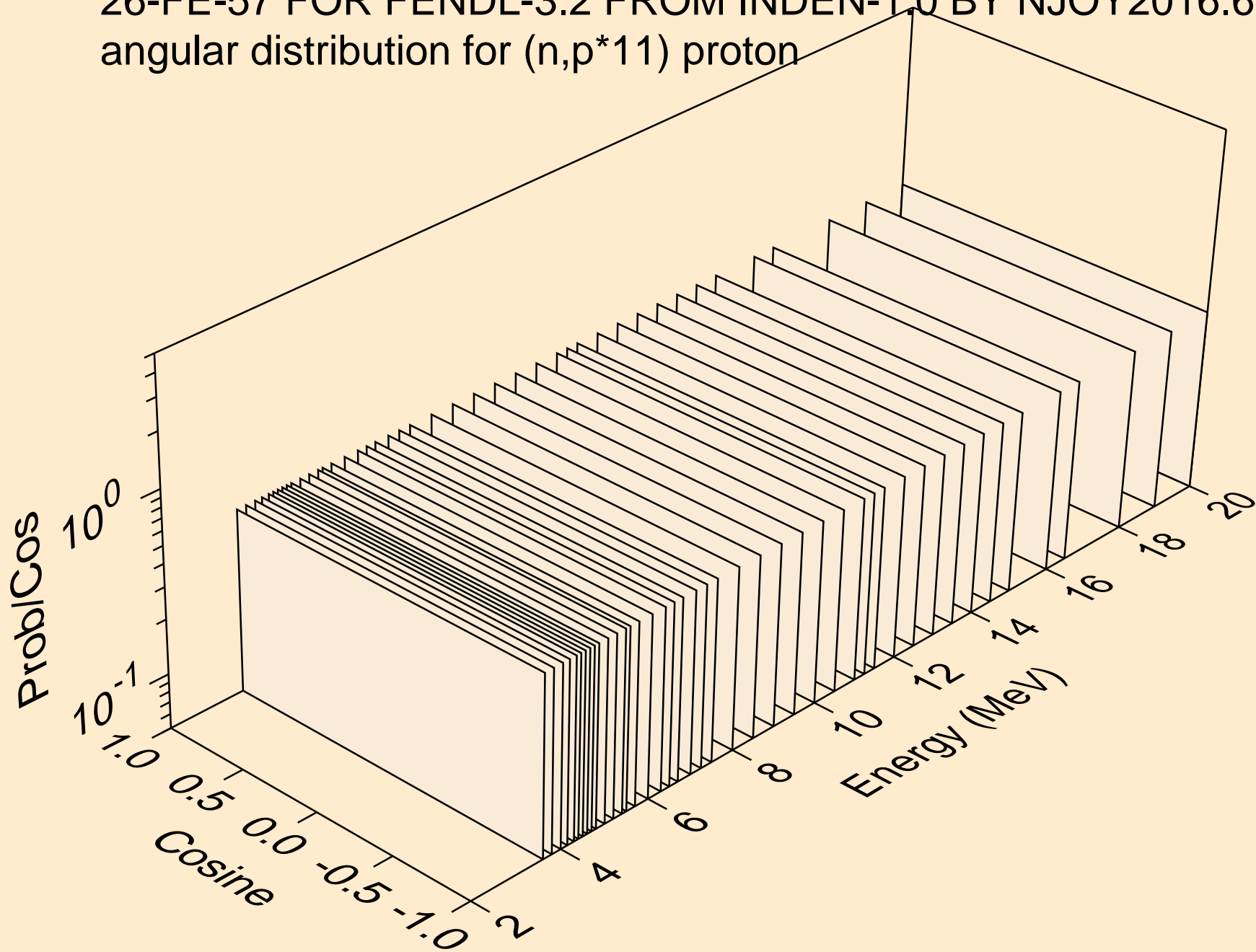

26-FE-57 FOR FENDL-3.2 FROM INDEN-1.0 BY NJOY2016.60+ ON
angular distribution for (n,p*11) proton

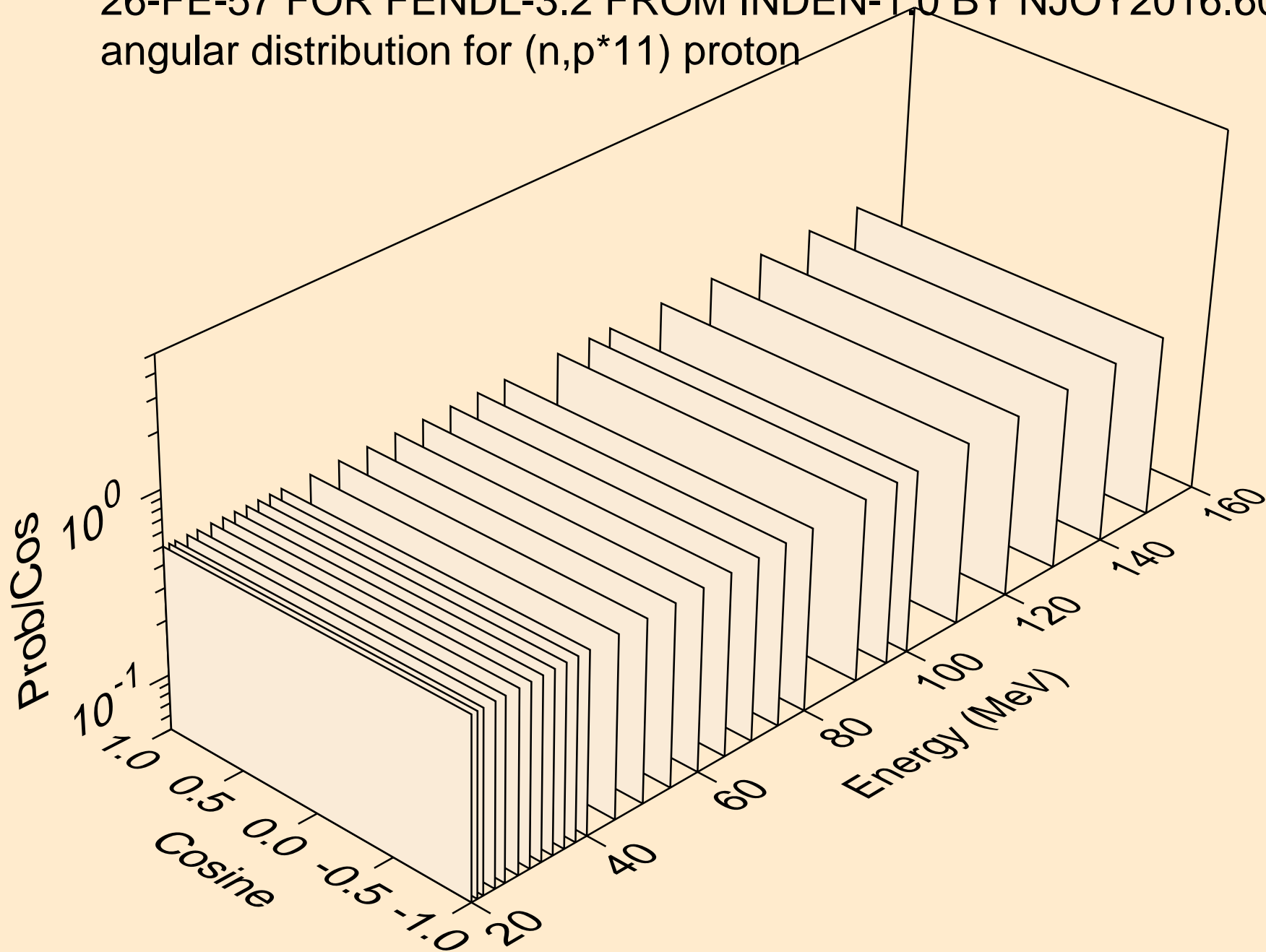

26-FE-57 FOR FENDL-3.2 FROM INDEN-1.0 BY NJOY2016.60+ ON
angular distribution for (n,p*12) proton

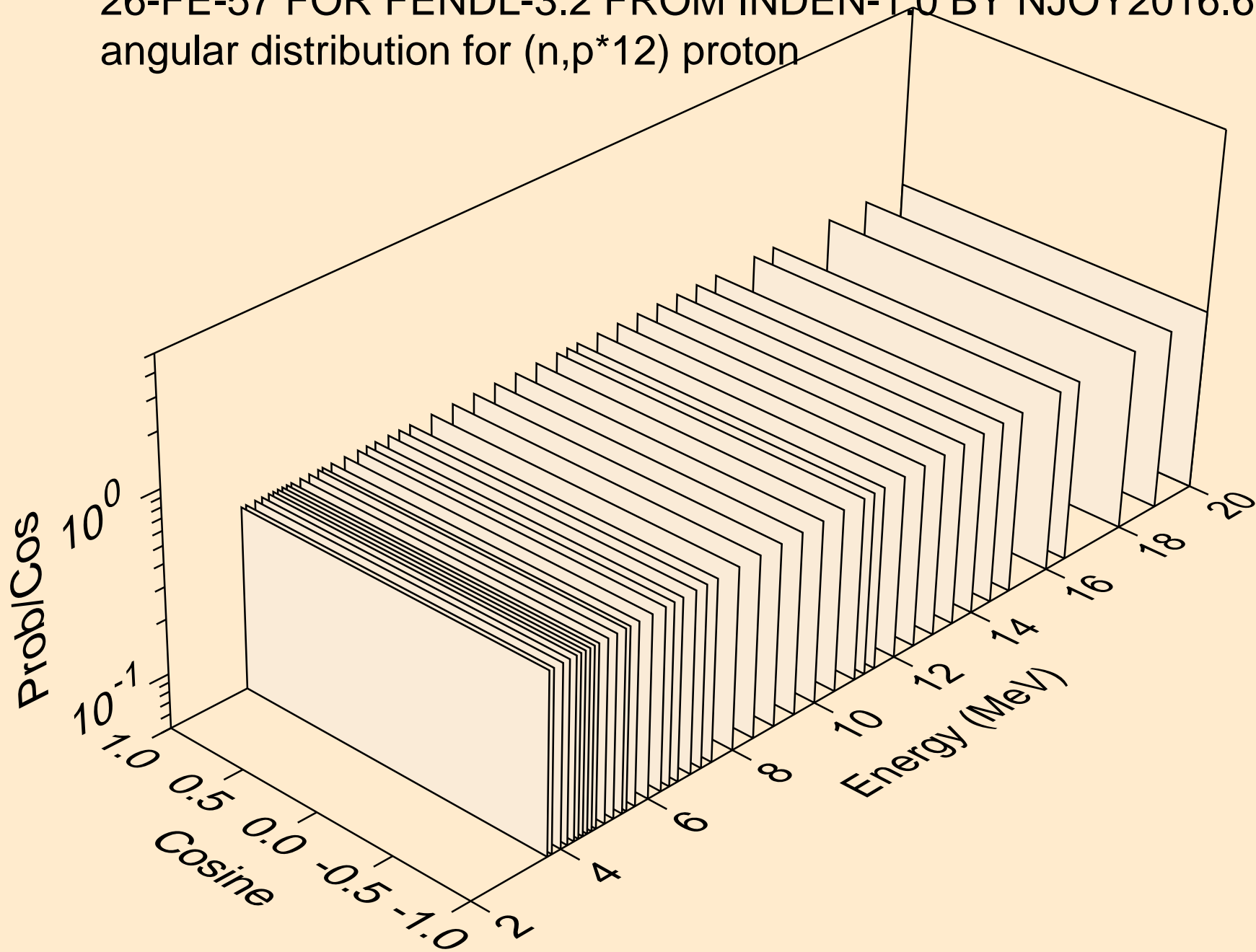

26-FE-57 FOR FENDL-3.2 FROM INDEN-1.0 BY NJOY2016.60+ ON
angular distribution for (n,p*12) proton

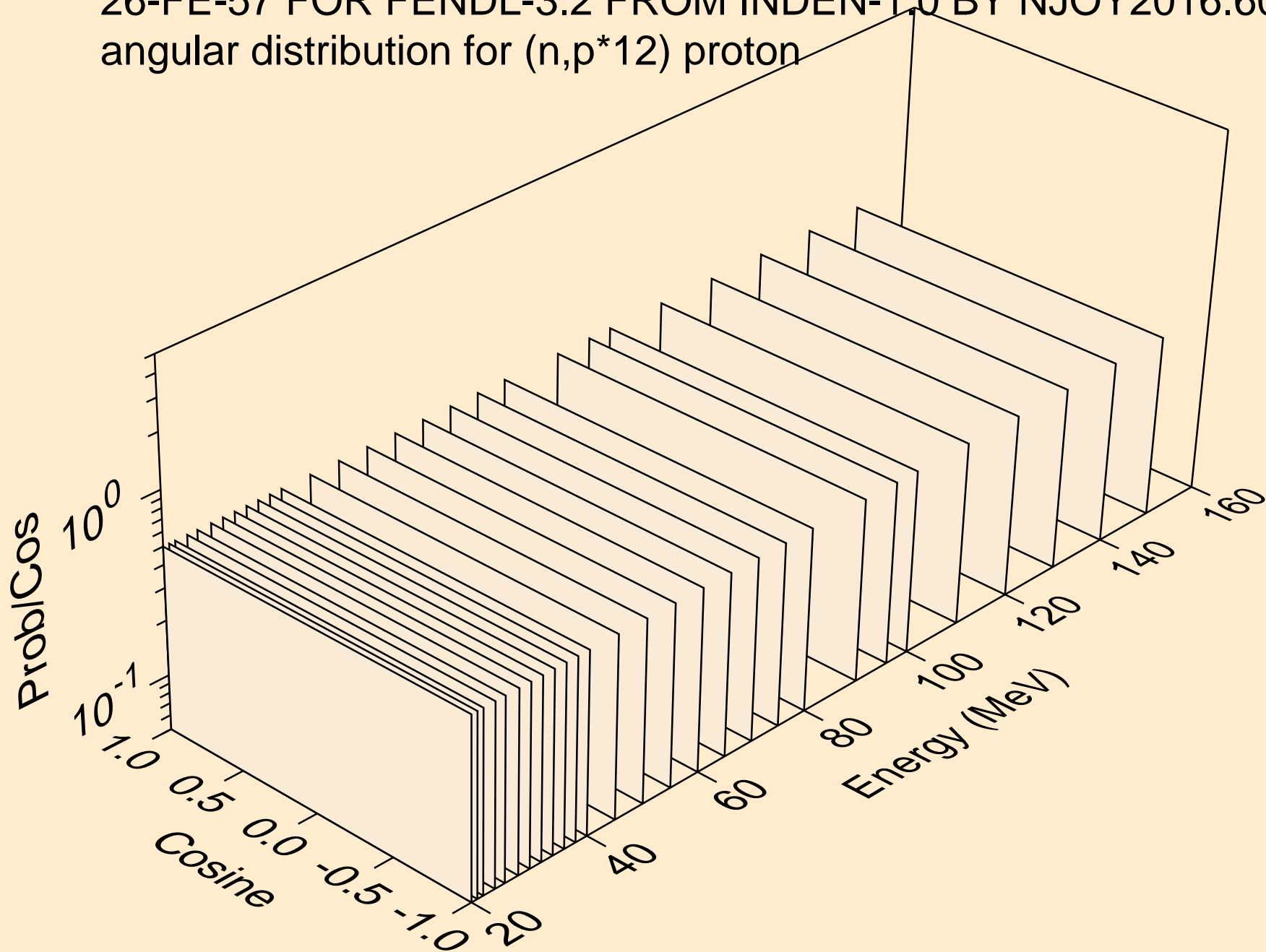

26-FE-57 FOR FENDL-3.2 FROM INDEN-1.0 BY NJOY2016.60+ ON
angular distribution for (n,p*13) proton

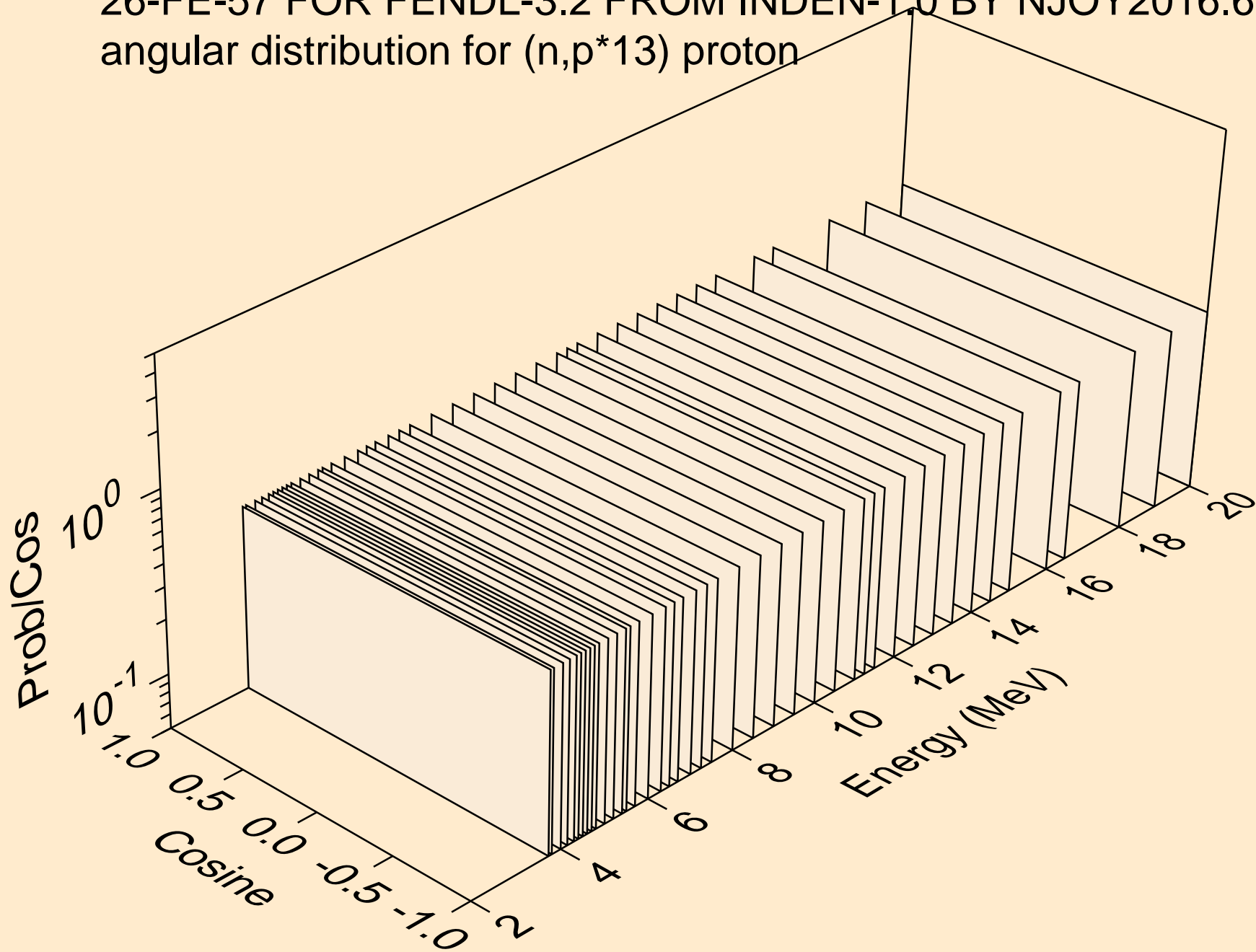

26-FE-57 FOR FENDL-3.2 FROM INDEN-1.0 BY NJOY2016.60+ ON
angular distribution for (n,p*13) proton

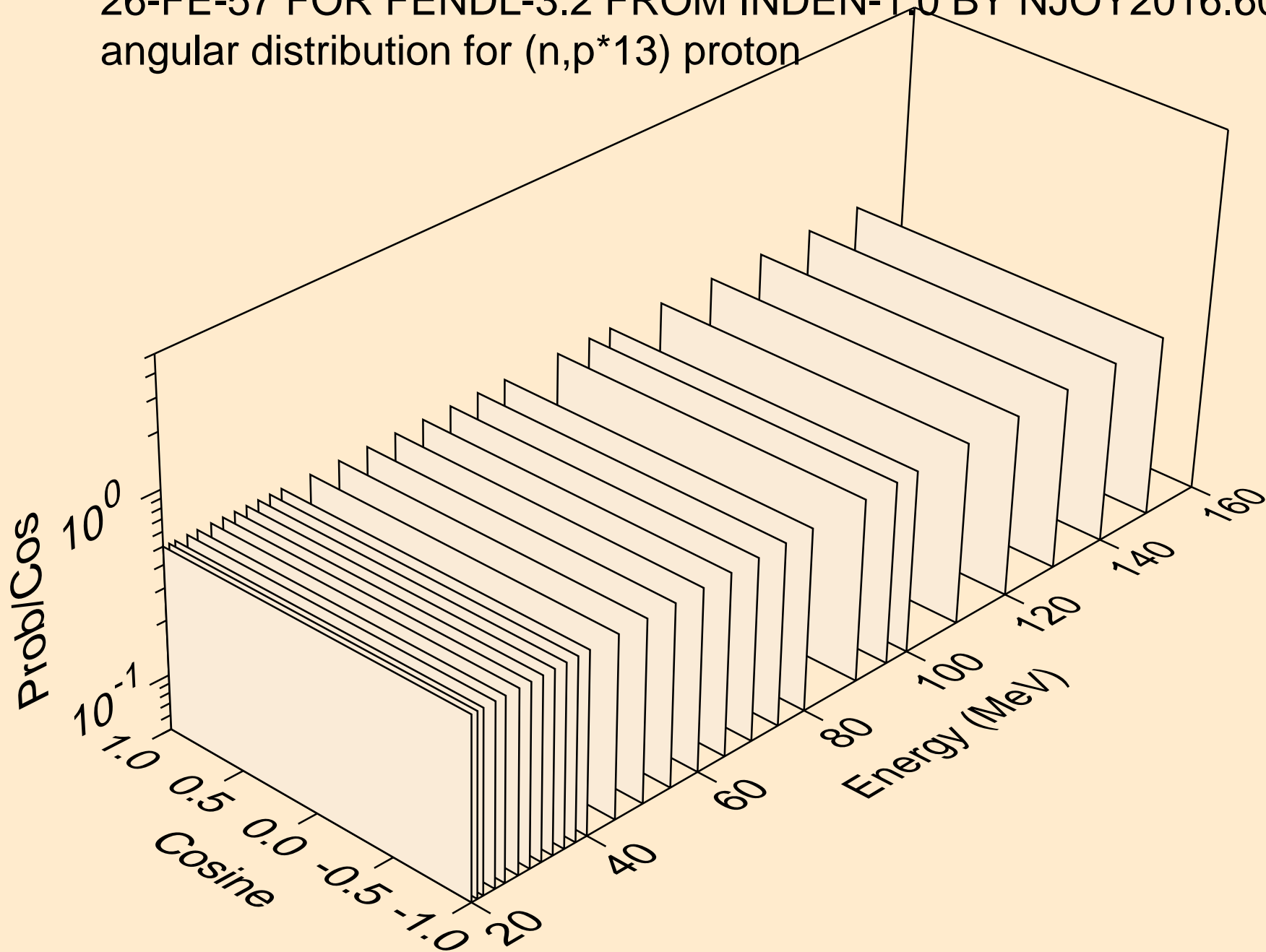

26-FE-57 FOR FENDL-3.2 FROM INDEN-1.0 BY NJOY2016.60+ ON
angular distribution for (n,p*14) proton

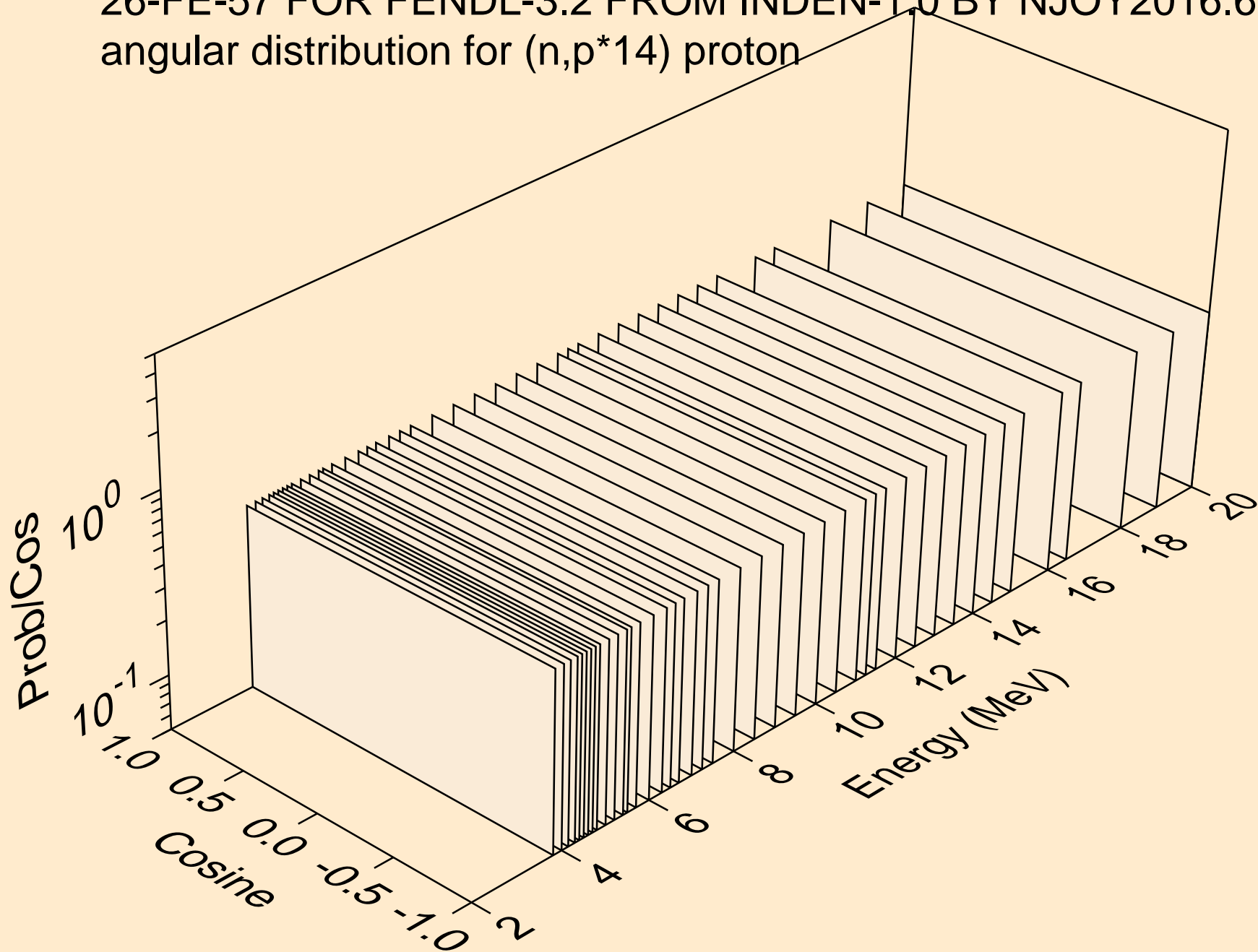

26-FE-57 FOR FENDL-3.2 FROM INDEN-1.0 BY NJOY2016.60+ ON
angular distribution for (n,p*14) proton

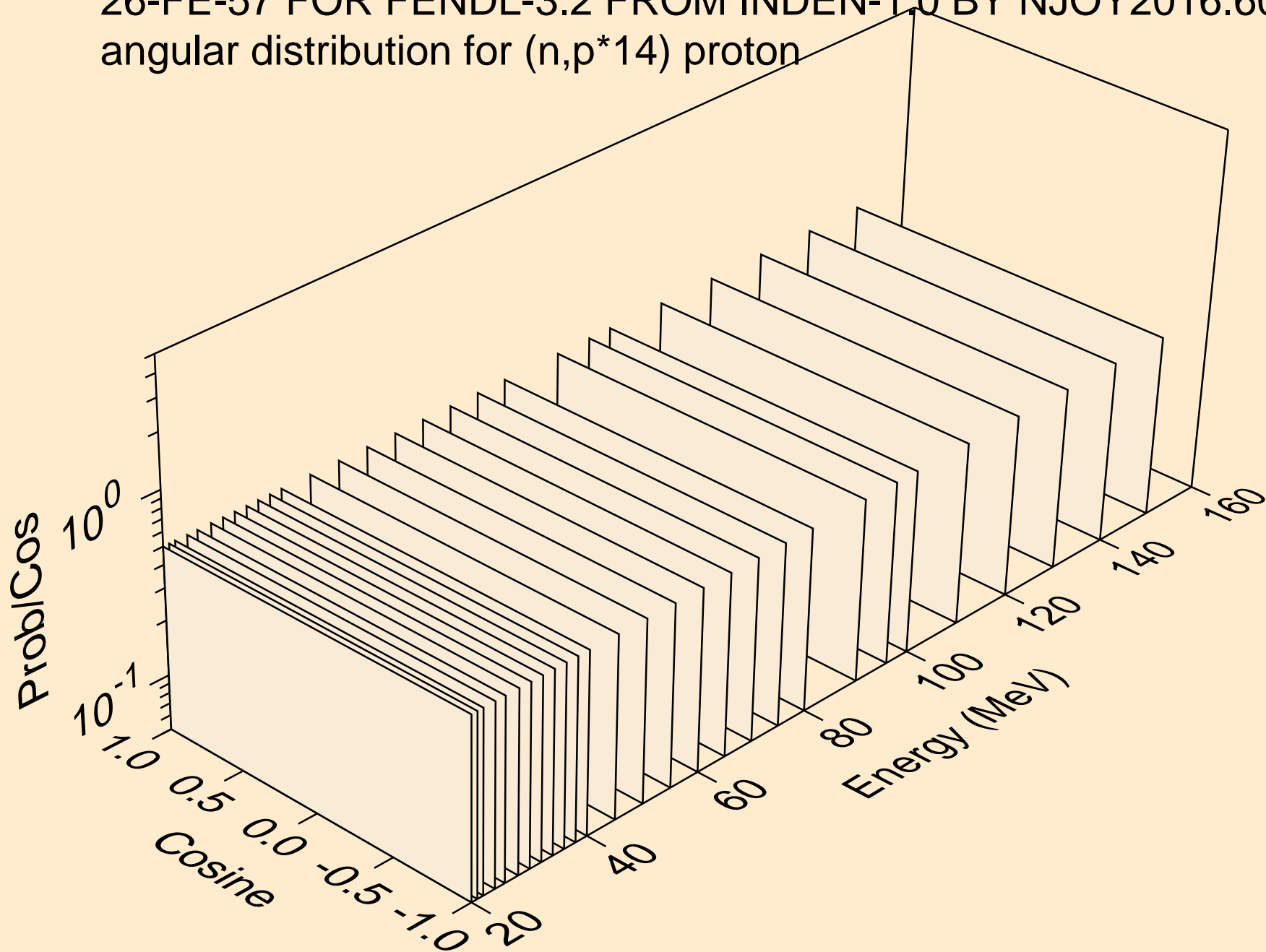

26-FE-57 FOR FENDL-3.2 FROM INDEN-1.0 BY NJOY2016.60+ ON
angular distribution for (n,p*15) proton

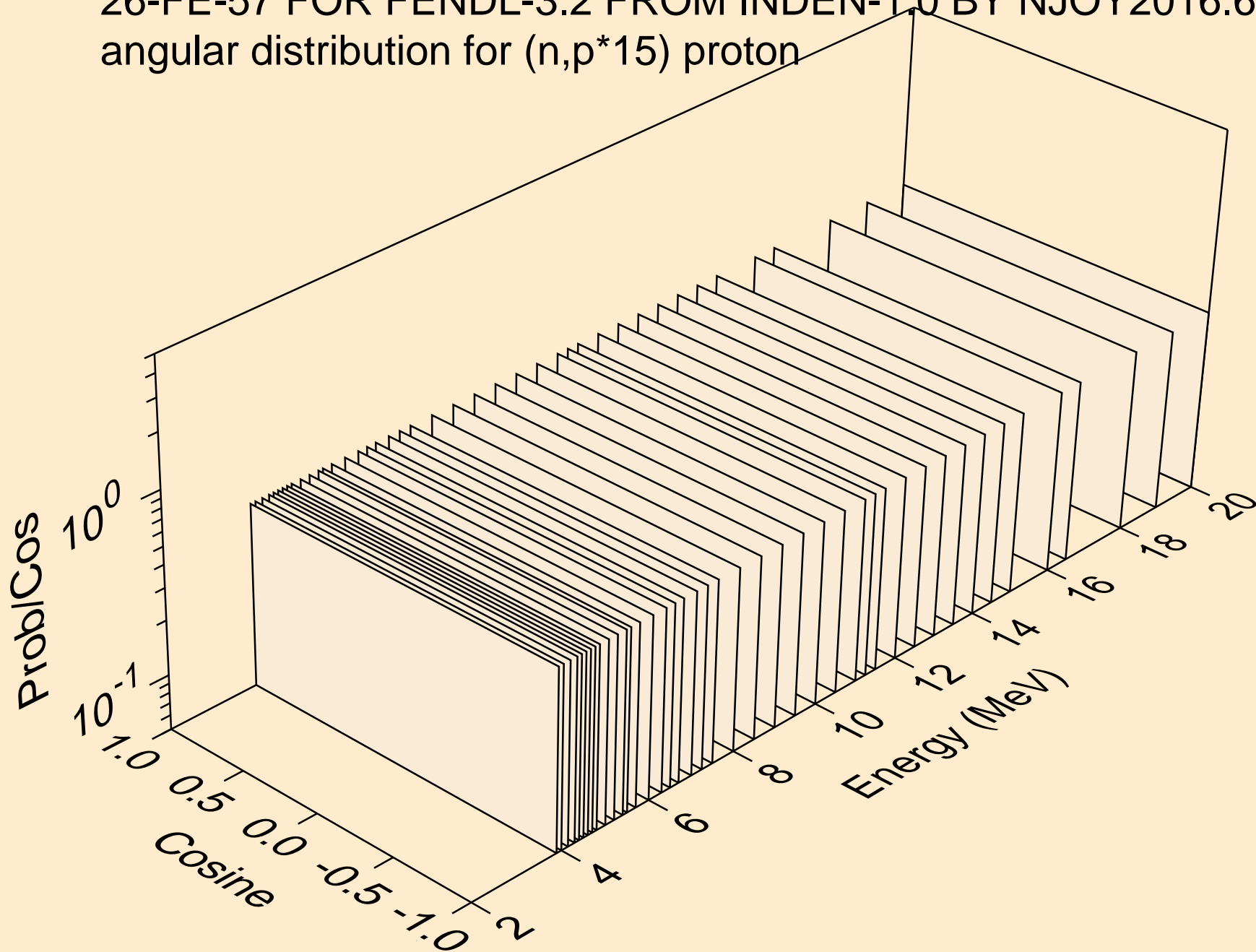

26-FE-57 FOR FENDL-3.2 FROM INDEN-1.0 BY NJOY2016.60+ ON
angular distribution for (n,p*15) proton

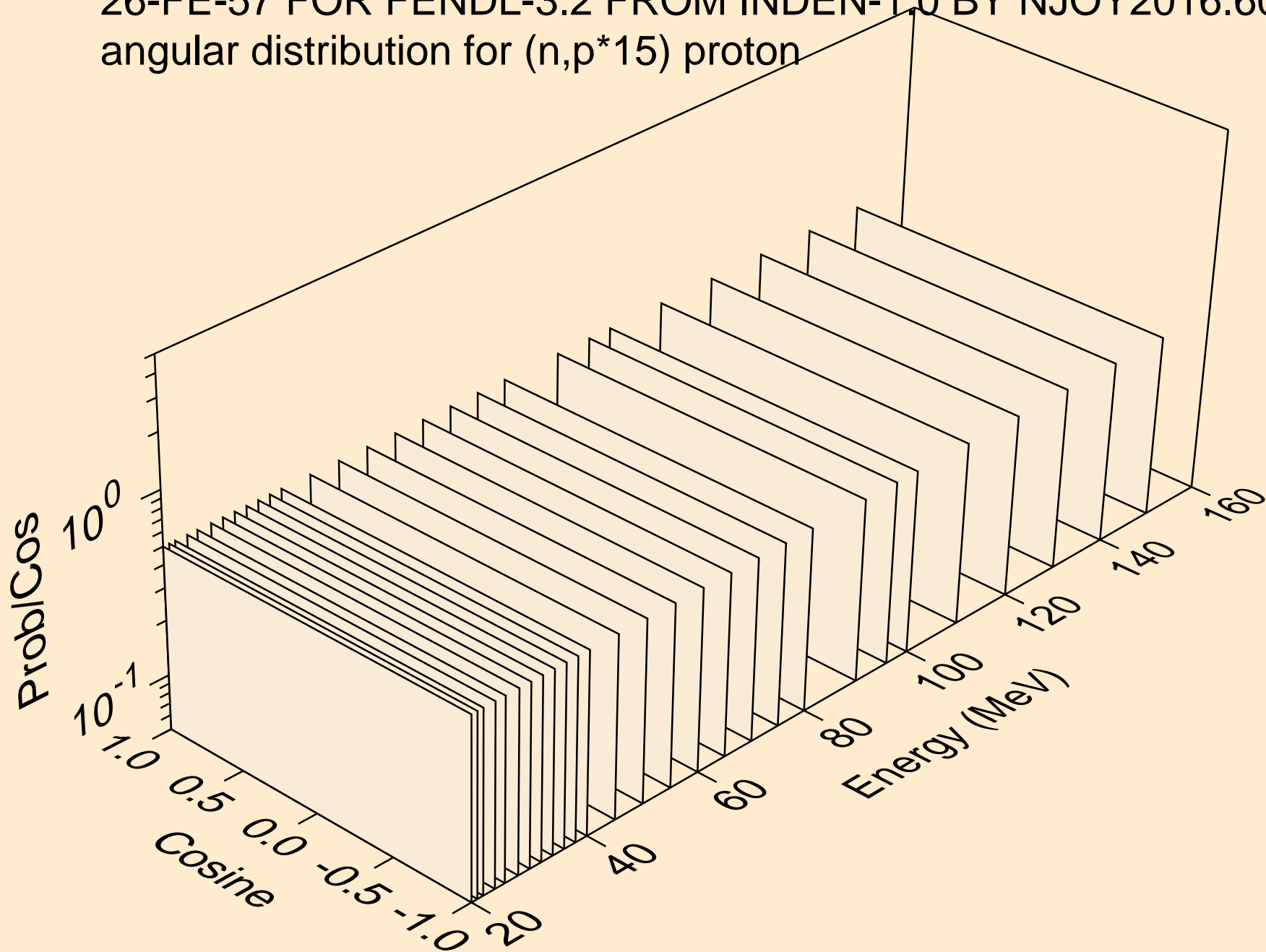

26-FE-57 FOR FENDL-3.2 FROM INDEN-1.0 BY NJOY2016.60+ ON
angular distribution for (n,p*16) proton

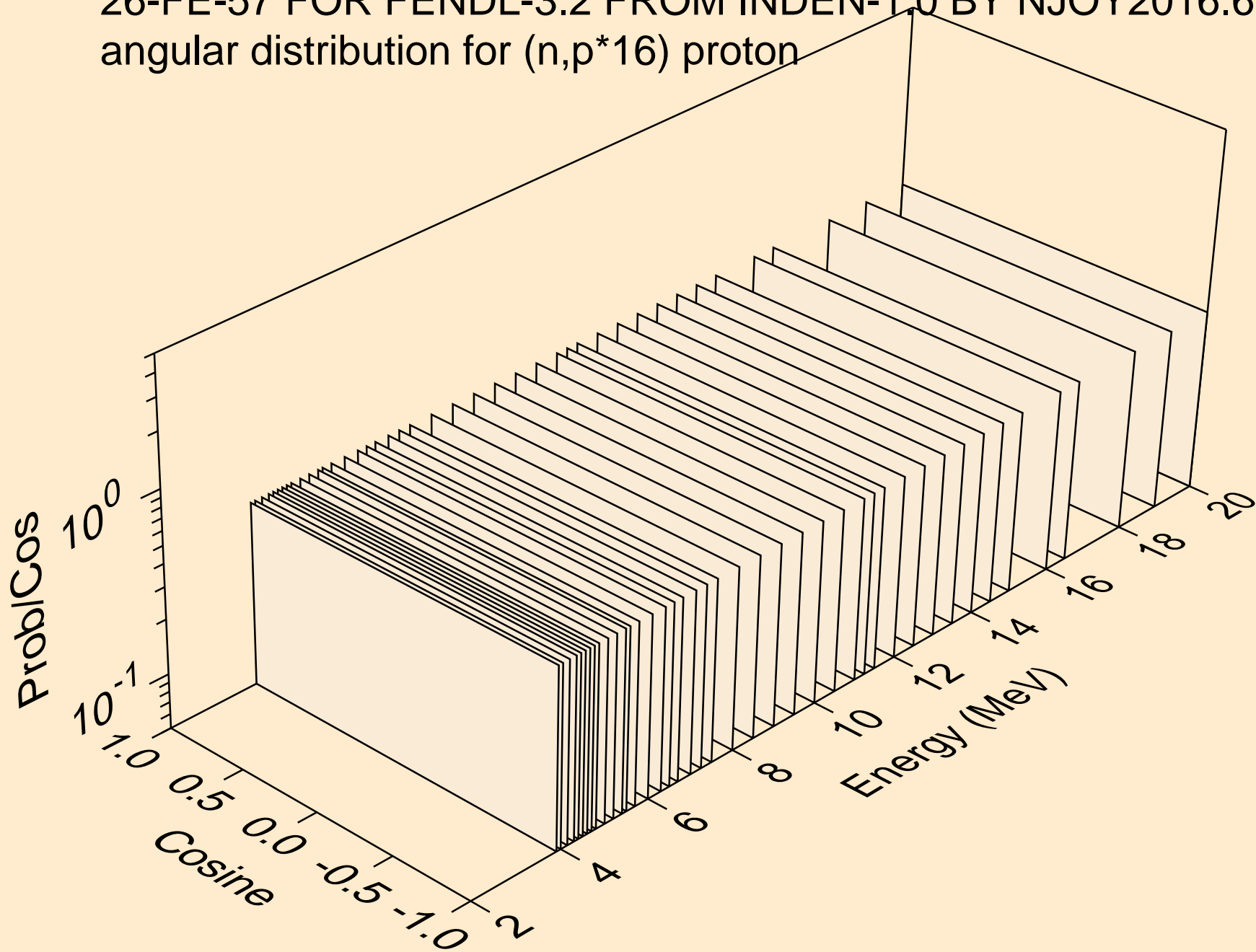

26-FE-57 FOR FENDL-3.2 FROM INDEN-1.0 BY NJOY2016.60+ ON
angular distribution for (n,p*16) proton

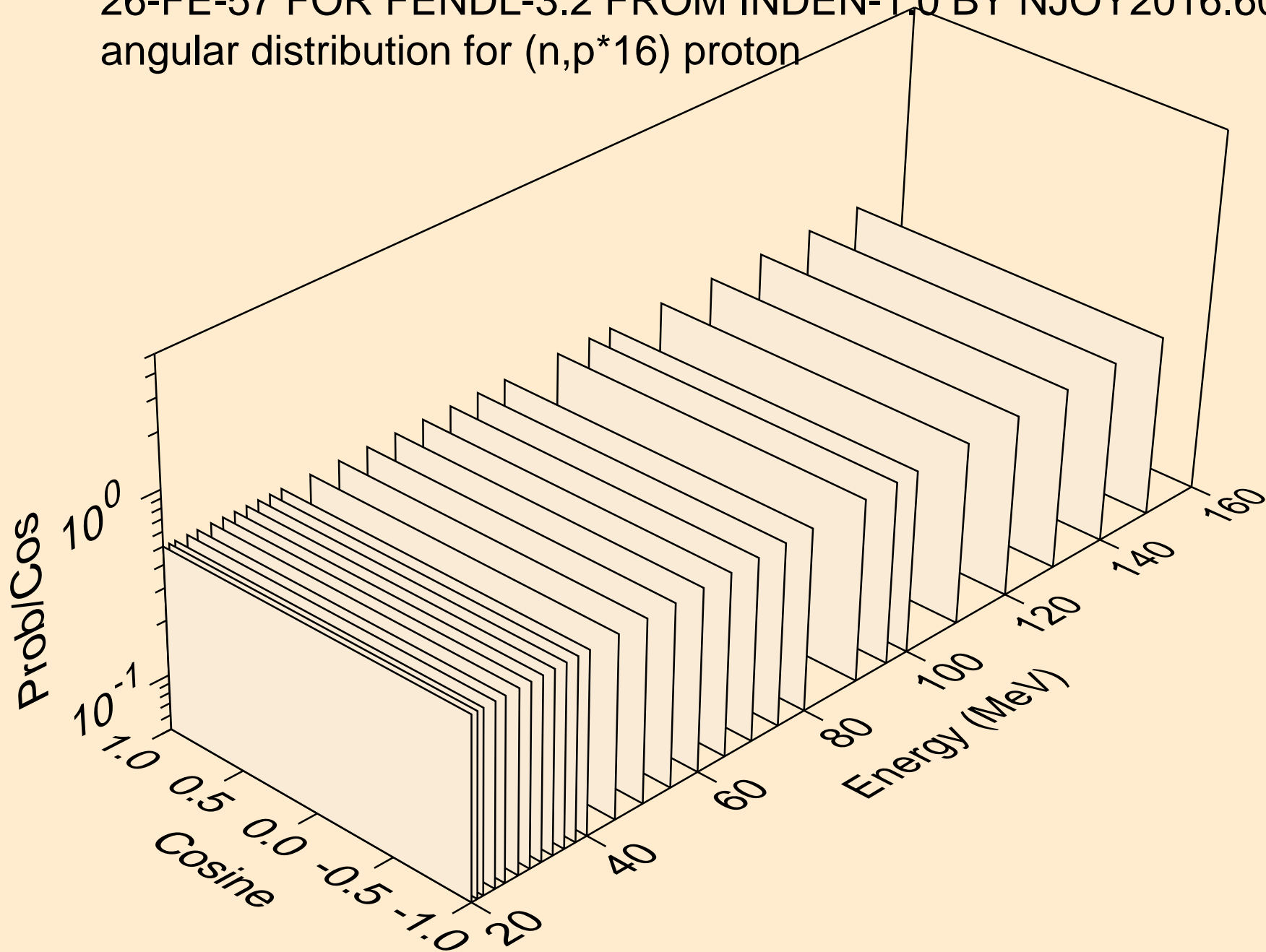

26-FE-57 FOR FENDL-3.2 FROM INDEN-1.0 BY NJOY2016.60+ ON
angular distribution for (n,p*17) proton

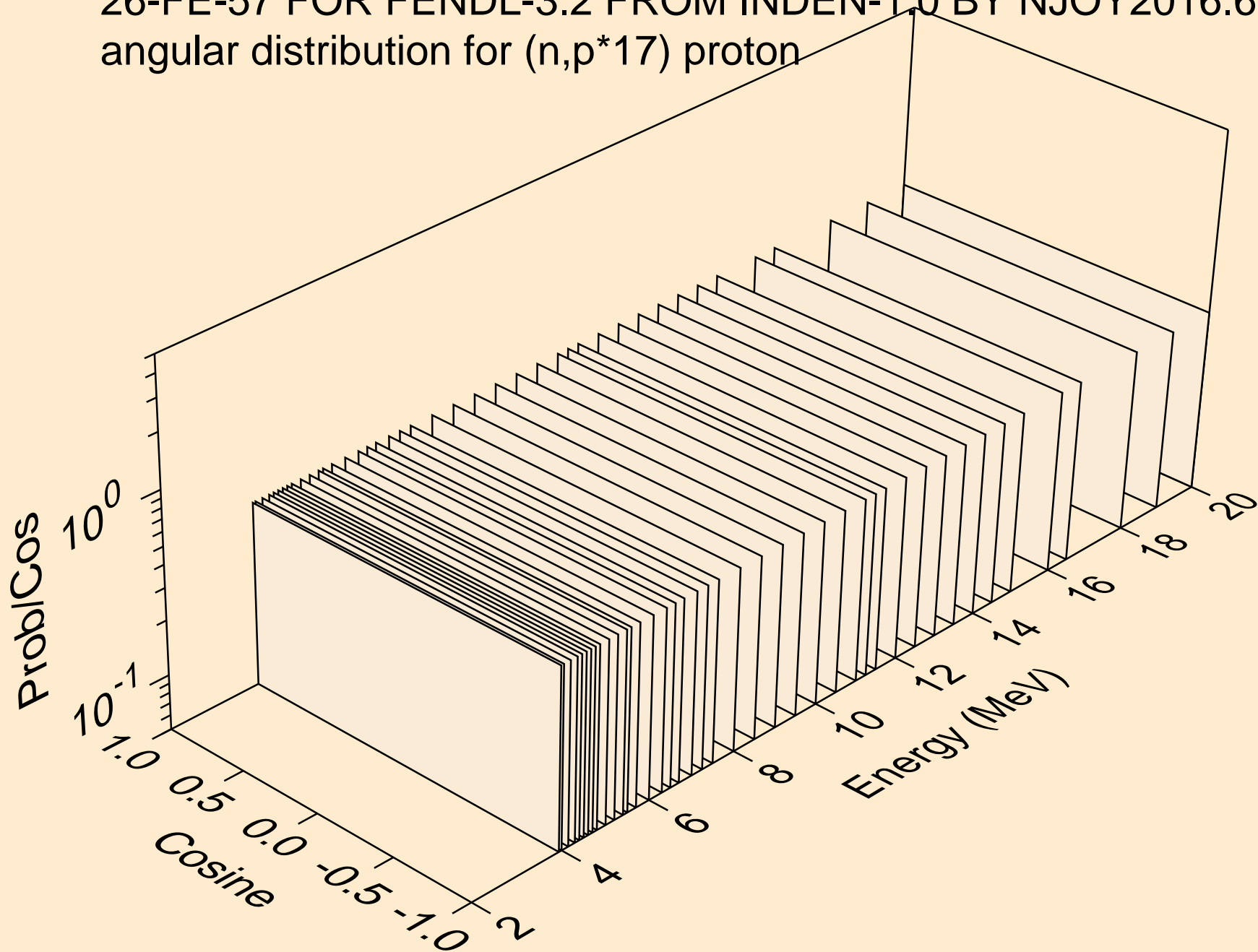

26-FE-57 FOR FENDL-3.2 FROM INDEN-1.0 BY NJOY2016.60+ ON
angular distribution for (n,p*17) proton

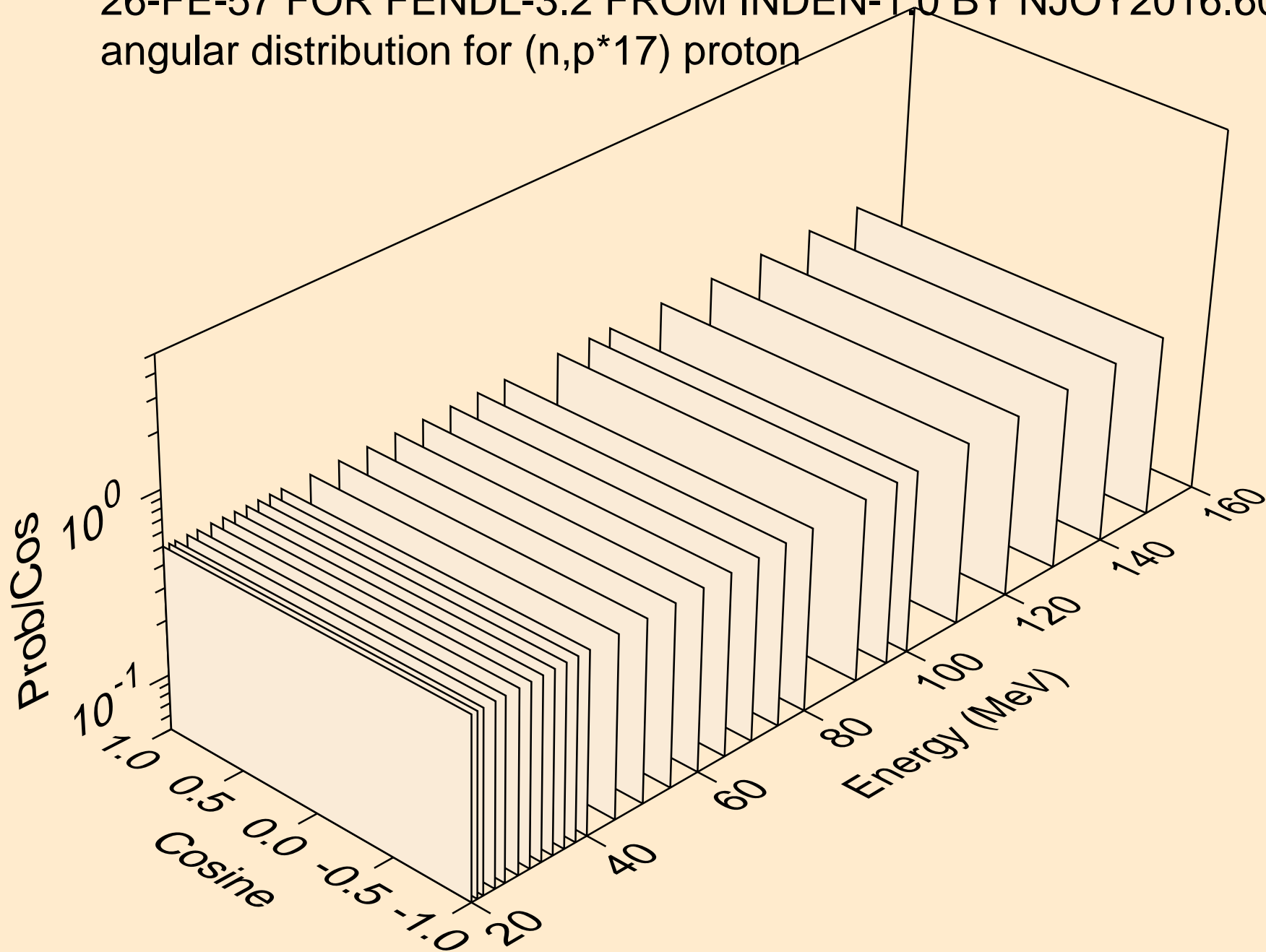

26-FE-57 FOR FENDL-3.2 FROM INDEN-1.0 BY NJOY2016.60+ ON
protons from (n,p*c)

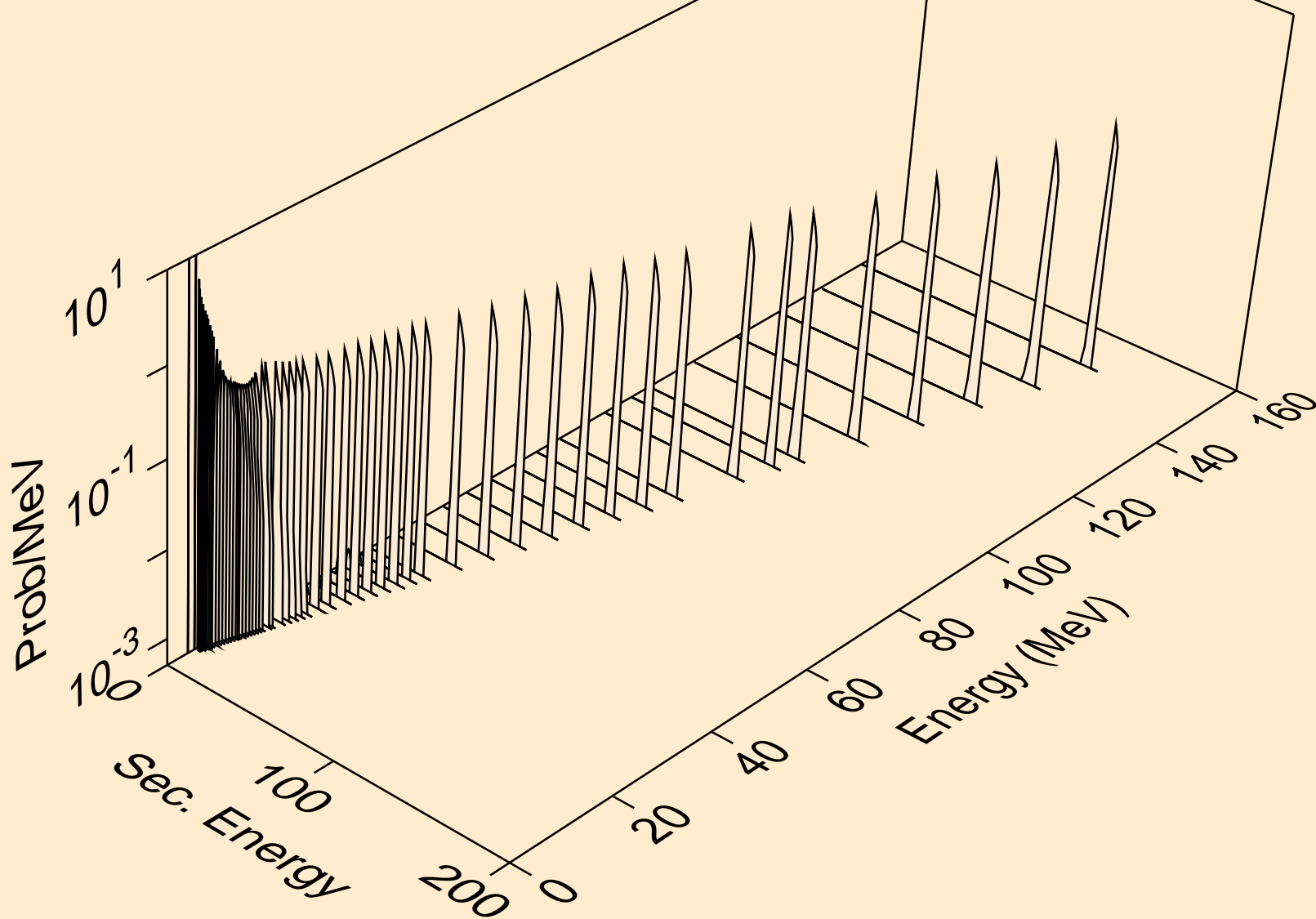

26-FE-57 FOR FENDL-3.2 FROM INDEN-1.0 BY NJOY2016.60+ ON
deuterons from (n,x)

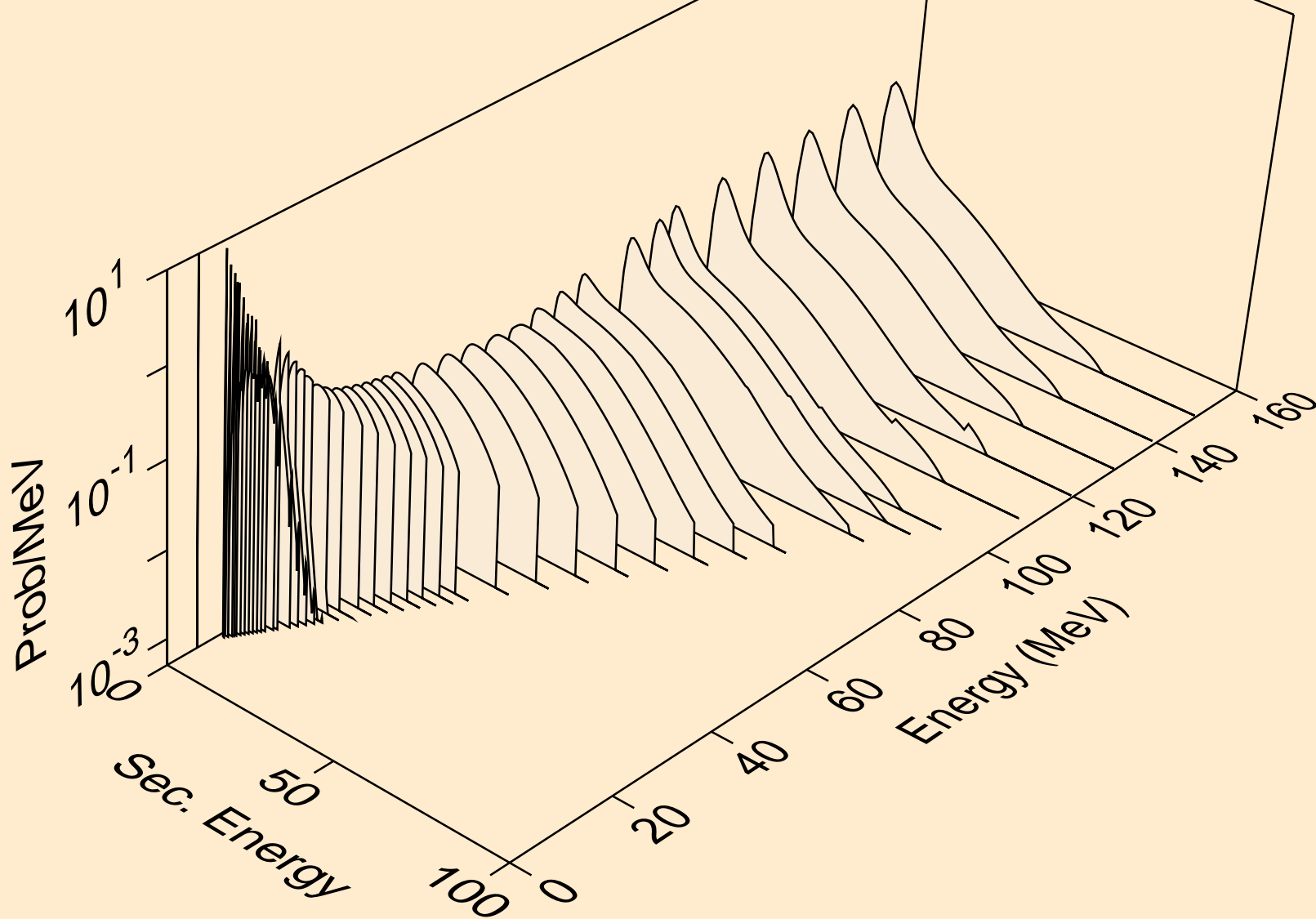

26-FE-57 FOR FENDL-3.2 FROM INDEN-1.0 BY NJOY2016.60+ ON
tritons from (n,x)

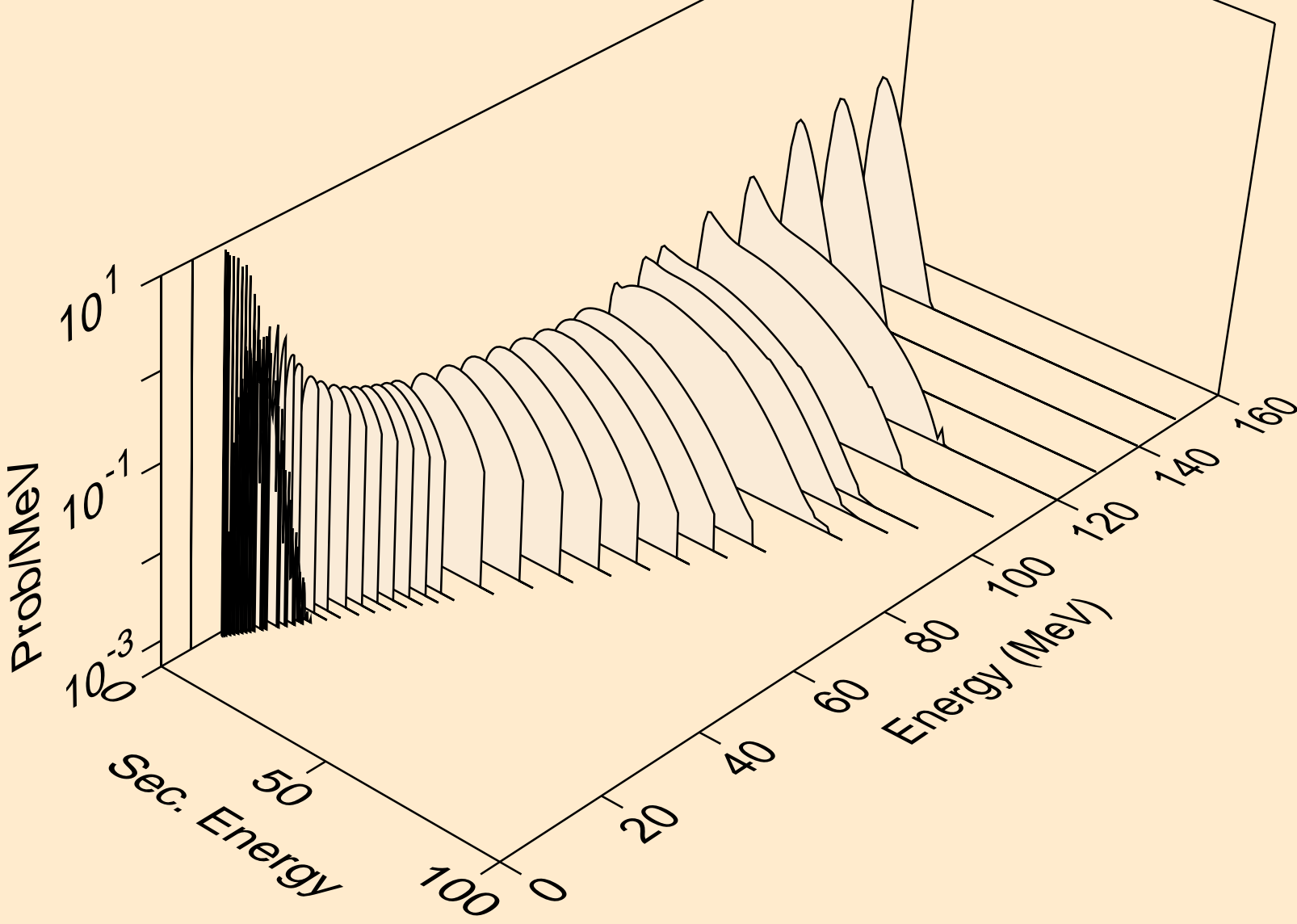

26-FE-57 FOR FENDL-3.2 FROM INDEN-1.0 BY NJOY2016.60+ ON
he3s from (n,x)

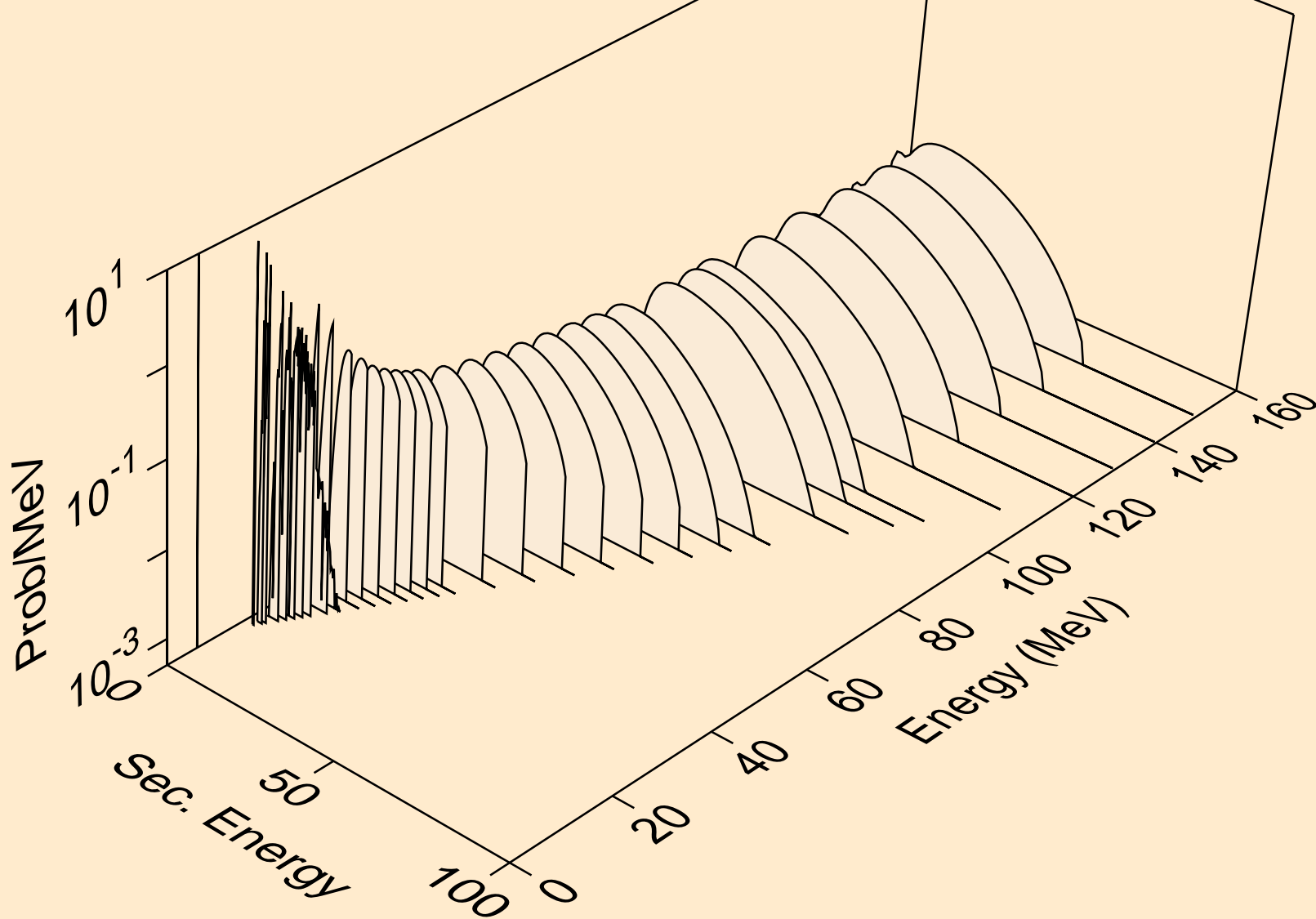

26-FE-57 FOR FENDL-3.2 FROM INDEN-1.0 BY NJOY2016.60+ ON
alphas from (n,x)

