

28-NI-61 FOR FENDL-3.2 FROM ENDF/B-VII BY NJOY2016.60+ ON  
Principal cross sections

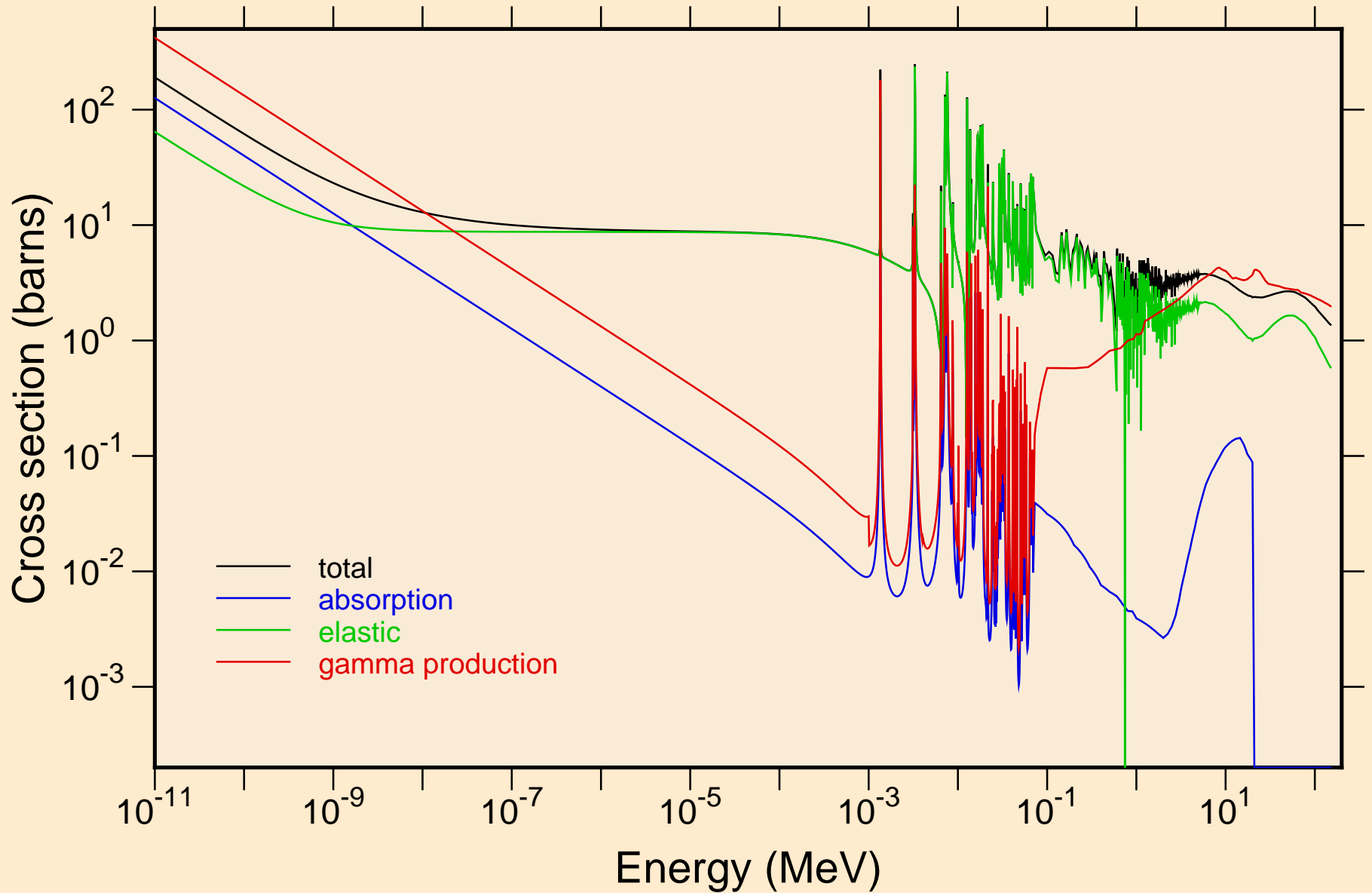

28-NI-61 FOR FENDL-3.2 FROM ENDF/B-VII BY NJOY2016.60+ ON  
resonance total cross section

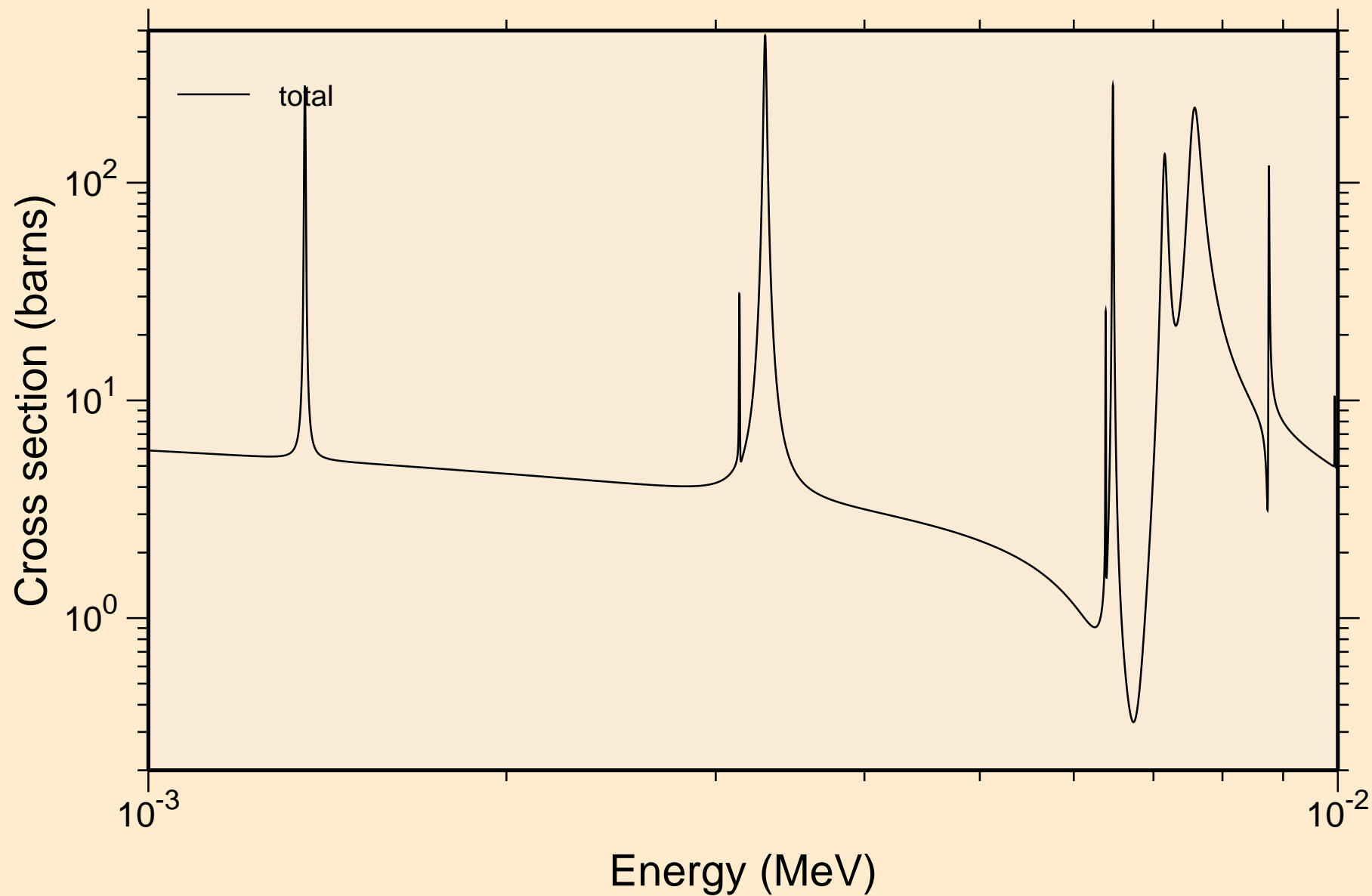

28-NI-61 FOR FENDL-3.2 FROM ENDF/B-VII BY NJOY2016.60+ ON  
resonance total cross section

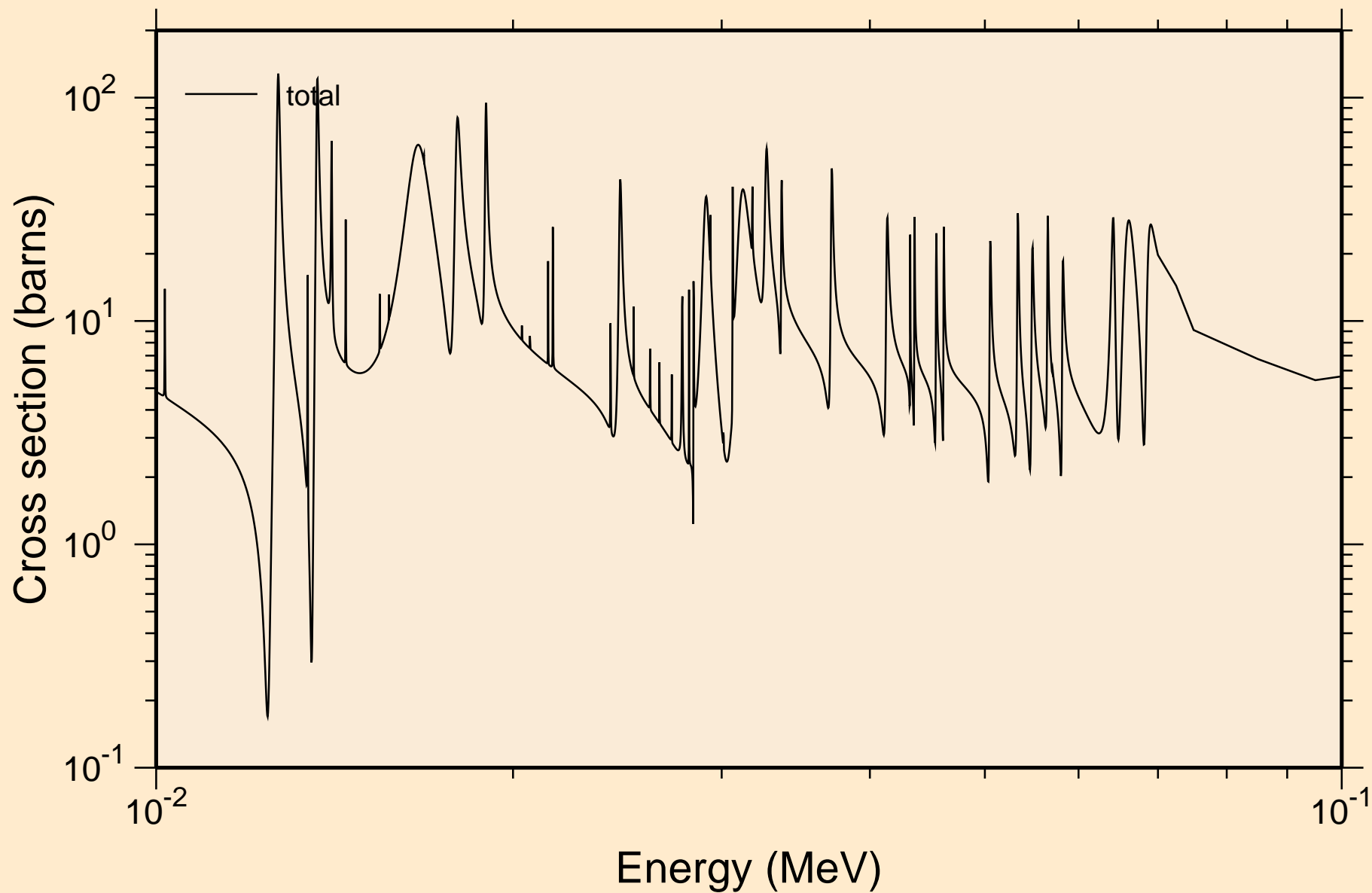

28-NI-61 FOR FENDL-3.2 FROM ENDF/B-VII BY NJOY2016.60+ ON  
resonance total cross section

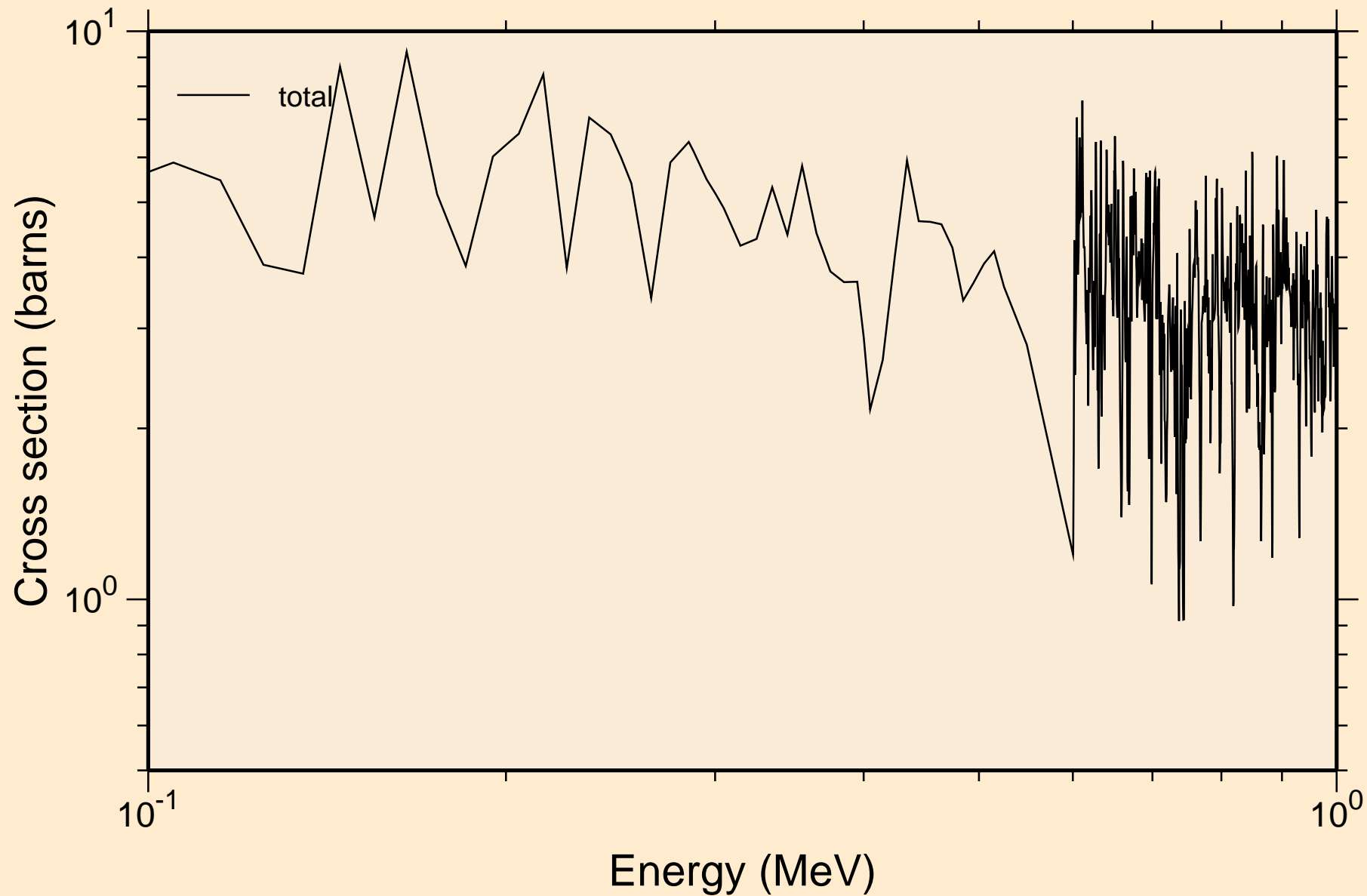

28-NI-61 FOR FENDL-3.2 FROM ENDF/B-VII BY NJOY2016.60+ ON  
resonance total cross section

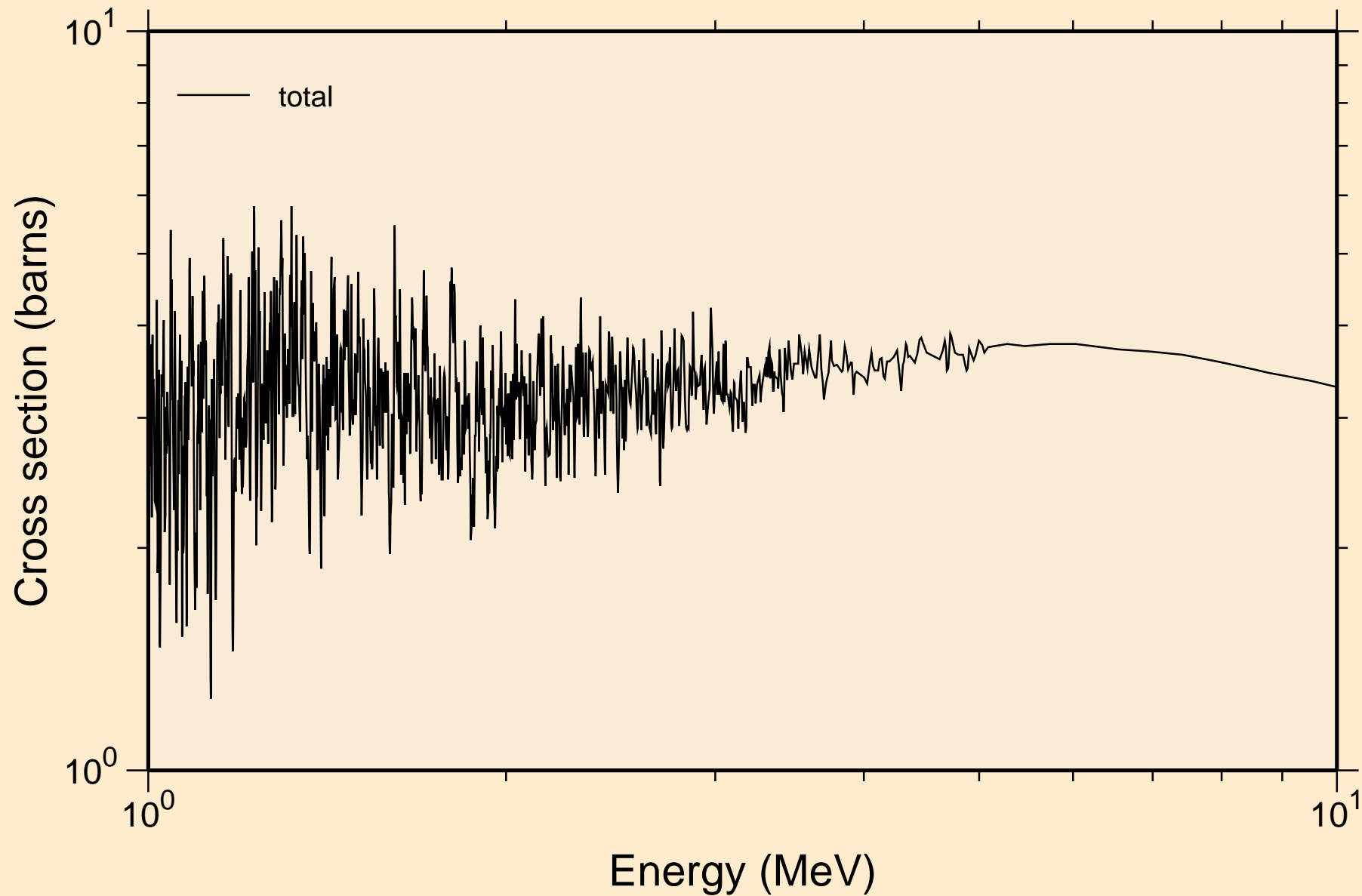

28-NI-61 FOR FENDL-3.2 FROM ENDF/B-VII BY NJOY2016.60+ ON  
resonance absorption cross sections

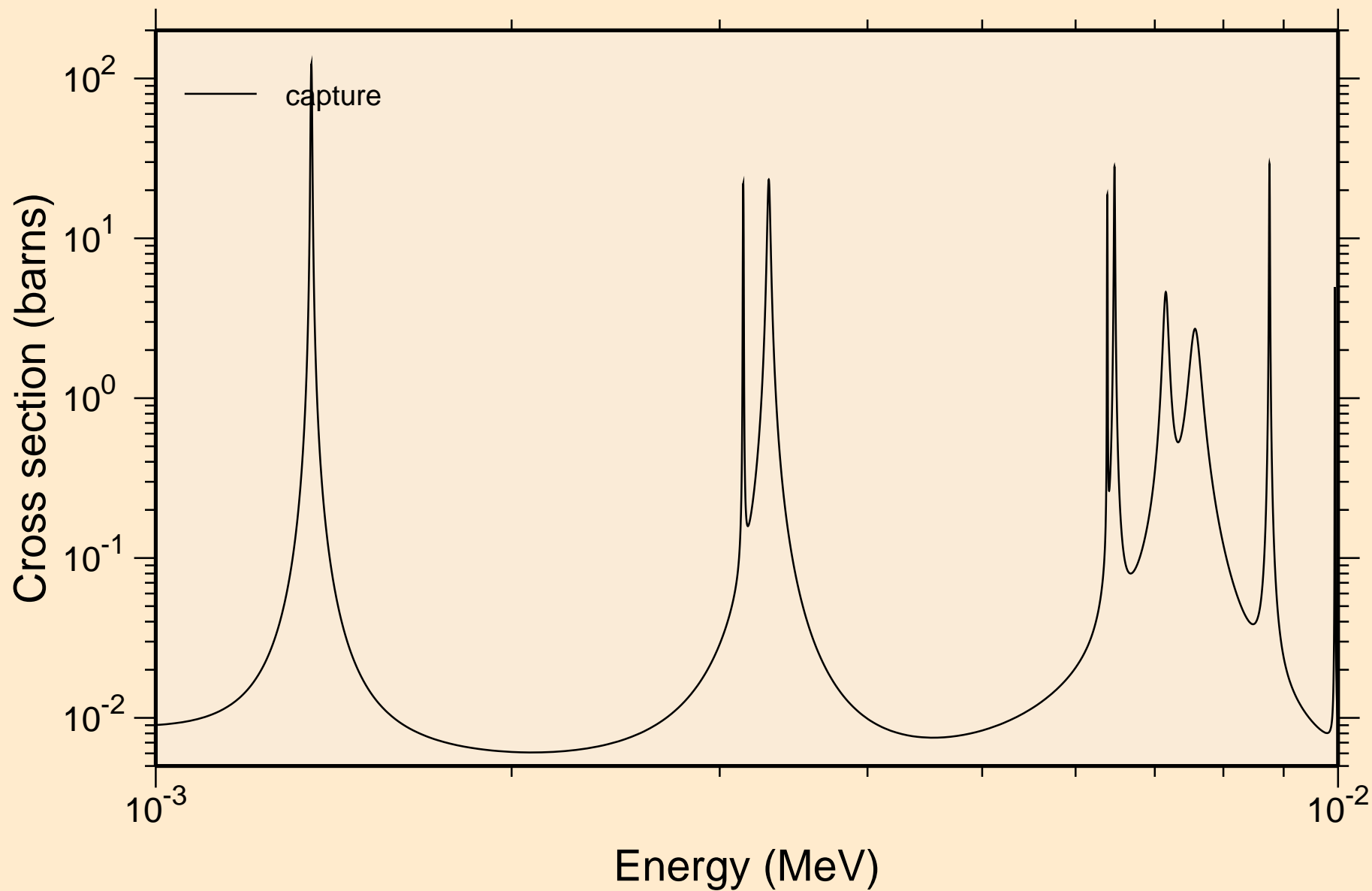

28-NI-61 FOR FENDL-3.2 FROM ENDF/B-VII BY NJOY2016.60+ ON  
resonance absorption cross sections

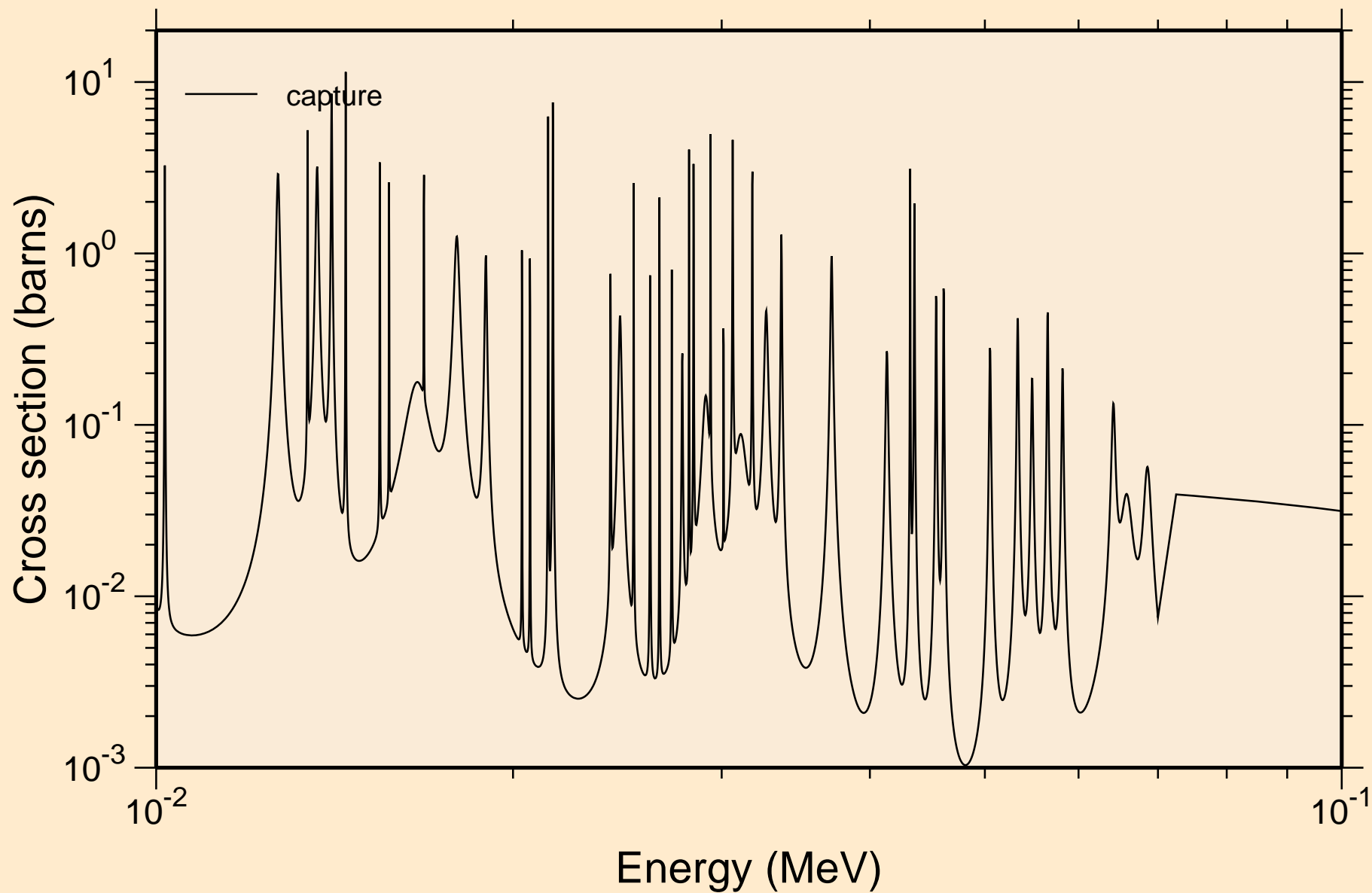

28-NI-61 FOR FENDL-3.2 FROM ENDF/B-VII BY NJOY2016.60+ ON  
resonance absorption cross sections

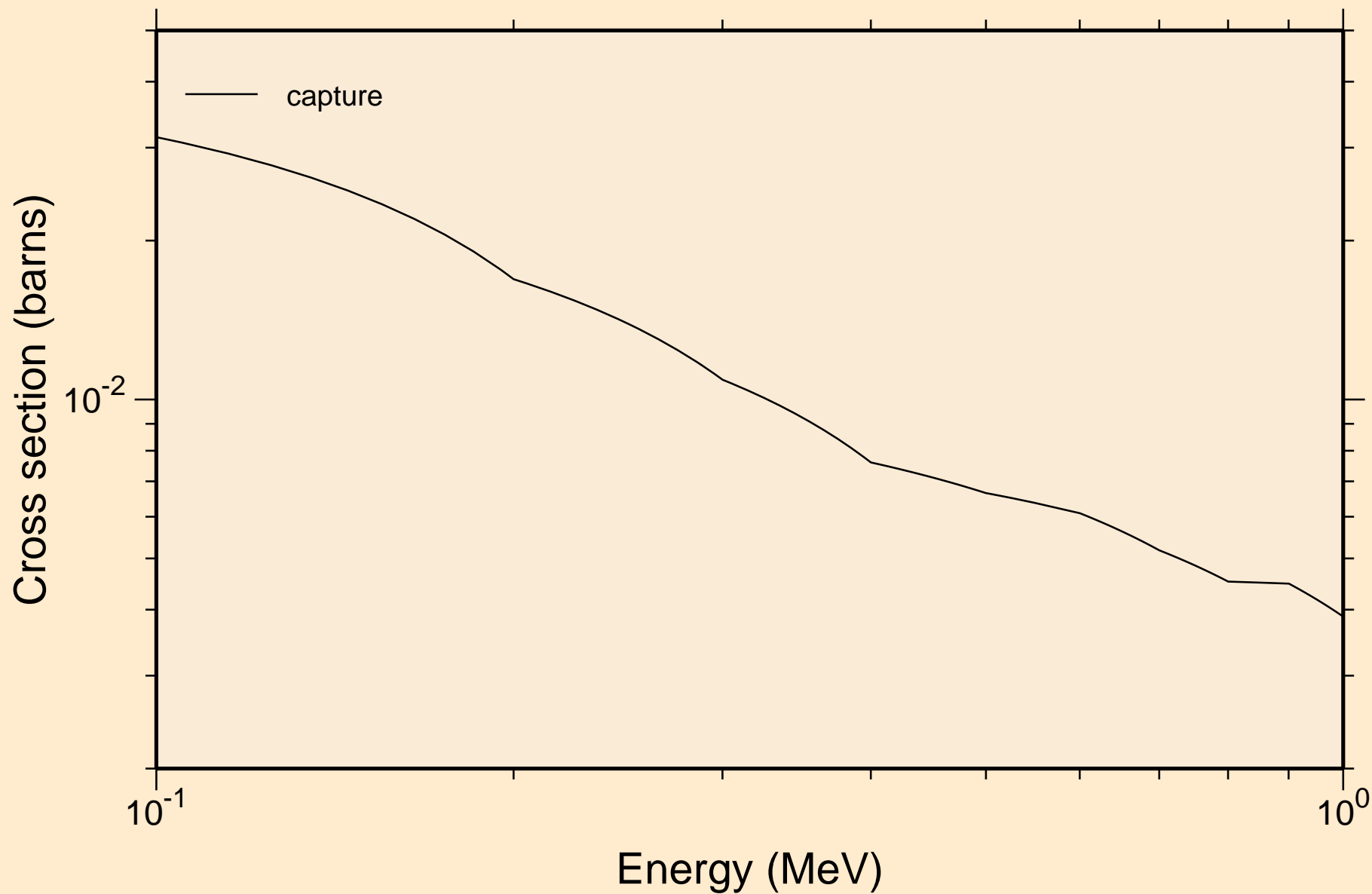



28-NI-61 FOR FENDL-3.2 FROM ENDF/B-VII BY NJOY2016.60+ ON  
resonance absorption cross sections

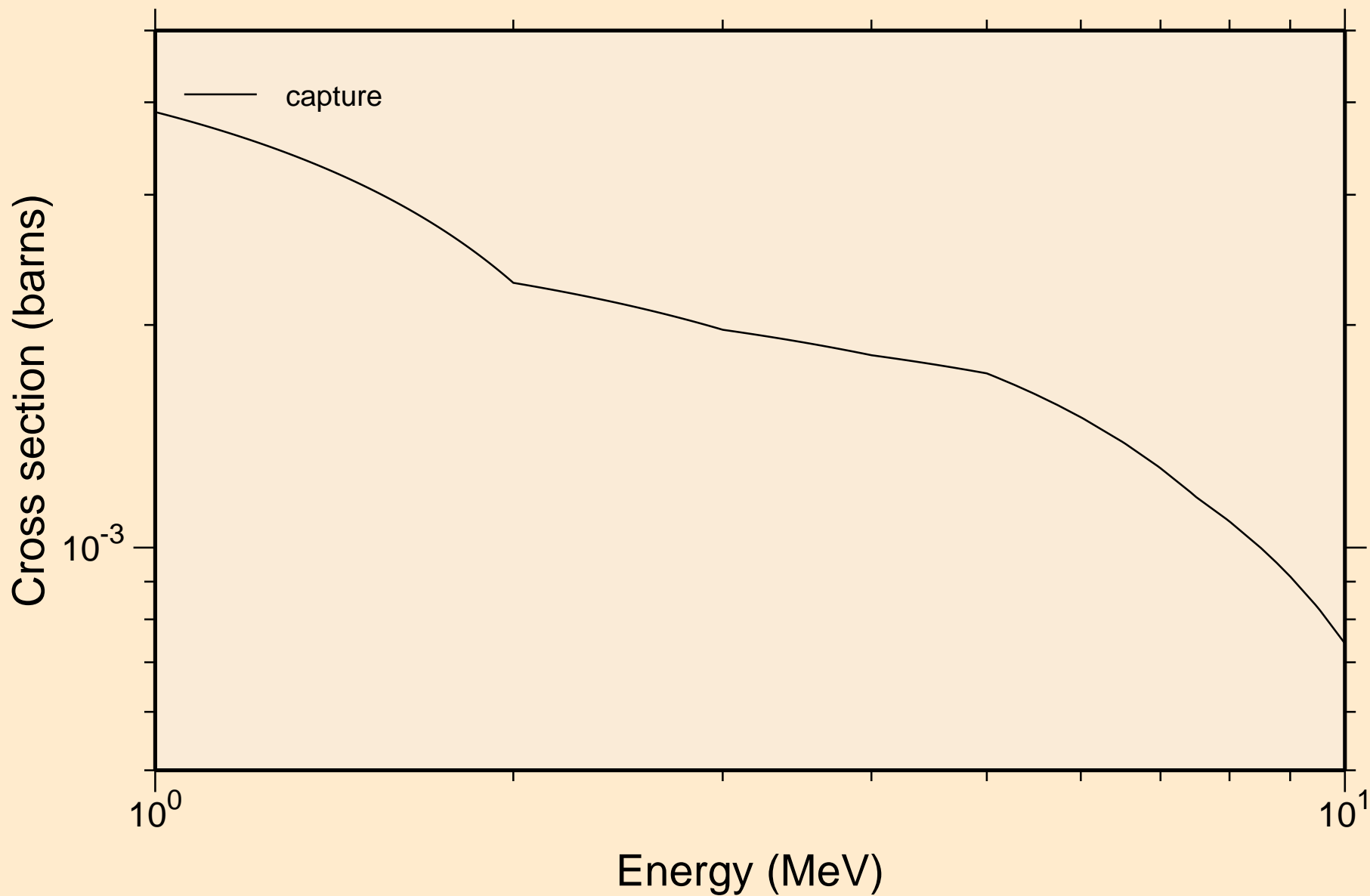

# 28-NI-61 FOR FENDL-3.2 FROM ENDF/B-VII BY NJOY2016.60+ ON Heating

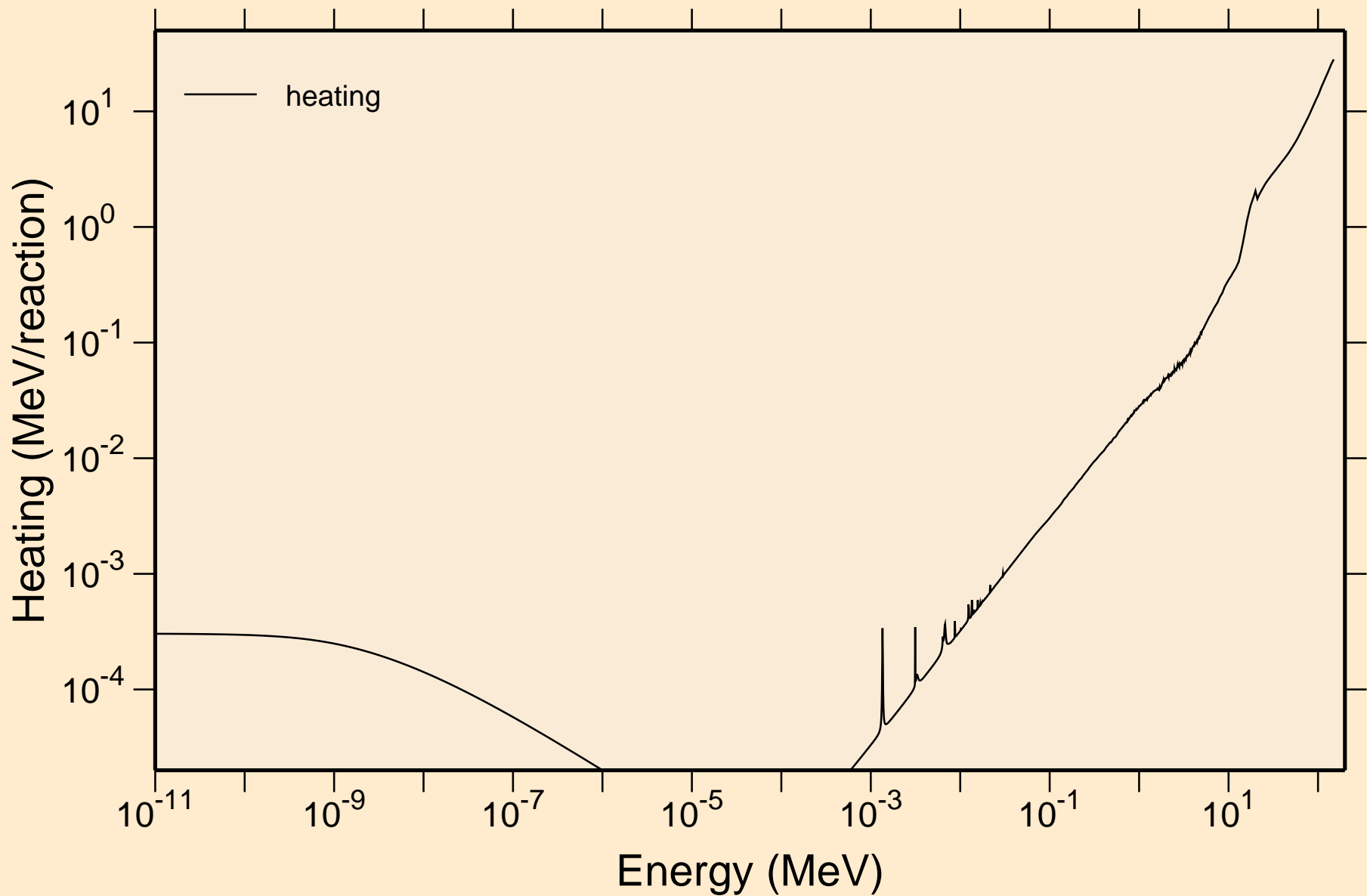

# 28-NI-61 FOR FENDL-3.2 FROM ENDF/B-VII BY NJOY2016.60+ ON Damage

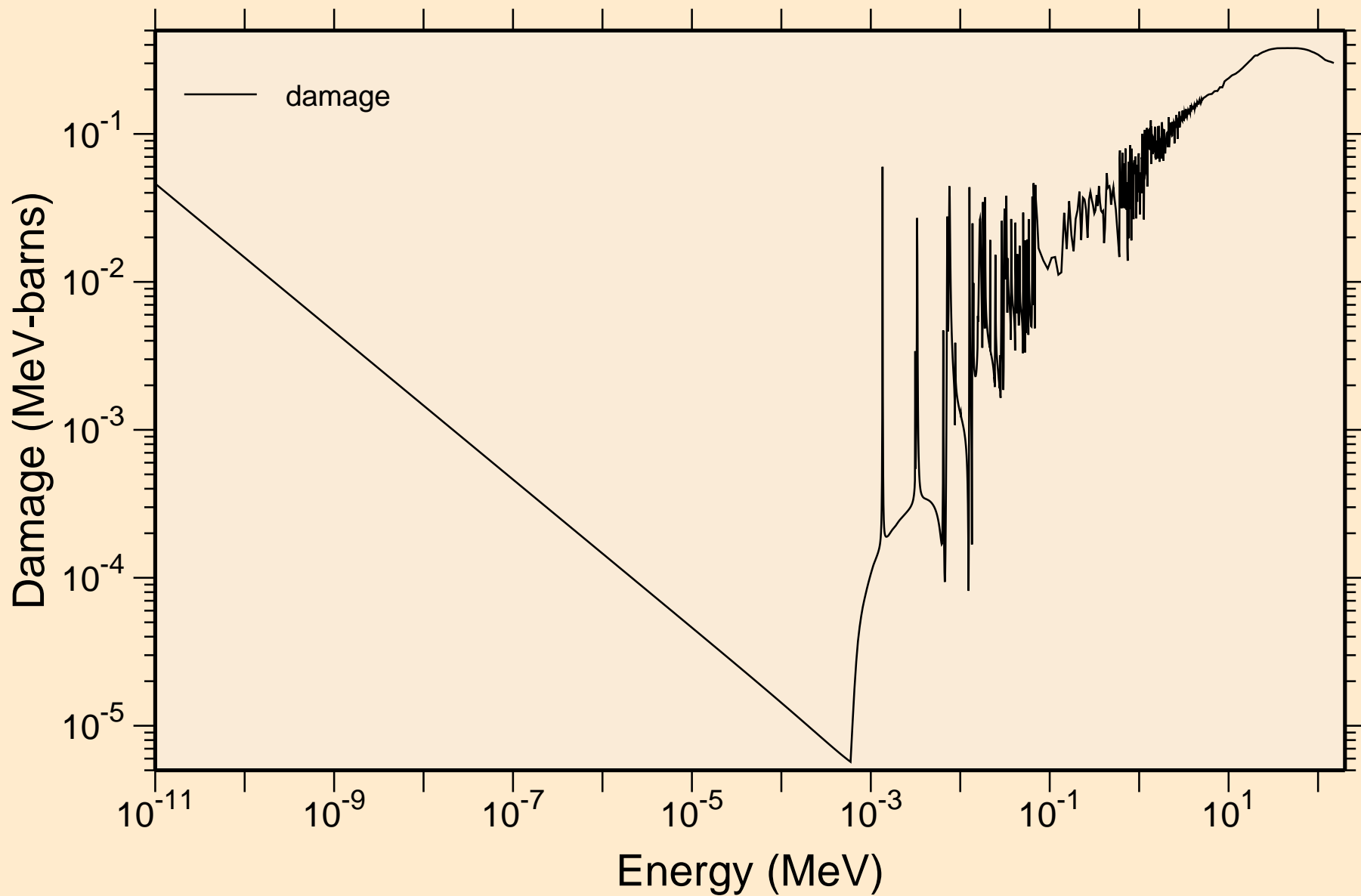

28-NI-61 FOR FENDL-3.2 FROM ENDF/B-VII BY NJOY2016.60+ ON  
Non-threshold reactions

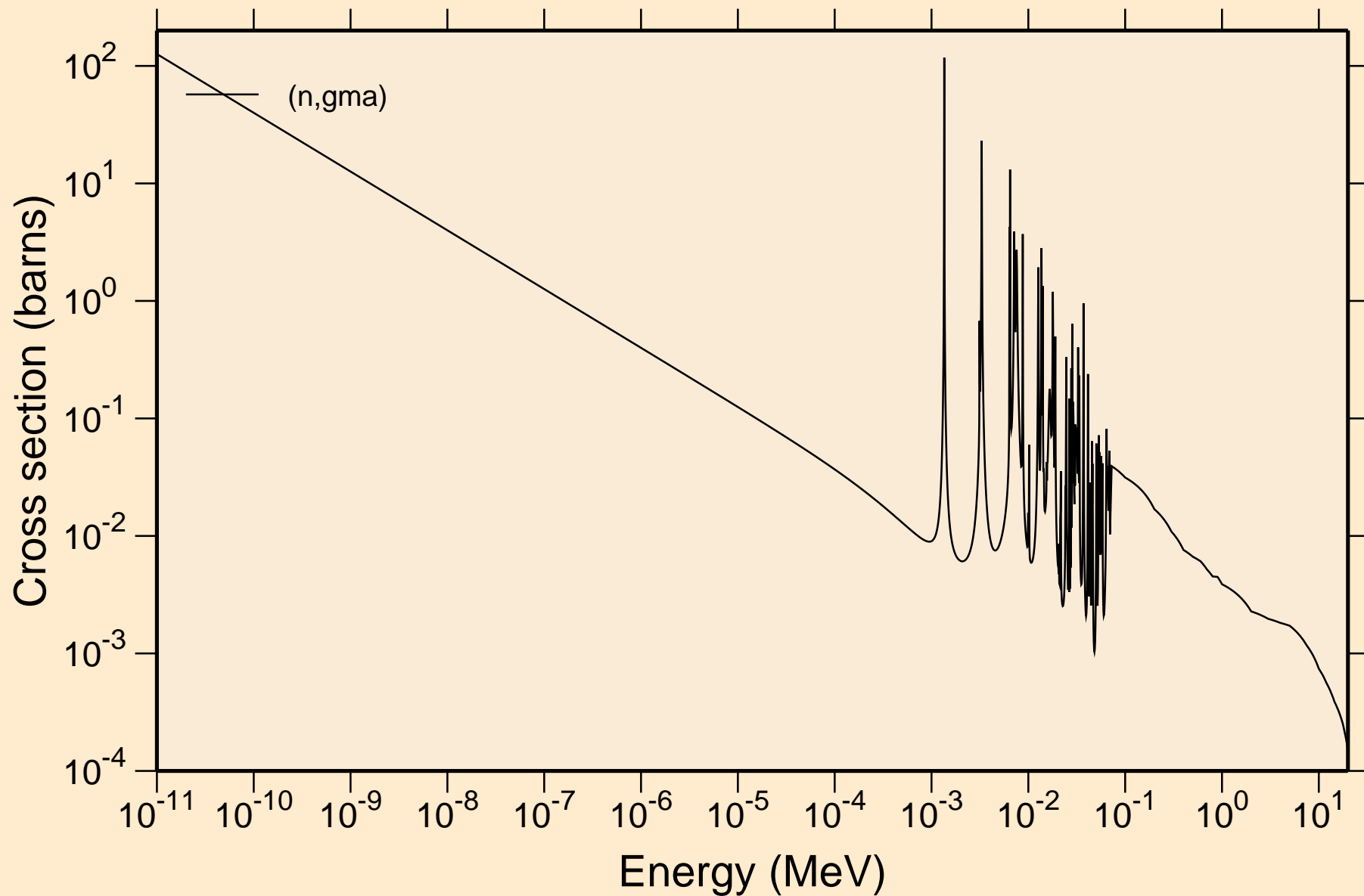

# 28-NI-61 FOR FENDL-3.2 FROM ENDF/B-VII BY NJOY2016.60+ ON

## Principal cross sections

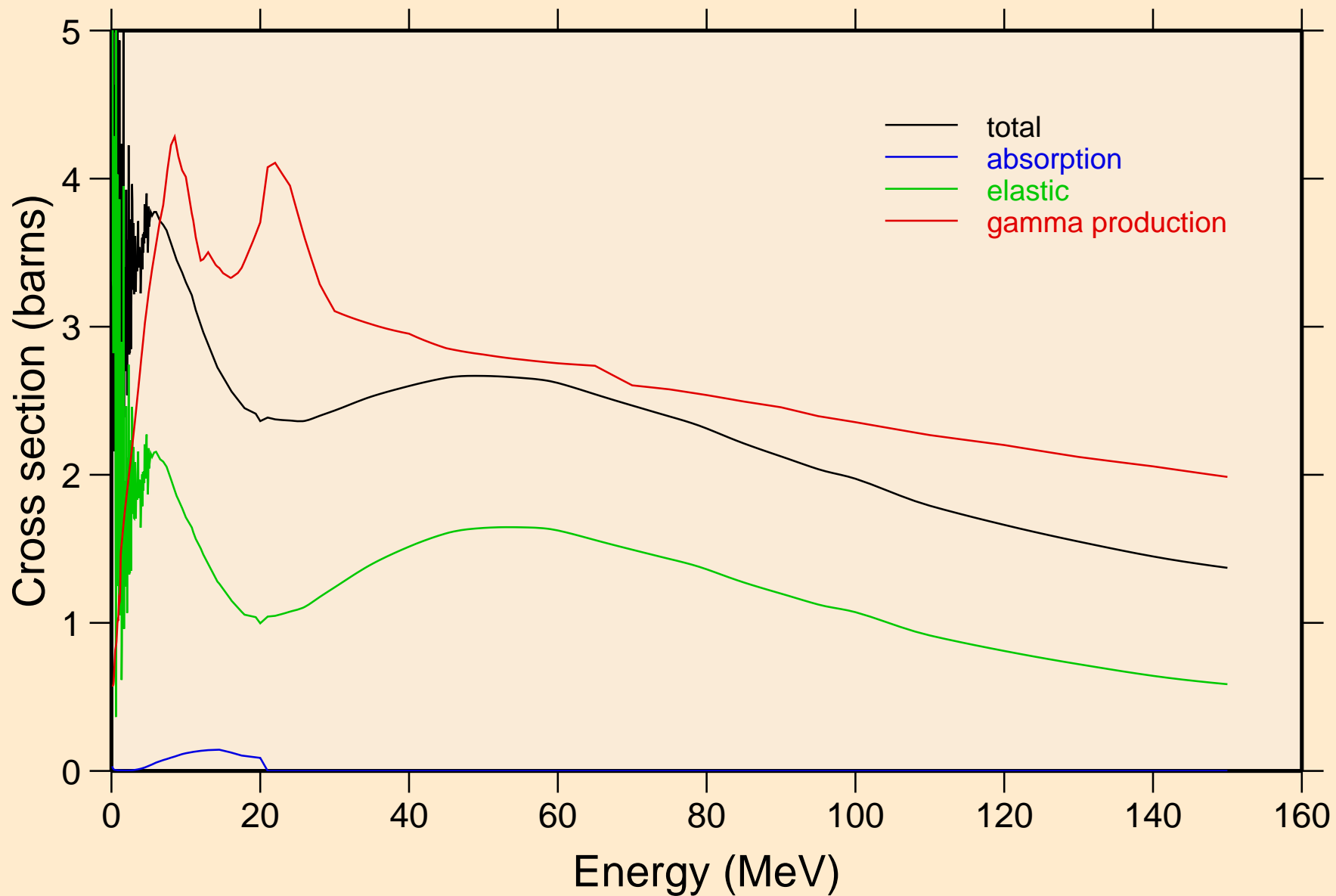

# 28-NI-61 FOR FENDL-3.2 FROM ENDF/B-VII BY NJOY2016.60+ ON Heating

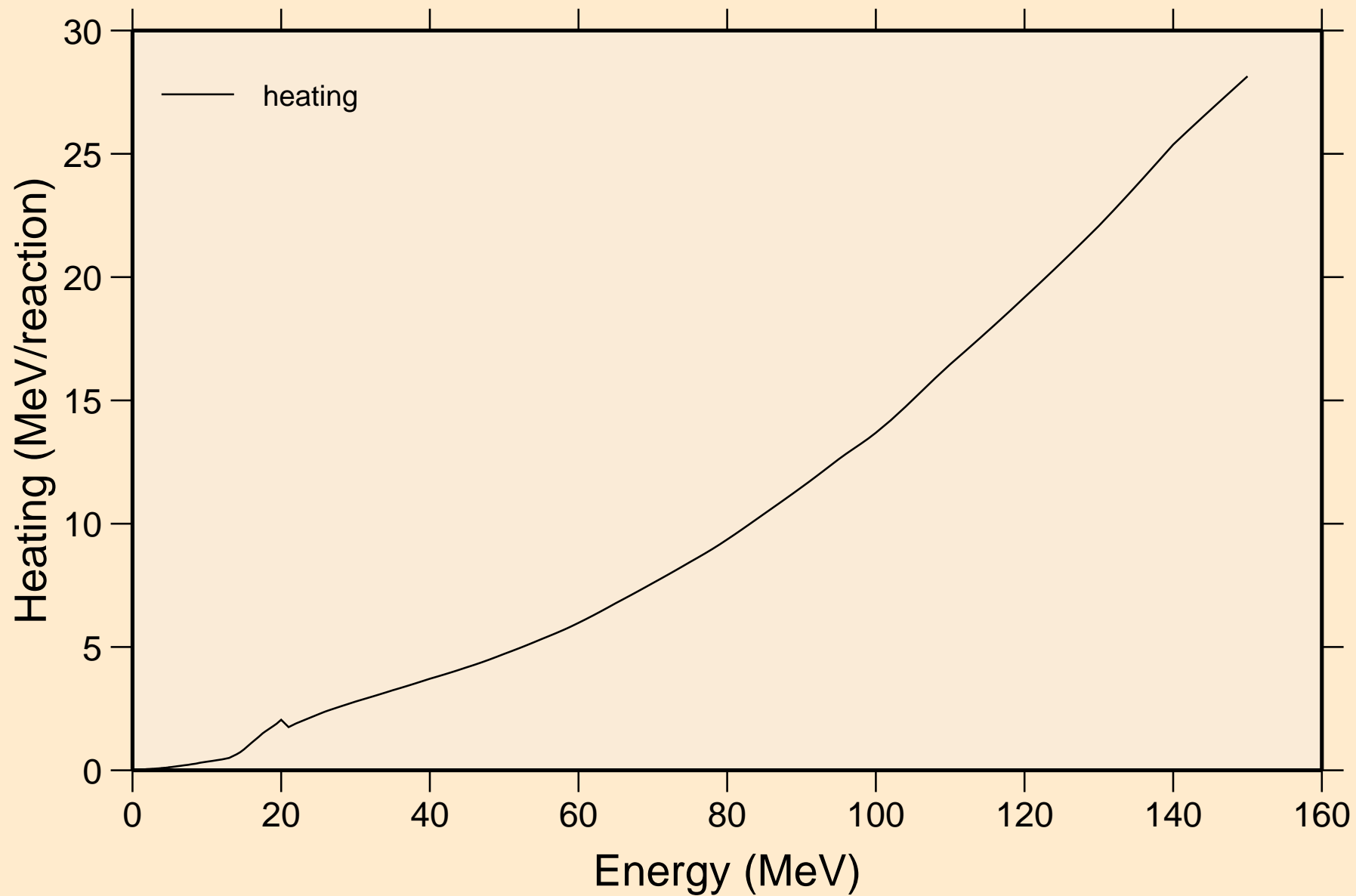

# 28-NI-61 FOR FENDL-3.2 FROM ENDF/B-VII BY NJOY2016.60+ ON Damage

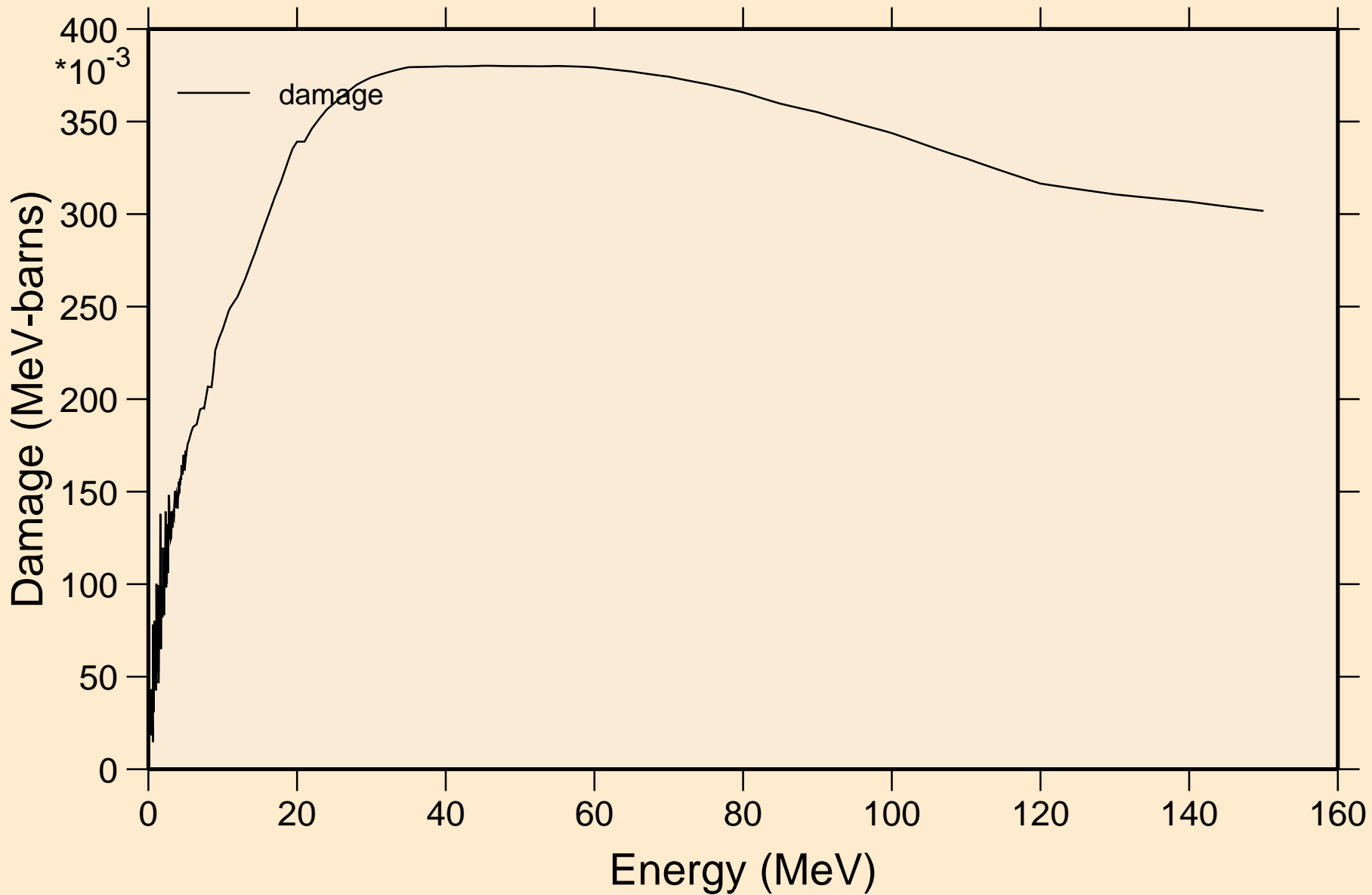

28-NI-61 FOR FENDL-3.2 FROM ENDF/B-VII BY NJOY2016.60+ ON  
Non-threshold reactions

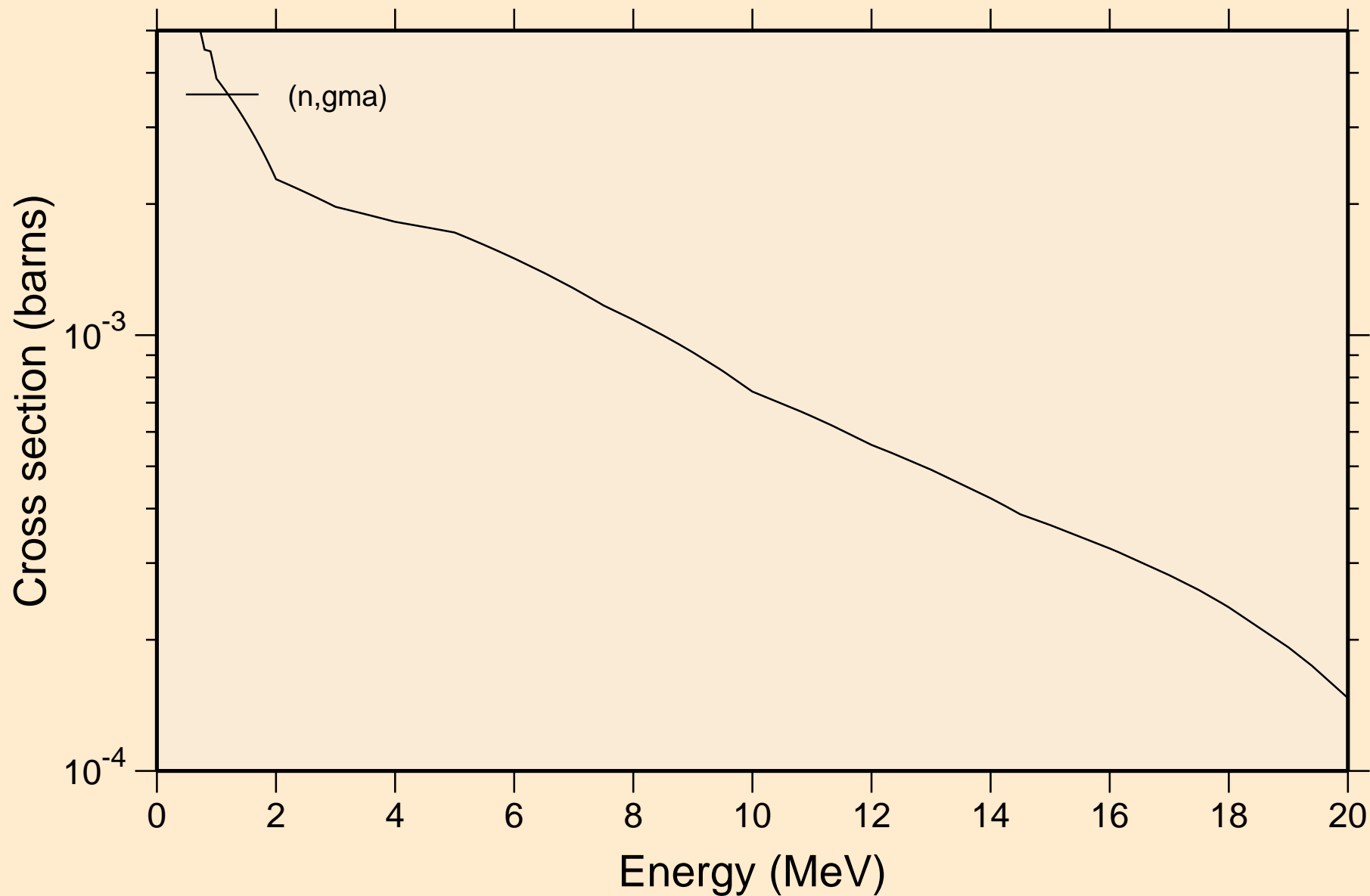



# 28-NI-61 FOR FENDL-3.2 FROM ENDF/B-VII BY NJOY2016.60+ ON Inelastic levels

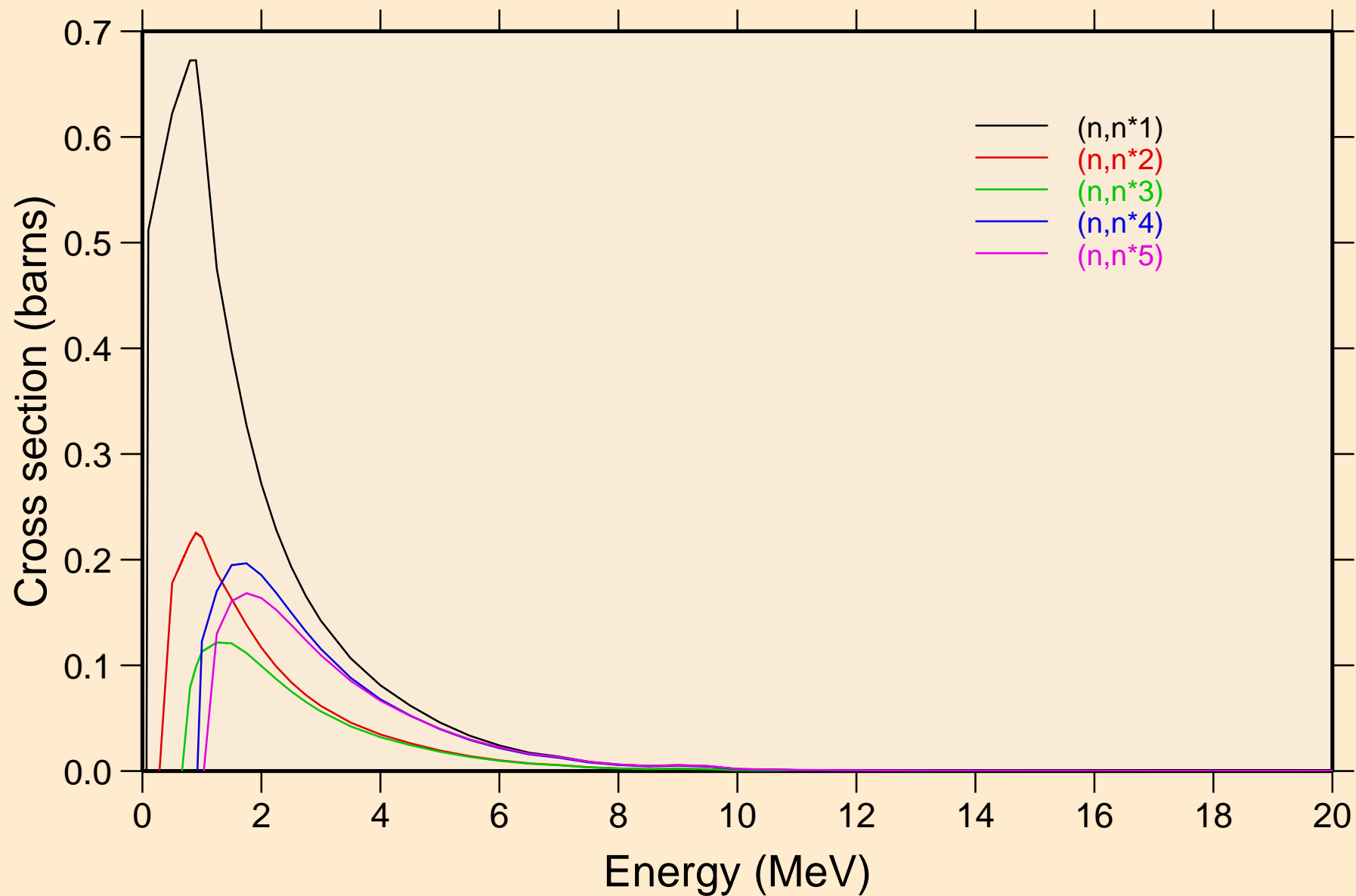

28-NI-61 FOR FENDL-3.2 FROM ENDF/B-VII BY NJOY2016.60+ ON  
Inelastic levels

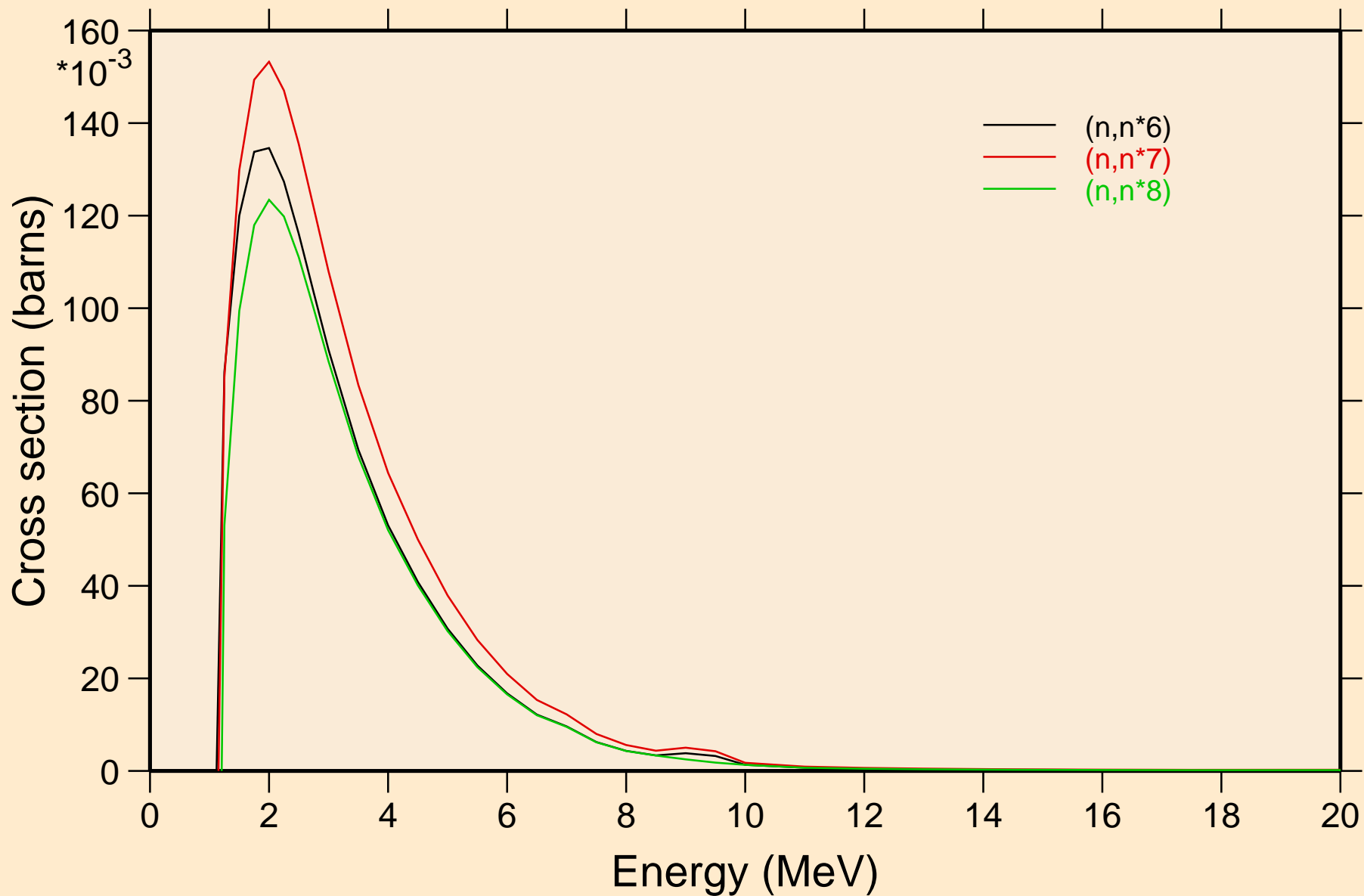

# 28-NI-61 FOR FENDL-3.2 FROM ENDF/B-VII BY NJOY2016.60+ ON Threshold reactions

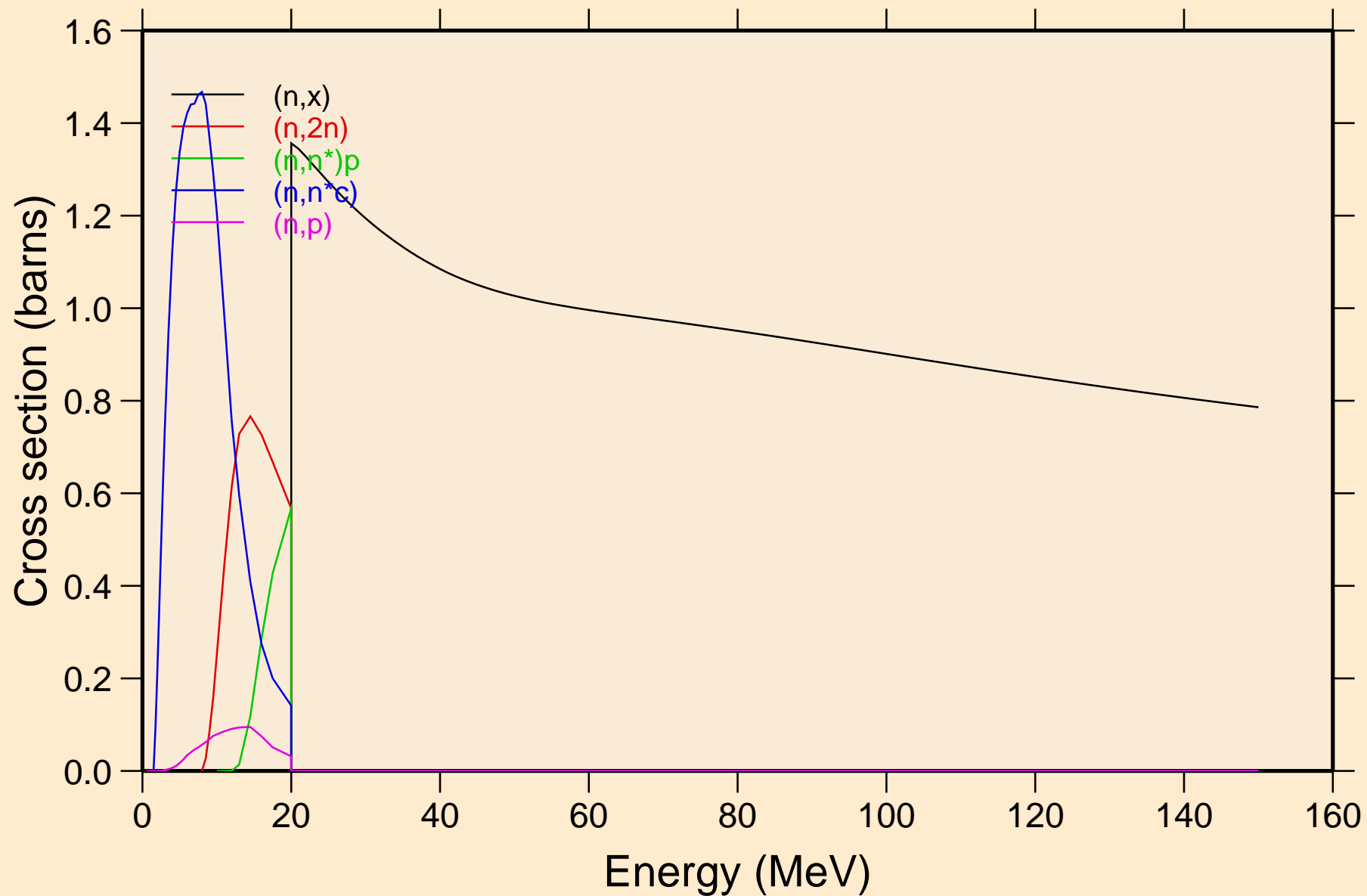

# 28-NI-61 FOR FENDL-3.2 FROM ENDF/B-VII BY NJOY2016.60+ ON Threshold reactions

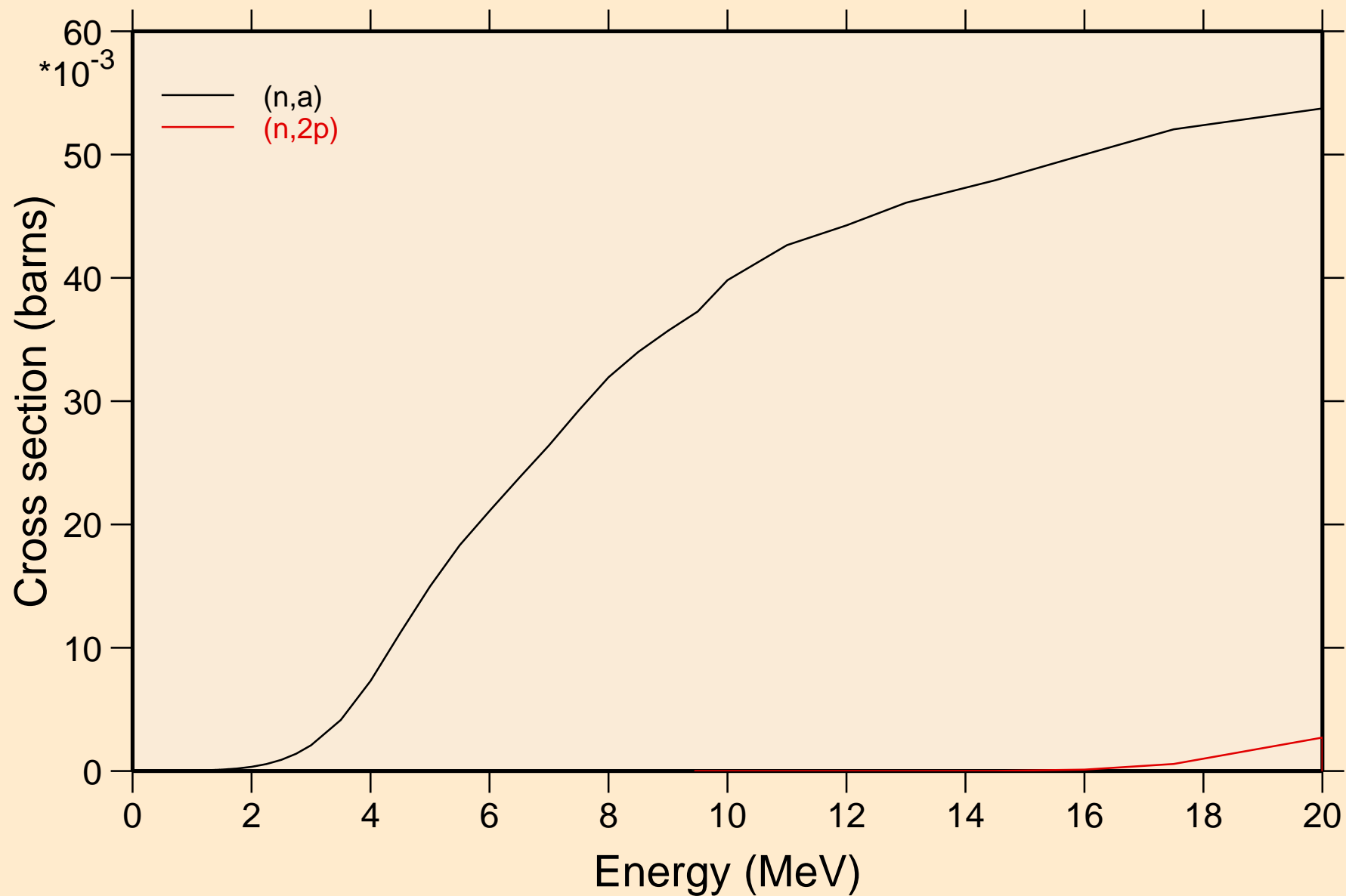

# 28-NI-61 FOR FENDL-3.2 FROM ENDF/B-VII BY NJOY2016.60+ ON Threshold reactions

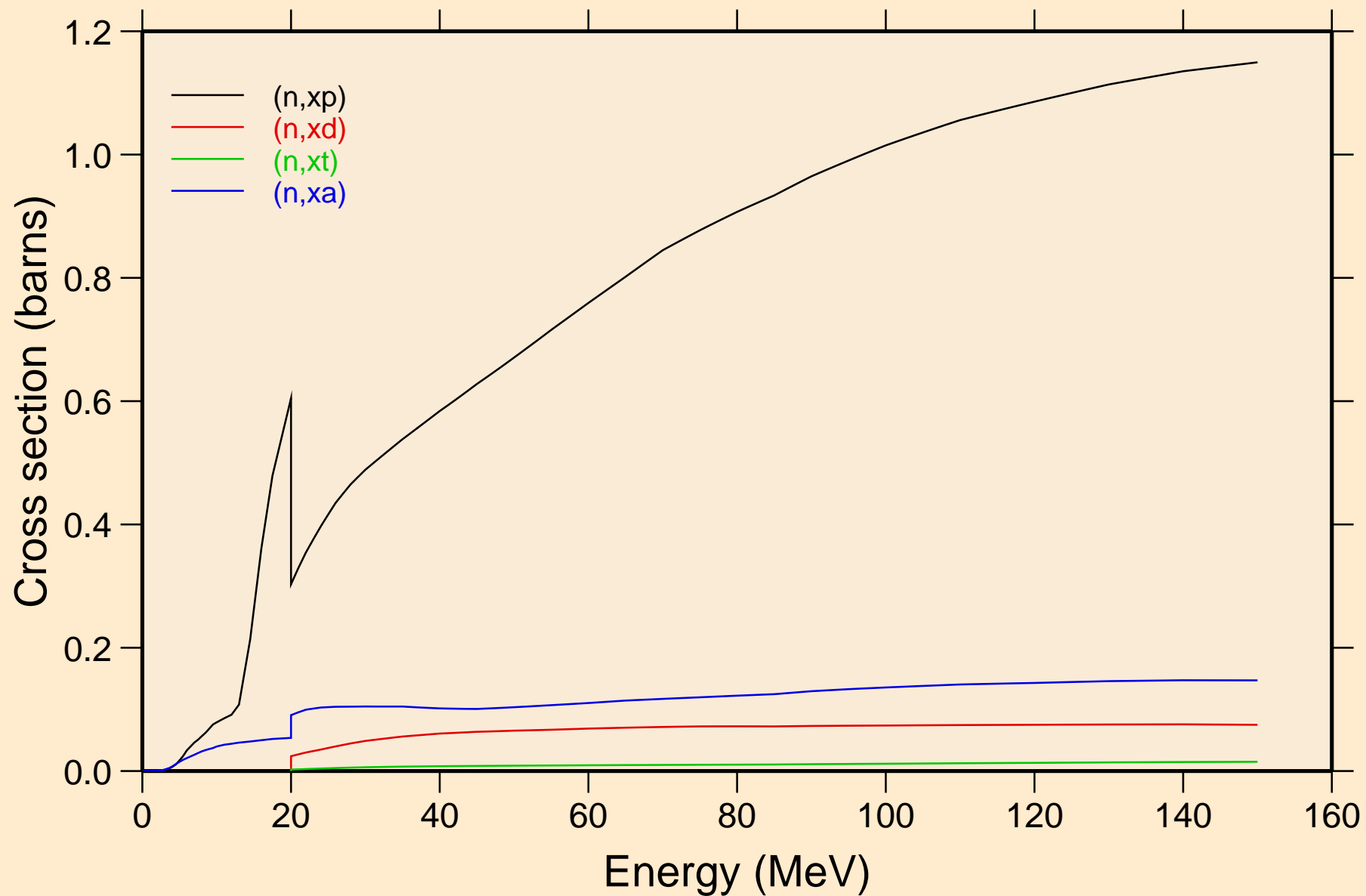

28-NI-61 FOR FENDL-3.2 FROM ENDF/B-VII BY NJOY2016.60+ ON  
angular distribution for elastic

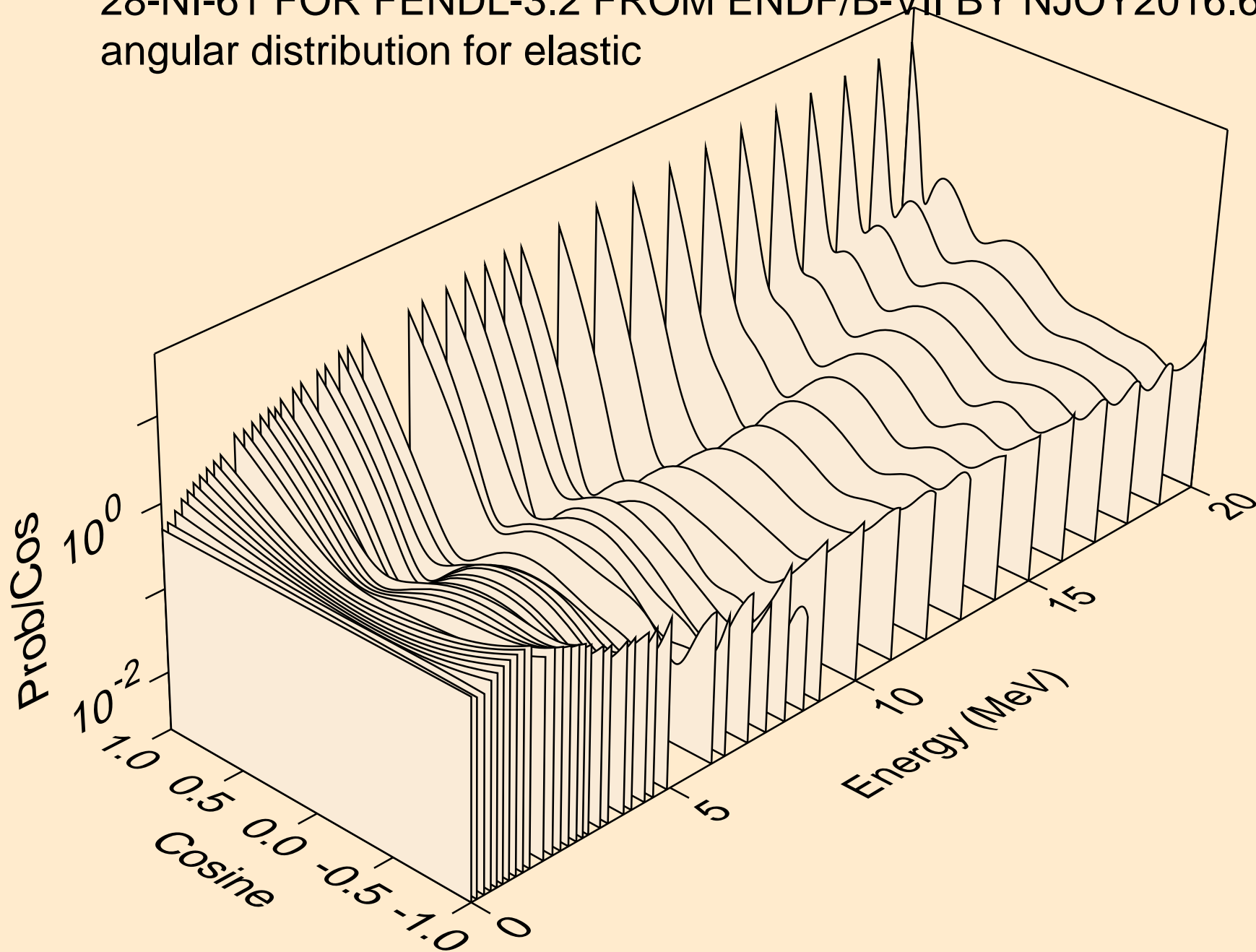

28-NI-61 FOR FENDL-3.2 FROM ENDF/B-VII BY NJOY2016.60+ ON  
angular distribution for elastic

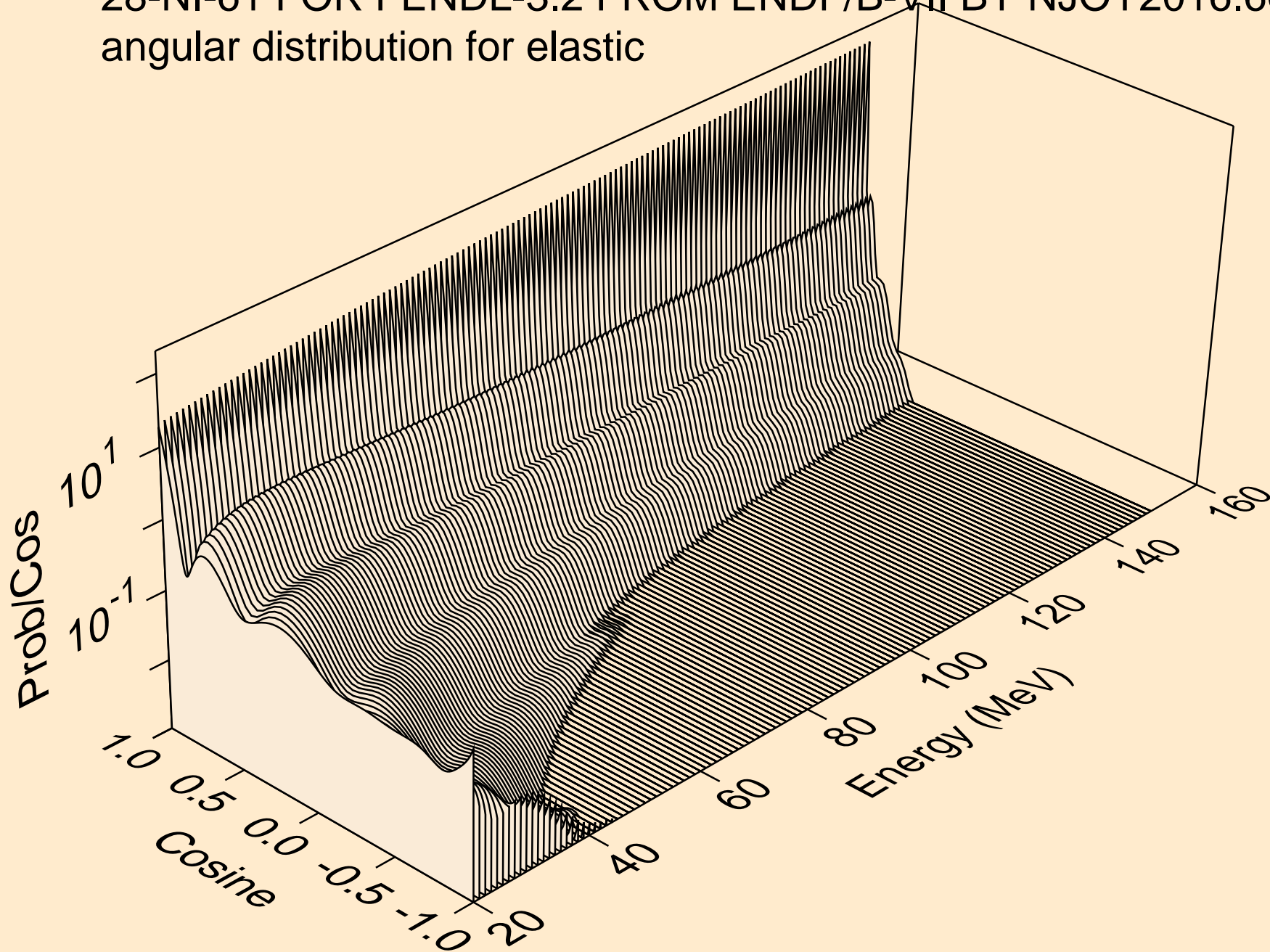

28-NI-61 FOR FENDL-3.2 FROM ENDF/B-VII BY NJOY2016.60+ ON  
Neutron emission for (n,x)

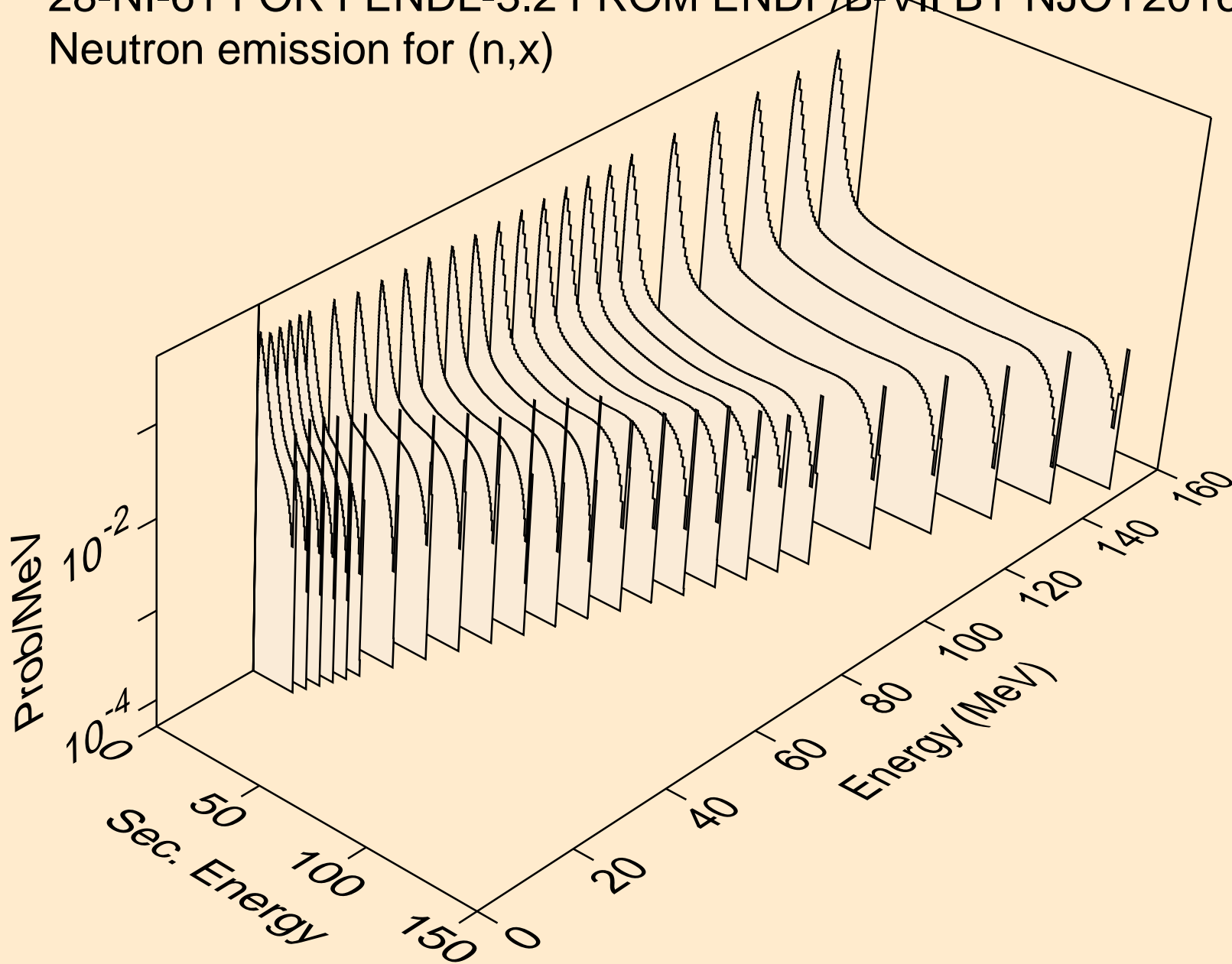



28-NI-61 FOR FENDL-3.2 FROM ENDF/B-VII BY NJOY2016.60+ ON  
Neutron emission for (n,2n)

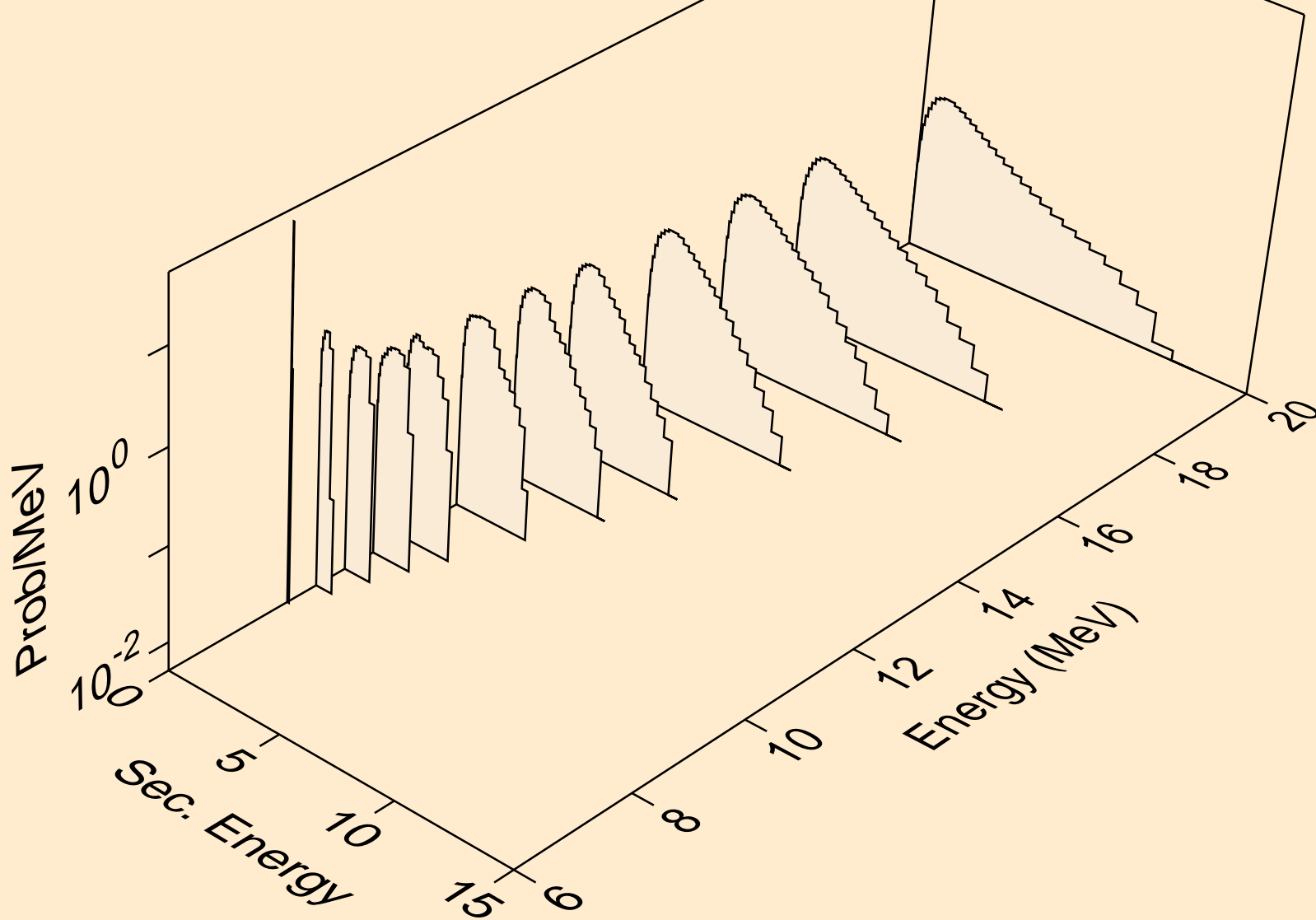

28-NI-61 FOR FENDL-3.2 FROM ENDF/B-VII BY NJOY2016.60+ ON  
Neutron emission for (n,n\*)p

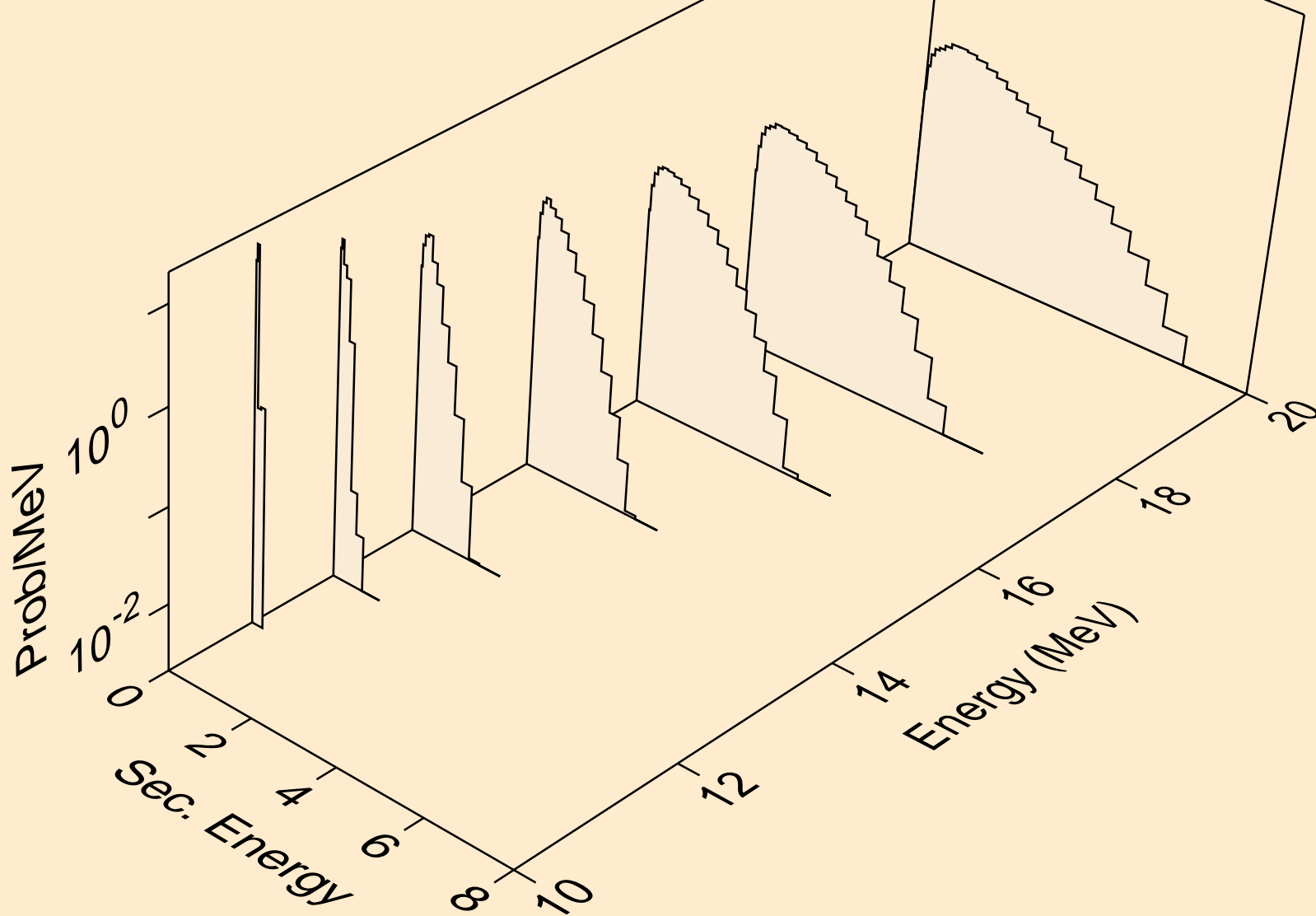

28-NI-61 FOR FENDL-3.2 FROM ENDF/B-VII BY NJOY2016.60+ ON  
Neutron emission for (n,n\*c)

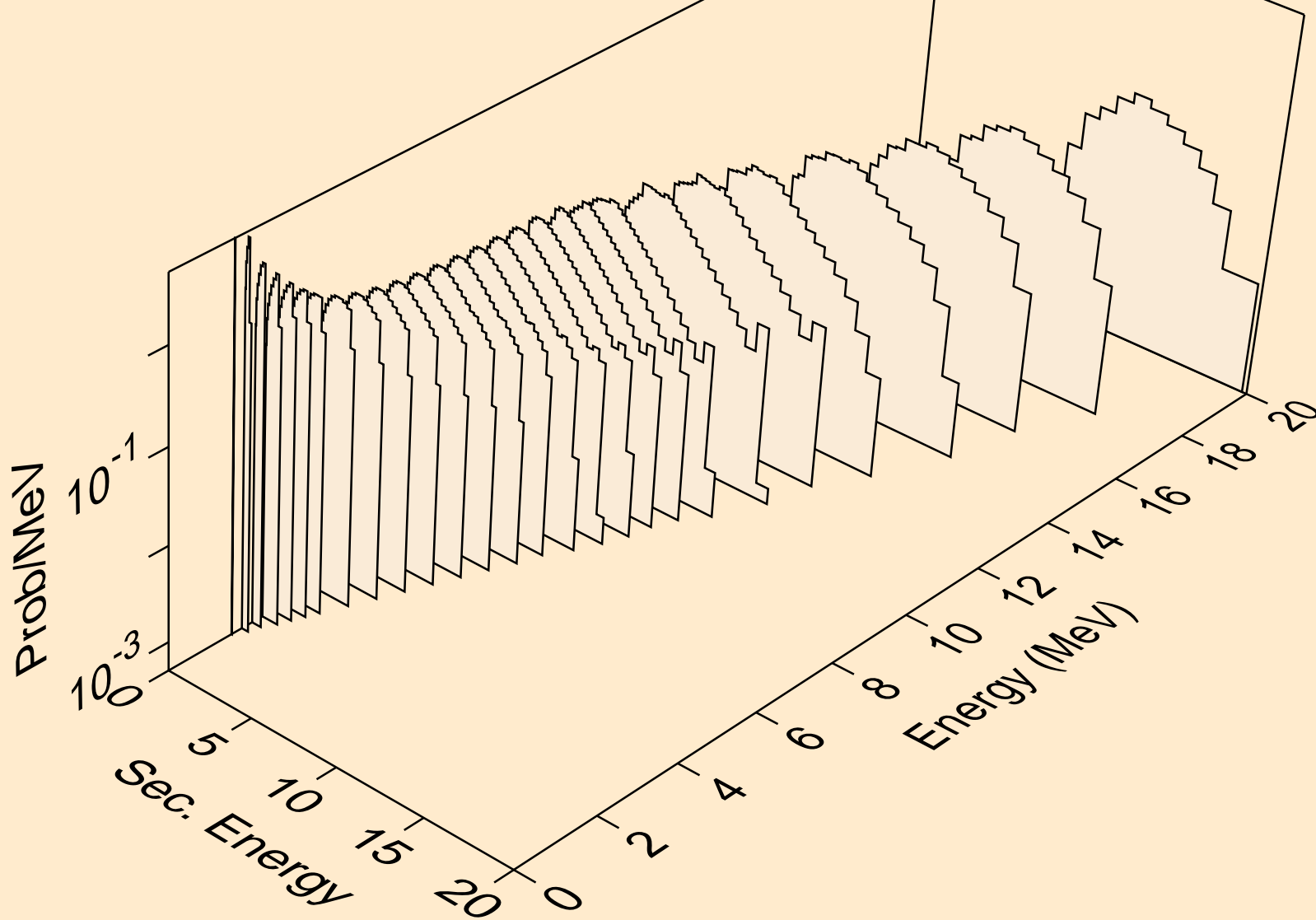

28-NI-61 FOR FENDL-3.2 FROM ENDF/B-VII BY NJOY2016.60+ ON  
Photon emission for (n,gma)

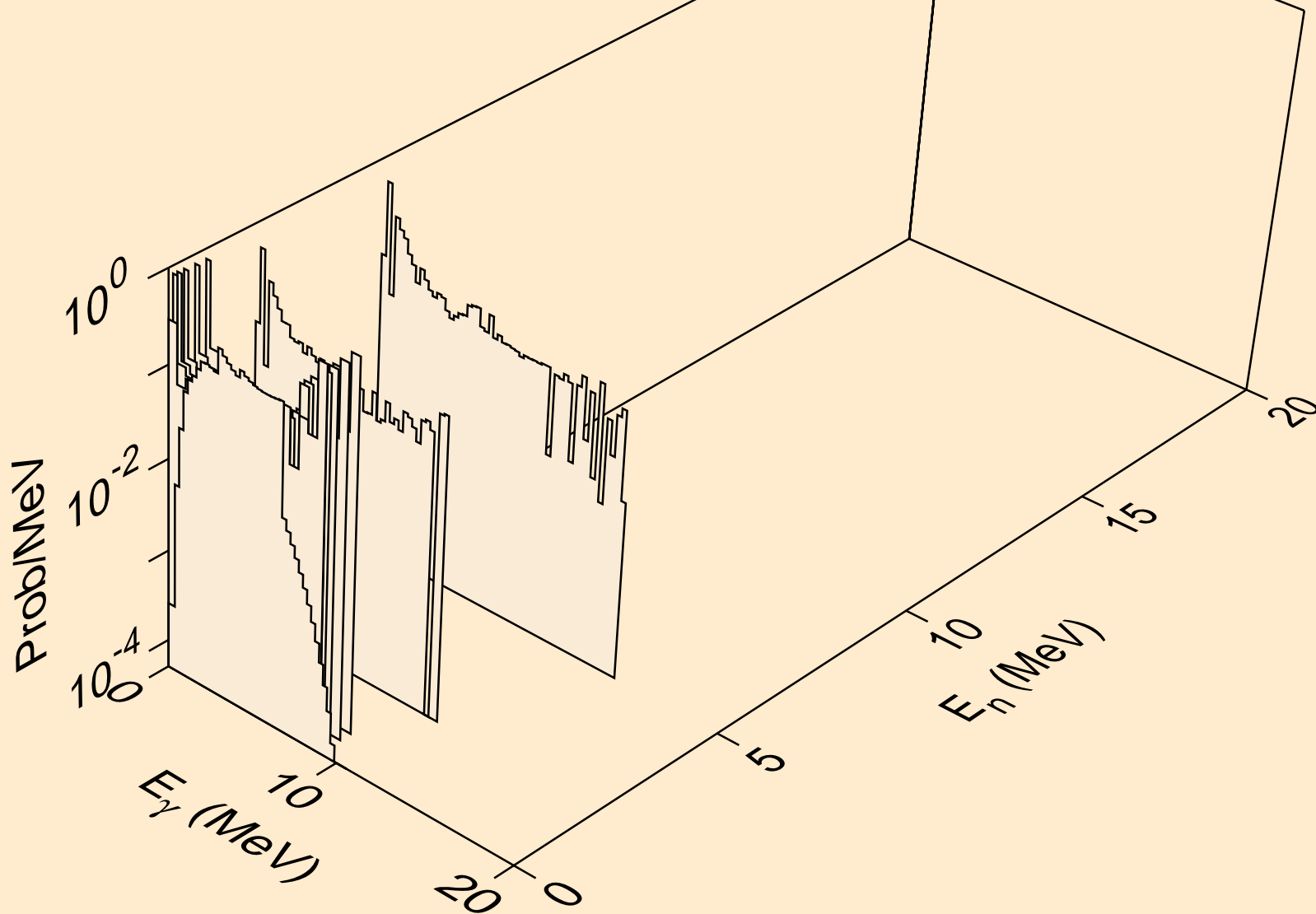

28-NI-61 FOR FENDL-3.2 FROM ENDF/B-VII BY NJOY2016.60+ ON  
Photon emission for (n,x)

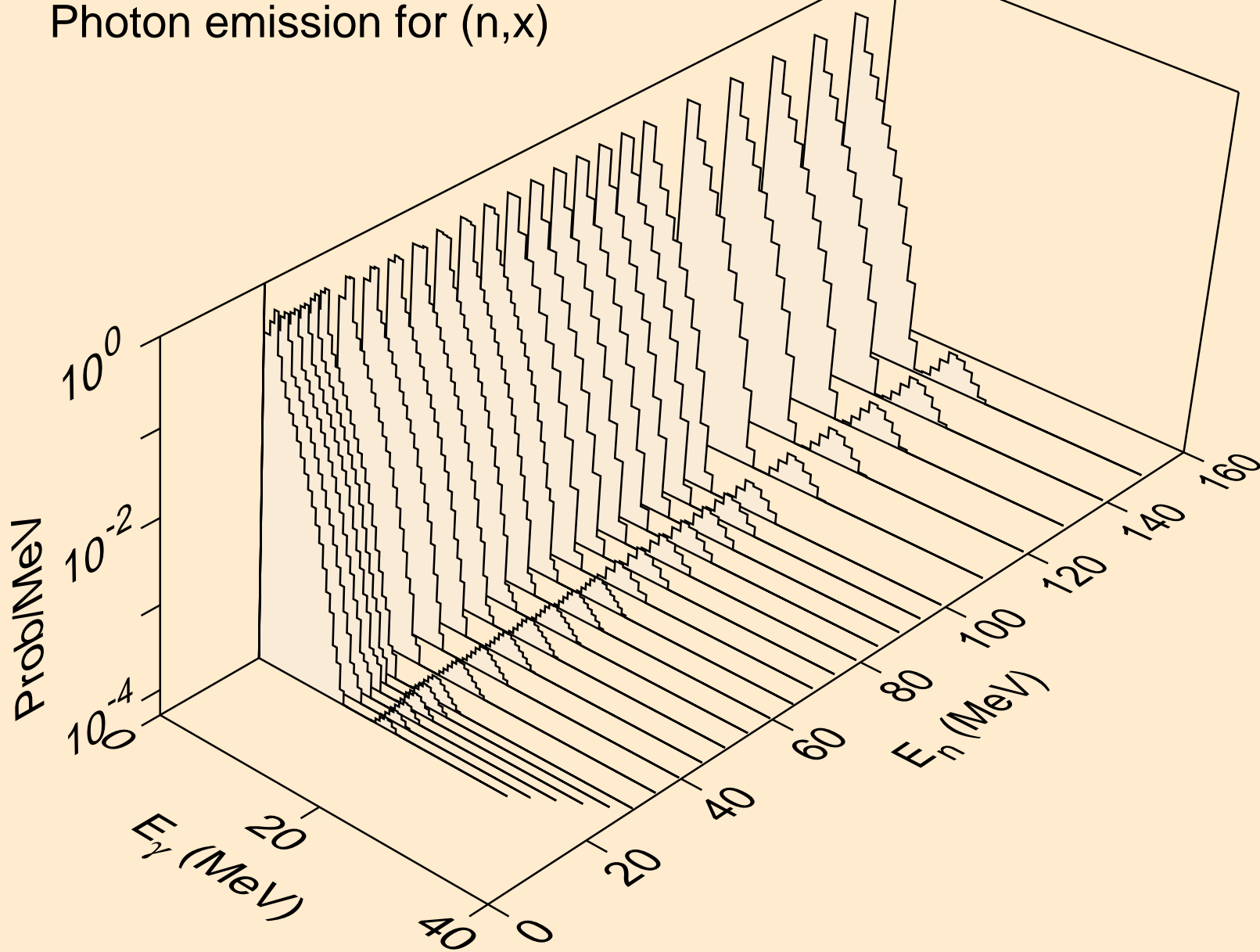

28-NI-61 FOR FENDL-3.2 FROM ENDF/B-VII BY NJOY2016.60+ ON  
Photon emission for (n,2n)

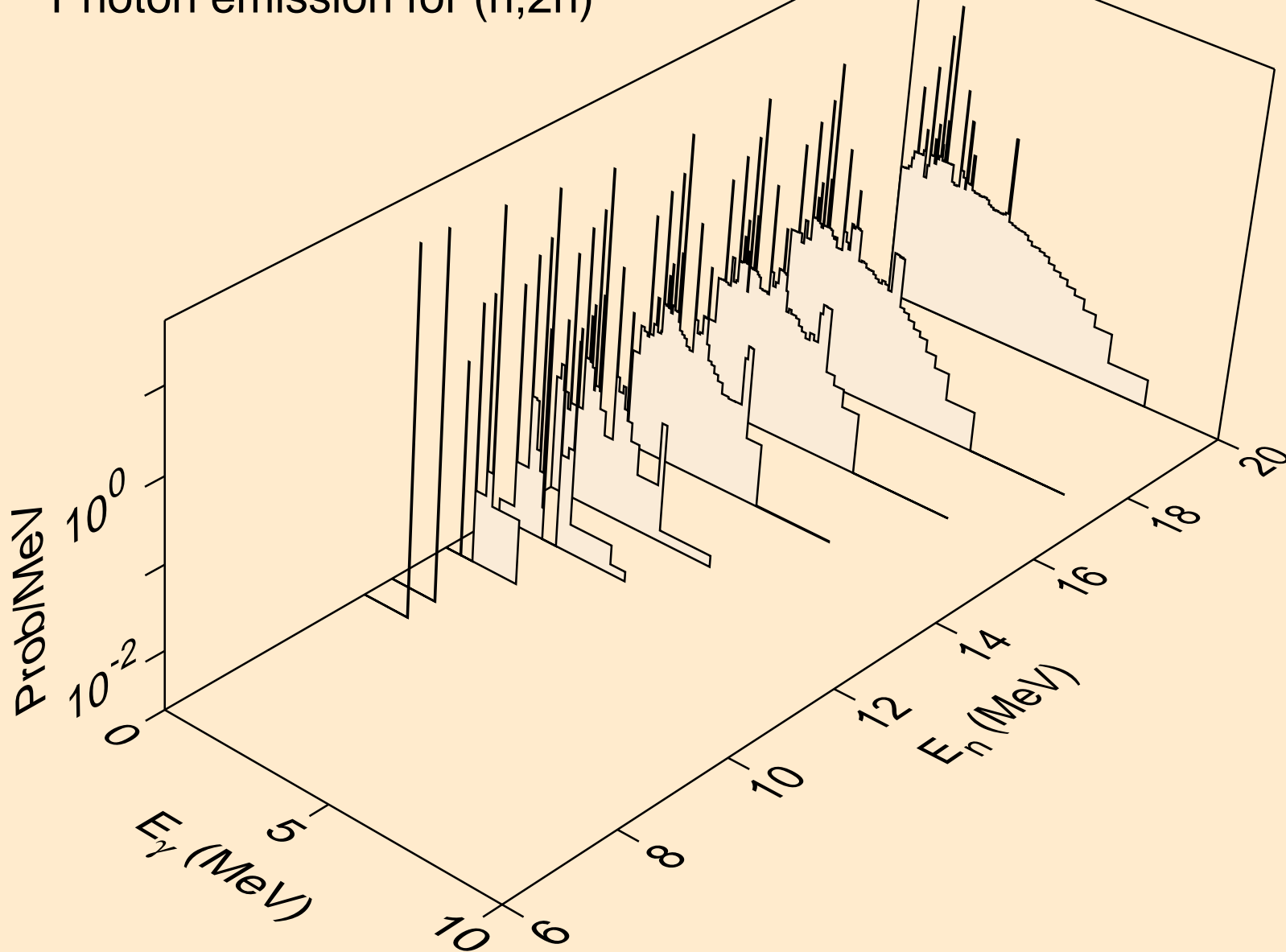

28-NI-61 FOR FENDL-3.2 FROM ENDF/B-VII BY NJOY2016.60+ ON  
Photon emission for (n,n\*)p

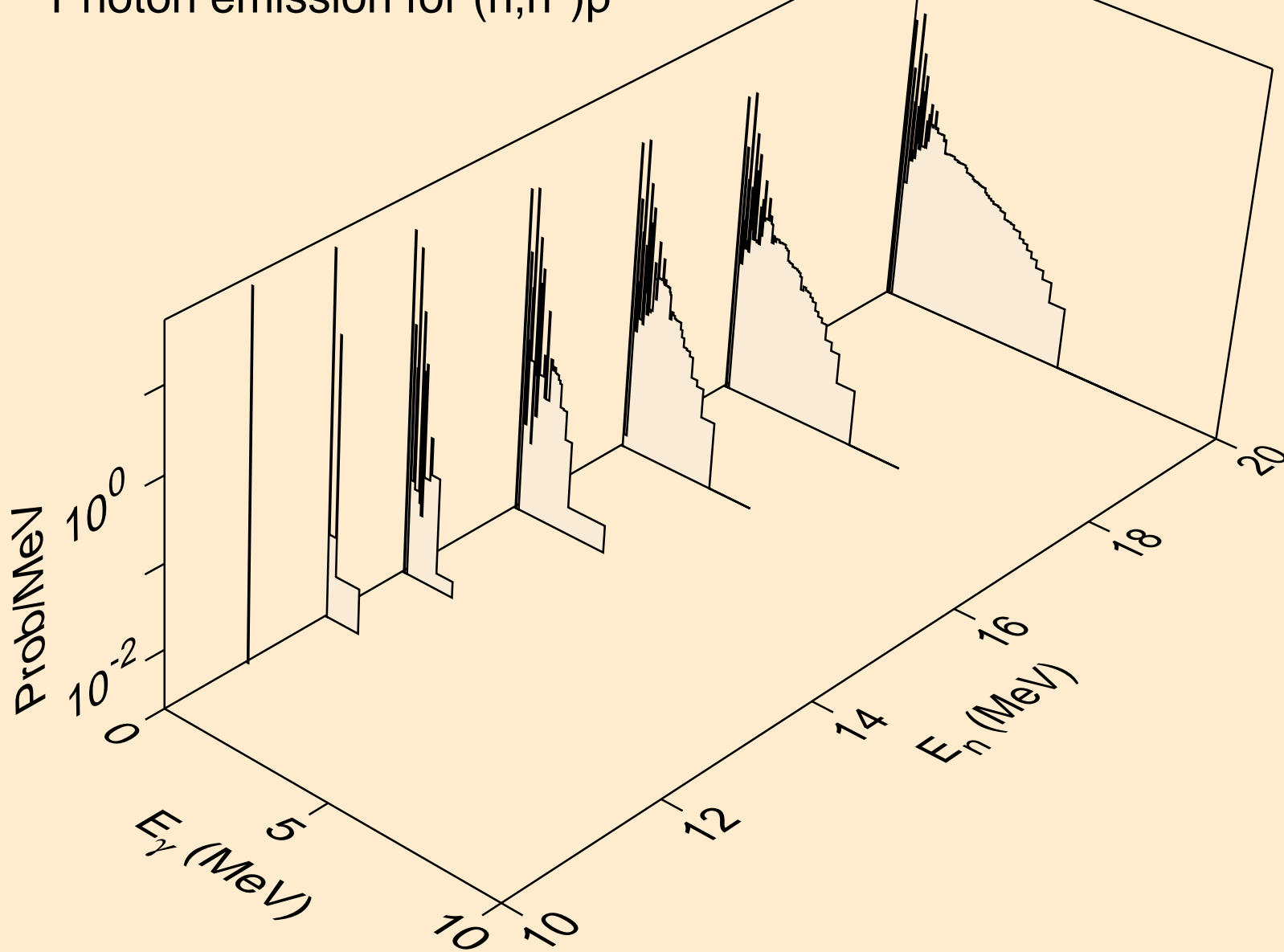

28-NI-61 FOR FENDL-3.2 FROM ENDF/B-VII BY NJOY2016.60+ ON  
Photon emission for (n,n\*c)

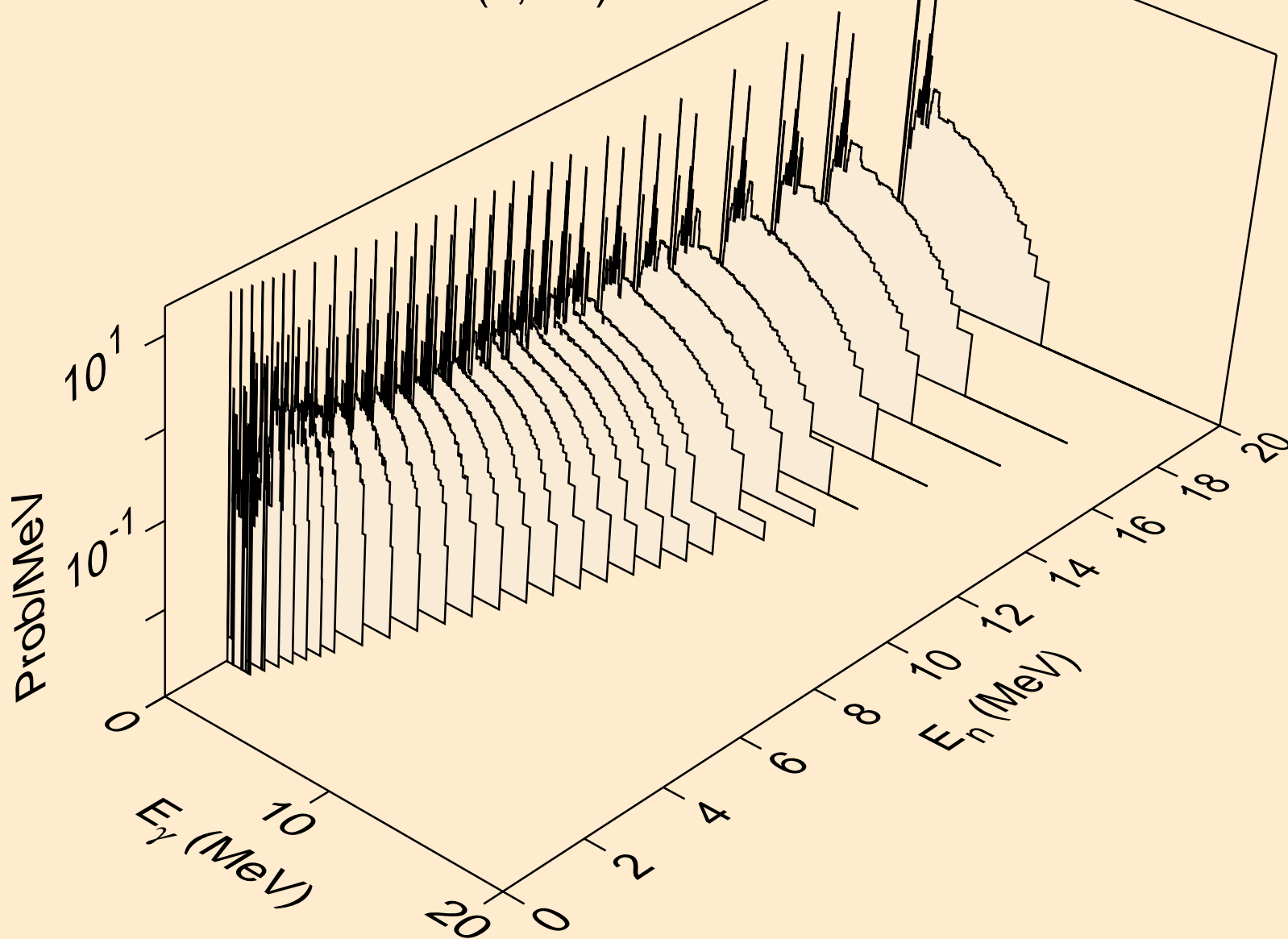



28-NI-61 FOR FENDL-3.2 FROM ENDF/B-VII BY NJOY2016.60+ ON  
Photon emission for (n,p)

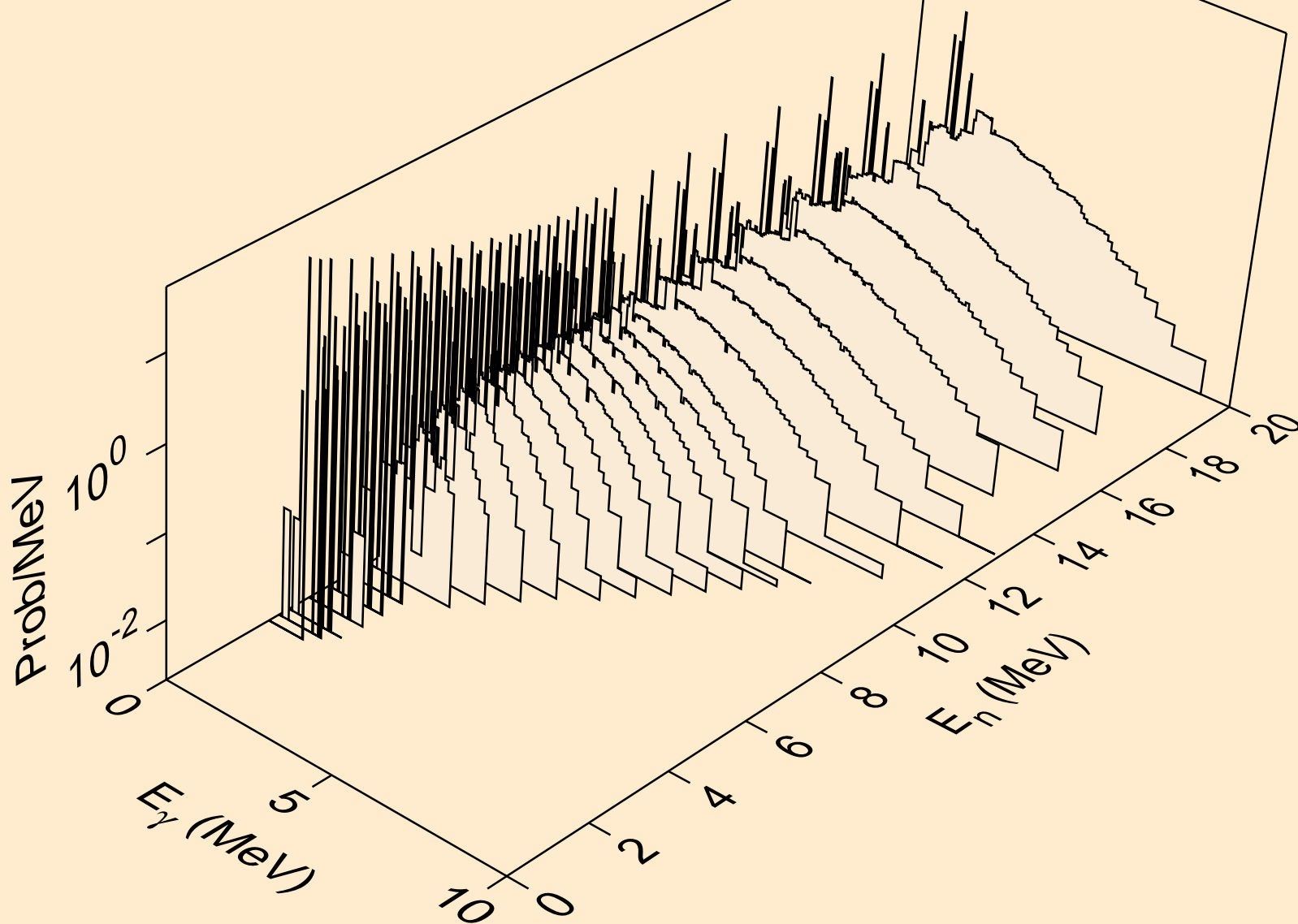

28-NI-61 FOR FENDL-3.2 FROM ENDF/B-VII BY NJOY2016.60+ ON  
Photon emission for (n,a)

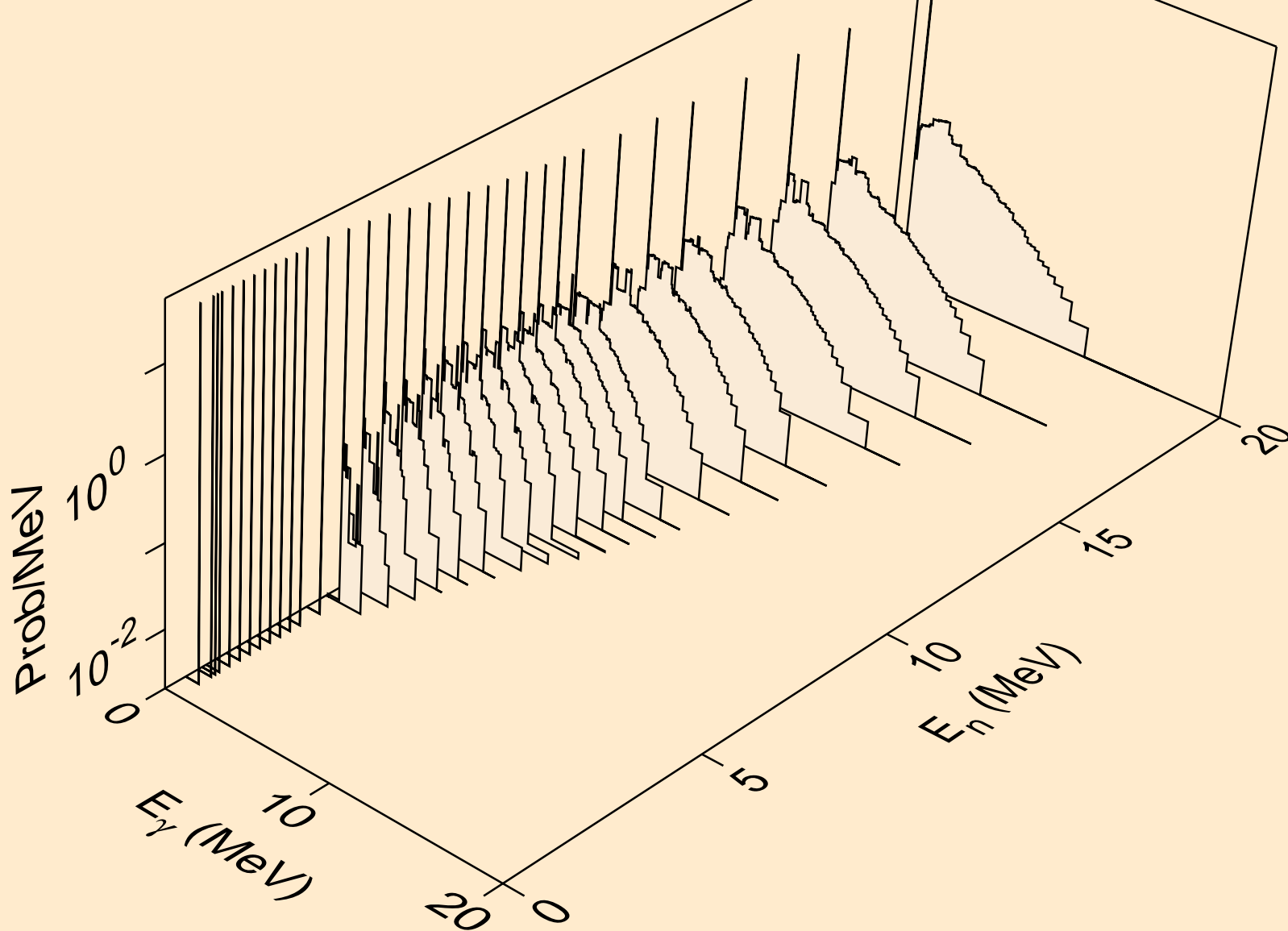

28-NI-61 FOR FENDL-3.2 FROM ENDF/B-VII BY NJOY2016.60+ ON  
thermal capture photon spectrum

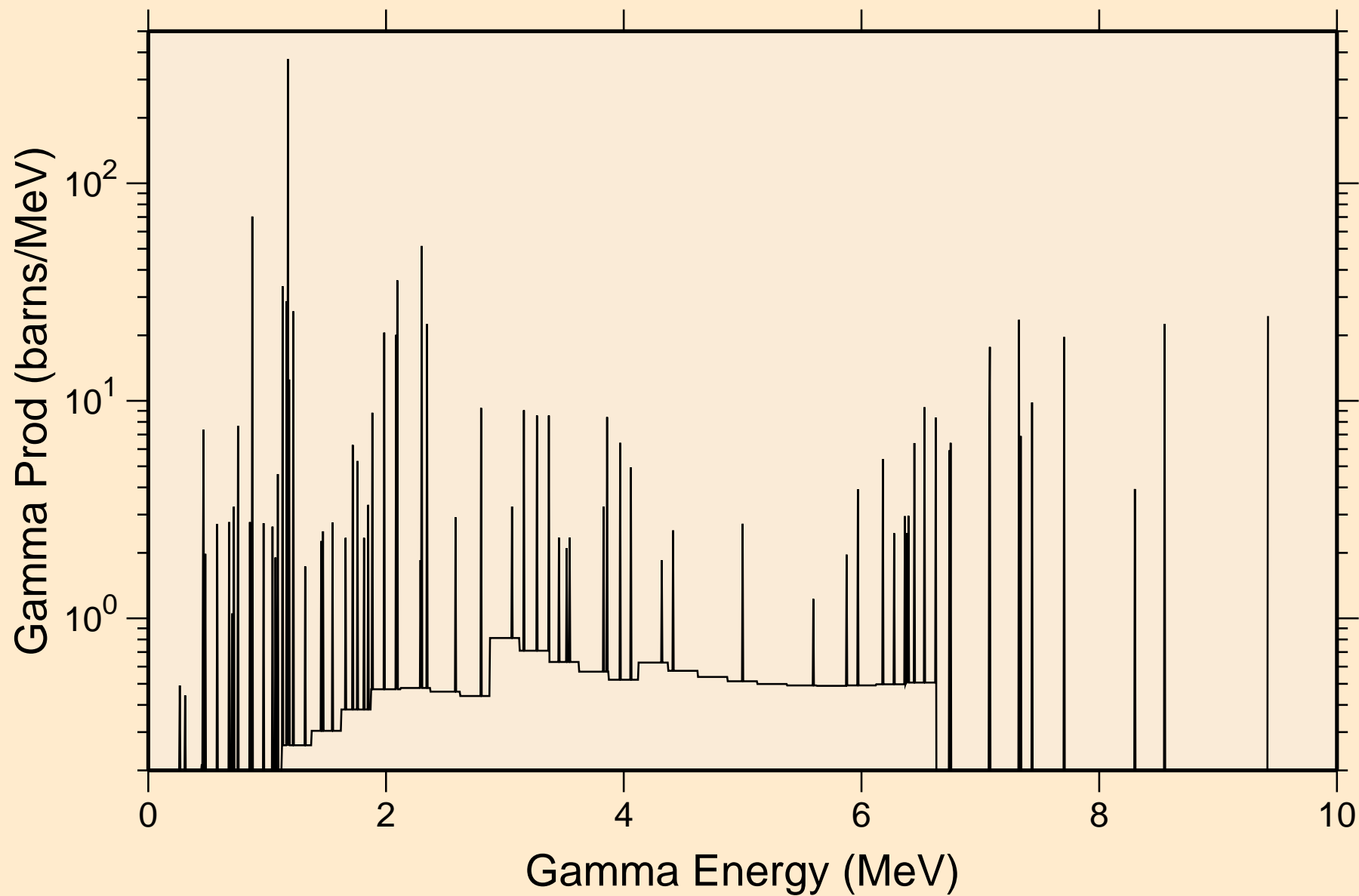

28-NI-61 FOR FENDL-3.2 FROM ENDF/B-VII BY NJOY2016.60+ ON  
14 MeV photon spectrum

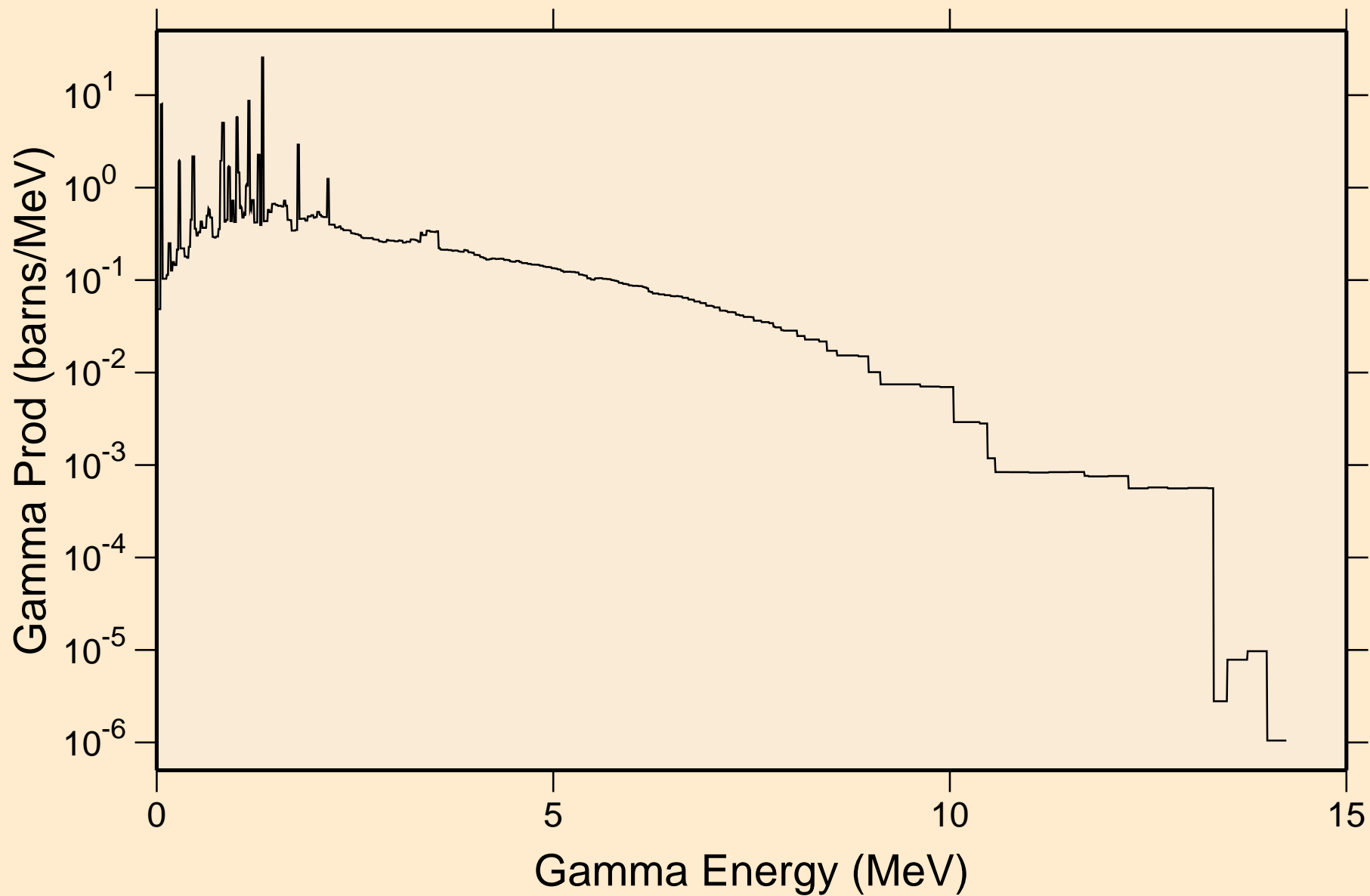

# 28-NI-61 FOR FENDL-3.2 FROM ENDF/B-VII BY NJOY2016.60+ ON Particle heating contributions

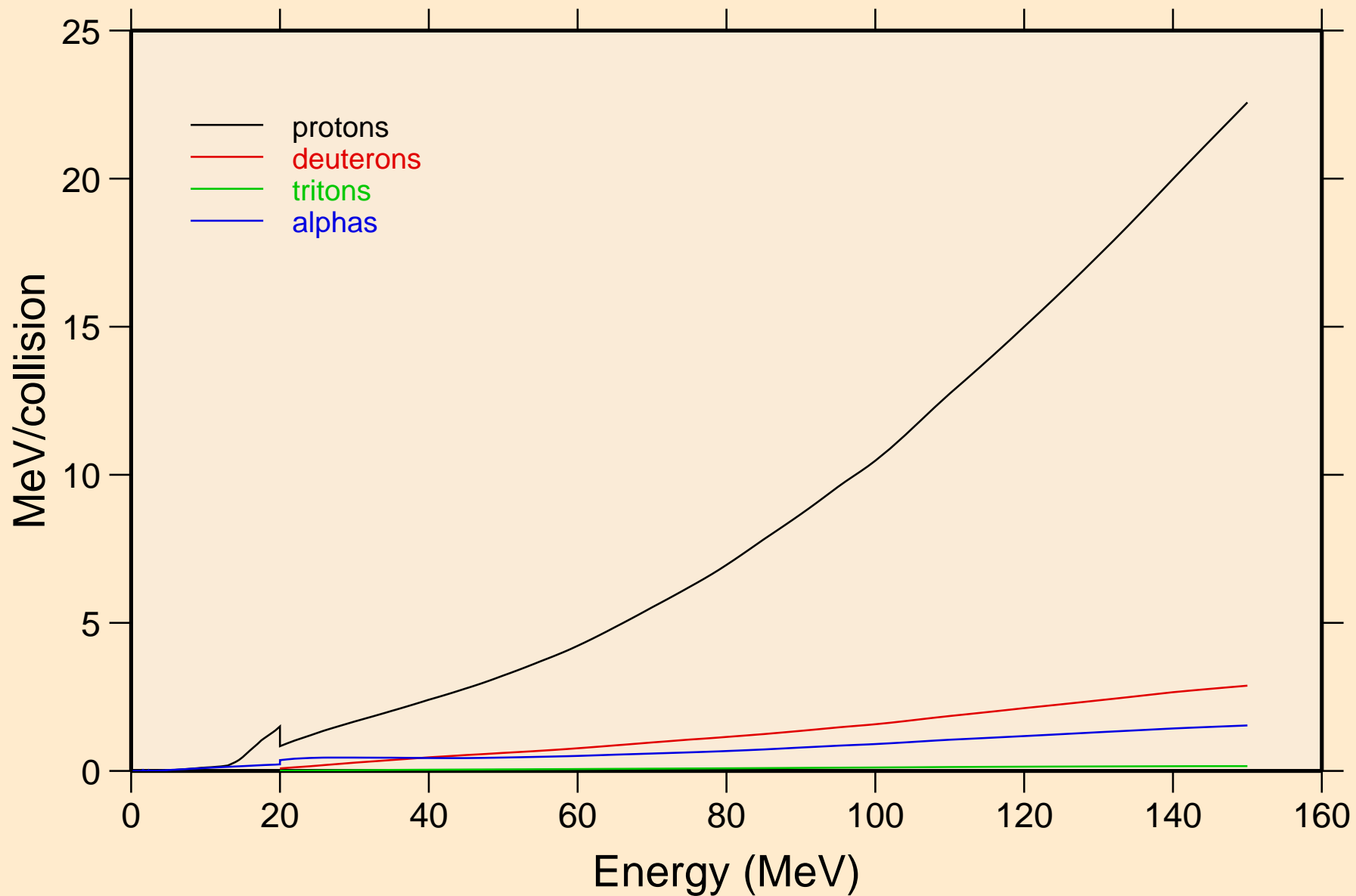

# 28-NI-61 FOR FENDL-3.2 FROM ENDF/B-VII BY NJOY2016.60+ ON Recoil Heating

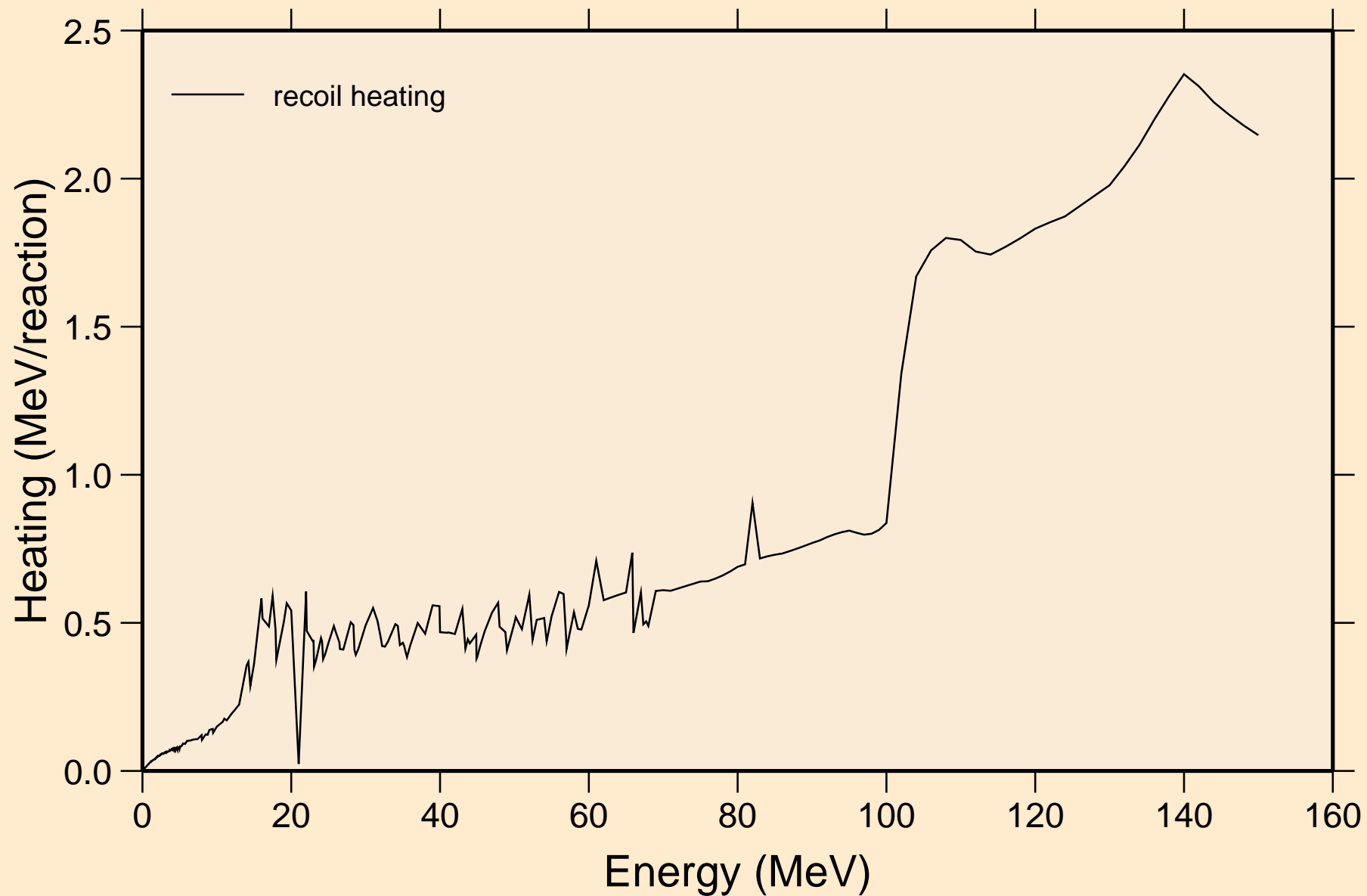

# 28-NI-61 FOR FENDL-3.2 FROM ENDF/B-VII BY NJOY2016.60+ ON

## Particle production cross sections

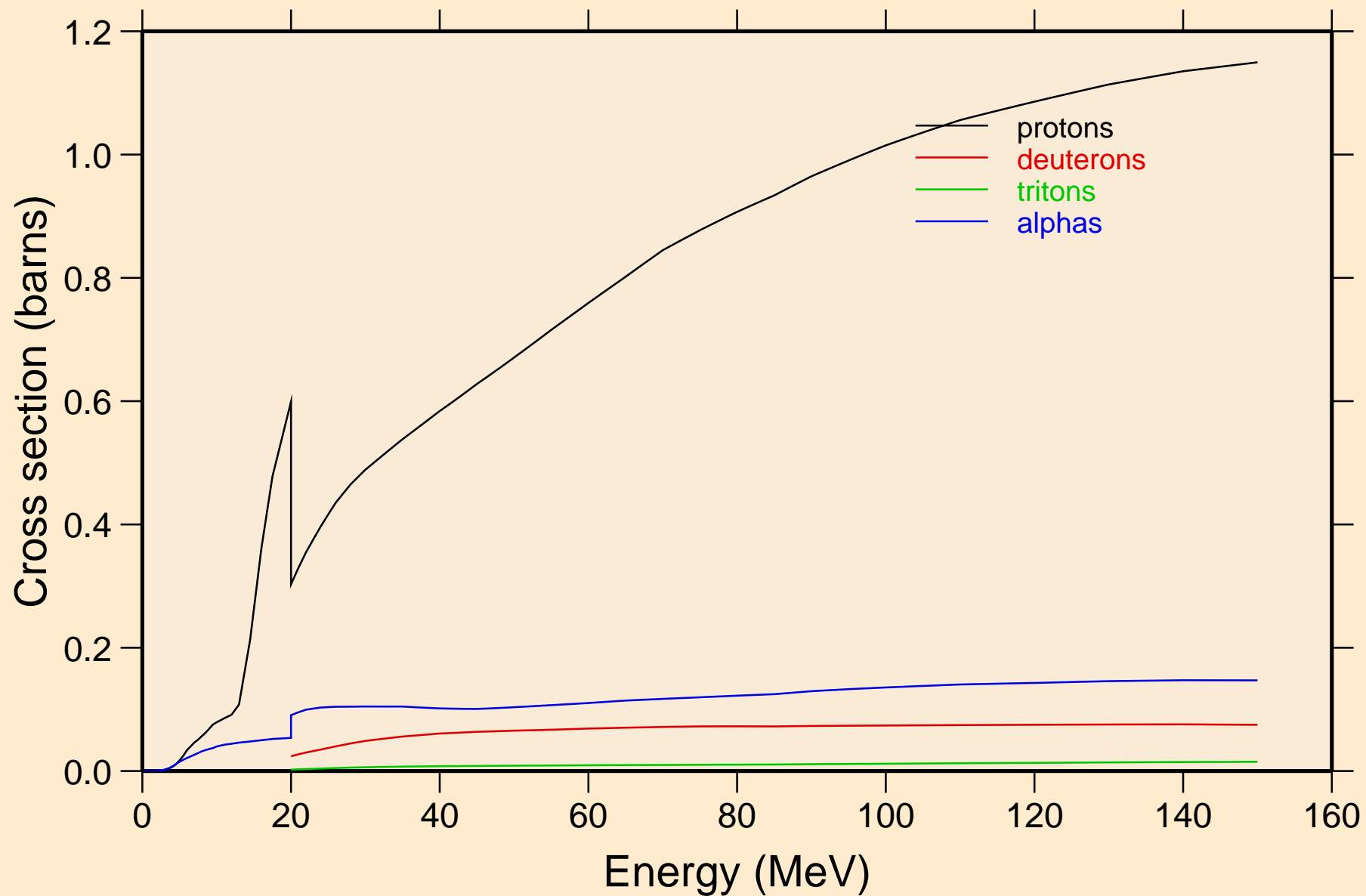

28-NI-61 FOR FENDL-3.2 FROM ENDF/B-VII BY NJOY2016.60+ ON  
protons from (n,x)

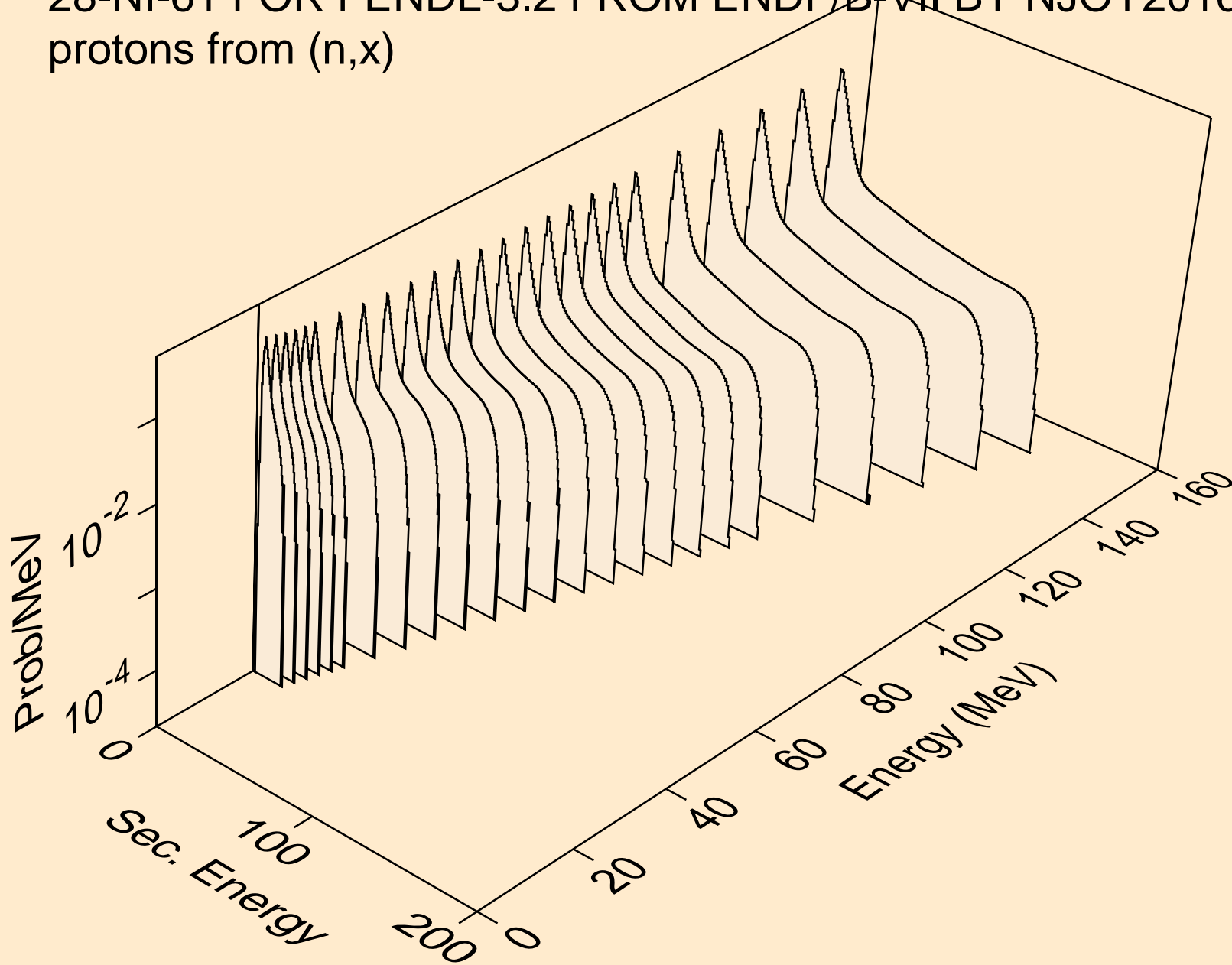



28-NI-61 FOR FENDL-3.2 FROM ENDF/B-VII BY NJOY2016.60+ ON  
protons from (n,n\*)p

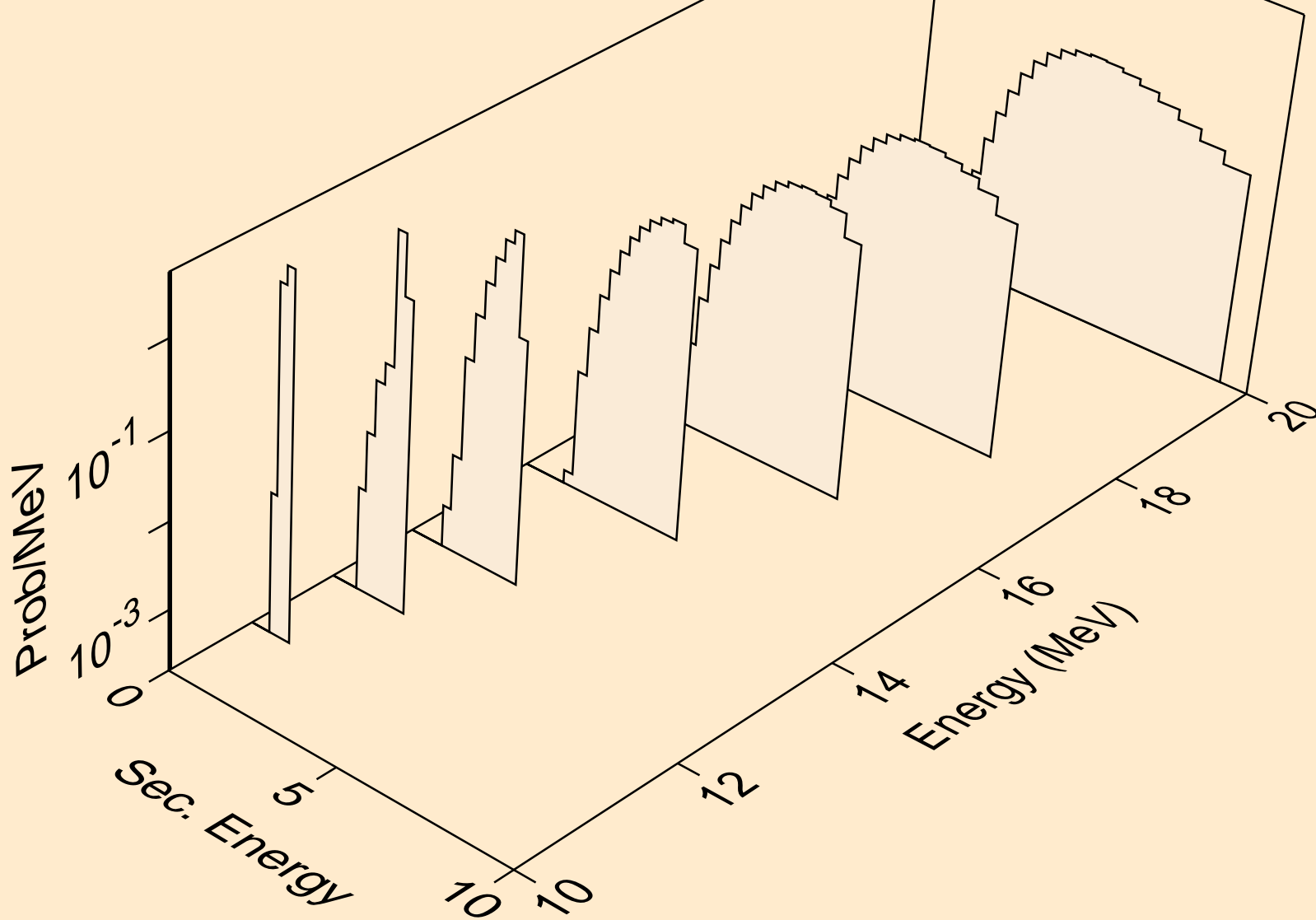

28-NI-61 FOR FENDL-3.2 FROM ENDF/B-VII BY NJOY2016.60+ ON  
protons from (n,p)

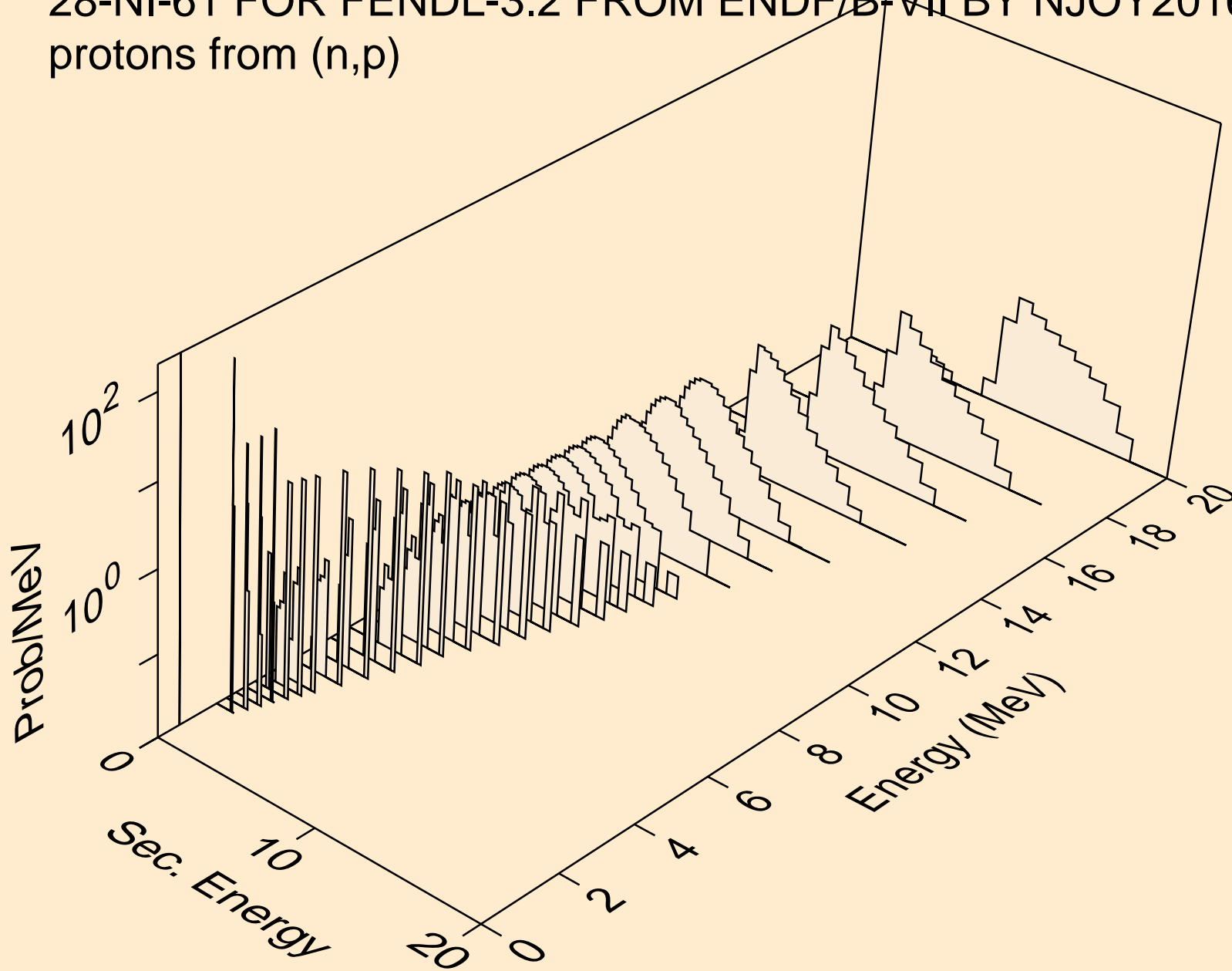

28-NI-61 FOR FENDL-3.2 FROM ENDF/B-VII BY NJOY2016.60+ ON  
deuterons from (n,x)

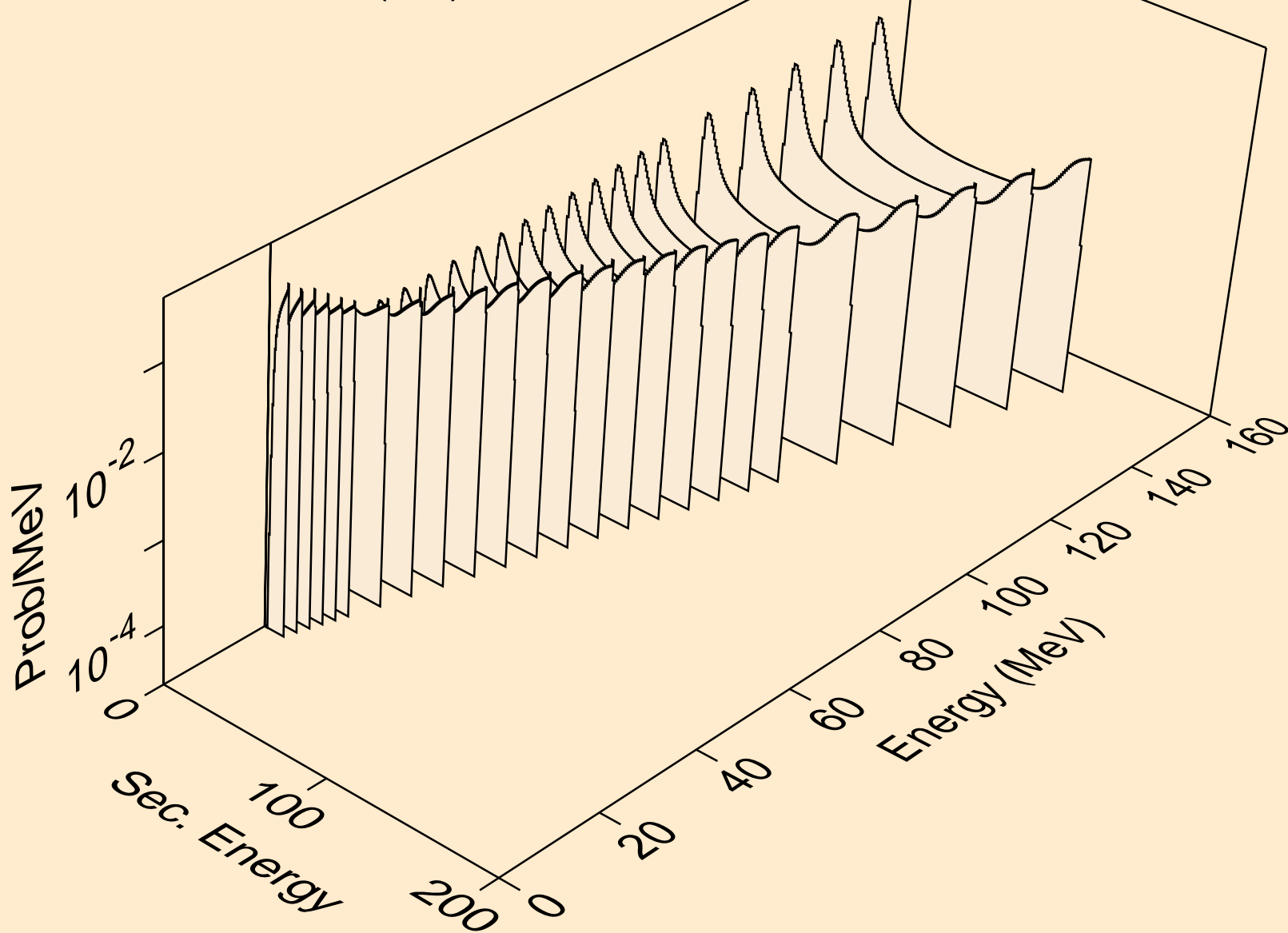

28-NI-61 FOR FENDL-3.2 FROM ENDF/B-VII BY NJOY2016.60+ ON  
tritons from (n,x)

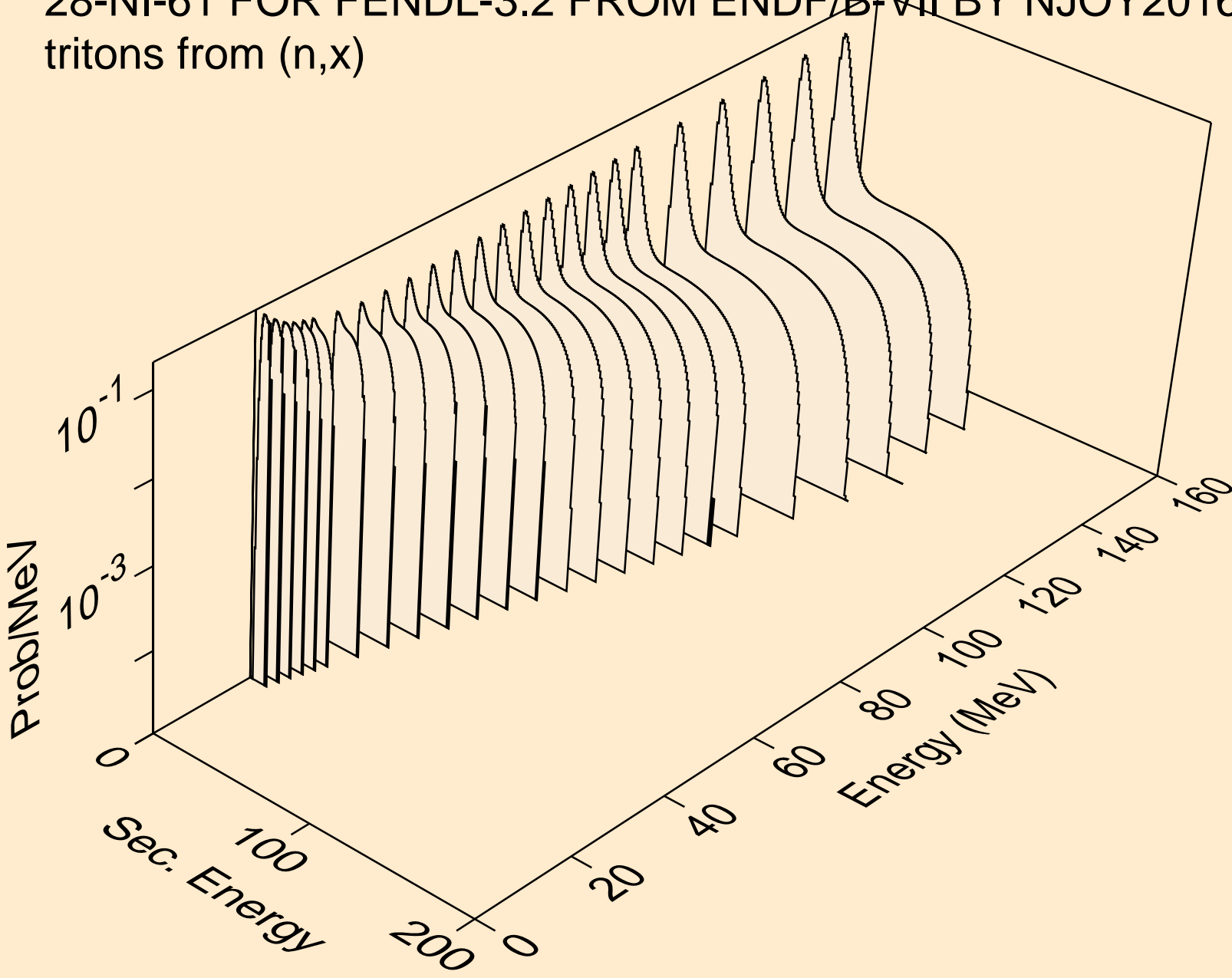

28-NI-61 FOR FENDL-3.2 FROM ENDF/B-VII BY NJOY2016.60+ ON  
alphas from (n,x)

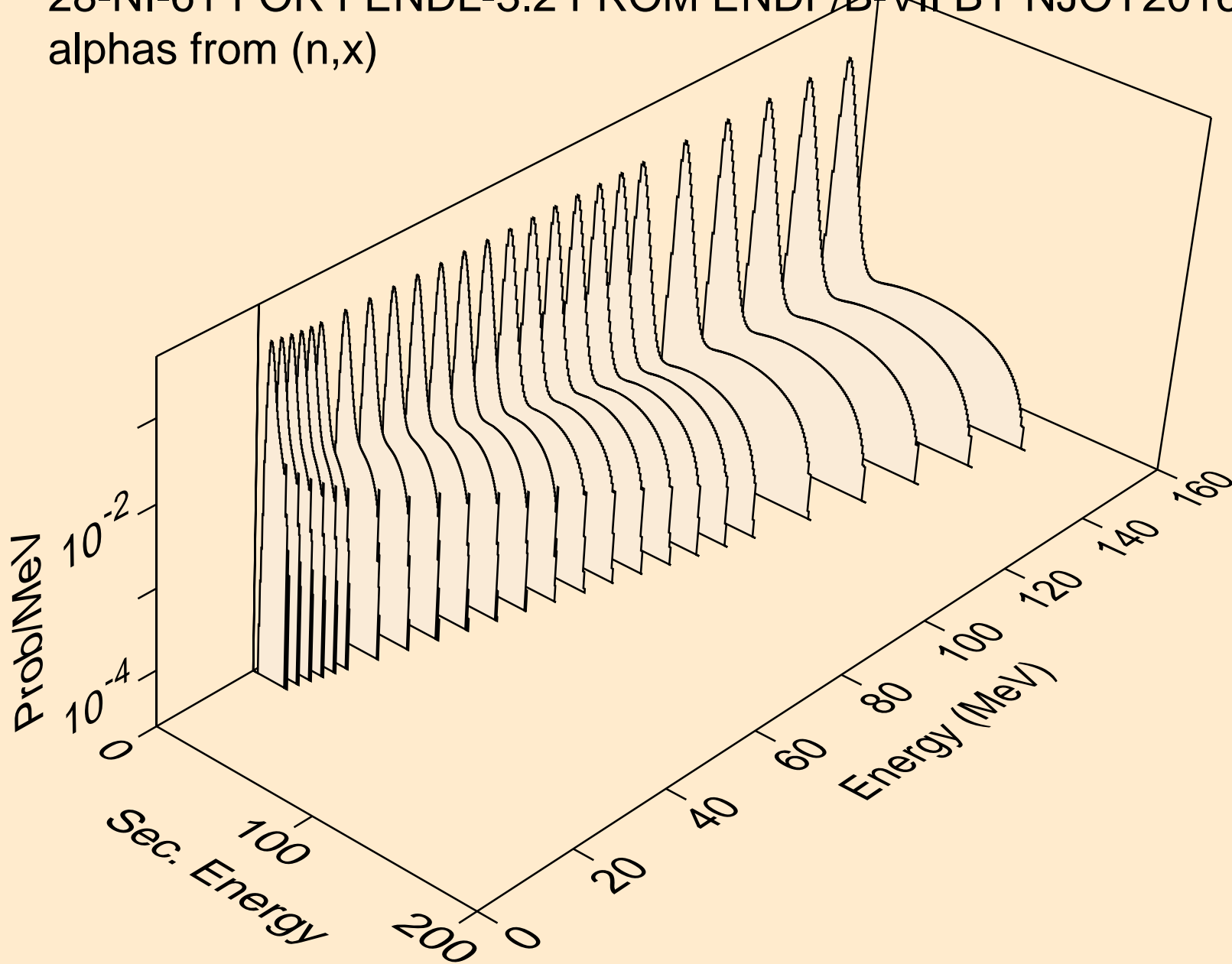

28-NI-61 FOR FENDL-3.2 FROM ENDF/B-VII BY NJOY2016.60+ ON  
alphas from (n,a)

