

30-ZN-66 FOR FENDL-3.2 FROM FENDL-3.2 BY NJOY2016.60+ O
Principal cross sections

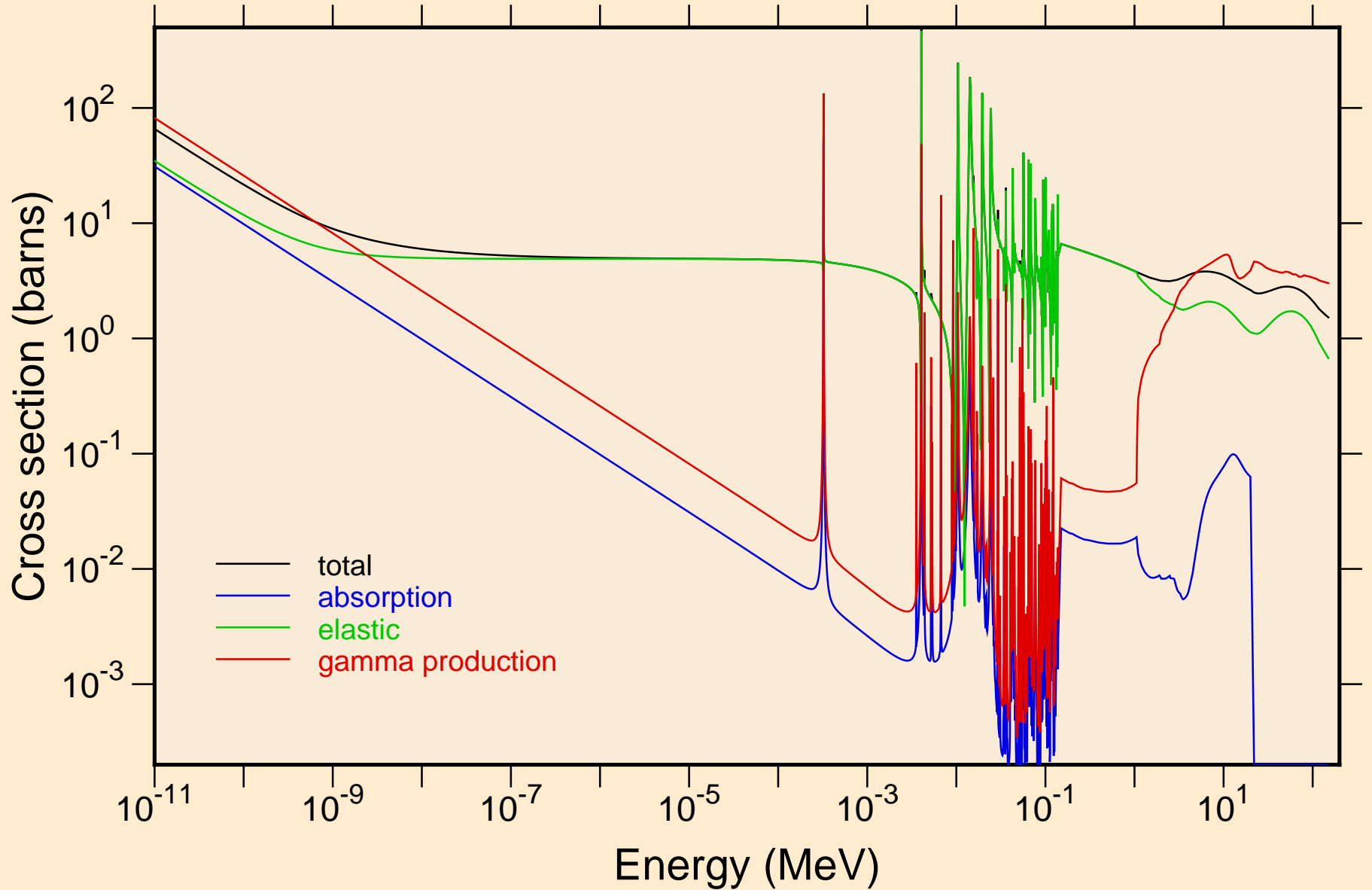

30-ZN-66 FOR FENDL-3.2 FROM FENDL-3.2 BY NJOY2016.60+ O
resonance total cross section

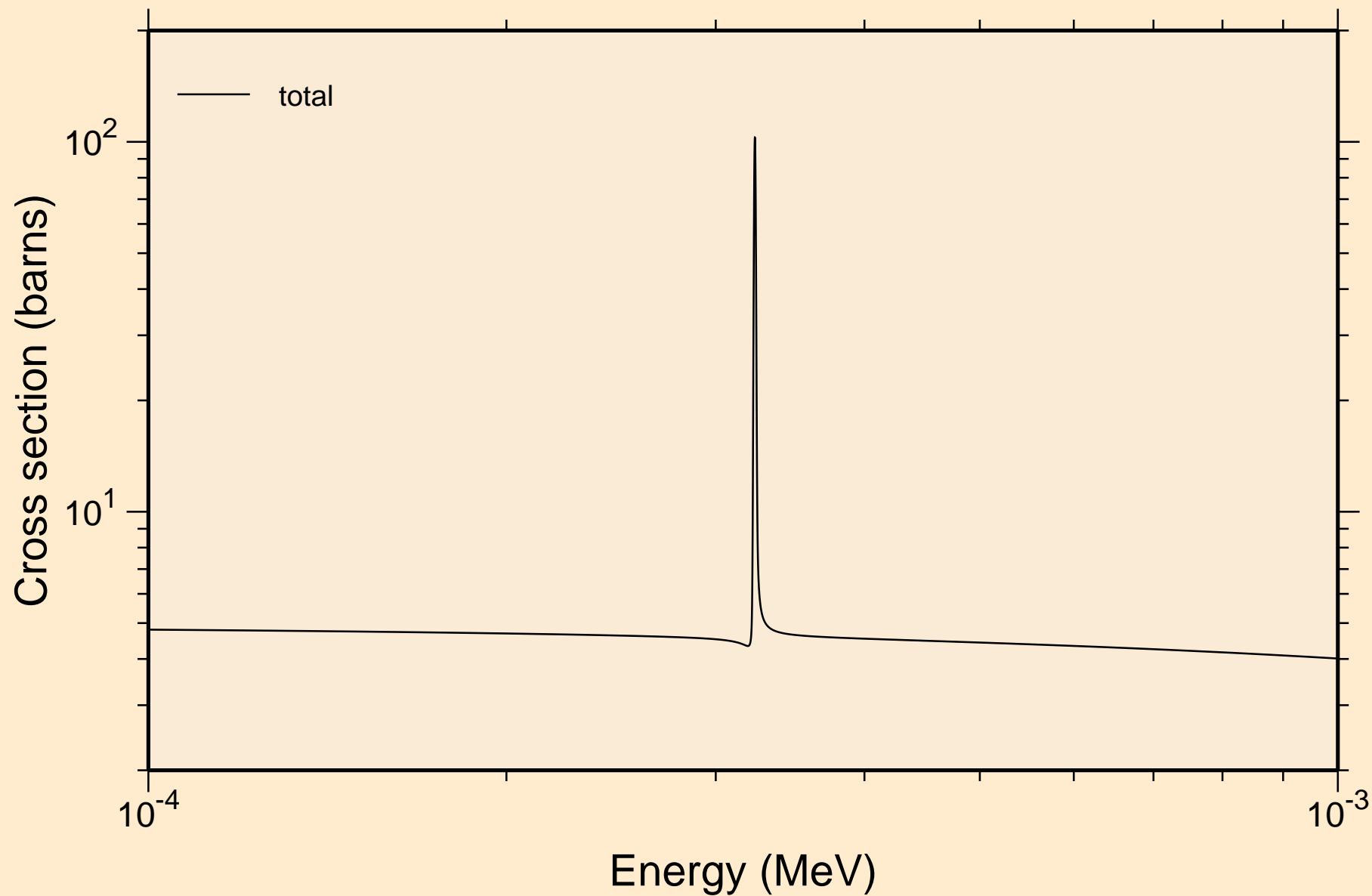

30-ZN-66 FOR FENDL-3.2 FROM FENDL-3.2 BY NJOY2016.60+ O
resonance total cross section

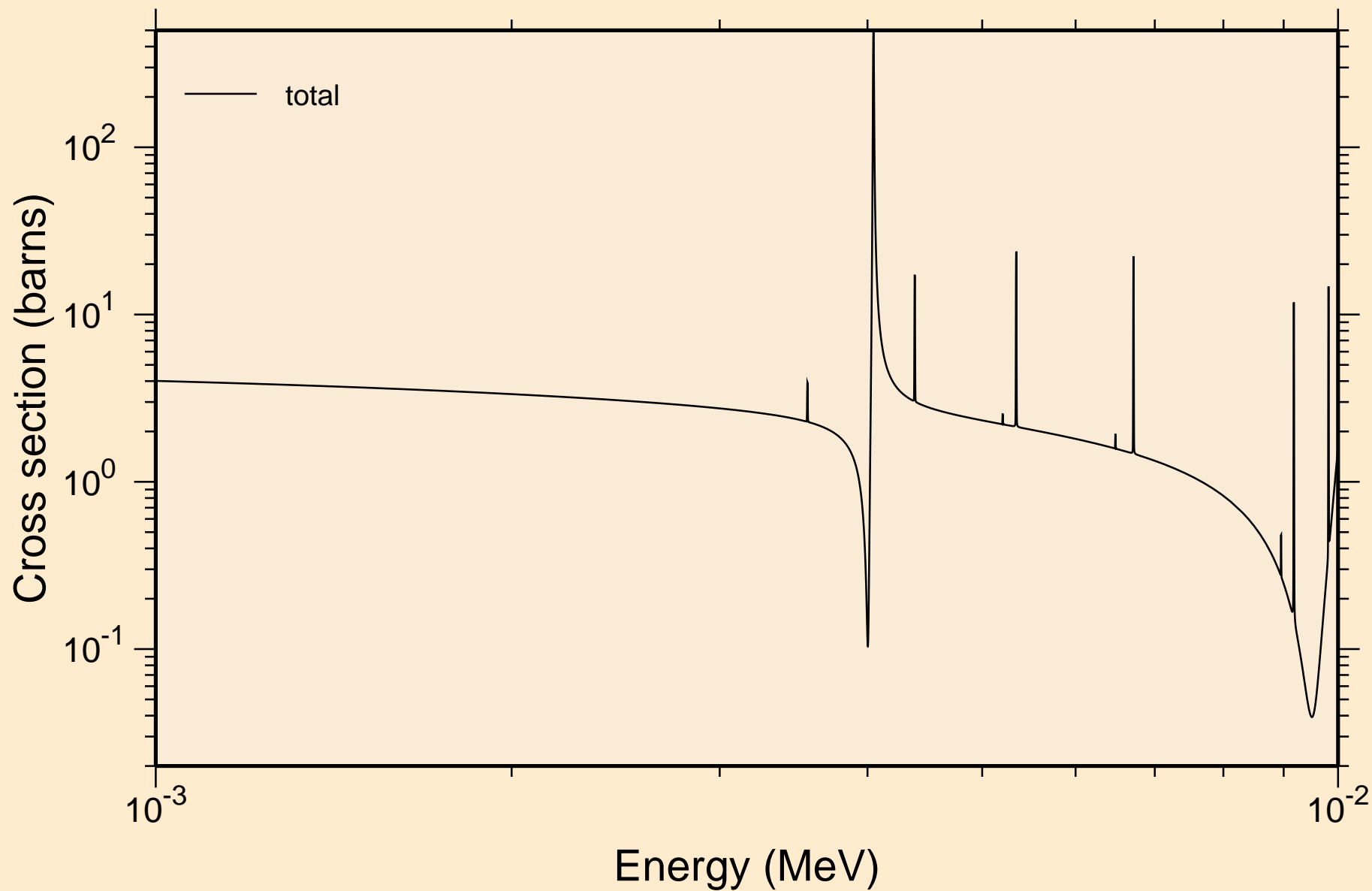

30-ZN-66 FOR FENDL-3.2 FROM FENDL-3.2 BY NJOY2016.60+ O
resonance total cross section

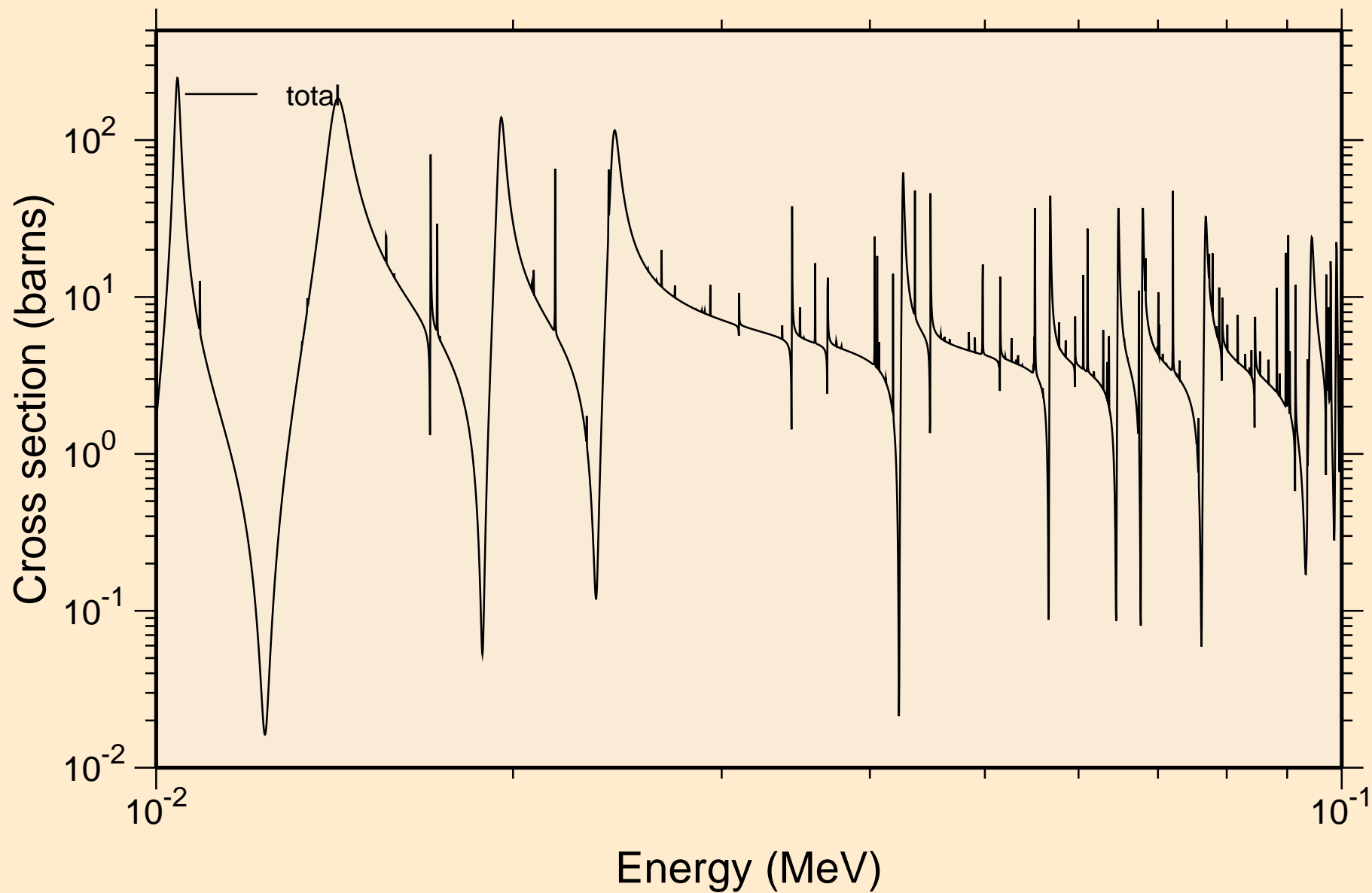

30-ZN-66 FOR FENDL-3.2 FROM FENDL-3.2 BY NJOY2016.60+ O
resonance total cross section

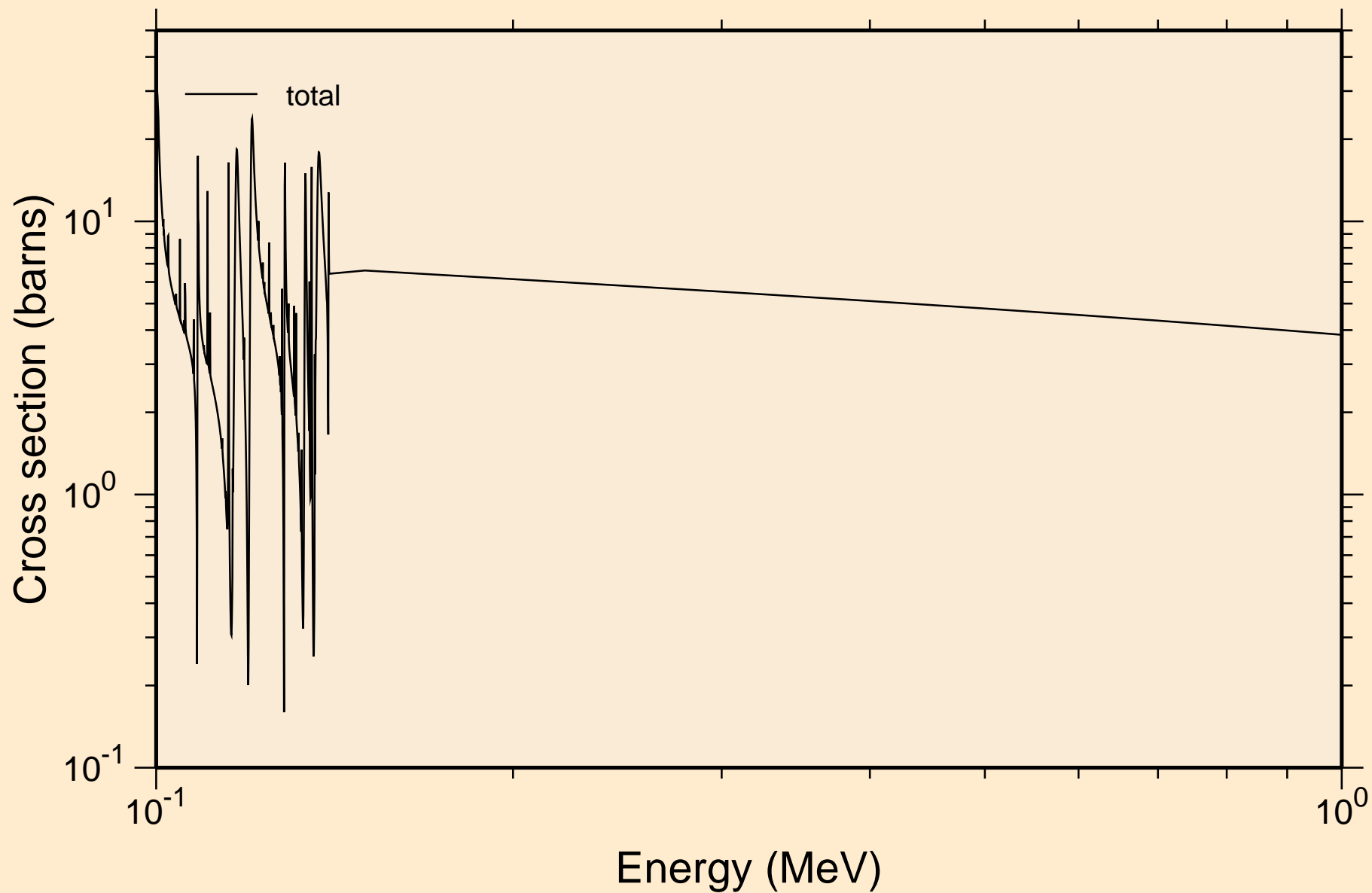

30-ZN-66 FOR FENDL-3.2 FROM FENDL-3.2 BY NJOY2016.60+ O
resonance total cross section

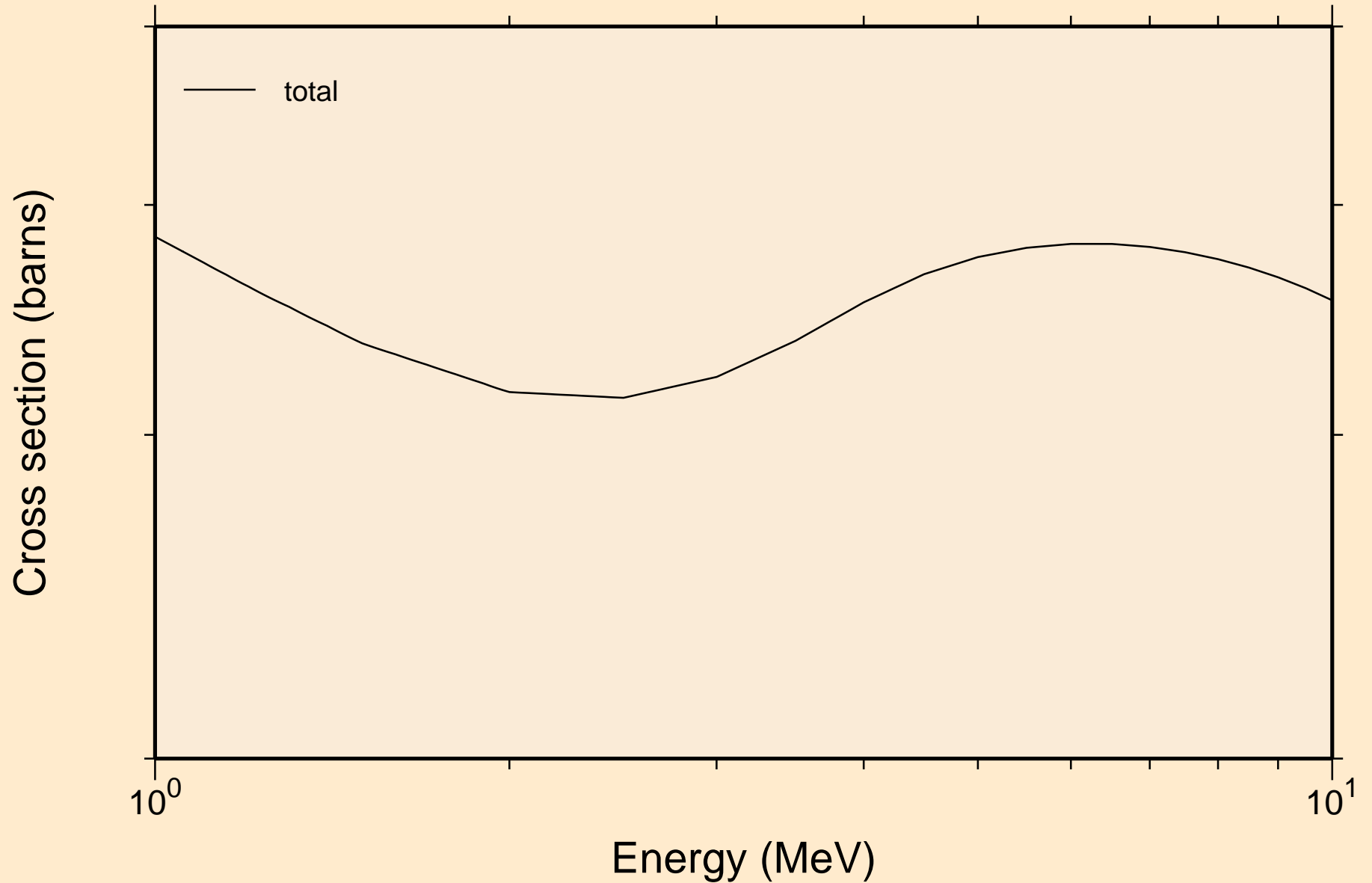

30-ZN-66 FOR FENDL-3.2 FROM FENDL-3.2 BY NJOY2016.60+ O
resonance absorption cross sections

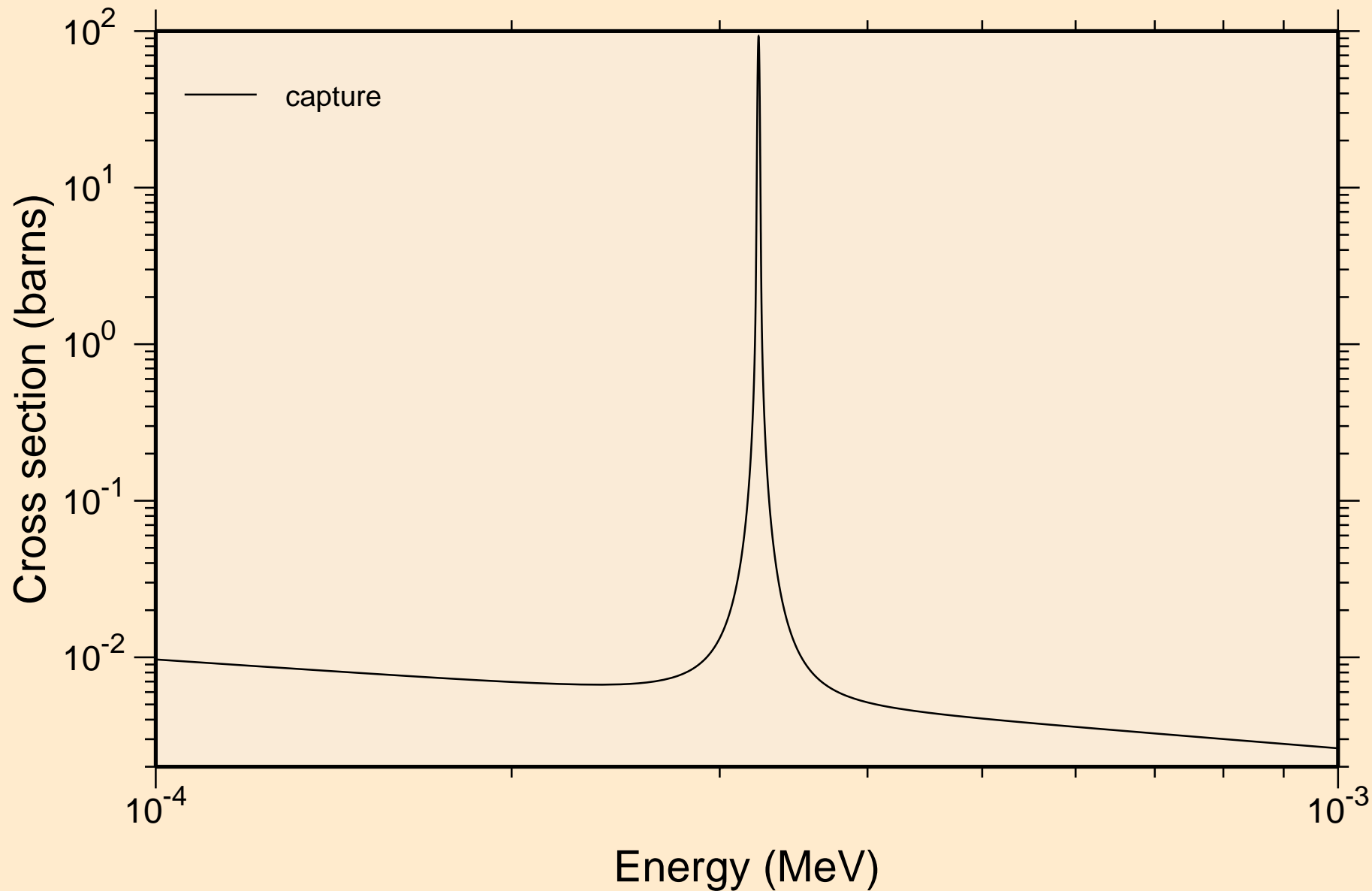

30-ZN-66 FOR FENDL-3.2 FROM FENDL-3.2 BY NJOY2016.60+ O
resonance absorption cross sections

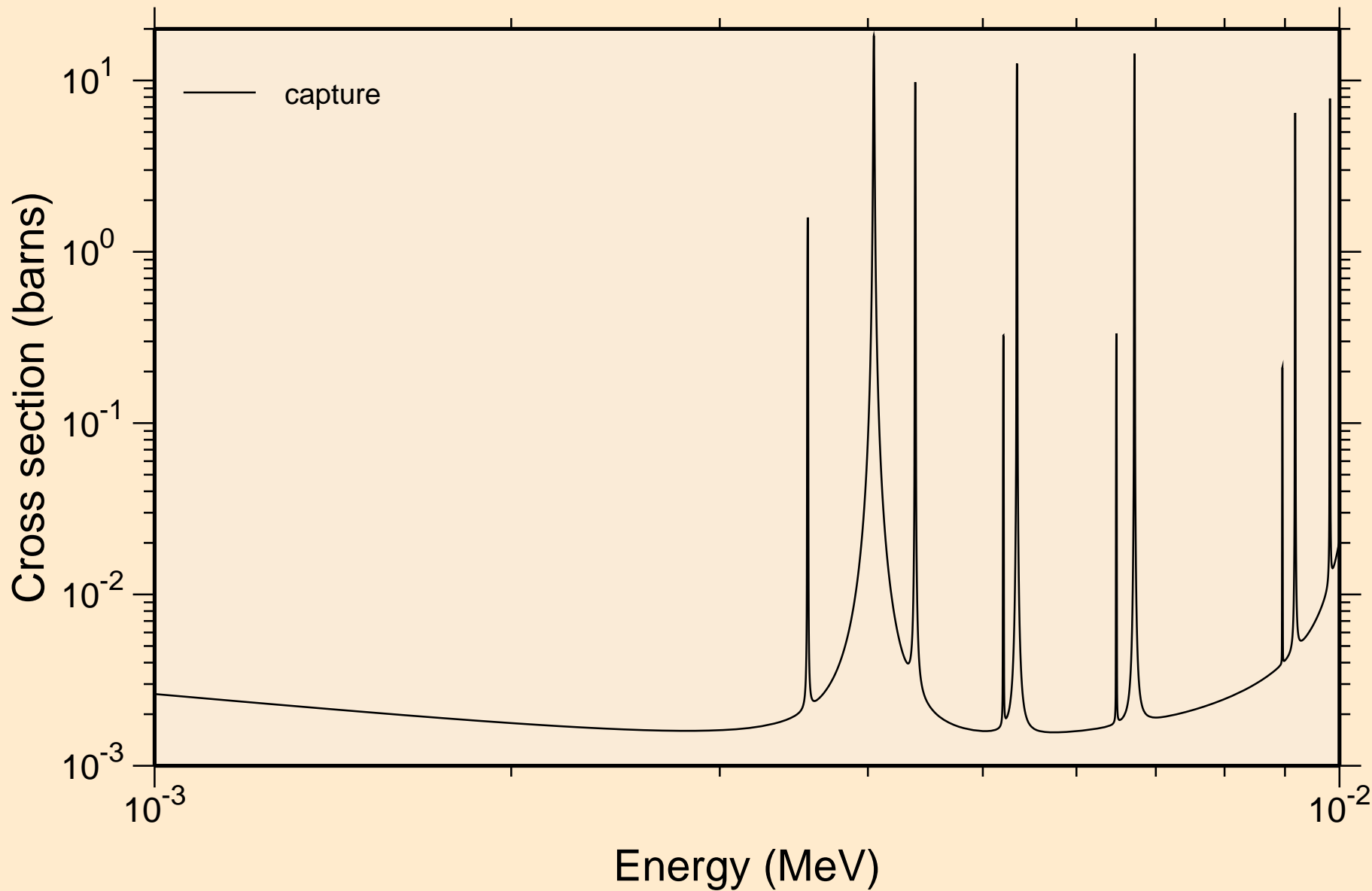

30-ZN-66 FOR FENDL-3.2 FROM FENDL-3.2 BY NJOY2016.60+ O
resonance absorption cross sections

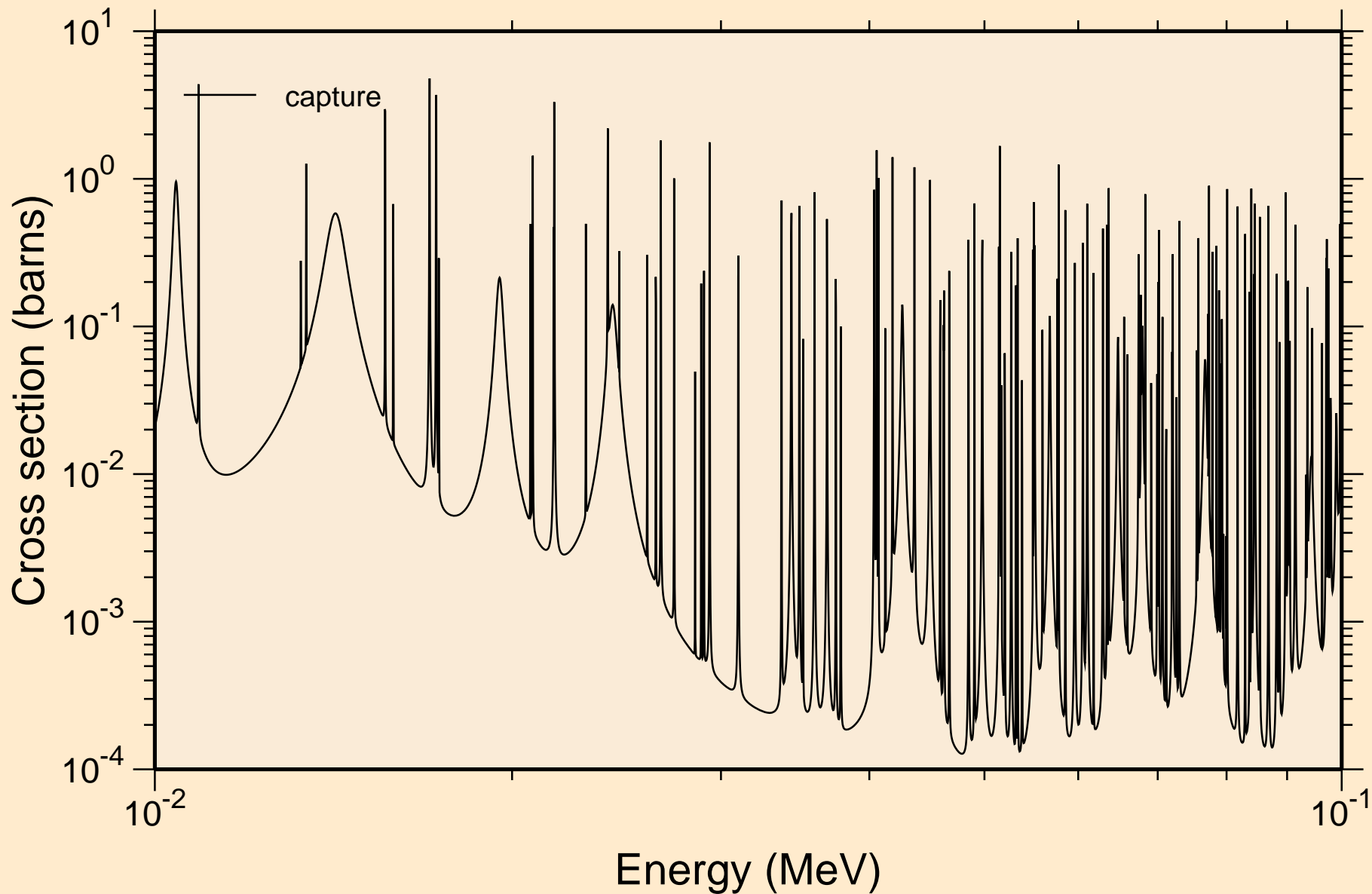

30-ZN-66 FOR FENDL-3.2 FROM FENDL-3.2 BY NJOY2016.60+ O
resonance absorption cross sections

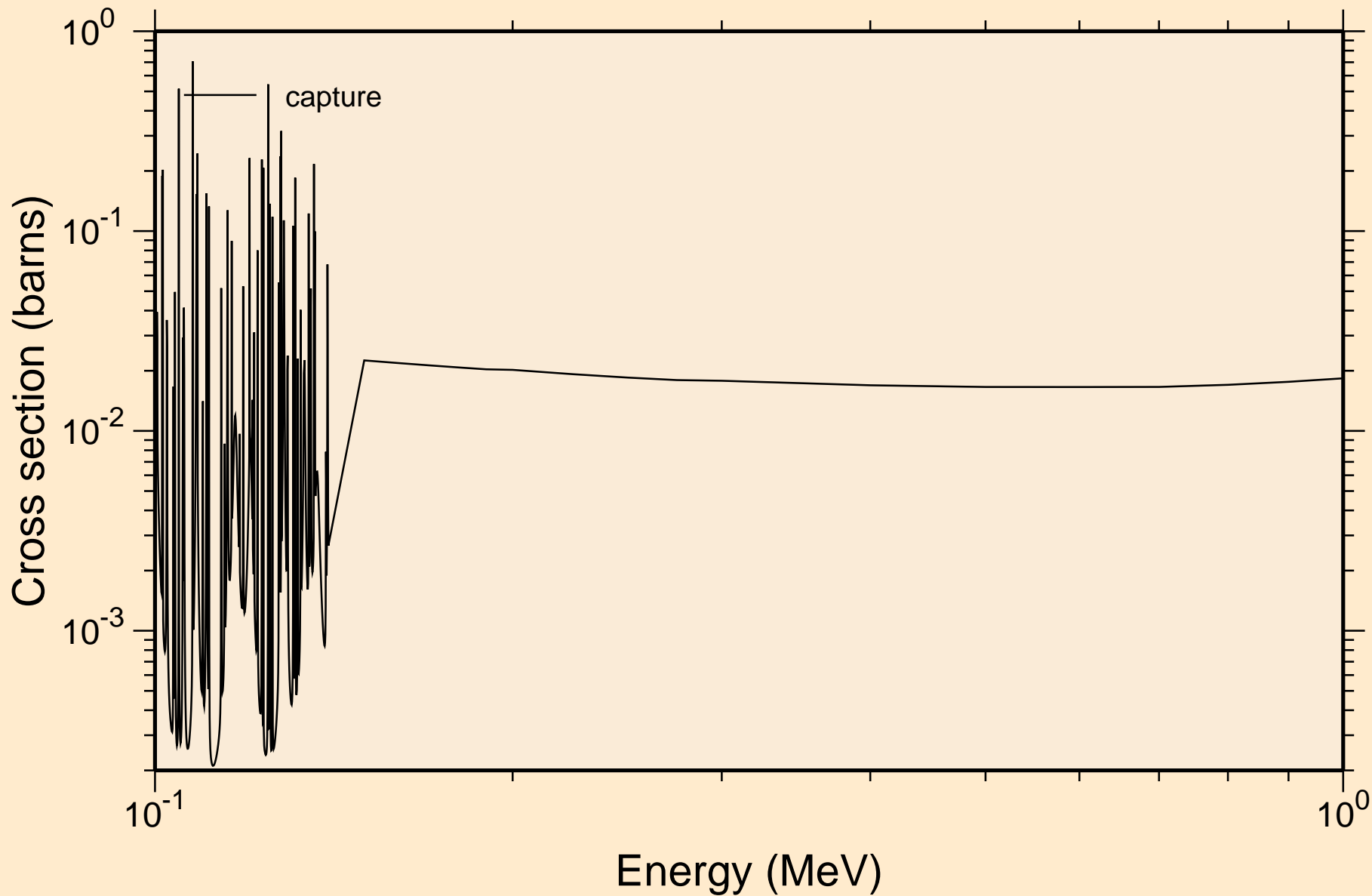

30-ZN-66 FOR FENDL-3.2 FROM FENDL-3.2 BY NJOY2016.60+ O
resonance absorption cross sections

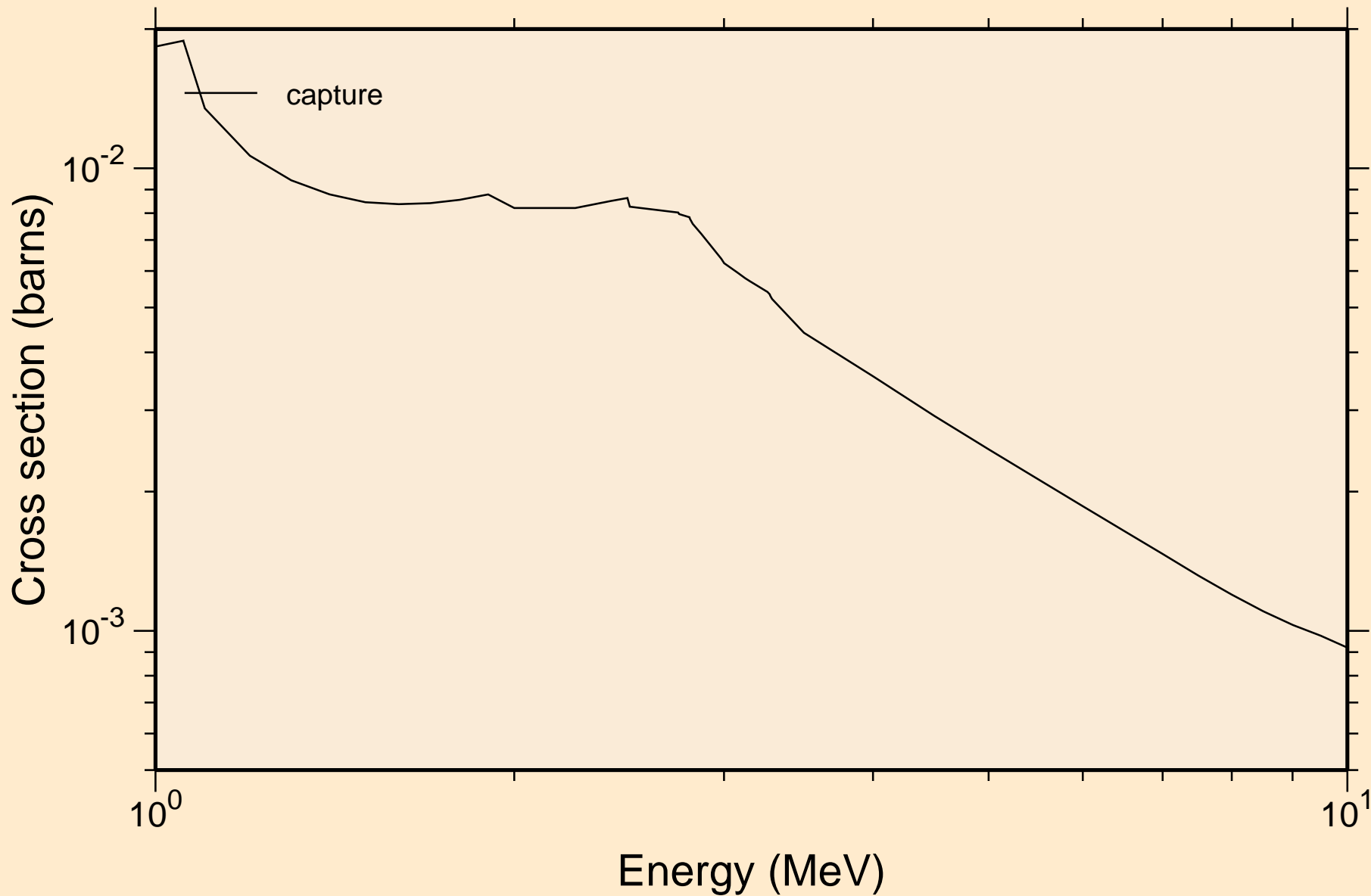

30-ZN-66 FOR FENDL-3.2 FROM FENDL-3.2 BY NJOY2016.60+ O
UR total cross section

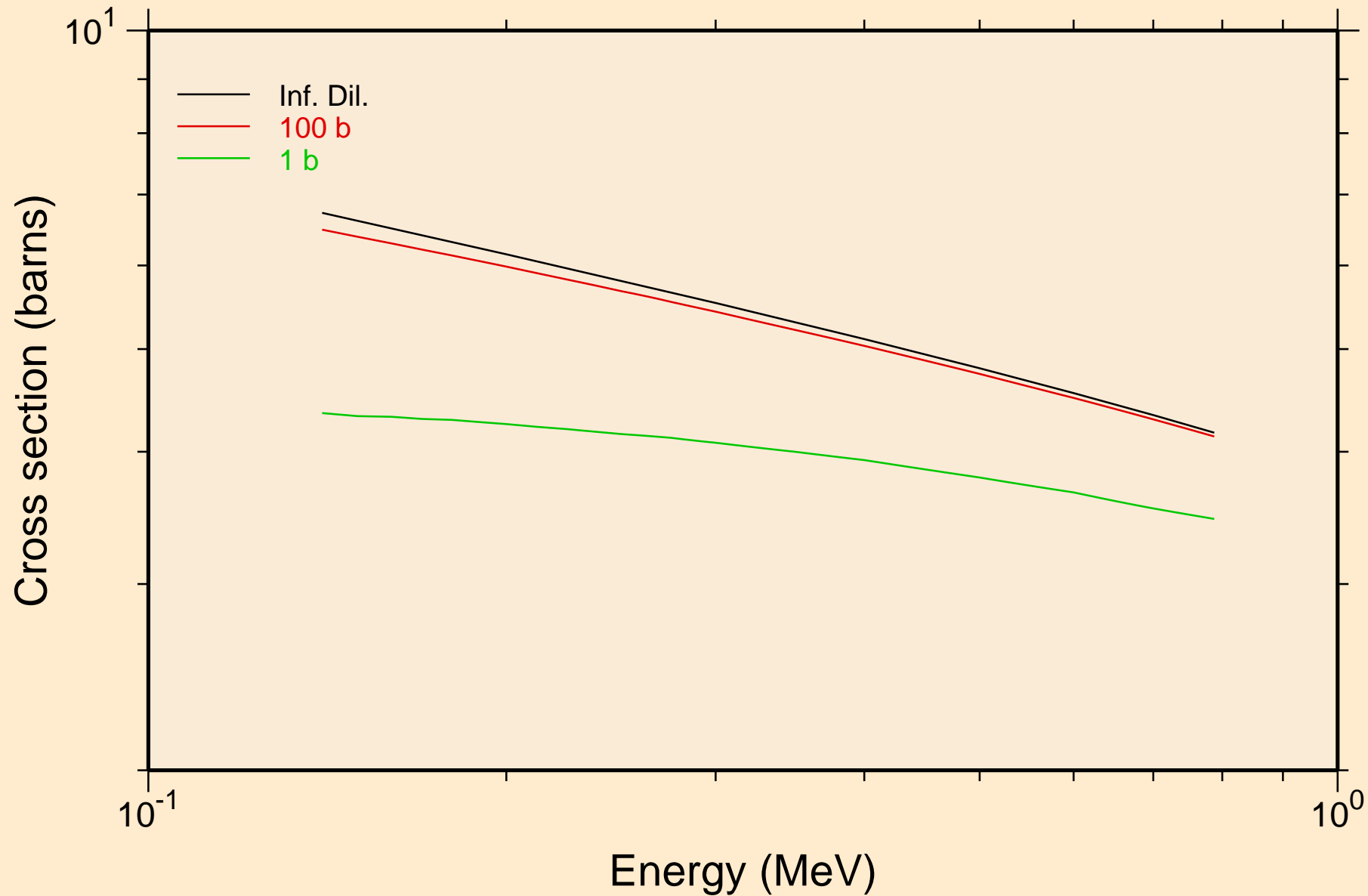

30-ZN-66 FOR FENDL-3.2 FROM FENDL-3.2 BY NJOY2016.60+ O
UR elastic cross section

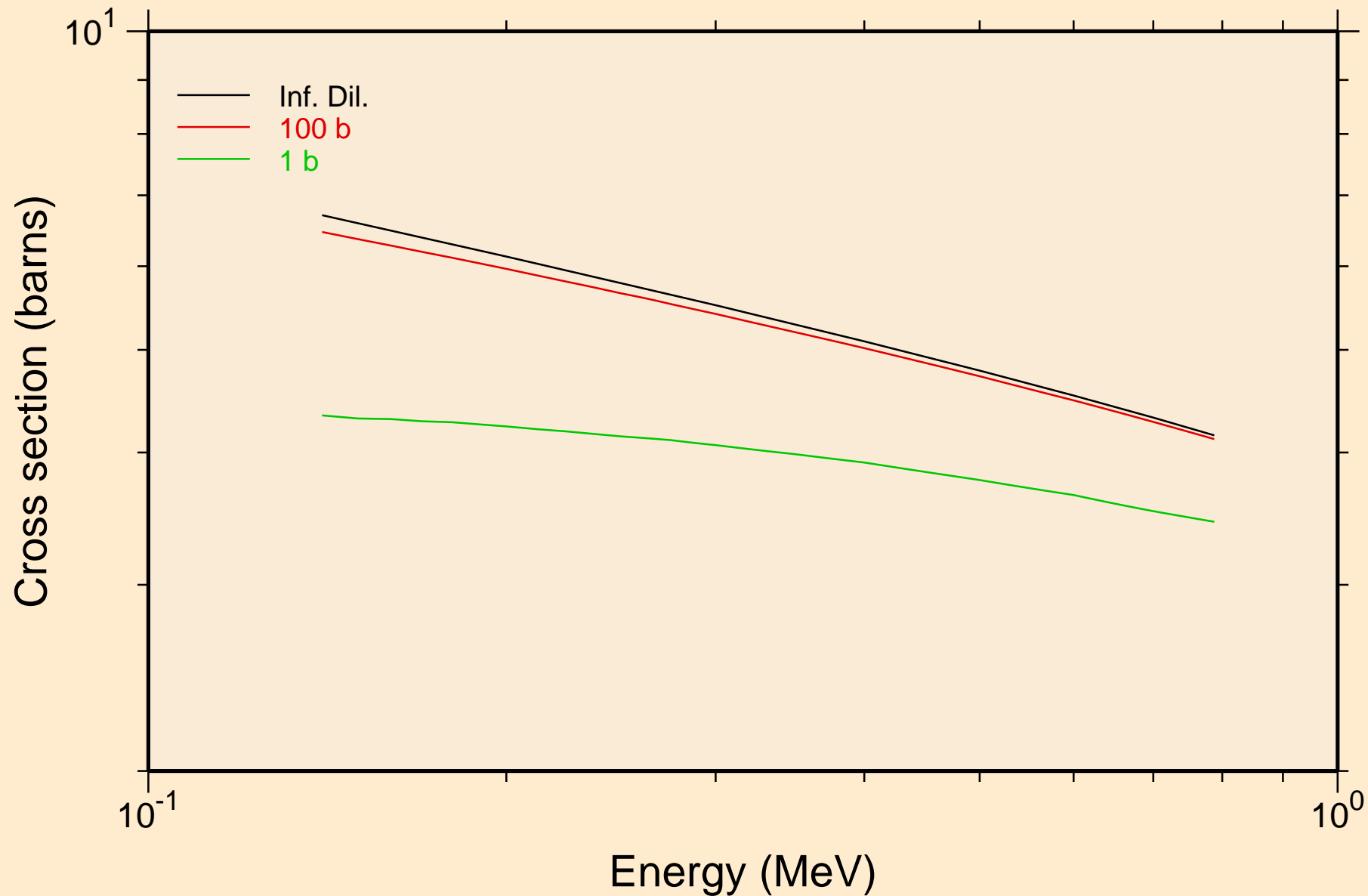

30-ZN-66 FOR FENDL-3.2 FROM FENDL-3.2 BY NJOY2016.60+ O
UR capture cross section

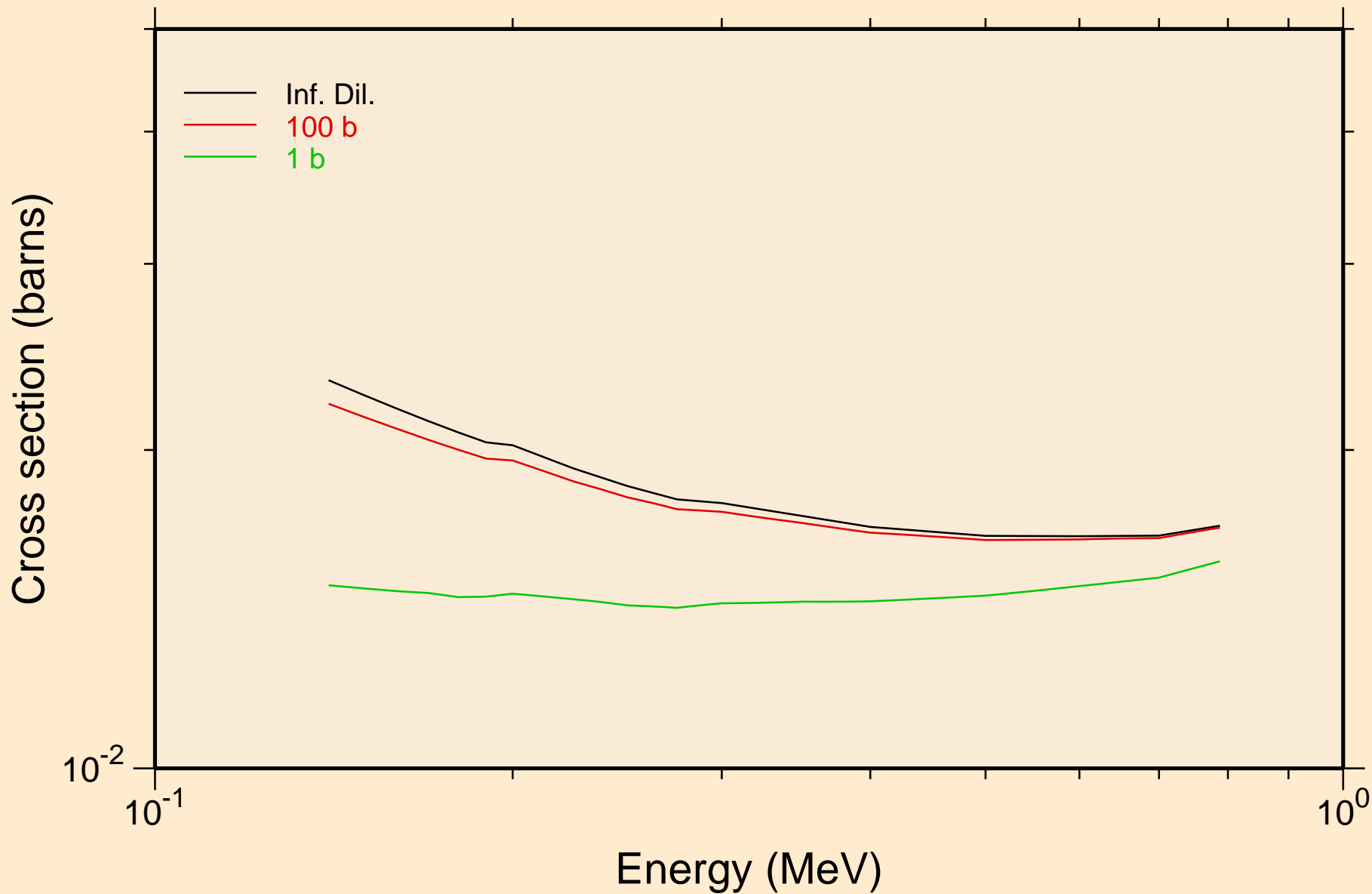

30-ZN-66 FOR FENDL-3.2 FROM FENDL-3.2 BY NJOY2016.60+ O Heating

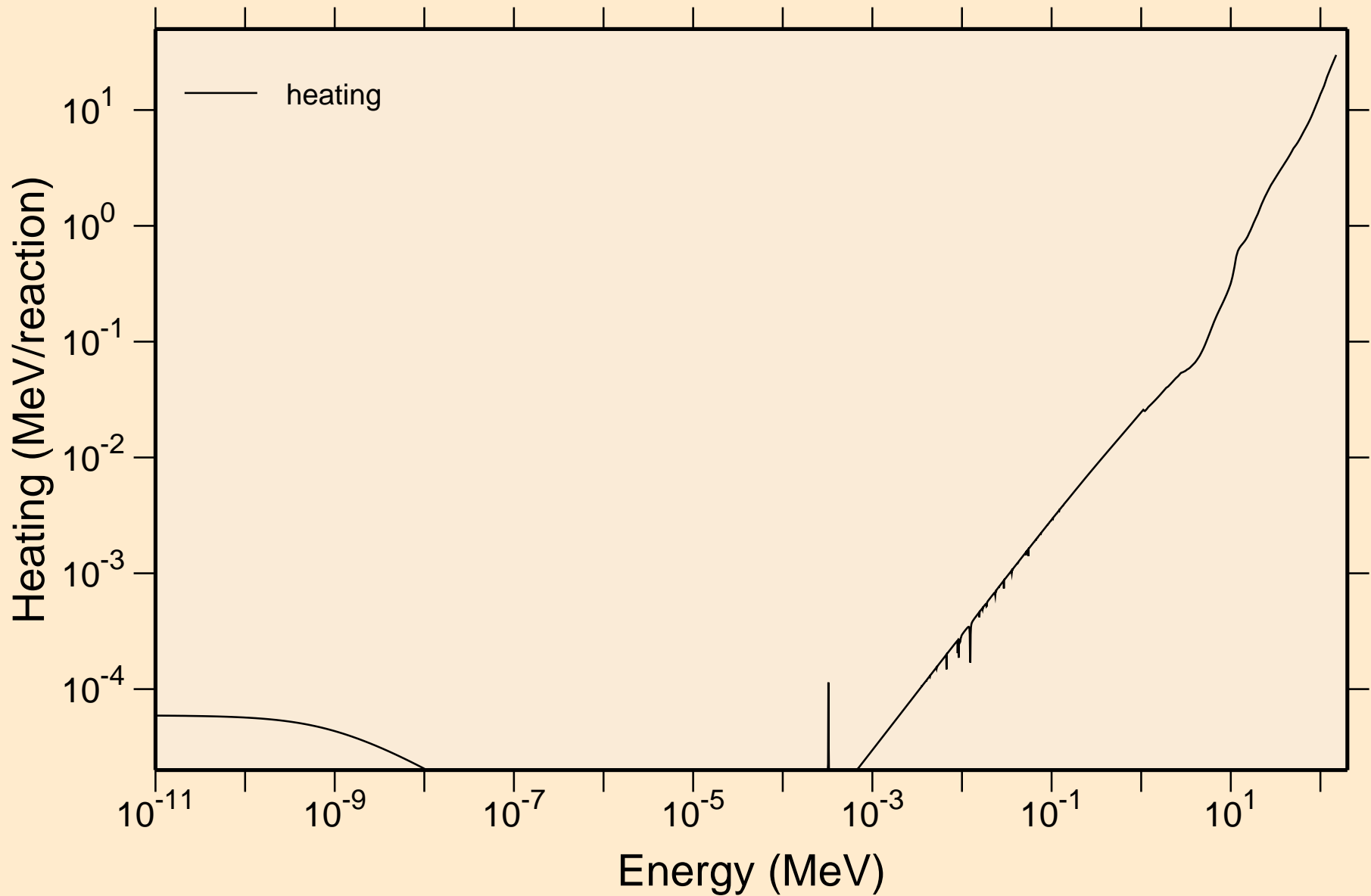

30-ZN-66 FOR FENDL-3.2 FROM FENDL-3.2 BY NJOY2016.60+ O Damage

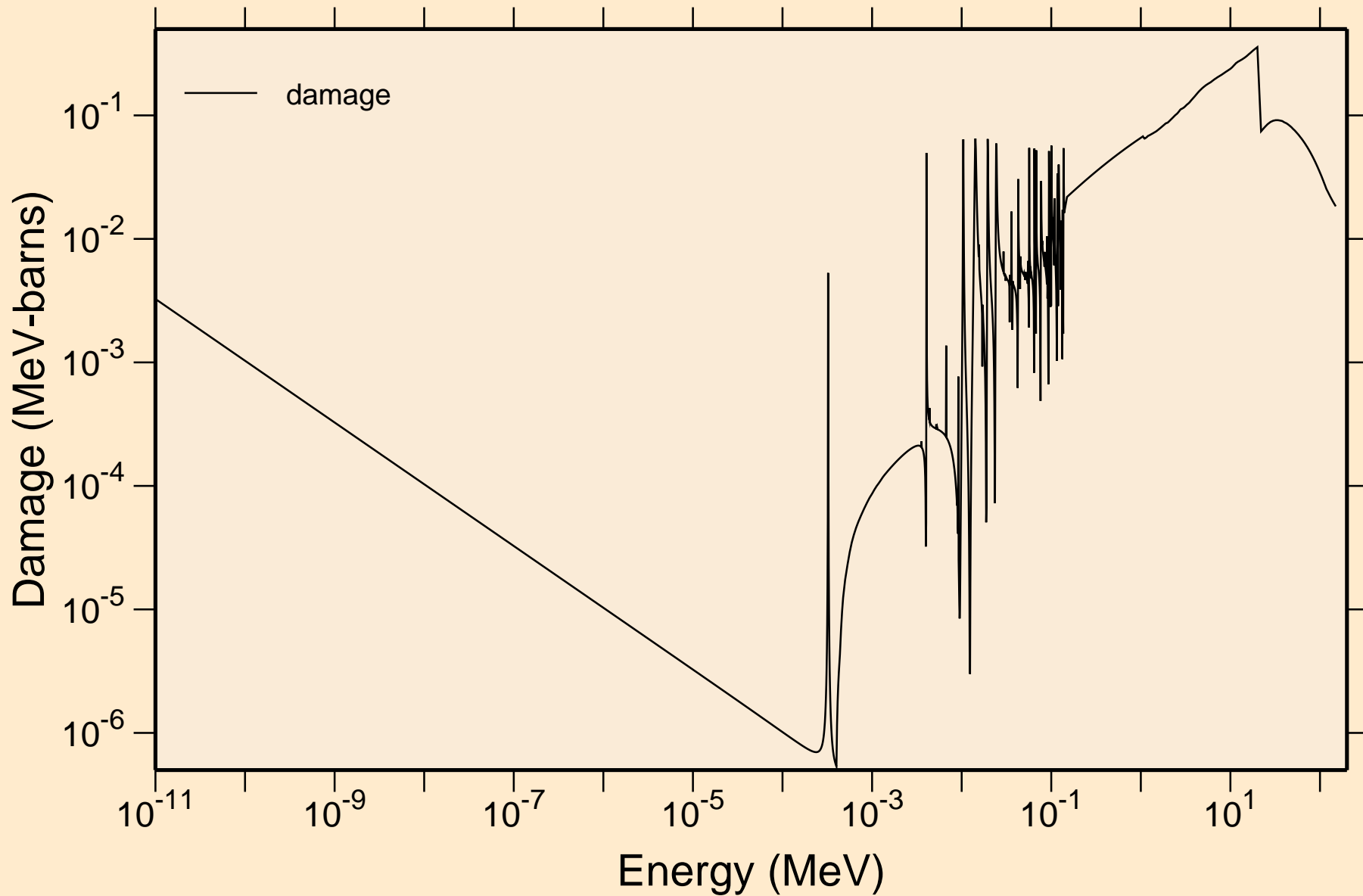

30-ZN-66 FOR FENDL-3.2 FROM FENDL-3.2 BY NJOY2016.60+ O
Non-threshold reactions

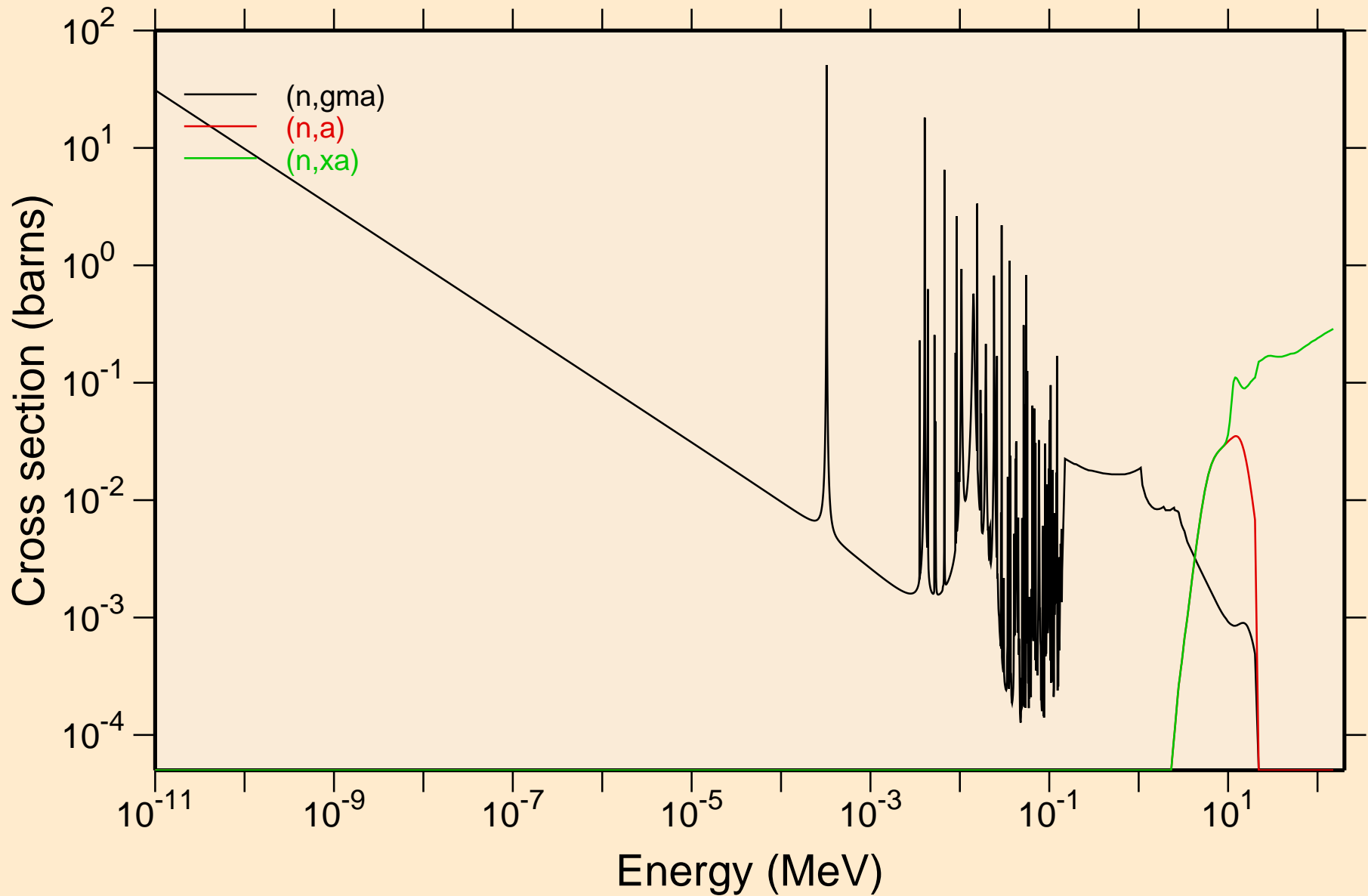

30-ZN-66 FOR FENDL-3.2 FROM FENDL-3.2 BY NJOY2016.60+ O
Principal cross sections

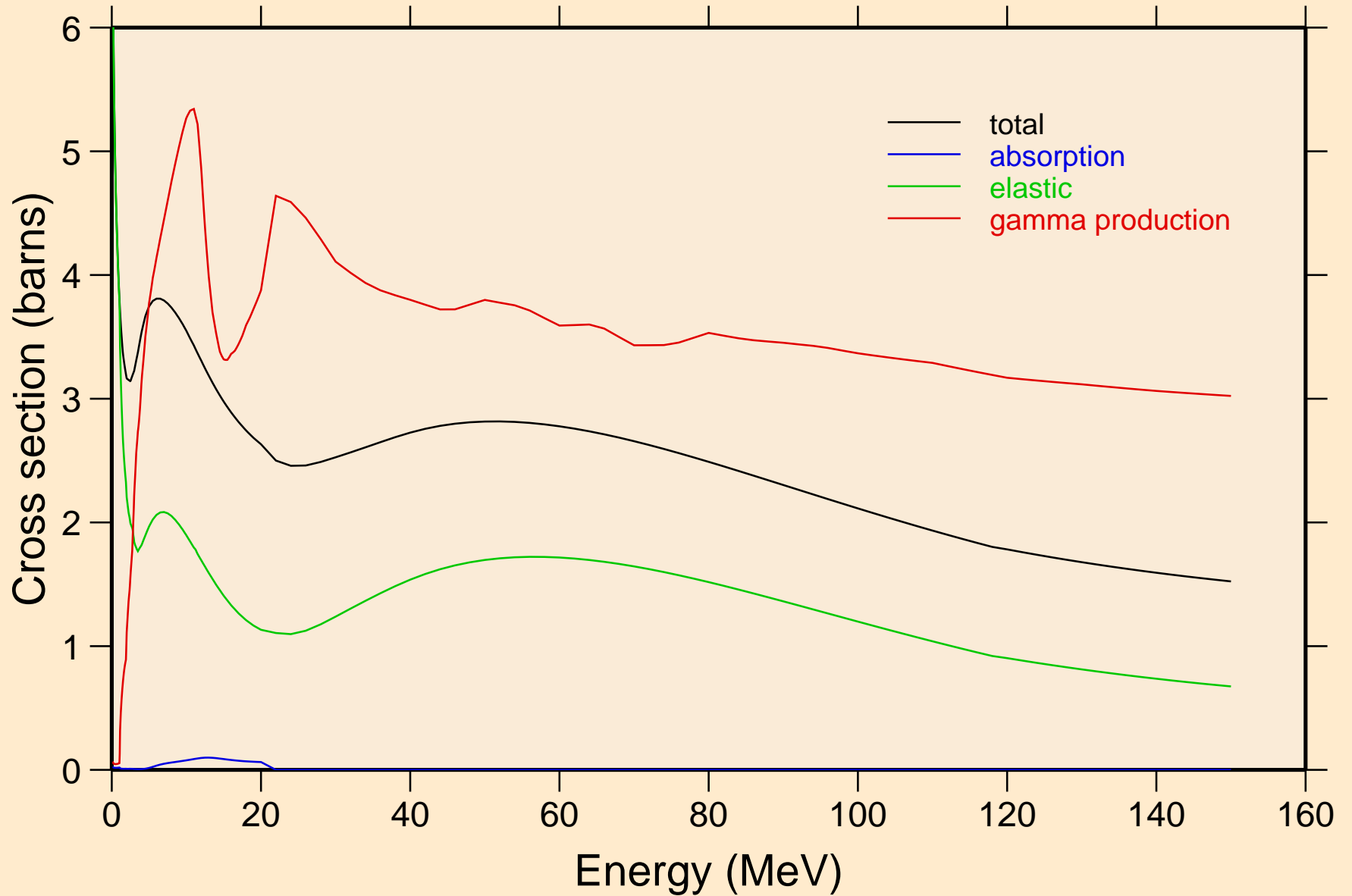

30-ZN-66 FOR FENDL-3.2 FROM FENDL-3.2 BY NJOY2016.60+ O Heating

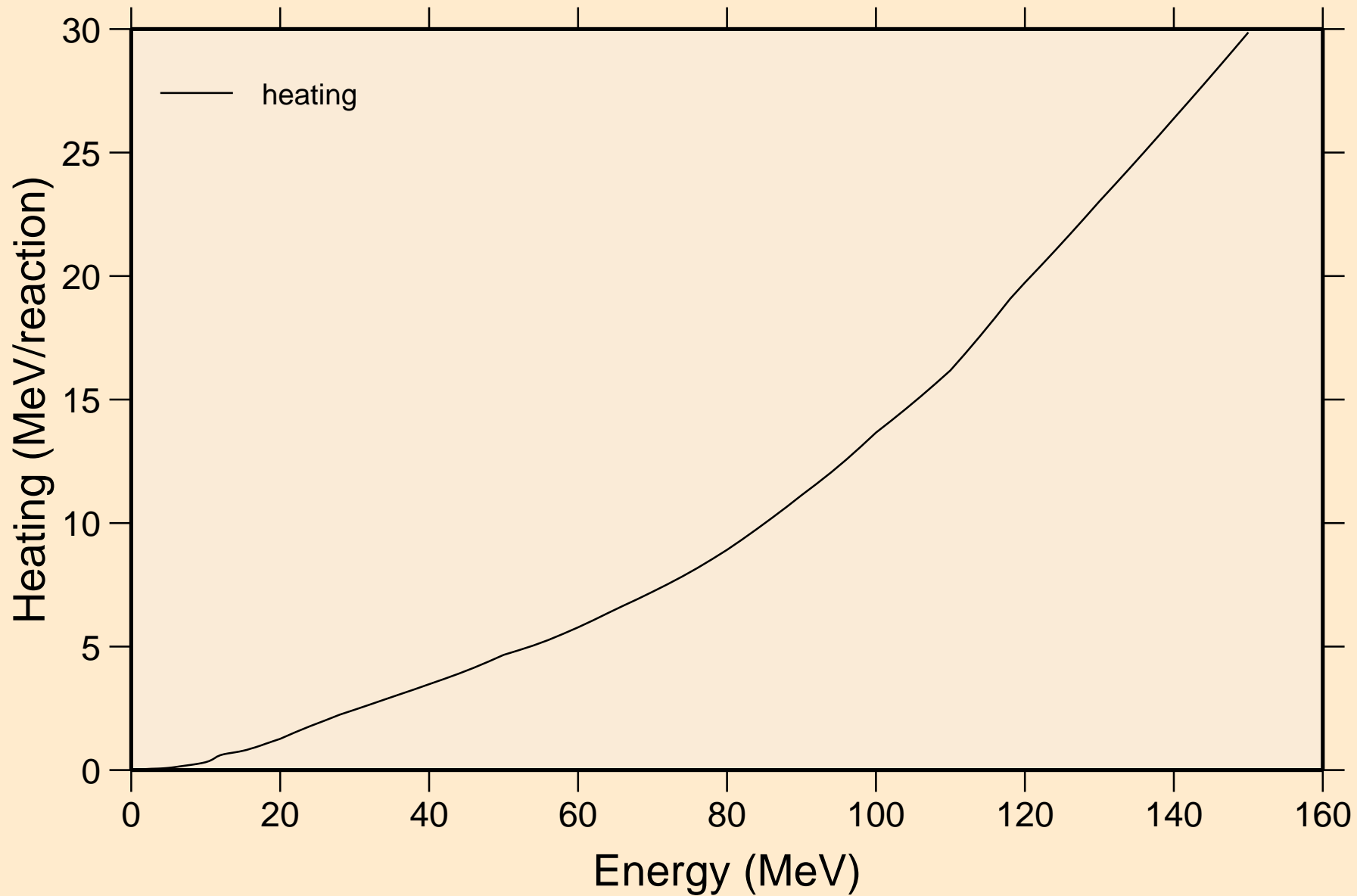

30-ZN-66 FOR FENDL-3.2 FROM FENDL-3.2 BY NJOY2016.60+ O Damage

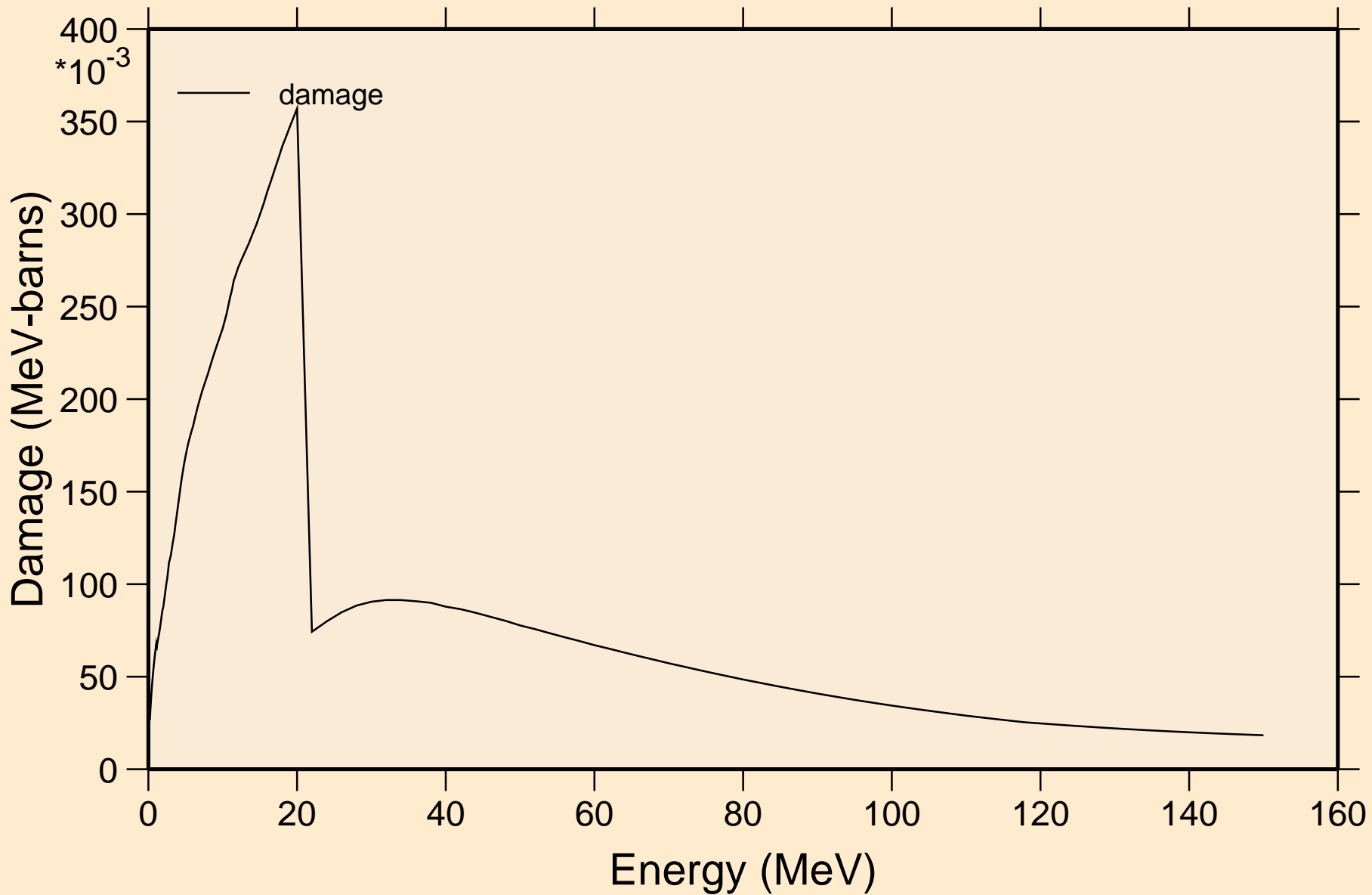

30-ZN-66 FOR FENDL-3.2 FROM FENDL-3.2 BY NJOY2016.60+ O
Non-threshold reactions

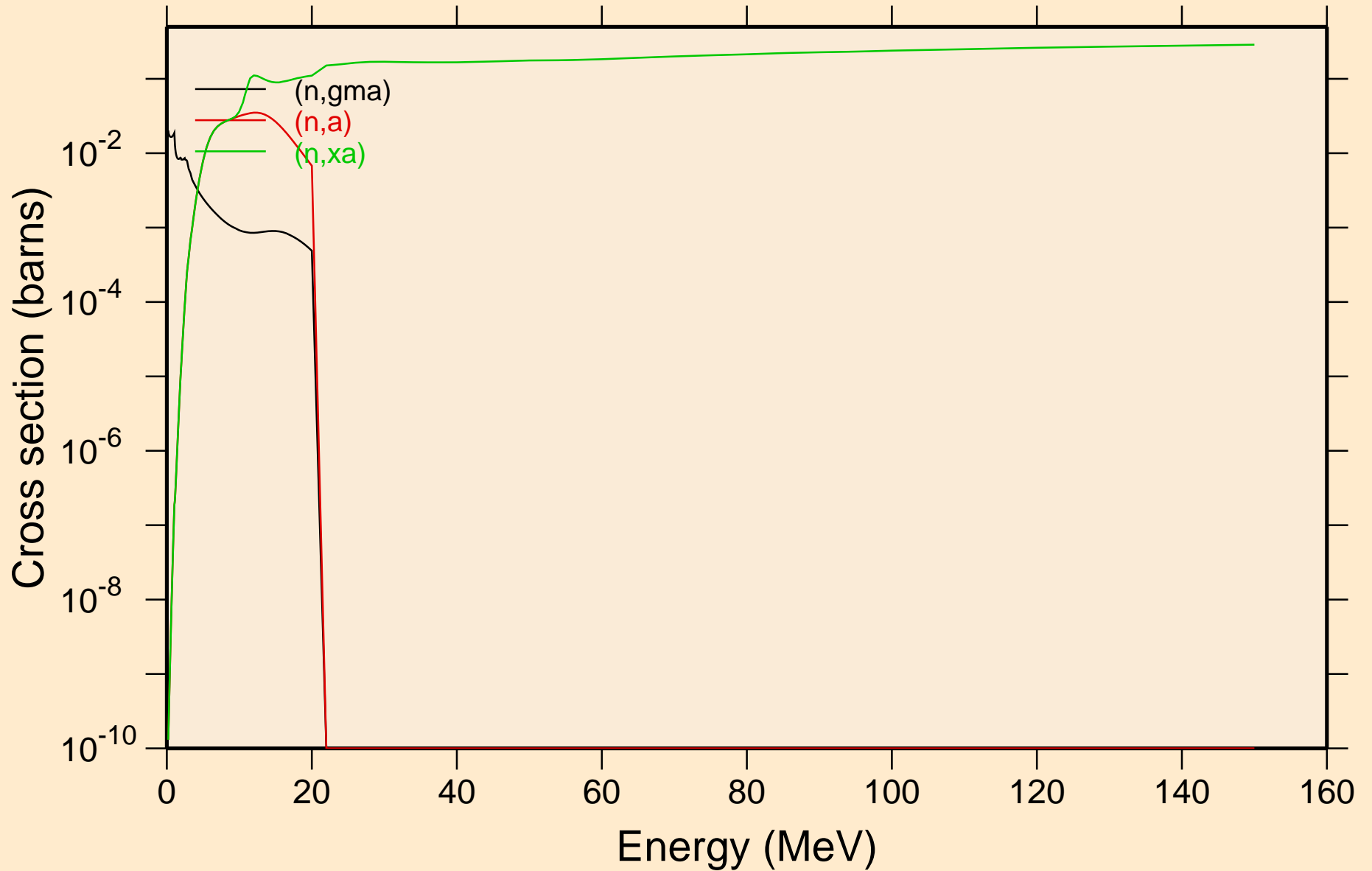

30-ZN-66 FOR FENDL-3.2 FROM FENDL-3.2 BY NJOY2016.60+ O
Inelastic levels

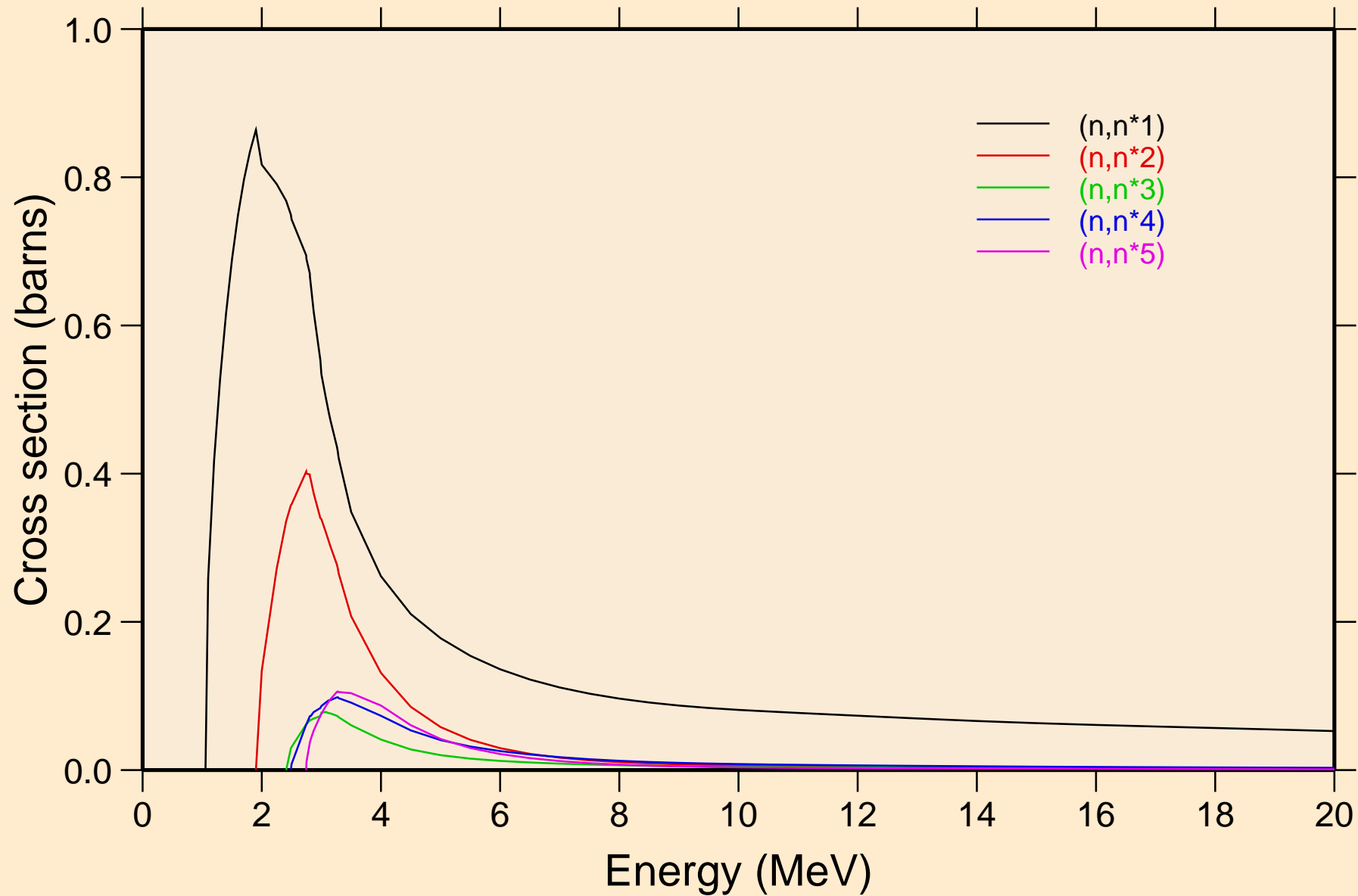

30-ZN-66 FOR FENDL-3.2 FROM FENDL-3.2 BY NJOY2016.60+ O Inelastic levels

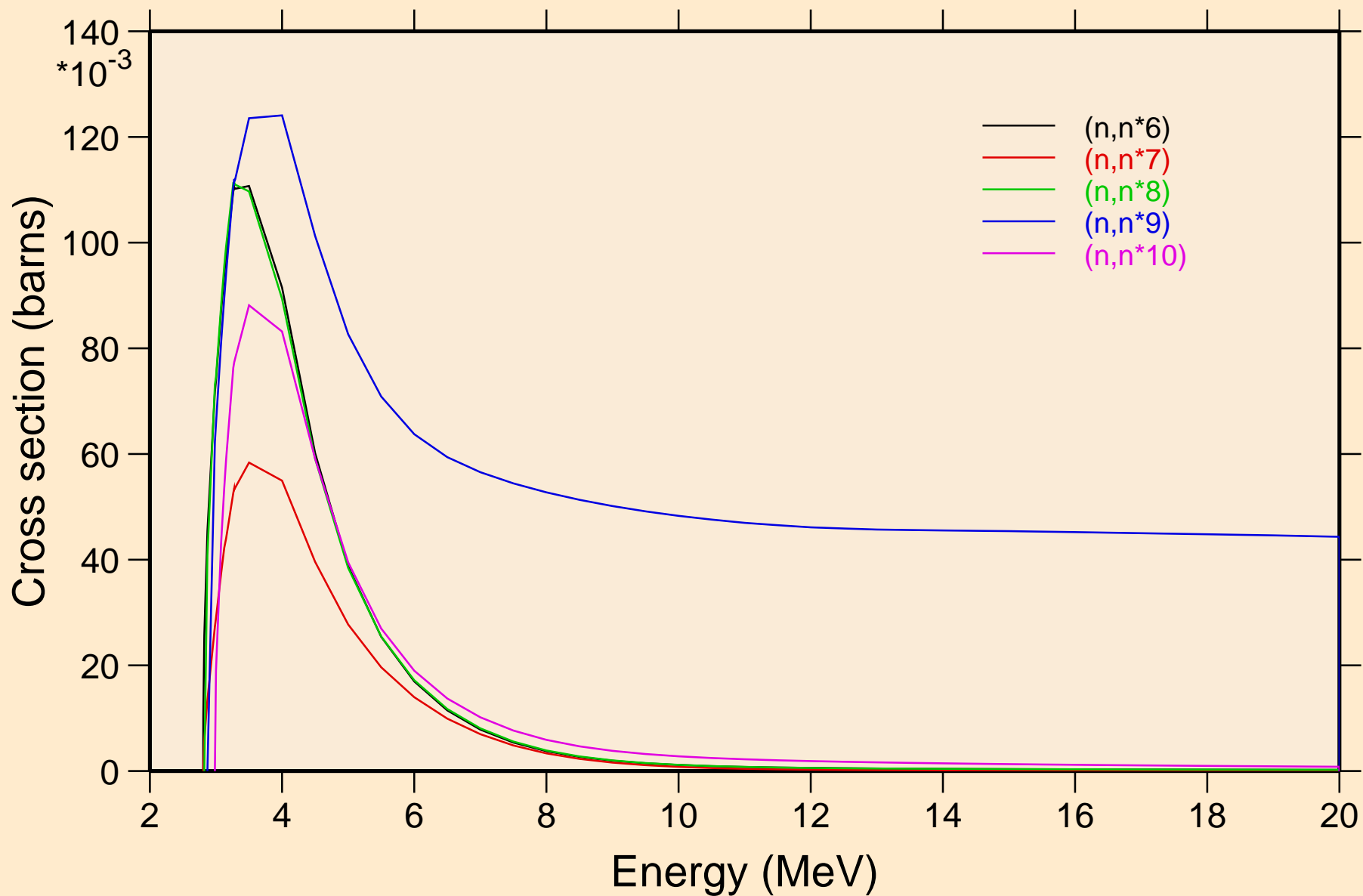

30-ZN-66 FOR FENDL-3.2 FROM FENDL-3.2 BY NJOY2016.60+ O Inelastic levels

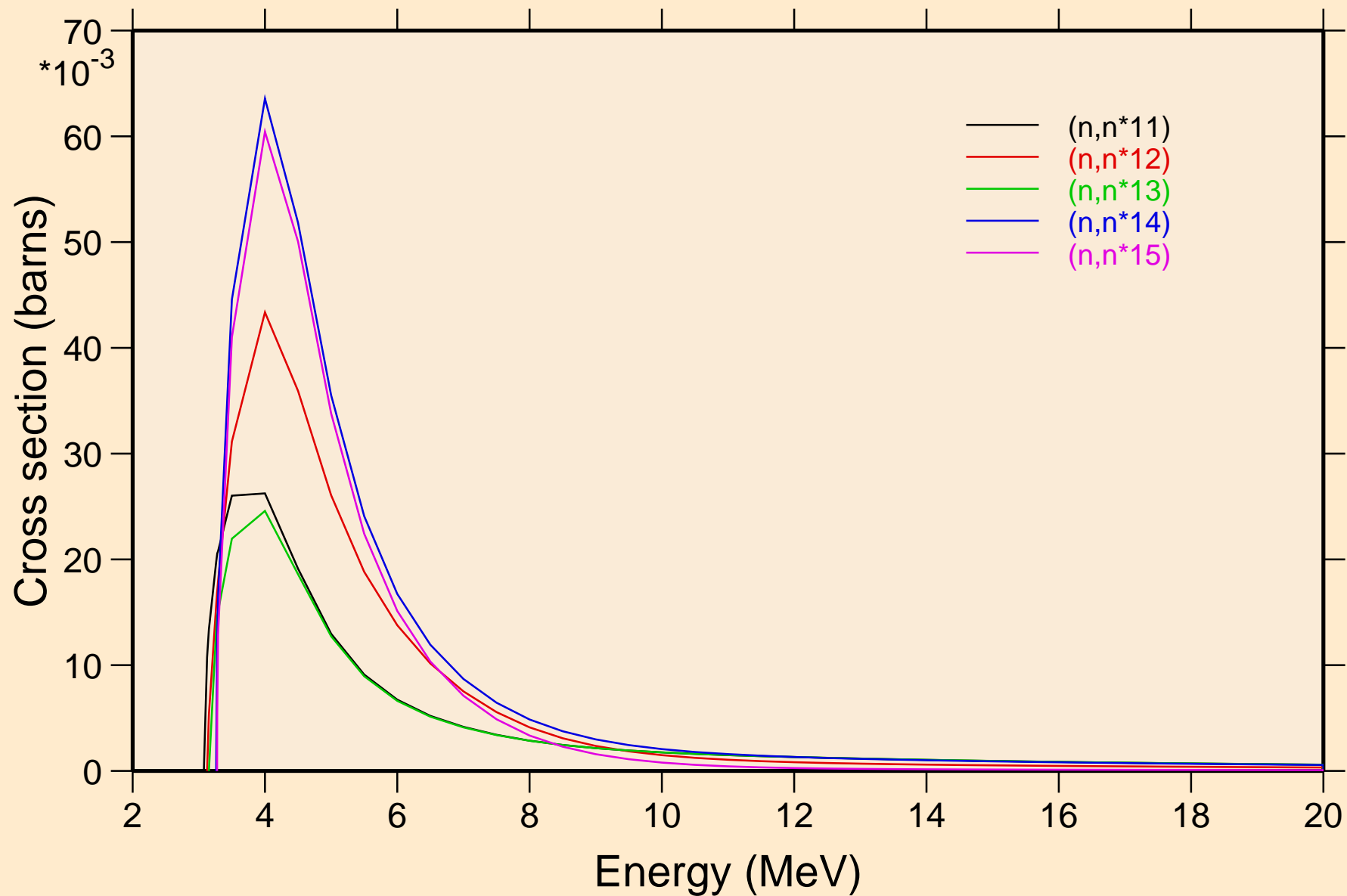

30-ZN-66 FOR FENDL-3.2 FROM FENDL-3.2 BY NJOY2016.60+ O Inelastic levels

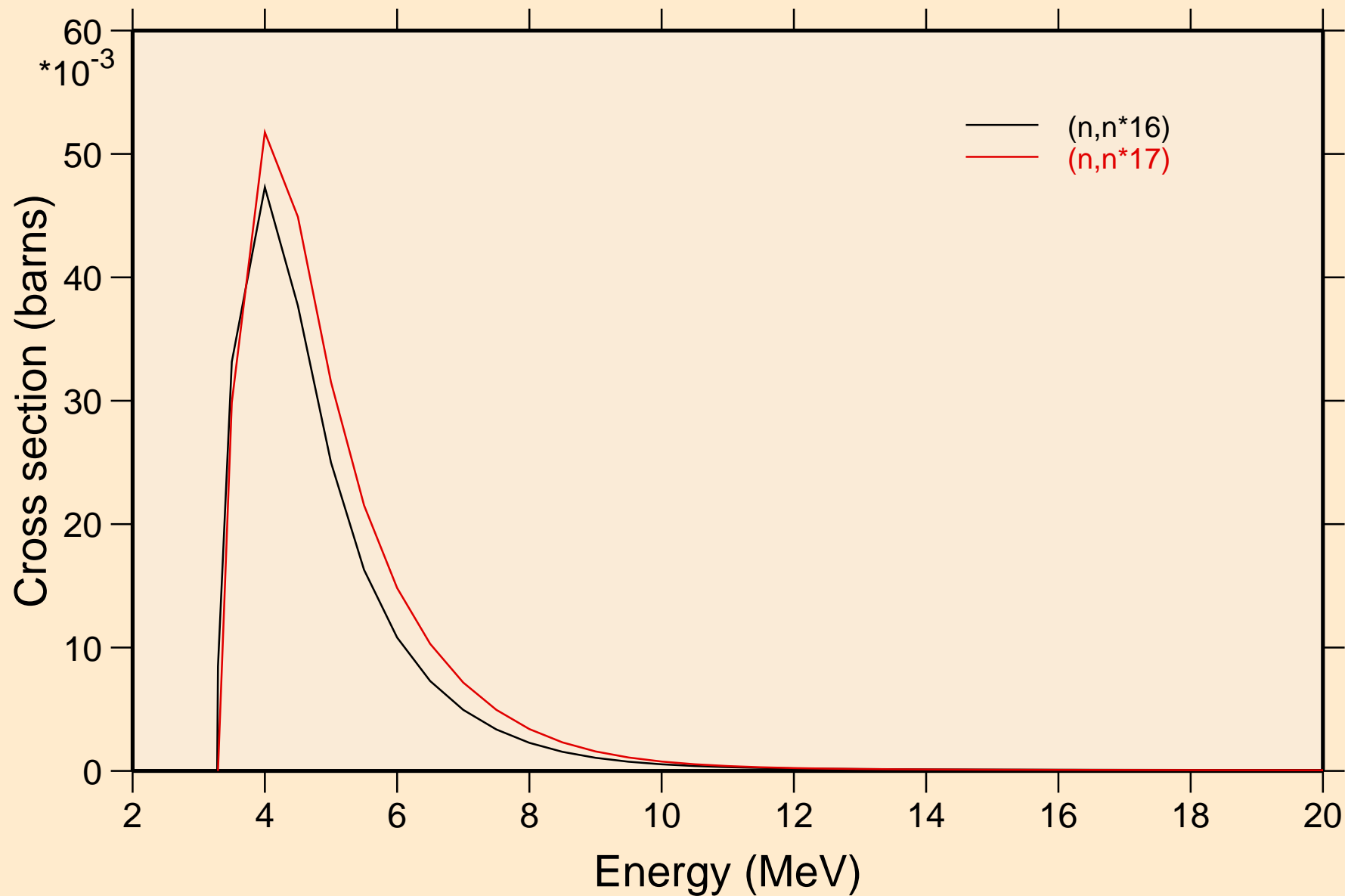

30-ZN-66 FOR FENDL-3.2 FROM FENDL-3.2 BY NJOY2016.60+ O
Threshold reactions

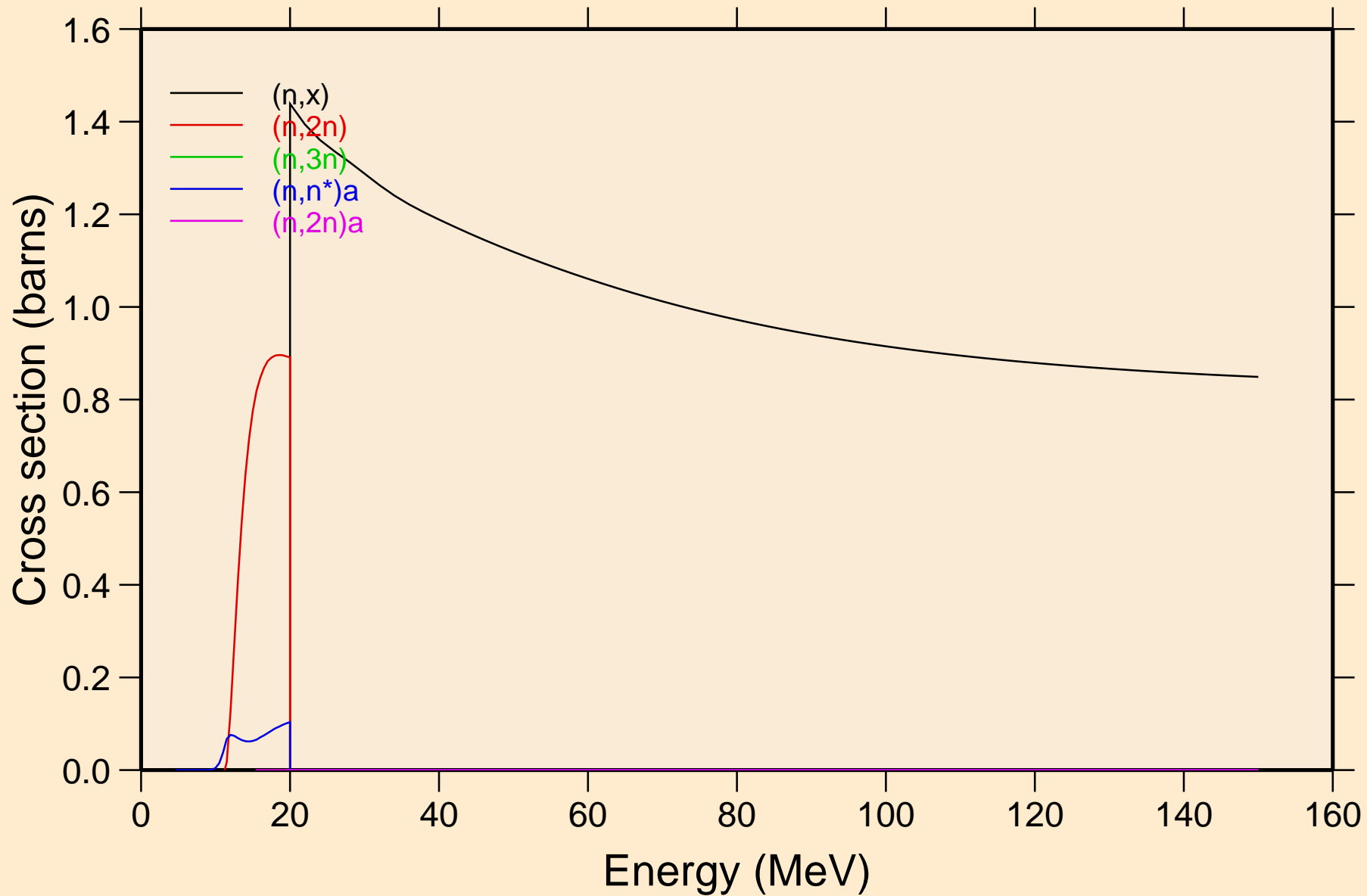

30-ZN-66 FOR FENDL-3.2 FROM FENDL-3.2 BY NJOY2016.60+ O Threshold reactions

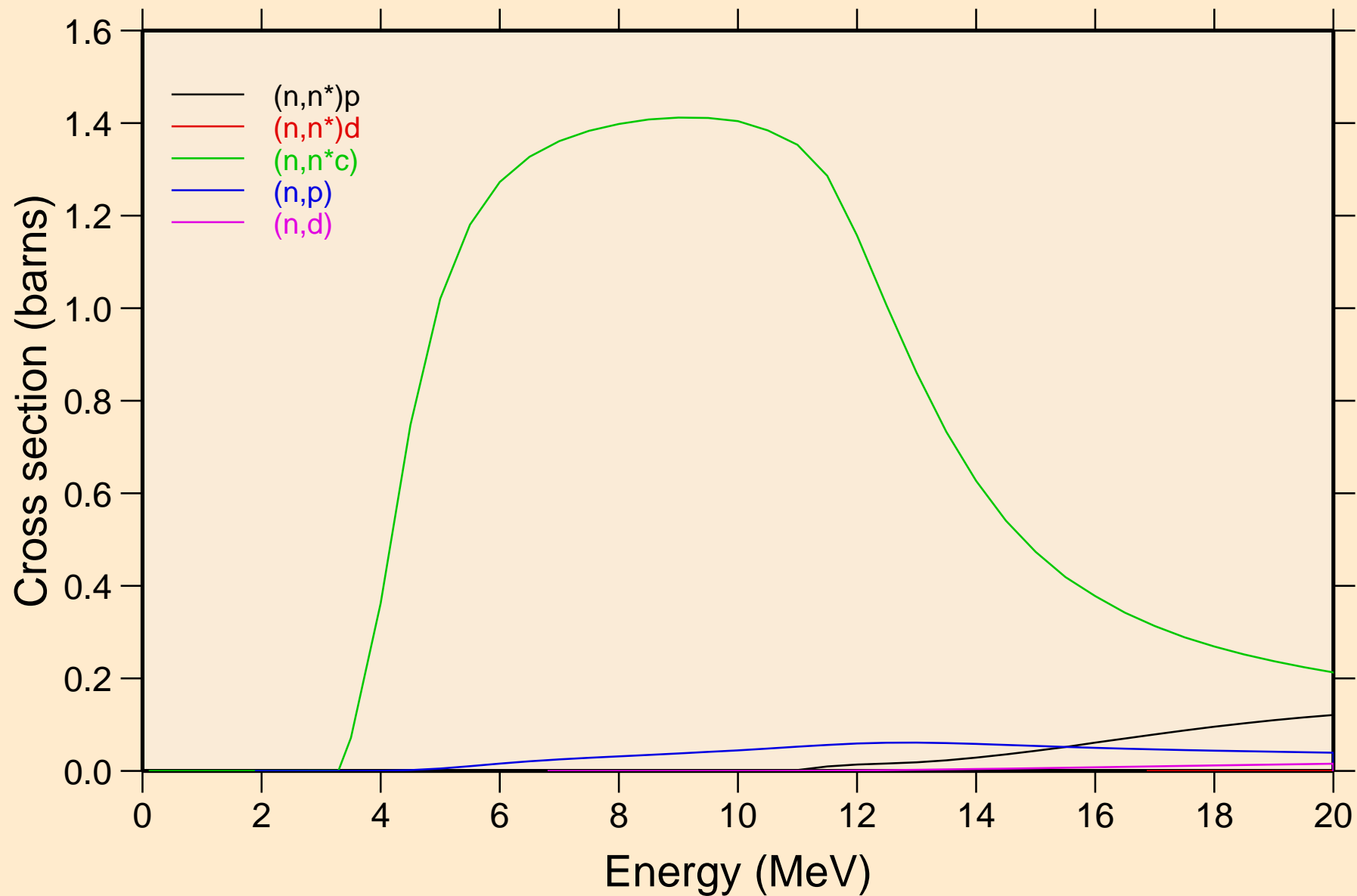

30-ZN-66 FOR FENDL-3.2 FROM FENDL-3.2 BY NJOY2016.60+ O
Threshold reactions

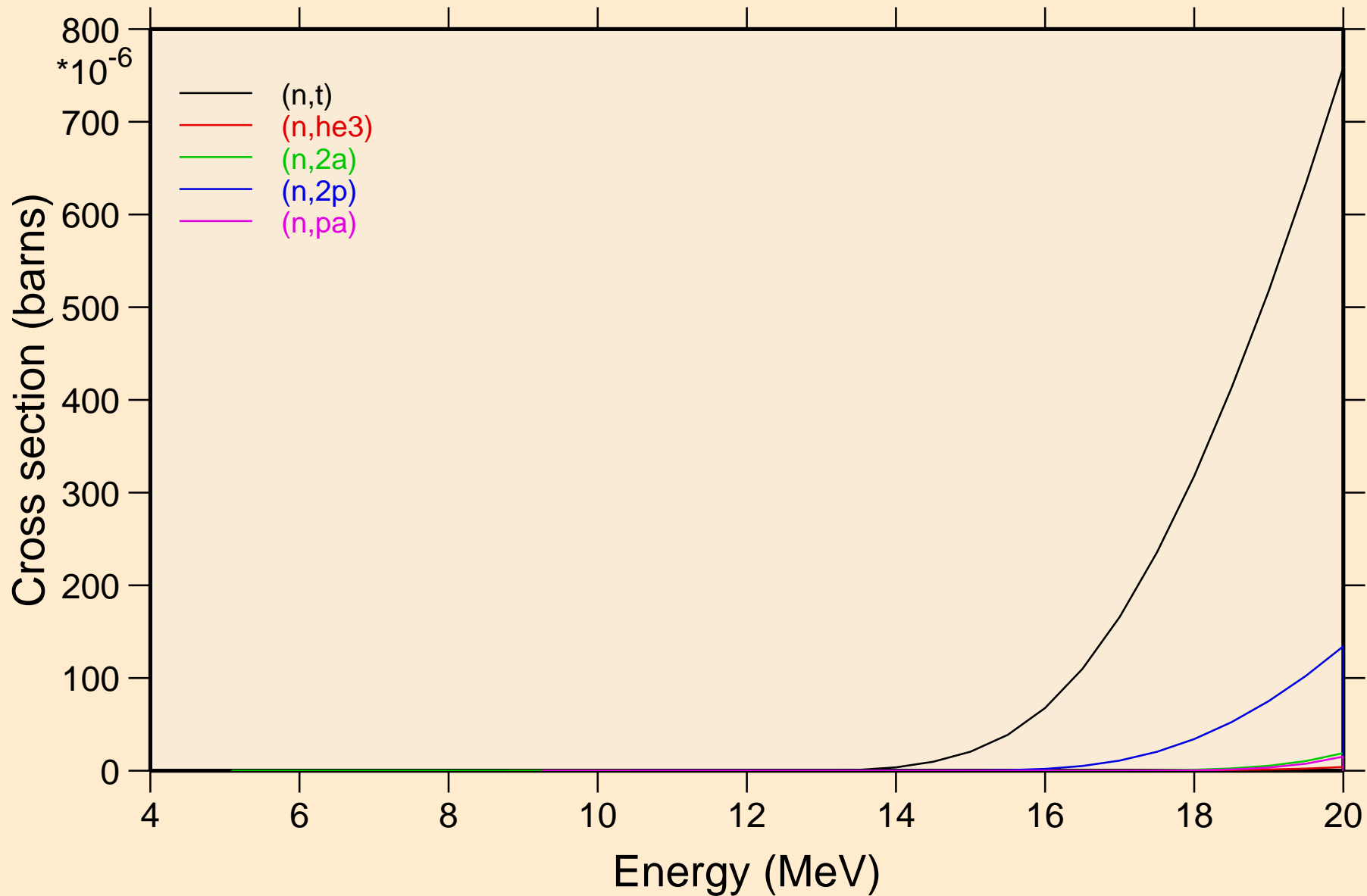

30-ZN-66 FOR FENDL-3.2 FROM FENDL-3.2 BY NJOY2016.60+ O
Threshold reactions

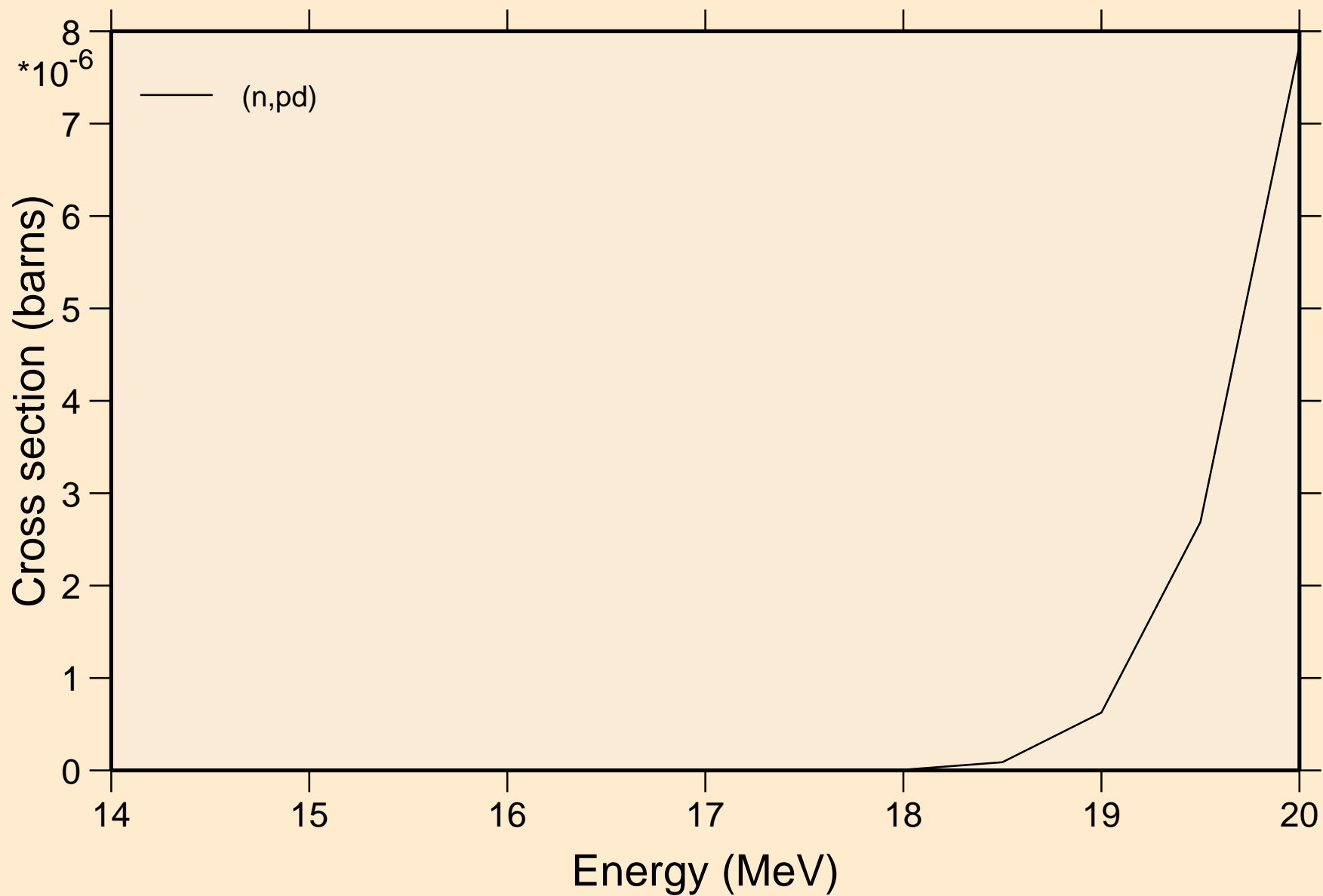

30-ZN-66 FOR FENDL-3.2 FROM FENDL-3.2 BY NJOY2016.60+ O Threshold reactions

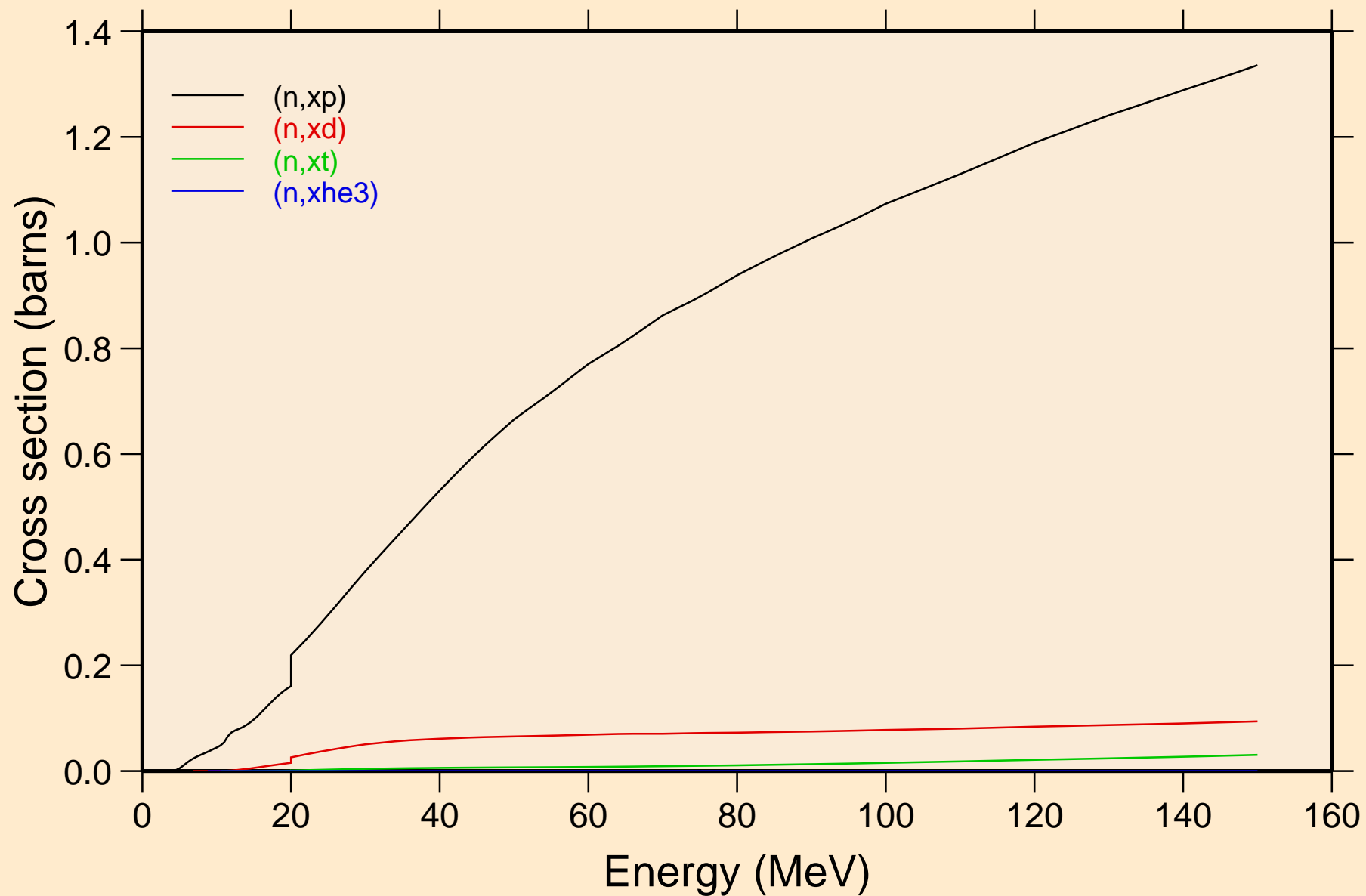

30-ZN-66 FOR FENDL-3.2 FROM FENDL-3.2 BY NJOY2016.60+ O
angular distribution for elastic

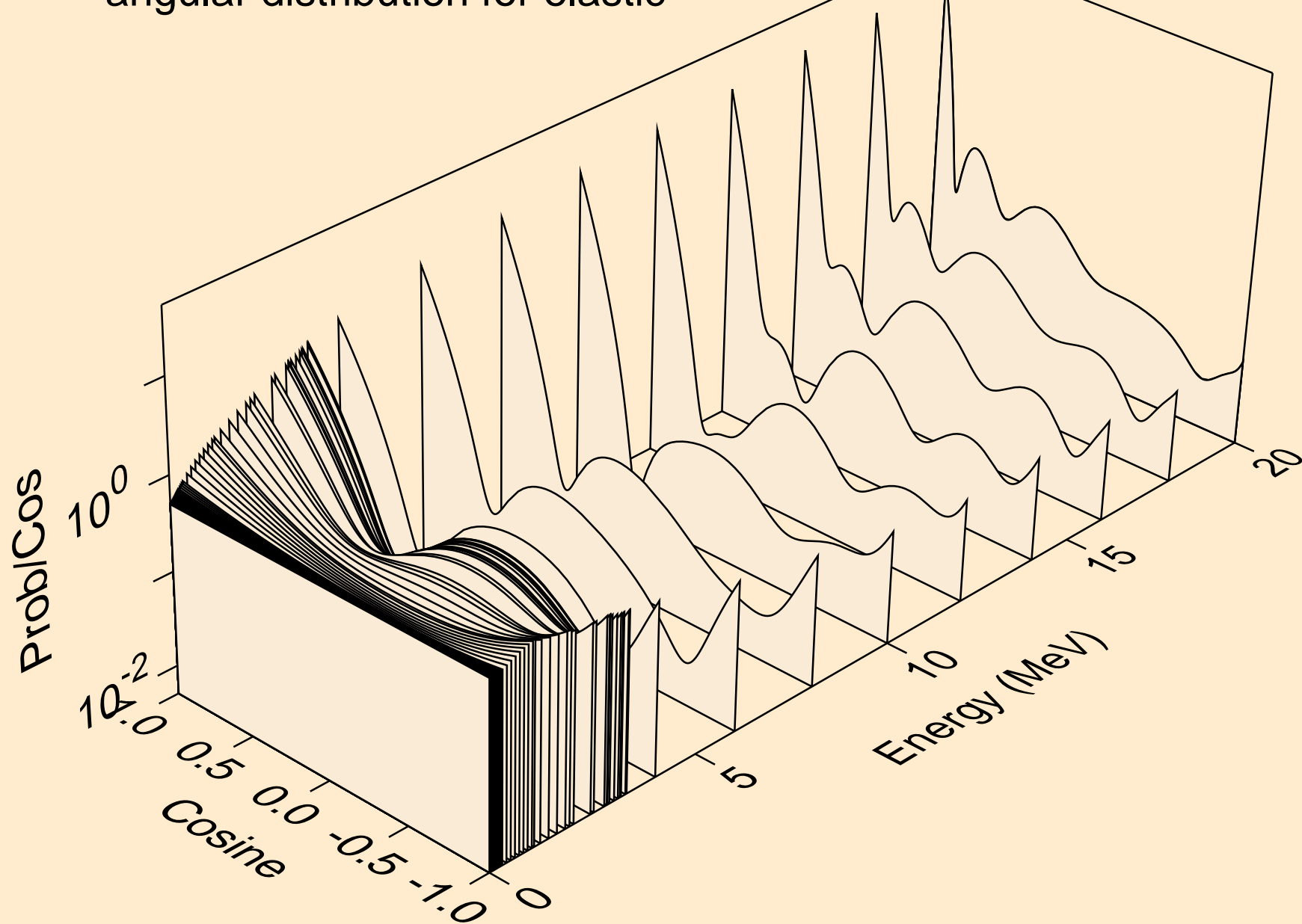

30-ZN-66 FOR FENDL-3.2 FROM FENDL-3.2 BY NJOY2016.60+ O
angular distribution for elastic

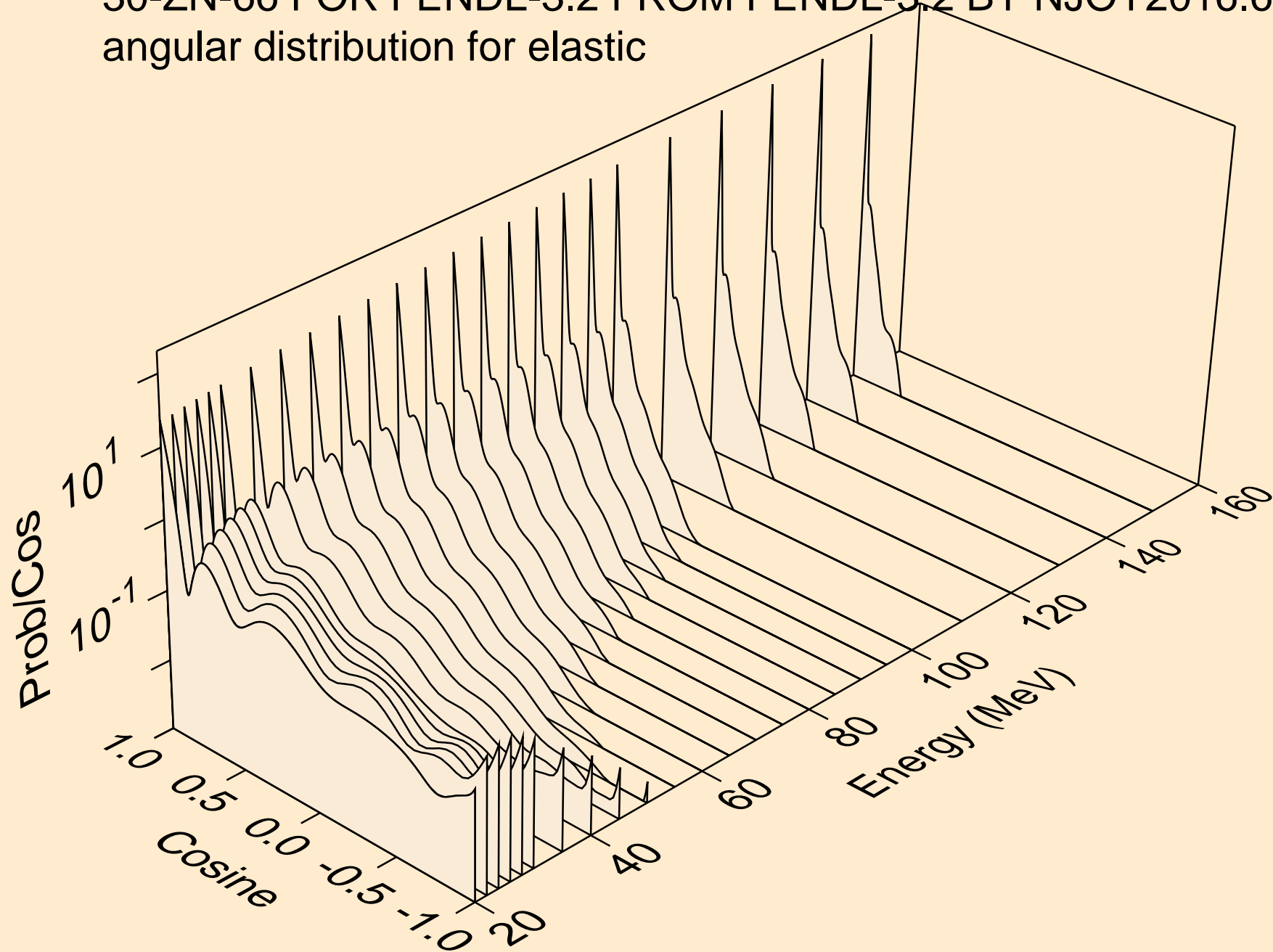

30-ZN-66 FOR FENDL-3.2 FROM FENDL-3.2 BY NJOY2016.60+ O
angular distribution for (n,n*1)

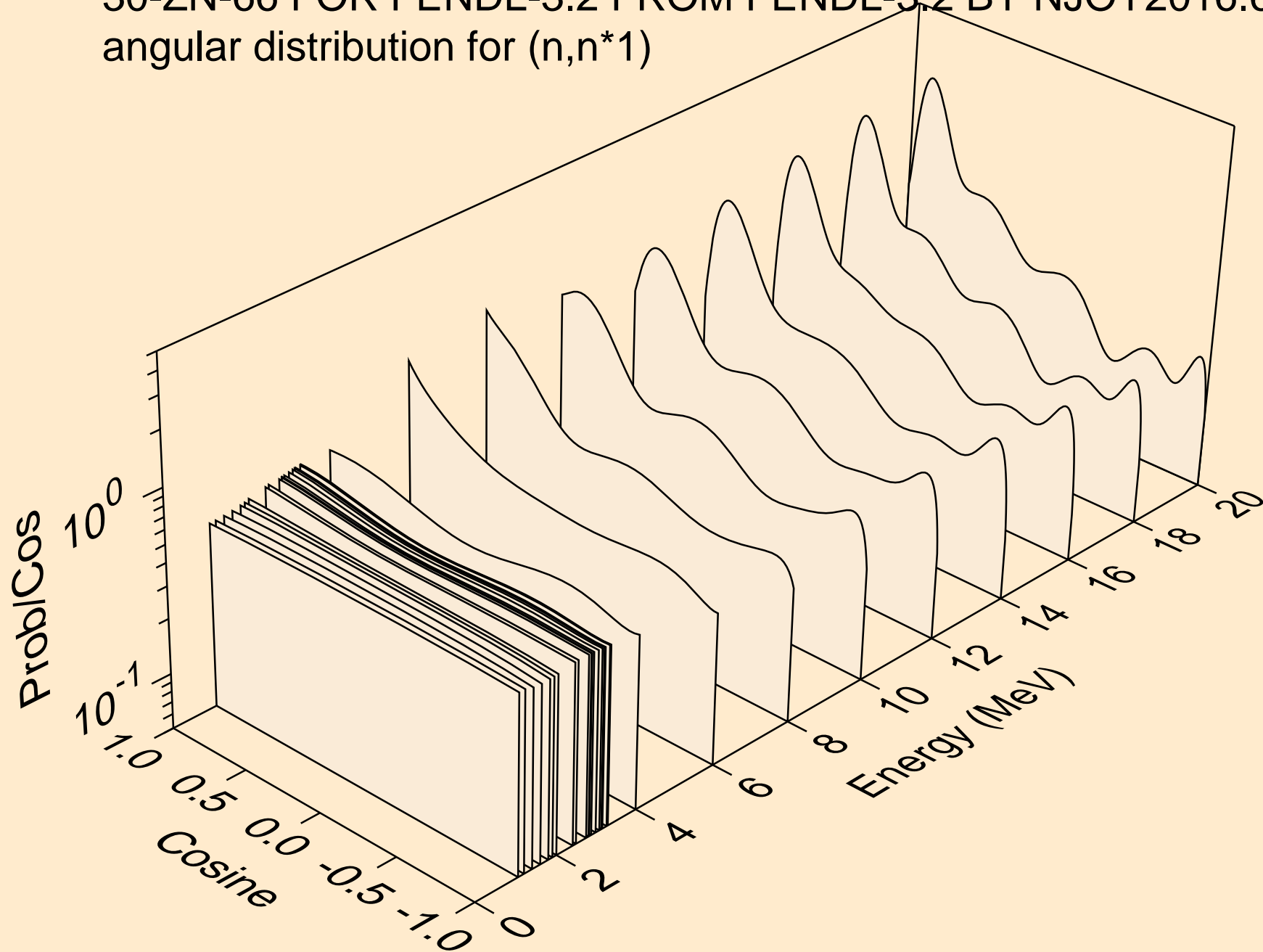

30-ZN-66 FOR FENDL-3.2 FROM FENDL-3.2 BY NJOY2016.60+ O
angular distribution for (n,n*2)

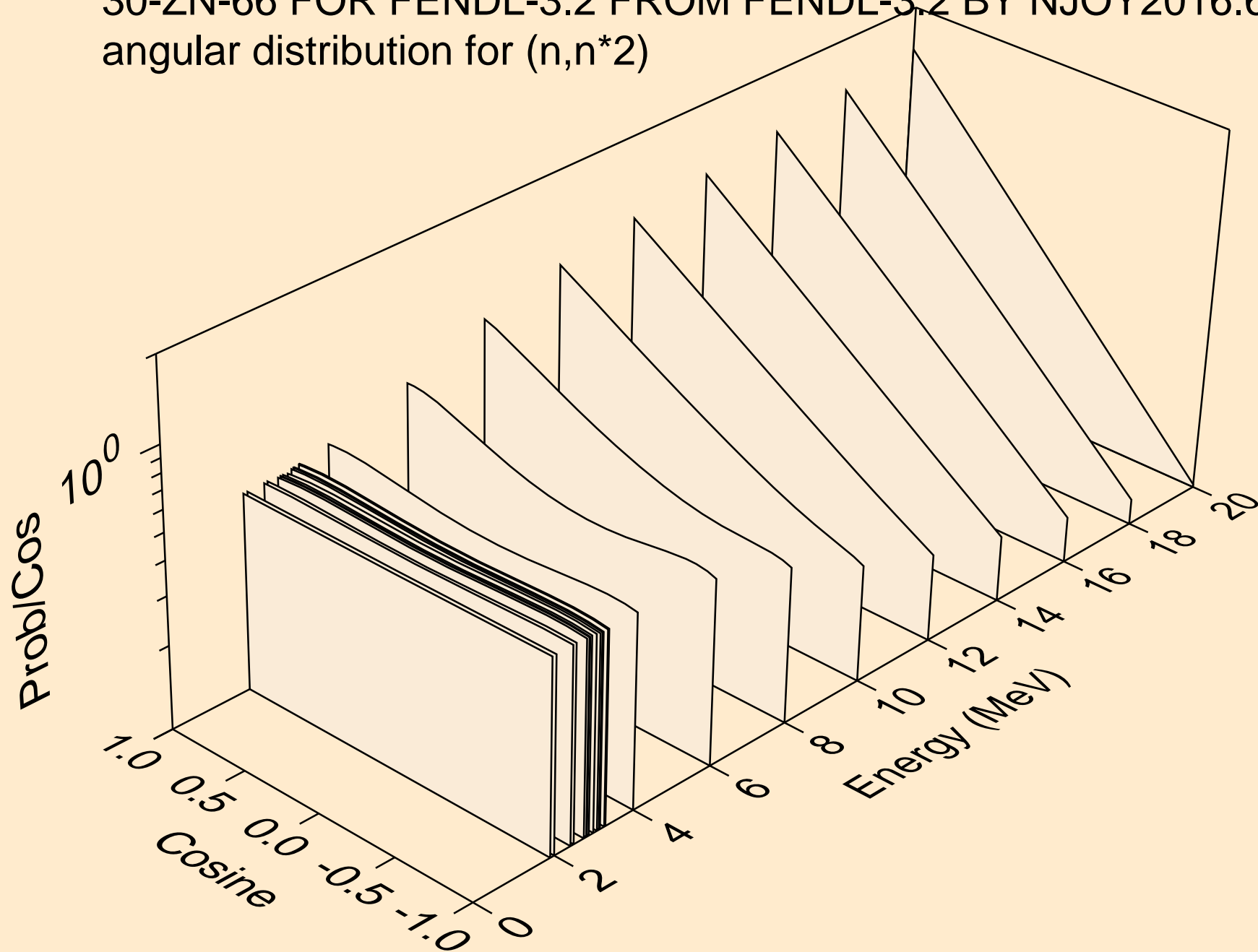

30-ZN-66 FOR FENDL-3.2 FROM FENDL-3.2 BY NJOY2016.60+ O
angular distribution for (n,n*3)

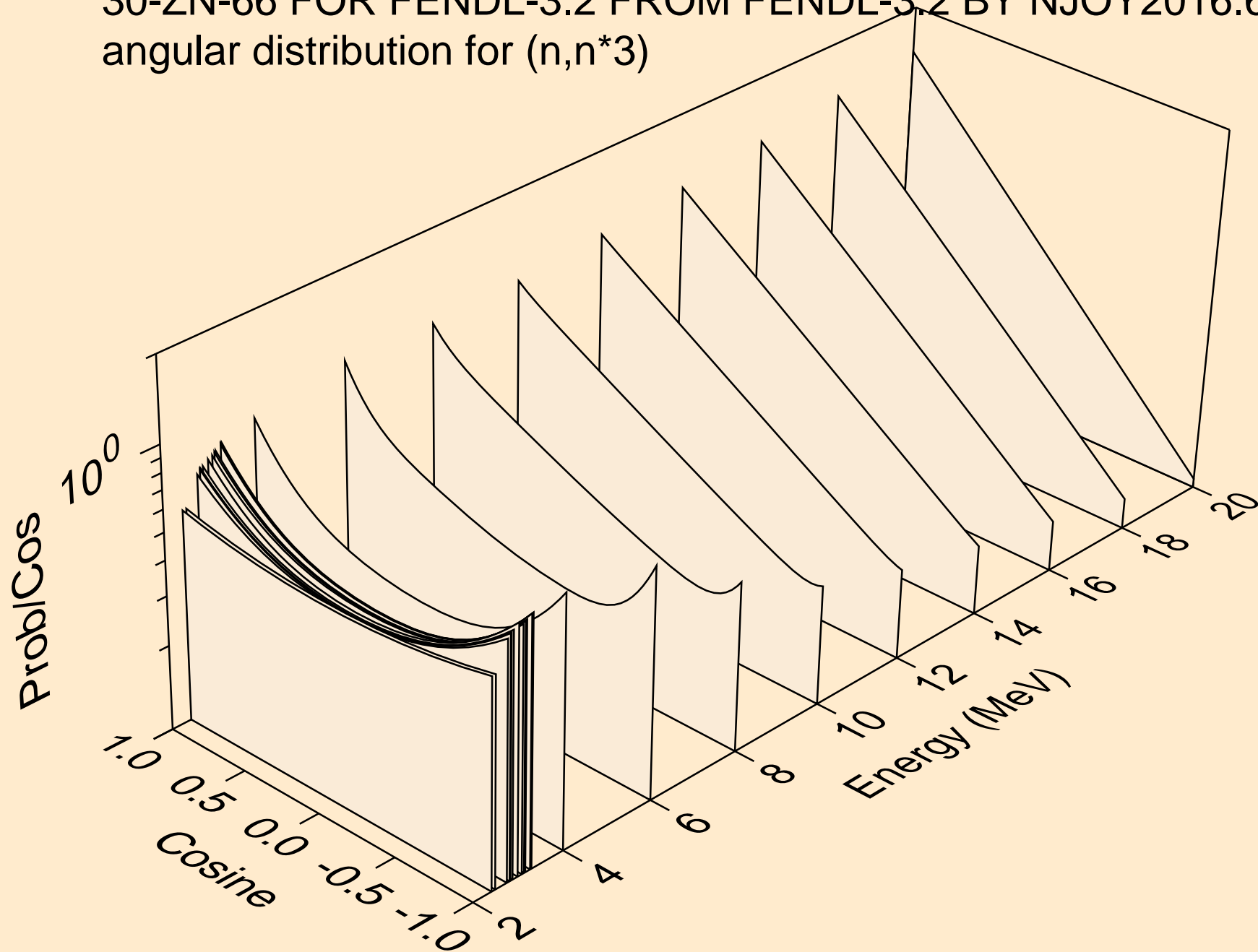

30-ZN-66 FOR FENDL-3.2 FROM FENDL-3.2 BY NJOY2016.60+ O
angular distribution for (n,n*4)

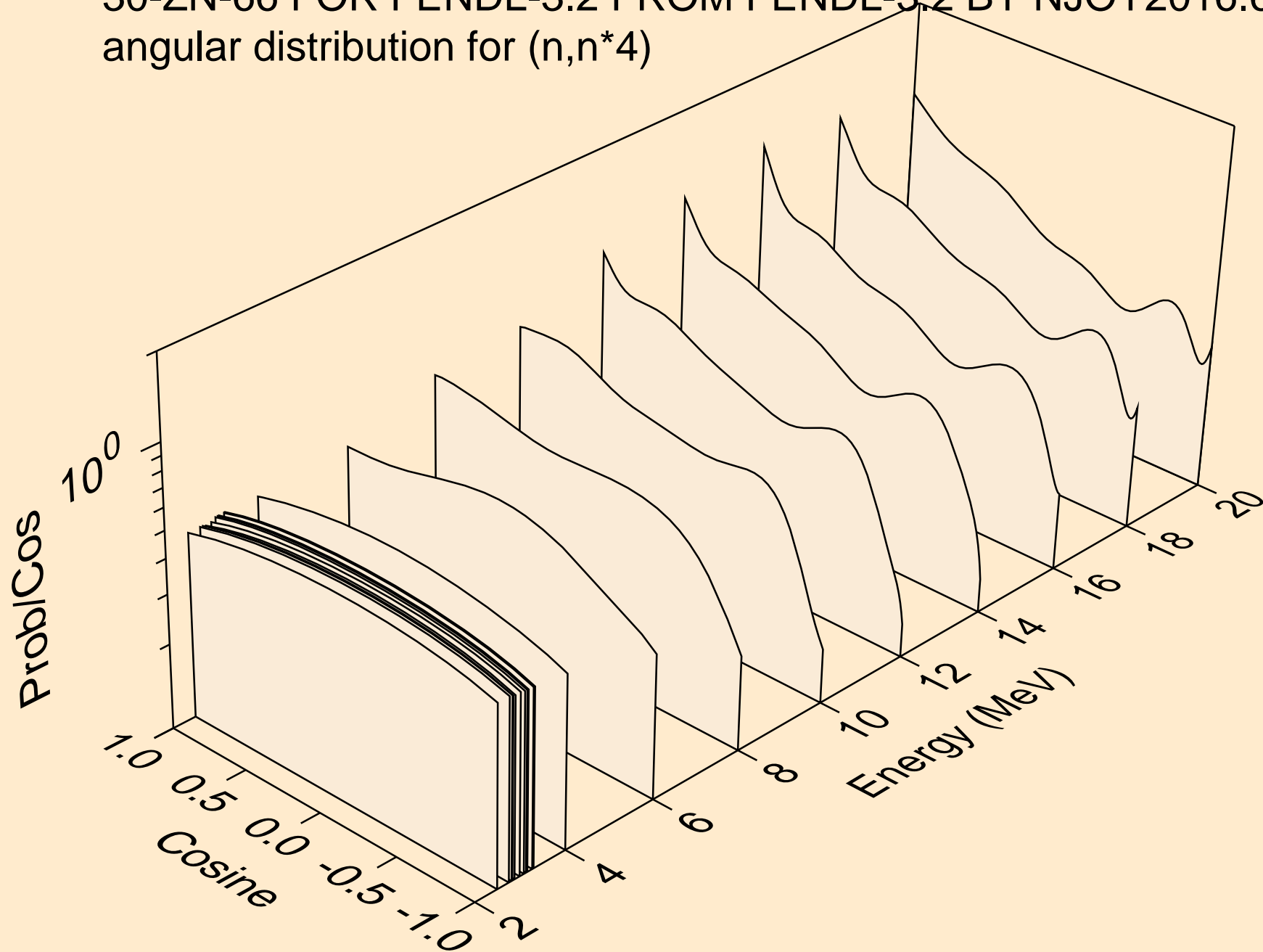

30-ZN-66 FOR FENDL-3.2 FROM FENDL-3.2 BY NJOY2016.60+ O
angular distribution for (n,n*5)

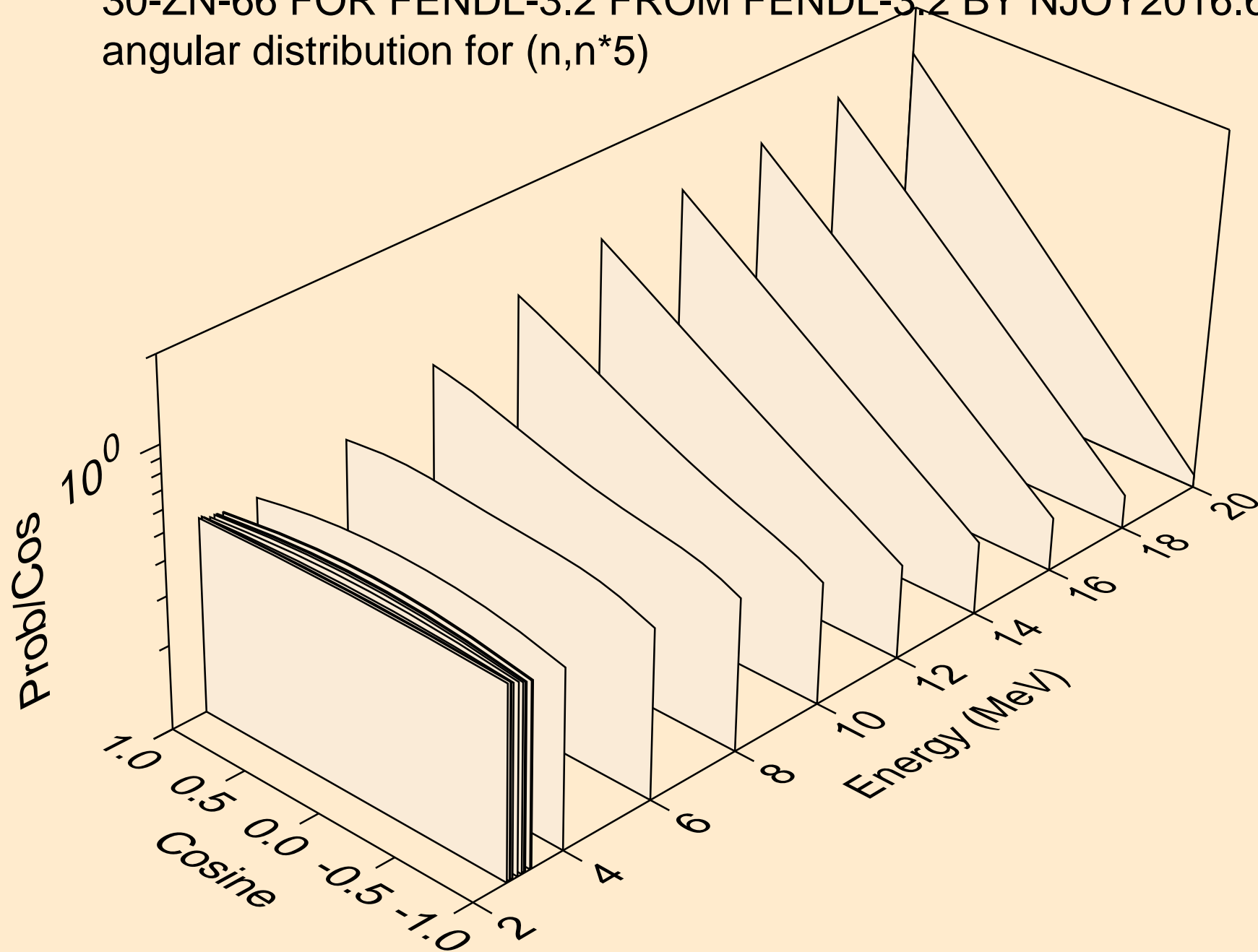

30-ZN-66 FOR FENDL-3.2 FROM FENDL-3.2 BY NJOY2016.60+ O
angular distribution for (n,n*6)

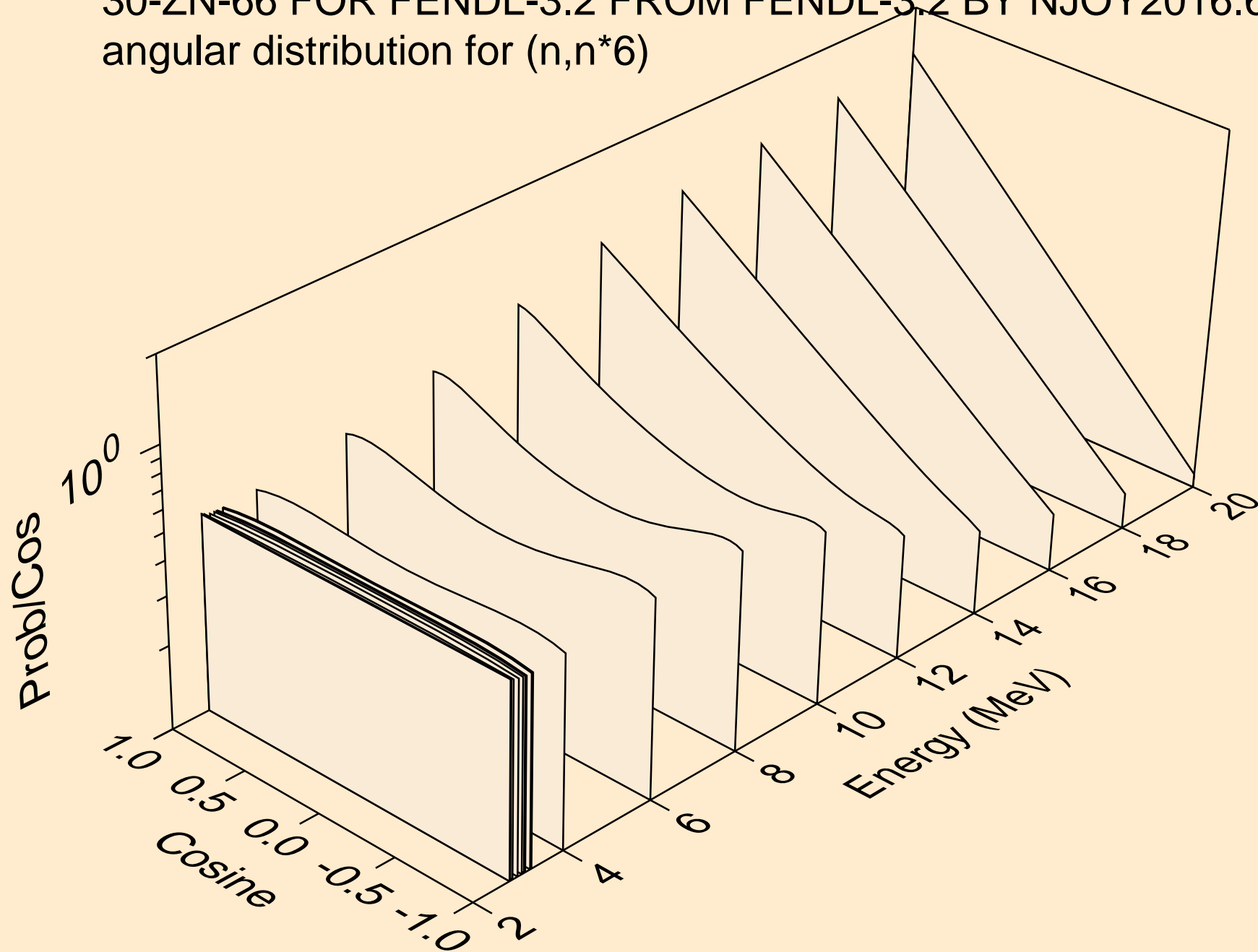

30-ZN-66 FOR FENDL-3.2 FROM FENDL-3.2 BY NJOY2016.60+ O
angular distribution for (n,n*7)

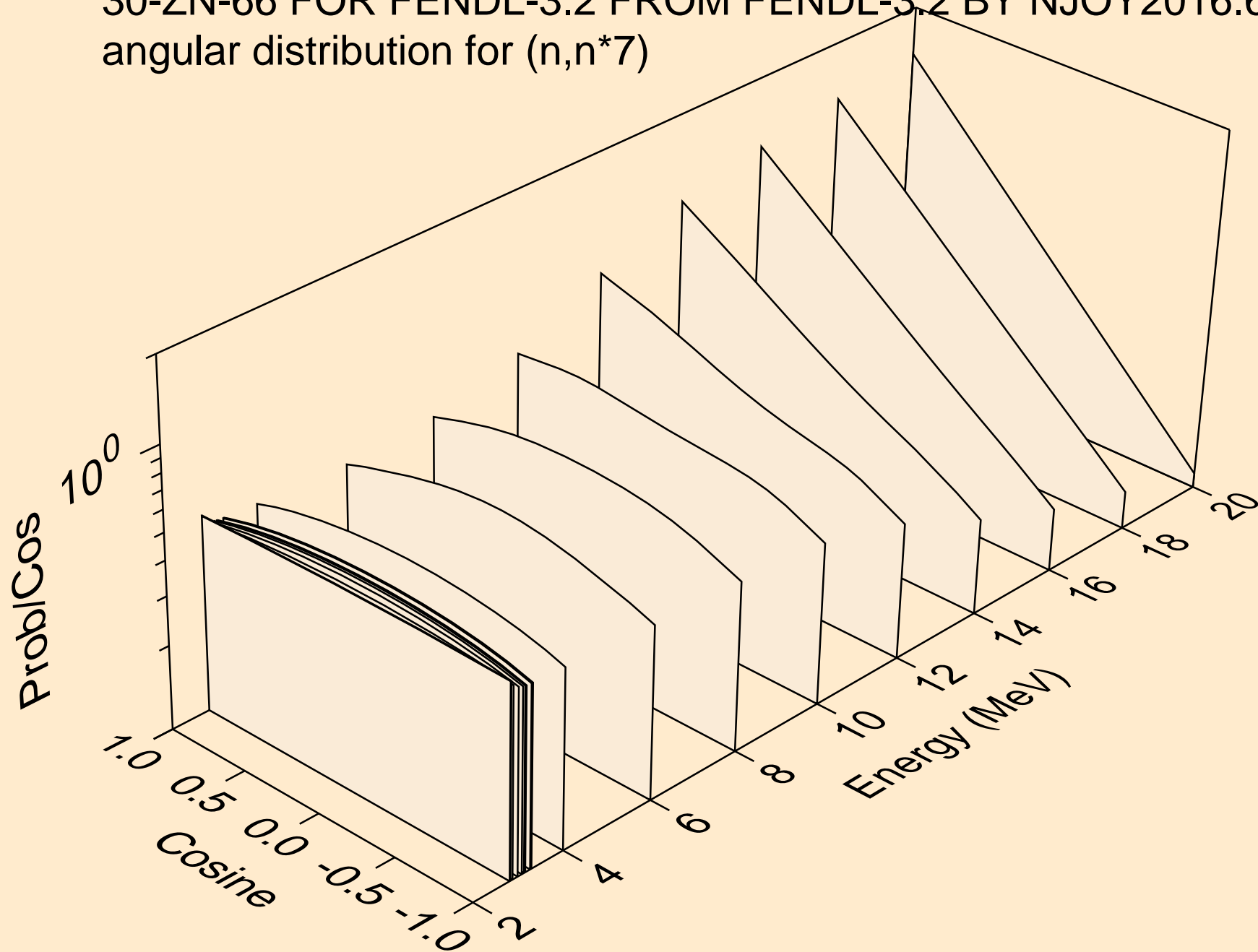

30-ZN-66 FOR FENDL-3.2 FROM FENDL-3.2 BY NJOY2016.60+ O
angular distribution for (n,n*8)

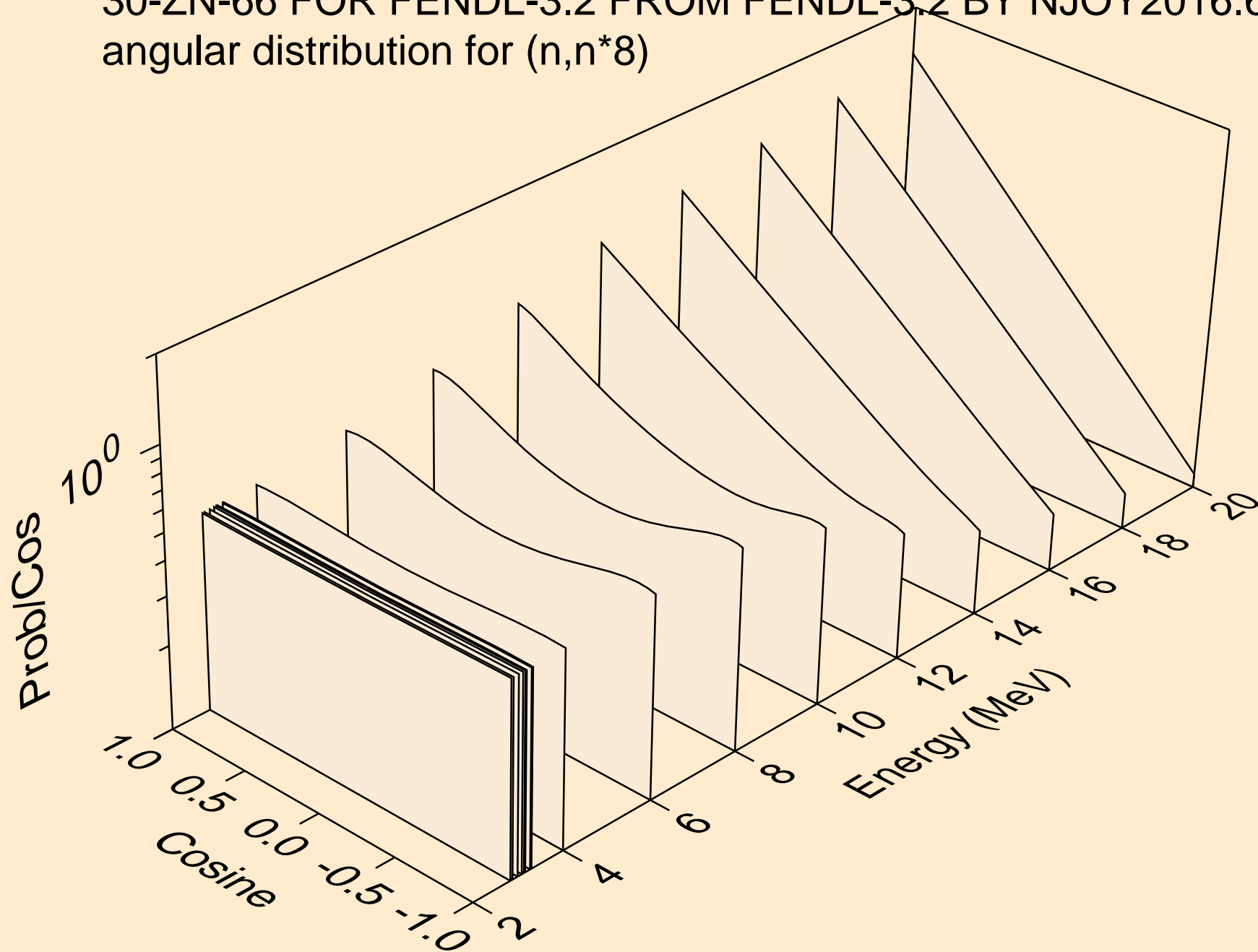

30-ZN-66 FOR FENDL-3.2 FROM FENDL-3.2 BY NJOY2016.60+ O
angular distribution for (n,n*9)

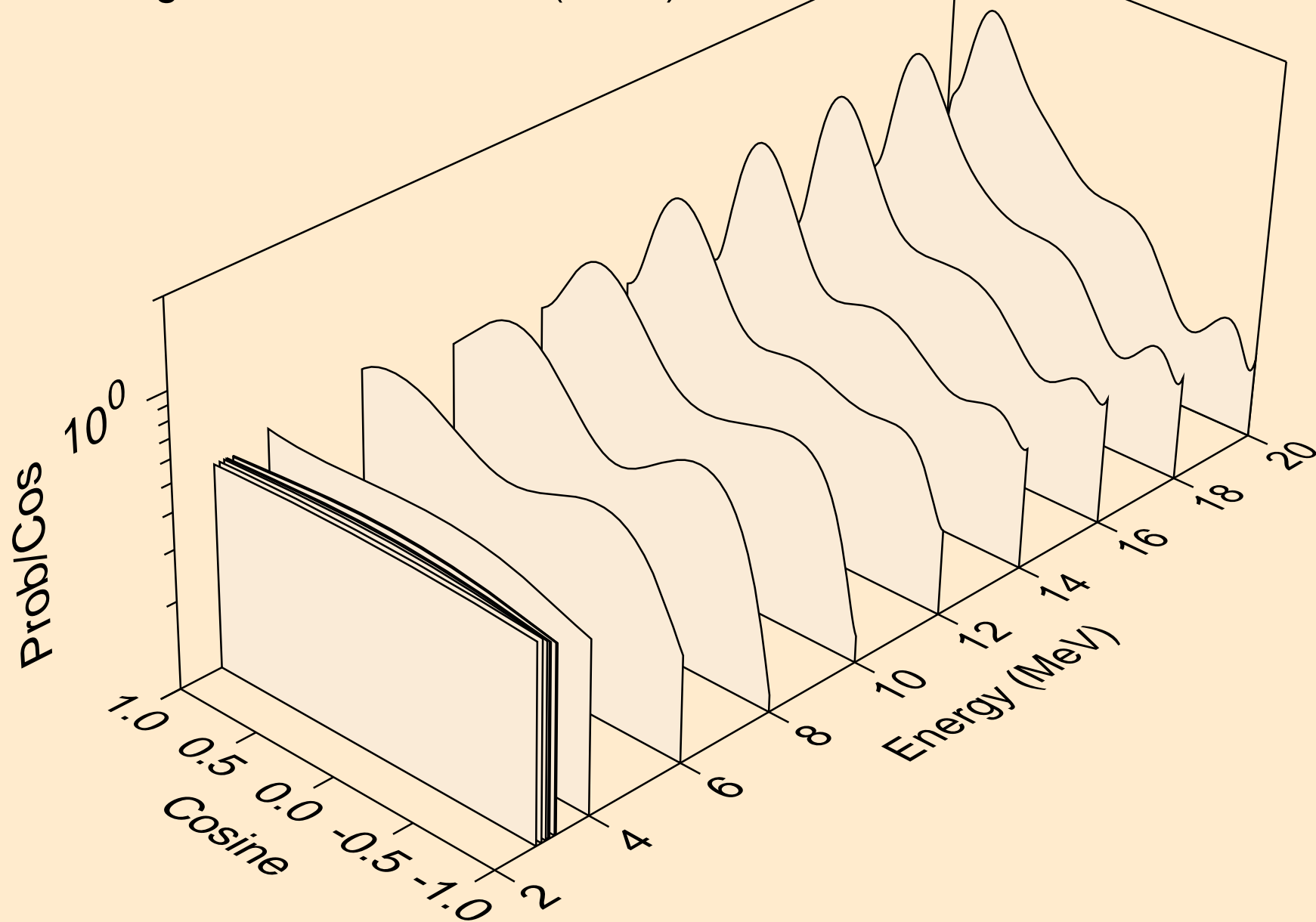

30-ZN-66 FOR FENDL-3.2 FROM FENDL-3.2 BY NJOY2016.60+ O
angular distribution for (n,n*10)

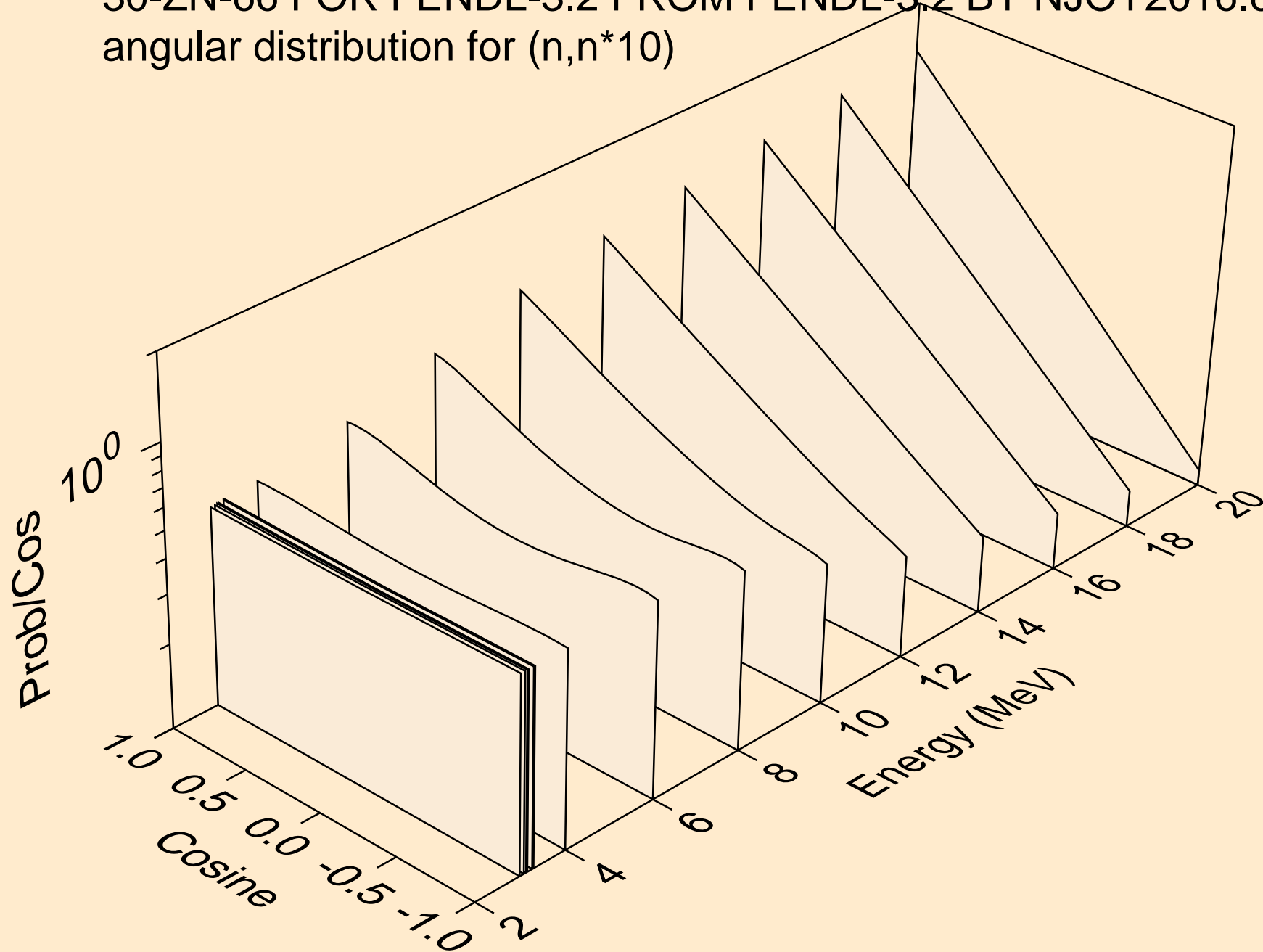

30-ZN-66 FOR FENDL-3.2 FROM FENDL-3.2 BY NJOY2016.60+ O
angular distribution for (n,n*11)

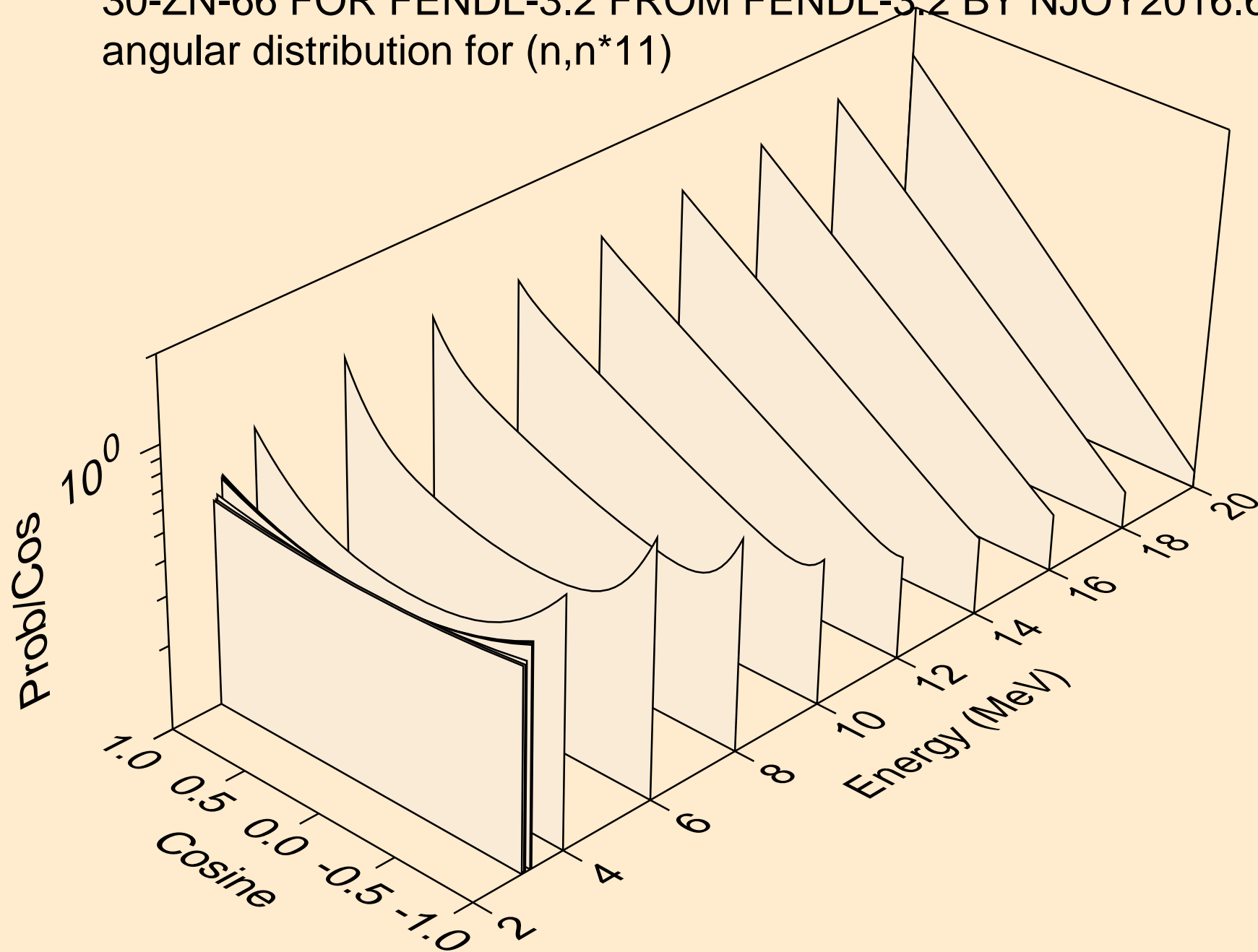

30-ZN-66 FOR FENDL-3.2 FROM FENDL-3.2 BY NJOY2016.60+ O
angular distribution for (n,n*12)

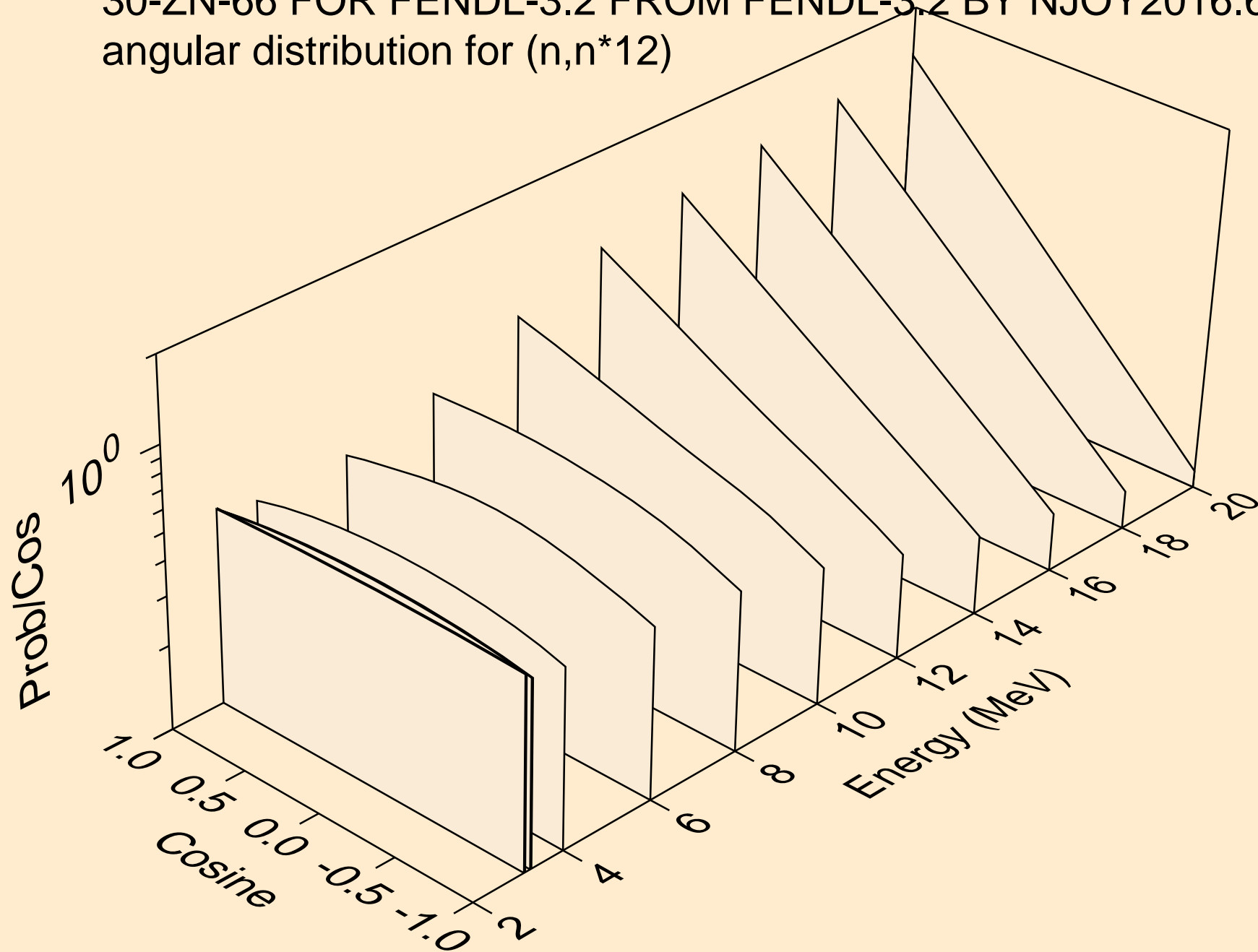

30-ZN-66 FOR FENDL-3.2 FROM FENDL-3.2 BY NJOY2016.60+ O
angular distribution for (n,n*13)

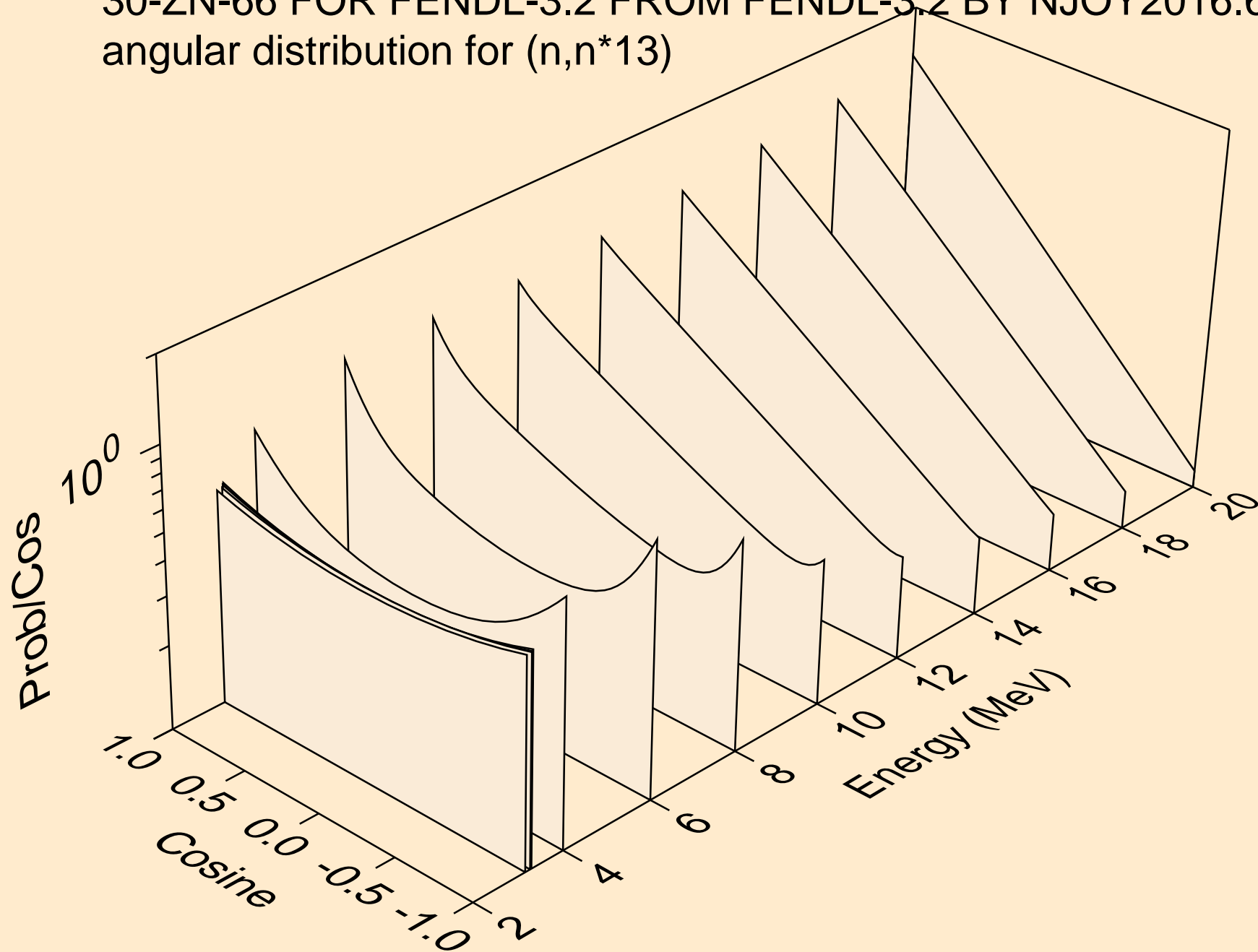

30-ZN-66 FOR FENDL-3.2 FROM FENDL-3.2 BY NJOY2016.60+ O
angular distribution for (n,n*14)

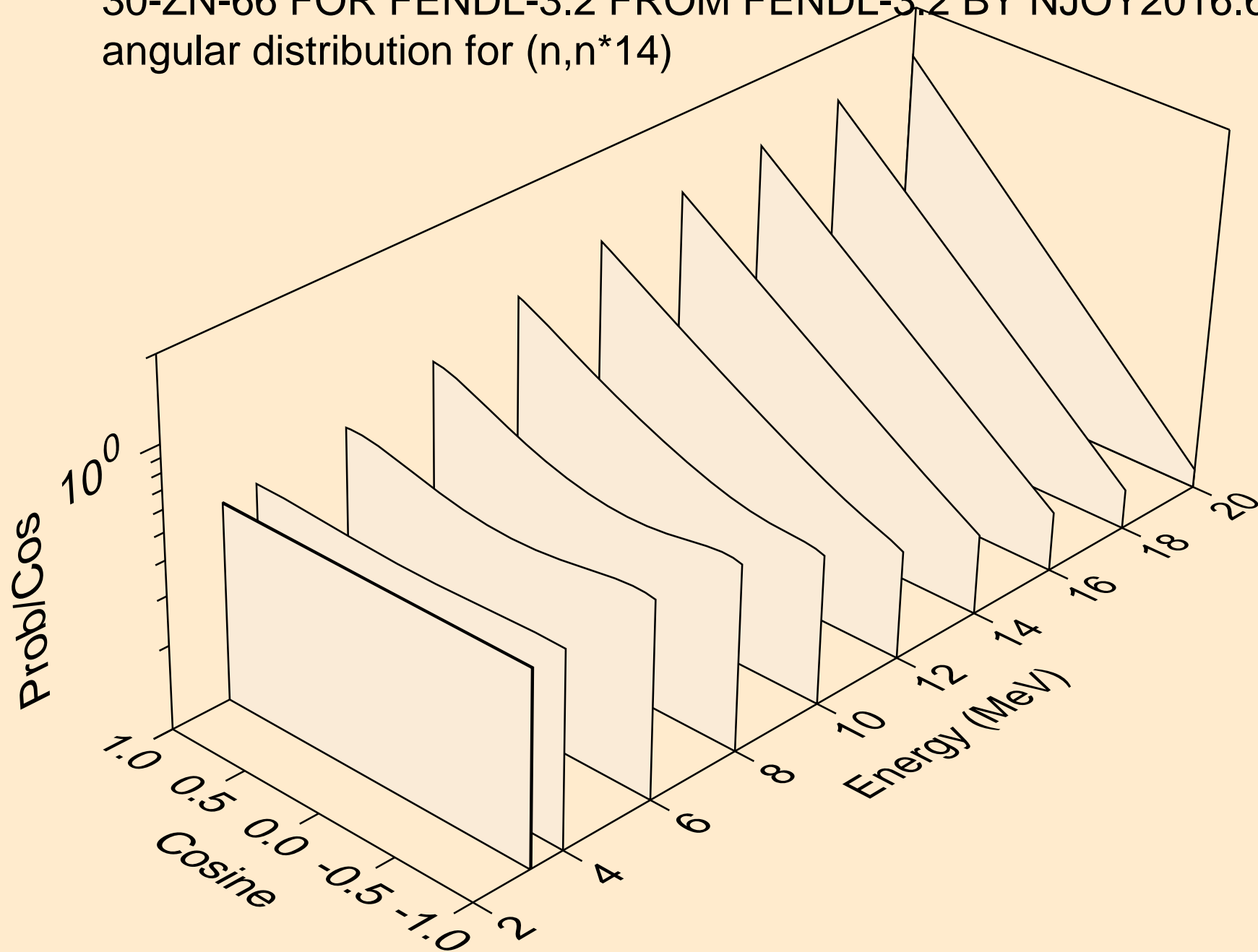

30-ZN-66 FOR FENDL-3.2 FROM FENDL-3.2 BY NJOY2016.60+ O
angular distribution for (n,n*15)

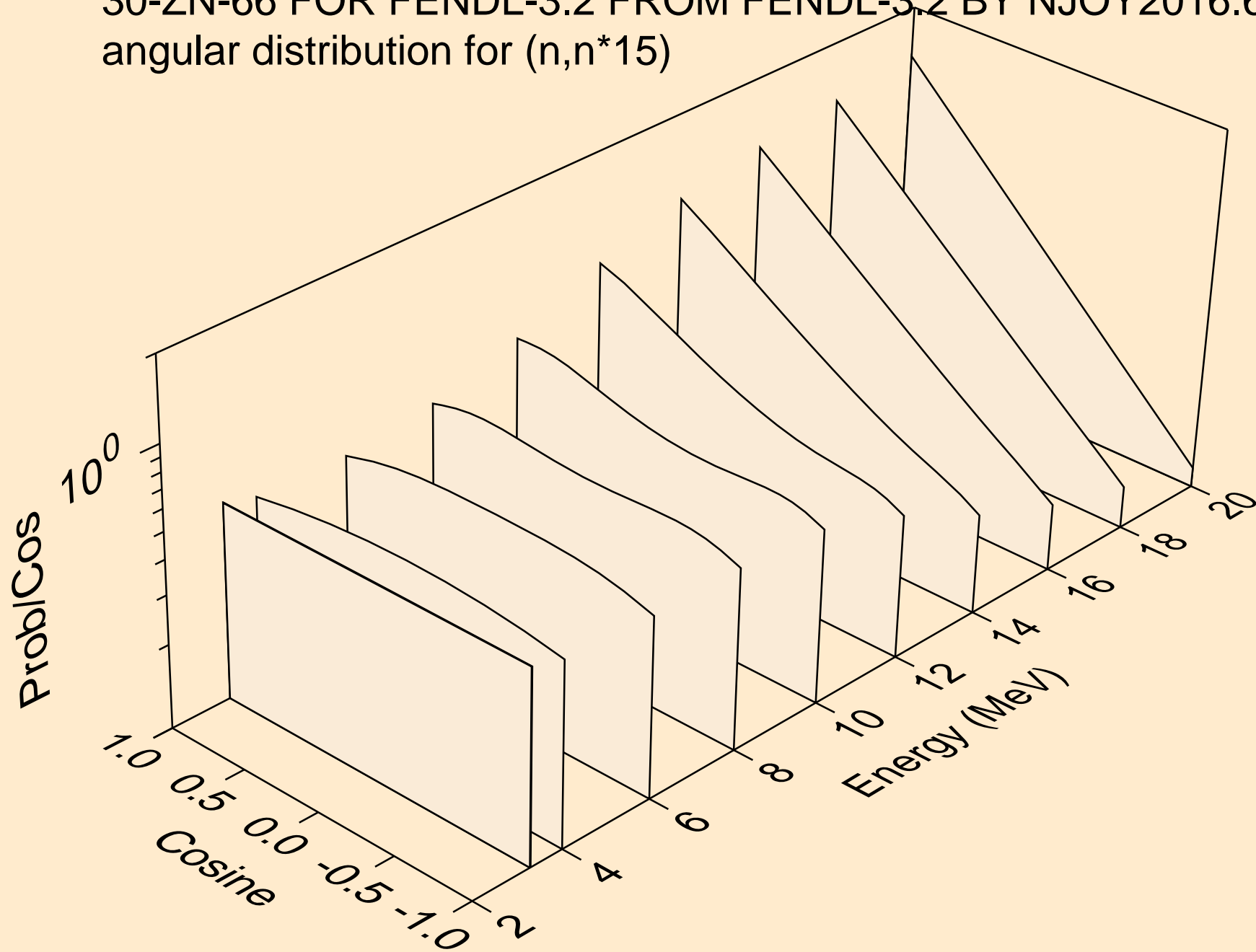

30-ZN-66 FOR FENDL-3.2 FROM FENDL-3.2 BY NJOY2016.60+ O
angular distribution for (n,n*16)

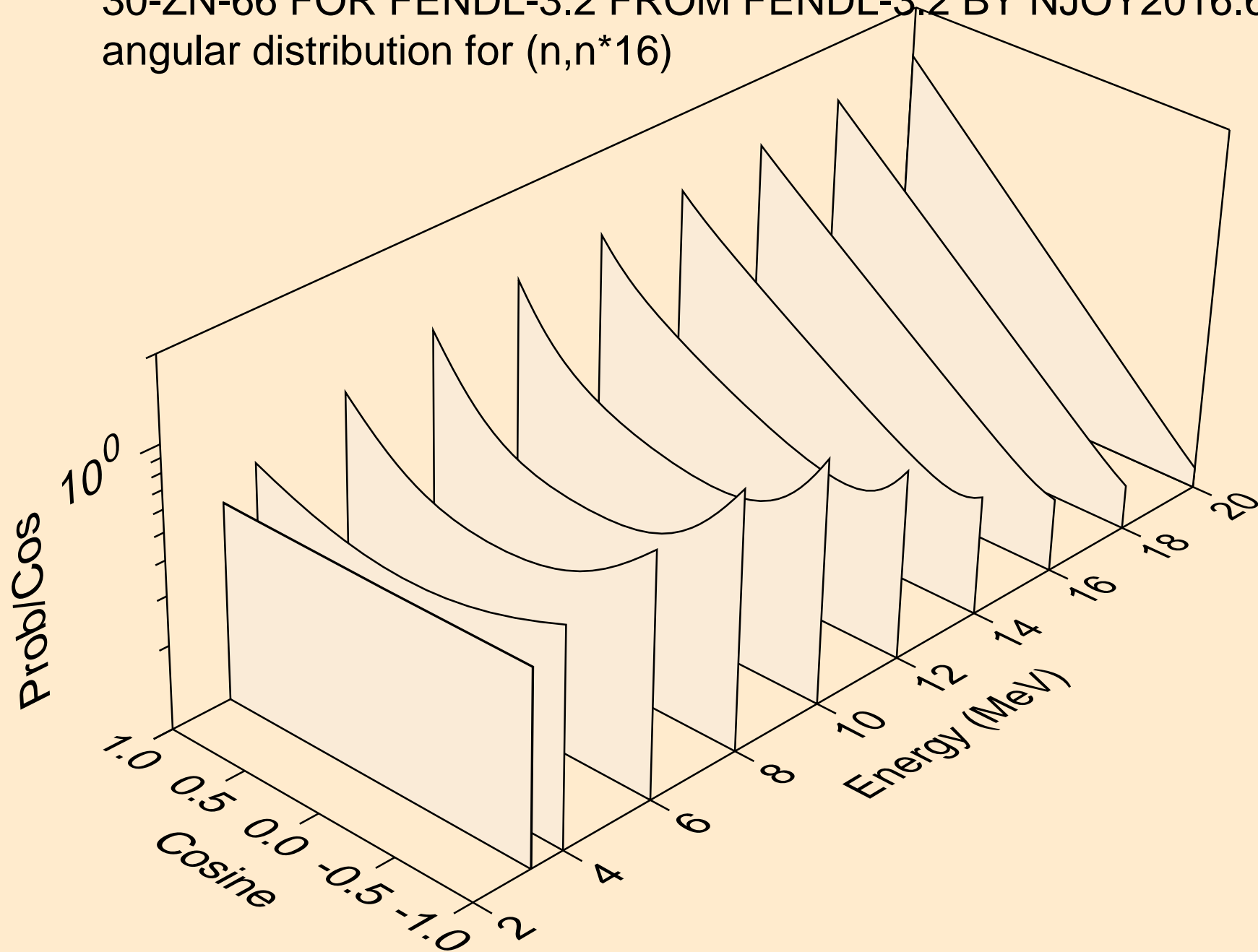

30-ZN-66 FOR FENDL-3.2 FROM FENDL-3.2 BY NJOY2016.60+ O
angular distribution for (n,n*17)

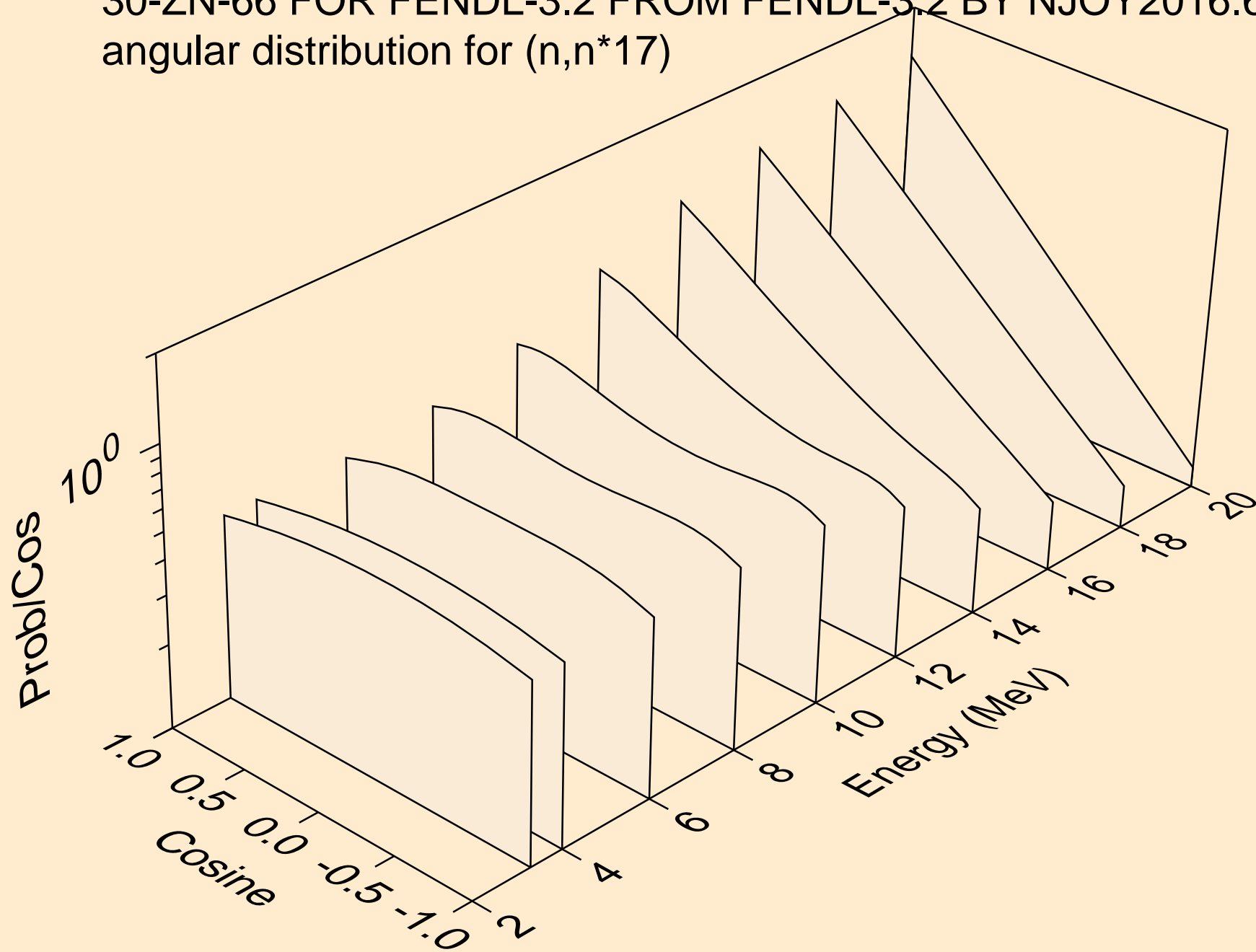

30-ZN-66 FOR FENDL-3.2 FROM FENDL-3.2 BY NJOY2016.60+ O
Neutron emission for (n,x)

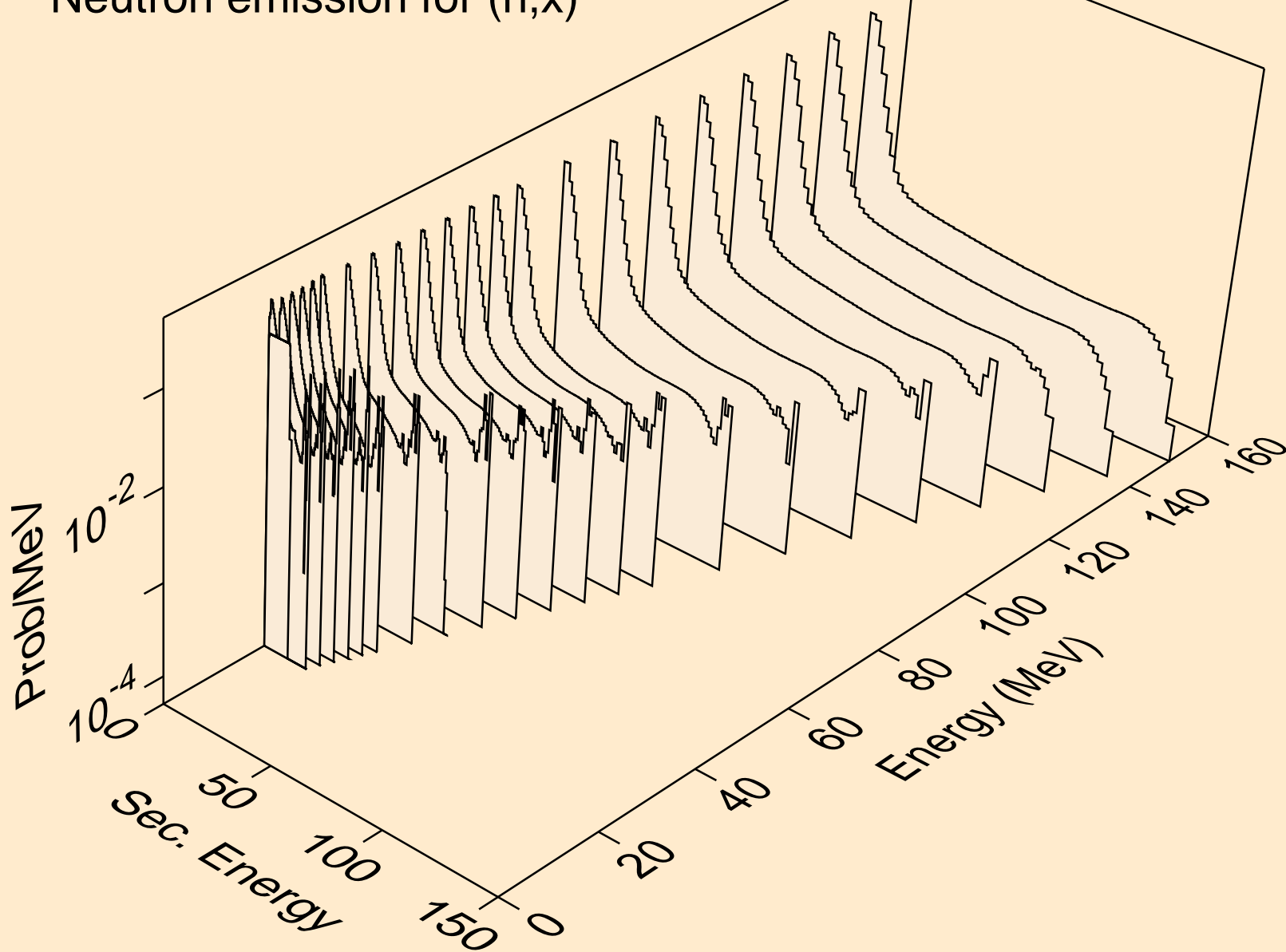

30-ZN-66 FOR FENDL-3.2 FROM FENDL-3.2 BY NJOY2016.60+ O
Neutron emission for (n,2n)

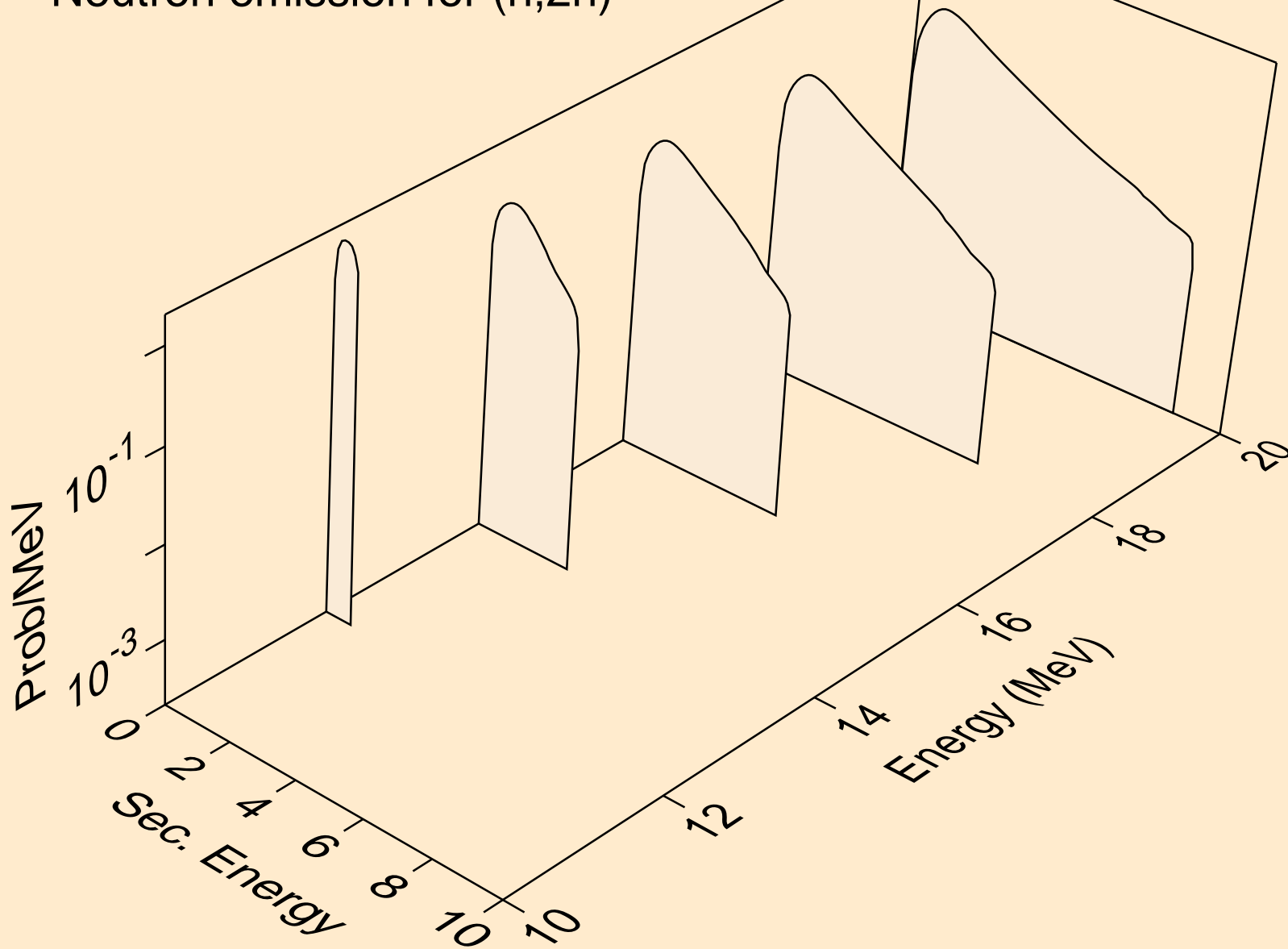

30-ZN-66 FOR FENDL-3.2 FROM FENDL-3.2 BY NJOY2016.60+ O
Neutron emission for (n,3n)

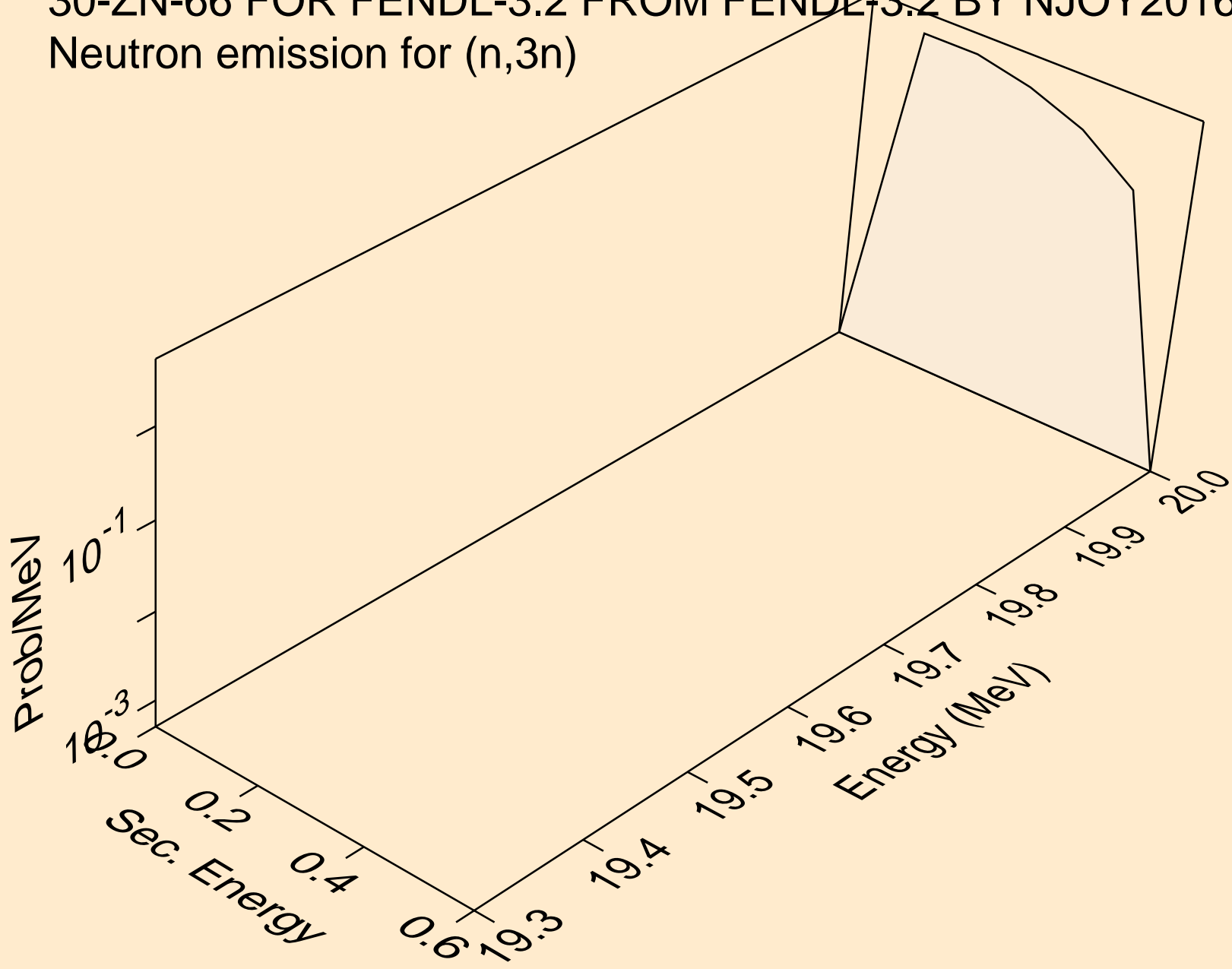

30-ZN-66 FOR FENDL-3.2 FROM FENDL-3.2 BY NJOY2016.60+ O
Neutron emission for (n,n*)a

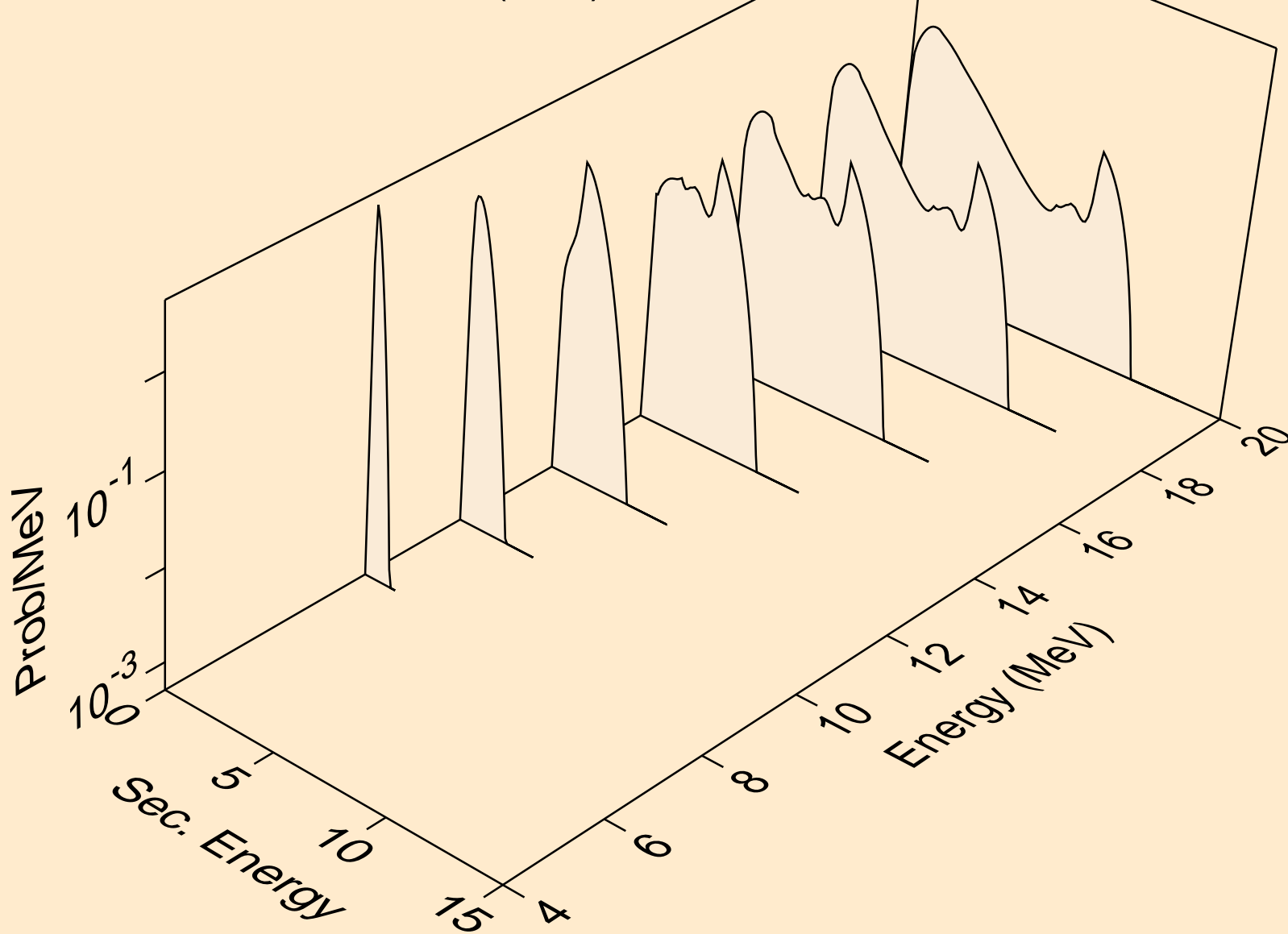

30-ZN-66 FOR FENDL-3.2 FROM FENDL-3.2 BY NJOY2016.60+ O
Neutron emission for (n,2n)a

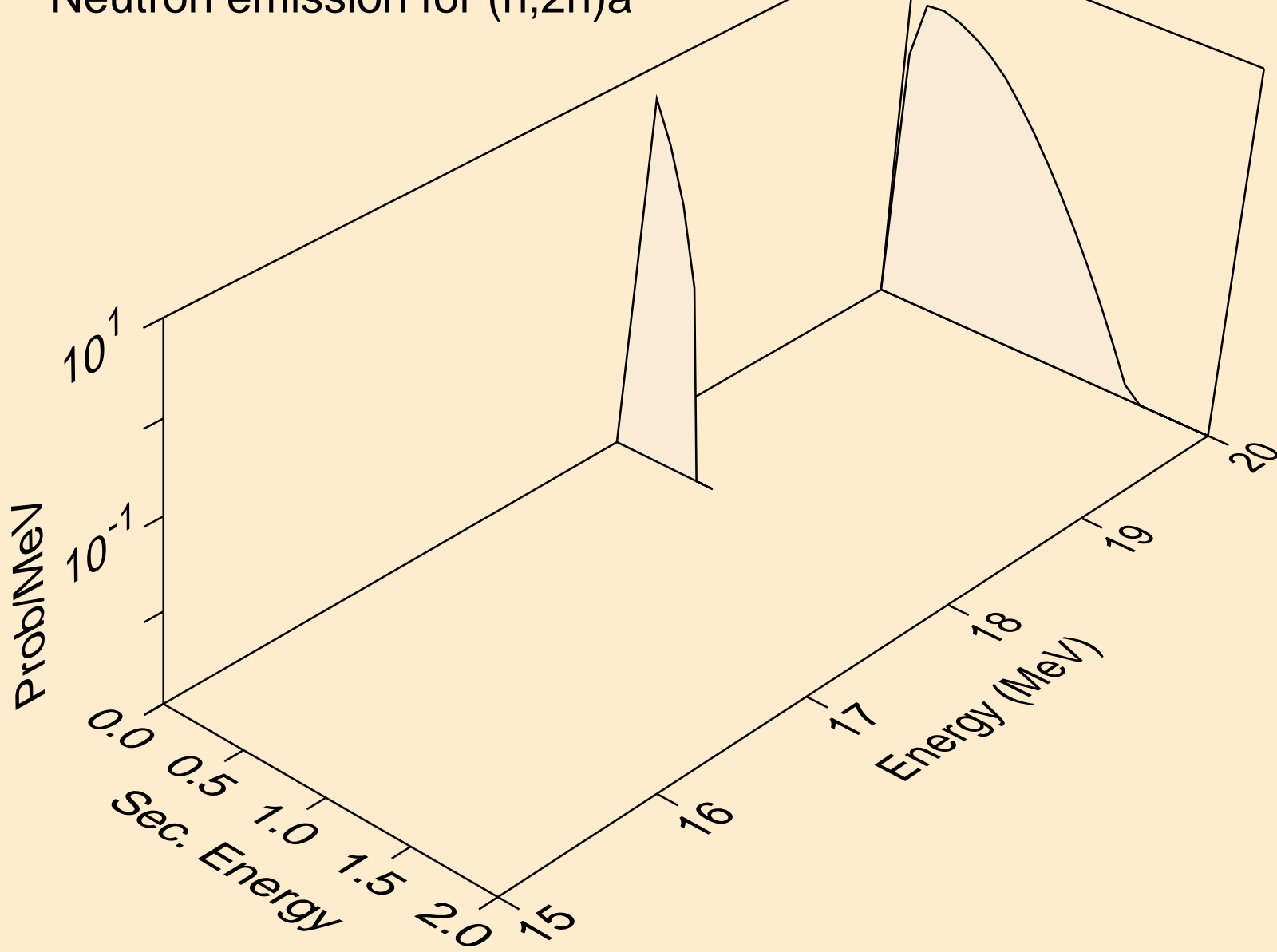

30-ZN-66 FOR FENDL-3.2 FROM FENDL-3.2 BY NJOY2016.60+ O
Neutron emission for (n,n*)p

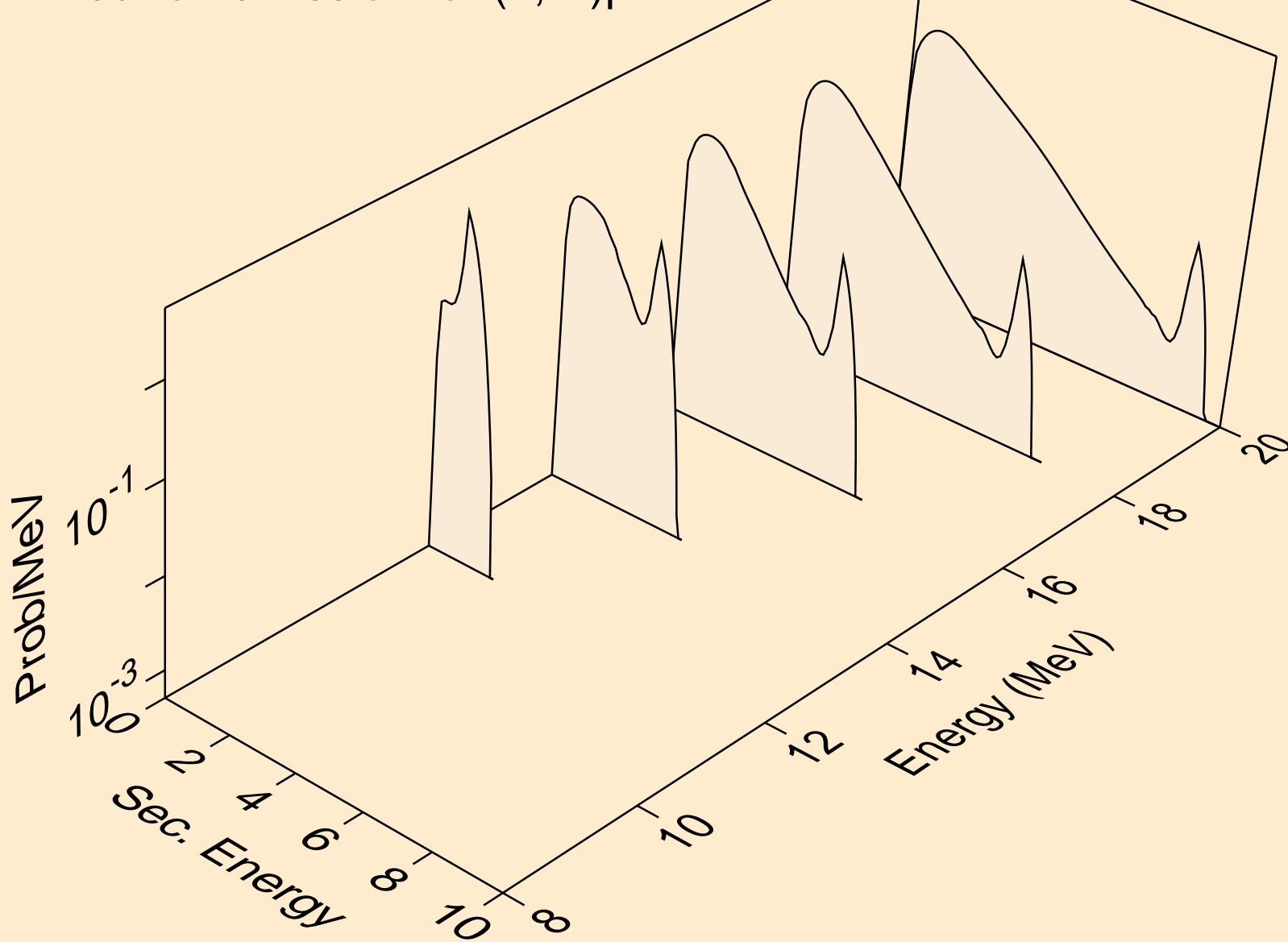

30-ZN-66 FOR FENDL-3.2 FROM FENDL-3.2 BY NJOY2016.60+ O
Neutron emission for (n,n*)d

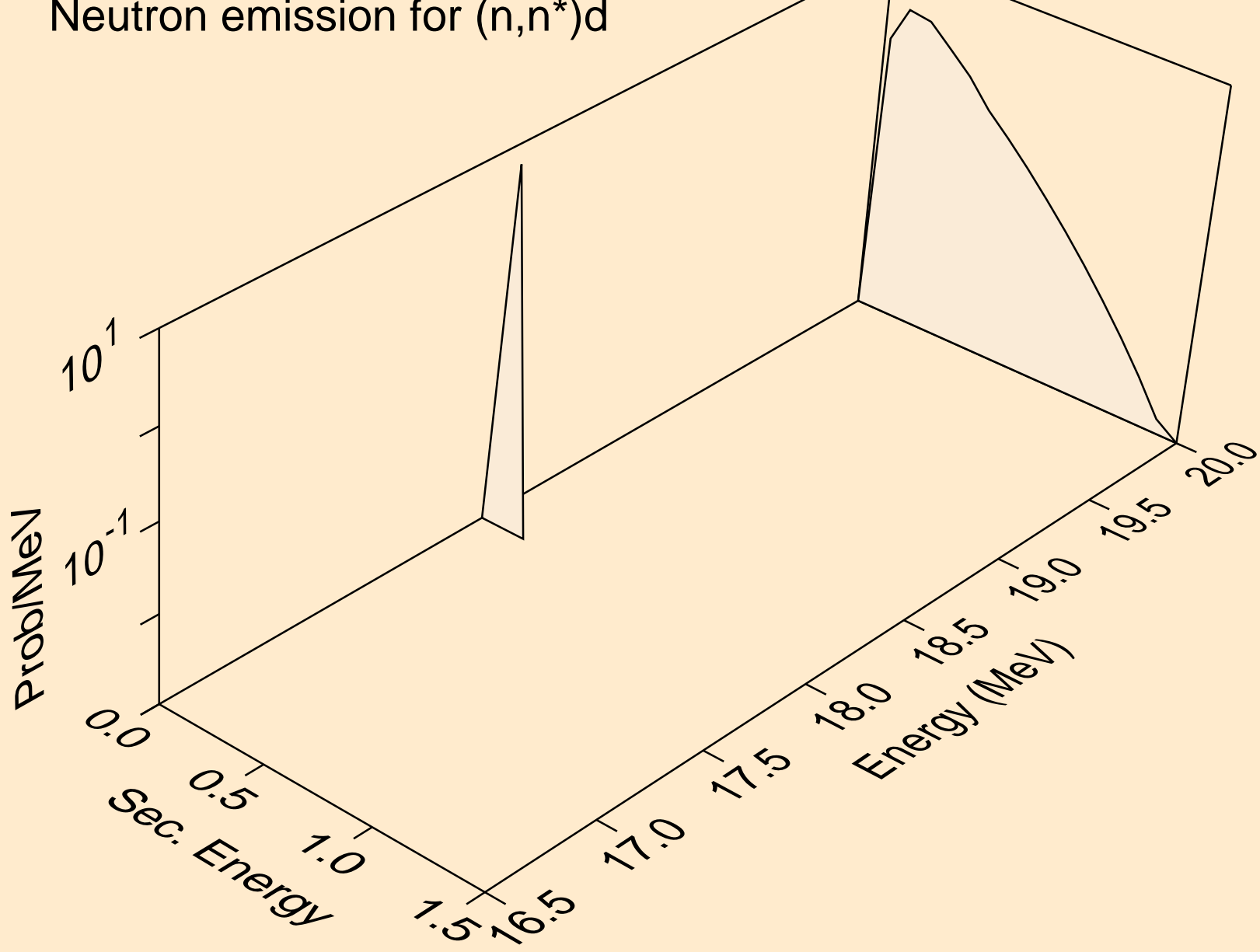

30-ZN-66 FOR FENDL-3.2 FROM FENDL-3.2 BY NJOY2016.60+ O
Neutron emission for (n,n*c)

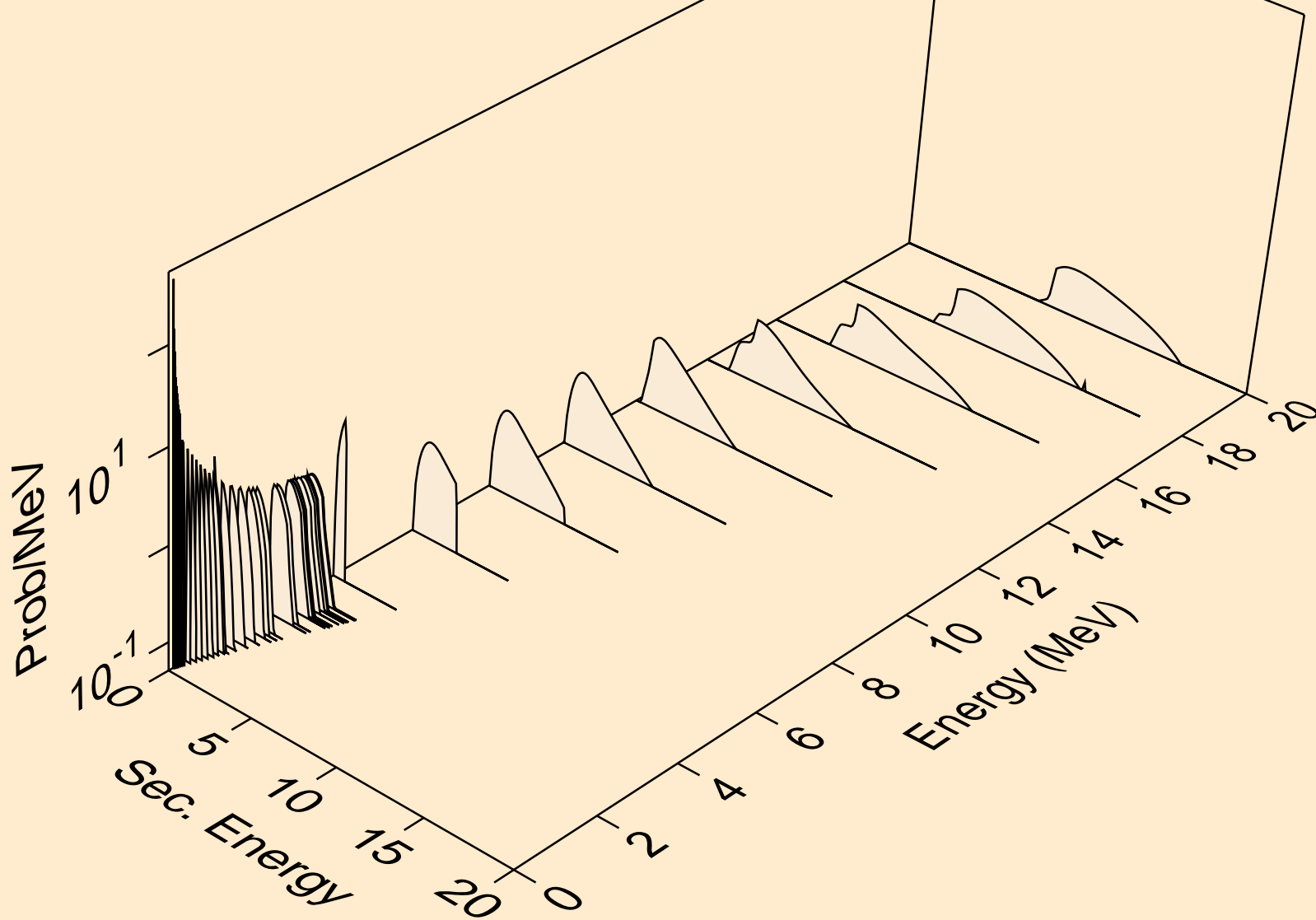

30-ZN-66 FOR FENDL-3.2 FROM FENDL-3.2 BY NJOY2016.60+ O
Photon emission for (n,x)

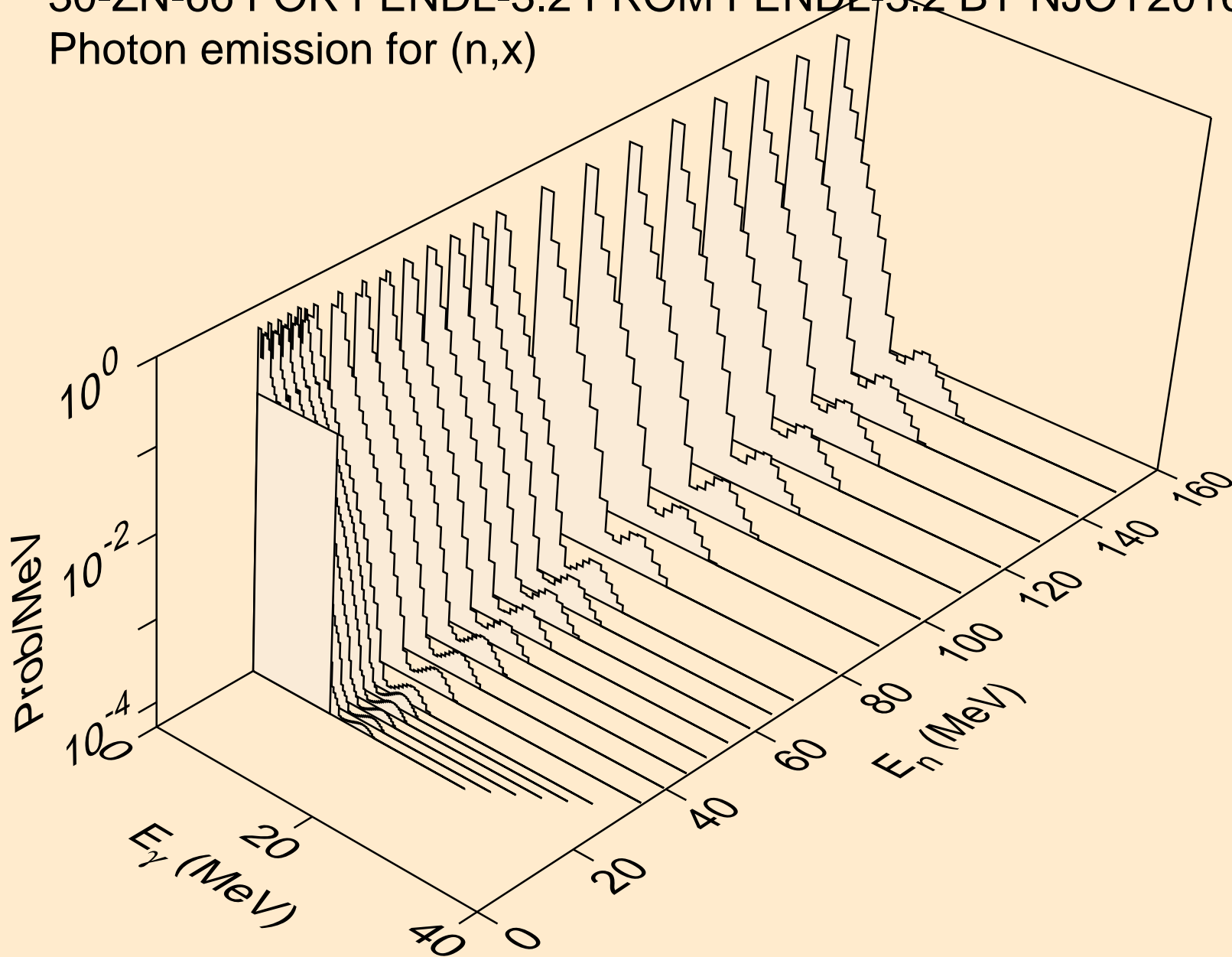

30-ZN-66 FOR FENDL-3.2 FROM FENDL-3.2 BY NJOY2016.60+ O
Photon emission for (n,2n)

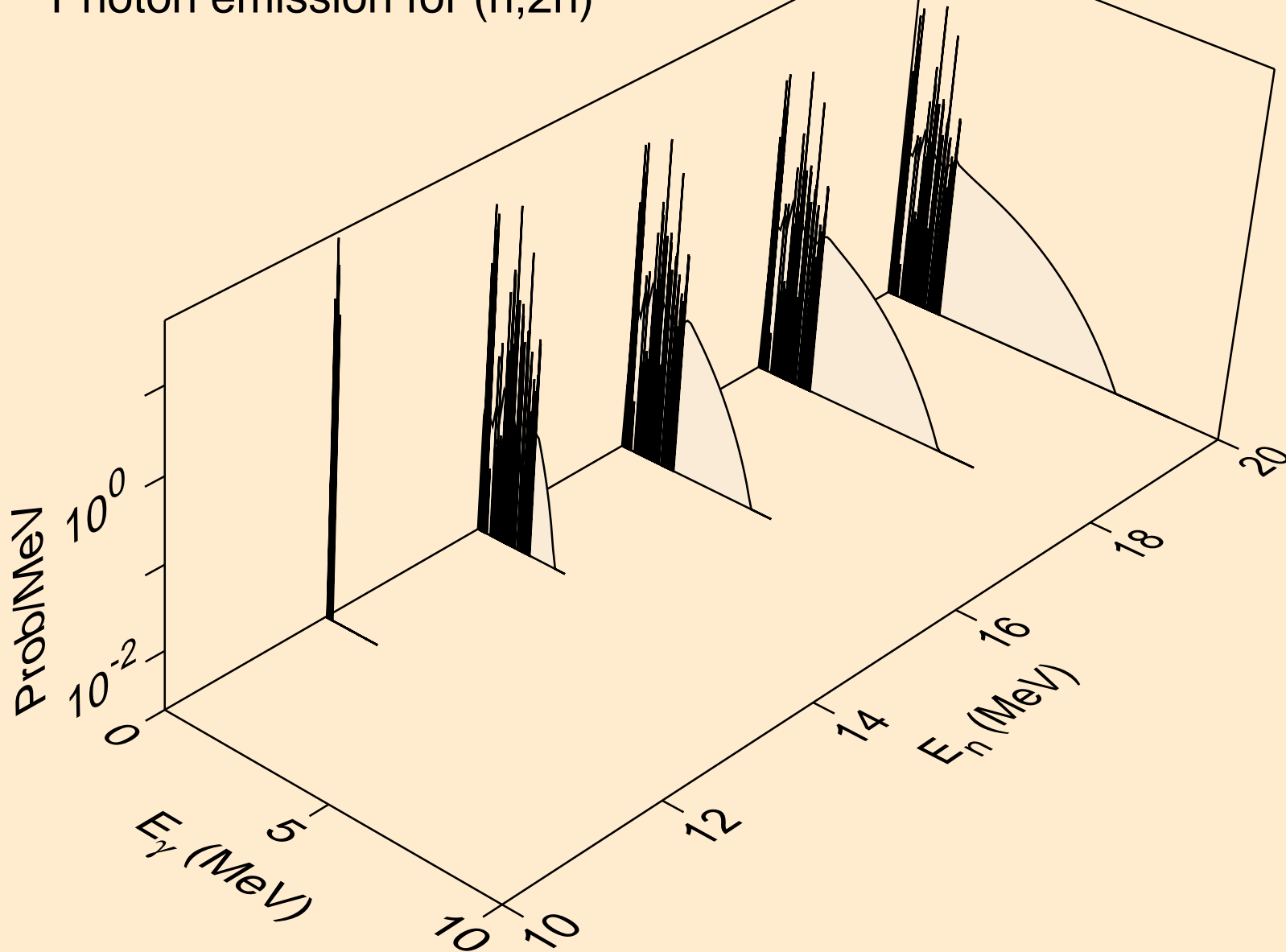

30-ZN-66 FOR FENDL-3.2 FROM FENDL-3.2 BY NJOY2016.60+ O
Photon emission for (n,3n)

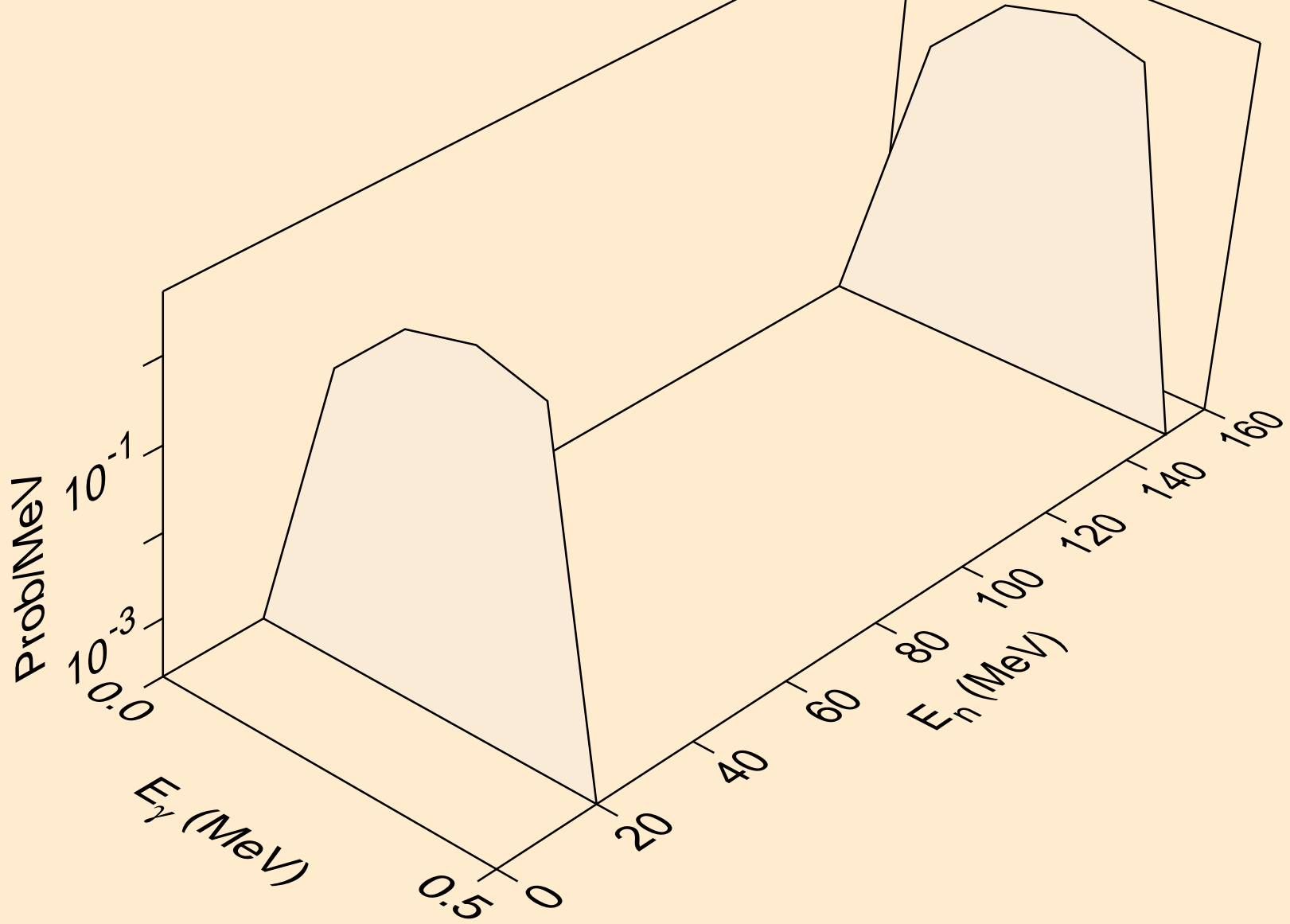

30-ZN-66 FOR FENDL-3.2 FROM FENDL-3.2 BY NJOY2016.60+ O
Photon emission for (n,n*)a

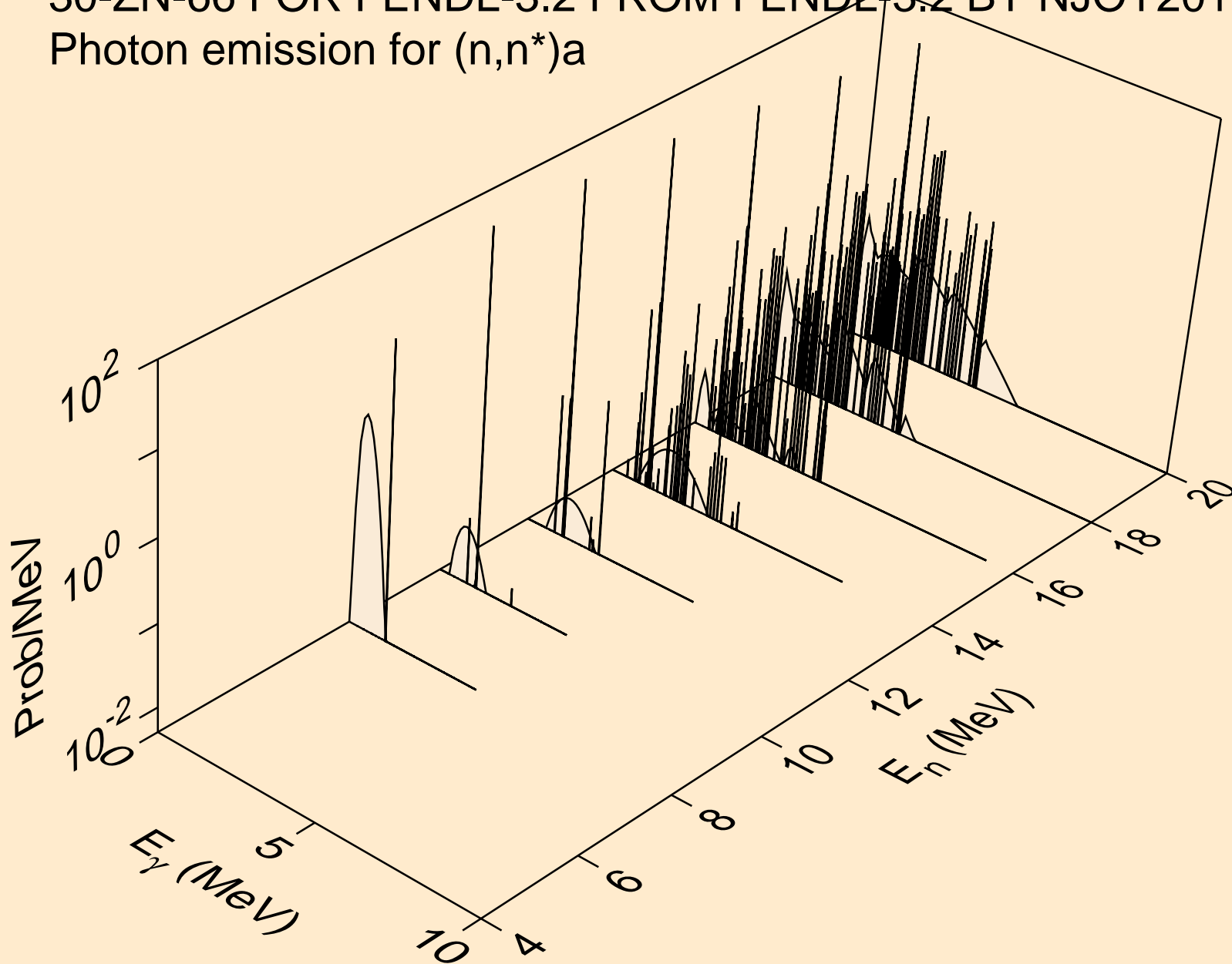

30-ZN-66 FOR FENDL-3.2 FROM FENDL-3.2 BY NJOY2016.60+ O
Photon emission for (n,2n)a

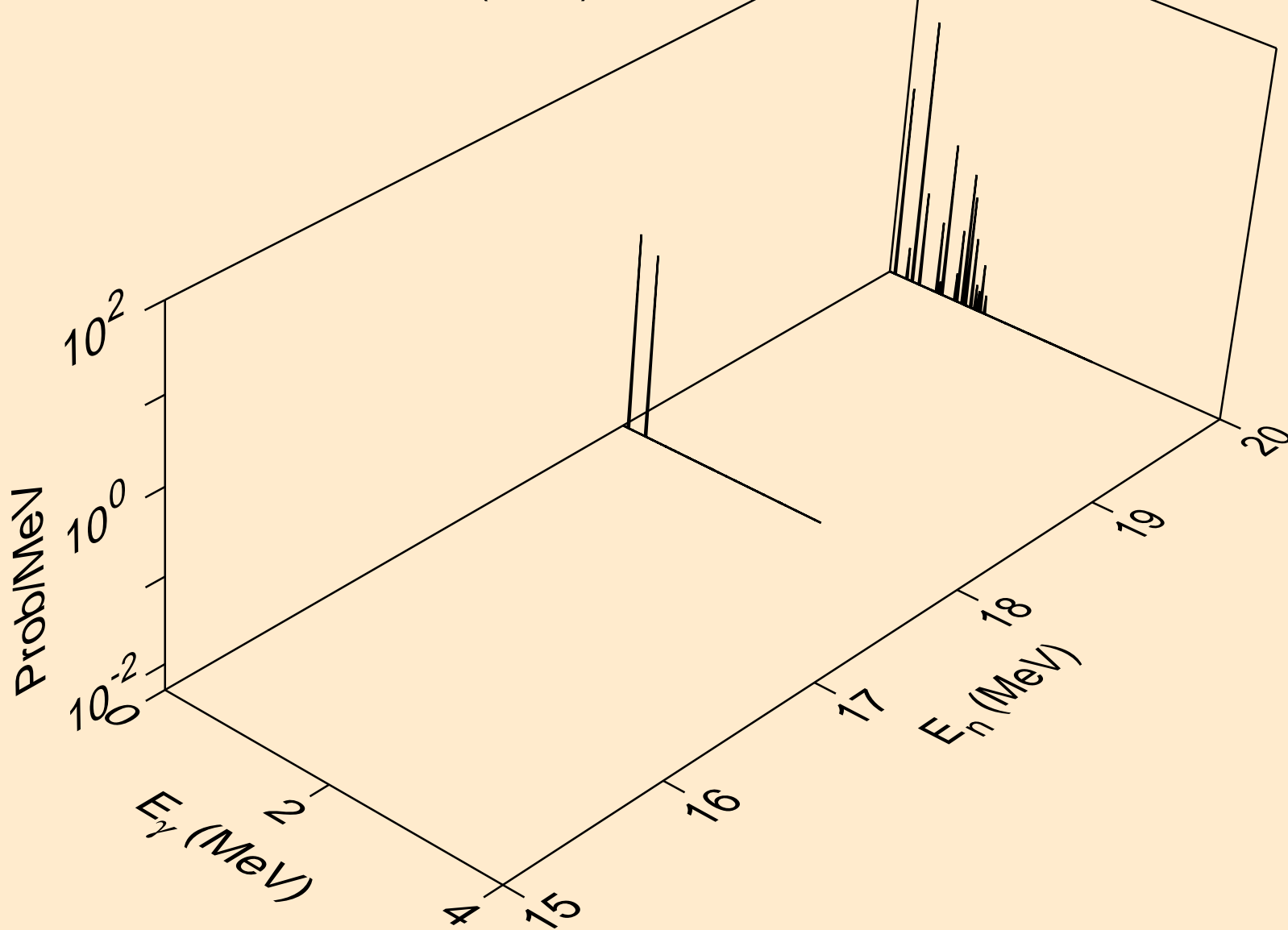

30-ZN-66 FOR FENDL-3.2 FROM FENDL-3.2 BY NJOY2016.60+ O
Photon emission for (n,n*)p

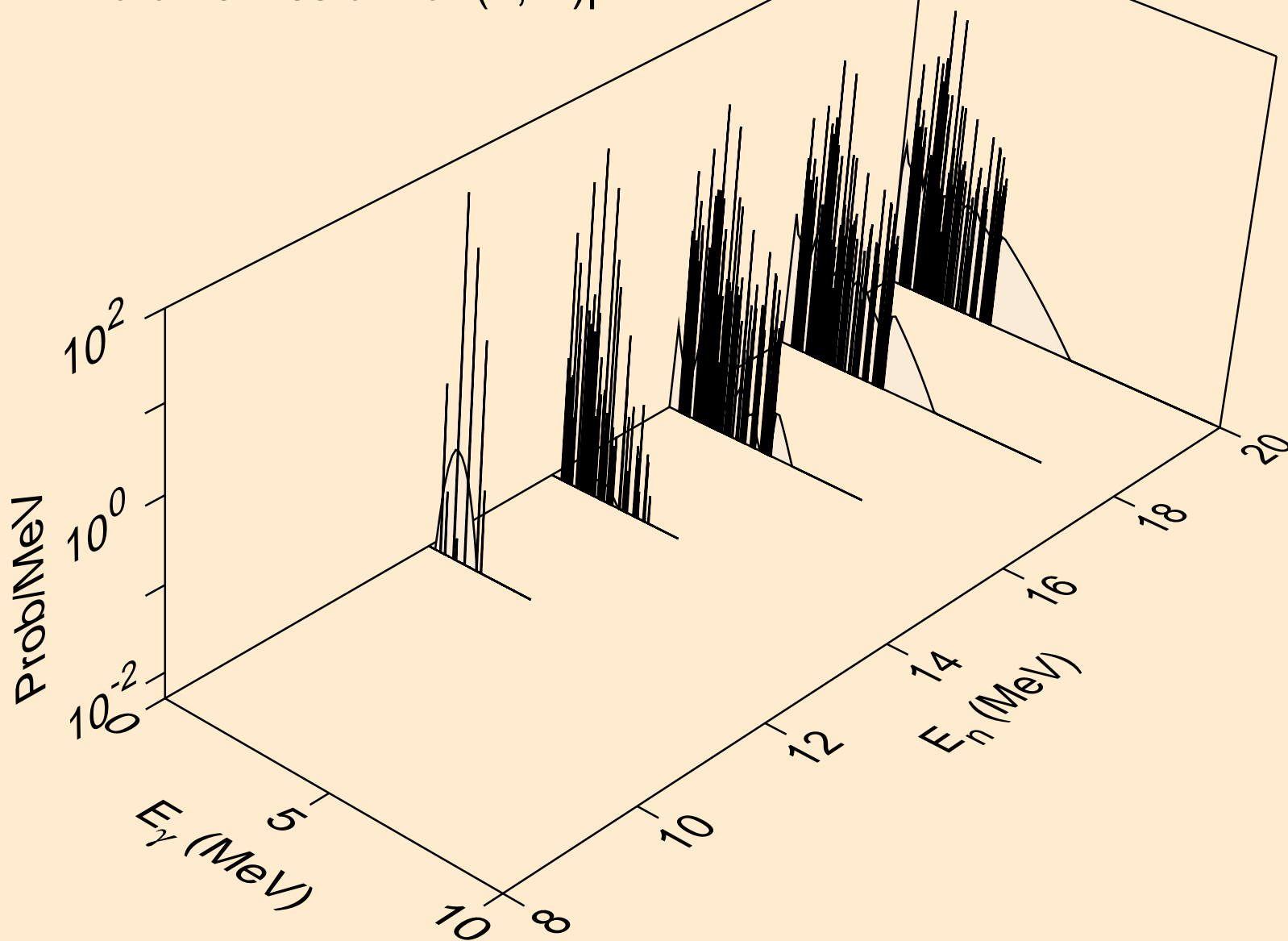

30-ZN-66 FOR FENDL-3.2 FROM FENDL-3.2 BY NJOY2016.60+ O
Photon emission for (n,n*)d

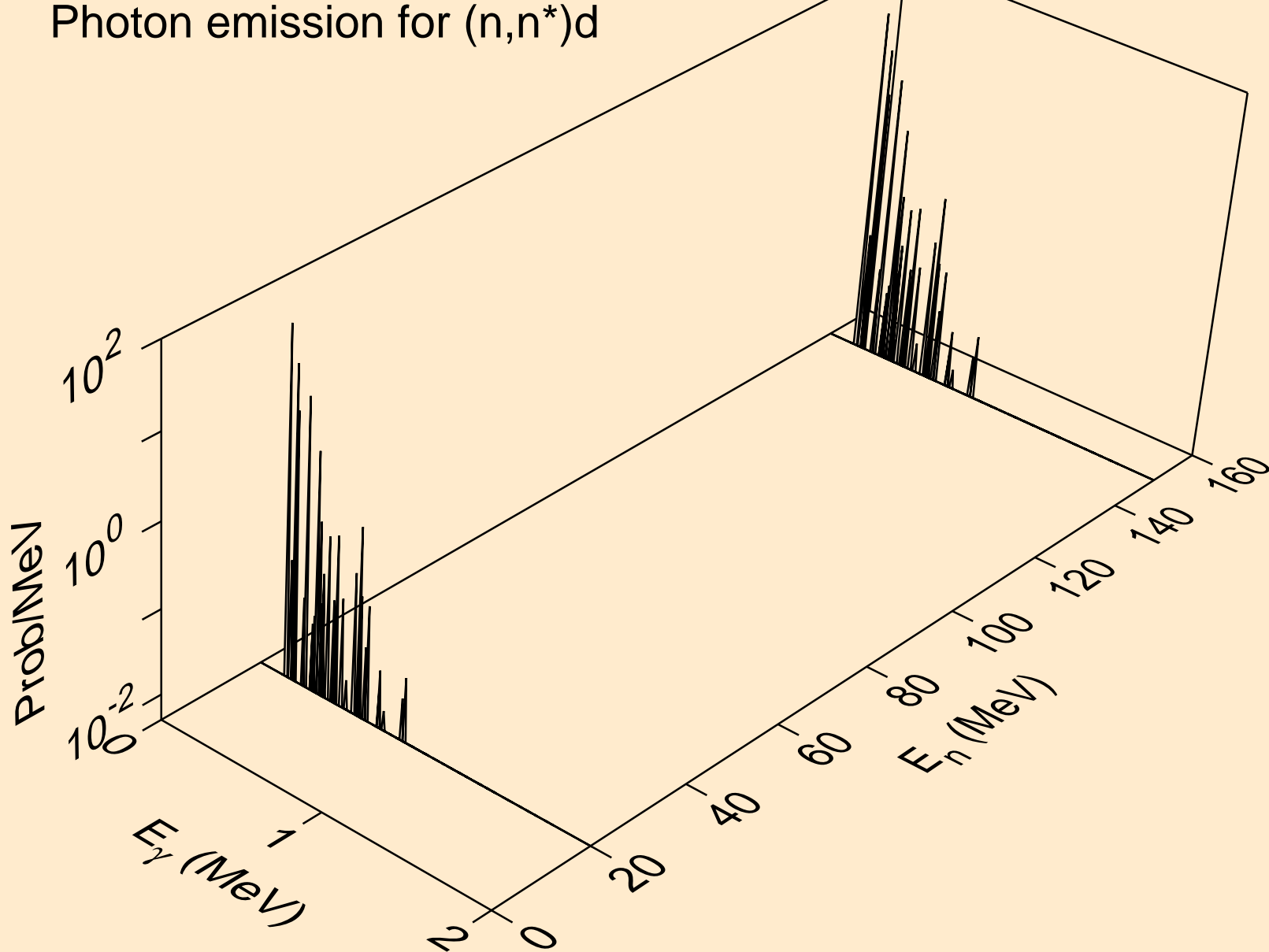

30-ZN-66 FOR FENDL-3.2 FROM FENDL-3.2 BY NJOY2016.60+ O
Photon emission for (n,n*1)

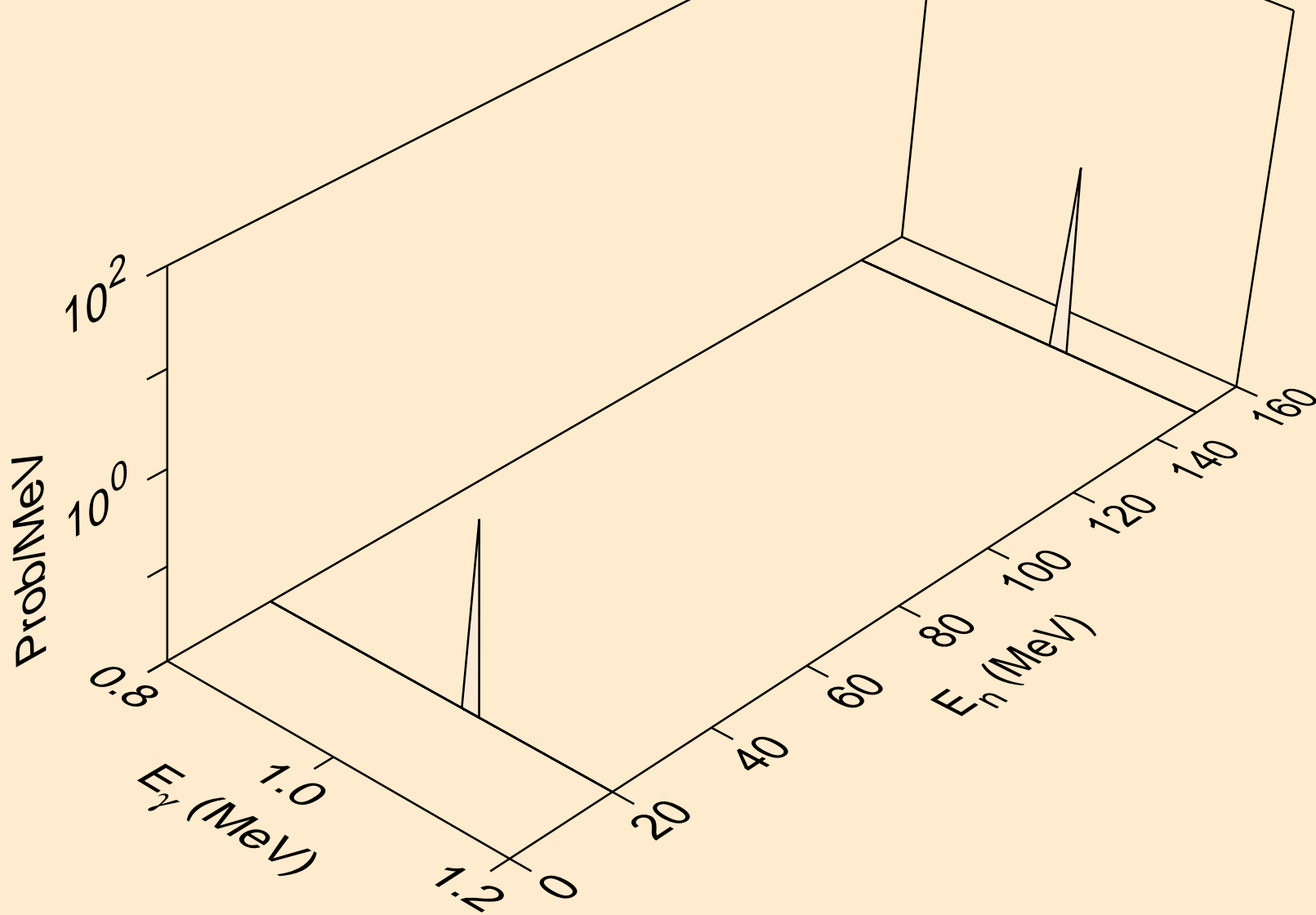

30-ZN-66 FOR FENDL-3.2 FROM FENDL-3.2 BY NJOY2016.60+ O
Photon emission for (n,n*2)

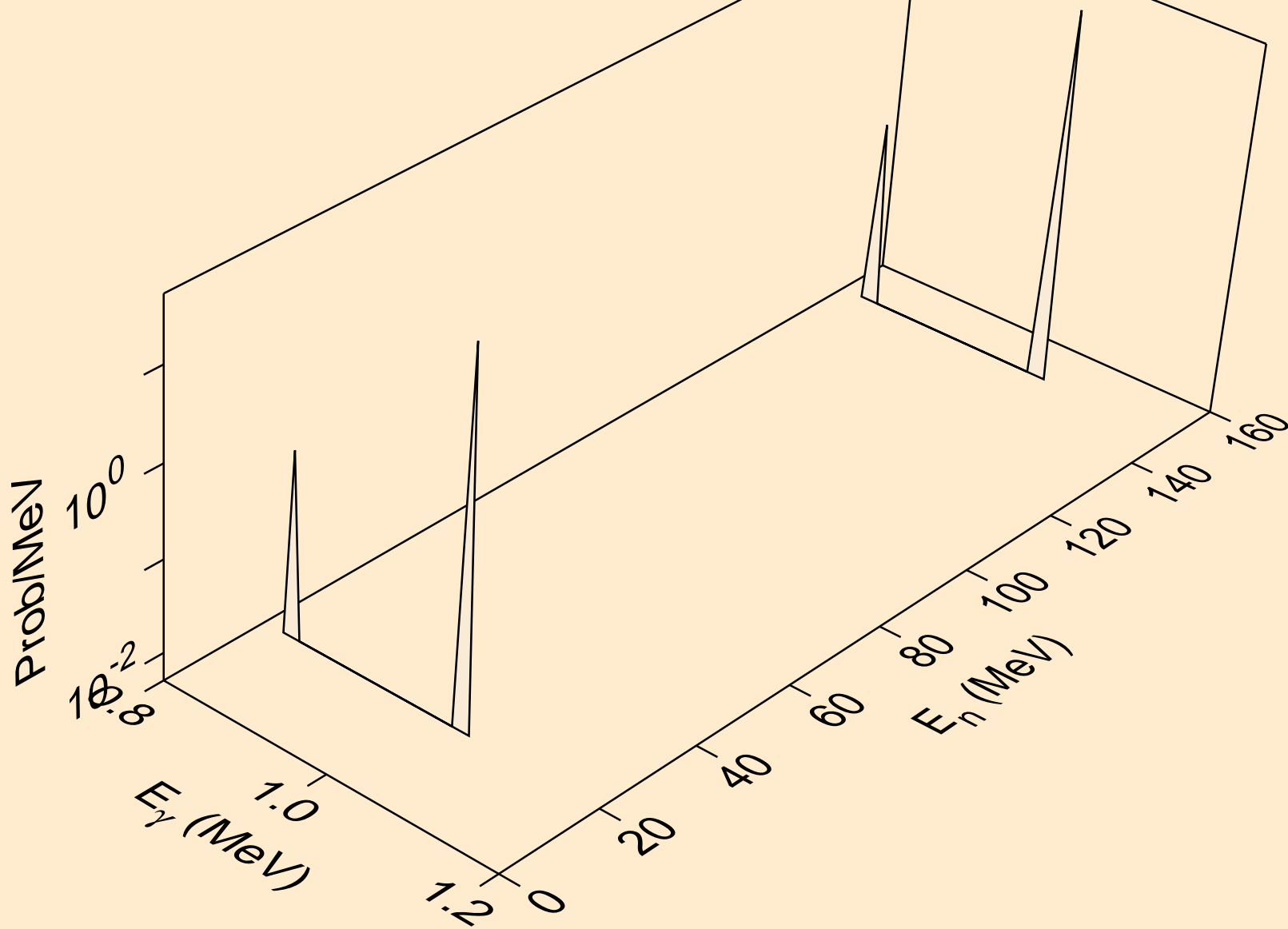

30-ZN-66 FOR FENDL-3.2 FROM FENDL-3.2 BY NJOY2016.60+ O
Photon emission for (n,n*3)

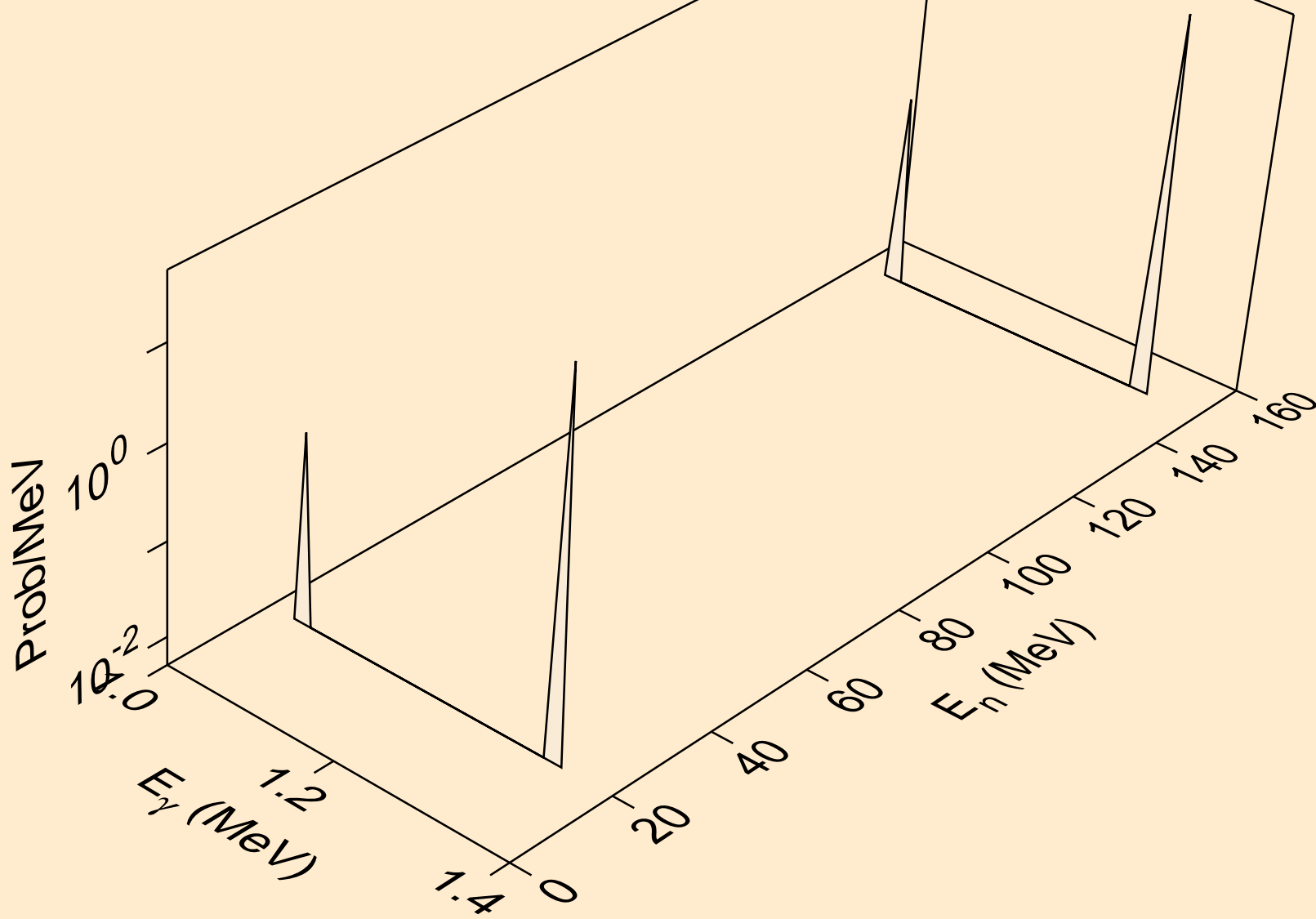

30-ZN-66 FOR FENDL-3.2 FROM FENDL-3.2 BY NJOY2016.60+ O
Photon emission for (n,n*4)

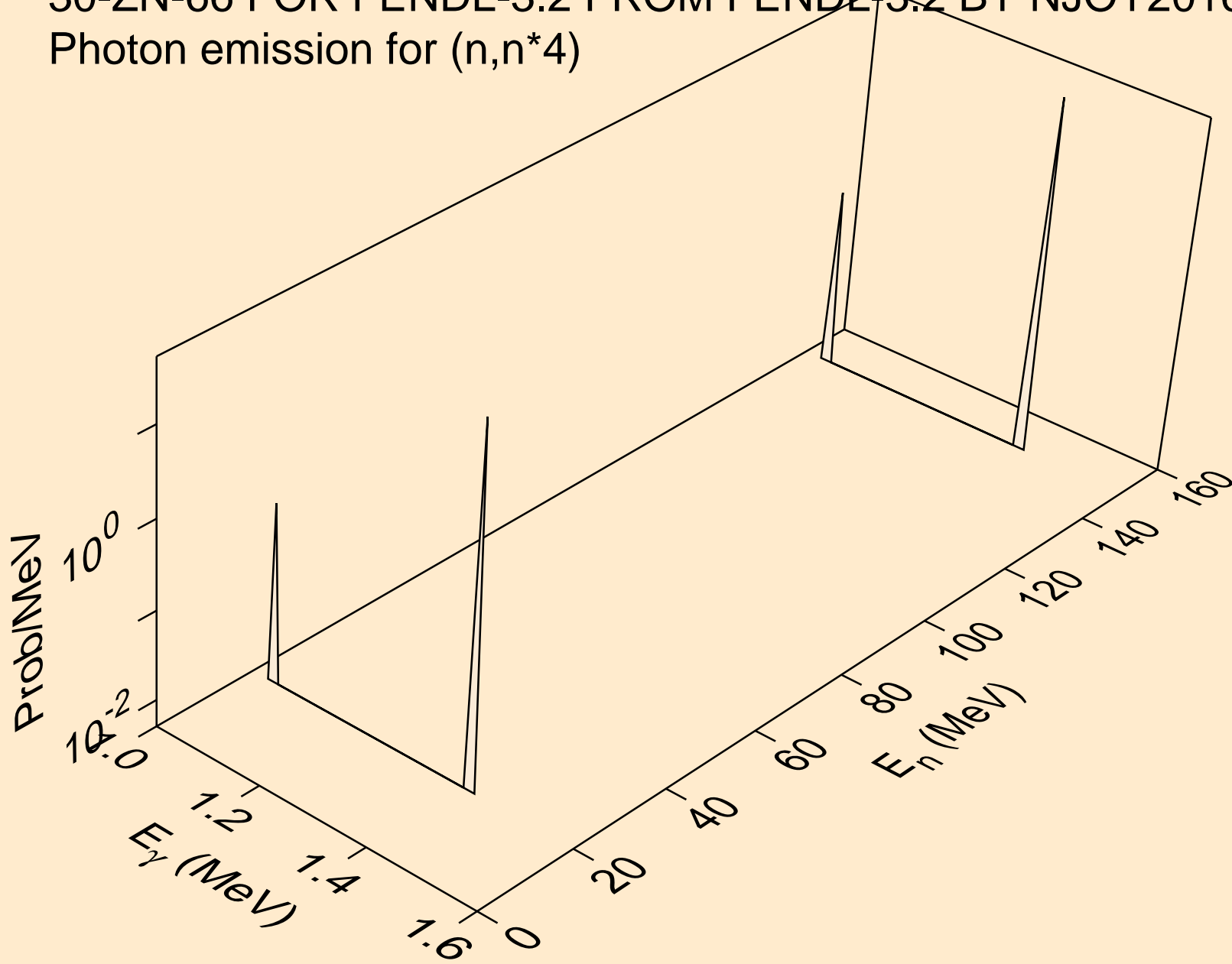

30-ZN-66 FOR FENDL-3.2 FROM FENDL-3.2 BY NJOY2016.60+ O
Photon emission for (n,n*5)

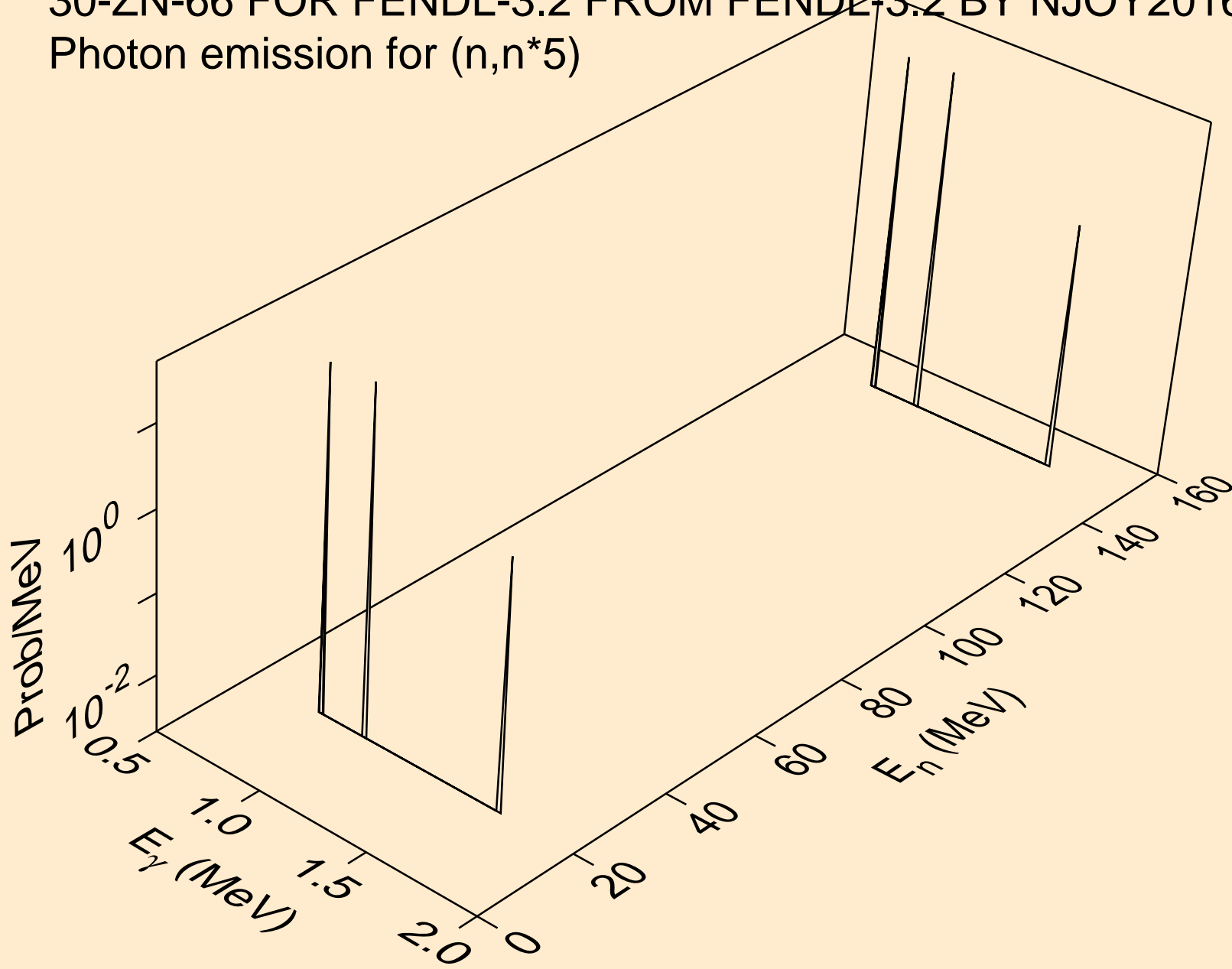

30-ZN-66 FOR FENDL-3.2 FROM FENDL-3.2 BY NJOY2016.60+ O
Photon emission for (n,n*6)

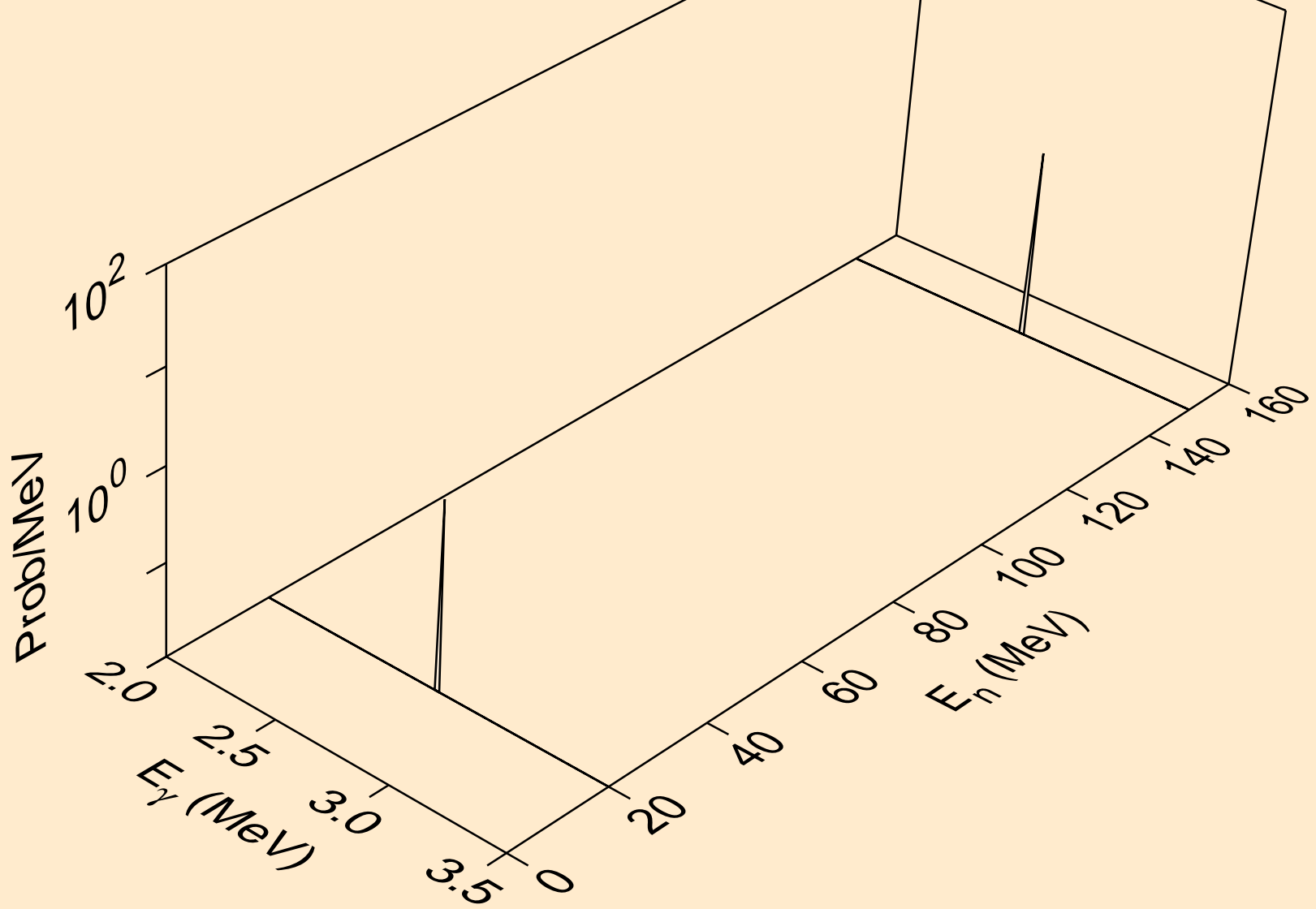

30-ZN-66 FOR FENDL-3.2 FROM FENDL-3.2 BY NJOY2016.60+ O
Photon emission for (n,n*7)

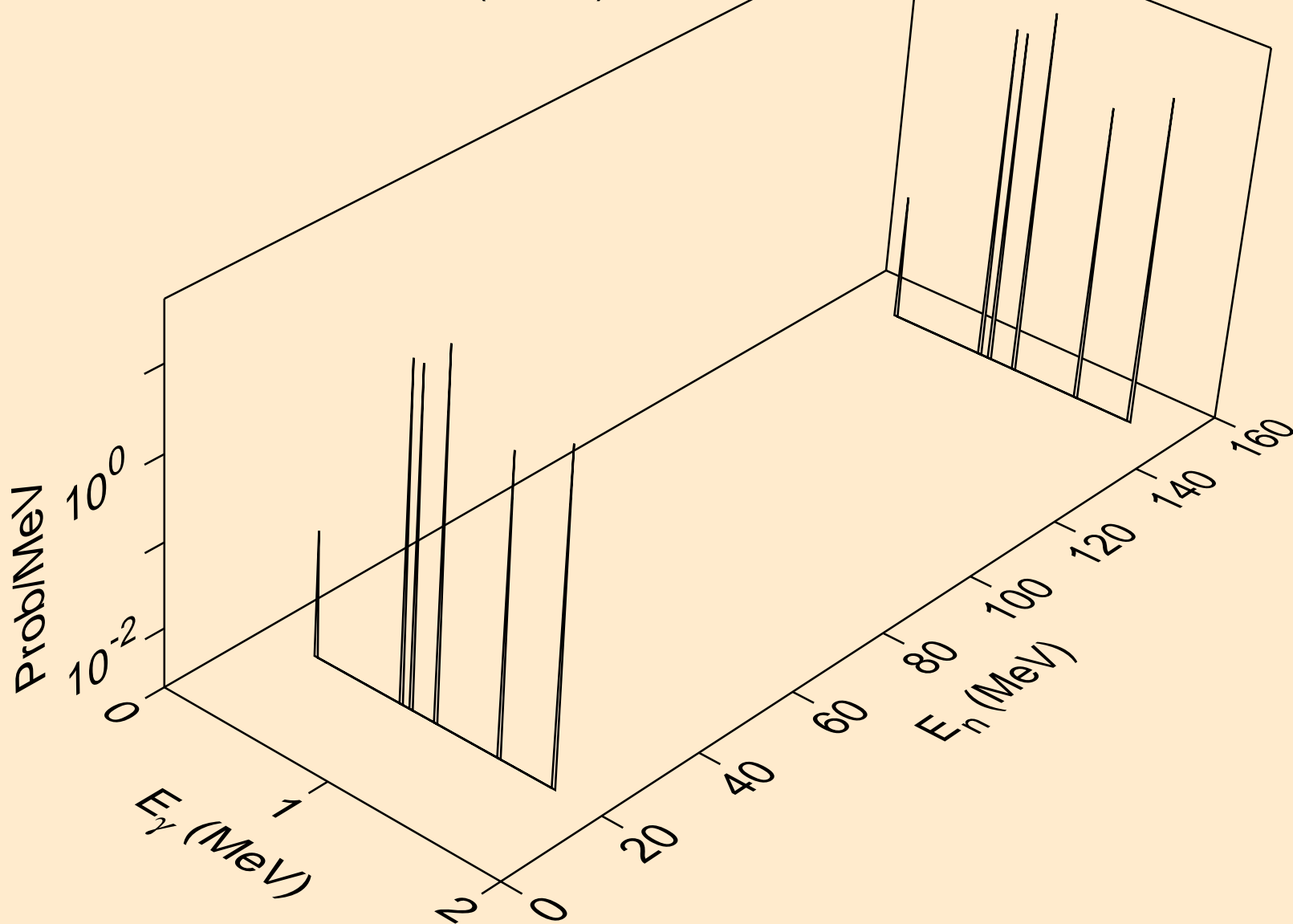

30-ZN-66 FOR FENDL-3.2 FROM FENDL-3.2 BY NJOY2016.60+ O
Photon emission for (n,n*8)

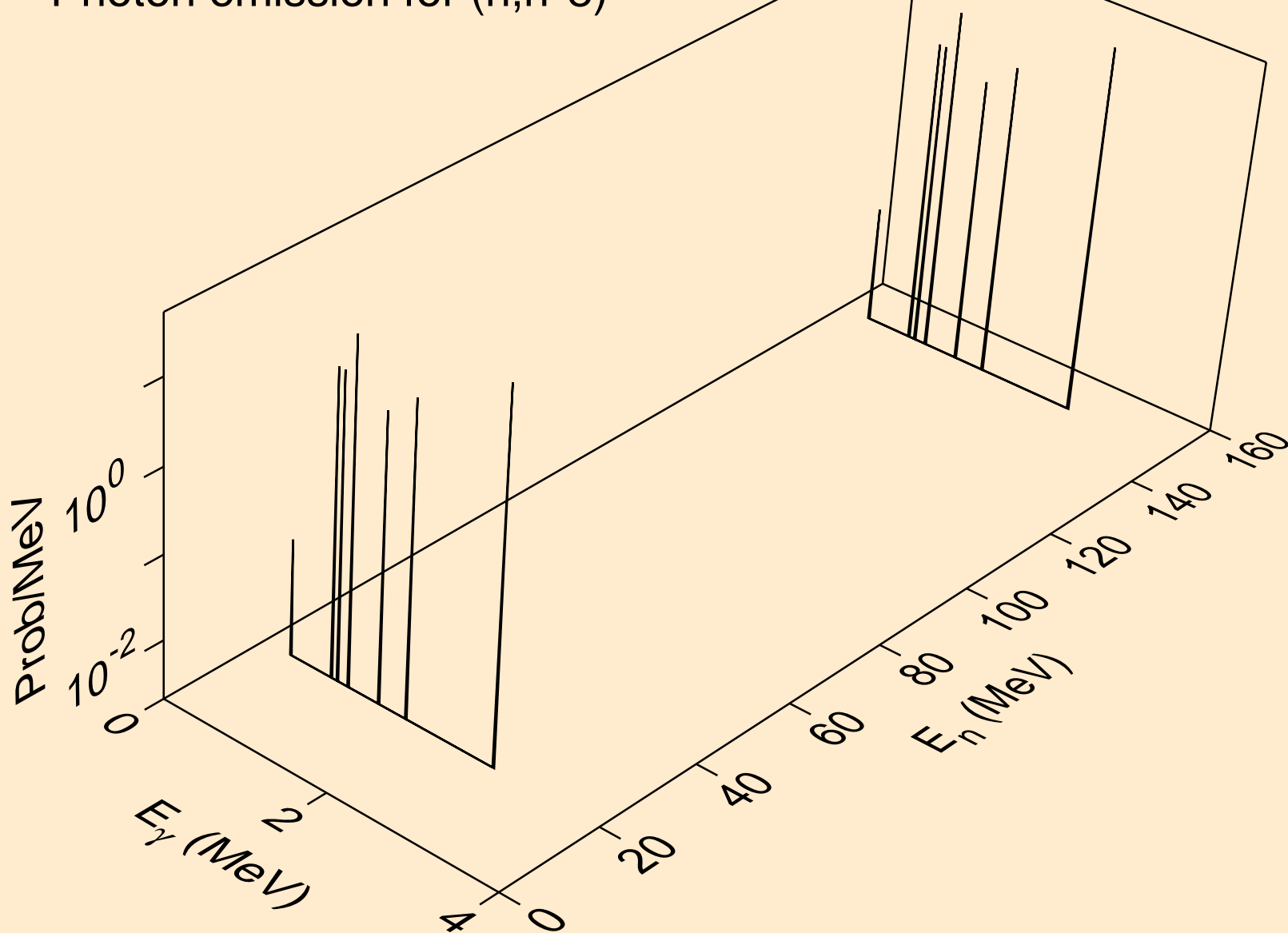

30-ZN-66 FOR FENDL-3.2 FROM FENDL-3.2 BY NJOY2016.60+ O
Photon emission for (n,n*9)

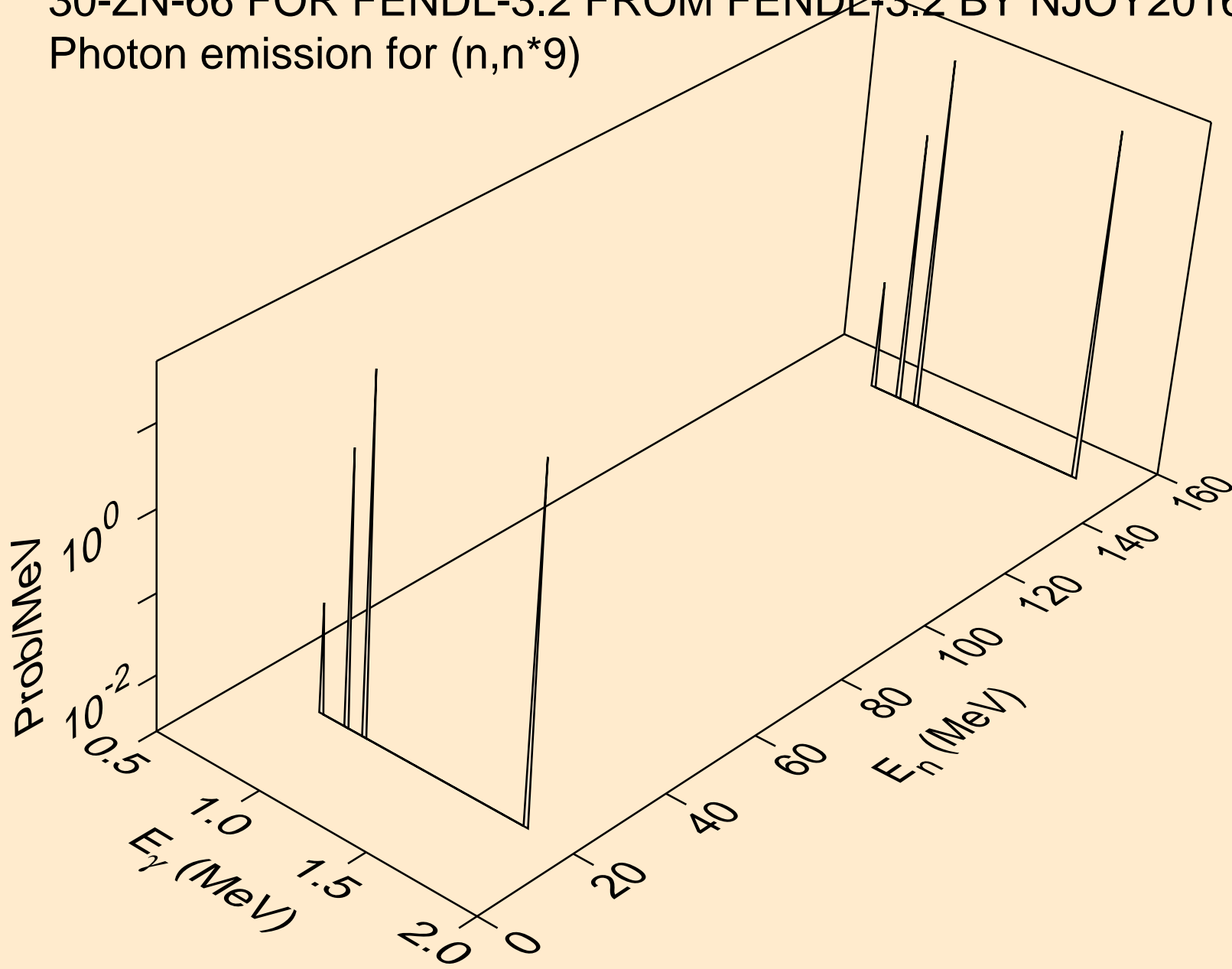

30-ZN-66 FOR FENDL-3.2 FROM FENDL-3.2 BY NJOY2016.60+ O
Photon emission for (n,n*10)

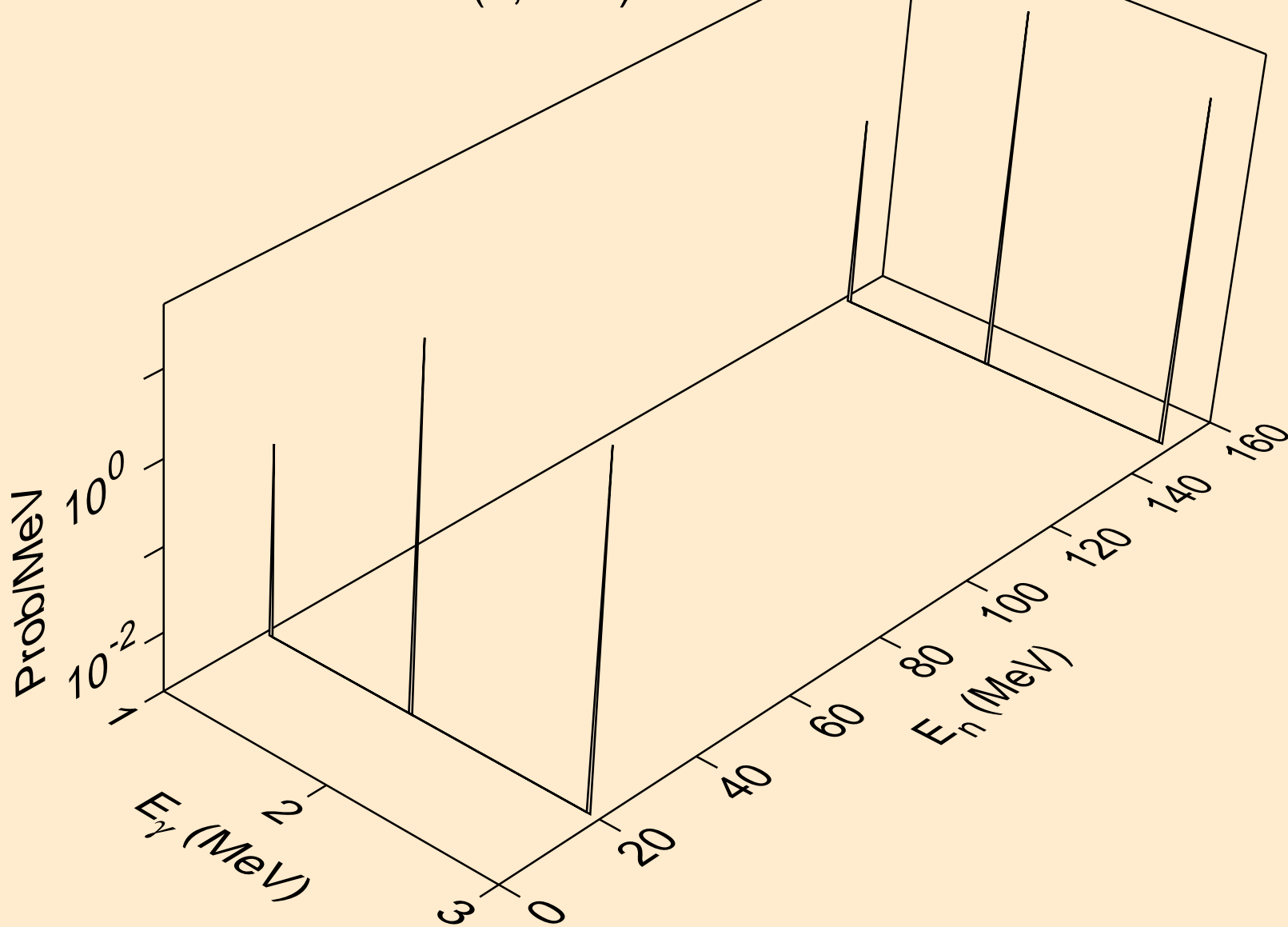

30-ZN-66 FOR FENDL-3.2 FROM FENDL-3.2 BY NJOY2016.60+ O
Photon emission for (n,n*11)

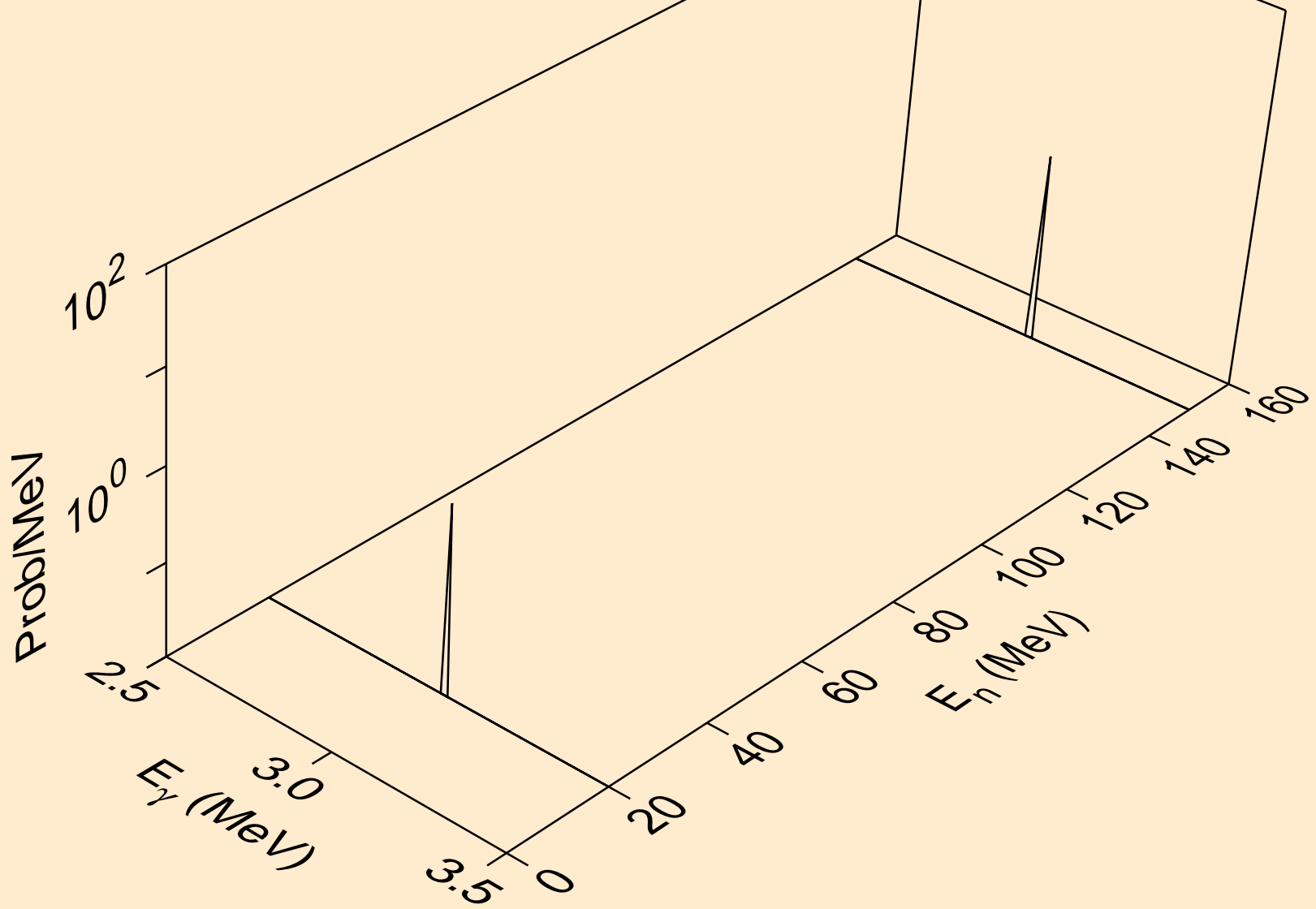

30-ZN-66 FOR FENDL-3.2 FROM FENDL-3.2 BY NJOY2016.60+ O
Photon emission for (n,n*12)

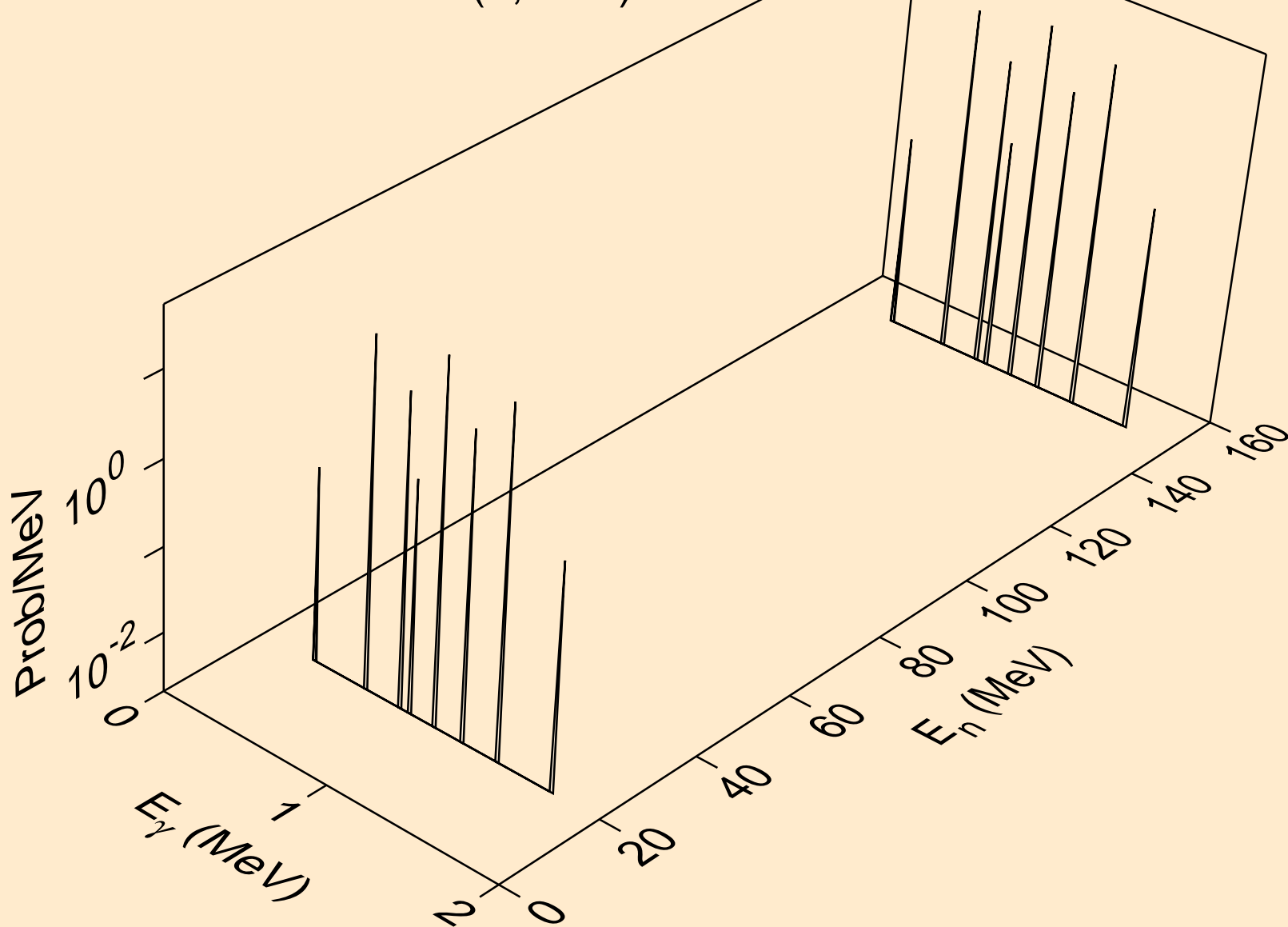

30-ZN-66 FOR FENDL-3.2 FROM FENDL-3.2 BY NJOY2016.60+ O
Photon emission for (n,n*13)

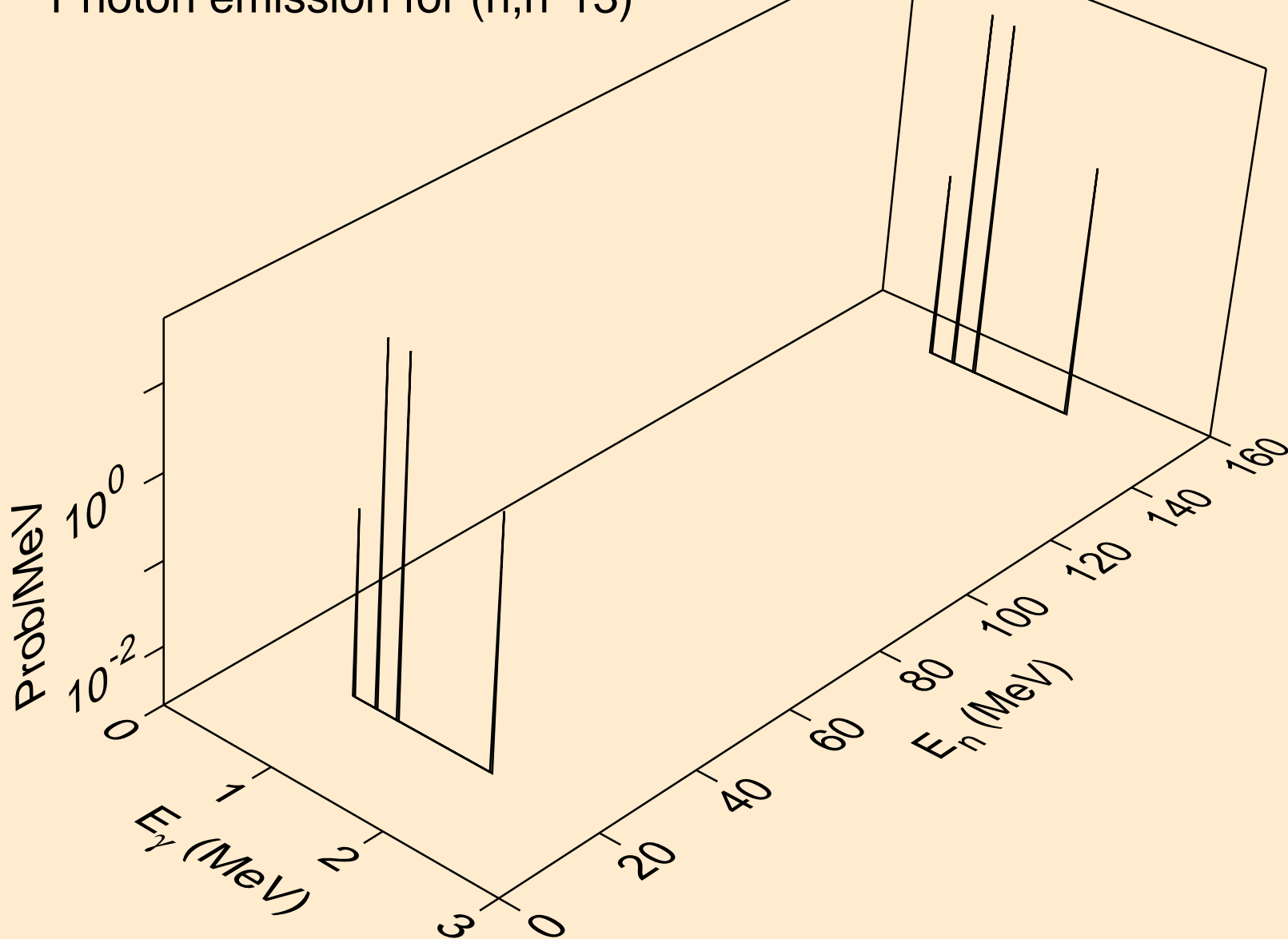

30-ZN-66 FOR FENDL-3.2 FROM FENDL-3.2 BY NJOY2016.60+ O
Photon emission for (n,n*14)

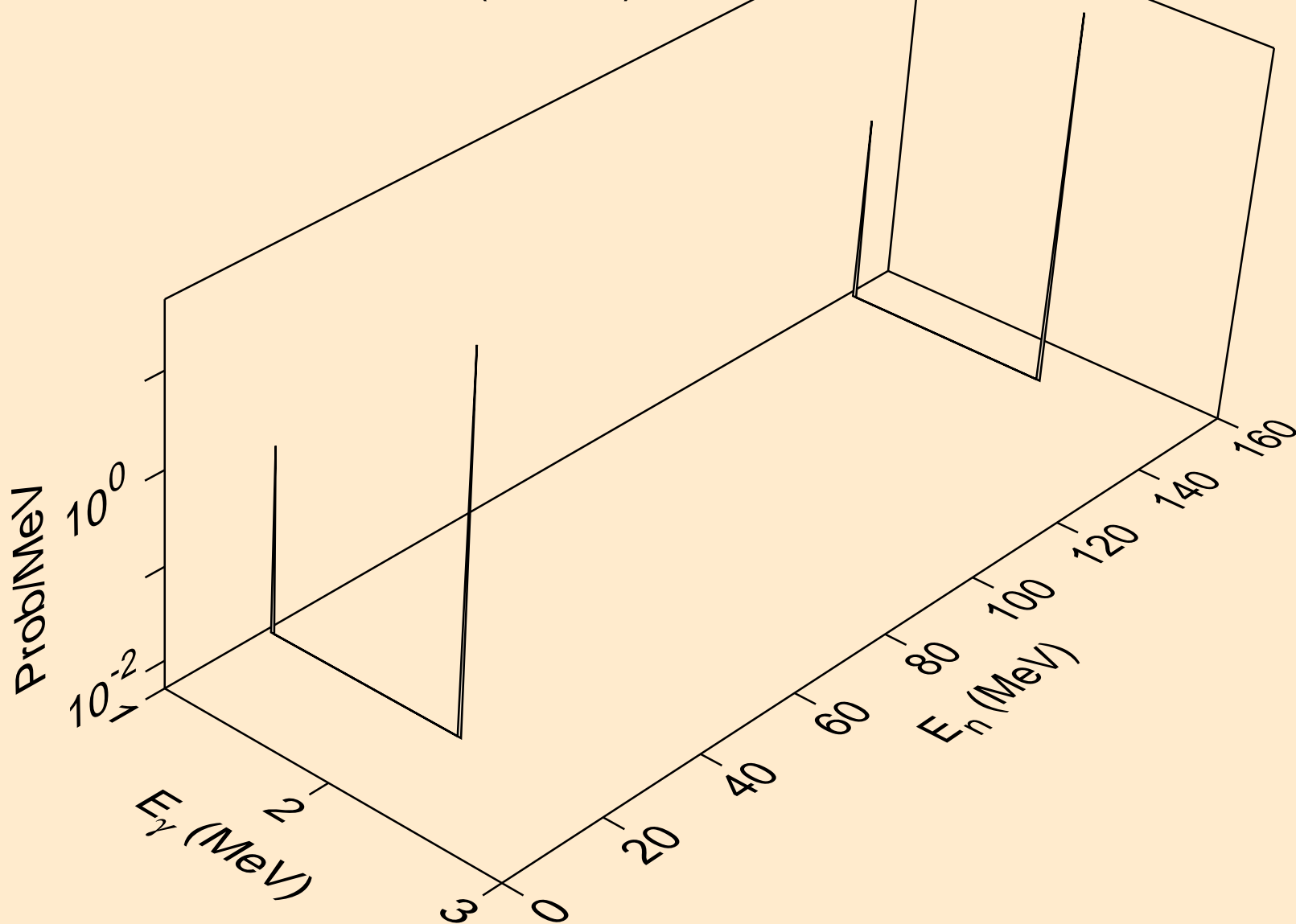

30-ZN-66 FOR FENDL-3.2 FROM FENDL-3.2 BY NJOY2016.60+ O
Photon emission for (n,n*15)

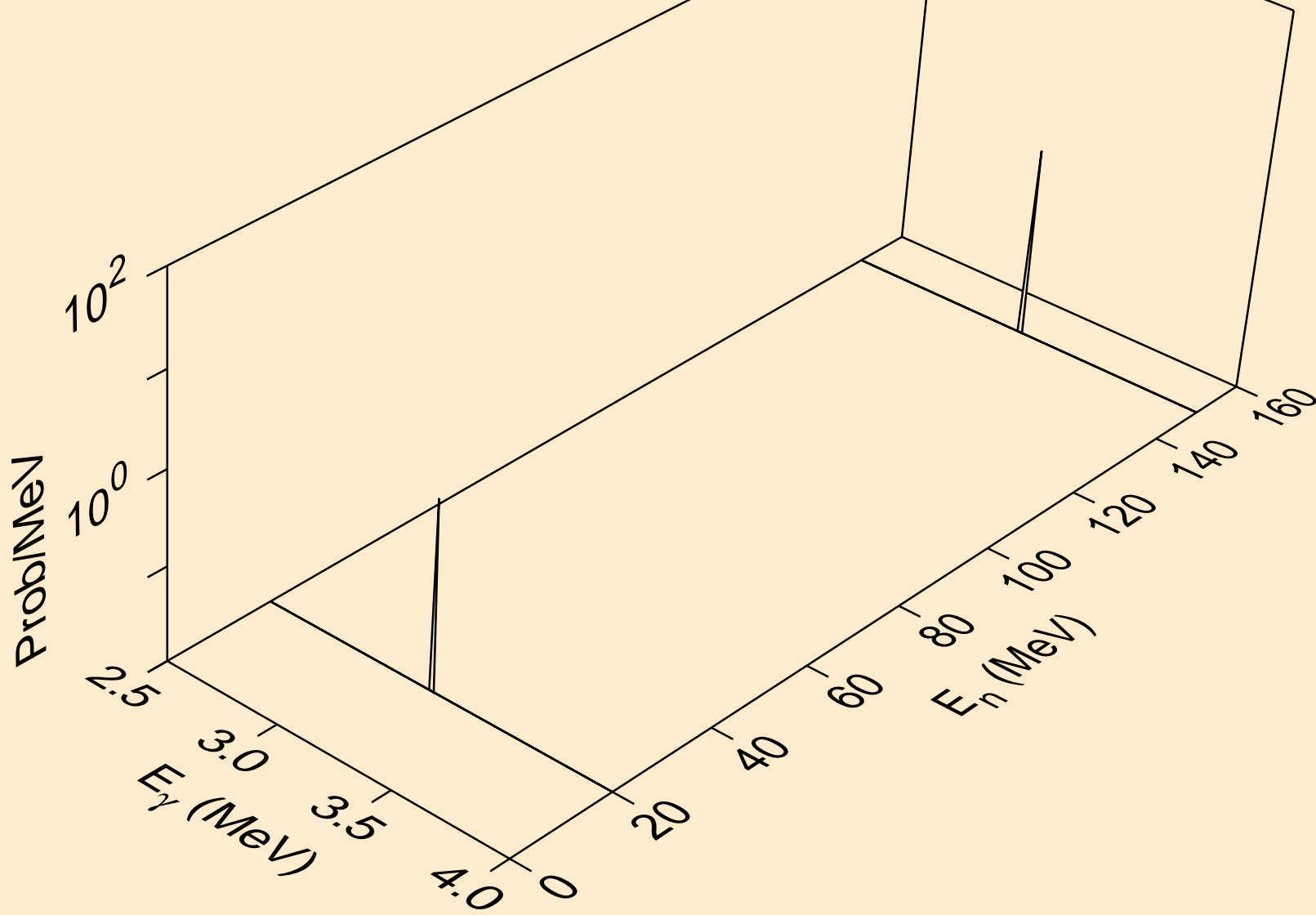

30-ZN-66 FOR FENDL-3.2 FROM FENDL-3.2 BY NJOY2016.60+ O
Photon emission for (n,n*16)

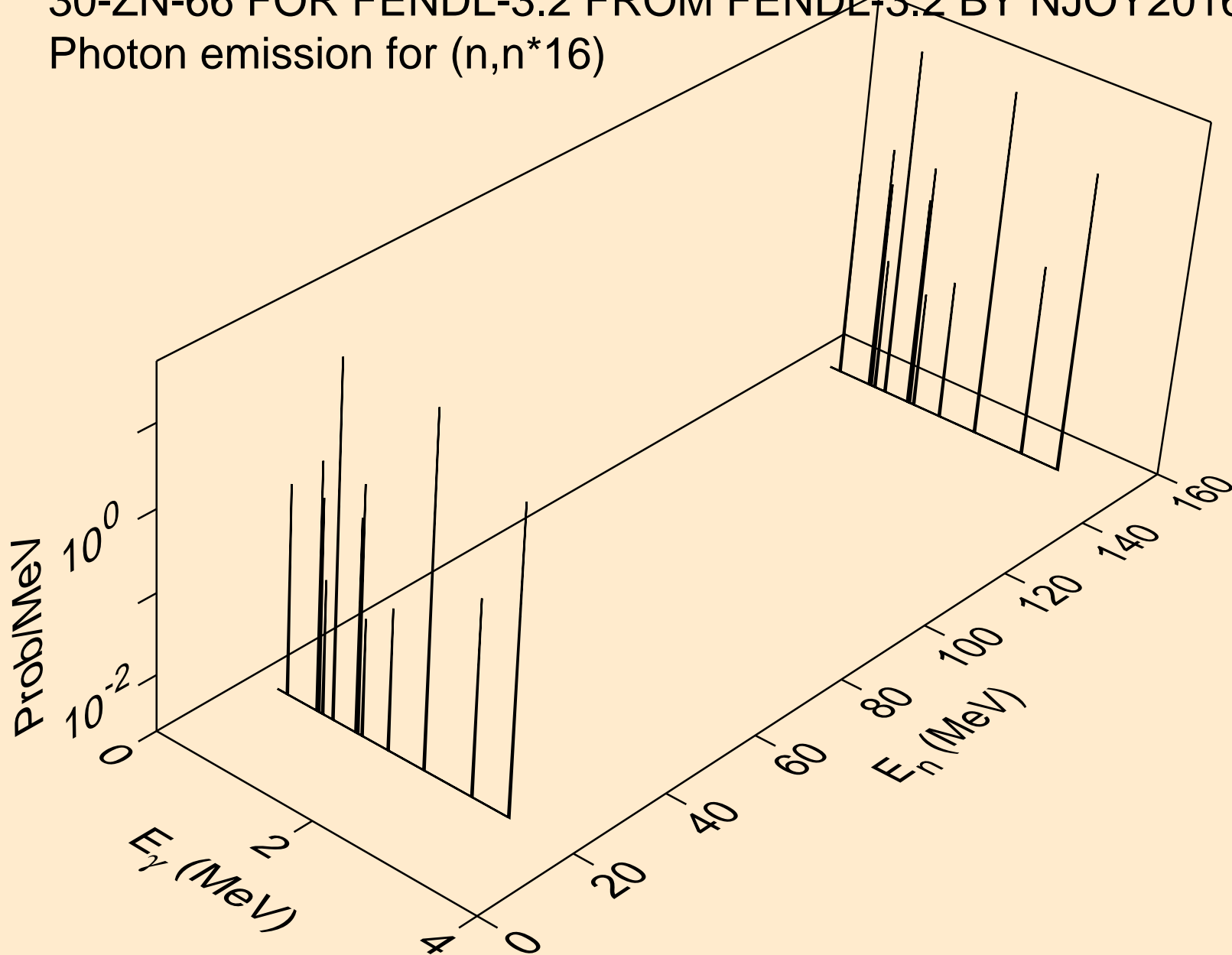

30-ZN-66 FOR FENDL-3.2 FROM FENDL-3.2 BY NJOY2016.60+ O
Photon emission for (n,n*17)

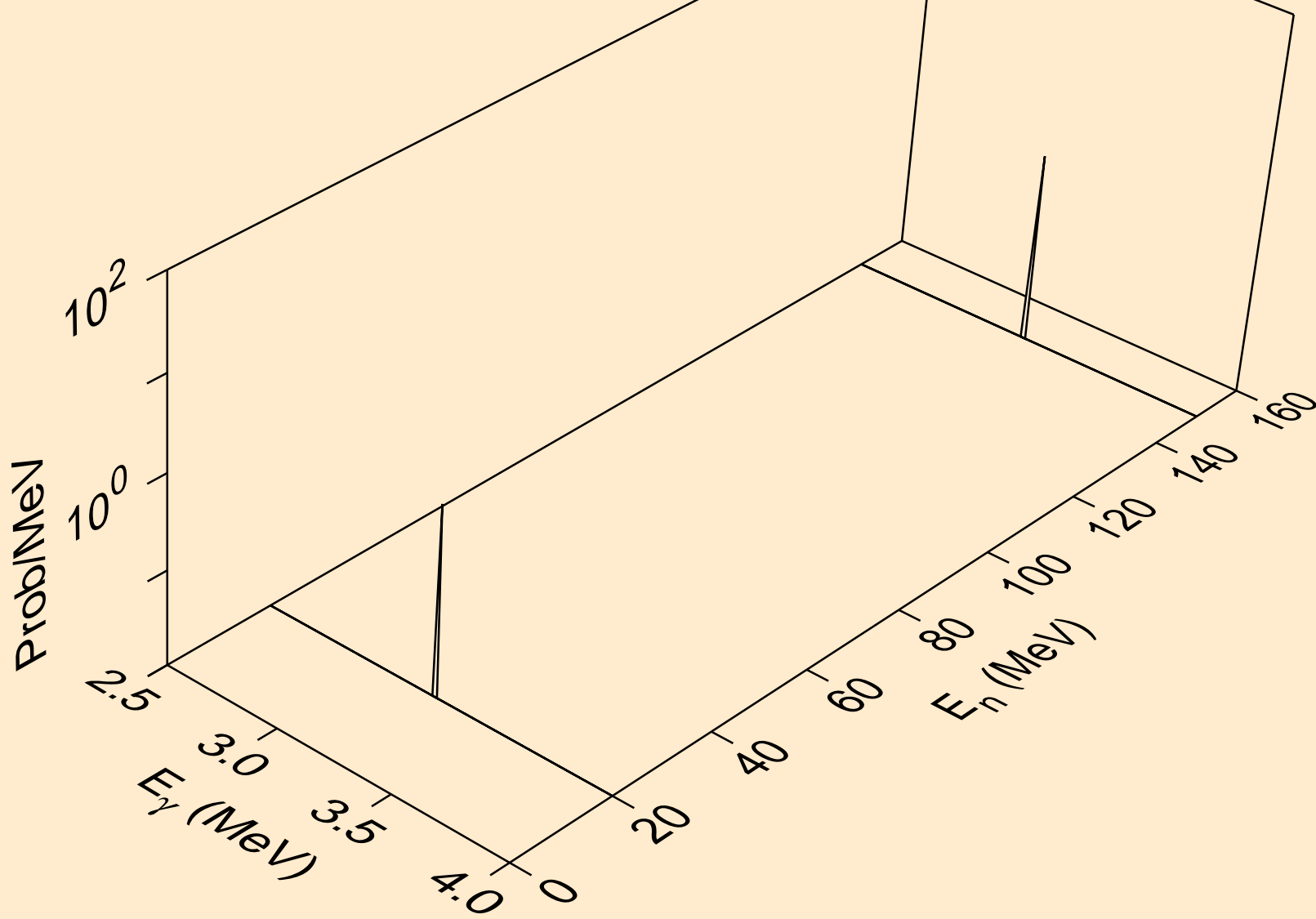

30-ZN-66 FOR FENDL-3.2 FROM FENDL-3.2 BY NJOY2016.60+ O
Photon emission for (n,n*c)

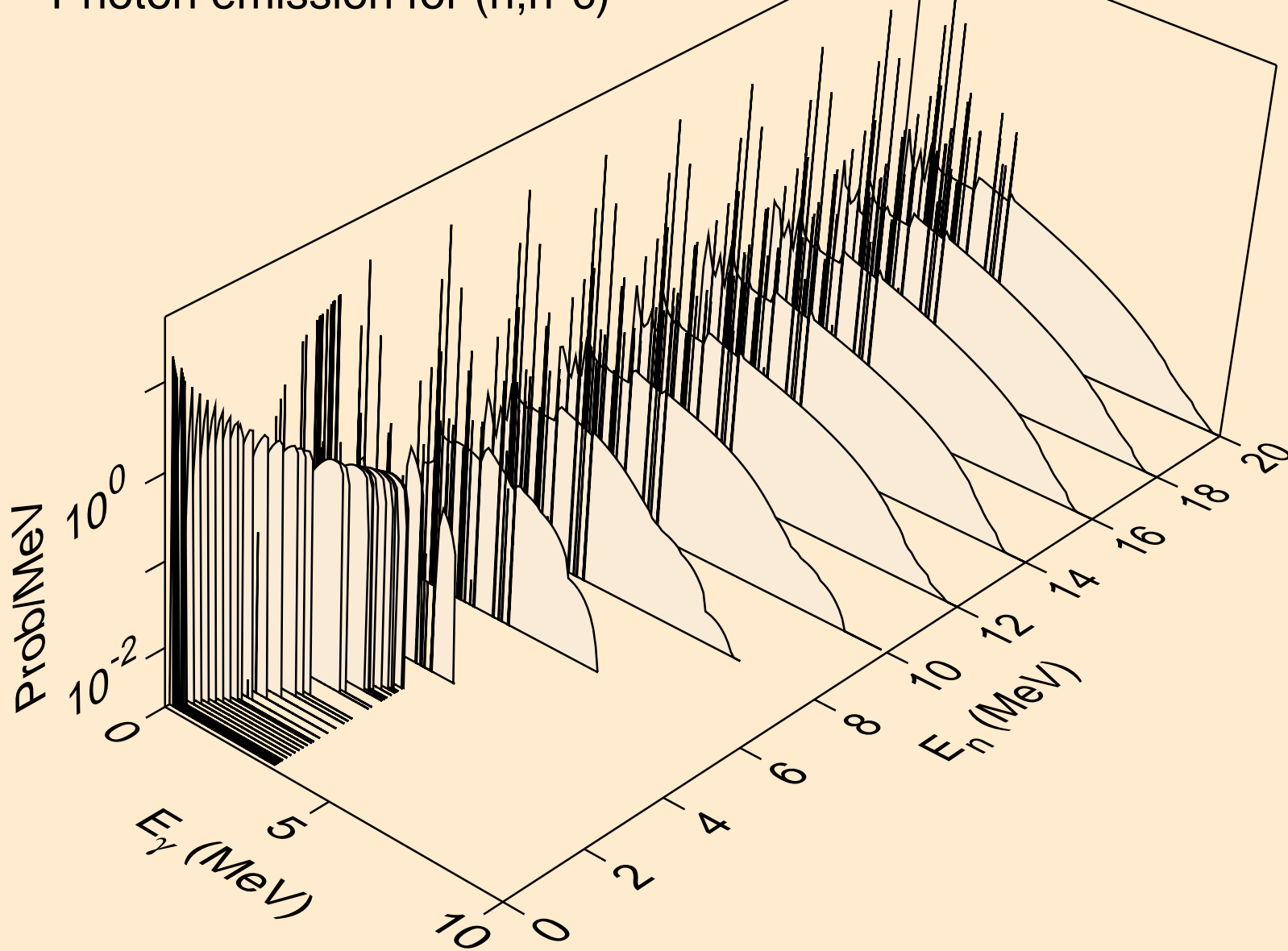

30-ZN-66 FOR FENDL-3.2 FROM FENDL-3.2 BY NJOY2016.60+ O
Photon emission for (n,gma)

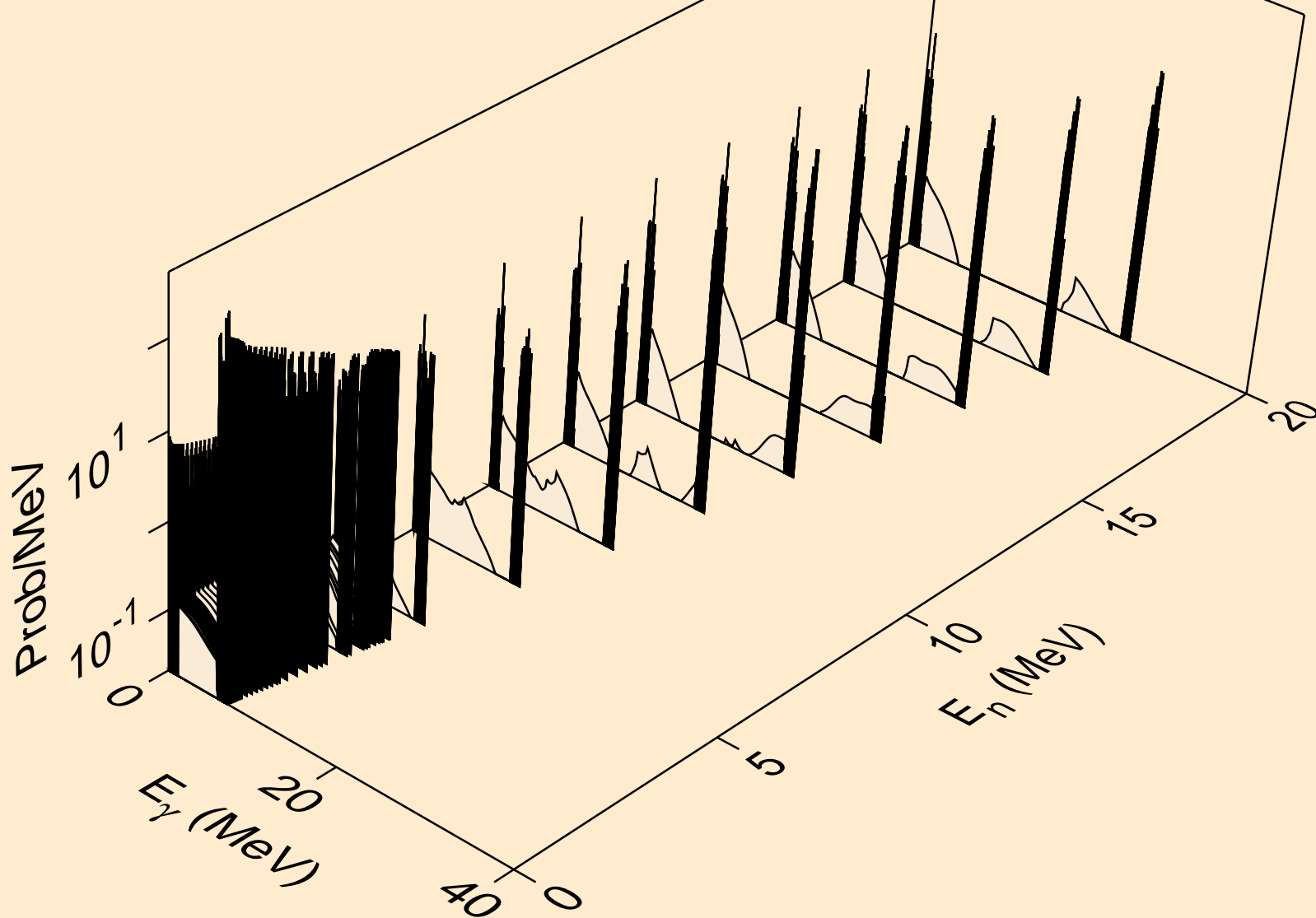

30-ZN-66 FOR FENDL-3.2 FROM FENDL-3.2 BY NJOY2016.60+ O
thermal capture photon spectrum

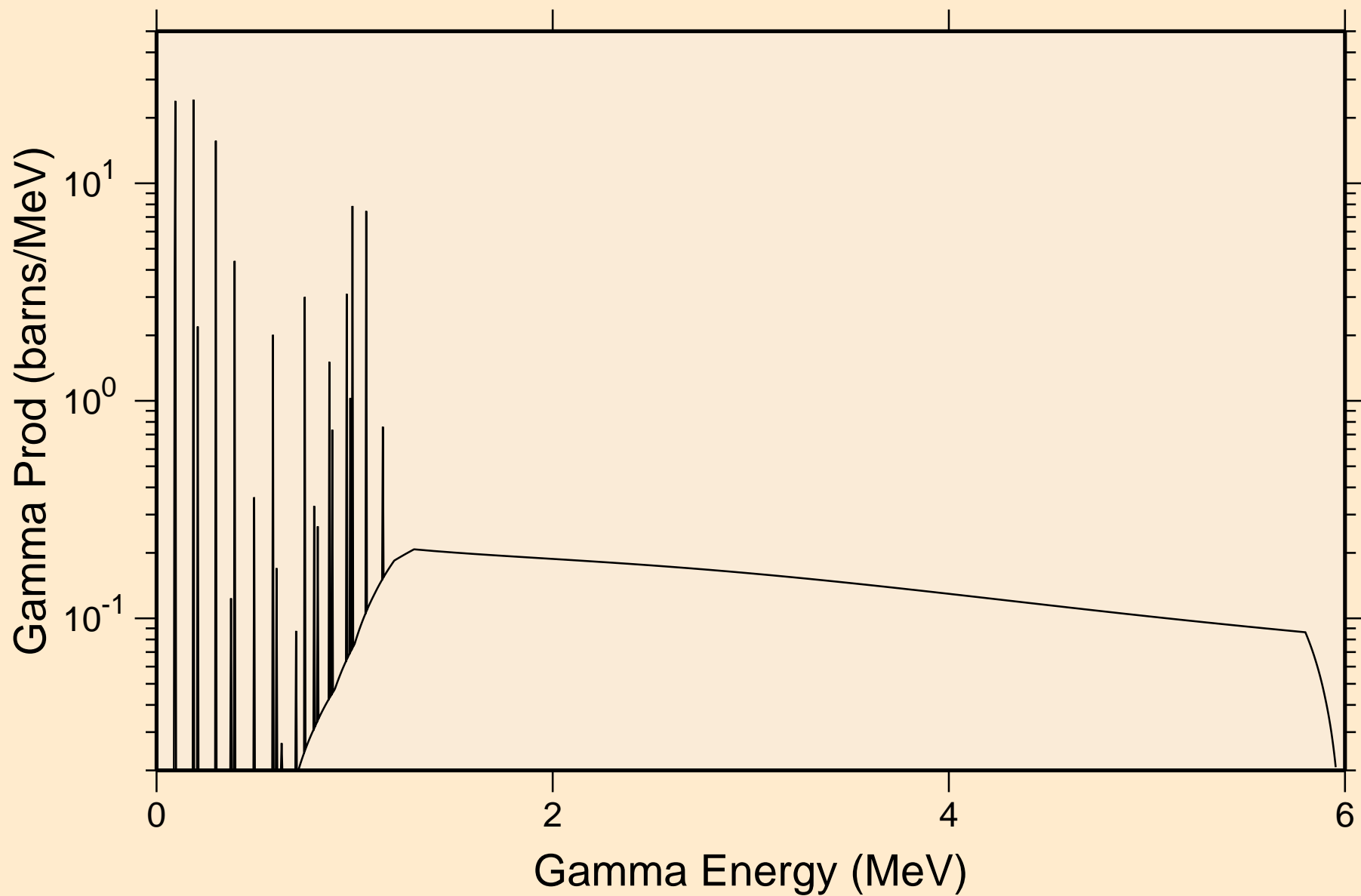

30-ZN-66 FOR FENDL-3.2 FROM FENDL-3.2 BY NJOY2016.60+ O
14 MeV photon spectrum

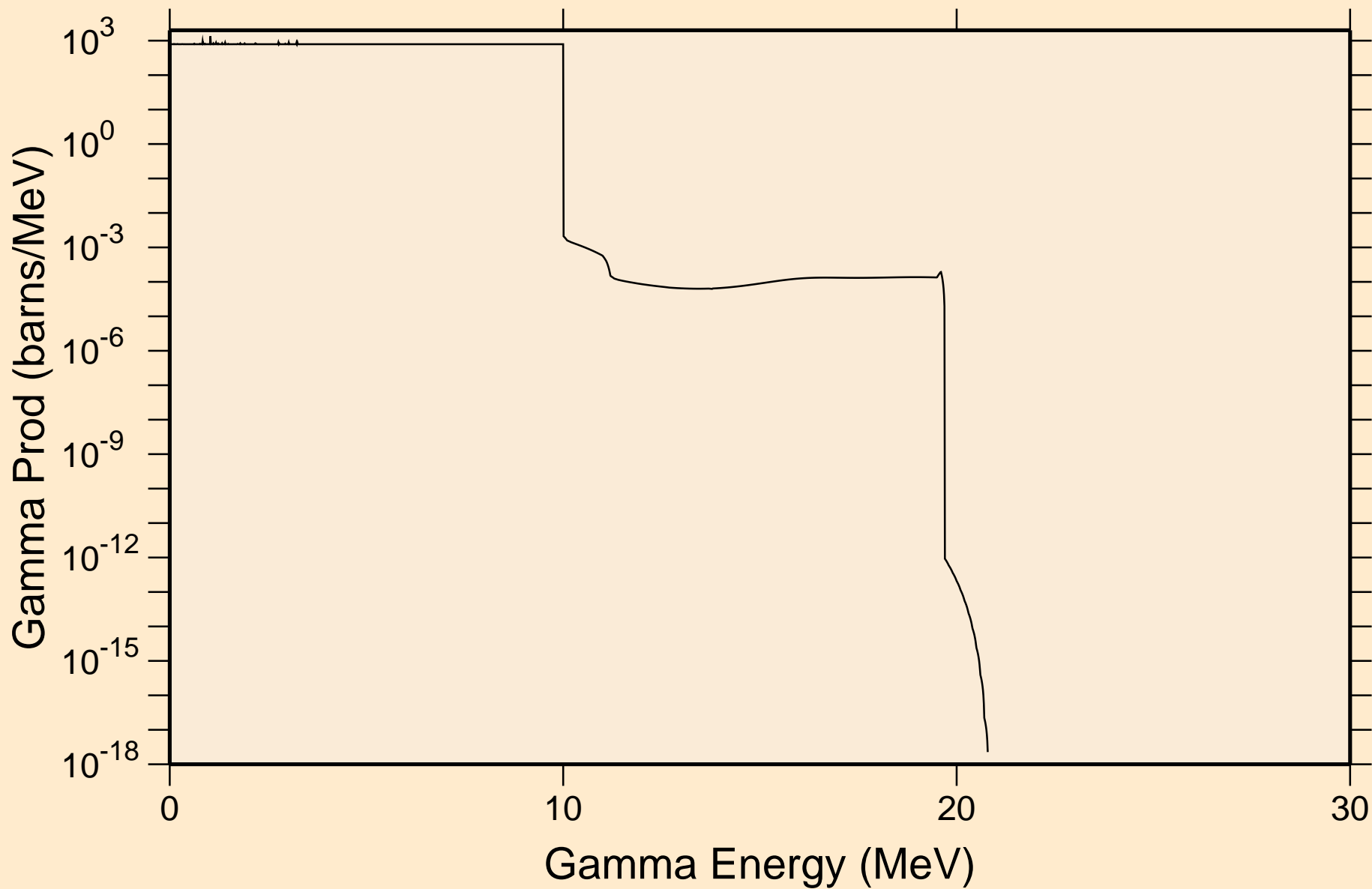

30-ZN-66 FOR FENDL-3.2 FROM FENDL-3.2 BY NJOY2016.60+ O

Particle heating contributions

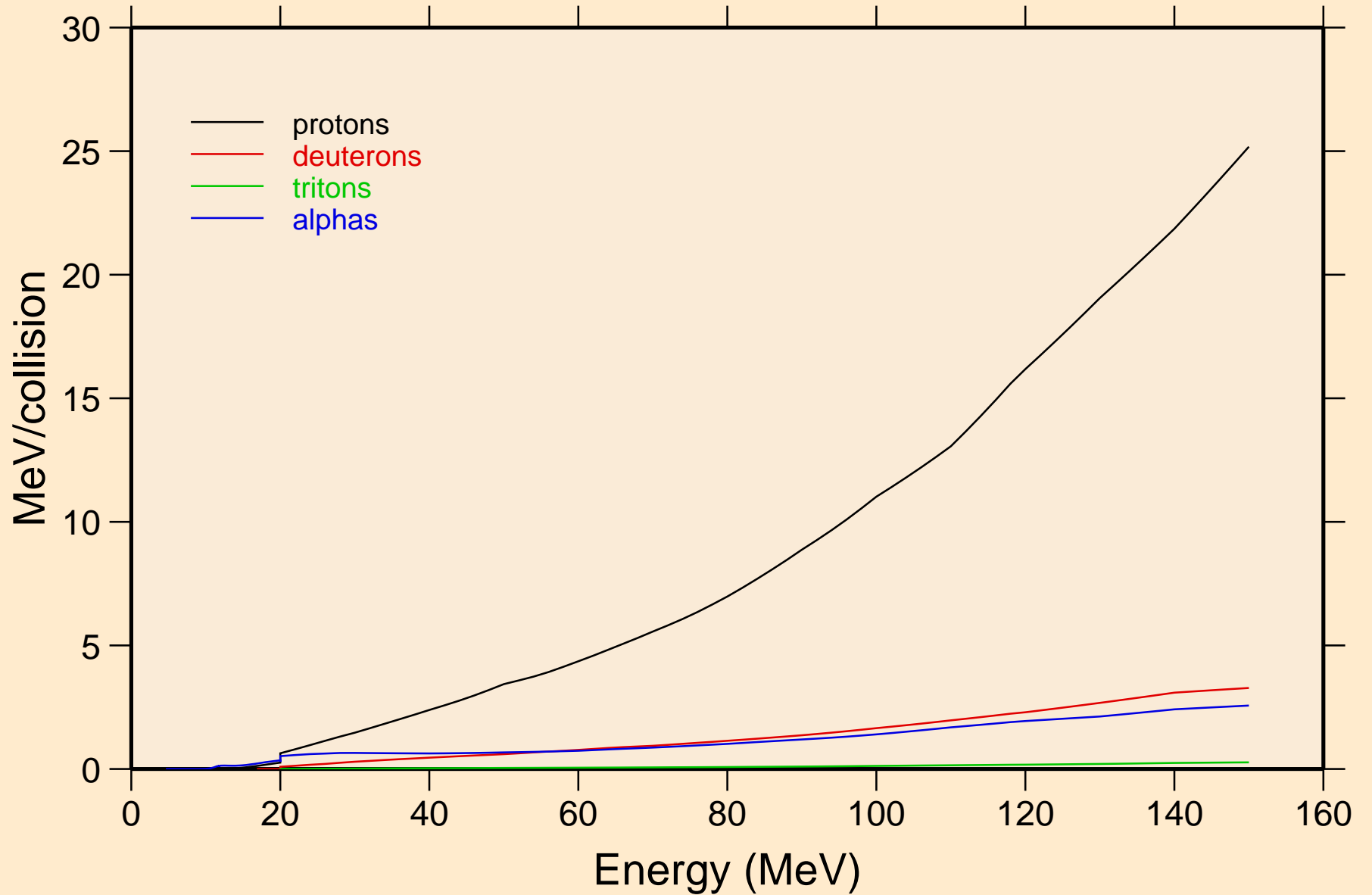

30-ZN-66 FOR FENDL-3.2 FROM FENDL-3.2 BY NJOY2016.60+ O Recoil Heating

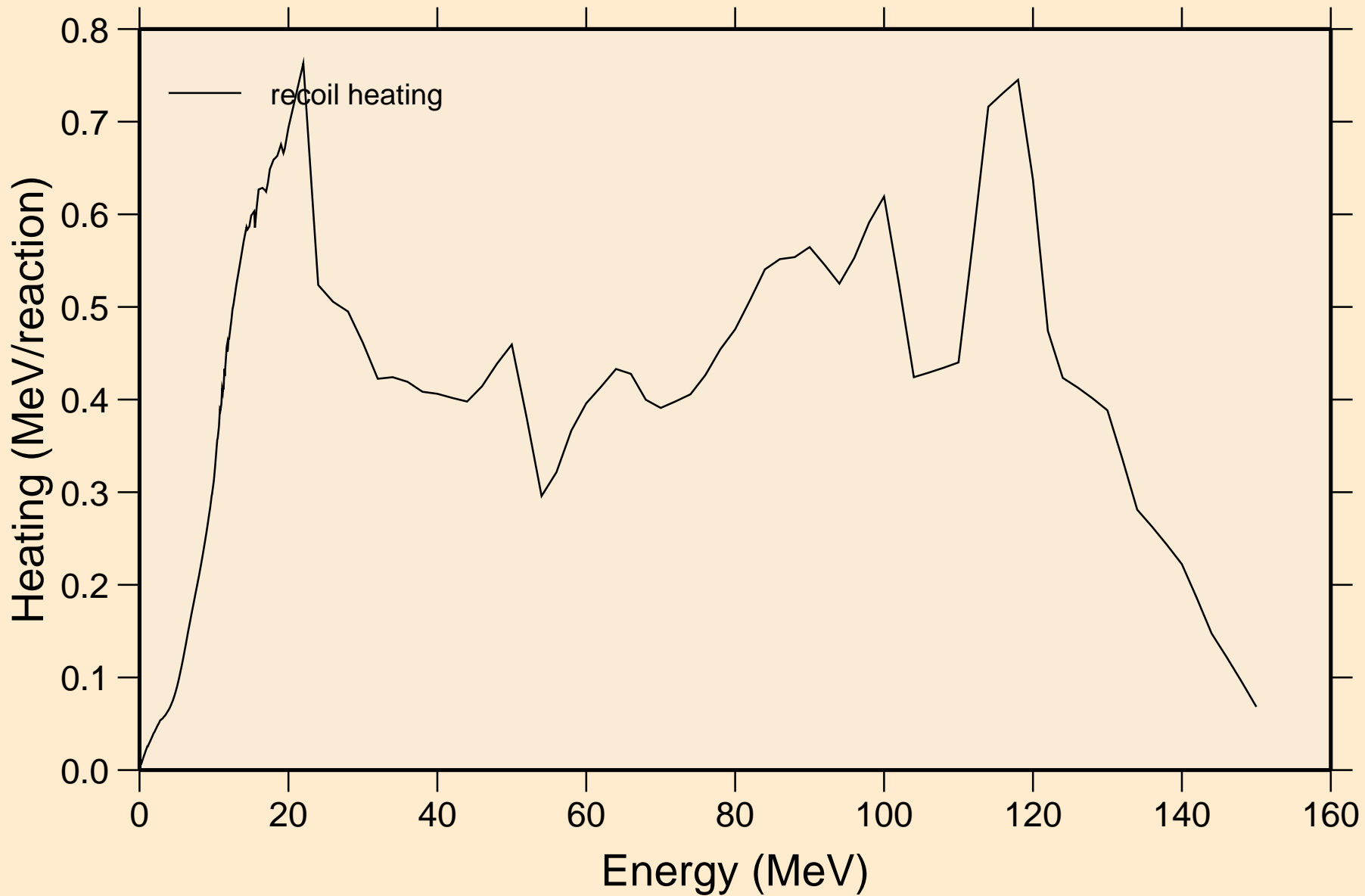

30-ZN-66 FOR FENDL-3.2 FROM FENDL-3.2 BY NJOY2016.60+ O
Particle production cross sections

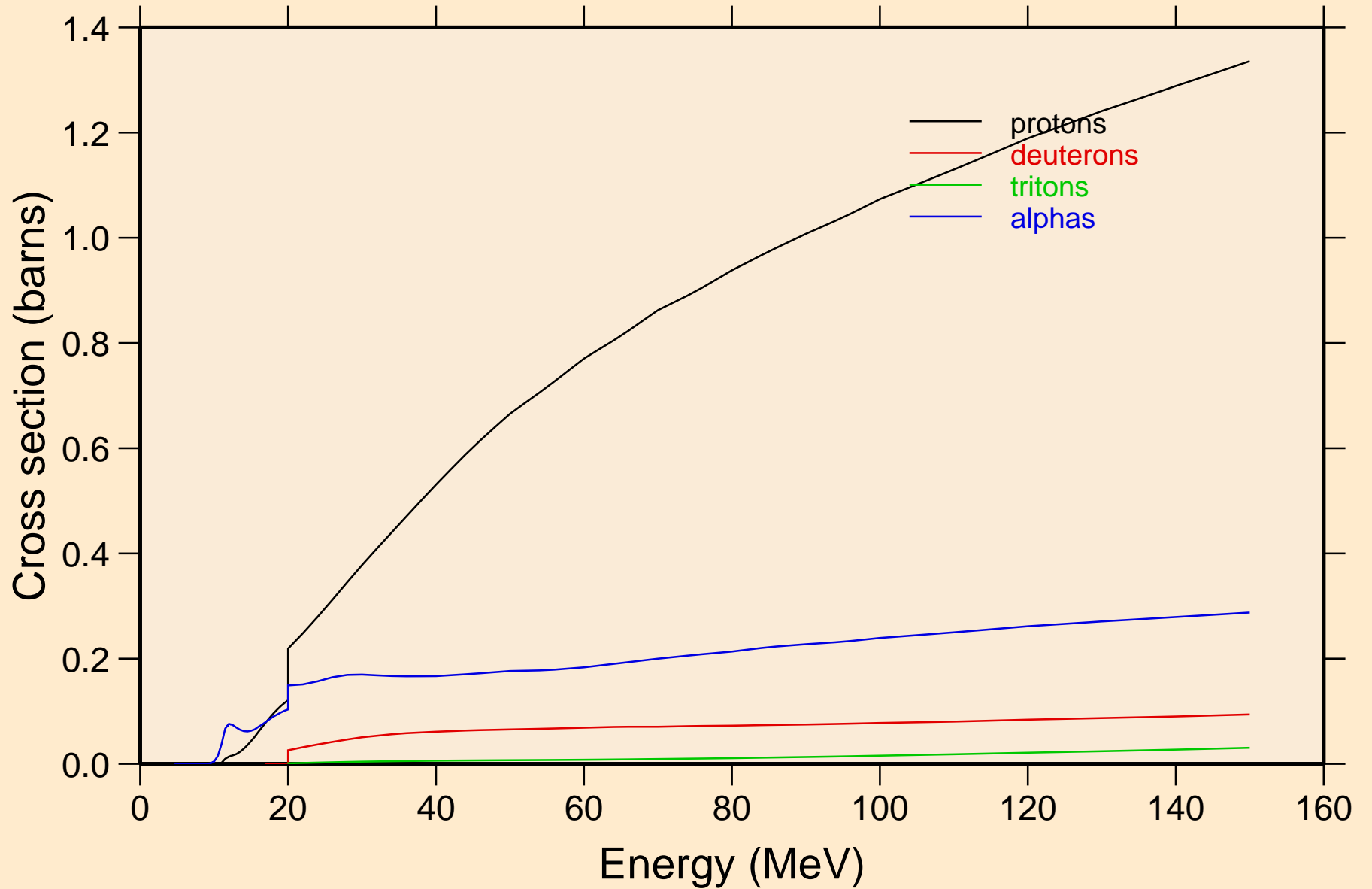

30-ZN-66 FOR FENDL-3.2 FROM FENDL-3.2 BY NJOY2016.60+ O
protons from (n,x)

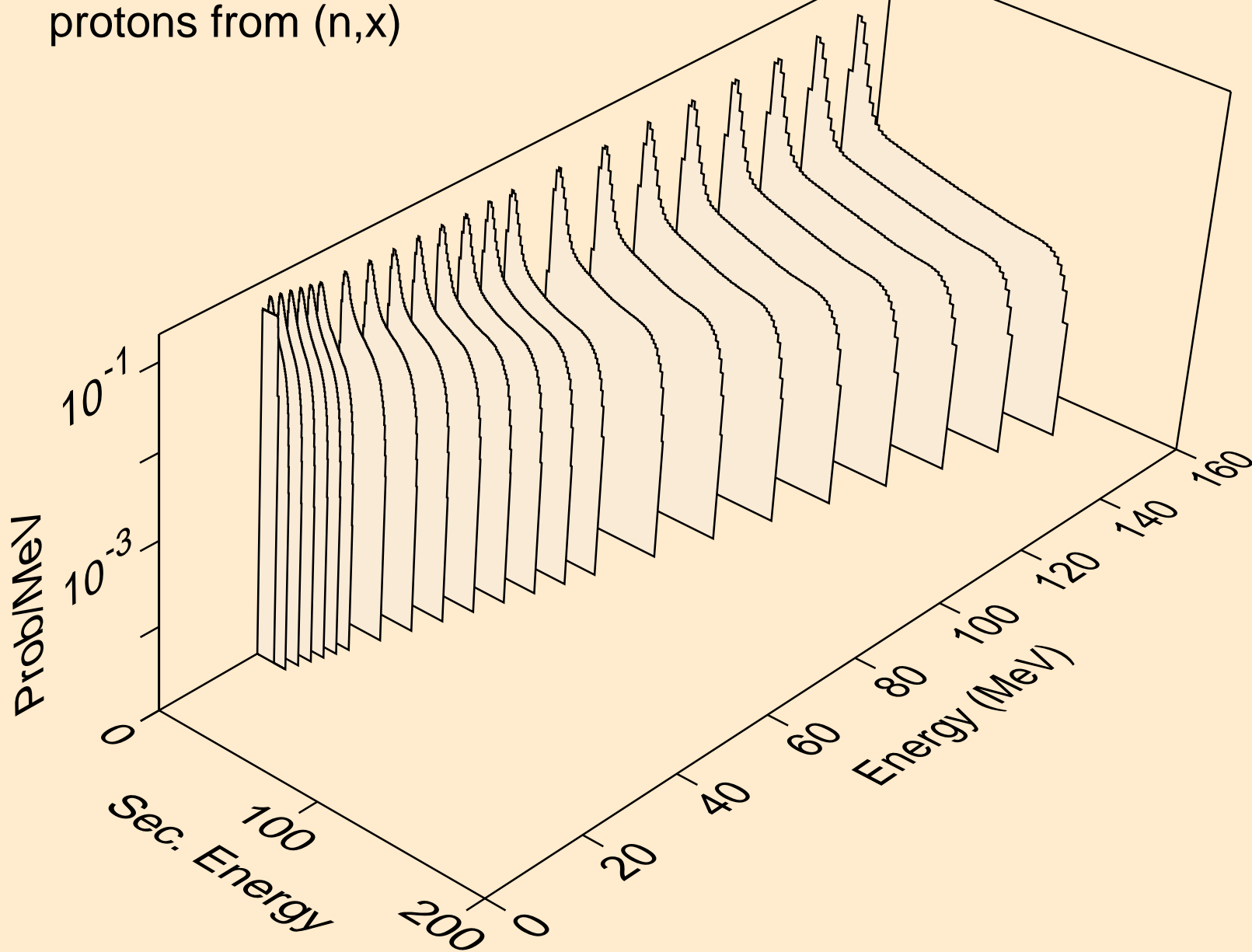

30-ZN-66 FOR FENDL-3.2 FROM FENDL-3.2 BY NJOY2016.60+ O
protons from (n,n*)p

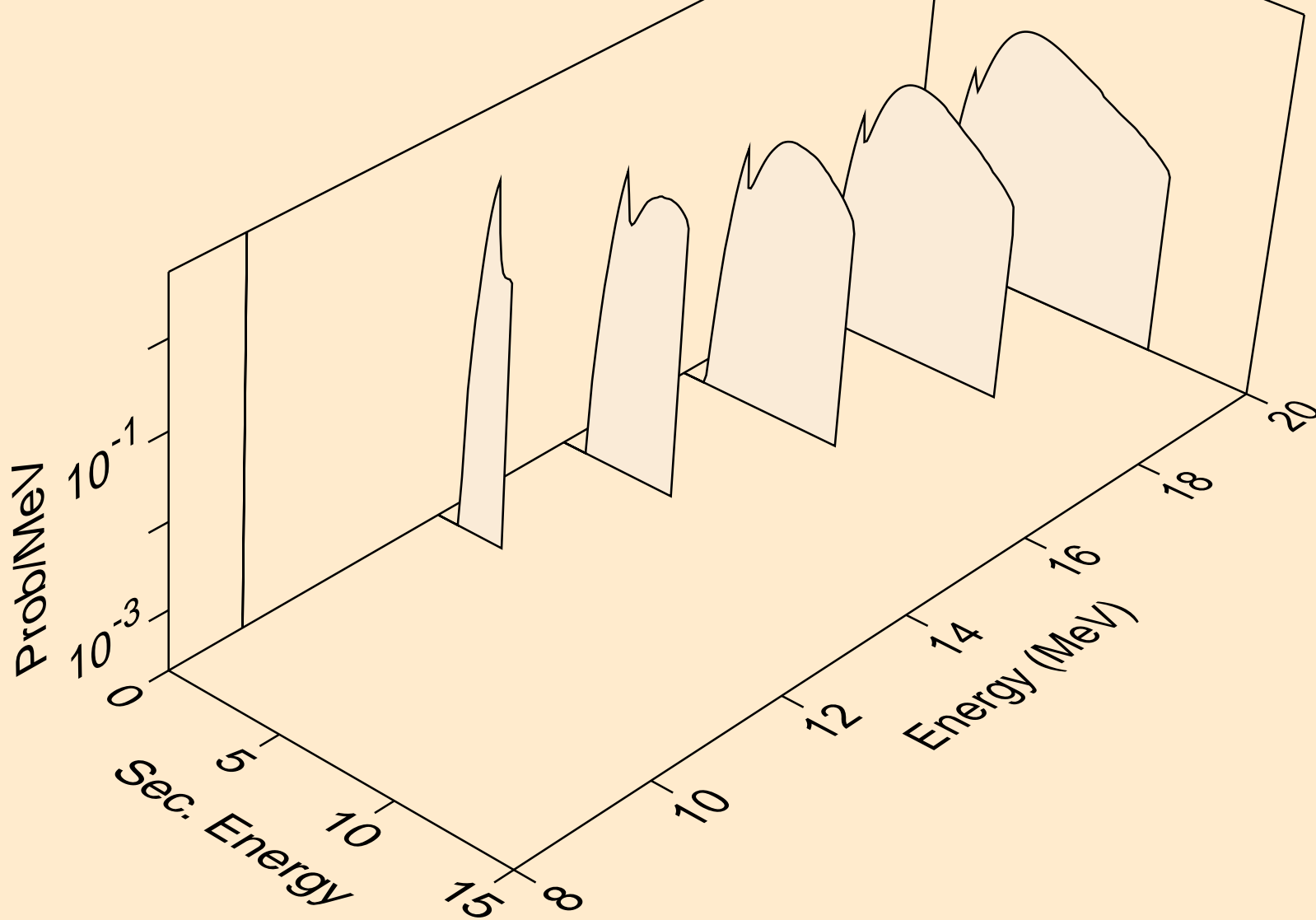

30-ZN-66 FOR FENDL-3.2 FROM FENDL-3.2 BY NJOY2016.60+ O
deuterons from (n,x)

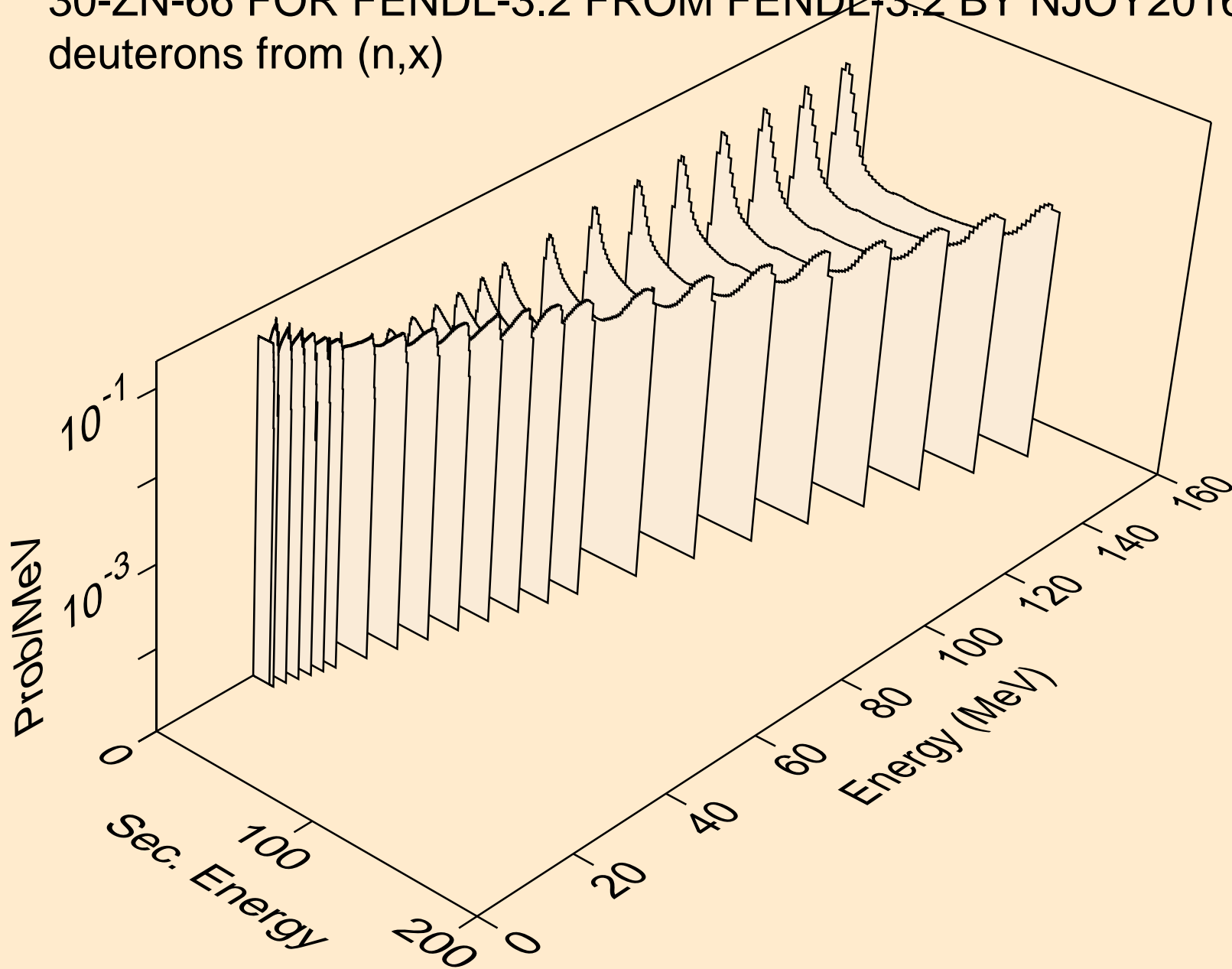

30-ZN-66 FOR FENDL-3.2 FROM FENDL-3.2 BY NJOY2016.60+ O
deuterons from (n,n*)d

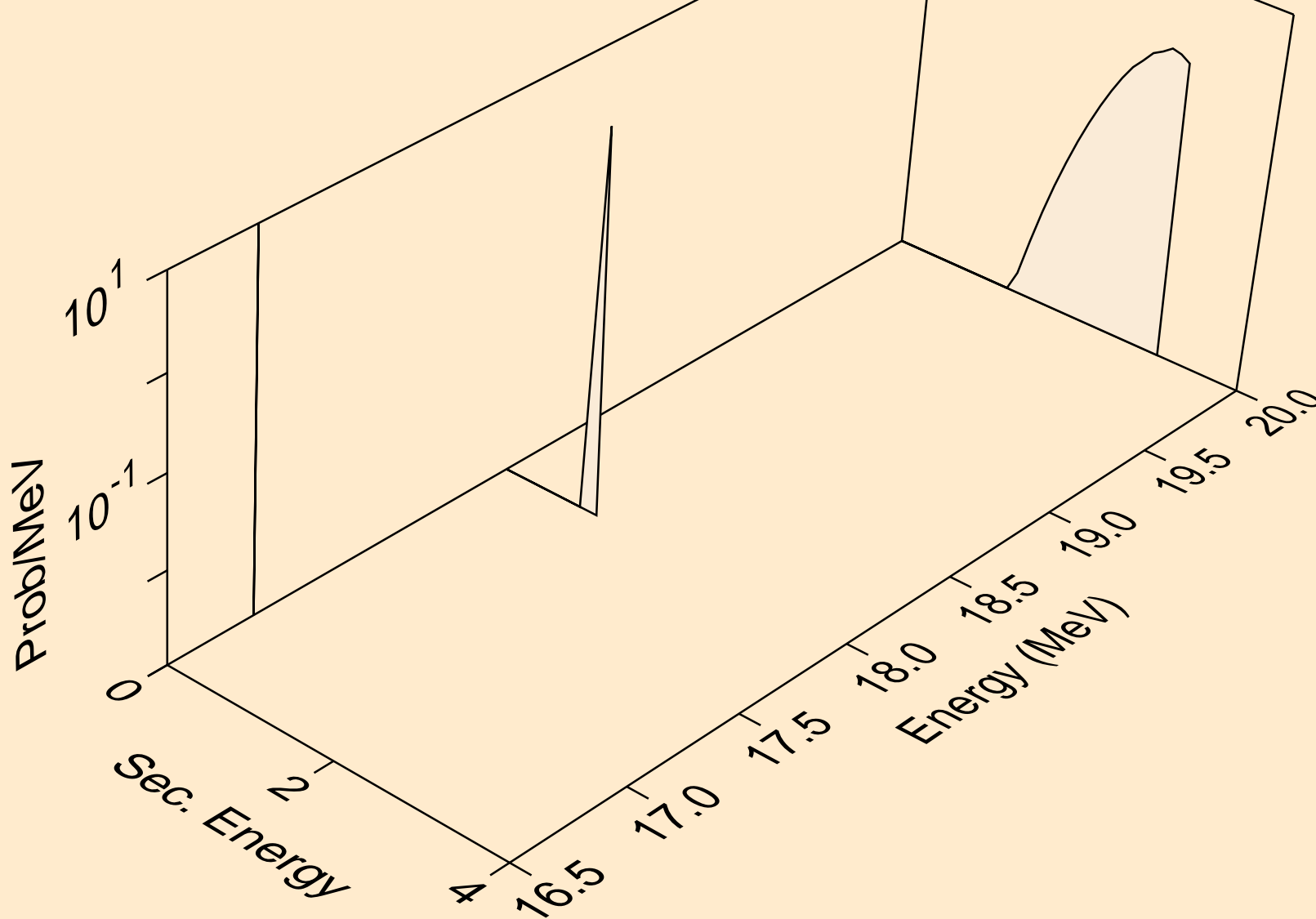

30-ZN-66 FOR FENDL-3.2 FROM FENDL-3.2 BY NJOY2016.60+ O
tritons from (n,x)

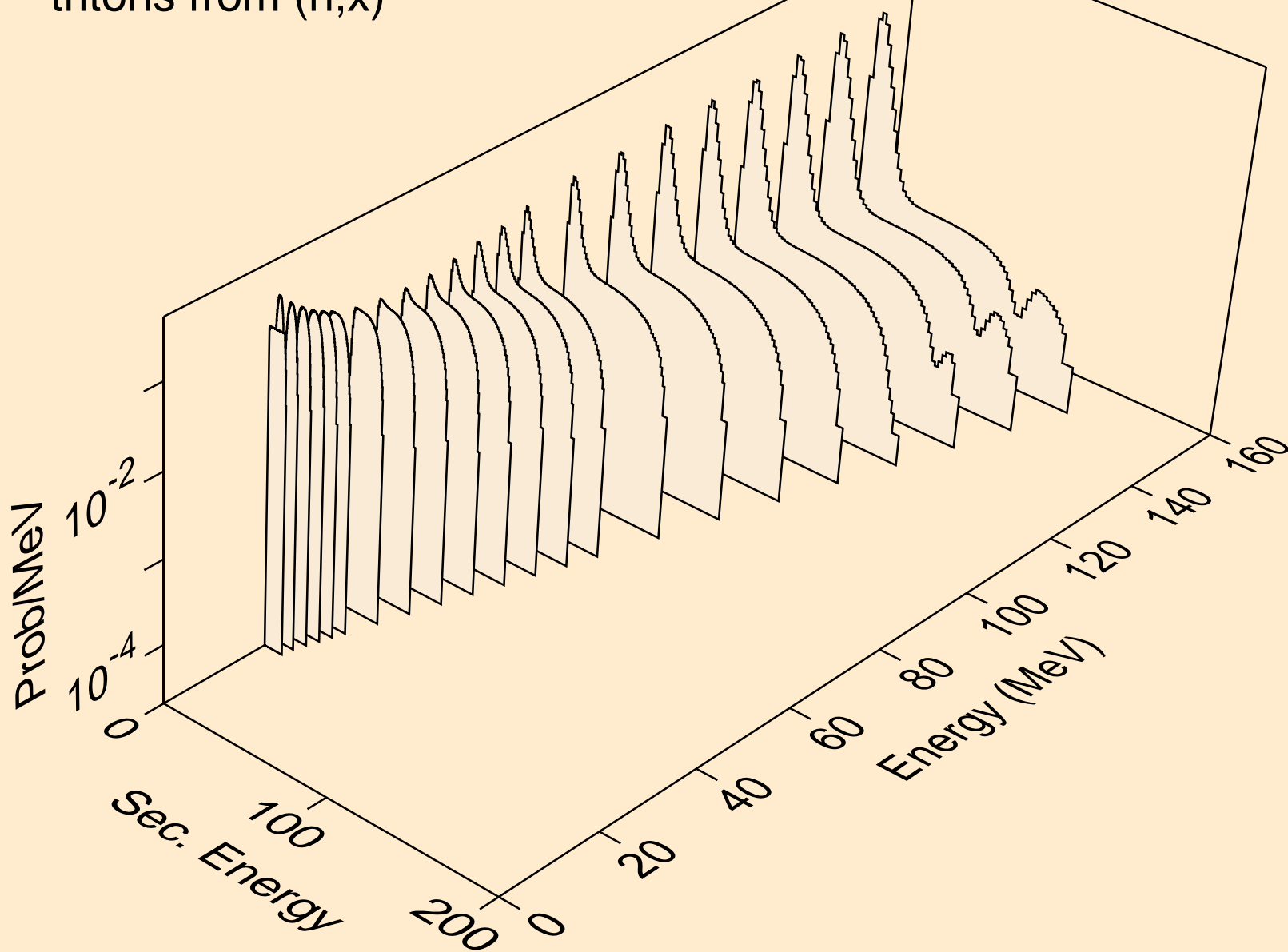

30-ZN-66 FOR FENDL-3.2 FROM FENDL-3.2 BY NJOY2016.60+ O
alphas from (n,x)

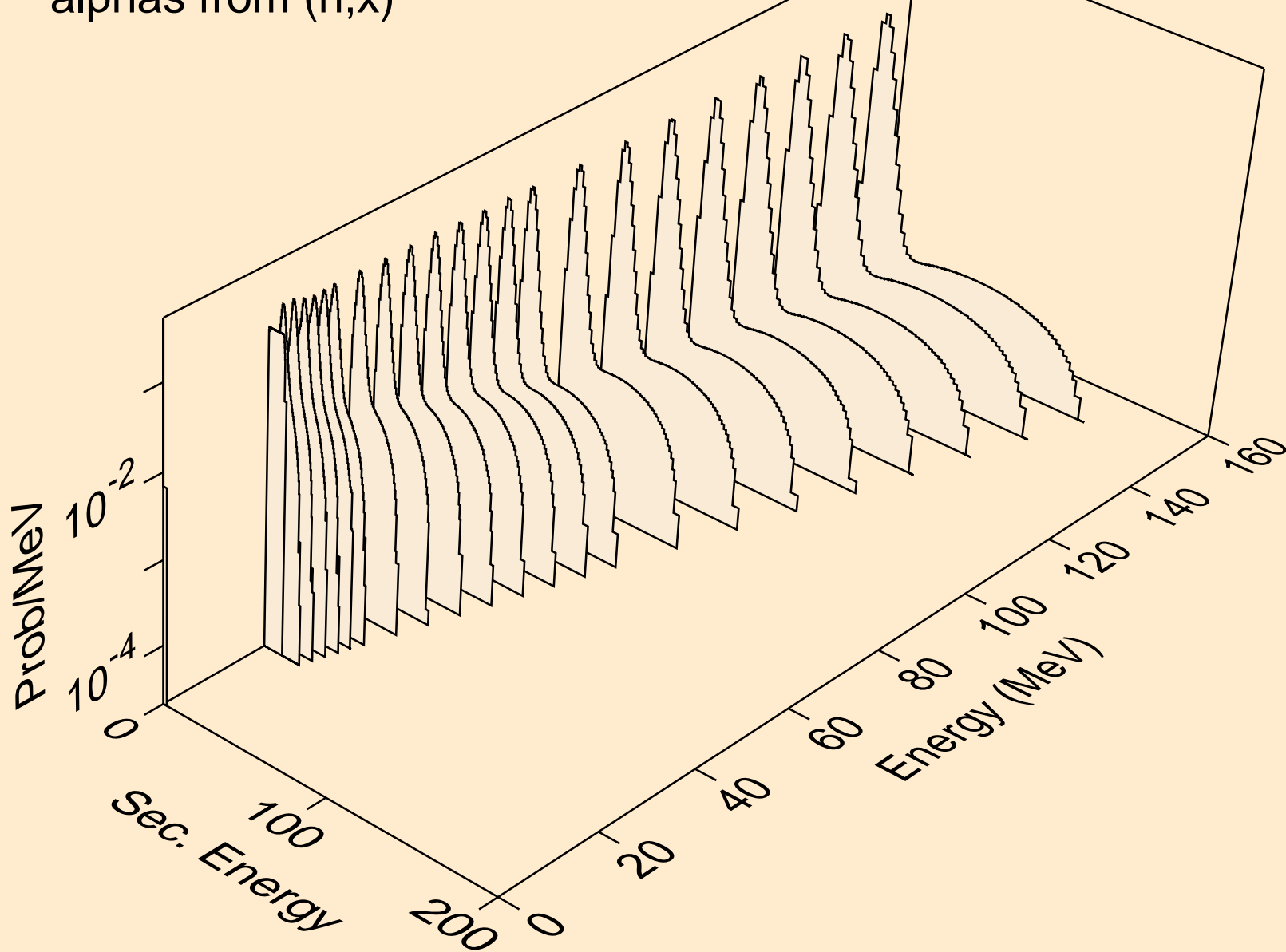

30-ZN-66 FOR FENDL-3.2 FROM FENDL-3.2 BY NJOY2016.60+ O
alphas from (n,n*)a

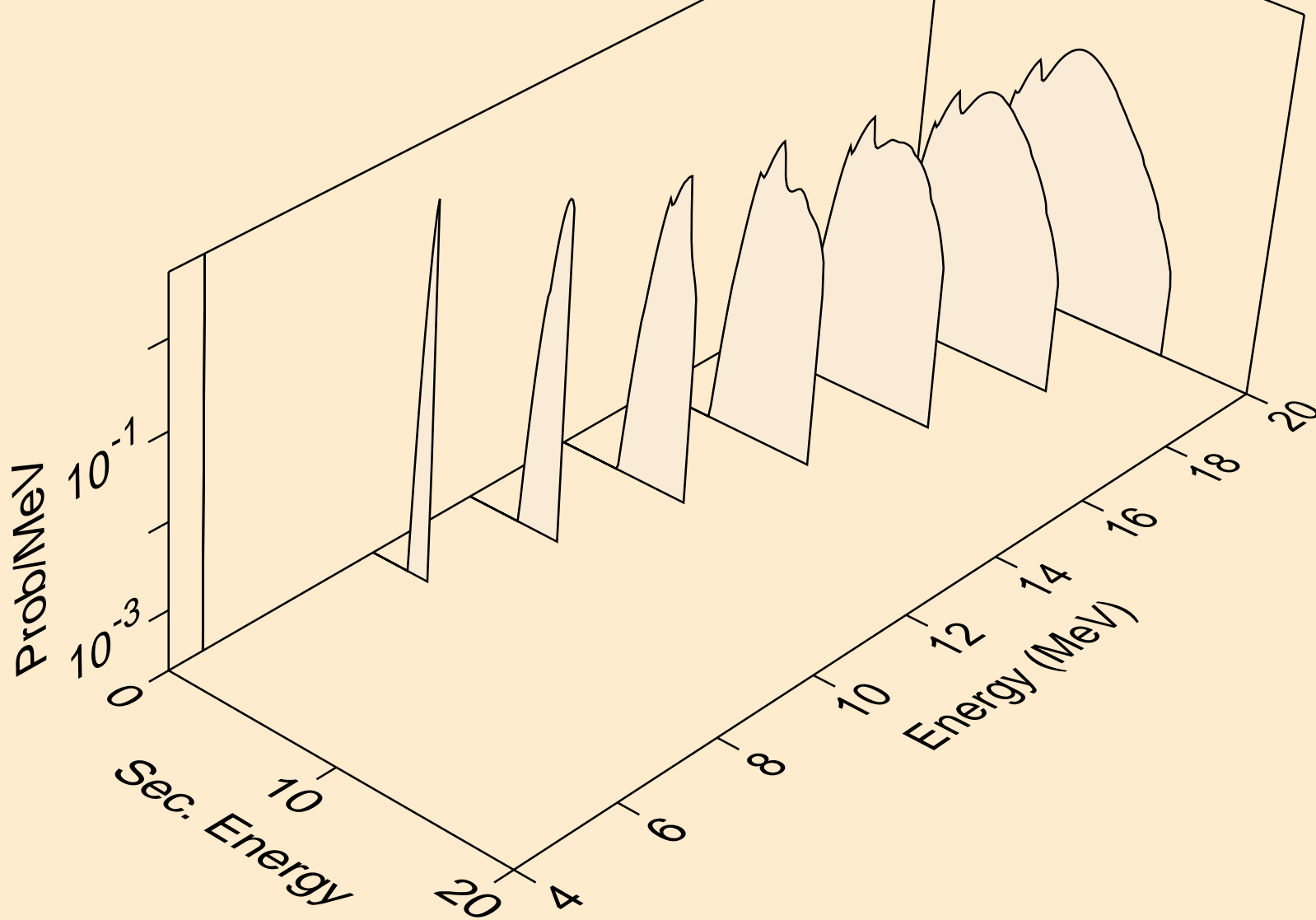

30-ZN-66 FOR FENDL-3.2 FROM FENDL-3.2 BY NJOY2016.60+ O
alphas from (n,2n)a

