

32-GE-73 FOR FENDL-3.2 FROM JEFF-3.1.1 BY NJOY2016.60+ O  
Principal cross sections

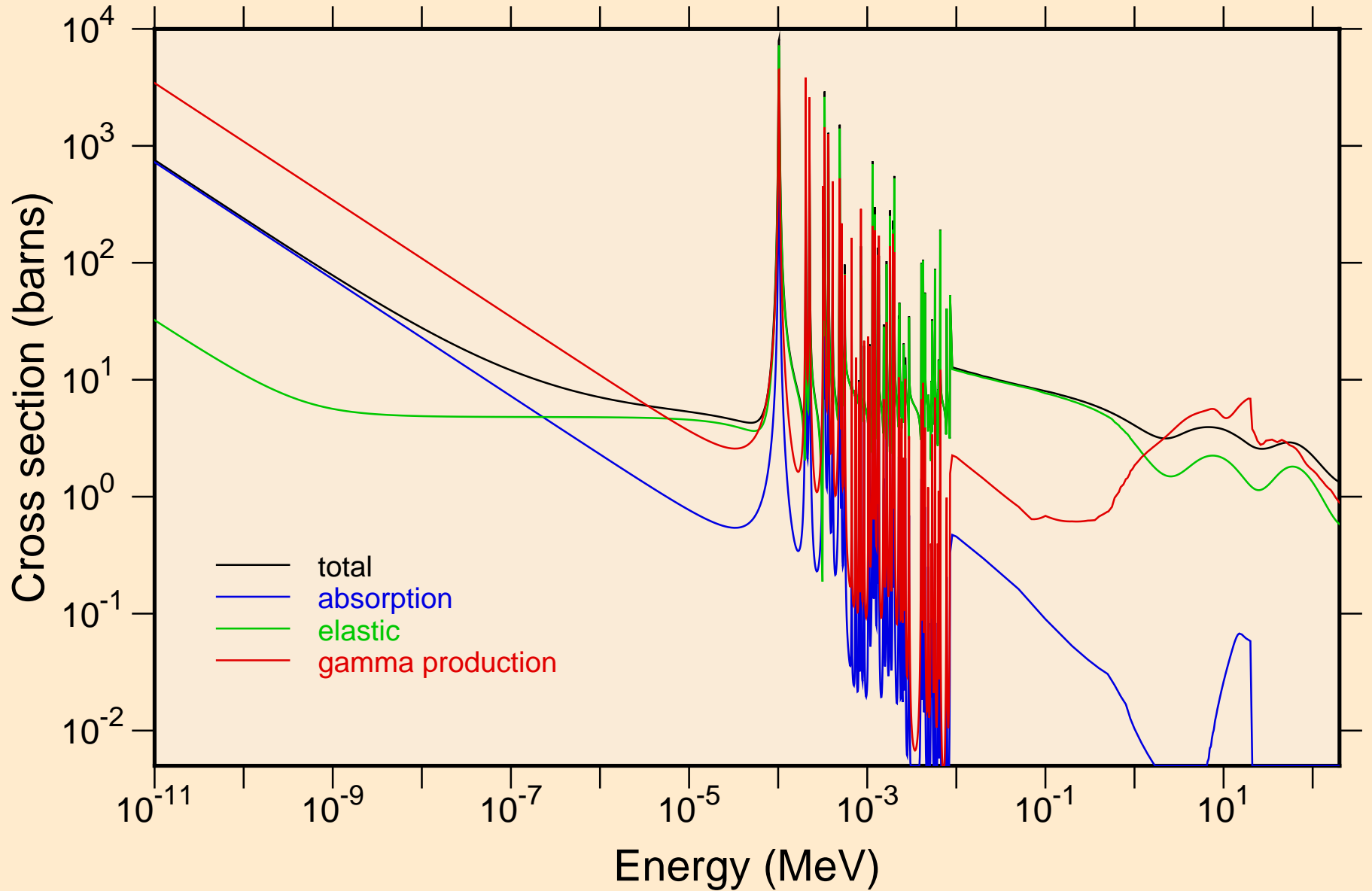

32-GE-73 FOR FENDL-3.2 FROM JEFF-3.1.1 BY NJOY2016.60+ O  
resonance total cross section

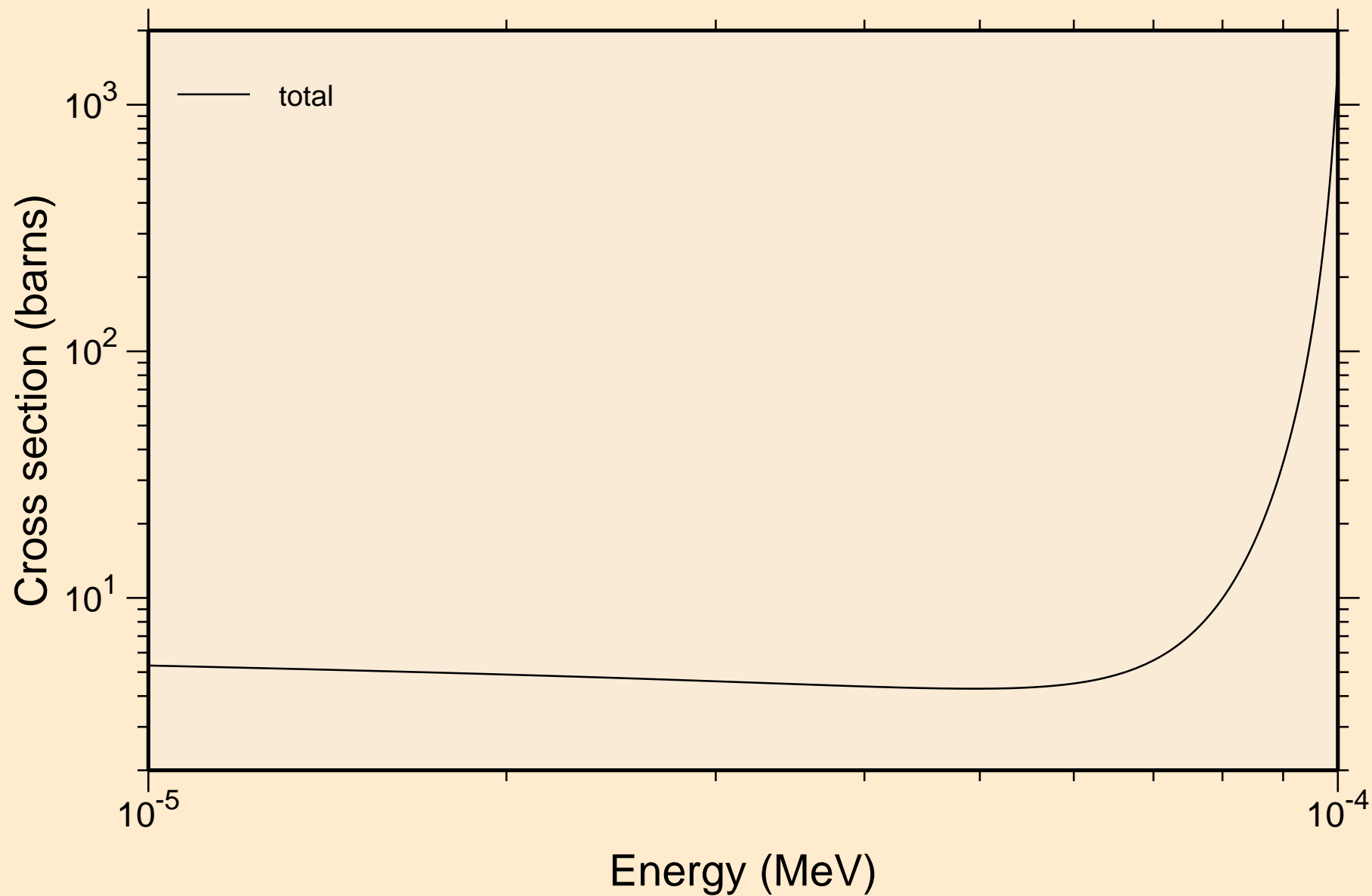

32-GE-73 FOR FENDL-3.2 FROM JEFF-3.1.1 BY NJOY2016.60+ O  
resonance total cross section

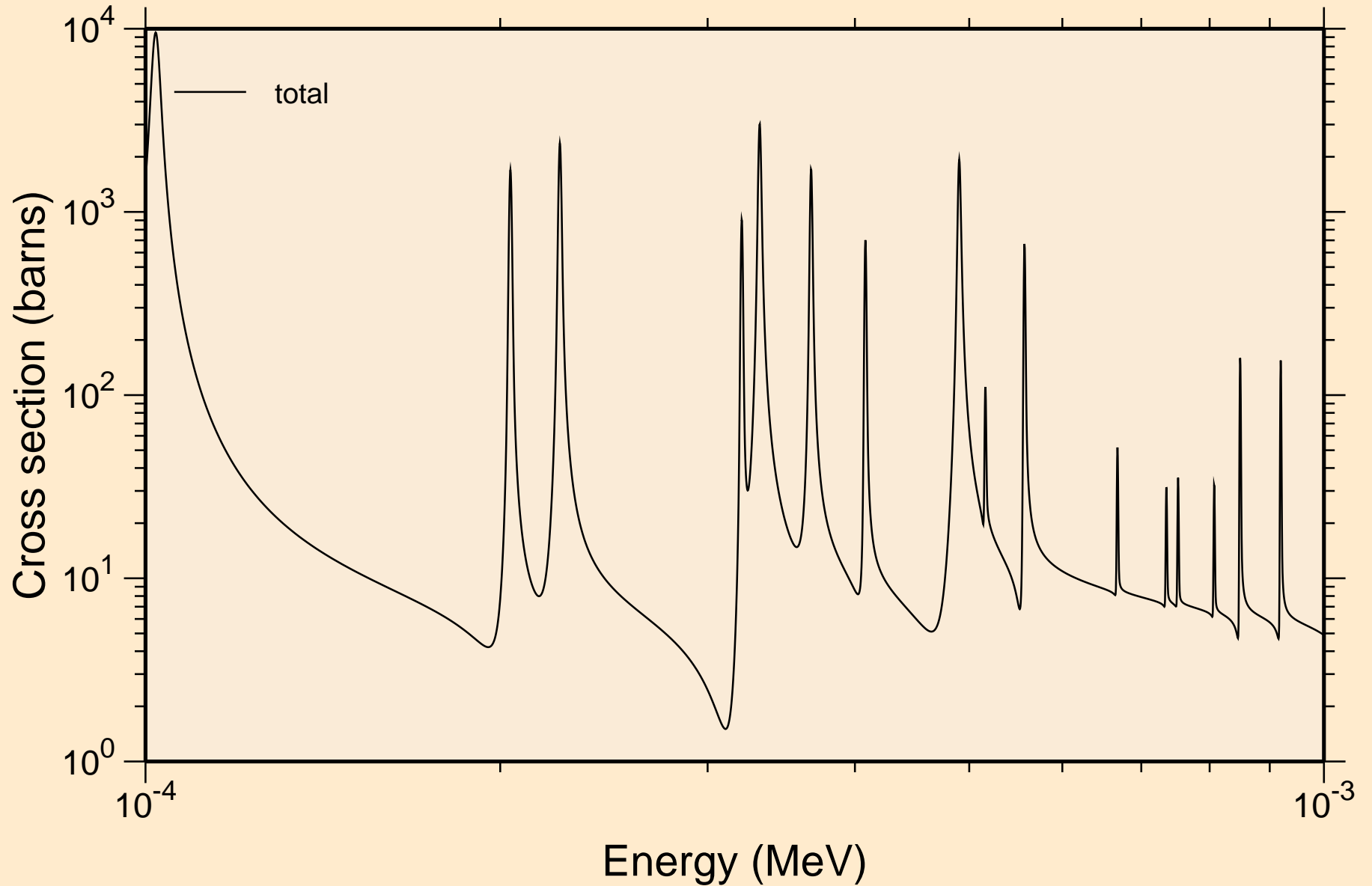

32-GE-73 FOR FENDL-3.2 FROM JEFF-3.1.1 BY NJOY2016.60+ O  
resonance total cross section

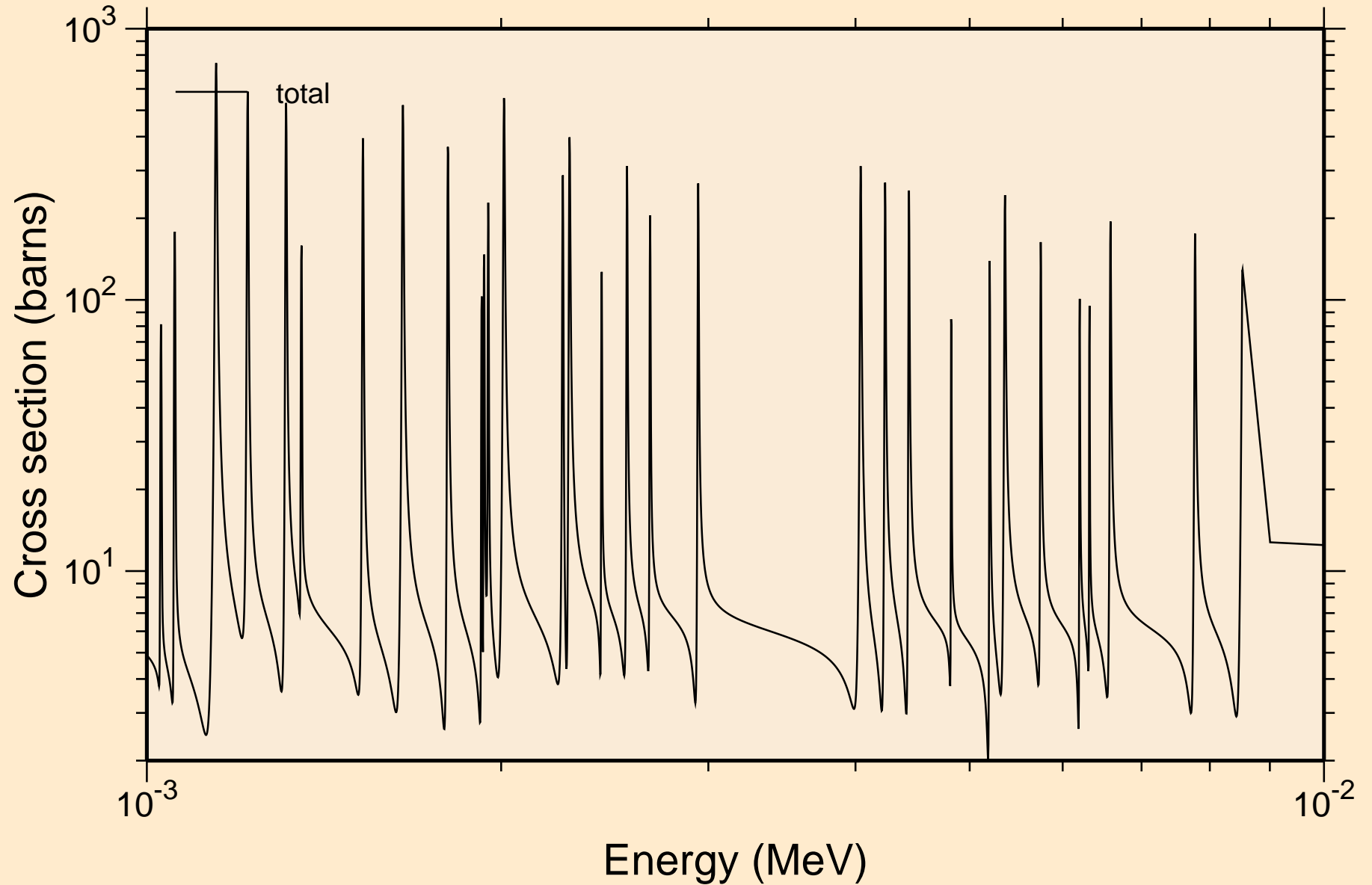

32-GE-73 FOR FENDL-3.2 FROM JEFF-3.1.1 BY NJOY2016.60+ O  
resonance total cross section

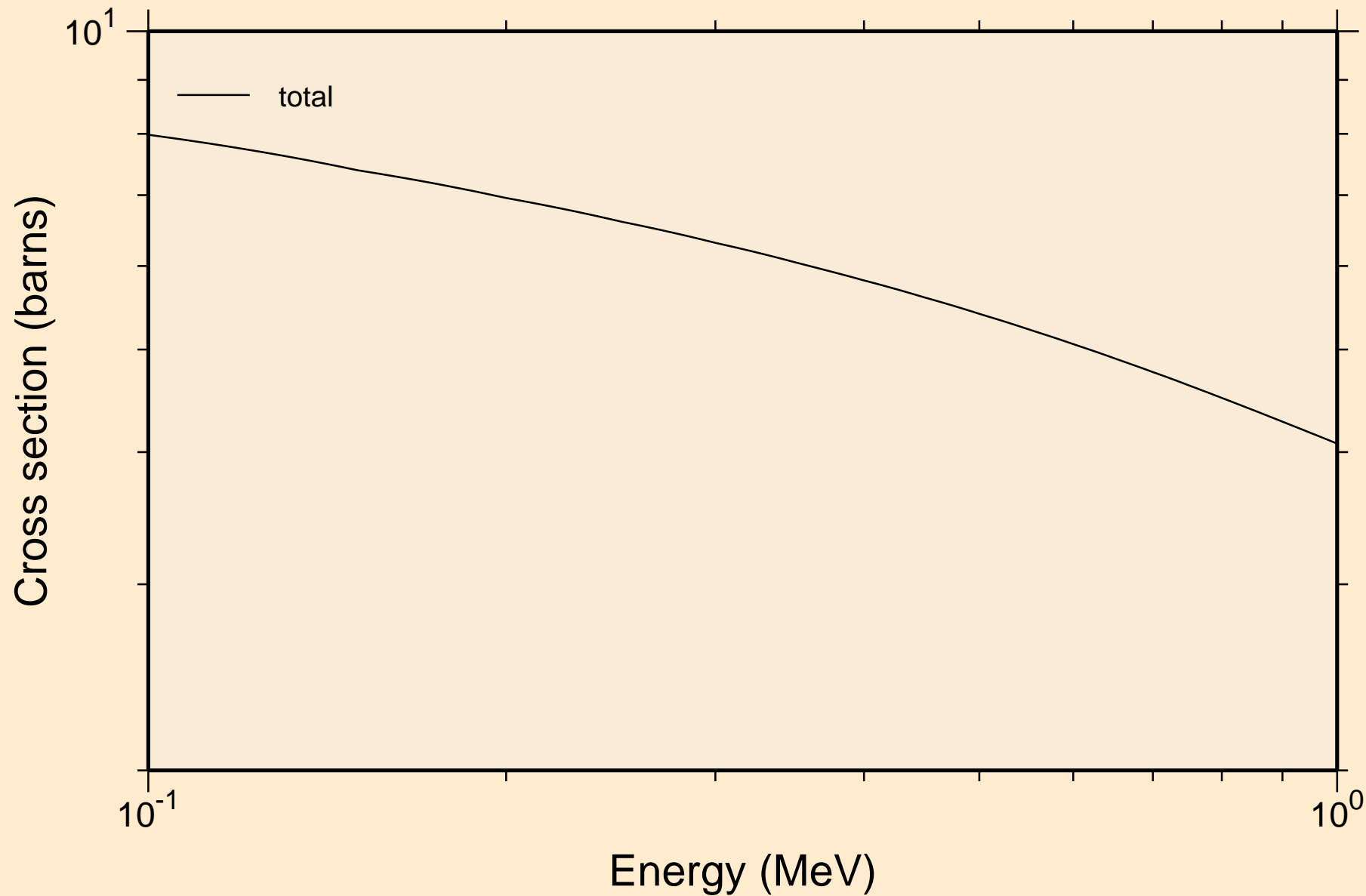

32-GE-73 FOR FENDL-3.2 FROM JEFF-3.1.1 BY NJOY2016.60+ O  
resonance total cross section

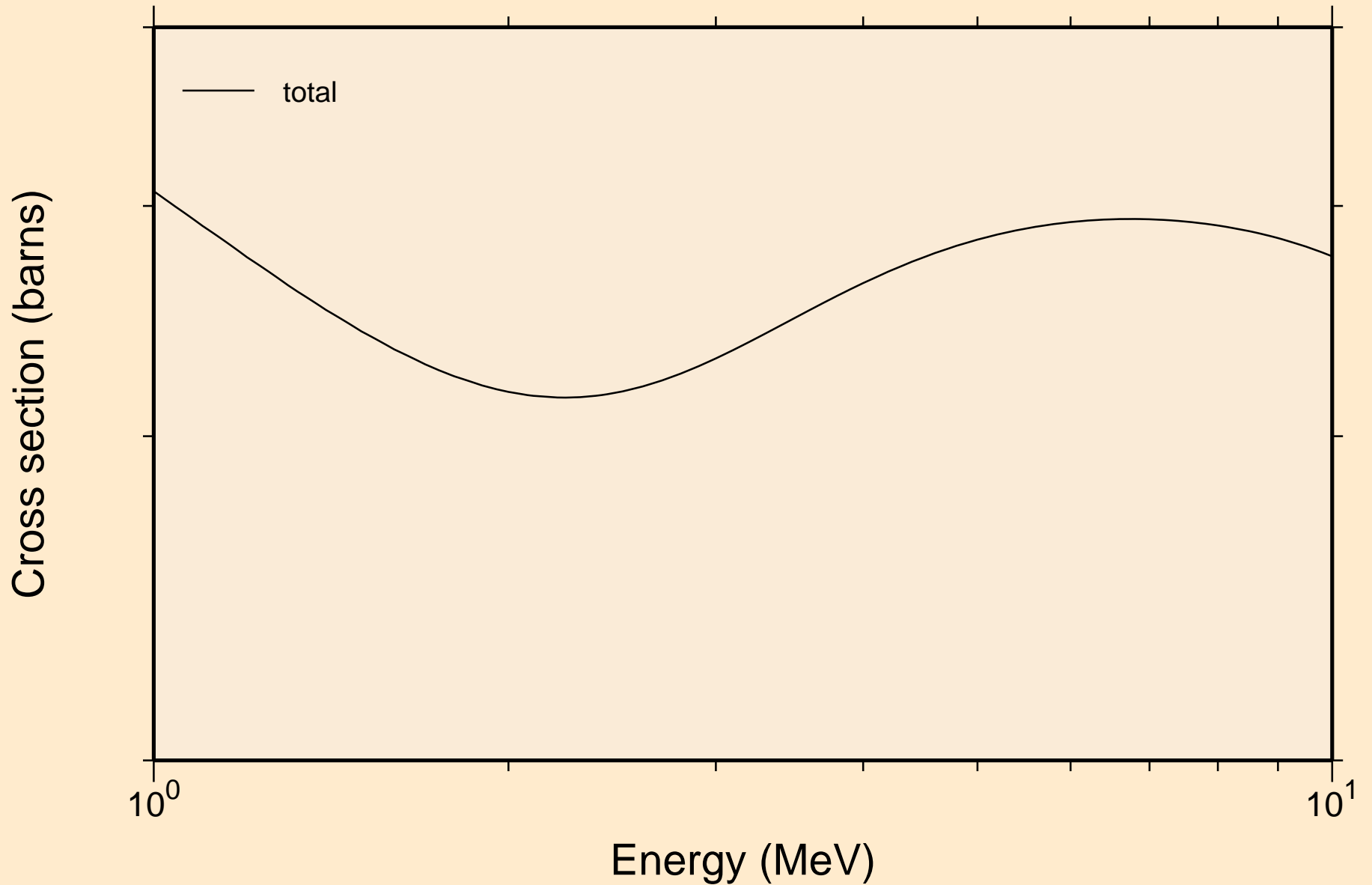

32-GE-73 FOR FENDL-3.2 FROM JEFF-3.1.1 BY NJOY2016.60+ O  
resonance absorption cross sections

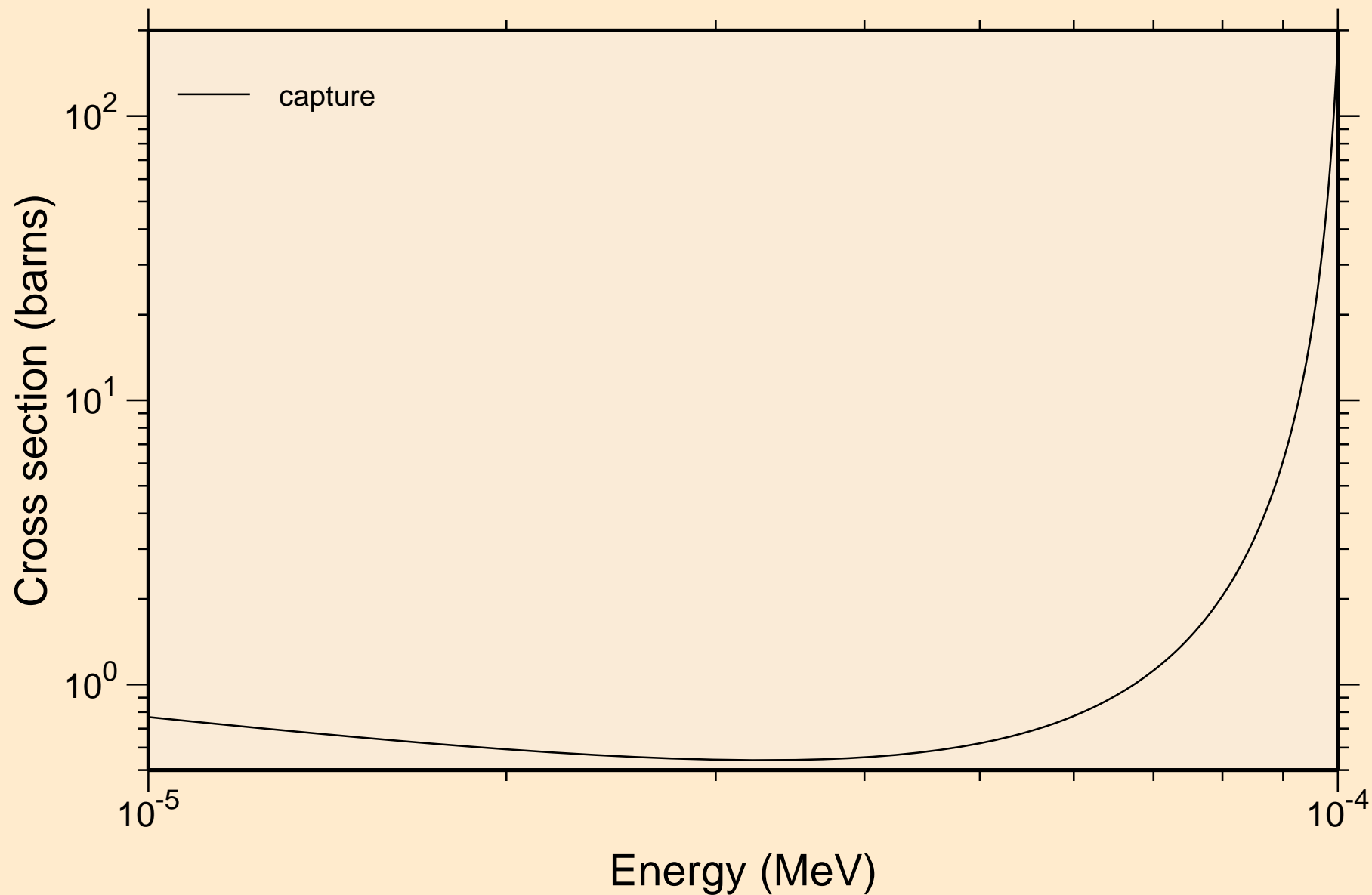

32-GE-73 FOR FENDL-3.2 FROM JEFF-3.1.1 BY NJOY2016.60+ O  
resonance absorption cross sections

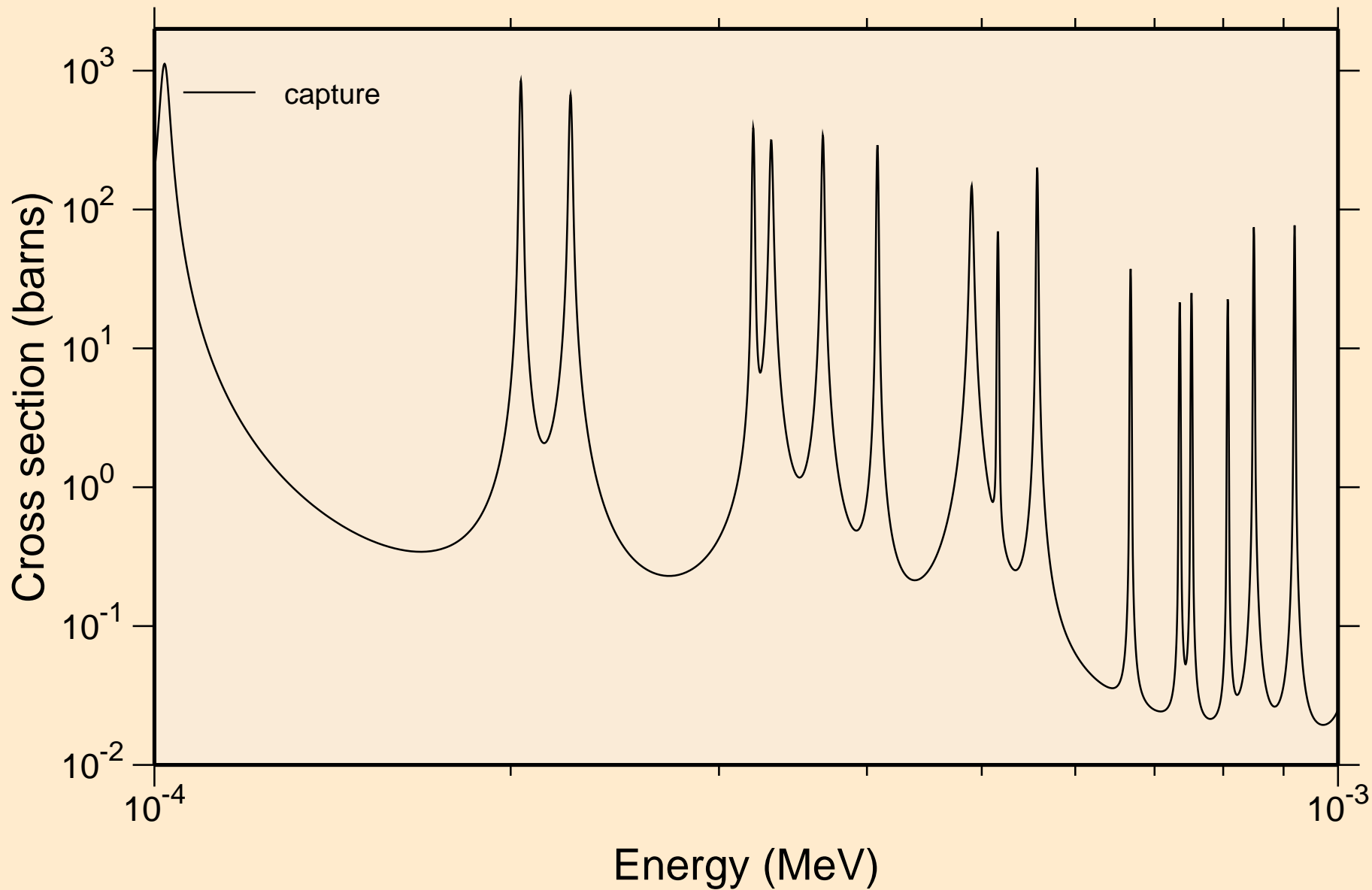



32-GE-73 FOR FENDL-3.2 FROM JEFF-3.1.1 BY NJOY2016.60+ O  
resonance absorption cross sections

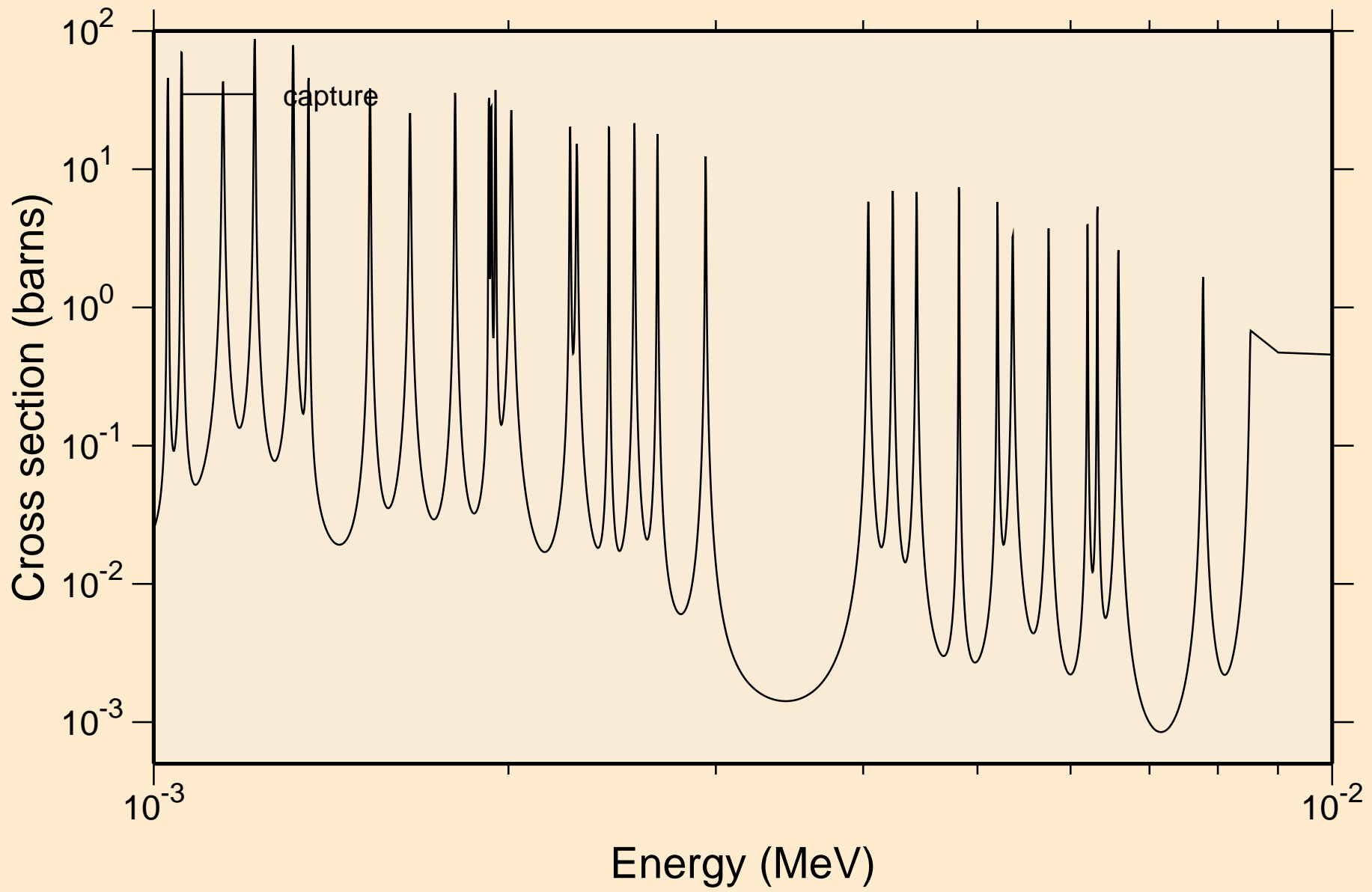

32-GE-73 FOR FENDL-3.2 FROM JEFF-3.1.1 BY NJOY2016.60+ O  
resonance absorption cross sections

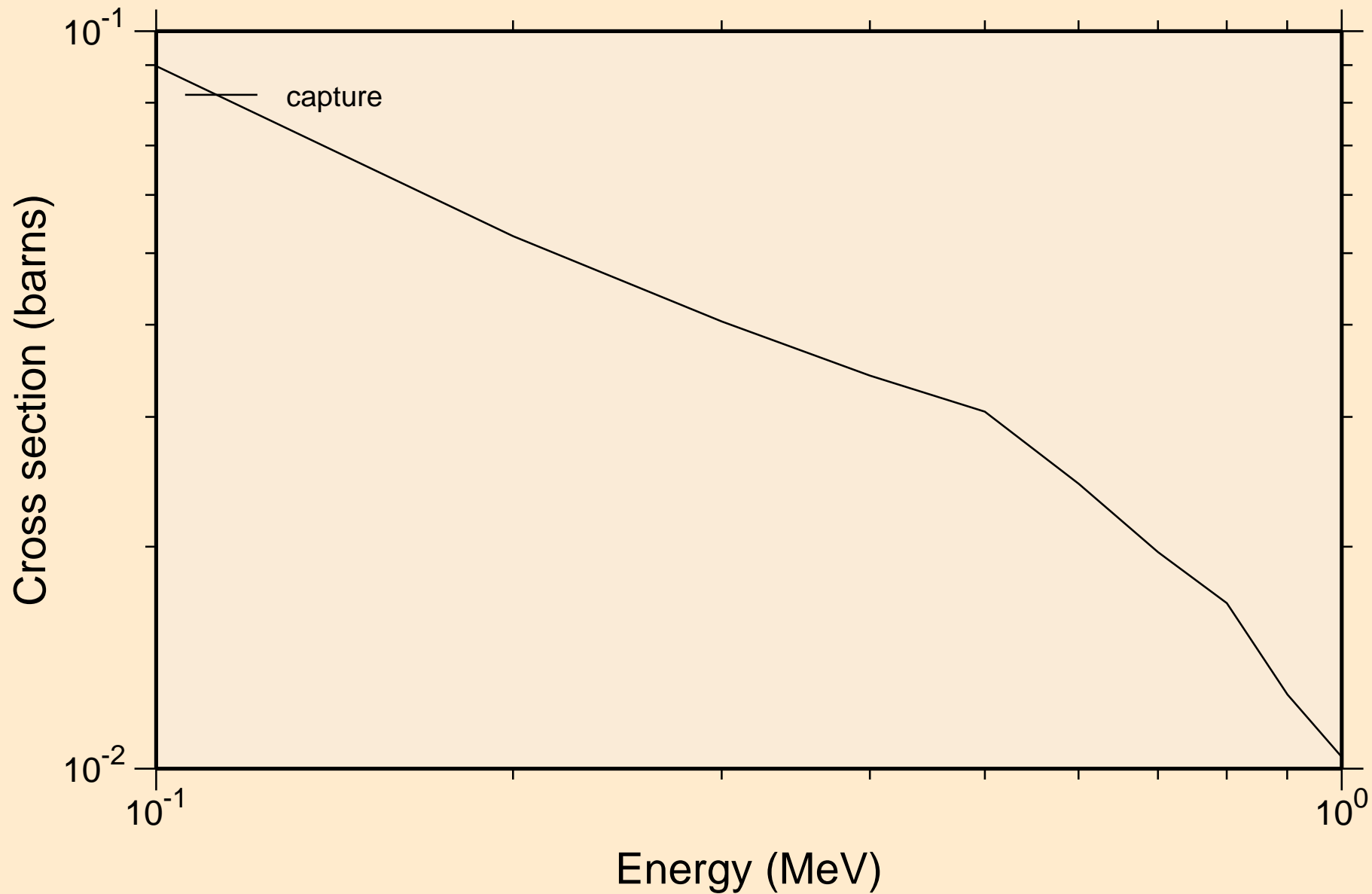

32-GE-73 FOR FENDL-3.2 FROM JEFF-3.1.1 BY NJOY2016.60+ O  
resonance absorption cross sections

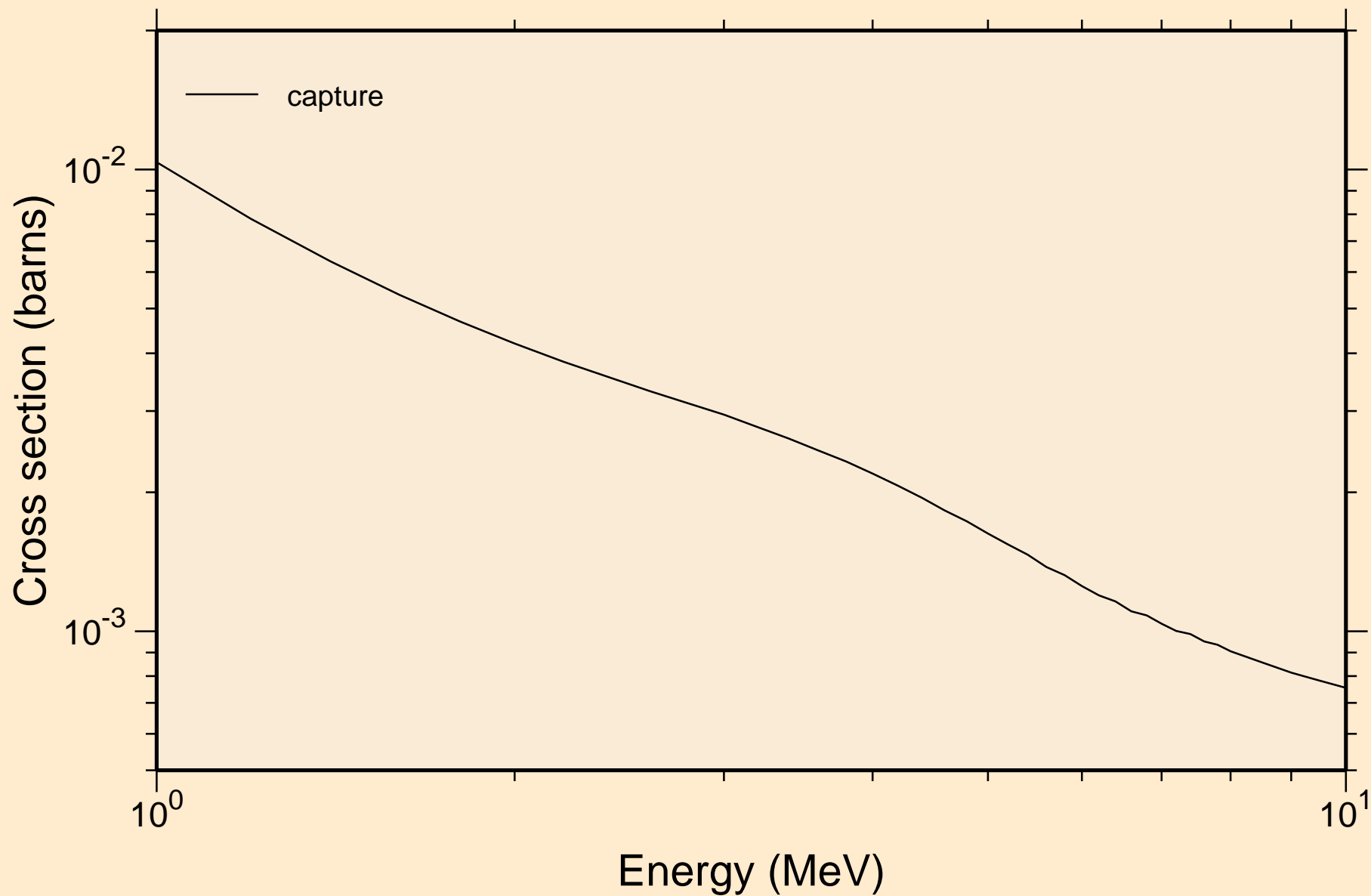

# 32-GE-73 FOR FENDL-3.2 FROM JEFF-3.1.1 BY NJOY2016.60+ O Heating

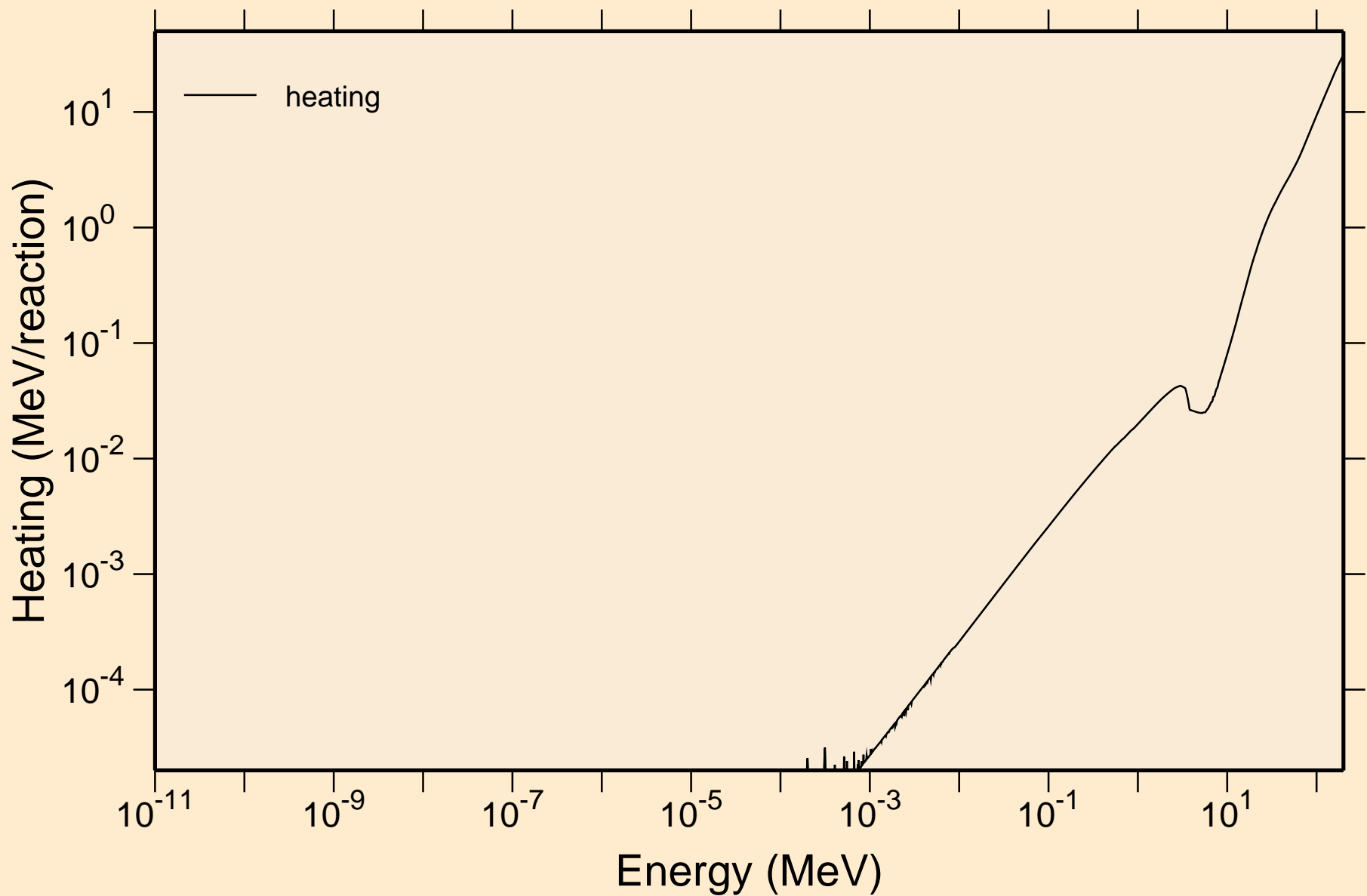

# 32-GE-73 FOR FENDL-3.2 FROM JEFF-3.1.1 BY NJOY2016.60+ O Damage

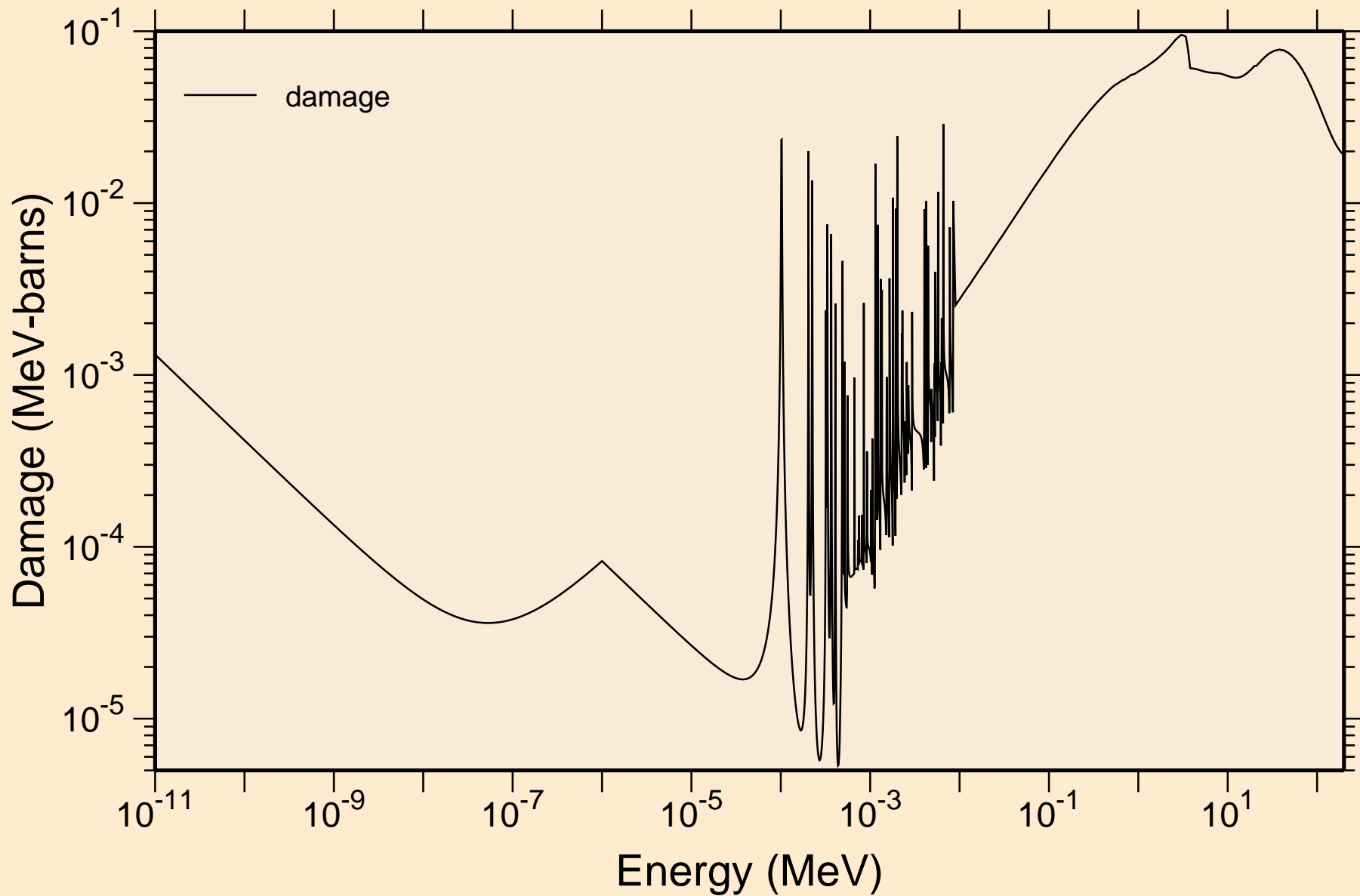

32-GE-73 FOR FENDL-3.2 FROM JEFF-3.1.1 BY NJOY2016.60+ O  
Non-threshold reactions

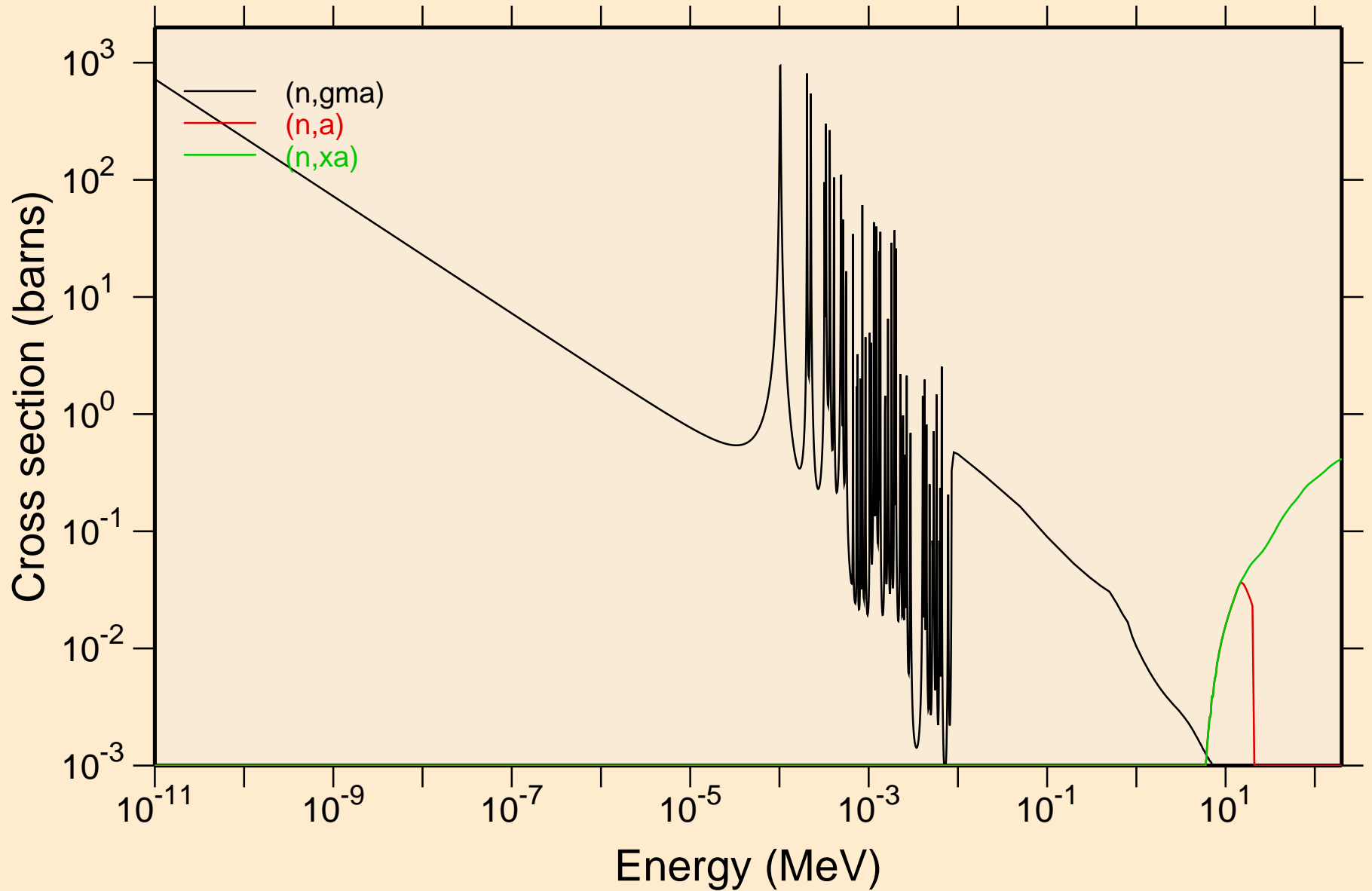

32-GE-73 FOR FENDL-3.2 FROM JEFF-3.1.1 BY NJOY2016.60+ O  
Principal cross sections

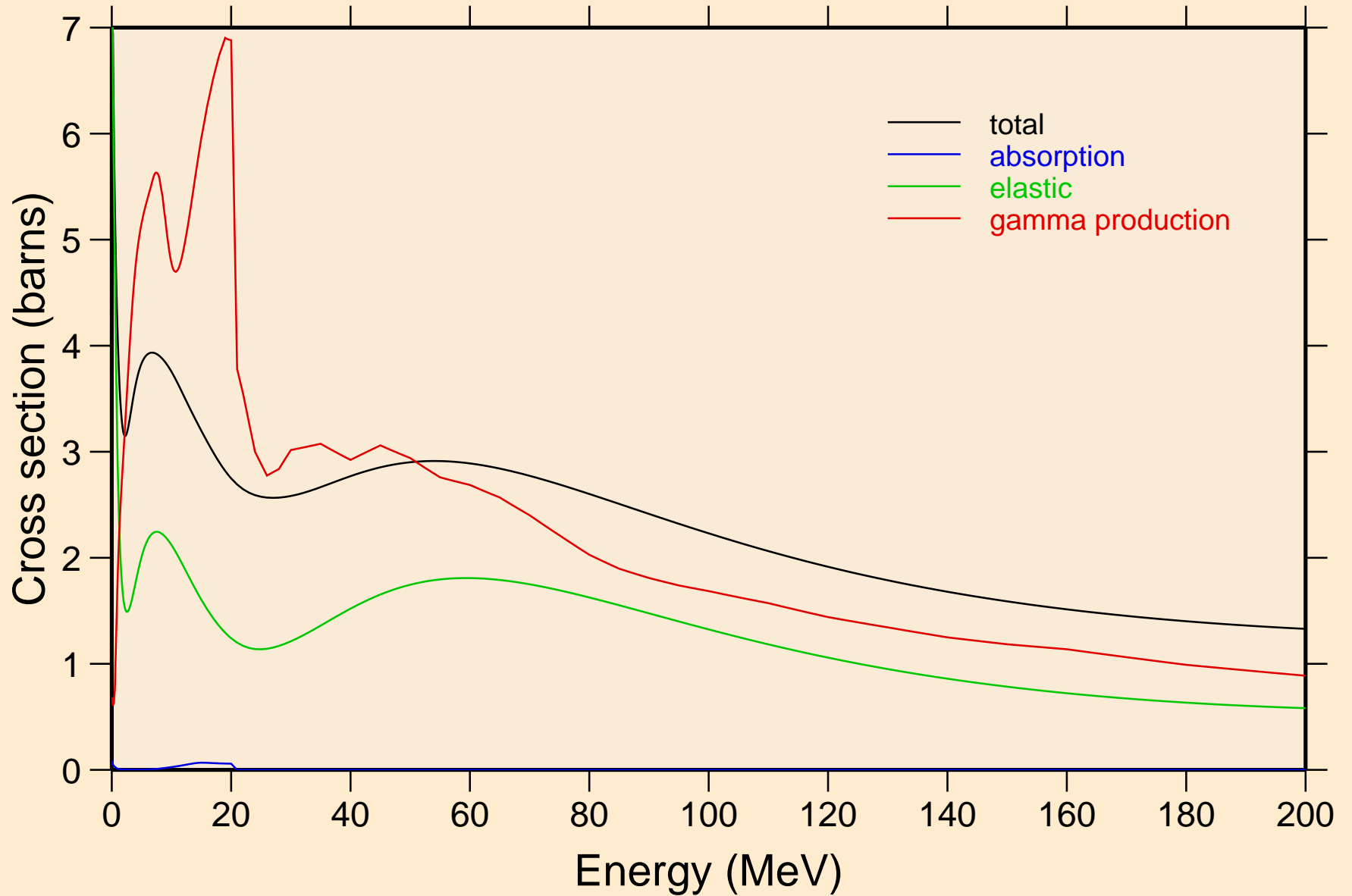

# 32-GE-73 FOR FENDL-3.2 FROM JEFF-3.1.1 BY NJOY2016.60+ O Heating

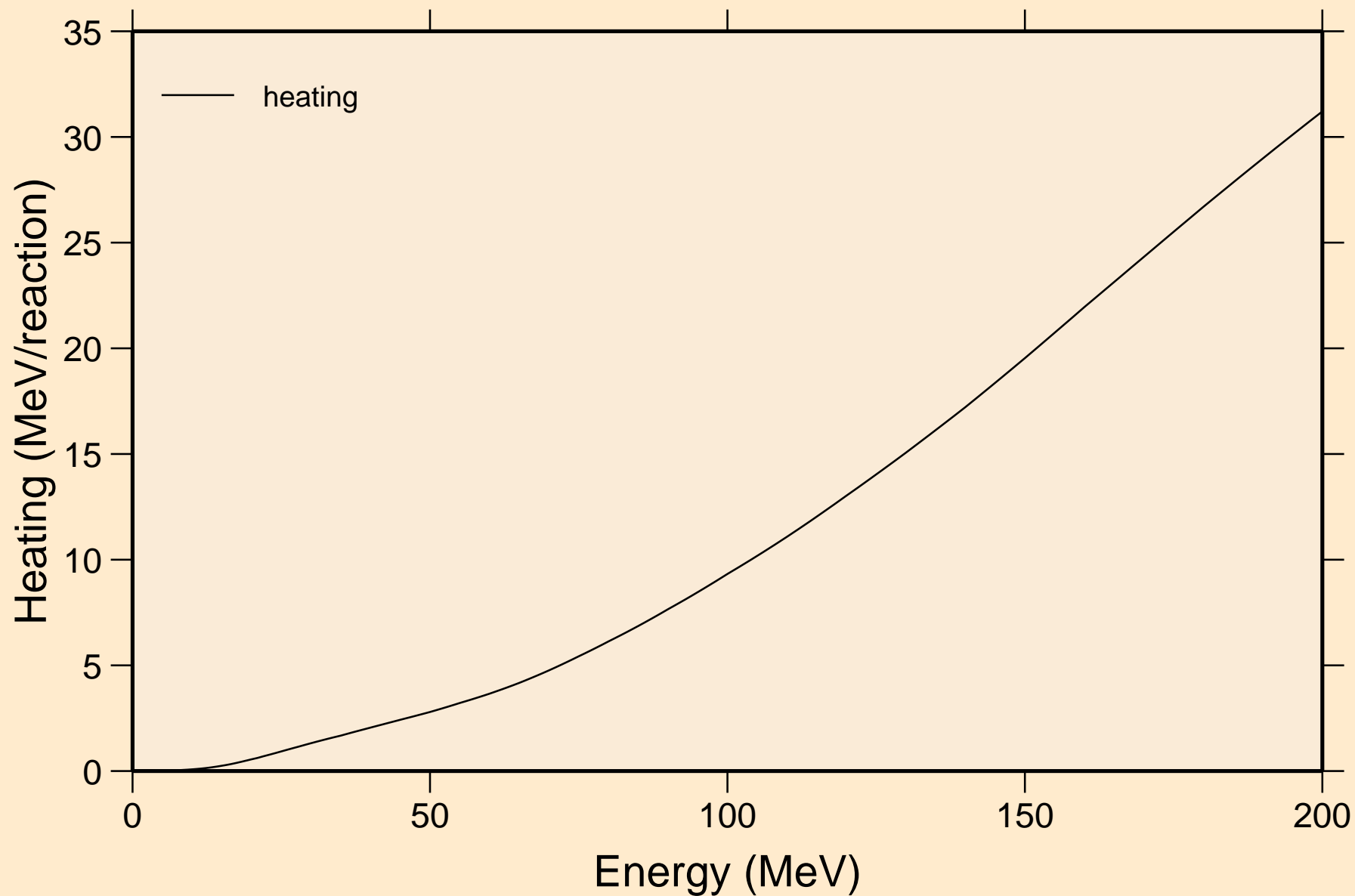



32-GE-73 FOR FENDL-3.2 FROM JEFF-3.1.1 BY NJOY2016.60+ O  
Damage

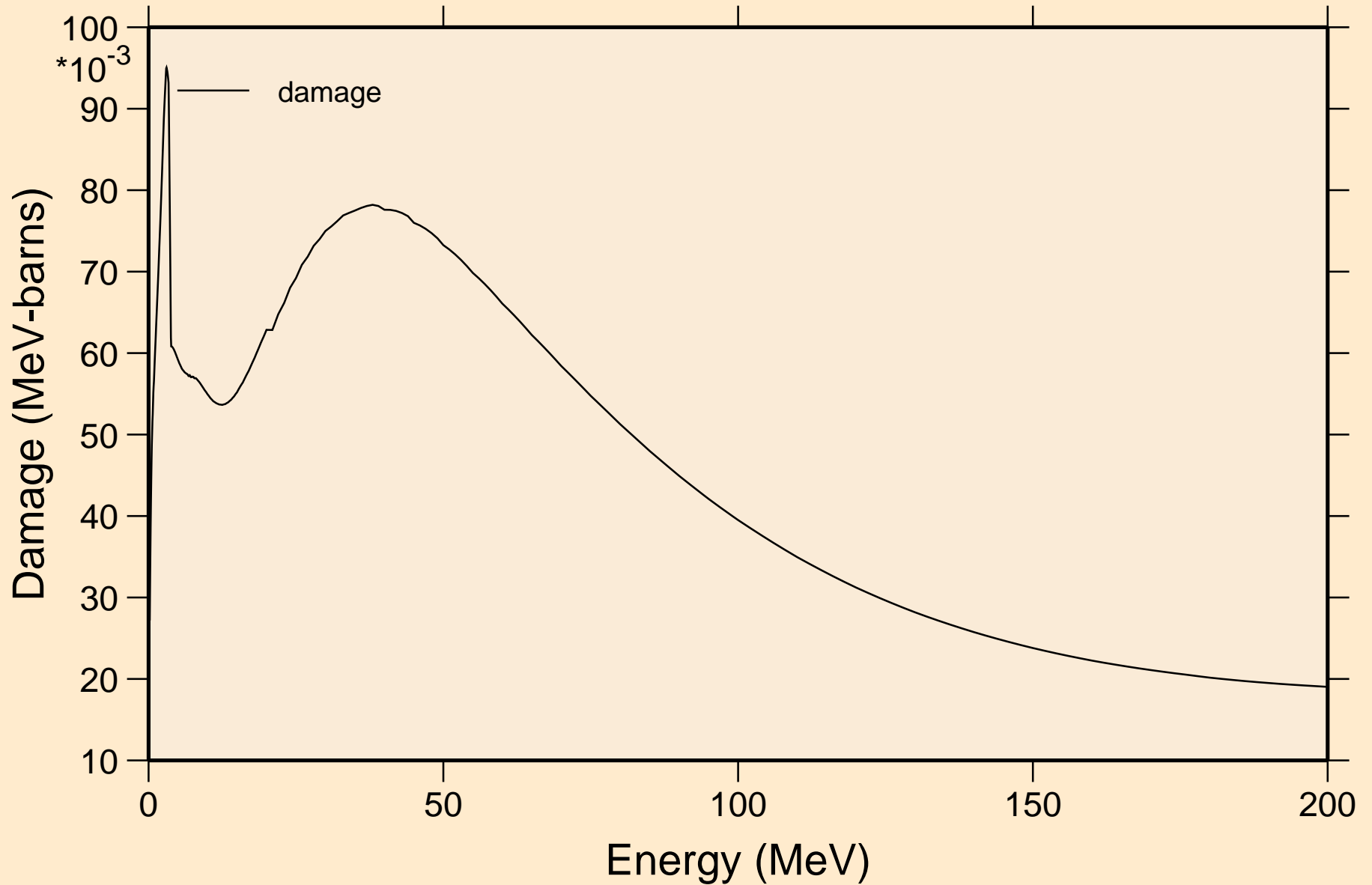

32-GE-73 FOR FENDL-3.2 FROM JEFF-3.1.1 BY NJOY2016.60+ O  
Non-threshold reactions

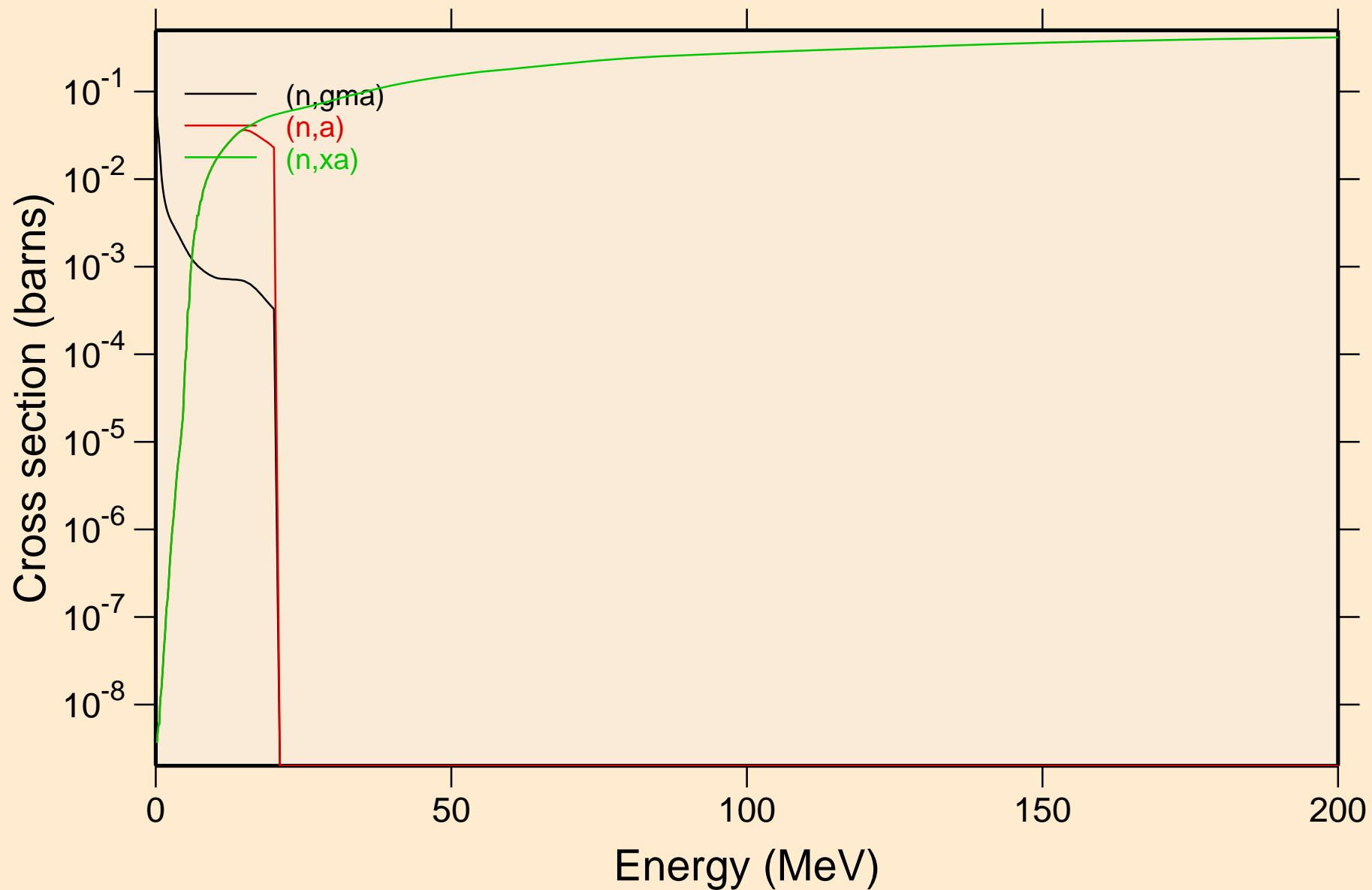

32-GE-73 FOR FENDL-3.2 FROM JEFF-3.1.1 BY NJOY2016.60+ O  
Inelastic levels

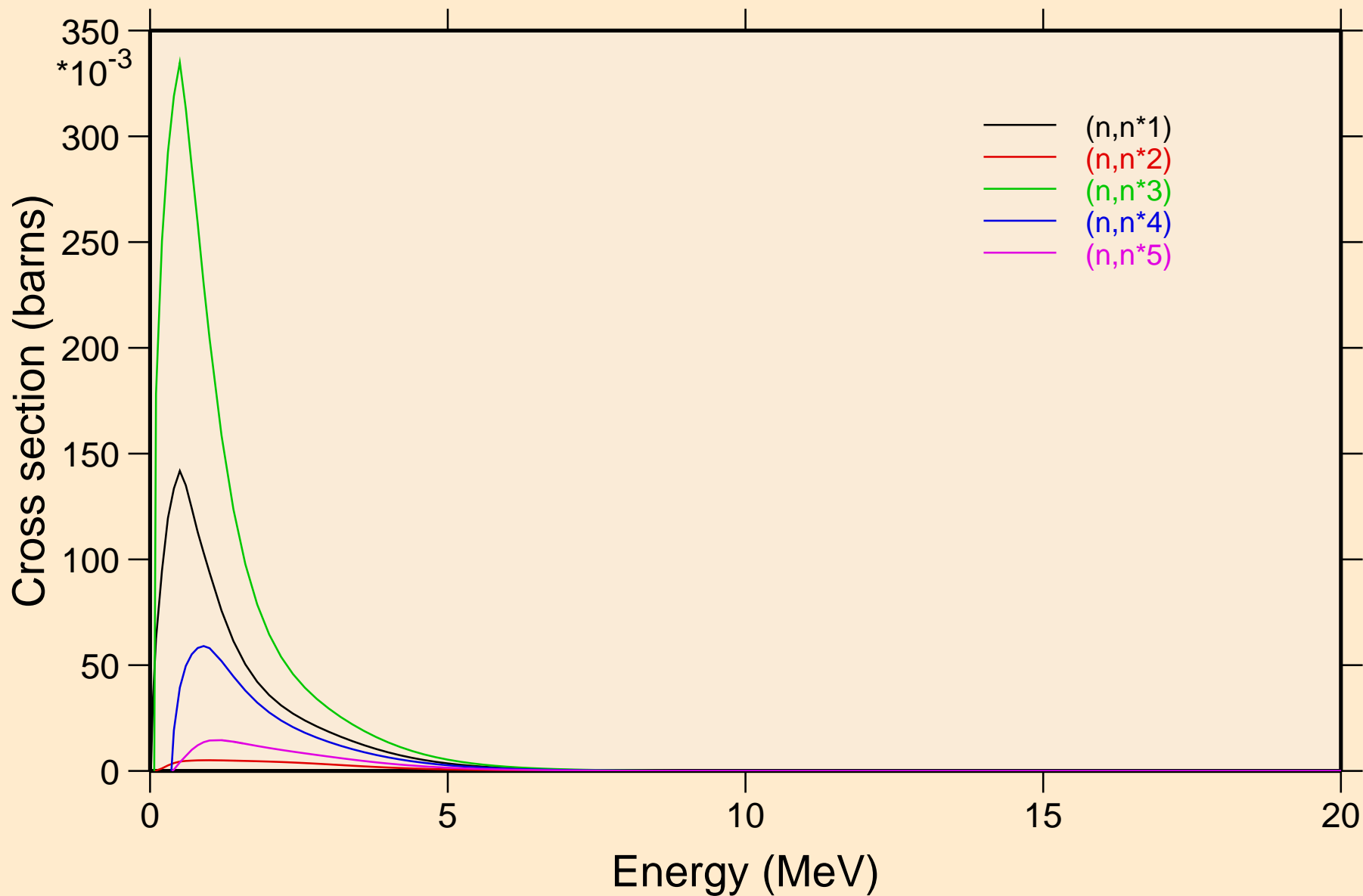

32-GE-73 FOR FENDL-3.2 FROM JEFF-3.1.1 BY NJOY2016.60+ O  
Inelastic levels

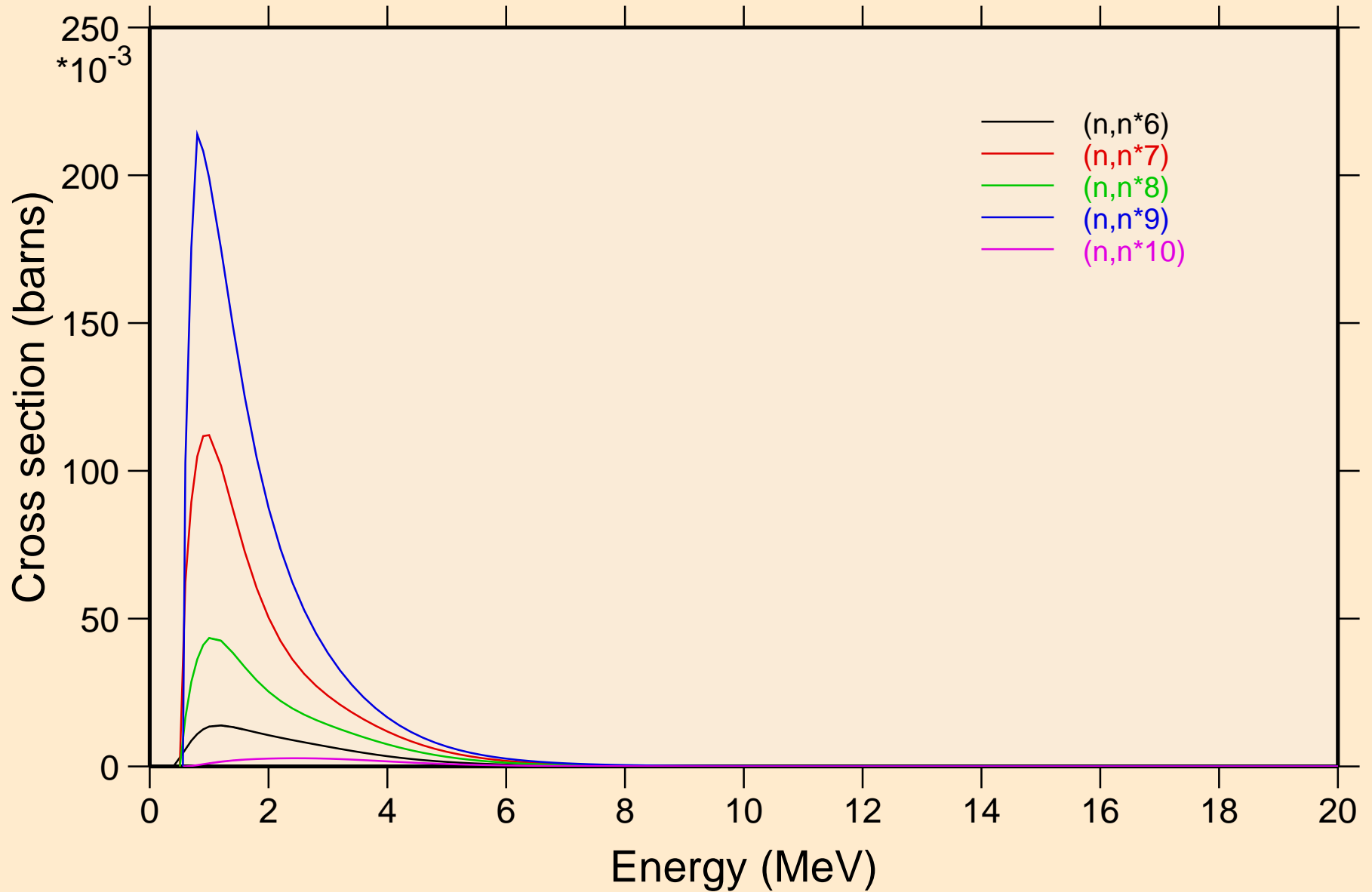

32-GE-73 FOR FENDL-3.2 FROM JEFF-3.1.1 BY NJOY2016.60+ O  
Inelastic levels

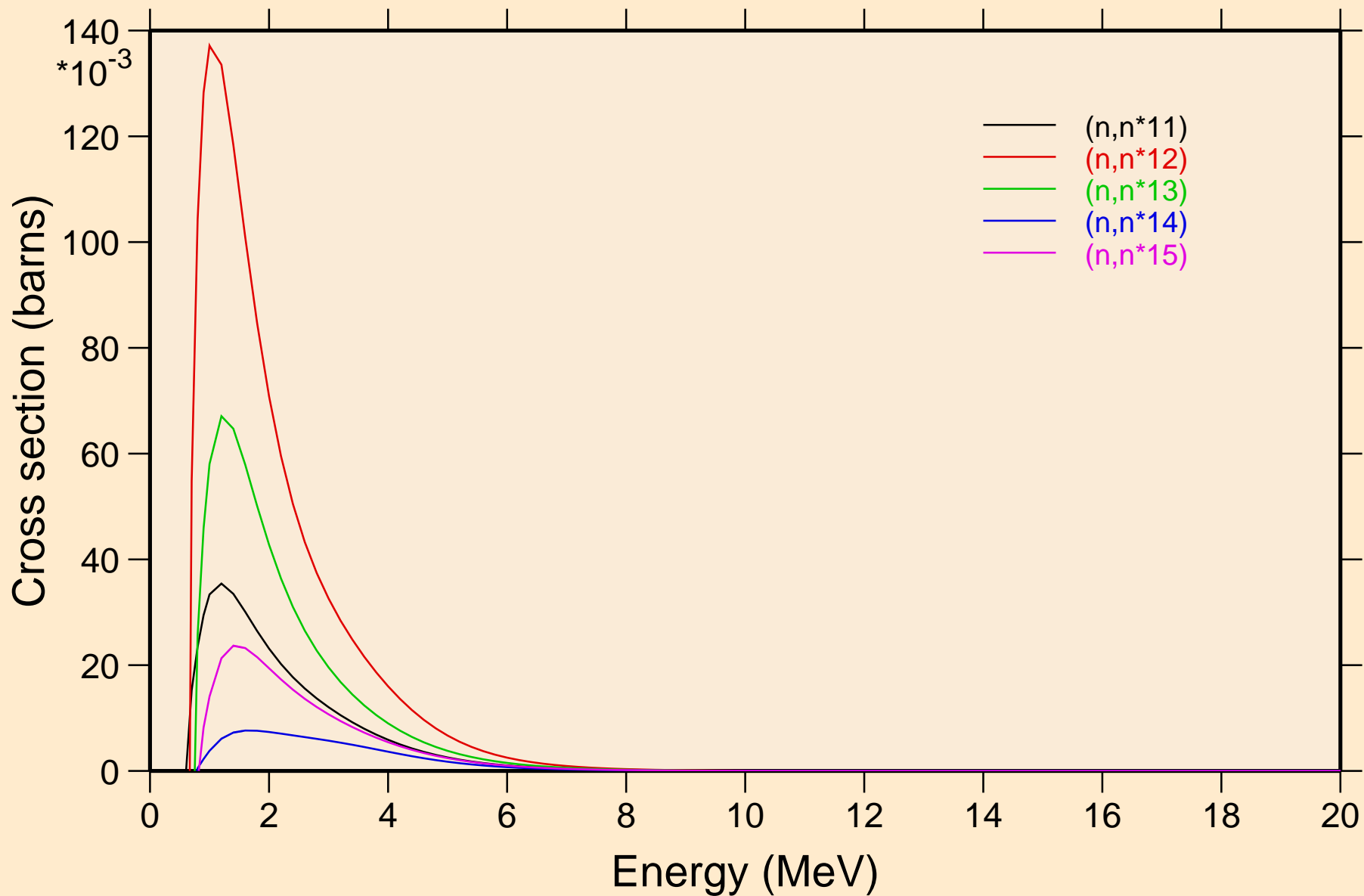

32-GE-73 FOR FENDL-3.2 FROM JEFF-3.1.1 BY NJOY2016.60+ O  
Inelastic levels

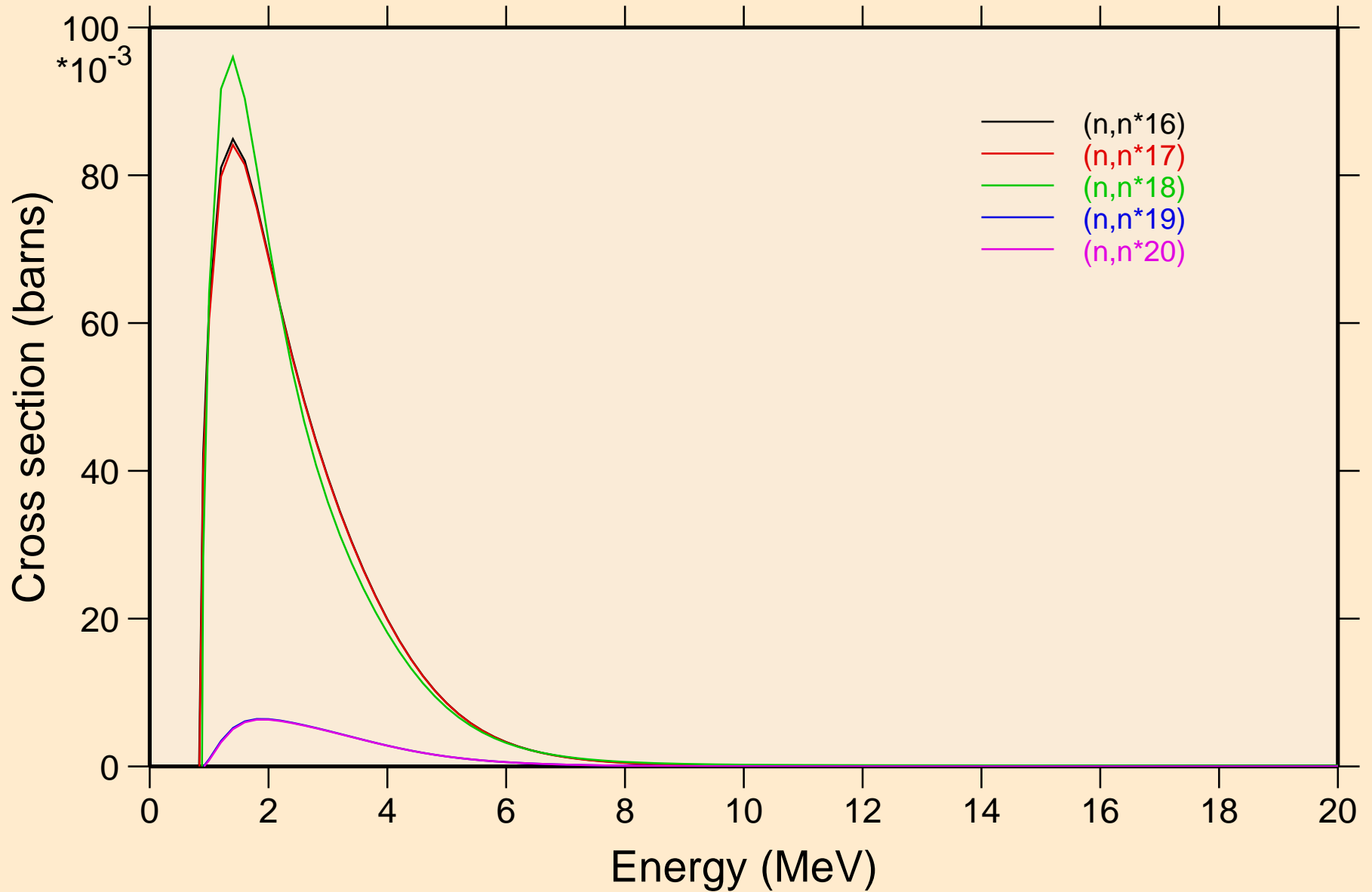

32-GE-73 FOR FENDL-3.2 FROM JEFF-3.1.1 BY NJOY2016.60+ O  
Threshold reactions

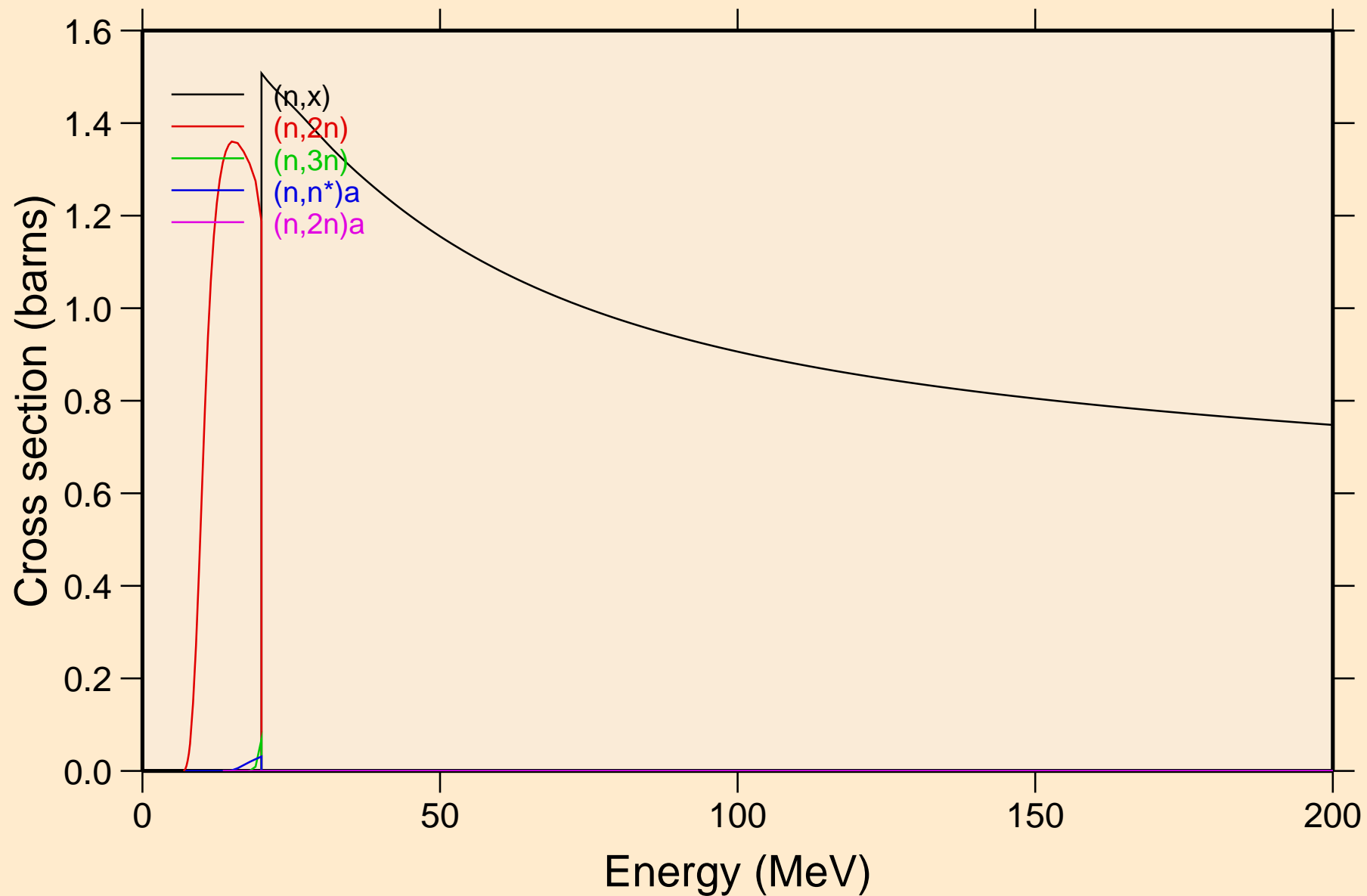

32-GE-73 FOR FENDL-3.2 FROM JEFF-3.1.1 BY NJOY2016.60+ O  
Threshold reactions

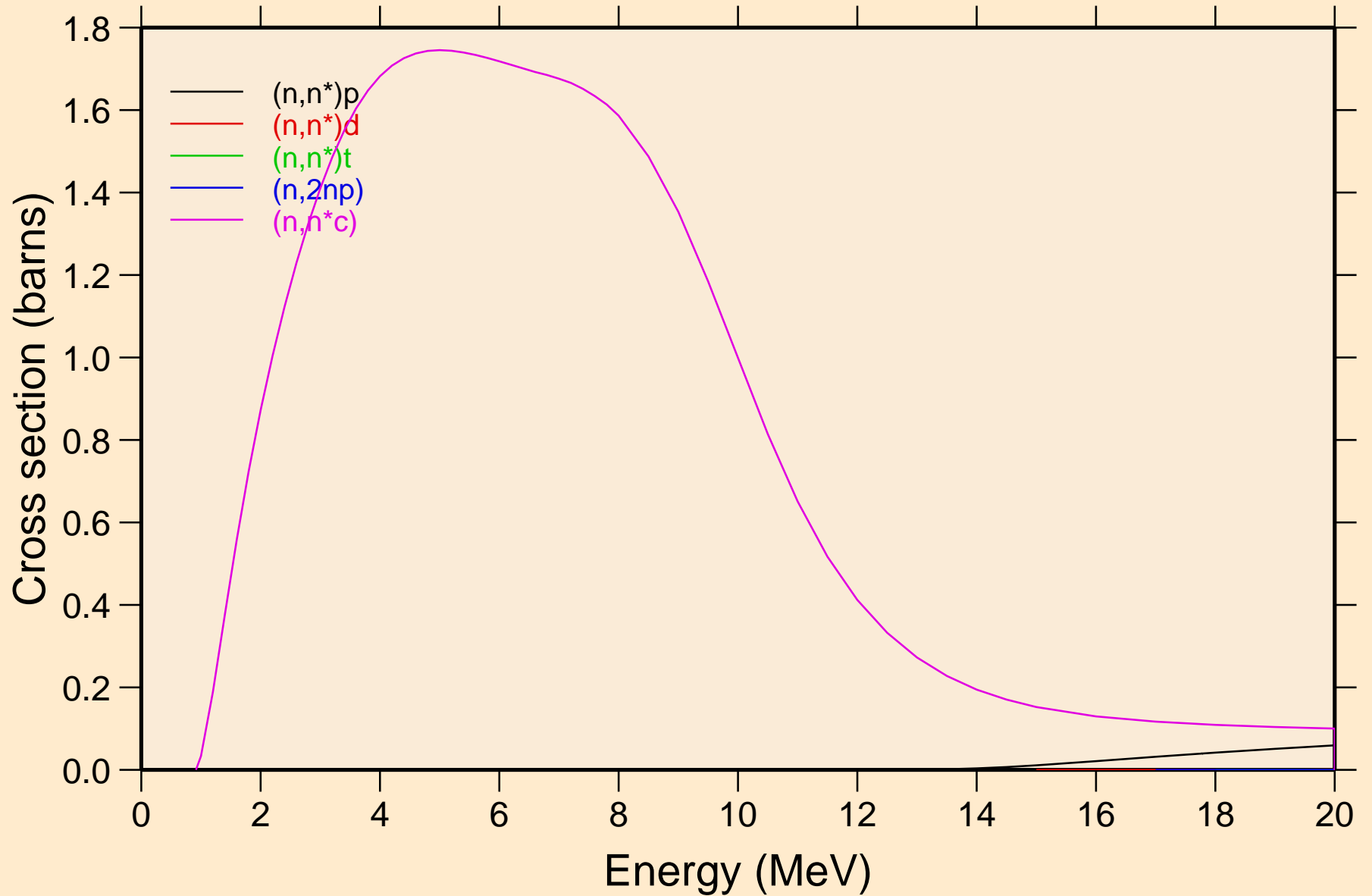



32-GE-73 FOR FENDL-3.2 FROM JEFF-3.1.1 BY NJOY2016.60+ O  
Threshold reactions

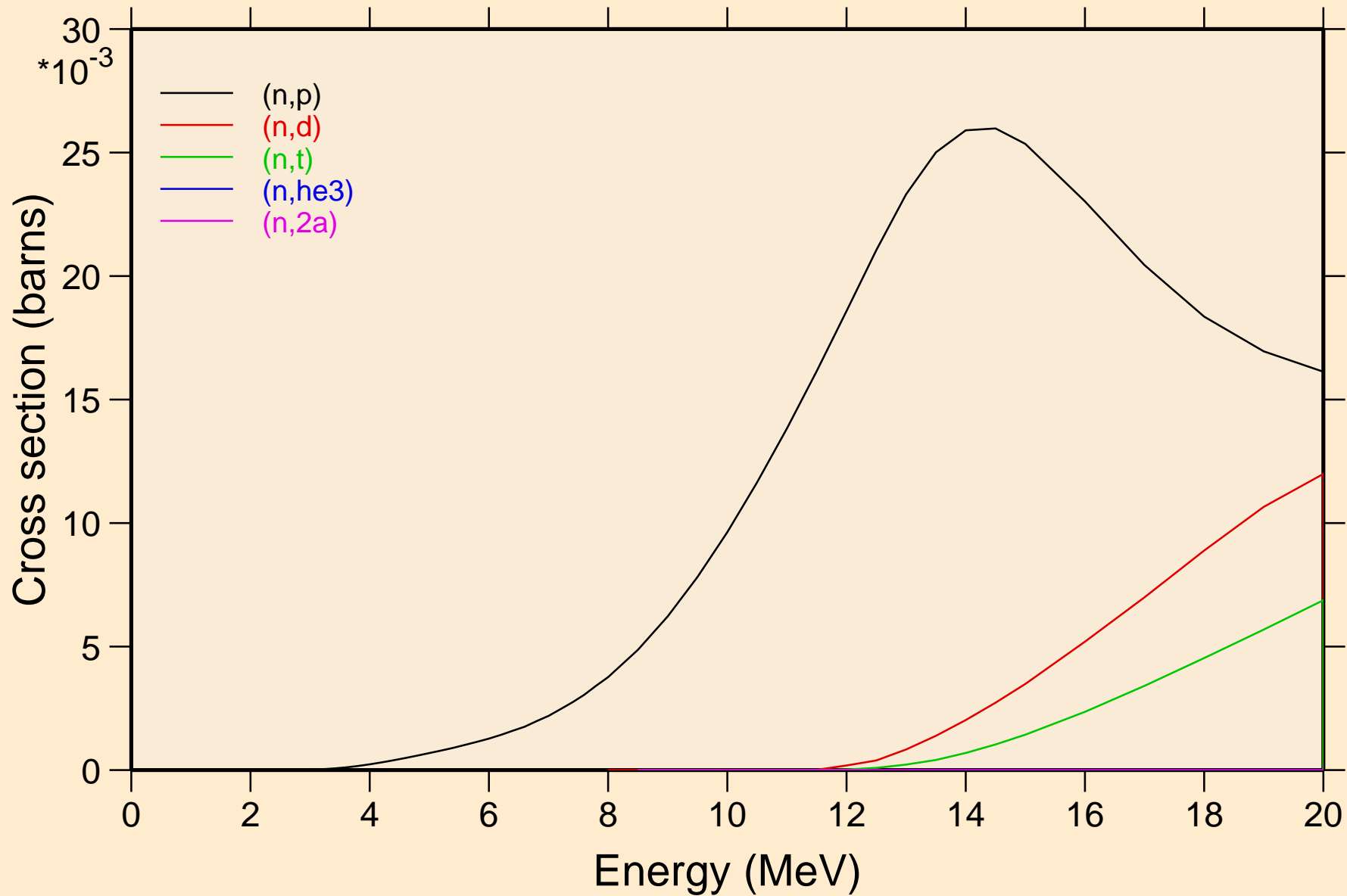

32-GE-73 FOR FENDL-3.2 FROM JEFF-3.1.1 BY NJOY2016.60+ O  
Threshold reactions

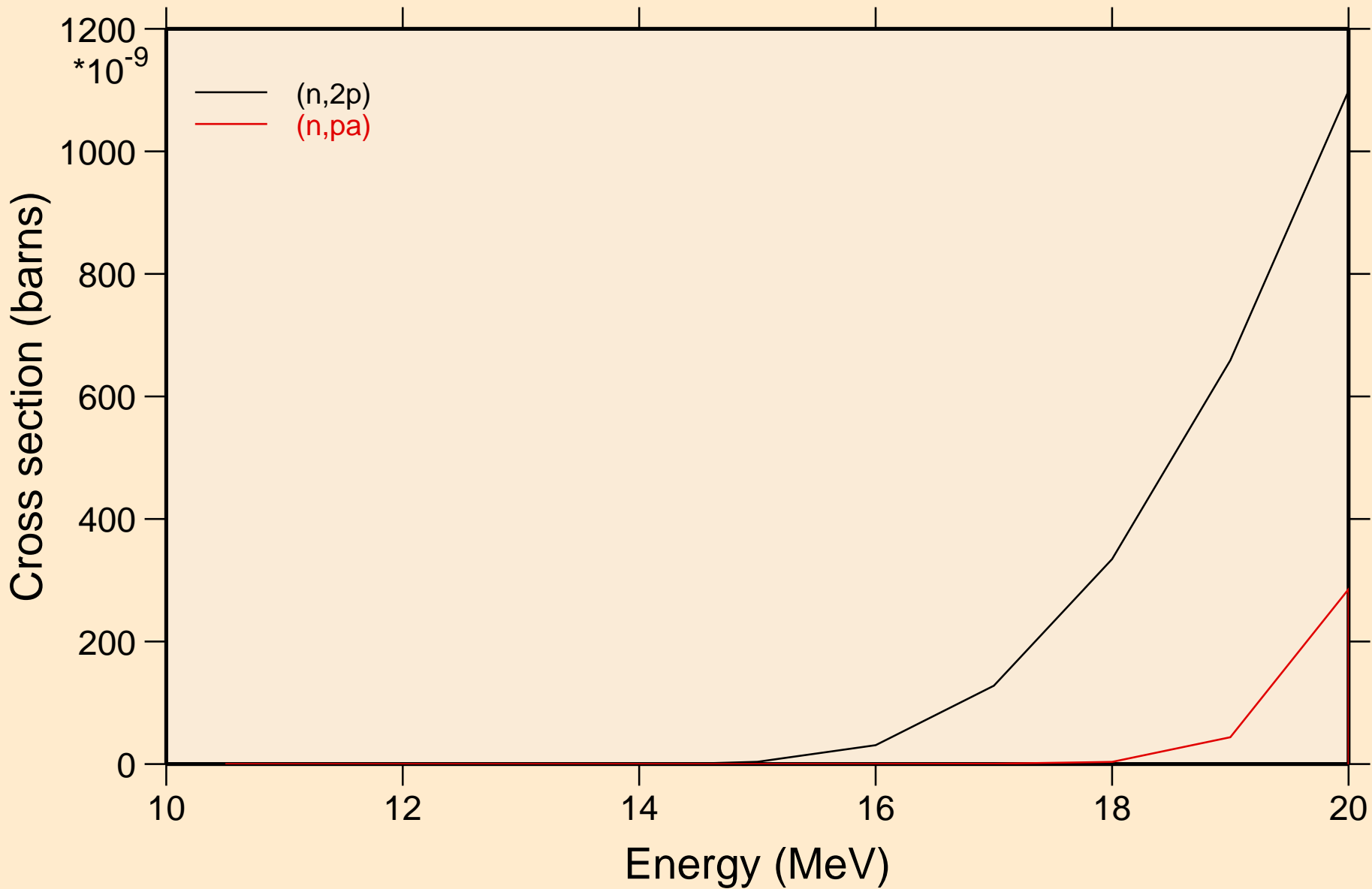

32-GE-73 FOR FENDL-3.2 FROM JEFF-3.1.1 BY NJOY2016.60+ O  
Threshold reactions

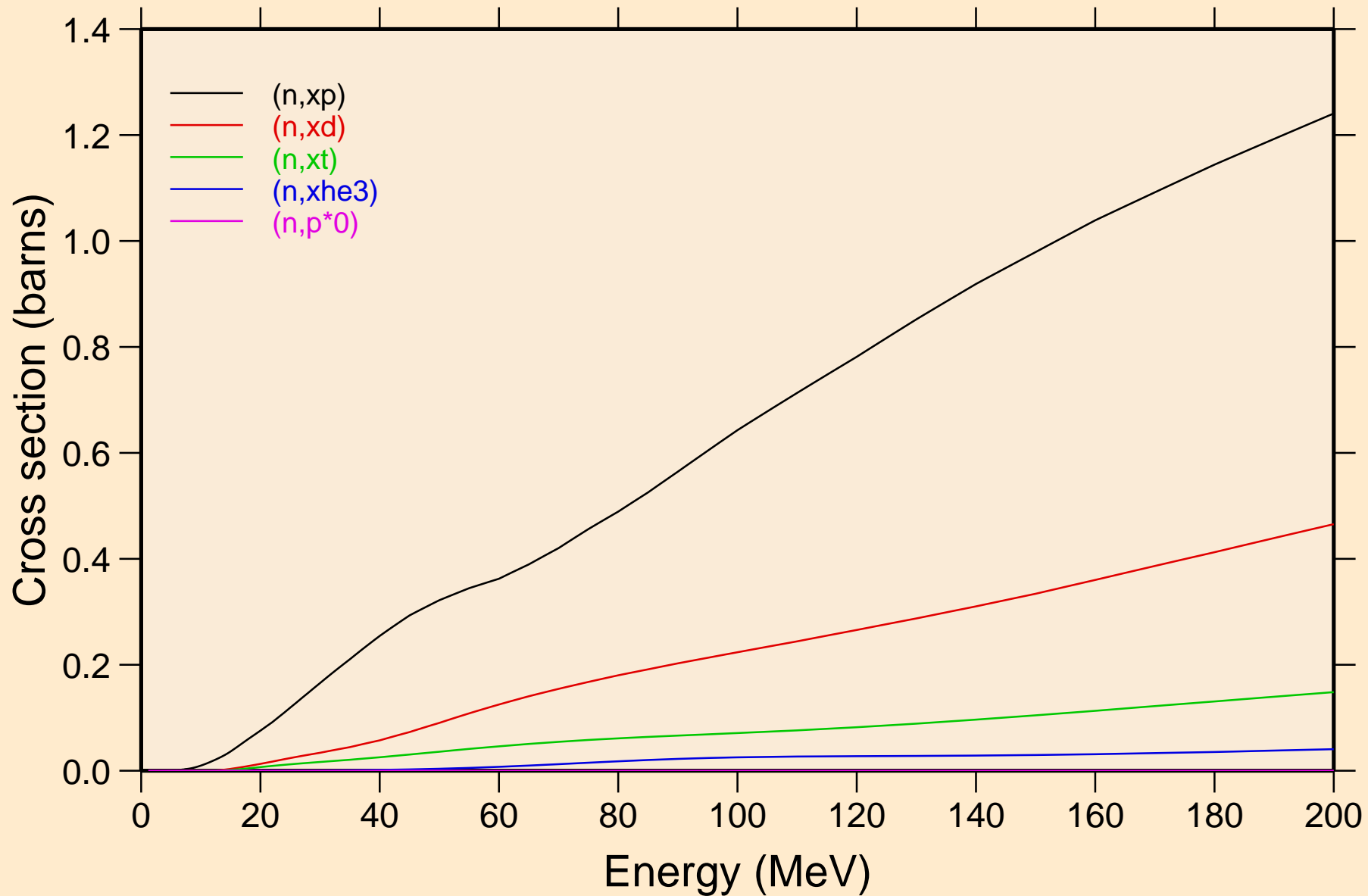

32-GE-73 FOR FENDL-3.2 FROM JEFF-3.1.1 BY NJOY2016.60+ O  
Threshold reactions

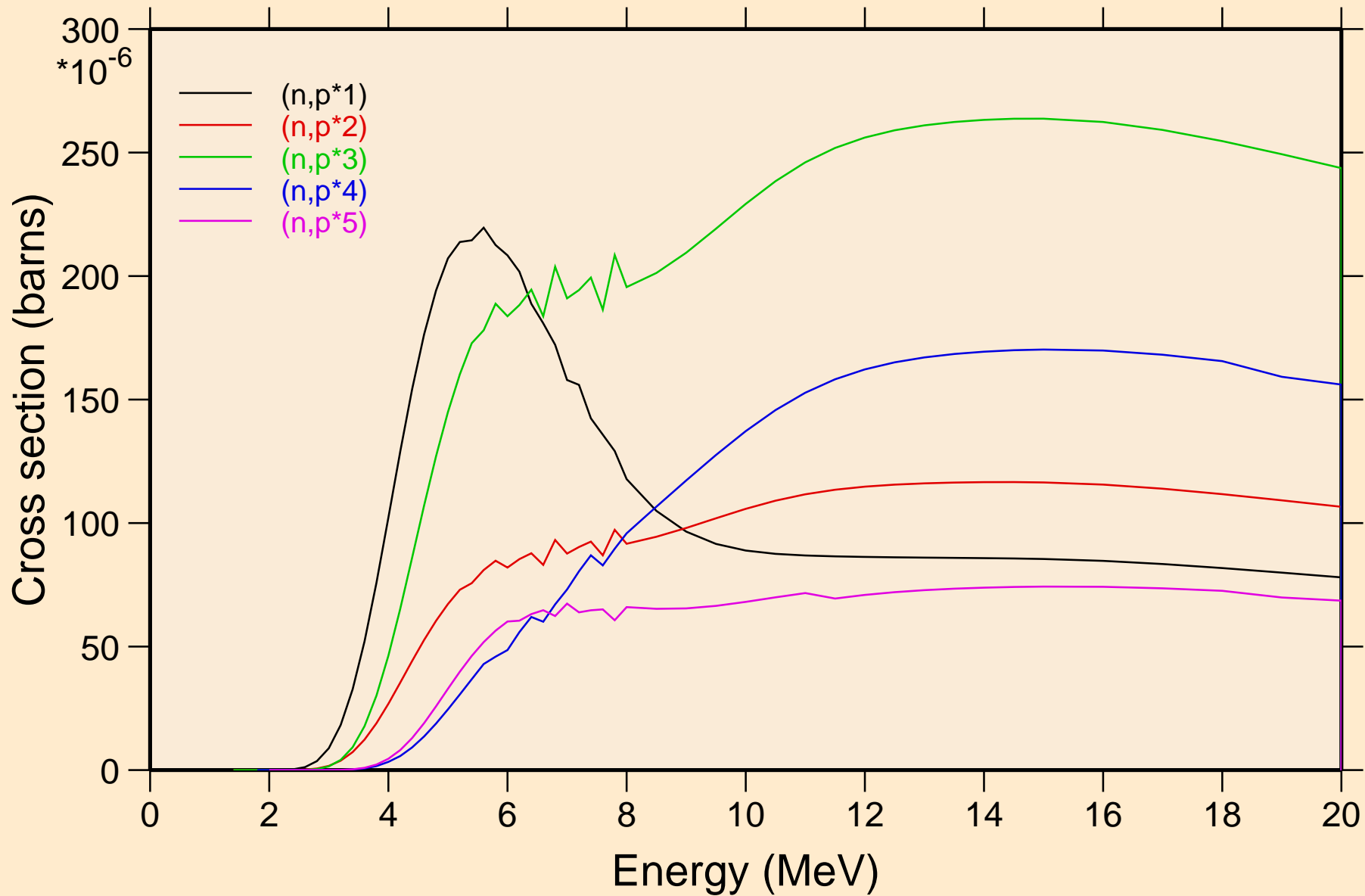

32-GE-73 FOR FENDL-3.2 FROM JEFF-3.1.1 BY NJOY2016.60+ O  
Threshold reactions

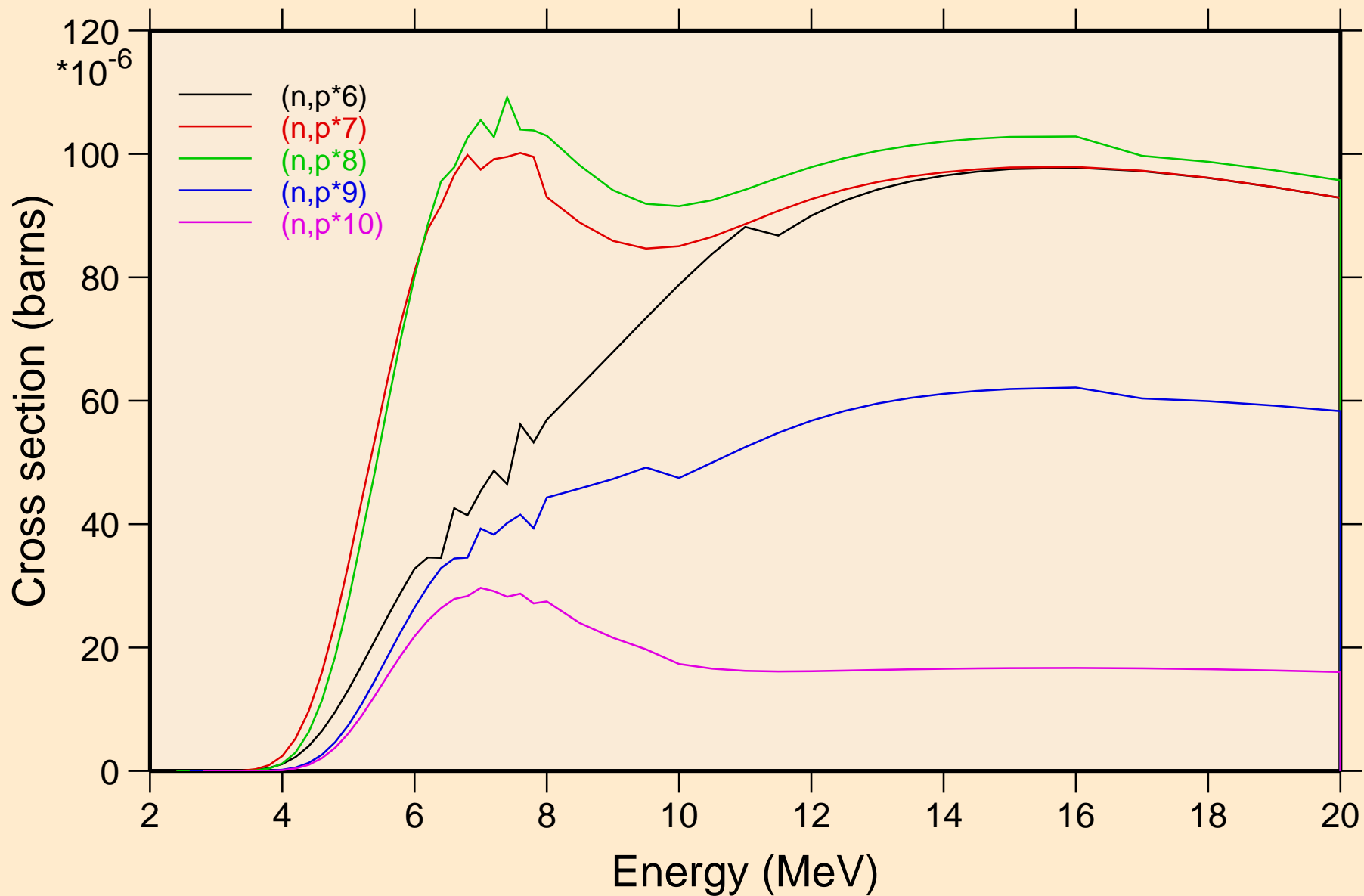

32-GE-73 FOR FENDL-3.2 FROM JEFF-3.1.1 BY NJOY2016.60+ O  
Threshold reactions

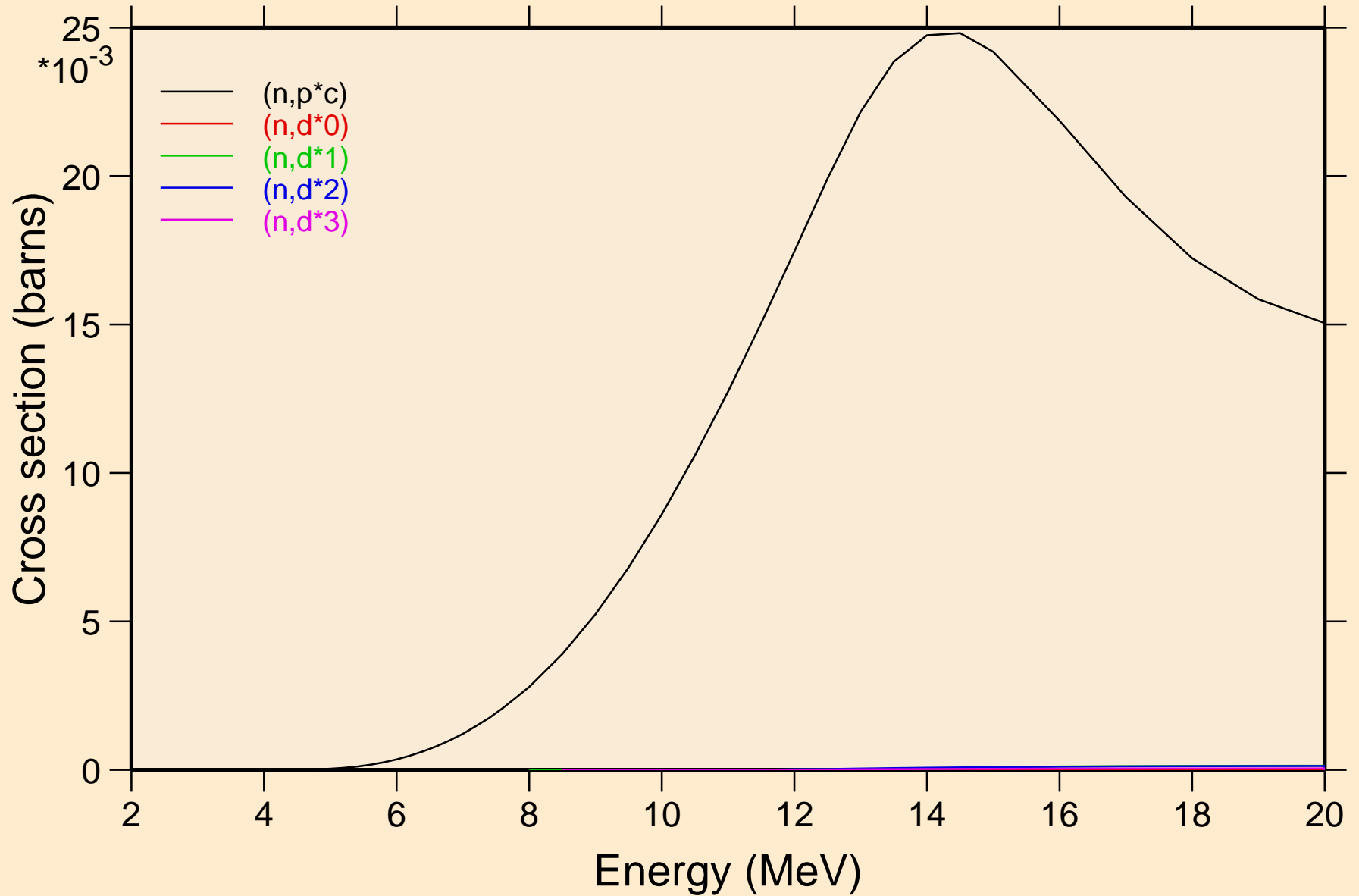

32-GE-73 FOR FENDL-3.2 FROM JEFF-3.1.1 BY NJOY2016.60+ O  
Threshold reactions

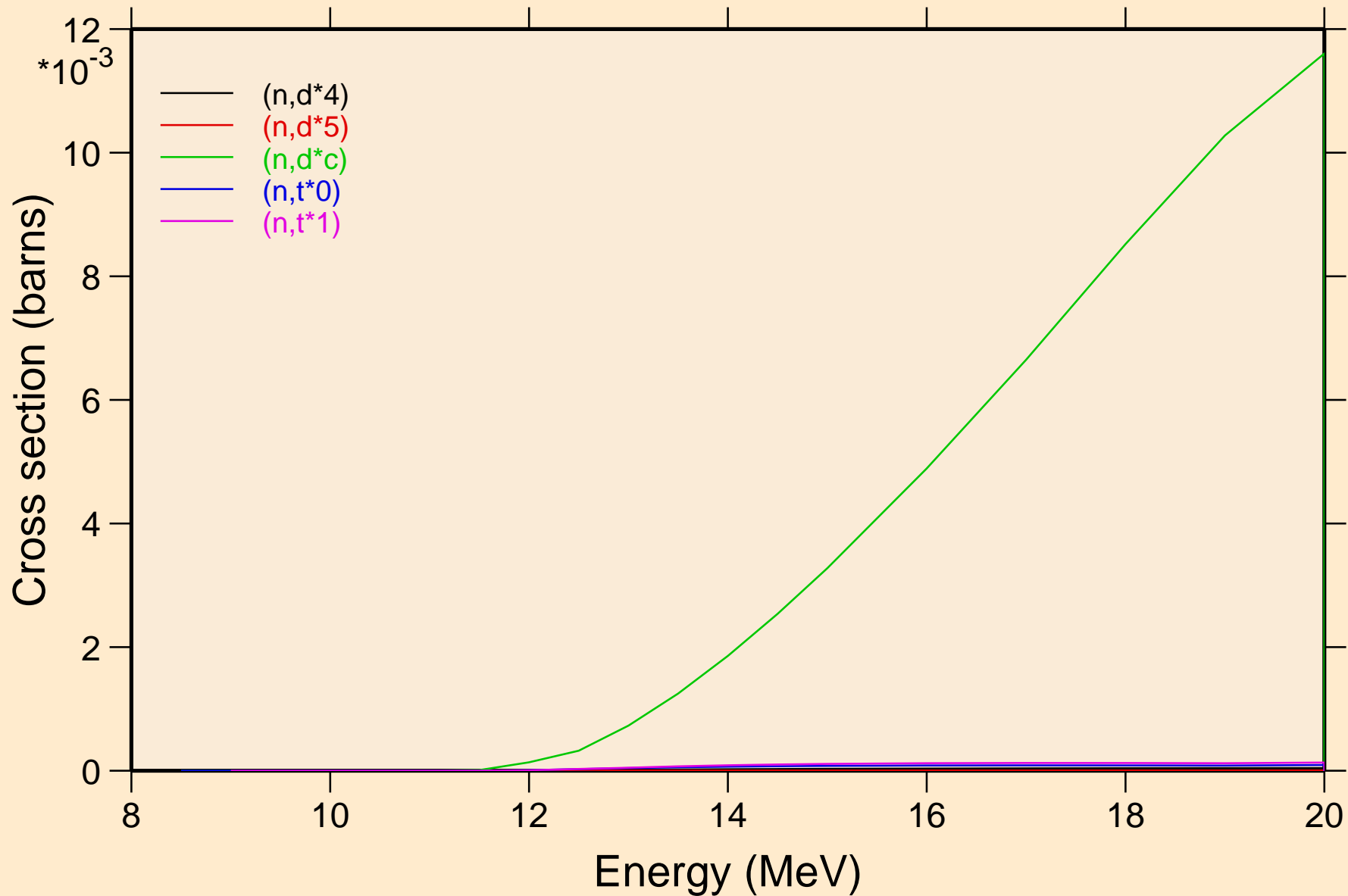

32-GE-73 FOR FENDL-3.2 FROM JEFF-3.1.1 BY NJOY2016.60+ O  
Threshold reactions

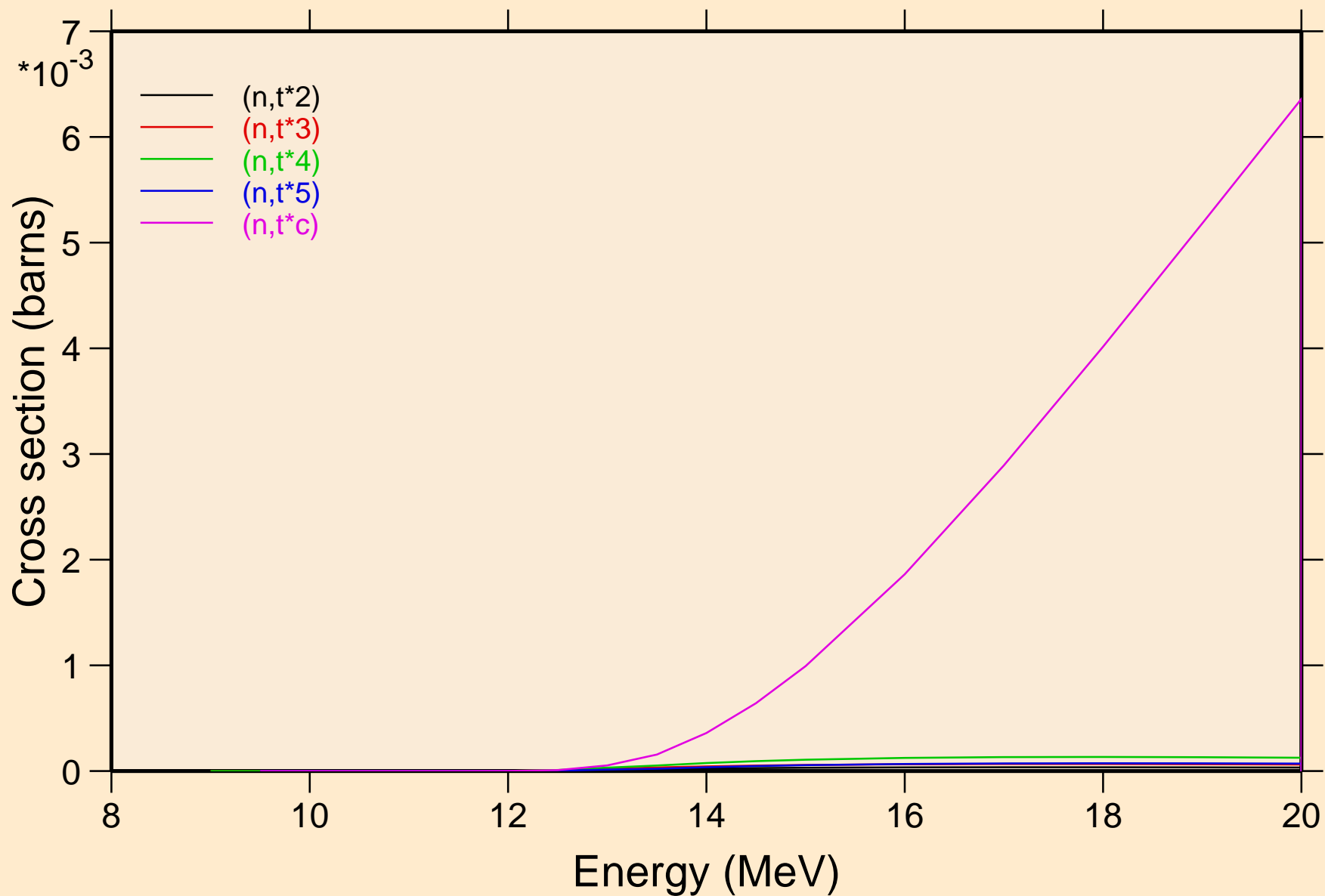



32-GE-73 FOR FENDL-3.2 FROM JEFF-3.1.1 BY NJOY2016.60+ O  
Threshold reactions

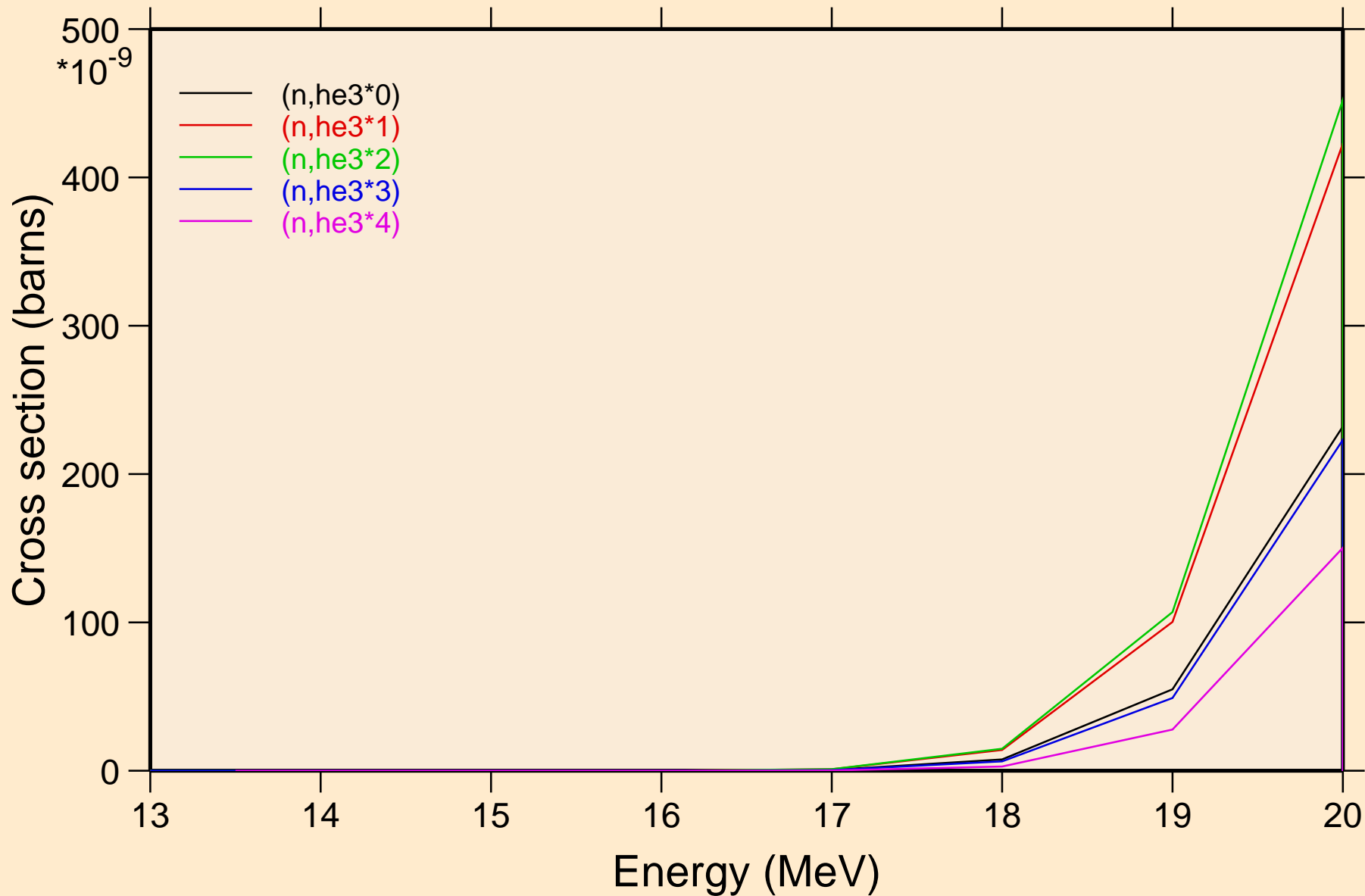

32-GE-73 FOR FENDL-3.2 FROM JEFF-3.1.1 BY NJOY2016.60+ O  
Threshold reactions

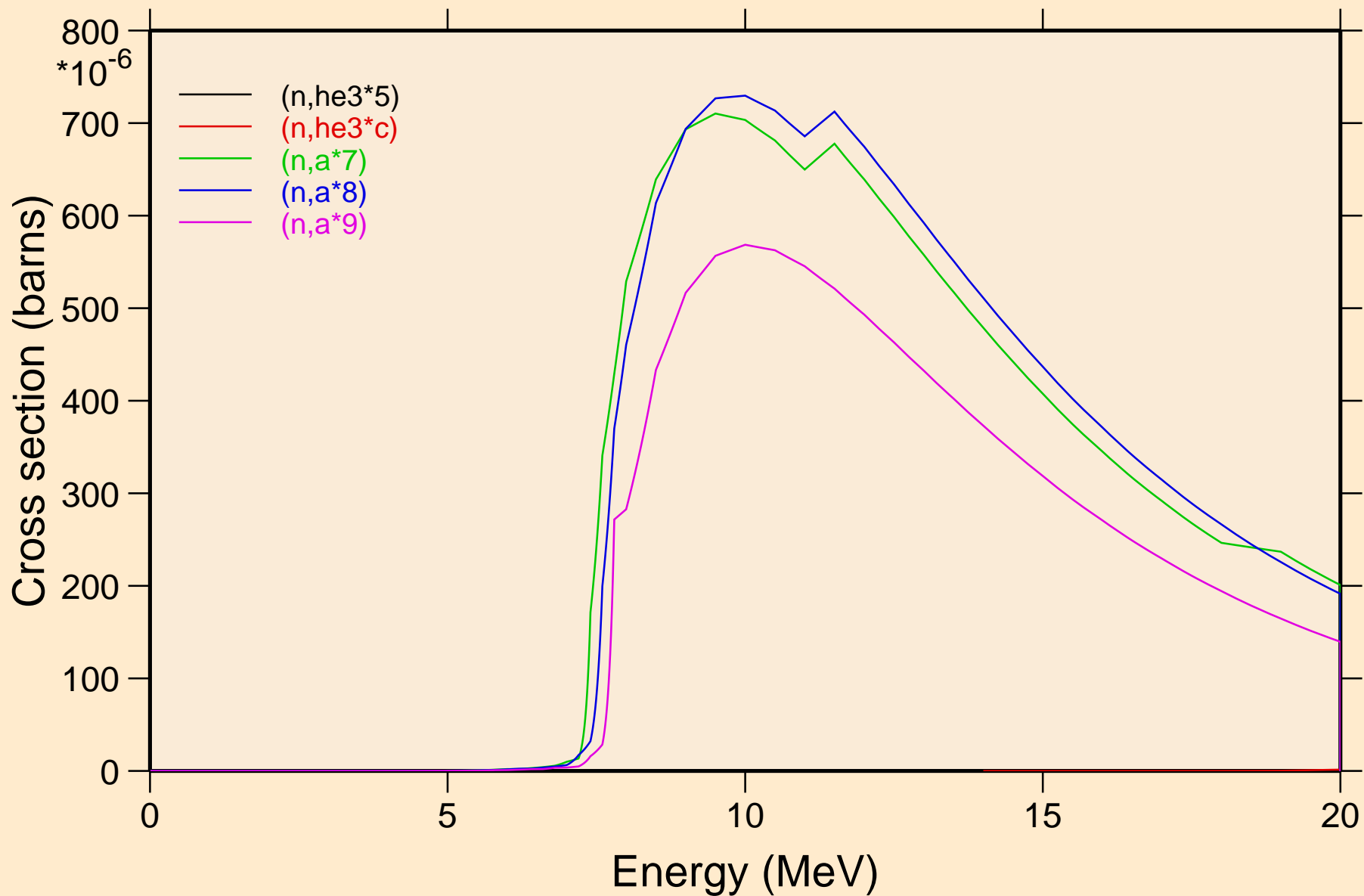

32-GE-73 FOR FENDL-3.2 FROM JEFF-3.1.1 BY NJOY2016.60+ O  
Threshold reactions

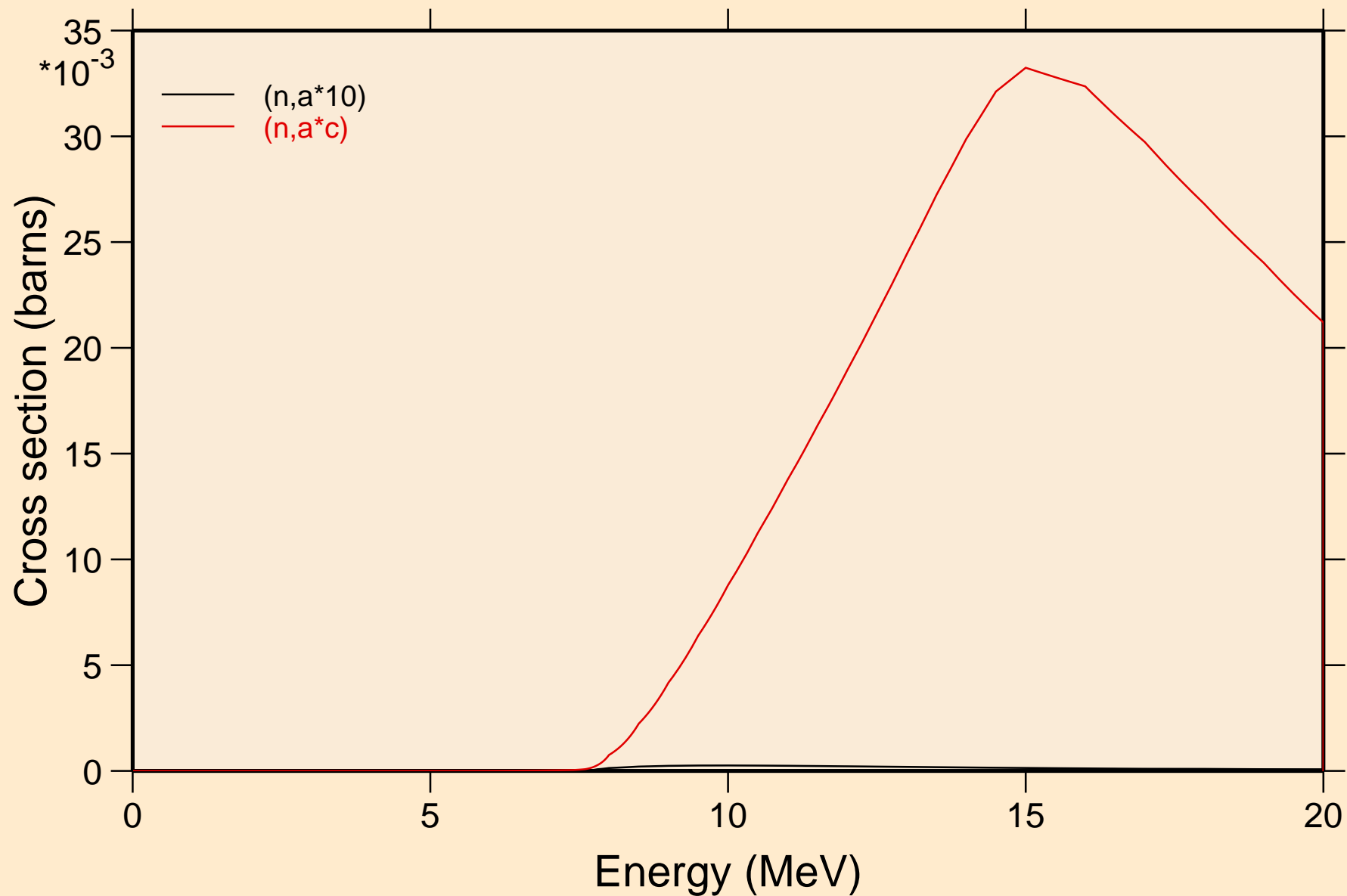

32-GE-73 FOR FENDL-3.2 FROM JEFF-3.1.1 BY NJOY2016.60+ O  
angular distribution for elastic

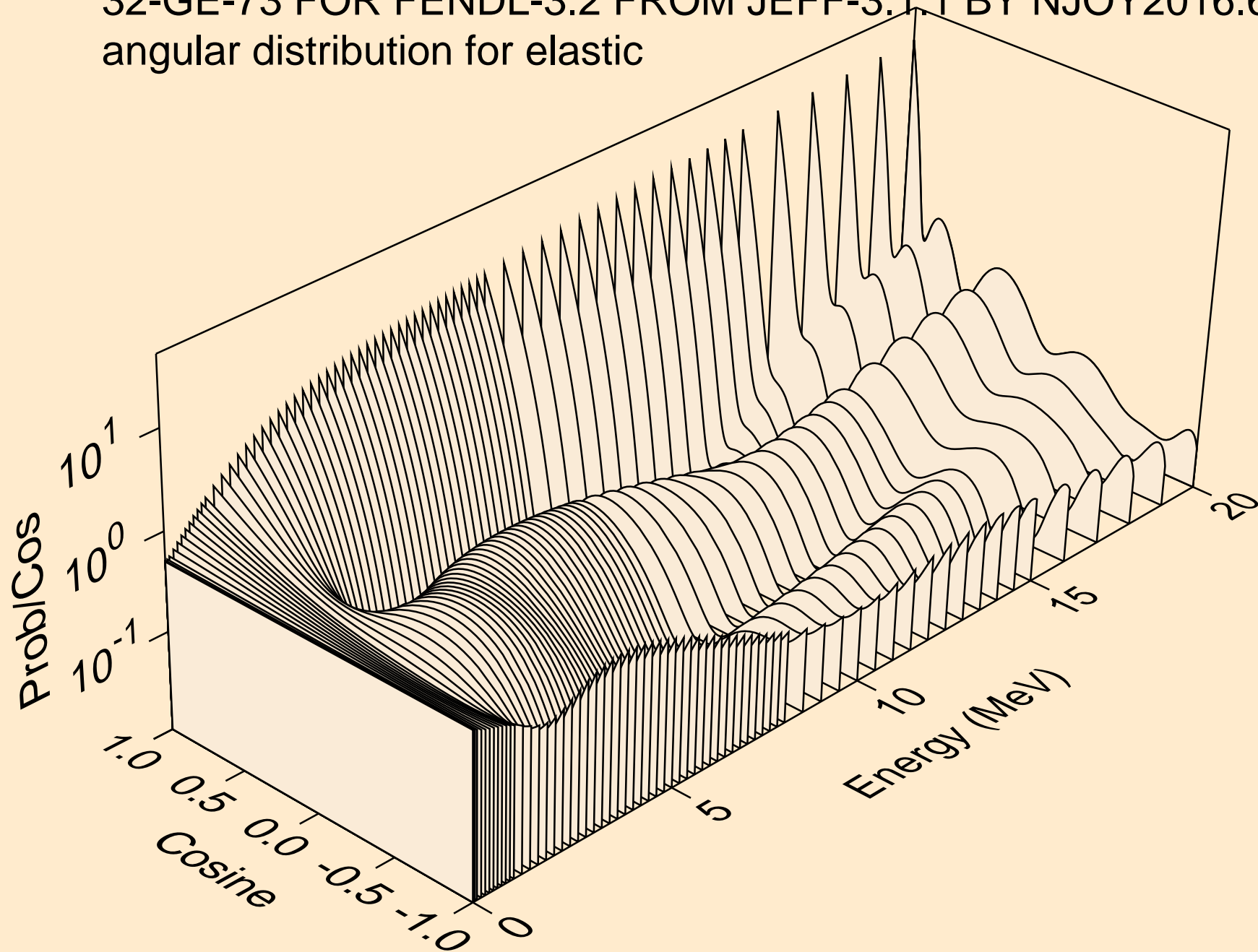

32-GE-73 FOR FENDL-3.2 FROM JEFF-3.1.1 BY NJOY2016.60+ O  
angular distribution for elastic

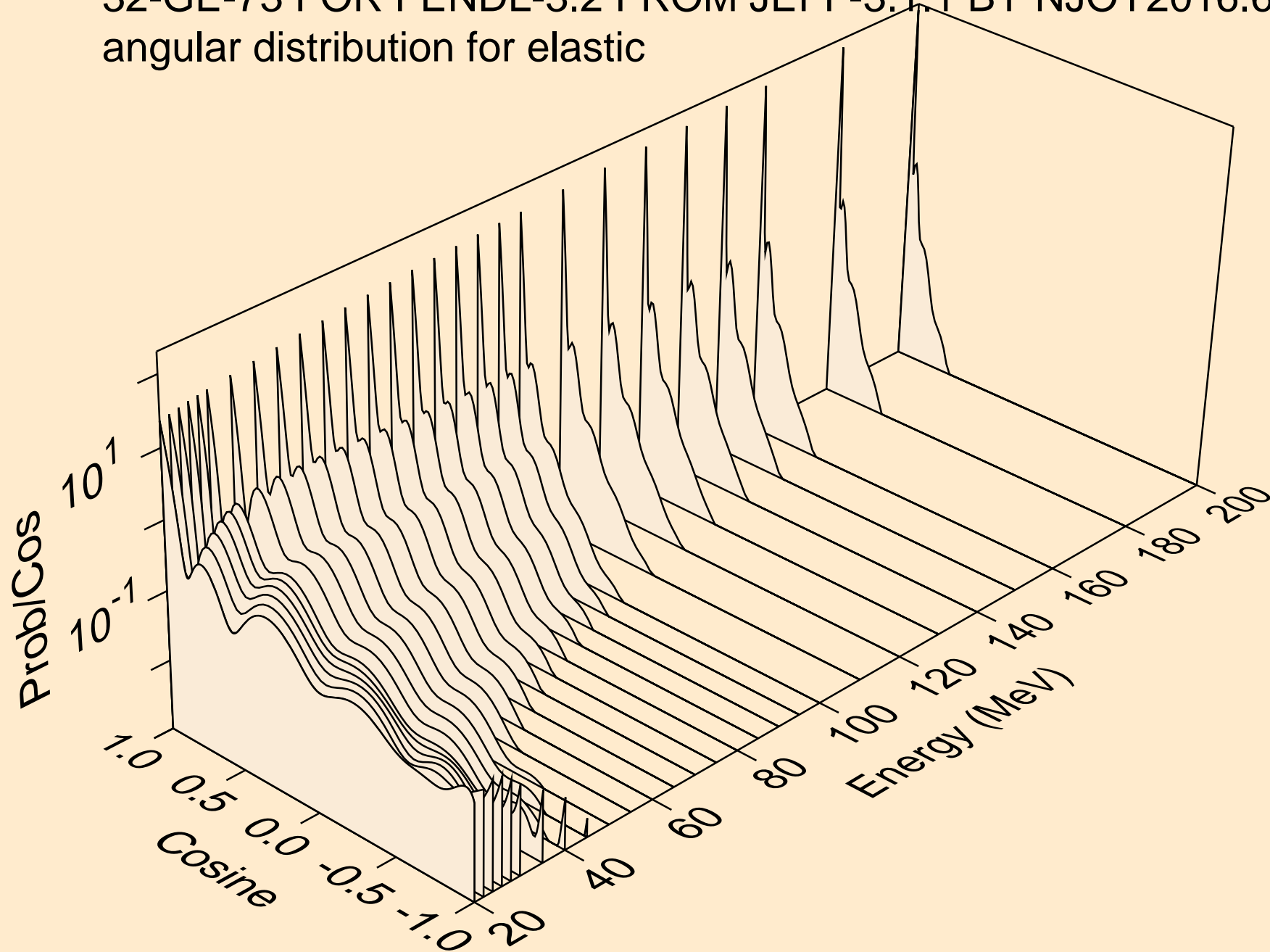

32-GE-73 FOR FENDL-3.2 FROM JEFF-3.1.1 BY NJOY2016.60+ O  
angular distribution for (n,n\*1)

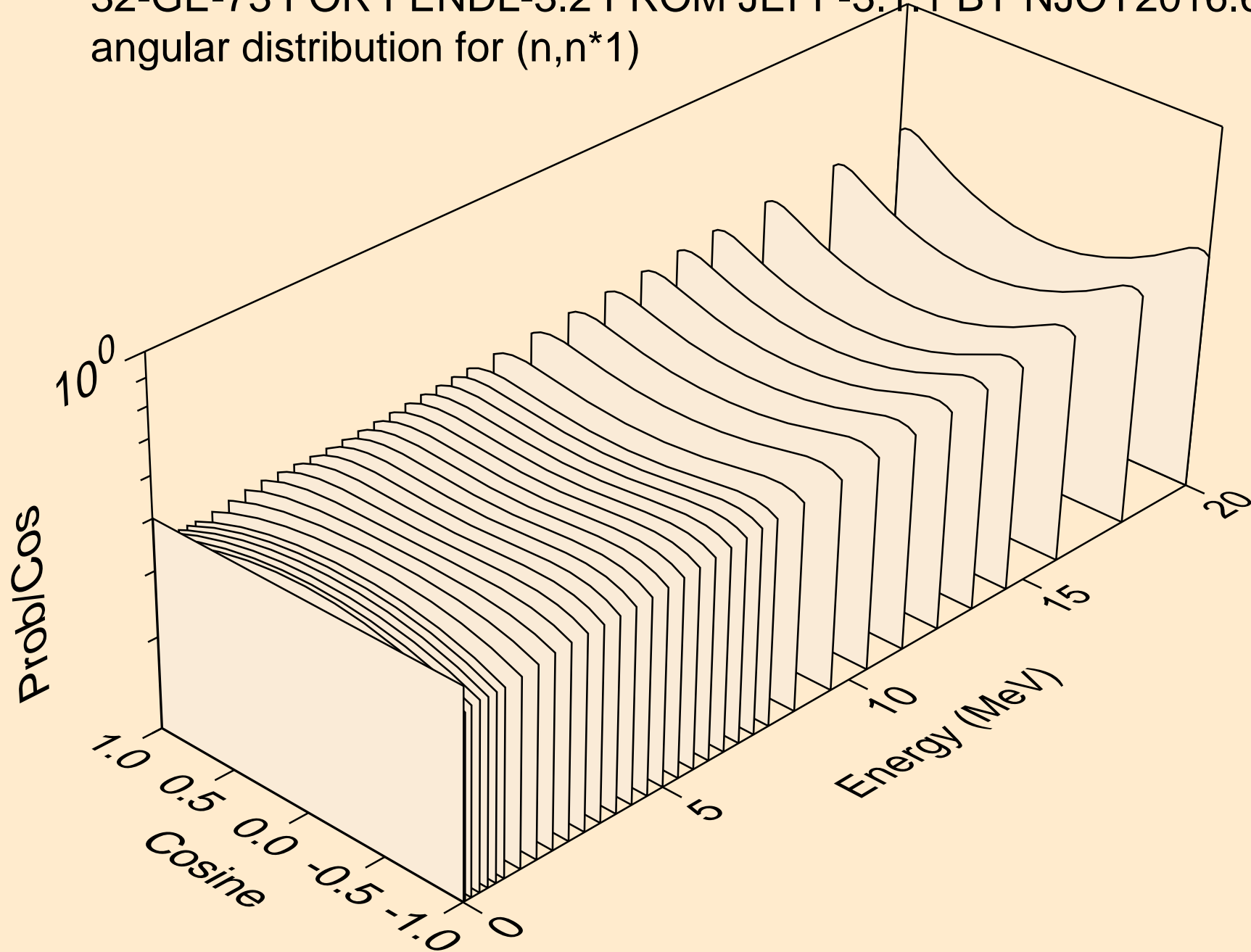

32-GE-73 FOR FENDL-3.2 FROM JEFF-3.1.1 BY NJOY2016.60+ O  
angular distribution for (n,n\*2)

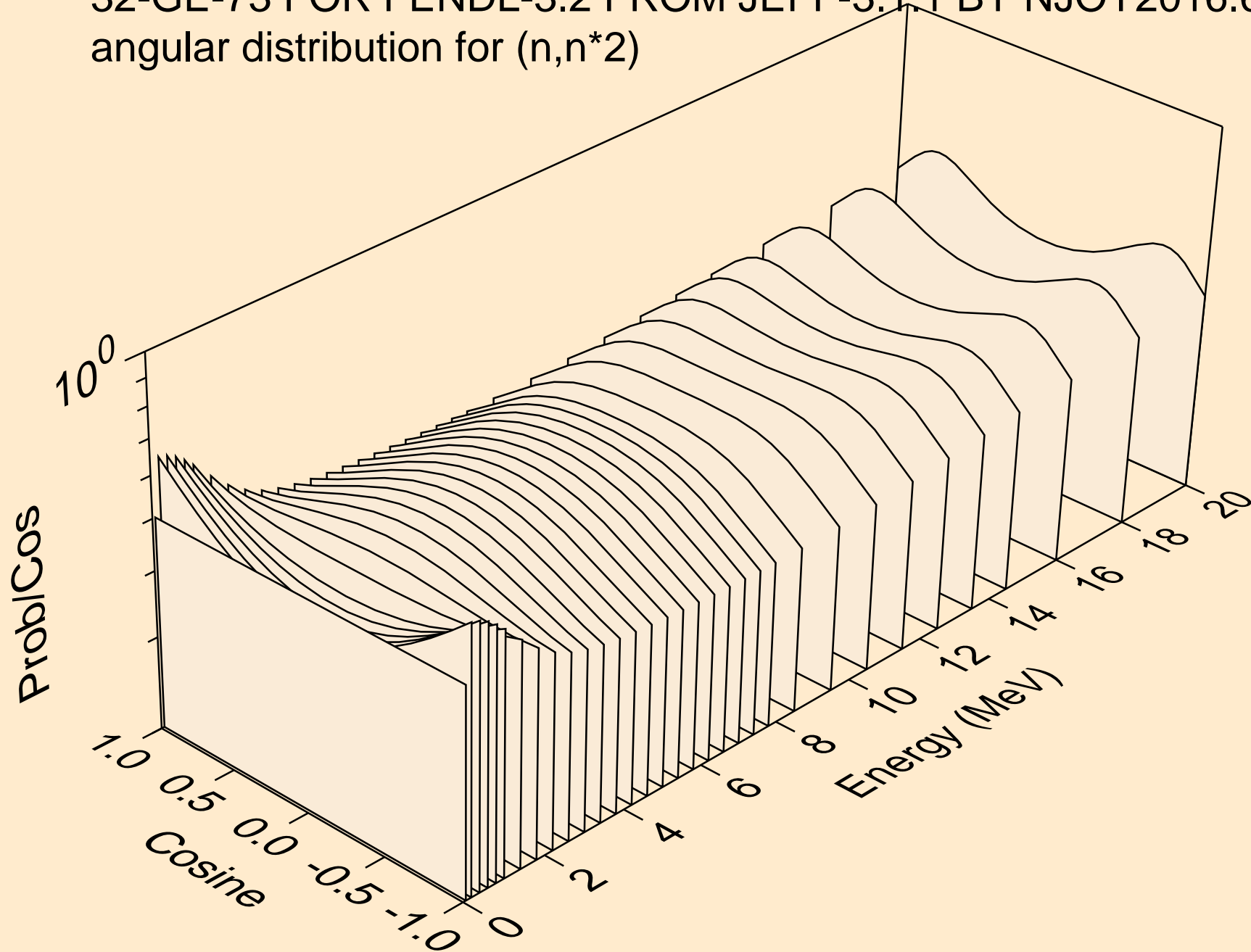

32-GE-73 FOR FENDL-3.2 FROM JEFF-3.1.1 BY NJOY2016.60+ O  
angular distribution for (n,n\*3)

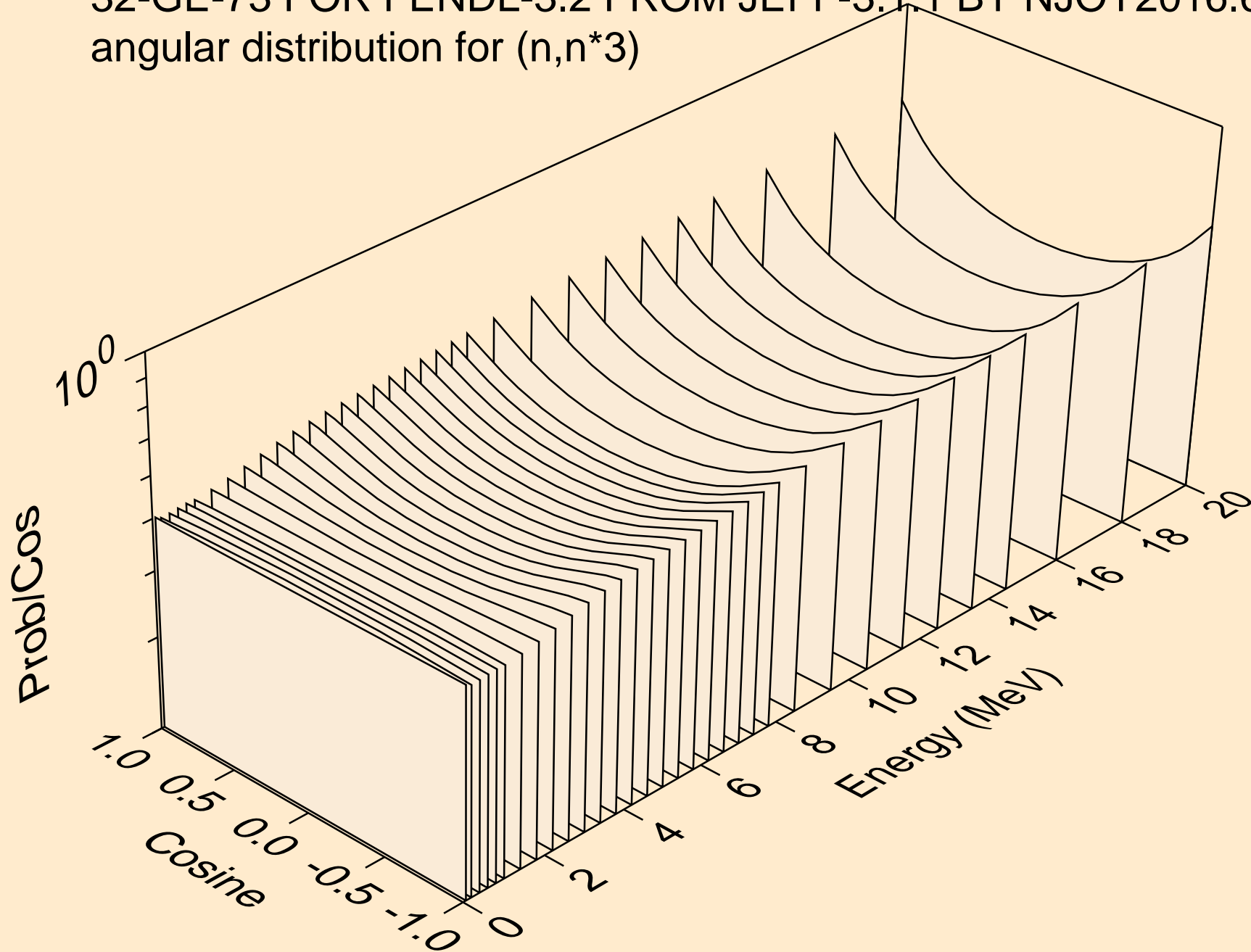



32-GE-73 FOR FENDL-3.2 FROM JEFF-3.1.1 BY NJOY2016.60+ O  
angular distribution for (n,n\*4)

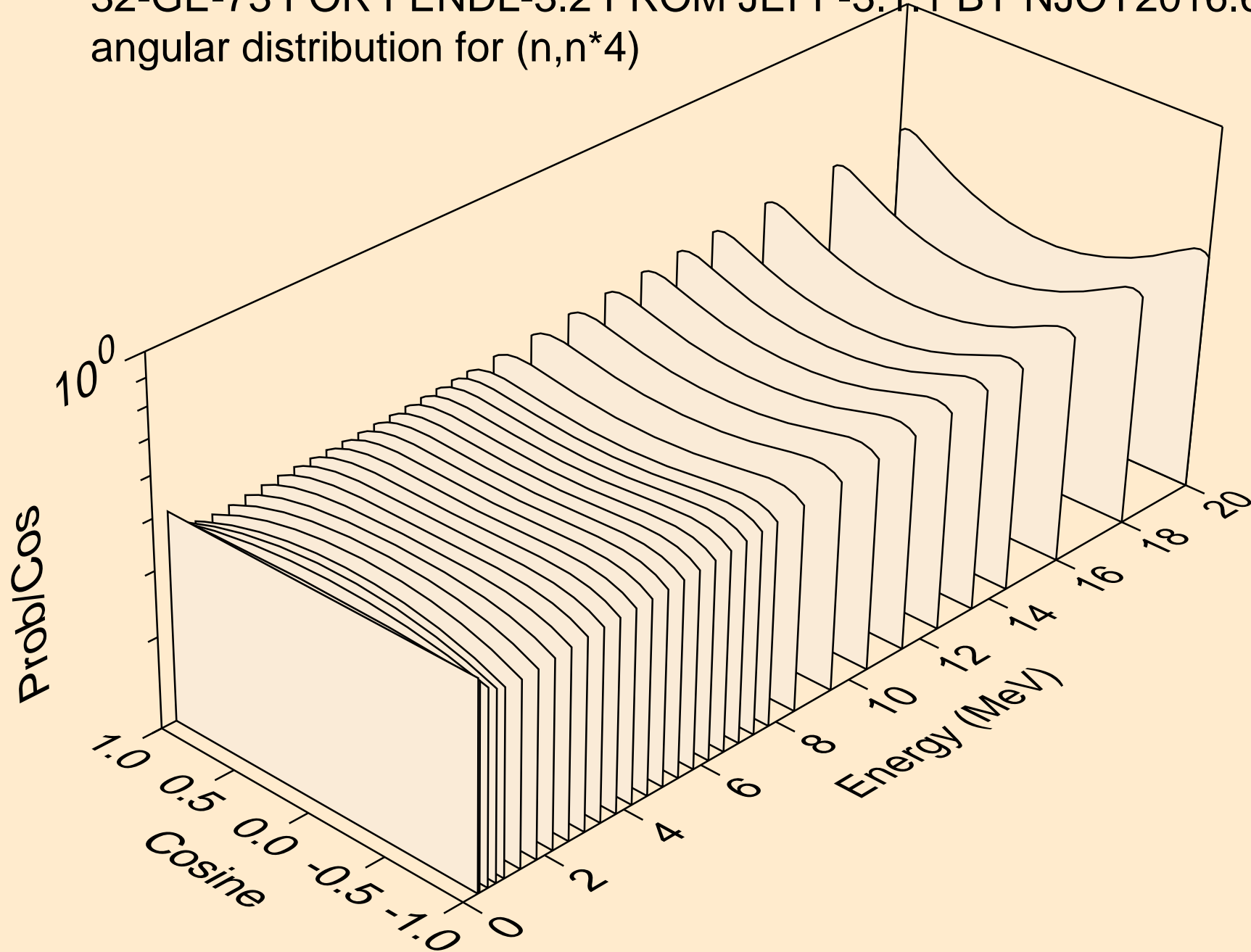

32-GE-73 FOR FENDL-3.2 FROM JEFF-3.1.1 BY NJOY2016.60+ O  
angular distribution for (n,n\*5)

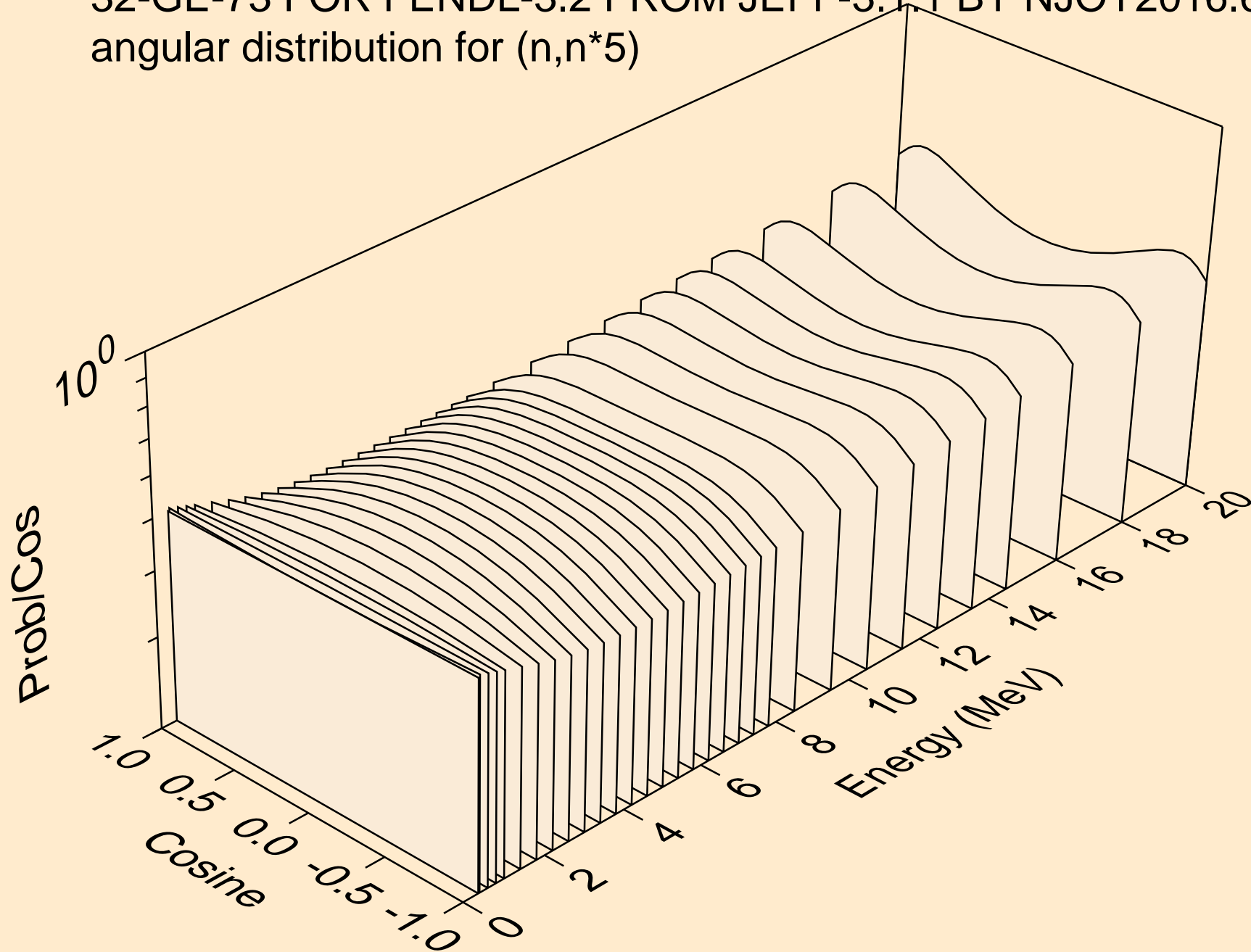

32-GE-73 FOR FENDL-3.2 FROM JEFF-3.1.1 BY NJOY2016.60+ O  
angular distribution for (n,n\*6)

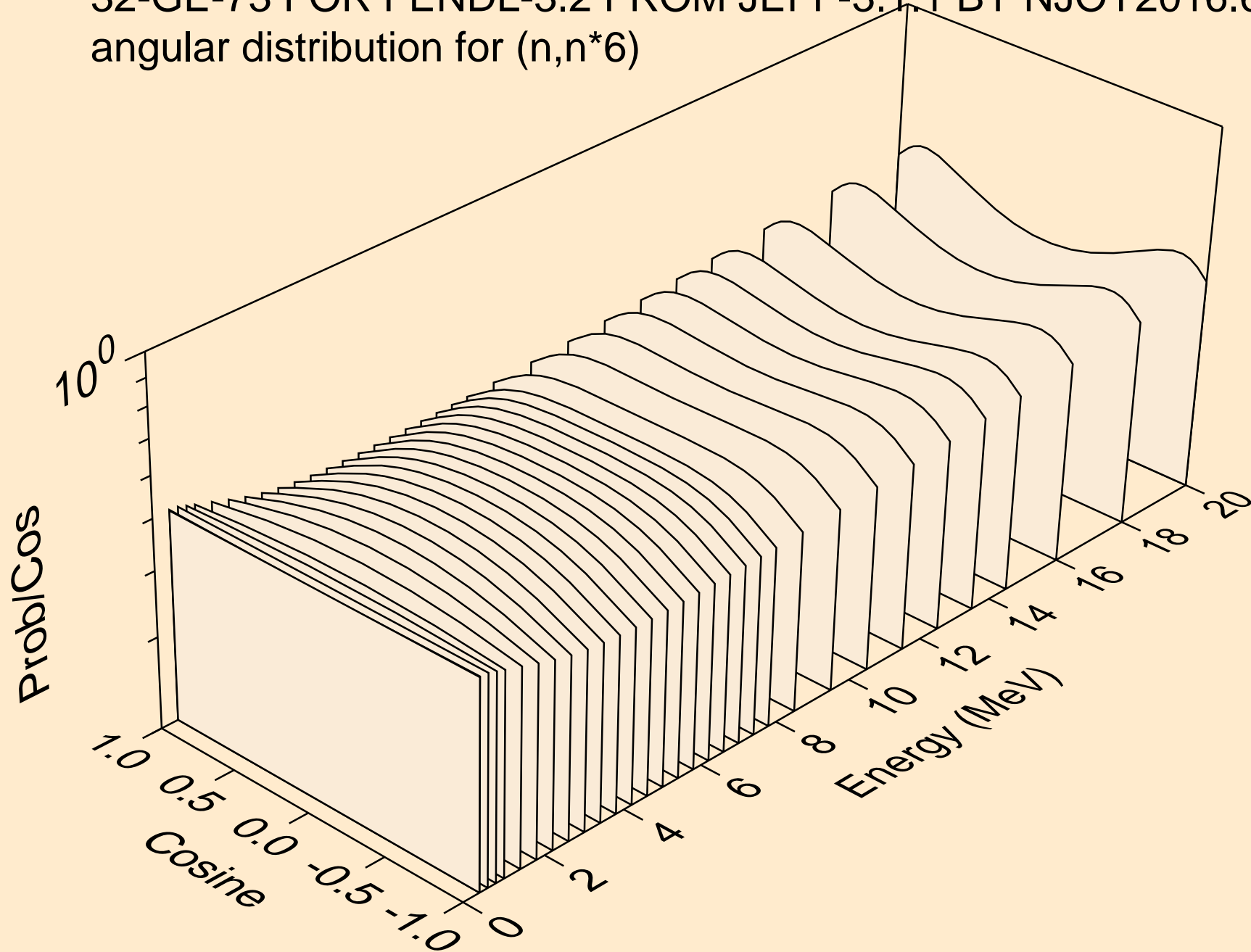

32-GE-73 FOR FENDL-3.2 FROM JEFF-3.1.1 BY NJOY2016.60+ O  
angular distribution for (n,n\*7)

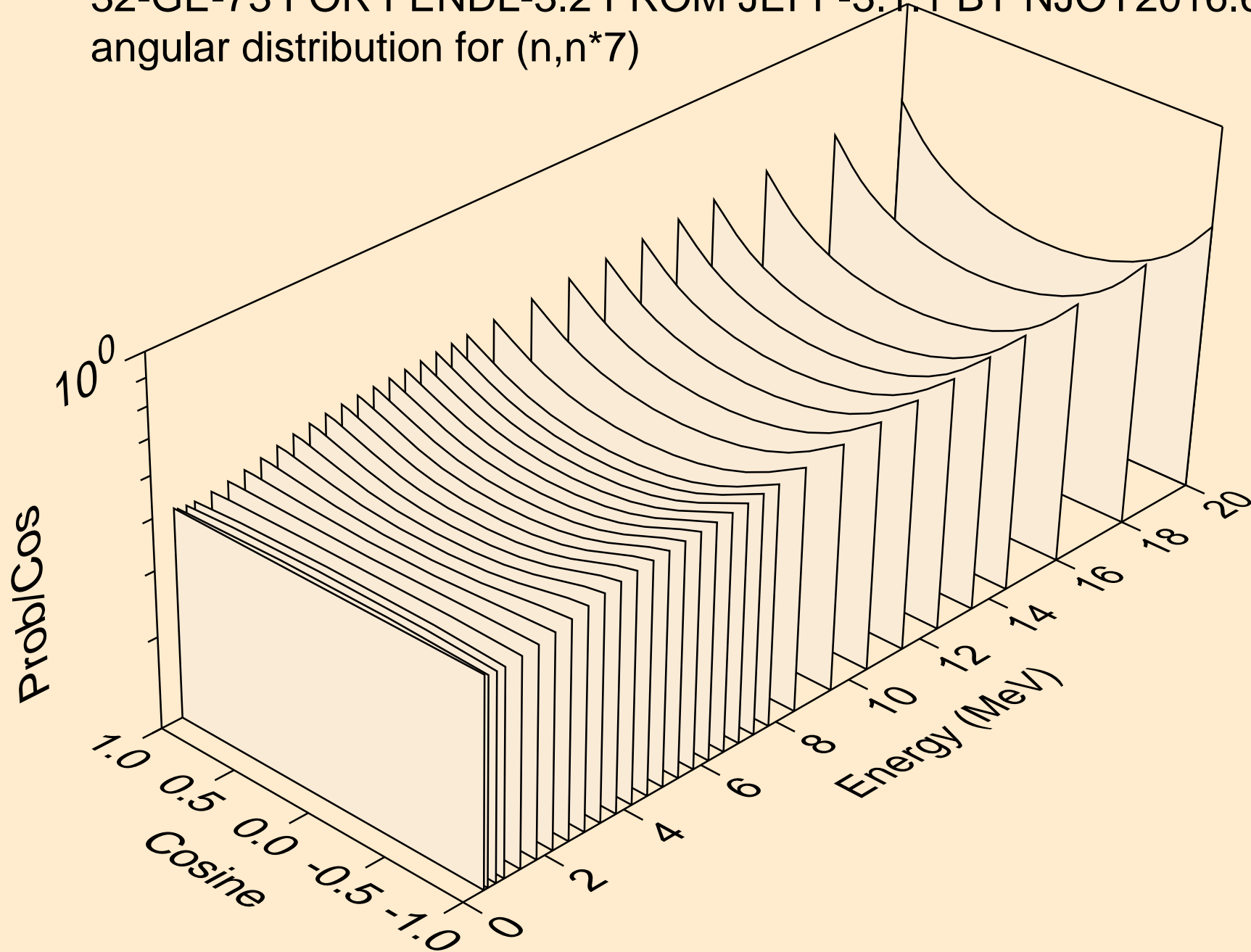

32-GE-73 FOR FENDL-3.2 FROM JEFF-3.1.1 BY NJOY2016.60+ O  
angular distribution for (n,n\*8)

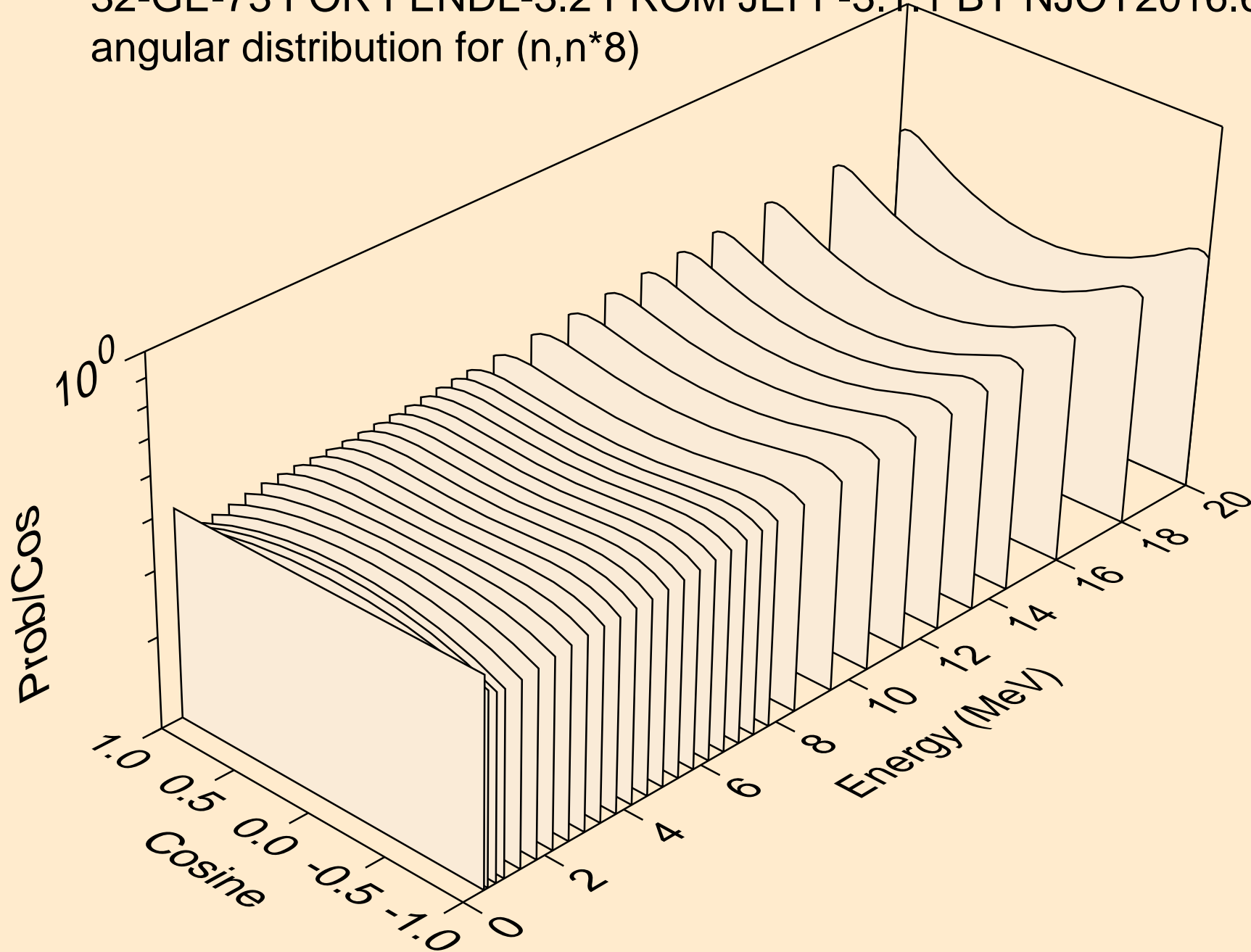

32-GE-73 FOR FENDL-3.2 FROM JEFF-3.1.1 BY NJOY2016.60+ O  
angular distribution for (n,n\*9)

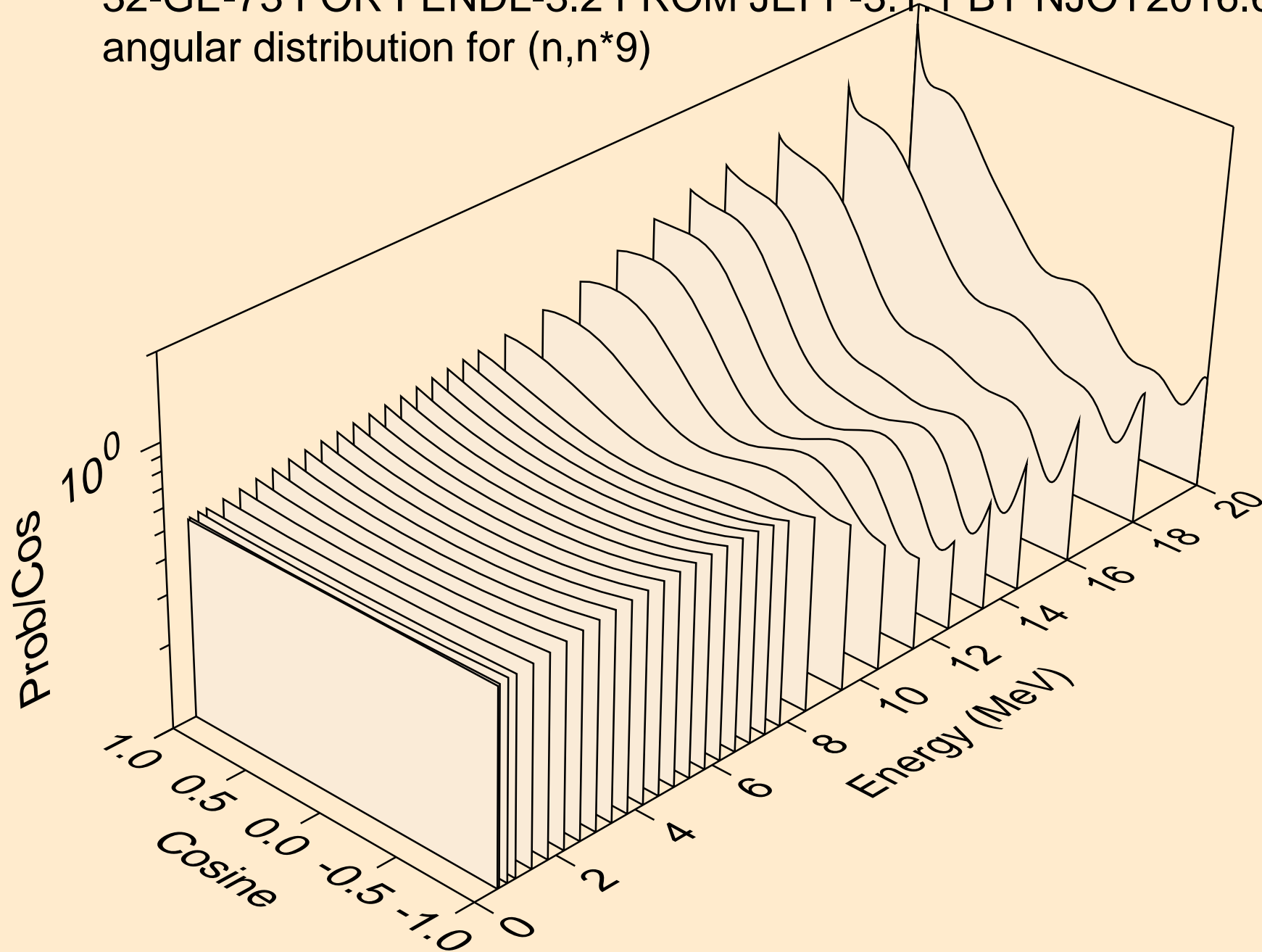

32-GE-73 FOR FENDL-3.2 FROM JEFF-3.1.1 BY NJOY2016.60+ O  
angular distribution for (n,n\*10)

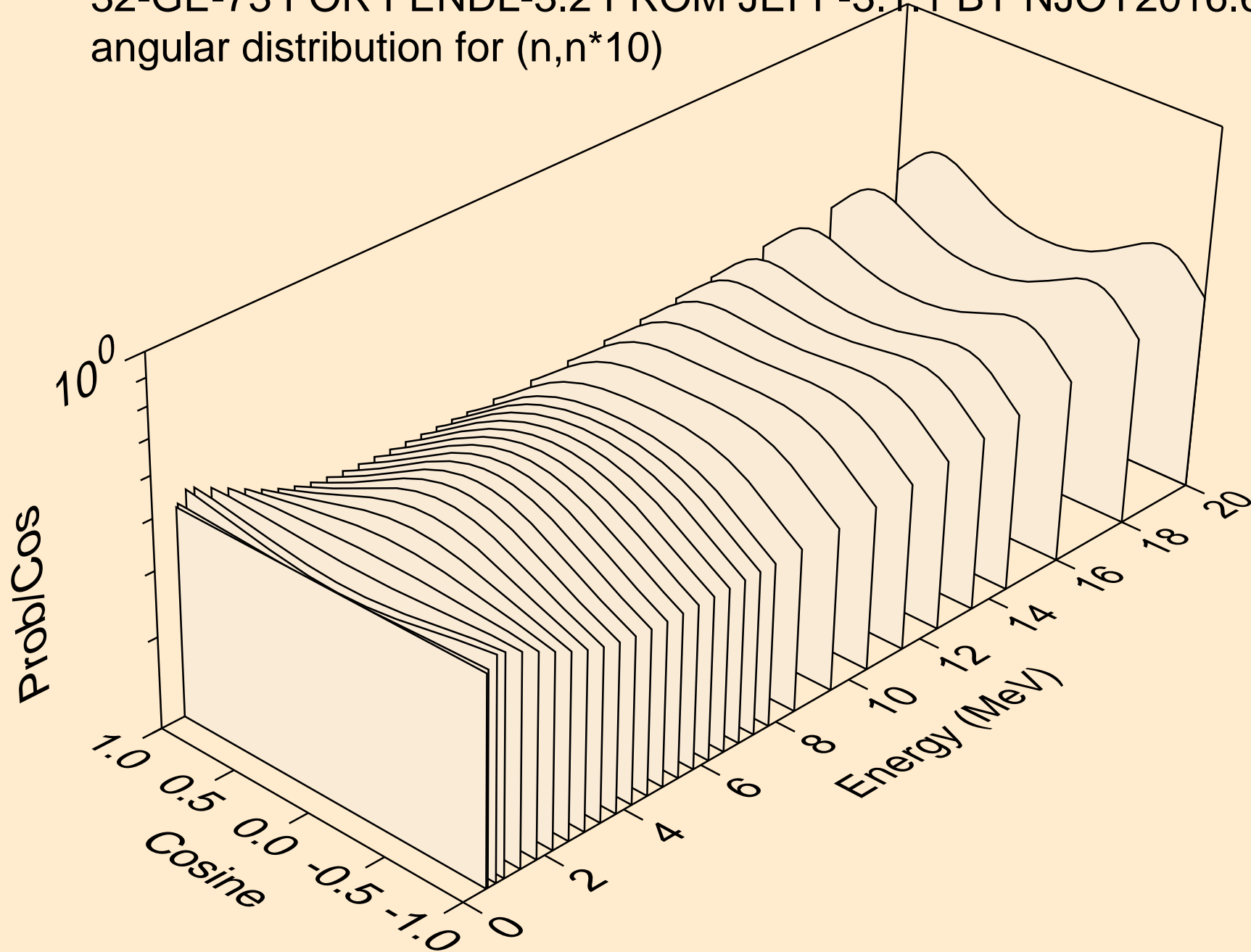

32-GE-73 FOR FENDL-3.2 FROM JEFF-3.1.1 BY NJOY2016.60+ O  
angular distribution for (n,n\*11)

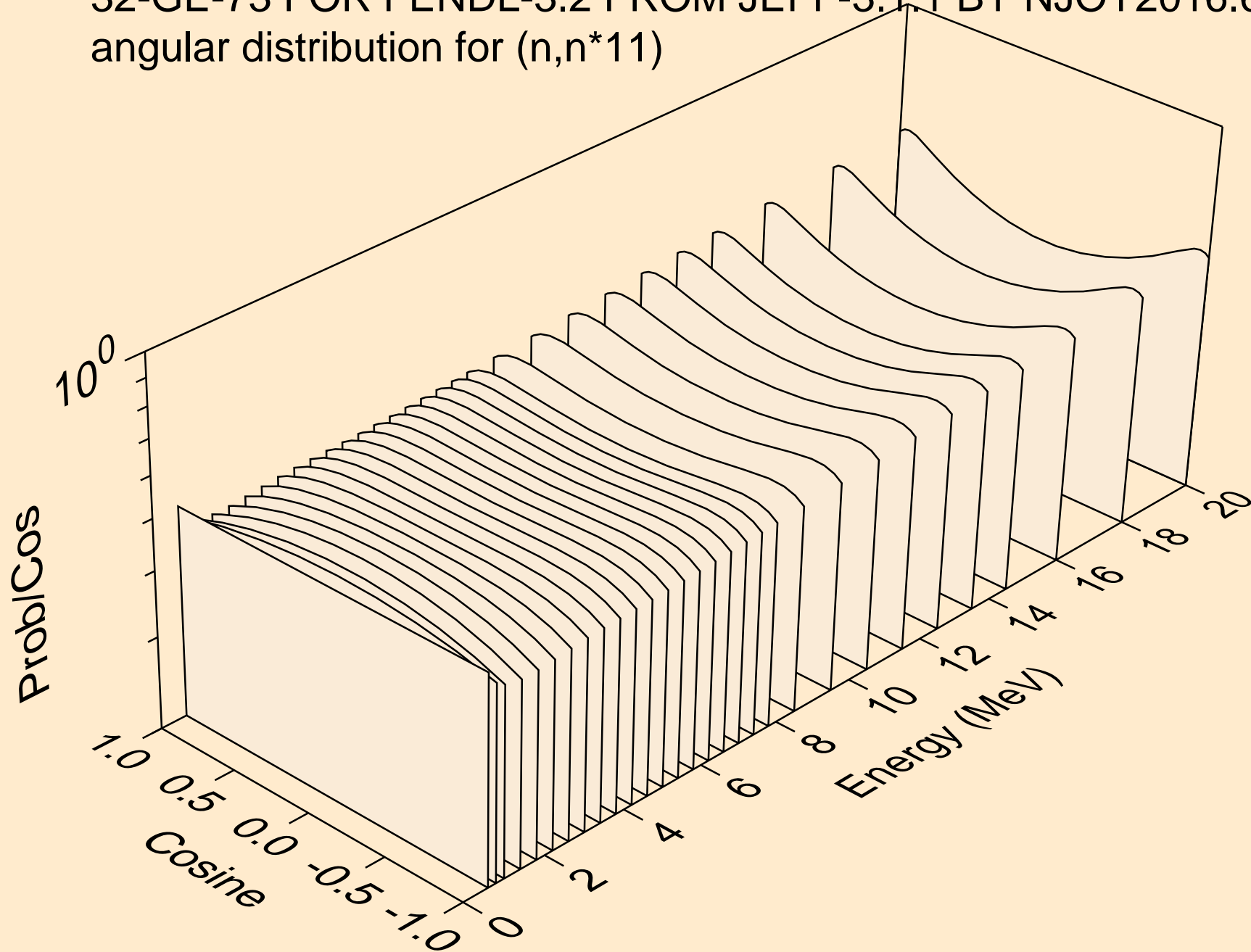



32-GE-73 FOR FENDL-3.2 FROM JEFF-3.1.1 BY NJOY2016.60+ O  
angular distribution for (n,n\*12)

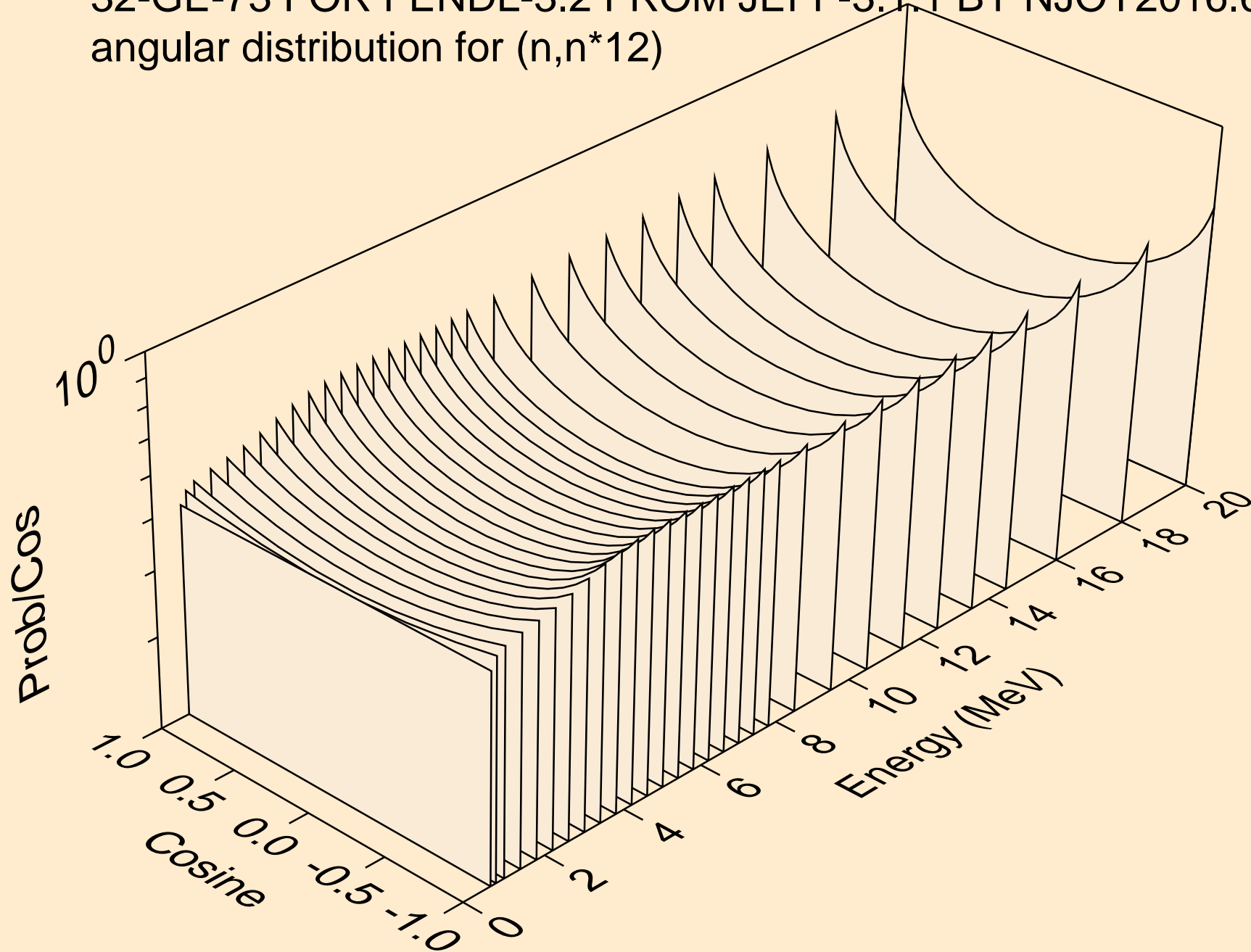

32-GE-73 FOR FENDL-3.2 FROM JEFF-3.1.1 BY NJOY2016.60+ O  
angular distribution for (n,n\*13)

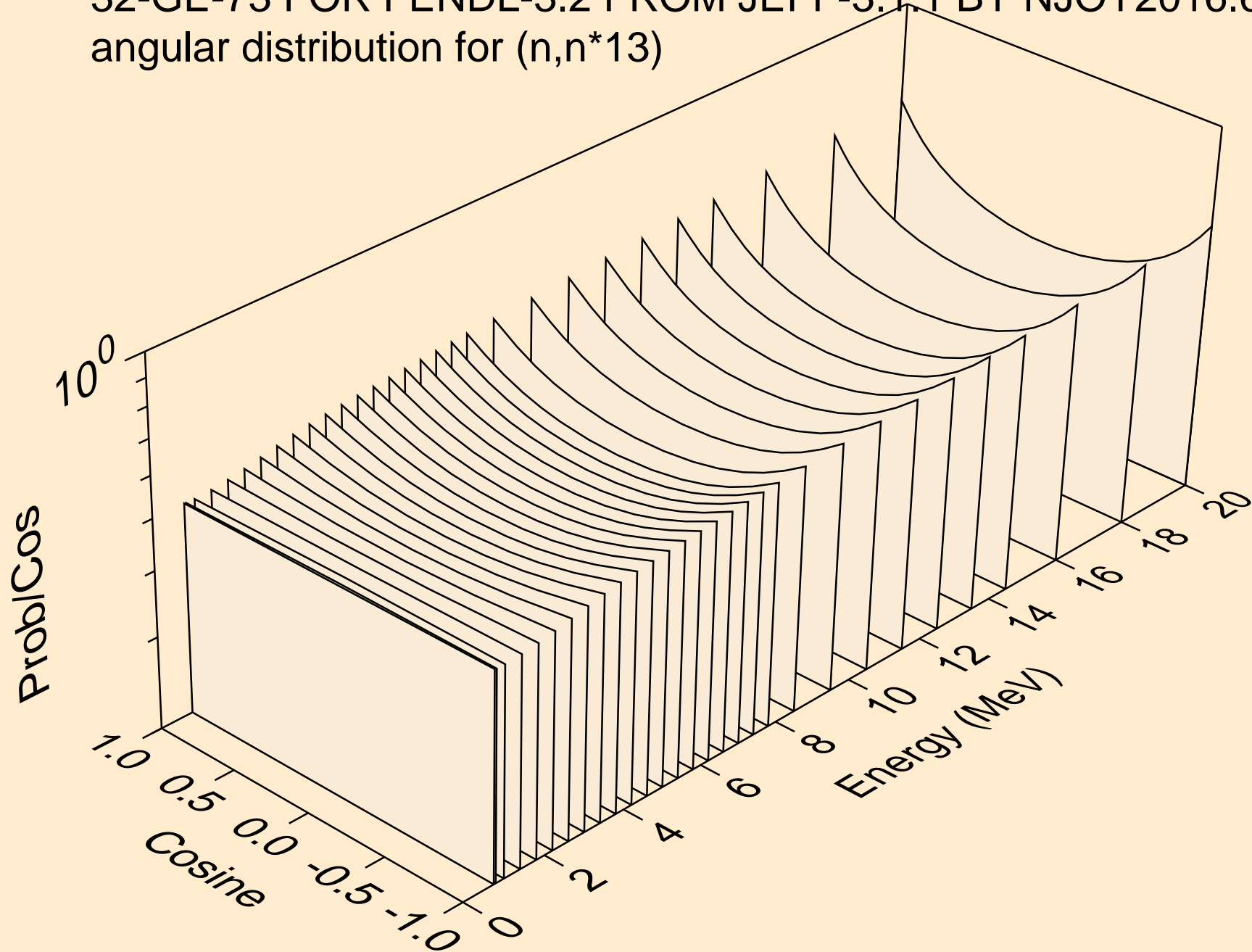

32-GE-73 FOR FENDL-3.2 FROM JEFF-3.1.1 BY NJOY2016.60+ O  
angular distribution for (n,n\*14)

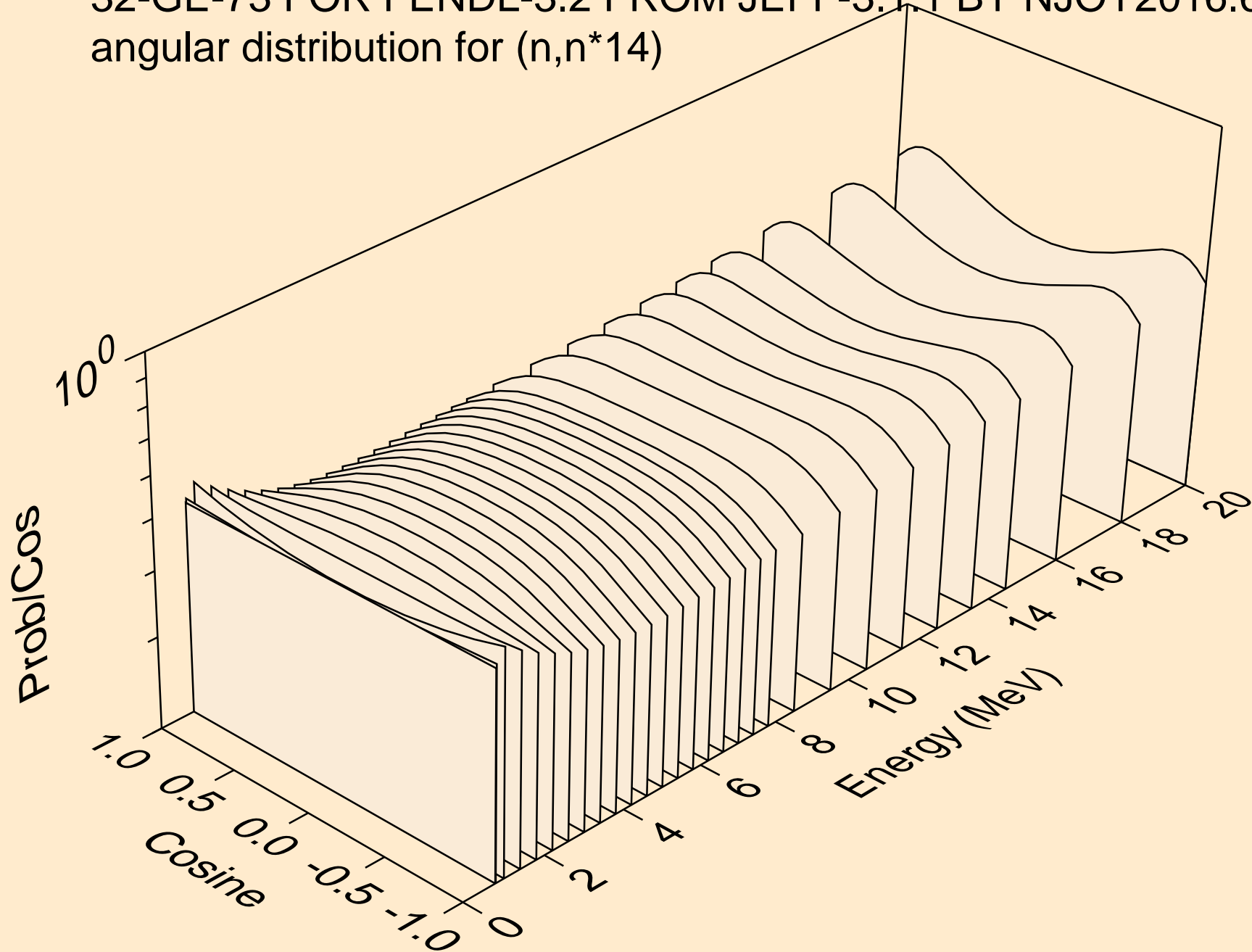

32-GE-73 FOR FENDL-3.2 FROM JEFF-3.1.1 BY NJOY2016.60+ O  
angular distribution for (n,n\*15)

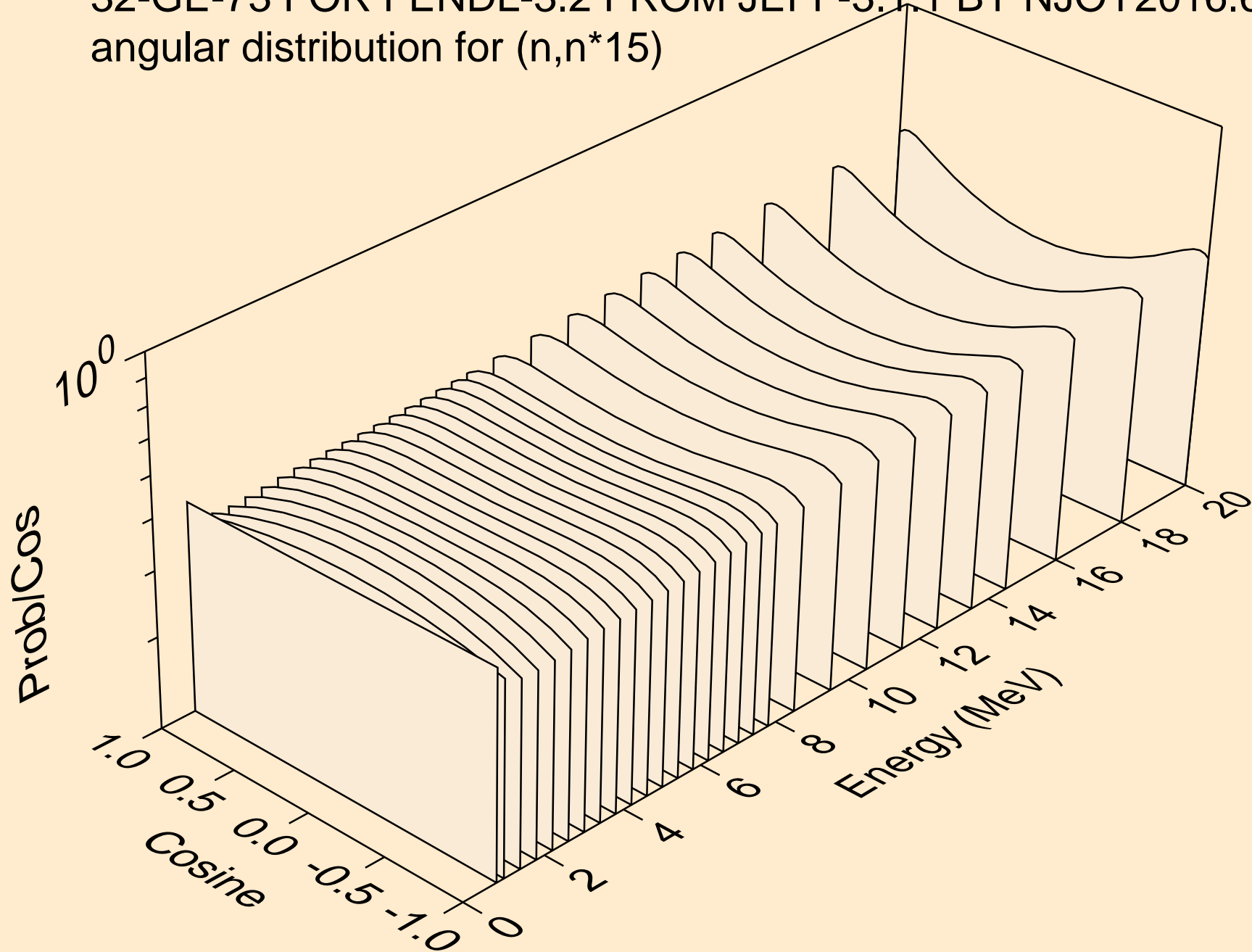

32-GE-73 FOR FENDL-3.2 FROM JEFF-3.1.1 BY NJOY2016.60+ O  
angular distribution for (n,n\*16)

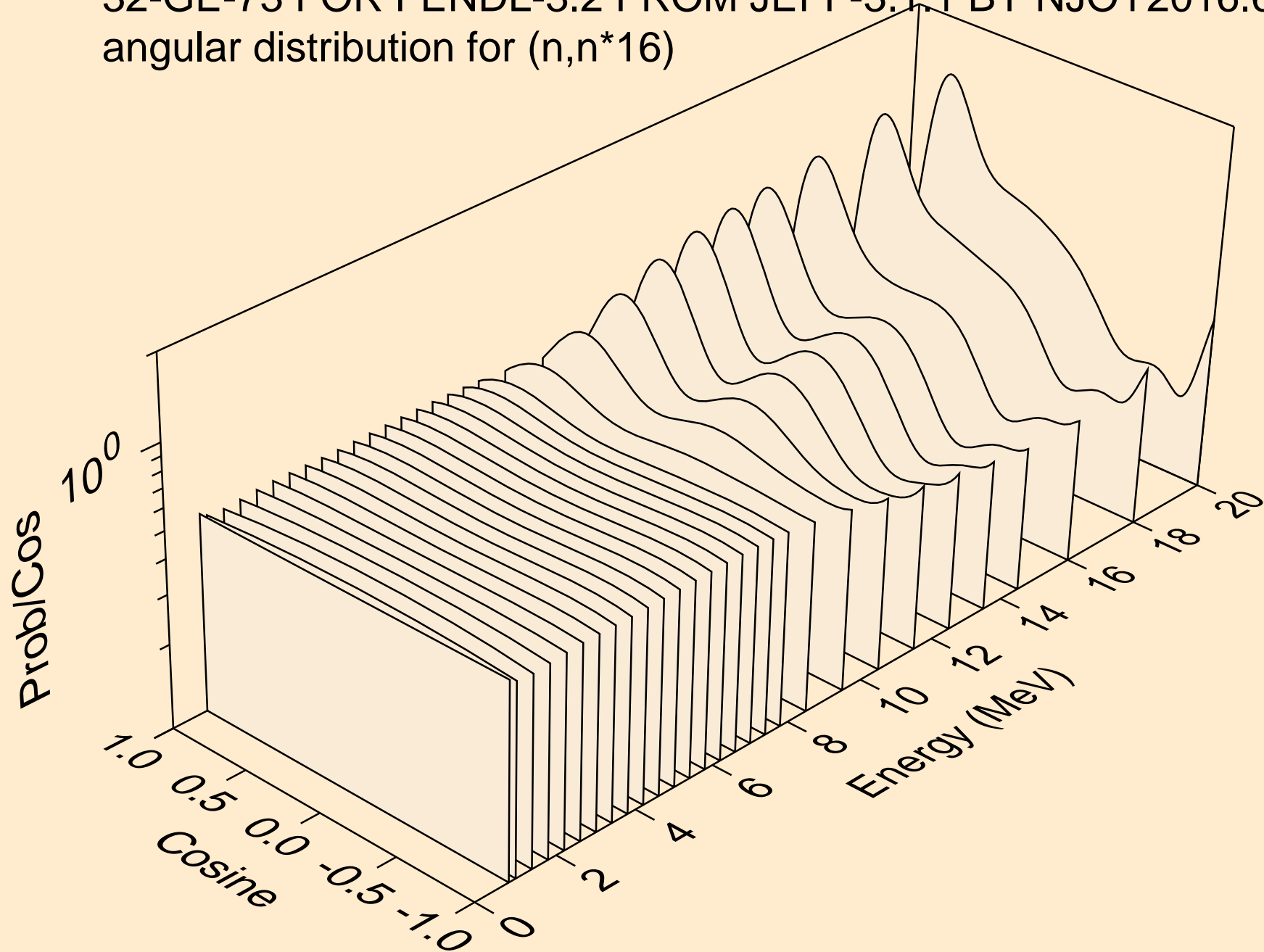

32-GE-73 FOR FENDL-3.2 FROM JEFF-3.1.1 BY NJOY2016.60+ O  
angular distribution for (n,n\*17)

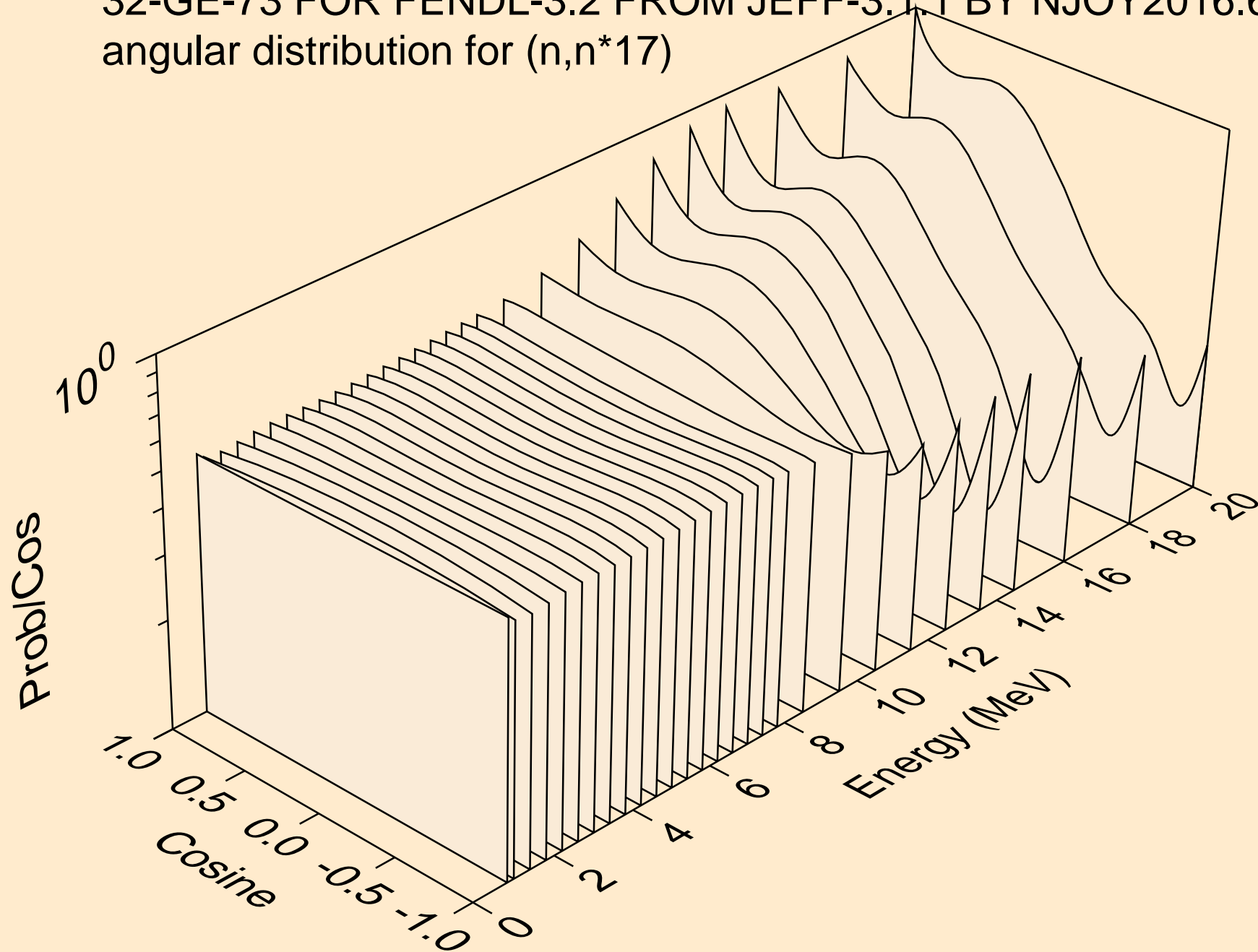

32-GE-73 FOR FENDL-3.2 FROM JEFF-3.1.1 BY NJOY2016.60+ O  
angular distribution for (n,n\*18)

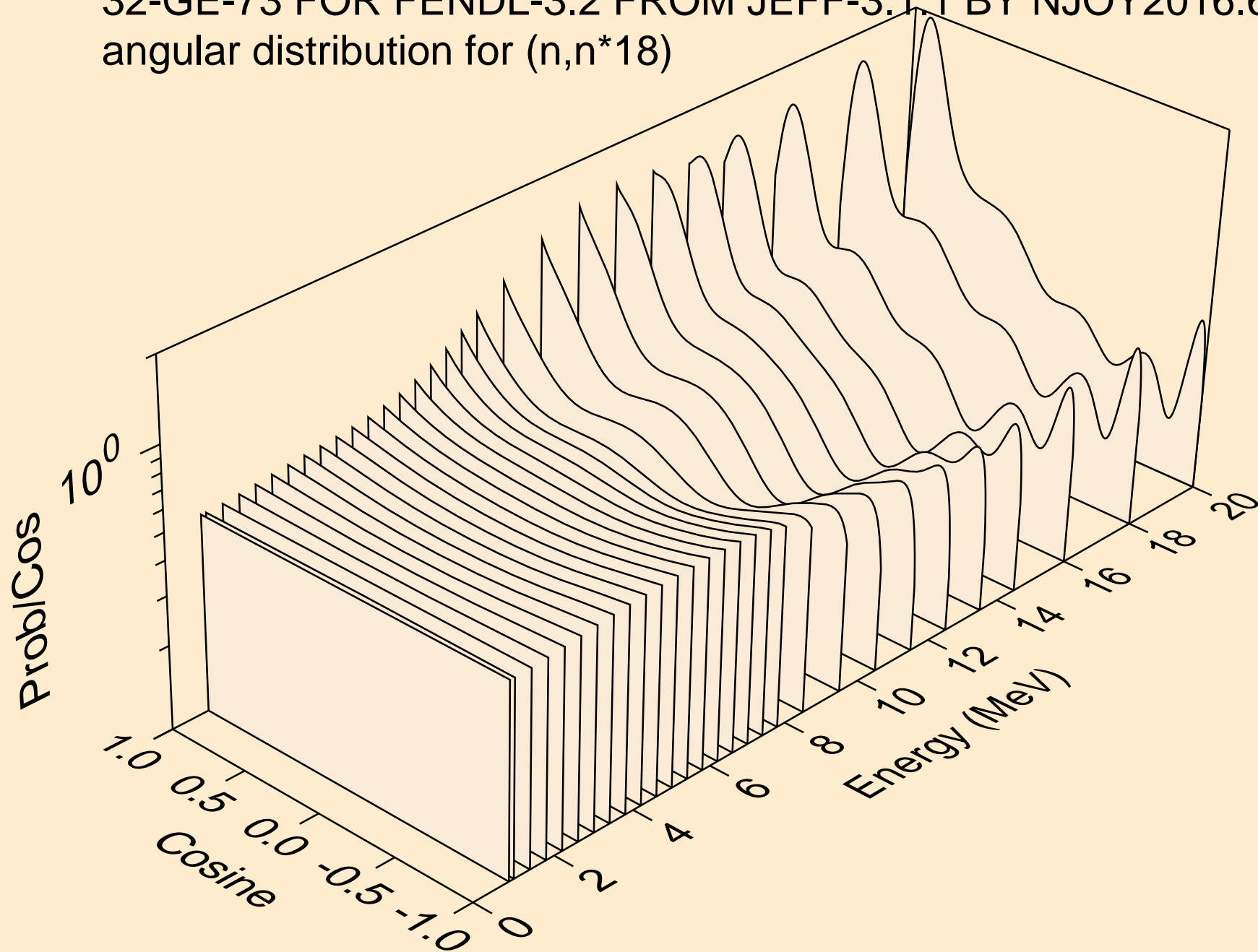

32-GE-73 FOR FENDL-3.2 FROM JEFF-3.1.1 BY NJOY2016.60+ O  
angular distribution for (n,n\*19)

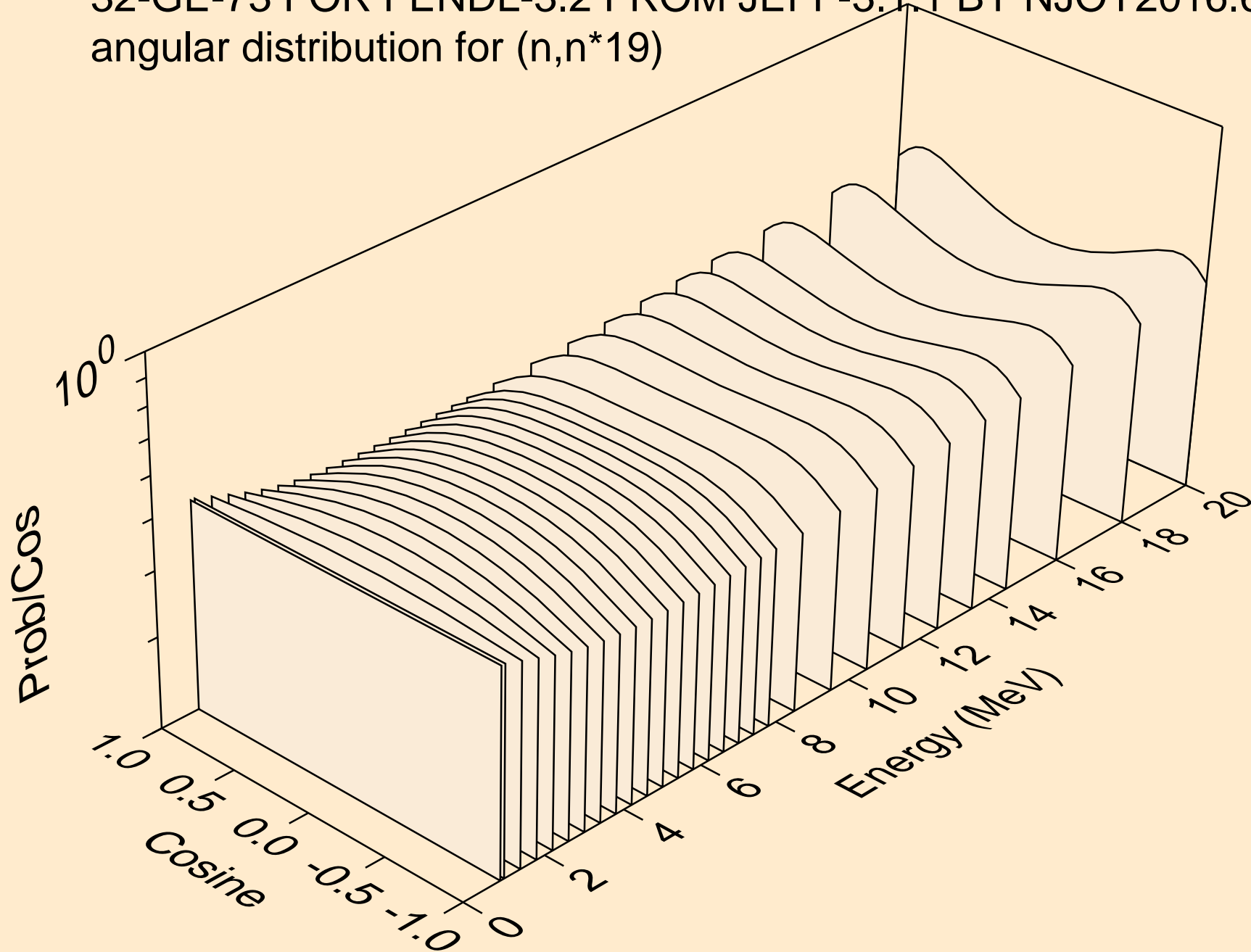



32-GE-73 FOR FENDL-3.2 FROM JEFF-3.1.1 BY NJOY2016.60+ O  
angular distribution for (n,n\*20)

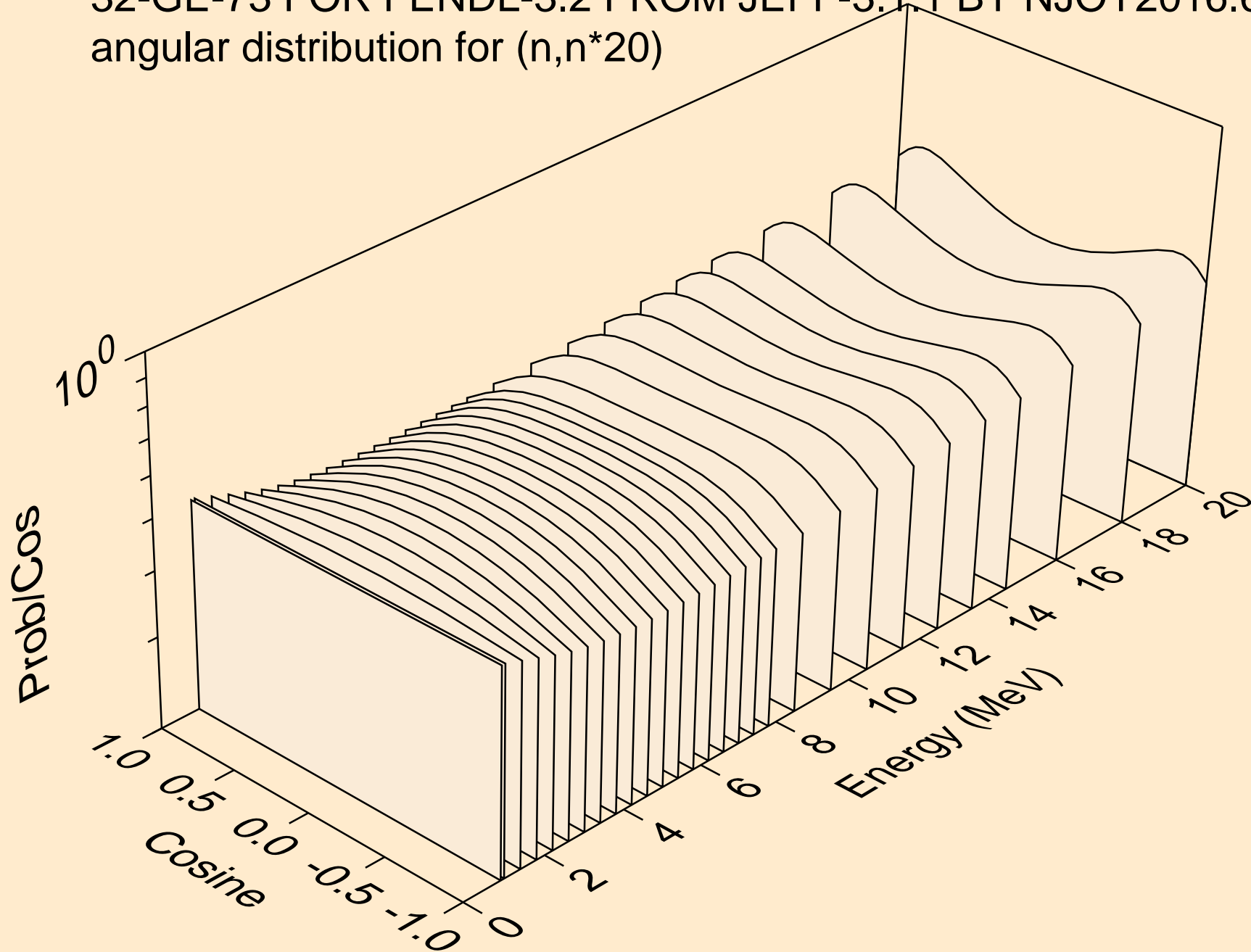

32-GE-73 FOR FENDL-3.2 FROM JEFF-3.1.1 BY NJOY2016.60+ O  
Neutron emission for (n,x)

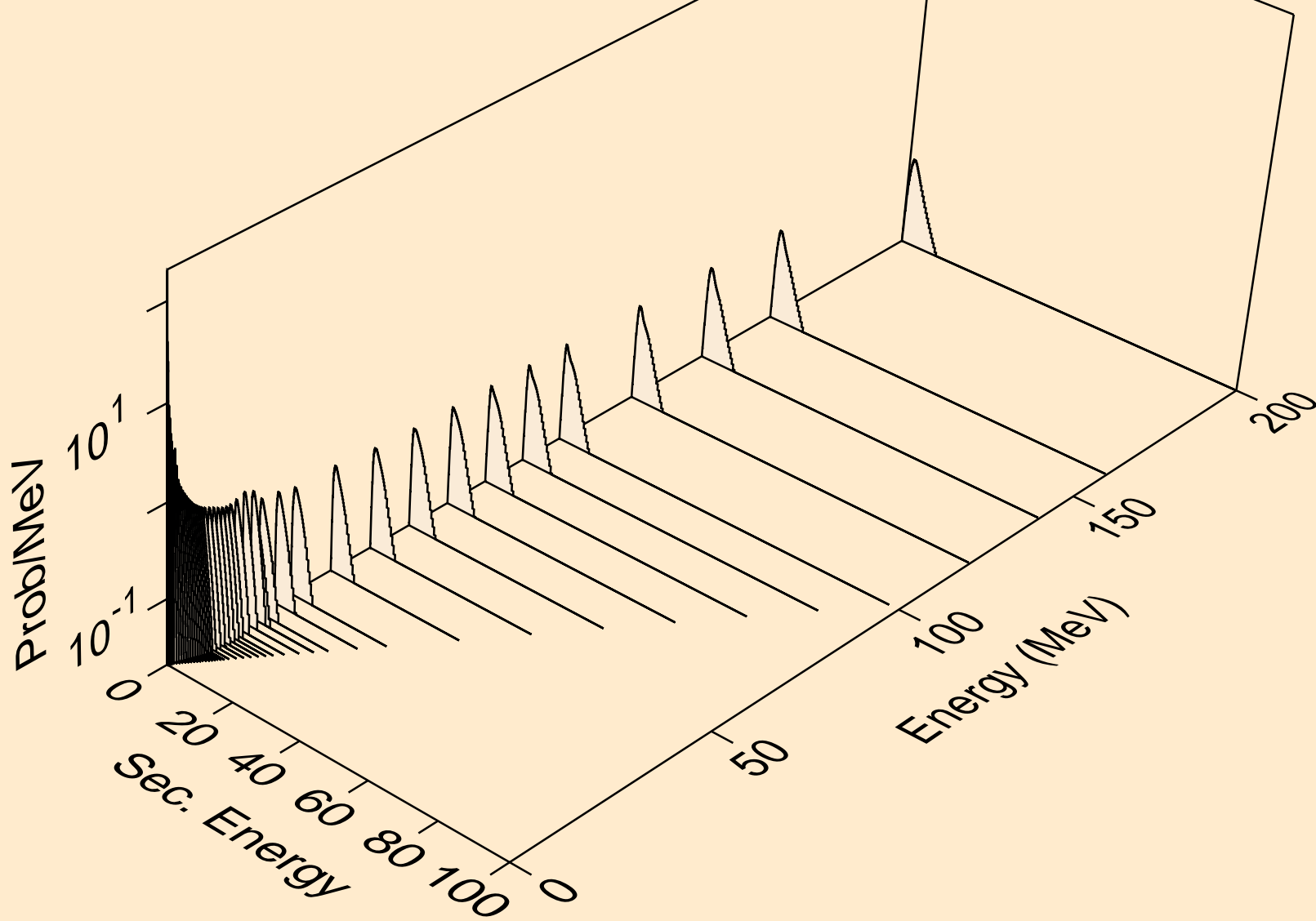

32-GE-73 FOR FENDL-3.2 FROM JEFF-3.1.1 BY NJOY2016.60+ O  
Neutron emission for (n,2n)

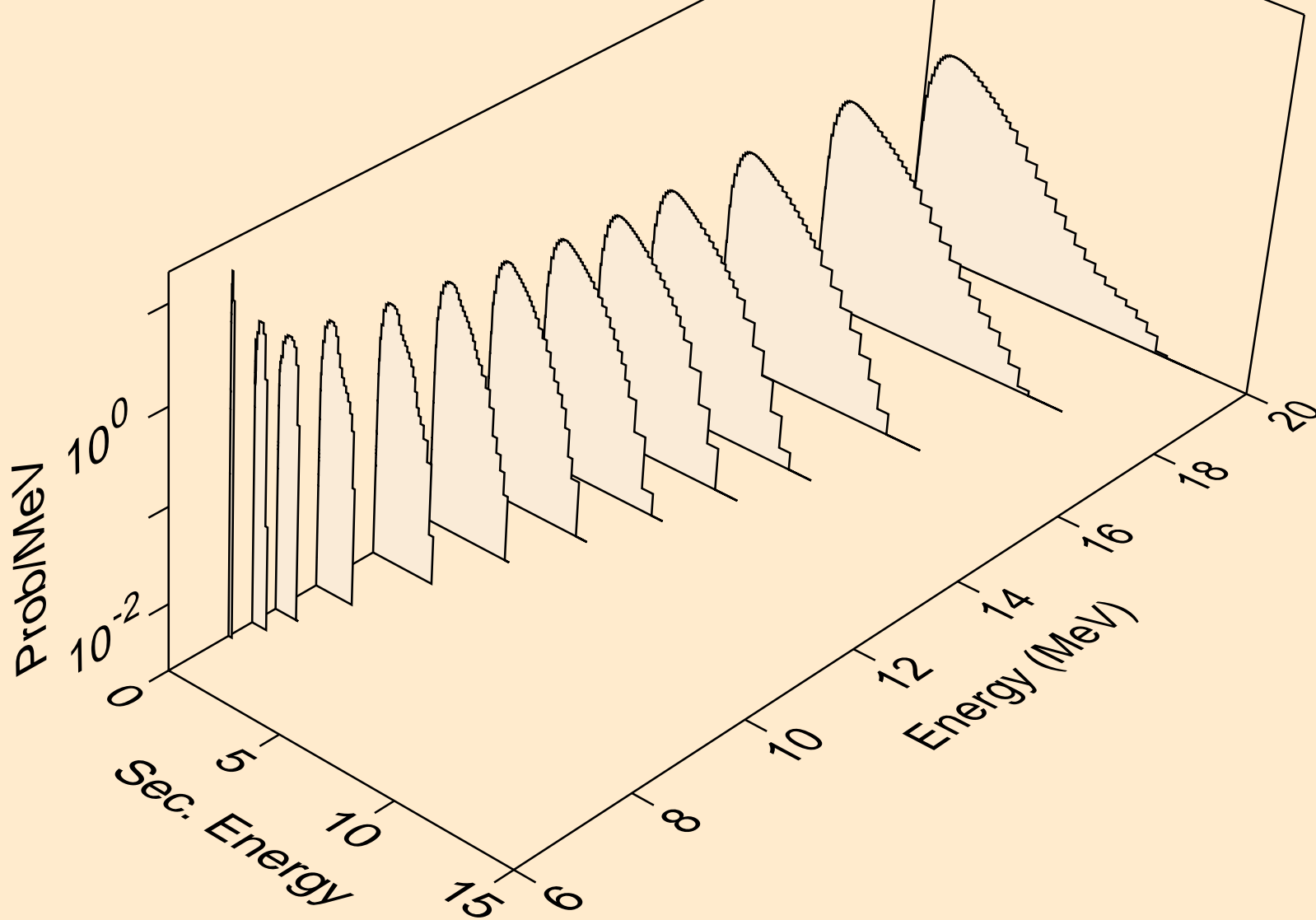

32-GE-73 FOR FENDL-3.2 FROM JEFF-3.1.1 BY NJOY2016.60+ O  
Neutron emission for (n,3n)

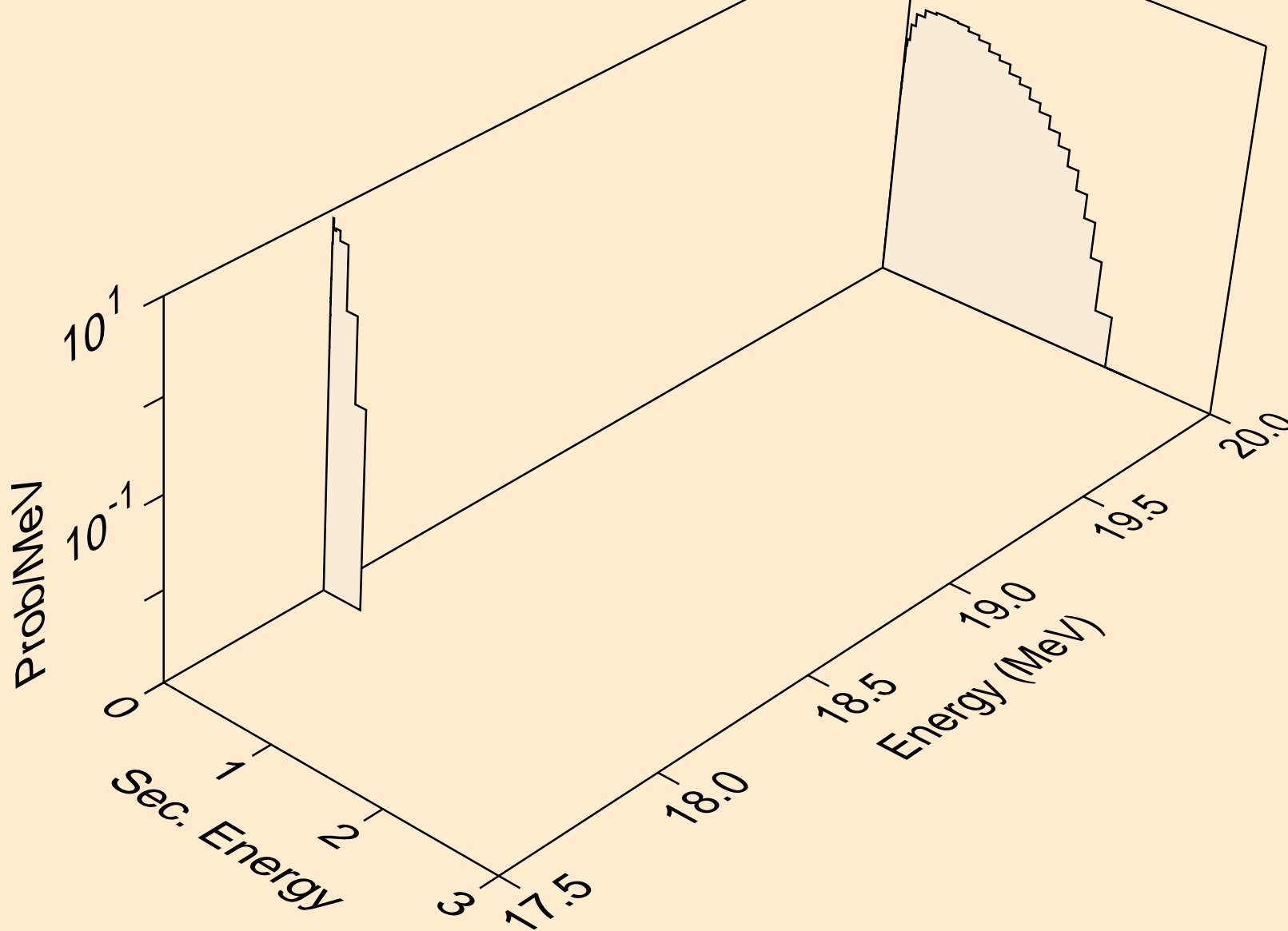

32-GE-73 FOR FENDL-3.2 FROM JEFF-3.1.1 BY NJOY2016.60+ O  
Neutron emission for (n,n\*)a

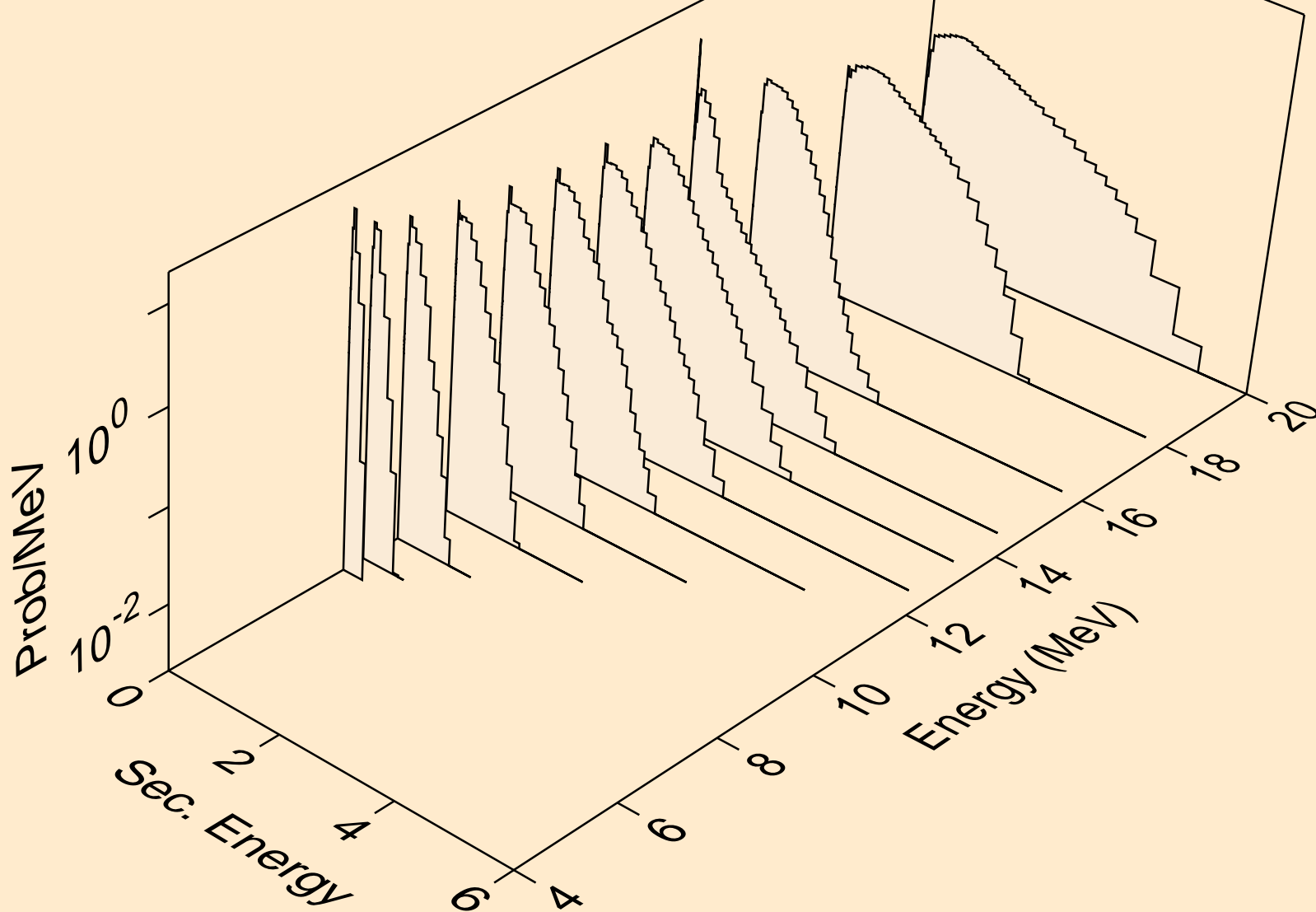

32-GE-73 FOR FENDL-3.2 FROM JEFF-3.1.1 BY NJOY2016.60+ O  
Neutron emission for (n,2n)a

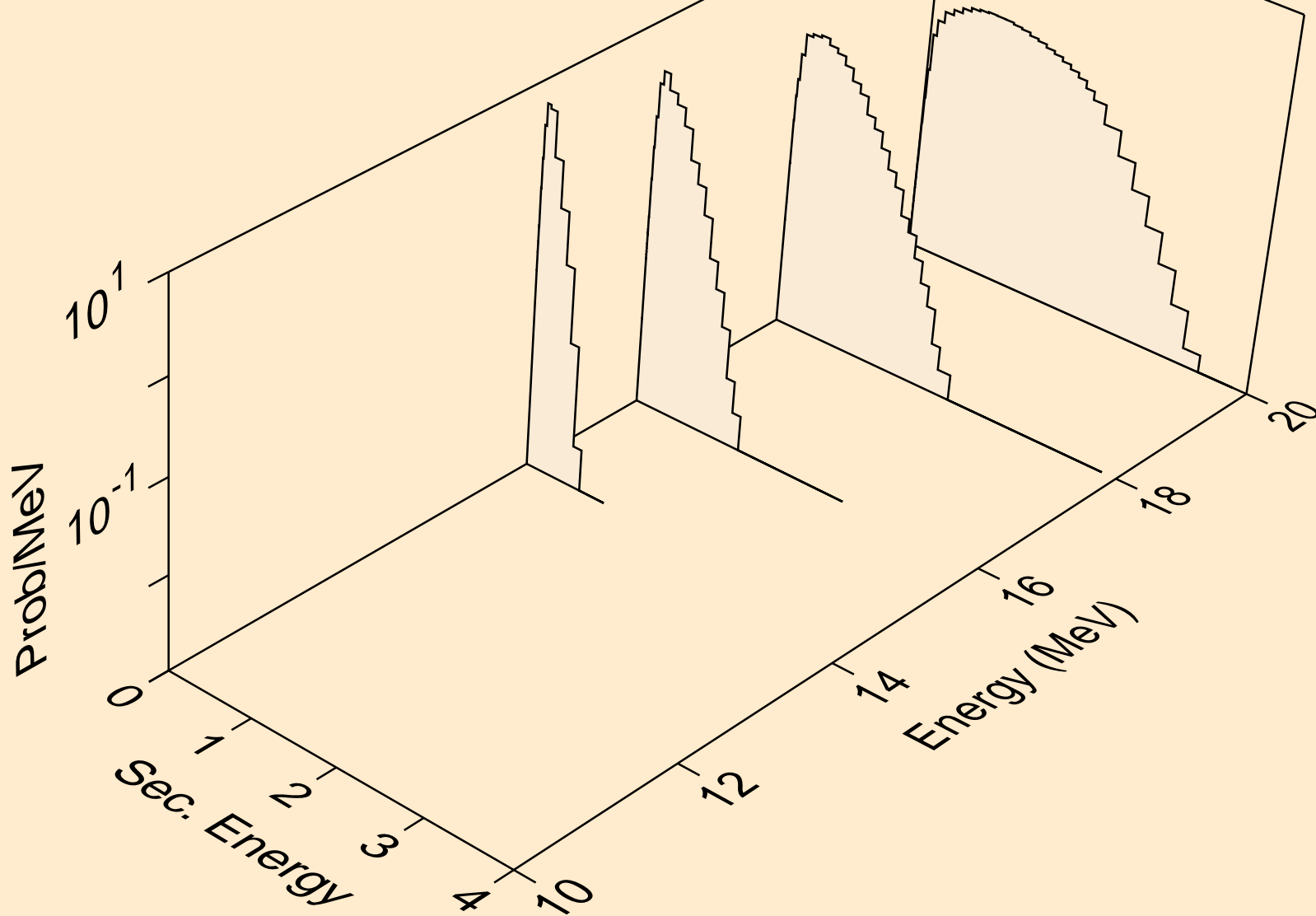

32-GE-73 FOR FENDL-3.2 FROM JEFF-3.1.1 BY NJOY2016.60+ O  
Neutron emission for (n,n\*)p

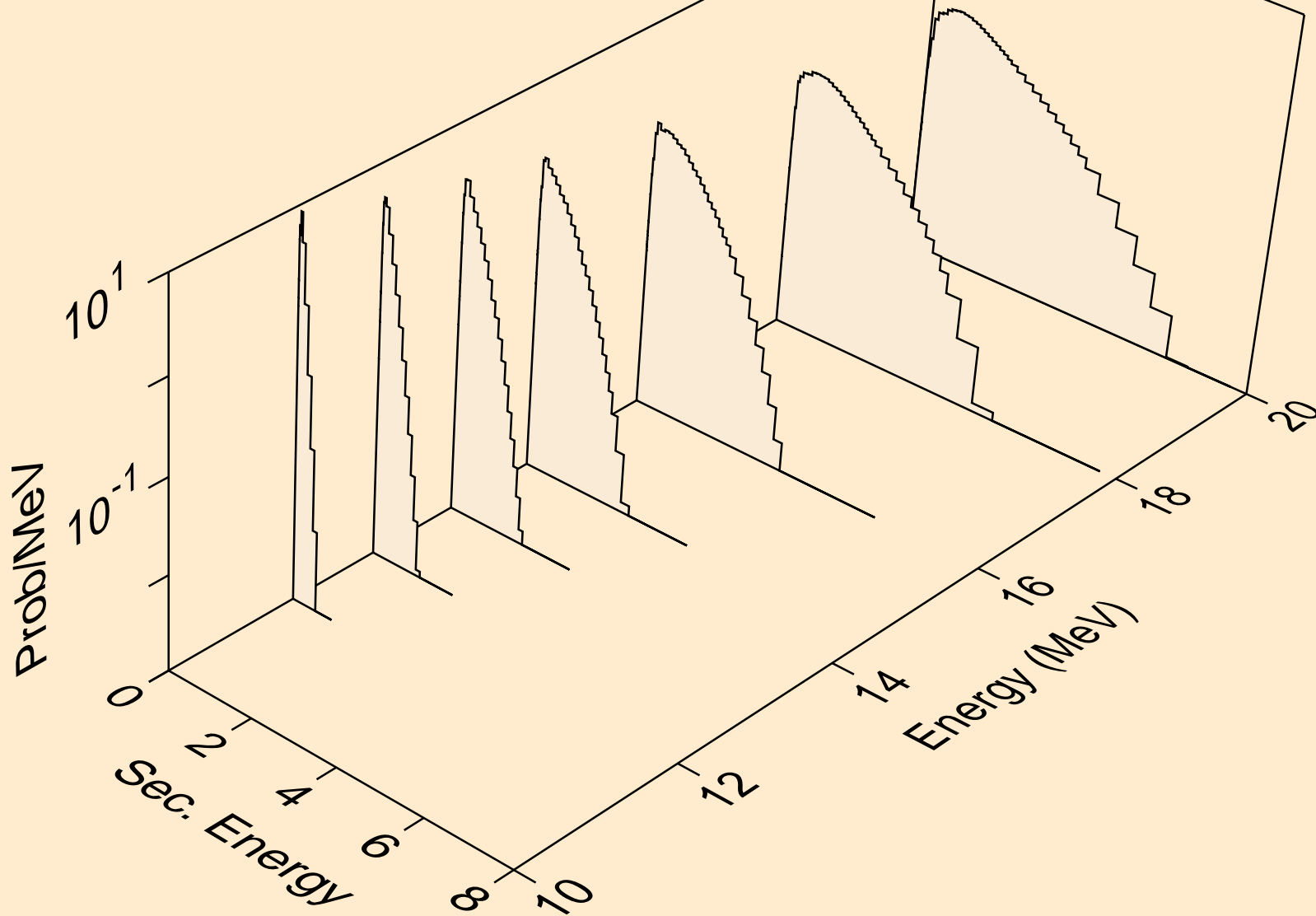

32-GE-73 FOR FENDL-3.2 FROM JEFF-3.1.1 BY NJOY2016.60+ O  
Neutron emission for (n,n\*)d

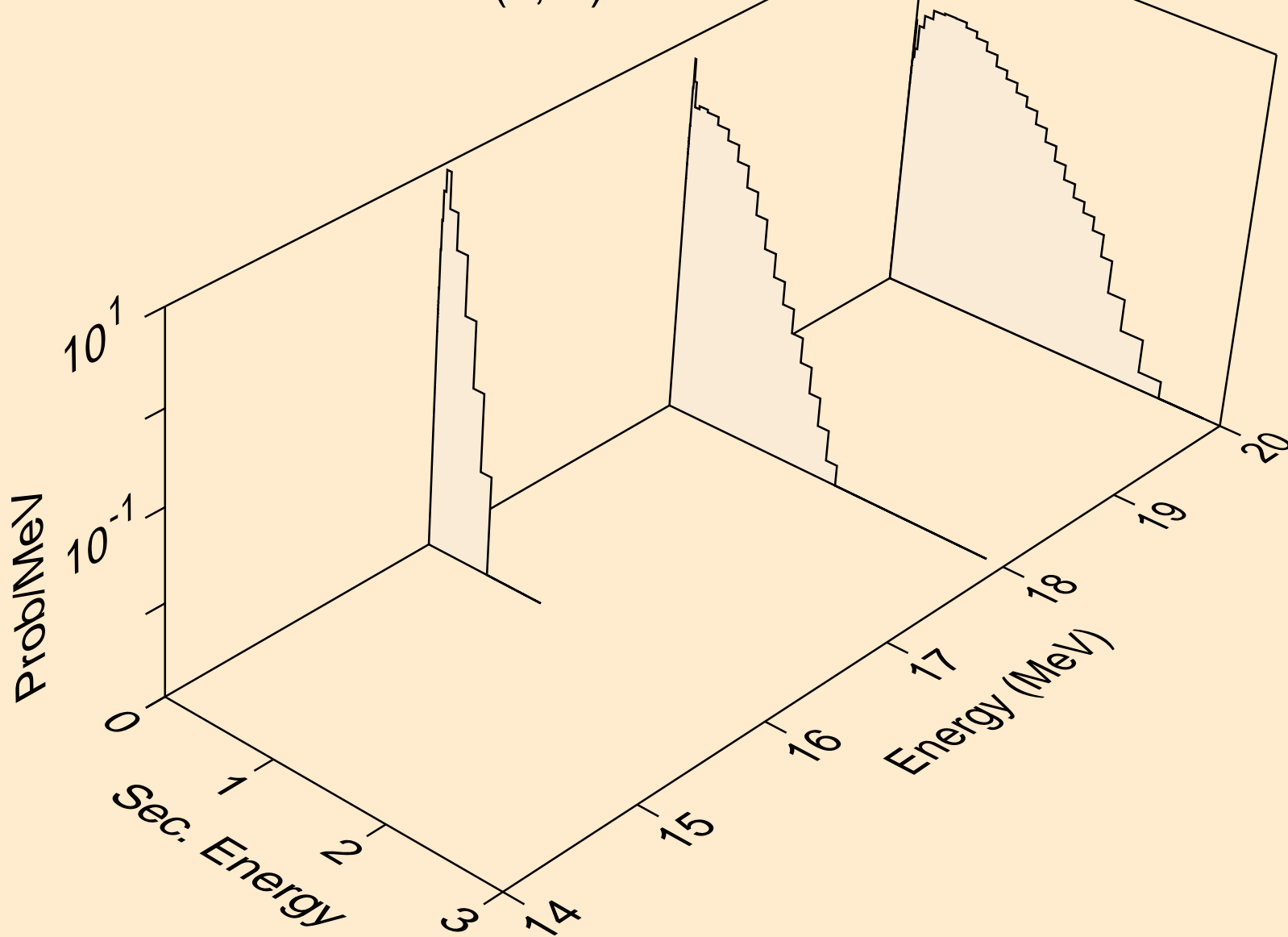



32-GE-73 FOR FENDL-3.2 FROM JEFF-3.1.1 BY NJOY2016.60+ O  
Neutron emission for (n,n\*)t

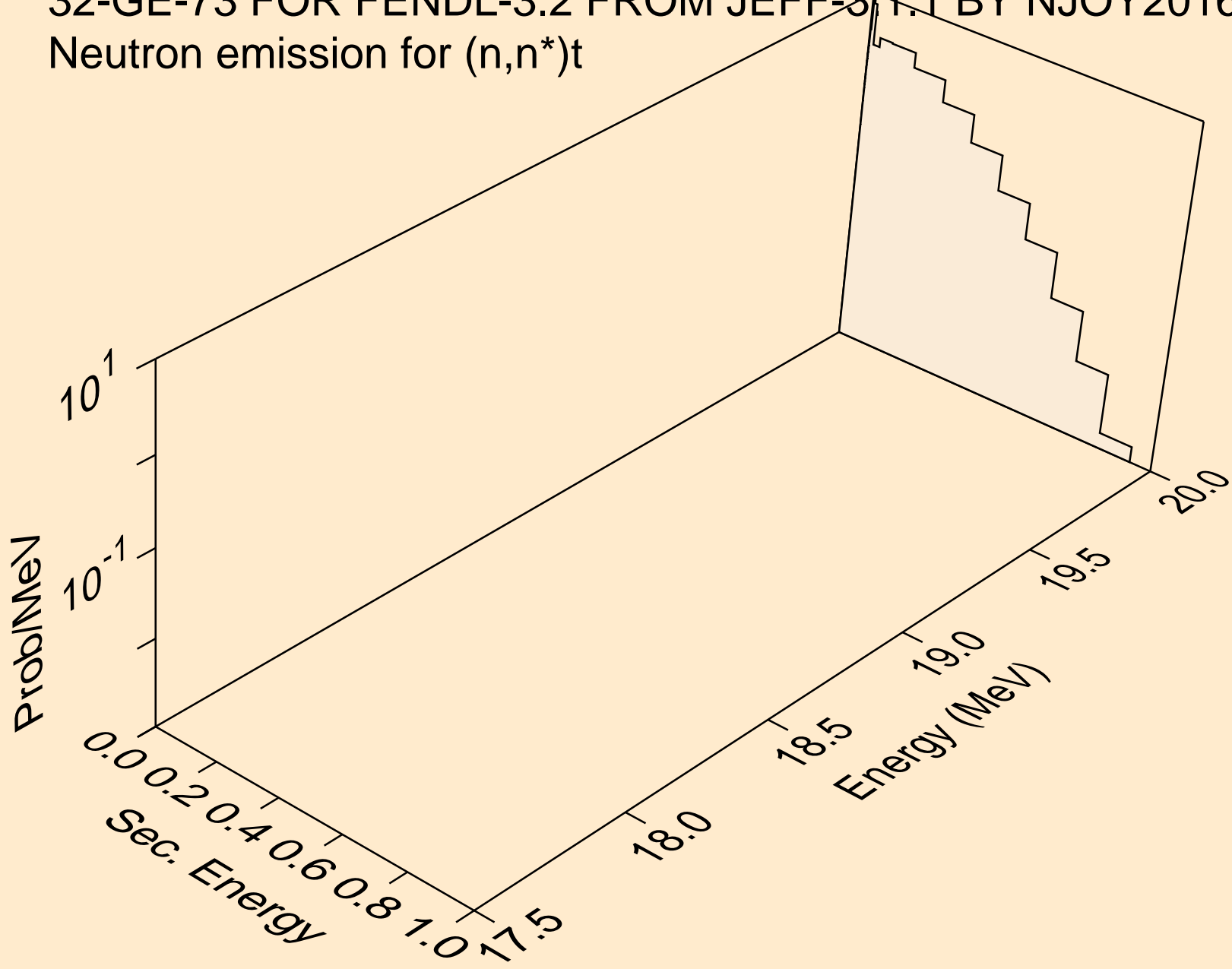

32-GE-73 FOR FENDL-3.2 FROM JEFF-3.1.1 BY NJOY2016.60+ O  
Neutron emission for (n,2np)

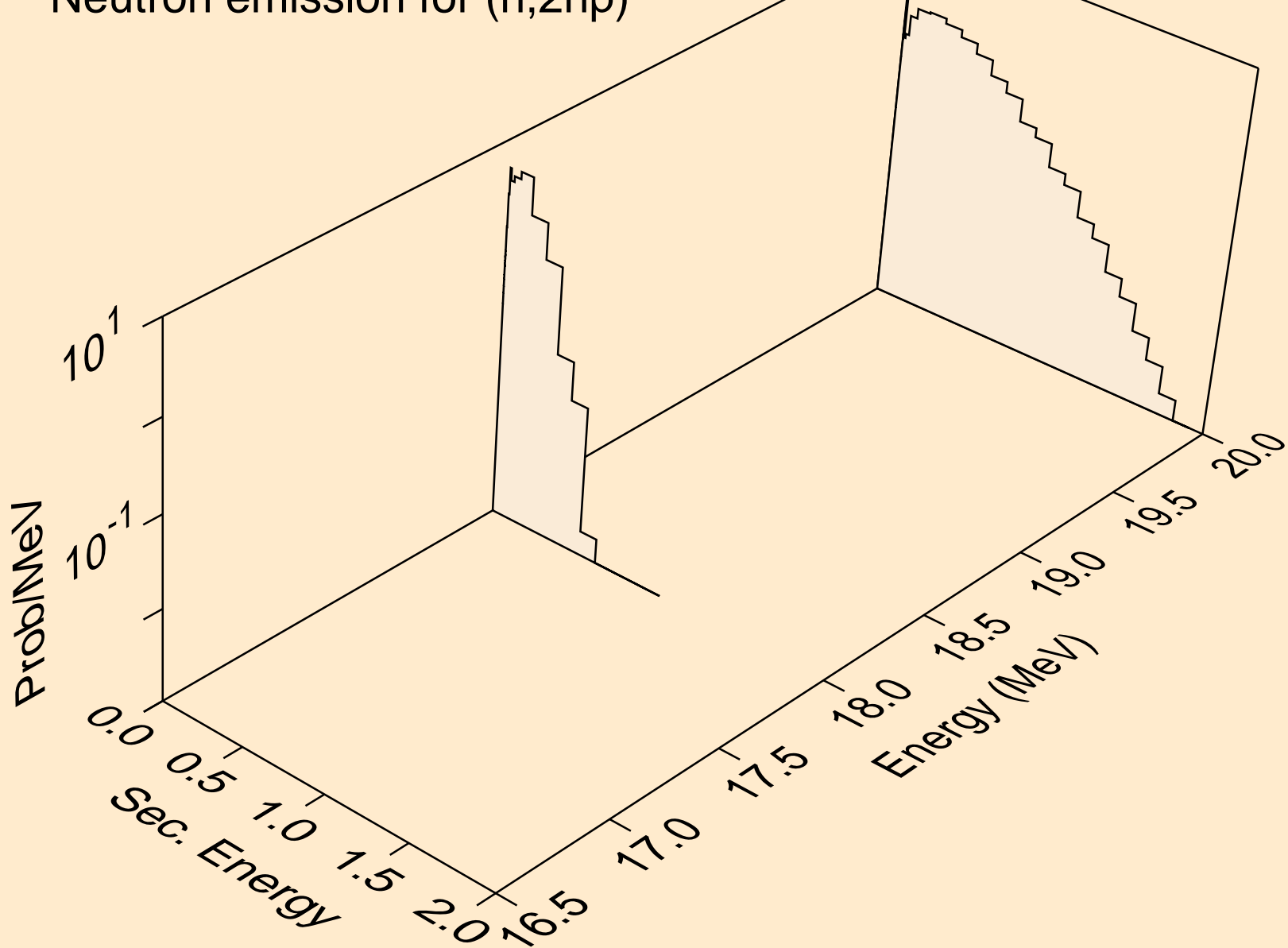

32-GE-73 FOR FENDL-3.2 FROM JEFF-3.1.1 BY NJOY2016.60+ O  
Neutron emission for (n,n\*c)

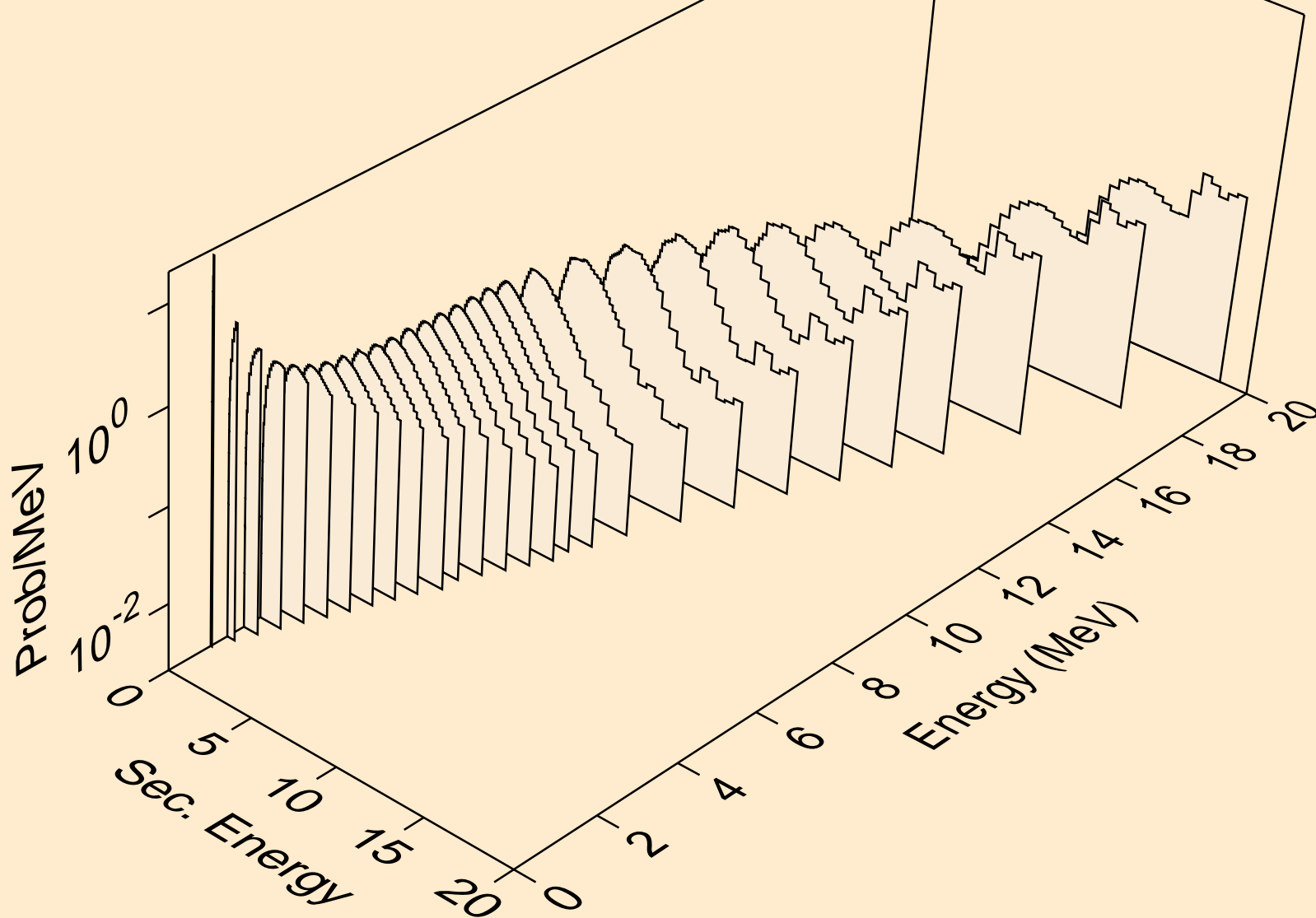

32-GE-73 FOR FENDL-3.2 FROM JEFF-3.1.1 BY NJOY2016.60+ O  
Photon emission for (n,x)

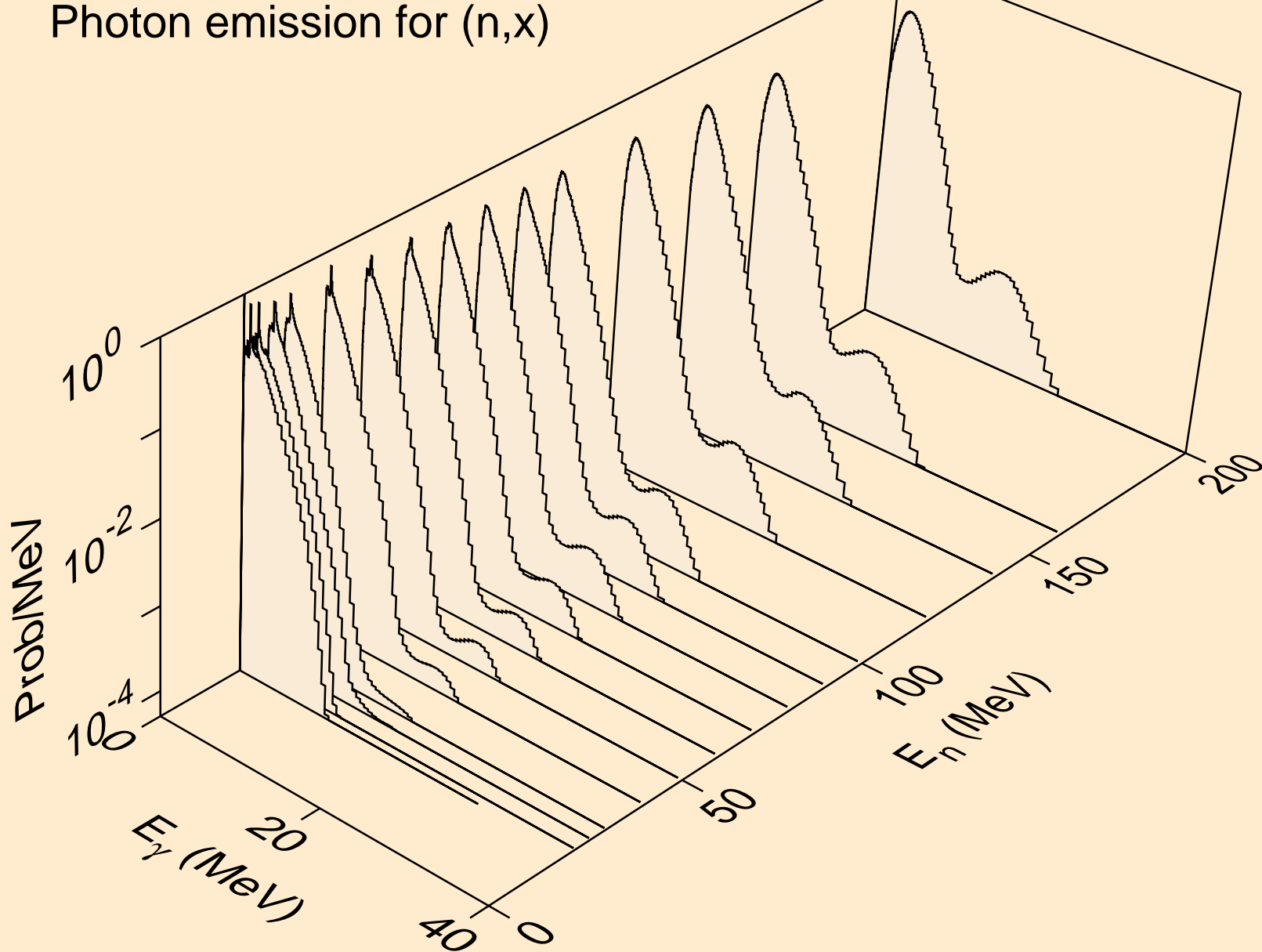

32-GE-73 FOR FENDL-3.2 FROM JEFF-3.1.1 BY NJOY2016.60+ O  
Photon emission for (n,2n)

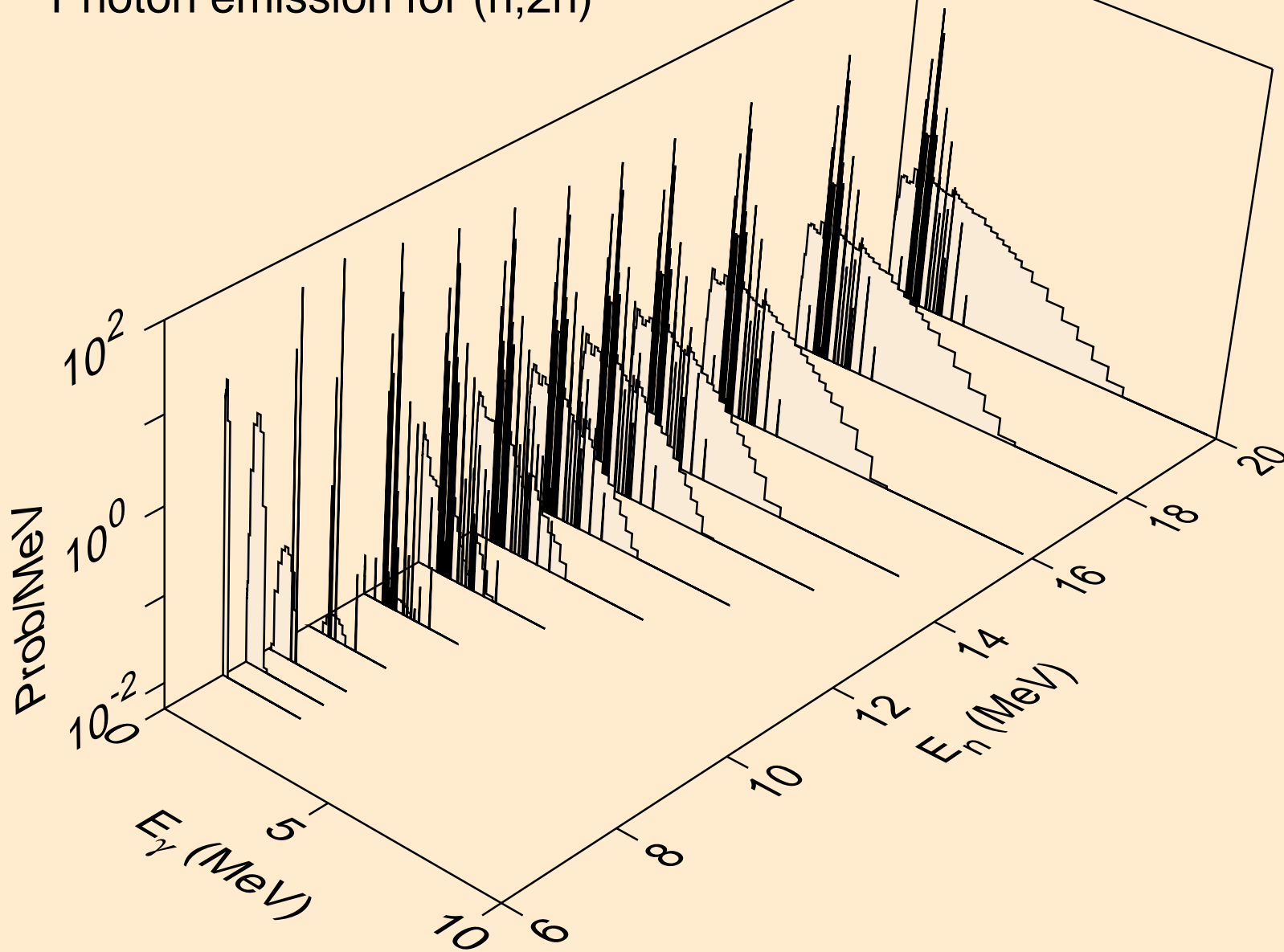

32-GE-73 FOR FENDL-3.2 FROM JEFF-3.1.1 BY NJOY2016.60+ O  
Photon emission for (n,3n)

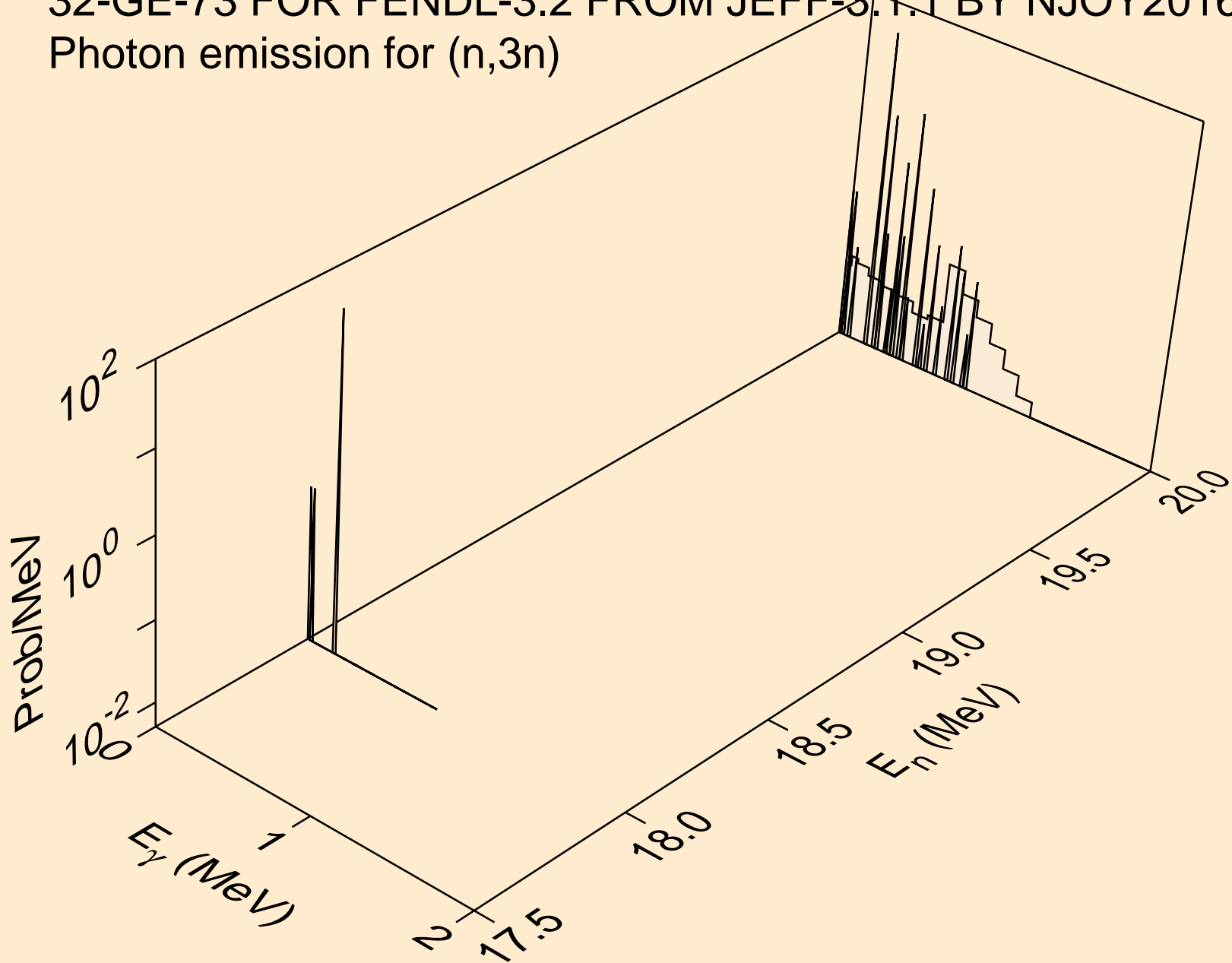

32-GE-73 FOR FENDL-3.2 FROM JEFF-3.1.1 BY NJOY2016.60+ O  
Photon emission for (n,n\*)a

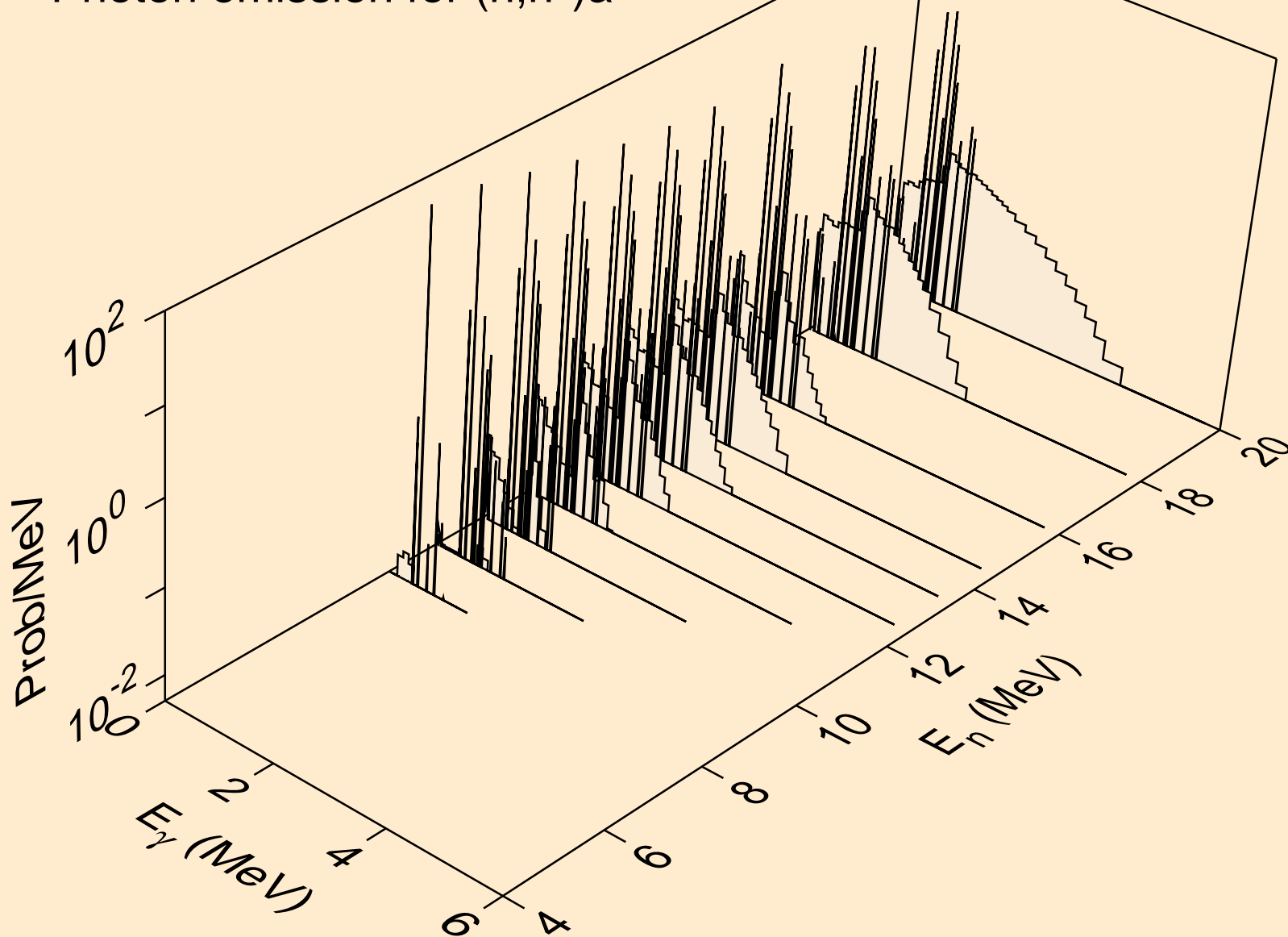

32-GE-73 FOR FENDL-3.2 FROM JEFF-3.1.1 BY NJOY2016.60+ O  
Photon emission for (n,2n)a

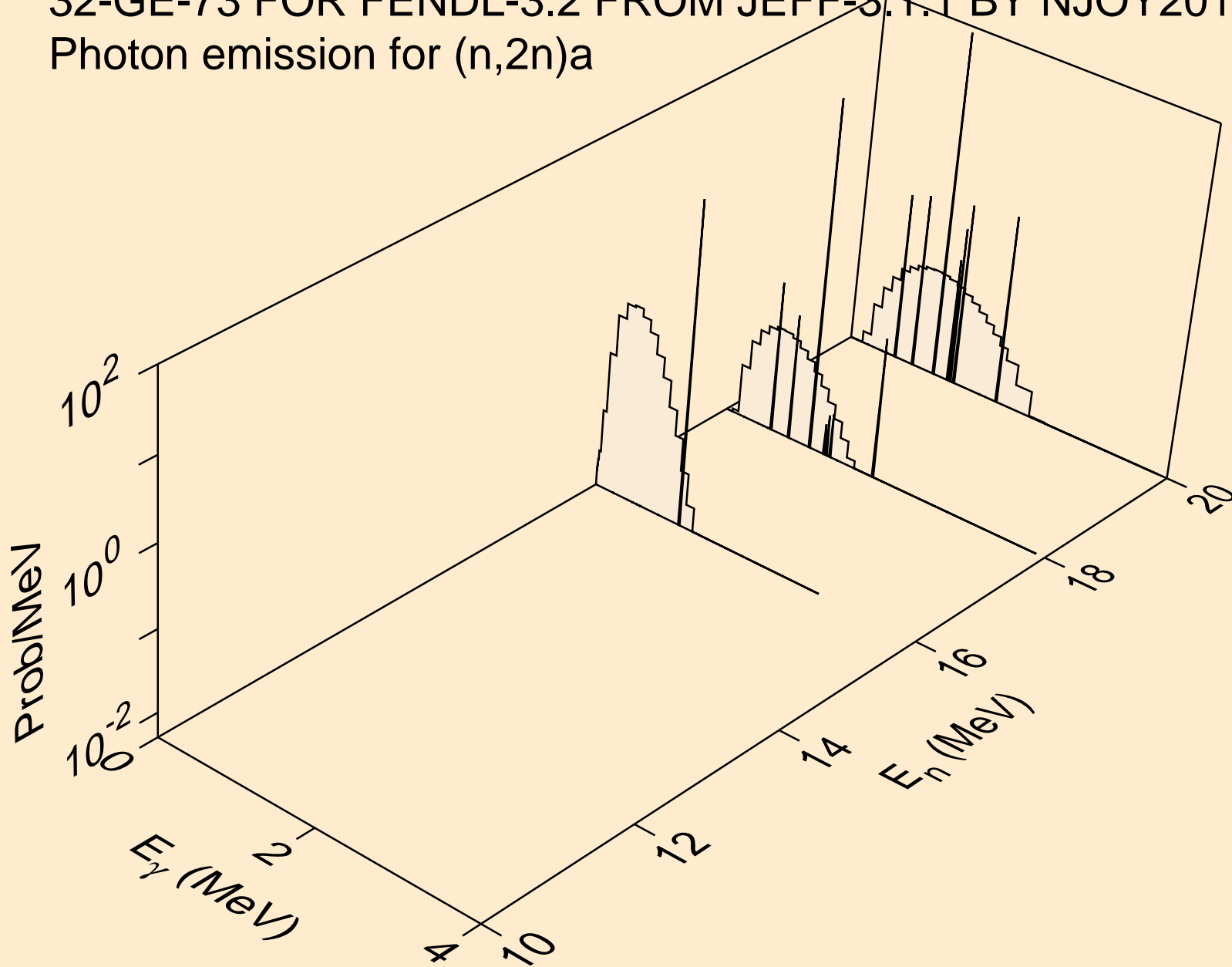



32-GE-73 FOR FENDL-3.2 FROM JEFF-3.1.1 BY NJOY2016.60+ O  
Photon emission for (n,n\*)p

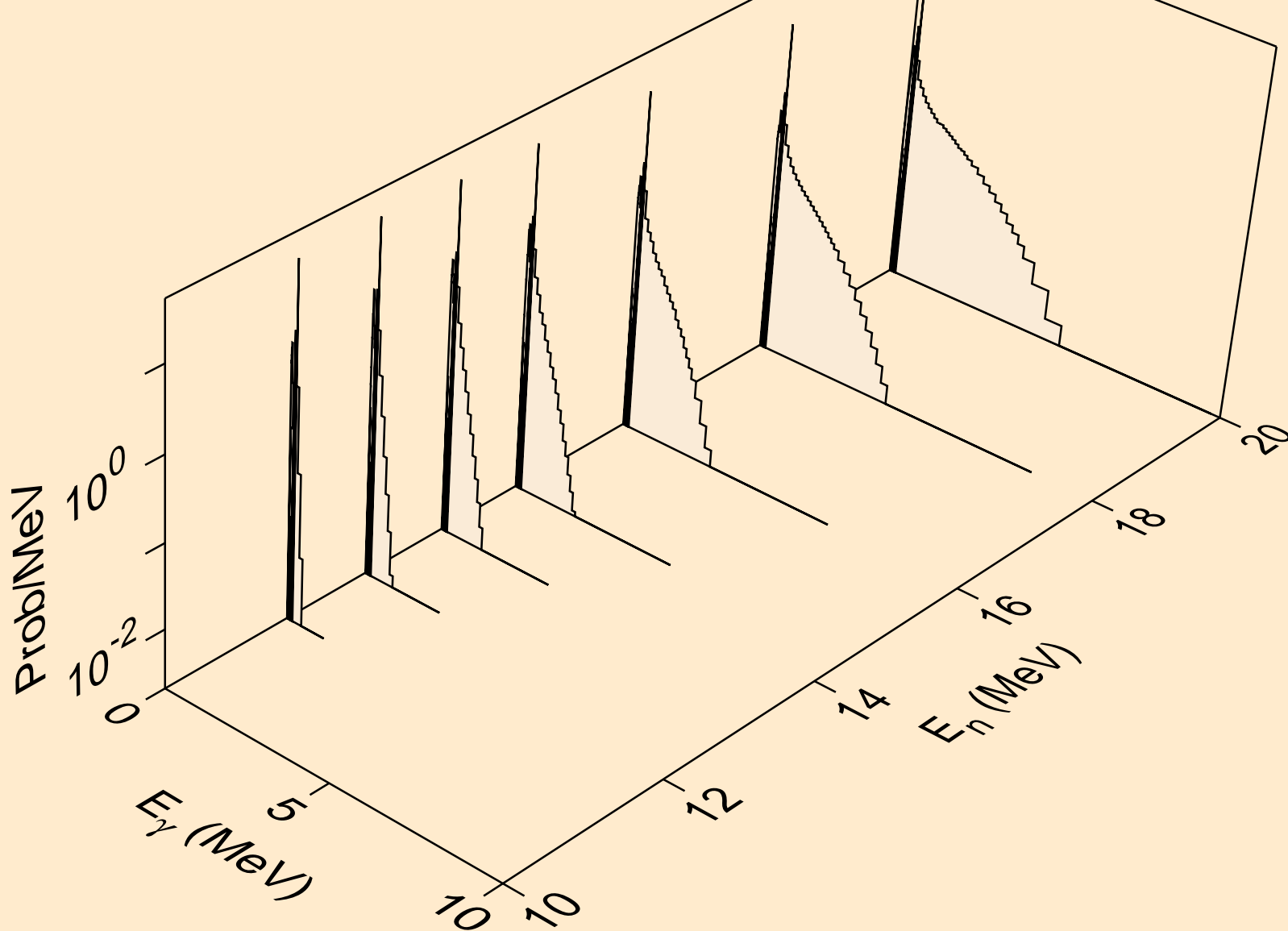

32-GE-73 FOR FENDL-3.2 FROM JEFF-3.1.1 BY NJOY2016.60+ O  
Photon emission for (n,n\*)d

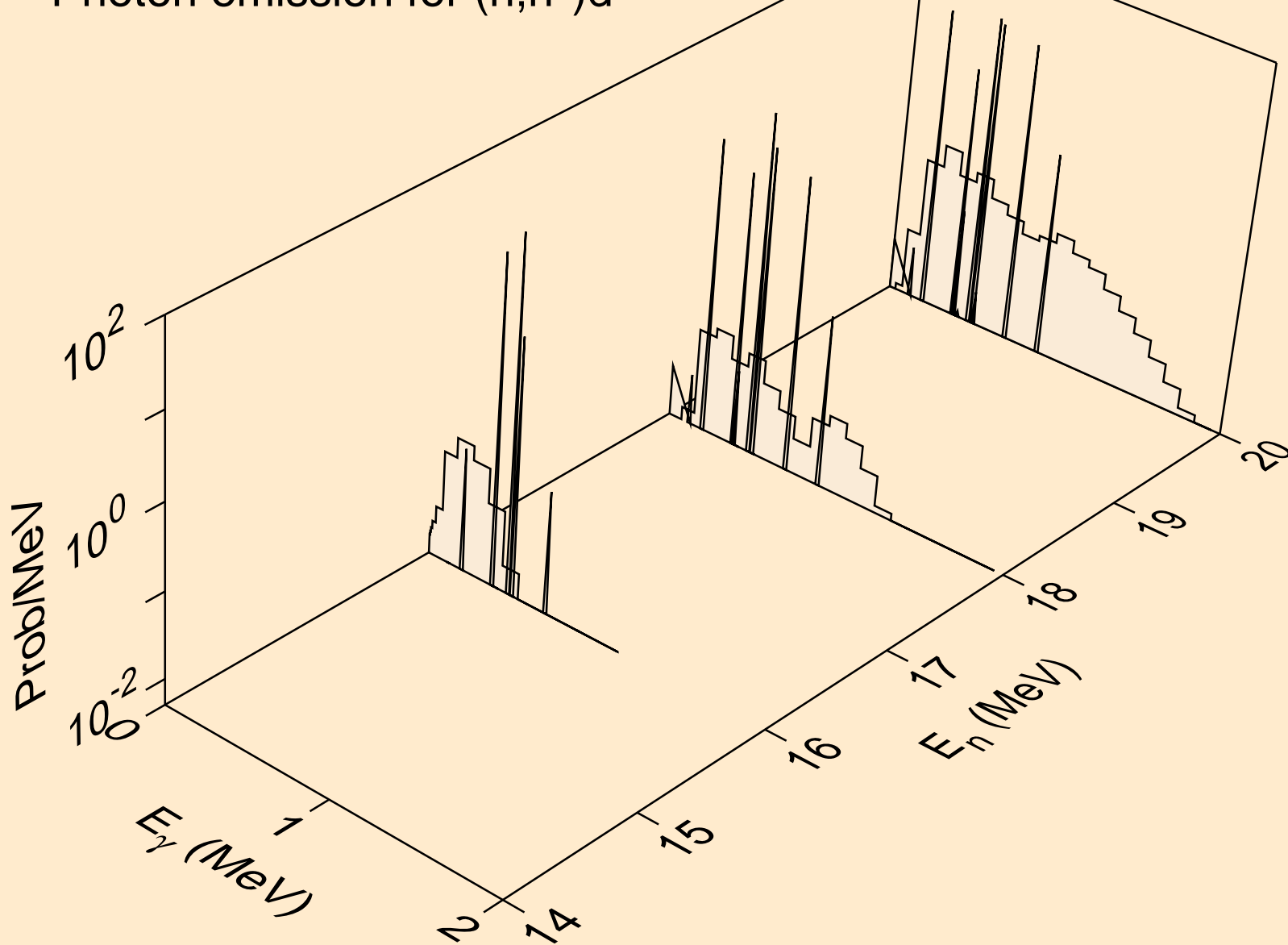

32-GE-73 FOR FENDL-3.2 FROM JEFF-3.1.1 BY NJOY2016.60+ O  
Photon emission for (n,n\*)t

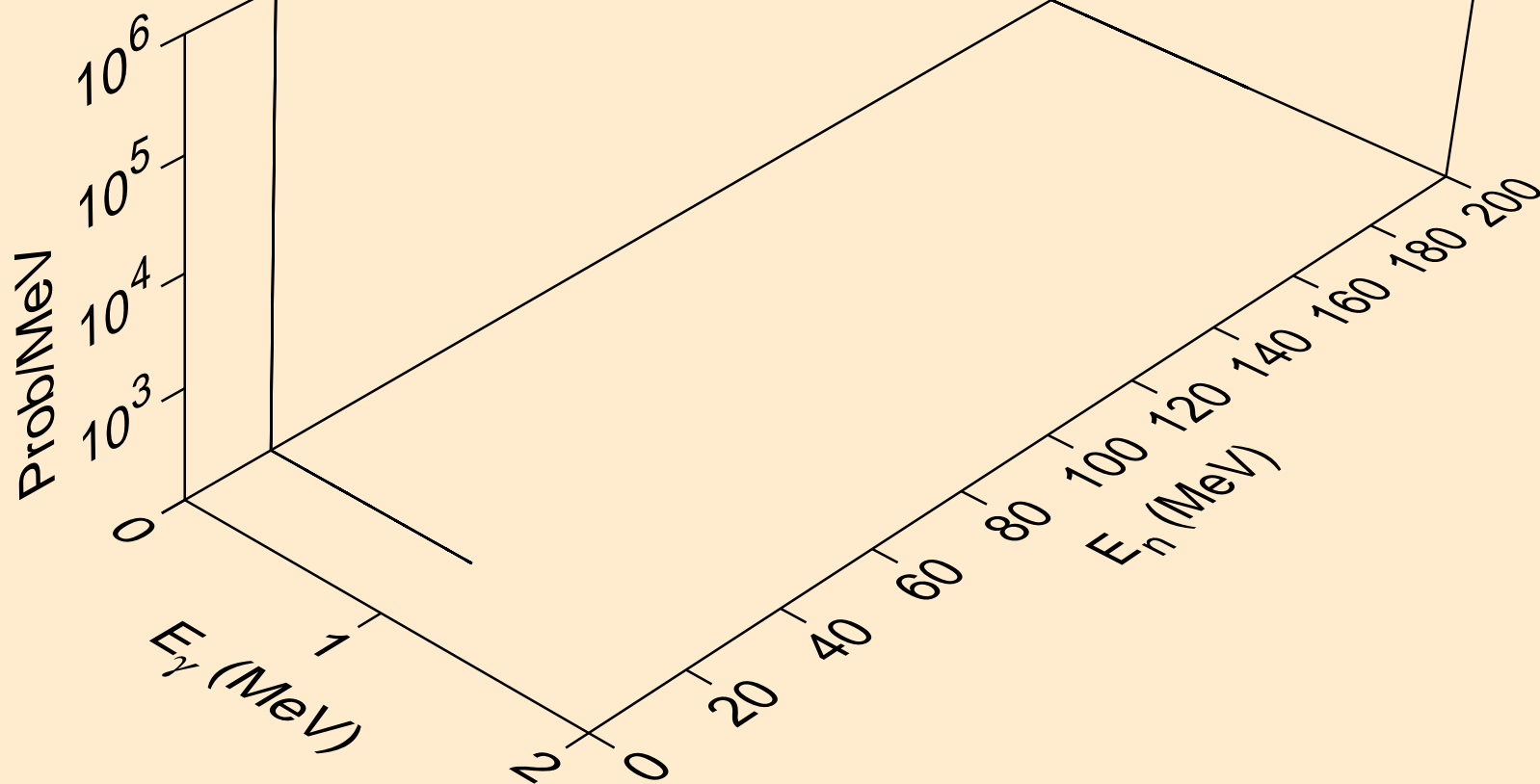

32-GE-73 FOR FENDL-3.2 FROM JEFF-3.1.1 BY NJOY2016.60+ O  
Photon emission for (n,2np)

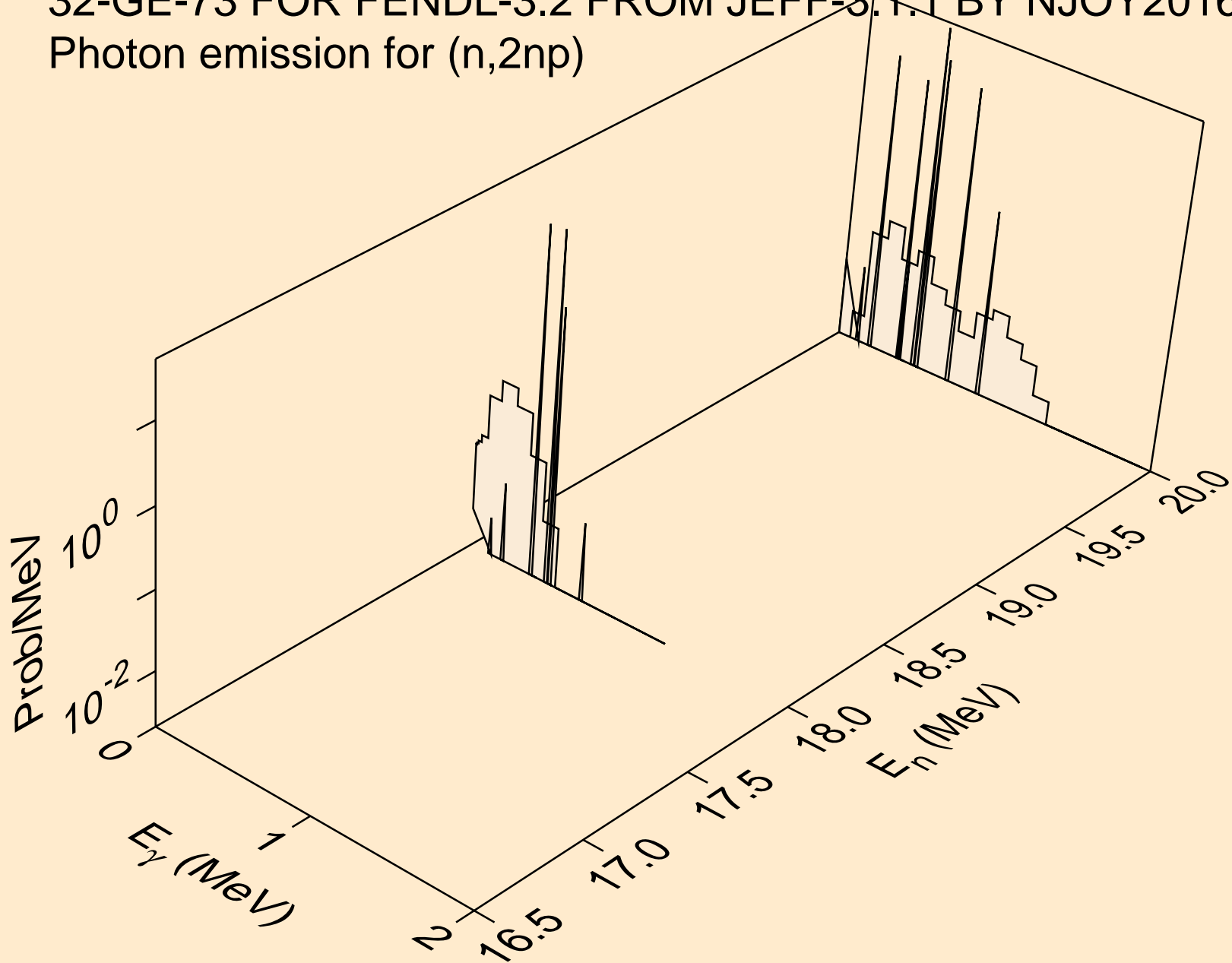

32-GE-73 FOR FENDL-3.2 FROM JEFF-3.1.1 BY NJOY2016.60+ O  
Photon emission for (n,n\*1)

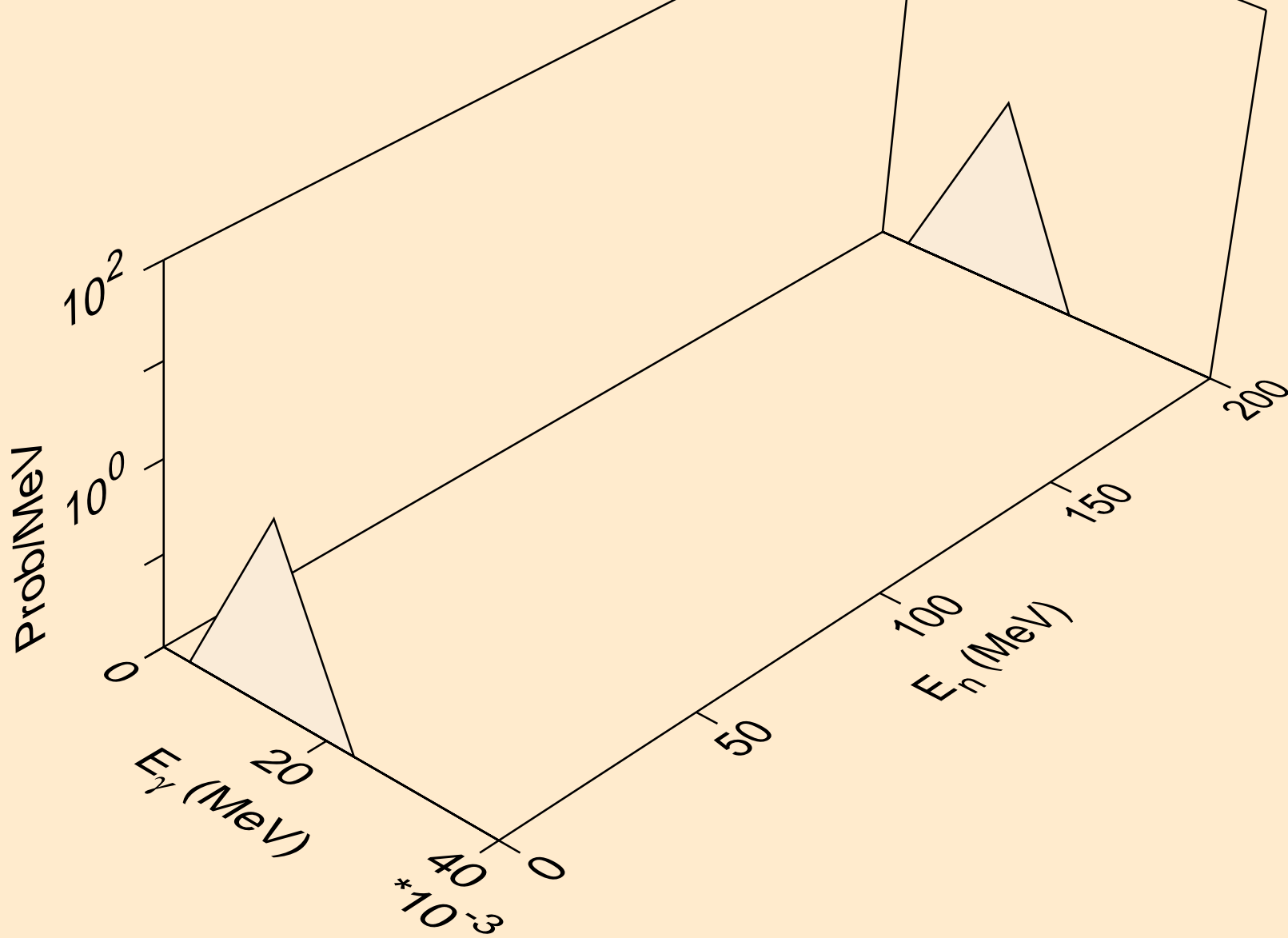

32-GE-73 FOR FENDL-3.2 FROM JEFF-3.1.1 BY NJOY2016.60+ O  
Photon emission for (n,n\*2)

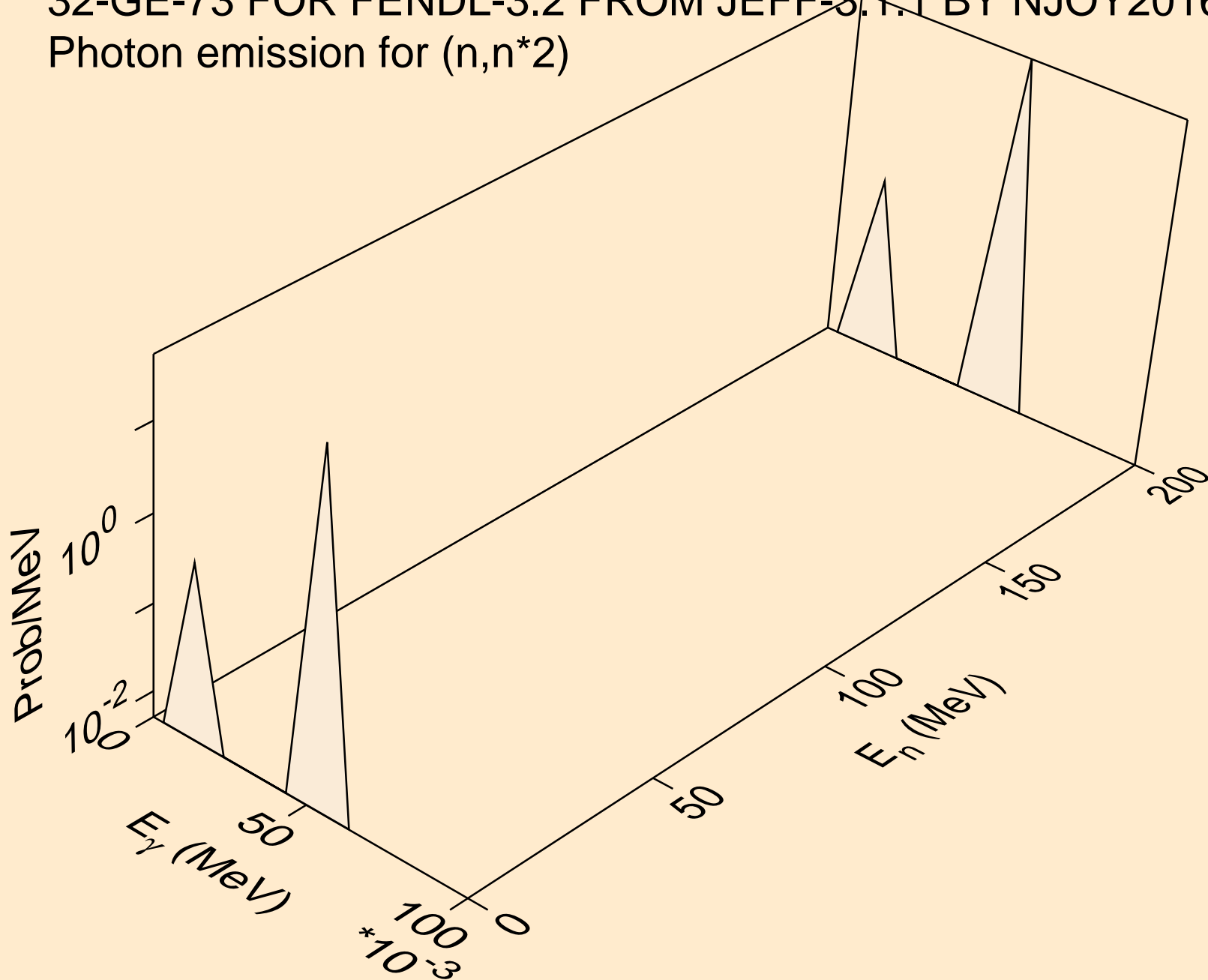

32-GE-73 FOR FENDL-3.2 FROM JEFF-3.1.1 BY NJOY2016.60+ O  
Photon emission for (n,n\*3)

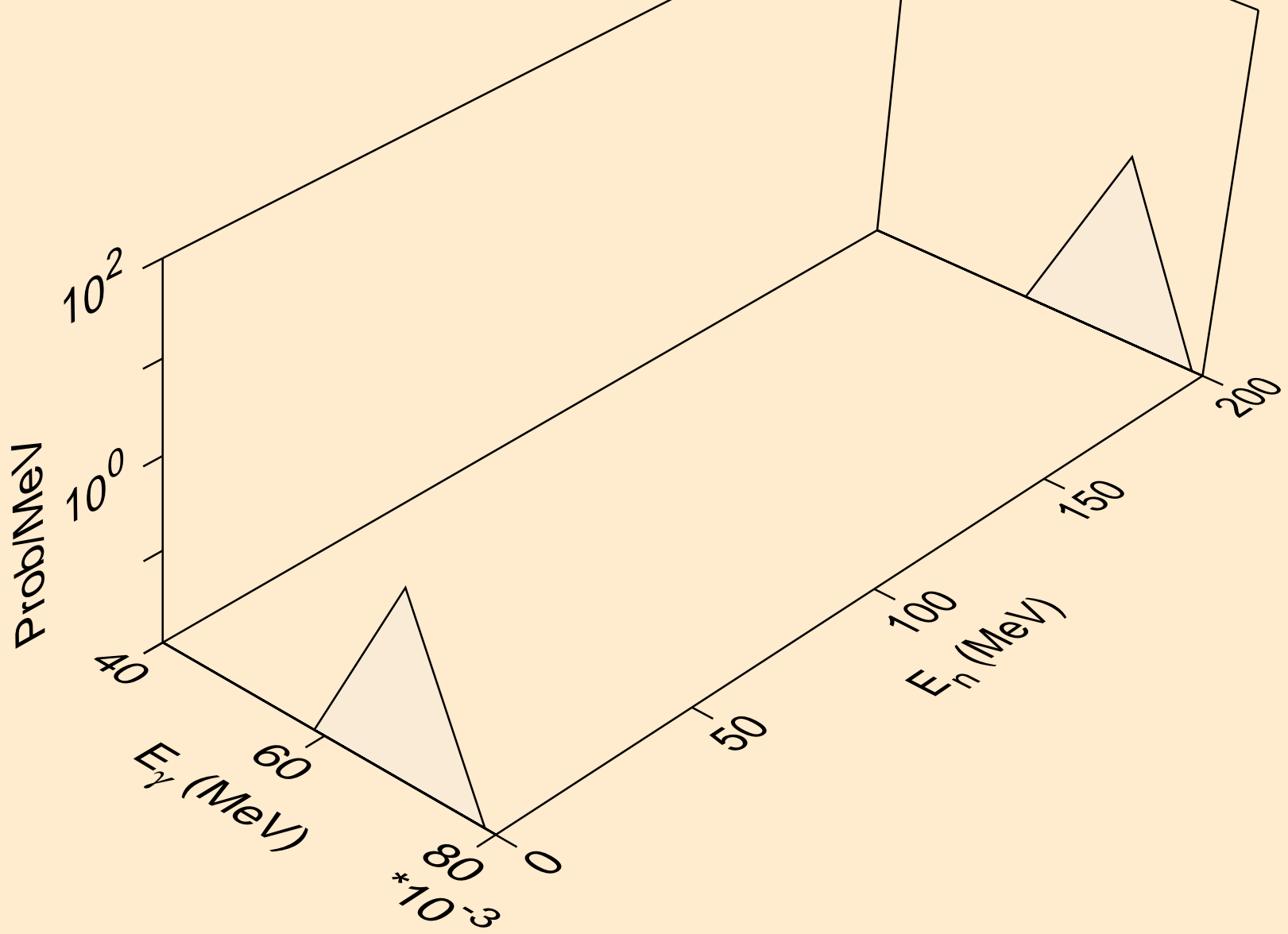

32-GE-73 FOR FENDL-3.2 FROM JEFF-3.1.1 BY NJOY2016.60+ O  
Photon emission for (n,n\*4)

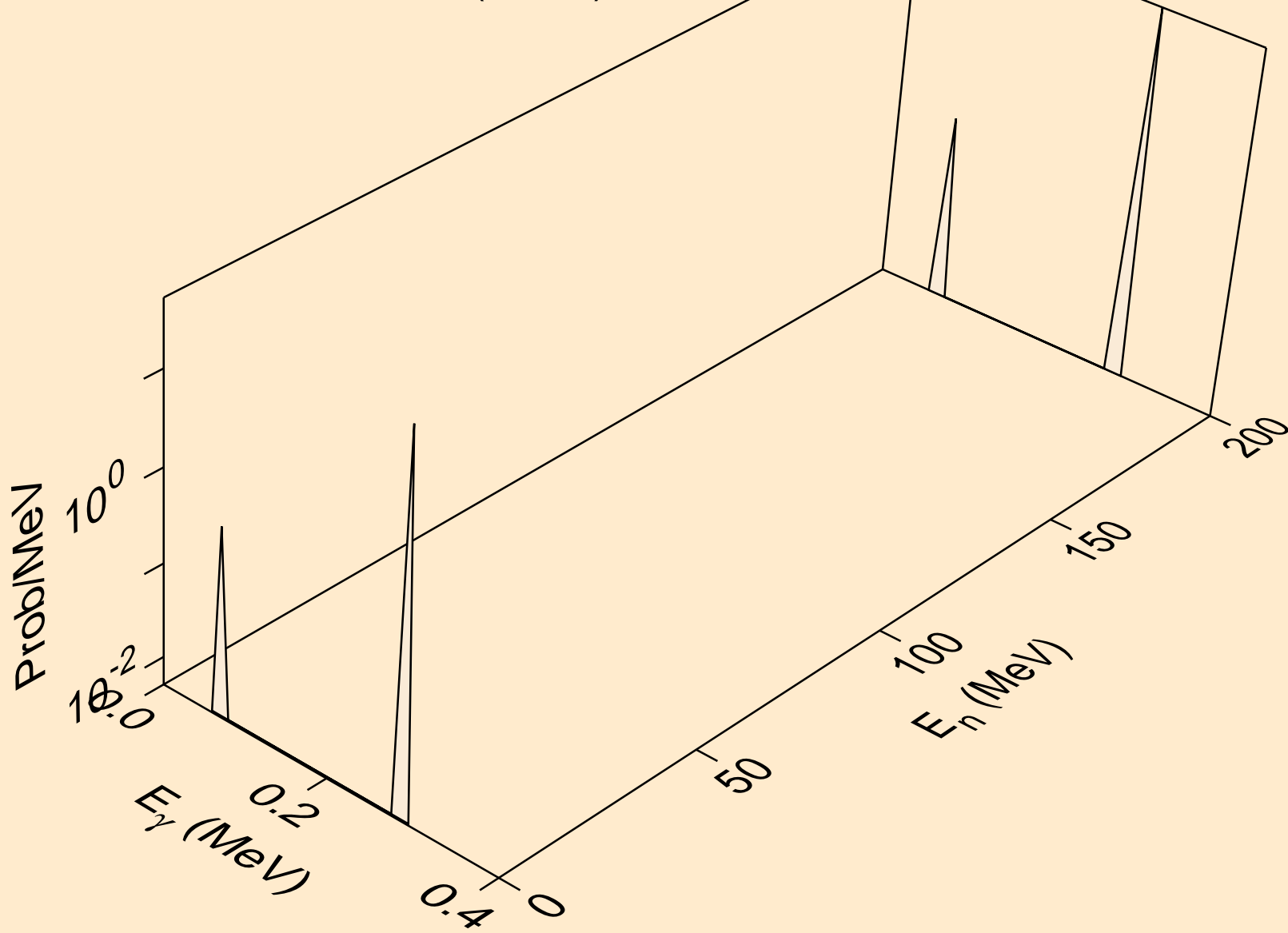



32-GE-73 FOR FENDL-3.2 FROM JEFF-3.1.1 BY NJOY2016.60+ O  
Photon emission for (n,n\*5)

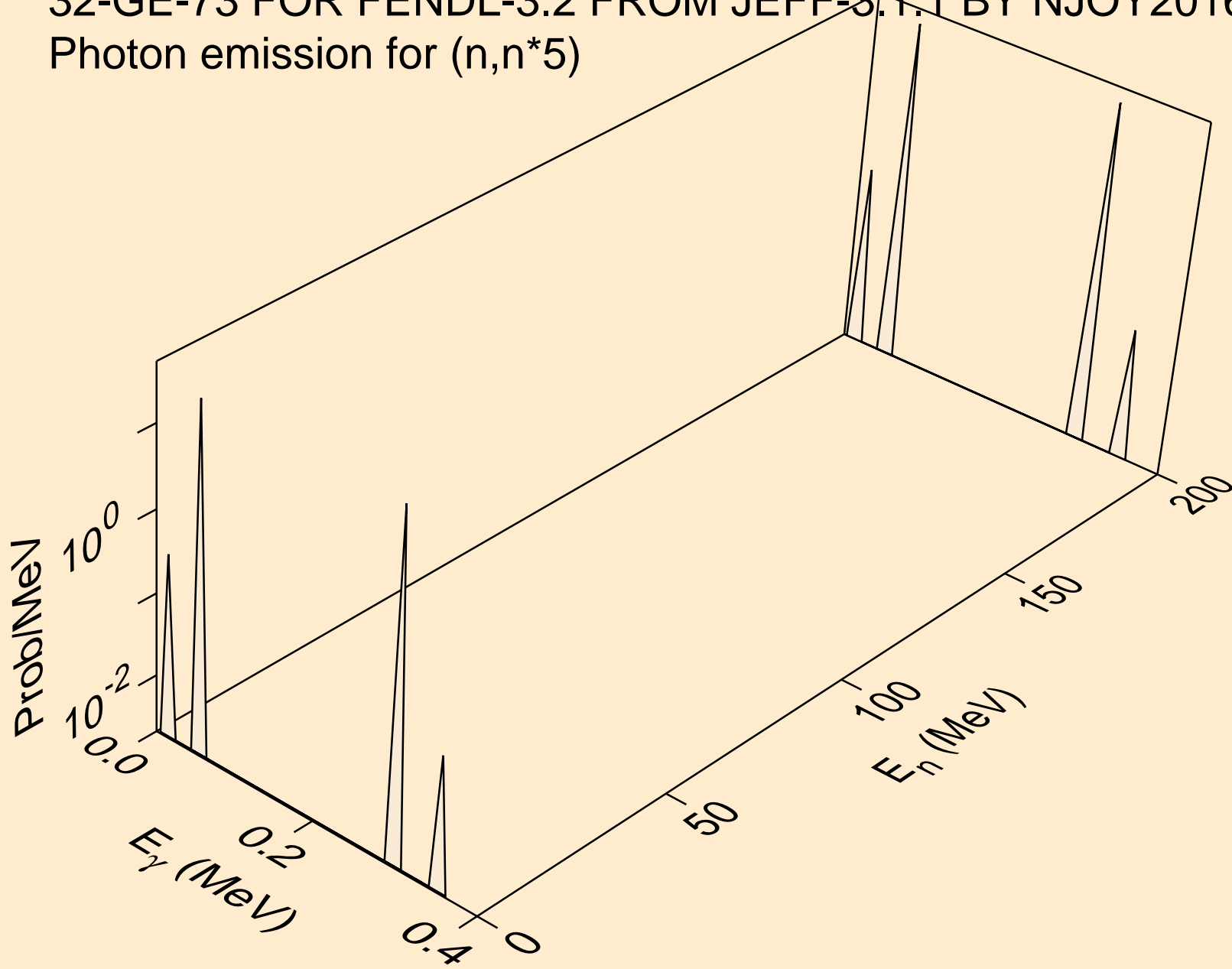

32-GE-73 FOR FENDL-3.2 FROM JEFF-3.1.1 BY NJOY2016.60+ O  
Photon emission for (n,n\*6)

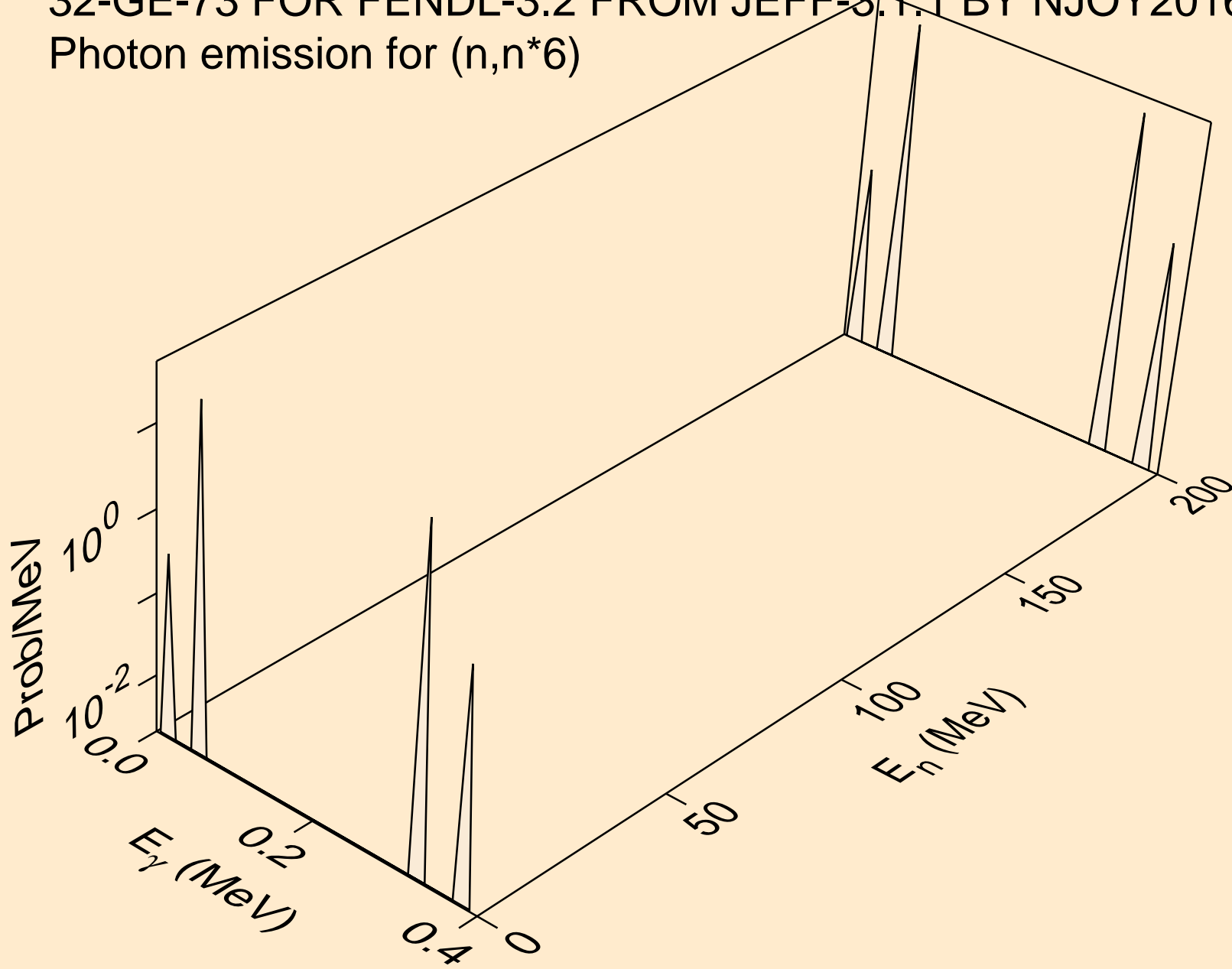

32-GE-73 FOR FENDL-3.2 FROM JEFF-3.1.1 BY NJOY2016.60+ O  
Photon emission for (n,n\*7)

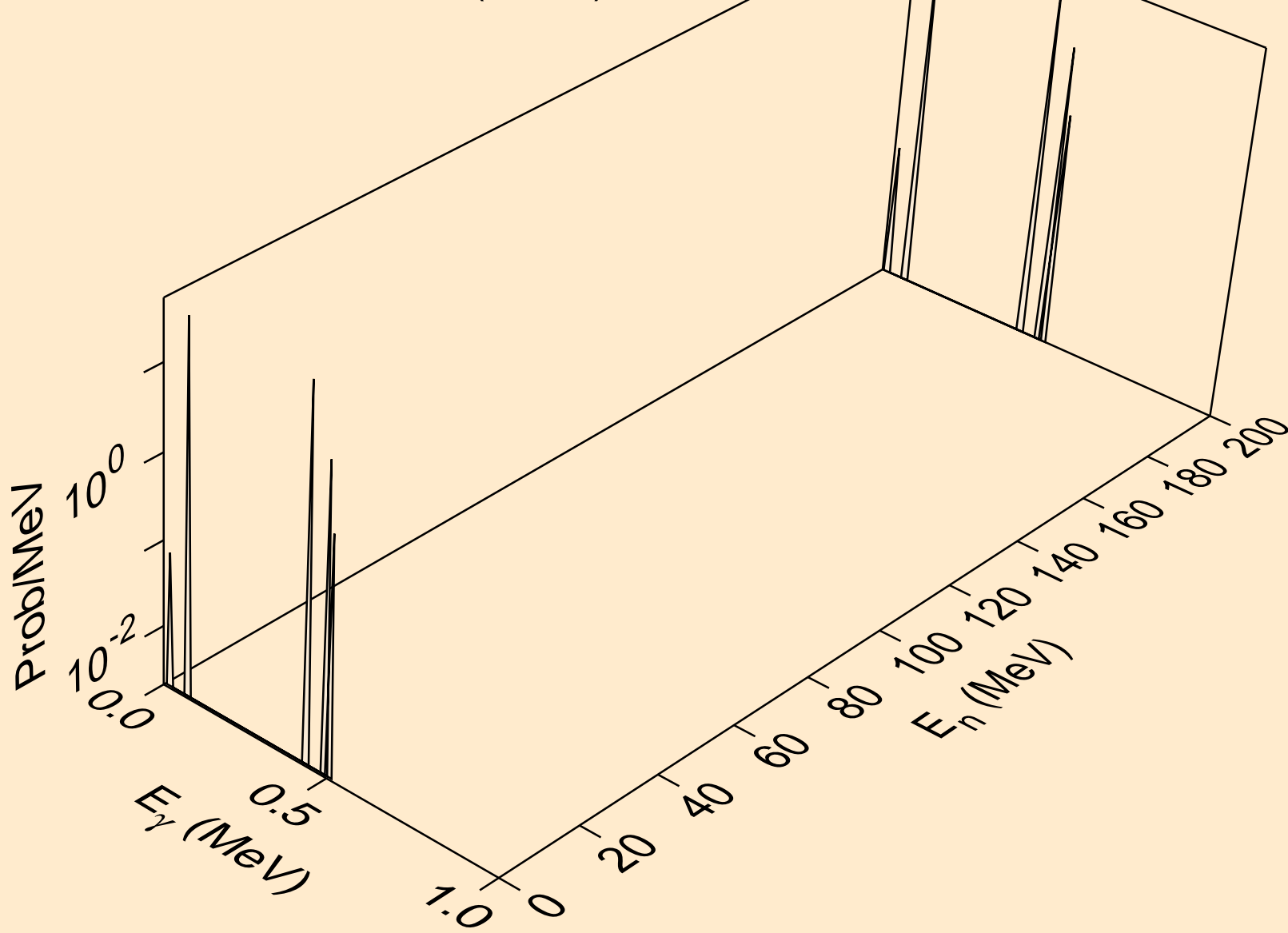

32-GE-73 FOR FENDL-3.2 FROM JEFF-3.1.1 BY NJOY2016.60+ O  
Photon emission for (n,n\*8)

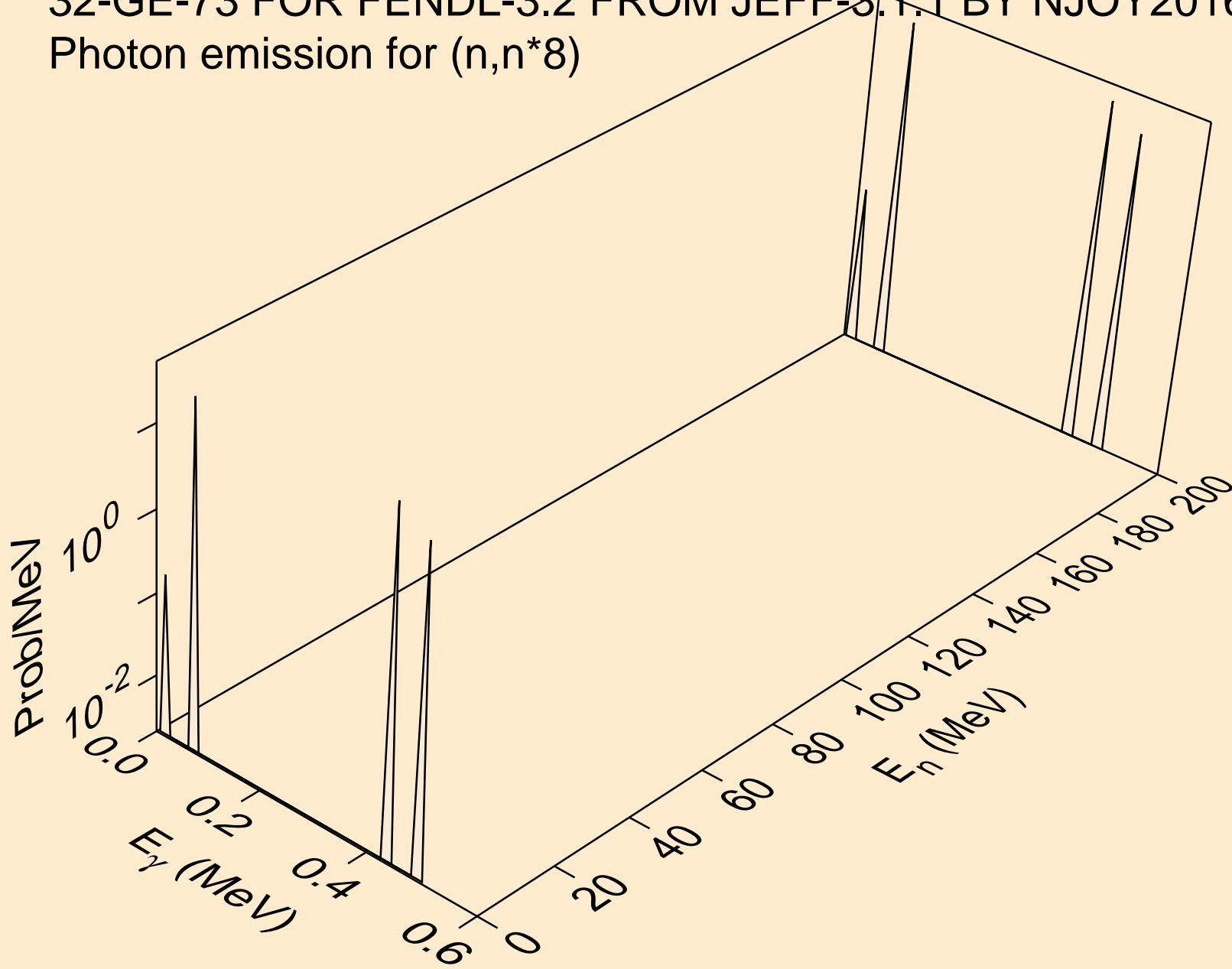

32-GE-73 FOR FENDL-3.2 FROM JEFF-3.1.1 BY NJOY2016.60+ O  
Photon emission for (n,n\*9)

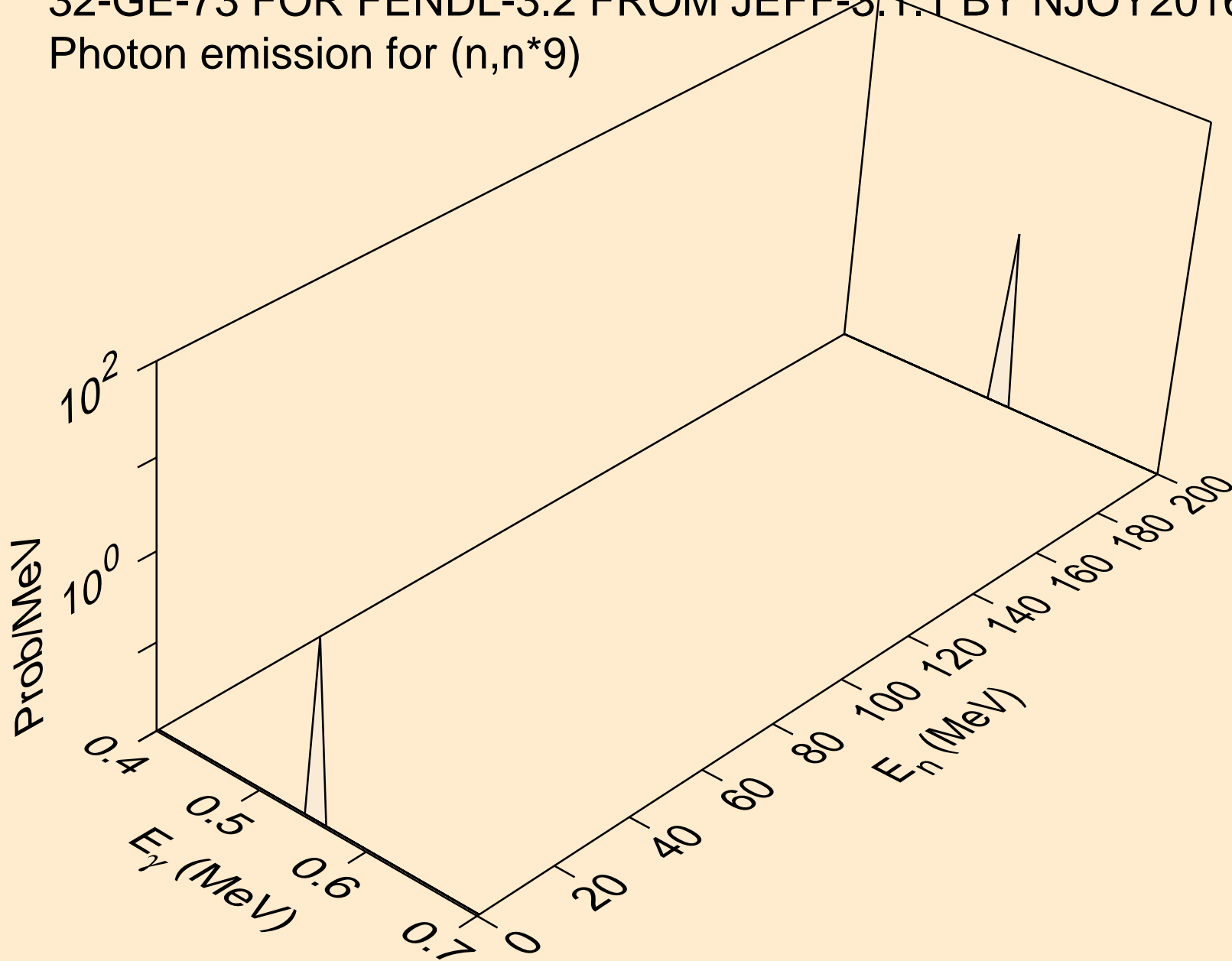

32-GE-73 FOR FENDL-3.2 FROM JEFF-3.1.1 BY NJOY2016.60+ O  
Photon emission for (n,n\*10)

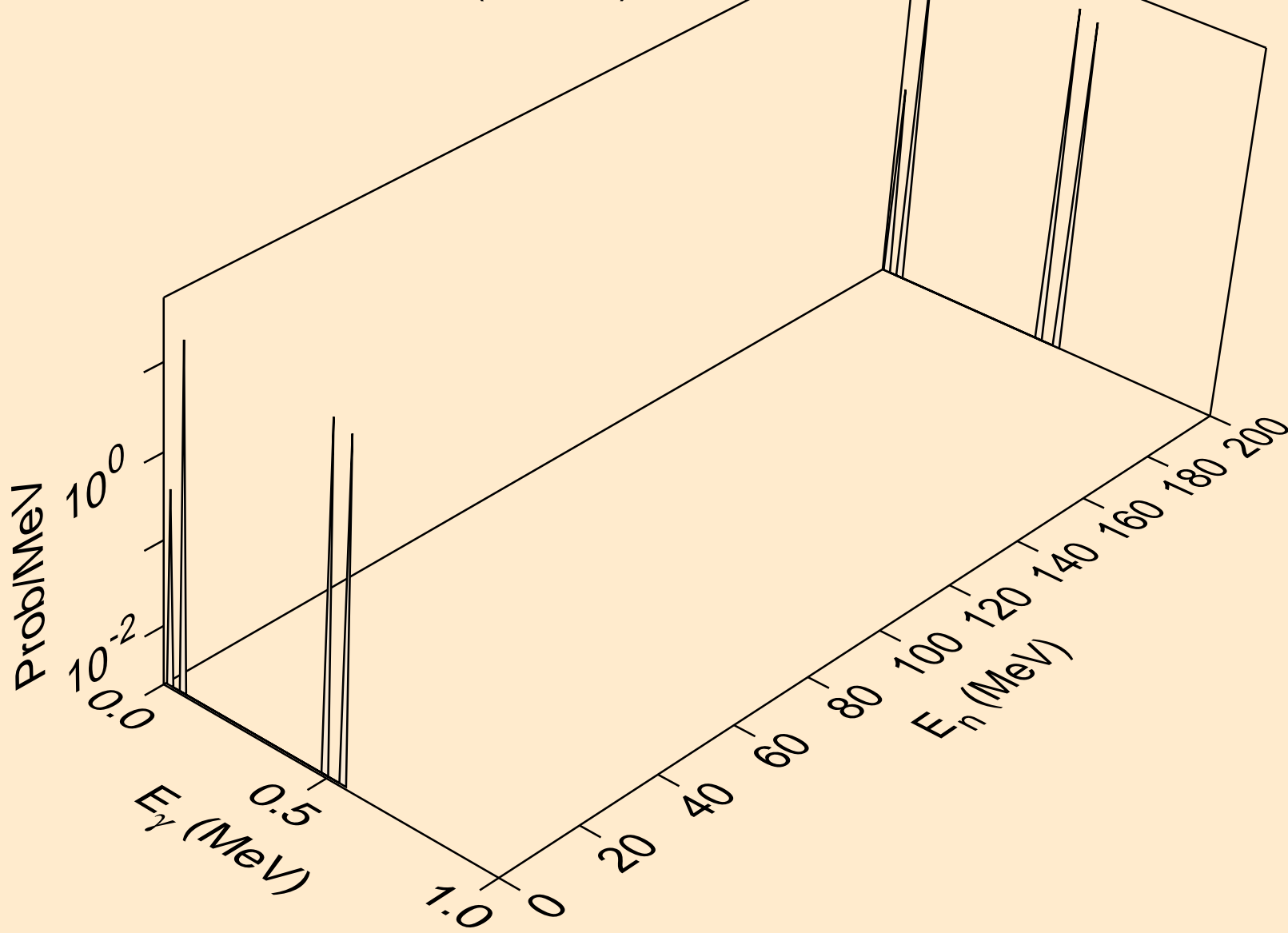

32-GE-73 FOR FENDL-3.2 FROM JEFF-3.1.1 BY NJOY2016.60+ O  
Photon emission for (n,n\*11)

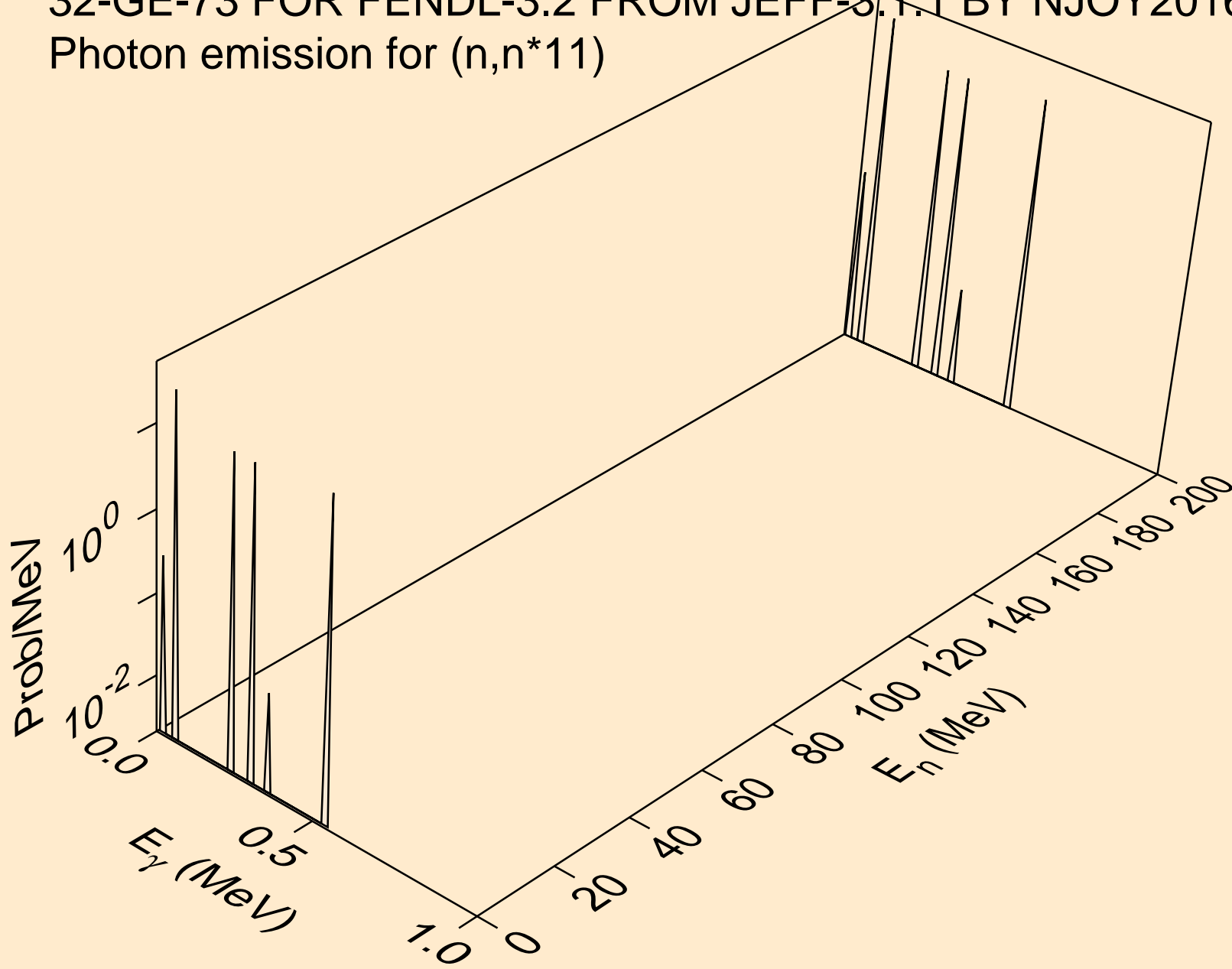

32-GE-73 FOR FENDL-3.2 FROM JEFF-3.1.1 BY NJOY2016.60+ O  
Photon emission for (n,n\*12)

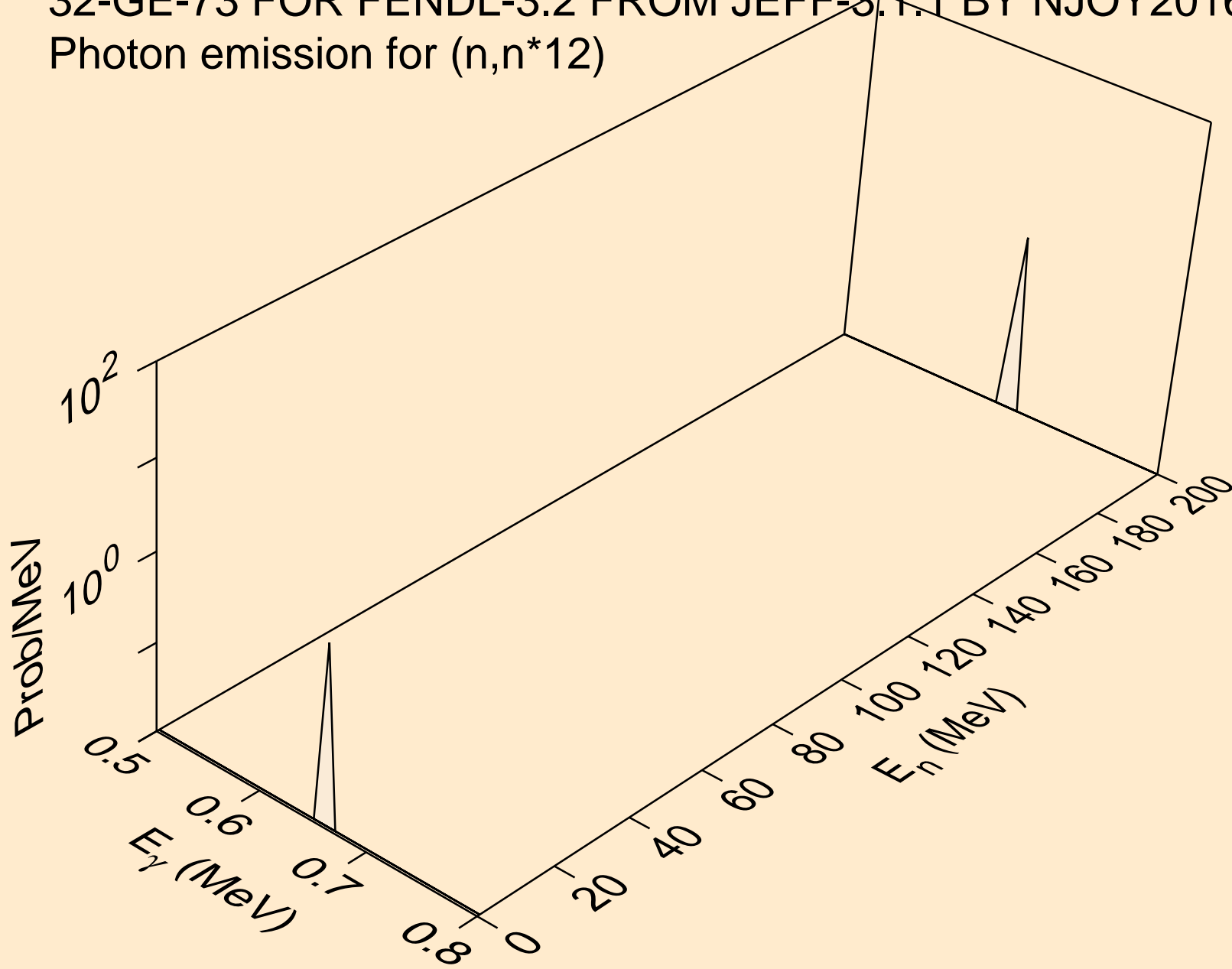



32-GE-73 FOR FENDL-3.2 FROM JEFF-3.1.1 BY NJOY2016.60+ O  
Photon emission for (n,n\*13)

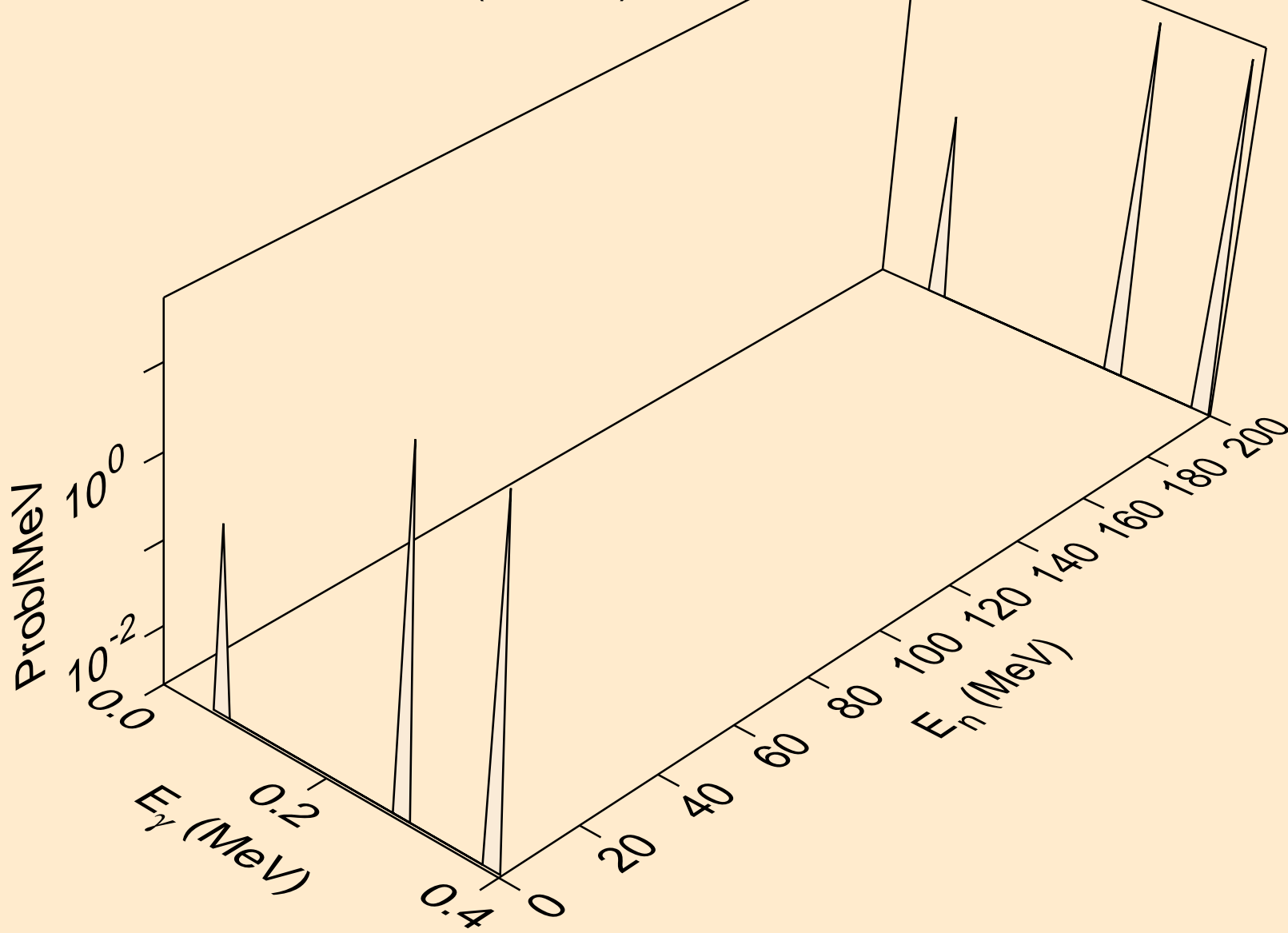

32-GE-73 FOR FENDL-3.2 FROM JEFF-3.1.1 BY NJOY2016.60+ O  
Photon emission for (n,n\*14)

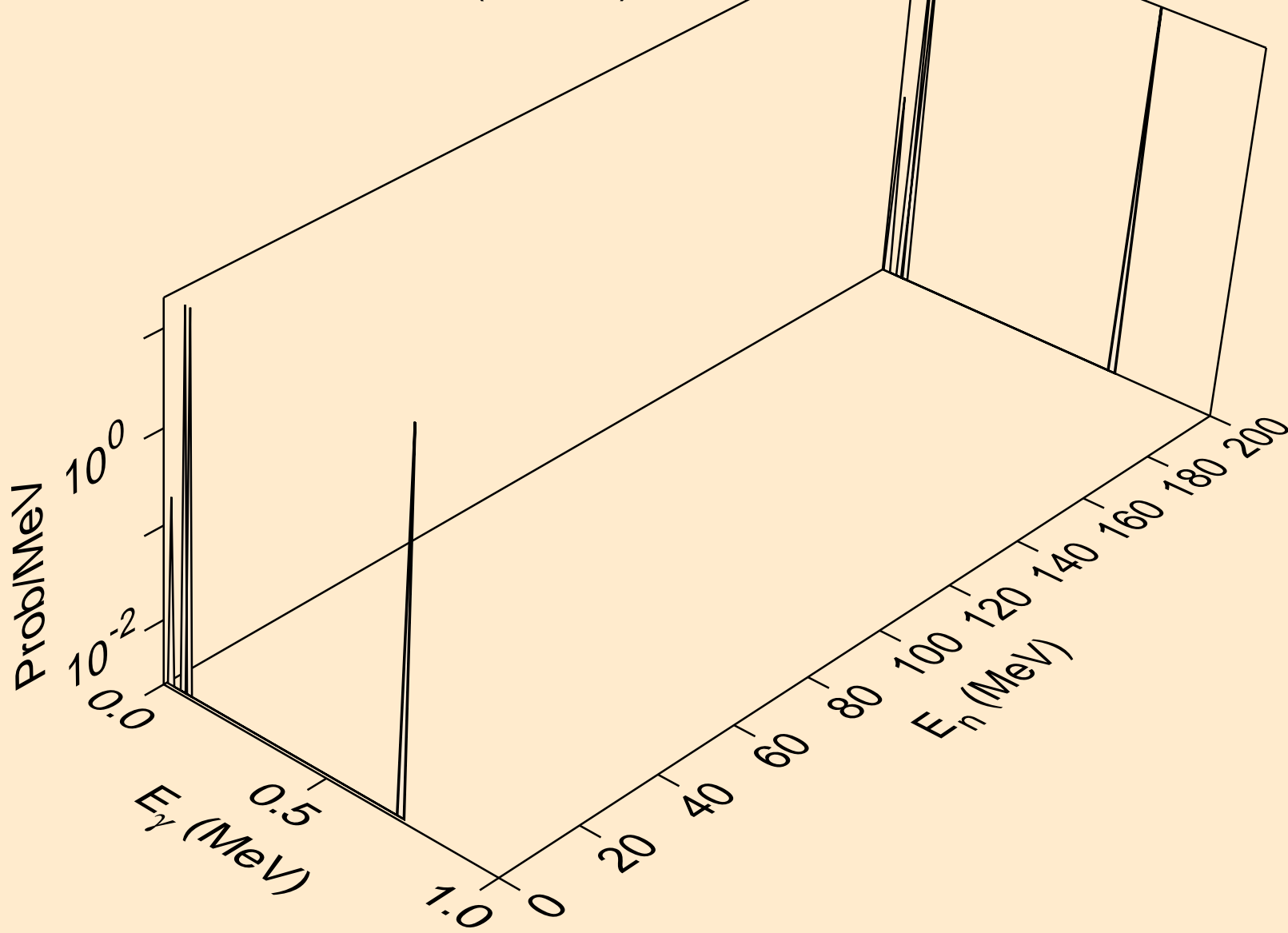

32-GE-73 FOR FENDL-3.2 FROM JEFF-3.1.1 BY NJOY2016.60+ O  
Photon emission for (n,n\*15)

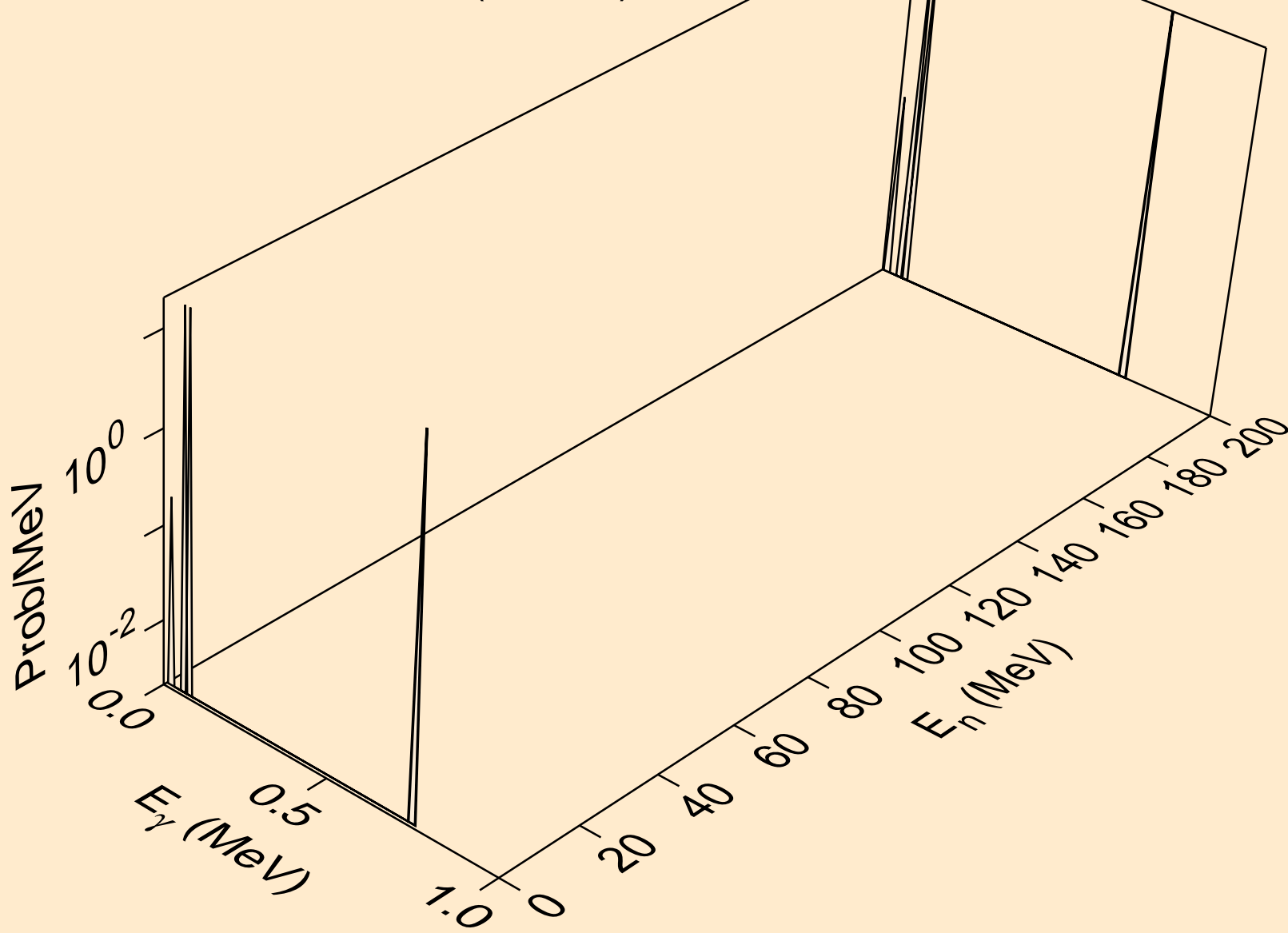

32-GE-73 FOR FENDL-3.2 FROM JEFF-3.1.1 BY NJOY2016.60+ O  
Photon emission for (n,n\*16)

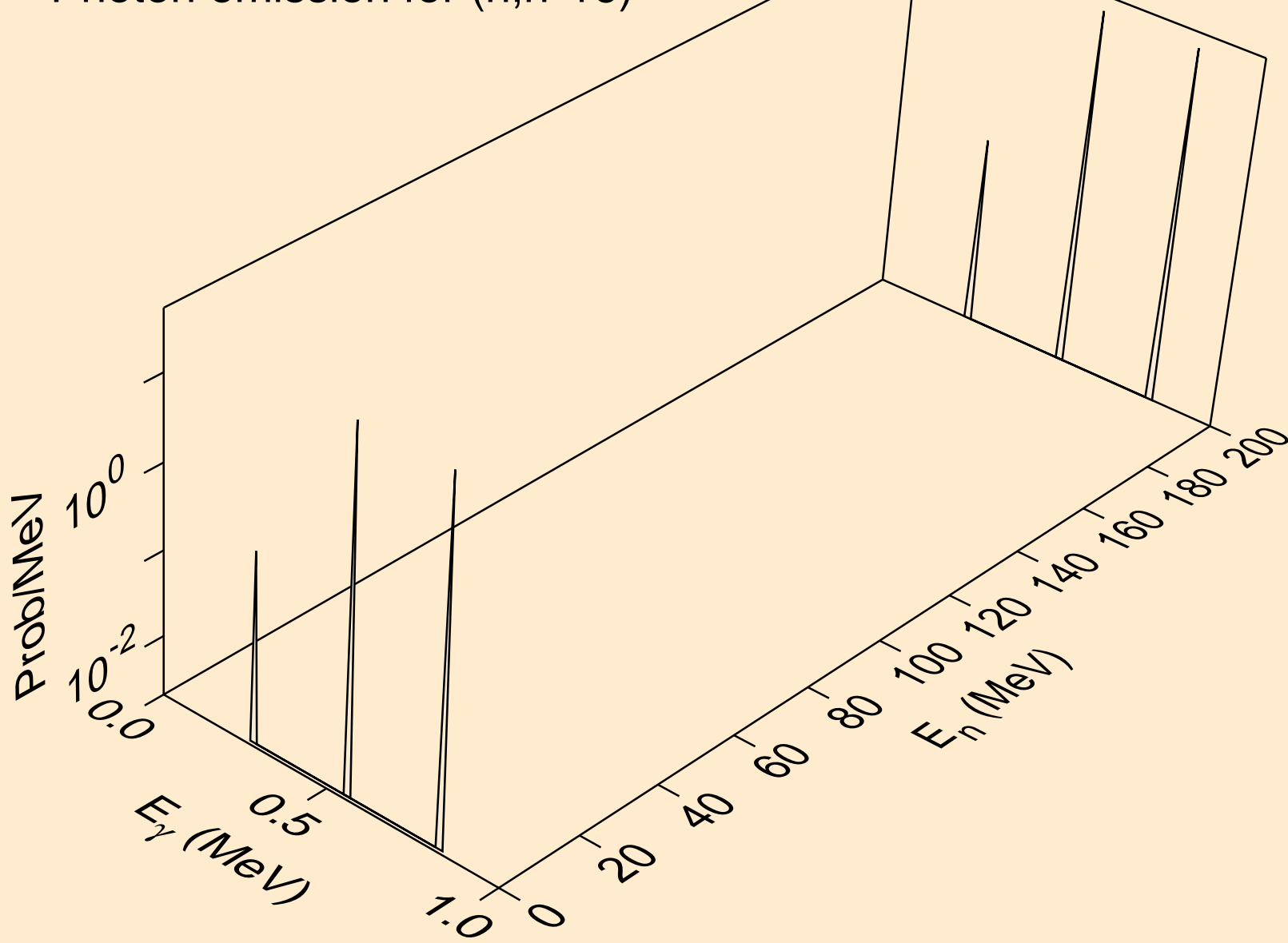

32-GE-73 FOR FENDL-3.2 FROM JEFF-3.1.1 BY NJOY2016.60+ O  
Photon emission for (n,n\*17)

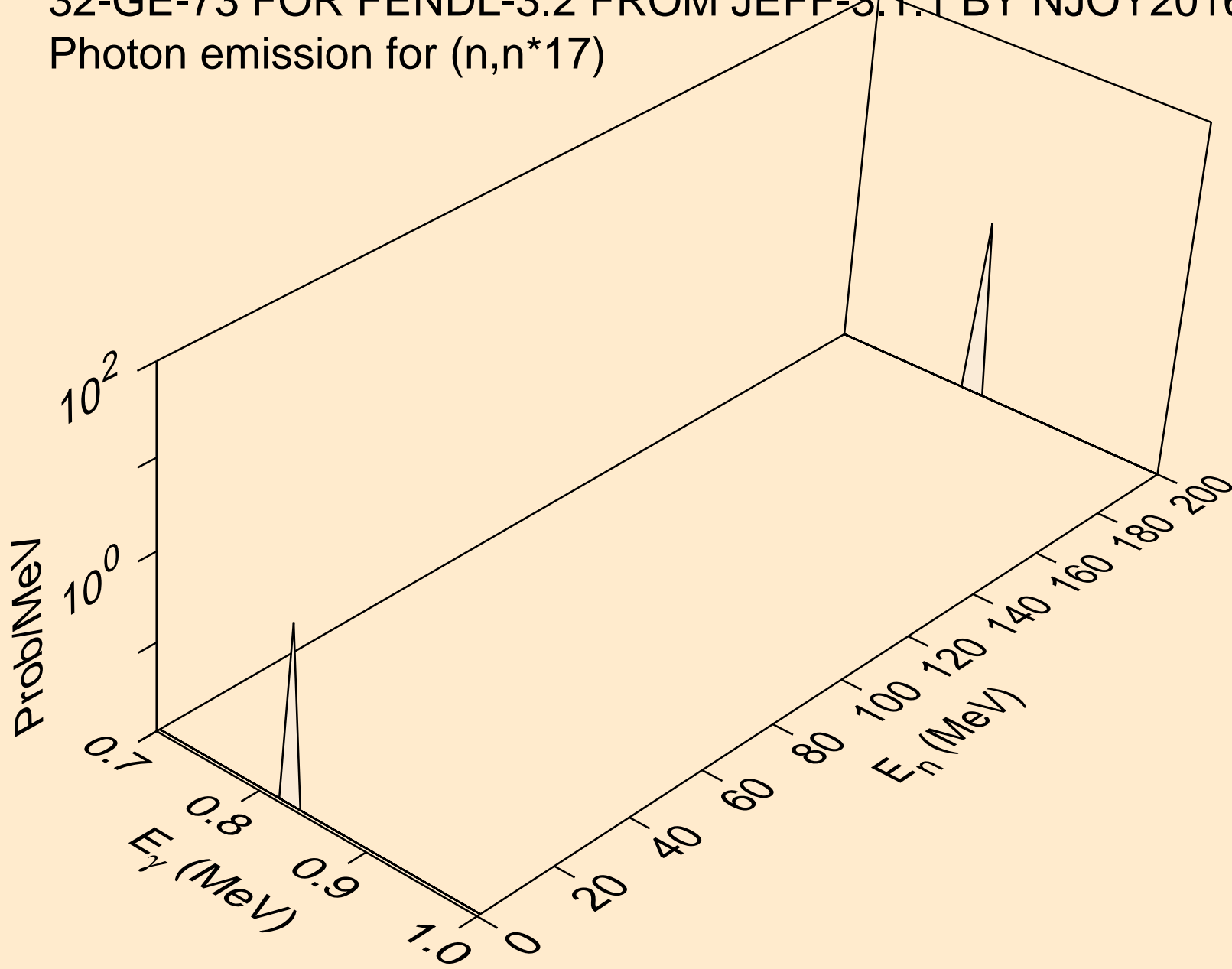

32-GE-73 FOR FENDL-3.2 FROM JEFF-3.1.1 BY NJOY2016.60+ O  
Photon emission for (n,n\*18)

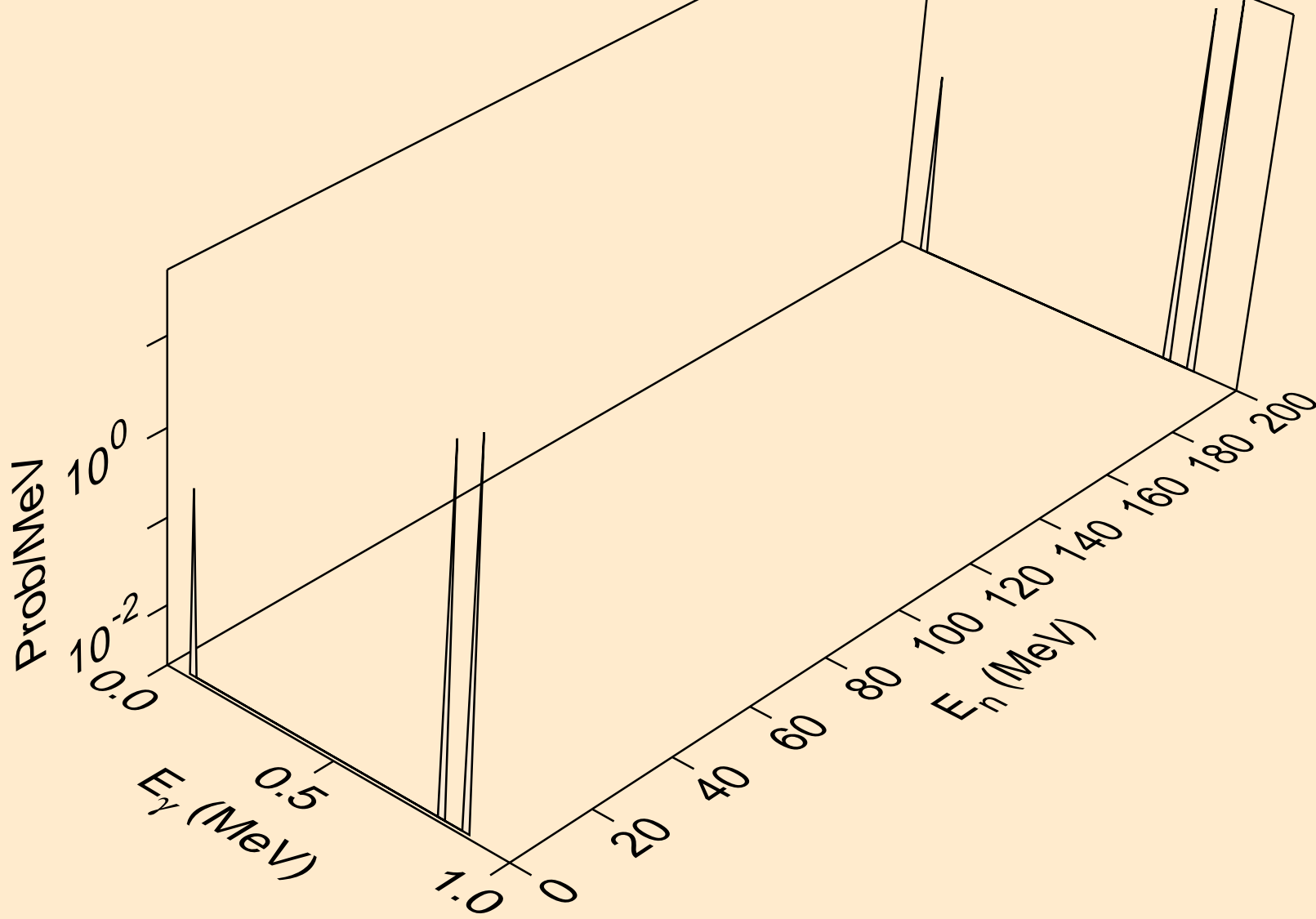

32-GE-73 FOR FENDL-3.2 FROM JEFF-3.1.1 BY NJOY2016.60+ O  
Photon emission for (n,n\*19)

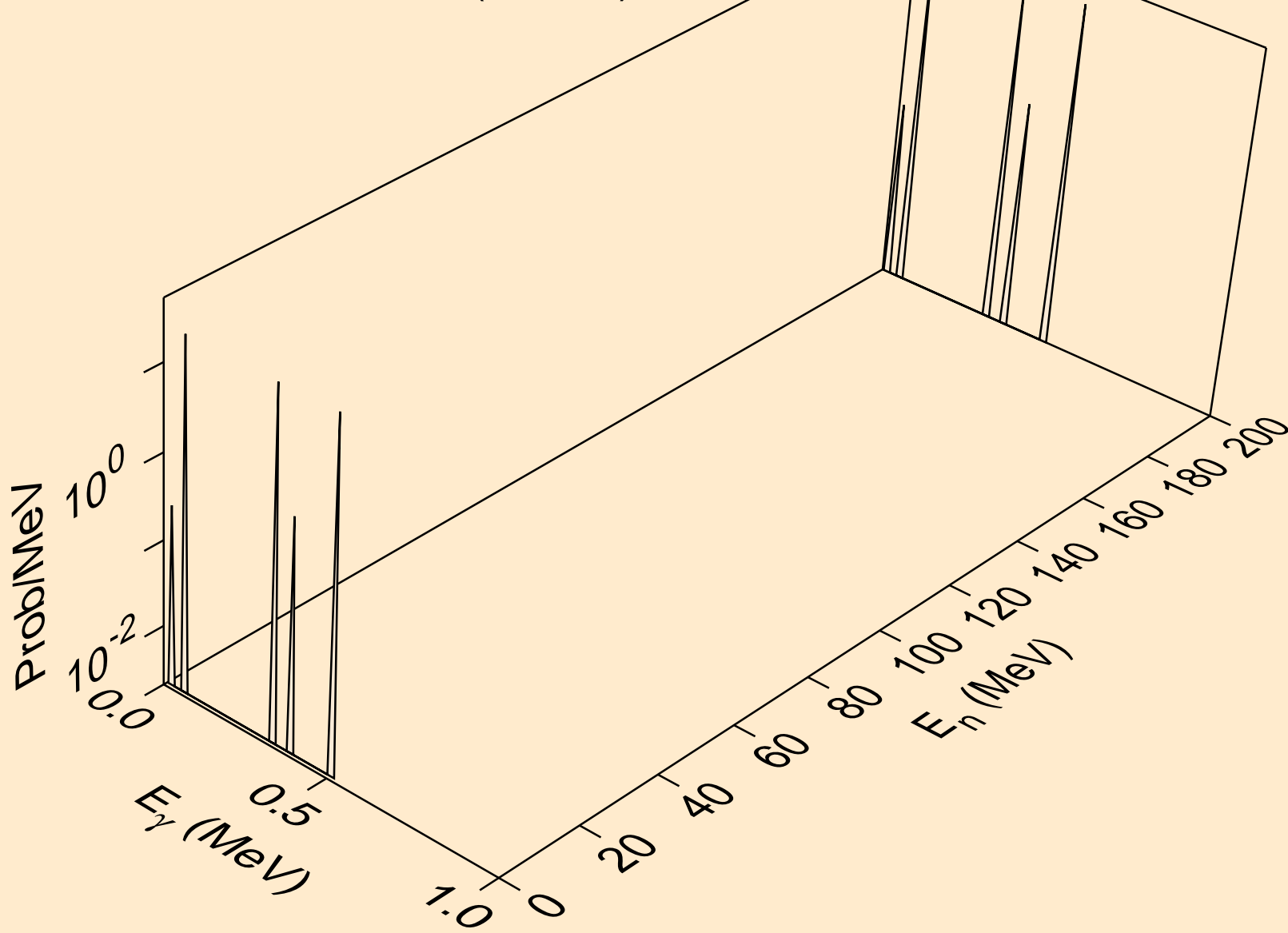

32-GE-73 FOR FENDL-3.2 FROM JEFF-3.1.1 BY NJOY2016.60+ O  
Photon emission for (n,n\*20)

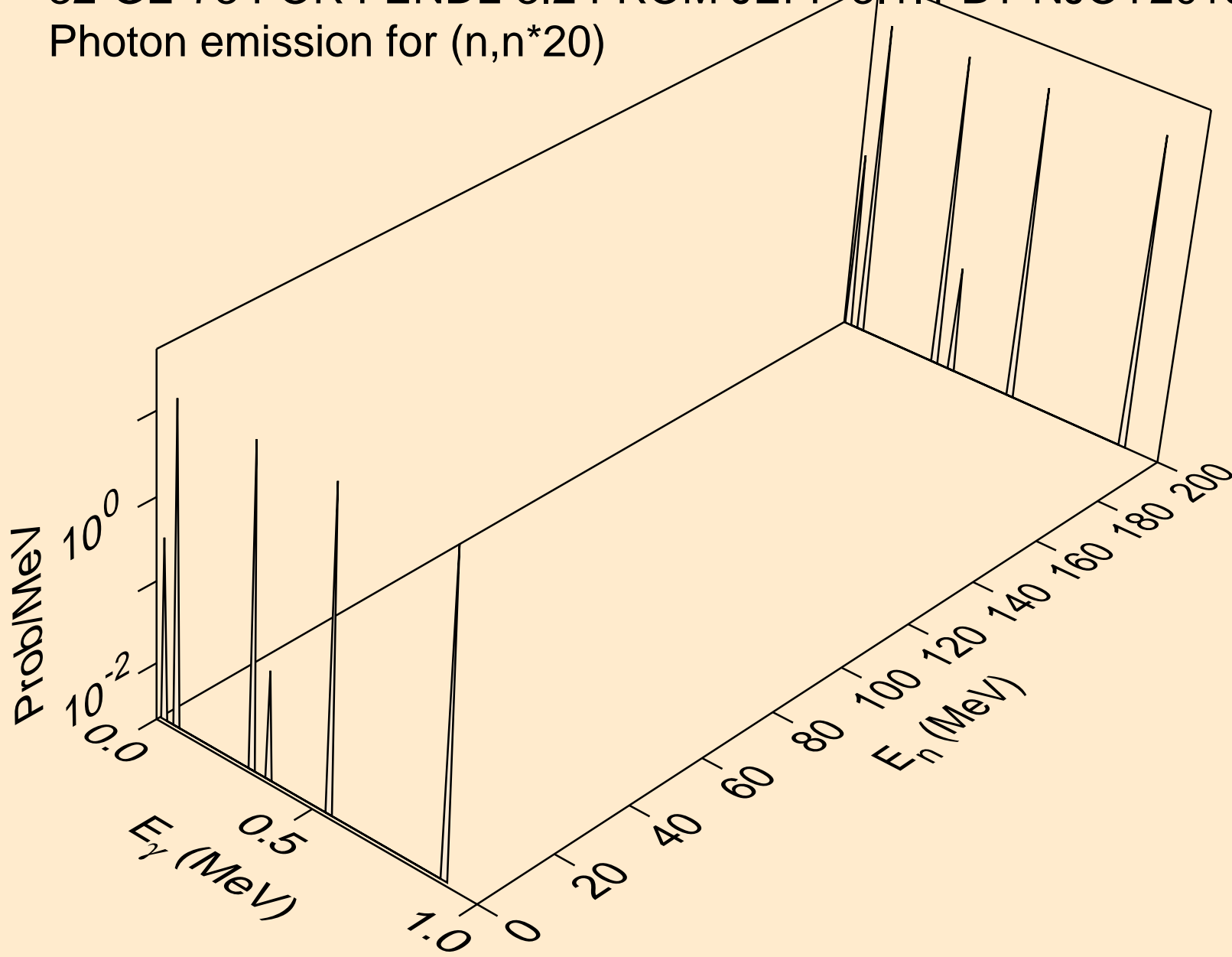



32-GE-73 FOR FENDL-3.2 FROM JEFF-3.1.1 BY NJOY2016.60+ O  
Photon emission for (n,n\*c)

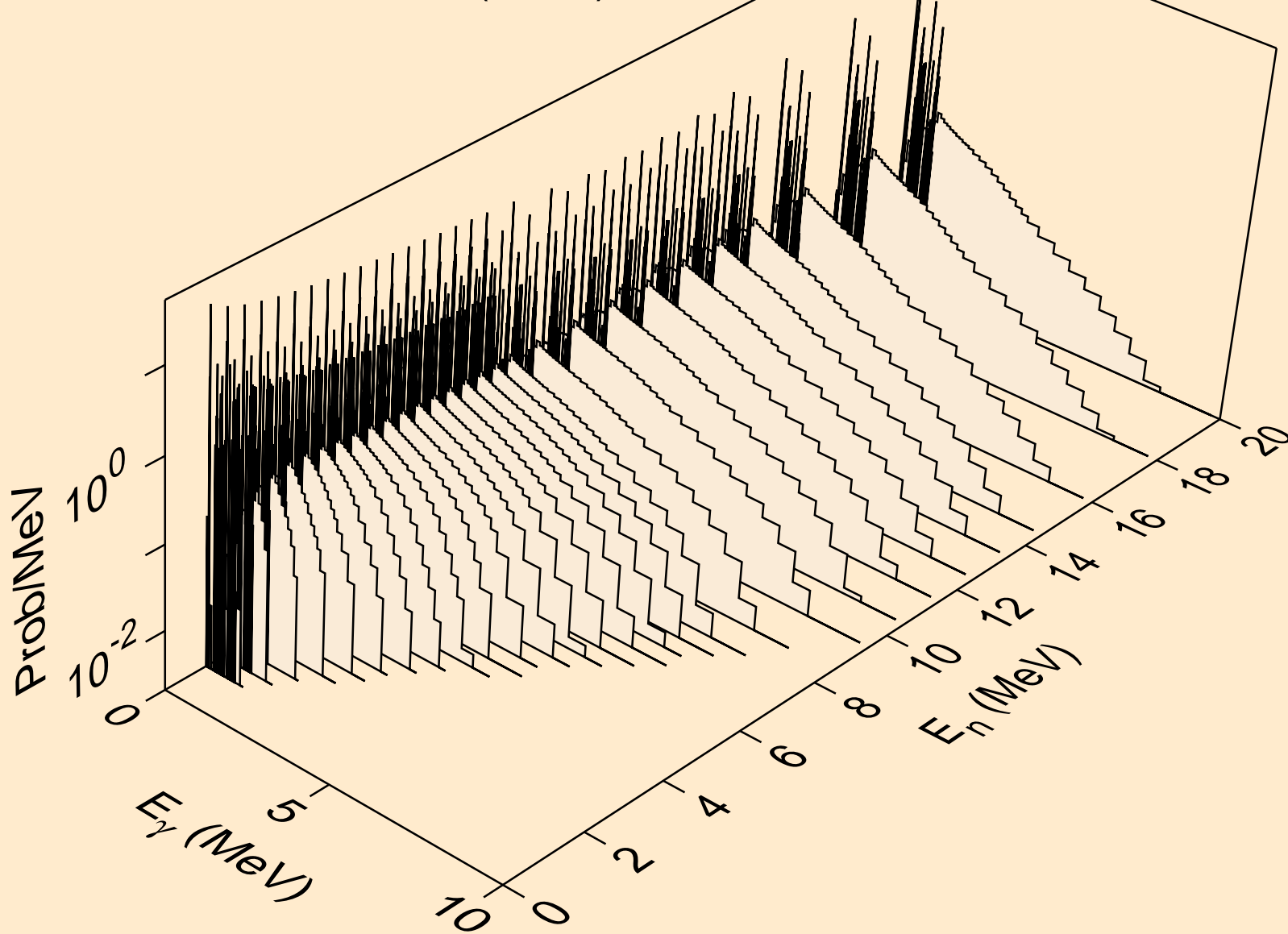

32-GE-73 FOR FENDL-3.2 FROM JEFF-3.1.1 BY NJOY2016.60+ O  
Photon emission for (n,gma)

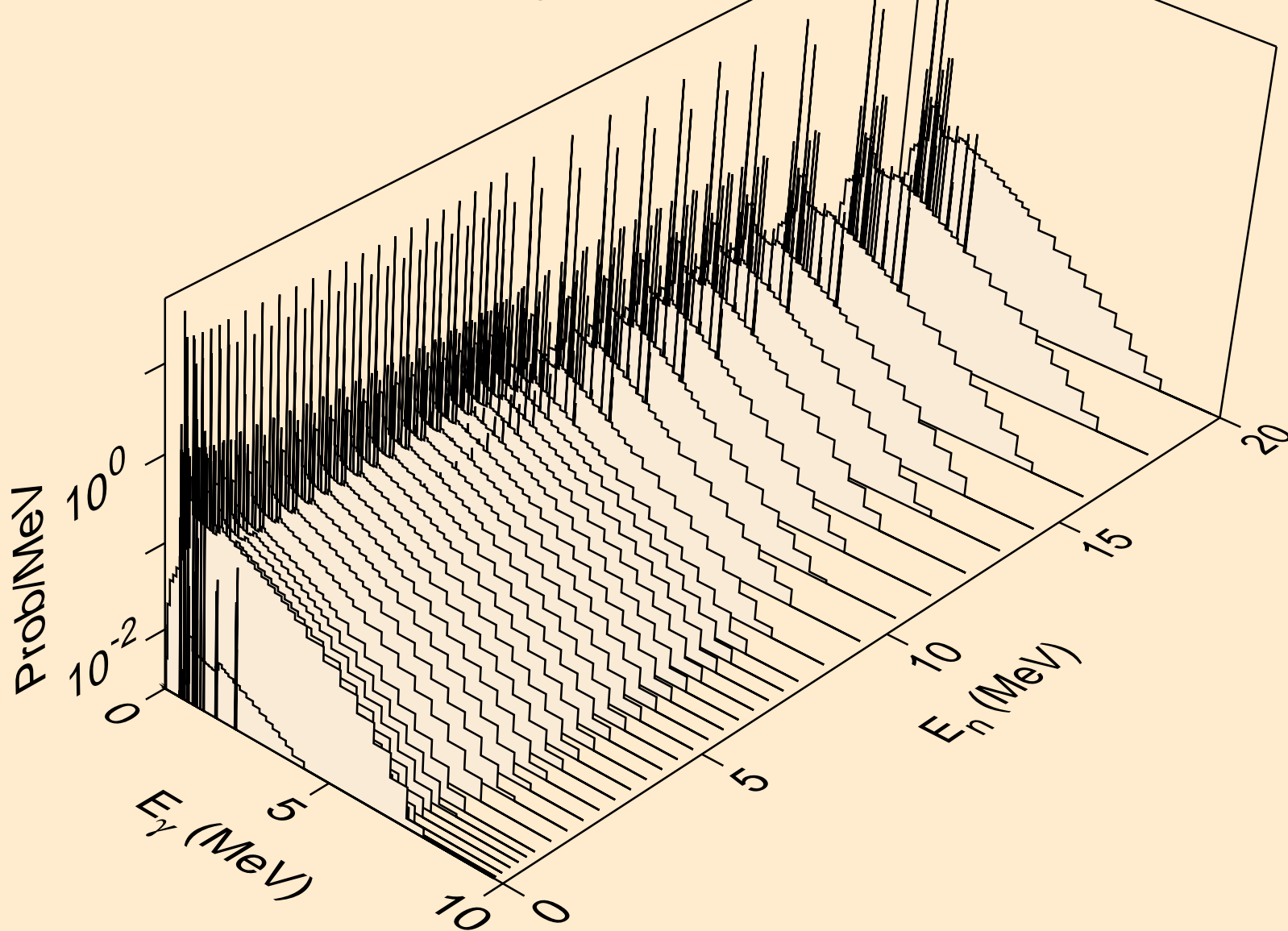

32-GE-73 FOR FENDL-3.2 FROM JEFF-3.1.1 BY NJOY2016.60+ O  
Photon emission for (n,2a)

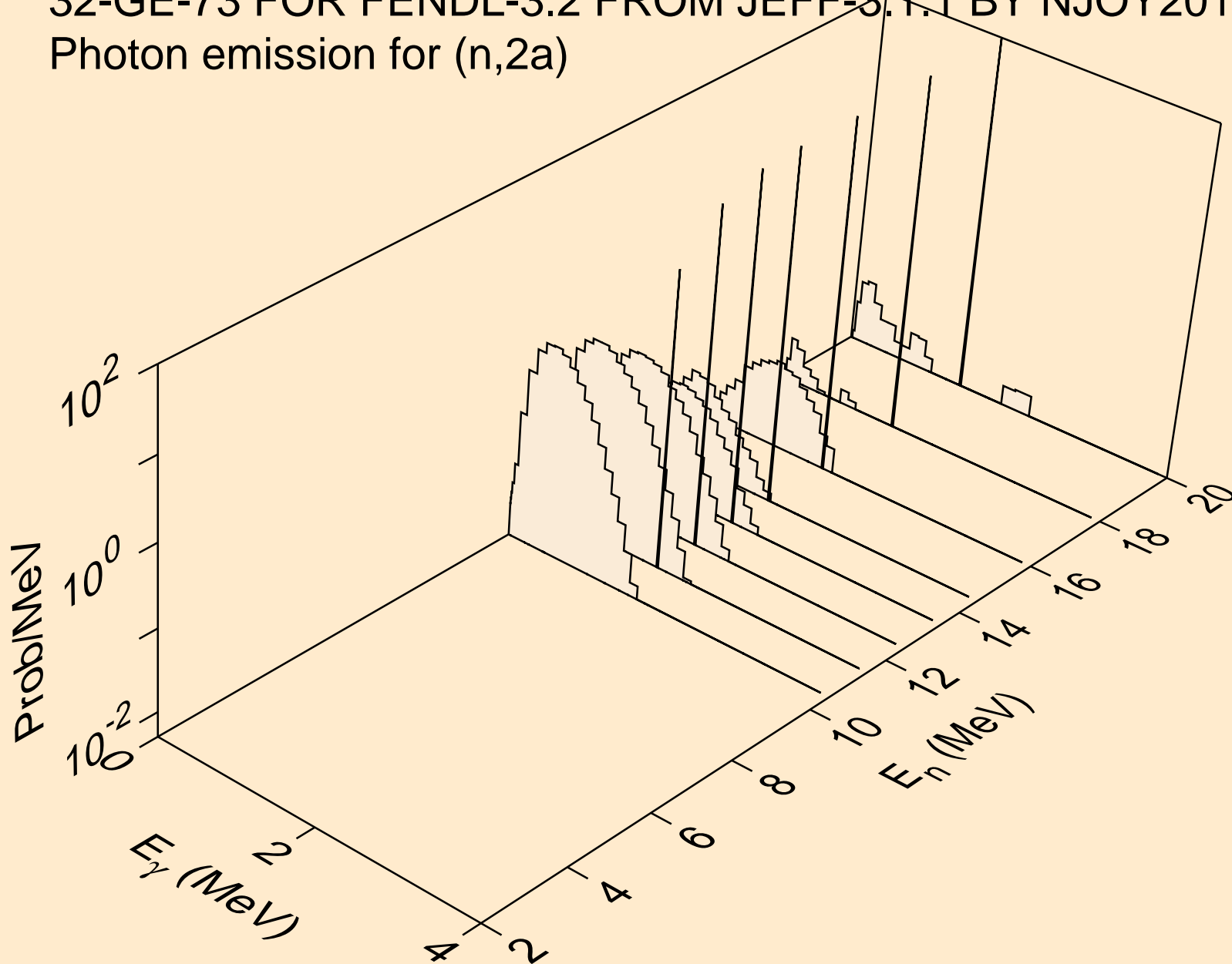

32-GE-73 FOR FENDL-3.2 FROM JEFF-3.1.1 BY NJOY2016.60+ O  
Photon emission for (n,2p)

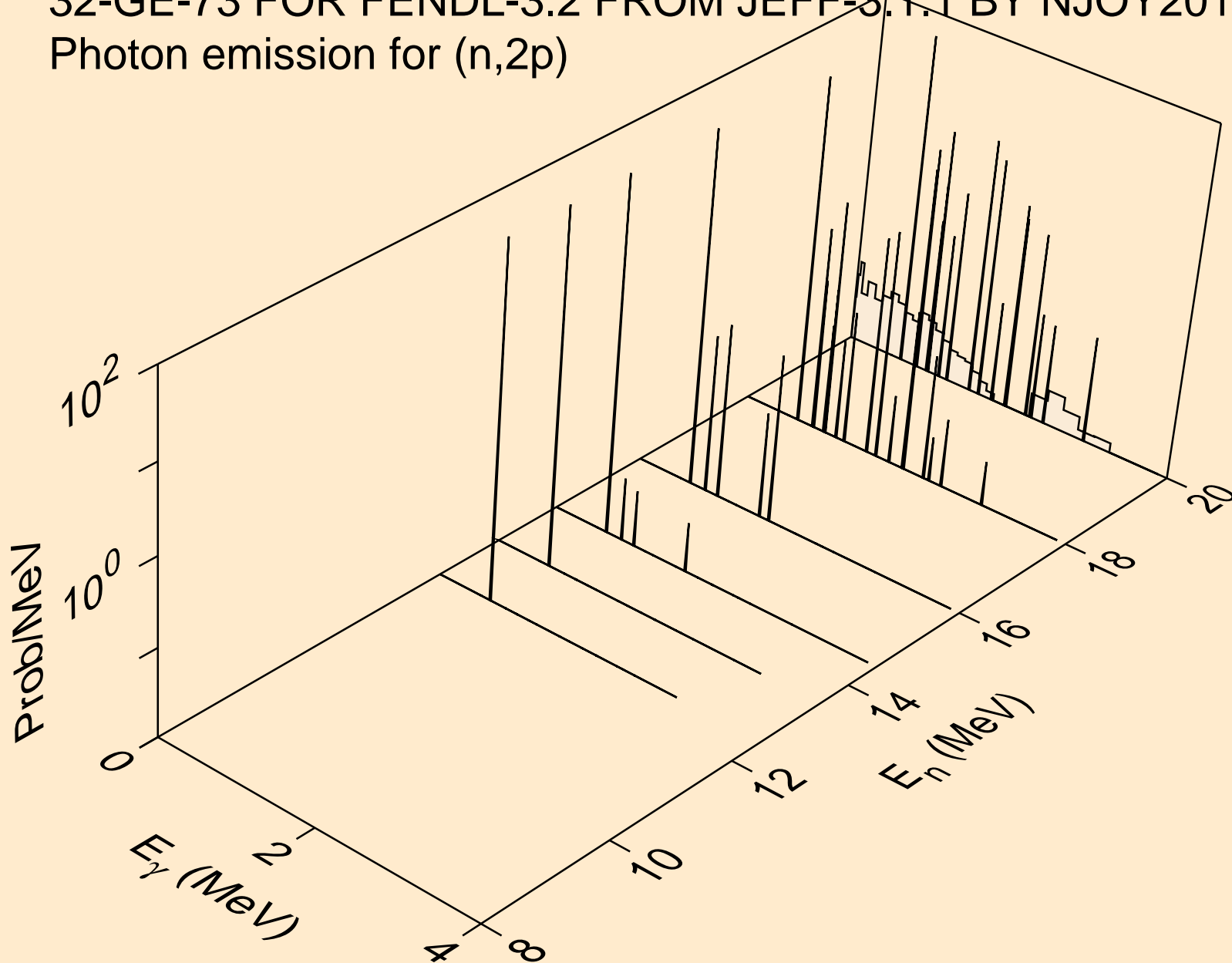

32-GE-73 FOR FENDL-3.2 FROM JEFF-3.1.1 BY NJOY2016.60+ O  
Photon emission for (n,pa)

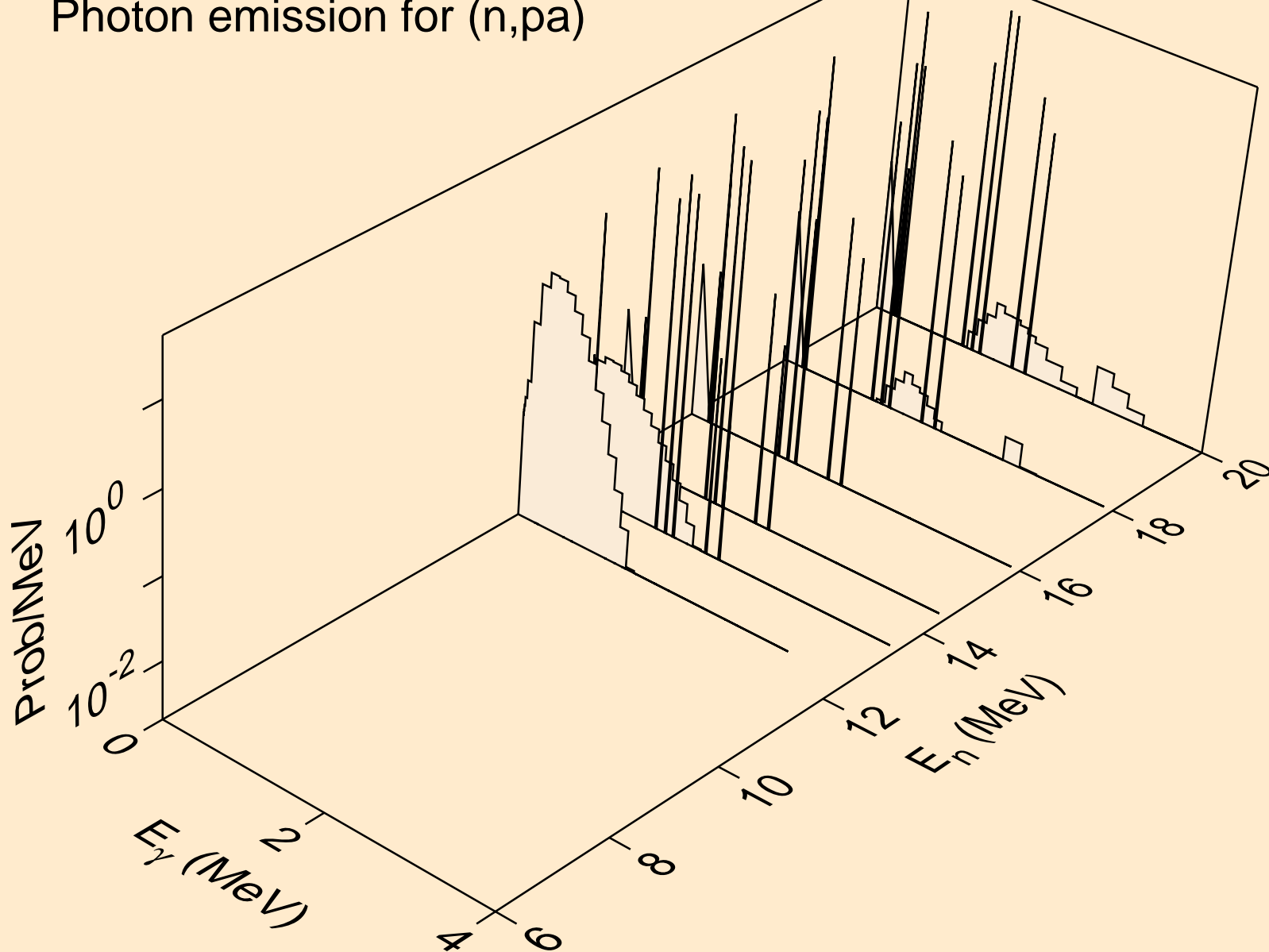

32-GE-73 FOR FENDL-3.2 FROM JEFF-3.1.1 BY NJOY2016.60+ O  
Photon emission for (n,p\*1)

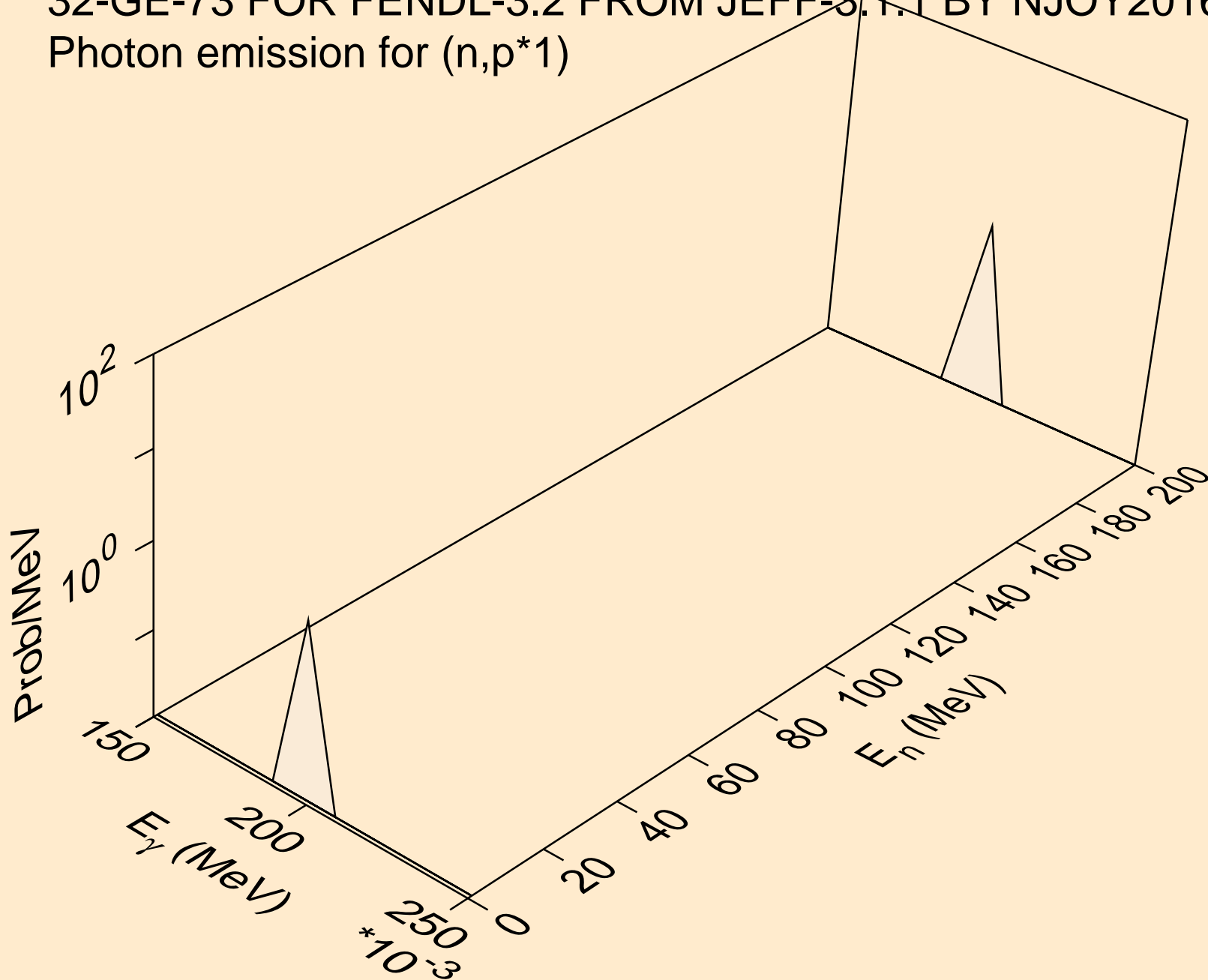

32-GE-73 FOR FENDL-3.2 FROM JEFF-3.1.1 BY NJOY2016.60+ O  
Photon emission for (n,p\*2)

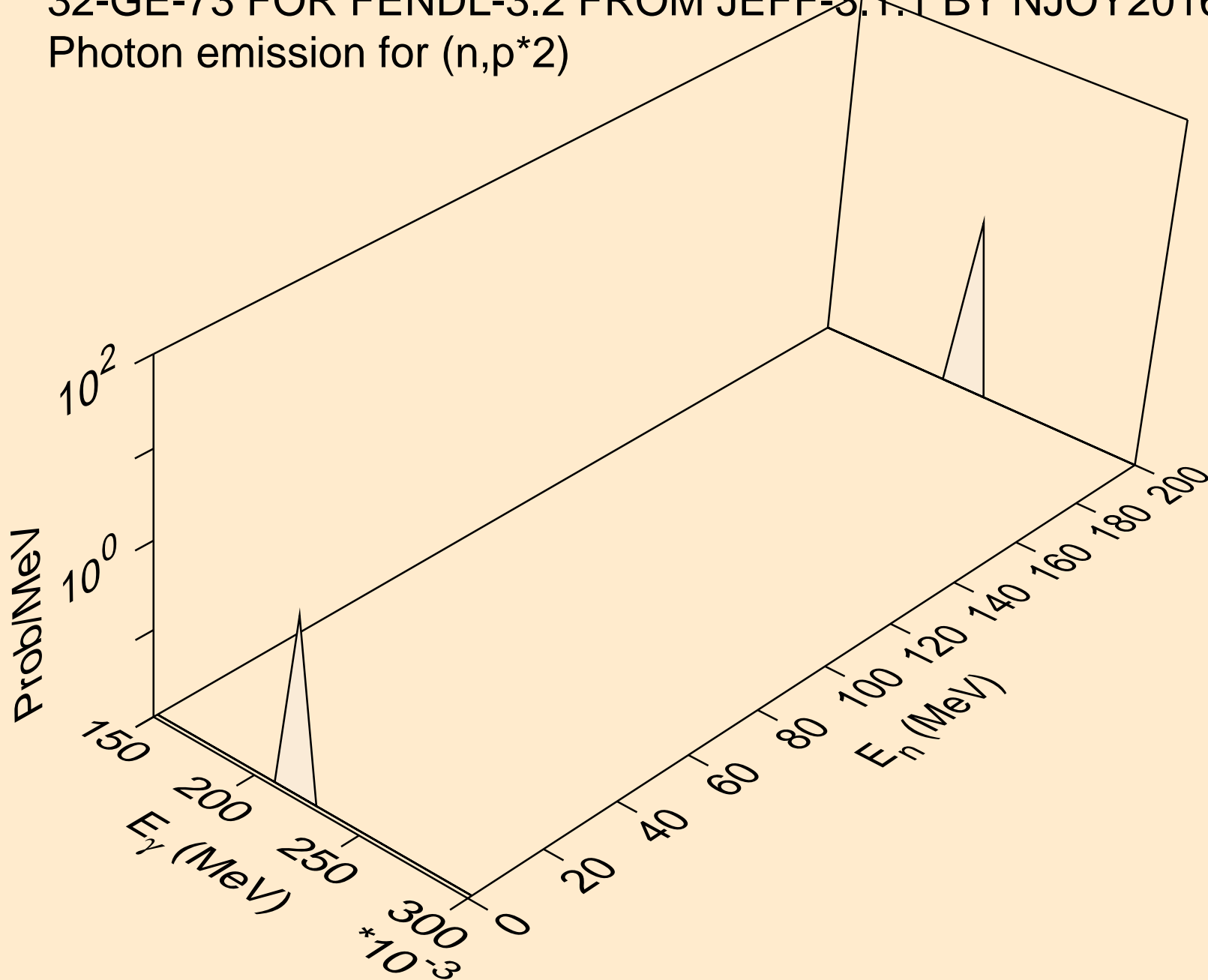

32-GE-73 FOR FENDL-3.2 FROM JEFF-3.1.1 BY NJOY2016.60+ O  
Photon emission for (n,p\*3)

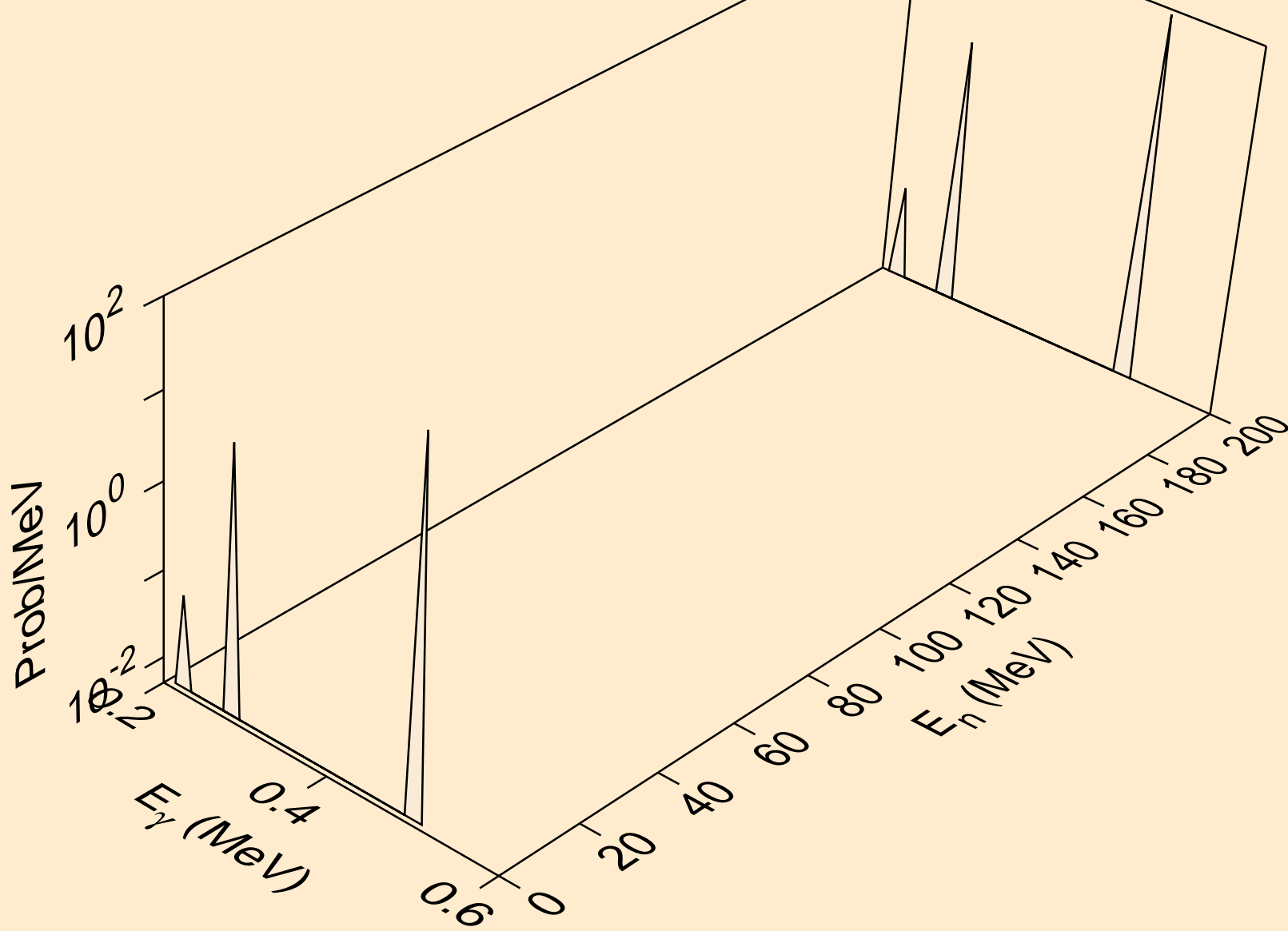



32-GE-73 FOR FENDL-3.2 FROM JEFF-3.1.1 BY NJOY2016.60+ O  
Photon emission for (n,p\*4)

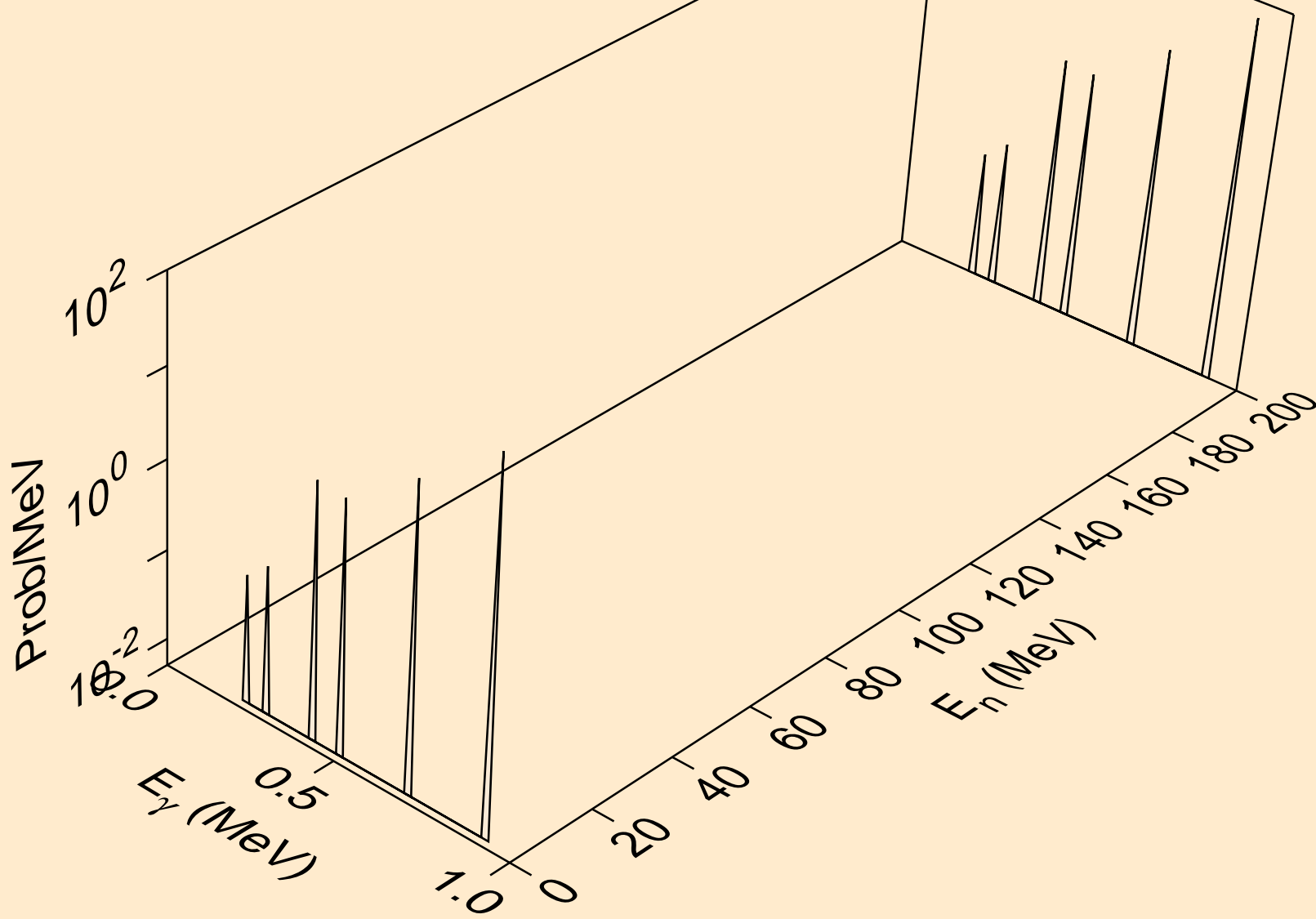

32-GE-73 FOR FENDL-3.2 FROM JEFF-3.1.1 BY NJOY2016.60+ O  
Photon emission for (n,p\*5)

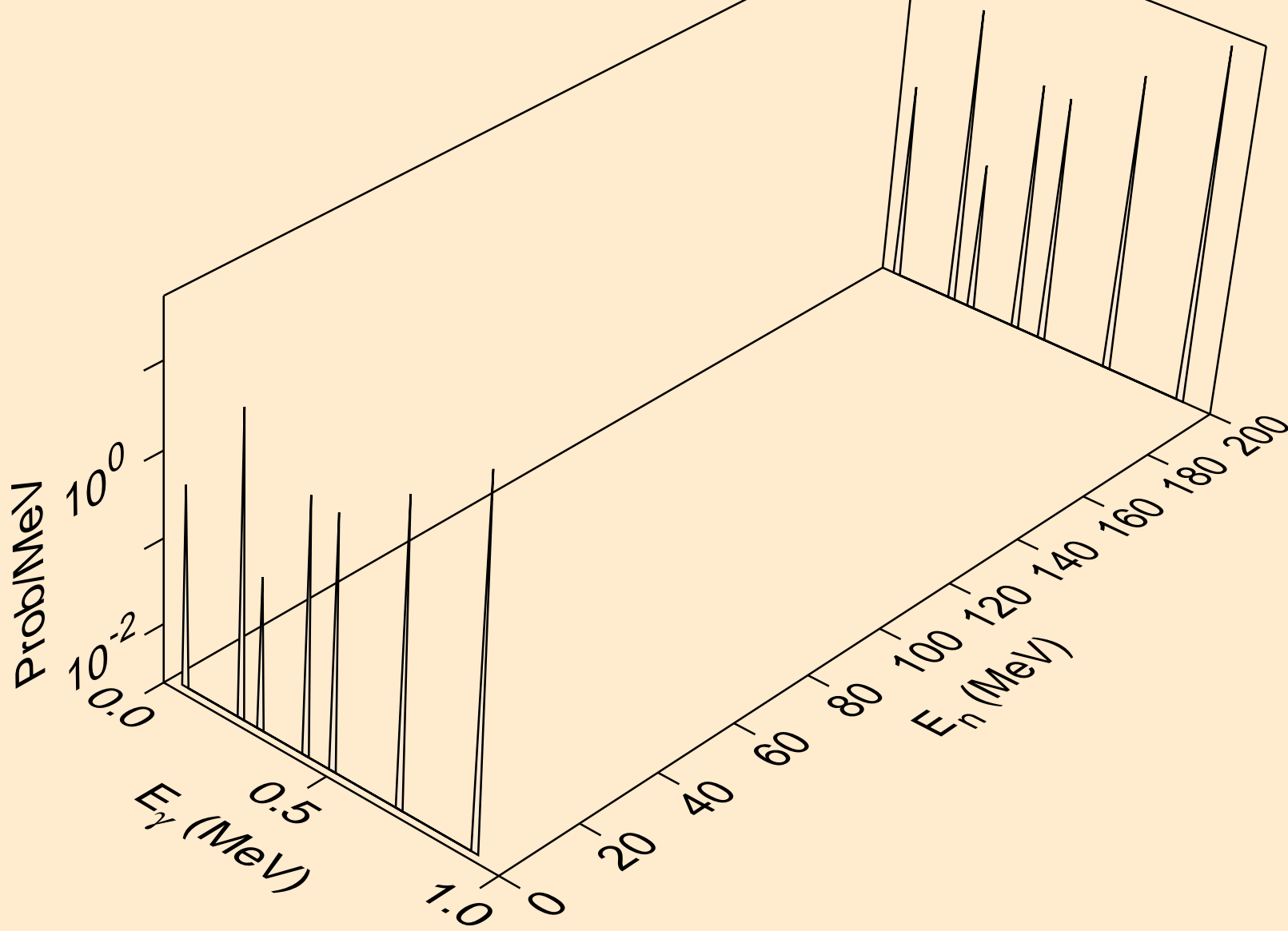

32-GE-73 FOR FENDL-3.2 FROM JEFF-3.1.1 BY NJOY2016.60+ O  
Photon emission for (n,p\*6)

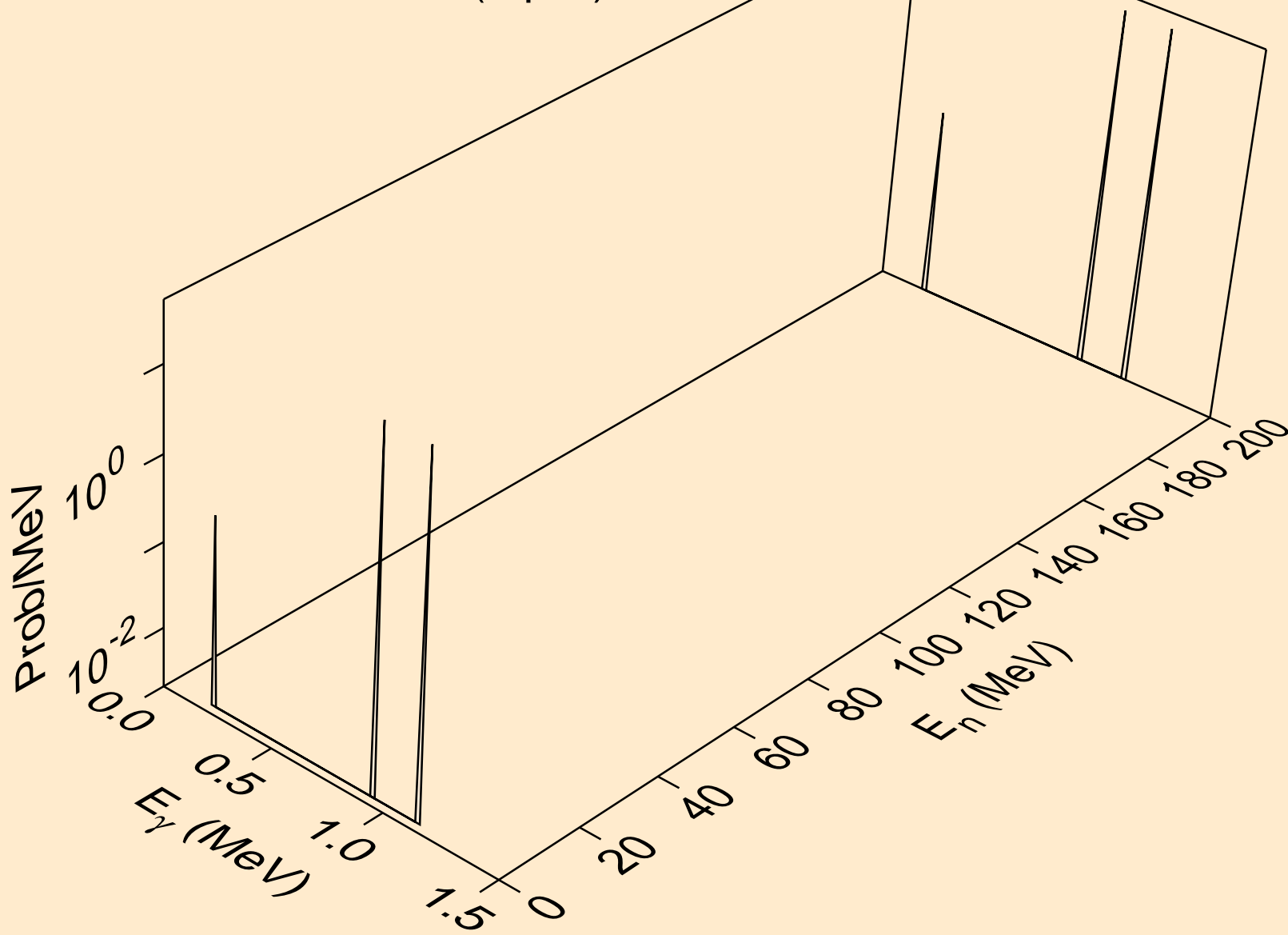

32-GE-73 FOR FENDL-3.2 FROM JEFF-3.1.1 BY NJOY2016.60+ O  
Photon emission for (n,p\*7)

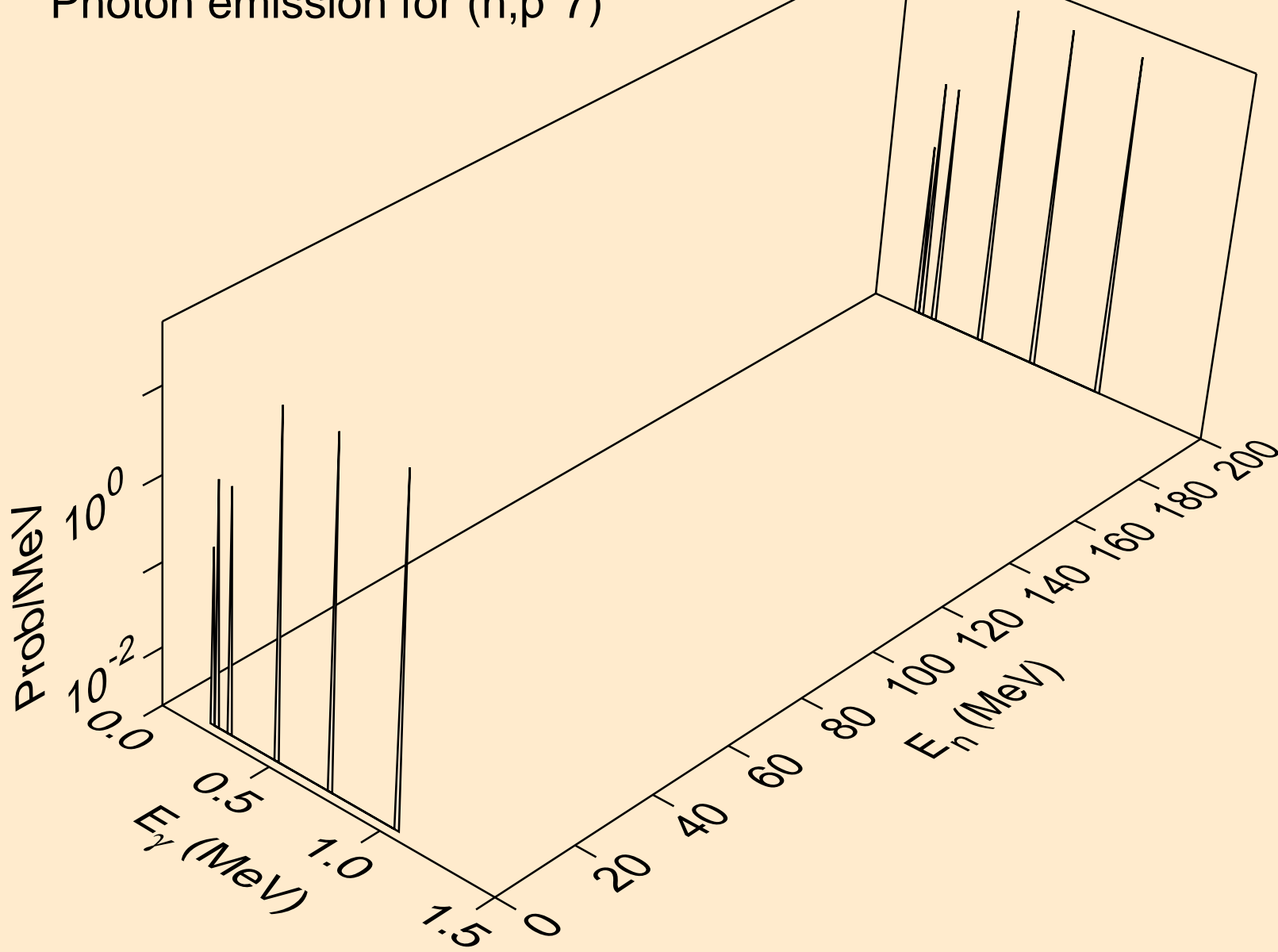

32-GE-73 FOR FENDL-3.2 FROM JEFF-3.1.1 BY NJOY2016.60+ O  
Photon emission for (n,p\*8)

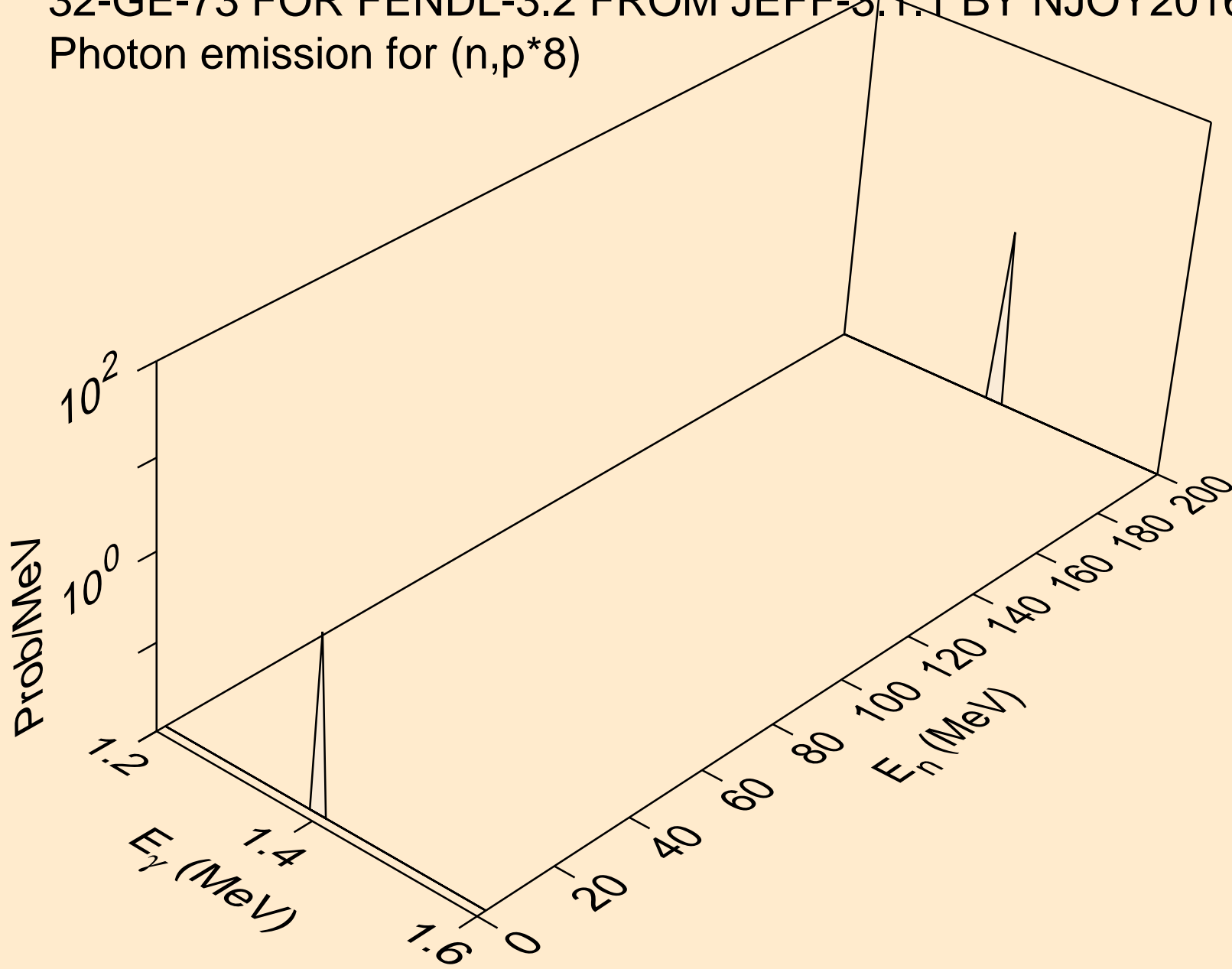

32-GE-73 FOR FENDL-3.2 FROM JEFF-3.1.1 BY NJOY2016.60+ O  
Photon emission for (n,p\*9)

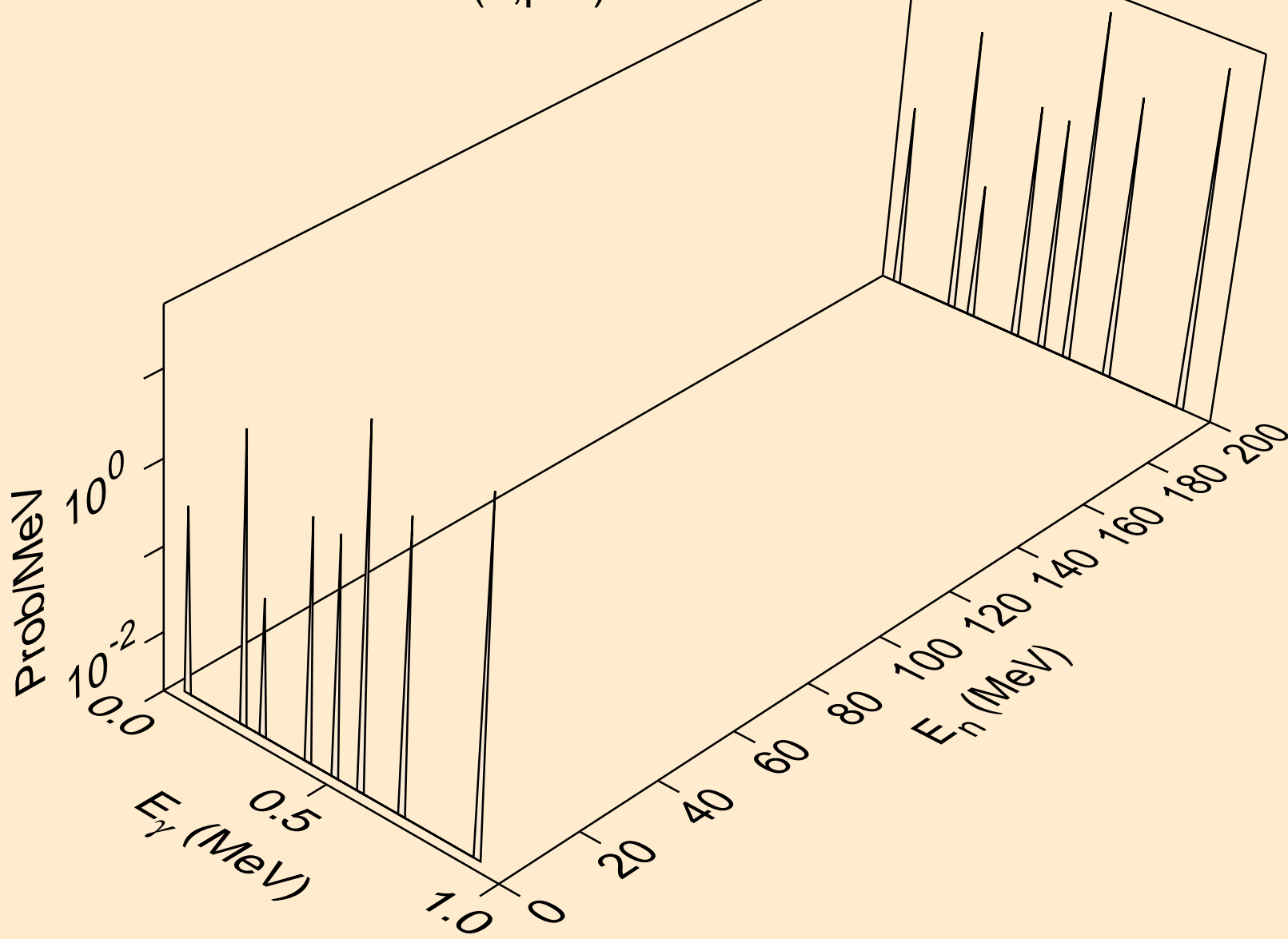

32-GE-73 FOR FENDL-3.2 FROM JEFF-3.1.1 BY NJOY2016.60+ O  
Photon emission for (n,p\*10)

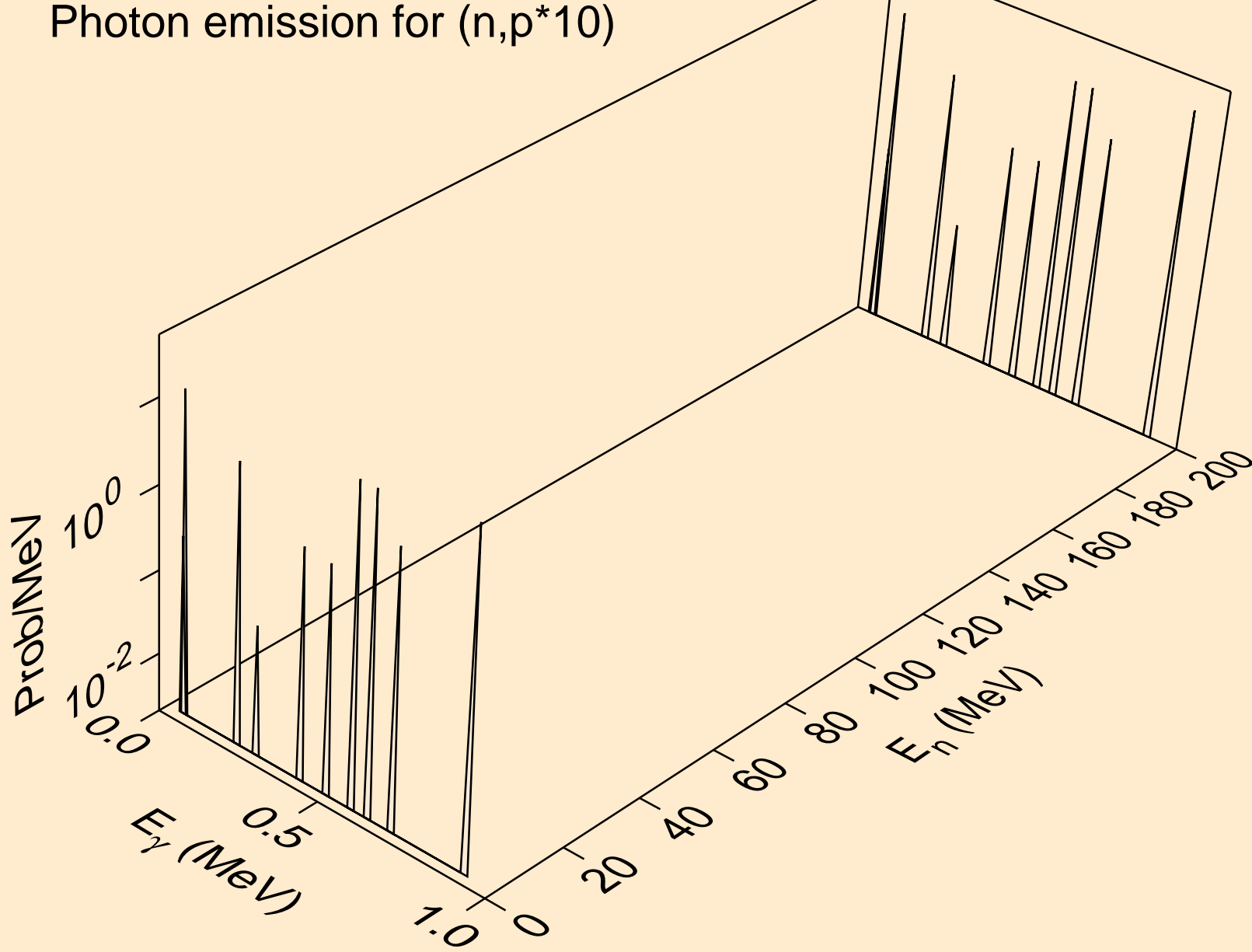

32-GE-73 FOR FENDL-3.2 FROM JEFF-3.1.1 BY NJOY2016.60+ O  
Photon emission for (n,p\*c)

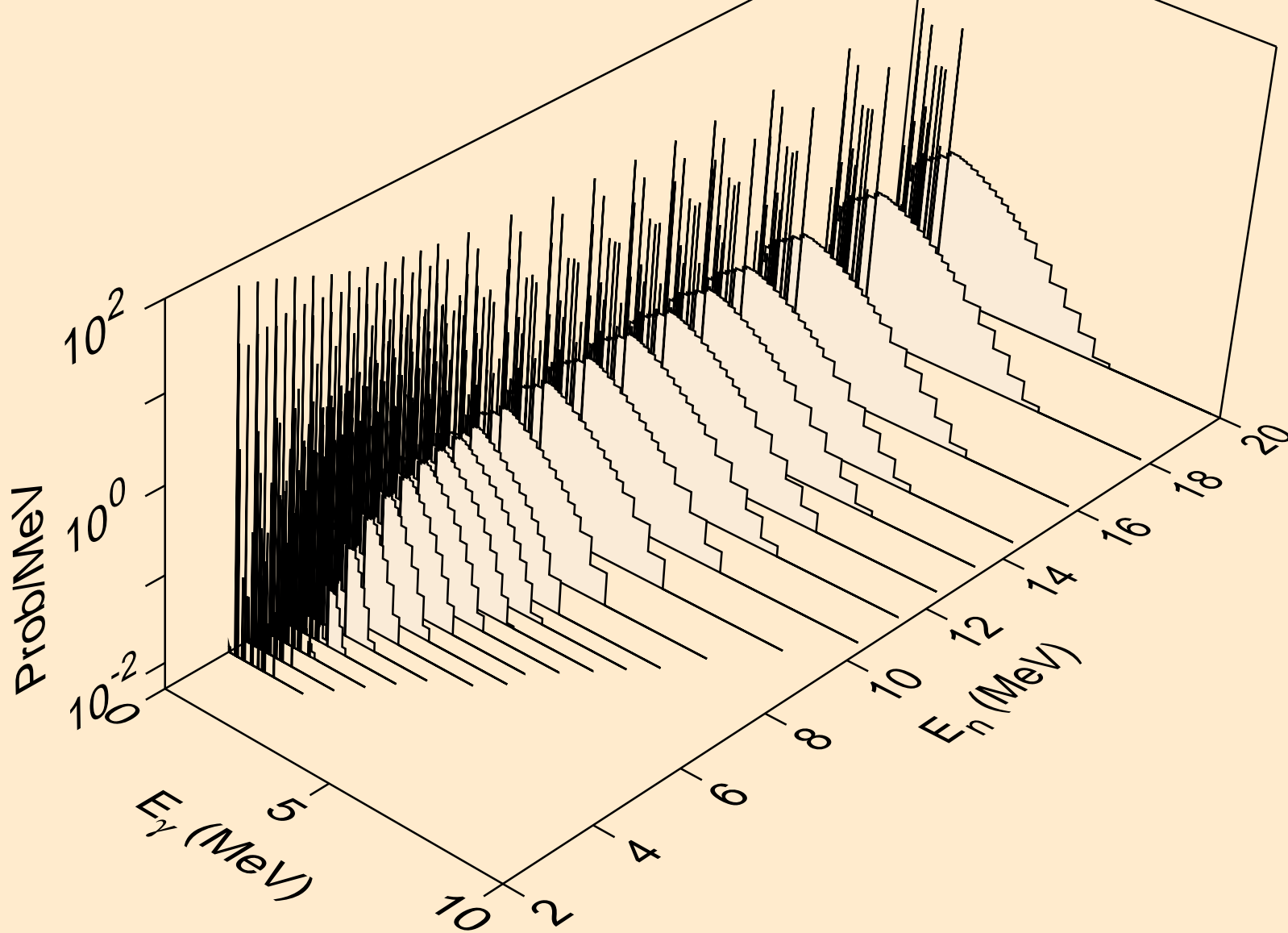



32-GE-73 FOR FENDL-3.2 FROM JEFF-3.1.1 BY NJOY2016.60+ O  
Photon emission for (n,d\*1)

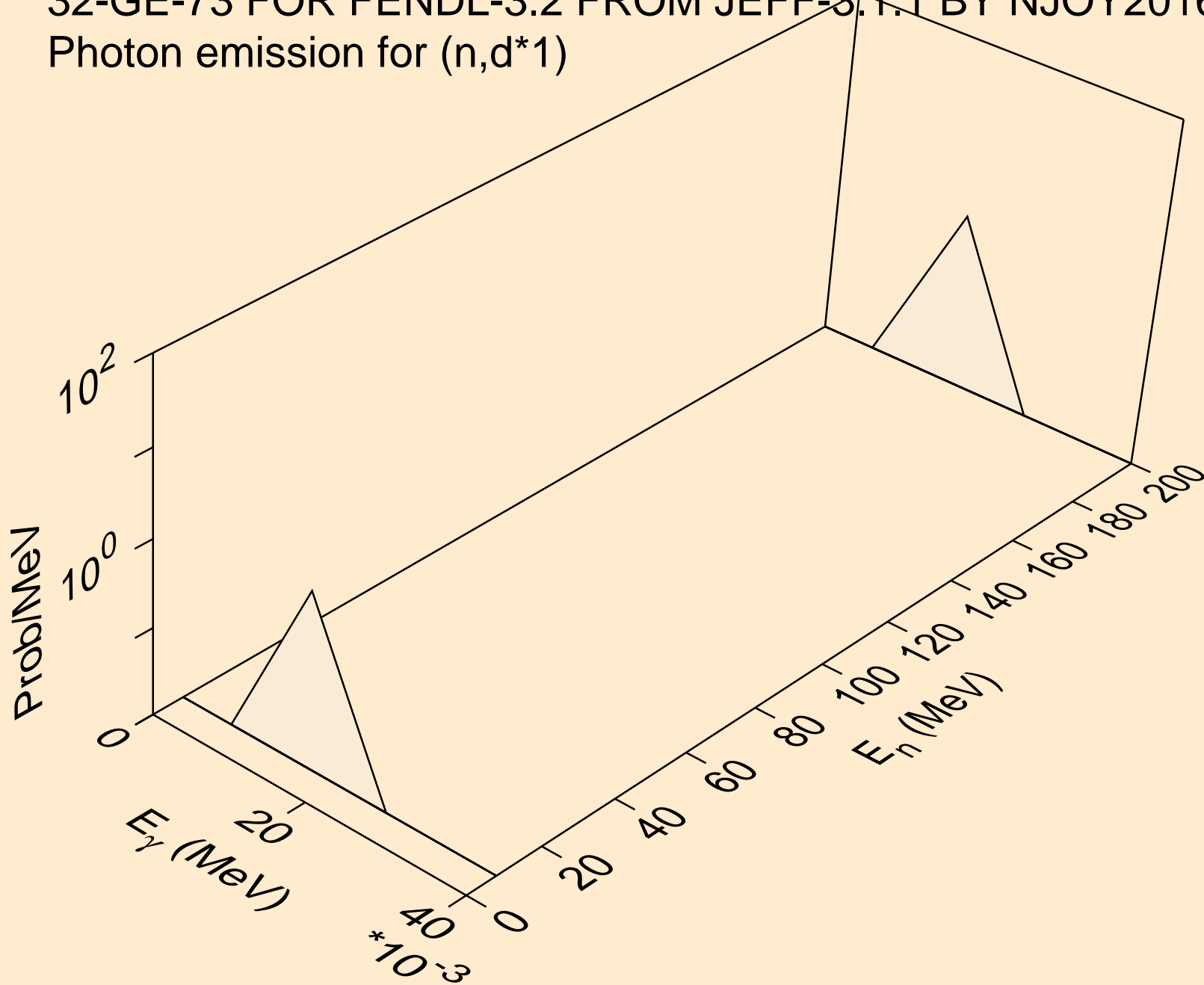

32-GE-73 FOR FENDL-3.2 FROM JEFF-3.1.1 BY NJOY2016.60+ O  
Photon emission for (n,d\*2)

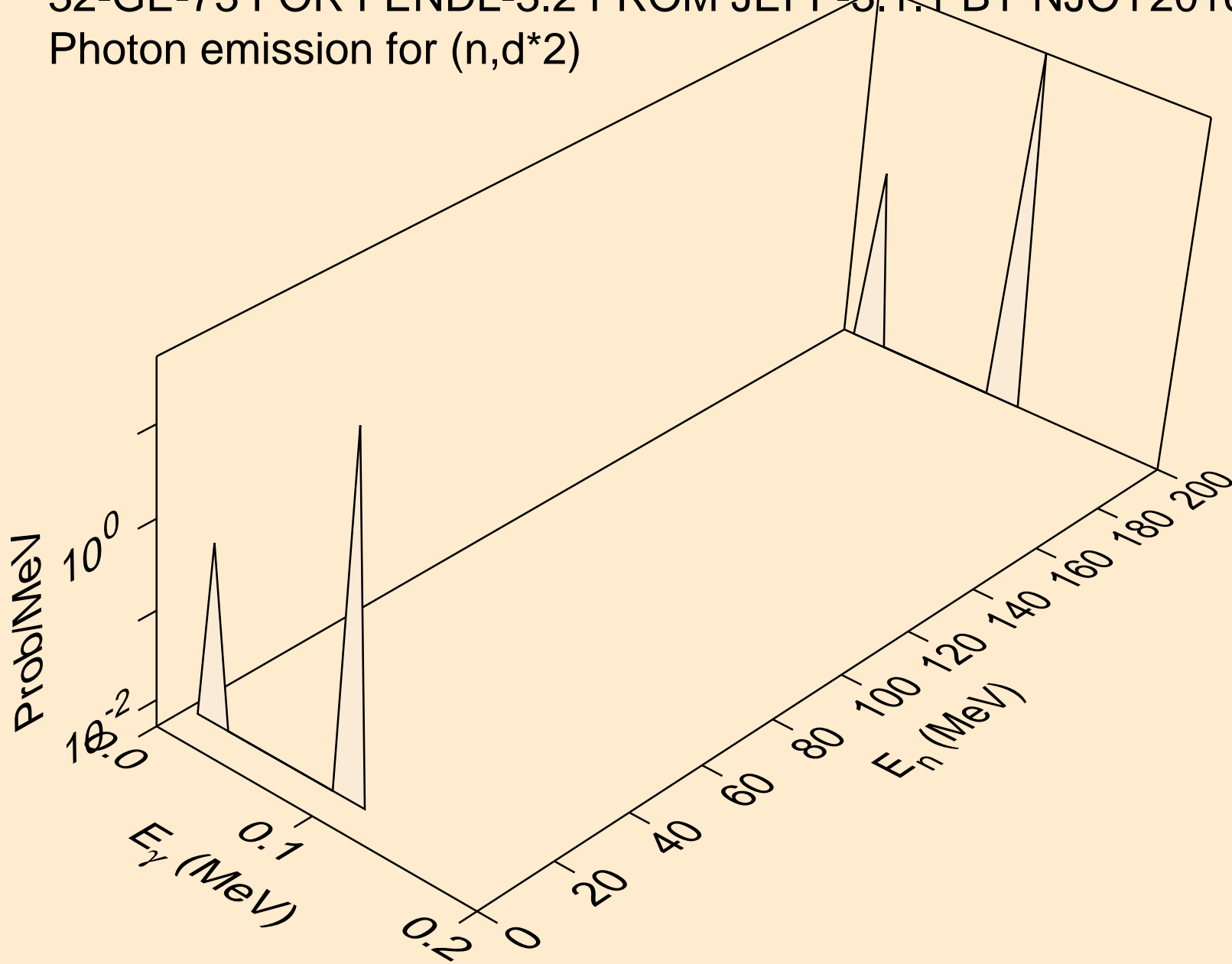

32-GE-73 FOR FENDL-3.2 FROM JEFF-3.1.1 BY NJOY2016.60+ O  
Photon emission for (n,d\*3)

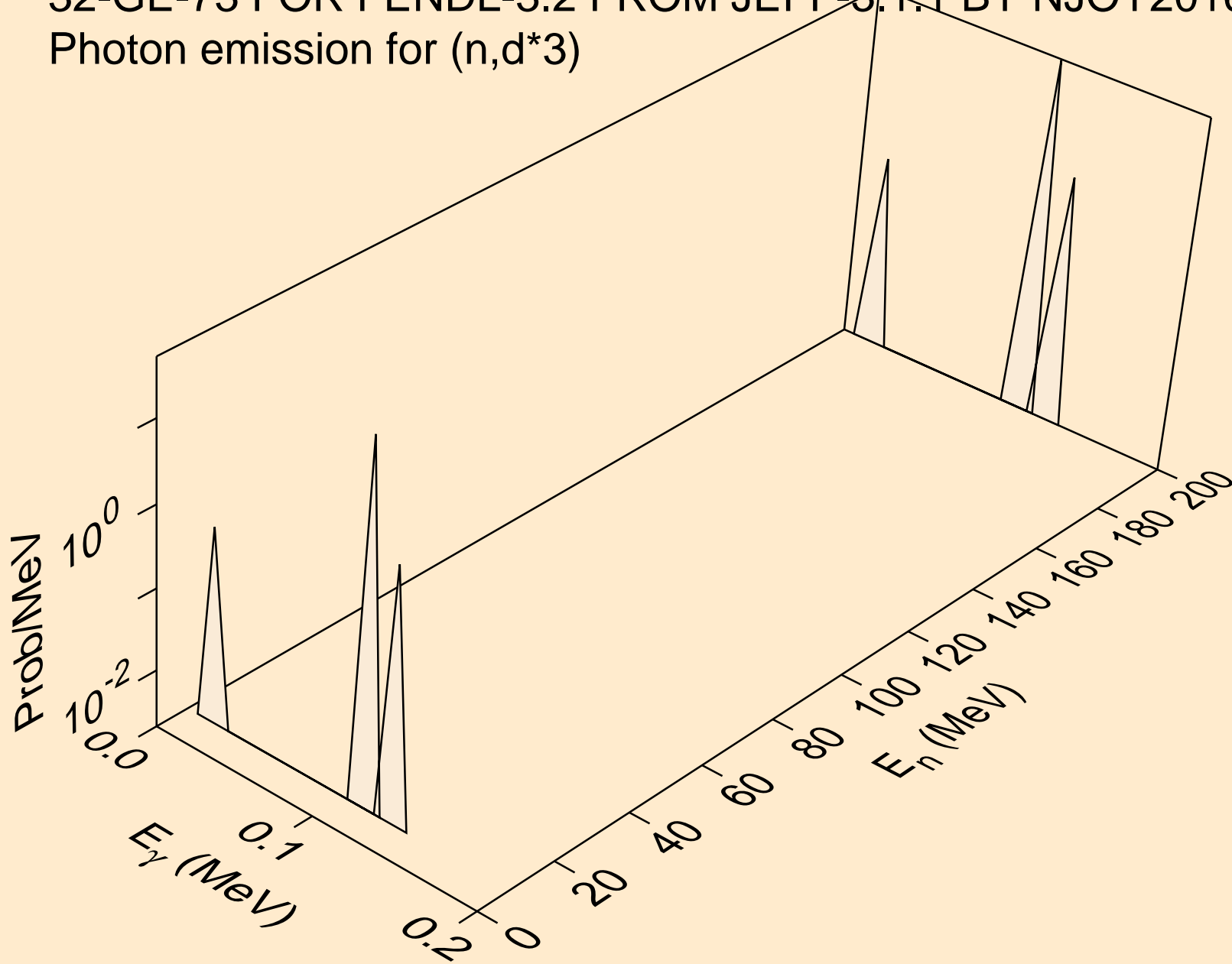

32-GE-73 FOR FENDL-3.2 FROM JEFF-3.1.1 BY NJOY2016.60+ O  
Photon emission for (n,d\*4)

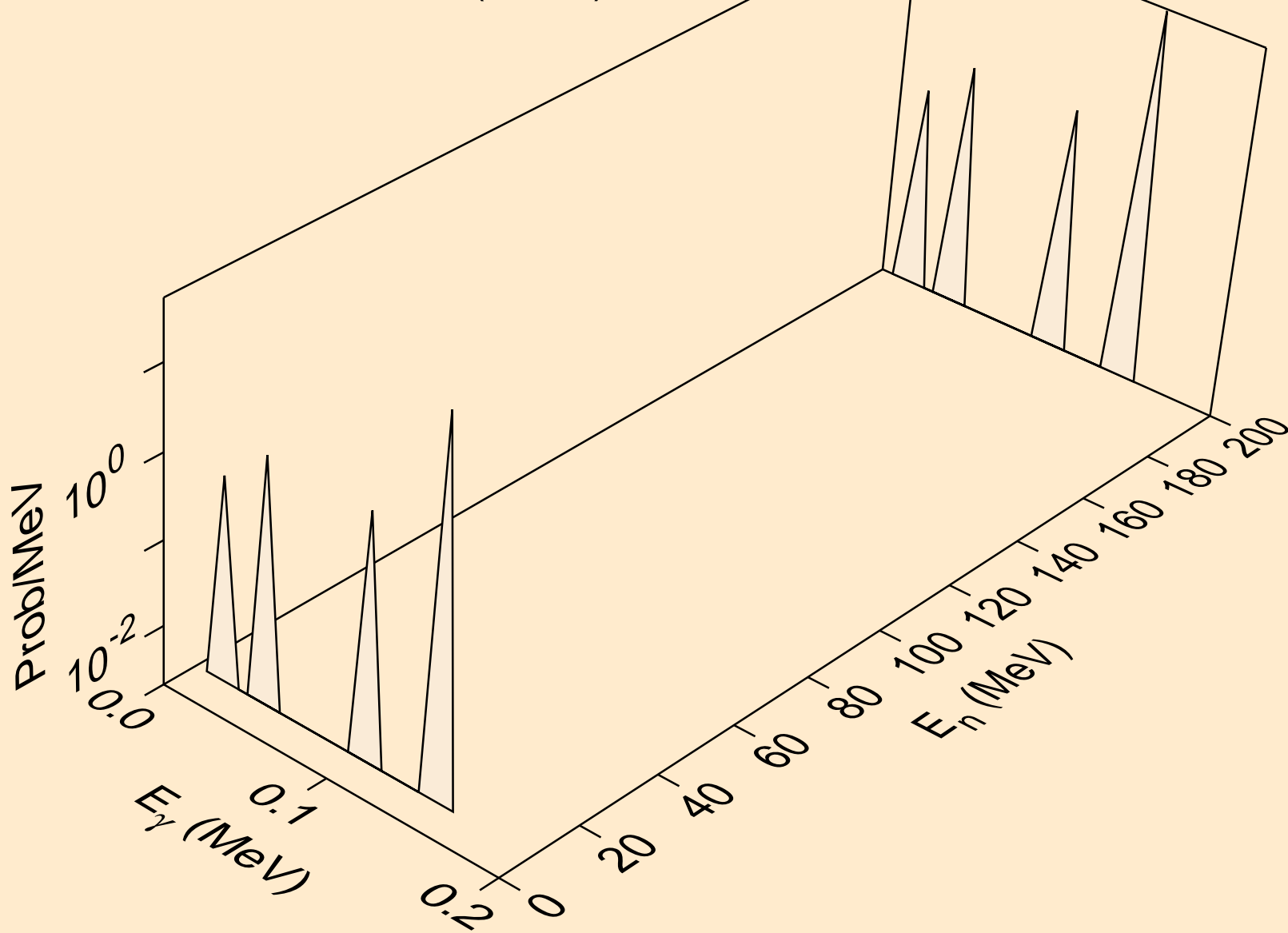

32-GE-73 FOR FENDL-3.2 FROM JEFF-3.1.1 BY NJOY2016.60+ O  
Photon emission for (n,d\*5)

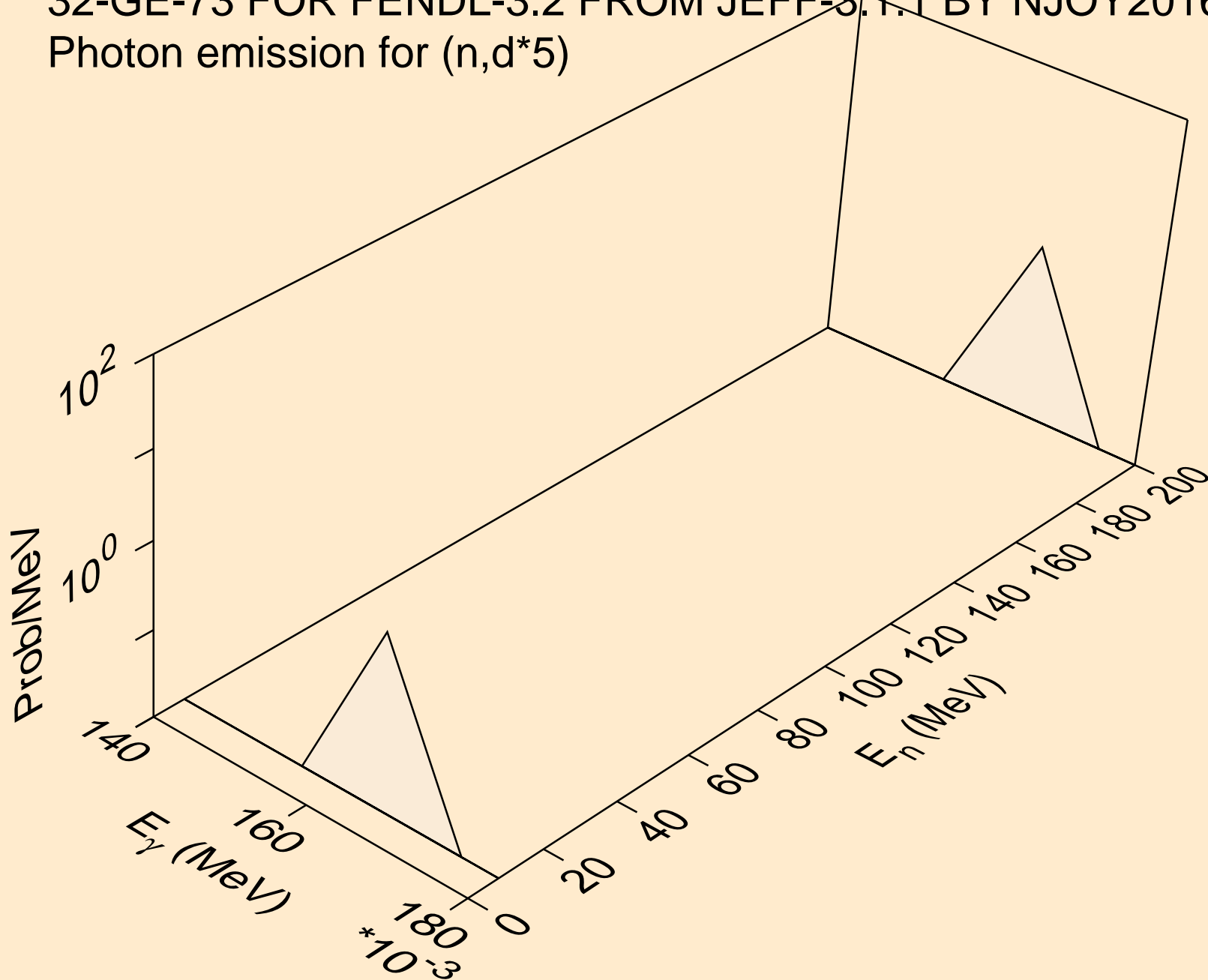

32-GE-73 FOR FENDL-3.2 FROM JEFF-3.1.1 BY NJOY2016.60+ O  
Photon emission for (n,d\*c)

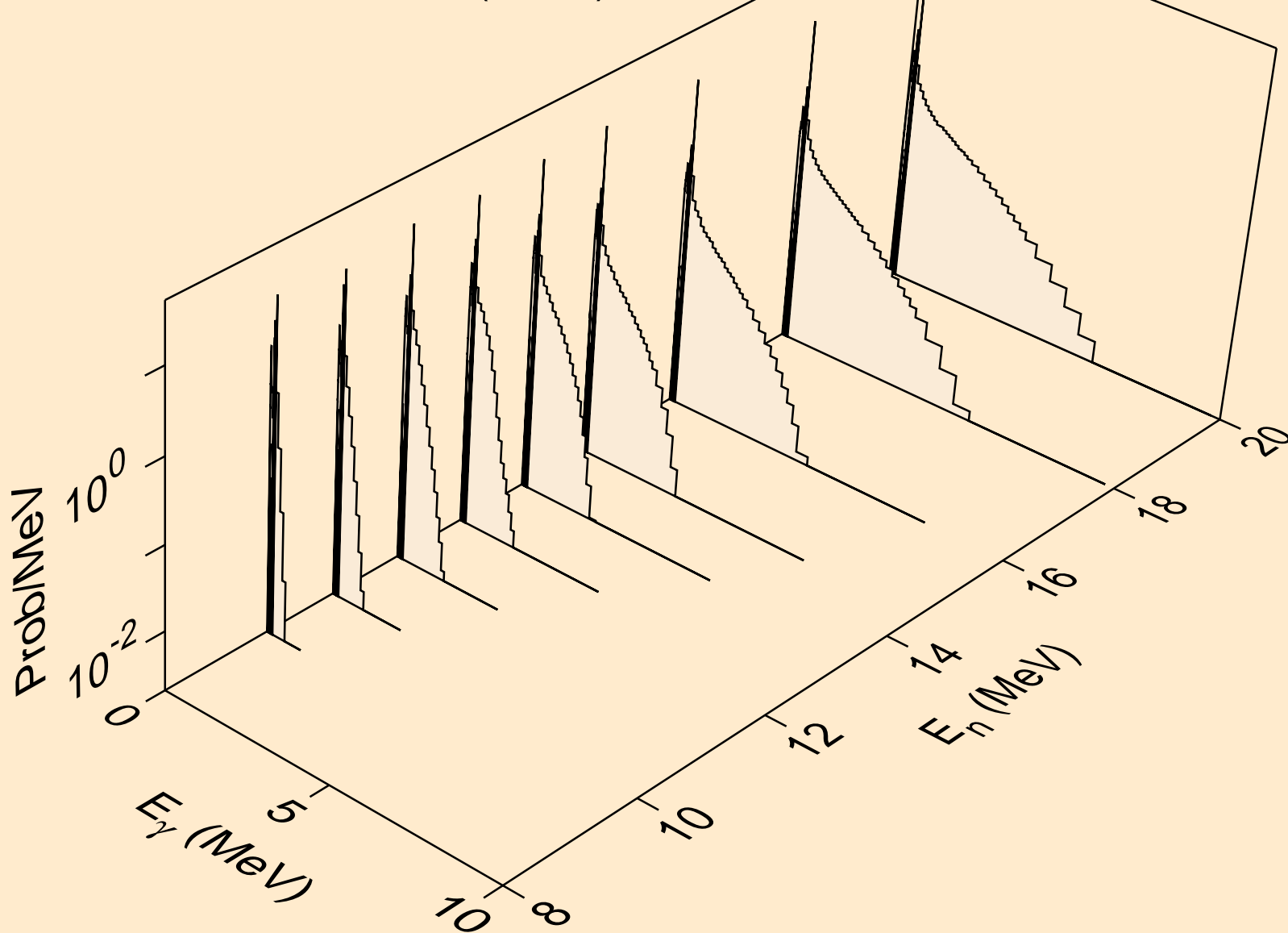

32-GE-73 FOR FENDL-3.2 FROM JEFF-3.1.1 BY NJOY2016.60+ O  
Photon emission for (n,t\*1)

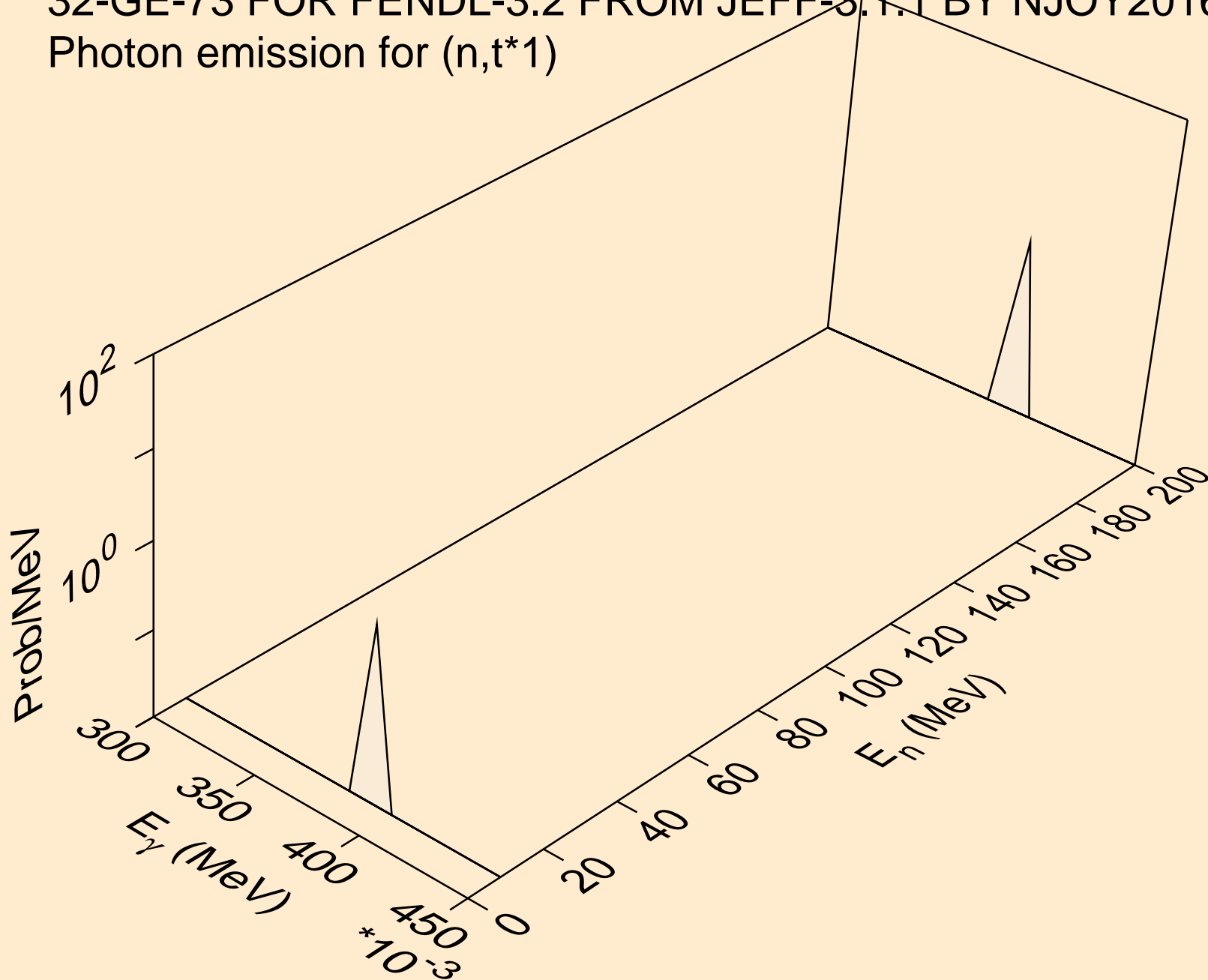

32-GE-73 FOR FENDL-3.2 FROM JEFF-3.1.1 BY NJOY2016.60+ O  
Photon emission for (n,t\*2)

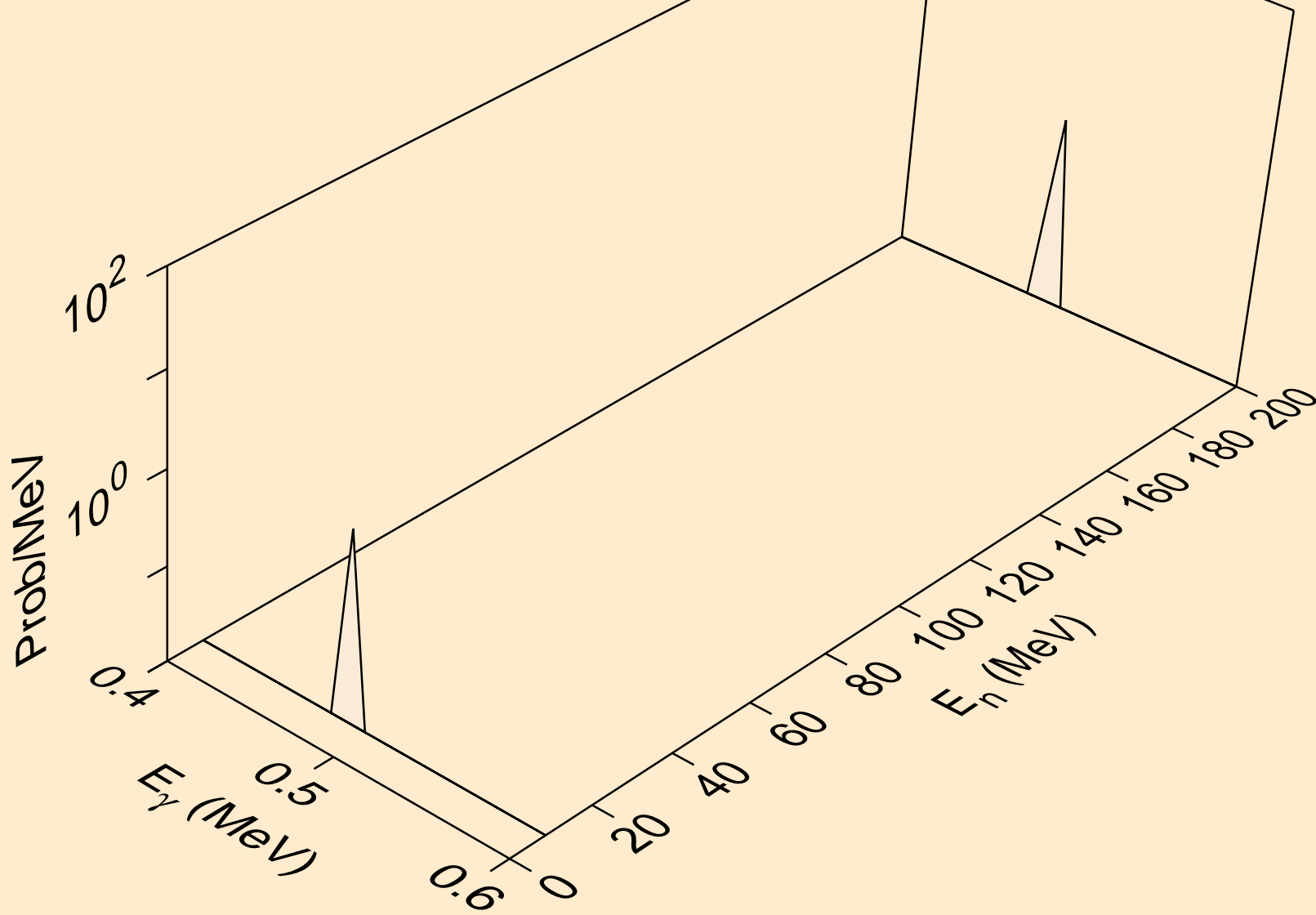



32-GE-73 FOR FENDL-3.2 FROM JEFF-3.1.1 BY NJOY2016.60+ O  
Photon emission for (n,t\*3)

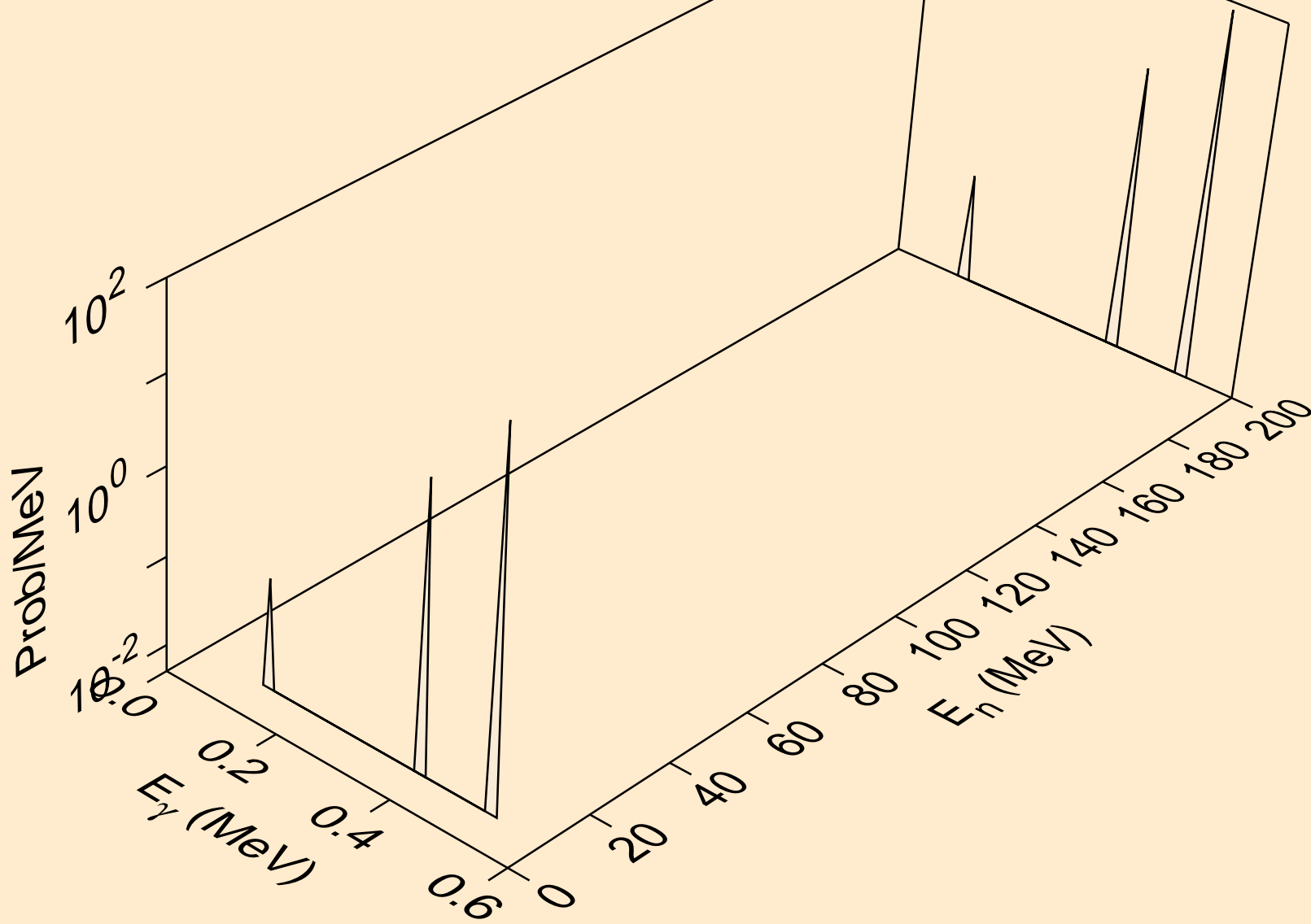

32-GE-73 FOR FENDL-3.2 FROM JEFF-3.1.1 BY NJOY2016.60+ O  
Photon emission for (n,t\*4)

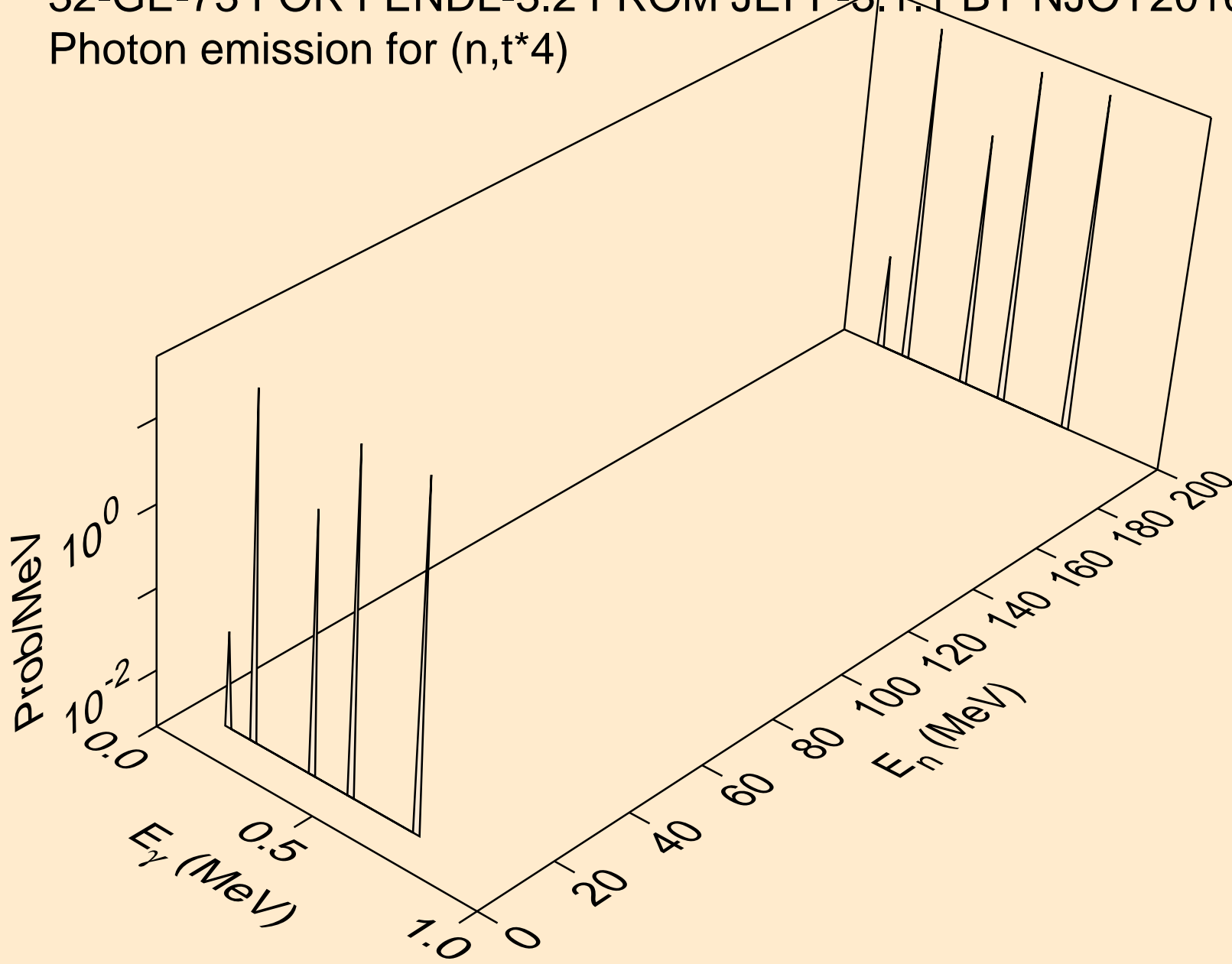

32-GE-73 FOR FENDL-3.2 FROM JEFF-3.1.1 BY NJOY2016.60+ O  
Photon emission for (n,t\*5)

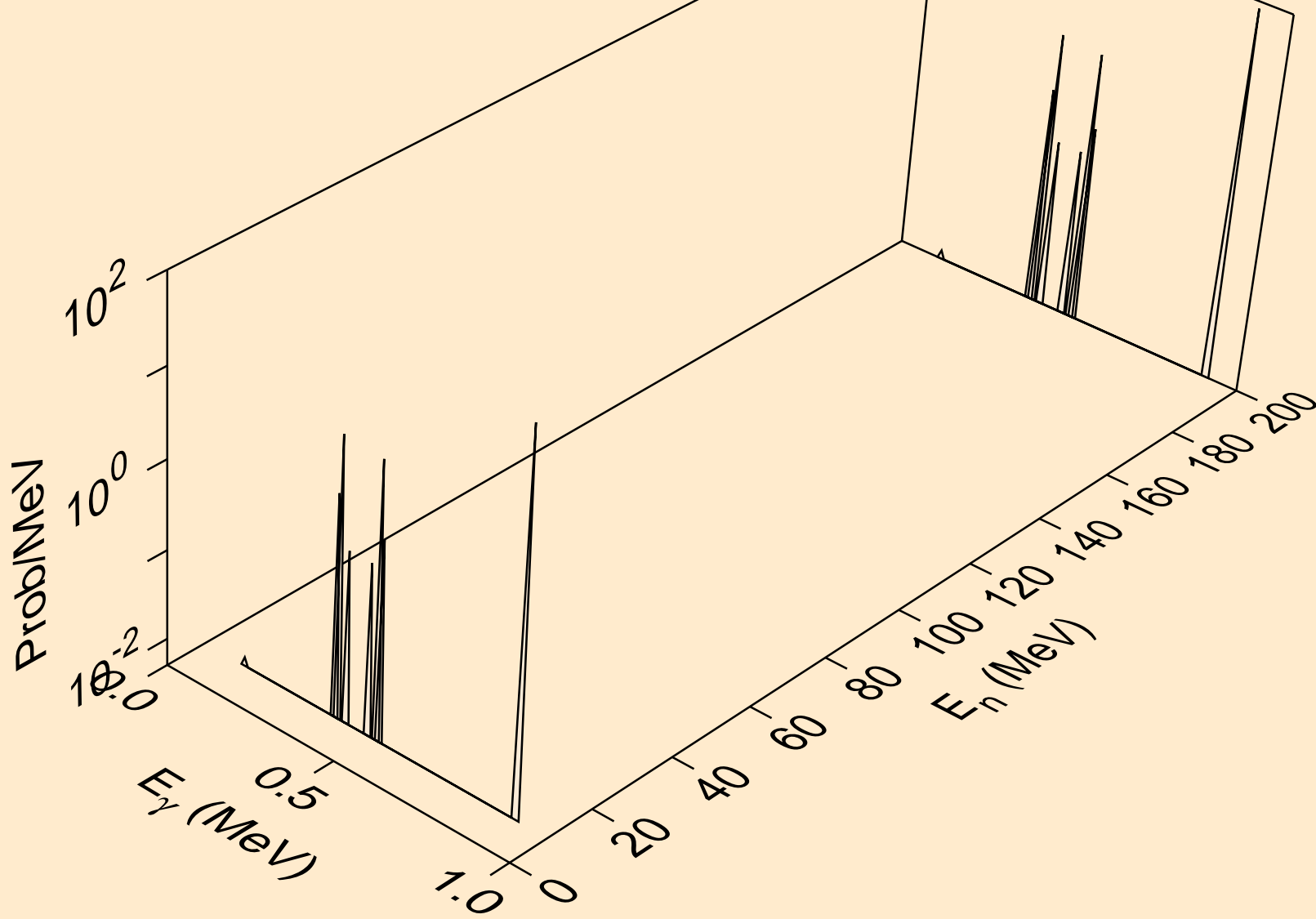

32-GE-73 FOR FENDL-3.2 FROM JEFF-3.1.1 BY NJOY2016.60+ O  
Photon emission for (n,t\*c)

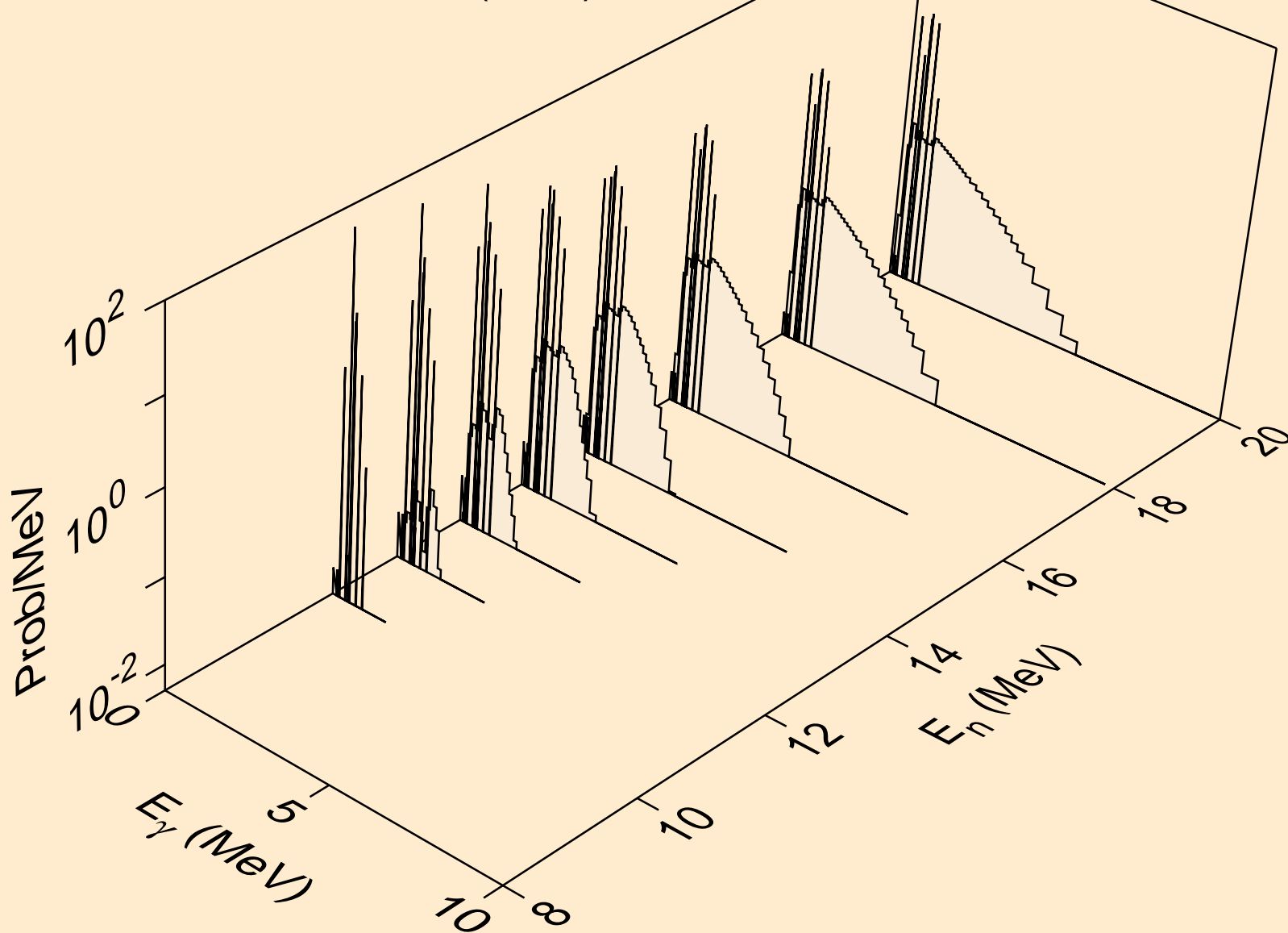

32-GE-73 FOR FENDL-3.2 FROM JEFF-3.1.1 BY NJOY2016.60+ O  
Photon emission for (n,he3\*2)

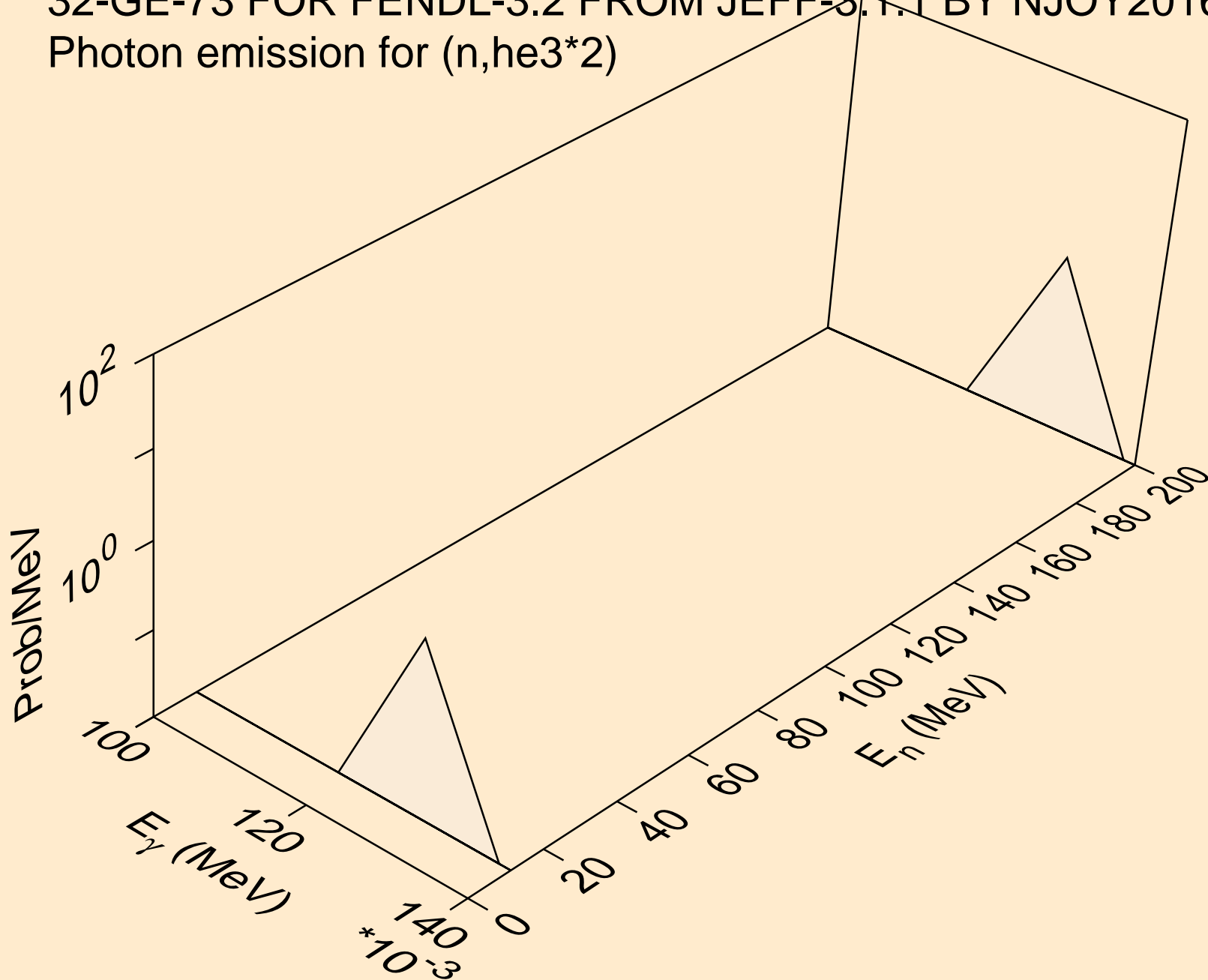

32-GE-73 FOR FENDL-3.2 FROM JEFF-3.1.1 BY NJOY2016.60+ O  
Photon emission for (n,he3\*3)

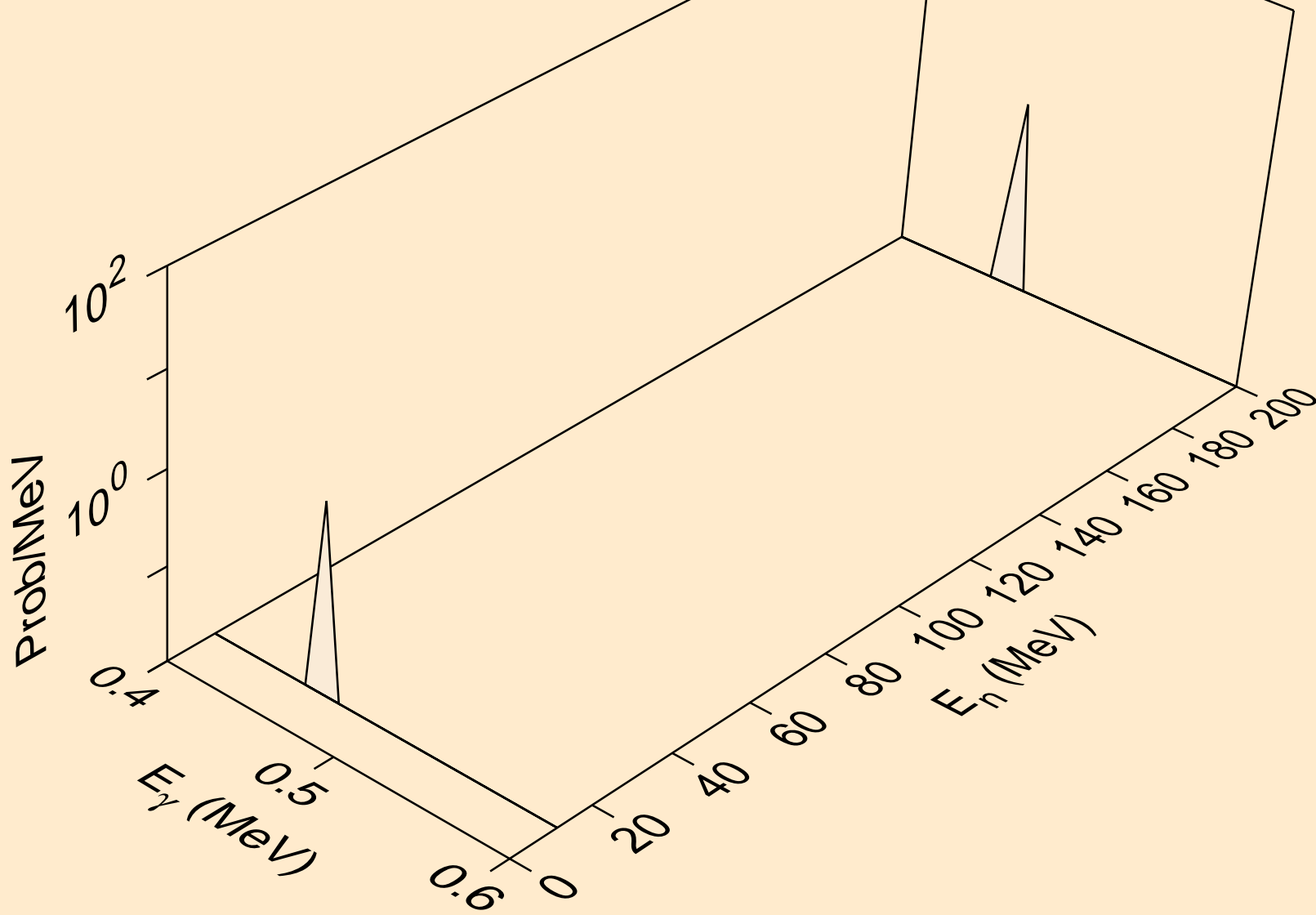

32-GE-73 FOR FENDL-3.2 FROM JEFF-3.1.1 BY NJOY2016.60+ O  
Photon emission for (n,he3\*4)

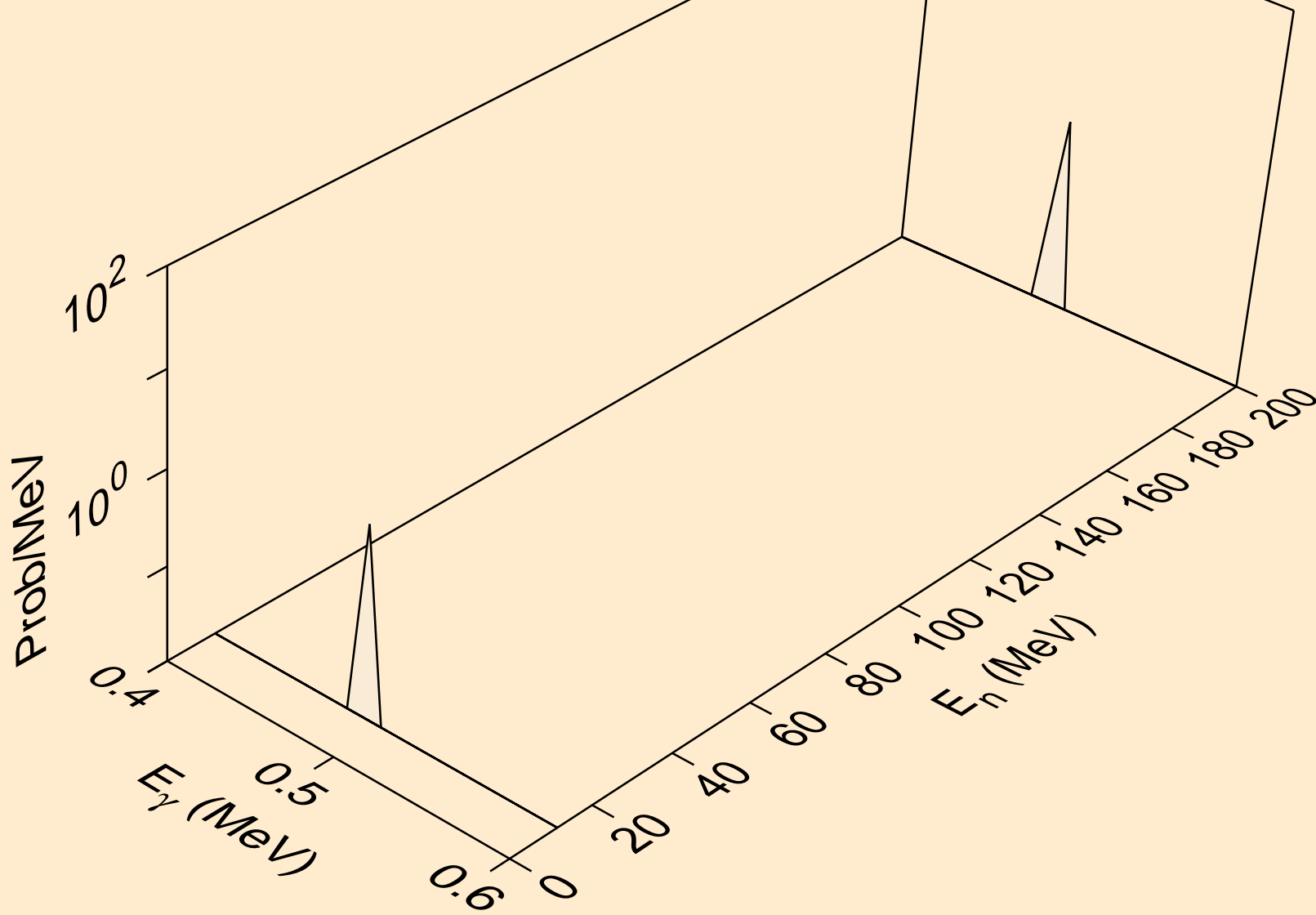

32-GE-73 FOR FENDL-3.2 FROM JEFF-3.1.1 BY NJOY2016.60+ O  
Photon emission for (n,he3\*5)

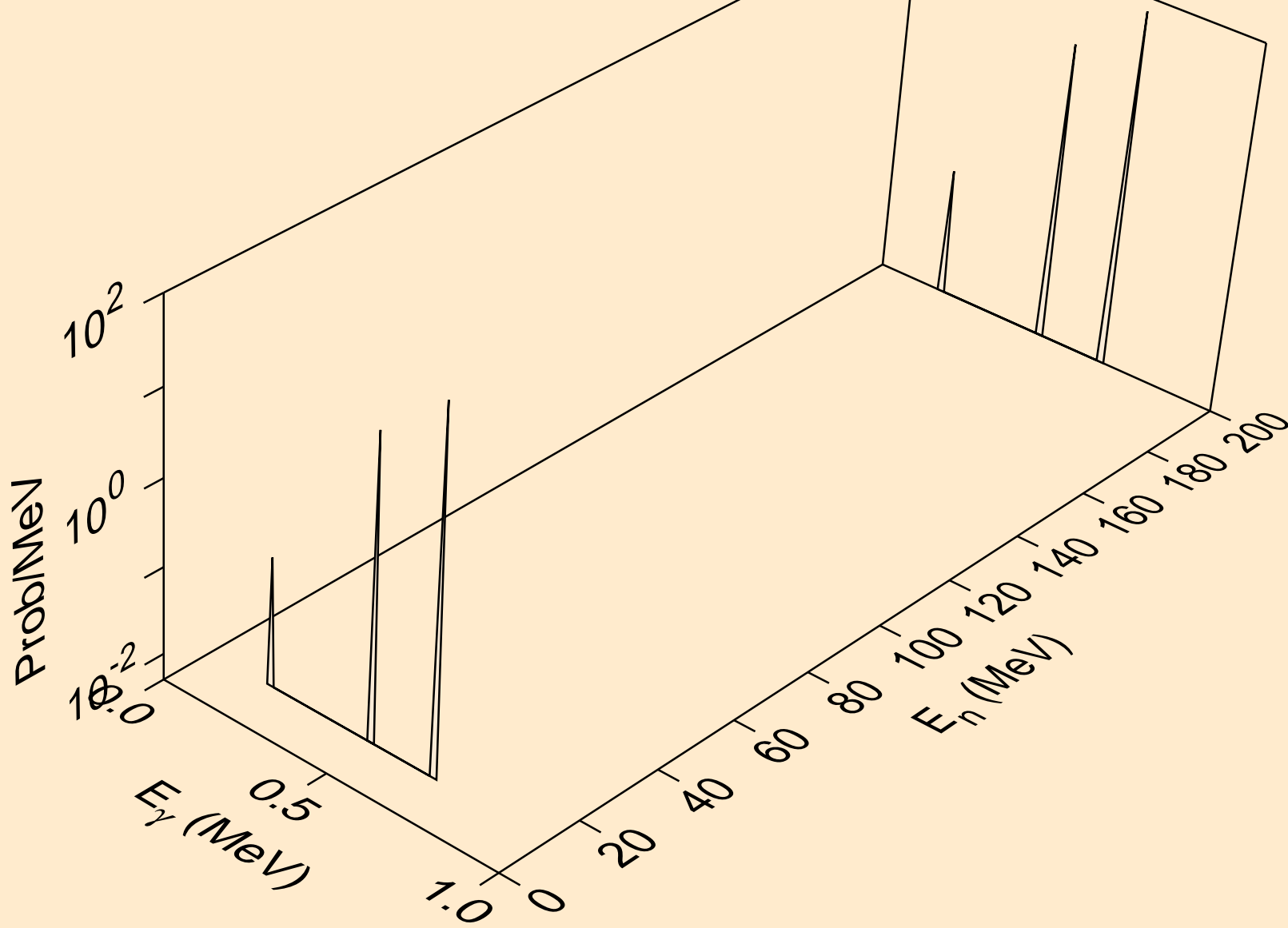



32-GE-73 FOR FENDL-3.2 FROM JEFF-3.1.1 BY NJOY2016.60+ O  
Photon emission for (n,he3\*c)

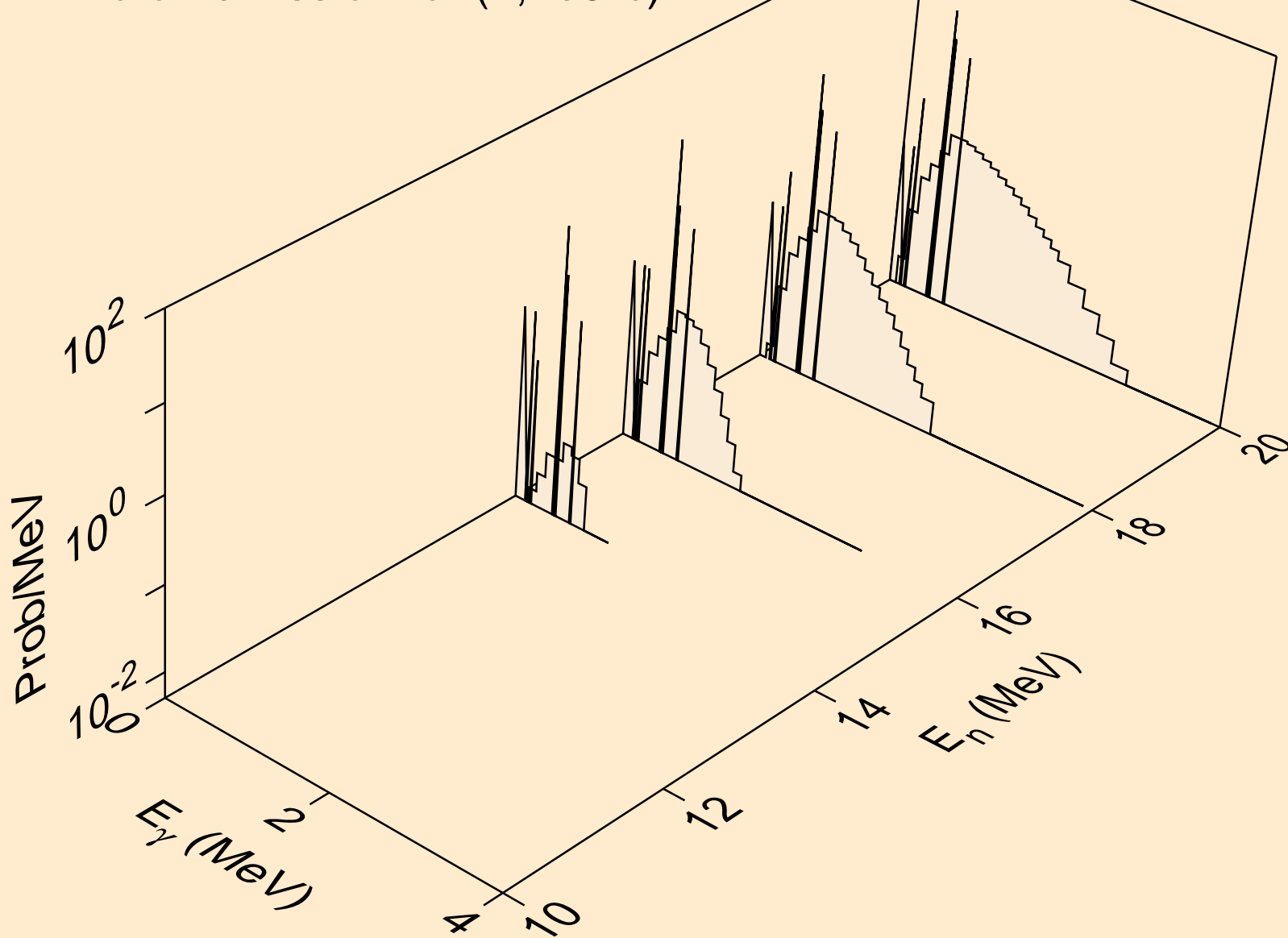

32-GE-73 FOR FENDL-3.2 FROM JEFF-3.1.1 BY NJOY2016.60+ O  
Photon emission for (n,a\*1)

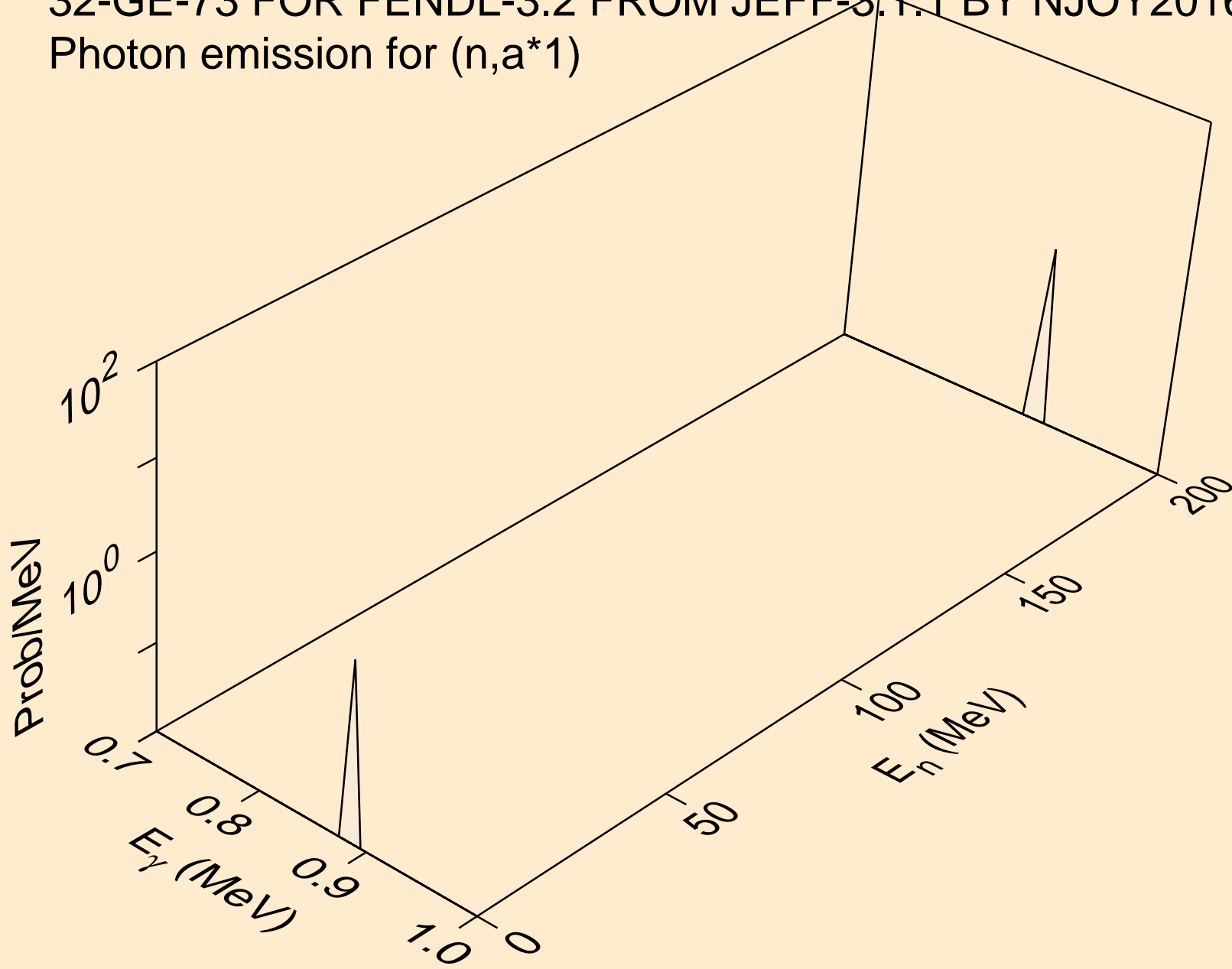

32-GE-73 FOR FENDL-3.2 FROM JEFF-3.1.1 BY NJOY2016.60+ O  
Photon emission for (n,a\*2)

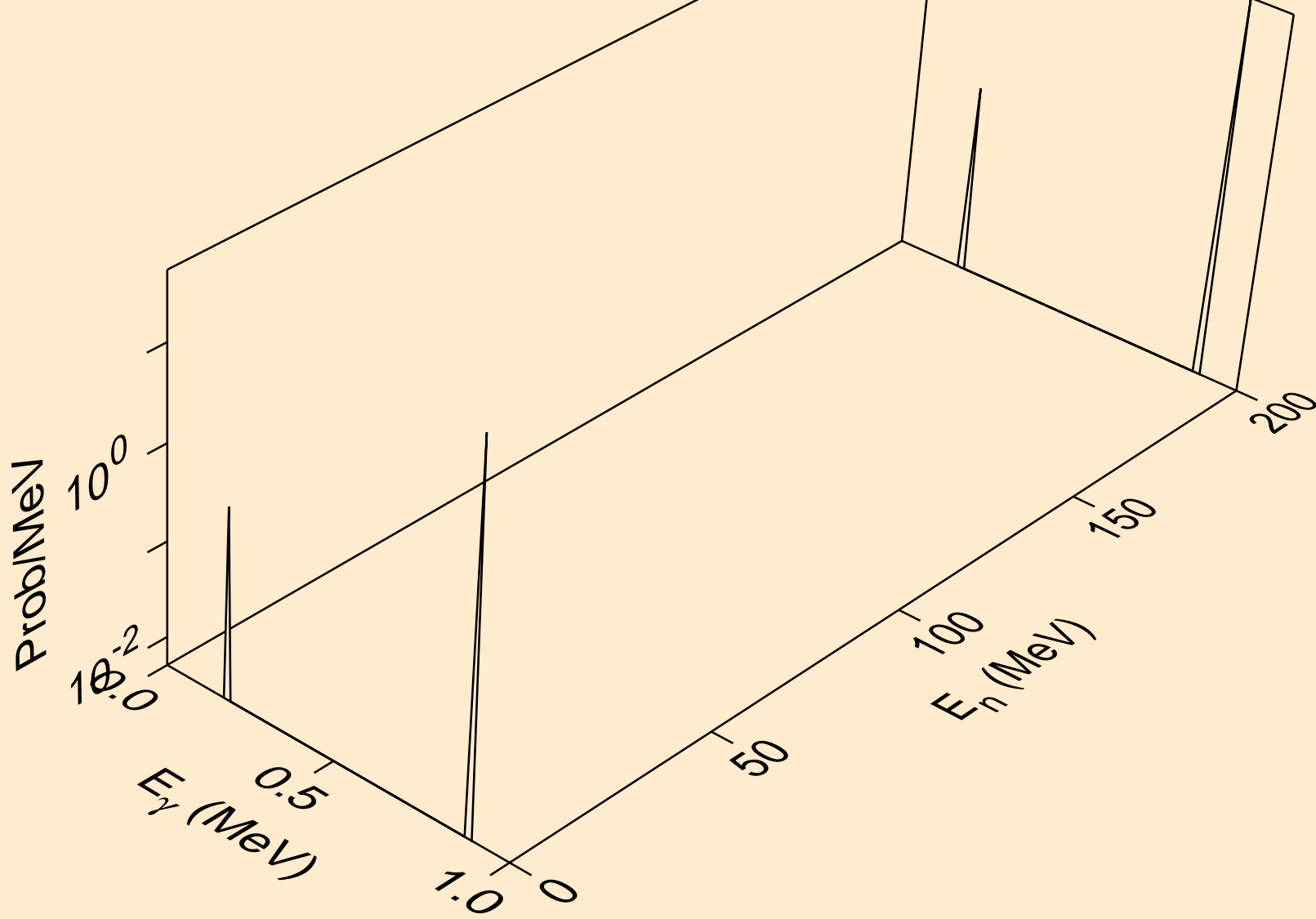

32-GE-73 FOR FENDL-3.2 FROM JEFF-3.1.1 BY NJOY2016.60+ O  
Photon emission for (n,a\*3)

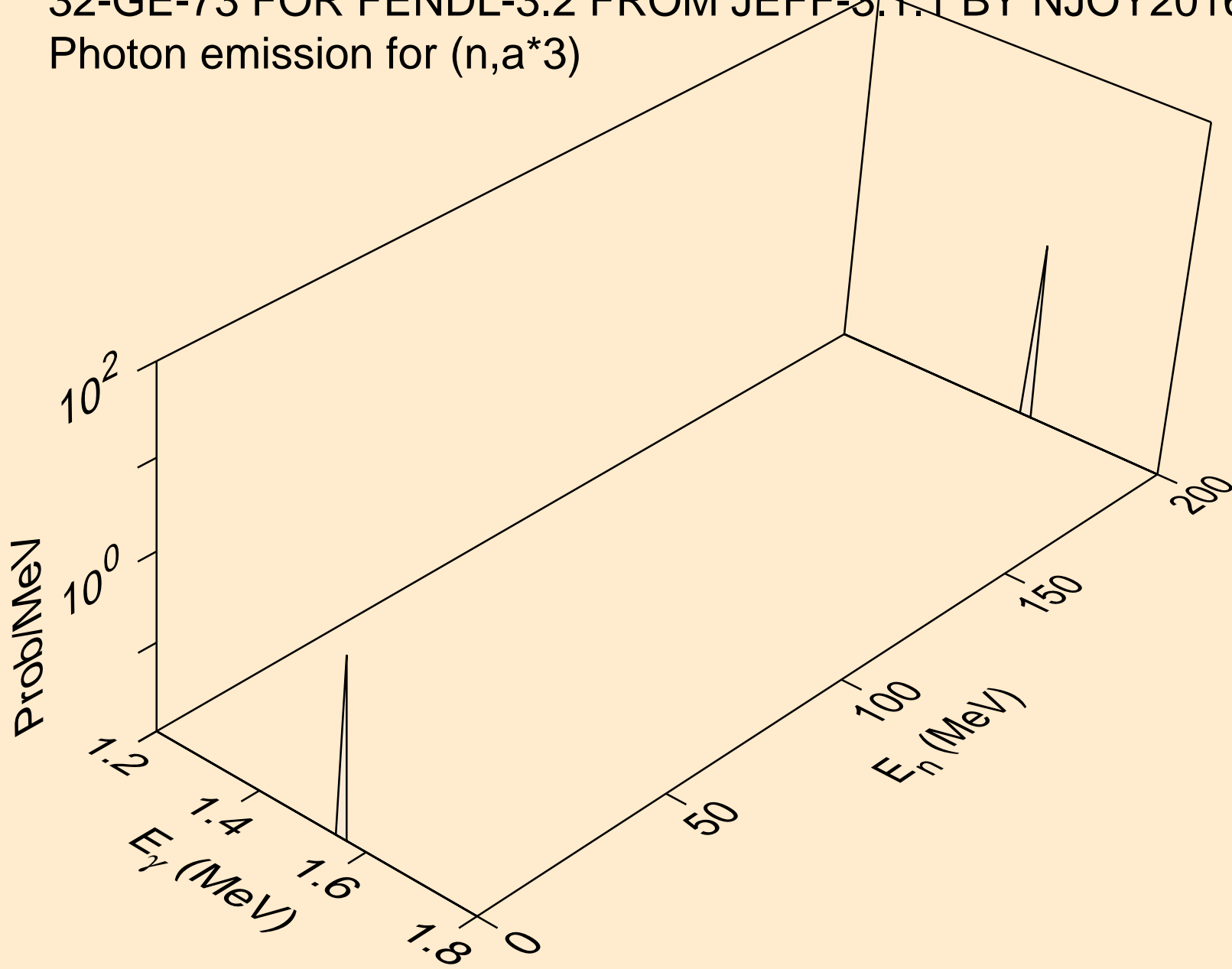

32-GE-73 FOR FENDL-3.2 FROM JEFF-3.1.1 BY NJOY2016.60+ O  
Photon emission for (n,a\*4)

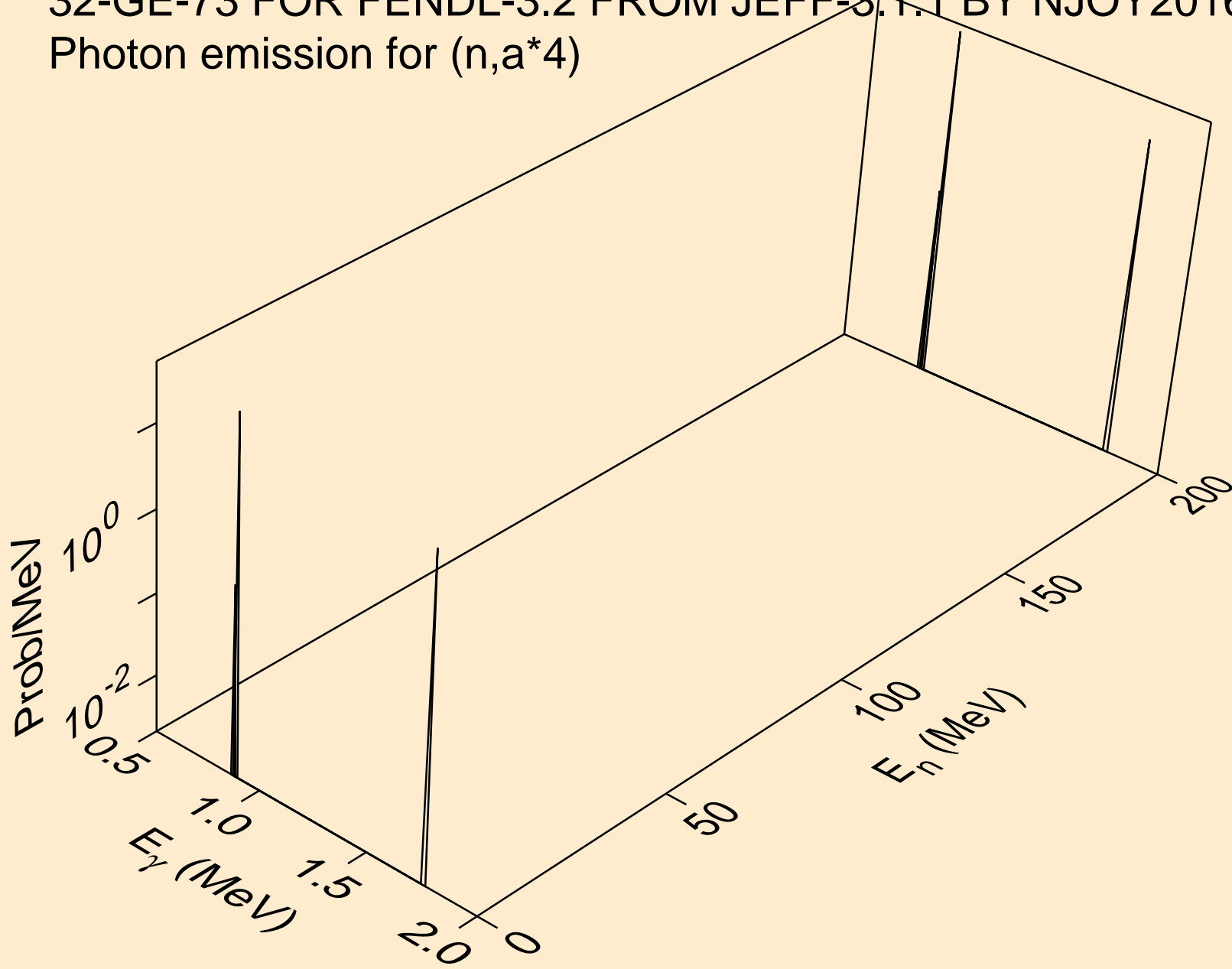

32-GE-73 FOR FENDL-3.2 FROM JEFF-3.1.1 BY NJOY2016.60+ O  
Photon emission for (n,a\*5)

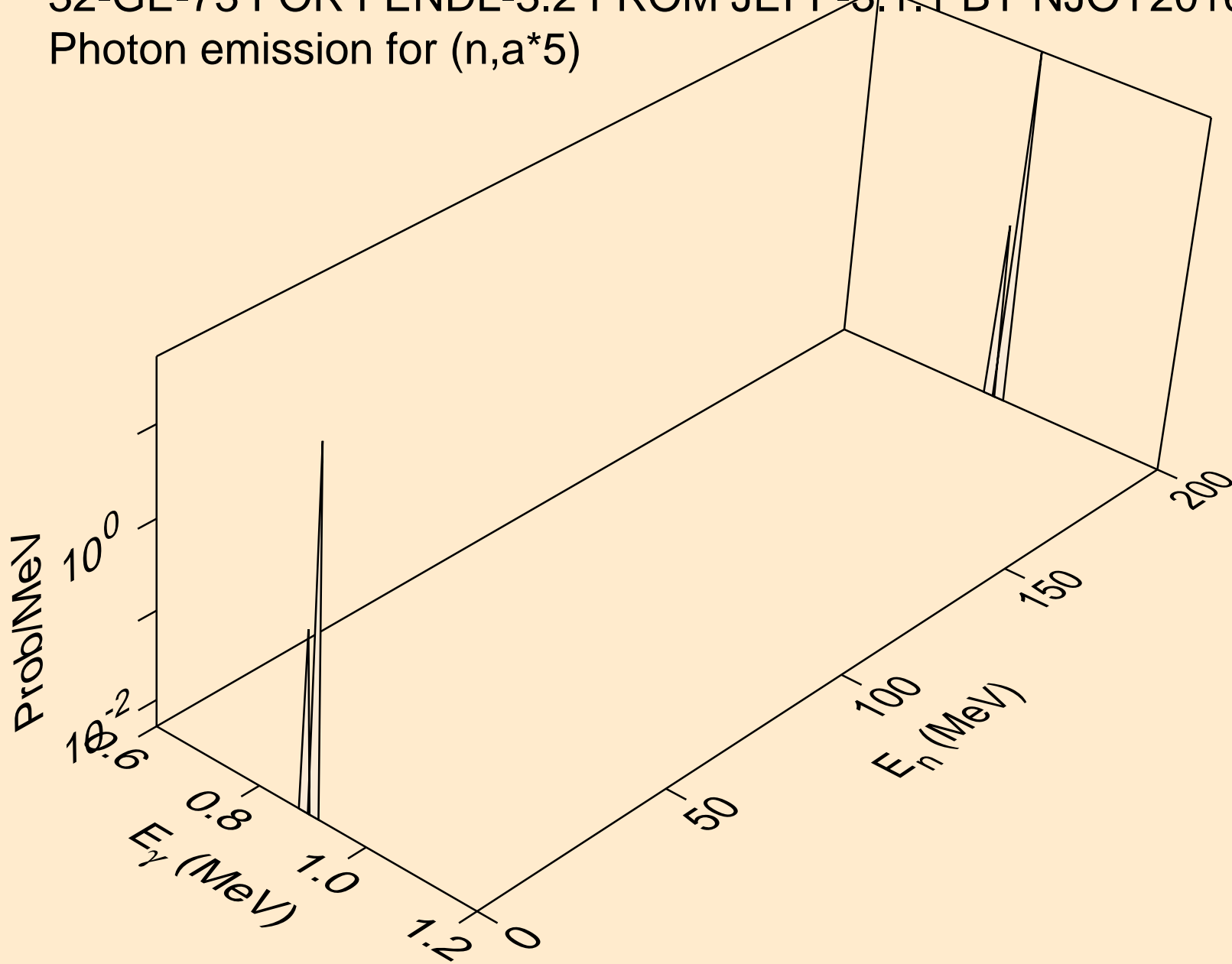

32-GE-73 FOR FENDL-3.2 FROM JEFF-3.1.1 BY NJOY2016.60+ O  
Photon emission for (n,a\*6)

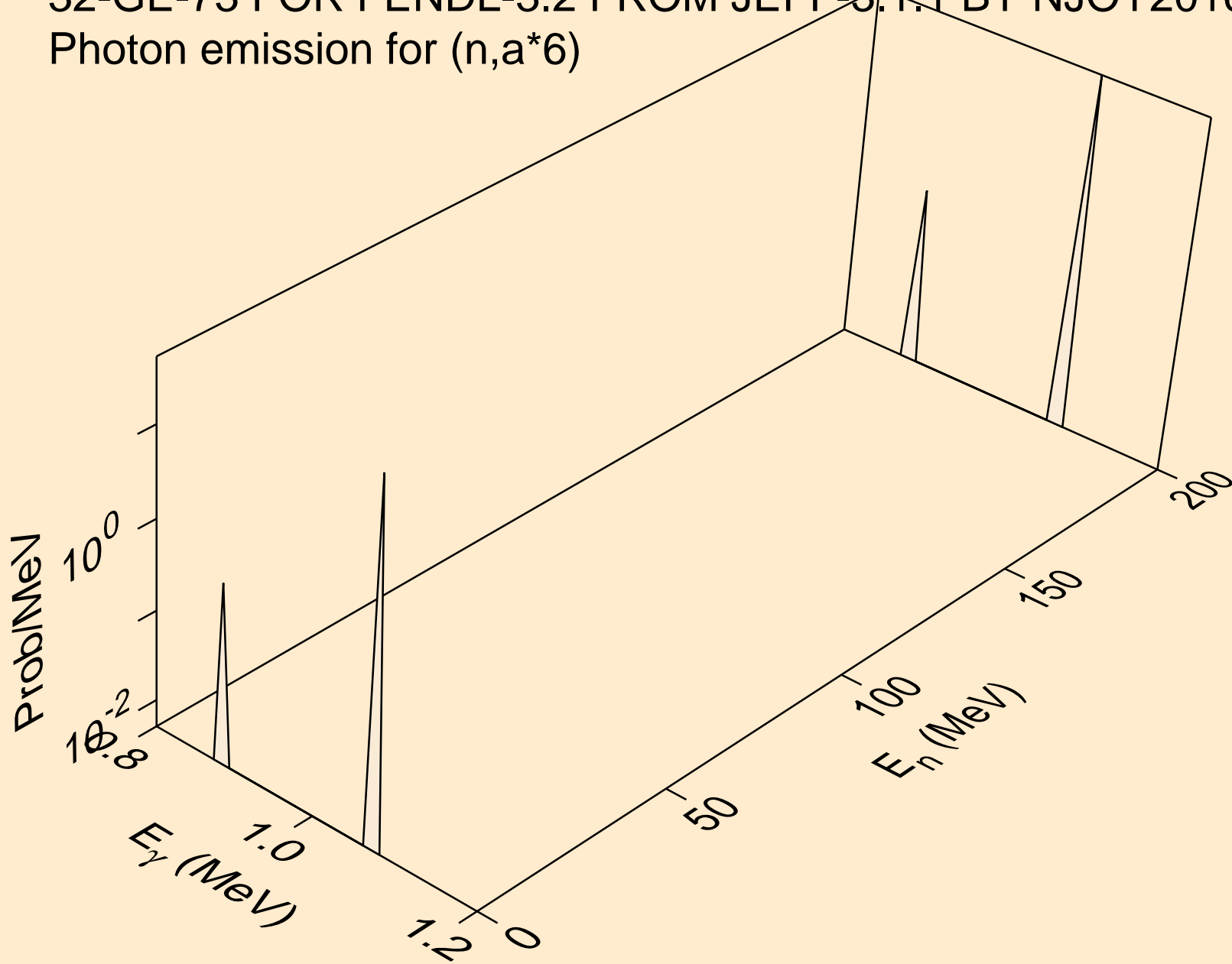

32-GE-73 FOR FENDL-3.2 FROM JEFF-3.1.1 BY NJOY2016.60+ O  
Photon emission for (n,a\*7)

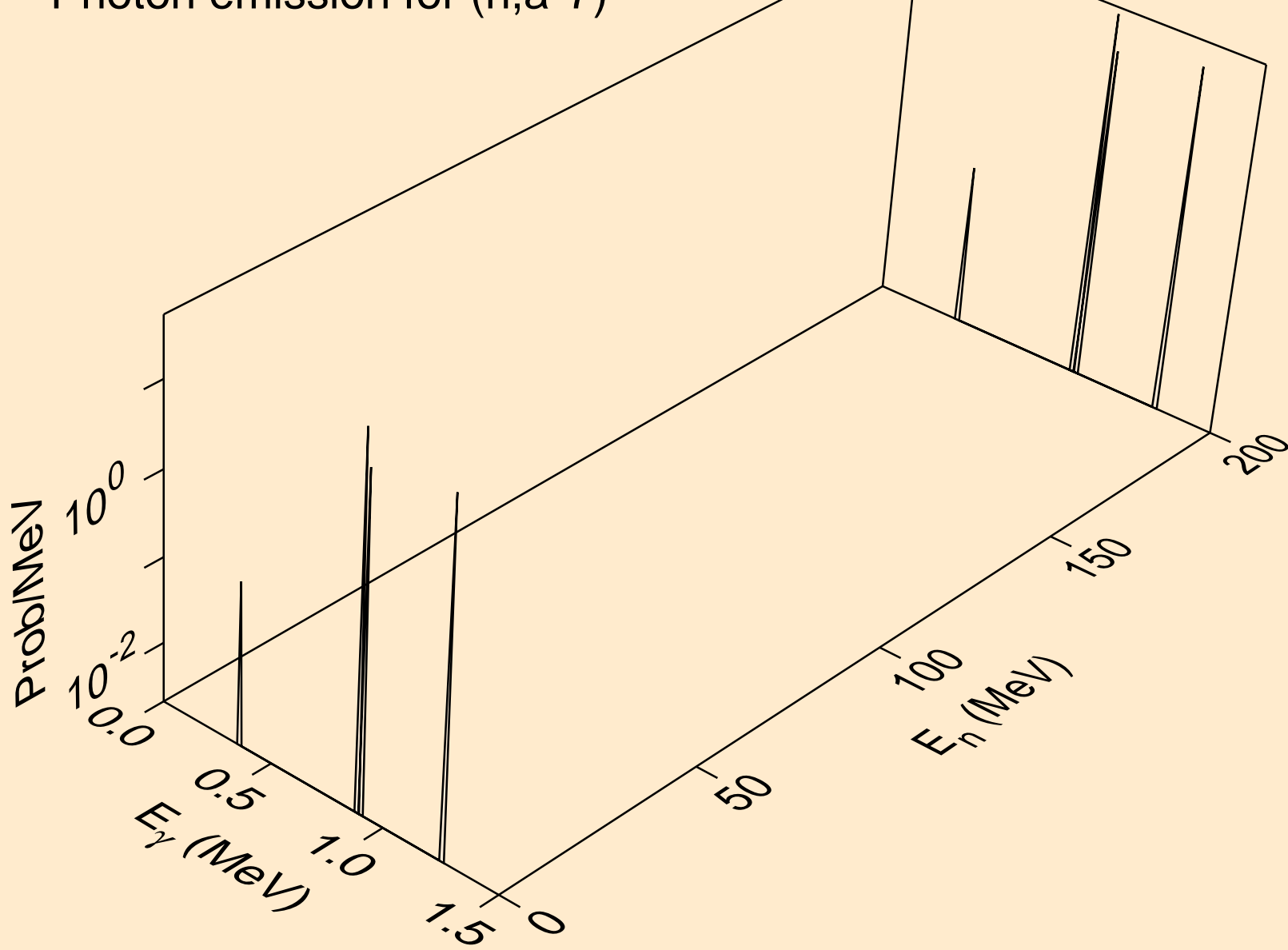



32-GE-73 FOR FENDL-3.2 FROM JEFF-3.1.1 BY NJOY2016.60+ O  
Photon emission for (n,a\*8)

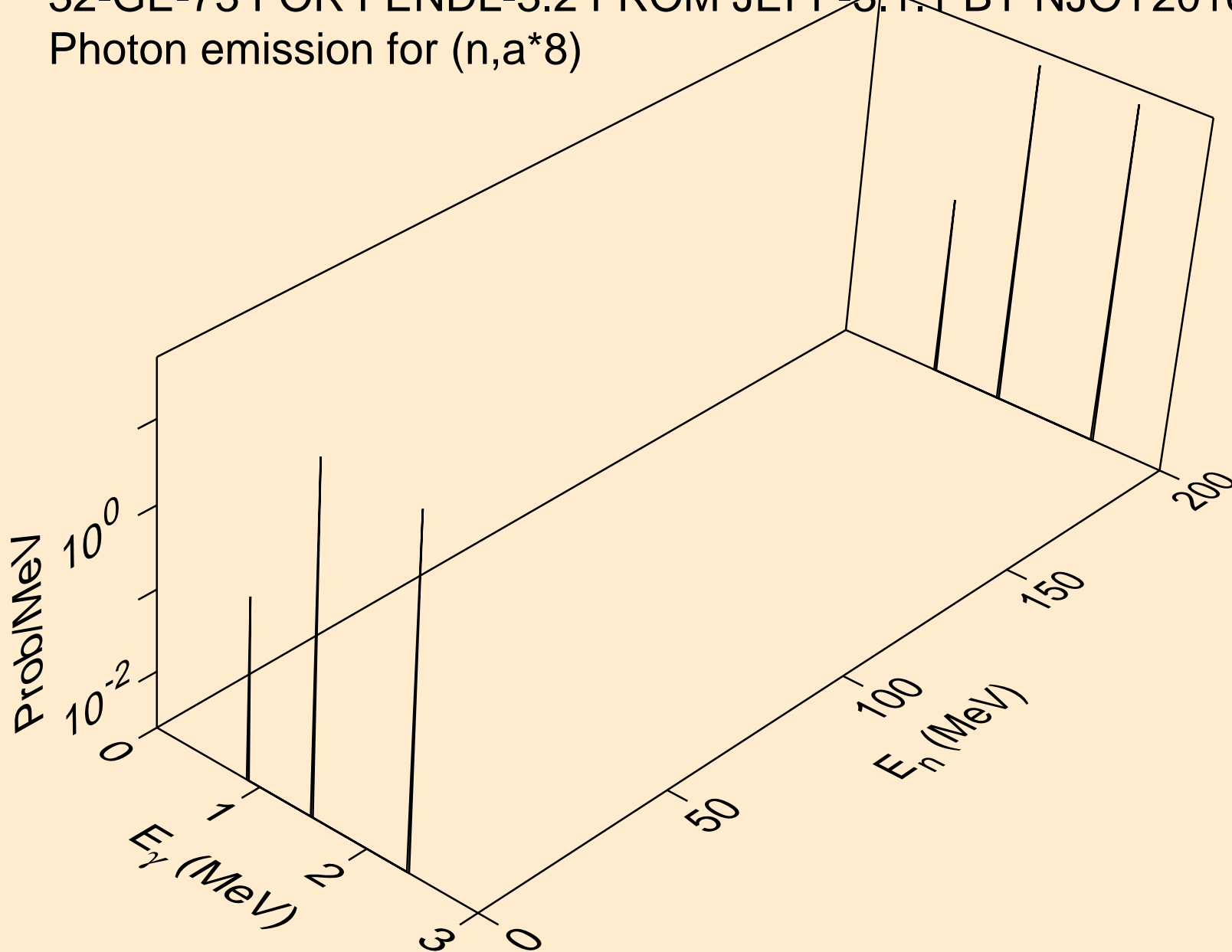

32-GE-73 FOR FENDL-3.2 FROM JEFF-3.1.1 BY NJOY2016.60+ O  
Photon emission for (n,a\*9)

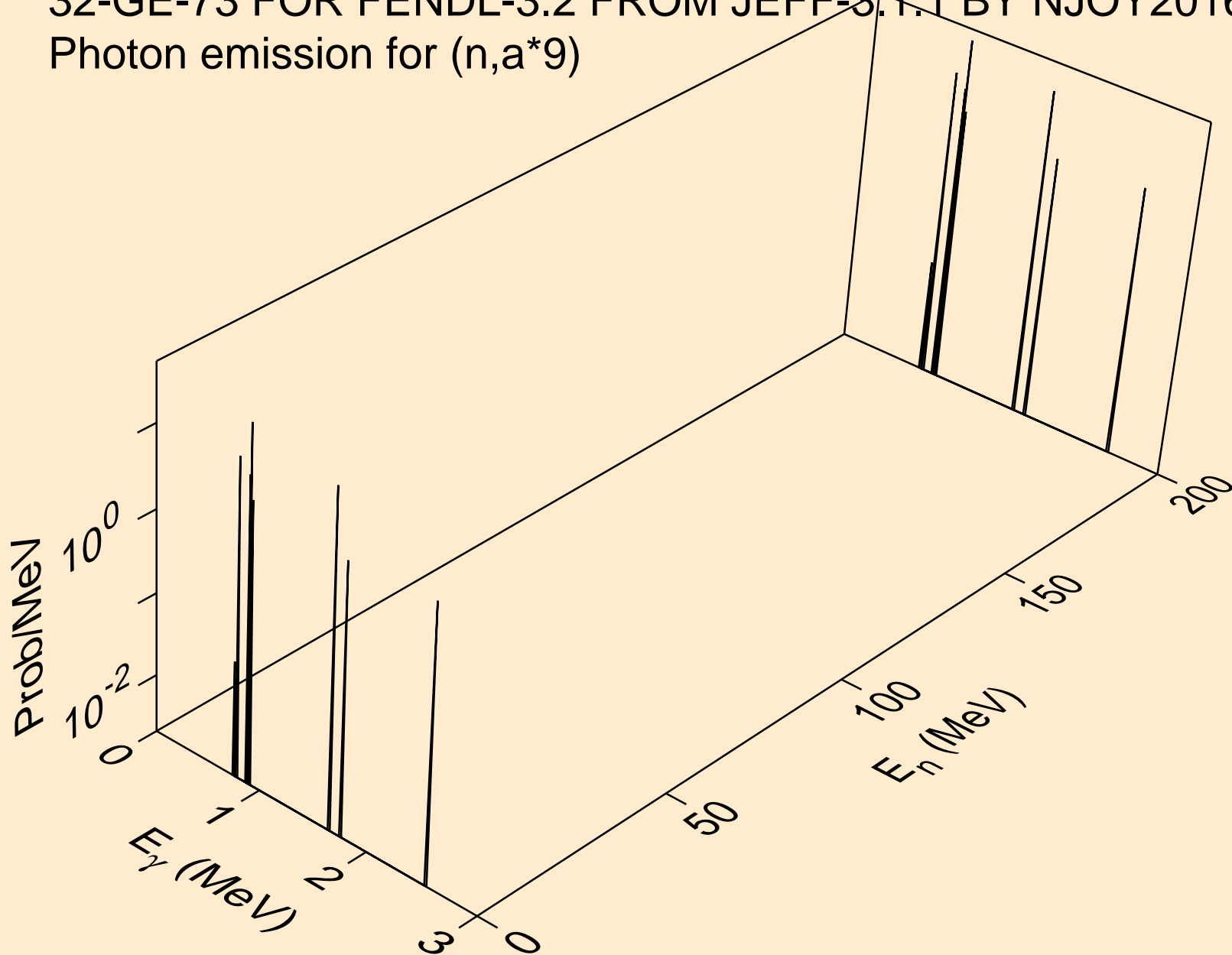

32-GE-73 FOR FENDL-3.2 FROM JEFF-3.1.1 BY NJOY2016.60+ O  
Photon emission for (n,a\*10)

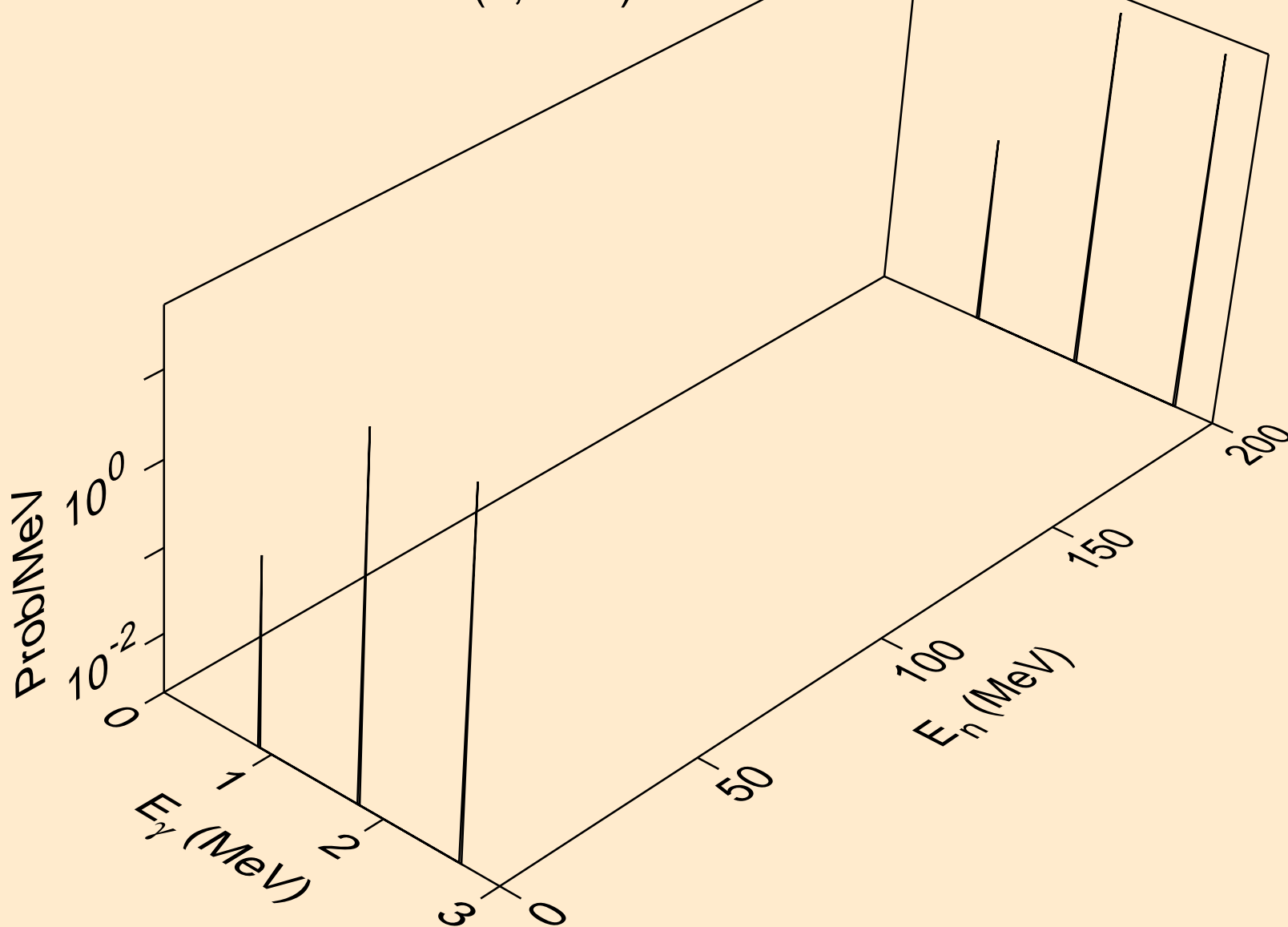

32-GE-73 FOR FENDL-3.2 FROM JEFF-3.1.1 BY NJOY2016.60+ O  
Photon emission for (n,a\*c)

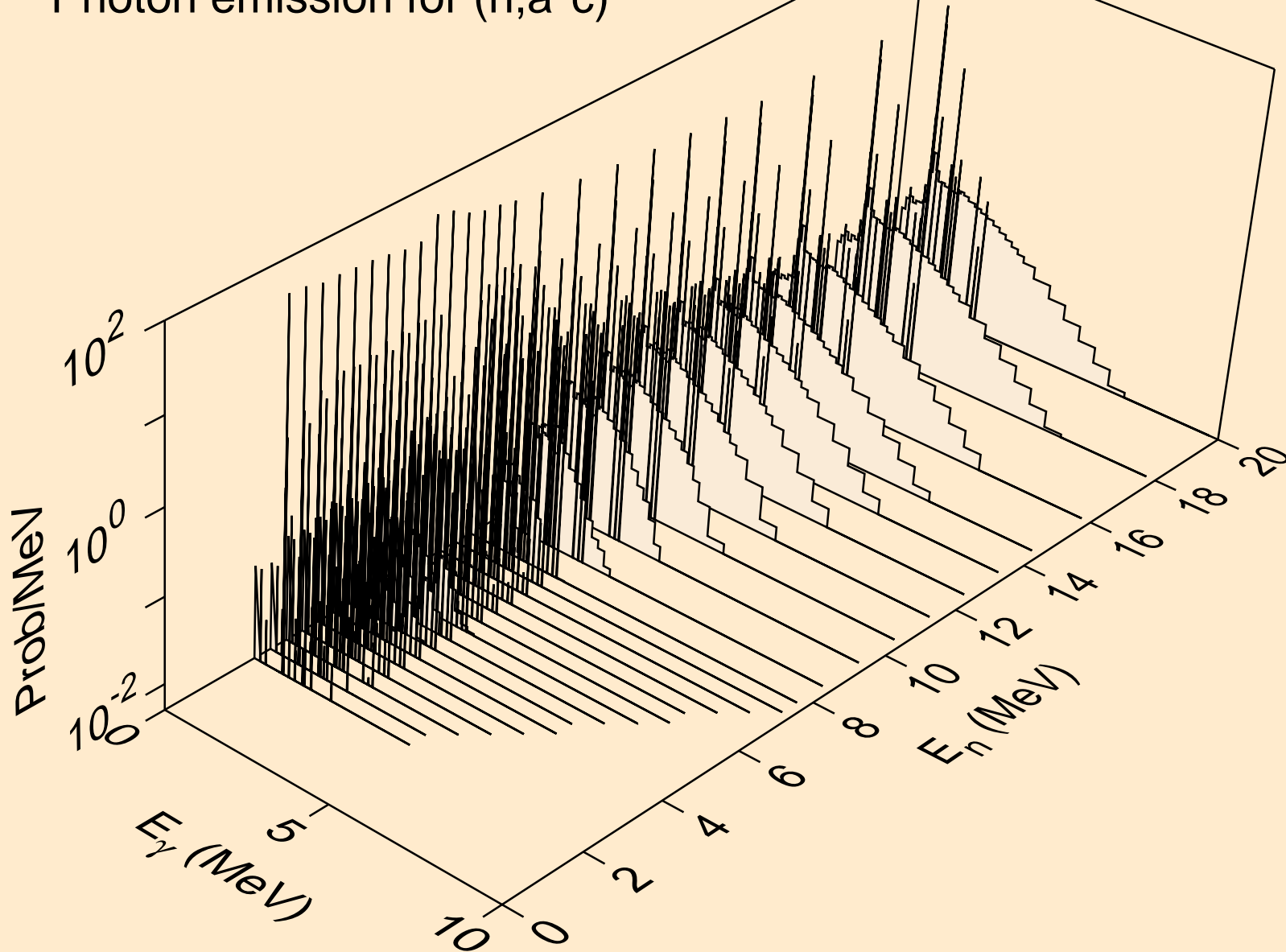

32-GE-73 FOR FENDL-3.2 FROM JEFF-3.1.1 BY NJOY2016.60+ O  
thermal capture photon spectrum

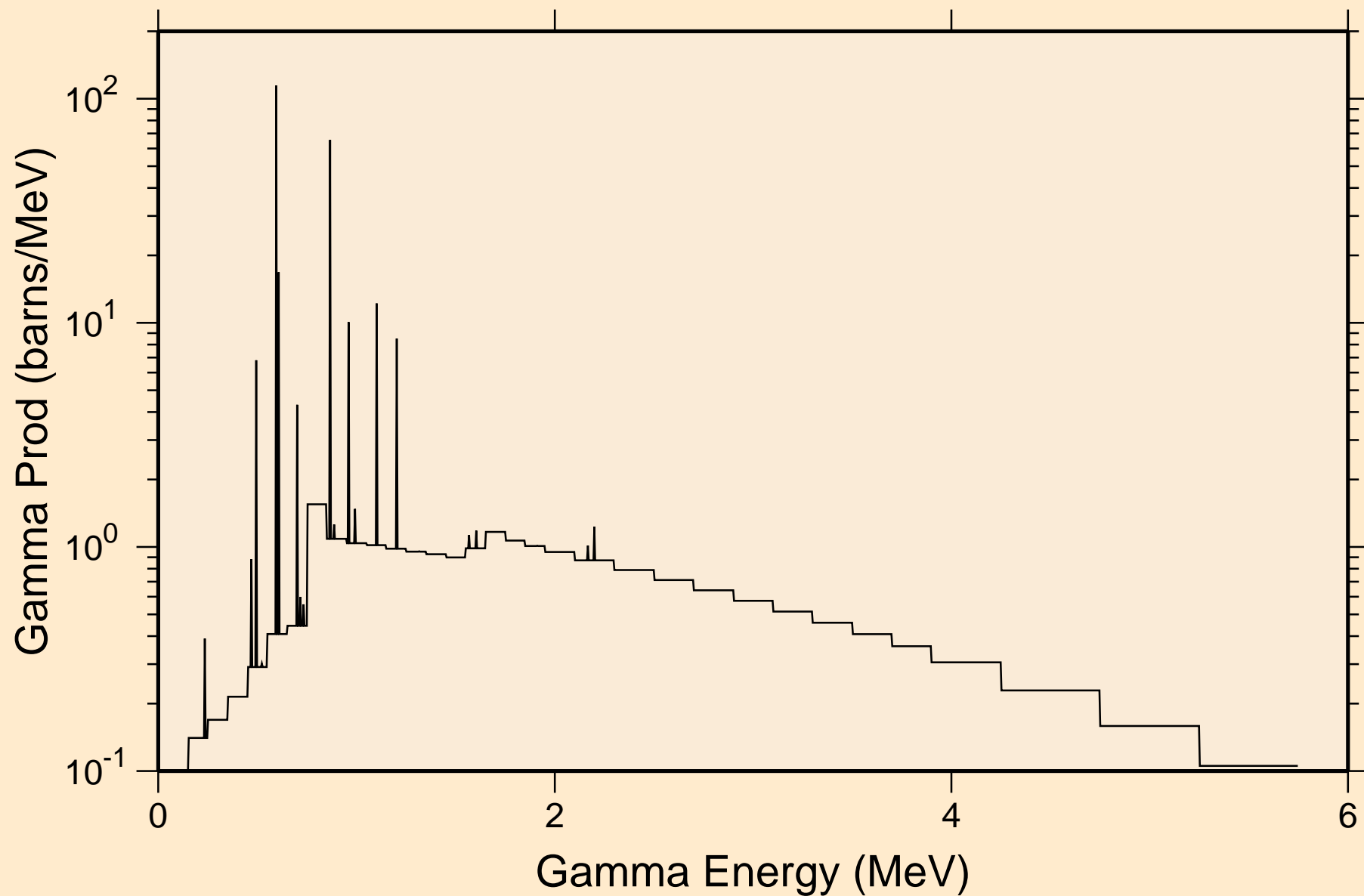

32-GE-73 FOR FENDL-3.2 FROM JEFF-3.1.1 BY NJOY2016.60+ O  
14 MeV photon spectrum

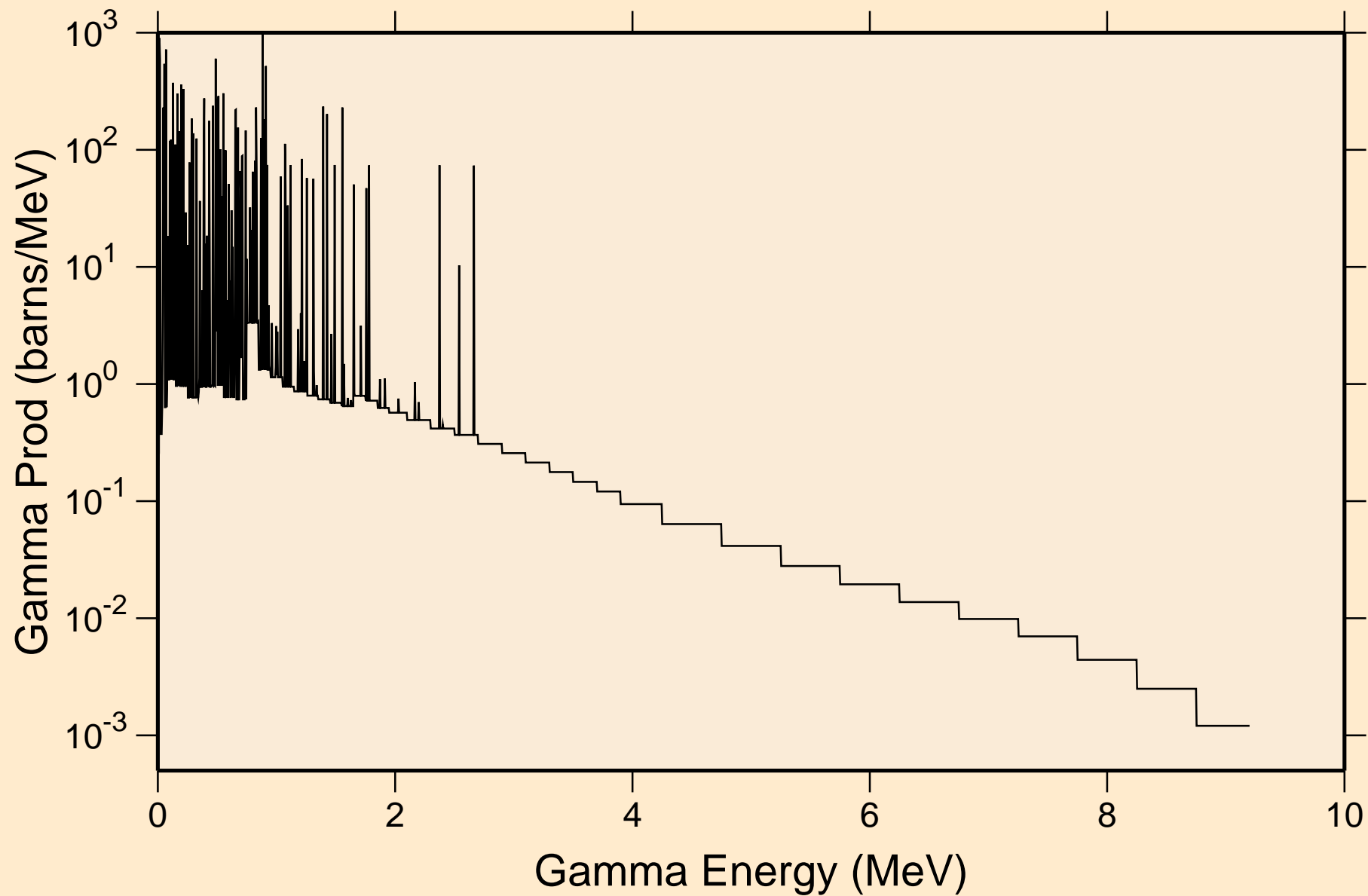

# 32-GE-73 FOR FENDL-3.2 FROM JEFF-3.1.1 BY NJOY2016.60+ O

## Particle heating contributions

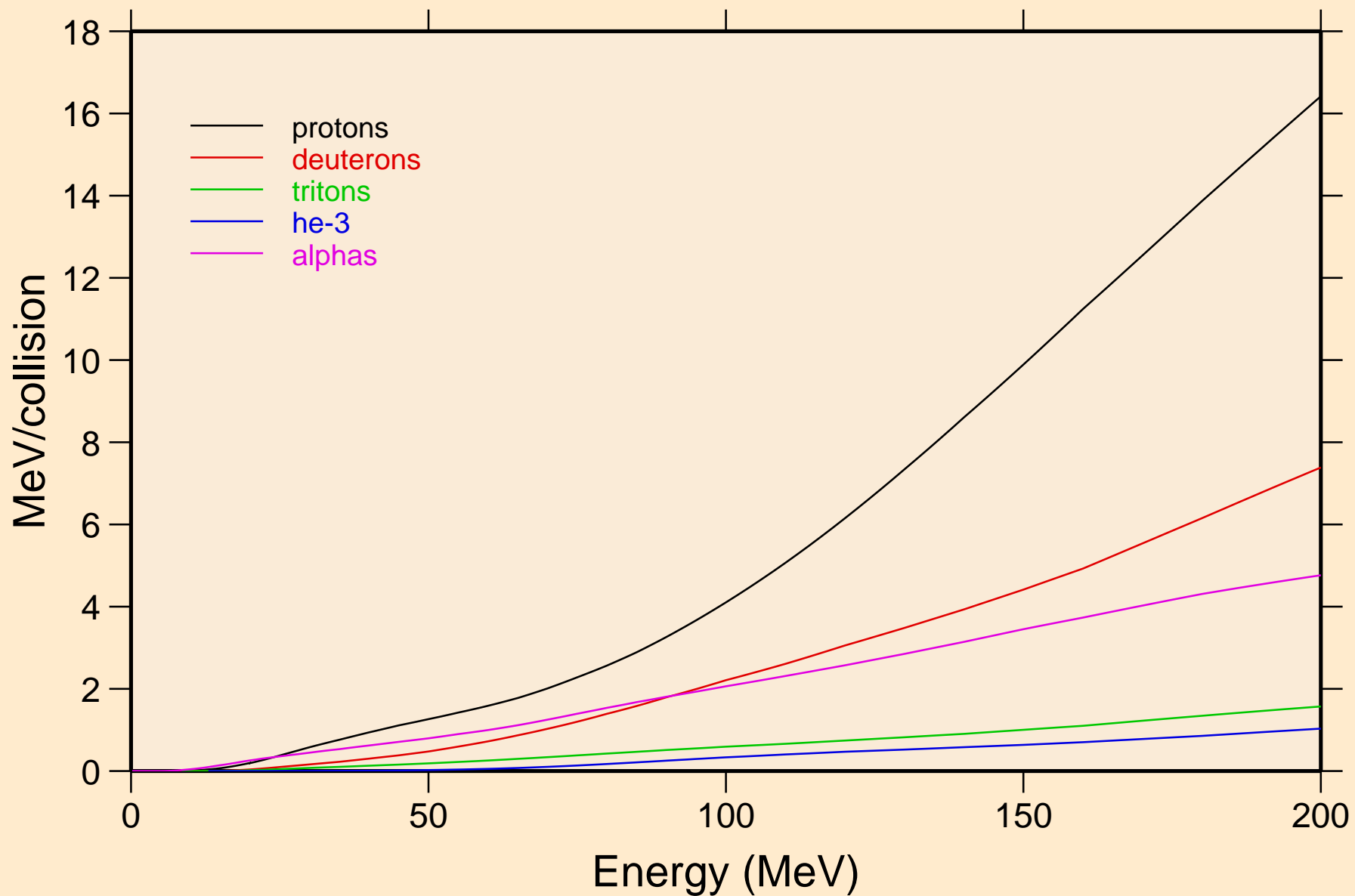

# 32-GE-73 FOR FENDL-3.2 FROM JEFF-3.1.1 BY NJOY2016.60+ O Recoil Heating

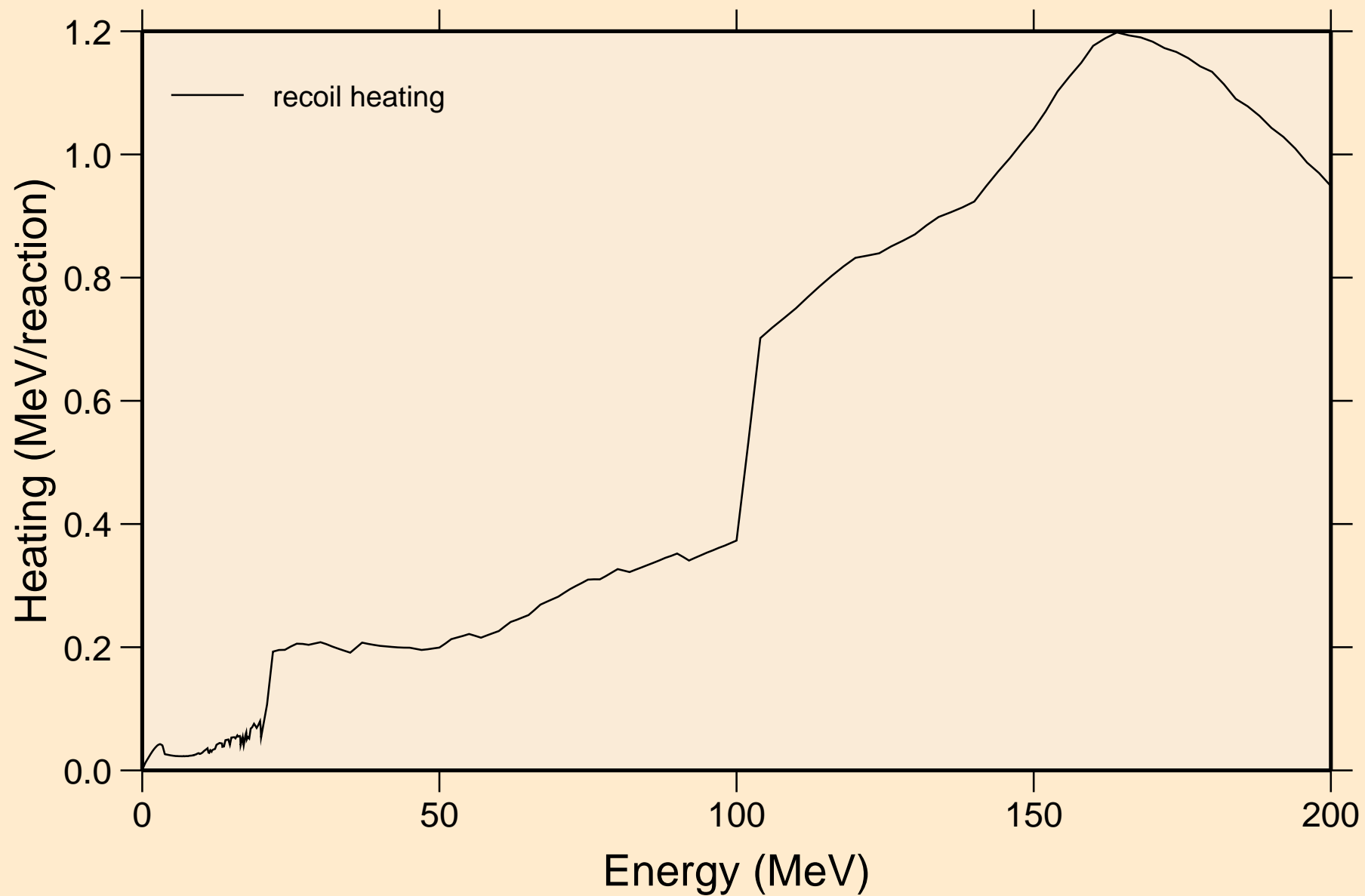



32-GE-73 FOR FENDL-3.2 FROM JEFF-3.1.1 BY NJOY2016.60+ O  
Particle production cross sections

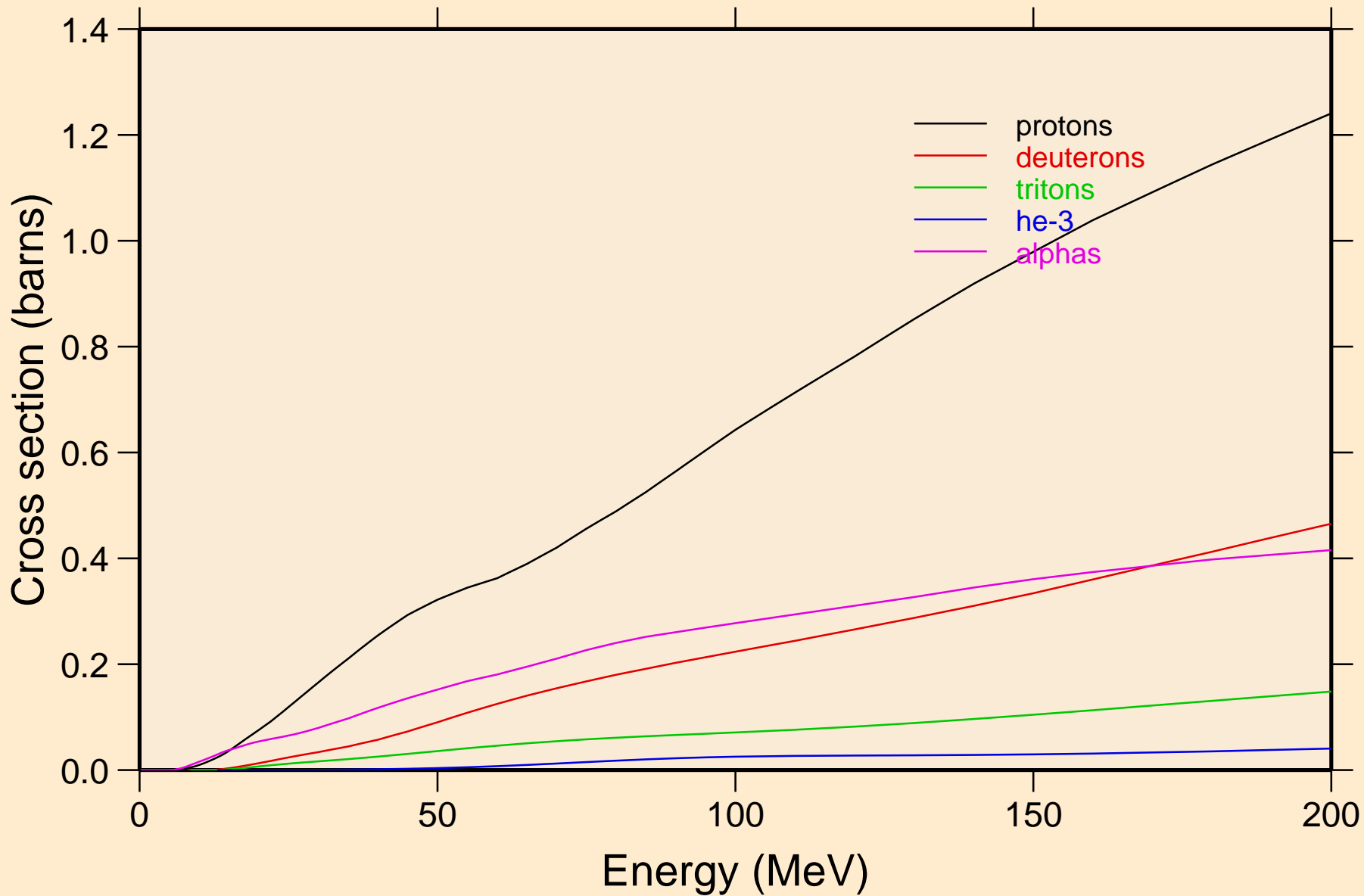

32-GE-73 FOR FENDL-3.2 FROM JEFF-3.1.1 BY NJOY2016.60+ O  
protons from (n,x)

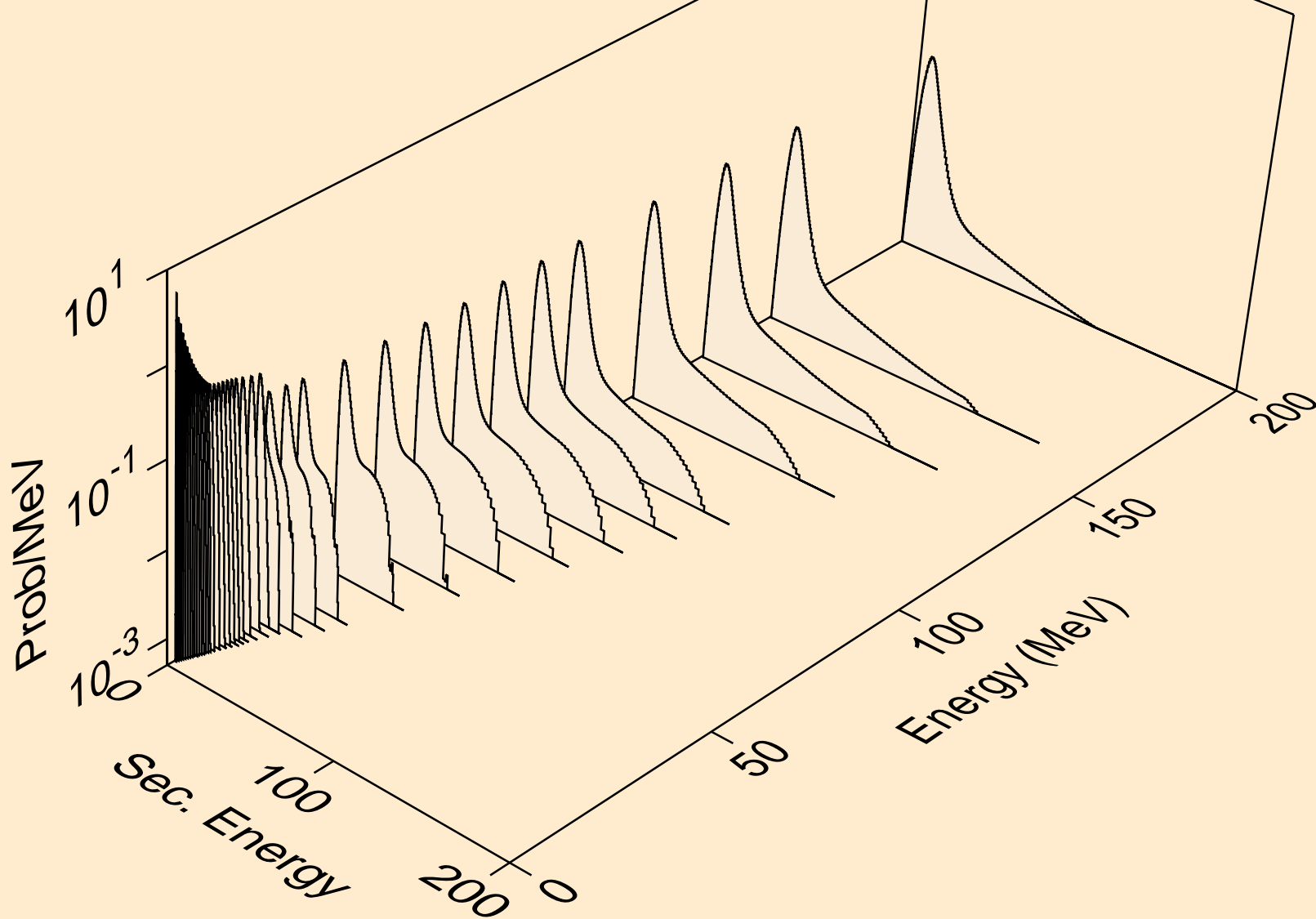

32-GE-73 FOR FENDL-3.2 FROM JEFF-3.1.1 BY NJOY2016.60+ O  
protons from (n,n\*)p

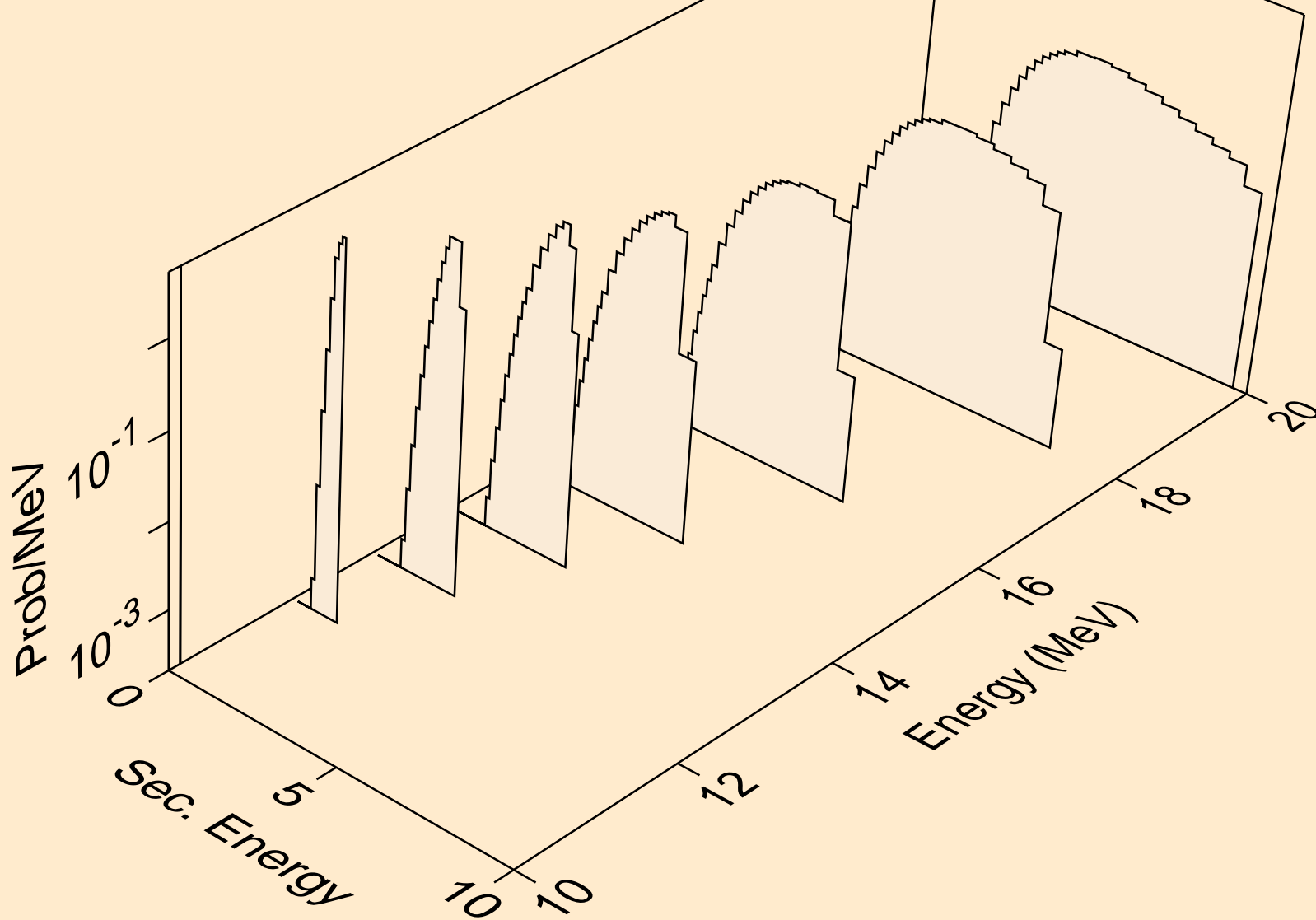

32-GE-73 FOR FENDL-3.2 FROM JEFF-3.1.1 BY NJOY2016.60+ O  
protons from (n,2np)

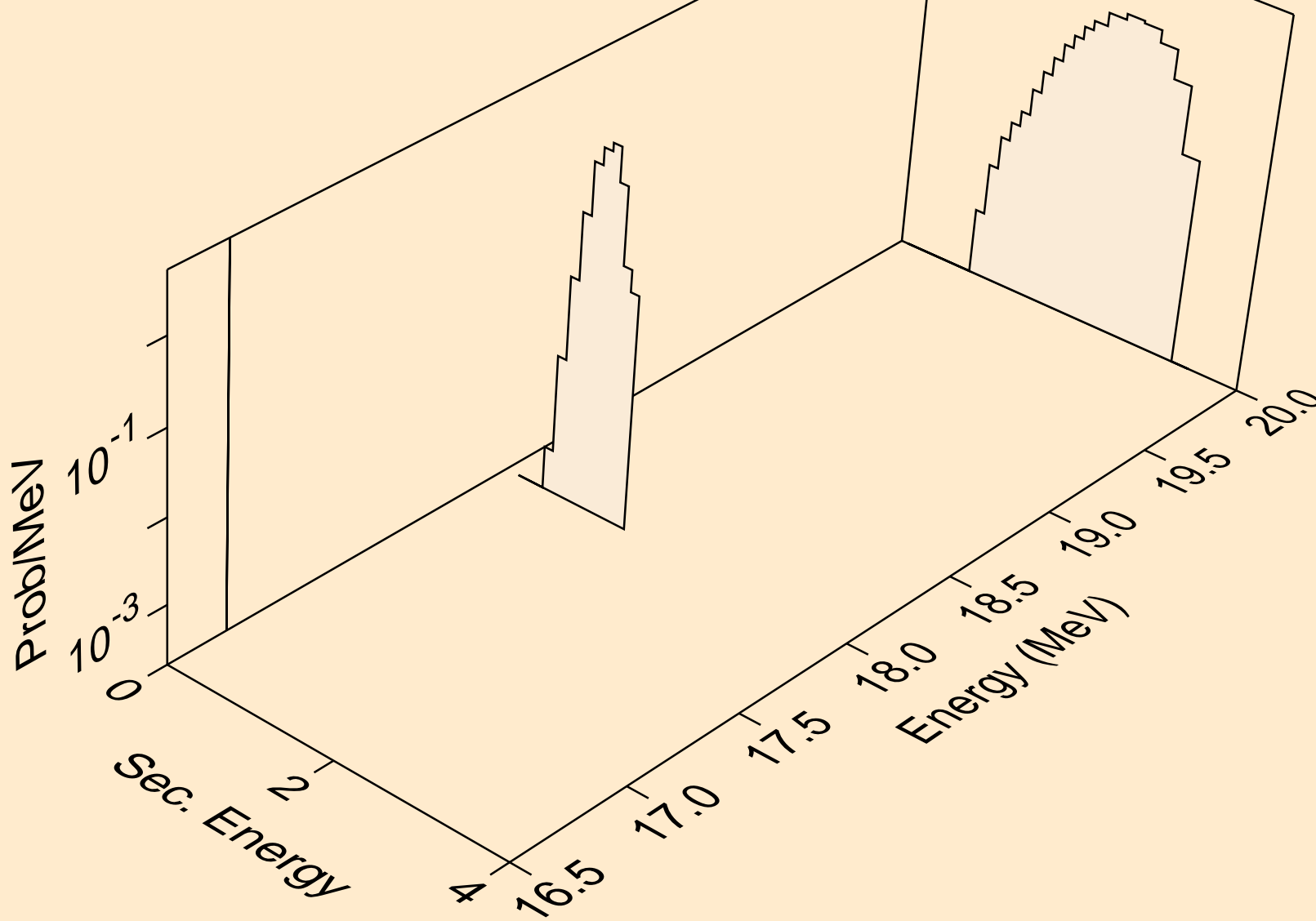

32-GE-73 FOR FENDL-3.2 FROM JEFF-3.1.1 BY NJOY2016.60+ O  
protons from (n,2p)

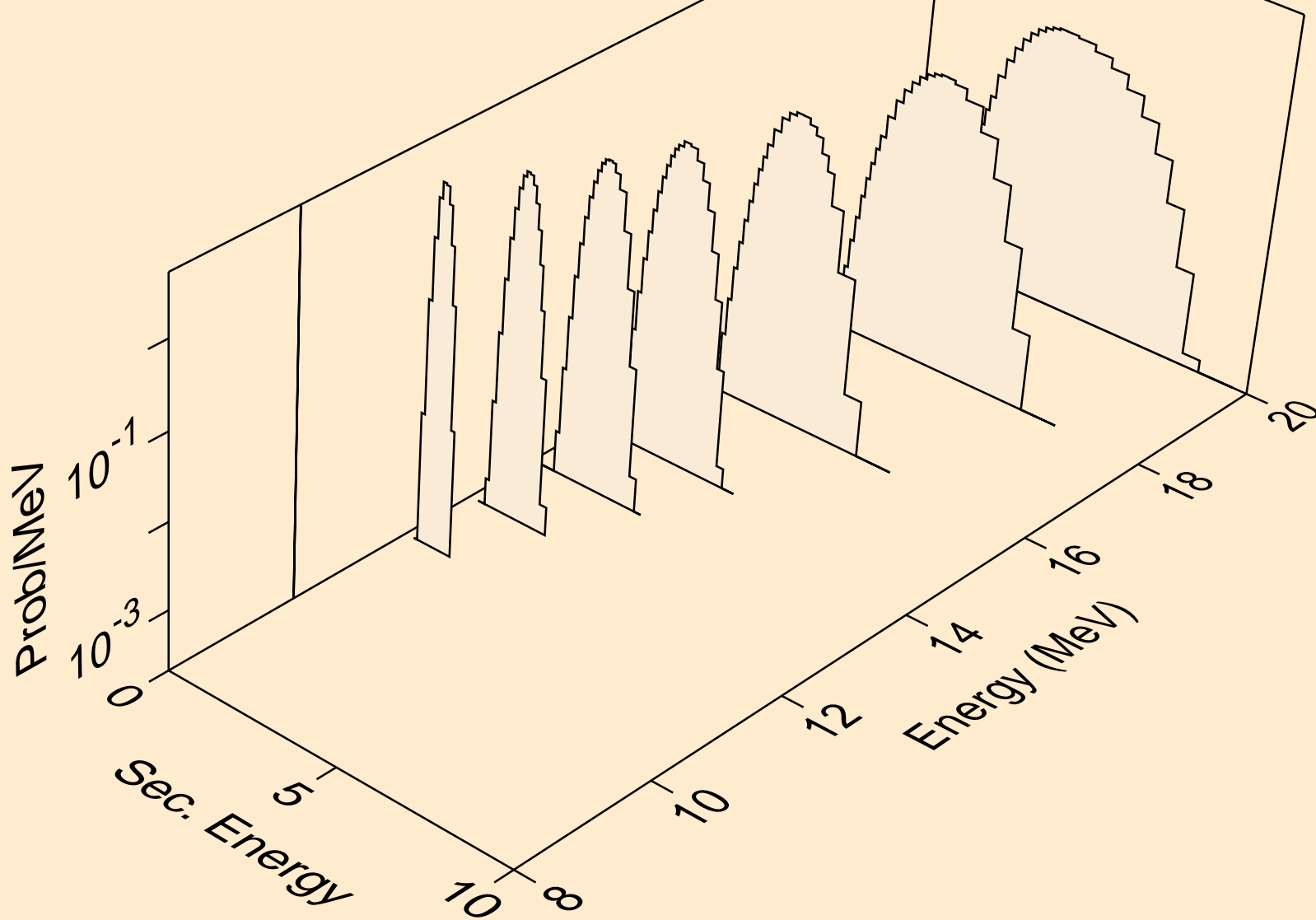

32-GE-73 FOR FENDL-3.2 FROM JEFF-3.1.1 BY NJOY2016.60+ O  
protons from (n,pa)

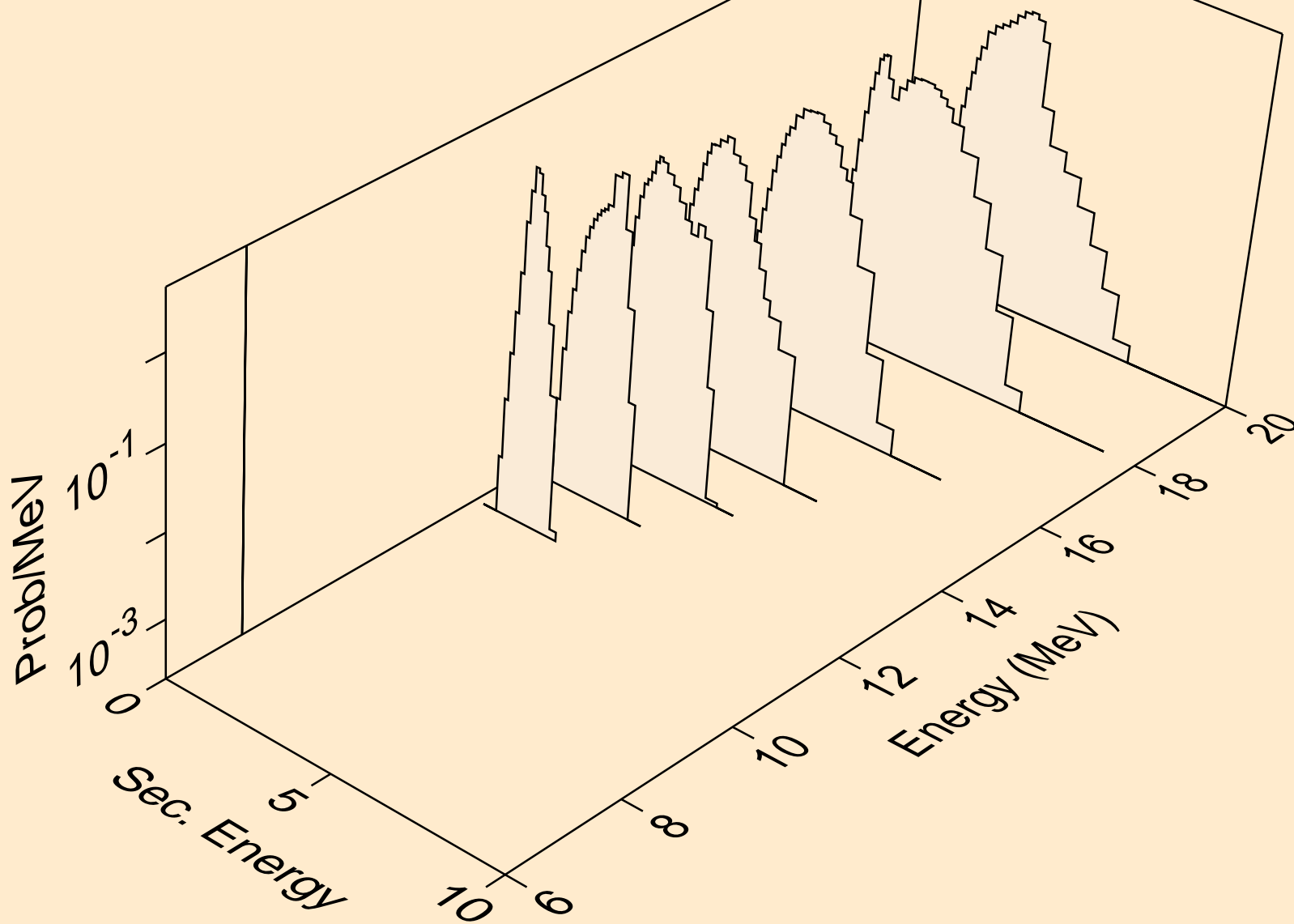

32-GE-73 FOR FENDL-3.2 FROM JEFF-3.1.1 BY NJOY2016.60+ O  
angular distribution for (n,p\*0) proton

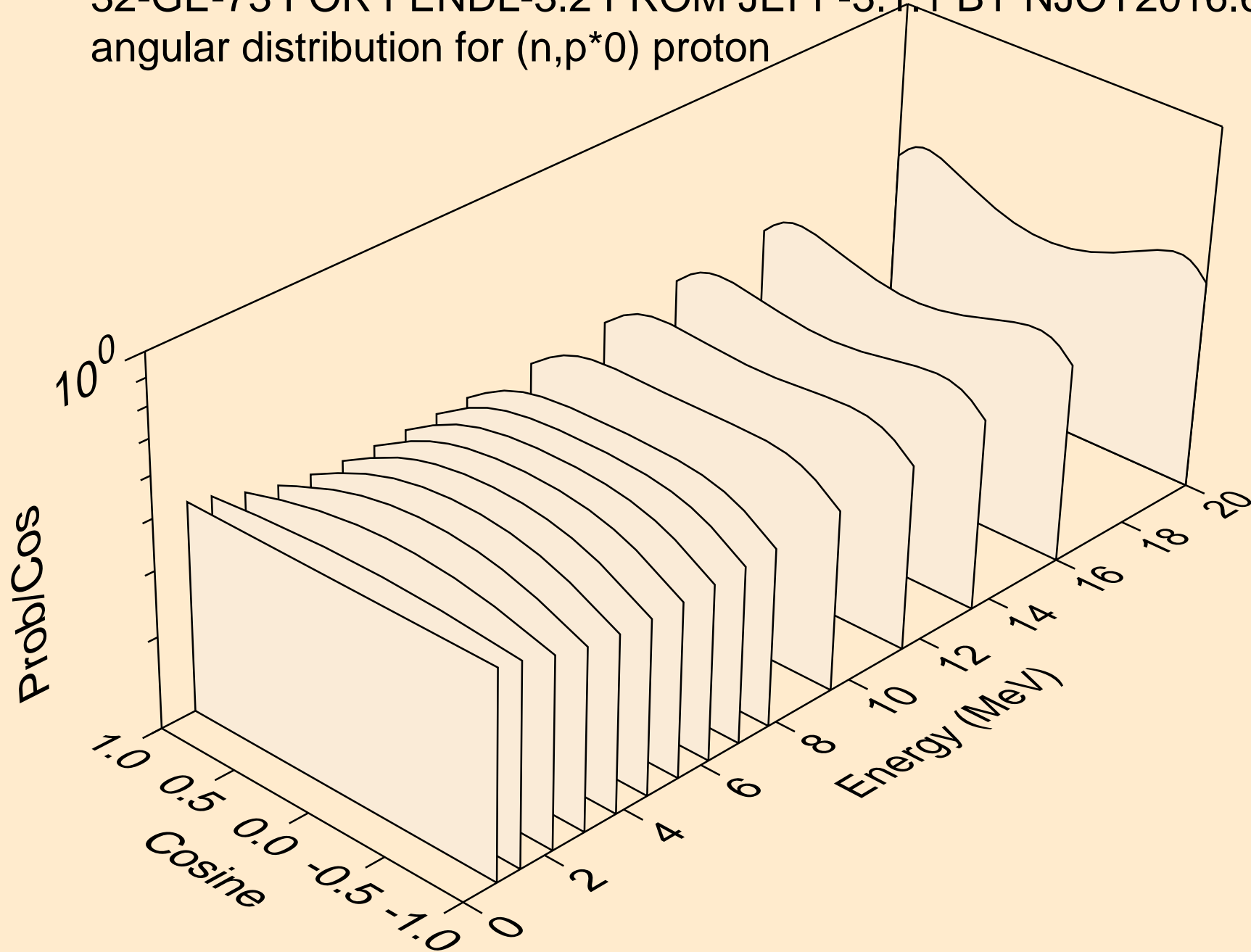

32-GE-73 FOR FENDL-3.2 FROM JEFF-3.1.1 BY NJOY2016.60+ O  
angular distribution for (n,p\*1) proton

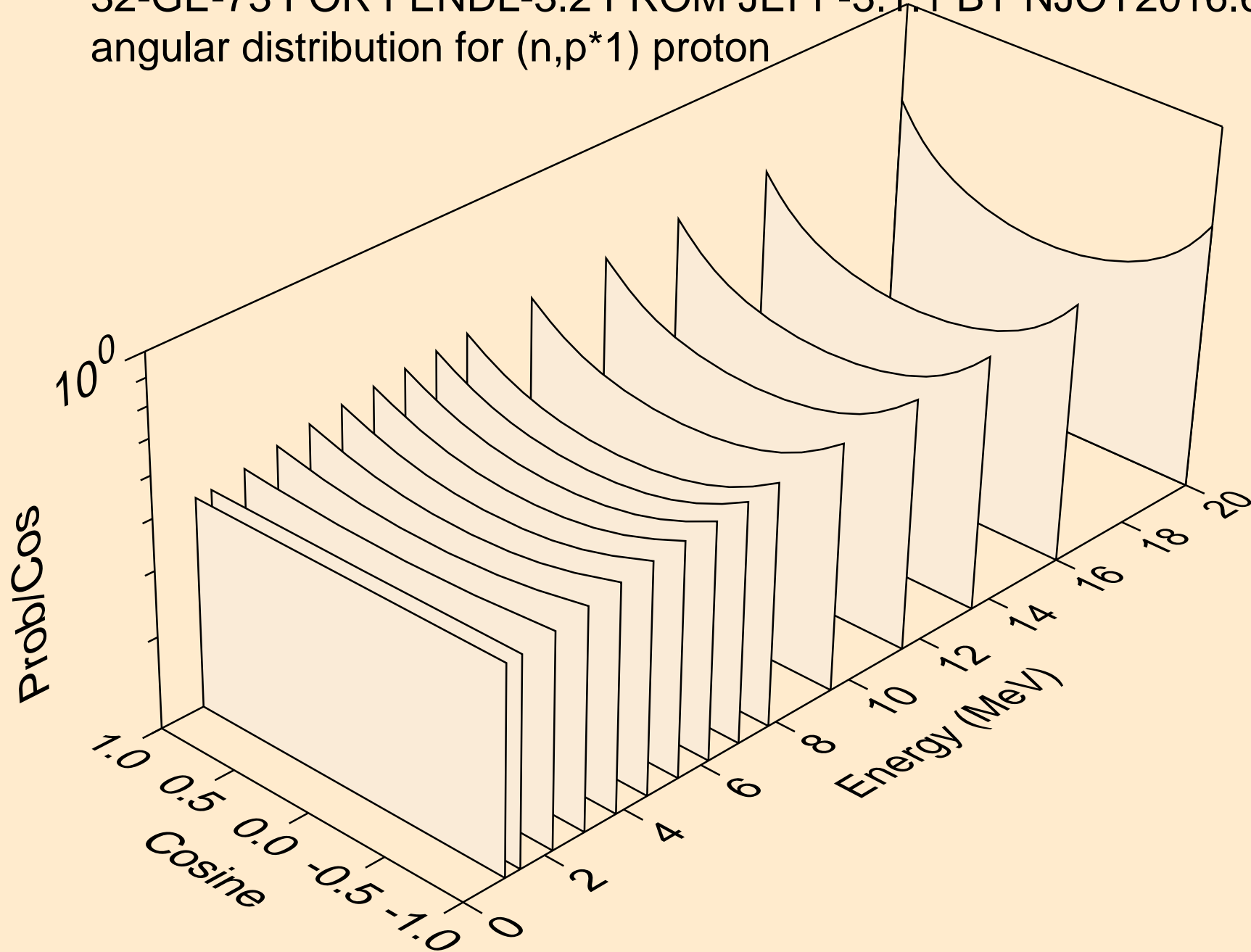



32-GE-73 FOR FENDL-3.2 FROM JEFF-3.1.1 BY NJOY2016.60+ O  
angular distribution for (n,p\*2) proton

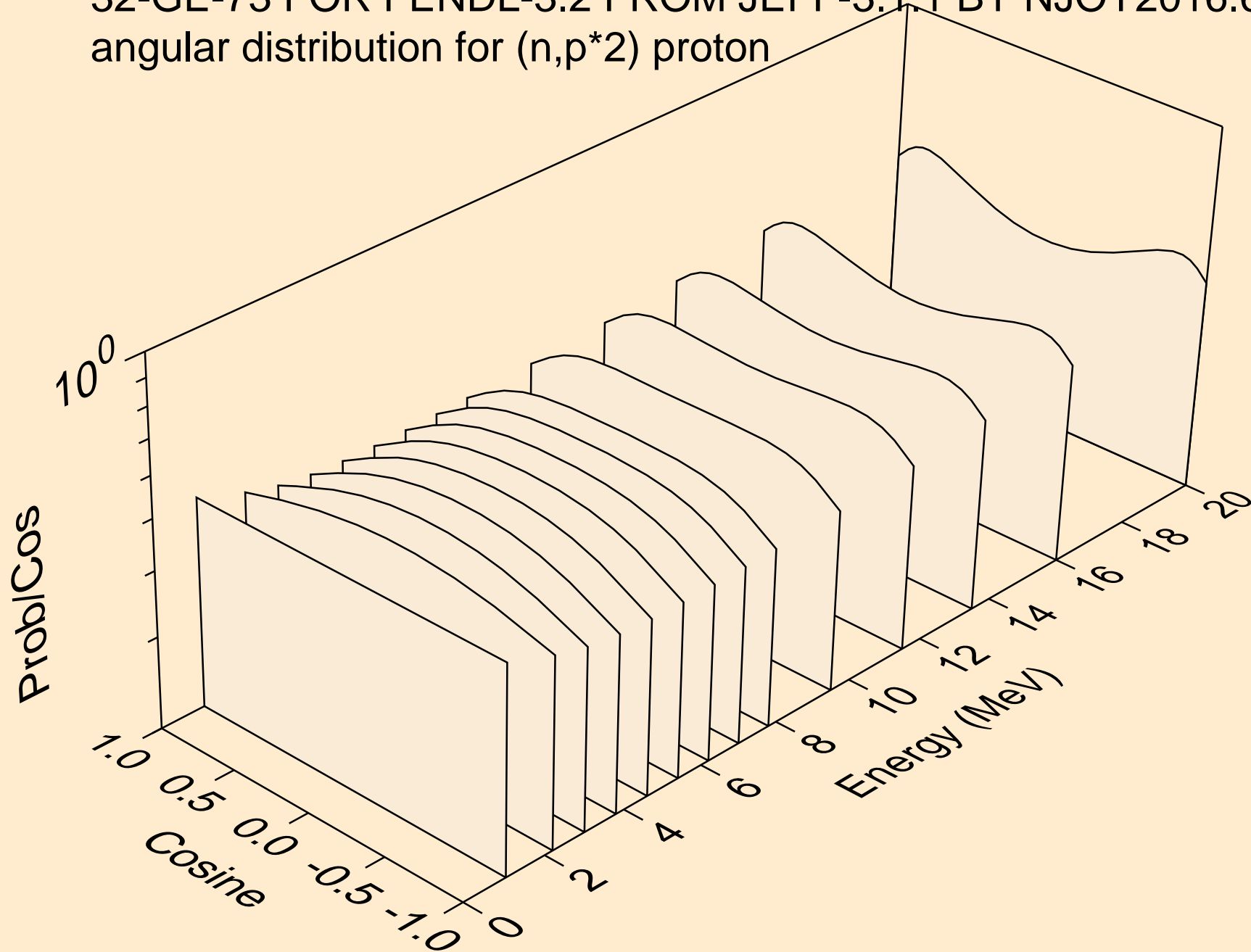

32-GE-73 FOR FENDL-3.2 FROM JEFF-3.1.1 BY NJOY2016.60+ O  
angular distribution for (n,p\*3) proton

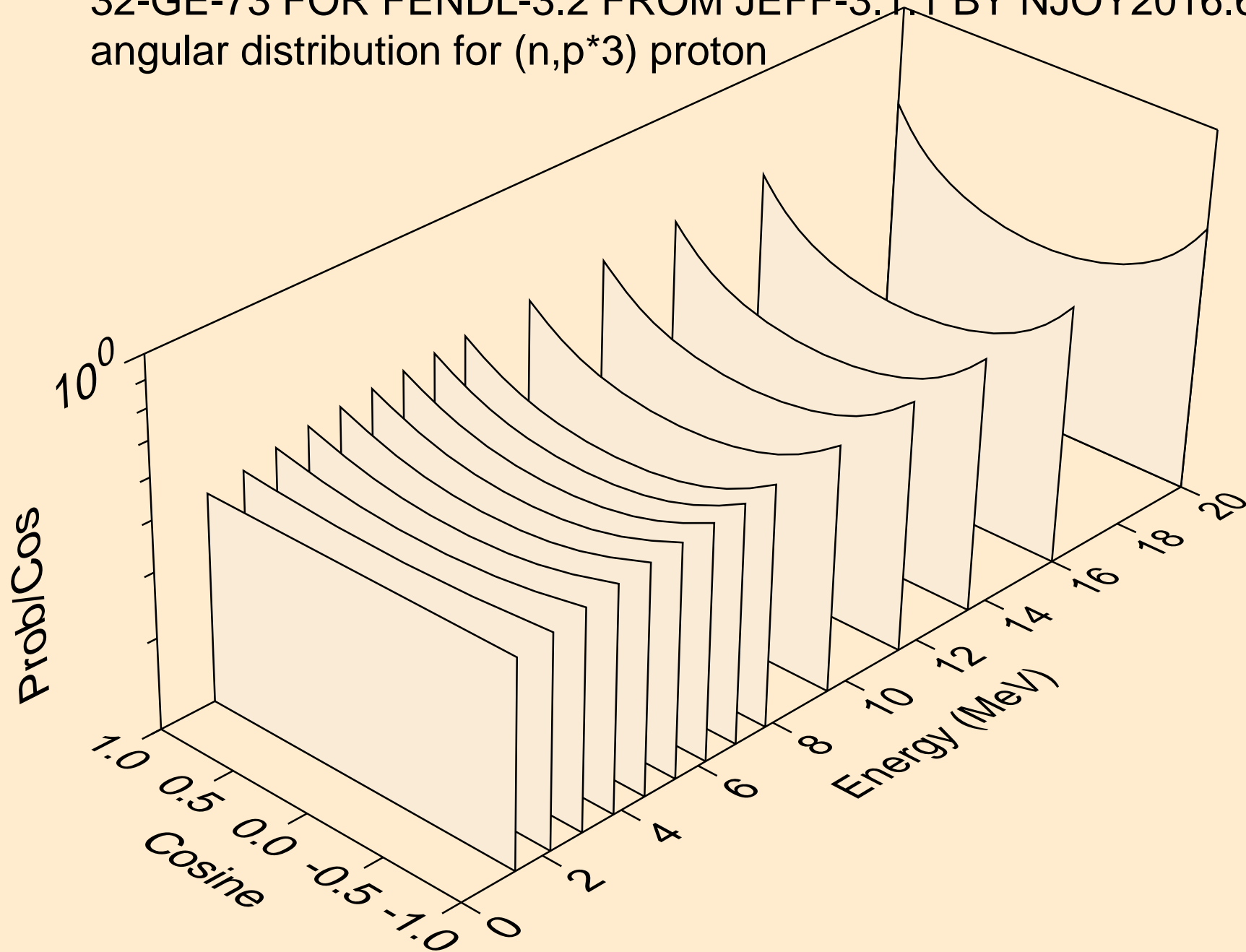

32-GE-73 FOR FENDL-3.2 FROM JEFF-3.1.1 BY NJOY2016.60+ O  
angular distribution for (n,p\*4) proton

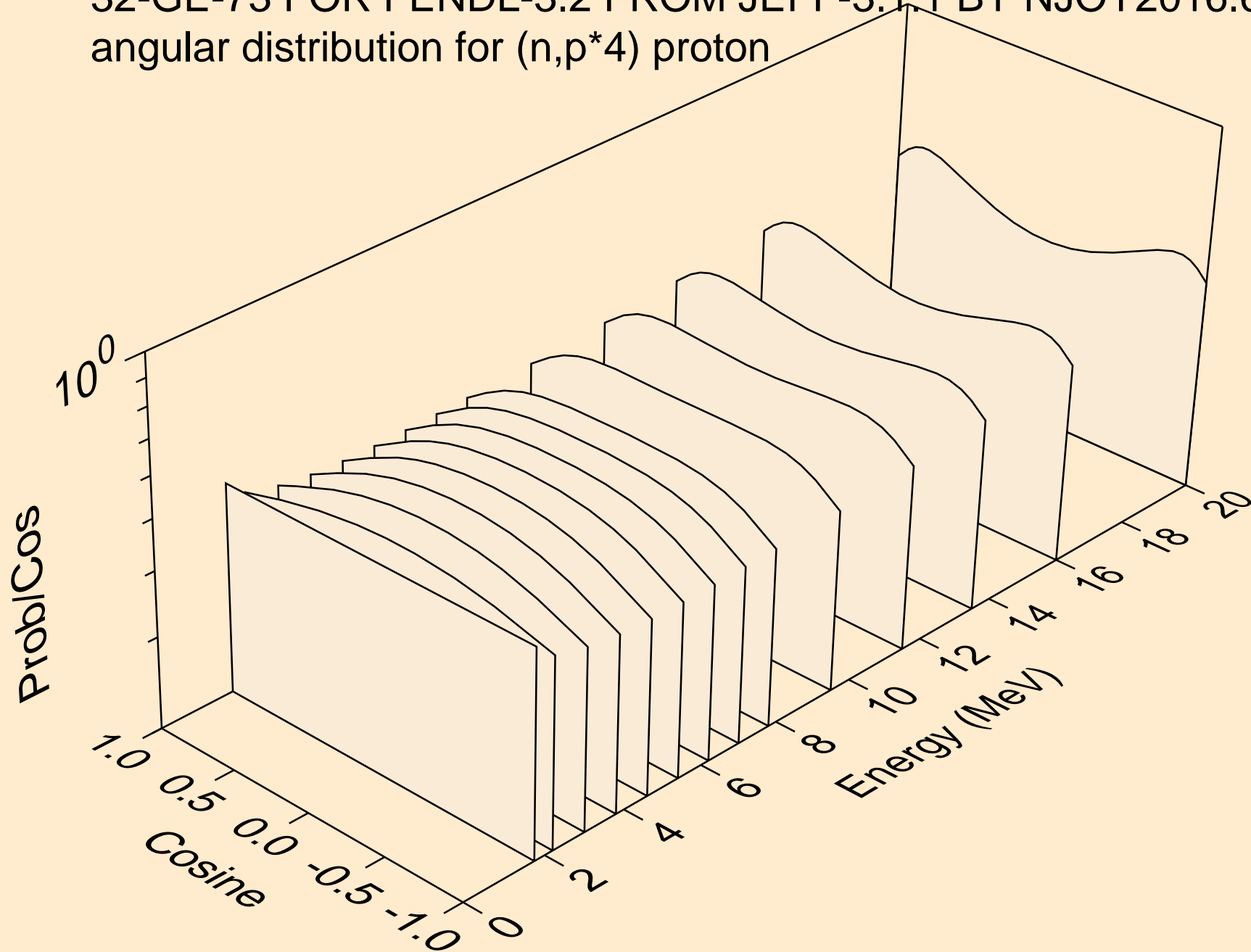

32-GE-73 FOR FENDL-3.2 FROM JEFF-3.1.1 BY NJOY2016.60+ O  
angular distribution for (n,p\*5) proton

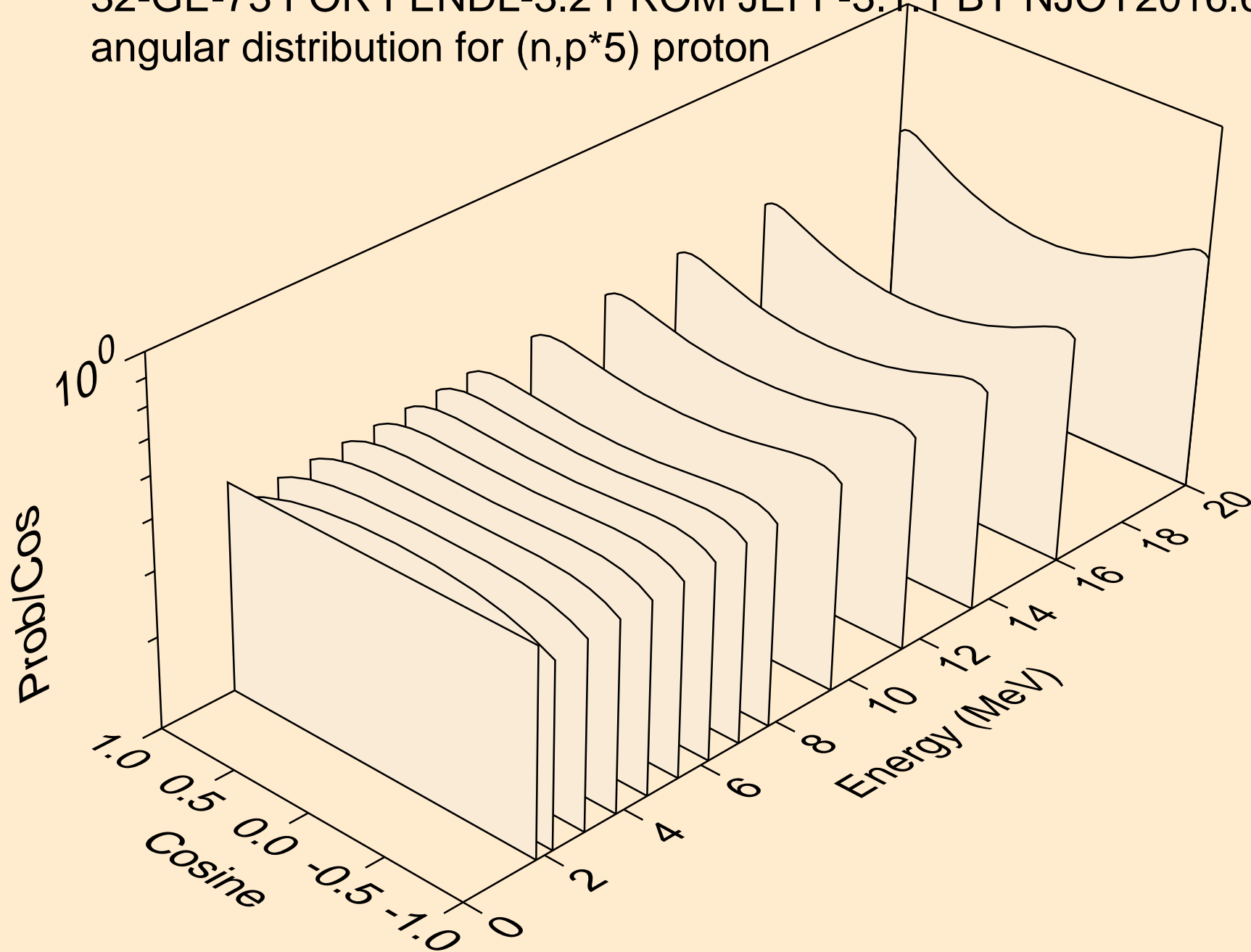

32-GE-73 FOR FENDL-3.2 FROM JEFF-3.1.1 BY NJOY2016.60+ O  
angular distribution for (n,p\*6) proton

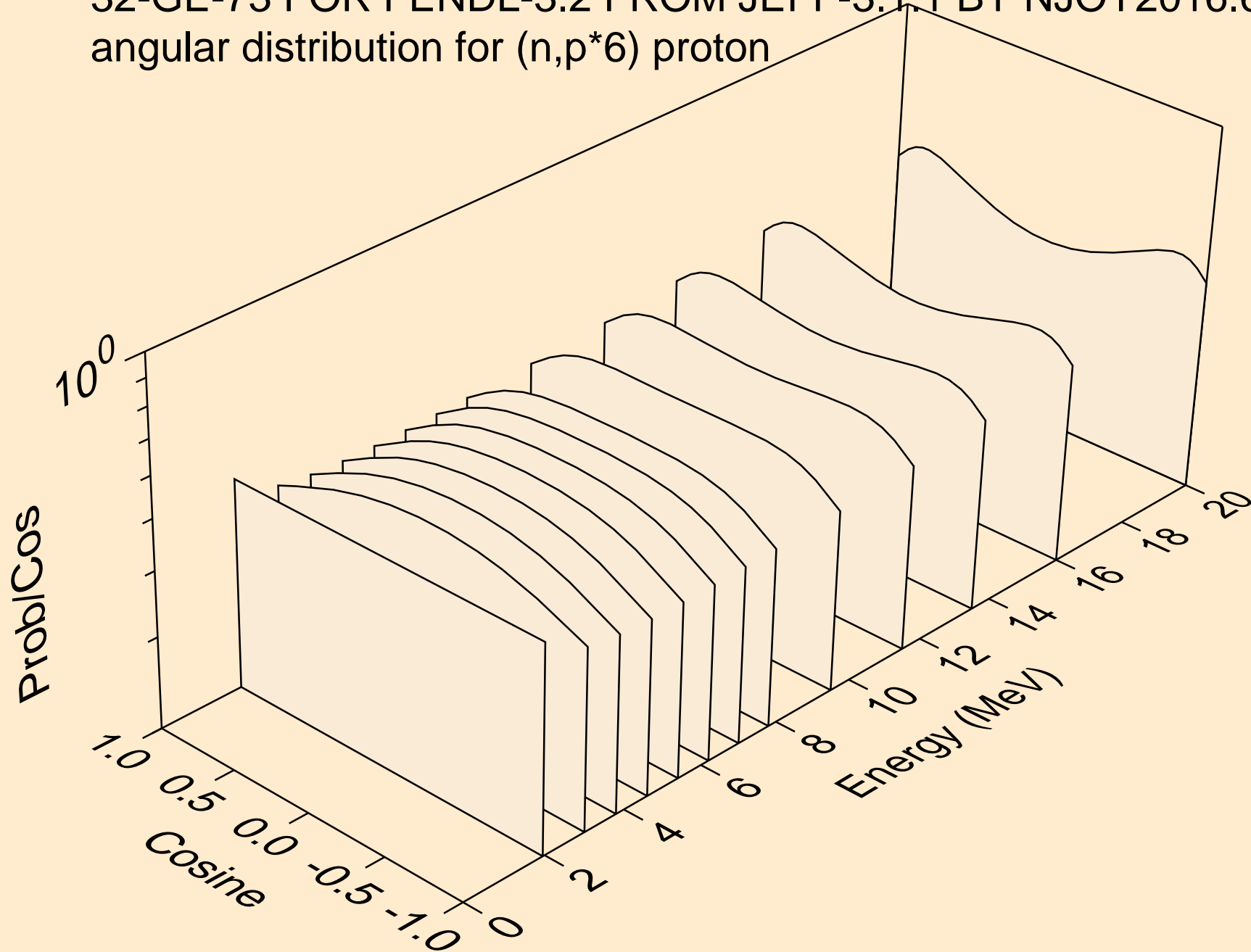

32-GE-73 FOR FENDL-3.2 FROM JEFF-3.1.1 BY NJOY2016.60+ O  
angular distribution for (n,p\*7) proton

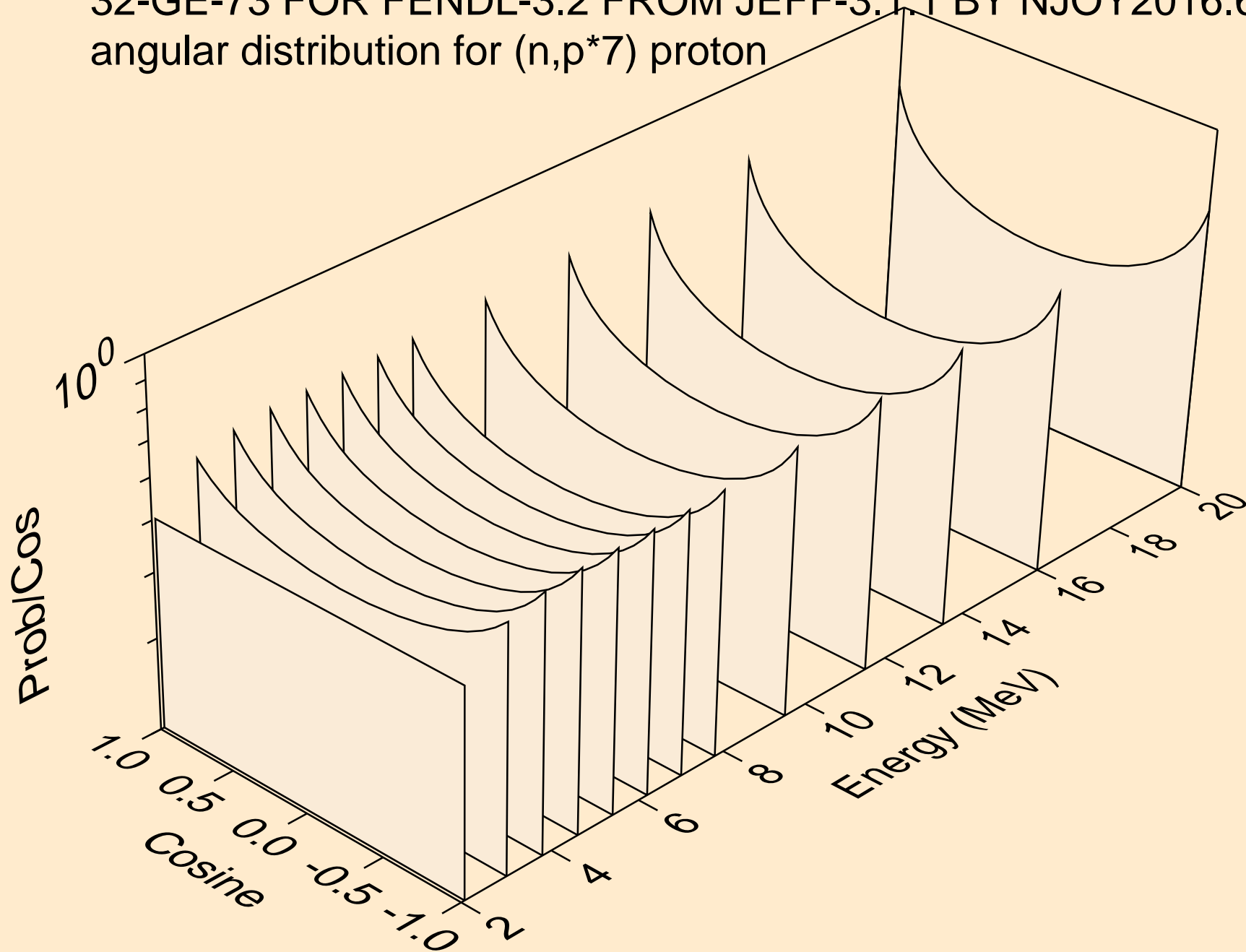

32-GE-73 FOR FENDL-3.2 FROM JEFF-3.1.1 BY NJOY2016.60+ O  
angular distribution for (n,p\*8) proton

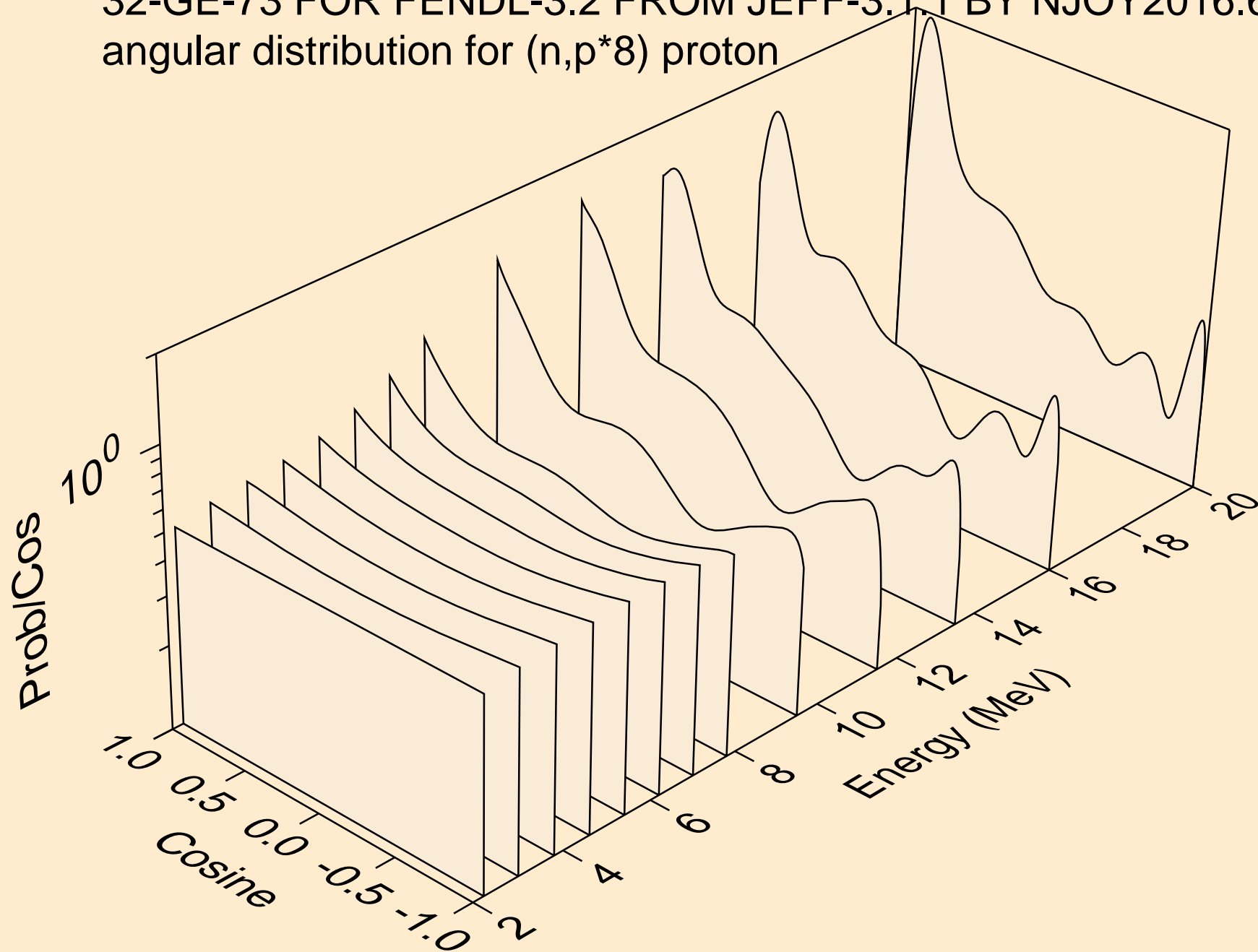

32-GE-73 FOR FENDL-3.2 FROM JEFF-3.1.1 BY NJOY2016.60+ O  
angular distribution for (n,p\*9) proton

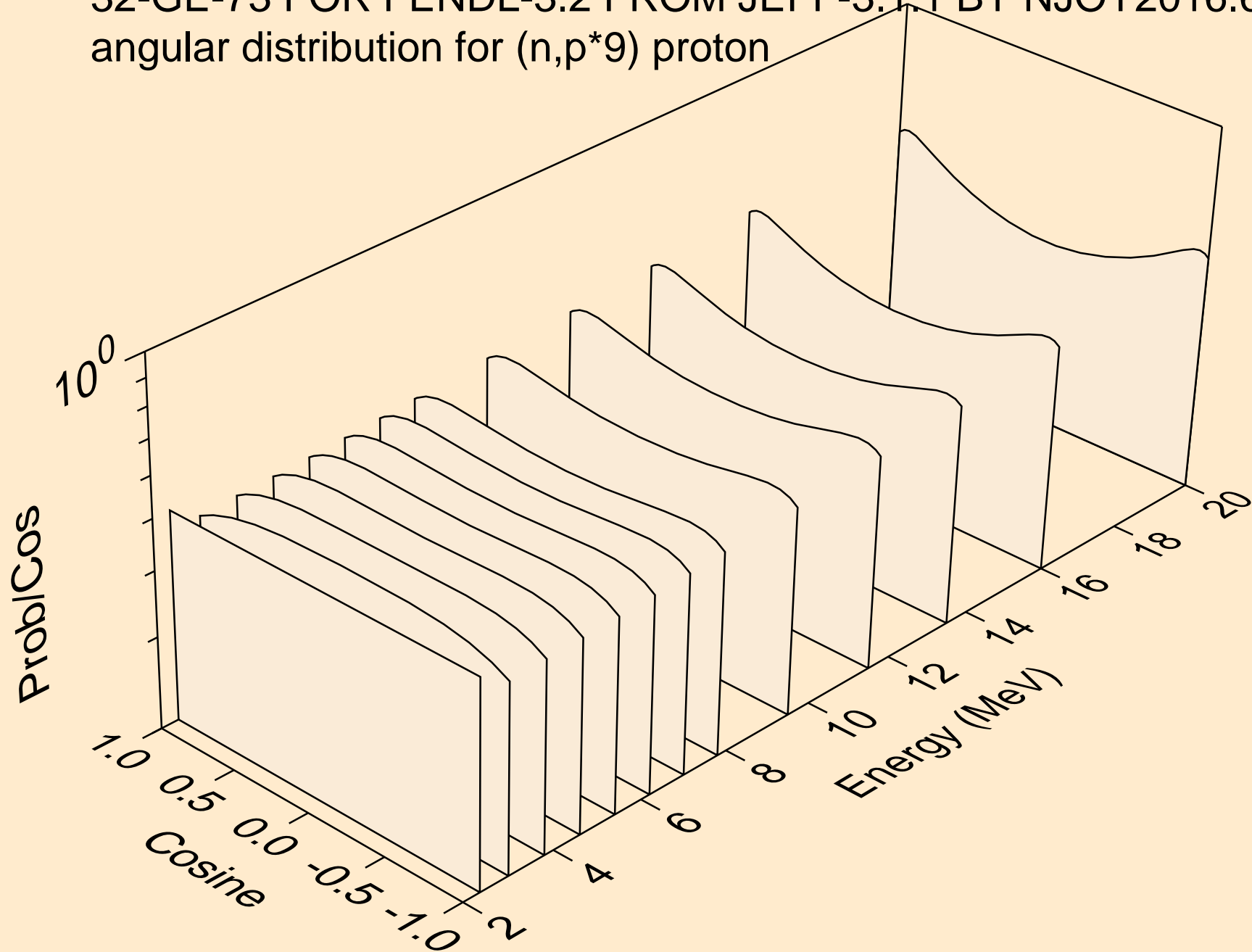



32-GE-73 FOR FENDL-3.2 FROM JEFF-3.1.1 BY NJOY2016.60+ O  
angular distribution for (n,p\*10) proton

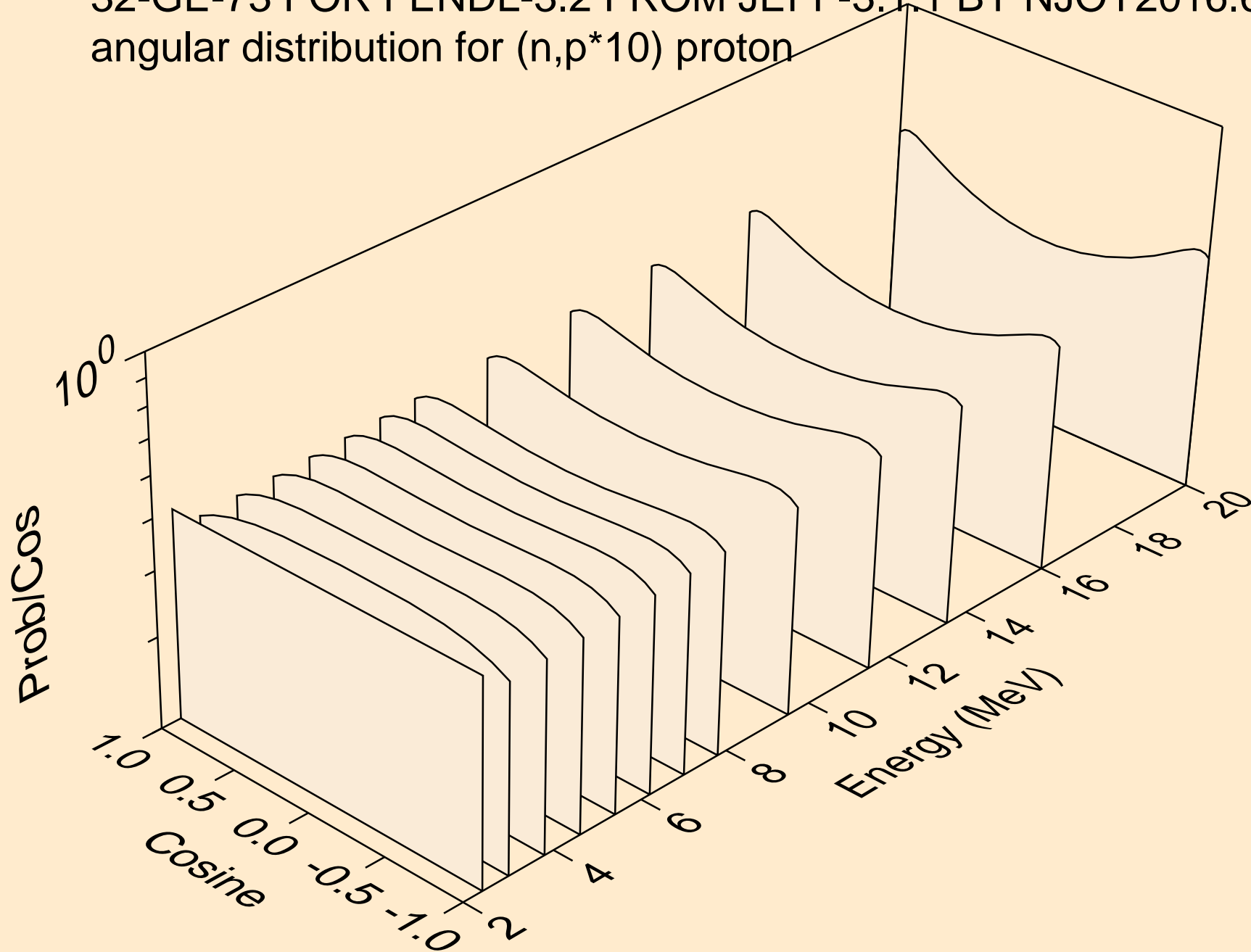

32-GE-73 FOR FENDL-3.2 FROM JEFF-3.1.1 BY NJOY2016.60+ O  
protons from (n,p\*c)

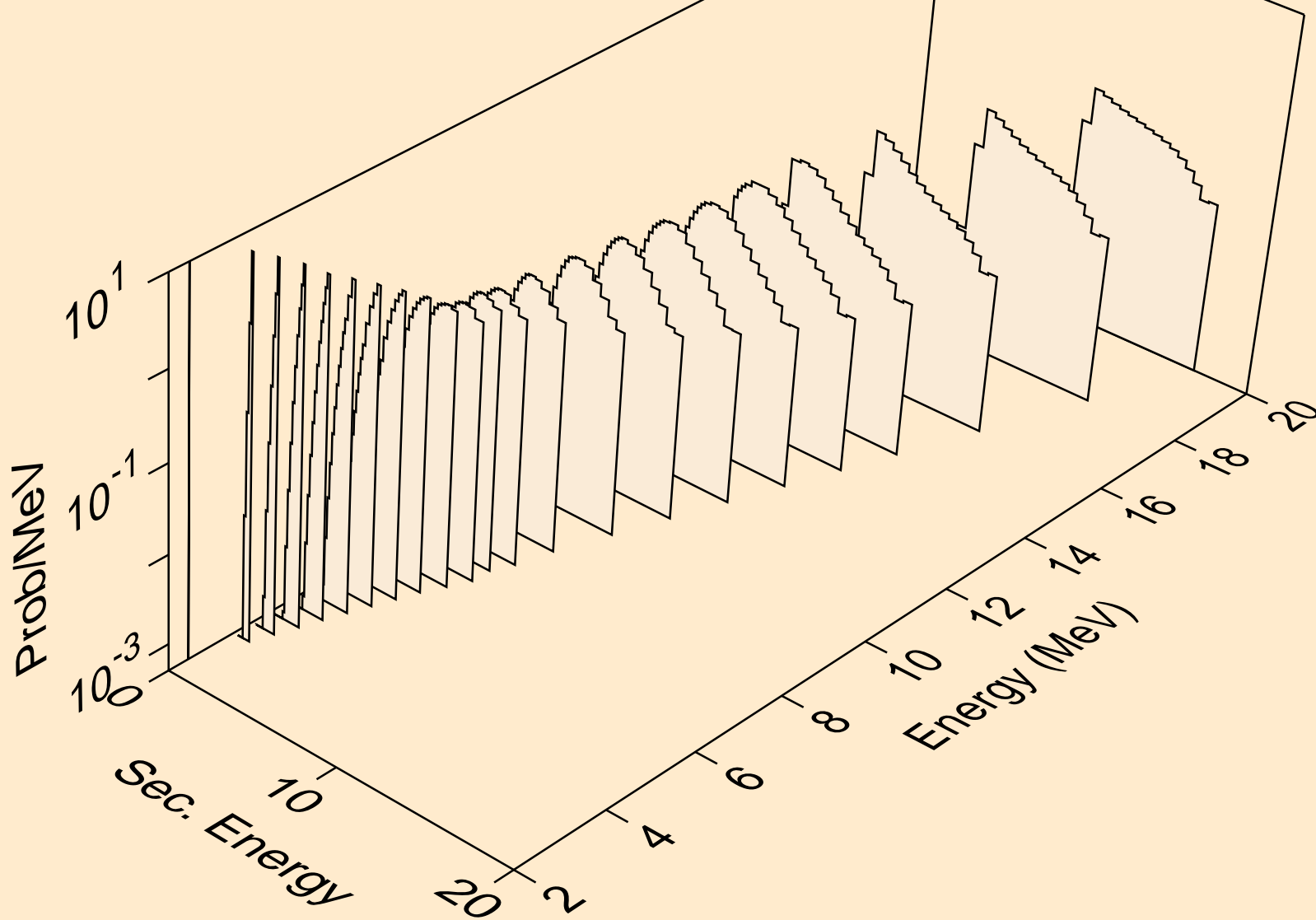

32-GE-73 FOR FENDL-3.2 FROM JEFF-3.1.1 BY NJOY2016.60+ O  
deuterons from (n,x)

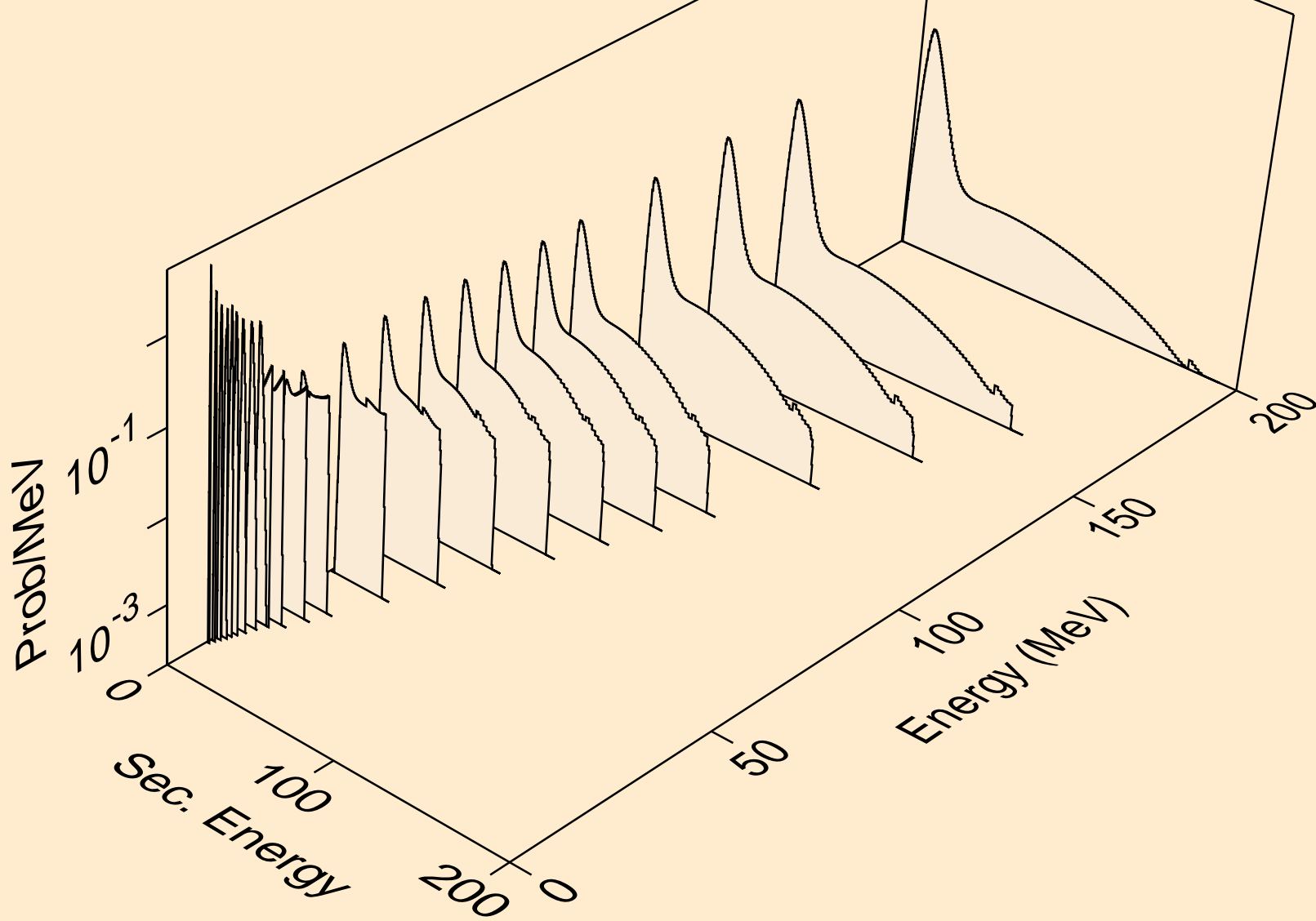

32-GE-73 FOR FENDL-3.2 FROM JEFF-3.1.1 BY NJOY2016.60+ O  
deuterons from (n,n\*)d

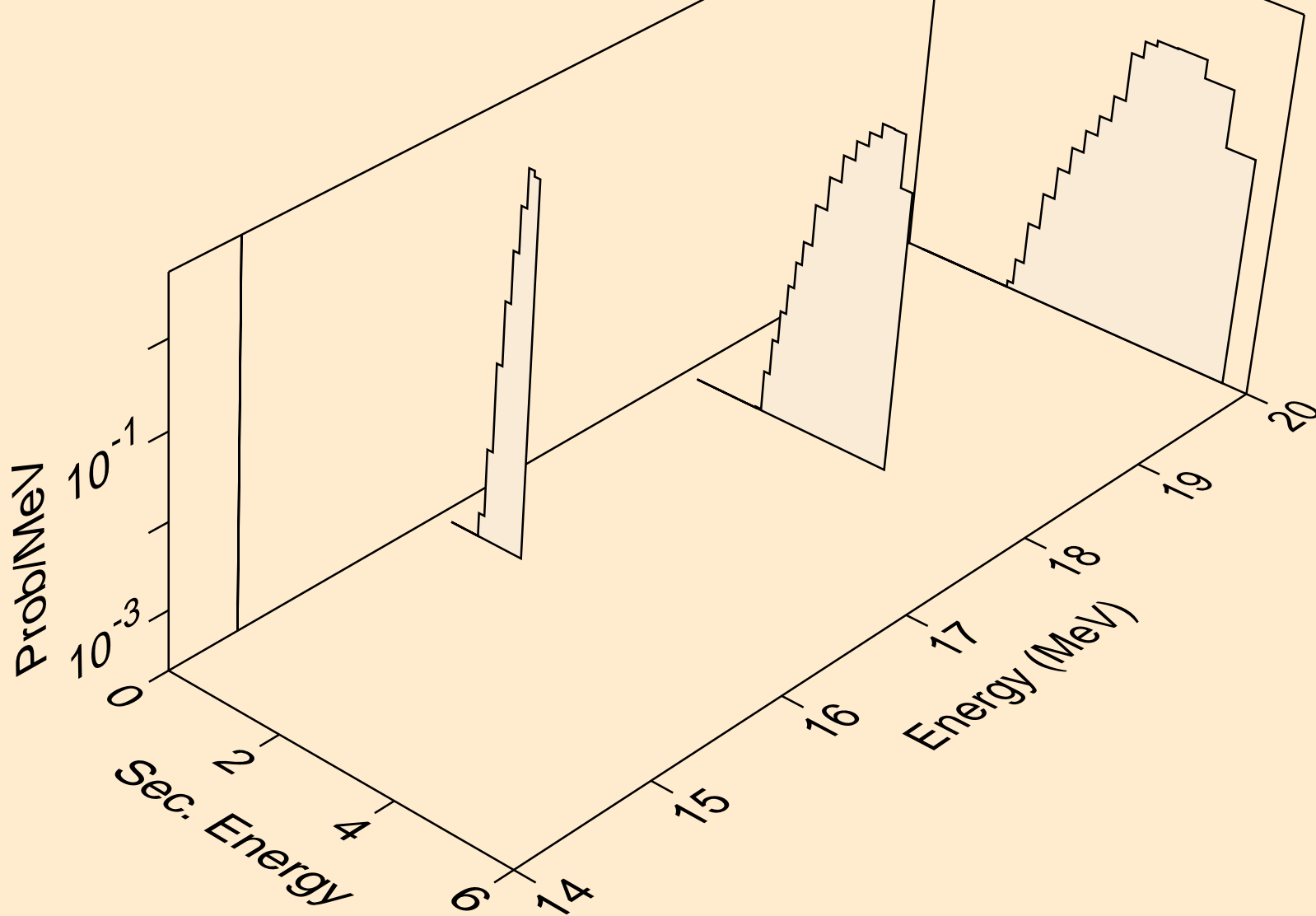

32-GE-73 FOR FENDL-3.2 FROM JEFF-3.1.1 BY NJOY2016.60+ O  
angular distribution for (n,d\*0) deuteron

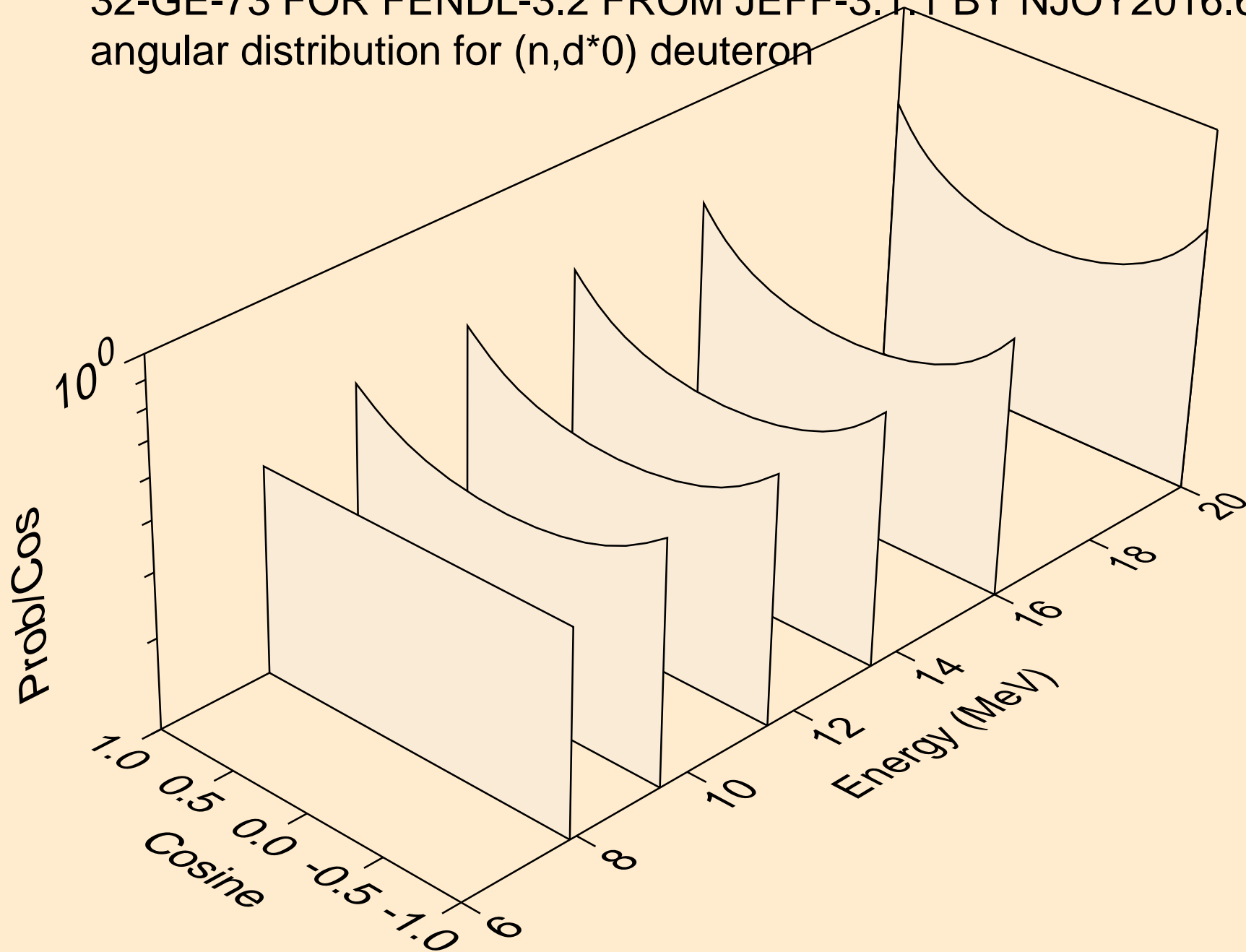

32-GE-73 FOR FENDL-3.2 FROM JEFF-3.1.1 BY NJOY2016.60+ O  
angular distribution for (n,d\*1) deuteron

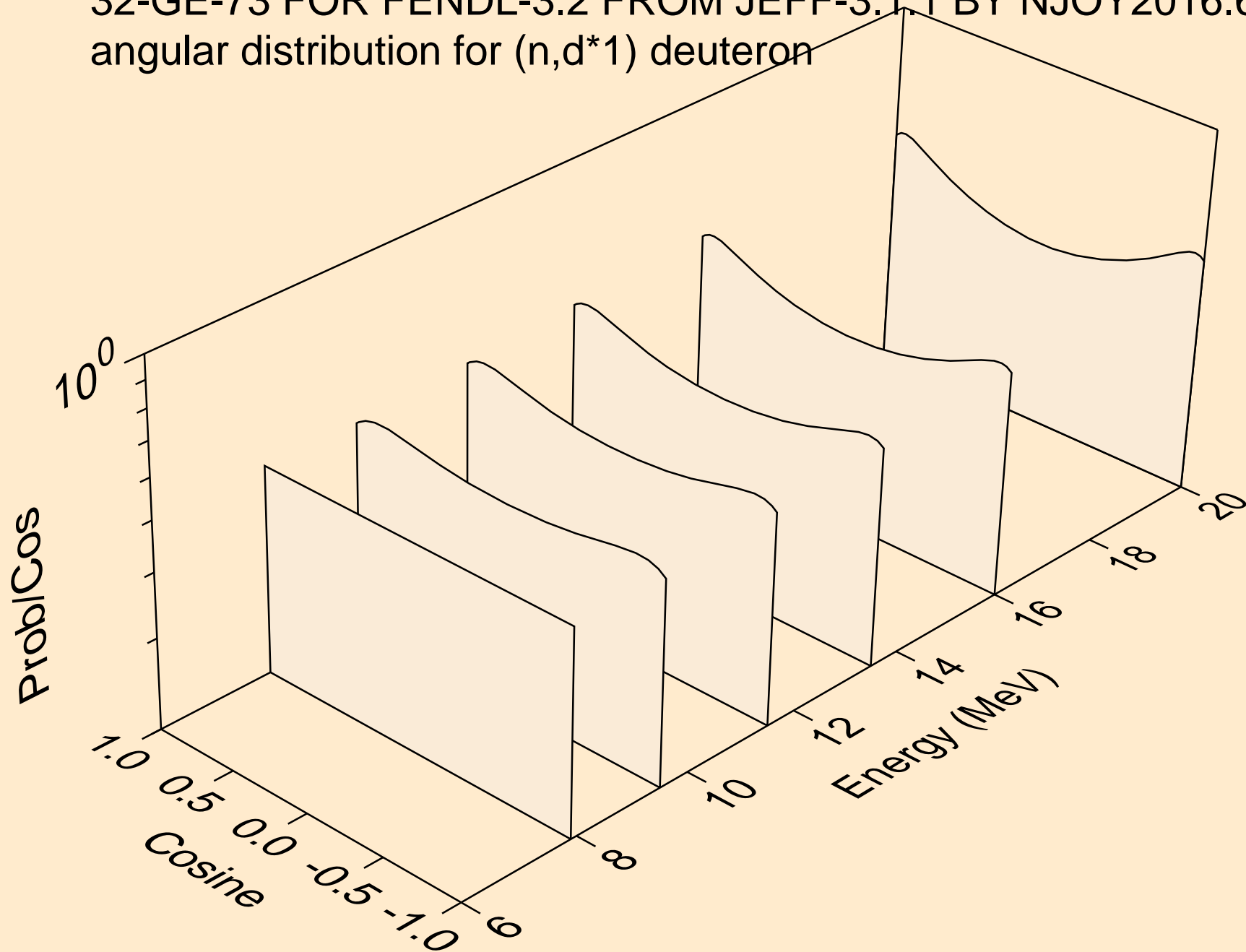

32-GE-73 FOR FENDL-3.2 FROM JEFF-3.1.1 BY NJOY2016.60+ O  
angular distribution for (n,d\*2) deuteron

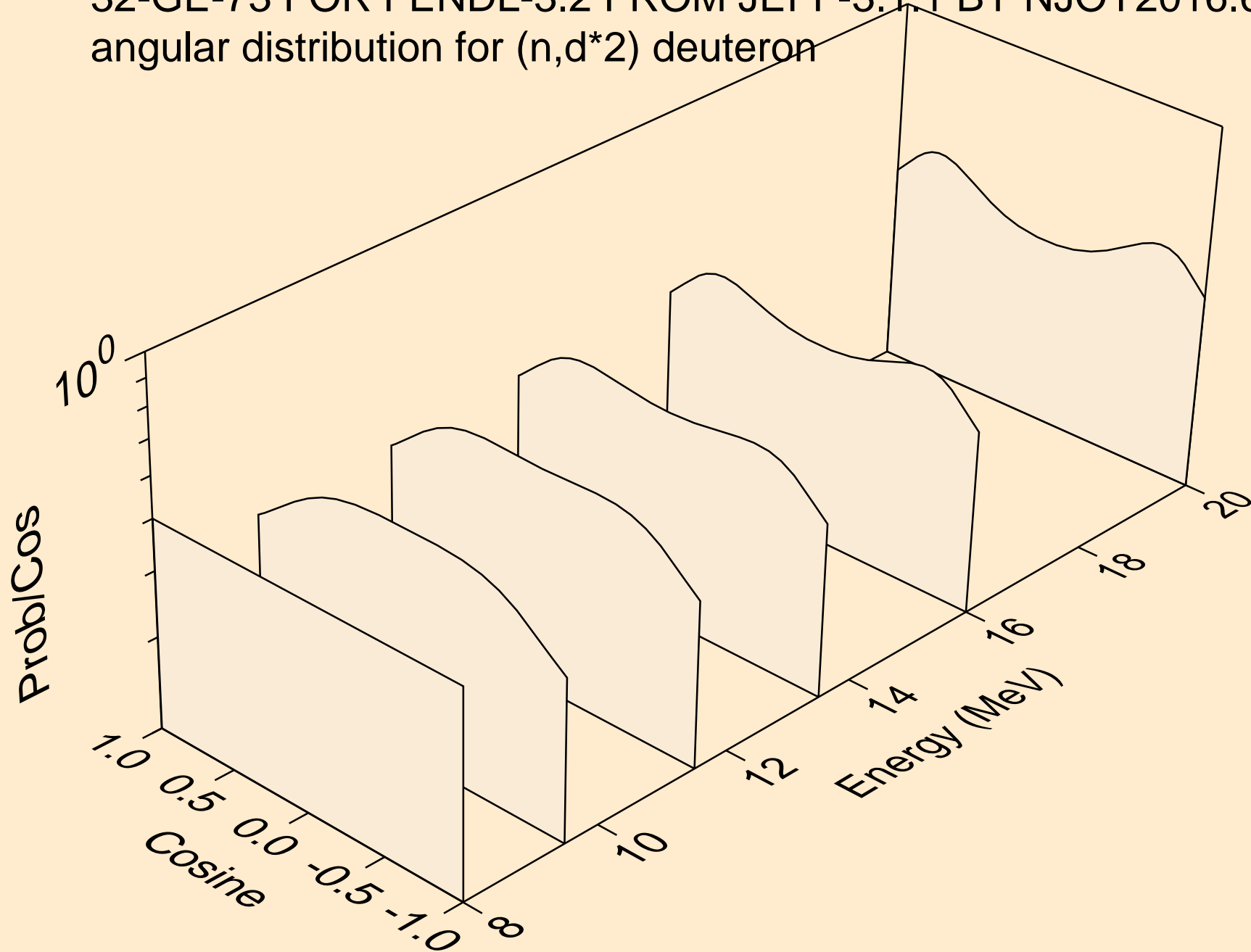

32-GE-73 FOR FENDL-3.2 FROM JEFF-3.1.1 BY NJOY2016.60+ O  
angular distribution for (n,d\*3) deuteron

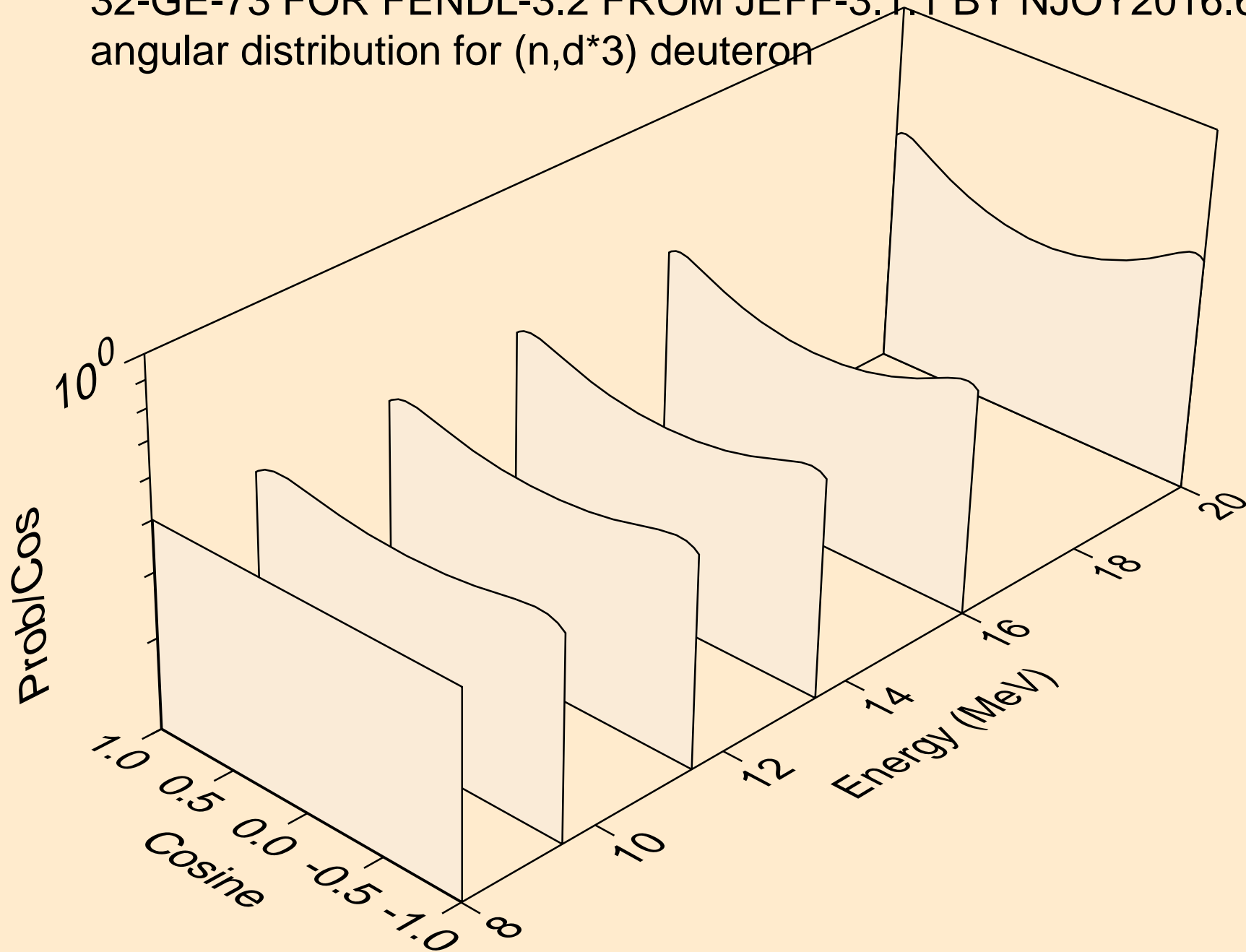



32-GE-73 FOR FENDL-3.2 FROM JEFF-3.1.1 BY NJOY2016.60+ O  
angular distribution for (n,d\*4) deuteron

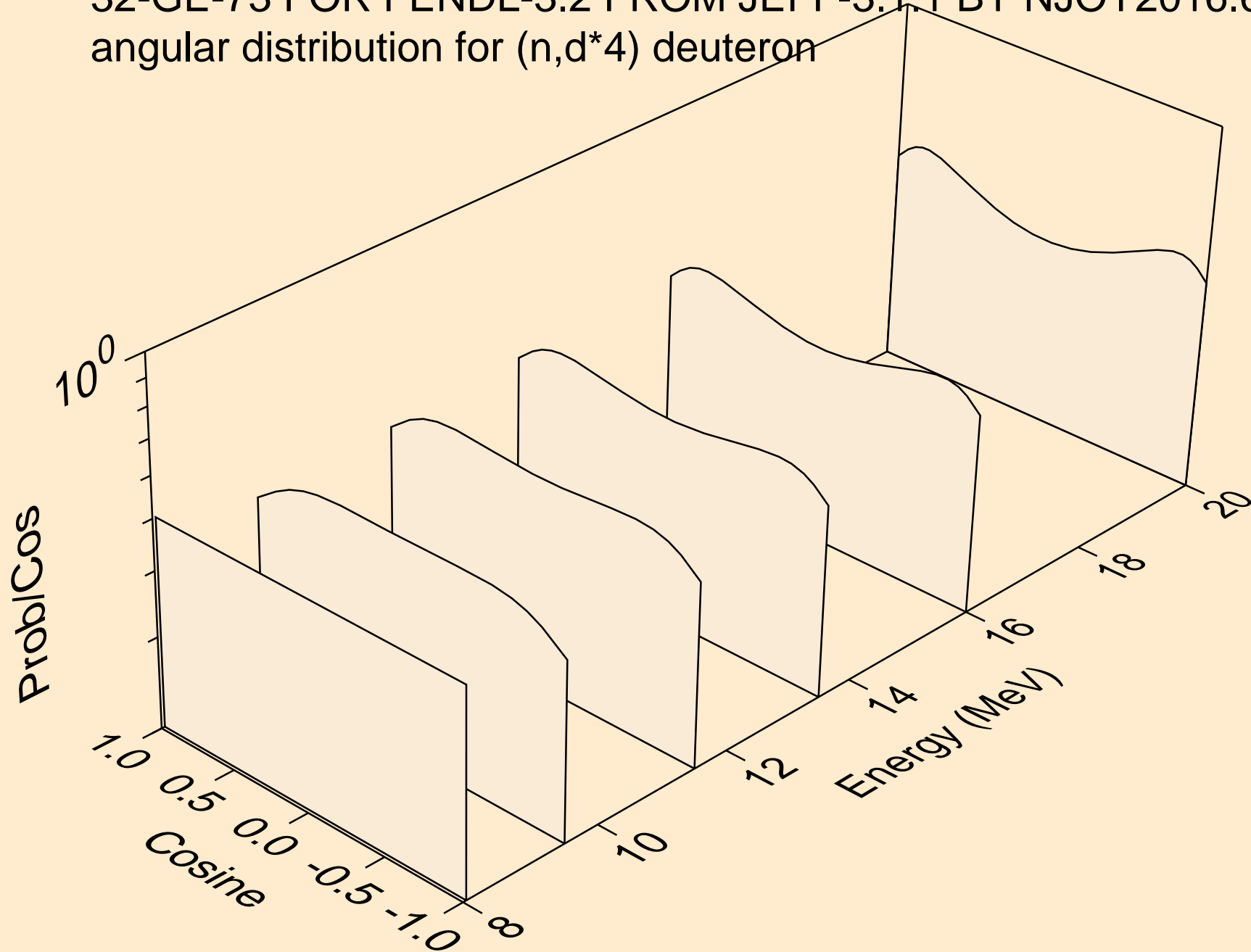

32-GE-73 FOR FENDL-3.2 FROM JEFF-3.1.1 BY NJOY2016.60+ O  
angular distribution for (n,d\*5) deuteron

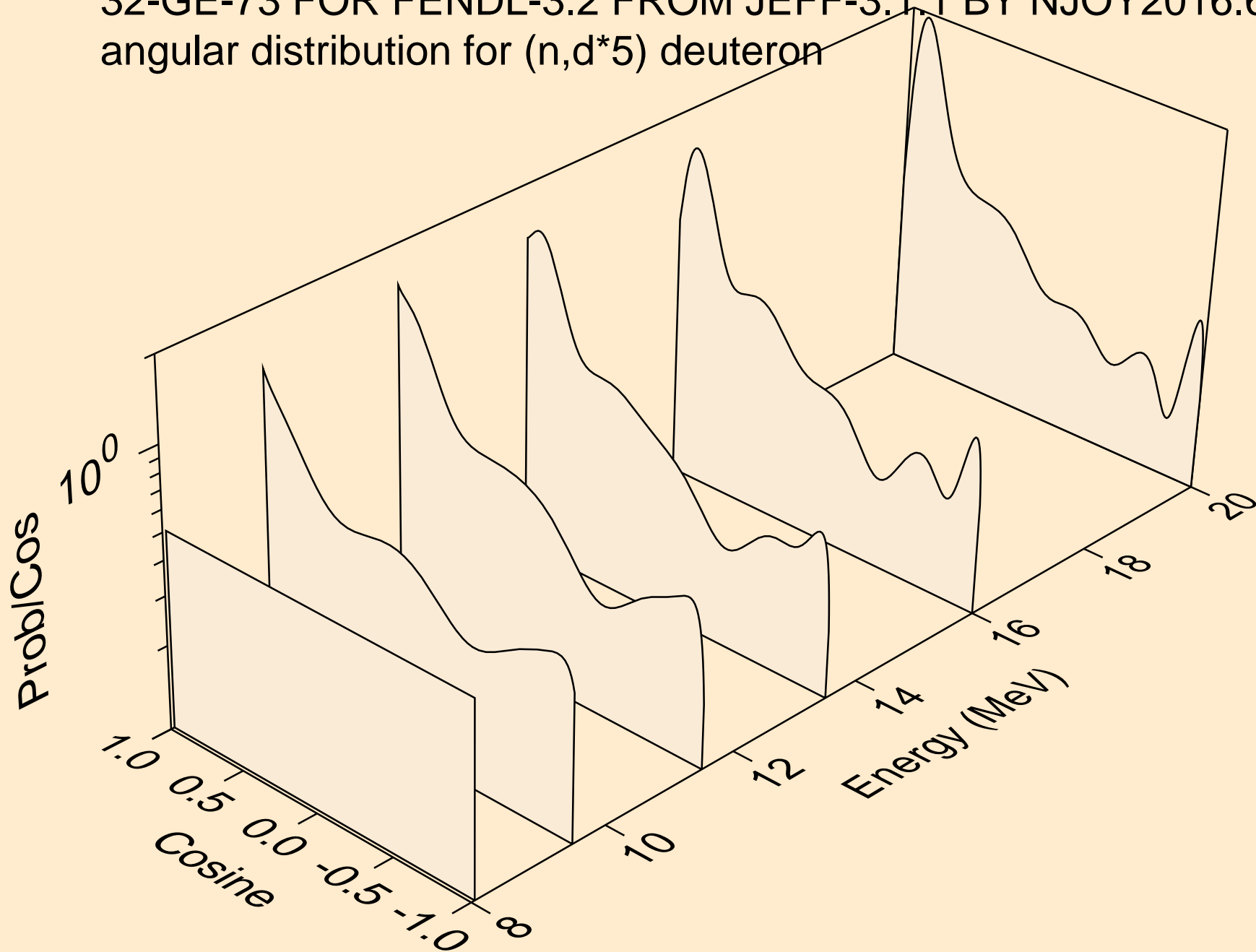

32-GE-73 FOR FENDL-3.2 FROM JEFF-3.1.1 BY NJOY2016.60+ O  
deuterons from (n,d\*c)

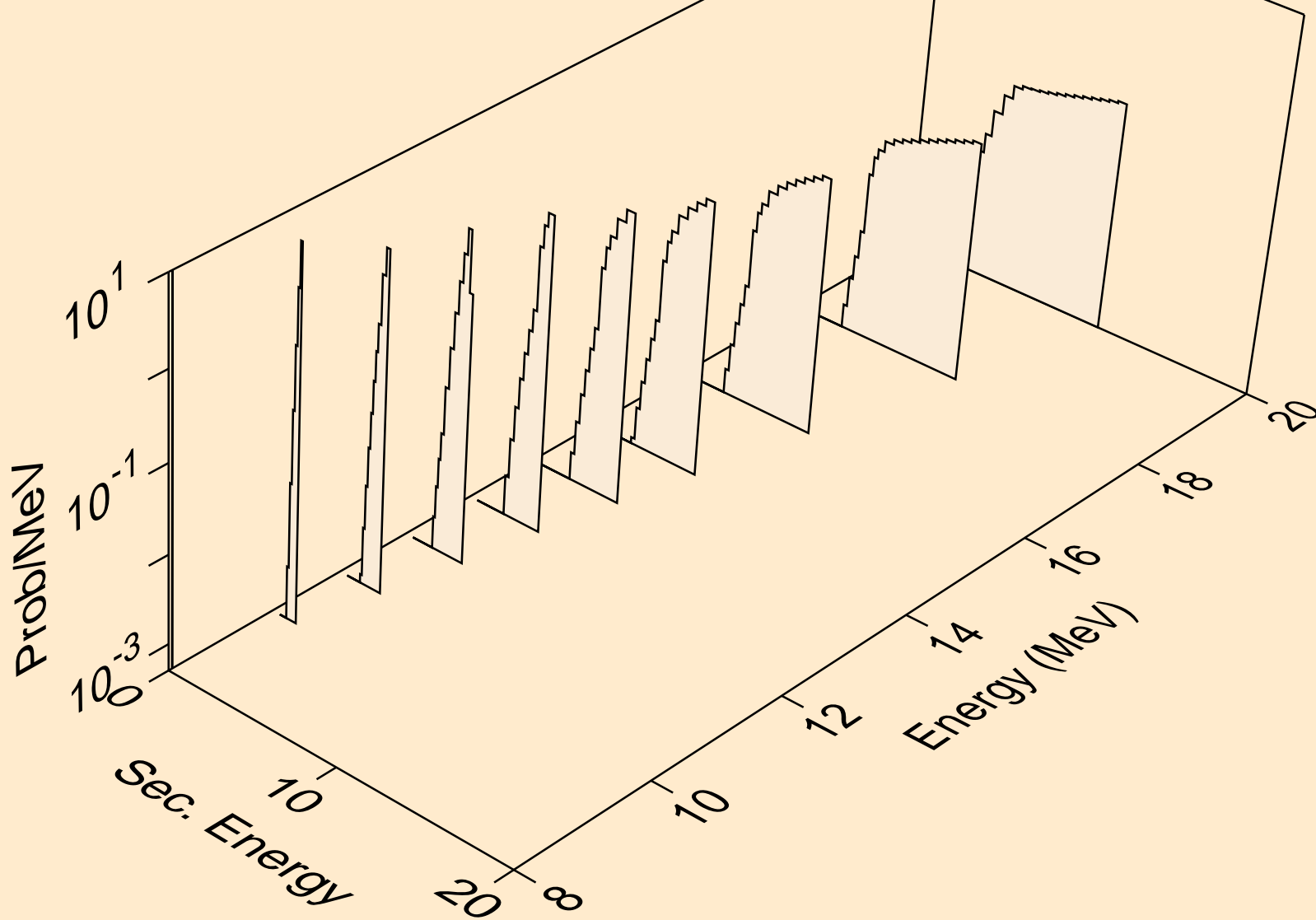

32-GE-73 FOR FENDL-3.2 FROM JEFF-3.1.1 BY NJOY2016.60+ O  
tritons from (n,x)

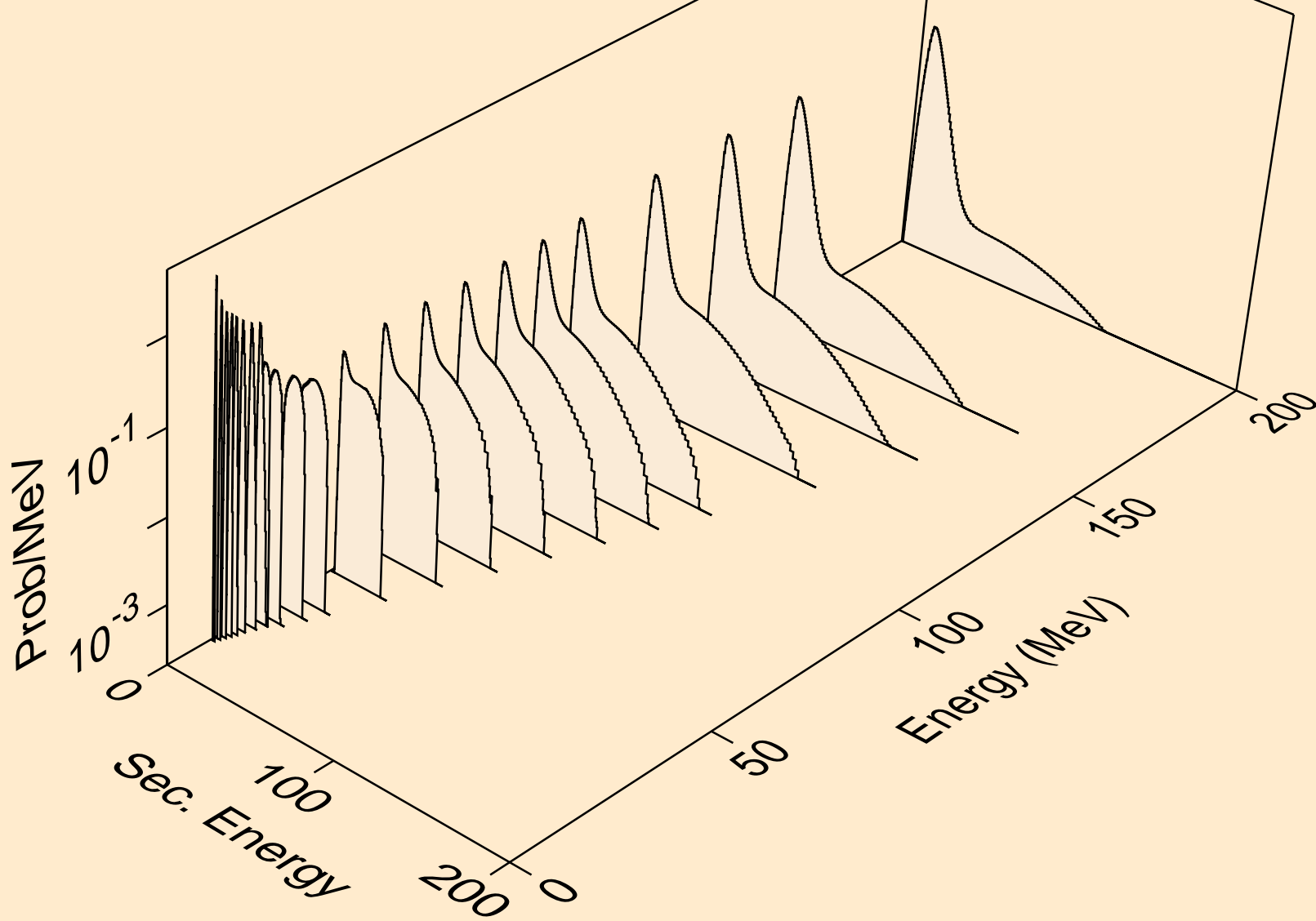

32-GE-73 FOR FENDL-3.2 FROM JEFF-3.1.1 BY NJOY2016.60+ O  
tritons from (n,n\*)t

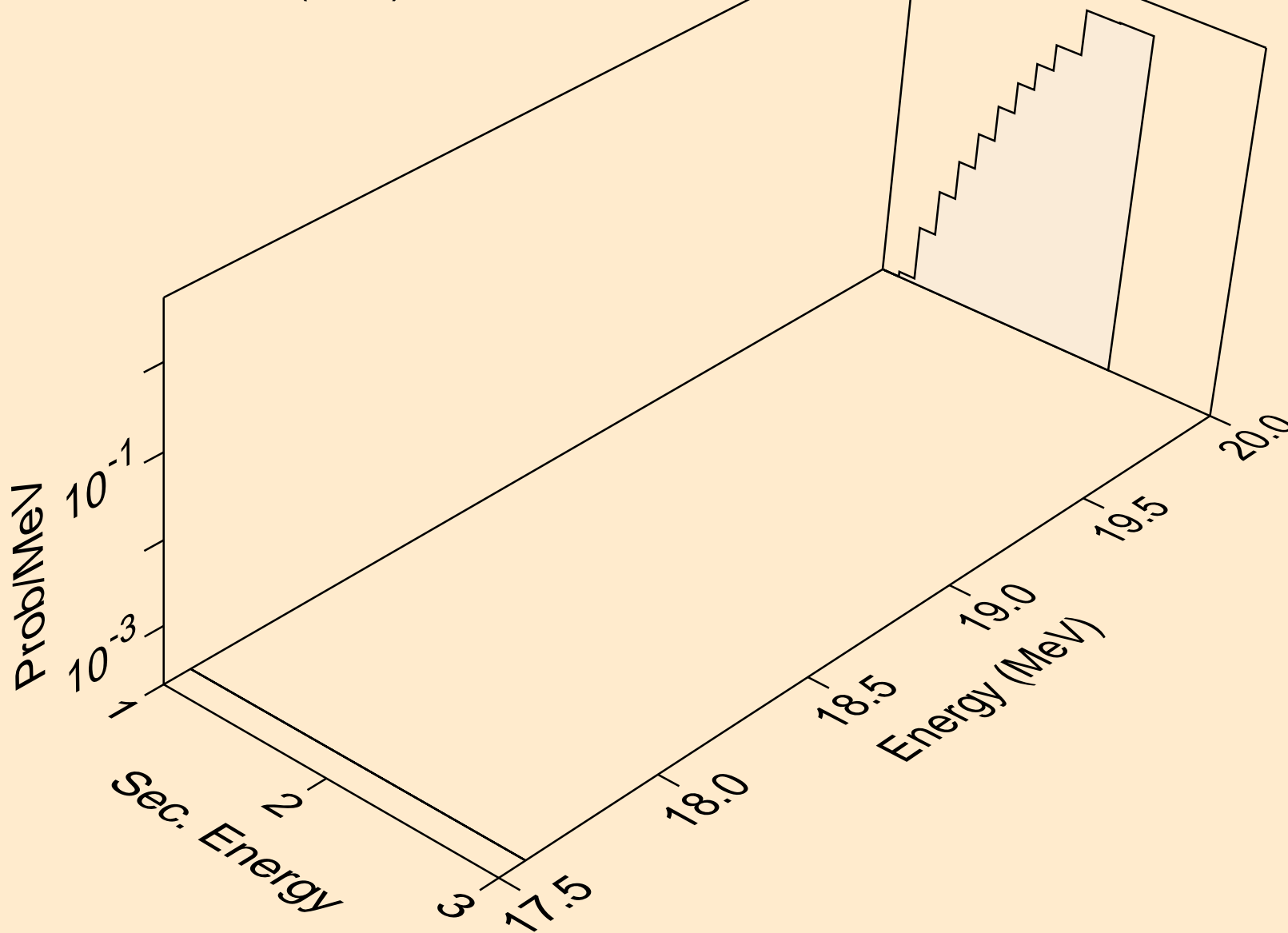

32-GE-73 FOR FENDL-3.2 FROM JEFF-3.1.1 BY NJOY2016.60+ O  
angular distribution for (n,t\*0) triton

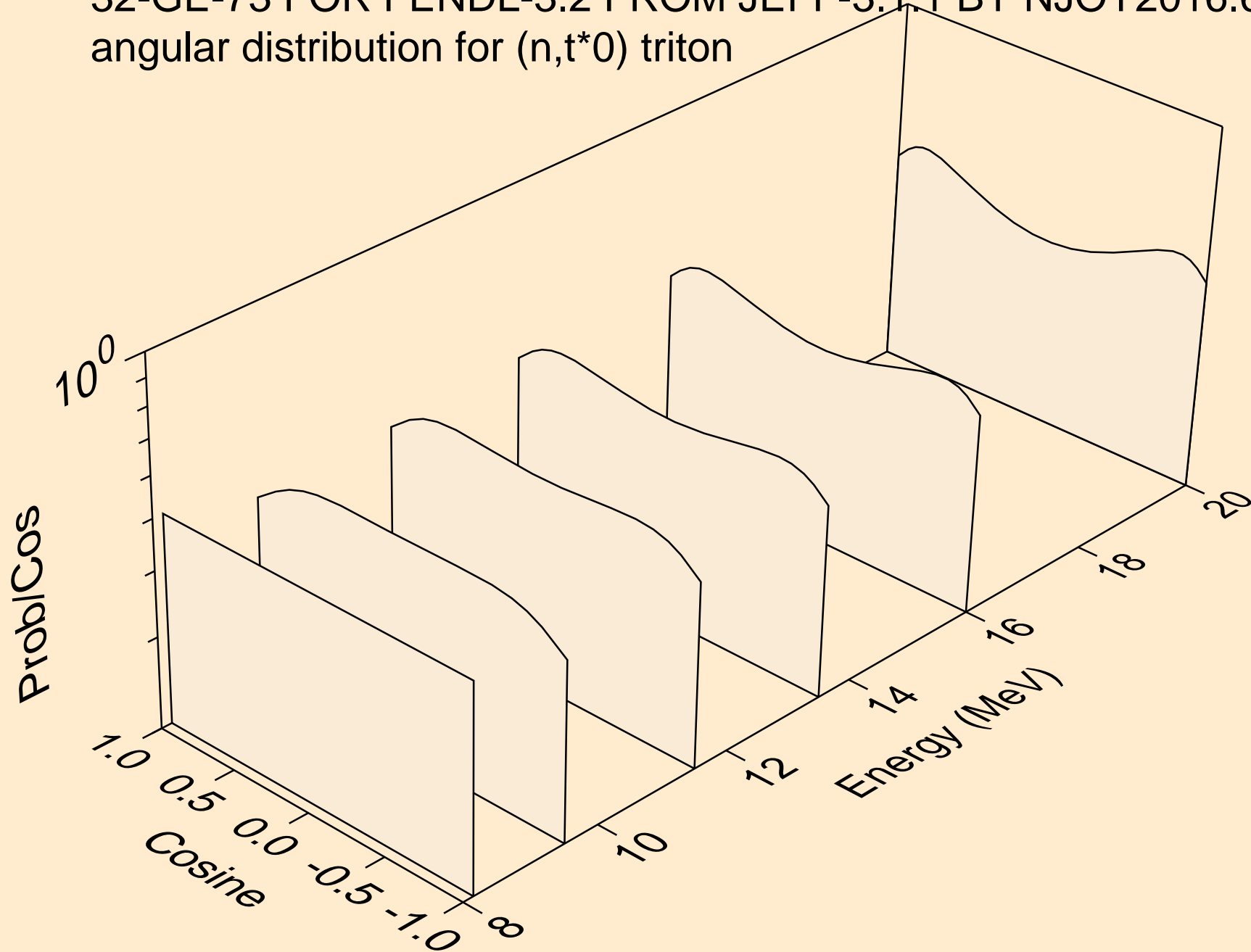

32-GE-73 FOR FENDL-3.2 FROM JEFF-3.1.1 BY NJOY2016.60+ O  
angular distribution for (n,t\*1) triton

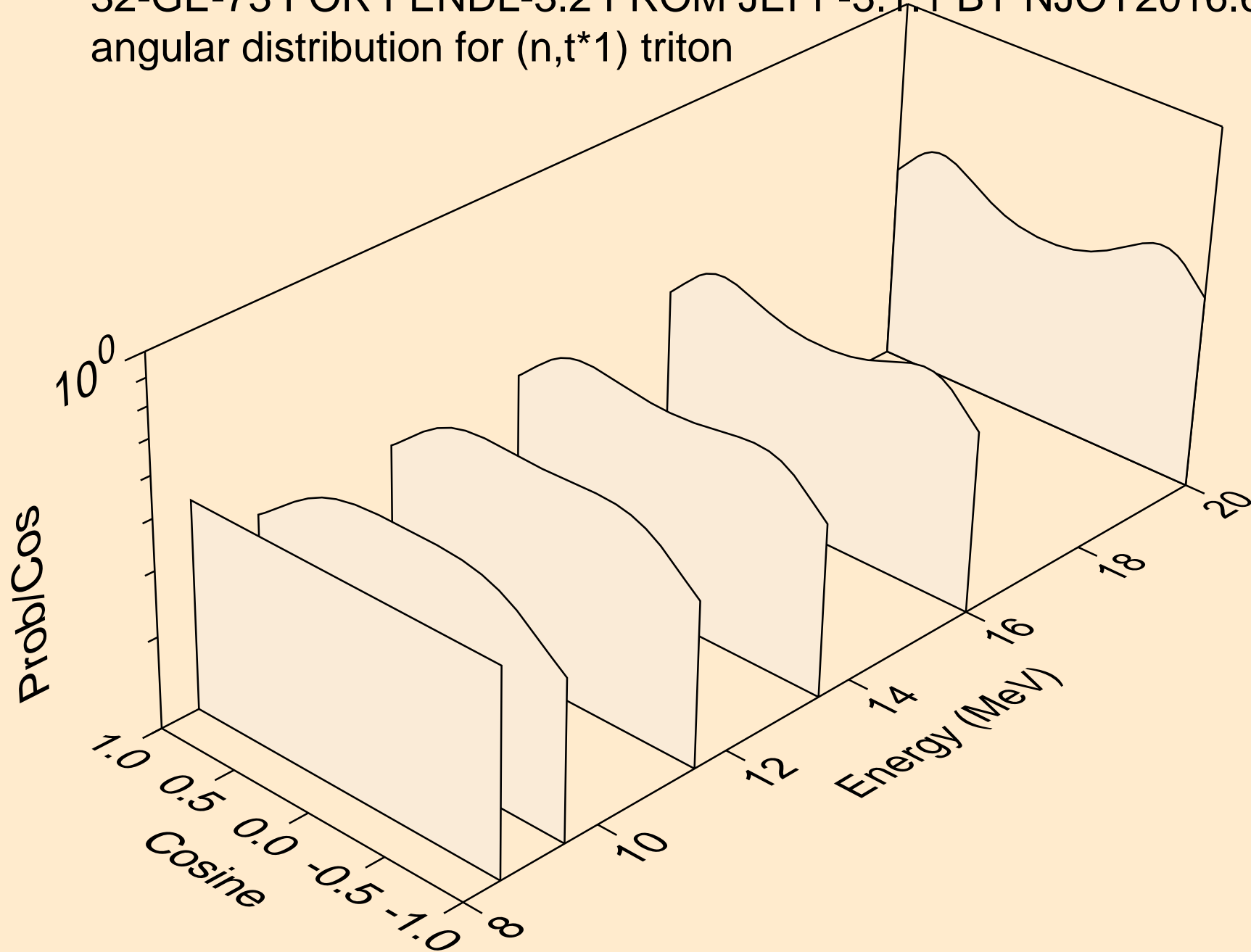

32-GE-73 FOR FENDL-3.2 FROM JEFF-3.1.1 BY NJOY2016.60+ O  
angular distribution for (n,t\*2) triton

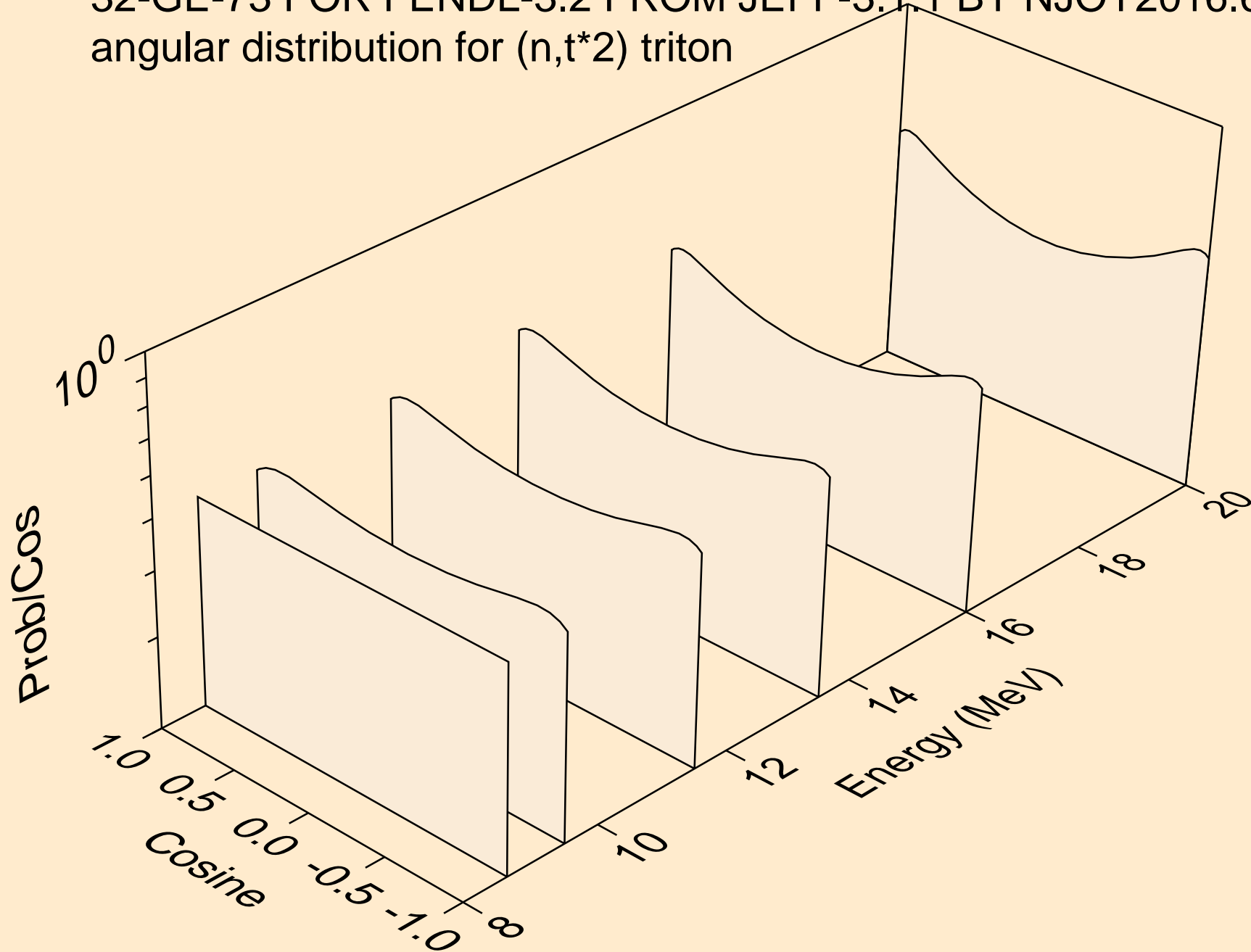



32-GE-73 FOR FENDL-3.2 FROM JEFF-3.1.1 BY NJOY2016.60+ O  
angular distribution for (n,t\*3) triton

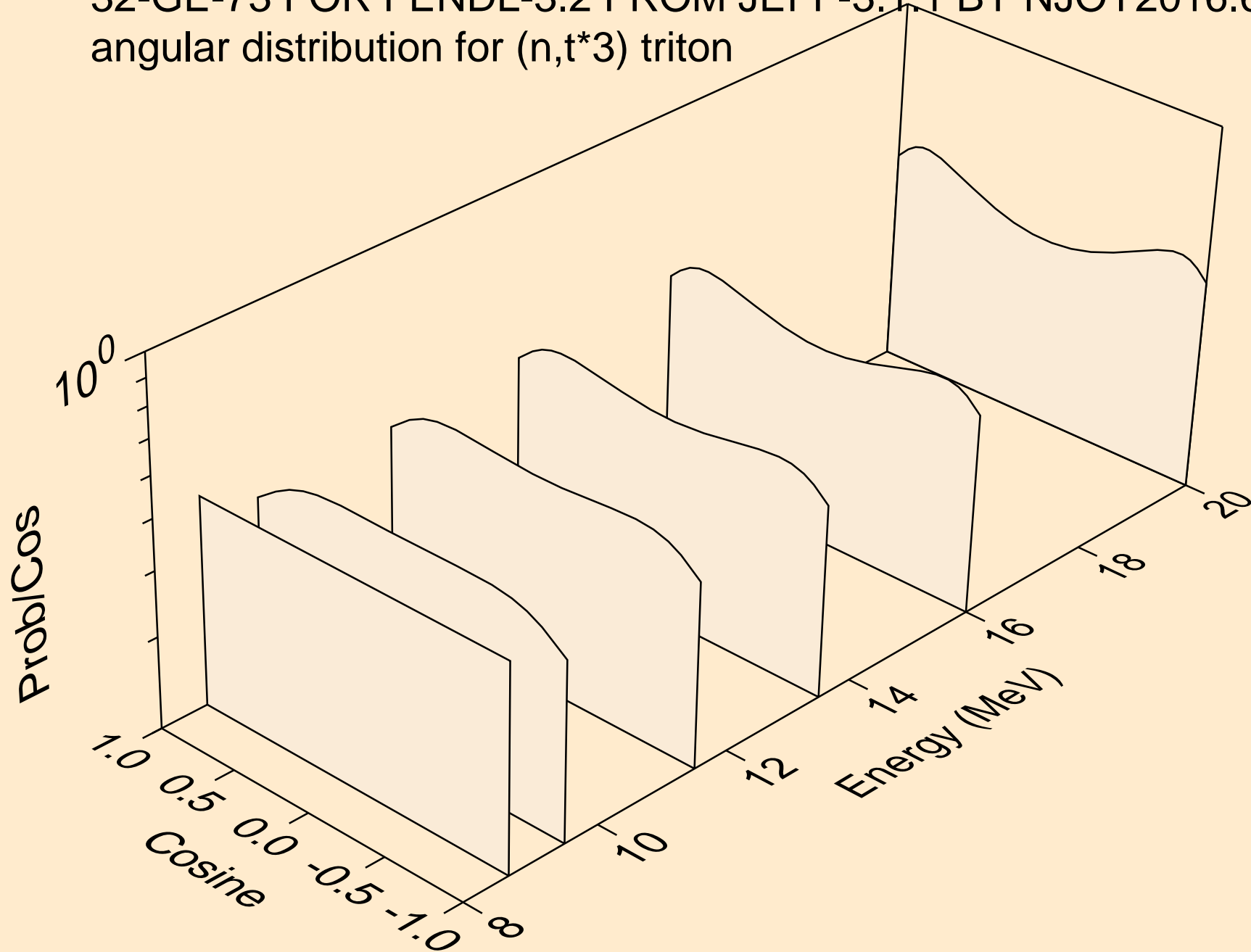

32-GE-73 FOR FENDL-3.2 FROM JEFF-3.1.1 BY NJOY2016.60+ O  
angular distribution for (n,t\*4) triton

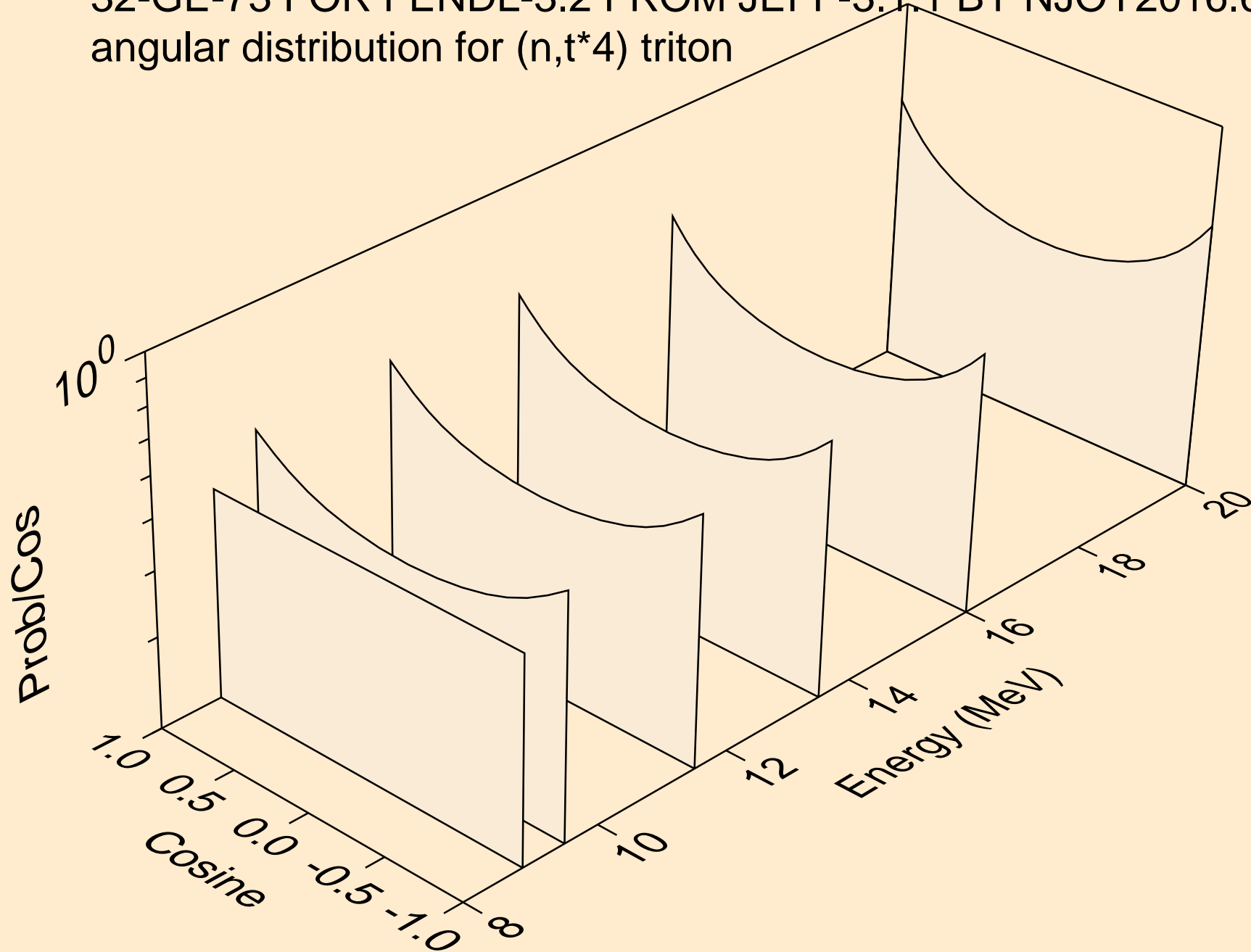

32-GE-73 FOR FENDL-3.2 FROM JEFF-3.1.1 BY NJOY2016.60+ O  
angular distribution for (n,t\*5) triton

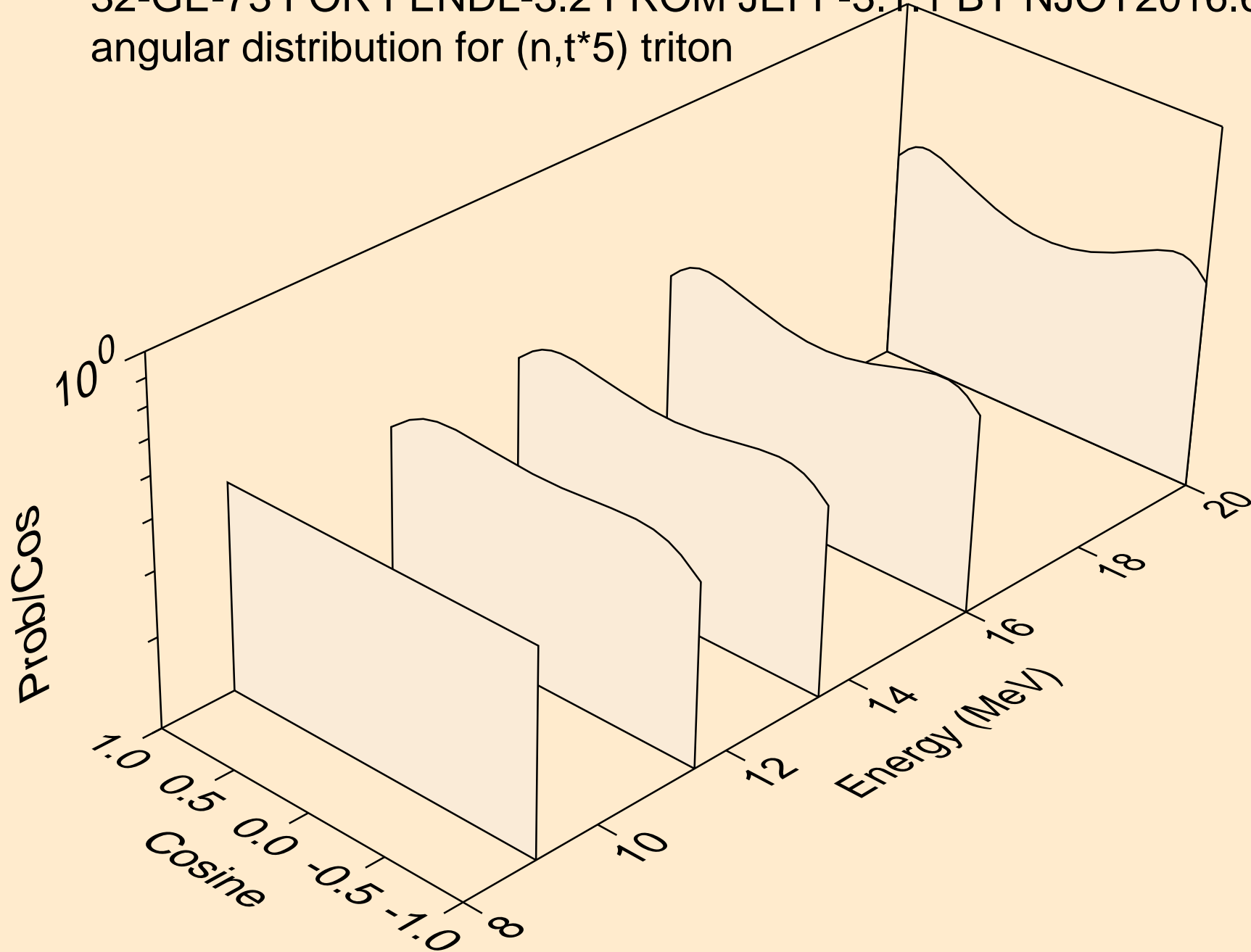

32-GE-73 FOR FENDL-3.2 FROM JEFF-3.1.1 BY NJOY2016.60+ O  
tritons from (n,t\*c)

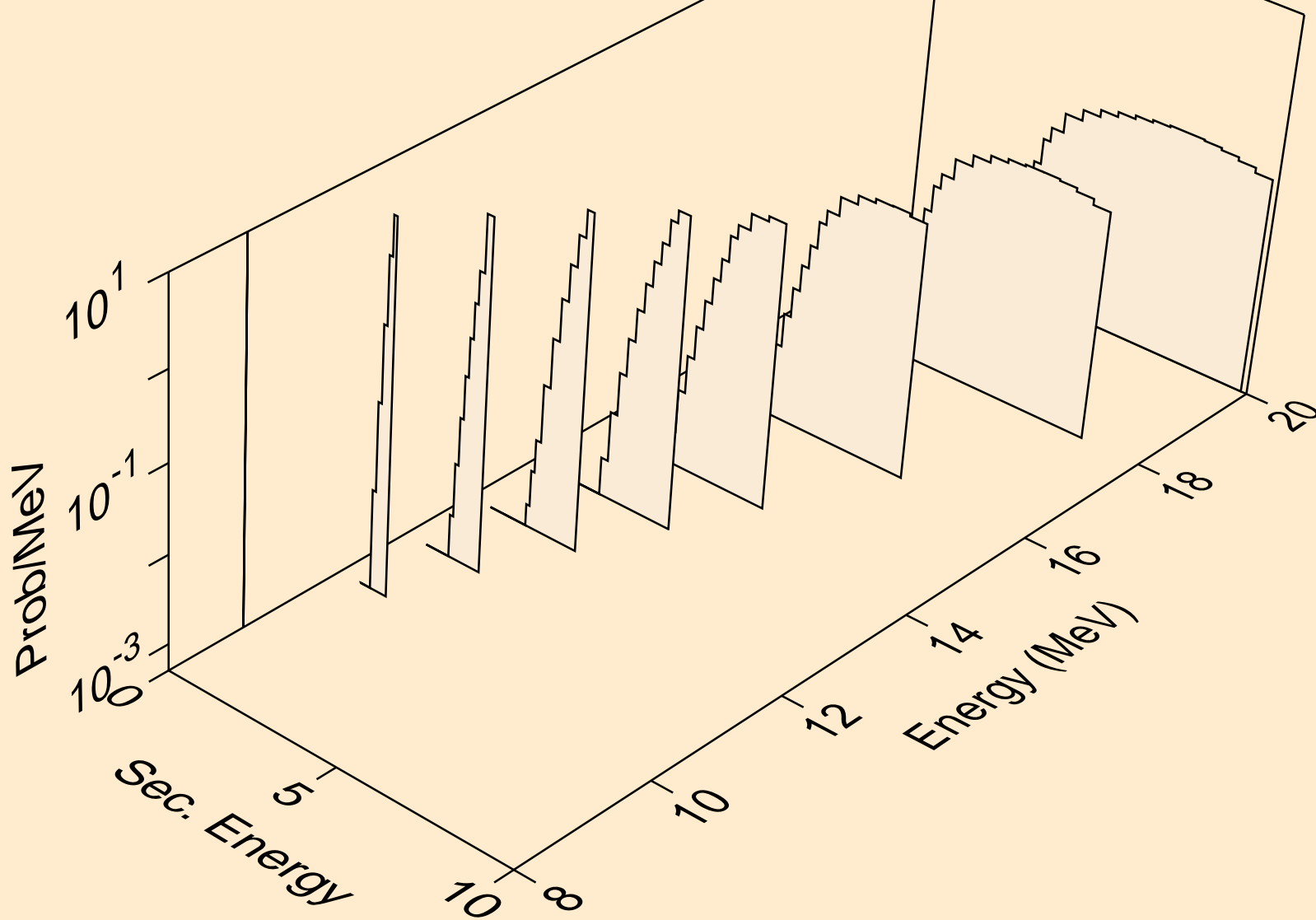

32-GE-73 FOR FENDL-3.2 FROM JEFF-3.1.1 BY NJOY2016.60+ O  
he3s from (n,x)

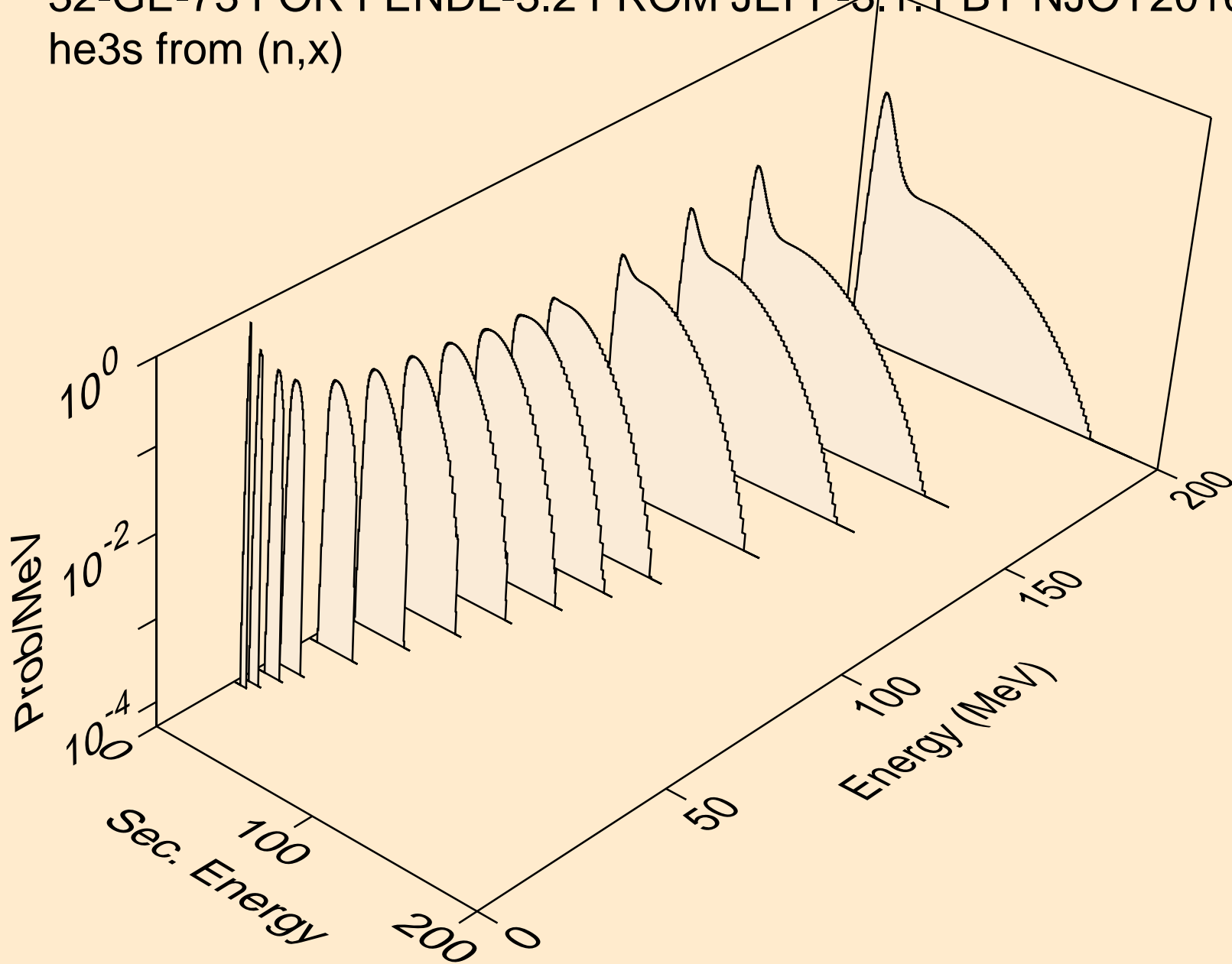

32-GE-73 FOR FENDL-3.2 FROM JEFF-3.1.1 BY NJOY2016.60+ O  
angular distribution for (n,he3\*0) 3he

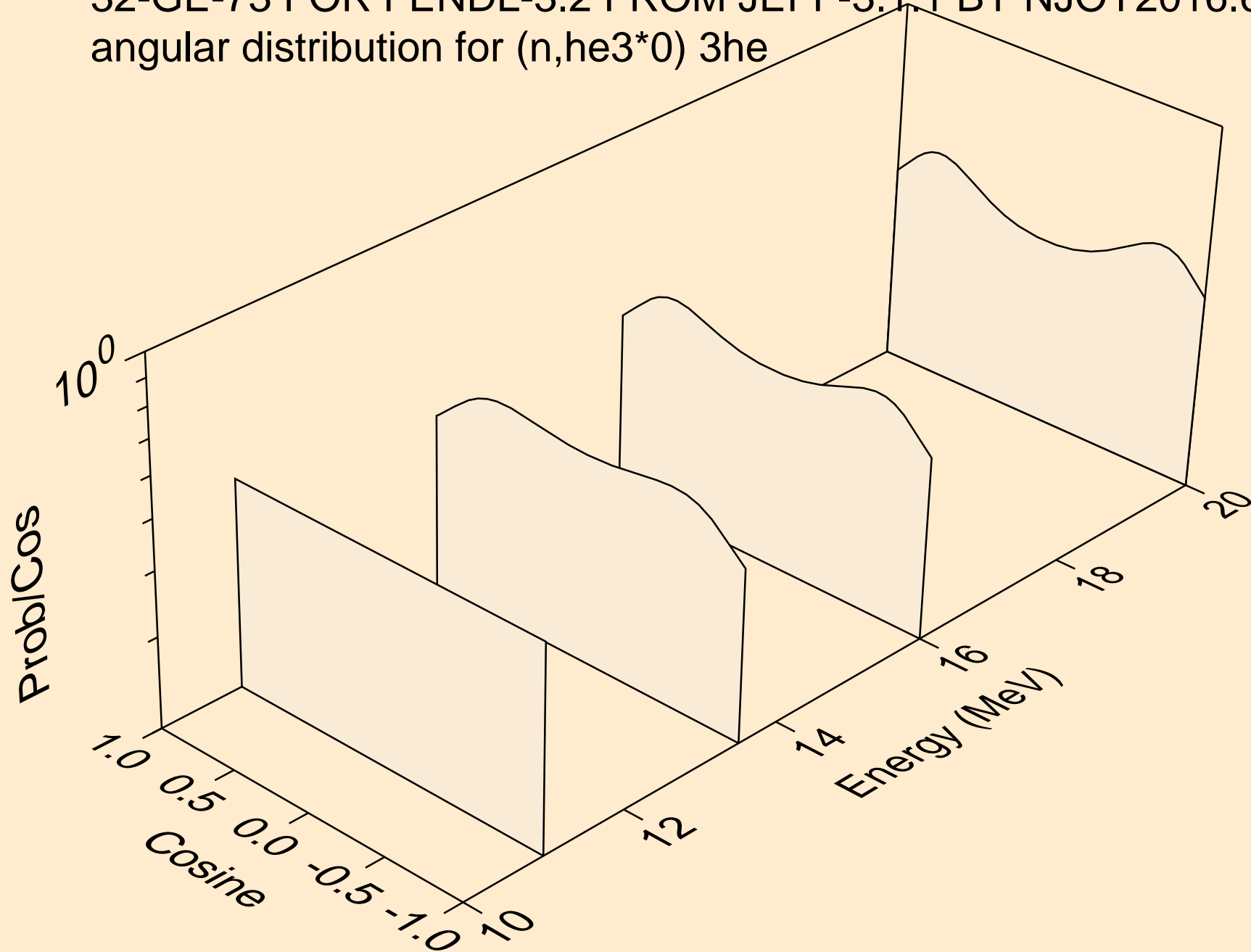

32-GE-73 FOR FENDL-3.2 FROM JEFF-3.1.1 BY NJOY2016.60+ O  
angular distribution for (n,he3\*1) 3he

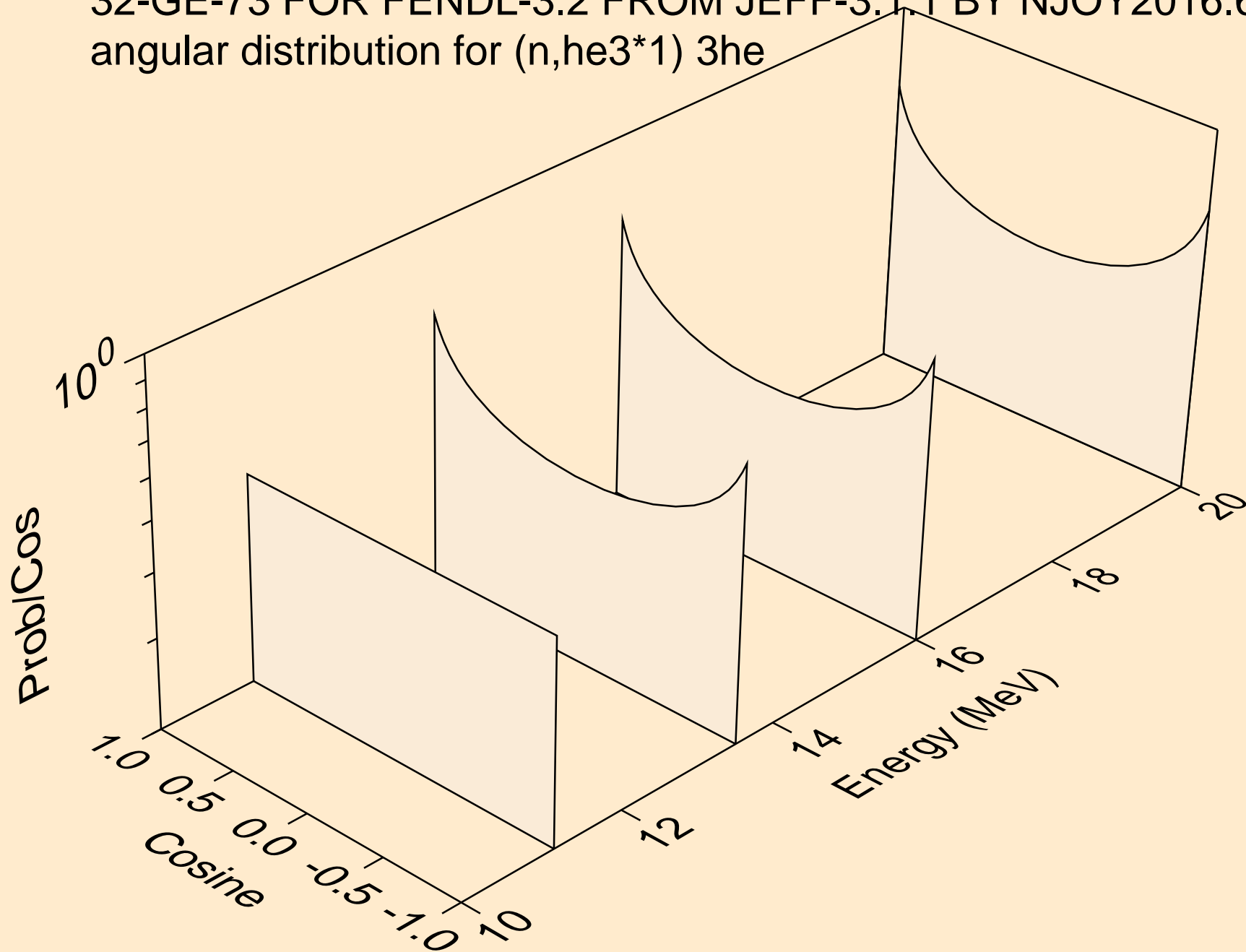

32-GE-73 FOR FENDL-3.2 FROM JEFF-3.1.1 BY NJOY2016.60+ O  
angular distribution for (n,he3\*2) 3he

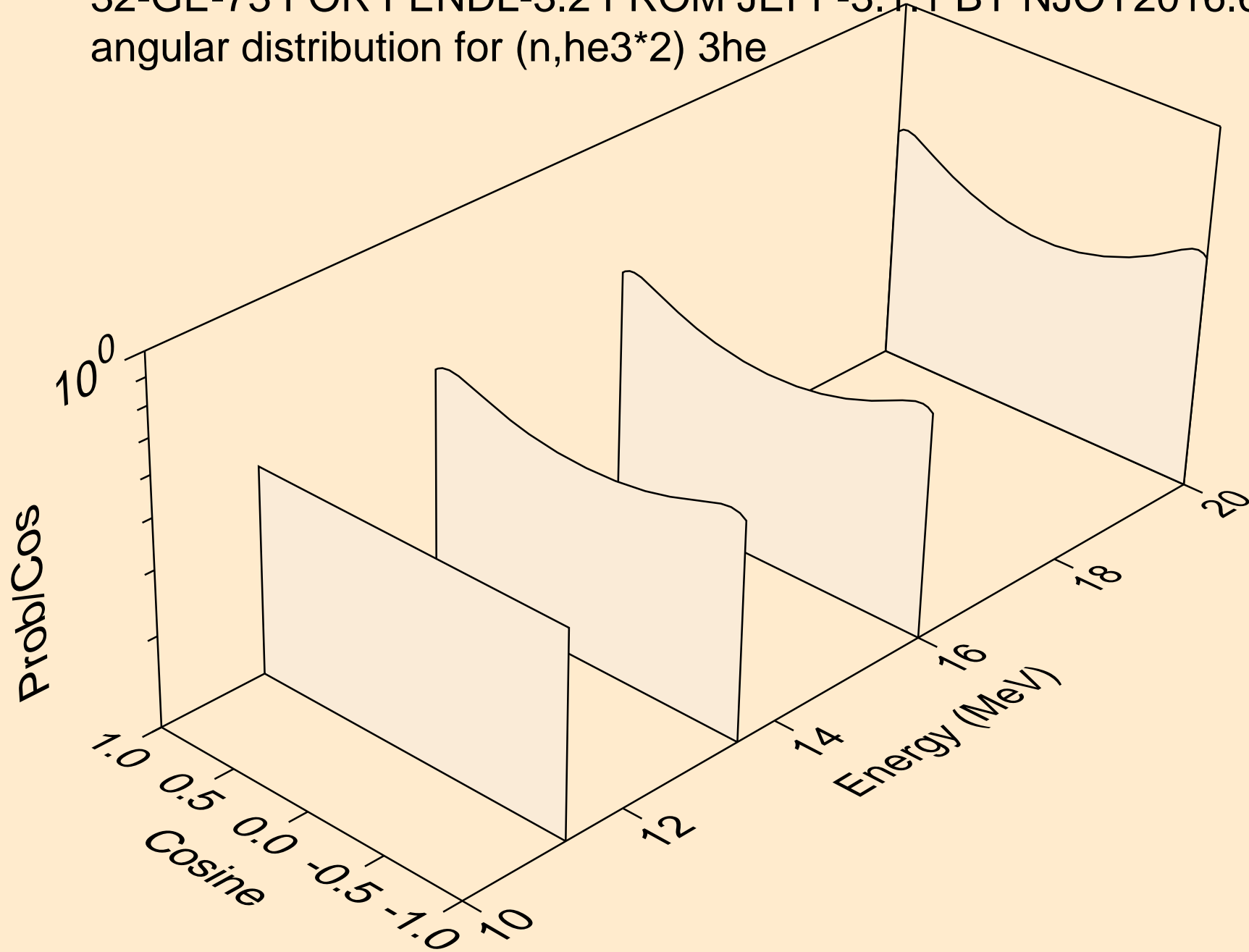



32-GE-73 FOR FENDL-3.2 FROM JEFF-3.1.1 BY NJOY2016.60+ O  
angular distribution for (n,he3\*3) 3he

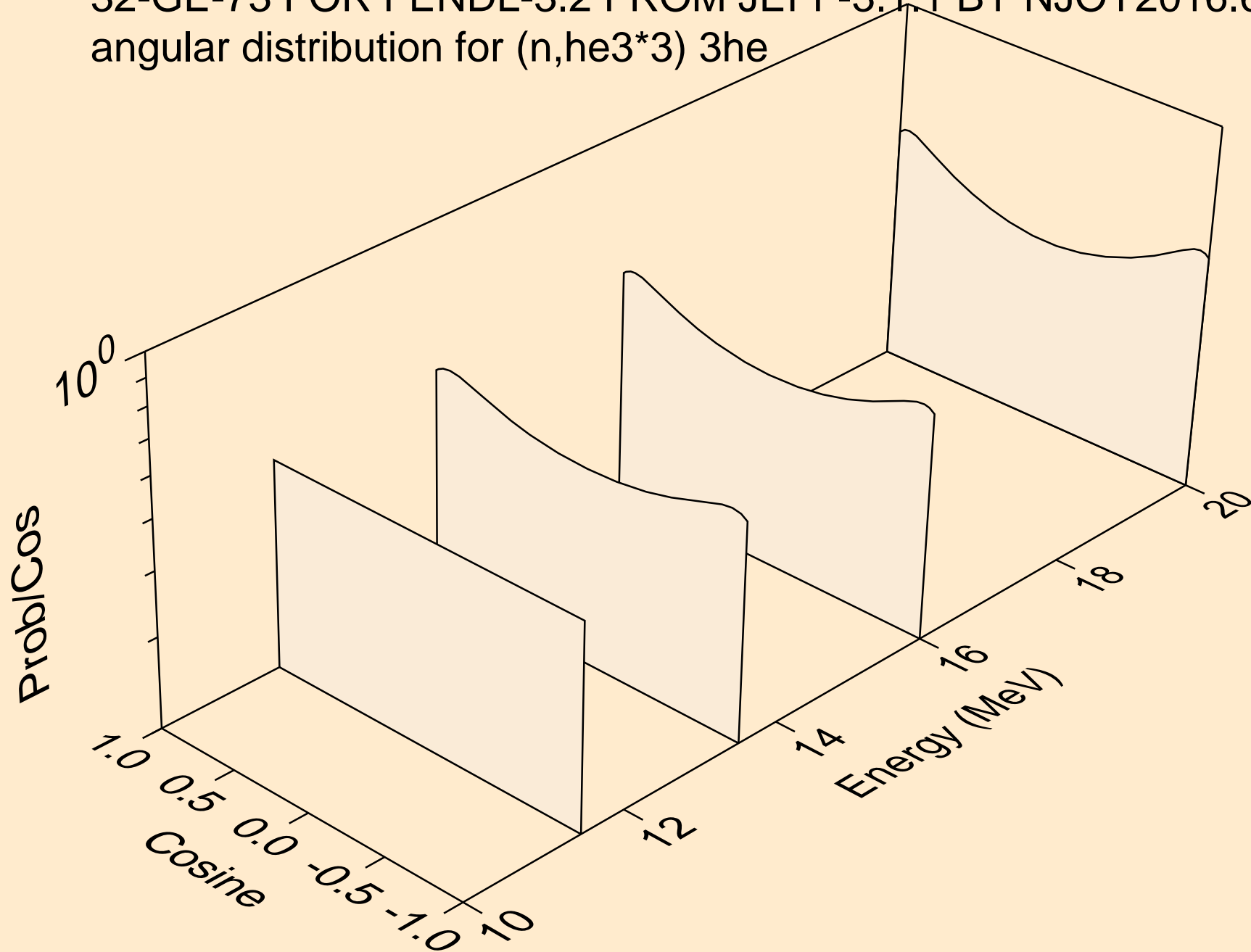

32-GE-73 FOR FENDL-3.2 FROM JEFF-3.1.1 BY NJOY2016.60+ O  
angular distribution for (n,he3\*4) 3he

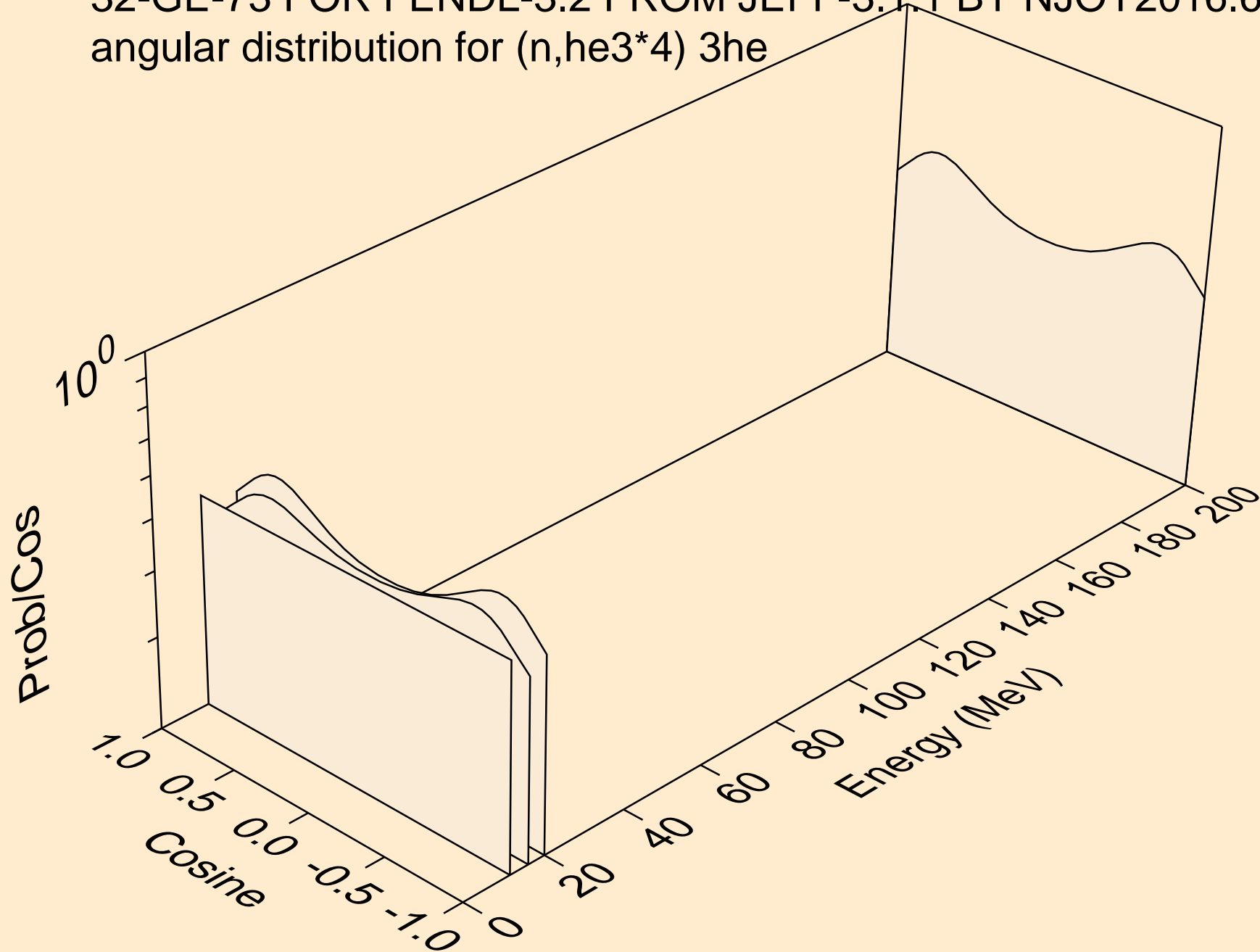

32-GE-73 FOR FENDL-3.2 FROM JEFF-3.1.1 BY NJOY2016.60+ O  
angular distribution for (n,he3\*5) 3he

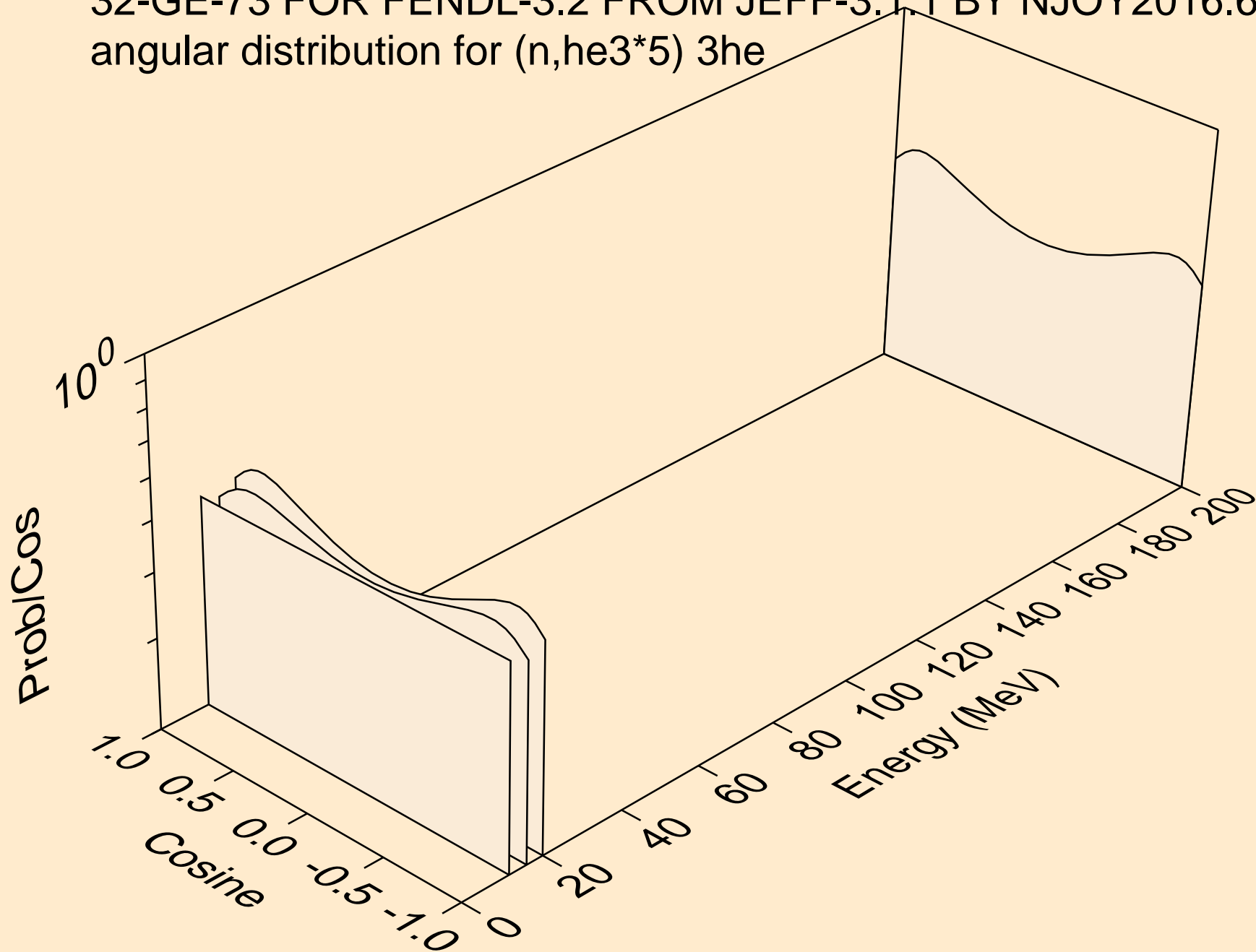

32-GE-73 FOR FENDL-3.2 FROM JEFF-3.1.1 BY NJOY2016.60+ O  
he3s from (n,he3\*c)

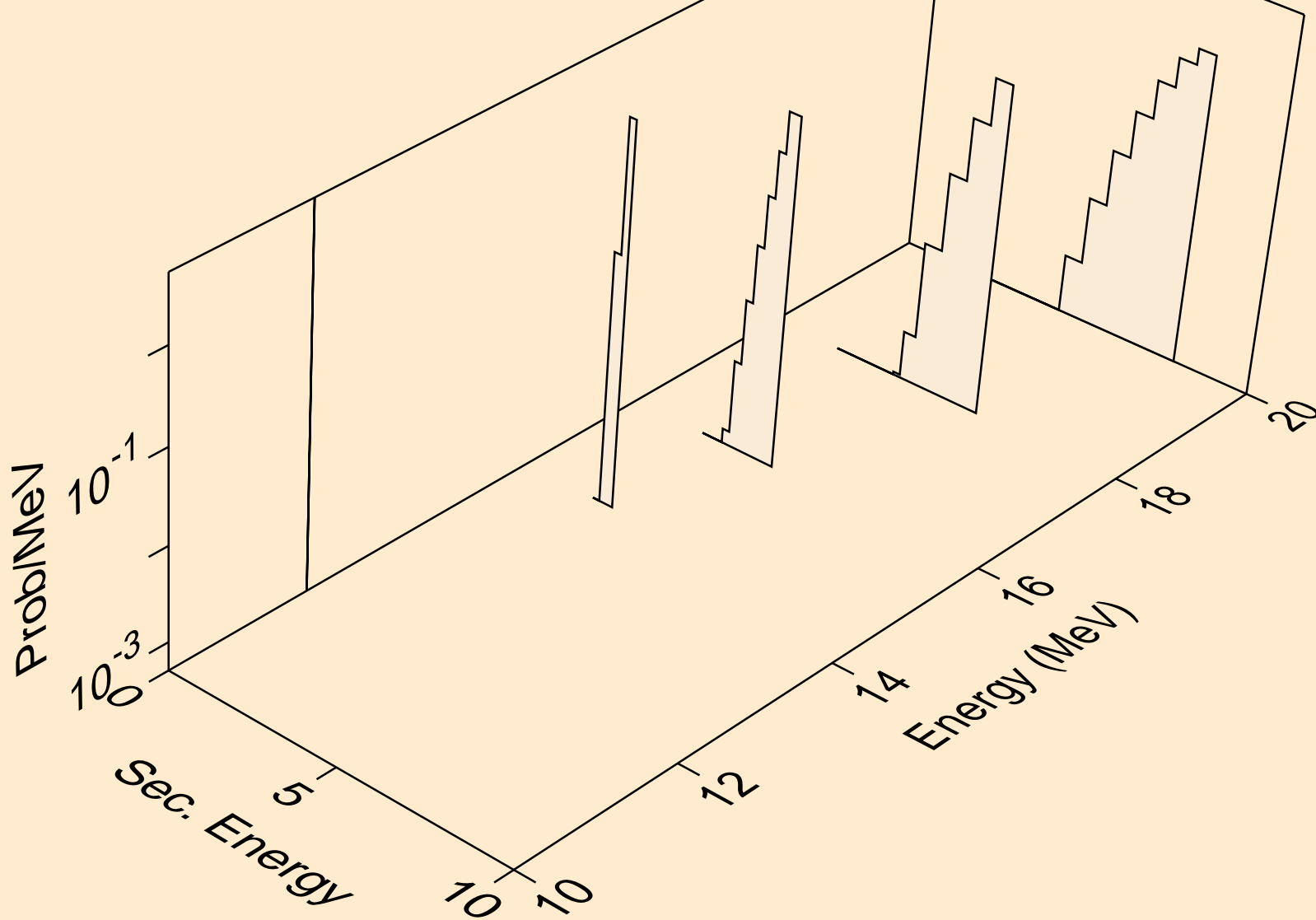

32-GE-73 FOR FENDL-3.2 FROM JEFF-3.1.1 BY NJOY2016.60+ O  
alphas from (n,x)

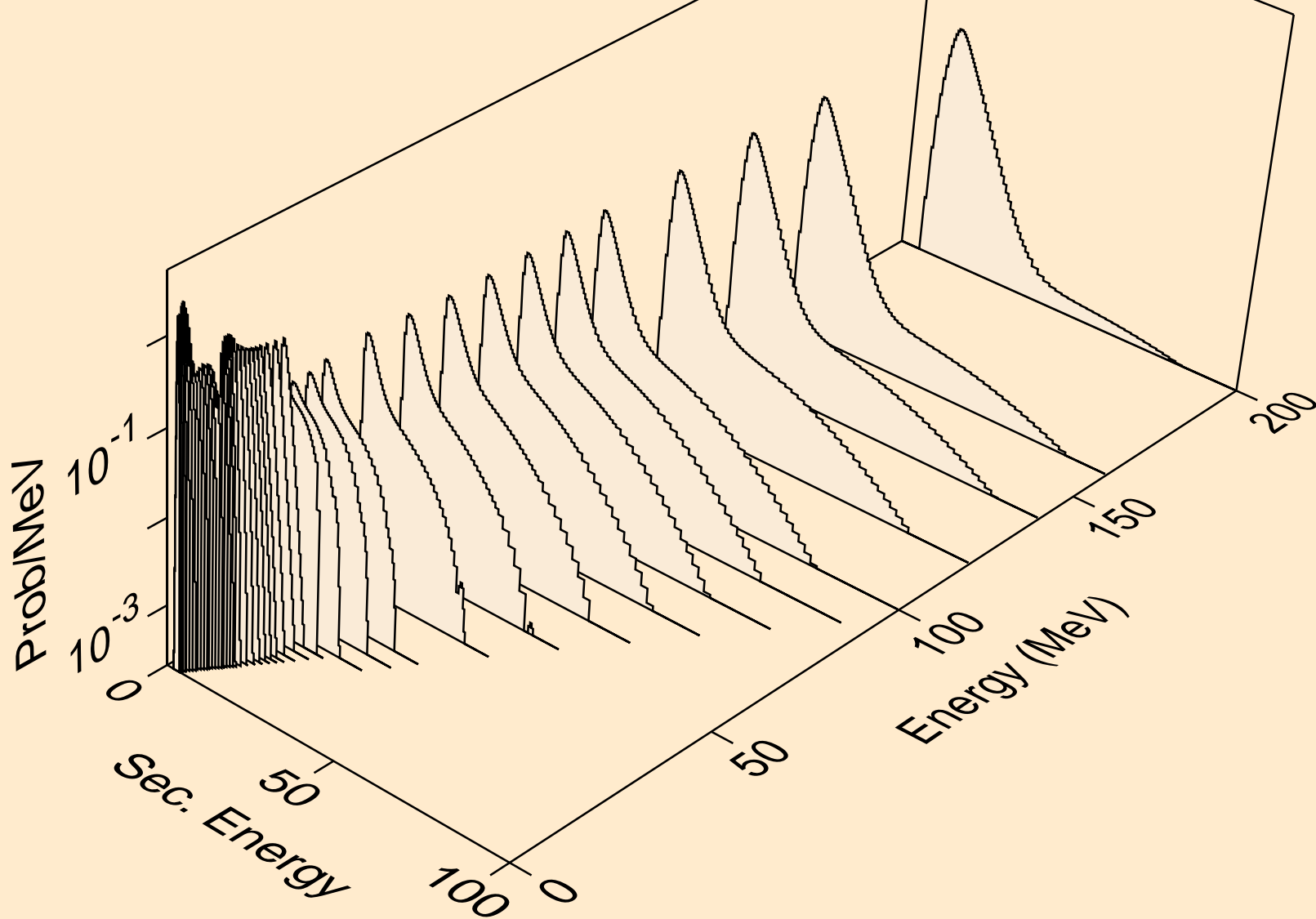

32-GE-73 FOR FENDL-3.2 FROM JEFF-3.1.1 BY NJOY2016.60+ O  
alphas from (n,n\*)a

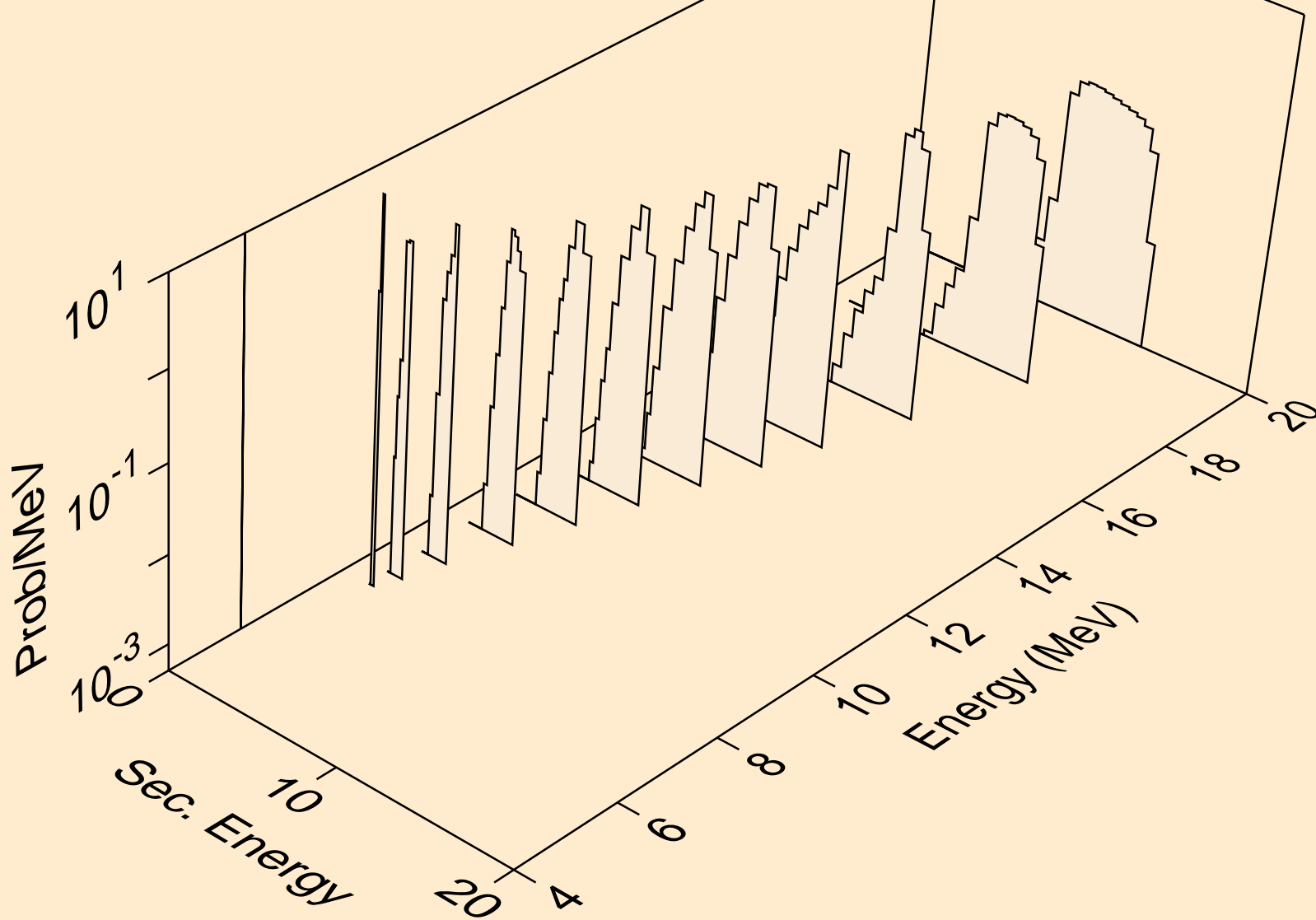

32-GE-73 FOR FENDL-3.2 FROM JEFF-3.1.1 BY NJOY2016.60+ O  
alphas from (n,2n)a

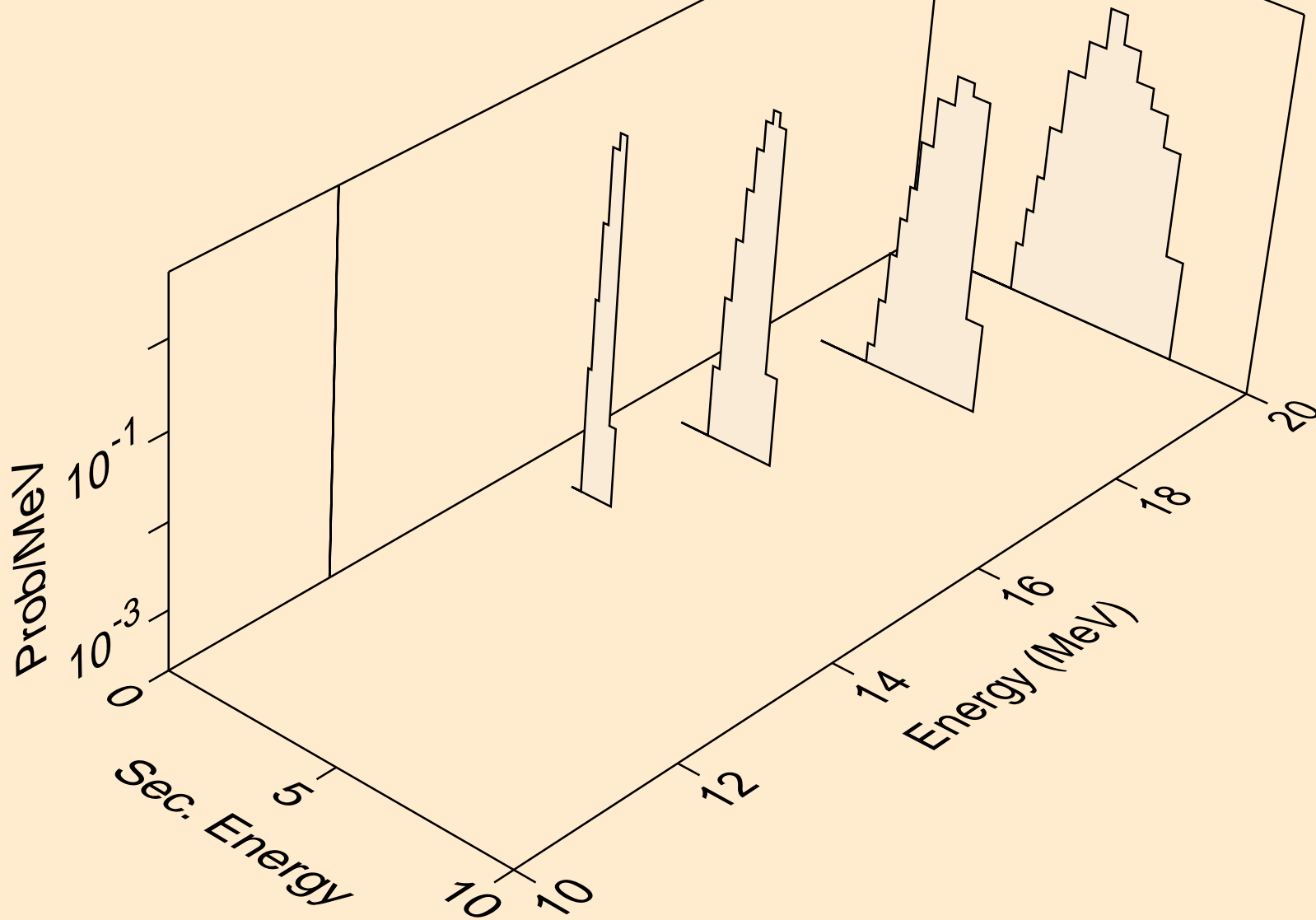

32-GE-73 FOR FENDL-3.2 FROM JEFF-3.1.1 BY NJOY2016.60+ O  
alphas from (n,2a)

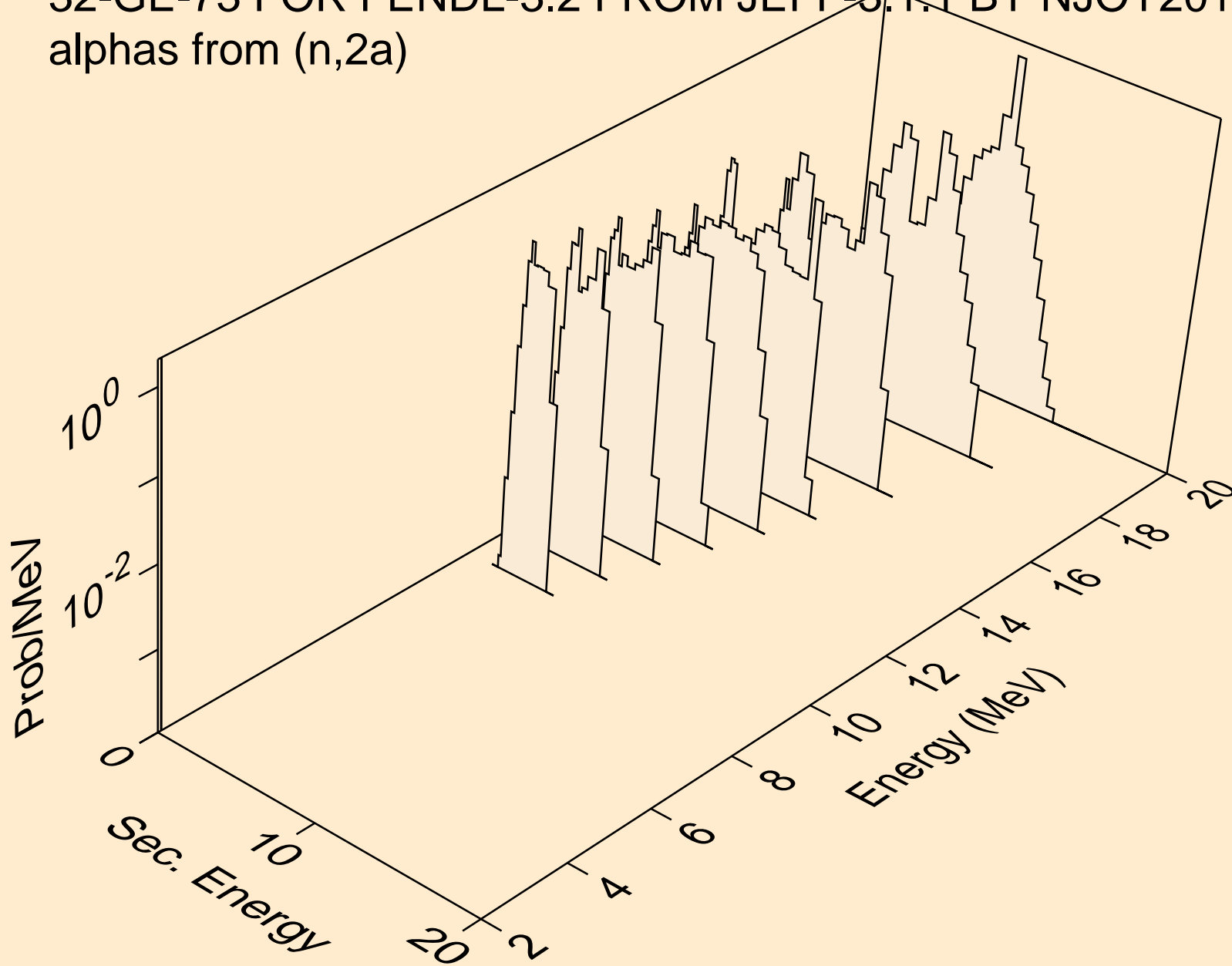



32-GE-73 FOR FENDL-3.2 FROM JEFF-3.1.1 BY NJOY2016.60+ O  
alphas from (n,pa)

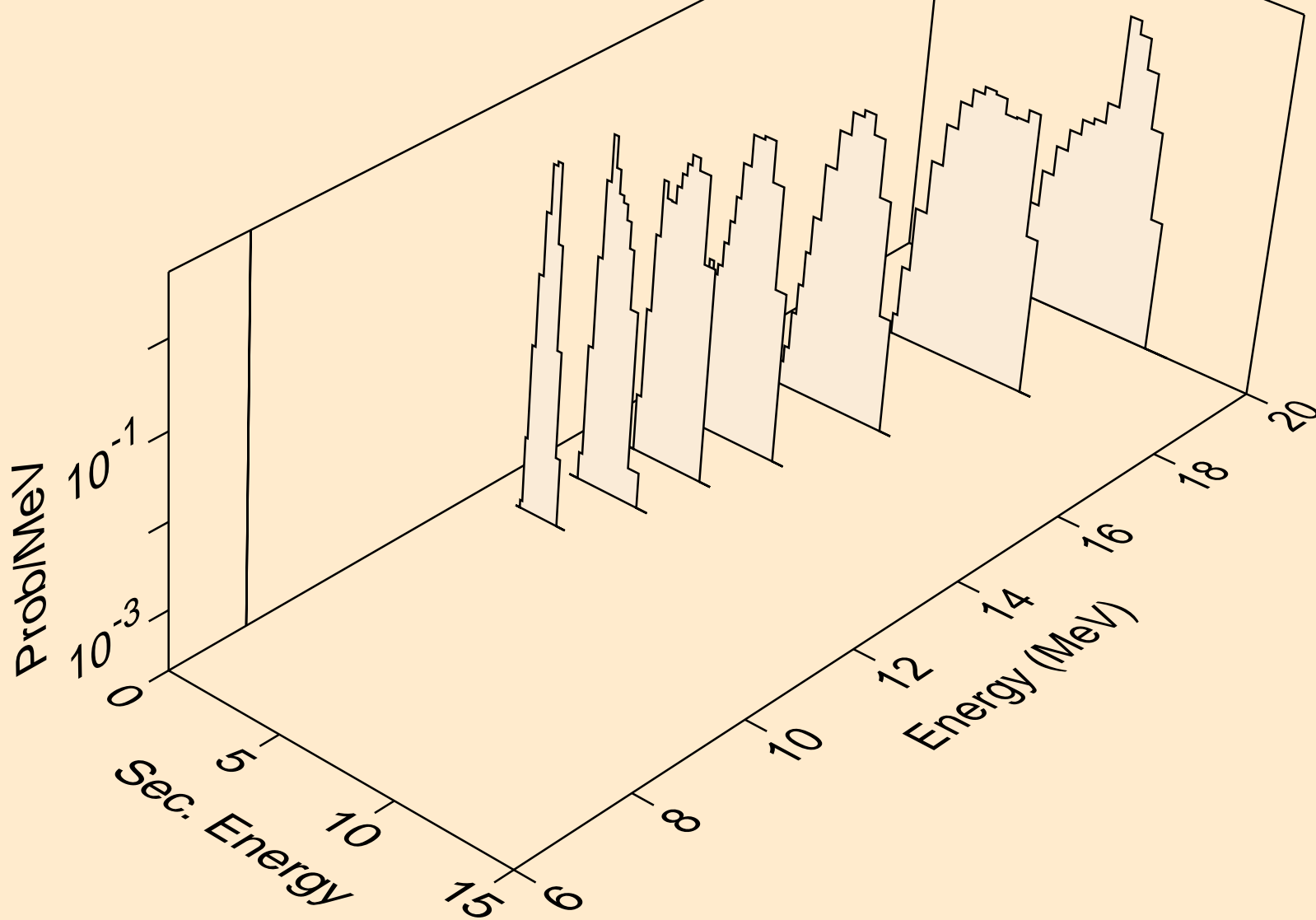

32-GE-73 FOR FENDL-3.2 FROM JEFF-3.1.1 BY NJOY2016.60+ O  
angular distribution for (n,a\*0) alpha

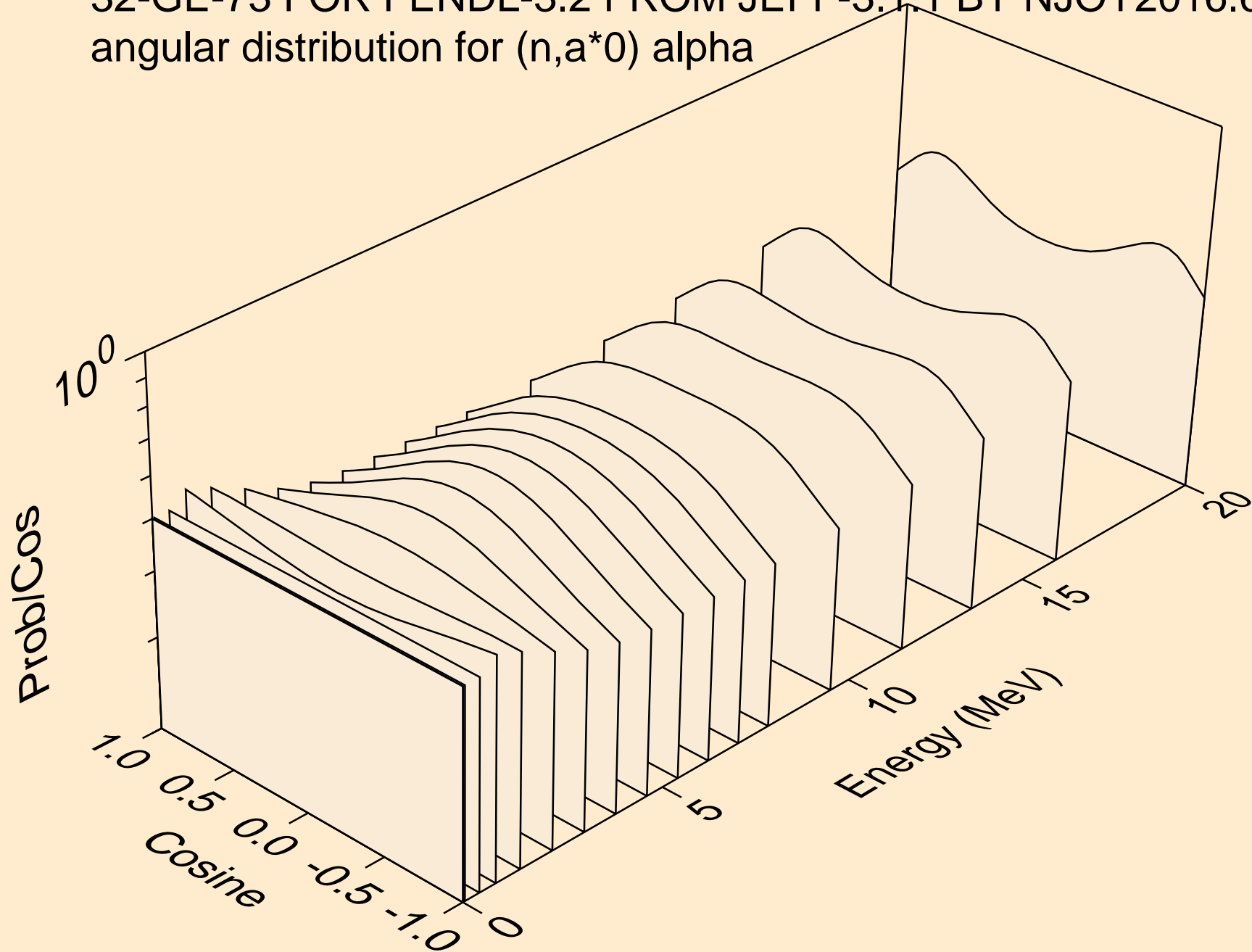

32-GE-73 FOR FENDL-3.2 FROM JEFF-3.1.1 BY NJOY2016.60+ O  
angular distribution for (n,a\*1) alpha

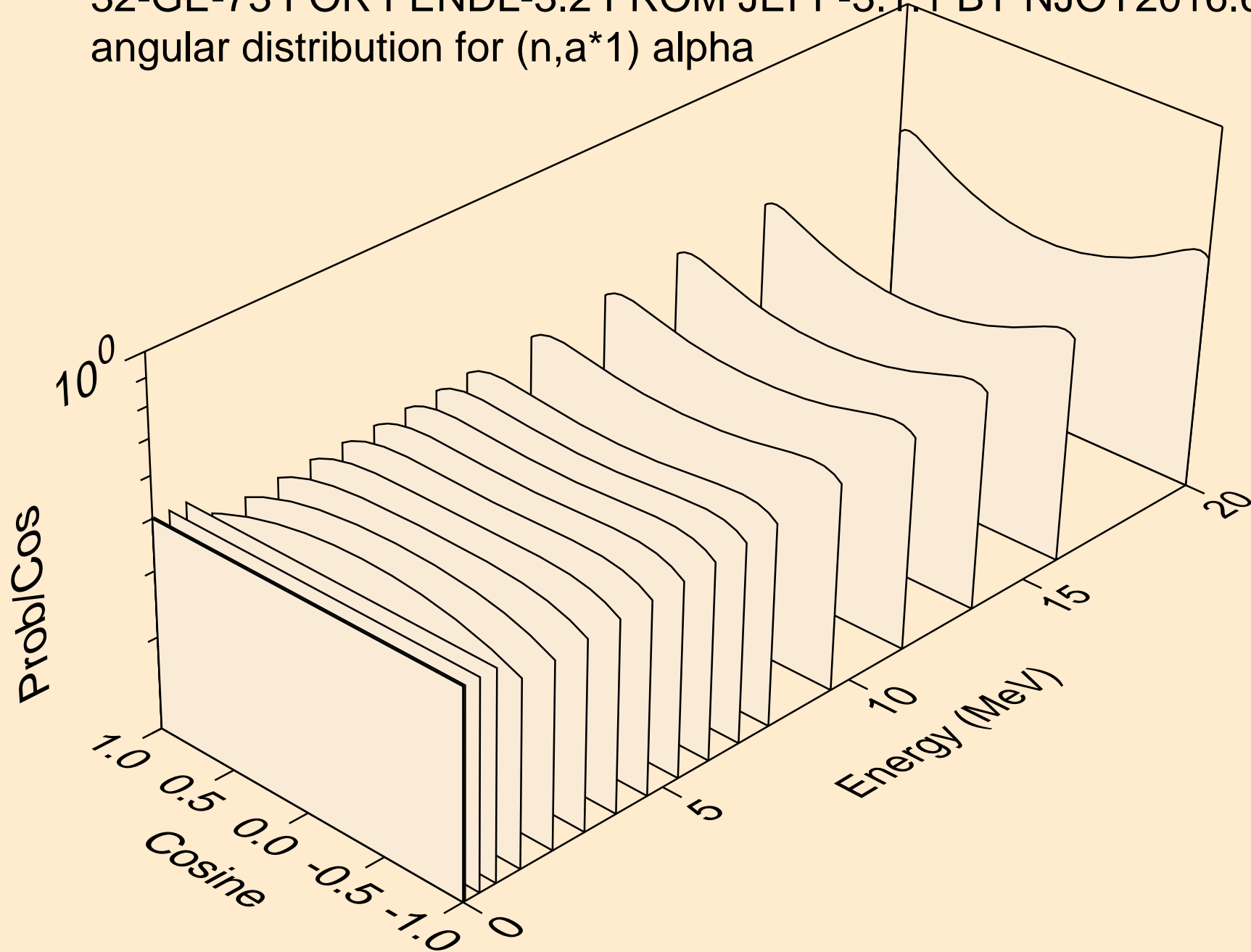

32-GE-73 FOR FENDL-3.2 FROM JEFF-3.1.1 BY NJOY2016.60+ O  
angular distribution for (n,a\*2) alpha

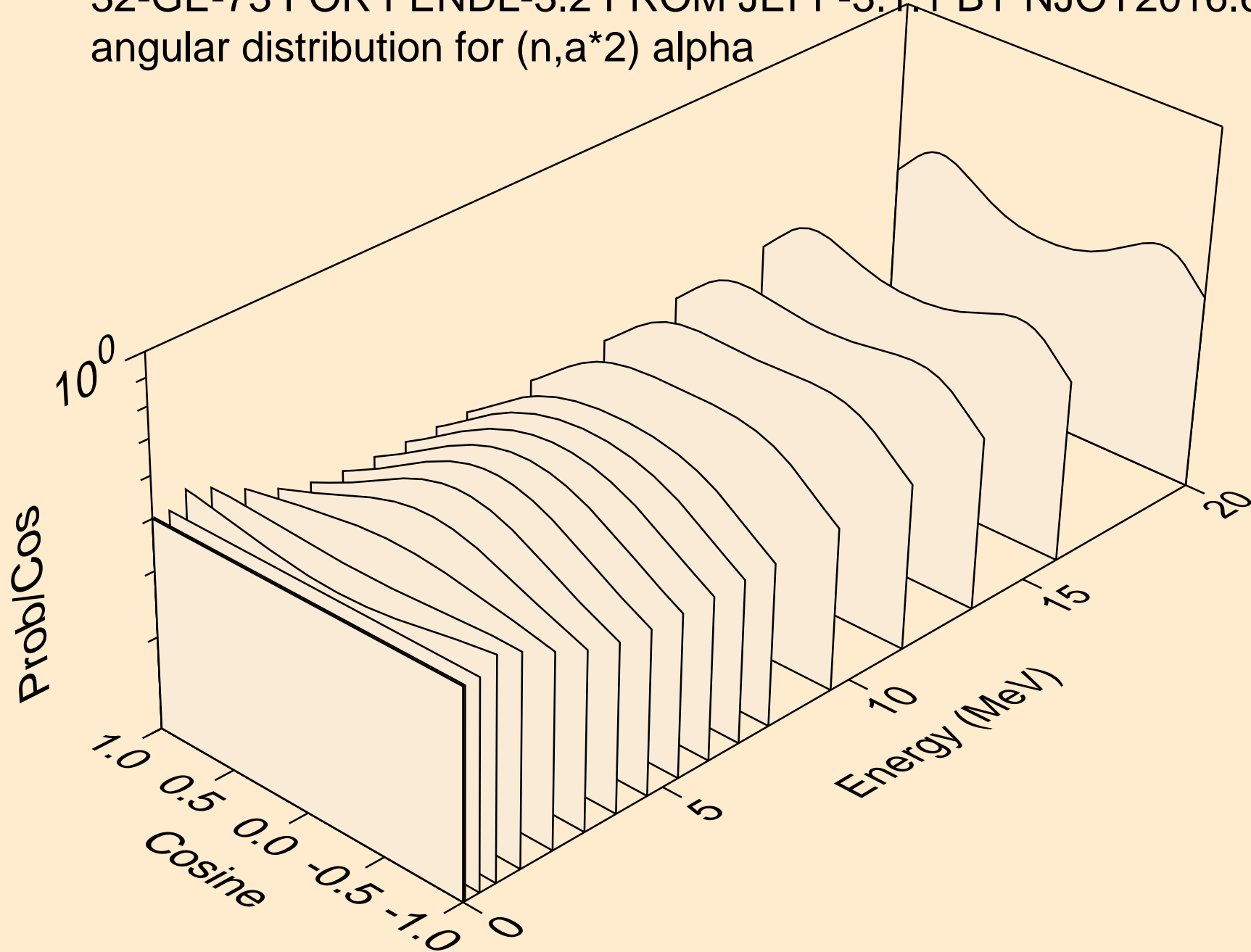

32-GE-73 FOR FENDL-3.2 FROM JEFF-3.1.1 BY NJOY2016.60+ O  
angular distribution for (n, $\alpha$ \*3) alpha

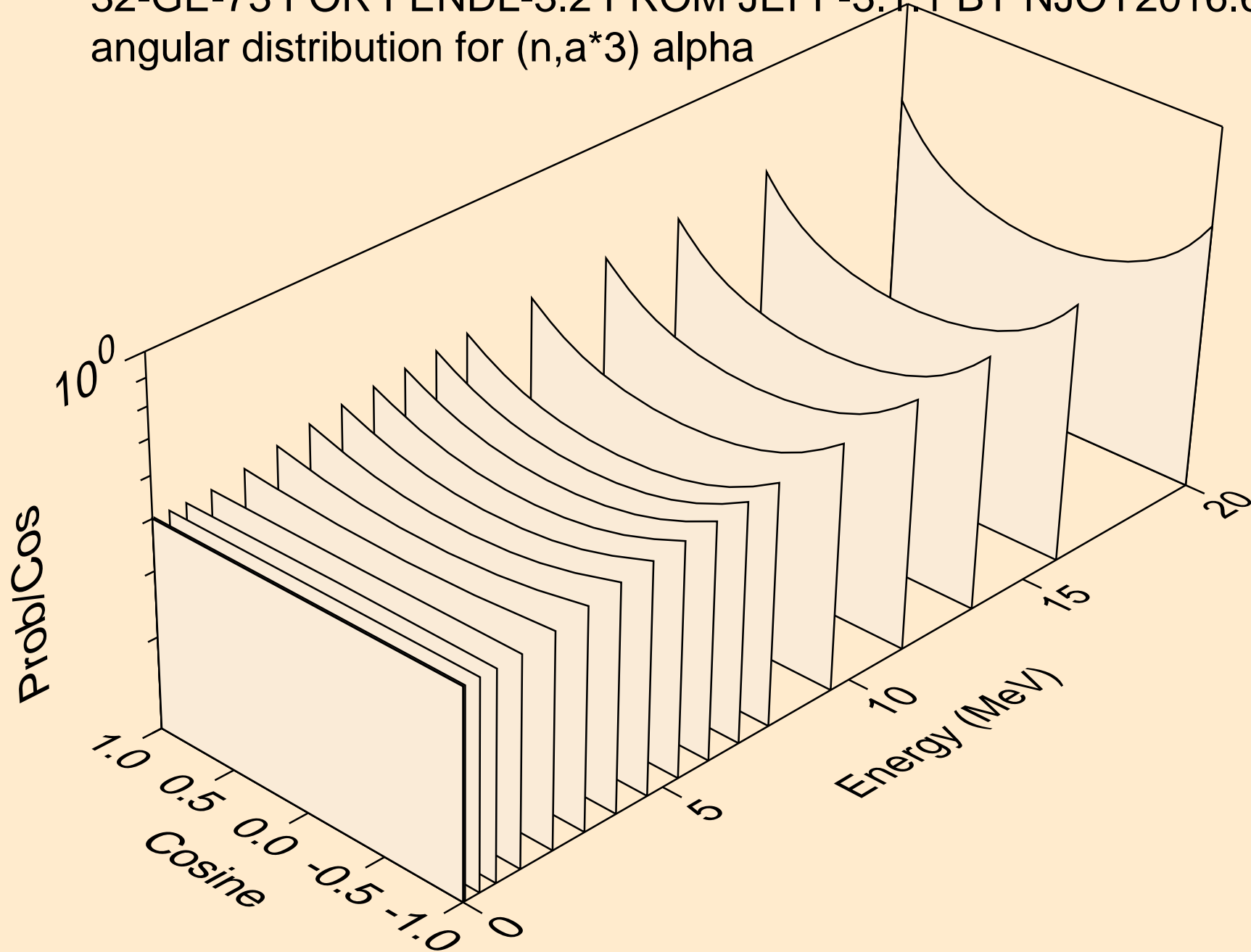

32-GE-73 FOR FENDL-3.2 FROM JEFF-3.1.1 BY NJOY2016.60+ O  
angular distribution for (n, $\alpha$ ) alpha

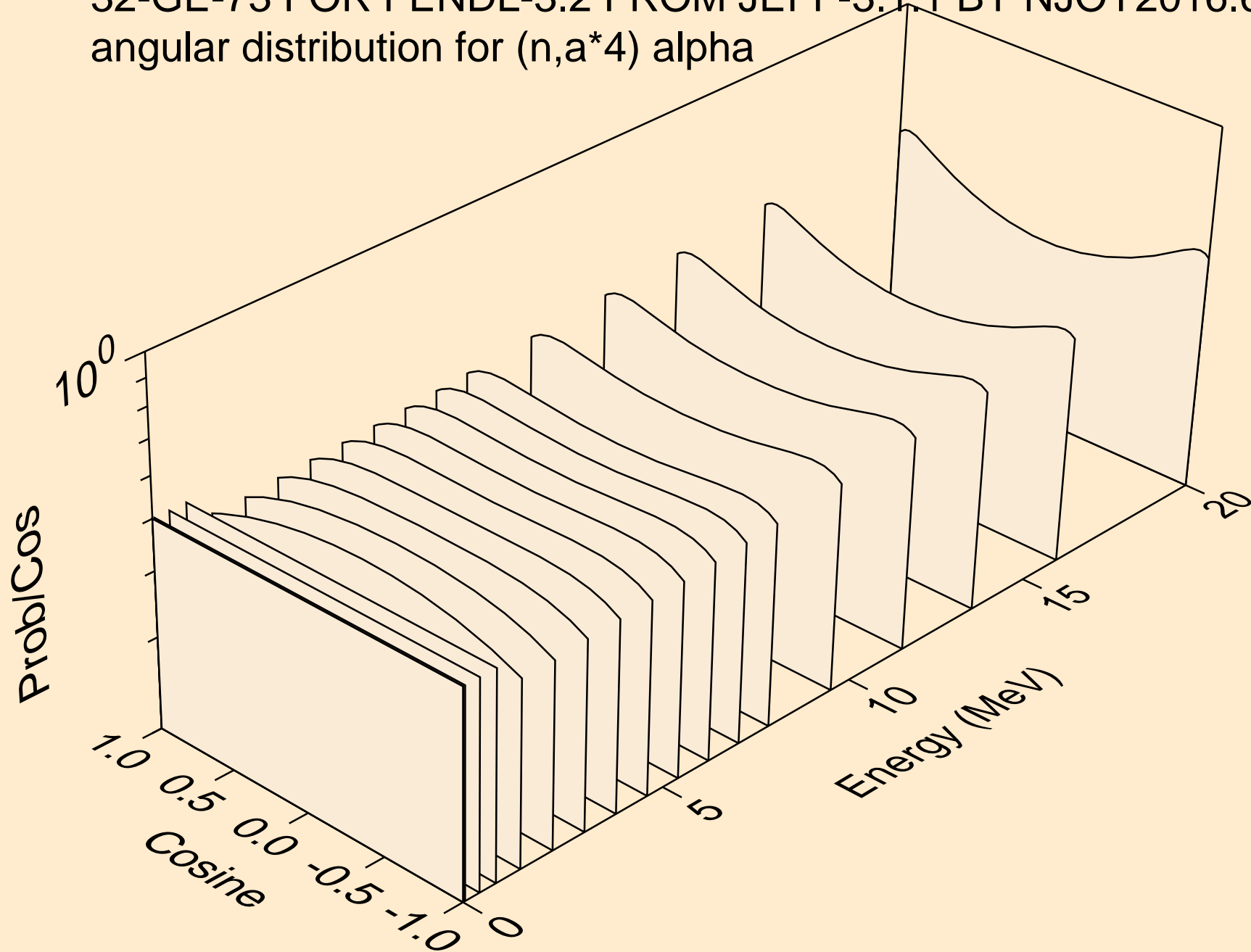

32-GE-73 FOR FENDL-3.2 FROM JEFF-3.1.1 BY NJOY2016.60+ O  
angular distribution for (n,a\*5) alpha

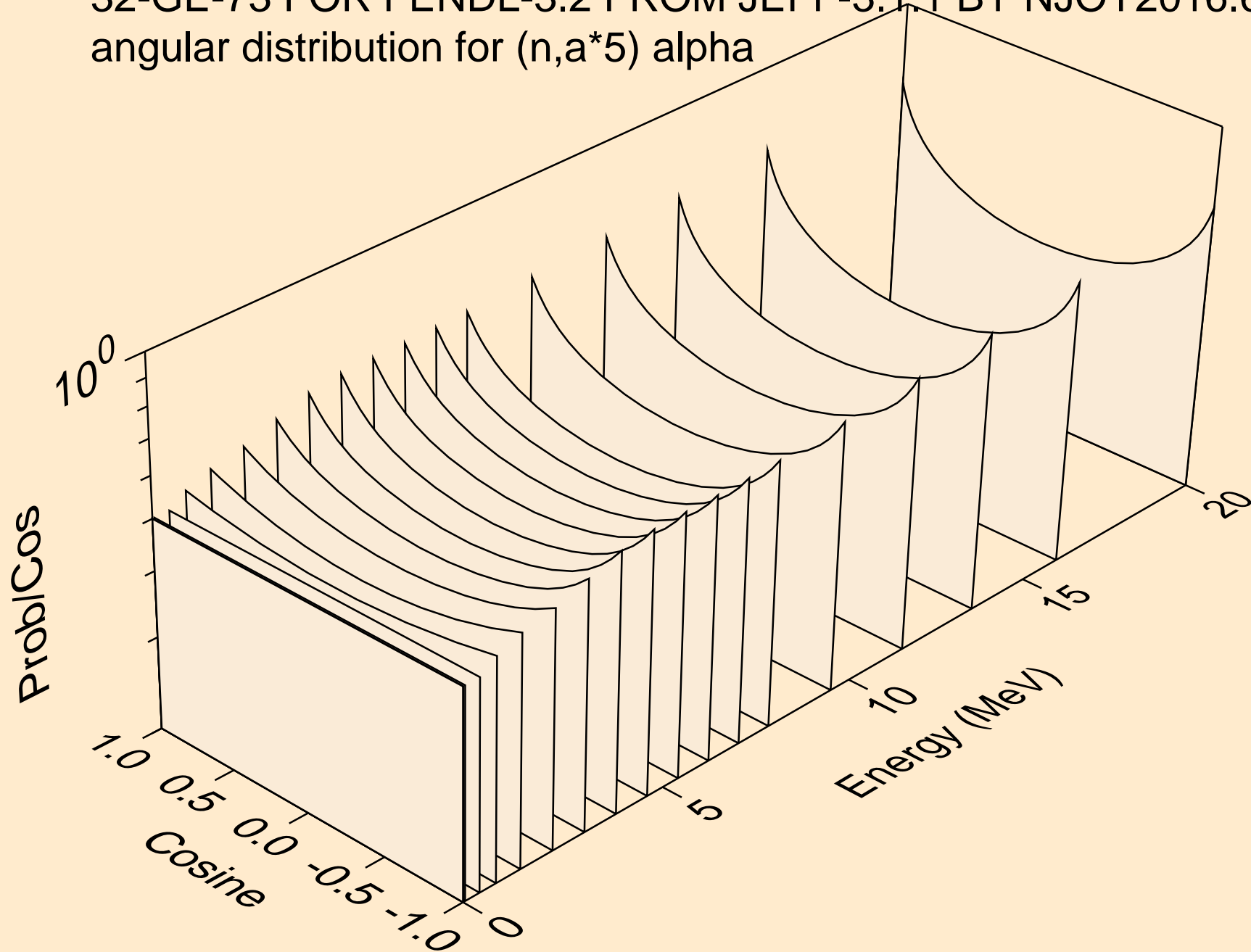

32-GE-73 FOR FENDL-3.2 FROM JEFF-3.1.1 BY NJOY2016.60+ O  
angular distribution for (n,a\*6) alpha

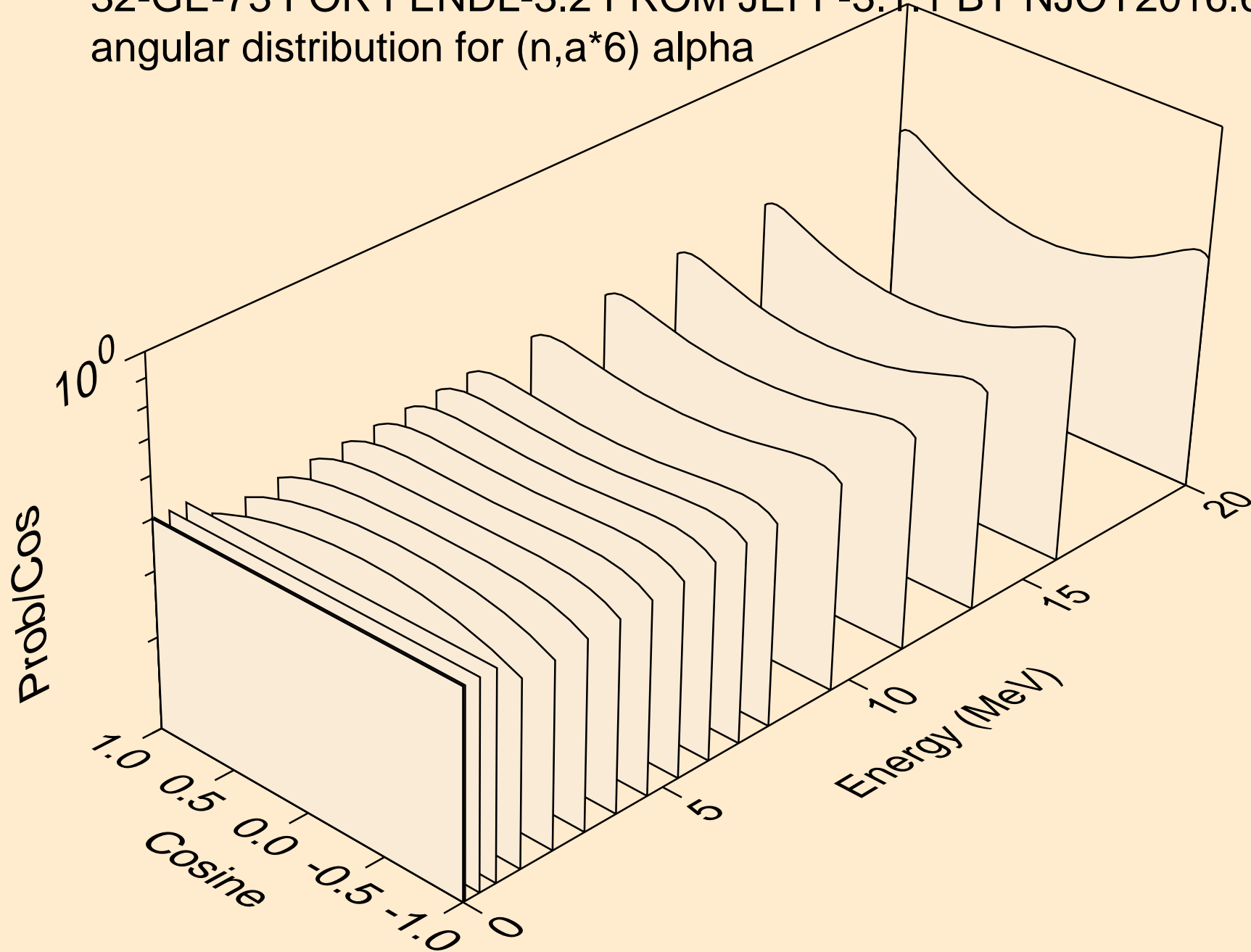



32-GE-73 FOR FENDL-3.2 FROM JEFF-3.1.1 BY NJOY2016.60+ O  
angular distribution for (n,a\*7) alpha

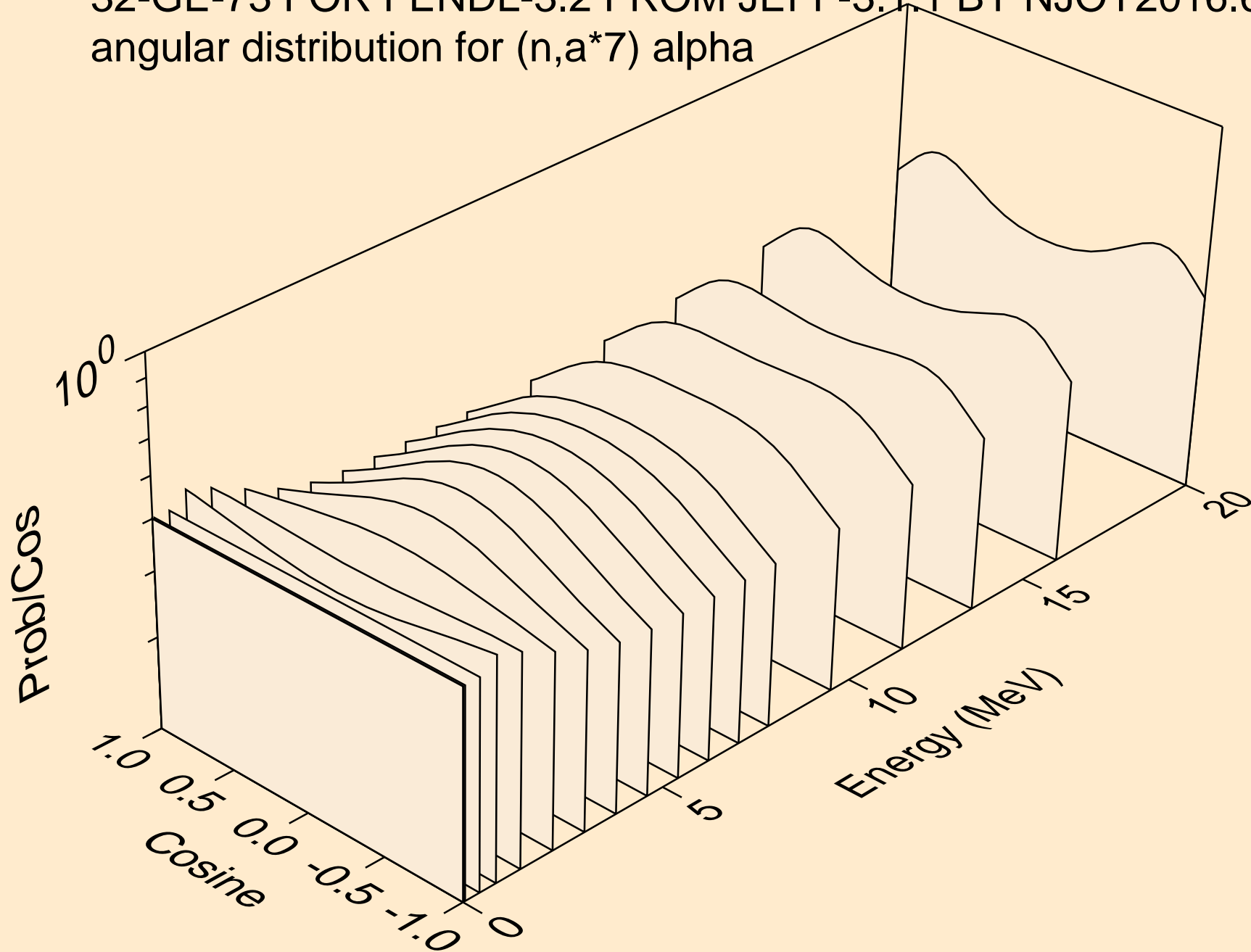

32-GE-73 FOR FENDL-3.2 FROM JEFF-3.1.1 BY NJOY2016.60+ O  
angular distribution for (n,a\*8) alpha

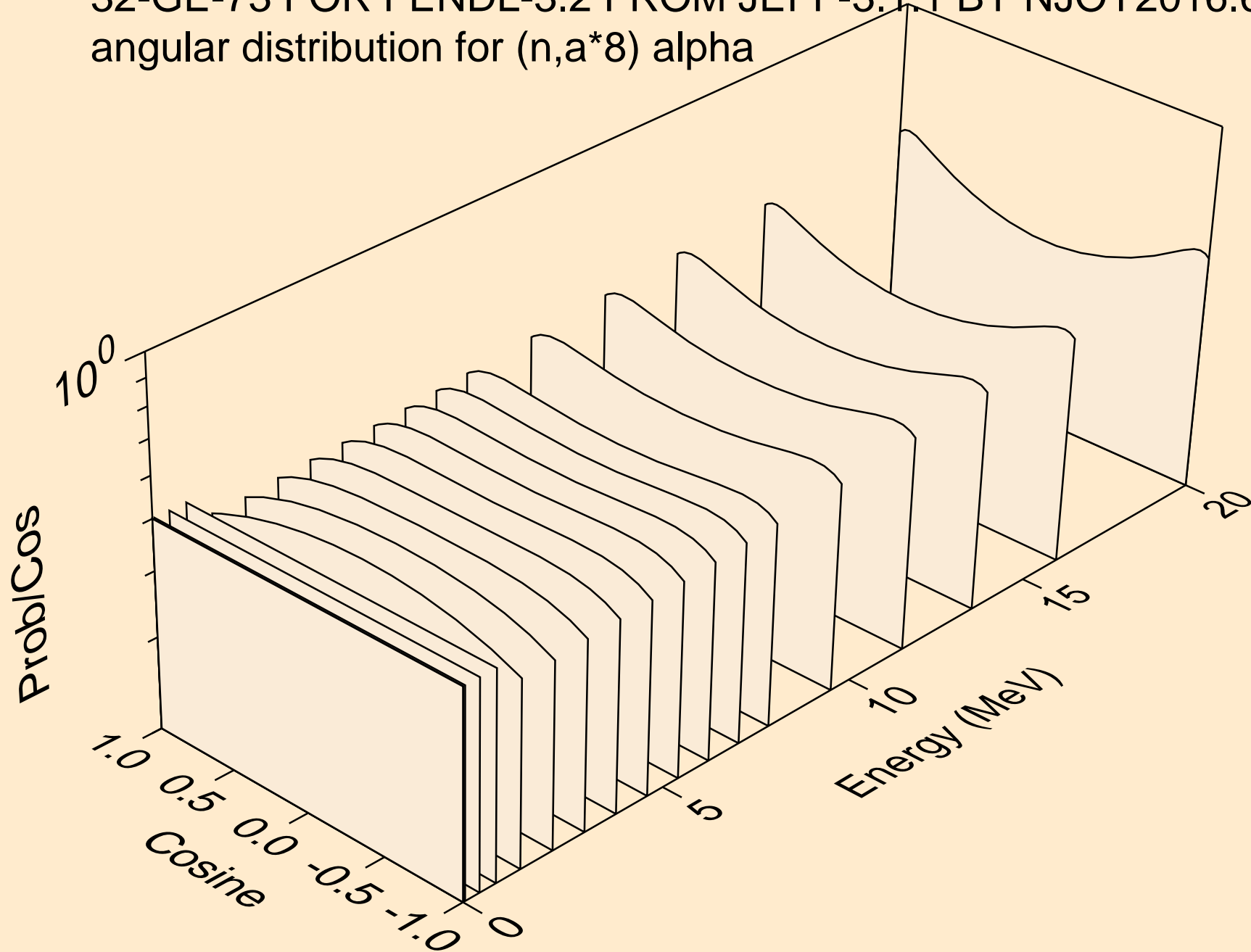

32-GE-73 FOR FENDL-3.2 FROM JEFF-3.1.1 BY NJOY2016.60+ O  
angular distribution for (n,a\*9) alpha

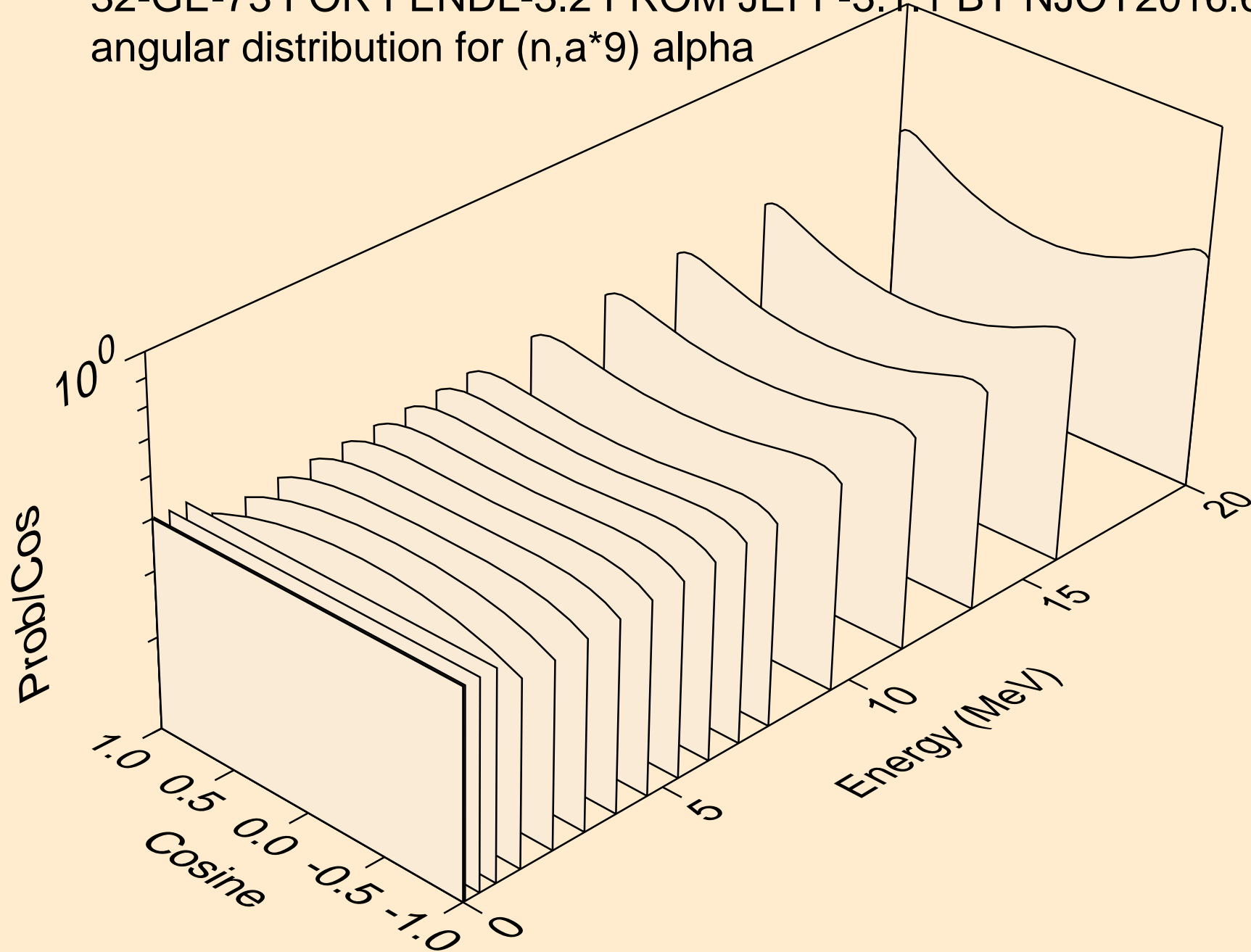

32-GE-73 FOR FENDL-3.2 FROM JEFF-3.1.1 BY NJOY2016.60+ O  
angular distribution for (n,a\*10) alpha

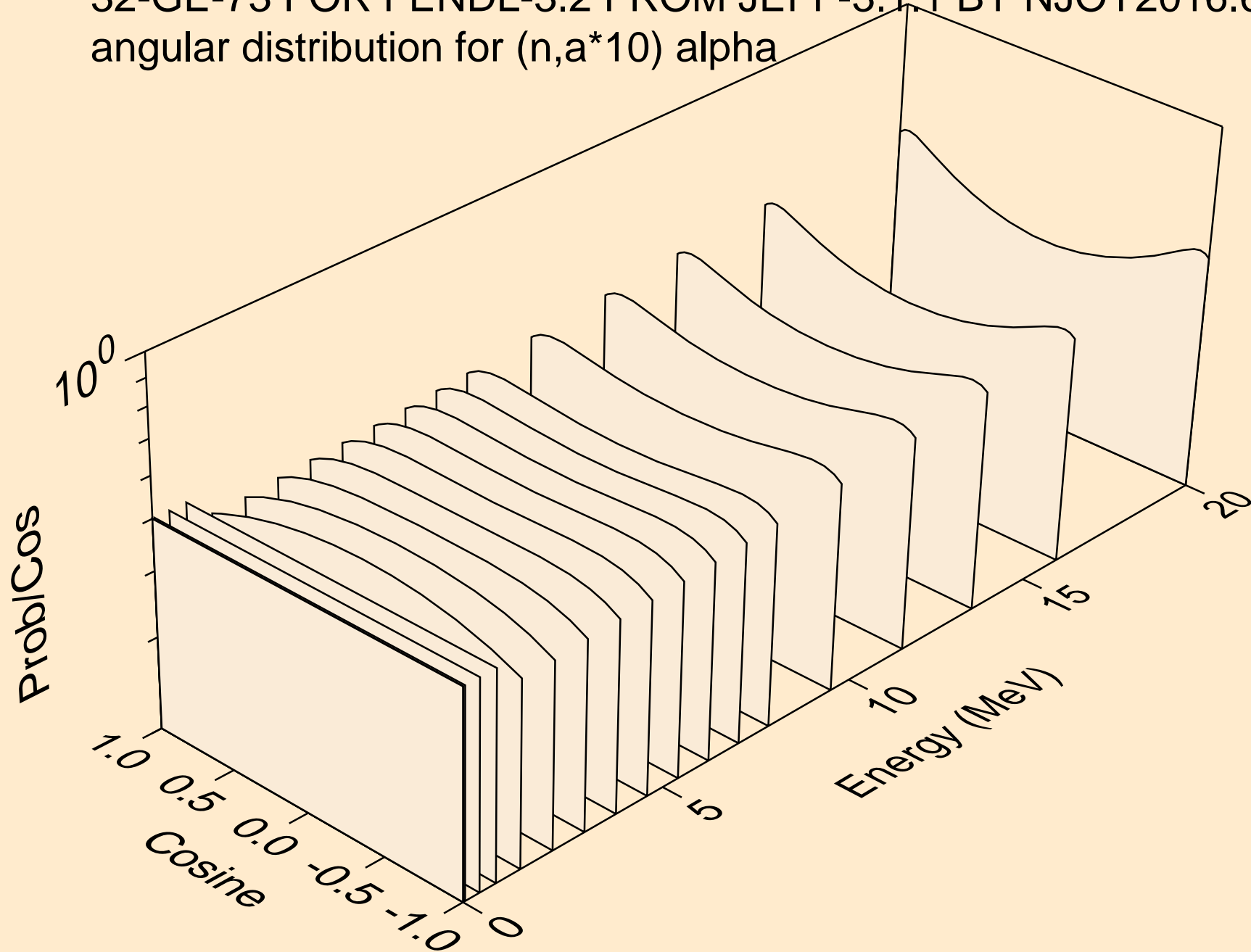

32-GE-73 FOR FENDL-3.2 FROM JEFF-3.1.1 BY NJOY2016.60+ O  
alphas from (n,a\*c)

