

32-GE-74 FOR FENDL-3.2 FROM JEFF-3.1.1 BY NJOY2016.60+ O
Principal cross sections

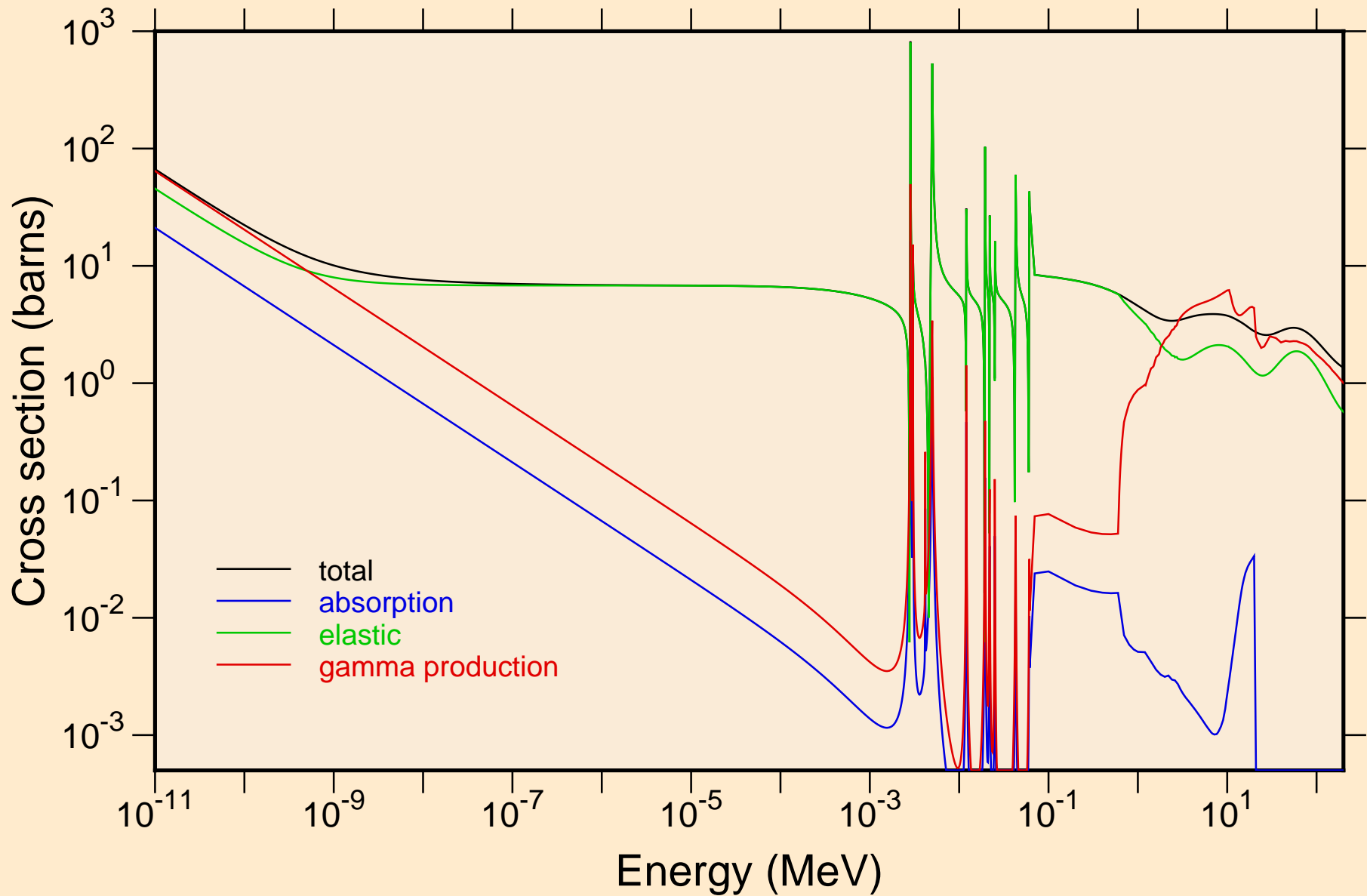

32-GE-74 FOR FENDL-3.2 FROM JEFF-3.1.1 BY NJOY2016.60+ O
resonance total cross section

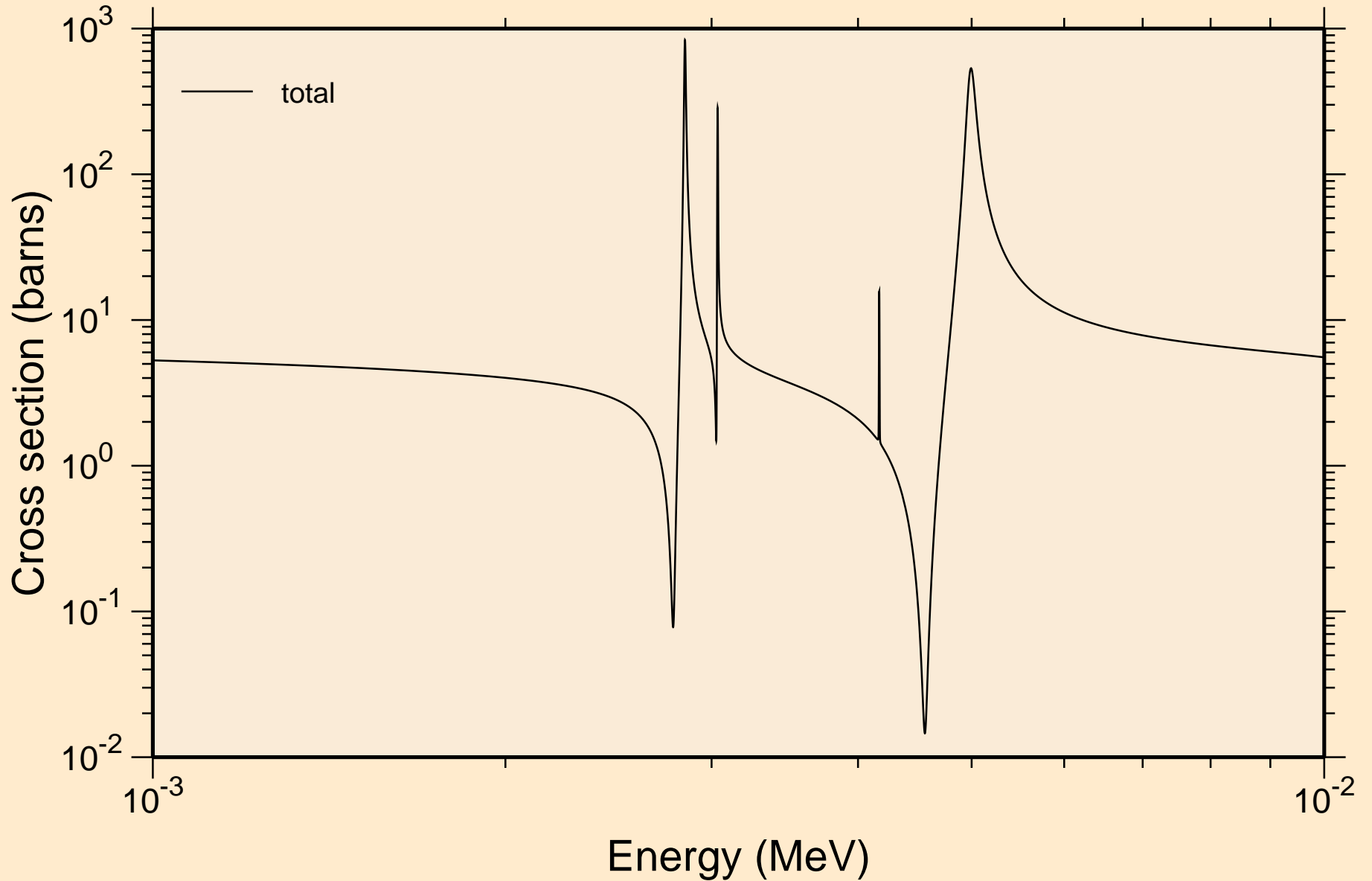

32-GE-74 FOR FENDL-3.2 FROM JEFF-3.1.1 BY NJOY2016.60+ O
resonance total cross section

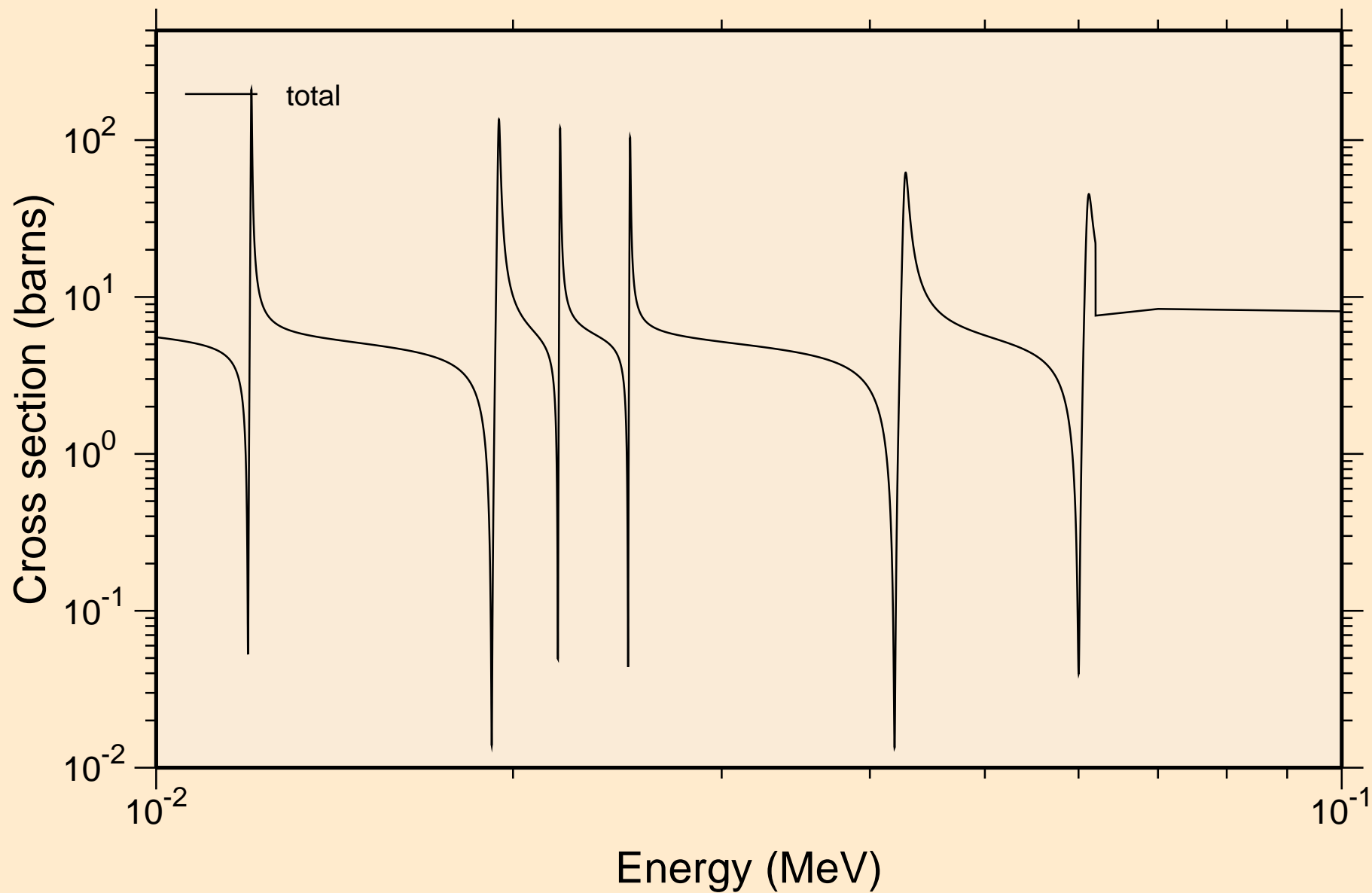

32-GE-74 FOR FENDL-3.2 FROM JEFF-3.1.1 BY NJOY2016.60+ O
resonance total cross section

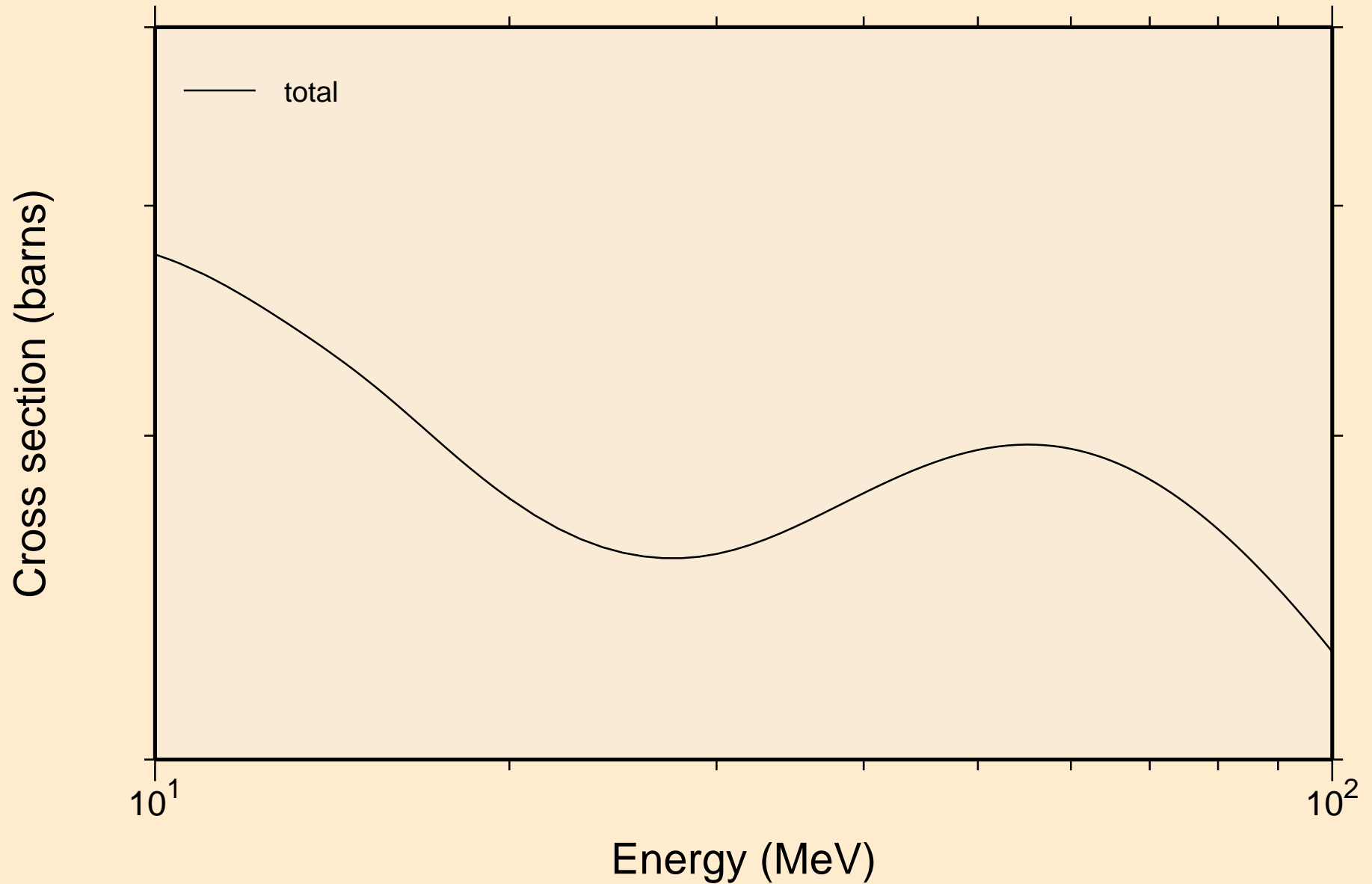

32-GE-74 FOR FENDL-3.2 FROM JEFF-3.1.1 BY NJOY2016.60+ O
resonance absorption cross sections

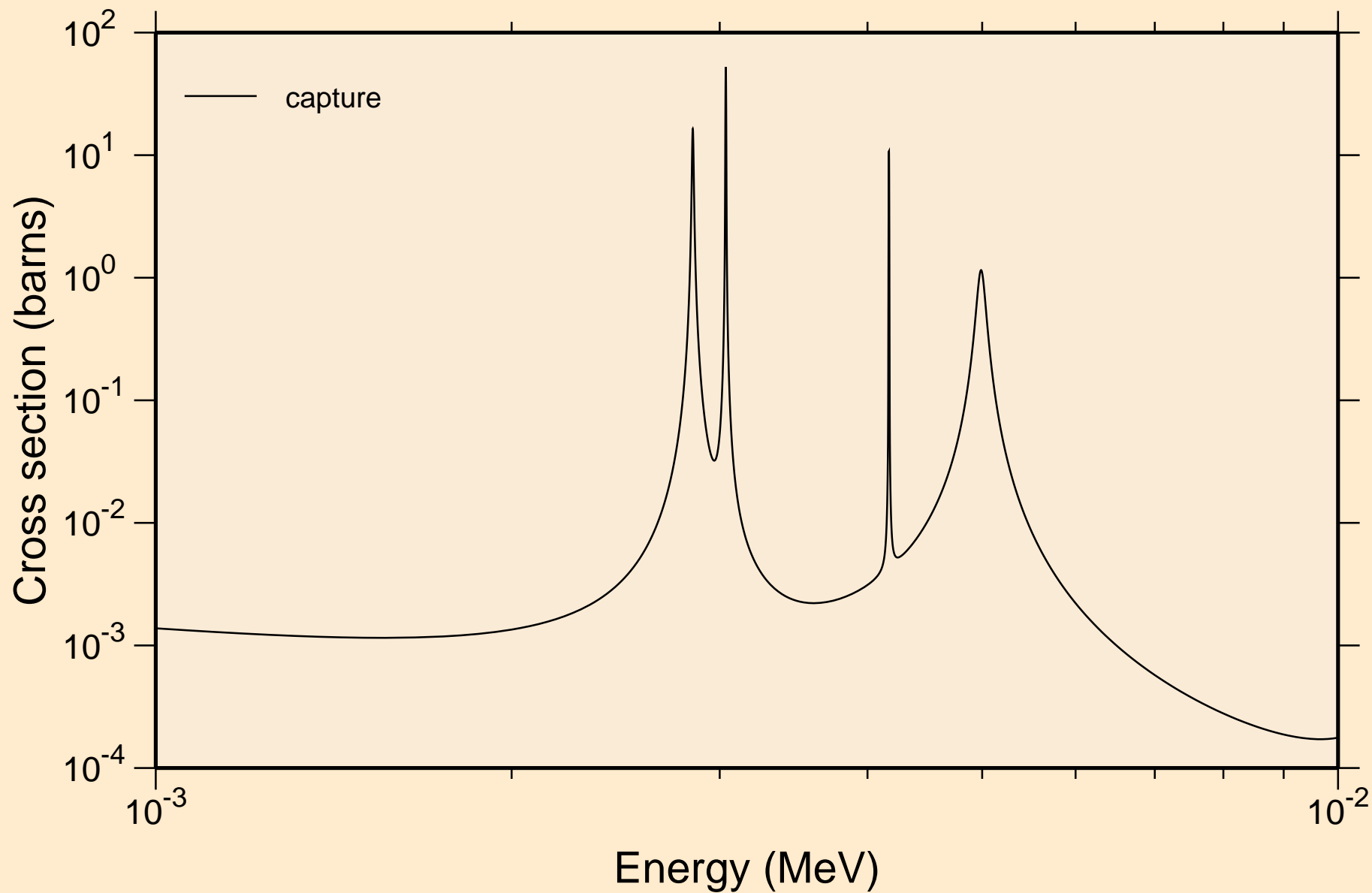

32-GE-74 FOR FENDL-3.2 FROM JEFF-3.1.1 BY NJOY2016.60+ O
resonance absorption cross sections

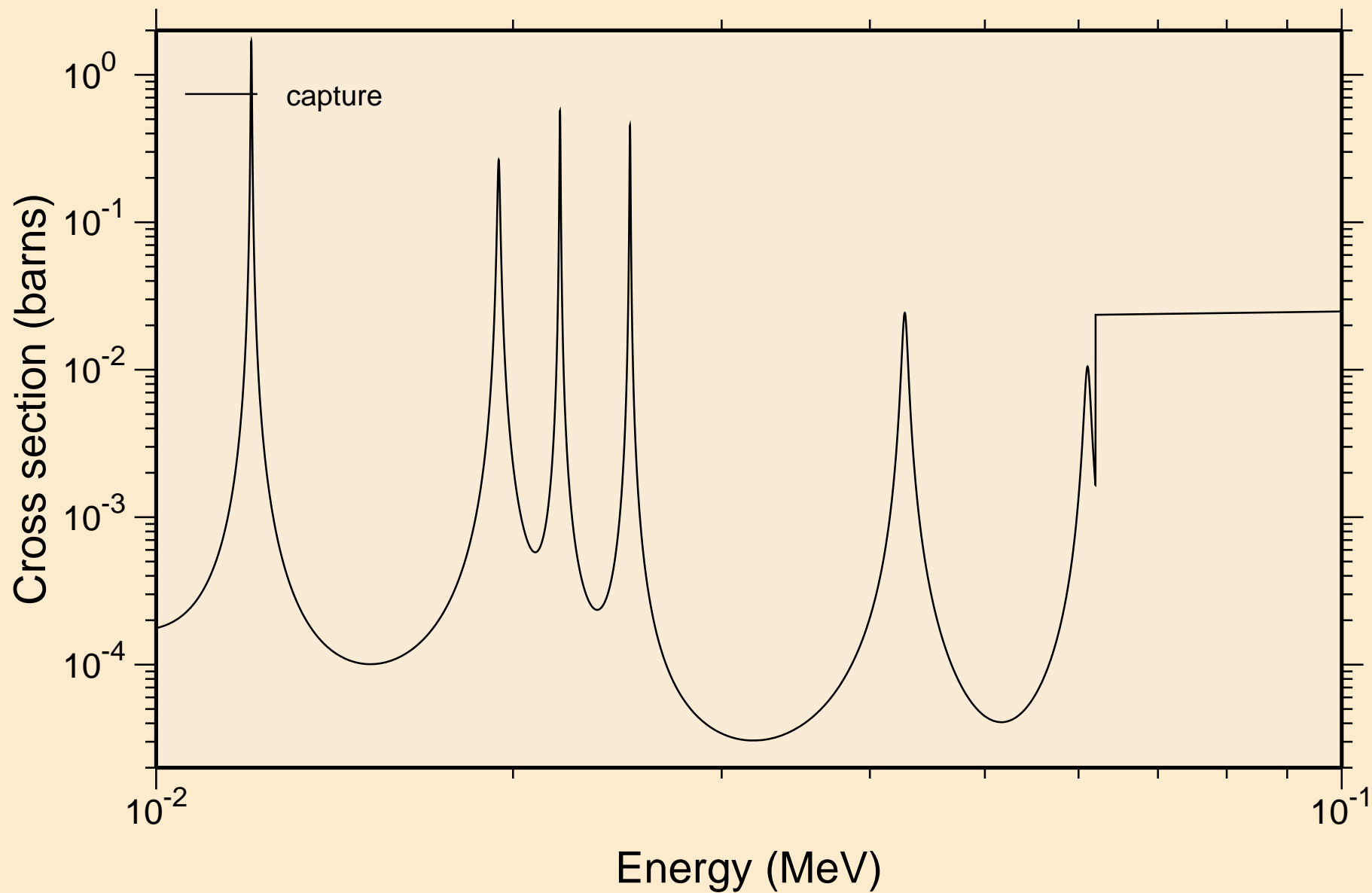

32-GE-74 FOR FENDL-3.2 FROM JEFF-3.1.1 BY NJOY2016.60+ O
resonance absorption cross sections

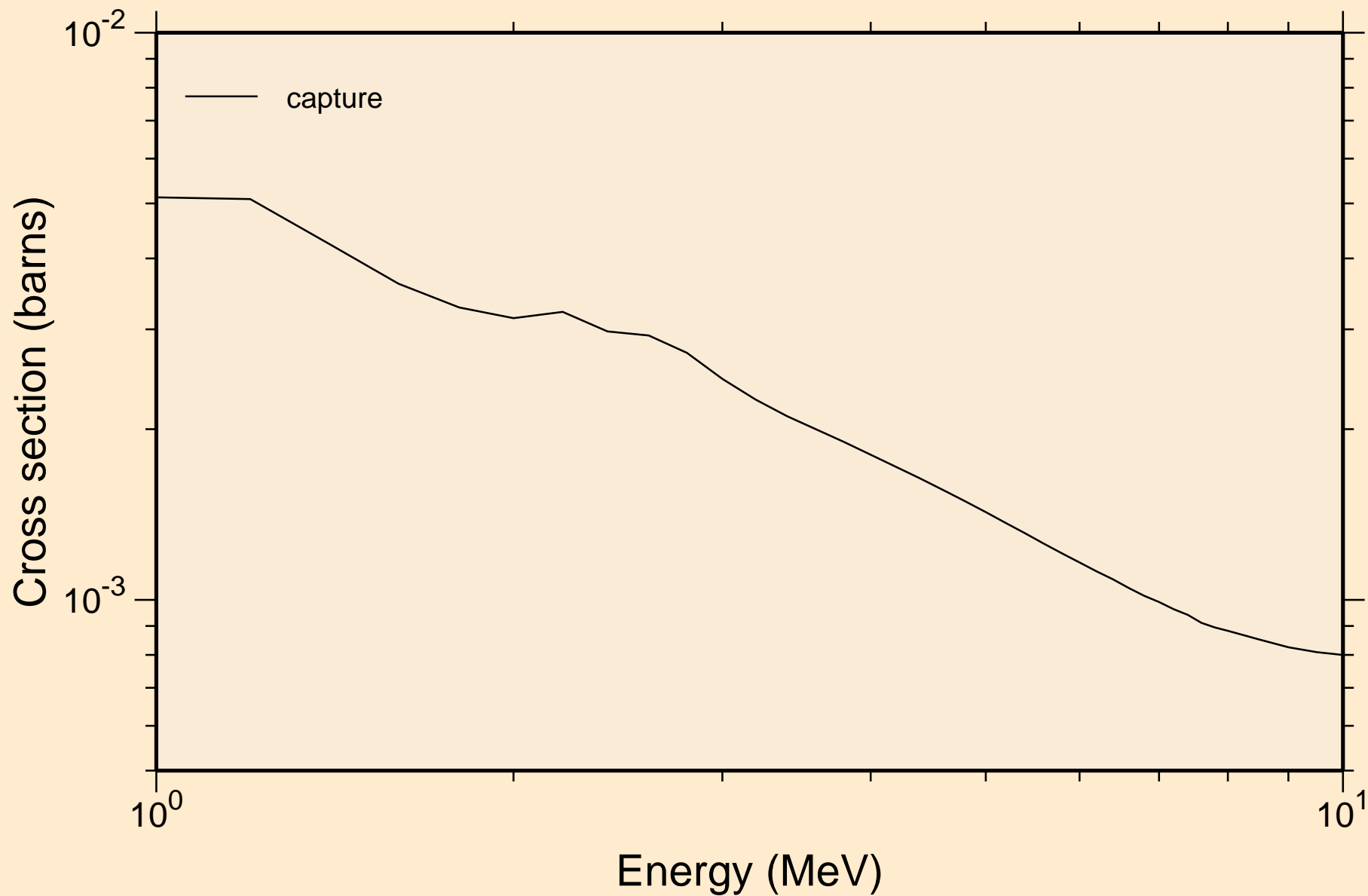

32-GE-74 FOR FENDL-3.2 FROM JEFF-3.1.1 BY NJOY2016.60+ O Heating

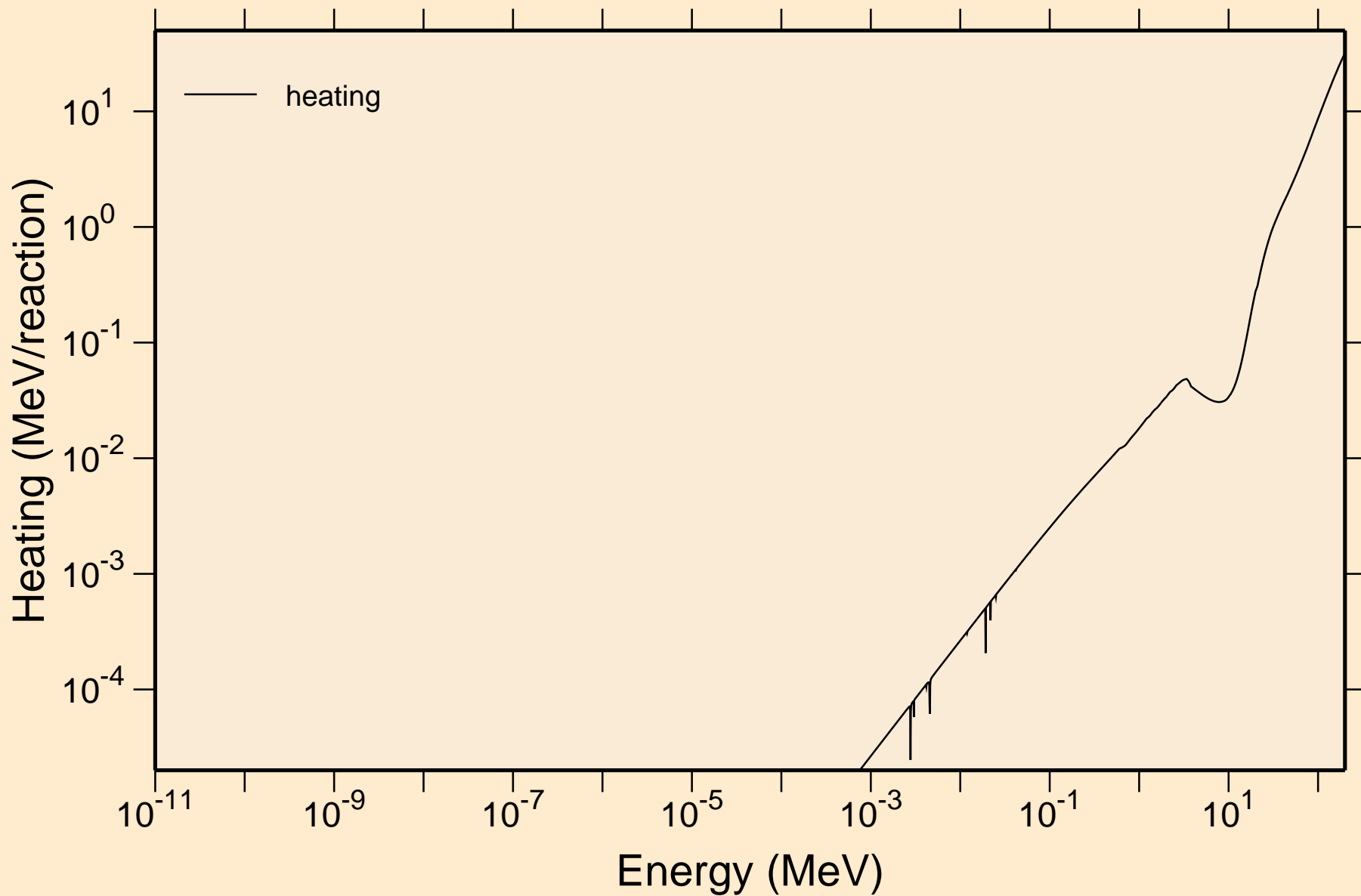

32-GE-74 FOR FENDL-3.2 FROM JEFF-3.1.1 BY NJOY2016.60+ O Damage

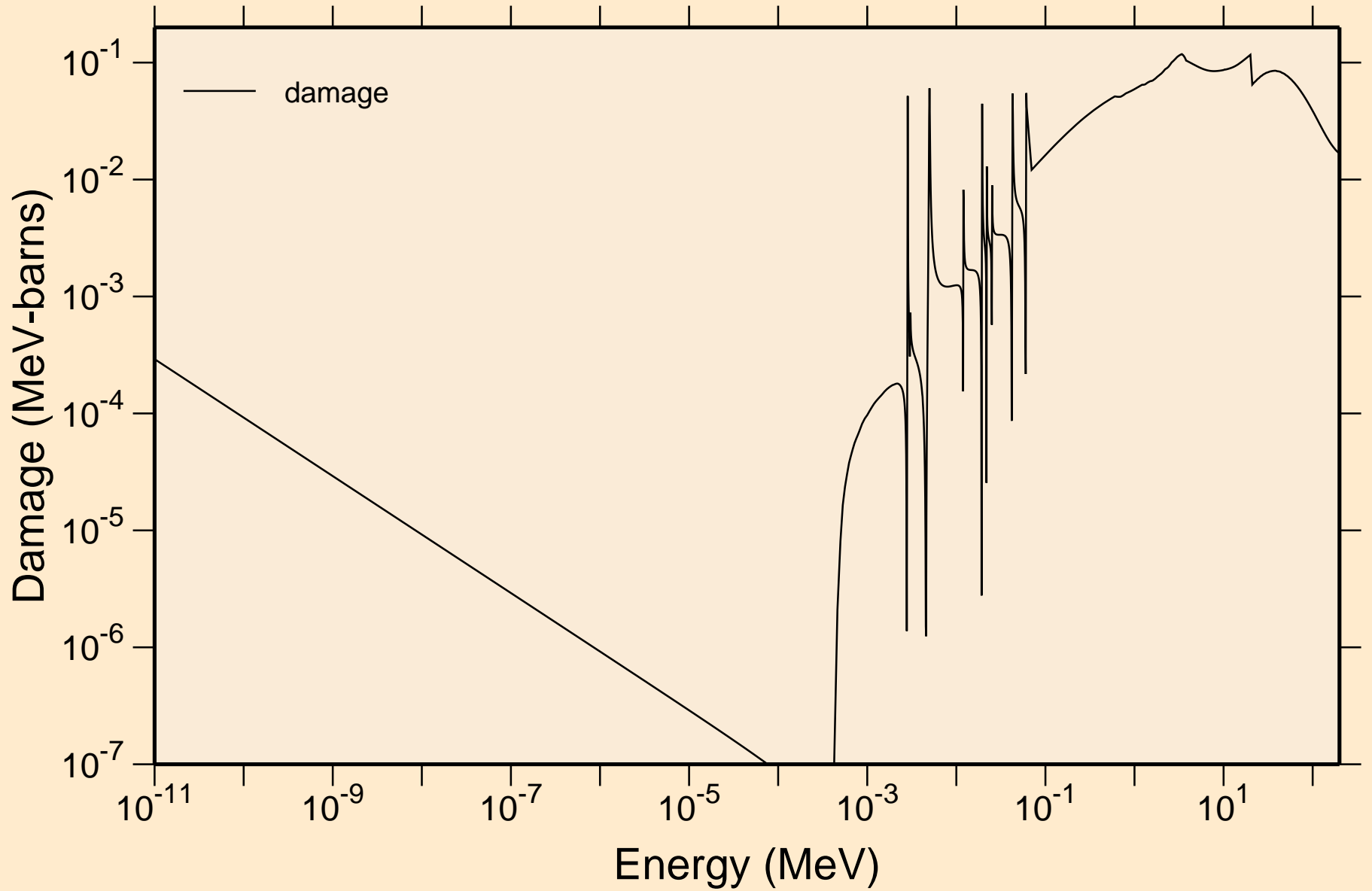

32-GE-74 FOR FENDL-3.2 FROM JEFF-3.1.1 BY NJOY2016.60+ O
Non-threshold reactions

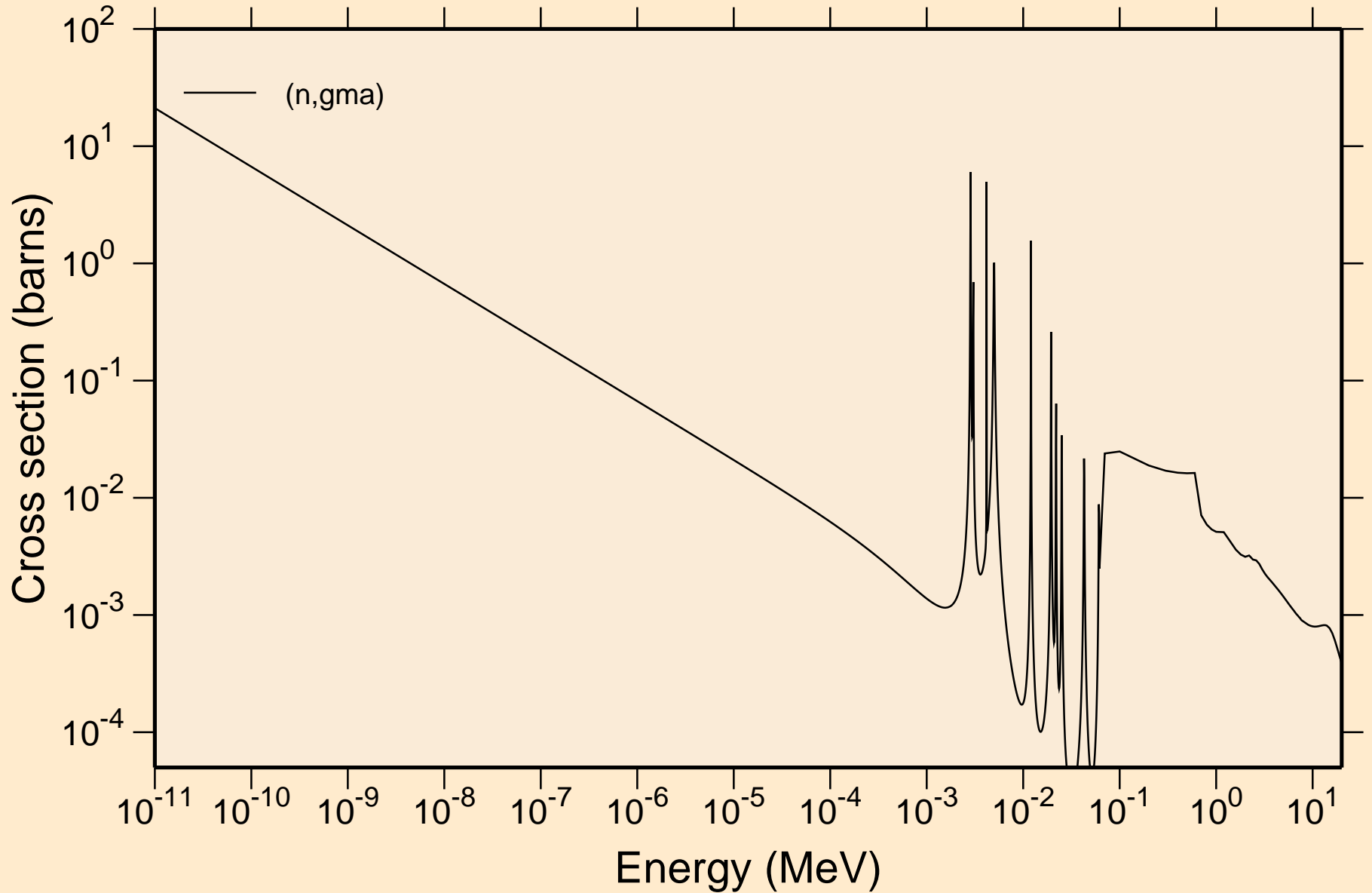

32-GE-74 FOR FENDL-3.2 FROM JEFF-3.1.1 BY NJOY2016.60+ O
Principal cross sections

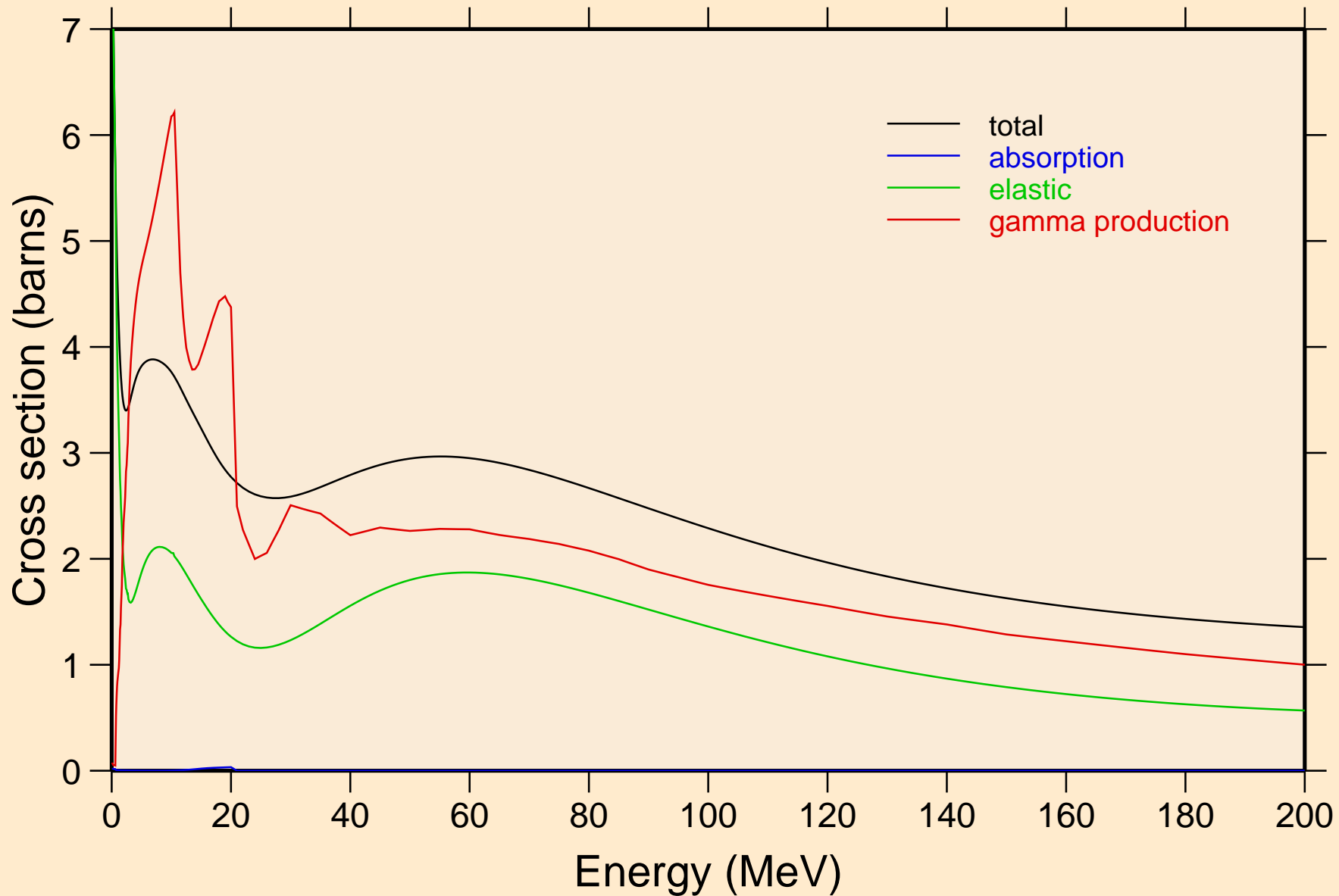

32-GE-74 FOR FENDL-3.2 FROM JEFF-3.1.1 BY NJOY2016.60+ O Heating

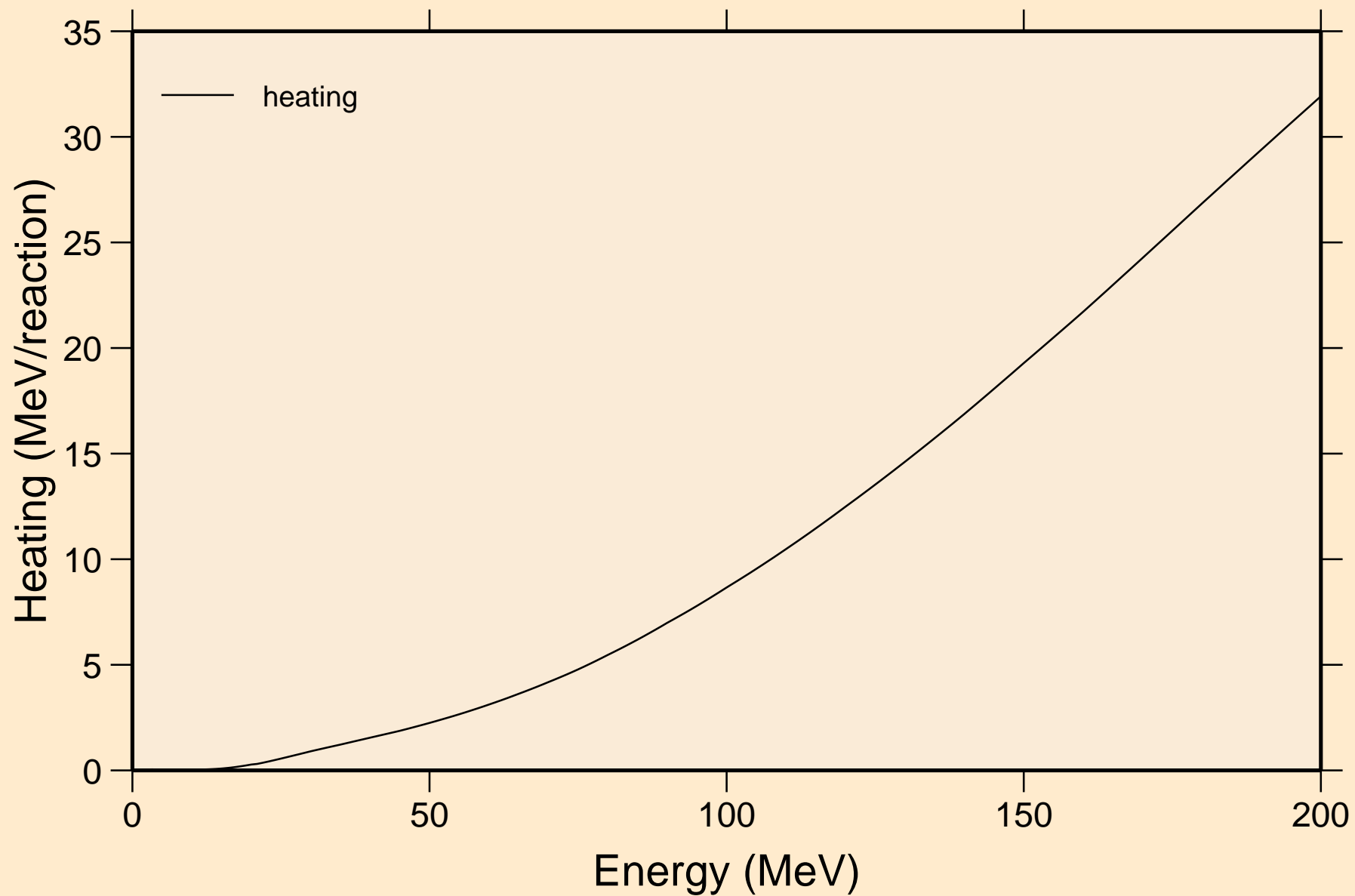

32-GE-74 FOR FENDL-3.2 FROM JEFF-3.1.1 BY NJOY2016.60+ O
Damage

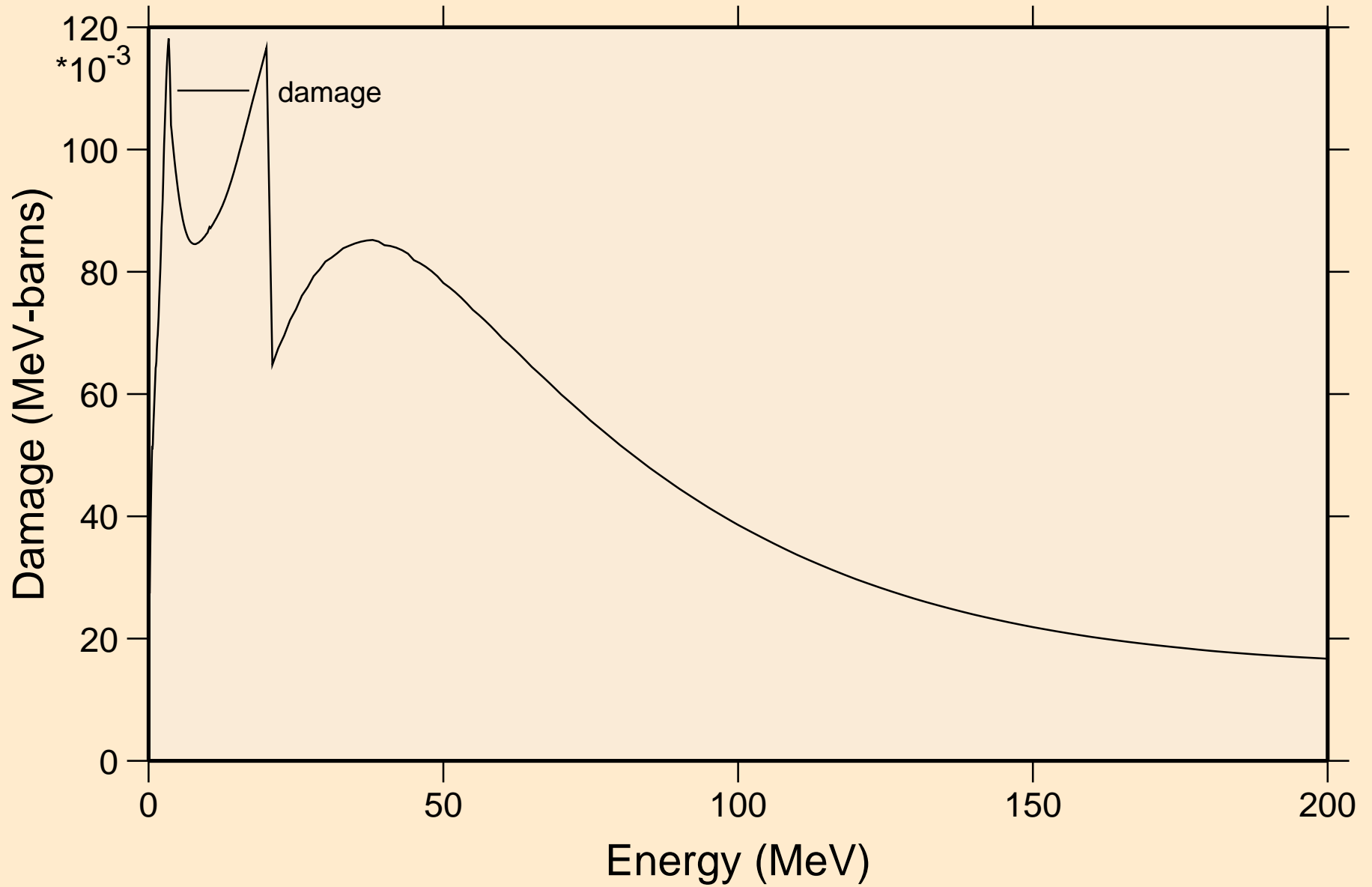

32-GE-74 FOR FENDL-3.2 FROM JEFF-3.1.1 BY NJOY2016.60+ O
Non-threshold reactions

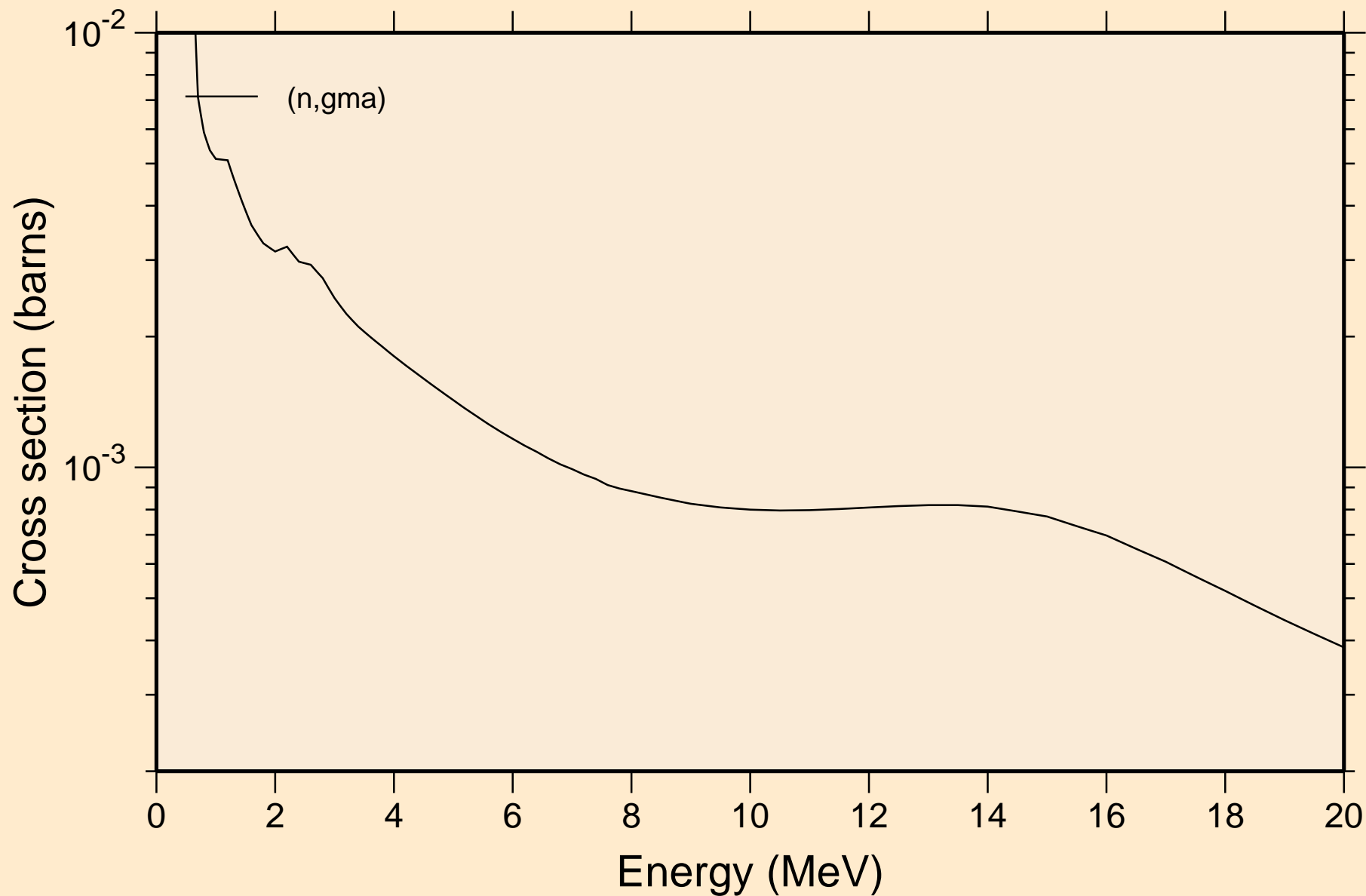

32-GE-74 FOR FENDL-3.2 FROM JEFF-3.1.1 BY NJOY2016.60+ O
Inelastic levels

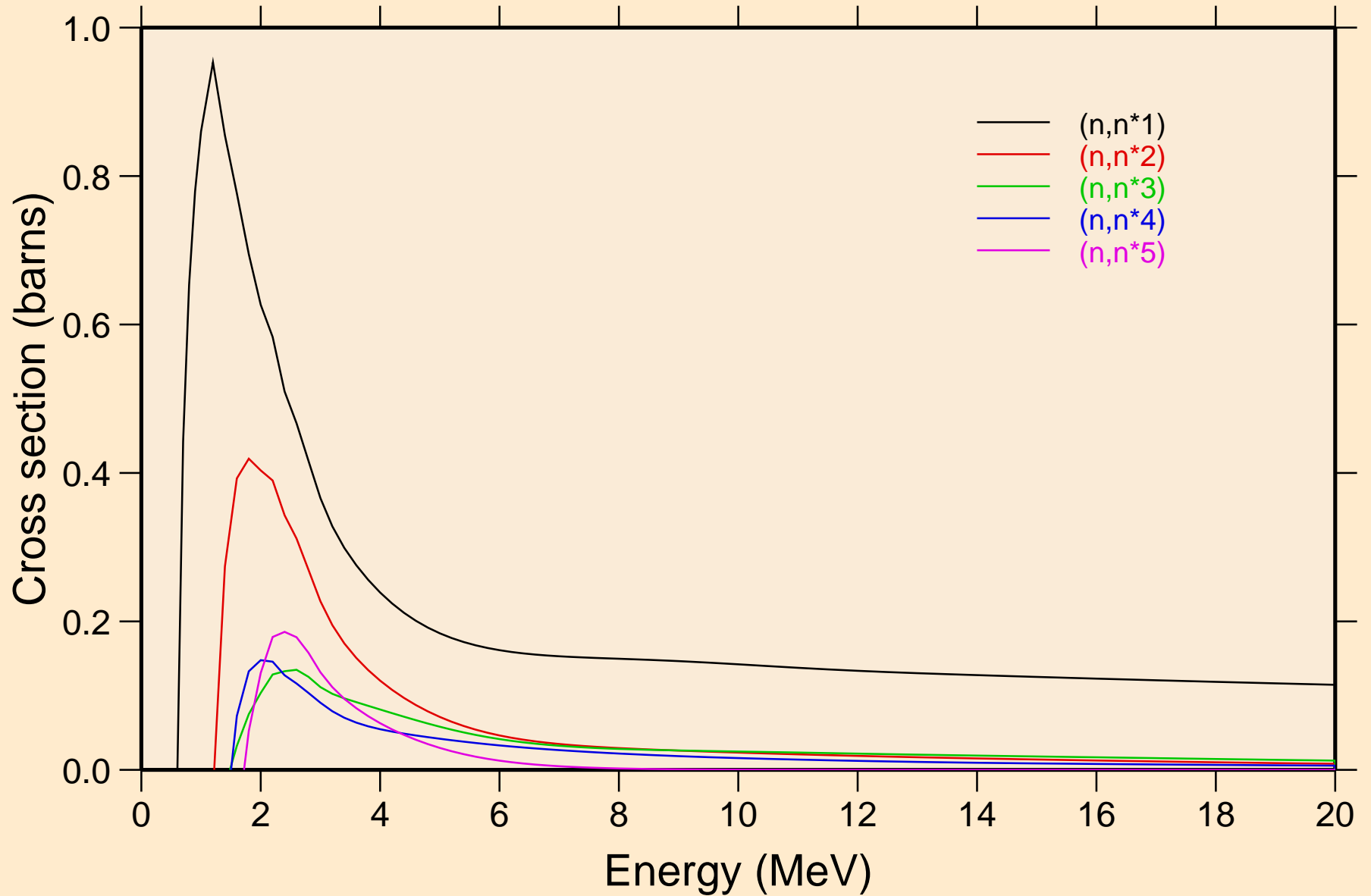

32-GE-74 FOR FENDL-3.2 FROM JEFF-3.1.1 BY NJOY2016.60+ O
Inelastic levels

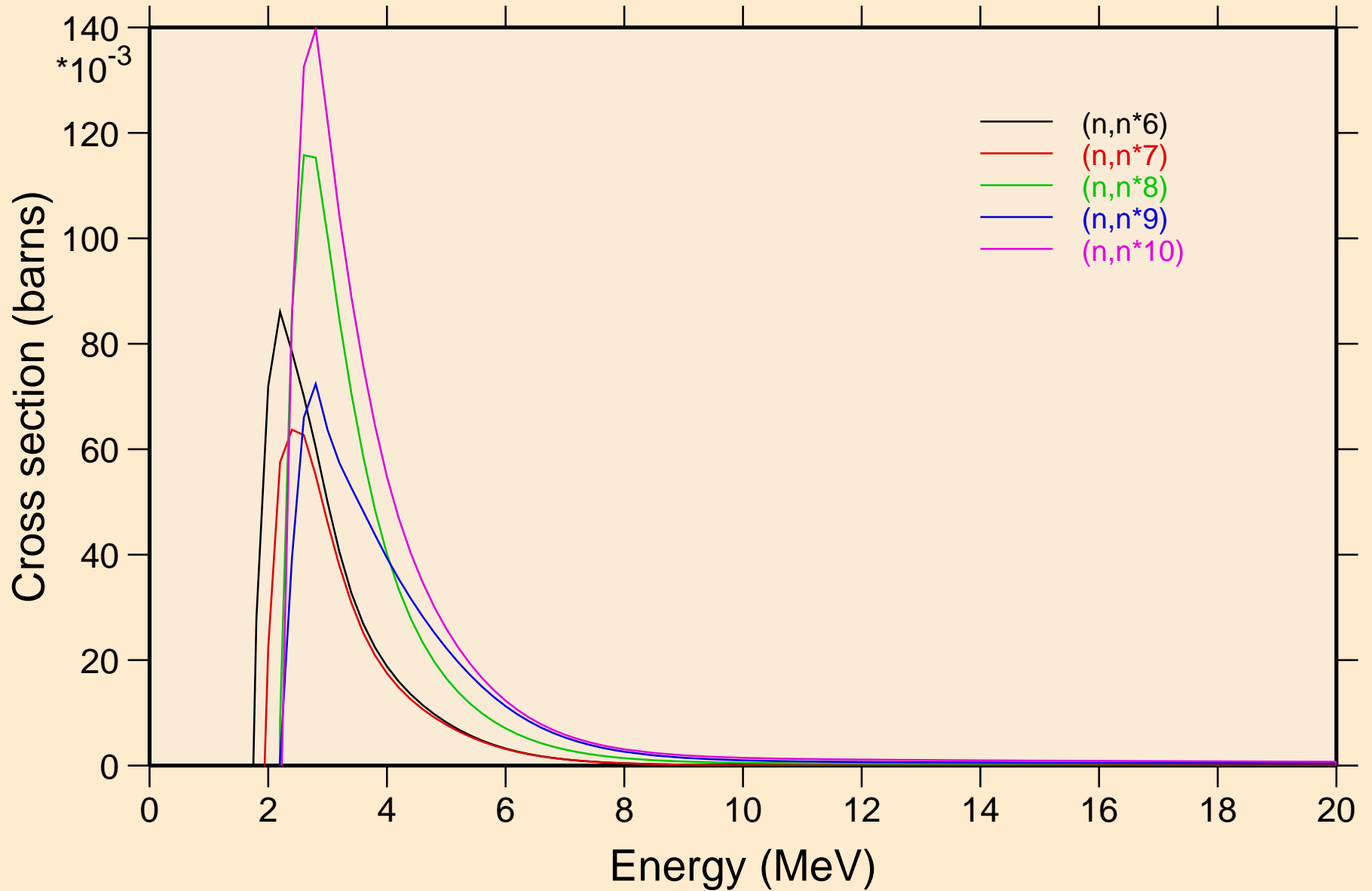

32-GE-74 FOR FENDL-3.2 FROM JEFF-3.1.1 BY NJOY2016.60+ O
Inelastic levels

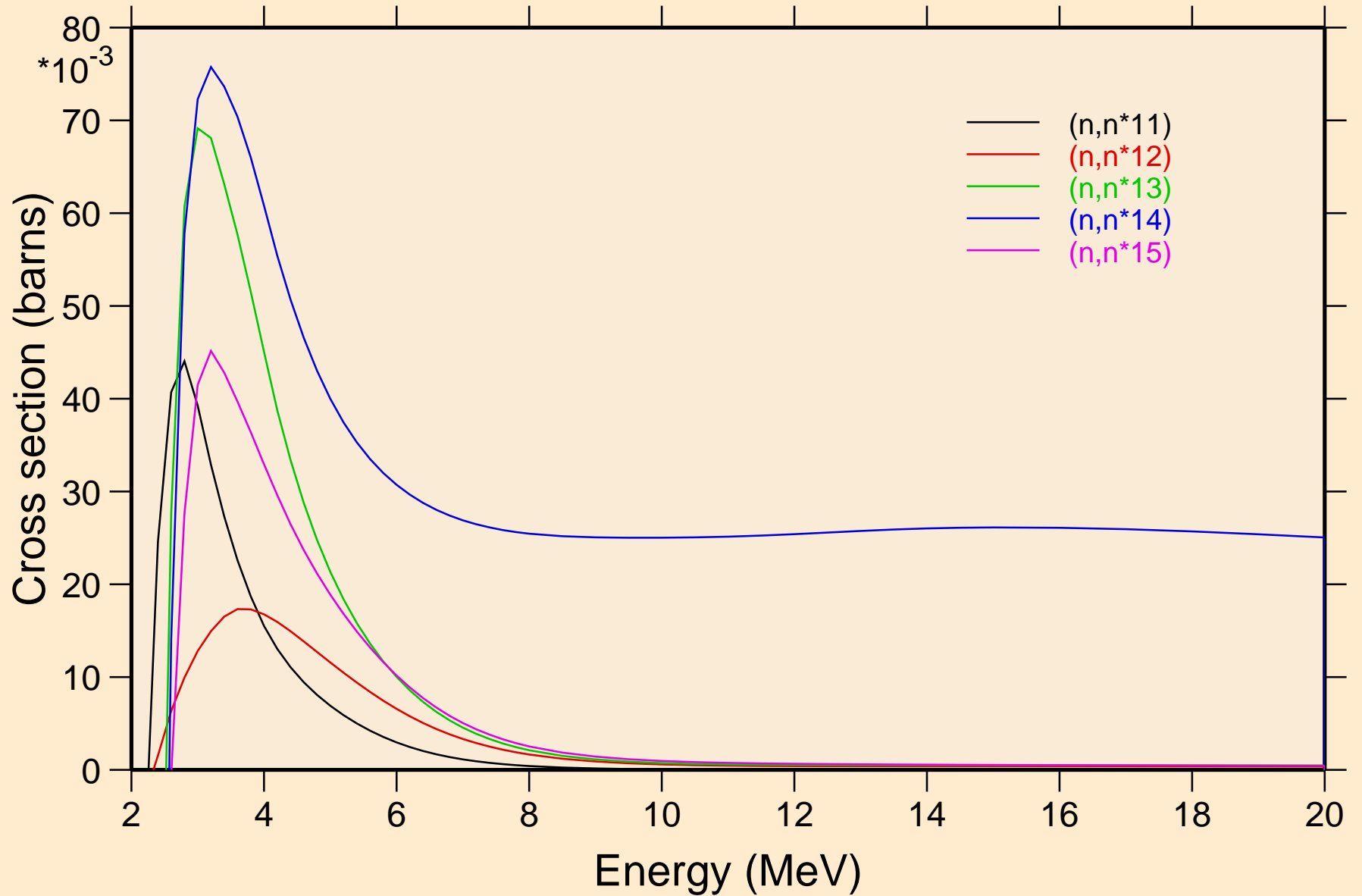

32-GE-74 FOR FENDL-3.2 FROM JEFF-3.1.1 BY NJOY2016.60+ O
Inelastic levels

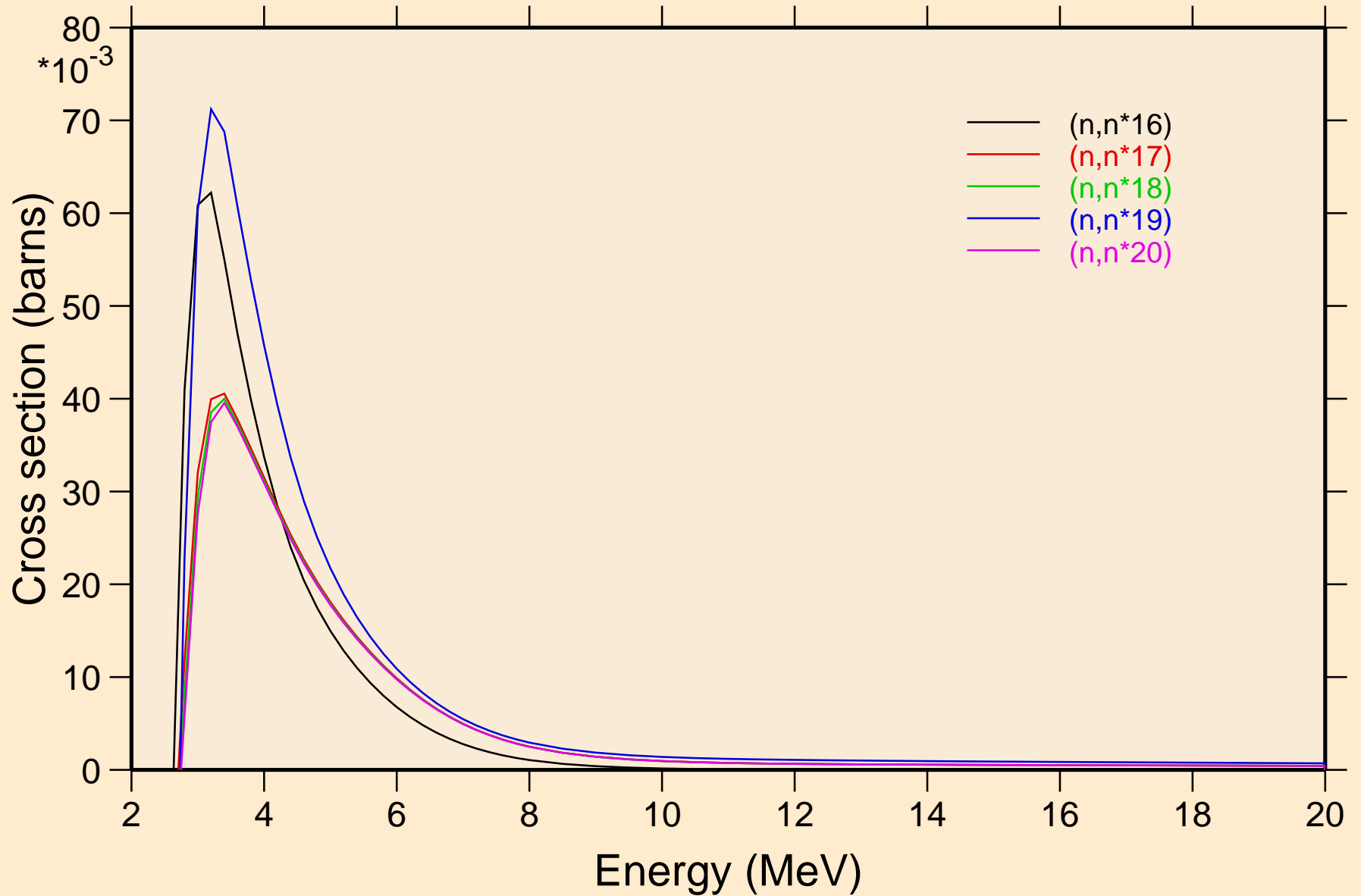

32-GE-74 FOR FENDL-3.2 FROM JEFF-3.1.1 BY NJOY2016.60+ O

Threshold reactions

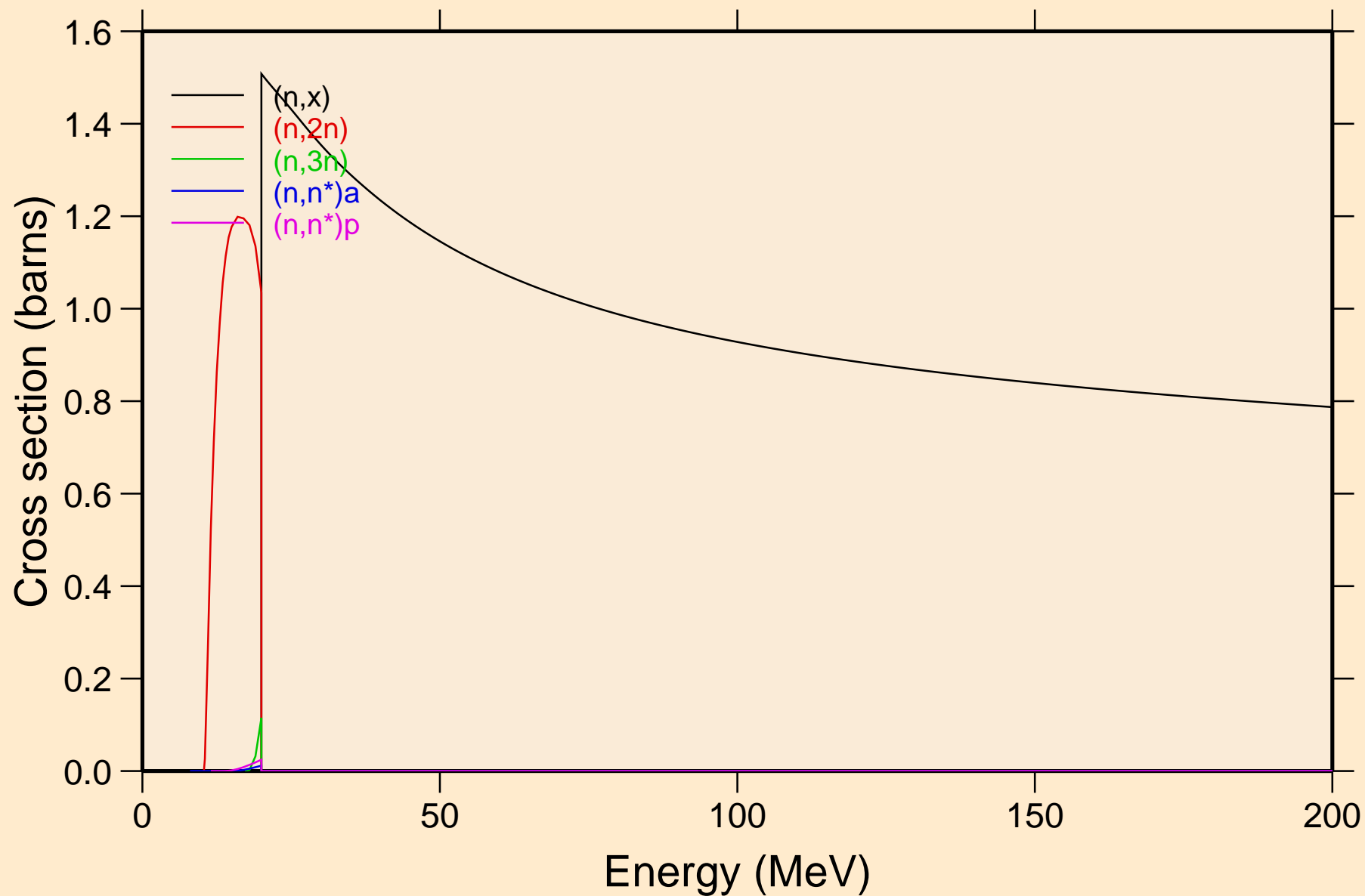

32-GE-74 FOR FENDL-3.2 FROM JEFF-3.1.1 BY NJOY2016.60+ O
Threshold reactions

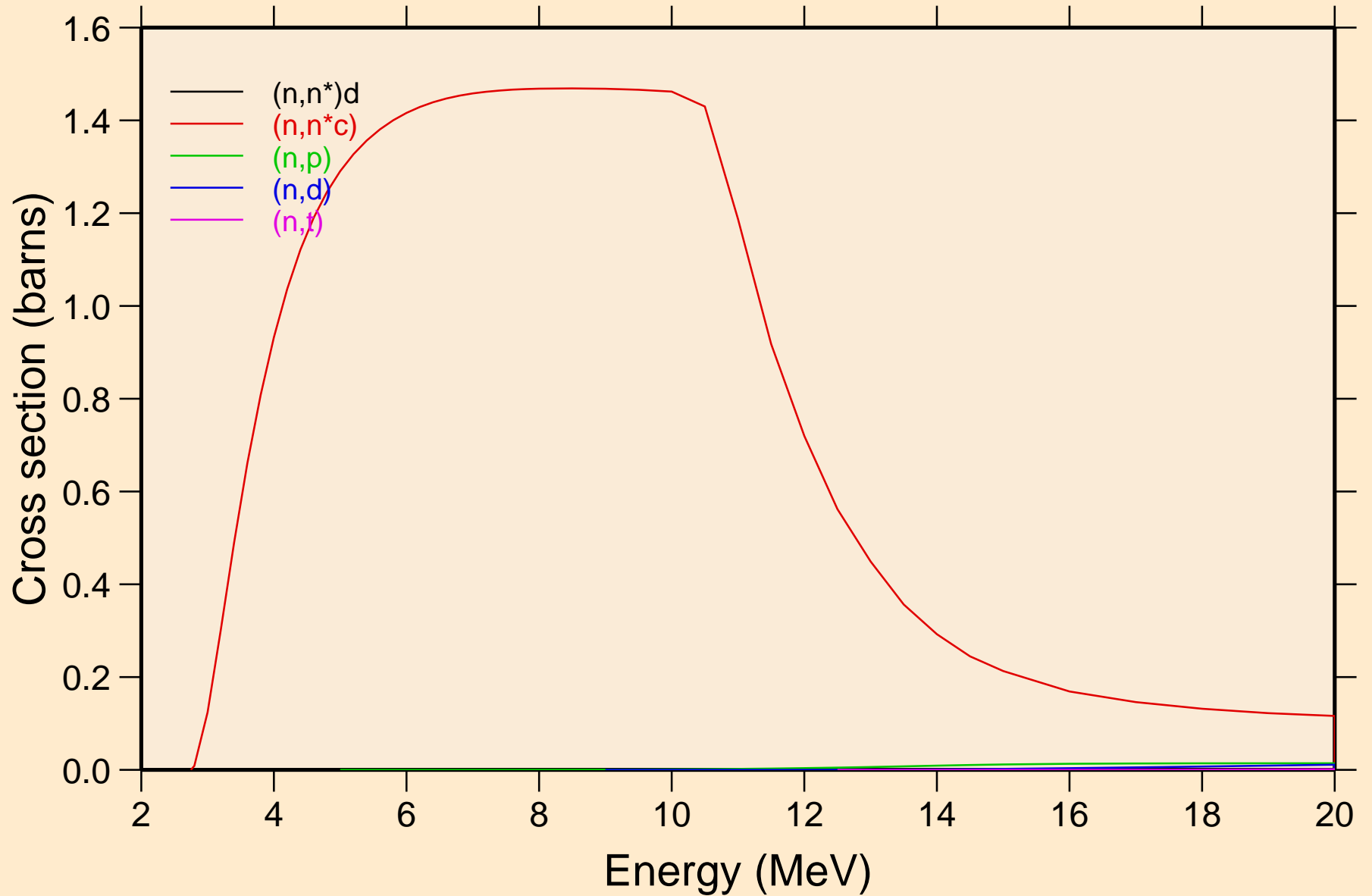

32-GE-74 FOR FENDL-3.2 FROM JEFF-3.1.1 BY NJOY2016.60+ O
Threshold reactions

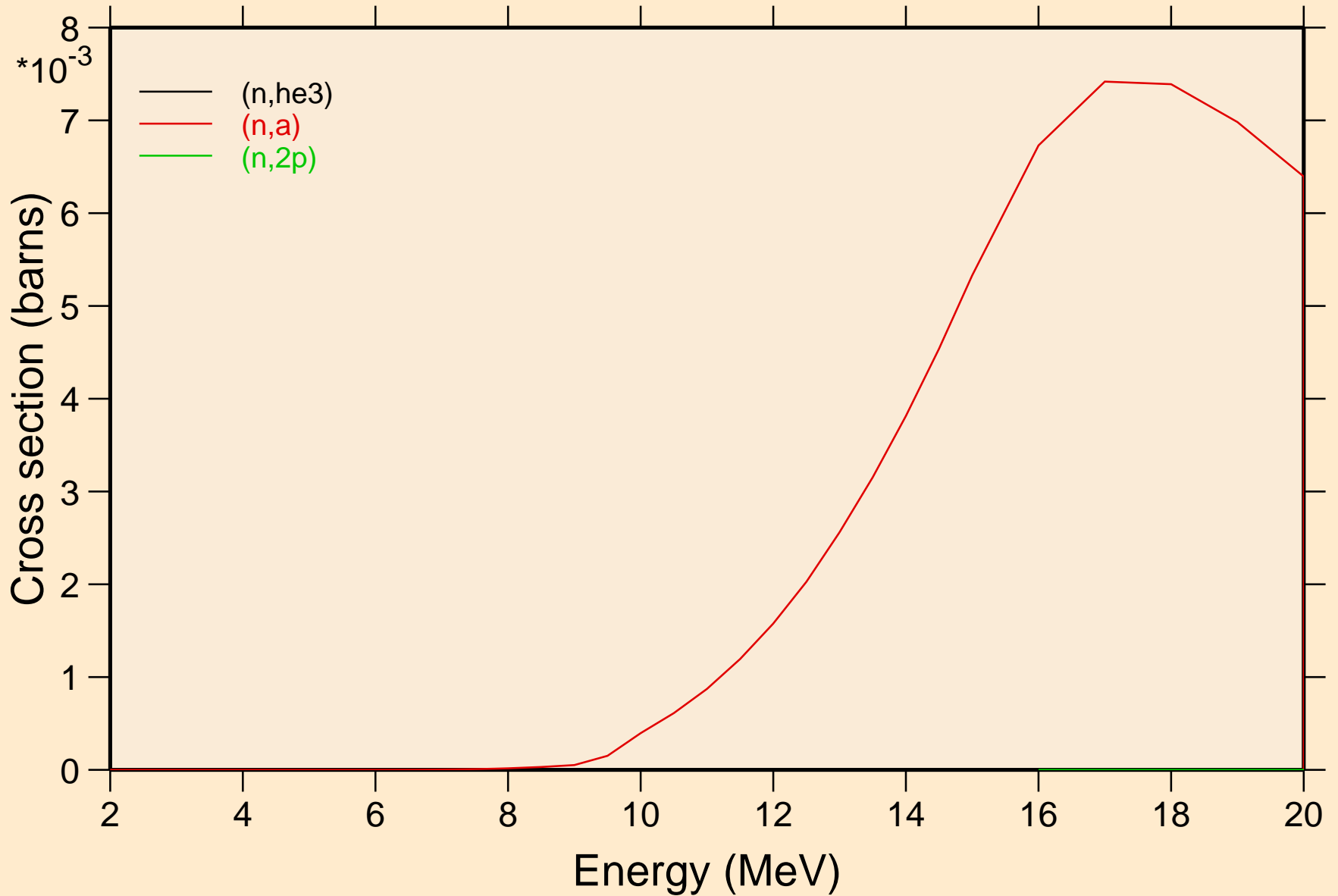

32-GE-74 FOR FENDL-3.2 FROM JEFF-3.1.1 BY NJOY2016.60+ O

Threshold reactions

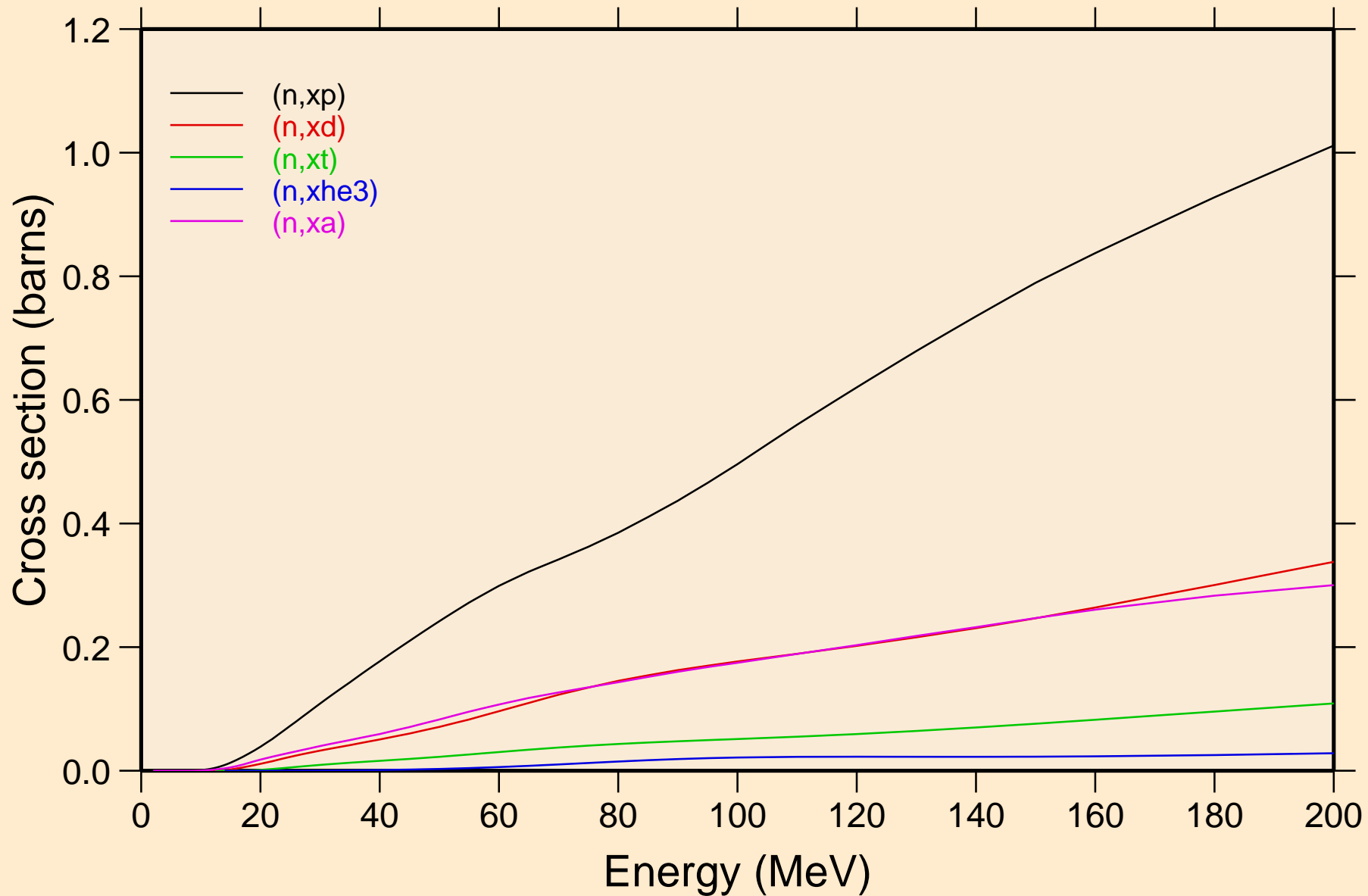

32-GE-74 FOR FENDL-3.2 FROM JEFF-3.1.1 BY NJOY2016.60+ O
Threshold reactions

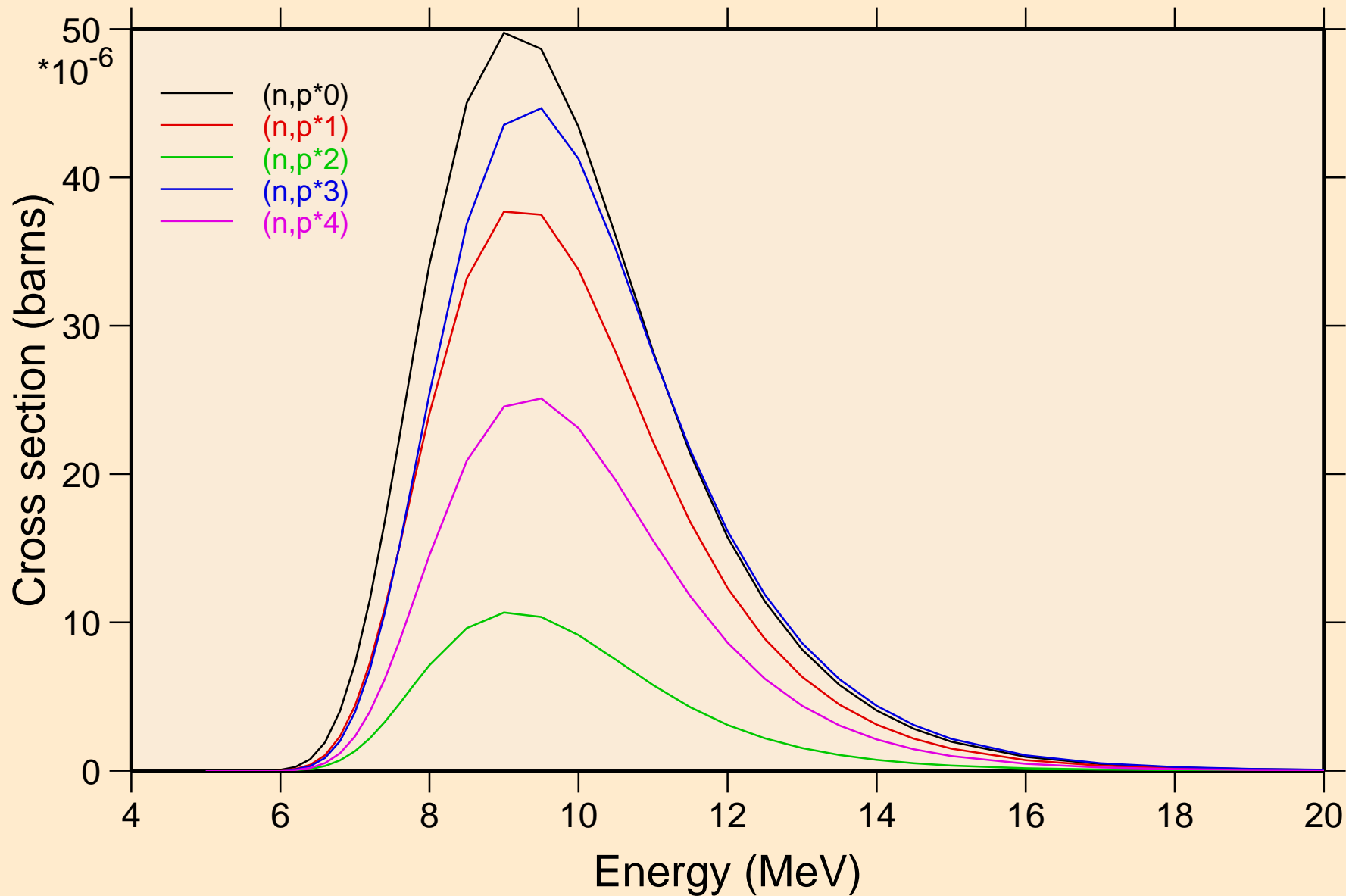

32-GE-74 FOR FENDL-3.2 FROM JEFF-3.1.1 BY NJOY2016.60+ O
Threshold reactions

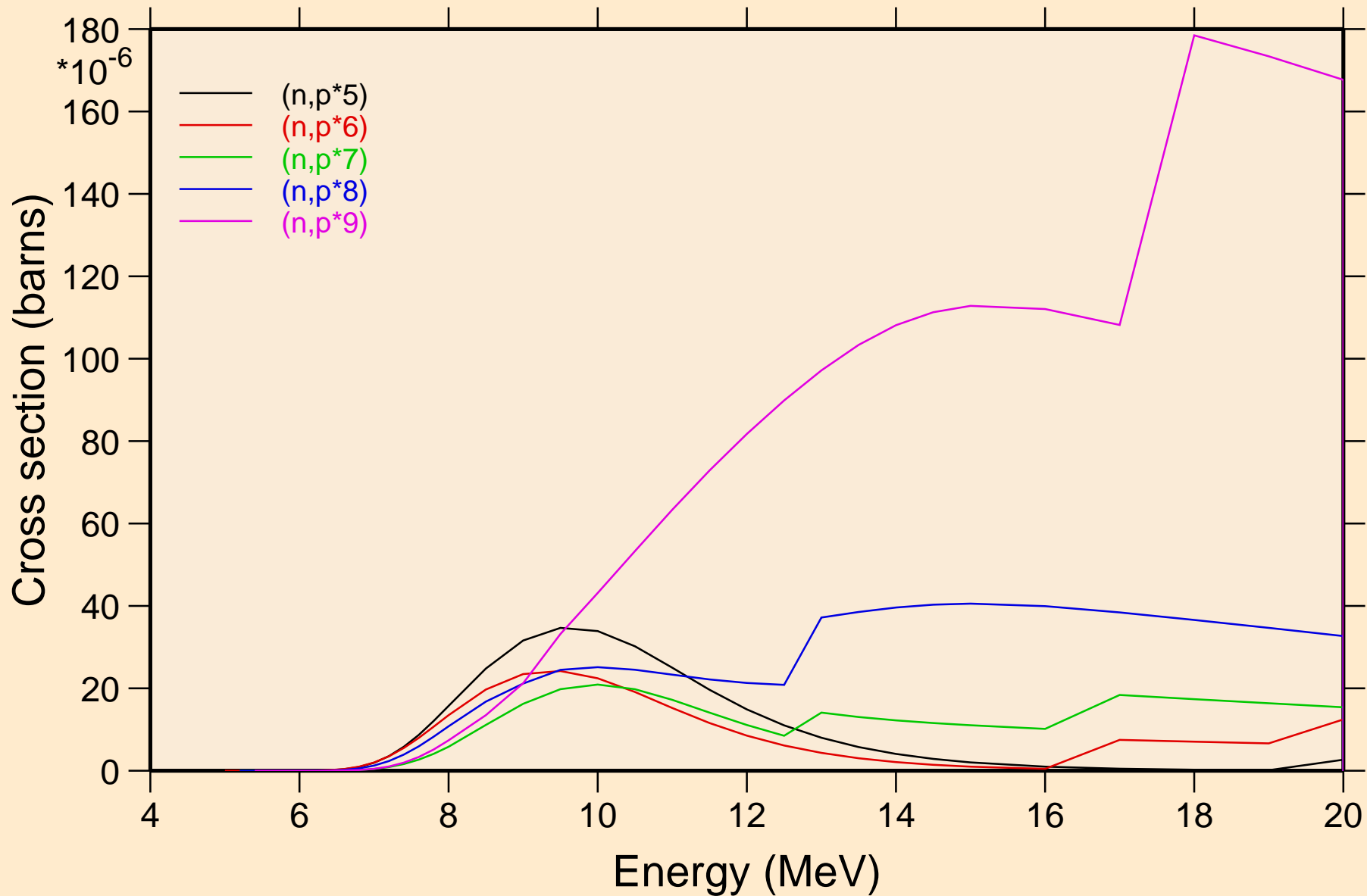

32-GE-74 FOR FENDL-3.2 FROM JEFF-3.1.1 BY NJOY2016.60+ O
Threshold reactions

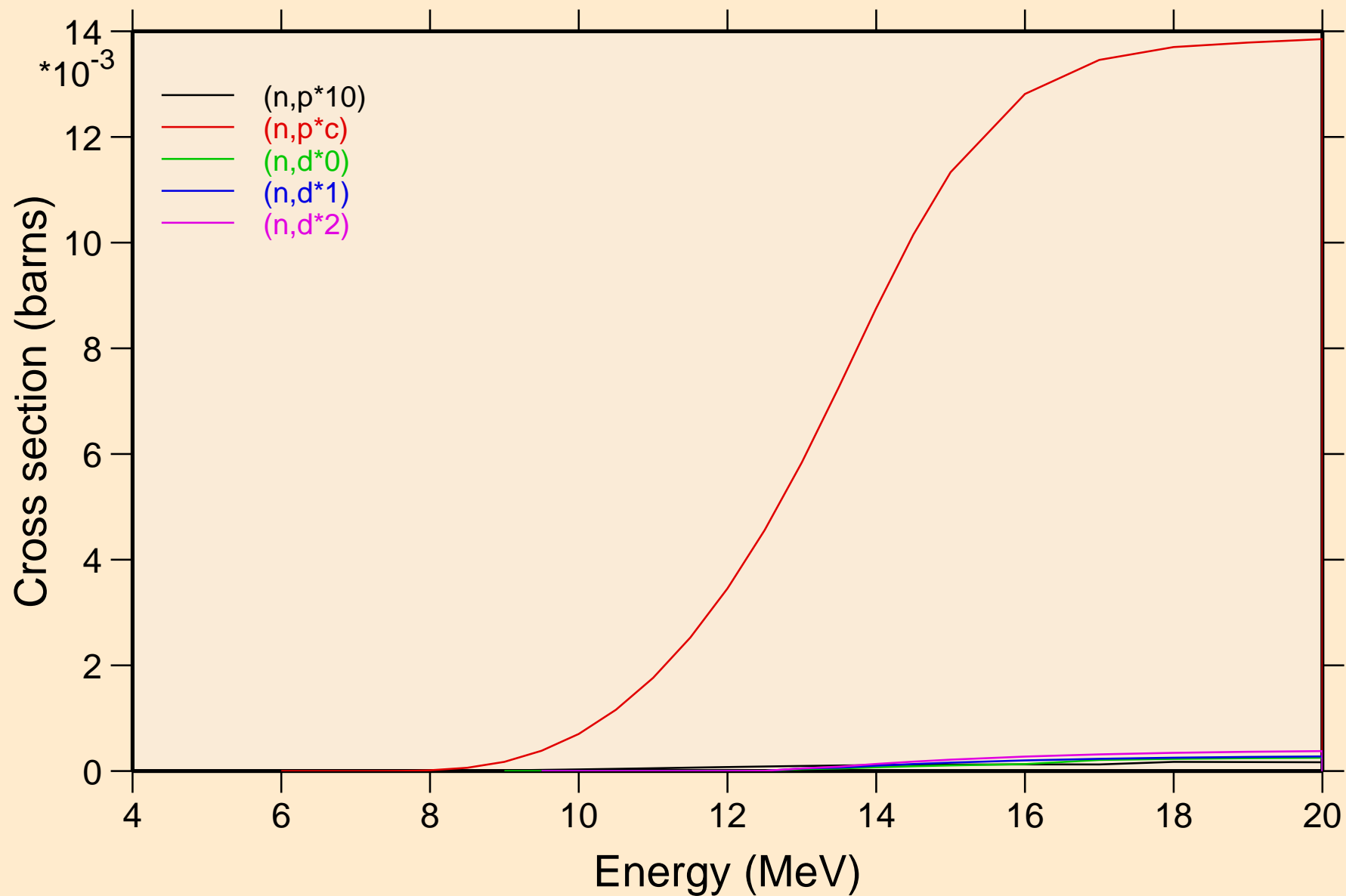

32-GE-74 FOR FENDL-3.2 FROM JEFF-3.1.1 BY NJOY2016.60+ O
Threshold reactions

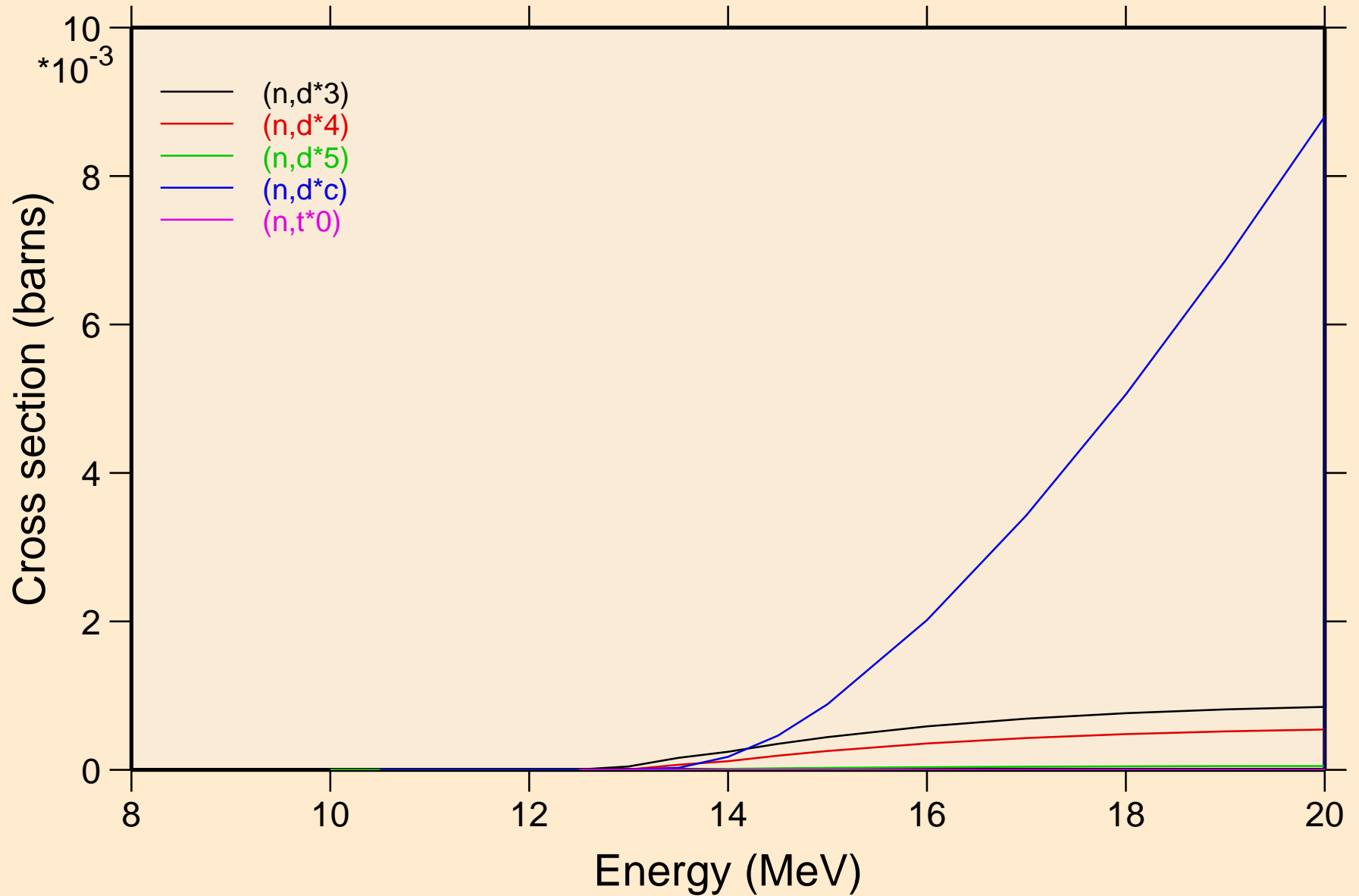

32-GE-74 FOR FENDL-3.2 FROM JEFF-3.1.1 BY NJOY2016.60+ O
Threshold reactions

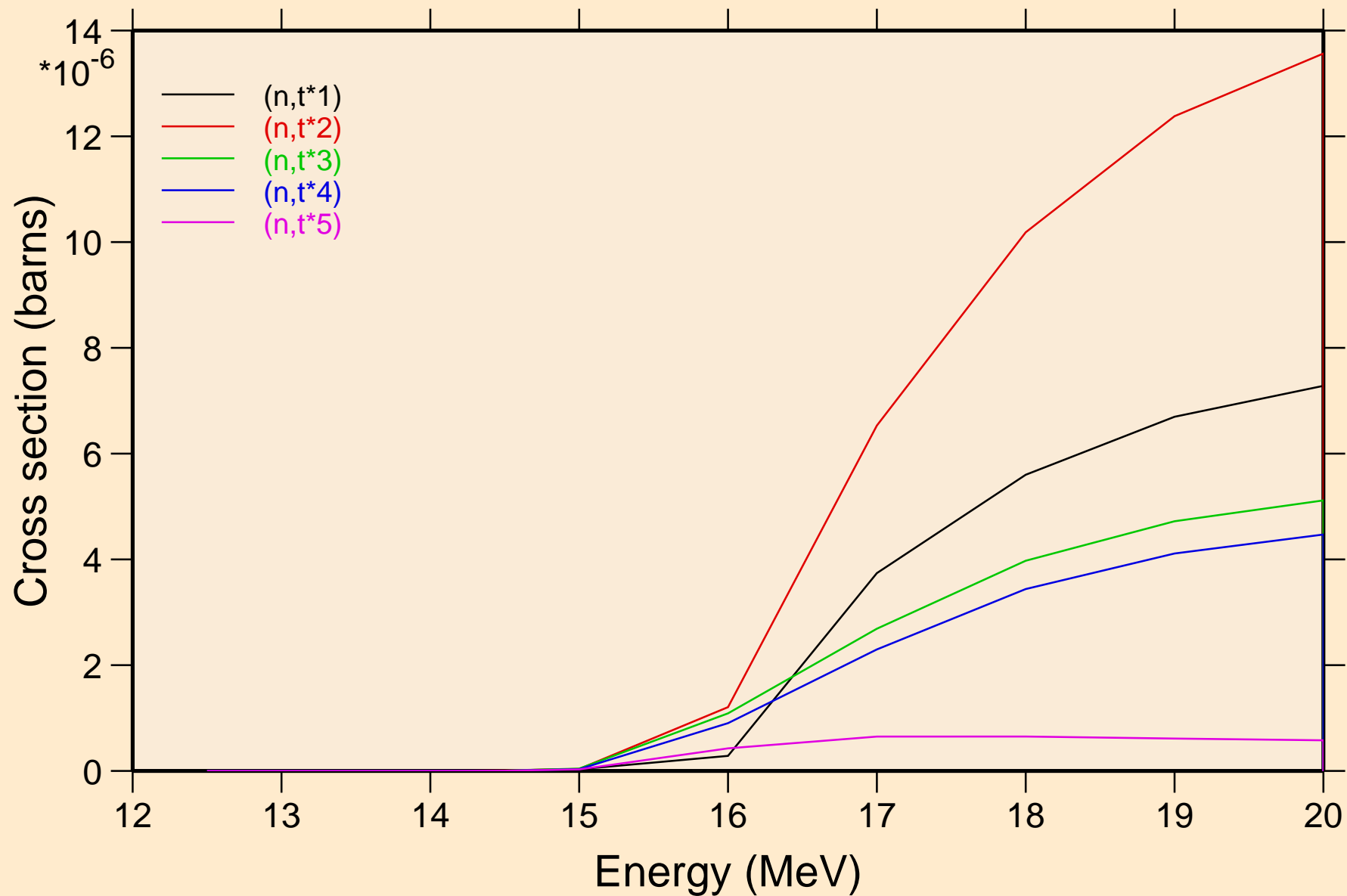

32-GE-74 FOR FENDL-3.2 FROM JEFF-3.1.1 BY NJOY2016.60+ O
Threshold reactions

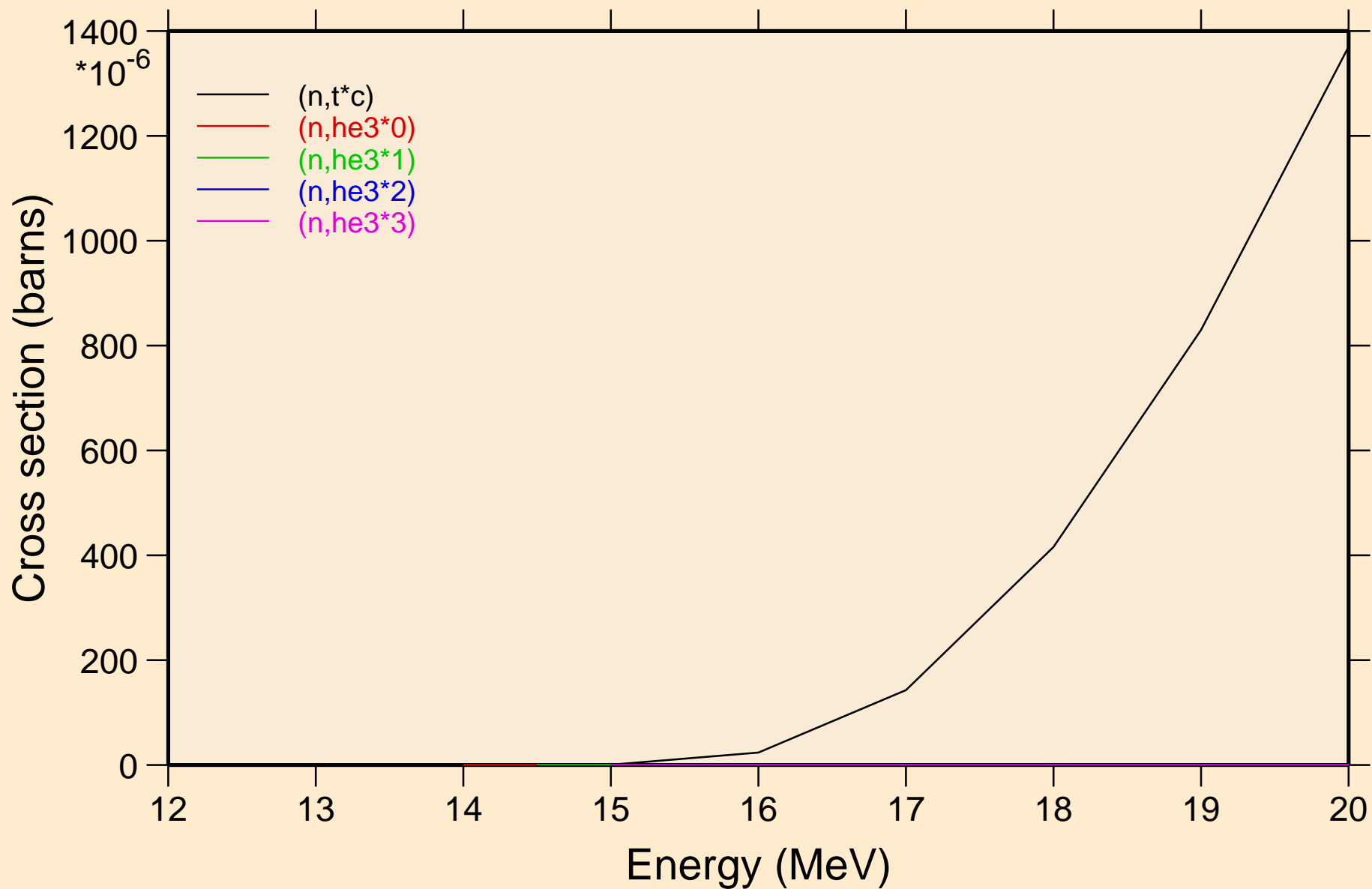

32-GE-74 FOR FENDL-3.2 FROM JEFF-3.1.1 BY NJOY2016.60+ O
Threshold reactions

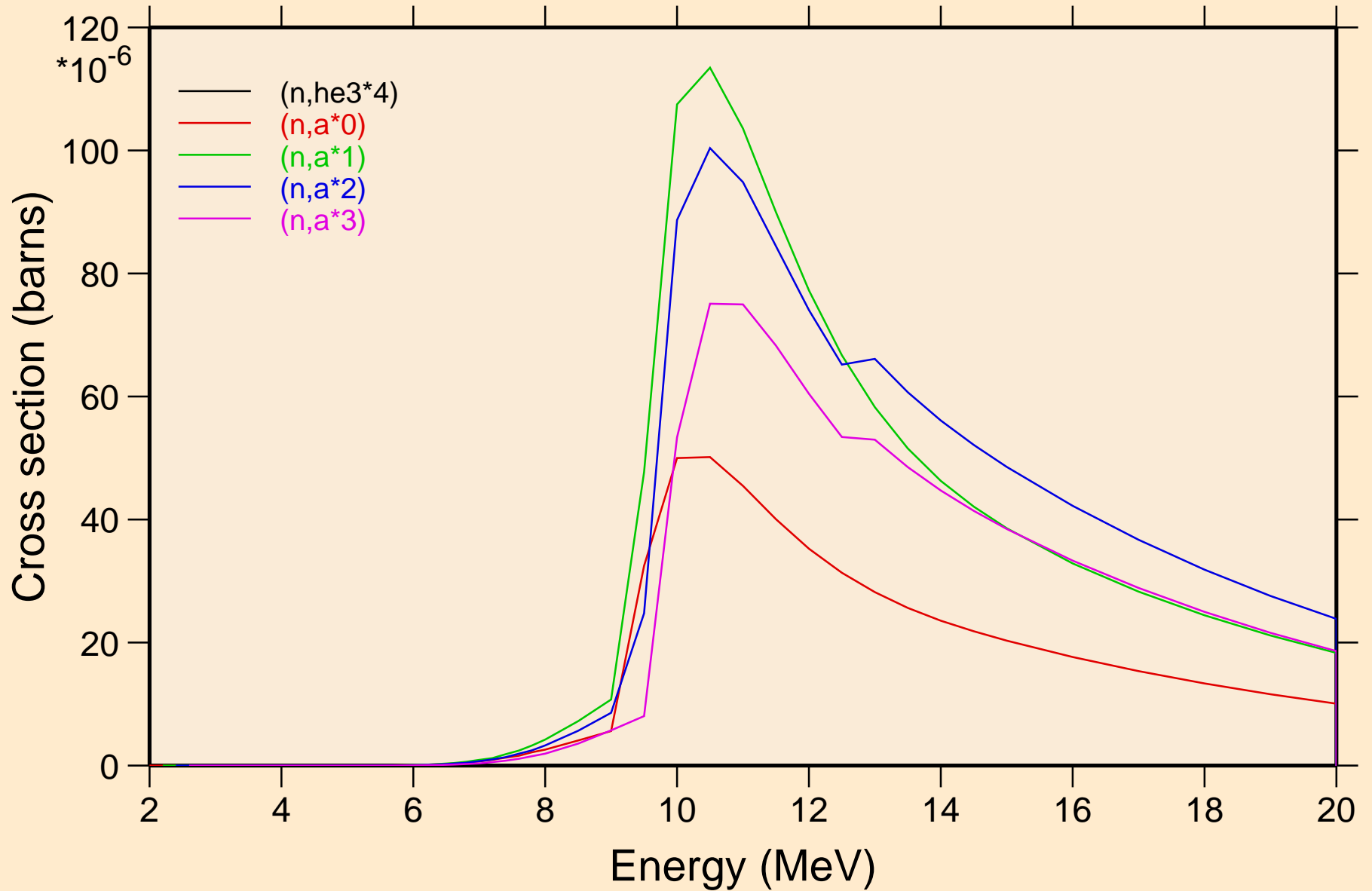

32-GE-74 FOR FENDL-3.2 FROM JEFF-3.1.1 BY NJOY2016.60+ O
Threshold reactions

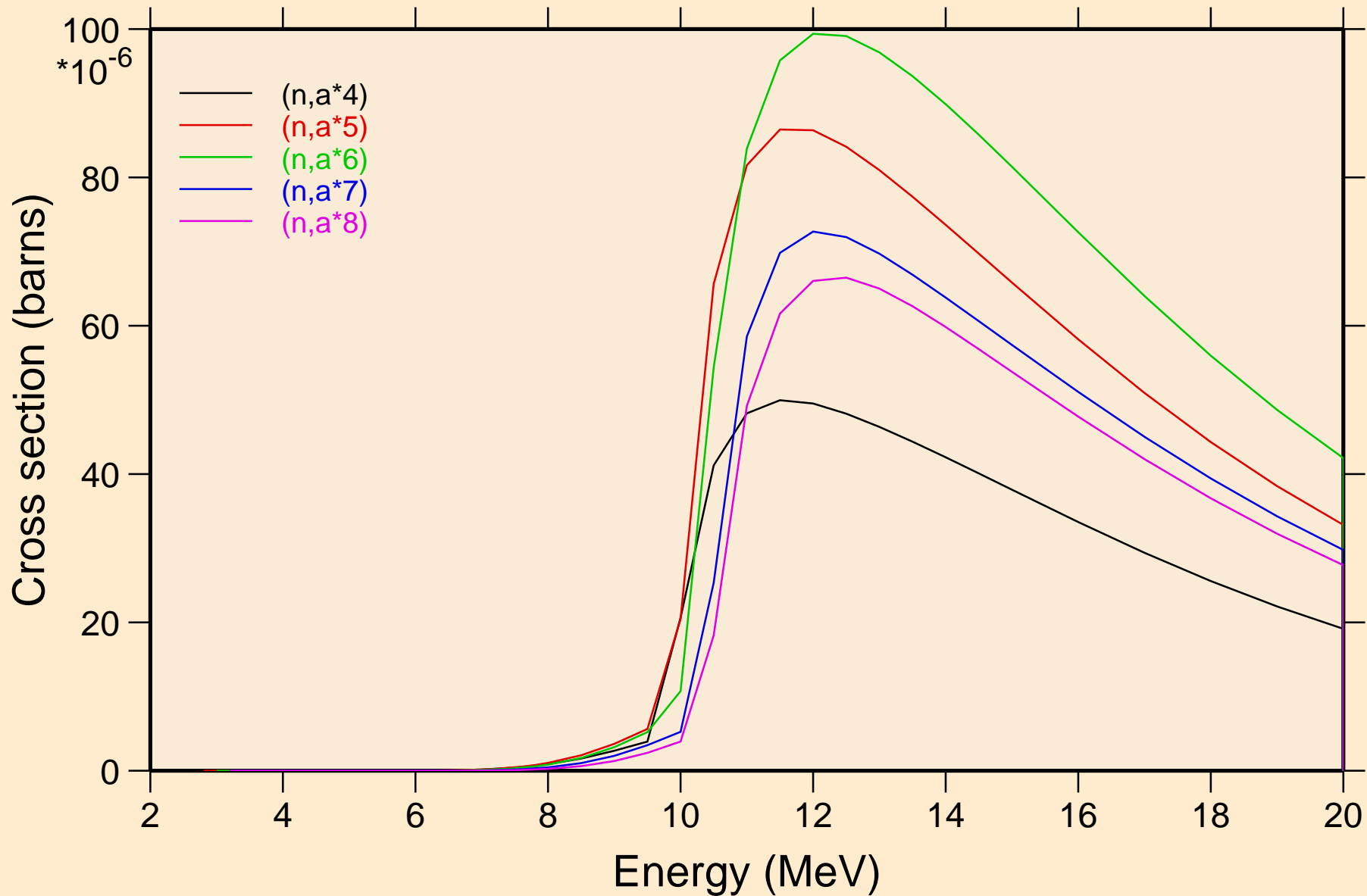

32-GE-74 FOR FENDL-3.2 FROM JEFF-3.1.1 BY NJOY2016.60+ O
Threshold reactions

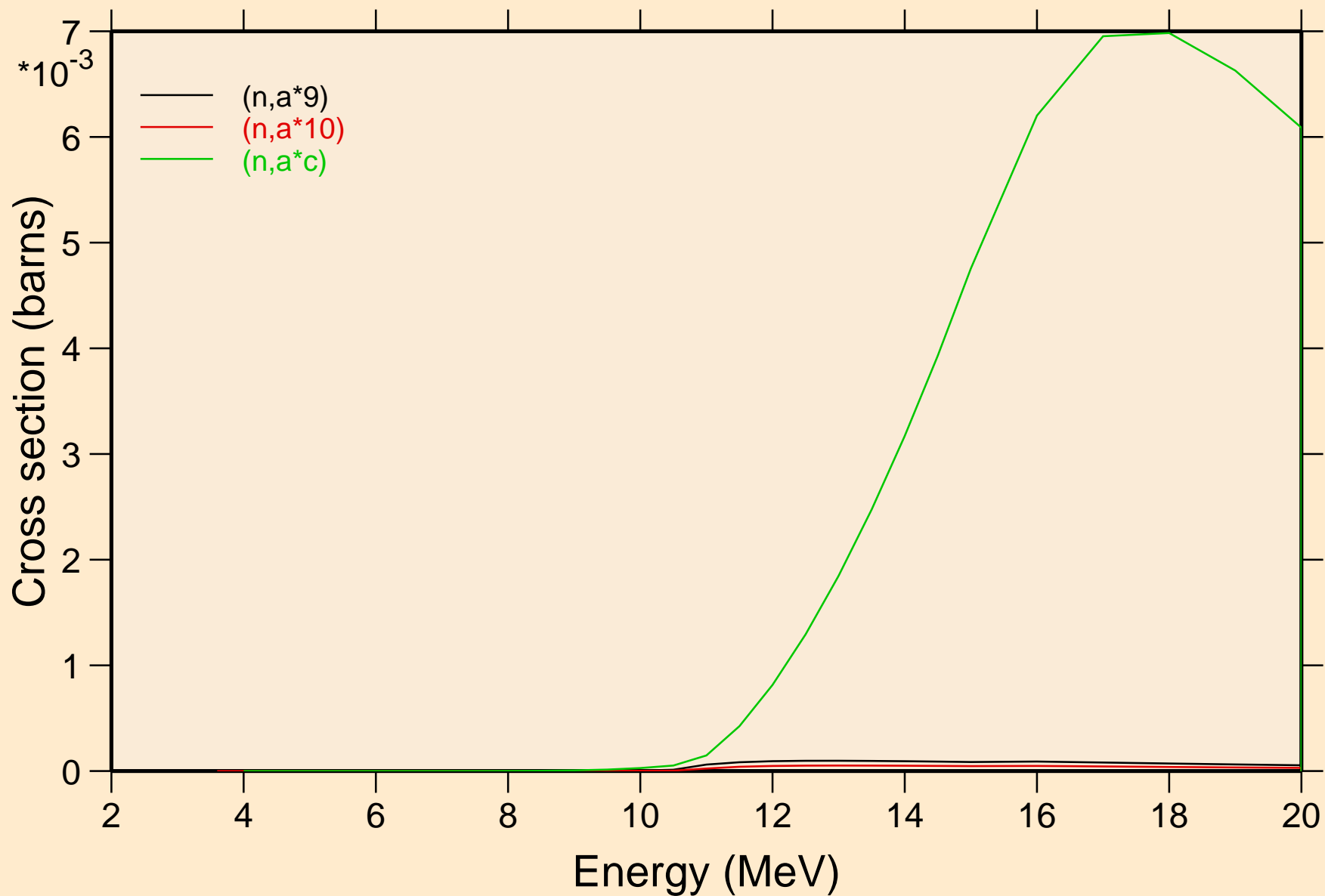

32-GE-74 FOR FENDL-3.2 FROM JEFF-3.1.1 BY NJOY2016.60+ O
angular distribution for elastic

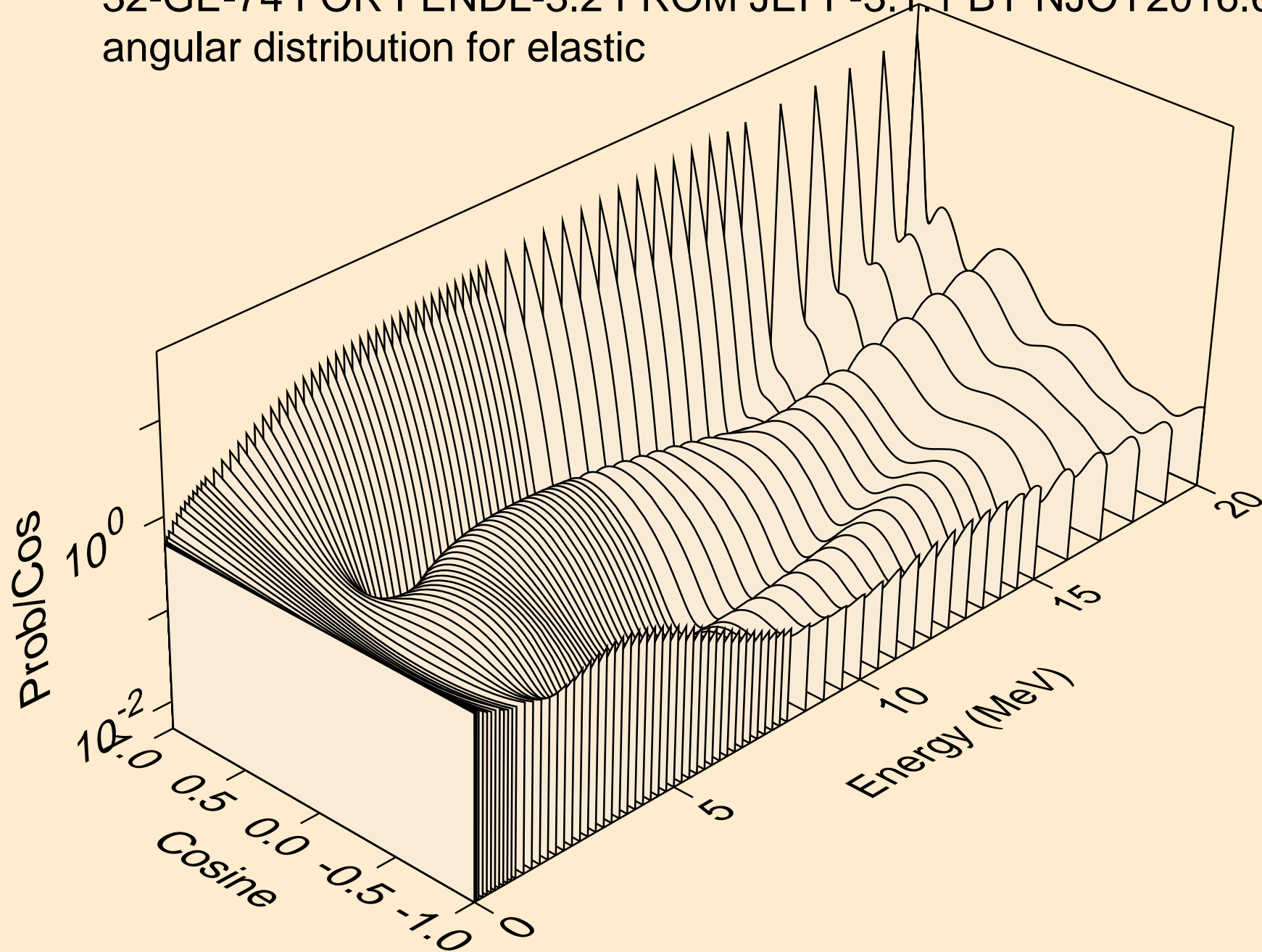

32-GE-74 FOR FENDL-3.2 FROM JEFF-3.1.1 BY NJOY2016.60+ O
angular distribution for elastic

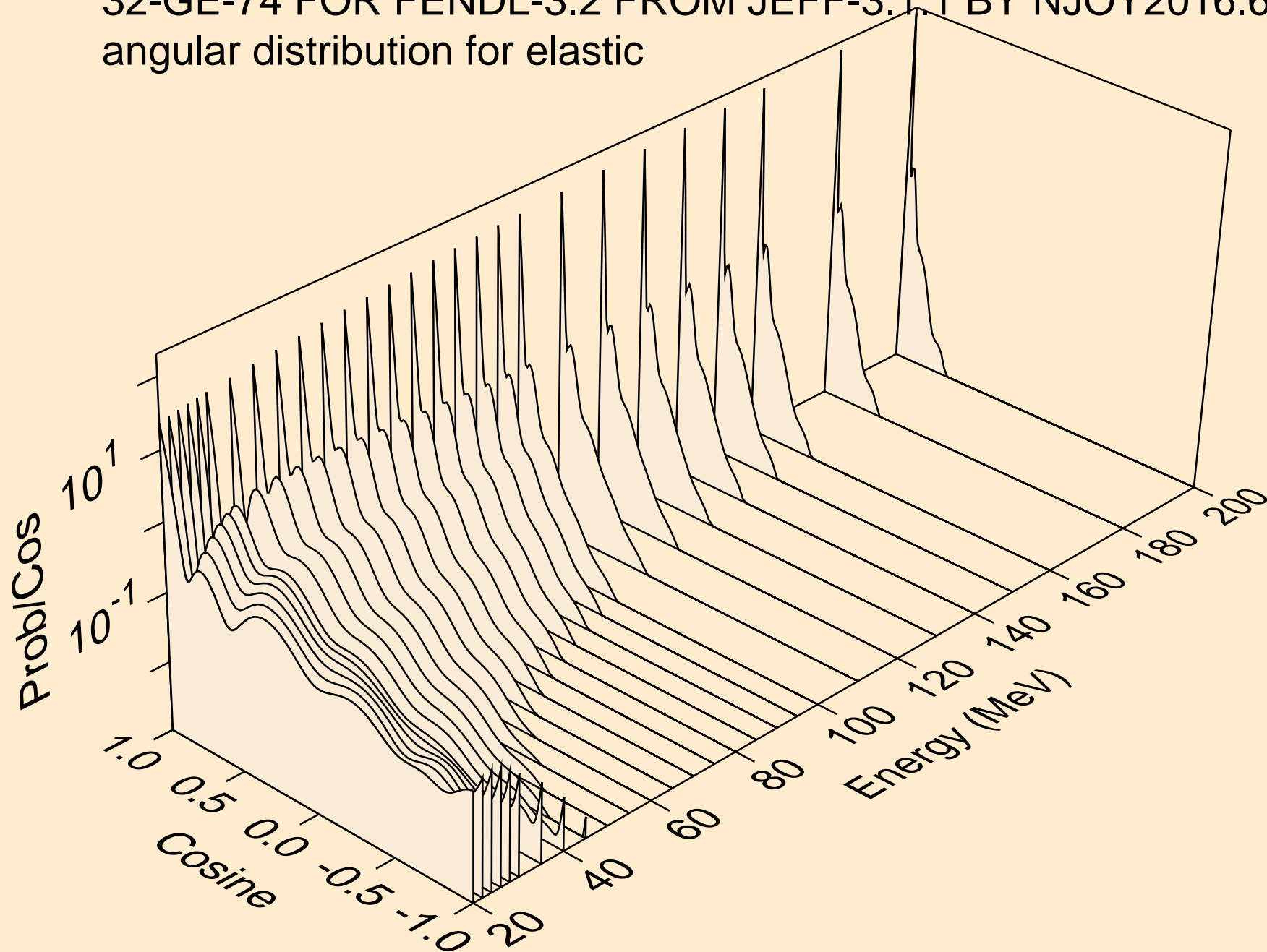

32-GE-74 FOR FENDL-3.2 FROM JEFF-3.1.1 BY NJOY2016.60+ O
angular distribution for (n,n*1)

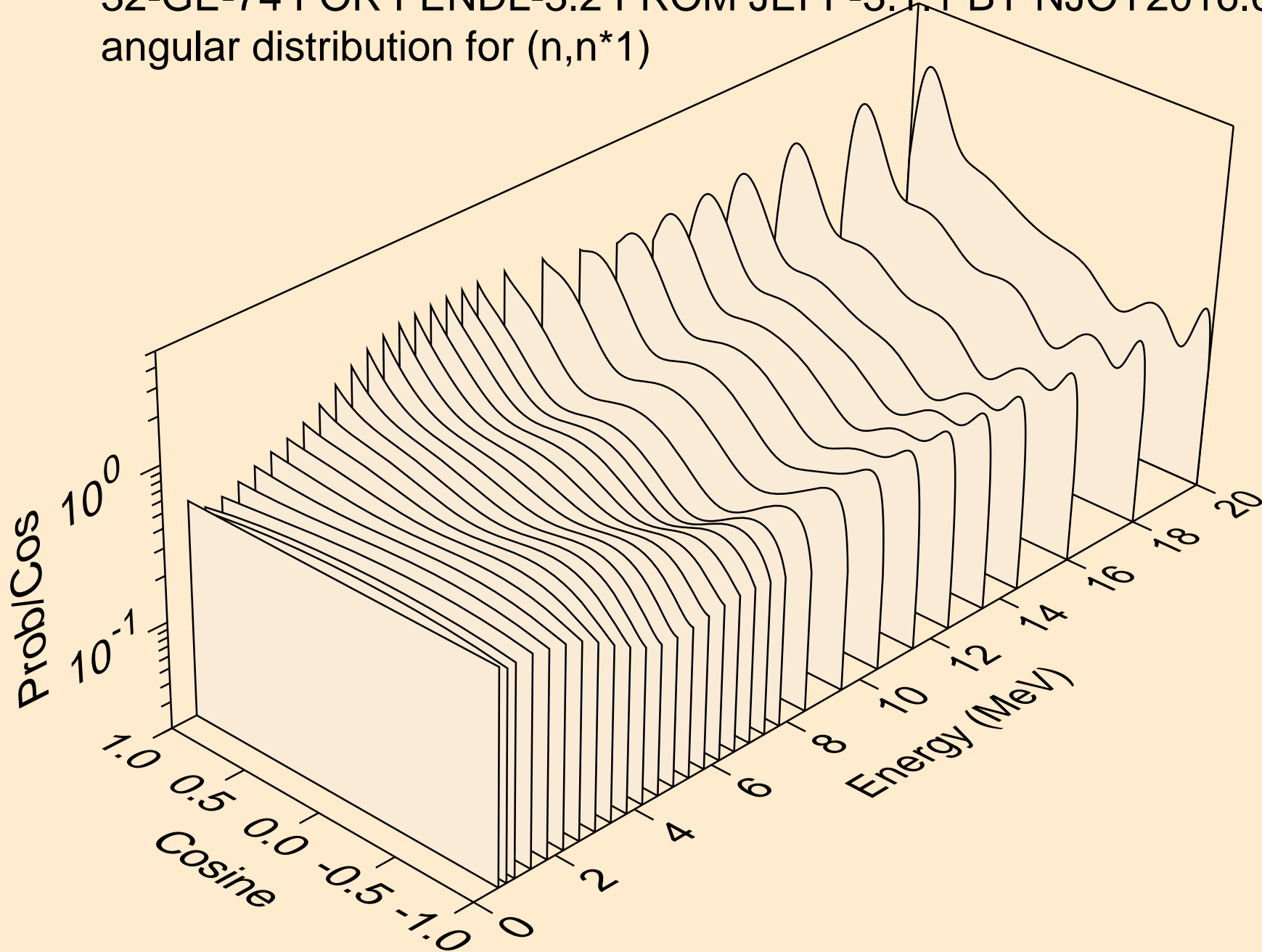

32-GE-74 FOR FENDL-3.2 FROM JEFF-3.1.1 BY NJOY2016.60+ O
angular distribution for (n,n*2)

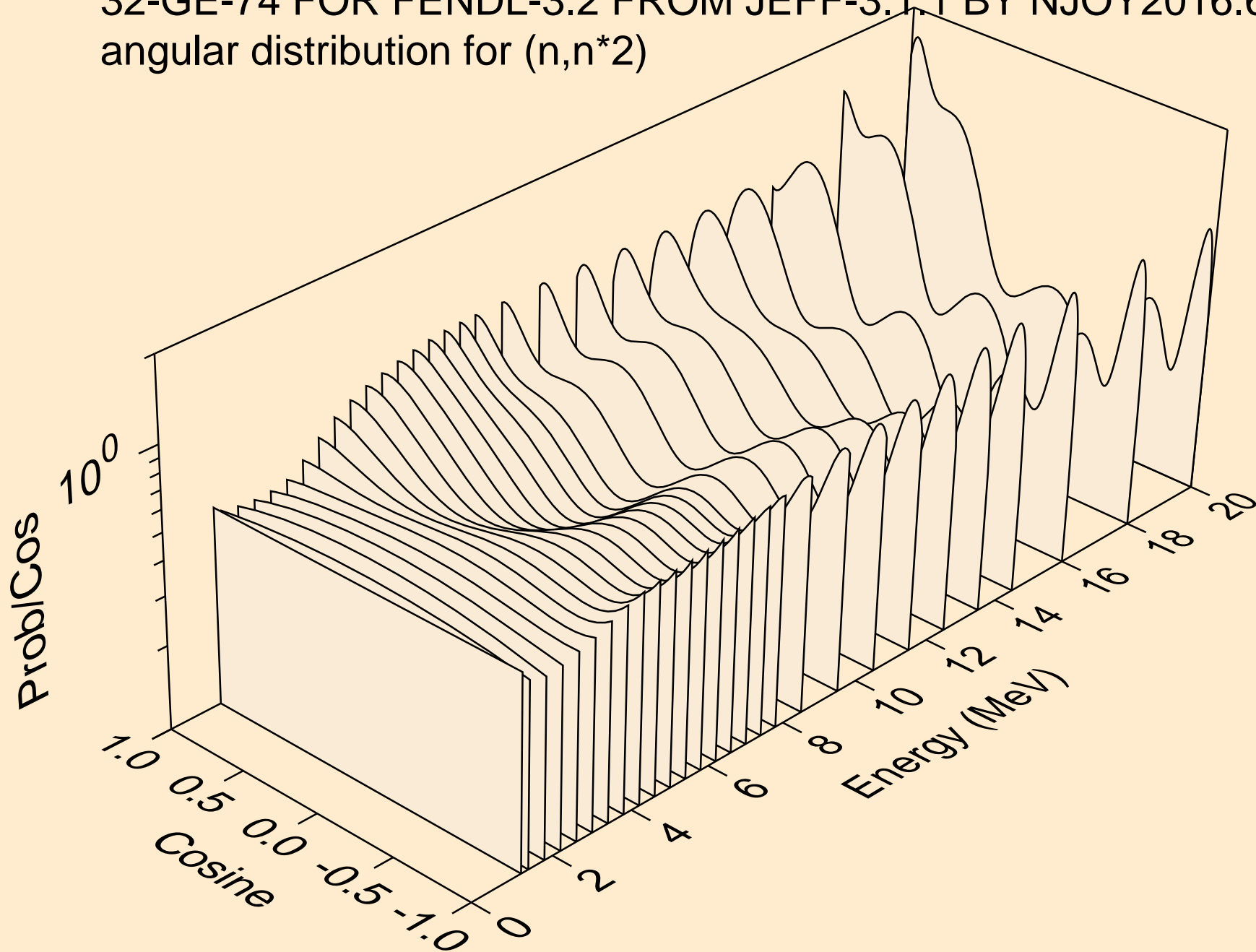

32-GE-74 FOR FENDL-3.2 FROM JEFF-3.1.1 BY NJOY2016.60+ O
angular distribution for (n,n*3)

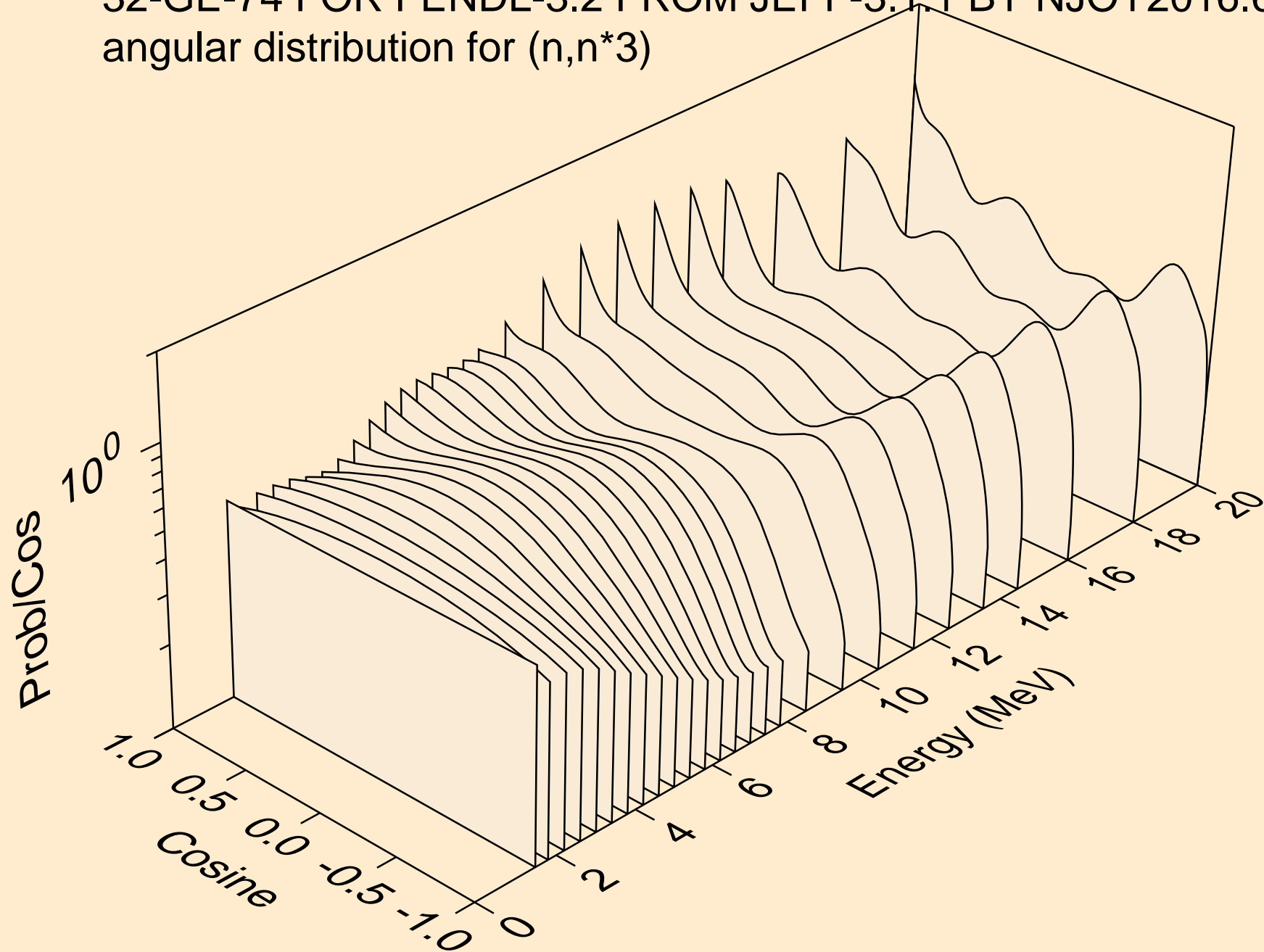

32-GE-74 FOR FENDL-3.2 FROM JEFF-3.1.1 BY NJOY2016.60+ O
angular distribution for (n,n*4)

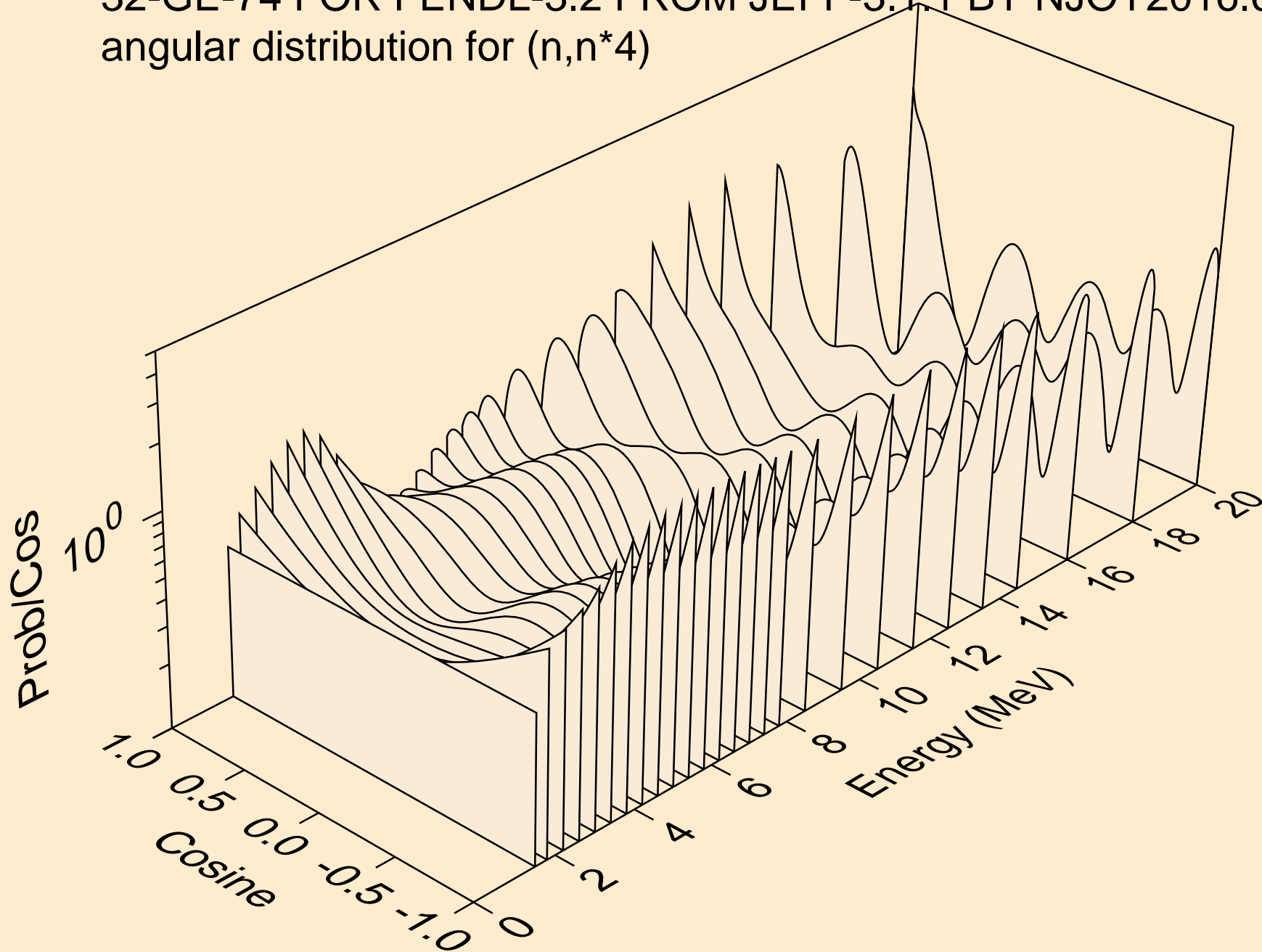

32-GE-74 FOR FENDL-3.2 FROM JEFF-3.1.1 BY NJOY2016.60+ O
angular distribution for (n,n*5)

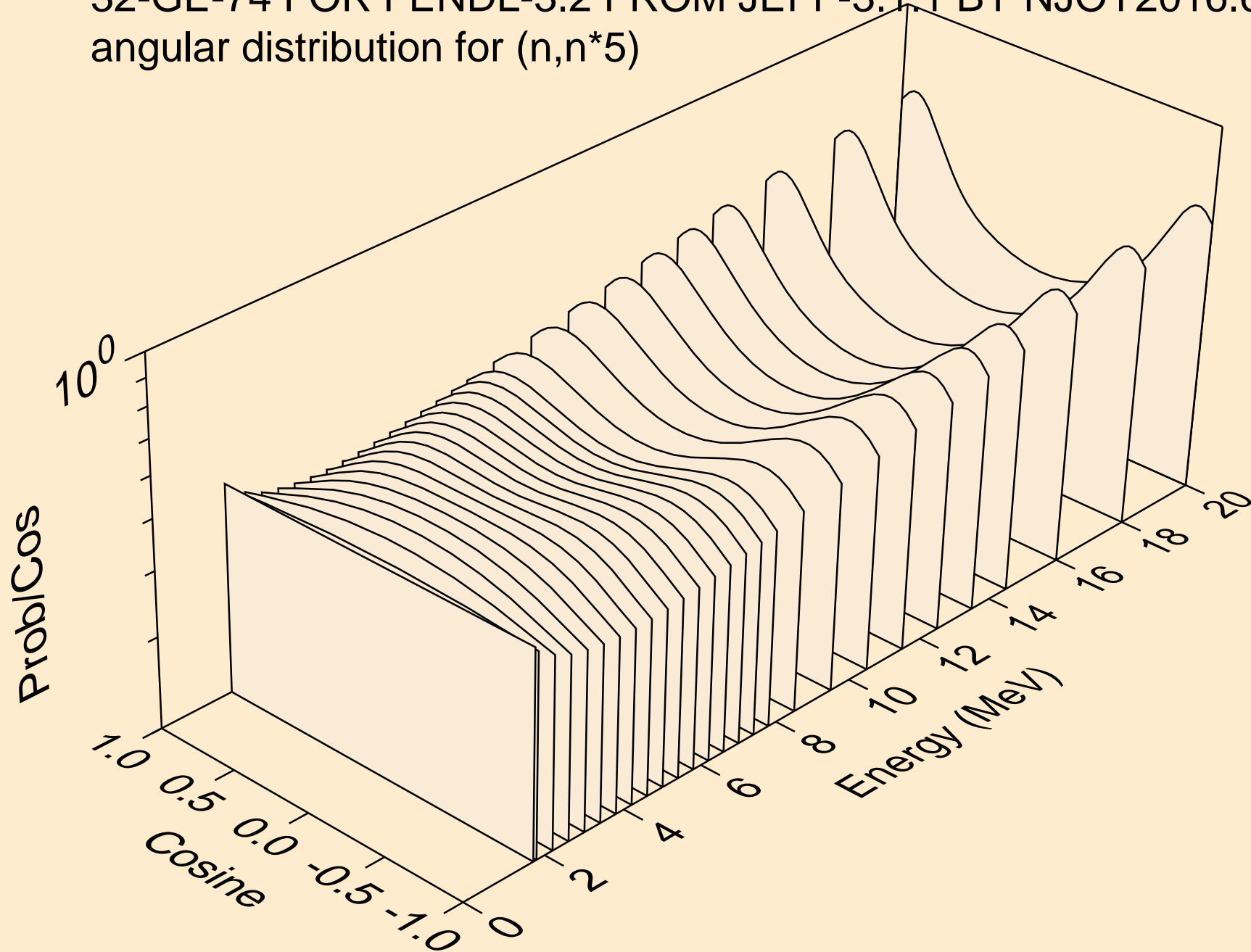

32-GE-74 FOR FENDL-3.2 FROM JEFF-3.1.1 BY NJOY2016.60+ O
angular distribution for (n,n*6)

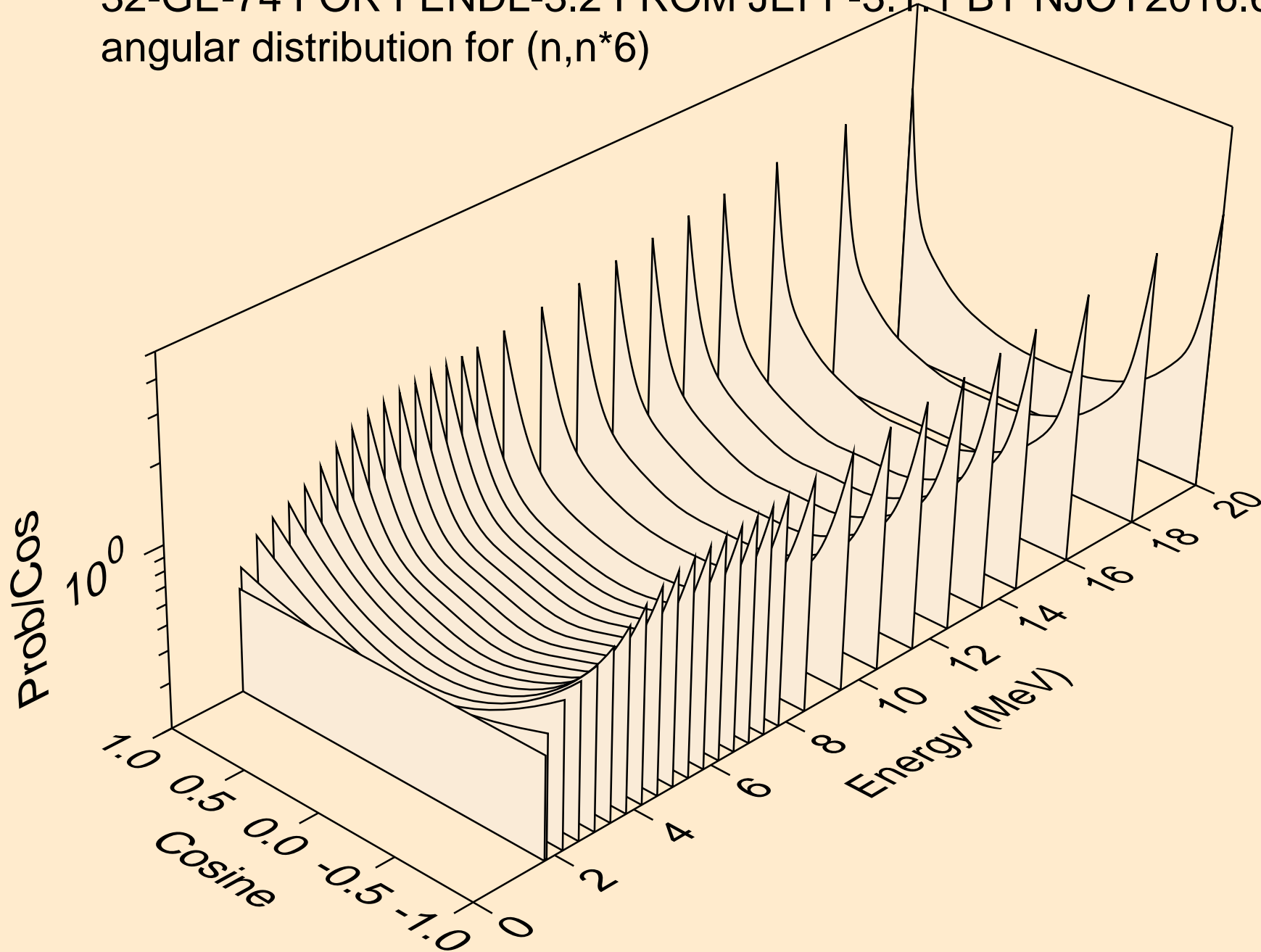

32-GE-74 FOR FENDL-3.2 FROM JEFF-3.1.1 BY NJOY2016.60+ O
angular distribution for (n,n*7)

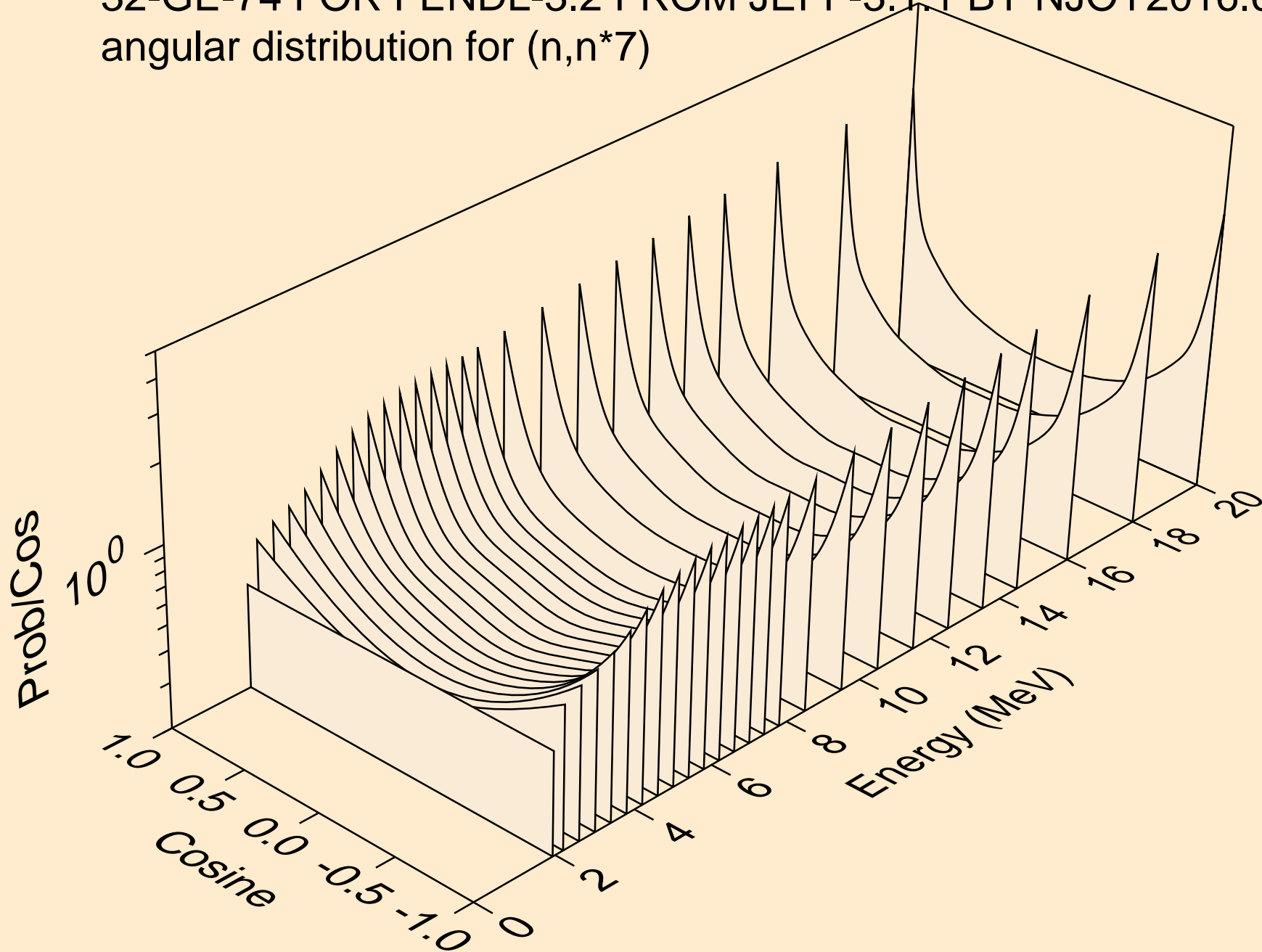

32-GE-74 FOR FENDL-3.2 FROM JEFF-3.1.1 BY NJOY2016.60+ O
angular distribution for (n,n*8)

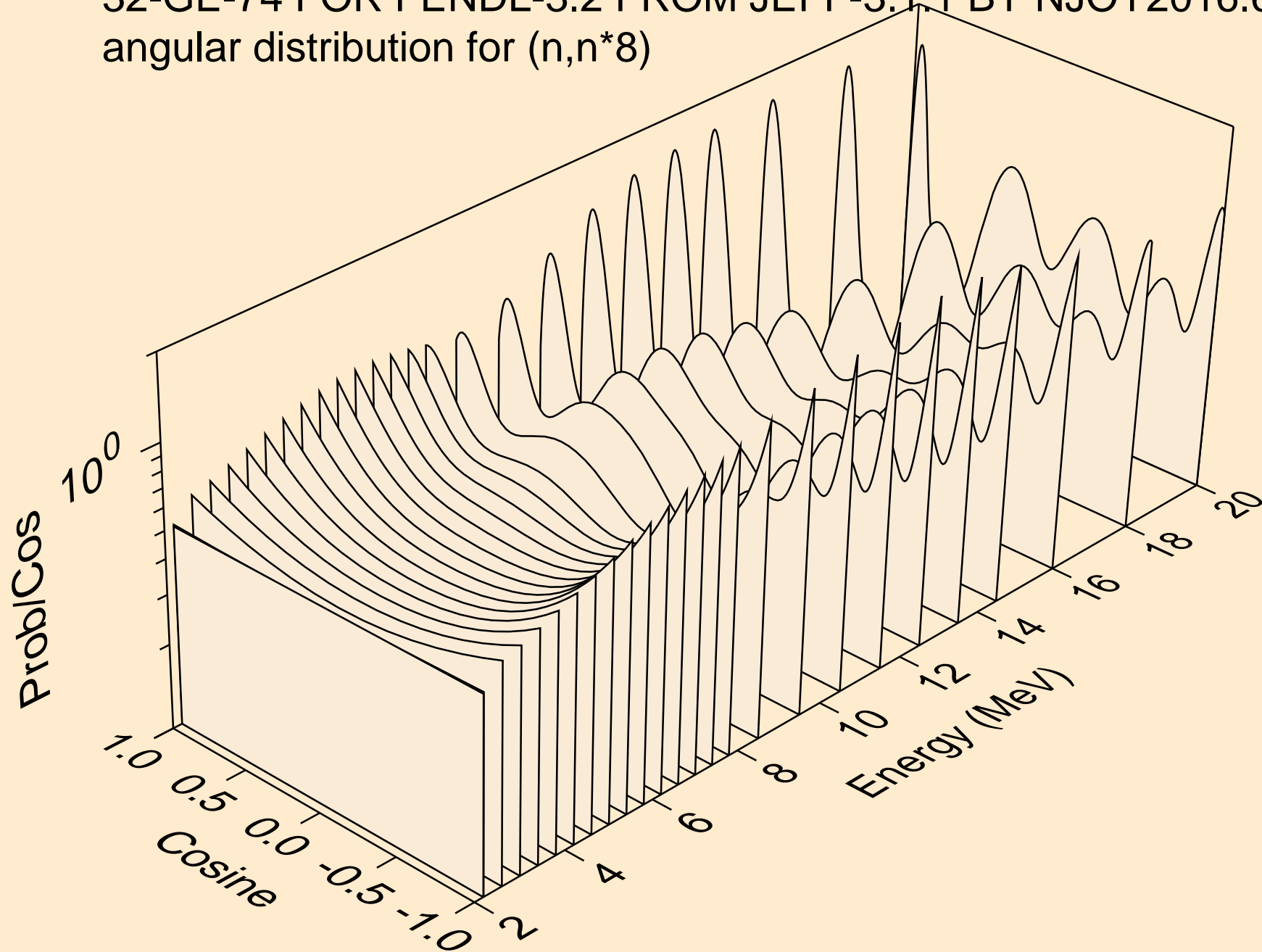

32-GE-74 FOR FENDL-3.2 FROM JEFF-3.1.1 BY NJOY2016.60+ O
angular distribution for (n,n*9)

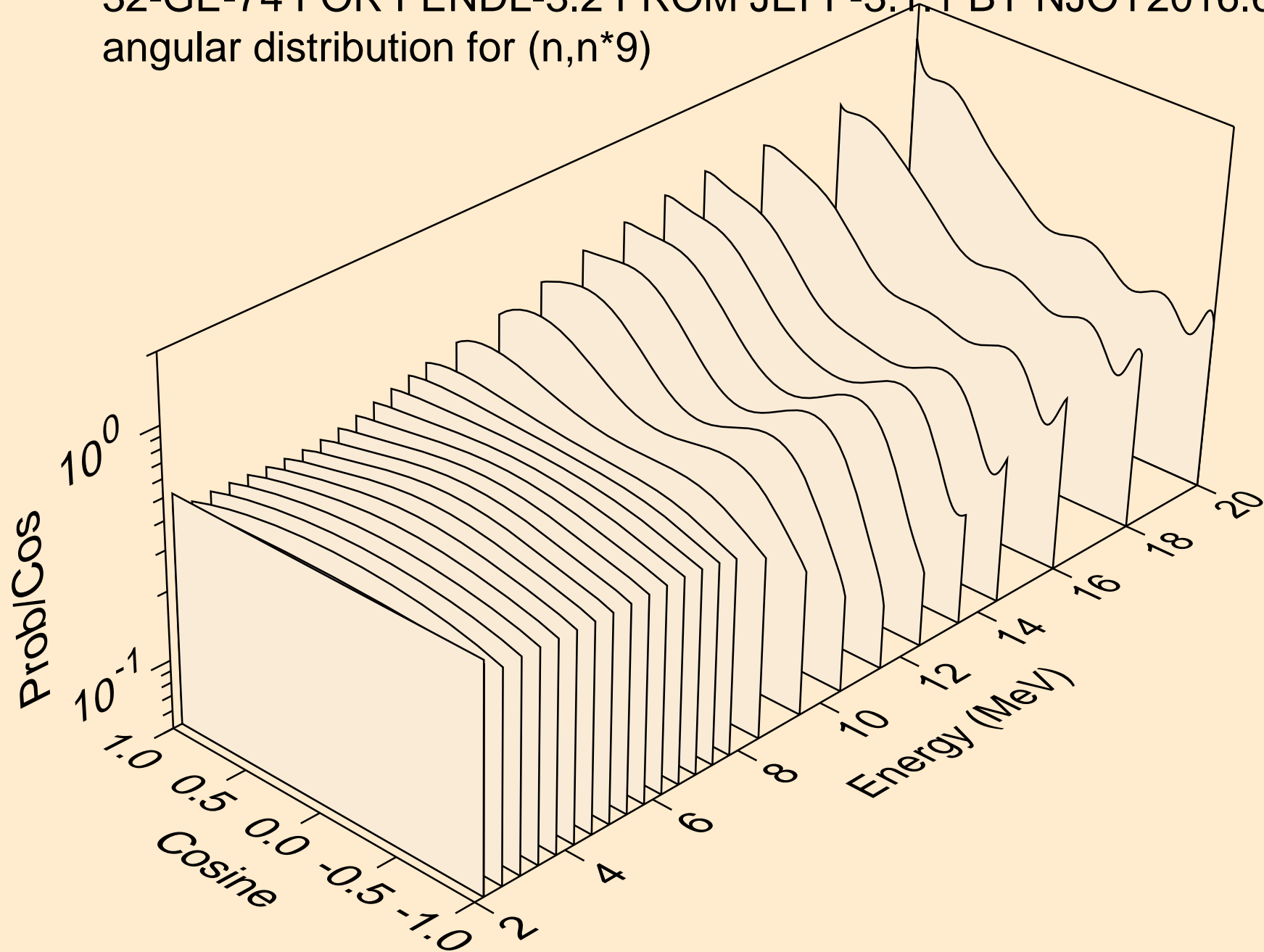

32-GE-74 FOR FENDL-3.2 FROM JEFF-3.1.1 BY NJOY2016.60+ O
angular distribution for (n,n*10)

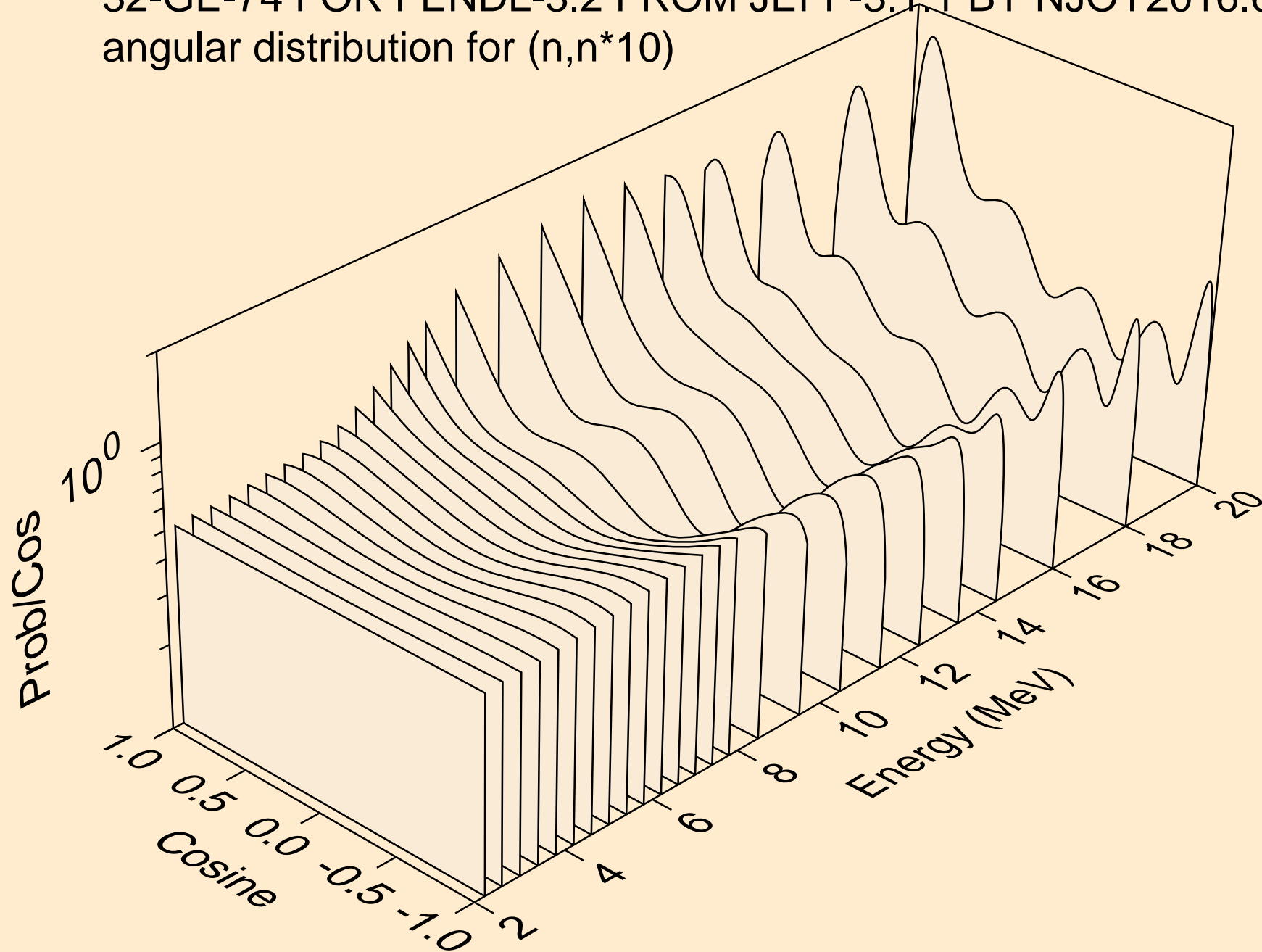

32-GE-74 FOR FENDL-3.2 FROM JEFF-3.1.1 BY NJOY2016.60+ O
angular distribution for (n,n*11)

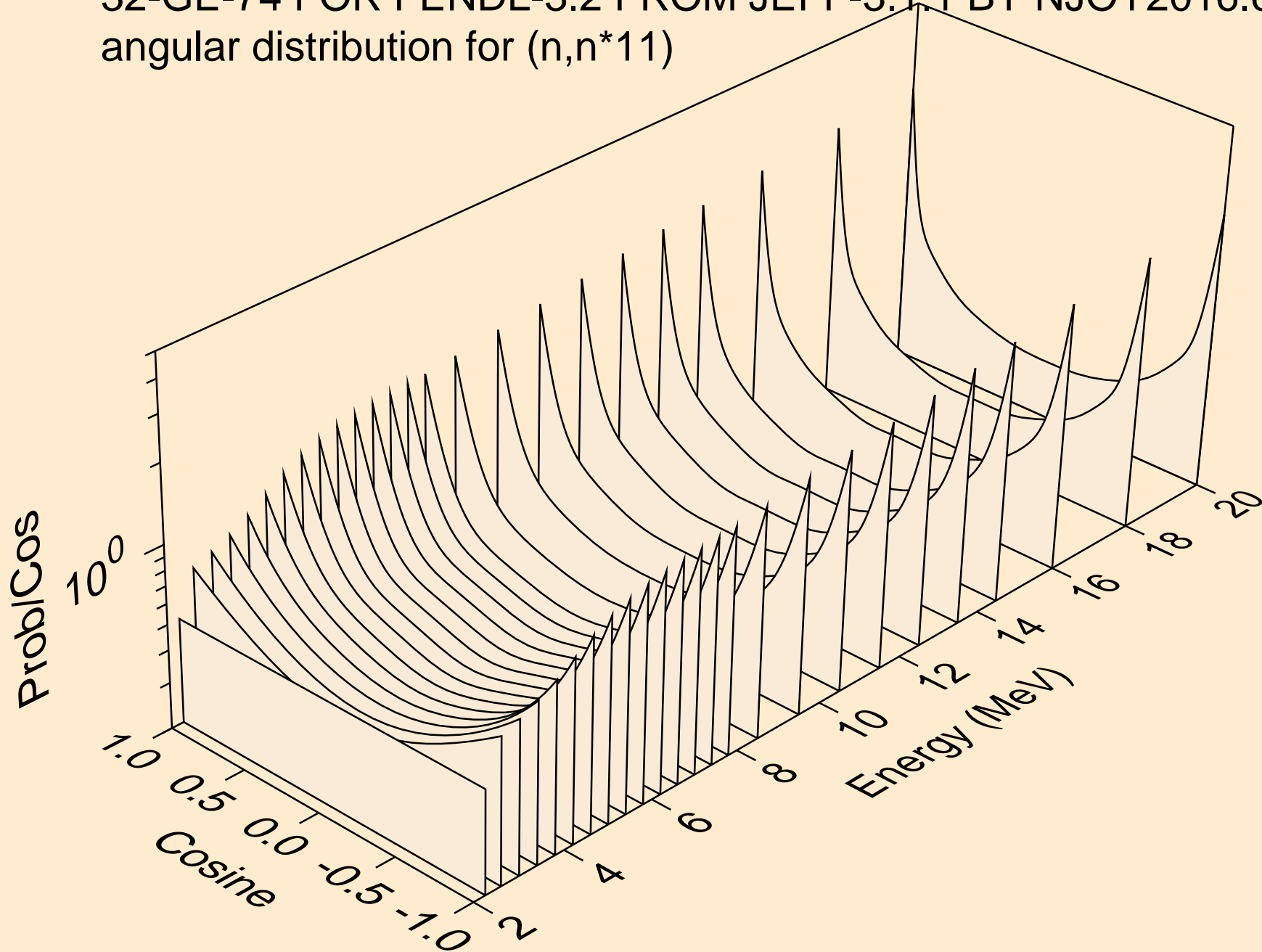

32-GE-74 FOR FENDL-3.2 FROM JEFF-3.1.1 BY NJOY2016.60+ O
angular distribution for (n,n*12)

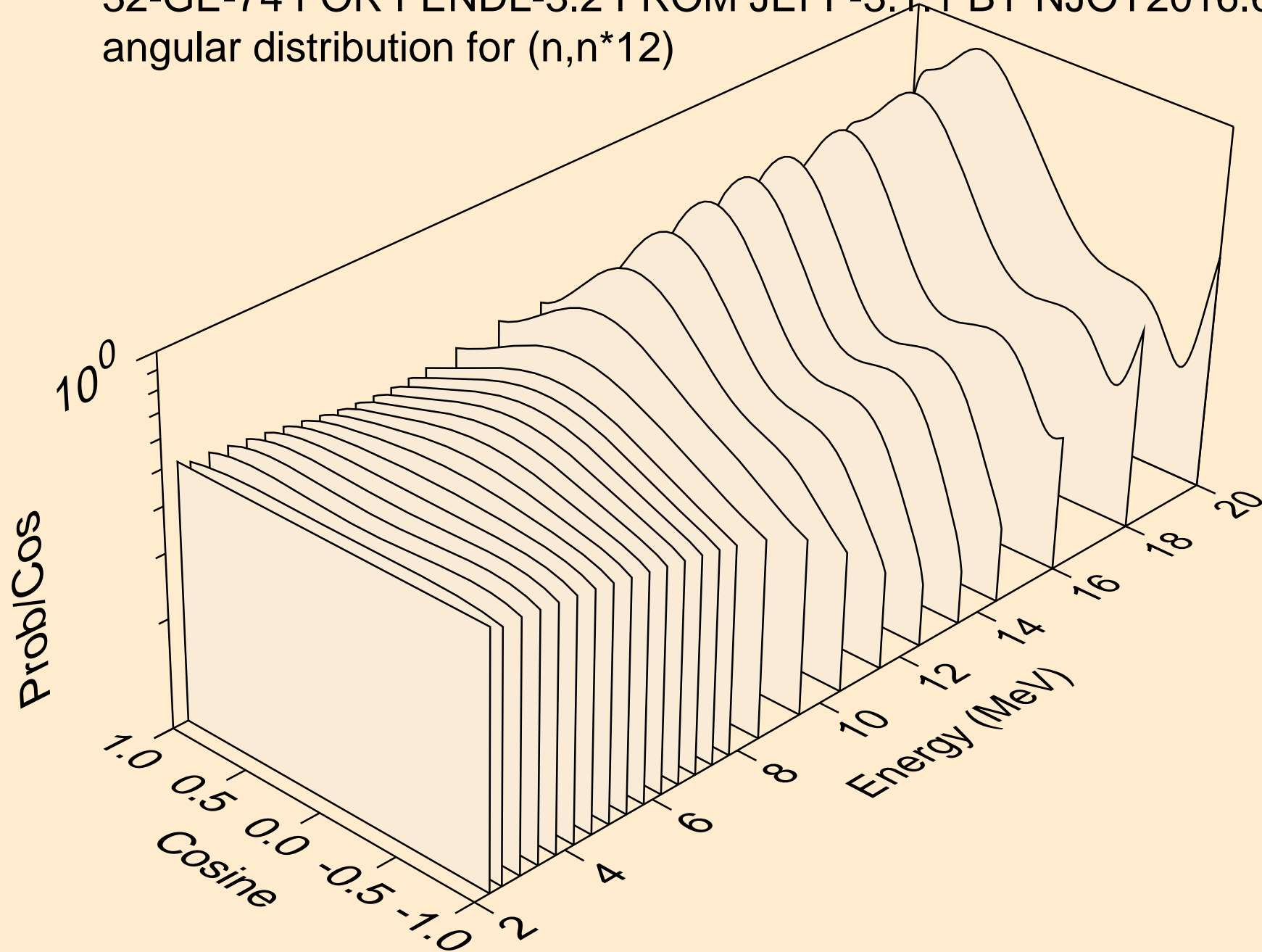

32-GE-74 FOR FENDL-3.2 FROM JEFF-3.1.1 BY NJOY2016.60+ O
angular distribution for (n,n*13)

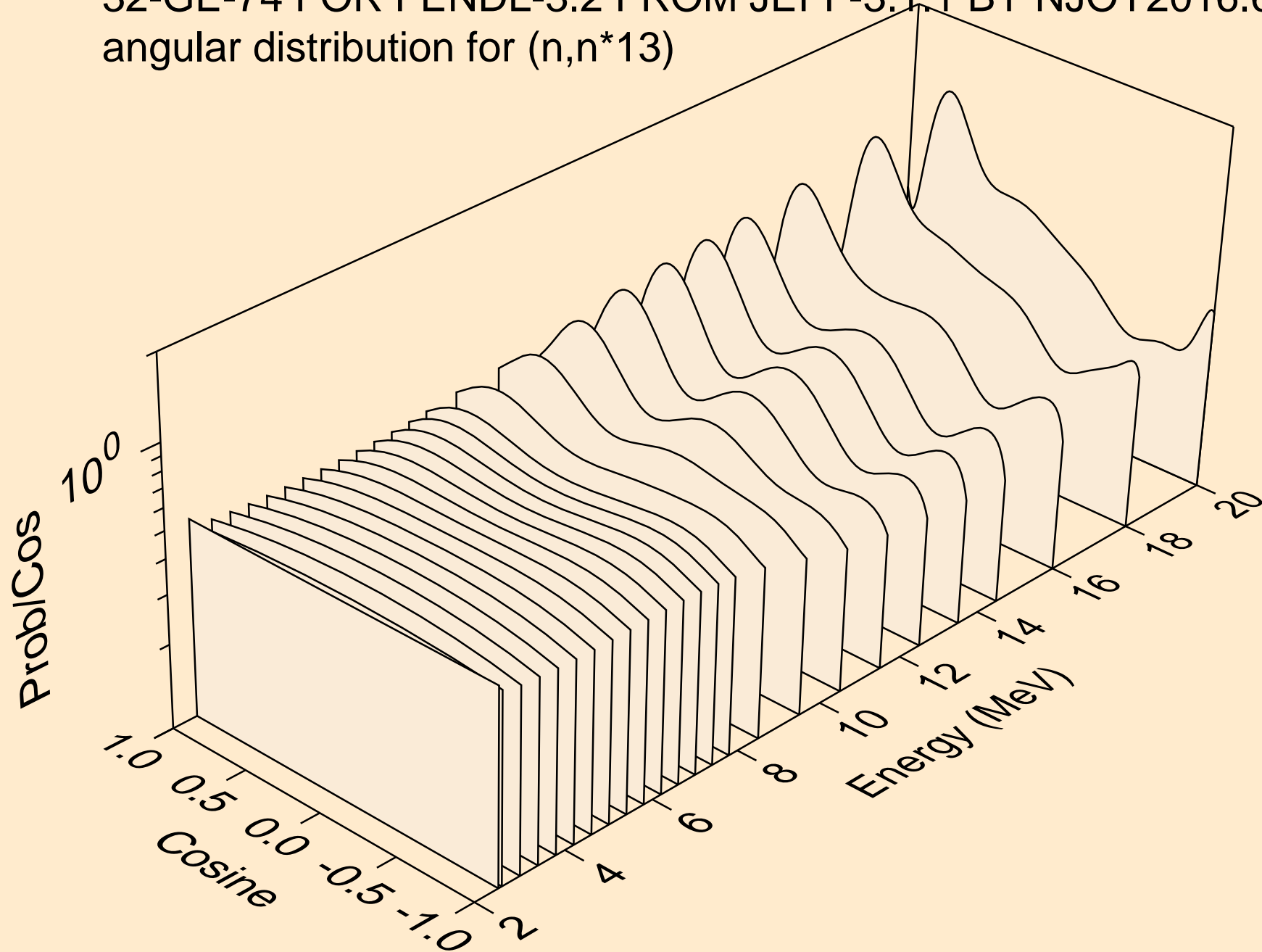

32-GE-74 FOR FENDL-3.2 FROM JEFF-3.1.1 BY NJOY2016.60+ O
angular distribution for (n,n*14)

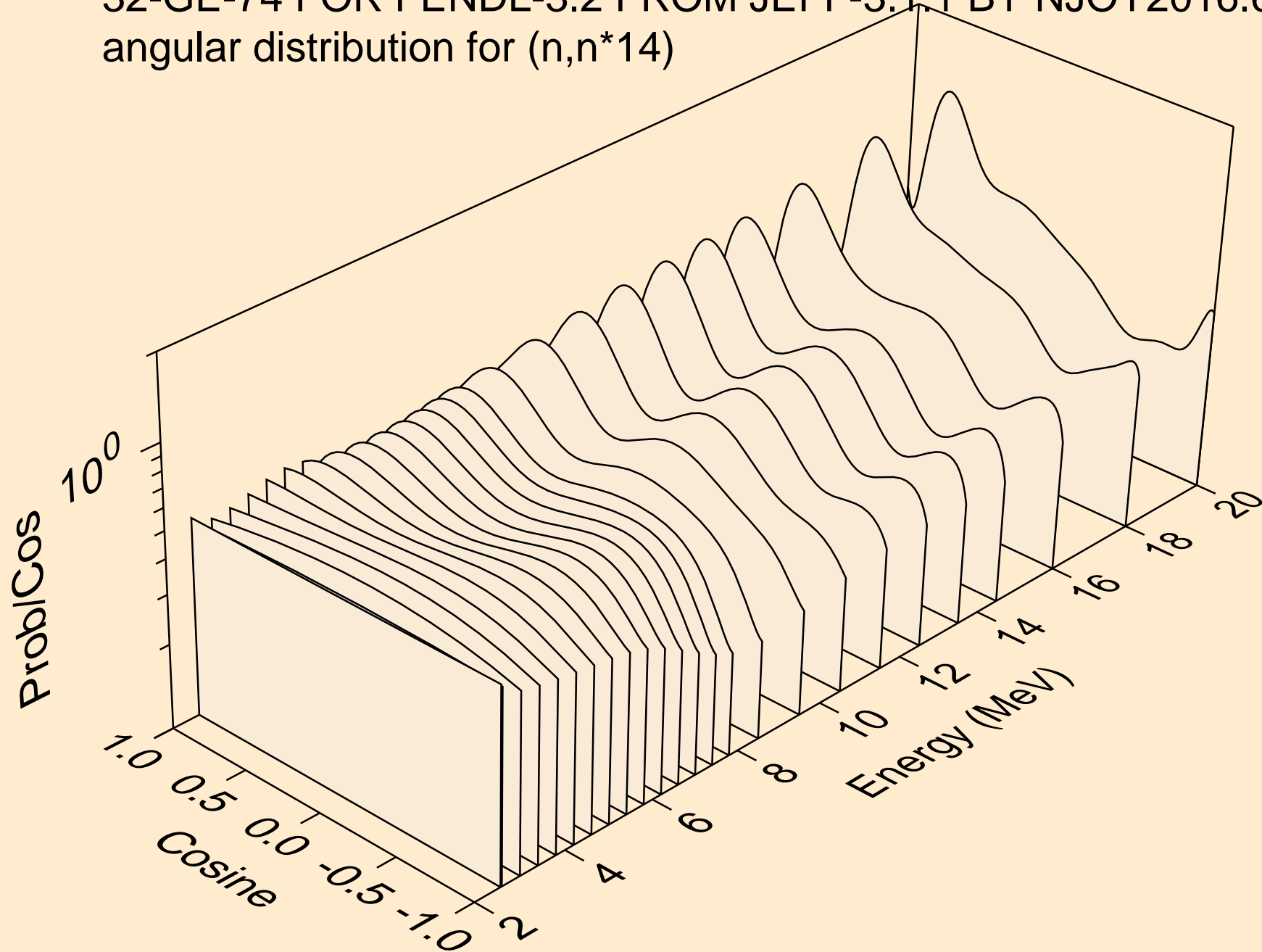

32-GE-74 FOR FENDL-3.2 FROM JEFF-3.1.1 BY NJOY2016.60+ O
angular distribution for (n,n*15)

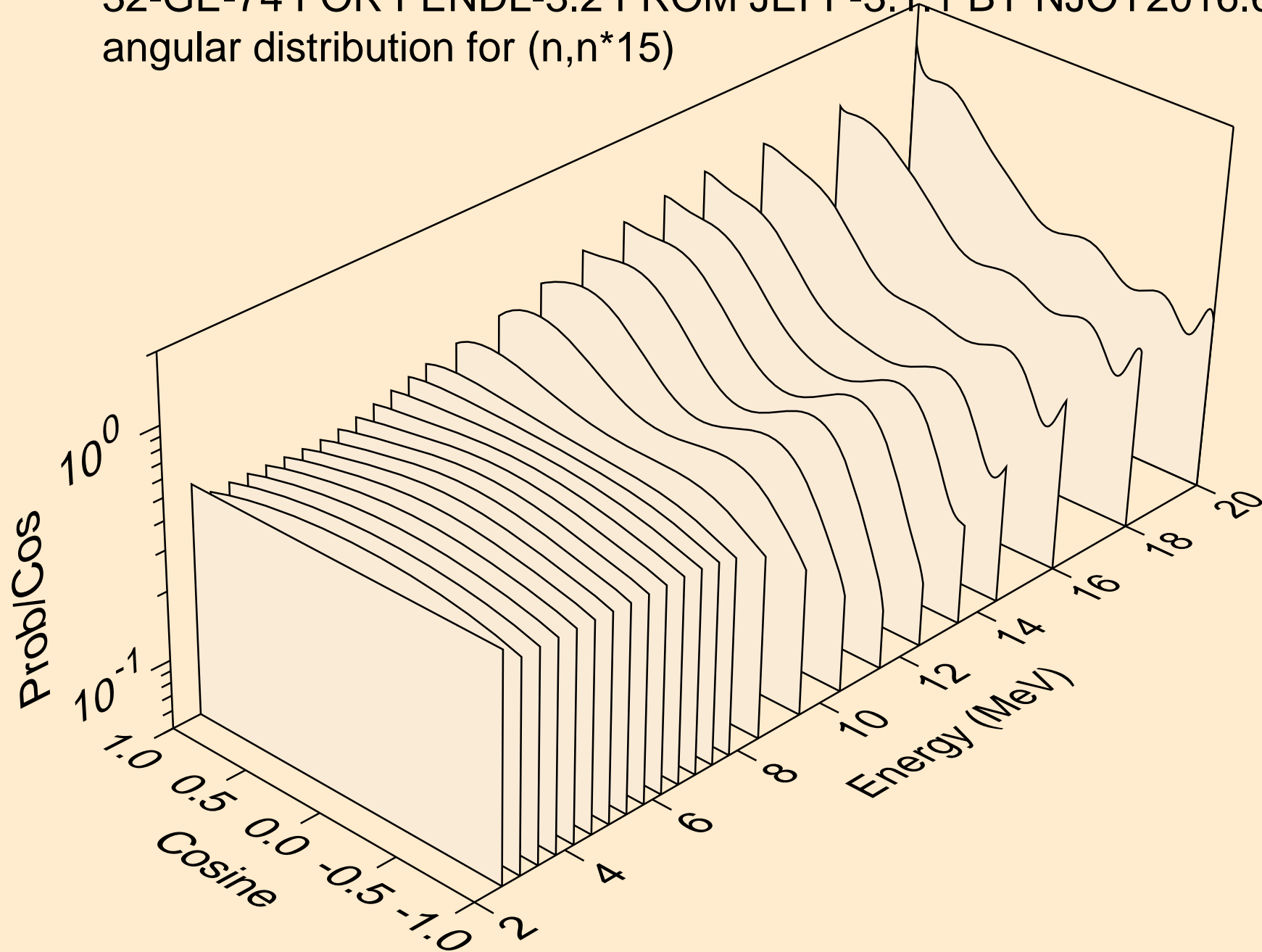

32-GE-74 FOR FENDL-3.2 FROM JEFF-3.1.1 BY NJOY2016.60+ O
angular distribution for (n,n*16)

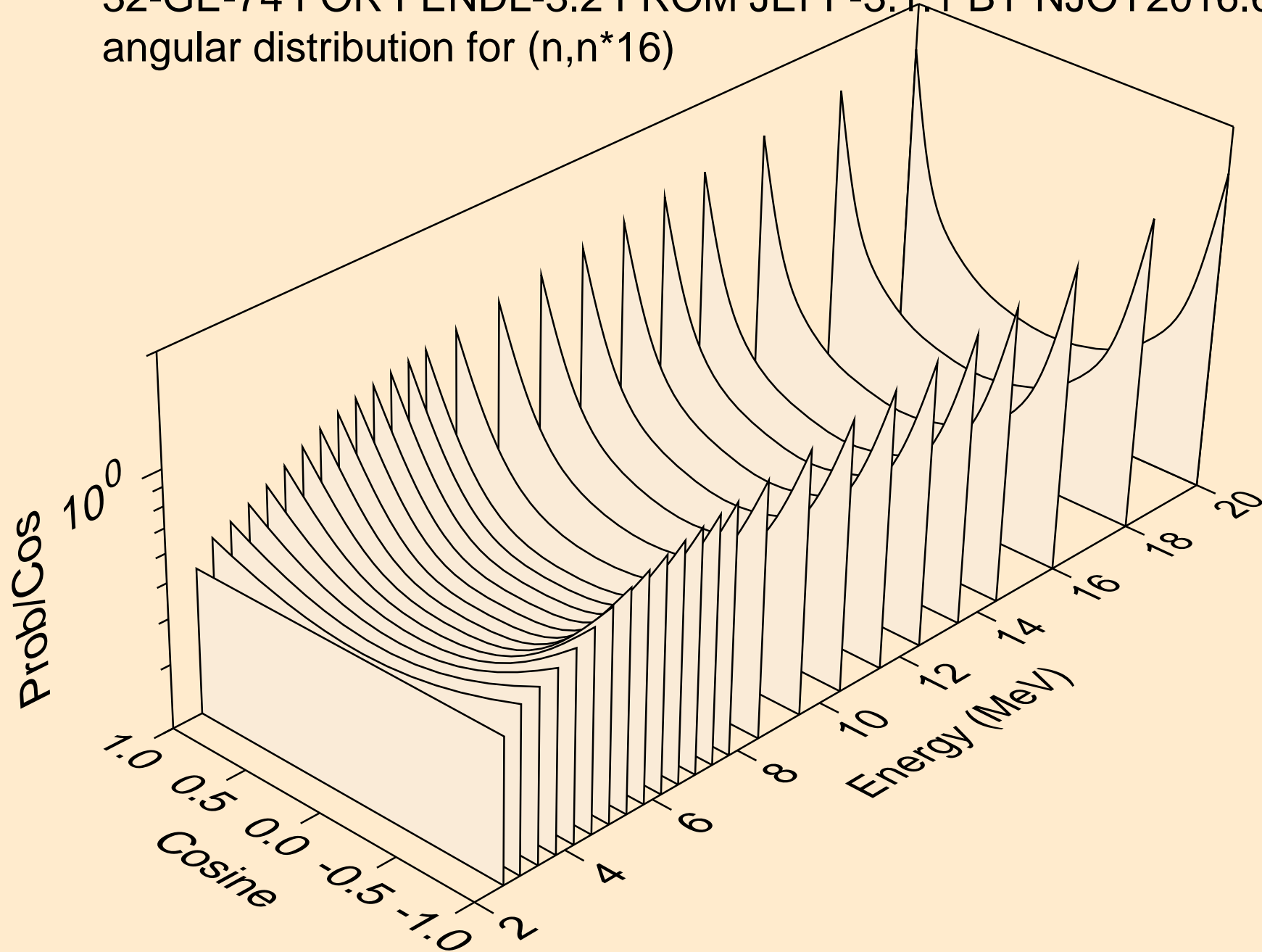

32-GE-74 FOR FENDL-3.2 FROM JEFF-3.1.1 BY NJOY2016.60+ O
angular distribution for (n,n*17)

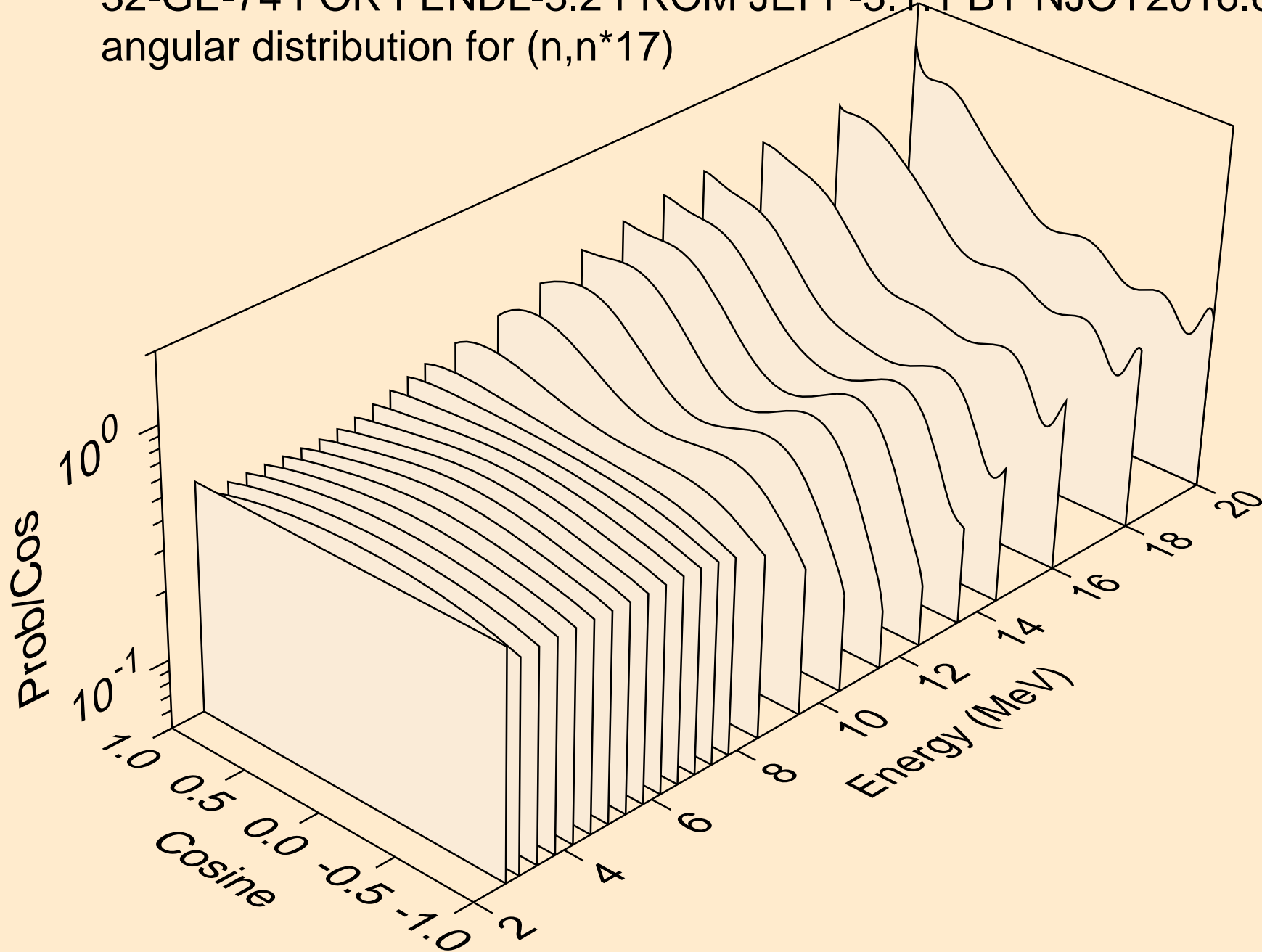

32-GE-74 FOR FENDL-3.2 FROM JEFF-3.1.1 BY NJOY2016.60+ O
angular distribution for (n,n*18)

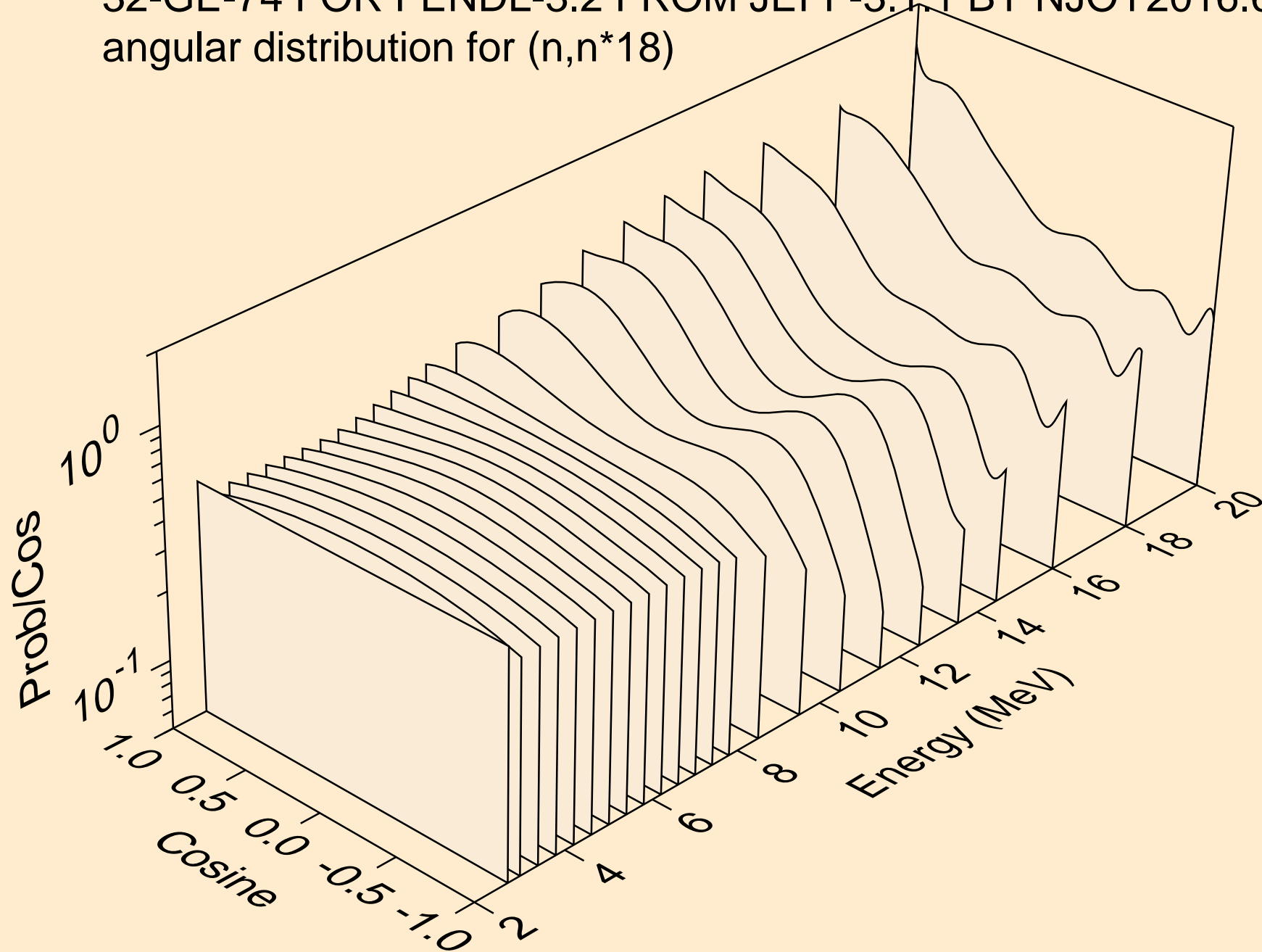

32-GE-74 FOR FENDL-3.2 FROM JEFF-3.1.1 BY NJOY2016.60+ O
angular distribution for (n,n*19)

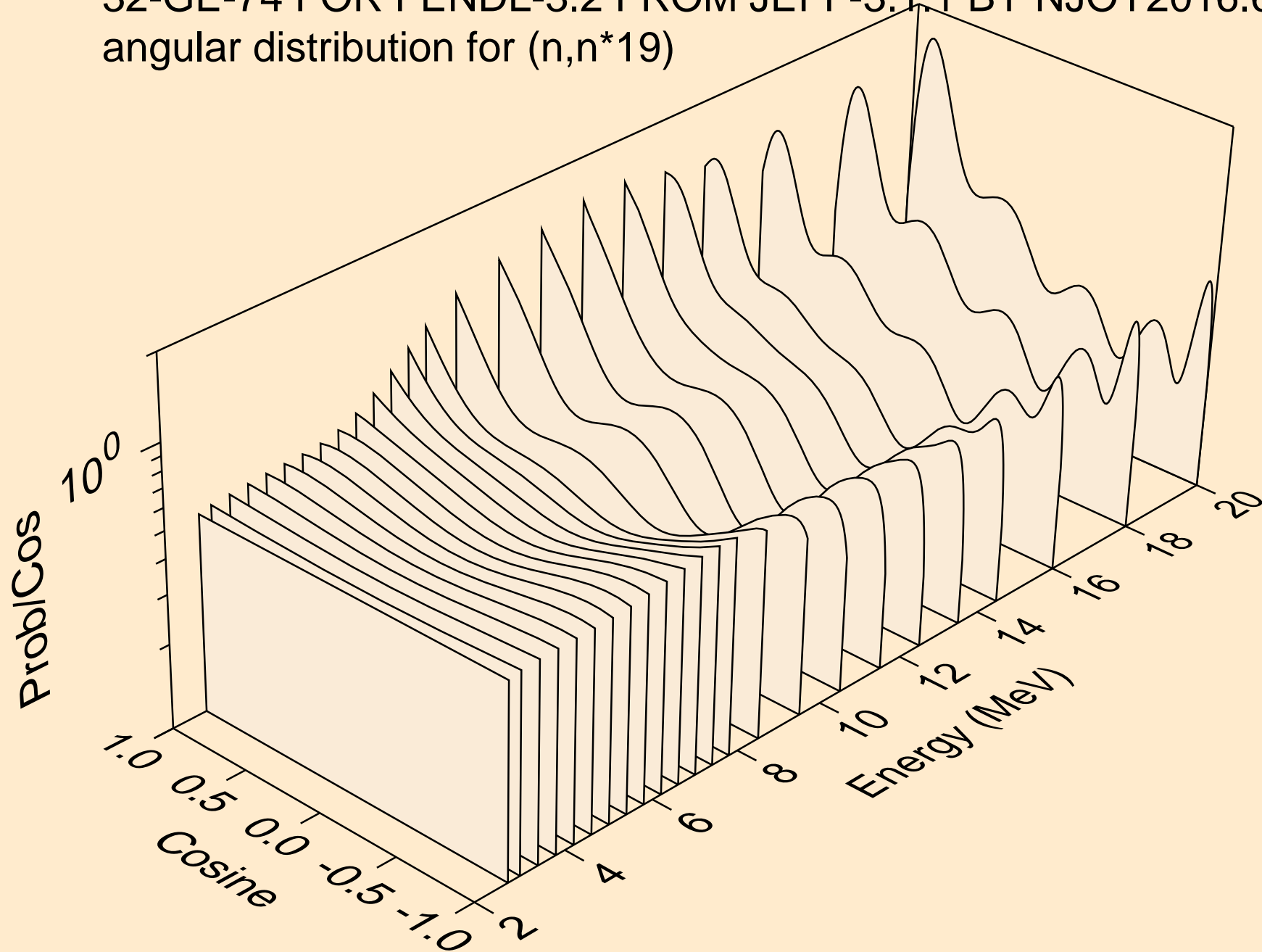

32-GE-74 FOR FENDL-3.2 FROM JEFF-3.1.1 BY NJOY2016.60+ O
angular distribution for (n,n*20)

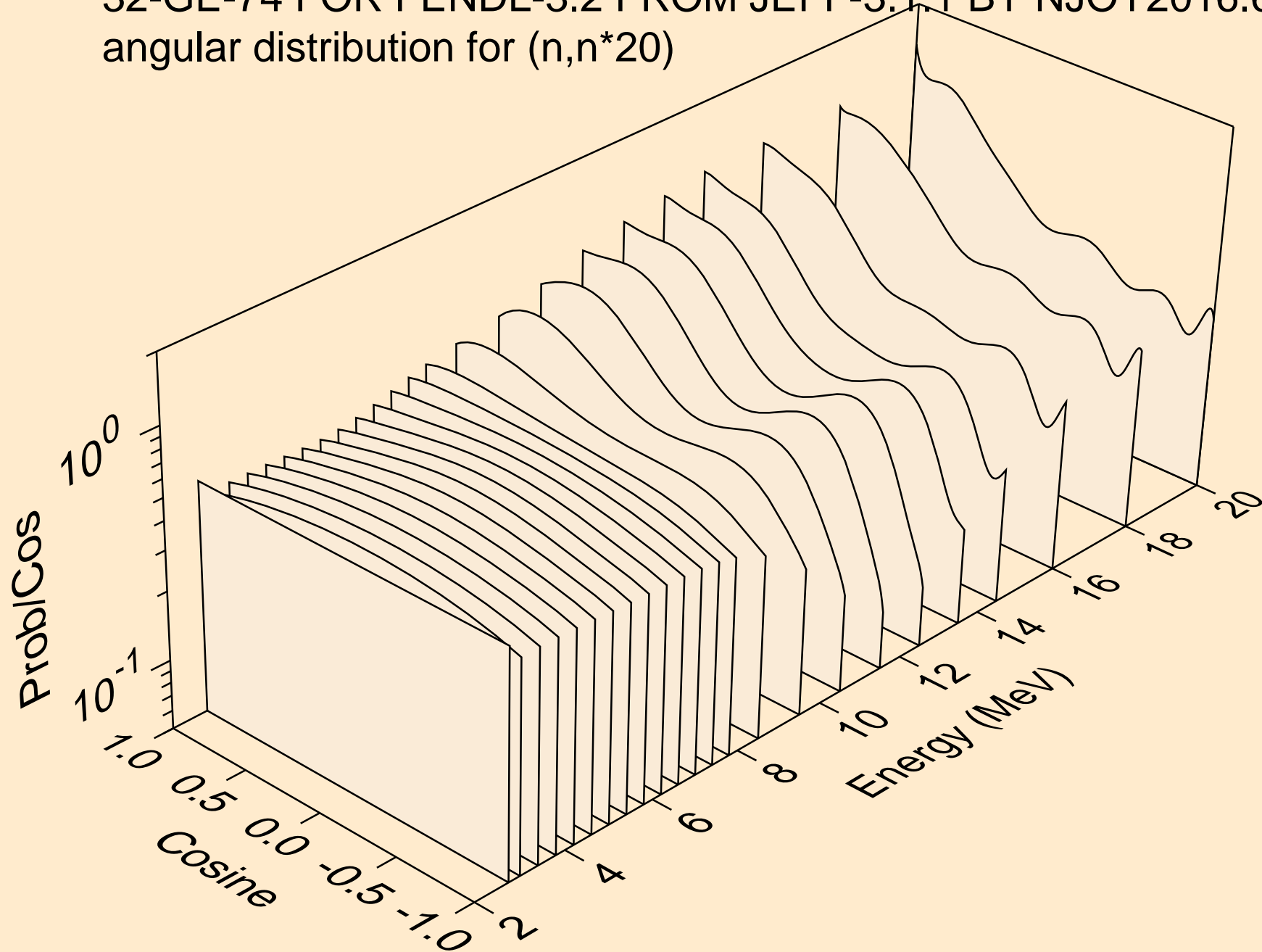

32-GE-74 FOR FENDL-3.2 FROM JEFF-3.1.1 BY NJOY2016.60+ O
Neutron emission for (n,x)

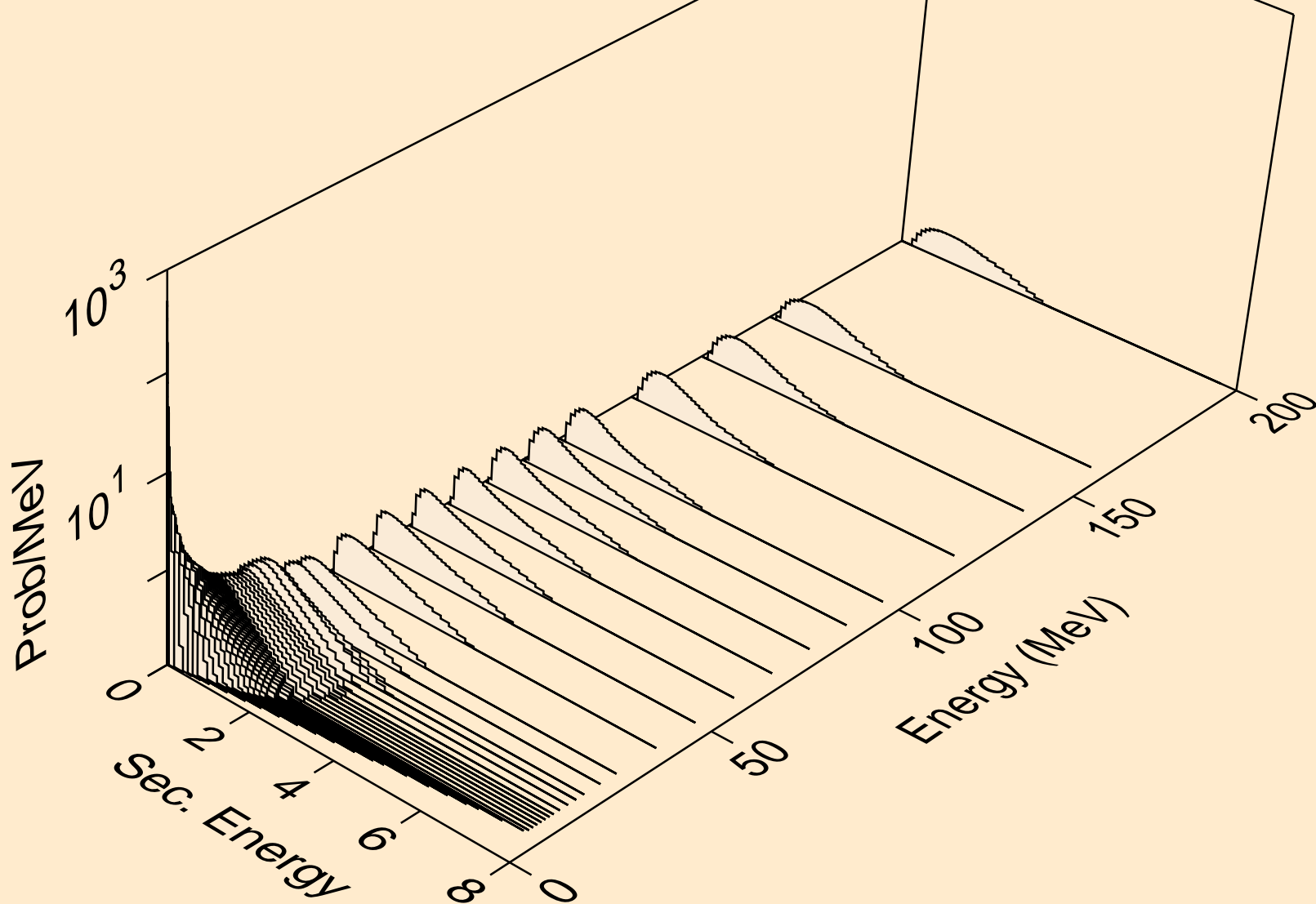

32-GE-74 FOR FENDL-3.2 FROM JEFF-3.1.1 BY NJOY2016.60+ O
Neutron emission for (n,2n)

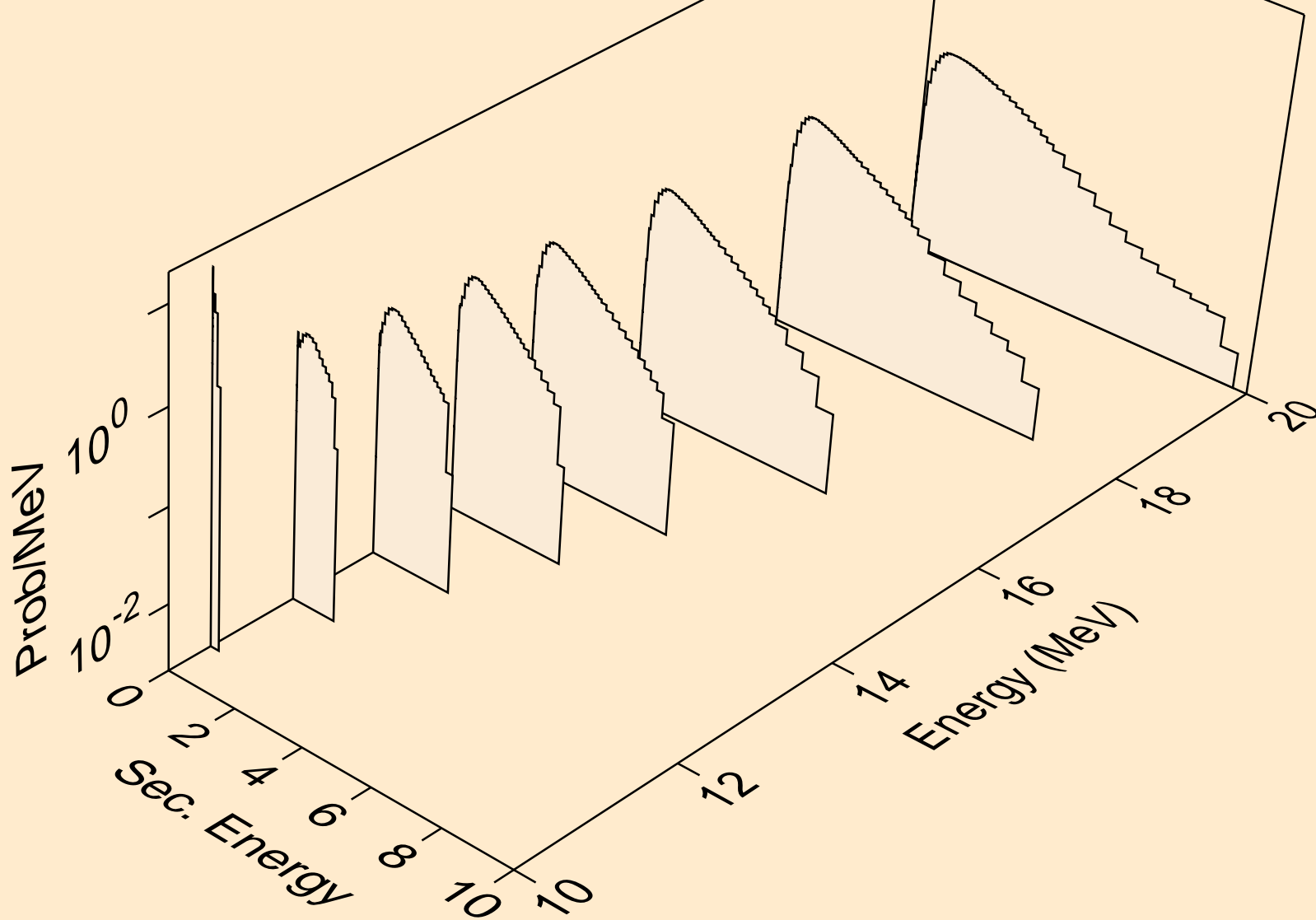

32-GE-74 FOR FENDL-3.2 FROM JEFF-3.1.1 BY NJOY2016.60+ O
Neutron emission for (n,3n)

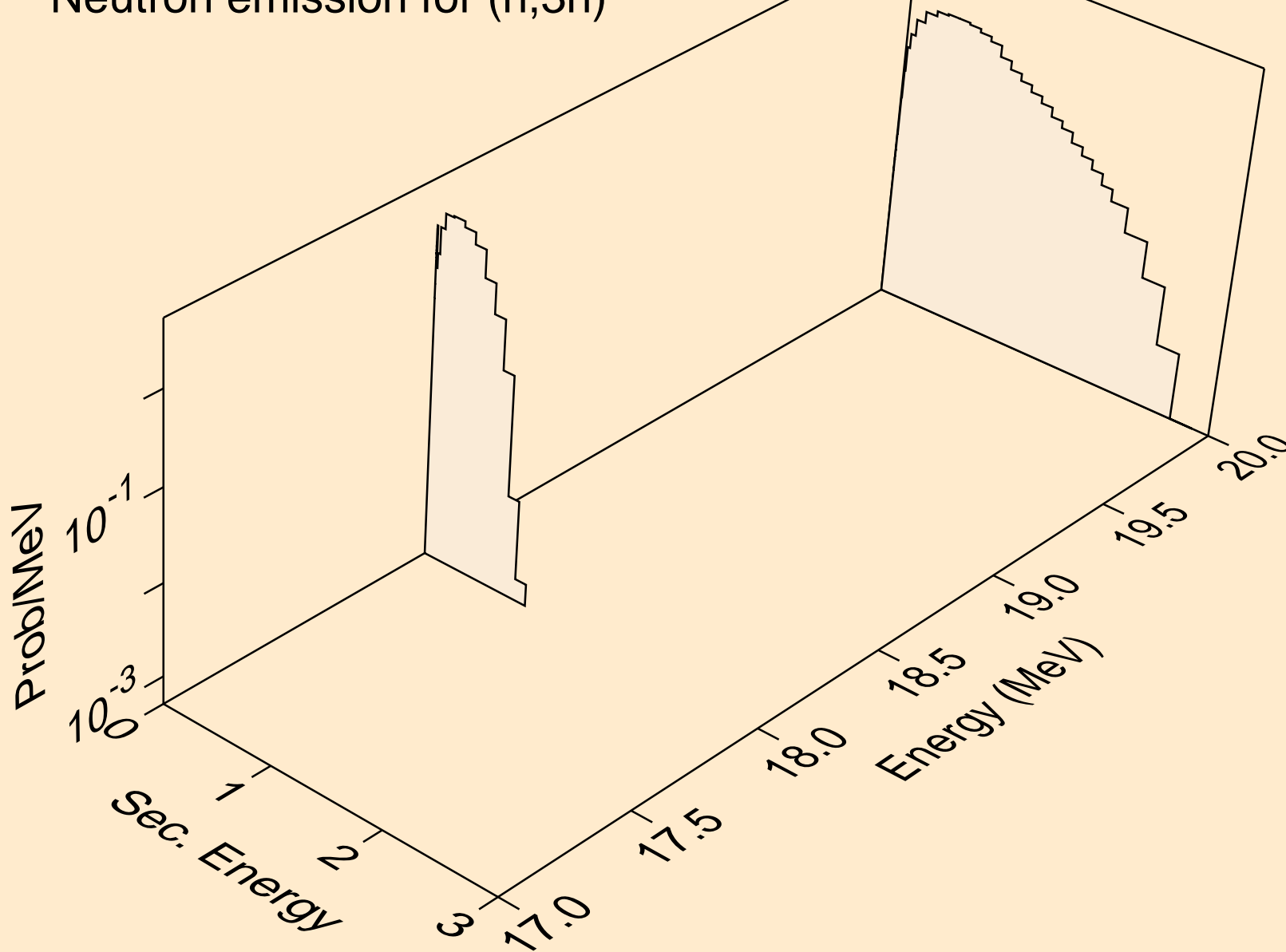

32-GE-74 FOR FENDL-3.2 FROM JEFF-3.1.1 BY NJOY2016.60+ O
Neutron emission for (n,n*)a

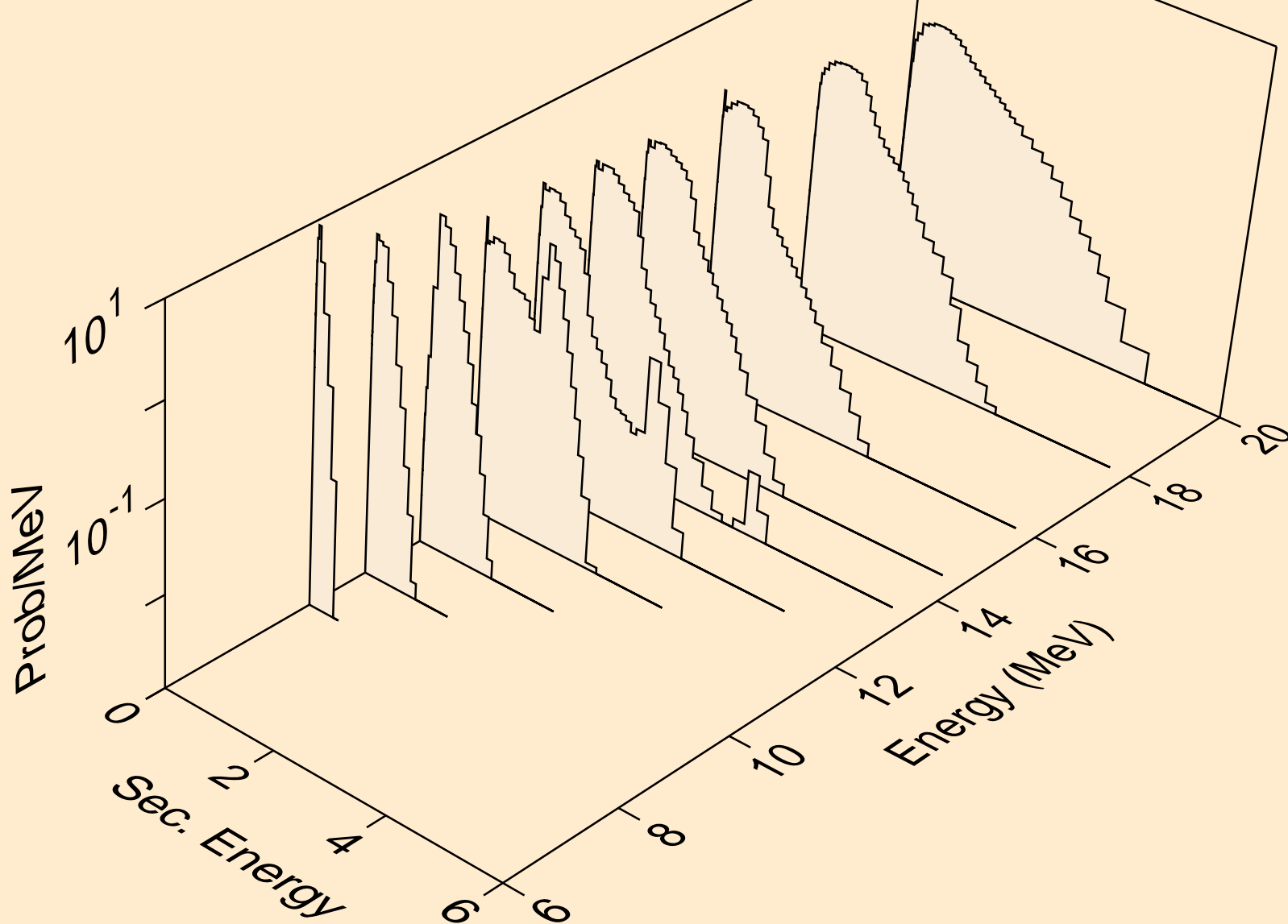

32-GE-74 FOR FENDL-3.2 FROM JEFF-3.1.1 BY NJOY2016.60+ O
Neutron emission for (n,n*)p

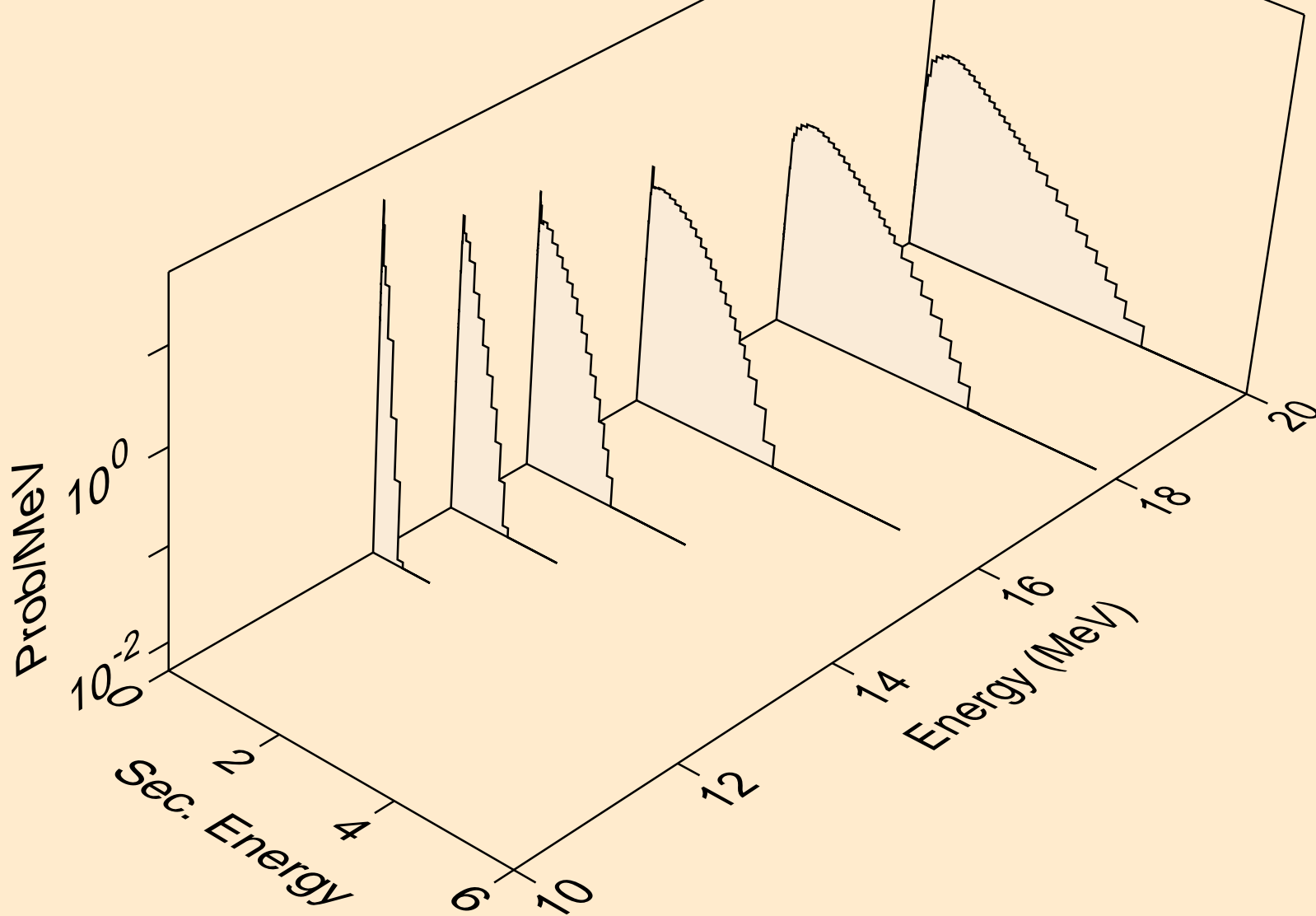

32-GE-74 FOR FENDL-3.2 FROM JEFF-3.1.1 BY NJOY2016.60+ O
Neutron emission for (n,n*)d

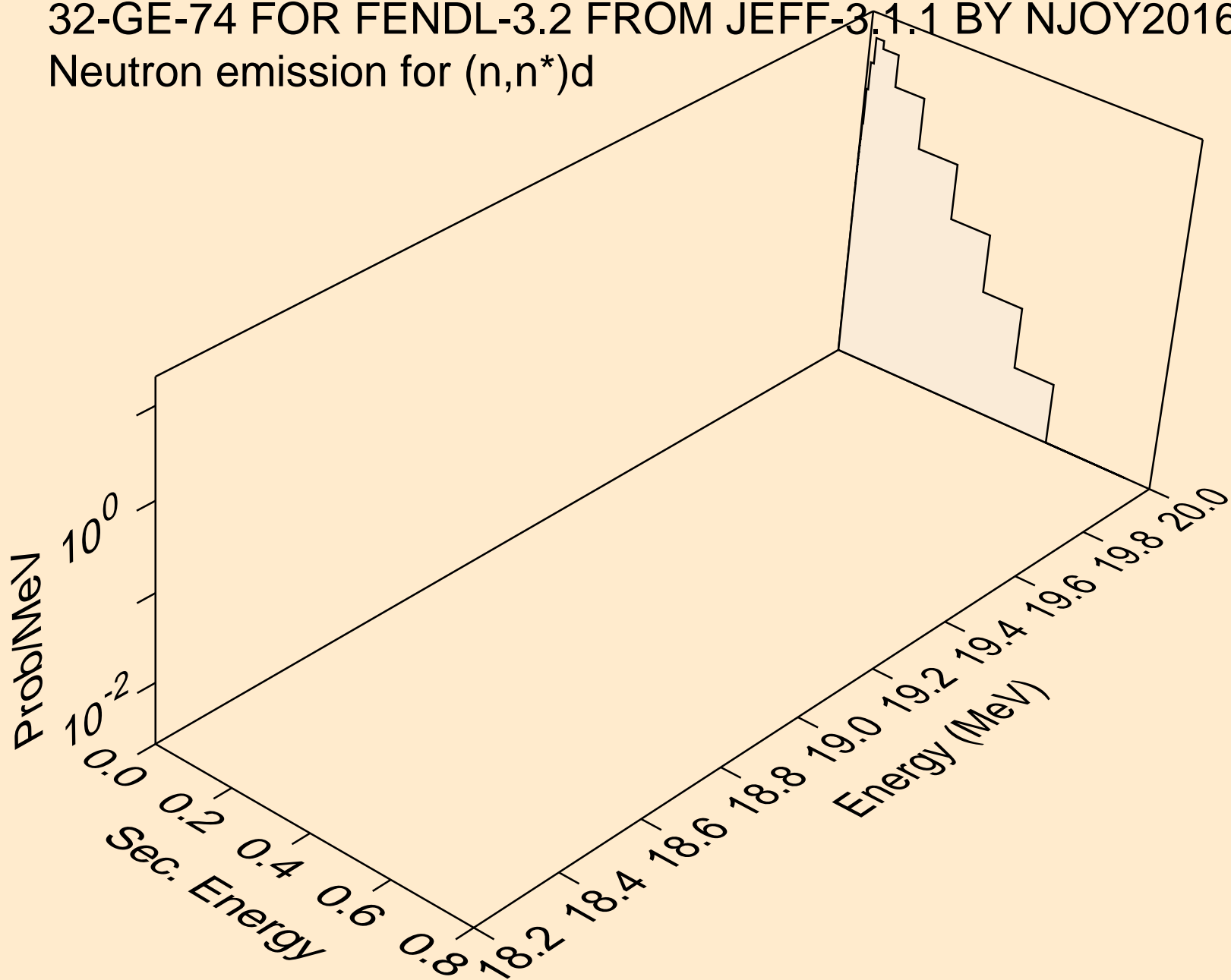

32-GE-74 FOR FENDL-3.2 FROM JEFF-3.1.1 BY NJOY2016.60+ O
Neutron emission for (n,n*c)

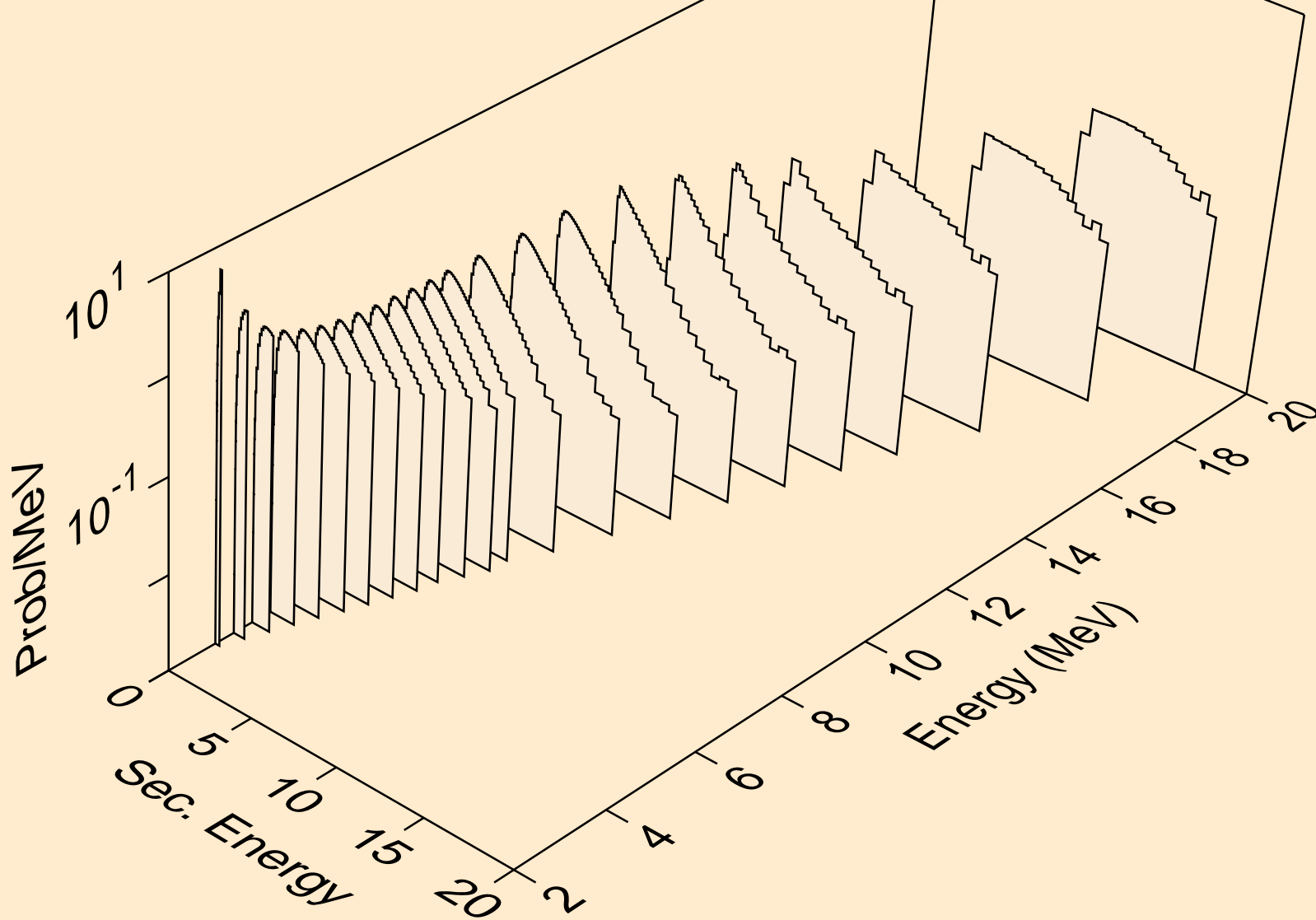

32-GE-74 FOR FENDL-3.2 FROM JEFF-3.1.1 BY NJOY2016.60+ O
Photon emission for (n,x)

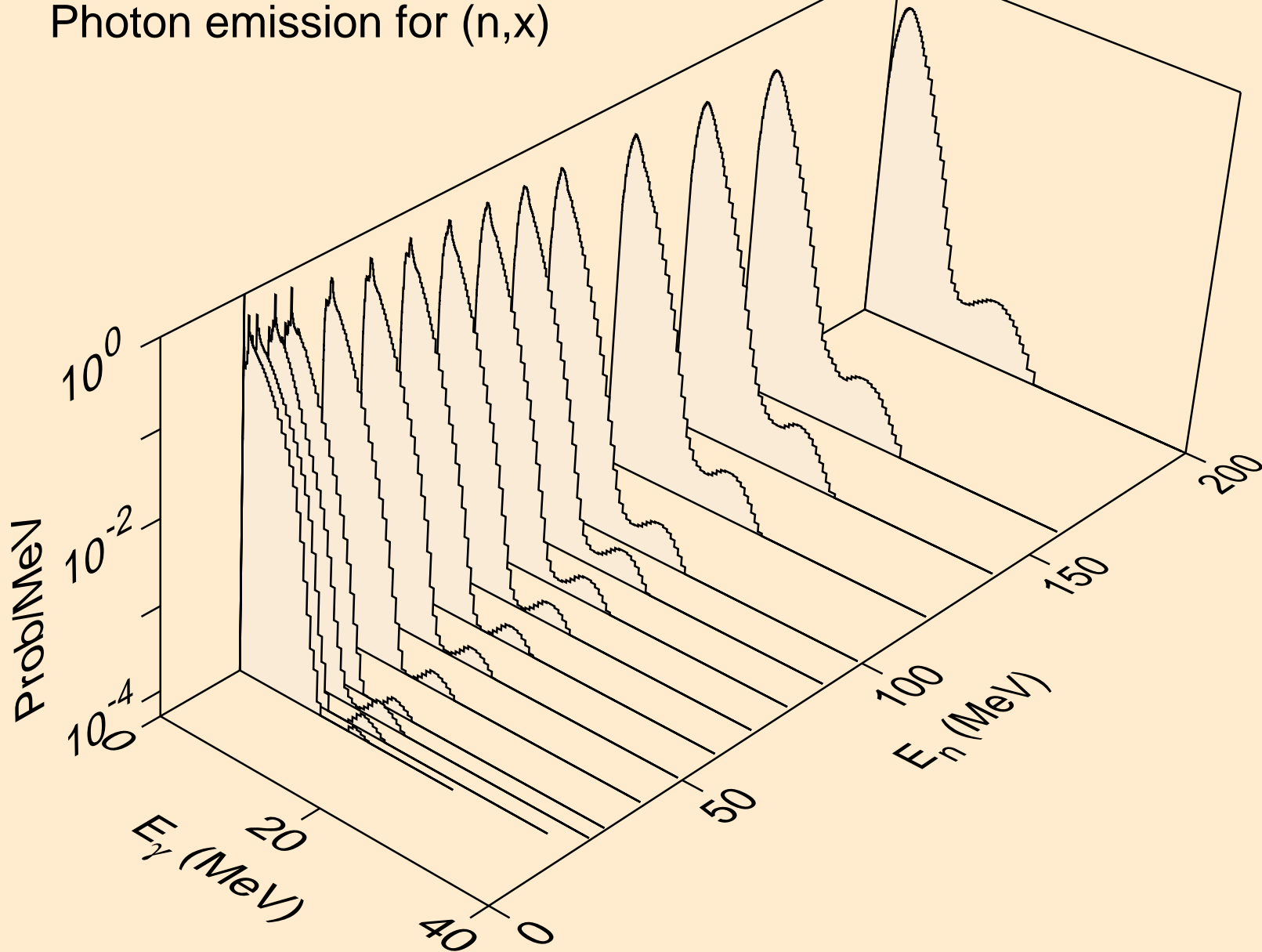

32-GE-74 FOR FENDL-3.2 FROM JEFF-3.1.1 BY NJOY2016.60+ O
Photon emission for (n,2n)

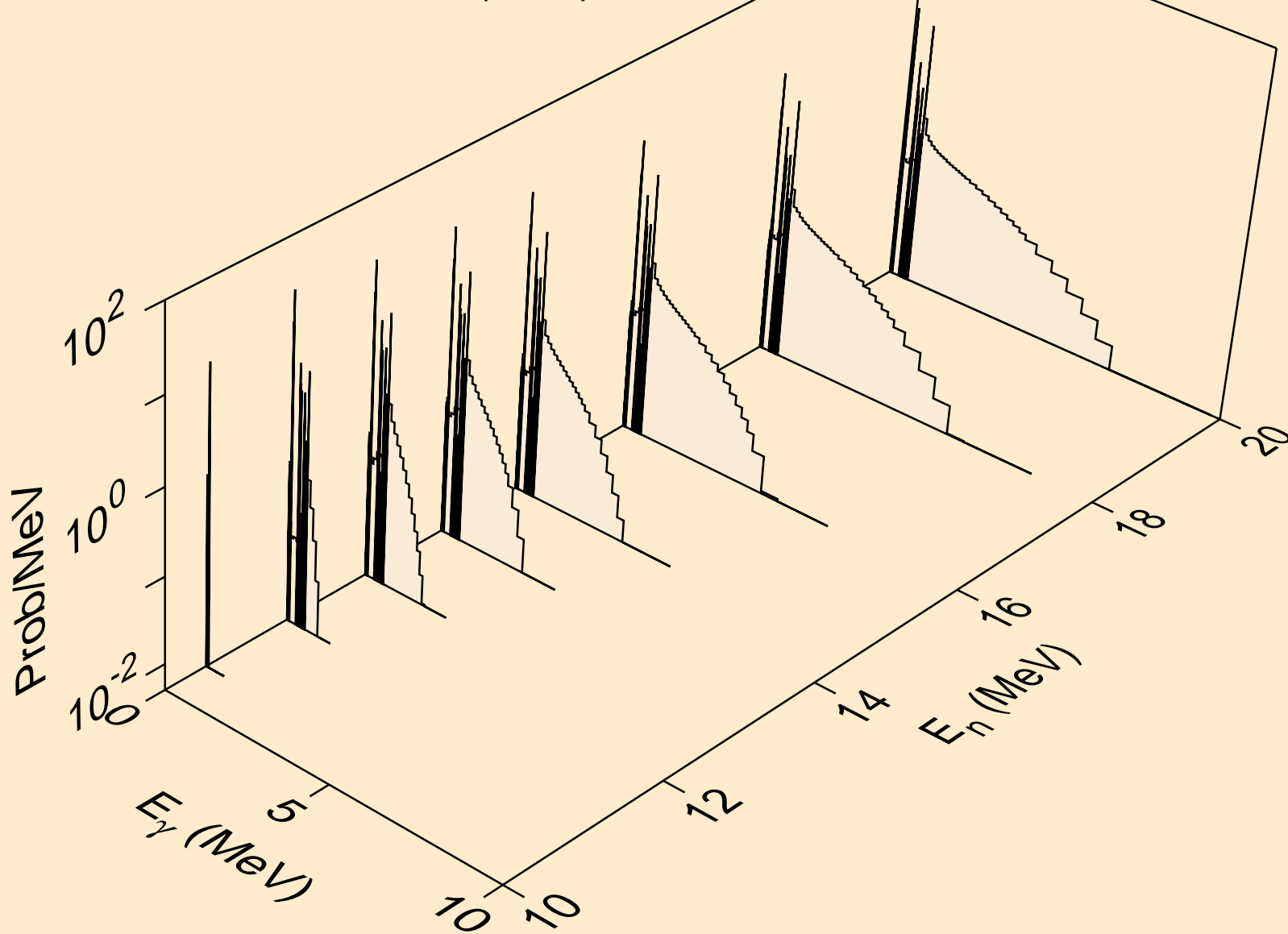

32-GE-74 FOR FENDL-3.2 FROM JEFF-3.1.1 BY NJOY2016.60+ O
Photon emission for (n,3n)

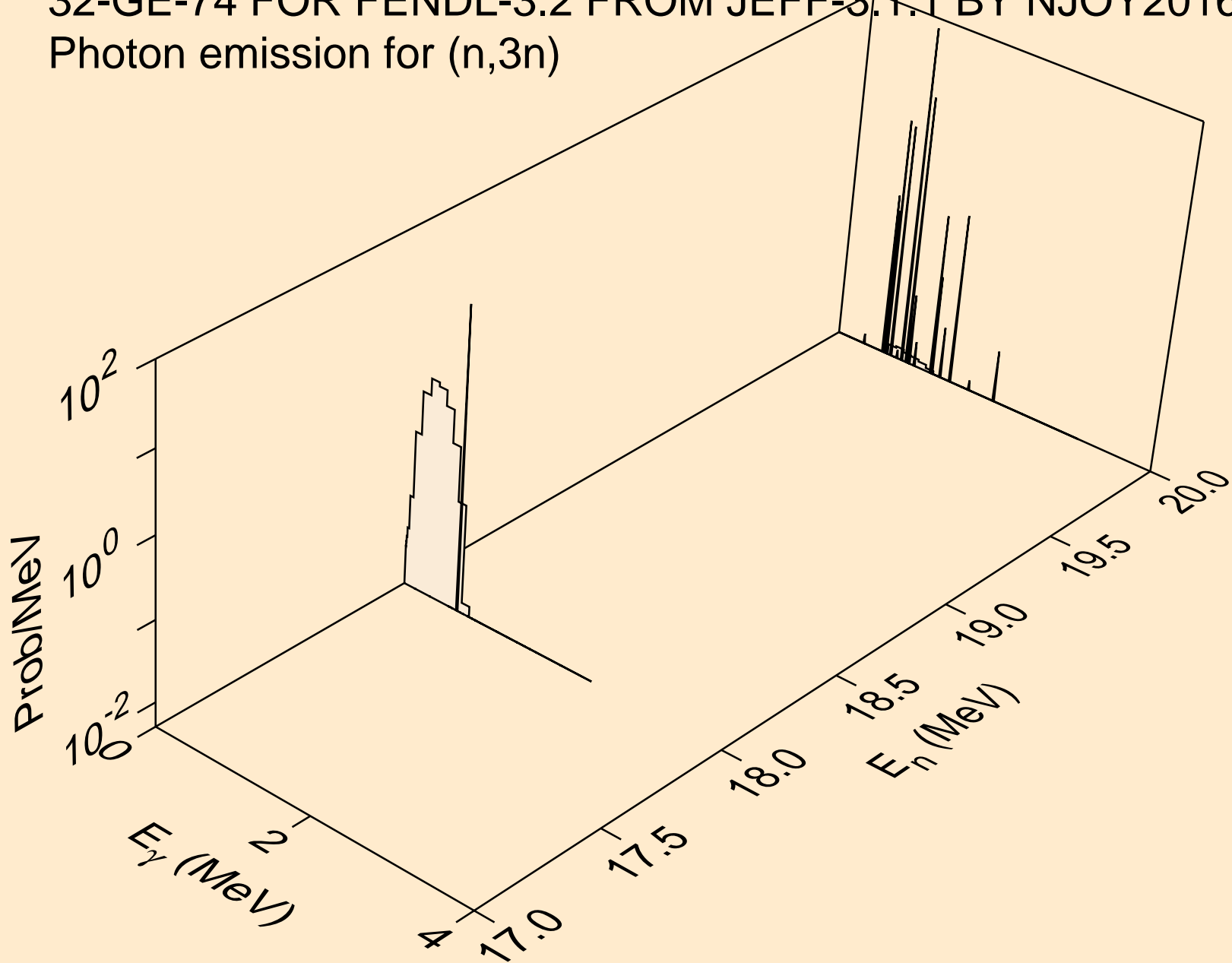

32-GE-74 FOR FENDL-3.2 FROM JEFF-3.1.1 BY NJOY2016.60+ O
Photon emission for (n,n*)a

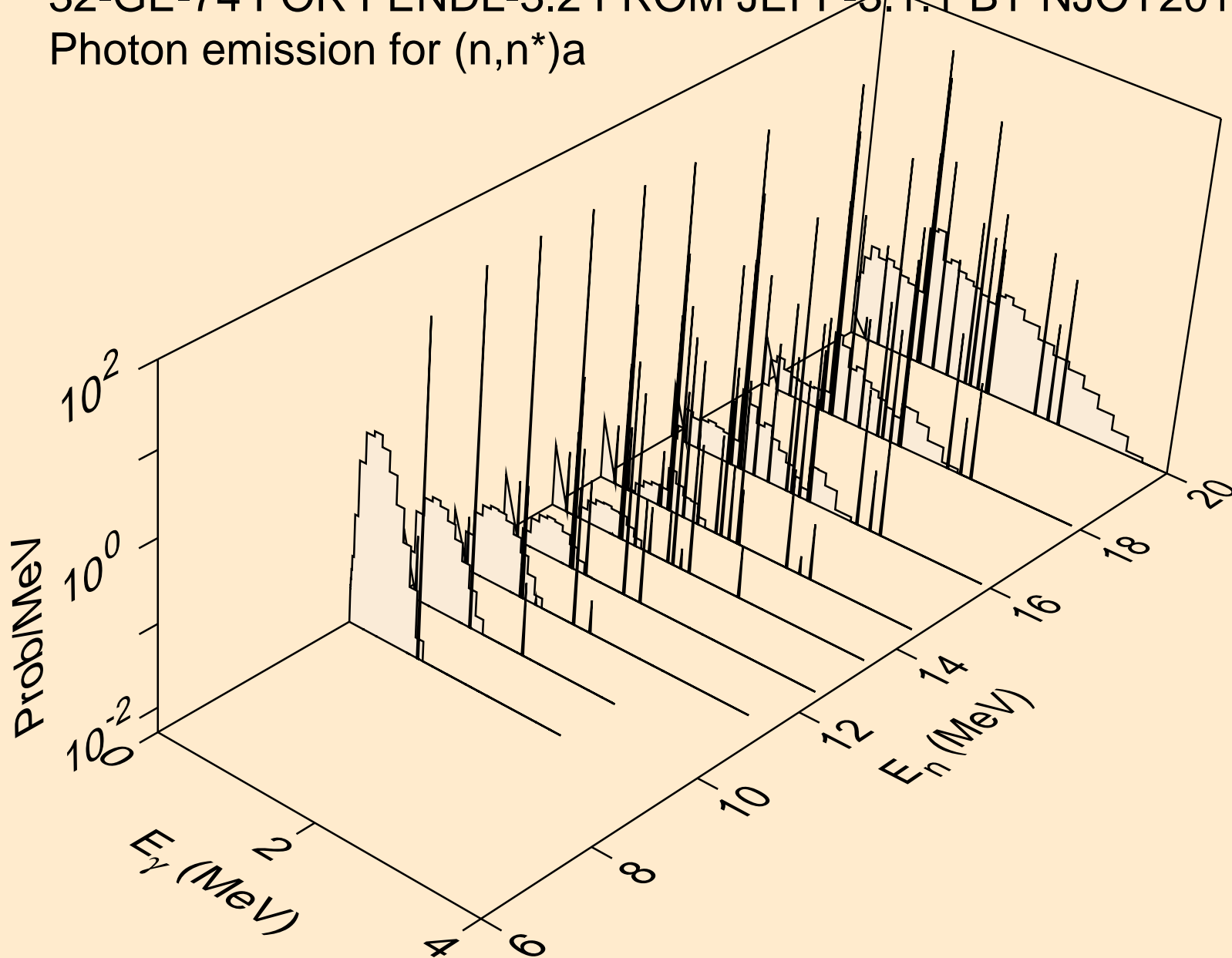

32-GE-74 FOR FENDL-3.2 FROM JEFF-3.1.1 BY NJOY2016.60+ O
Photon emission for (n,n*)p

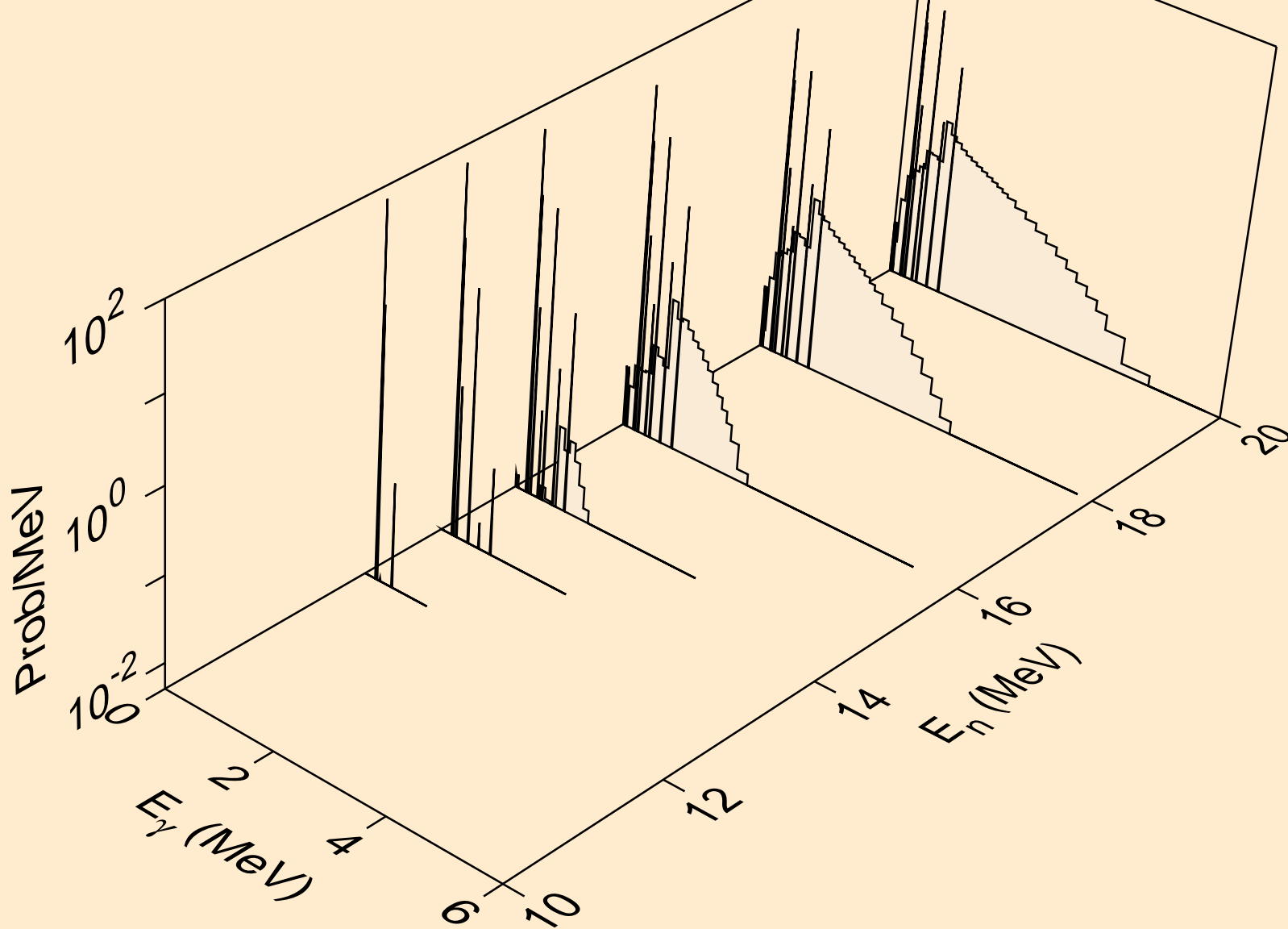

32-GE-74 FOR FENDL-3.2 FROM JEFF-3.1.1 BY NJOY2016.60+ O
Photon emission for (n,n*)d

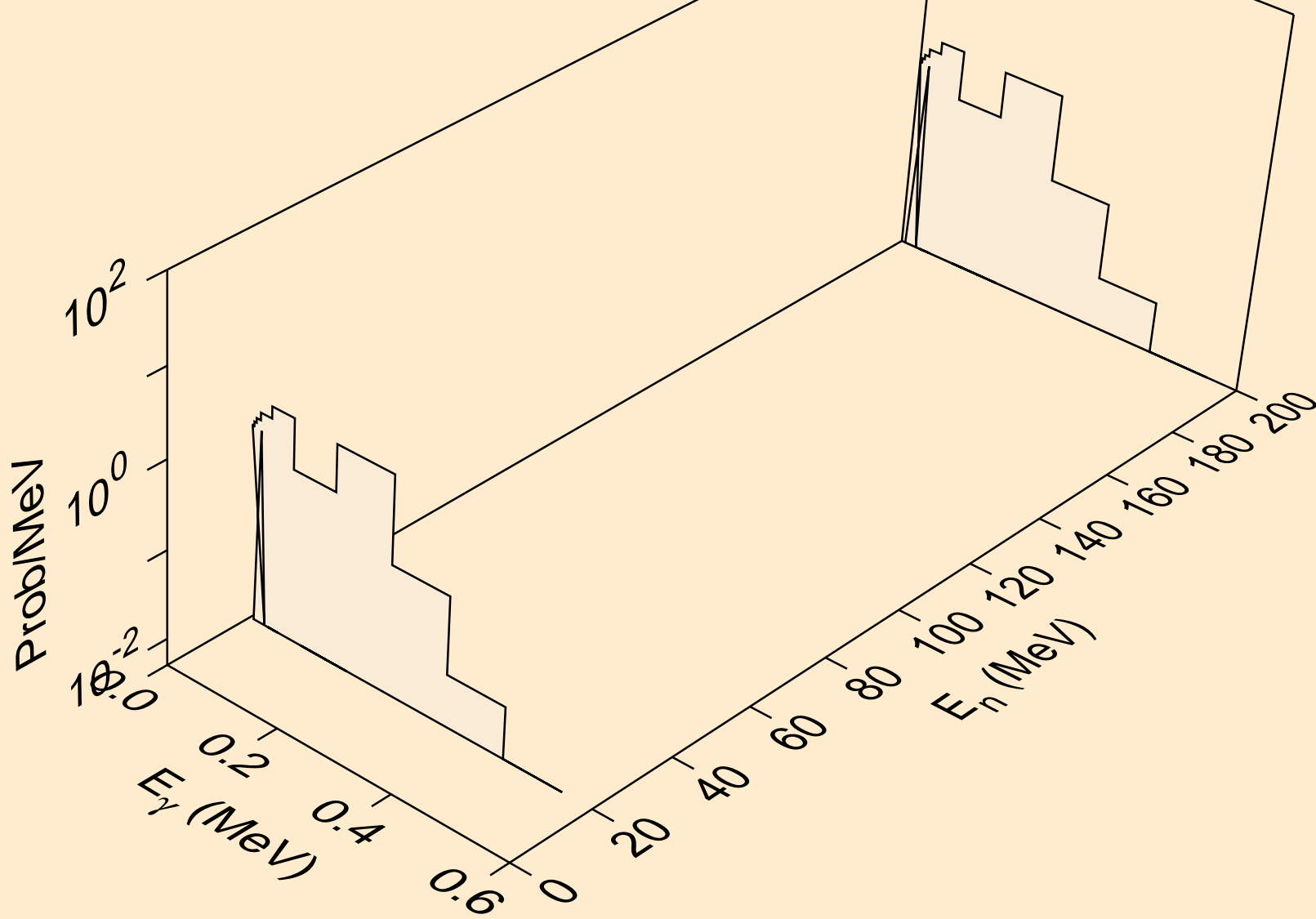

32-GE-74 FOR FENDL-3.2 FROM JEFF-3.1.1 BY NJOY2016.60+ O
Photon emission for (n,n*1)

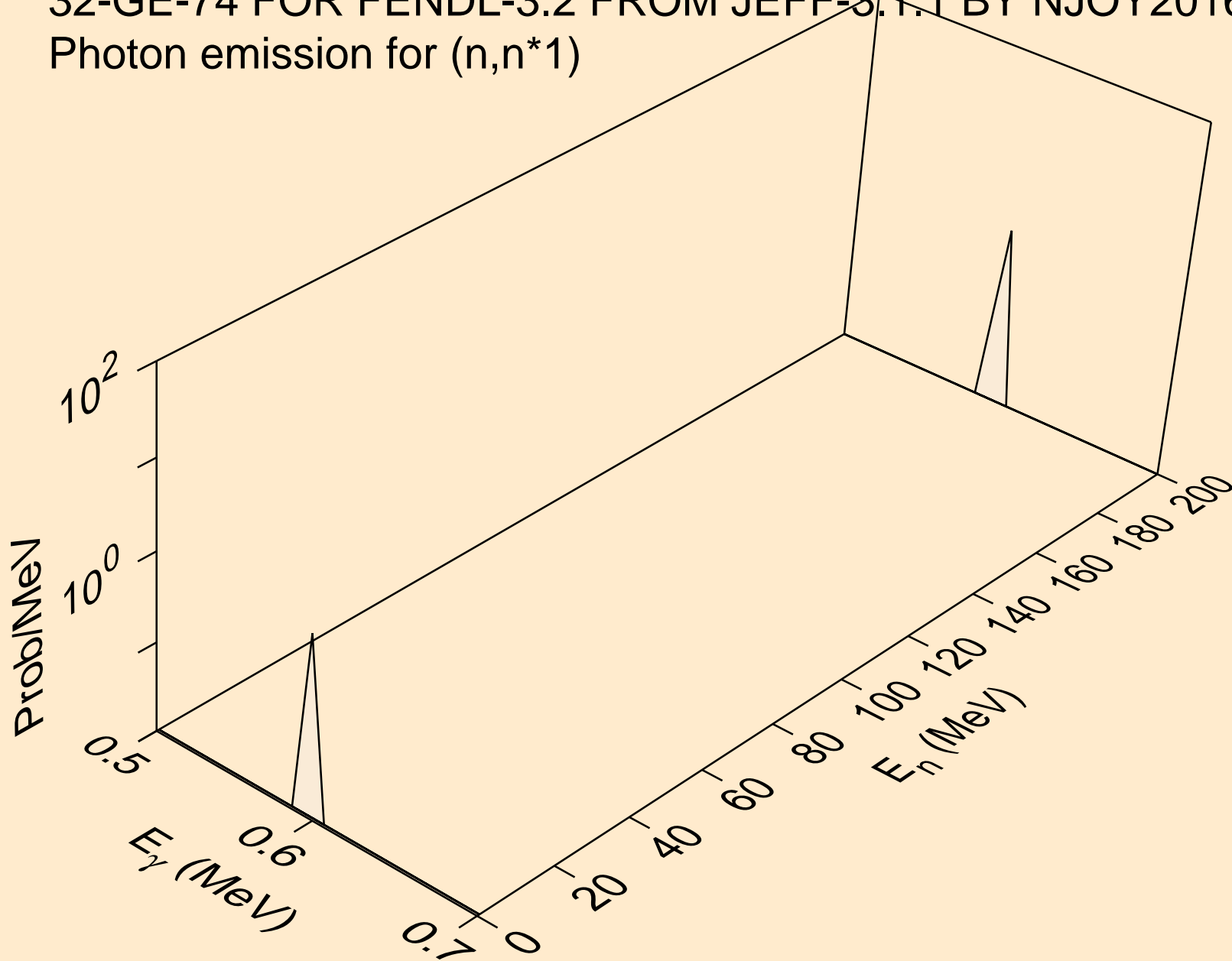

32-GE-74 FOR FENDL-3.2 FROM JEFF-3.1.1 BY NJOY2016.60+ O
Photon emission for (n,n*2)

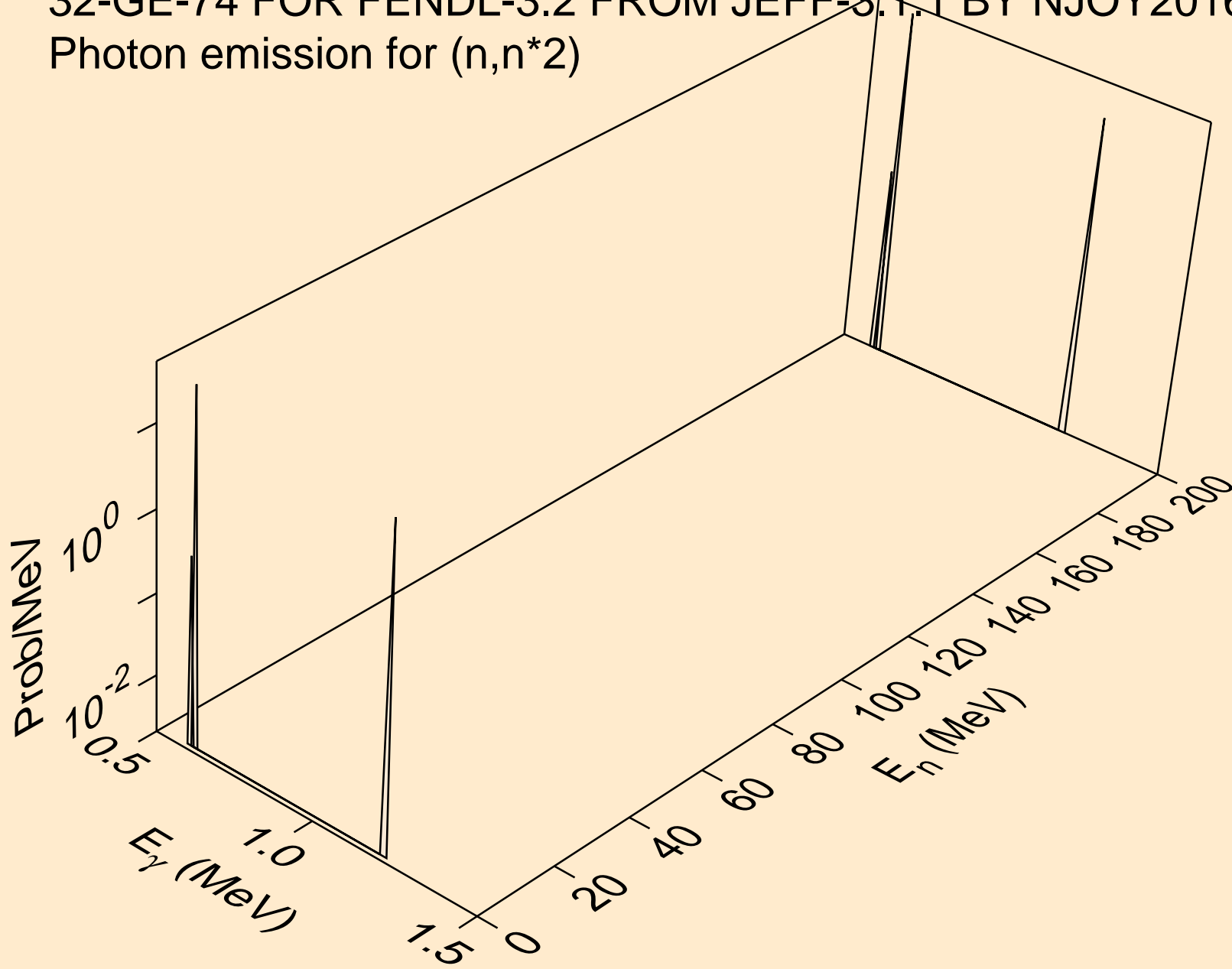

32-GE-74 FOR FENDL-3.2 FROM JEFF-3.1.1 BY NJOY2016.60+ O
Photon emission for (n,n*3)

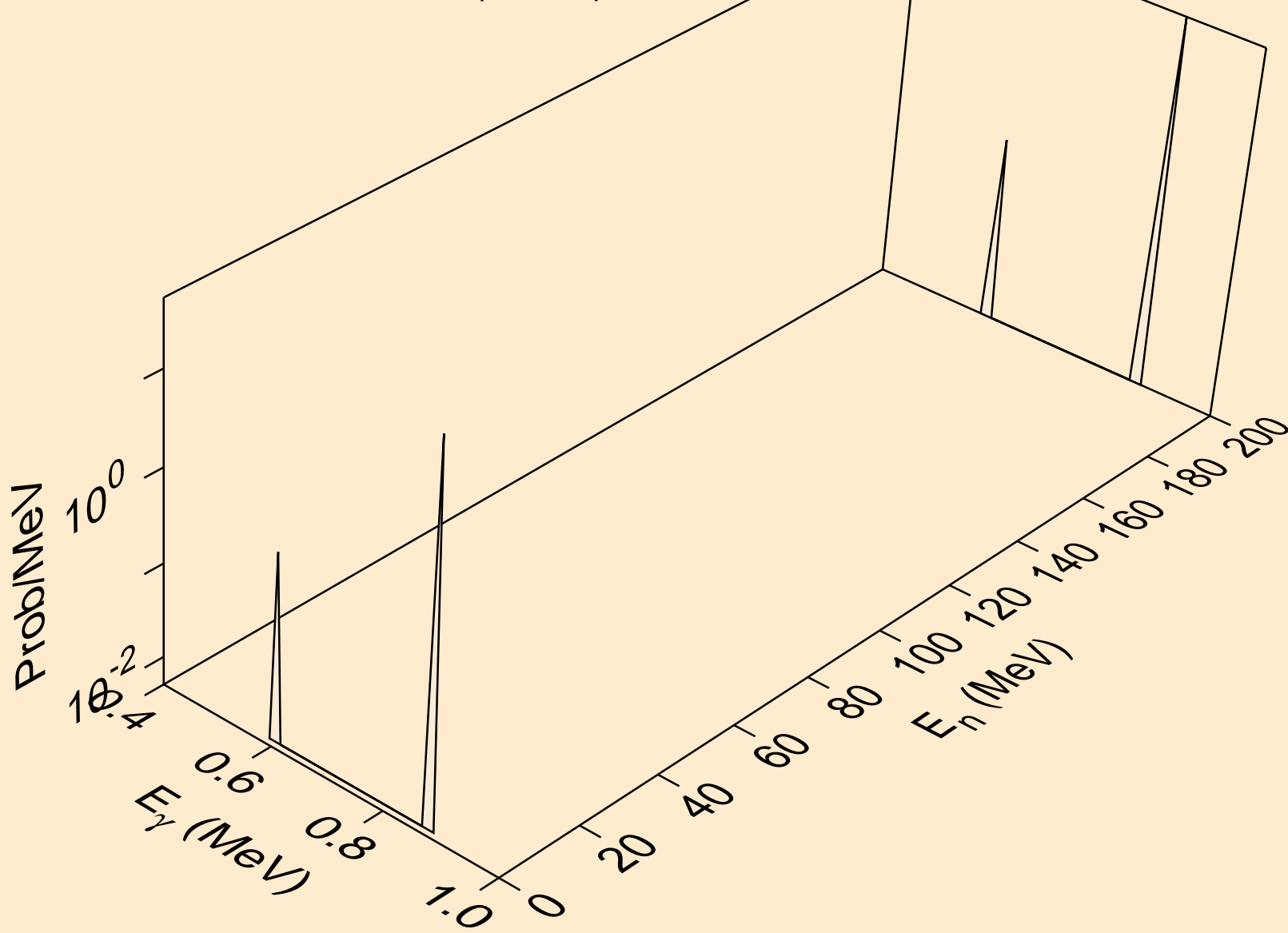

32-GE-74 FOR FENDL-3.2 FROM JEFF-3.1.1 BY NJOY2016.60+ O
Photon emission for (n,n*4)

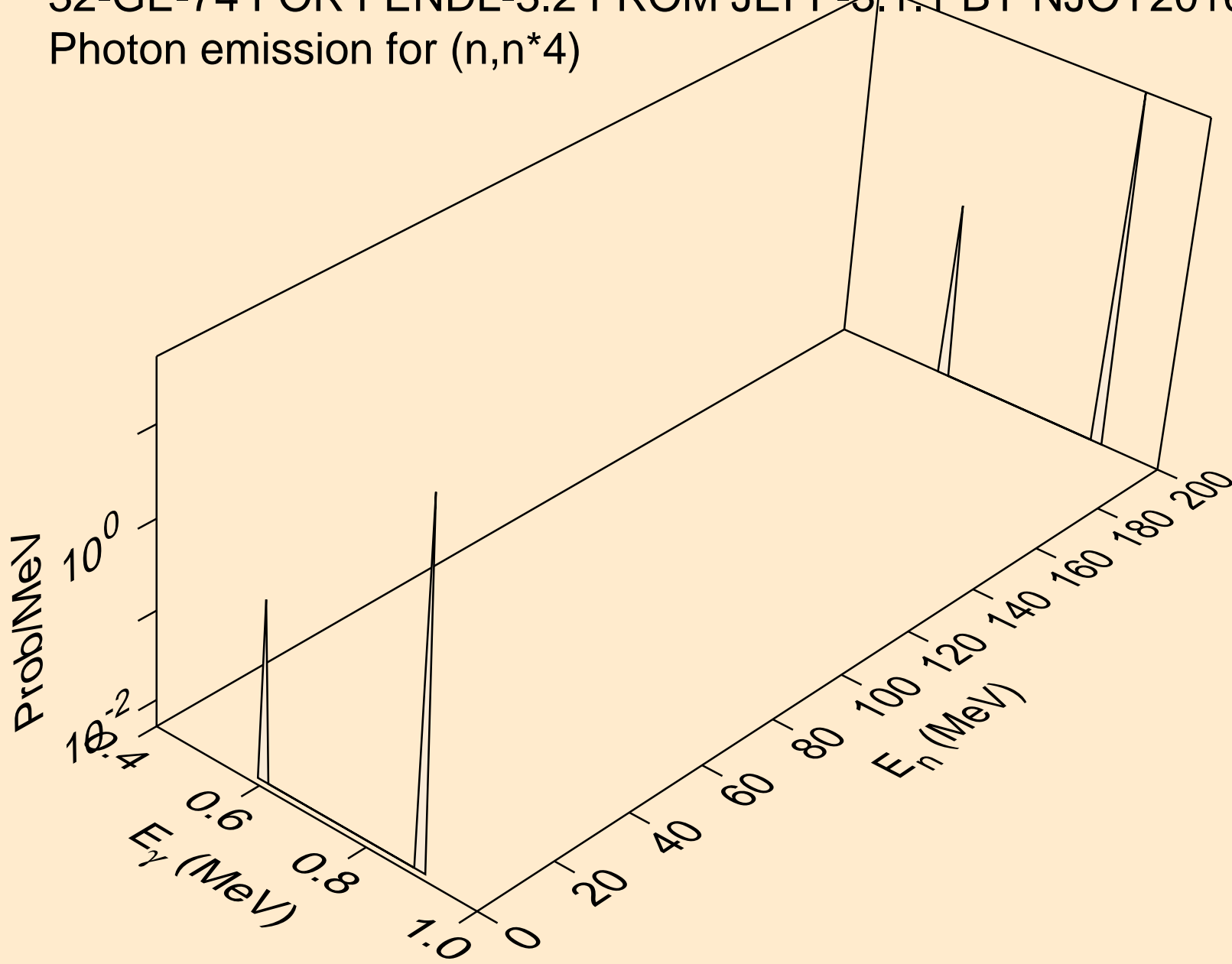

32-GE-74 FOR FENDL-3.2 FROM JEFF-3.1.1 BY NJOY2016.60+ O
Photon emission for (n,n*5)

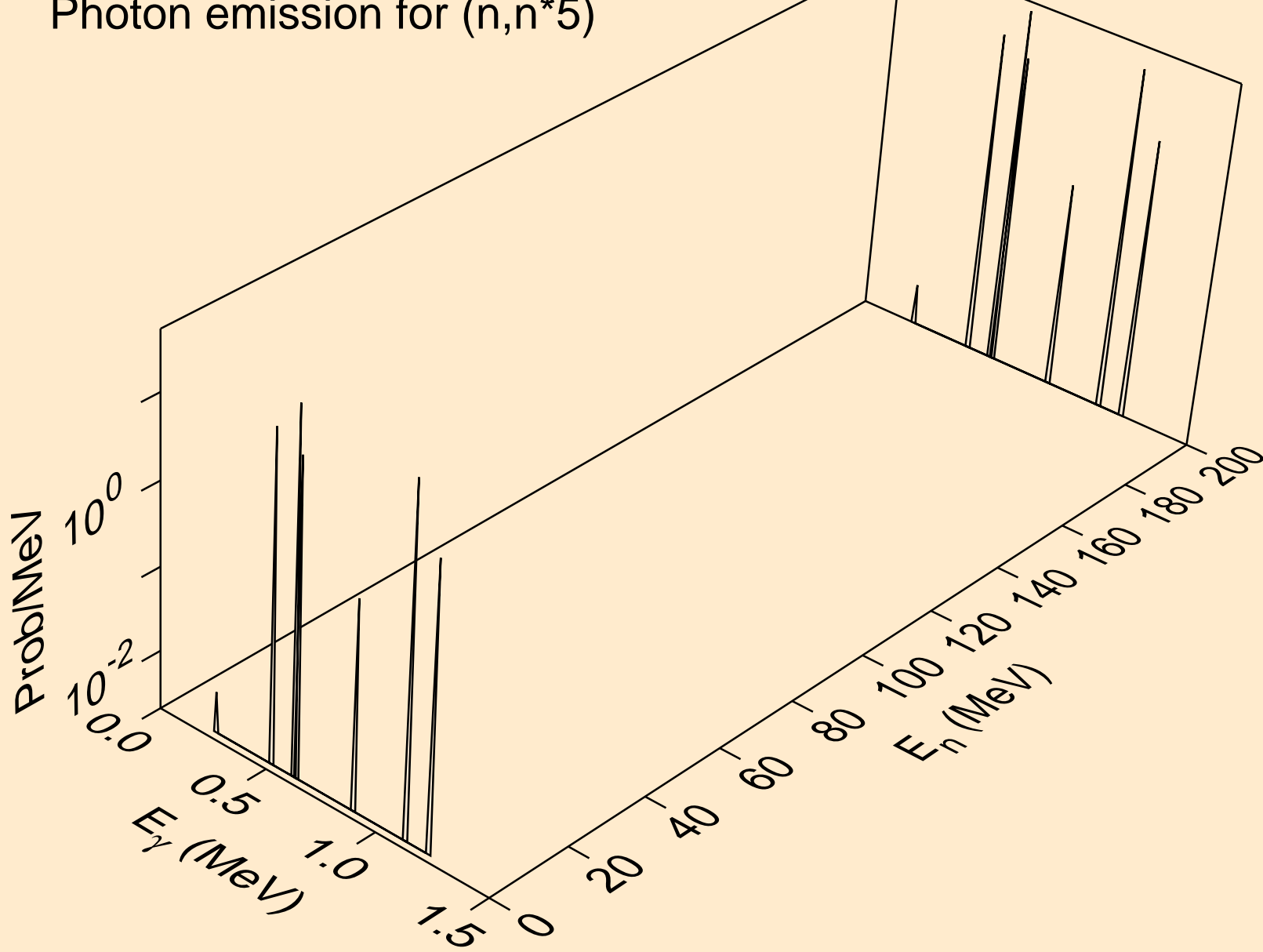

32-GE-74 FOR FENDL-3.2 FROM JEFF-3.1.1 BY NJOY2016.60+ O
Photon emission for (n,n*6)

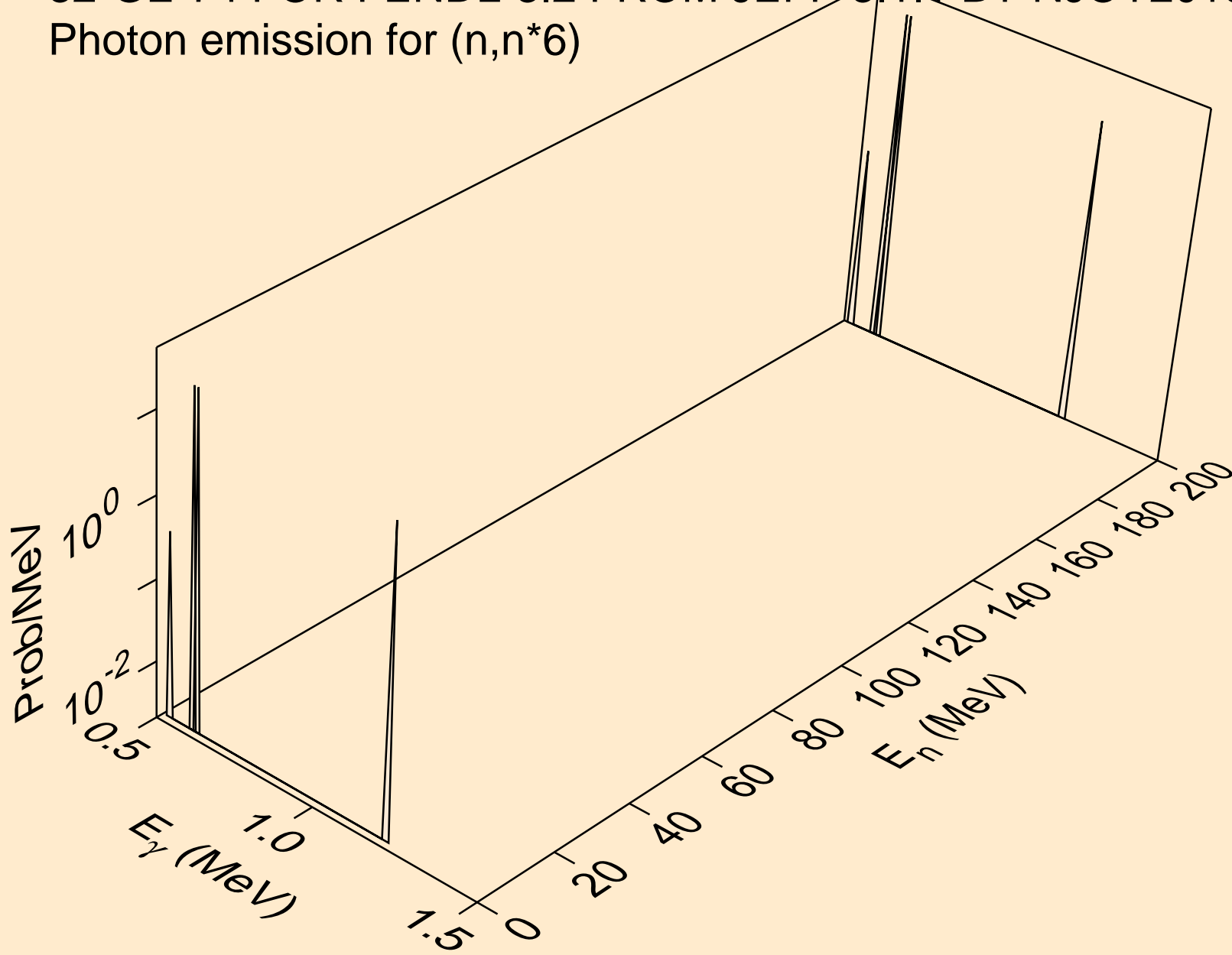

32-GE-74 FOR FENDL-3.2 FROM JEFF-3.1.1 BY NJOY2016.60+ O
Photon emission for (n,n*7)

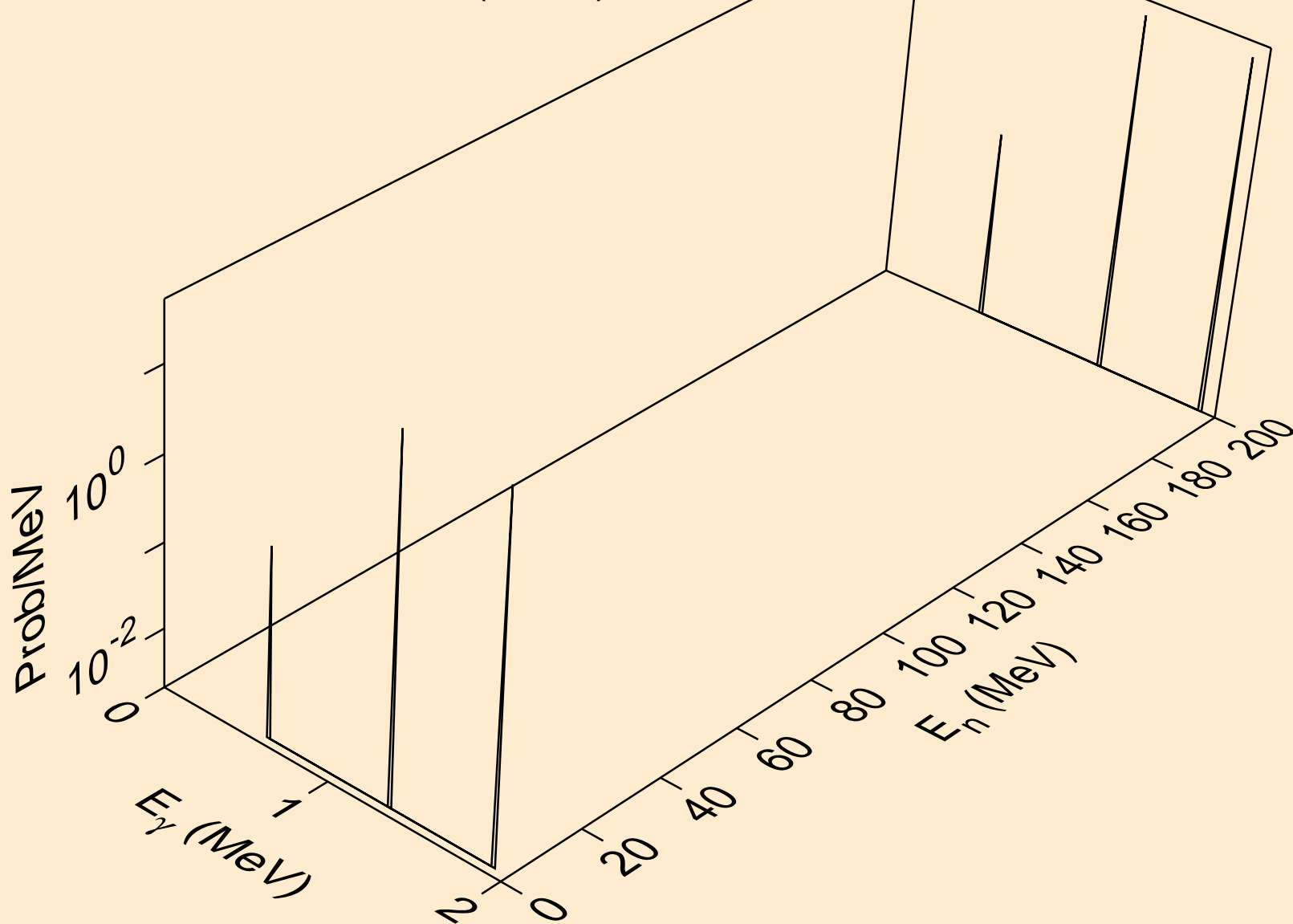

32-GE-74 FOR FENDL-3.2 FROM JEFF-3.1.1 BY NJOY2016.60+ O
Photon emission for (n,n*8)

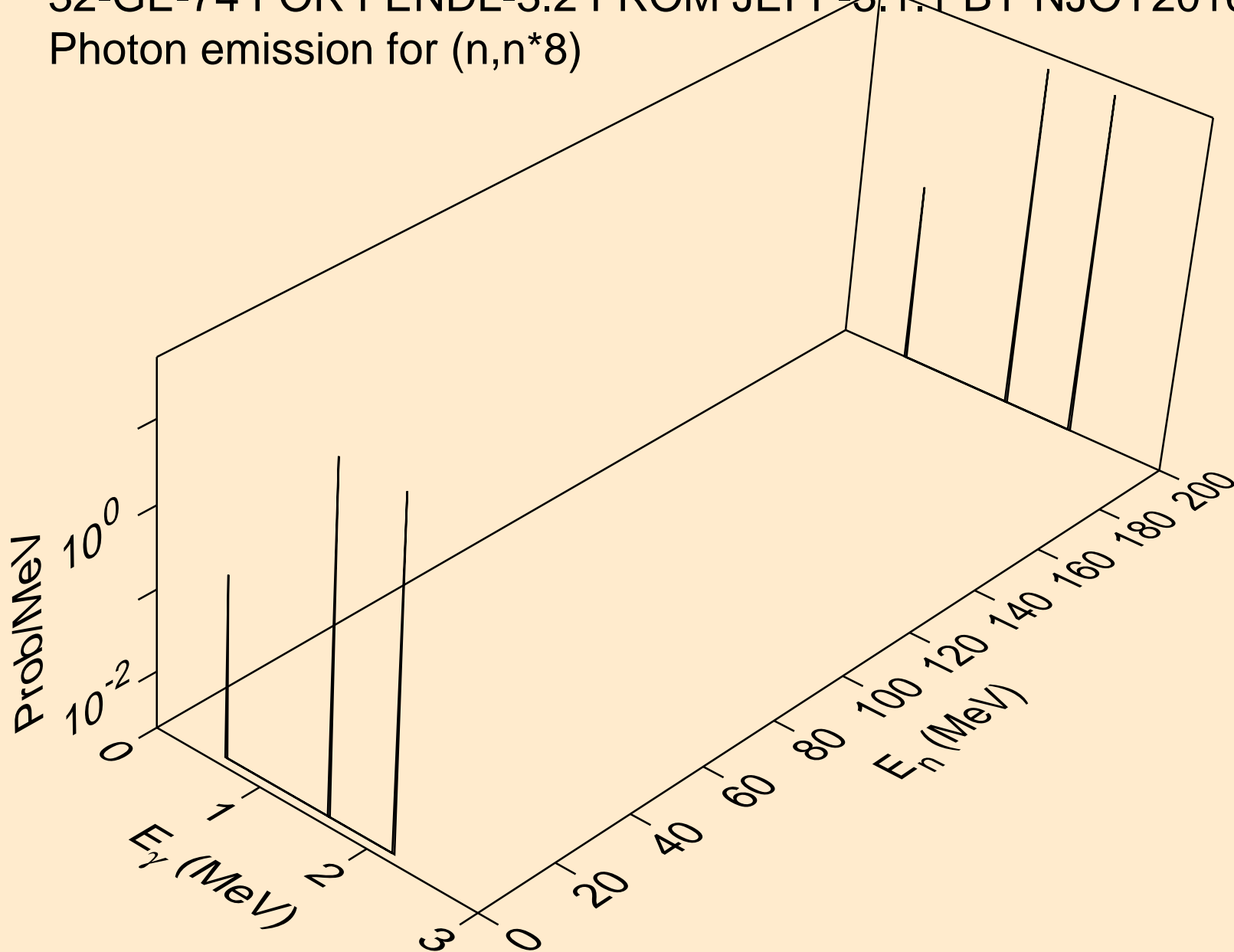

32-GE-74 FOR FENDL-3.2 FROM JEFF-3.1.1 BY NJOY2016.60+ O
Photon emission for (n,n*9)

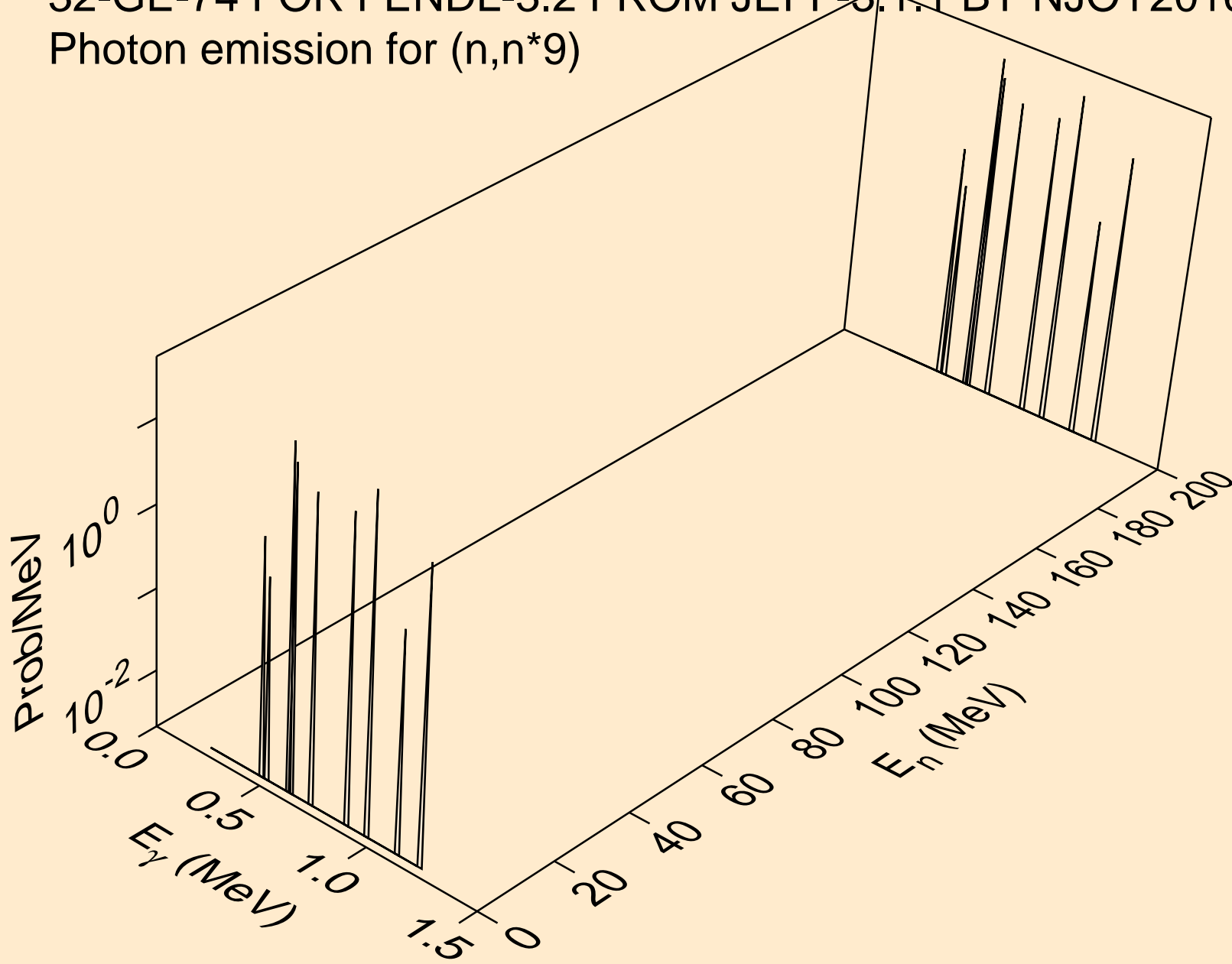

32-GE-74 FOR FENDL-3.2 FROM JEFF-3.1.1 BY NJOY2016.60+ O
Photon emission for (n,n*10)

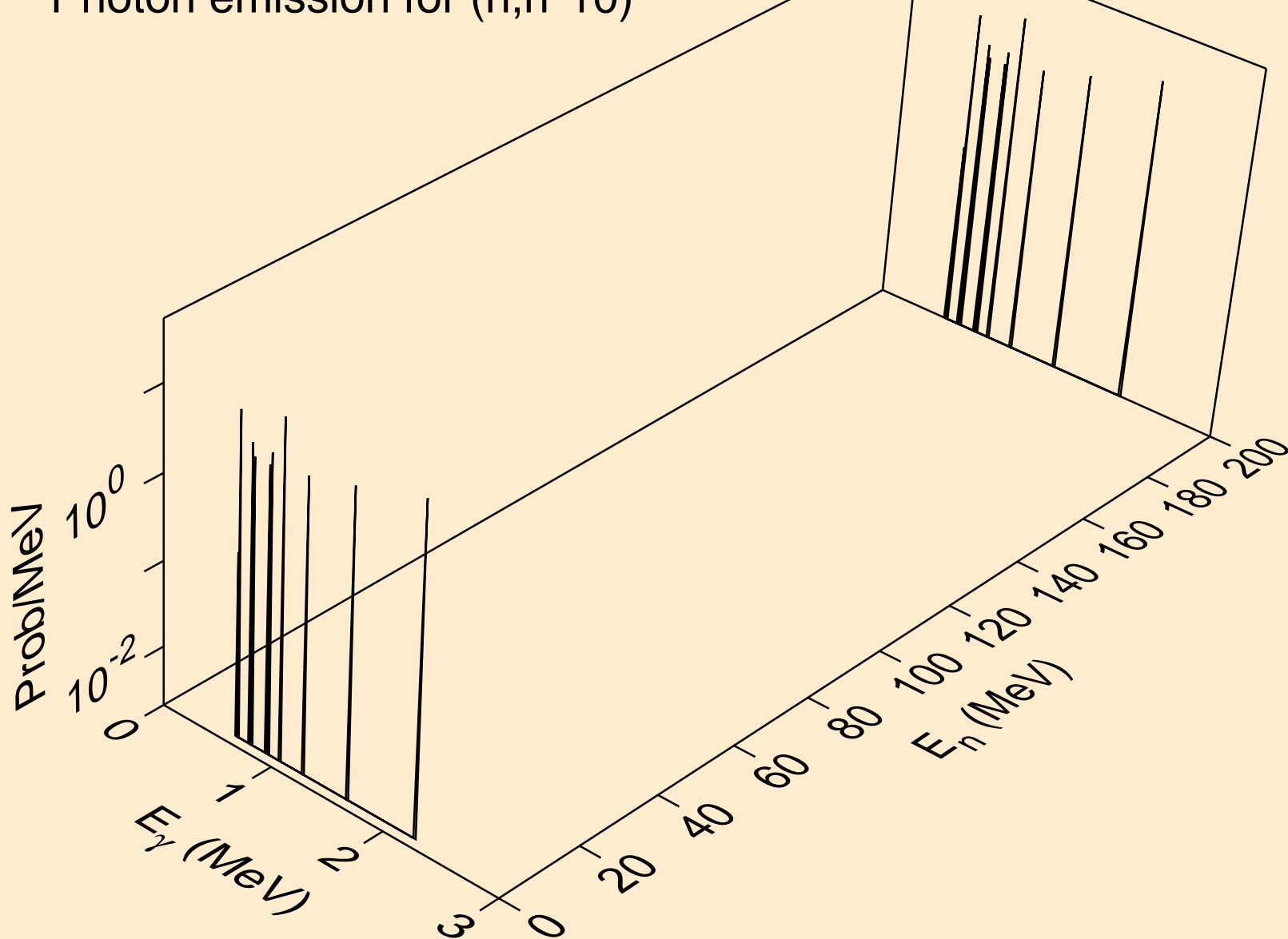

32-GE-74 FOR FENDL-3.2 FROM JEFF-3.1.1 BY NJOY2016.60+ O
Photon emission for (n,n*11)

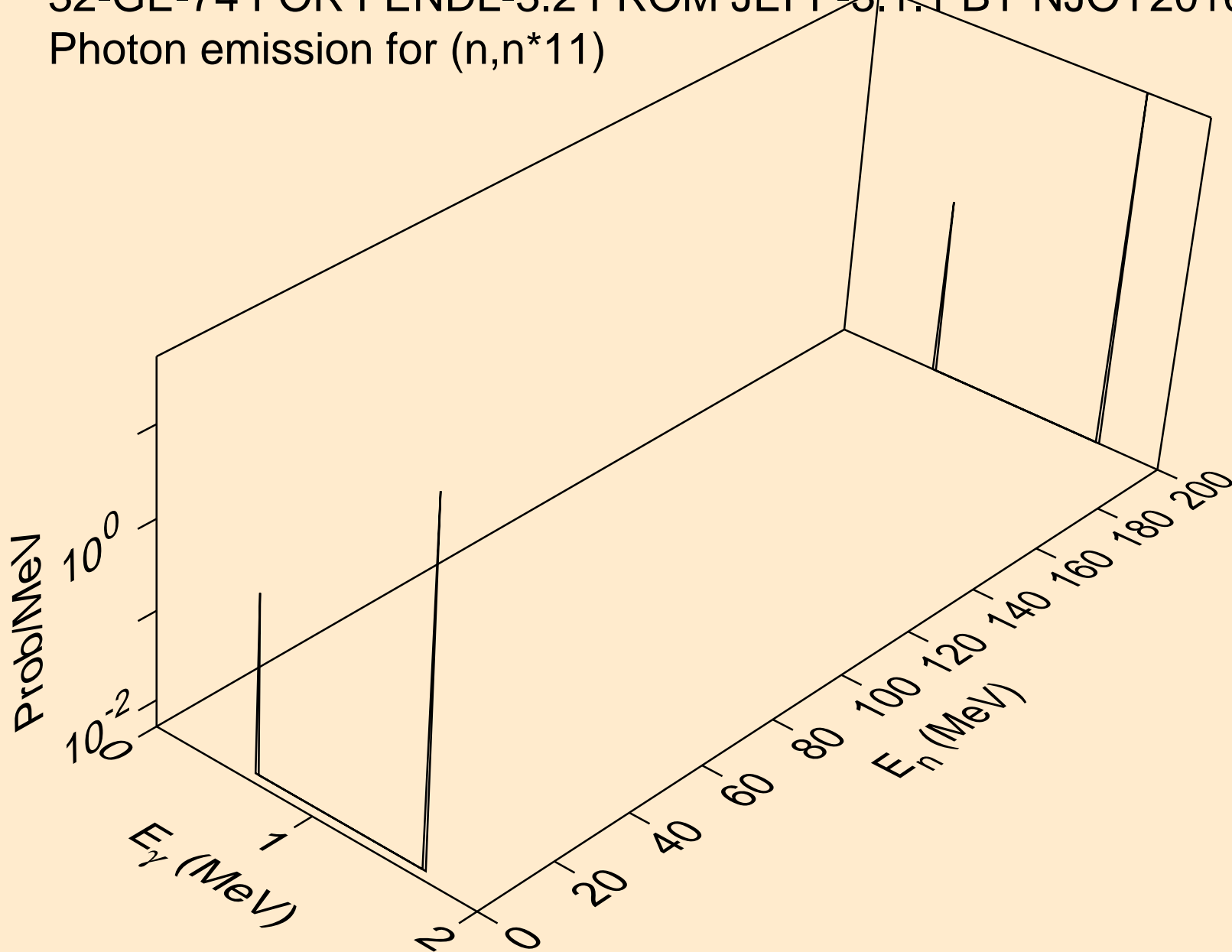

32-GE-74 FOR FENDL-3.2 FROM JEFF-3.1.1 BY NJOY2016.60+ O
Photon emission for (n,n*12)

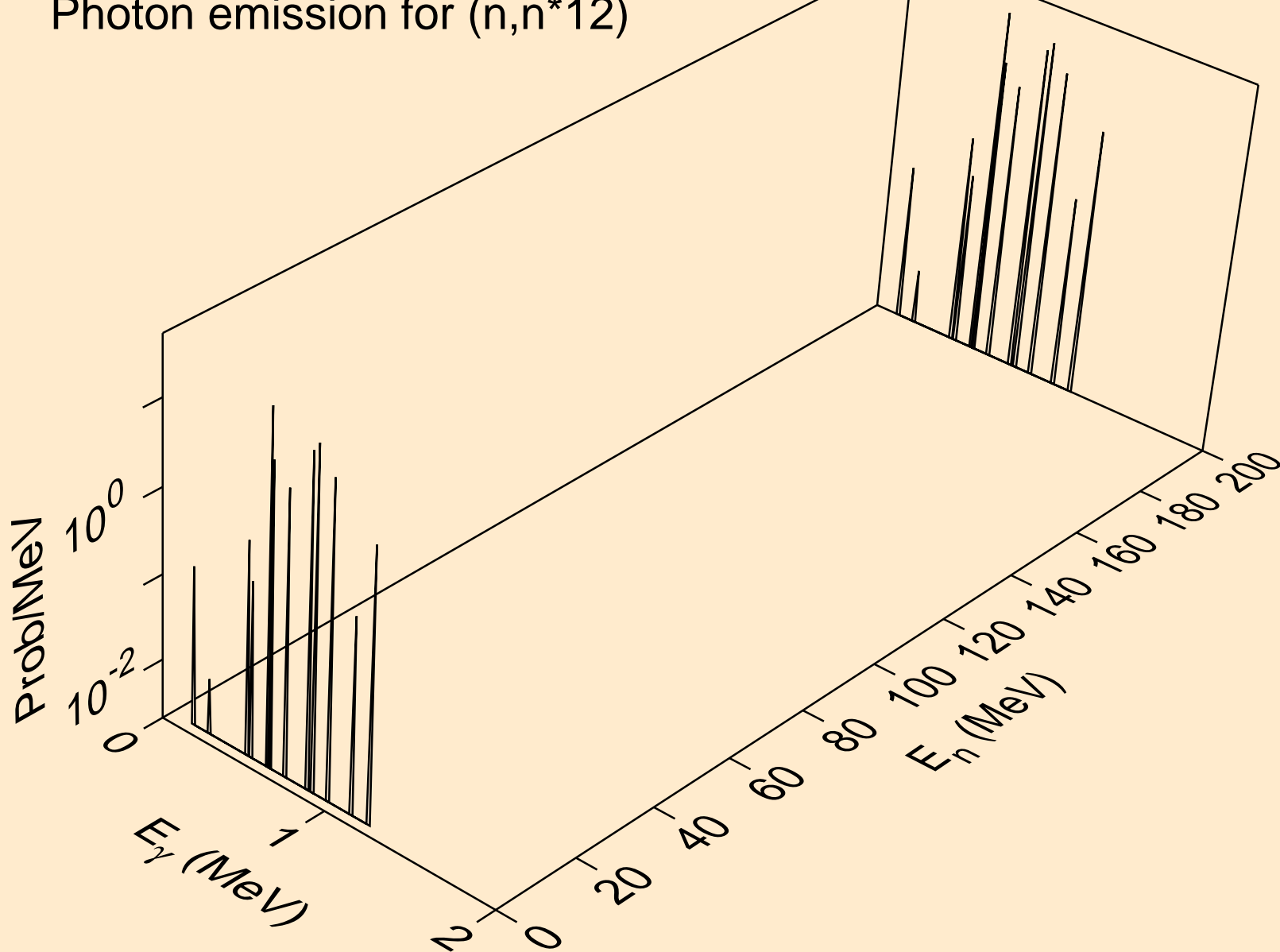

32-GE-74 FOR FENDL-3.2 FROM JEFF-3.1.1 BY NJOY2016.60+ O
Photon emission for (n,n*13)

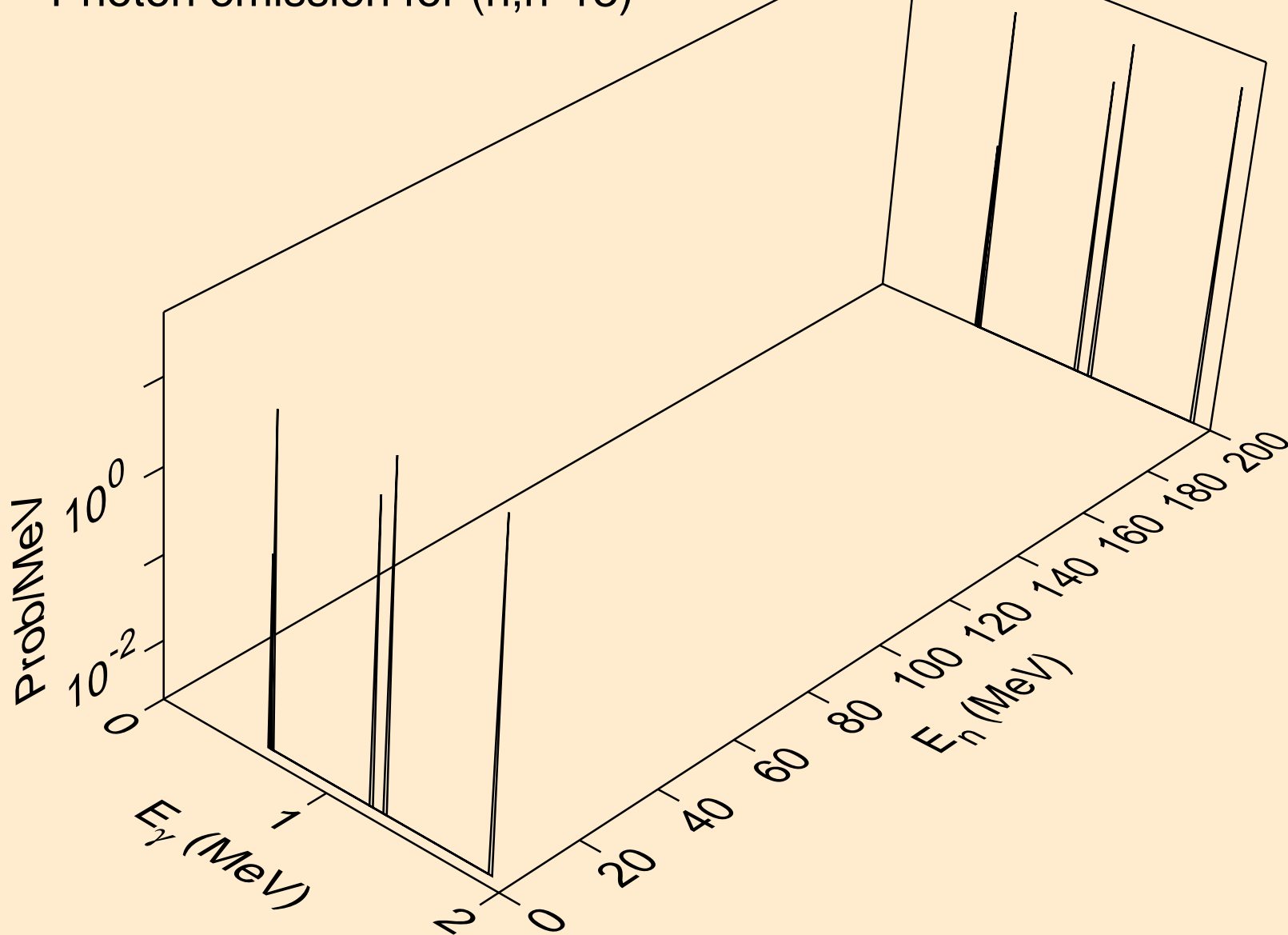

32-GE-74 FOR FENDL-3.2 FROM JEFF-3.1.1 BY NJOY2016.60+ O
Photon emission for (n,n*14)

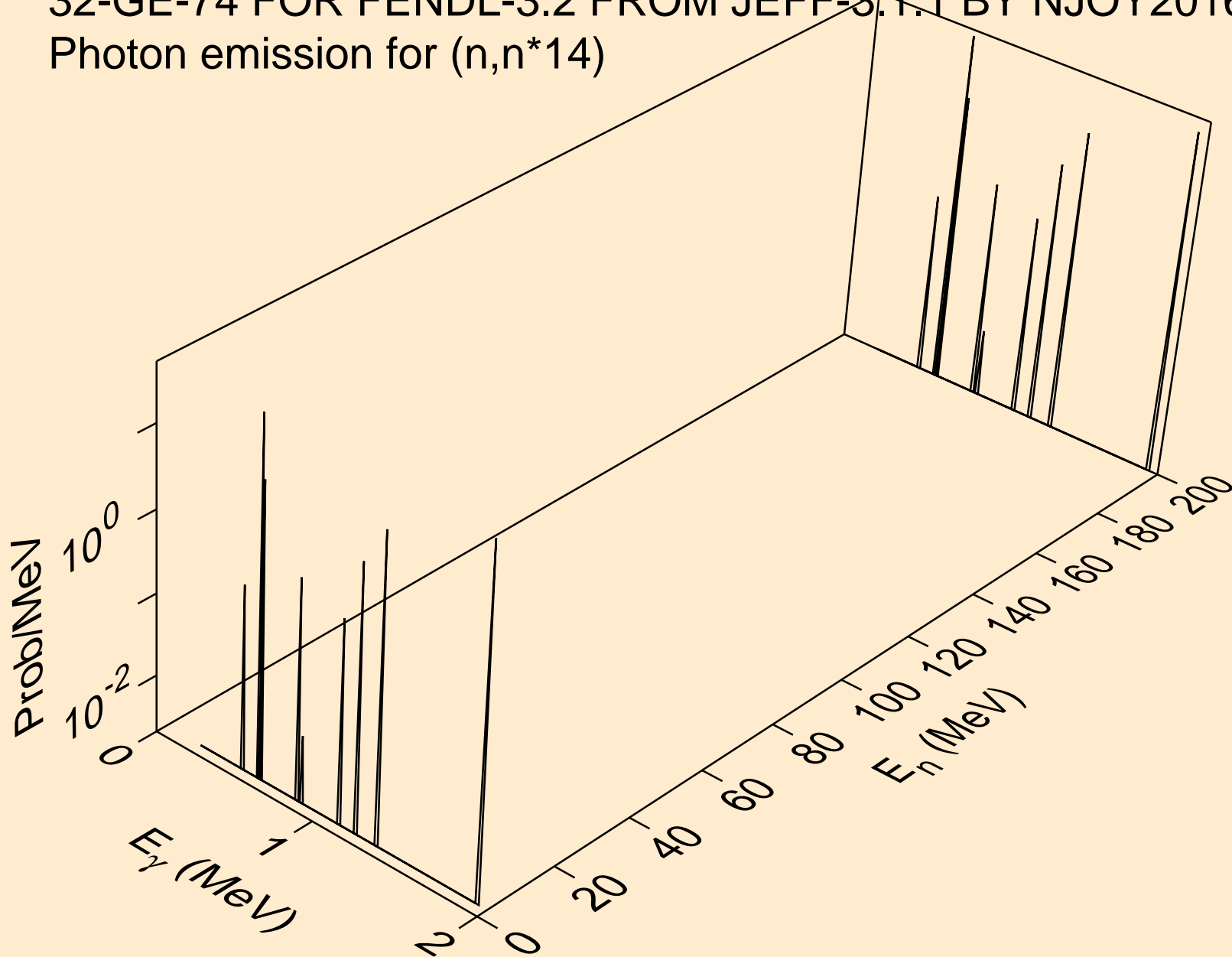

32-GE-74 FOR FENDL-3.2 FROM JEFF-3.1.1 BY NJOY2016.60+ O
Photon emission for (n,n*15)

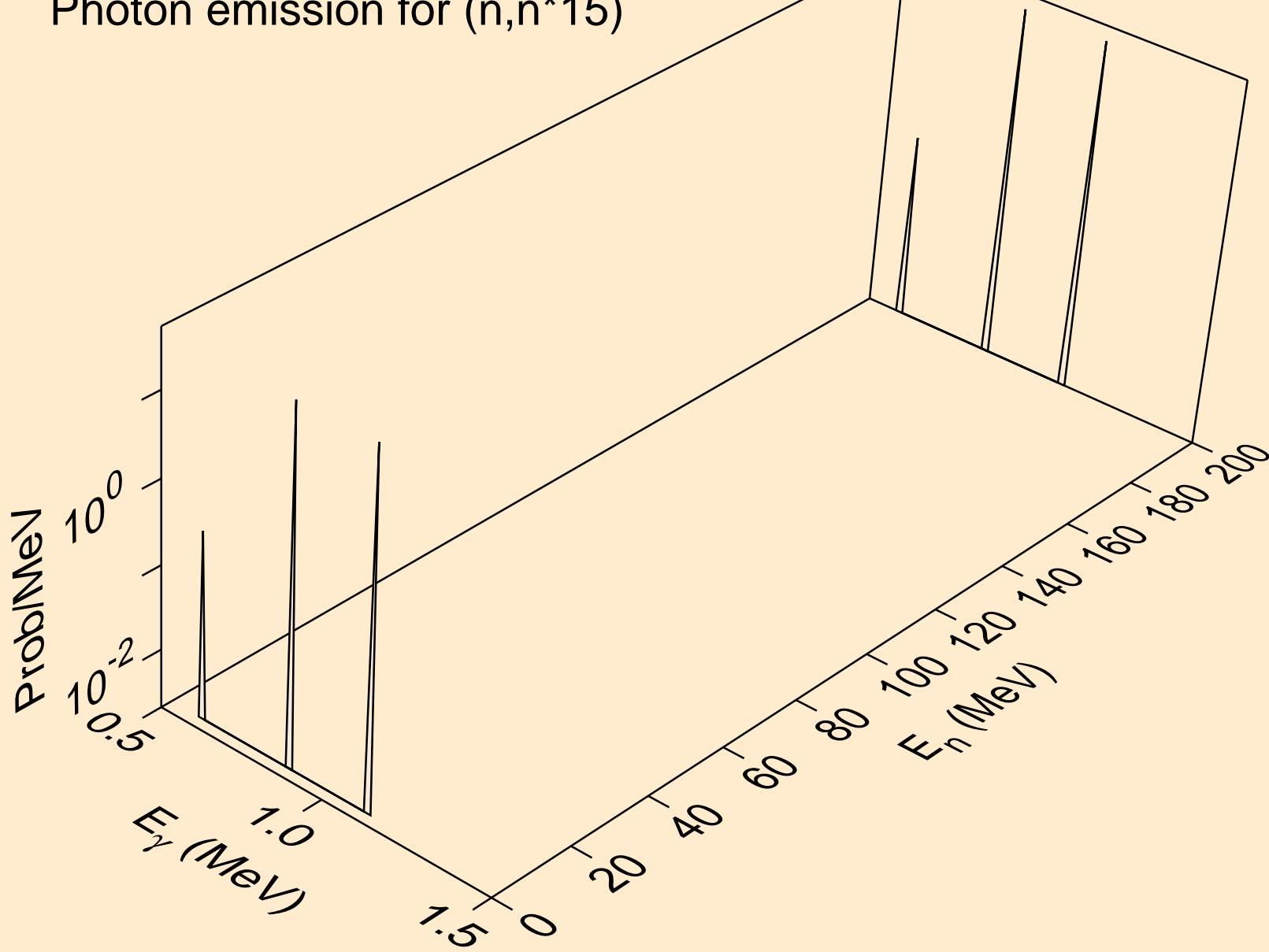

32-GE-74 FOR FENDL-3.2 FROM JEFF-3.1.1 BY NJOY2016.60+ O
Photon emission for (n,n*16)

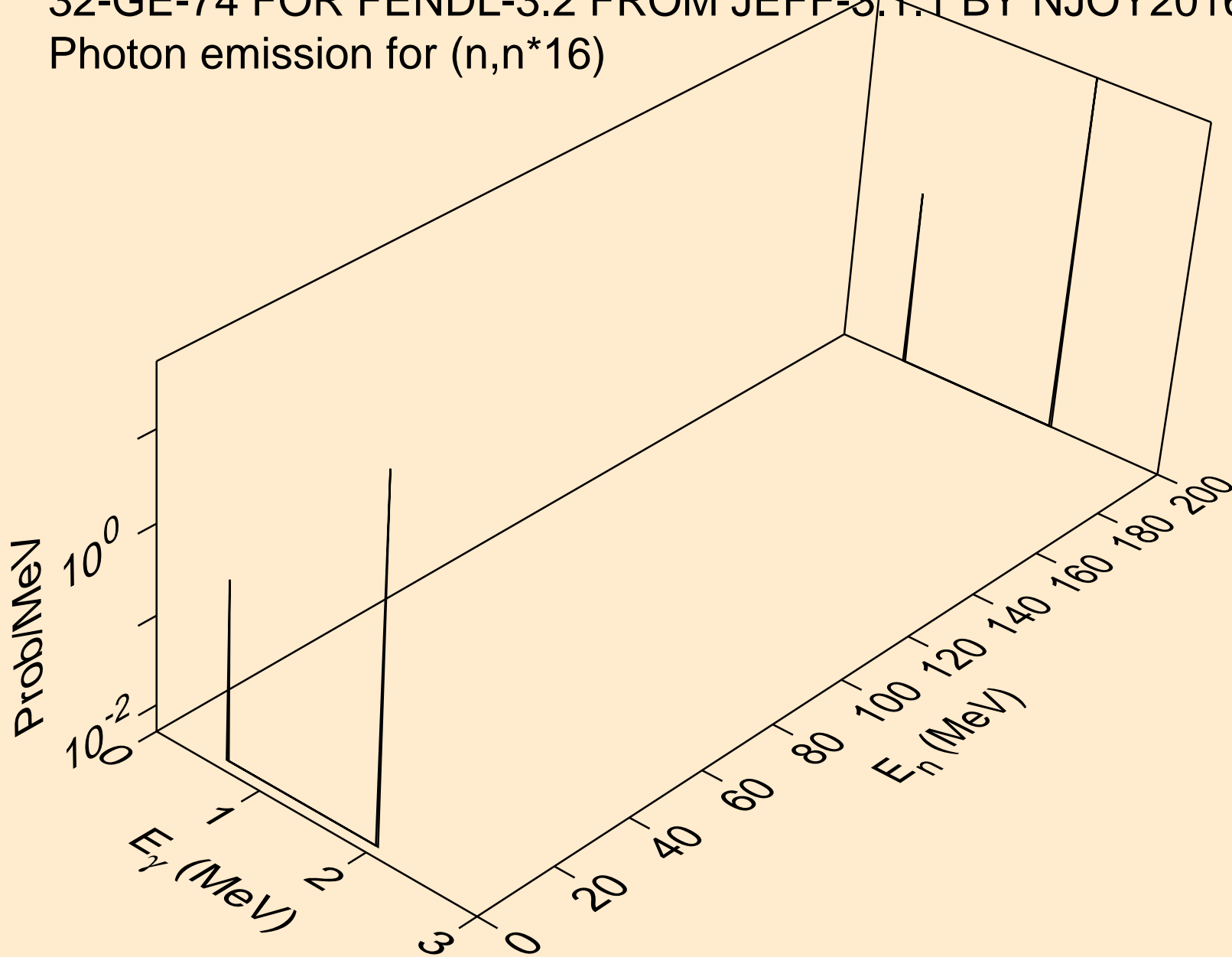

32-GE-74 FOR FENDL-3.2 FROM JEFF-3.1.1 BY NJOY2016.60+ O
Photon emission for (n,n*17)

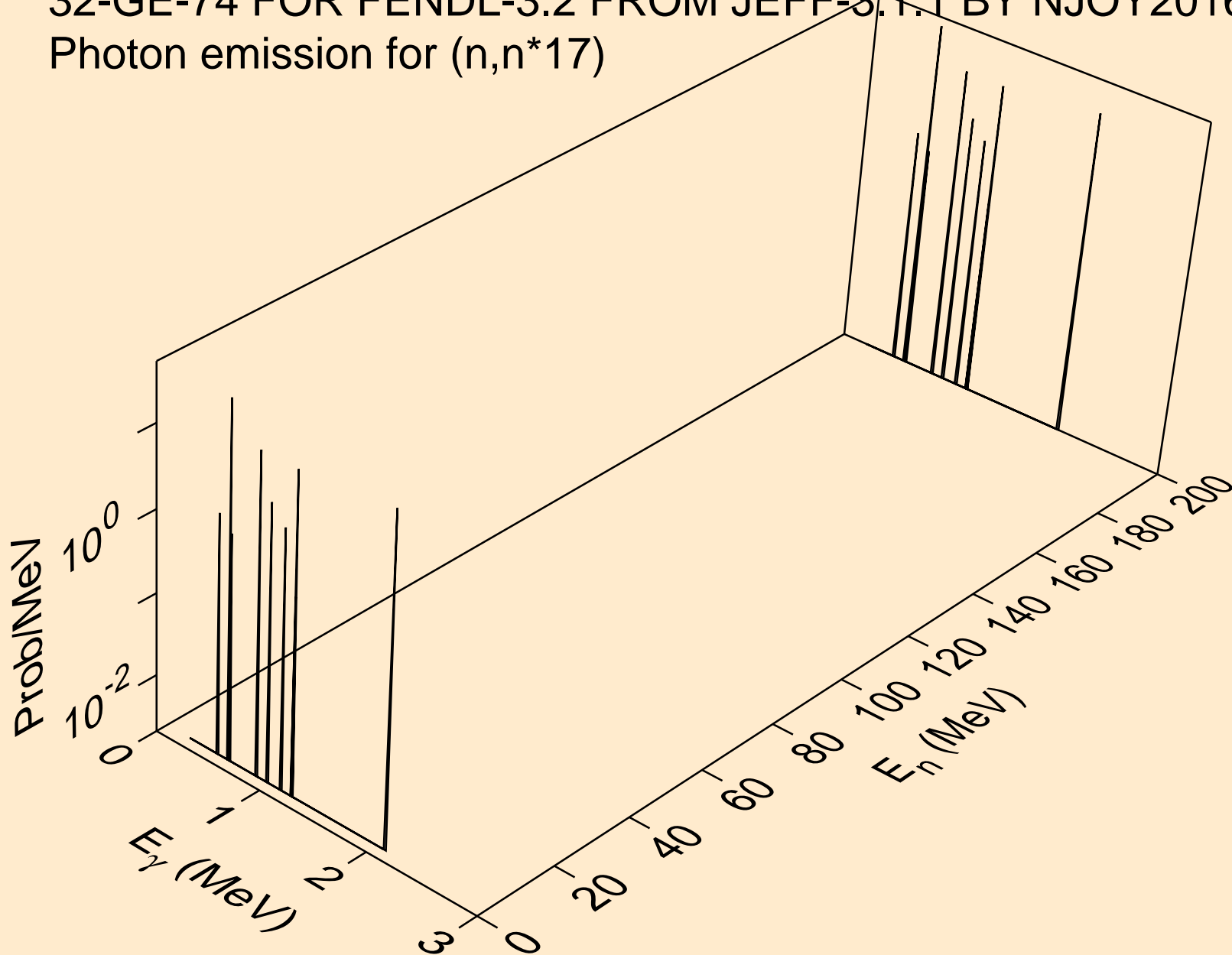

32-GE-74 FOR FENDL-3.2 FROM JEFF-3.1.1 BY NJOY2016.60+ O
Photon emission for (n,n*18)

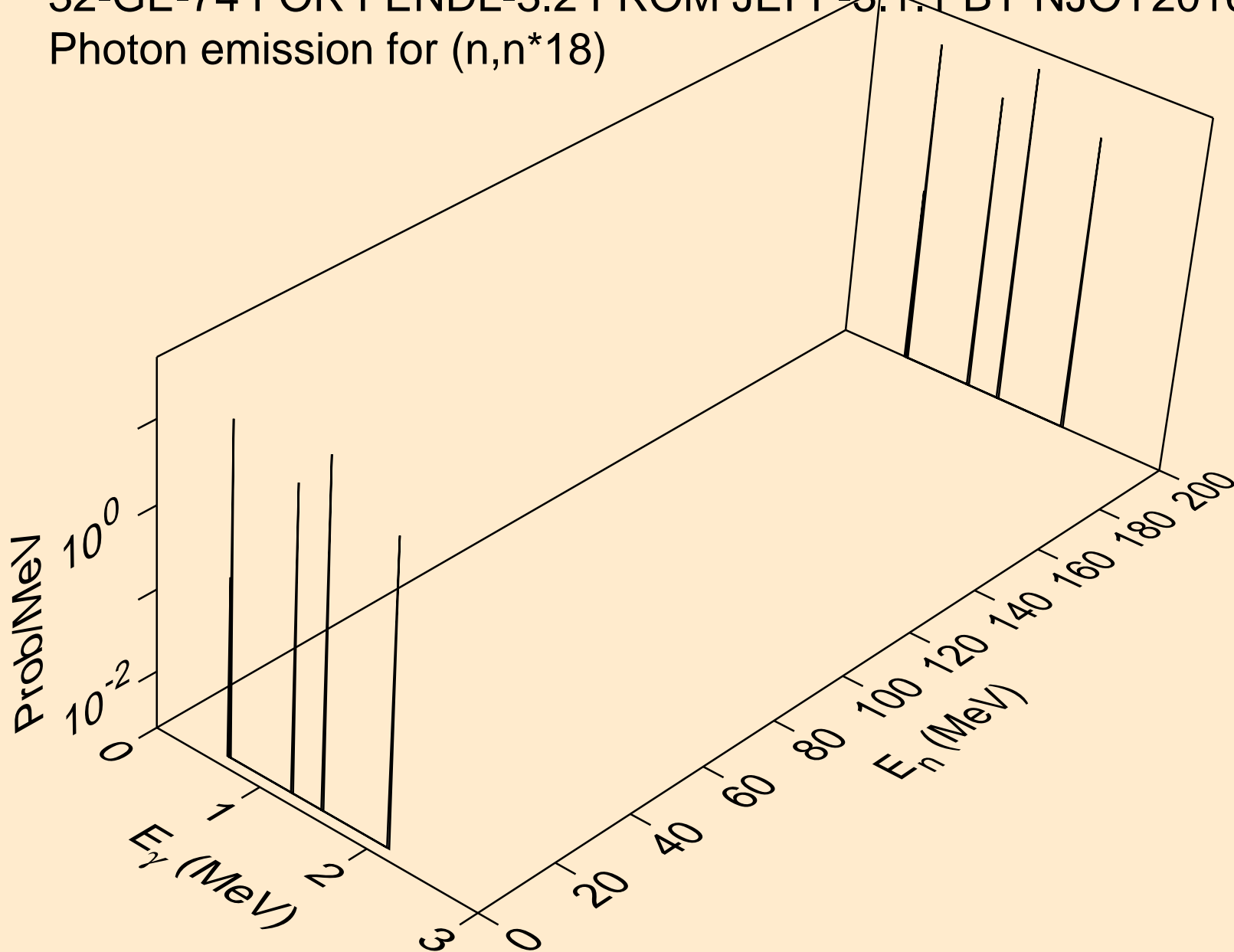

32-GE-74 FOR FENDL-3.2 FROM JEFF-3.1.1 BY NJOY2016.60+ O
Photon emission for (n,n*19)

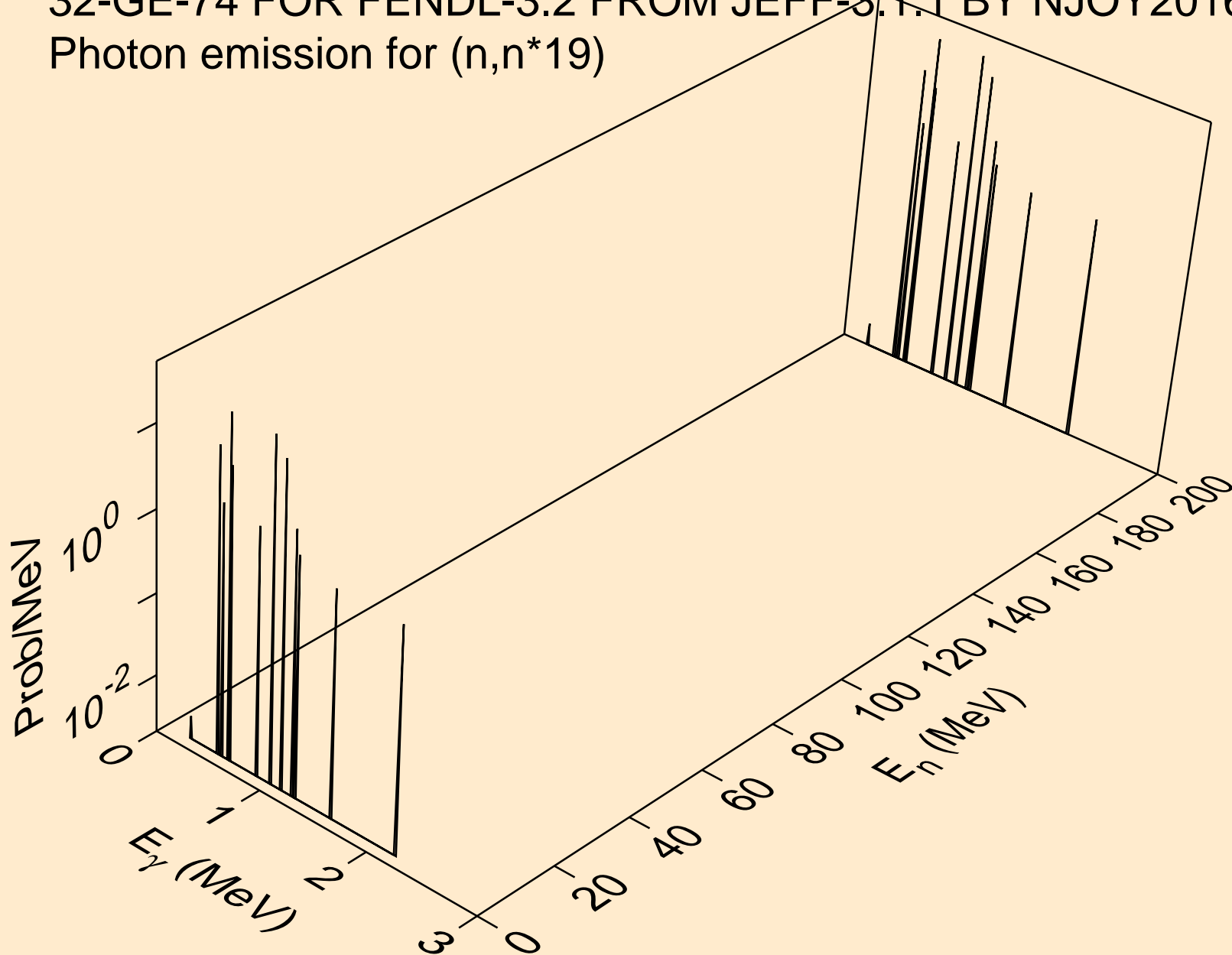

32-GE-74 FOR FENDL-3.2 FROM JEFF-3.1.1 BY NJOY2016.60+ O
Photon emission for (n,n*20)

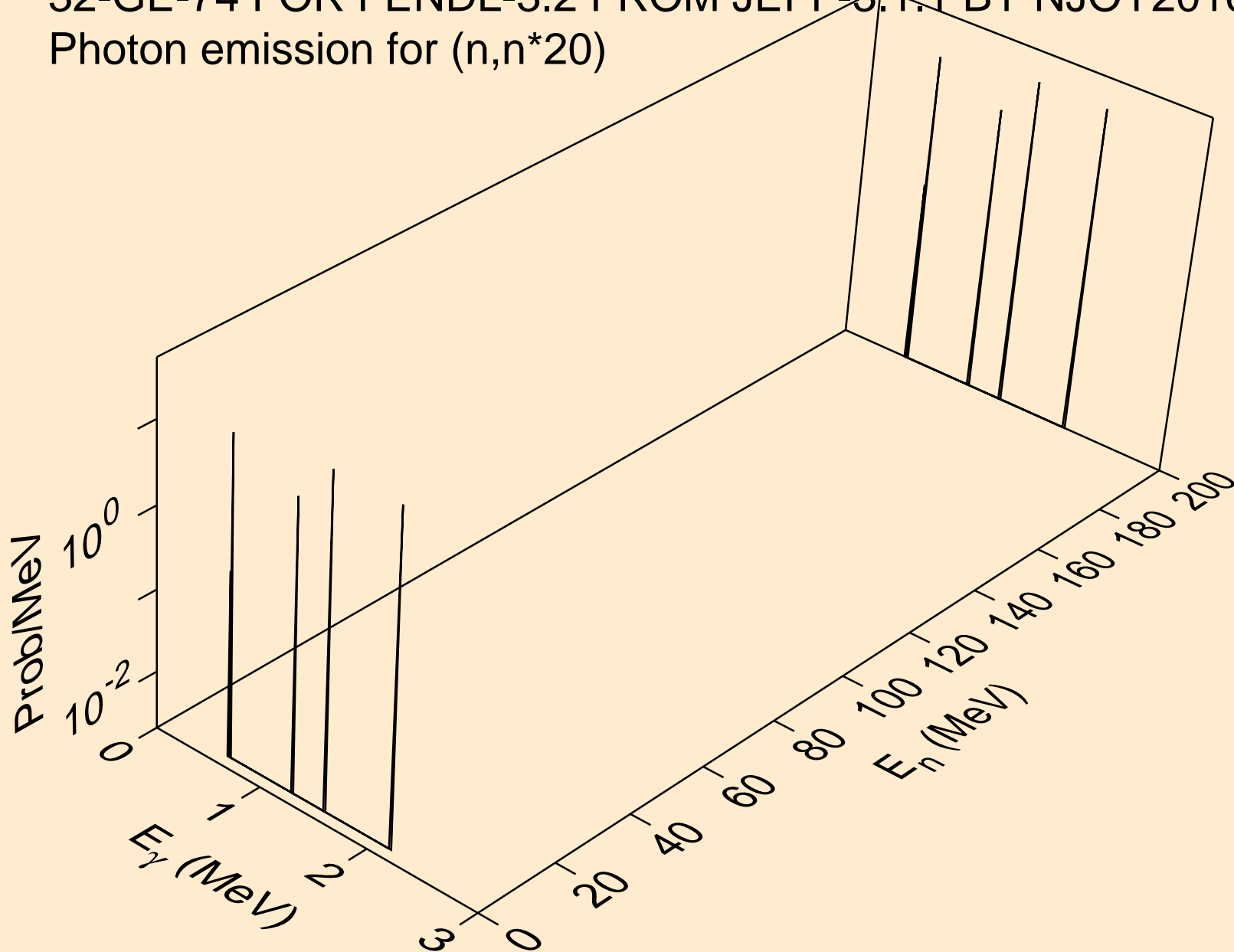

32-GE-74 FOR FENDL-3.2 FROM JEFF-3.1.1 BY NJOY2016.60+ O
Photon emission for (n,n*c)

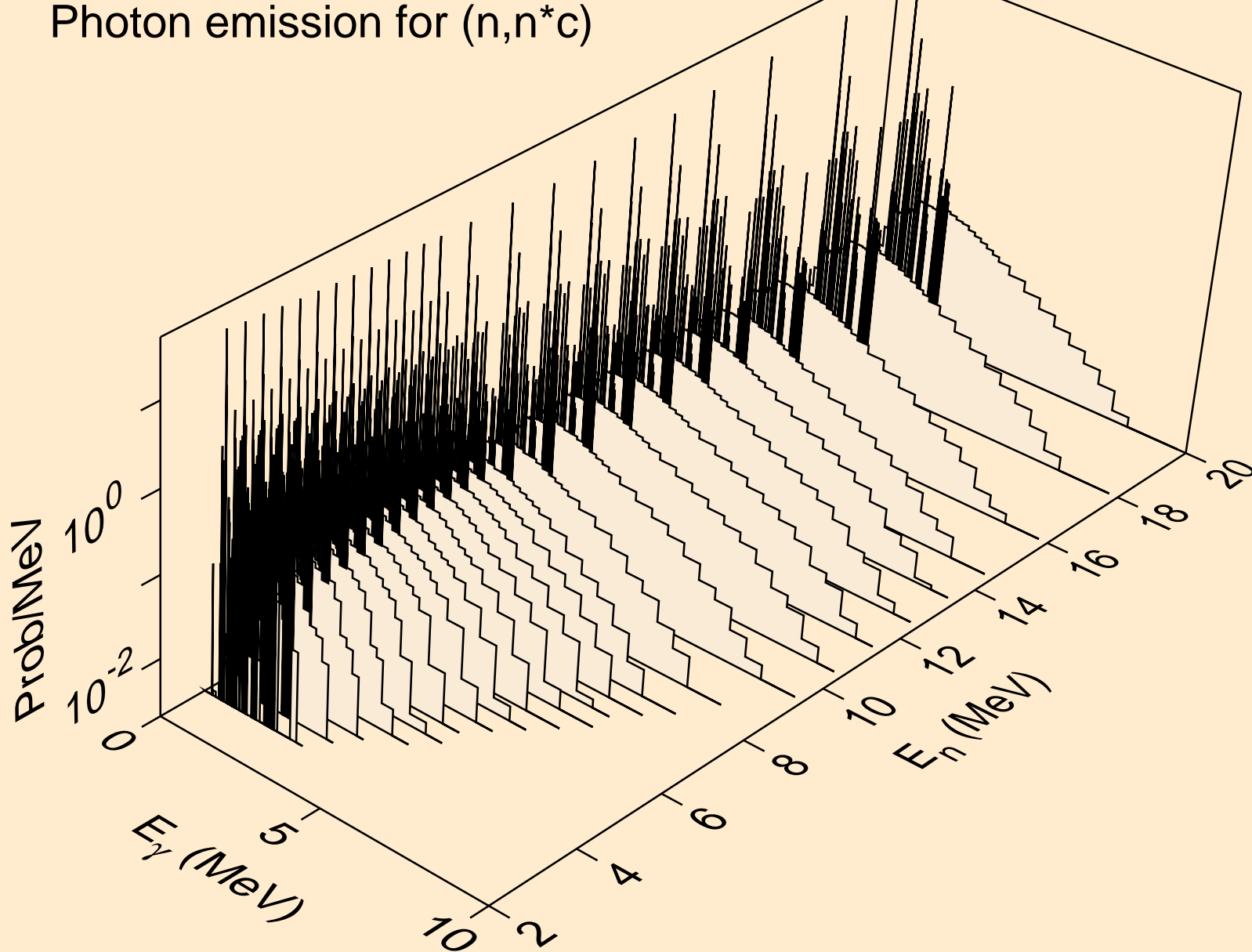

32-GE-74 FOR FENDL-3.2 FROM JEFF-3.1.1 BY NJOY2016.60+ O
Photon emission for (n,gma)

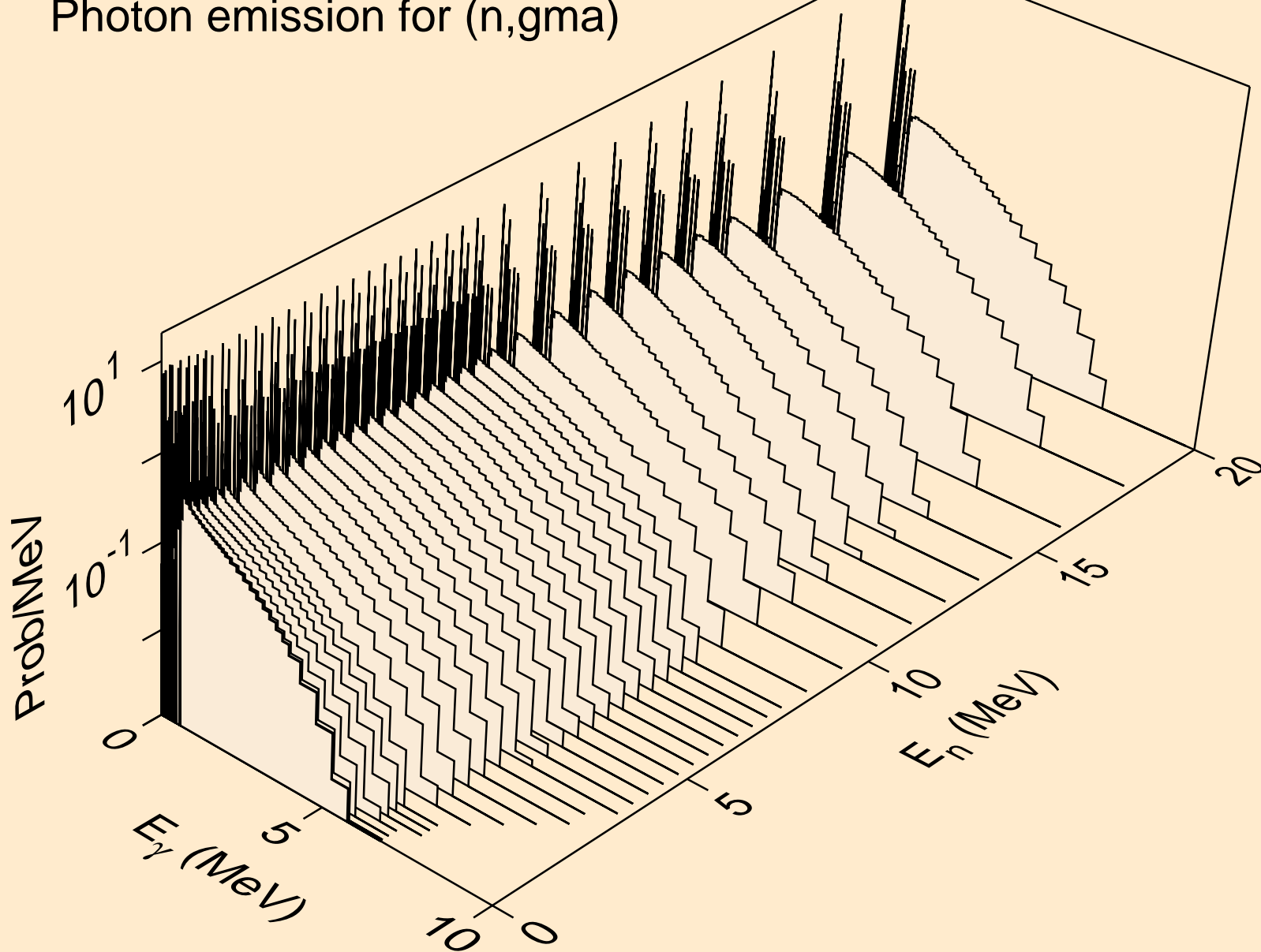

32-GE-74 FOR FENDL-3.2 FROM JEFF-3.1.1 BY NJOY2016.60+ O
Photon emission for (n,2p)

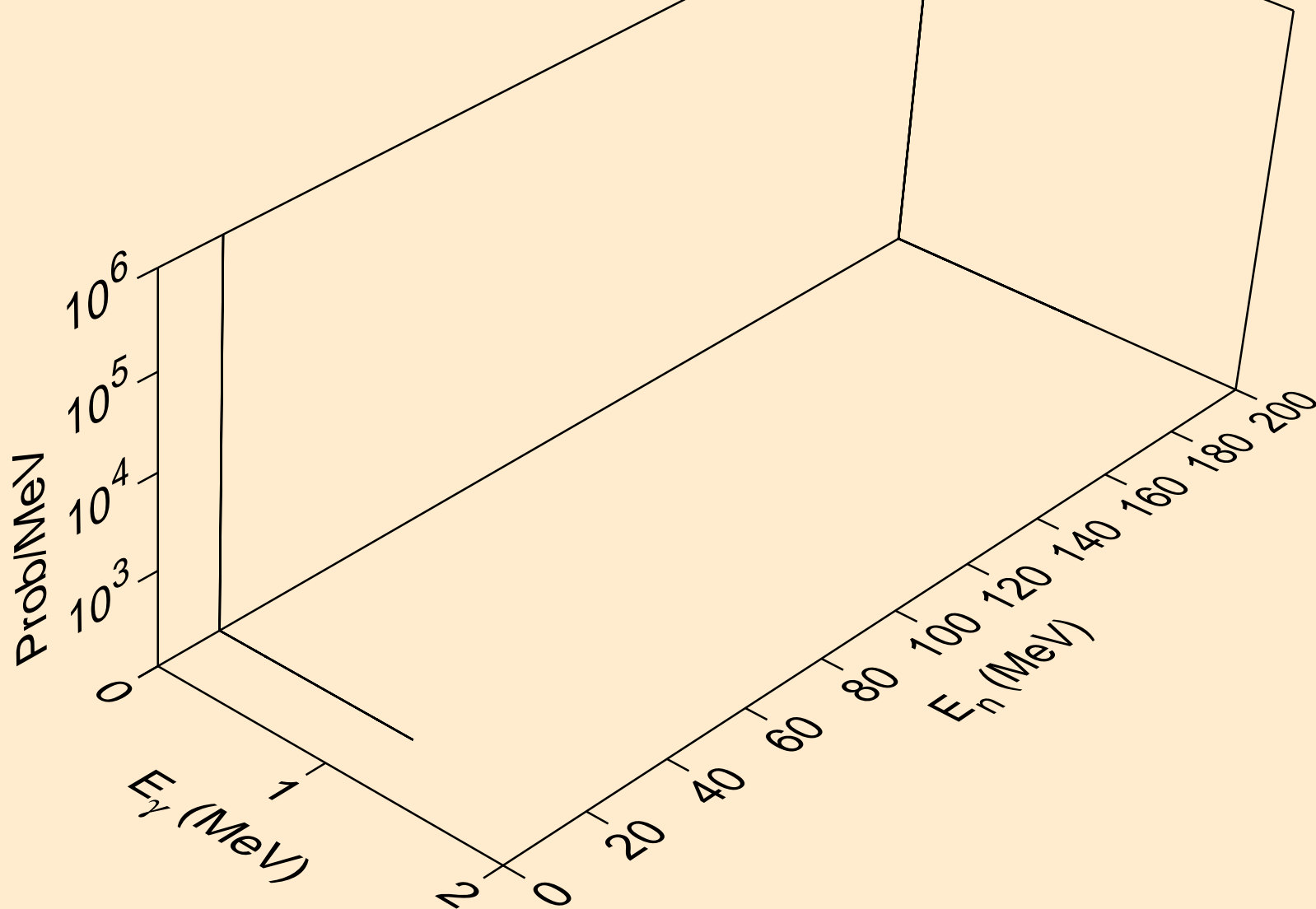

32-GE-74 FOR FENDL-3.2 FROM JEFF-3.1.1 BY NJOY2016.60+ O
Photon emission for (n,p*1)

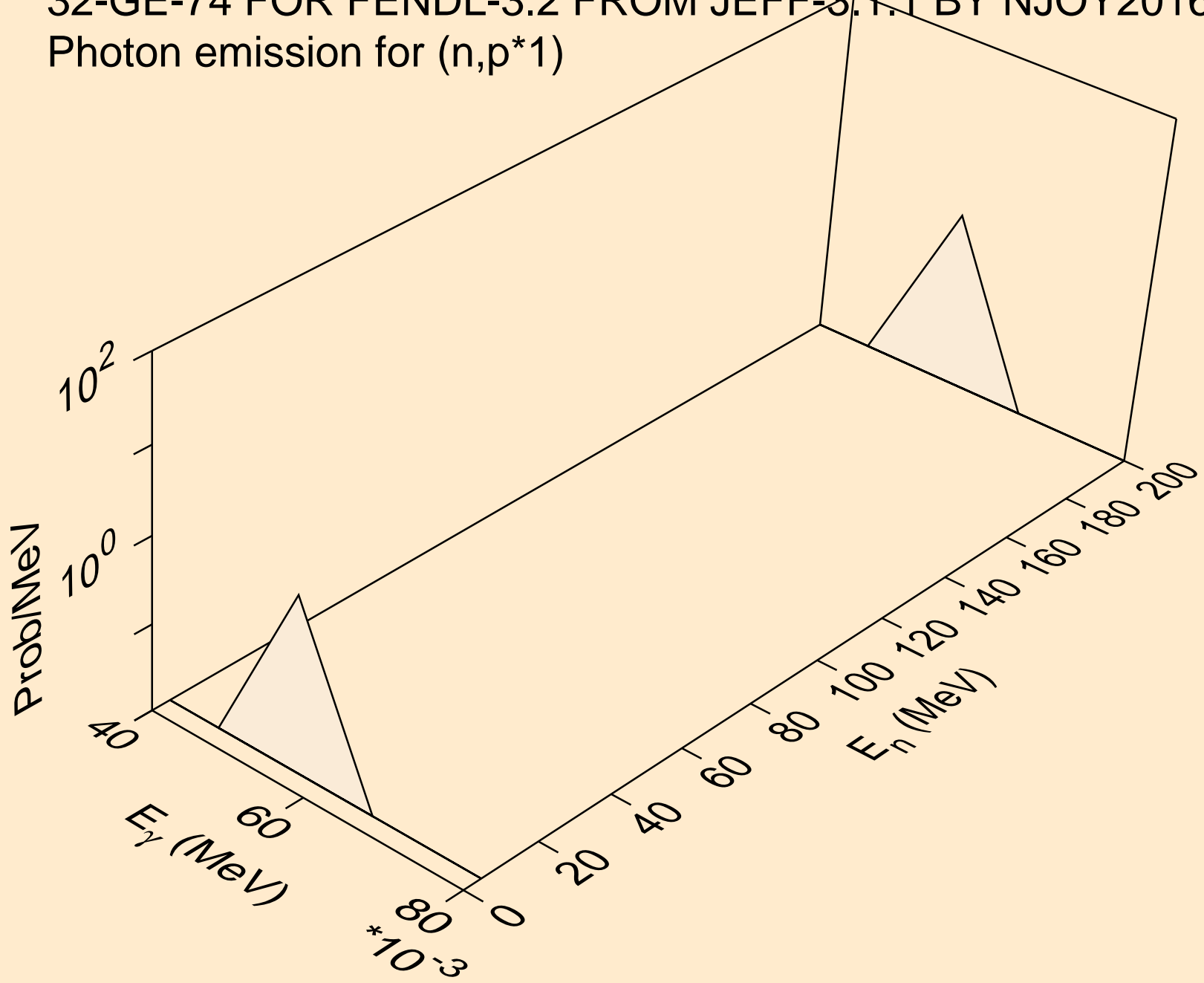

32-GE-74 FOR FENDL-3.2 FROM JEFF-3.1.1 BY NJOY2016.60+ O
Photon emission for (n,p*3)

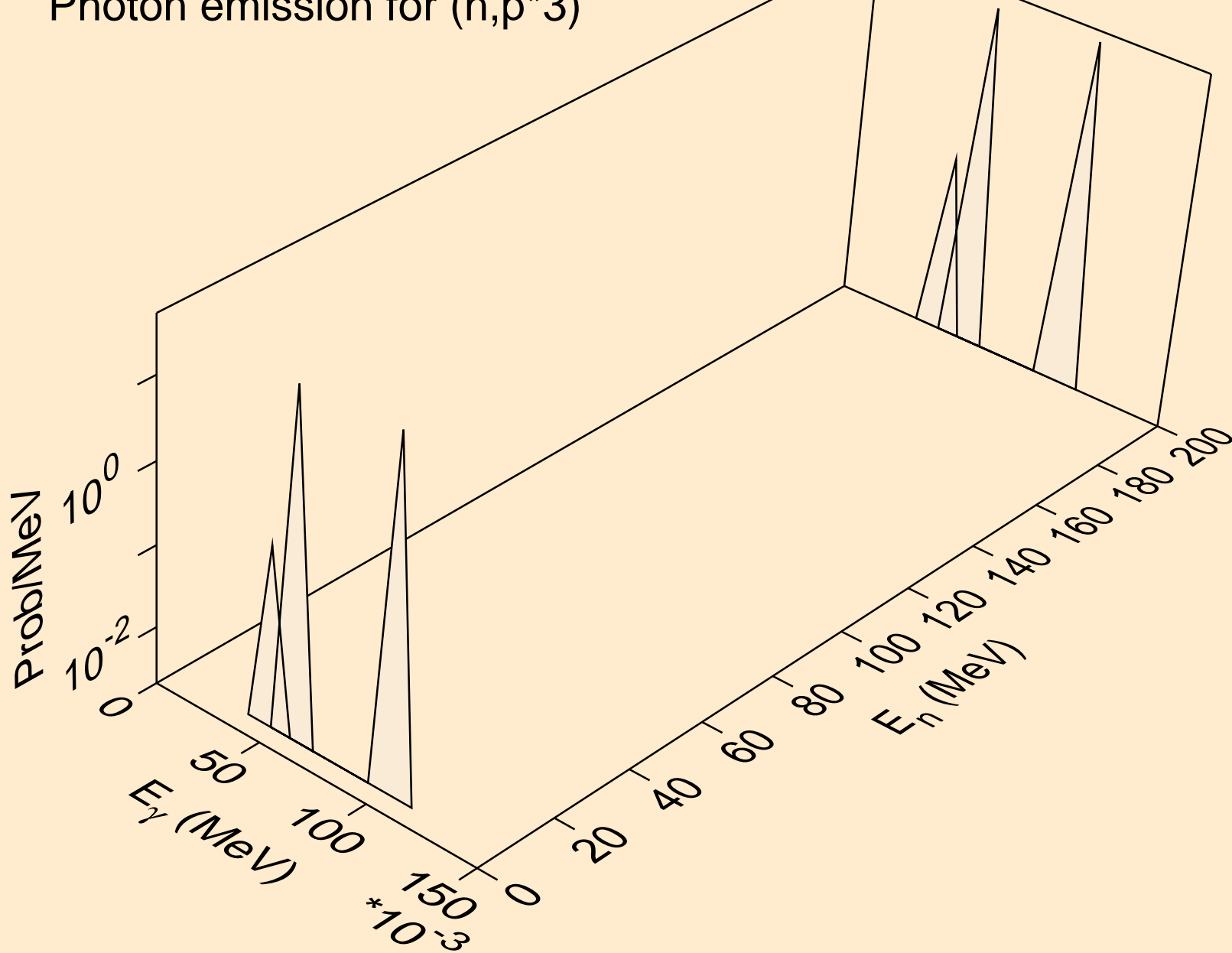

32-GE-74 FOR FENDL-3.2 FROM JEFF-3.1.1 BY NJOY2016.60+ O
Photon emission for (n,p*4)

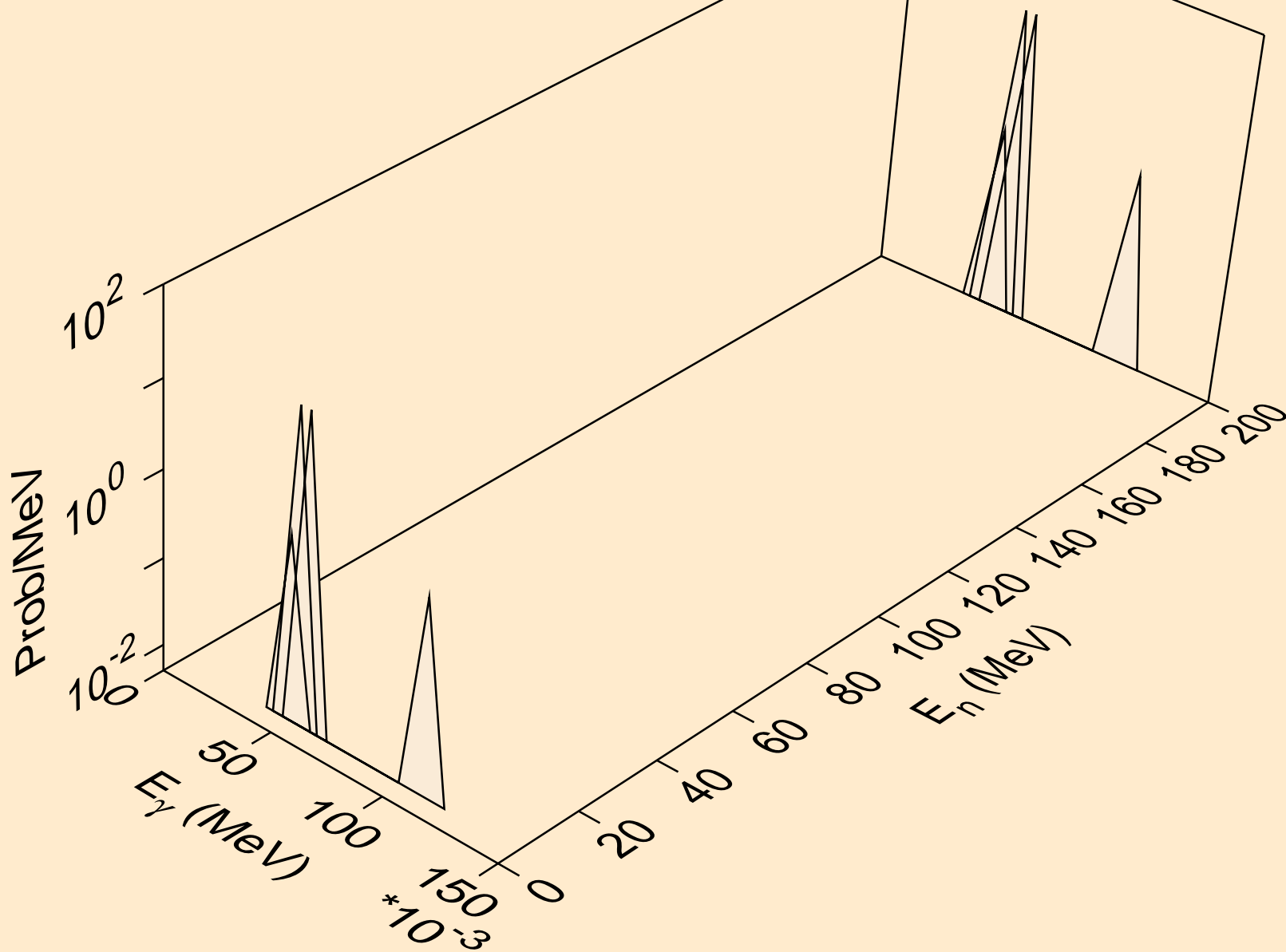

32-GE-74 FOR FENDL-3.2 FROM JEFF-3.1.1 BY NJOY2016.60+ O
Photon emission for (n,p*5)

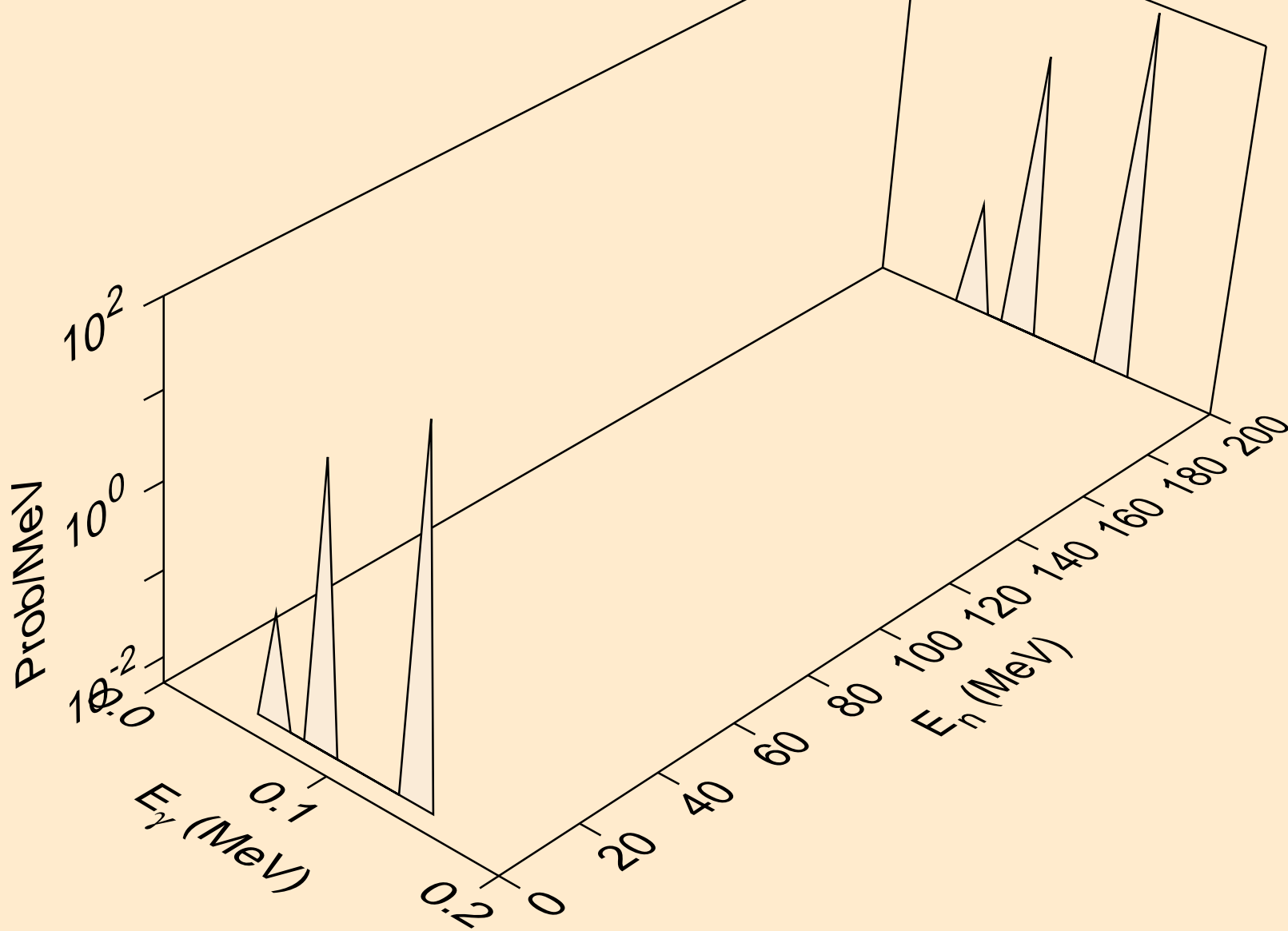

32-GE-74 FOR FENDL-3.2 FROM JEFF-3.1.1 BY NJOY2016.60+ O
Photon emission for (n,p*6)

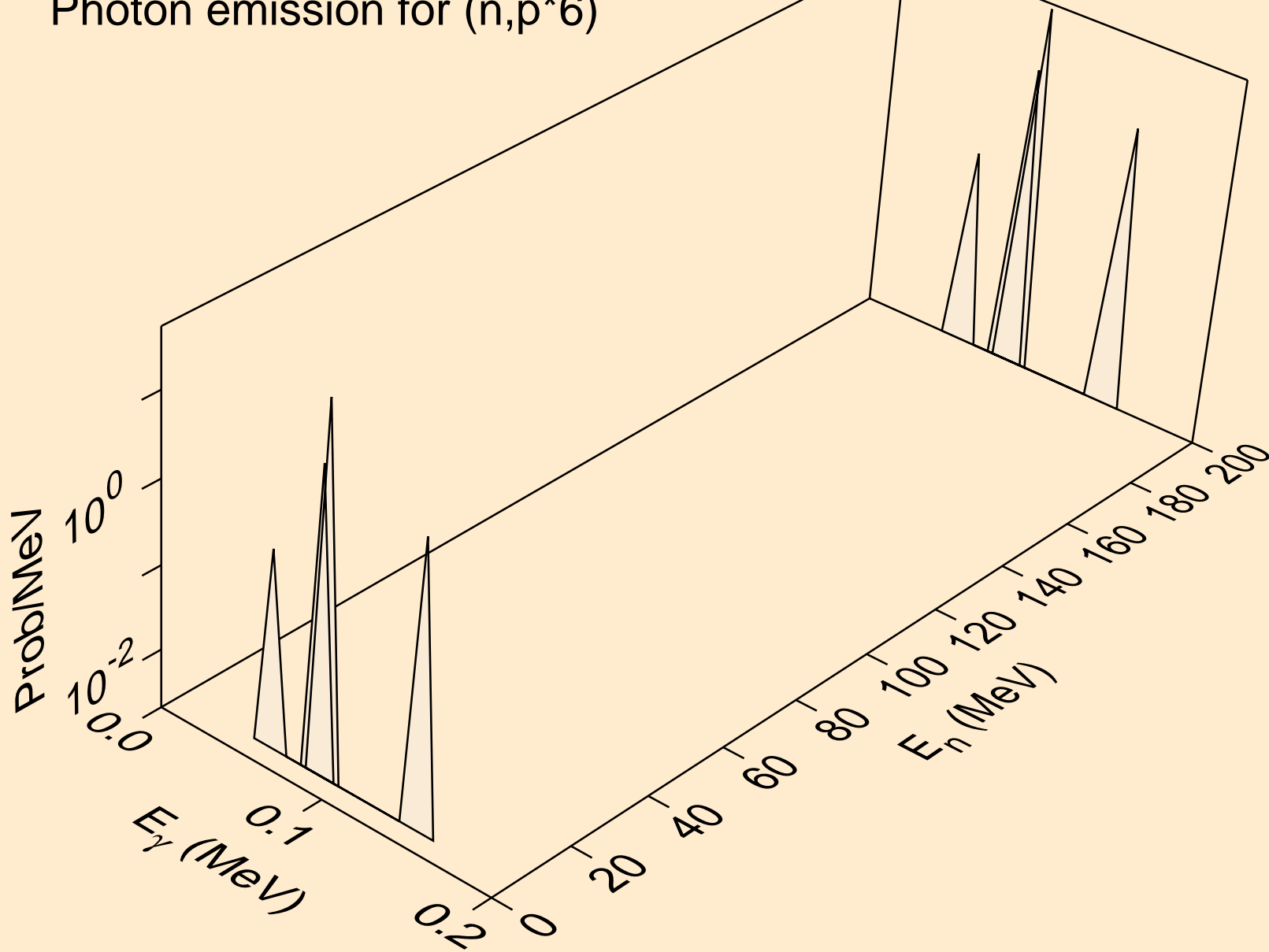

32-GE-74 FOR FENDL-3.2 FROM JEFF-3.1.1 BY NJOY2016.60+ O
Photon emission for (n,p*7)

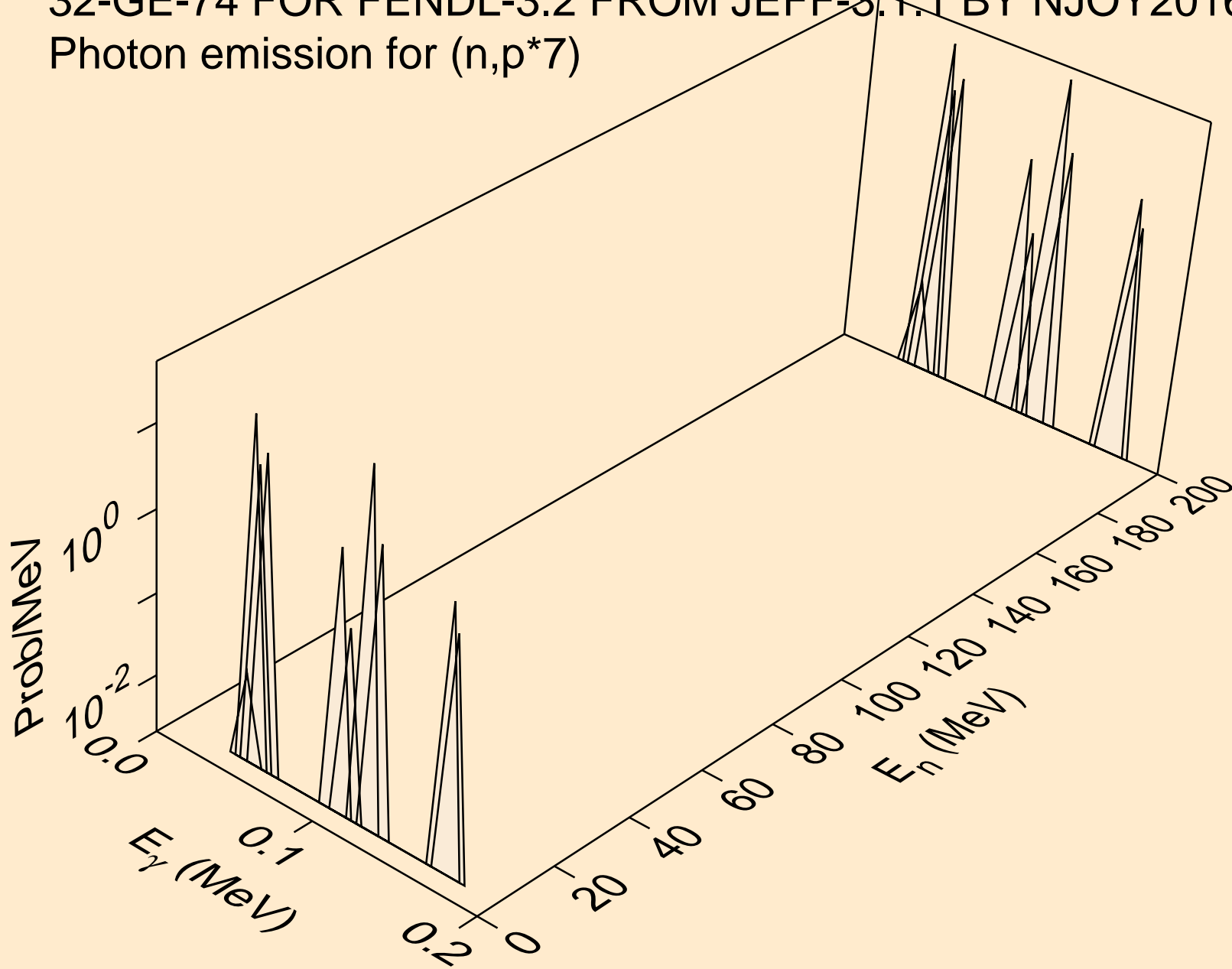

32-GE-74 FOR FENDL-3.2 FROM JEFF-3.1.1 BY NJOY2016.60+ O
Photon emission for (n,p*8)

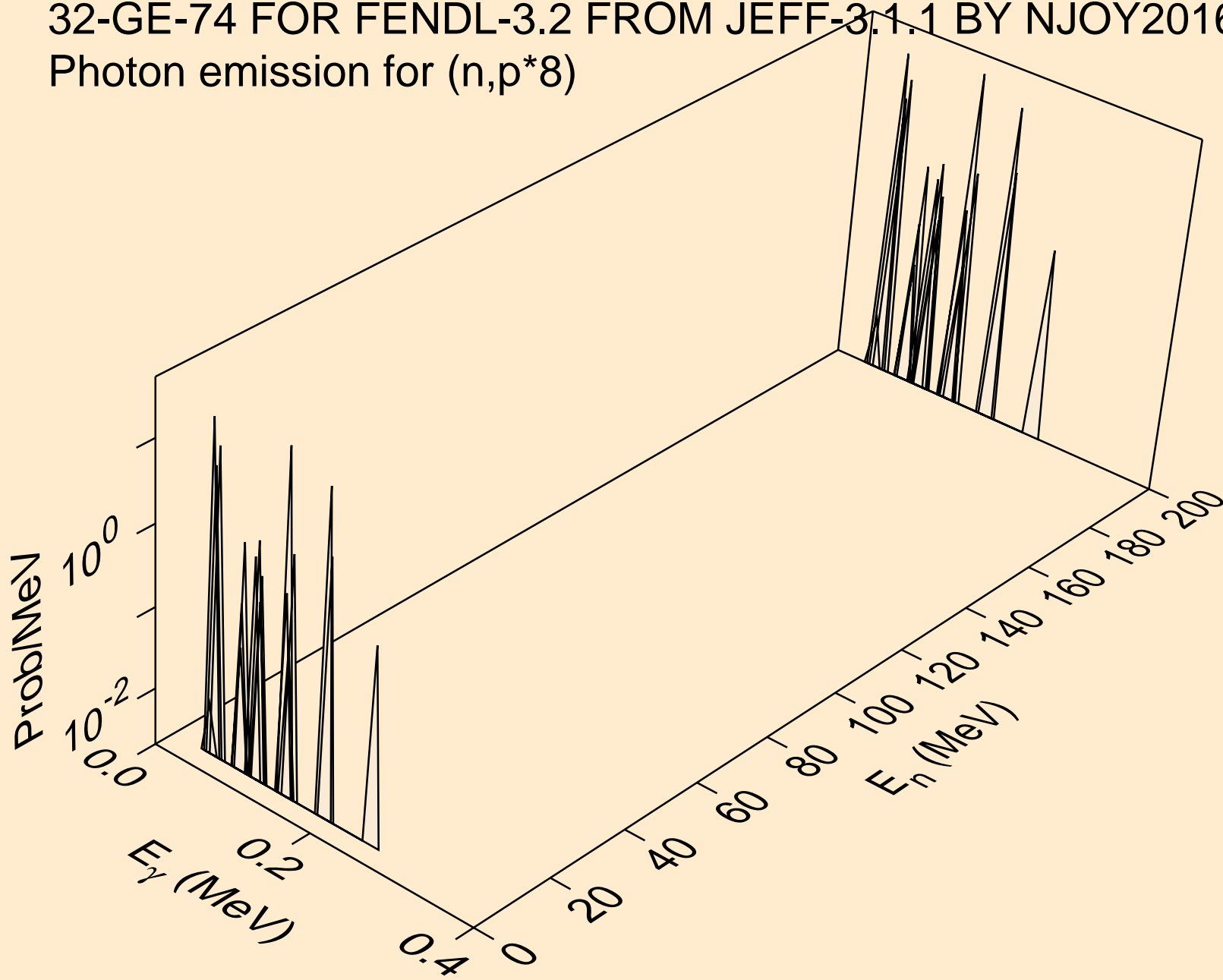

32-GE-74 FOR FENDL-3.2 FROM JEFF-3.1.1 BY NJOY2016.60+ O
Photon emission for (n,p*9)

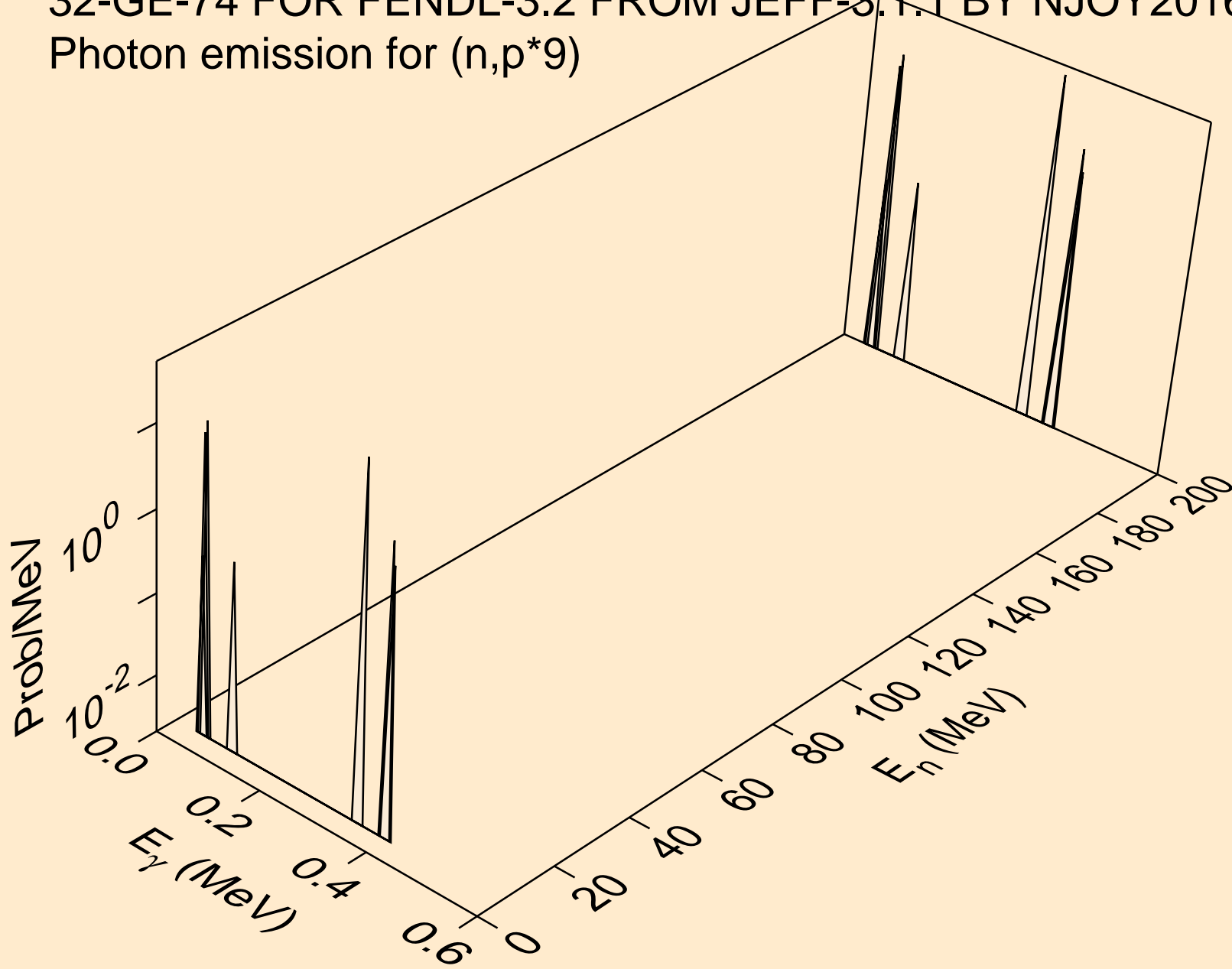

32-GE-74 FOR FENDL-3.2 FROM JEFF-3.1.1 BY NJOY2016.60+ O
Photon emission for (n,p*10)

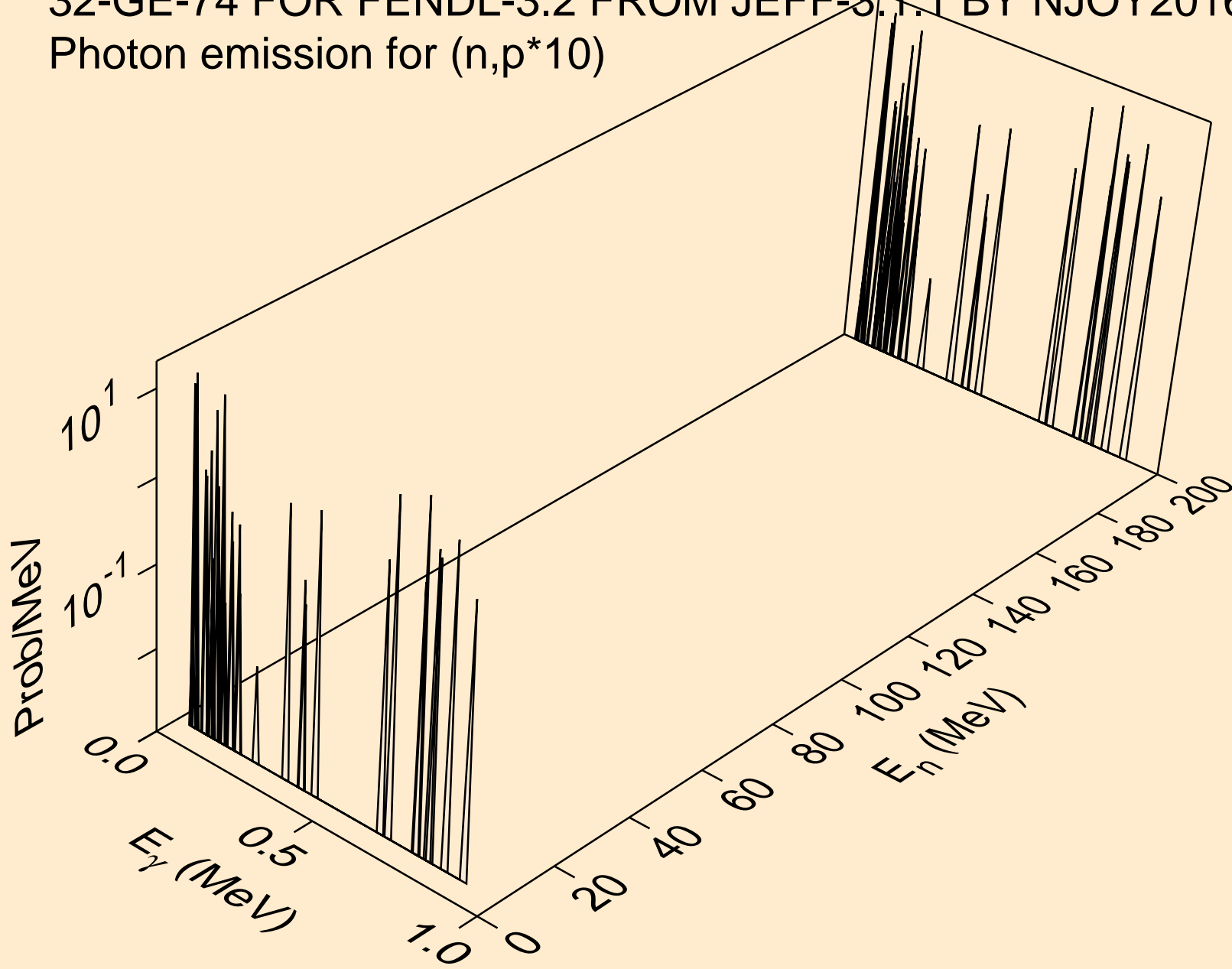

32-GE-74 FOR FENDL-3.2 FROM JEFF-3.1.1 BY NJOY2016.60+ O
Photon emission for (n,p*c)

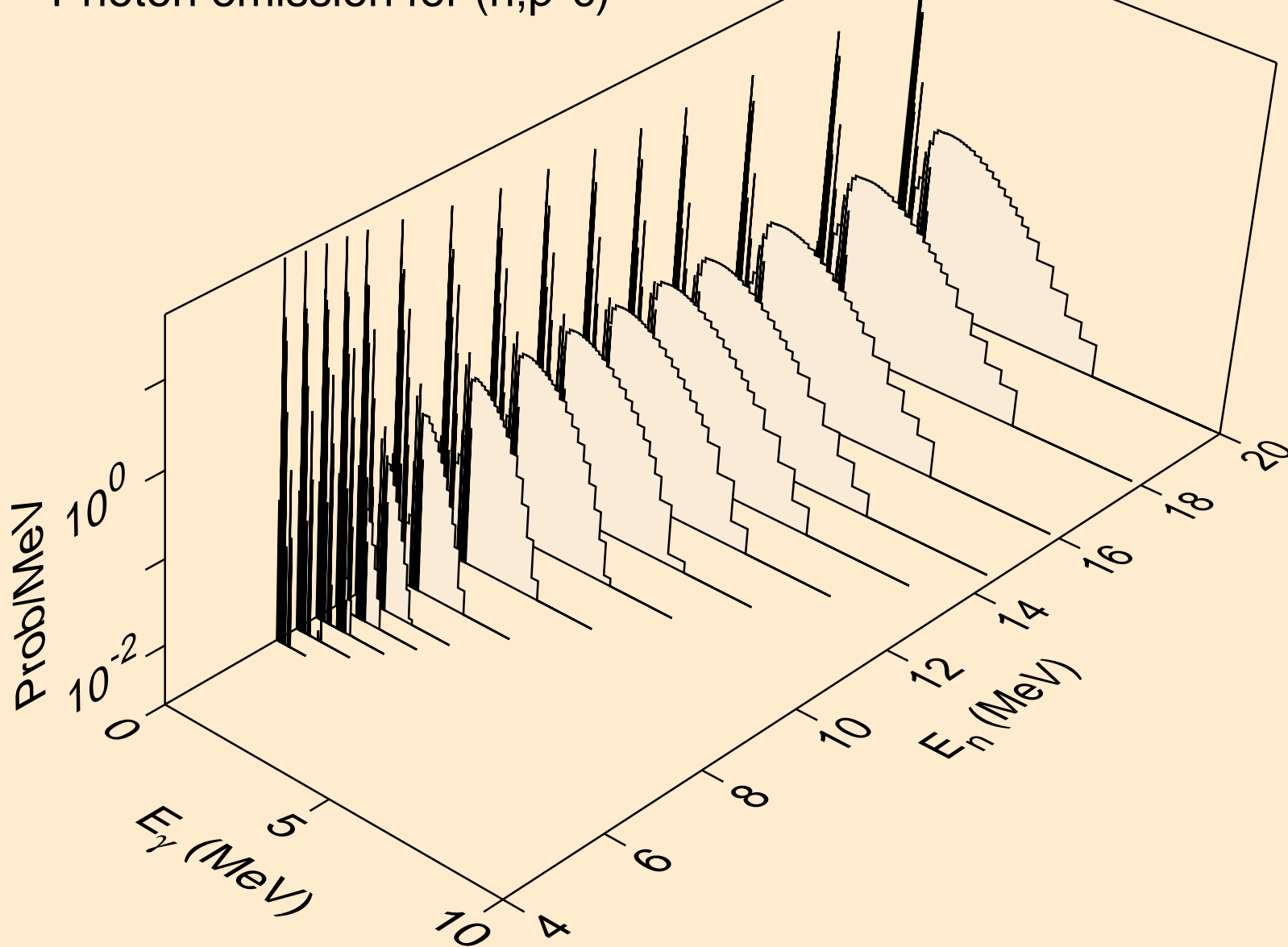

32-GE-74 FOR FENDL-3.2 FROM JEFF-3.1.1 BY NJOY2016.60+ O
Photon emission for (n,d*1)

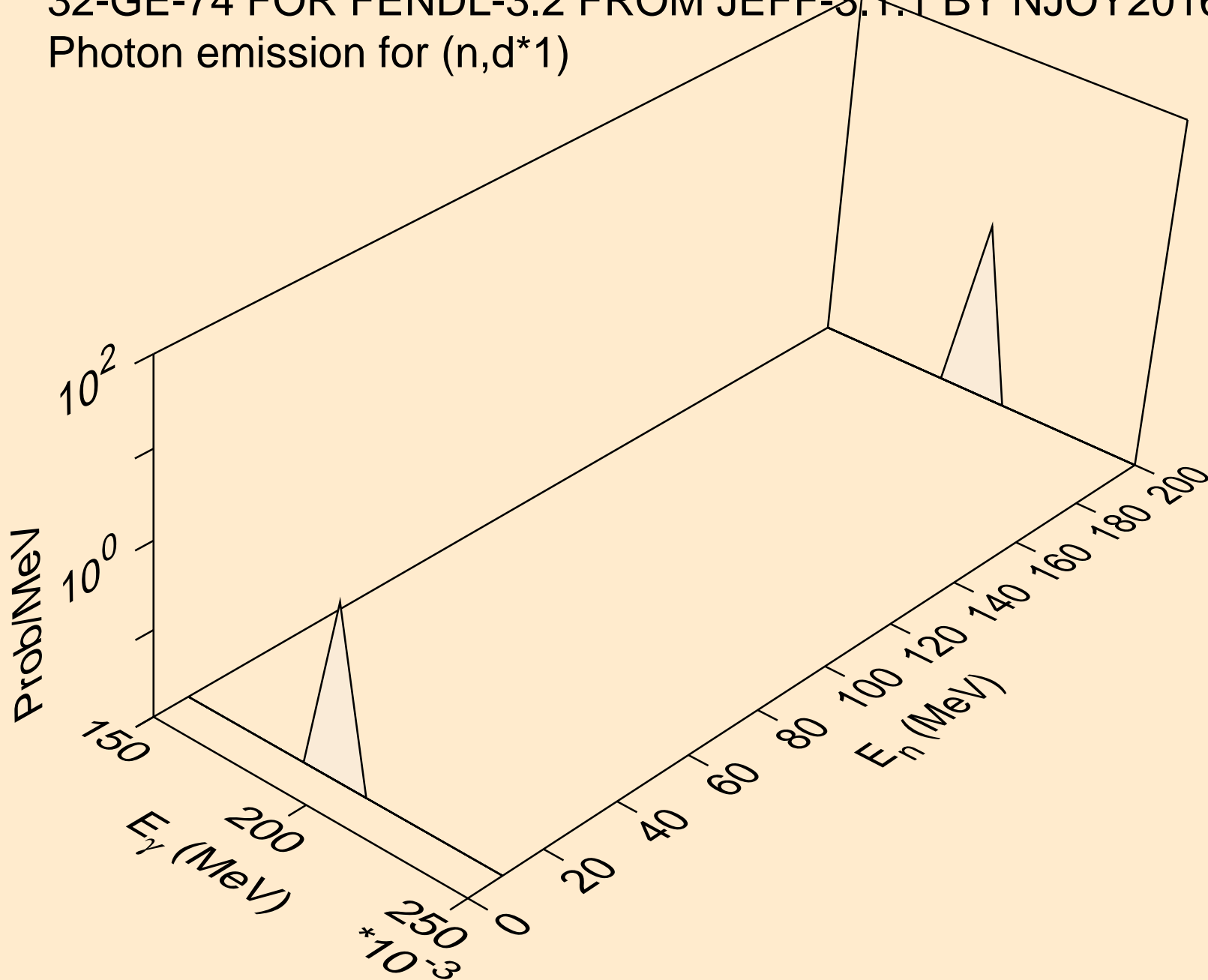

32-GE-74 FOR FENDL-3.2 FROM JEFF-3.1.1 BY NJOY2016.60+ O
Photon emission for (n,d*2)

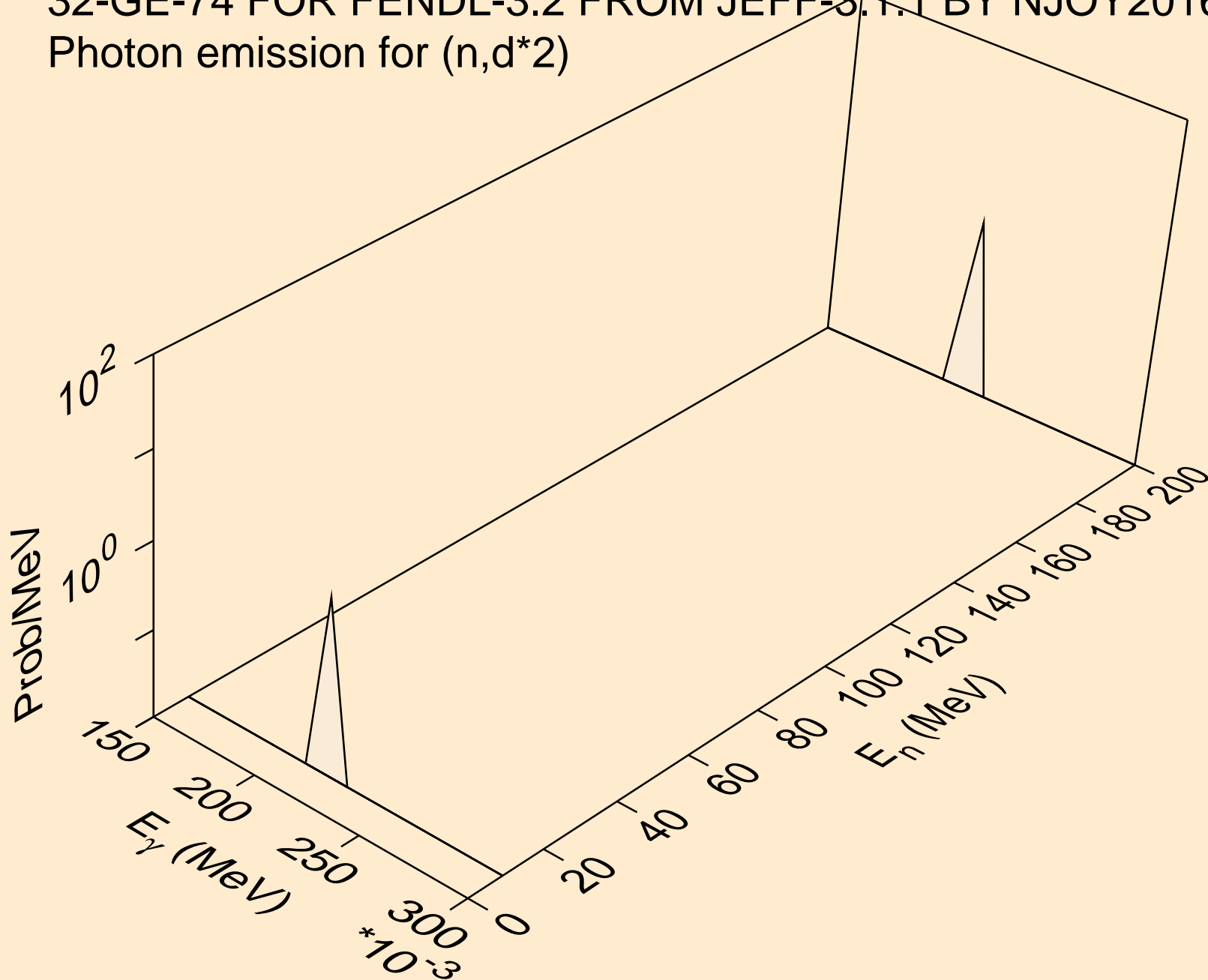

32-GE-74 FOR FENDL-3.2 FROM JEFF-3.1.1 BY NJOY2016.60+ O
Photon emission for (n,d*3)

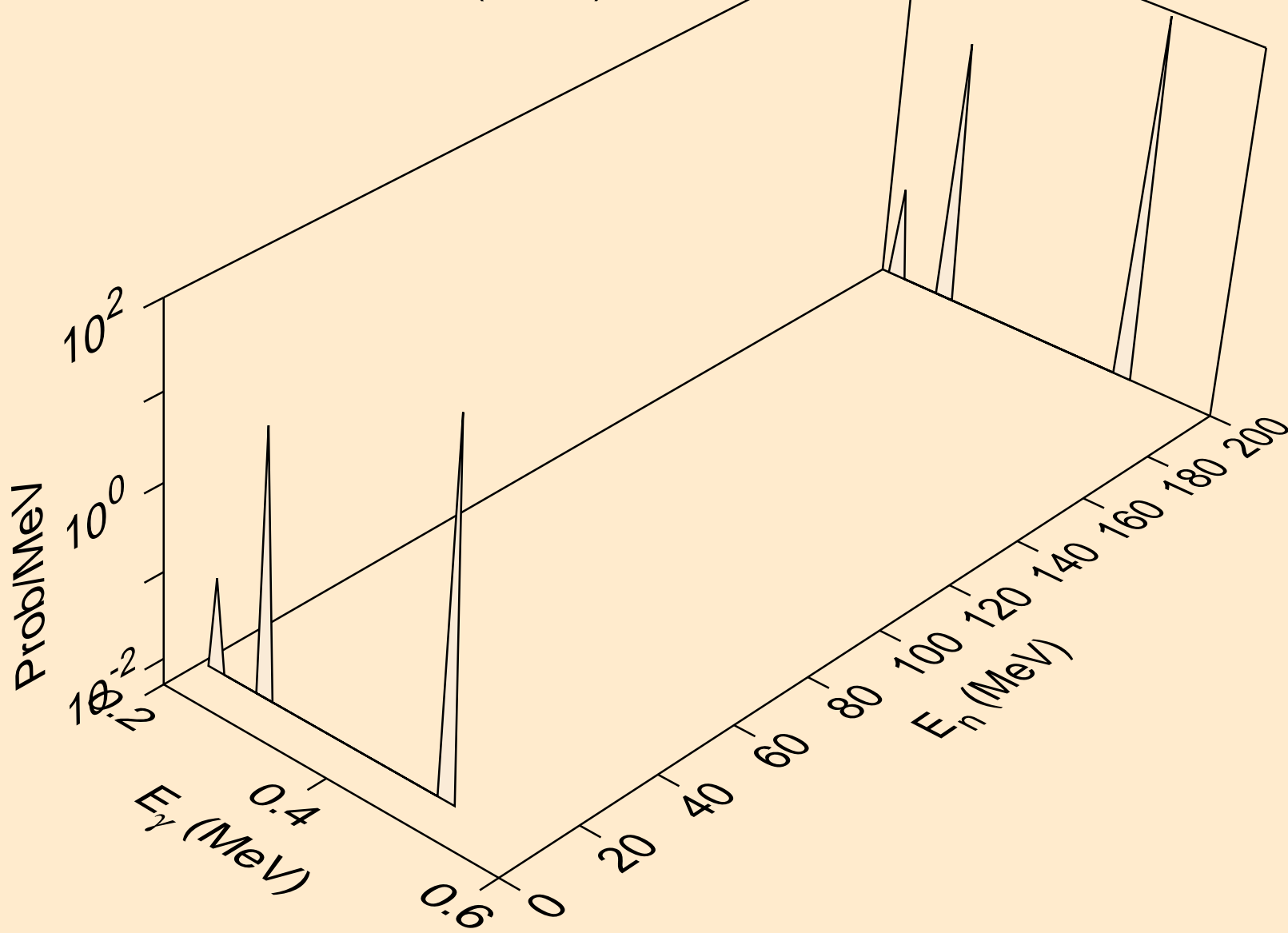

32-GE-74 FOR FENDL-3.2 FROM JEFF-3.1.1 BY NJOY2016.60+ O
Photon emission for (n,d*4)

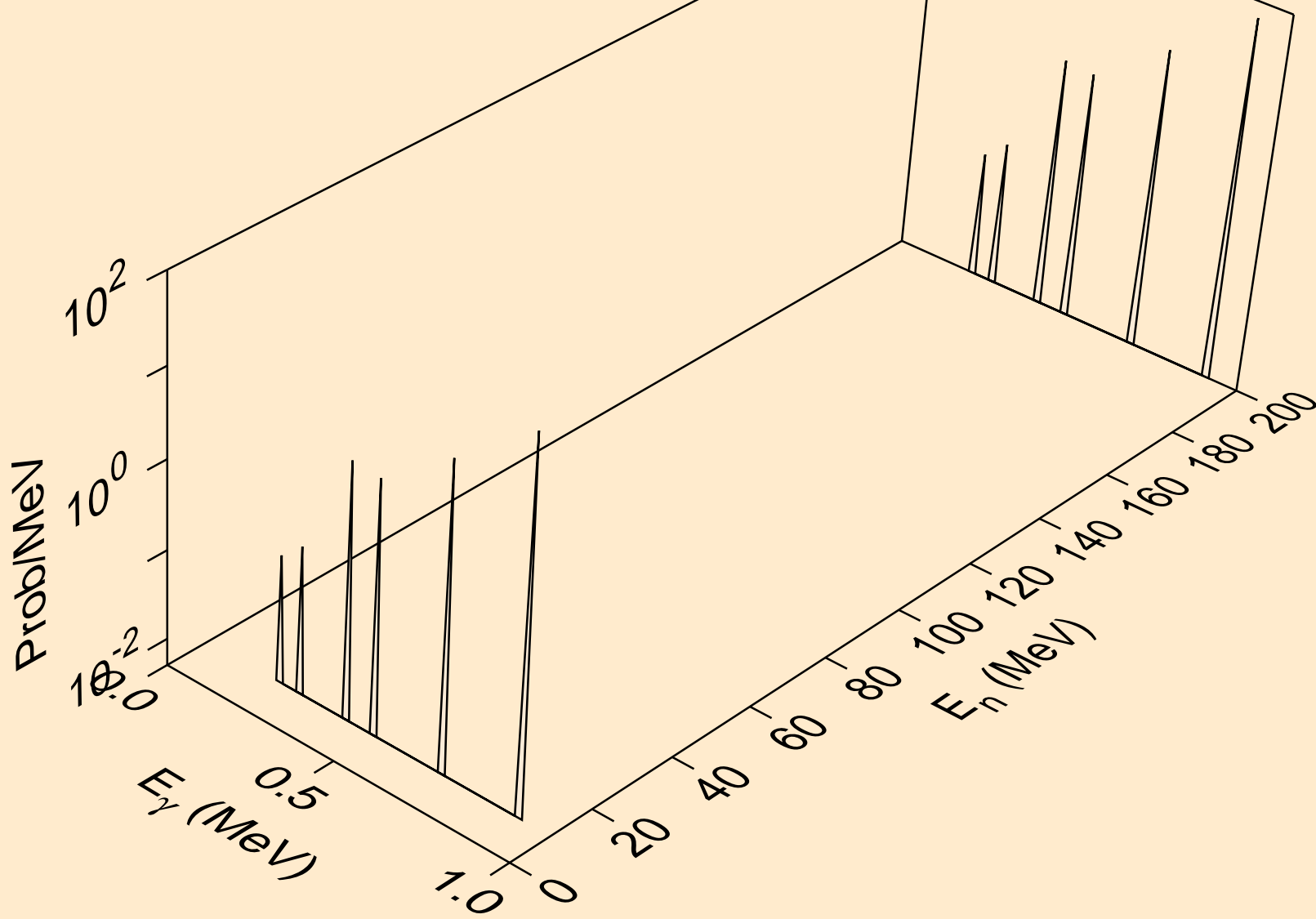

32-GE-74 FOR FENDL-3.2 FROM JEFF-3.1.1 BY NJOY2016.60+ O
Photon emission for (n,d*5)

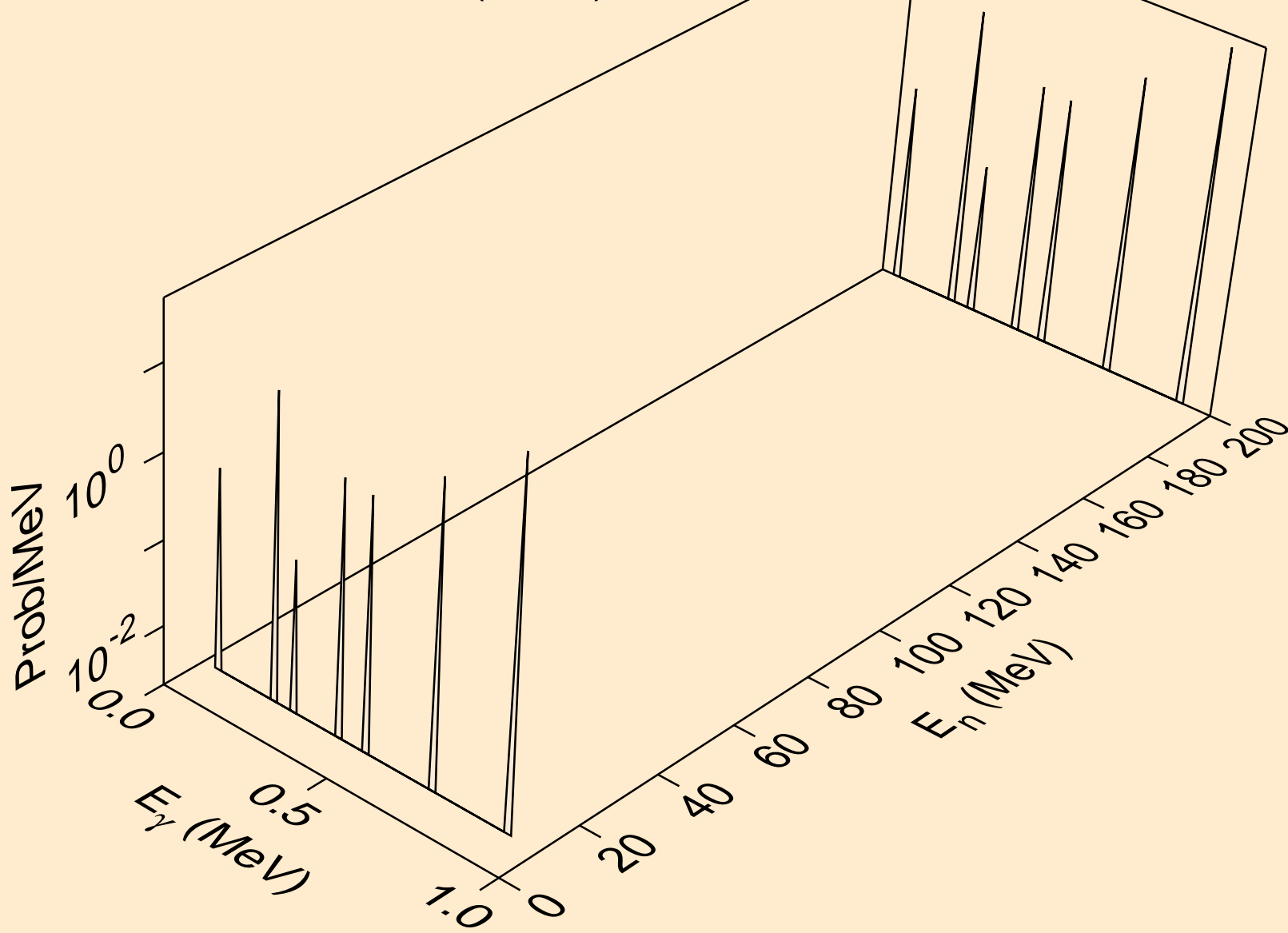

32-GE-74 FOR FENDL-3.2 FROM JEFF-3.1.1 BY NJOY2016.60+ O
Photon emission for (n,d*c)

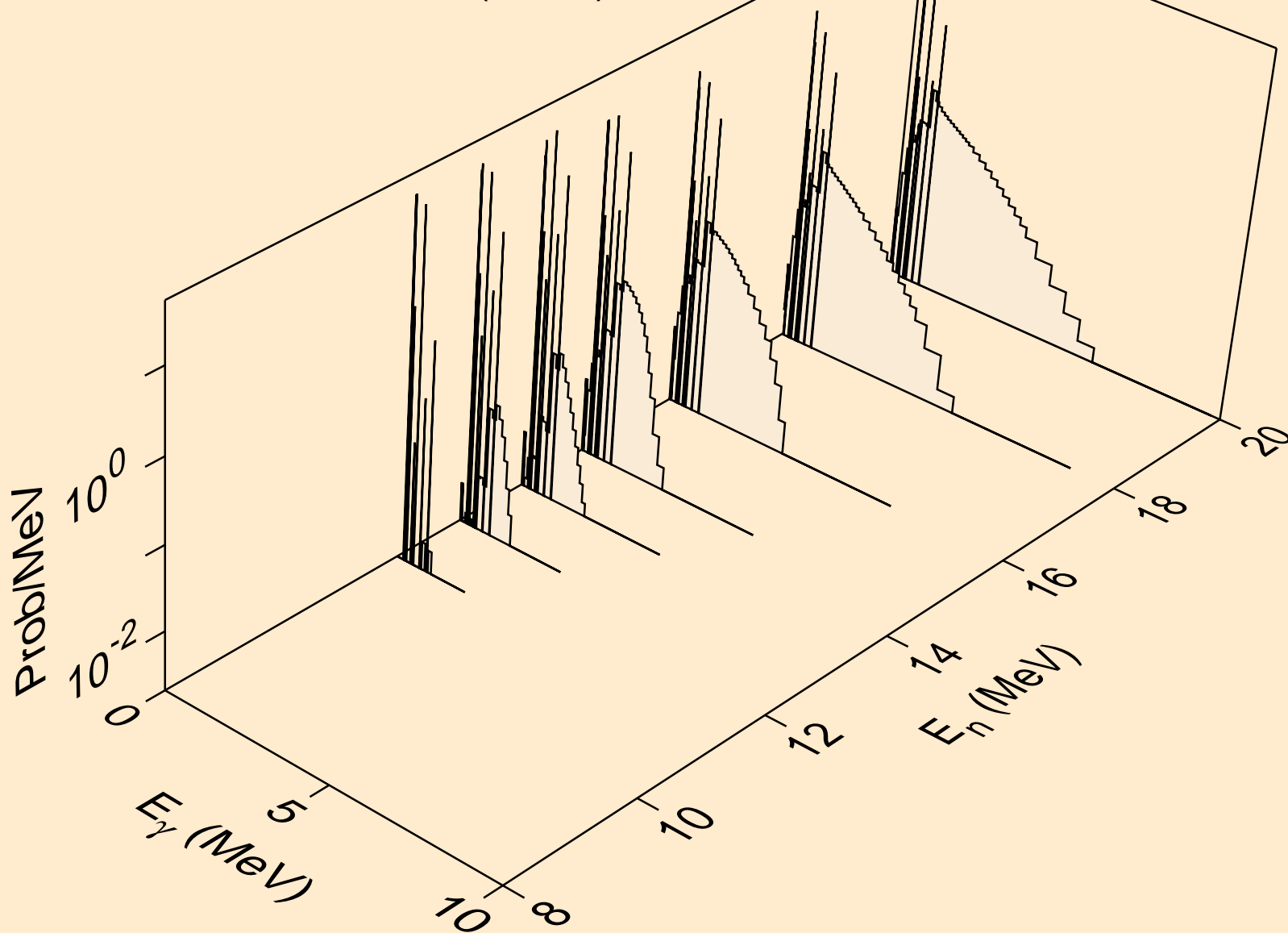

32-GE-74 FOR FENDL-3.2 FROM JEFF-3.1.1 BY NJOY2016.60+ O
Photon emission for (n,t*1)

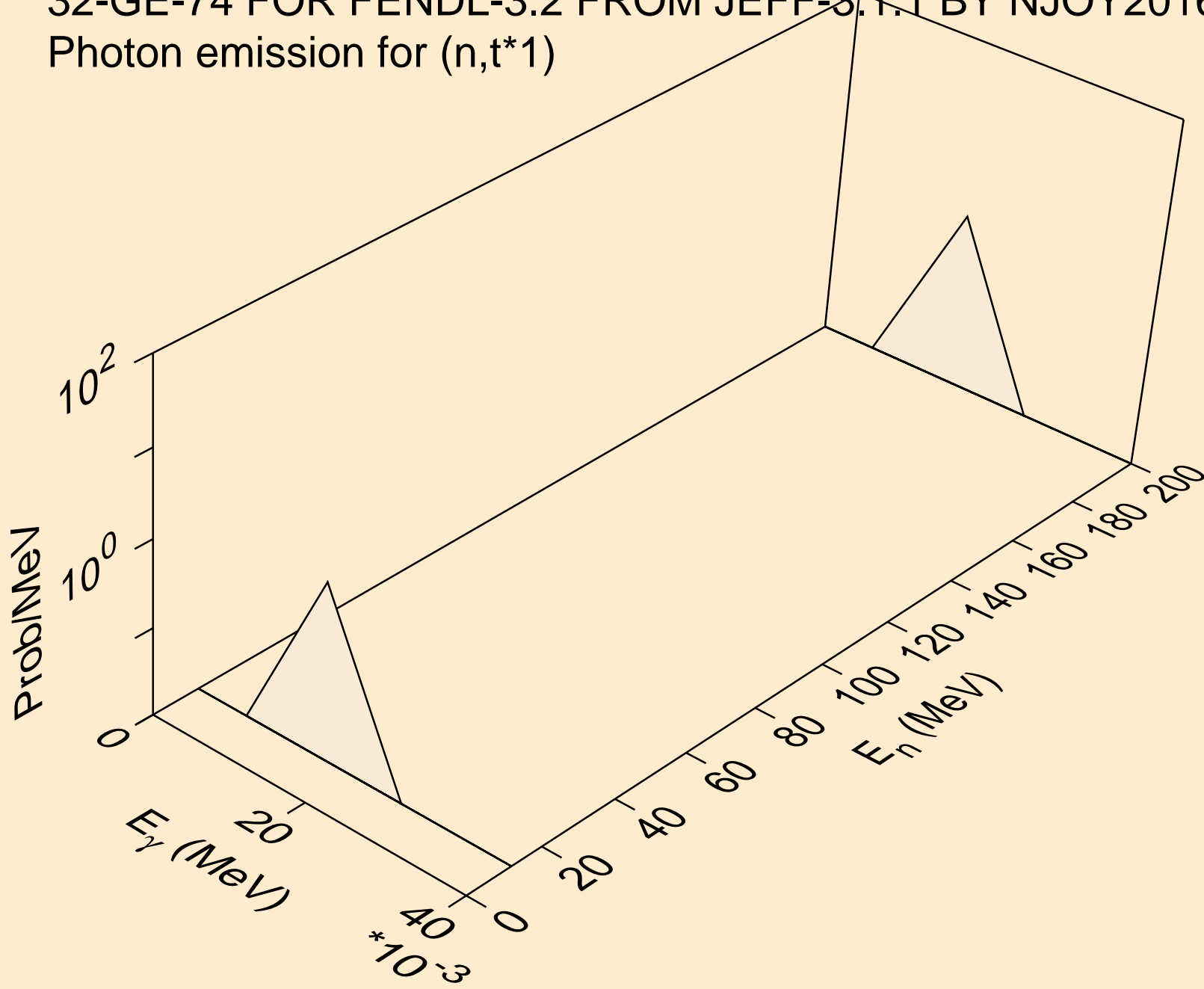

32-GE-74 FOR FENDL-3.2 FROM JEFF-3.1.1 BY NJOY2016.60+ O
Photon emission for (n,t*2)

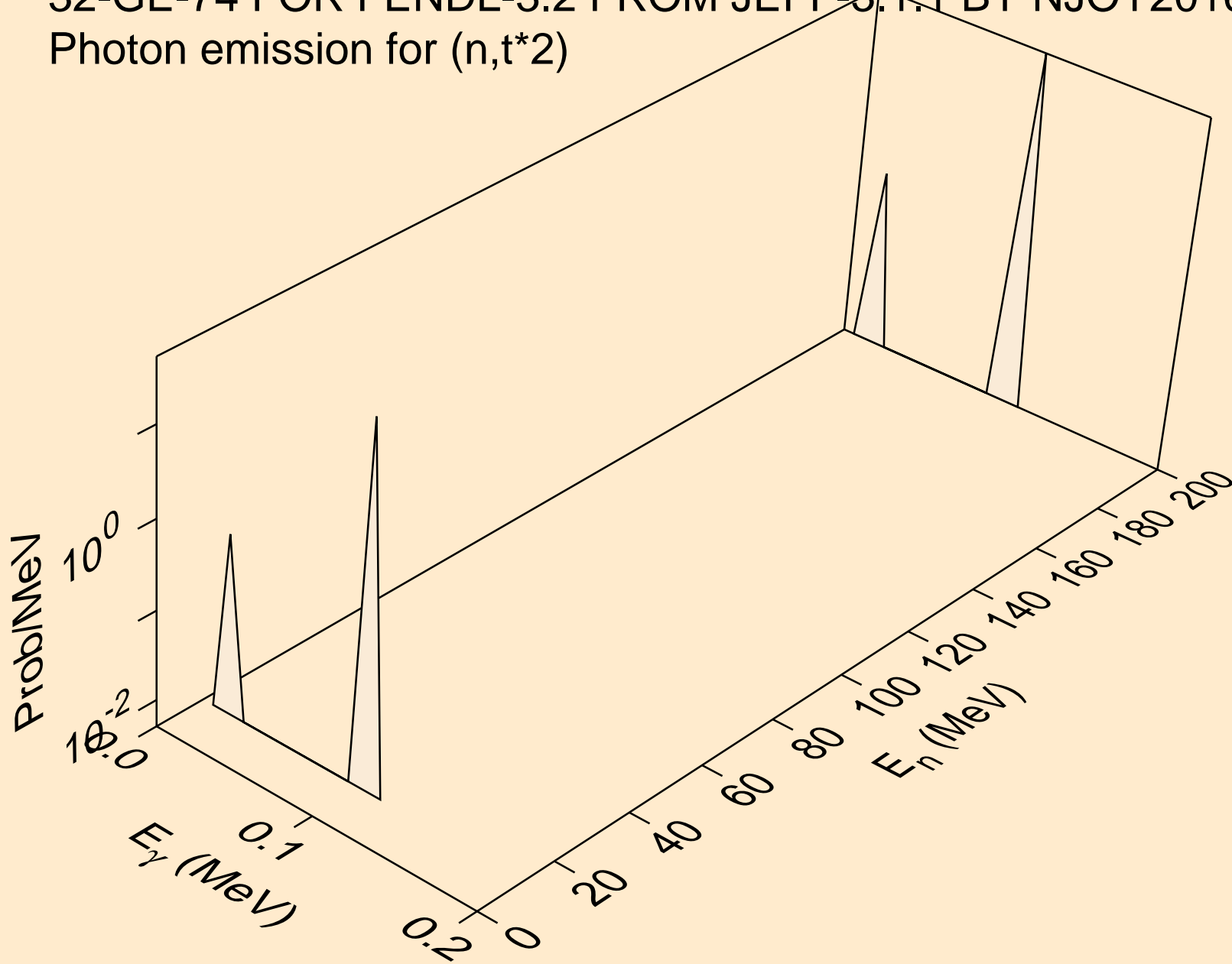

32-GE-74 FOR FENDL-3.2 FROM JEFF-3.1.1 BY NJOY2016.60+ O
Photon emission for (n,t*3)

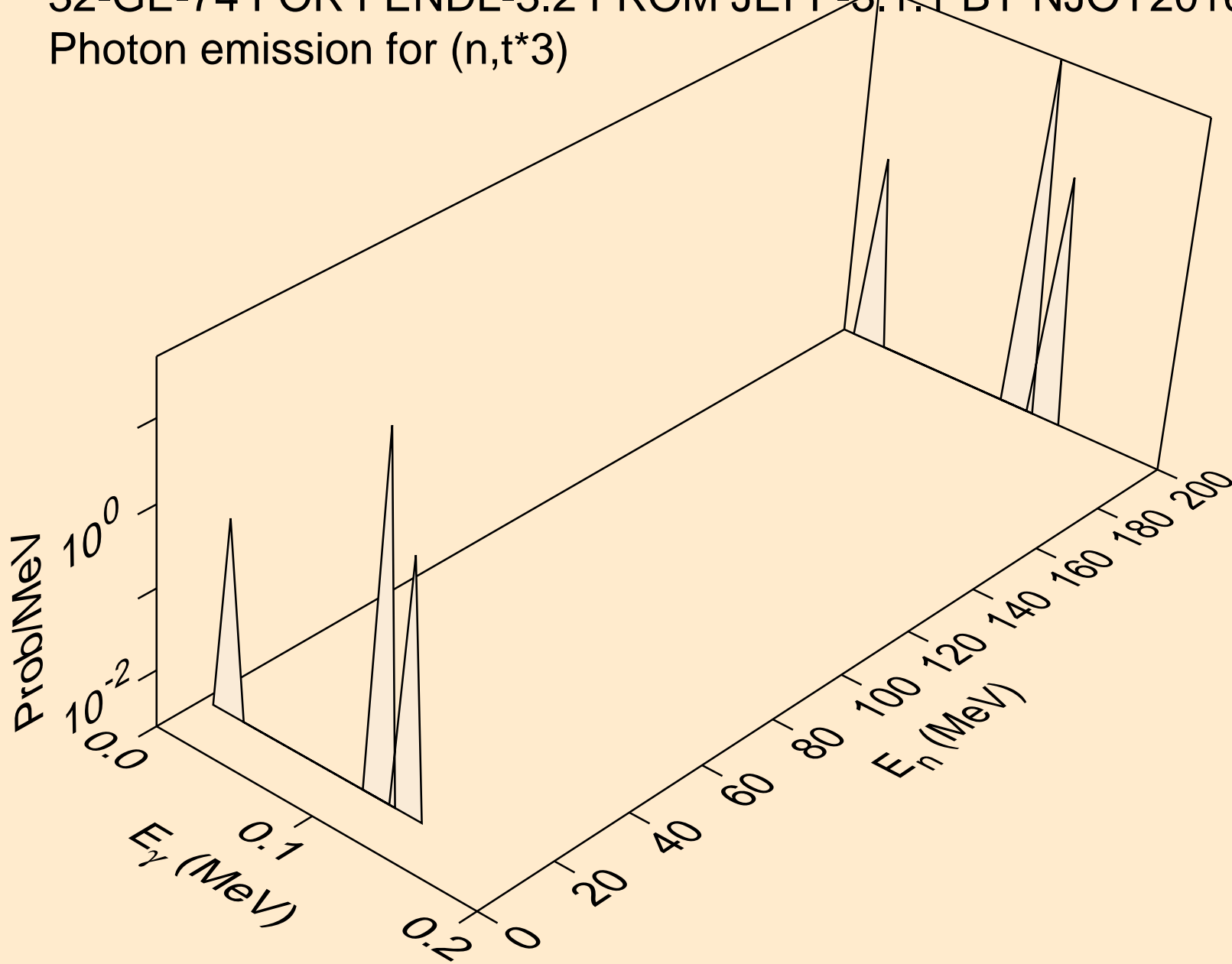

32-GE-74 FOR FENDL-3.2 FROM JEFF-3.1.1 BY NJOY2016.60+ O
Photon emission for (n,t*4)

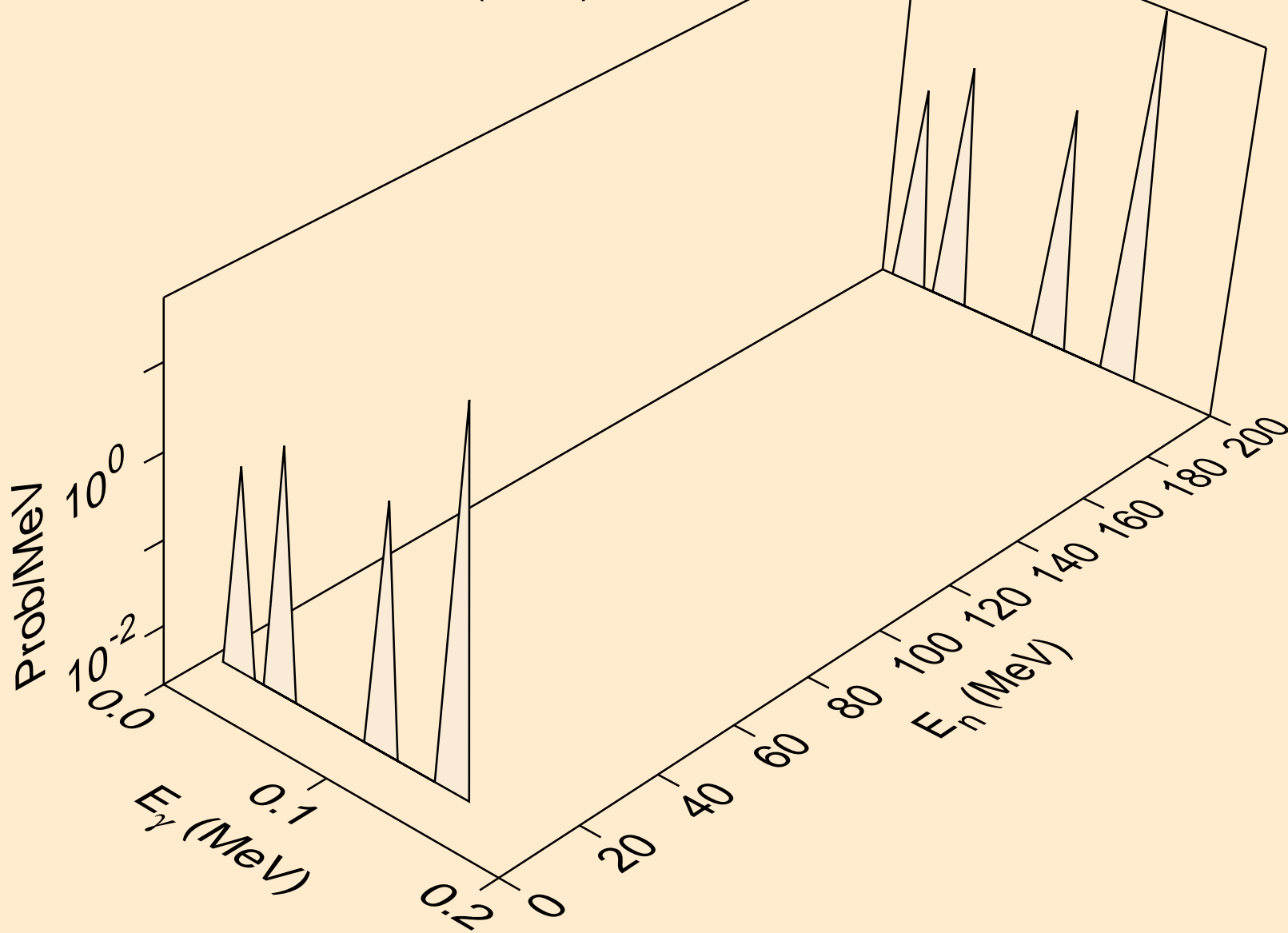

32-GE-74 FOR FENDL-3.2 FROM JEFF-3.1.1 BY NJOY2016.60+ O
Photon emission for (n,t*5)

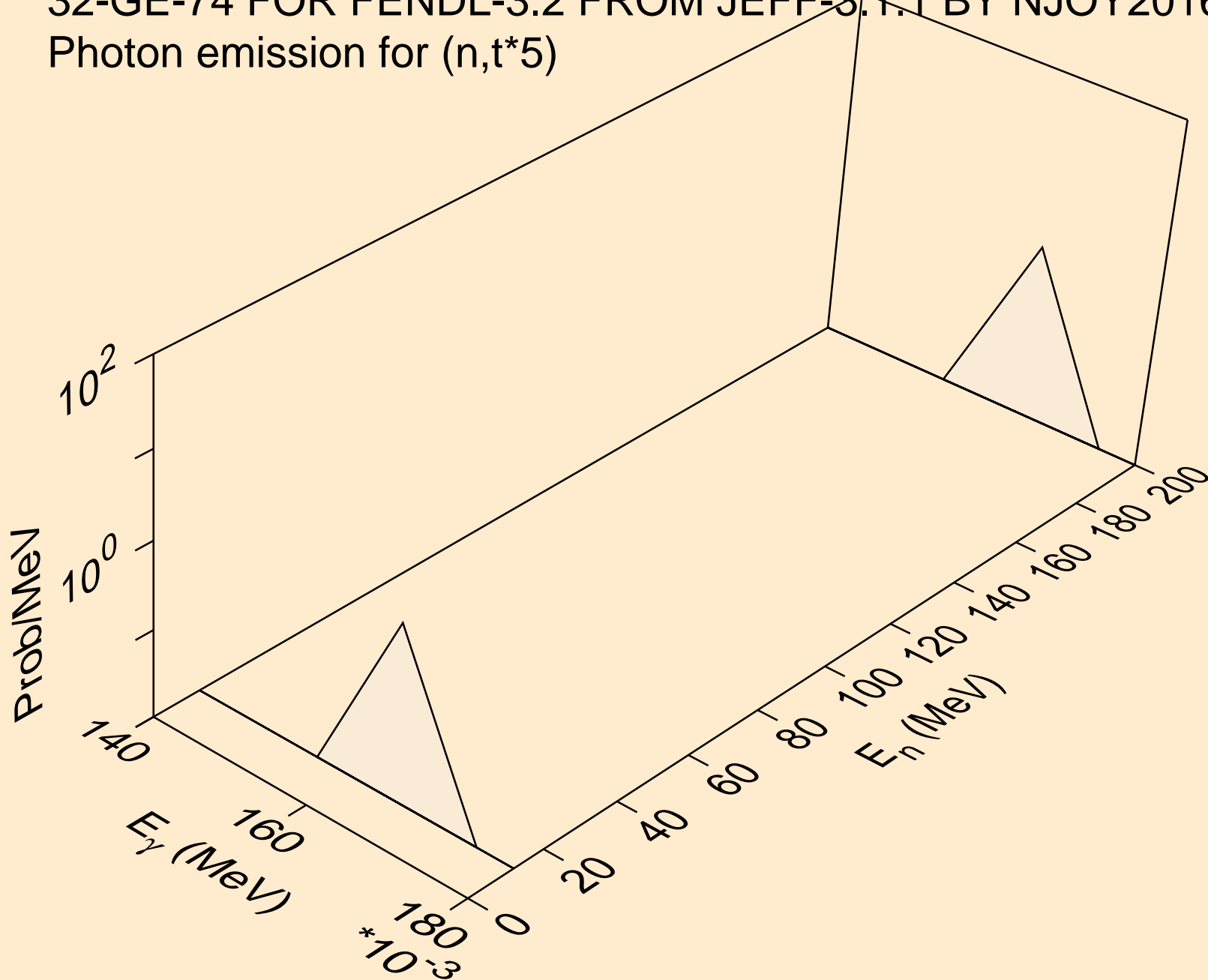

32-GE-74 FOR FENDL-3.2 FROM JEFF-3.1.1 BY NJOY2016.60+ O
Photon emission for (n,t*c)

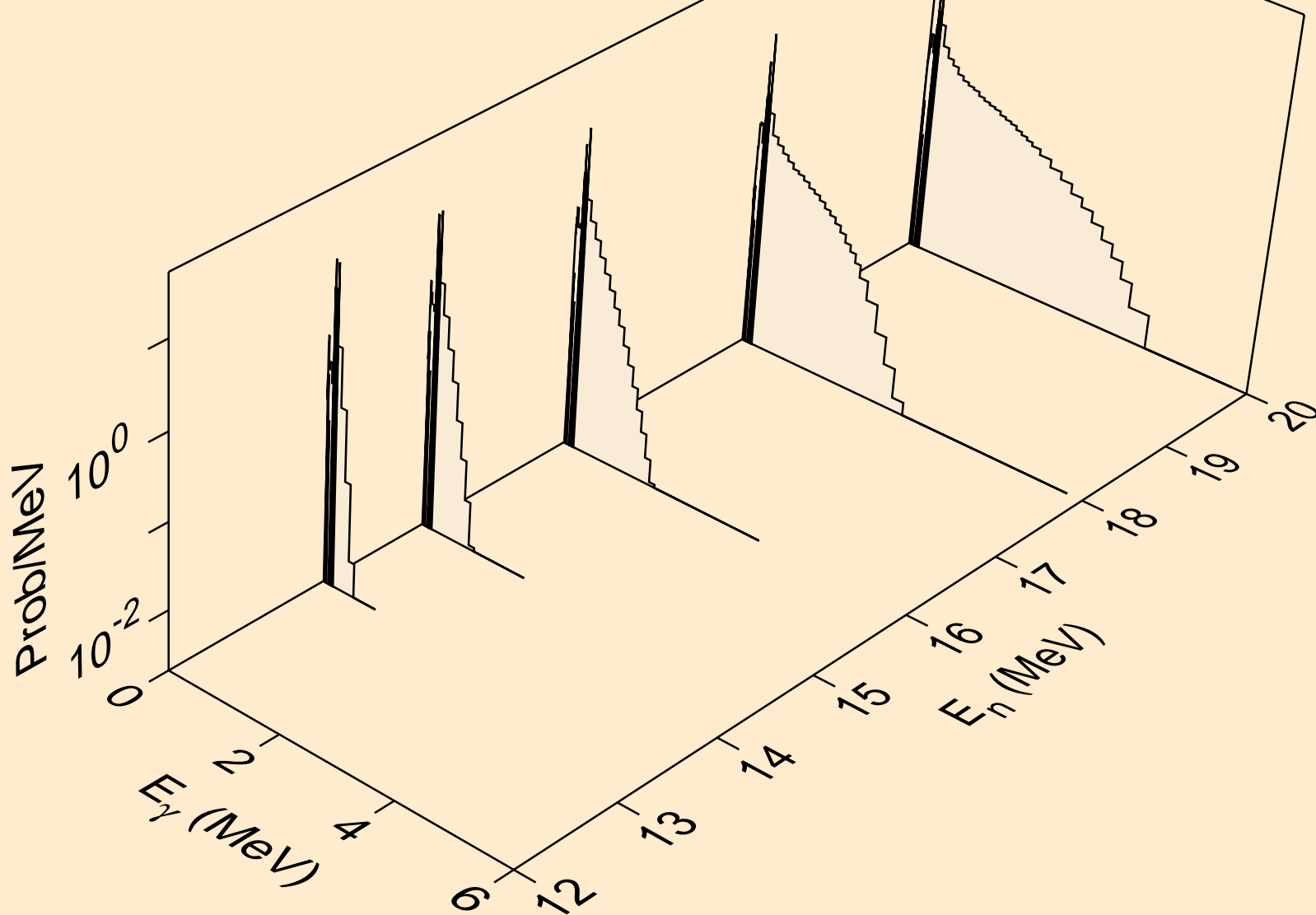

32-GE-74 FOR FENDL-3.2 FROM JEFF-3.1.1 BY NJOY2016.60+ O
Photon emission for (n,he3*1)

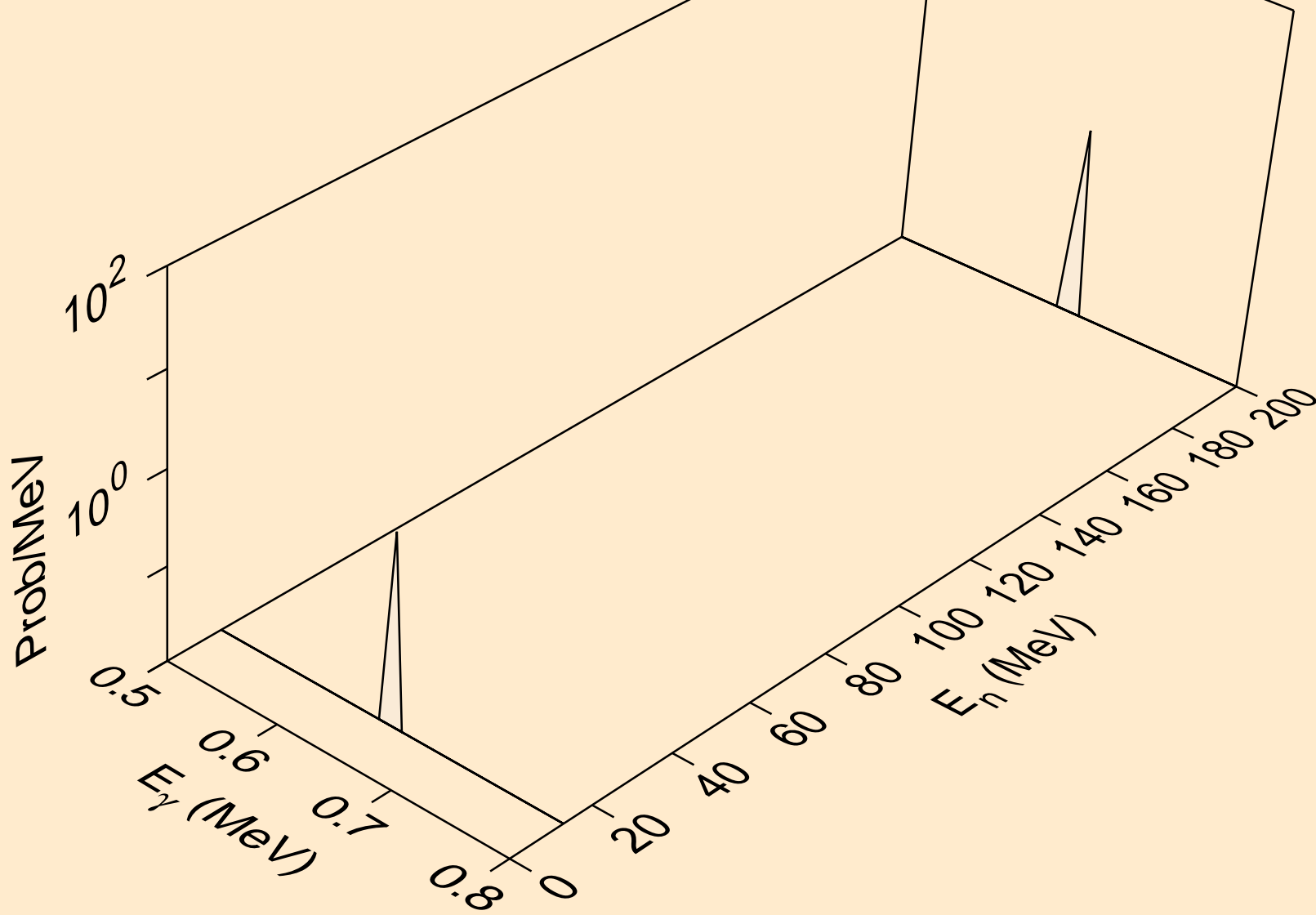

32-GE-74 FOR FENDL-3.2 FROM JEFF-3.1.1 BY NJOY2016.60+ O
Photon emission for (n,he3*2)

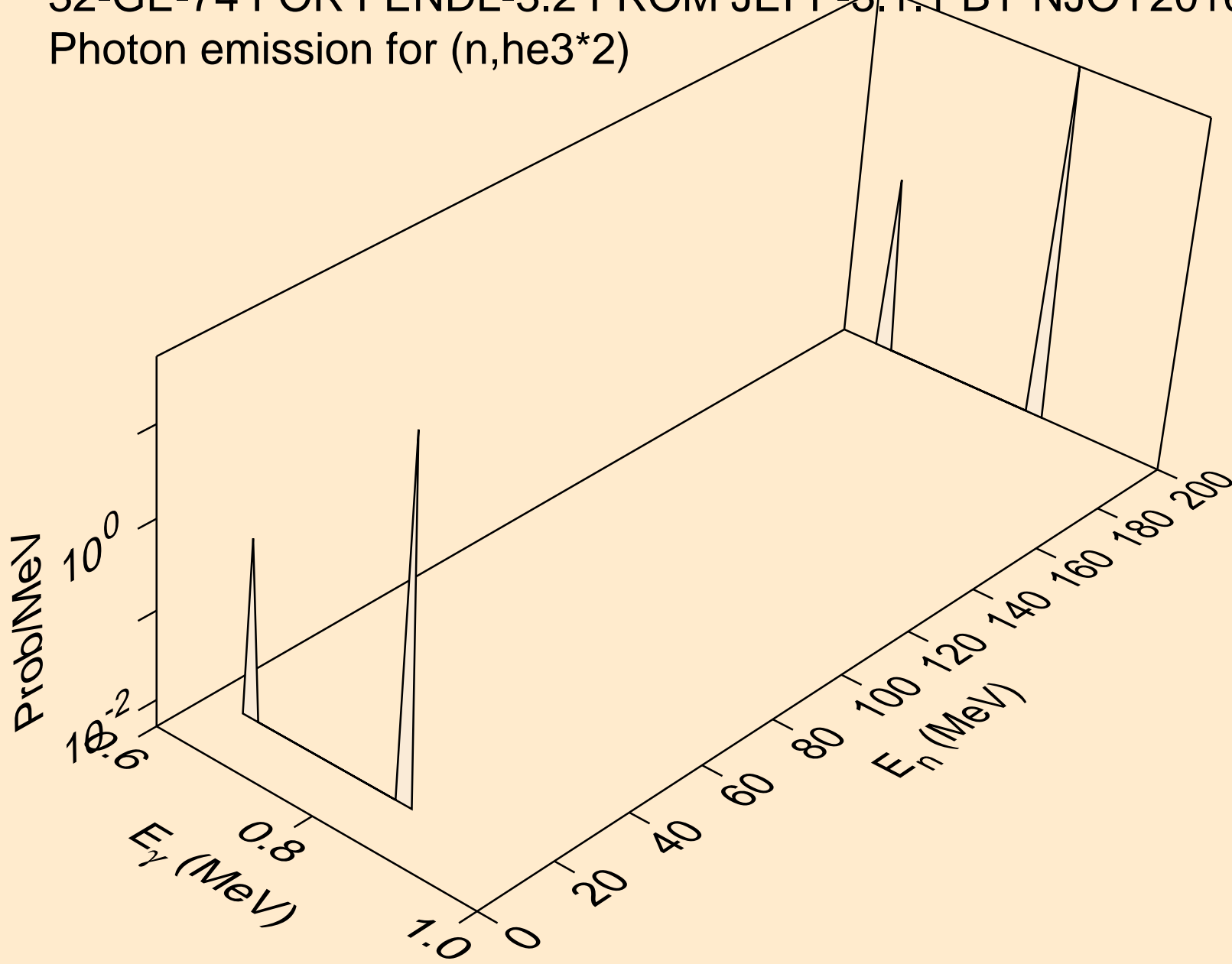

32-GE-74 FOR FENDL-3.2 FROM JEFF-3.1.1 BY NJOY2016.60+ O
Photon emission for (n,he3*3)

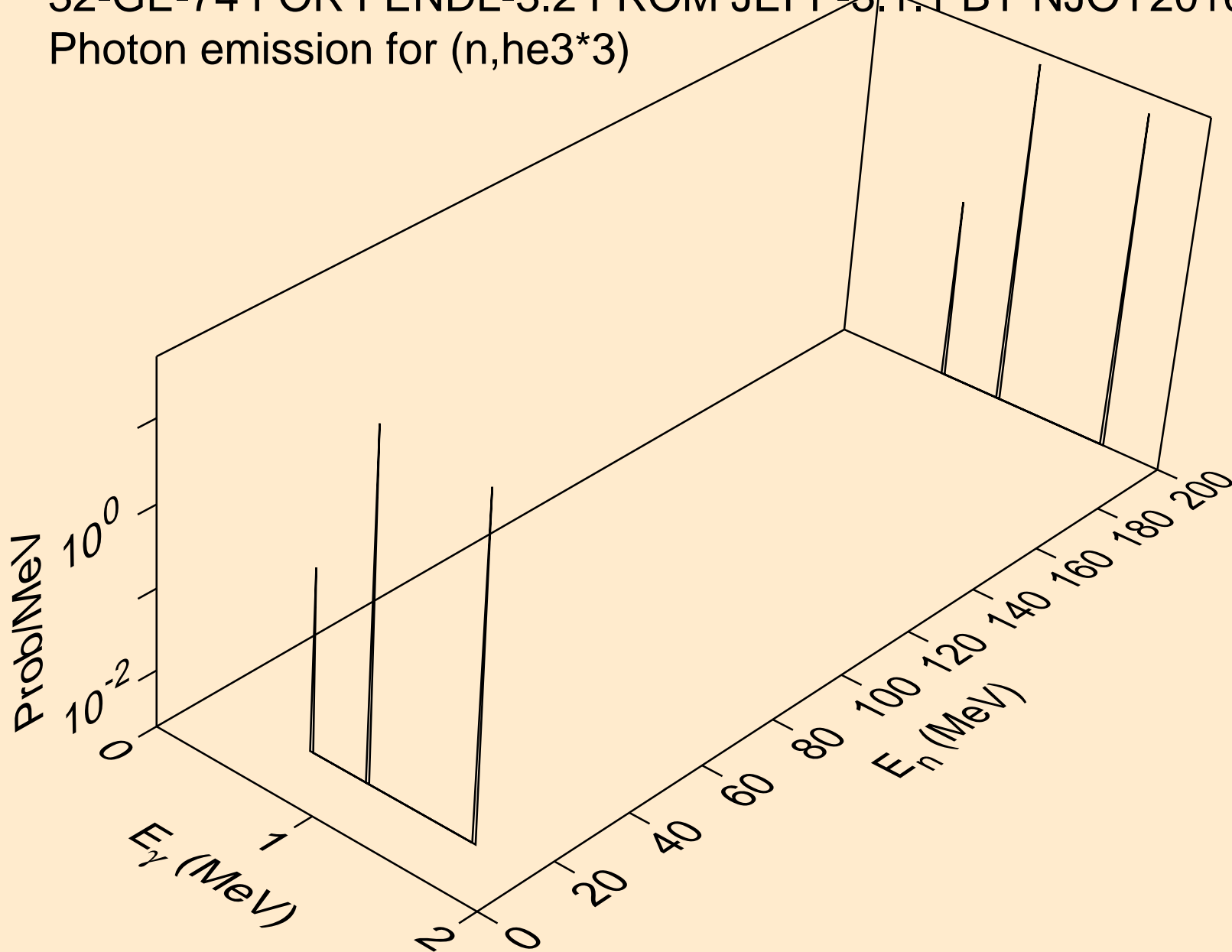

32-GE-74 FOR FENDL-3.2 FROM JEFF-3.1.1 BY NJOY2016.60+ O
Photon emission for (n,he3*4)

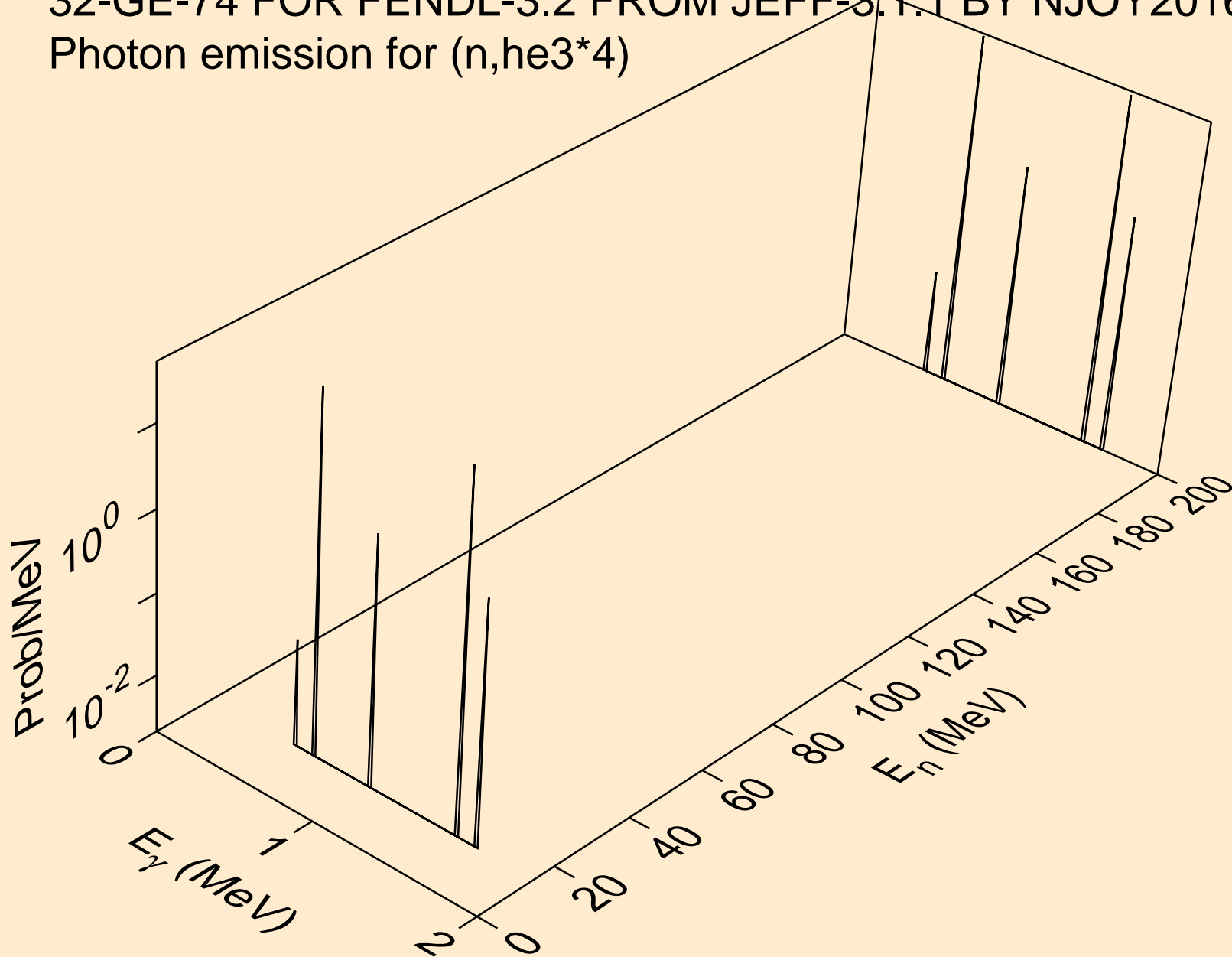

32-GE-74 FOR FENDL-3.2 FROM JEFF-3.1.1 BY NJOY2016.60+ O
Photon emission for (n,a*2)

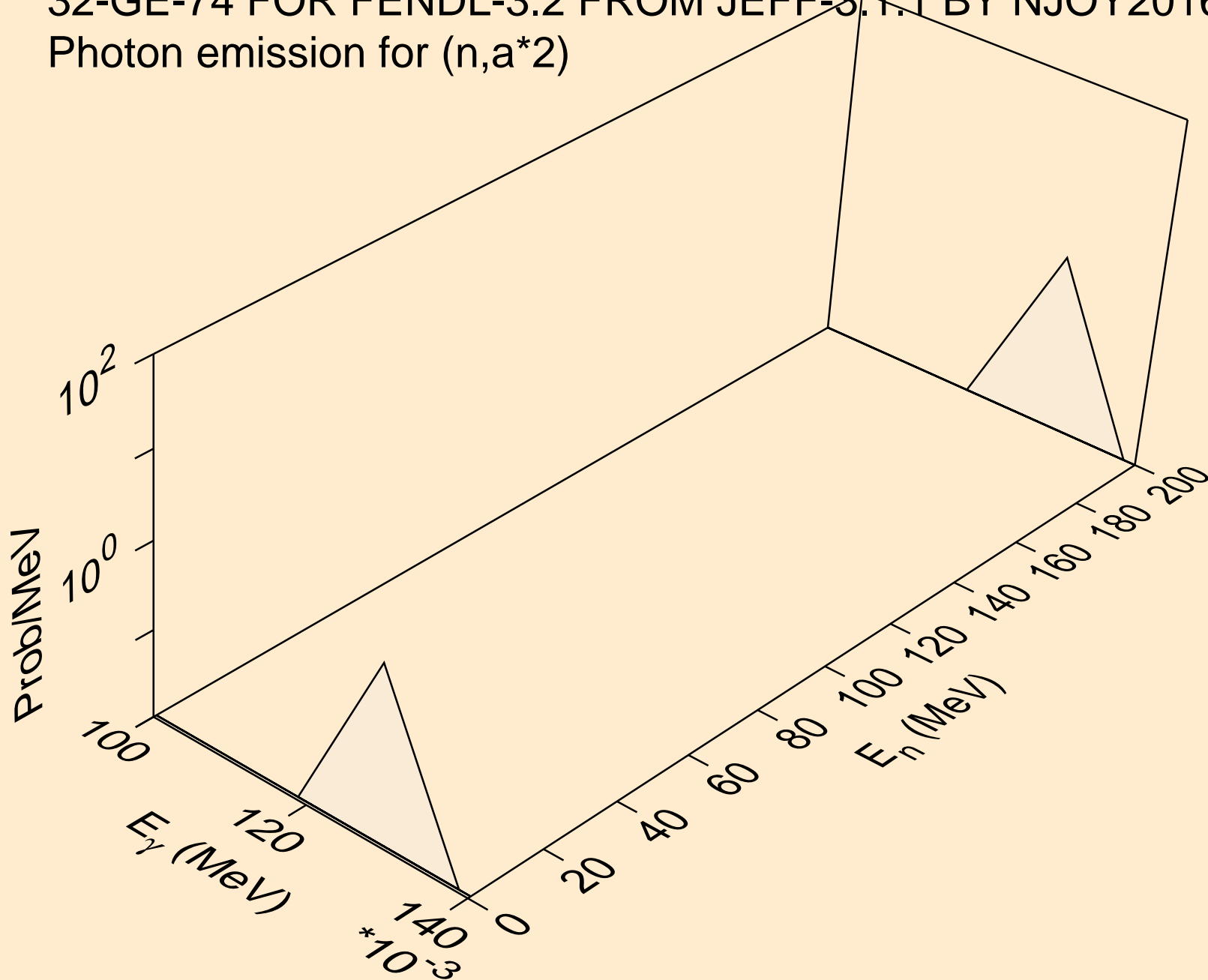

32-GE-74 FOR FENDL-3.2 FROM JEFF-3.1.1 BY NJOY2016.60+ O
Photon emission for (n,a*3)

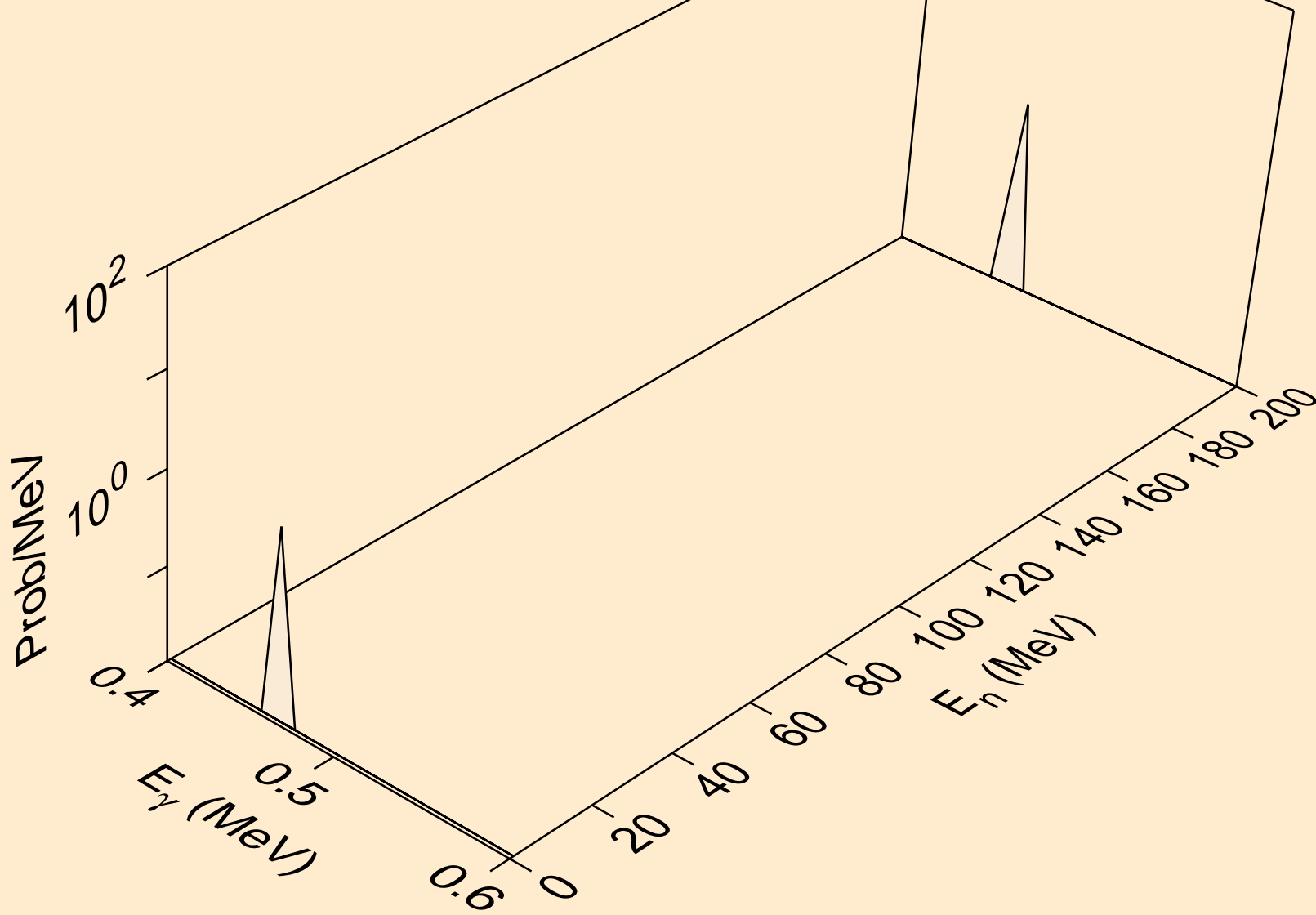

32-GE-74 FOR FENDL-3.2 FROM JEFF-3.1.1 BY NJOY2016.60+ O
Photon emission for (n,a*4)

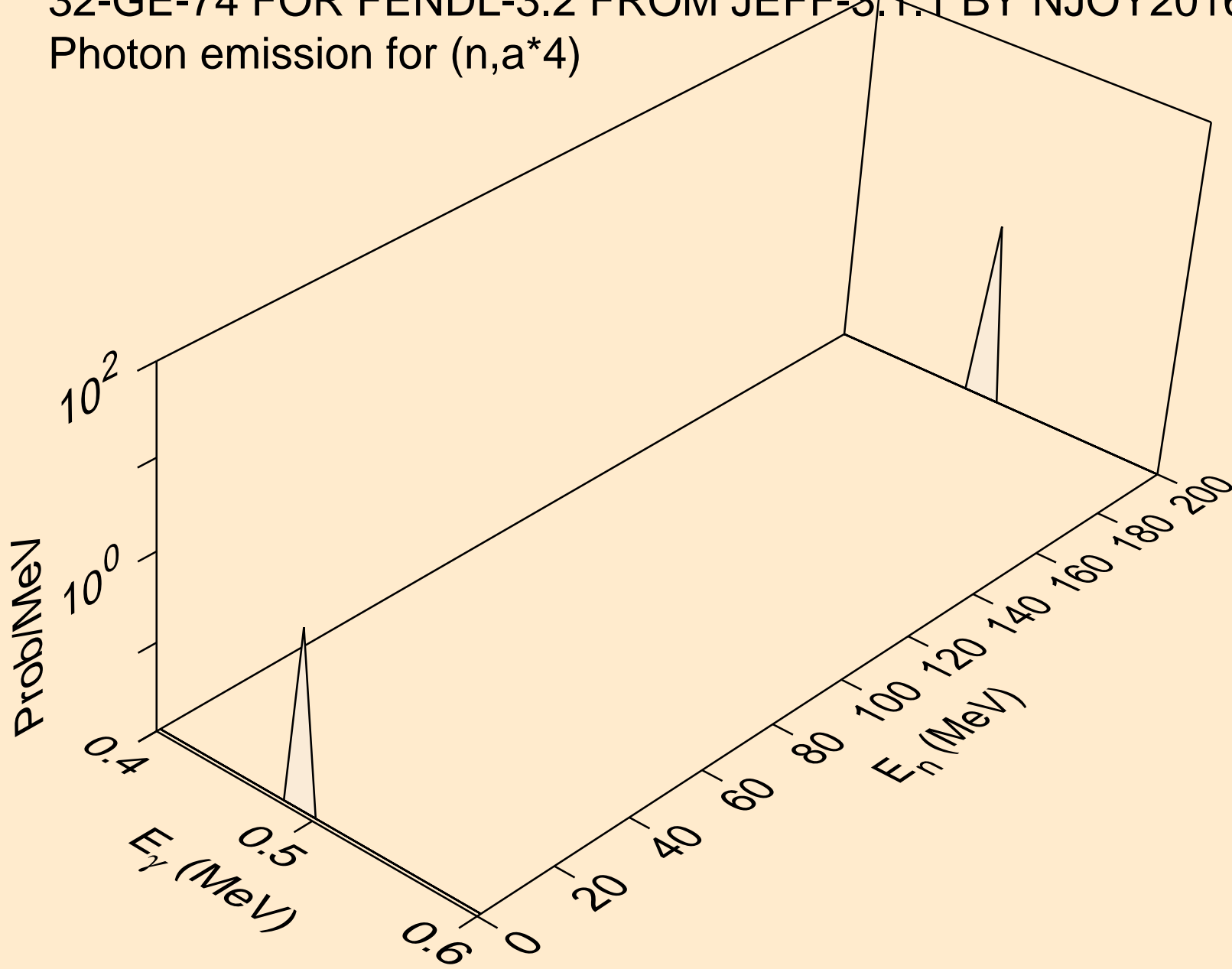

32-GE-74 FOR FENDL-3.2 FROM JEFF-3.1.1 BY NJOY2016.60+ O
Photon emission for (n,a*5)

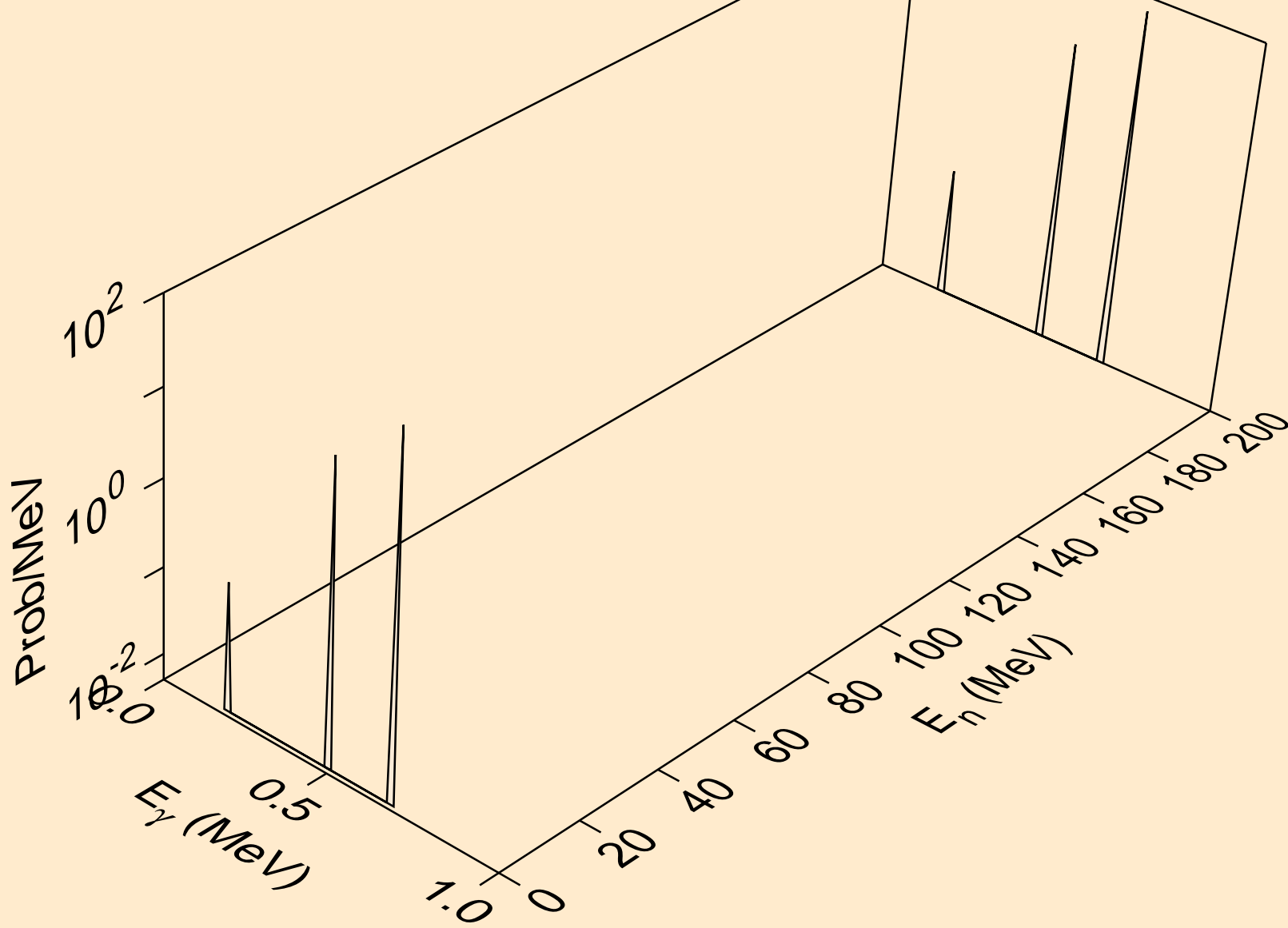

32-GE-74 FOR FENDL-3.2 FROM JEFF-3.1.1 BY NJOY2016.60+ O
Photon emission for (n,a*6)

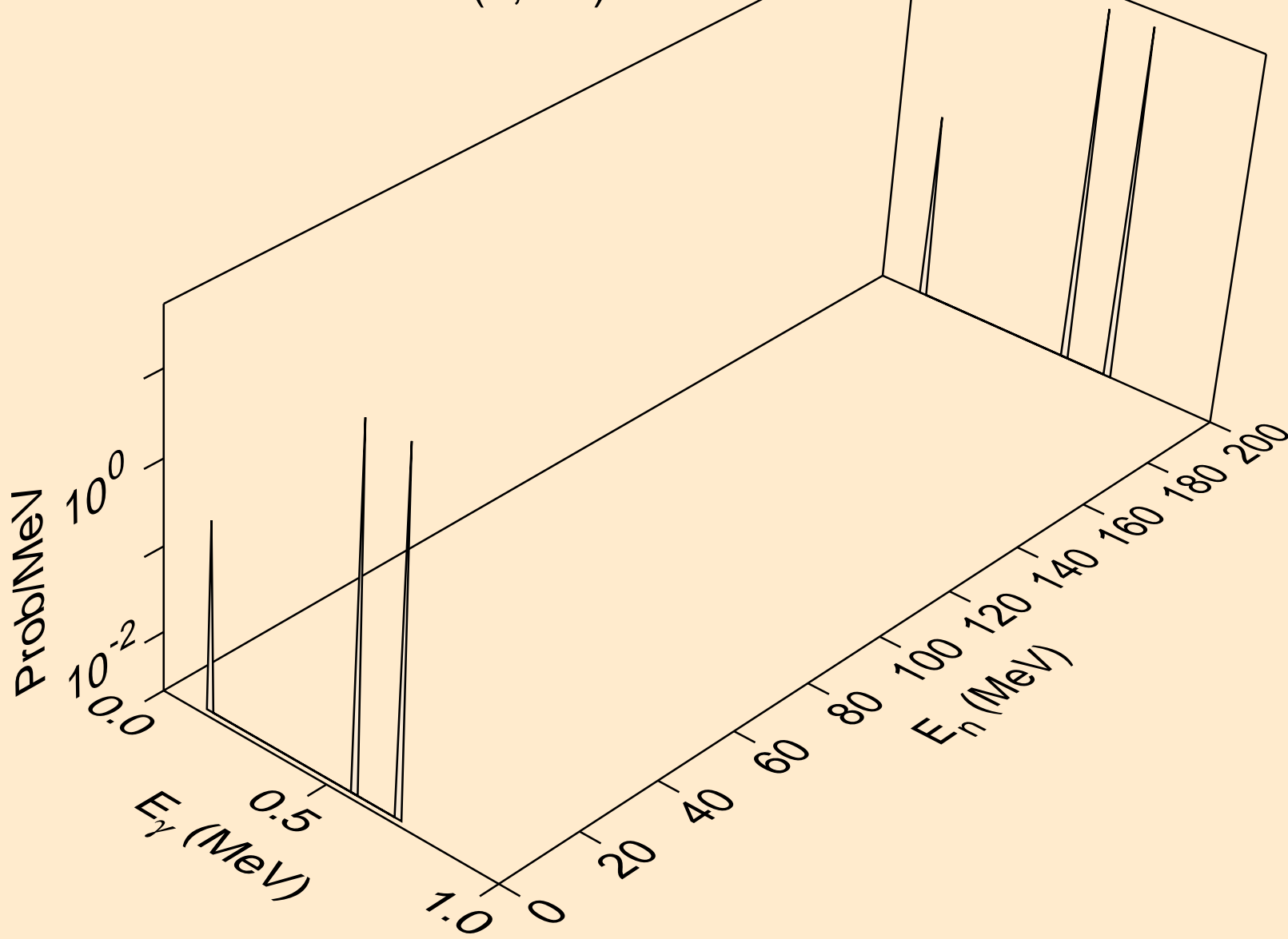

32-GE-74 FOR FENDL-3.2 FROM JEFF-3.1.1 BY NJOY2016.60+ O
Photon emission for (n,a*7)

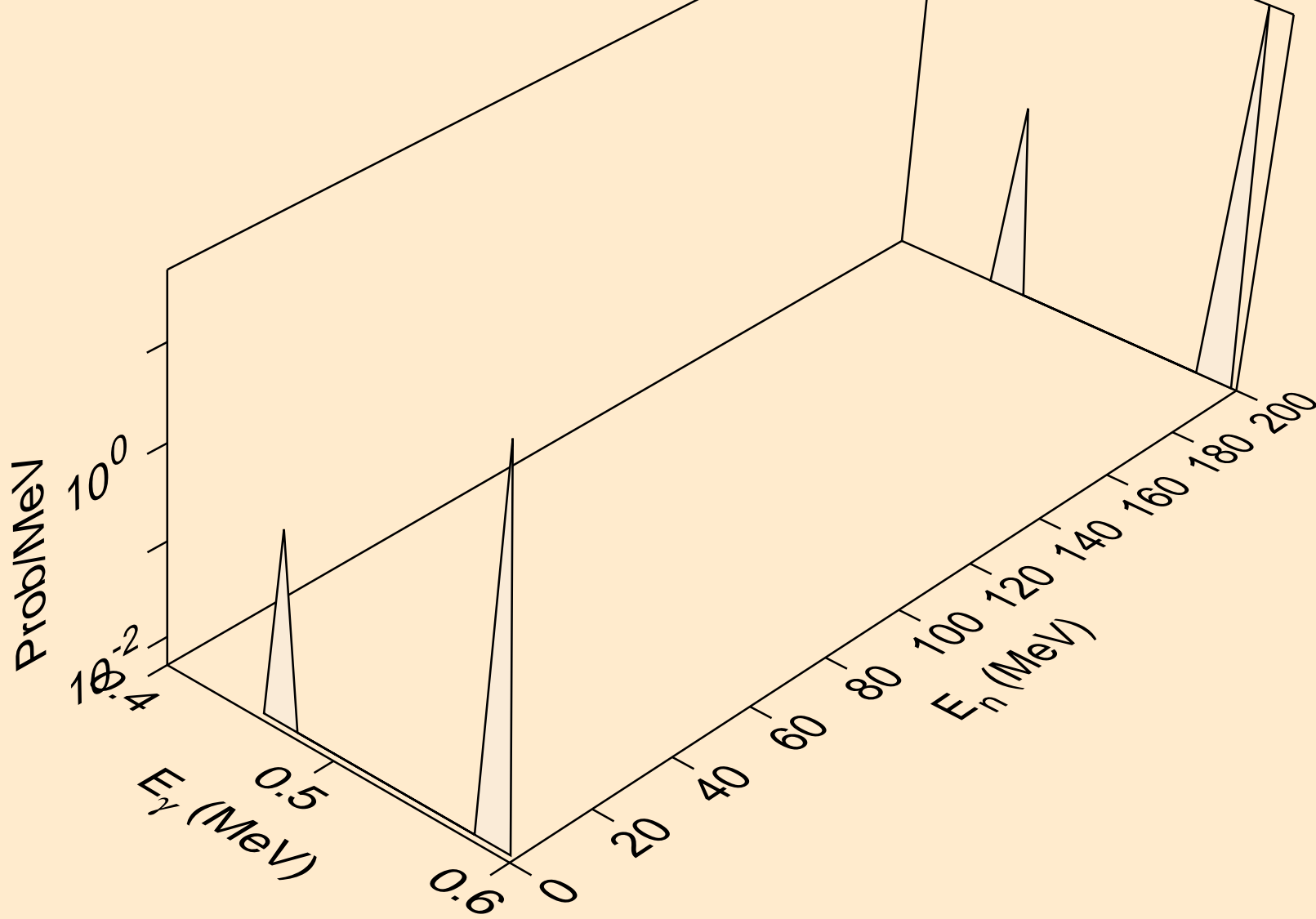

32-GE-74 FOR FENDL-3.2 FROM JEFF-3.1.1 BY NJOY2016.60+ O
Photon emission for (n,a*8)

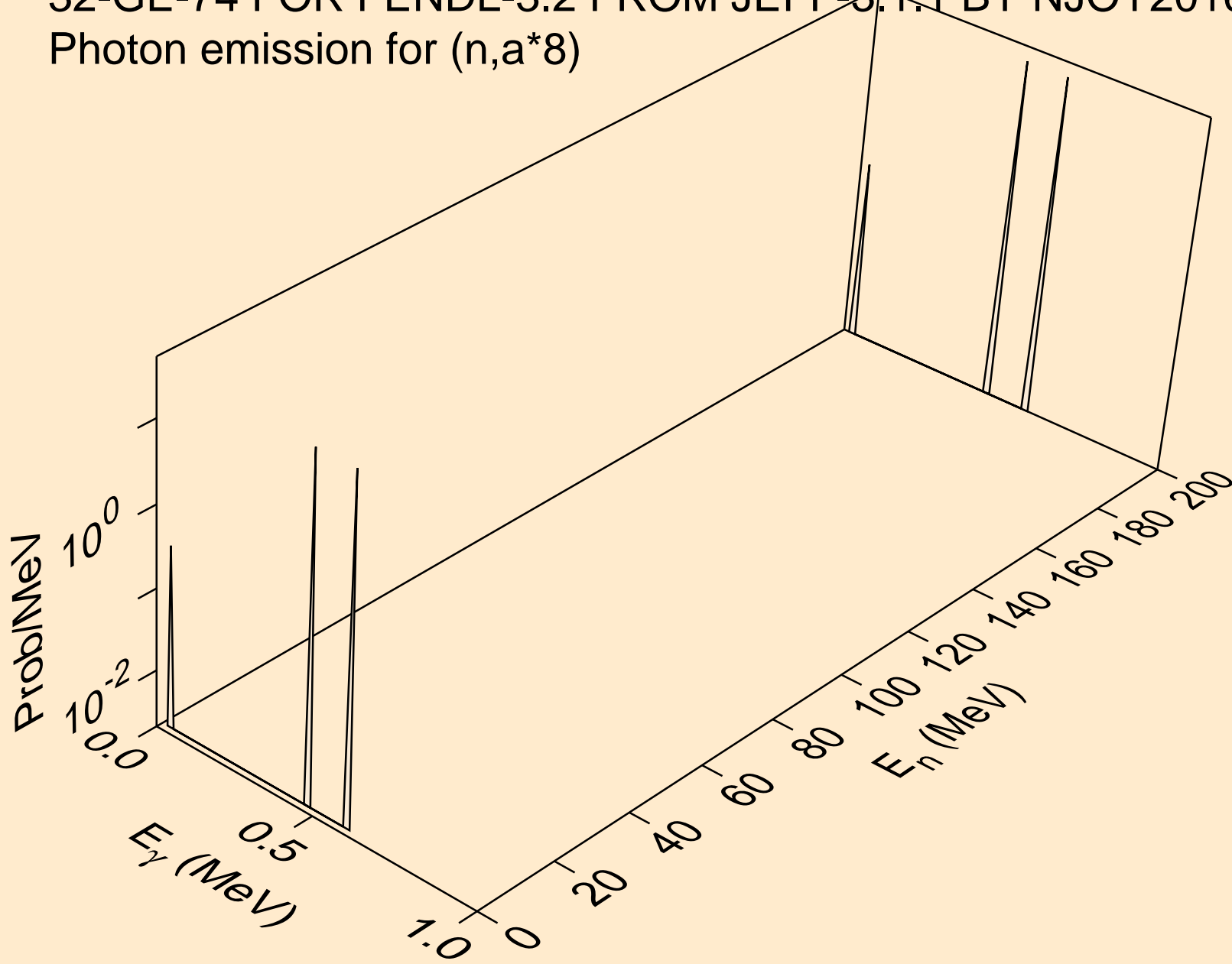

32-GE-74 FOR FENDL-3.2 FROM JEFF-3.1.1 BY NJOY2016.60+ O
Photon emission for (n,a*9)

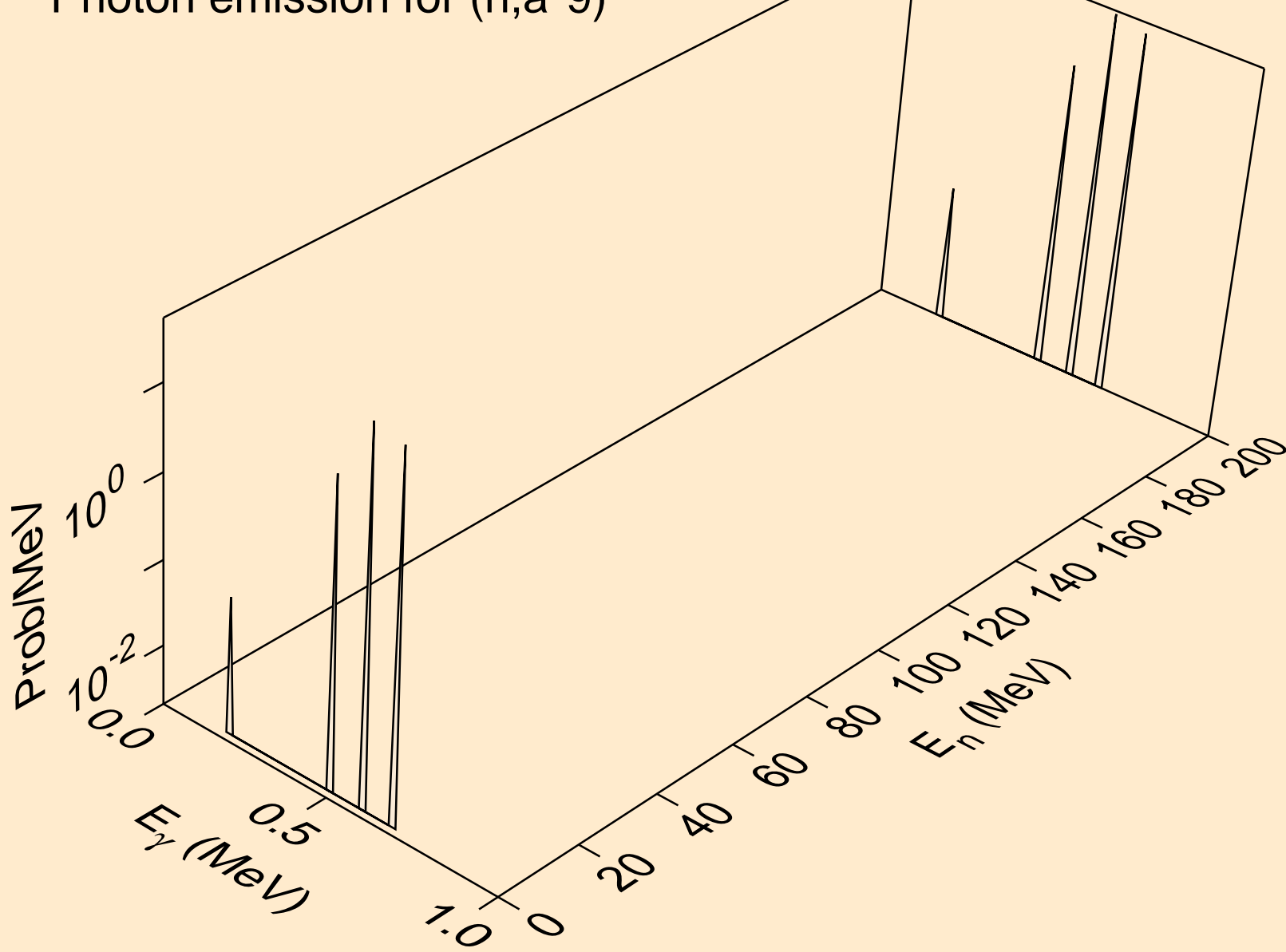

32-GE-74 FOR FENDL-3.2 FROM JEFF-3.1.1 BY NJOY2016.60+ O
Photon emission for (n,a*10)

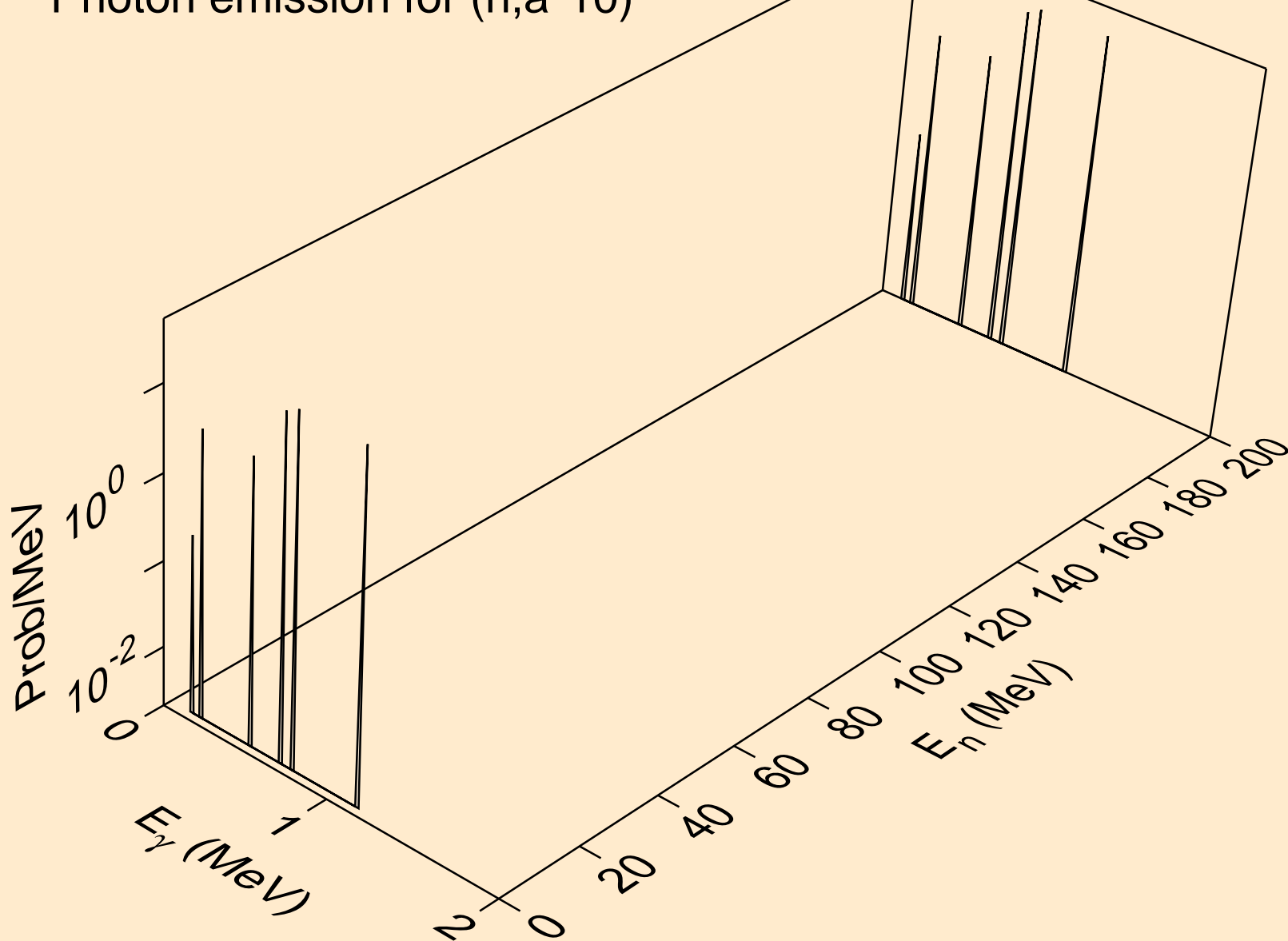

32-GE-74 FOR FENDL-3.2 FROM JEFF-3.1.1 BY NJOY2016.60+ O
Photon emission for (n,a*c)

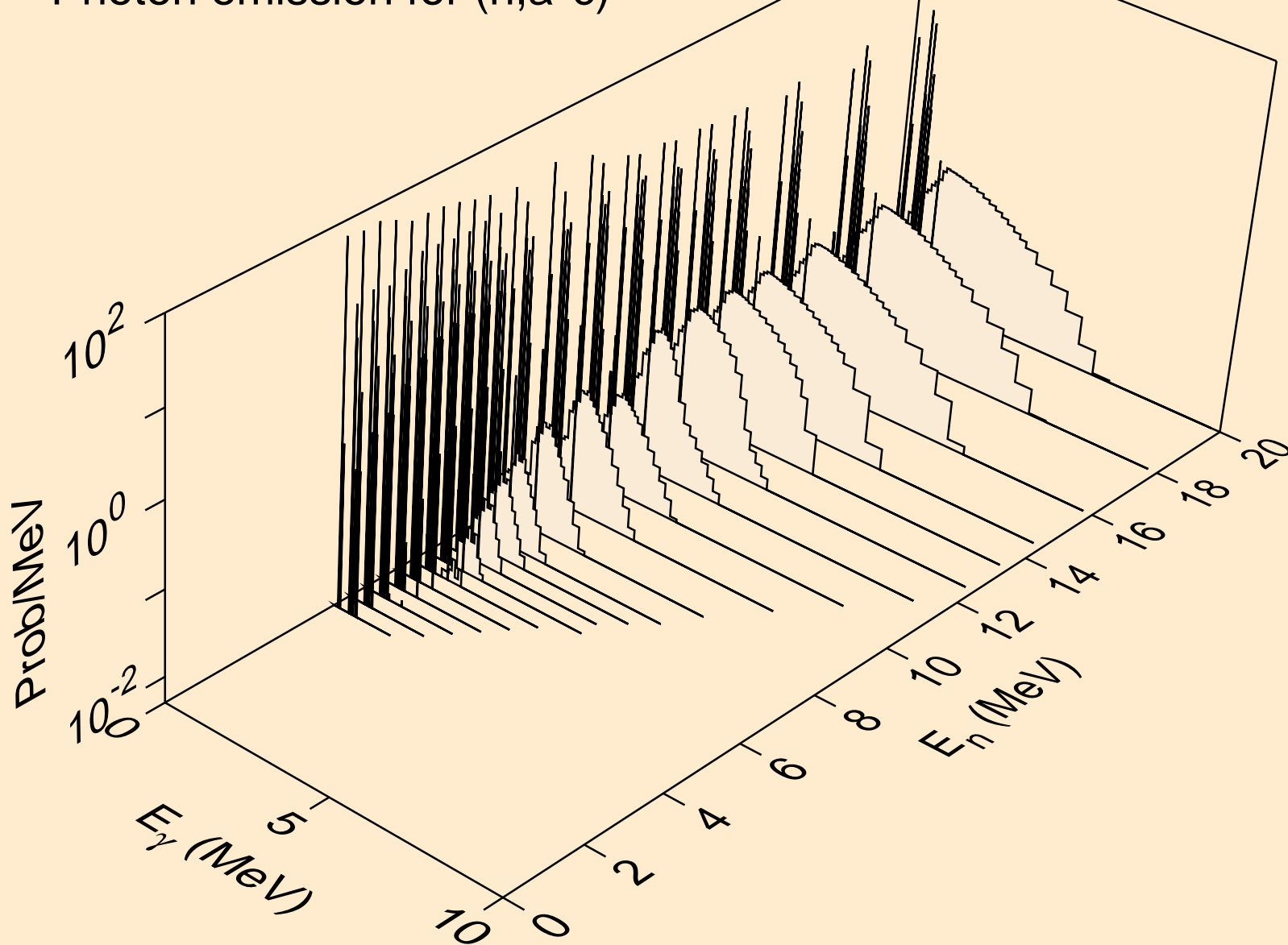

32-GE-74 FOR FENDL-3.2 FROM JEFF-3.1.1 BY NJOY2016.60+ O
thermal capture photon spectrum

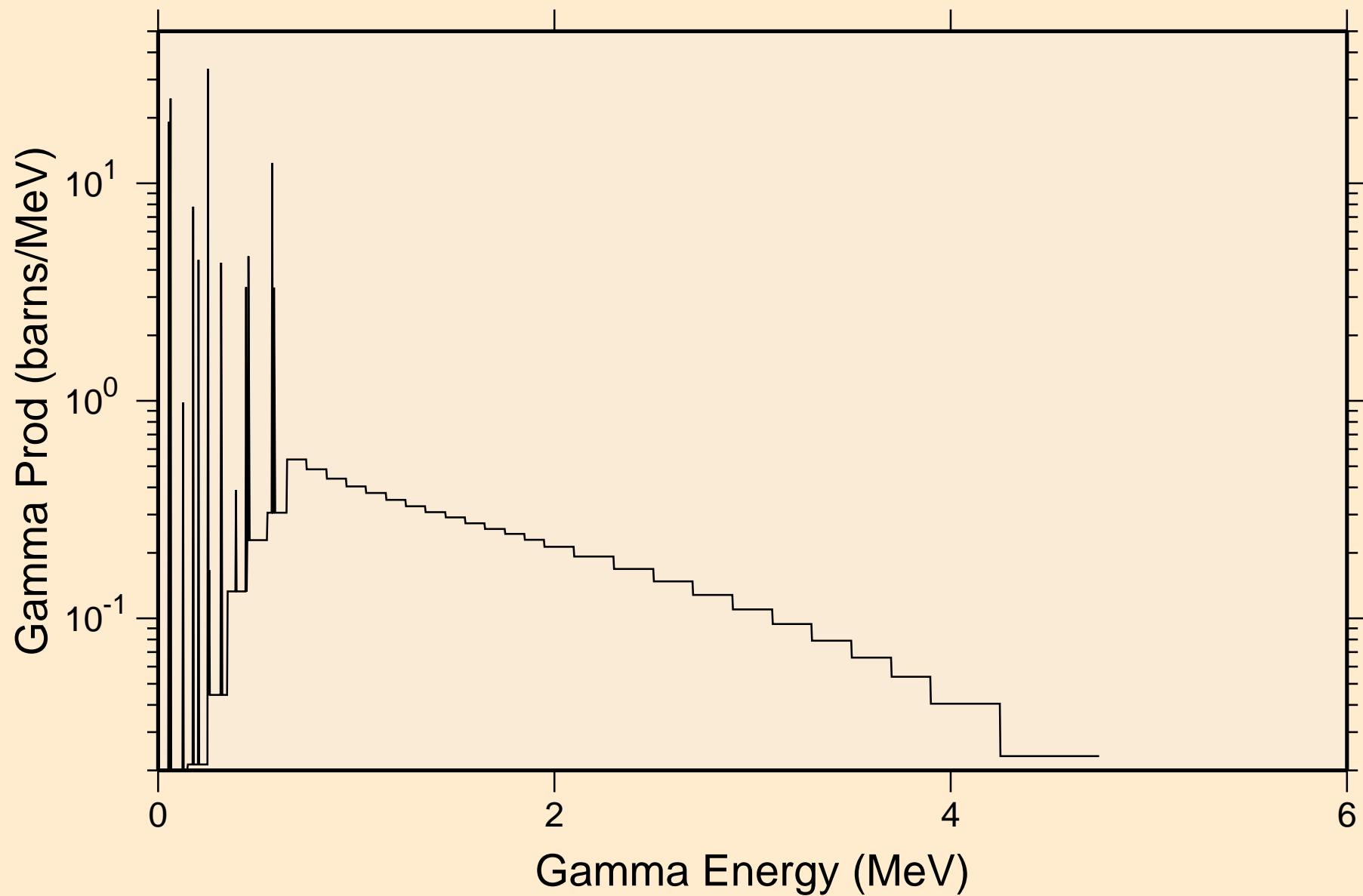

32-GE-74 FOR FENDL-3.2 FROM JEFF-3.1.1 BY NJOY2016.60+ O
14 MeV photon spectrum

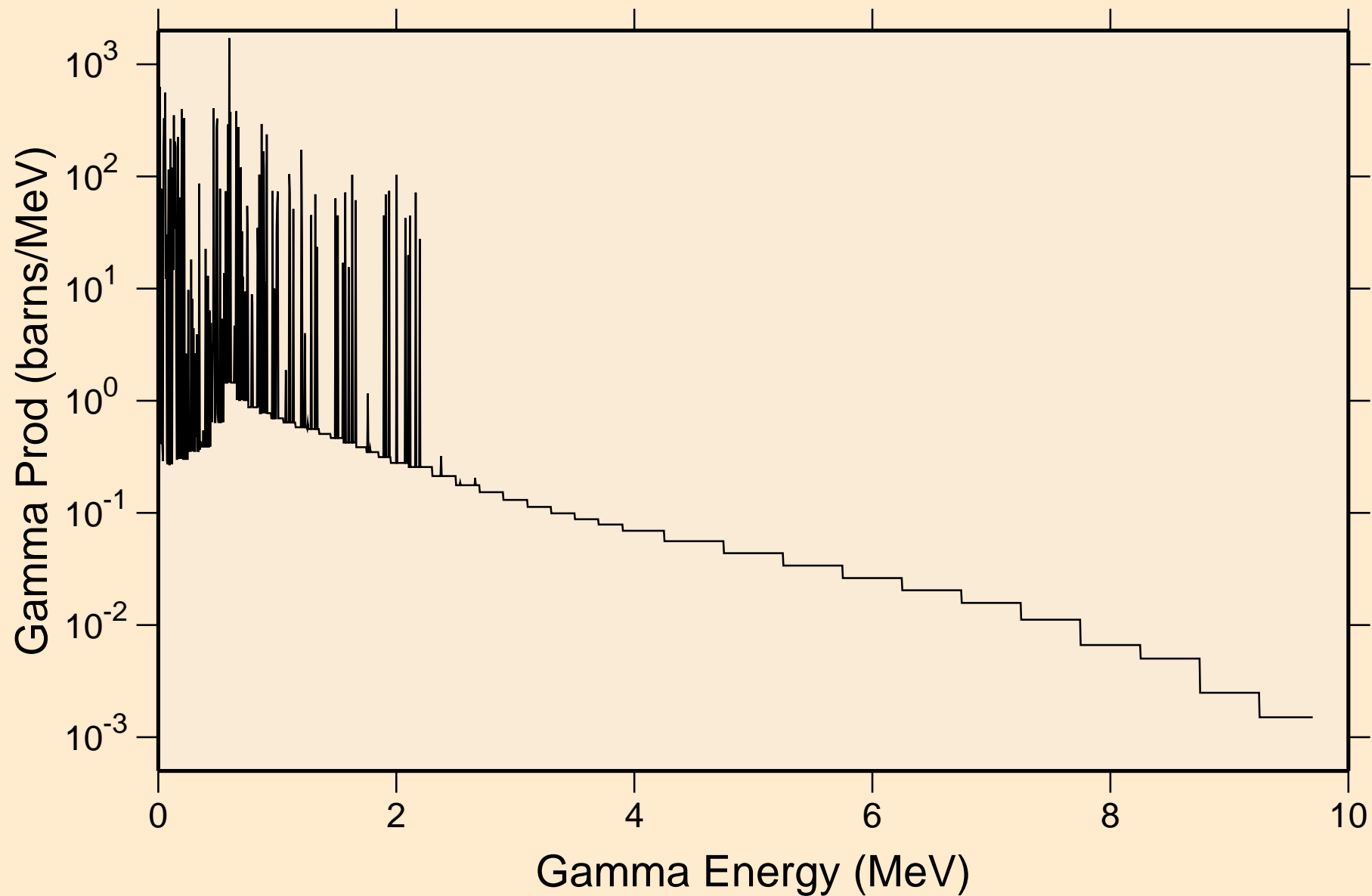

32-GE-74 FOR FENDL-3.2 FROM JEFF-3.1.1 BY NJOY2016.60+ O

Particle heating contributions

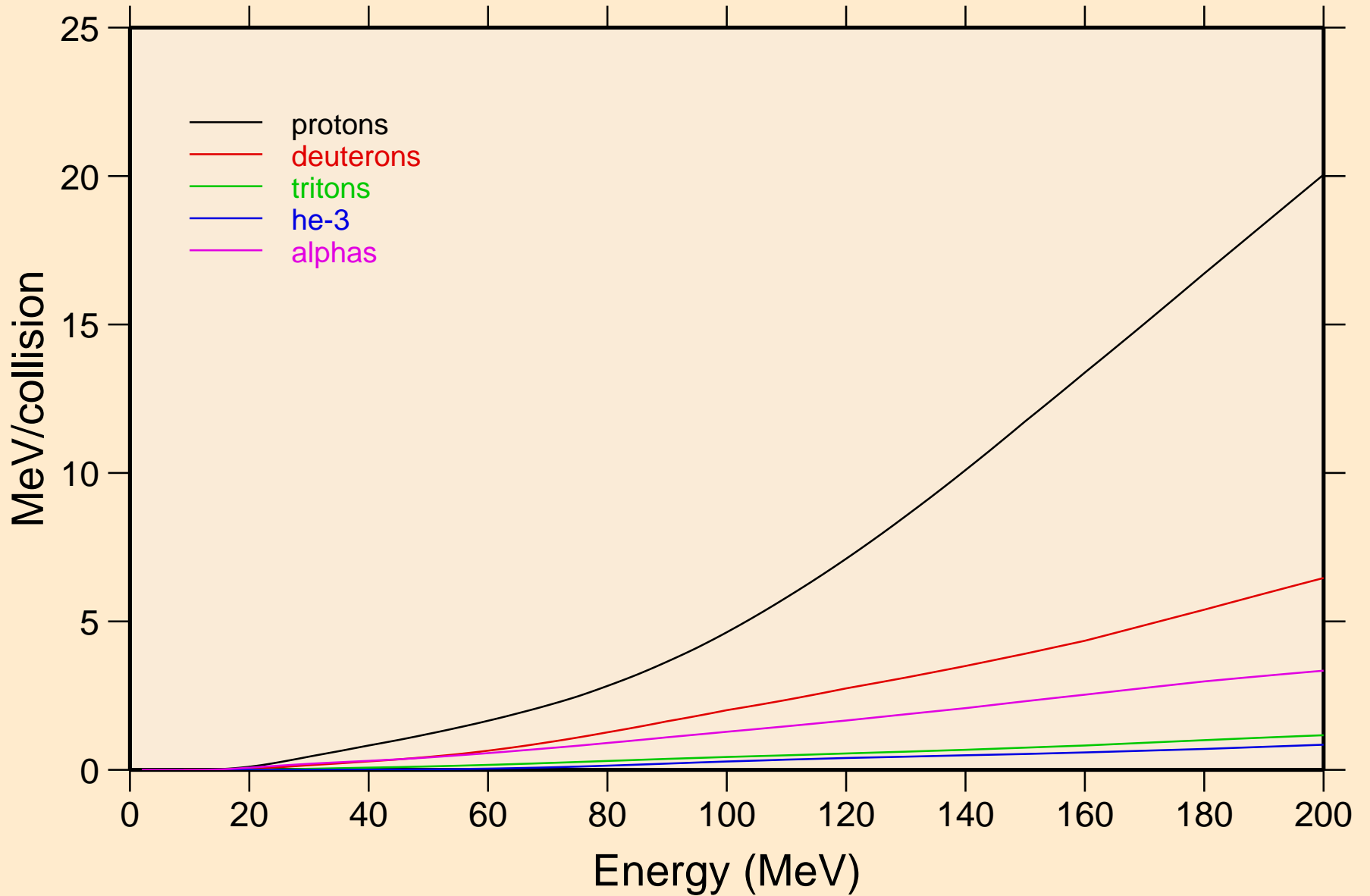

32-GE-74 FOR FENDL-3.2 FROM JEFF-3.1.1 BY NJOY2016.60+ O
Recoil Heating

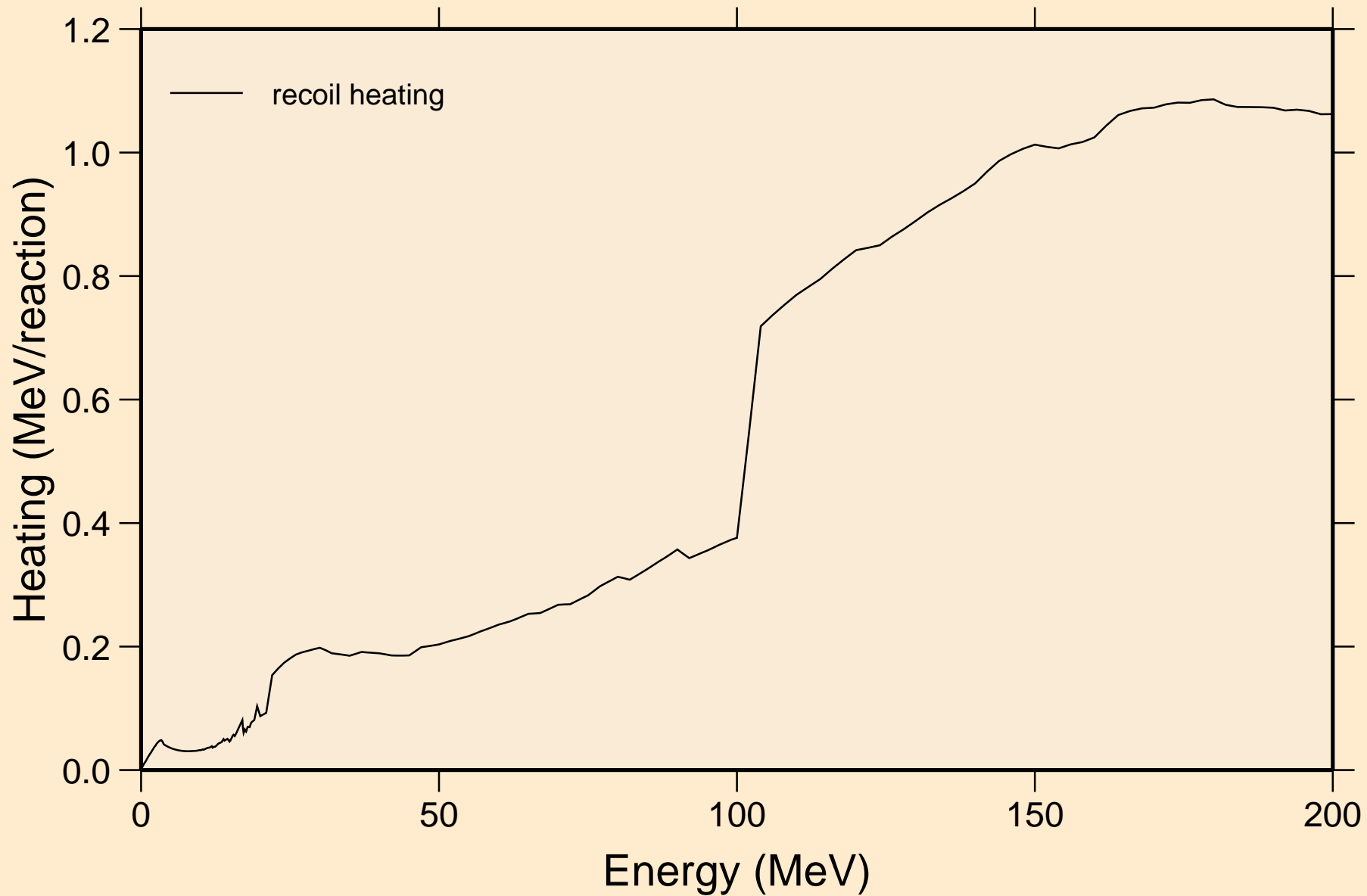

32-GE-74 FOR FENDL-3.2 FROM JEFF-3.1.1 BY NJOY2016.60+ O
Particle production cross sections

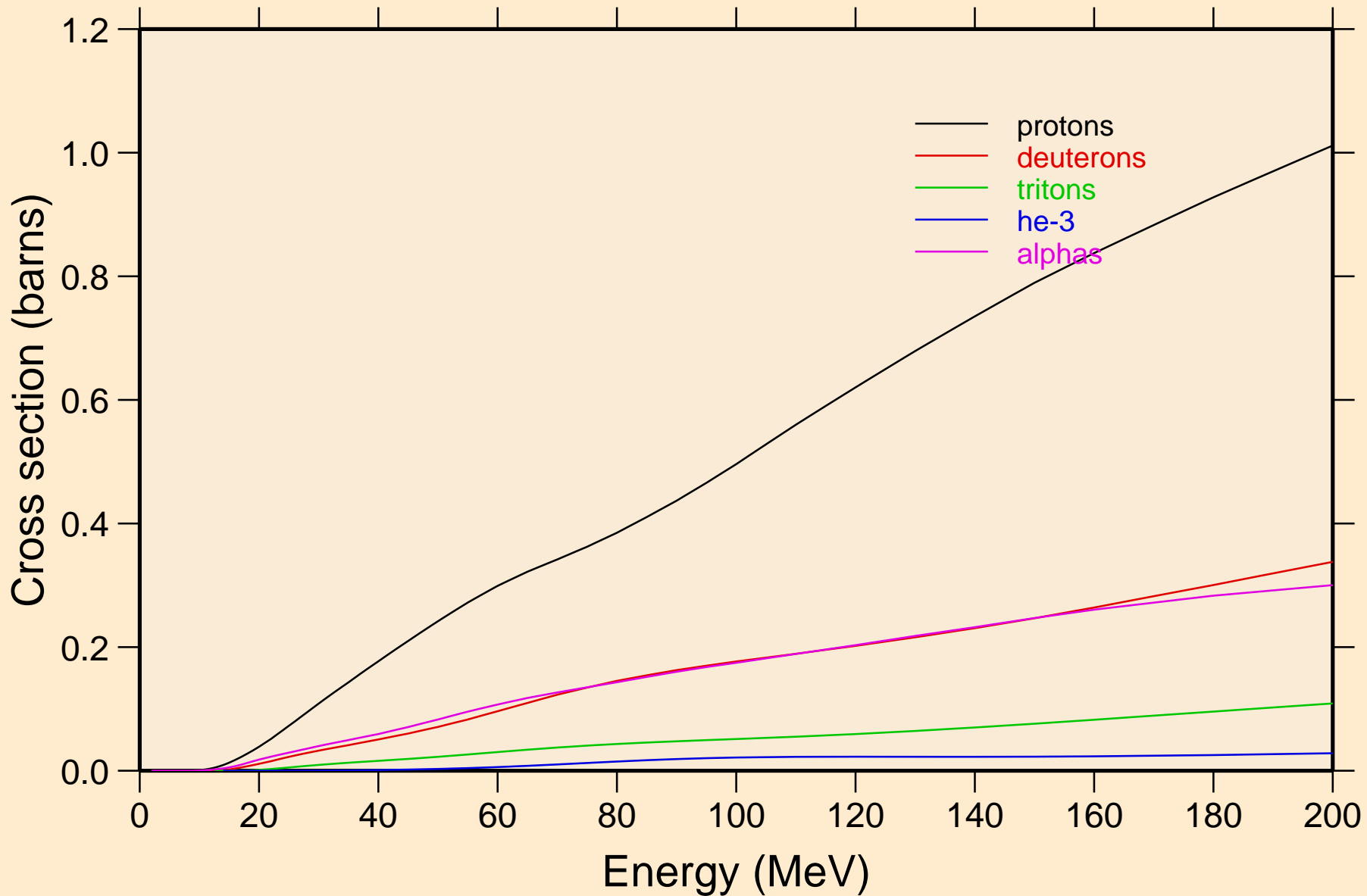

32-GE-74 FOR FENDL-3.2 FROM JEFF-3.1.1 BY NJOY2016.60+ O
protons from (n,x)

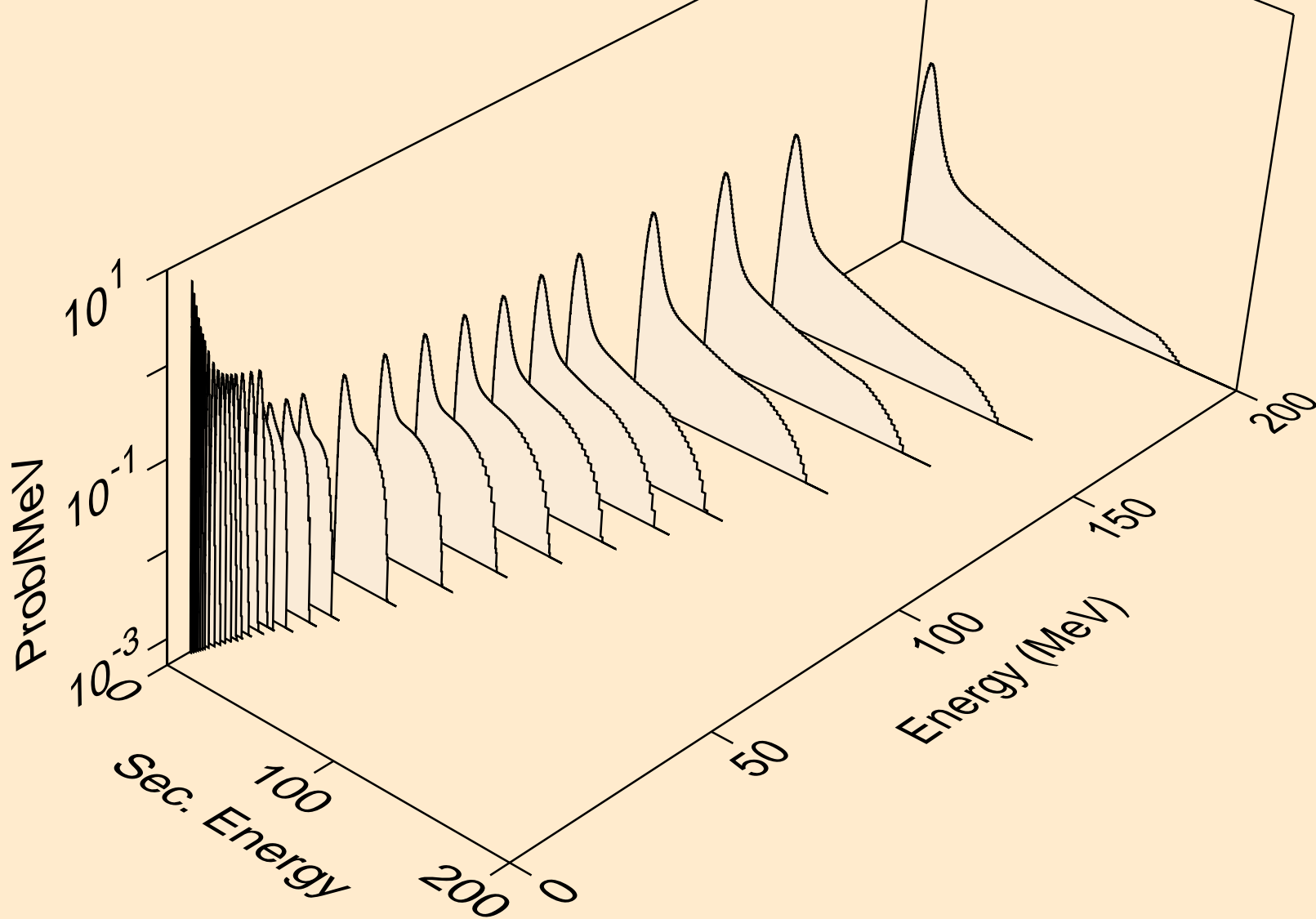

32-GE-74 FOR FENDL-3.2 FROM JEFF-3.1.1 BY NJOY2016.60+ O
protons from (n,n*)p

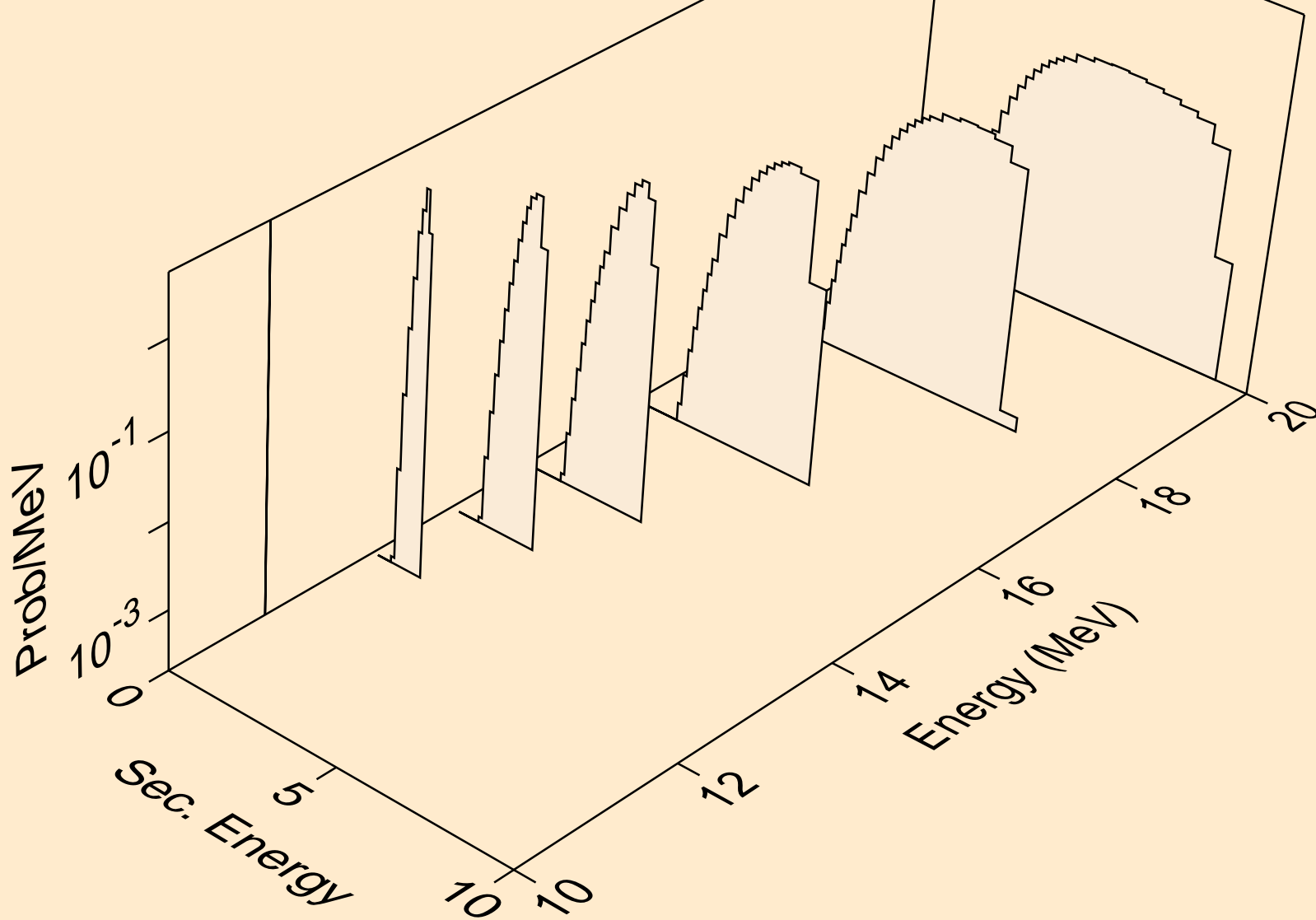

32-GE-74 FOR FENDL-3.2 FROM JEFF-3.1.1 BY NJOY2016.60+ O
protons from (n,2p)

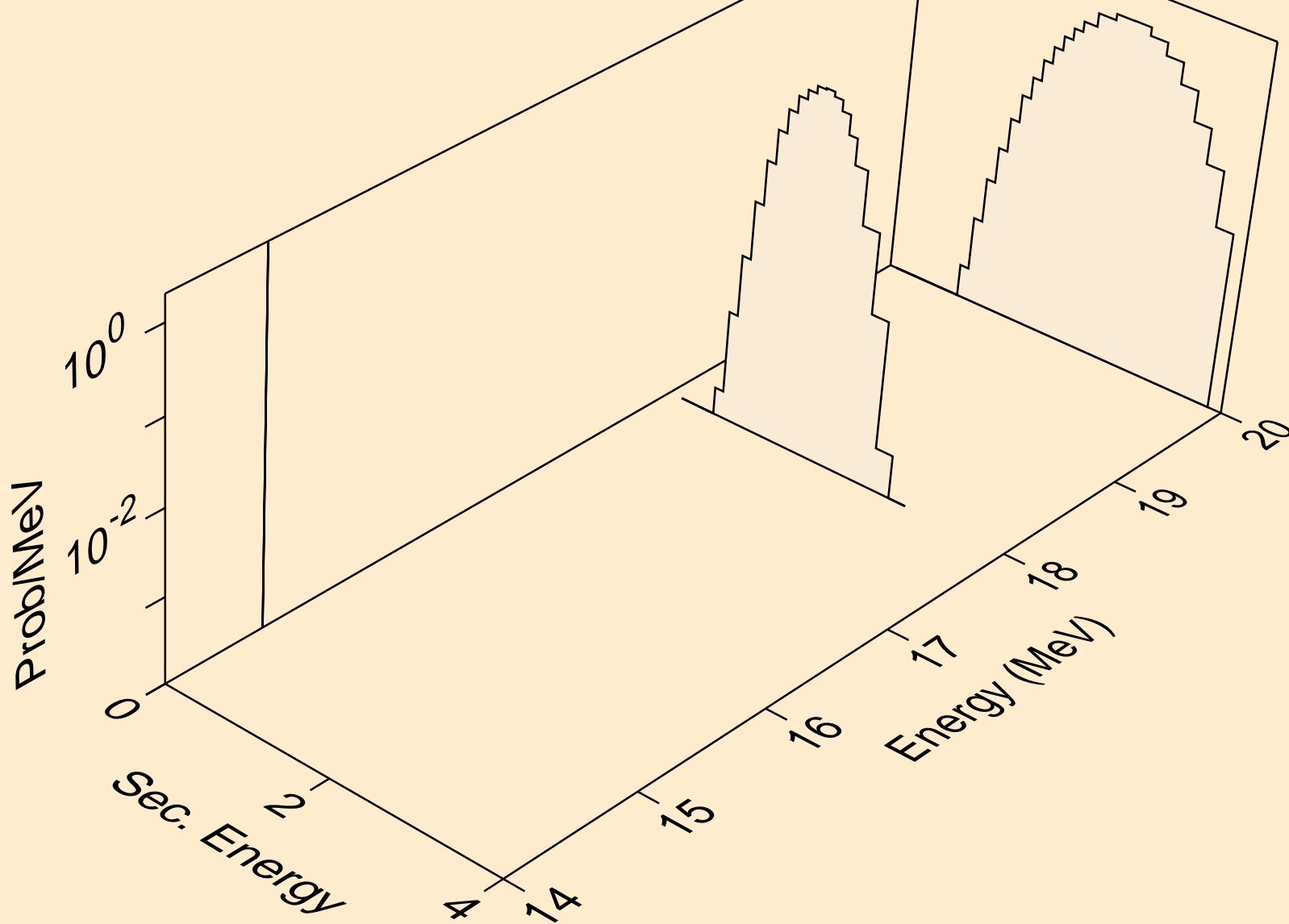

32-GE-74 FOR FENDL-3.2 FROM JEFF-3.1.1 BY NJOY2016.60+ O
angular distribution for (n,p*0) proton

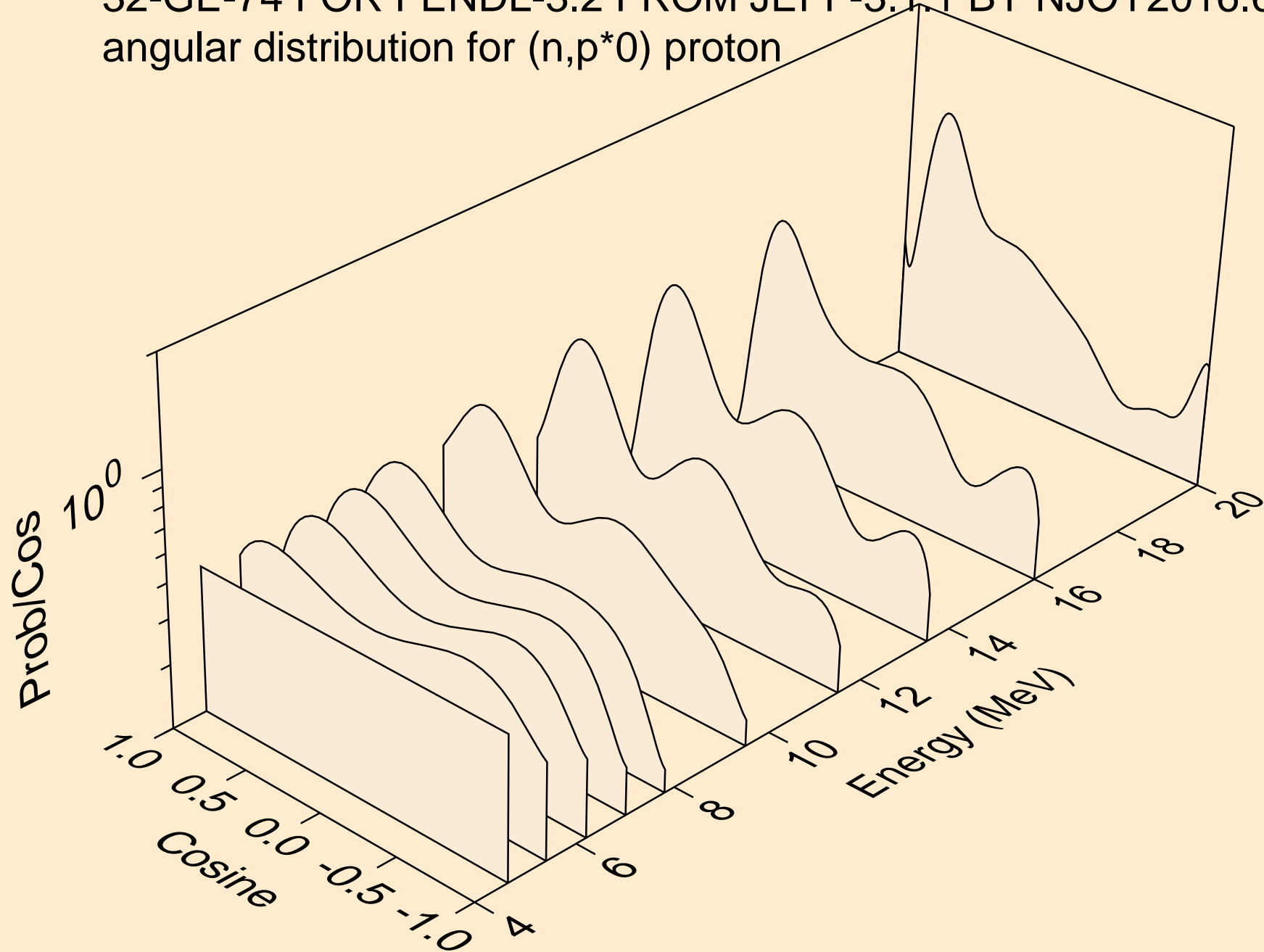

32-GE-74 FOR FENDL-3.2 FROM JEFF-3.1.1 BY NJOY2016.60+ O
angular distribution for (n,p*1) proton

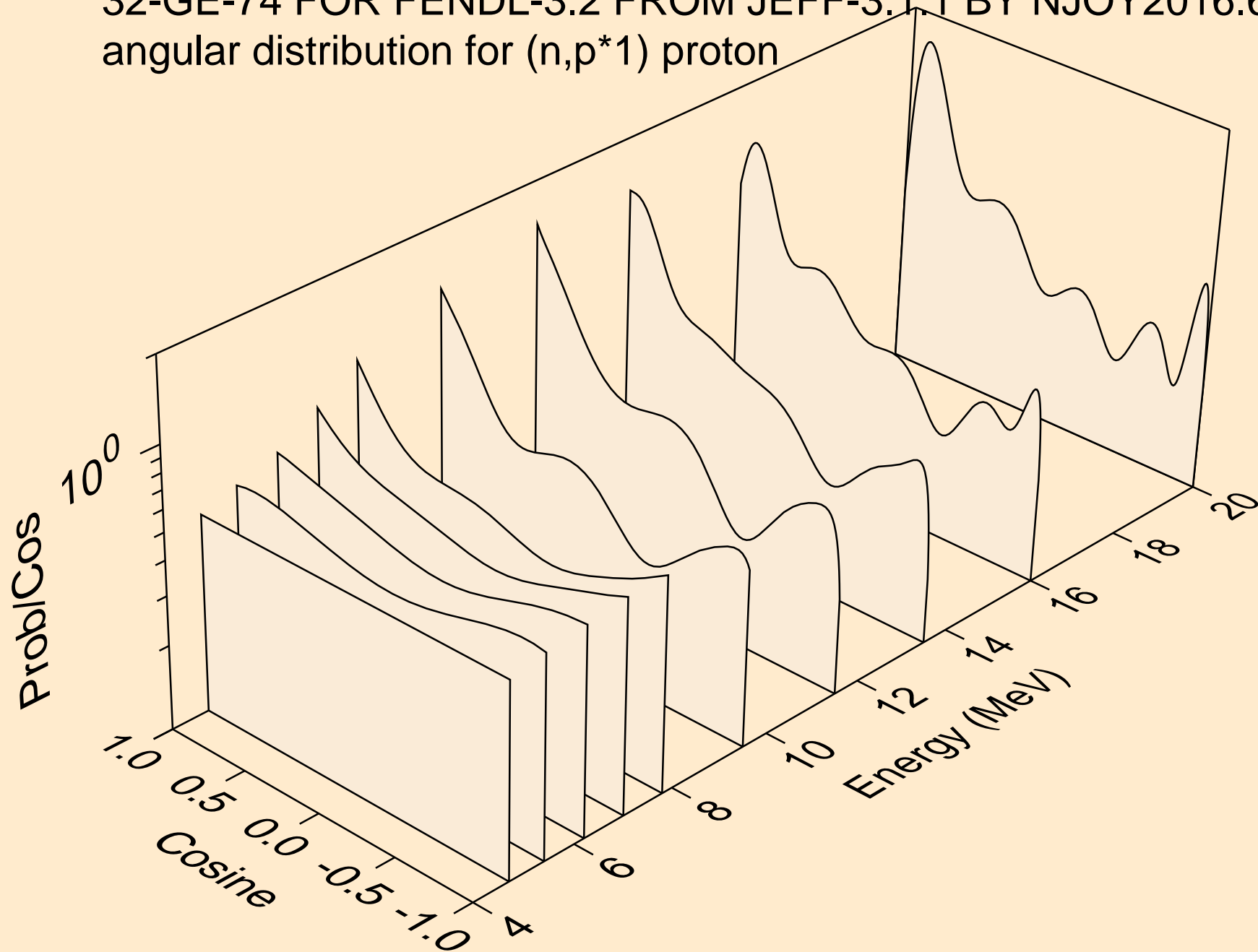

32-GE-74 FOR FENDL-3.2 FROM JEFF-3.1.1 BY NJOY2016.60+ O
angular distribution for (n,p*2) proton

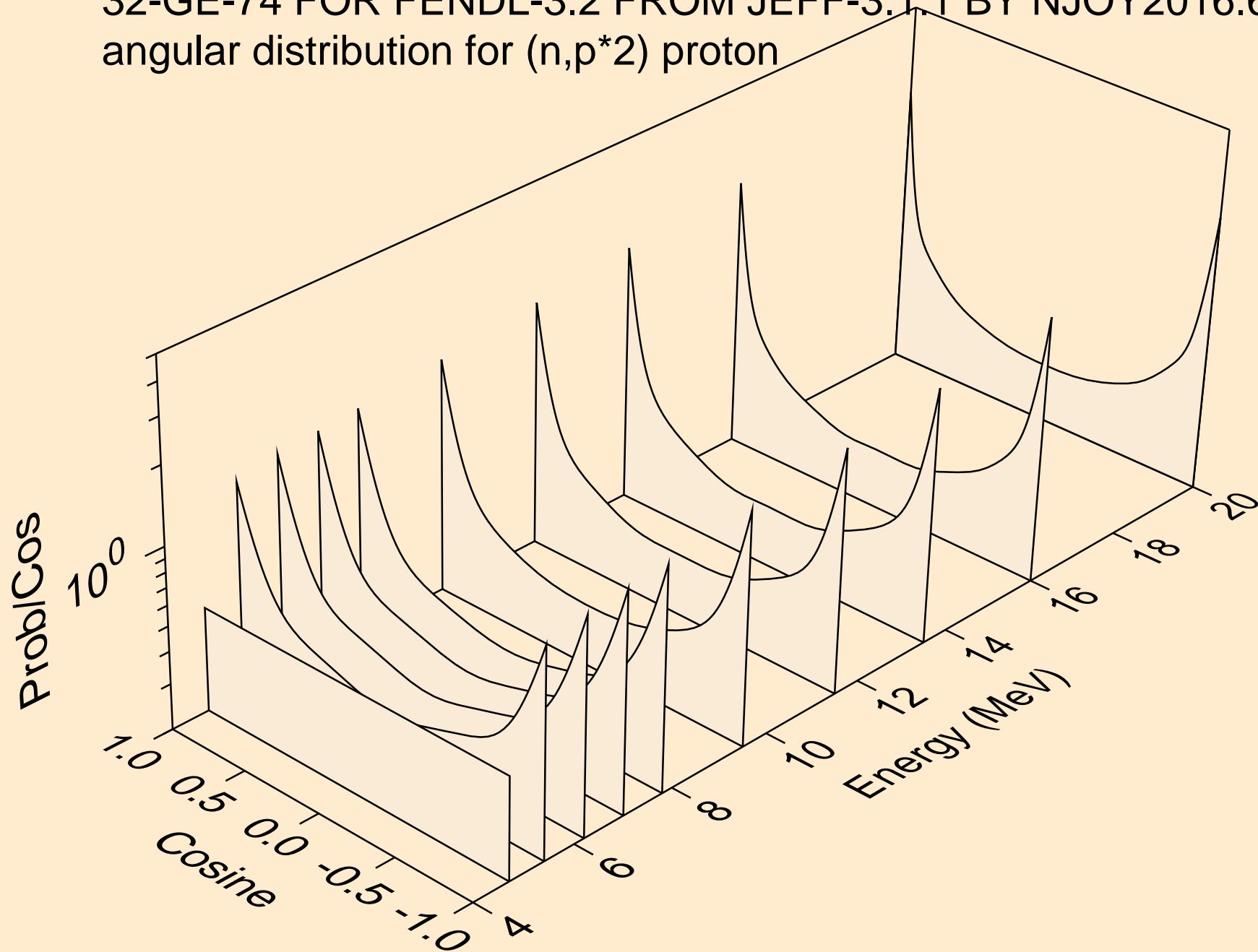

32-GE-74 FOR FENDL-3.2 FROM JEFF-3.1.1 BY NJOY2016.60+ O
angular distribution for (n,p*3) proton

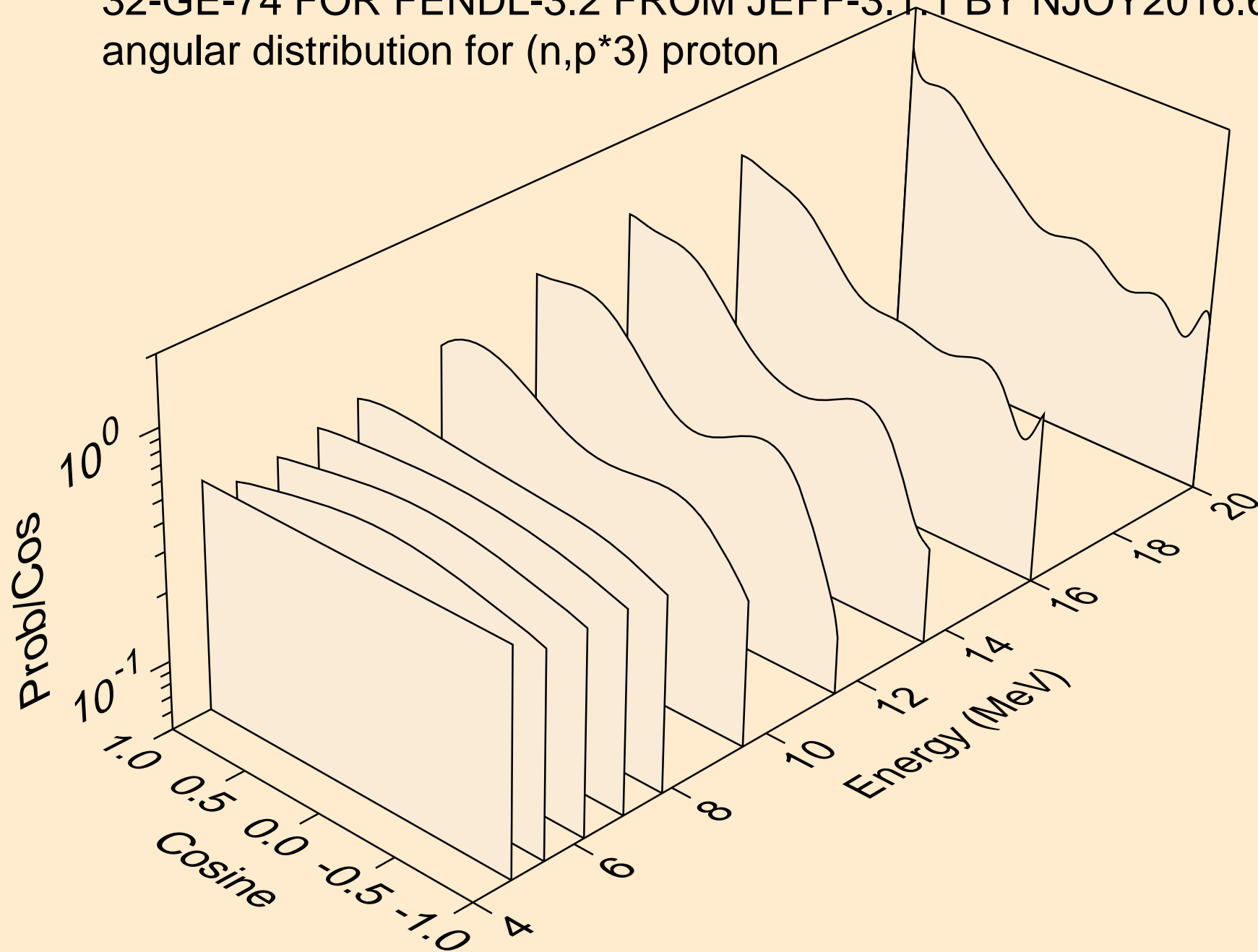

32-GE-74 FOR FENDL-3.2 FROM JEFF-3.1.1 BY NJOY2016.60+ O
angular distribution for (n,p*4) proton

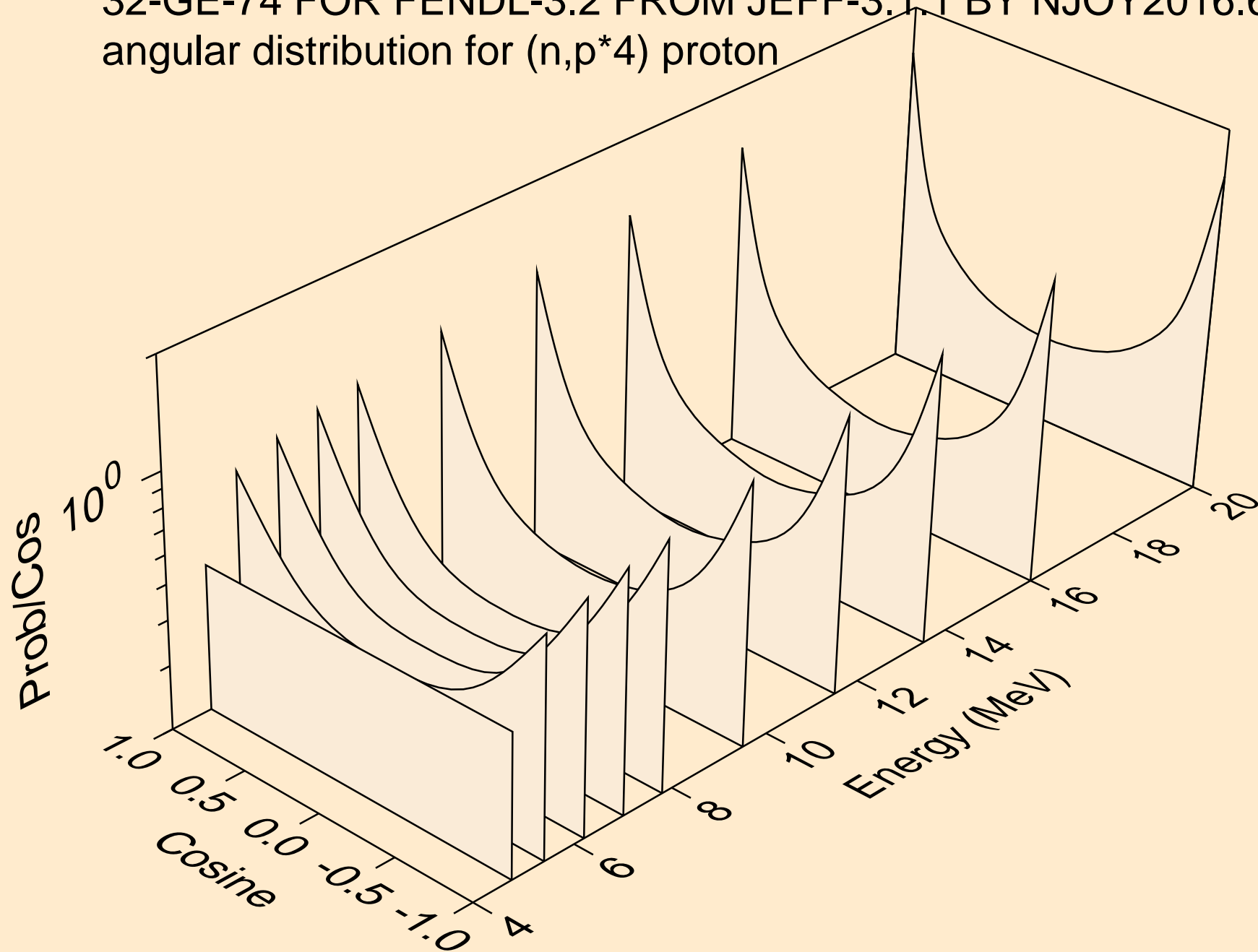

32-GE-74 FOR FENDL-3.2 FROM JEFF-3.1.1 BY NJOY2016.60+ O
angular distribution for (n,p*5) proton

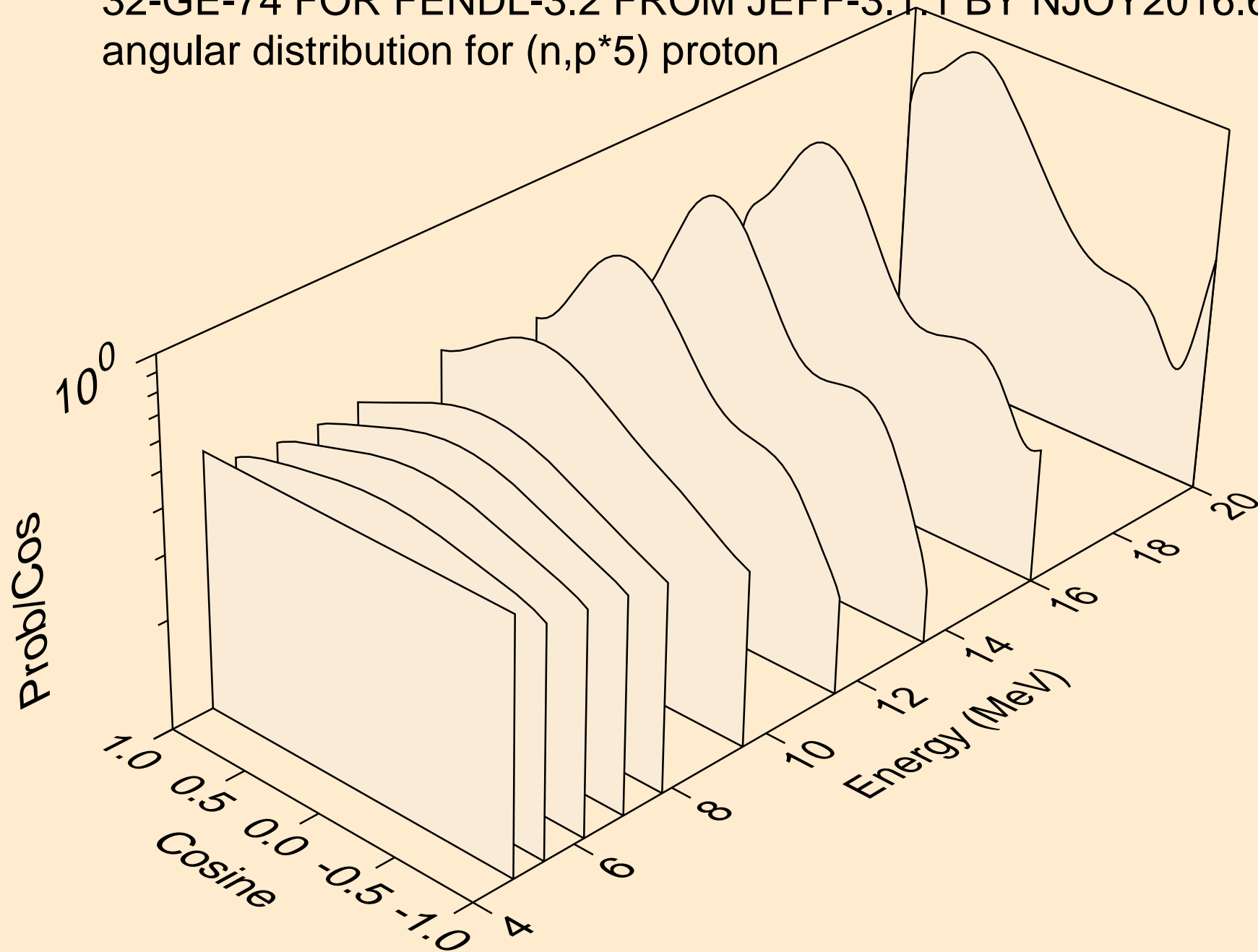

32-GE-74 FOR FENDL-3.2 FROM JEFF-3.1.1 BY NJOY2016.60+ O
angular distribution for (n,p*6) proton

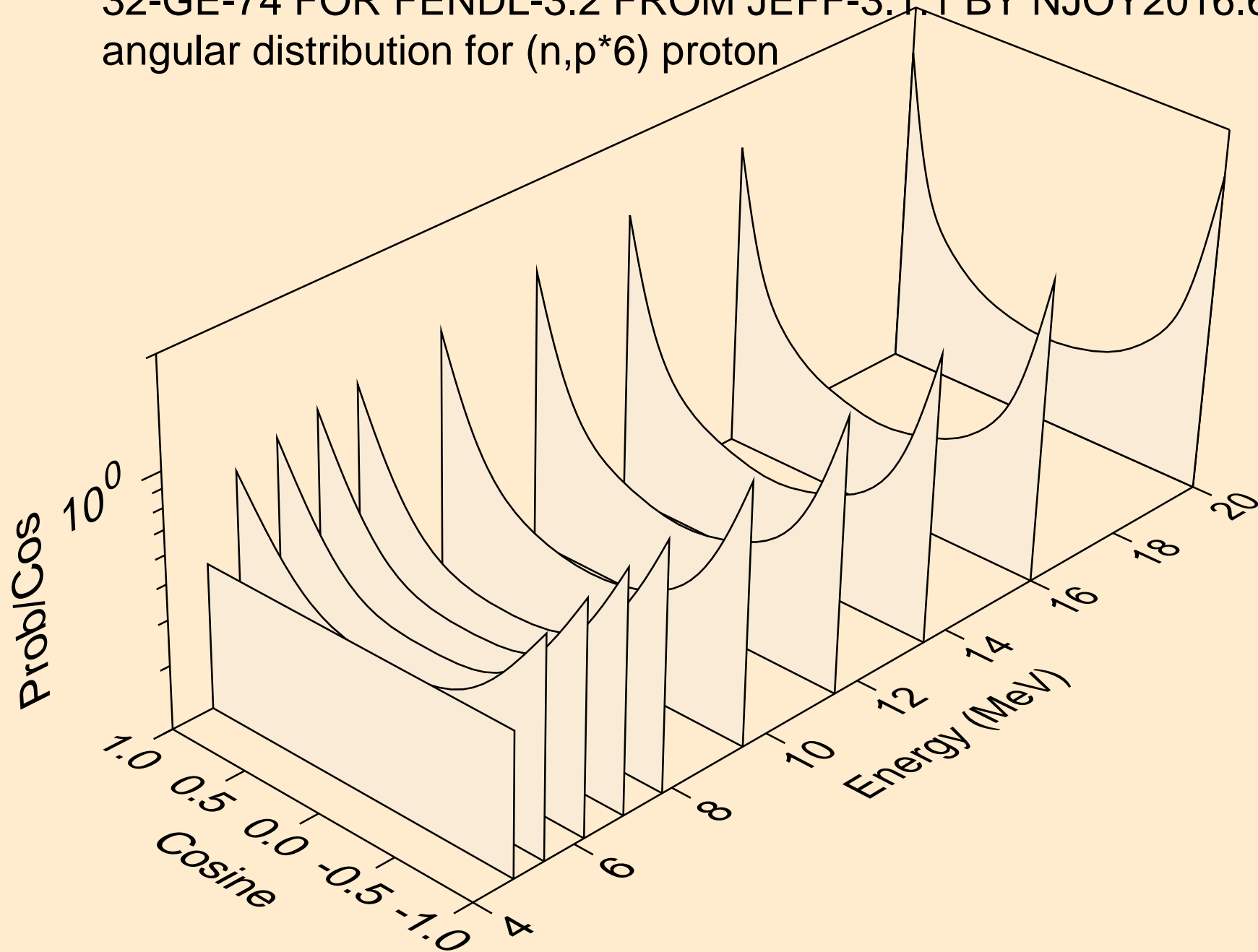

32-GE-74 FOR FENDL-3.2 FROM JEFF-3.1.1 BY NJOY2016.60+ O
angular distribution for (n,p*7) proton

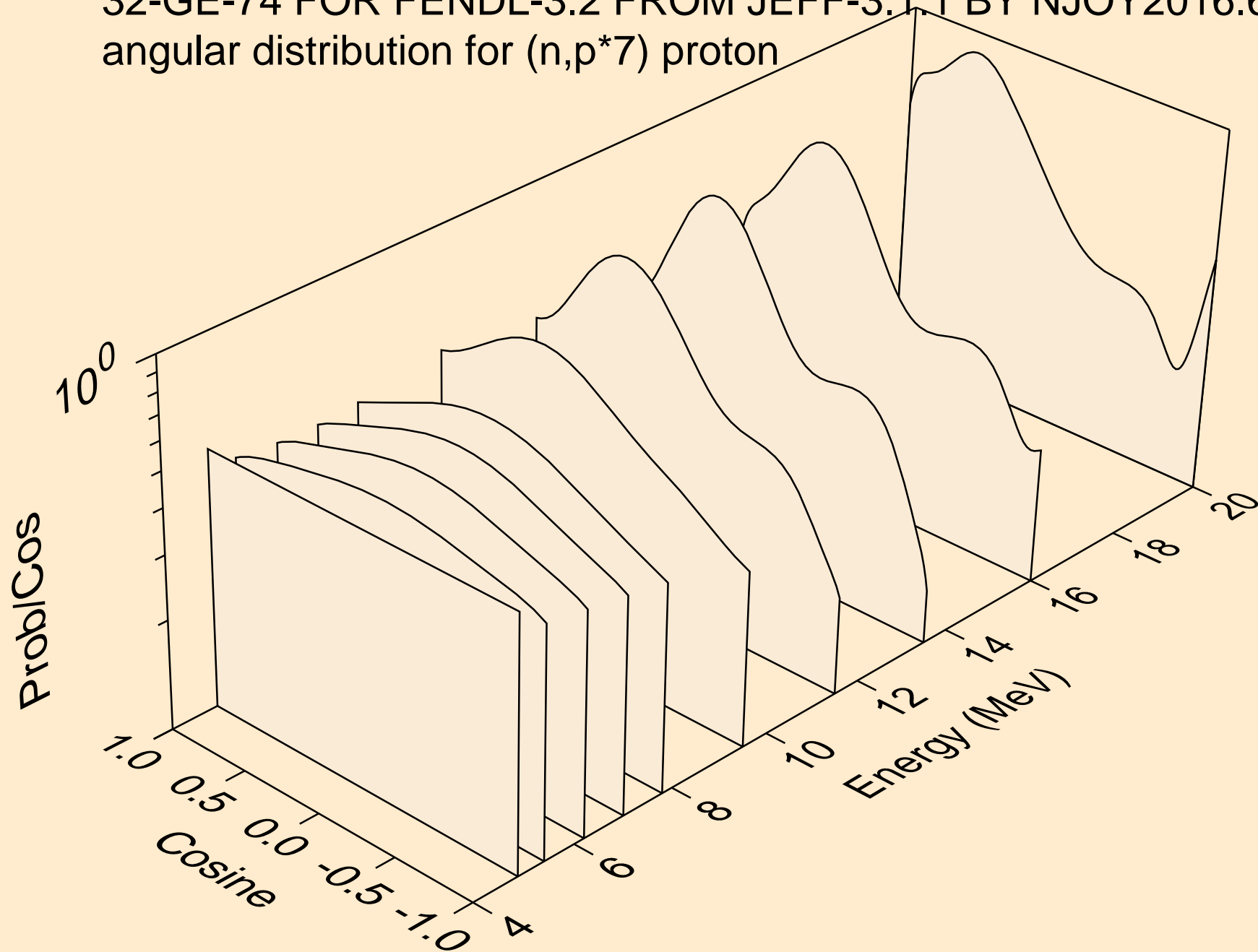

32-GE-74 FOR FENDL-3.2 FROM JEFF-3.1.1 BY NJOY2016.60+ O
angular distribution for (n,p*8) proton

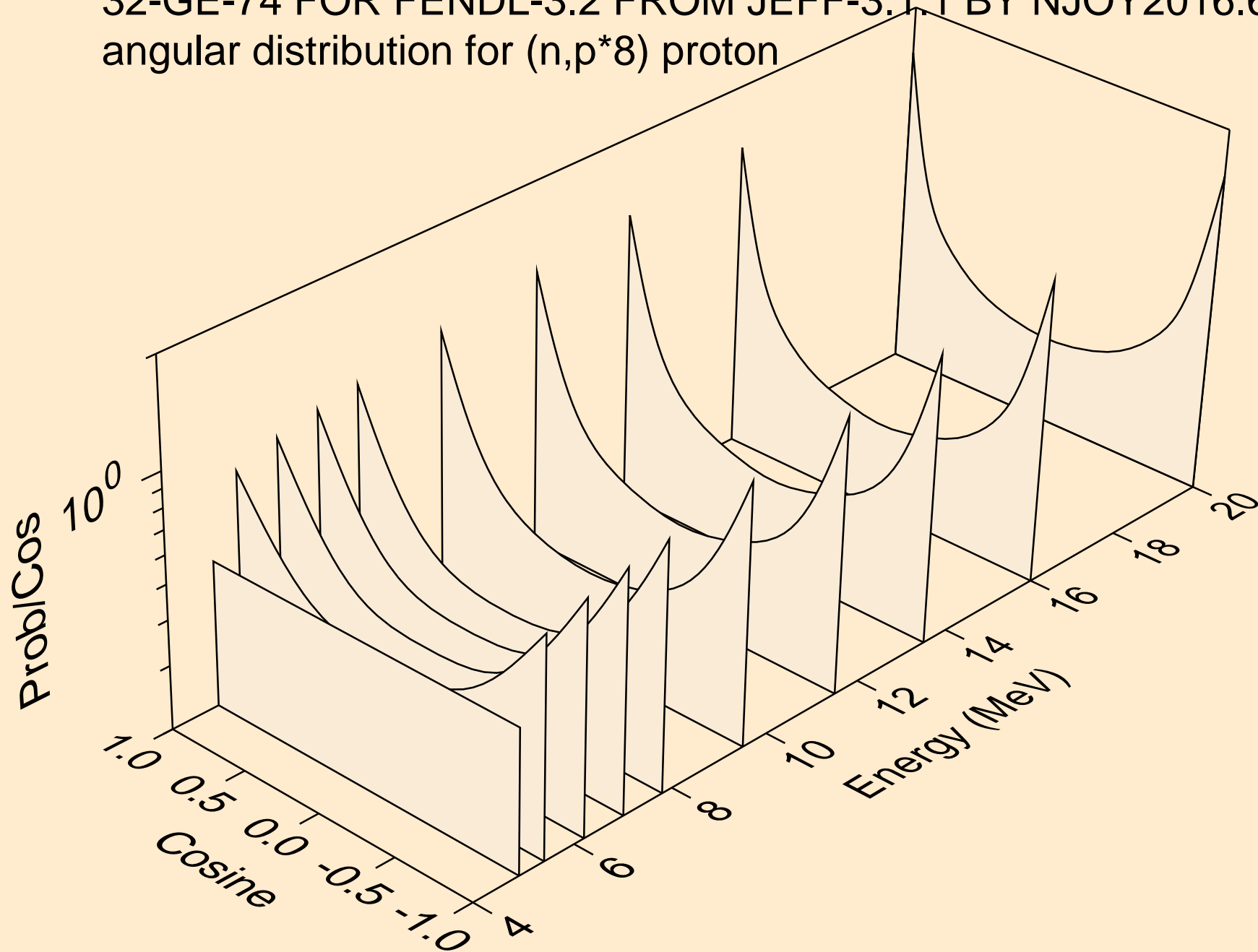

32-GE-74 FOR FENDL-3.2 FROM JEFF-3.1.1 BY NJOY2016.60+ O
angular distribution for (n,p*9) proton

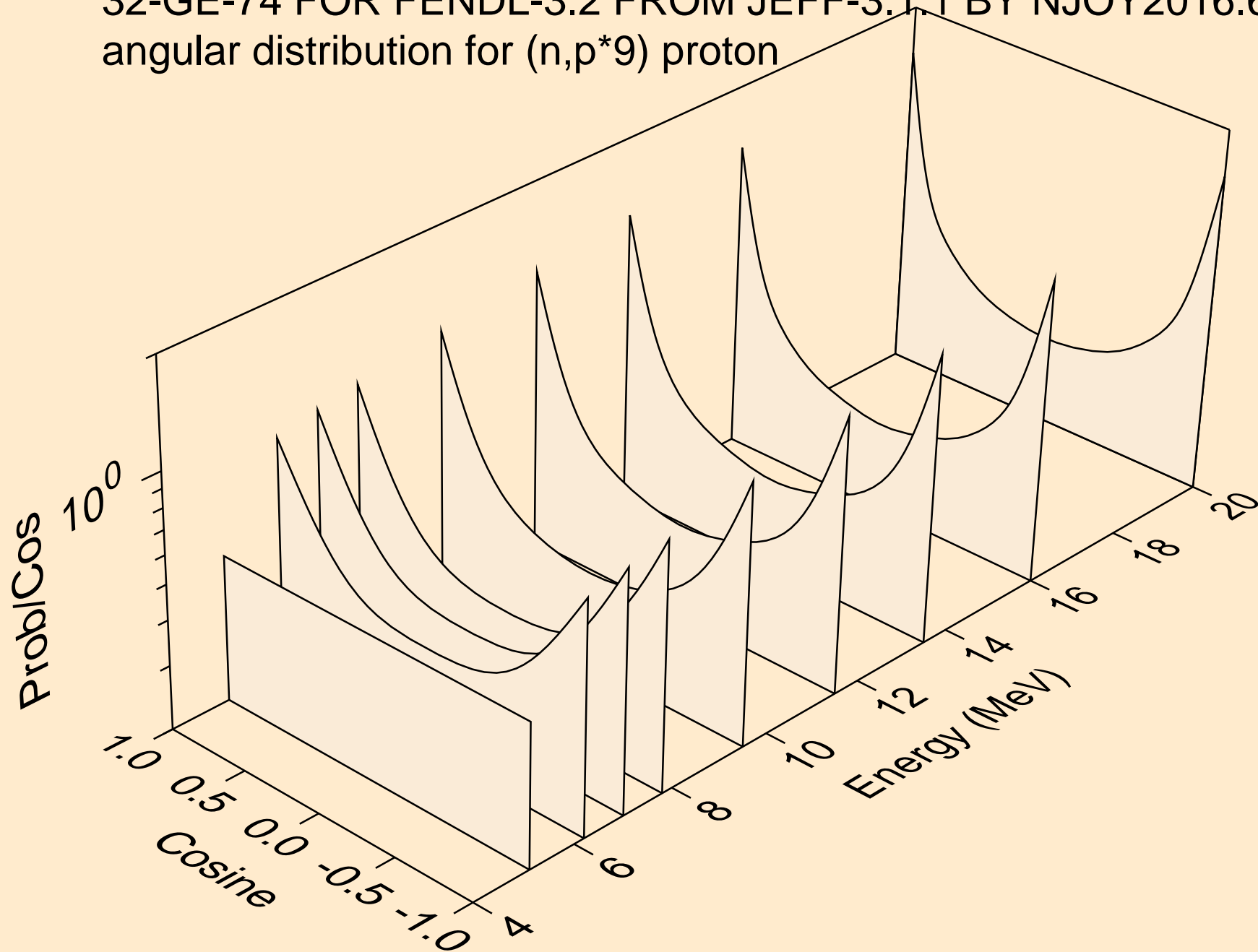

32-GE-74 FOR FENDL-3.2 FROM JEFF-3.1.1 BY NJOY2016.60+ O
angular distribution for (n,p*10) proton

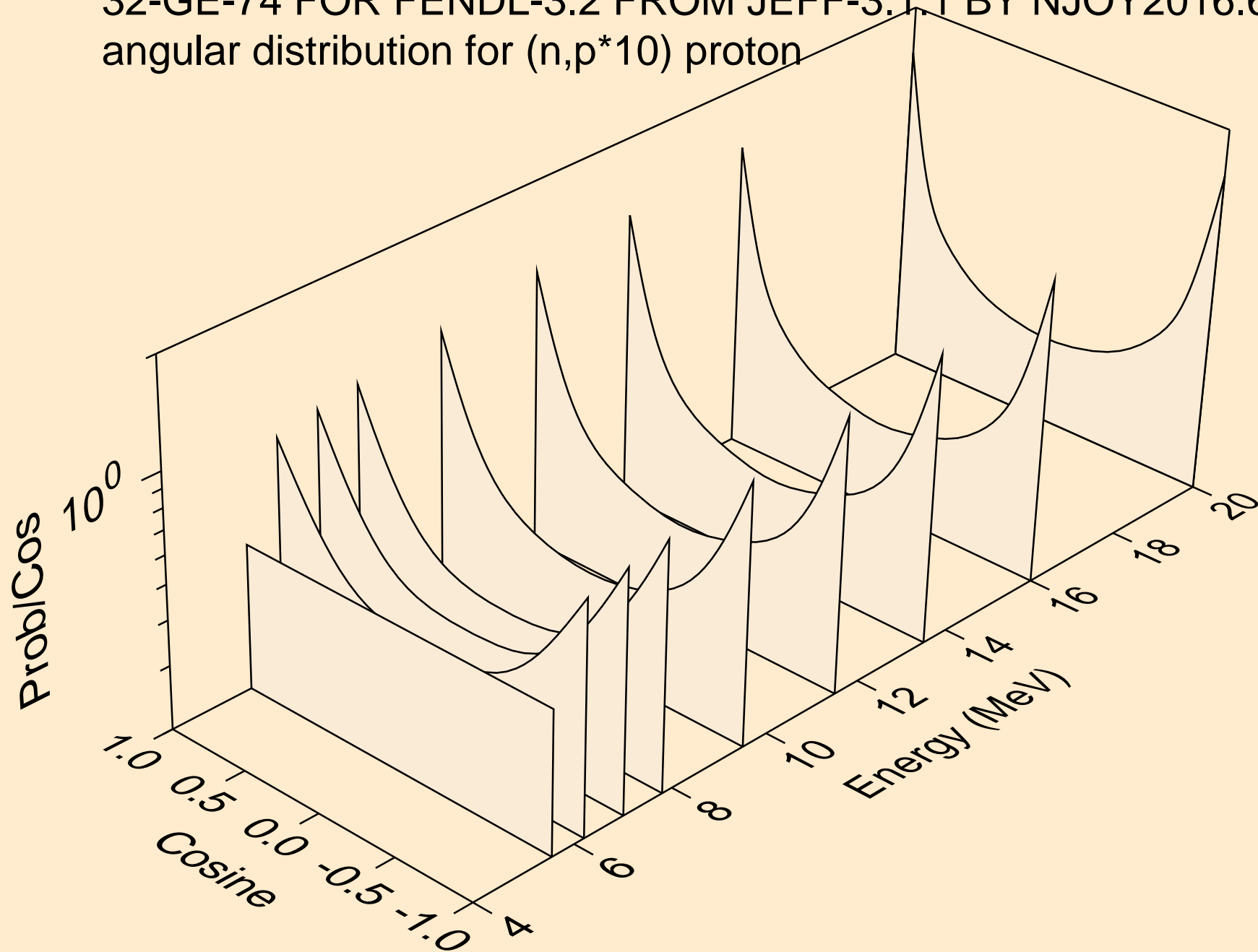

32-GE-74 FOR FENDL-3.2 FROM JEFF-3.1.1 BY NJOY2016.60+ O
protons from (n,p*c)

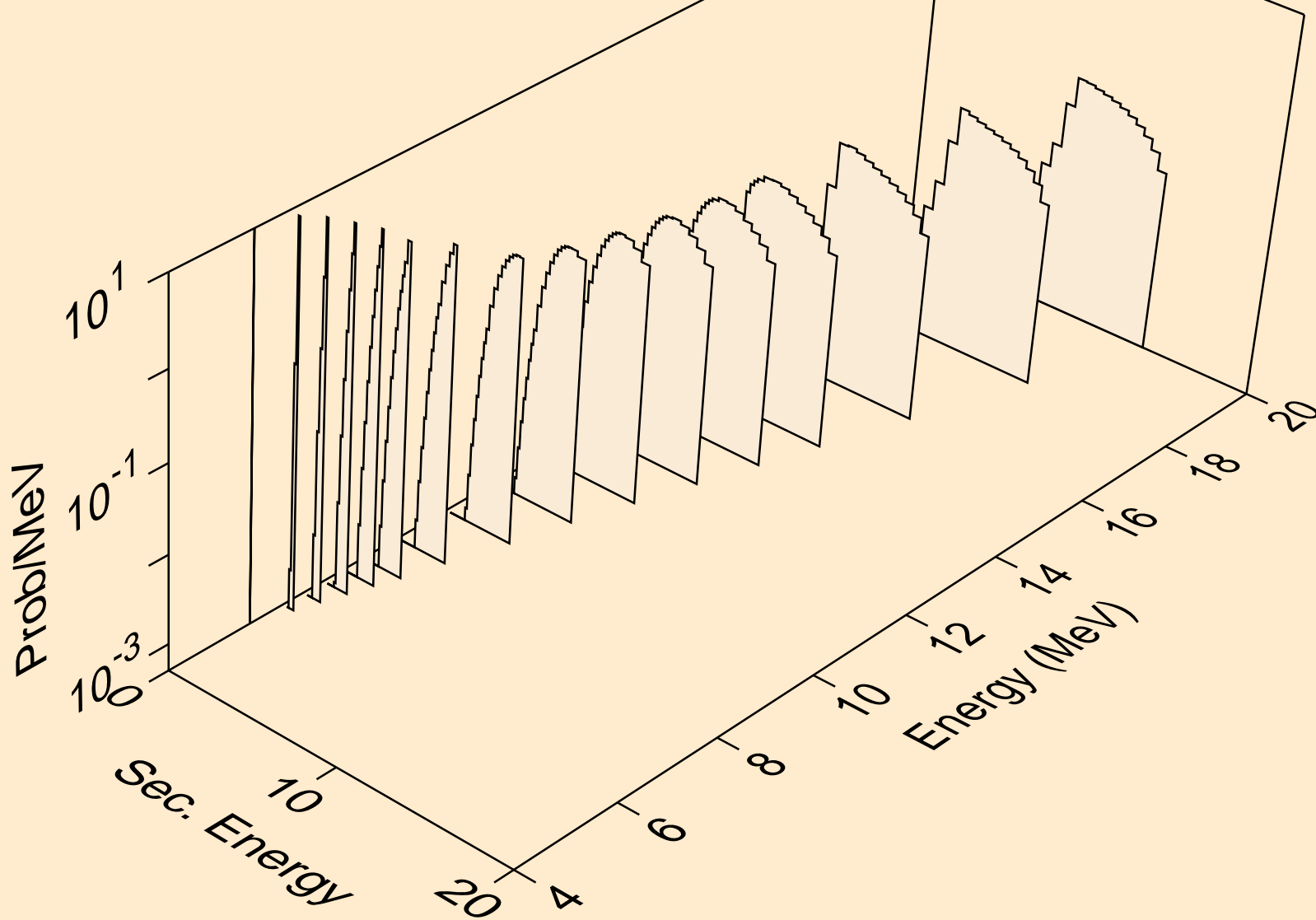

32-GE-74 FOR FENDL-3.2 FROM JEFF-3.1.1 BY NJOY2016.60+ O
deuterons from (n,x)

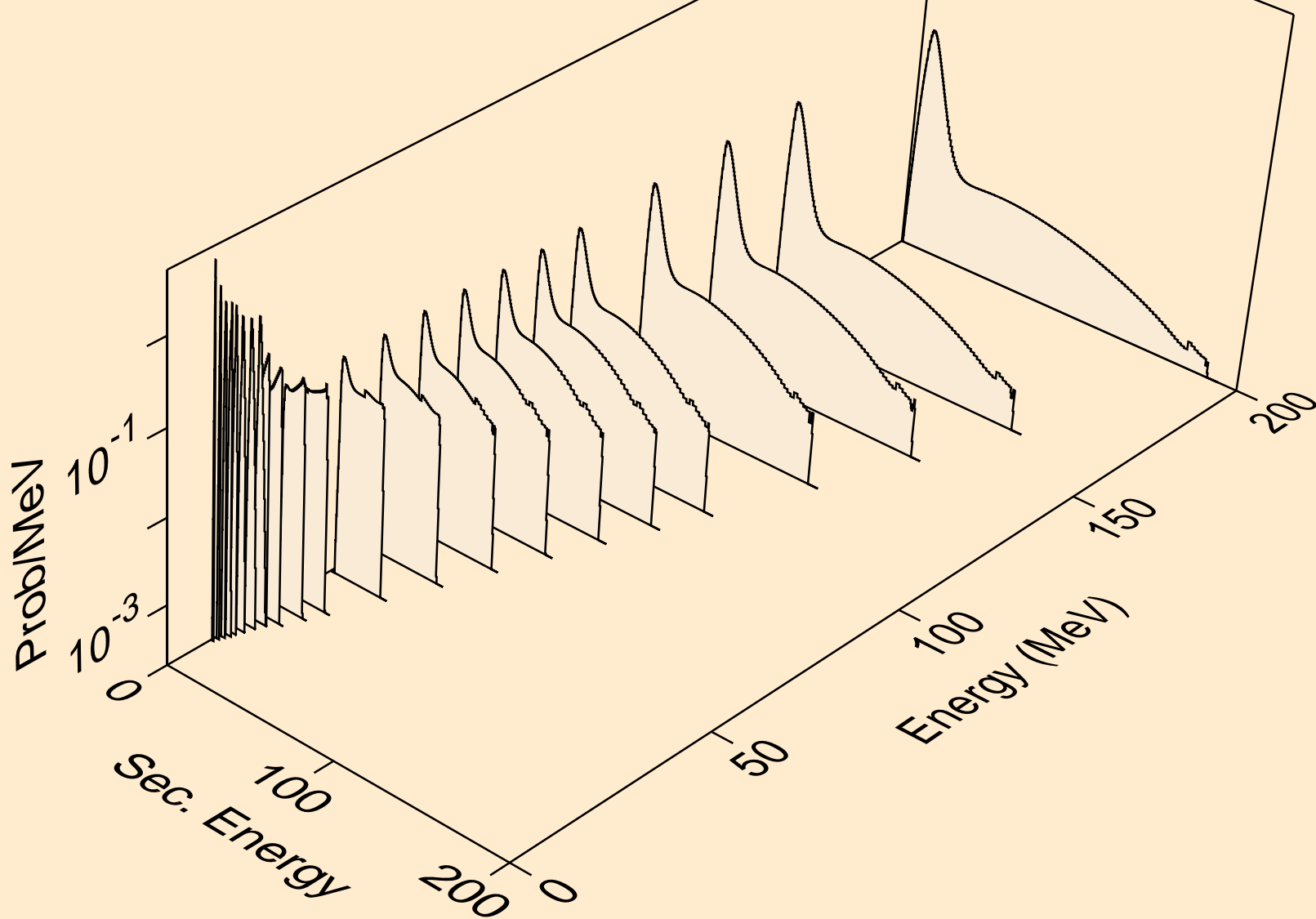

32-GE-74 FOR FENDL-3.2 FROM JEFF-3.1.1 BY NJOY2016.60+ O
deuterons from (n,n*)d

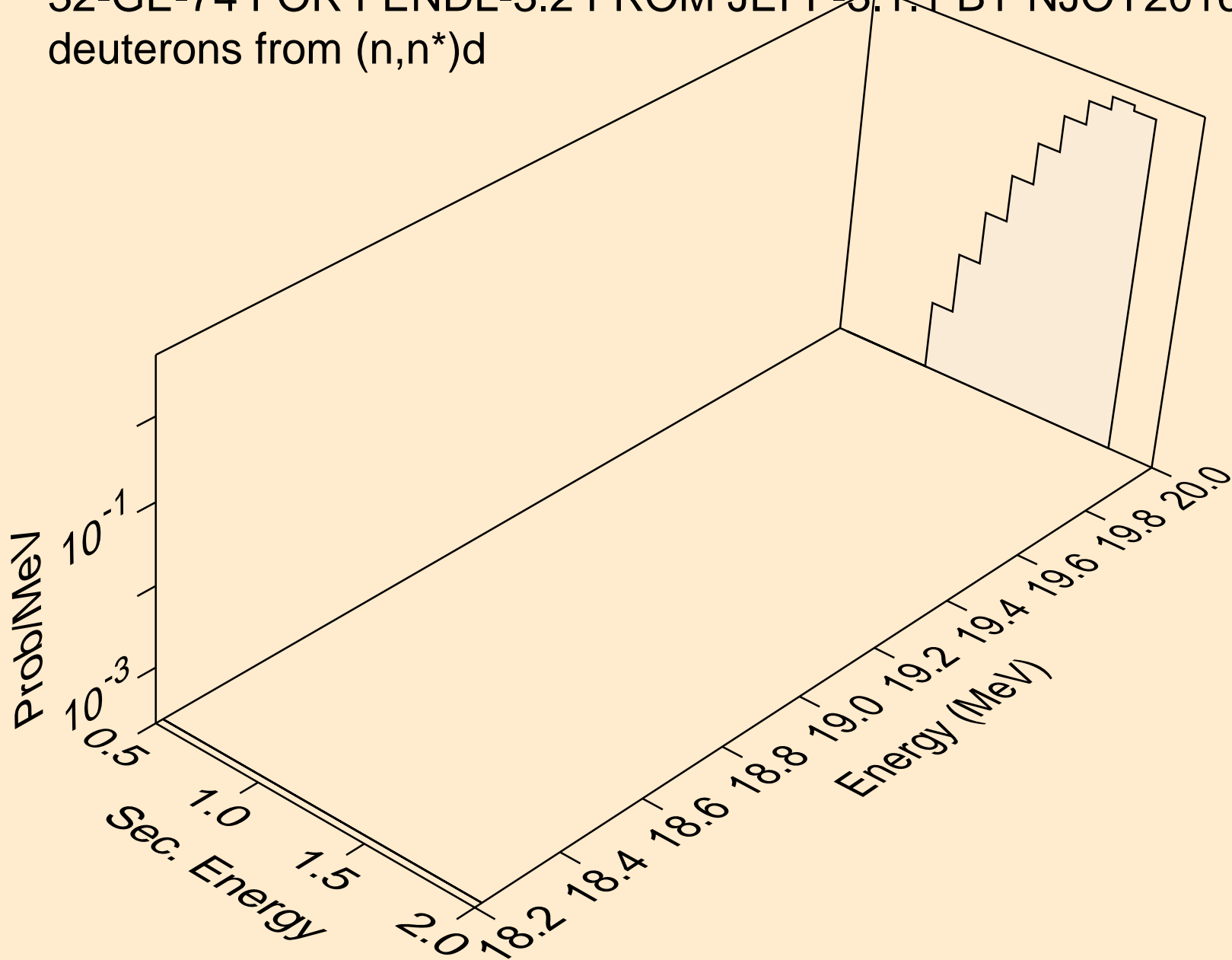

32-GE-74 FOR FENDL-3.2 FROM JEFF-3.1.1 BY NJOY2016.60+ O
angular distribution for (n,d*0) deuteron

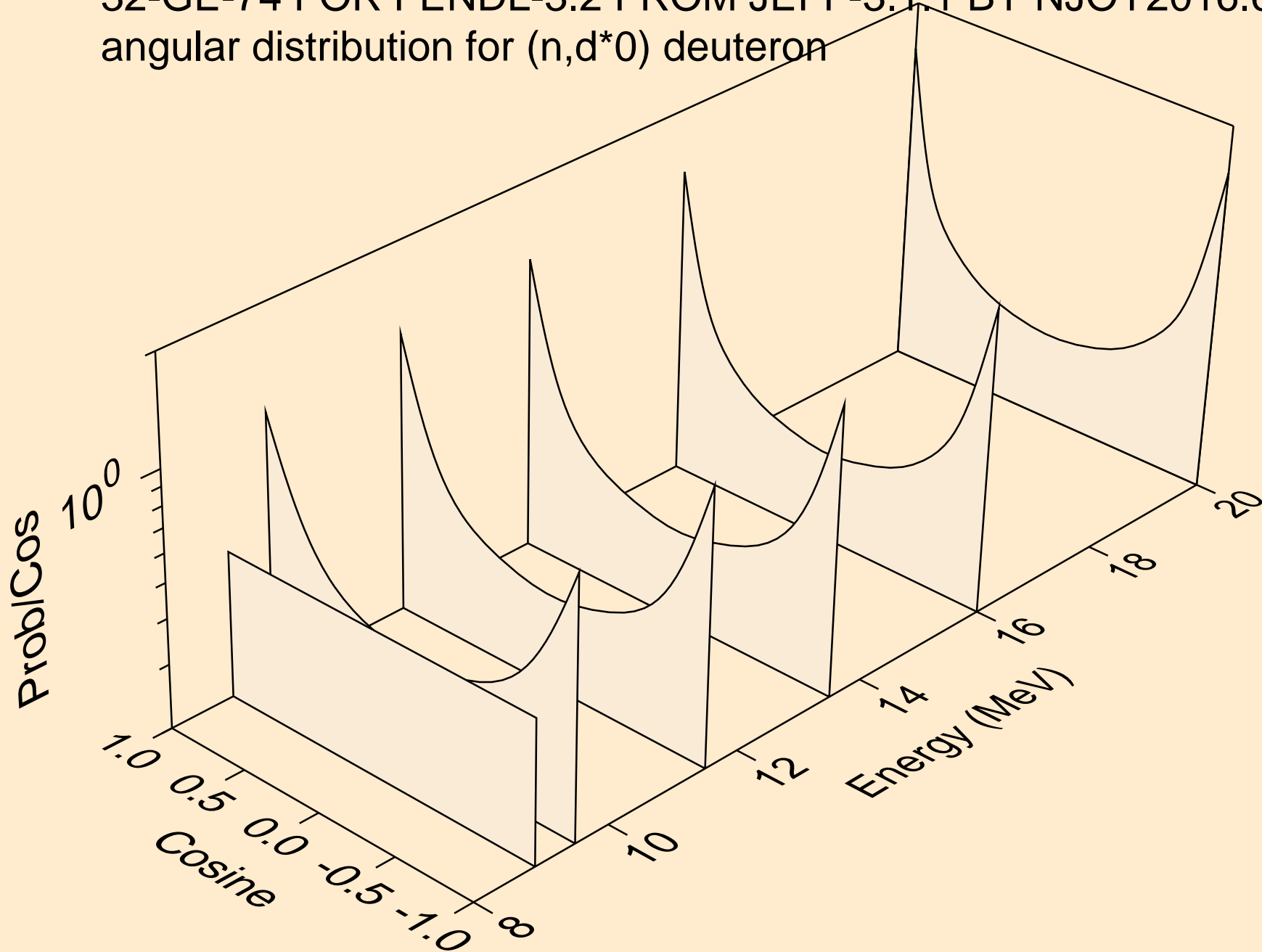

32-GE-74 FOR FENDL-3.2 FROM JEFF-3.1.1 BY NJOY2016.60+ O
angular distribution for (n,d*1) deuteron

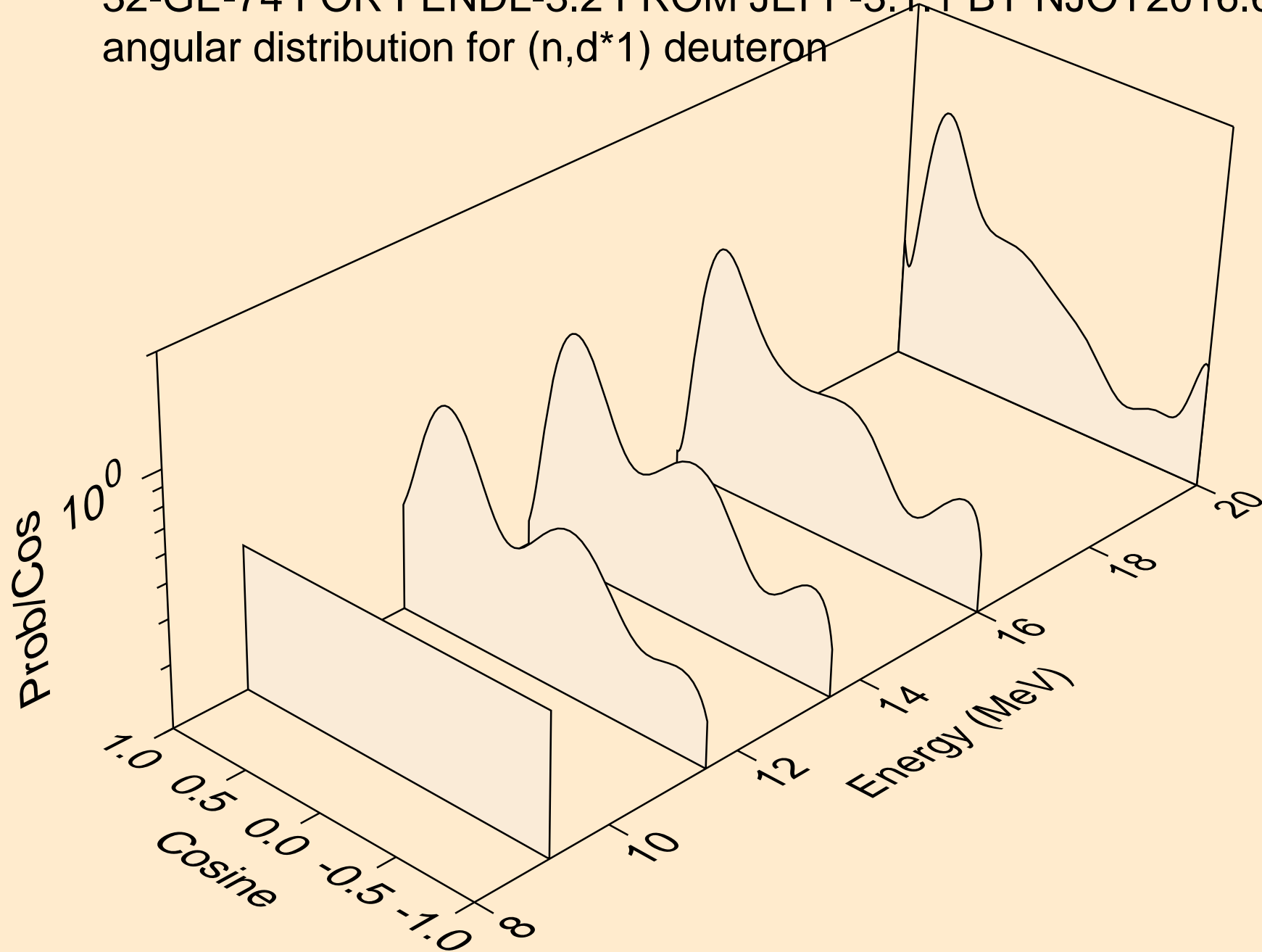

32-GE-74 FOR FENDL-3.2 FROM JEFF-3.1.1 BY NJOY2016.60+ O
angular distribution for (n,d*2) deuteron

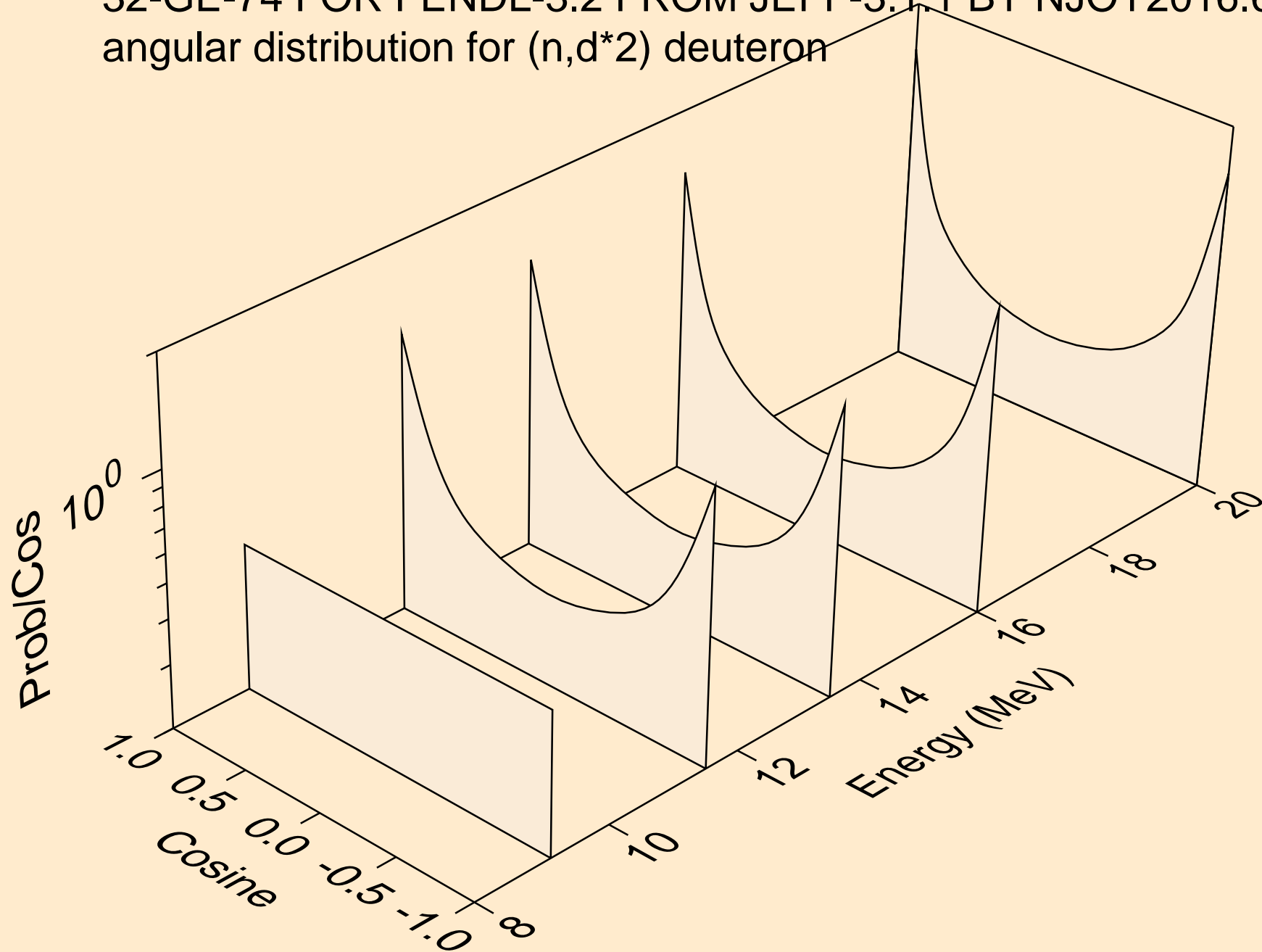

32-GE-74 FOR FENDL-3.2 FROM JEFF-3.1.1 BY NJOY2016.60+ O
angular distribution for (n,d*3) deuteron

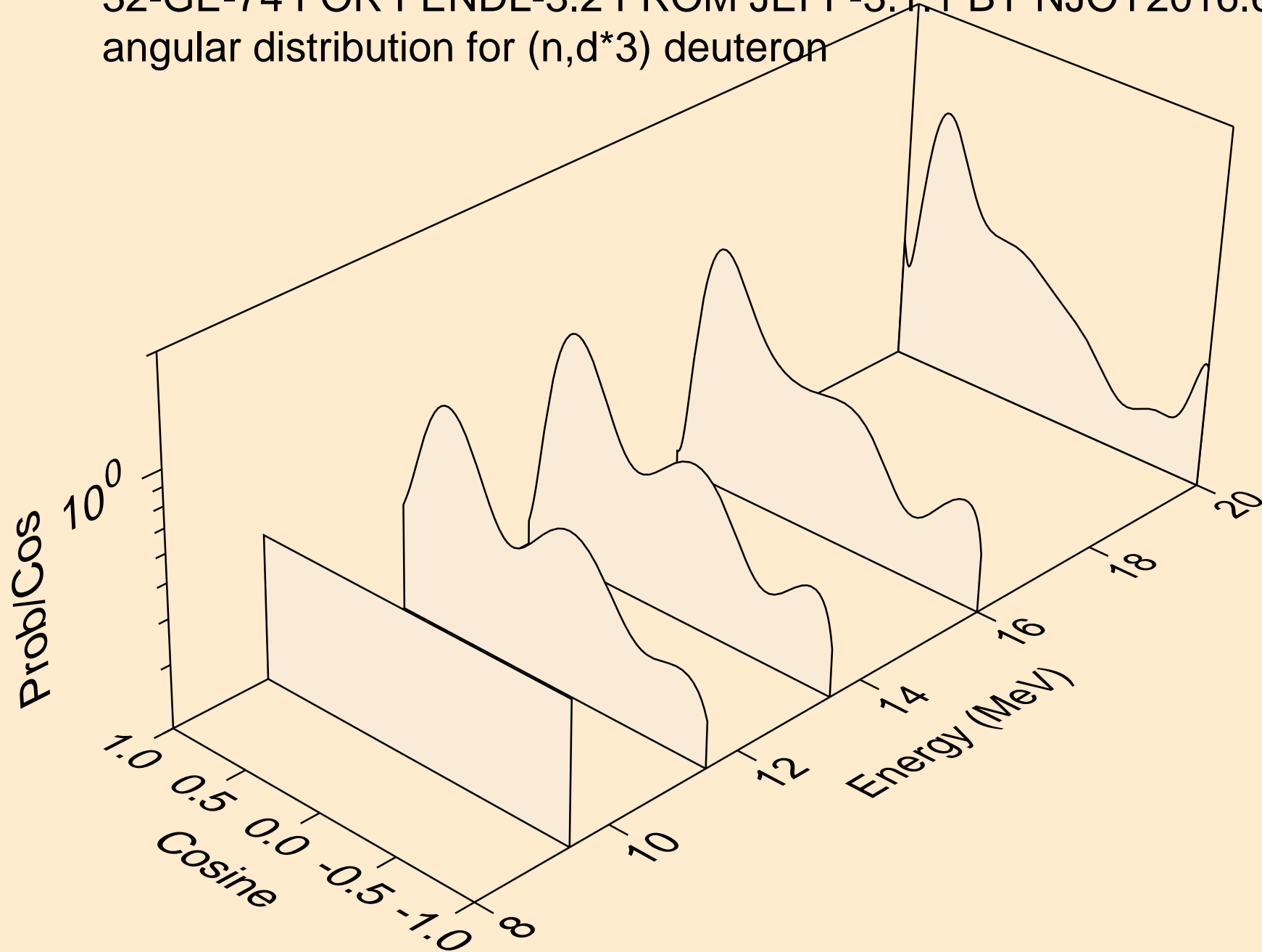

32-GE-74 FOR FENDL-3.2 FROM JEFF-3.1.1 BY NJOY2016.60+ O
angular distribution for (n,d*4) deuteron

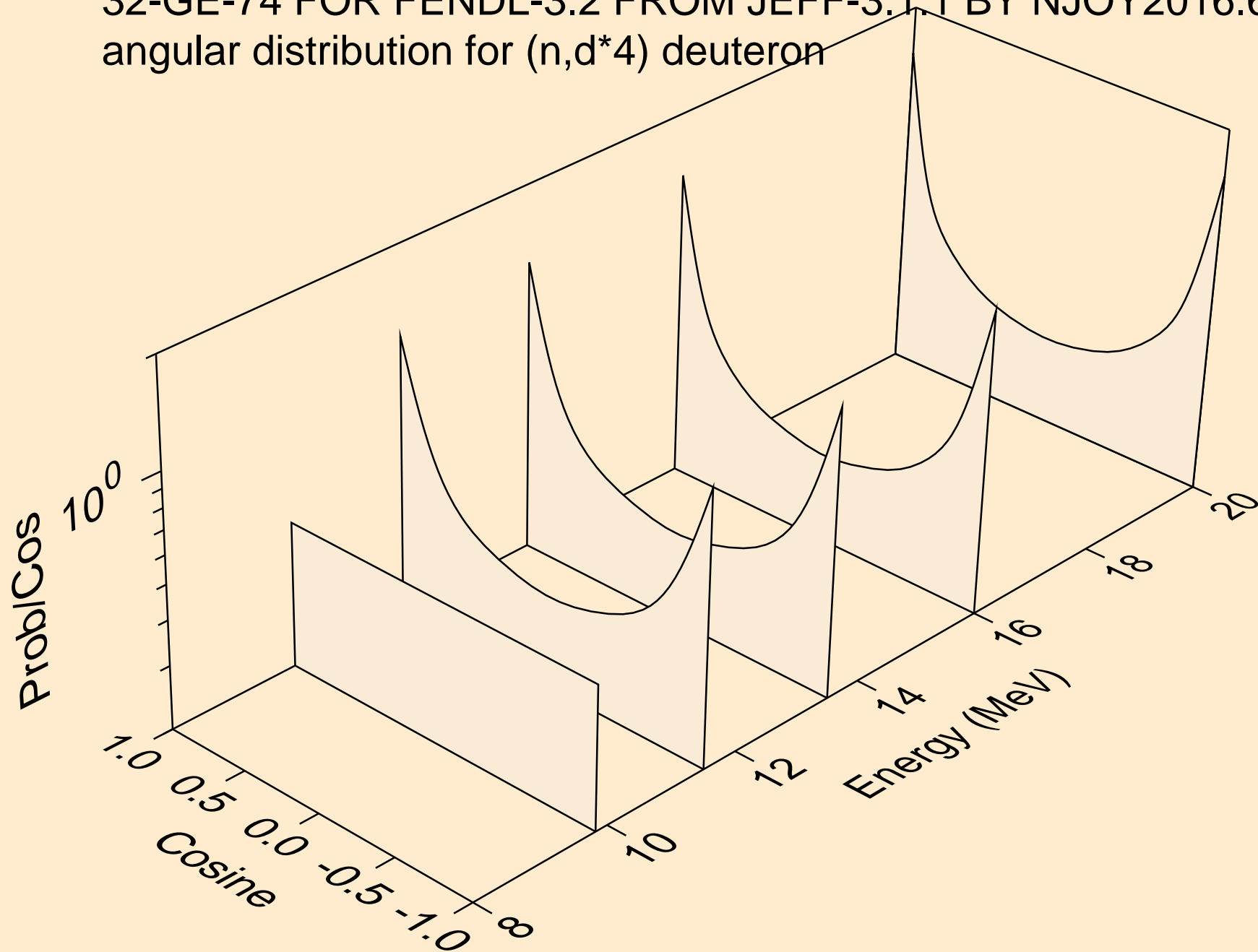

32-GE-74 FOR FENDL-3.2 FROM JEFF-3.1.1 BY NJOY2016.60+ O
angular distribution for (n,d*5) deuteron

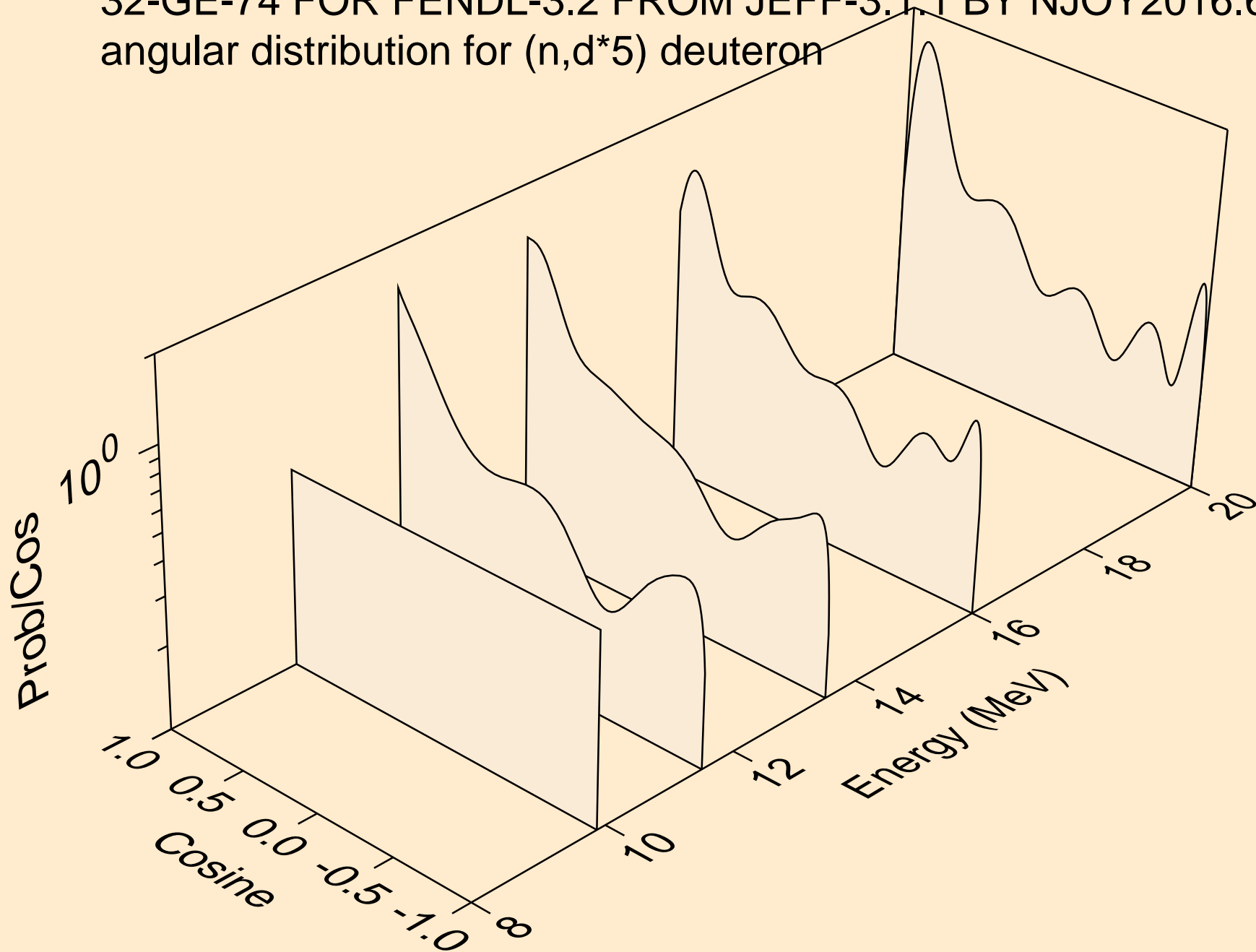

32-GE-74 FOR FENDL-3.2 FROM JEFF-3.1.1 BY NJOY2016.60+ O
deuterons from (n,d*c)

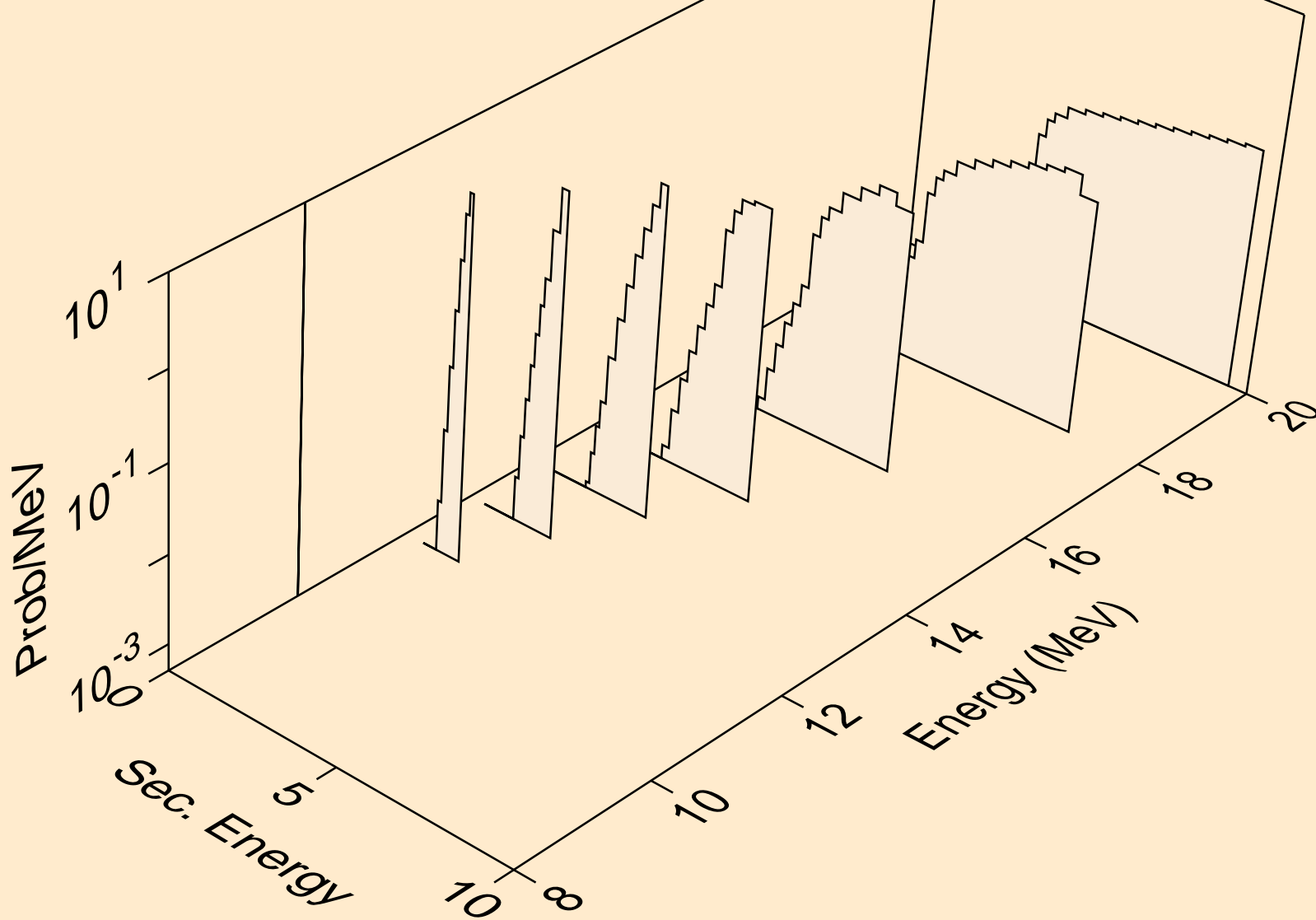

32-GE-74 FOR FENDL-3.2 FROM JEFF-3.1.1 BY NJOY2016.60+ O
tritons from (n,x)

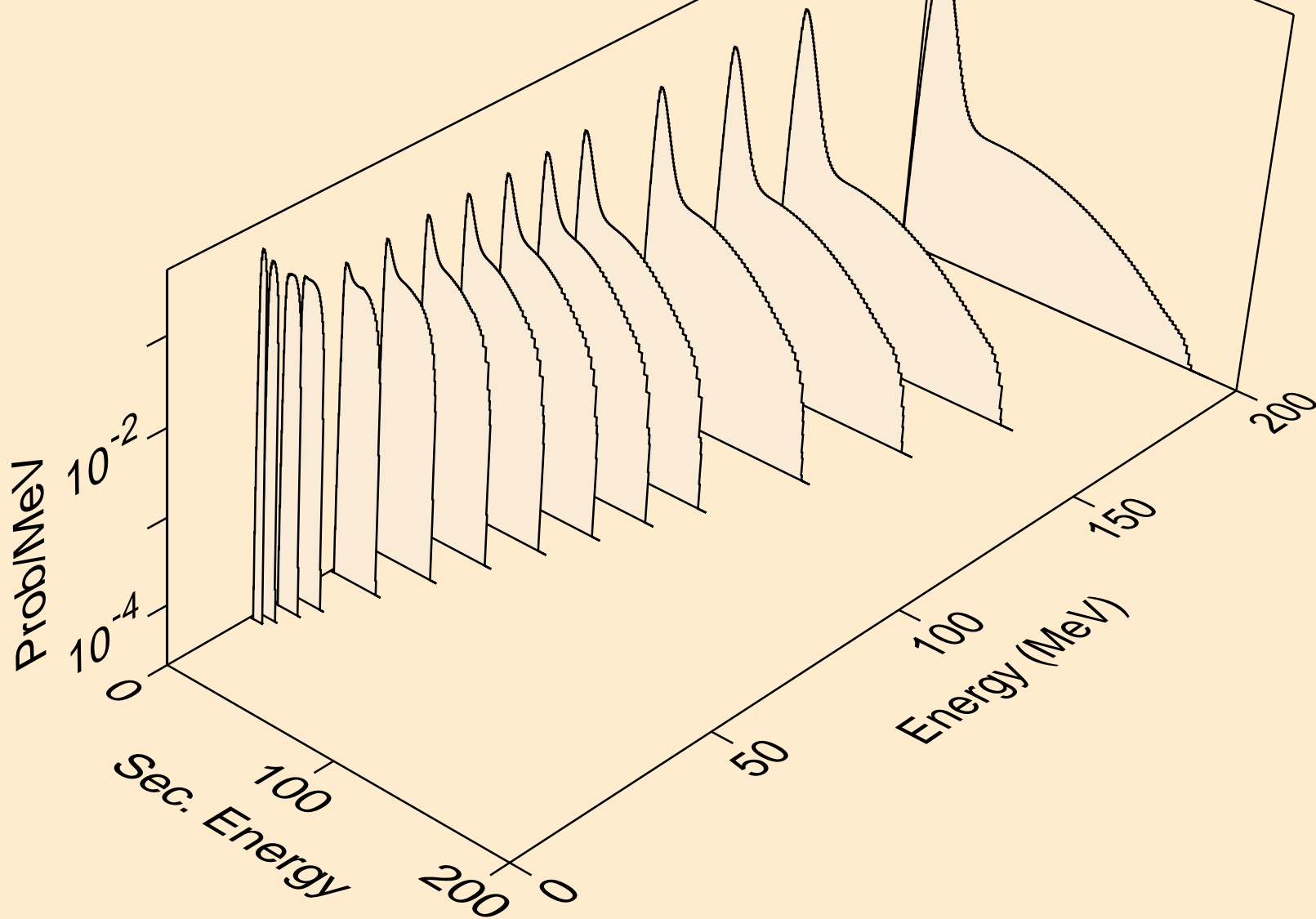

32-GE-74 FOR FENDL-3.2 FROM JEFF-3.1.1 BY NJOY2016.60+ O
angular distribution for (n,t*0) triton

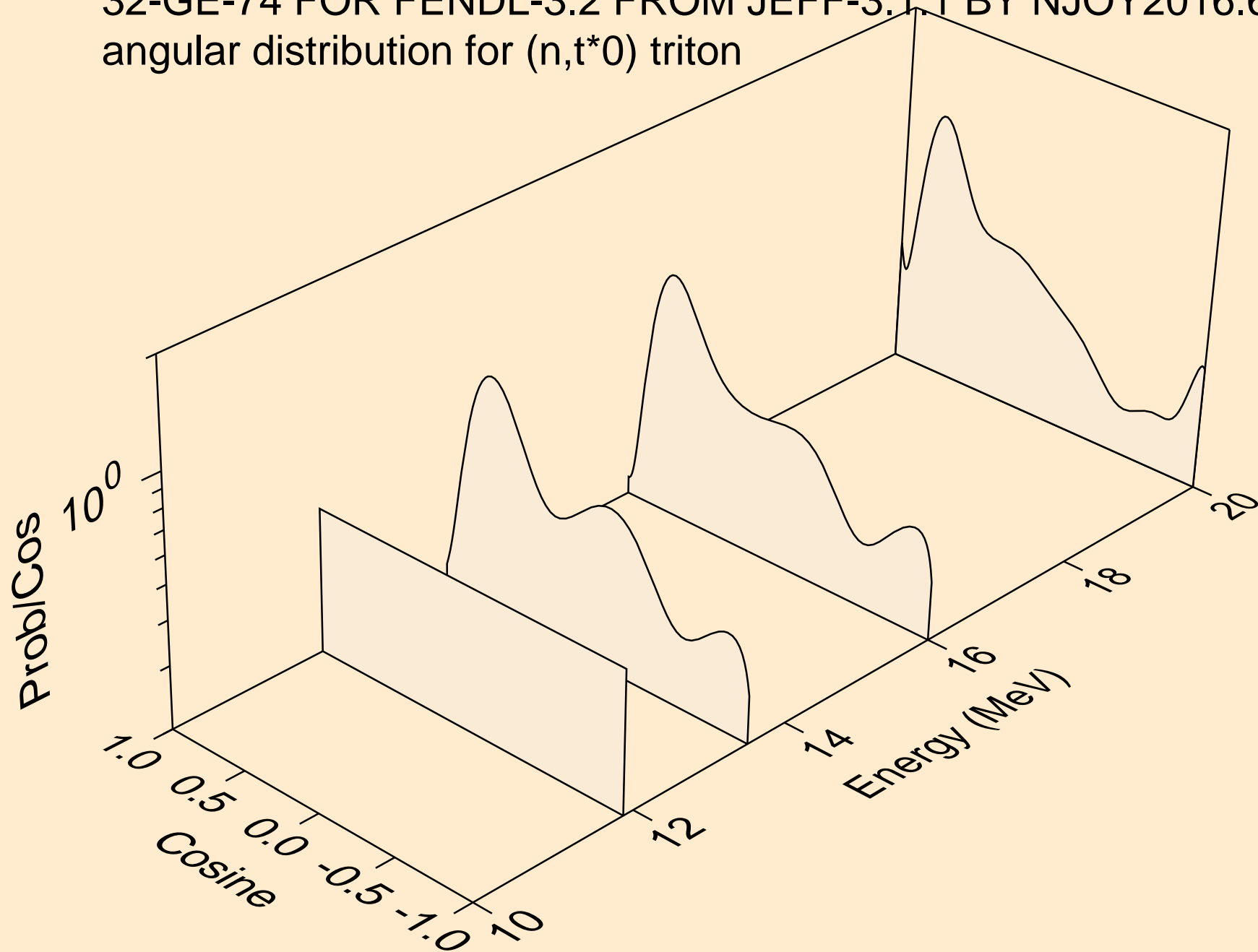

32-GE-74 FOR FENDL-3.2 FROM JEFF-3.1.1 BY NJOY2016.60+ O
angular distribution for (n,t*1) triton

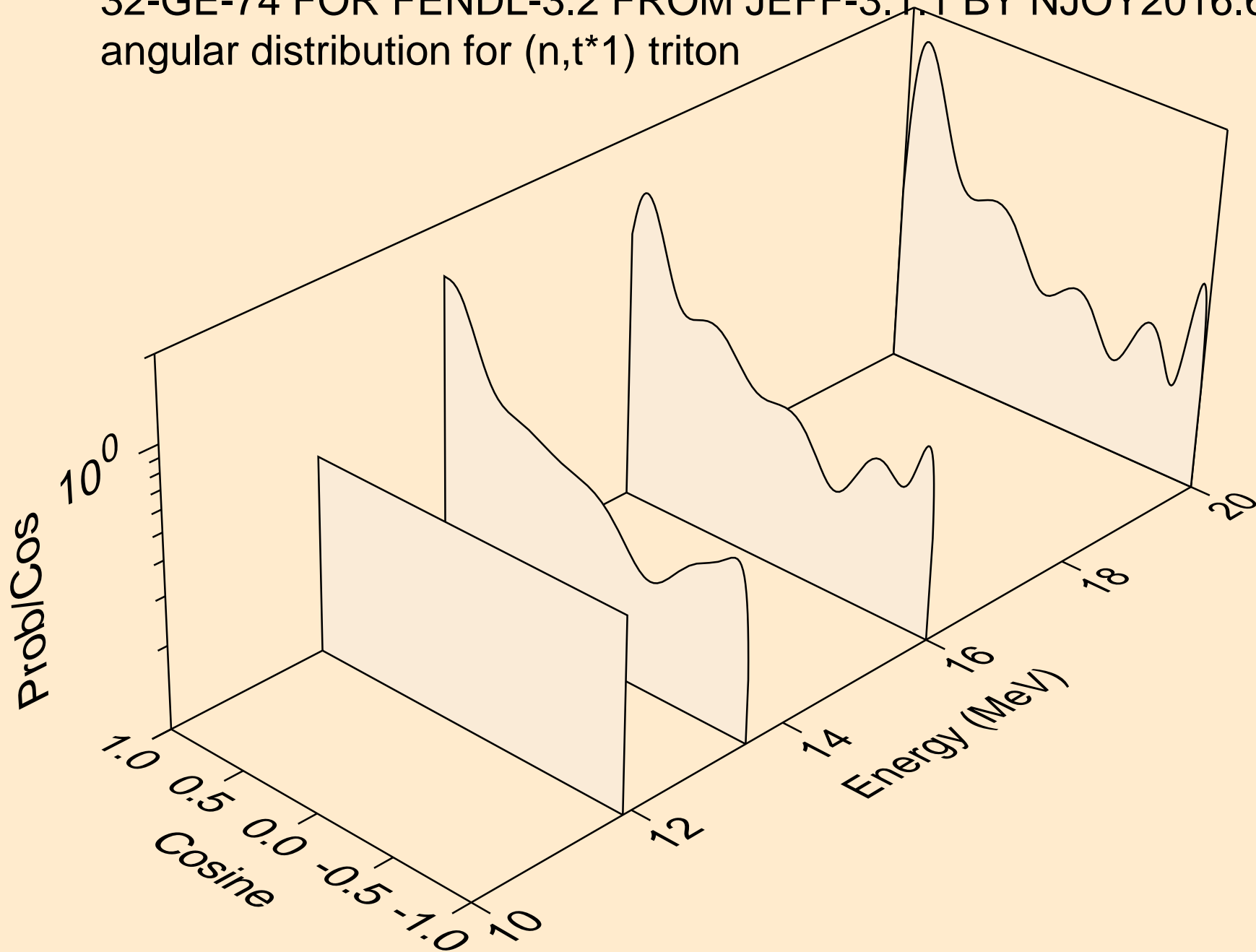

32-GE-74 FOR FENDL-3.2 FROM JEFF-3.1.1 BY NJOY2016.60+ O
angular distribution for (n,t*2) triton

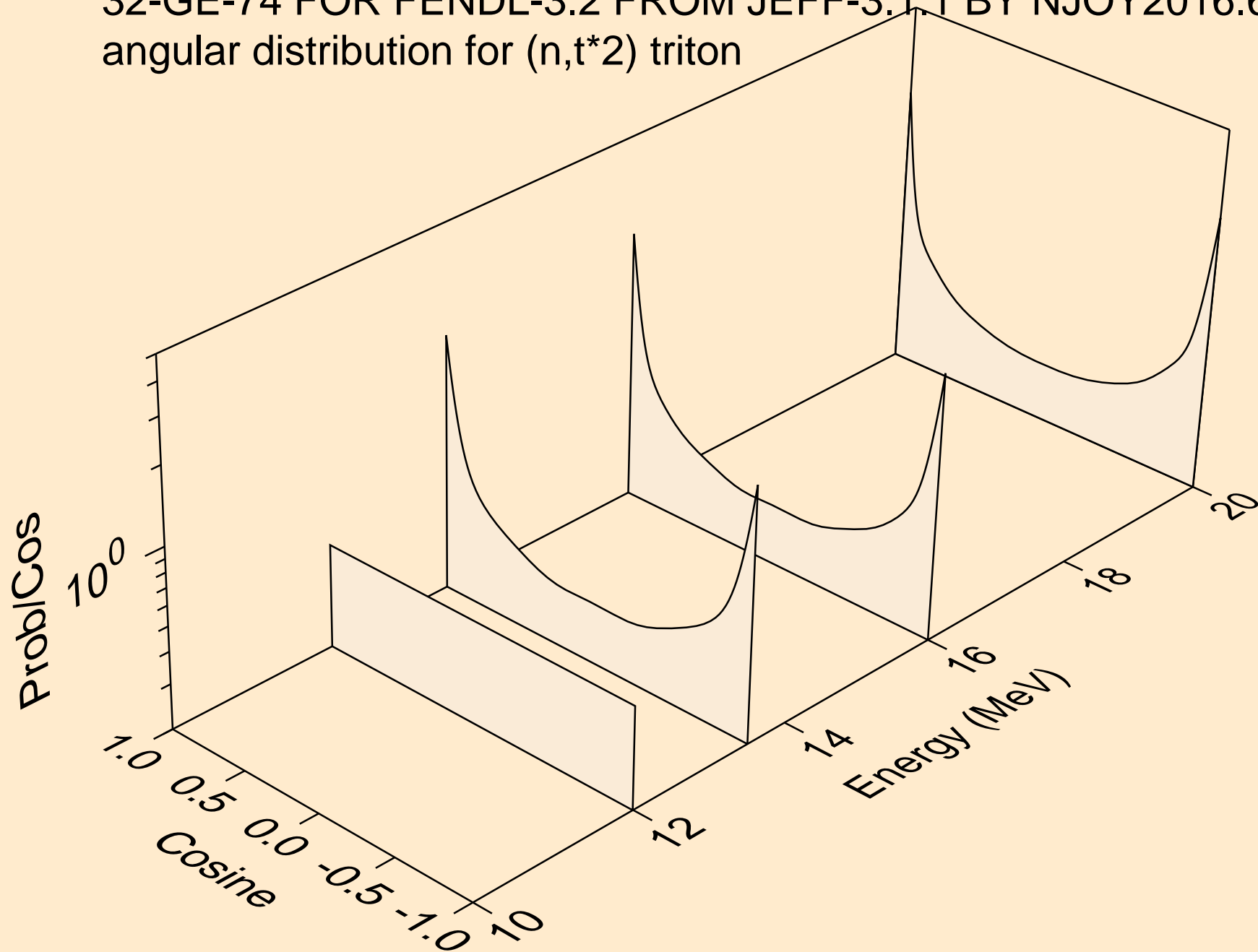

32-GE-74 FOR FENDL-3.2 FROM JEFF-3.1.1 BY NJOY2016.60+ O
angular distribution for (n,t*3) triton

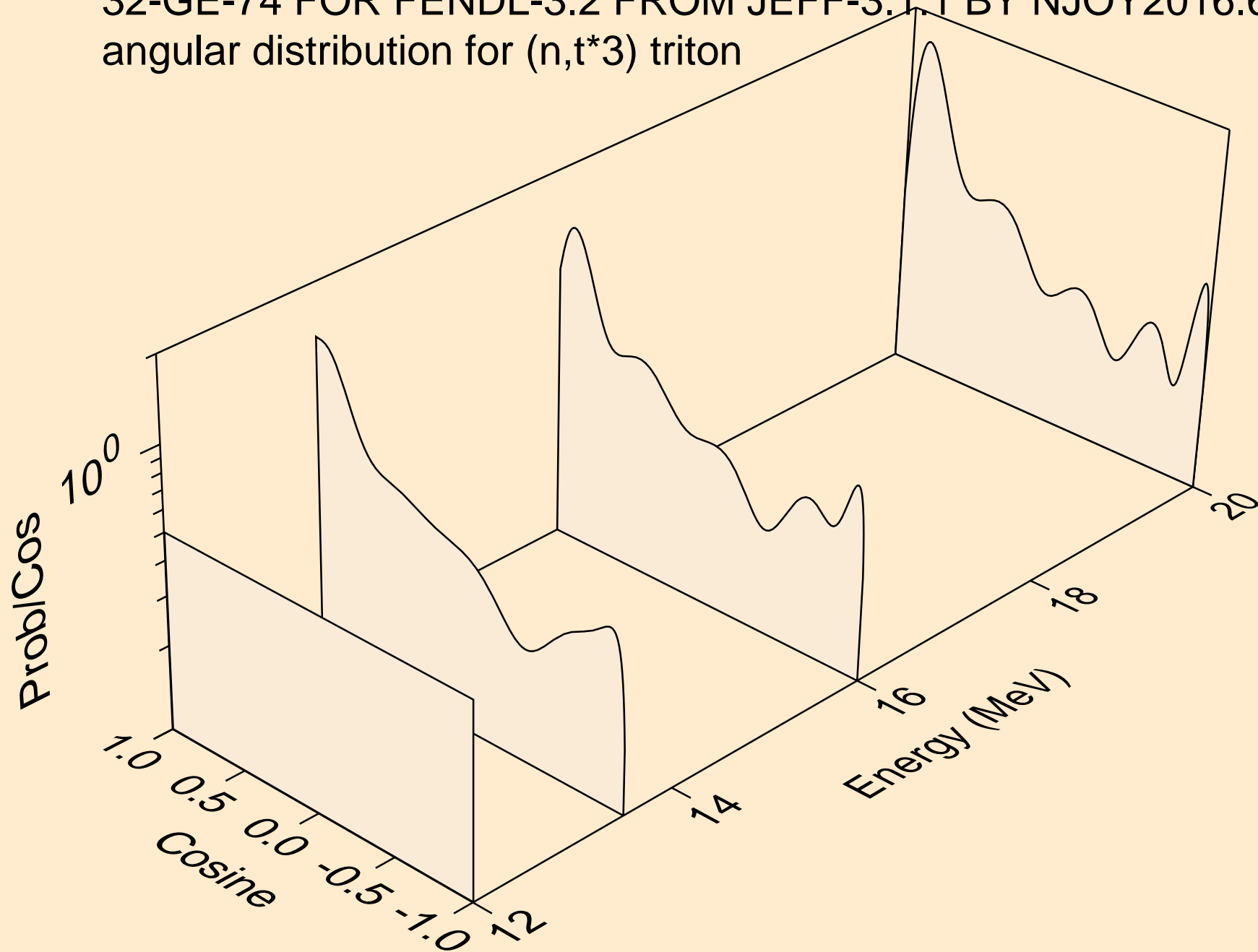

32-GE-74 FOR FENDL-3.2 FROM JEFF-3.1.1 BY NJOY2016.60+ O
angular distribution for (n,t*4) triton

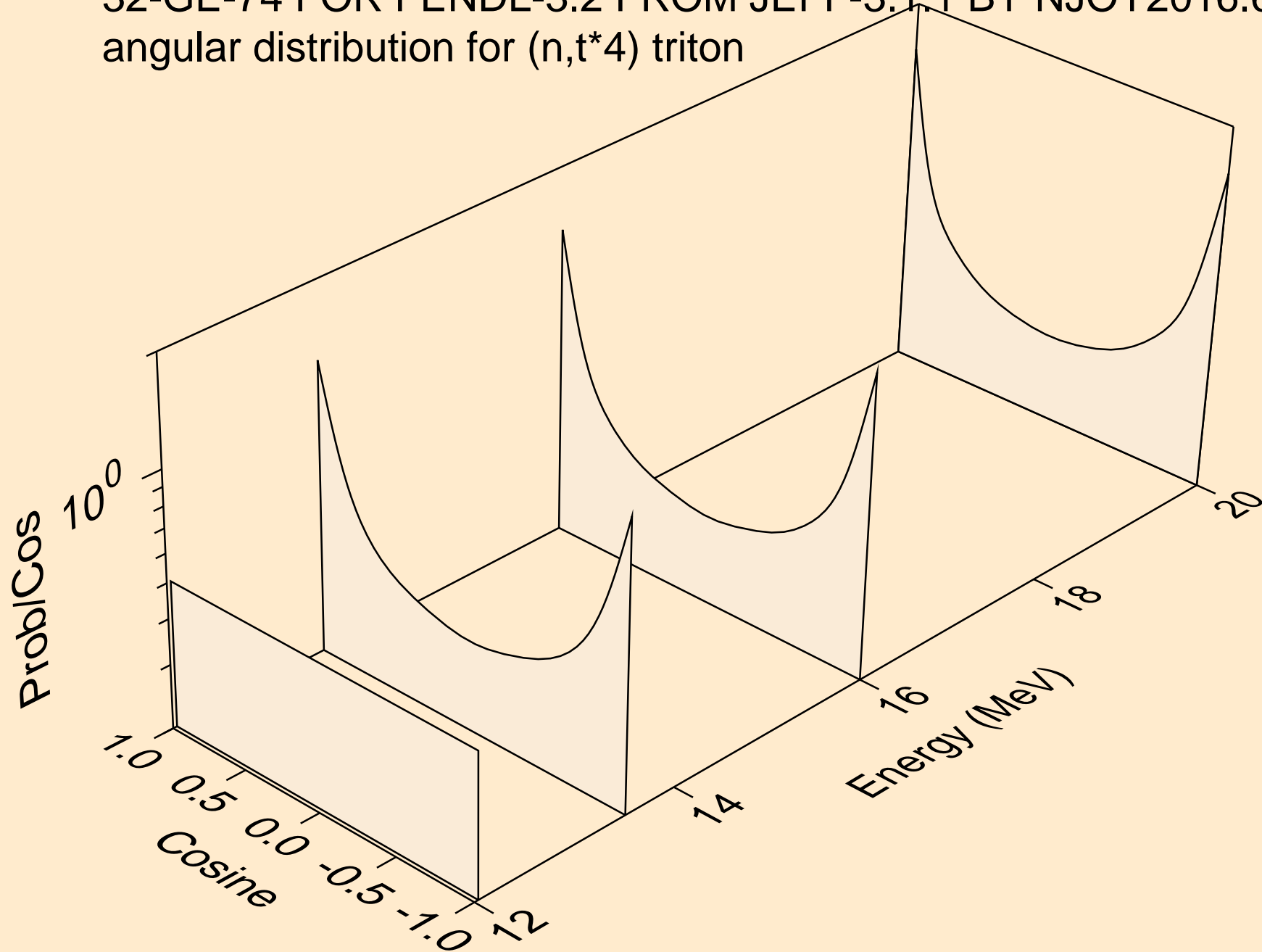

32-GE-74 FOR FENDL-3.2 FROM JEFF-3.1.1 BY NJOY2016.60+ O
angular distribution for (n,t*5) triton

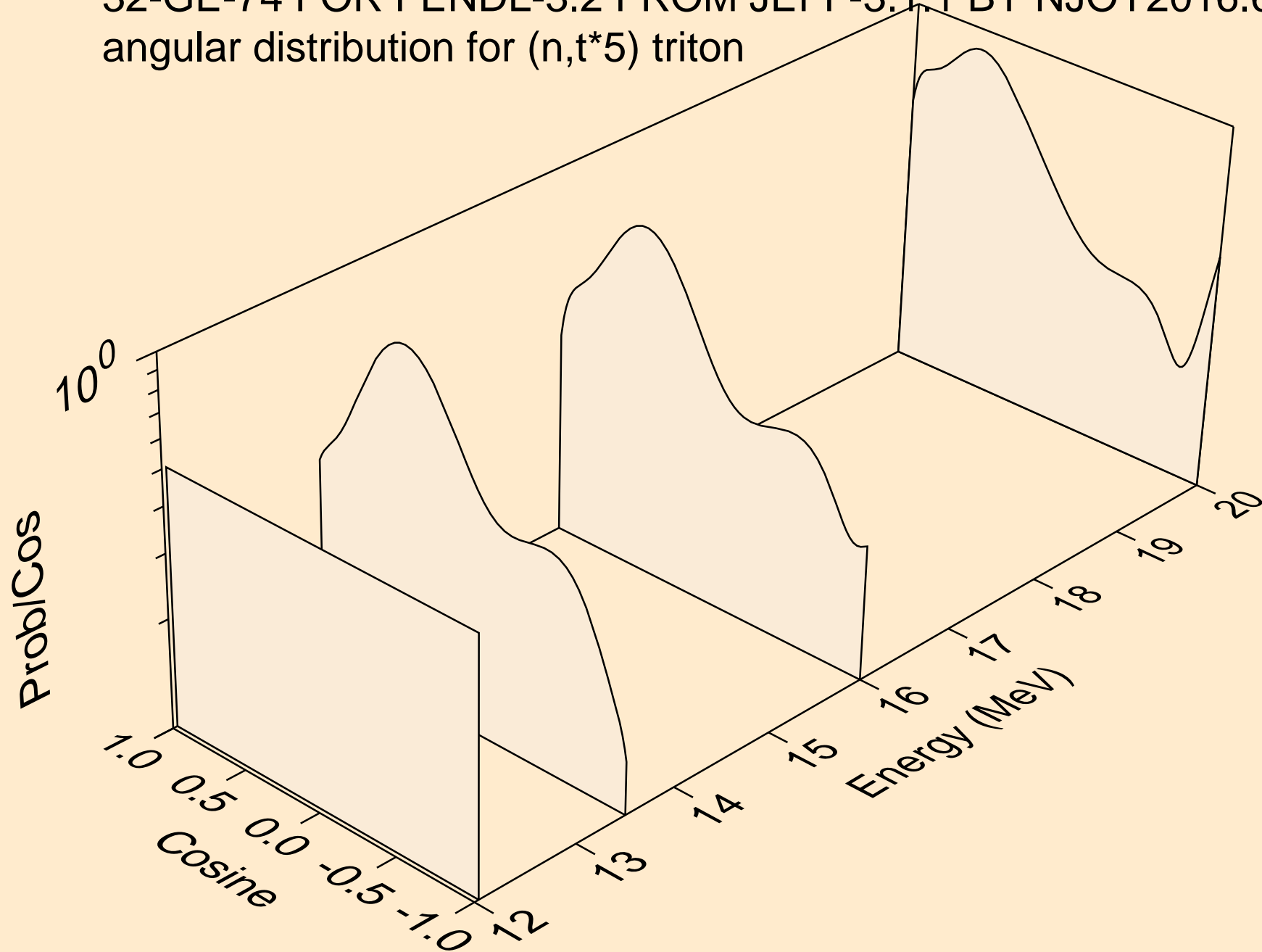

32-GE-74 FOR FENDL-3.2 FROM JEFF-3.1.1 BY NJOY2016.60+ O
tritons from (n,t*c)

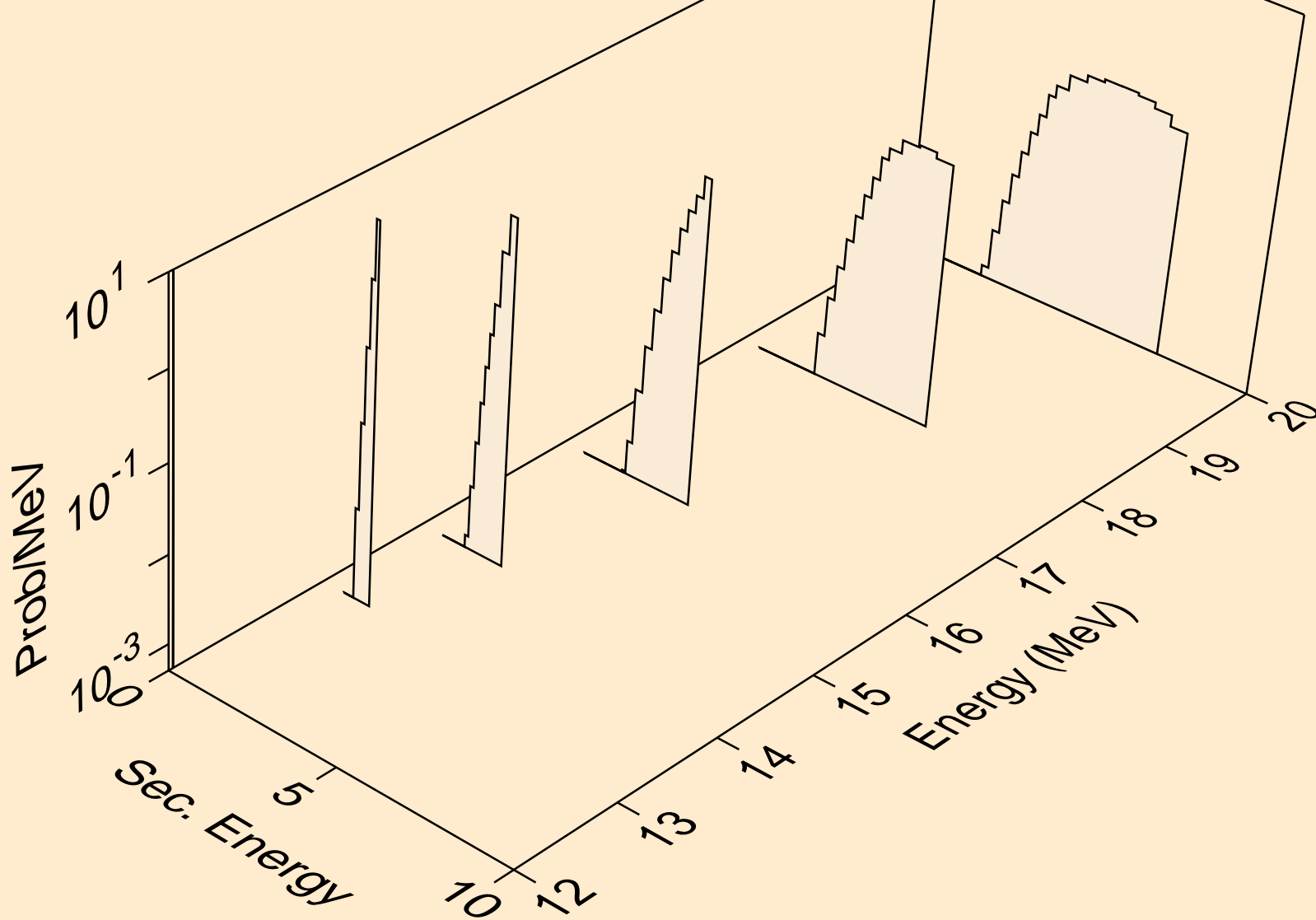

32-GE-74 FOR FENDL-3.2 FROM JEFF-3.1.1 BY NJOY2016.60+ O
he3s from (n,x)

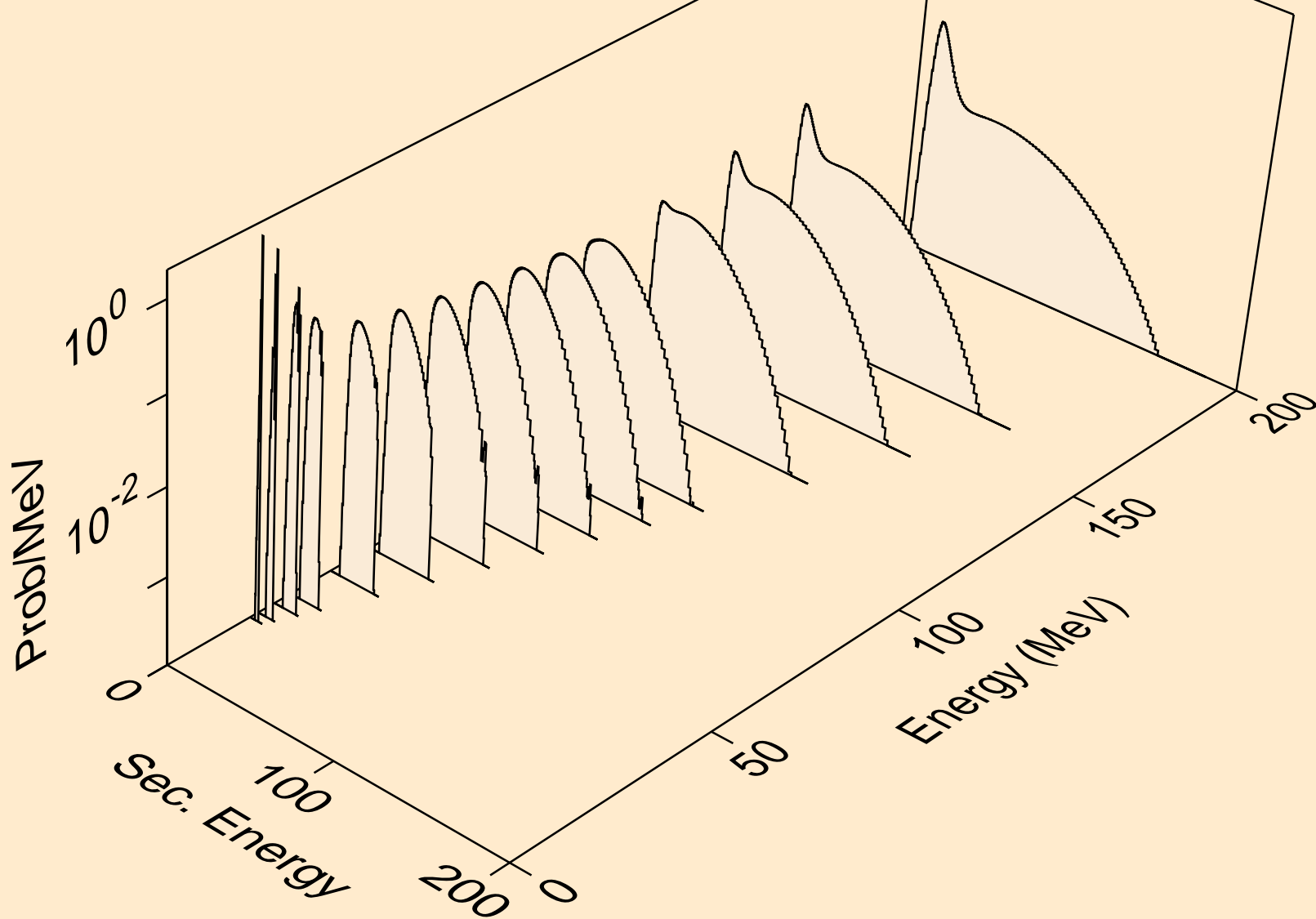

32-GE-74 FOR FENDL-3.2 FROM JEFF-3.1.1 BY NJOY2016.60+ O
angular distribution for (n,he3*0) 3he

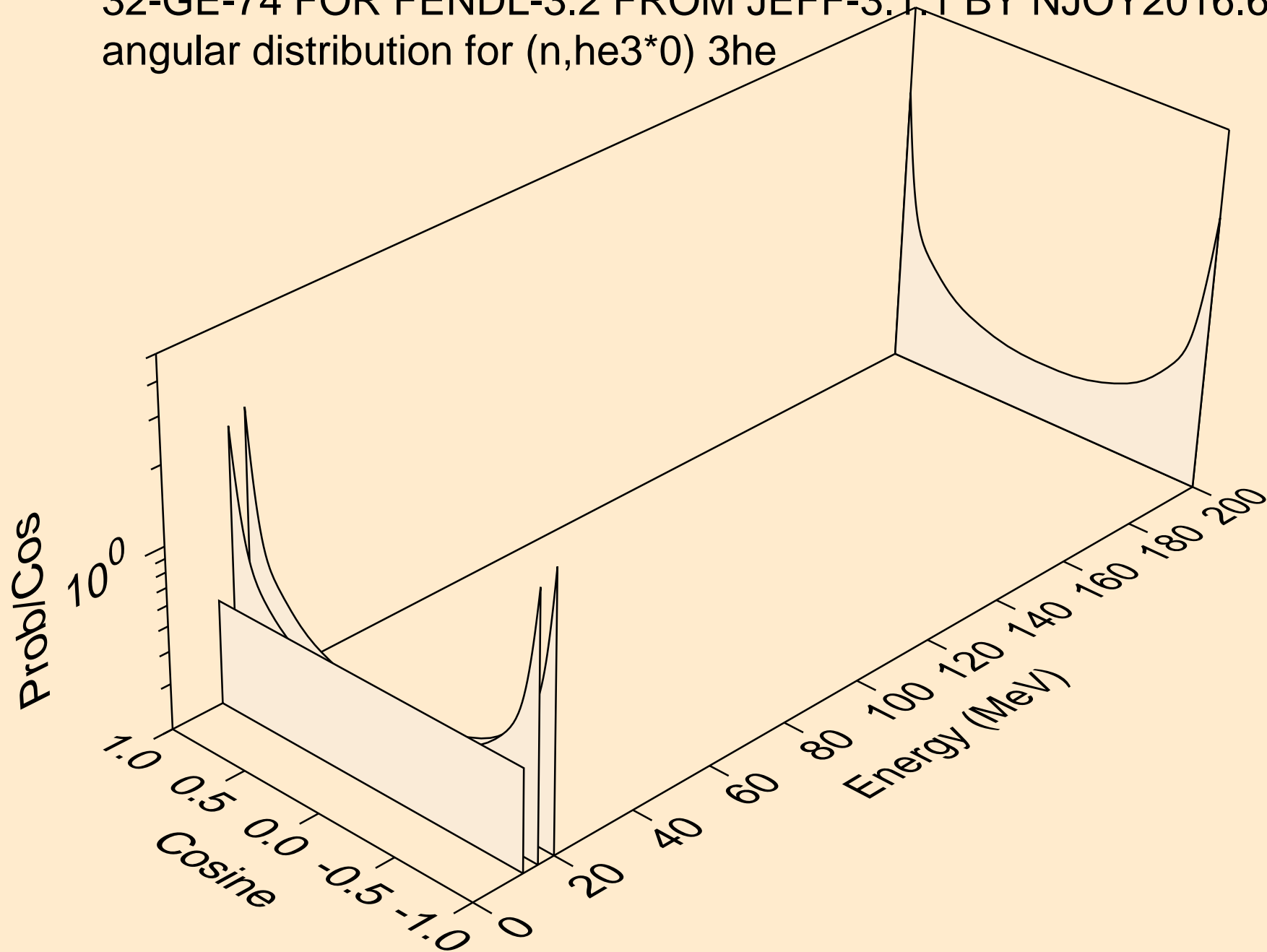

32-GE-74 FOR FENDL-3.2 FROM JEFF-3.1.1 BY NJOY2016.60+ O
angular distribution for (n,he3*1) 3he

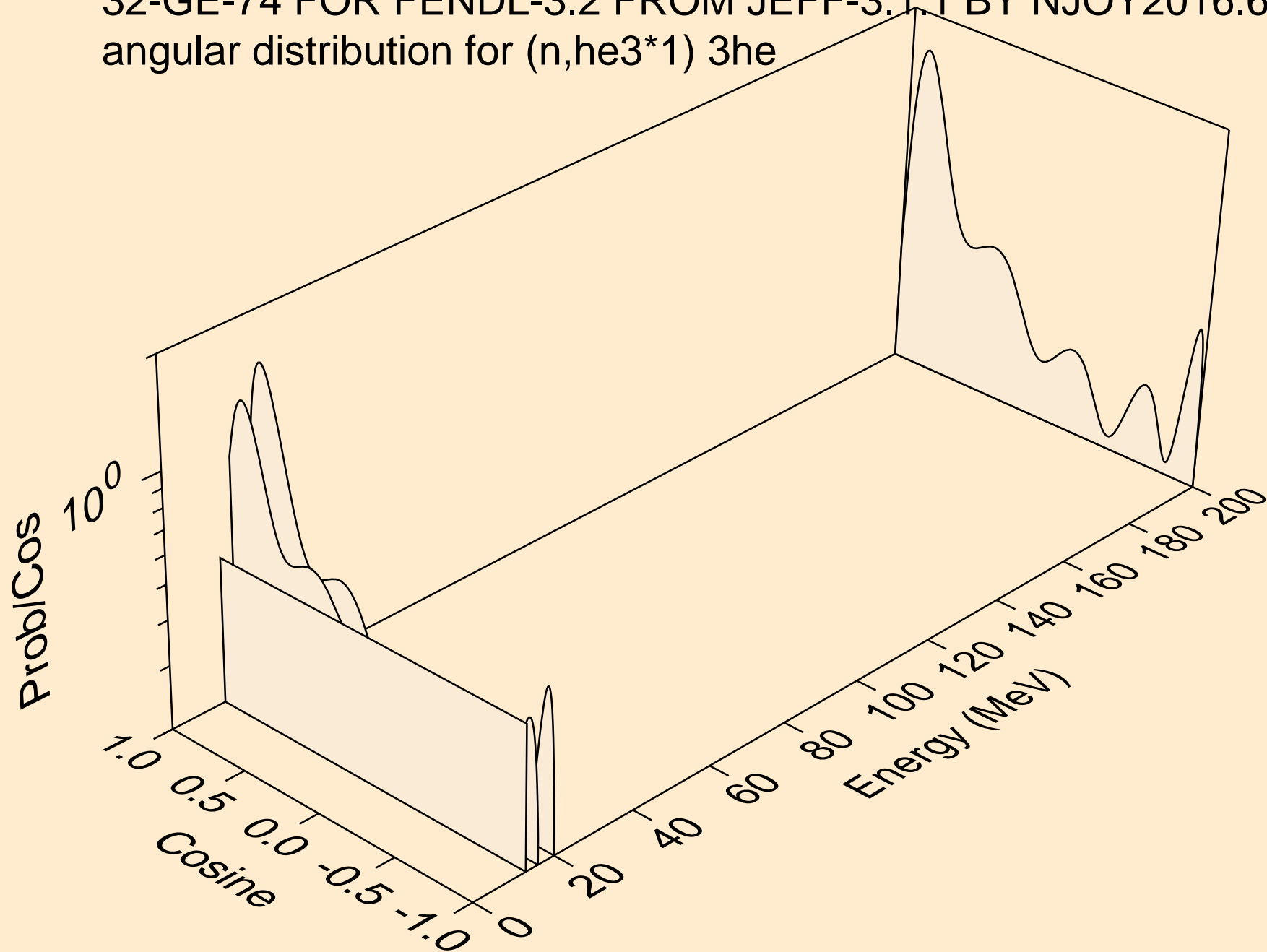

32-GE-74 FOR FENDL-3.2 FROM JEFF-3.1.1 BY NJOY2016.60+ O
angular distribution for (n,he3*2) 3he

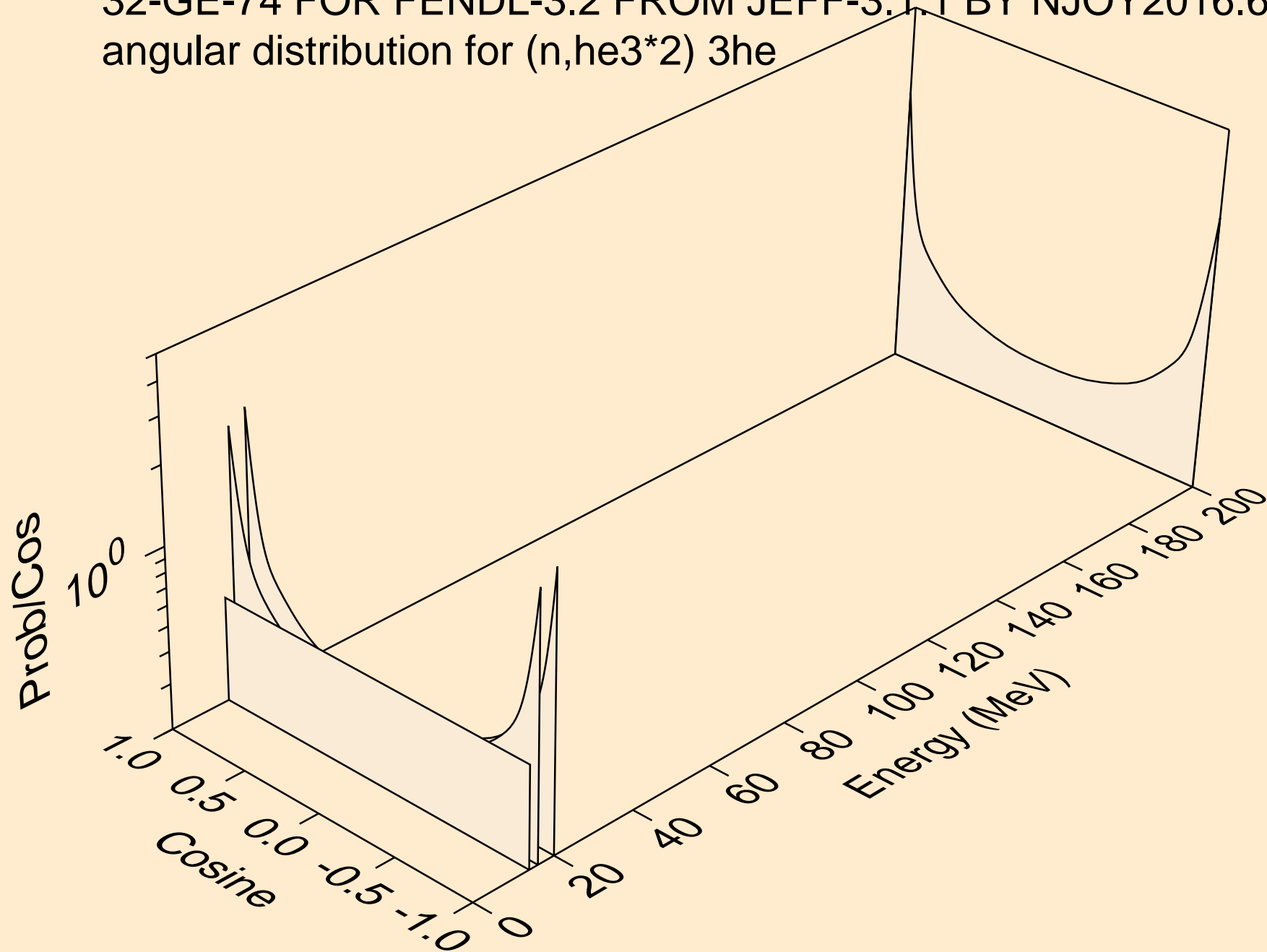

32-GE-74 FOR FENDL-3.2 FROM JEFF-3.1.1 BY NJOY2016.60+ O
angular distribution for (n,he3*3) 3he

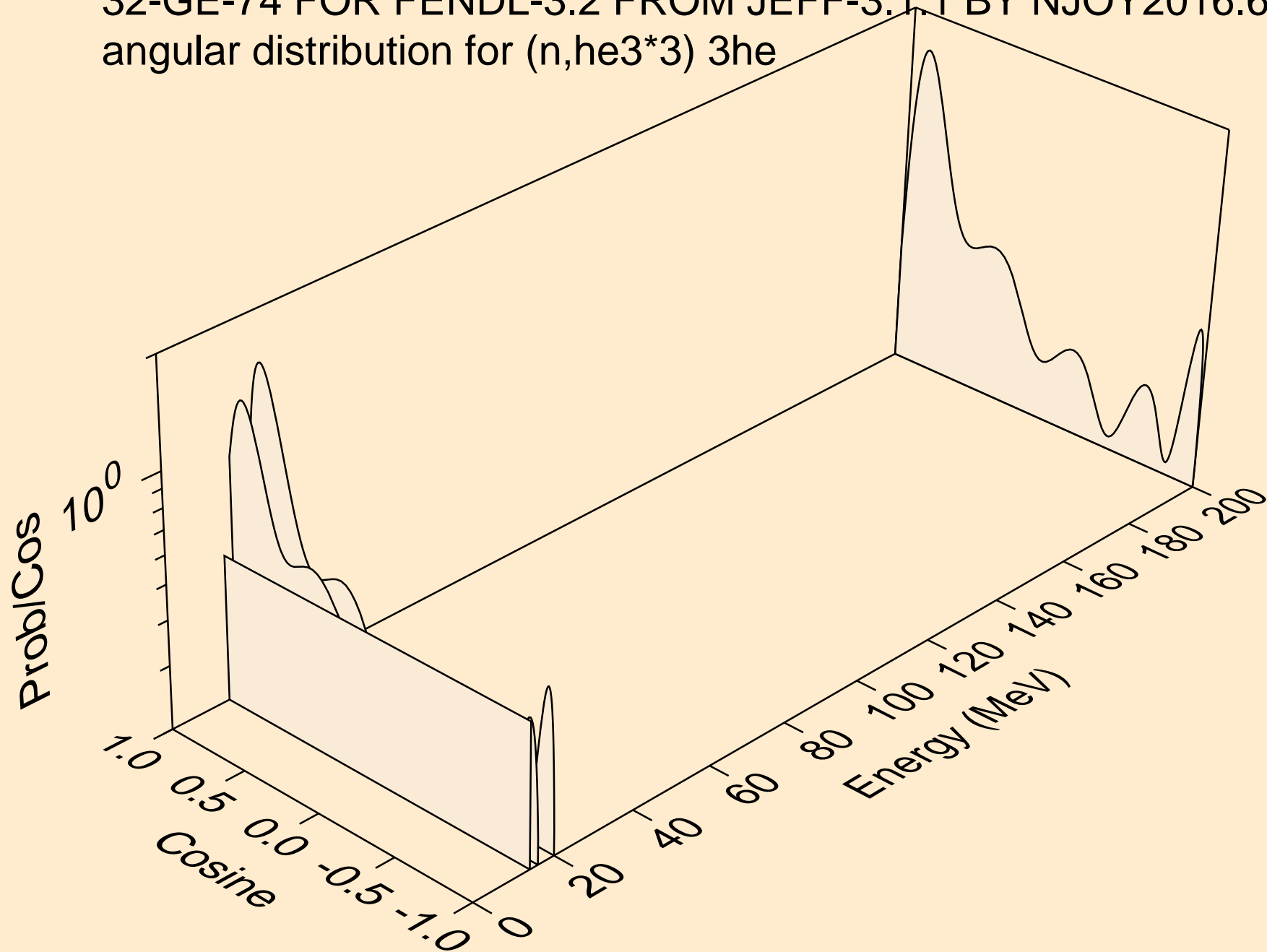

32-GE-74 FOR FENDL-3.2 FROM JEFF-3.1.1 BY NJOY2016.60+ O
angular distribution for (n,he3*4) 3he

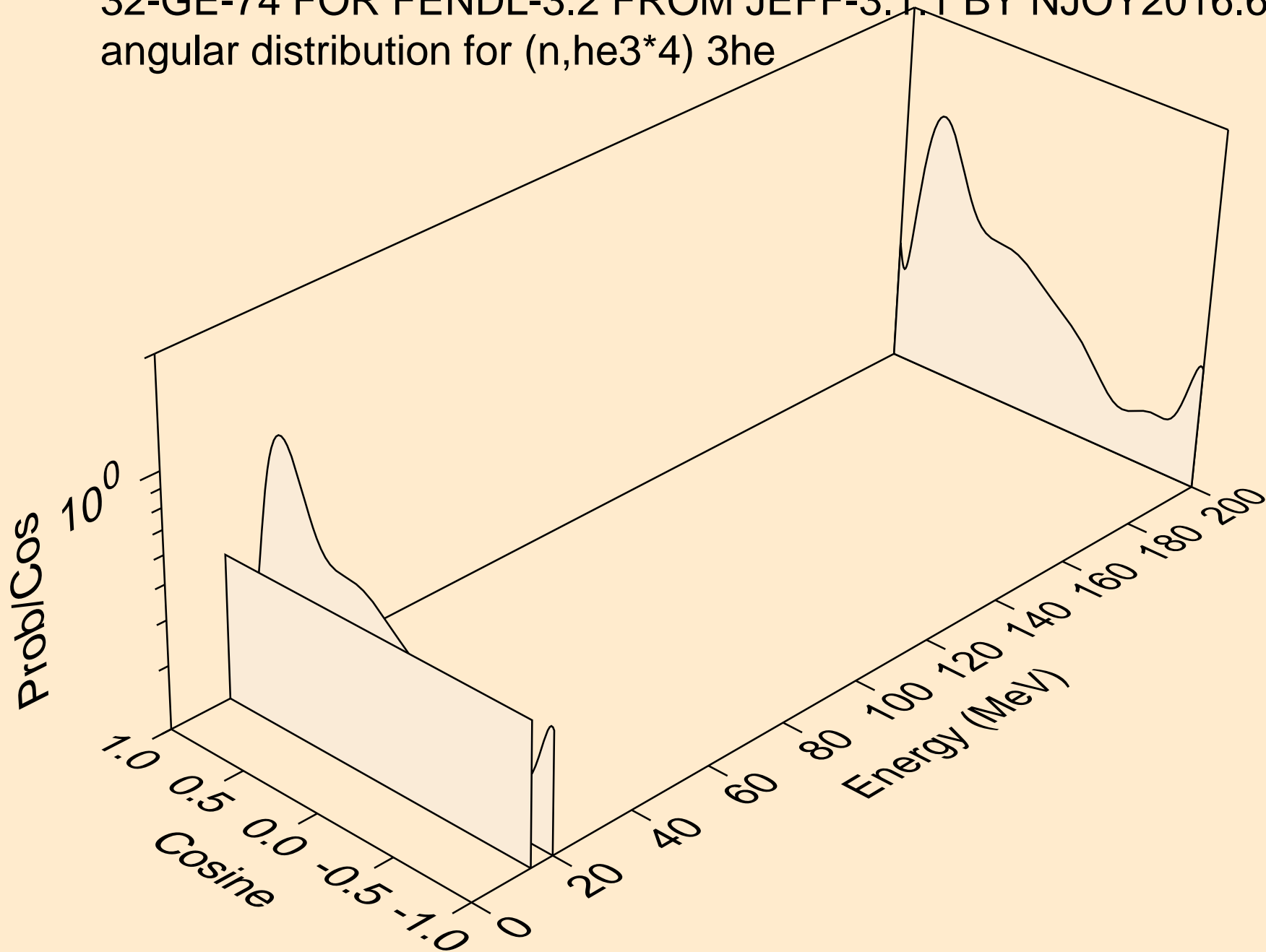

32-GE-74 FOR FENDL-3.2 FROM JEFF-3.1.1 BY NJOY2016.60+ O
alphas from (n,x)

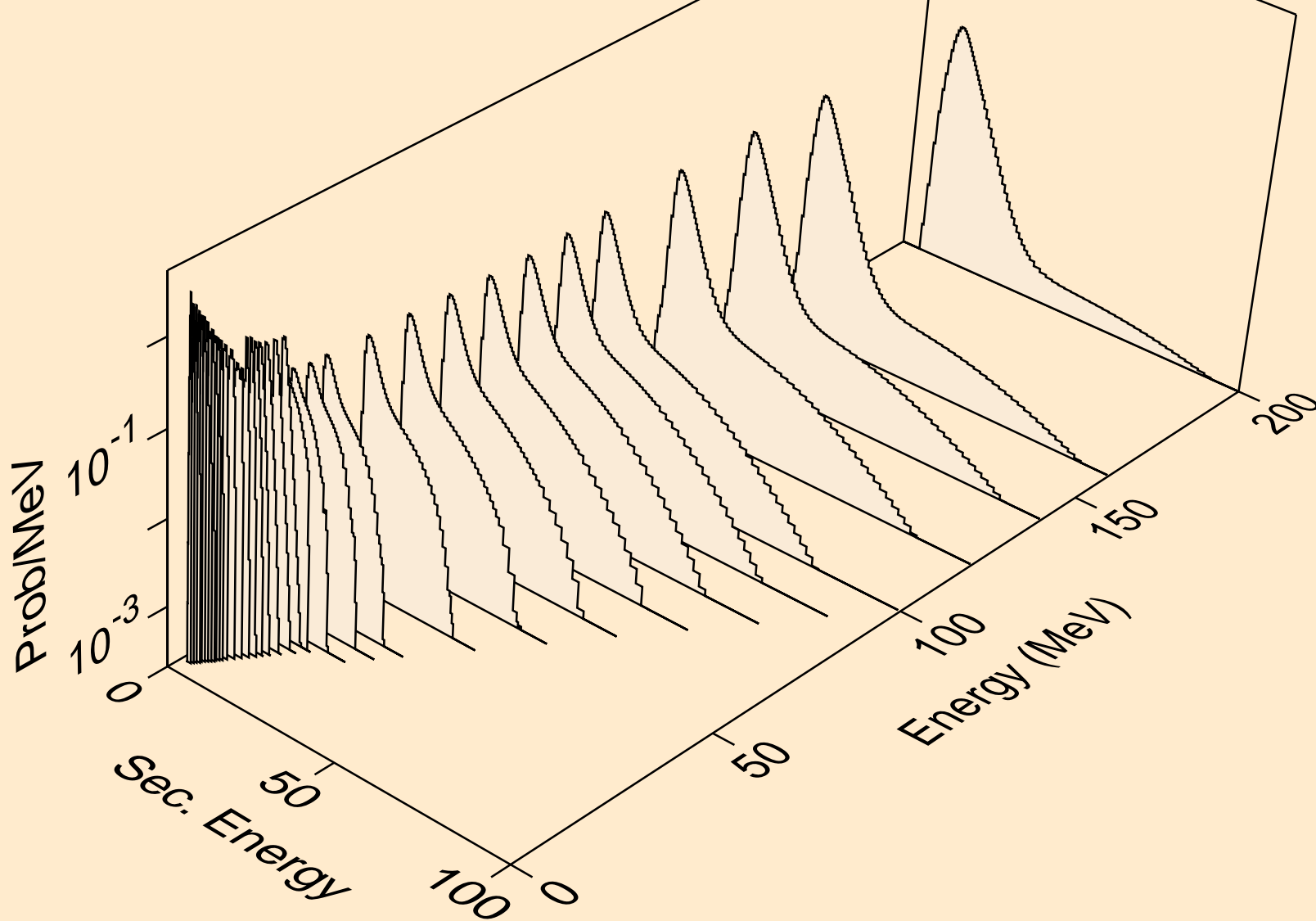

32-GE-74 FOR FENDL-3.2 FROM JEFF-3.1.1 BY NJOY2016.60+ O
alphas from (n,n*)a

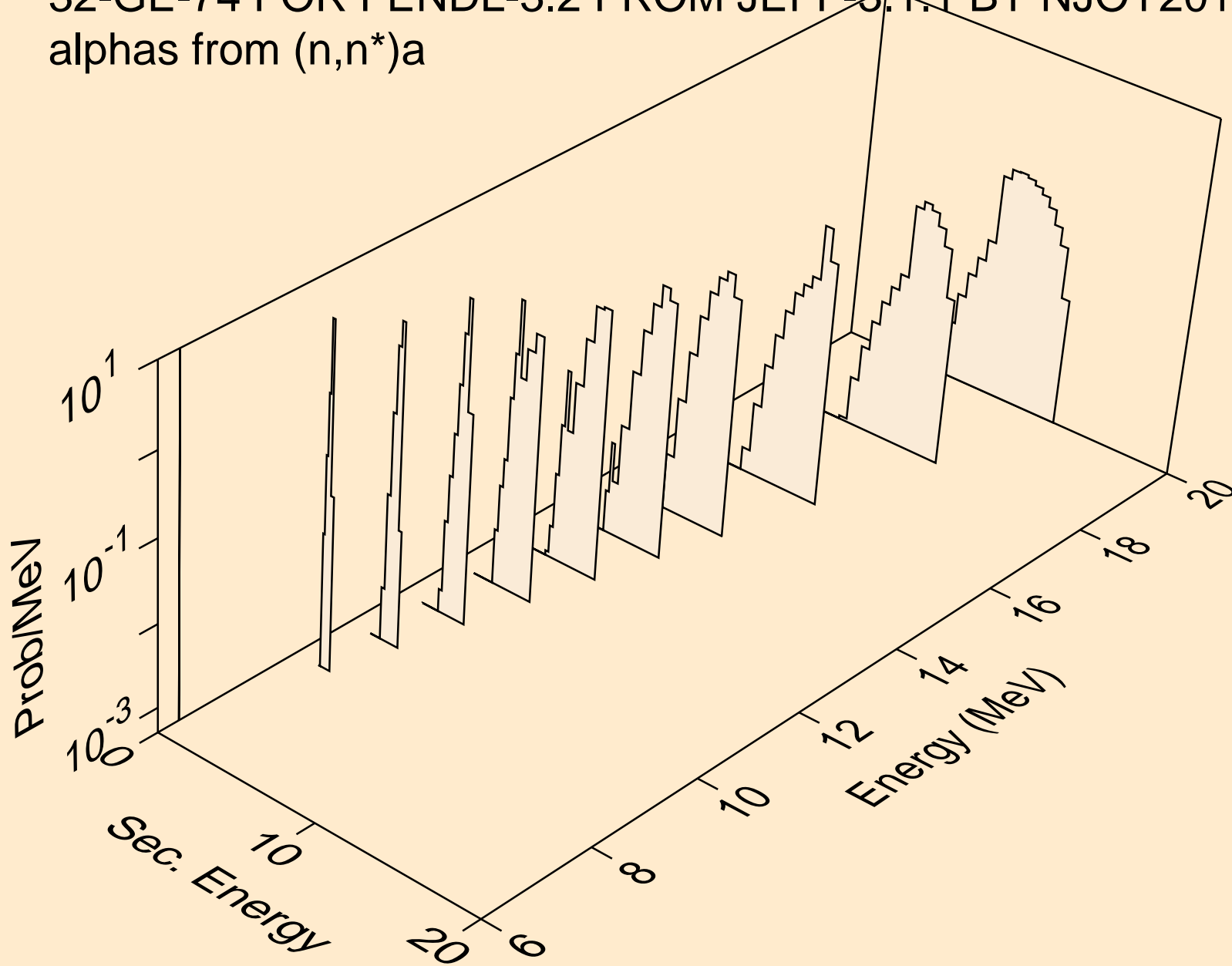

32-GE-74 FOR FENDL-3.2 FROM JEFF-3.1.1 BY NJOY2016.60+ O
angular distribution for (n,a*0) alpha

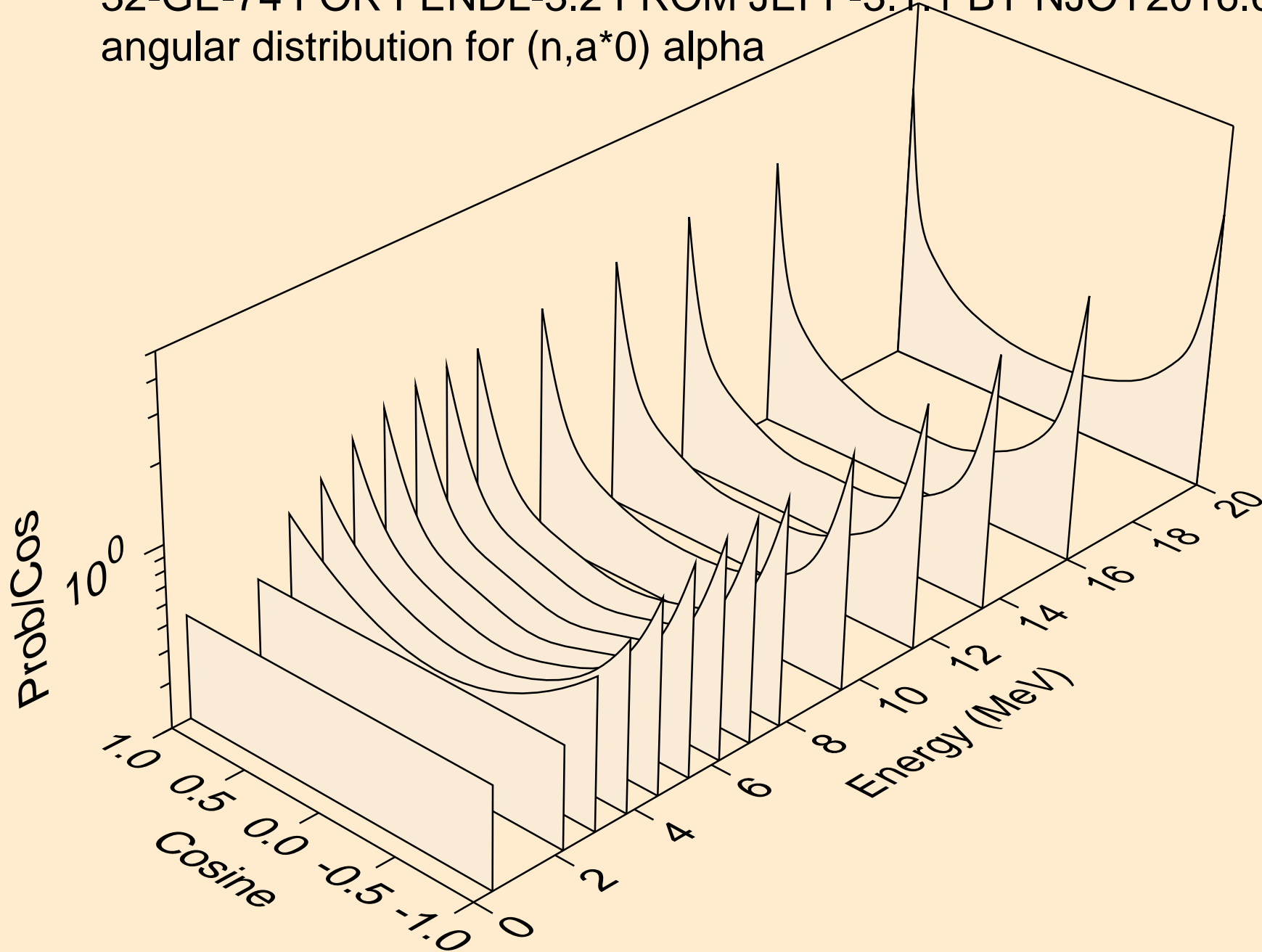

32-GE-74 FOR FENDL-3.2 FROM JEFF-3.1.1 BY NJOY2016.60+ O
angular distribution for (n,a*1) alpha

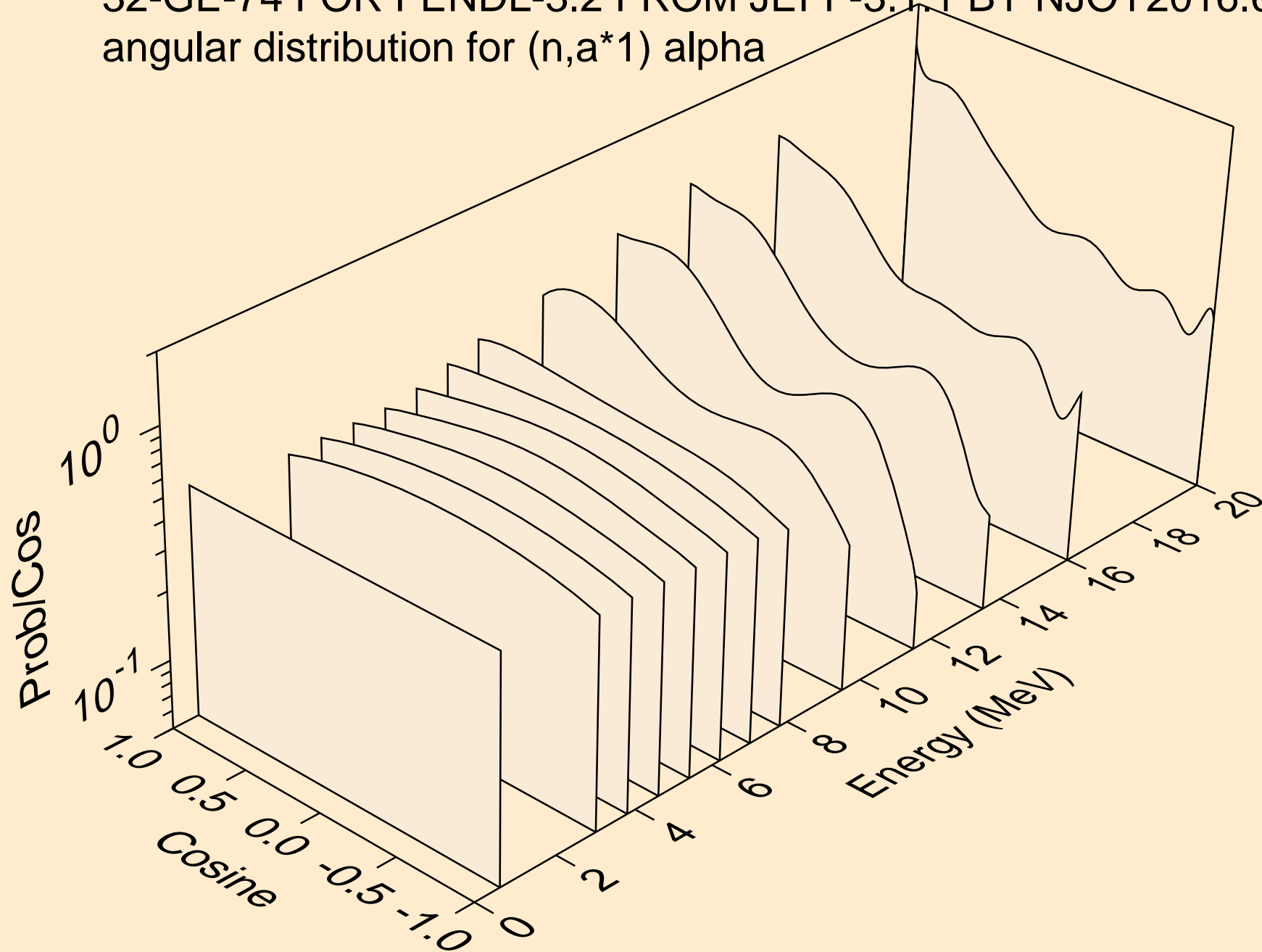

32-GE-74 FOR FENDL-3.2 FROM JEFF-3.1.1 BY NJOY2016.60+ O
angular distribution for (n,a*2) alpha

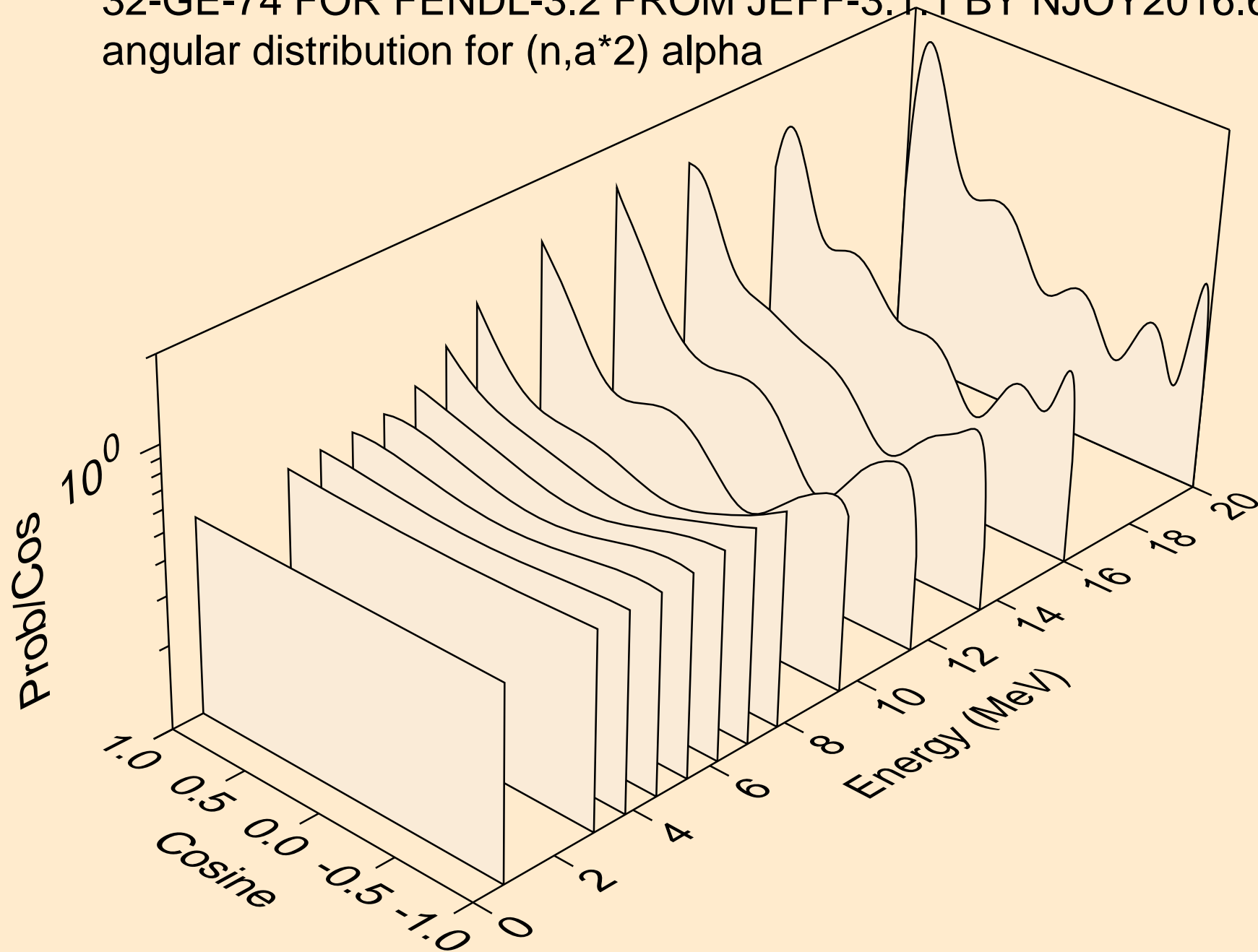

32-GE-74 FOR FENDL-3.2 FROM JEFF-3.1.1 BY NJOY2016.60+ O
angular distribution for (n,a*3) alpha

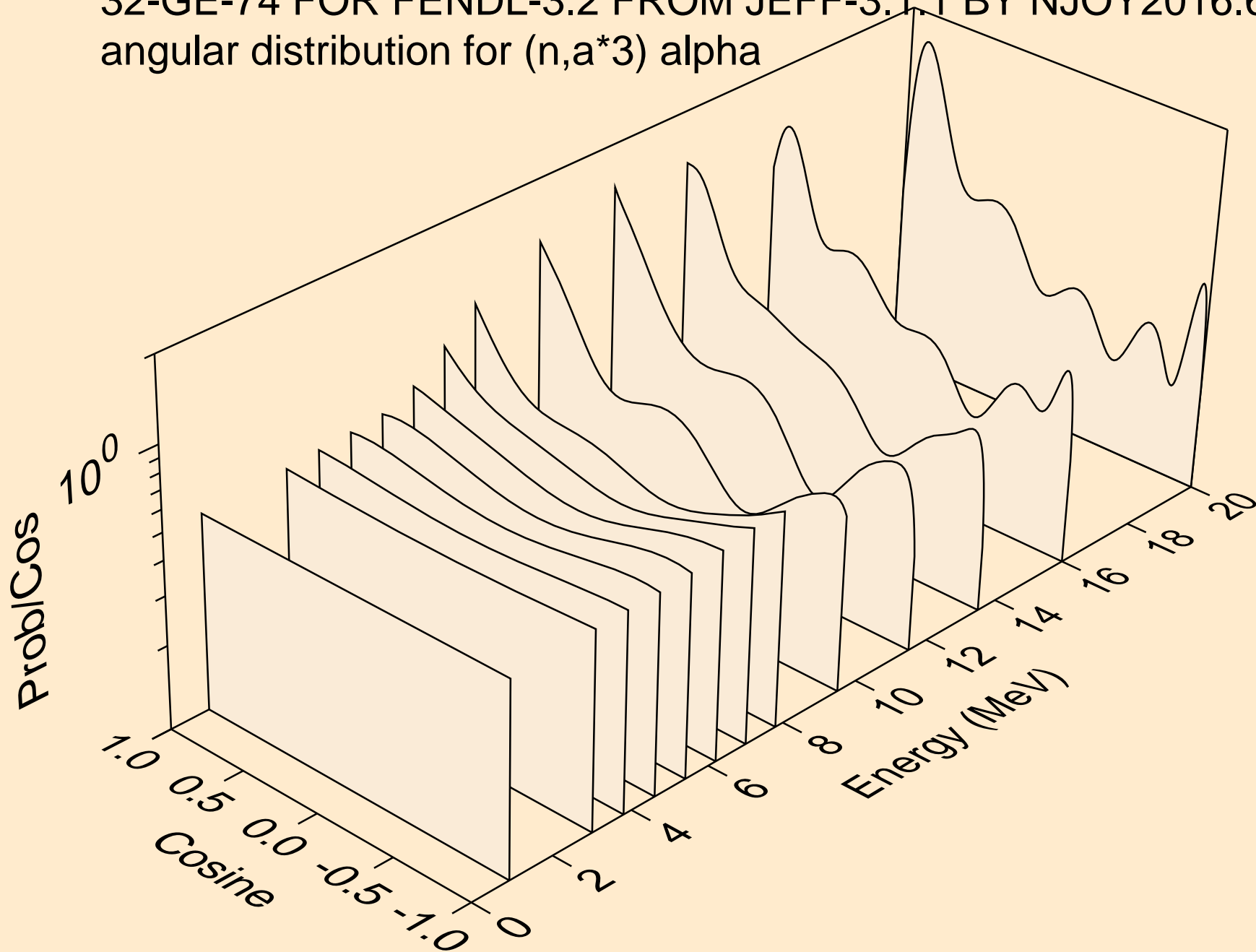

32-GE-74 FOR FENDL-3.2 FROM JEFF-3.1.1 BY NJOY2016.60+ O
angular distribution for (n,a*4) alpha

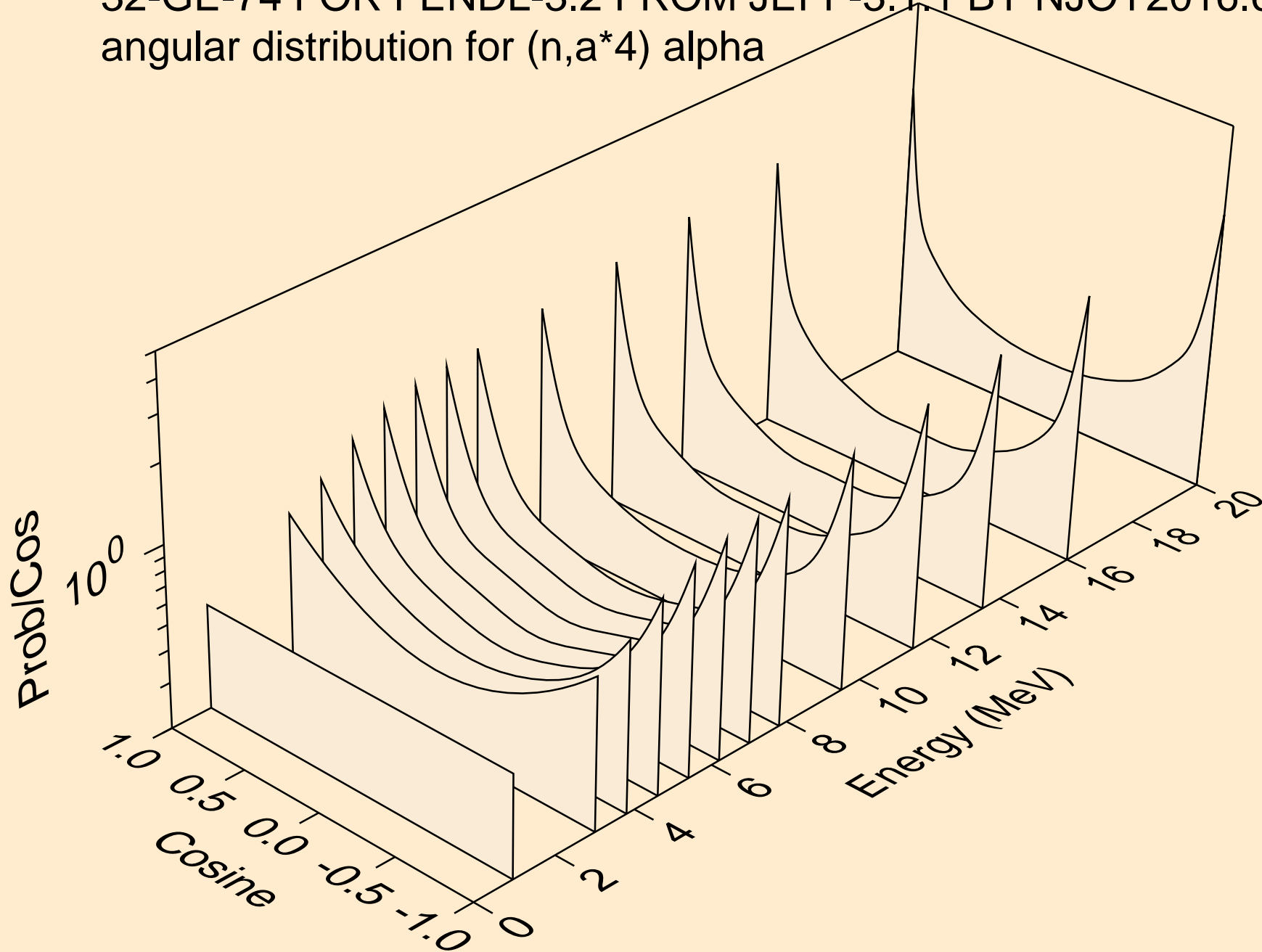

32-GE-74 FOR FENDL-3.2 FROM JEFF-3.1.1 BY NJOY2016.60+ O
angular distribution for (n, α *5) alpha

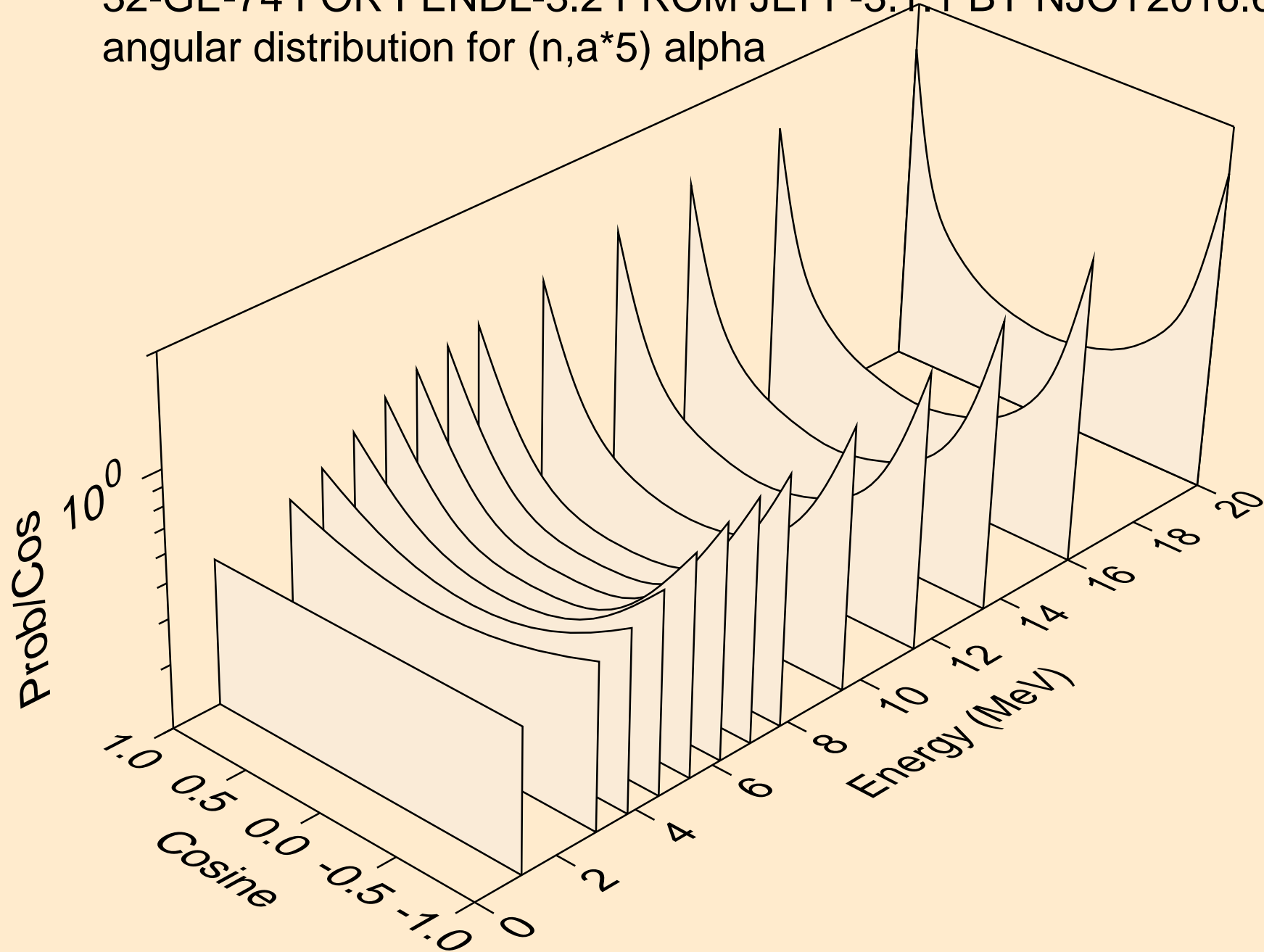

32-GE-74 FOR FENDL-3.2 FROM JEFF-3.1.1 BY NJOY2016.60+ O
angular distribution for (n,a*6) alpha

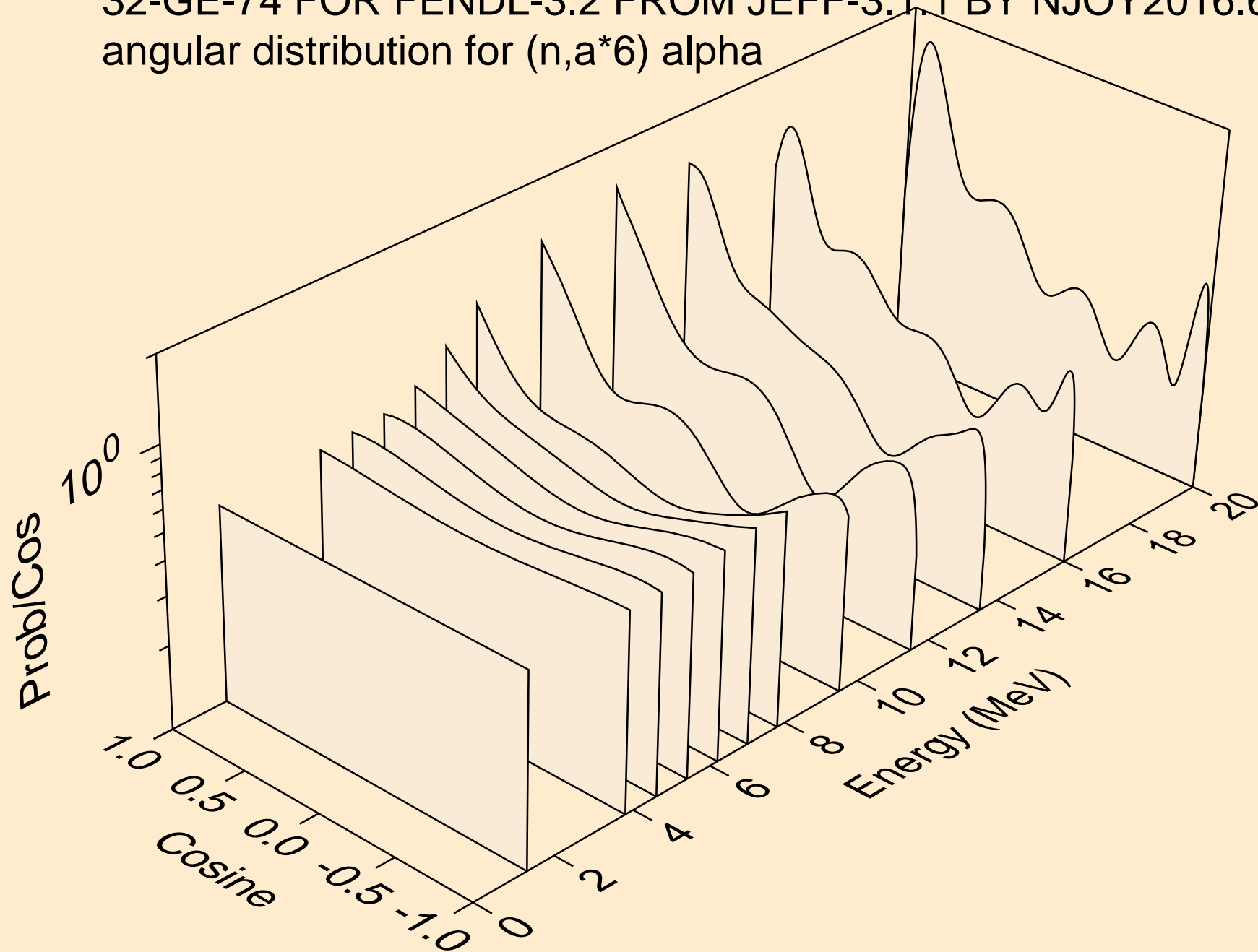

32-GE-74 FOR FENDL-3.2 FROM JEFF-3.1.1 BY NJOY2016.60+ O
angular distribution for (n,a*7) alpha

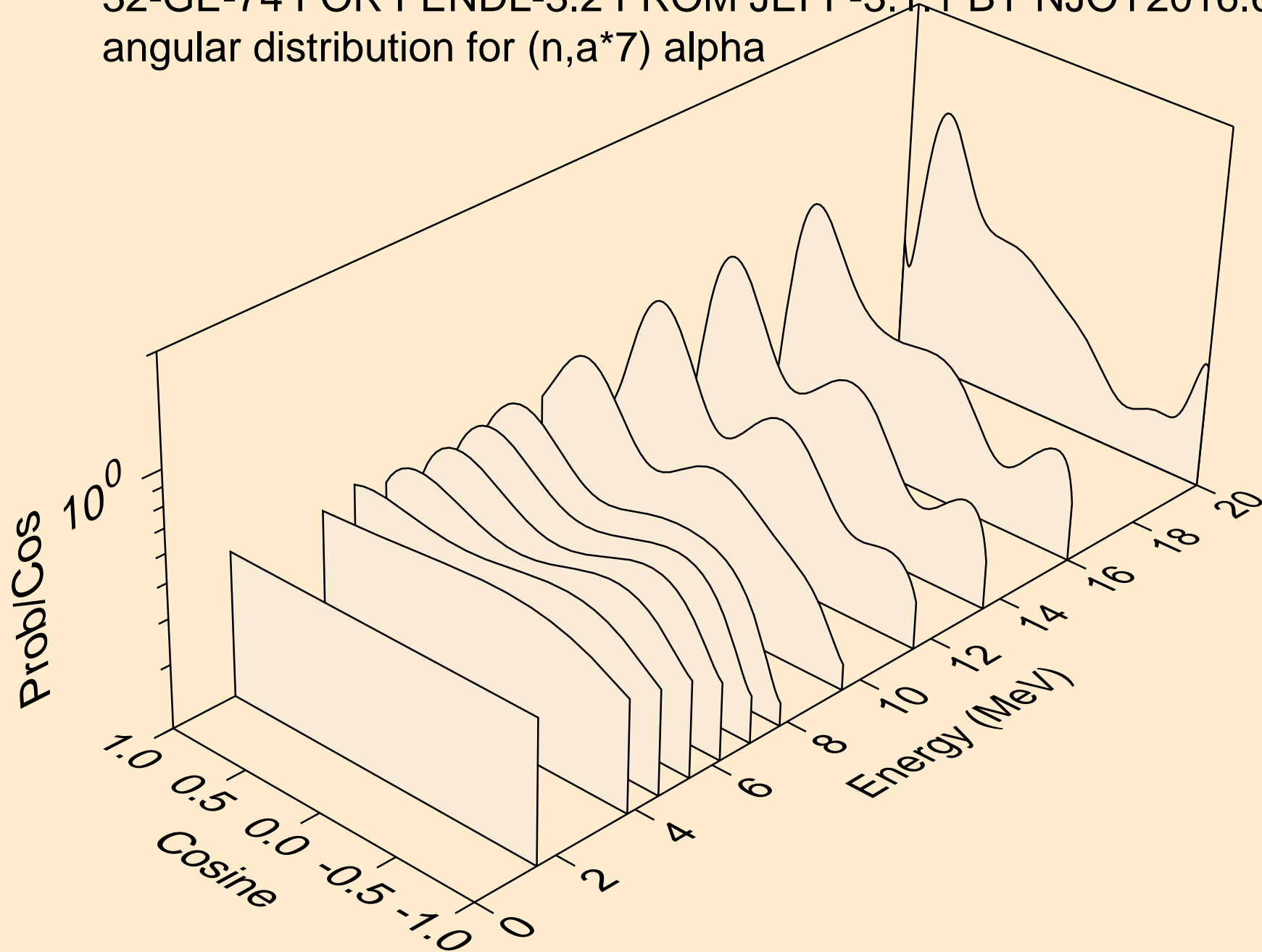

32-GE-74 FOR FENDL-3.2 FROM JEFF-3.1.1 BY NJOY2016.60+ O
angular distribution for (n,a*8) alpha

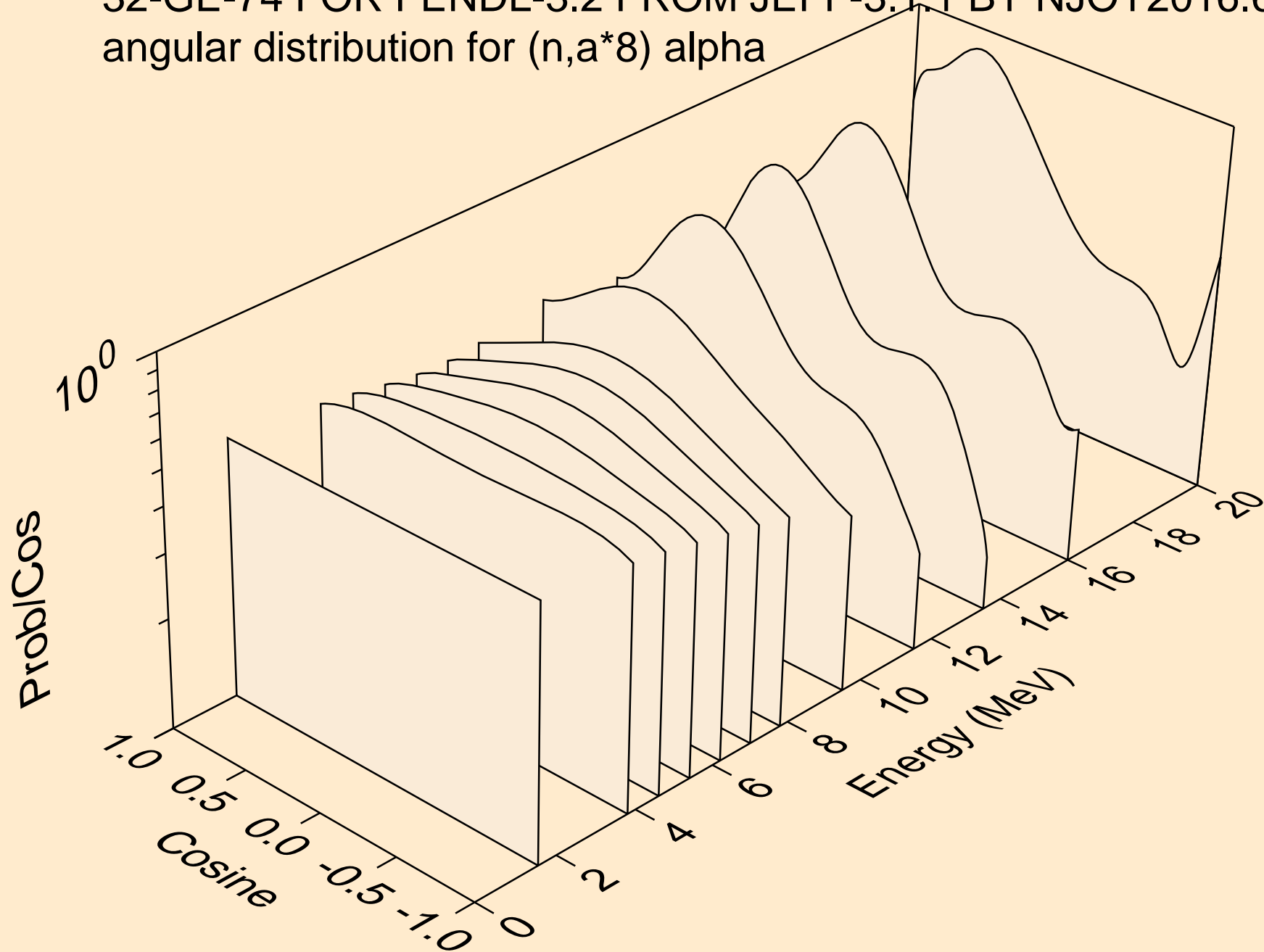

32-GE-74 FOR FENDL-3.2 FROM JEFF-3.1.1 BY NJOY2016.60+ O
angular distribution for (n,a*9) alpha

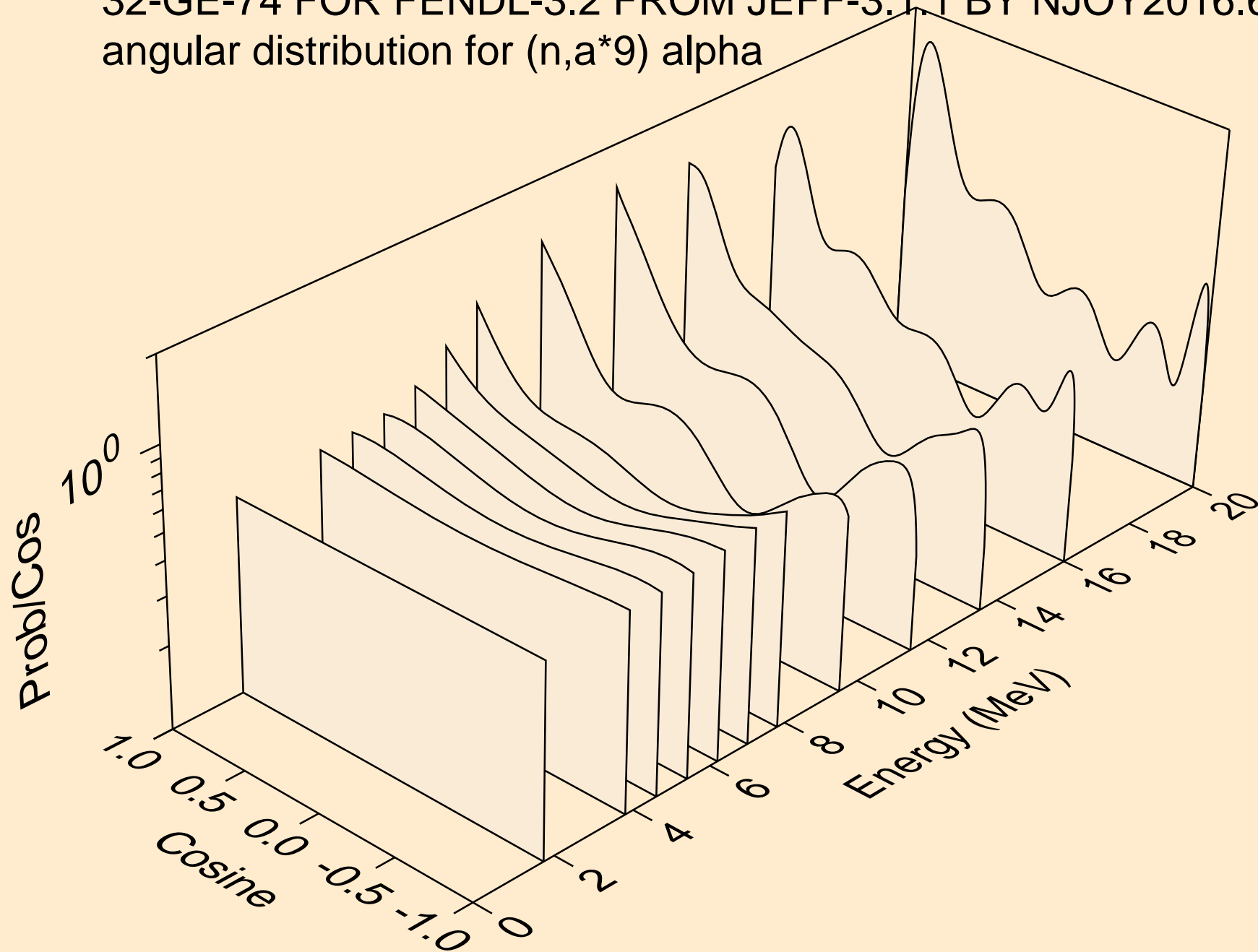

32-GE-74 FOR FENDL-3.2 FROM JEFF-3.1.1 BY NJOY2016.60+ O
angular distribution for (n,a*10) alpha

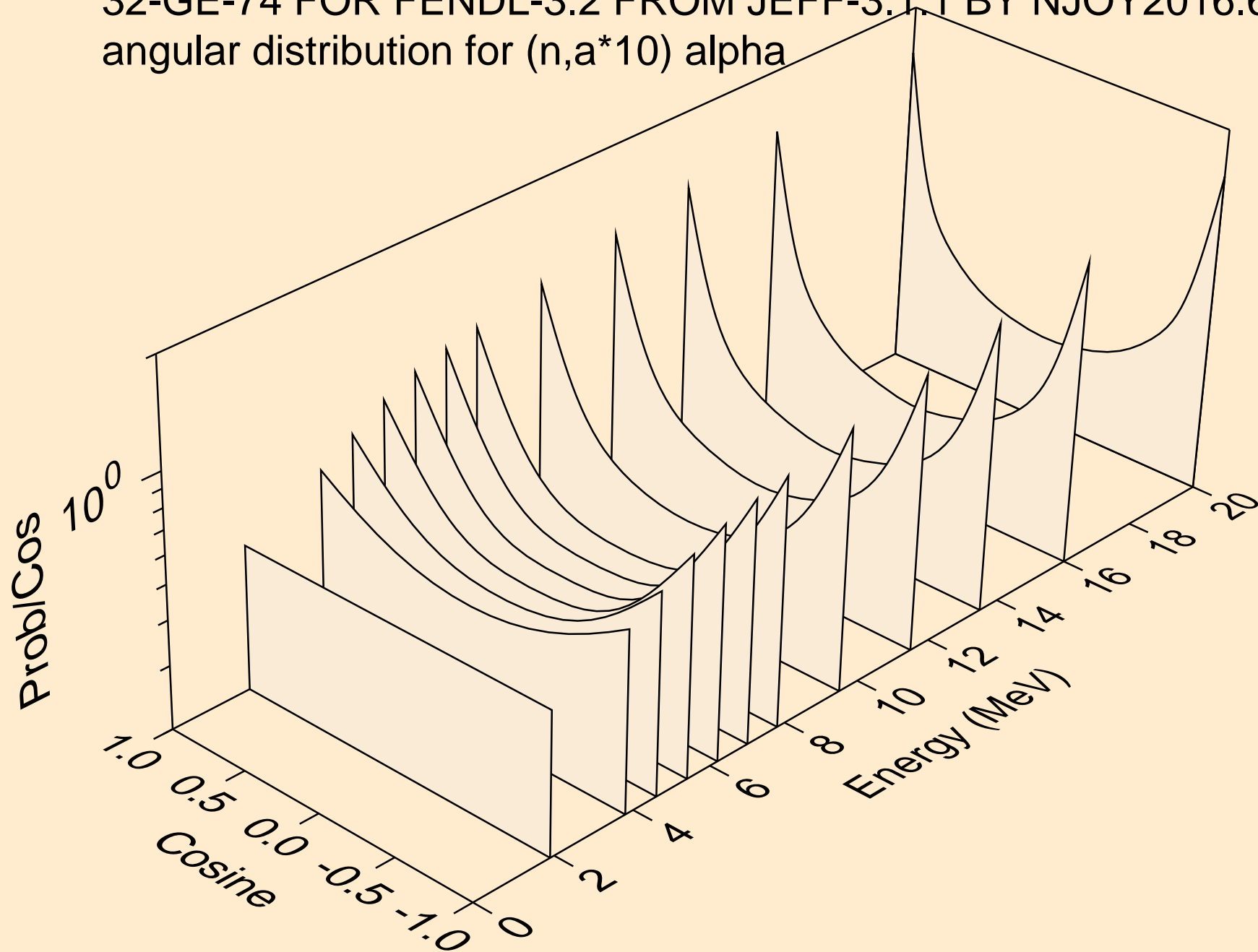

32-GE-74 FOR FENDL-3.2 FROM JEFF-3.1.1 BY NJOY2016.60+ O
alphas from (n,a*c)

