

35-BR-79 FOR FENDL-3.2 FROM FENDL-3.2 BY NJOY2016.60+ O
Principal cross sections

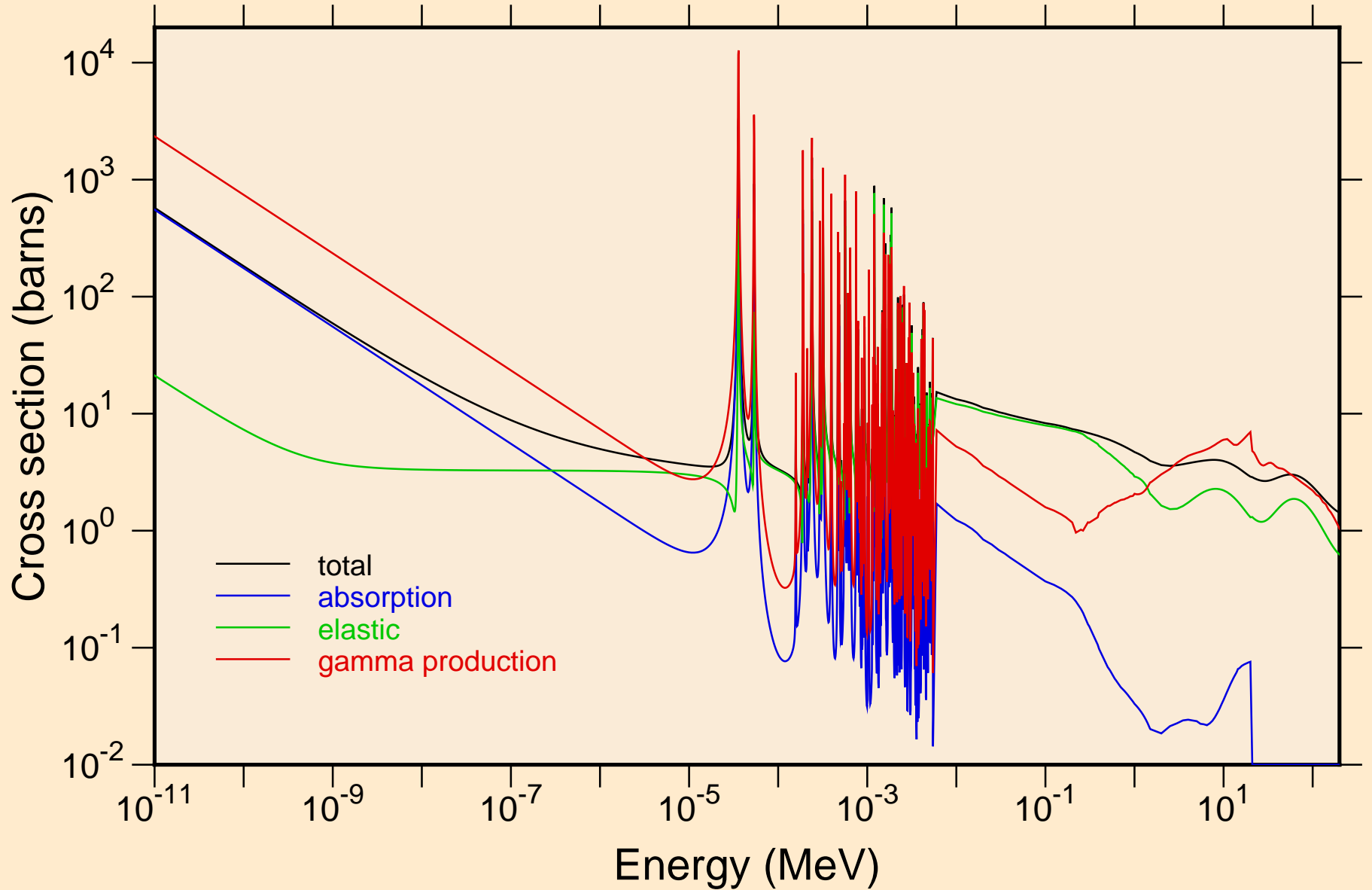

35-BR-79 FOR FENDL-3.2 FROM FENDL-3.2 BY NJOY2016.60+ O
resonance total cross section

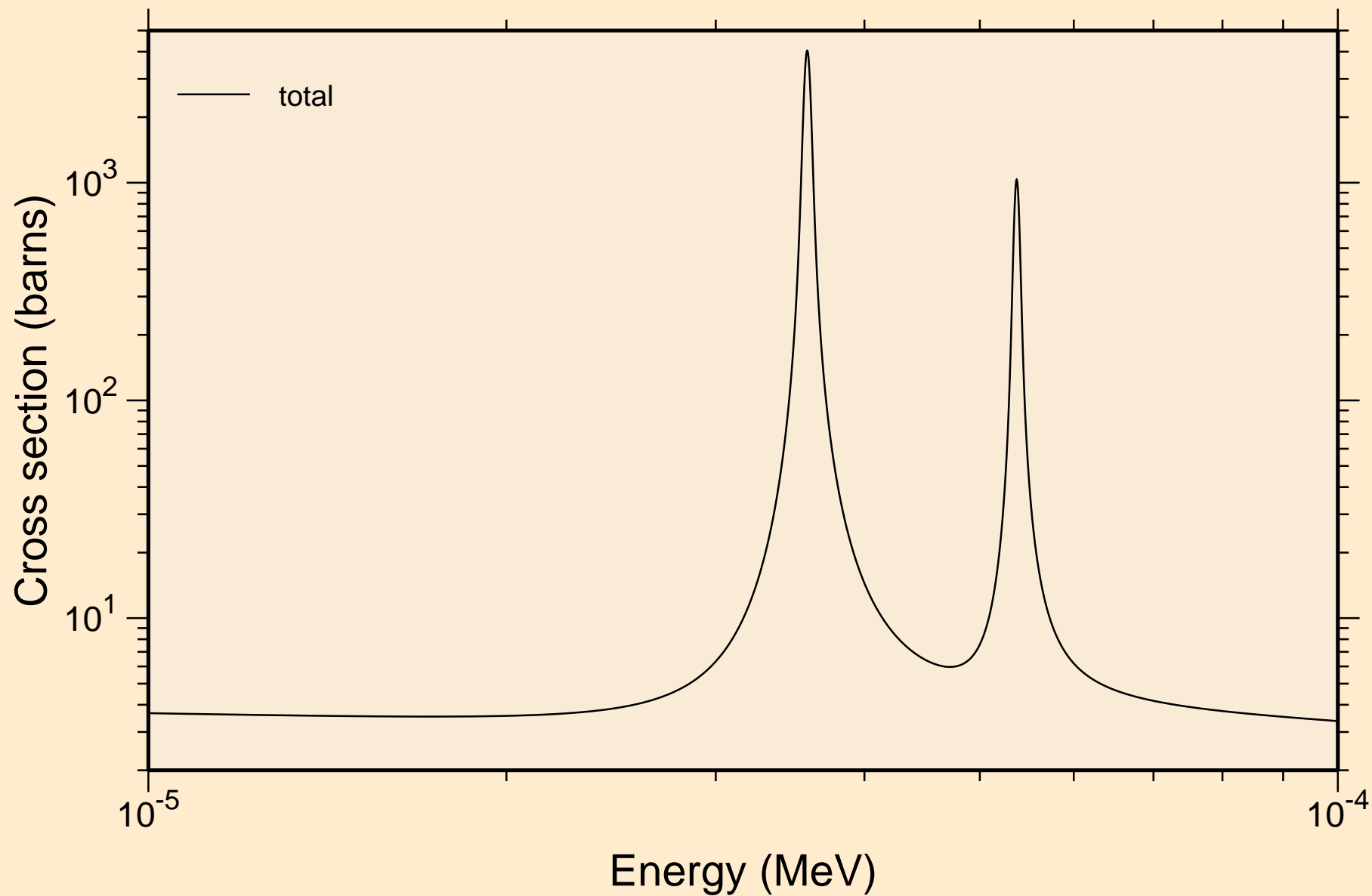

35-BR-79 FOR FENDL-3.2 FROM FENDL-3.2 BY NJOY2016.60+ O
resonance total cross section

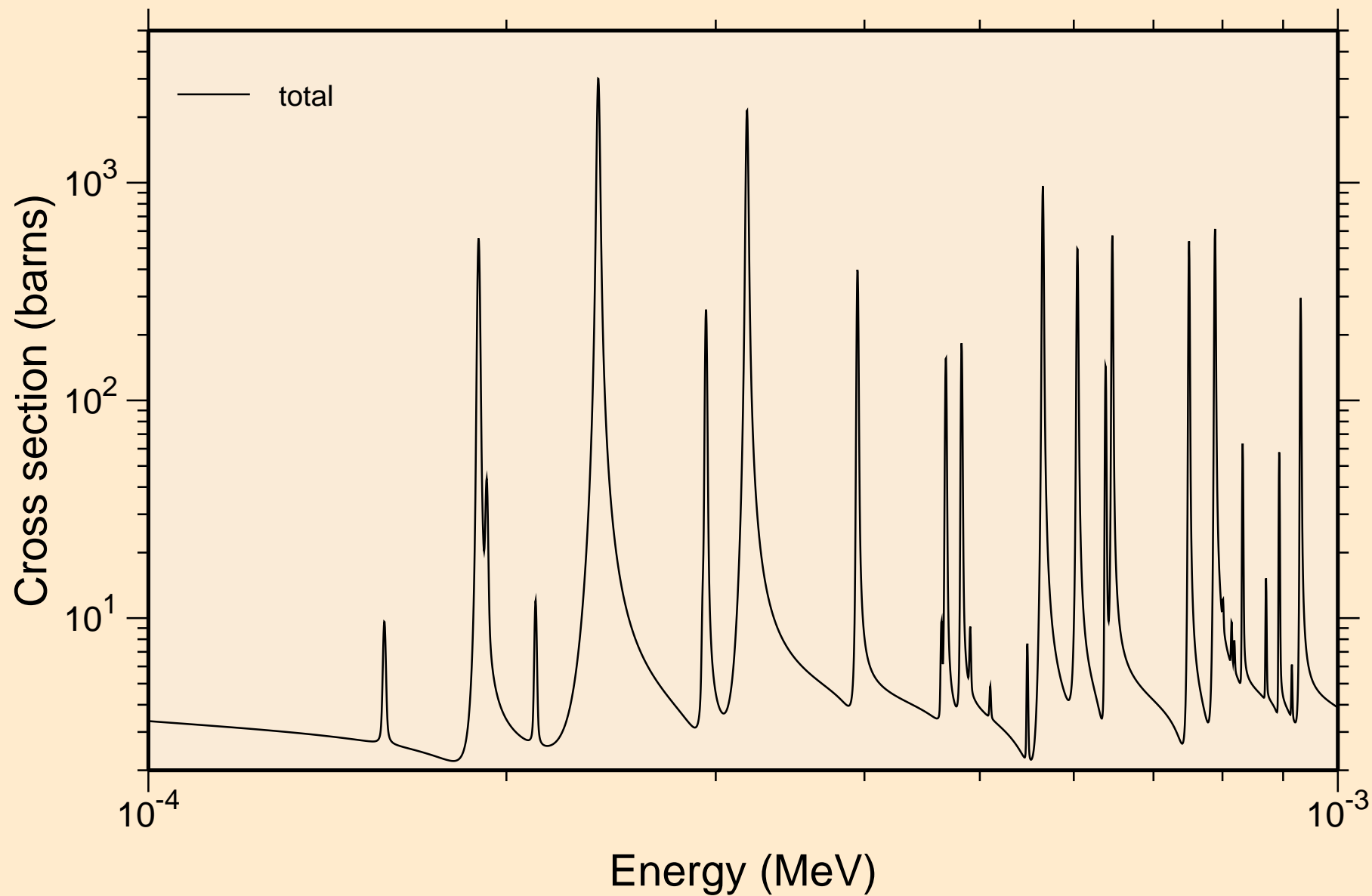

35-BR-79 FOR FENDL-3.2 FROM FENDL-3.2 BY NJOY2016.60+ O
resonance total cross section

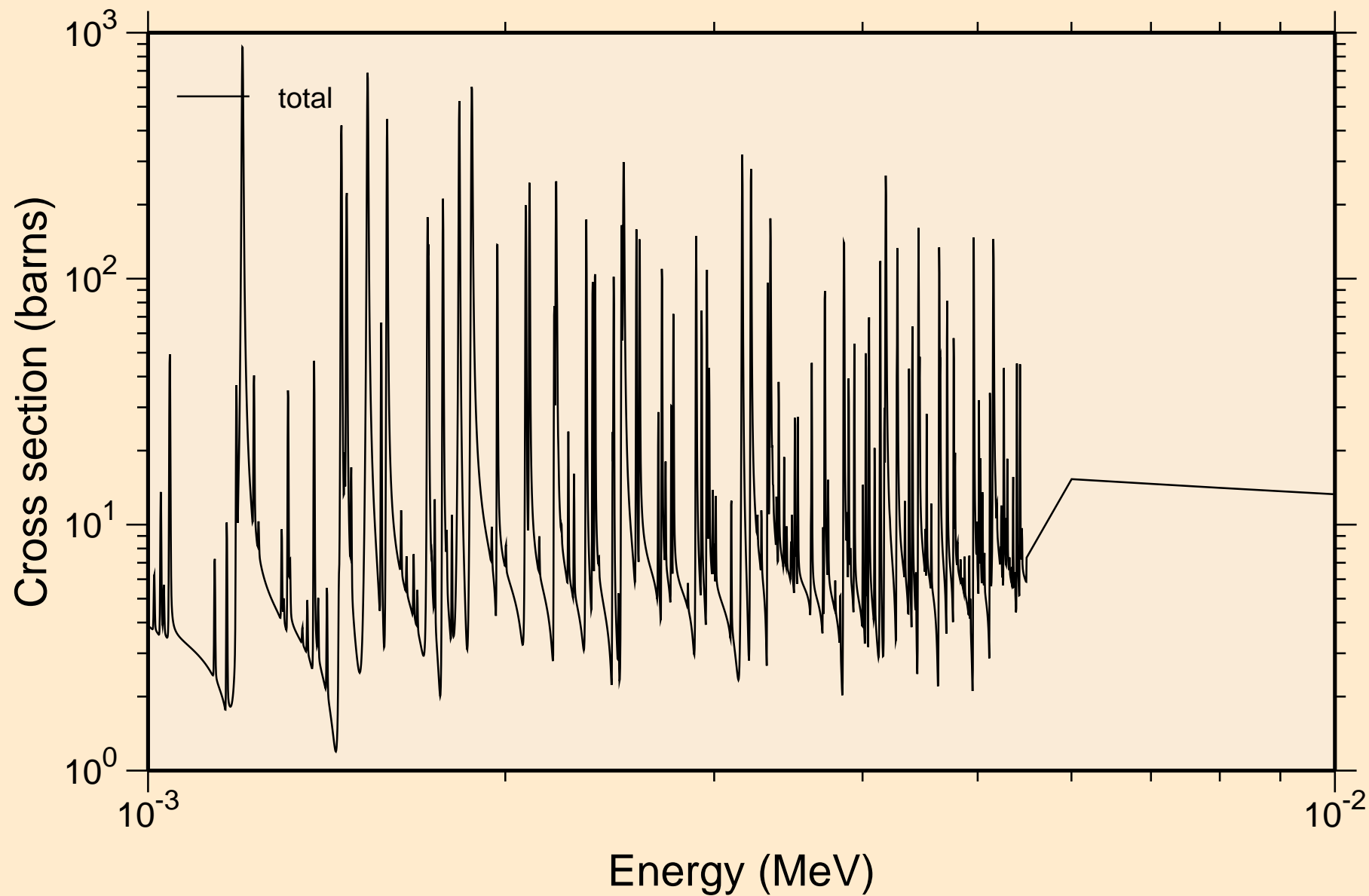

35-BR-79 FOR FENDL-3.2 FROM FENDL-3.2 BY NJOY2016.60+ O
resonance absorption cross sections

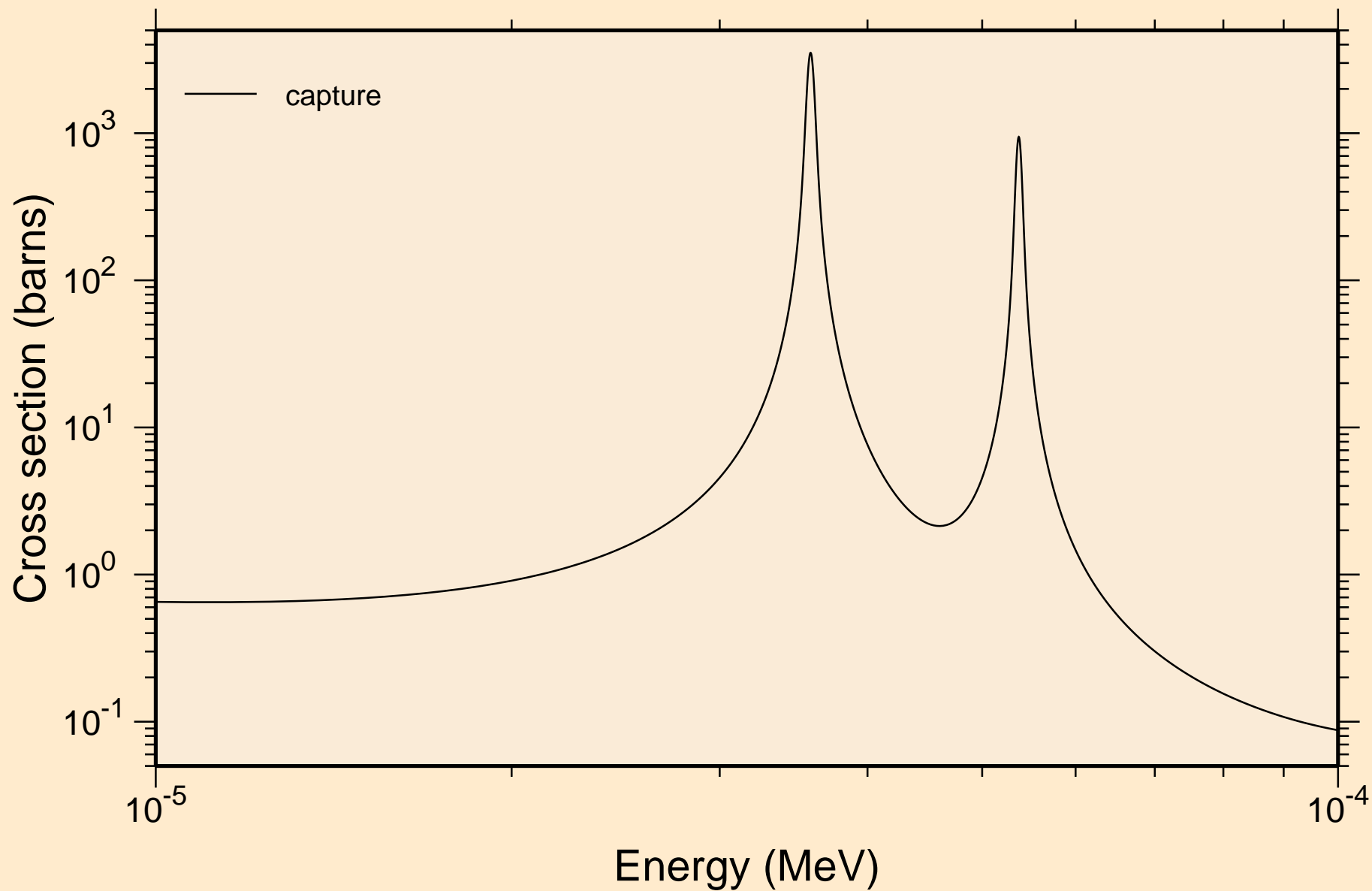

35-BR-79 FOR FENDL-3.2 FROM FENDL-3.2 BY NJOY2016.60+ O resonance absorption cross sections

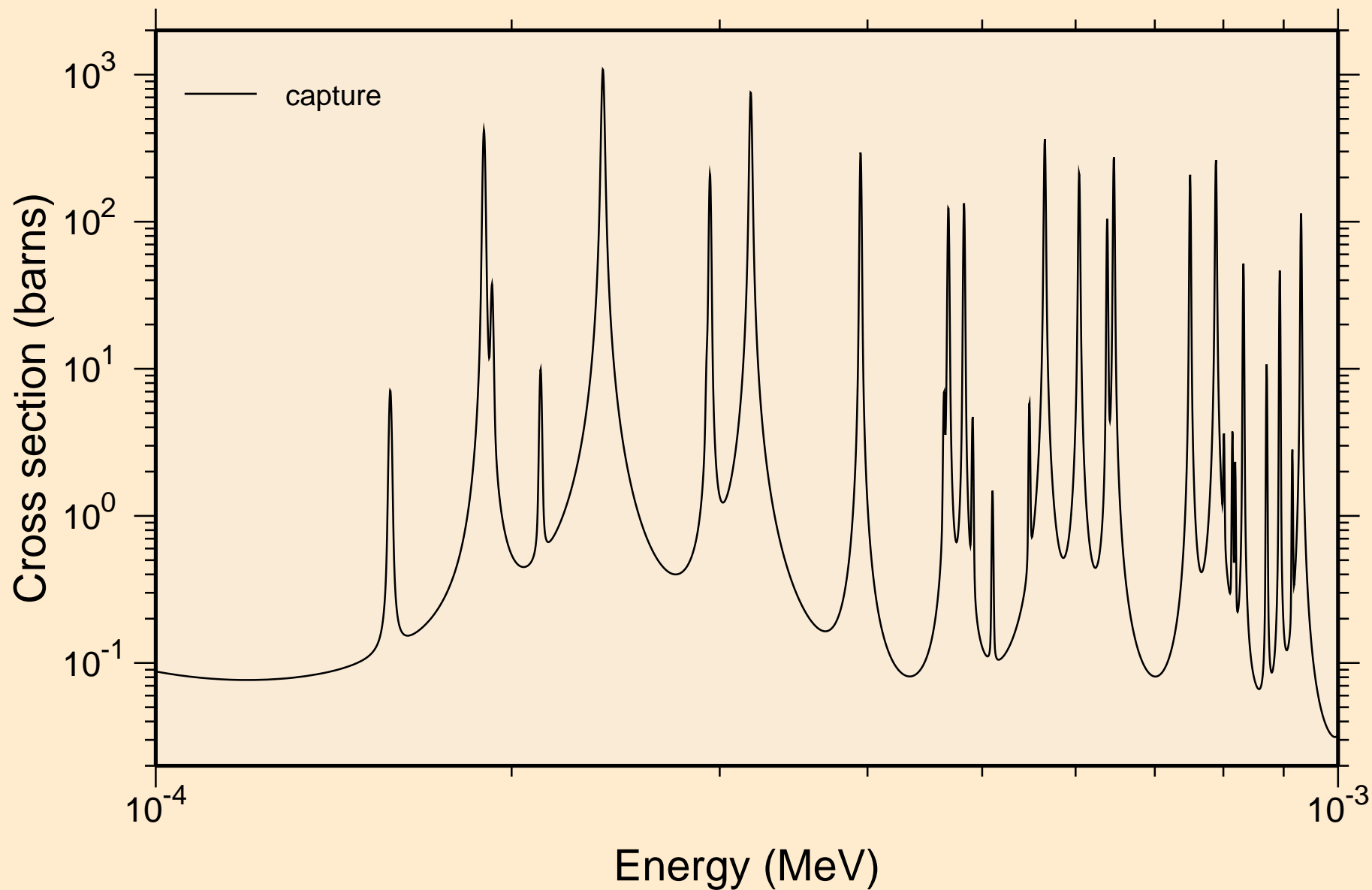

35-BR-79 FOR FENDL-3.2 FROM FENDL-3.2 BY NJOY2016.60+ O
resonance absorption cross sections

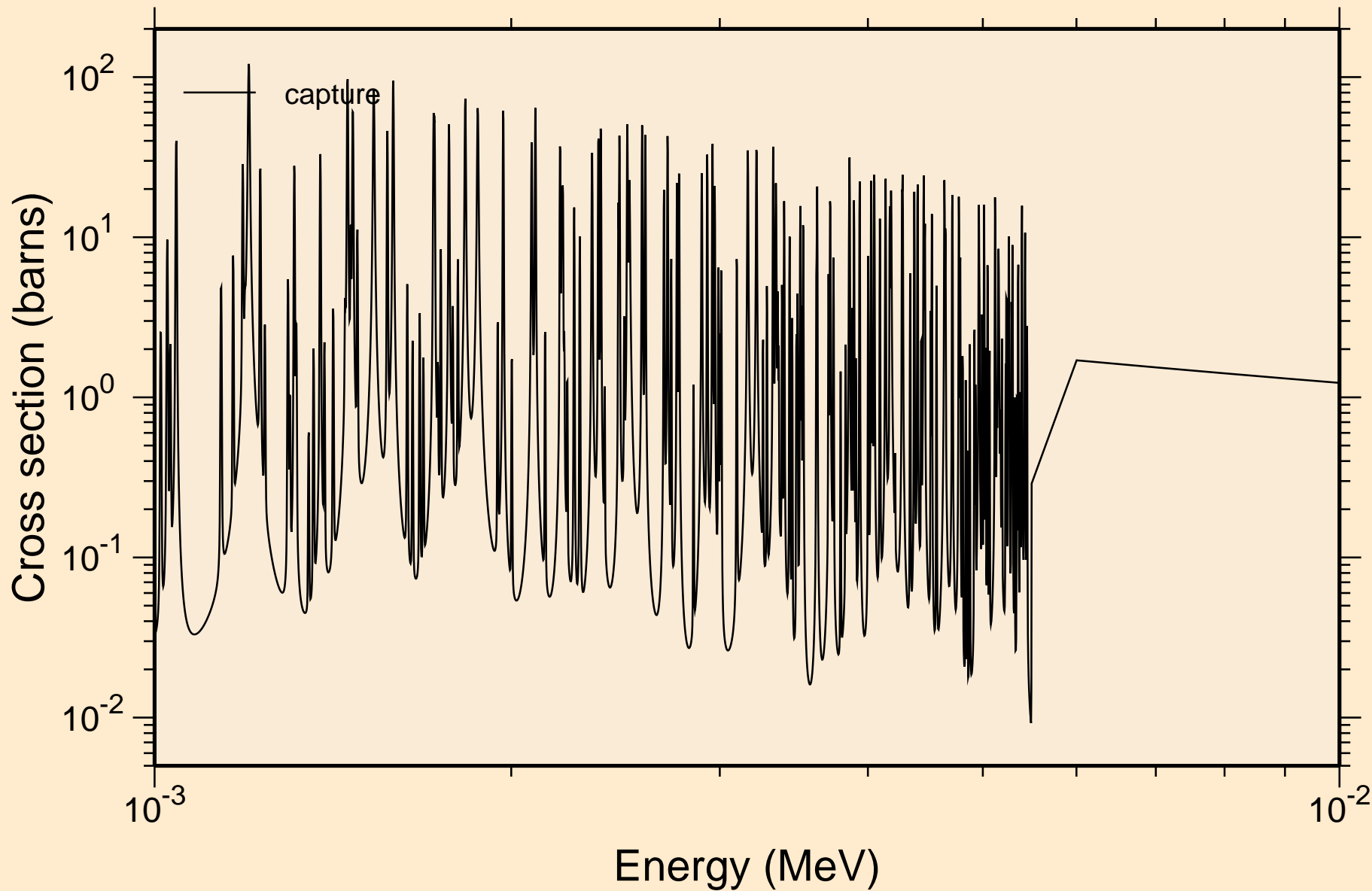

35-BR-79 FOR FENDL-3.2 FROM FENDL-3.2 BY NJOY2016.60+ O
UR total cross section

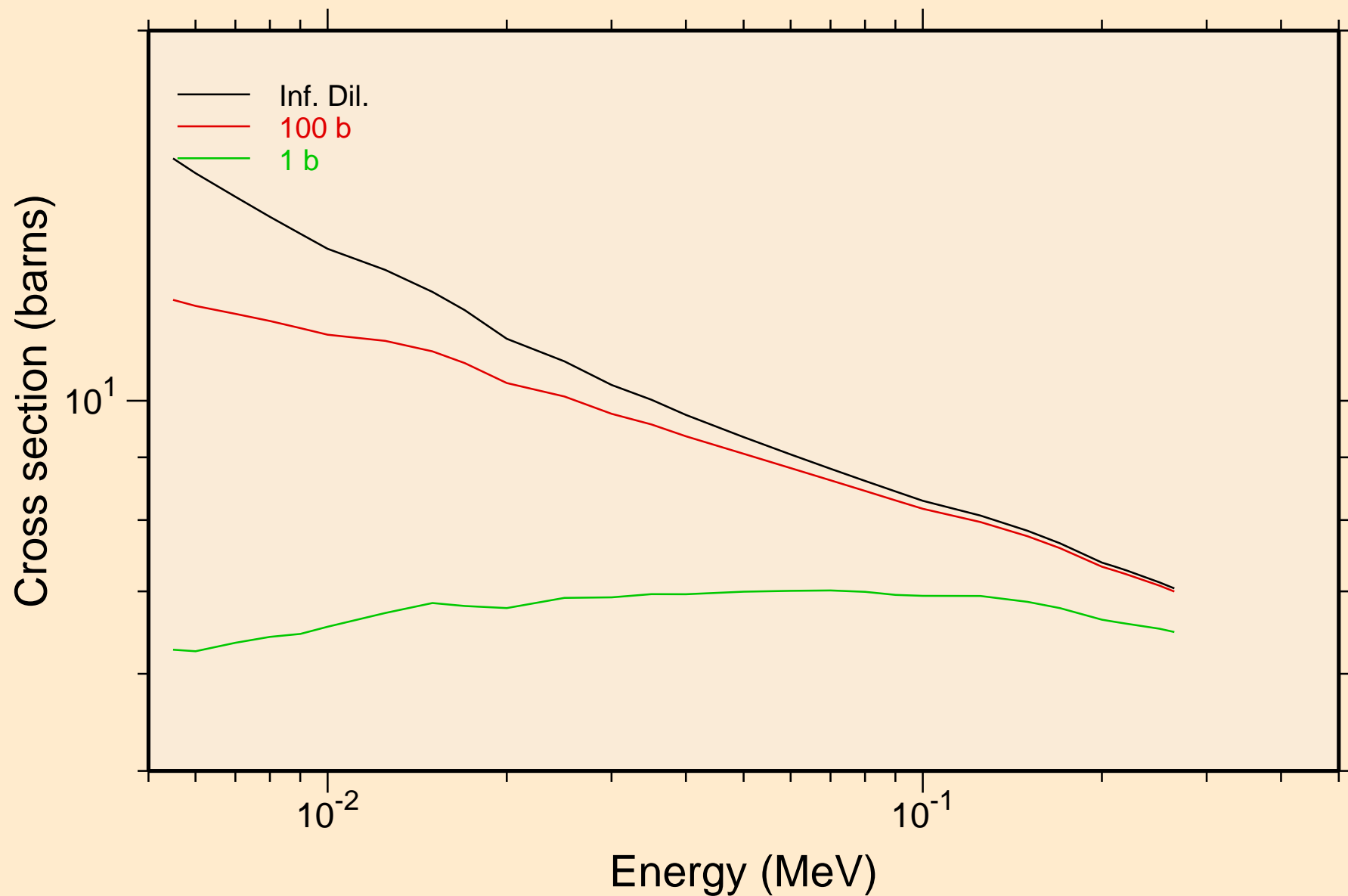

35-BR-79 FOR FENDL-3.2 FROM FENDL-3.2 BY NJOY2016.60+ O
UR elastic cross section

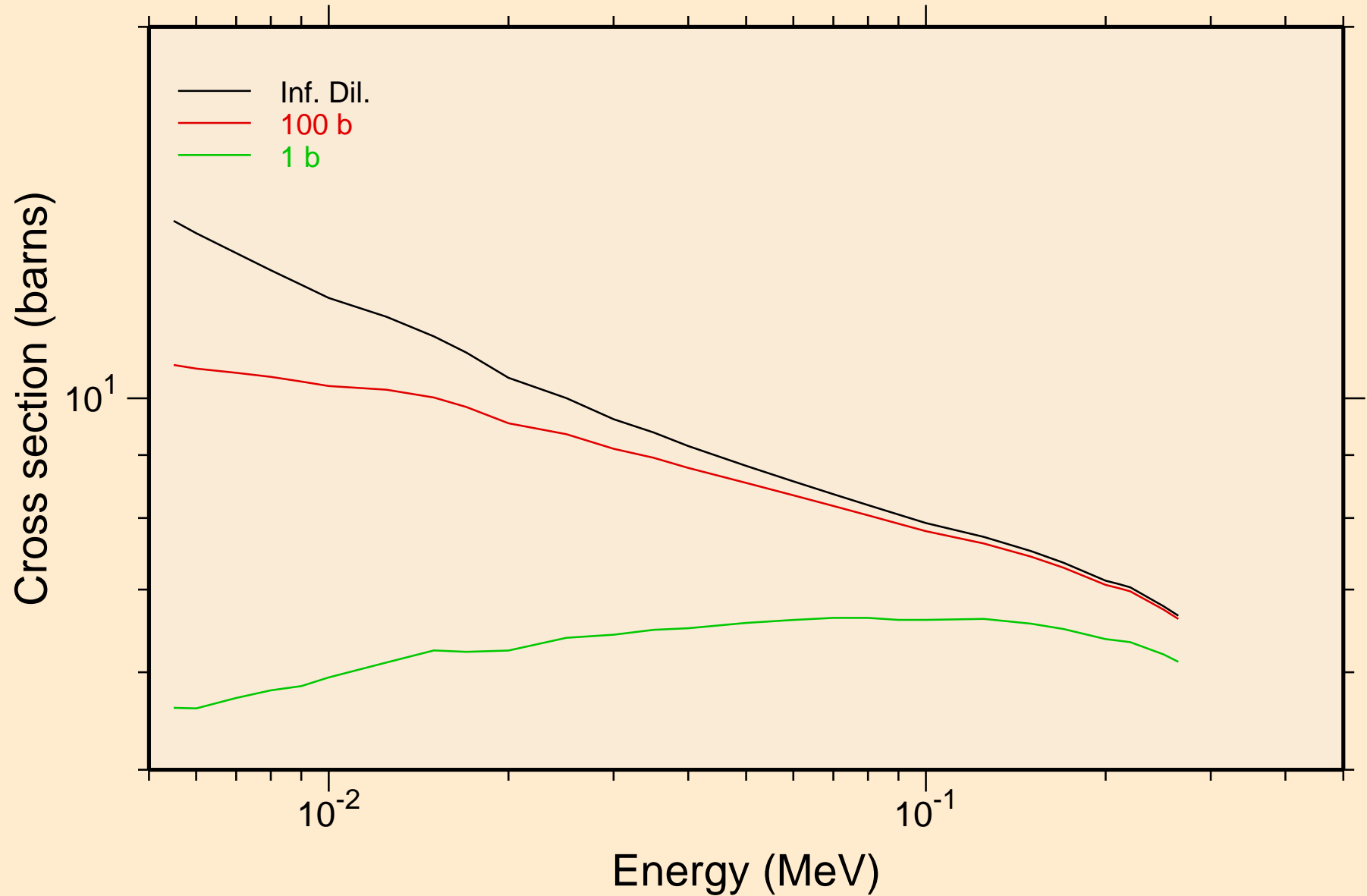

35-BR-79 FOR FENDL-3.2 FROM FENDL-3.2 BY NJOY2016.60+ O
UR capture cross section

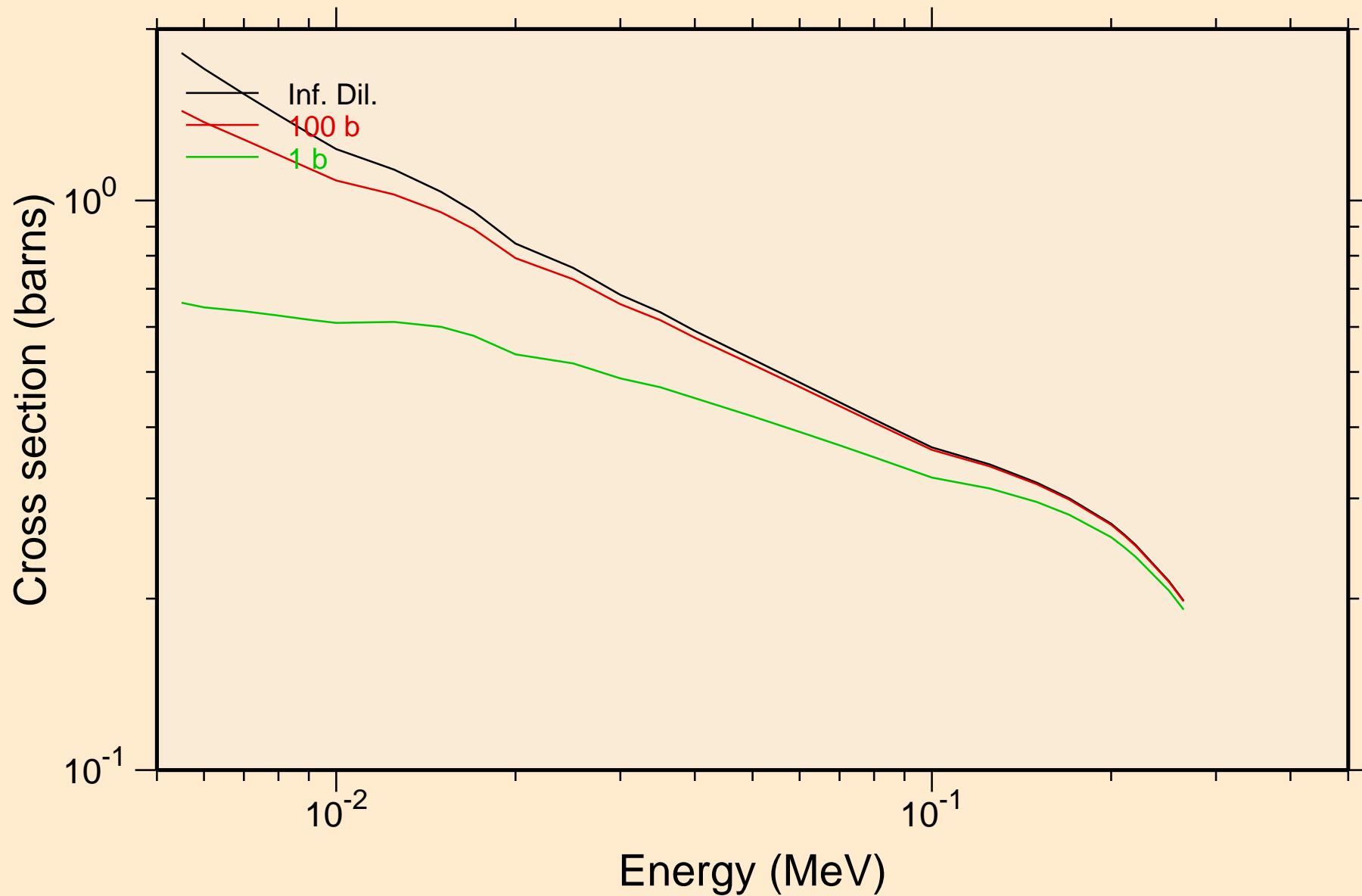

35-BR-79 FOR FENDL-3.2 FROM FENDL-3.2 BY NJOY2016.60+ O Heating

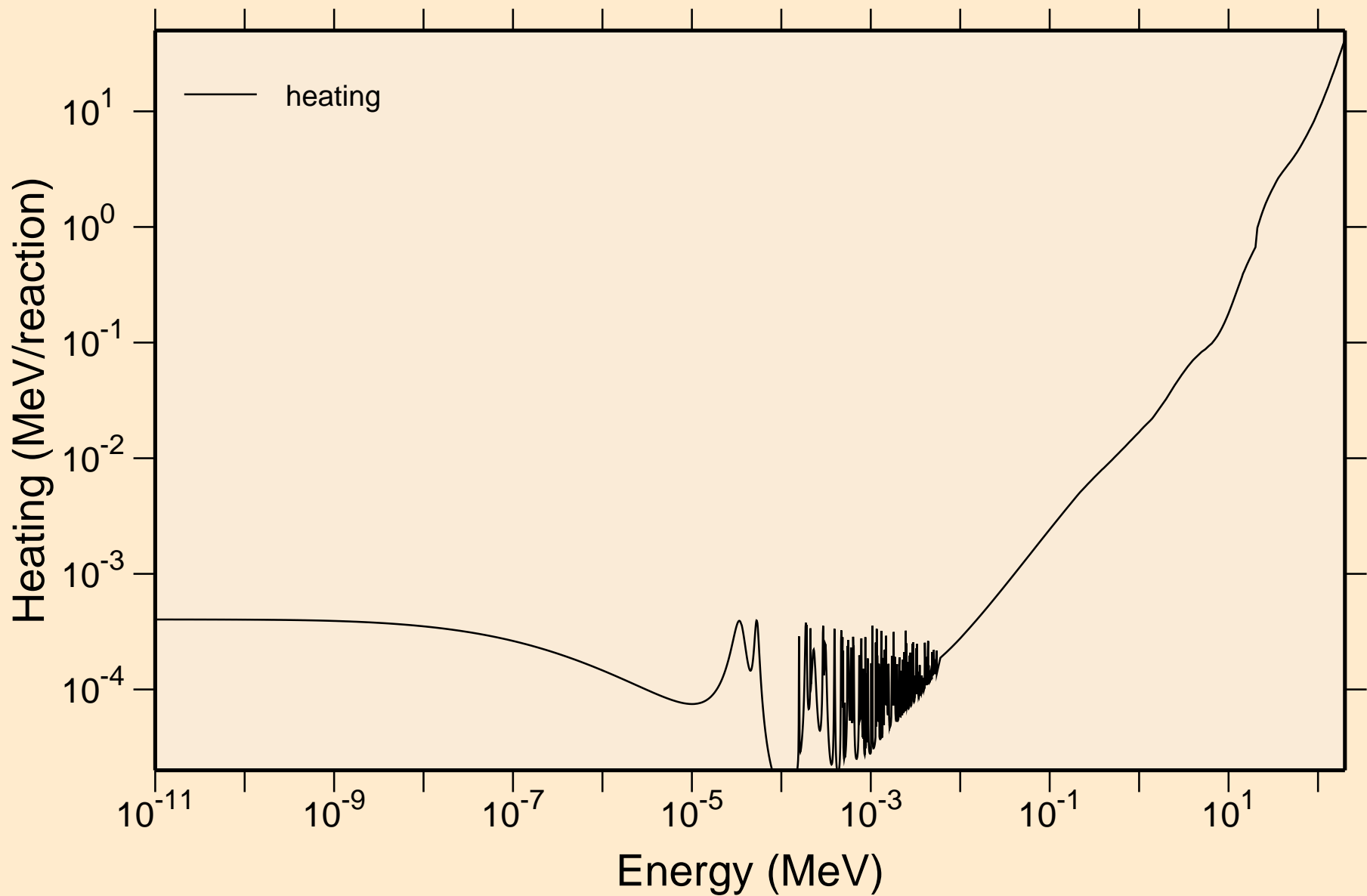

35-BR-79 FOR FENDL-3.2 FROM FENDL-3.2 BY NJOY2016.60+ O Damage

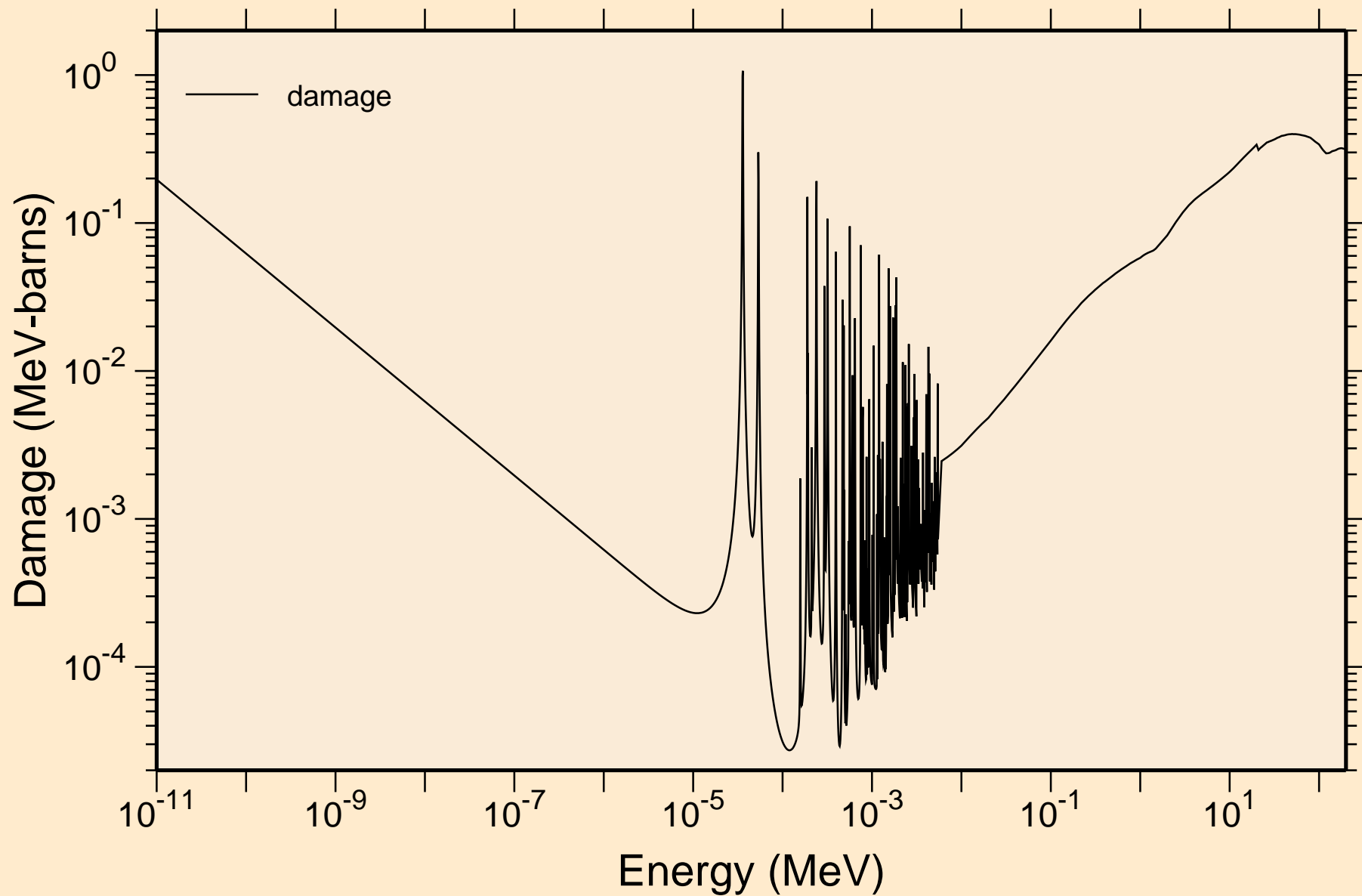

35-BR-79 FOR FENDL-3.2 FROM FENDL-3.2 BY NJOY2016.60+ O
Non-threshold reactions

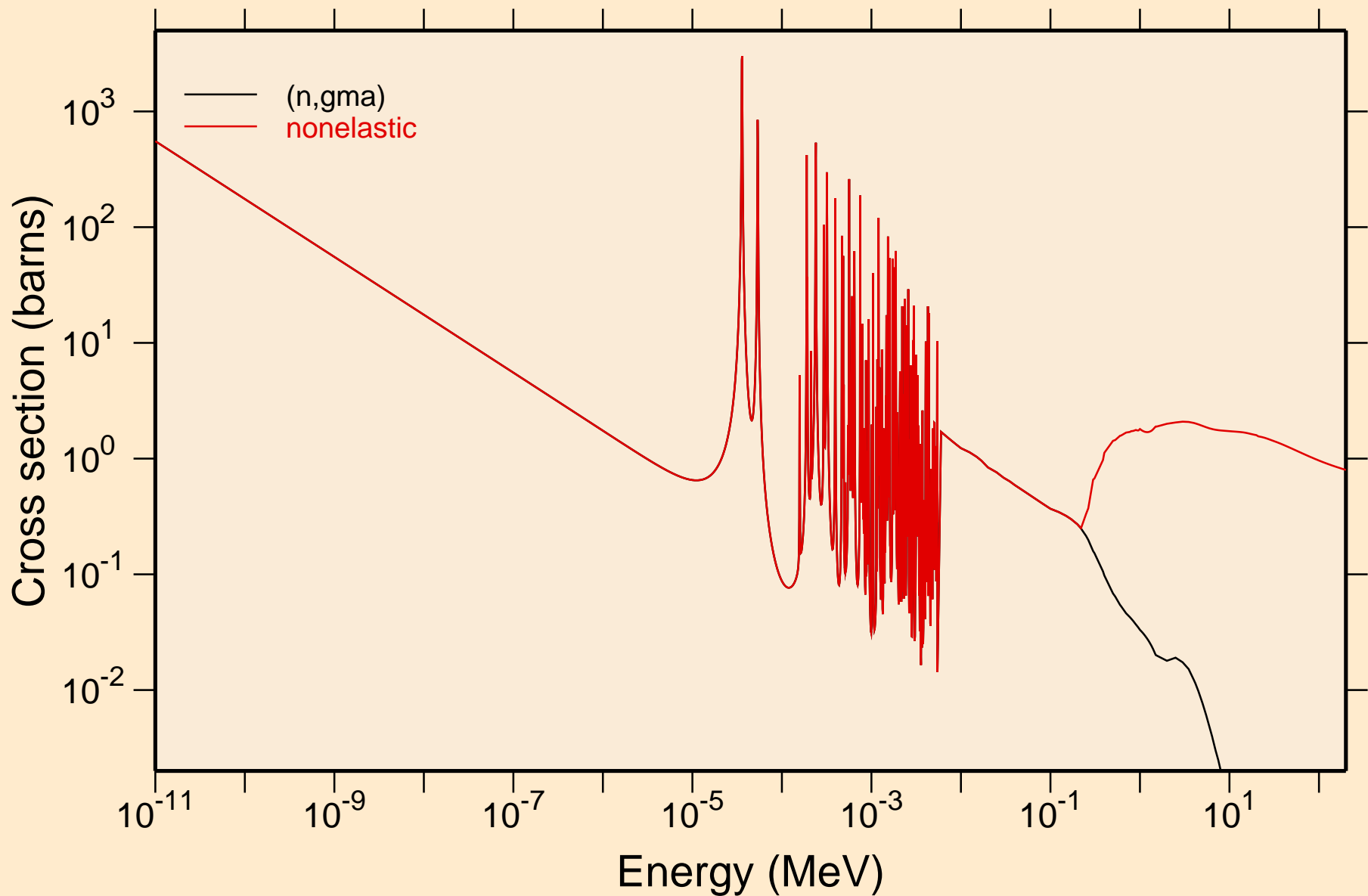

35-BR-79 FOR FENDL-3.2 FROM FENDL-3.2 BY NJOY2016.60+ O
Non-threshold reactions

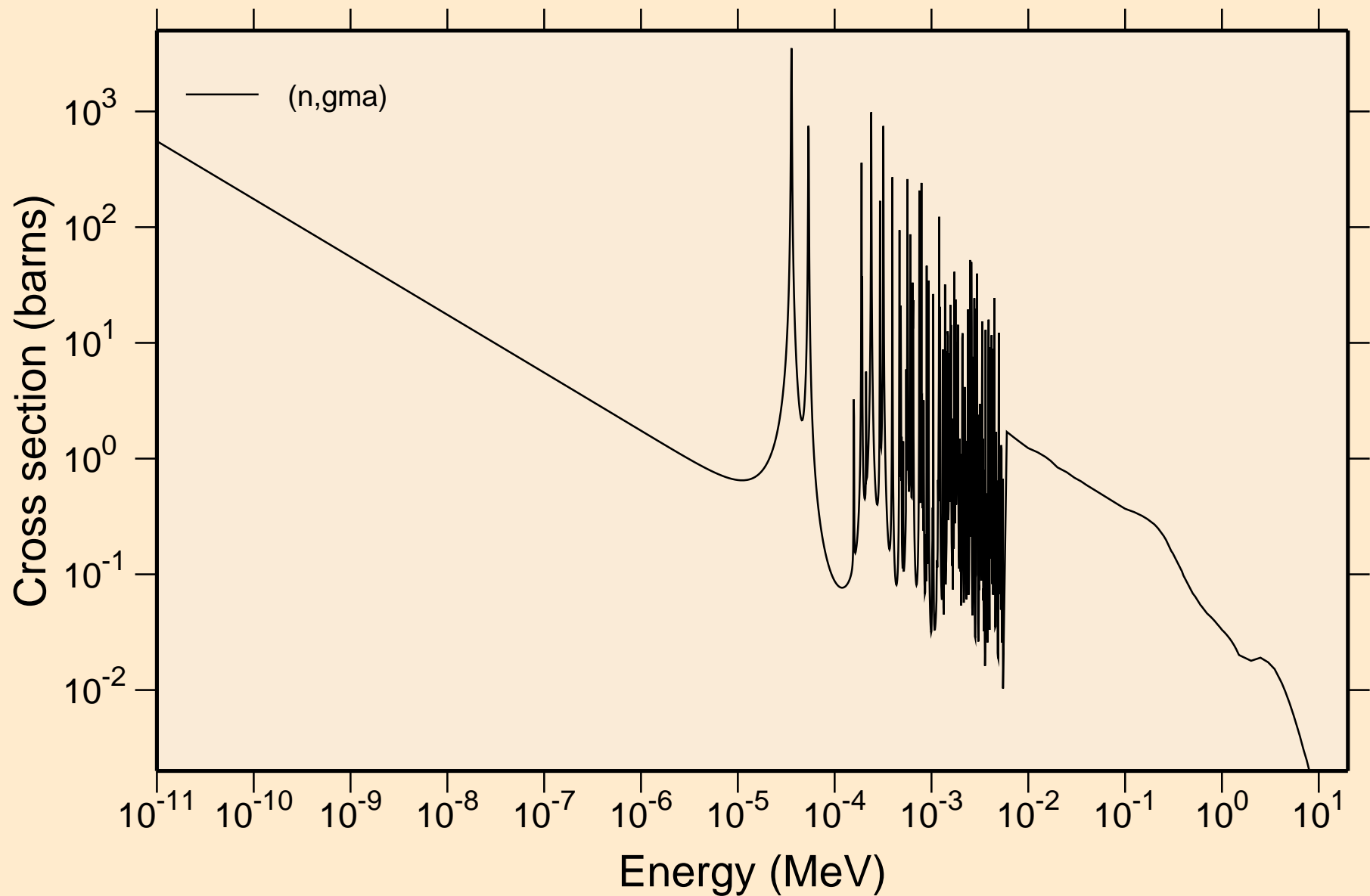

35-BR-79 FOR FENDL-3.2 FROM FENDL-3.2 BY NJOY2016.60+ O
Principal cross sections

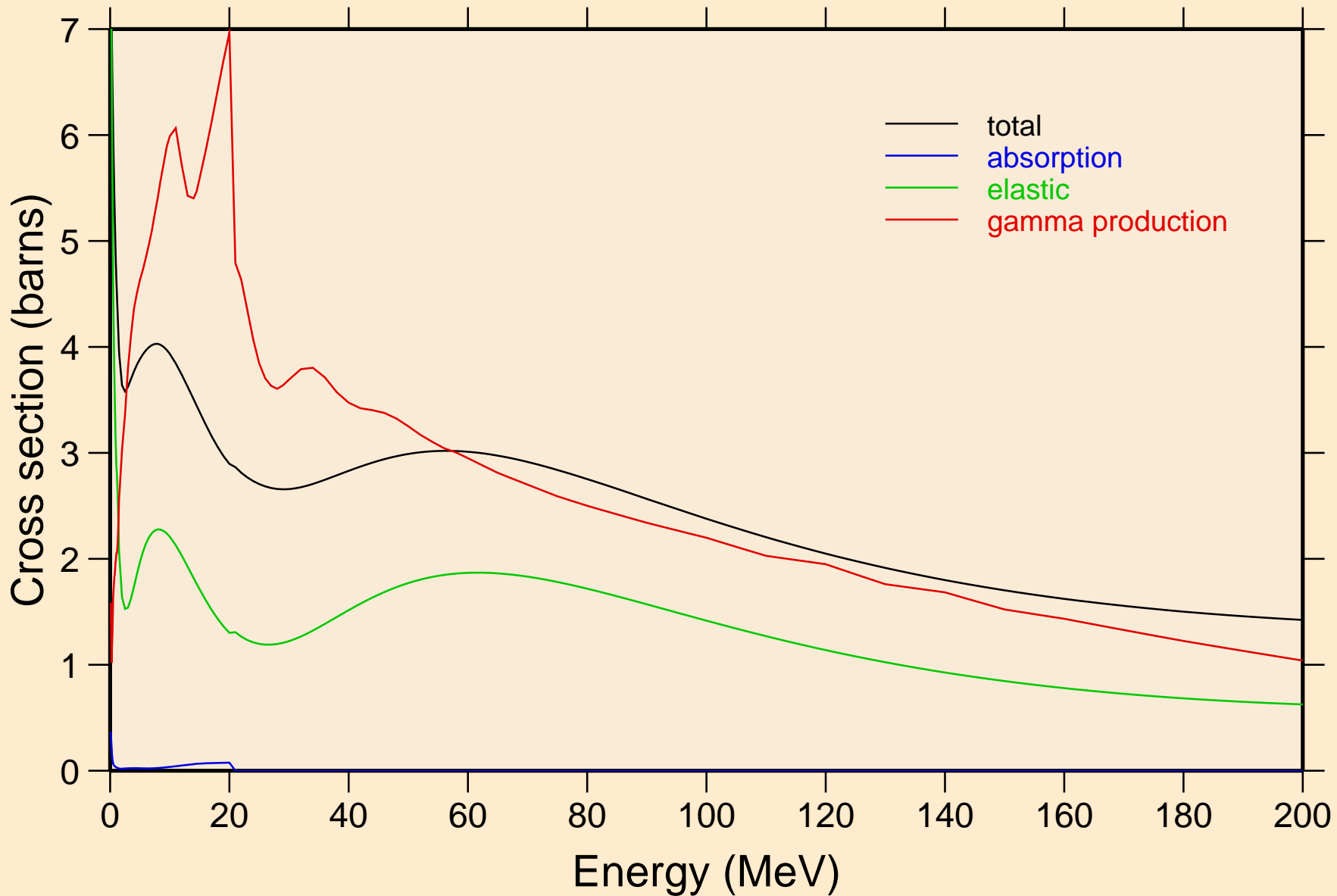

35-BR-79 FOR FENDL-3.2 FROM FENDL-3.2 BY NJOY2016.60+ O Heating

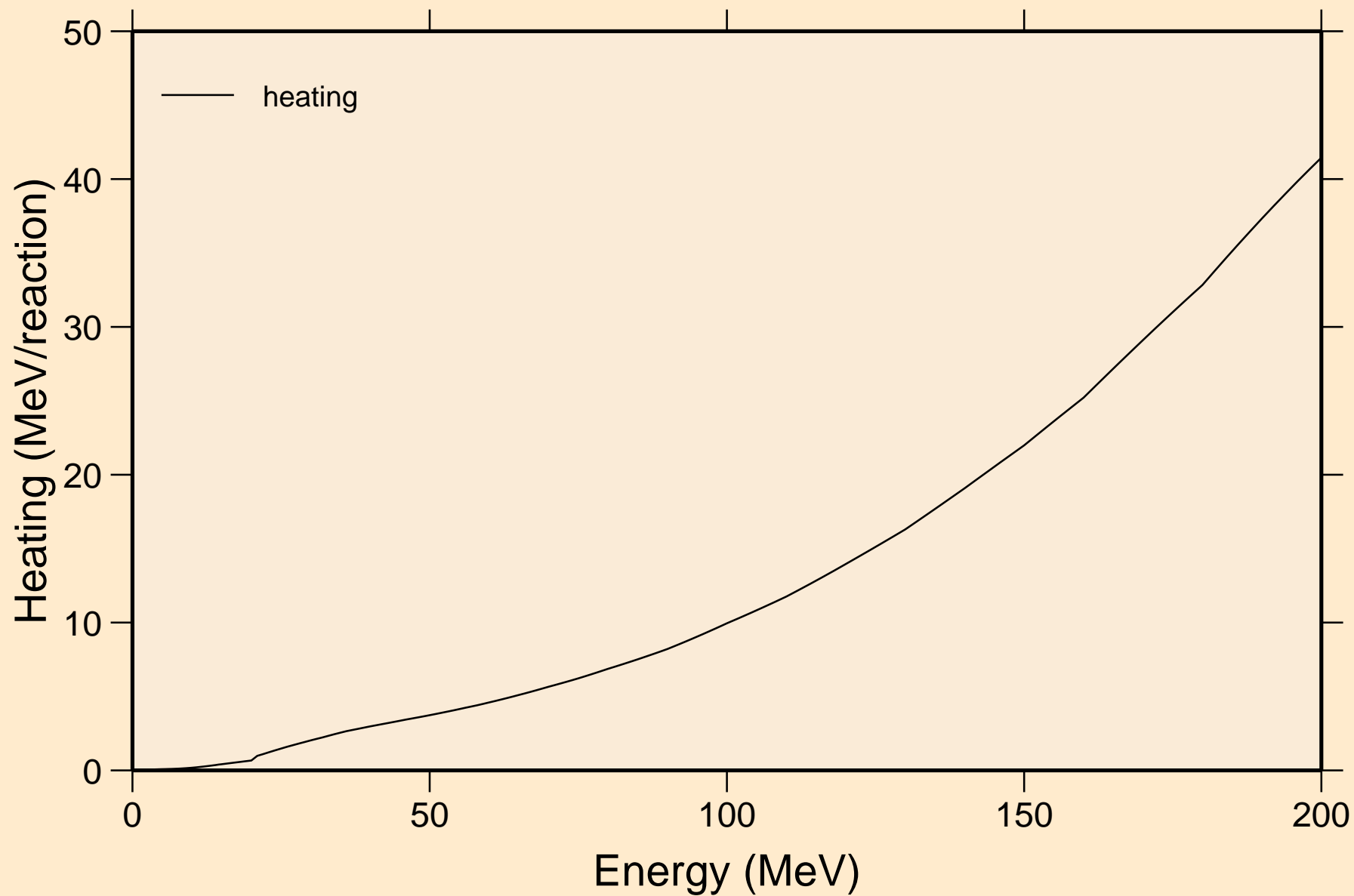

35-BR-79 FOR FENDL-3.2 FROM FENDL-3.2 BY NJOY2016.60+ O Damage

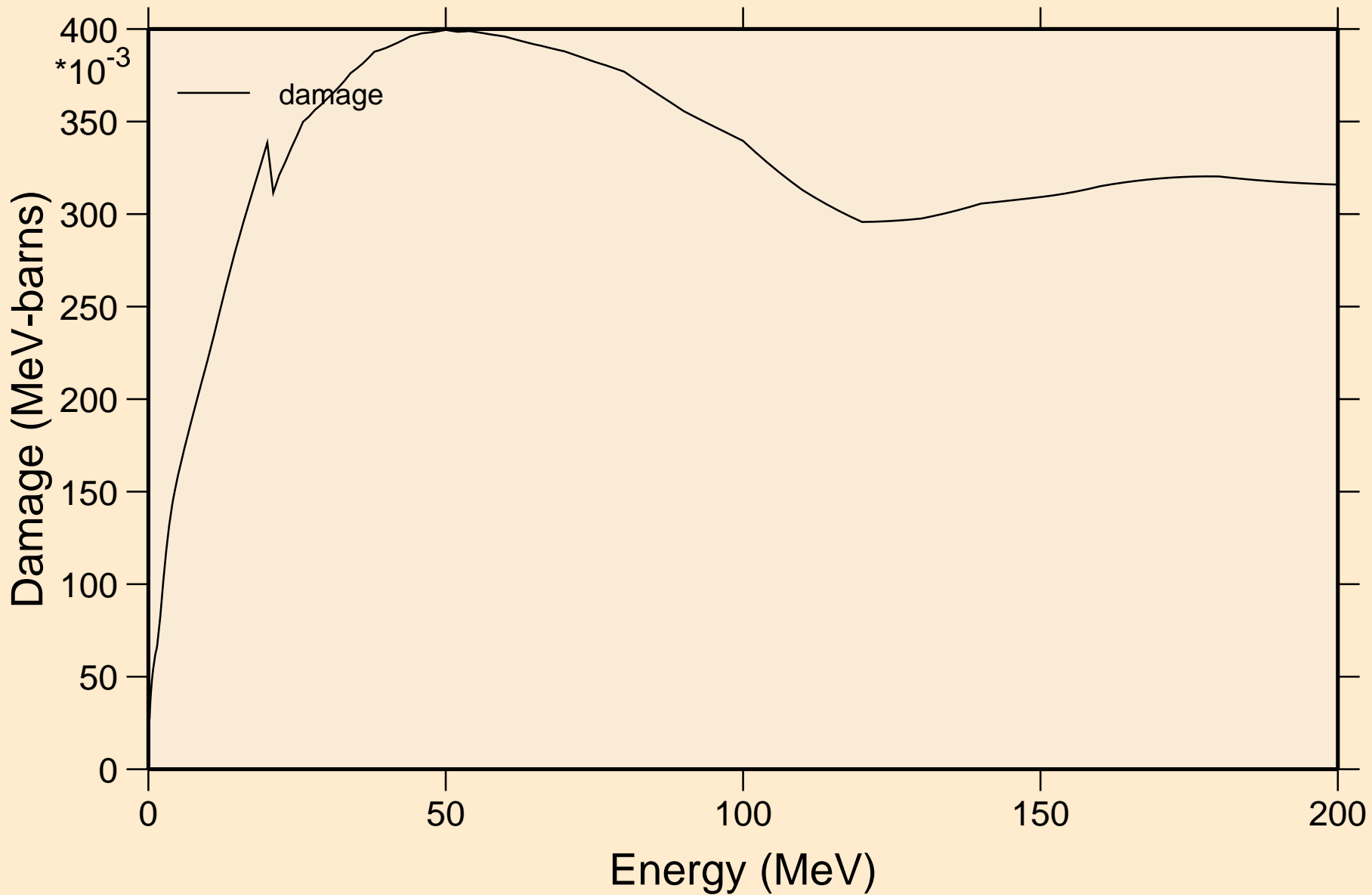

35-BR-79 FOR FENDL-3.2 FROM FENDL-3.2 BY NJOY2016.60+ O
Non-threshold reactions

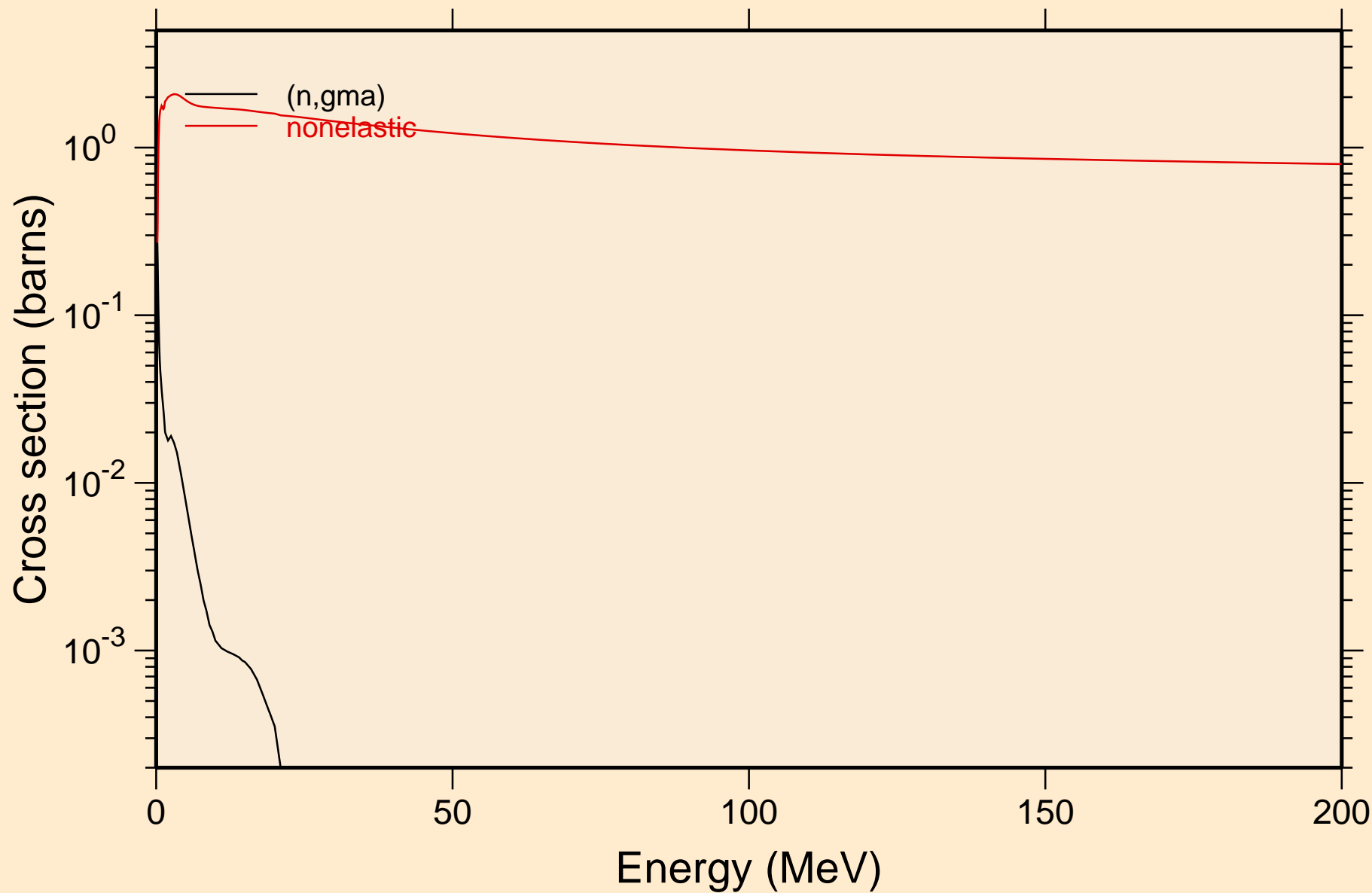

35-BR-79 FOR FENDL-3.2 FROM FENDL-3.2 BY NJOY2016.60+ O
Non-threshold reactions

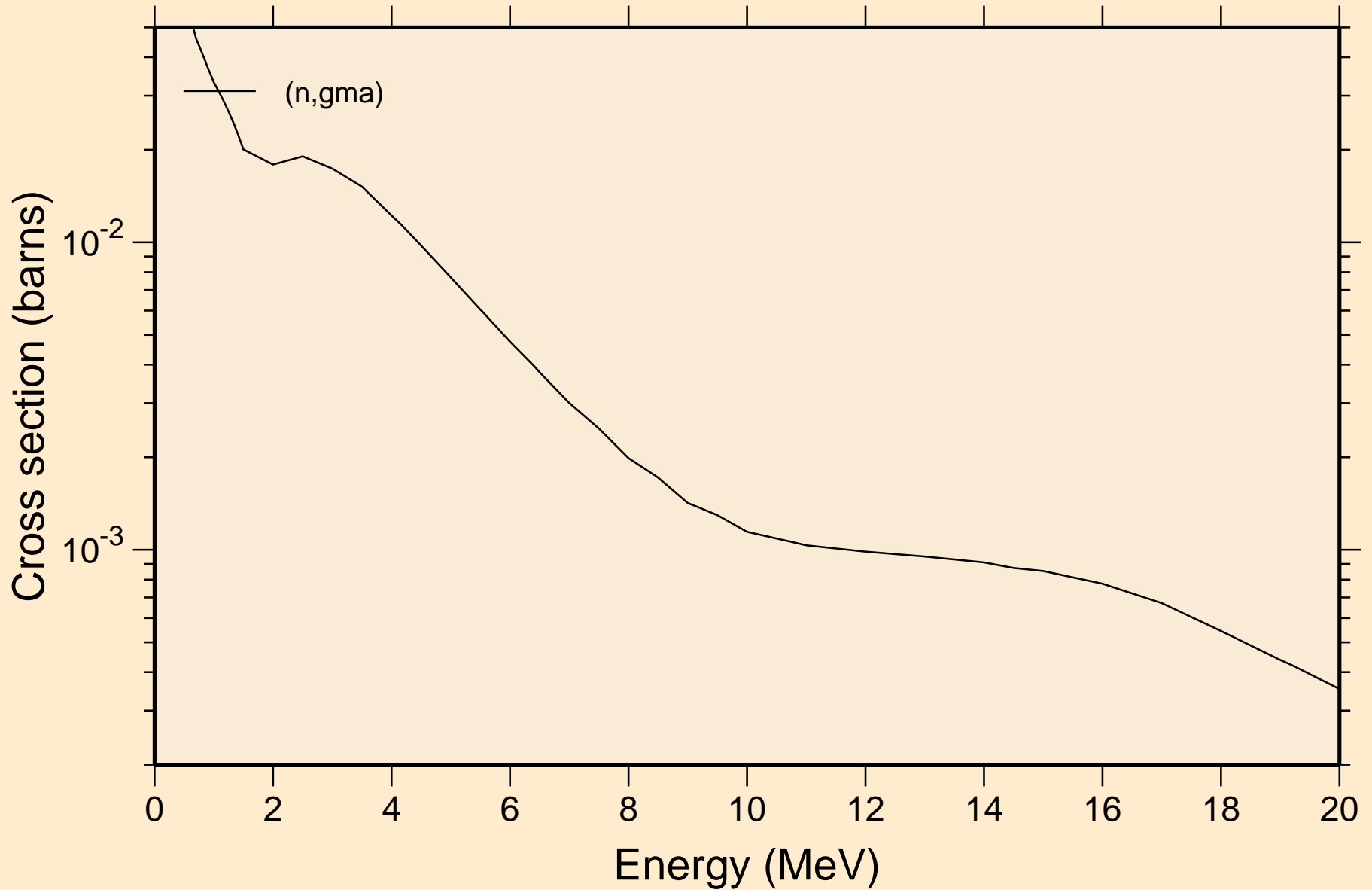

35-BR-79 FOR FENDL-3.2 FROM FENDL-3.2 BY NJOY2016.60+ O
Inelastic levels

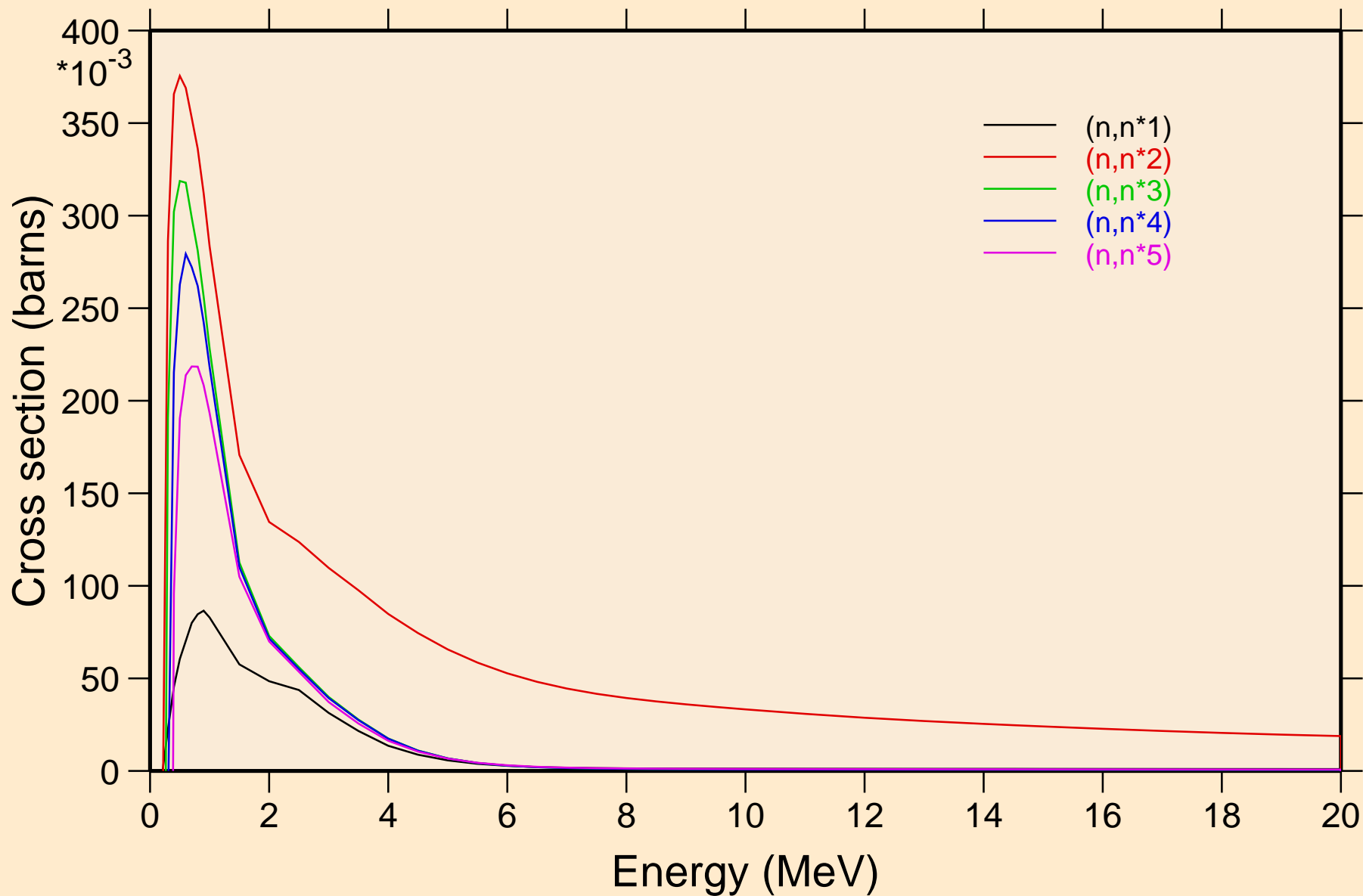

35-BR-79 FOR FENDL-3.2 FROM FENDL-3.2 BY NJOY2016.60+ O Inelastic levels

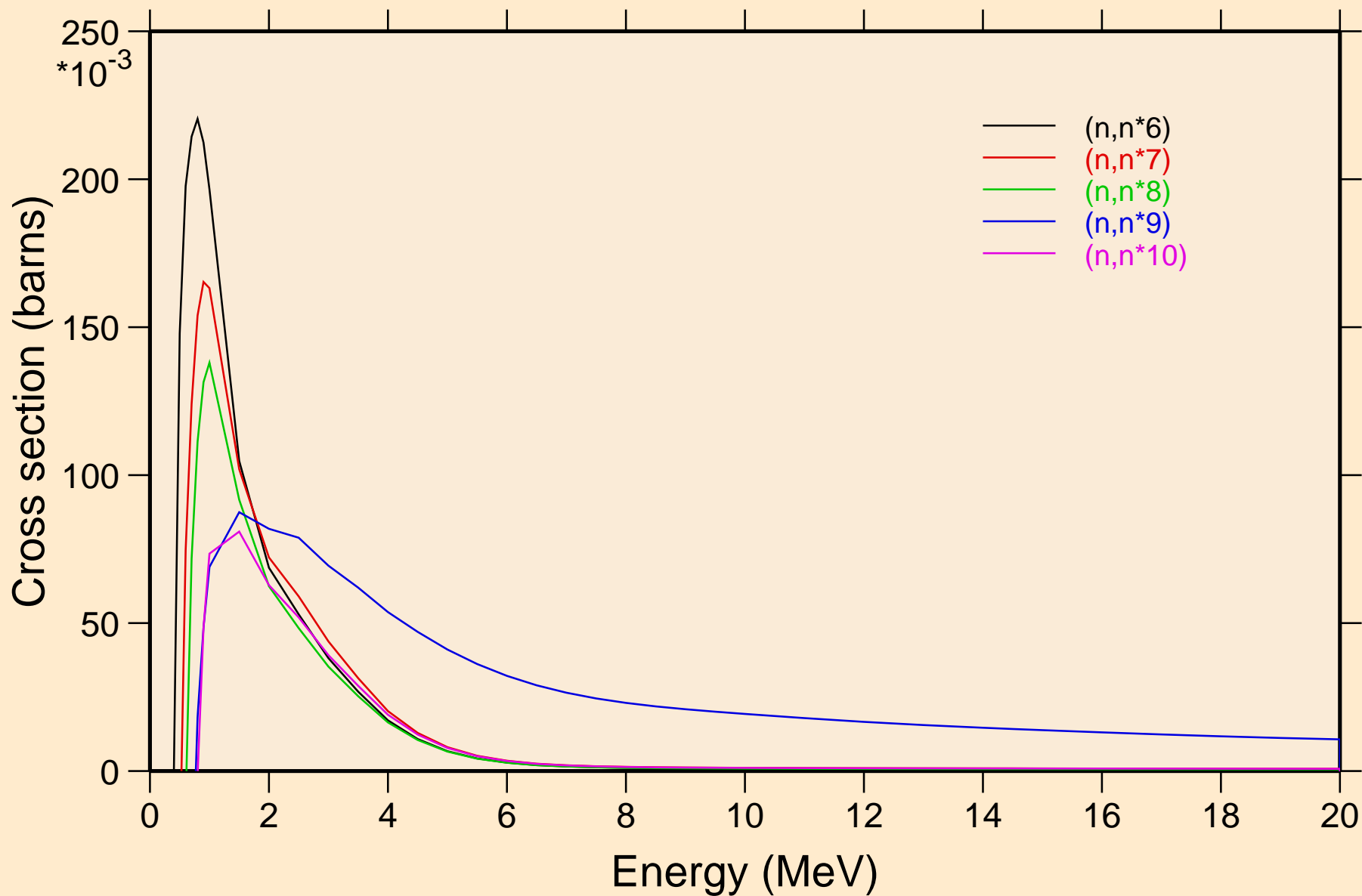

35-BR-79 FOR FENDL-3.2 FROM FENDL-3.2 BY NJOY2016.60+ O
Inelastic levels

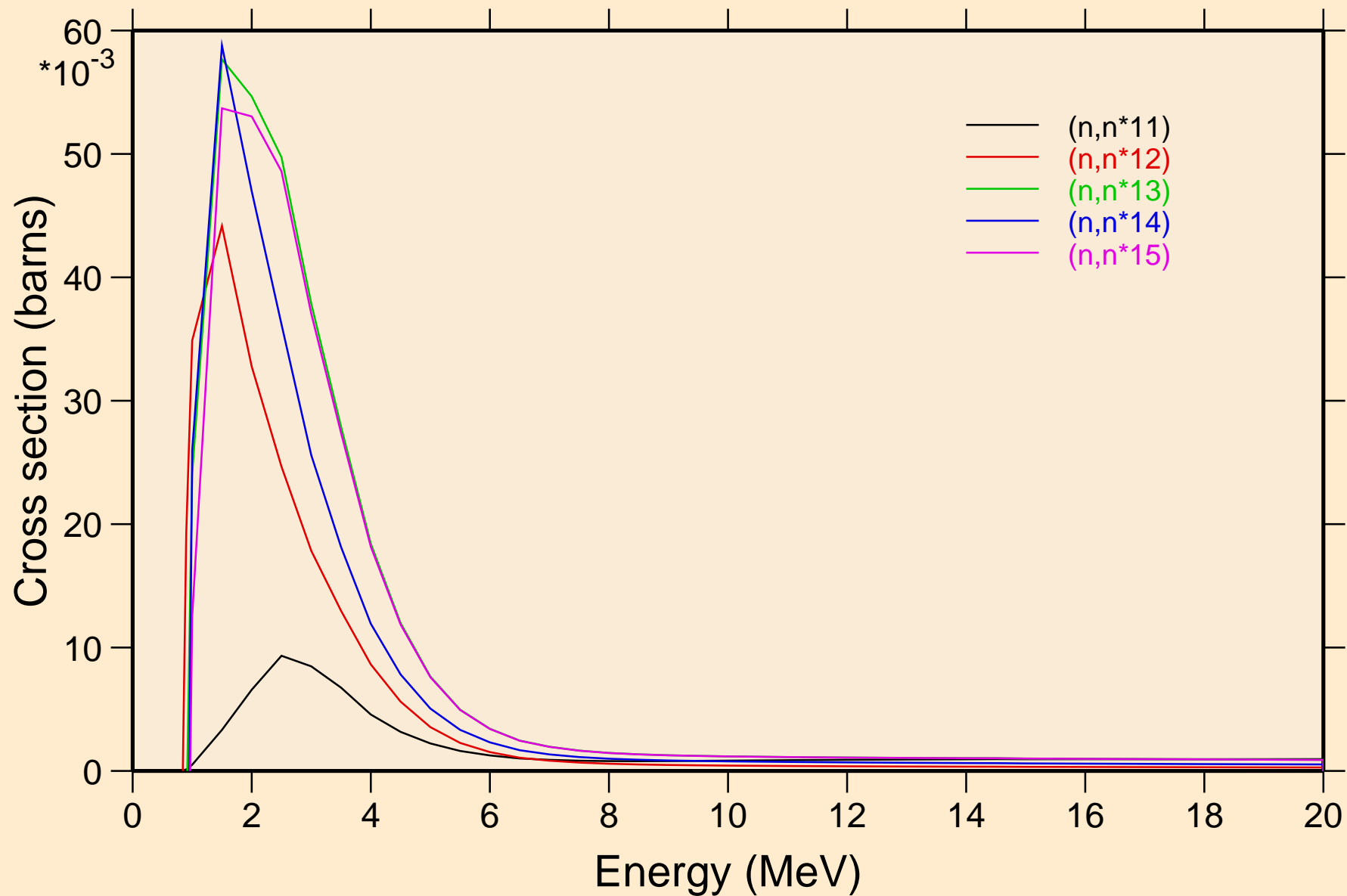

35-BR-79 FOR FENDL-3.2 FROM FENDL-3.2 BY NJOY2016.60+ O
Inelastic levels

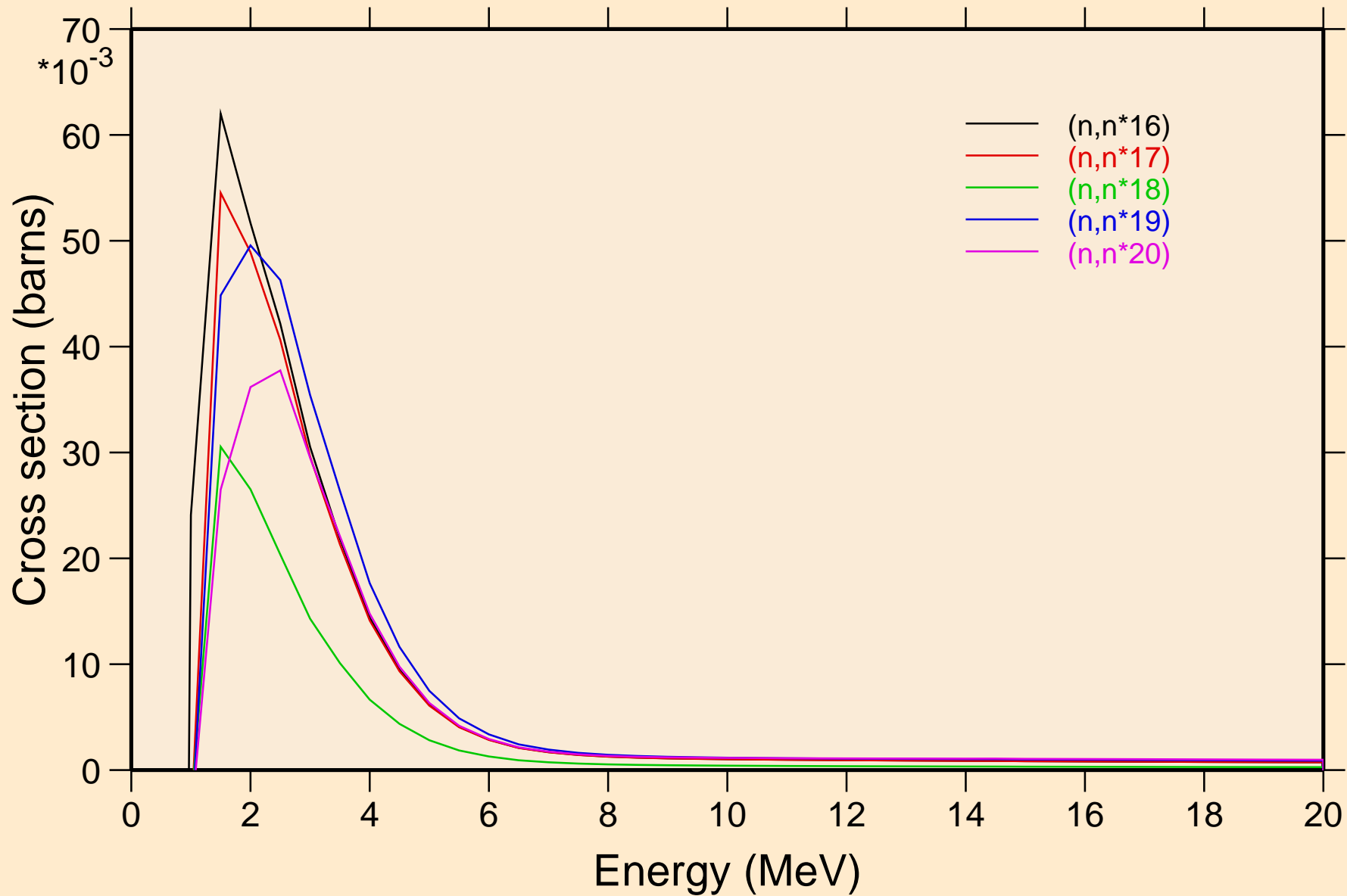

35-BR-79 FOR FENDL-3.2 FROM FENDL-3.2 BY NJOY2016.60+ O Inelastic levels

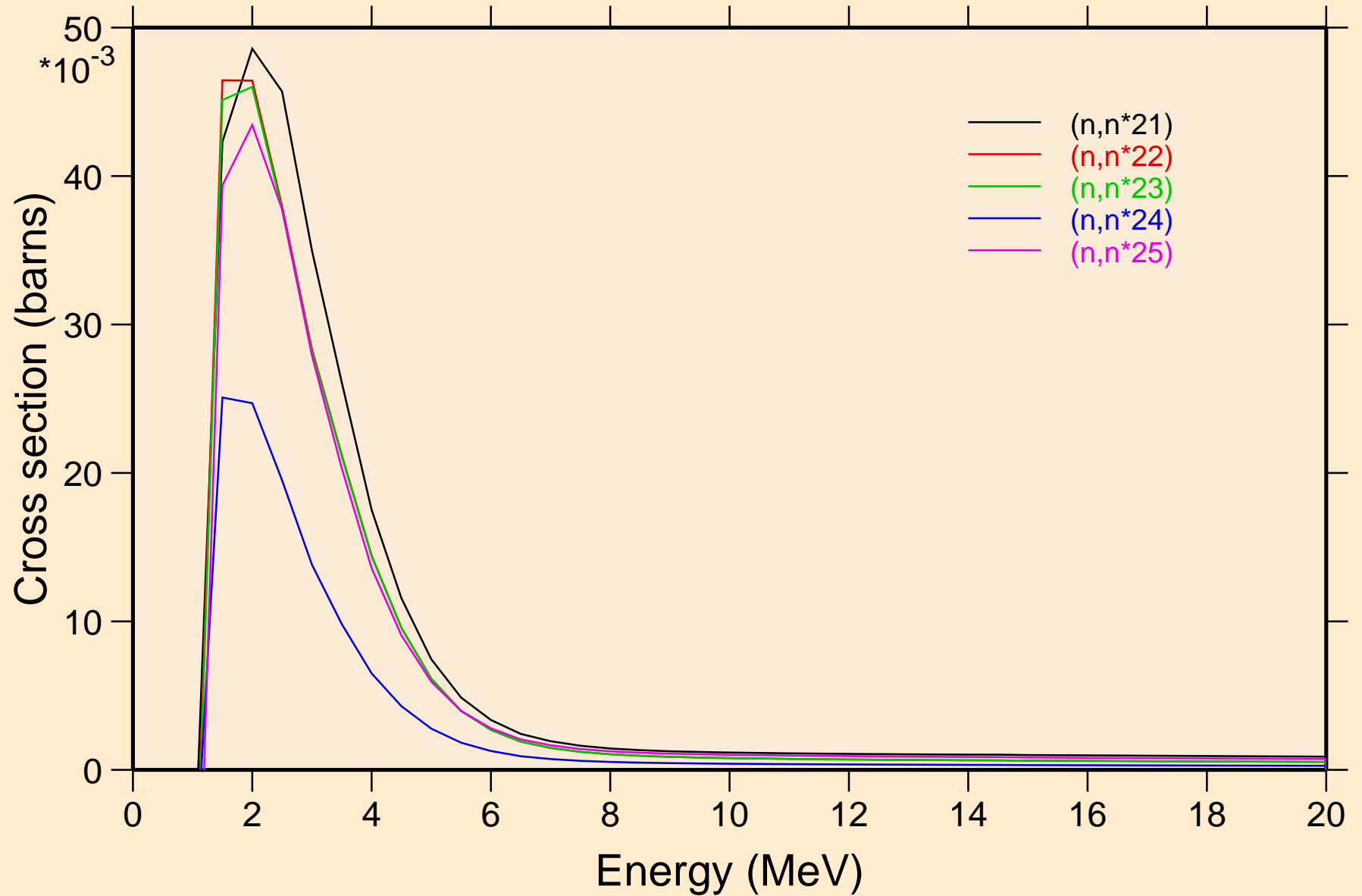

35-BR-79 FOR FENDL-3.2 FROM FENDL-3.2 BY NJOY2016.60+ O
Inelastic levels

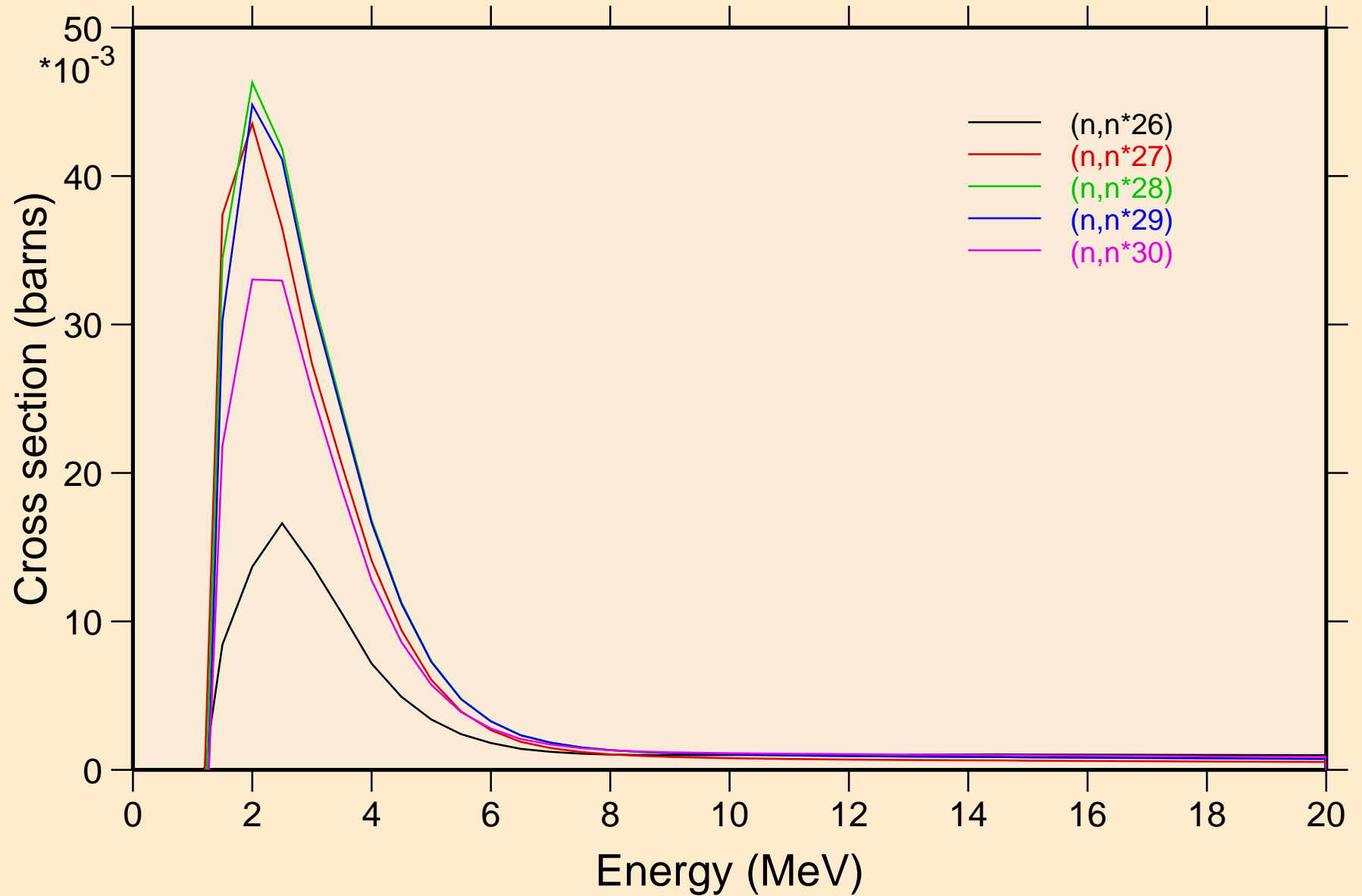

35-BR-79 FOR FENDL-3.2 FROM FENDL-3.2 BY NJOY2016.60+ O
Inelastic levels

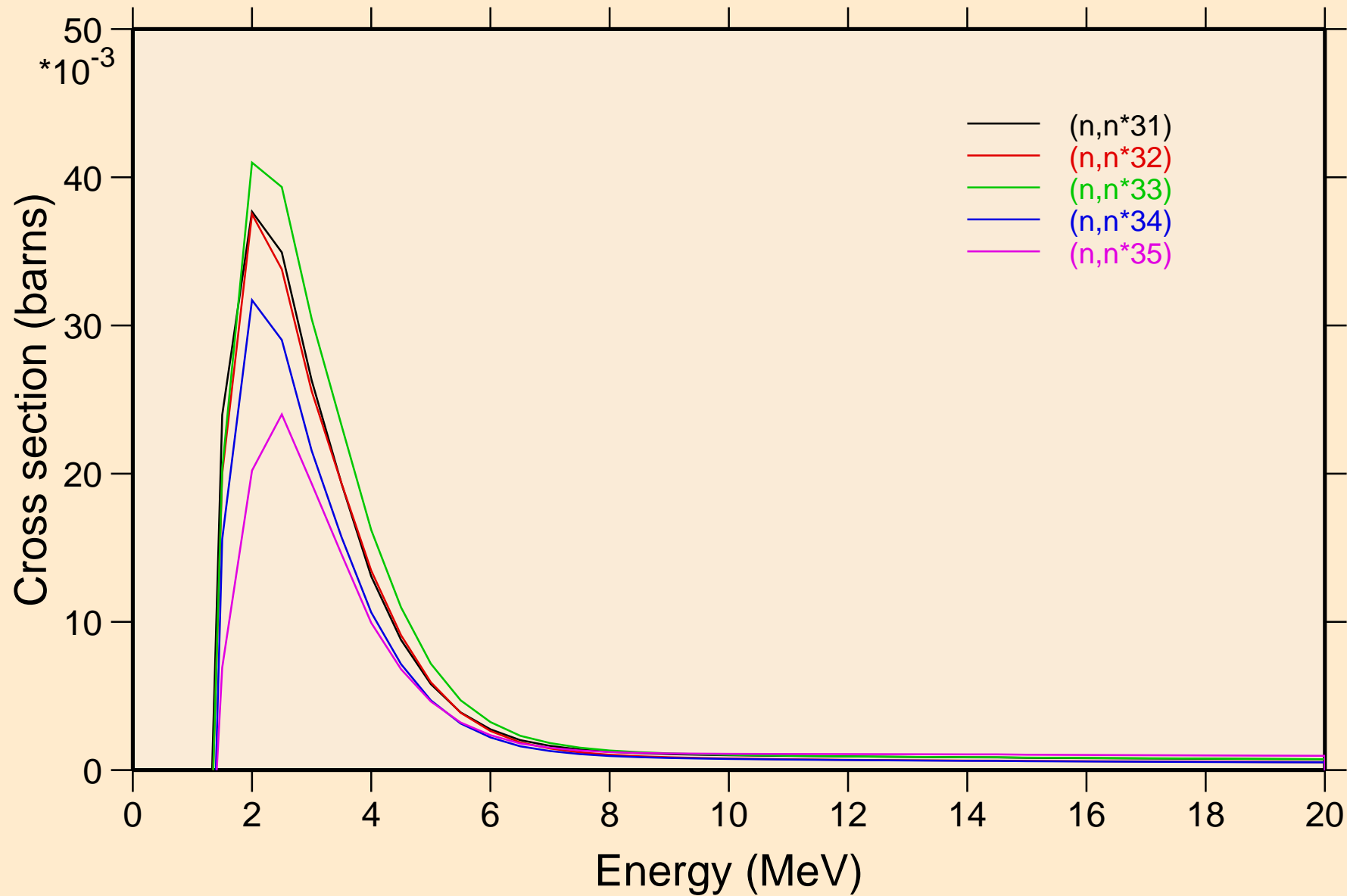

35-BR-79 FOR FENDL-3.2 FROM FENDL-3.2 BY NJOY2016.60+ O
Inelastic levels

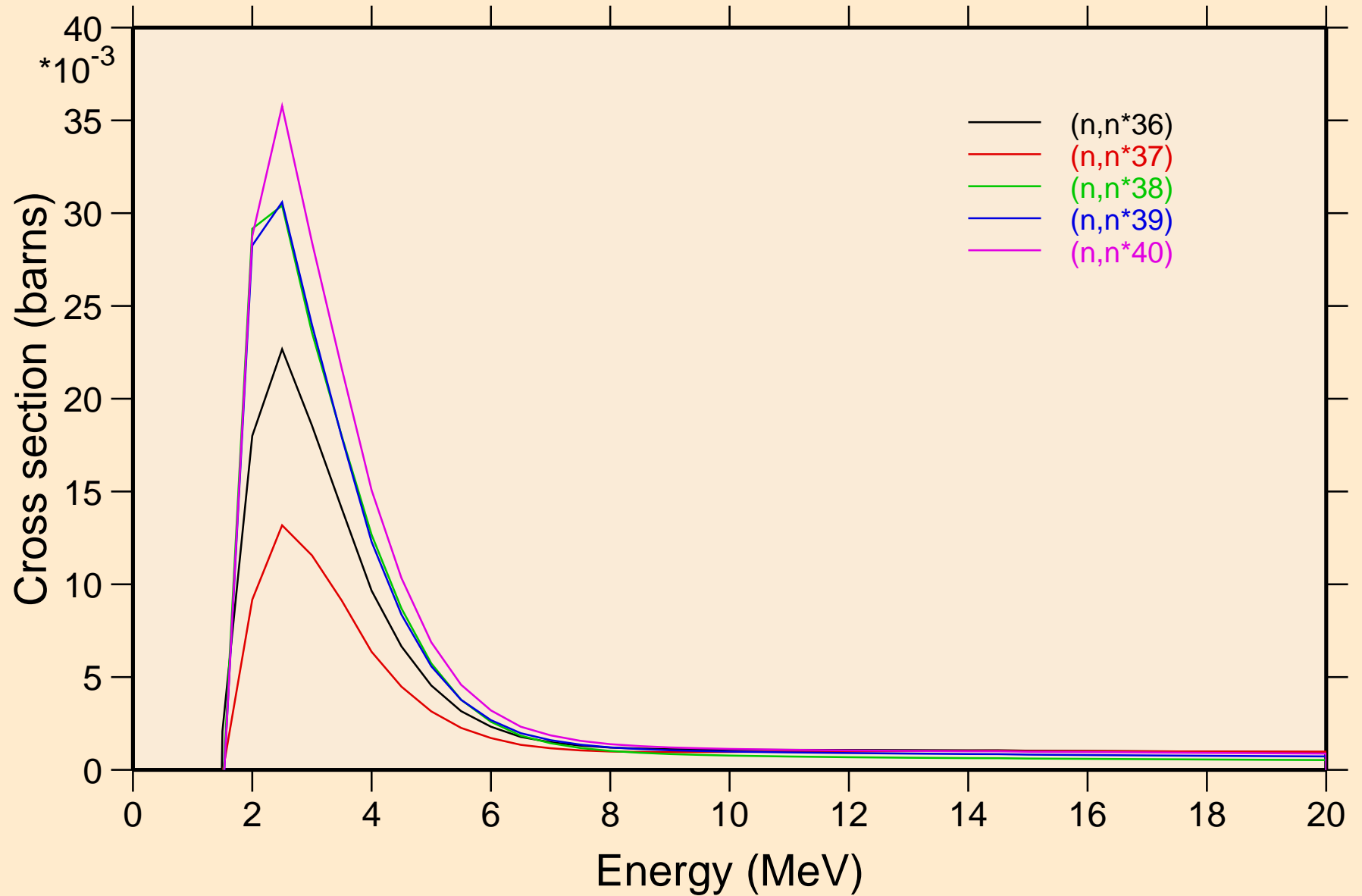

35-BR-79 FOR FENDL-3.2 FROM FENDL-3.2 BY NJOY2016.60+ O
Threshold reactions

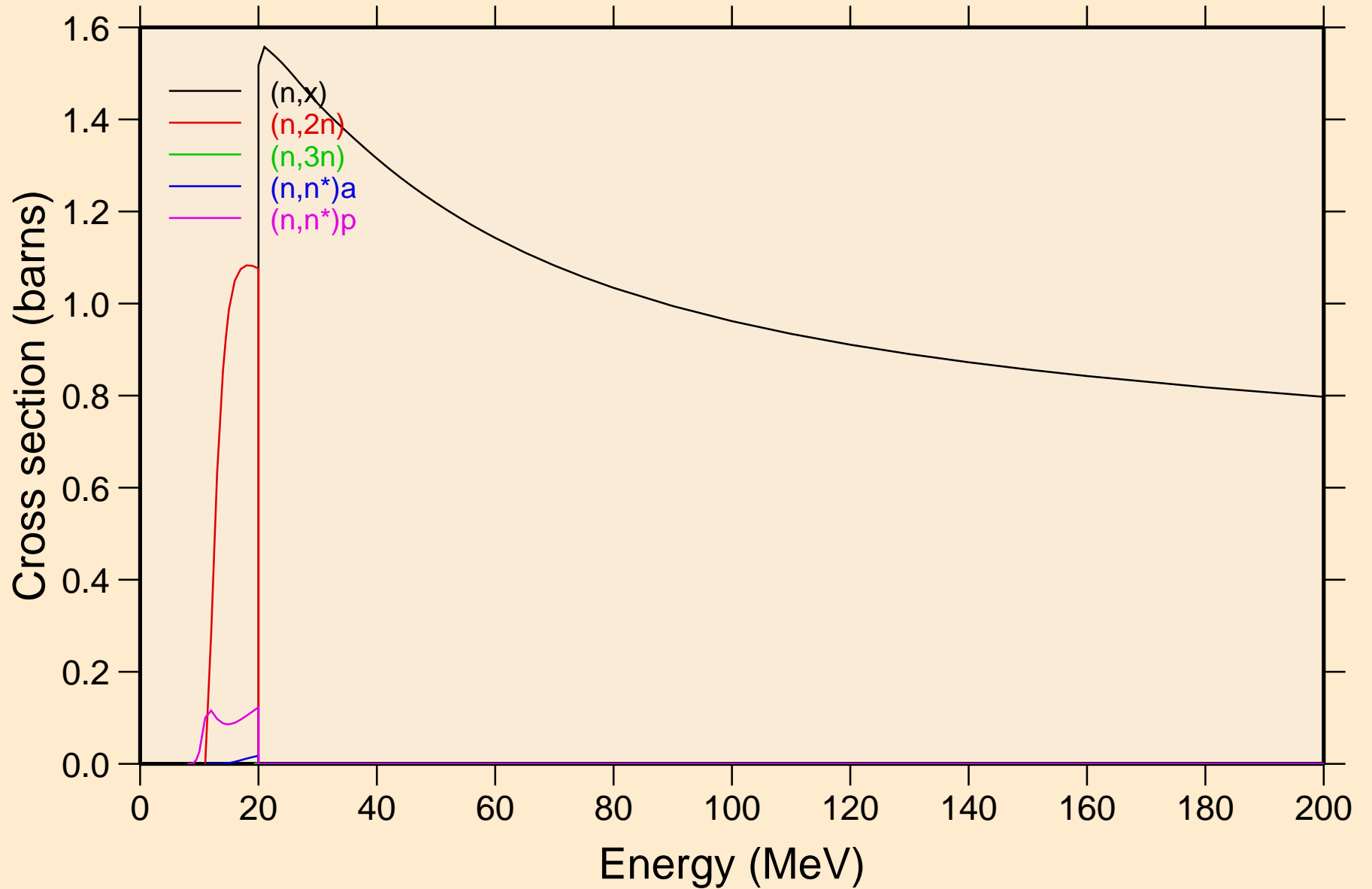

35-BR-79 FOR FENDL-3.2 FROM FENDL-3.2 BY NJOY2016.60+ O
Threshold reactions

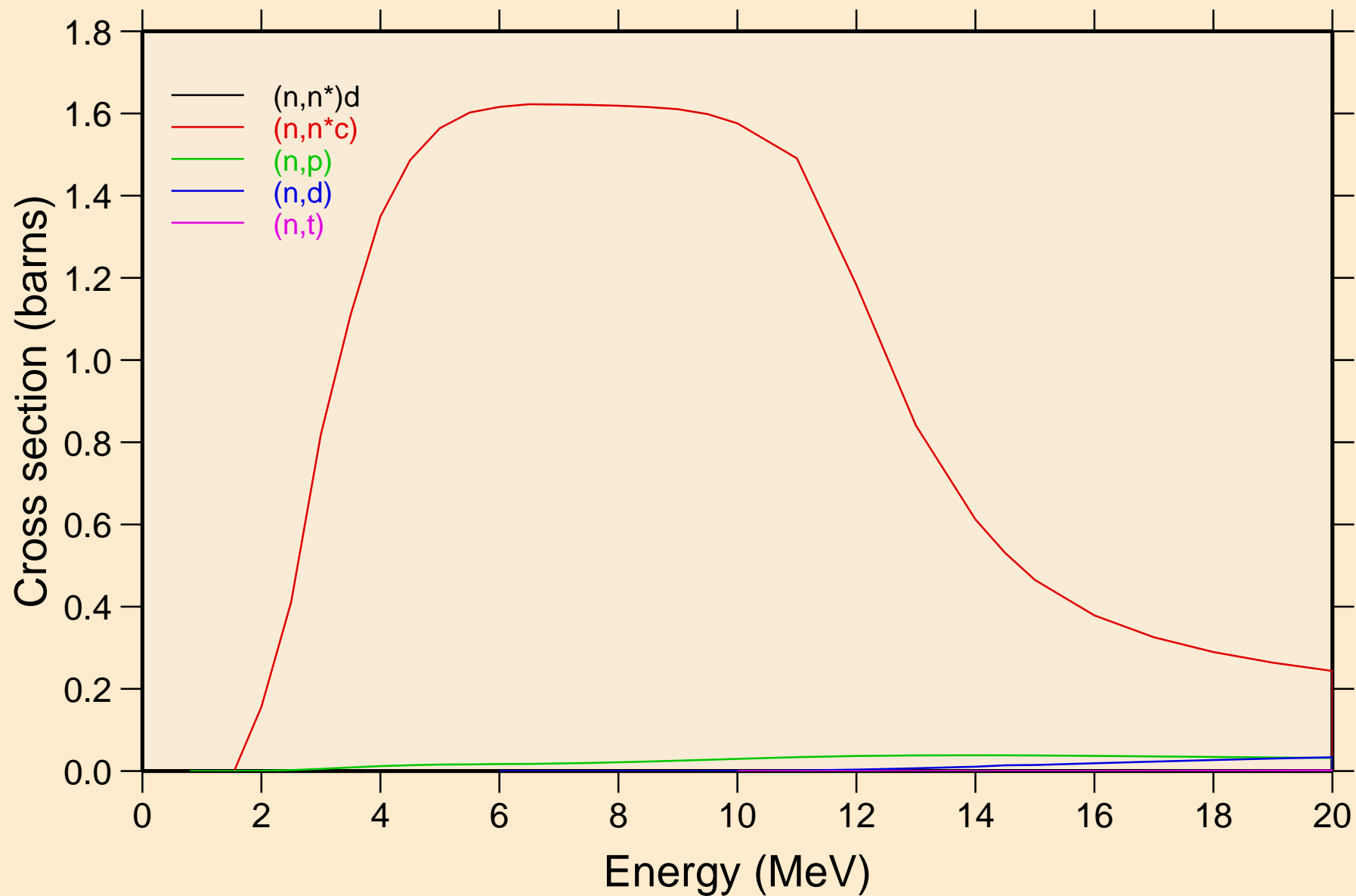

35-BR-79 FOR FENDL-3.2 FROM FENDL-3.2 BY NJOY2016.60+ O
Threshold reactions

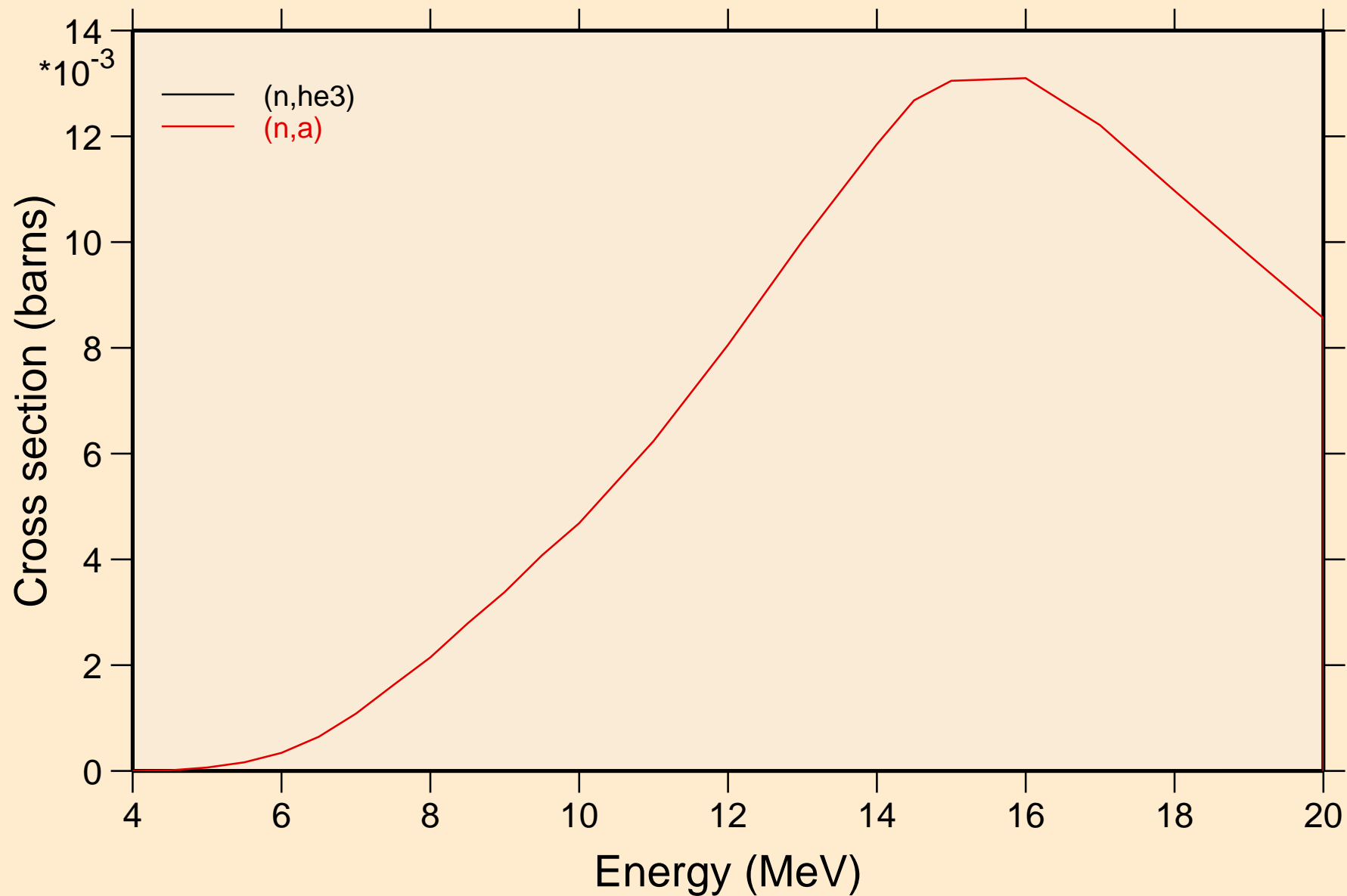

35-BR-79 FOR FENDL-3.2 FROM FENDL-3.2 BY NJOY2016.60+ O
Threshold reactions

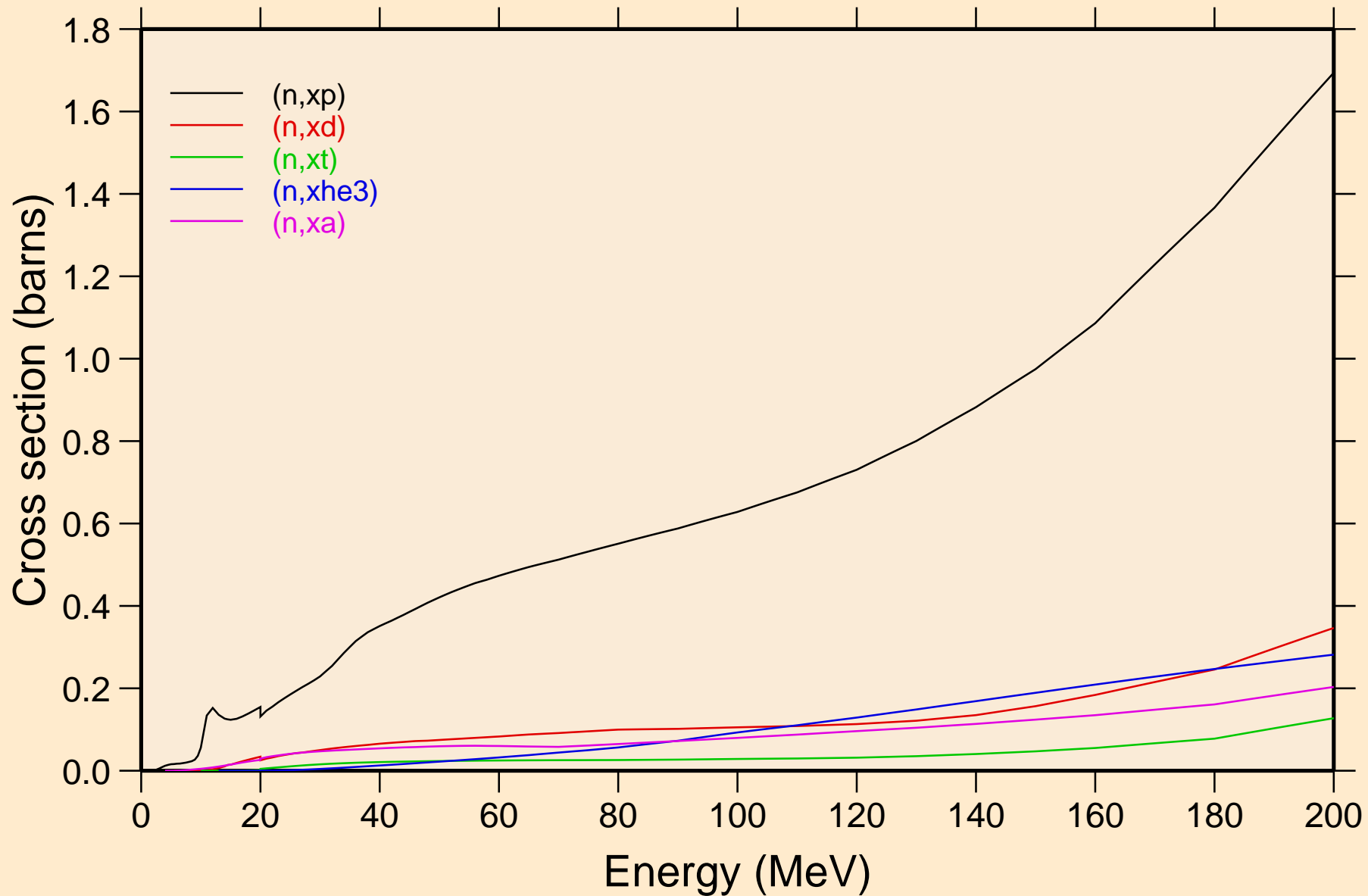

35-BR-79 FOR FENDL-3.2 FROM FENDL-3.2 BY NJOY2016.60+ O
angular distribution for elastic

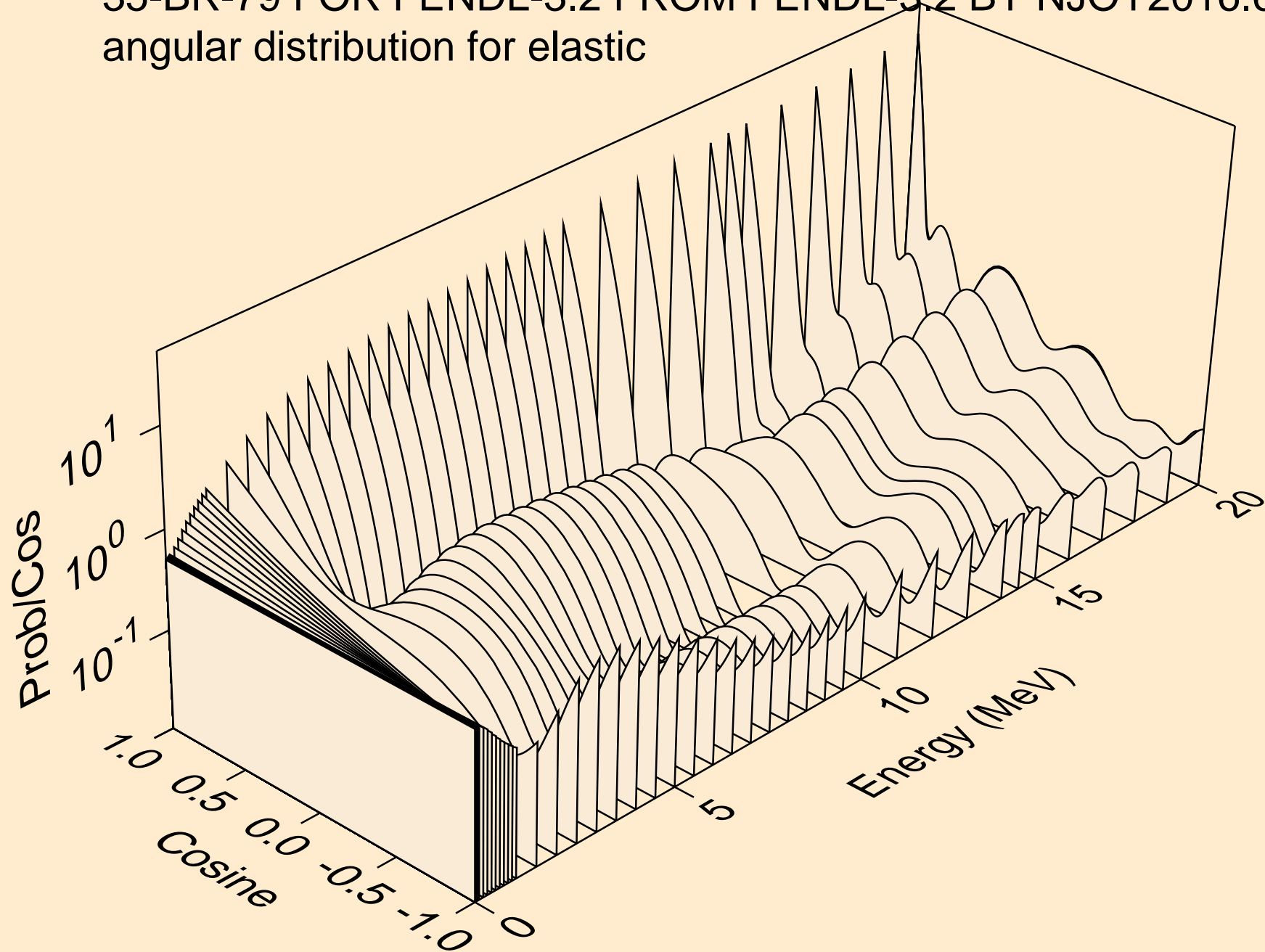

35-BR-79 FOR FENDL-3.2 FROM FENDL-3.2 BY NJOY2016.60+ O
angular distribution for elastic

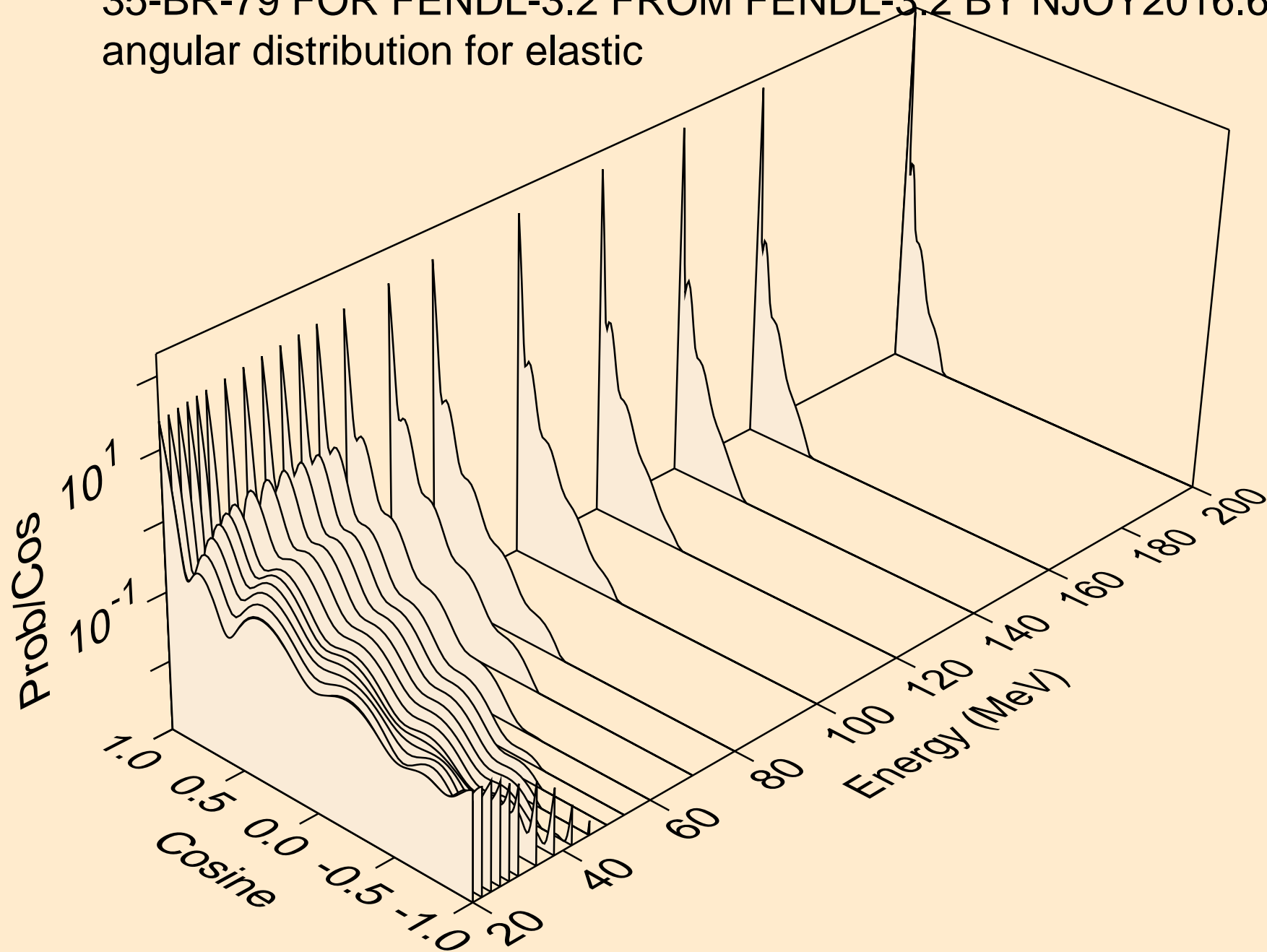

35-BR-79 FOR FENDL-3.2 FROM FENDL-3.2 BY NJOY2016.60+ O
angular distribution for (n,n*1)

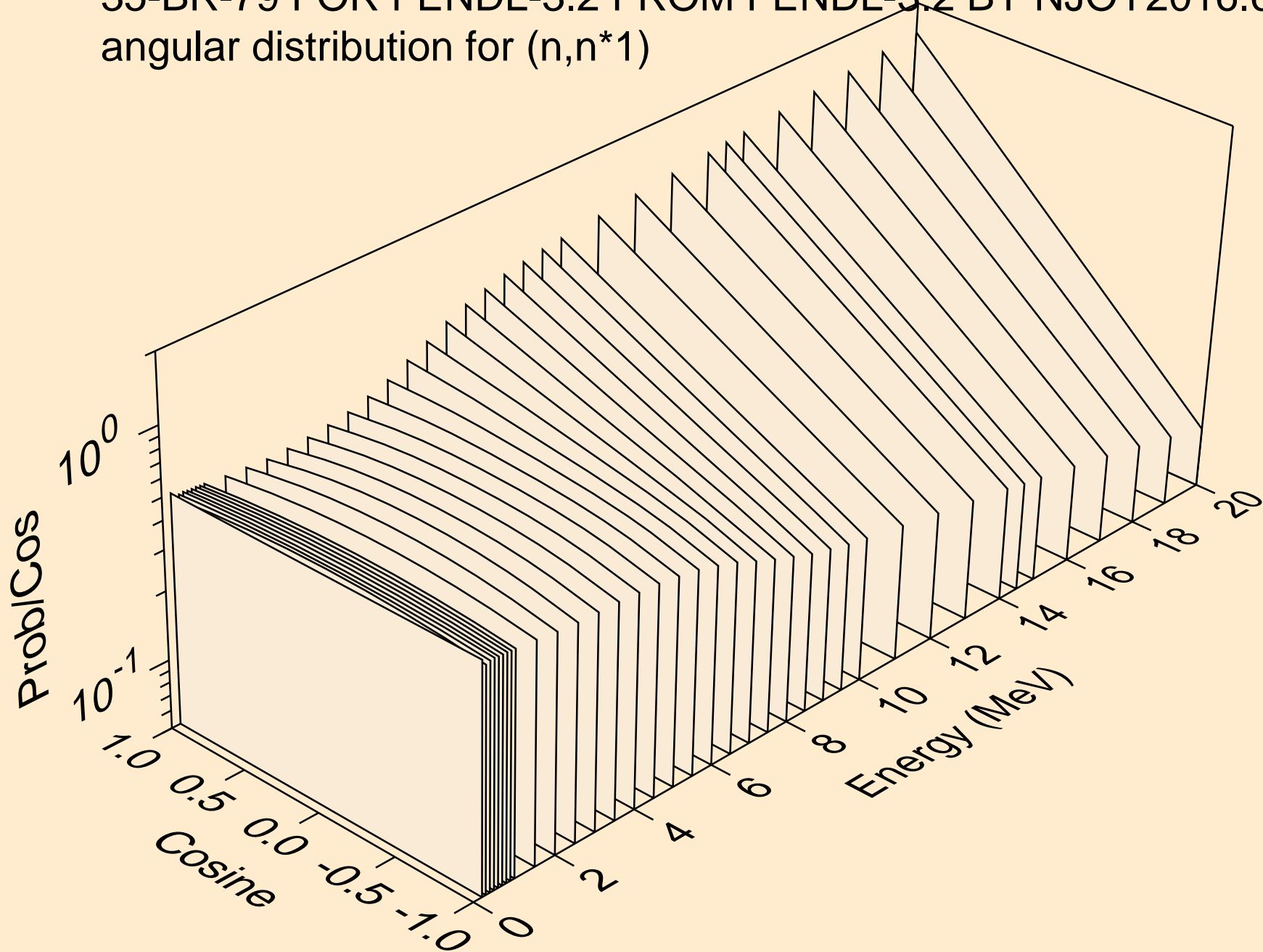

35-BR-79 FOR FENDL-3.2 FROM FENDL-3.2 BY NJOY2016.60+ O
angular distribution for (n,n*2)

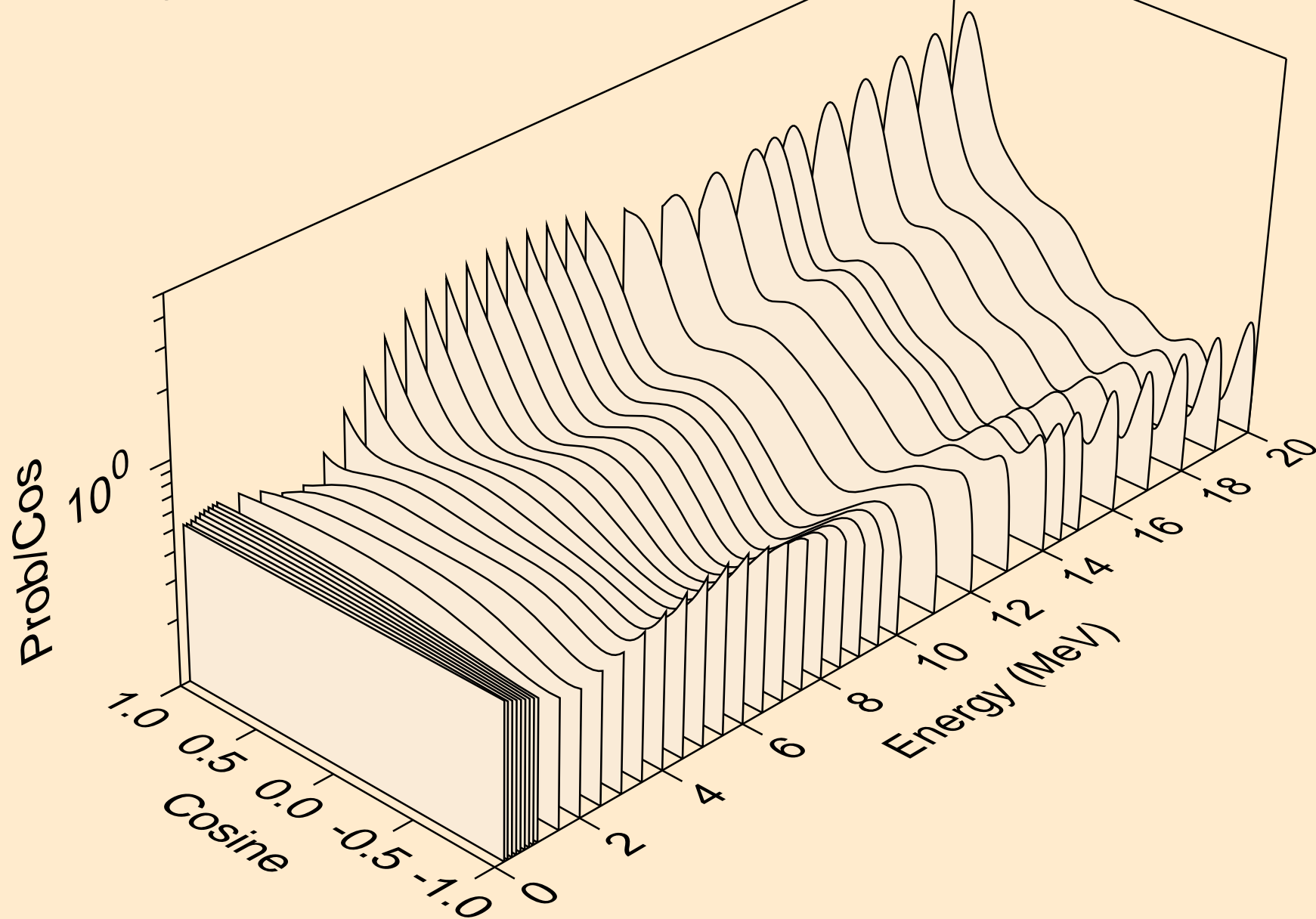

35-BR-79 FOR FENDL-3.2 FROM FENDL-3.2 BY NJOY2016.60+ O
angular distribution for (n,n*3)

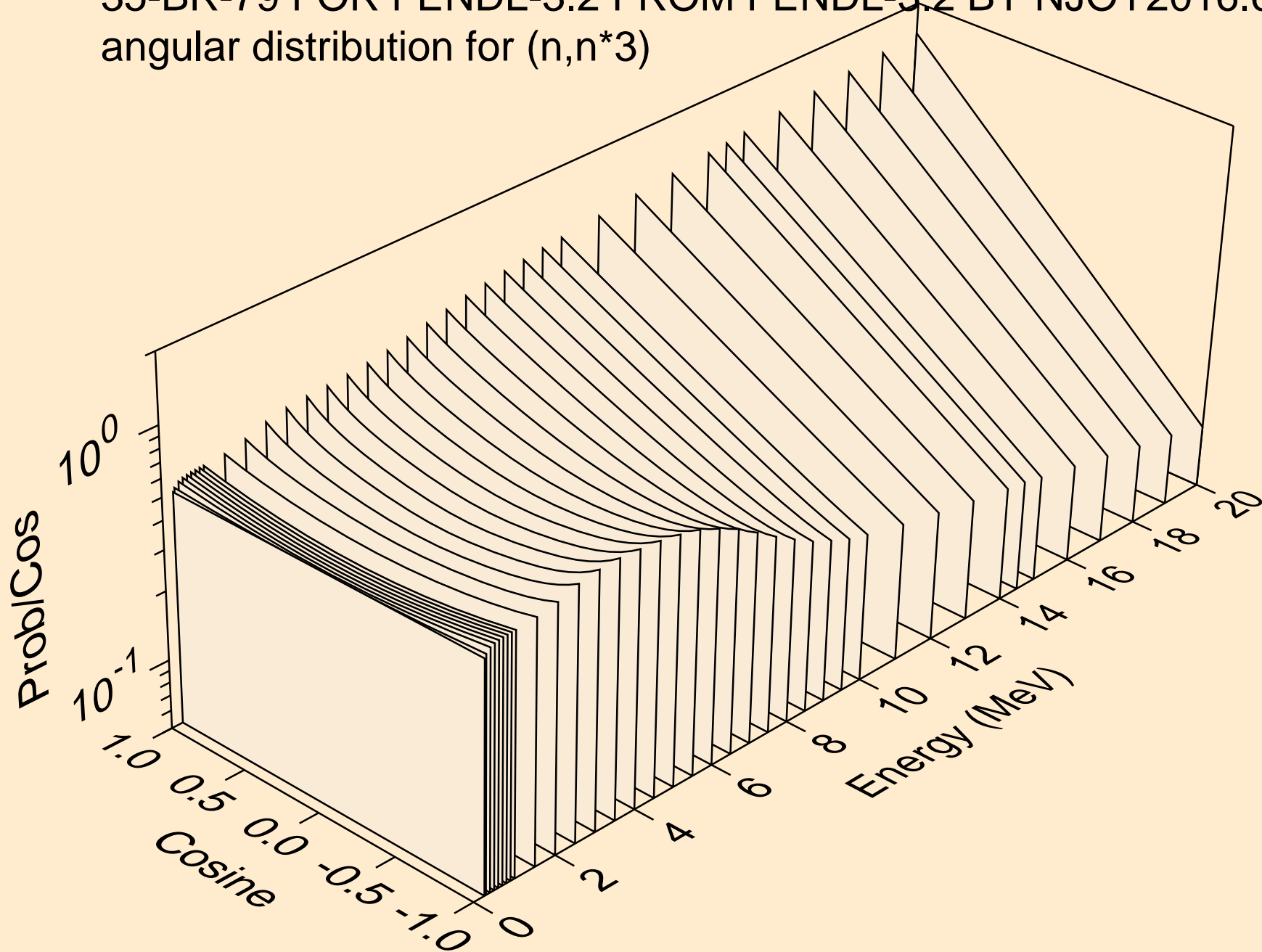

35-BR-79 FOR FENDL-3.2 FROM FENDL-3.2 BY NJOY2016.60+ O
angular distribution for (n,n*4)

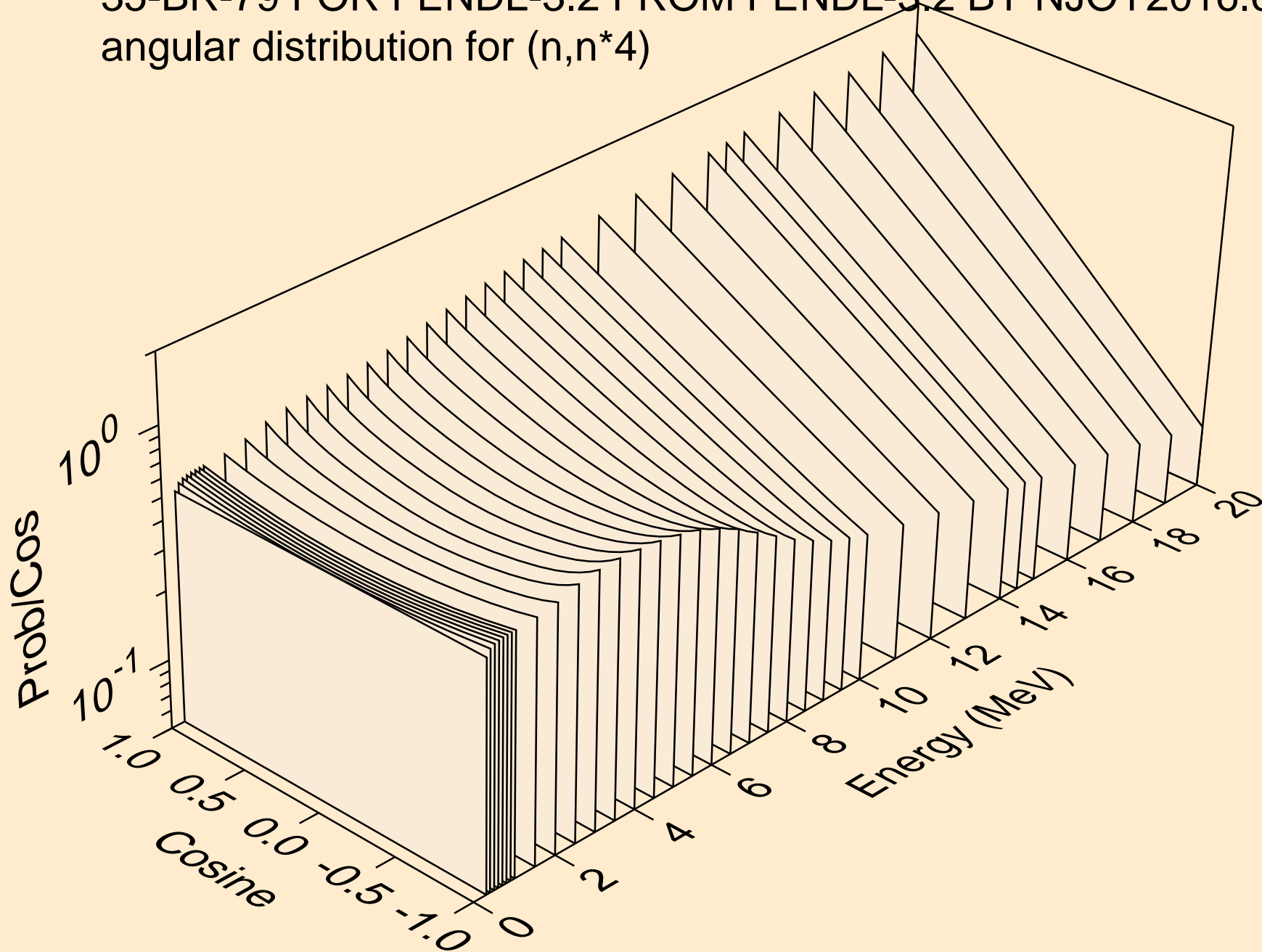

35-BR-79 FOR FENDL-3.2 FROM FENDL-3.2 BY NJOY2016.60+ O
angular distribution for (n,n*5)

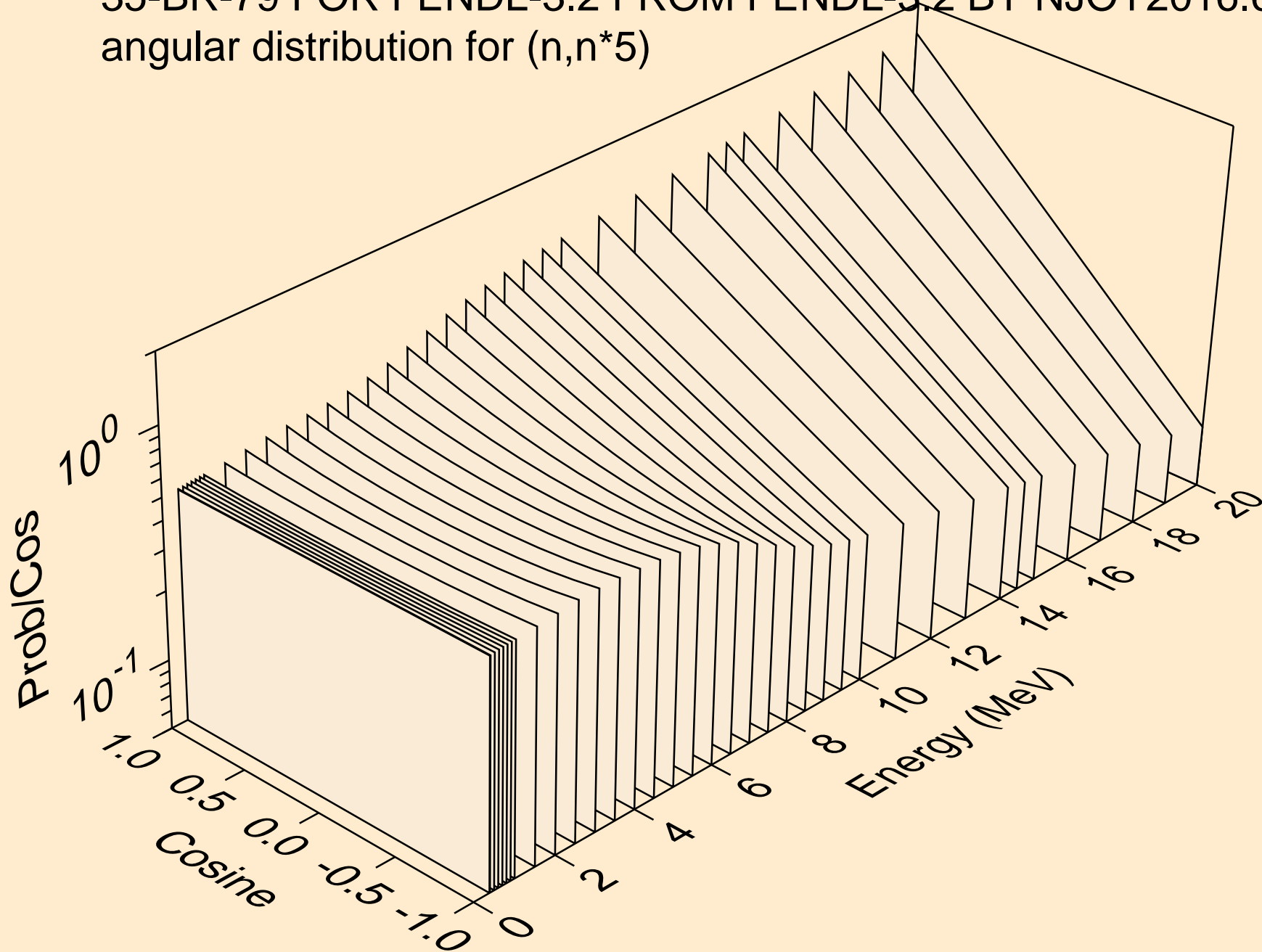

35-BR-79 FOR FENDL-3.2 FROM FENDL-3.2 BY NJOY2016.60+ O
angular distribution for (n,n*6)

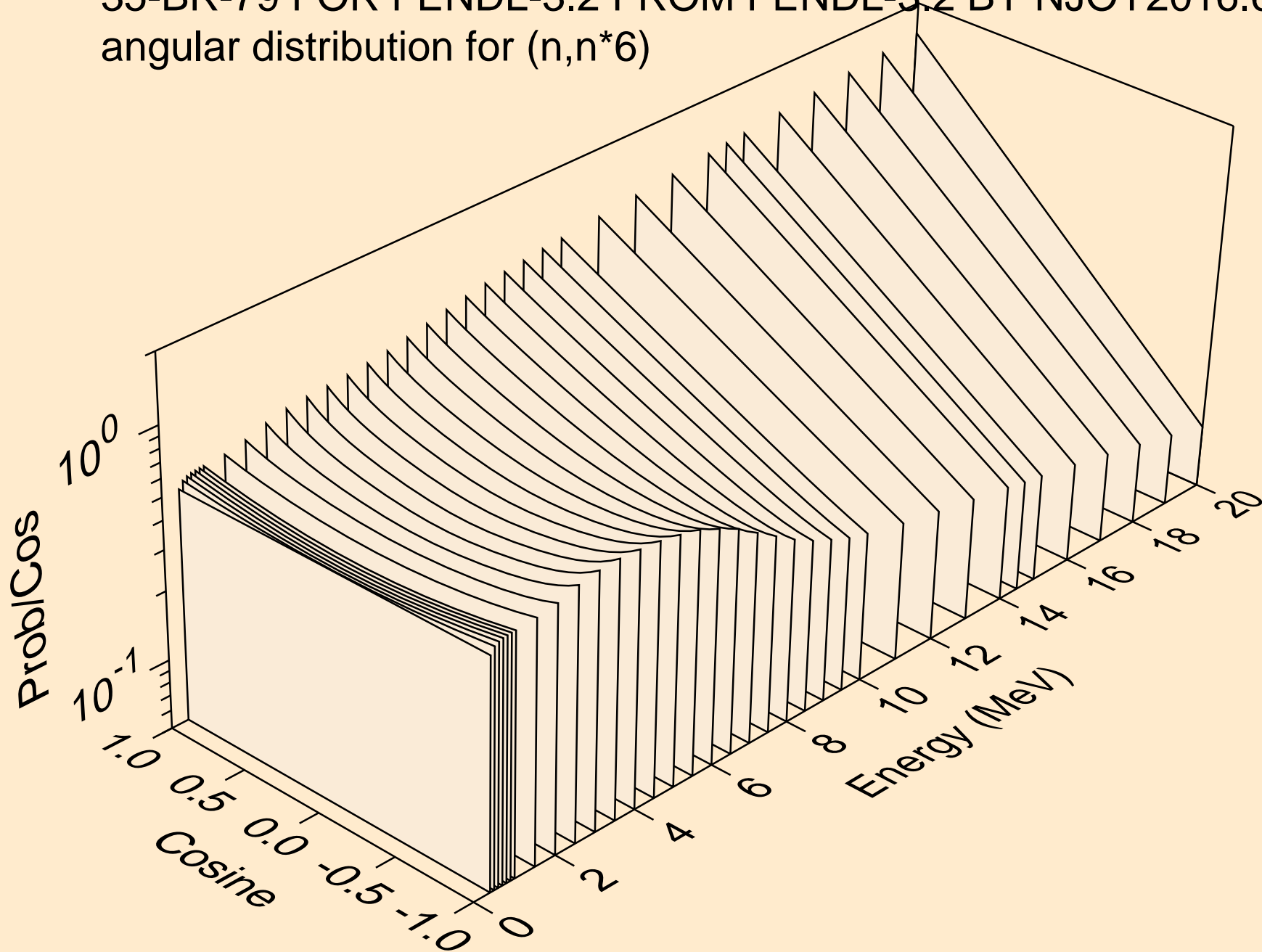

35-BR-79 FOR FENDL-3.2 FROM FENDL-3.2 BY NJOY2016.60+ O
angular distribution for (n,n*7)

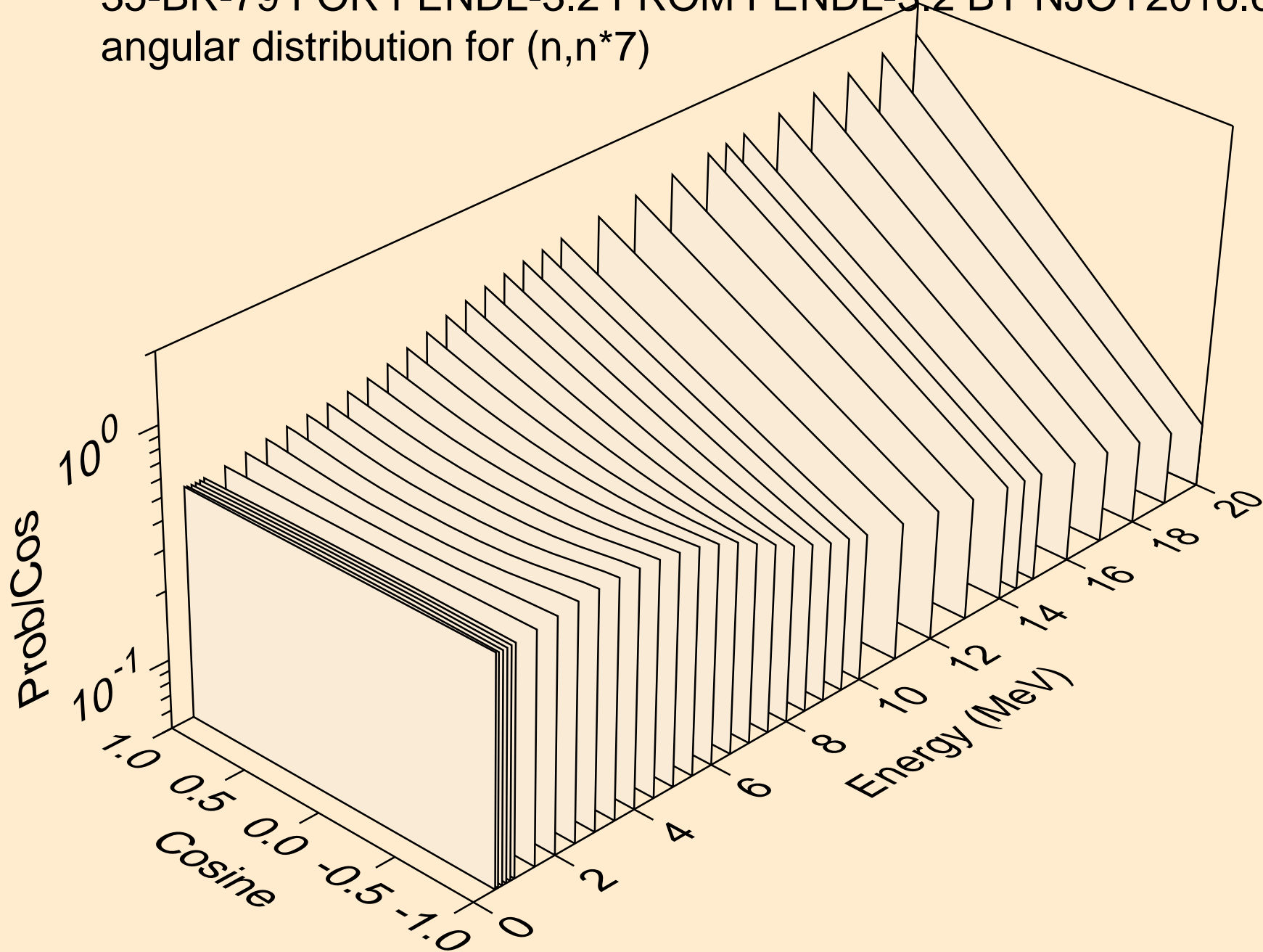

35-BR-79 FOR FENDL-3.2 FROM FENDL-3.2 BY NJOY2016.60+ O
angular distribution for (n,n*8)

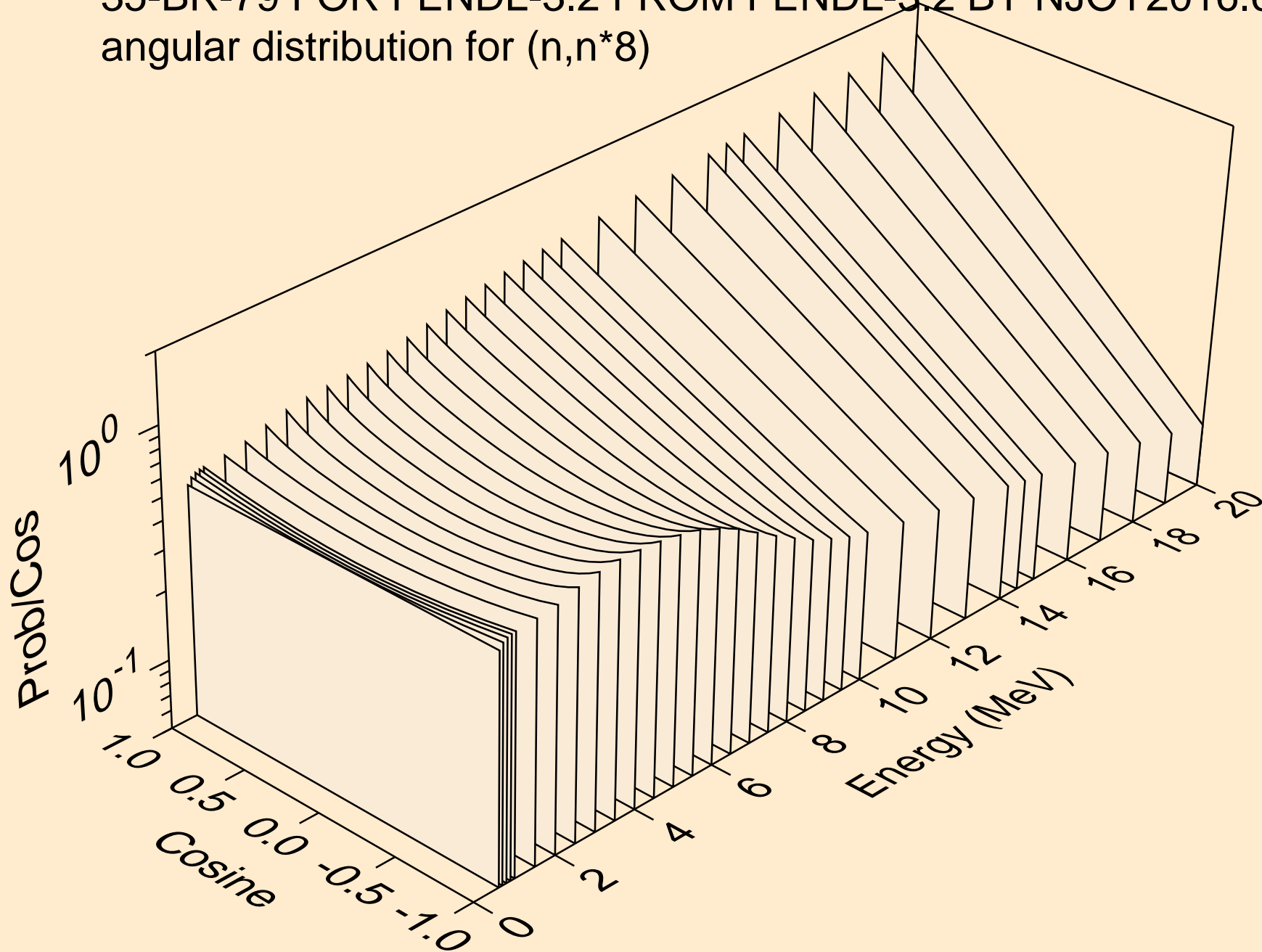

35-BR-79 FOR FENDL-3.2 FROM FENDL-3.2 BY NJOY2016.60+ O
angular distribution for (n,n*9)

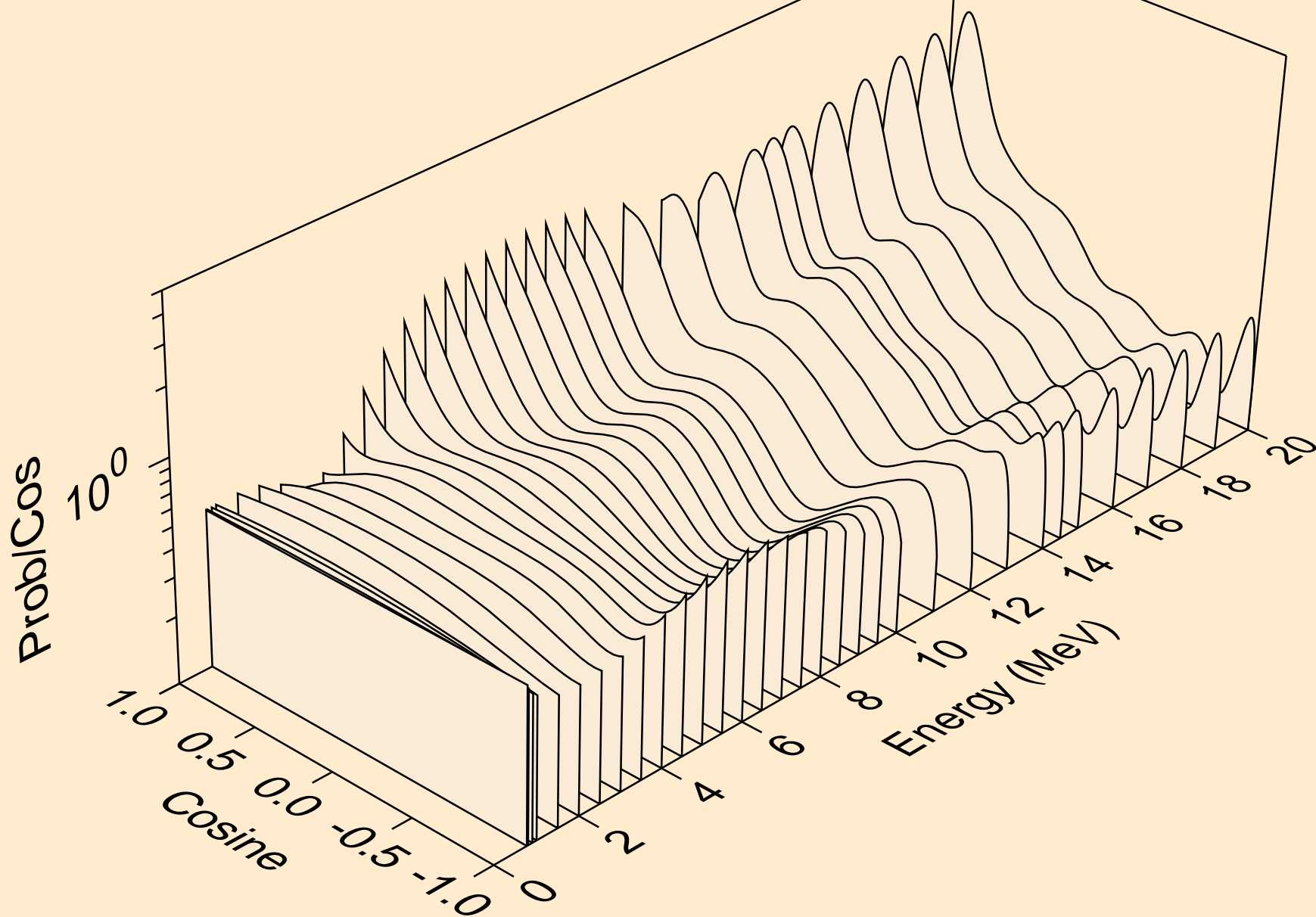

35-BR-79 FOR FENDL-3.2 FROM FENDL-3.2 BY NJOY2016.60+ O
angular distribution for (n,n*10)

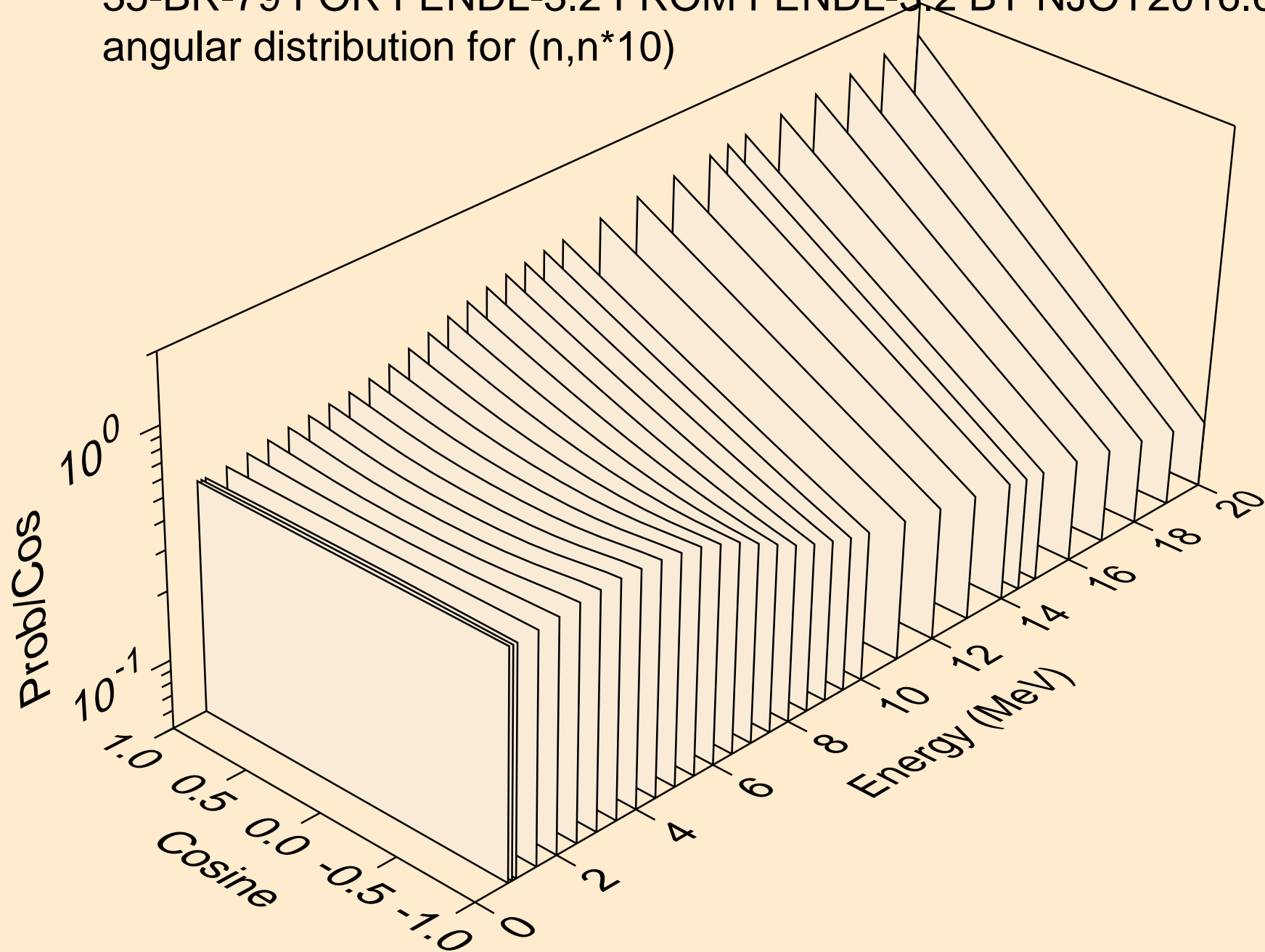

35-BR-79 FOR FENDL-3.2 FROM FENDL-3.2 BY NJOY2016.60+ O
angular distribution for (n,n*11)

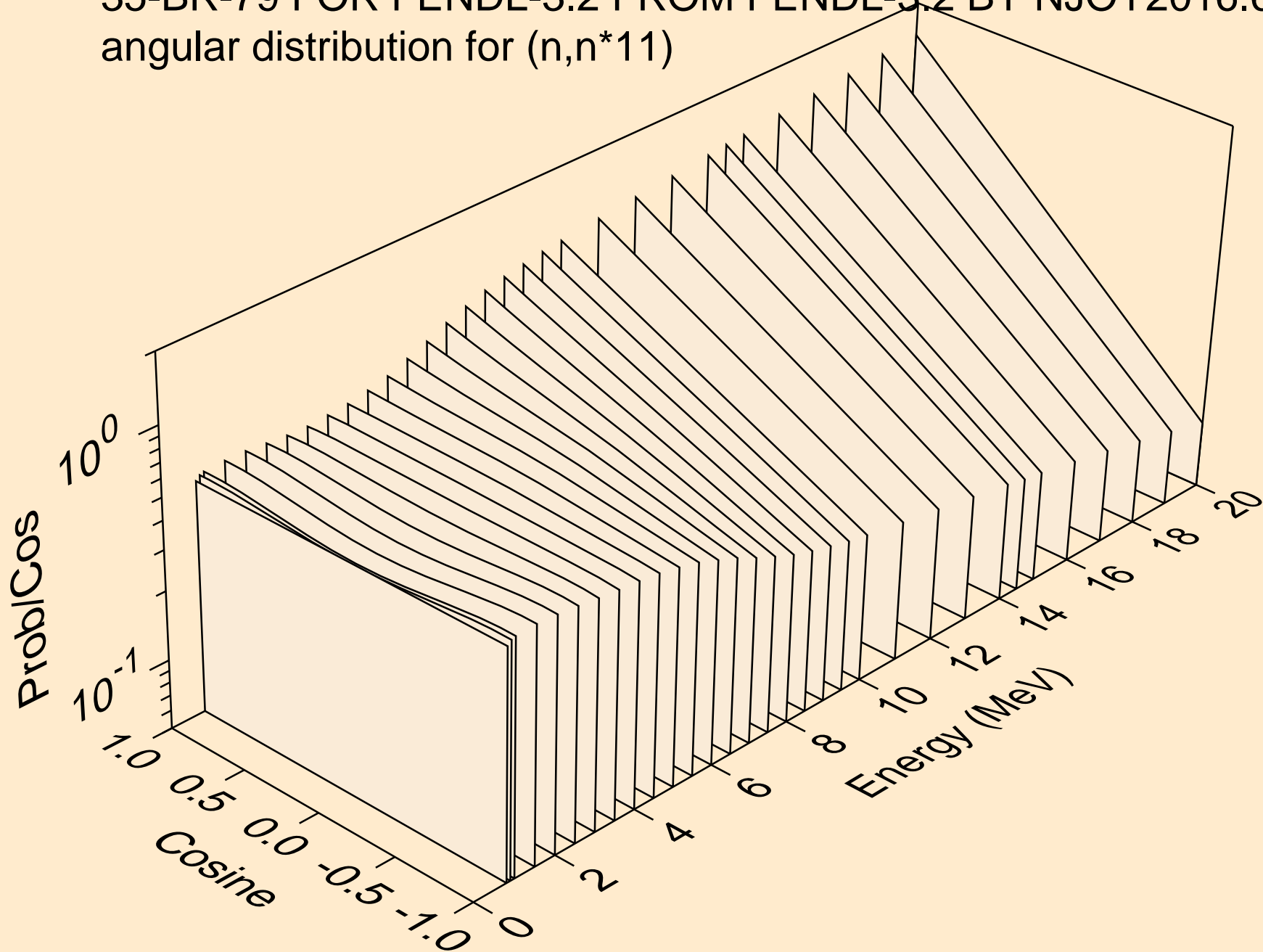

35-BR-79 FOR FENDL-3.2 FROM FENDL-3.2 BY NJOY2016.60+ O
angular distribution for (n,n*12)

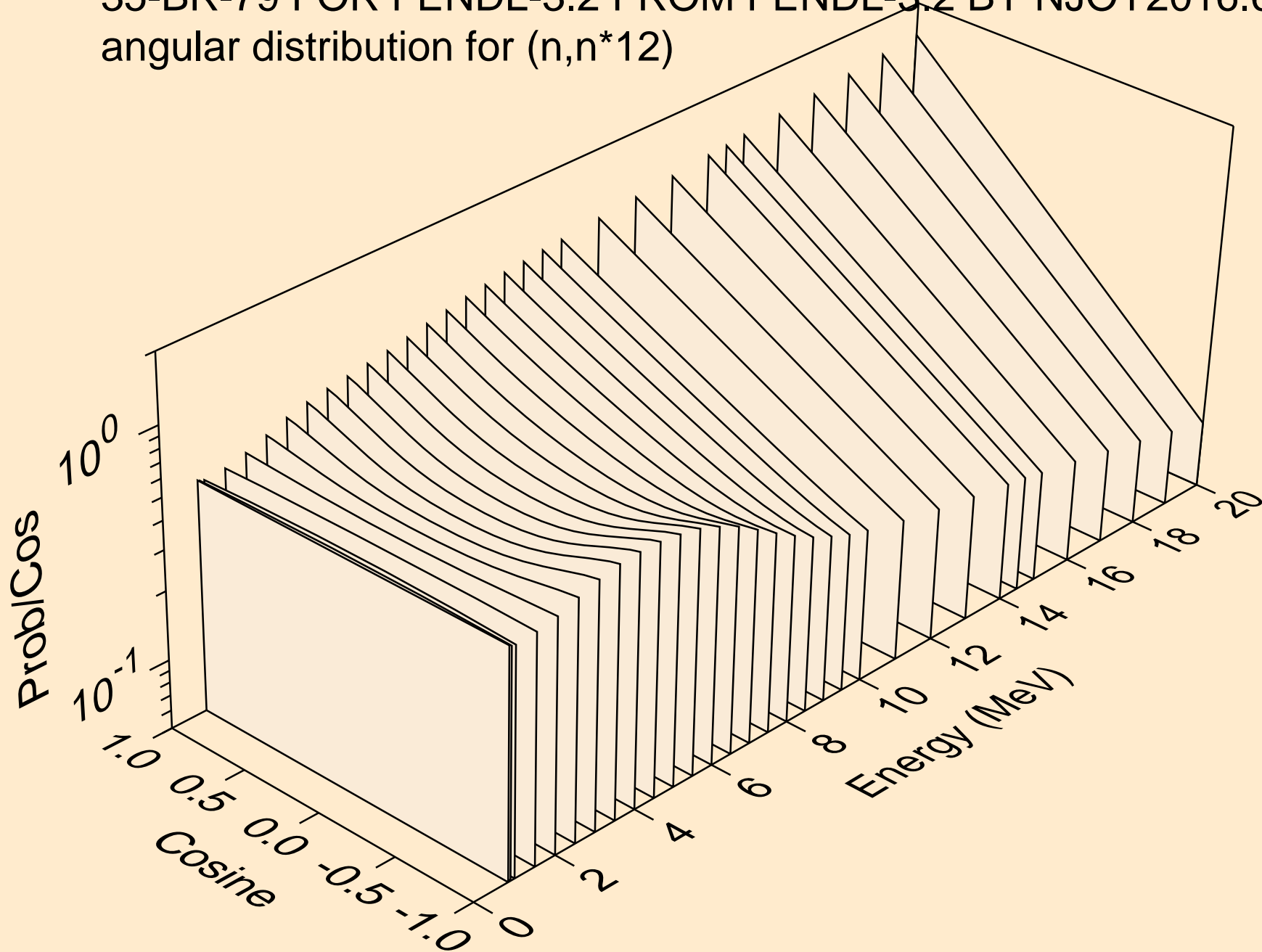

35-BR-79 FOR FENDL-3.2 FROM FENDL-3.2 BY NJOY2016.60+ O
angular distribution for (n,n*13)

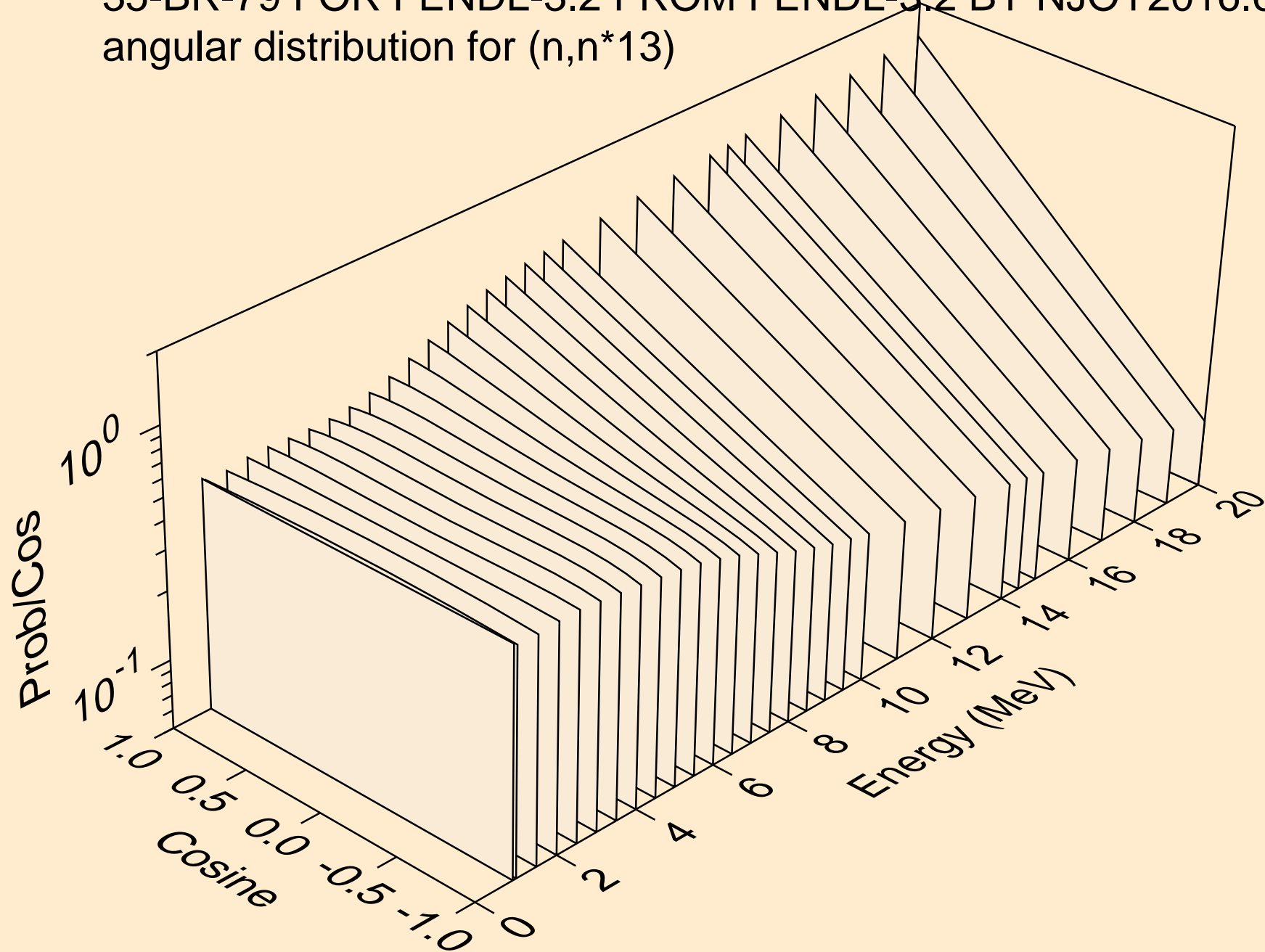

35-BR-79 FOR FENDL-3.2 FROM FENDL-3.2 BY NJOY2016.60+ O
angular distribution for (n,n*14)

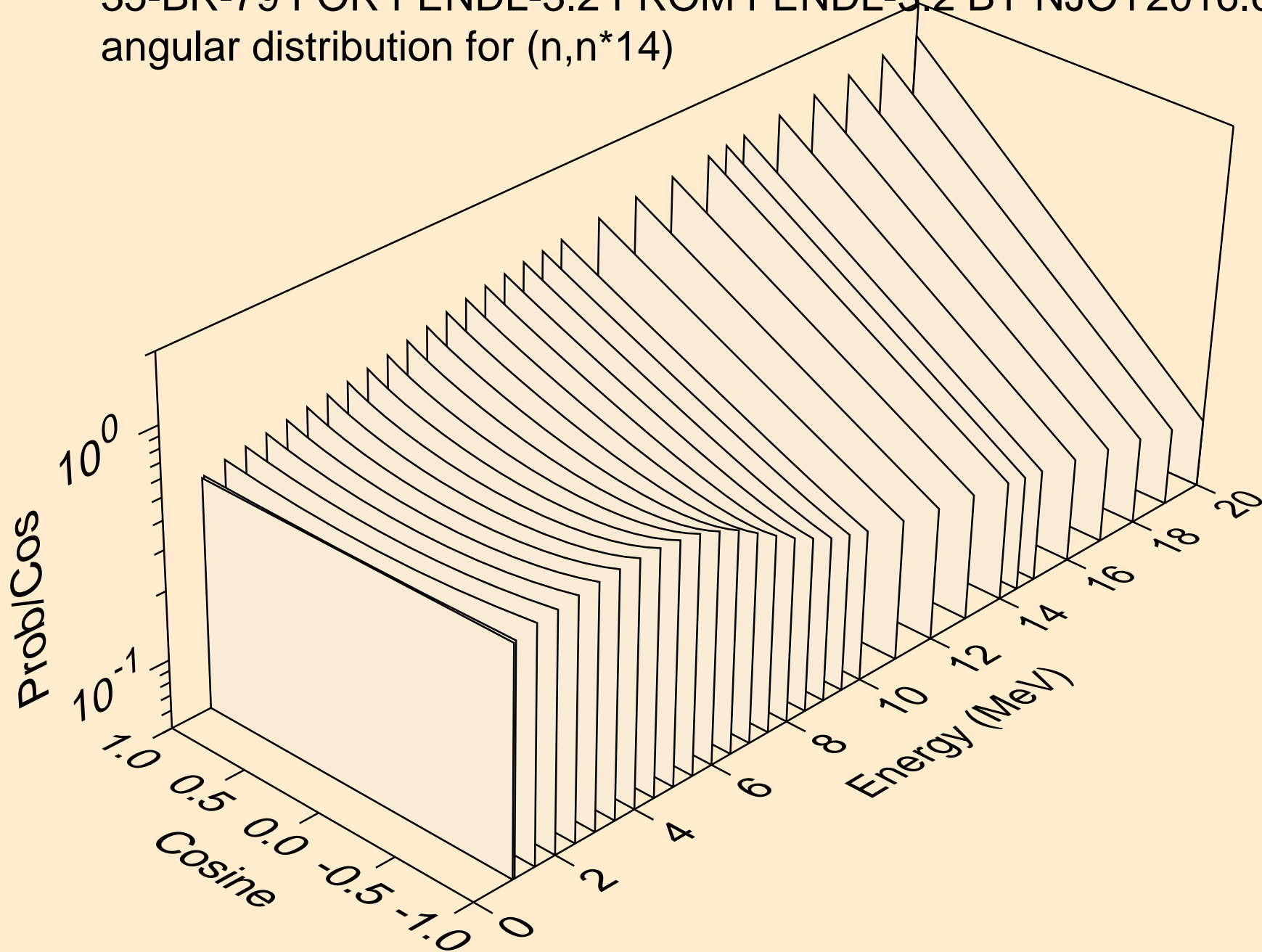

35-BR-79 FOR FENDL-3.2 FROM FENDL-3.2 BY NJOY2016.60+ O
angular distribution for (n,n*15)

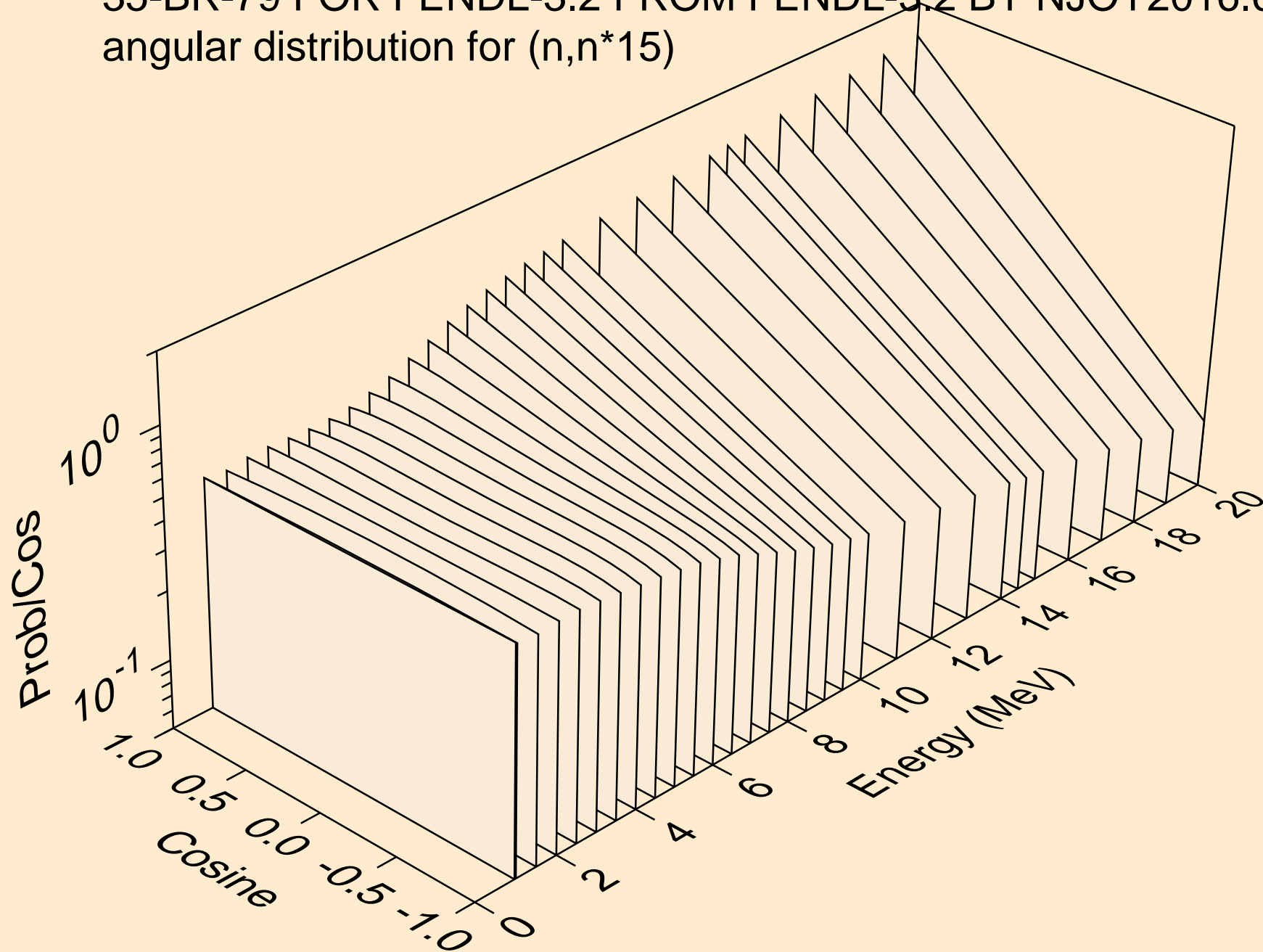

35-BR-79 FOR FENDL-3.2 FROM FENDL-3.2 BY NJOY2016.60+ O
angular distribution for (n,n*16)

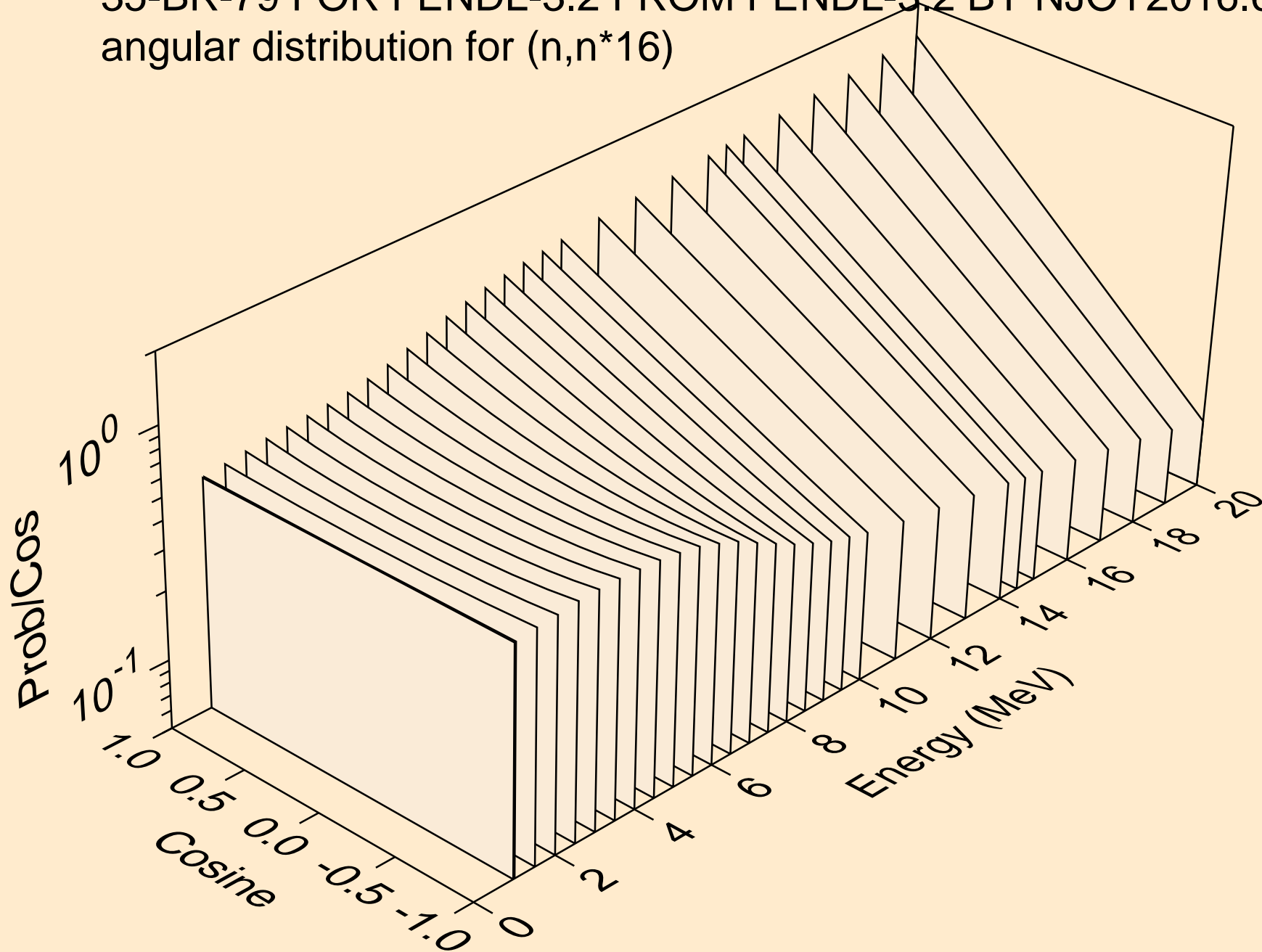

35-BR-79 FOR FENDL-3.2 FROM FENDL-3.2 BY NJOY2016.60+ O
angular distribution for (n,n*17)

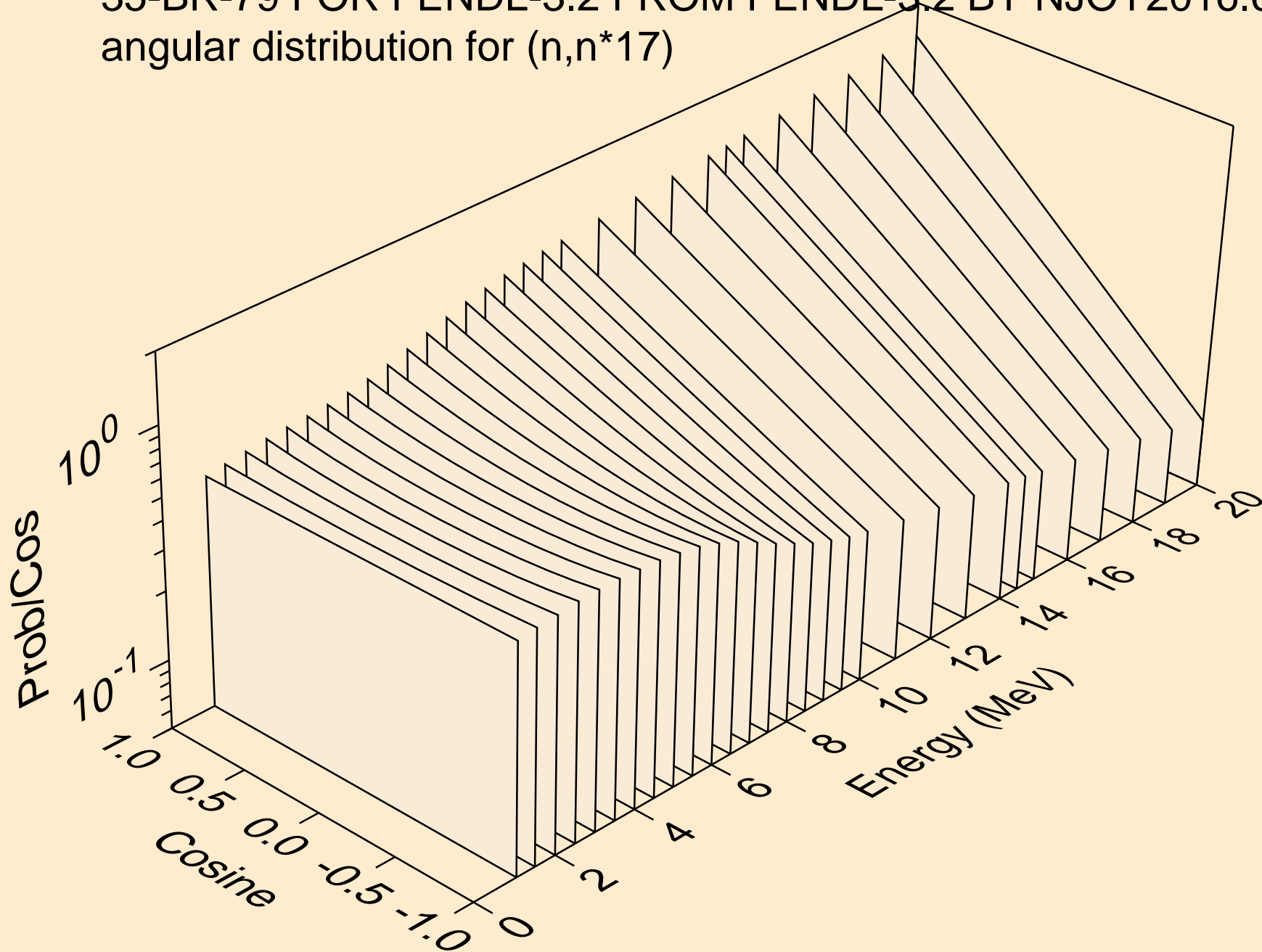

35-BR-79 FOR FENDL-3.2 FROM FENDL-3.2 BY NJOY2016.60+ O
angular distribution for (n,n*18)

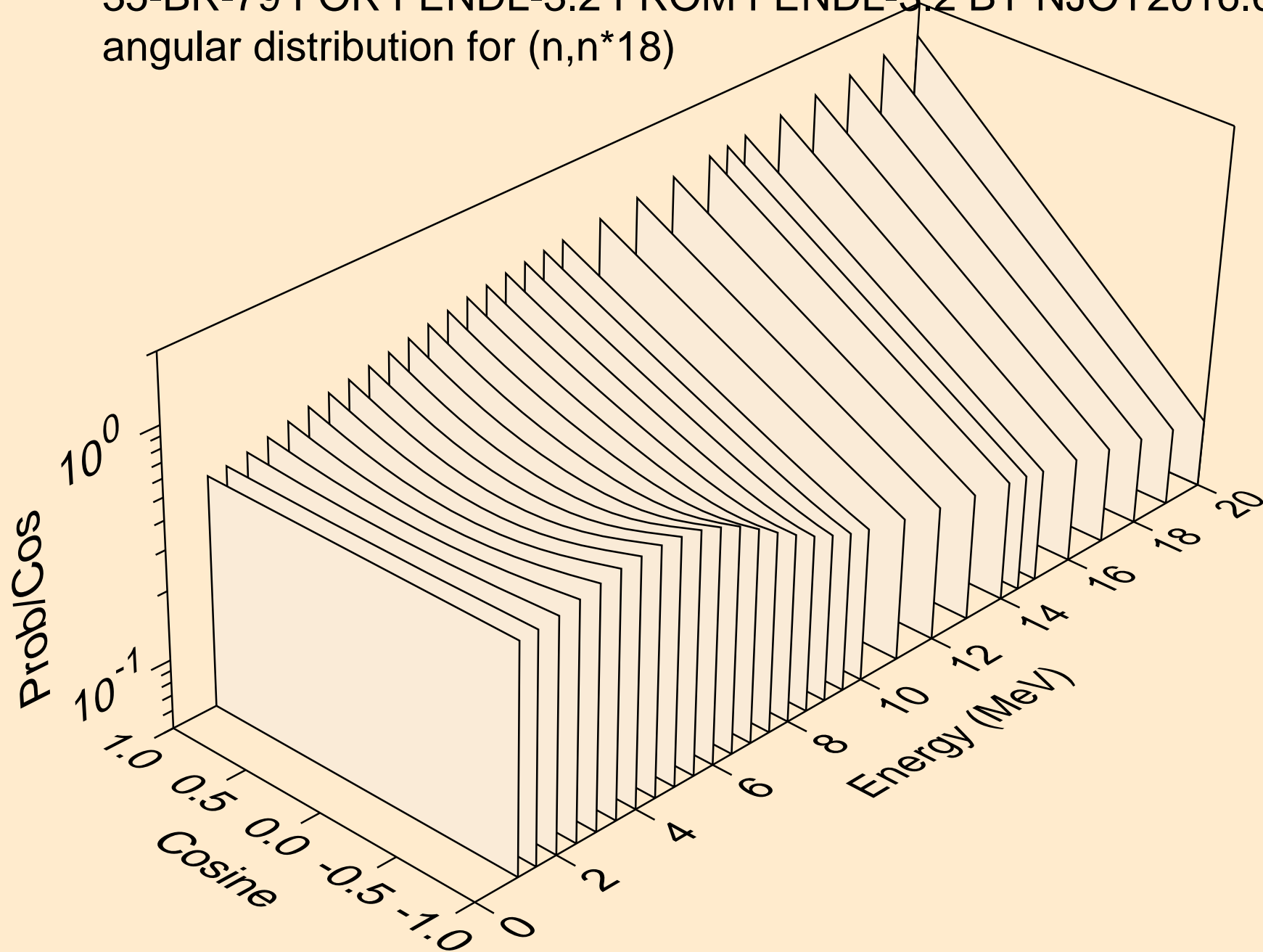

35-BR-79 FOR FENDL-3.2 FROM FENDL-3.2 BY NJOY2016.60+ O
angular distribution for (n,n*19)

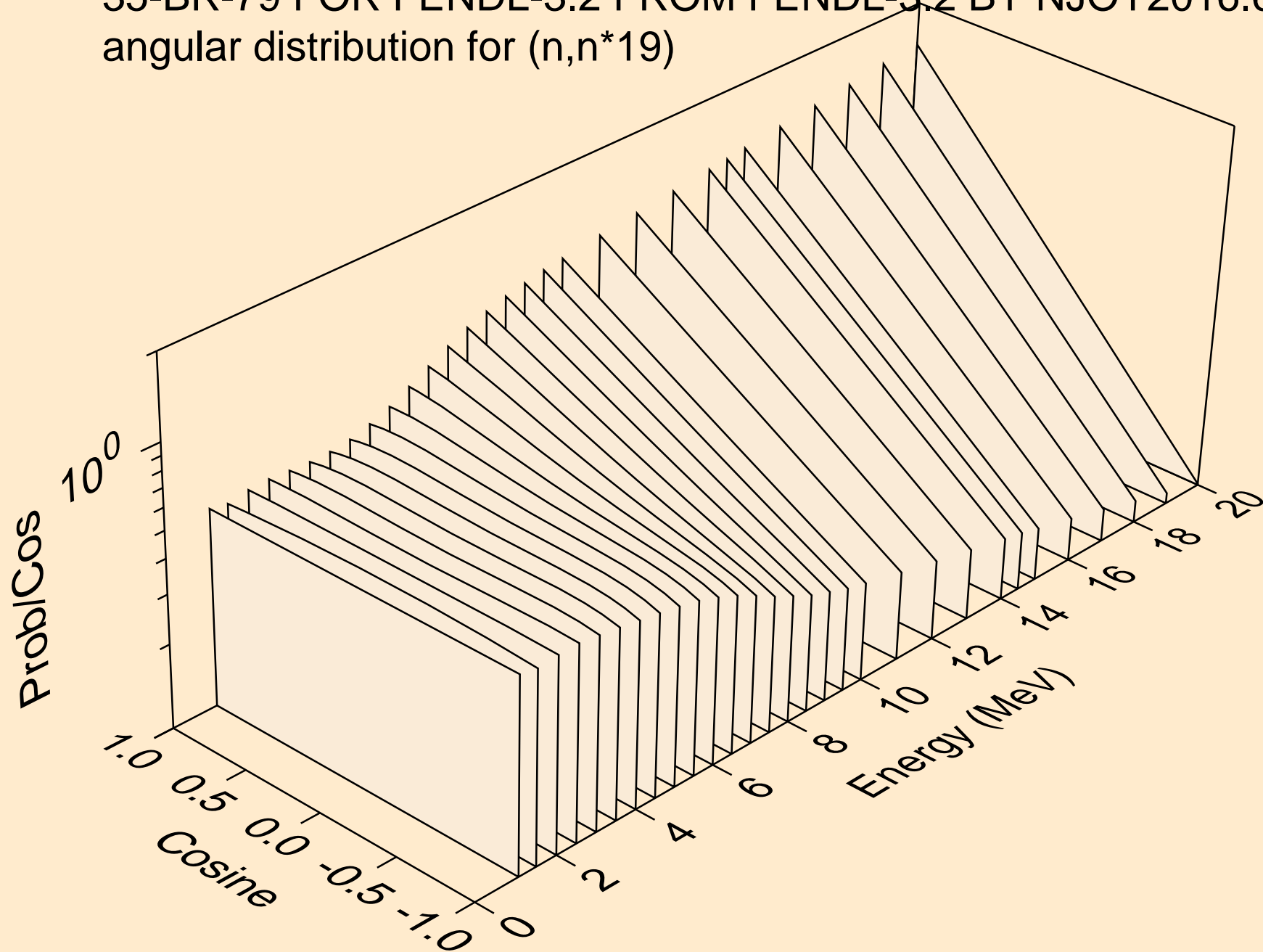

35-BR-79 FOR FENDL-3.2 FROM FENDL-3.2 BY NJOY2016.60+ O
angular distribution for (n,n*20)

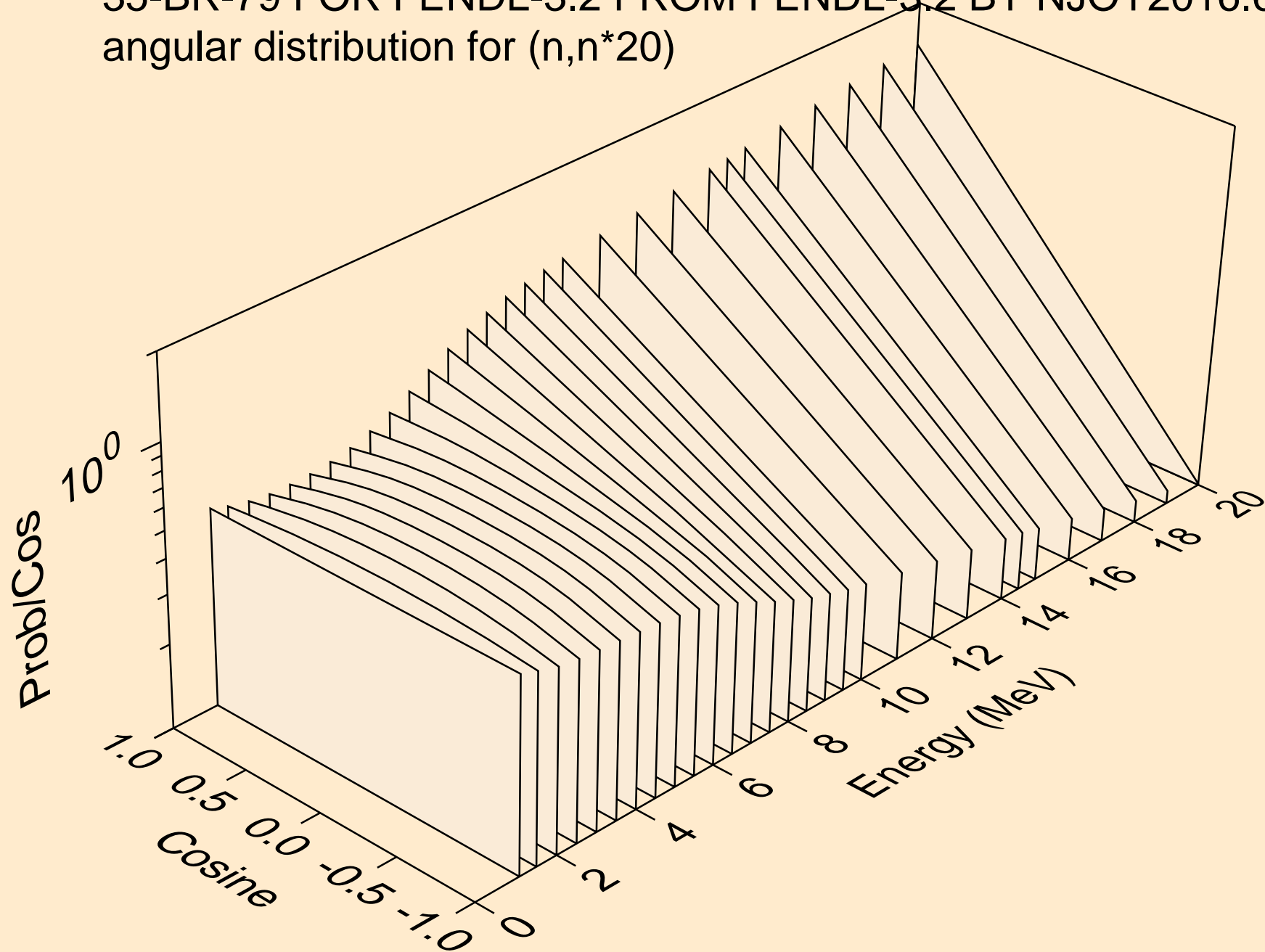

35-BR-79 FOR FENDL-3.2 FROM FENDL-3.2 BY NJOY2016.60+ O
angular distribution for (n,n*21)

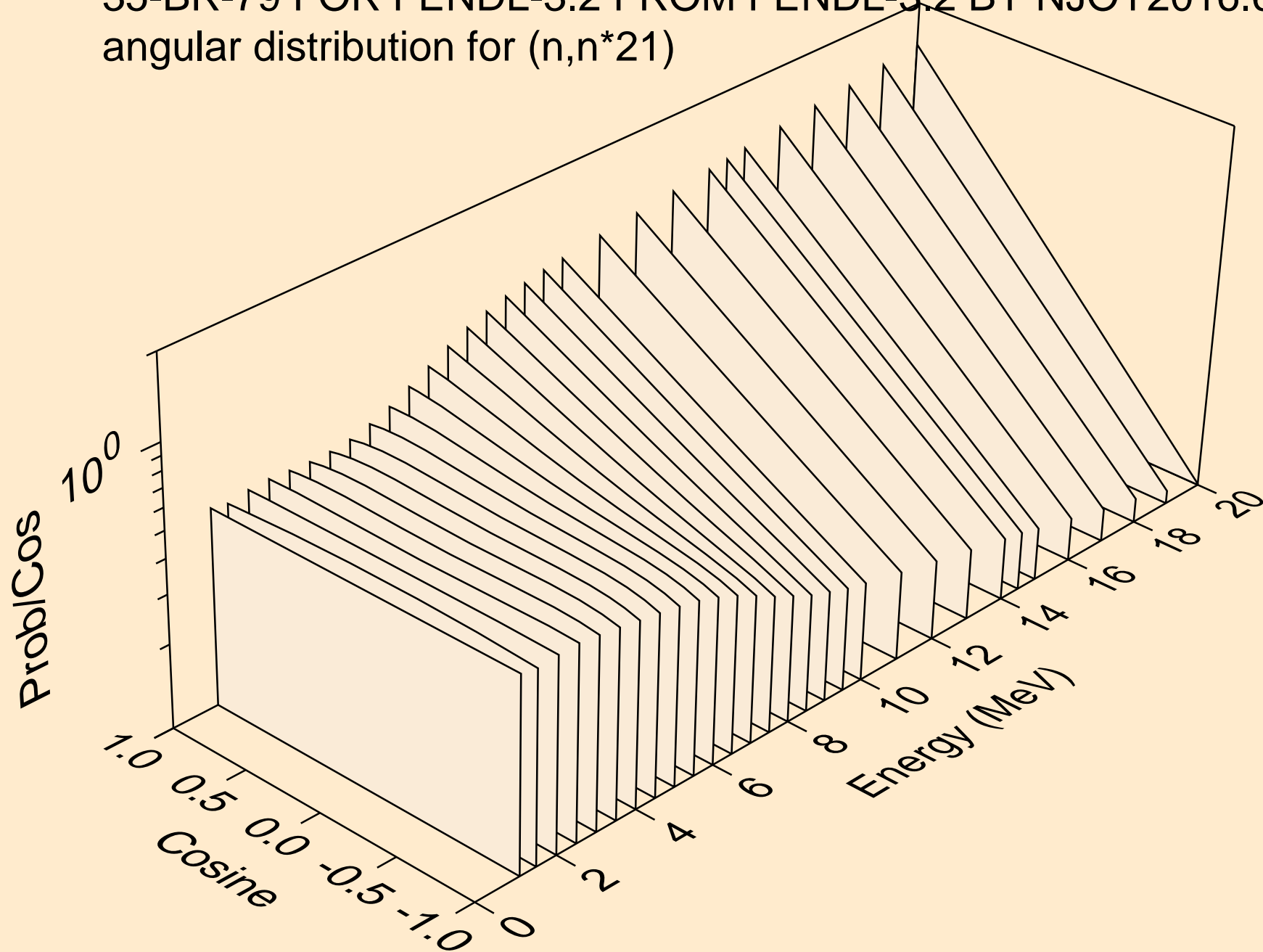

35-BR-79 FOR FENDL-3.2 FROM FENDL-3.2 BY NJOY2016.60+ O
angular distribution for (n,n*22)

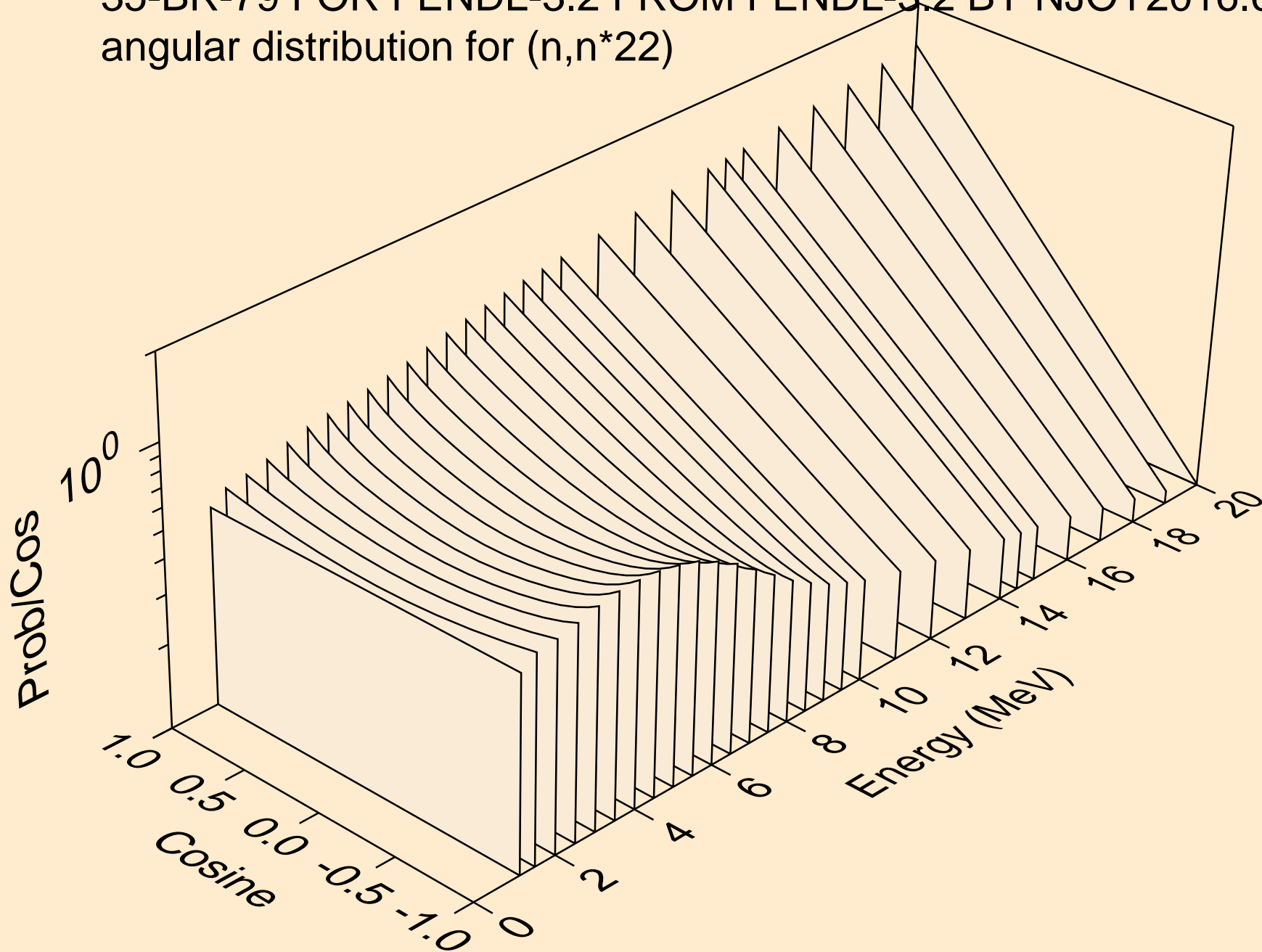

35-BR-79 FOR FENDL-3.2 FROM FENDL-3.2 BY NJOY2016.60+ O
angular distribution for (n,n*23)

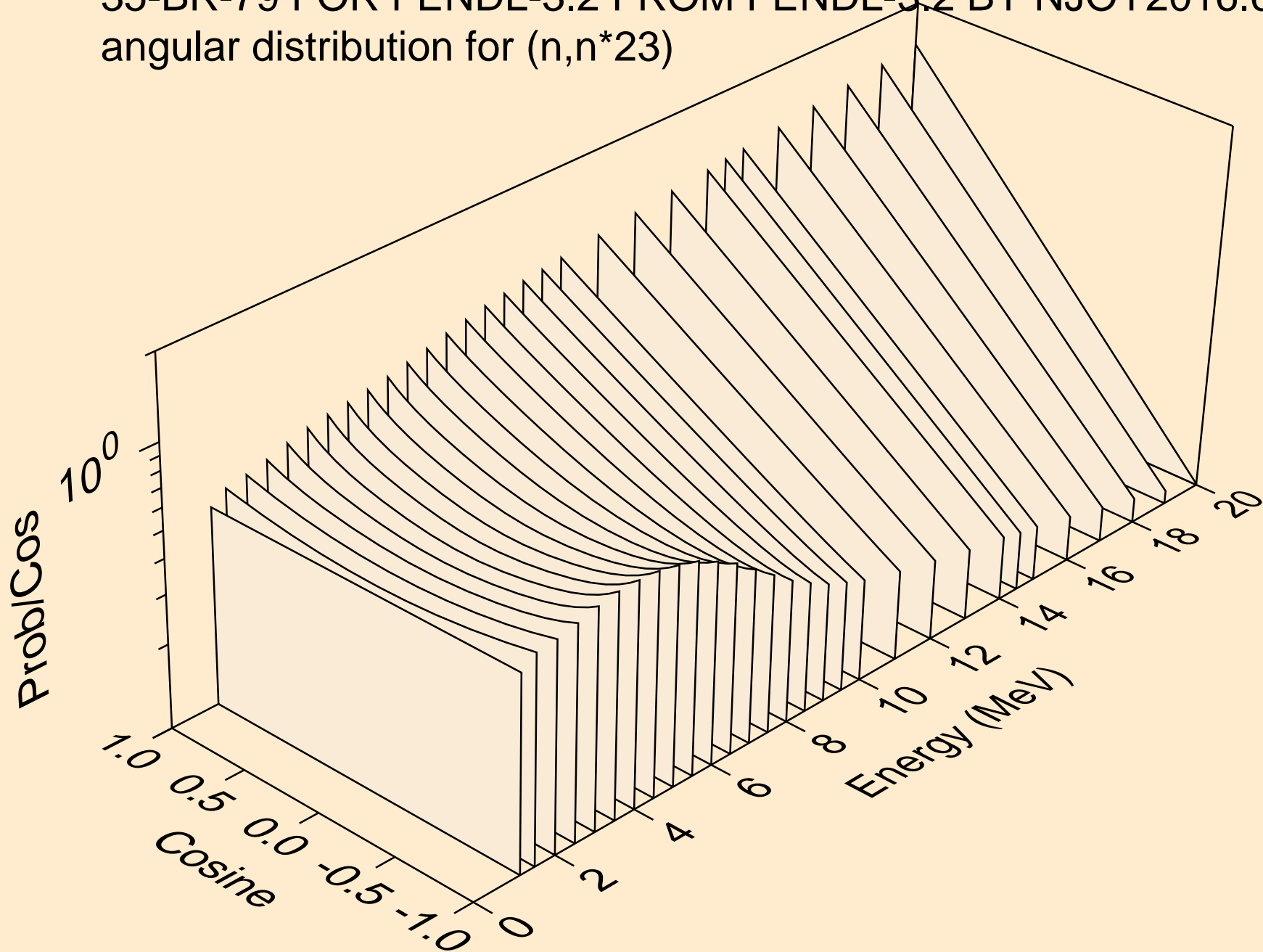

35-BR-79 FOR FENDL-3.2 FROM FENDL-3.2 BY NJOY2016.60+ O
angular distribution for (n,n*24)

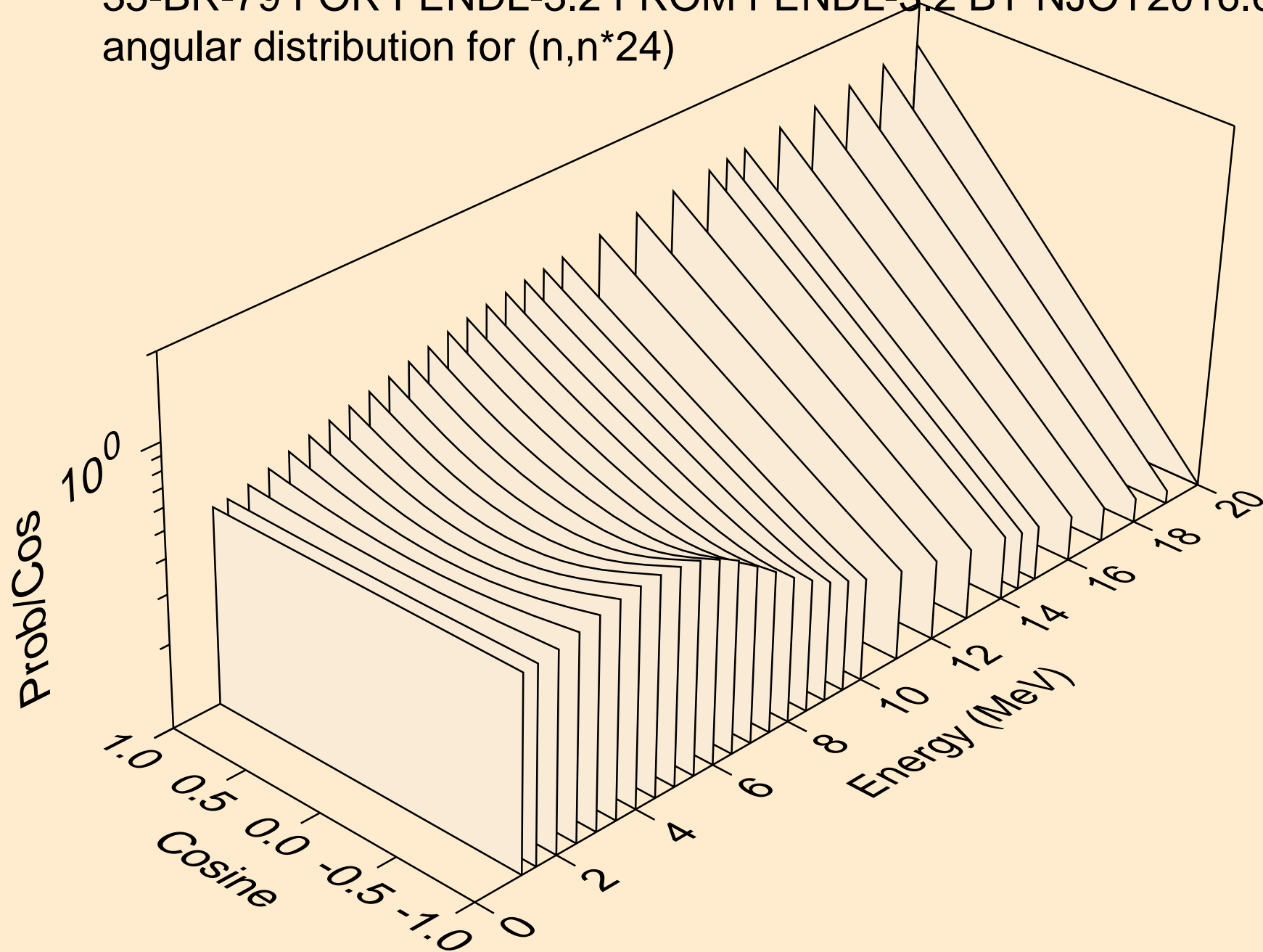

35-BR-79 FOR FENDL-3.2 FROM FENDL-3.2 BY NJOY2016.60+ O
angular distribution for (n,n*25)

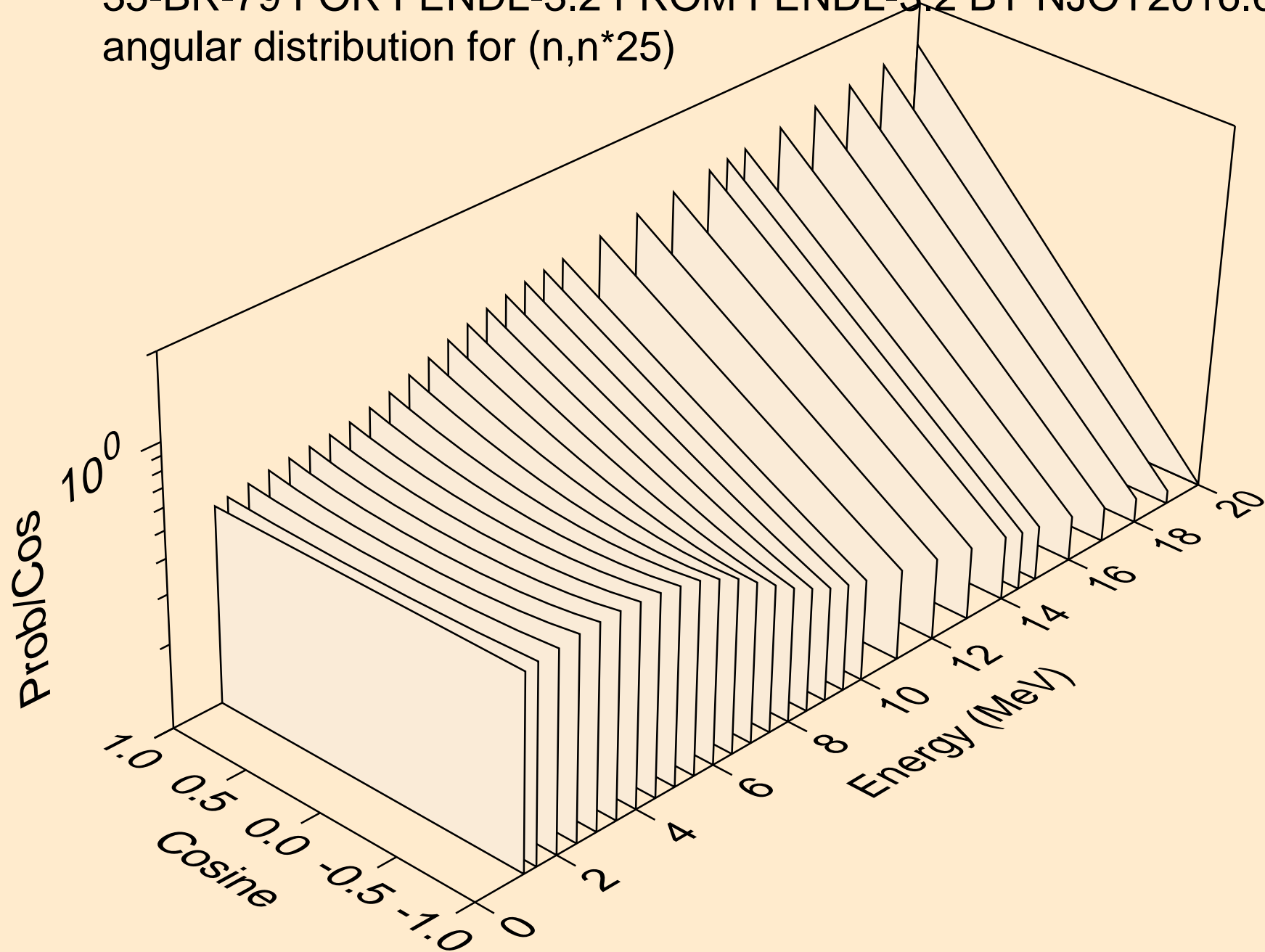

35-BR-79 FOR FENDL-3.2 FROM FENDL-3.2 BY NJOY2016.60+ O
angular distribution for (n,n*26)

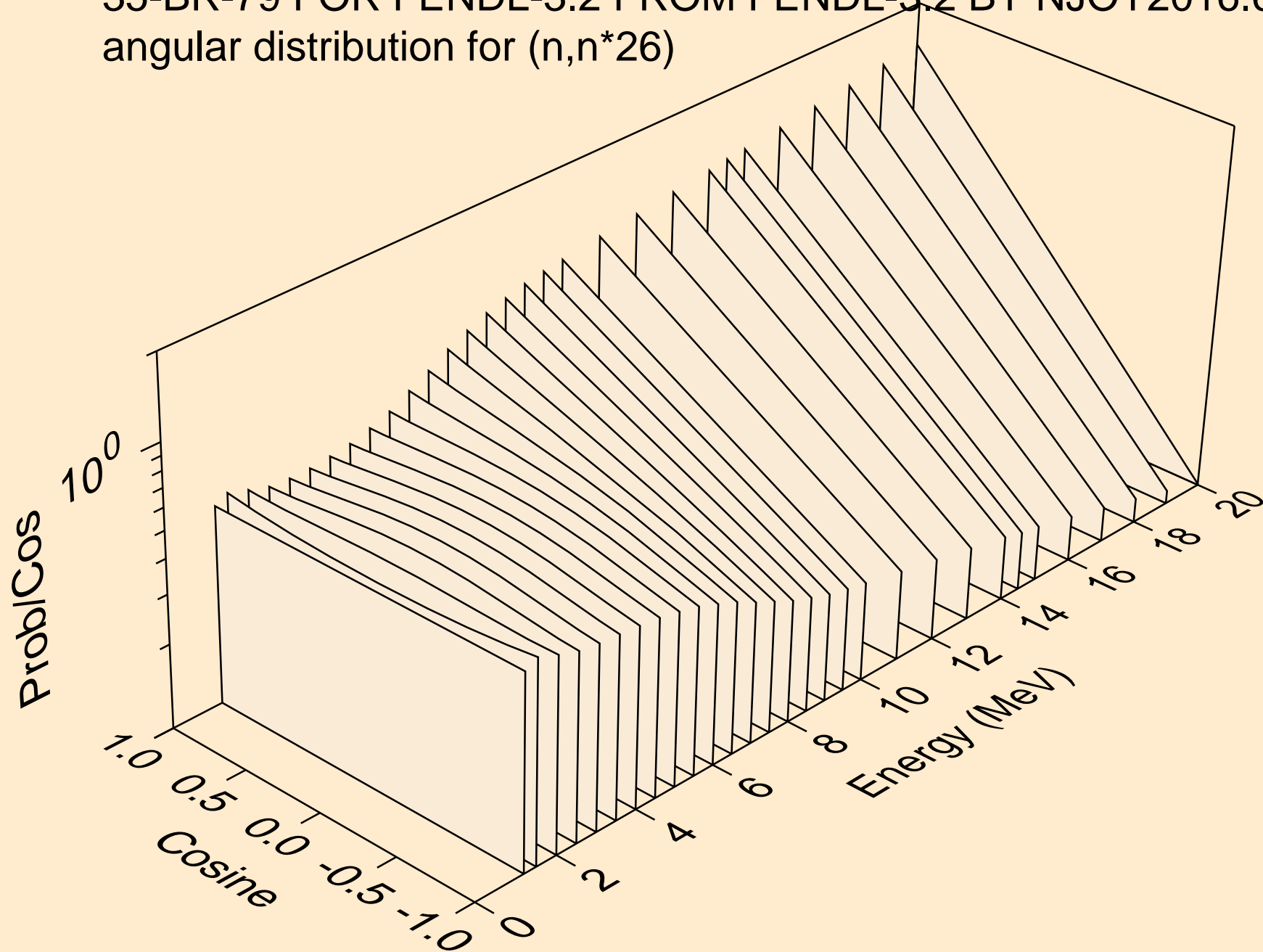

35-BR-79 FOR FENDL-3.2 FROM FENDL-3.2 BY NJOY2016.60+ O
angular distribution for (n,n*27)

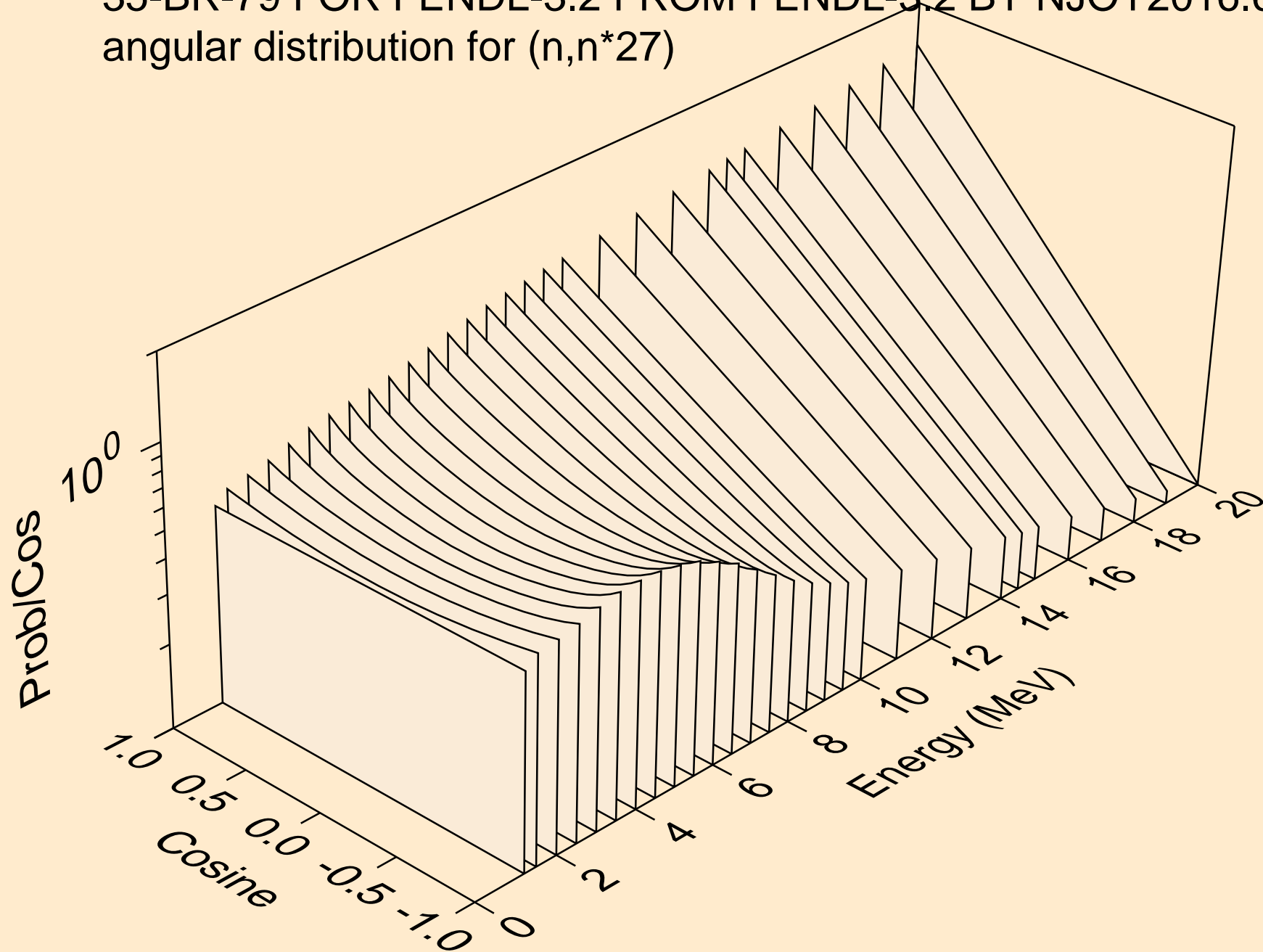

35-BR-79 FOR FENDL-3.2 FROM FENDL-3.2 BY NJOY2016.60+ O
angular distribution for (n,n*28)

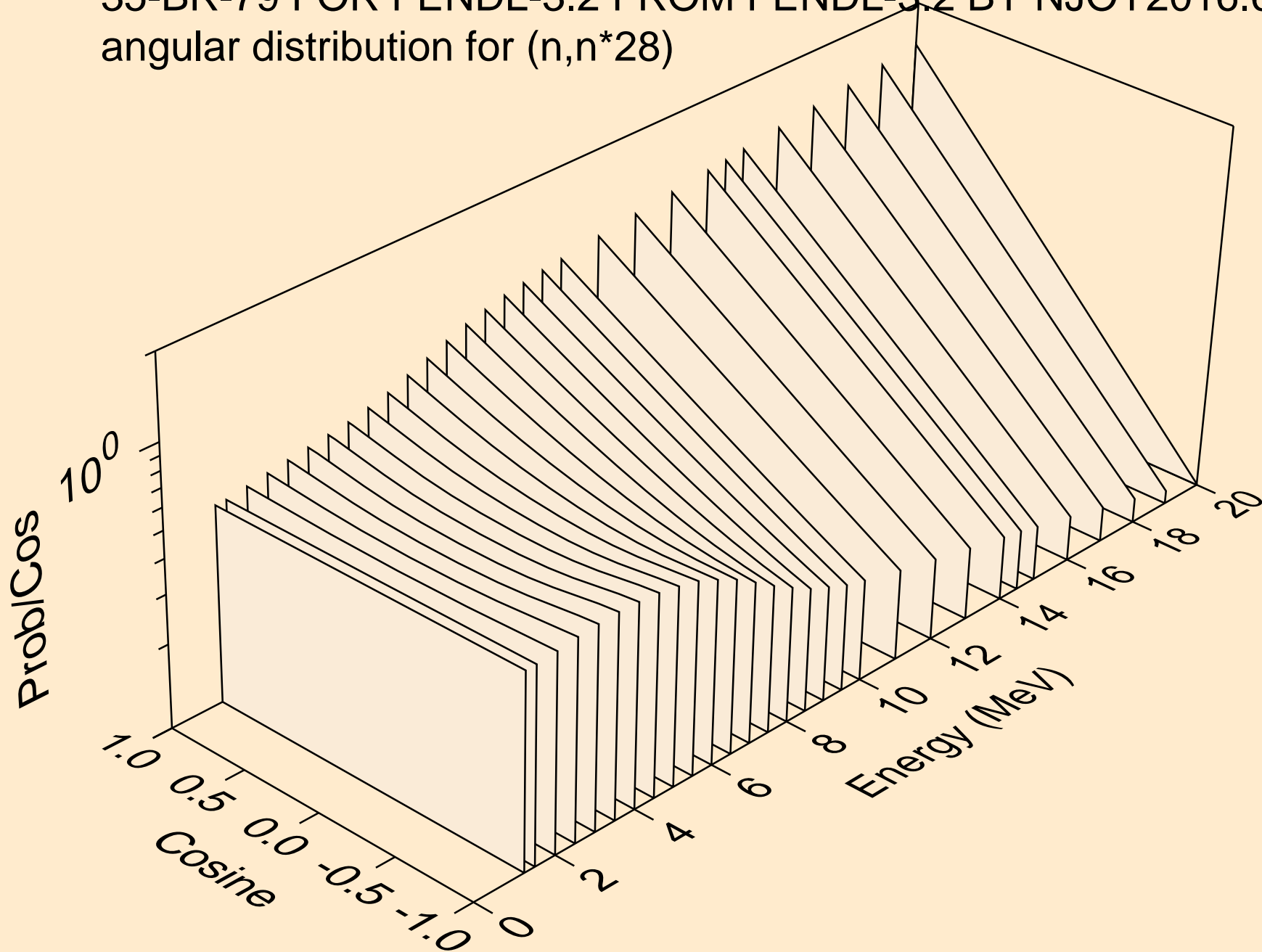

35-BR-79 FOR FENDL-3.2 FROM FENDL-3.2 BY NJOY2016.60+ O
angular distribution for (n,n*29)

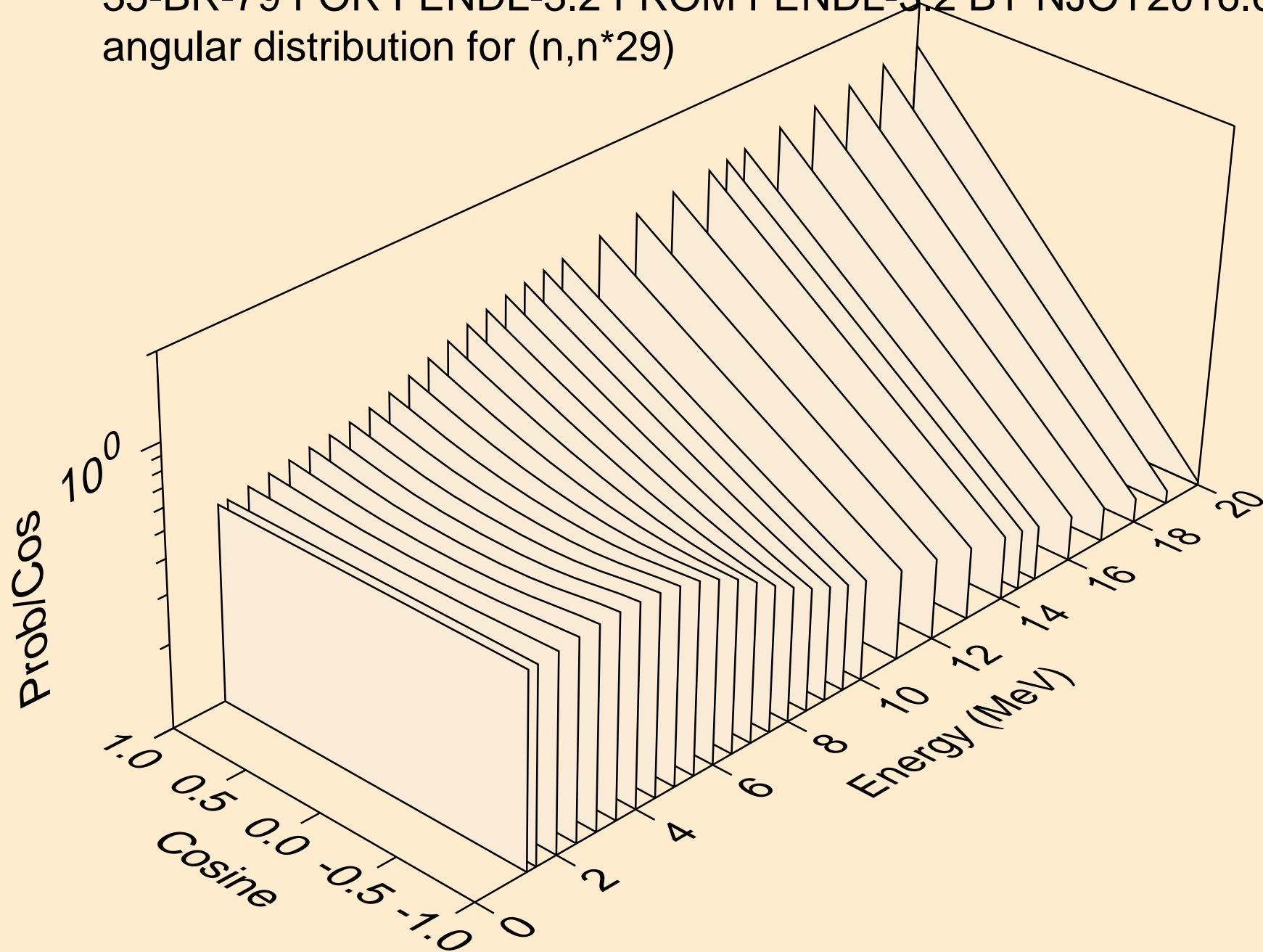

35-BR-79 FOR FENDL-3.2 FROM FENDL-3.2 BY NJOY2016.60+ O
angular distribution for (n,n*30)

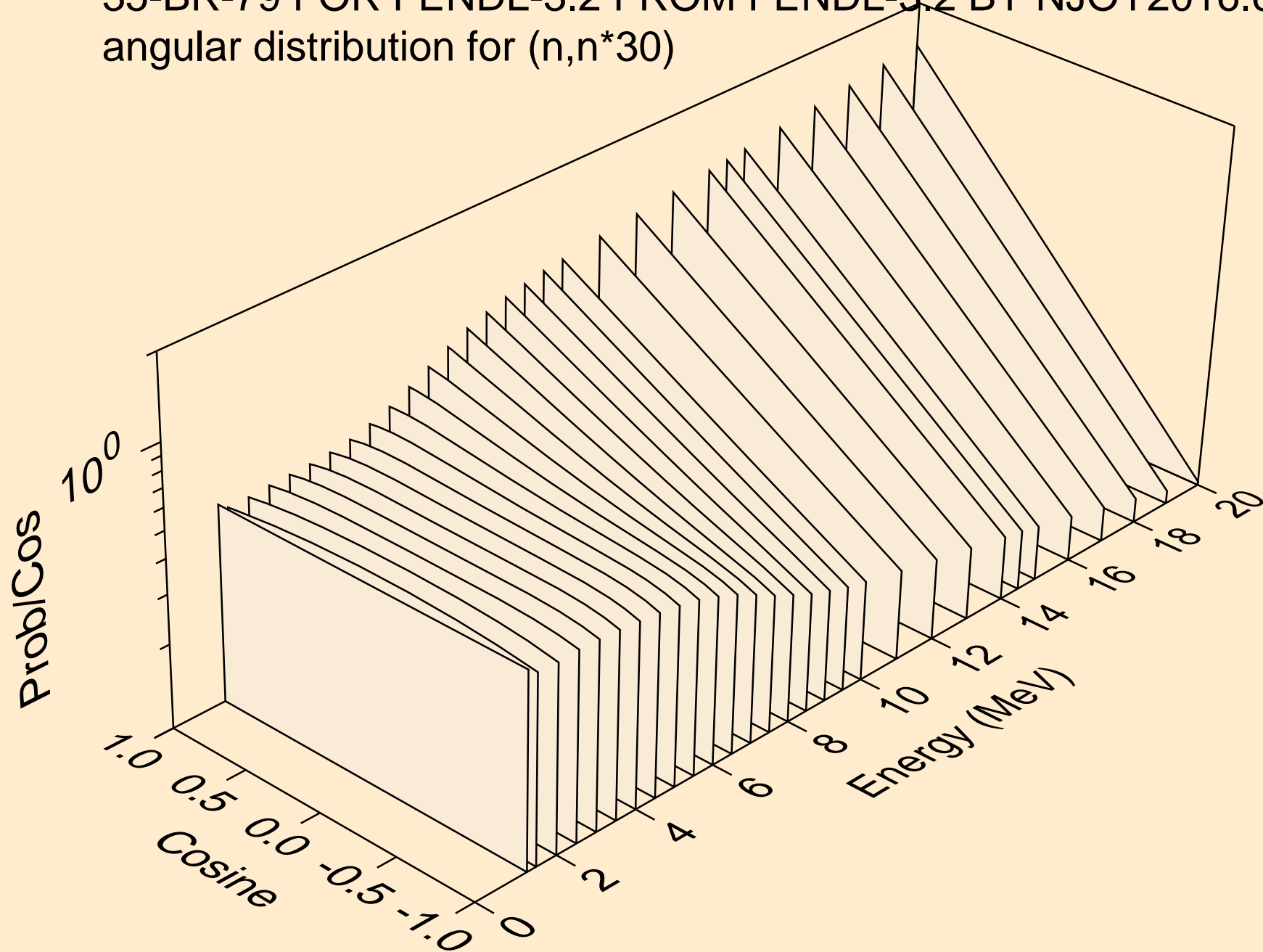

35-BR-79 FOR FENDL-3.2 FROM FENDL-3.2 BY NJOY2016.60+ O
angular distribution for (n,n*31)

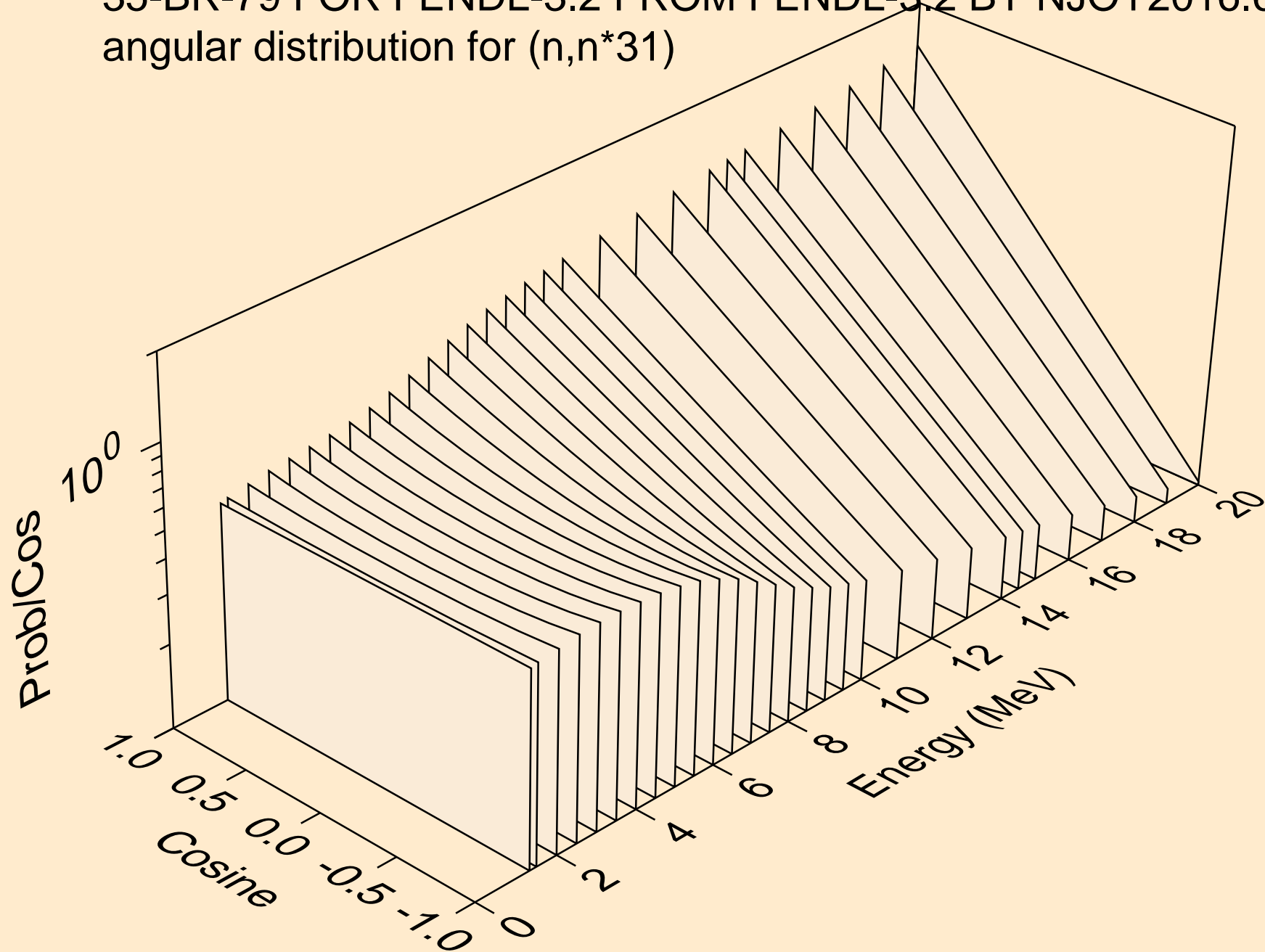

35-BR-79 FOR FENDL-3.2 FROM FENDL-3.2 BY NJOY2016.60+ O
angular distribution for (n,n*32)

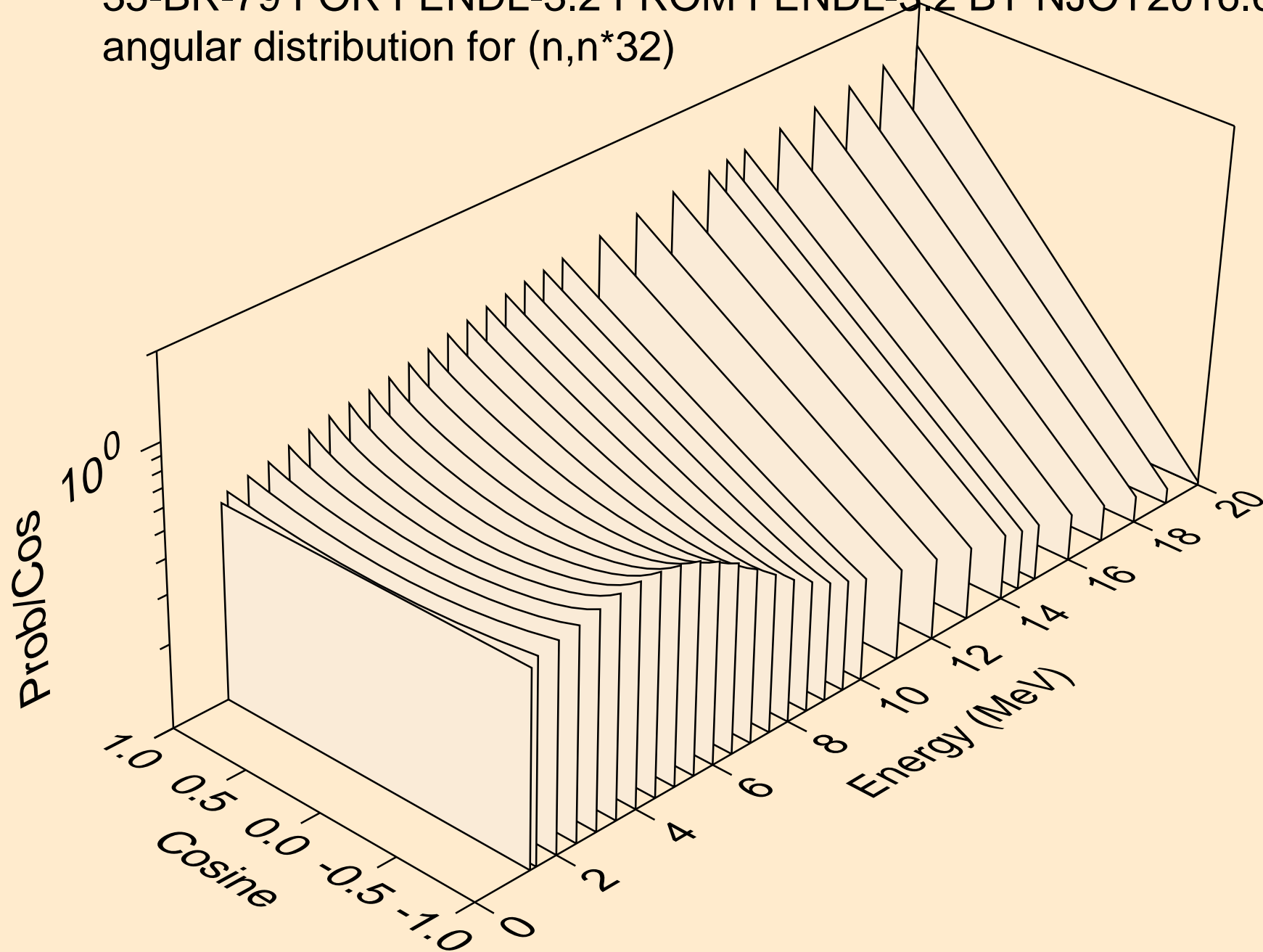

35-BR-79 FOR FENDL-3.2 FROM FENDL-3.2 BY NJOY2016.60+ O
angular distribution for (n,n*33)

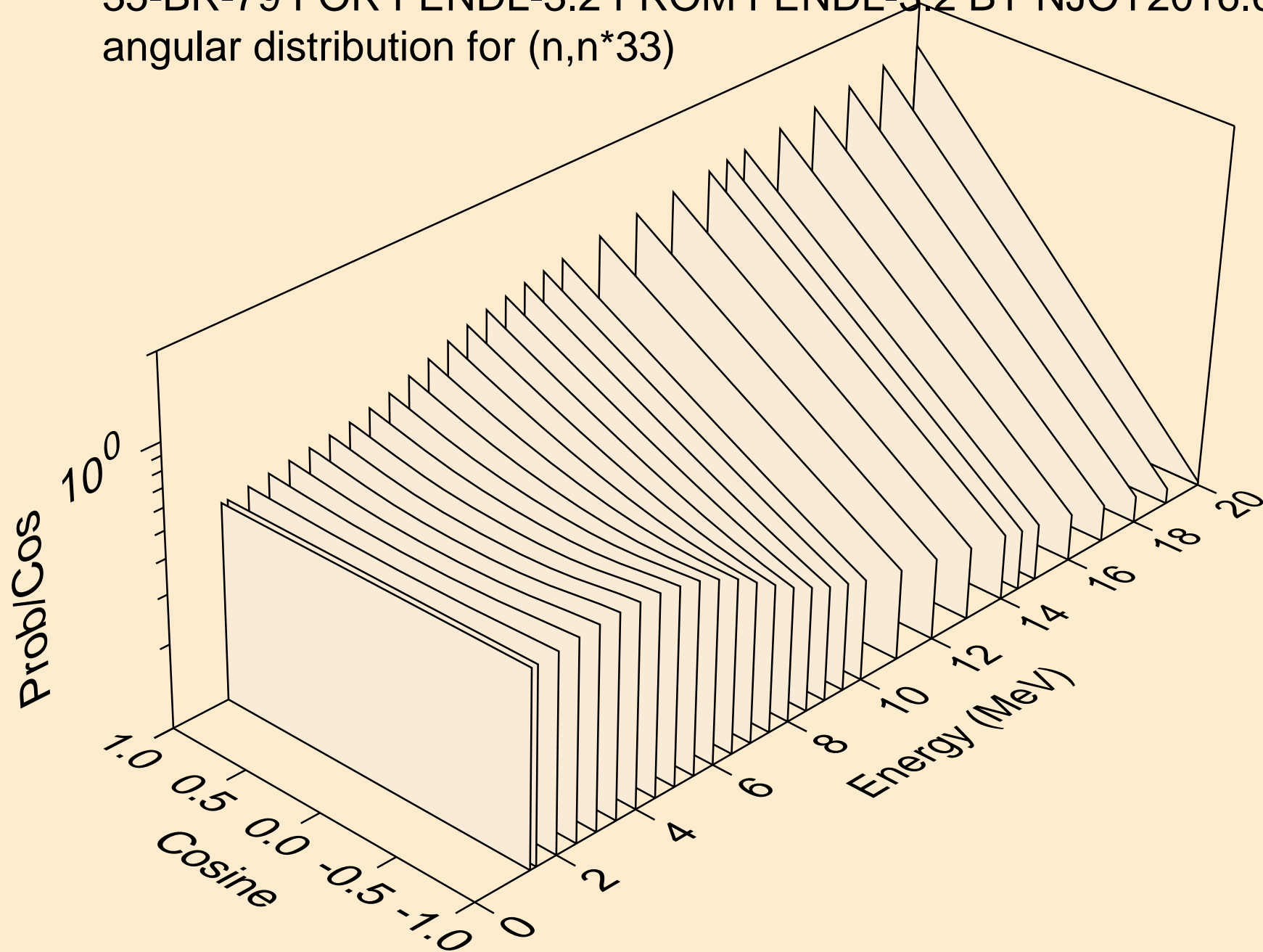

35-BR-79 FOR FENDL-3.2 FROM FENDL-3.2 BY NJOY2016.60+ O
angular distribution for (n,n*34)

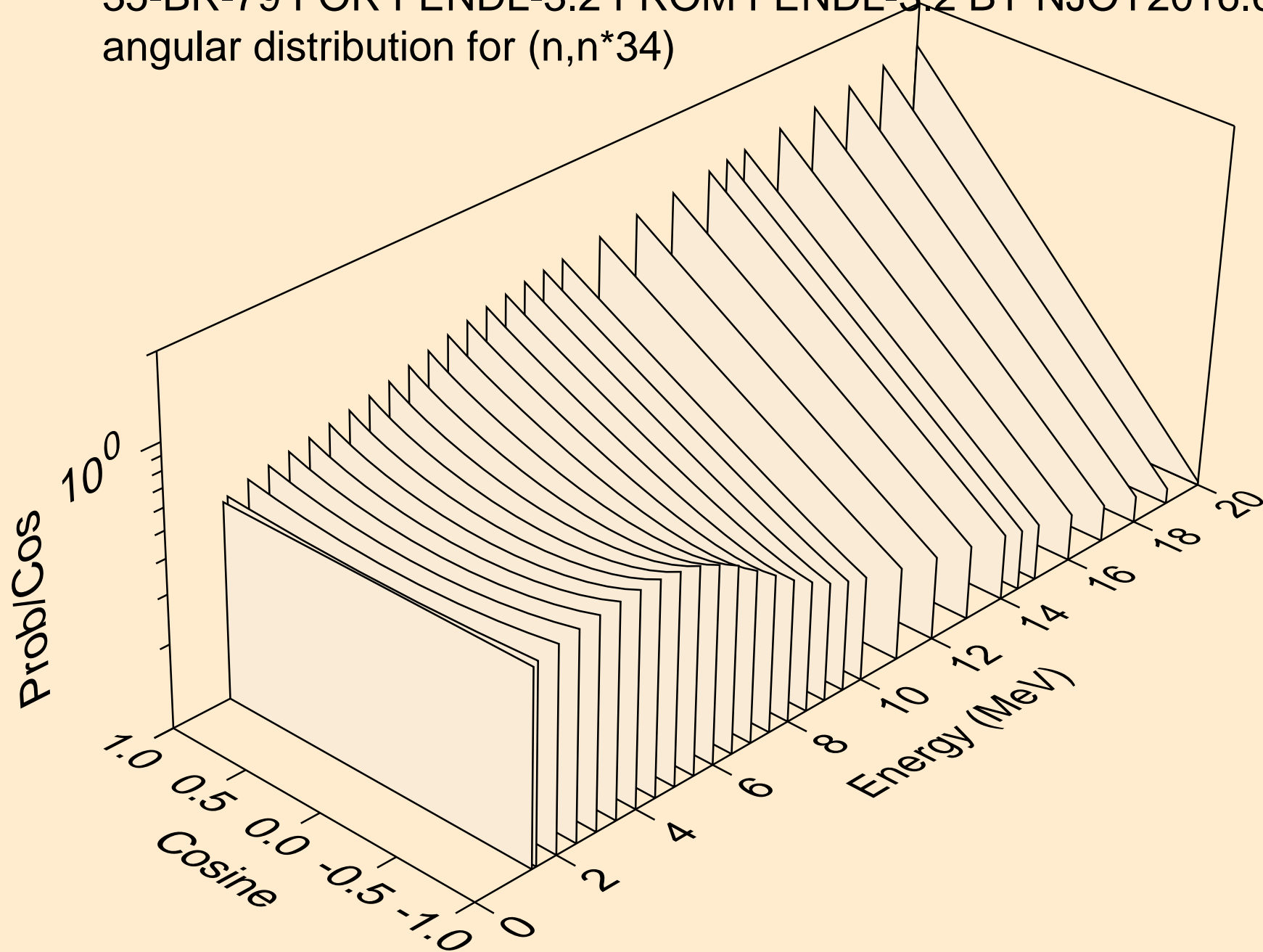

35-BR-79 FOR FENDL-3.2 FROM FENDL-3.2 BY NJOY2016.60+ O
angular distribution for (n,n*35)

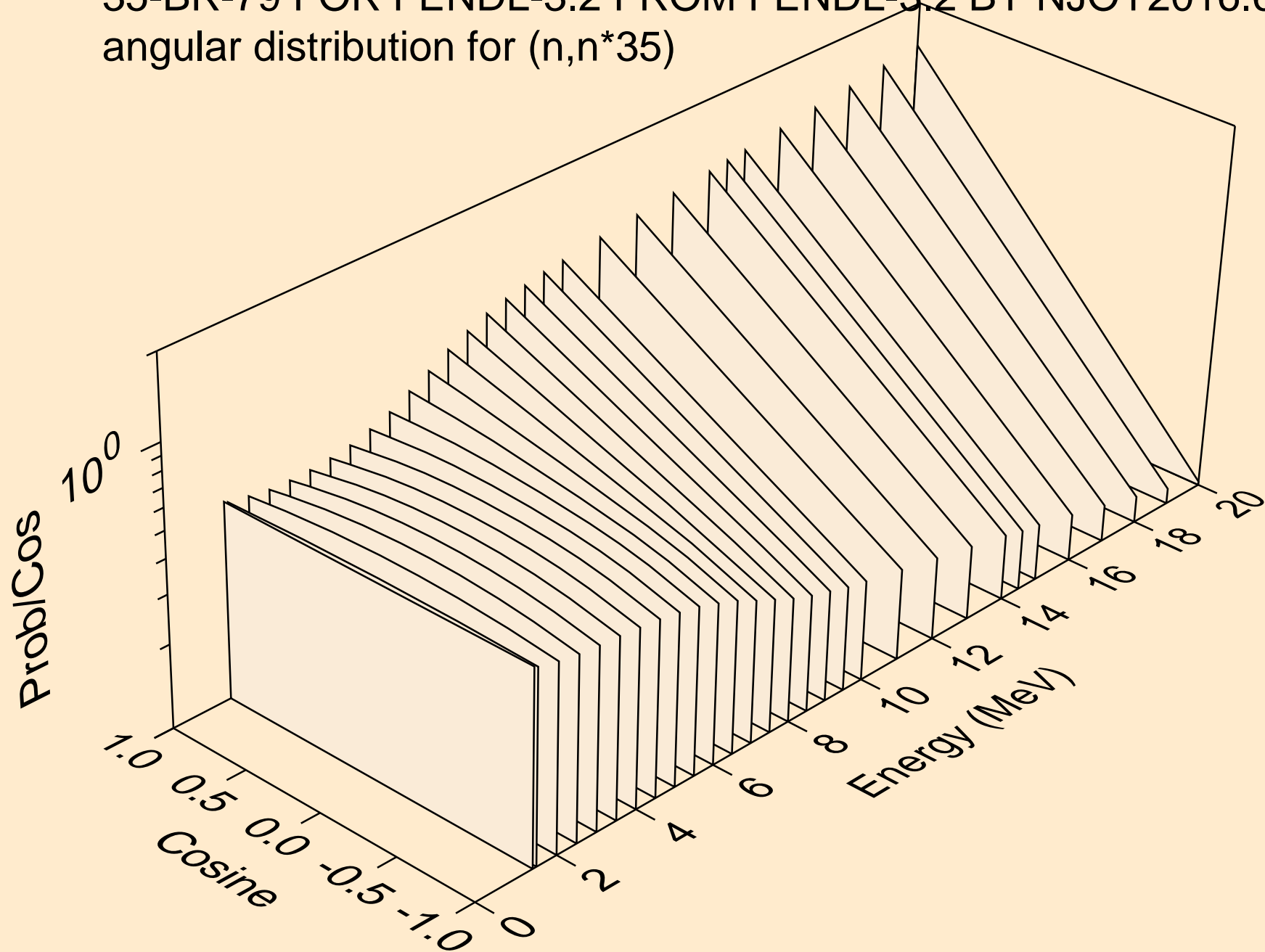

35-BR-79 FOR FENDL-3.2 FROM FENDL-3.2 BY NJOY2016.60+ O
angular distribution for (n,n*36)

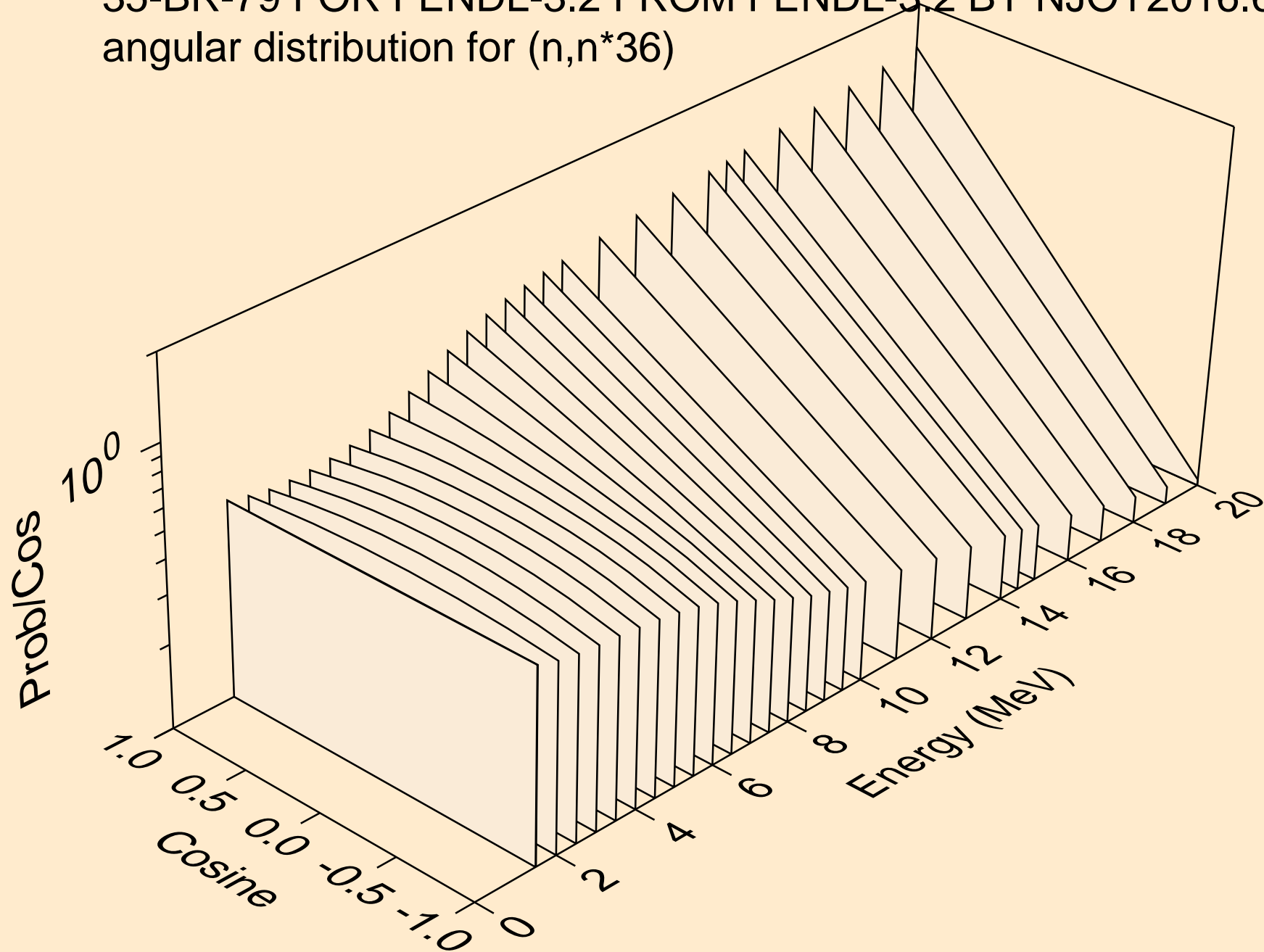

35-BR-79 FOR FENDL-3.2 FROM FENDL-3.2 BY NJOY2016.60+ O
angular distribution for (n,n*37)

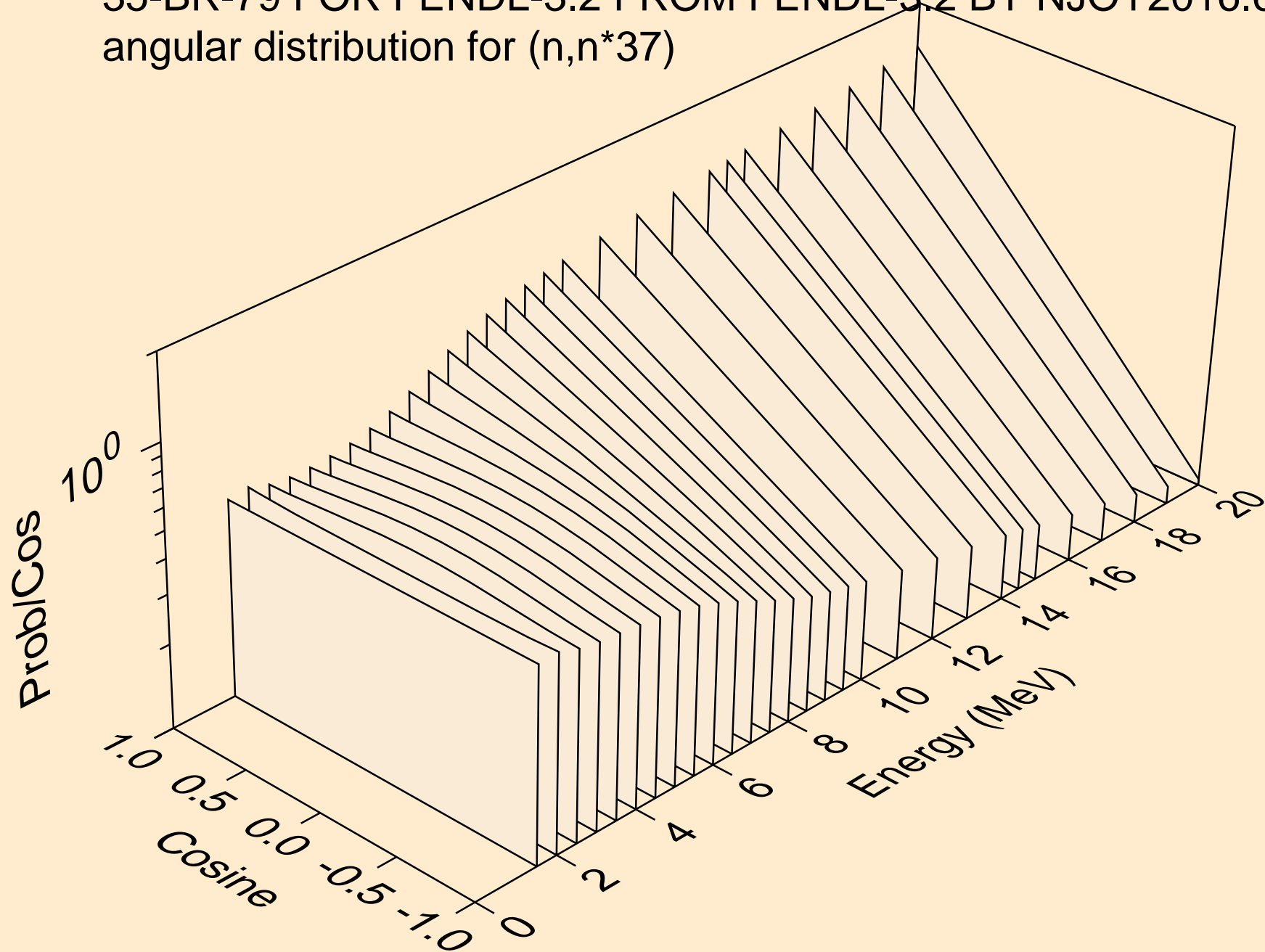

35-BR-79 FOR FENDL-3.2 FROM FENDL-3.2 BY NJOY2016.60+ O
angular distribution for (n,n*38)

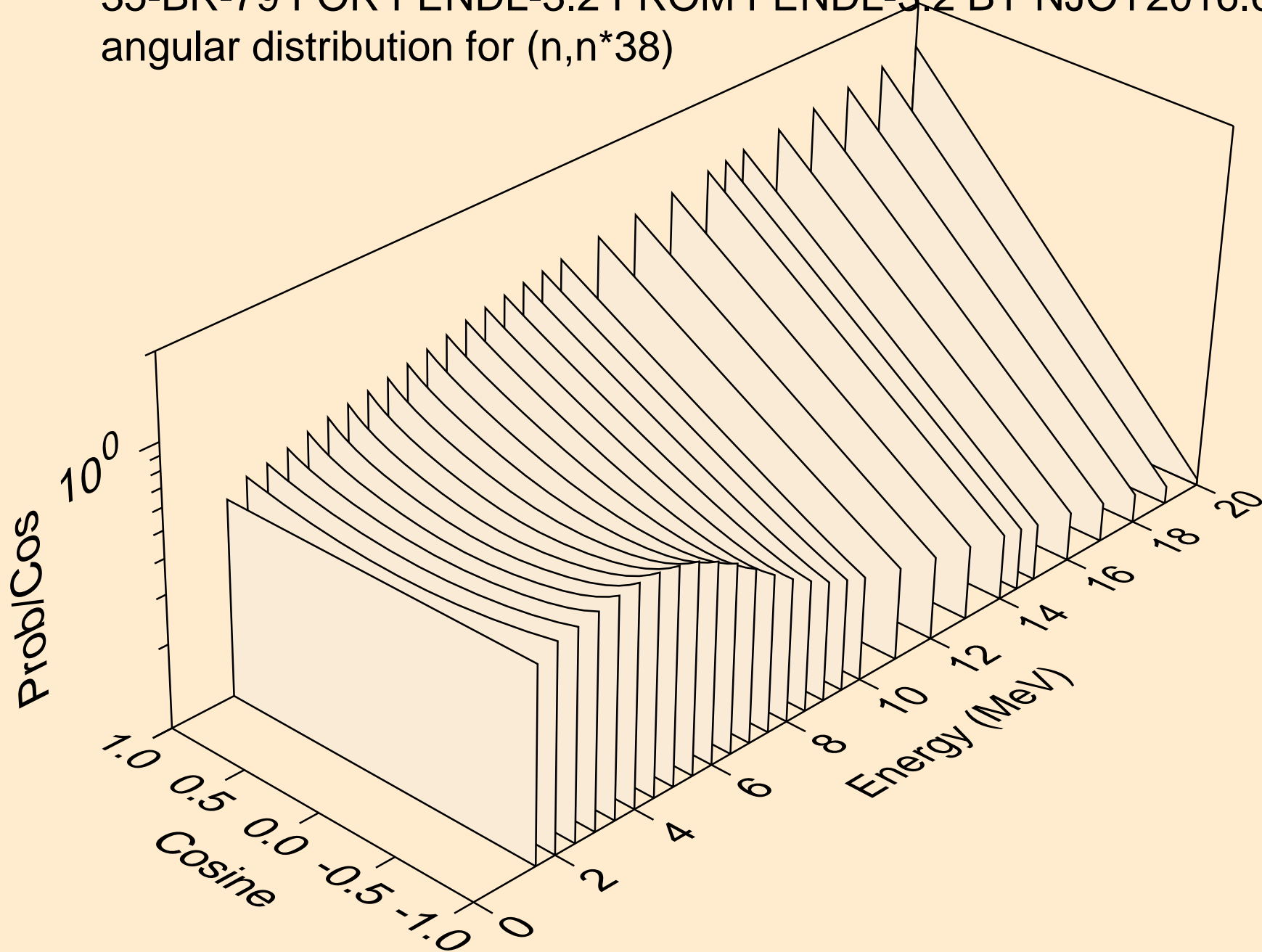

35-BR-79 FOR FENDL-3.2 FROM FENDL-3.2 BY NJOY2016.60+ O
angular distribution for (n,n*39)

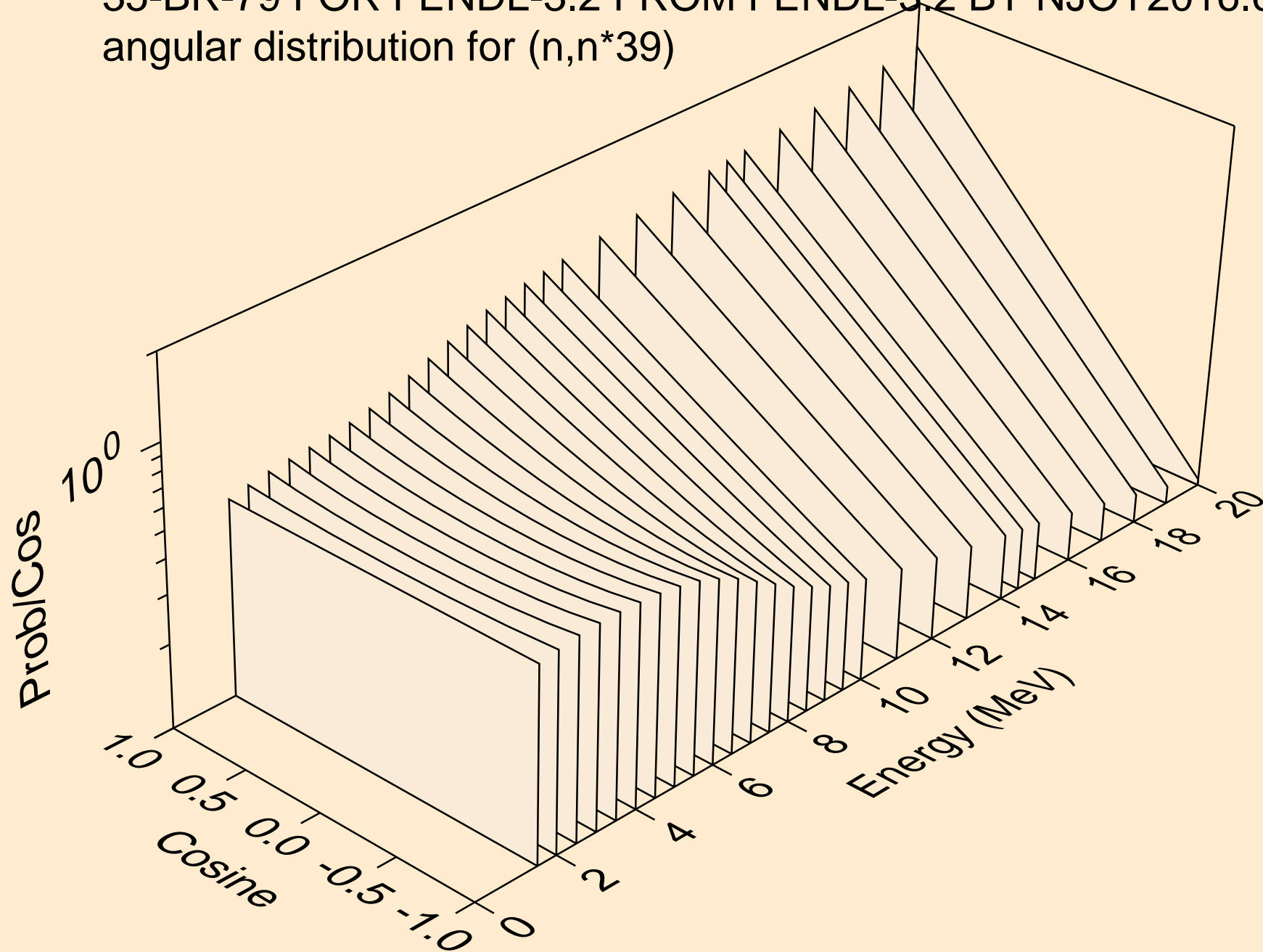

35-BR-79 FOR FENDL-3.2 FROM FENDL-3.2 BY NJOY2016.60+ O
angular distribution for (n,n*40)

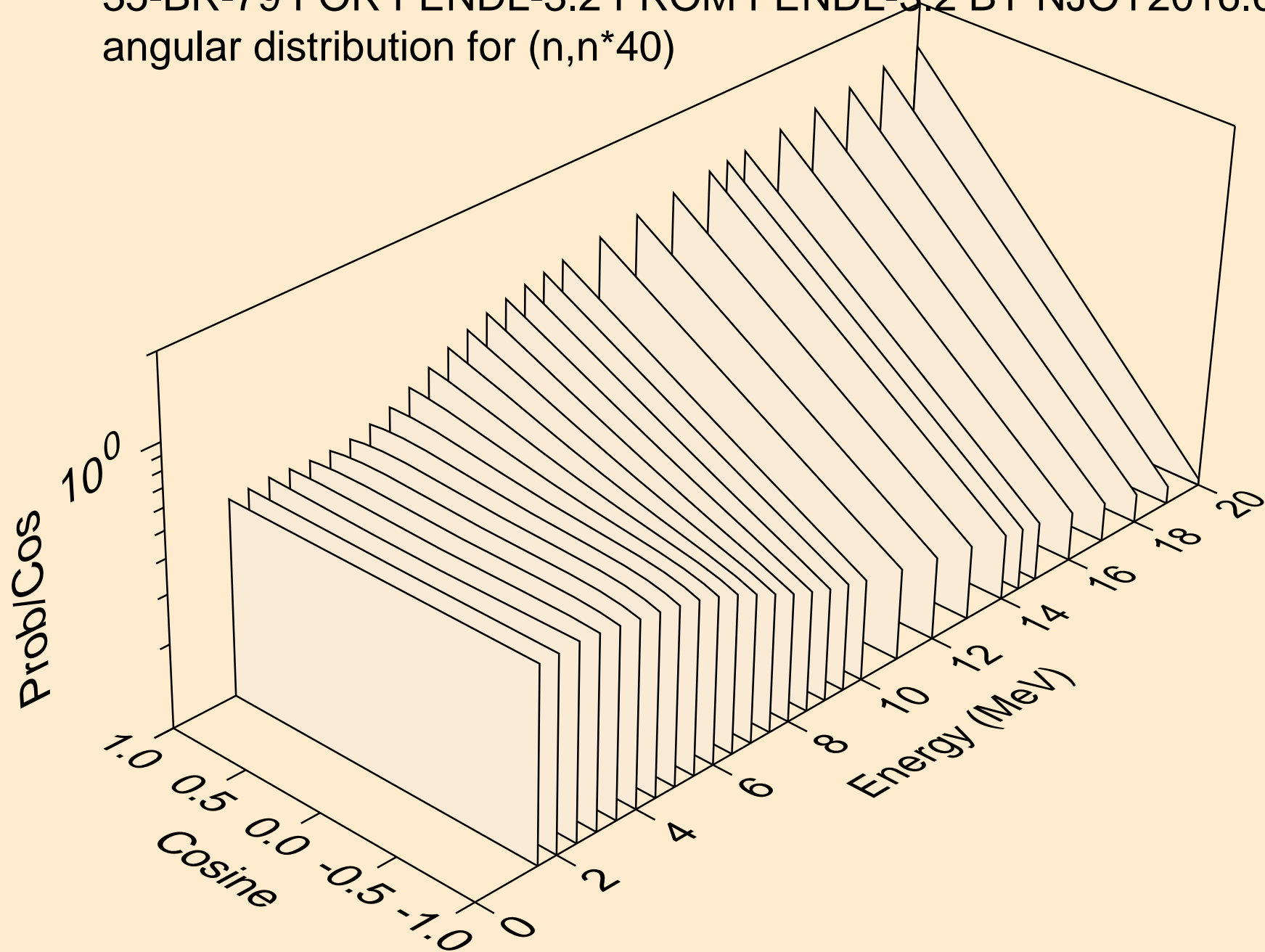

35-BR-79 FOR FENDL-3.2 FROM FENDL-3.2 BY NJOY2016.60+ O
Neutron emission for (n,x)

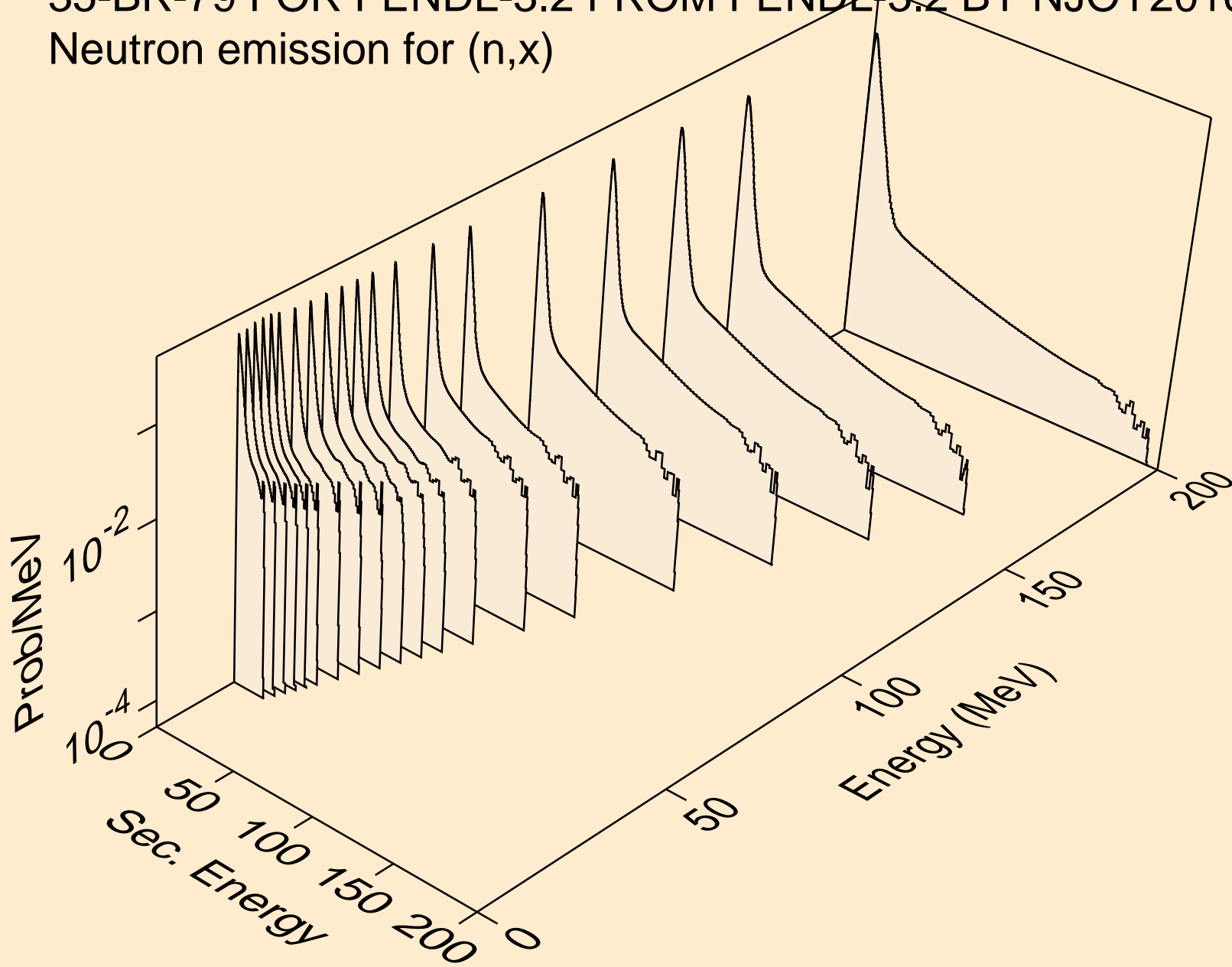

35-BR-79 FOR FENDL-3.2 FROM FENDL-3.2 BY NJOY2016.60+ O
Neutron emission for (n,2n)

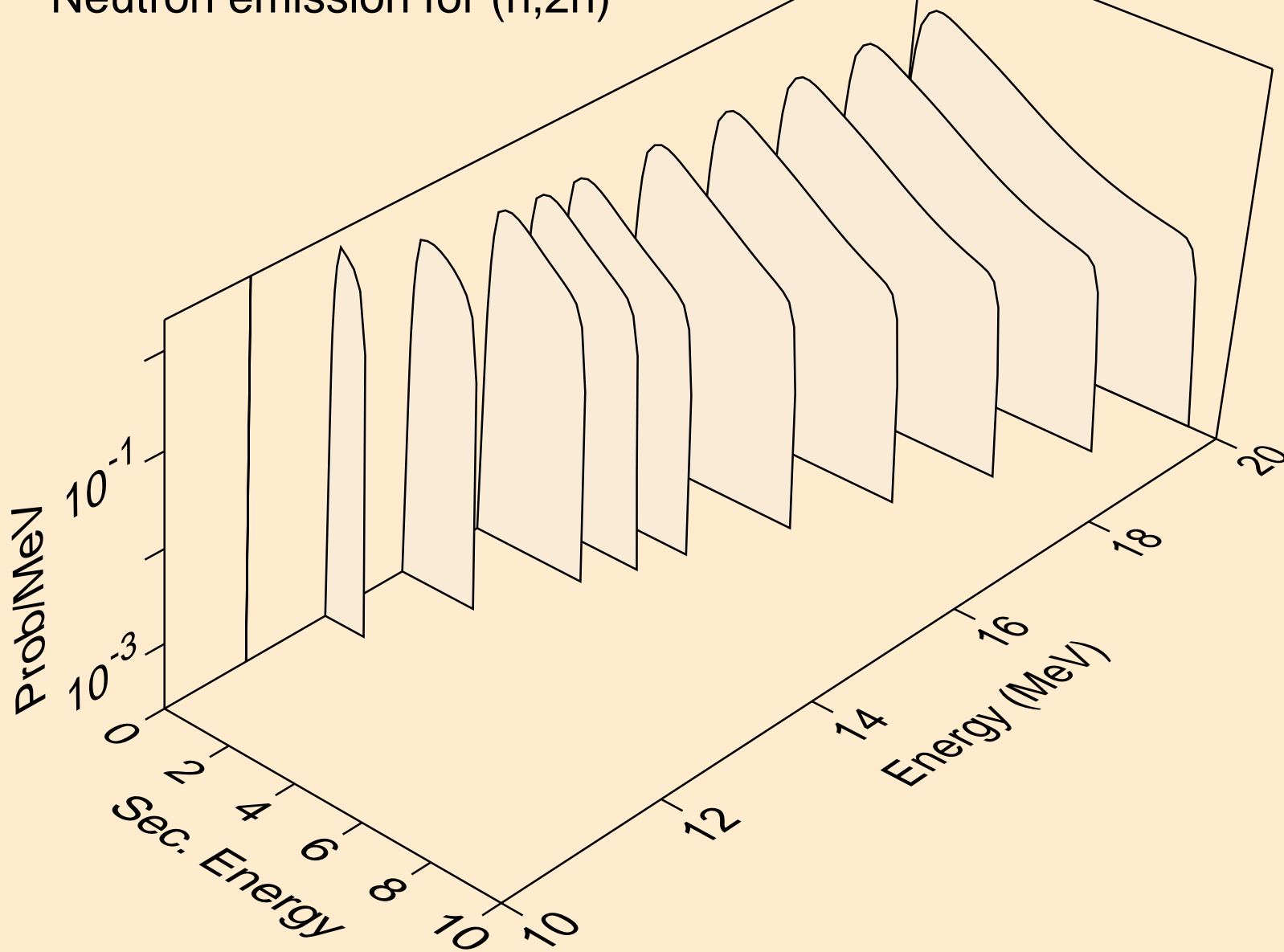

35-BR-79 FOR FENDL-3.2 FROM FENDL-3.2 BY NJOY2016.60+ O
Neutron emission for (n,3n)

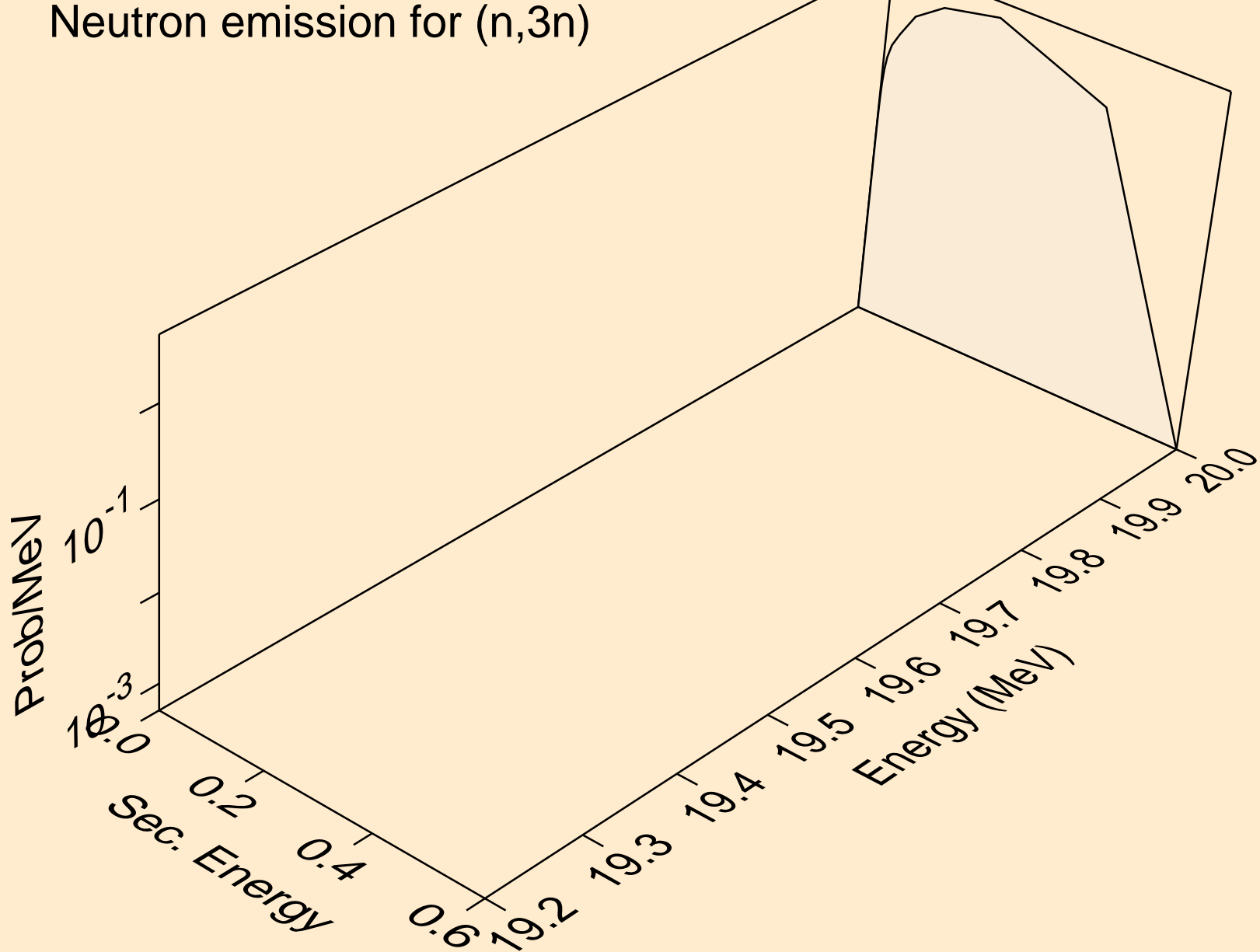

35-BR-79 FOR FENDL-3.2 FROM FENDL-3.2 BY NJOY2016.60+ O
Neutron emission for (n,n*)a

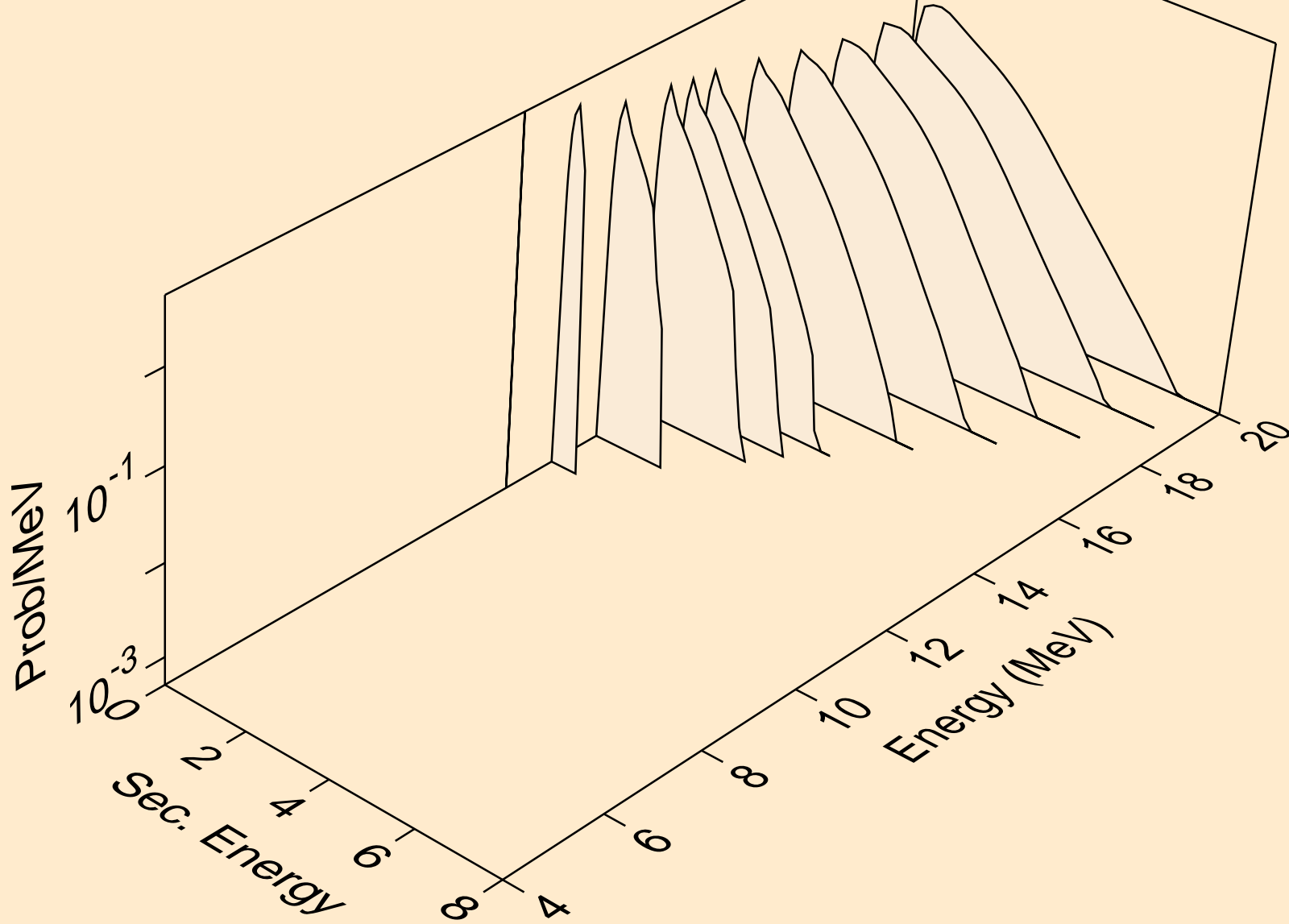

35-BR-79 FOR FENDL-3.2 FROM FENDL-3.2 BY NJOY2016.60+ O
Neutron emission for (n,n*)p

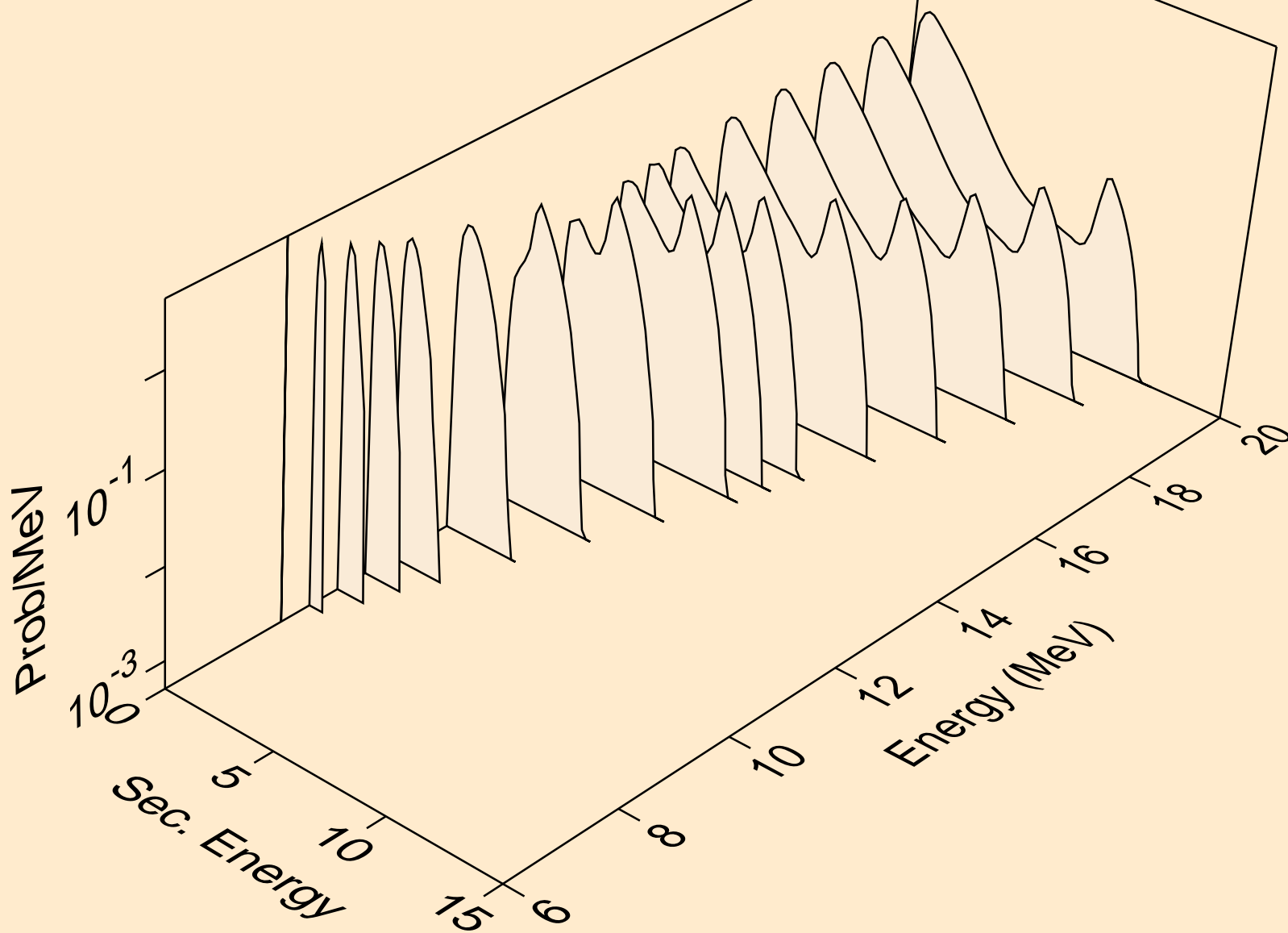

35-BR-79 FOR FENDL-3.2 FROM FENDL-3.2 BY NJOY2016.60+ O
Neutron emission for (n,n*)d

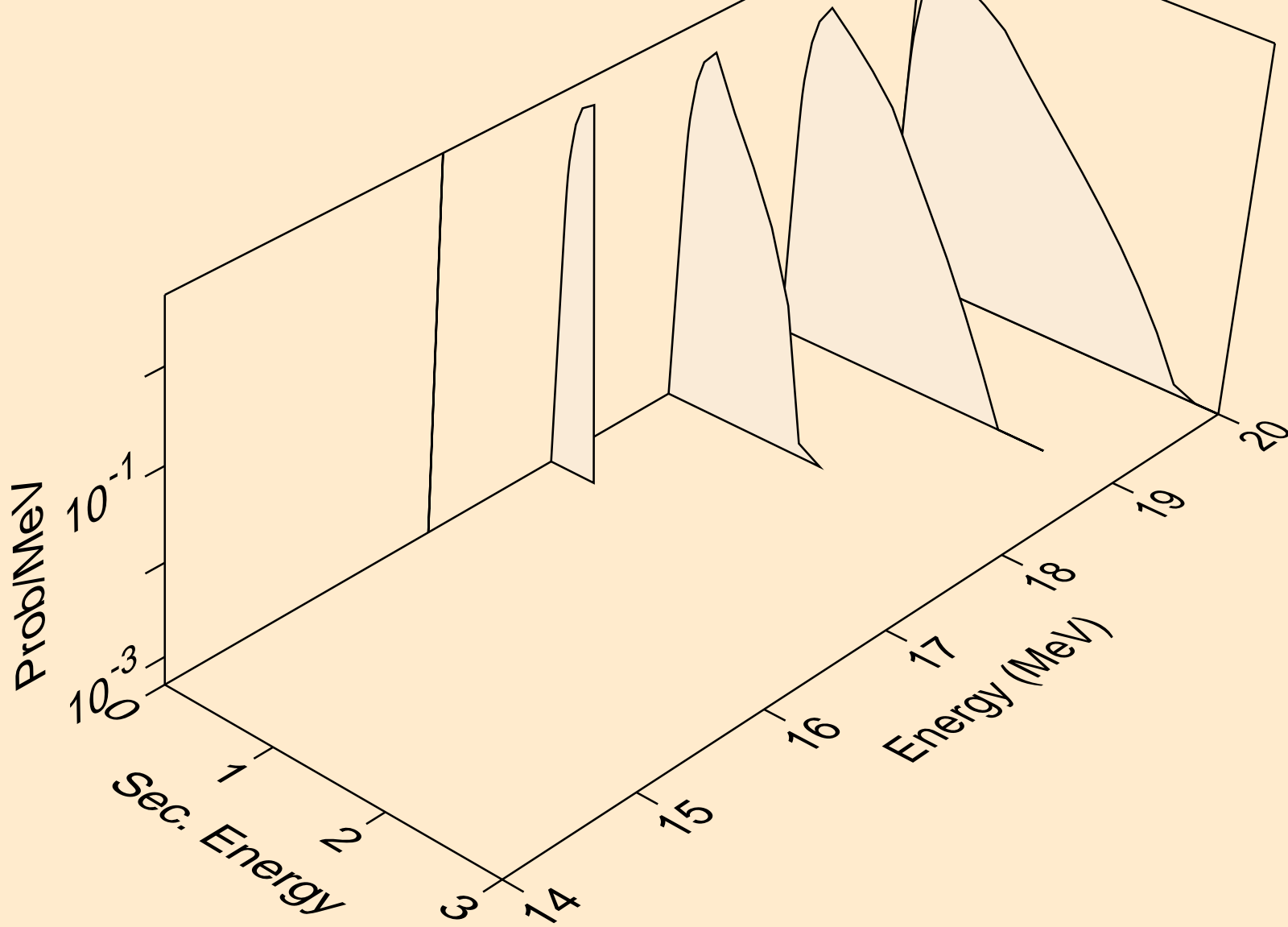

35-BR-79 FOR FENDL-3.2 FROM FENDL-3.2 BY NJOY2016.60+ O
Neutron emission for (n,n*c)

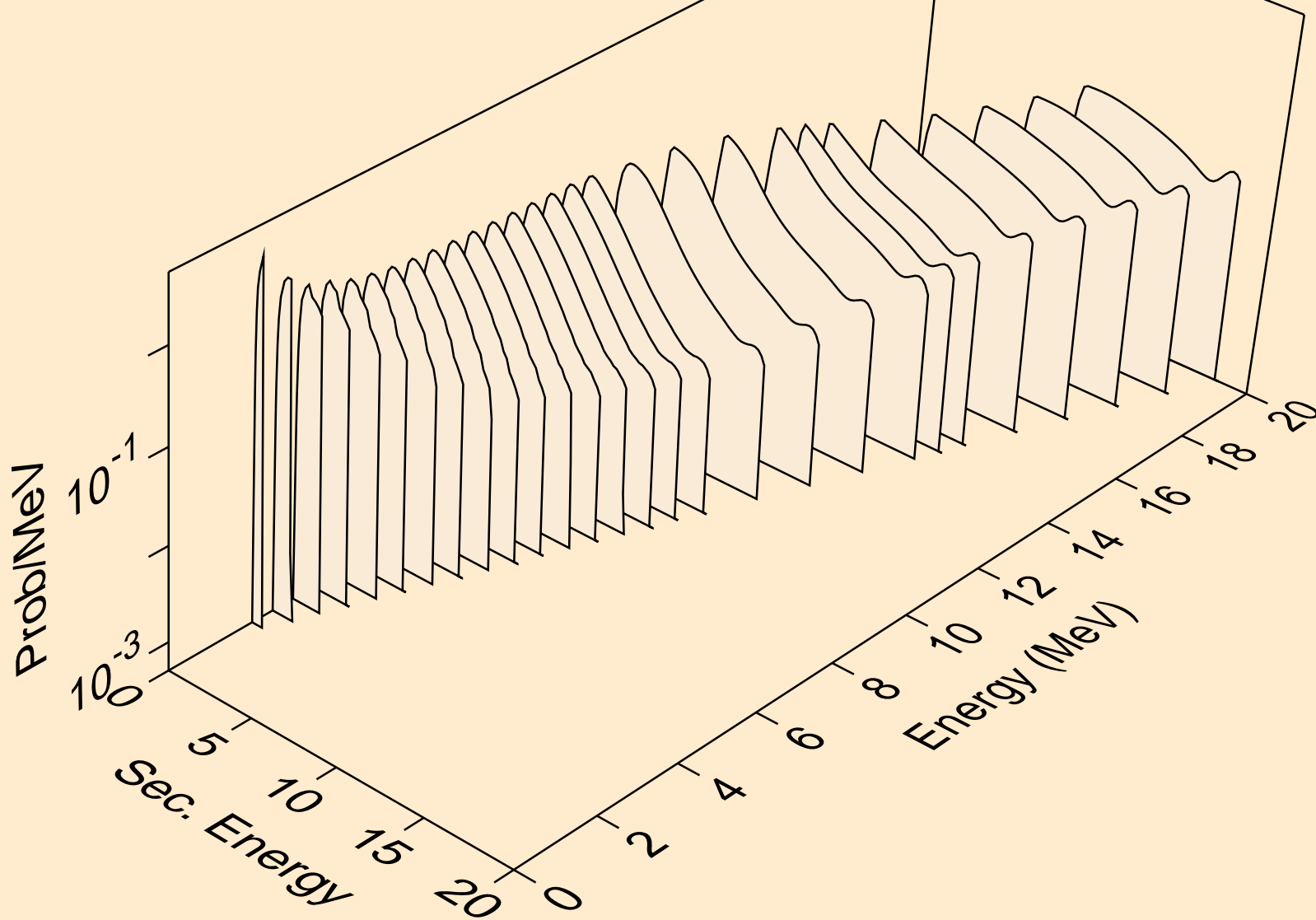

35-BR-79 FOR FENDL-3.2 FROM FENDL-3.2 BY NJOY2016.60+ O
Photon emission for nonelastic

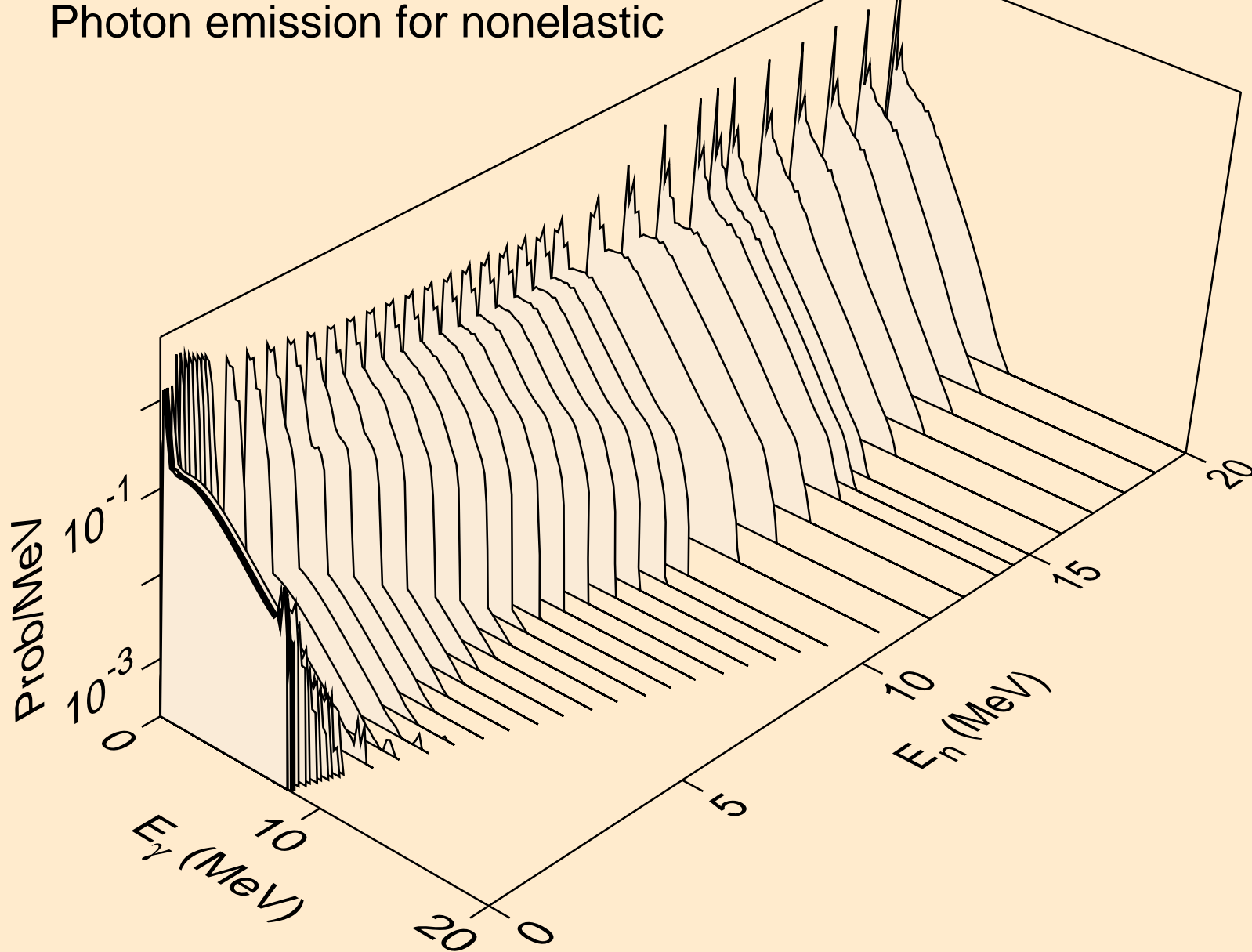

35-BR-79 FOR FENDL-3.2 FROM FENDL-3.2 BY NJOY2016.60+ O
Photon emission for (n,x)

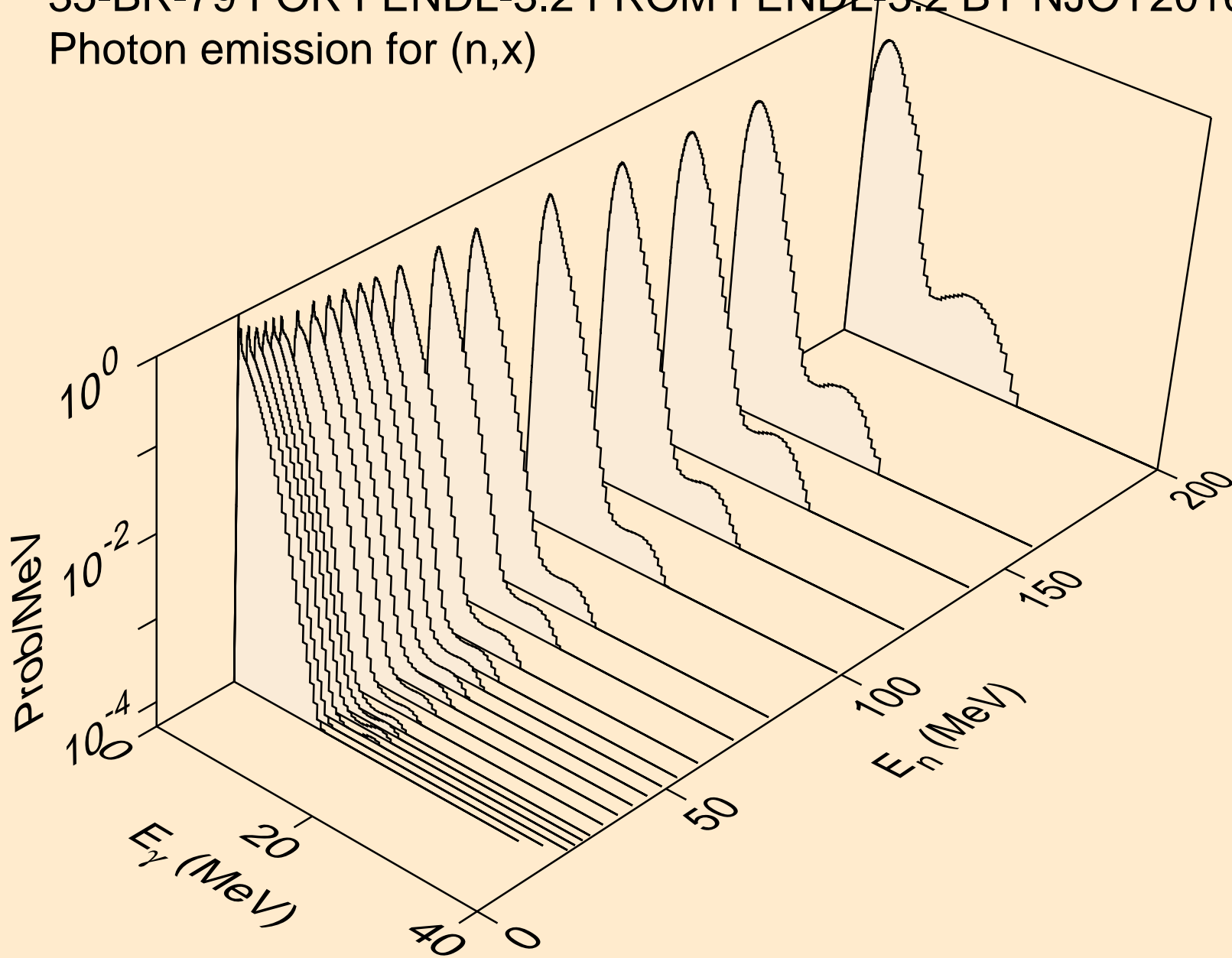

35-BR-79 FOR FENDL-3.2 FROM FENDL-3.2 BY NJOY2016.60+ O
14 MeV photon spectrum

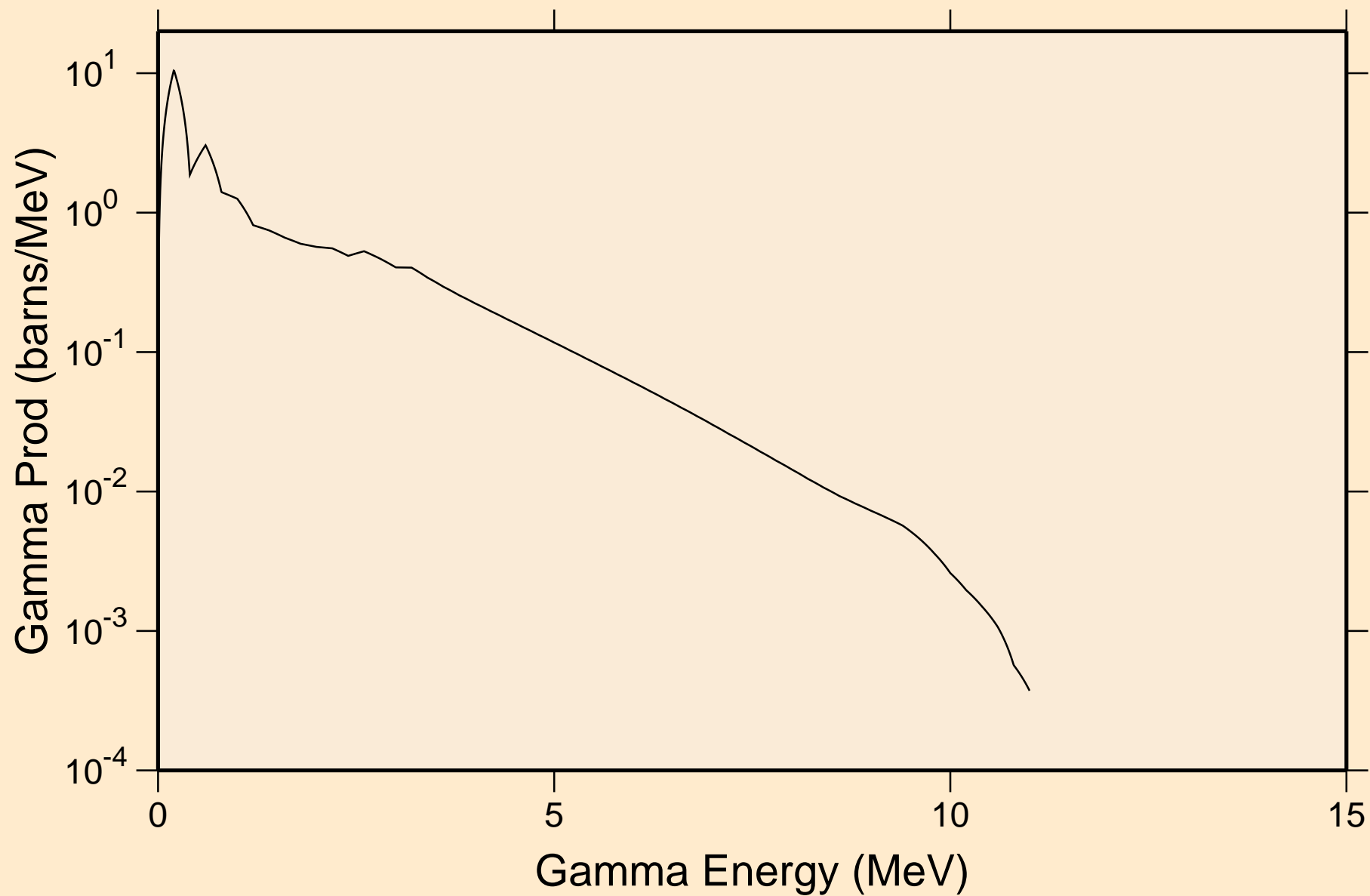

35-BR-79 FOR FENDL-3.2 FROM FENDL-3.2 BY NJOY2016.60+ O

Particle heating contributions

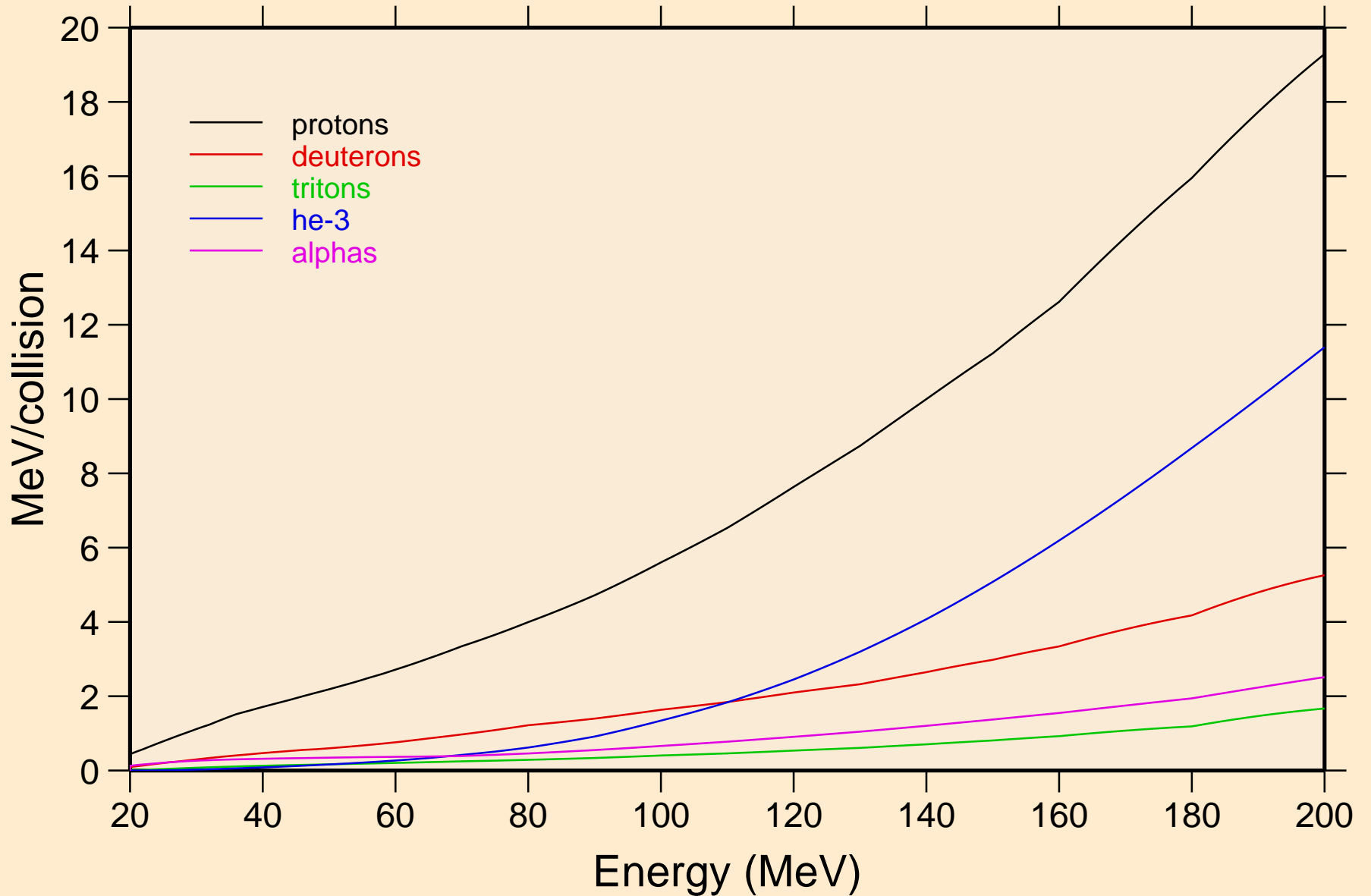

35-BR-79 FOR FENDL-3.2 FROM FENDL-3.2 BY NJOY2016.60+ O Recoil Heating

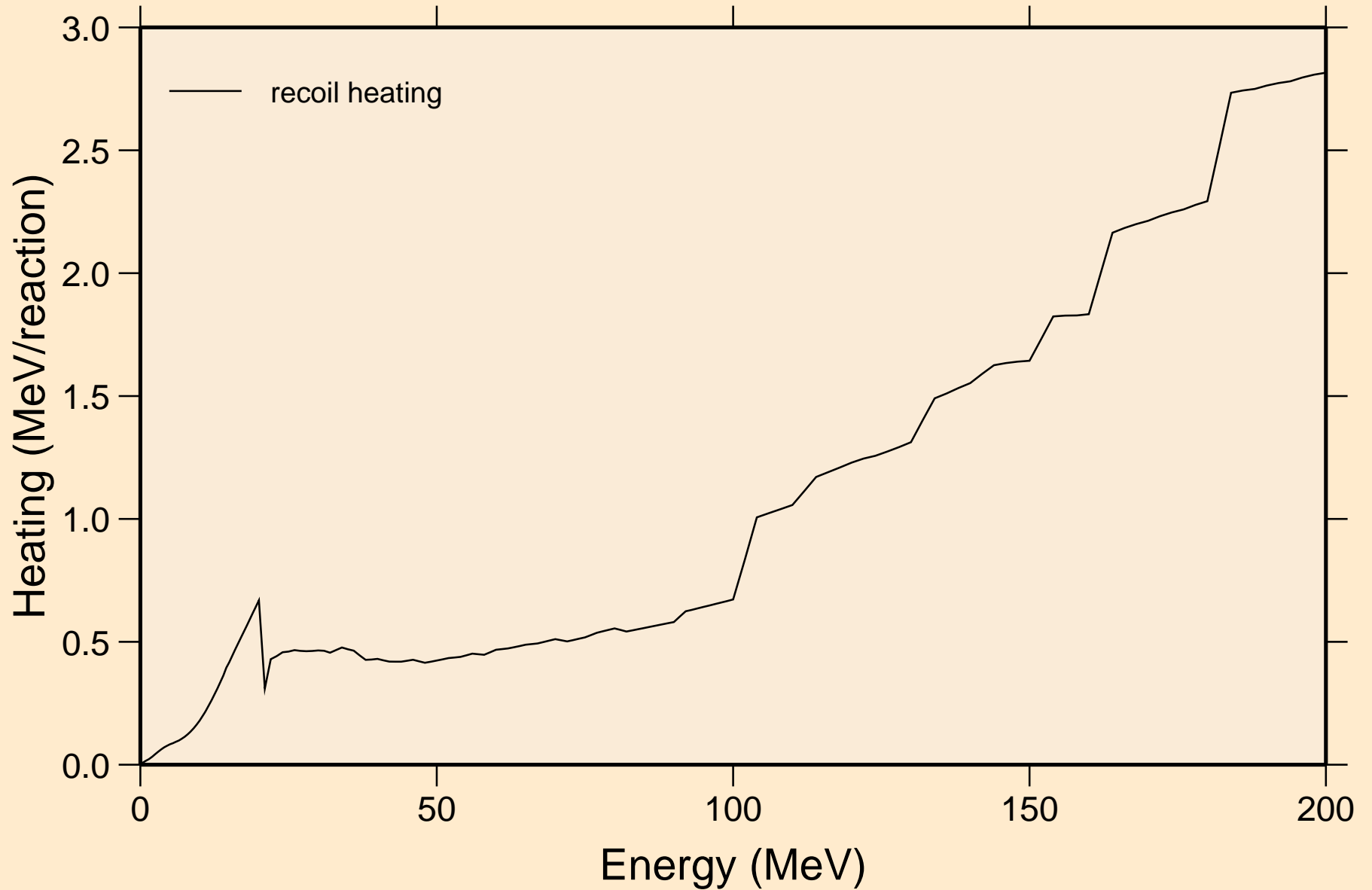

35-BR-79 FOR FENDL-3.2 FROM FENDL-3.2 BY NJOY2016.60+ O
Particle production cross sections

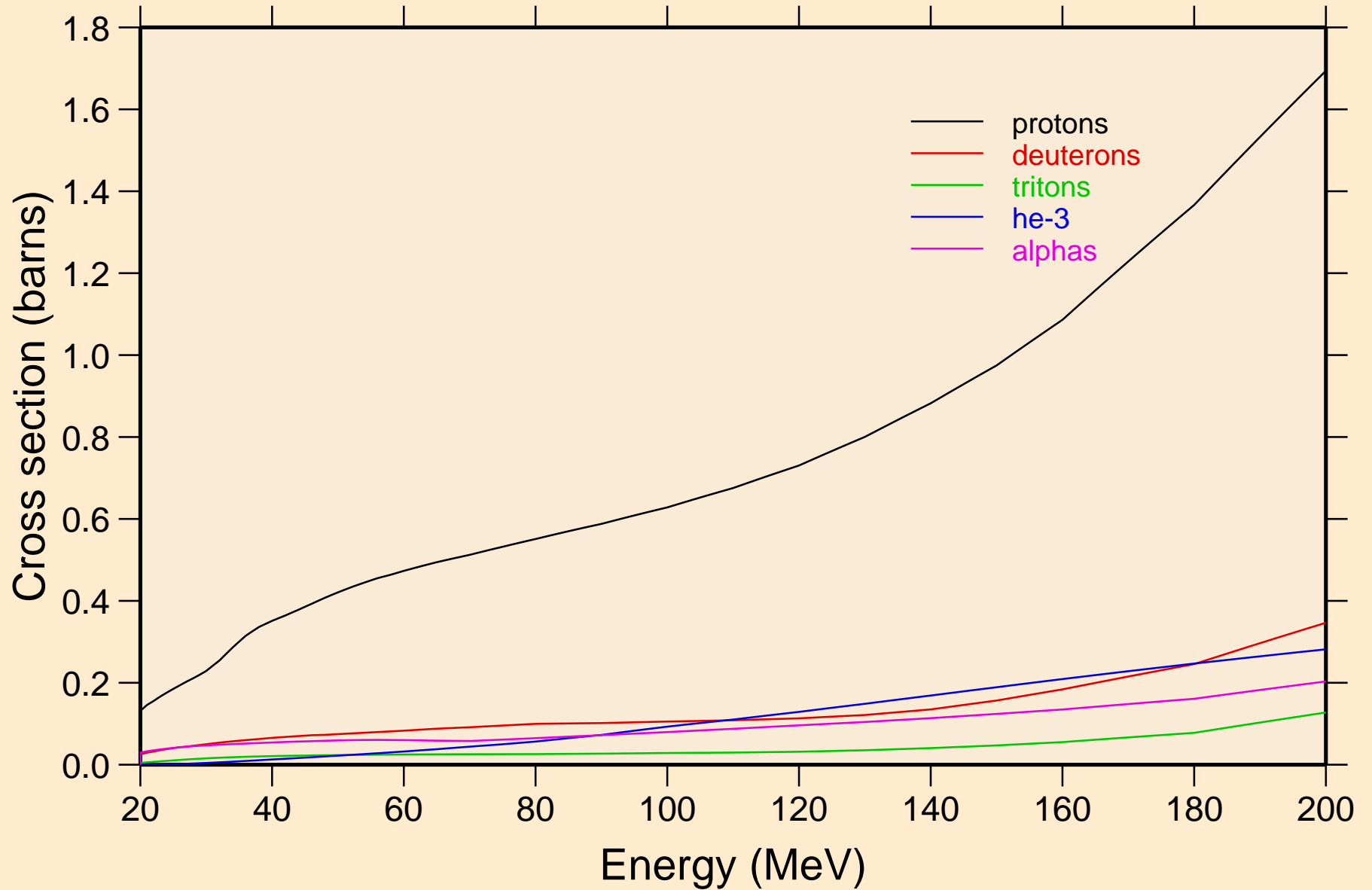

35-BR-79 FOR FENDL-3.2 FROM FENDL-3.2 BY NJOY2016.60+ O
protons from (n,x)

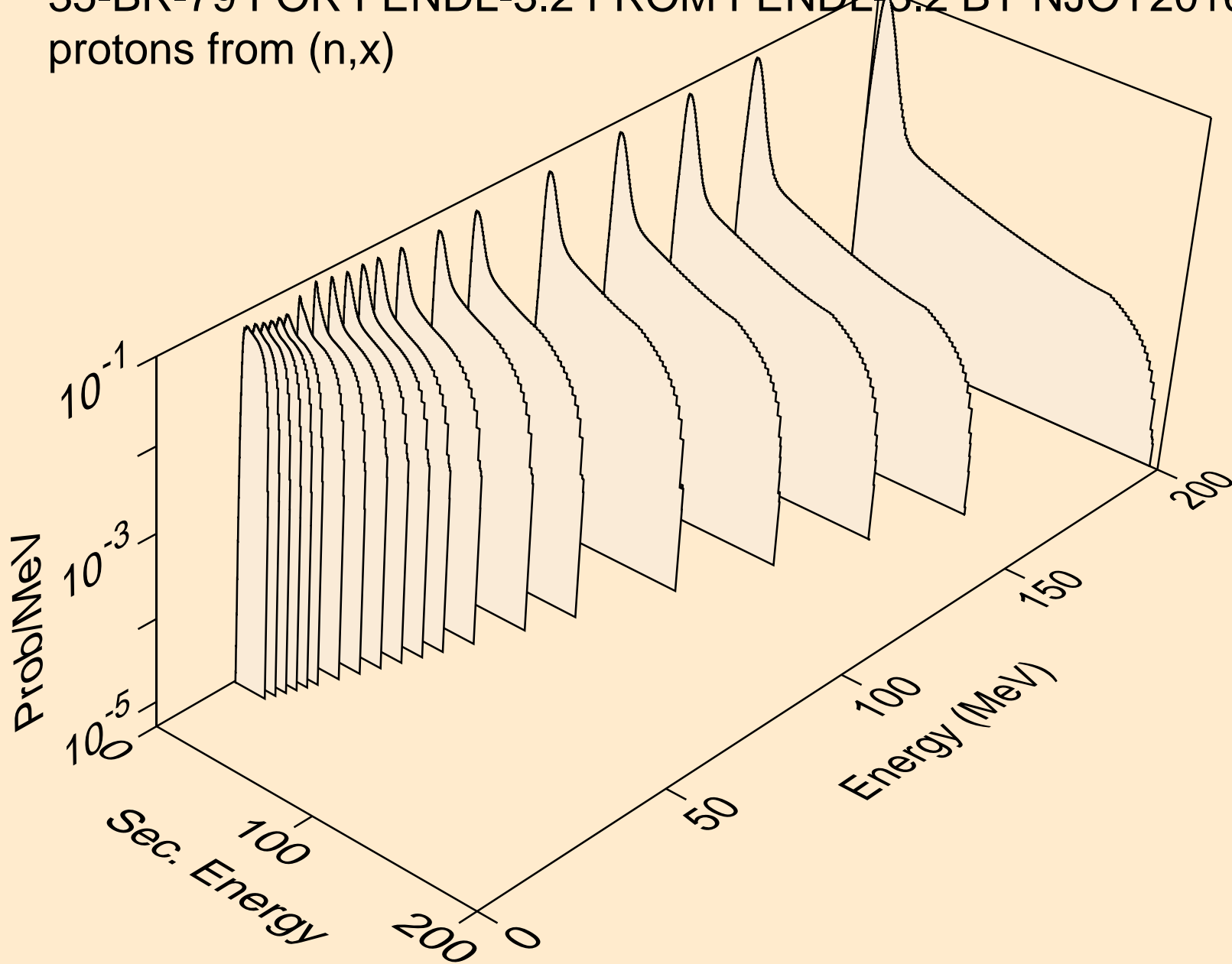

35-BR-79 FOR FENDL-3.2 FROM FENDL-3.2 BY NJOY2016.60+ O
deuterons from (n,x)

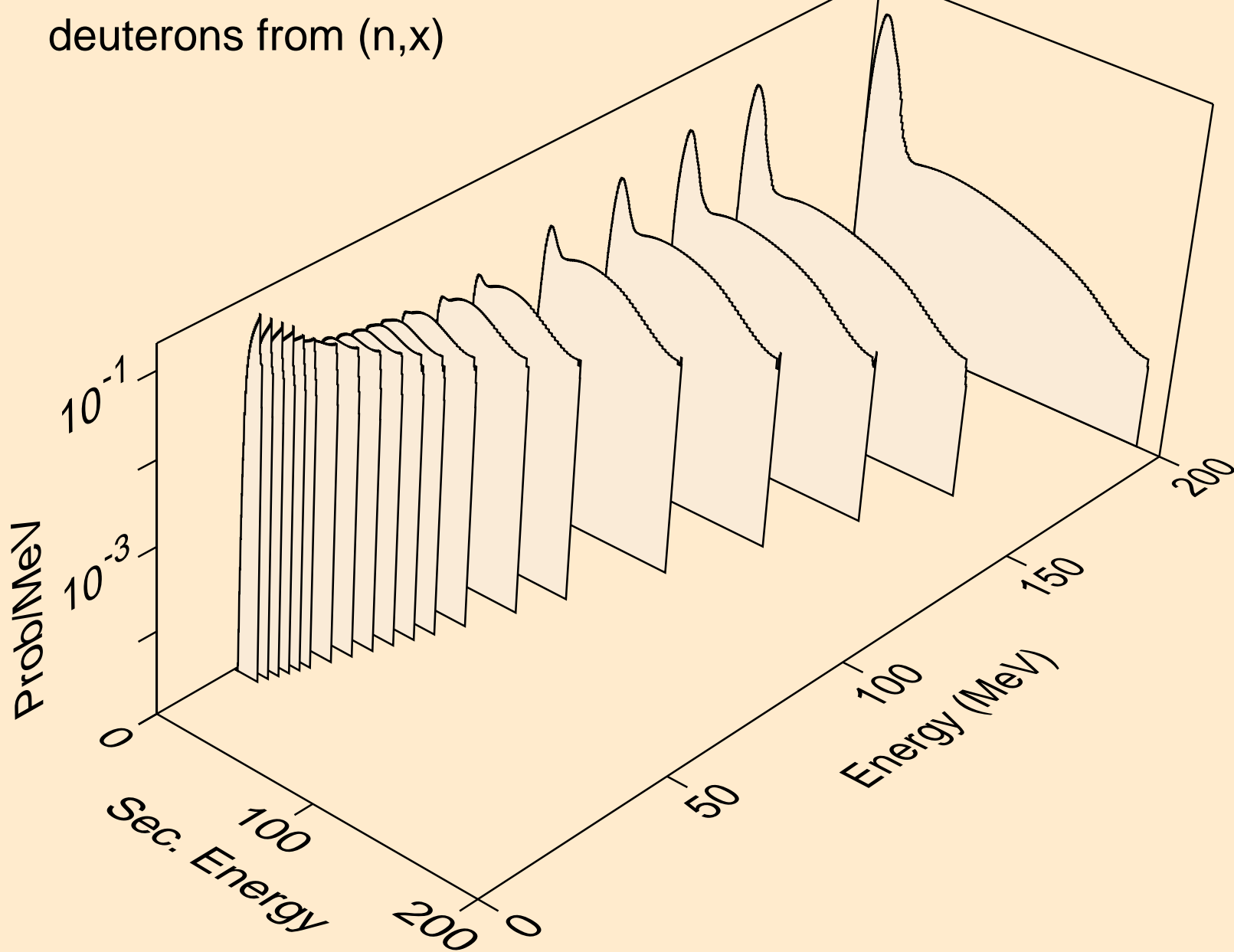

35-BR-79 FOR FENDL-3.2 FROM FENDL-3.2 BY NJOY2016.60+ O
tritons from (n,x)

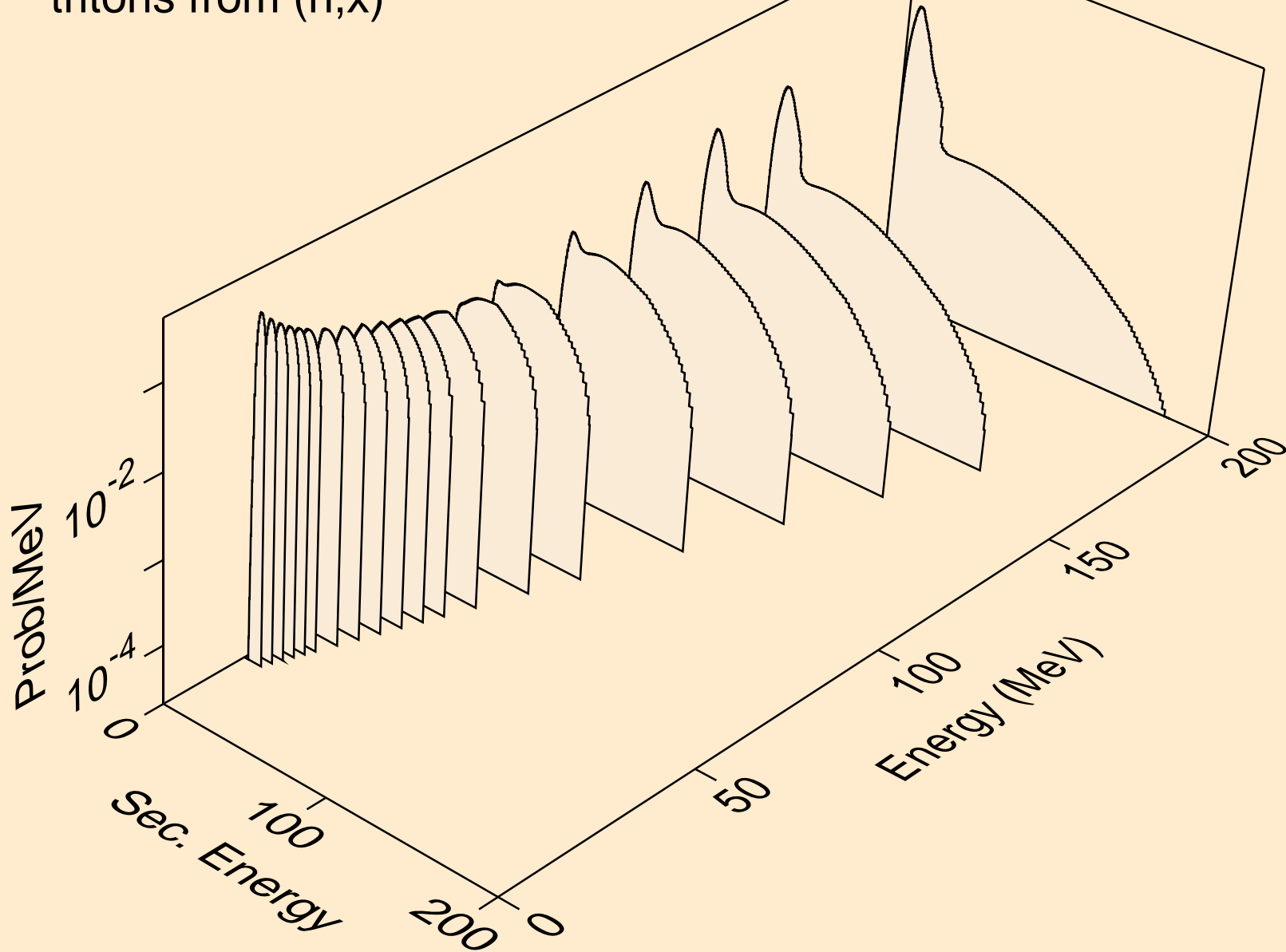

35-BR-79 FOR FENDL-3.2 FROM FENDL-3.2 BY NJOY2016.60+ O
he3s from (n,x)

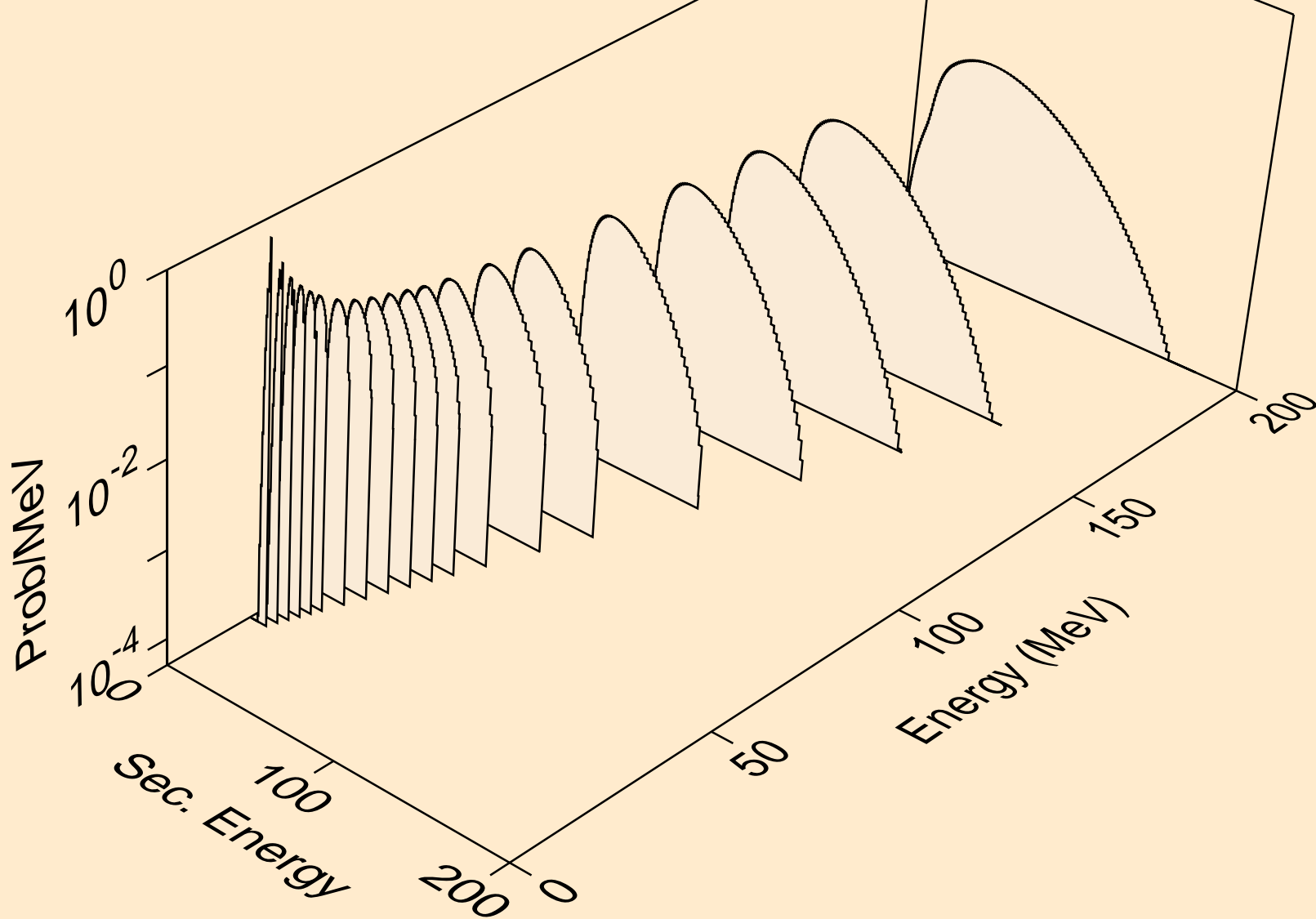

35-BR-79 FOR FENDL-3.2 FROM FENDL-3.2 BY NJOY2016.60+ O
alphas from (n,x)

