

45-RH-103 FOR FENDL-3.2 FROM FENDL-3.2 BY NJOY2016.60+ C
Principal cross sections

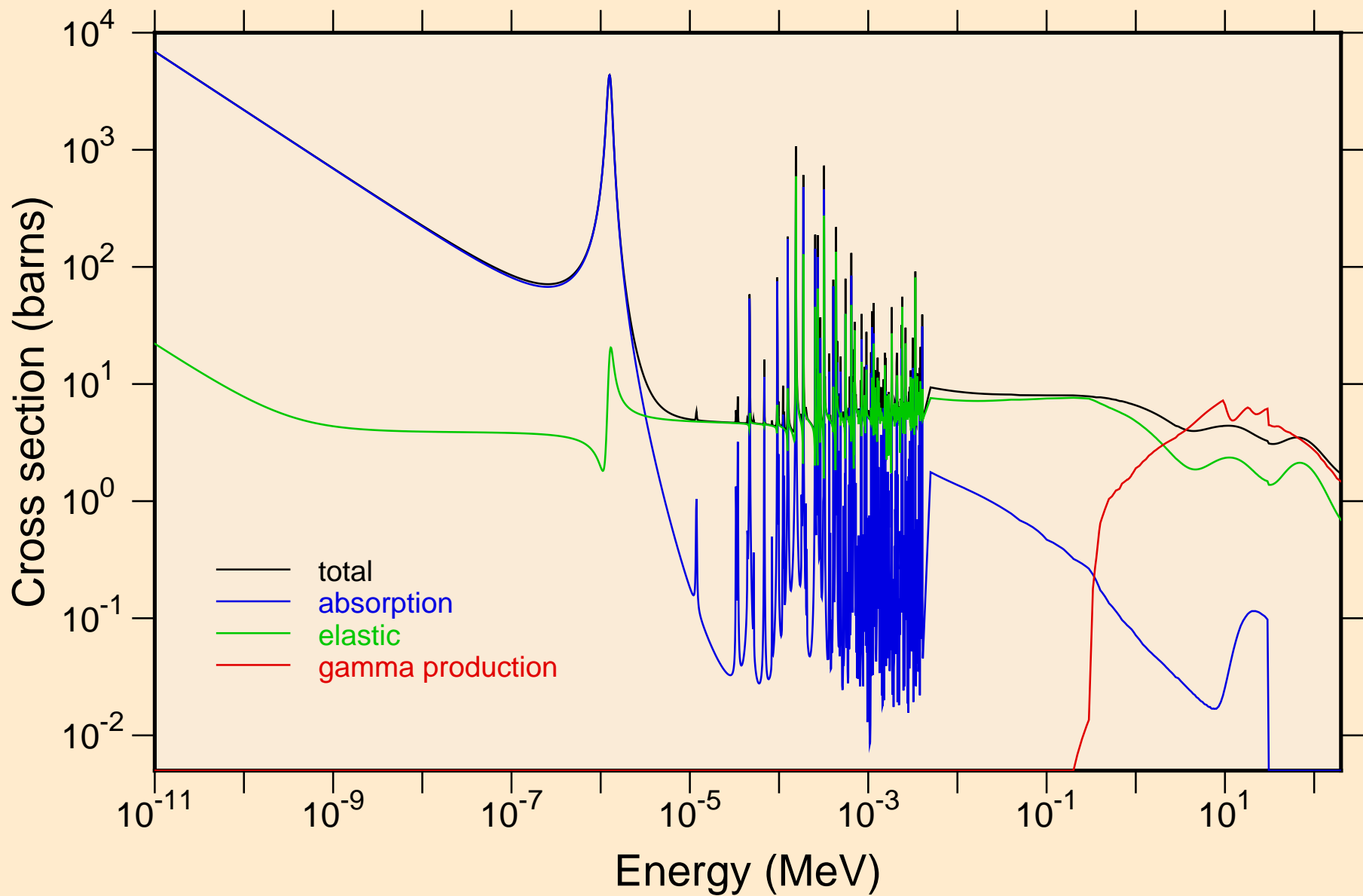

45-RH-103 FOR FENDL-3.2 FROM FENDL-3.2 BY NJOY2016.60+ C
resonance total cross section

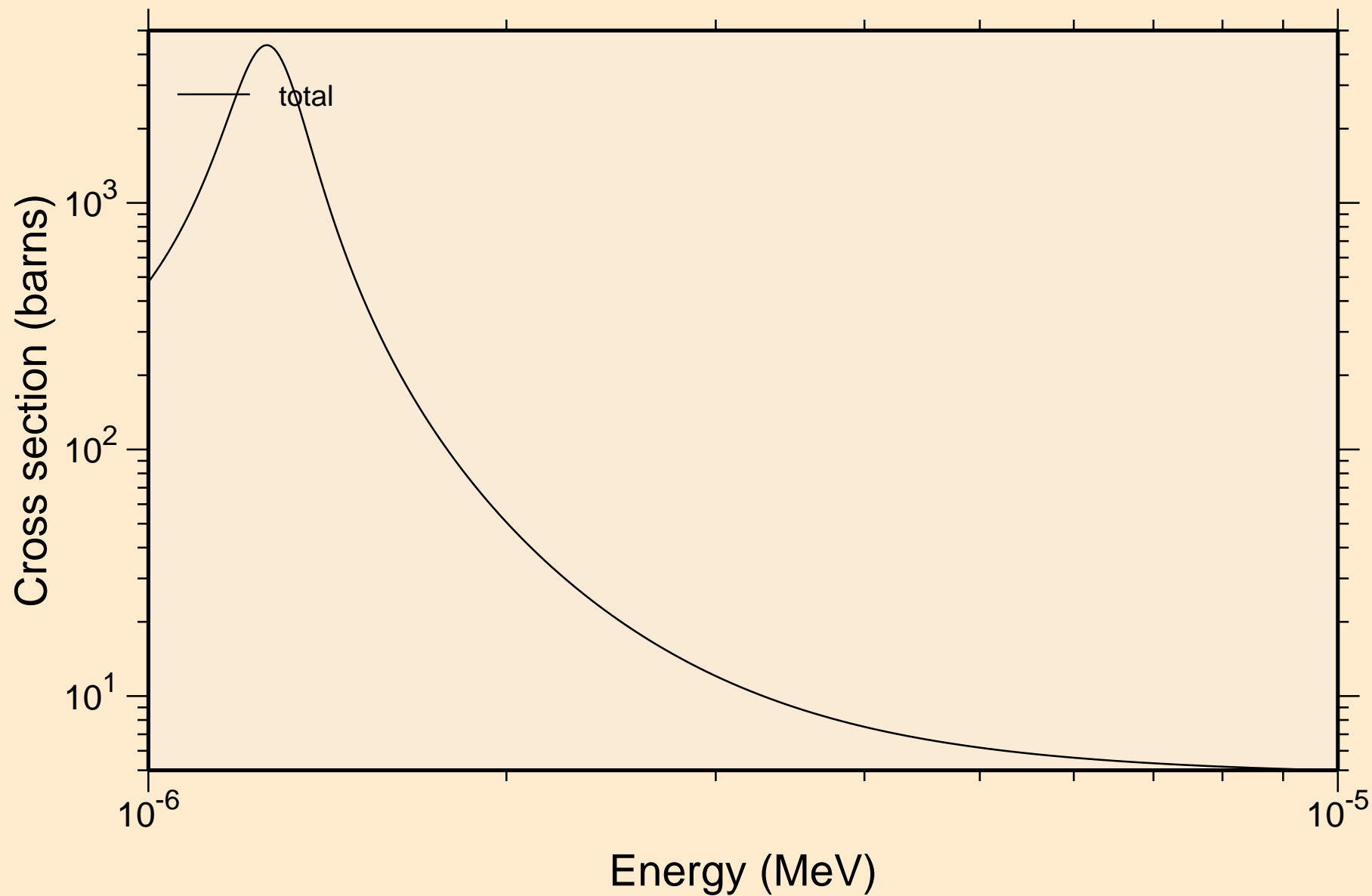

45-RH-103 FOR FENDL-3.2 FROM FENDL-3.2 BY NJOY2016.60+ C
resonance total cross section

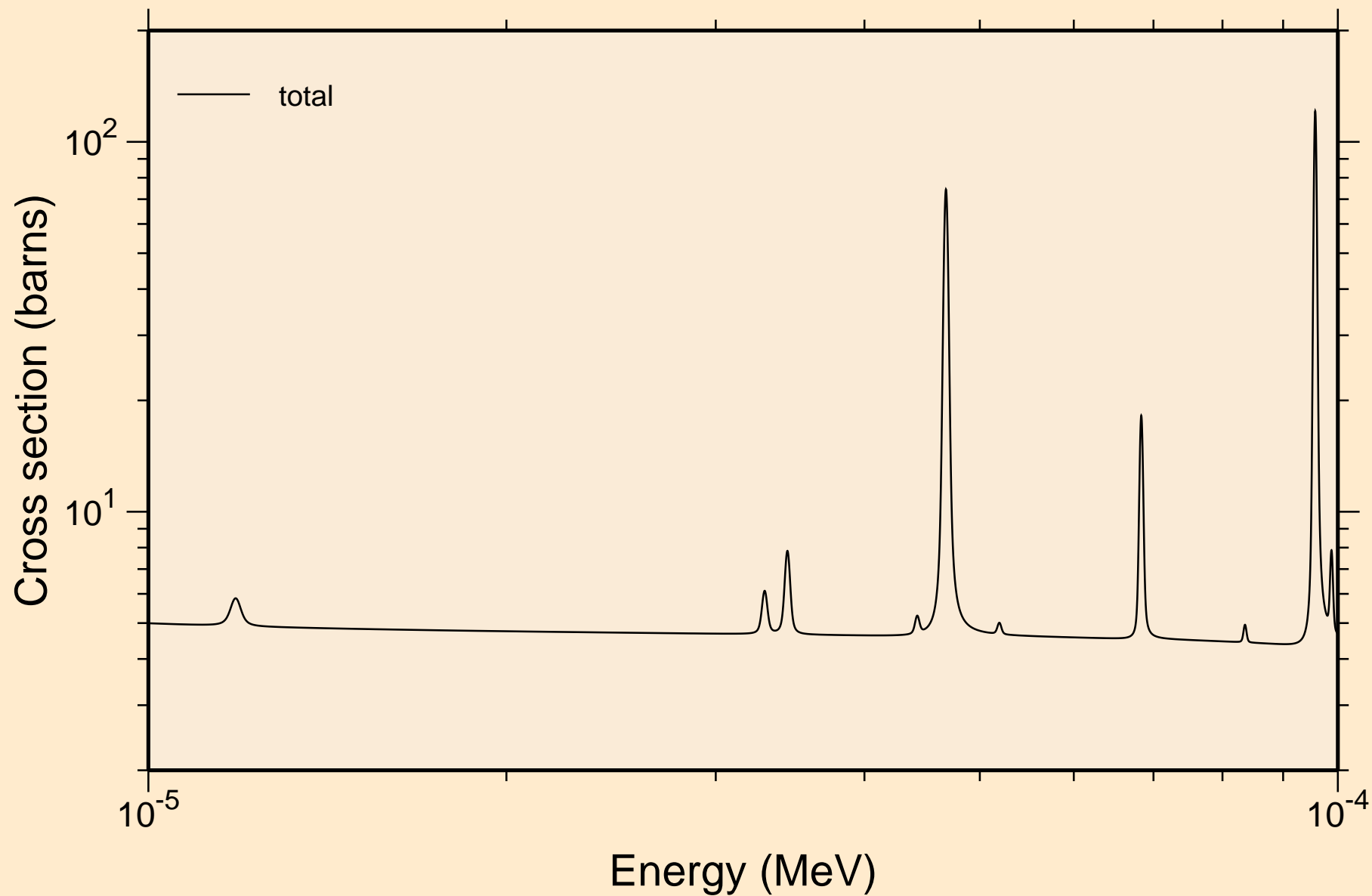

45-RH-103 FOR FENDL-3.2 FROM FENDL-3.2 BY NJOY2016.60+ C
resonance total cross section

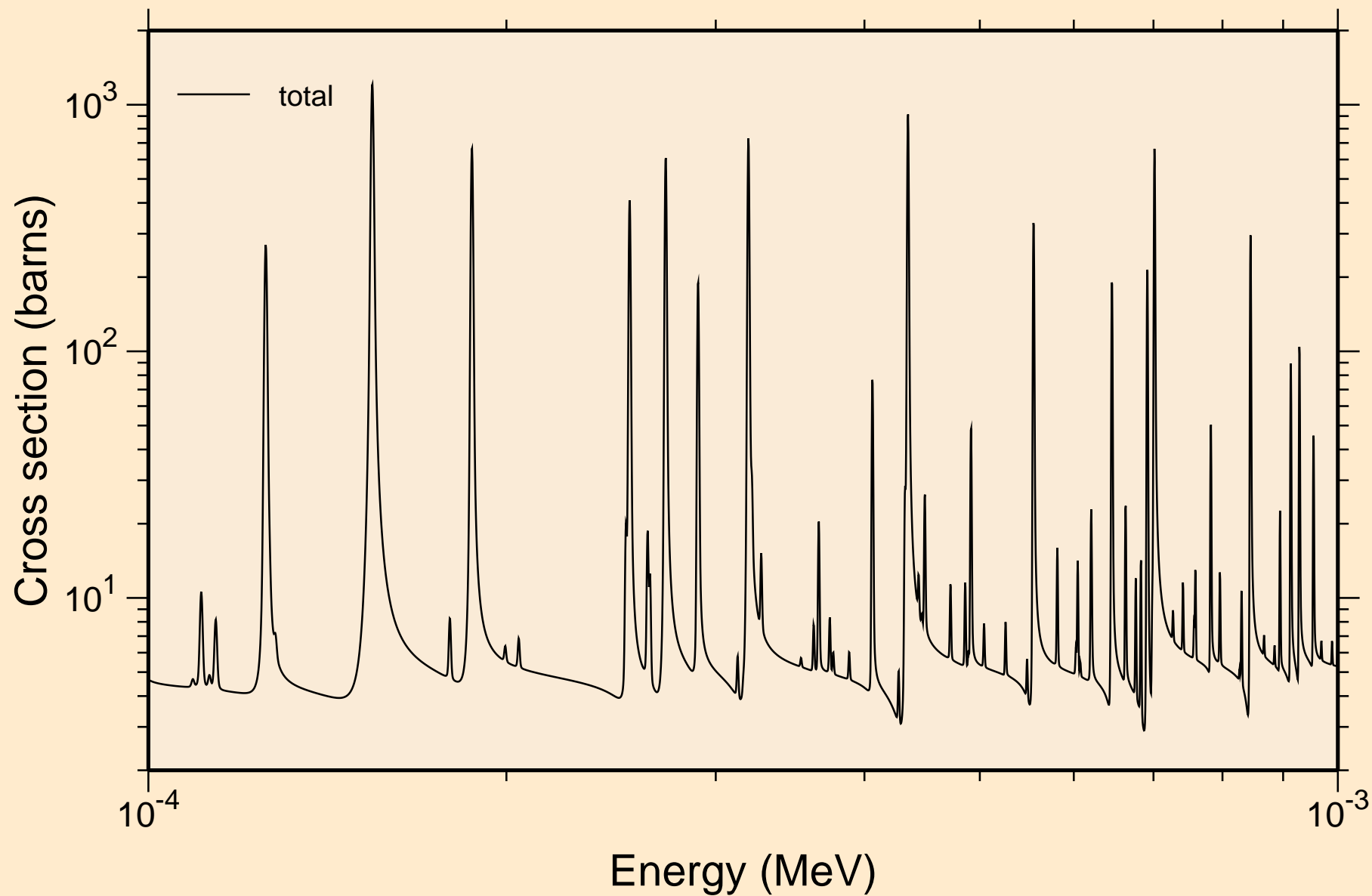

45-RH-103 FOR FENDL-3.2 FROM FENDL-3.2 BY NJOY2016.60+ C
resonance total cross section

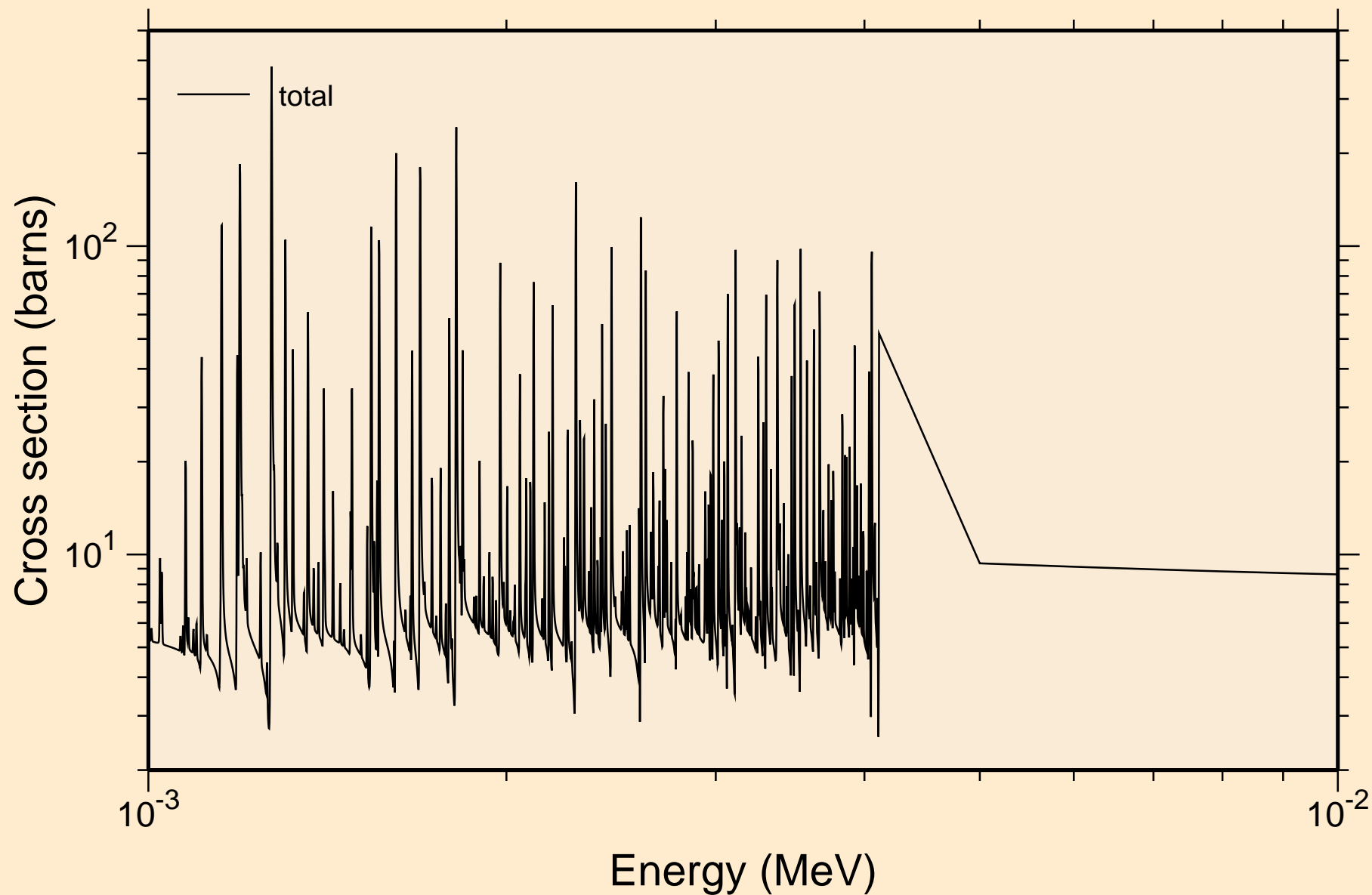

45-RH-103 FOR FENDL-3.2 FROM FENDL-3.2 BY NJOY2016.60+ C
resonance total cross section

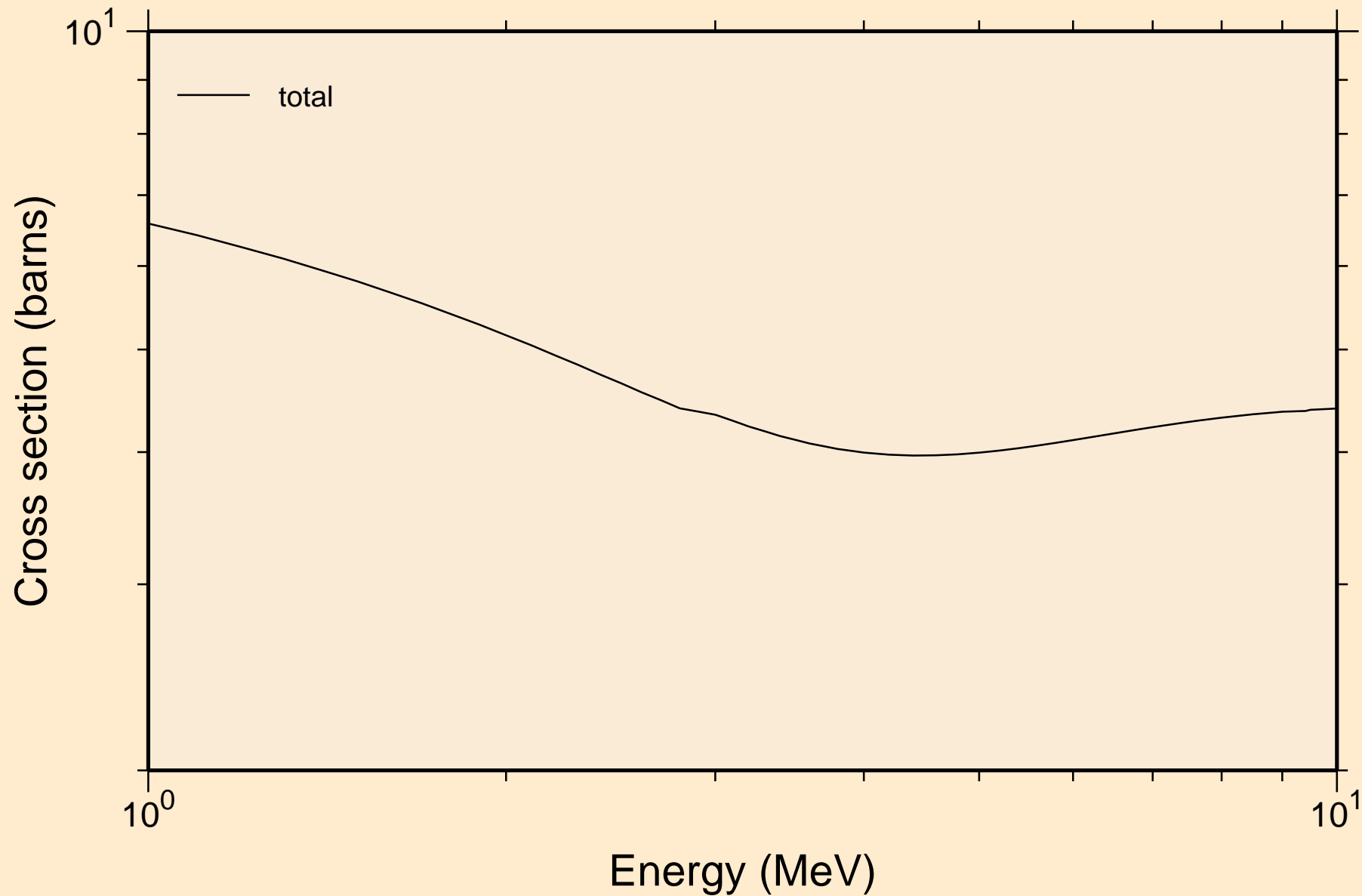

45-RH-103 FOR FENDL-3.2 FROM FENDL-3.2 BY NJOY2016.60+ C
resonance absorption cross sections

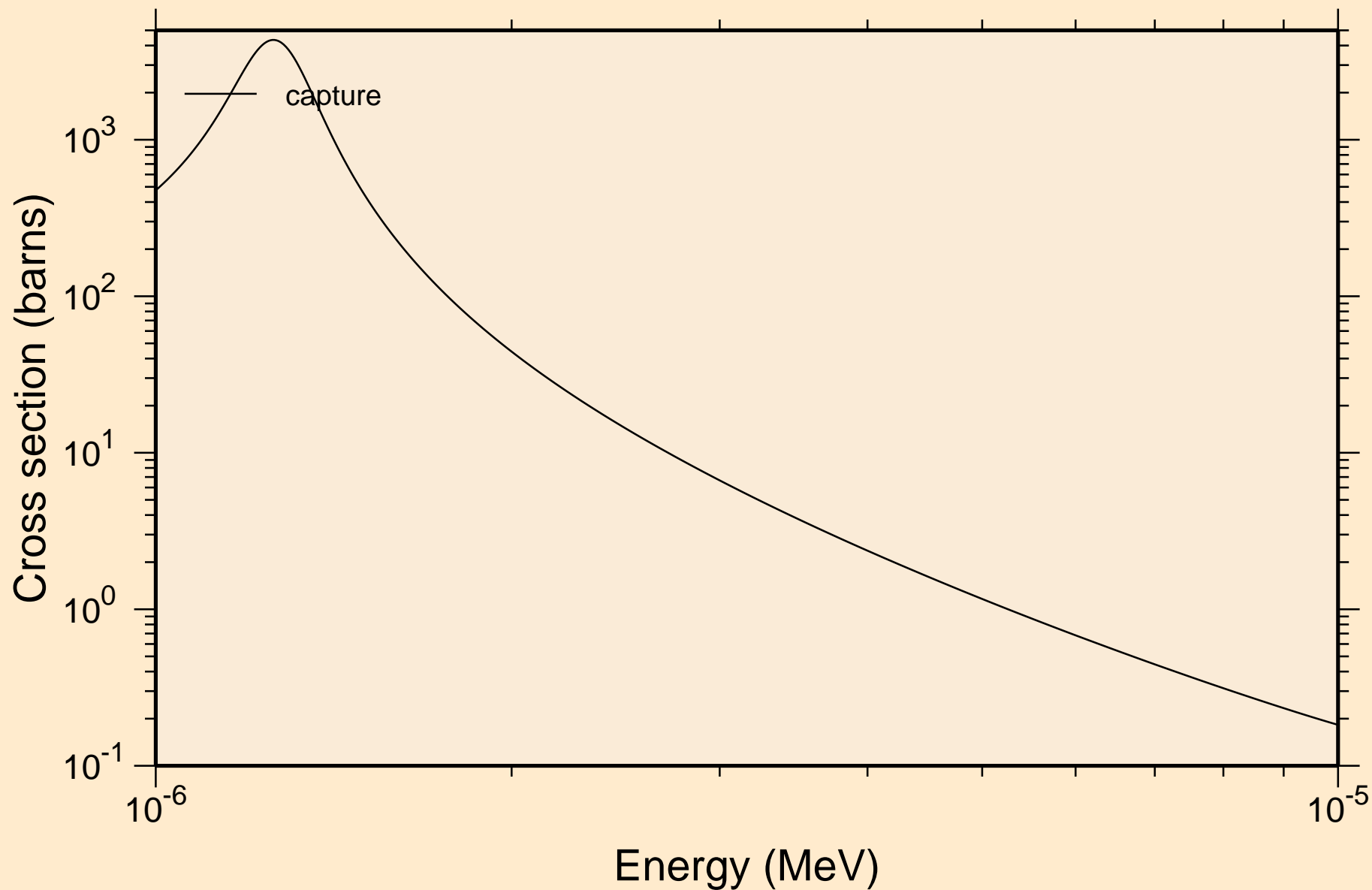

45-RH-103 FOR FENDL-3.2 FROM FENDL-3.2 BY NJOY2016.60+ C
resonance absorption cross sections

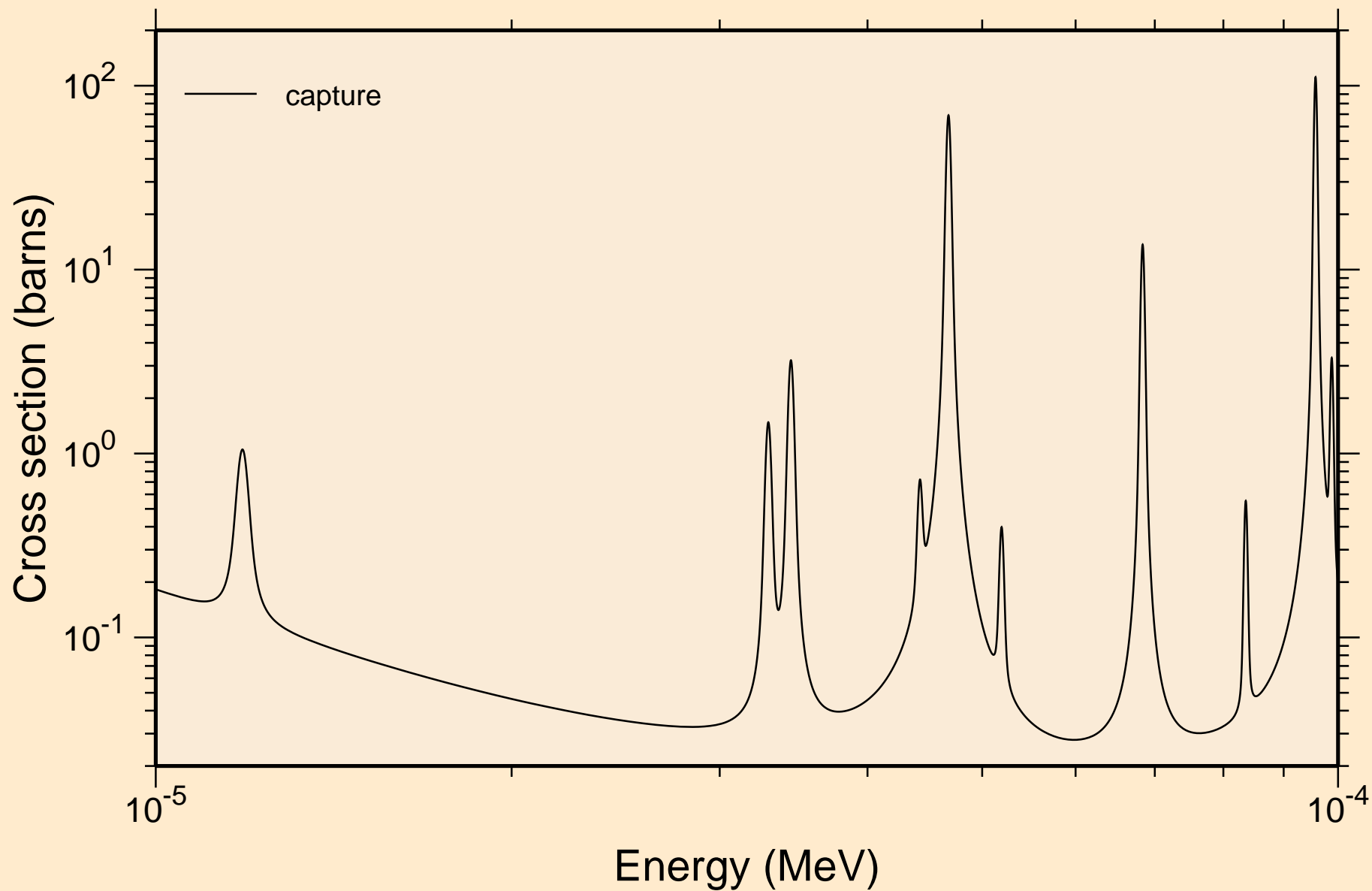

45-RH-103 FOR FENDL-3.2 FROM FENDL-3.2 BY NJOY2016.60+ C
resonance absorption cross sections

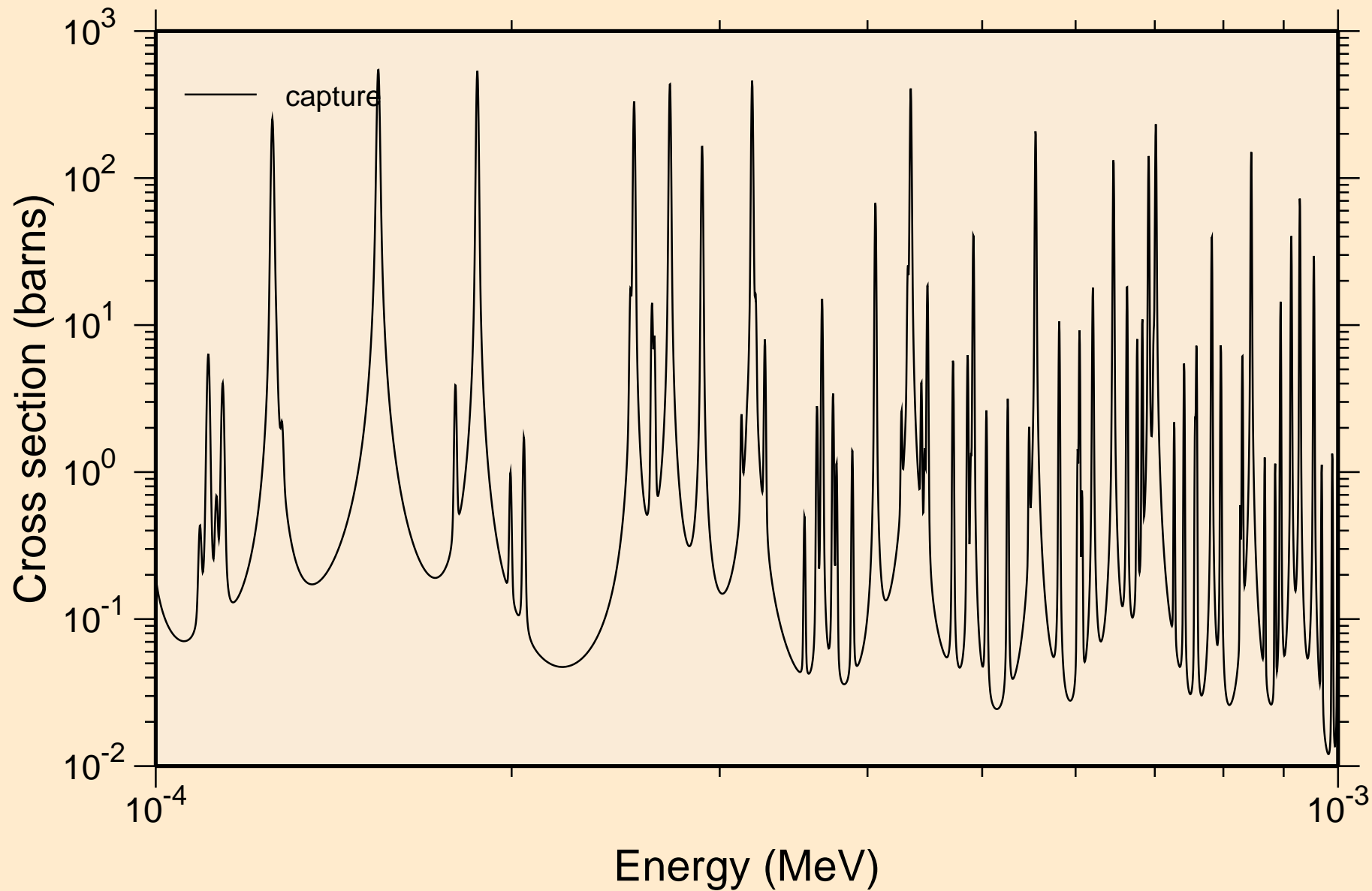

45-RH-103 FOR FENDL-3.2 FROM FENDL-3.2 BY NJOY2016.60+ C
resonance absorption cross sections

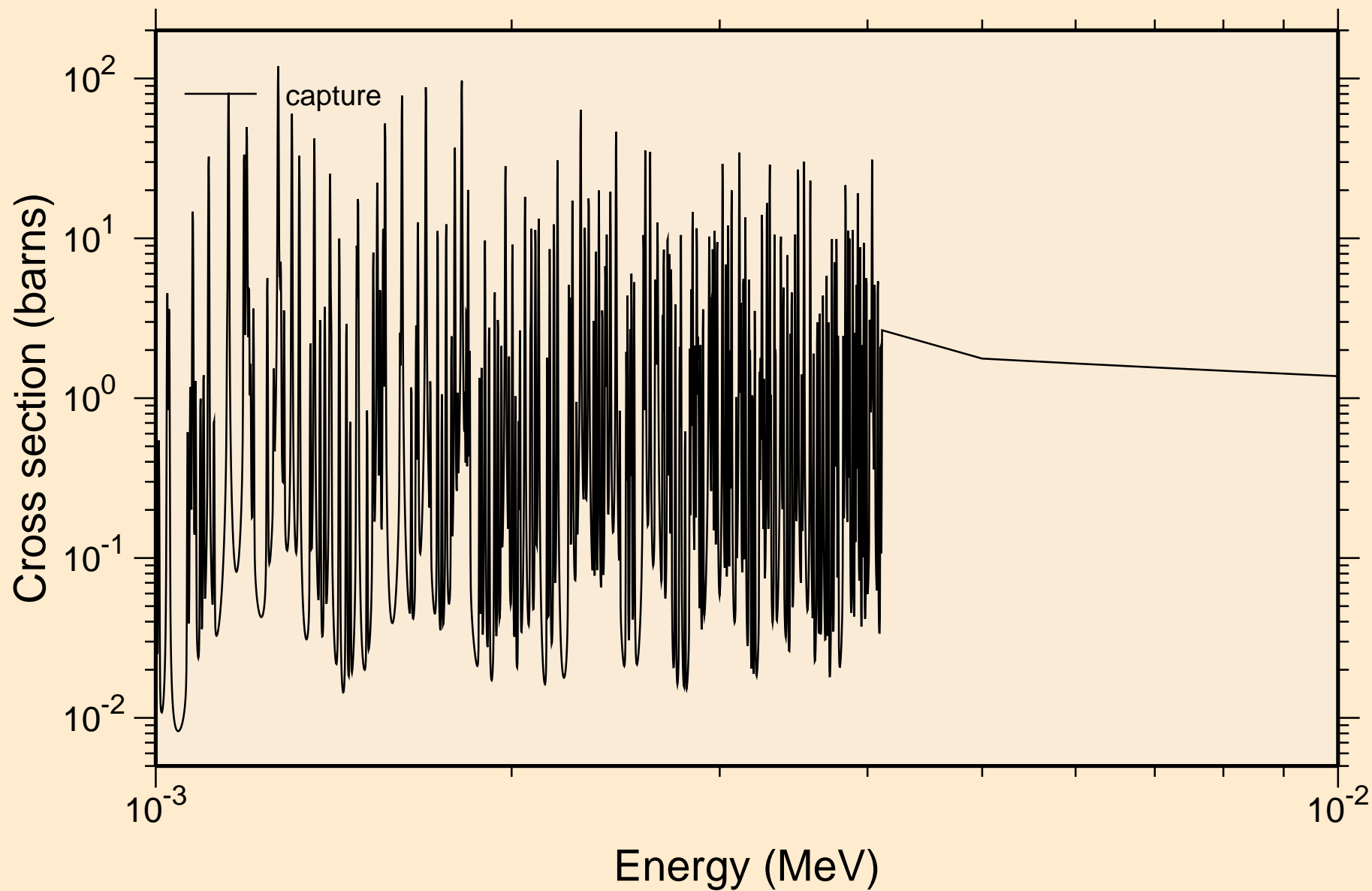

45-RH-103 FOR FENDL-3.2 FROM FENDL-3.2 BY NJOY2016.60+ C
resonance absorption cross sections

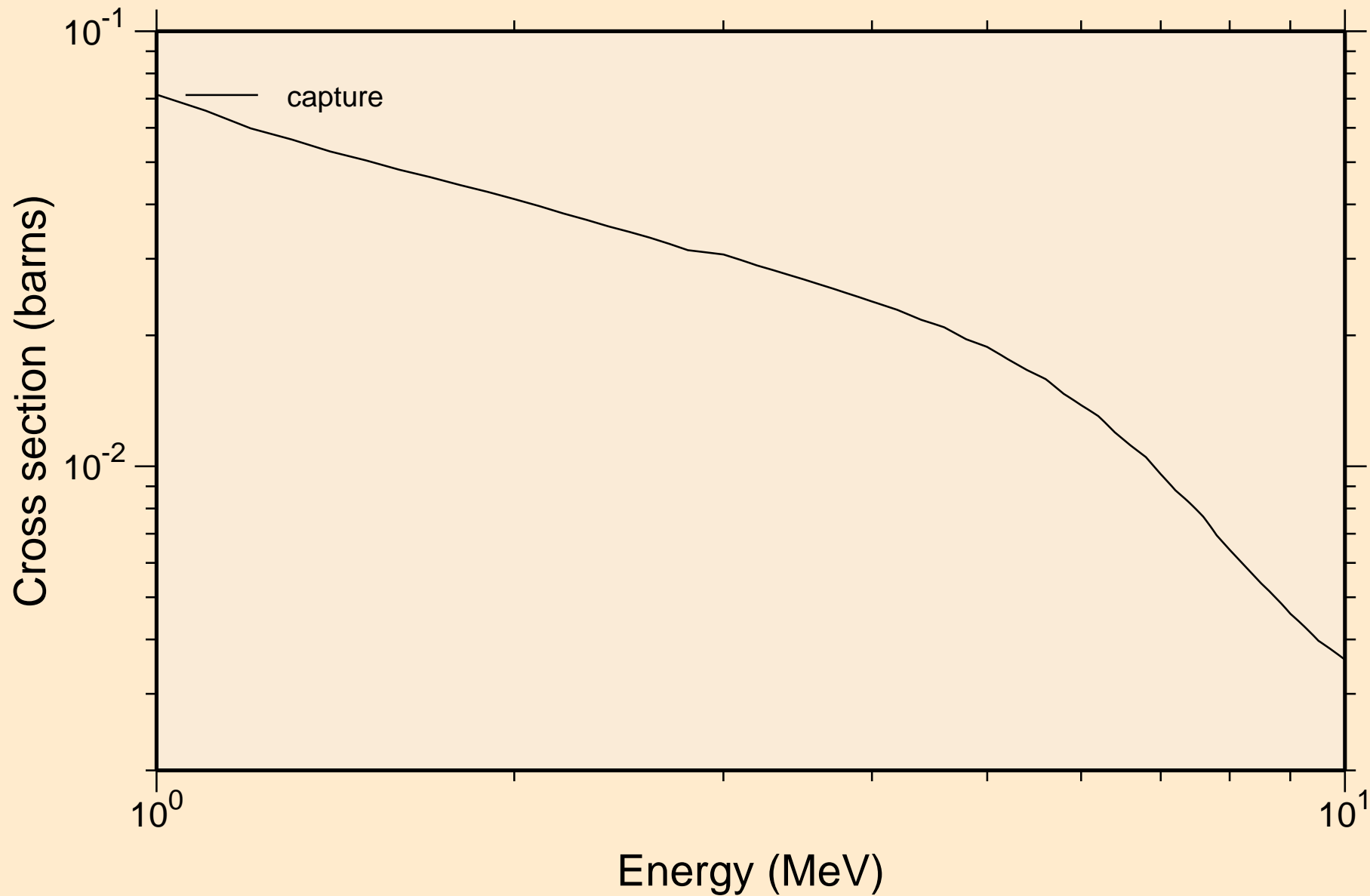

45-RH-103 FOR FENDL-3.2 FROM FENDL-3.2 BY NJOY2016.60+ C
UR total cross section

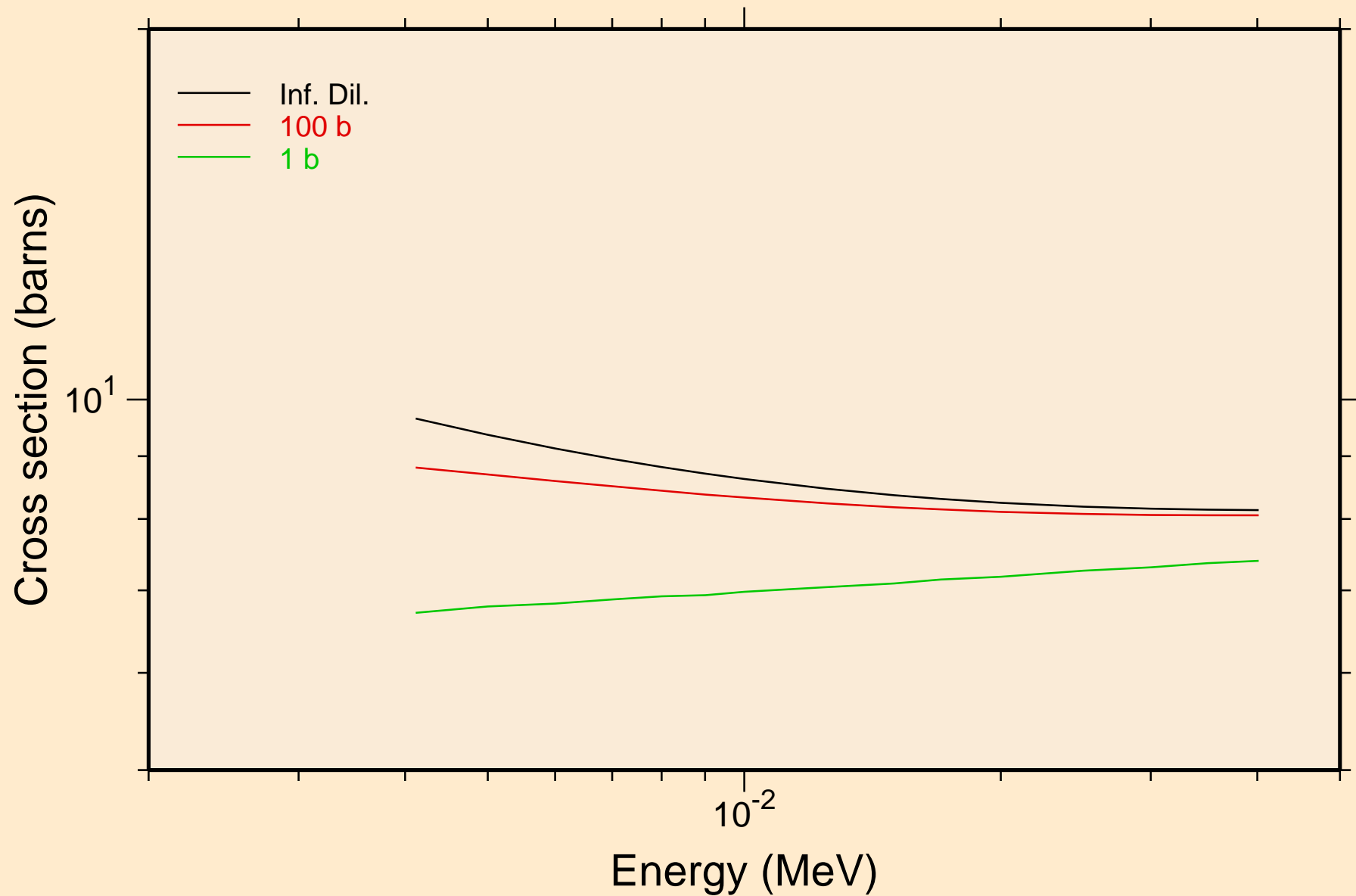

45-RH-103 FOR FENDL-3.2 FROM FENDL-3.2 BY NJOY2016.60+ C
UR elastic cross section

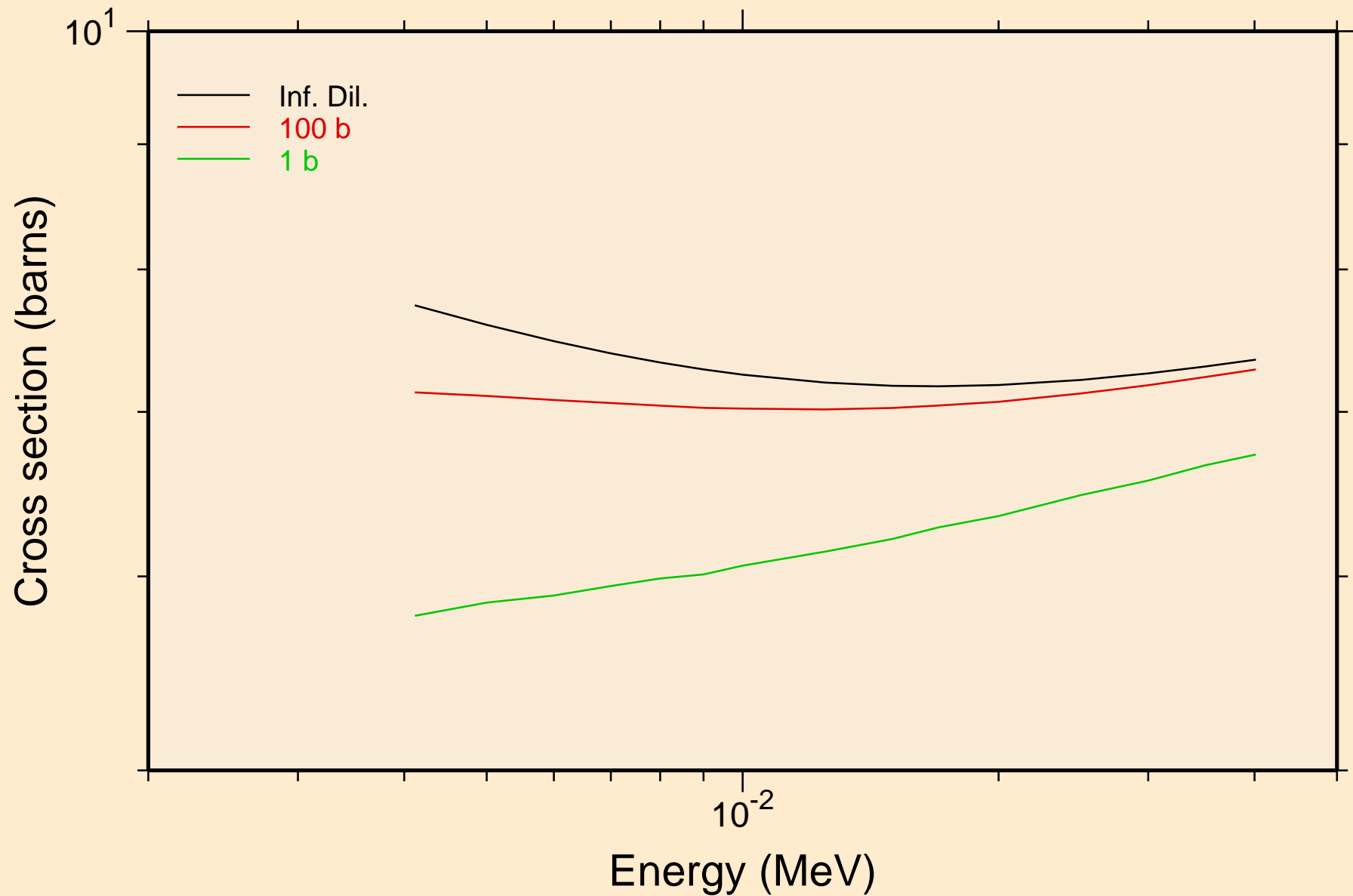

45-RH-103 FOR FENDL-3.2 FROM FENDL-3.2 BY NJOY2016.60+ C
UR capture cross section

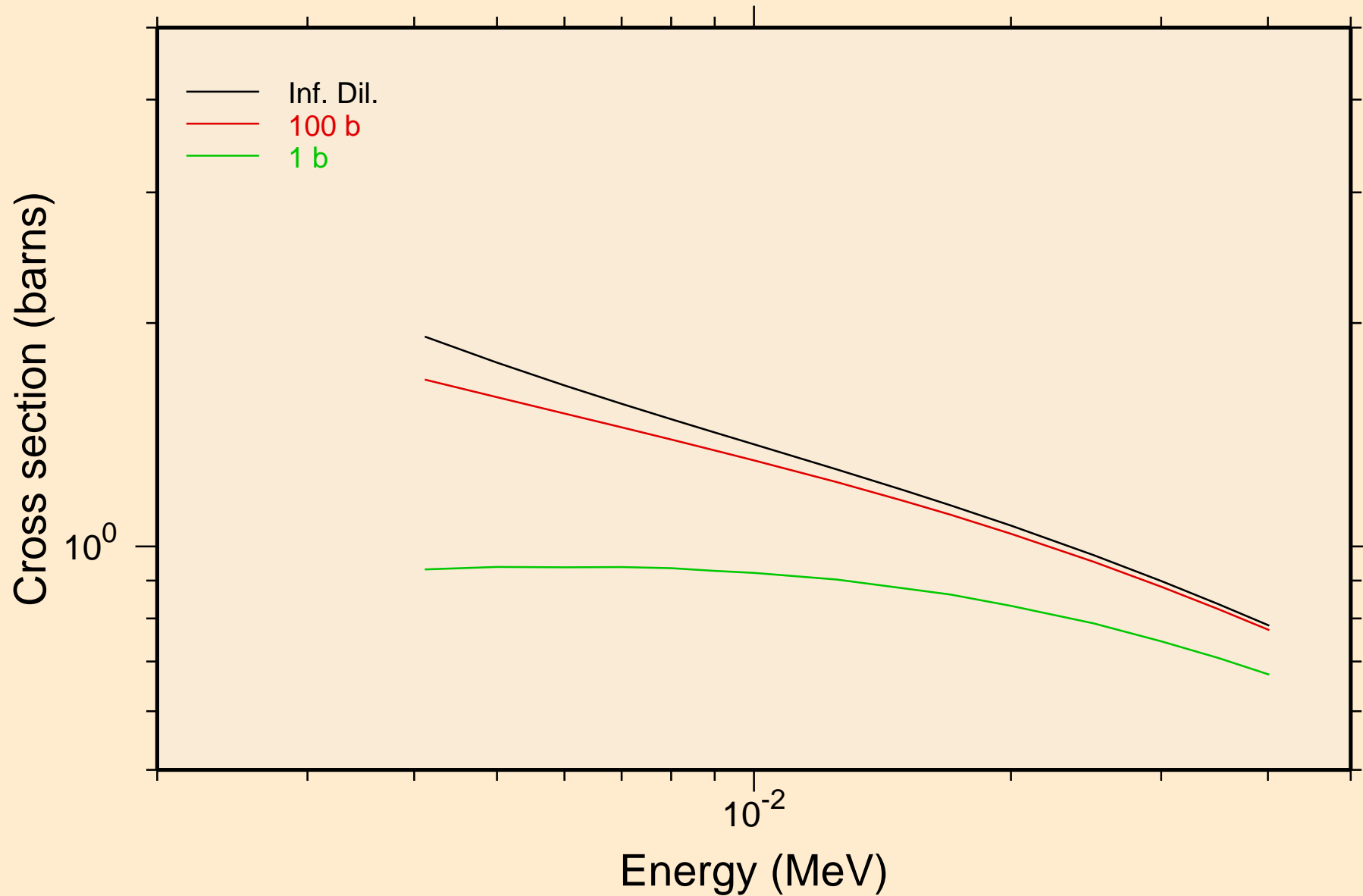

45-RH-103 FOR FENDL-3.2 FROM FENDL-3.2 BY NJOY2016.60+ C
Heating

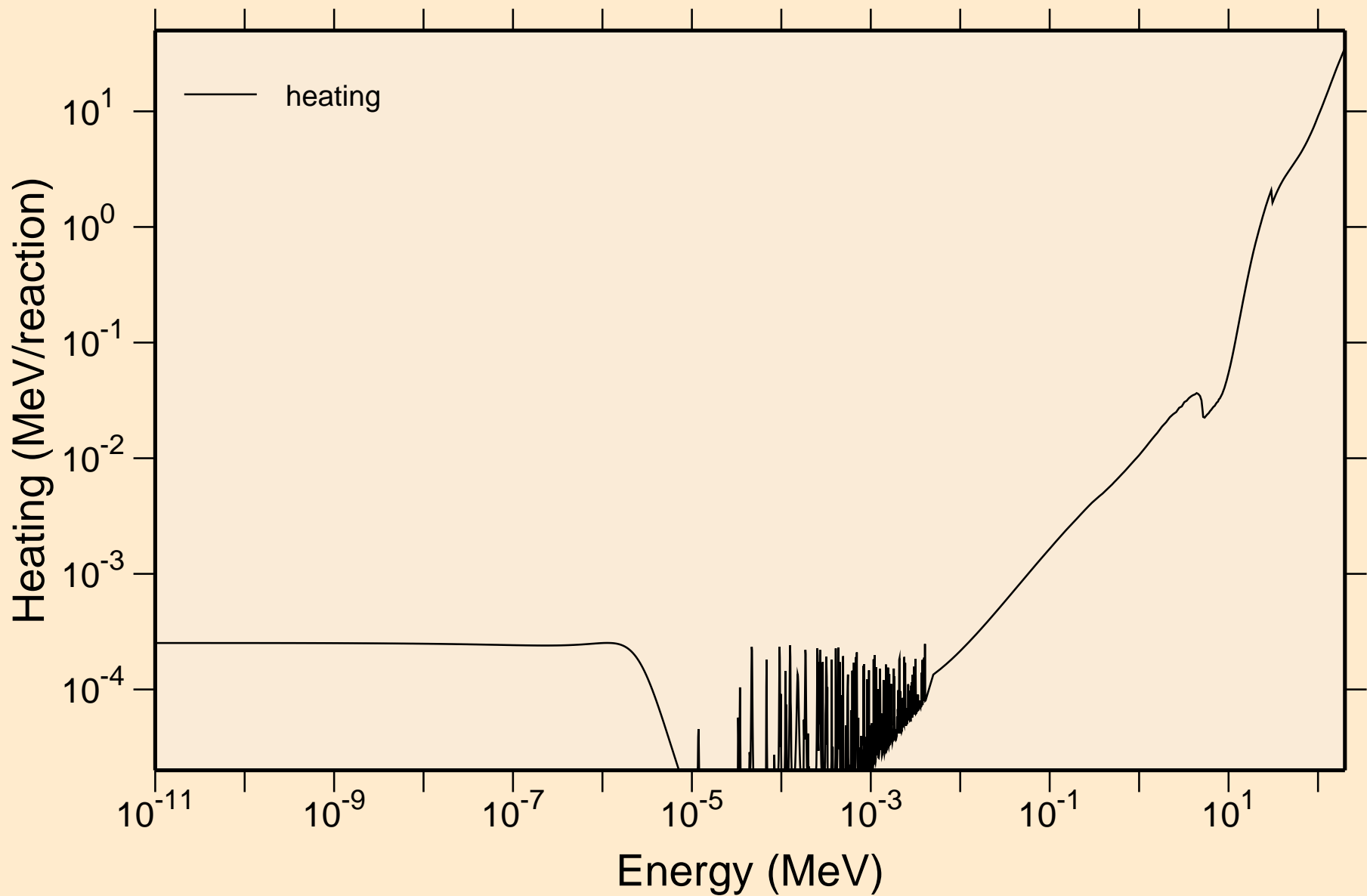

45-RH-103 FOR FENDL-3.2 FROM FENDL-3.2 BY NJOY2016.60+ C
Damage

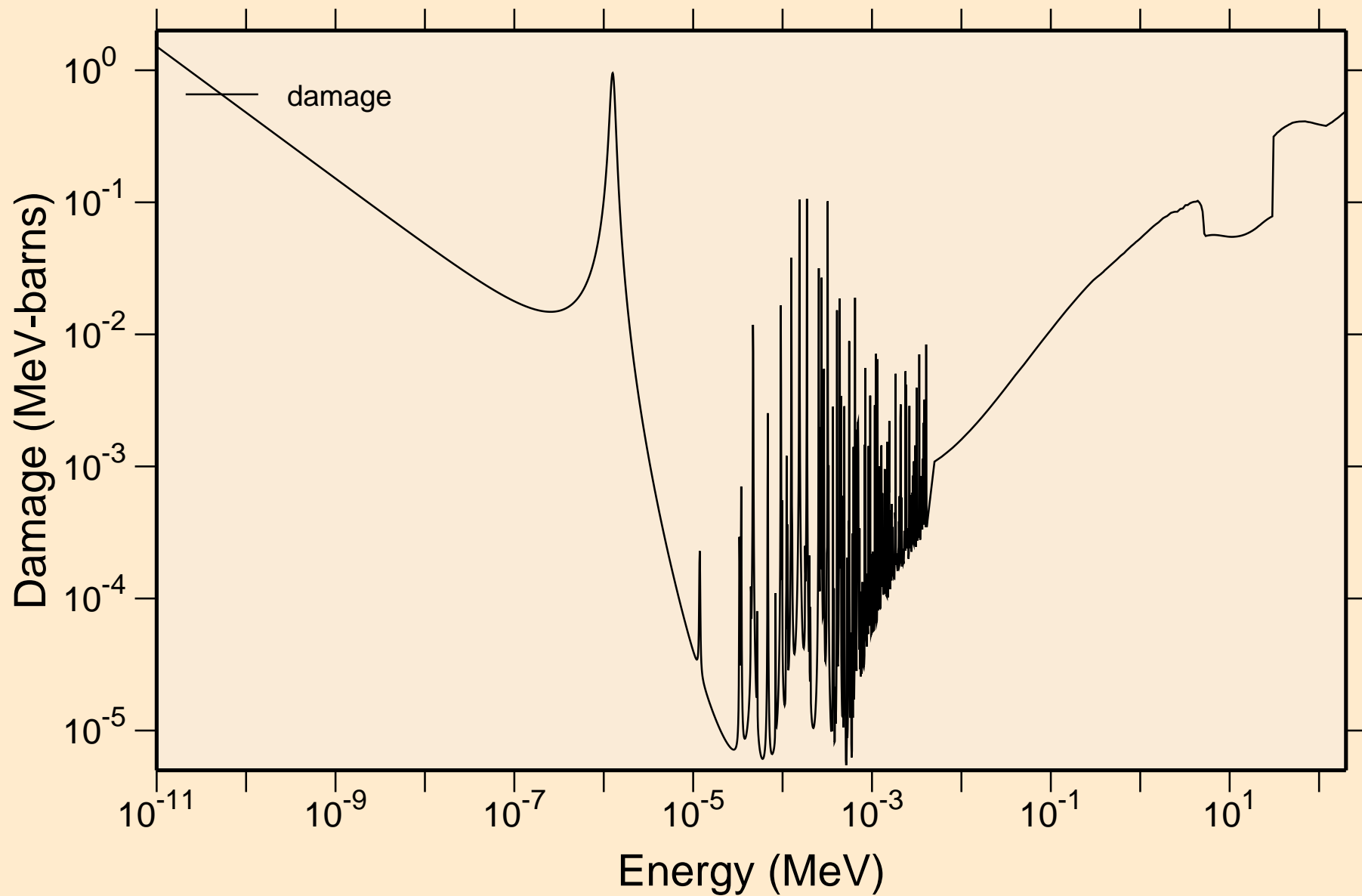

45-RH-103 FOR FENDL-3.2 FROM FENDL-3.2 BY NJOY2016.60+ C
Non-threshold reactions

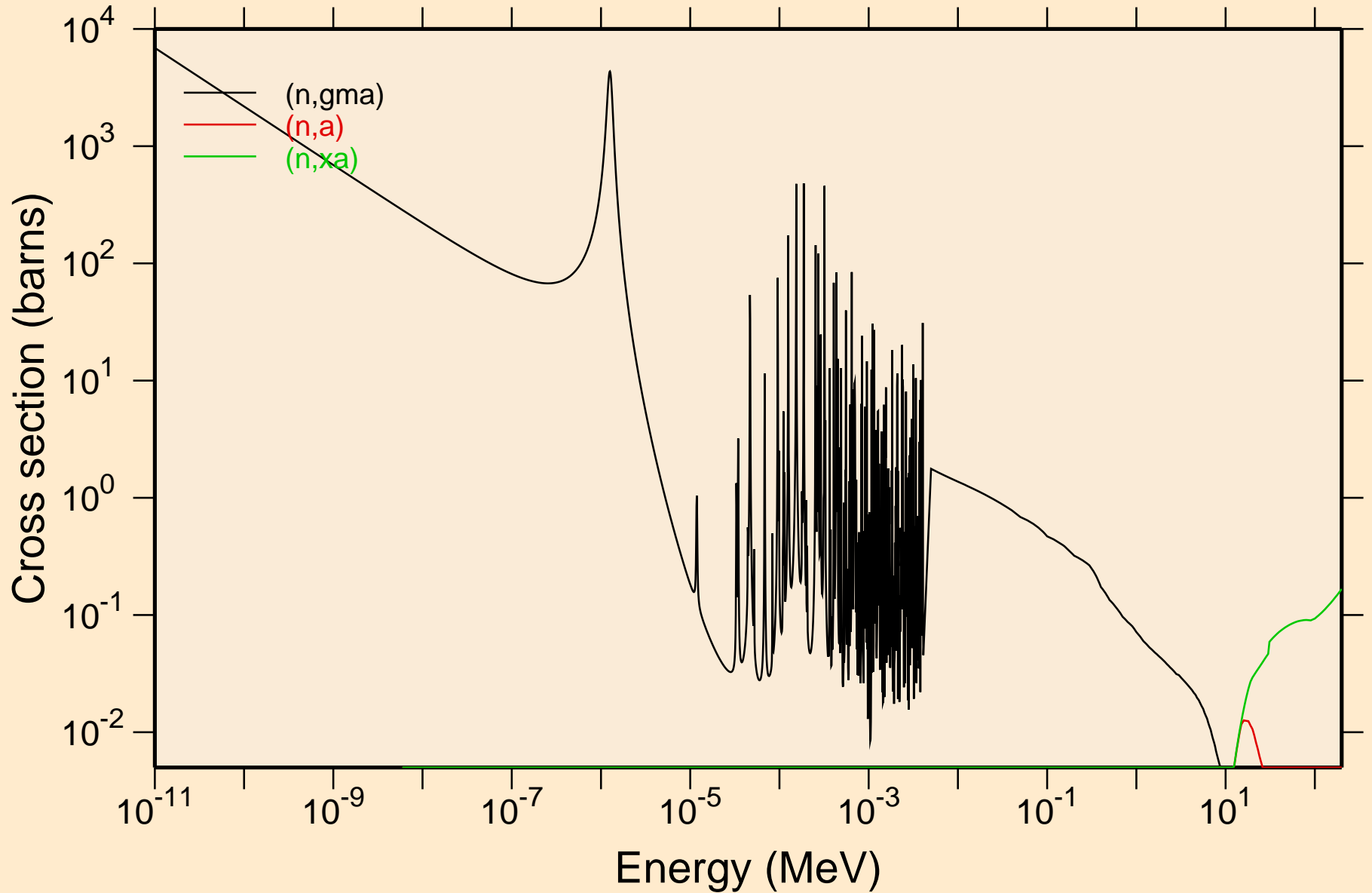

45-RH-103 FOR FENDL-3.2 FROM FENDL-3.2 BY NJOY2016.60+ C
Principal cross sections

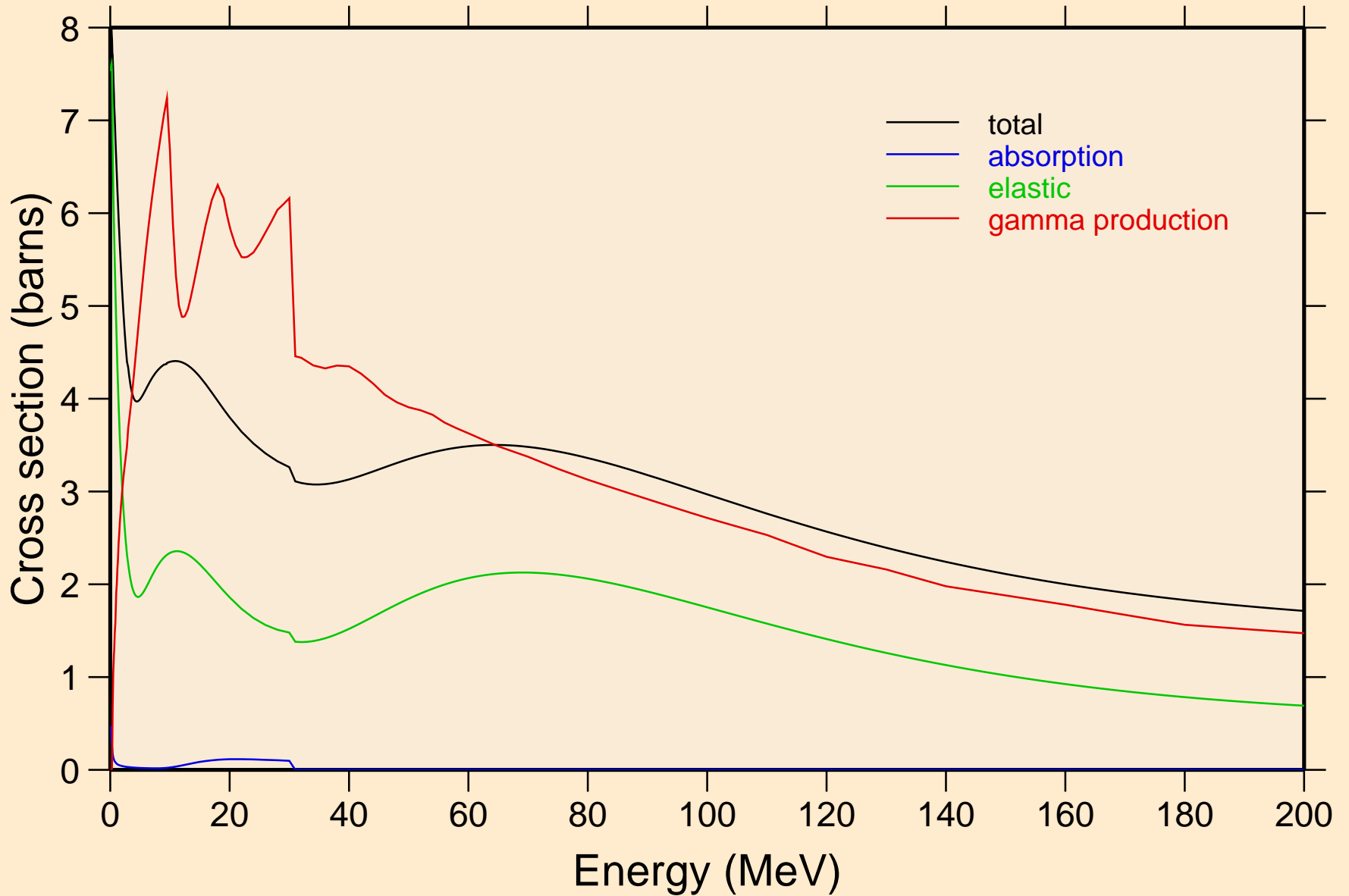

45-RH-103 FOR FENDL-3.2 FROM FENDL-3.2 BY NJOY2016.60+ C Heating

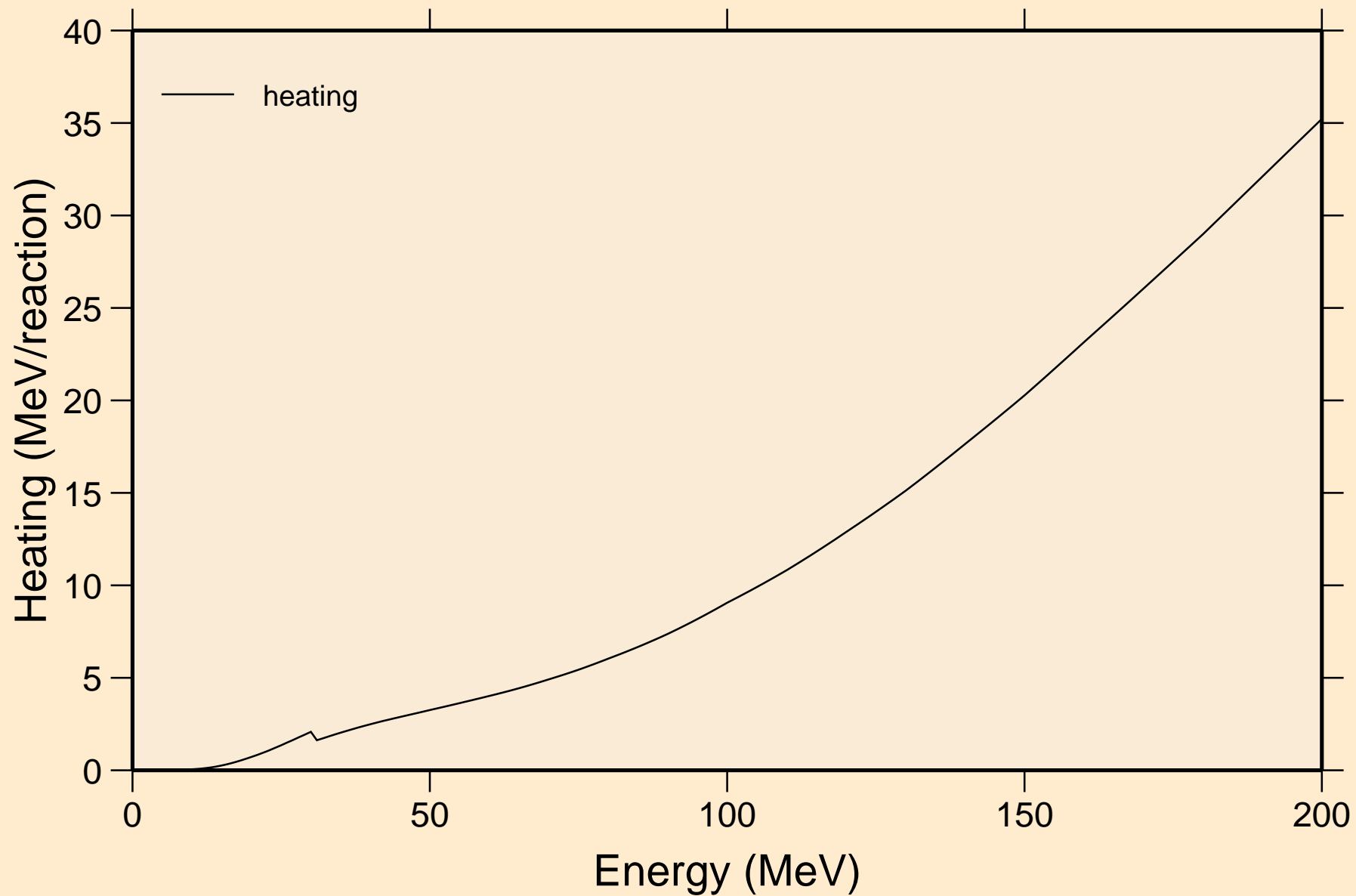

45-RH-103 FOR FENDL-3.2 FROM FENDL-3.2 BY NJOY2016.60+ C Damage

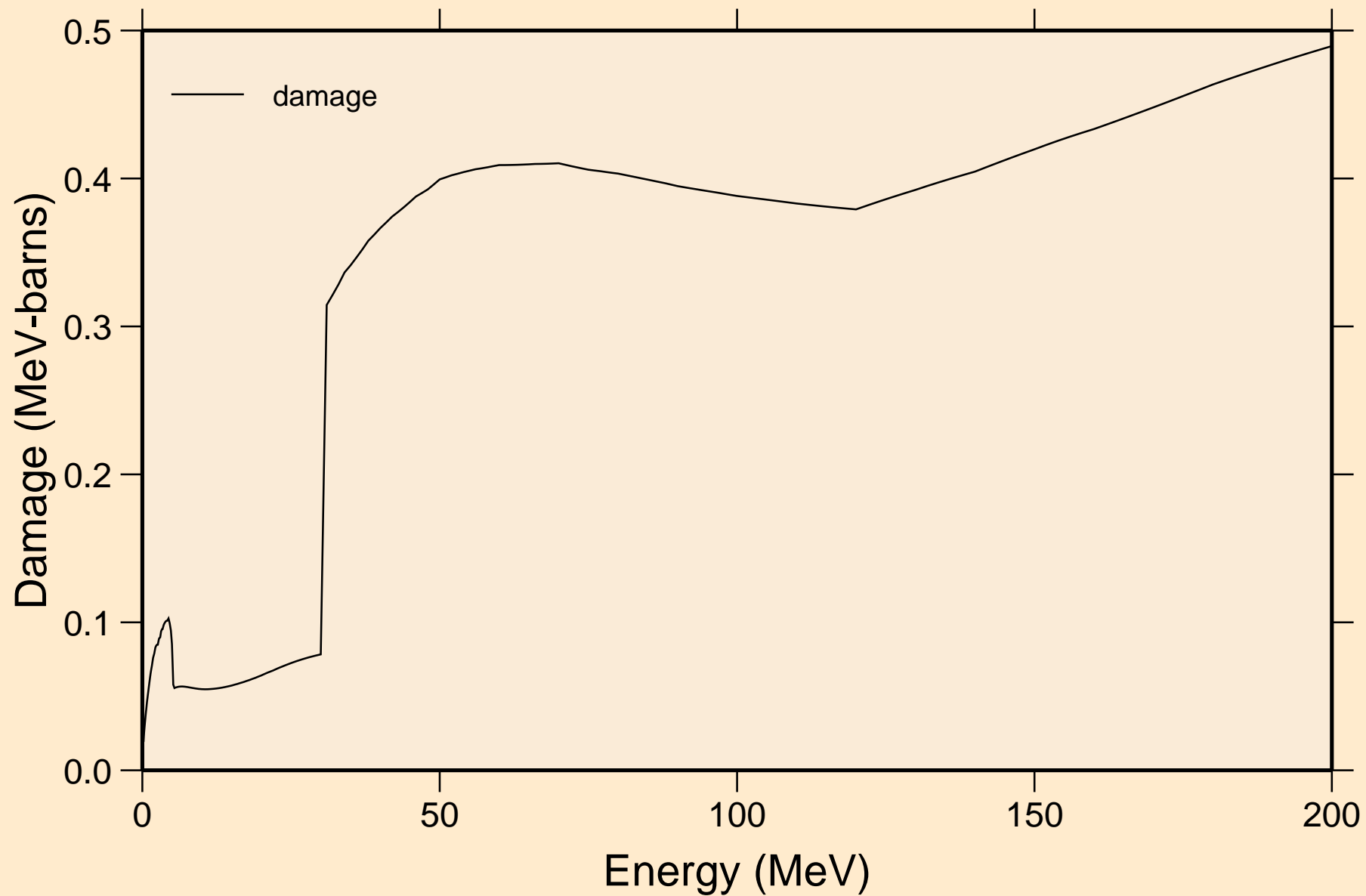

45-RH-103 FOR FENDL-3.2 FROM FENDL-3.2 BY NJOY2016.60+ C
Non-threshold reactions

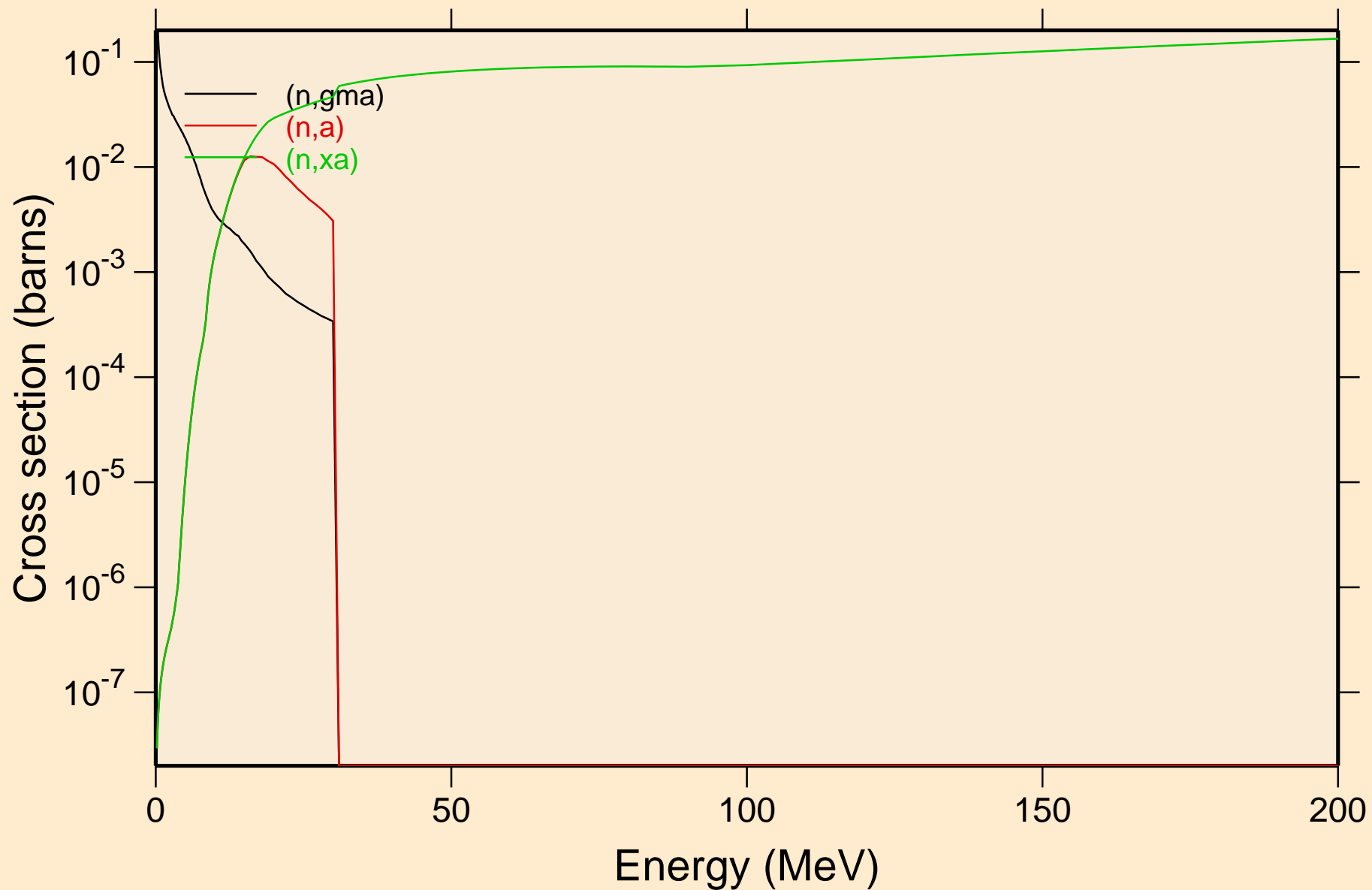

45-RH-103 FOR FENDL-3.2 FROM FENDL-3.2 BY NJOY2016.60+ C
Inelastic levels

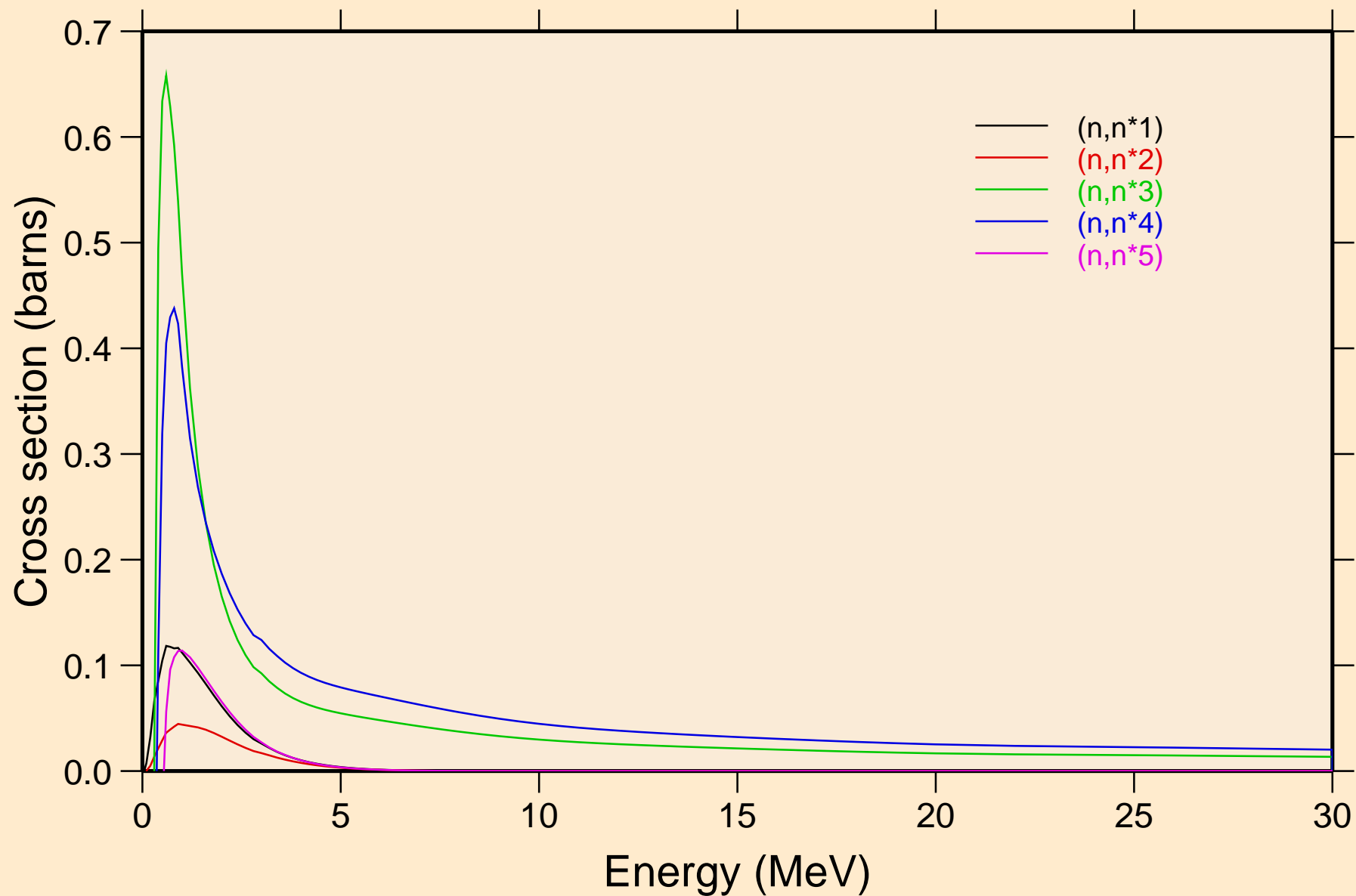

45-RH-103 FOR FENDL-3.2 FROM FENDL-3.2 BY NJOY2016.60+ C
Inelastic levels

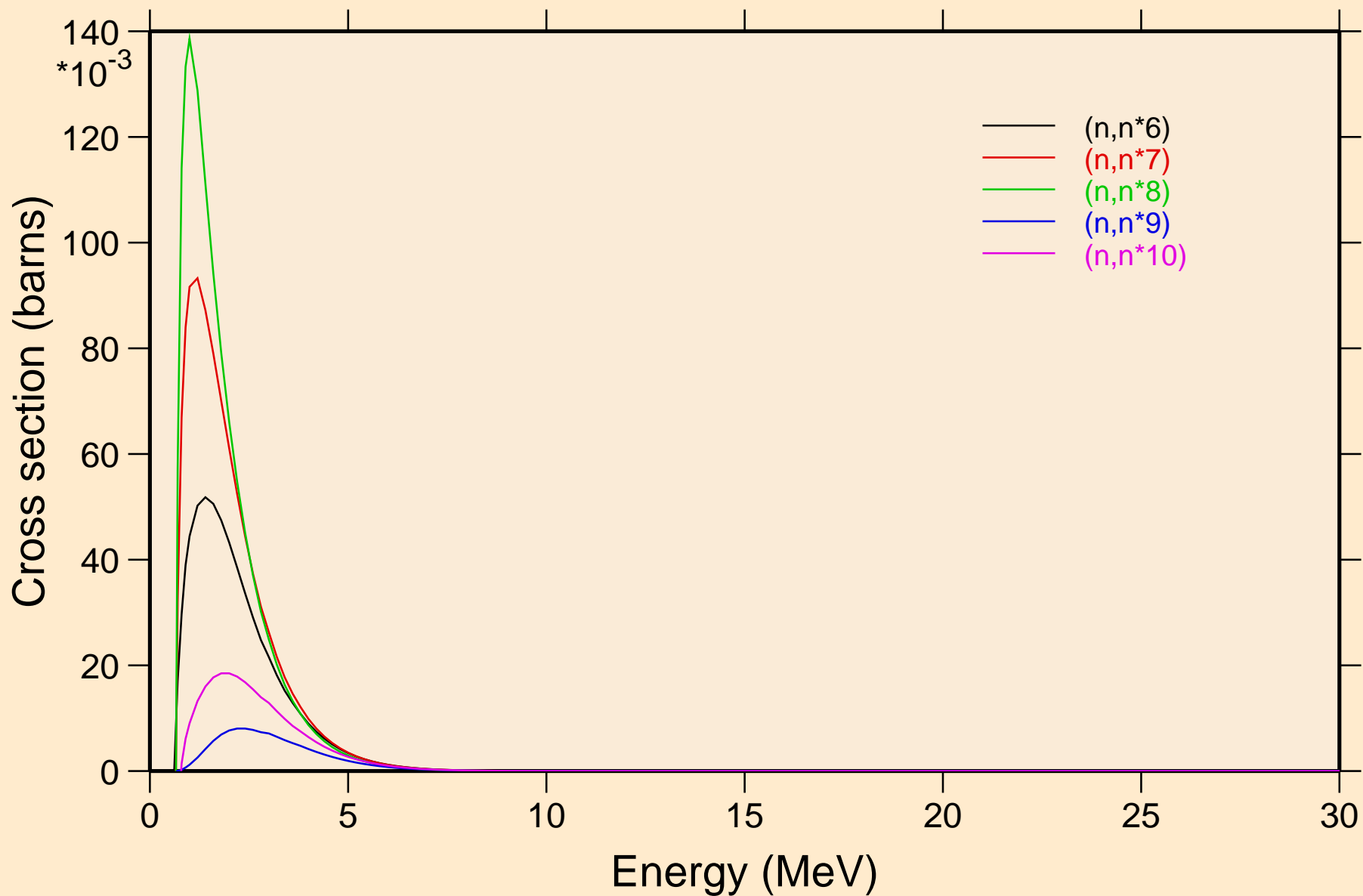

45-RH-103 FOR FENDL-3.2 FROM FENDL-3.2 BY NJOY2016.60+ C
Inelastic levels

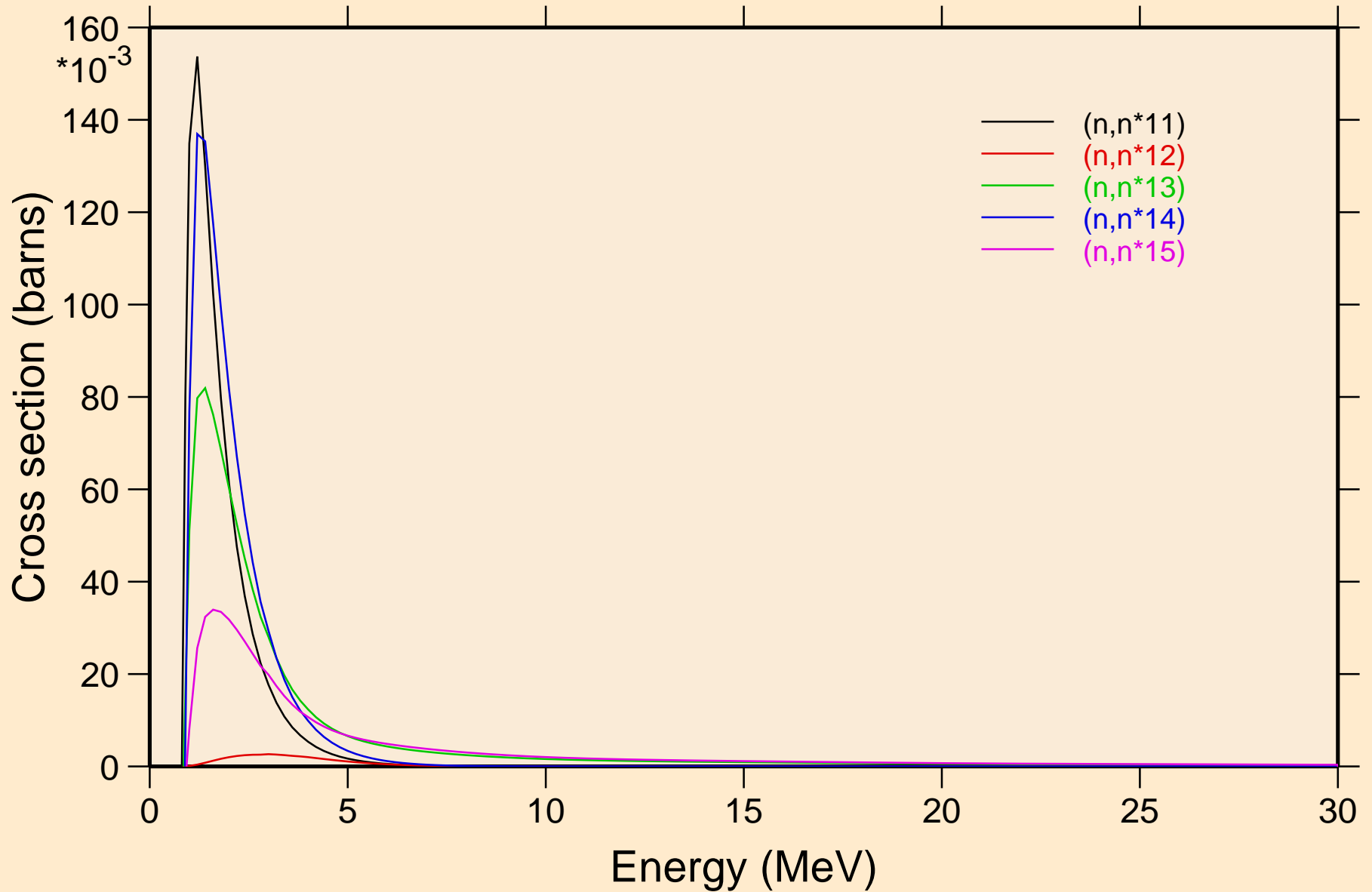

45-RH-103 FOR FENDL-3.2 FROM FENDL-3.2 BY NJOY2016.60+ C
Threshold reactions

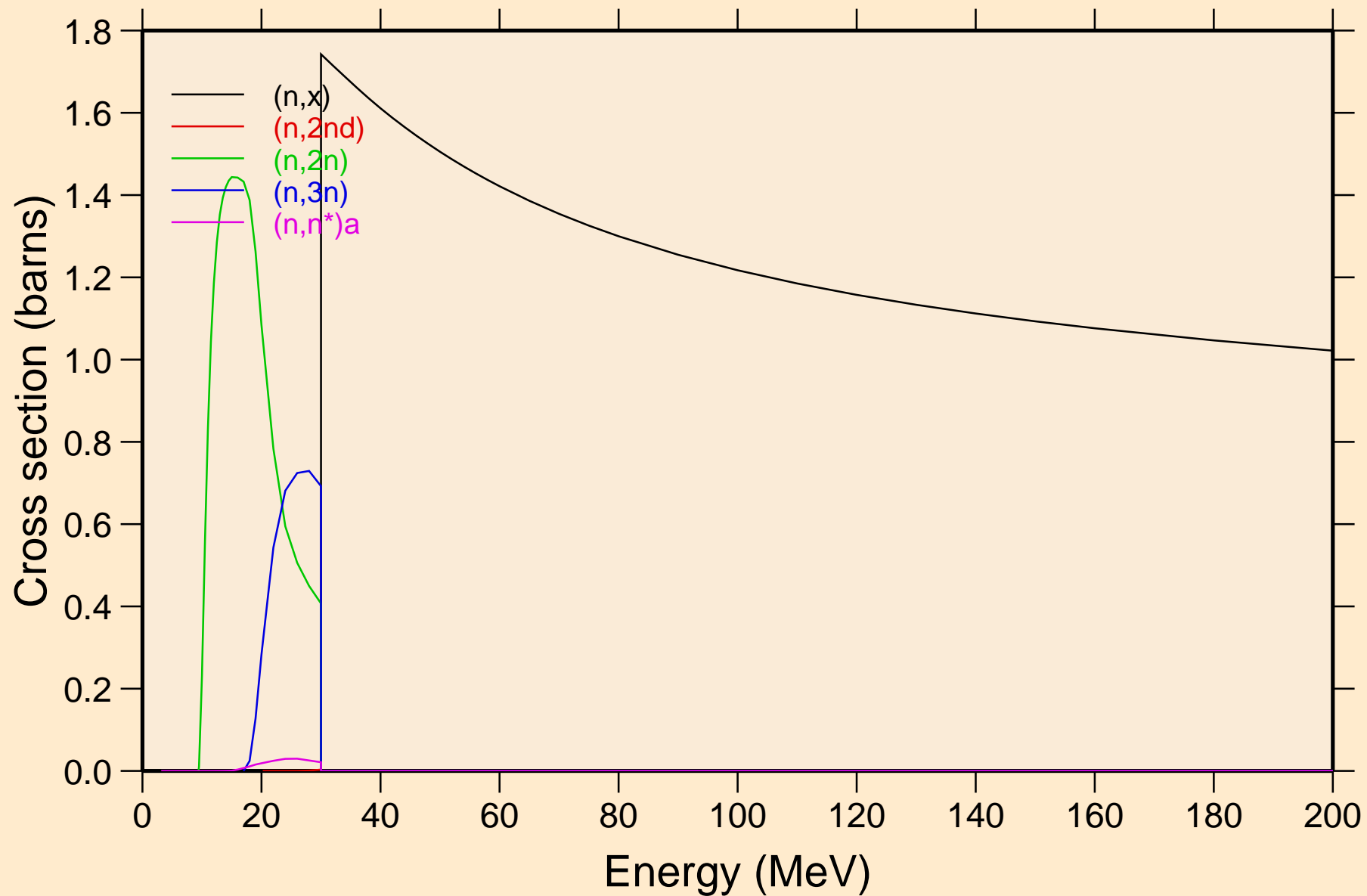

45-RH-103 FOR FENDL-3.2 FROM FENDL-3.2 BY NJOY2016.60+ C
Threshold reactions

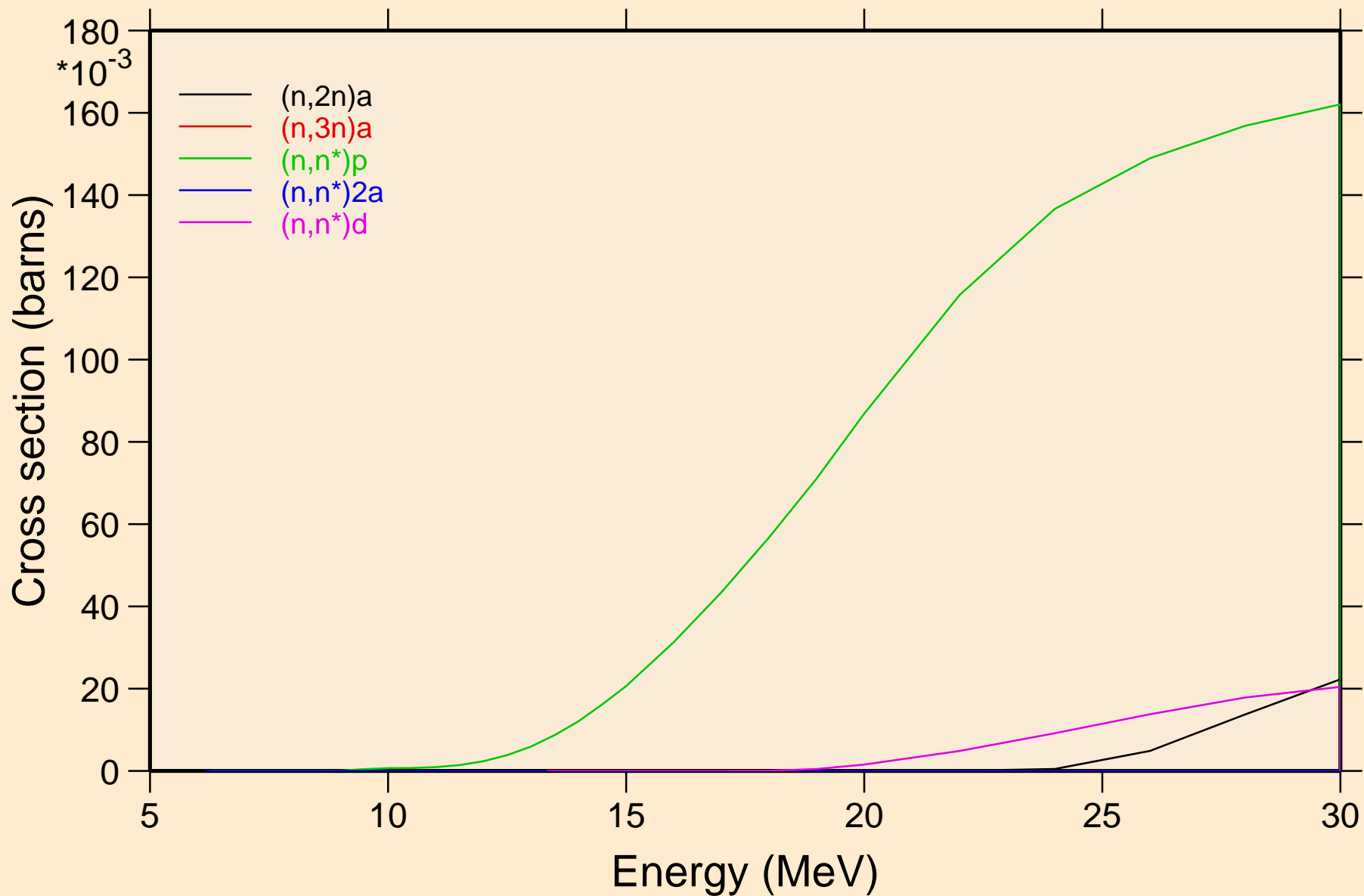

45-RH-103 FOR FENDL-3.2 FROM FENDL-3.2 BY NJOY2016.60+ C
Threshold reactions

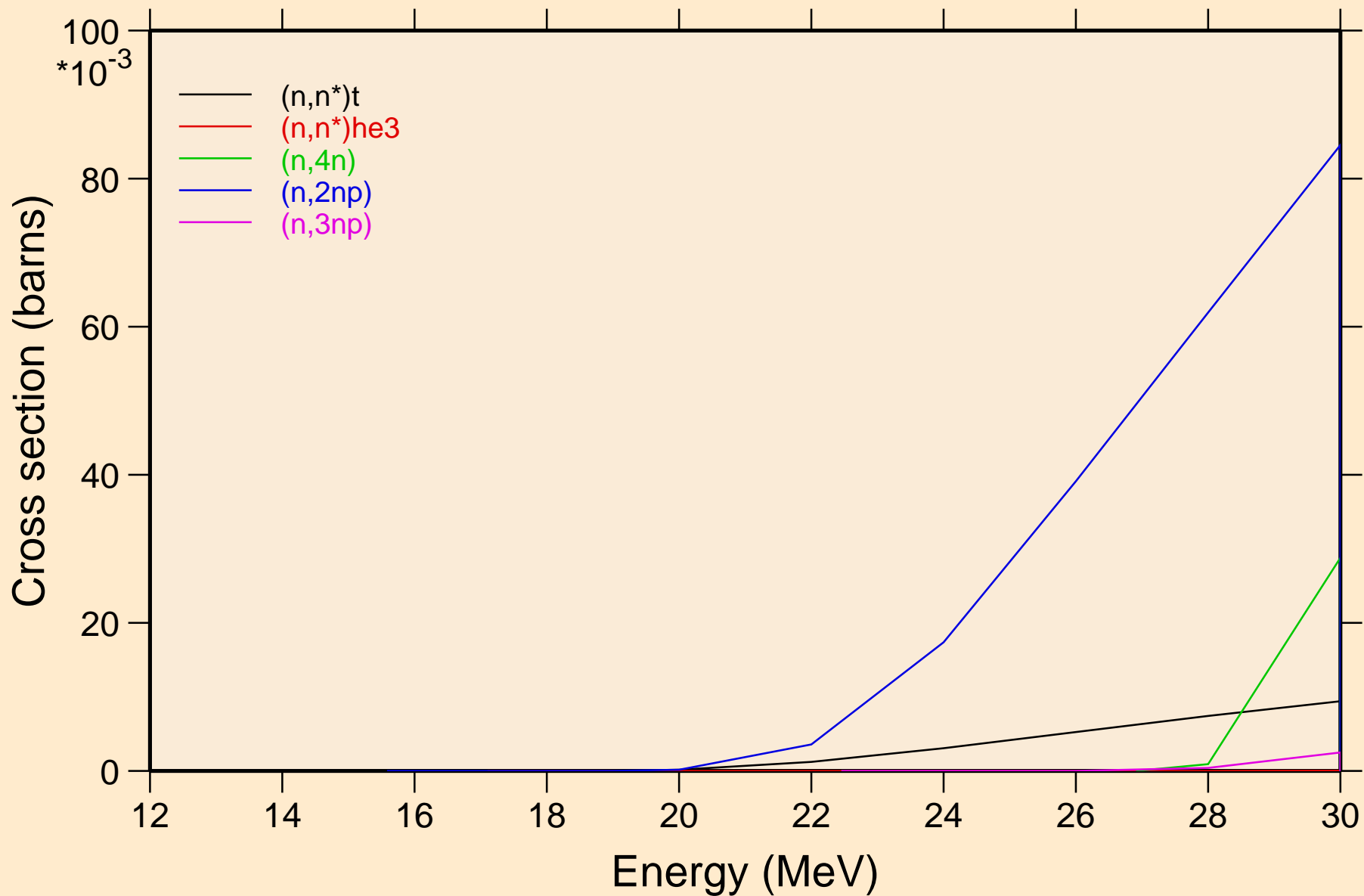

45-RH-103 FOR FENDL-3.2 FROM FENDL-3.2 BY NJOY2016.60+ C
Threshold reactions

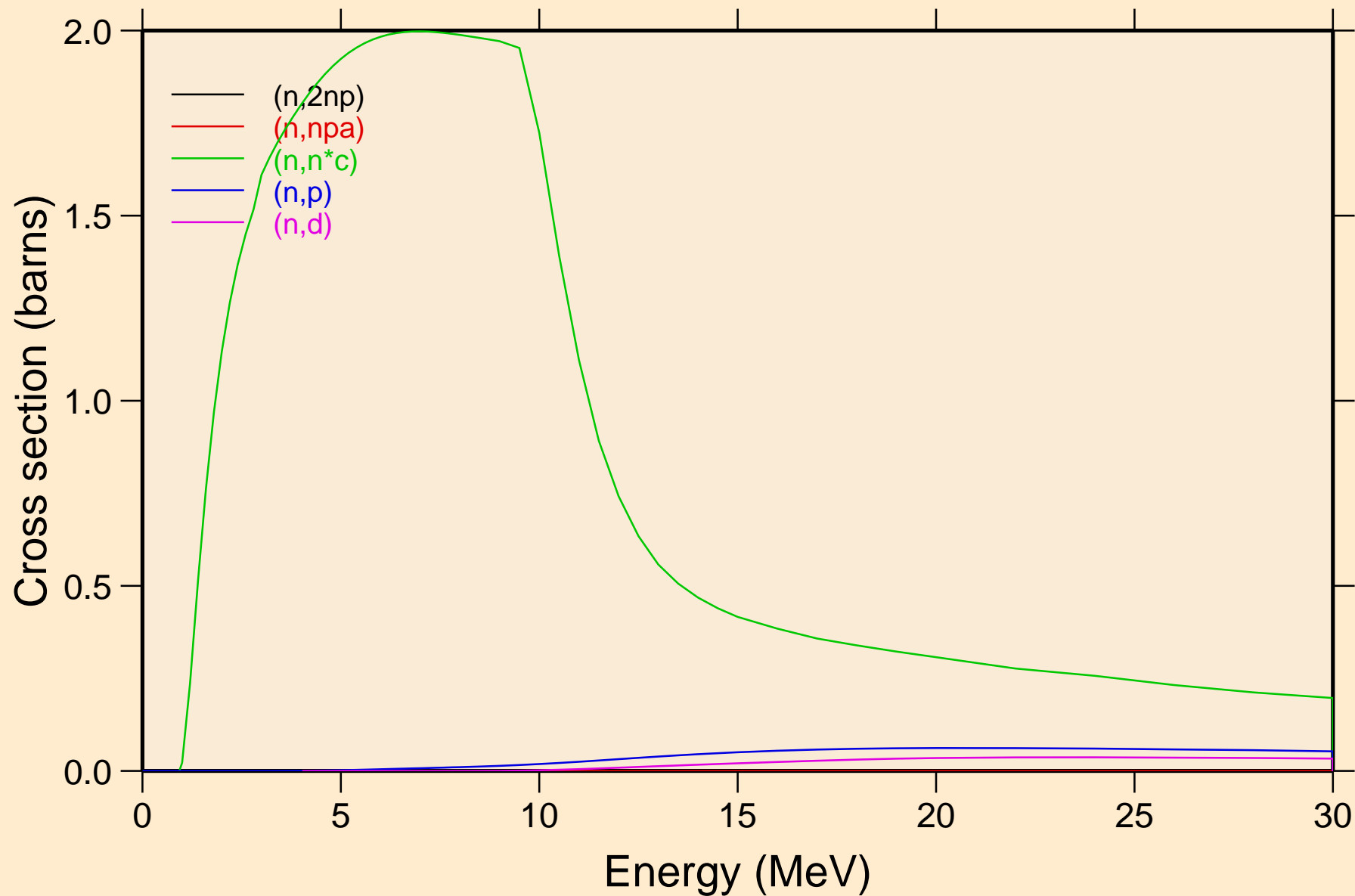

45-RH-103 FOR FENDL-3.2 FROM FENDL-3.2 BY NJOY2016.60+ C
Threshold reactions

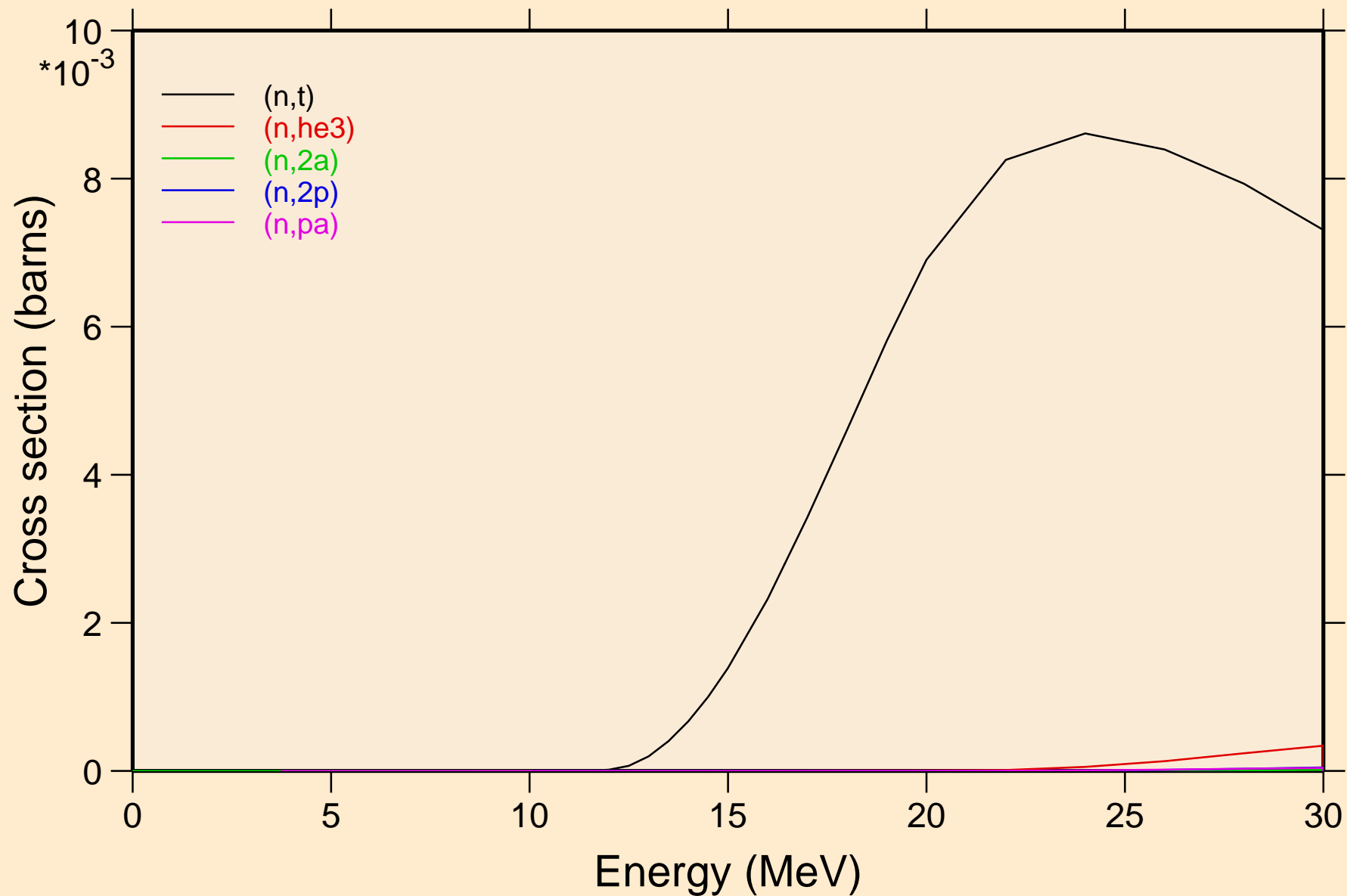

45-RH-103 FOR FENDL-3.2 FROM FENDL-3.2 BY NJOY2016.60+ C
Threshold reactions

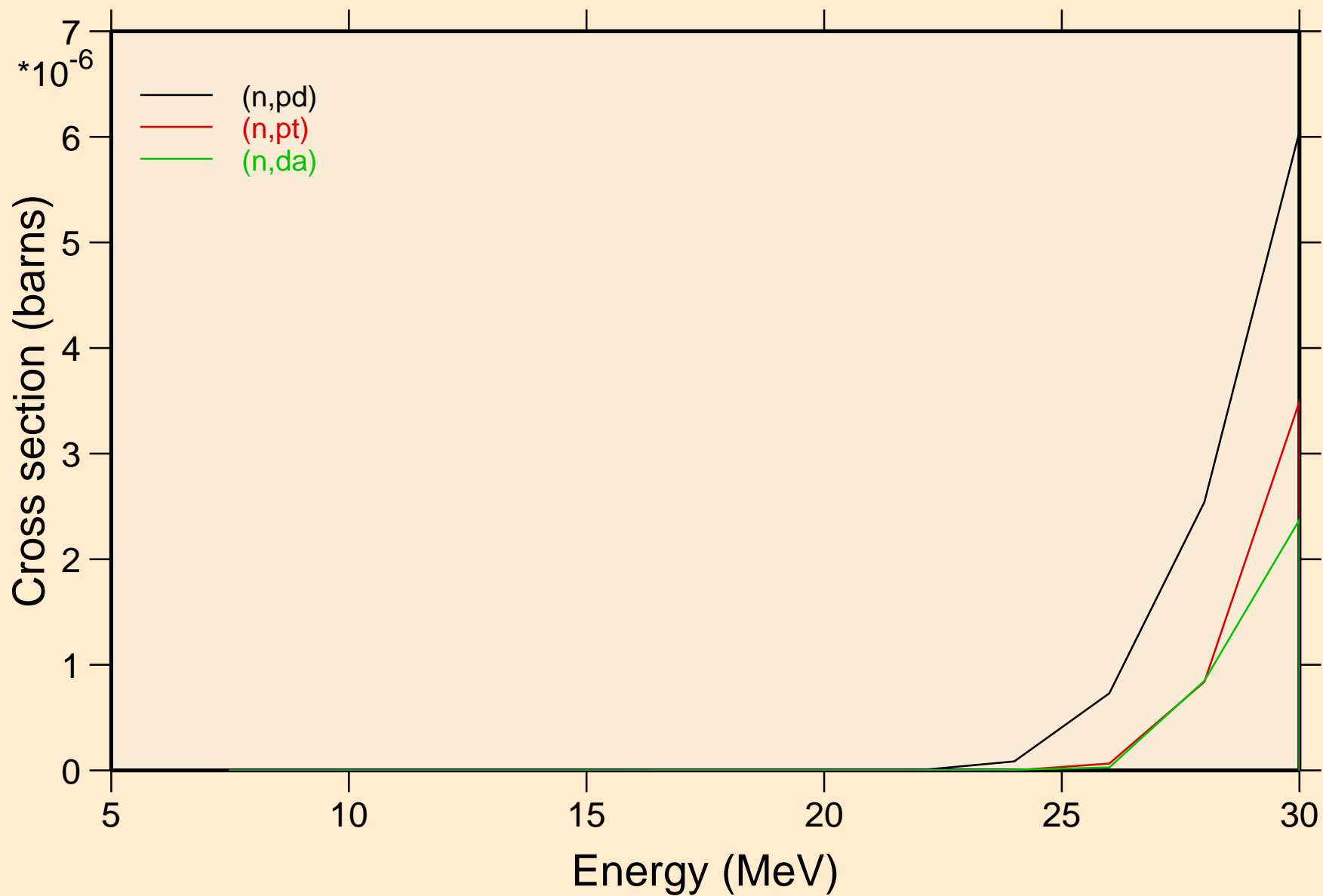

45-RH-103 FOR FENDL-3.2 FROM FENDL-3.2 BY NJOY2016.60+ C
Threshold reactions

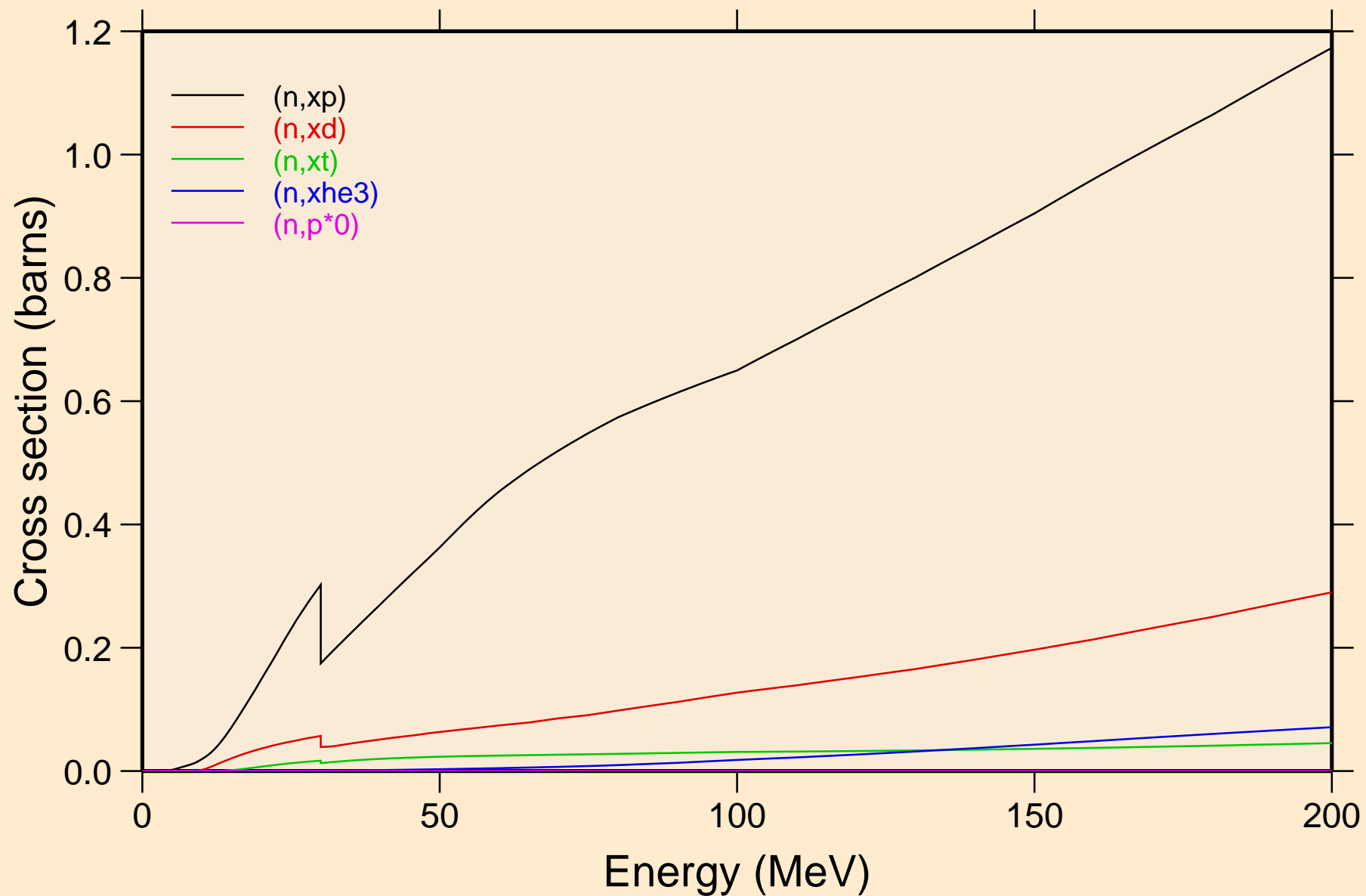

45-RH-103 FOR FENDL-3.2 FROM FENDL-3.2 BY NJOY2016.60+ C
Threshold reactions

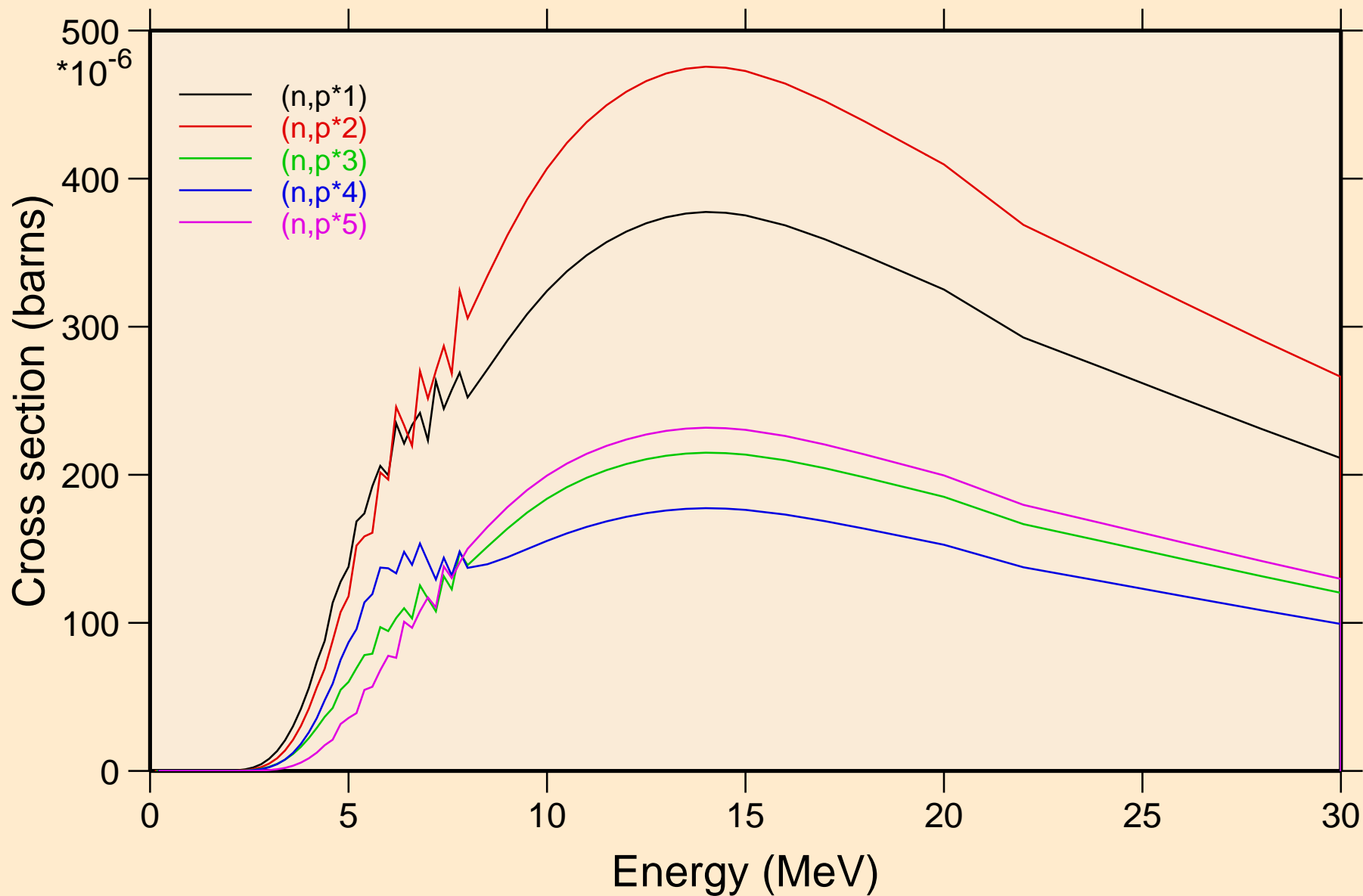

45-RH-103 FOR FENDL-3.2 FROM FENDL-3.2 BY NJOY2016.60+ C
Threshold reactions

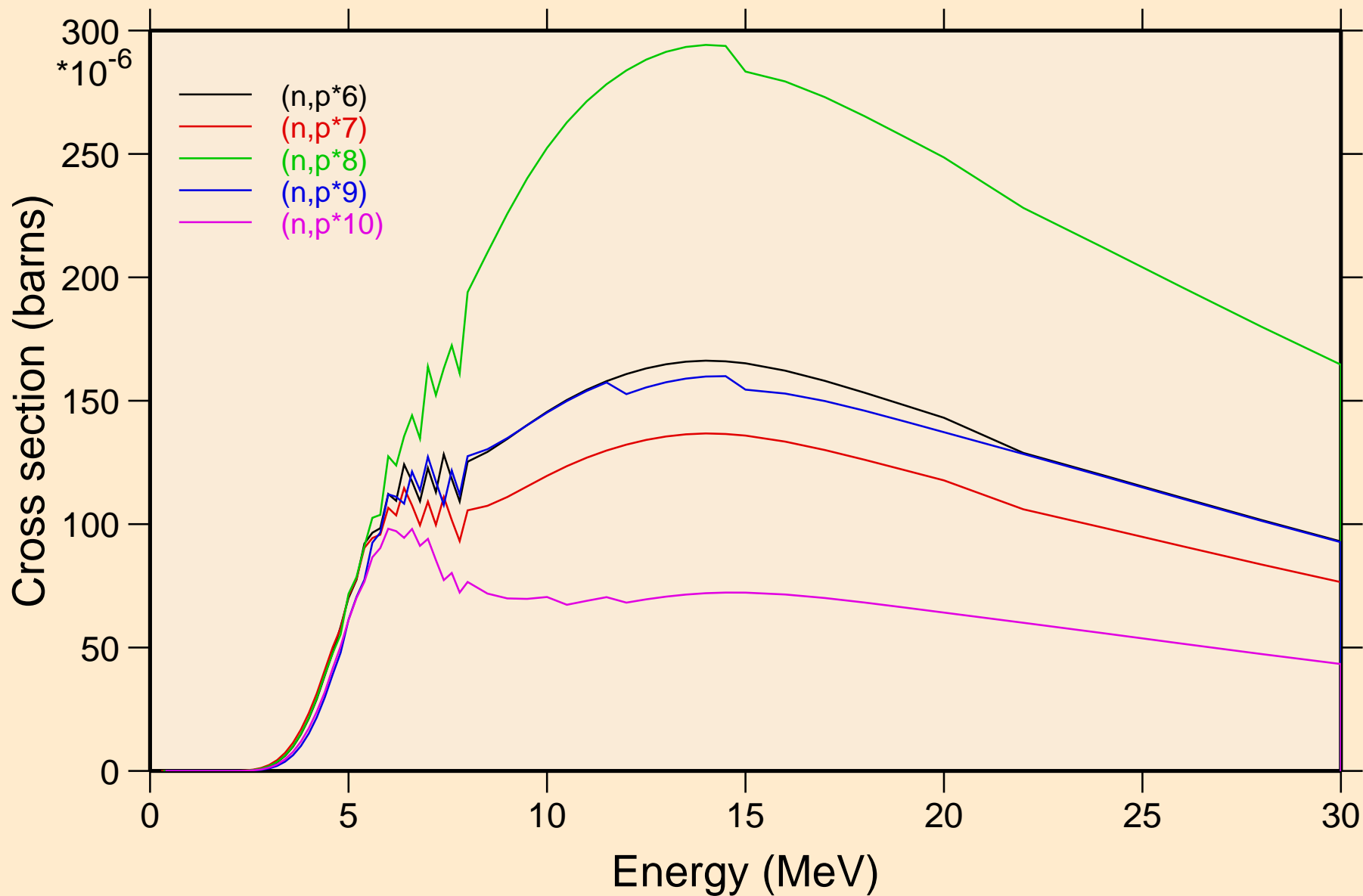

45-RH-103 FOR FENDL-3.2 FROM FENDL-3.2 BY NJOY2016.60+ C
Threshold reactions

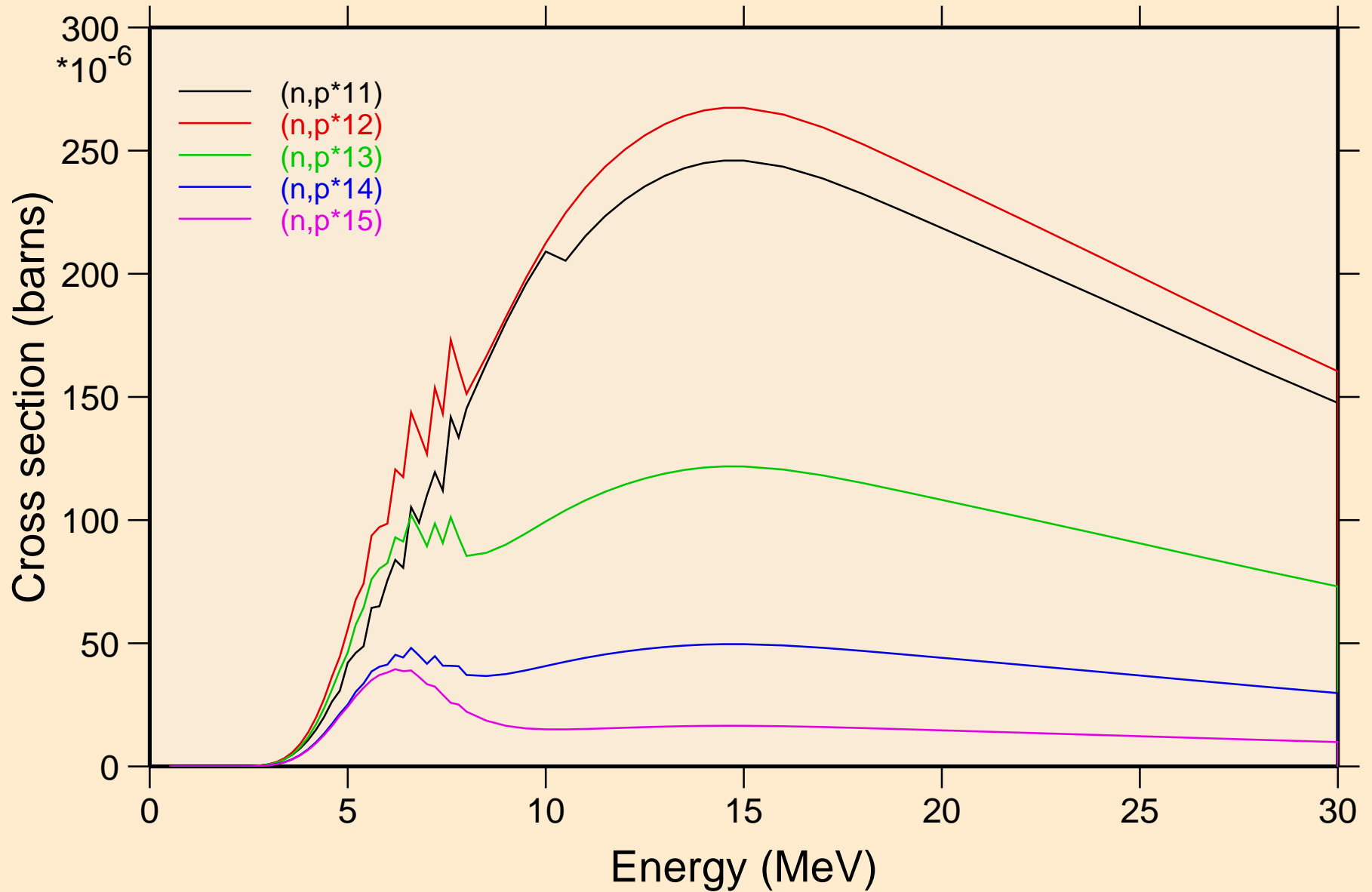

45-RH-103 FOR FENDL-3.2 FROM FENDL-3.2 BY NJOY2016.60+ C
Threshold reactions

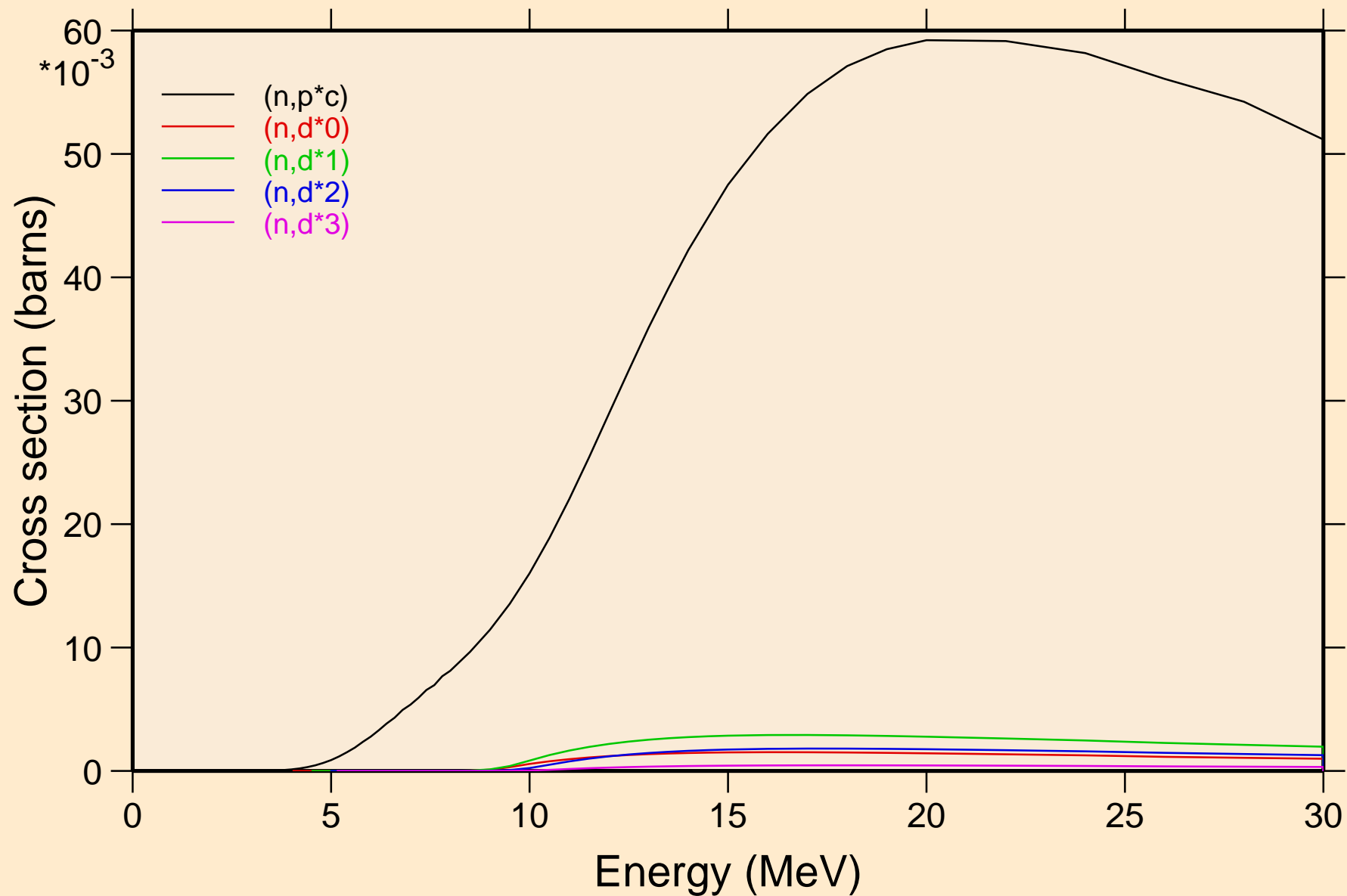

45-RH-103 FOR FENDL-3.2 FROM FENDL-3.2 BY NJOY2016.60+ C
Threshold reactions

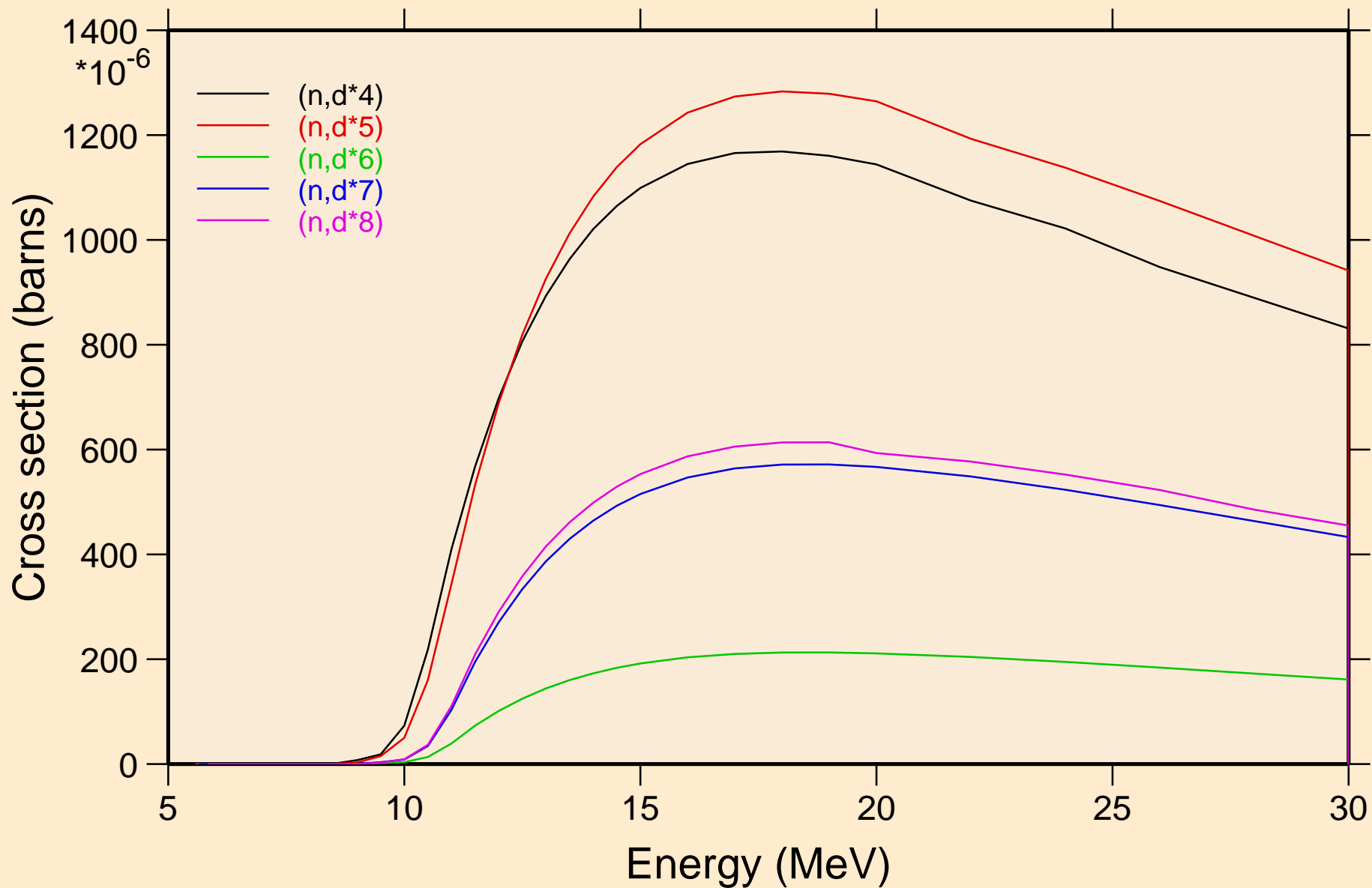

45-RH-103 FOR FENDL-3.2 FROM FENDL-3.2 BY NJOY2016.60+ C
Threshold reactions

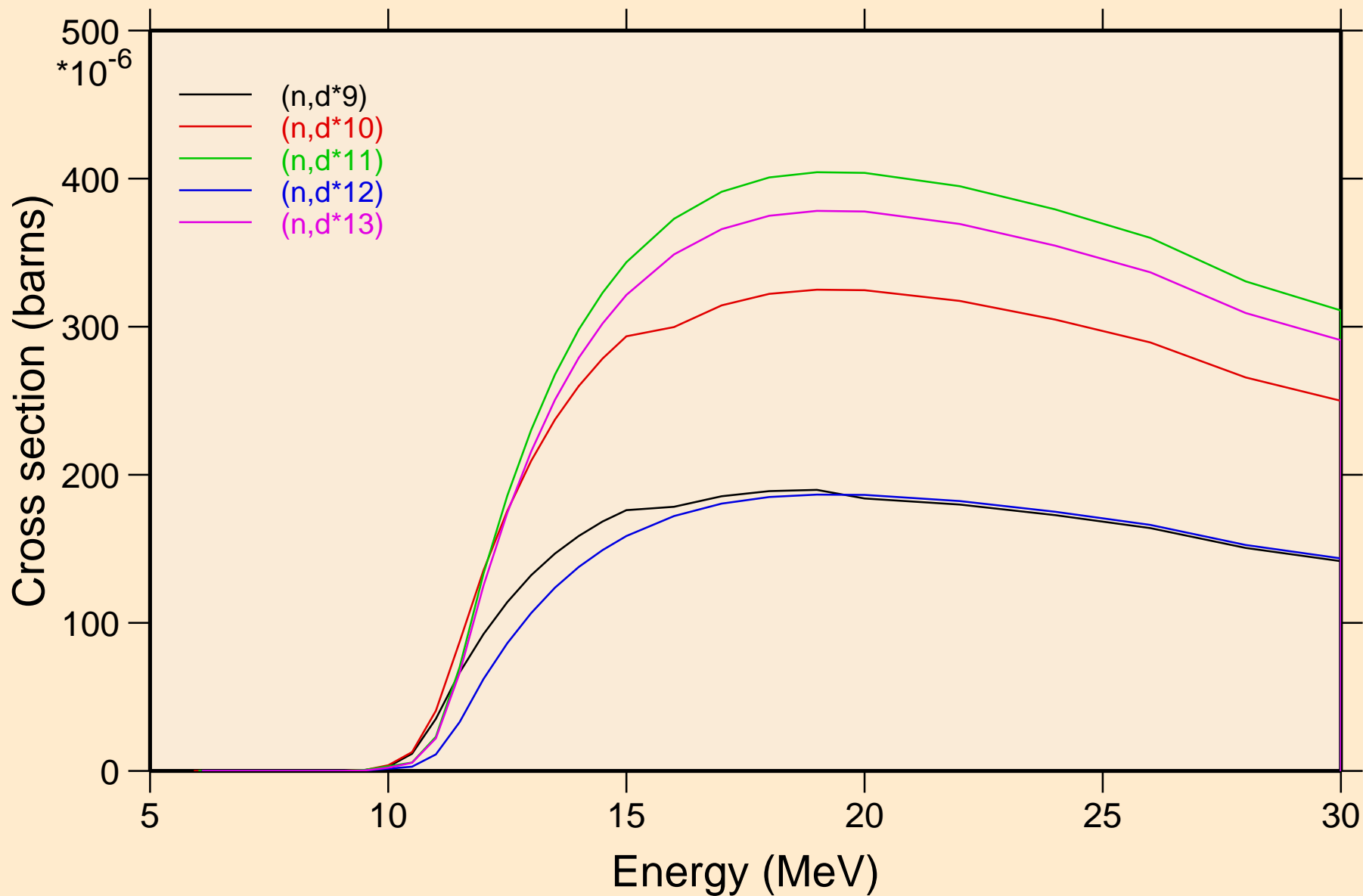

45-RH-103 FOR FENDL-3.2 FROM FENDL-3.2 BY NJOY2016.60+ C
Threshold reactions

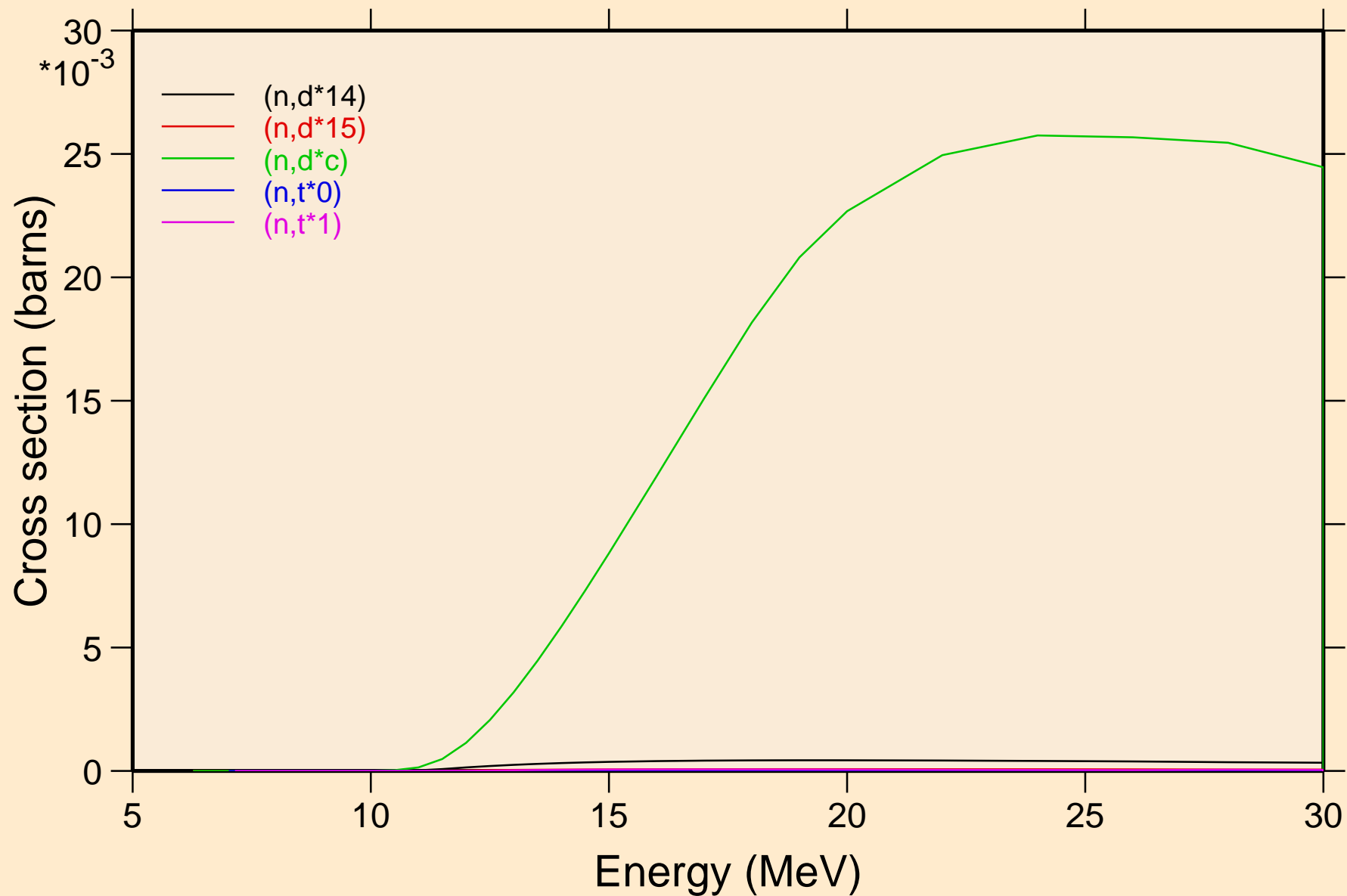

45-RH-103 FOR FENDL-3.2 FROM FENDL-3.2 BY NJOY2016.60+ C
Threshold reactions

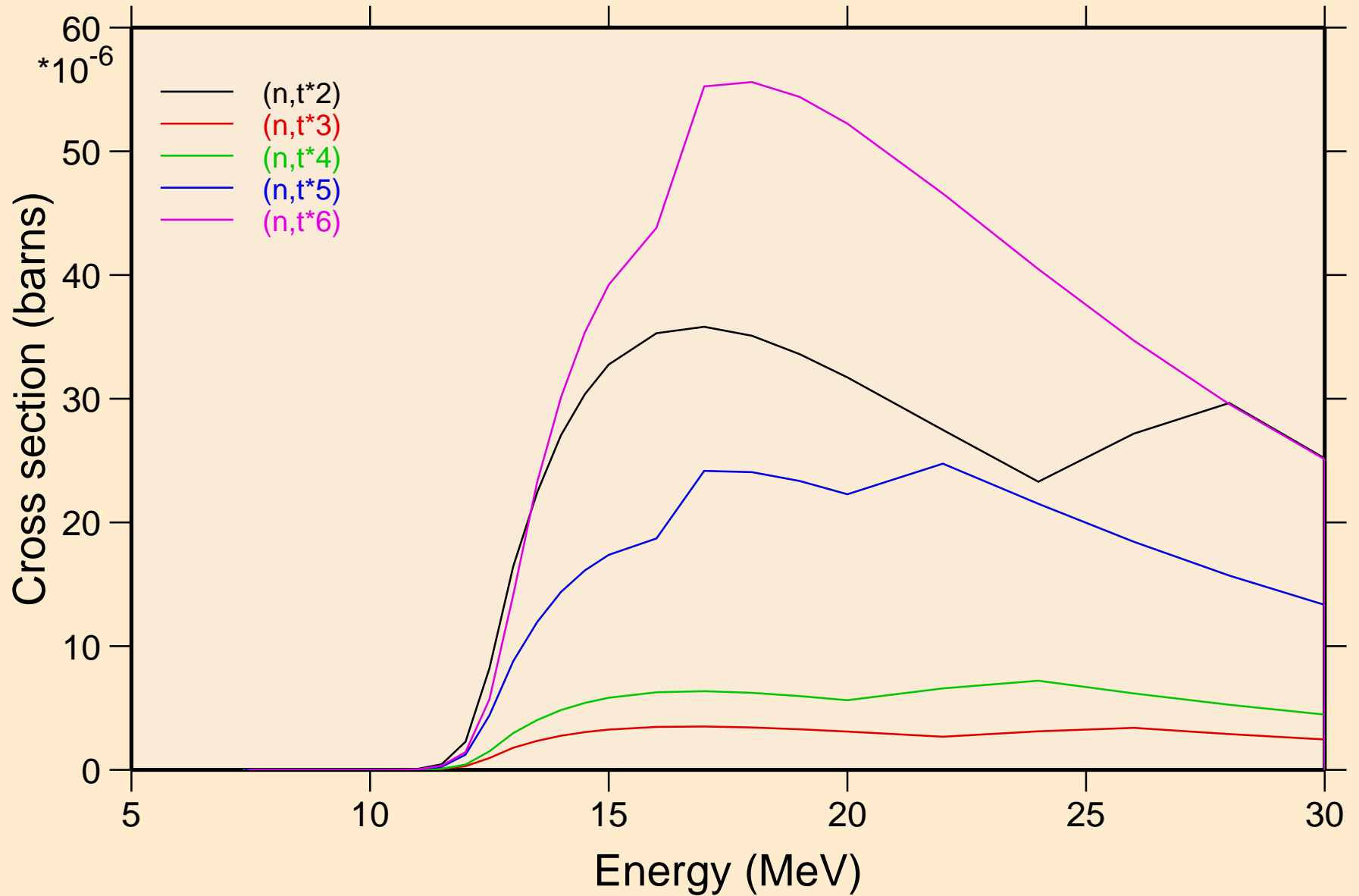

45-RH-103 FOR FENDL-3.2 FROM FENDL-3.2 BY NJOY2016.60+ C
Threshold reactions

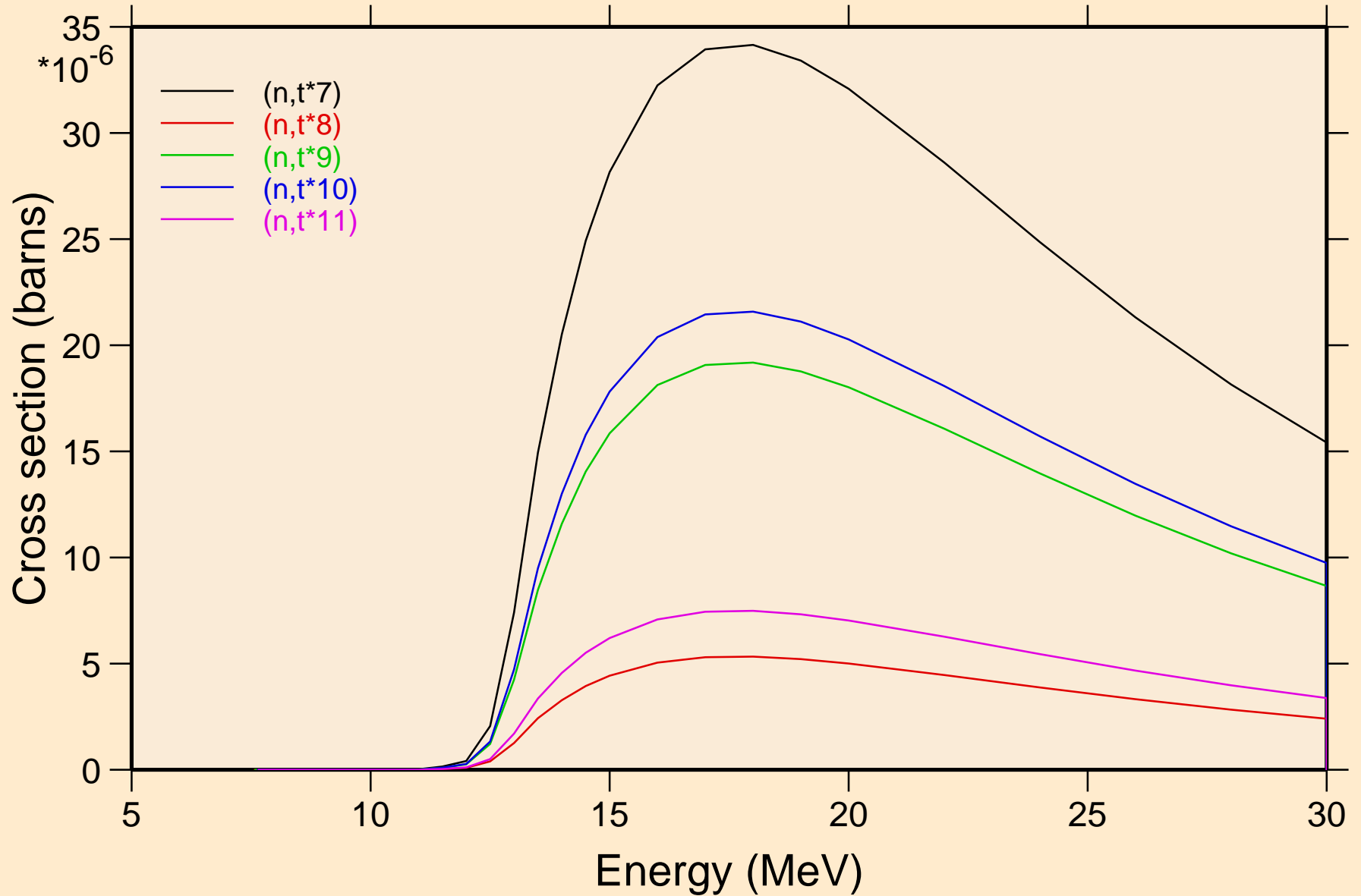

45-RH-103 FOR FENDL-3.2 FROM FENDL-3.2 BY NJOY2016.60+ C
Threshold reactions

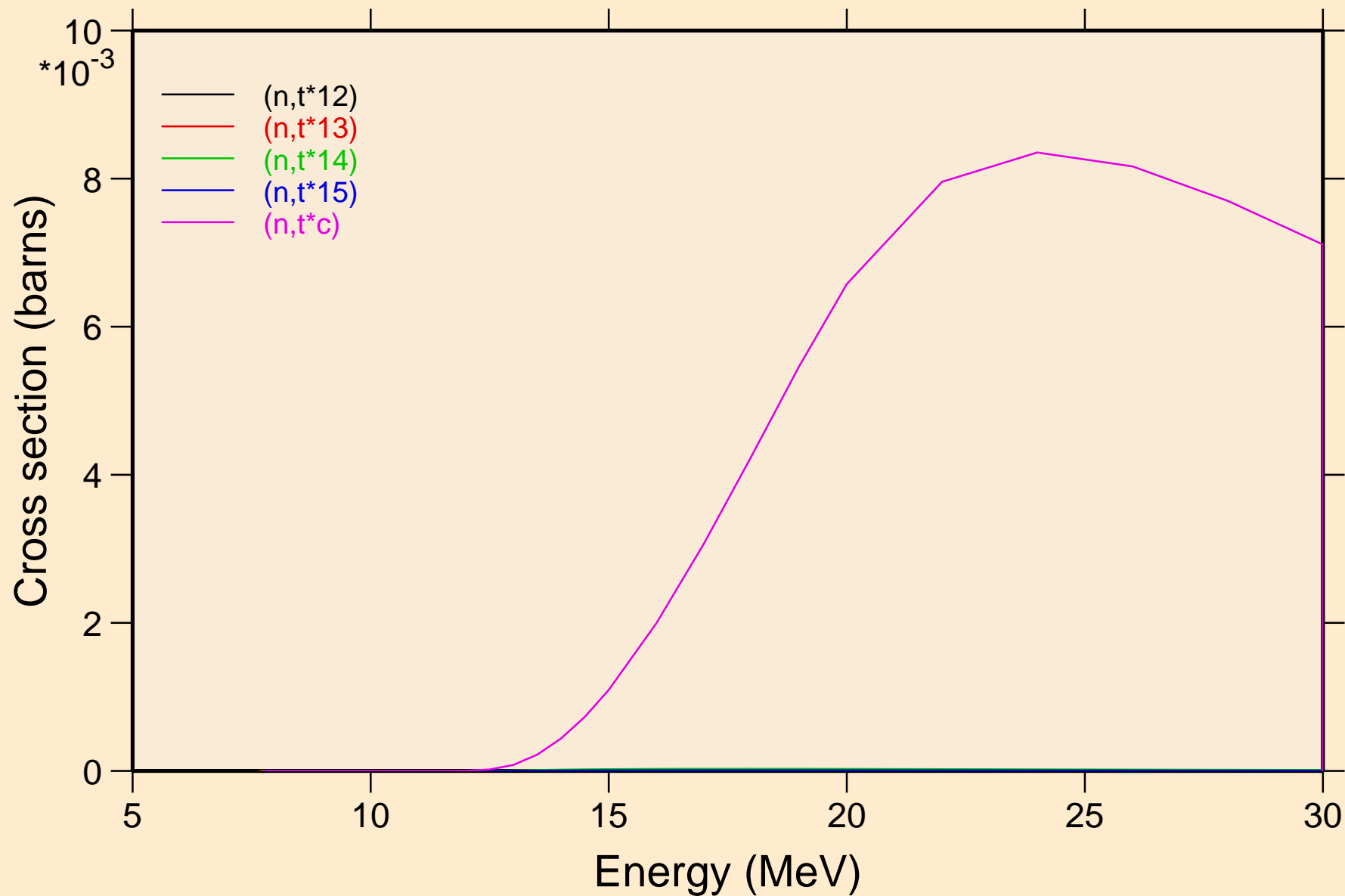

45-RH-103 FOR FENDL-3.2 FROM FENDL-3.2 BY NJOY2016.60+ C
Threshold reactions

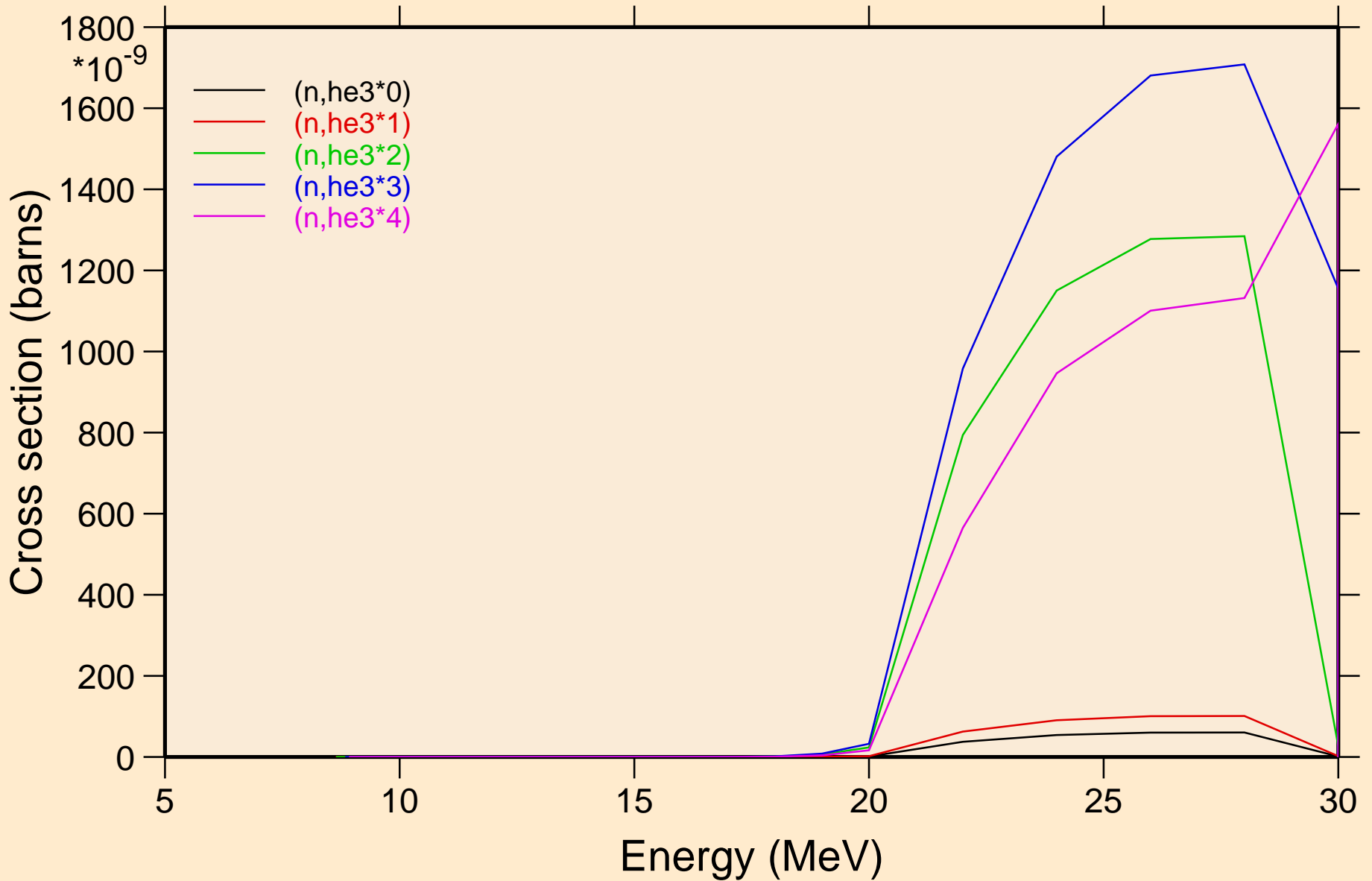

45-RH-103 FOR FENDL-3.2 FROM FENDL-3.2 BY NJOY2016.60+ C
Threshold reactions

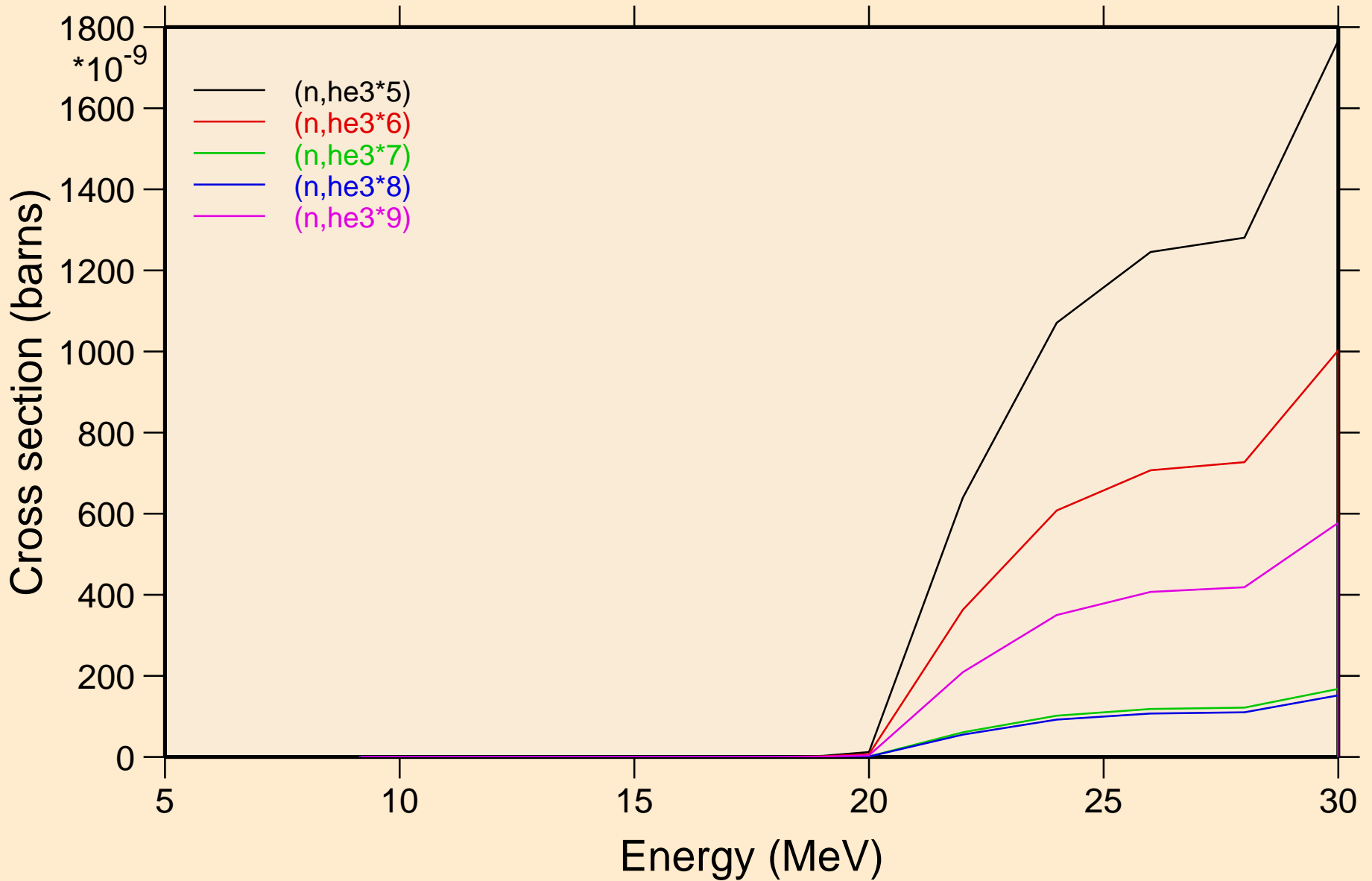

45-RH-103 FOR FENDL-3.2 FROM FENDL-3.2 BY NJOY2016.60+ C
Threshold reactions

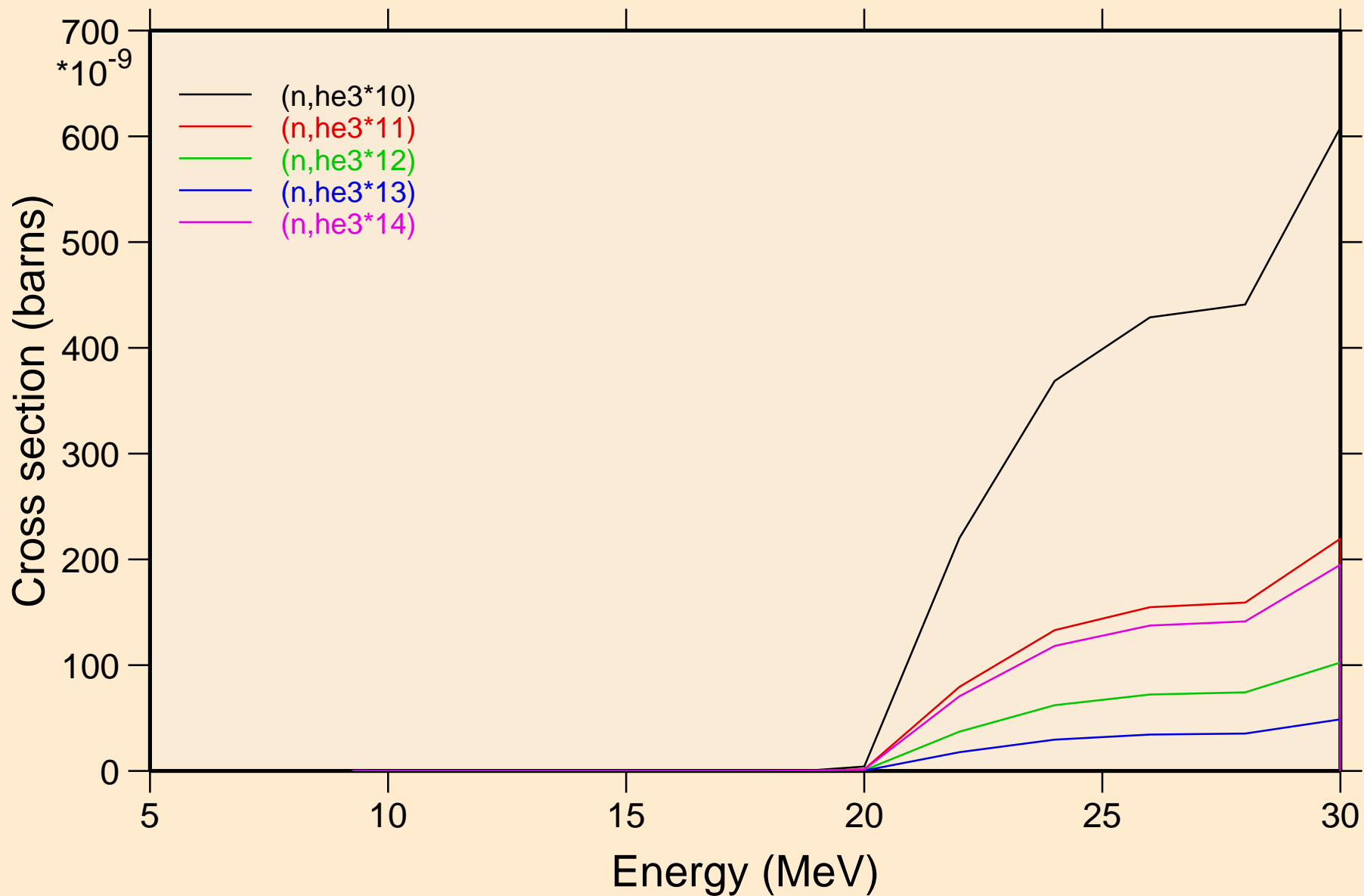

45-RH-103 FOR FENDL-3.2 FROM FENDL-3.2 BY NJOY2016.60+ C

Threshold reactions

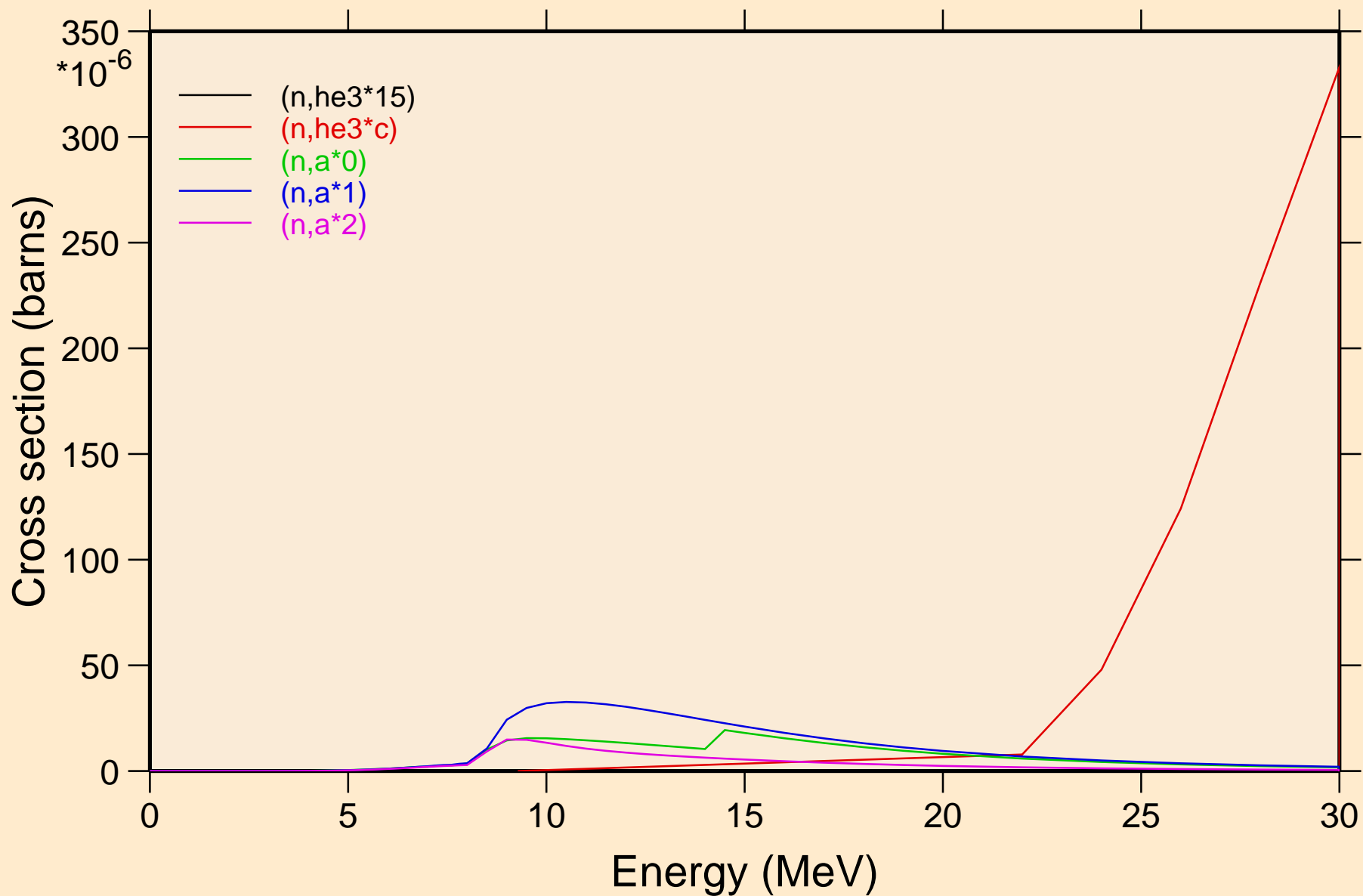

45-RH-103 FOR FENDL-3.2 FROM FENDL-3.2 BY NJOY2016.60+ C
Threshold reactions

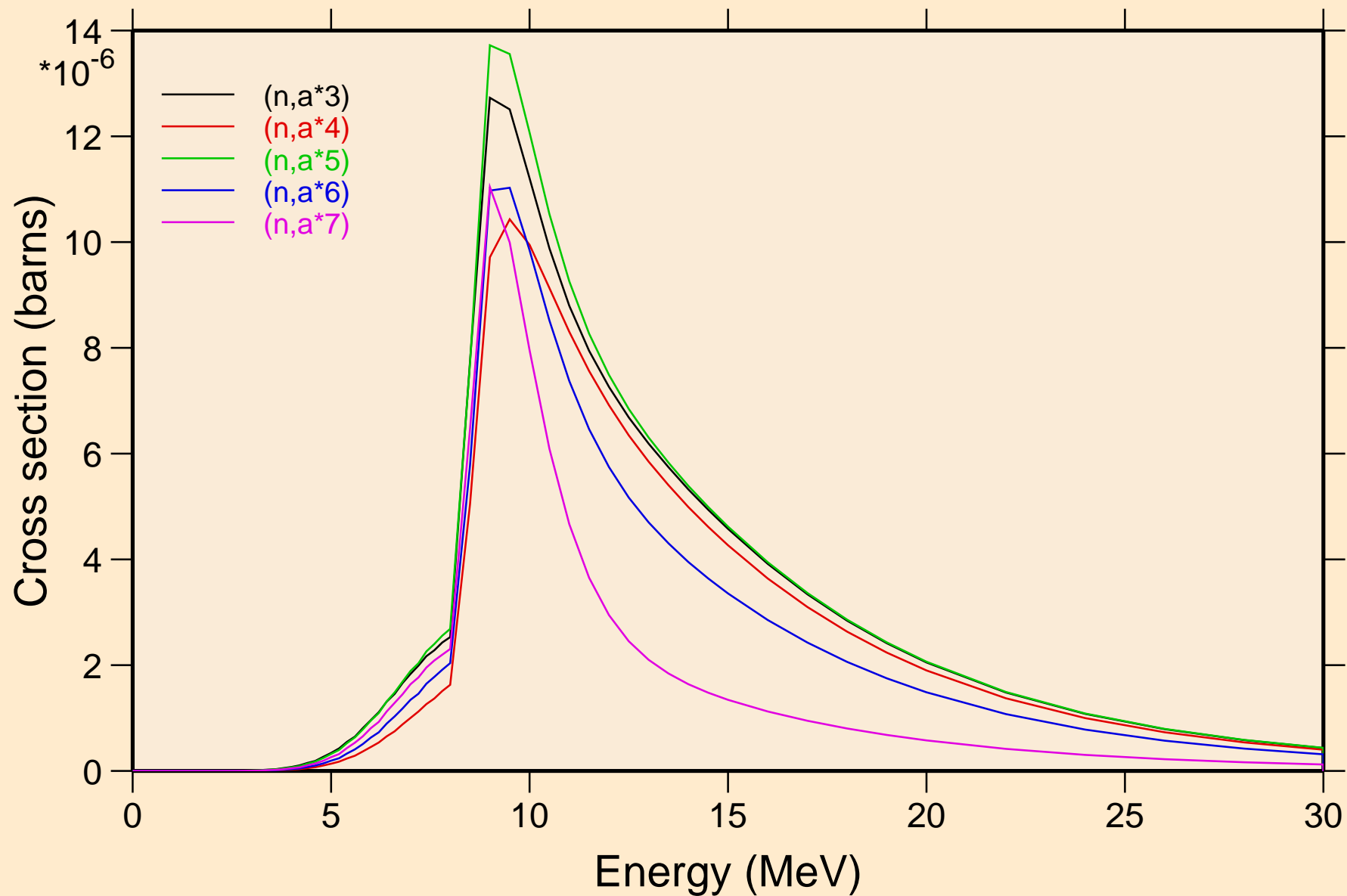

45-RH-103 FOR FENDL-3.2 FROM FENDL-3.2 BY NJOY2016.60+ C
Threshold reactions

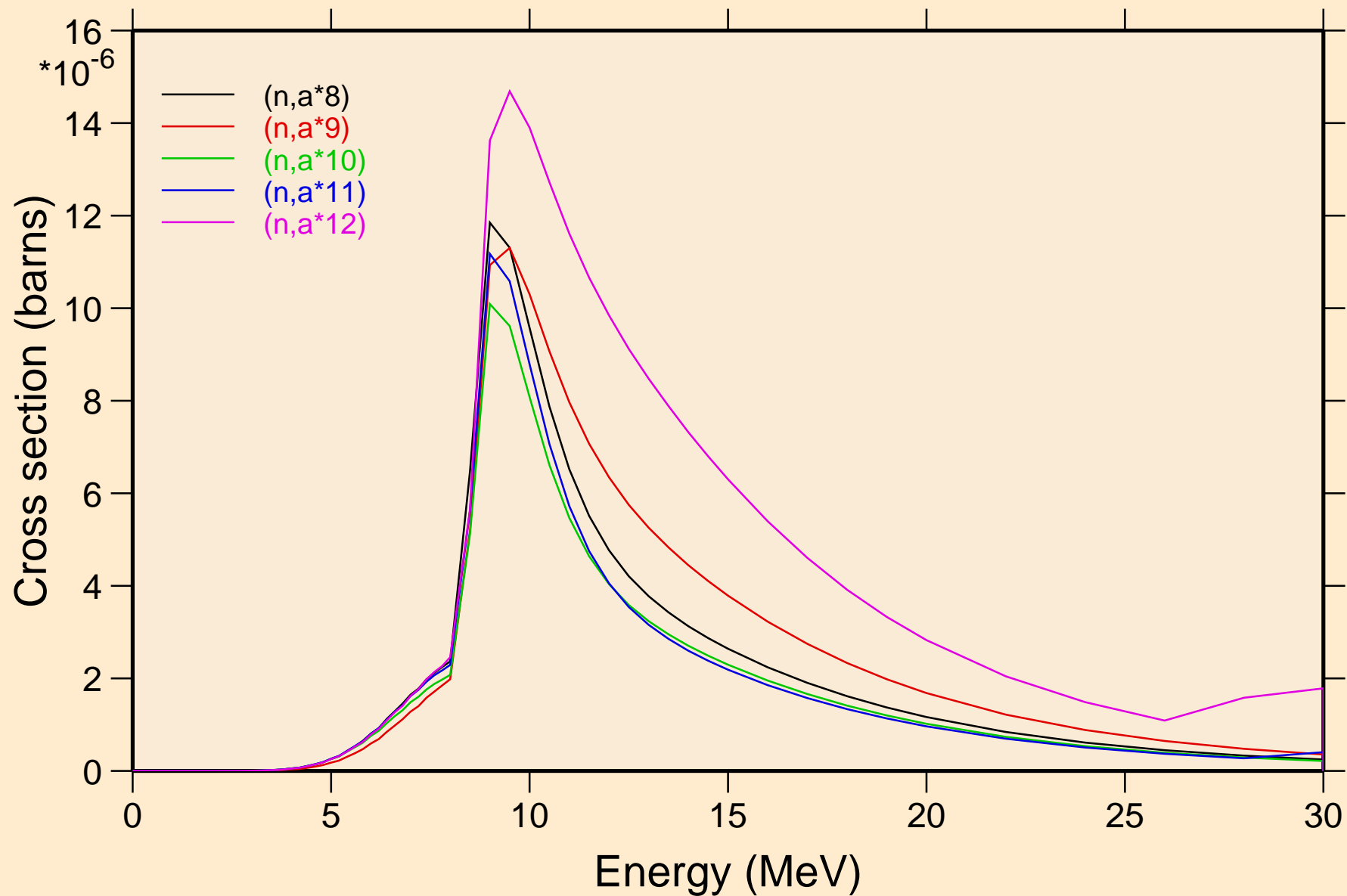

45-RH-103 FOR FENDL-3.2 FROM FENDL-3.2 BY NJOY2016.60+ C
Threshold reactions

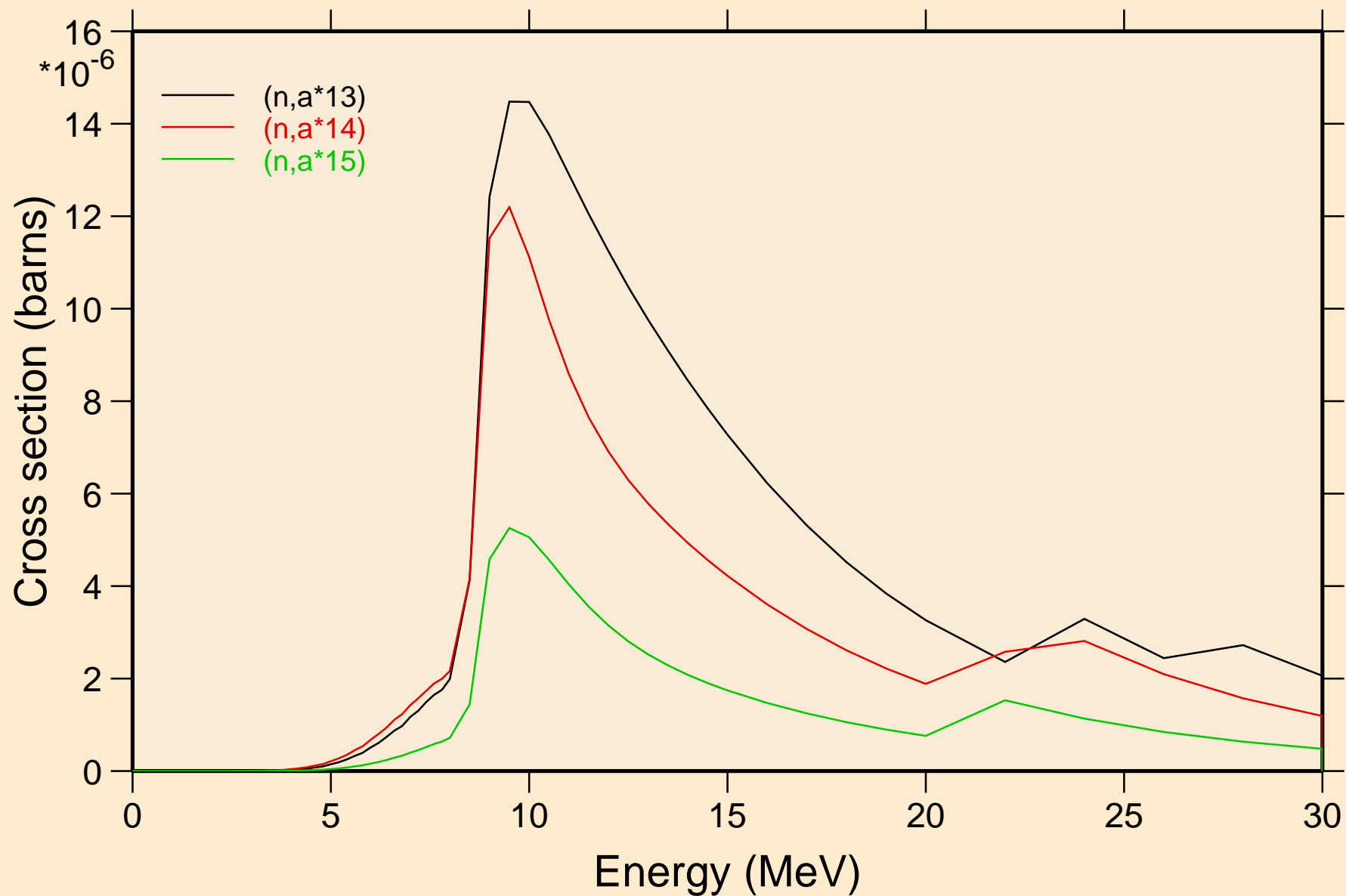

45-RH-103 FOR FENDL-3.2 FROM FENDL-3.2 BY NJOY2016.60+ C
angular distribution for elastic

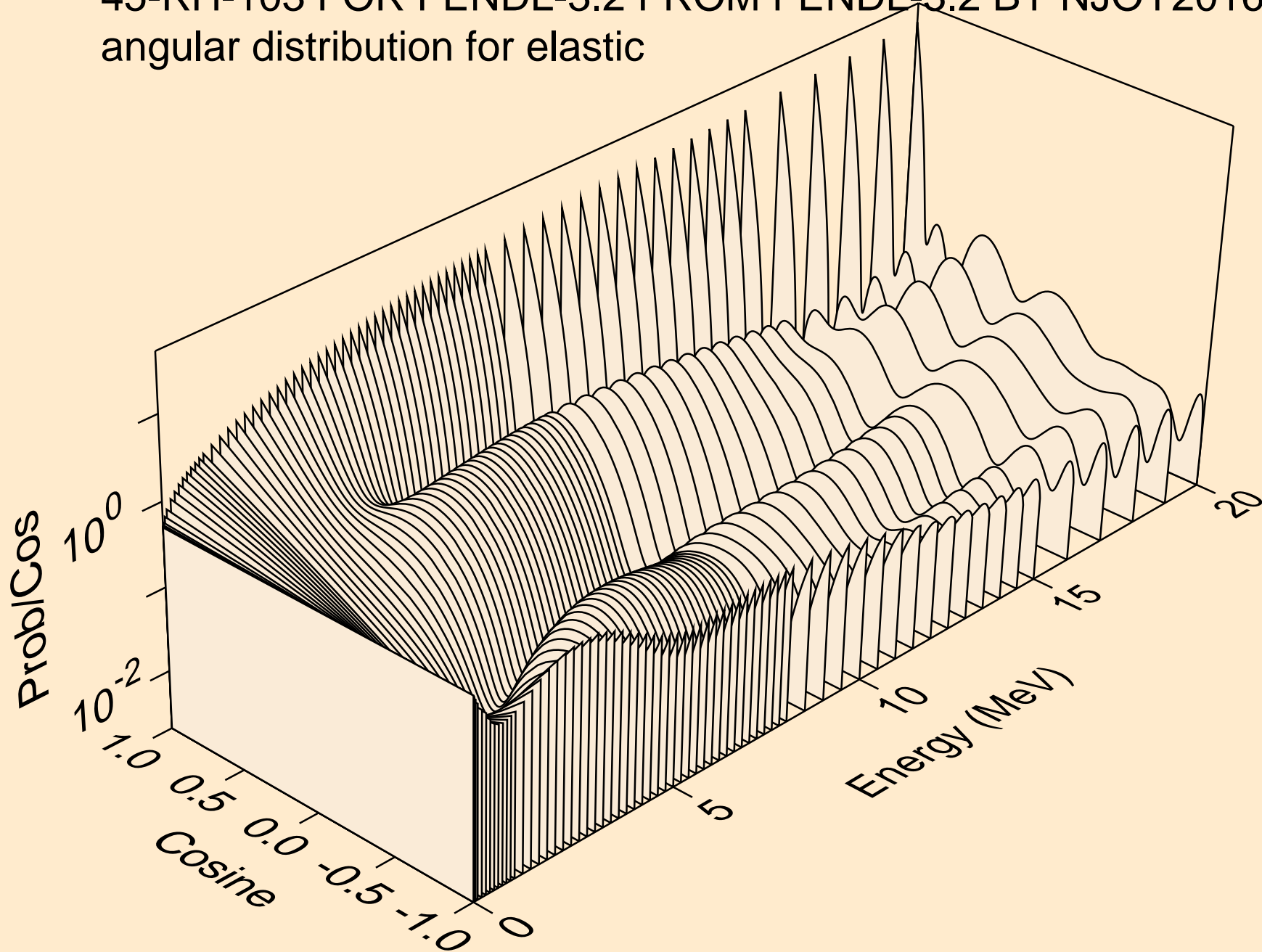

45-RH-103 FOR FENDL-3.2 FROM FENDL-3.2 BY NJOY2016.60+ C
angular distribution for elastic

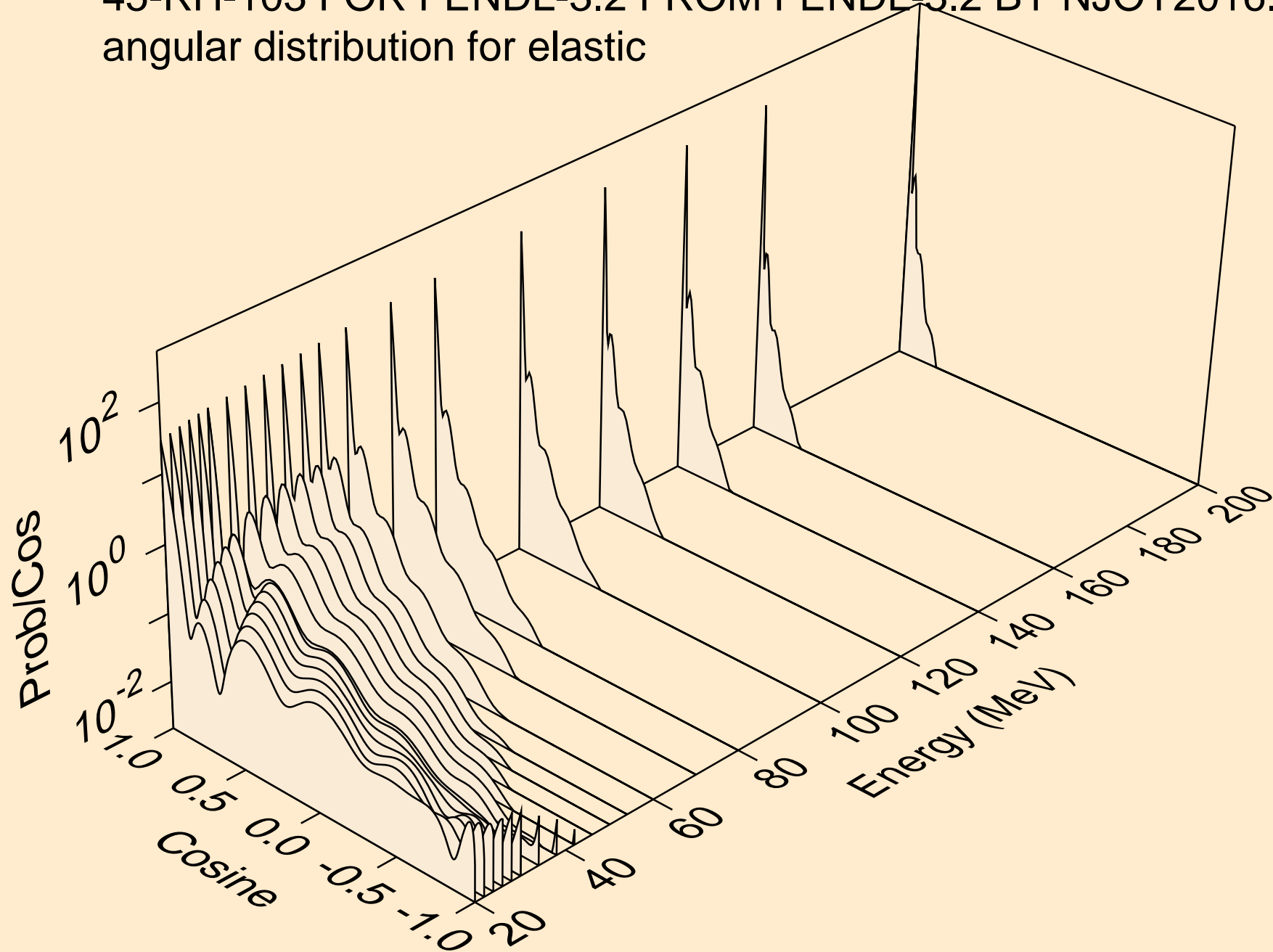

45-RH-103 FOR FENDL-3.2 FROM FENDL-3.2 BY NJOY2016.60+ C
angular distribution for (n,n*1)

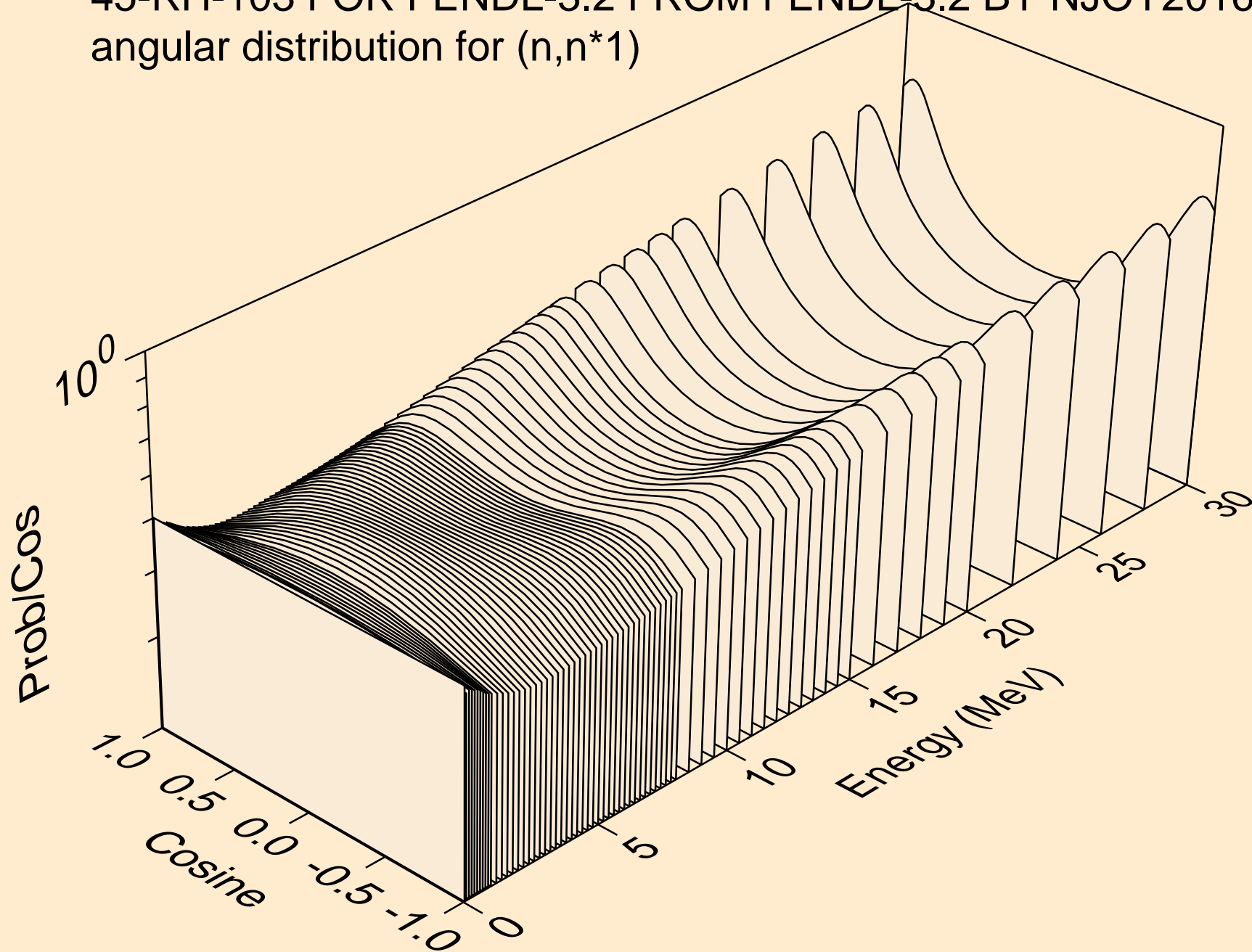

45-RH-103 FOR FENDL-3.2 FROM FENDL-3.2 BY NJOY2016.60+ C
angular distribution for (n,n*2)

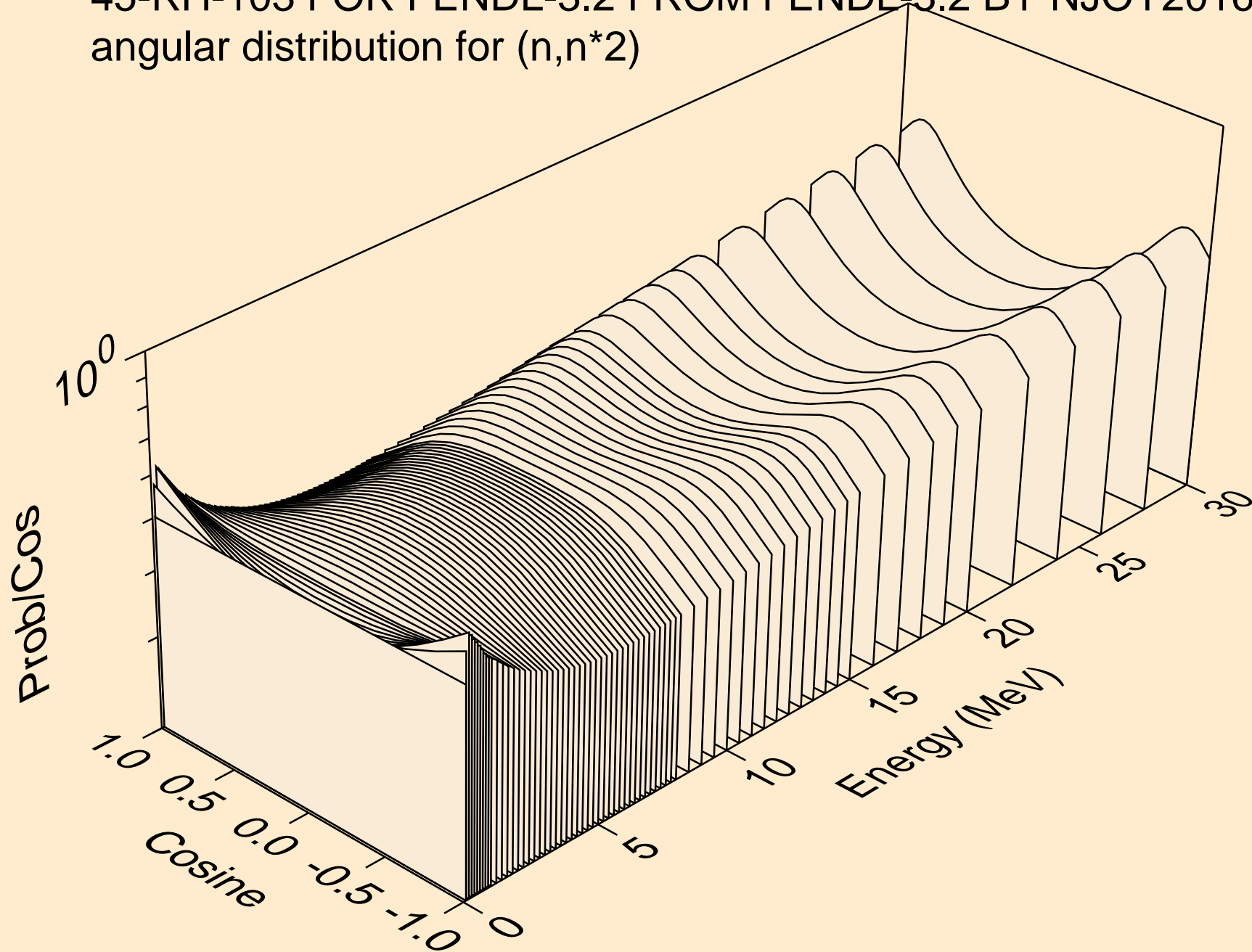

45-RH-103 FOR FENDL-3.2 FROM FENDL-3.2 BY NJOY2016.60+ C
angular distribution for (n,n*3)

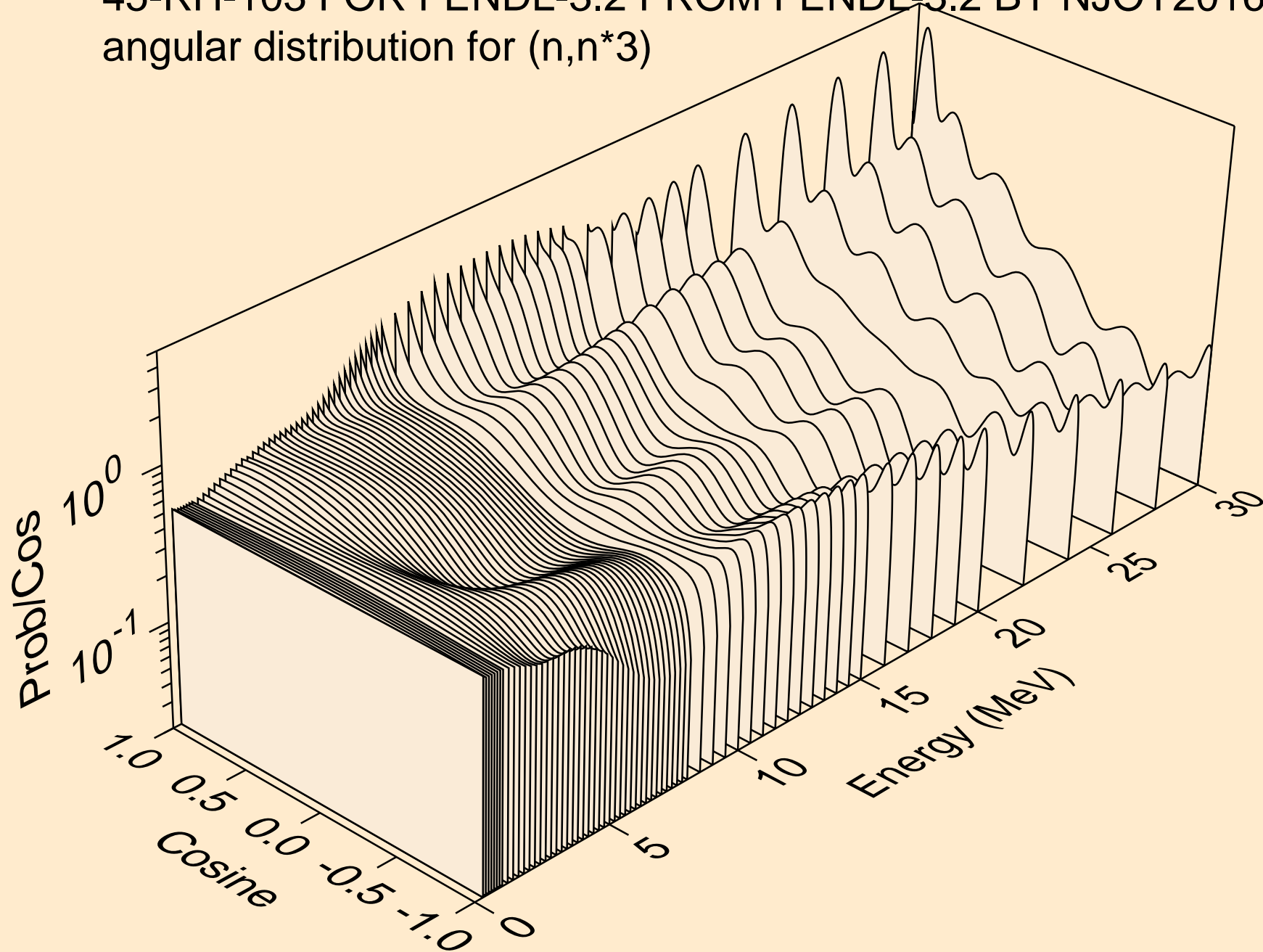

45-RH-103 FOR FENDL-3.2 FROM FENDL-3.2 BY NJOY2016.60+ C
angular distribution for (n,n*4)

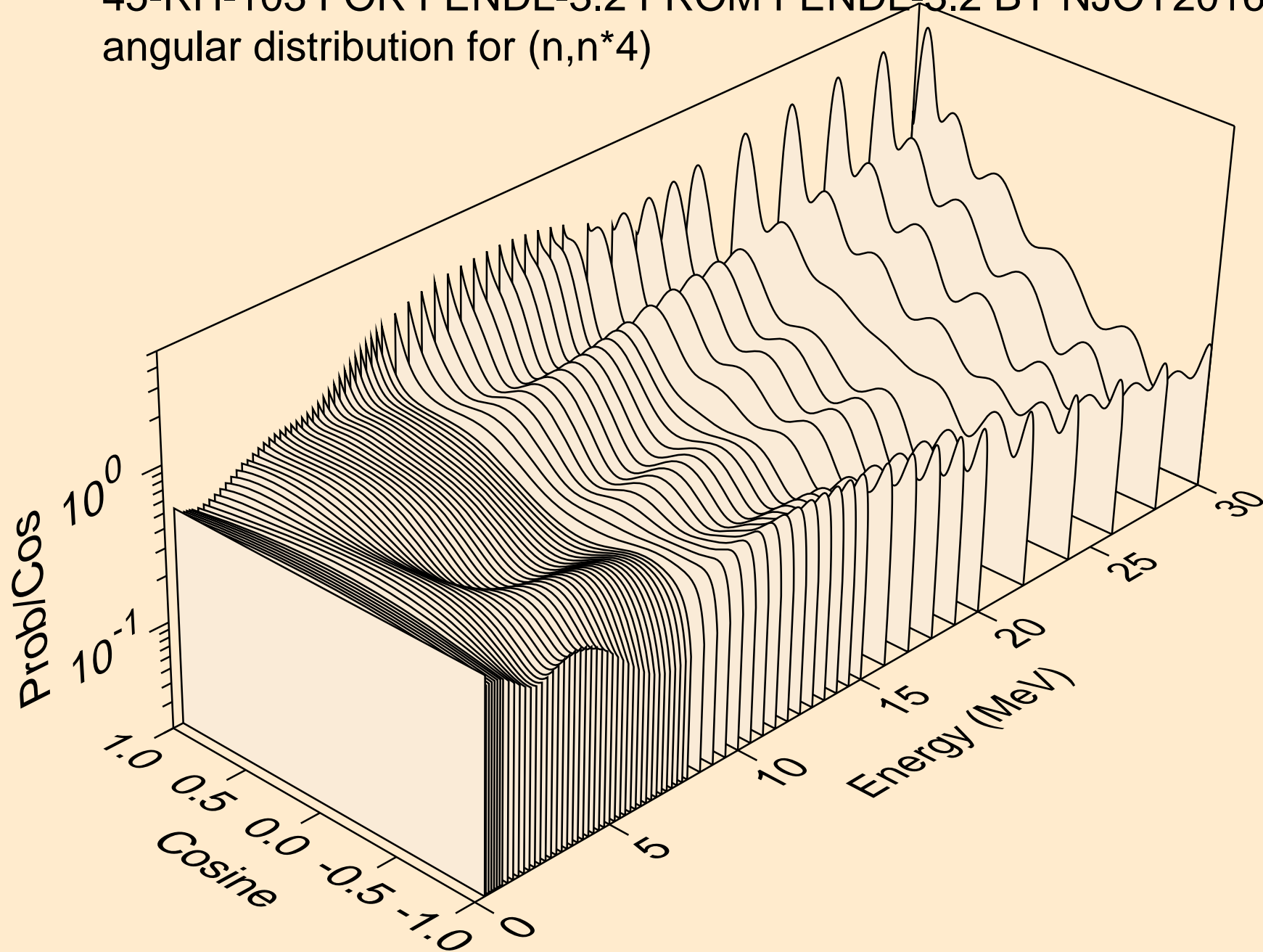

45-RH-103 FOR FENDL-3.2 FROM FENDL-3.2 BY NJOY2016.60+ C
angular distribution for (n,n*5)

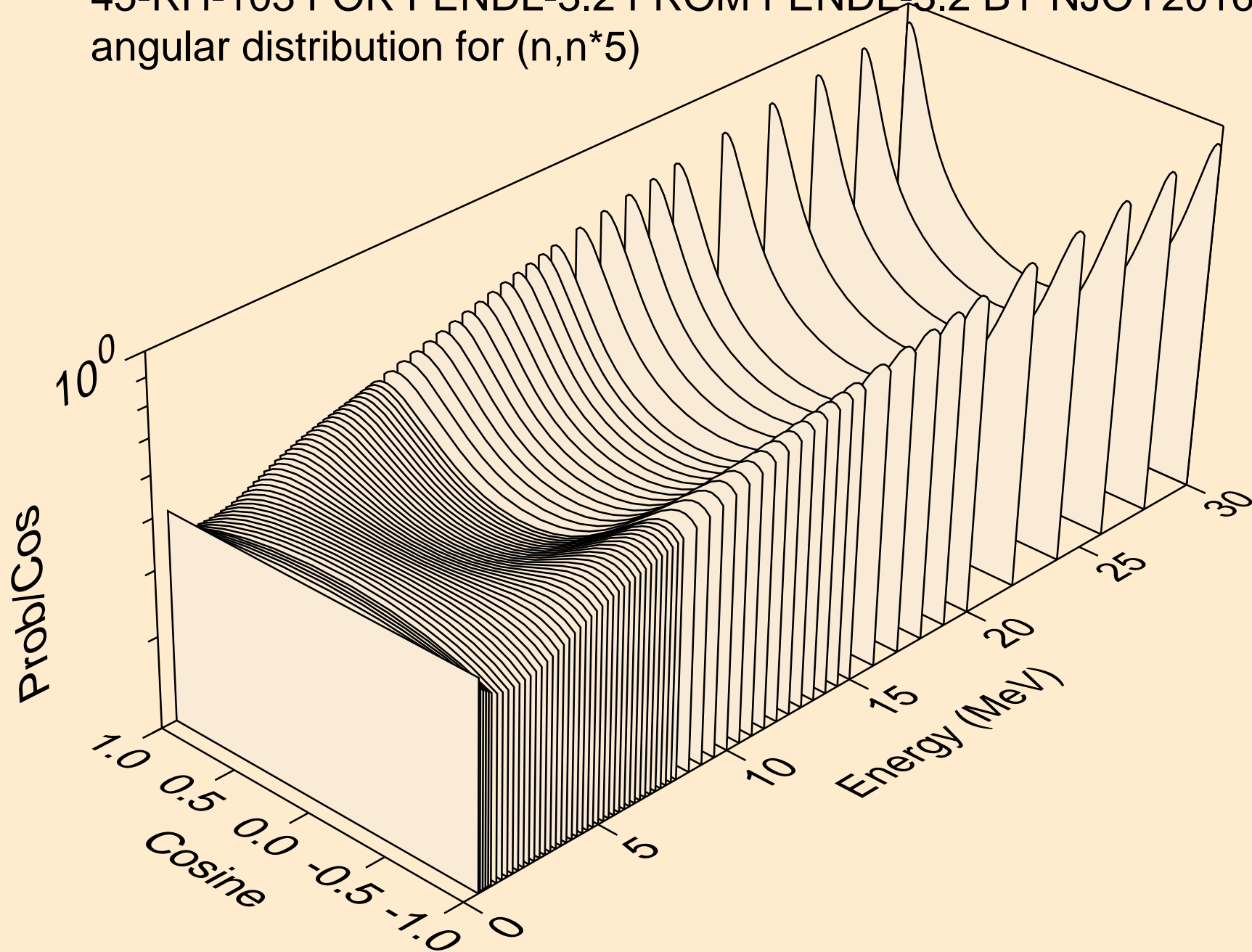

45-RH-103 FOR FENDL-3.2 FROM FENDL-3.2 BY NJOY2016.60+ C
angular distribution for (n,n*6)

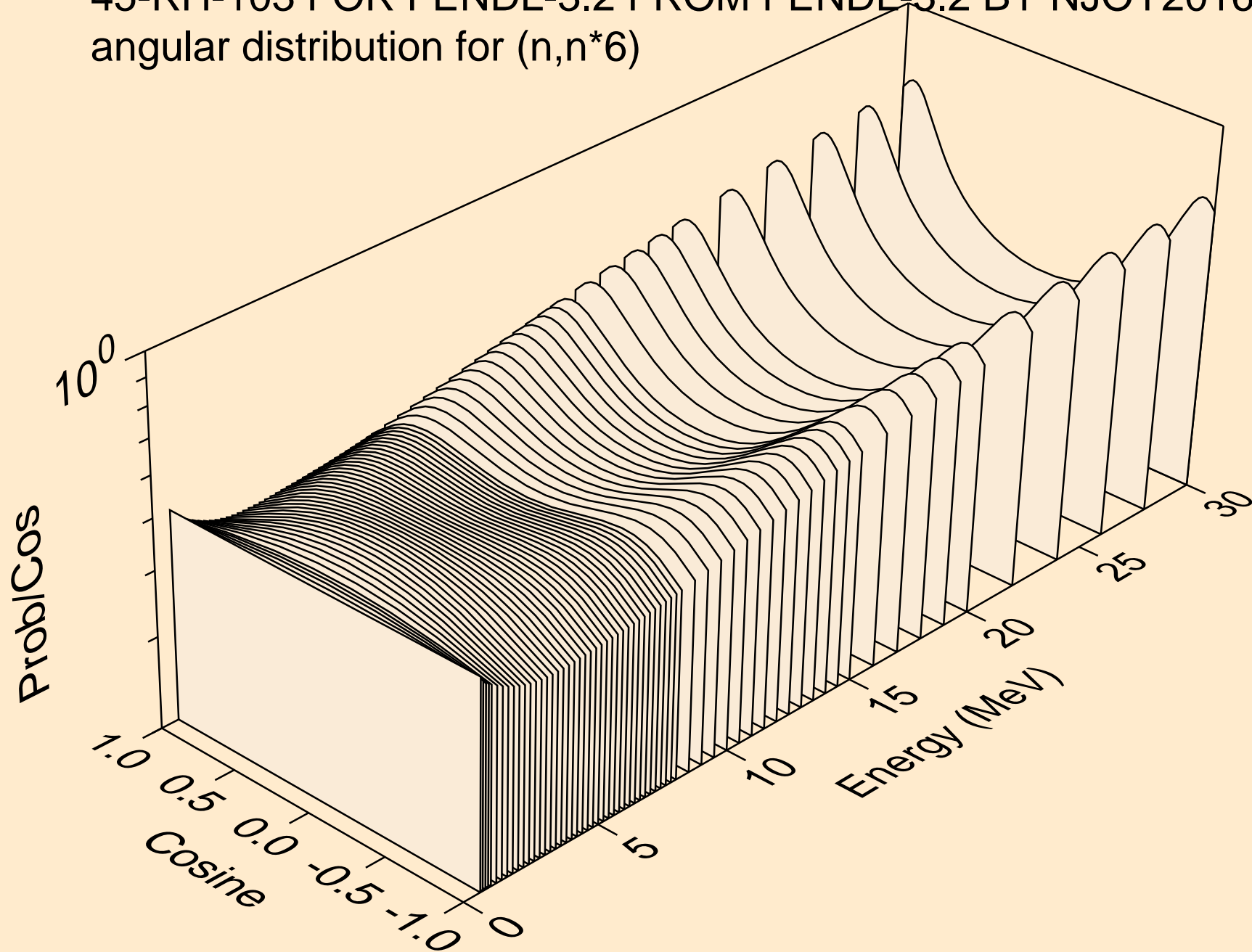

45-RH-103 FOR FENDL-3.2 FROM FENDL-3.2 BY NJOY2016.60+ C
angular distribution for (n,n*7)

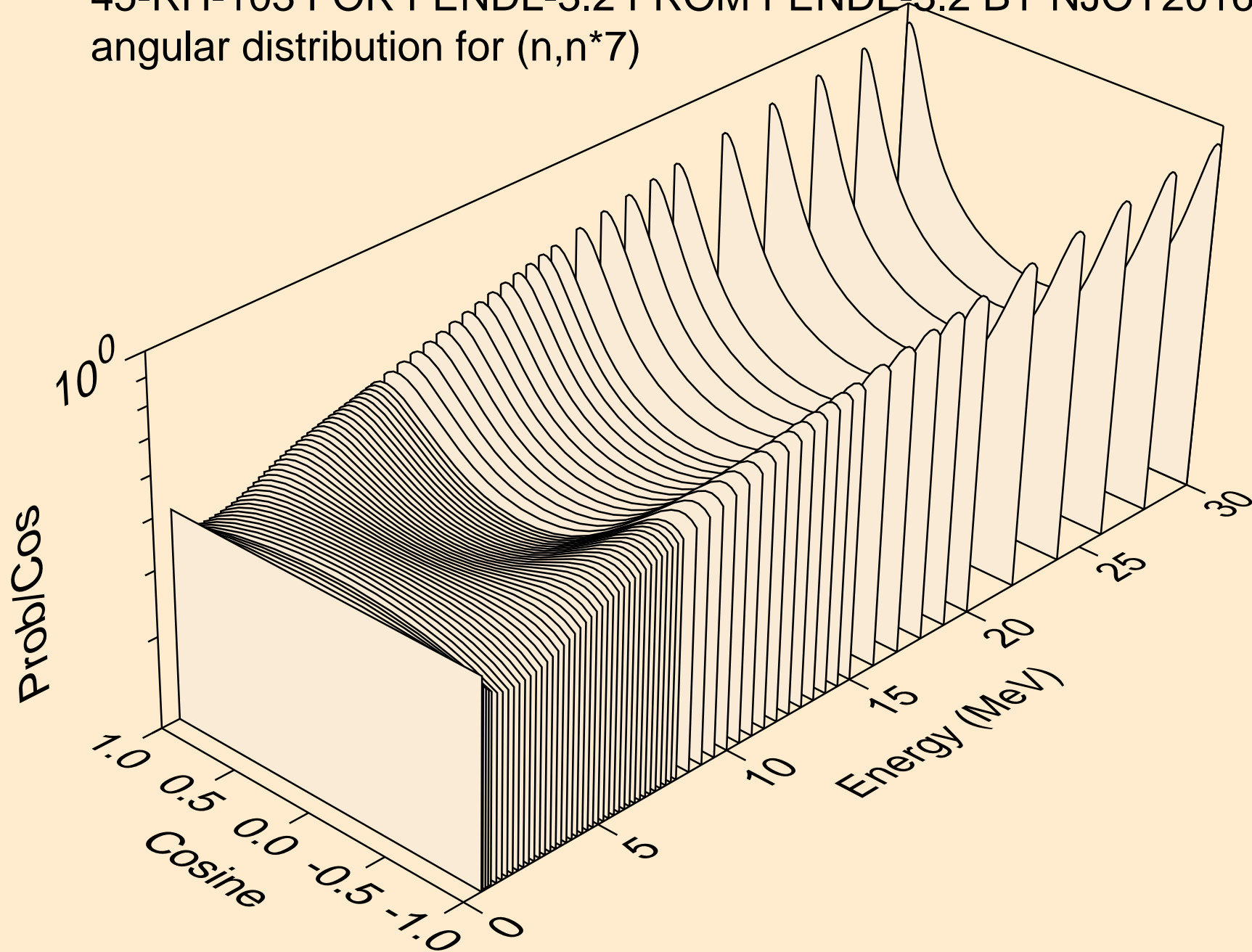

45-RH-103 FOR FENDL-3.2 FROM FENDL-3.2 BY NJOY2016.60+ C
angular distribution for (n,n*8)

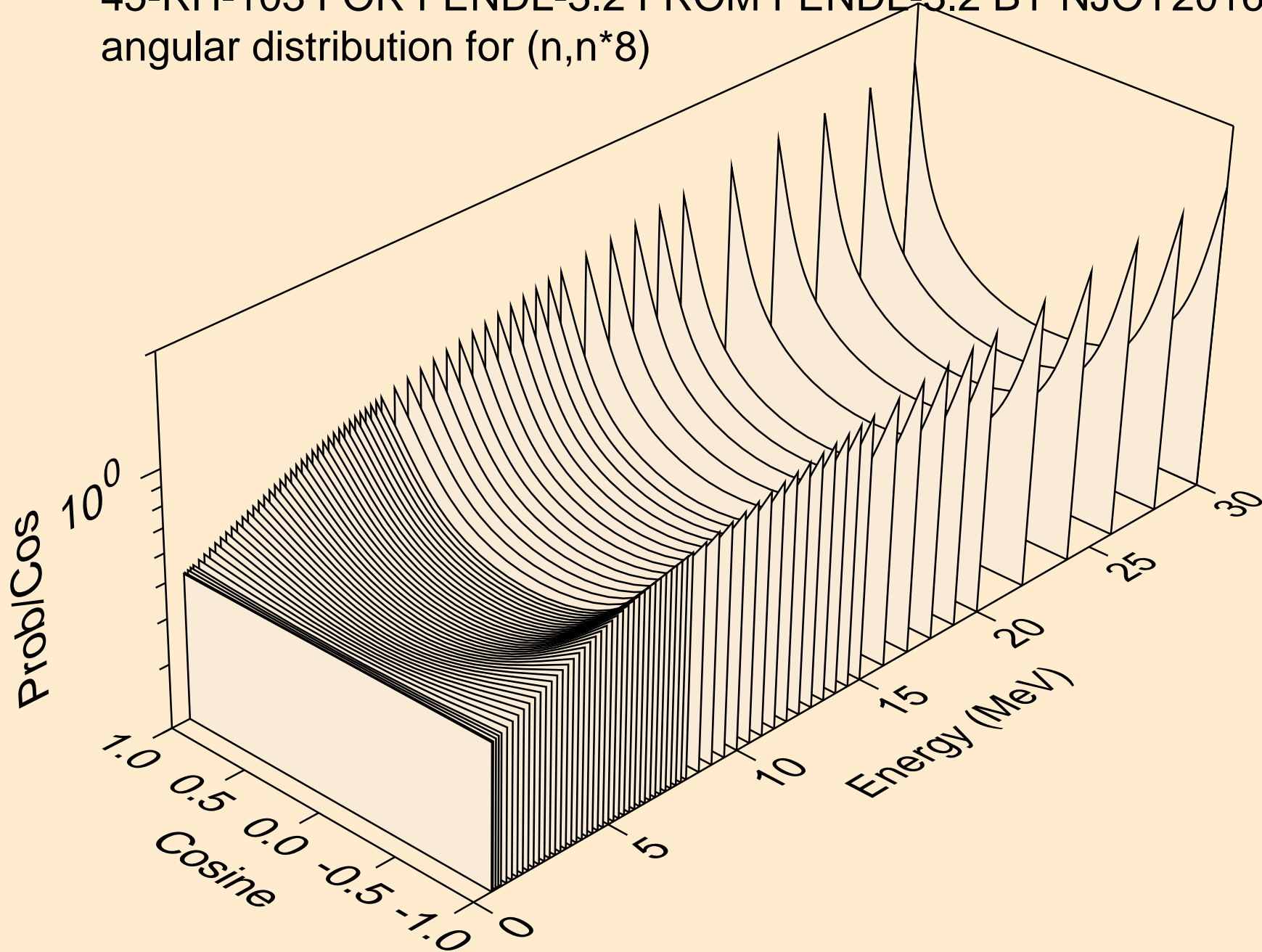

45-RH-103 FOR FENDL-3.2 FROM FENDL-3.2 BY NJOY2016.60+ C
angular distribution for (n,n*9)

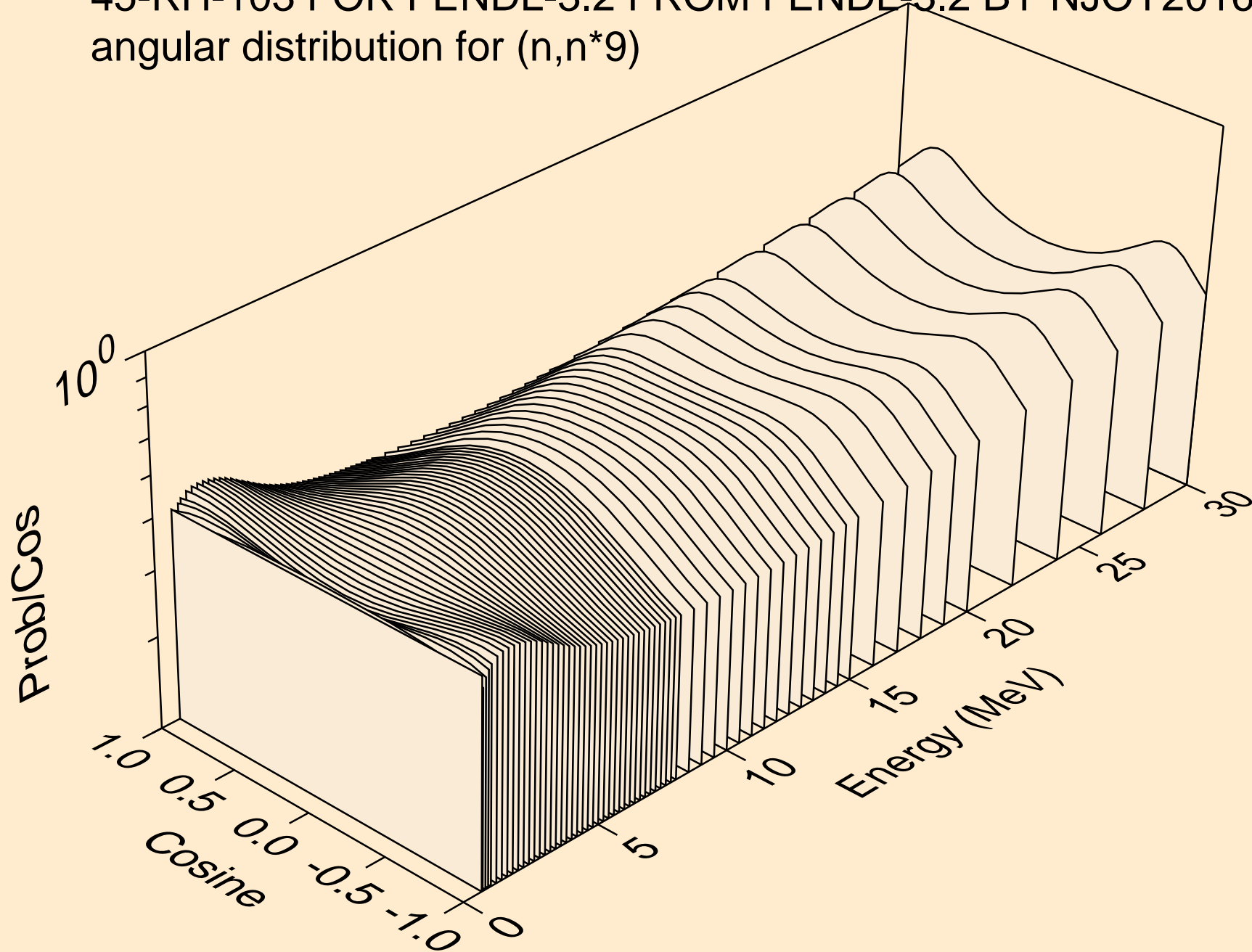

45-RH-103 FOR FENDL-3.2 FROM FENDL-3.2 BY NJOY2016.60+ C
angular distribution for (n,n*10)

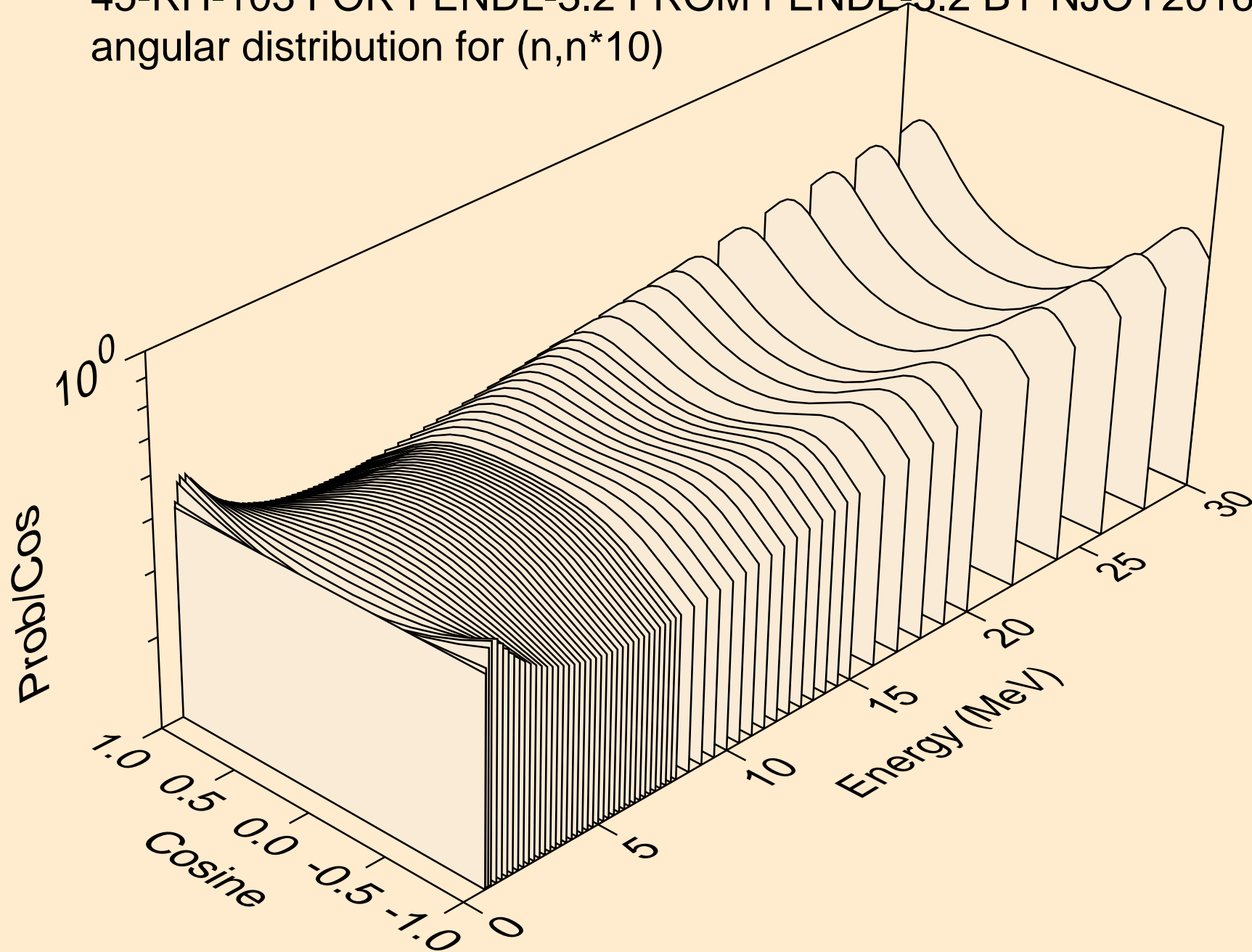

45-RH-103 FOR FENDL-3.2 FROM FENDL-3.2 BY NJOY2016.60+ C
angular distribution for (n,n*11)

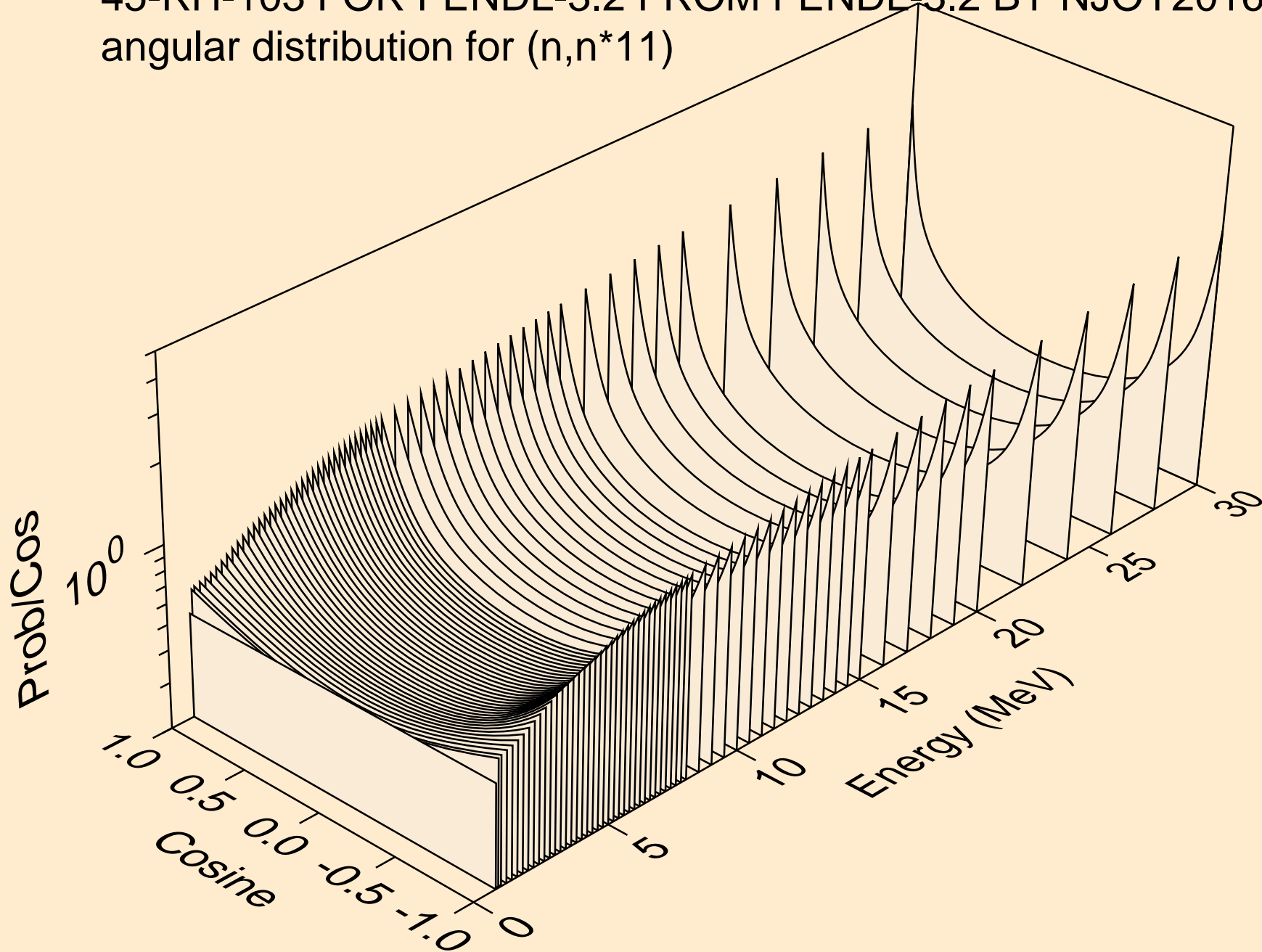

45-RH-103 FOR FENDL-3.2 FROM FENDL-3.2 BY NJOY2016.60+ C
angular distribution for (n,n*12)

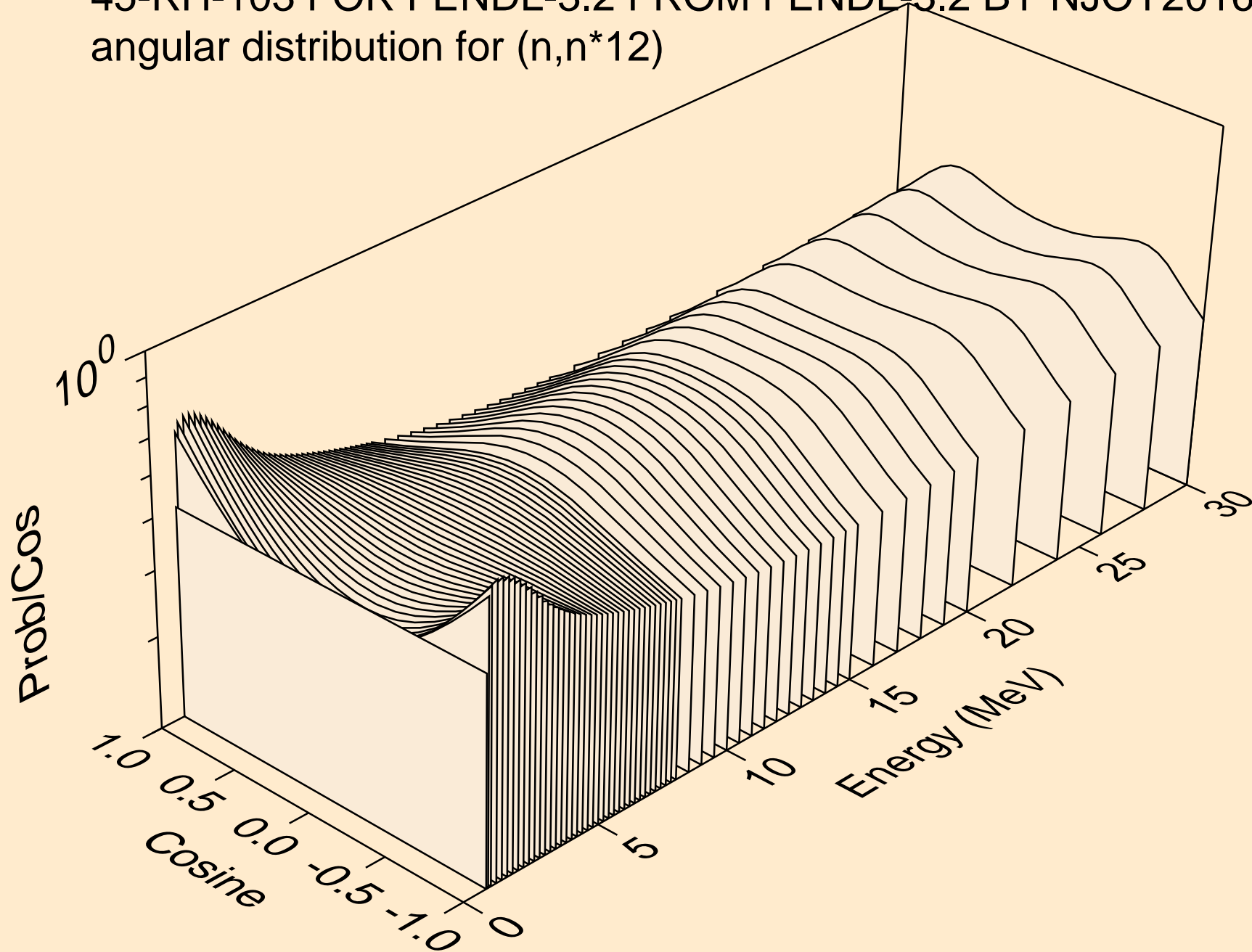

45-RH-103 FOR FENDL-3.2 FROM FENDL-3.2 BY NJOY2016.60+ C
angular distribution for (n,n*13)

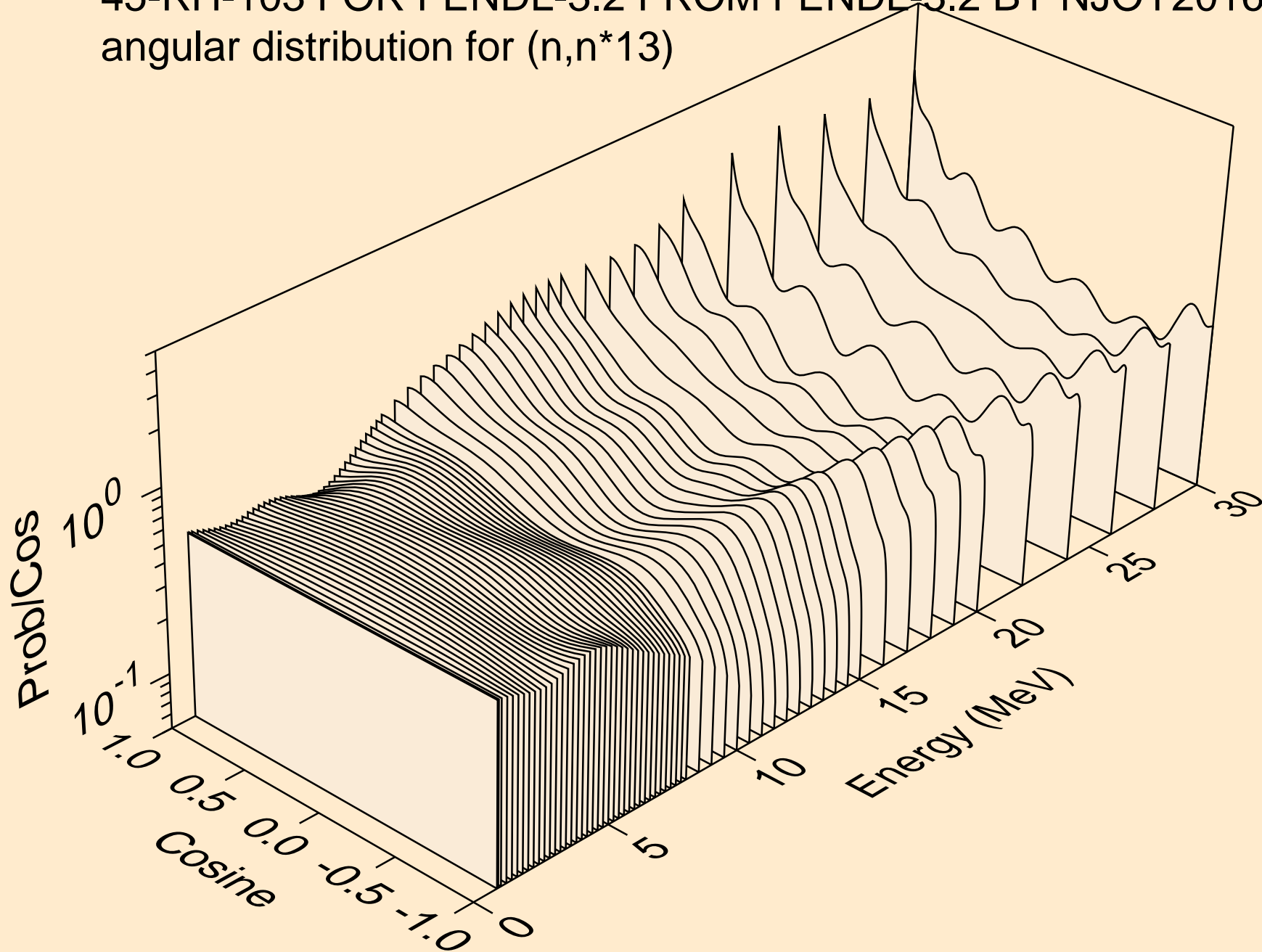

45-RH-103 FOR FENDL-3.2 FROM FENDL-3.2 BY NJOY2016.60+ C
angular distribution for (n,n*14)

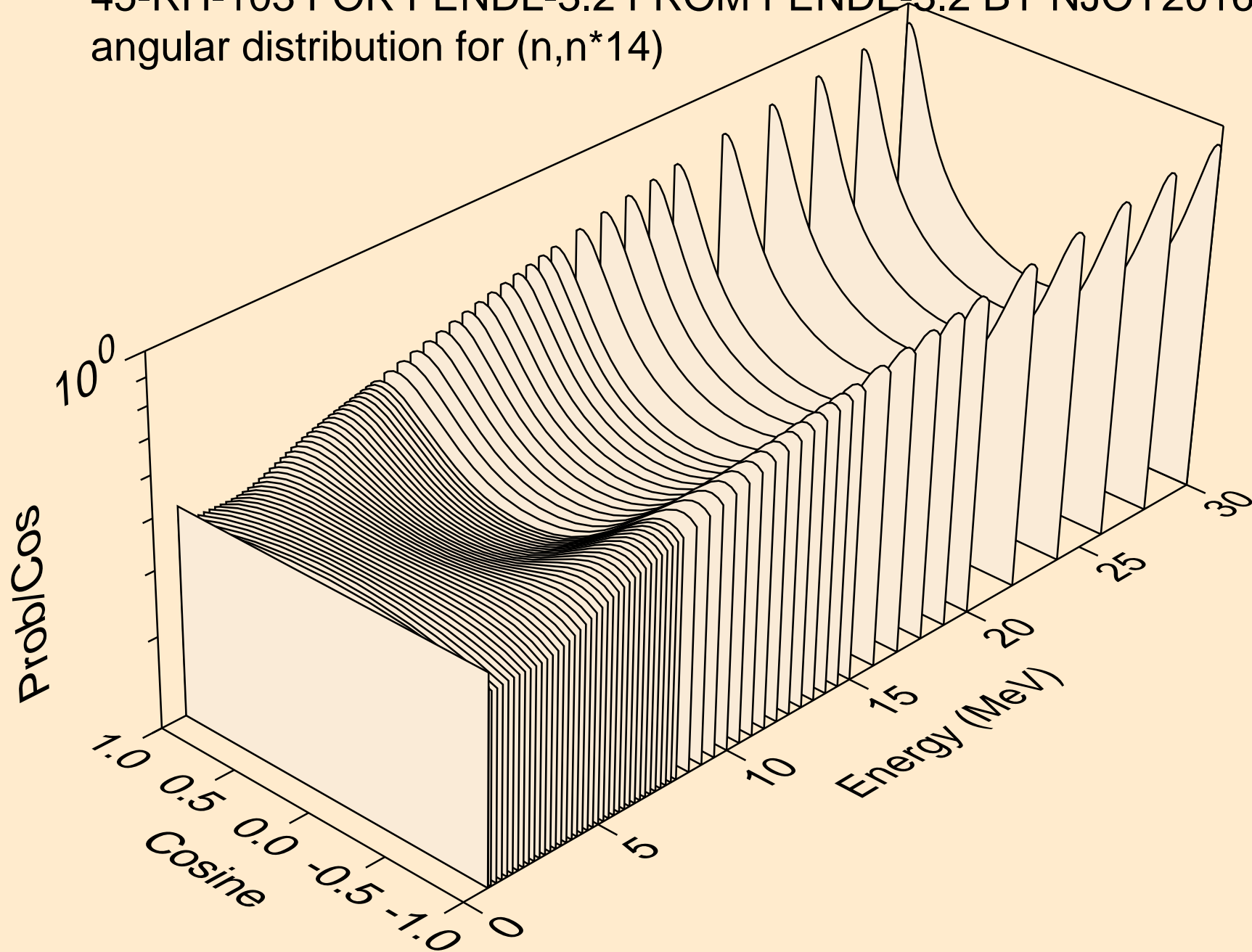

45-RH-103 FOR FENDL-3.2 FROM FENDL-3.2 BY NJOY2016.60+ C
angular distribution for (n,n*15)

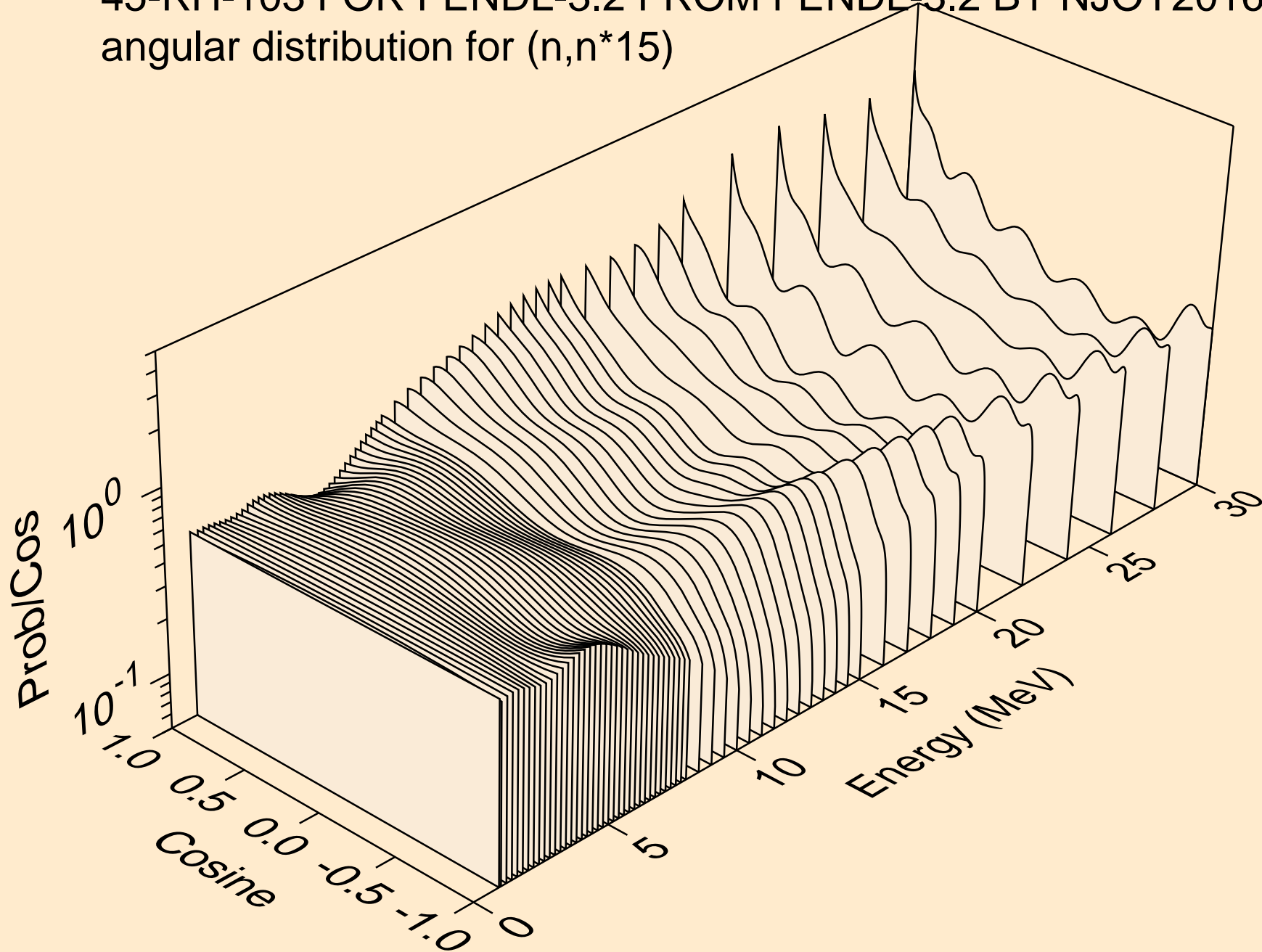

45-RH-103 FOR FENDL-3.2 FROM FENDL-3.2 BY NJOY2016.60+ C
Neutron emission for (n,x)

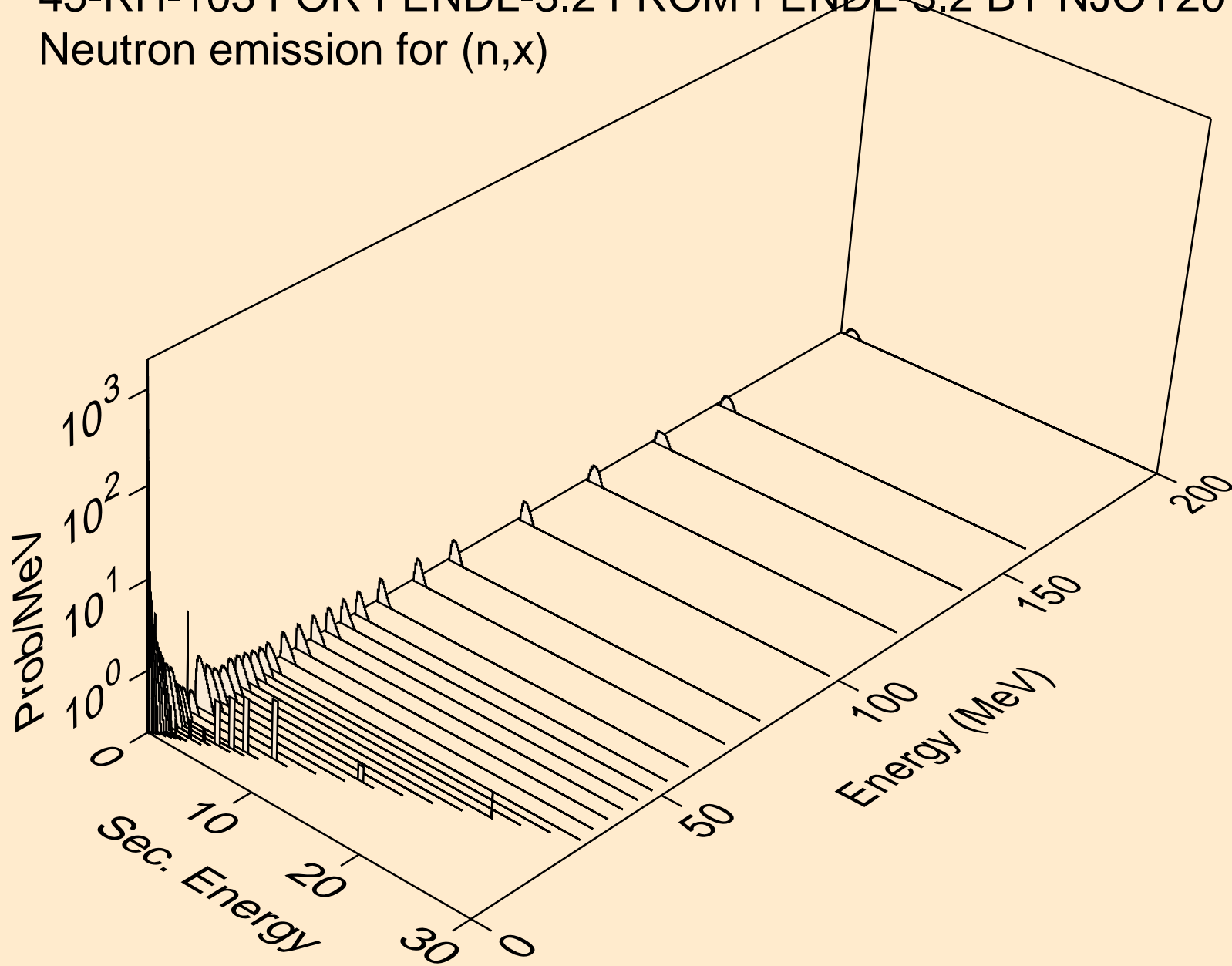

45-RH-103 FOR FENDL-3.2 FROM FENDL-3.2 BY NJOY2016.60+ C
Neutron emission for (n,2nd)

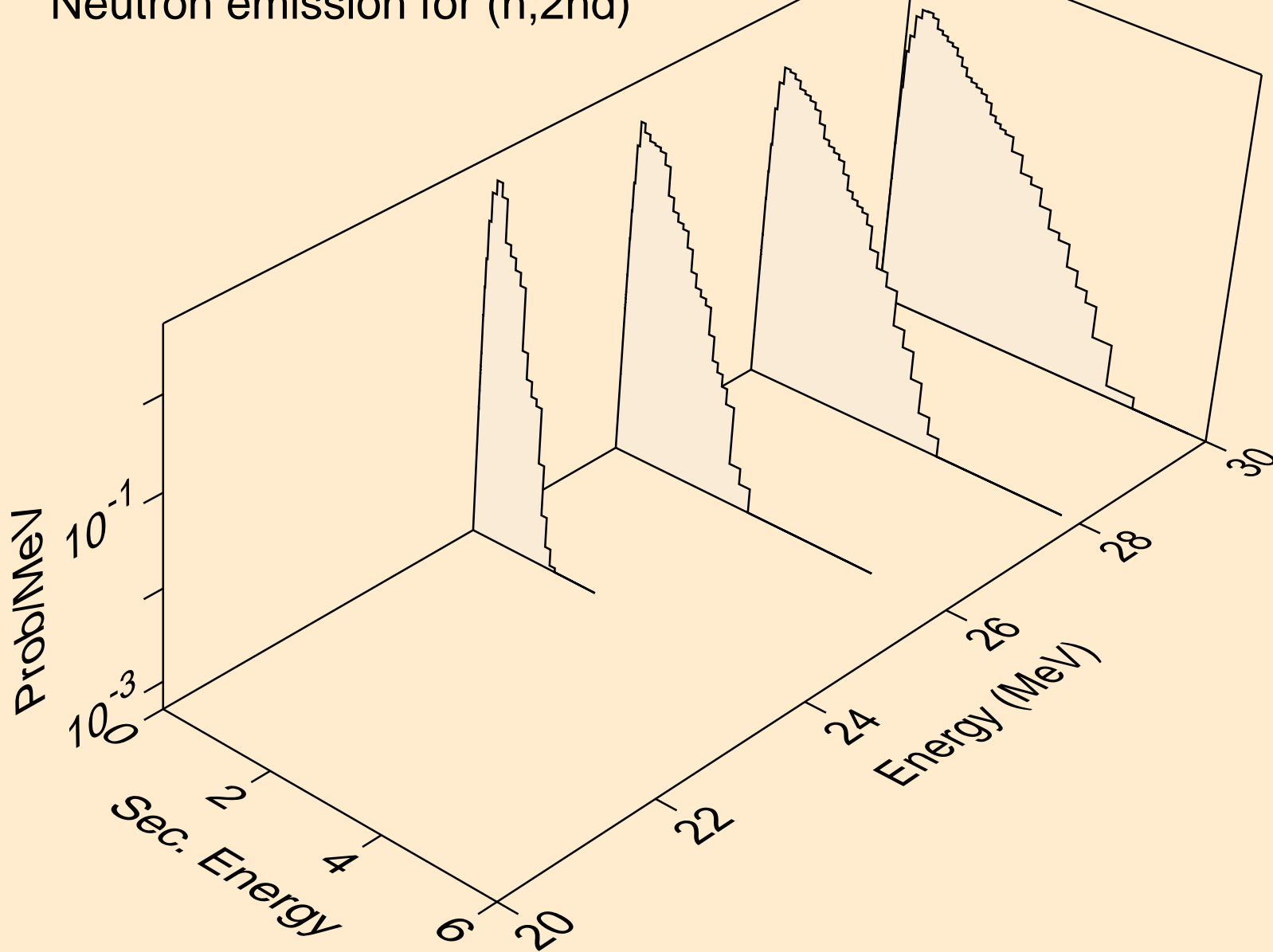

45-RH-103 FOR FENDL-3.2 FROM FENDL-3.2 BY NJOY2016.60+ C
Neutron emission for (n,2n)

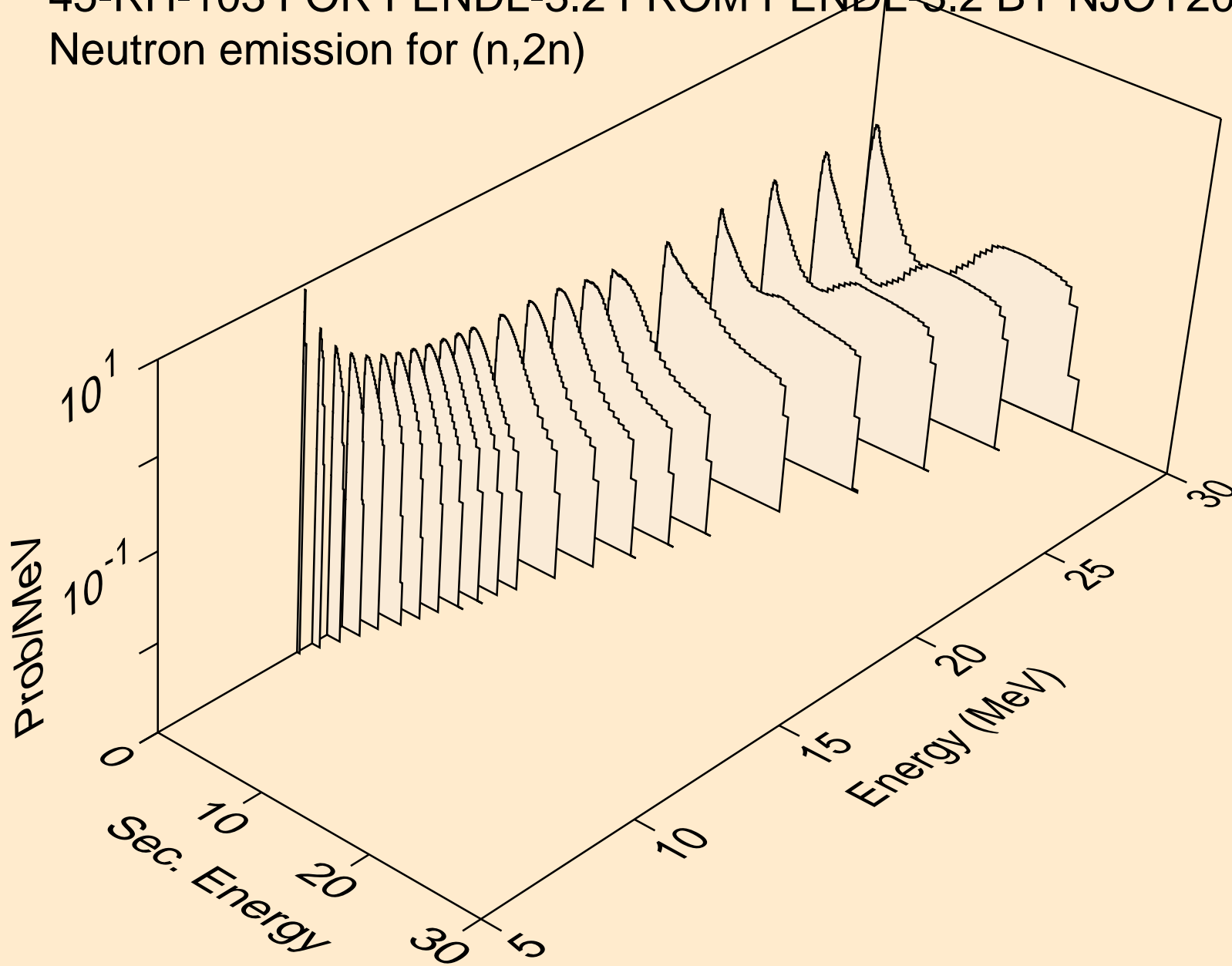

45-RH-103 FOR FENDL-3.2 FROM FENDL-3.2 BY NJOY2016.60+ C
Neutron emission for (n,3n)

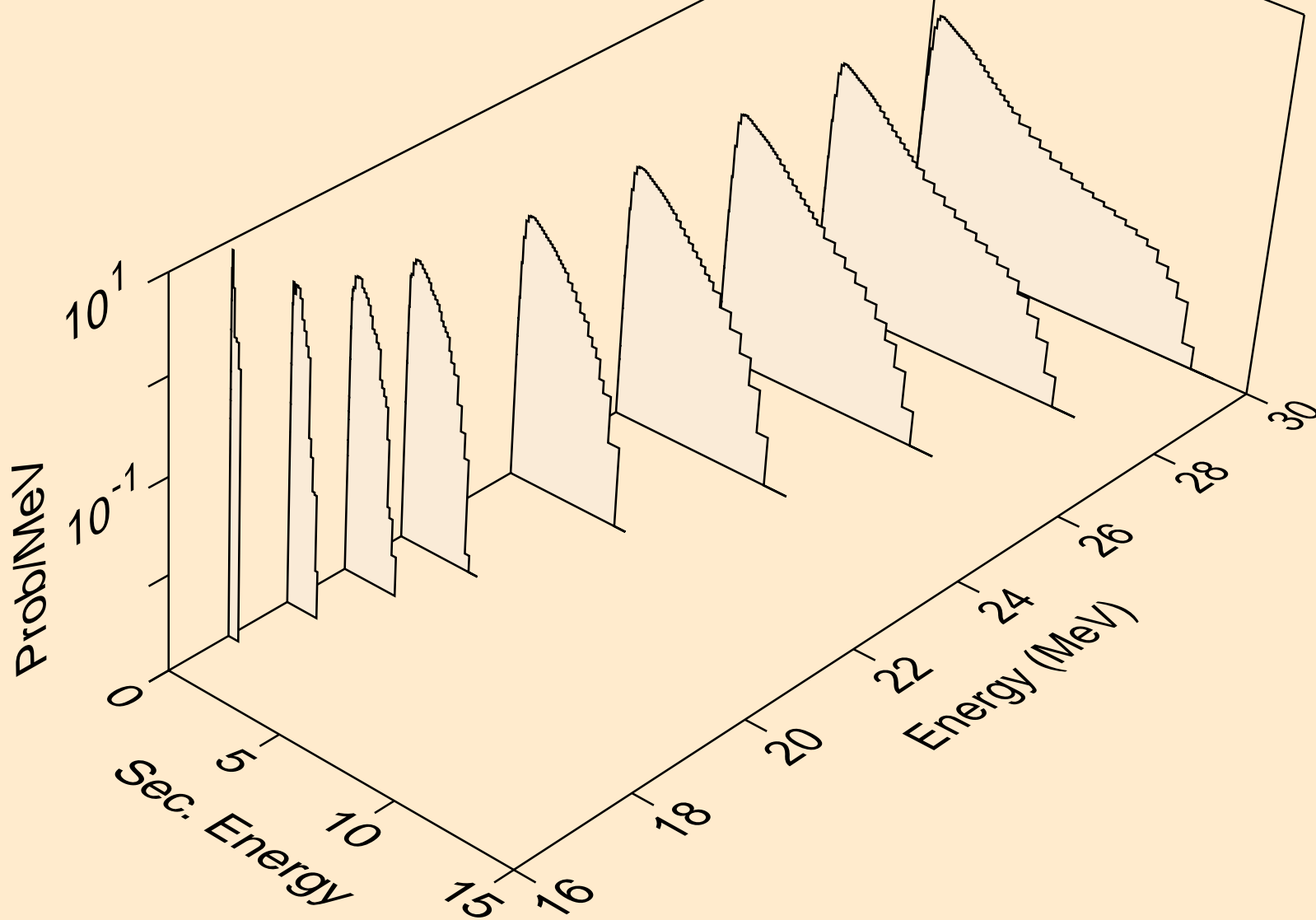

45-RH-103 FOR FENDL-3.2 FROM FENDL-3.2 BY NJOY2016.60+ C
Neutron emission for (n,n*)a

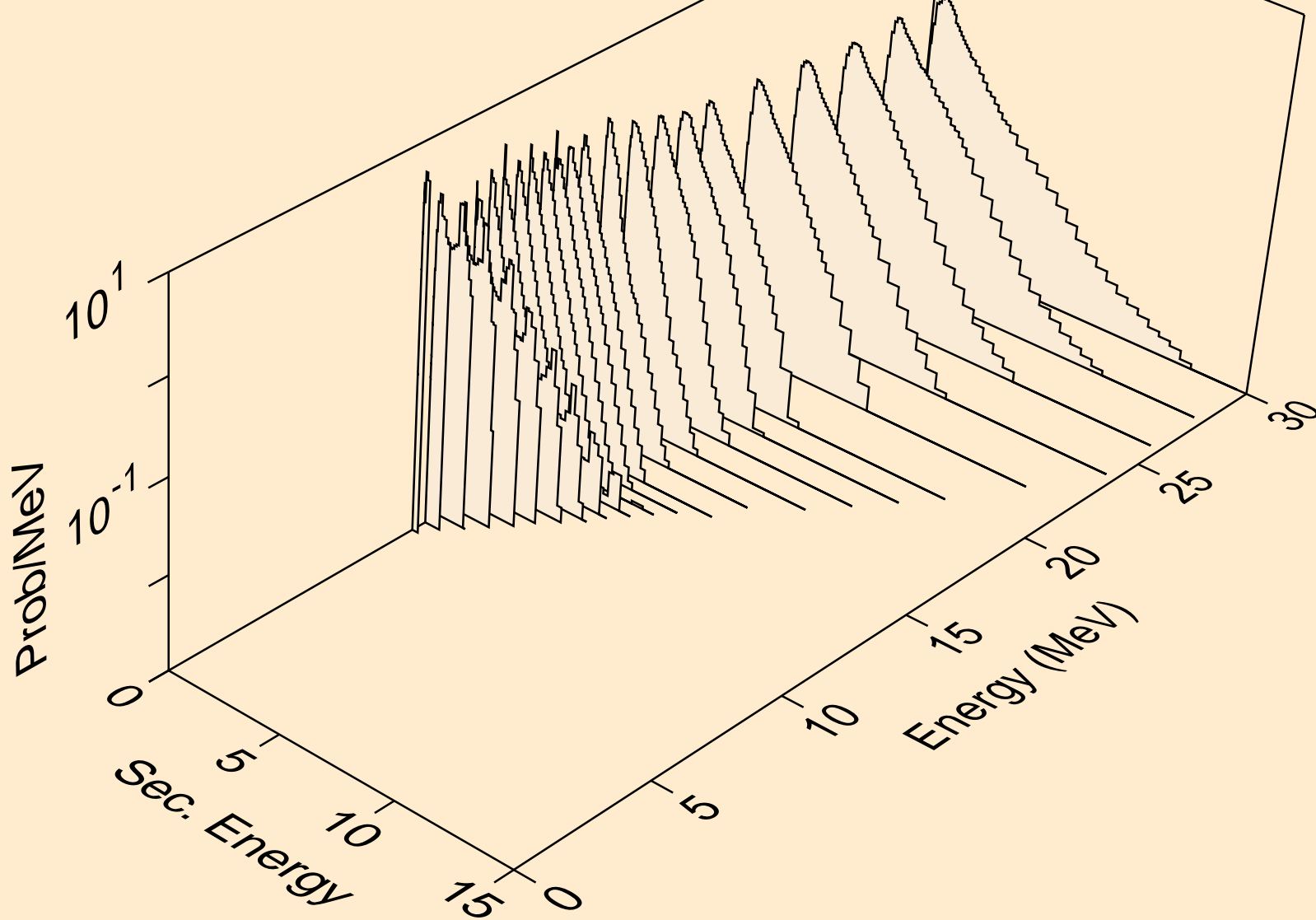

45-RH-103 FOR FENDL-3.2 FROM FENDL-3.2 BY NJOY2016.60+ C
Neutron emission for (n,2n)a

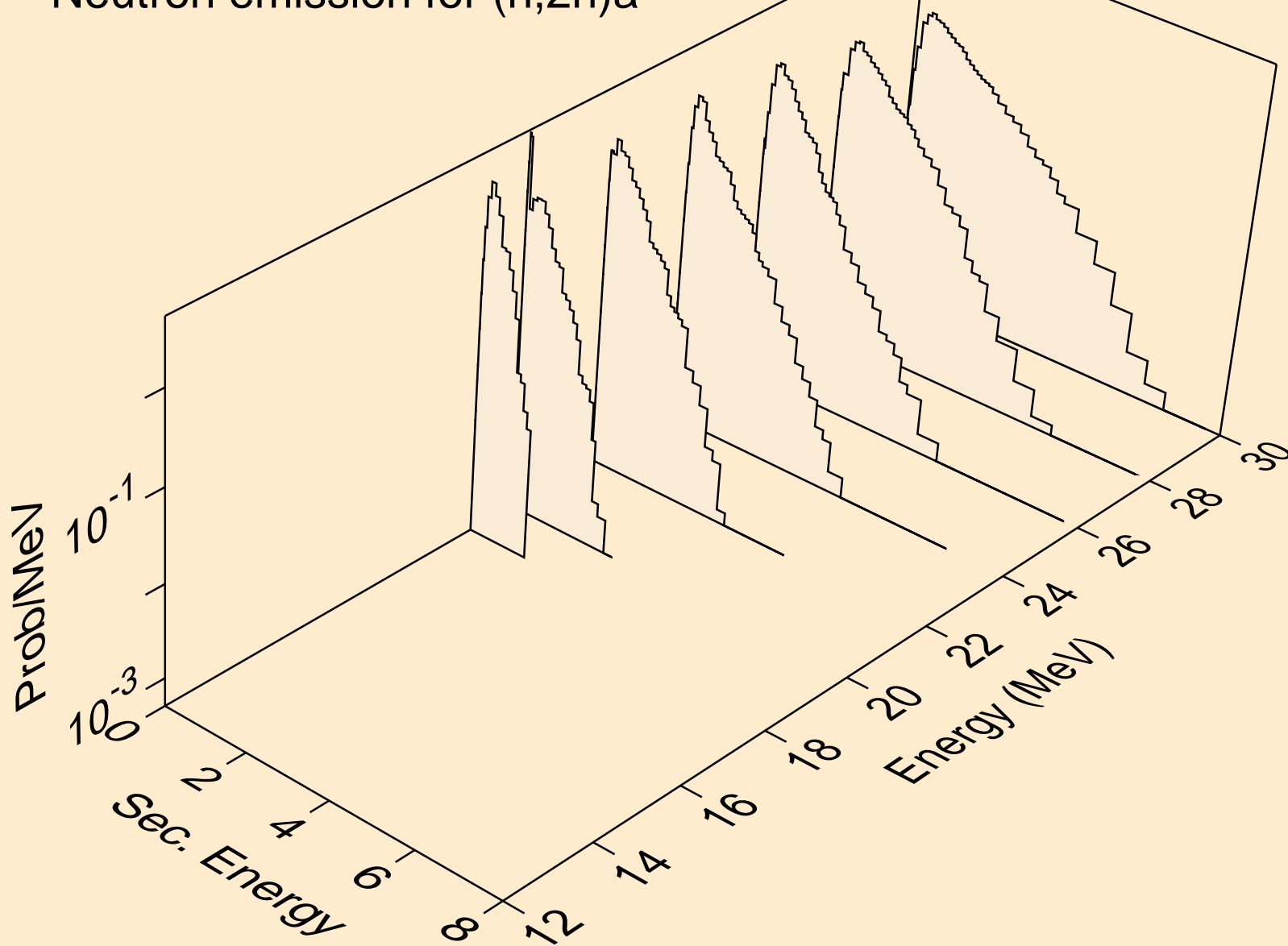

45-RH-103 FOR FENDL-3.2 FROM FENDL-3.2 BY NJOY2016.60+ C
Neutron emission for (n,3n)a

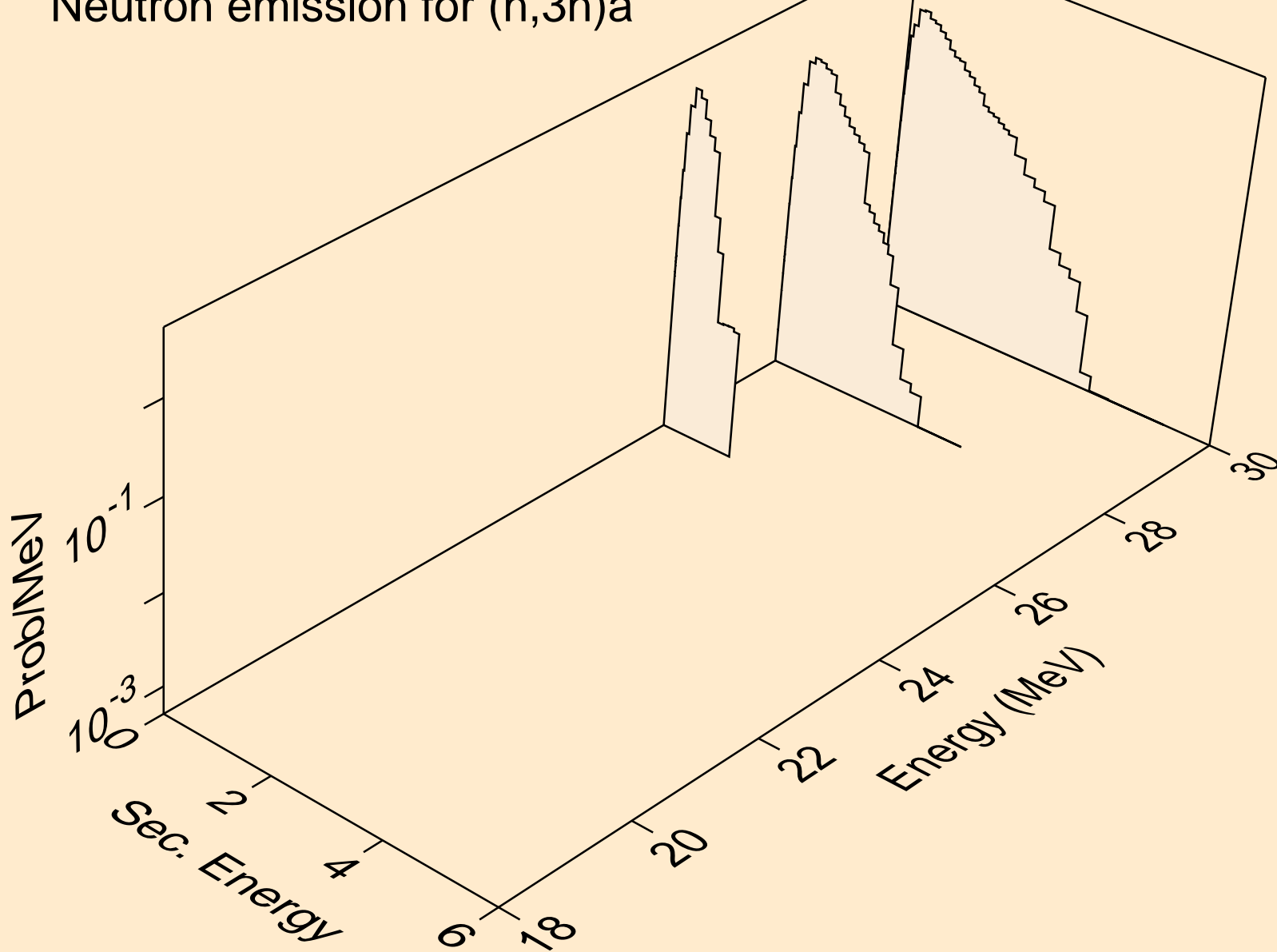

45-RH-103 FOR FENDL-3.2 FROM FENDL-3.2 BY NJOY2016.60+ C
Neutron emission for (n,n*)p

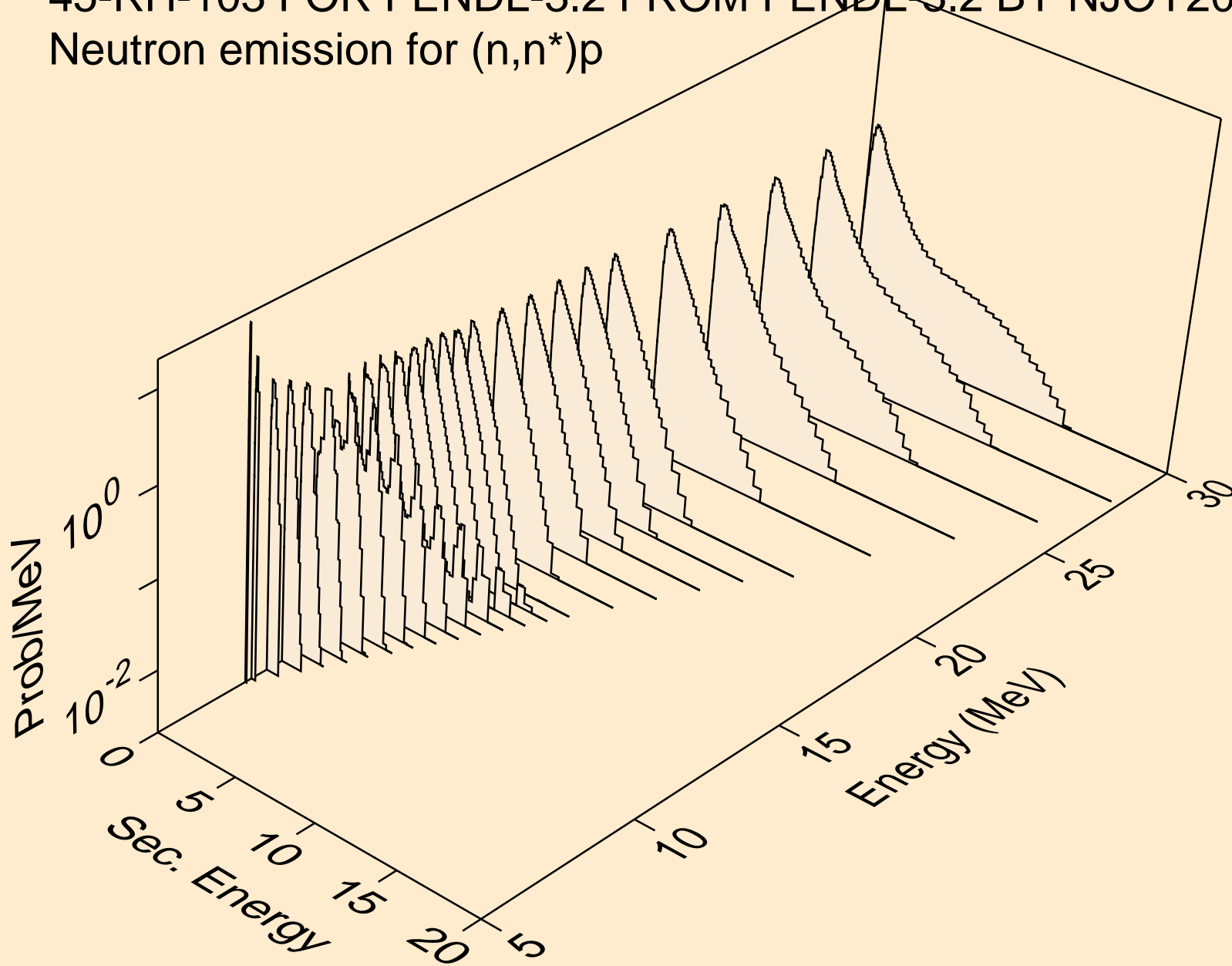

45-RH-103 FOR FENDL-3.2 FROM FENDL-3.2 BY NJOY2016.60+ C
Neutron emission for (n,n*)2a

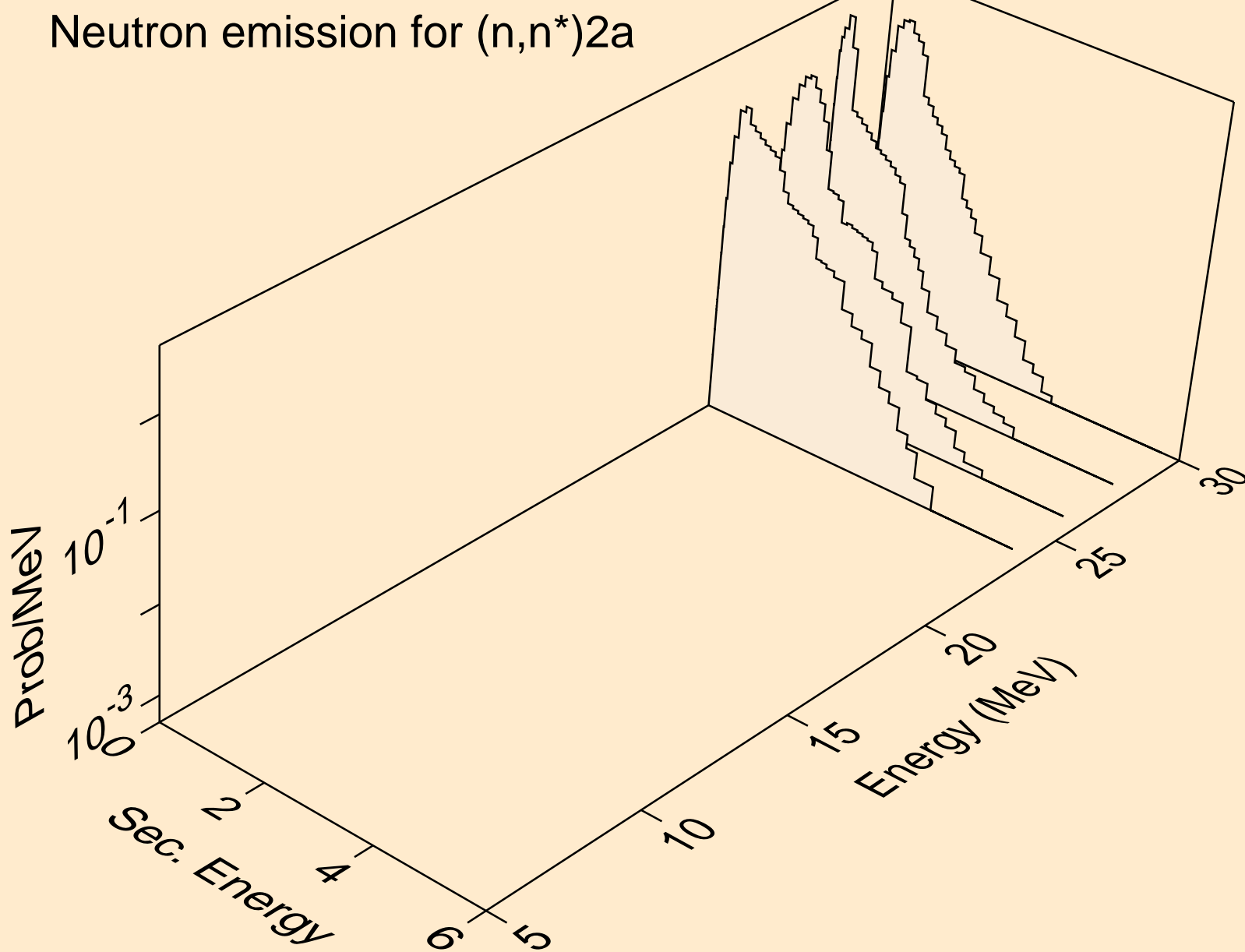

45-RH-103 FOR FENDL-3.2 FROM FENDL-3.2 BY NJOY2016.60+ C
Neutron emission for (n,n*)d

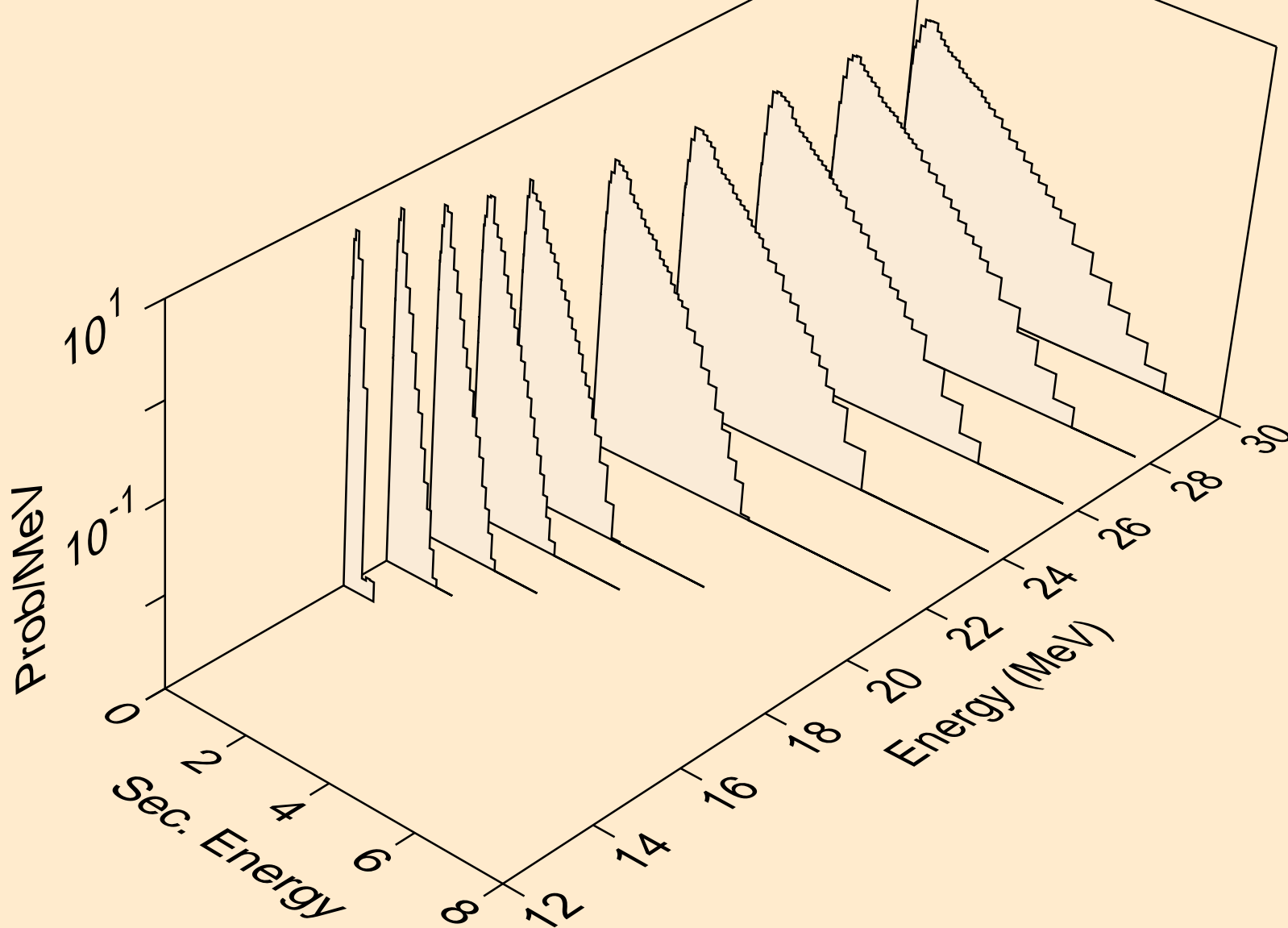

45-RH-103 FOR FENDL-3.2 FROM FENDL-3.2 BY NJOY2016.60+ C
Neutron emission for (n,n*)t

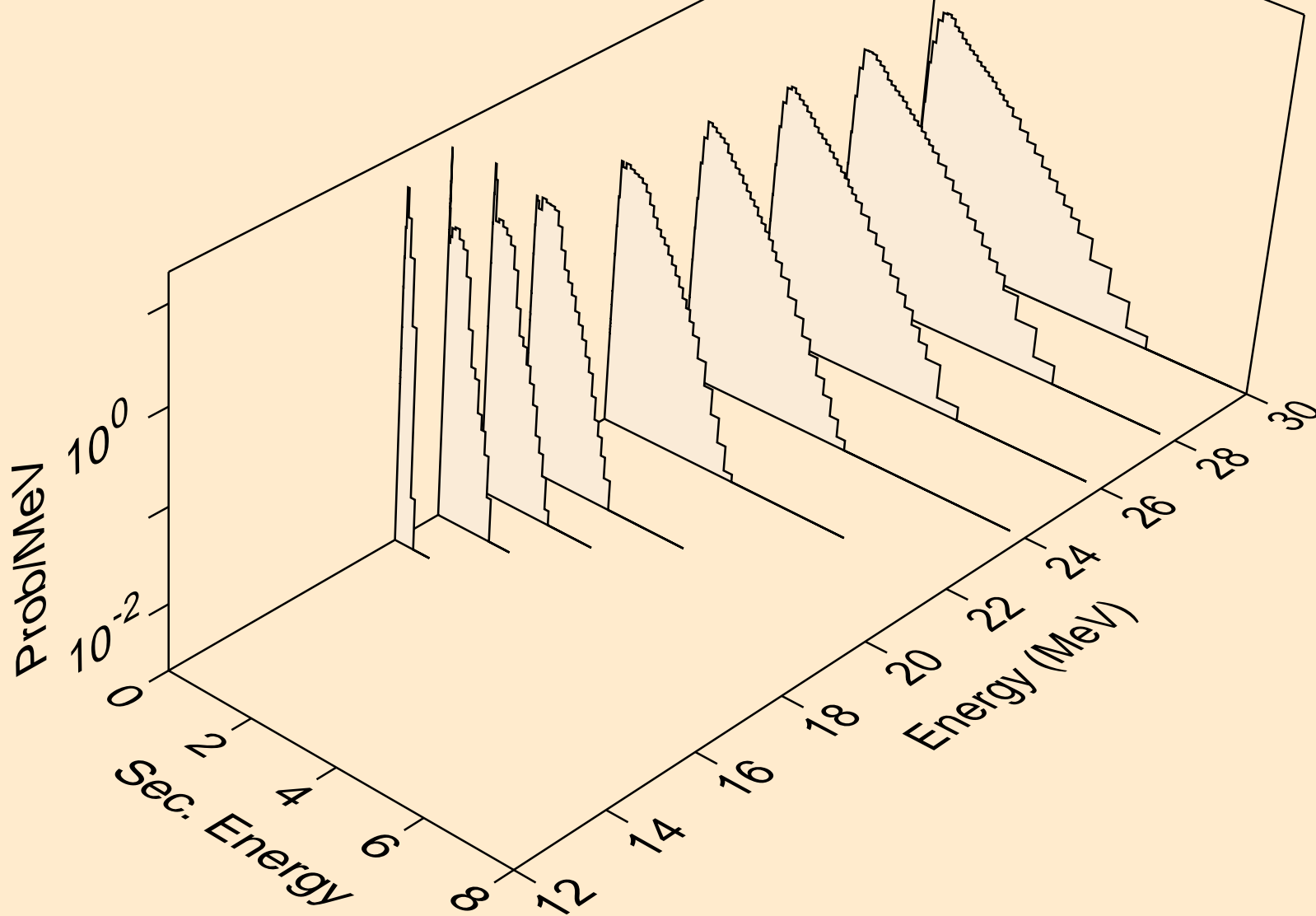

45-RH-103 FOR FENDL-3.2 FROM FENDL-3.2 BY NJOY2016.60+ C
Neutron emission for (n,n*)he3

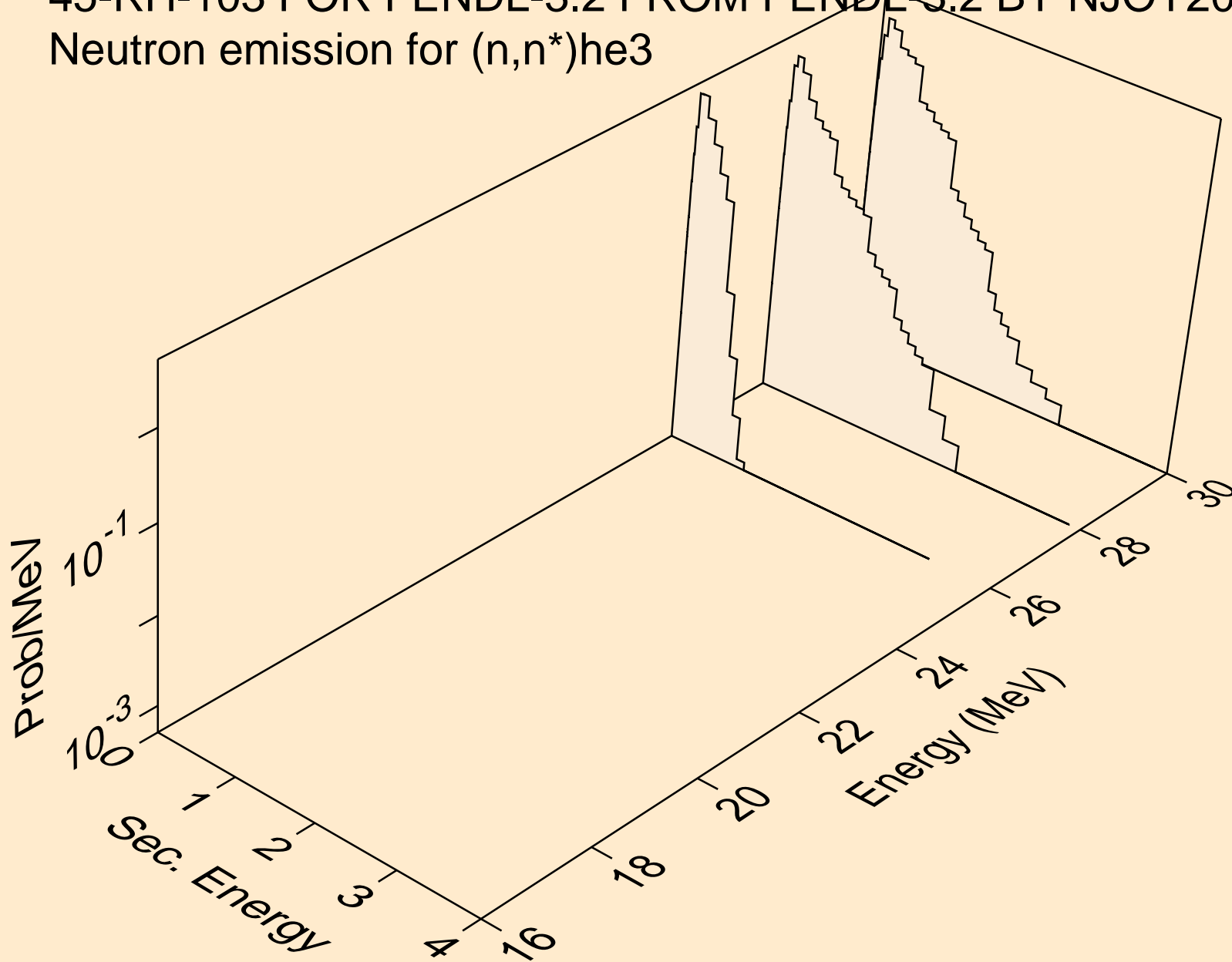

45-RH-103 FOR FENDL-3.2 FROM FENDL-3.2 BY NJOY2016.60+ C
Neutron emission for (n,4n)

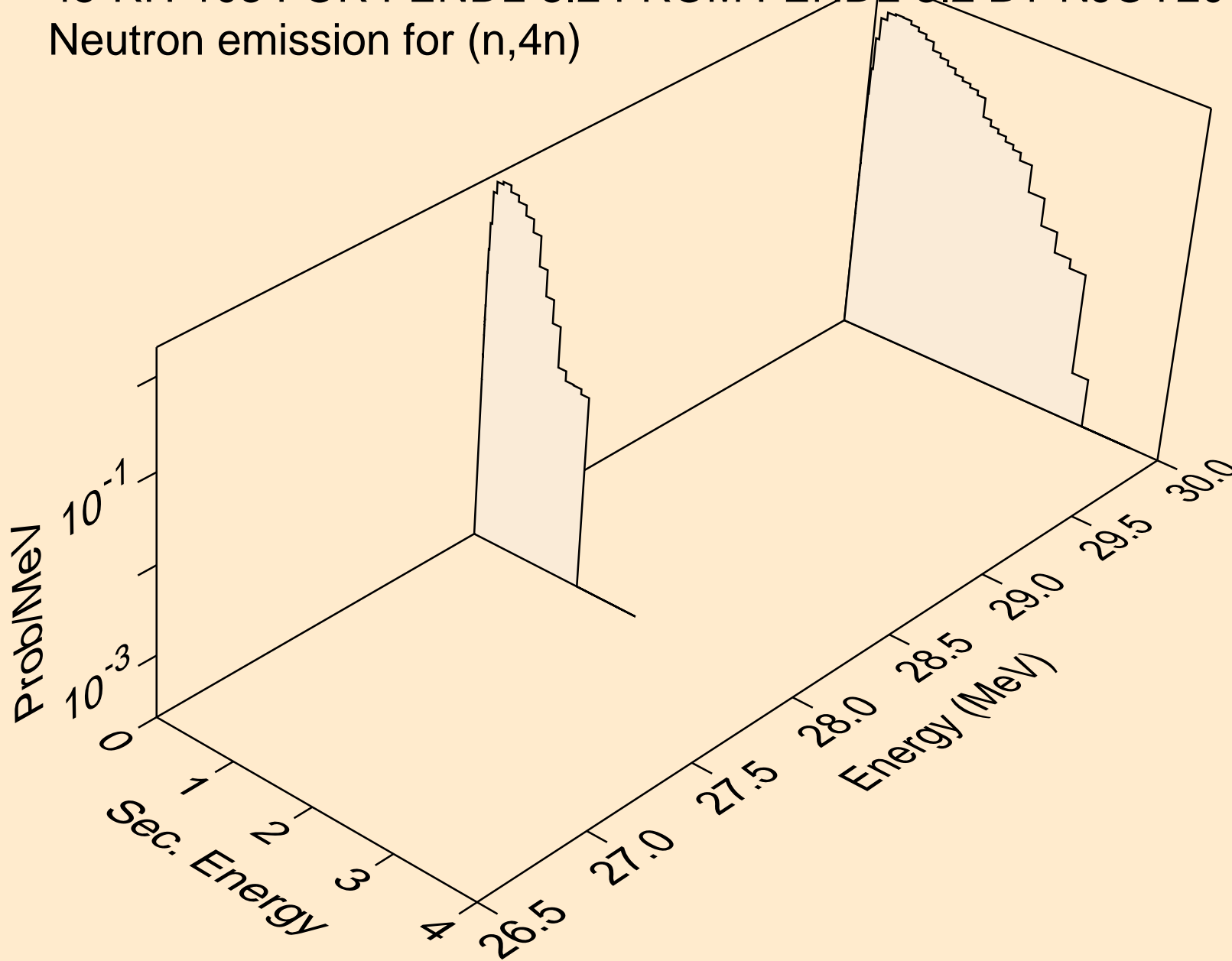

45-RH-103 FOR FENDL-3.2 FROM FENDL-3.2 BY NJOY2016.60+ C
Neutron emission for (n,2np)

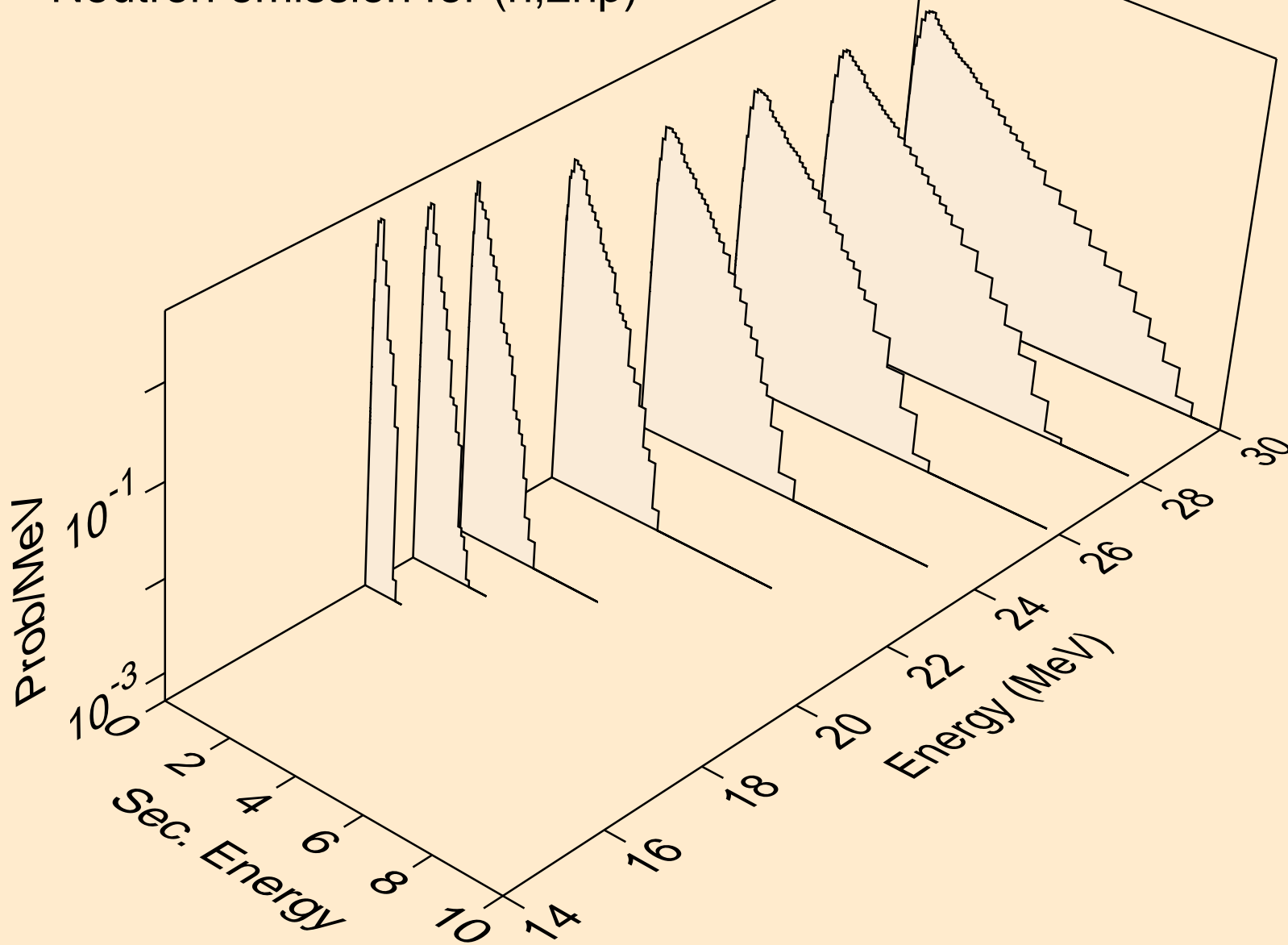

45-RH-103 FOR FENDL-3.2 FROM FENDL-3.2 BY NJOY2016.60+ C
Neutron emission for (n,3np)

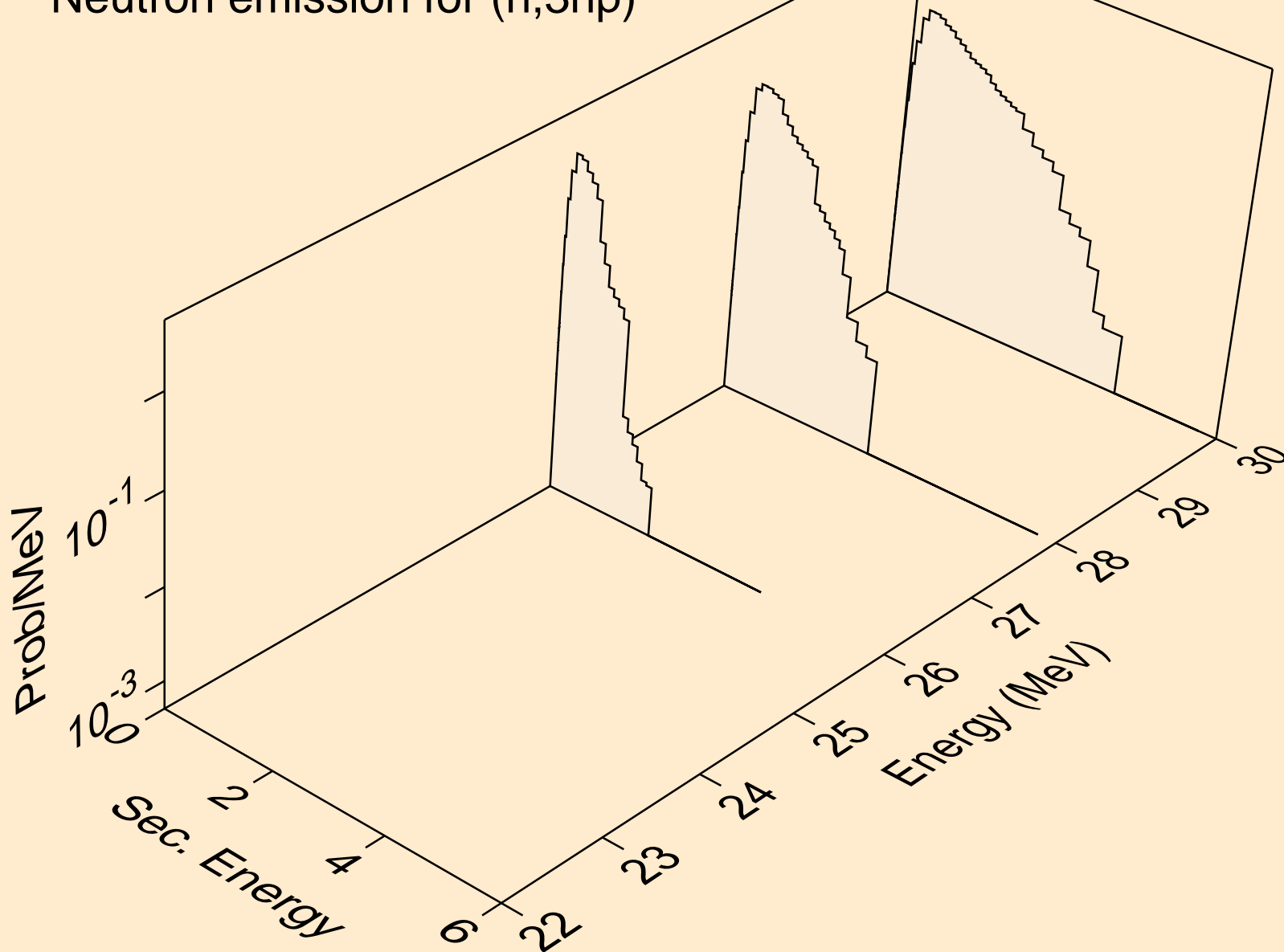

45-RH-103 FOR FENDL-3.2 FROM FENDL-3.2 BY NJOY2016.60+ C
Neutron emission for (n,2np)

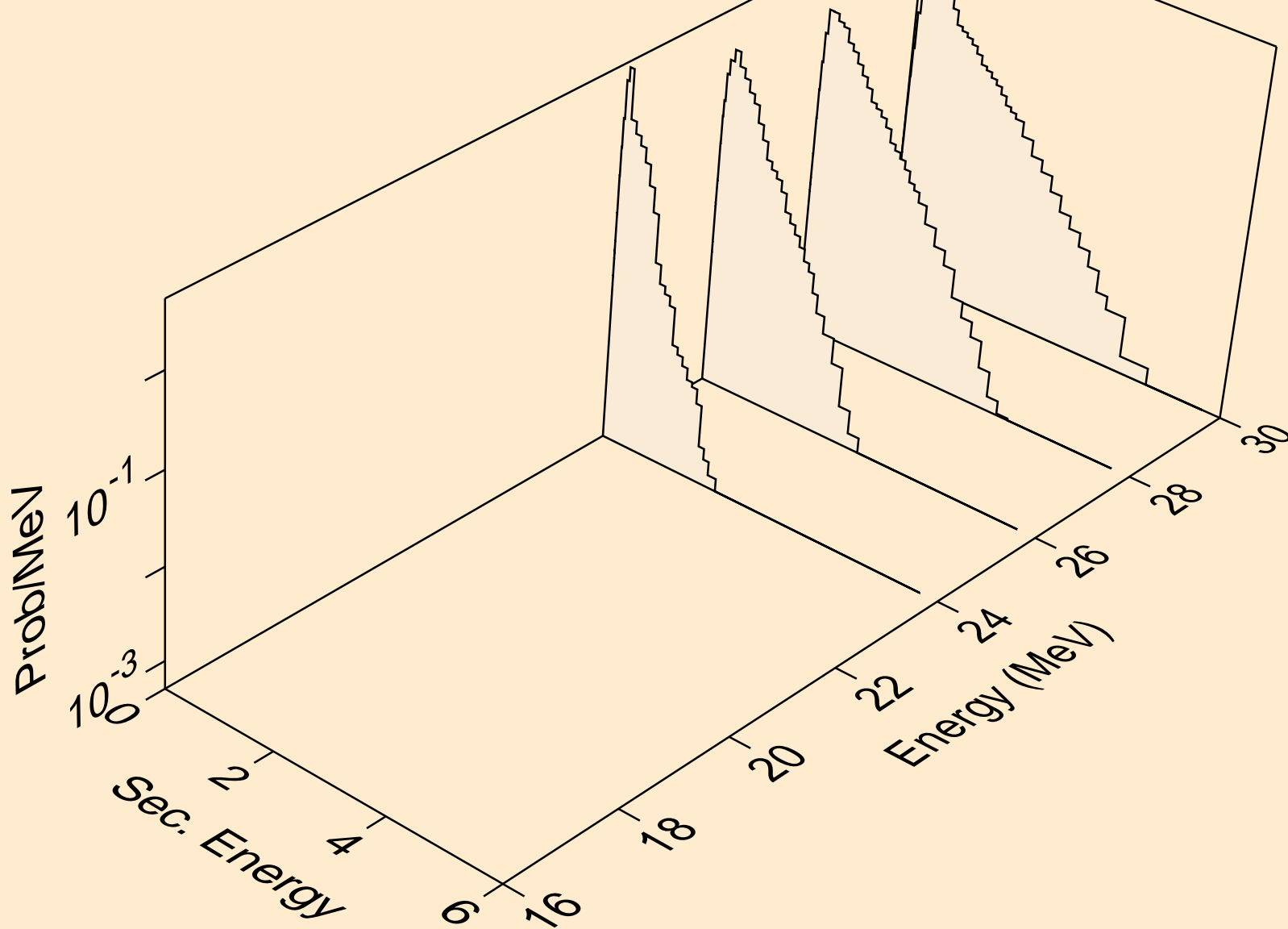

45-RH-103 FOR FENDL-3.2 FROM FENDL-3.2 BY NJOY2016.60+ C
Neutron emission for (n,npa)

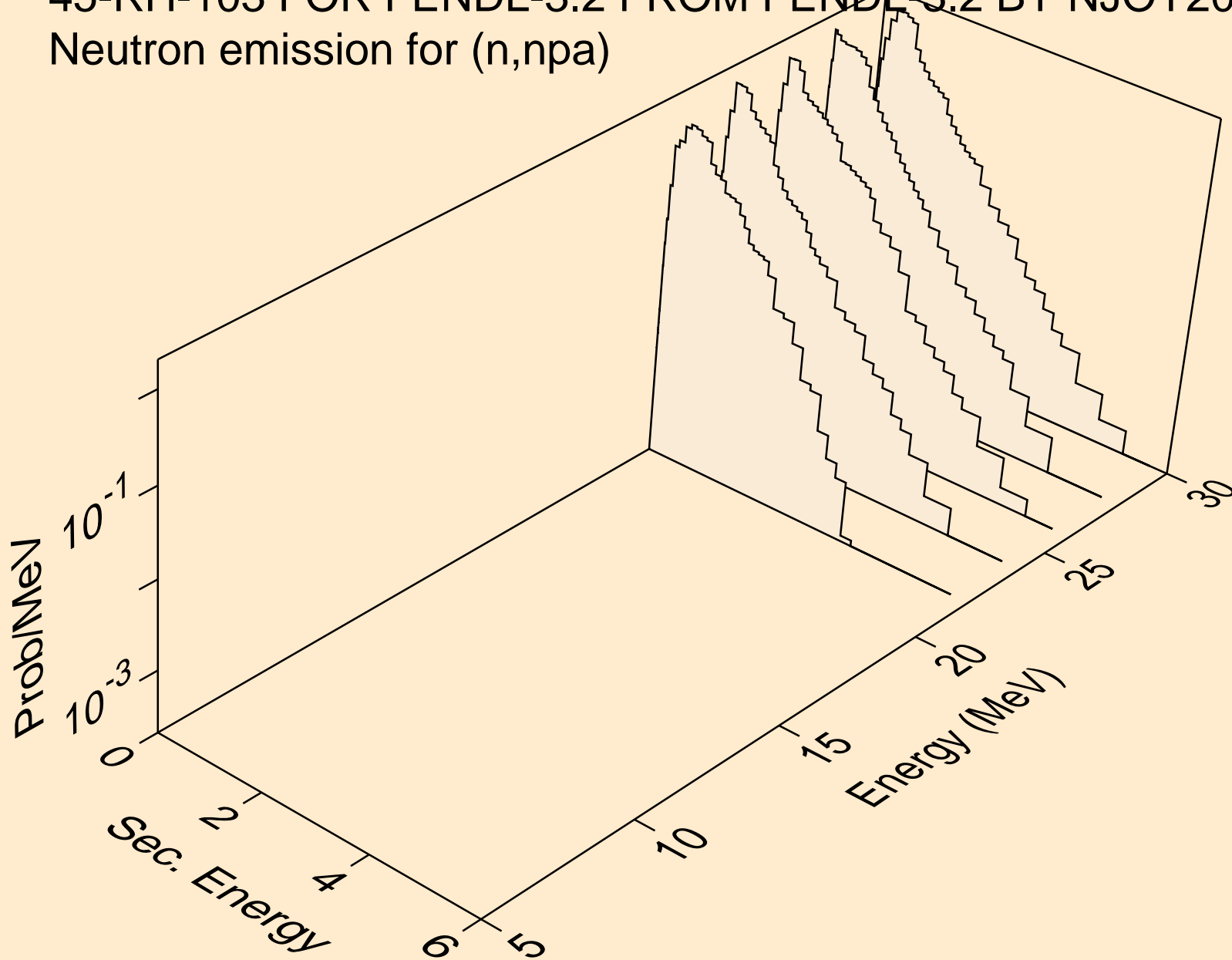

45-RH-103 FOR FENDL-3.2 FROM FENDL-3.2 BY NJOY2016.60+ C
Neutron emission for (n,n*c)

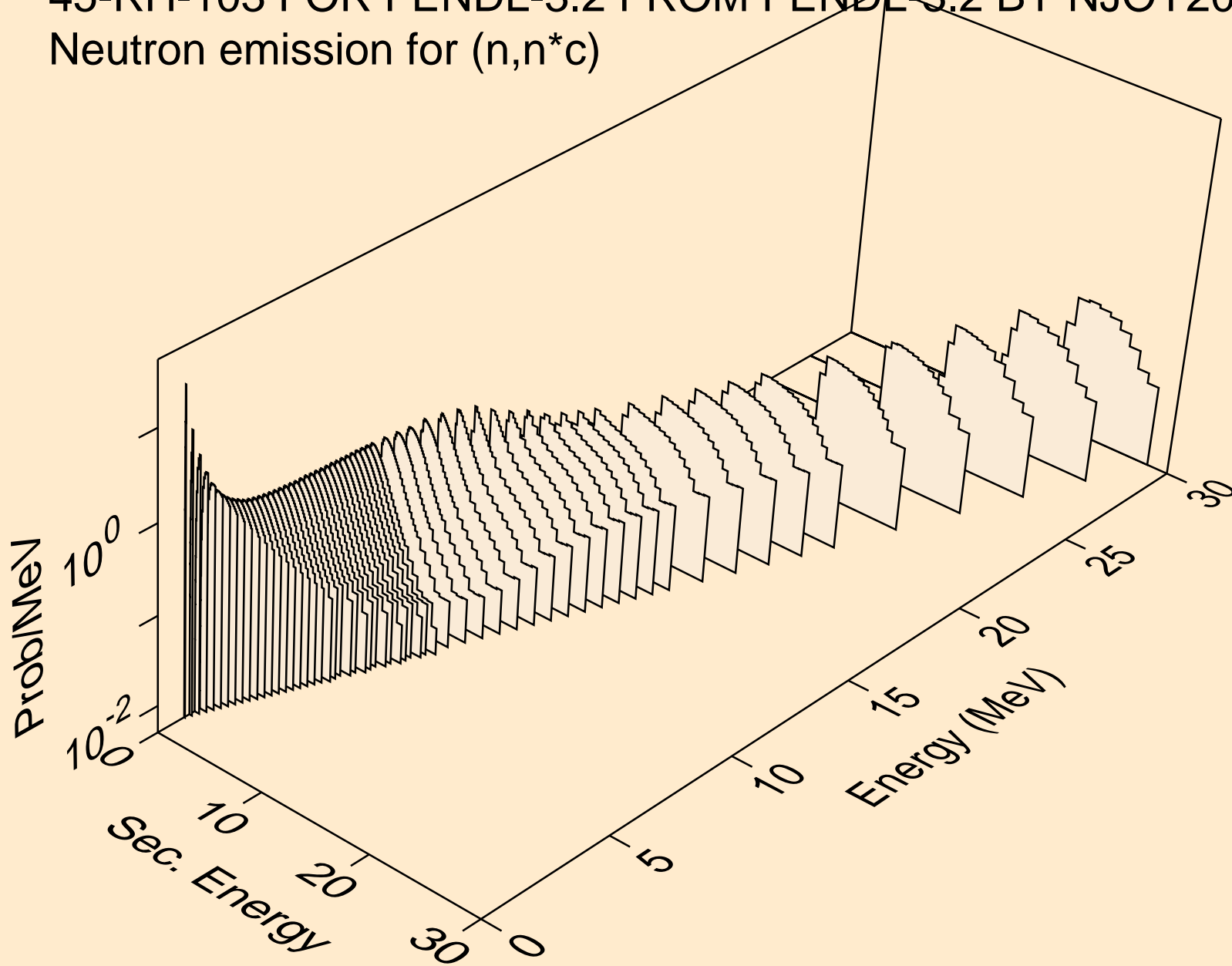

45-RH-103 FOR FENDL-3.2 FROM FENDL-3.2 BY NJOY2016.60+ C
Photon emission for (n,x)

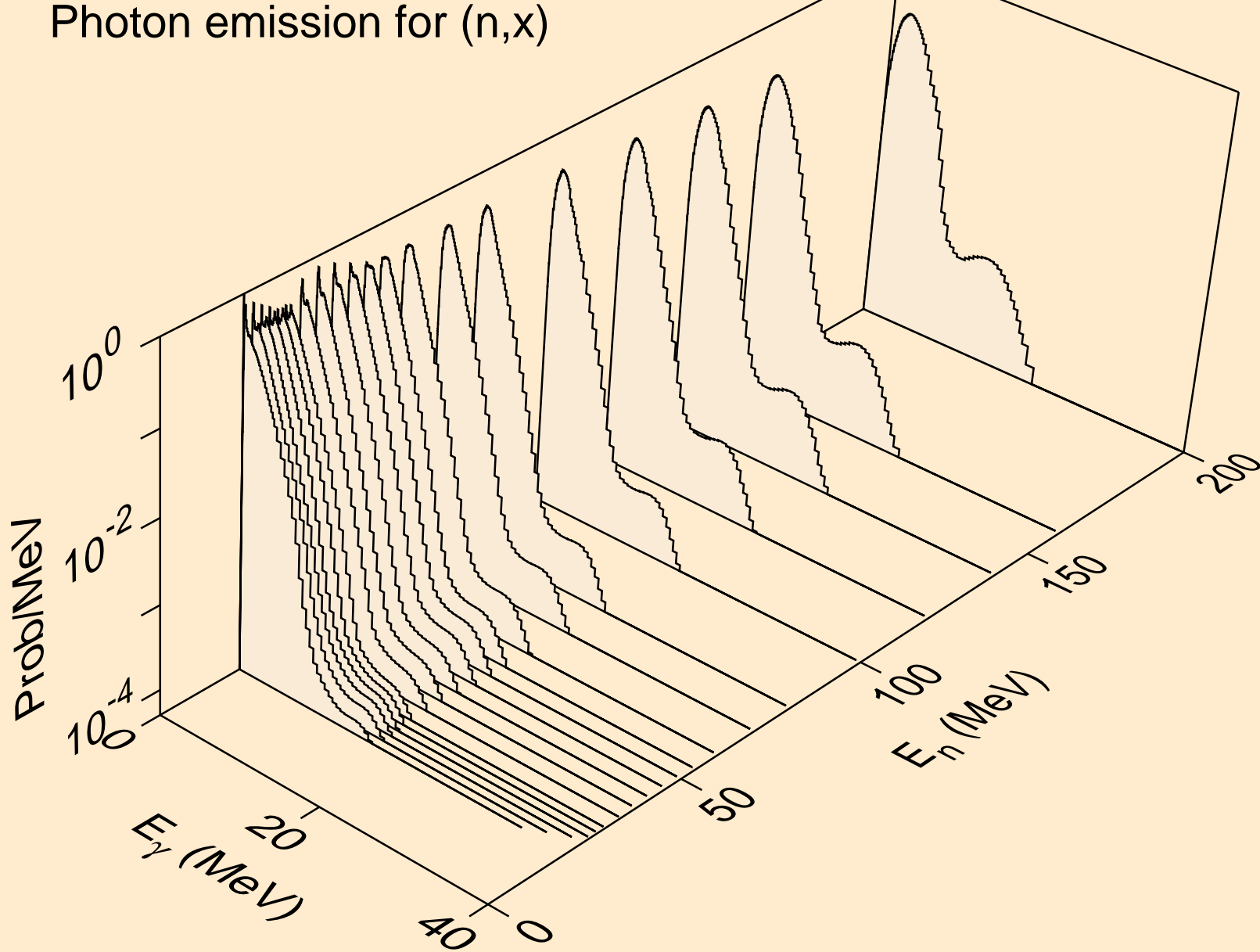

45-RH-103 FOR FENDL-3.2 FROM FENDL-3.2 BY NJOY2016.60+ C
Photon emission for (n,2nd)

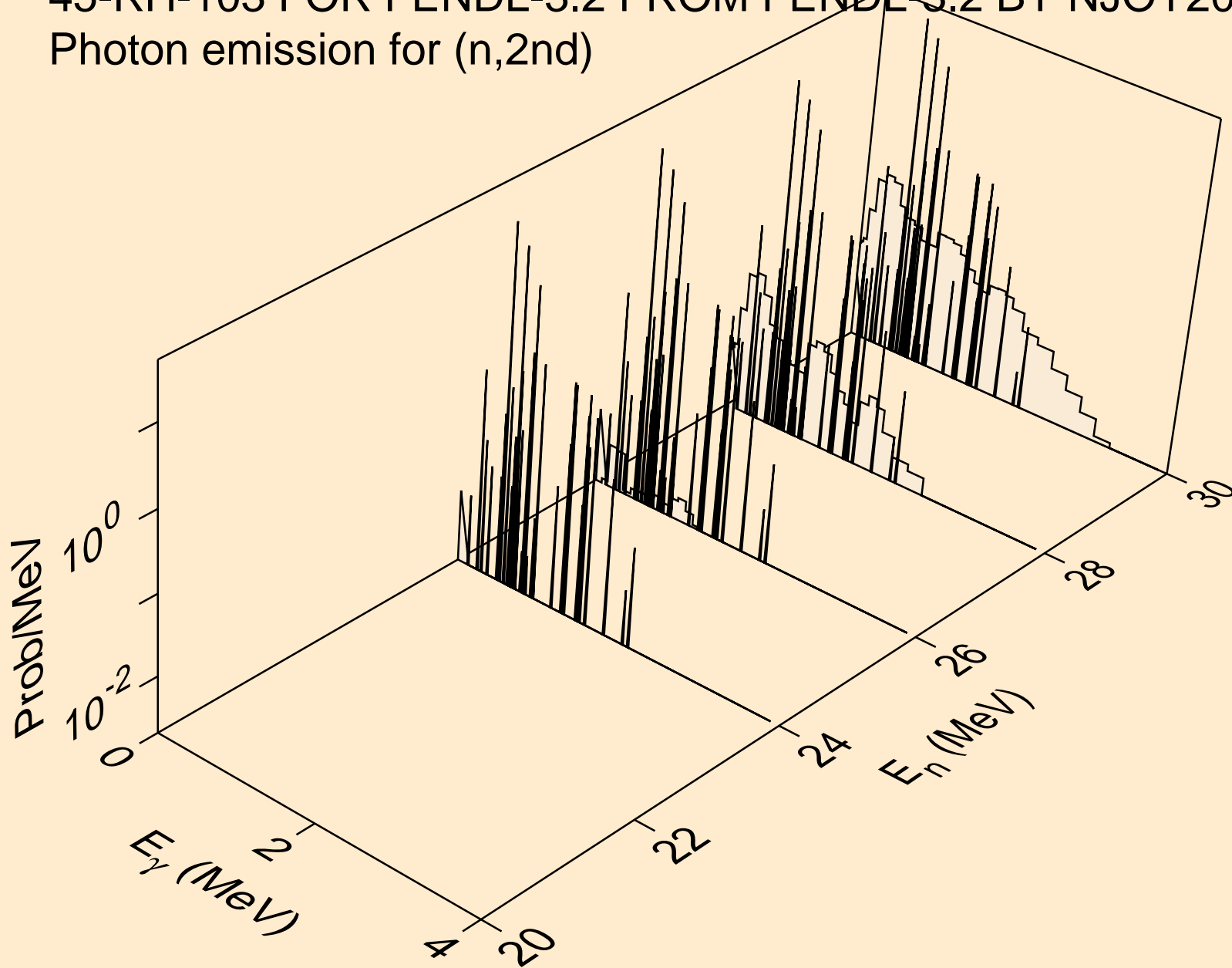

45-RH-103 FOR FENDL-3.2 FROM FENDL-3.2 BY NJOY2016.60+ C
Photon emission for (n,2n)

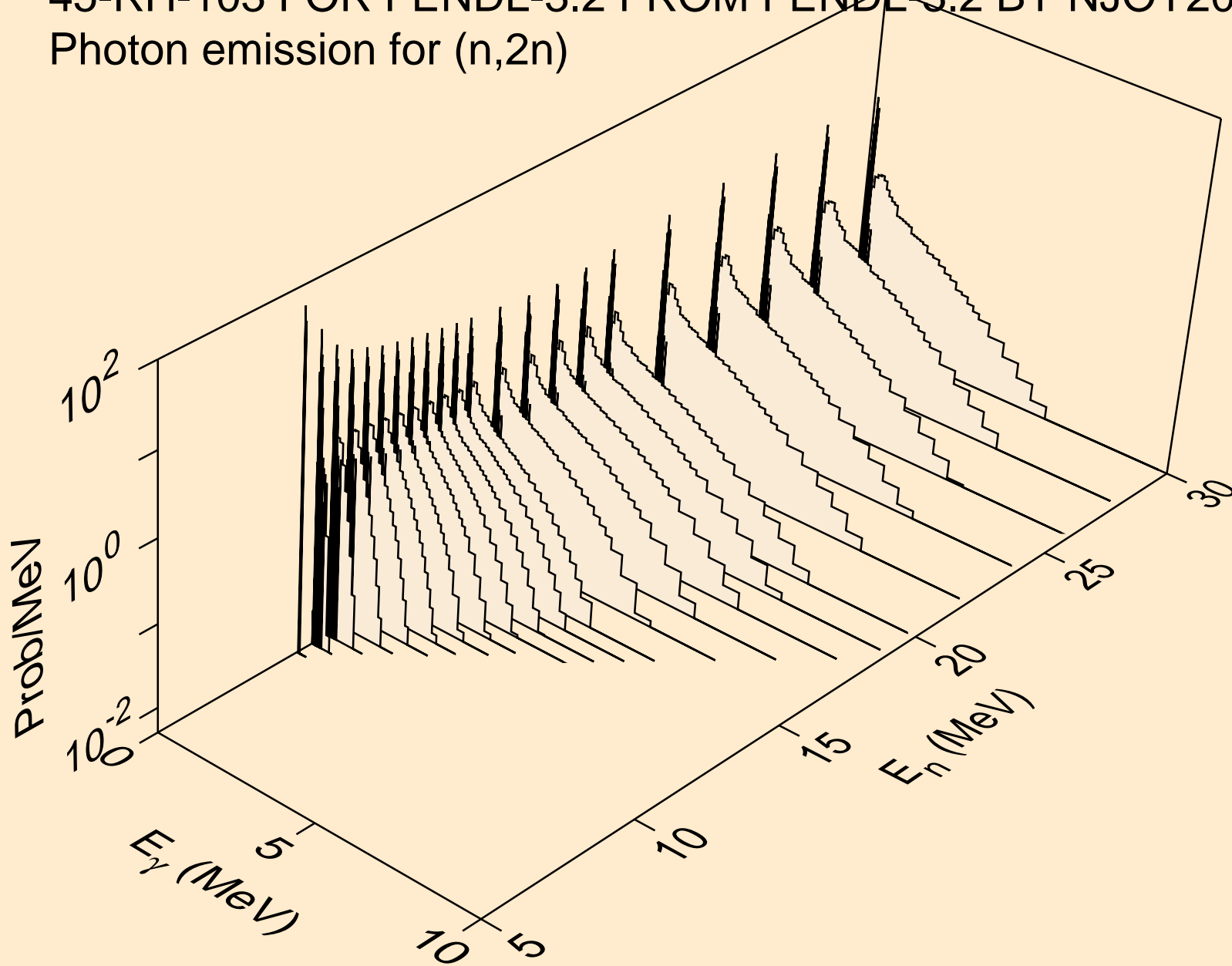

45-RH-103 FOR FENDL-3.2 FROM FENDL-3.2 BY NJOY2016.60+ C
Photon emission for (n,3n)

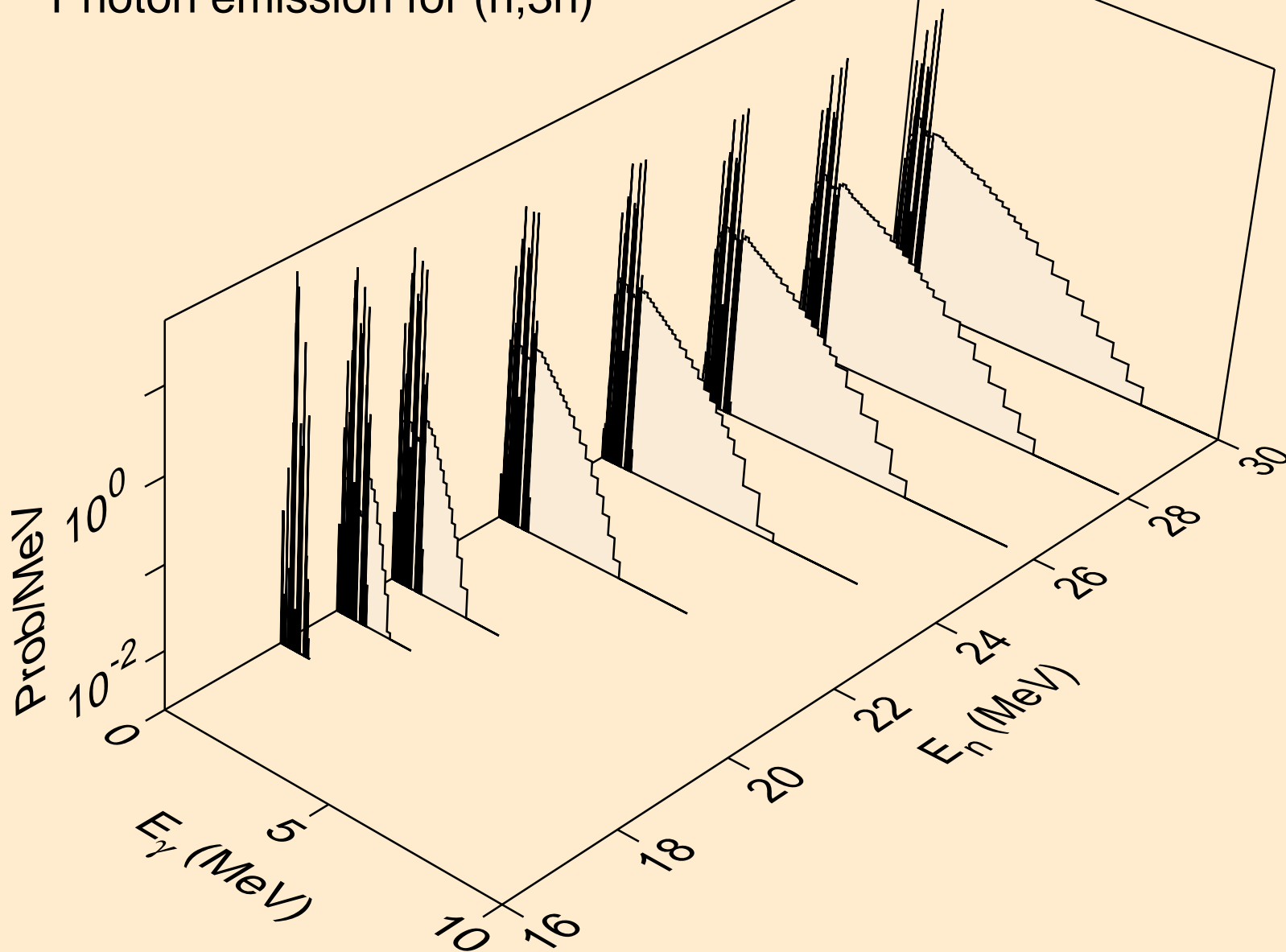

45-RH-103 FOR FENDL-3.2 FROM FENDL-3.2 BY NJOY2016.60+ C
Photon emission for (n,n*)a

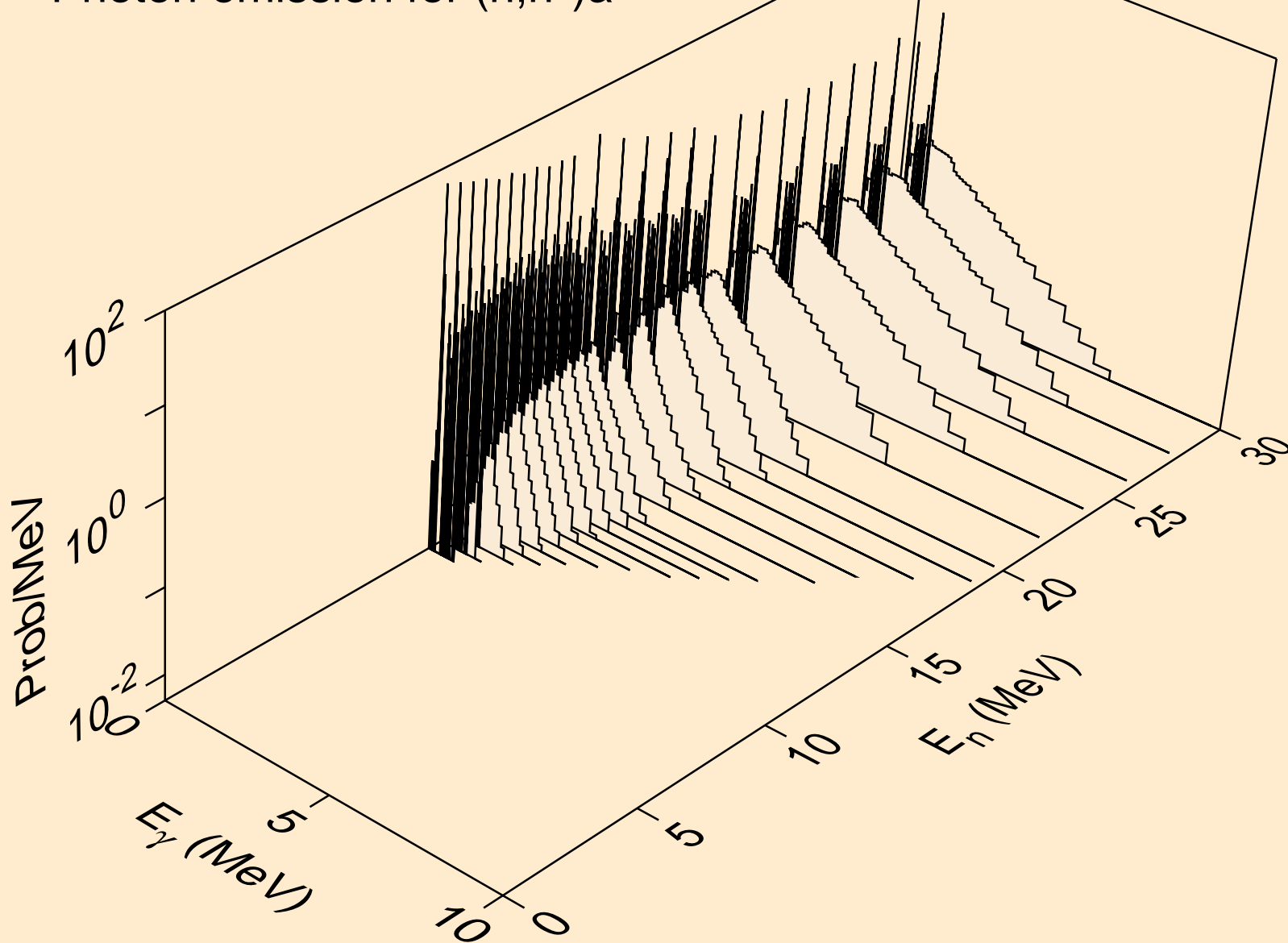

45-RH-103 FOR FENDL-3.2 FROM FENDL-3.2 BY NJOY2016.60+ C
Photon emission for (n,2n)a

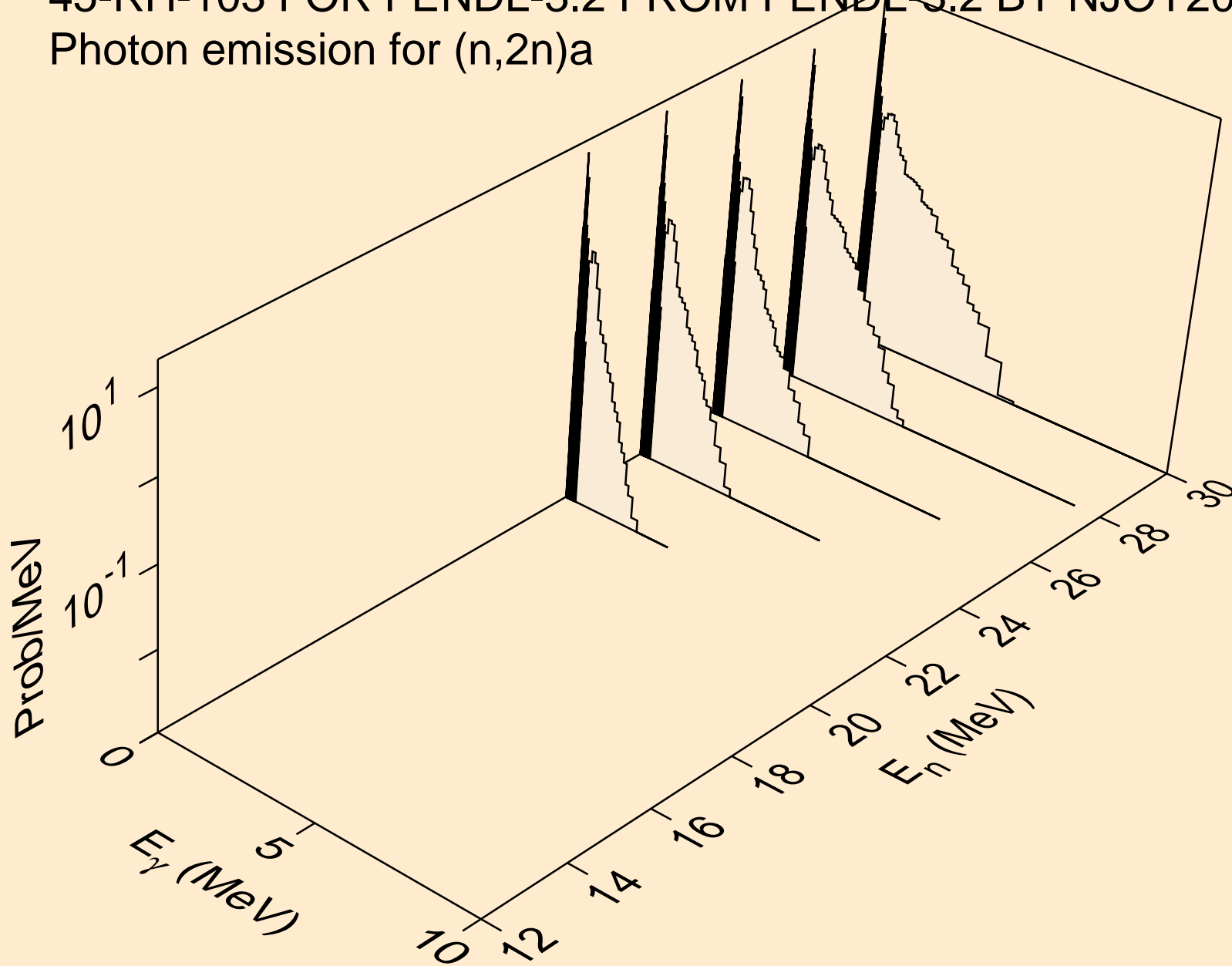

45-RH-103 FOR FENDL-3.2 FROM FENDL-3.2 BY NJOY2016.60+ C
Photon emission for (n,3n)a

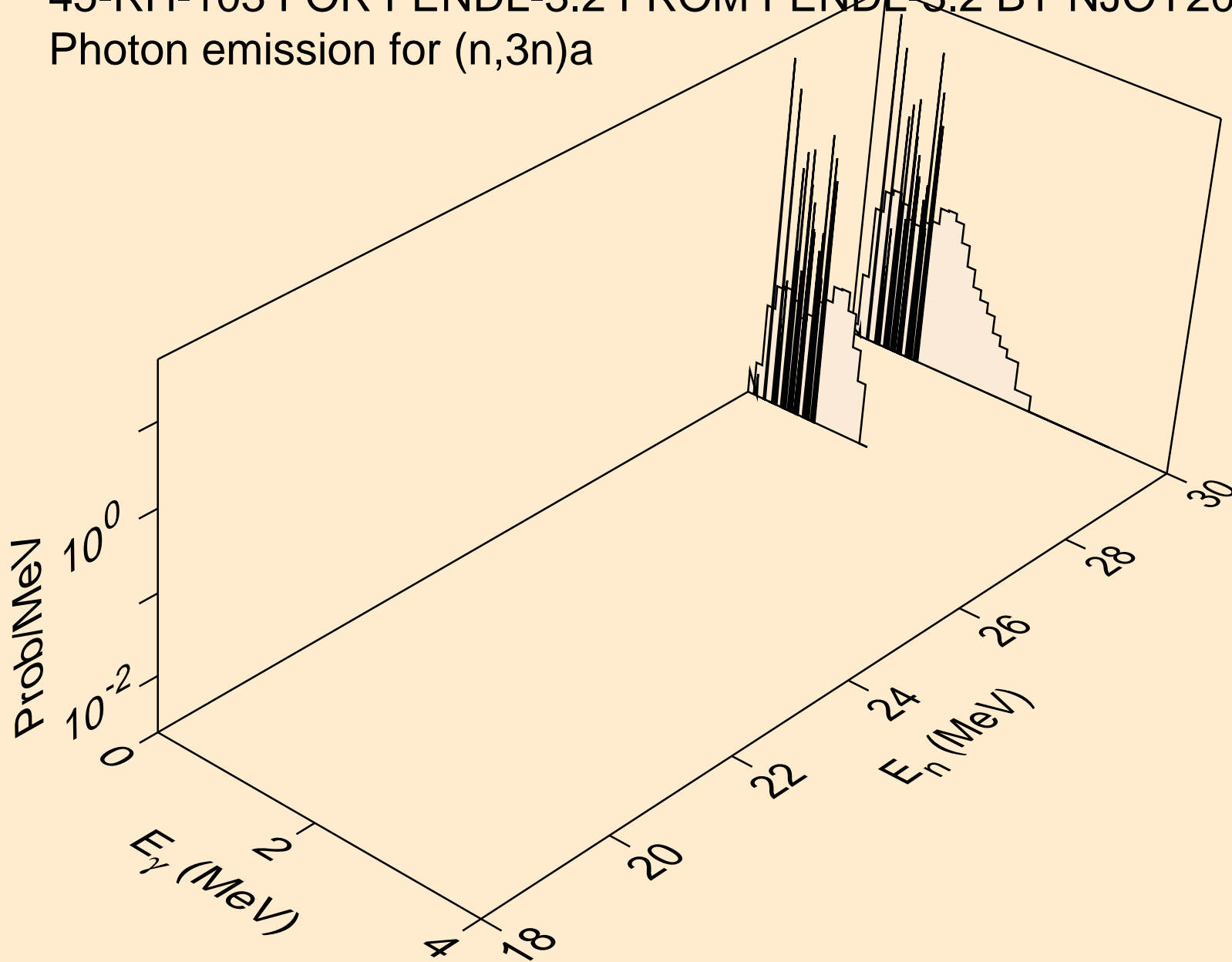

45-RH-103 FOR FENDL-3.2 FROM FENDL-3.2 BY NJOY2016.60+ C
Photon emission for (n,n*)p

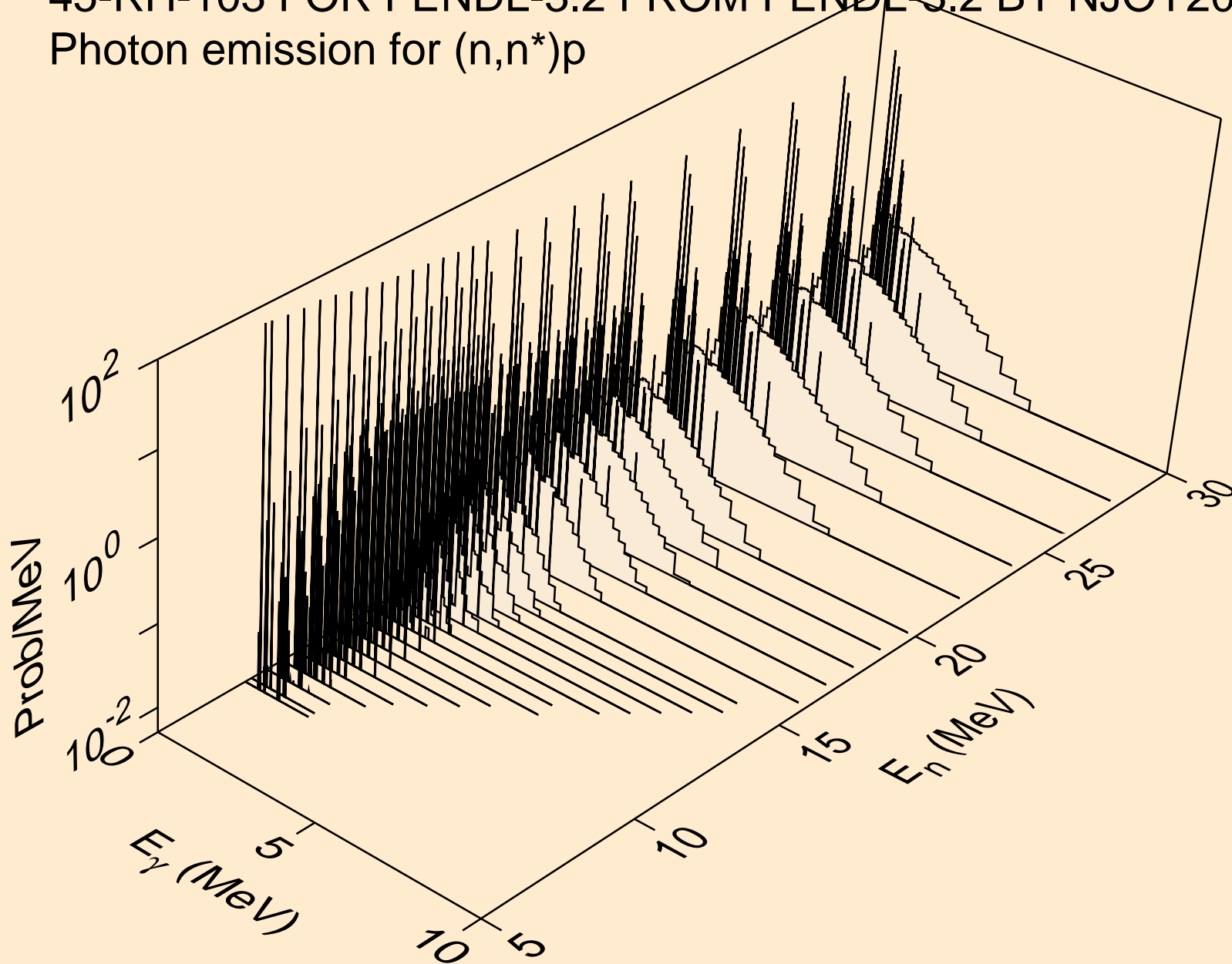

45-RH-103 FOR FENDL-3.2 FROM FENDL-3.2 BY NJOY2016.60+ C
Photon emission for (n,n*)2a

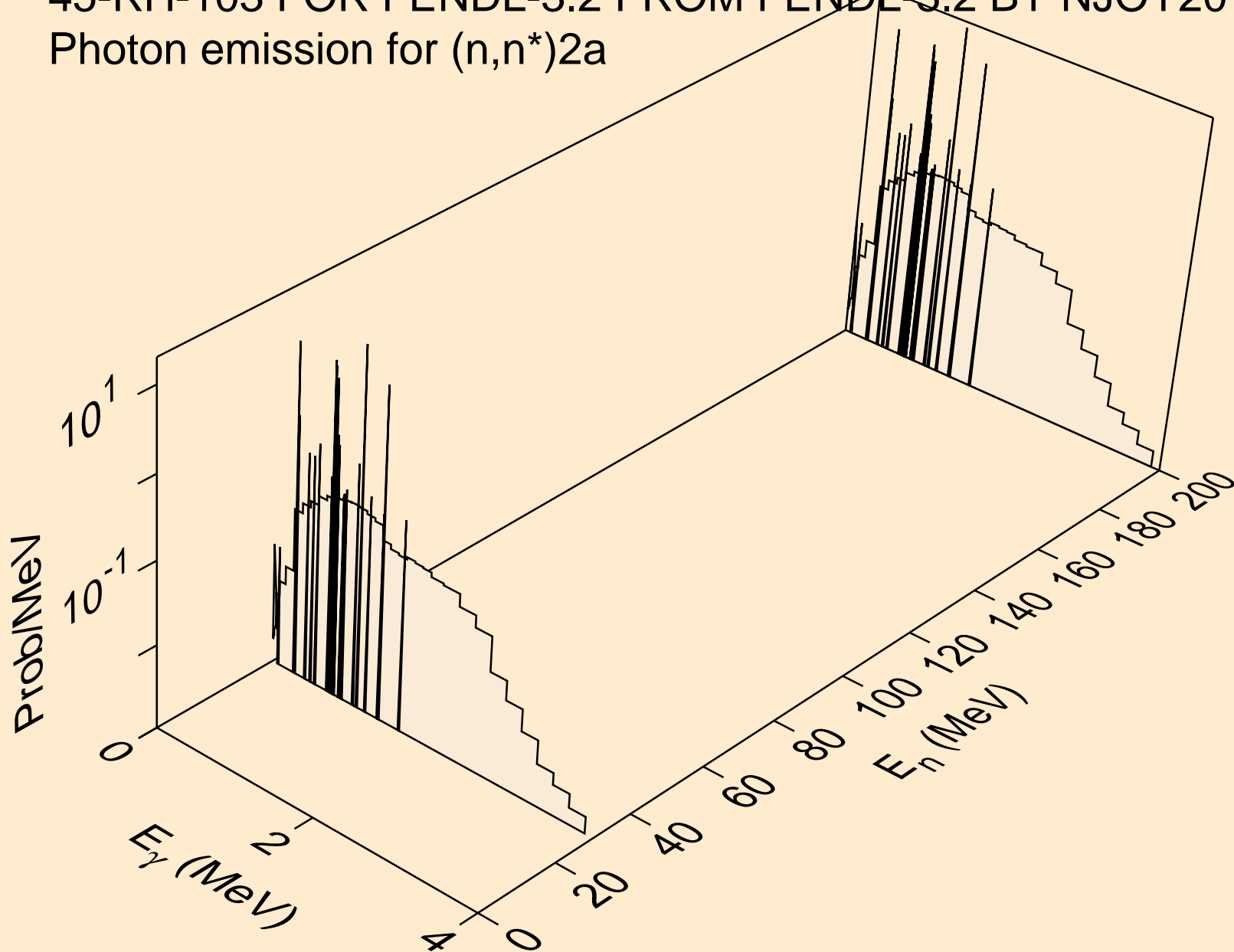

45-RH-103 FOR FENDL-3.2 FROM FENDL-3.2 BY NJOY2016.60+ C
Photon emission for (n,n*)d

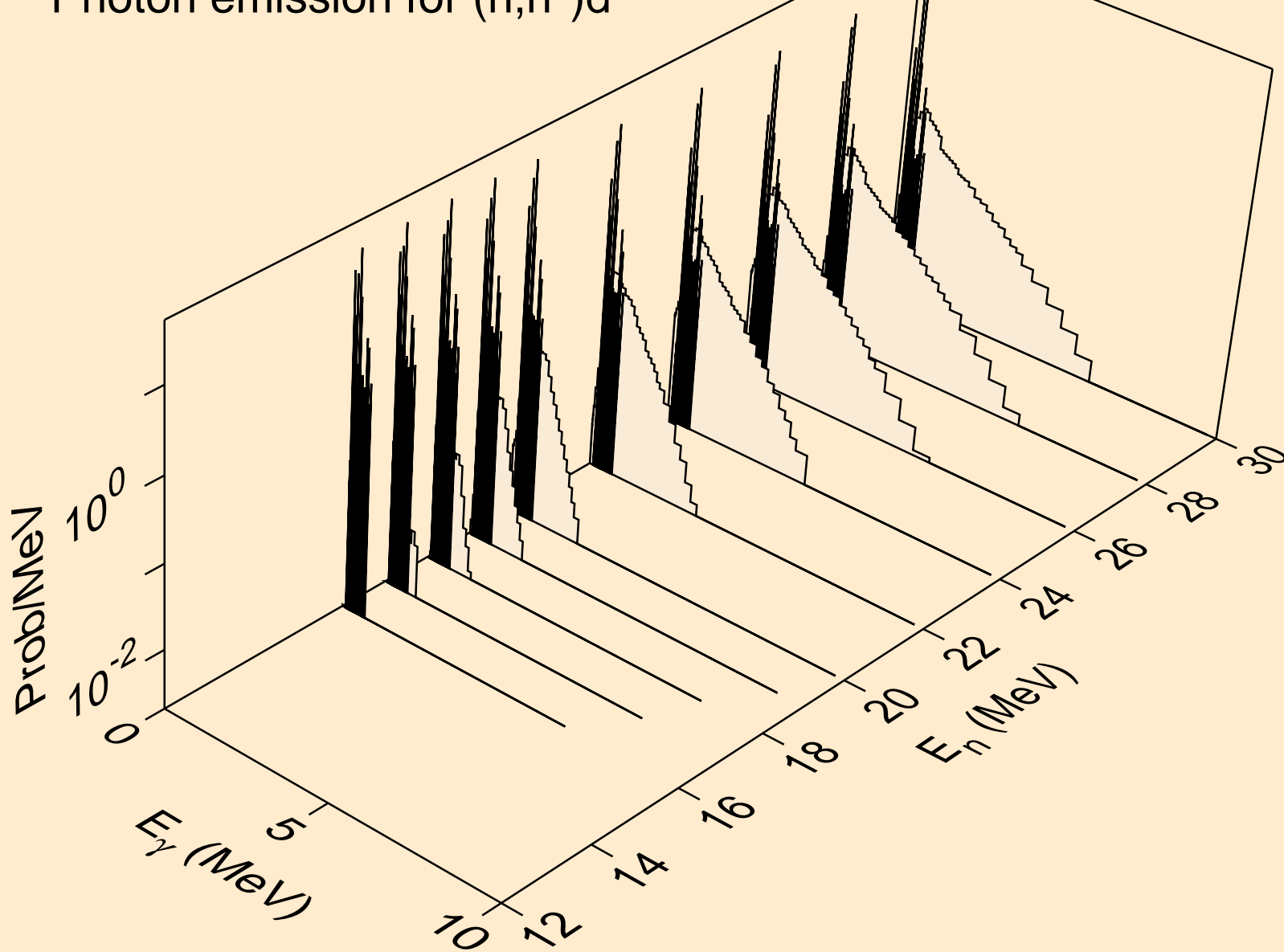

45-RH-103 FOR FENDL-3.2 FROM FENDL-3.2 BY NJOY2016.60+ C
Photon emission for (n,n*)t

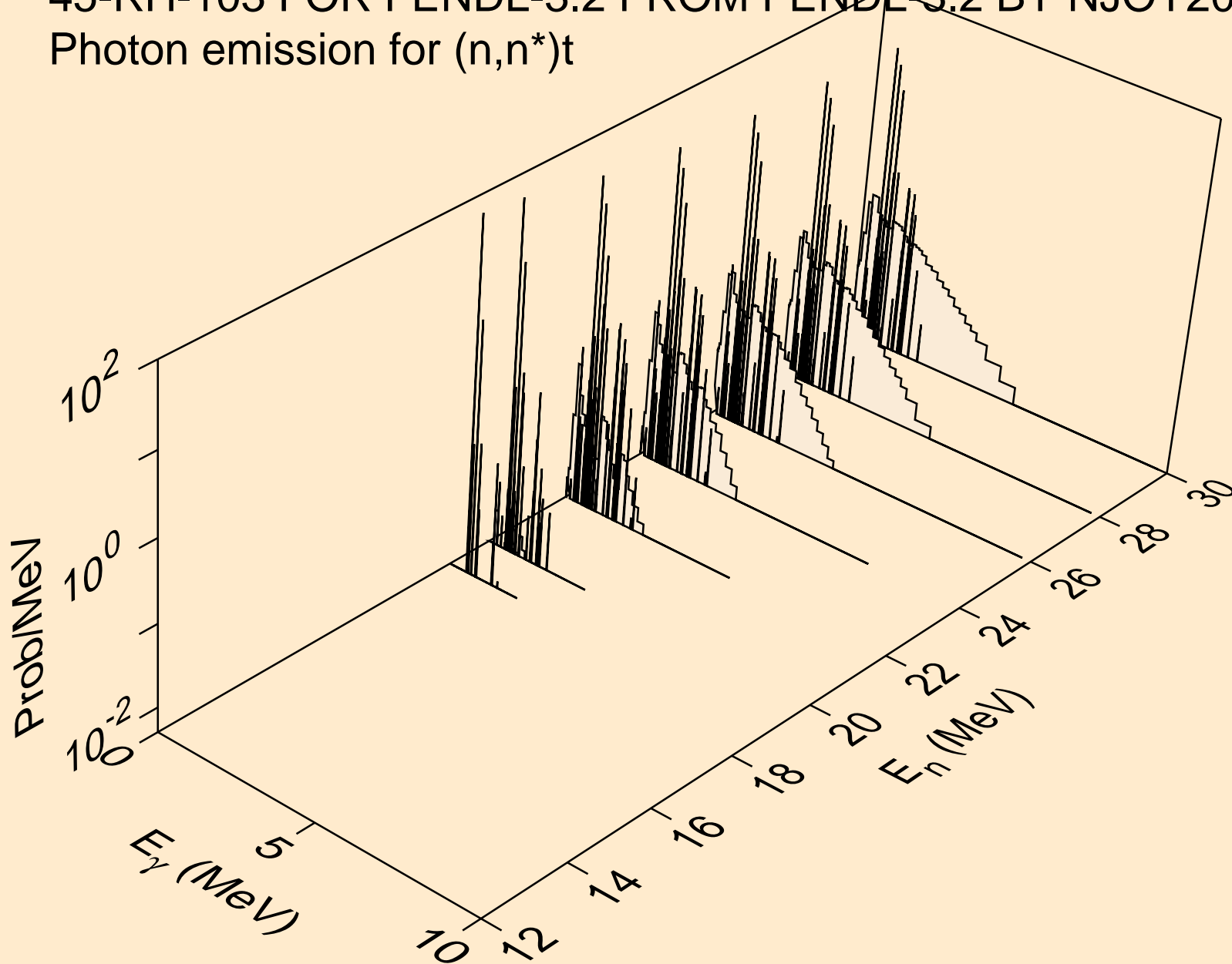

45-RH-103 FOR FENDL-3.2 FROM FENDL-3.2 BY NJOY2016.60+ C
Photon emission for (n,n*)he3

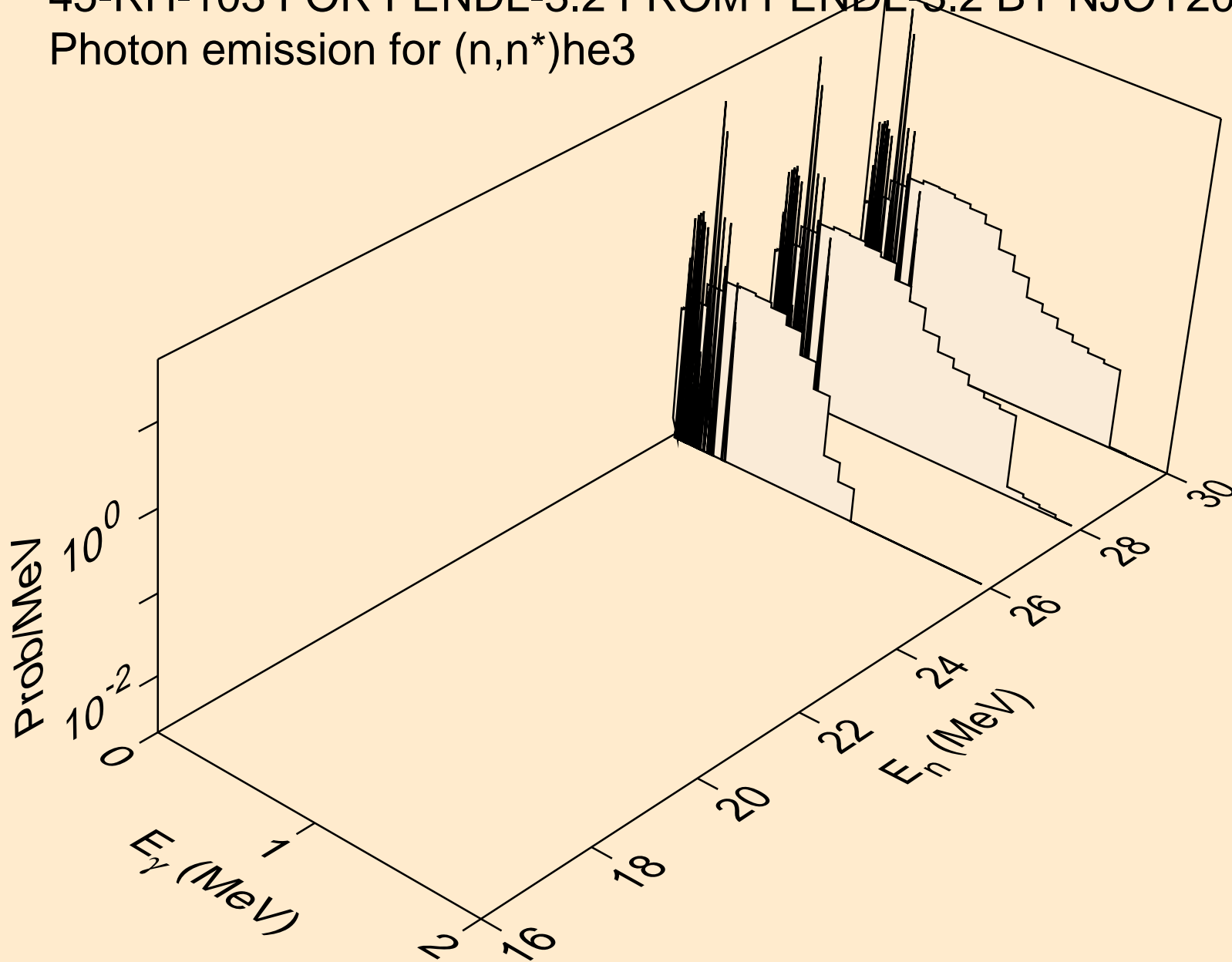

45-RH-103 FOR FENDL-3.2 FROM FENDL-3.2 BY NJOY2016.60+ C
Photon emission for (n,4n)

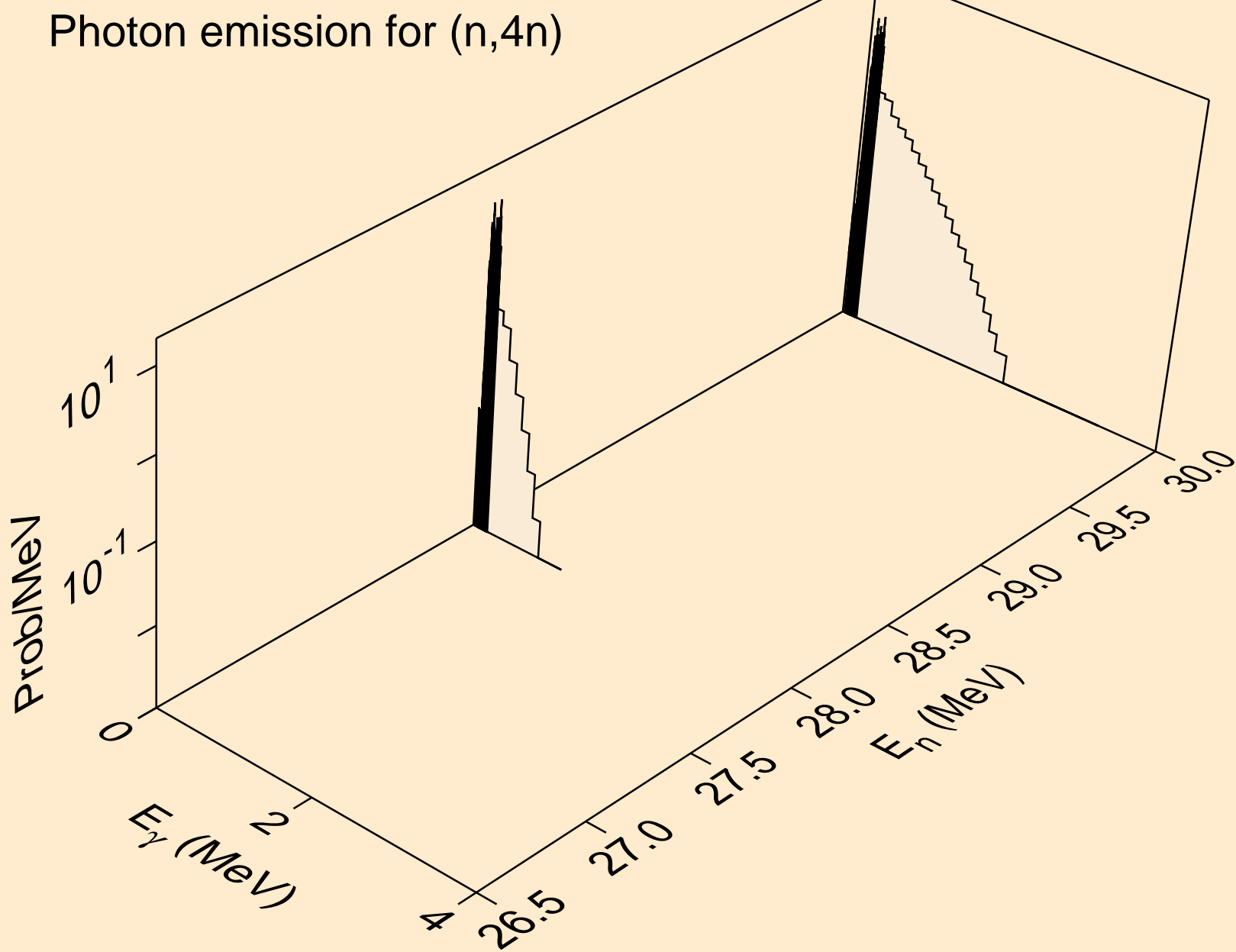

45-RH-103 FOR FENDL-3.2 FROM FENDL-3.2 BY NJOY2016.60+ C
Photon emission for (n,2np)

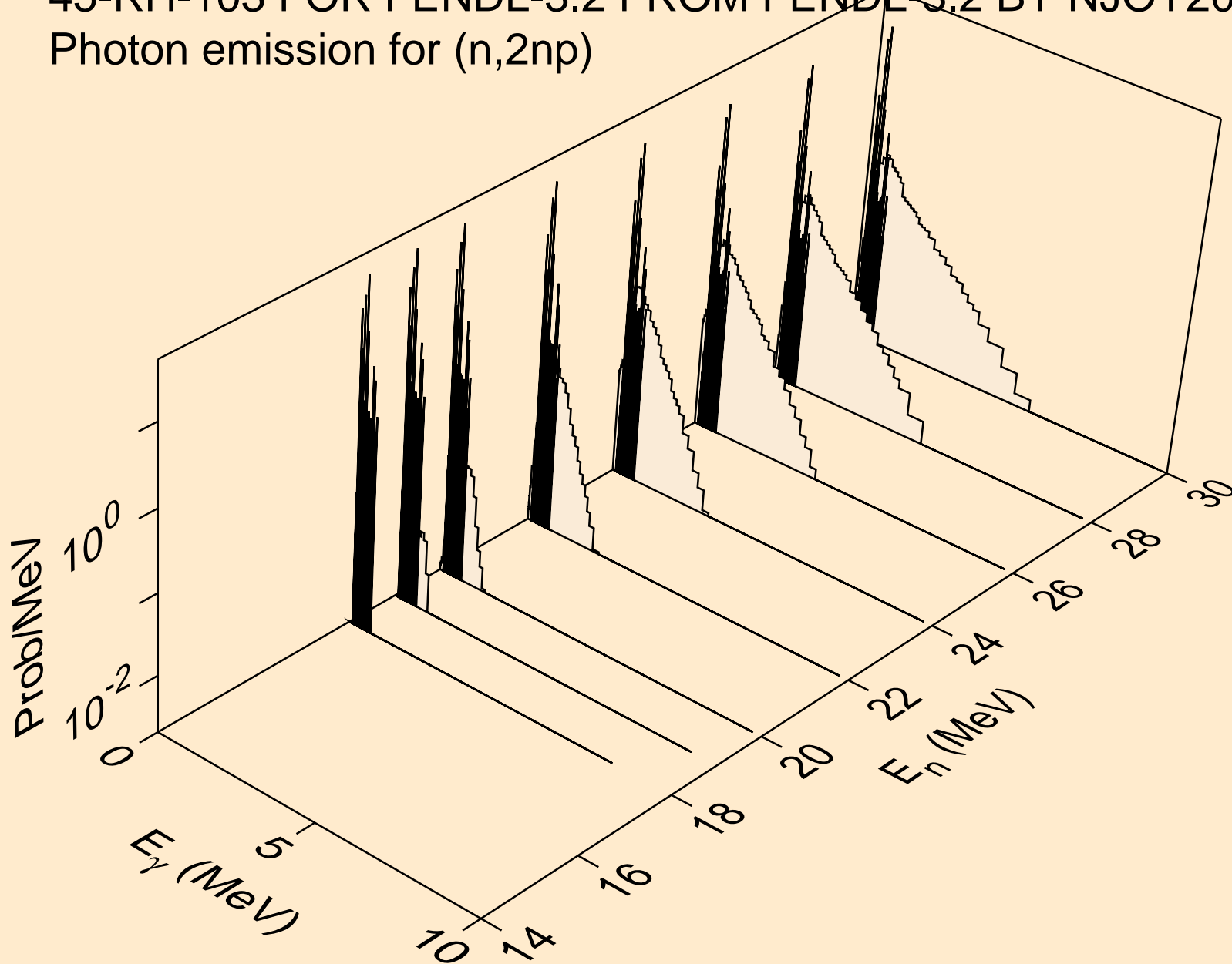

45-RH-103 FOR FENDL-3.2 FROM FENDL-3.2 BY NJOY2016.60+ C
Photon emission for (n,3np)

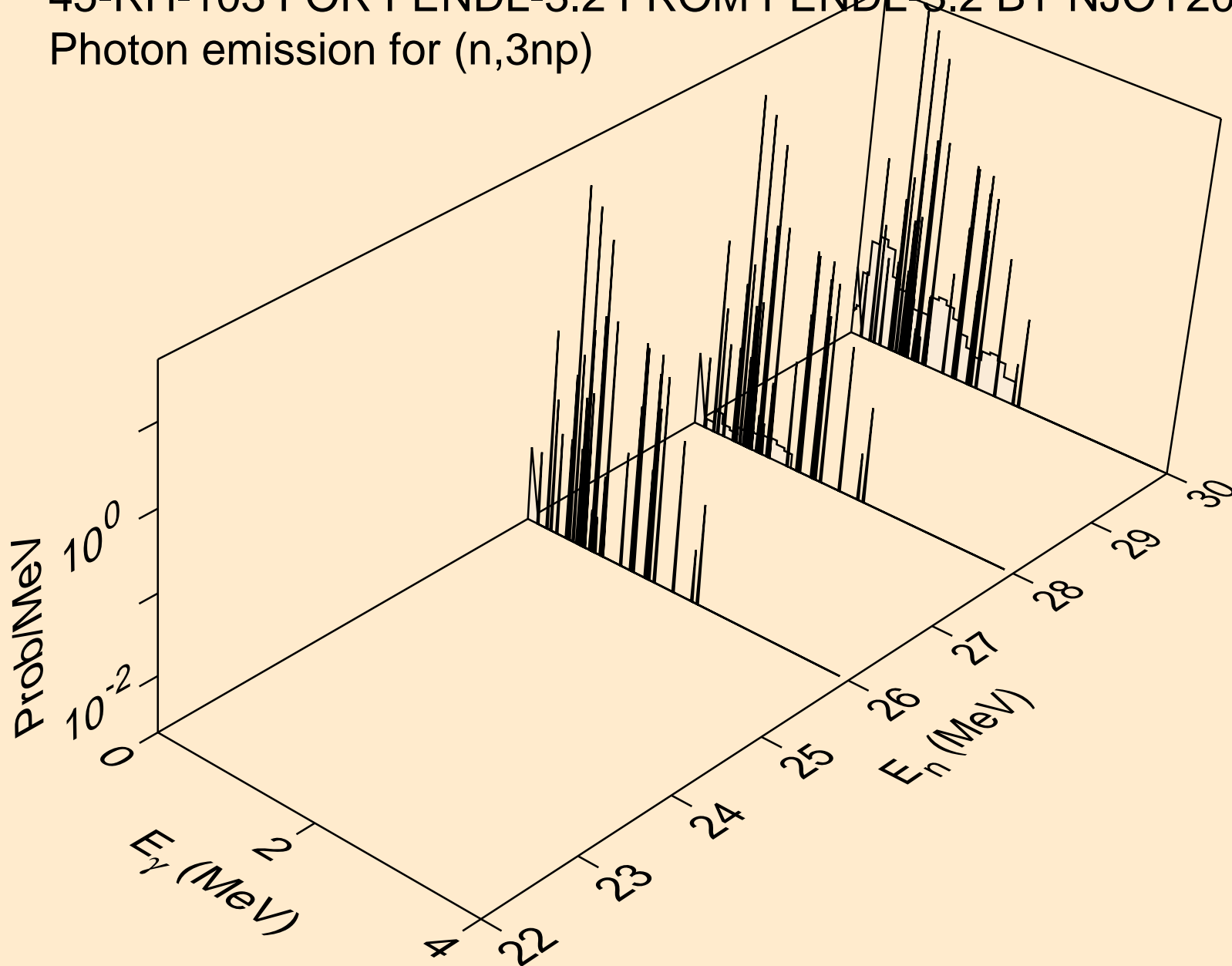

45-RH-103 FOR FENDL-3.2 FROM FENDL-3.2 BY NJOY2016.60+ C
Photon emission for (n,2np)

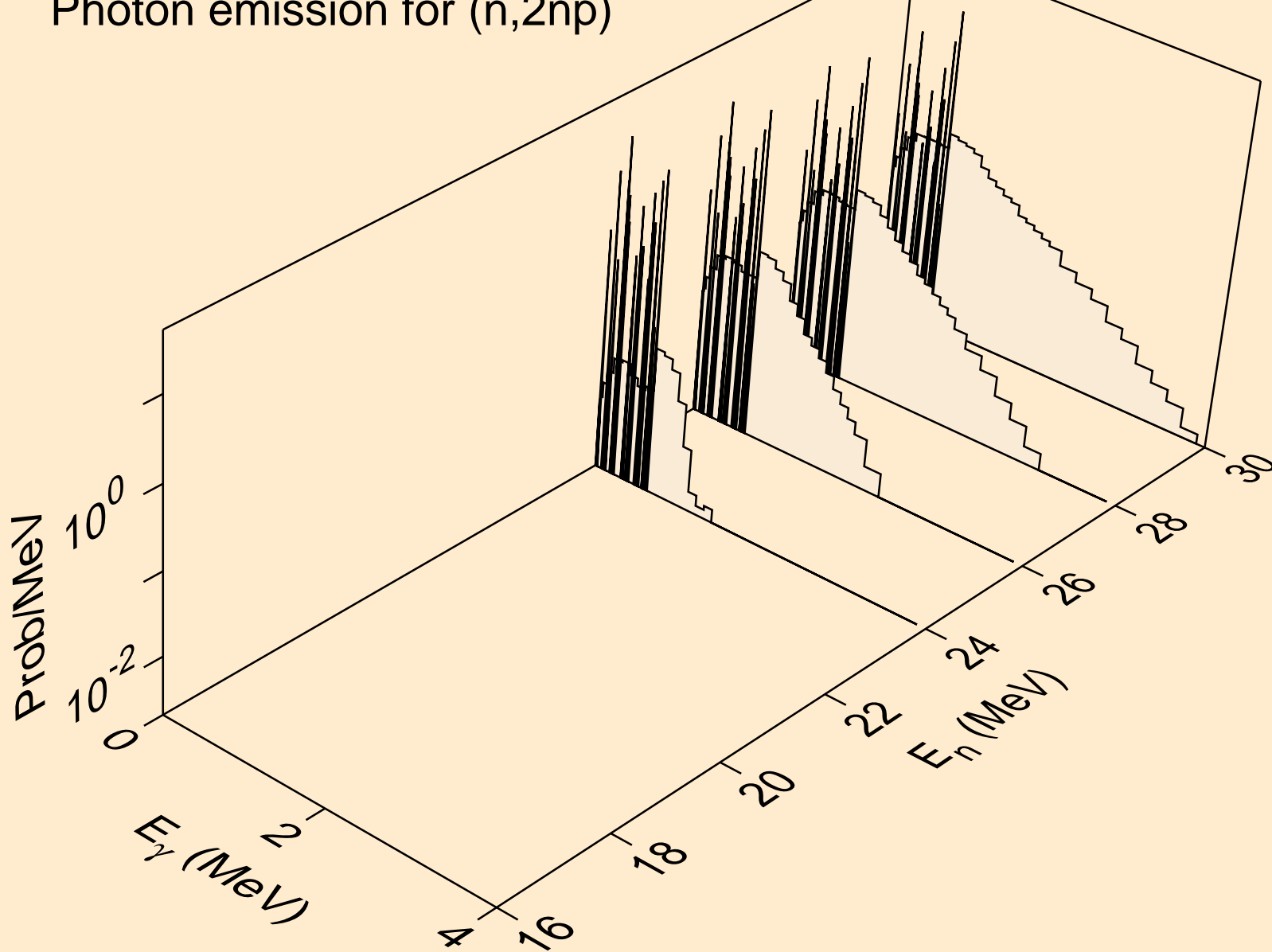

45-RH-103 FOR FENDL-3.2 FROM FENDL-3.2 BY NJOY2016.60+ C
Photon emission for (n,npa)

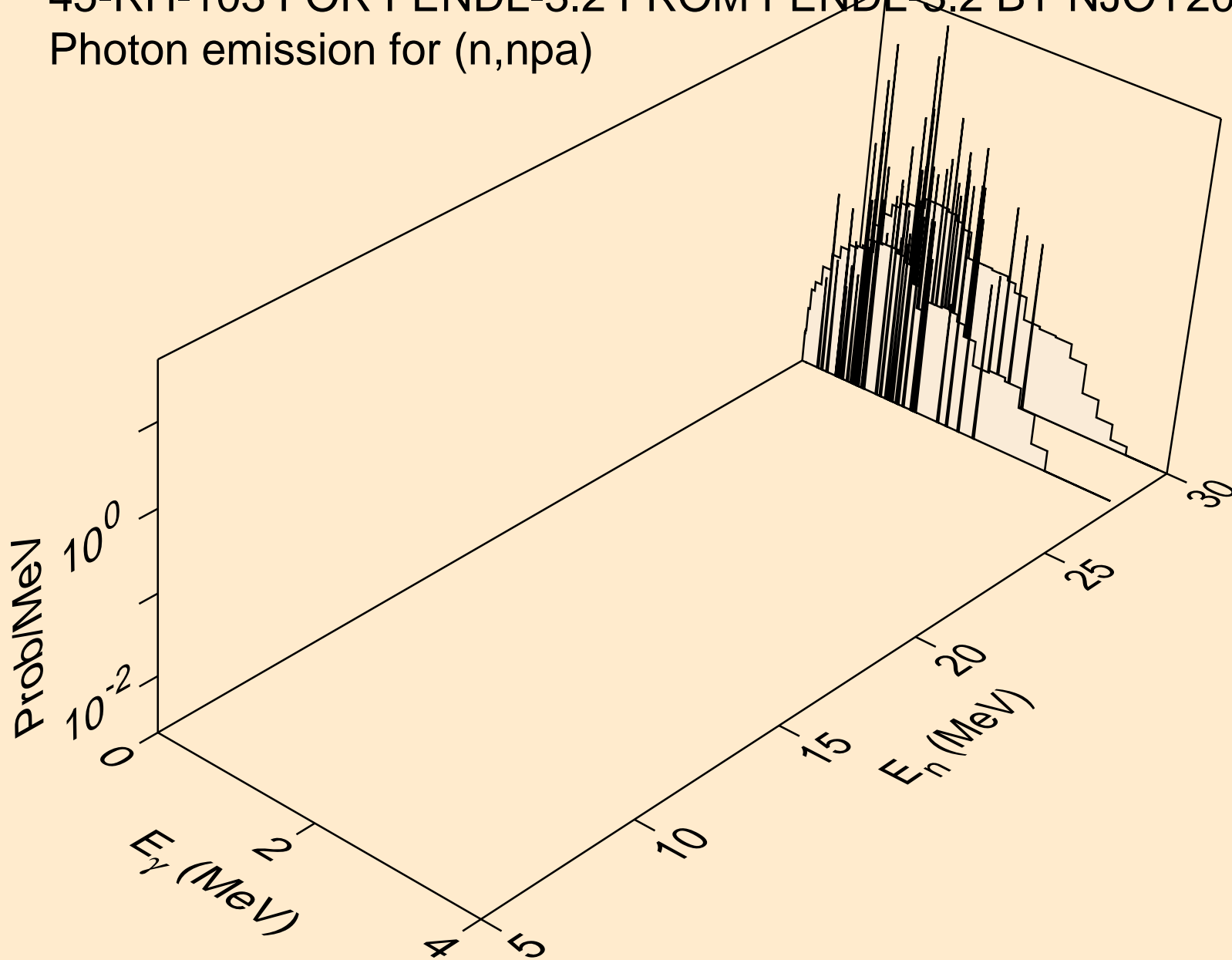

45-RH-103 FOR FENDL-3.2 FROM FENDL-3.2 BY NJOY2016.60+ C
Photon emission for (n,n*2)

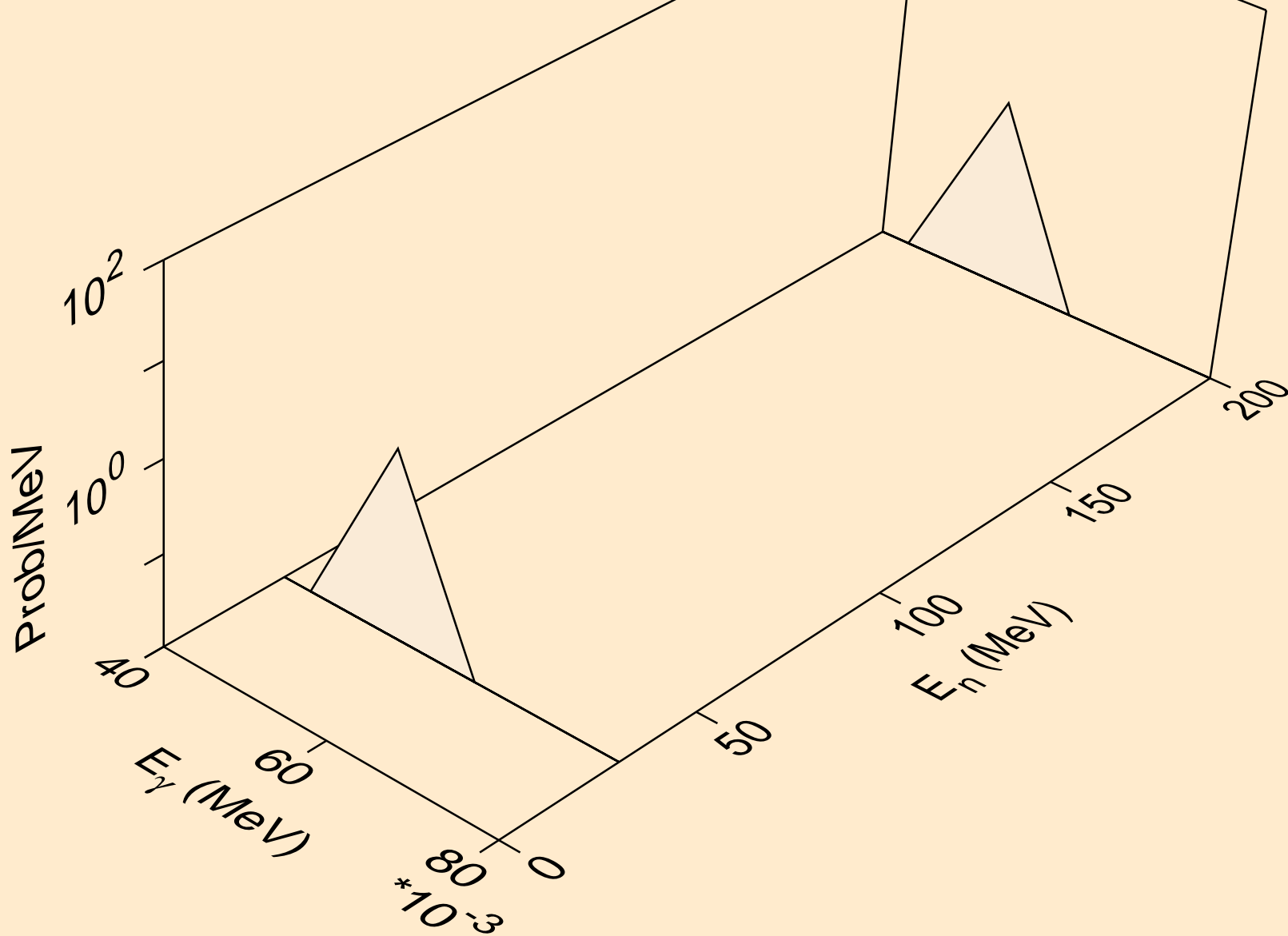

45-RH-103 FOR FENDL-3.2 FROM FENDL-3.2 BY NJOY2016.60+ C
Photon emission for (n,n*3)

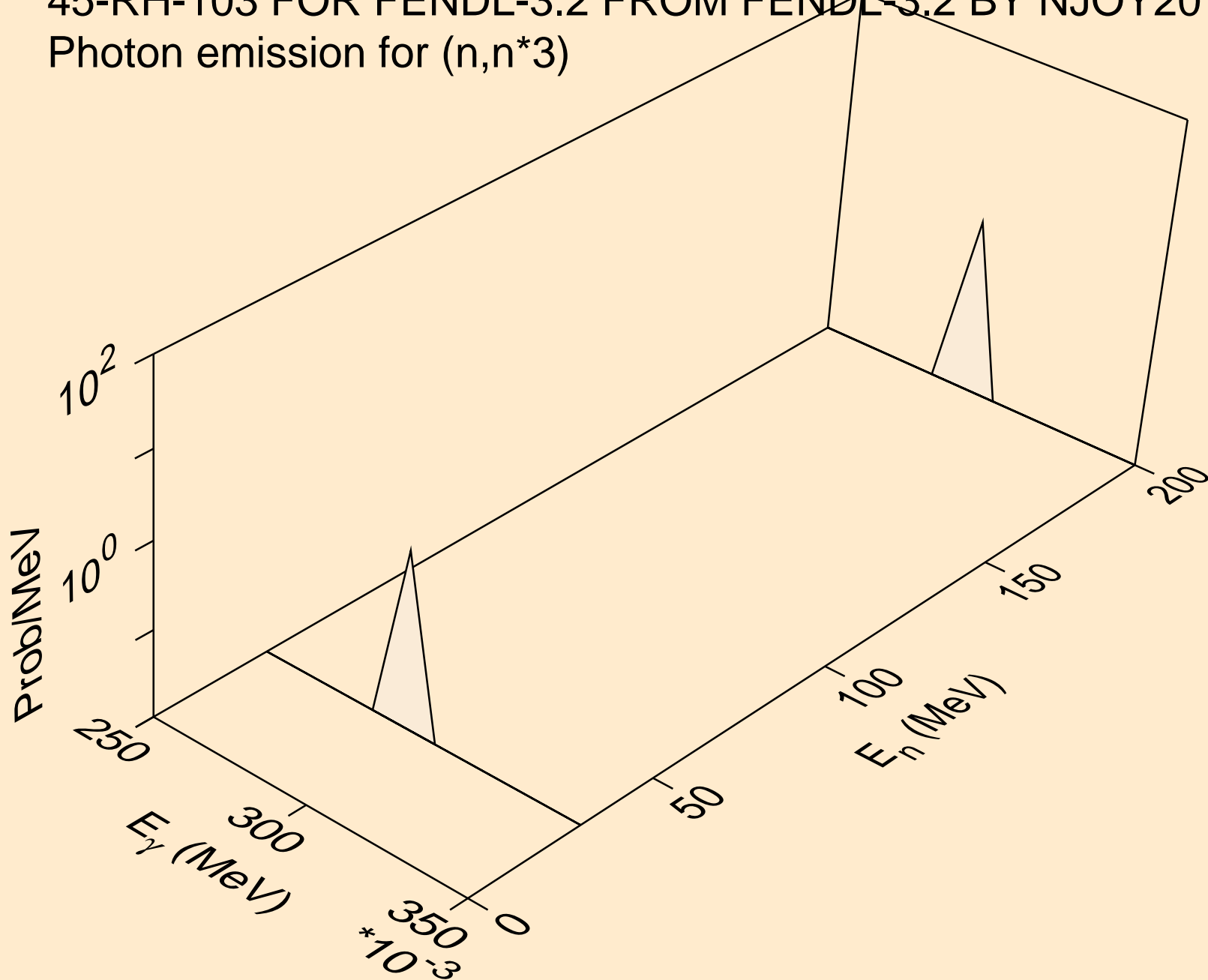

45-RH-103 FOR FENDL-3.2 FROM FENDL-3.2 BY NJOY2016.60+ C
Photon emission for (n,n*4)

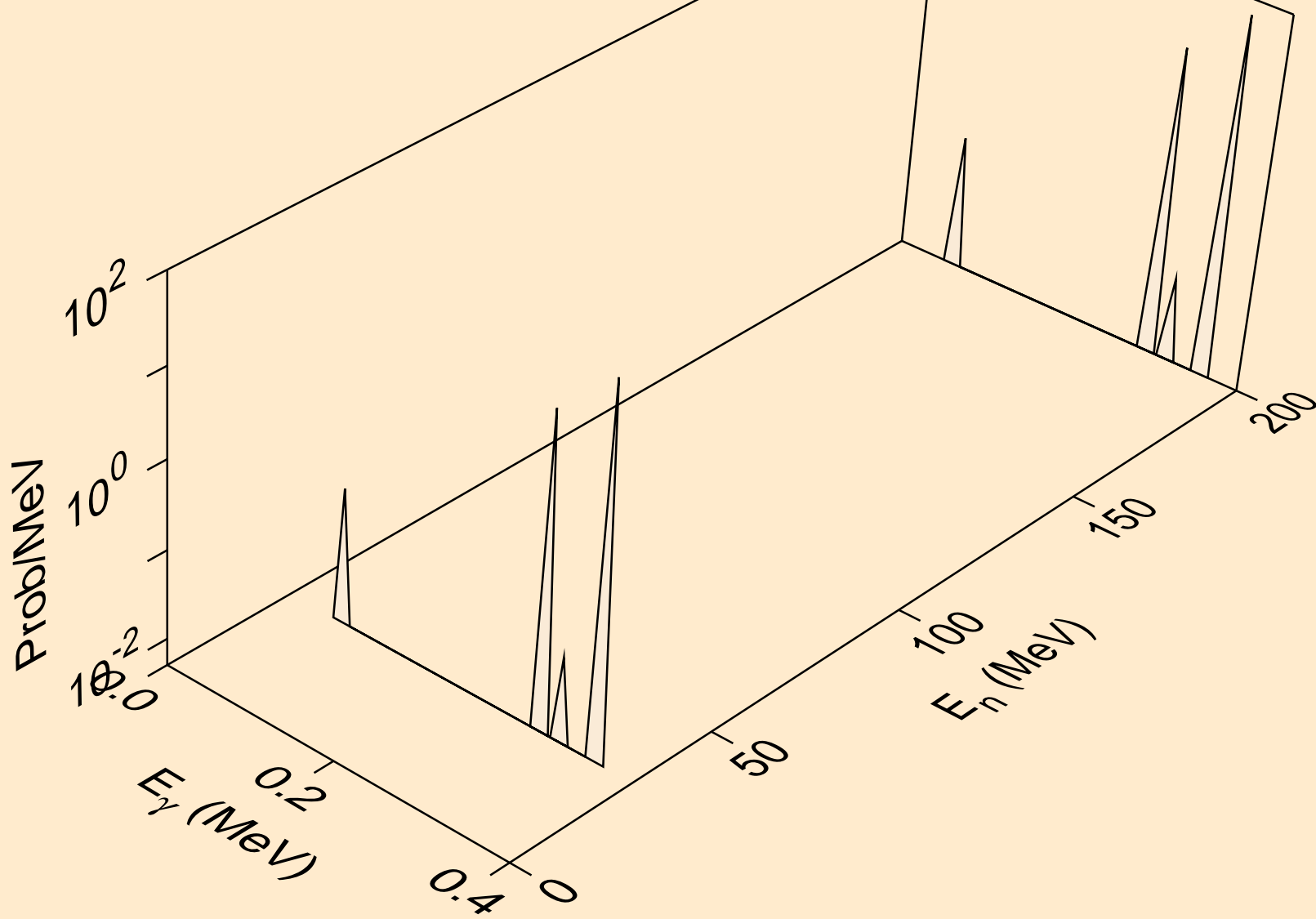

45-RH-103 FOR FENDL-3.2 FROM FENDL-3.2 BY NJOY2016.60+ C
Photon emission for (n,n*5)

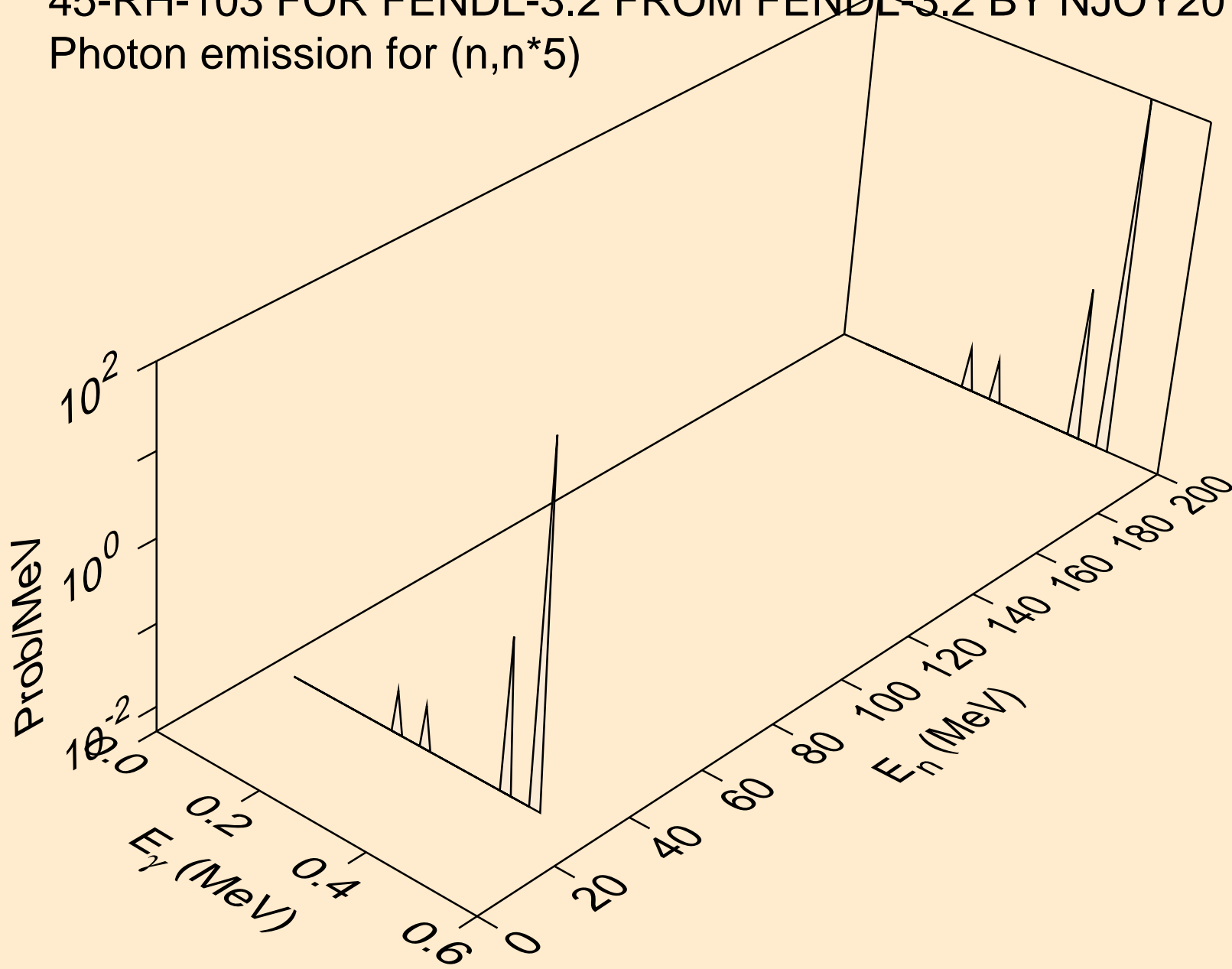

45-RH-103 FOR FENDL-3.2 FROM FENDL-3.2 BY NJOY2016.60+ C
Photon emission for (n,n*6)

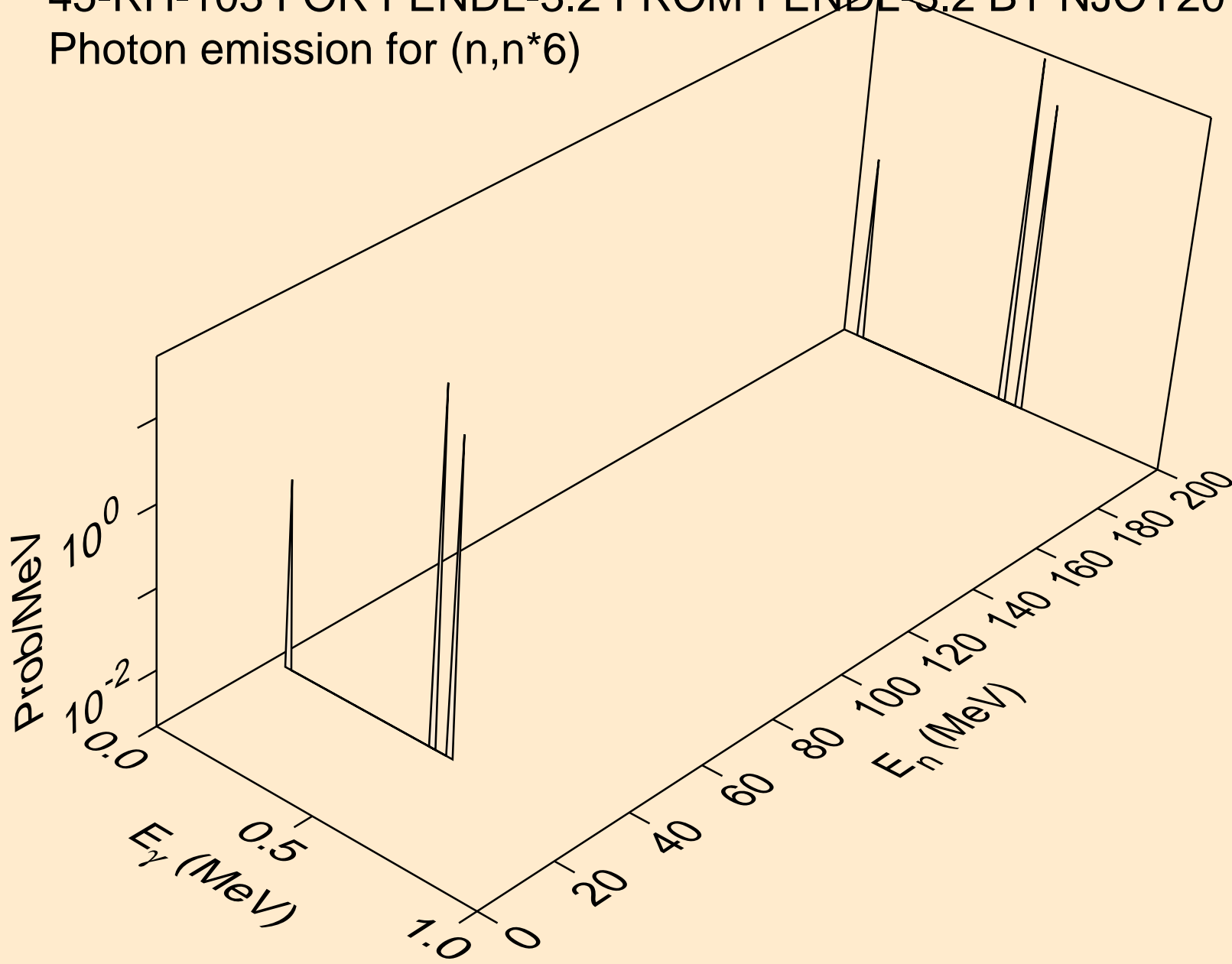

45-RH-103 FOR FENDL-3.2 FROM FENDL-3.2 BY NJOY2016.60+ C
Photon emission for (n,n*7)

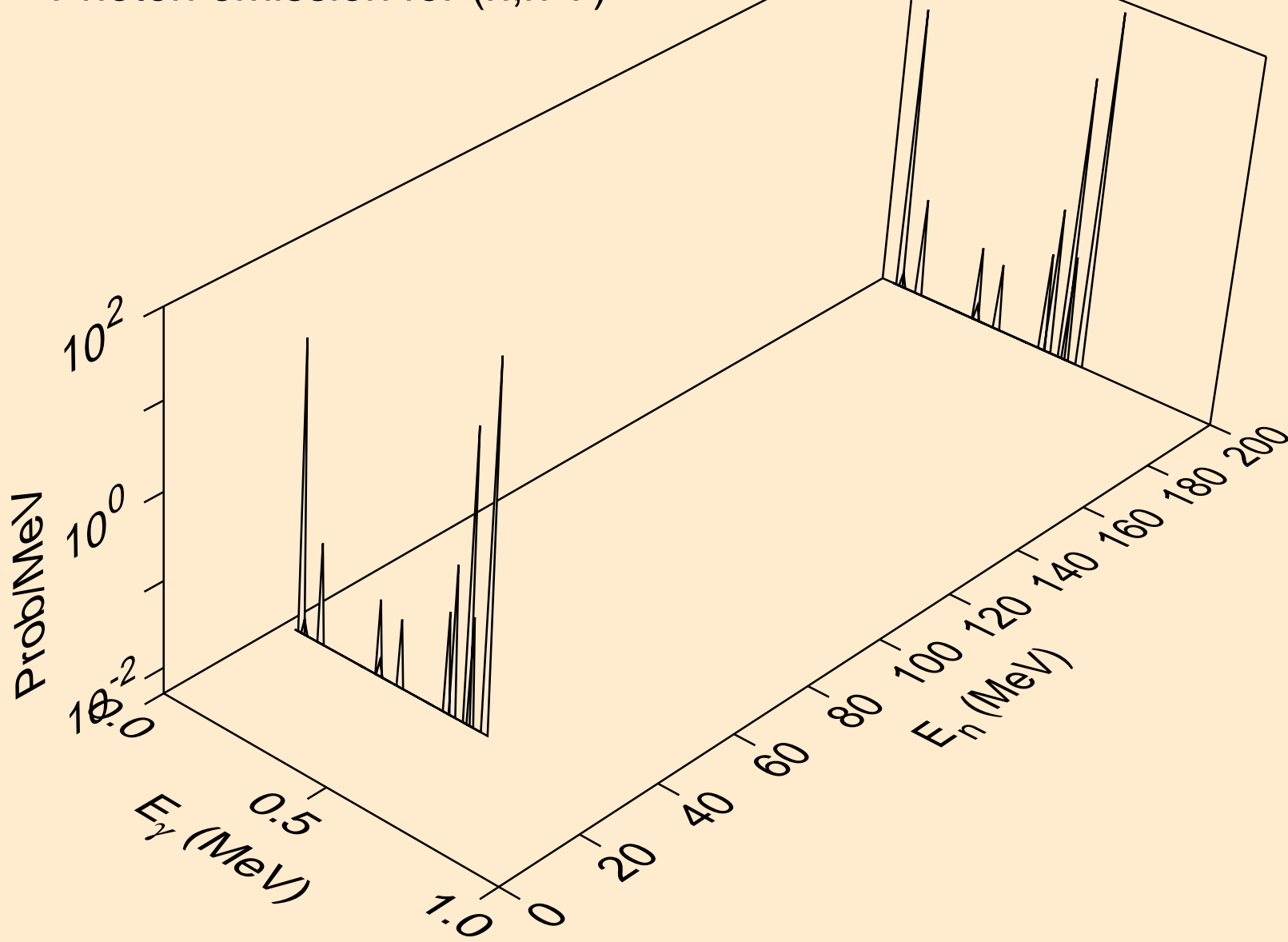

45-RH-103 FOR FENDL-3.2 FROM FENDL-3.2 BY NJOY2016.60+ C
Photon emission for (n,n*8)

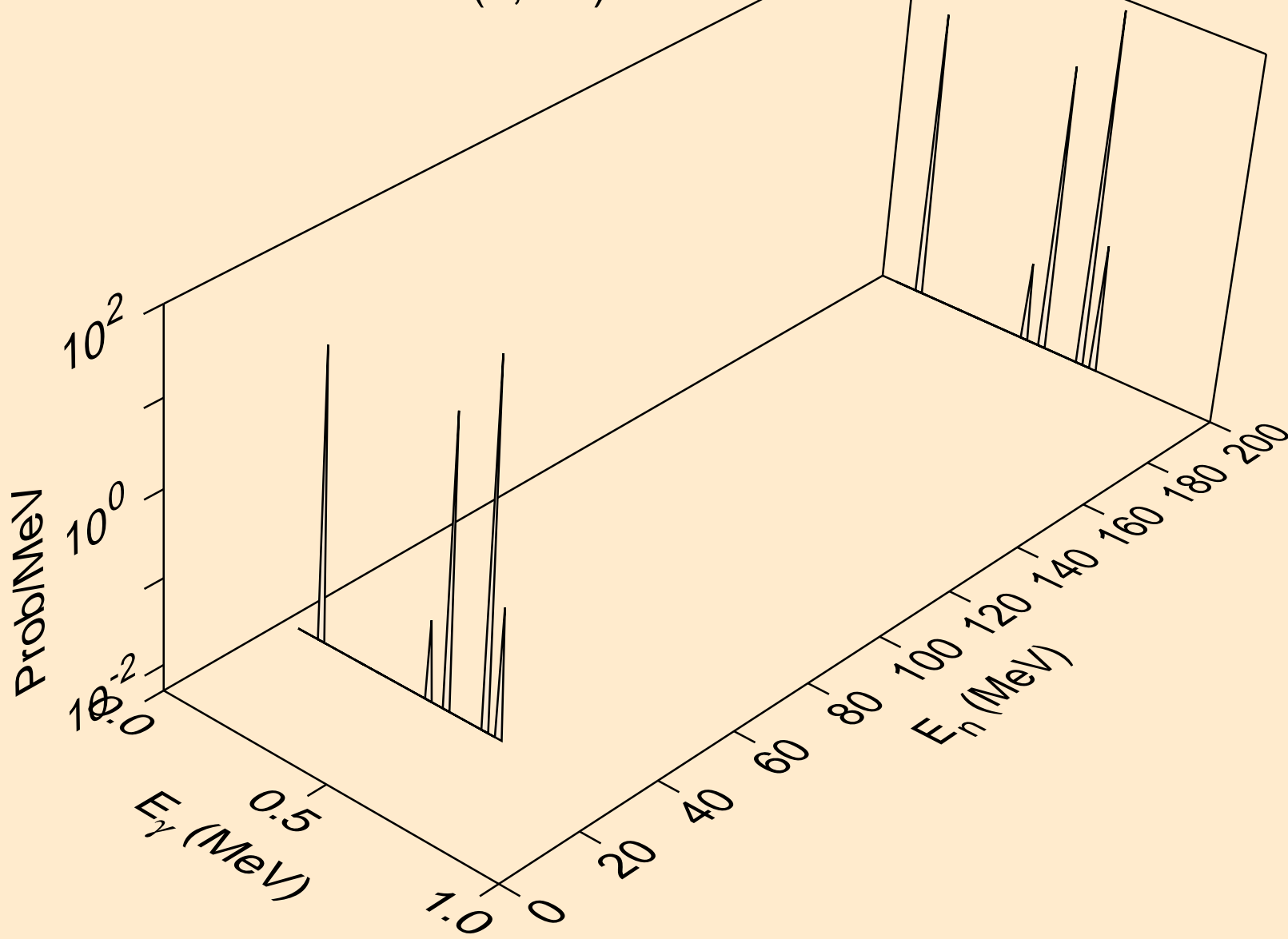

45-RH-103 FOR FENDL-3.2 FROM FENDL-3.2 BY NJOY2016.60+ C
Photon emission for (n,n*9)

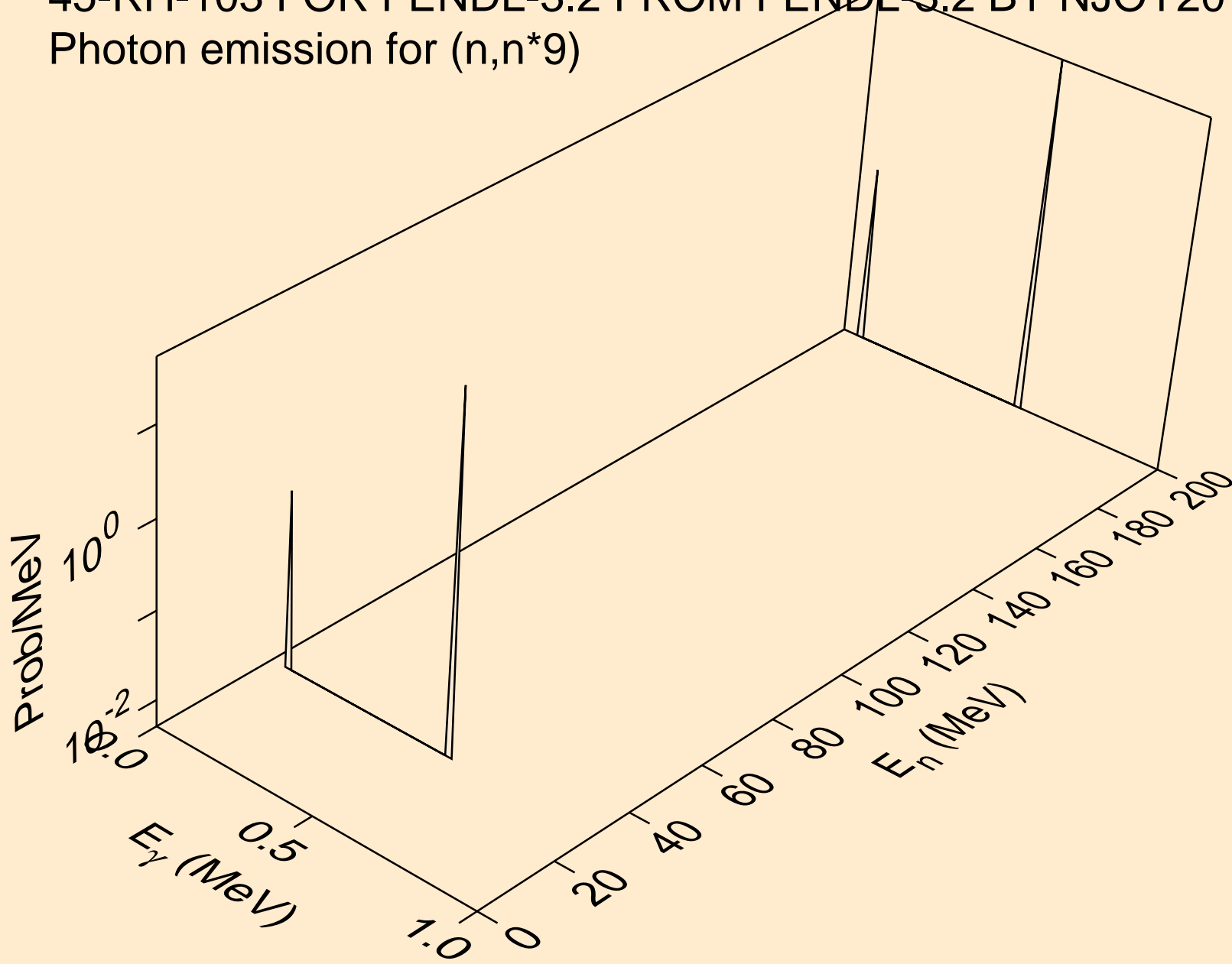

45-RH-103 FOR FENDL-3.2 FROM FENDL-3.2 BY NJOY2016.60+ C
Photon emission for (n,n*10)

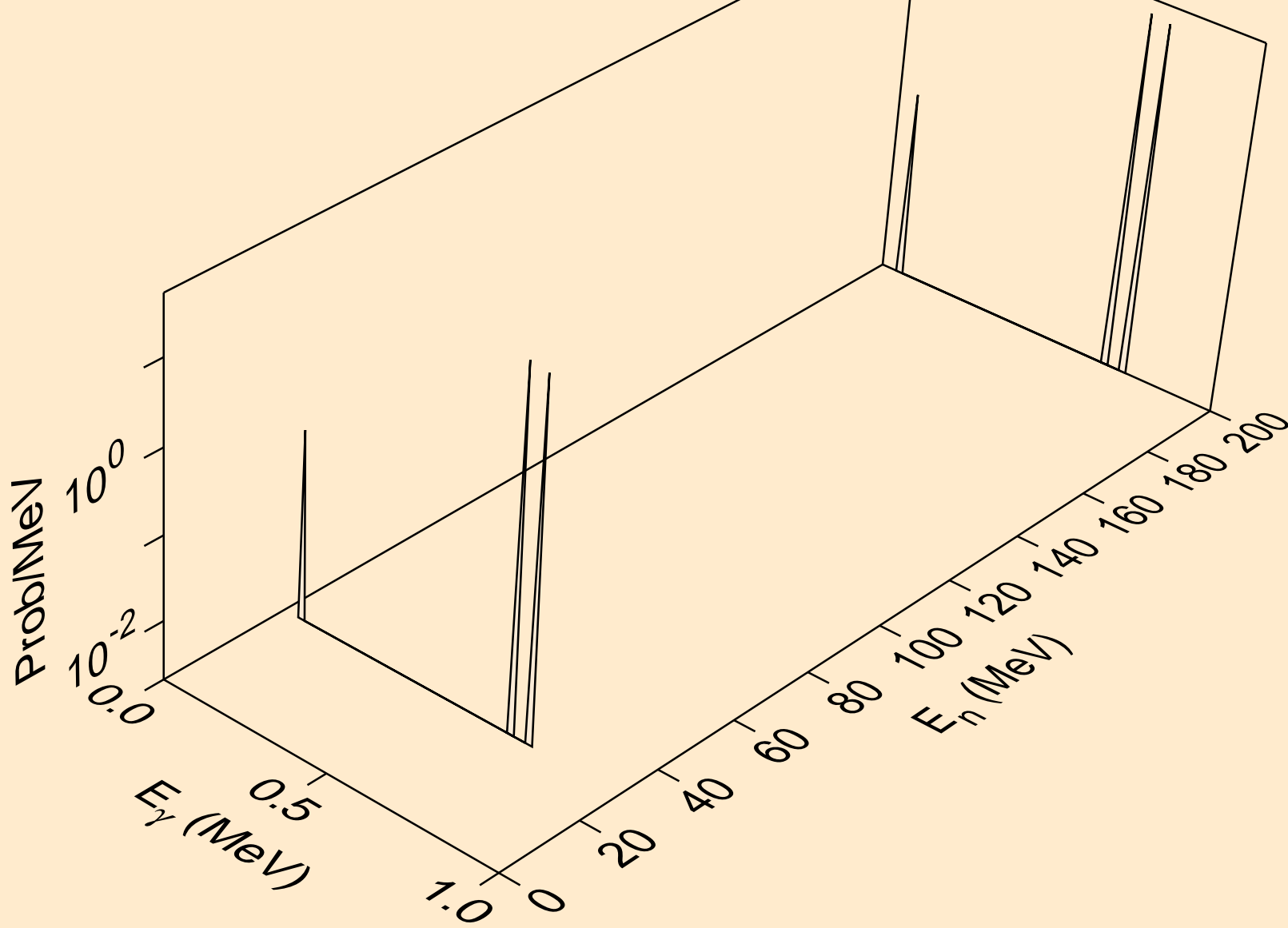

45-RH-103 FOR FENDL-3.2 FROM FENDL-3.2 BY NJOY2016.60+ C
Photon emission for (n,n*11)

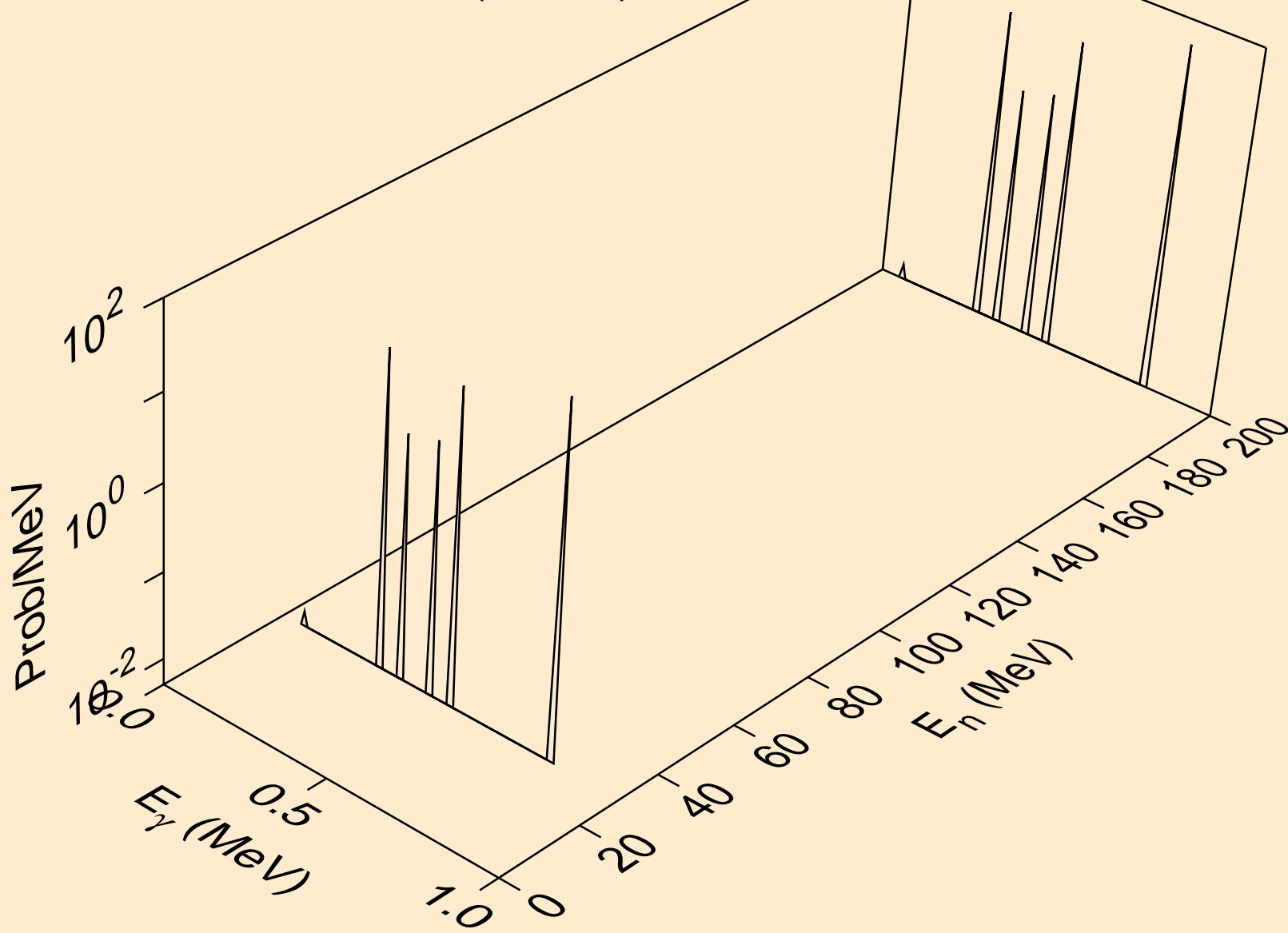

45-RH-103 FOR FENDL-3.2 FROM FENDL-3.2 BY NJOY2016.60+ C
Photon emission for (n,n*12)

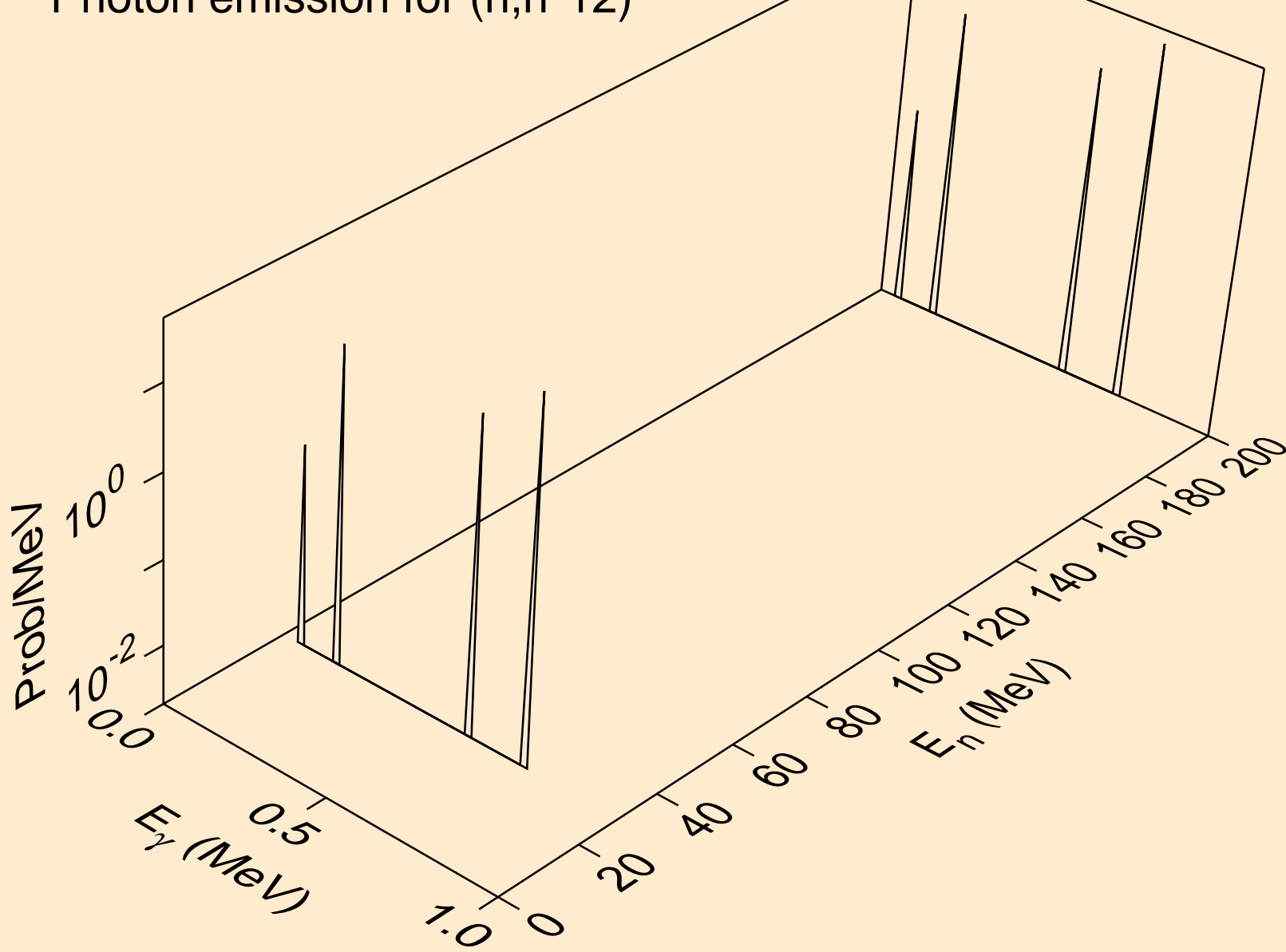

45-RH-103 FOR FENDL-3.2 FROM FENDL-3.2 BY NJOY2016.60+ C
Photon emission for (n,n*13)

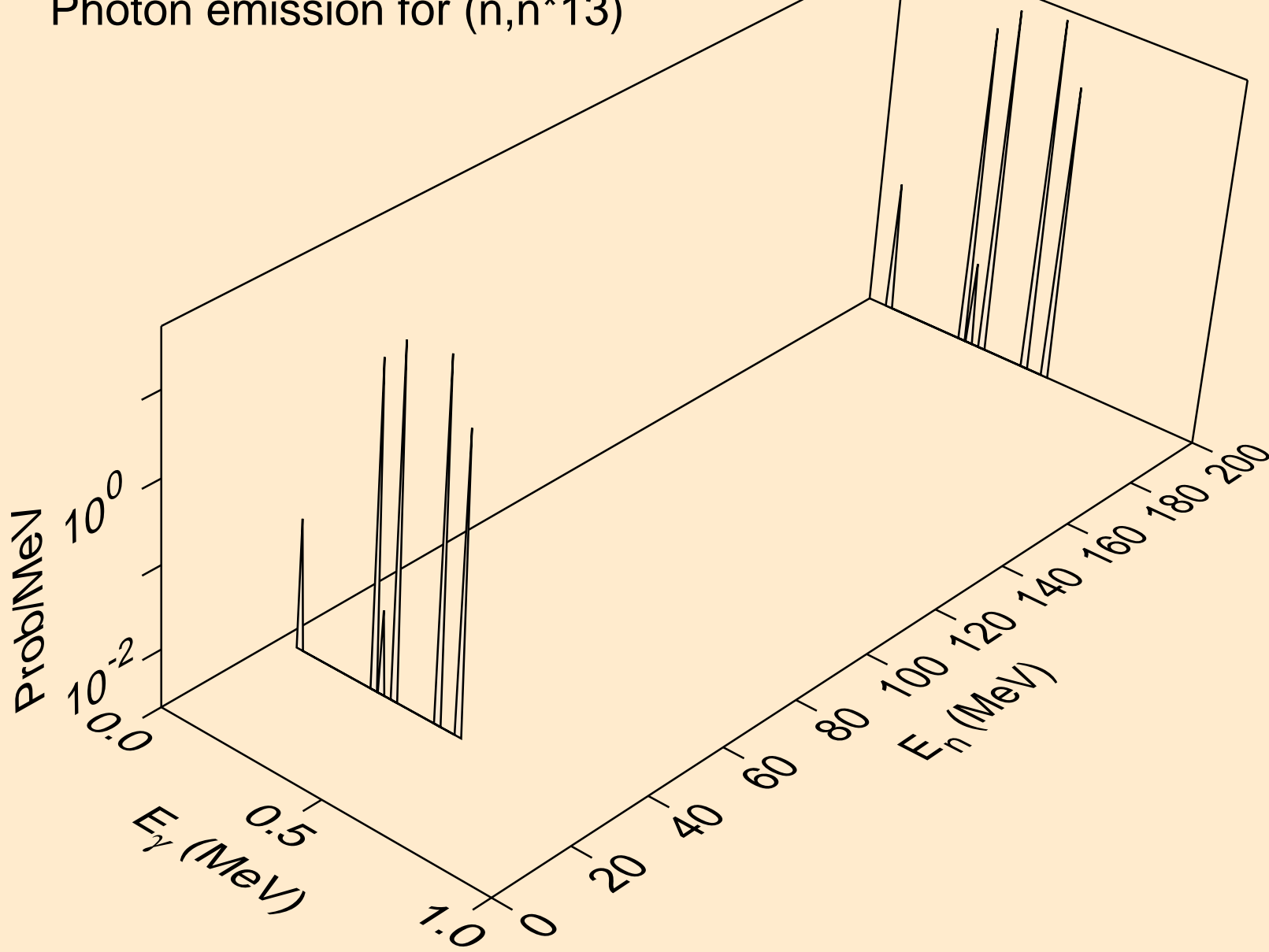

45-RH-103 FOR FENDL-3.2 FROM FENDL-3.2 BY NJOY2016.60+ C
Photon emission for (n,n*14)

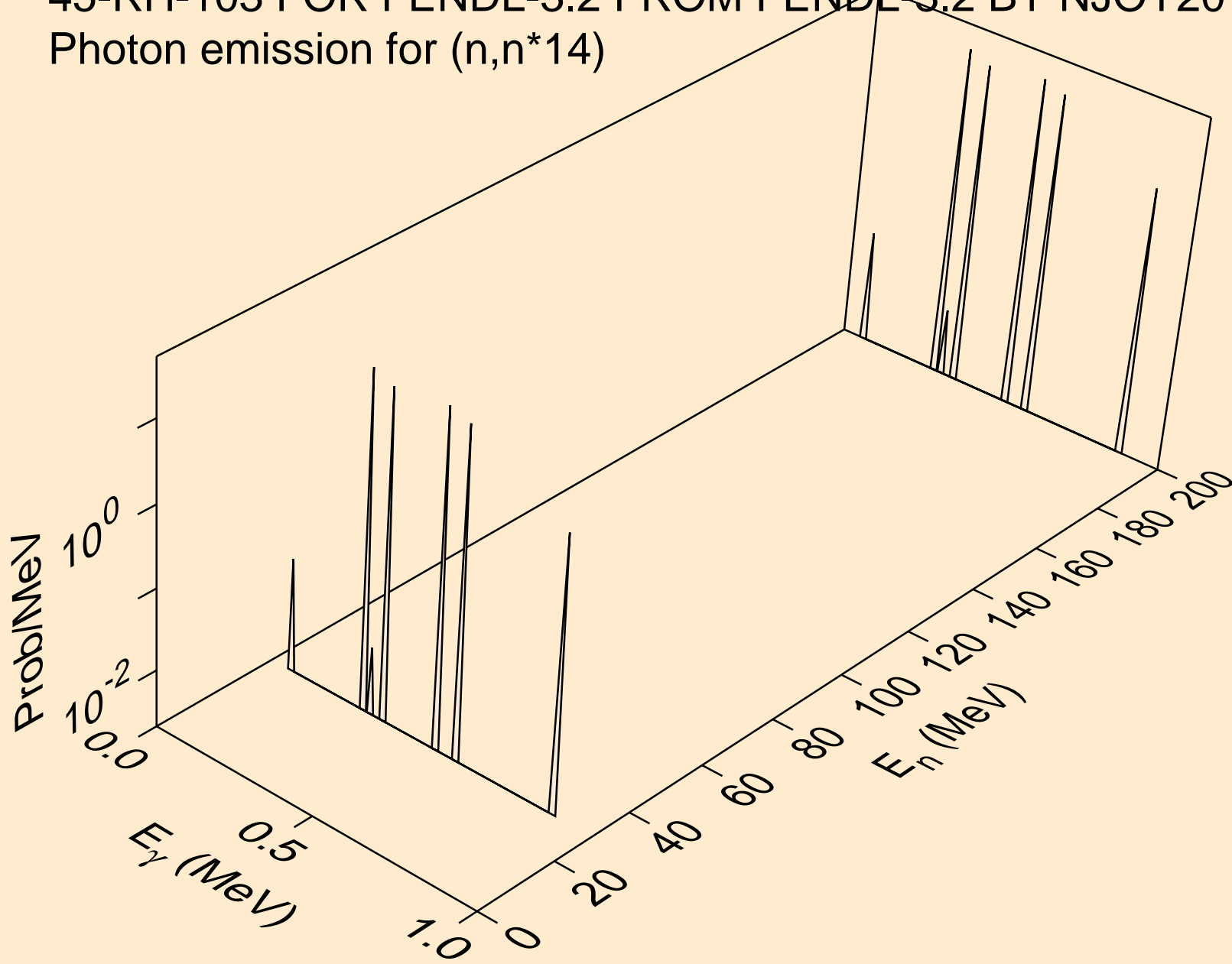

45-RH-103 FOR FENDL-3.2 FROM FENDL-3.2 BY NJOY2016.60+ C
Photon emission for (n,n*15)

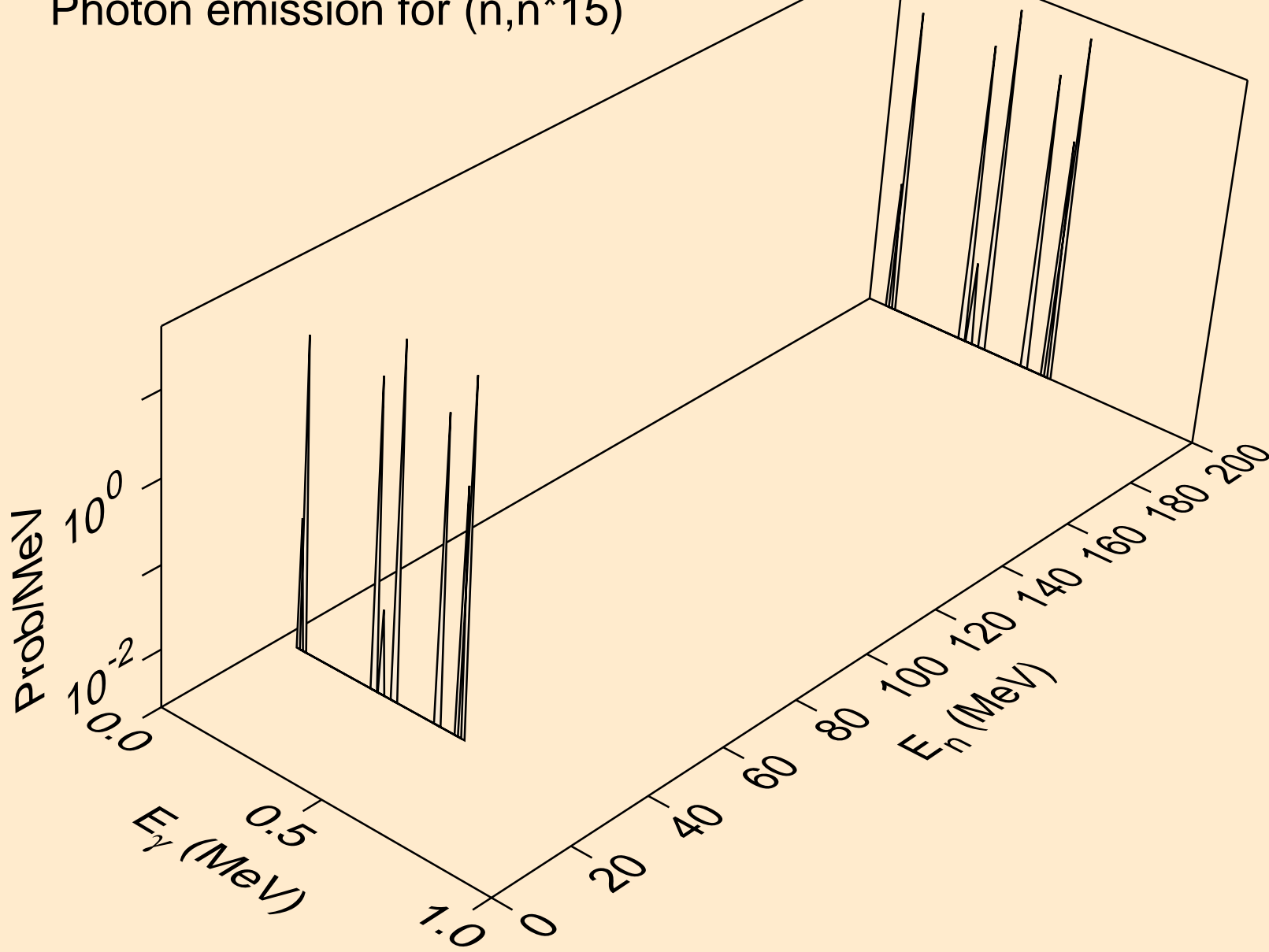

45-RH-103 FOR FENDL-3.2 FROM FENDL-3.2 BY NJOY2016.60+ C
Photon emission for (n,n*c)

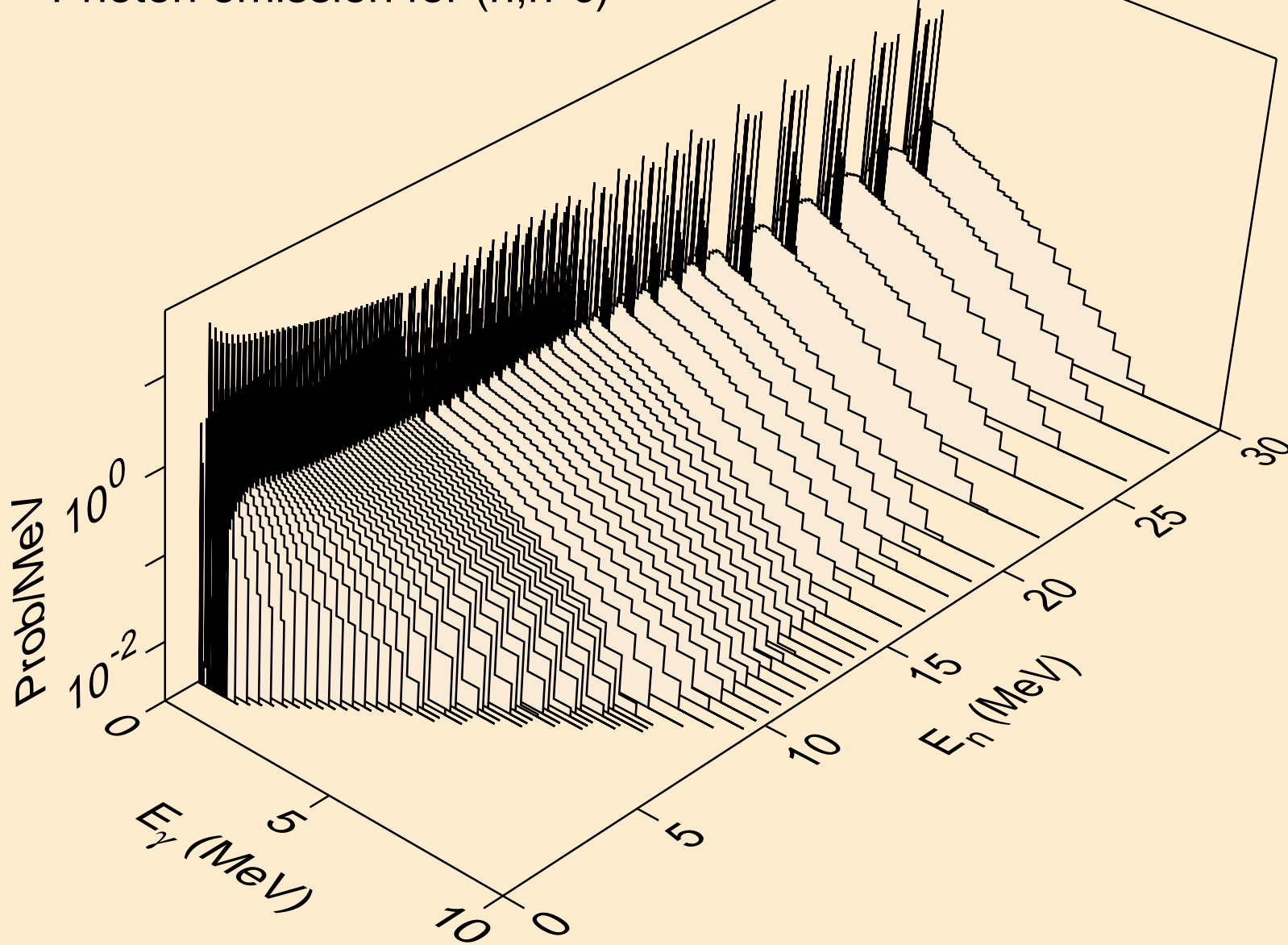

45-RH-103 FOR FENDL-3.2 FROM FENDL-3.2 BY NJOY2016.60+ C
Photon emission for (n,2a)

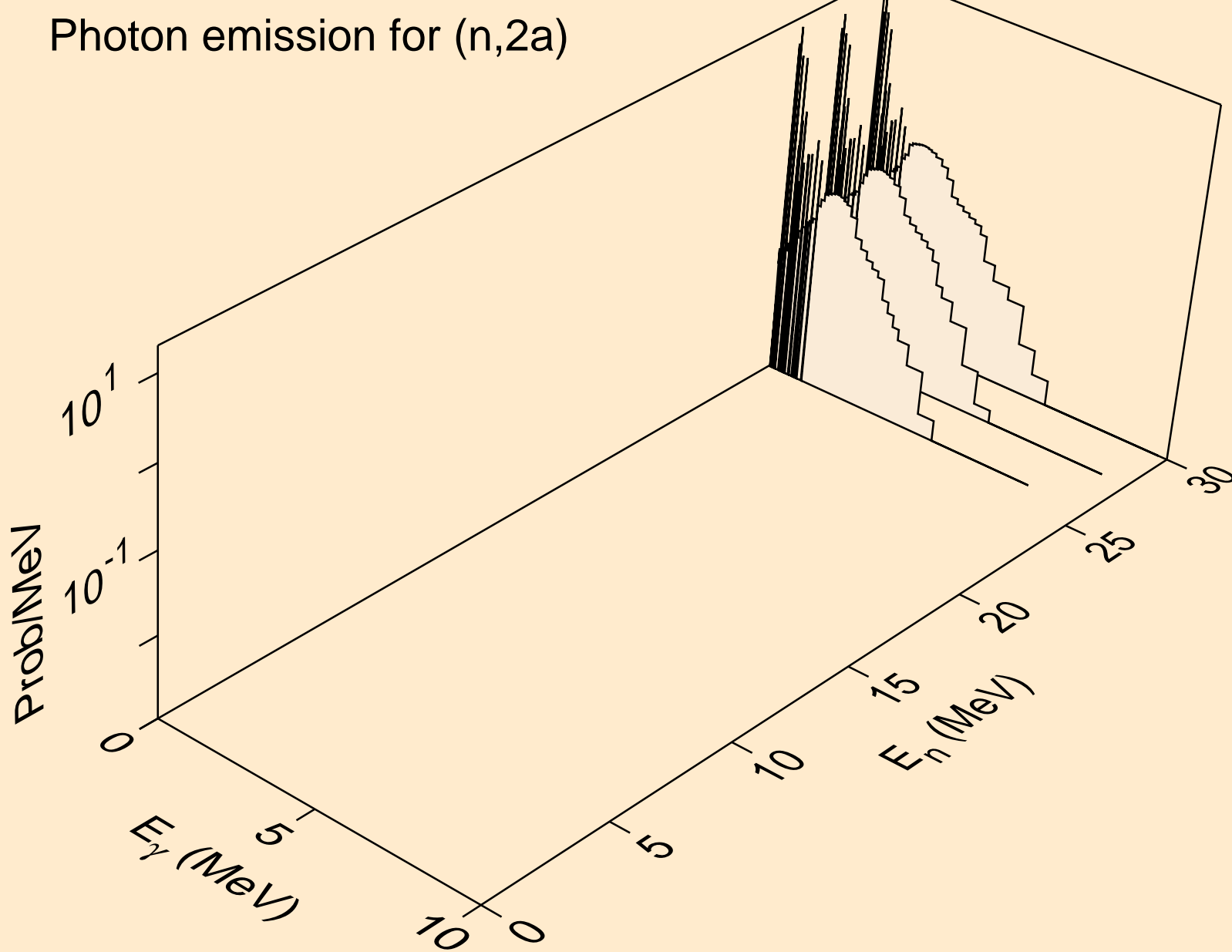

45-RH-103 FOR FENDL-3.2 FROM FENDL-3.2 BY NJOY2016.60+ C
Photon emission for (n,2p)

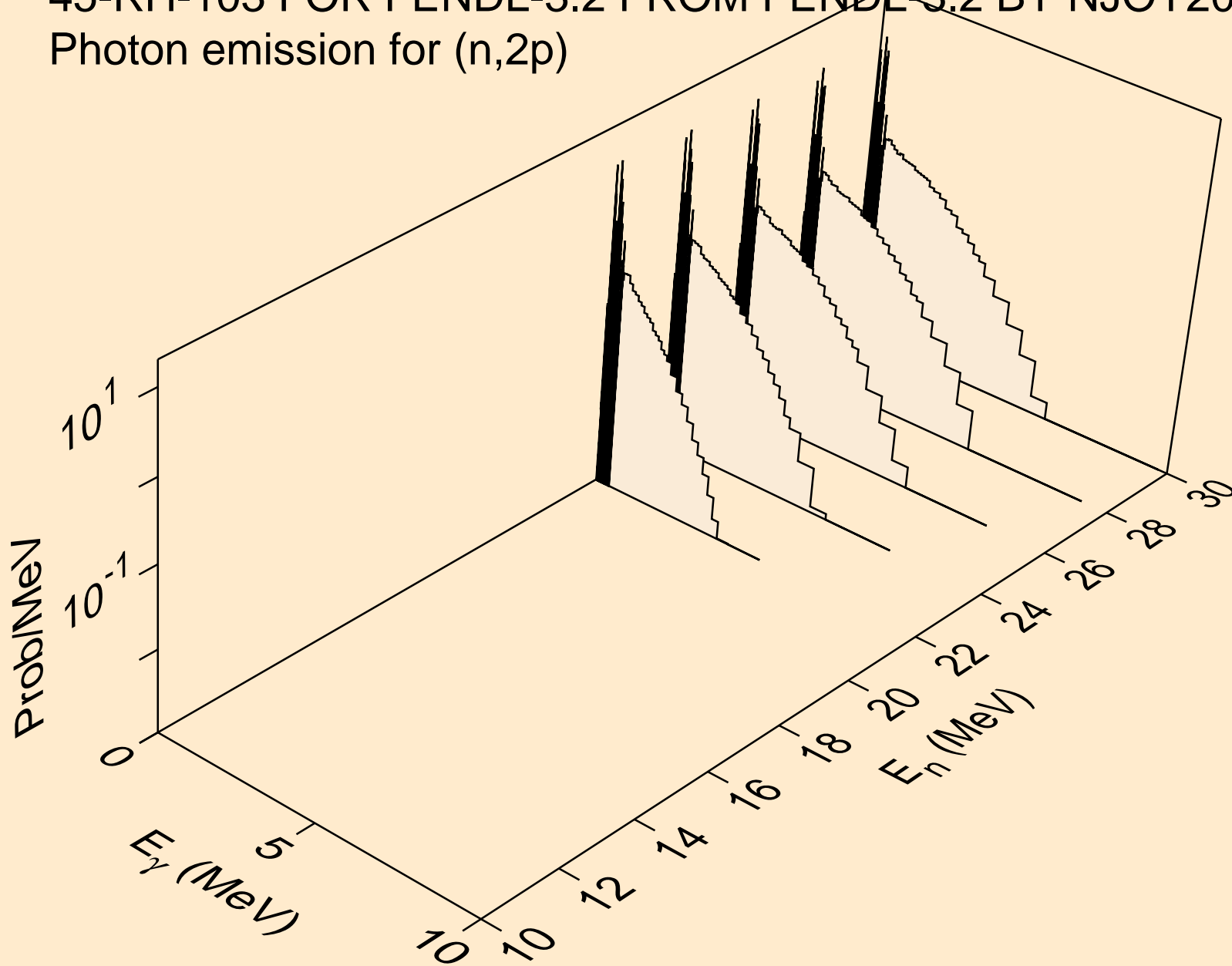

45-RH-103 FOR FENDL-3.2 FROM FENDL-3.2 BY NJOY2016.60+ C
Photon emission for (n,pa)

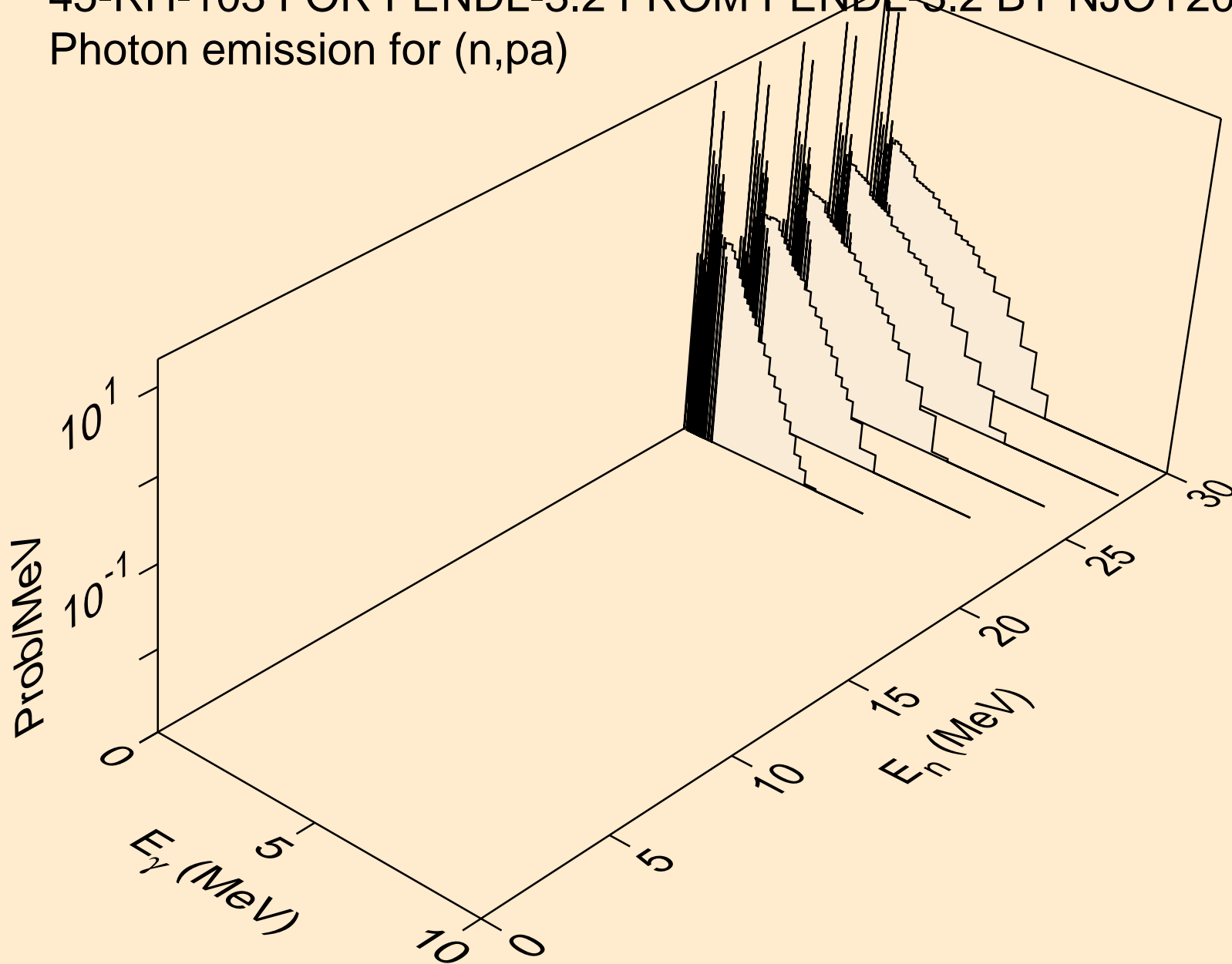

45-RH-103 FOR FENDL-3.2 FROM FENDL-3.2 BY NJOY2016.60+ C
Photon emission for (n,pd)

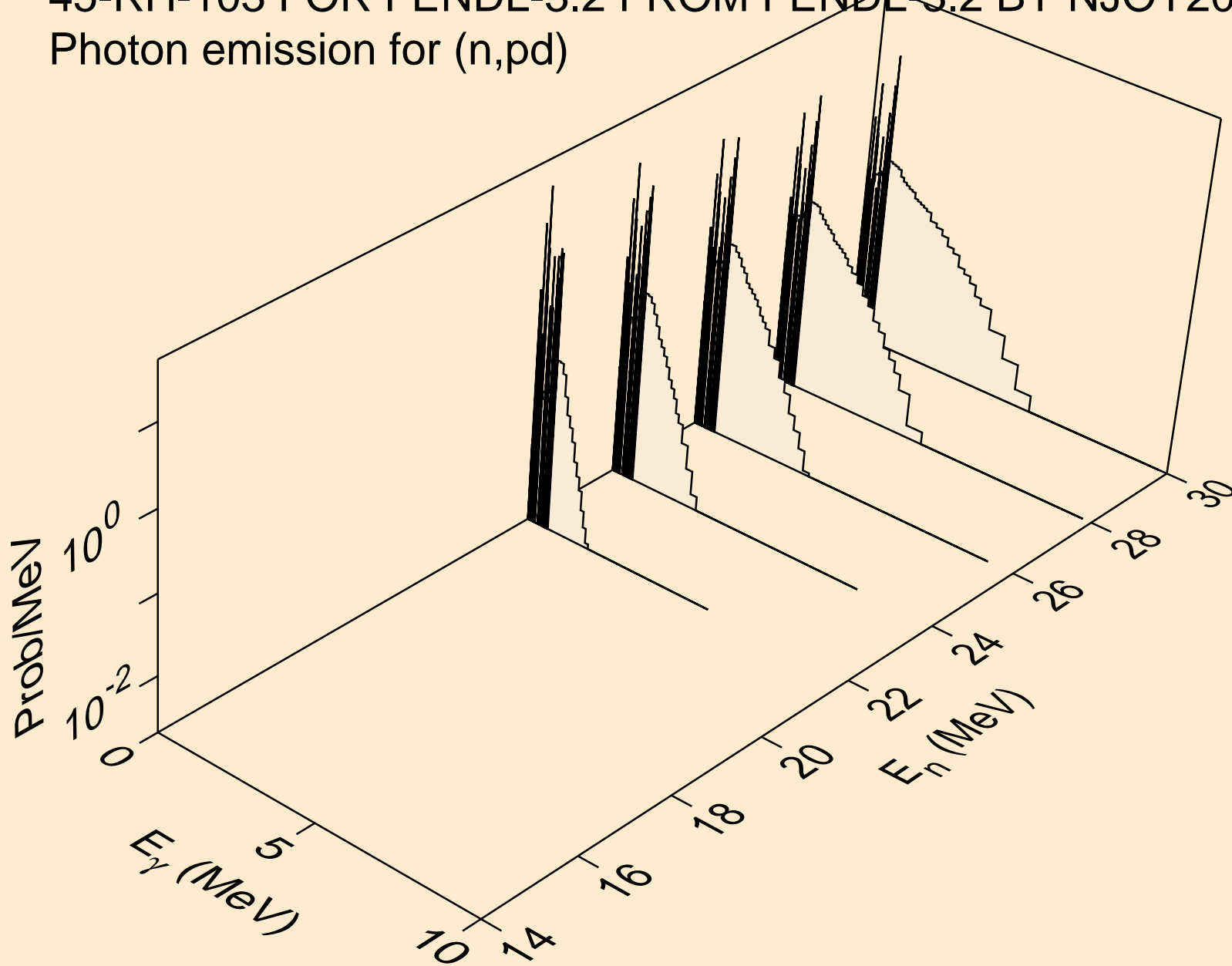

45-RH-103 FOR FENDL-3.2 FROM FENDL-3.2 BY NJOY2016.60+ C
Photon emission for (n,pt)

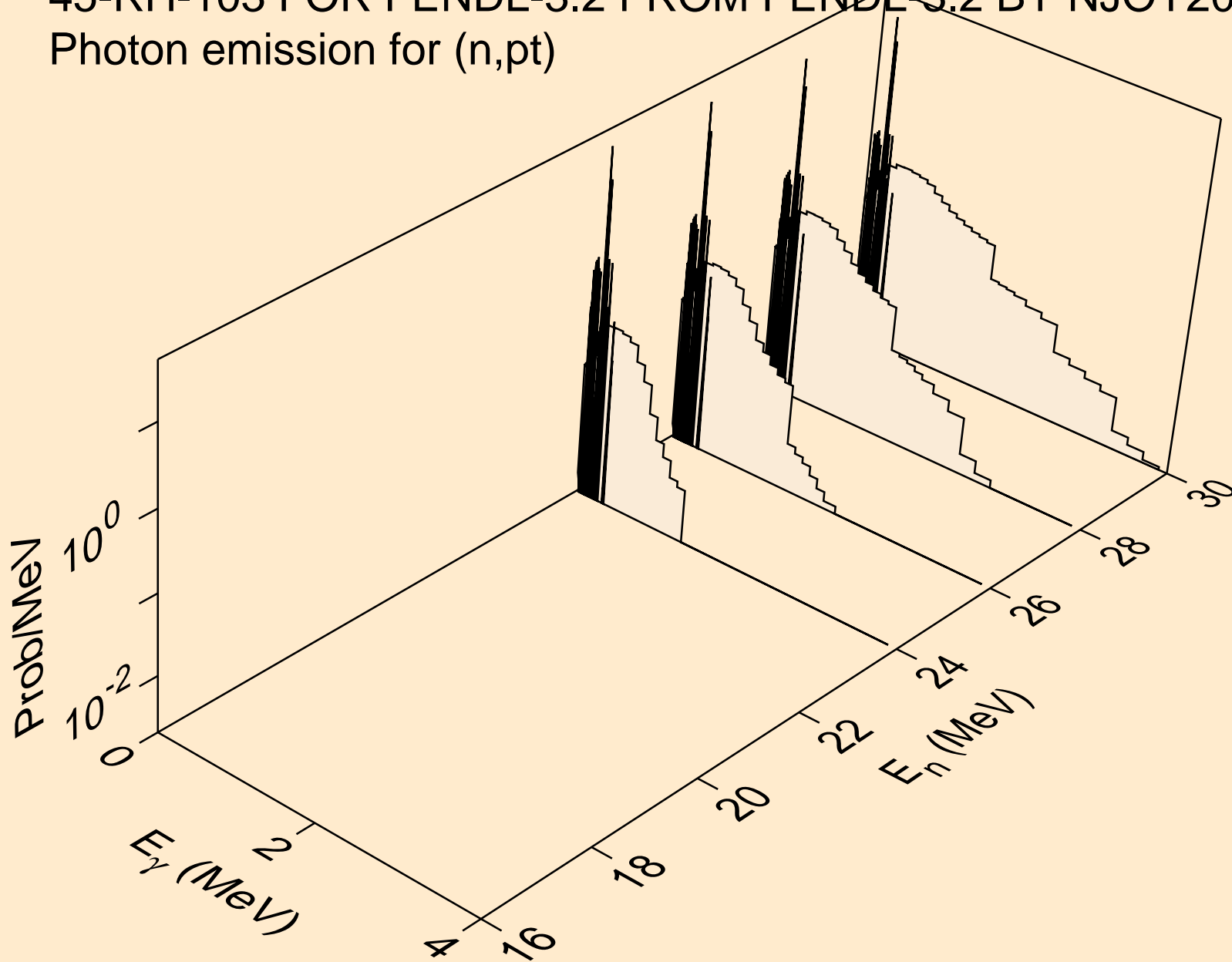

45-RH-103 FOR FENDL-3.2 FROM FENDL-3.2 BY NJOY2016.60+ C
Photon emission for (n,da)

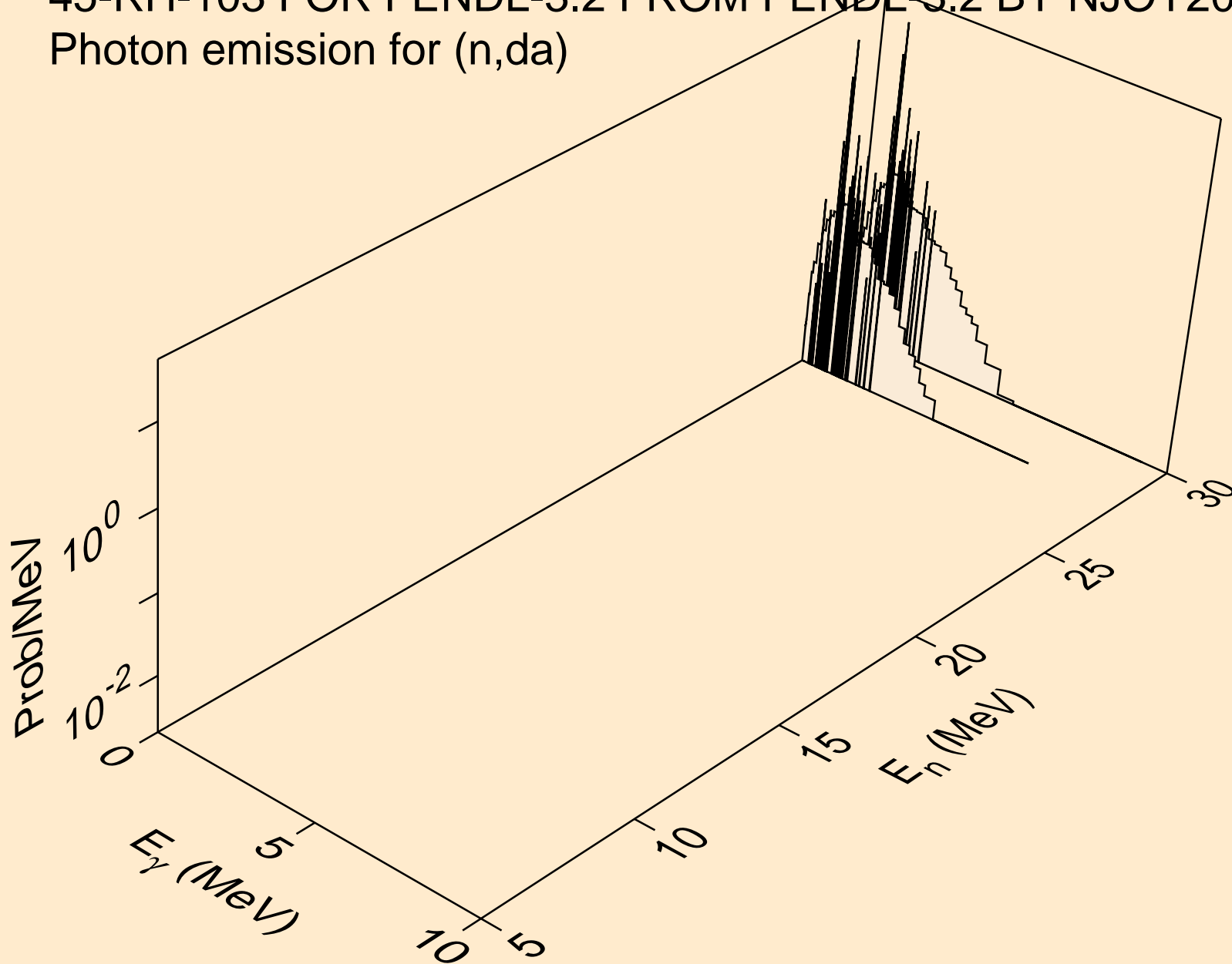

45-RH-103 FOR FENDL-3.2 FROM FENDL-3.2 BY NJOY2016.60+ C
Photon emission for (n,p*1)

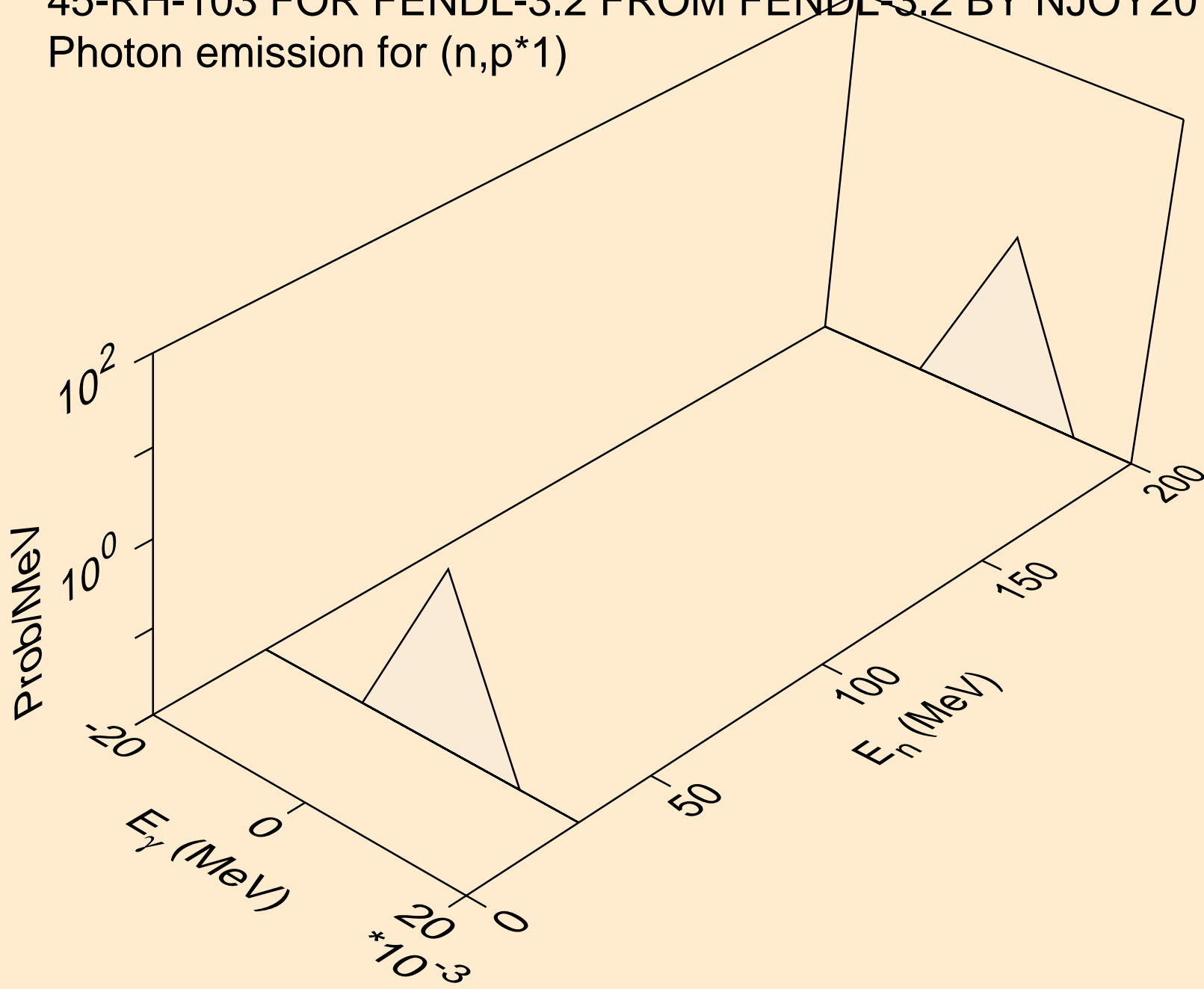

45-RH-103 FOR FENDL-3.2 FROM FENDL-3.2 BY NJOY2016.60+ C
Photon emission for (n,p*2)

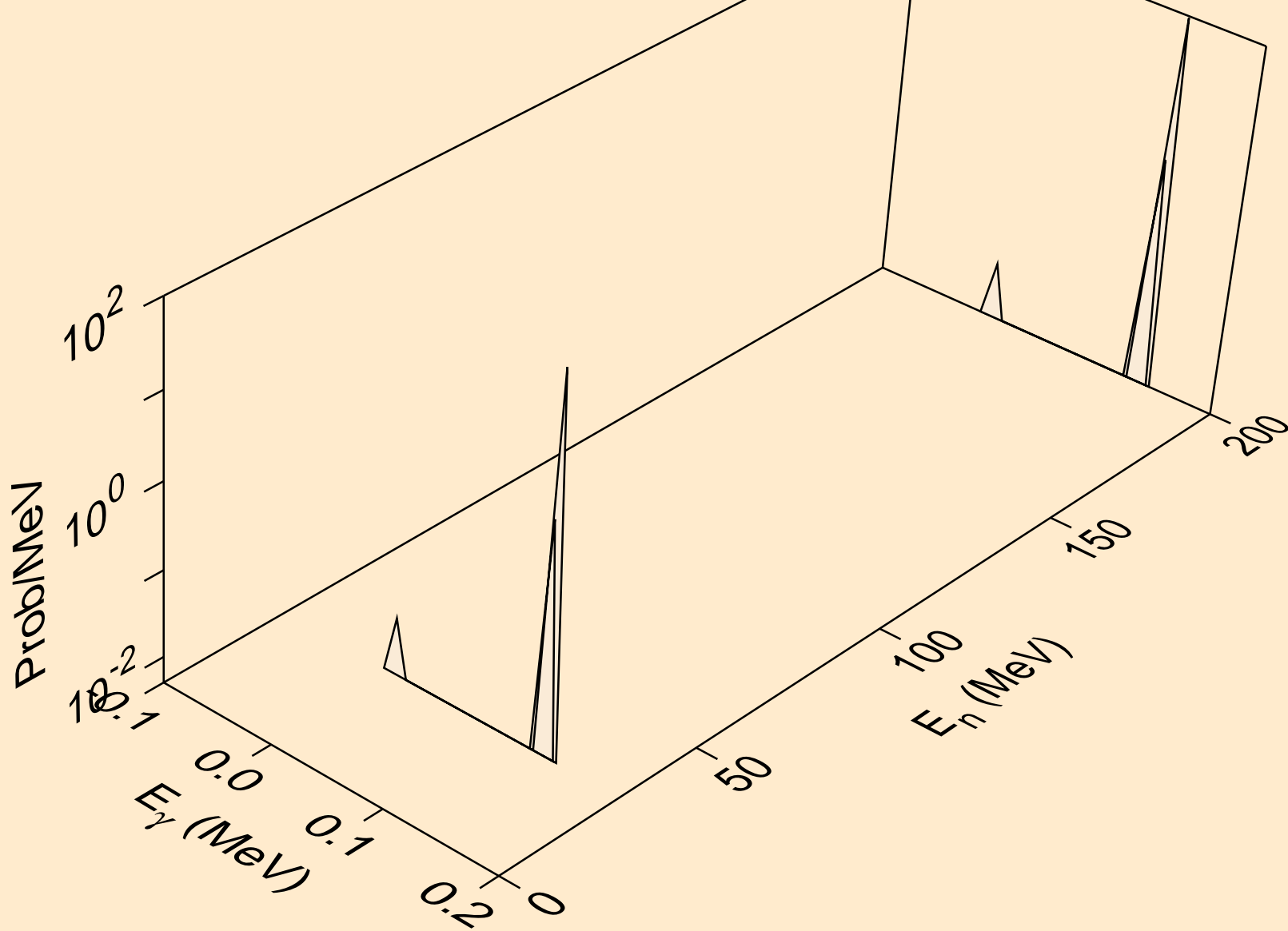

45-RH-103 FOR FENDL-3.2 FROM FENDL-3.2 BY NJOY2016.60+ C
Photon emission for (n,p*3)

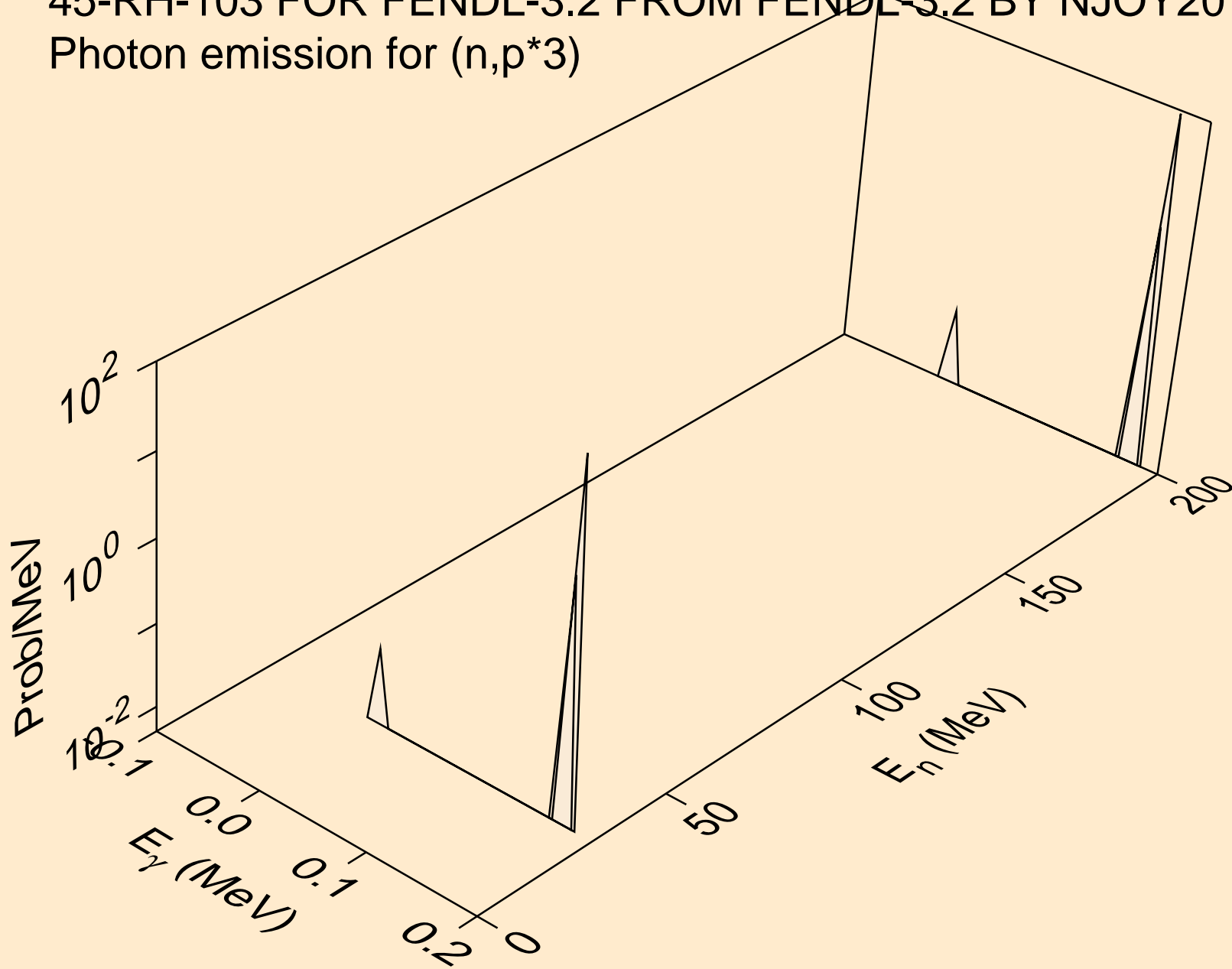

45-RH-103 FOR FENDL-3.2 FROM FENDL-3.2 BY NJOY2016.60+ C
Photon emission for (n,p*4)

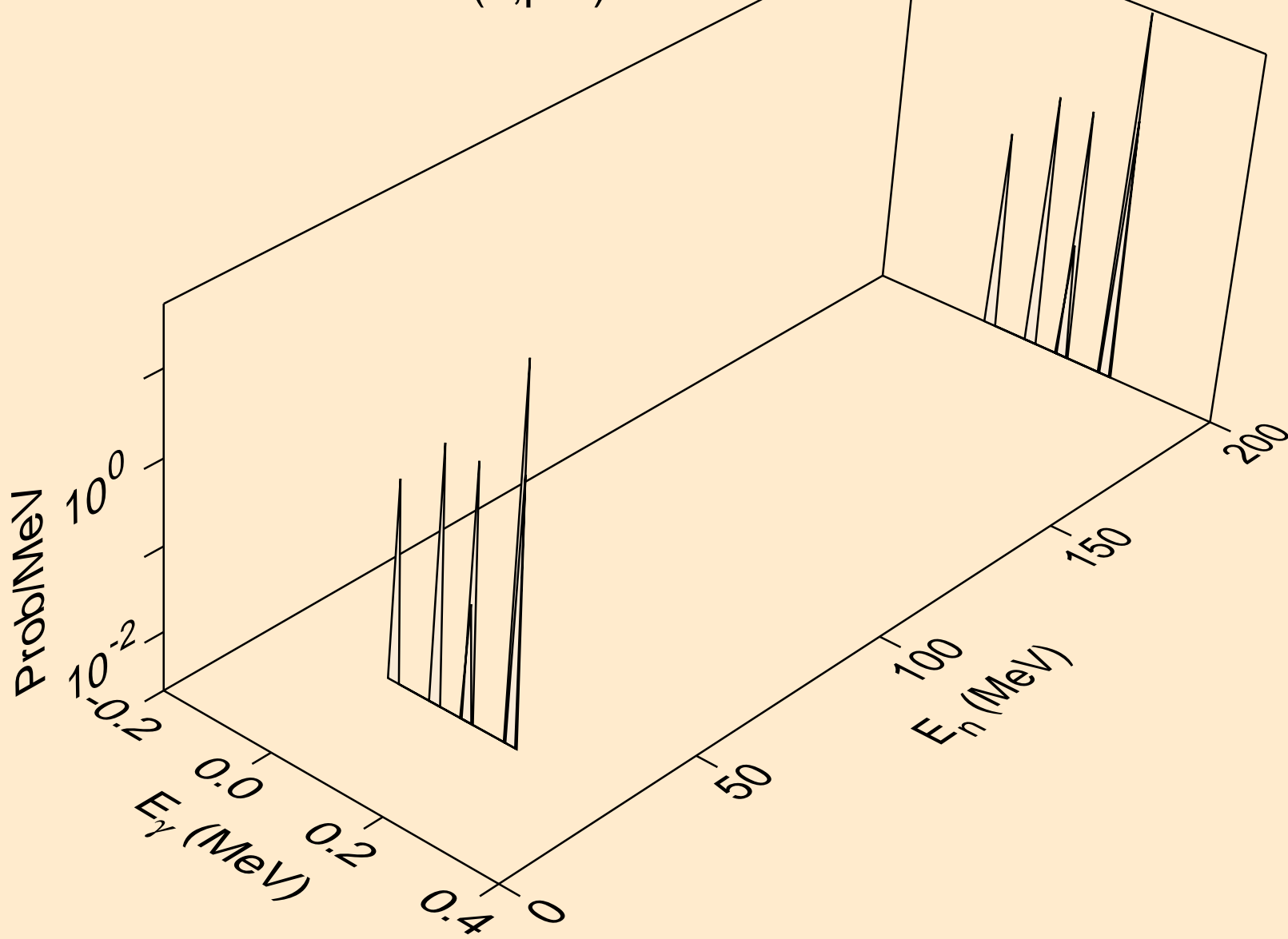

45-RH-103 FOR FENDL-3.2 FROM FENDL-3.2 BY NJOY2016.60+ C
Photon emission for (n,p*5)

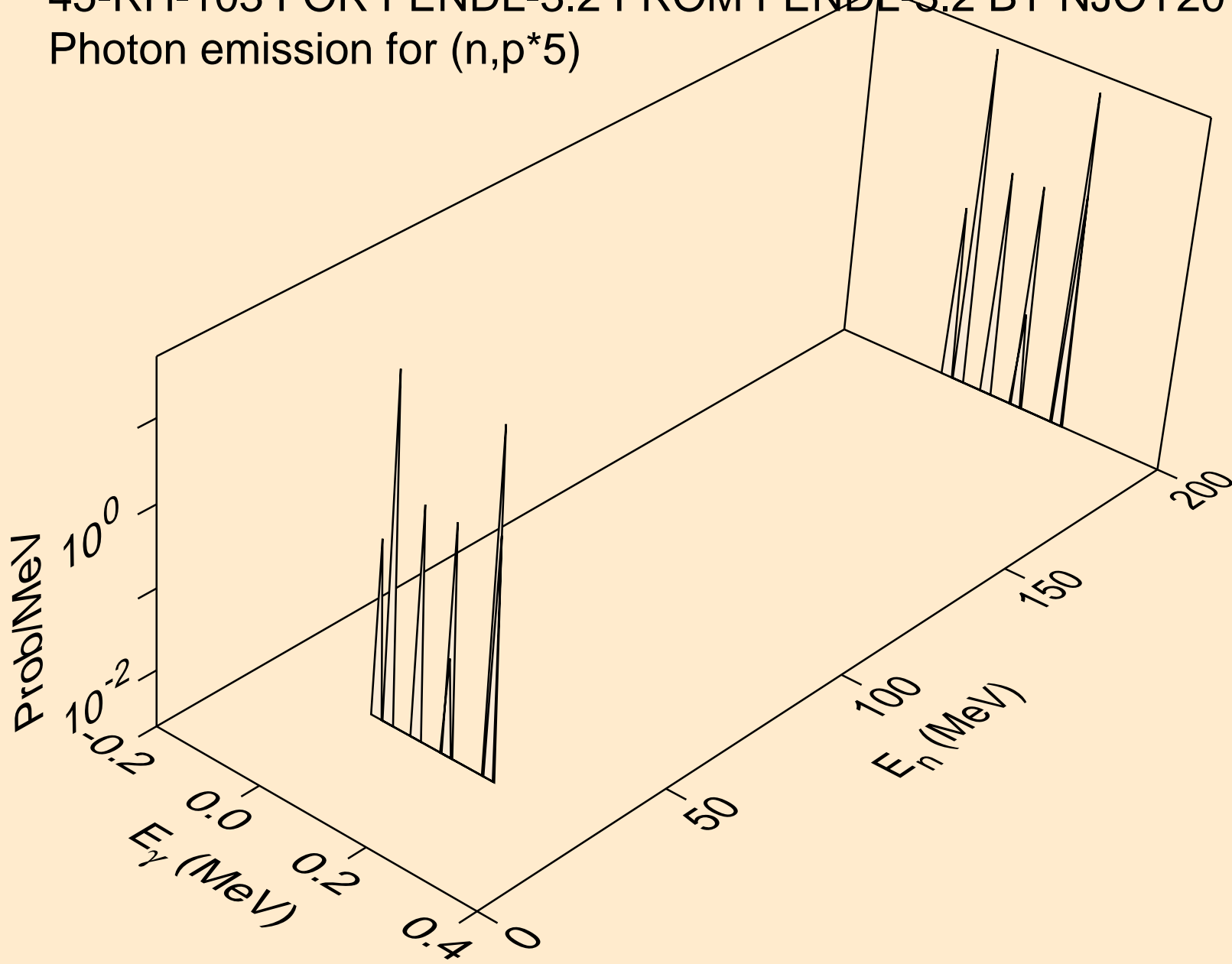

45-RH-103 FOR FENDL-3.2 FROM FENDL-3.2 BY NJOY2016.60+ C
Photon emission for (n,p*6)

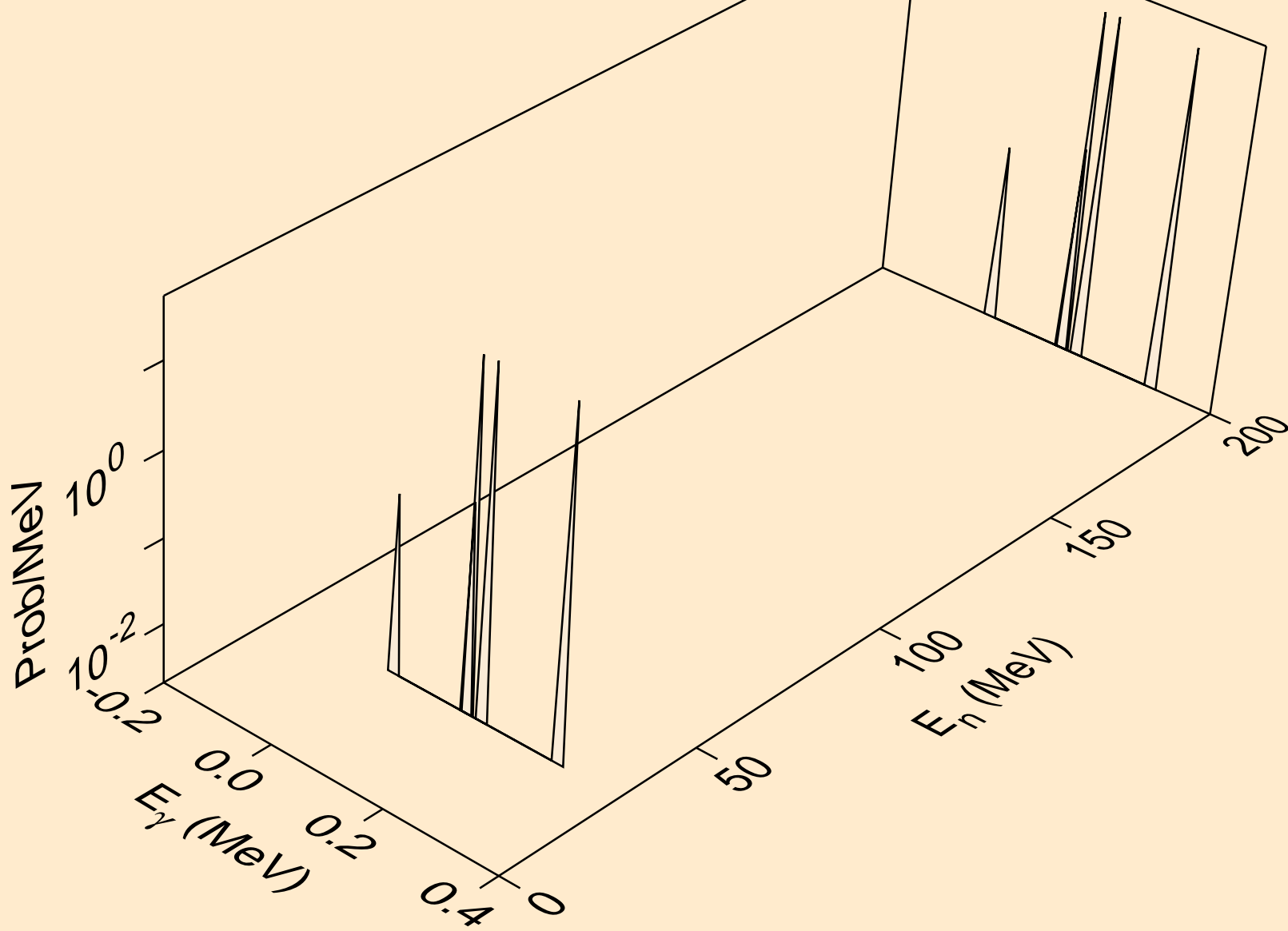

45-RH-103 FOR FENDL-3.2 FROM FENDL-3.2 BY NJOY2016.60+ C
Photon emission for (n,p*7)

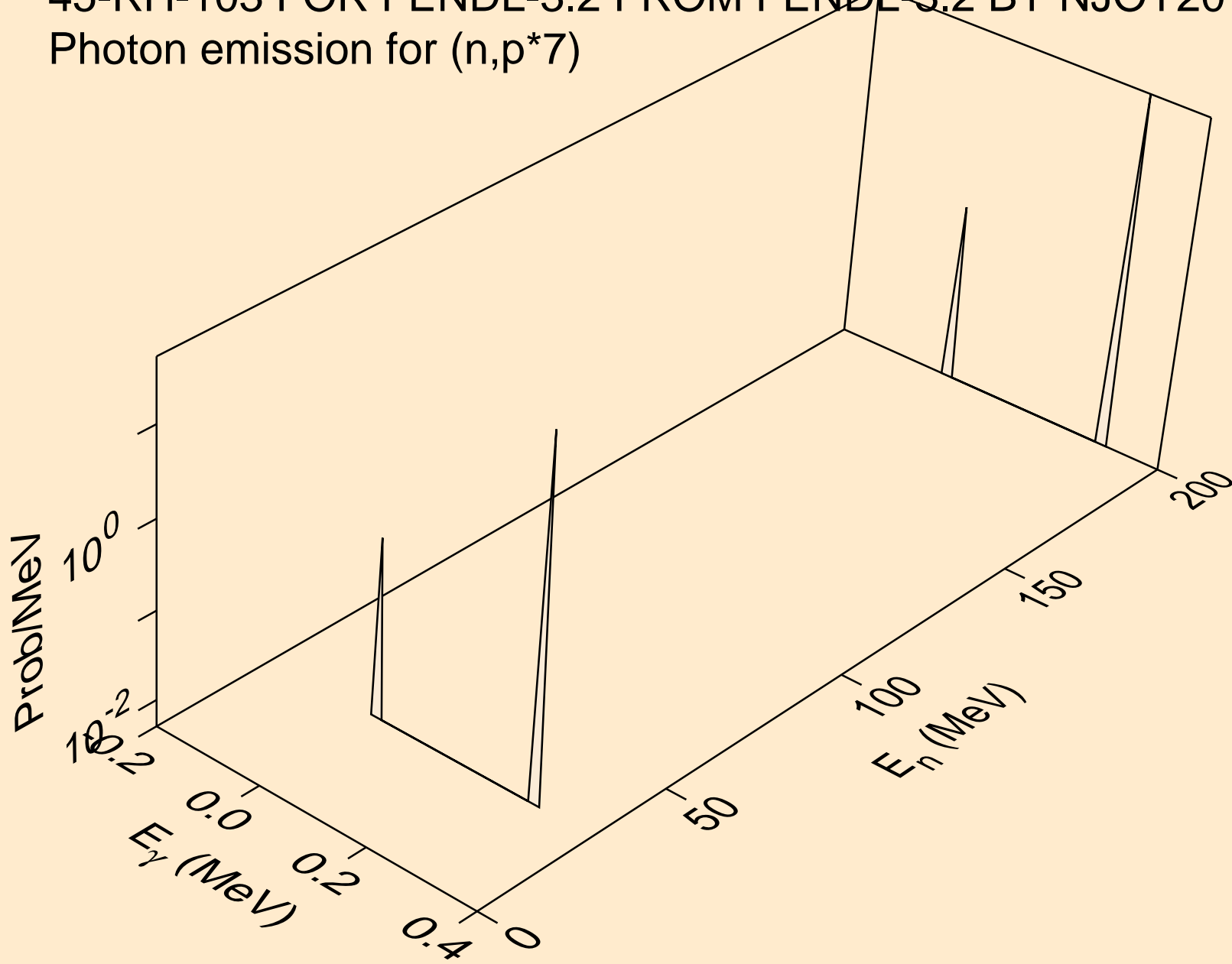

45-RH-103 FOR FENDL-3.2 FROM FENDL-3.2 BY NJOY2016.60+ C
Photon emission for (n,p*8)

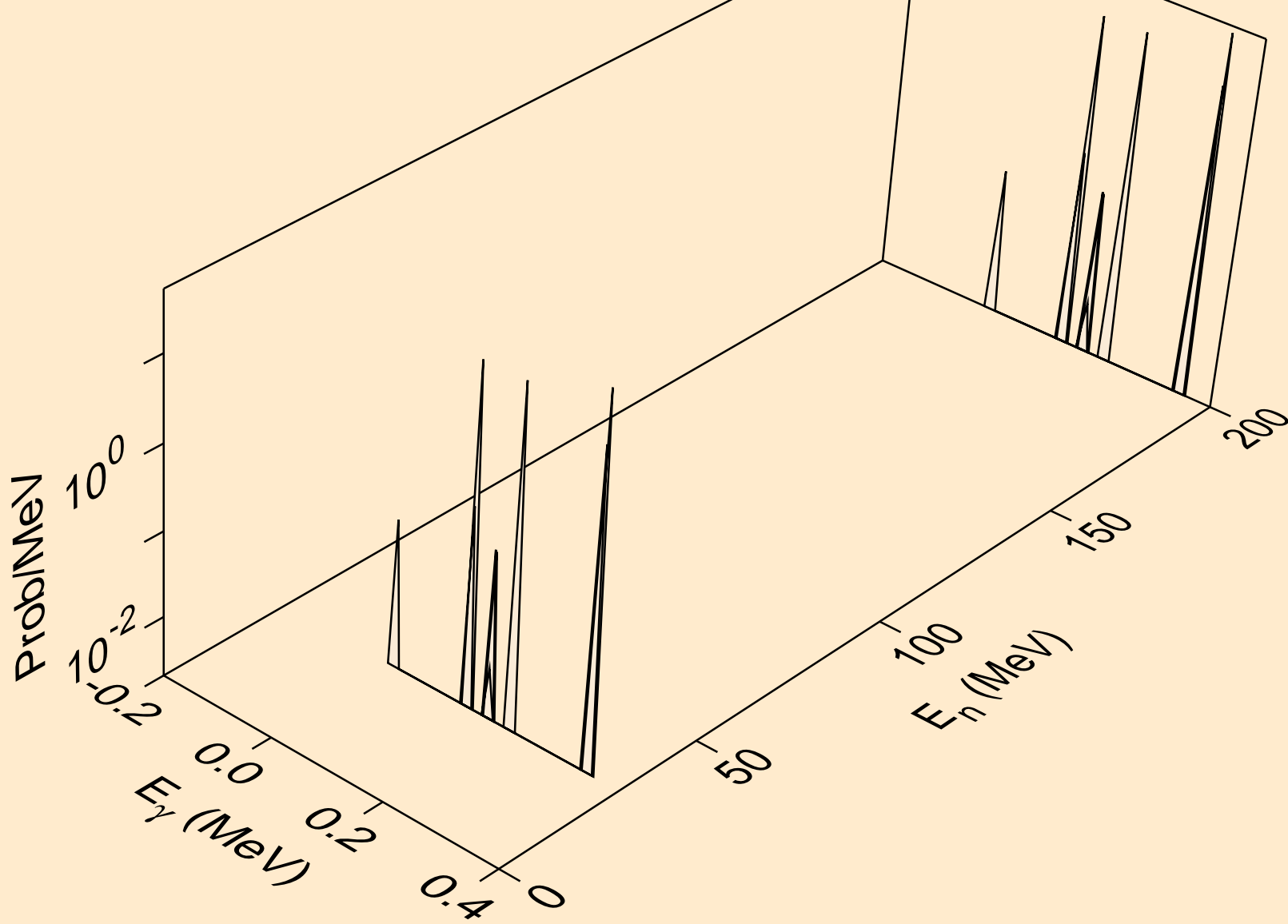

45-RH-103 FOR FENDL-3.2 FROM FENDL-3.2 BY NJOY2016.60+ C
Photon emission for (n,p*9)

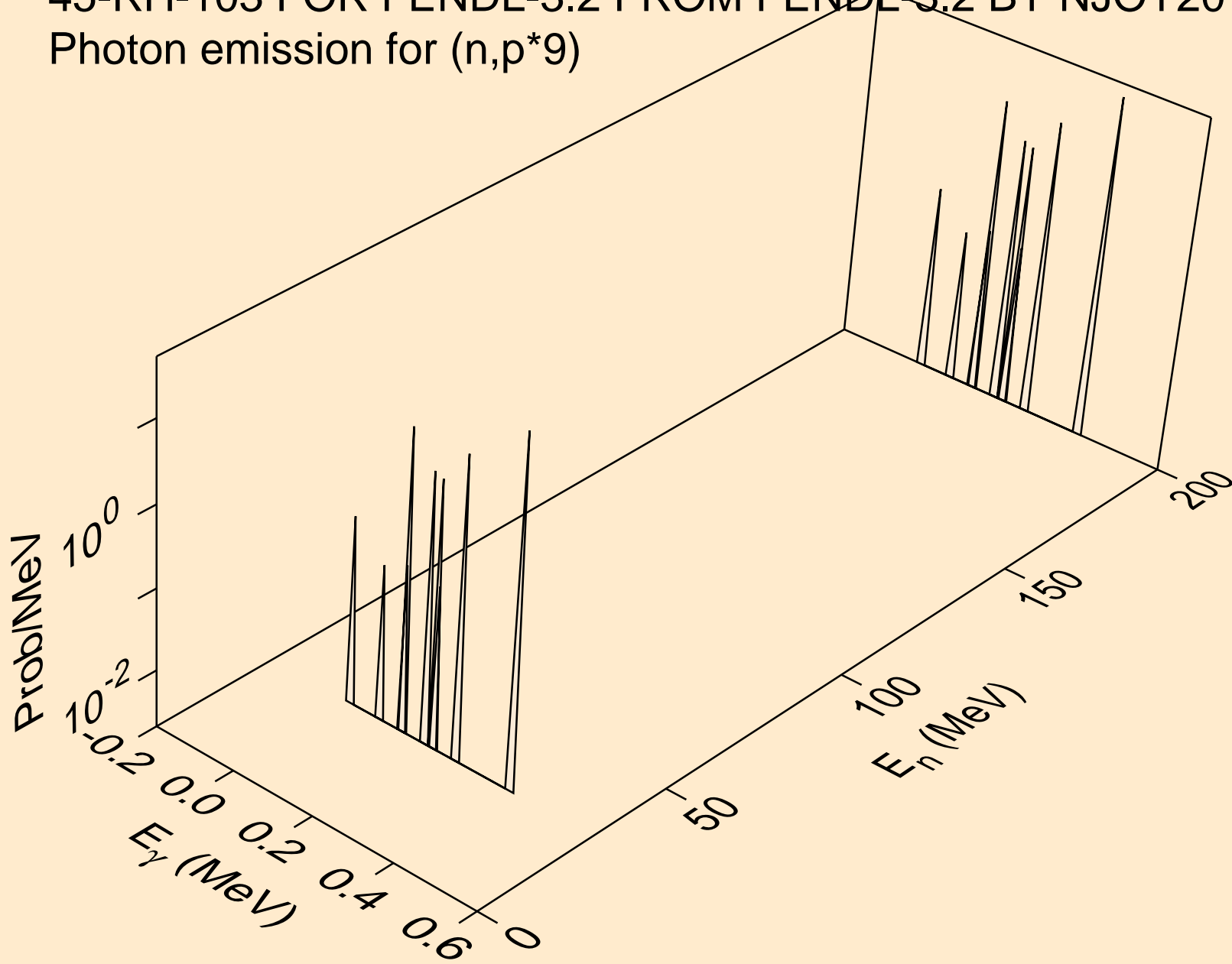

45-RH-103 FOR FENDL-3.2 FROM FENDL-3.2 BY NJOY2016.60+ C
Photon emission for (n,p*10)

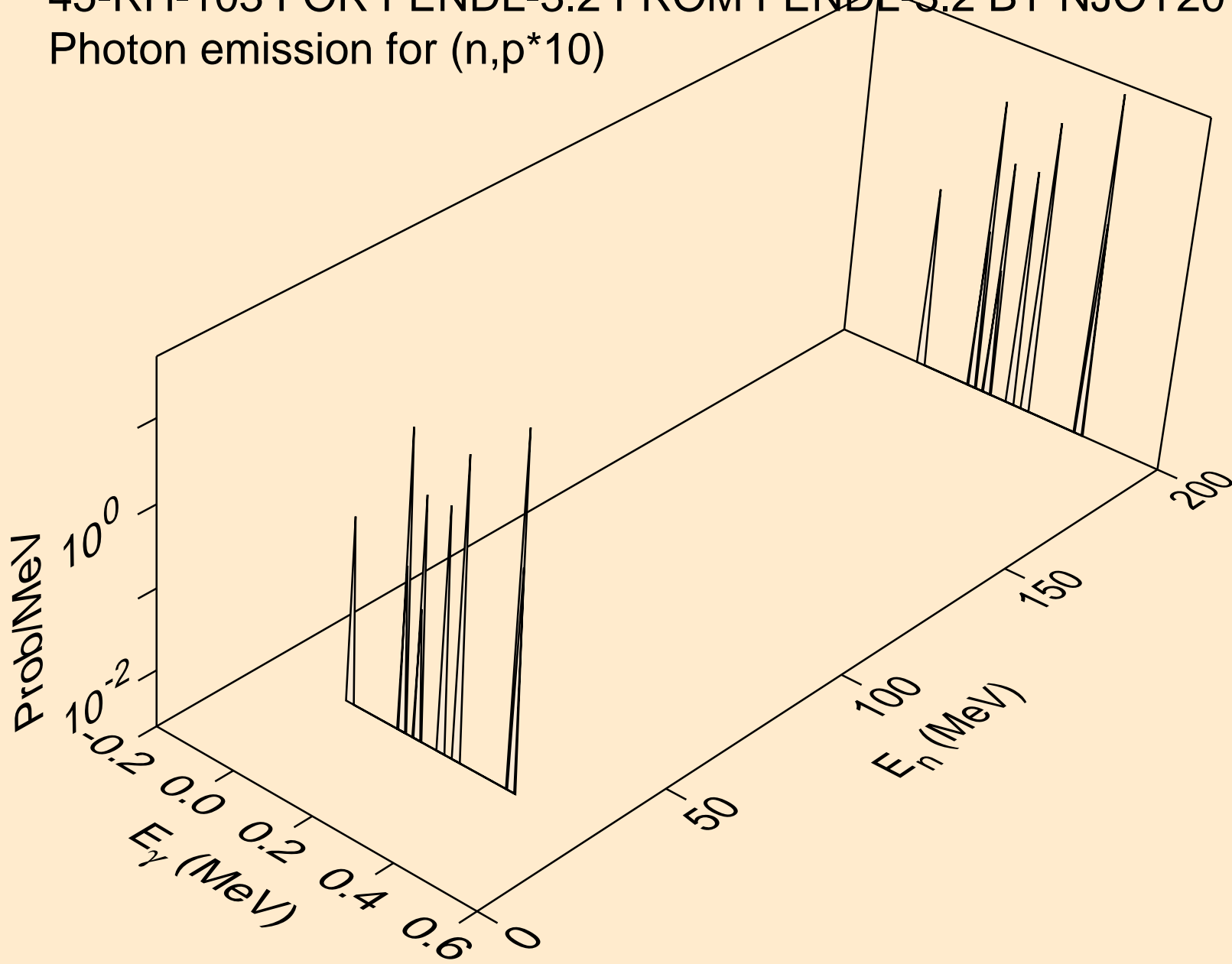

45-RH-103 FOR FENDL-3.2 FROM FENDL-3.2 BY NJOY2016.60+ C
Photon emission for (n,p*11)

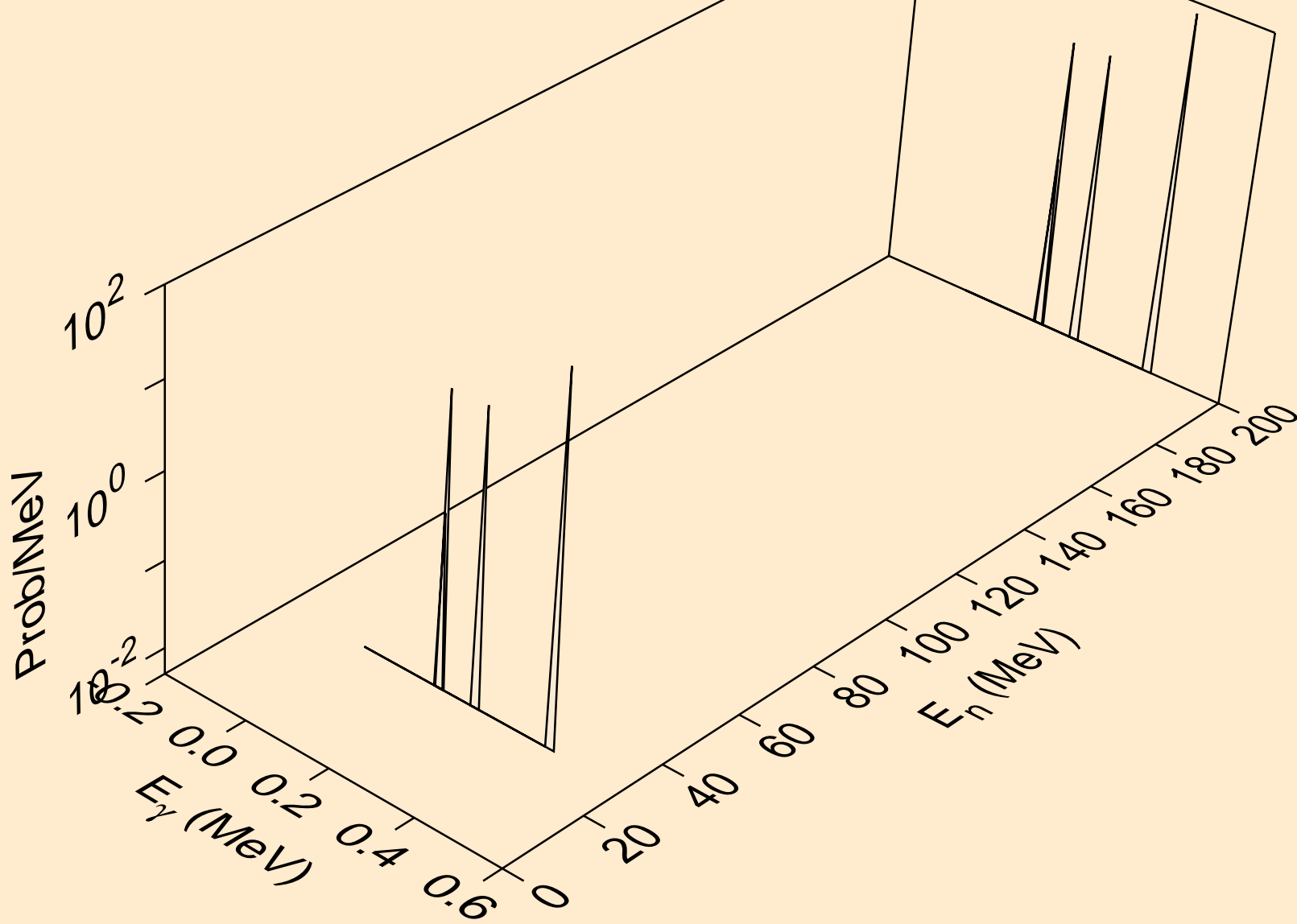

45-RH-103 FOR FENDL-3.2 FROM FENDL-3.2 BY NJOY2016.60+ C
Photon emission for (n,p*12)

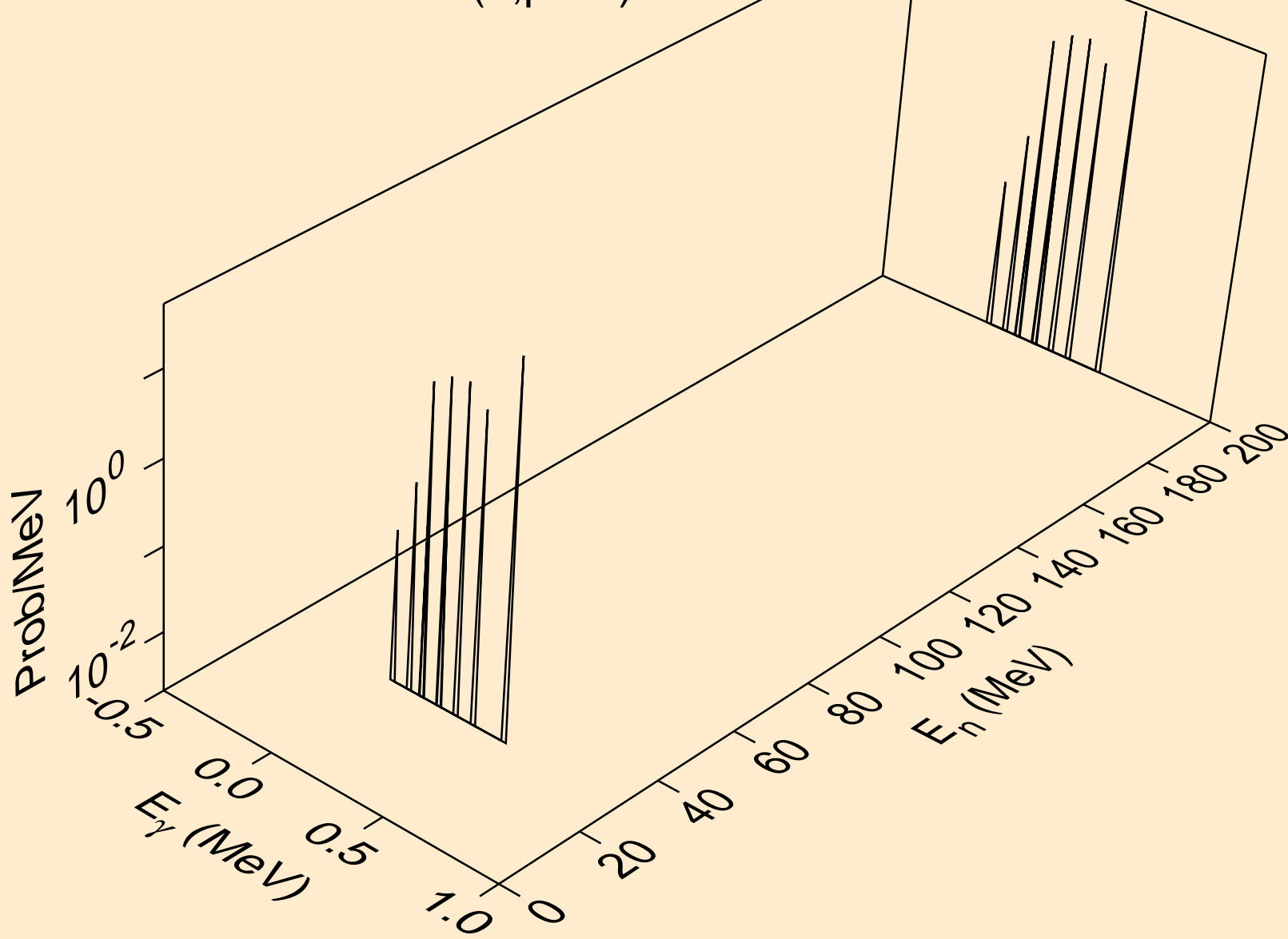

45-RH-103 FOR FENDL-3.2 FROM FENDL-3.2 BY NJOY2016.60+ C
Photon emission for (n,p*13)

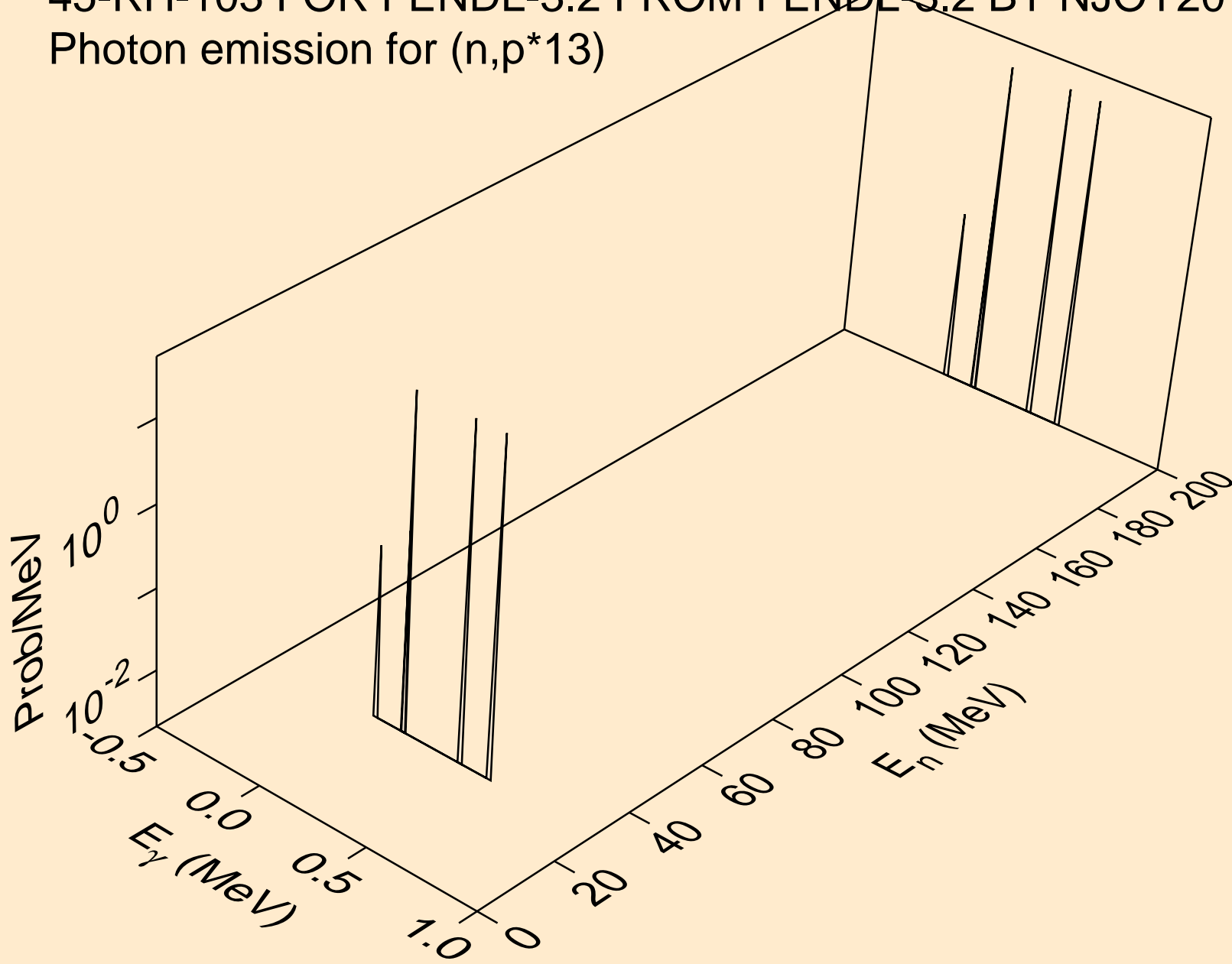

45-RH-103 FOR FENDL-3.2 FROM FENDL-3.2 BY NJOY2016.60+ C
Photon emission for (n,p*14)

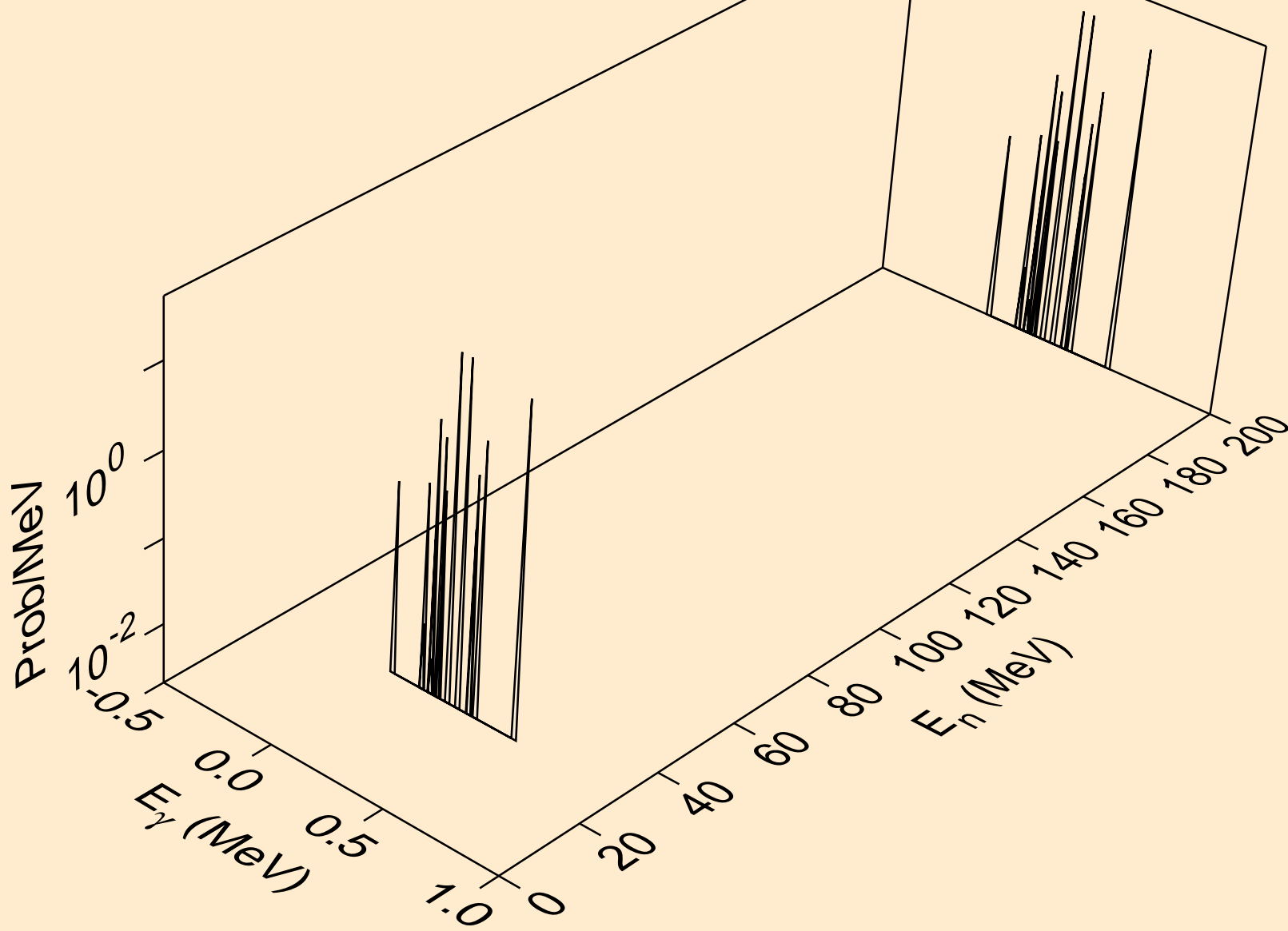

45-RH-103 FOR FENDL-3.2 FROM FENDL-3.2 BY NJOY2016.60+ C
Photon emission for (n,p*15)

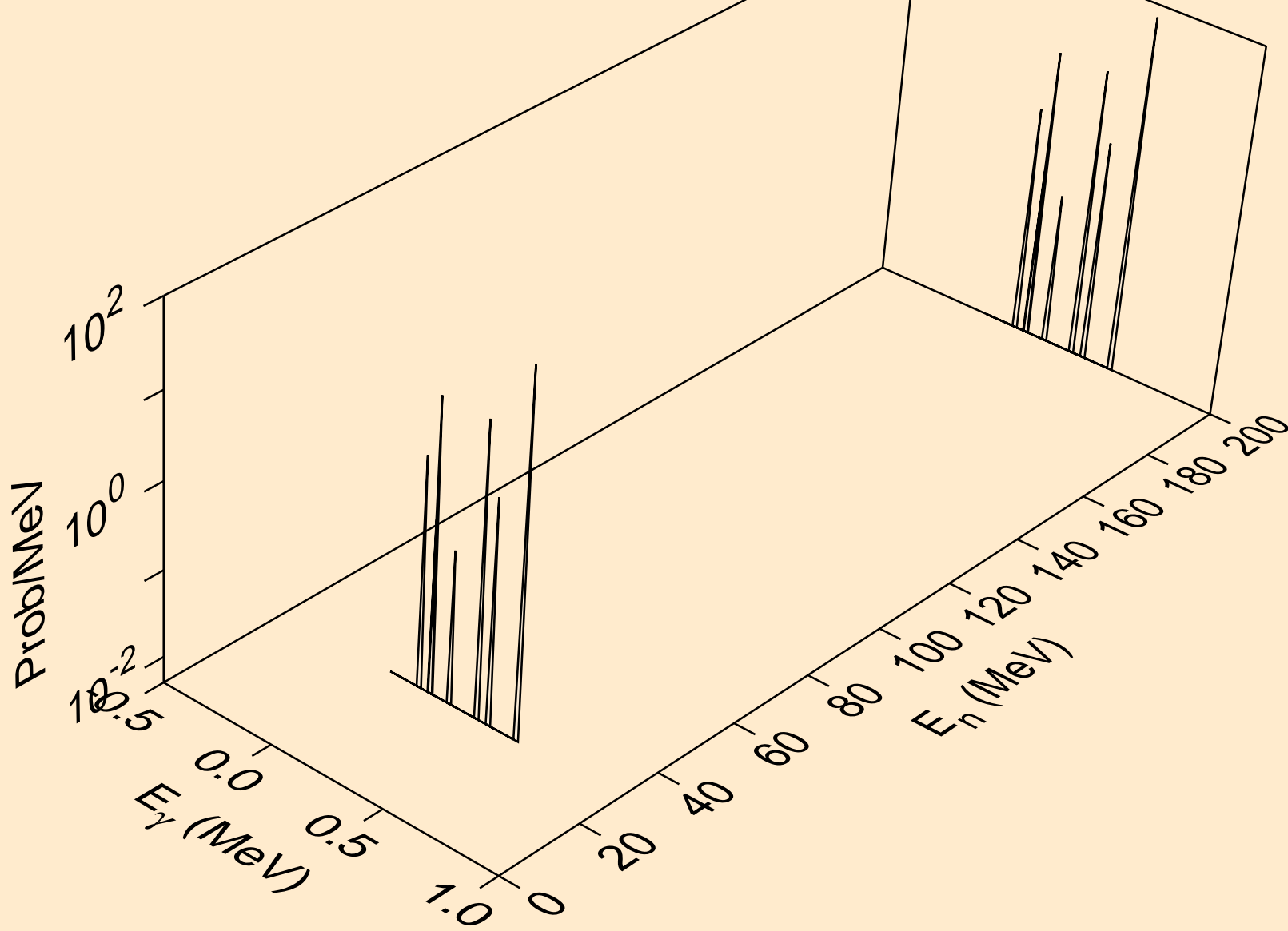

45-RH-103 FOR FENDL-3.2 FROM FENDL-3.2 BY NJOY2016.60+ C
Photon emission for (n,p*c)

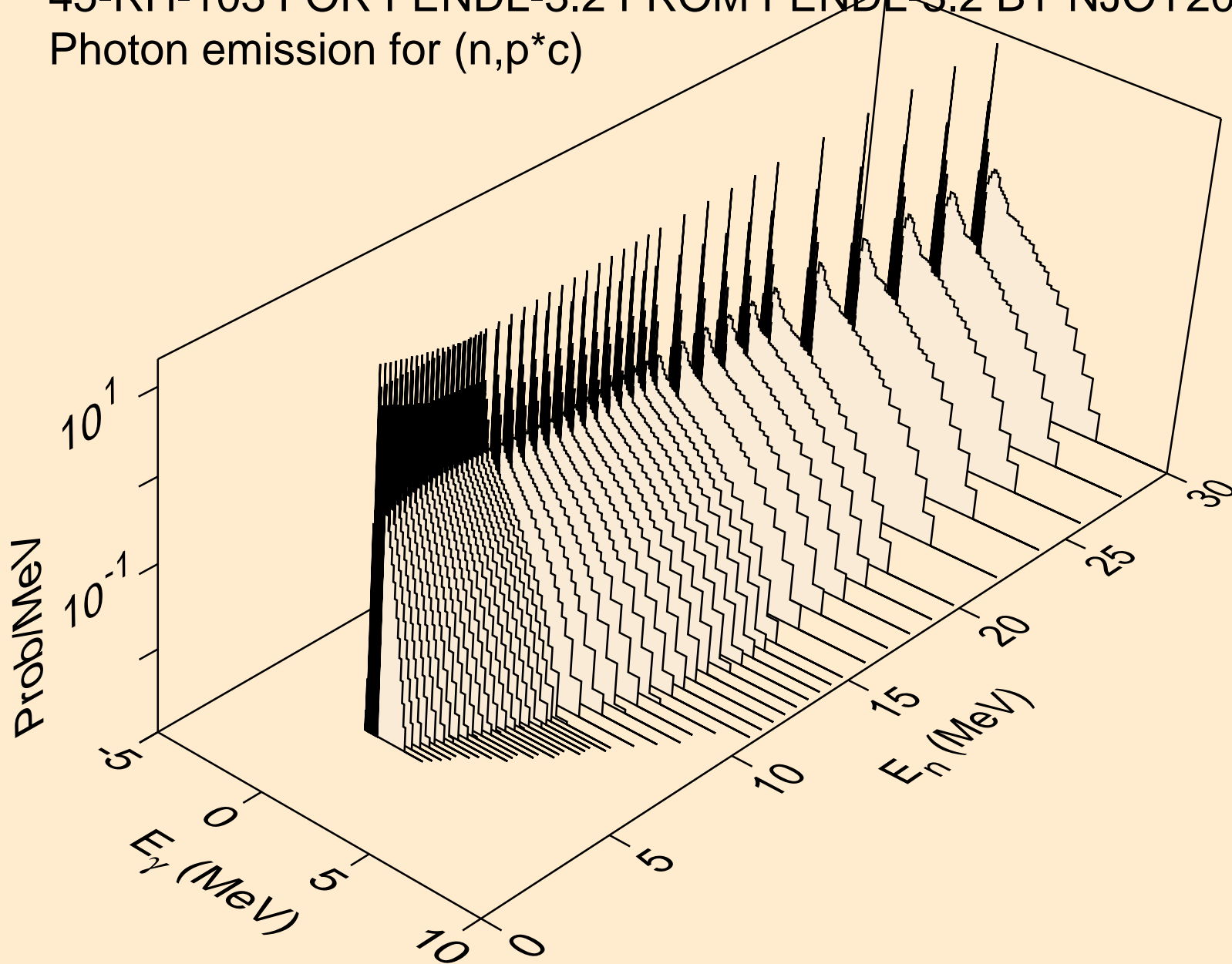

45-RH-103 FOR FENDL-3.2 FROM FENDL-3.2 BY NJOY2016.60+ C
Photon emission for (n,d*1)

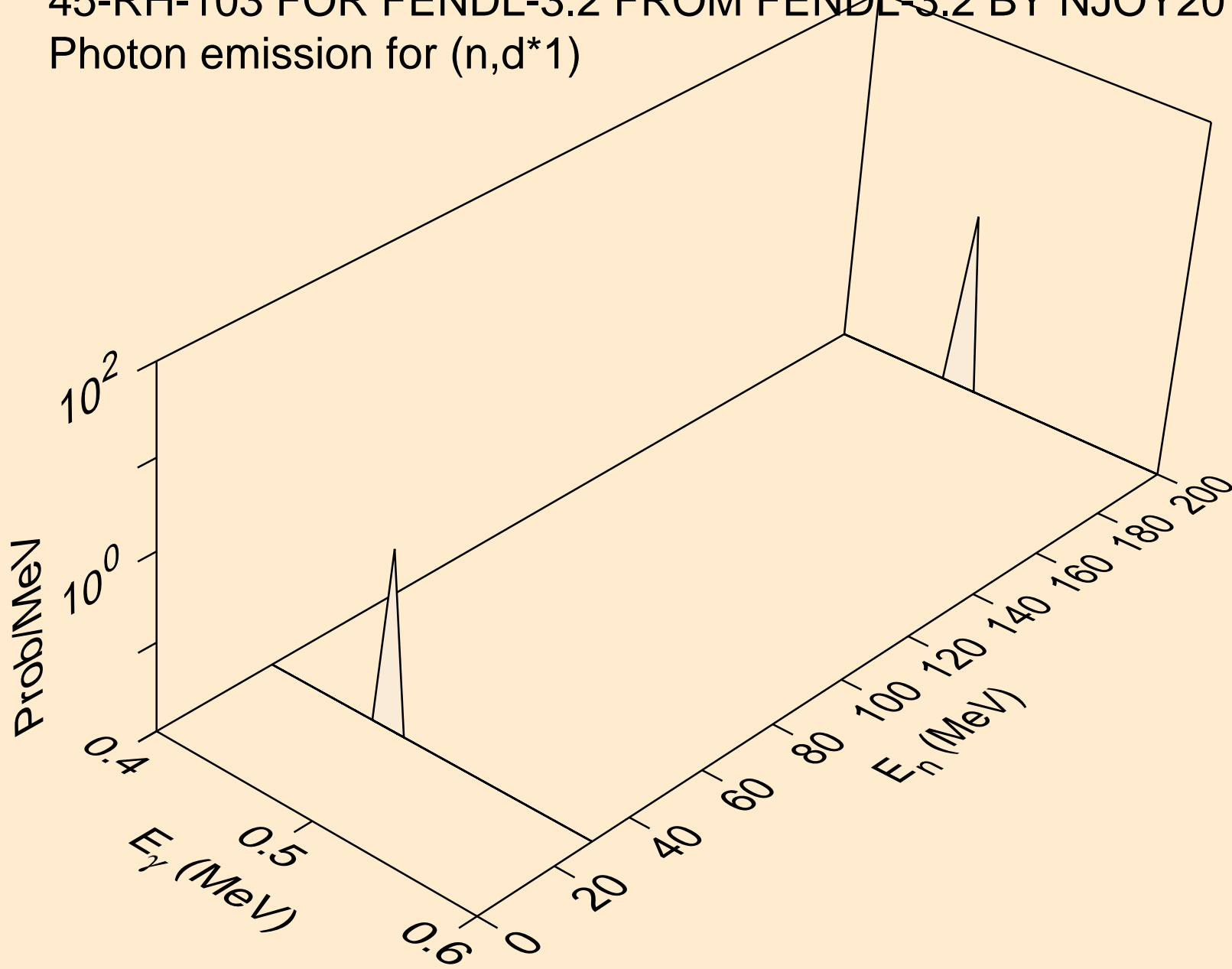

45-RH-103 FOR FENDL-3.2 FROM FENDL-3.2 BY NJOY2016.60+ C
Photon emission for (n,d*2)

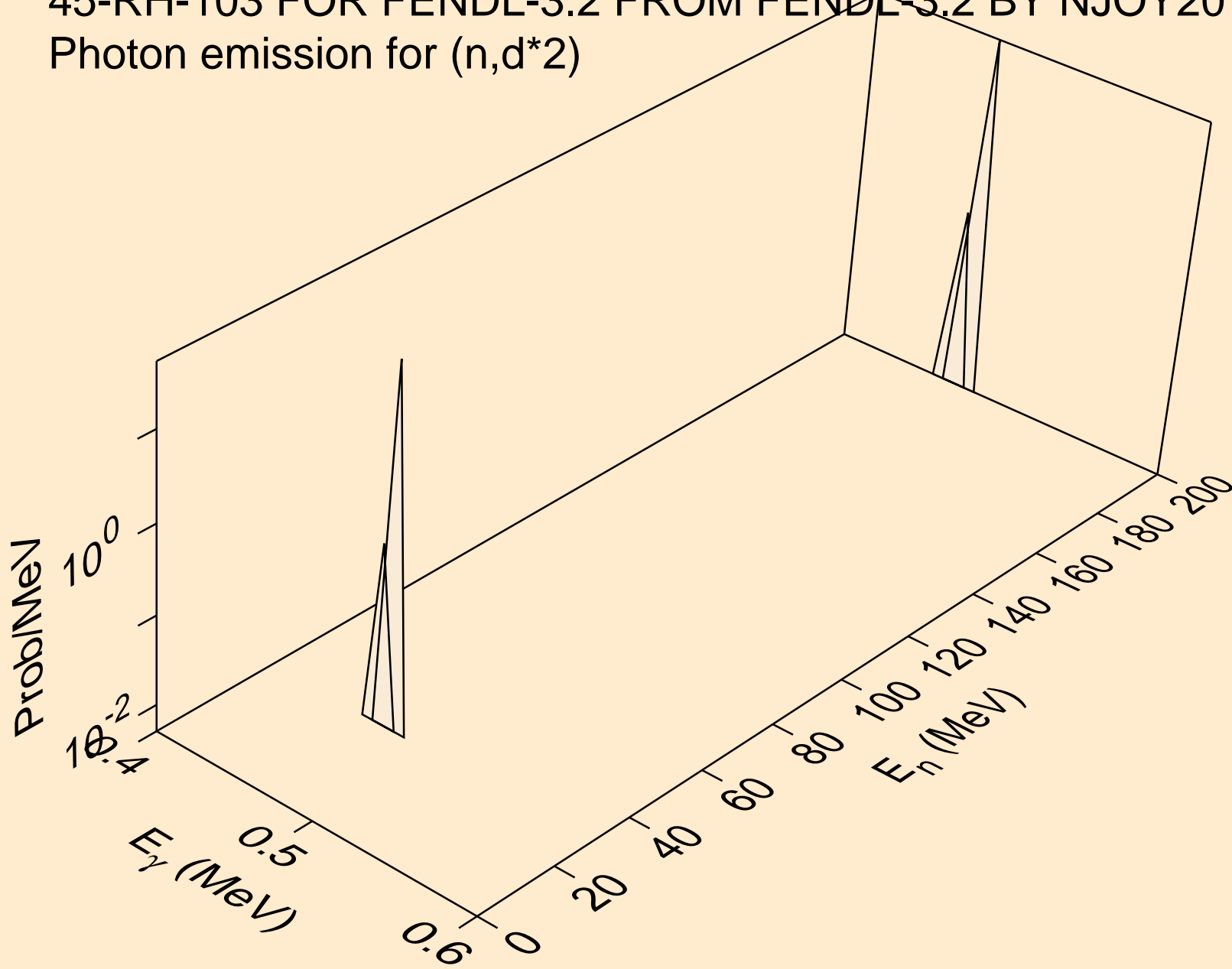

45-RH-103 FOR FENDL-3.2 FROM FENDL-3.2 BY NJOY2016.60+ C
Photon emission for (n,d*3)

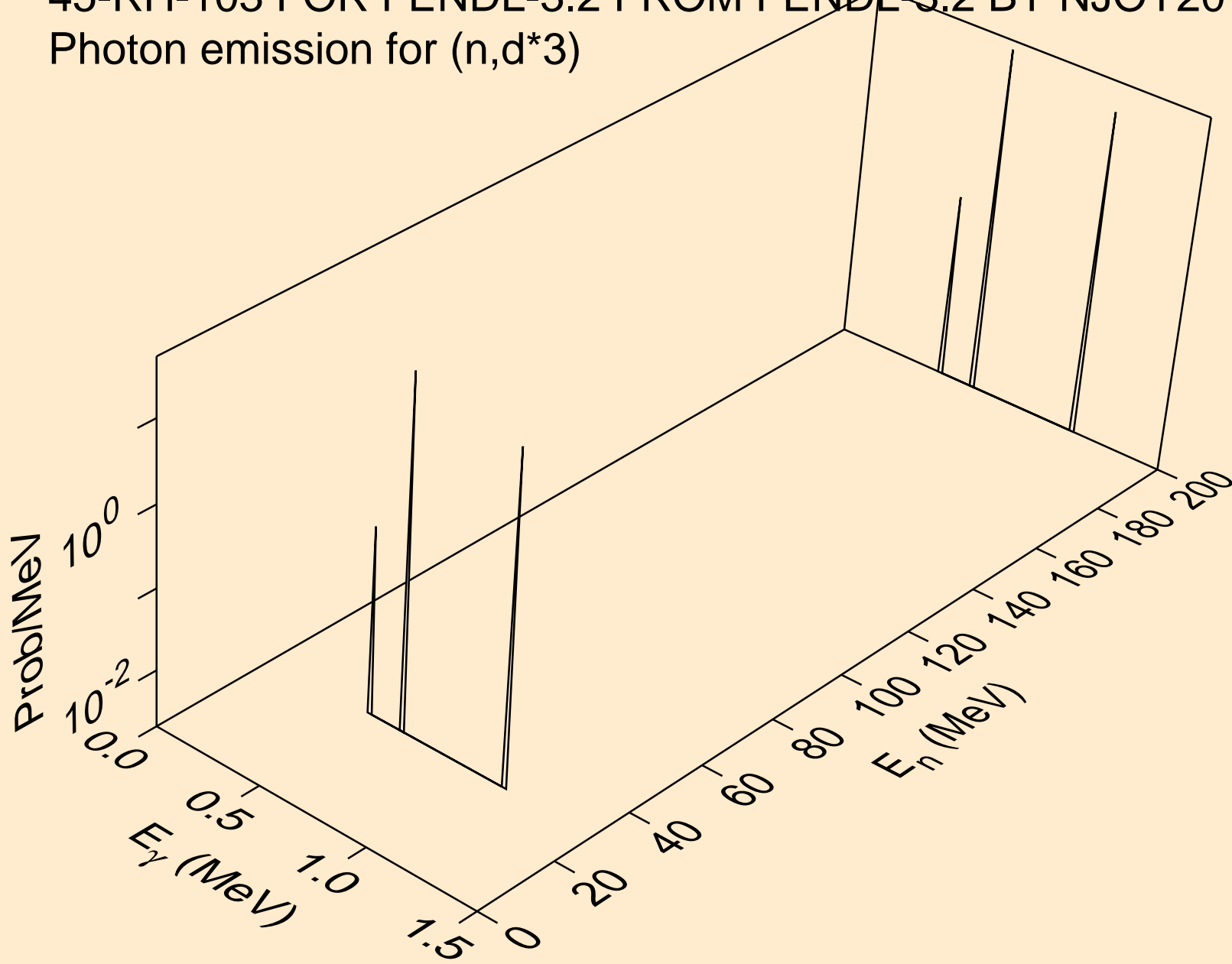

45-RH-103 FOR FENDL-3.2 FROM FENDL-3.2 BY NJOY2016.60+ C
Photon emission for (n,d*4)

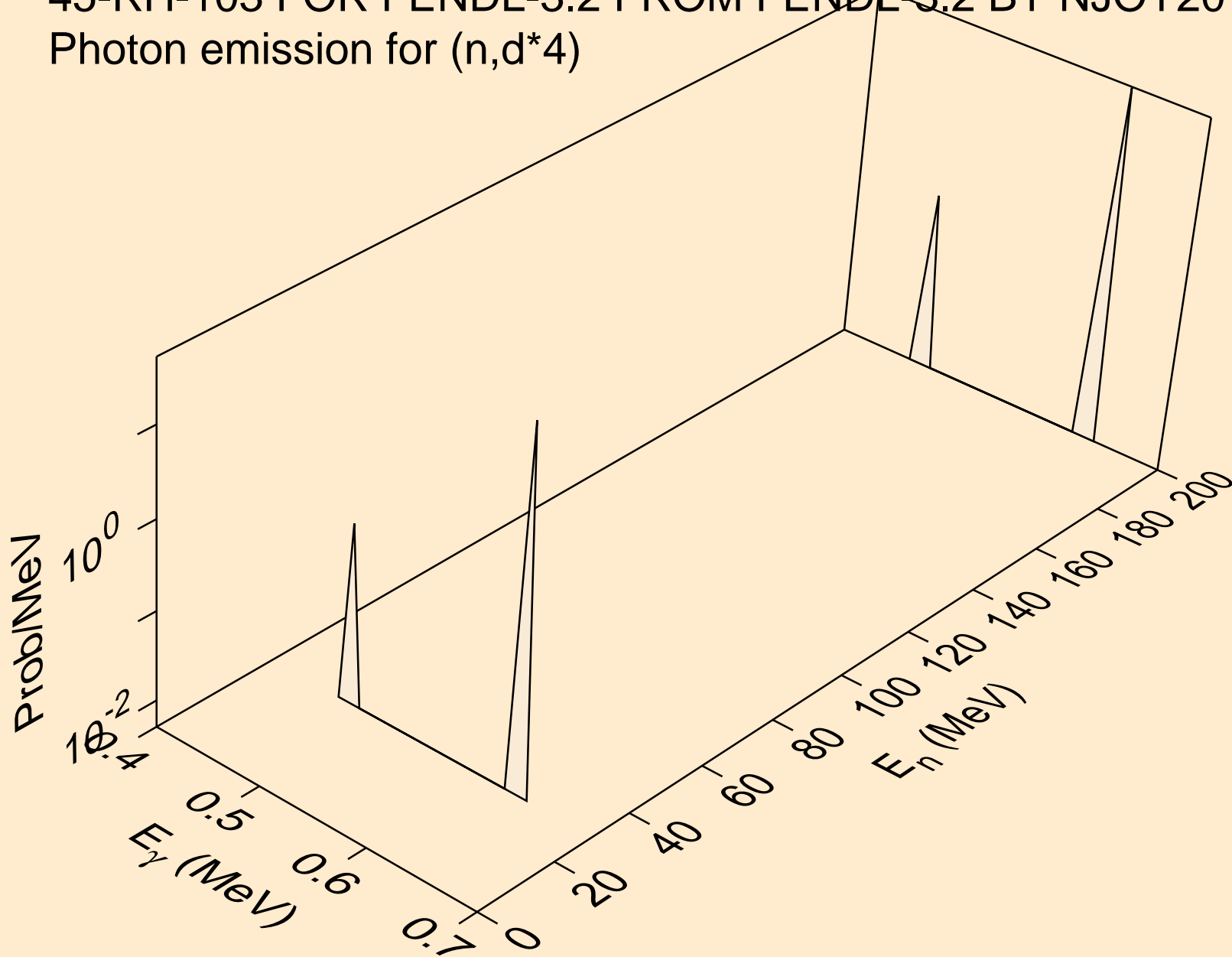

45-RH-103 FOR FENDL-3.2 FROM FENDL-3.2 BY NJOY2016.60+ C
Photon emission for (n,d*5)

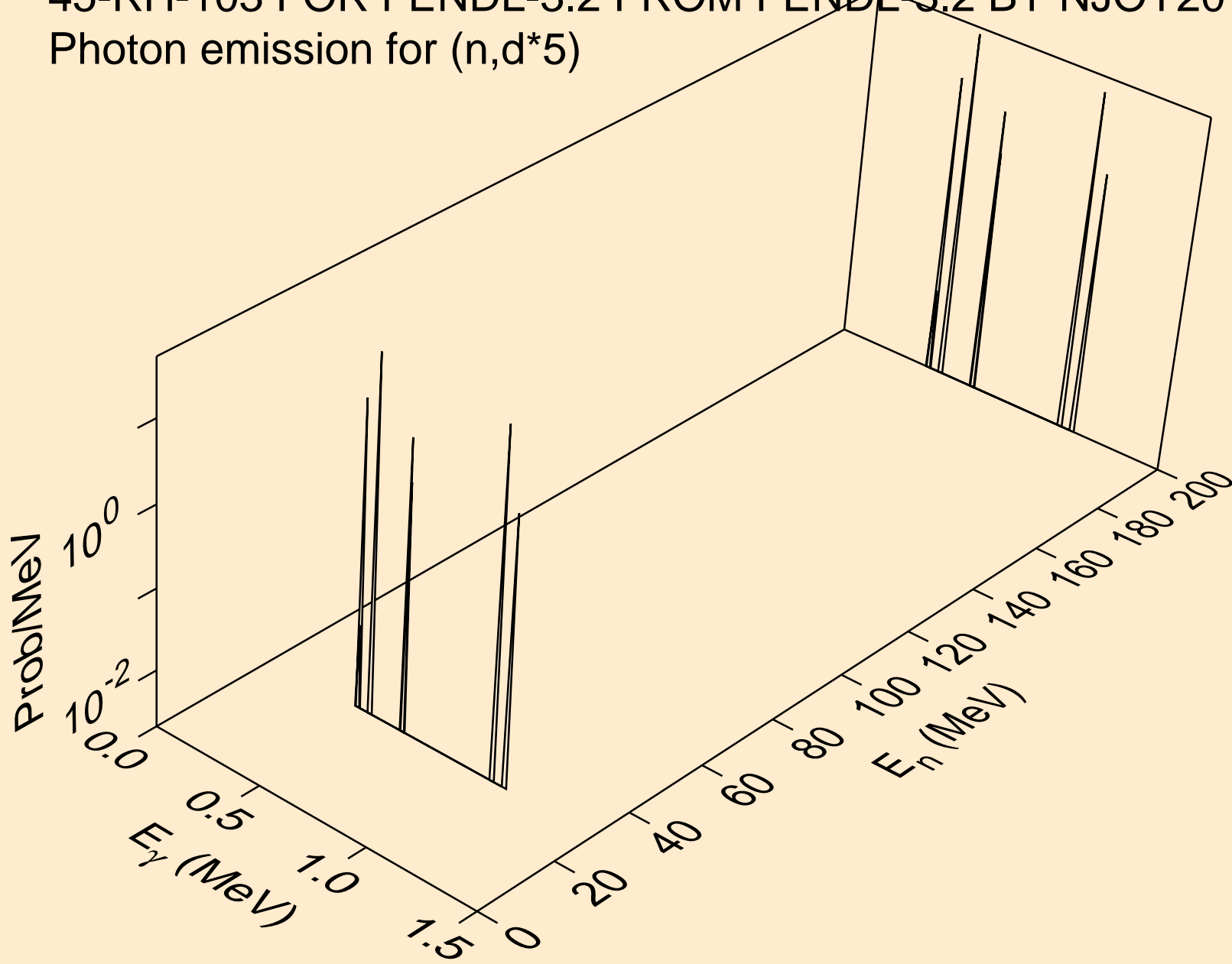

45-RH-103 FOR FENDL-3.2 FROM FENDL-3.2 BY NJOY2016.60+ C
Photon emission for (n,d*6)

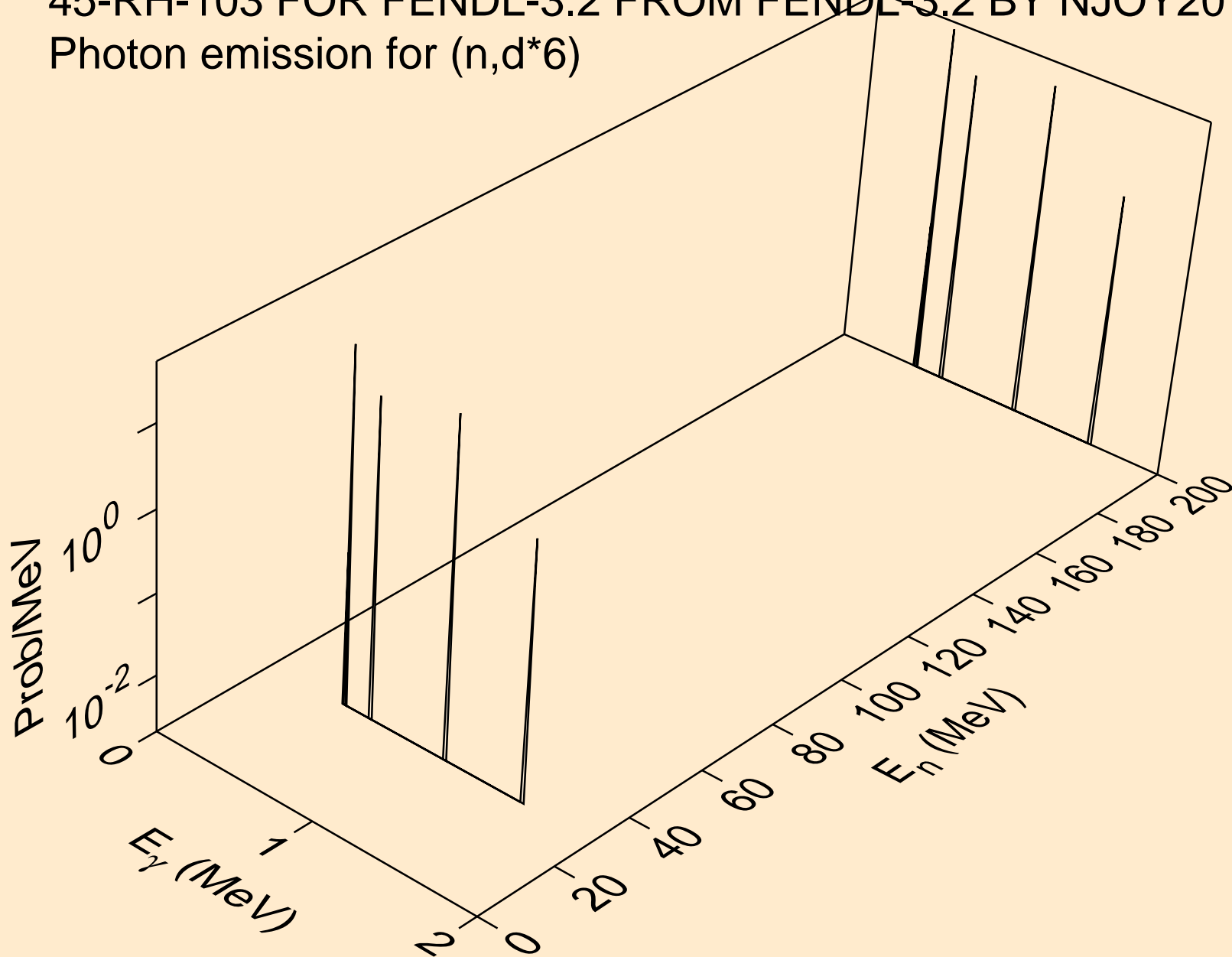

45-RH-103 FOR FENDL-3.2 FROM FENDL-3.2 BY NJOY2016.60+ C
Photon emission for (n,d*7)

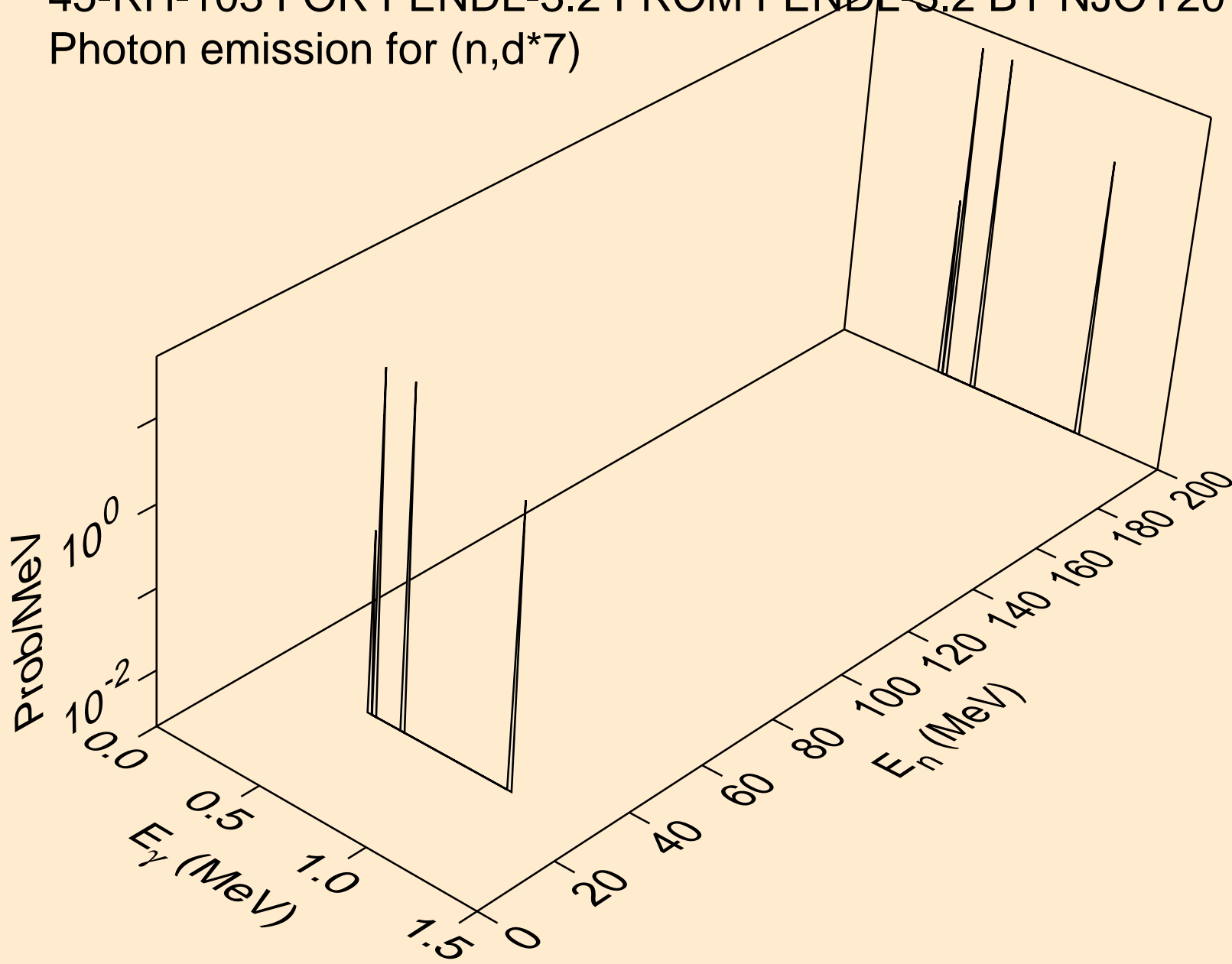

45-RH-103 FOR FENDL-3.2 FROM FENDL-3.2 BY NJOY2016.60+ C
Photon emission for (n,d*8)

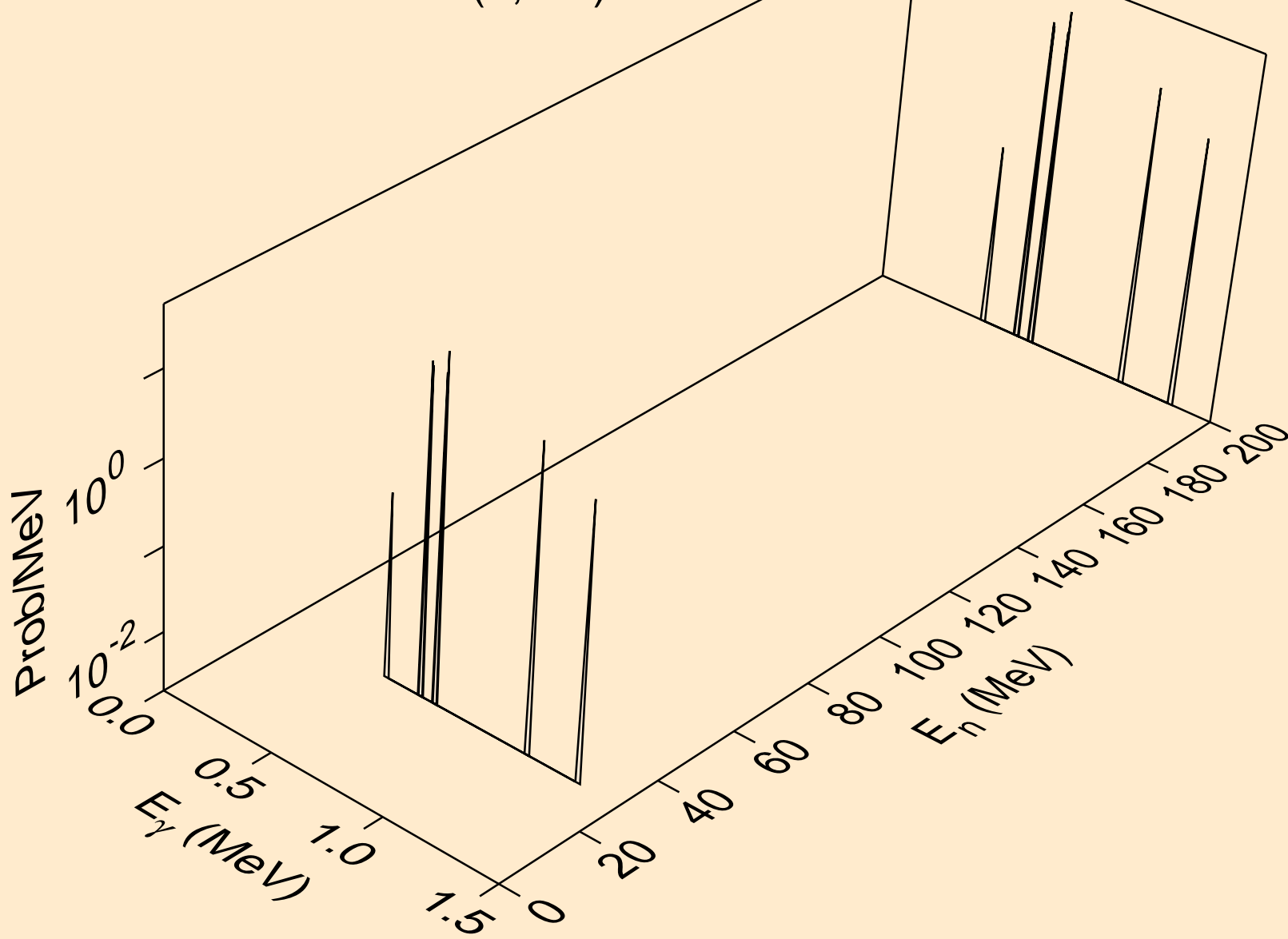

45-RH-103 FOR FENDL-3.2 FROM FENDL-3.2 BY NJOY2016.60+ C
Photon emission for (n,d*9)

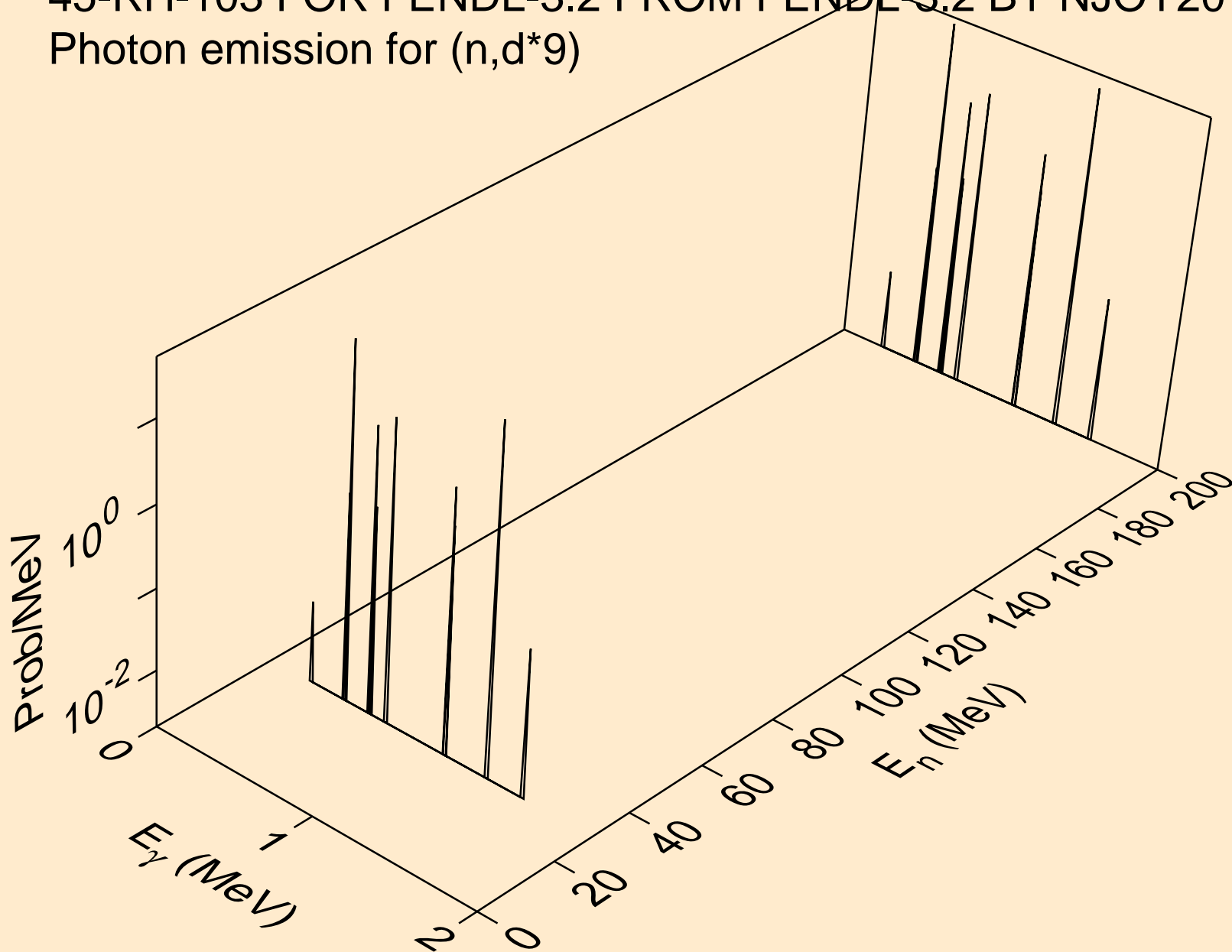

45-RH-103 FOR FENDL-3.2 FROM FENDL-3.2 BY NJOY2016.60+ C
Photon emission for (n,d*10)

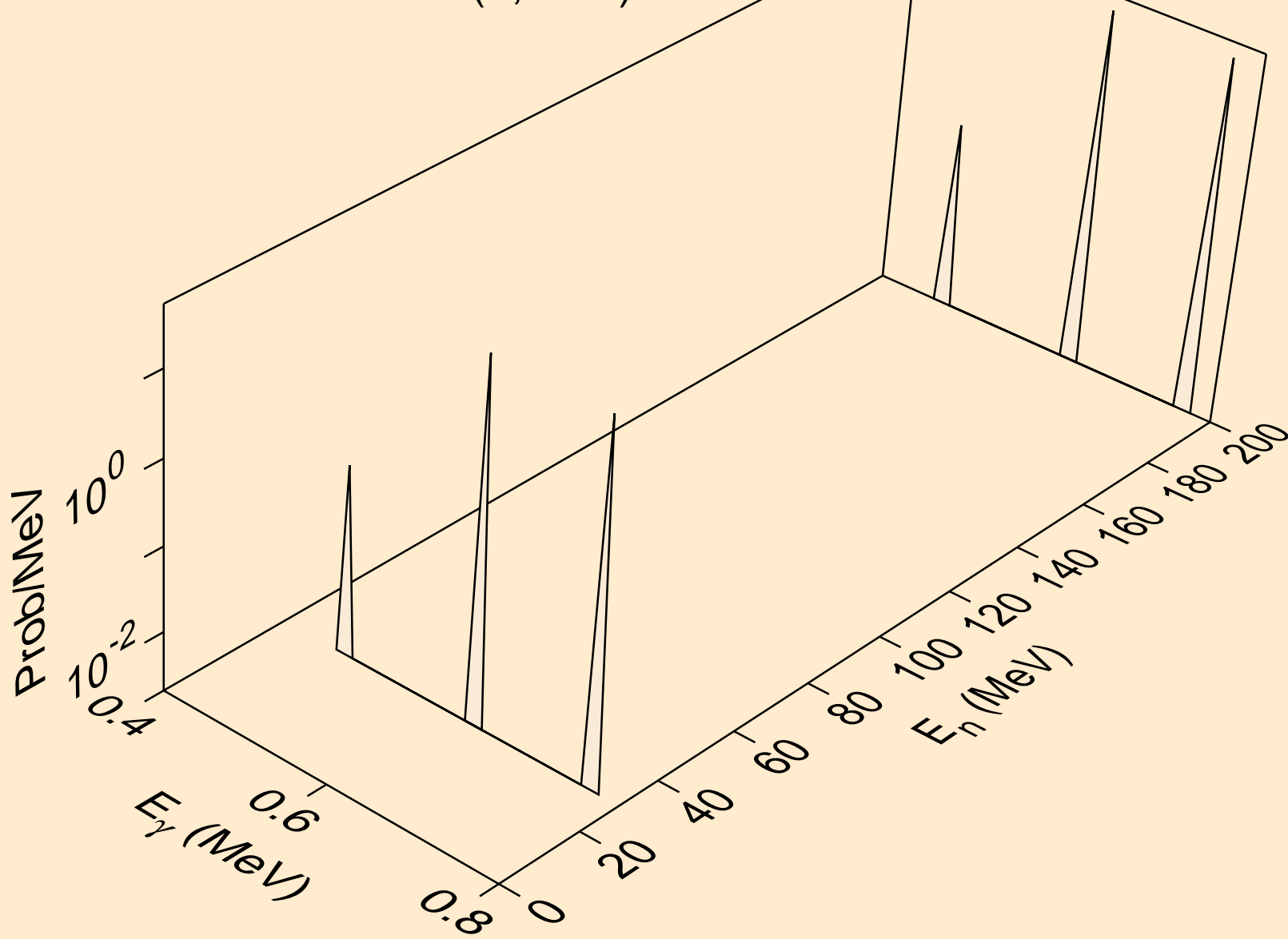

45-RH-103 FOR FENDL-3.2 FROM FENDL-3.2 BY NJOY2016.60+ C
Photon emission for (n,d*11)

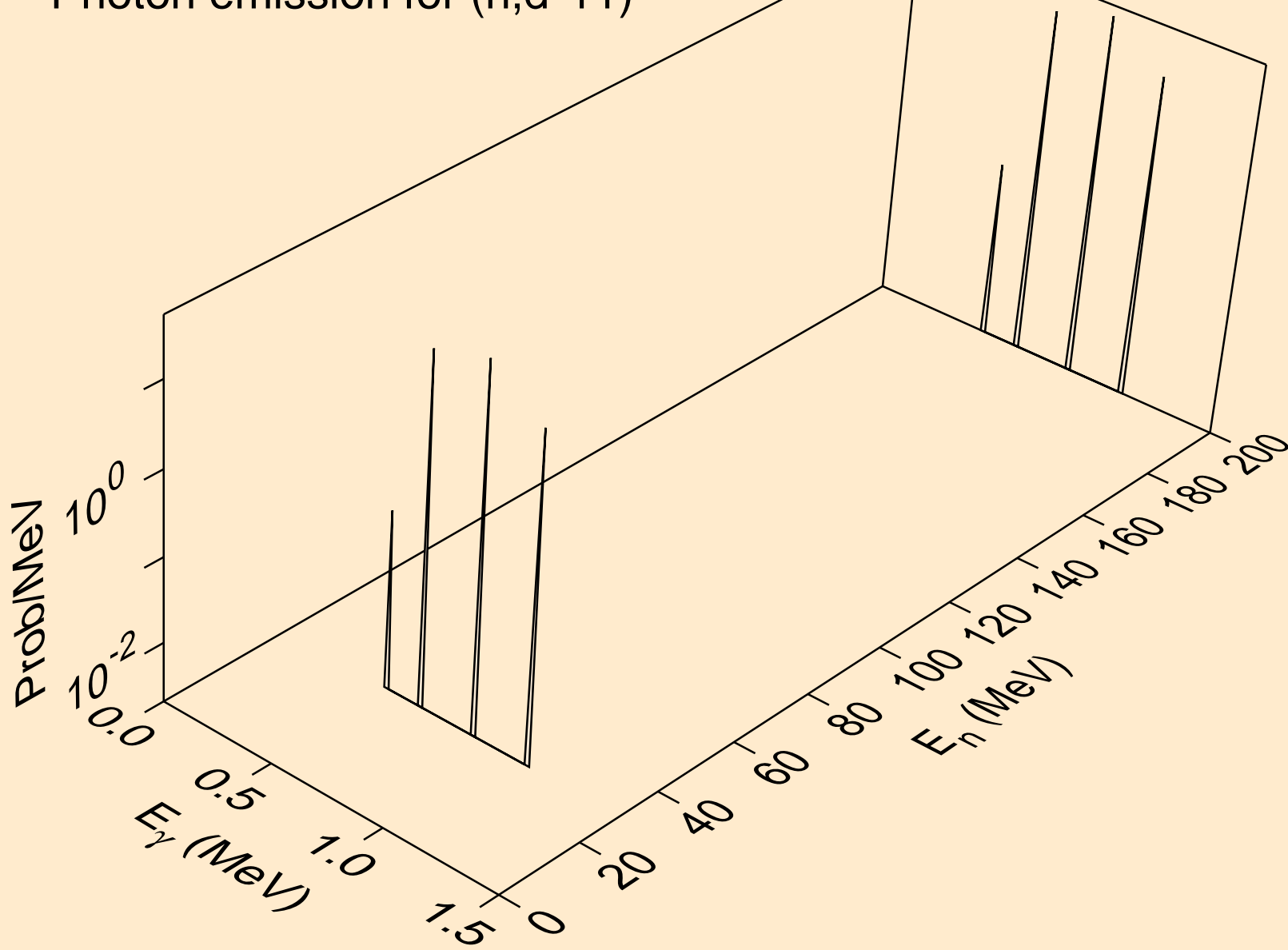

45-RH-103 FOR FENDL-3.2 FROM FENDL-3.2 BY NJOY2016.60+ C
Photon emission for (n,d*12)

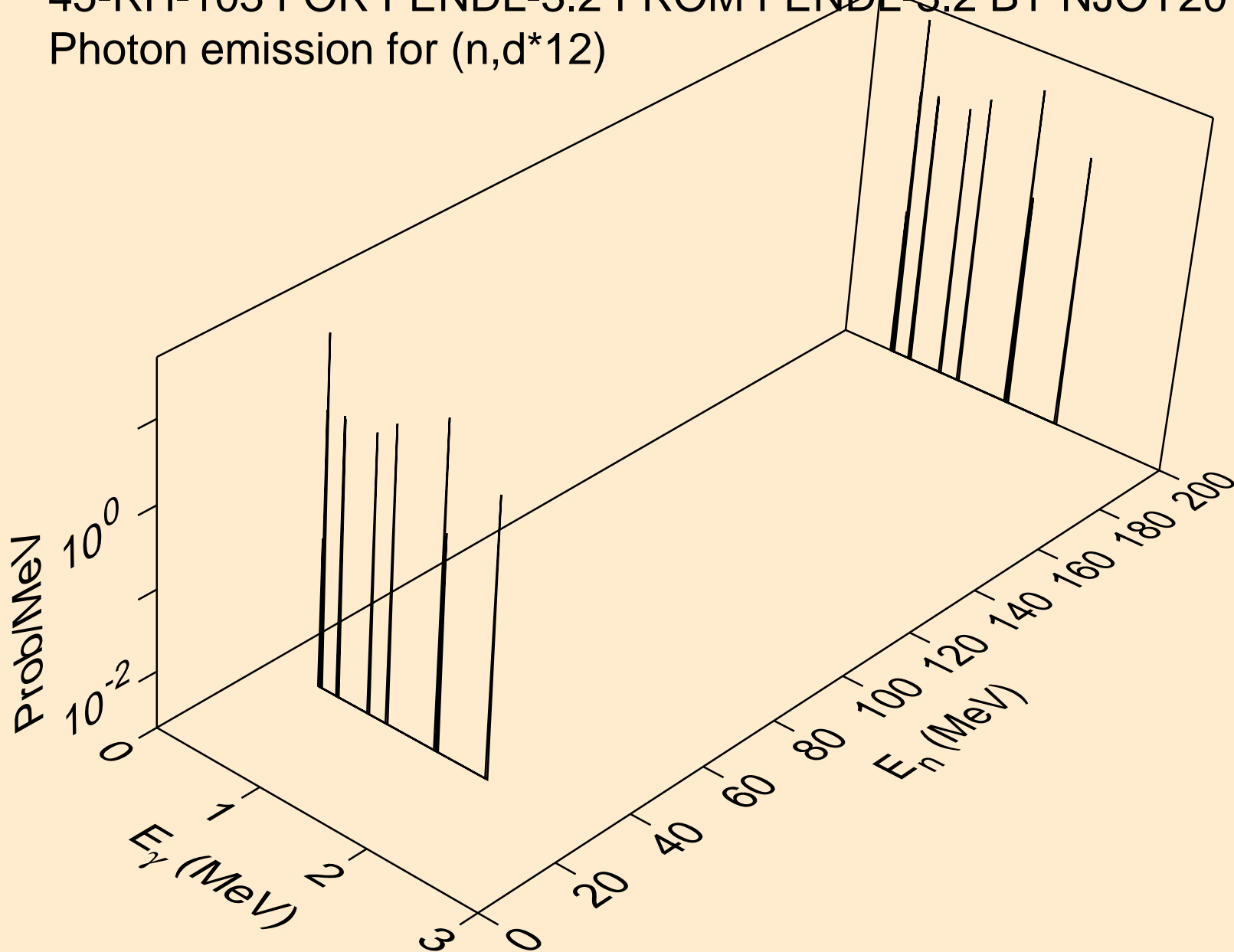

45-RH-103 FOR FENDL-3.2 FROM FENDL-3.2 BY NJOY2016.60+ C
Photon emission for (n,d*13)

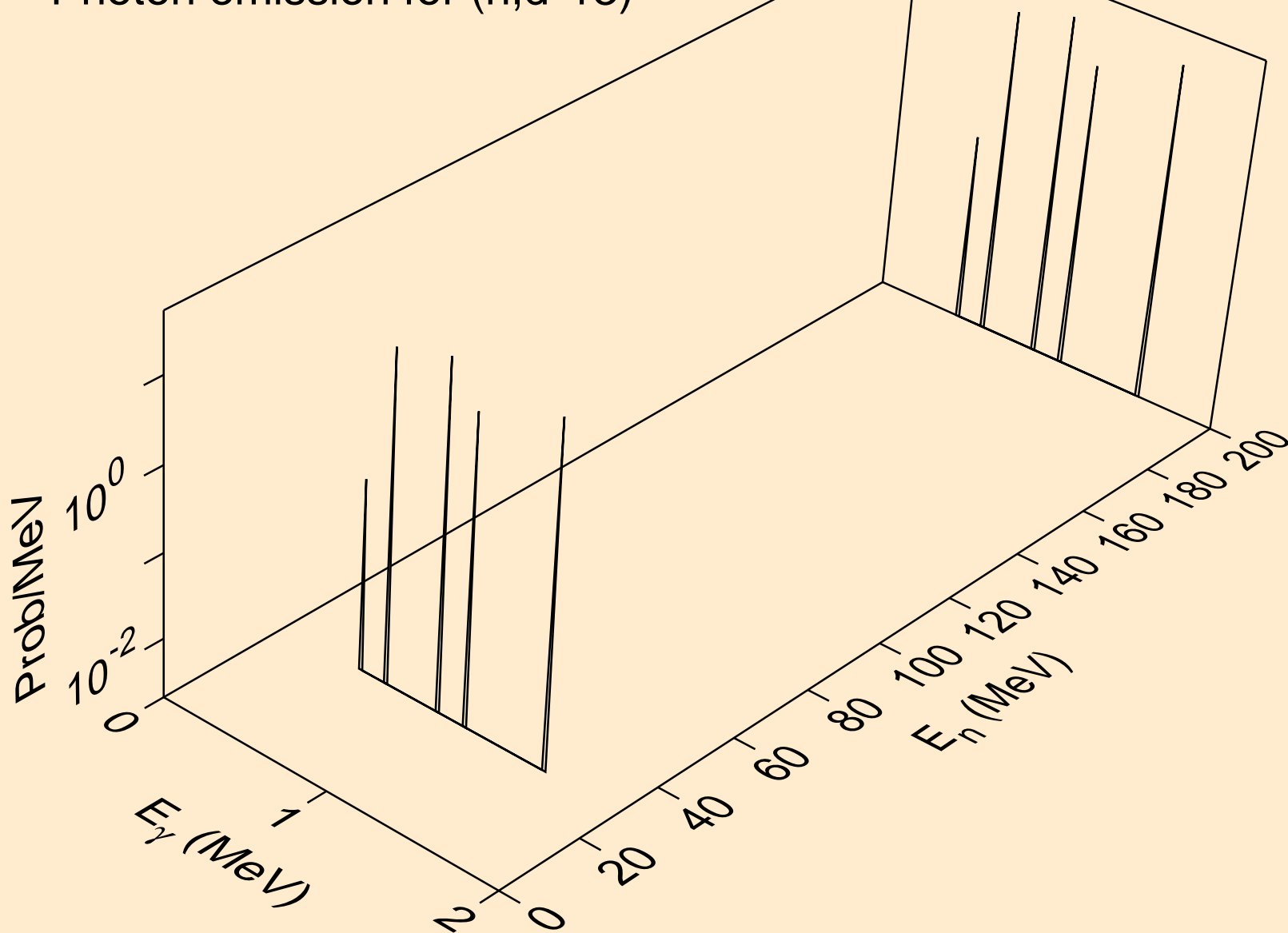

45-RH-103 FOR FENDL-3.2 FROM FENDL-3.2 BY NJOY2016.60+ C
Photon emission for (n,d*14)

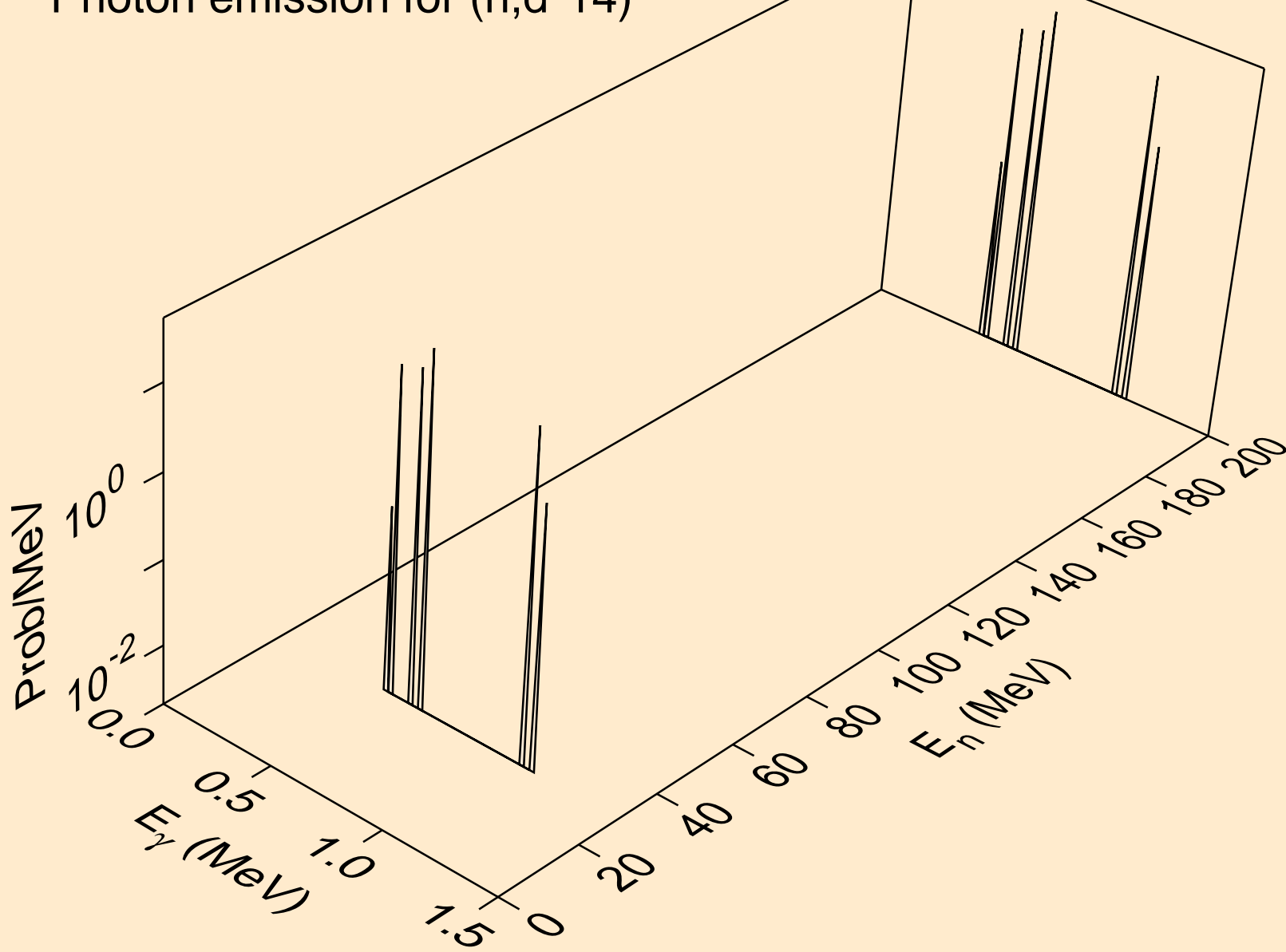

45-RH-103 FOR FENDL-3.2 FROM FENDL-3.2 BY NJOY2016.60+ C
Photon emission for (n,d*15)

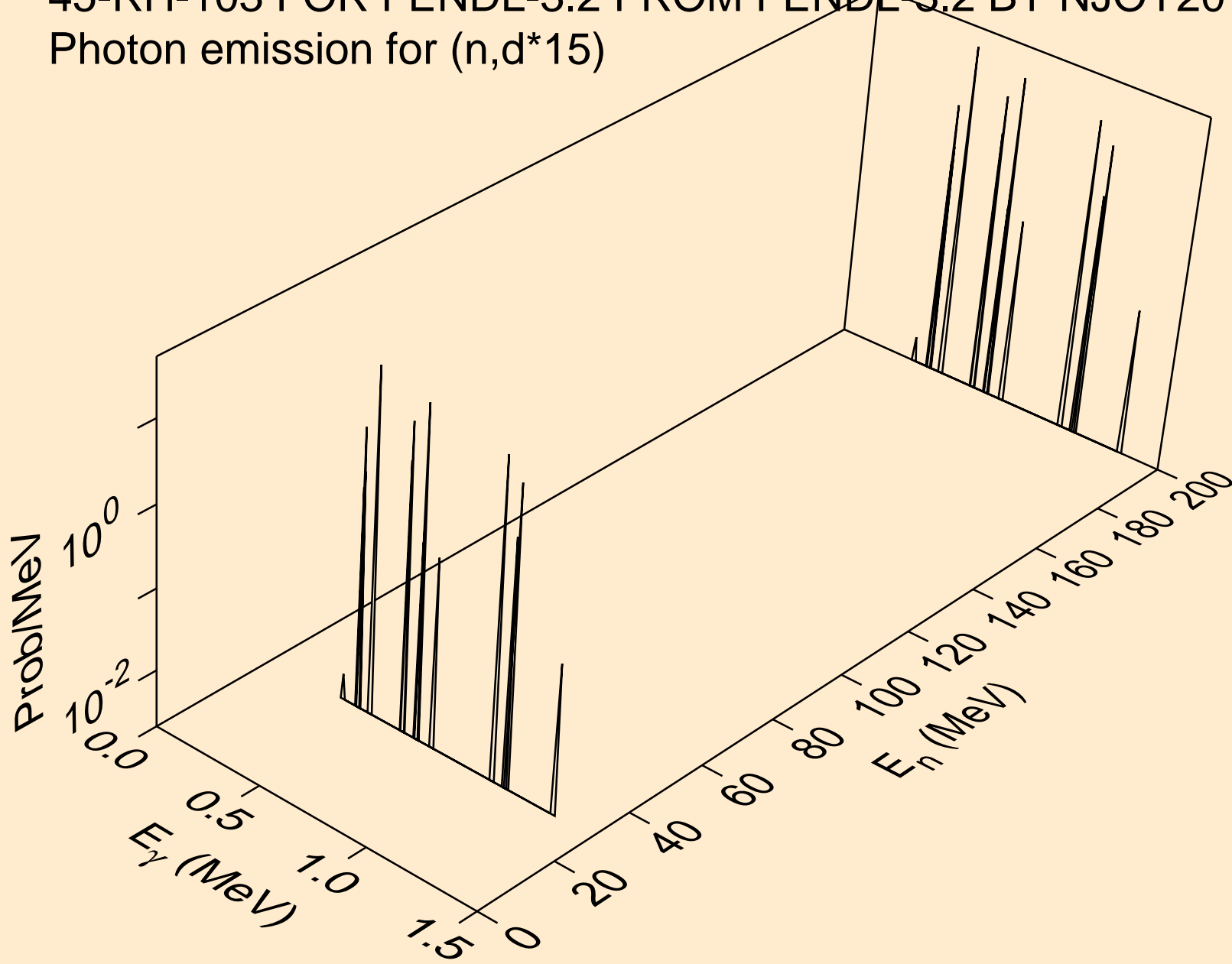

45-RH-103 FOR FENDL-3.2 FROM FENDL-3.2 BY NJOY2016.60+ C
Photon emission for (n,d*c)

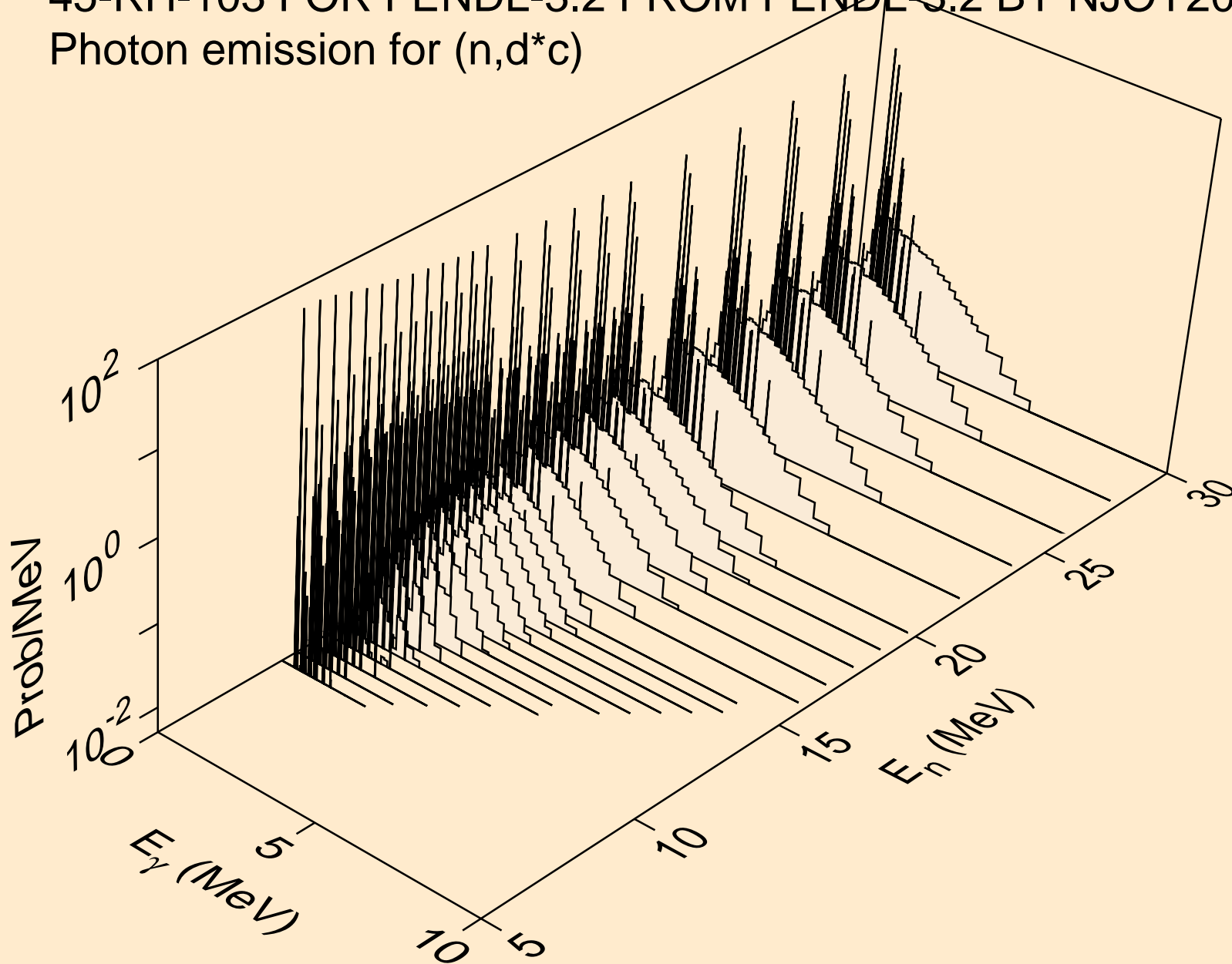

45-RH-103 FOR FENDL-3.2 FROM FENDL-3.2 BY NJOY2016.60+ C
Photon emission for (n,t*1)

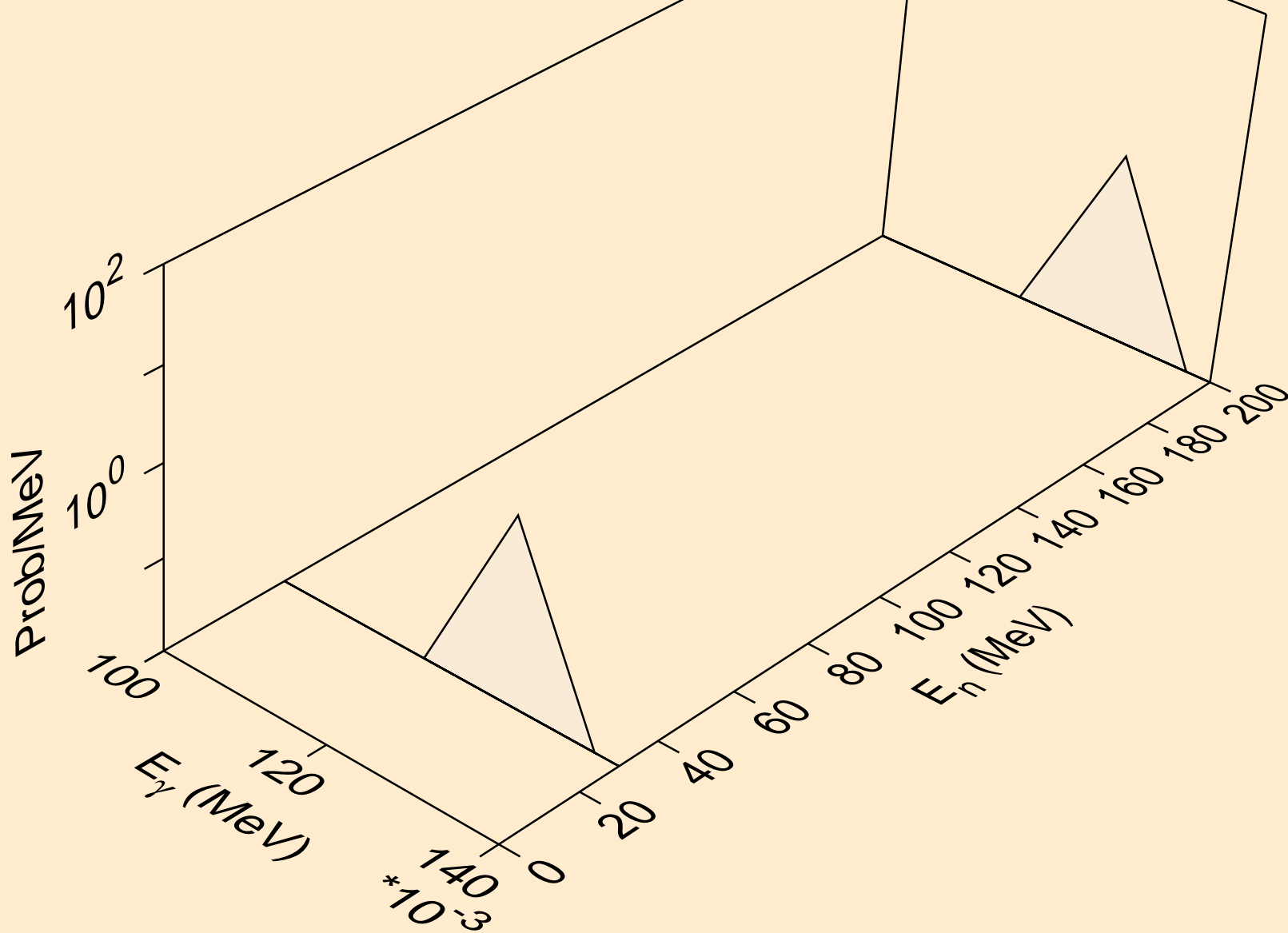

45-RH-103 FOR FENDL-3.2 FROM FENDL-3.2 BY NJOY2016.60+ C
Photon emission for (n,t*2)

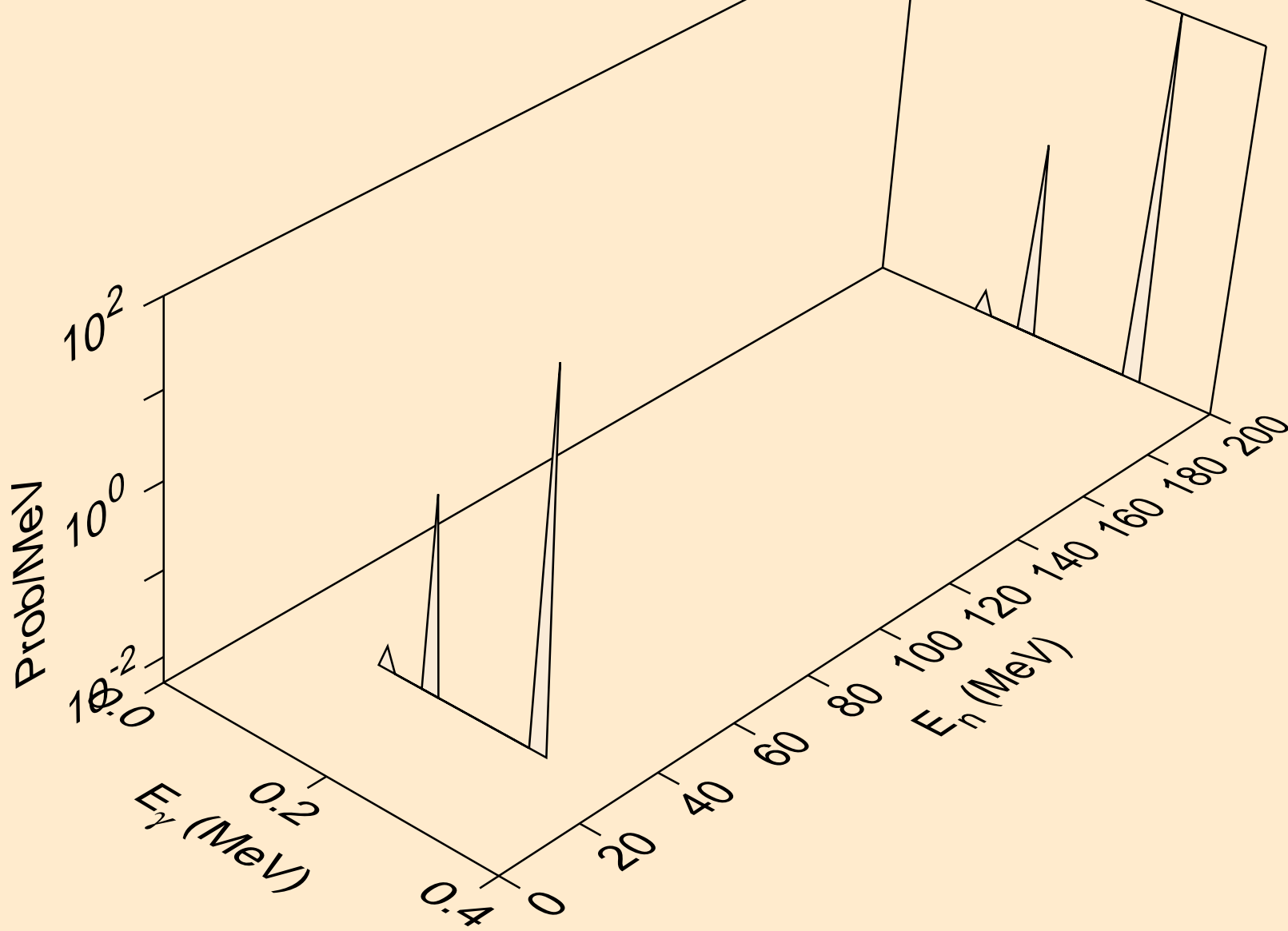

45-RH-103 FOR FENDL-3.2 FROM FENDL-3.2 BY NJOY2016.60+ C
Photon emission for (n,t*3)

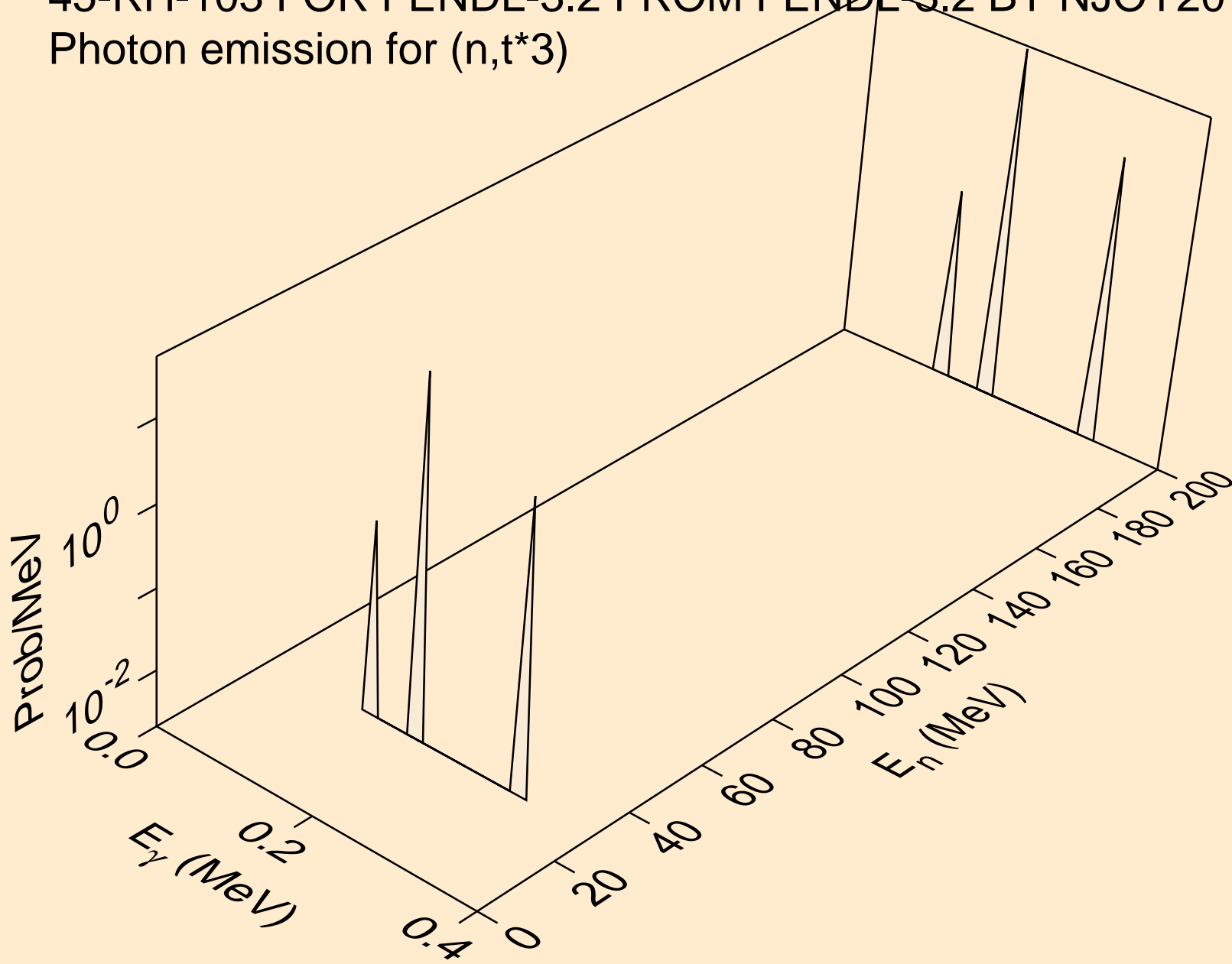

45-RH-103 FOR FENDL-3.2 FROM FENDL-3.2 BY NJOY2016.60+ C
Photon emission for (n,t*4)

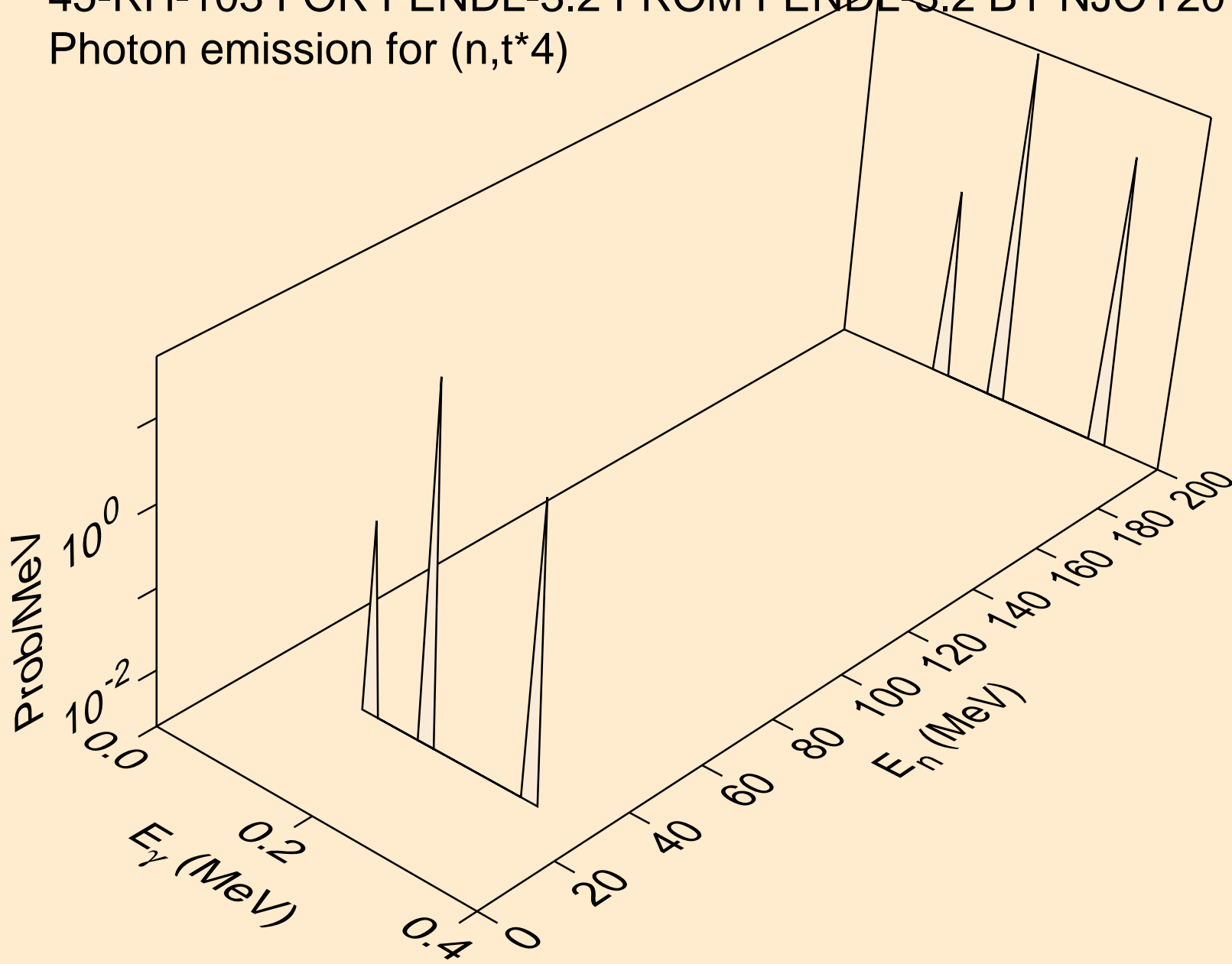

45-RH-103 FOR FENDL-3.2 FROM FENDL-3.2 BY NJOY2016.60+ C
Photon emission for (n,t*5)

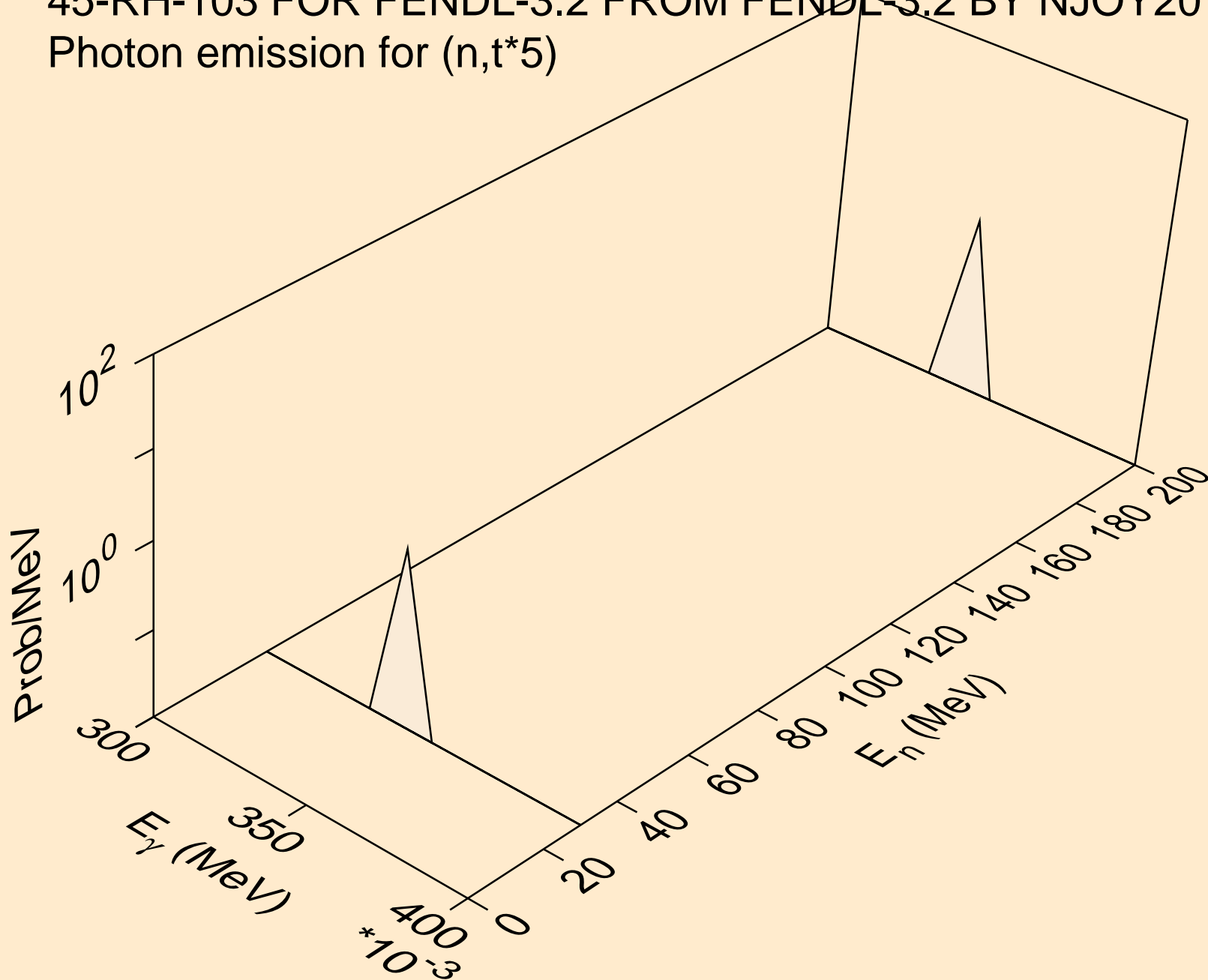

45-RH-103 FOR FENDL-3.2 FROM FENDL-3.2 BY NJOY2016.60+ C
Photon emission for (n,t*6)

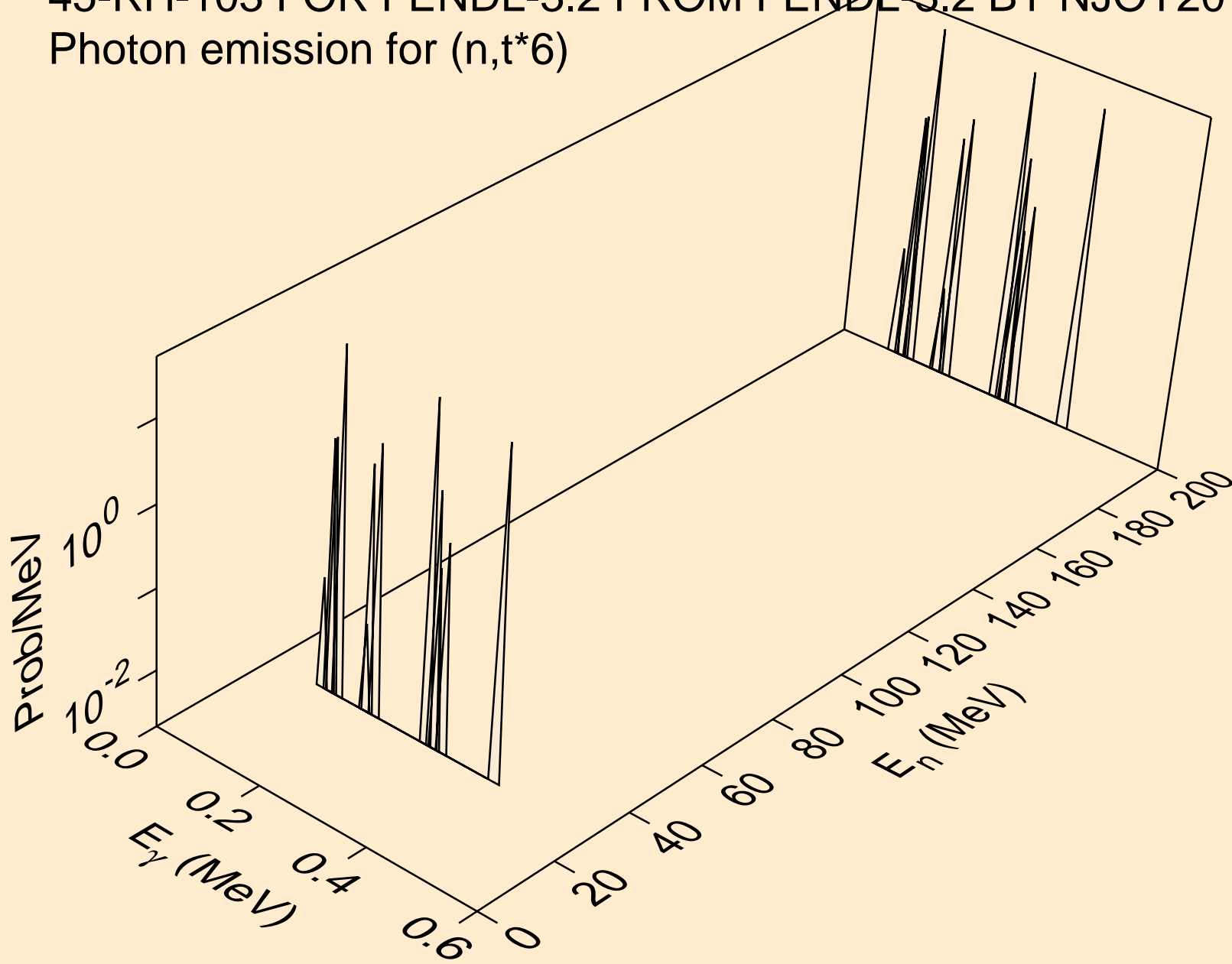

45-RH-103 FOR FENDL-3.2 FROM FENDL-3.2 BY NJOY2016.60+ C
Photon emission for (n,t*7)

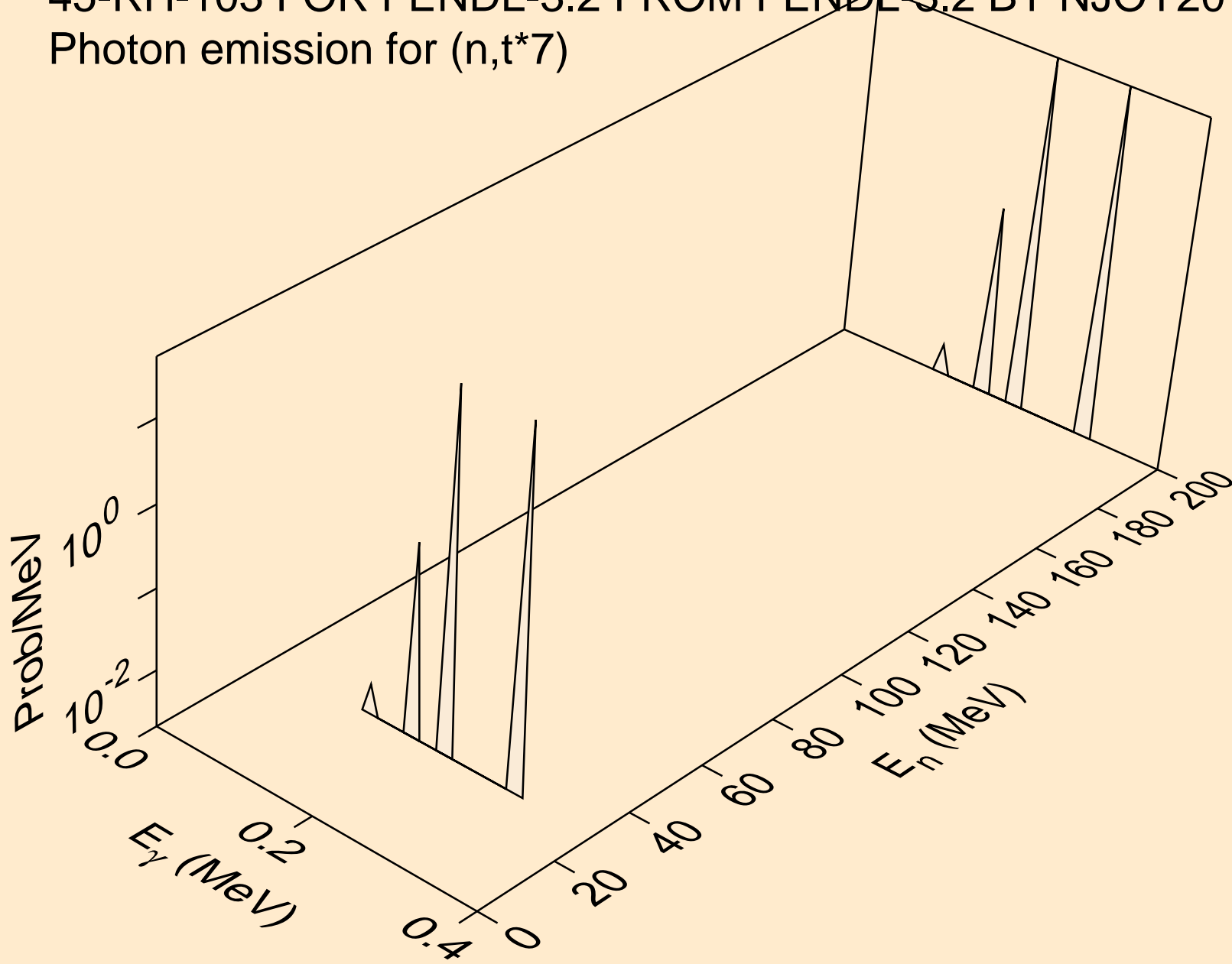

45-RH-103 FOR FENDL-3.2 FROM FENDL-3.2 BY NJOY2016.60+ C
Photon emission for (n,t*8)

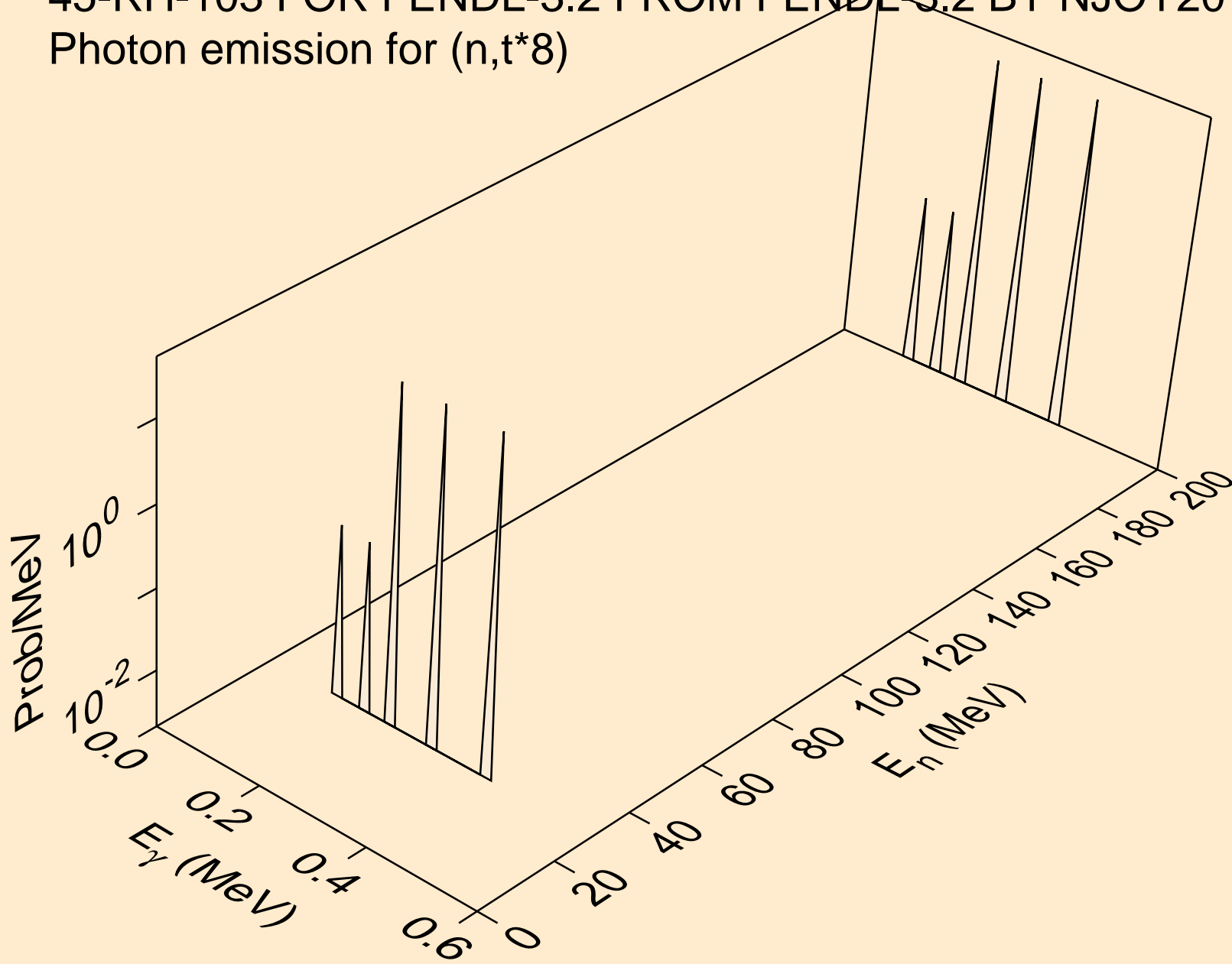

45-RH-103 FOR FENDL-3.2 FROM FENDL-3.2 BY NJOY2016.60+ C
Photon emission for (n,t*9)

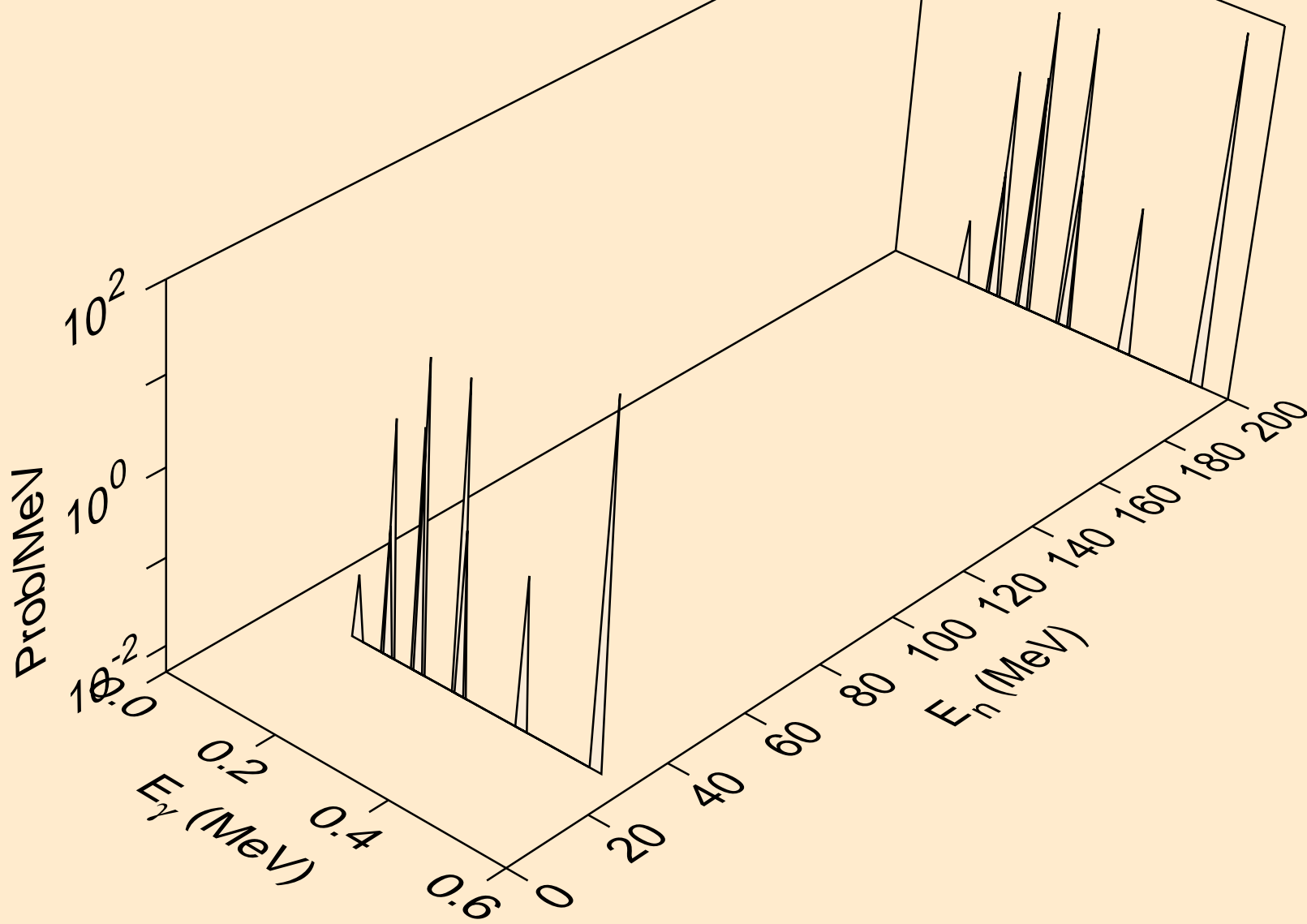

45-RH-103 FOR FENDL-3.2 FROM FENDL-3.2 BY NJOY2016.60+ C
Photon emission for (n,t*10)

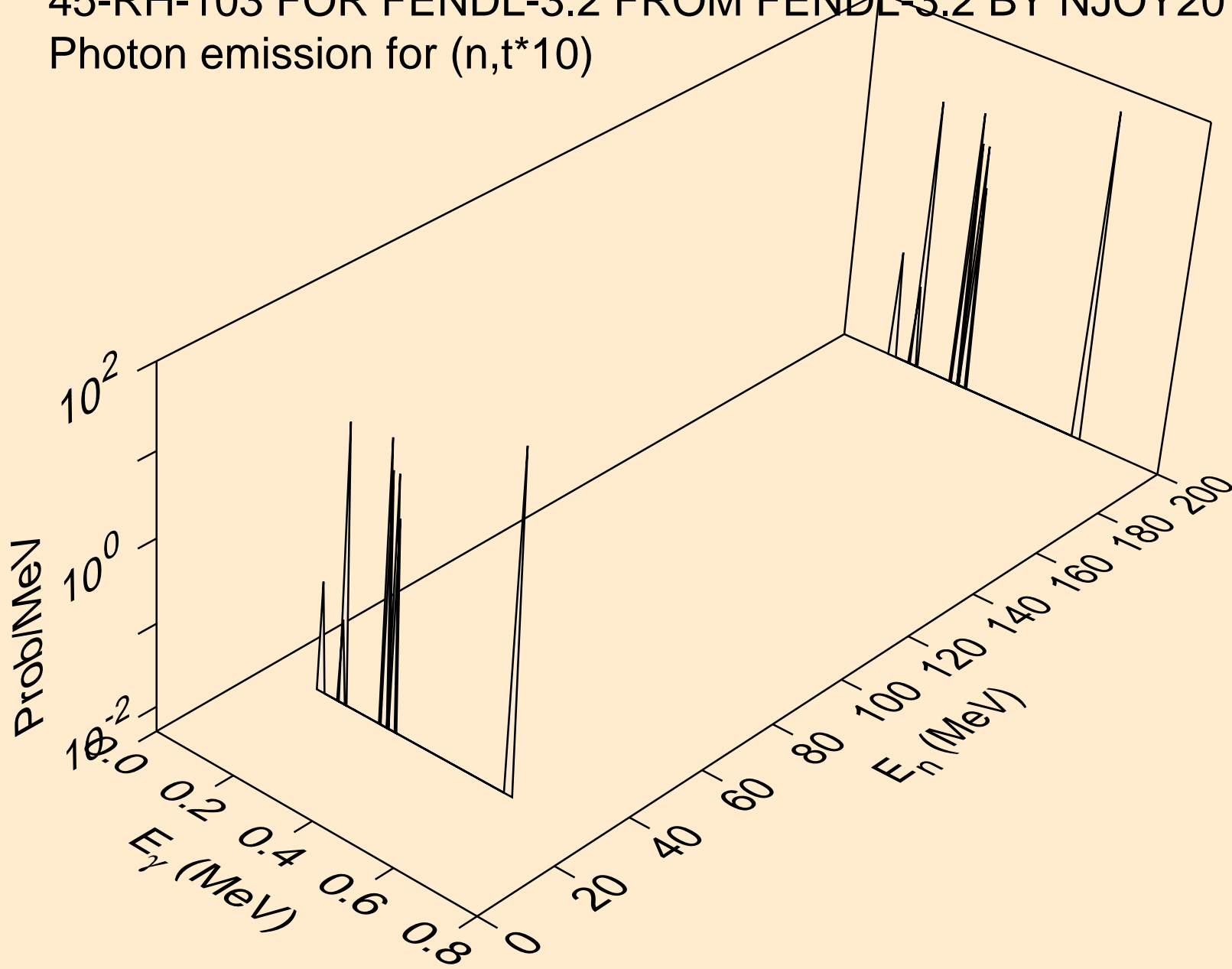

45-RH-103 FOR FENDL-3.2 FROM FENDL-3.2 BY NJOY2016.60+ C
Photon emission for (n,t*11)

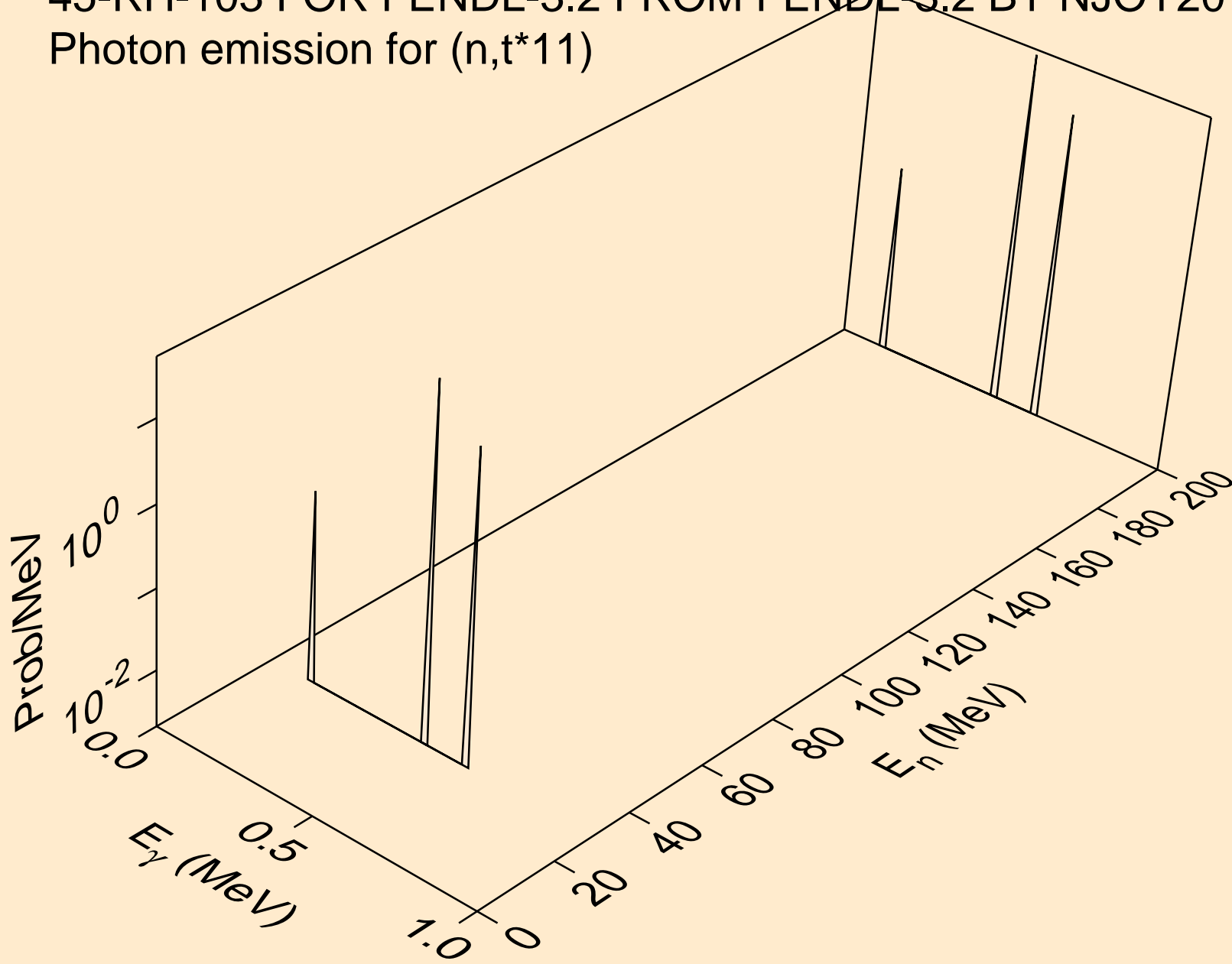

45-RH-103 FOR FENDL-3.2 FROM FENDL-3.2 BY NJOY2016.60+ C
Photon emission for (n,t*12)

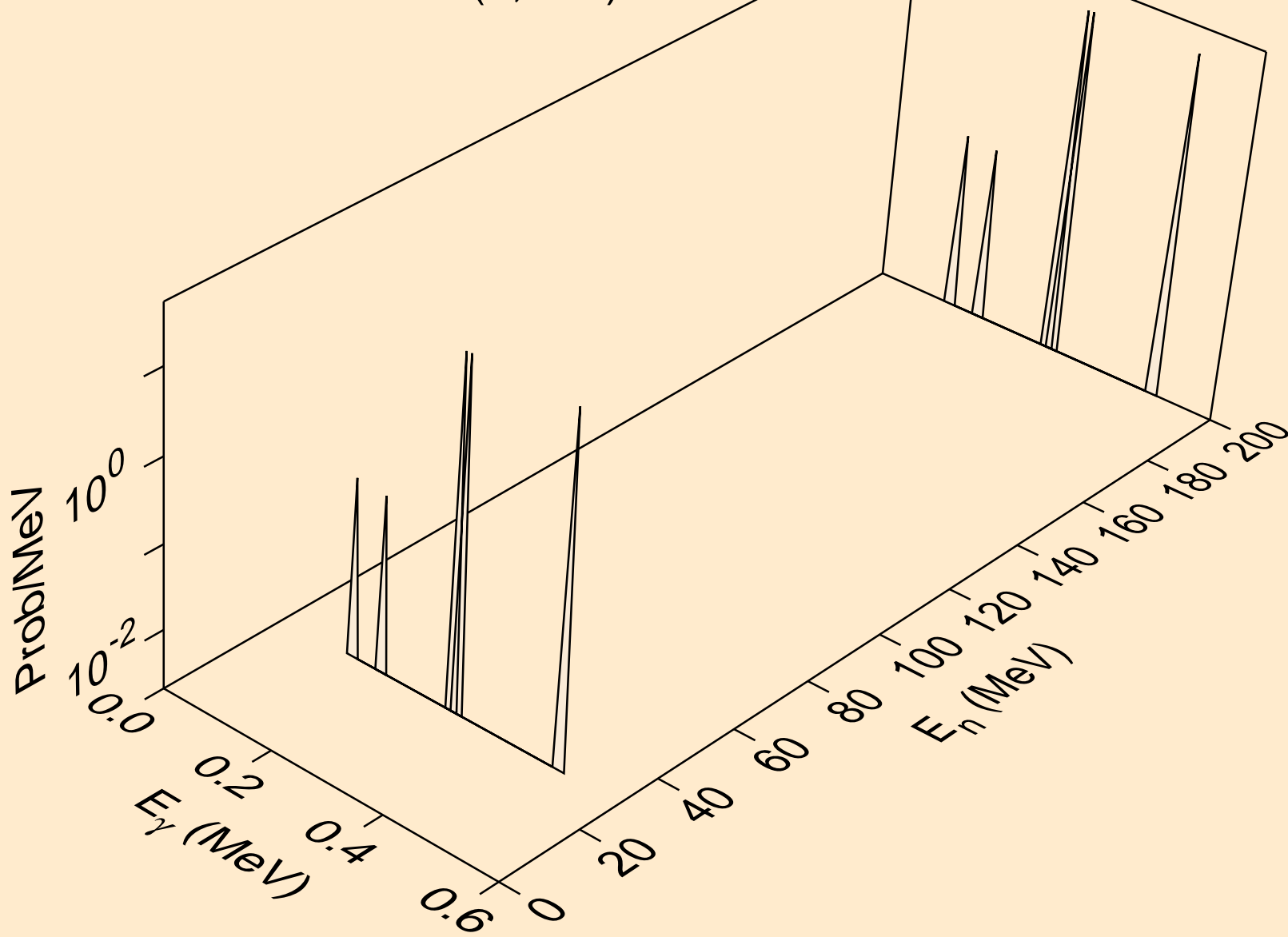

45-RH-103 FOR FENDL-3.2 FROM FENDL-3.2 BY NJOY2016.60+ C
Photon emission for (n,t*13)

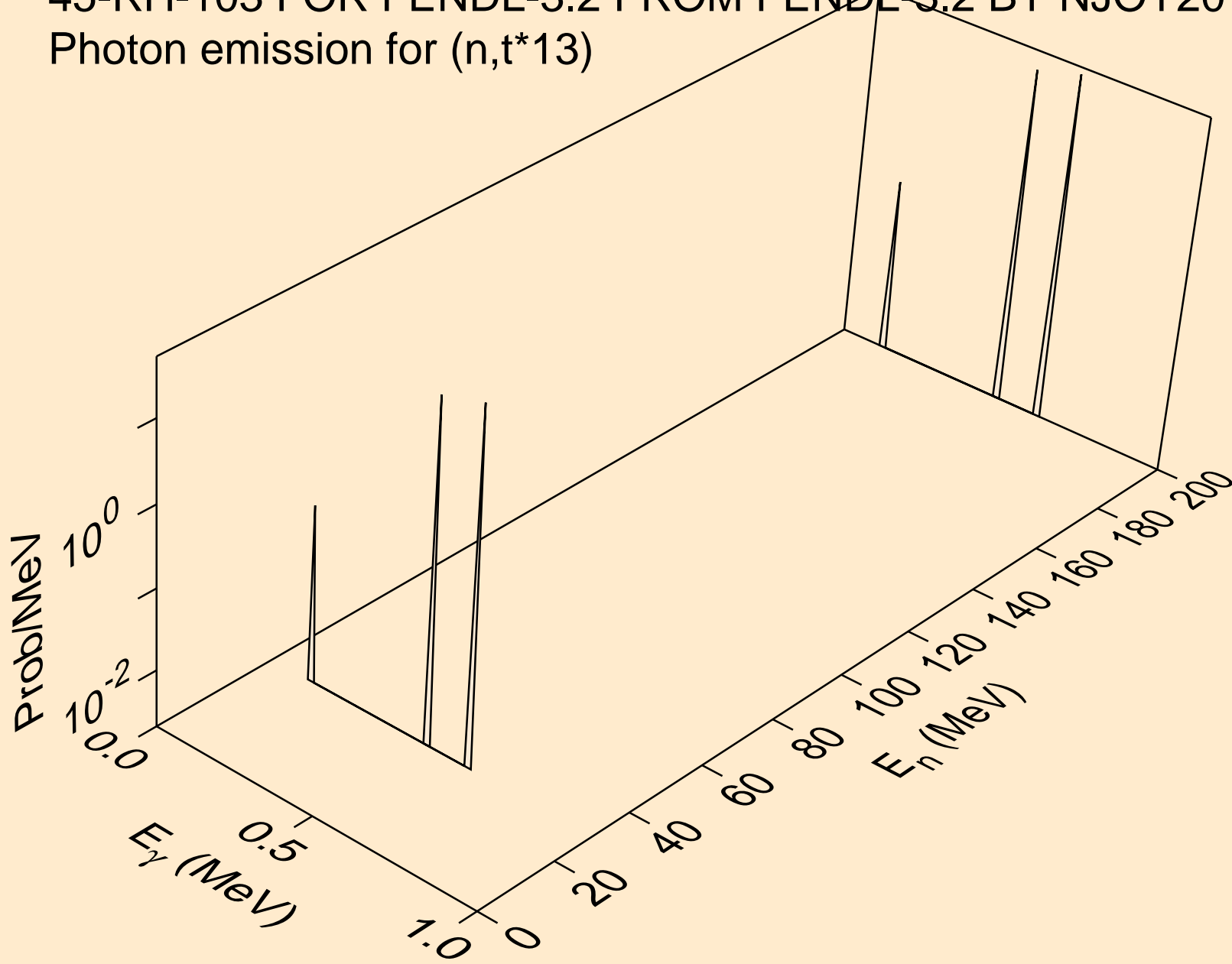

45-RH-103 FOR FENDL-3.2 FROM FENDL-3.2 BY NJOY2016.60+ C
Photon emission for (n,t*14)

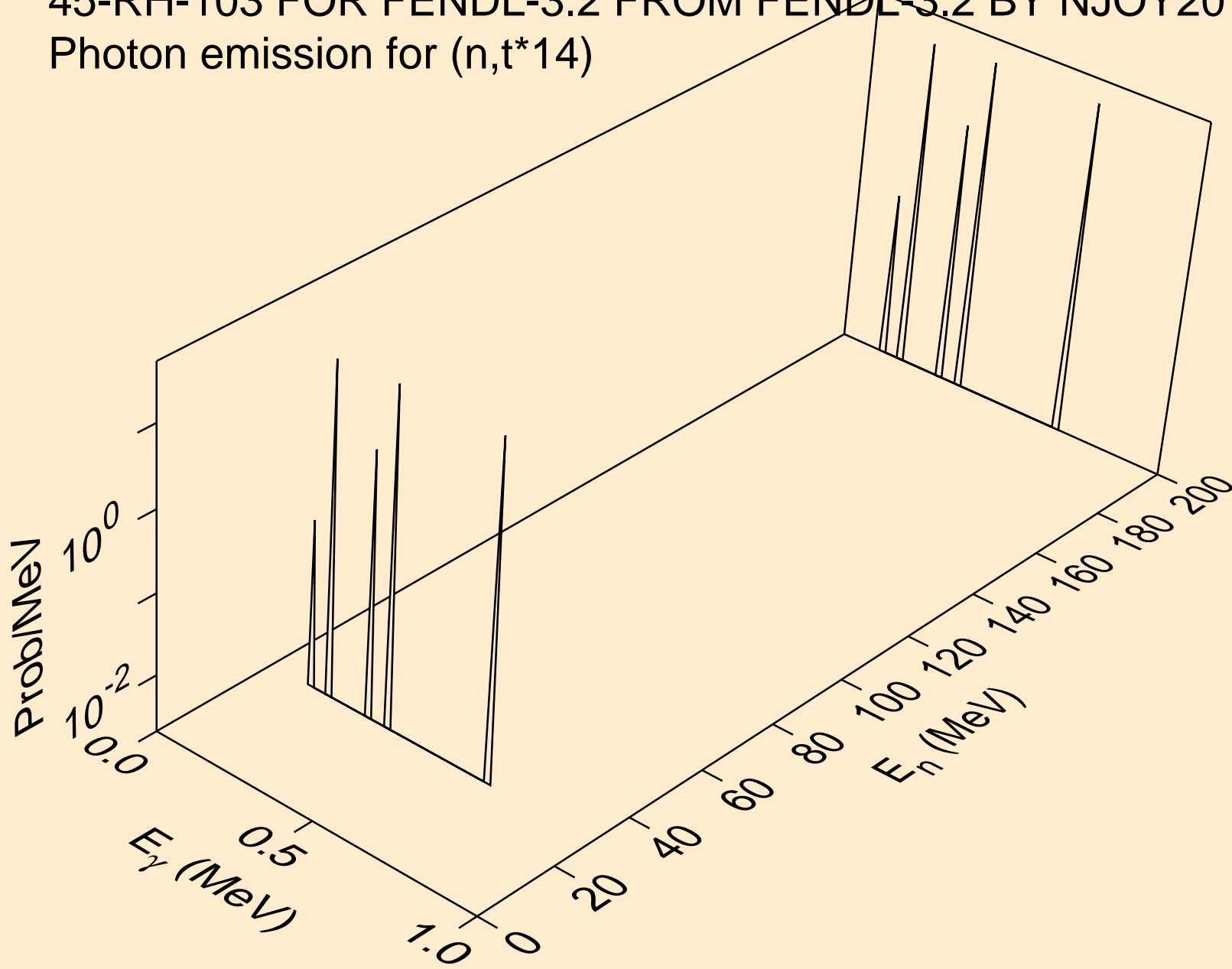

45-RH-103 FOR FENDL-3.2 FROM FENDL-3.2 BY NJOY2016.60+ C
Photon emission for (n,t*15)

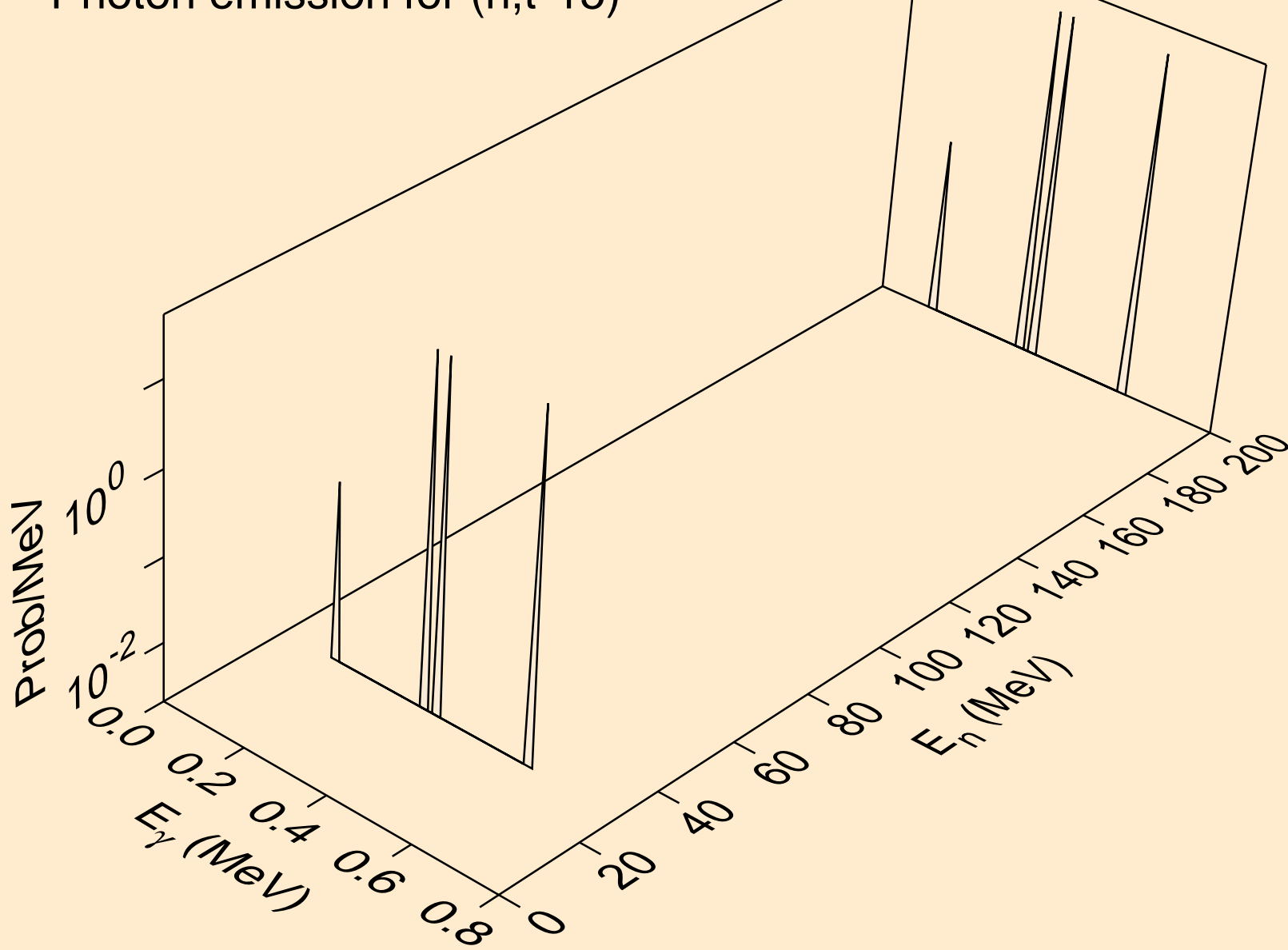

45-RH-103 FOR FENDL-3.2 FROM FENDL-3.2 BY NJOY2016.60+ C
Photon emission for (n,t*c)

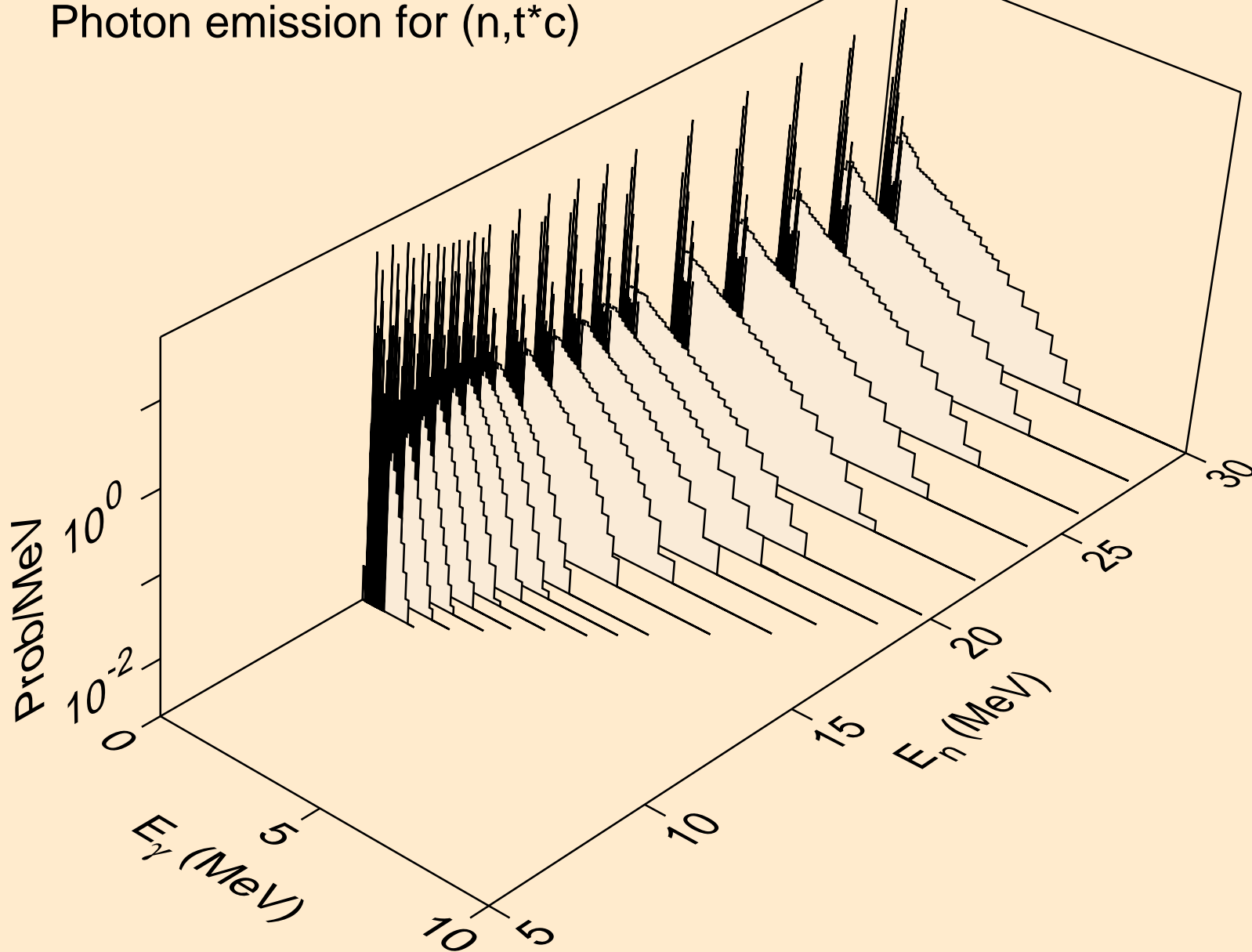

45-RH-103 FOR FENDL-3.2 FROM FENDL-3.2 BY NJOY2016.60+ C
Photon emission for (n,he3*1)

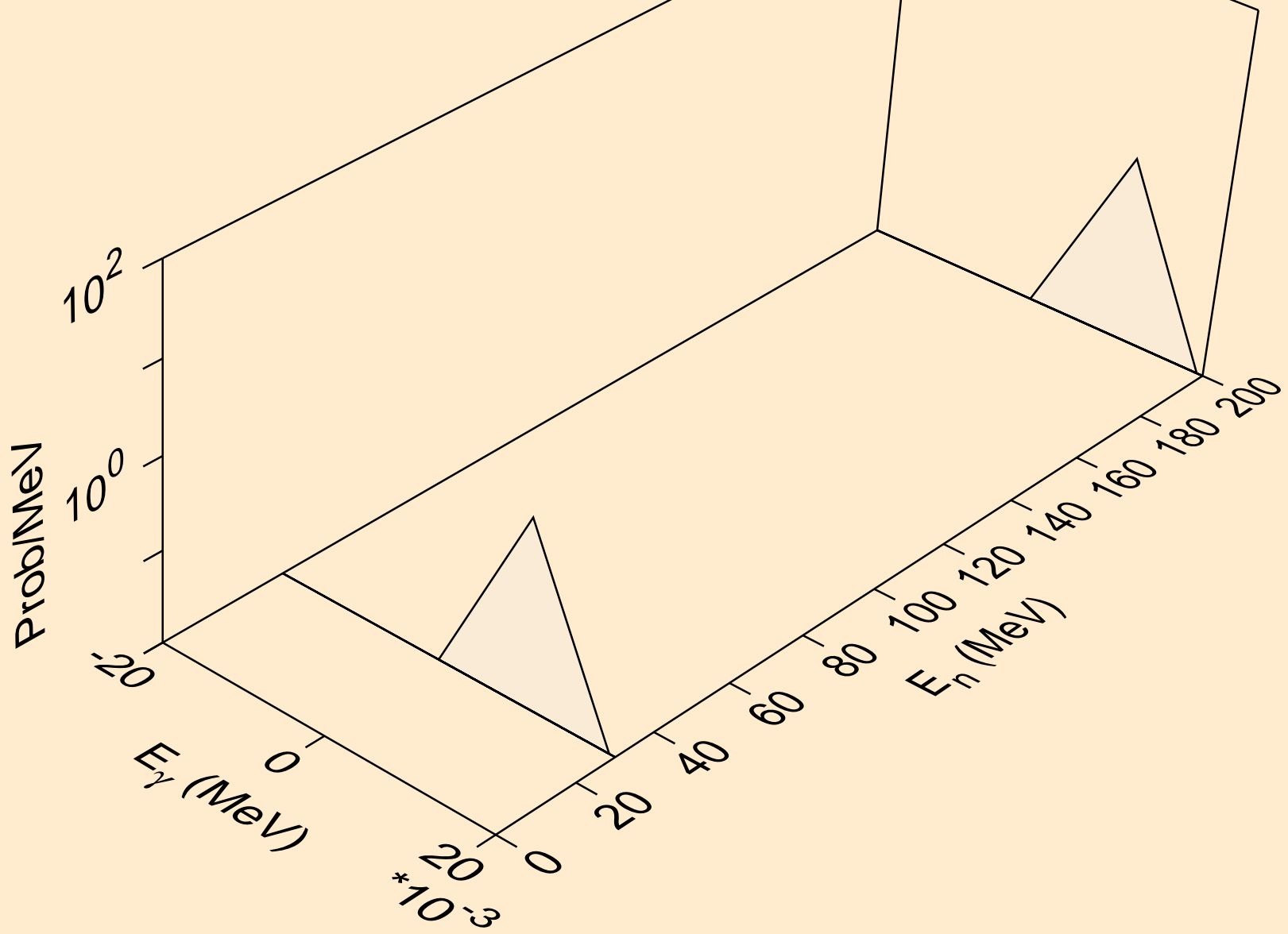

45-RH-103 FOR FENDL-3.2 FROM FENDL-3.2 BY NJOY2016.60+ C
Photon emission for (n,he3*2)

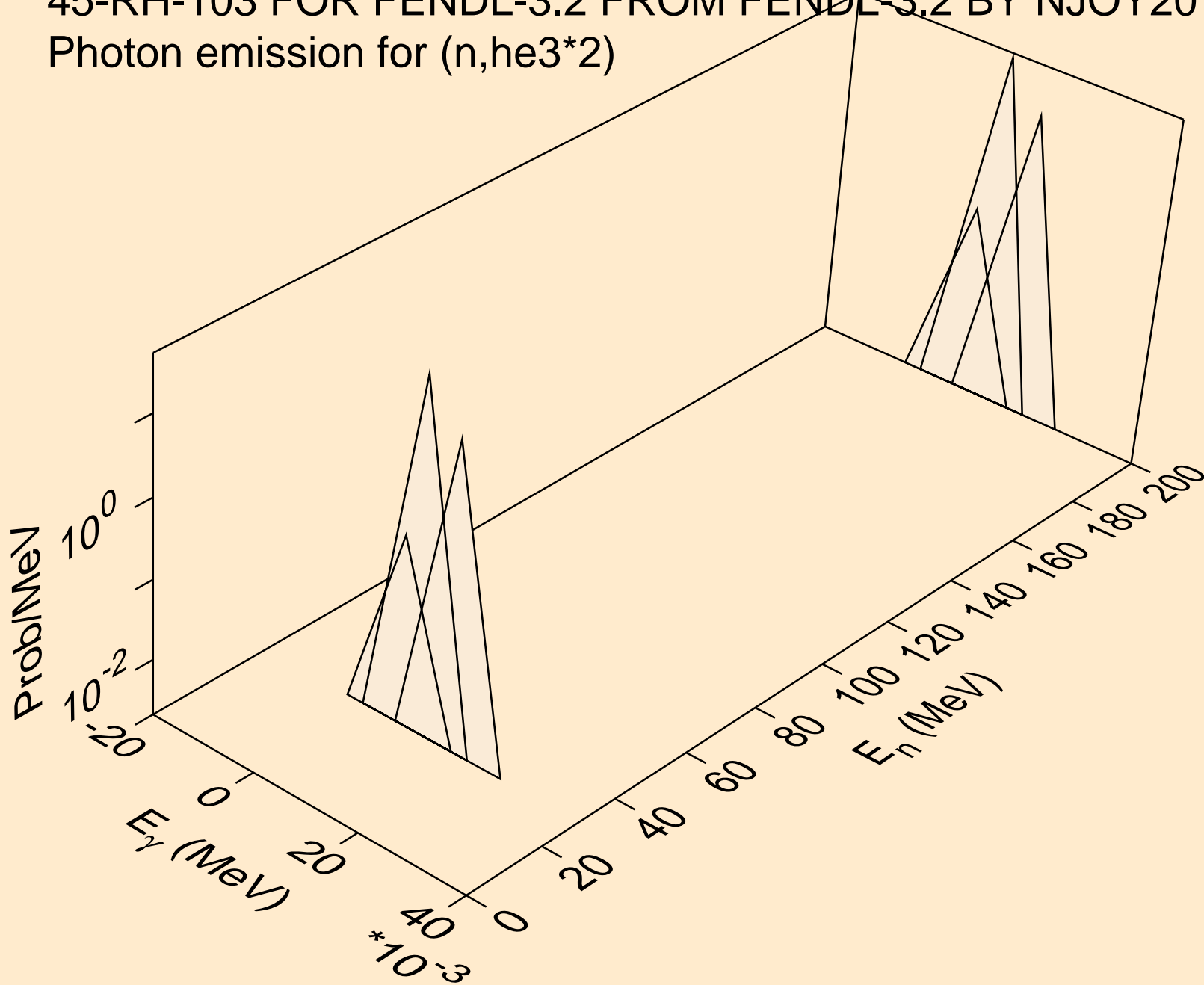

45-RH-103 FOR FENDL-3.2 FROM FENDL-3.2 BY NJOY2016.60+ C
Photon emission for (n,he3*3)

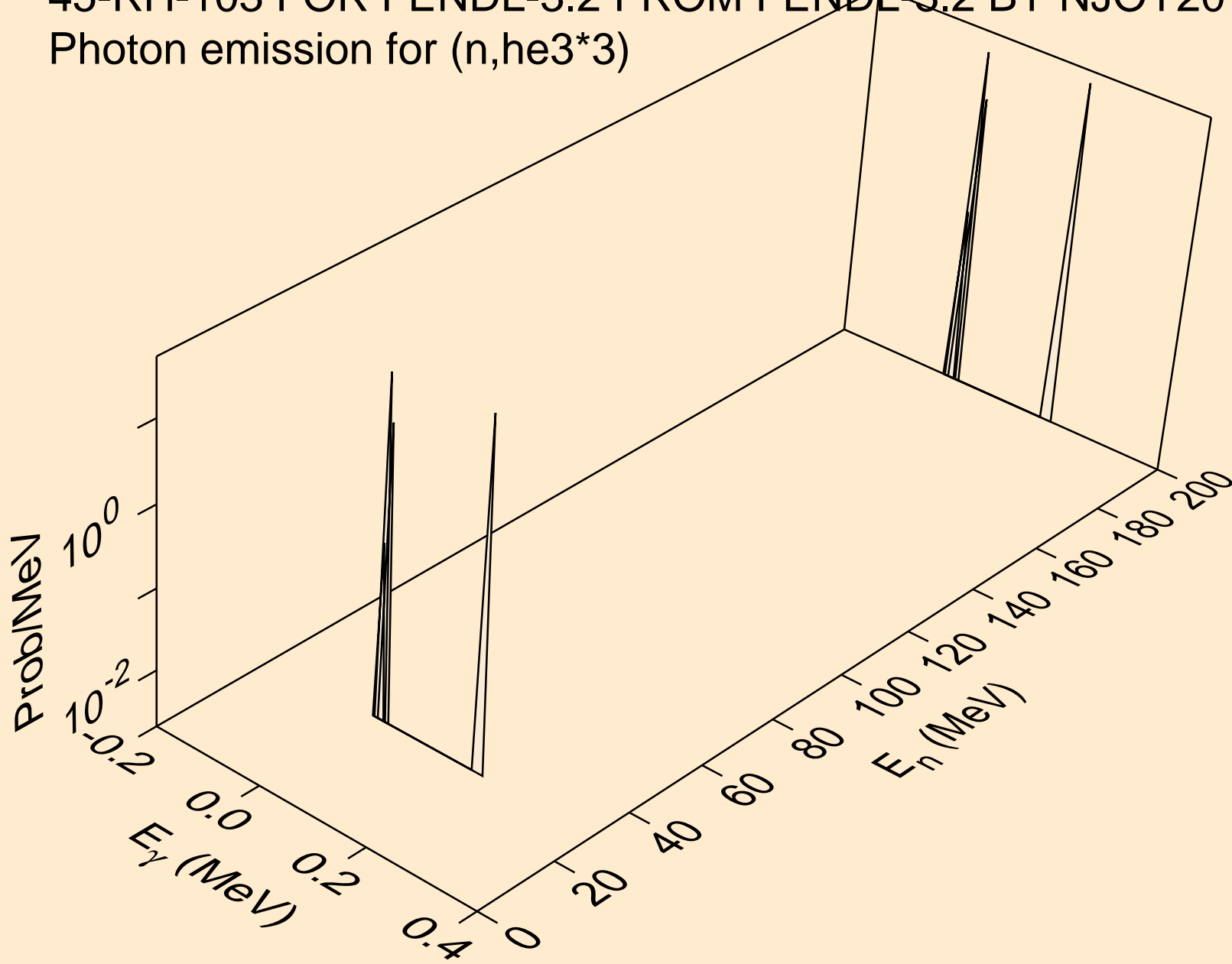

45-RH-103 FOR FENDL-3.2 FROM FENDL-3.2 BY NJOY2016.60+ C
Photon emission for (n,he3*4)

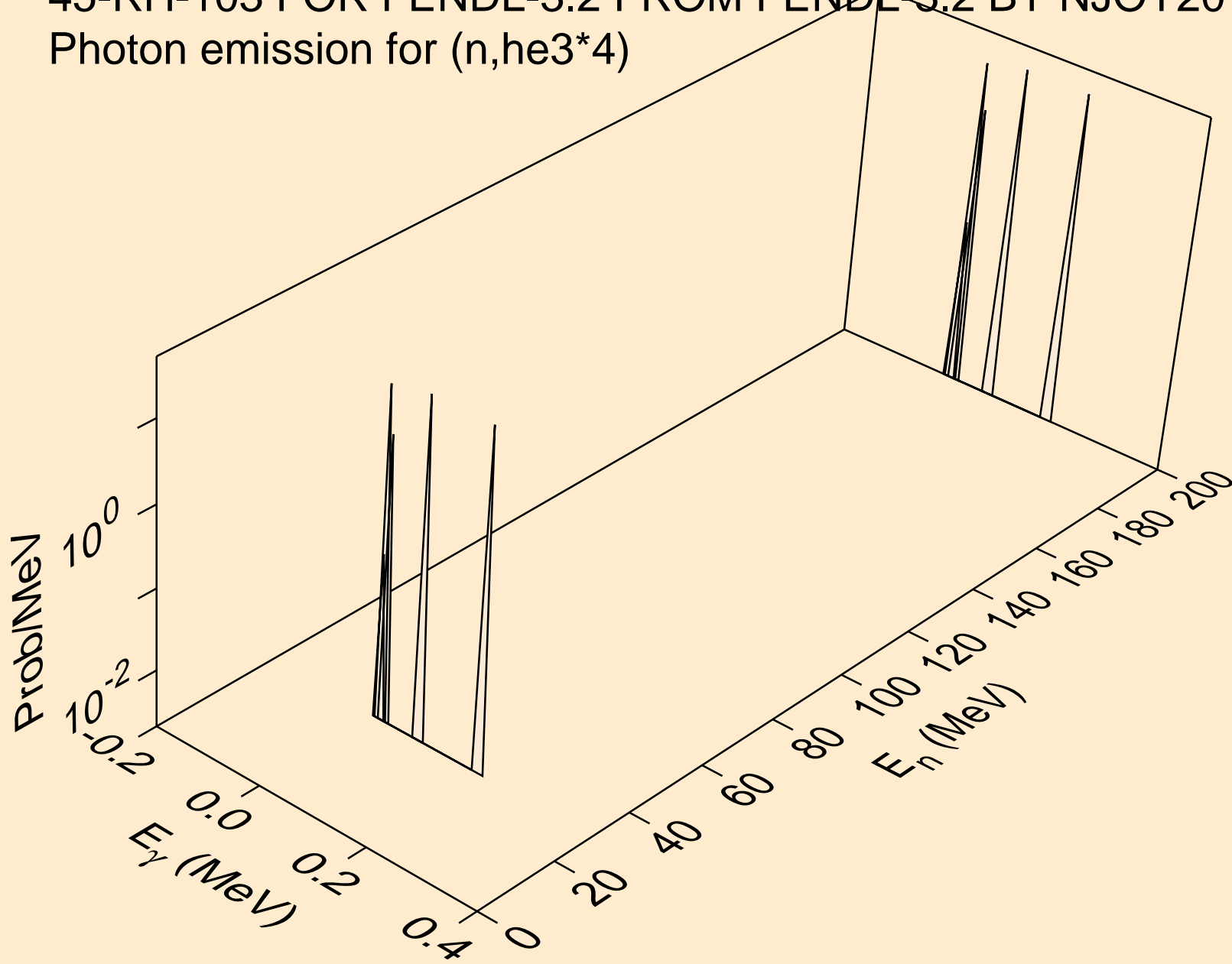

45-RH-103 FOR FENDL-3.2 FROM FENDL-3.2 BY NJOY2016.60+ C
Photon emission for (n,he3*5)

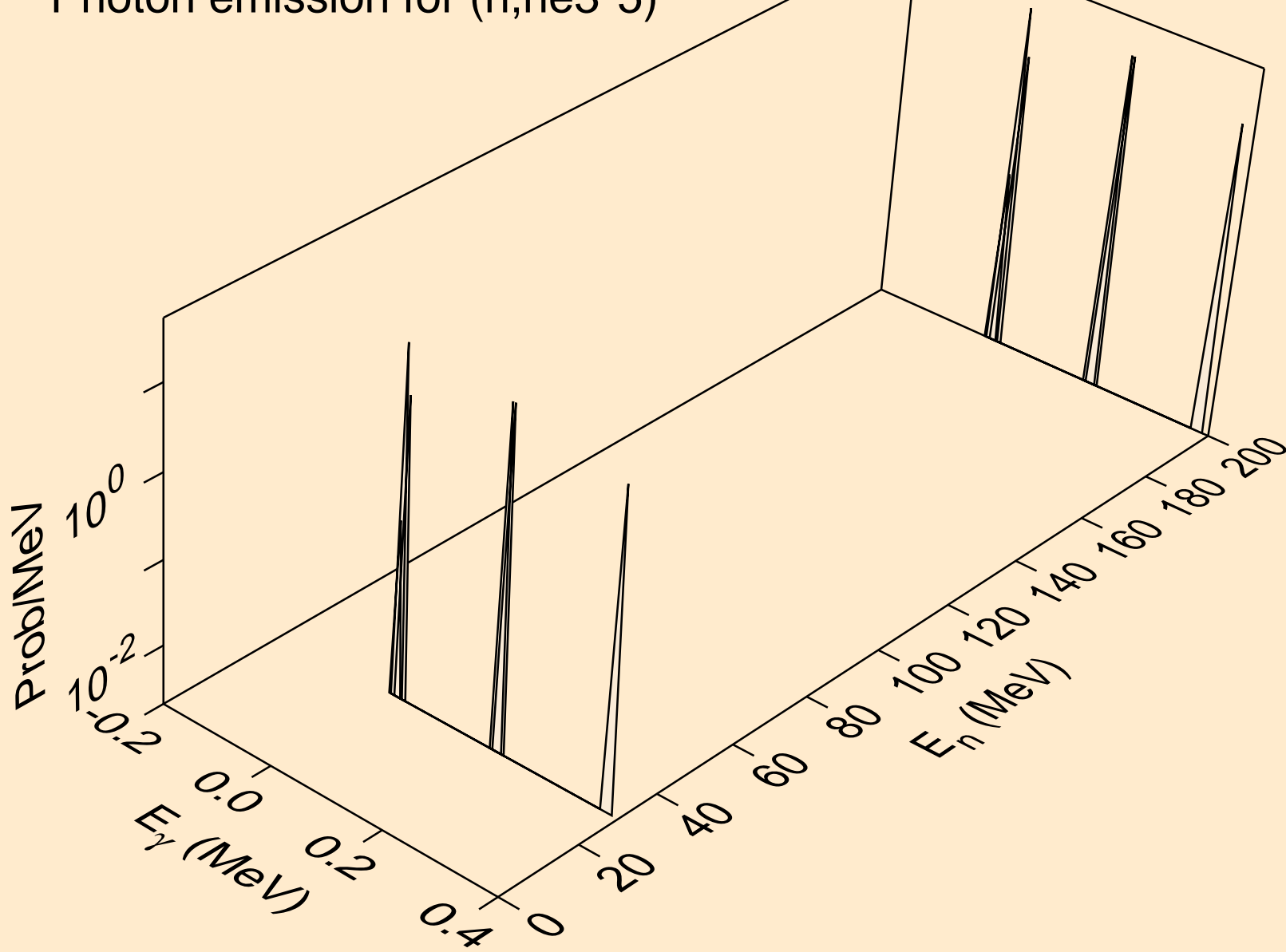

45-RH-103 FOR FENDL-3.2 FROM FENDL-3.2 BY NJOY2016.60+ C
Photon emission for (n,he3*6)

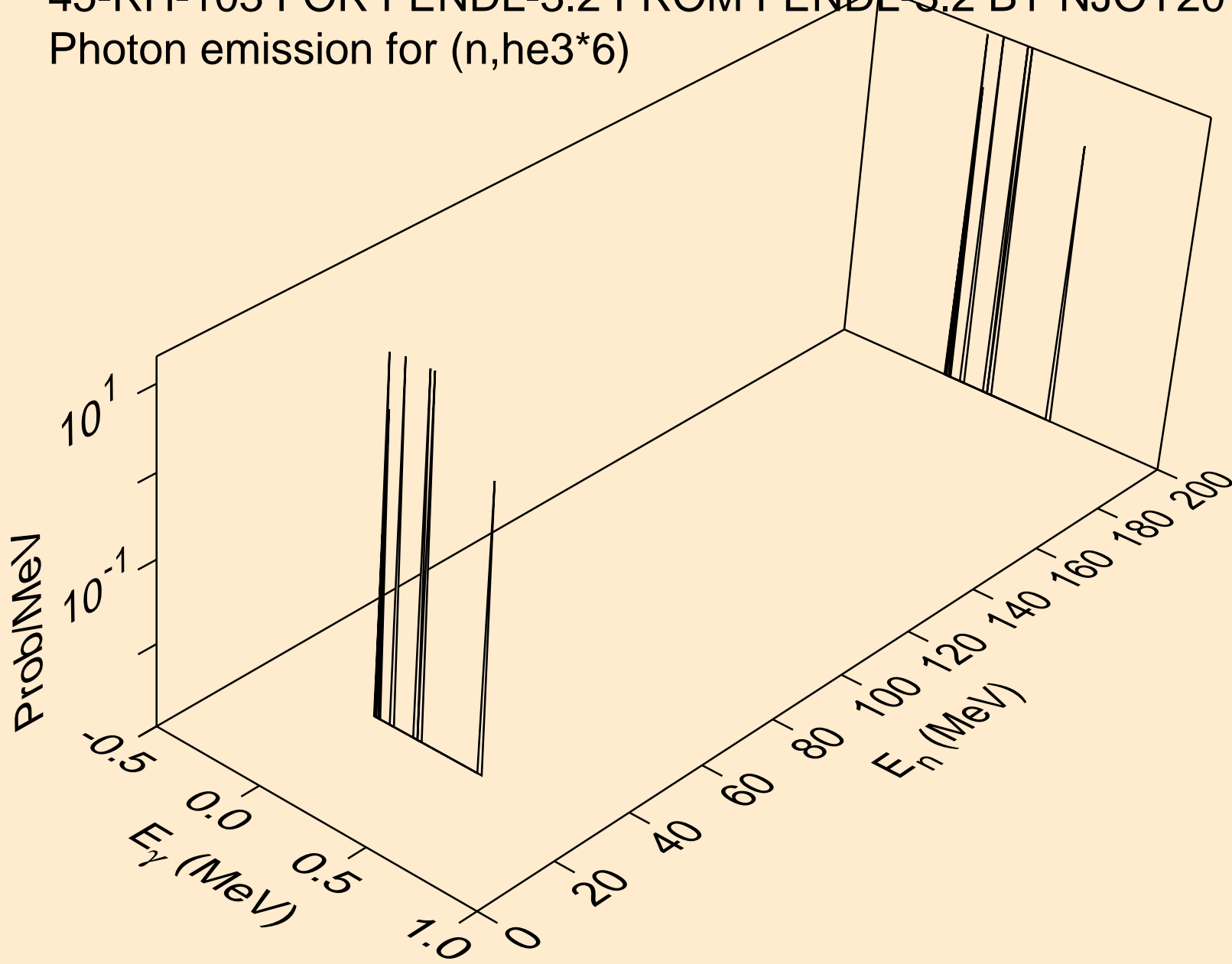

45-RH-103 FOR FENDL-3.2 FROM FENDL-3.2 BY NJOY2016.60+ C
Photon emission for (n,he3*7)

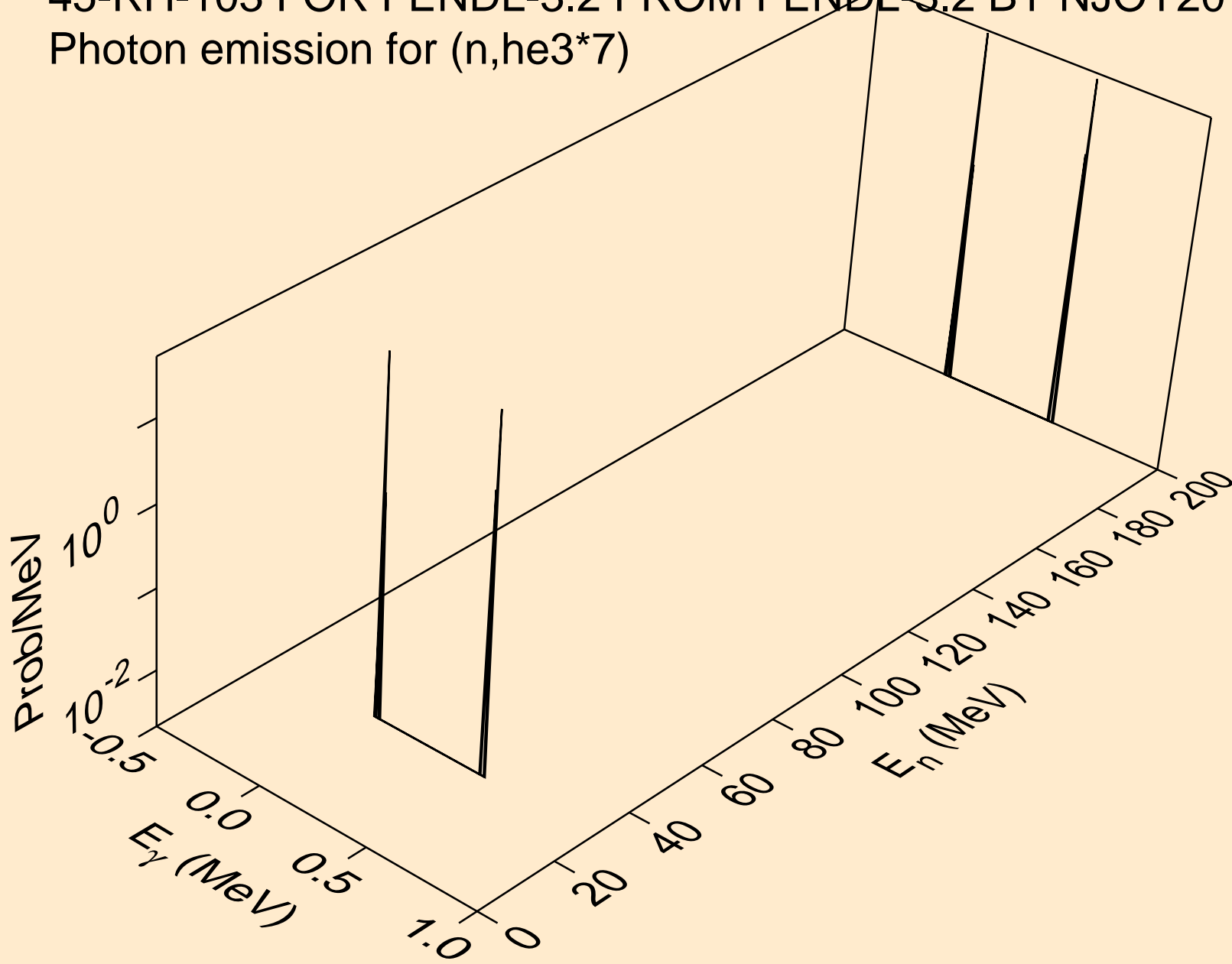

45-RH-103 FOR FENDL-3.2 FROM FENDL-3.2 BY NJOY2016.60+ C
Photon emission for (n,he3*8)

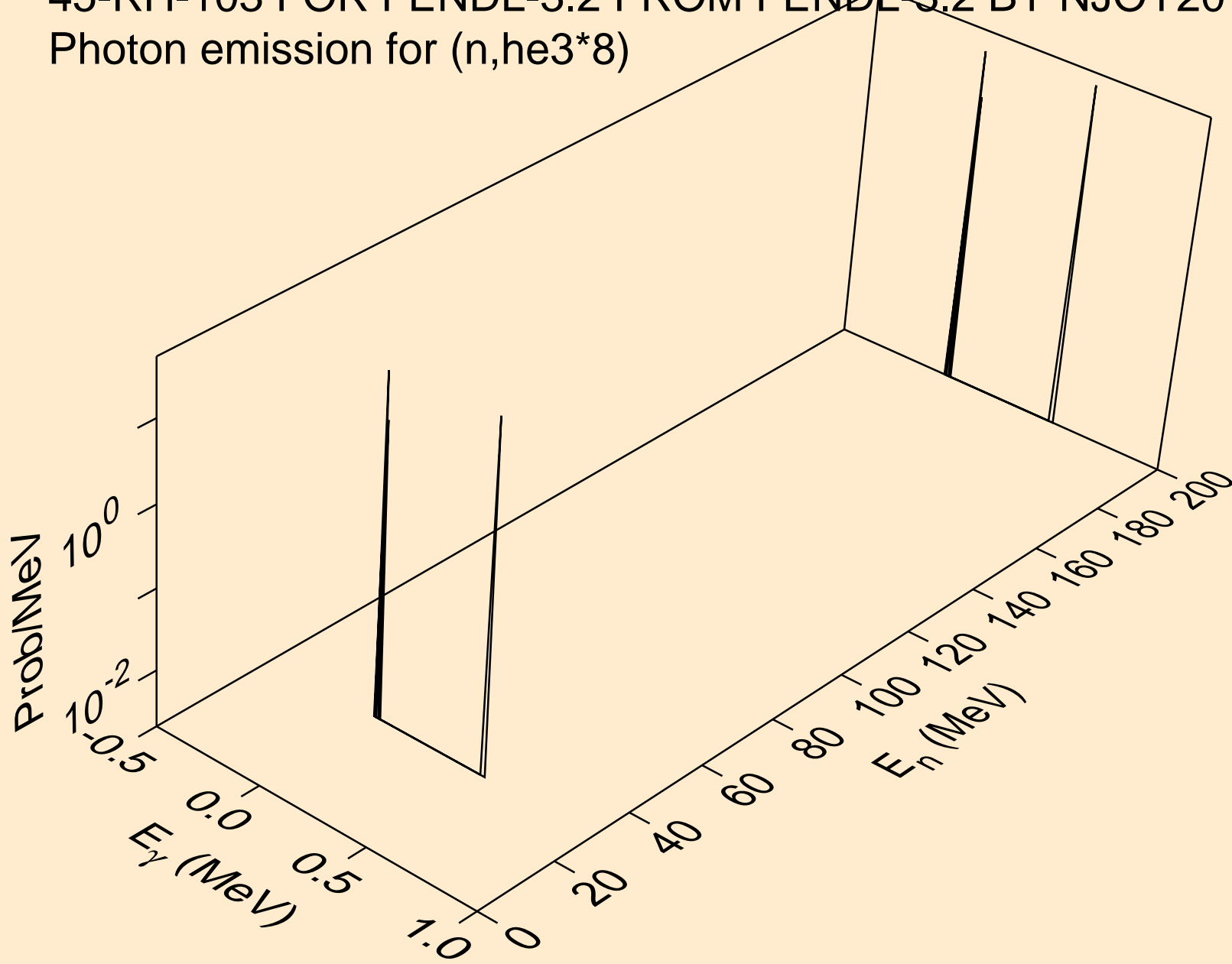

45-RH-103 FOR FENDL-3.2 FROM FENDL-3.2 BY NJOY2016.60+ C
Photon emission for (n,he3*9)

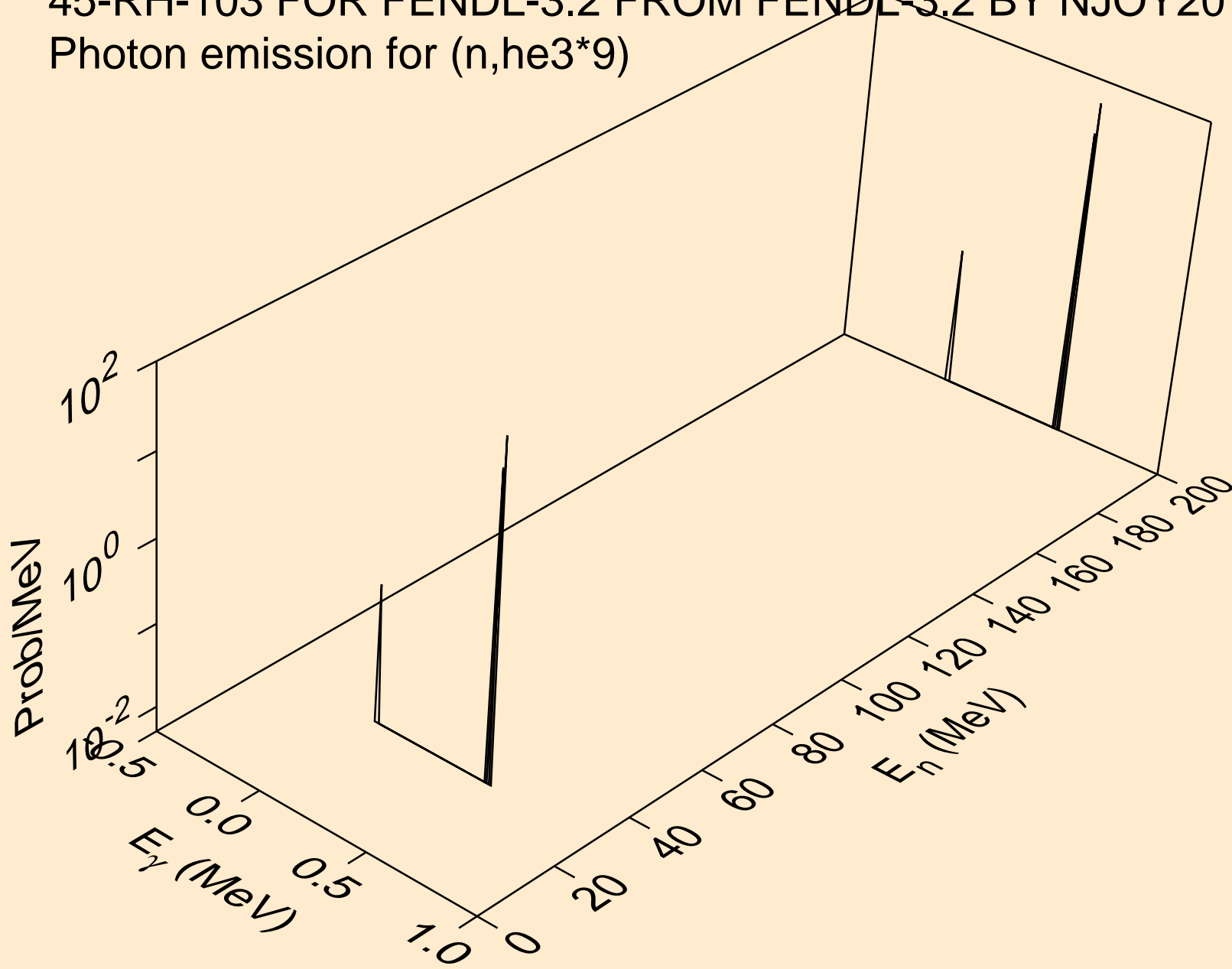

45-RH-103 FOR FENDL-3.2 FROM FENDL-3.2 BY NJOY2016.60+ C
Photon emission for (n,he3*10)

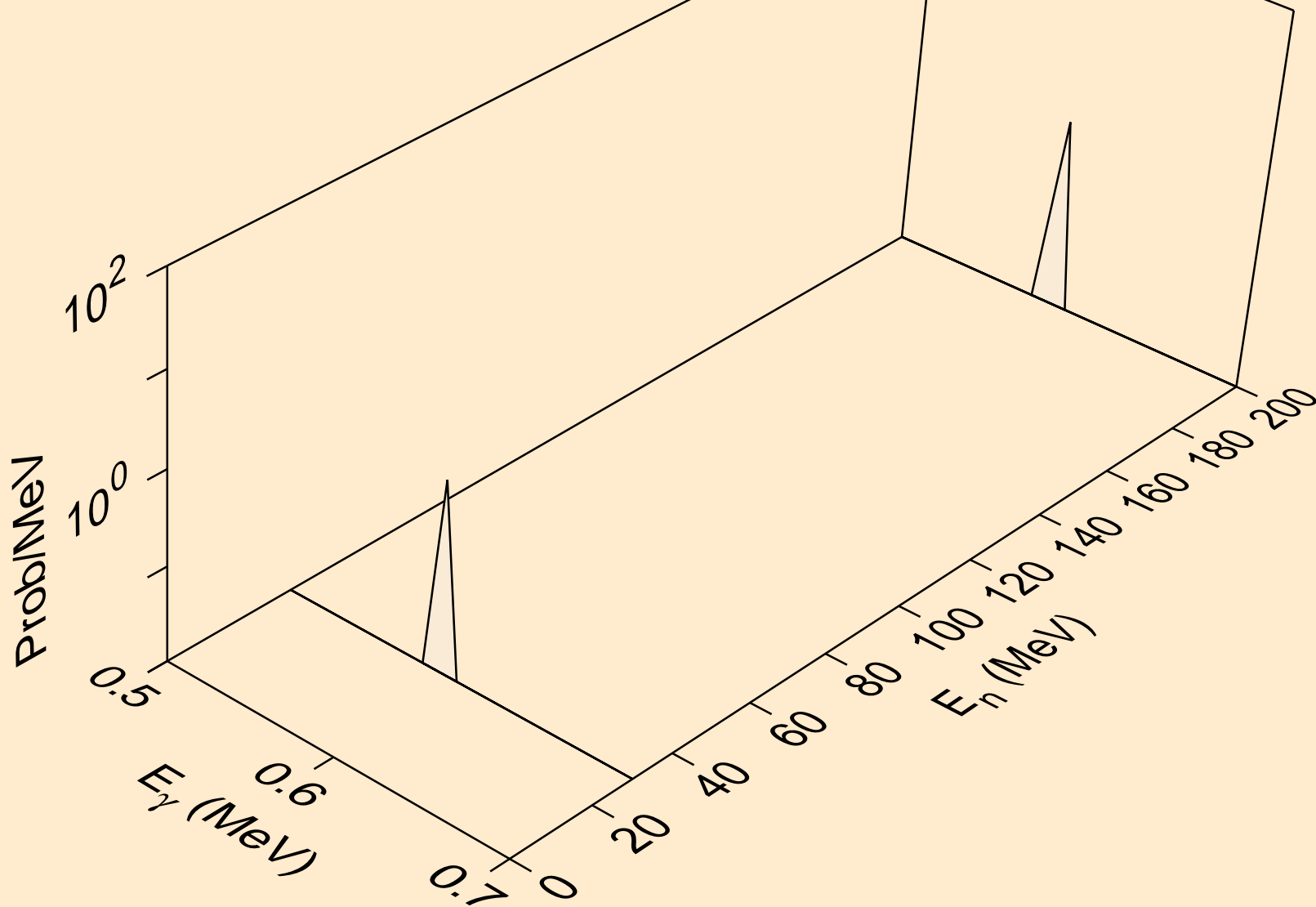

45-RH-103 FOR FENDL-3.2 FROM FENDL-3.2 BY NJOY2016.60+ C
Photon emission for (n,he3*11)

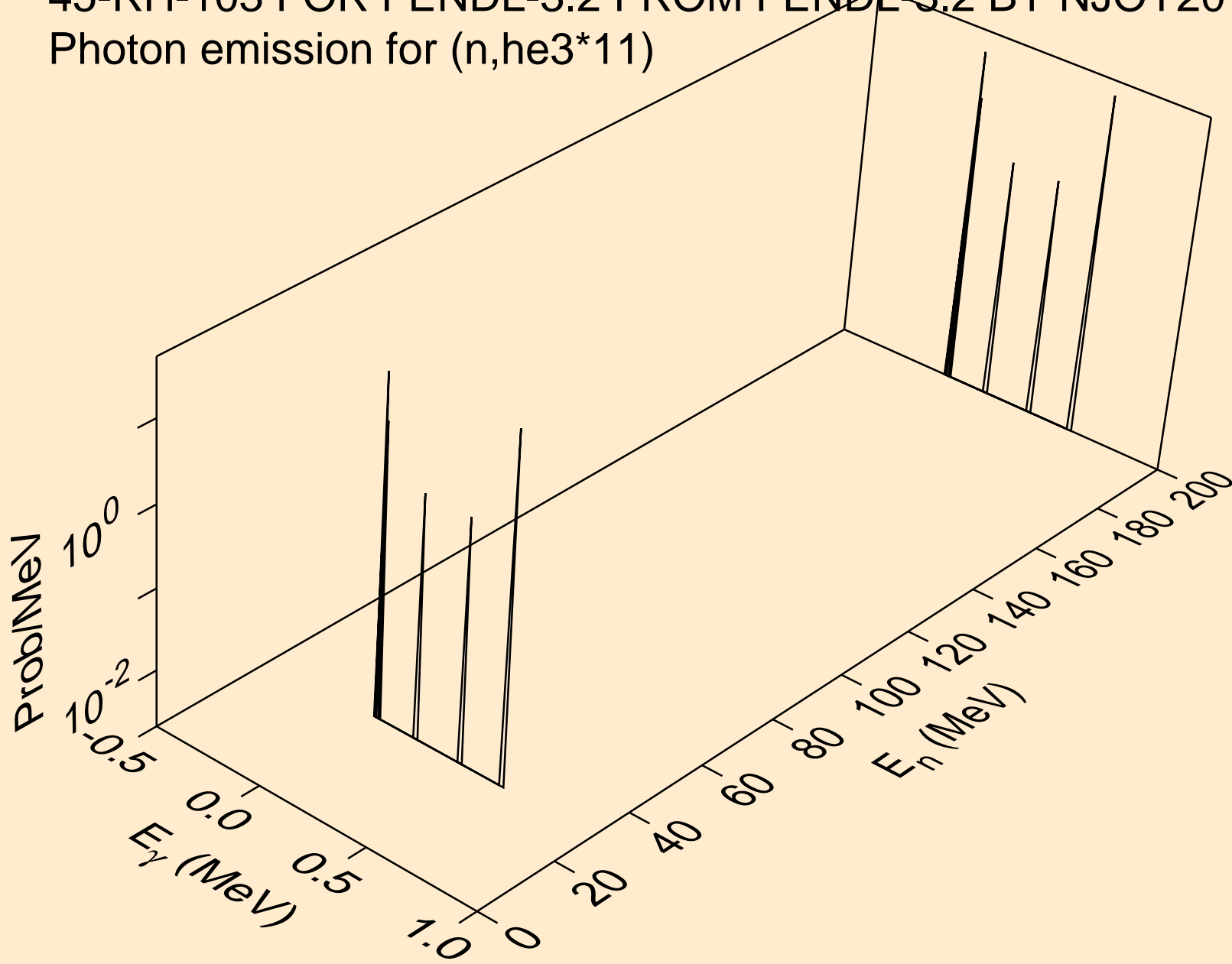

45-RH-103 FOR FENDL-3.2 FROM FENDL-3.2 BY NJOY2016.60+ C
Photon emission for (n,he3*12)

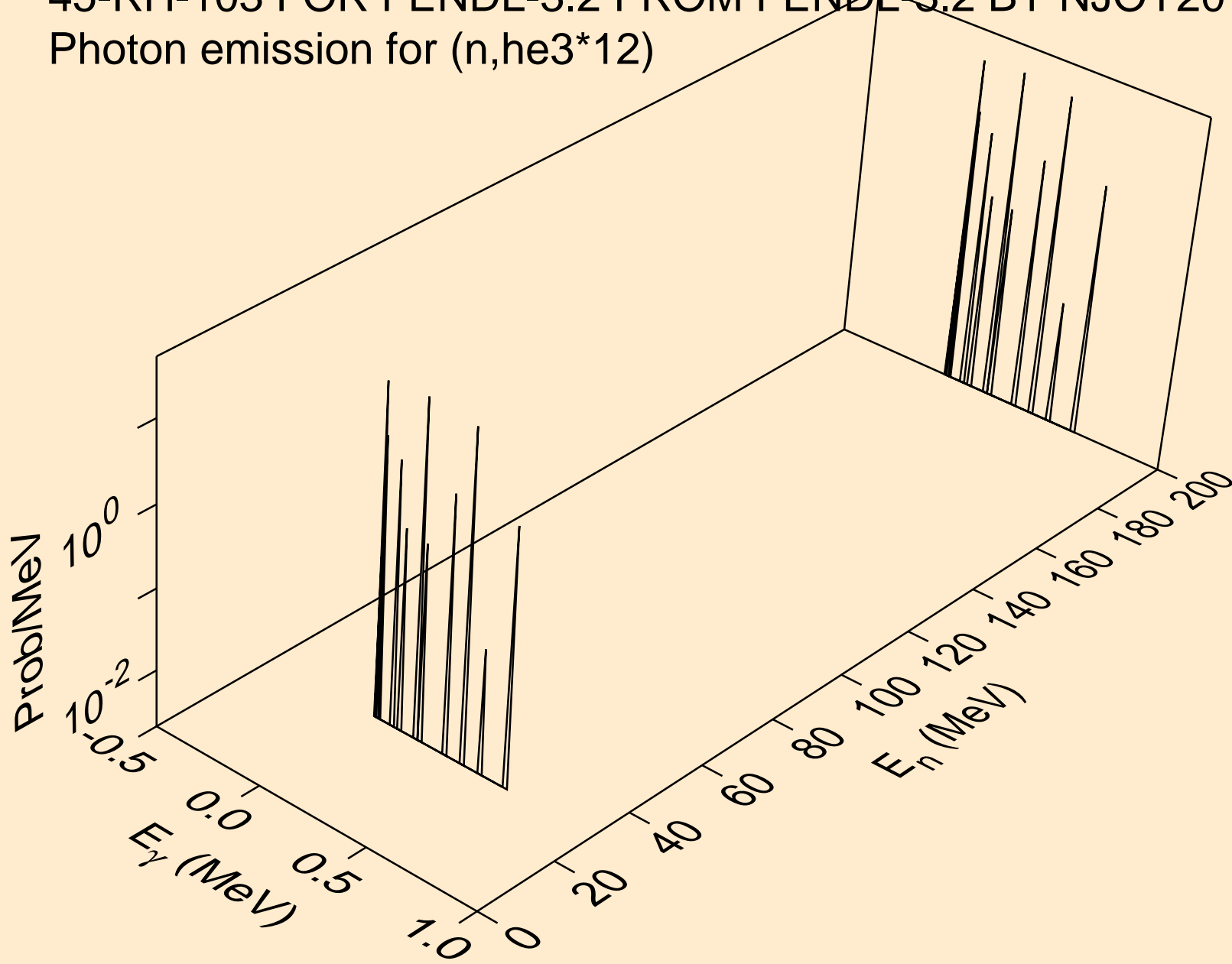

45-RH-103 FOR FENDL-3.2 FROM FENDL-3.2 BY NJOY2016.60+ C
Photon emission for (n,he3*13)

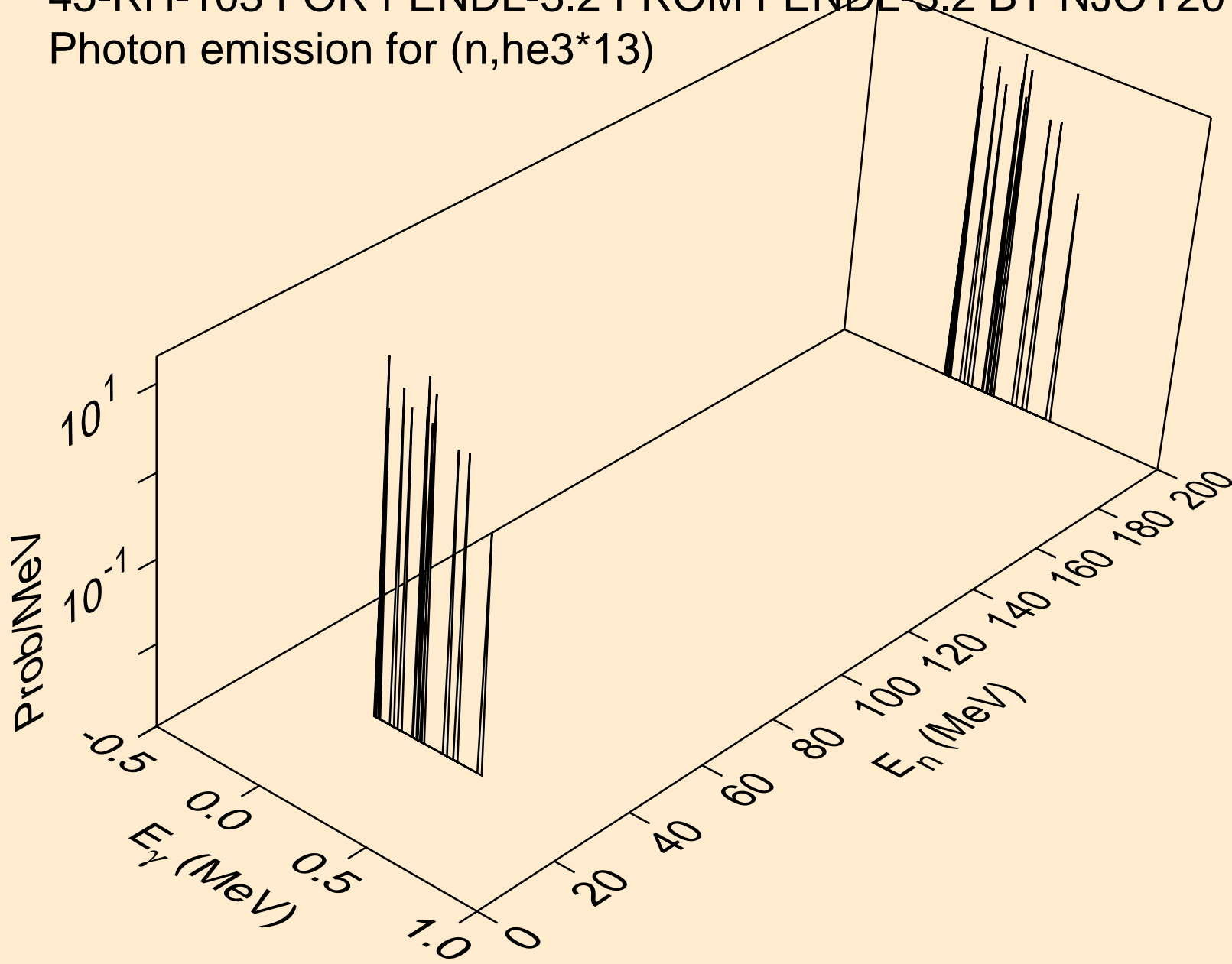

45-RH-103 FOR FENDL-3.2 FROM FENDL-3.2 BY NJOY2016.60+ C
Photon emission for (n,he3*14)

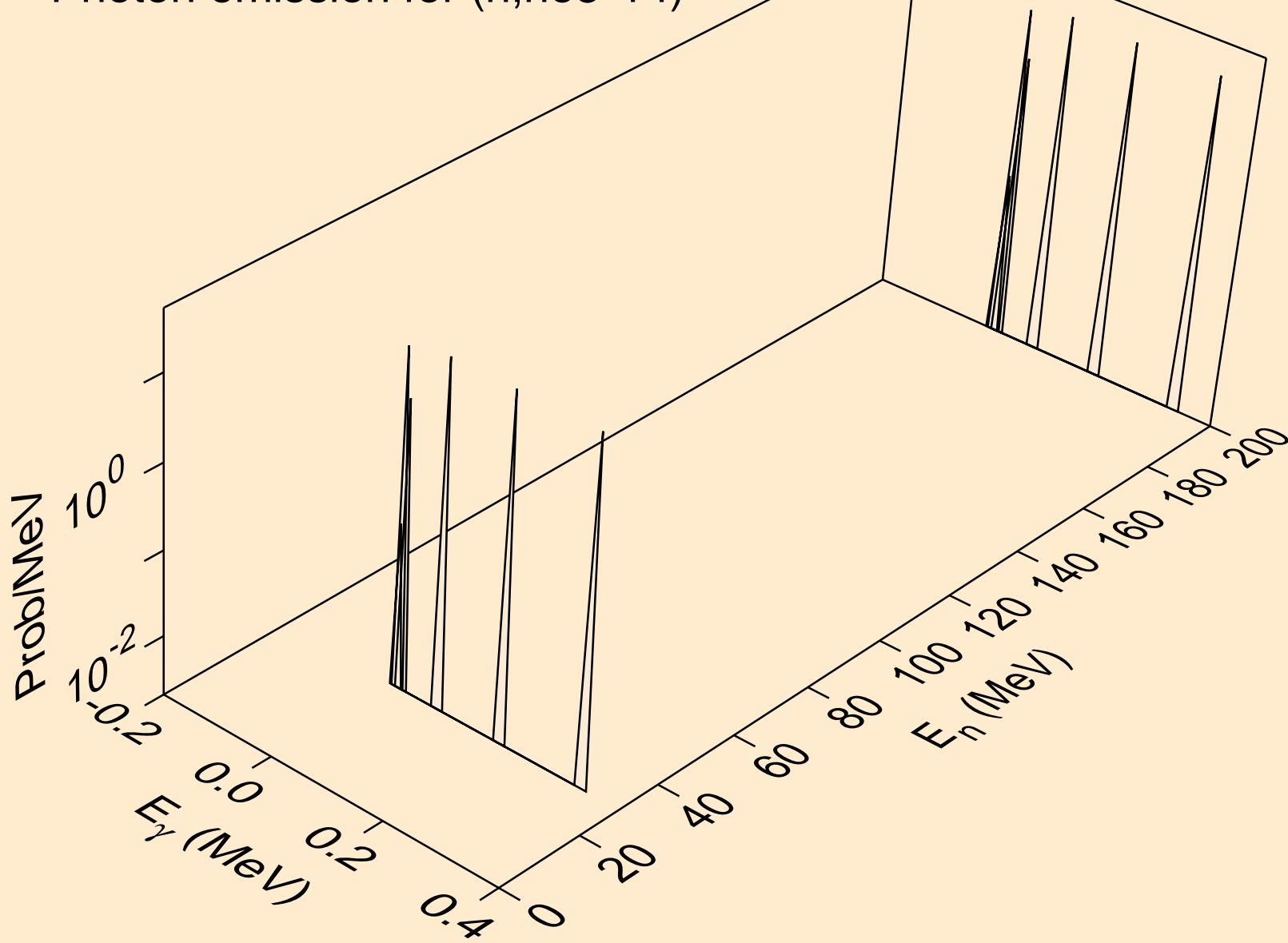

45-RH-103 FOR FENDL-3.2 FROM FENDL-3.2 BY NJOY2016.60+ C
Photon emission for (n,he3*15)

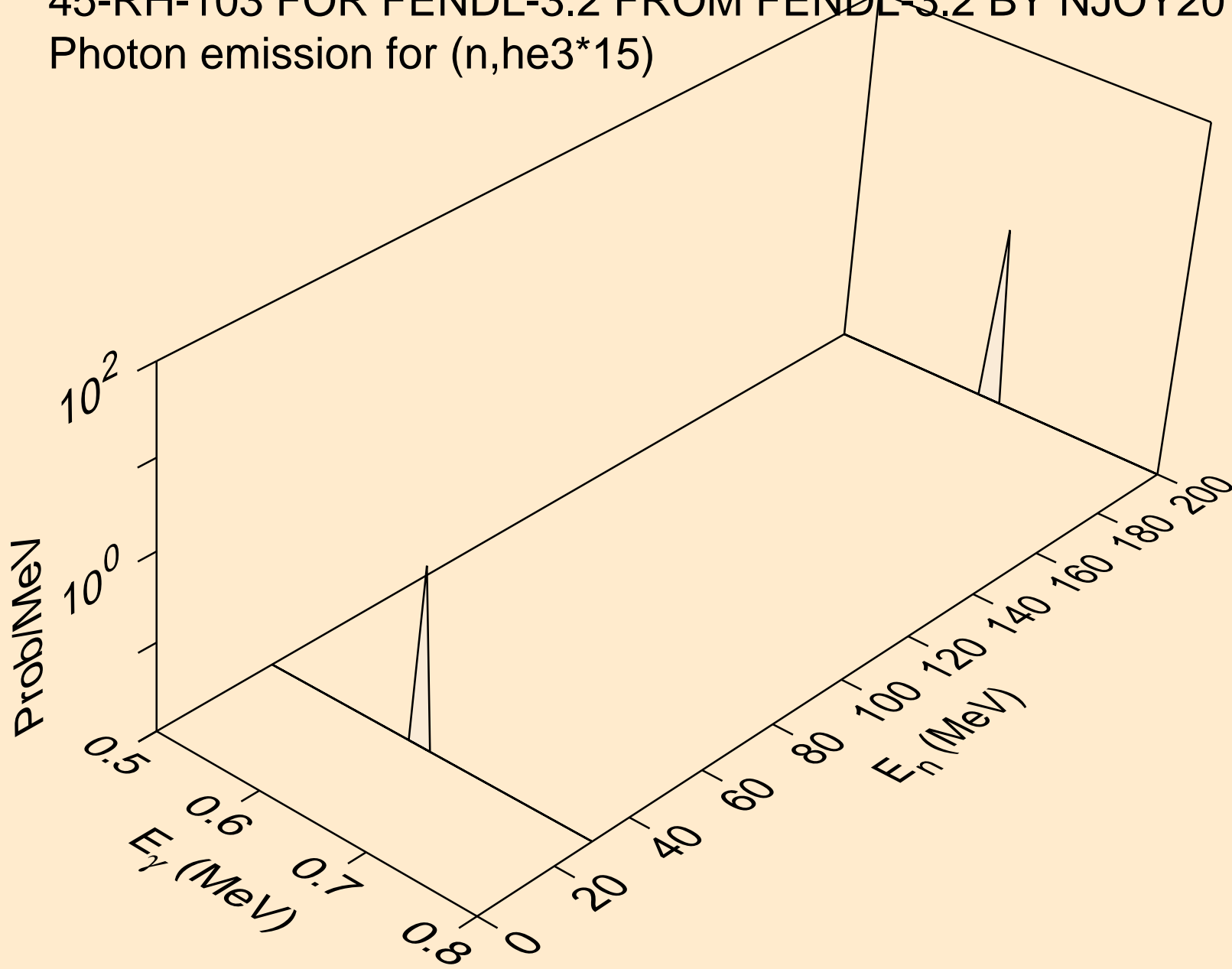

45-RH-103 FOR FENDL-3.2 FROM FENDL-3.2 BY NJOY2016.60+ C
Photon emission for (n,he3*c)

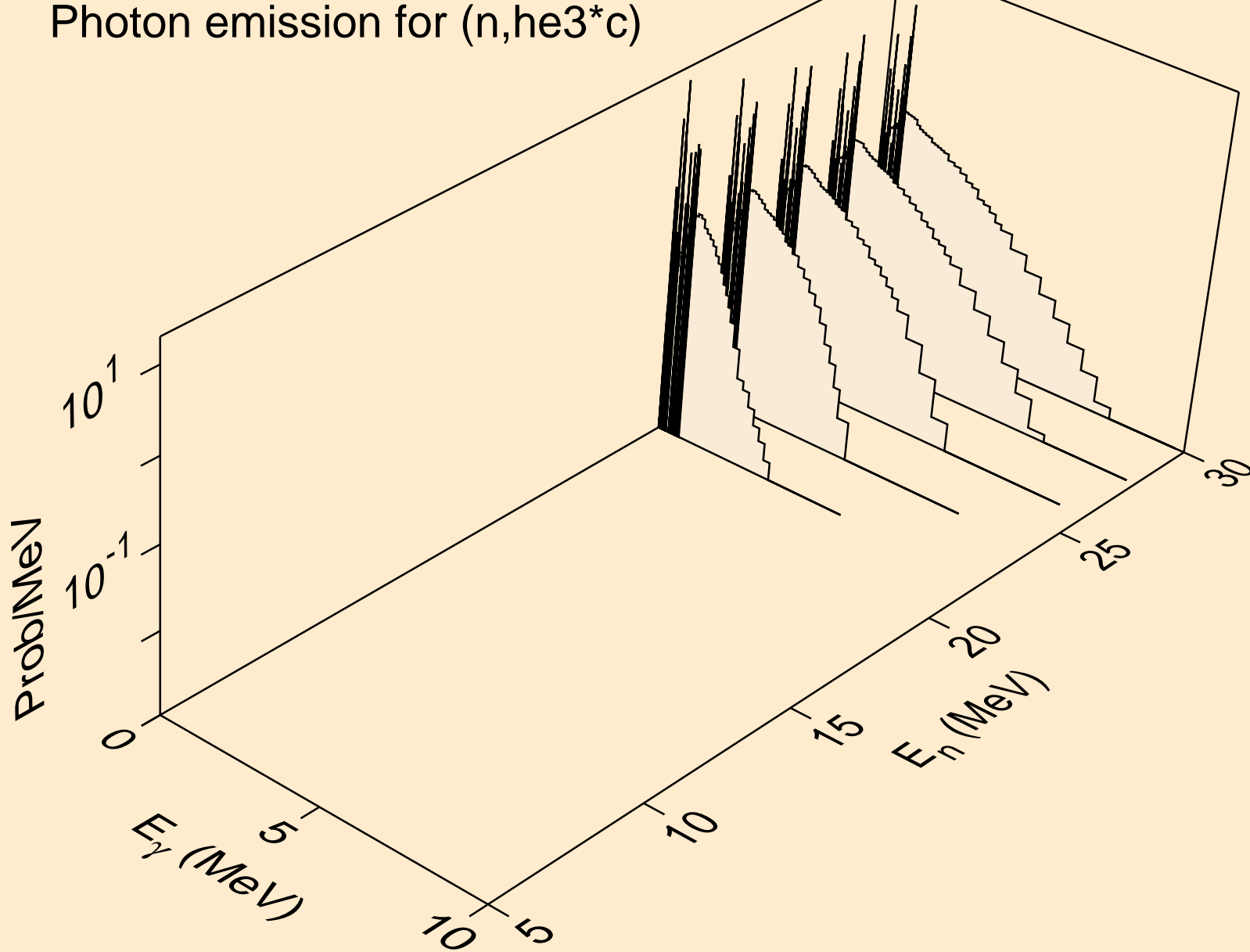

45-RH-103 FOR FENDL-3.2 FROM FENDL-3.2 BY NJOY2016.60+ C
Photon emission for (n,a*1)

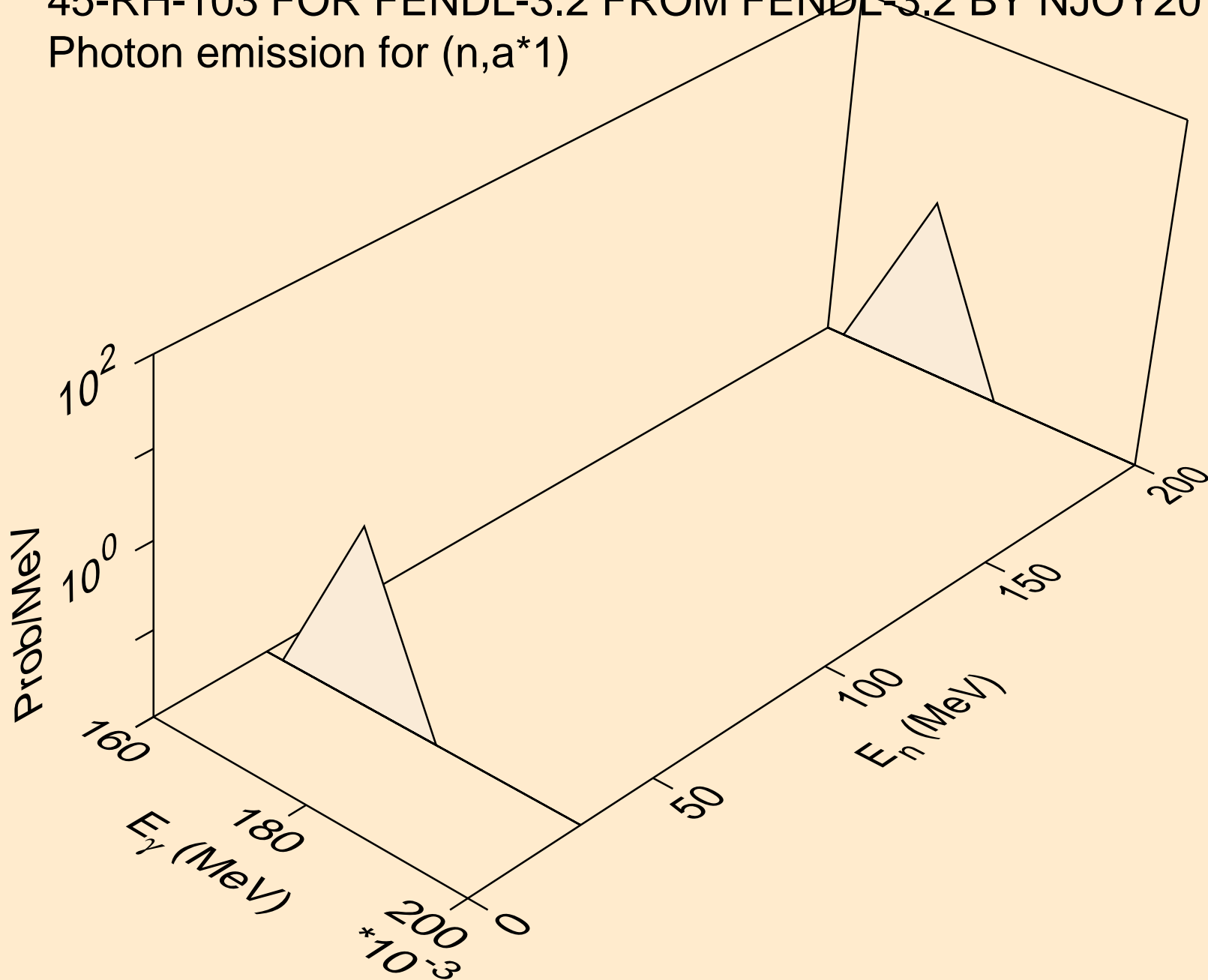

45-RH-103 FOR FENDL-3.2 FROM FENDL-3.2 BY NJOY2016.60+ C
Photon emission for (n,a*2)

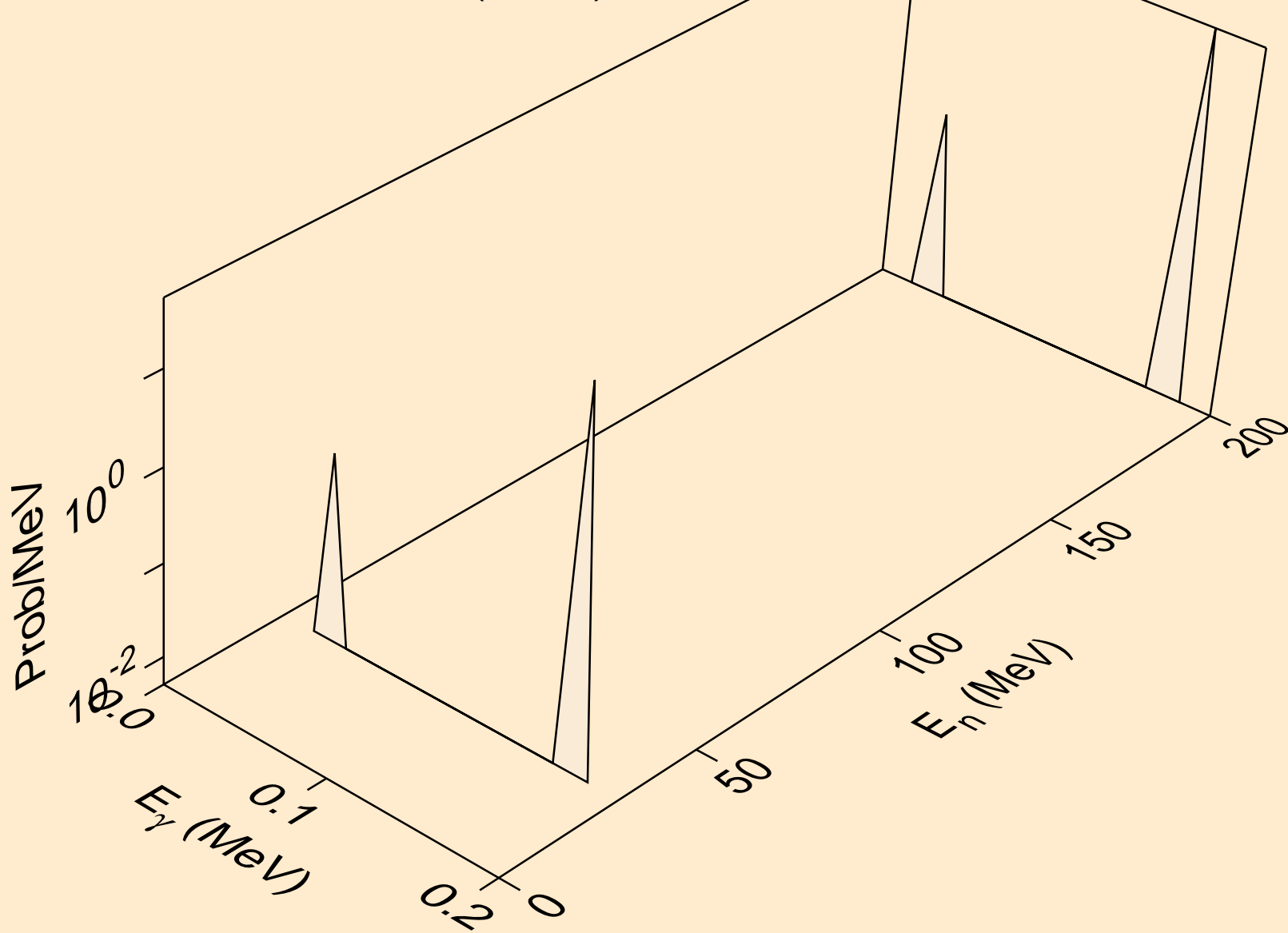

45-RH-103 FOR FENDL-3.2 FROM FENDL-3.2 BY NJOY2016.60+ C
Photon emission for (n,a*3)

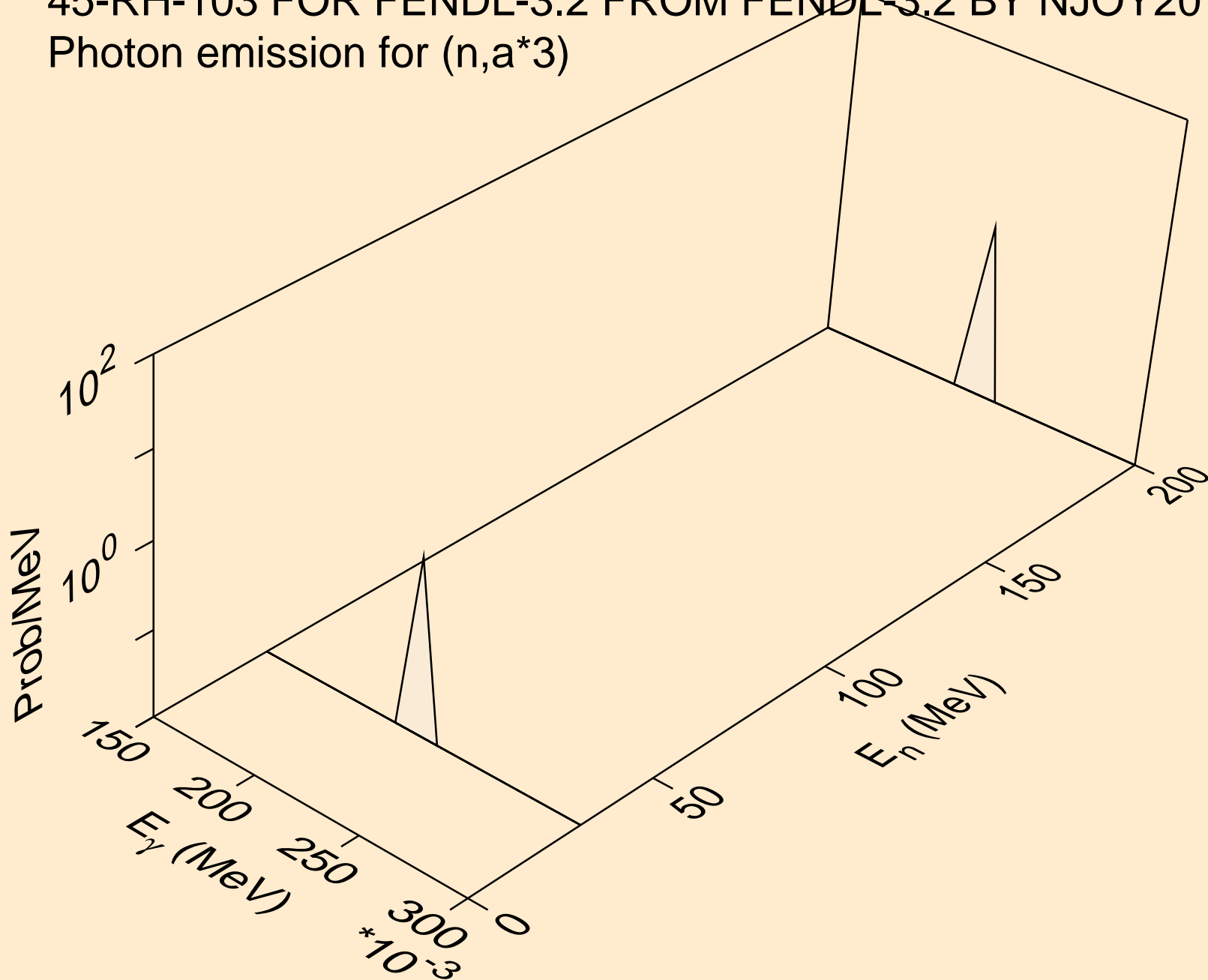

45-RH-103 FOR FENDL-3.2 FROM FENDL-3.2 BY NJOY2016.60+ C
Photon emission for (n,a*4)

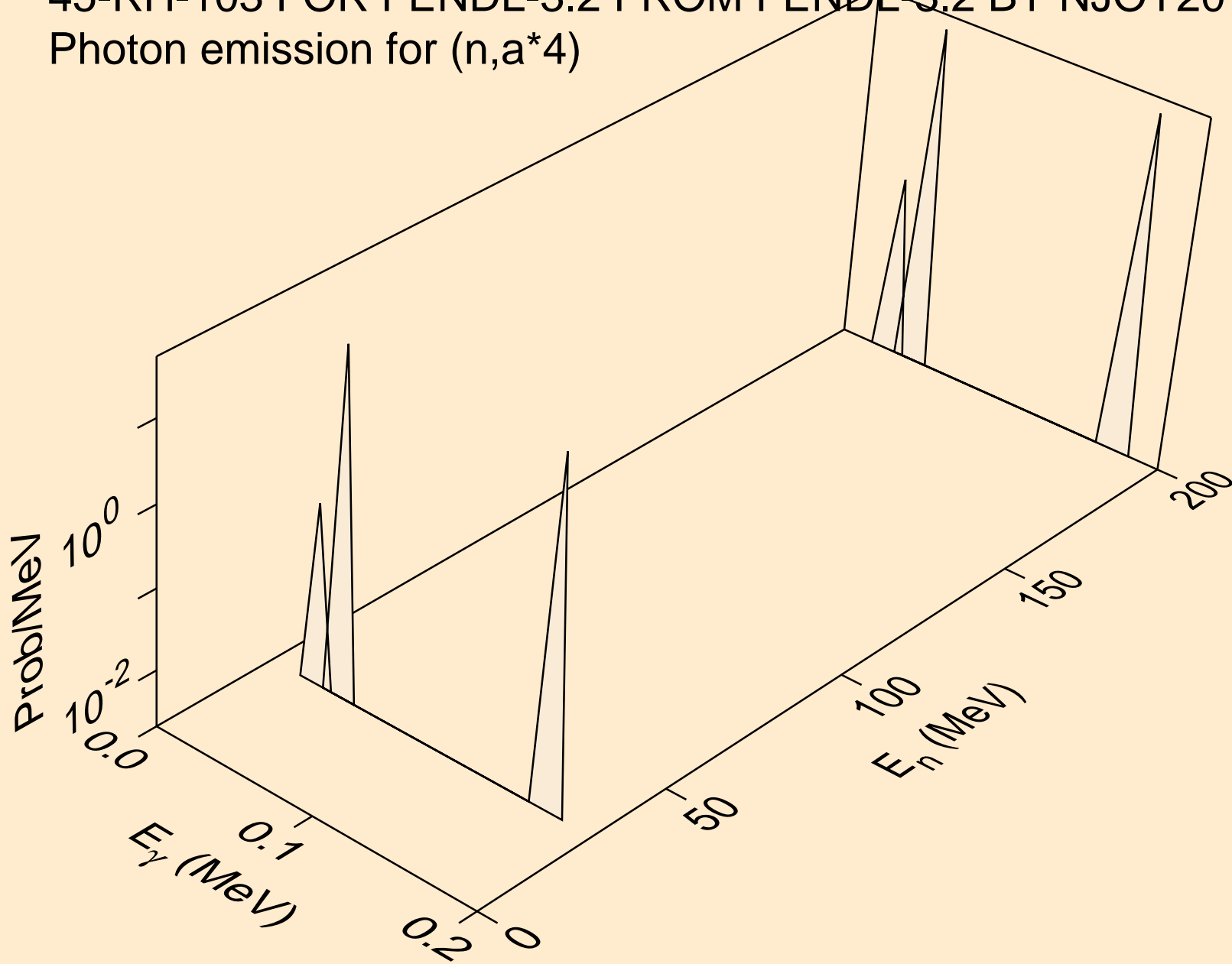

45-RH-103 FOR FENDL-3.2 FROM FENDL-3.2 BY NJOY2016.60+ C
Photon emission for (n,a*5)

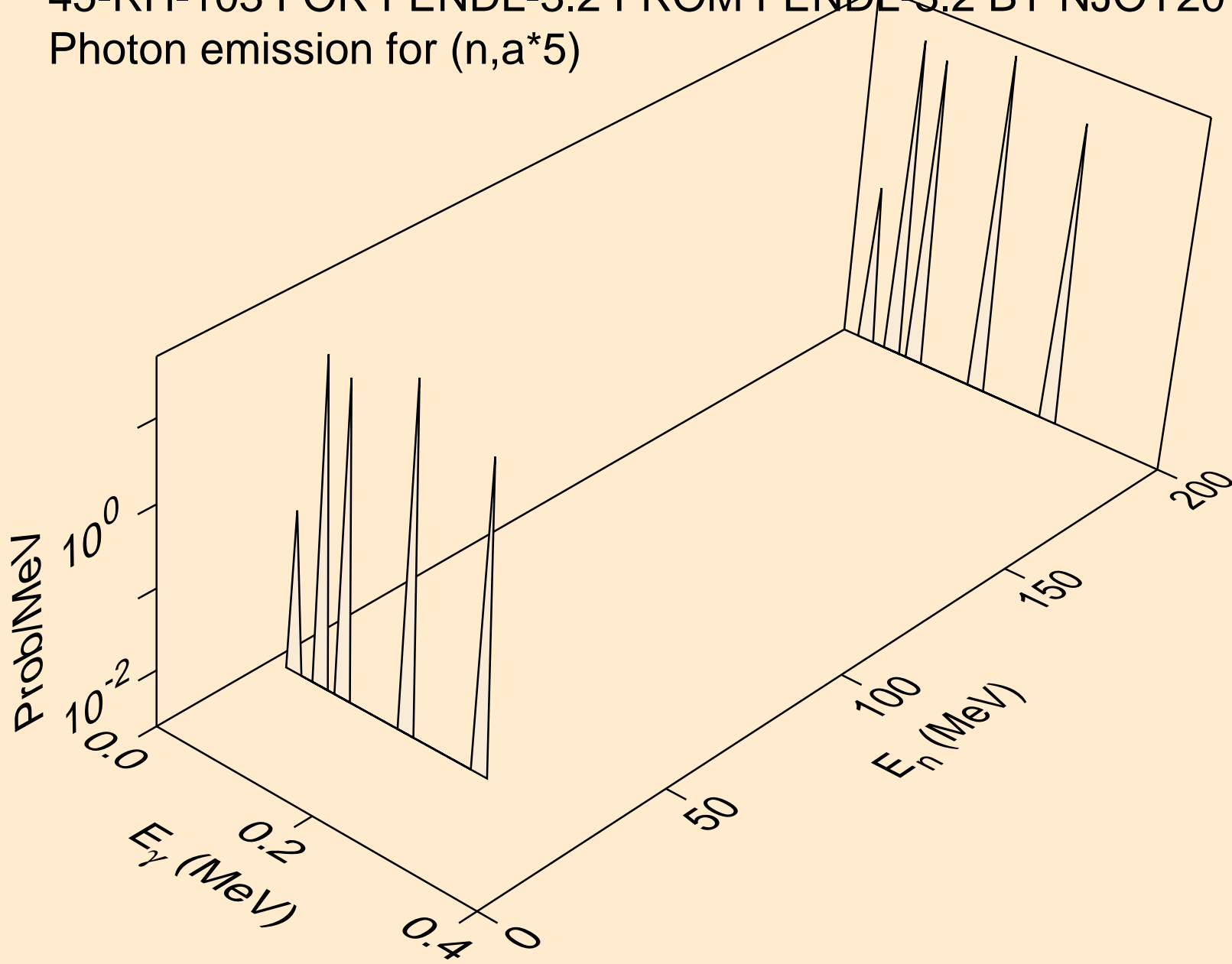

45-RH-103 FOR FENDL-3.2 FROM FENDL-3.2 BY NJOY2016.60+ C
Photon emission for (n,a*6)

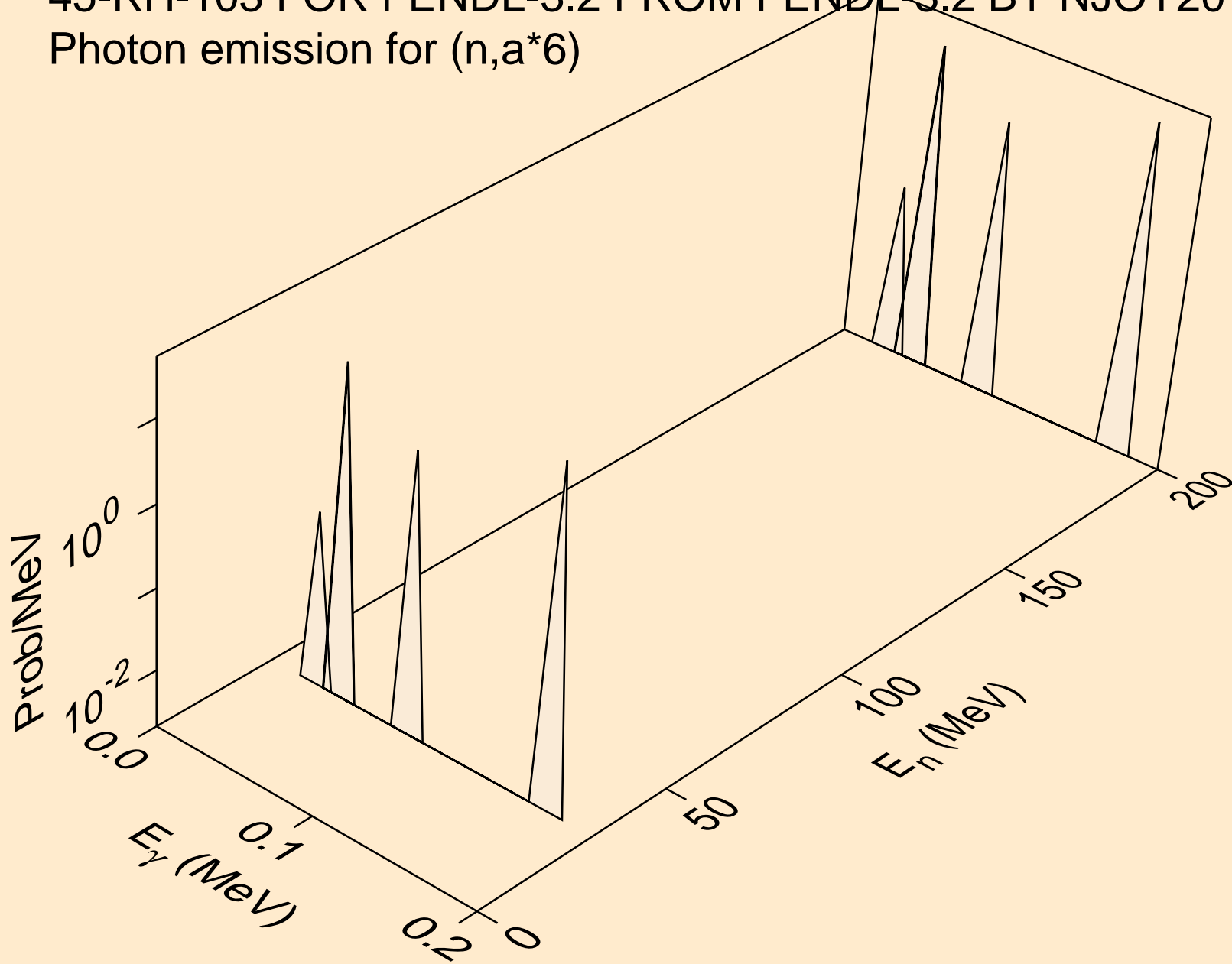

45-RH-103 FOR FENDL-3.2 FROM FENDL-3.2 BY NJOY2016.60+ C
Photon emission for (n,a*7)

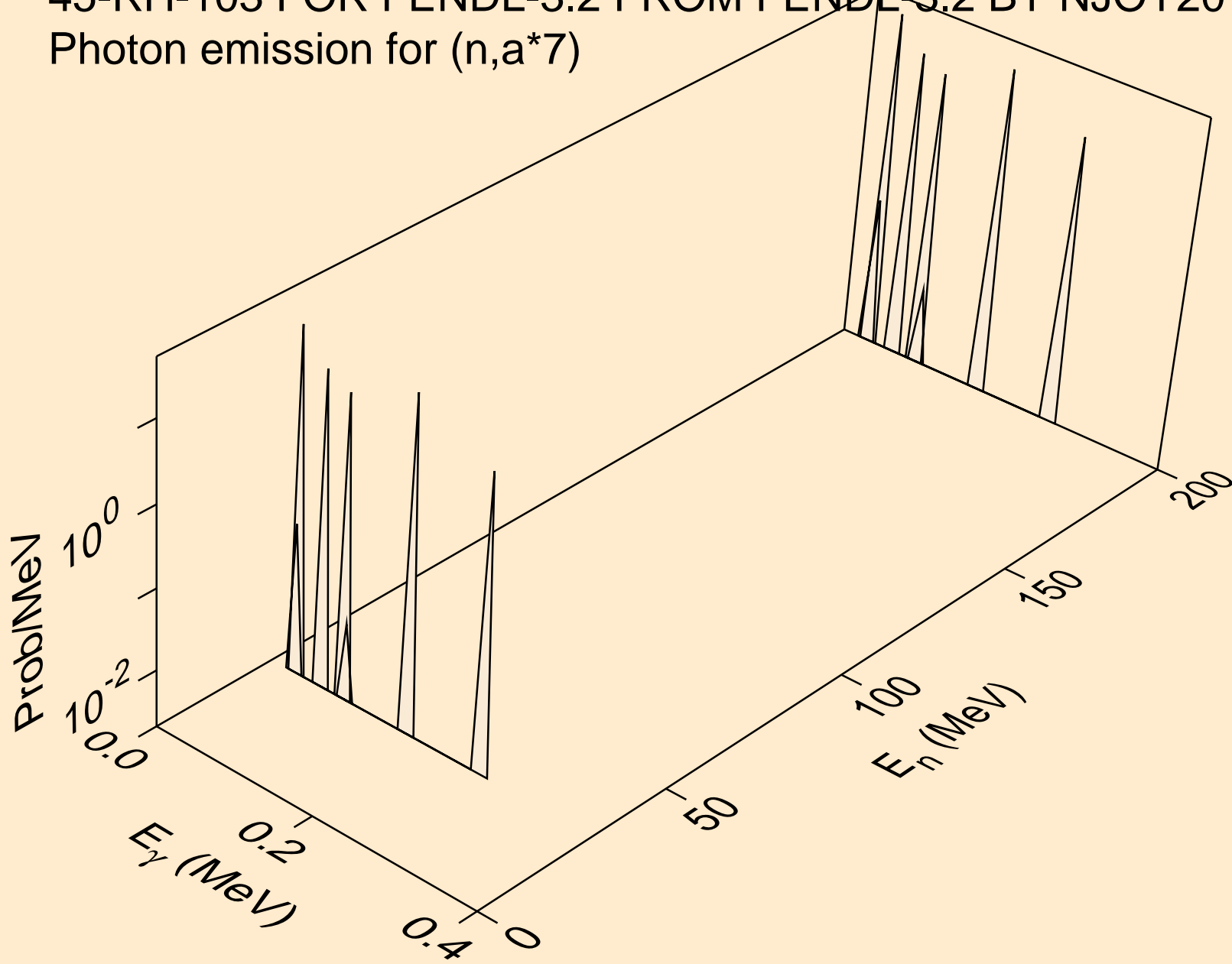

45-RH-103 FOR FENDL-3.2 FROM FENDL-3.2 BY NJOY2016.60+ C
Photon emission for (n,a*8)

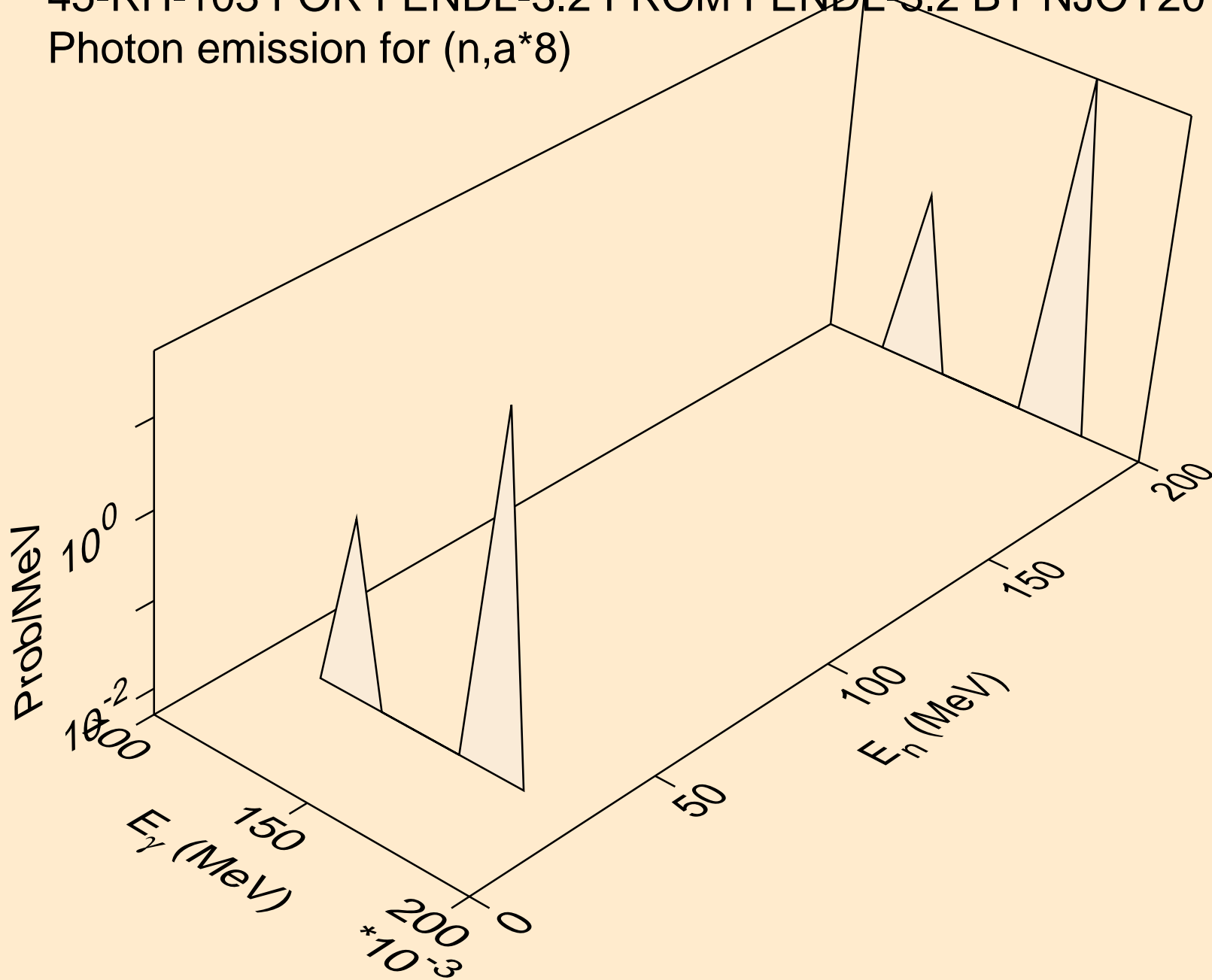

45-RH-103 FOR FENDL-3.2 FROM FENDL-3.2 BY NJOY2016.60+ C
Photon emission for (n,a*9)

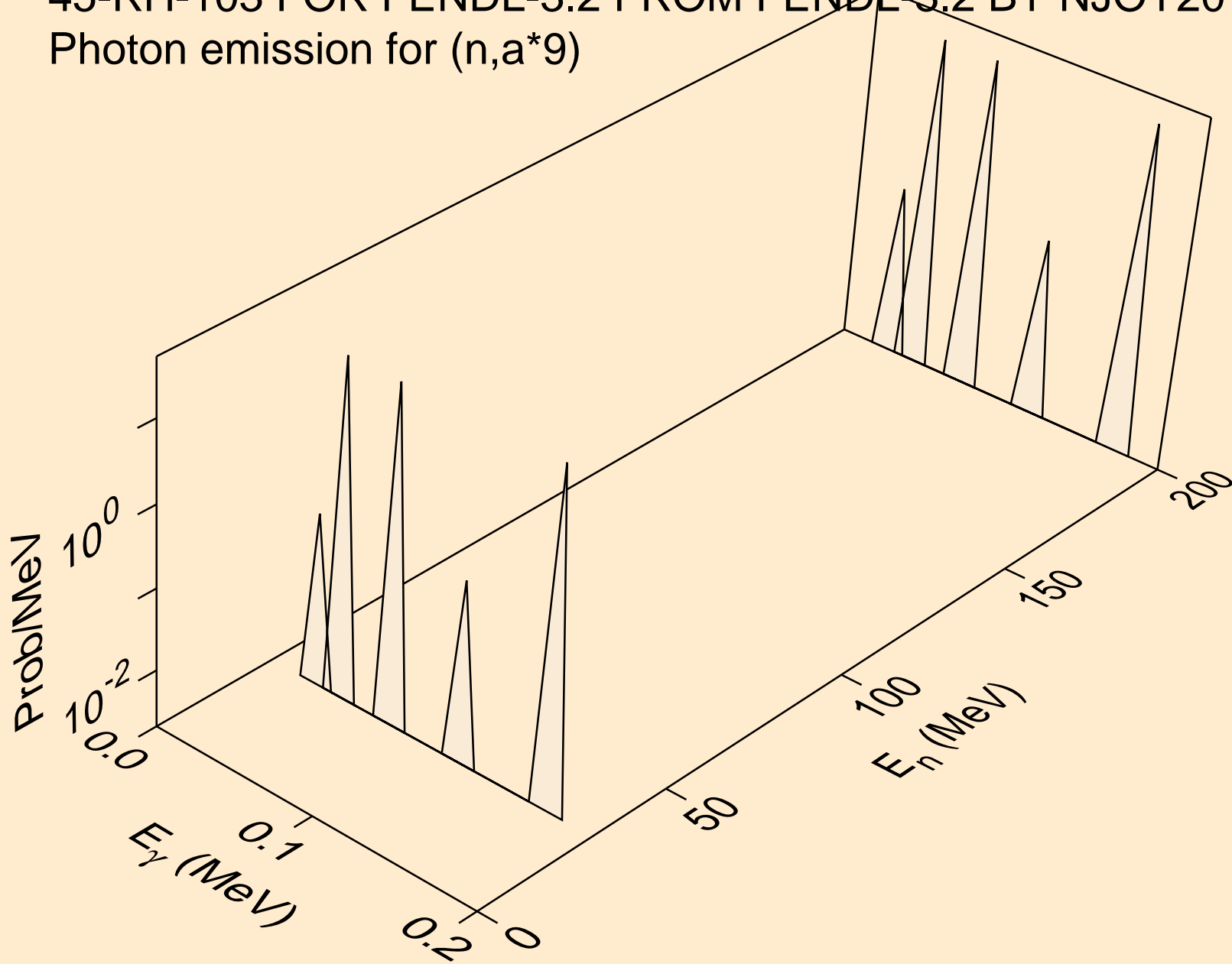

45-RH-103 FOR FENDL-3.2 FROM FENDL-3.2 BY NJOY2016.60+ C
Photon emission for (n,a*10)

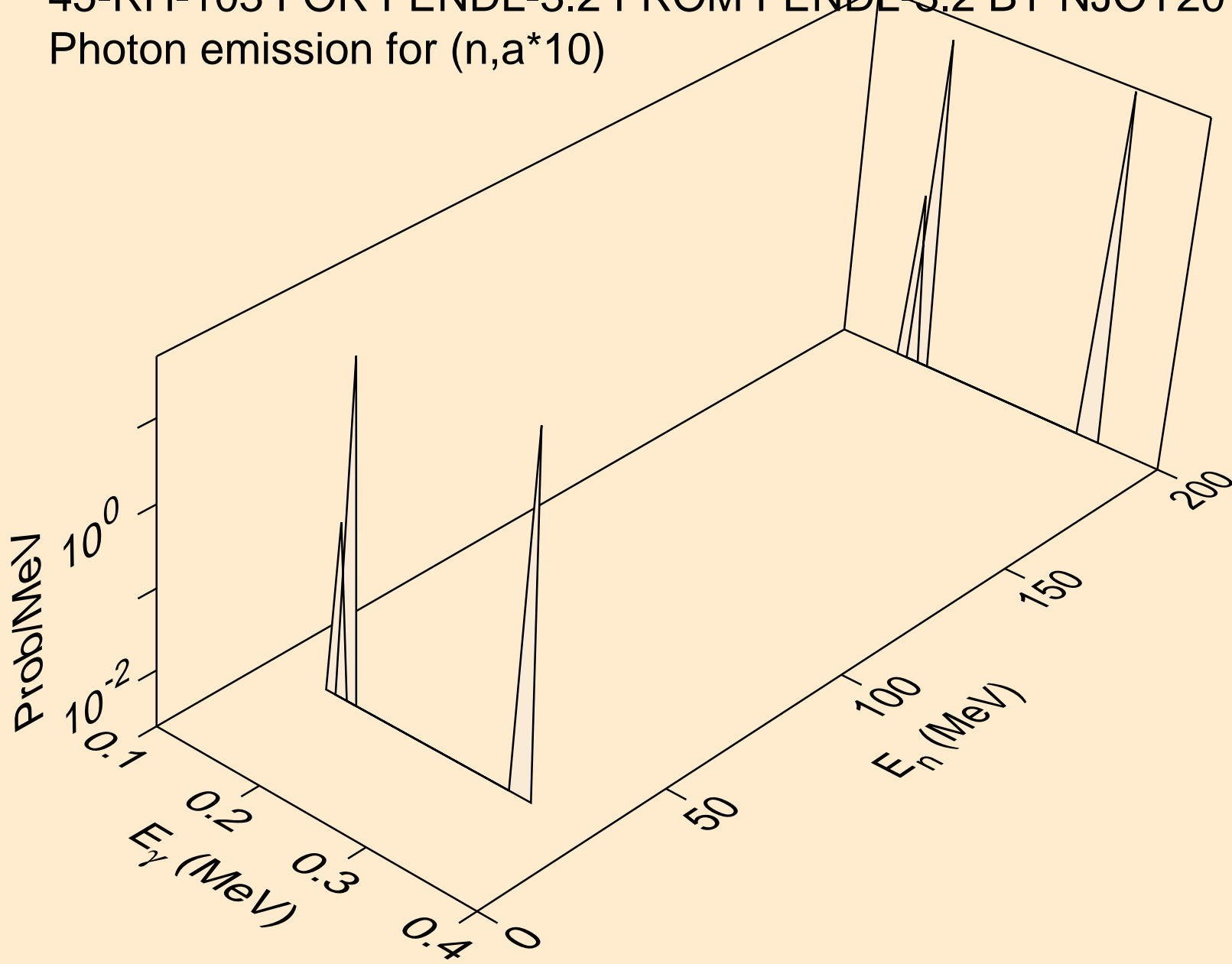

45-RH-103 FOR FENDL-3.2 FROM FENDL-3.2 BY NJOY2016.60+ C
Photon emission for (n,a*11)

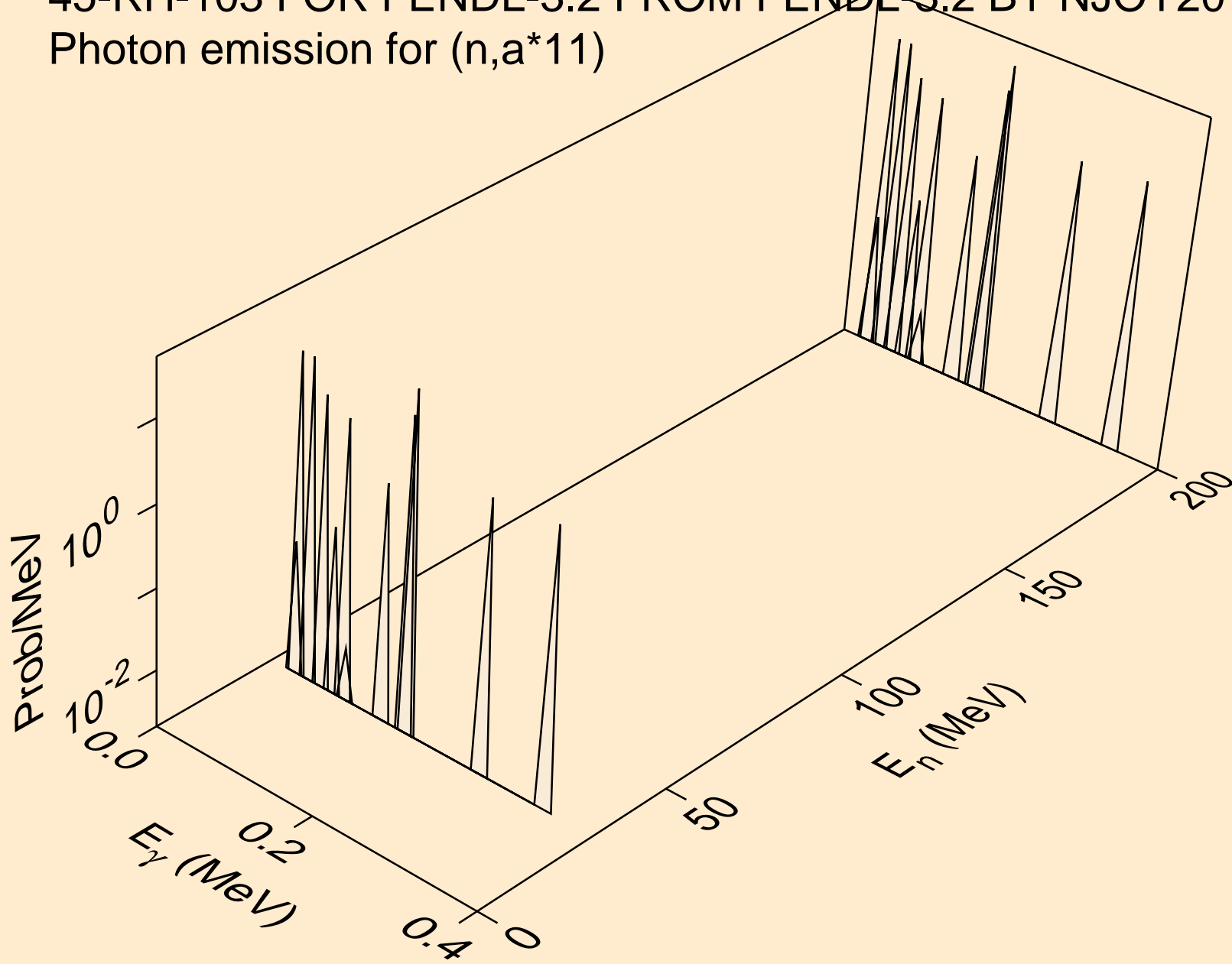

45-RH-103 FOR FENDL-3.2 FROM FENDL-3.2 BY NJOY2016.60+ C
Photon emission for (n,a*12)

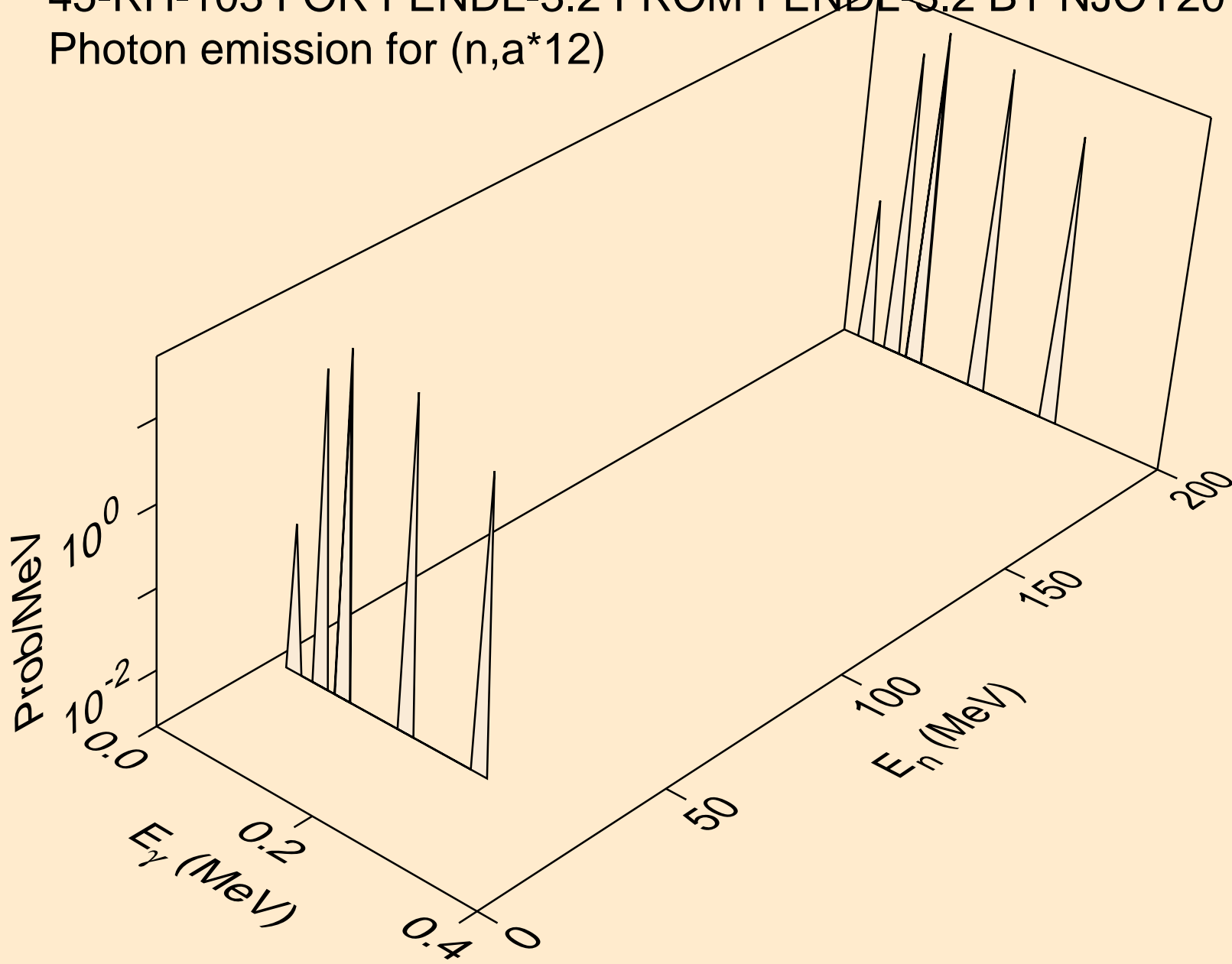

45-RH-103 FOR FENDL-3.2 FROM FENDL-3.2 BY NJOY2016.60+ C
Photon emission for (n,a*13)

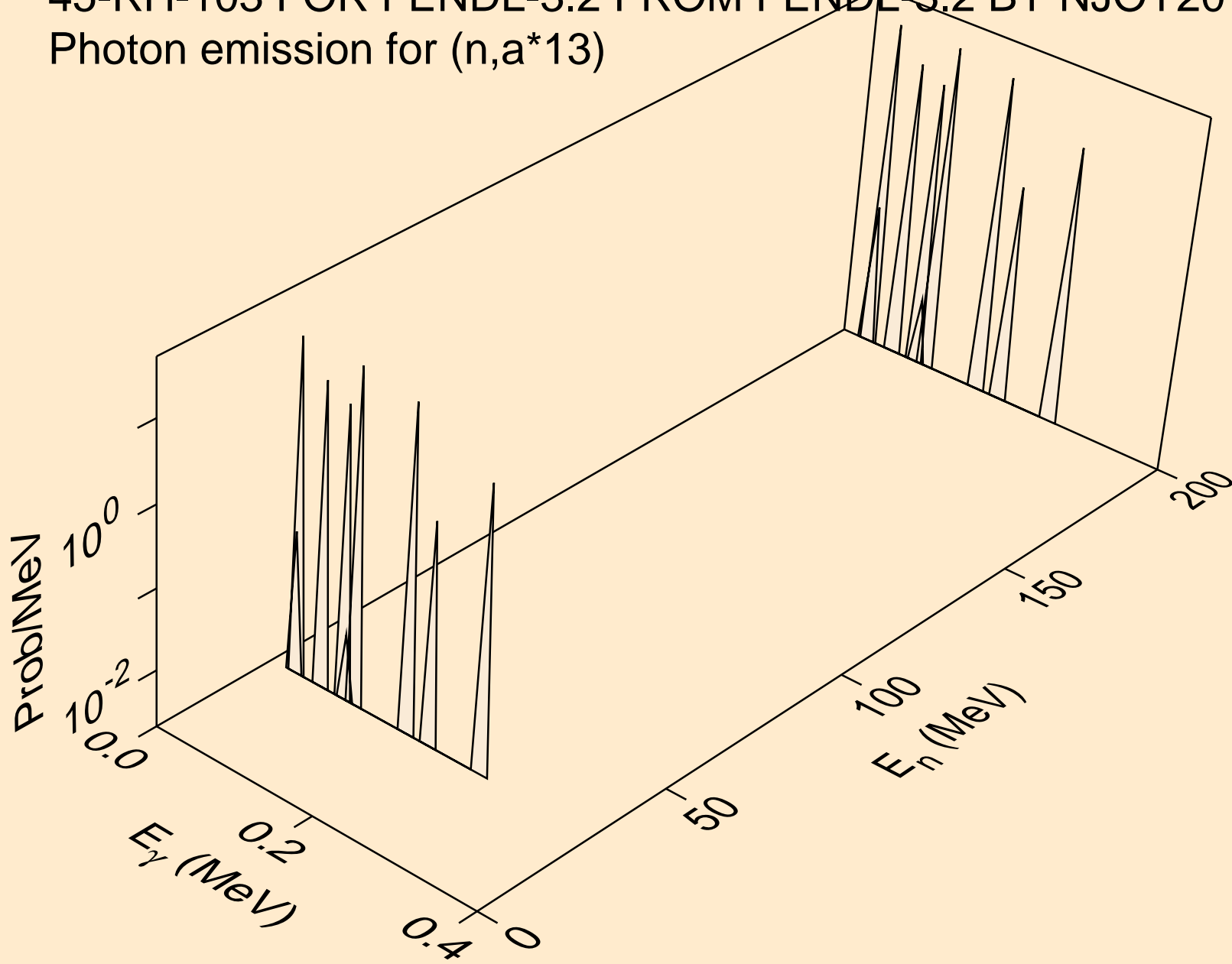

45-RH-103 FOR FENDL-3.2 FROM FENDL-3.2 BY NJOY2016.60+ C
Photon emission for (n,a*14)

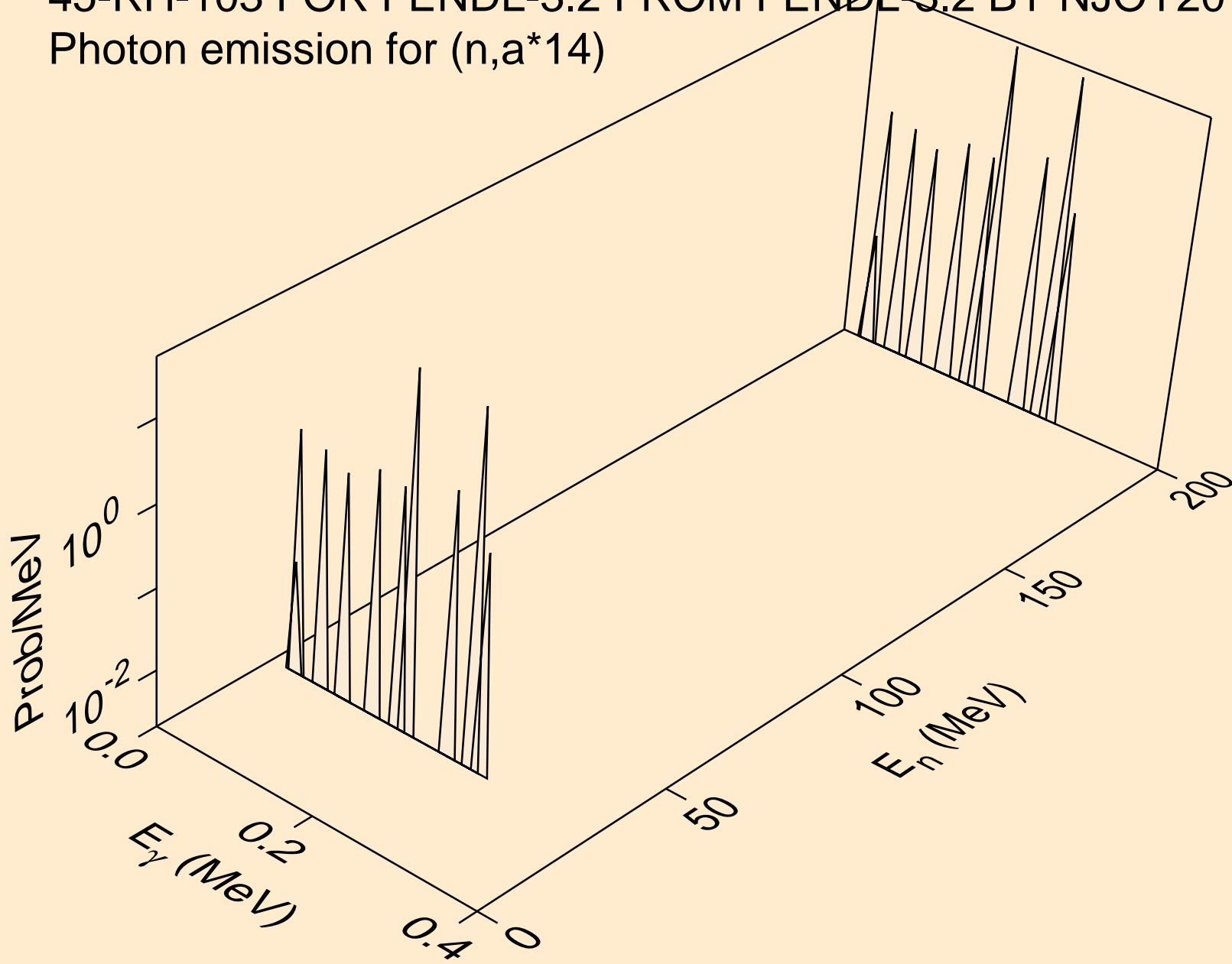

45-RH-103 FOR FENDL-3.2 FROM FENDL-3.2 BY NJOY2016.60+ C
Photon emission for (n,a*15)

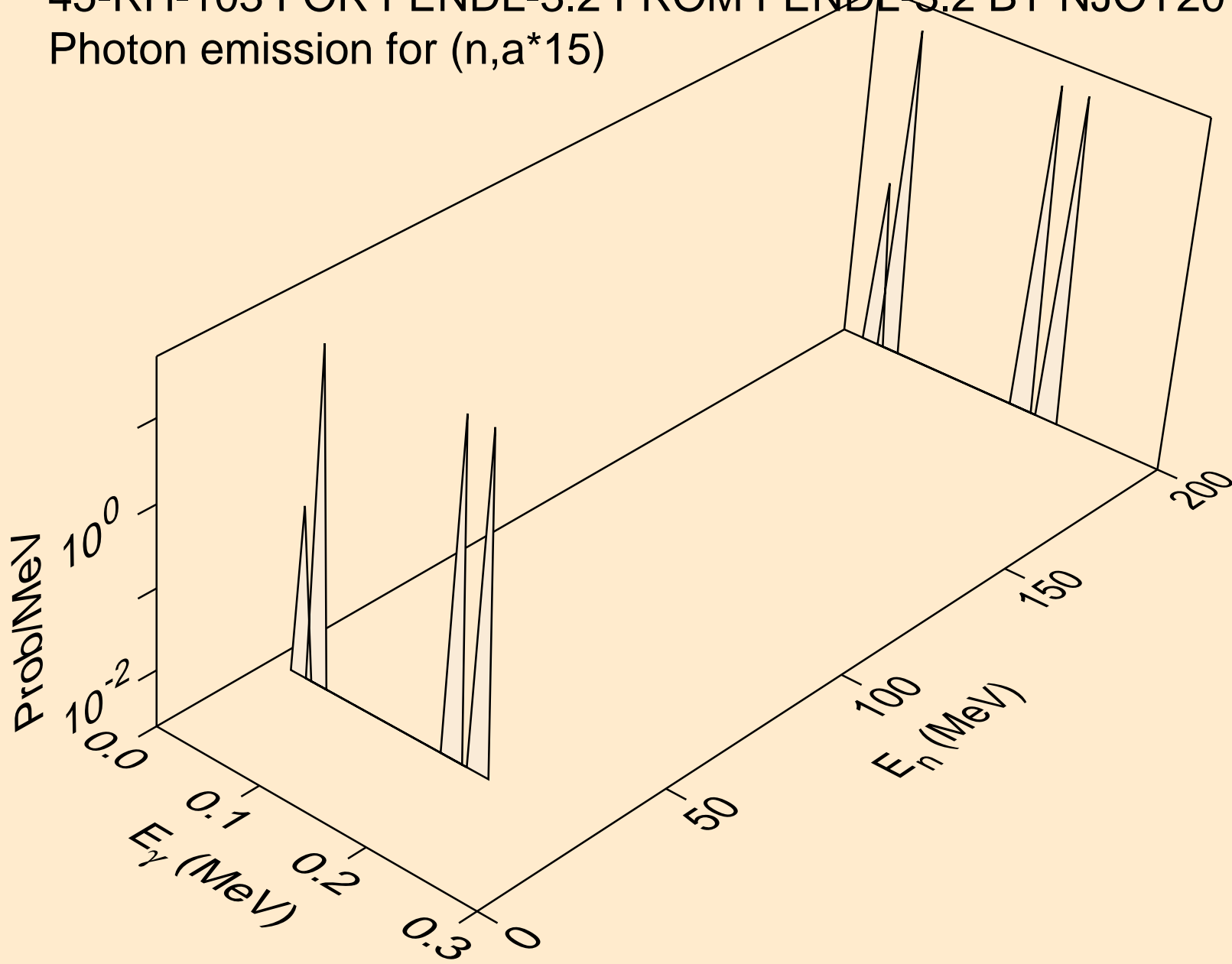

45-RH-103 FOR FENDL-3.2 FROM FENDL-3.2 BY NJOY2016.60+ C
Photon emission for (n,a*c)

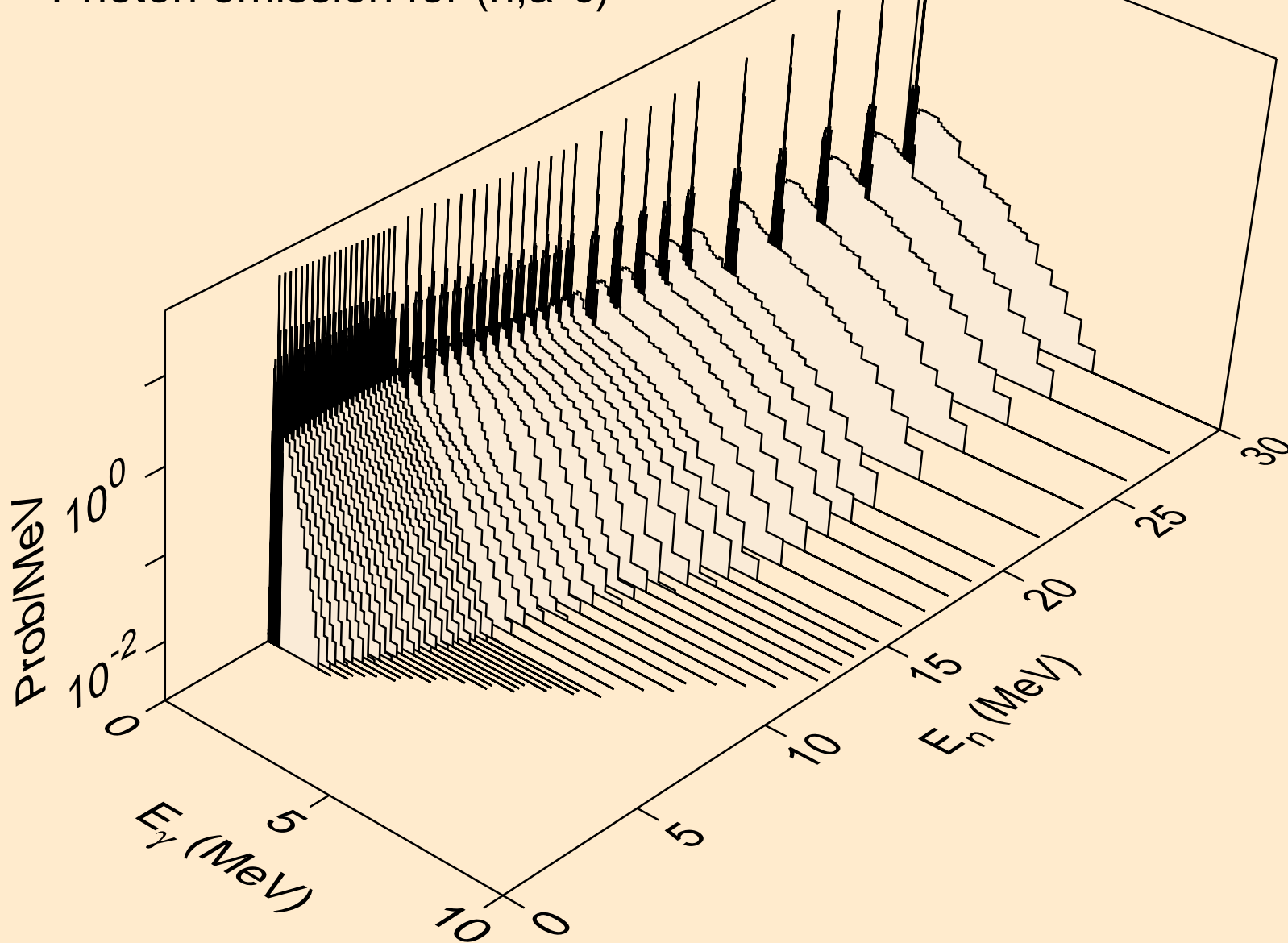

45-RH-103 FOR FENDL-3.2 FROM FENDL-3.2 BY NJOY2016.60+ C
14 MeV photon spectrum

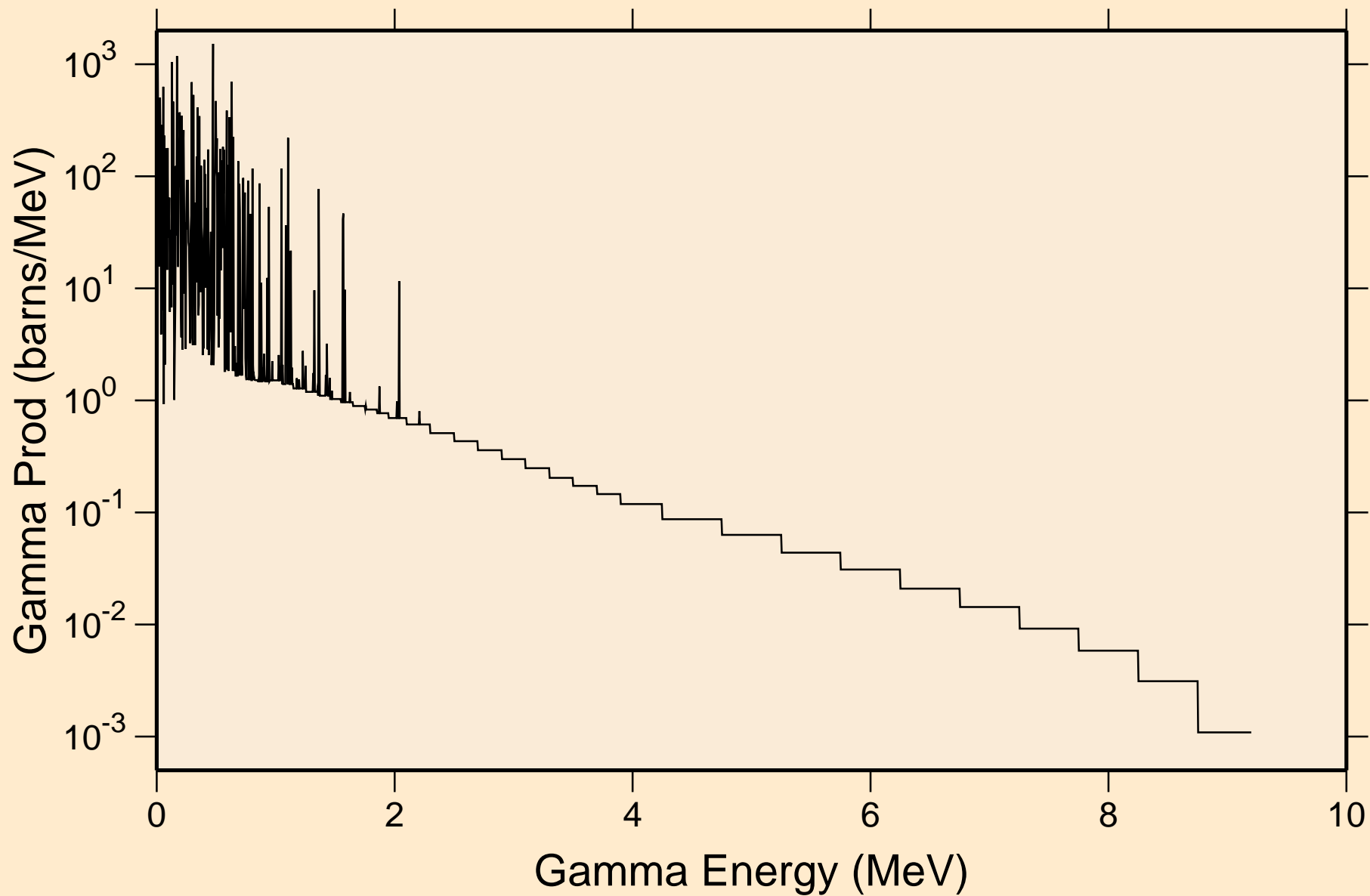

45-RH-103 FOR FENDL-3.2 FROM FENDL-3.2 BY NJOY2016.60+ C

Particle heating contributions

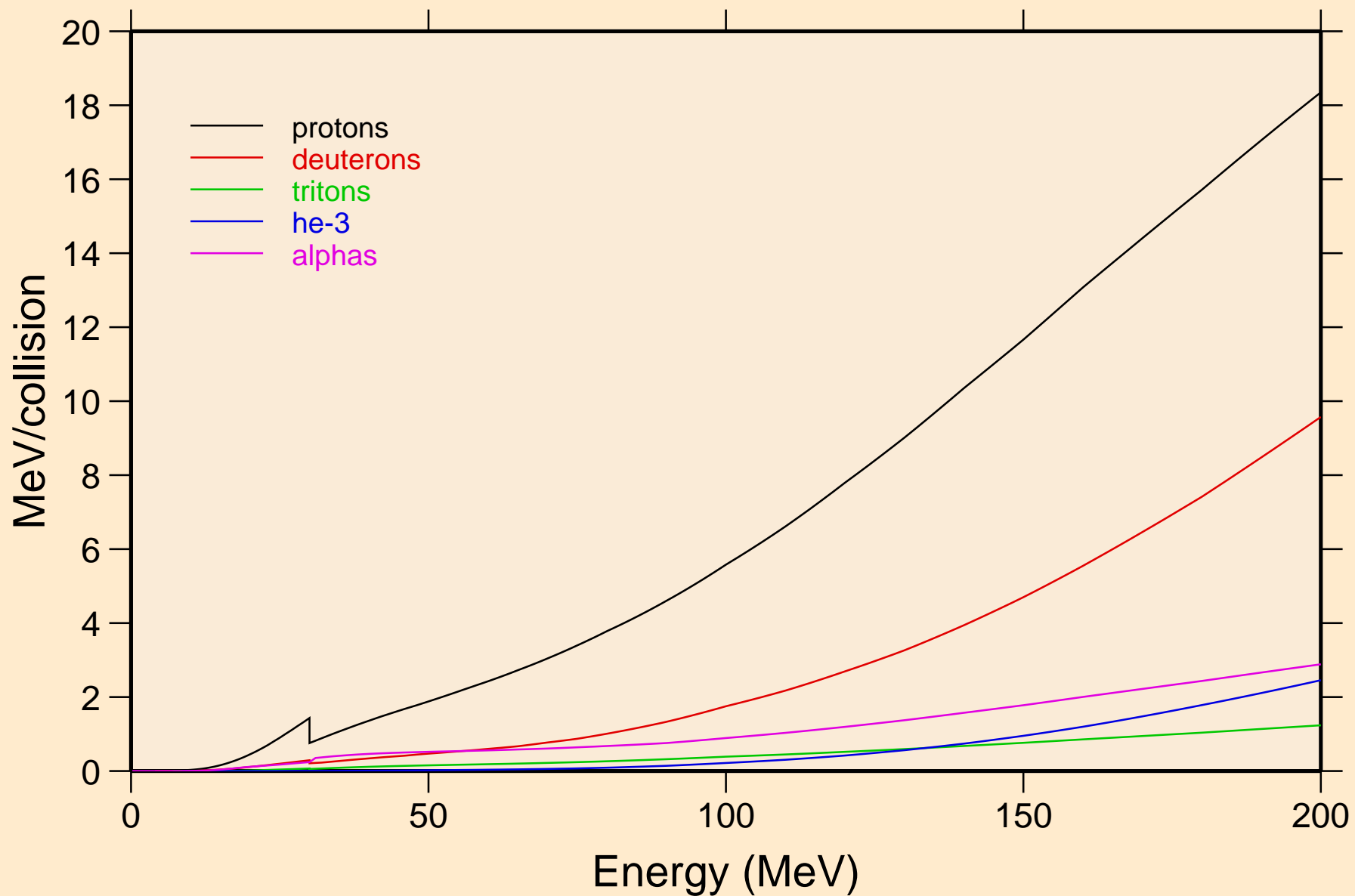

45-RH-103 FOR FENDL-3.2 FROM FENDL-3.2 BY NJOY2016.60+ C
Recoil Heating

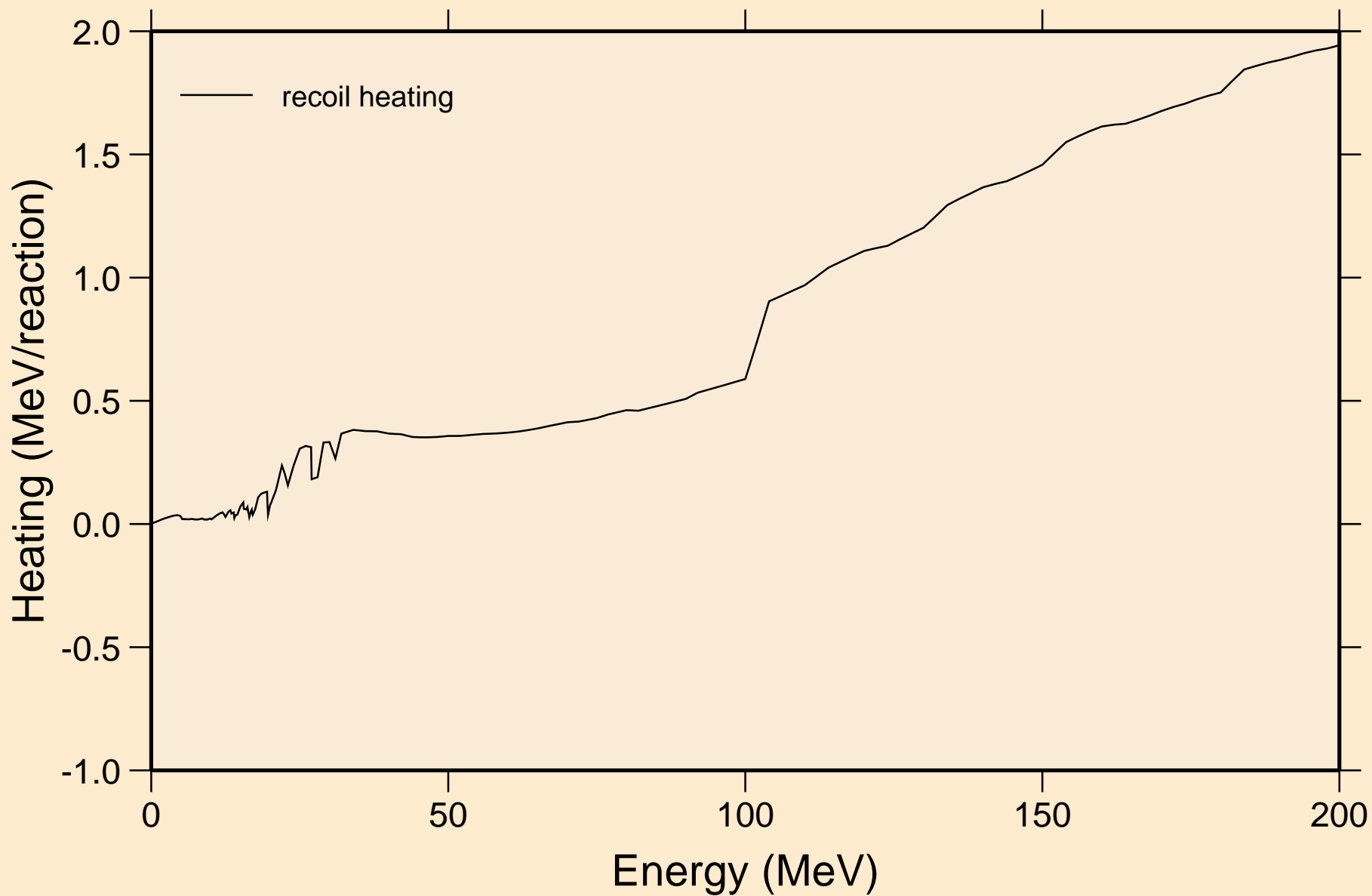

45-RH-103 FOR FENDL-3.2 FROM FENDL-3.2 BY NJOY2016.60+ C
Particle production cross sections

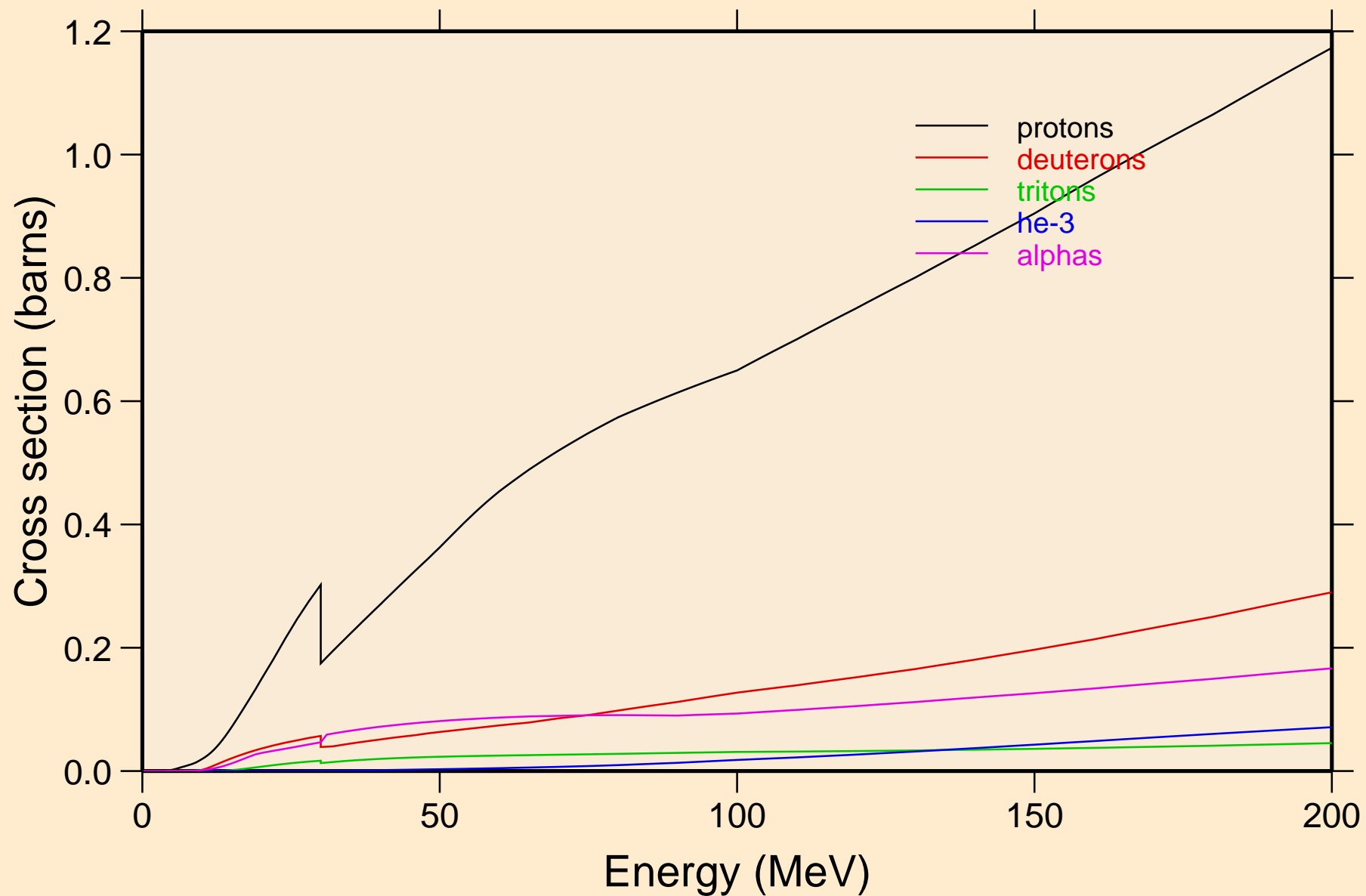

45-RH-103 FOR FENDL-3.2 FROM FENDL-3.2 BY NJOY2016.60+ C
protons from (n,x)

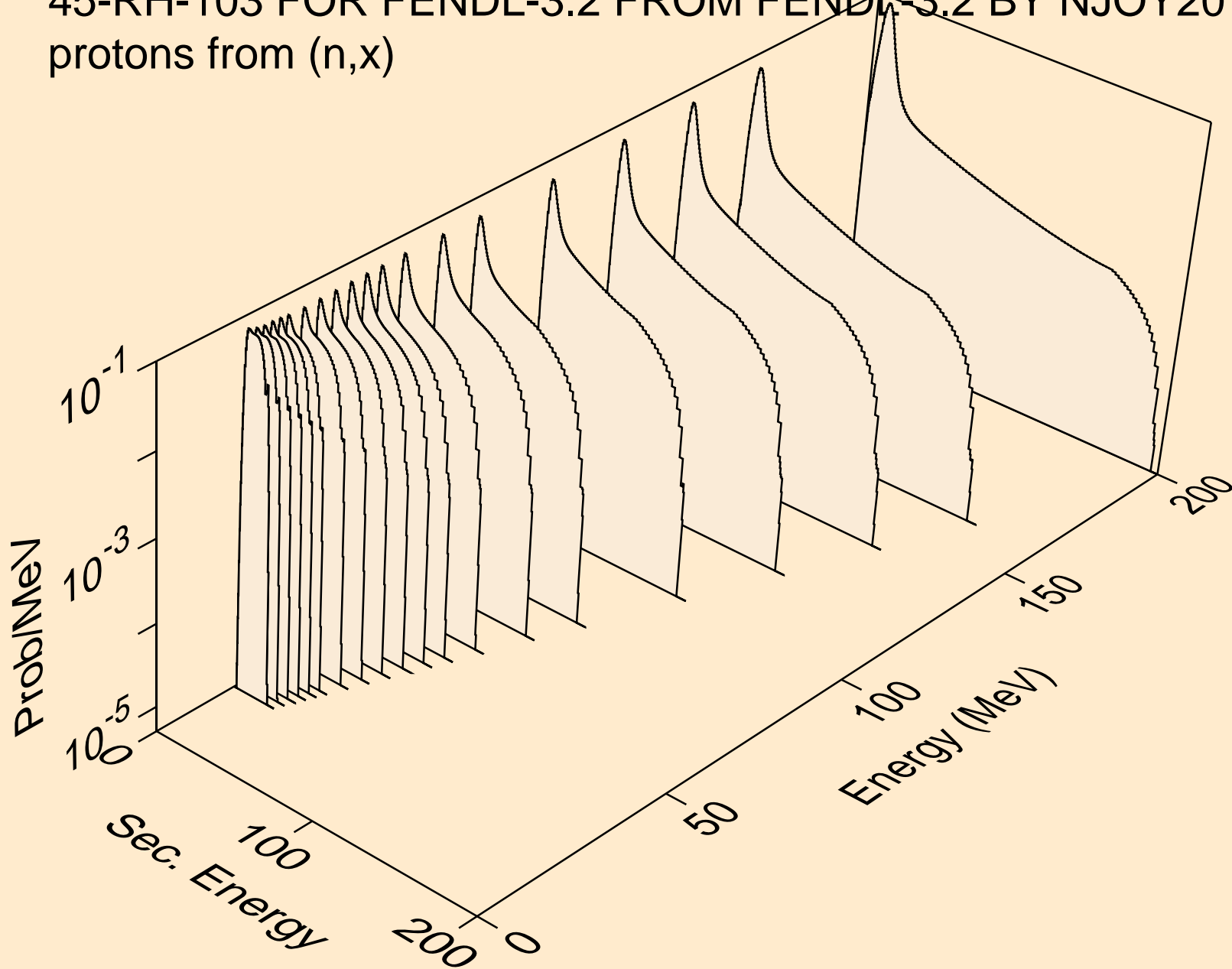

45-RH-103 FOR FENDL-3.2 FROM FENDL-3.2 BY NJOY2016.60+ C
protons from (n,n*)p

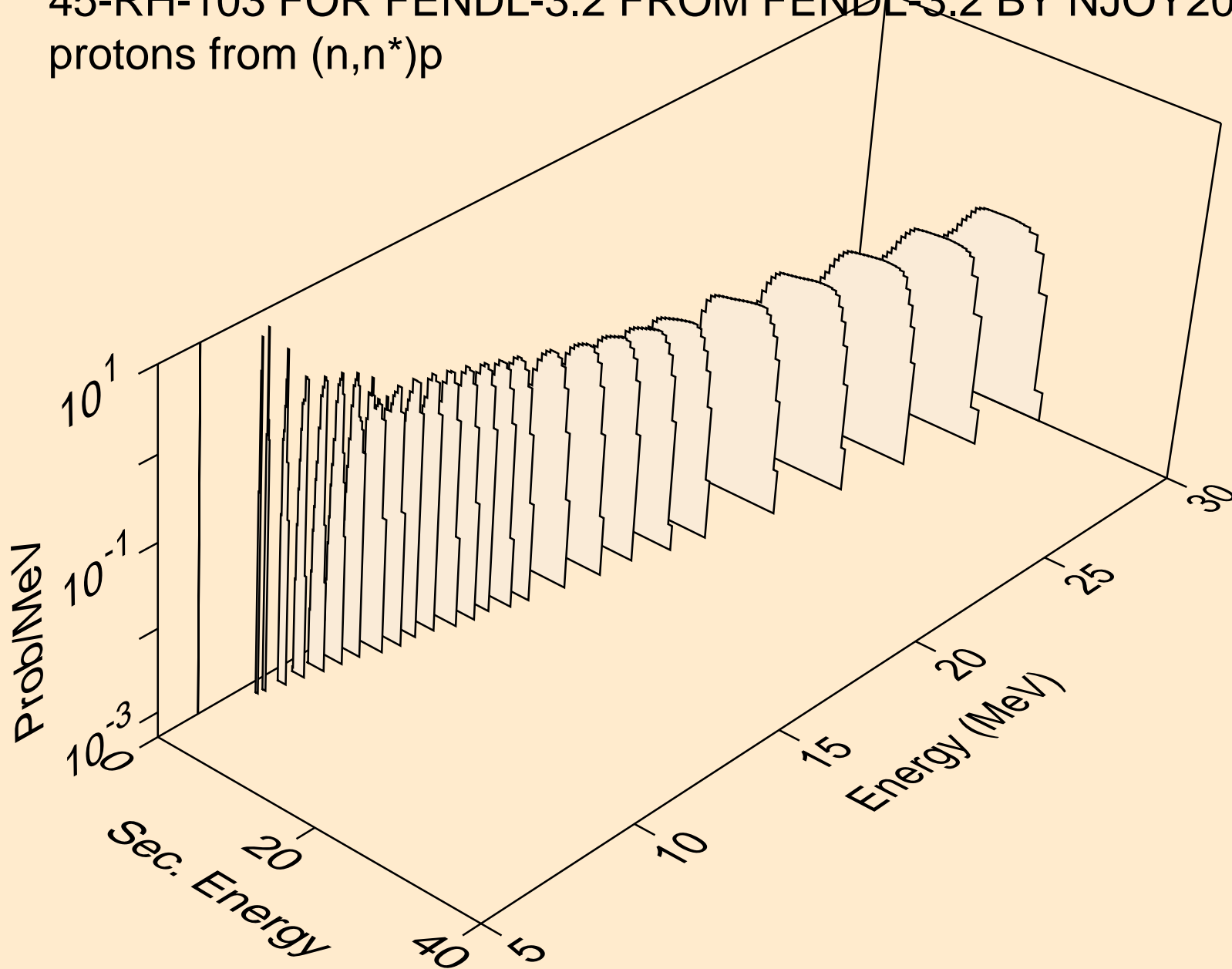

45-RH-103 FOR FENDL-3.2 FROM FENDL-3.2 BY NJOY2016.60+ C
protons from (n,2np)

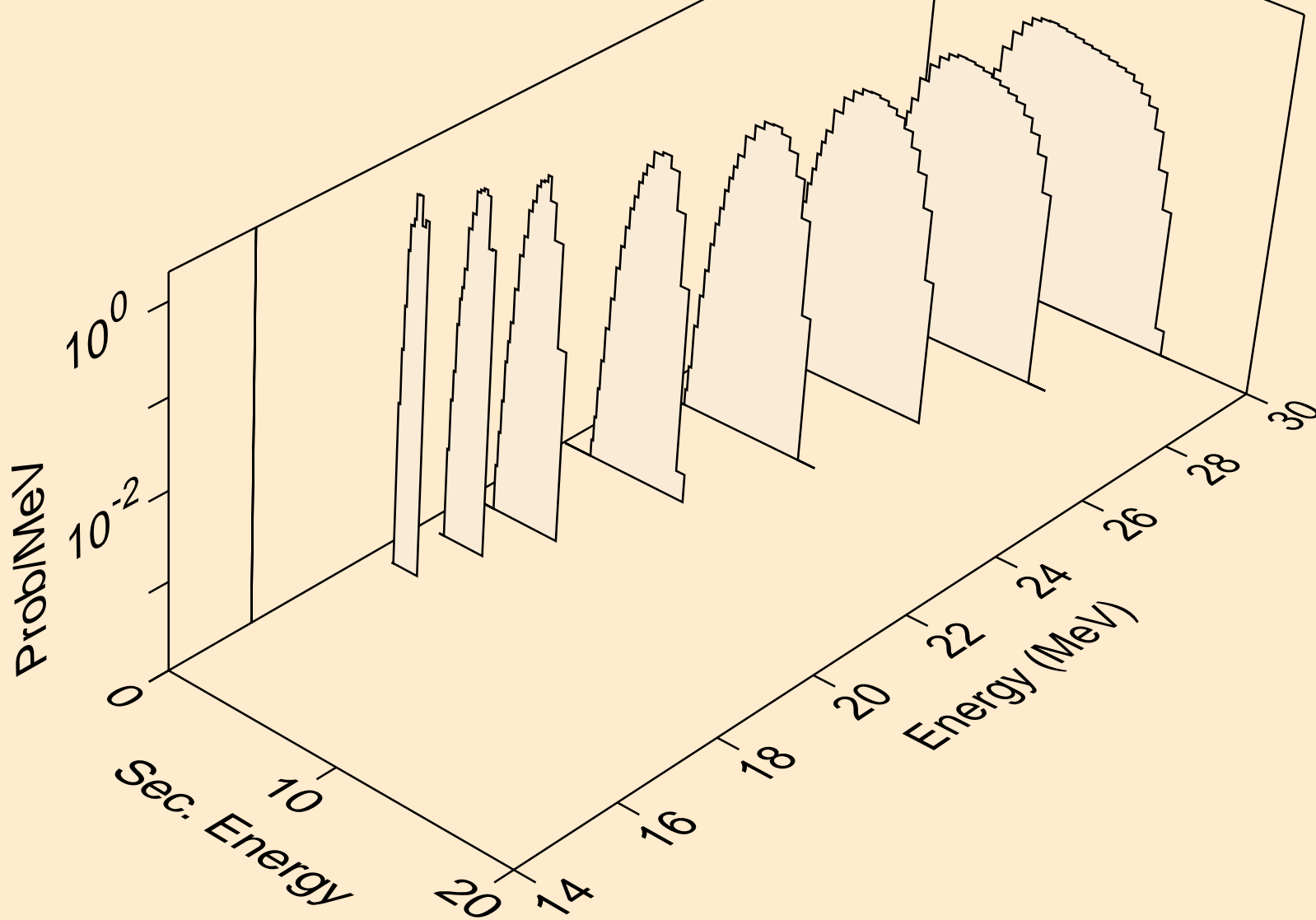

45-RH-103 FOR FENDL-3.2 FROM FENDL-3.2 BY NJOY2016.60+ C
protons from (n,3np)

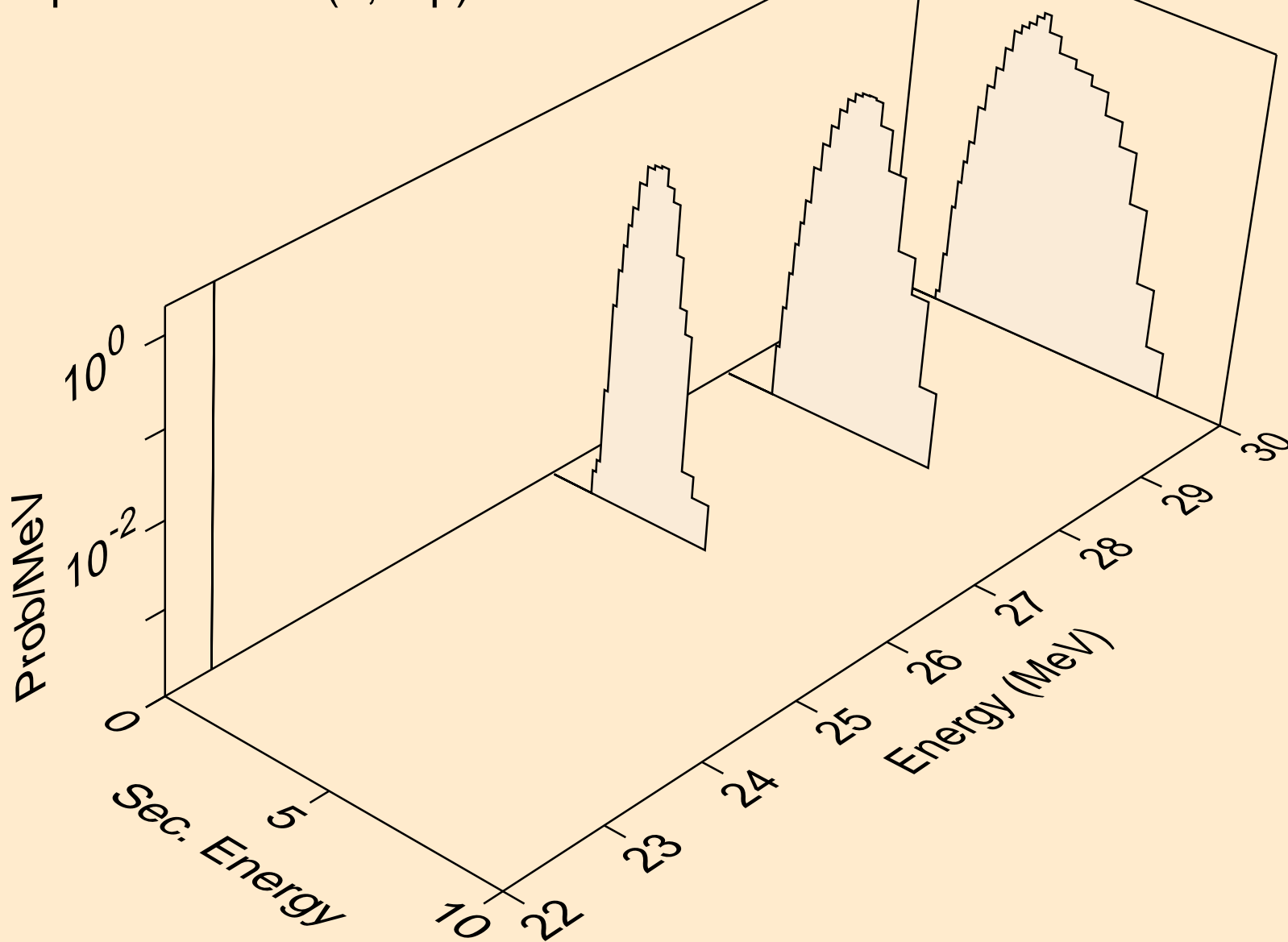

45-RH-103 FOR FENDL-3.2 FROM FENDL-3.2 BY NJOY2016.60+ C
protons from (n,2np)

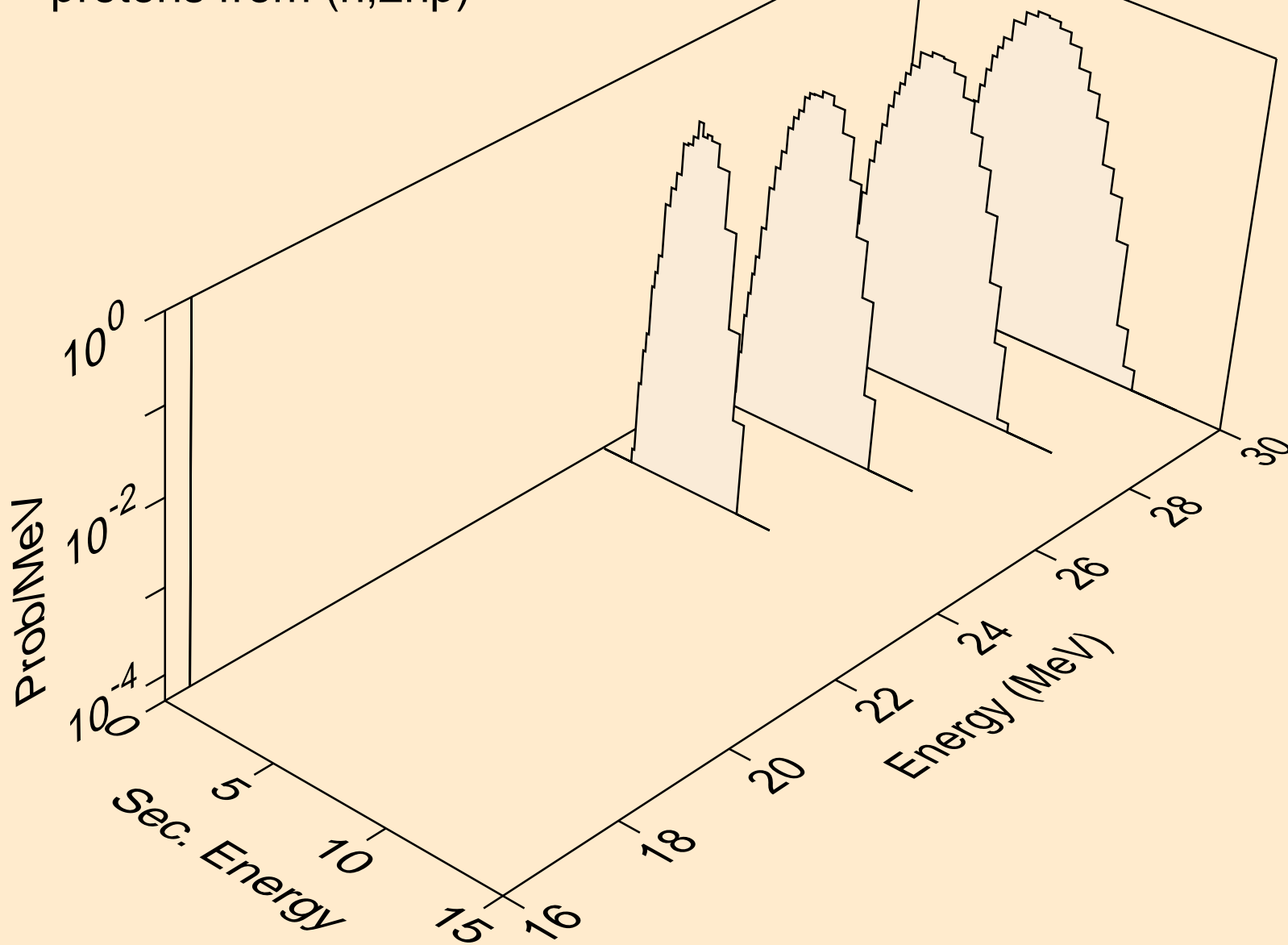

45-RH-103 FOR FENDL-3.2 FROM FENDL-3.2 BY NJOY2016.60+ C
protons from (n,npa)

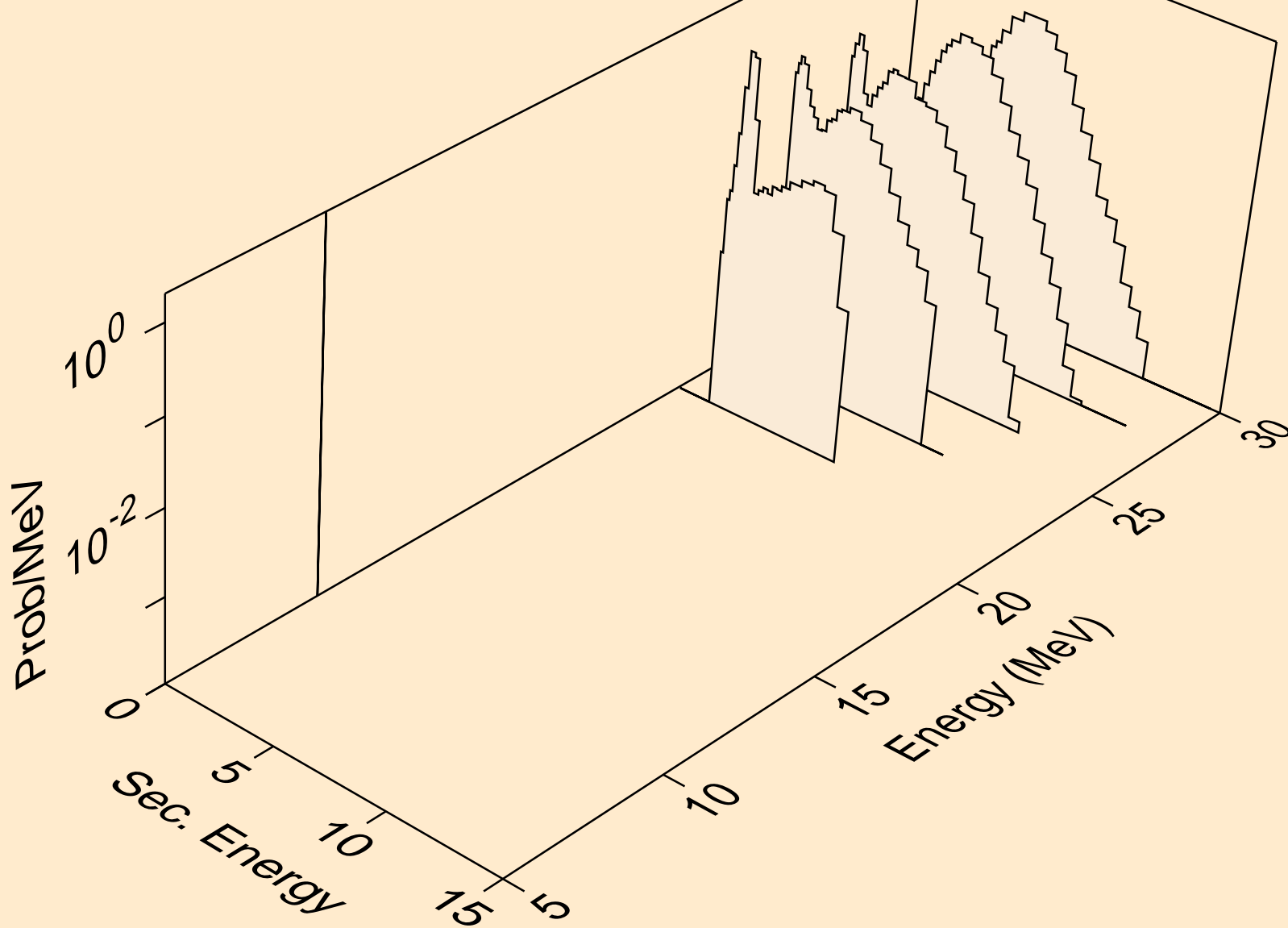

45-RH-103 FOR FENDL-3.2 FROM FENDL-3.2 BY NJOY2016.60+ C
protons from (n,2p)

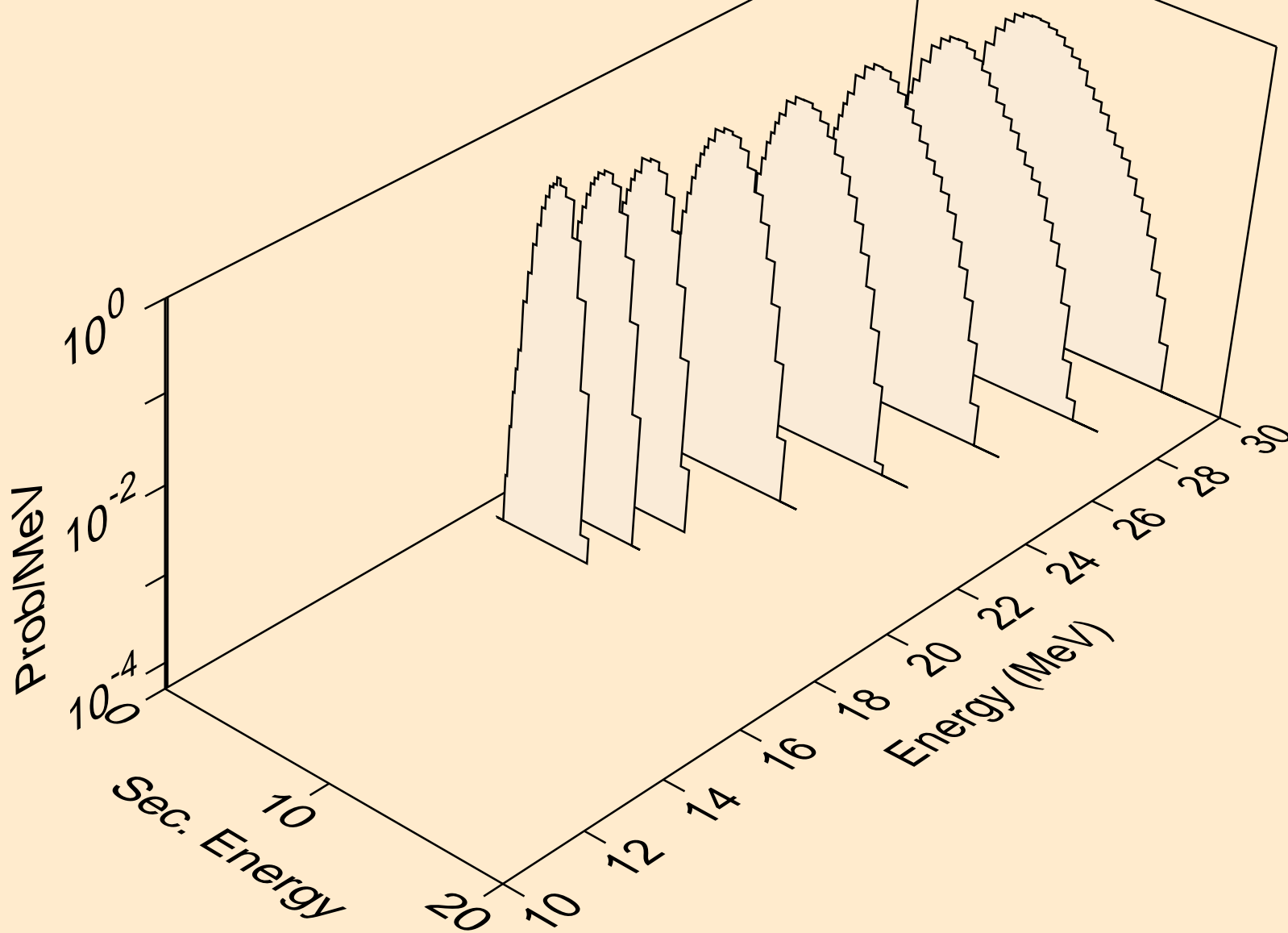

45-RH-103 FOR FENDL-3.2 FROM FENDL-3.2 BY NJOY2016.60+ C
protons from (n,pa)

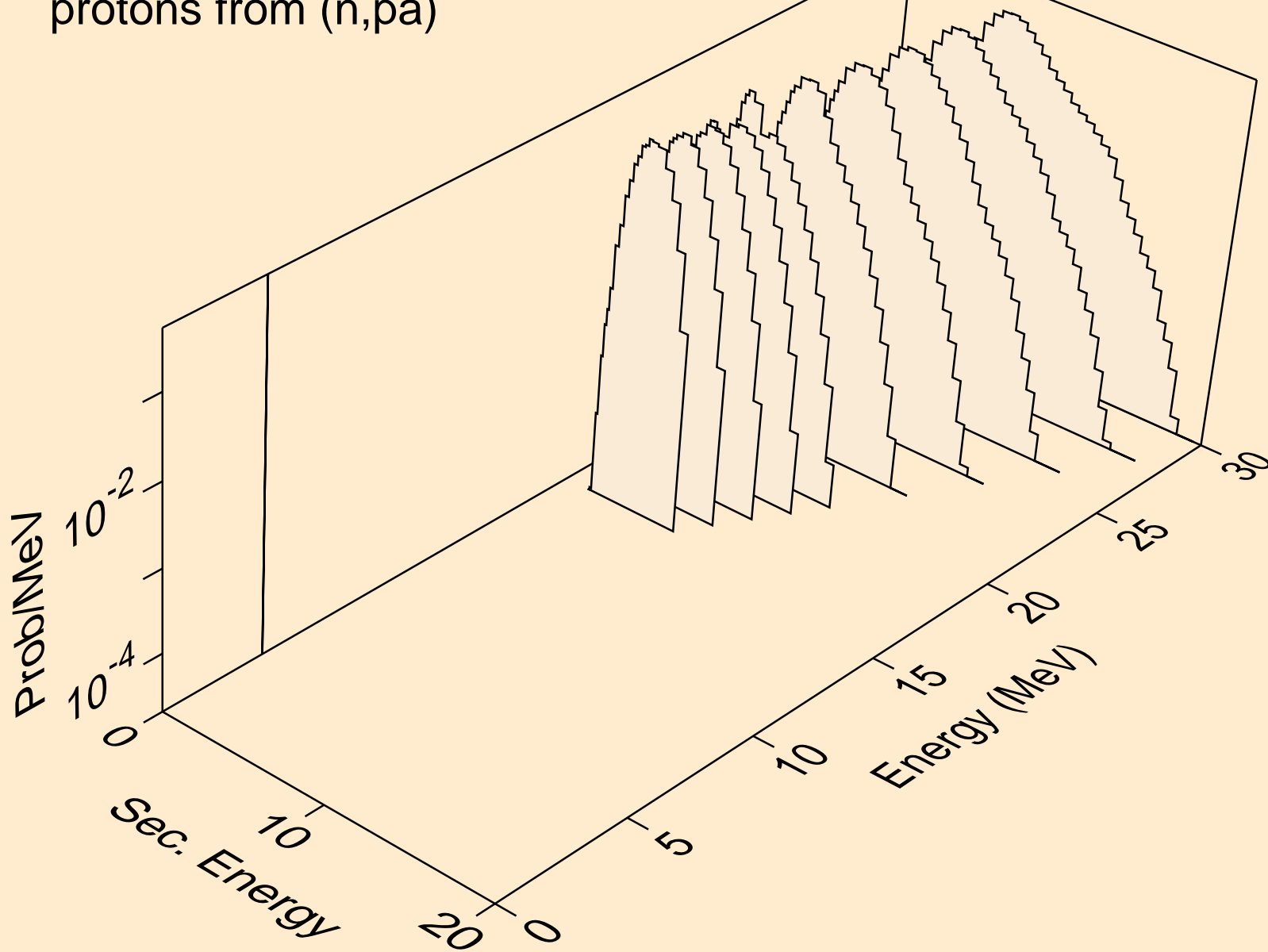

45-RH-103 FOR FENDL-3.2 FROM FENDL-3.2 BY NJOY2016.60+ C
protons from (n,pd)

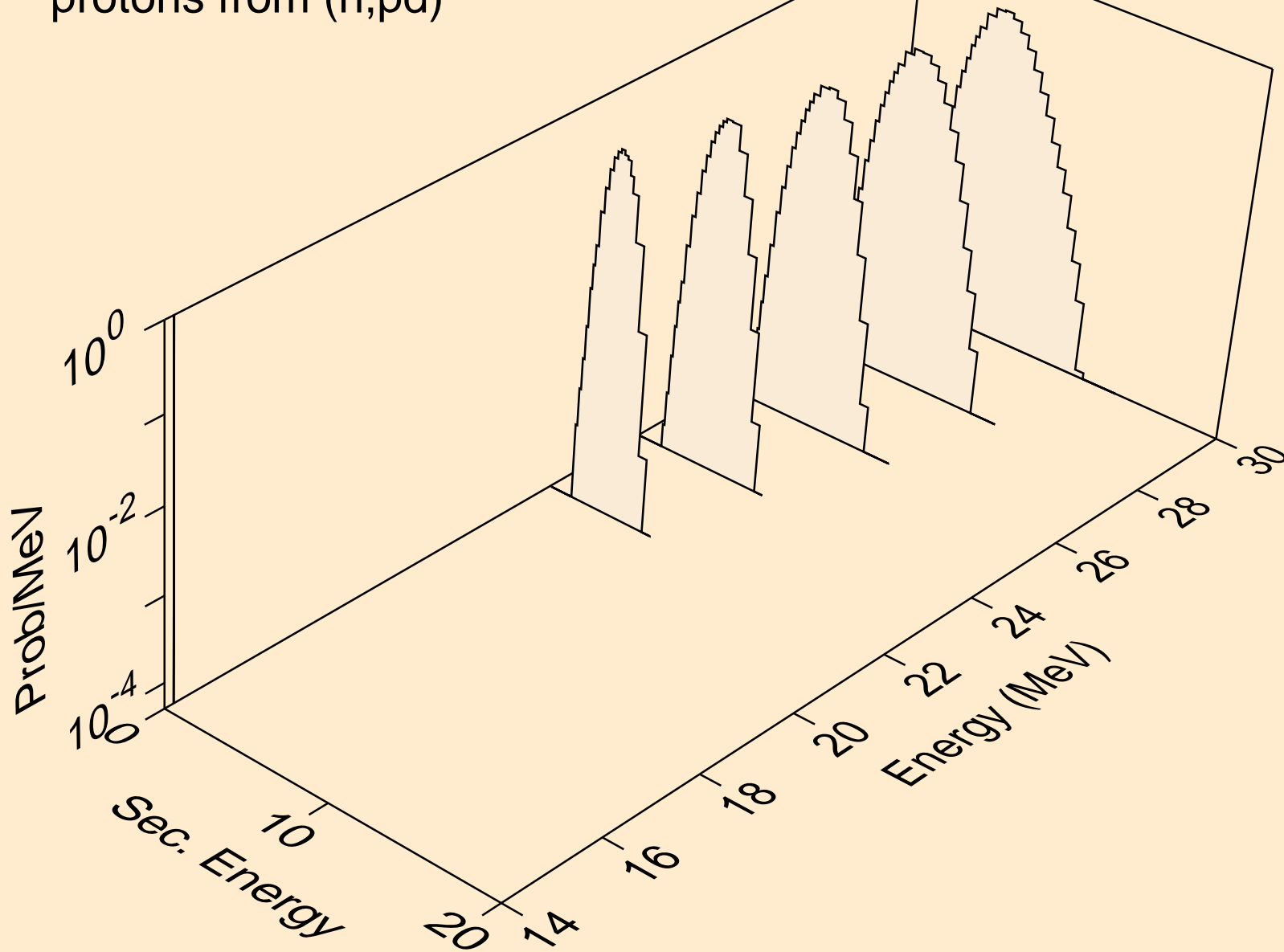

45-RH-103 FOR FENDL-3.2 FROM FENDL-3.2 BY NJOY2016.60+ C
protons from (n,pt)

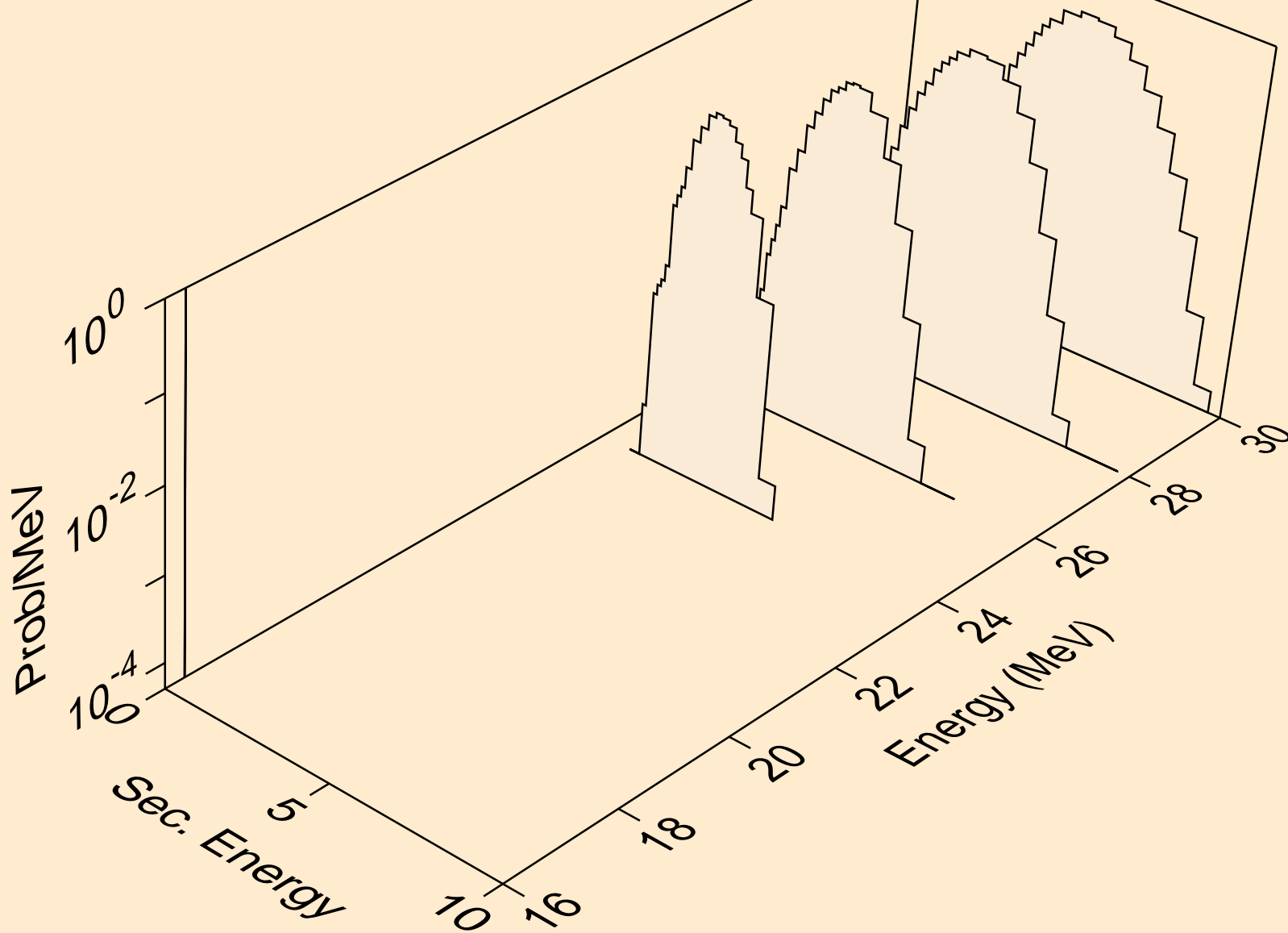

45-RH-103 FOR FENDL-3.2 FROM FENDL-3.2 BY NJOY2016.60+ C
angular distribution for (n,p*0) proton

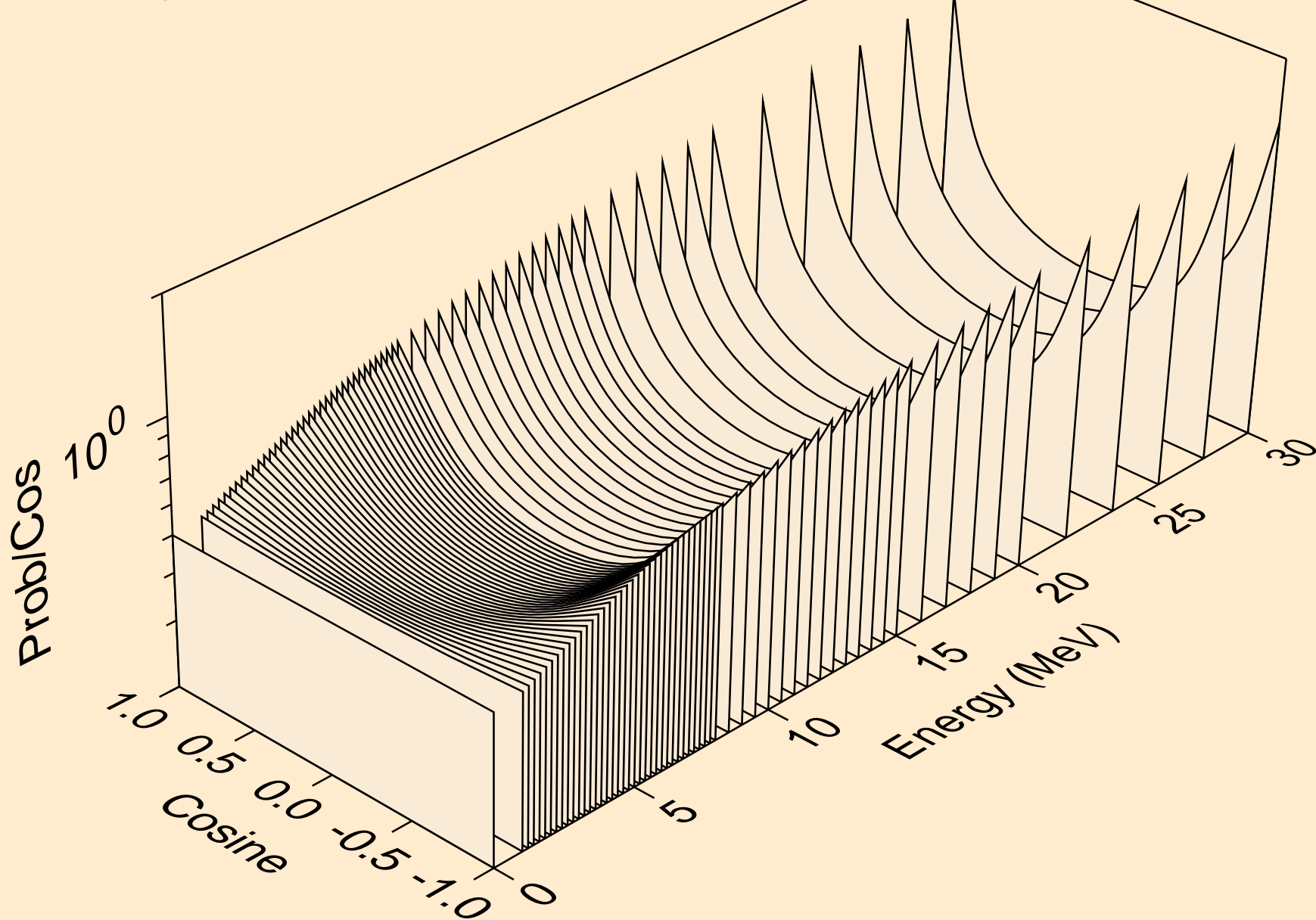

45-RH-103 FOR FENDL-3.2 FROM FENDL-3.2 BY NJOY2016.60+ C
angular distribution for (n,p*1) proton

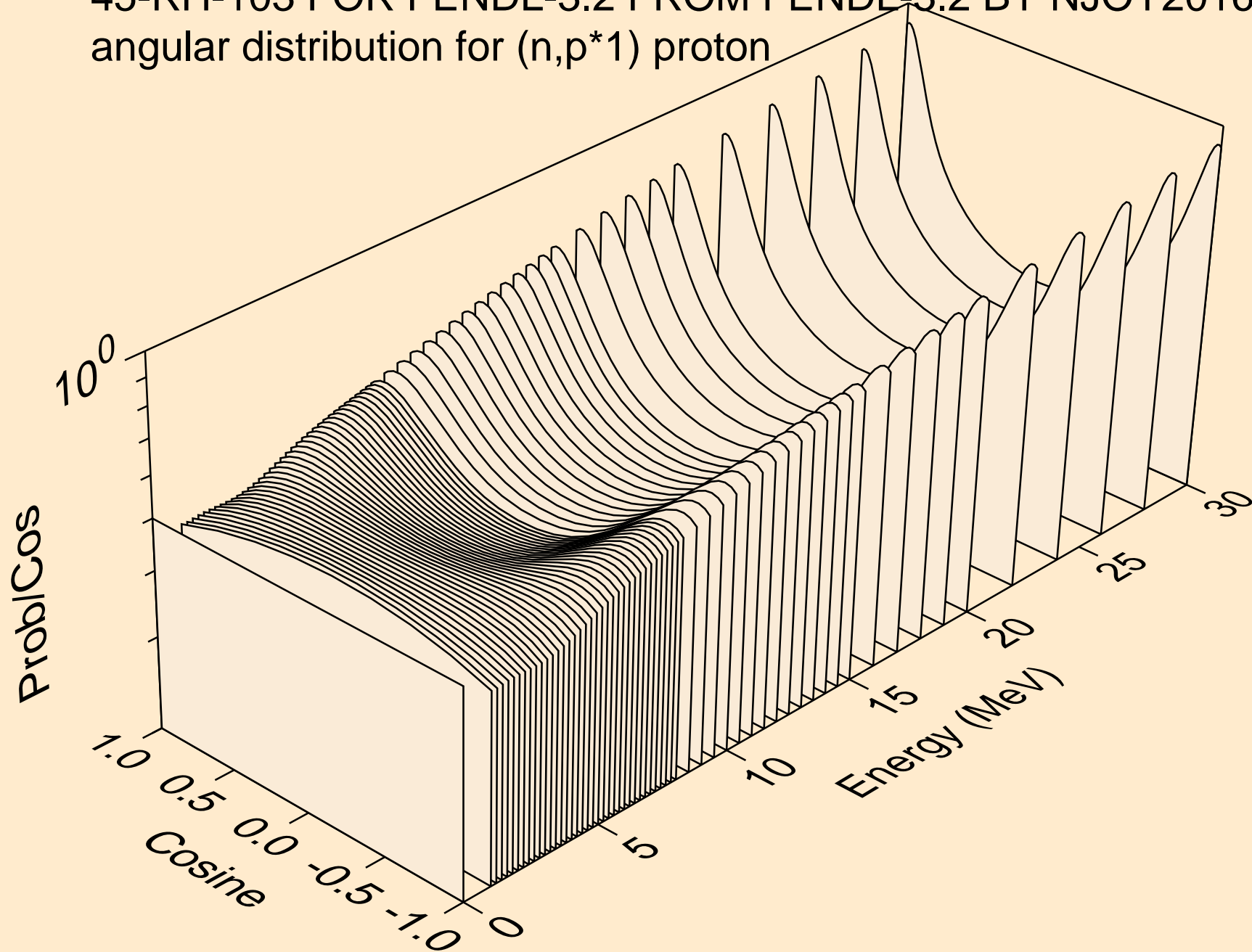

45-RH-103 FOR FENDL-3.2 FROM FENDL-3.2 BY NJOY2016.60+ C
angular distribution for (n,p*2) proton

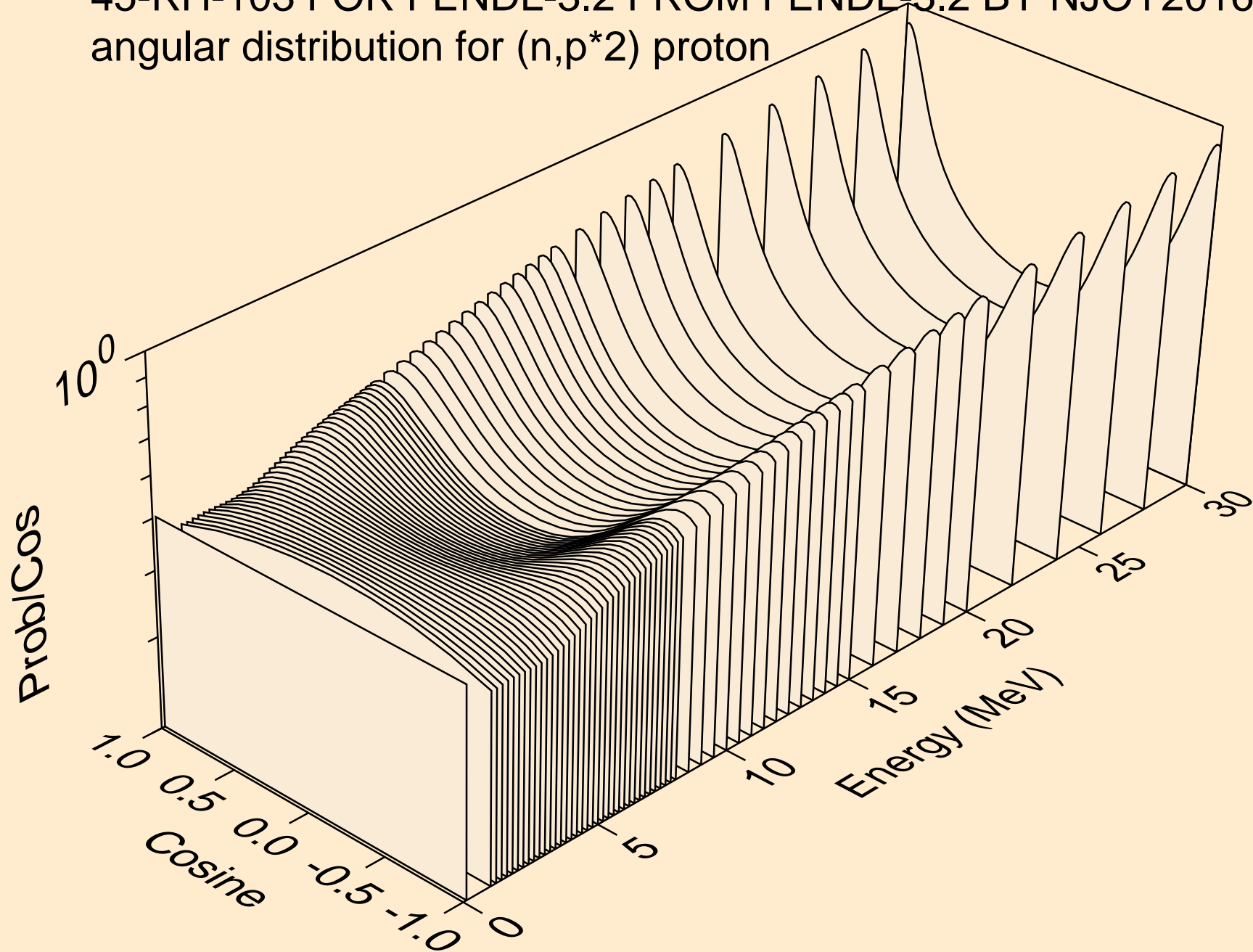

45-RH-103 FOR FENDL-3.2 FROM FENDL-3.2 BY NJOY2016.60+ C
angular distribution for (n,p*3) proton

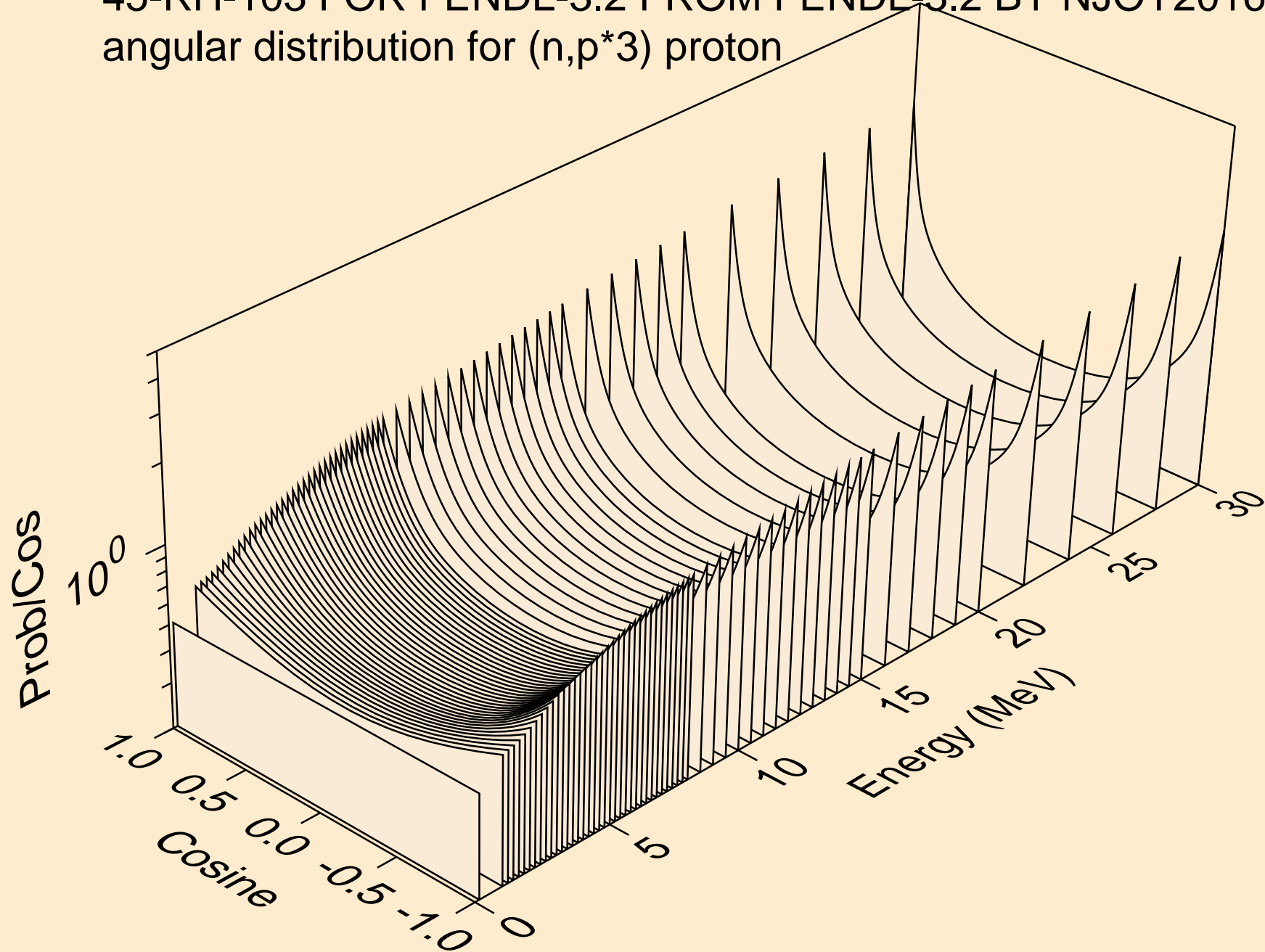

45-RH-103 FOR FENDL-3.2 FROM FENDL-3.2 BY NJOY2016.60+ C
angular distribution for (n,p*4) proton

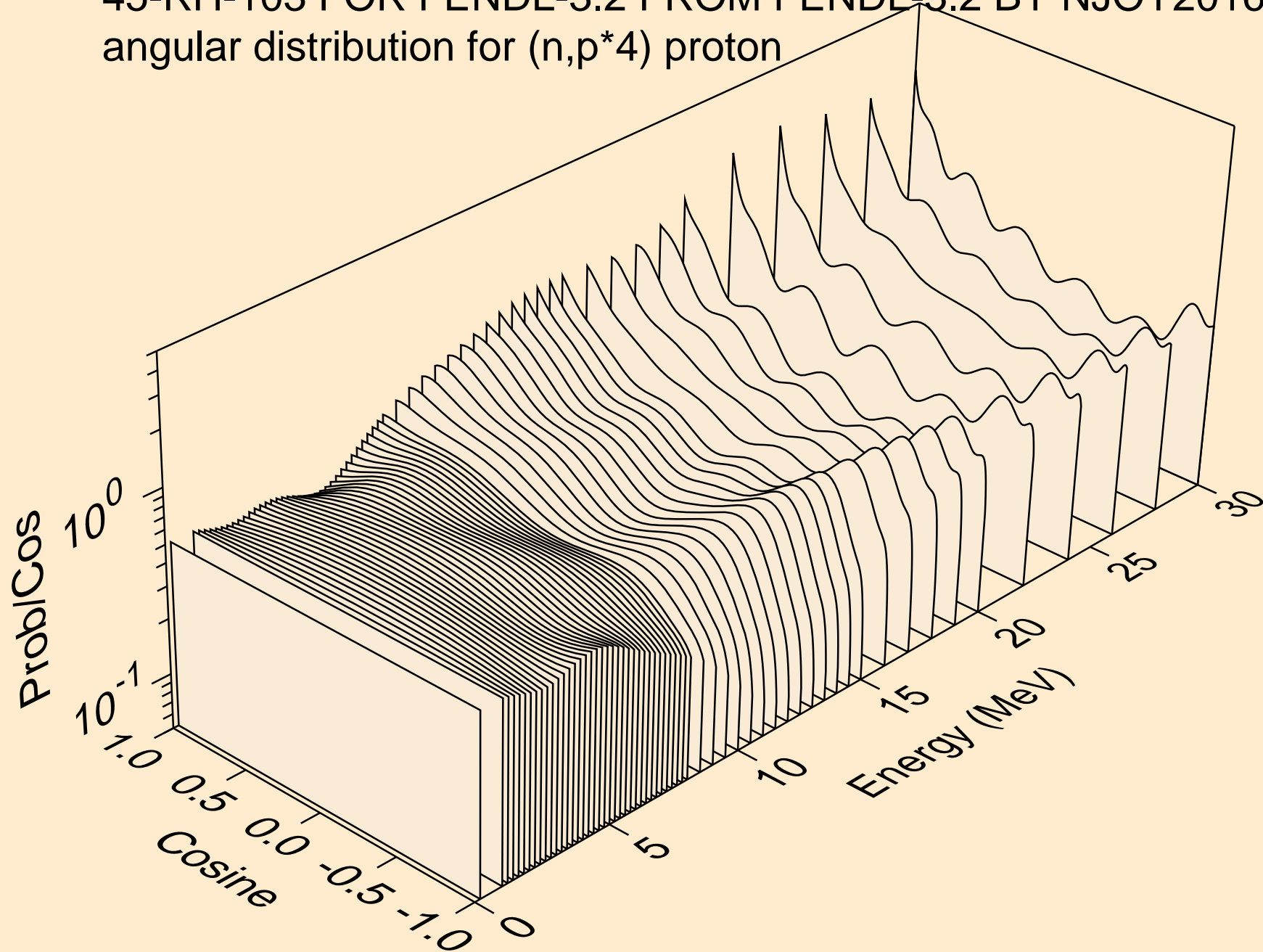

45-RH-103 FOR FENDL-3.2 FROM FENDL-3.2 BY NJOY2016.60+ C
angular distribution for (n,p*5) proton

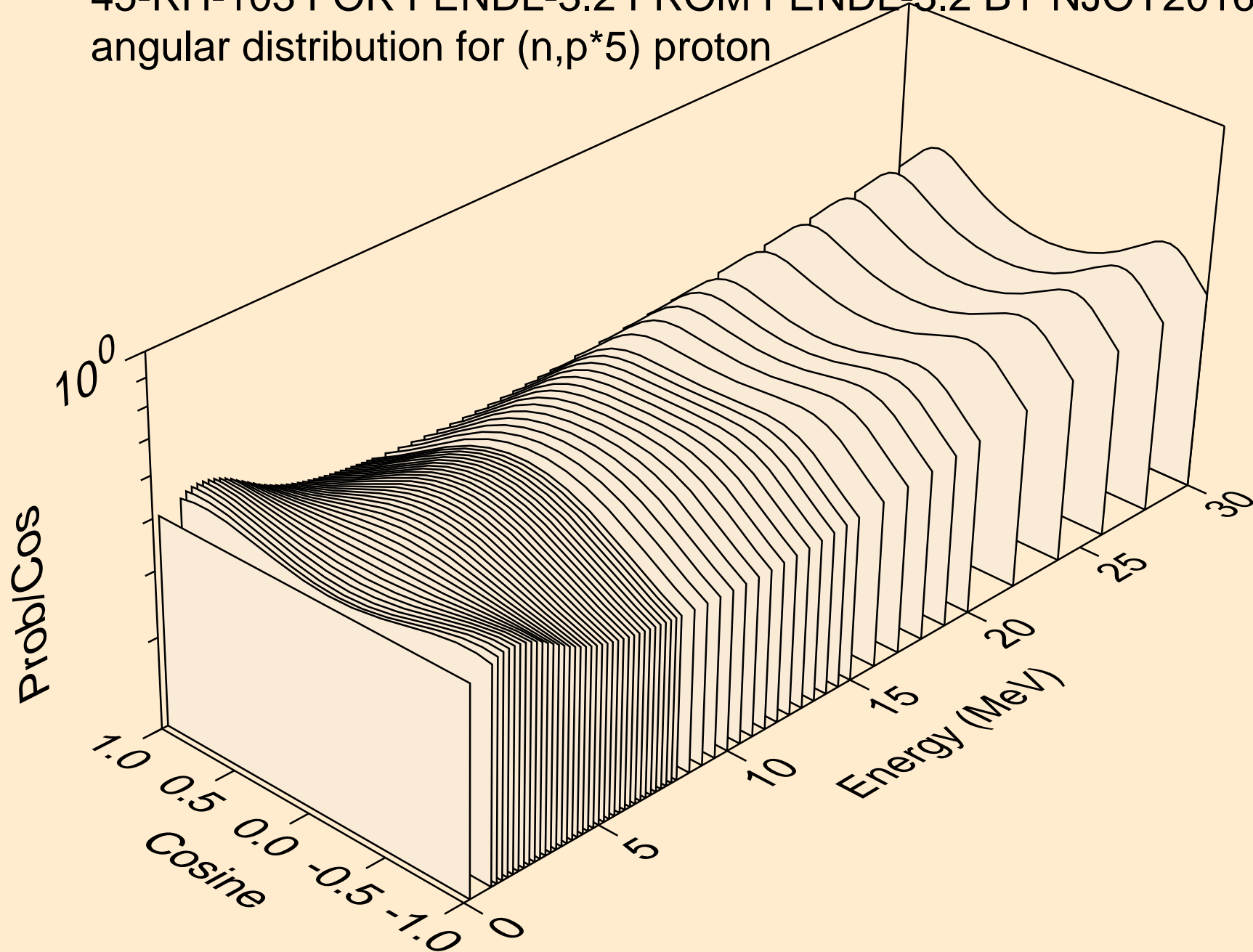

45-RH-103 FOR FENDL-3.2 FROM FENDL-3.2 BY NJOY2016.60+ C
angular distribution for (n,p*6) proton

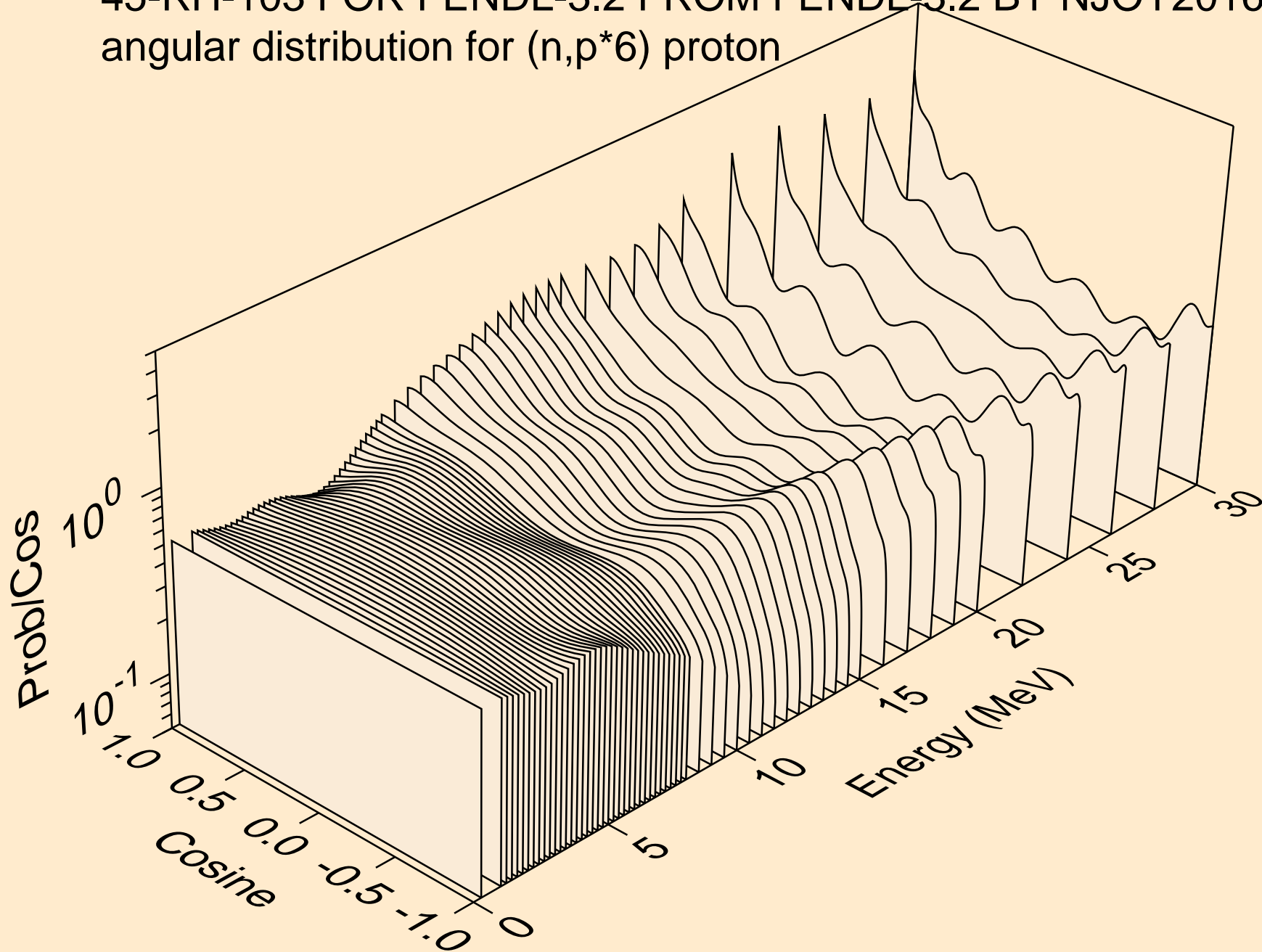

45-RH-103 FOR FENDL-3.2 FROM FENDL-3.2 BY NJOY2016.60+ C
angular distribution for (n,p*7) proton

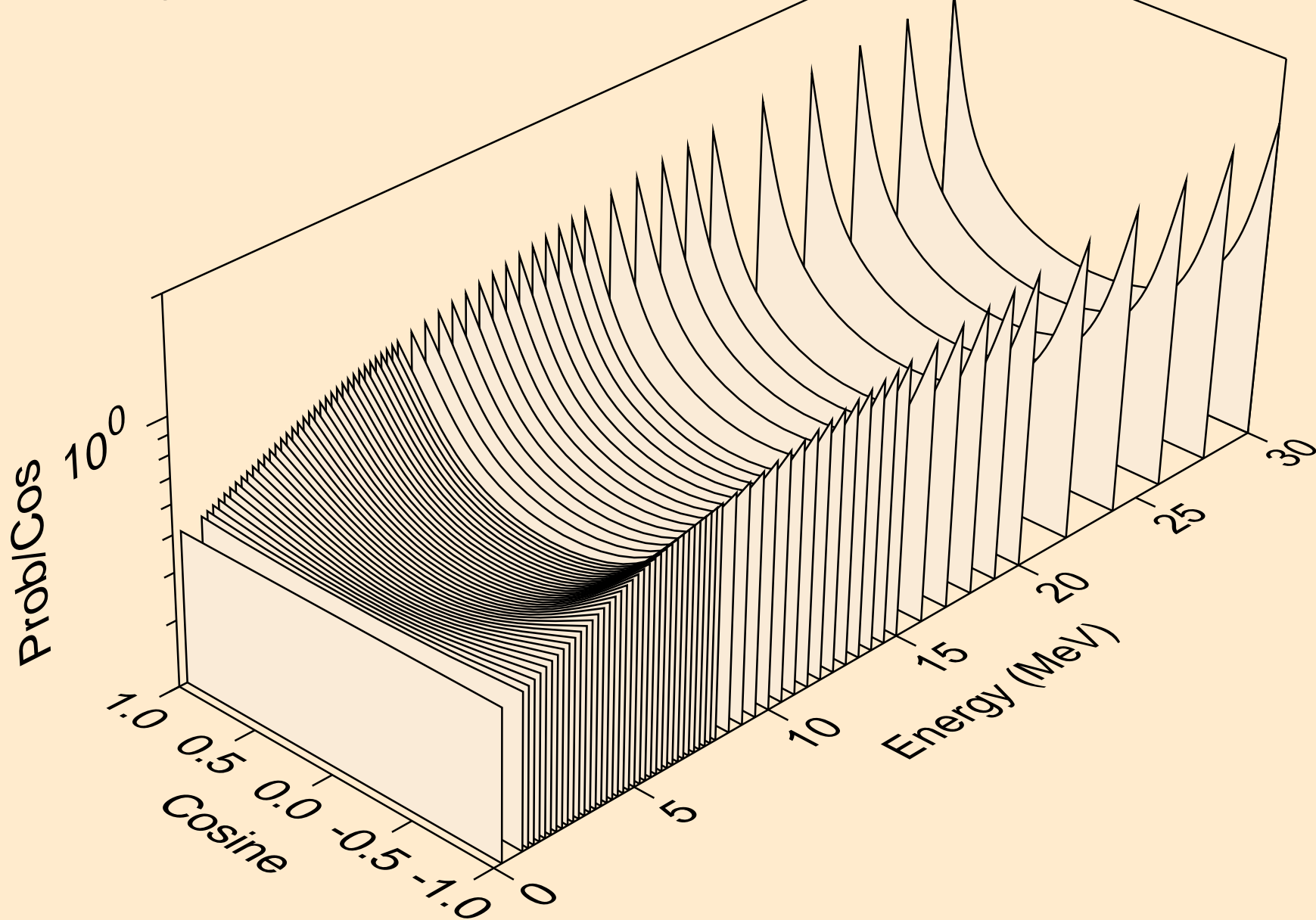

45-RH-103 FOR FENDL-3.2 FROM FENDL-3.2 BY NJOY2016.60+ C
angular distribution for (n,p*8) proton

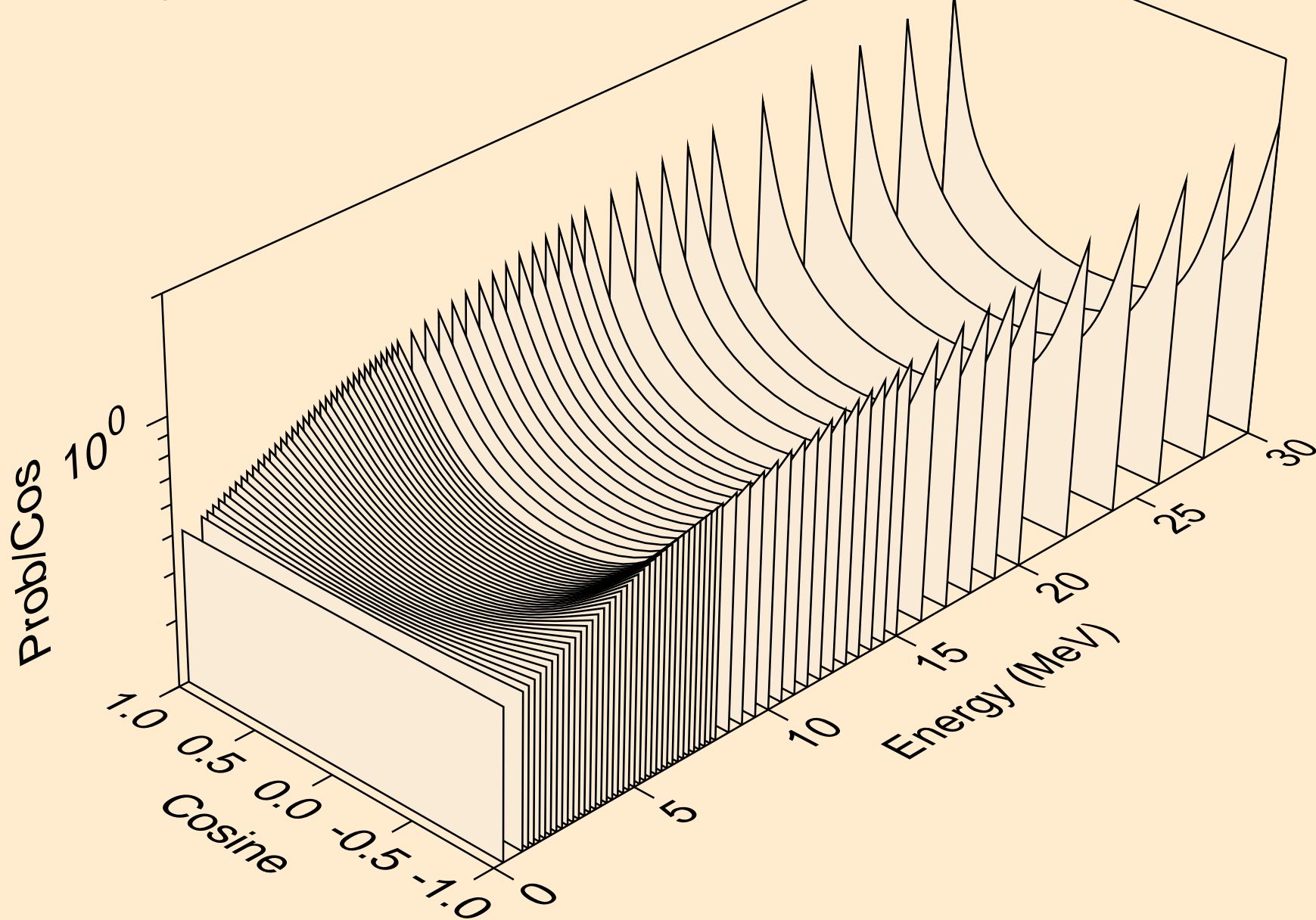

45-RH-103 FOR FENDL-3.2 FROM FENDL-3.2 BY NJOY2016.60+ C
angular distribution for (n,p*9) proton

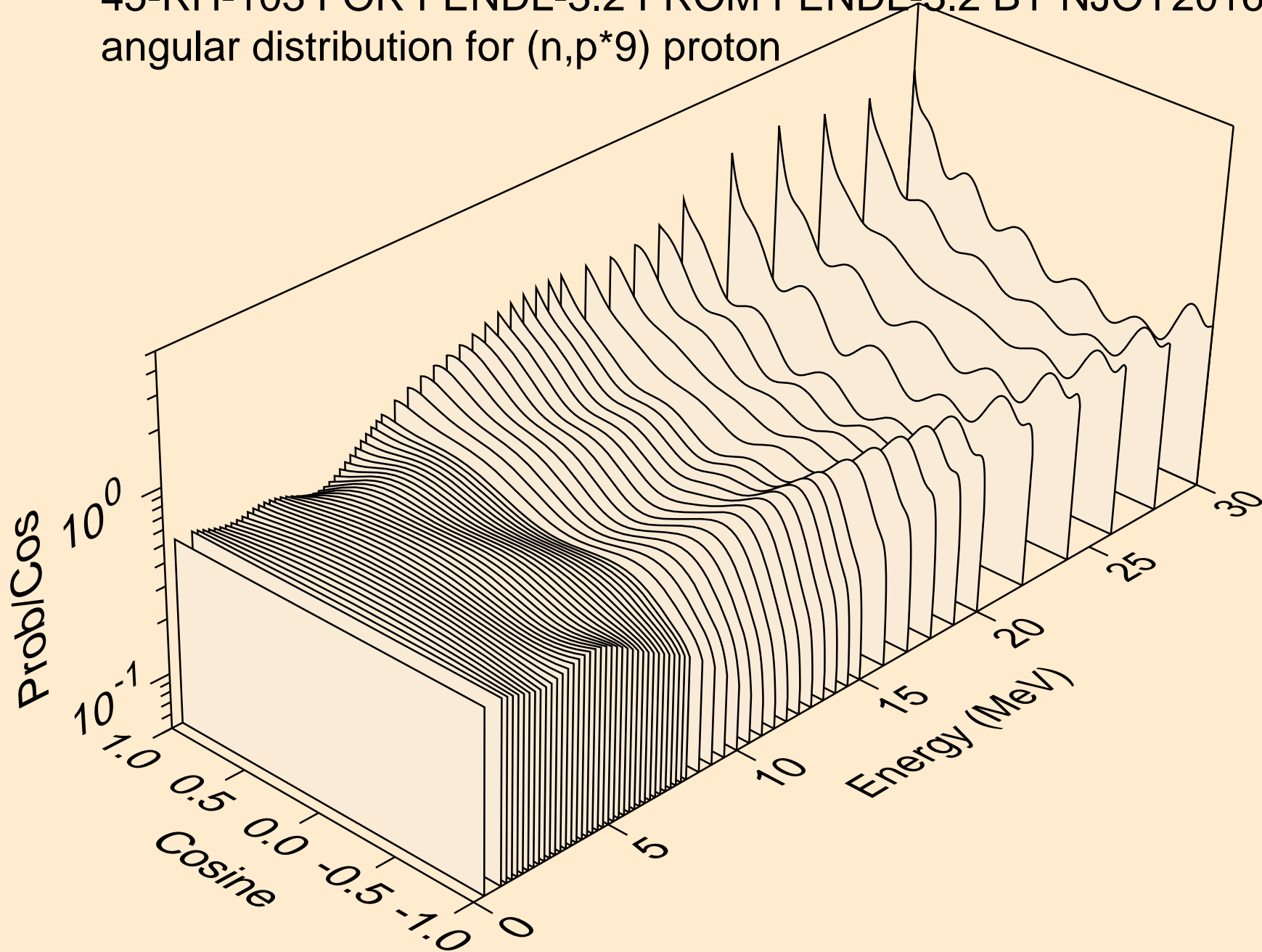

45-RH-103 FOR FENDL-3.2 FROM FENDL-3.2 BY NJOY2016.60+ C
angular distribution for (n,p*10) proton

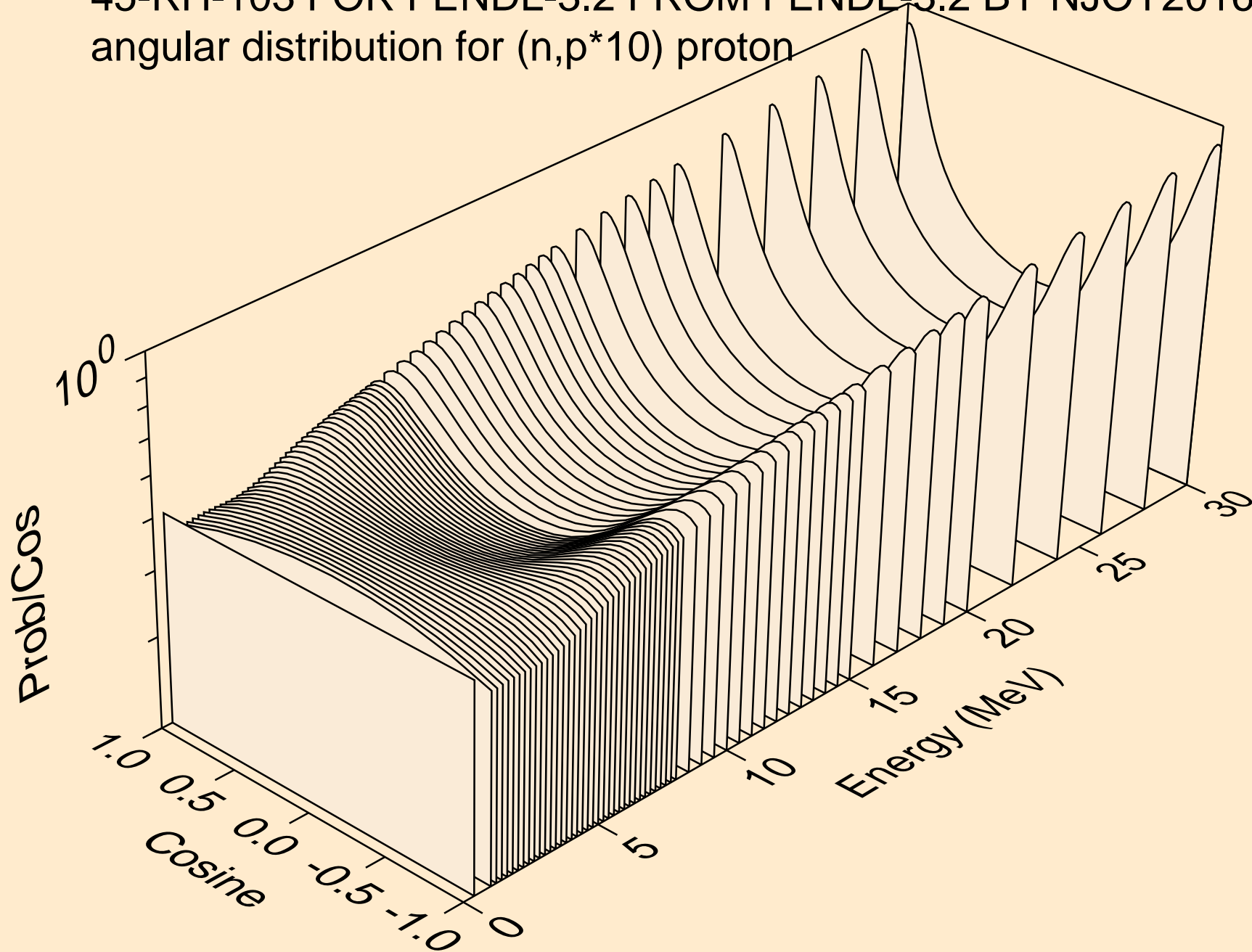

45-RH-103 FOR FENDL-3.2 FROM FENDL-3.2 BY NJOY2016.60+ C
angular distribution for (n,p*11) proton

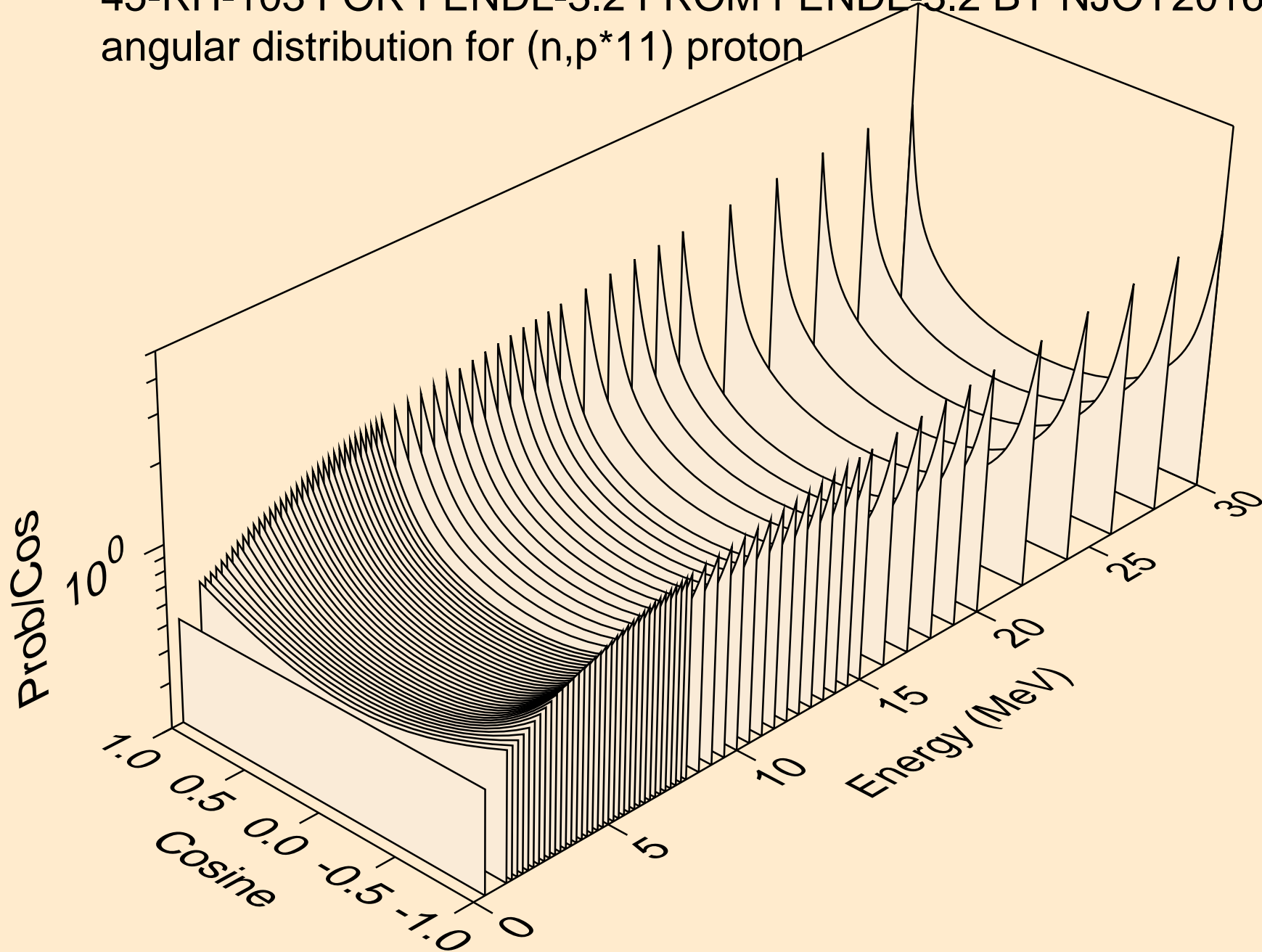

45-RH-103 FOR FENDL-3.2 FROM FENDL-3.2 BY NJOY2016.60+ C
angular distribution for (n,p*12) proton

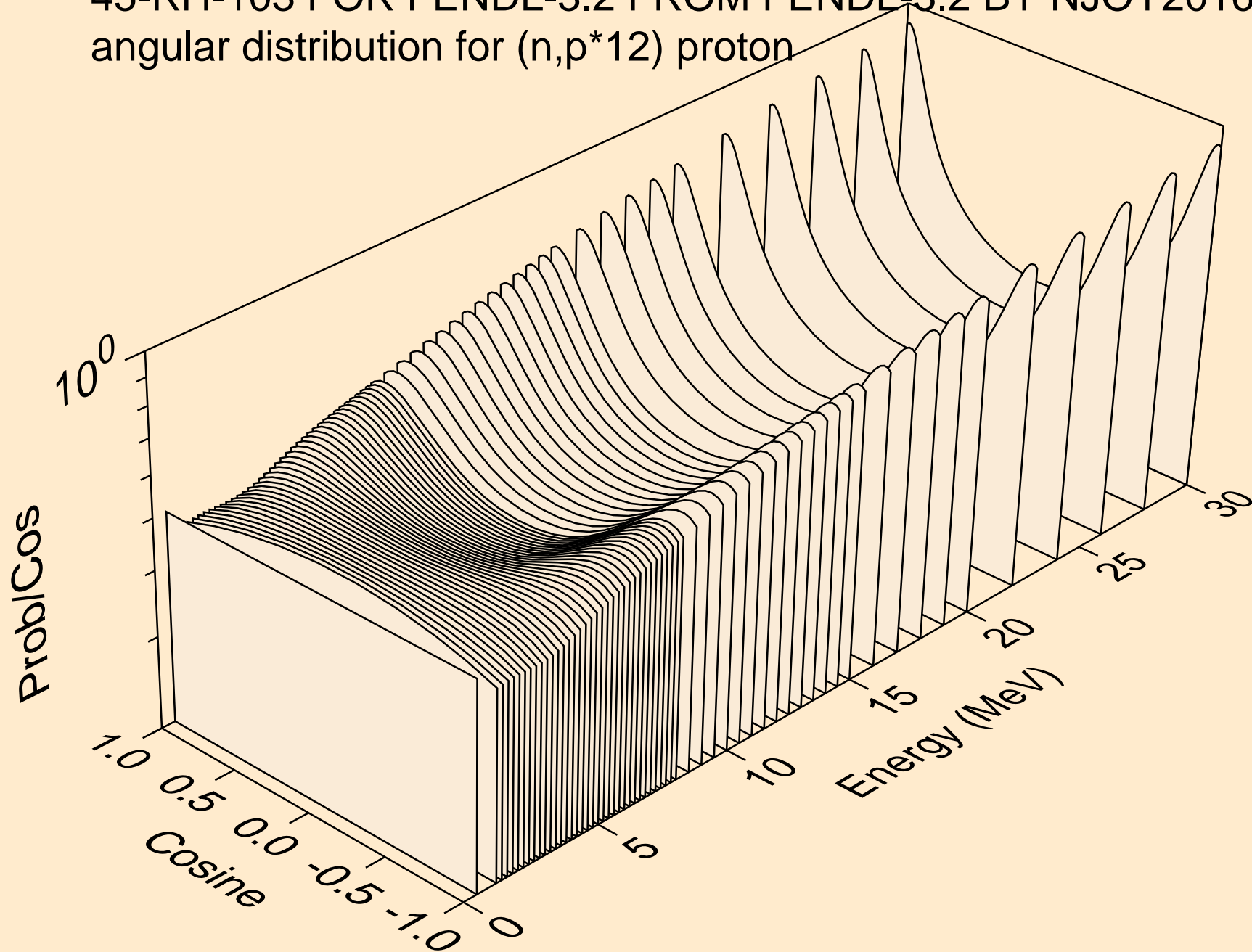

45-RH-103 FOR FENDL-3.2 FROM FENDL-3.2 BY NJOY2016.60+ C
angular distribution for (n,p*13) proton

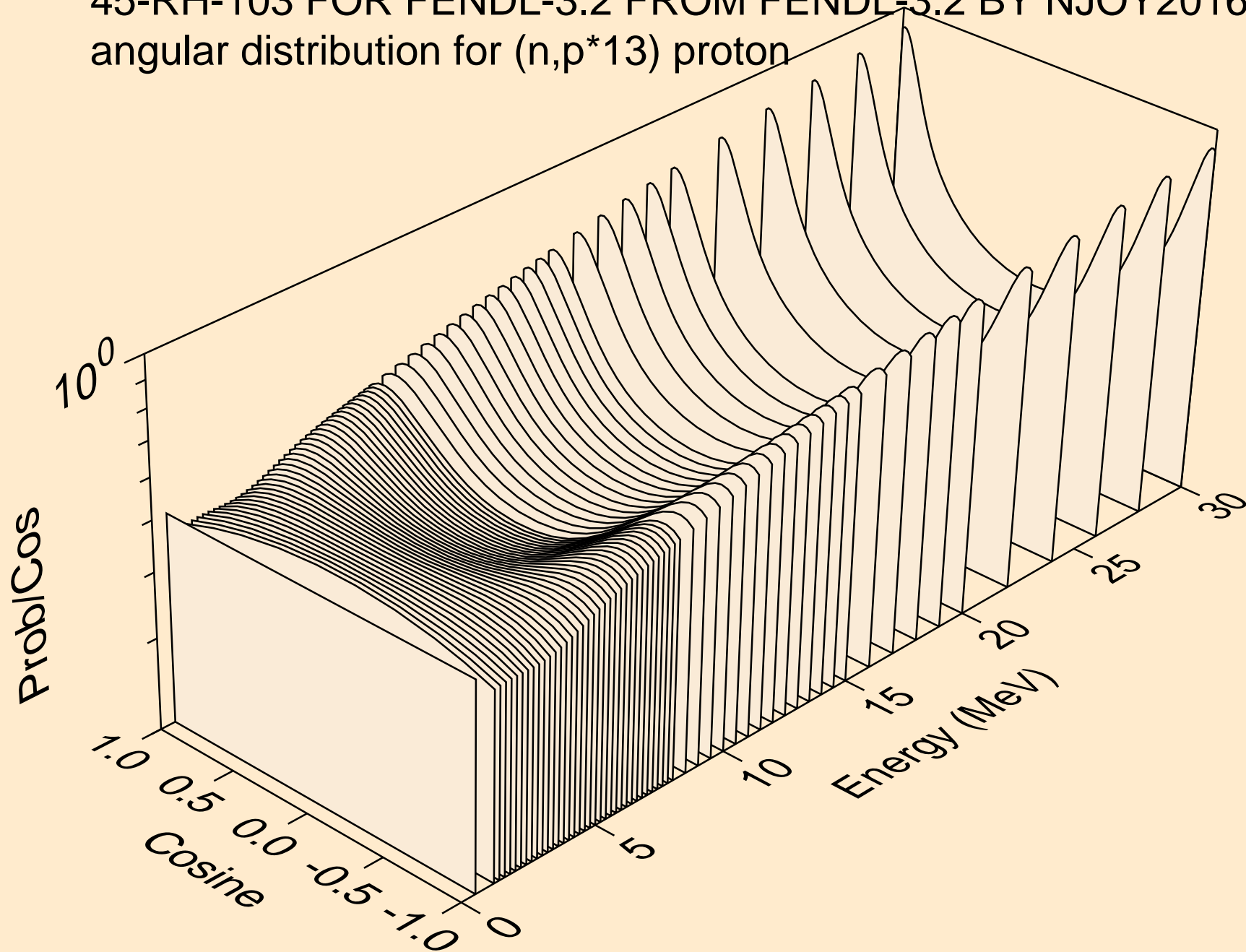

45-RH-103 FOR FENDL-3.2 FROM FENDL-3.2 BY NJOY2016.60+ C
angular distribution for (n,p*14) proton

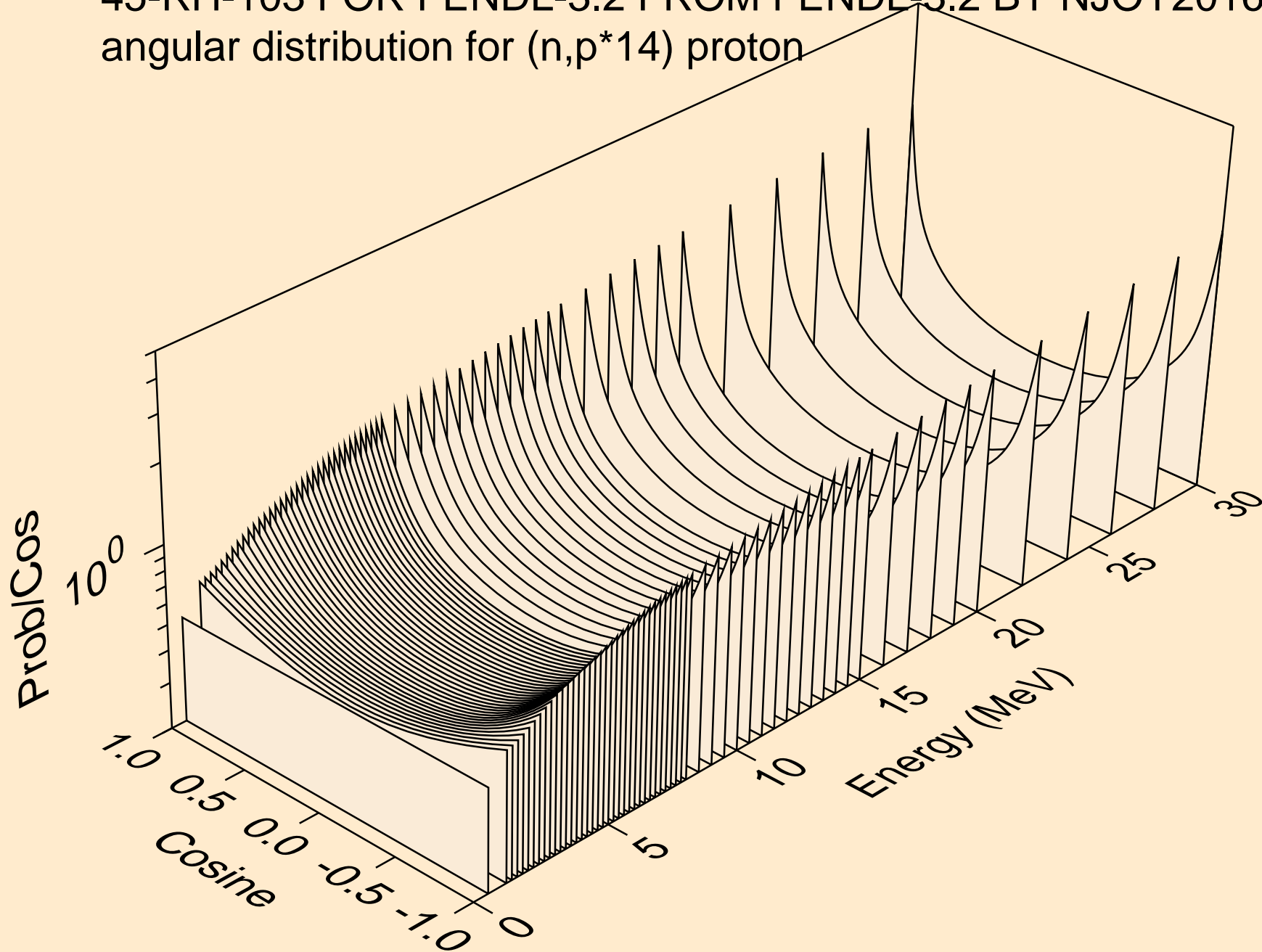

45-RH-103 FOR FENDL-3.2 FROM FENDL-3.2 BY NJOY2016.60+ C
angular distribution for (n,p*15) proton

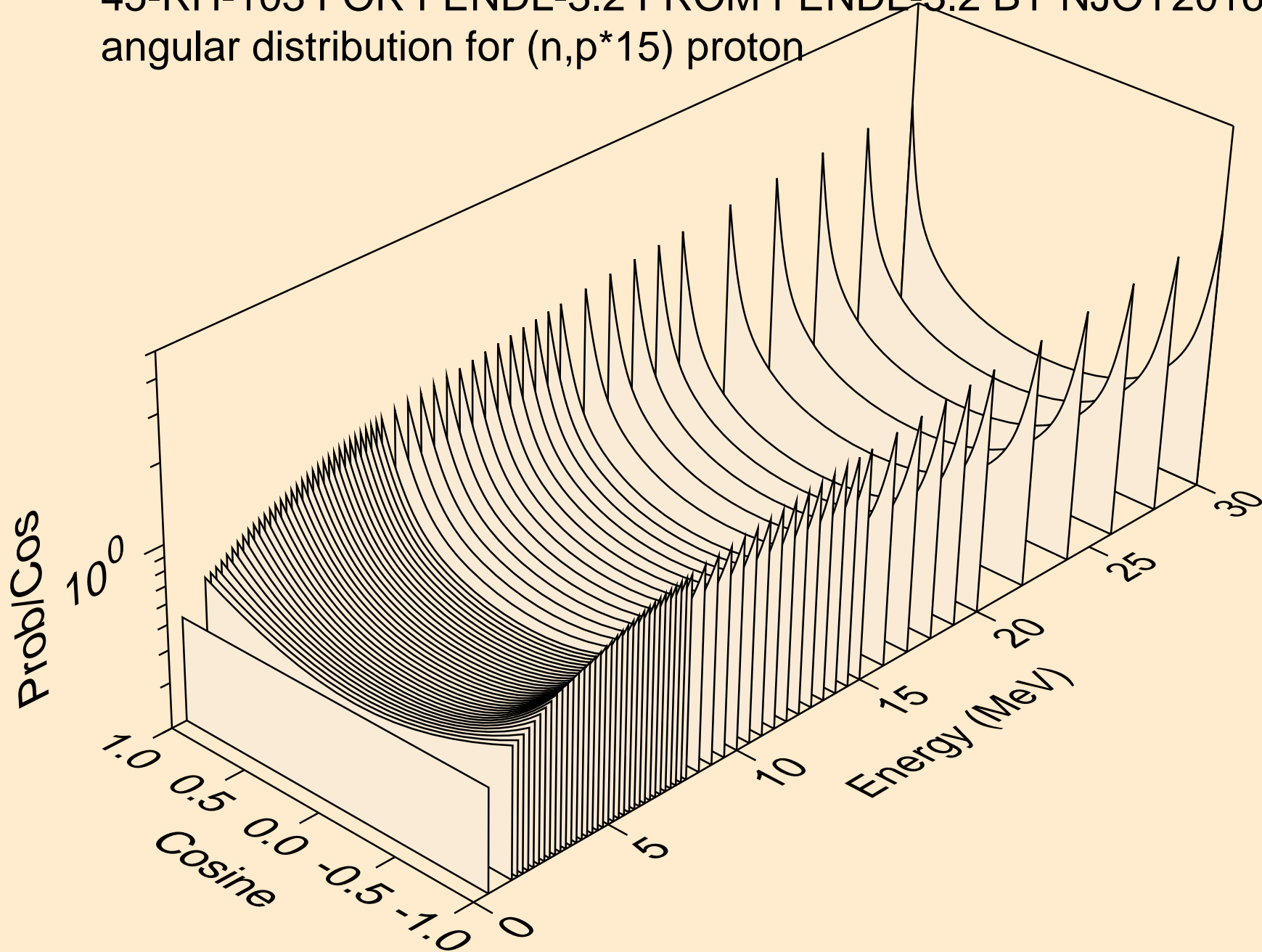

45-RH-103 FOR FENDL-3.2 FROM FENDL-3.2 BY NJOY2016.60+ C
protons from (n,p*c)

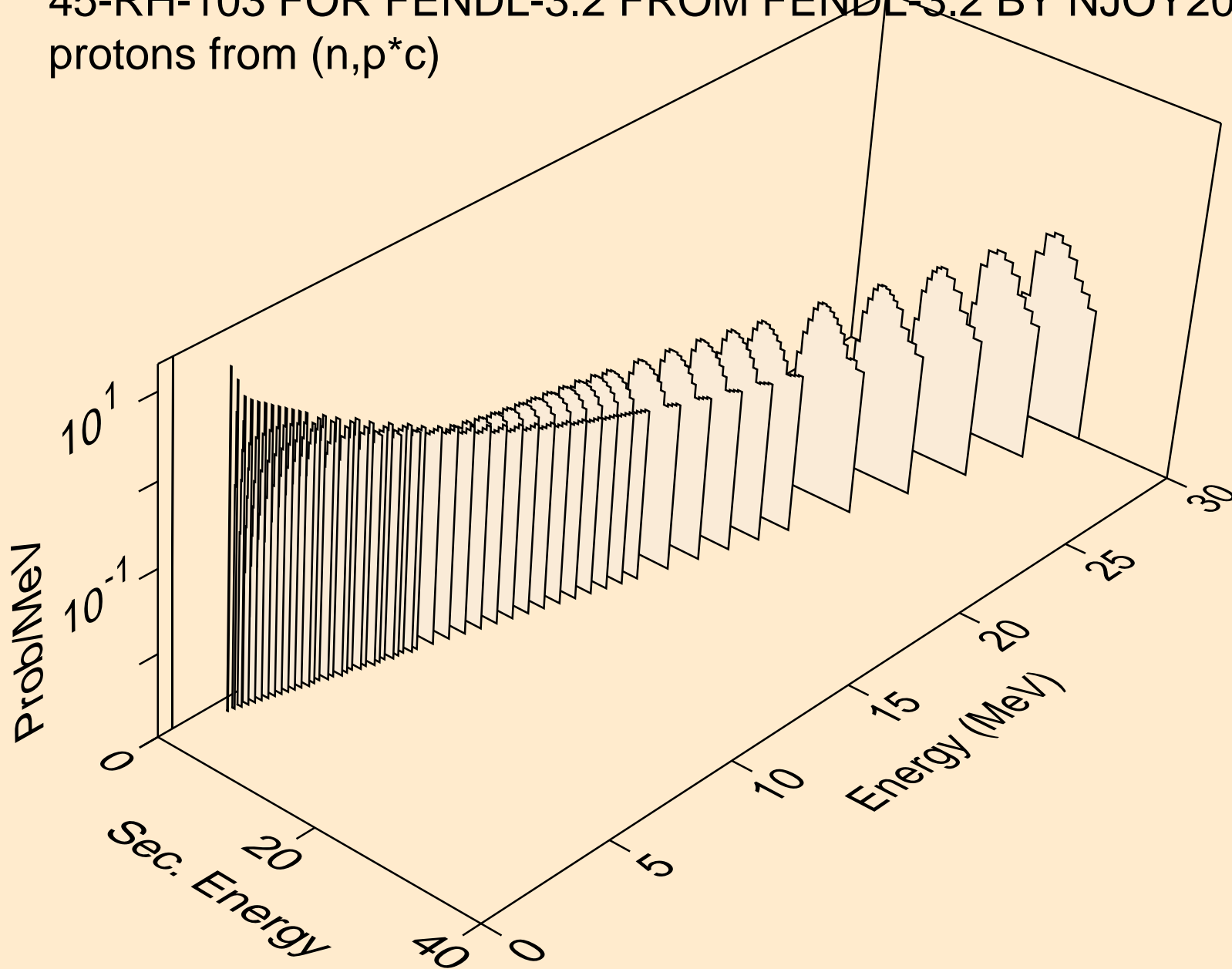

45-RH-103 FOR FENDL-3.2 FROM FENDL-3.2 BY NJOY2016.60+ C
deuterons from (n,x)

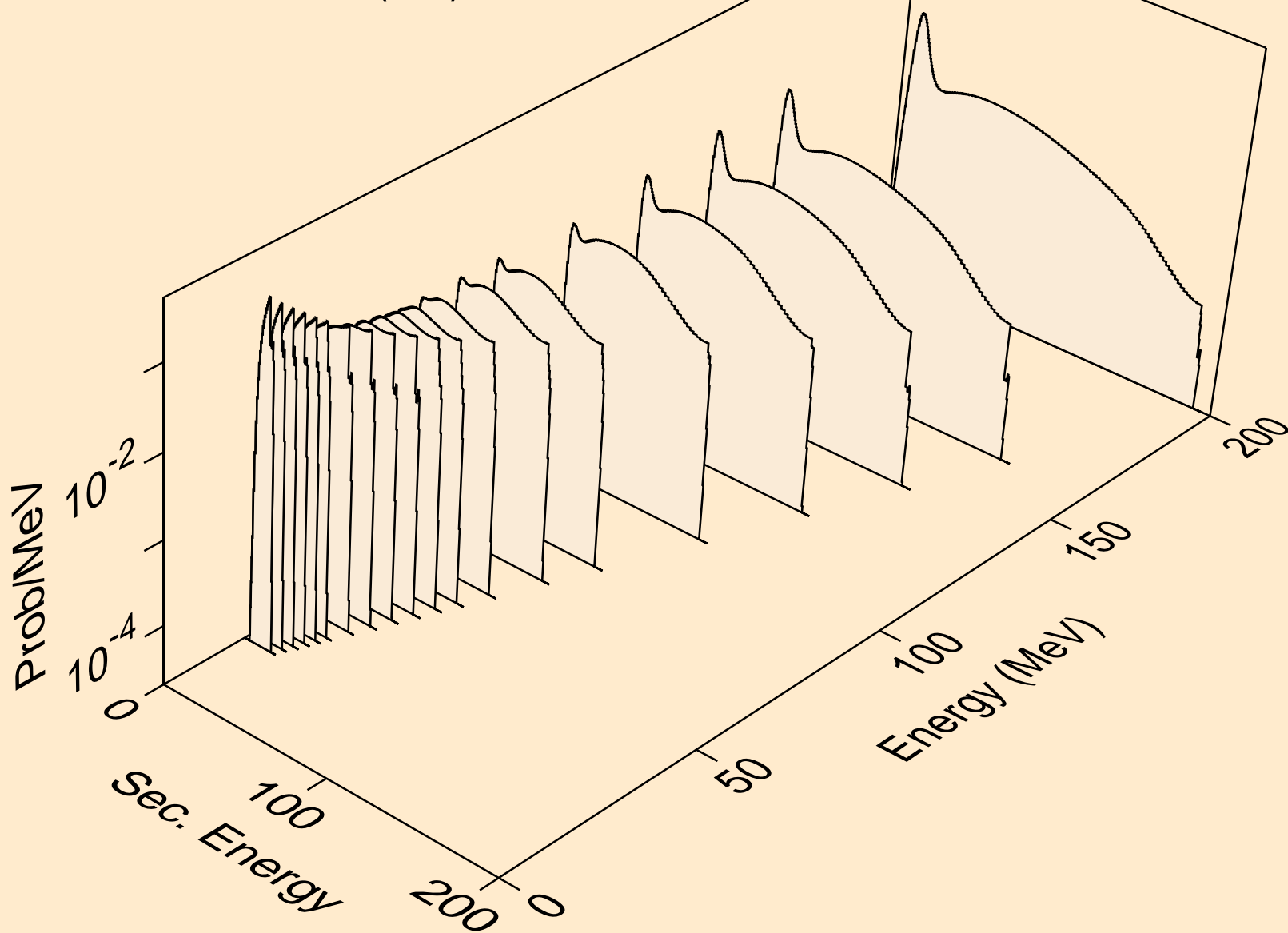

45-RH-103 FOR FENDL-3.2 FROM FENDL-3.2 BY NJOY2016.60+ C
deuterons from (n,2nd)

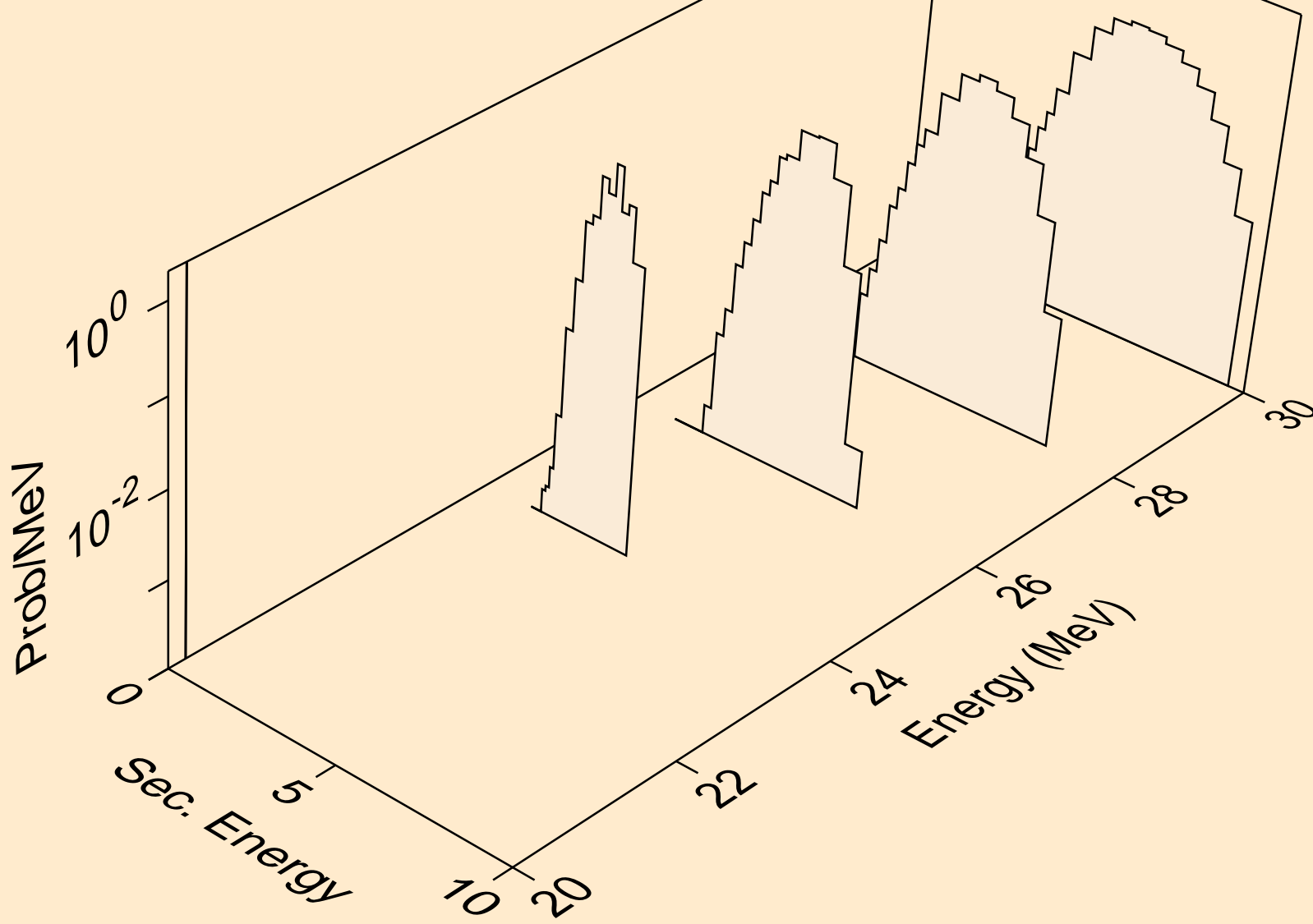

45-RH-103 FOR FENDL-3.2 FROM FENDL-3.2 BY NJOY2016.60+ C
deuterons from (n,n*)d

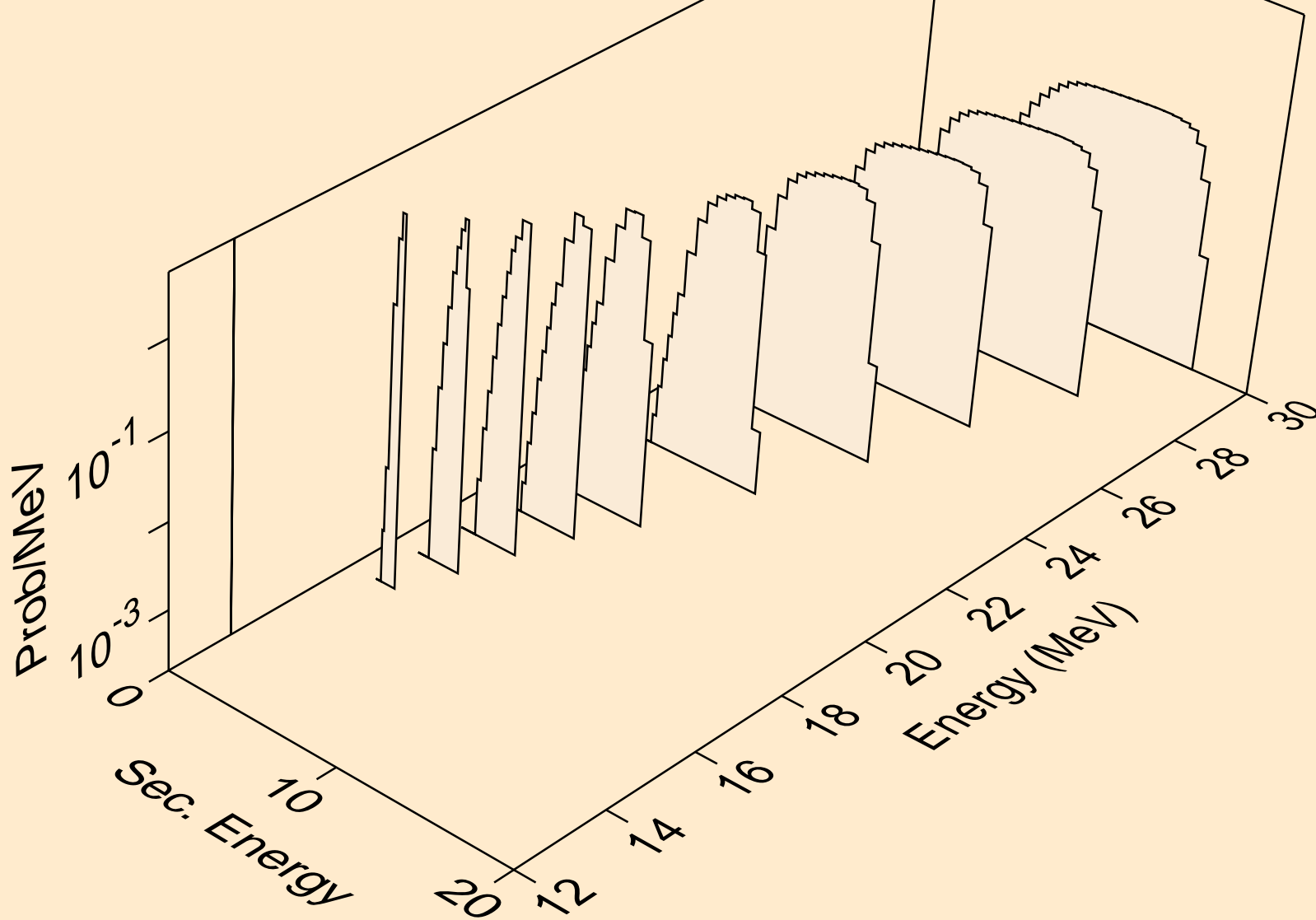

45-RH-103 FOR FENDL-3.2 FROM FENDL-3.2 BY NJOY2016.60+ C
deuterons from (n,pd)

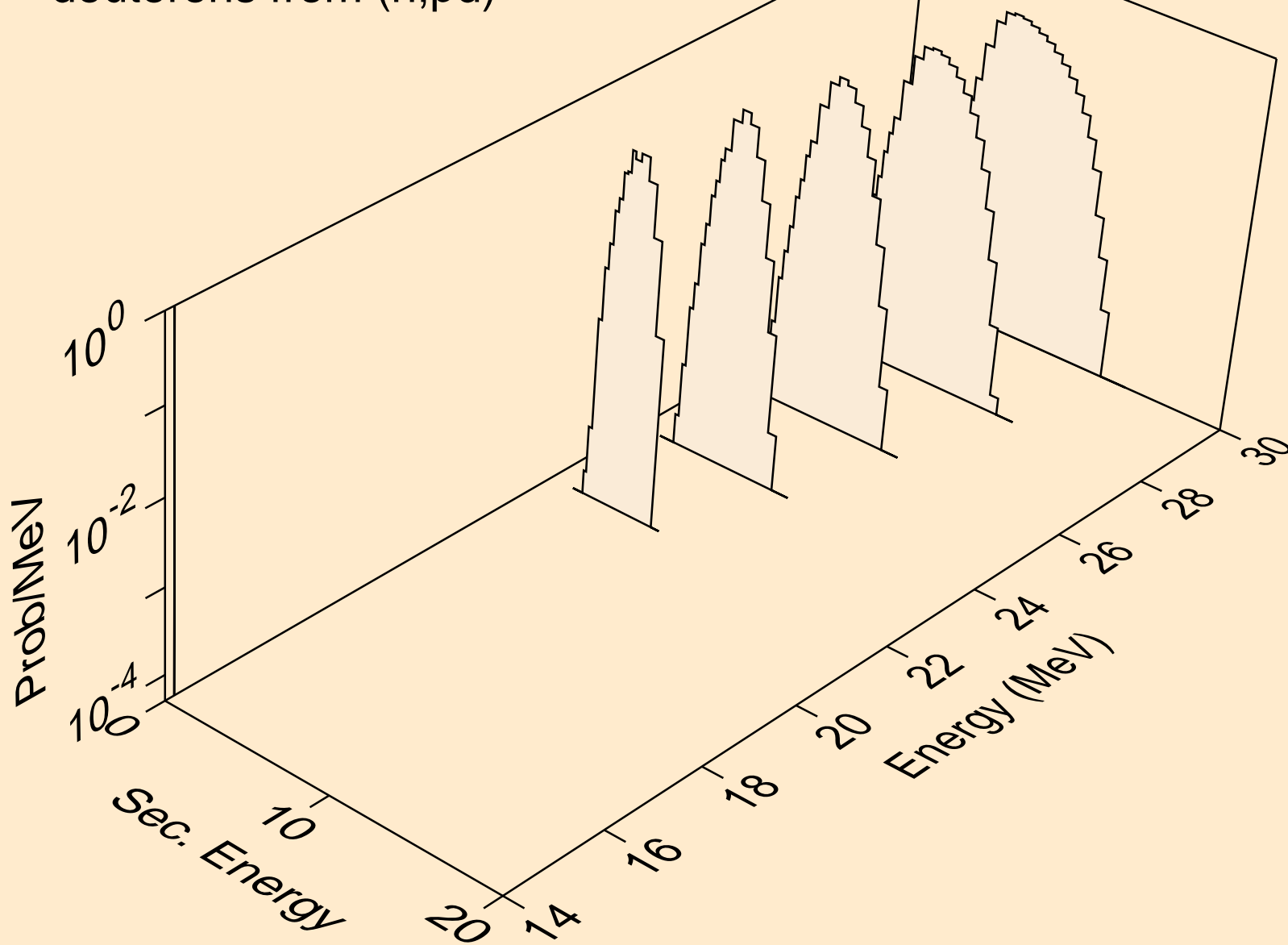

45-RH-103 FOR FENDL-3.2 FROM FENDL-3.2 BY NJOY2016.60+ C
deuterons from (n,da)

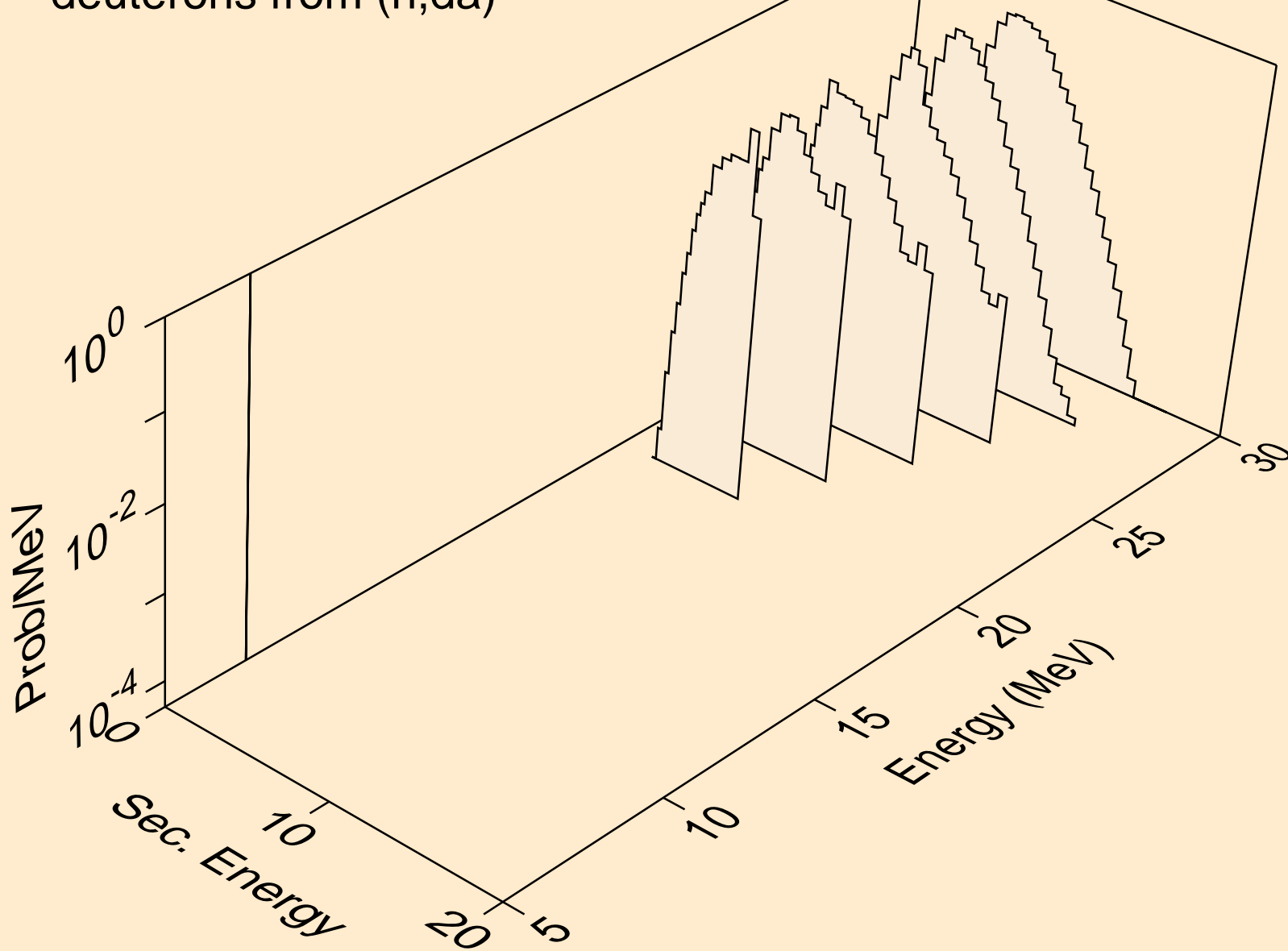

45-RH-103 FOR FENDL-3.2 FROM FENDL-3.2 BY NJOY2016.60+ C
angular distribution for (n,d*0) deuteron

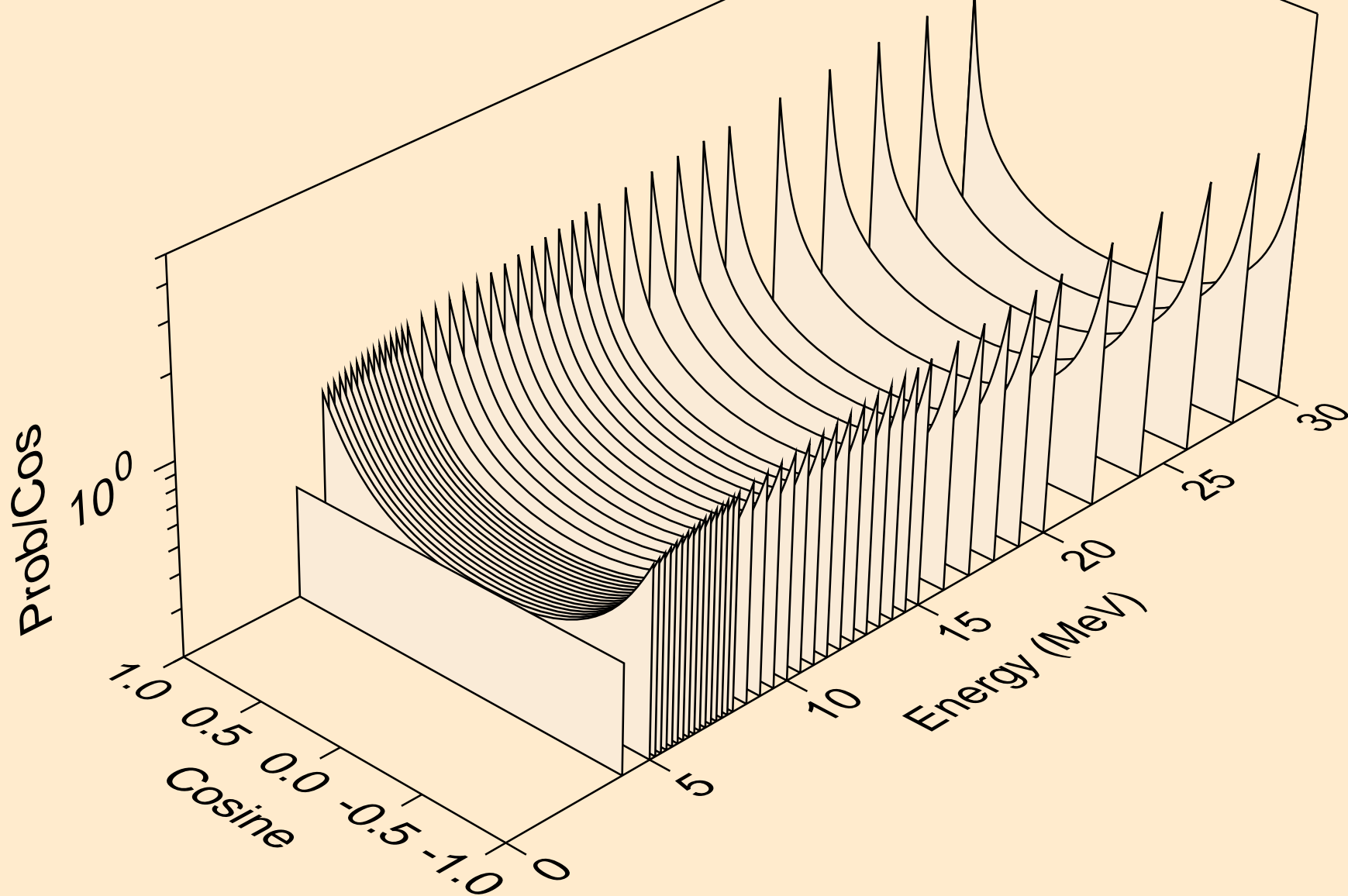

45-RH-103 FOR FENDL-3.2 FROM FENDL-3.2 BY NJOY2016.60+ C
angular distribution for (n,d*1) deuteron

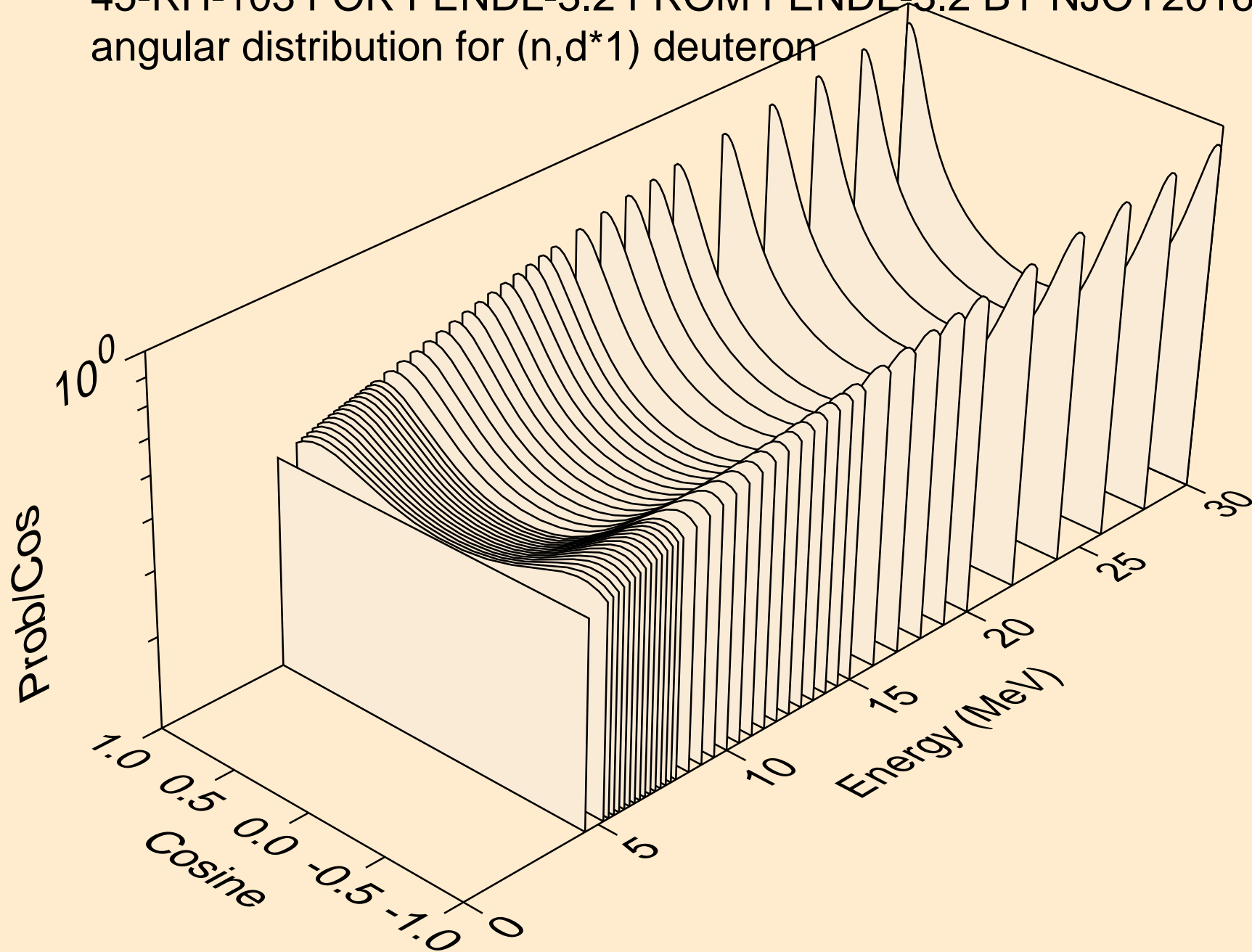

45-RH-103 FOR FENDL-3.2 FROM FENDL-3.2 BY NJOY2016.60+ C
angular distribution for (n,d*2) deuteron

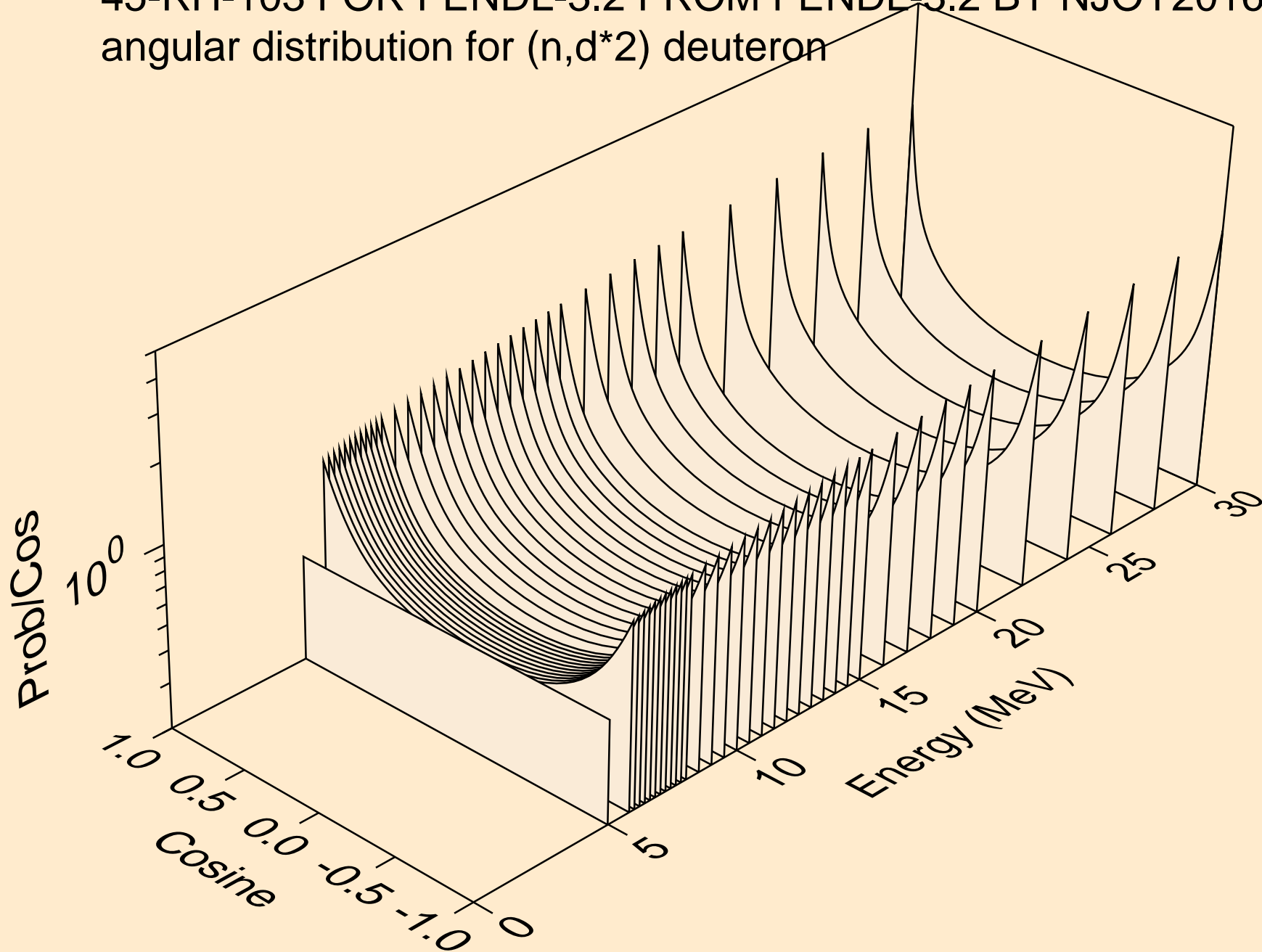

45-RH-103 FOR FENDL-3.2 FROM FENDL-3.2 BY NJOY2016.60+ C
angular distribution for (n,d*3) deuteron

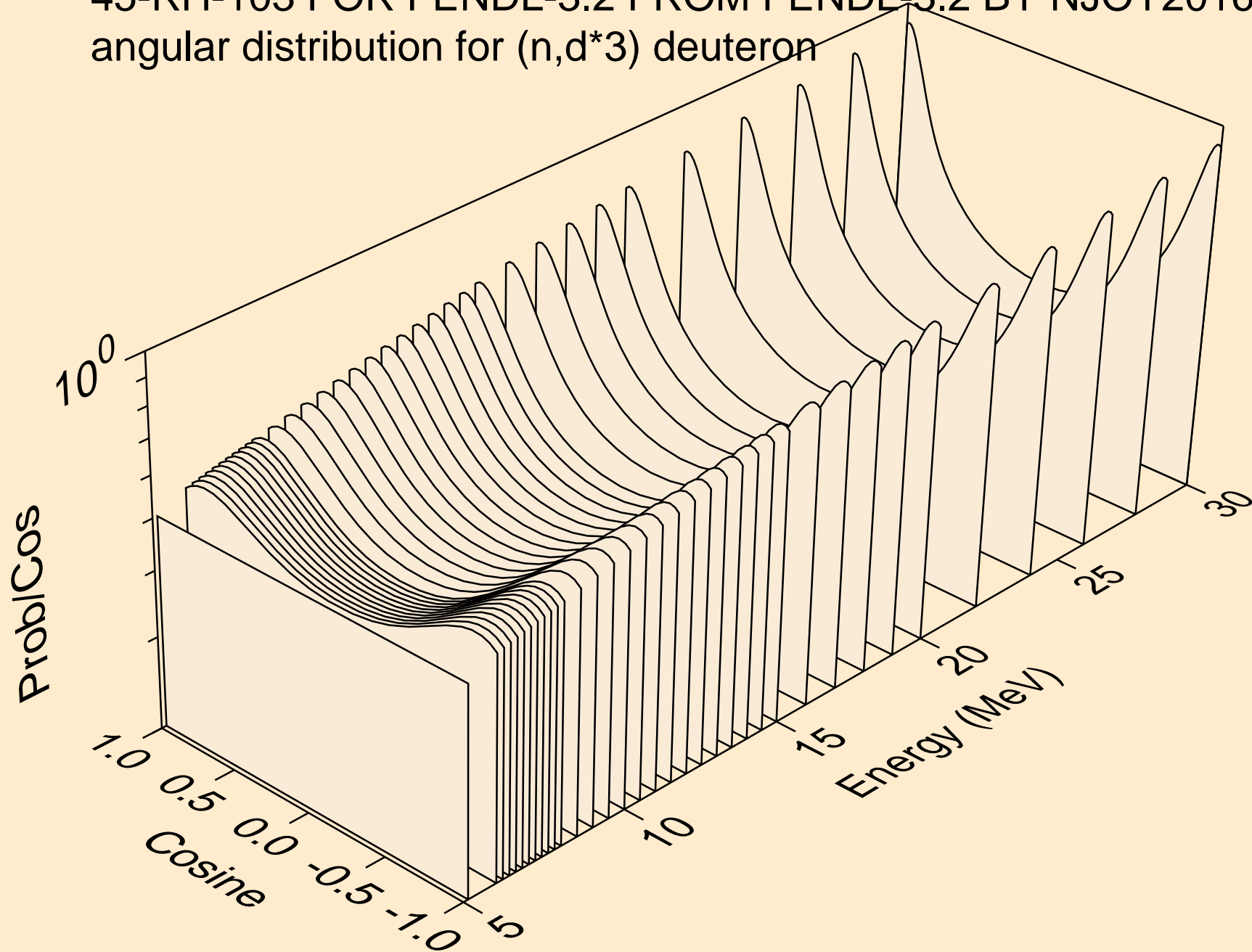

45-RH-103 FOR FENDL-3.2 FROM FENDL-3.2 BY NJOY2016.60+ C
angular distribution for (n,d*4) deuteron

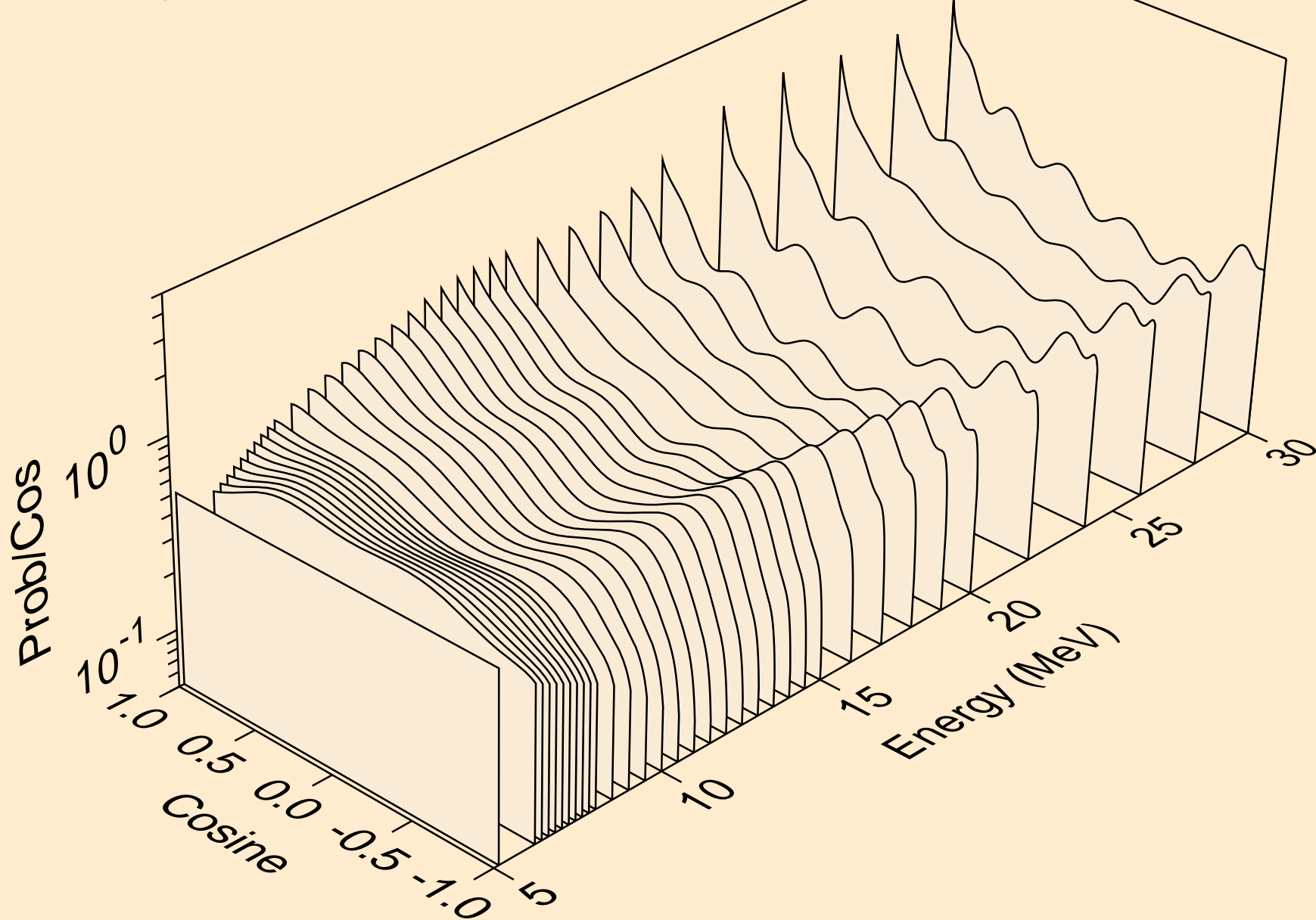

45-RH-103 FOR FENDL-3.2 FROM FENDL-3.2 BY NJOY2016.60+ C
angular distribution for (n,d*5) deuteron

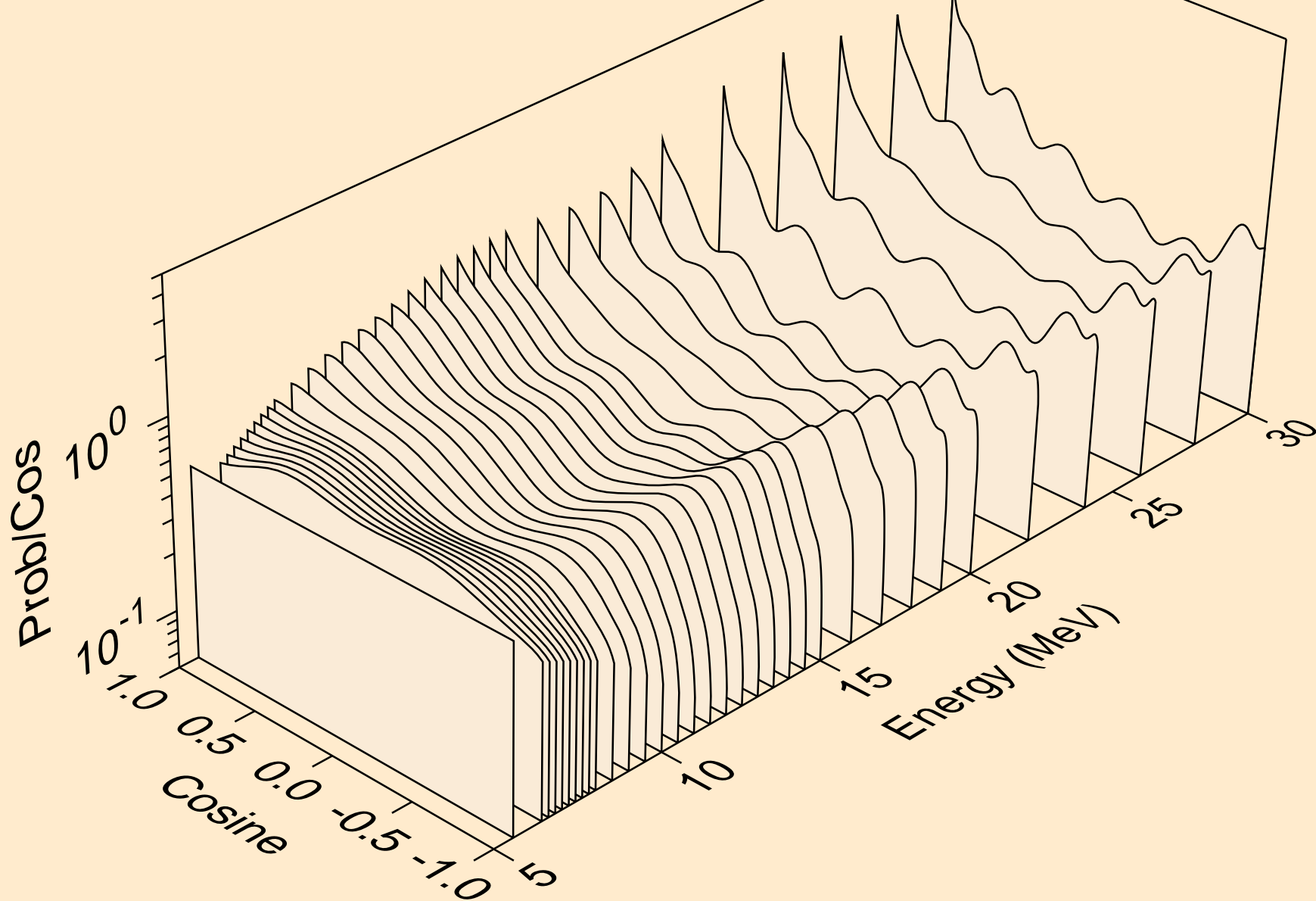

45-RH-103 FOR FENDL-3.2 FROM FENDL-3.2 BY NJOY2016.60+ C
angular distribution for (n,d*6) deuteron

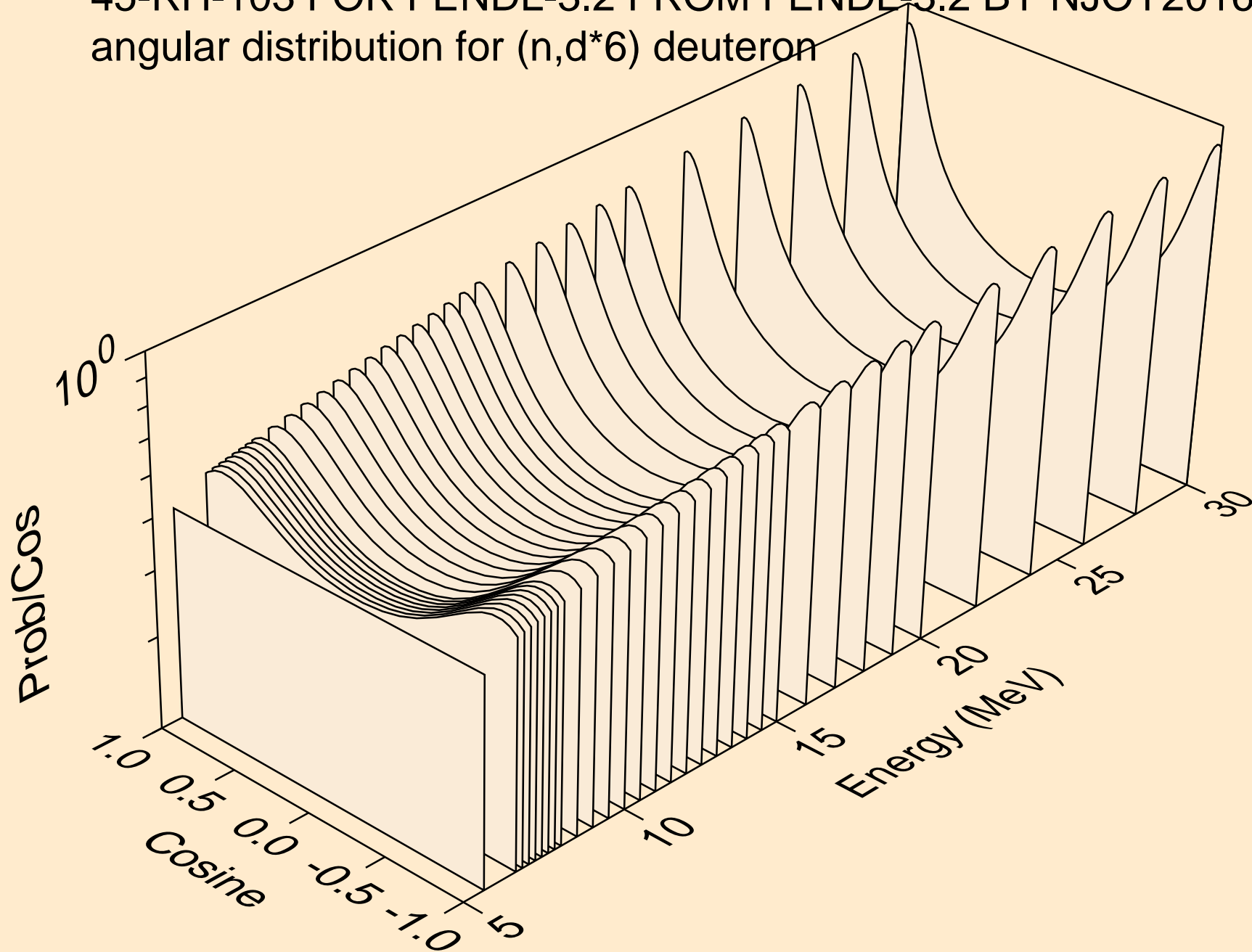

45-RH-103 FOR FENDL-3.2 FROM FENDL-3.2 BY NJOY2016.60+ C
angular distribution for (n,d*7) deuteron

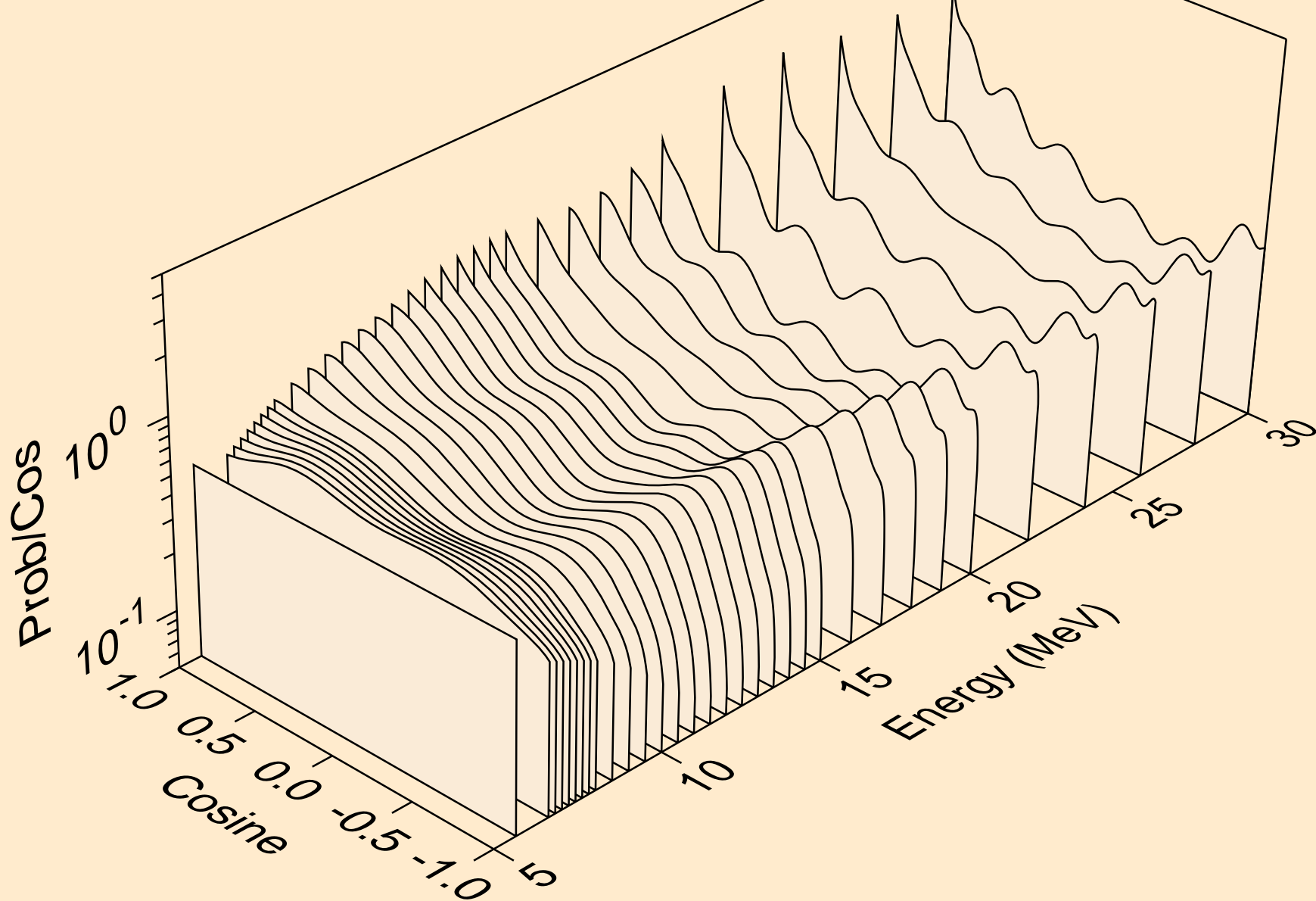

45-RH-103 FOR FENDL-3.2 FROM FENDL-3.2 BY NJOY2016.60+ C
angular distribution for (n,d*8) deuteron

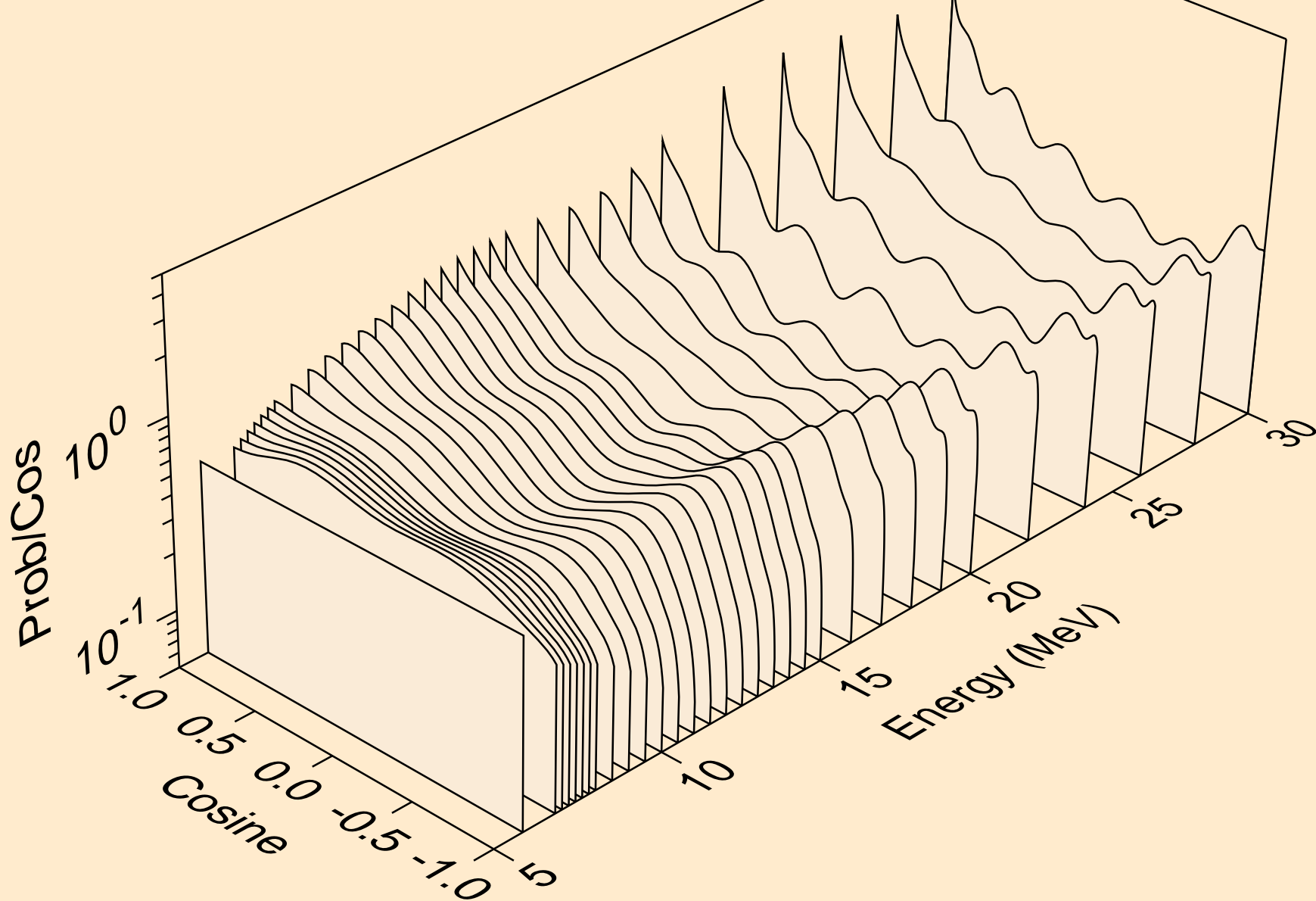

45-RH-103 FOR FENDL-3.2 FROM FENDL-3.2 BY NJOY2016.60+ C
angular distribution for (n,d*9) deuteron

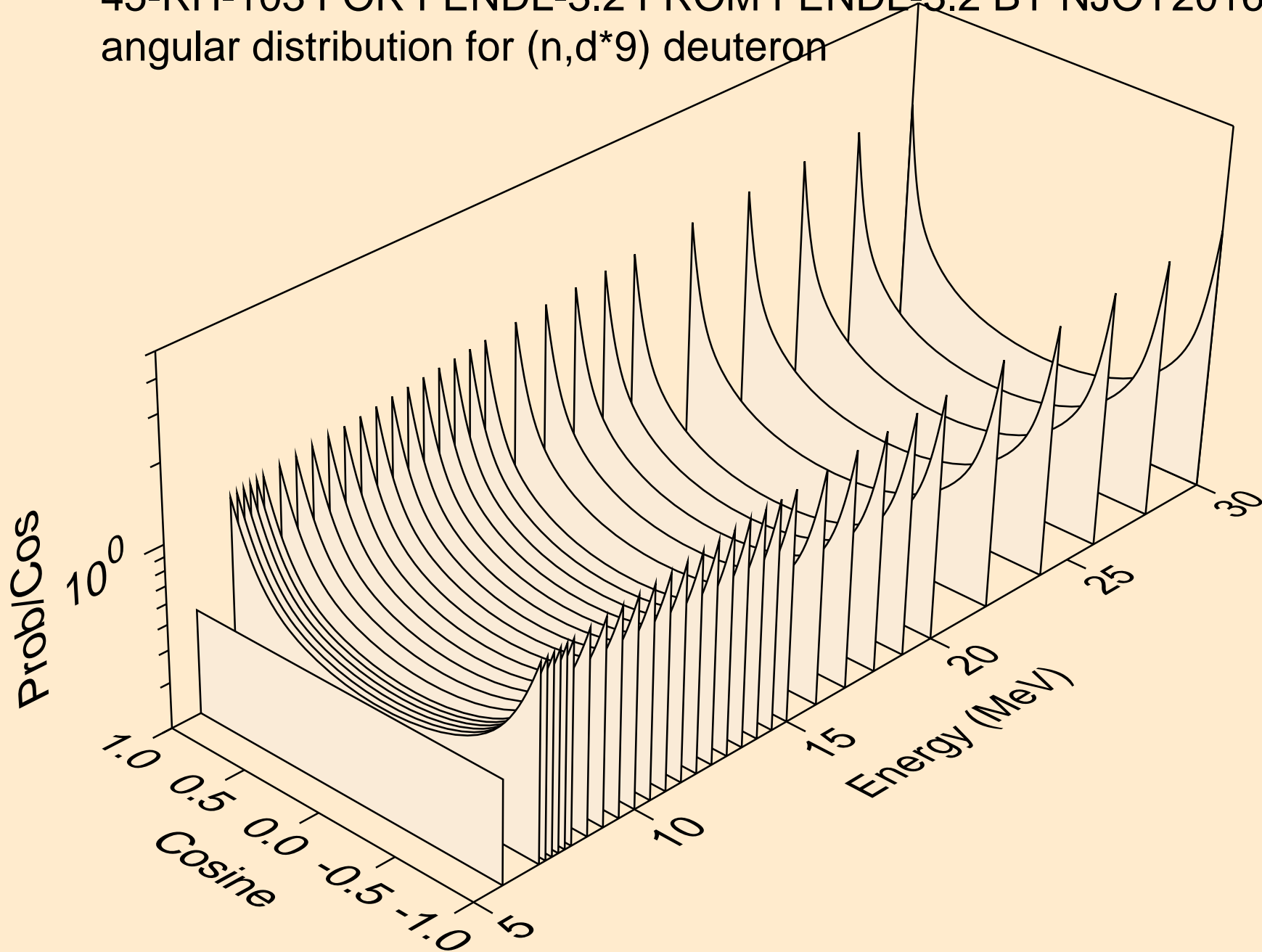

45-RH-103 FOR FENDL-3.2 FROM FENDL-3.2 BY NJOY2016.60+ C
angular distribution for (n,d*10) deuteron

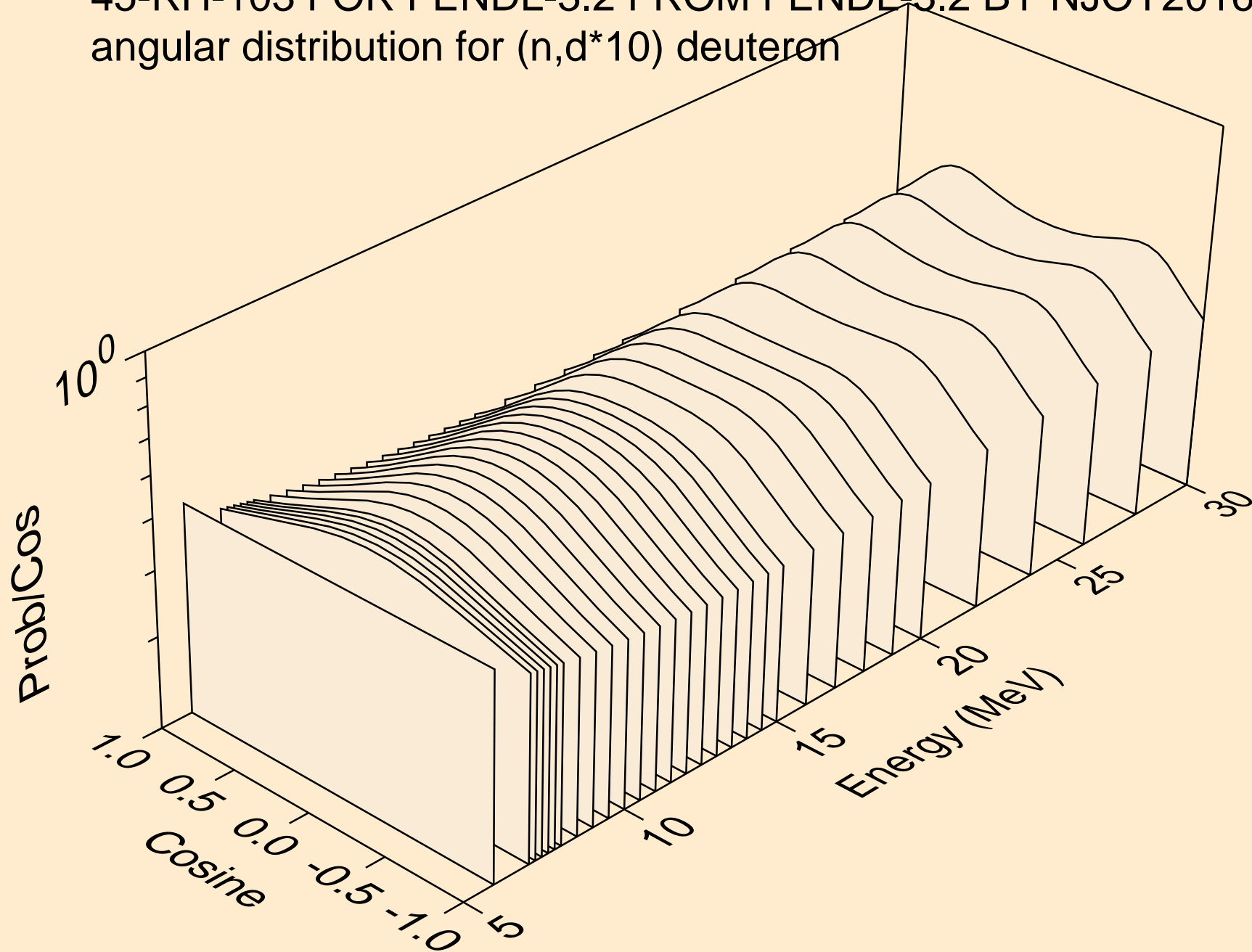

45-RH-103 FOR FENDL-3.2 FROM FENDL-3.2 BY NJOY2016.60+ C
angular distribution for (n,d*11) deuteron

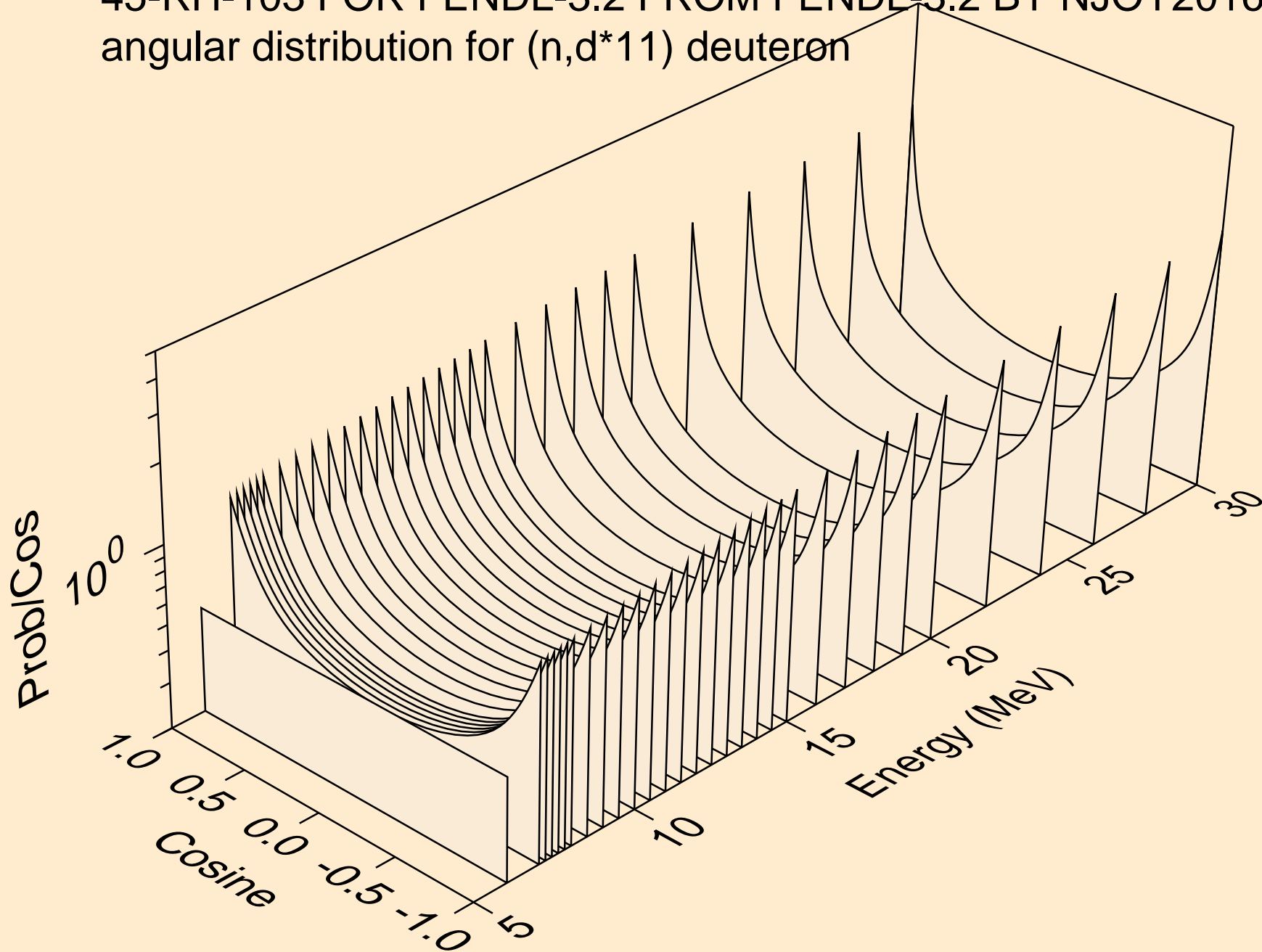

45-RH-103 FOR FENDL-3.2 FROM FENDL-3.2 BY NJOY2016.60+ C
angular distribution for (n,d*12) deuteron

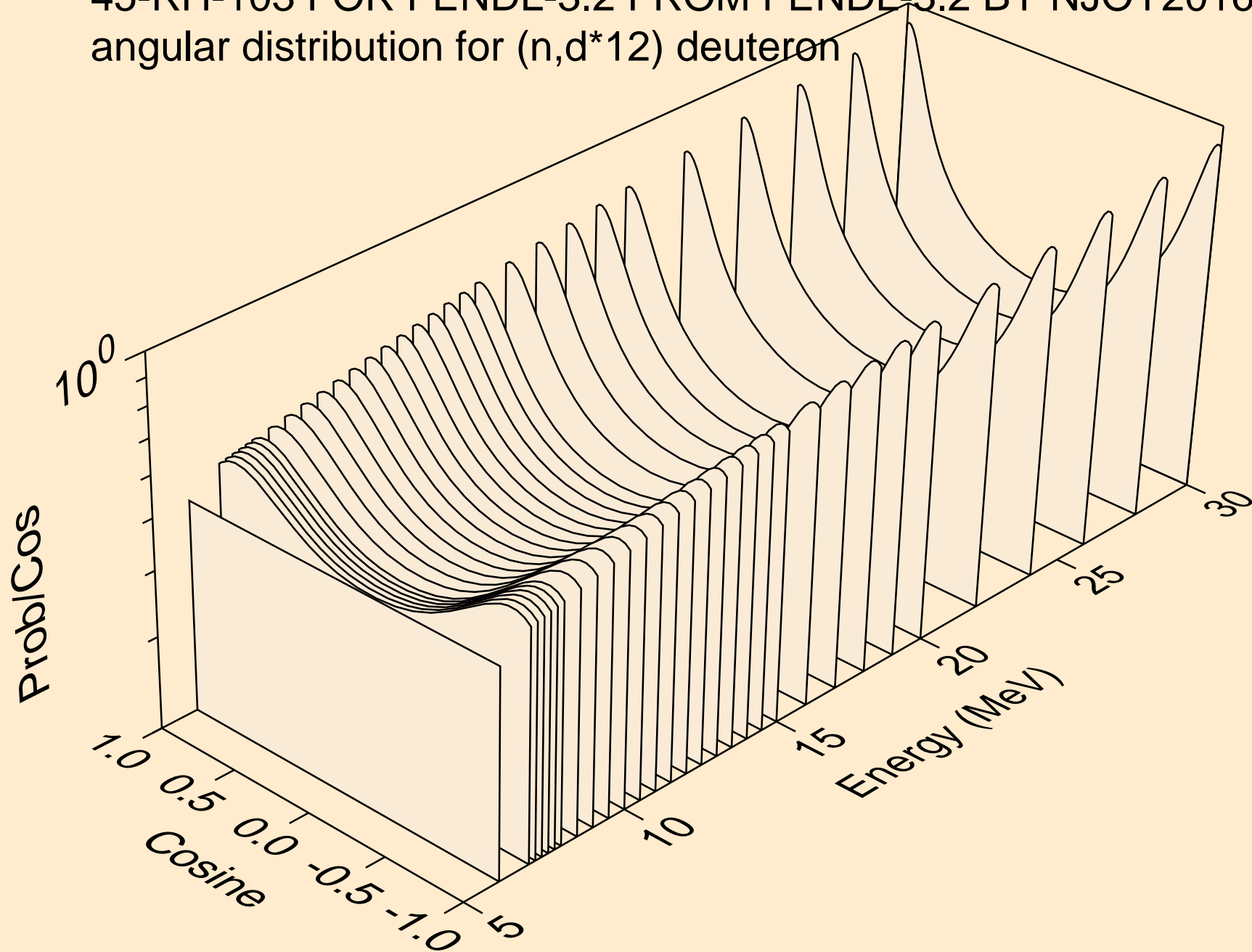

45-RH-103 FOR FENDL-3.2 FROM FENDL-3.2 BY NJOY2016.60+ C
angular distribution for (n,d*13) deuteron

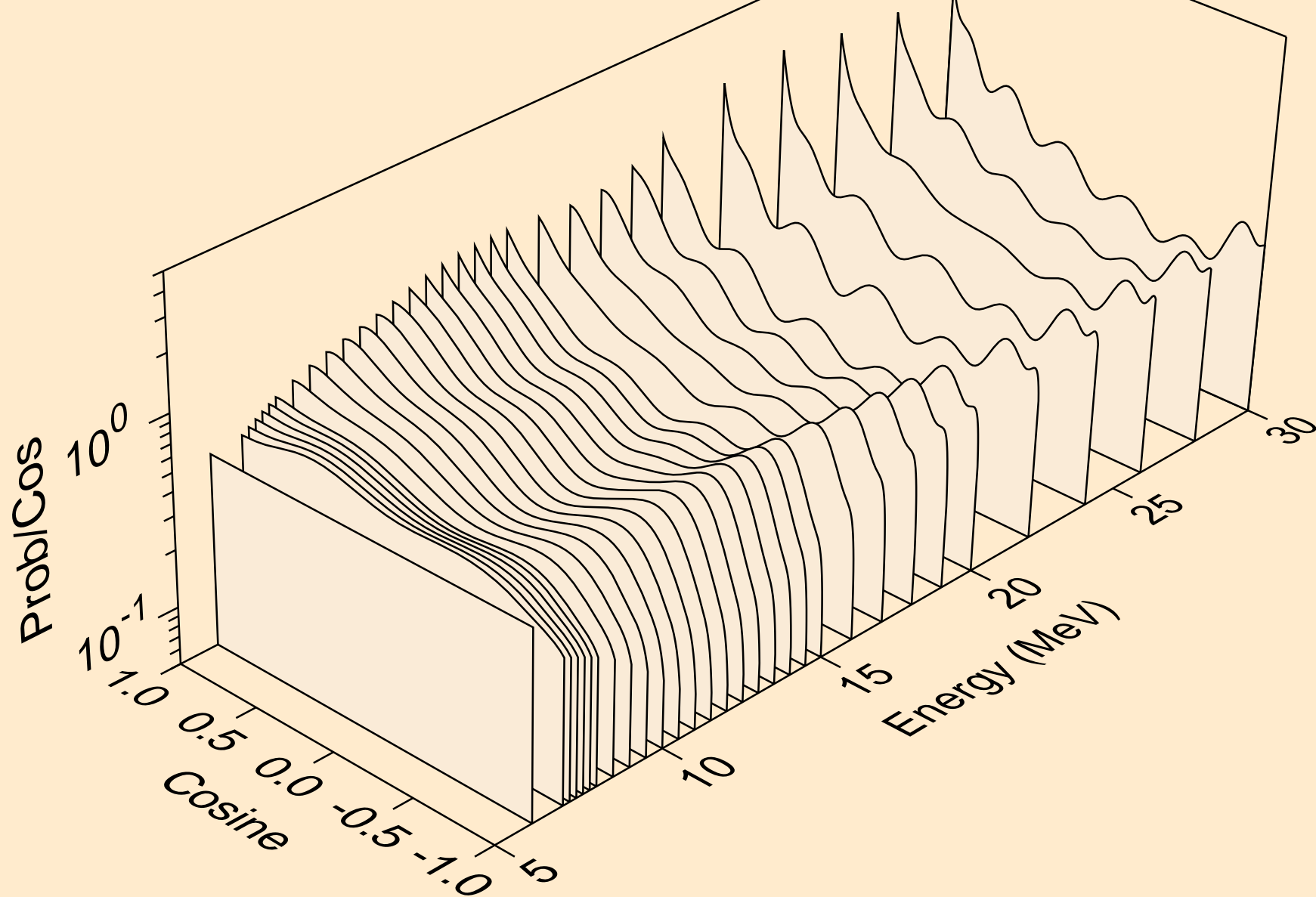

45-RH-103 FOR FENDL-3.2 FROM FENDL-3.2 BY NJOY2016.60+ C
angular distribution for (n,d*14) deuteron

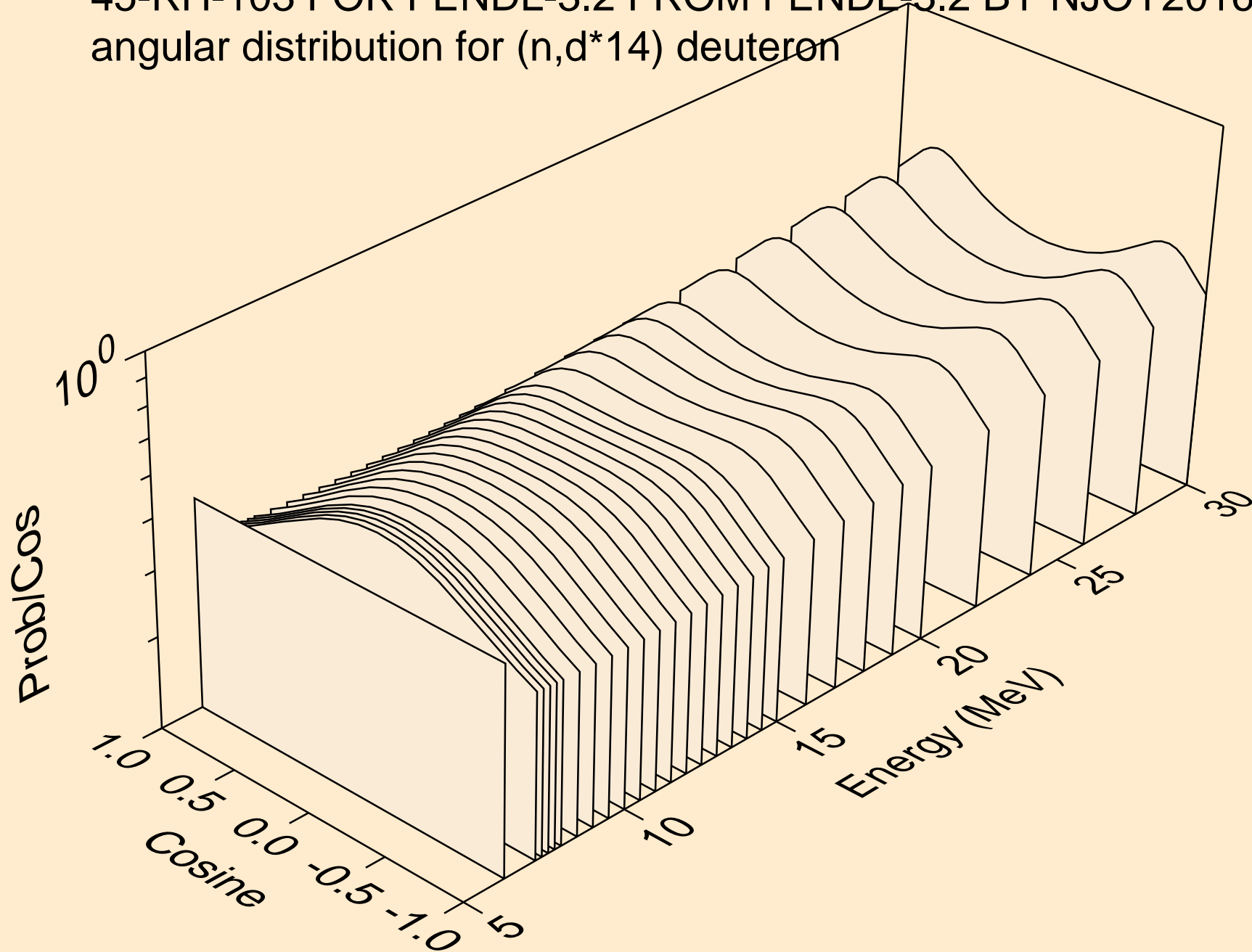

45-RH-103 FOR FENDL-3.2 FROM FENDL-3.2 BY NJOY2016.60+ C
angular distribution for (n,d*15) deuteron

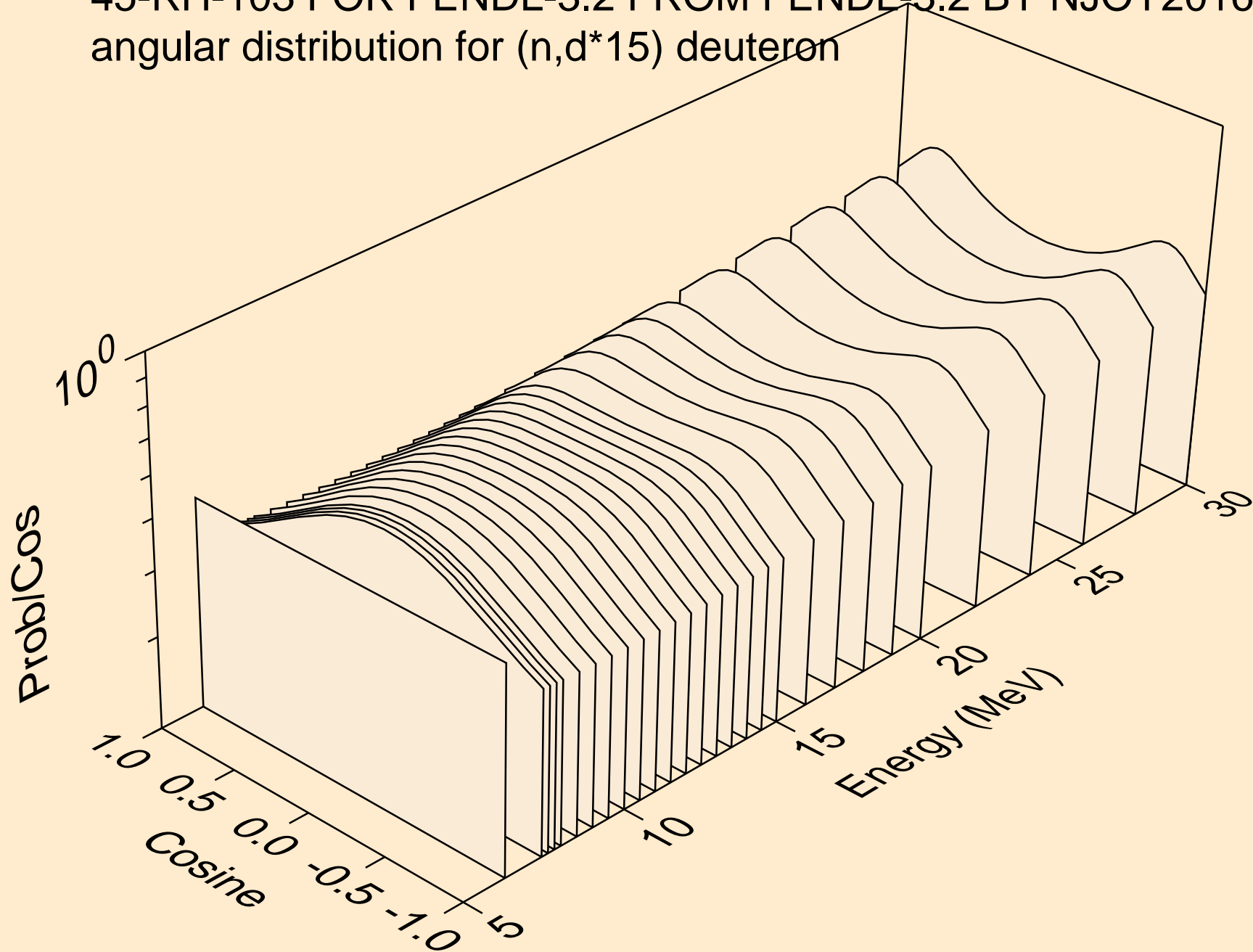

45-RH-103 FOR FENDL-3.2 FROM FENDL-3.2 BY NJOY2016.60+ C
deuterons from (n,d*c)

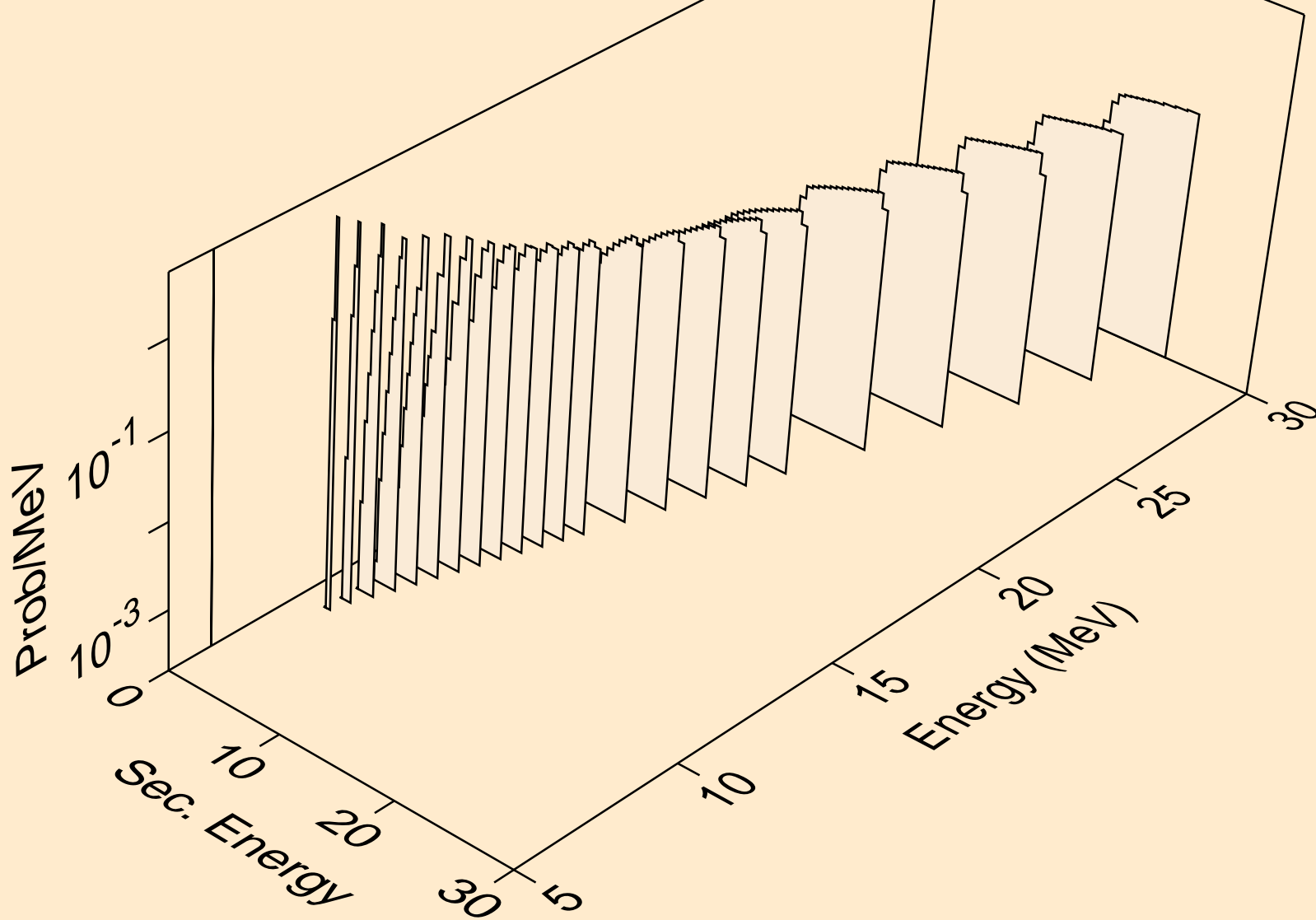

45-RH-103 FOR FENDL-3.2 FROM FENDL-3.2 BY NJOY2016.60+ C
tritons from (n,x)

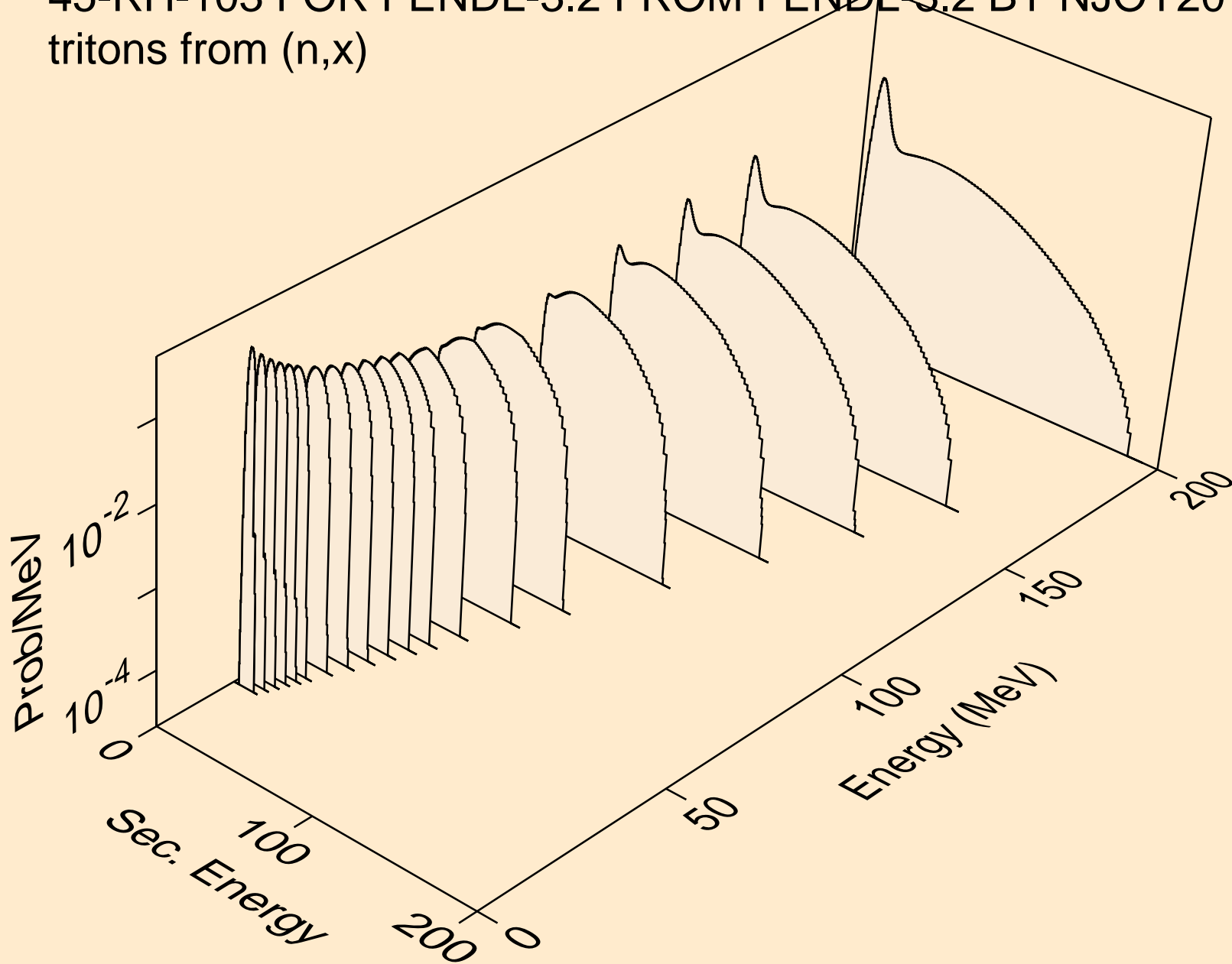

45-RH-103 FOR FENDL-3.2 FROM FENDL-3.2 BY NJOY2016.60+ C
tritons from (n,n*)t

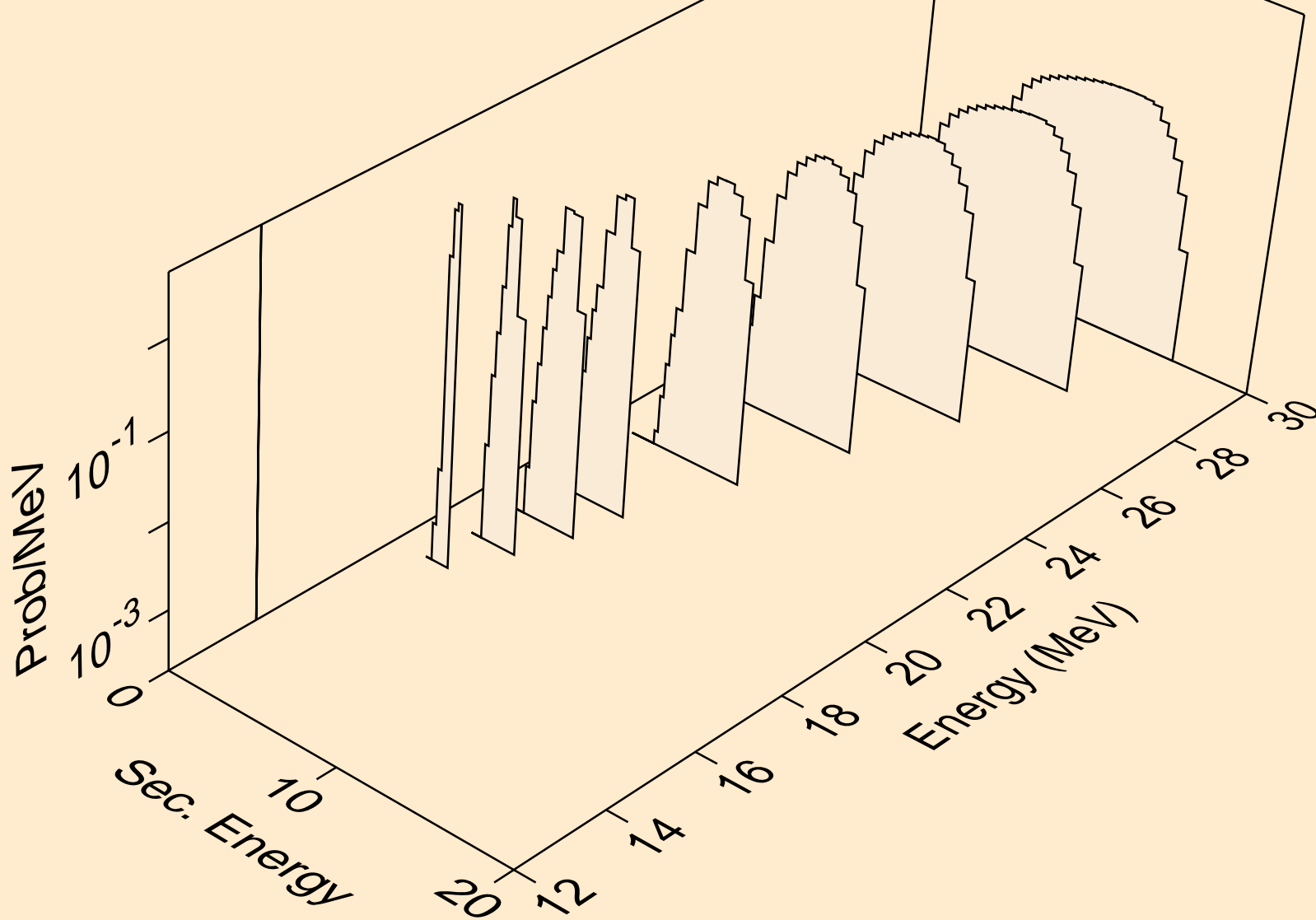

45-RH-103 FOR FENDL-3.2 FROM FENDL-3.2 BY NJOY2016.60+ C
tritons from (n,pt)

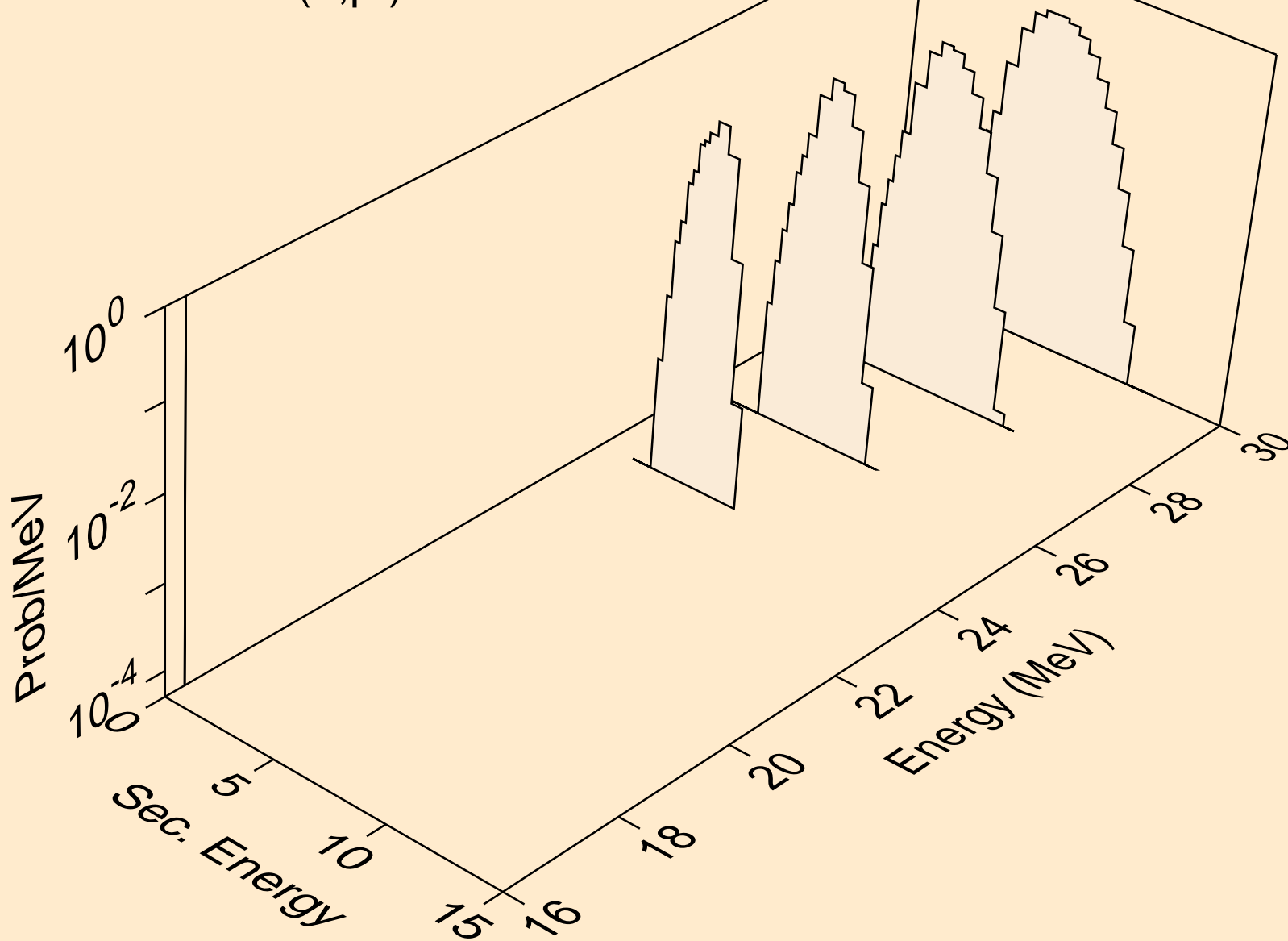

45-RH-103 FOR FENDL-3.2 FROM FENDL-3.2 BY NJOY2016.60+ C
angular distribution for (n,t*0) triton

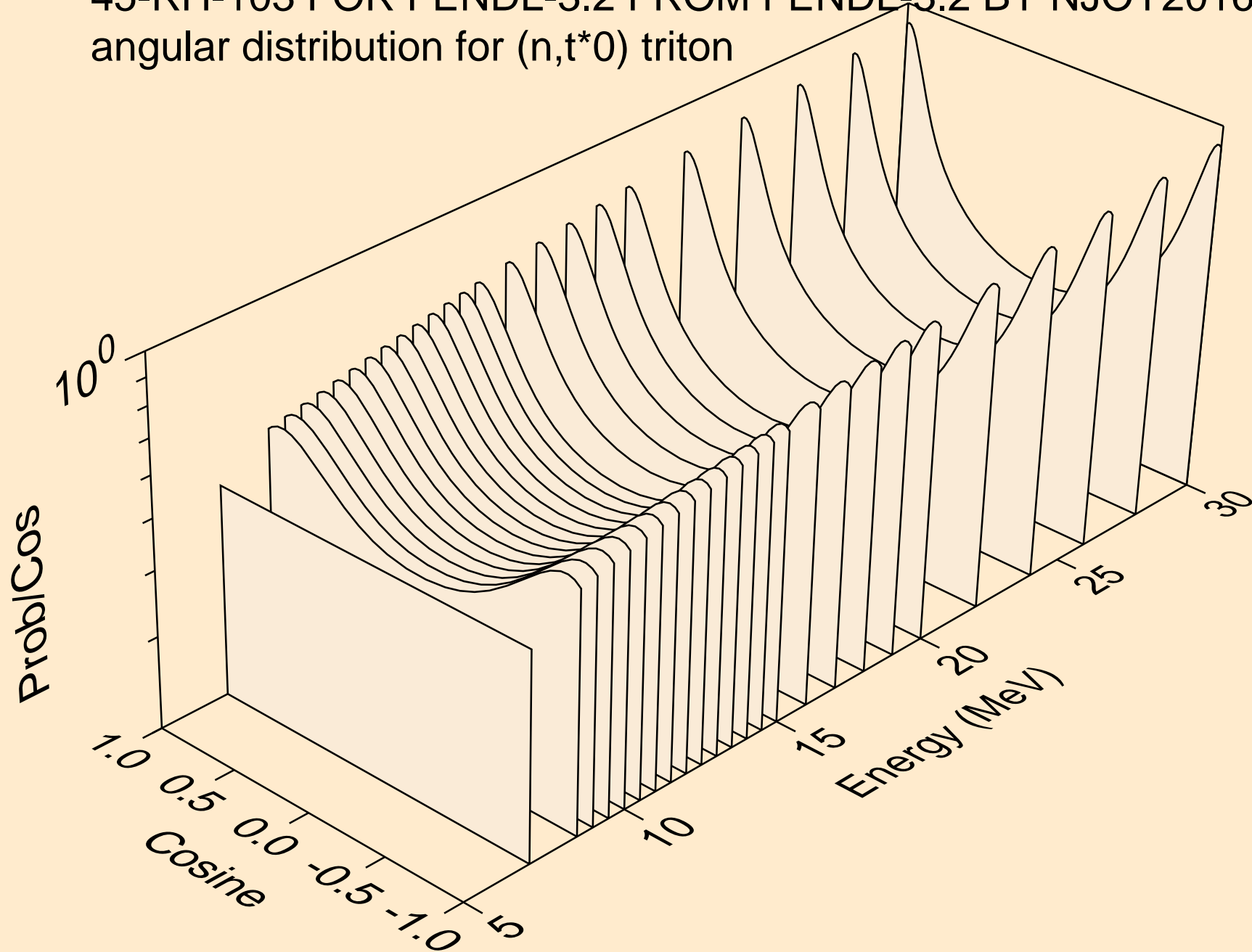

45-RH-103 FOR FENDL-3.2 FROM FENDL-3.2 BY NJOY2016.60+ C
angular distribution for (n,t*1) triton

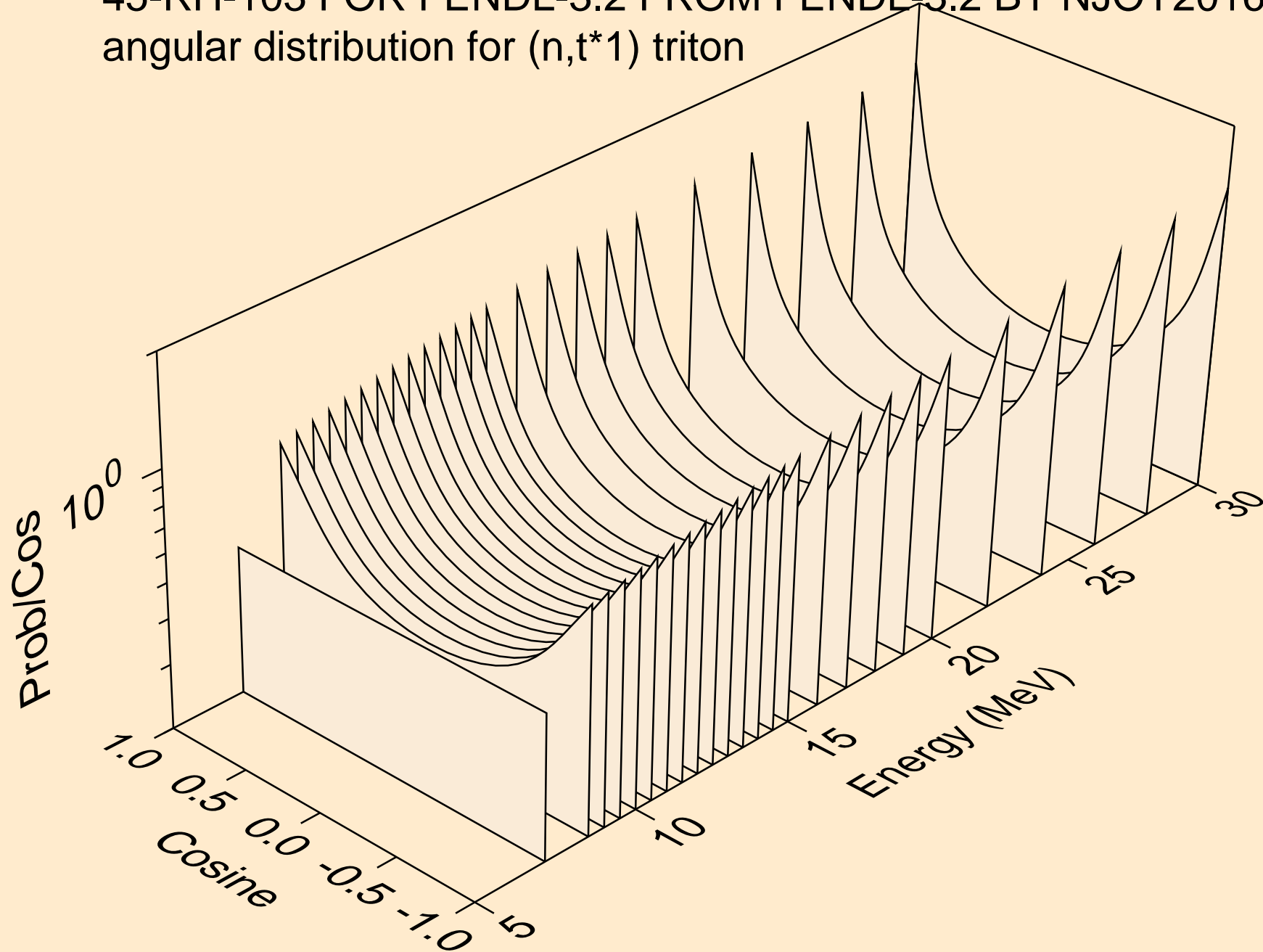

45-RH-103 FOR FENDL-3.2 FROM FENDL-3.2 BY NJOY2016.60+ C
angular distribution for (n,t*2) triton

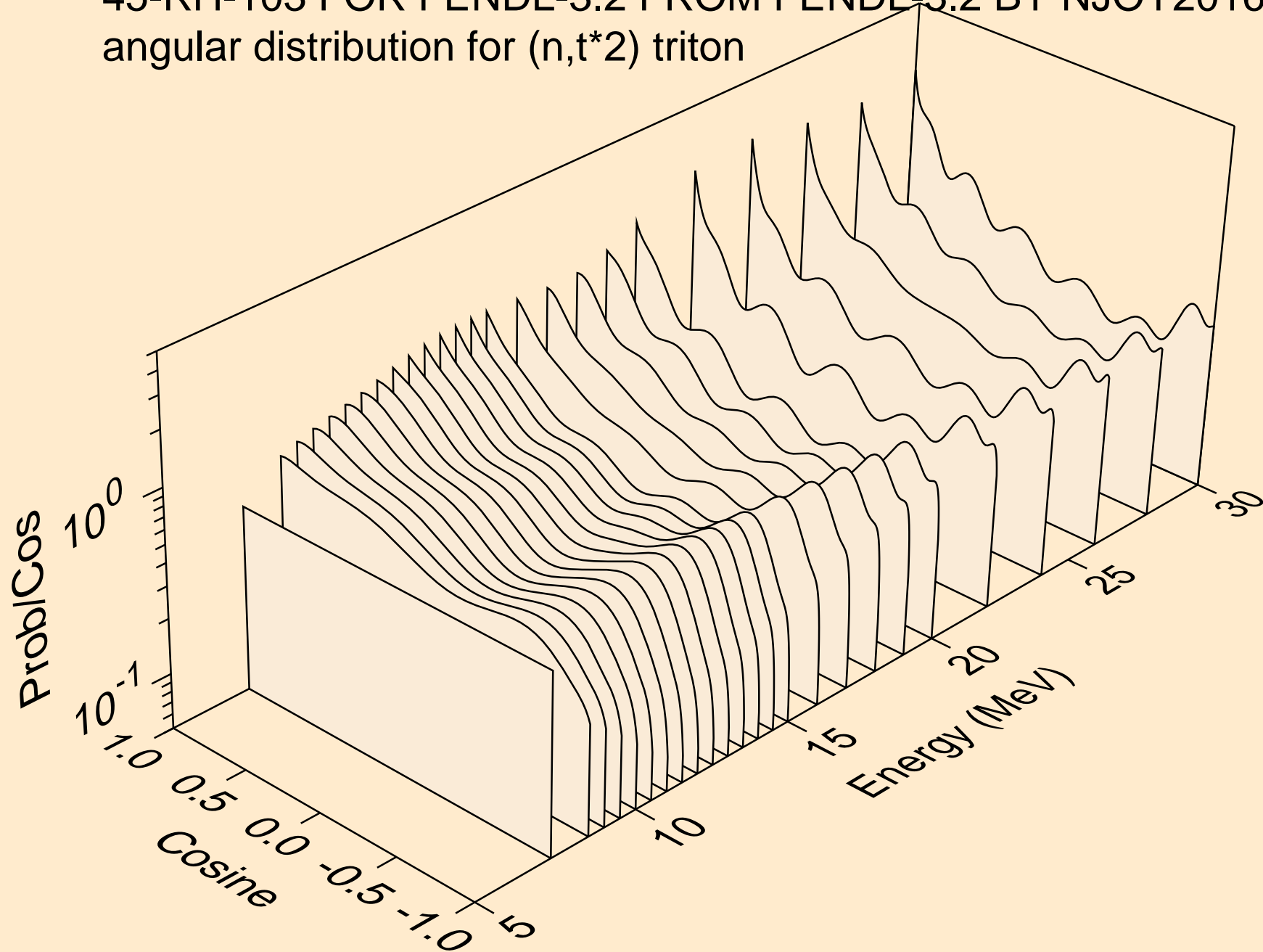

45-RH-103 FOR FENDL-3.2 FROM FENDL-3.2 BY NJOY2016.60+ C
angular distribution for (n,t*3) triton

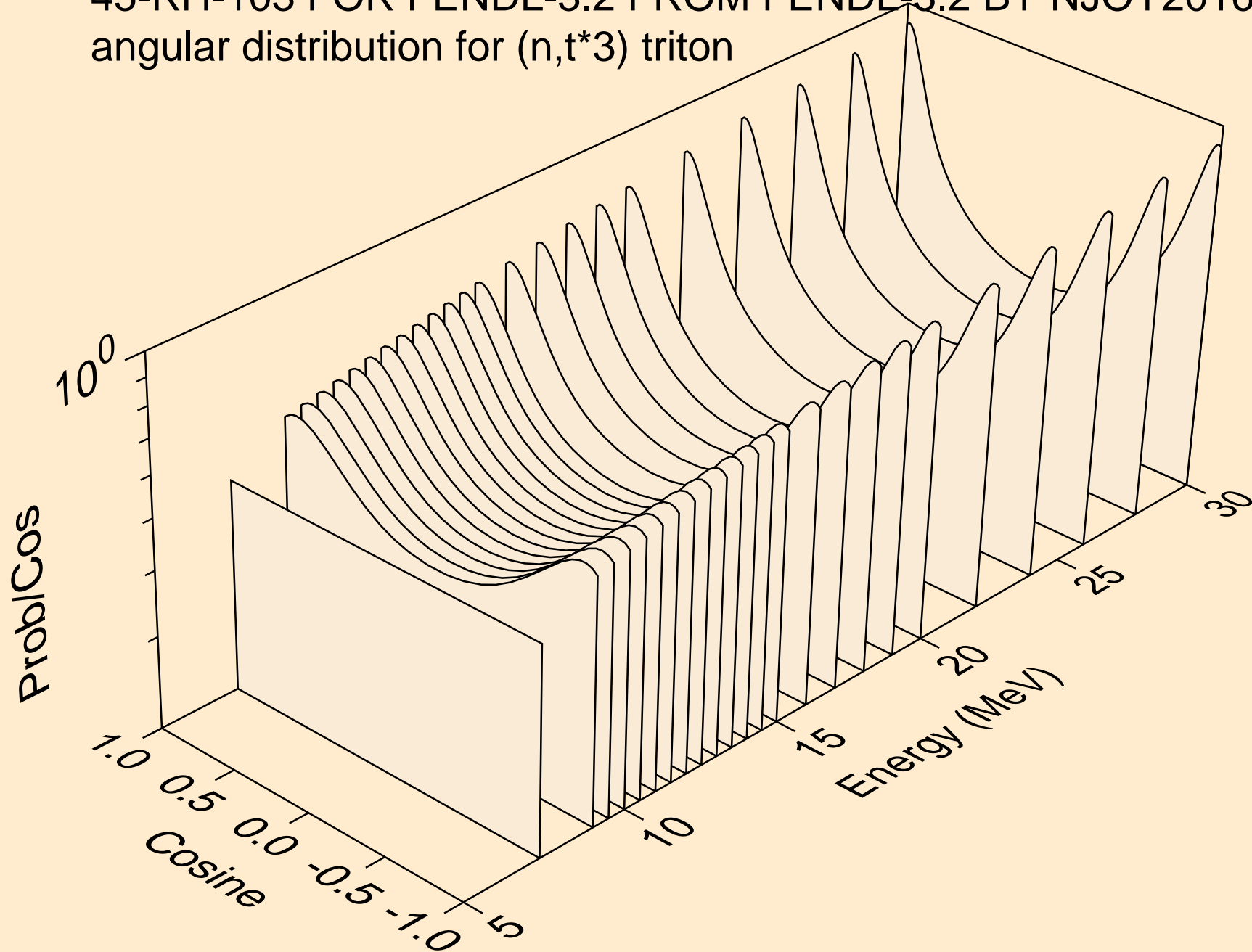

45-RH-103 FOR FENDL-3.2 FROM FENDL-3.2 BY NJOY2016.60+ C
angular distribution for (n,t*4) triton

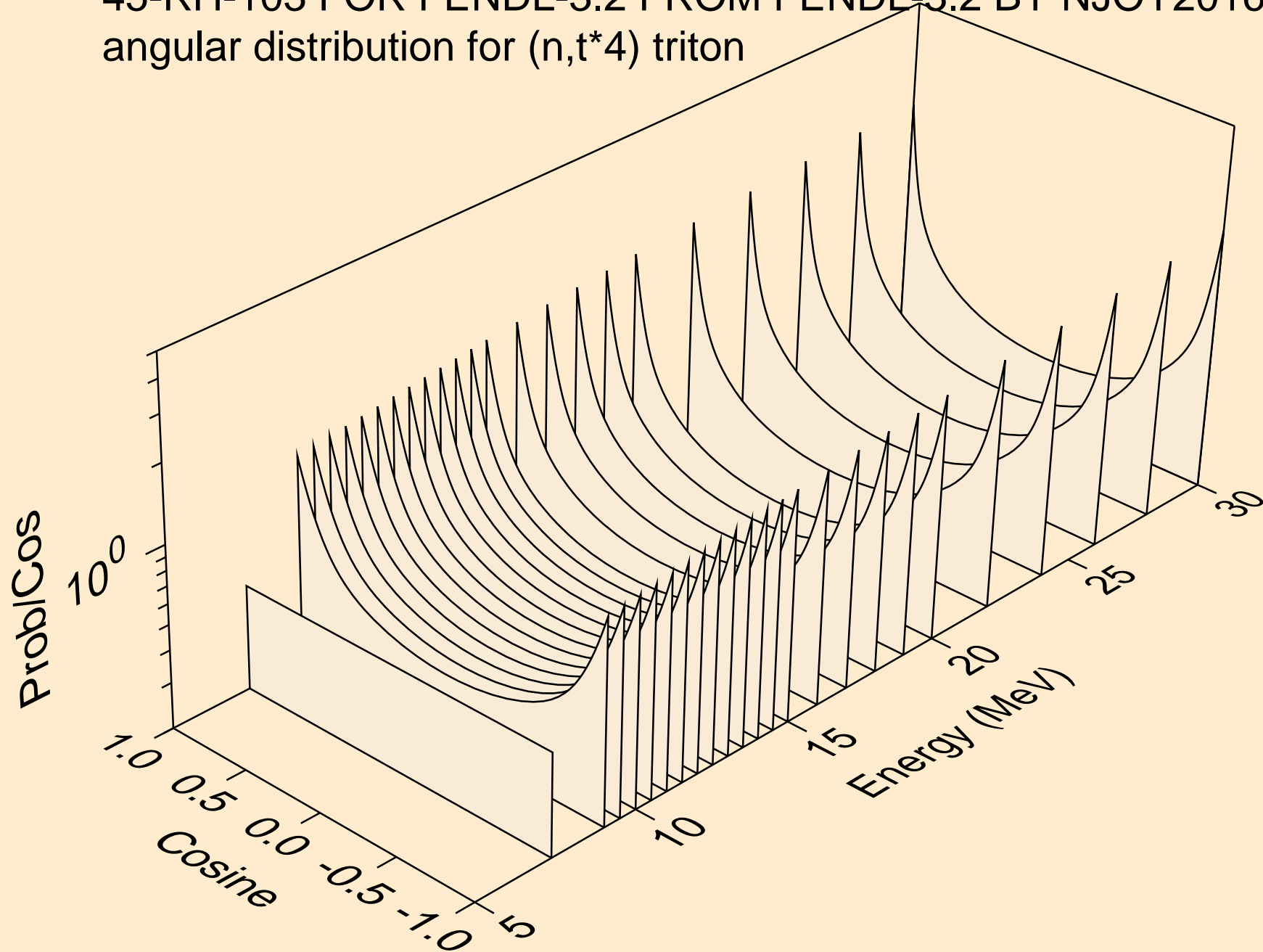

45-RH-103 FOR FENDL-3.2 FROM FENDL-3.2 BY NJOY2016.60+ C
angular distribution for (n,t*5) triton

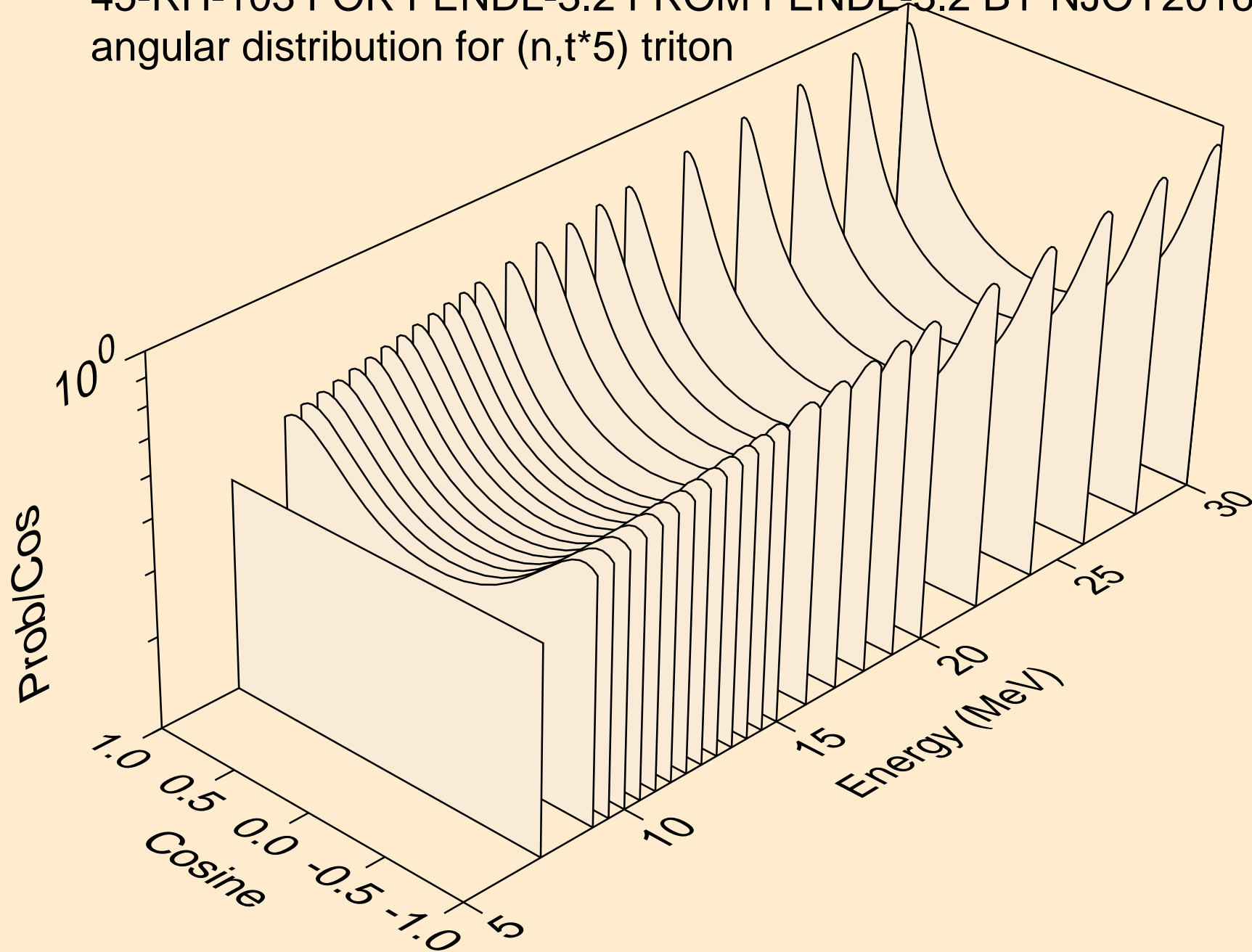

45-RH-103 FOR FENDL-3.2 FROM FENDL-3.2 BY NJOY2016.60+ C
angular distribution for (n,t*6) triton

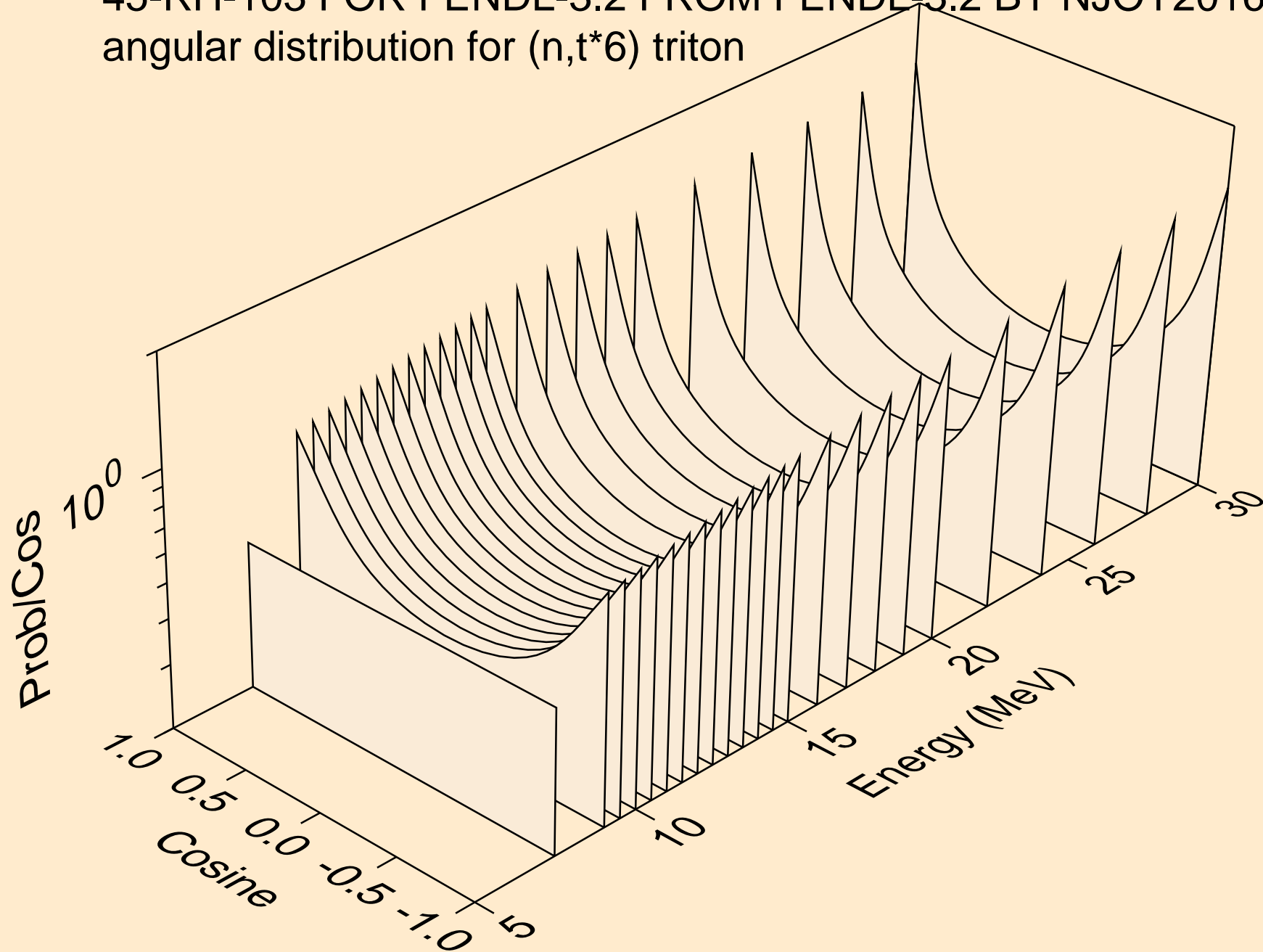

45-RH-103 FOR FENDL-3.2 FROM FENDL-3.2 BY NJOY2016.60+ C
angular distribution for (n,t*7) triton

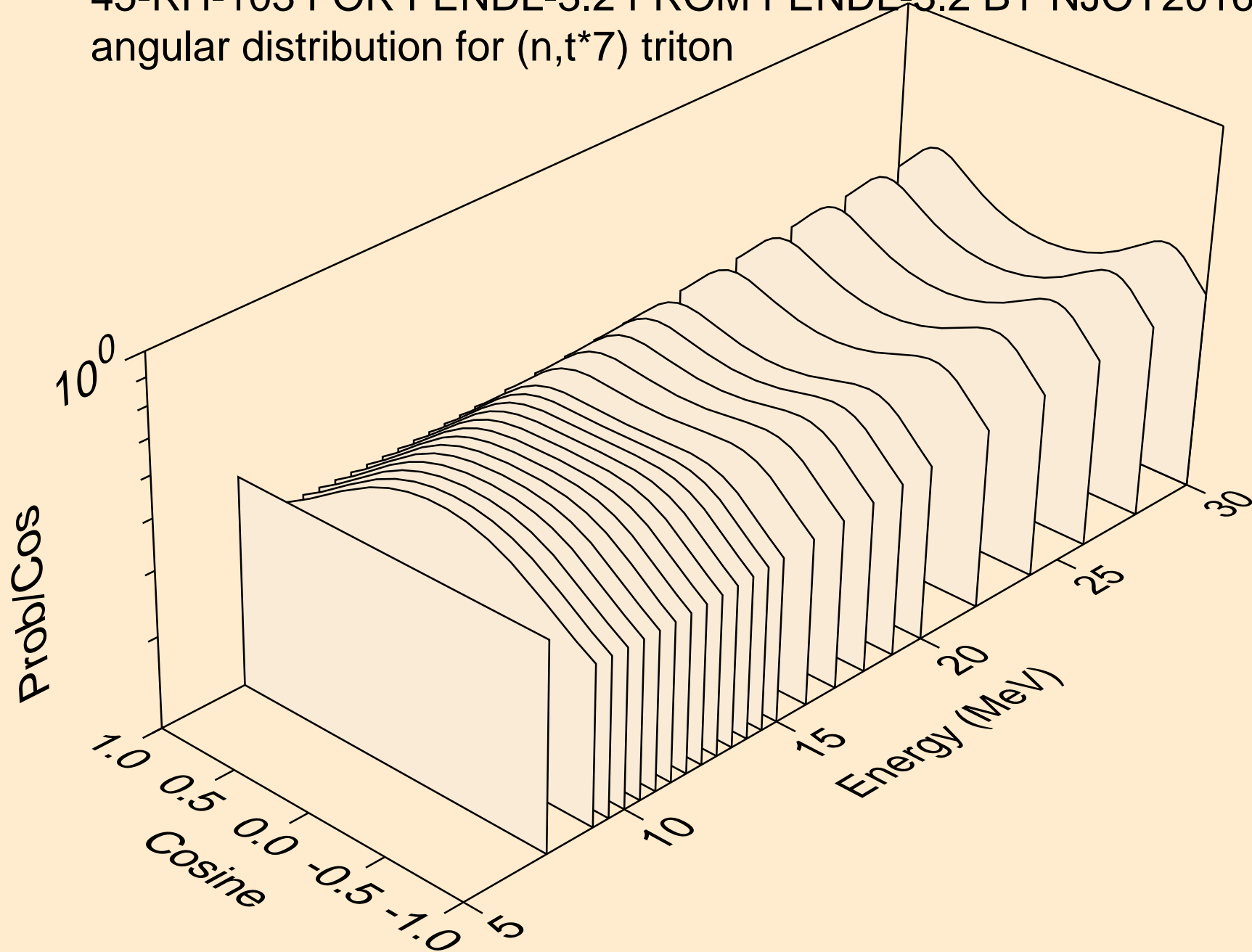

45-RH-103 FOR FENDL-3.2 FROM FENDL-3.2 BY NJOY2016.60+ C
angular distribution for (n,t*8) triton

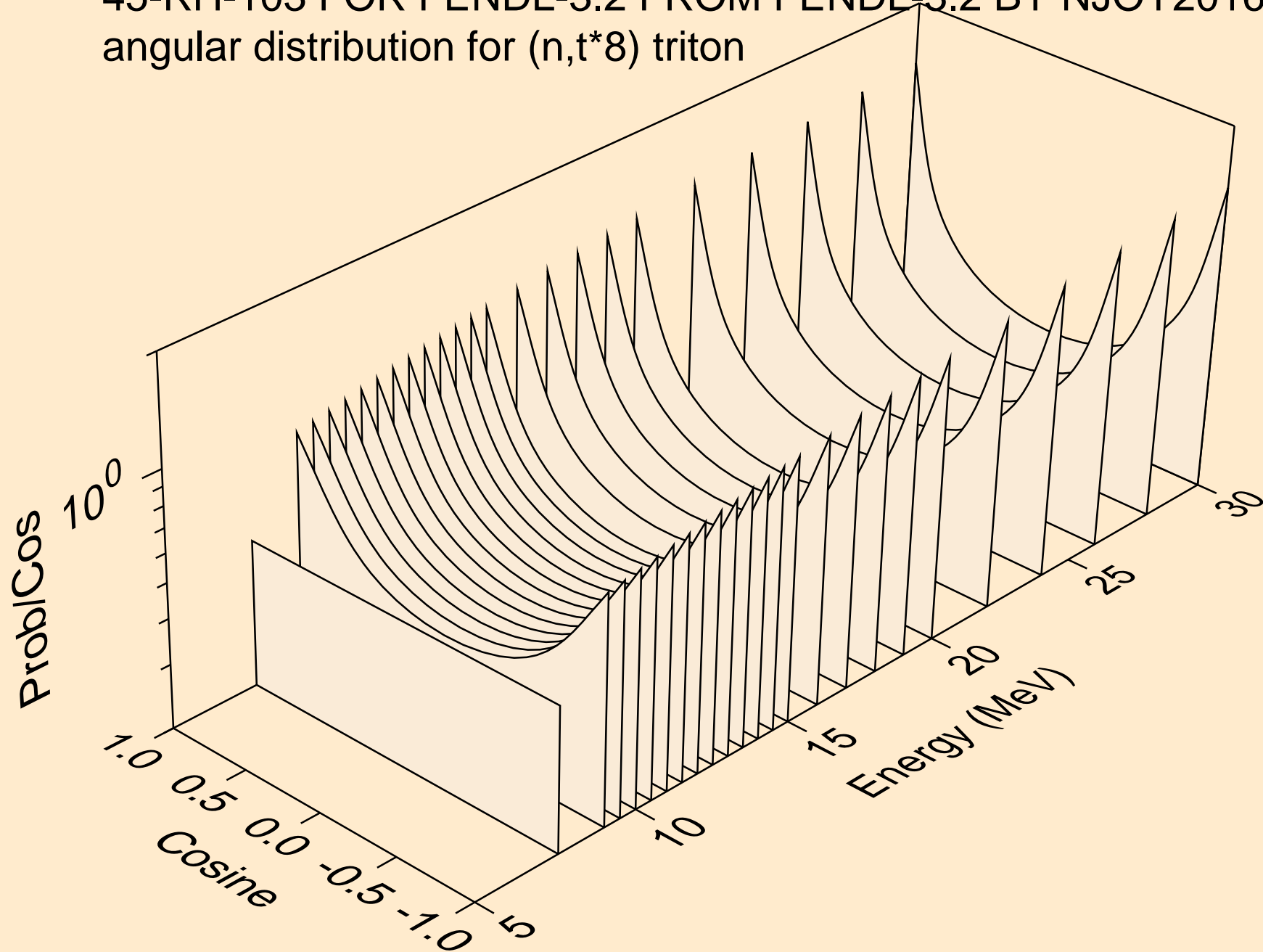

45-RH-103 FOR FENDL-3.2 FROM FENDL-3.2 BY NJOY2016.60+ C
angular distribution for (n,t*9) triton

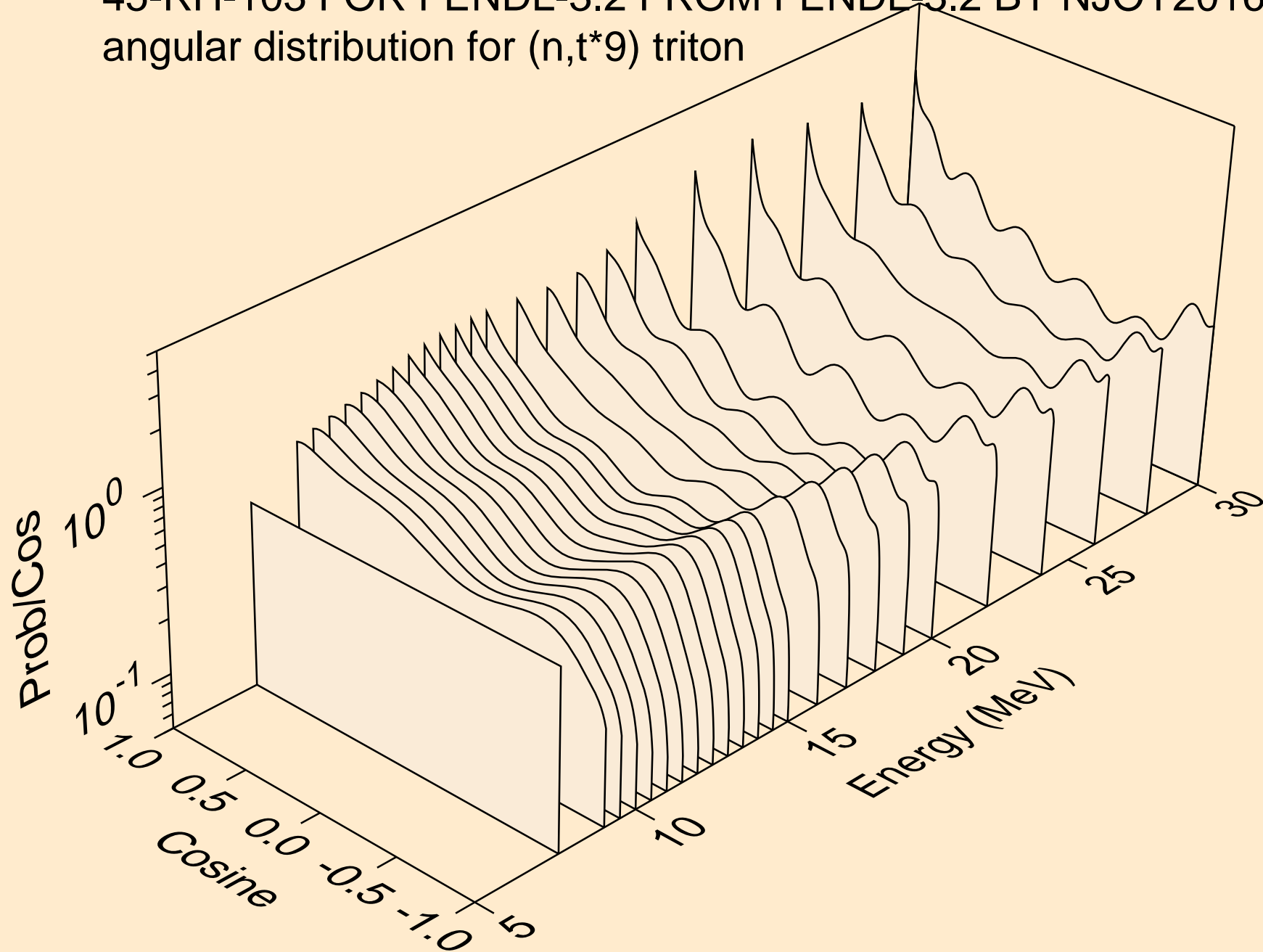

45-RH-103 FOR FENDL-3.2 FROM FENDL-3.2 BY NJOY2016.60+ C
angular distribution for (n,t*10) triton

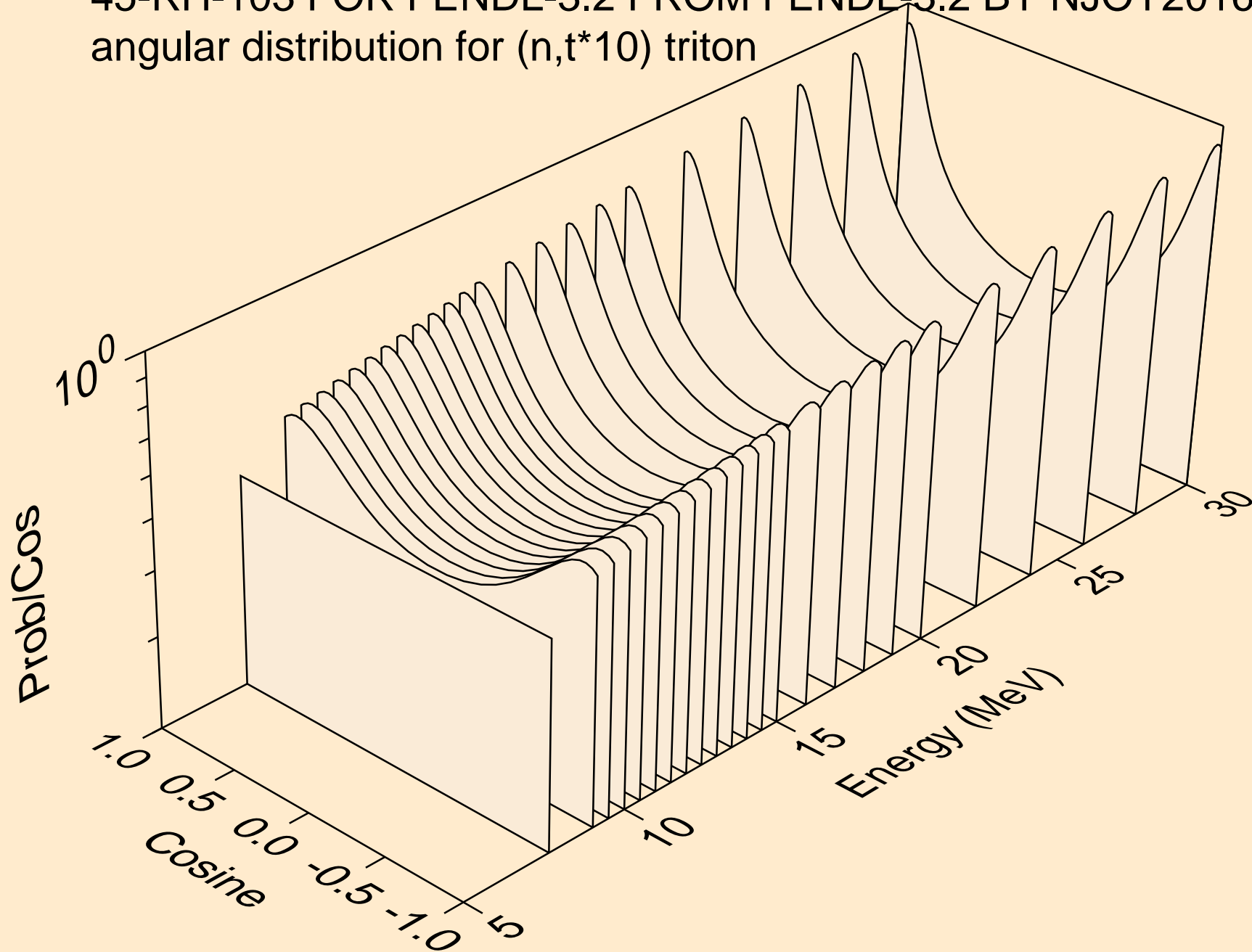

45-RH-103 FOR FENDL-3.2 FROM FENDL-3.2 BY NJOY2016.60+ C
angular distribution for (n,t*11) triton

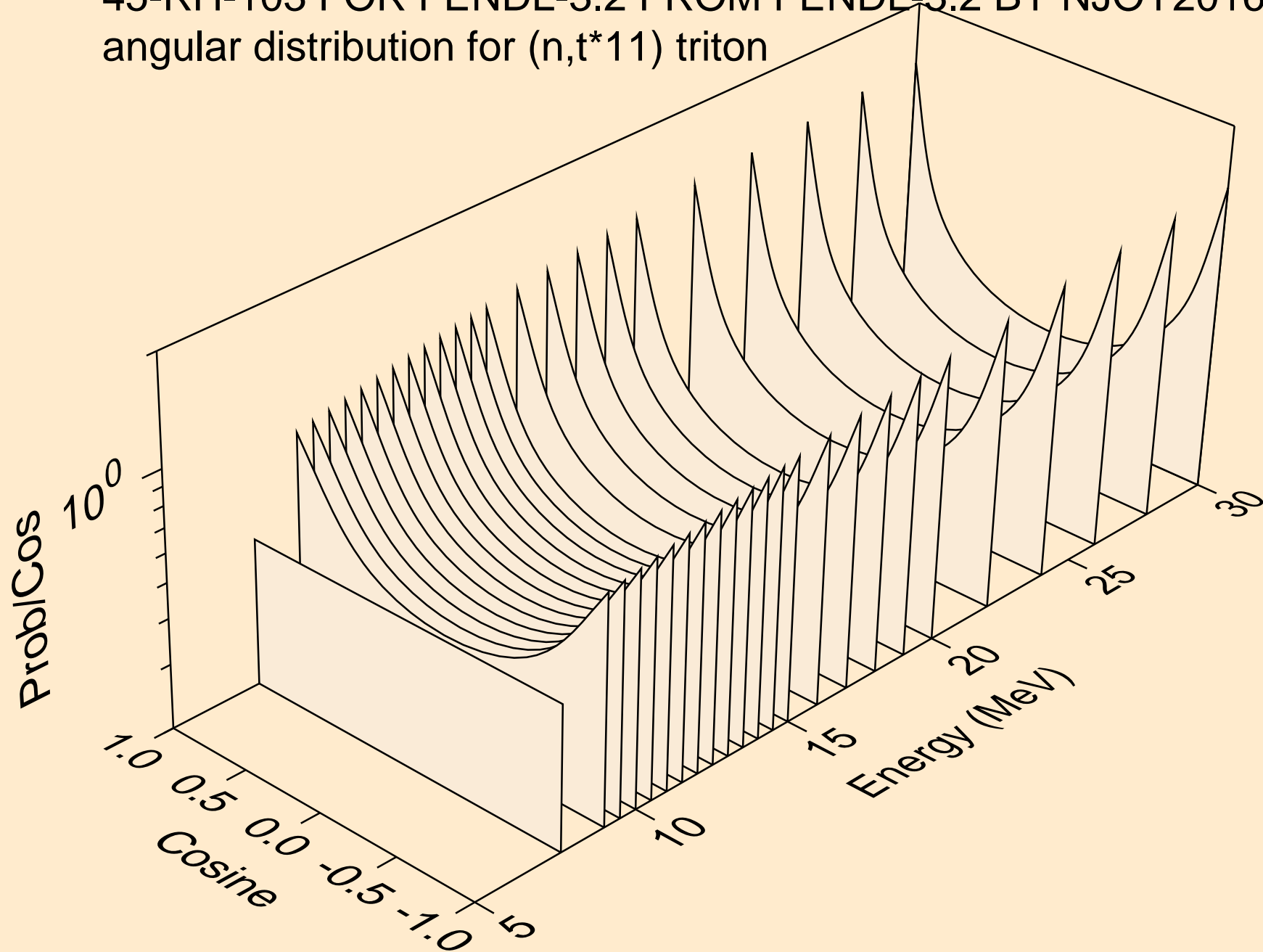

45-RH-103 FOR FENDL-3.2 FROM FENDL-3.2 BY NJOY2016.60+ C
angular distribution for (n,t*12) triton

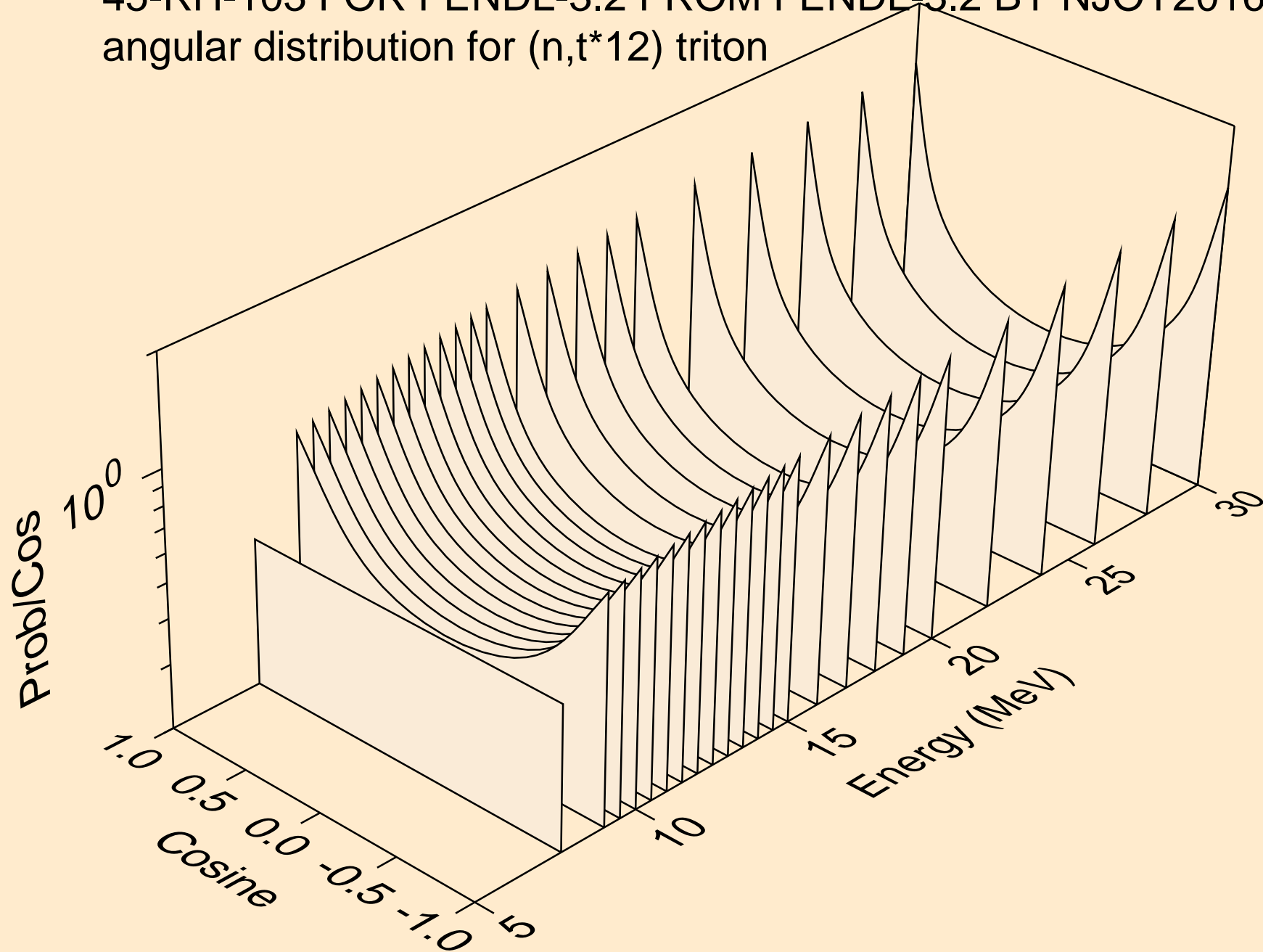

45-RH-103 FOR FENDL-3.2 FROM FENDL-3.2 BY NJOY2016.60+ C
angular distribution for (n,t*13) triton

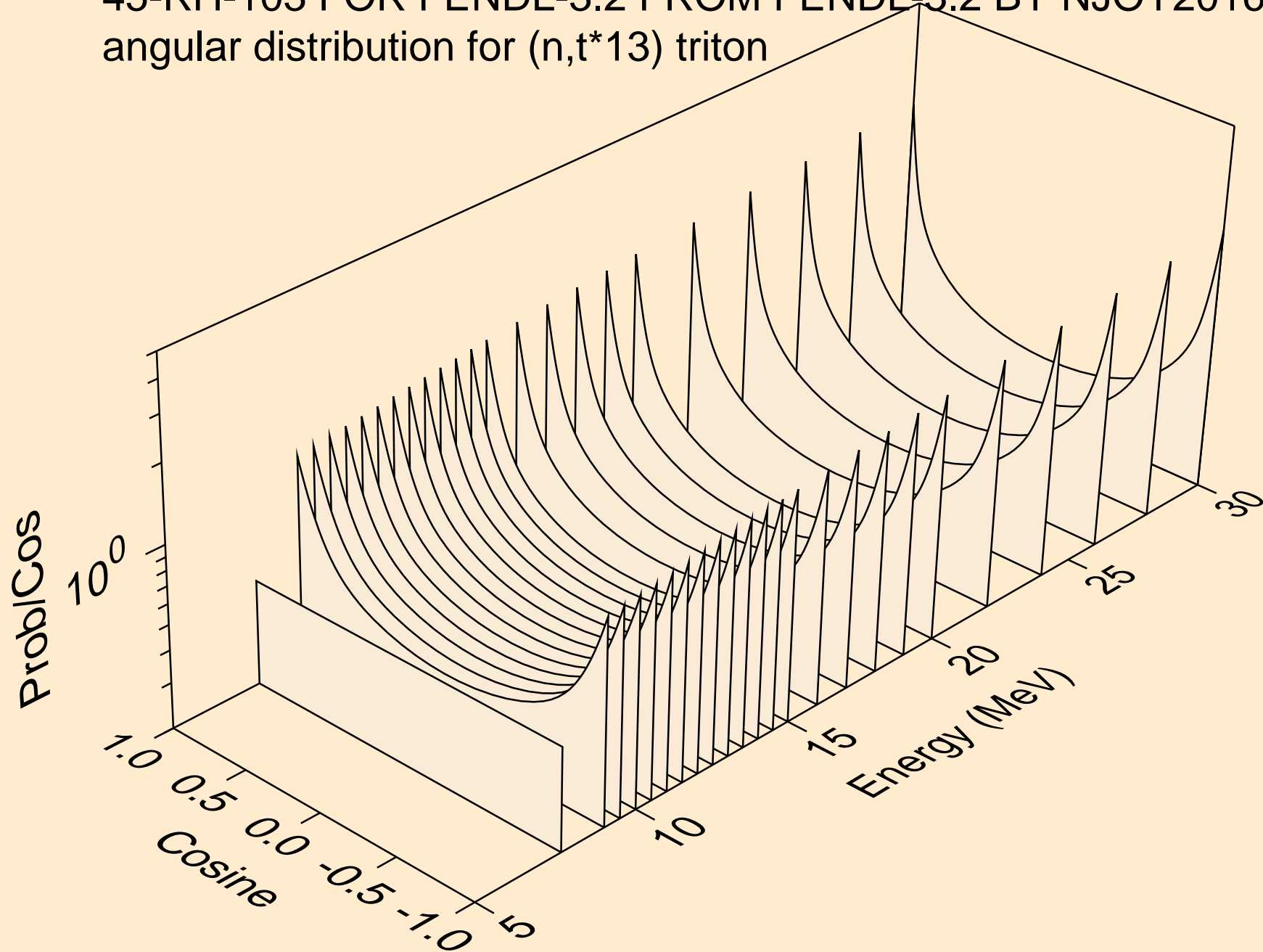

45-RH-103 FOR FENDL-3.2 FROM FENDL-3.2 BY NJOY2016.60+ C
angular distribution for (n,t*14) triton

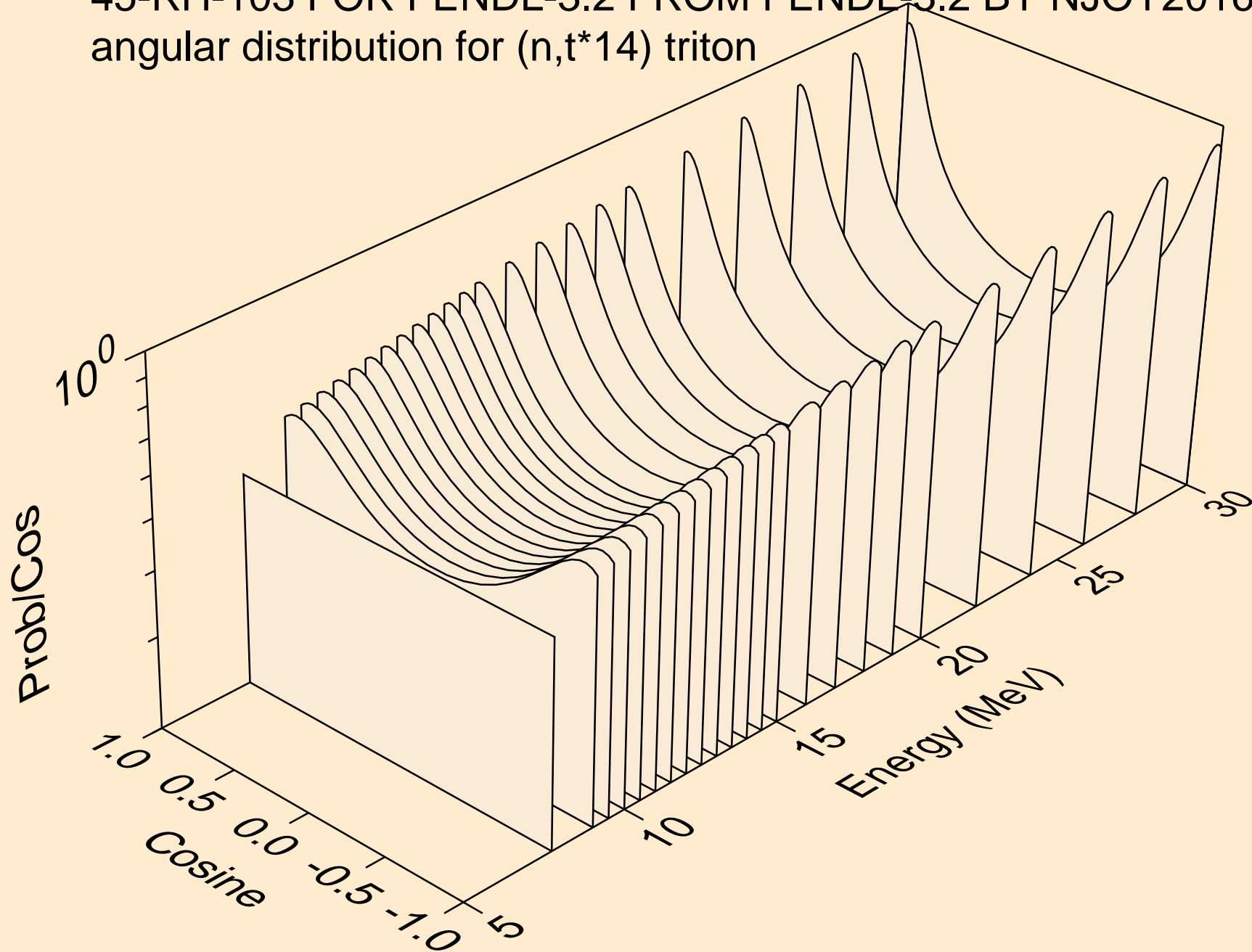

45-RH-103 FOR FENDL-3.2 FROM FENDL-3.2 BY NJOY2016.60+ C
angular distribution for (n,t*15) triton

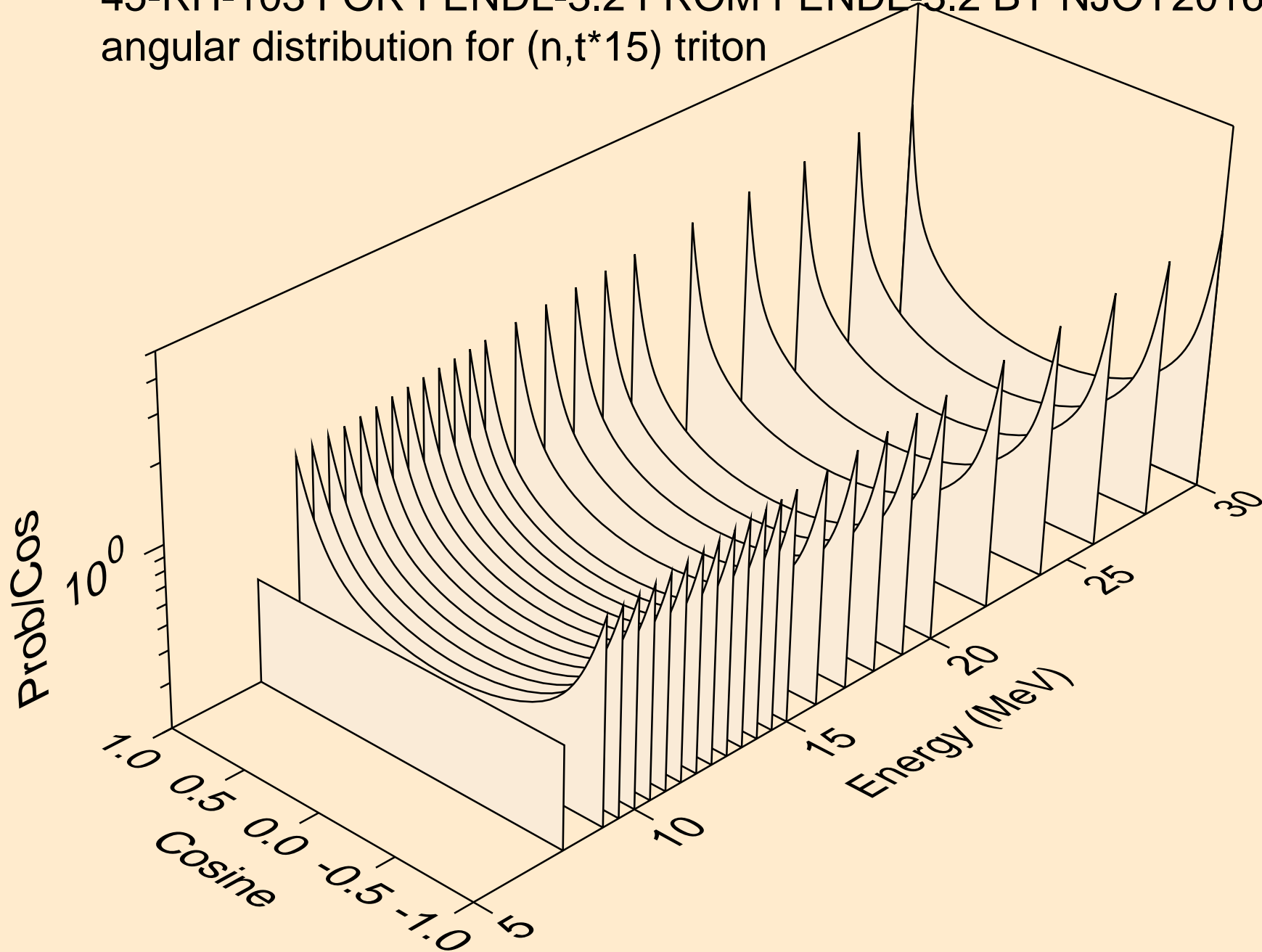

45-RH-103 FOR FENDL-3.2 FROM FENDL-3.2 BY NJOY2016.60+ C
tritons from (n,t*c)

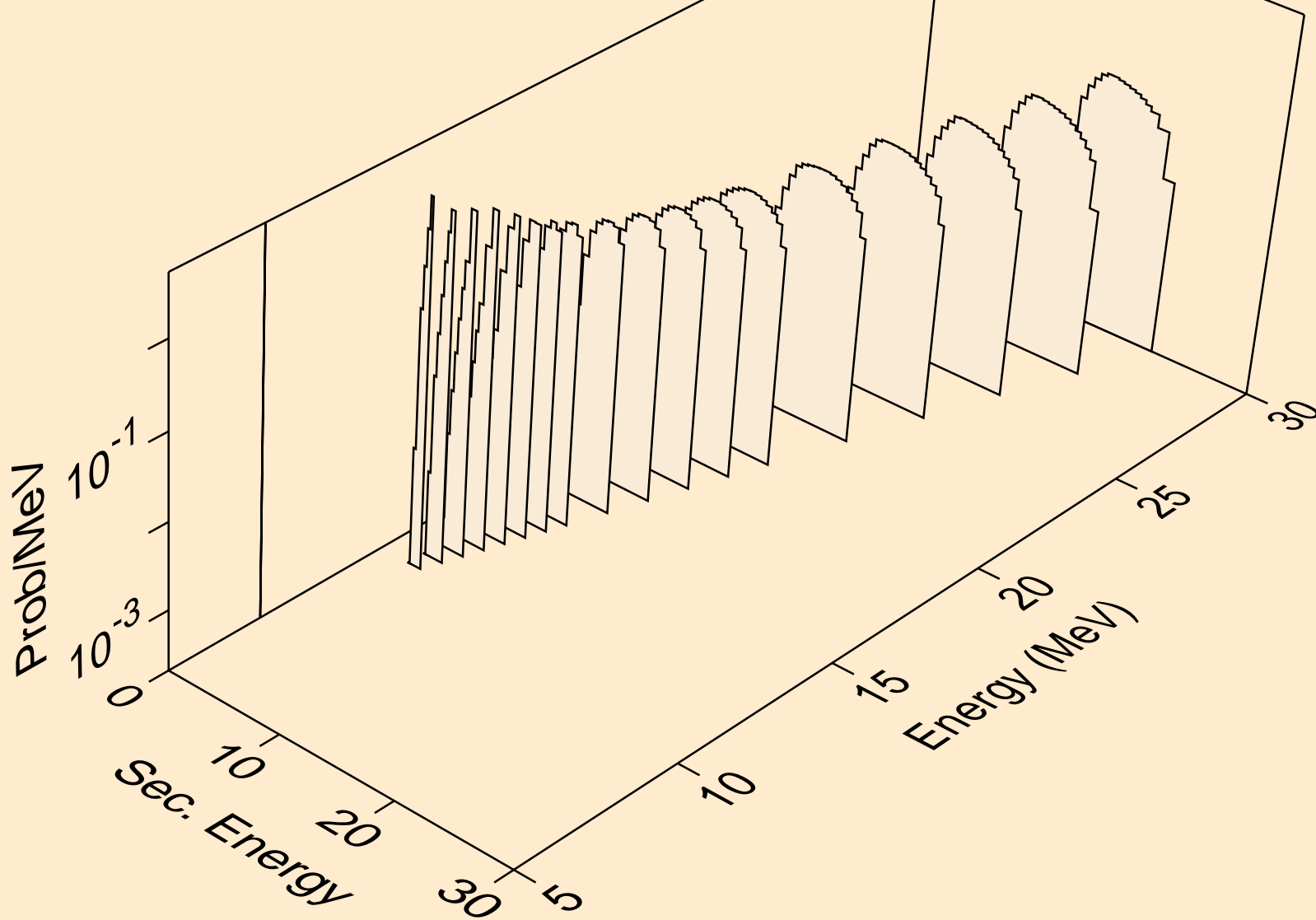

45-RH-103 FOR FENDL-3.2 FROM FENDL-3.2 BY NJOY2016.60+ C
he3s from (n,x)

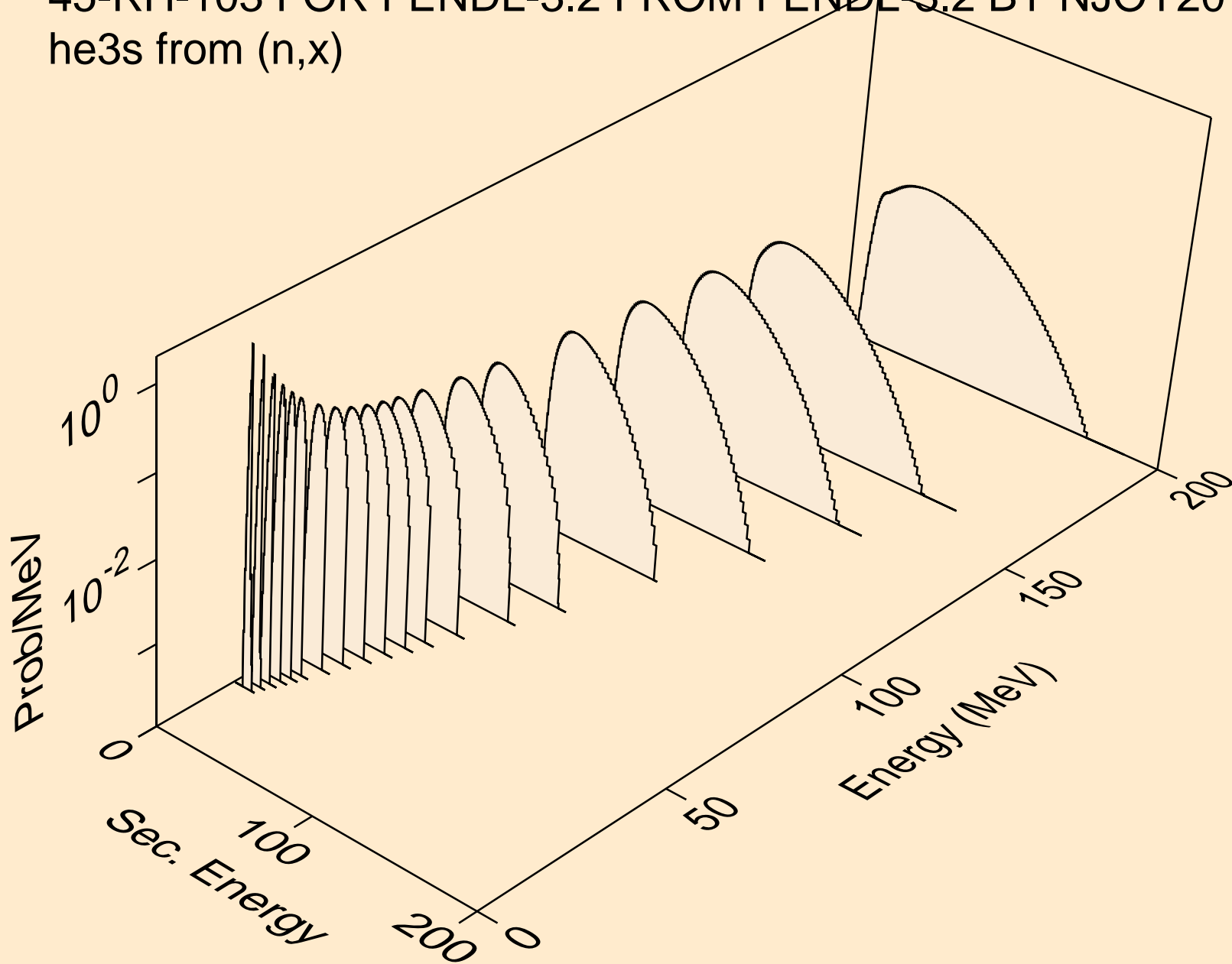

45-RH-103 FOR FENDL-3.2 FROM FENDL-3.2 BY NJOY2016.60+ C
he3s from (n,n*)he3

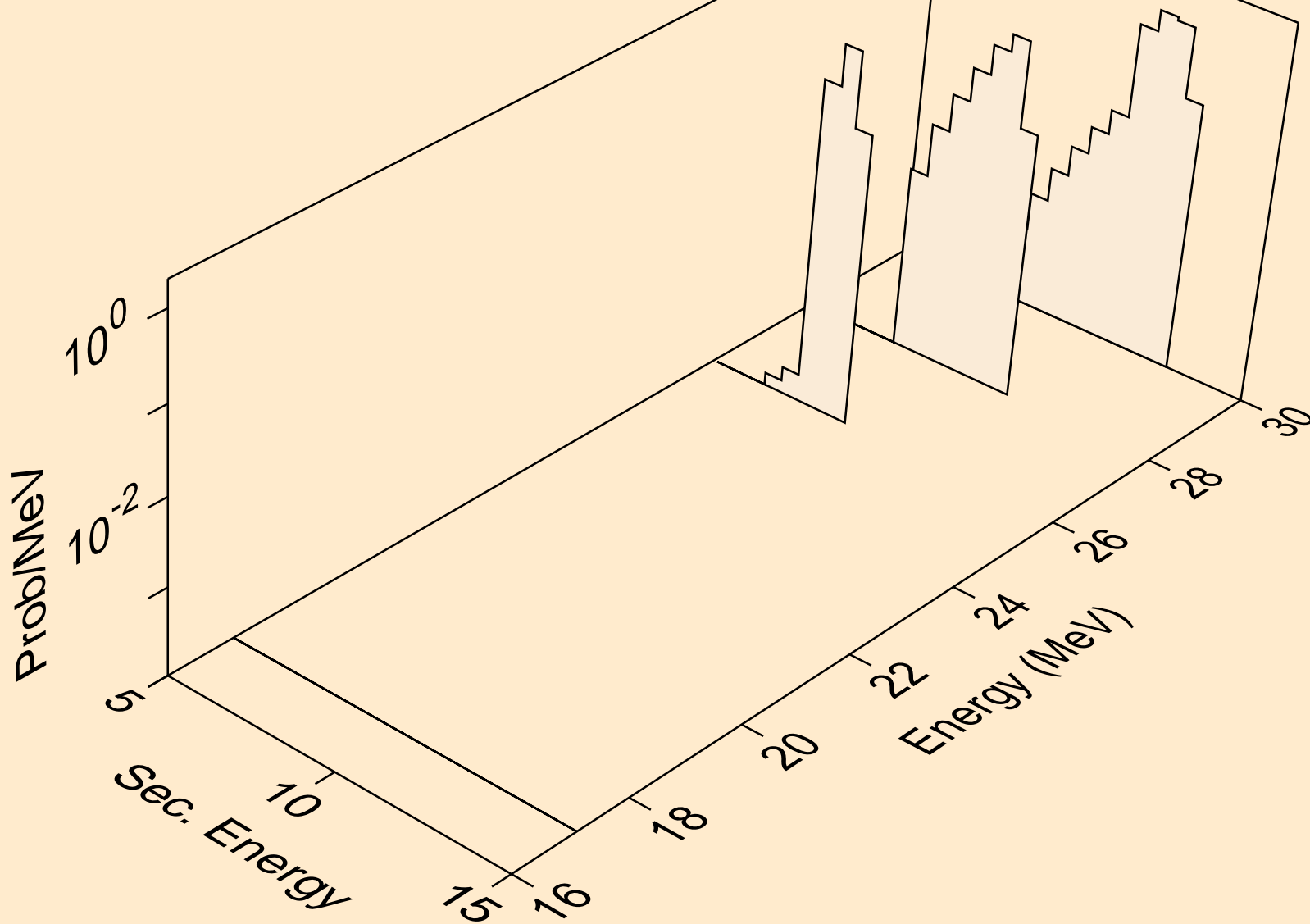

45-RH-103 FOR FENDL-3.2 FROM FENDL-3.2 BY NJOY2016.60+ C
angular distribution for (n,he3*0) 3he

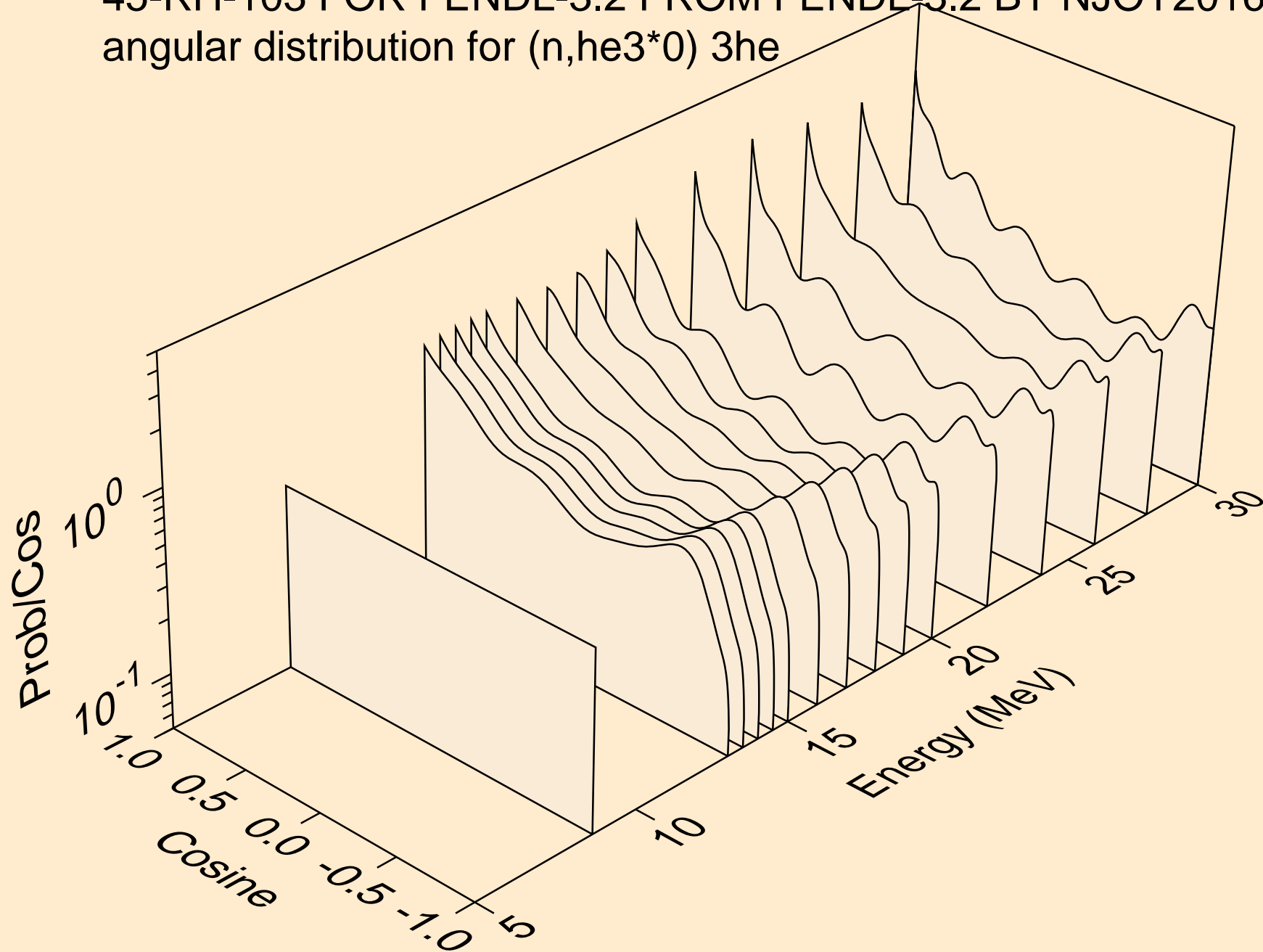

45-RH-103 FOR FENDL-3.2 FROM FENDL-3.2 BY NJOY2016.60+ C
angular distribution for (n,he3*1) 3he

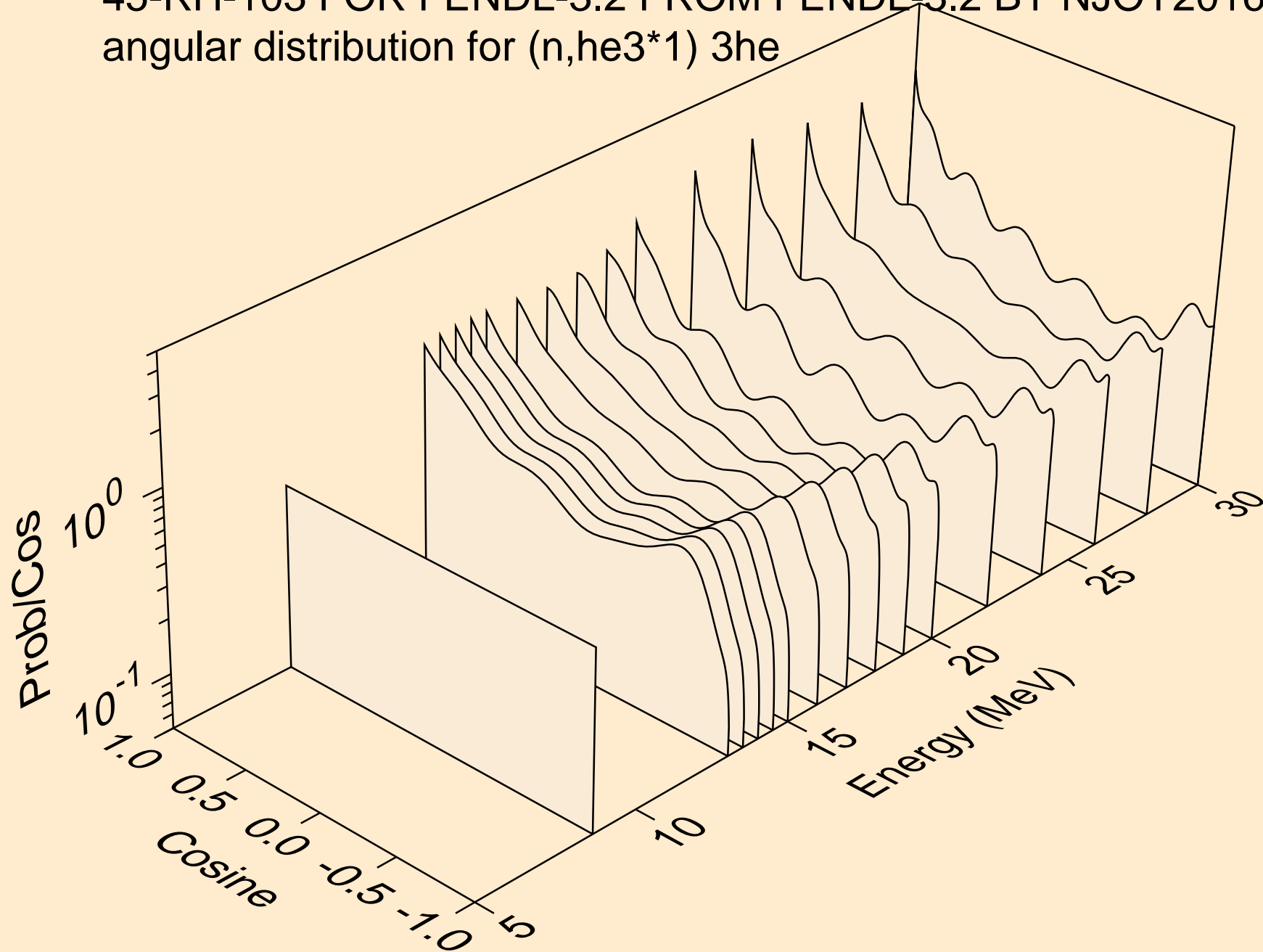

45-RH-103 FOR FENDL-3.2 FROM FENDL-3.2 BY NJOY2016.60+ C
angular distribution for (n,he3*2) 3he

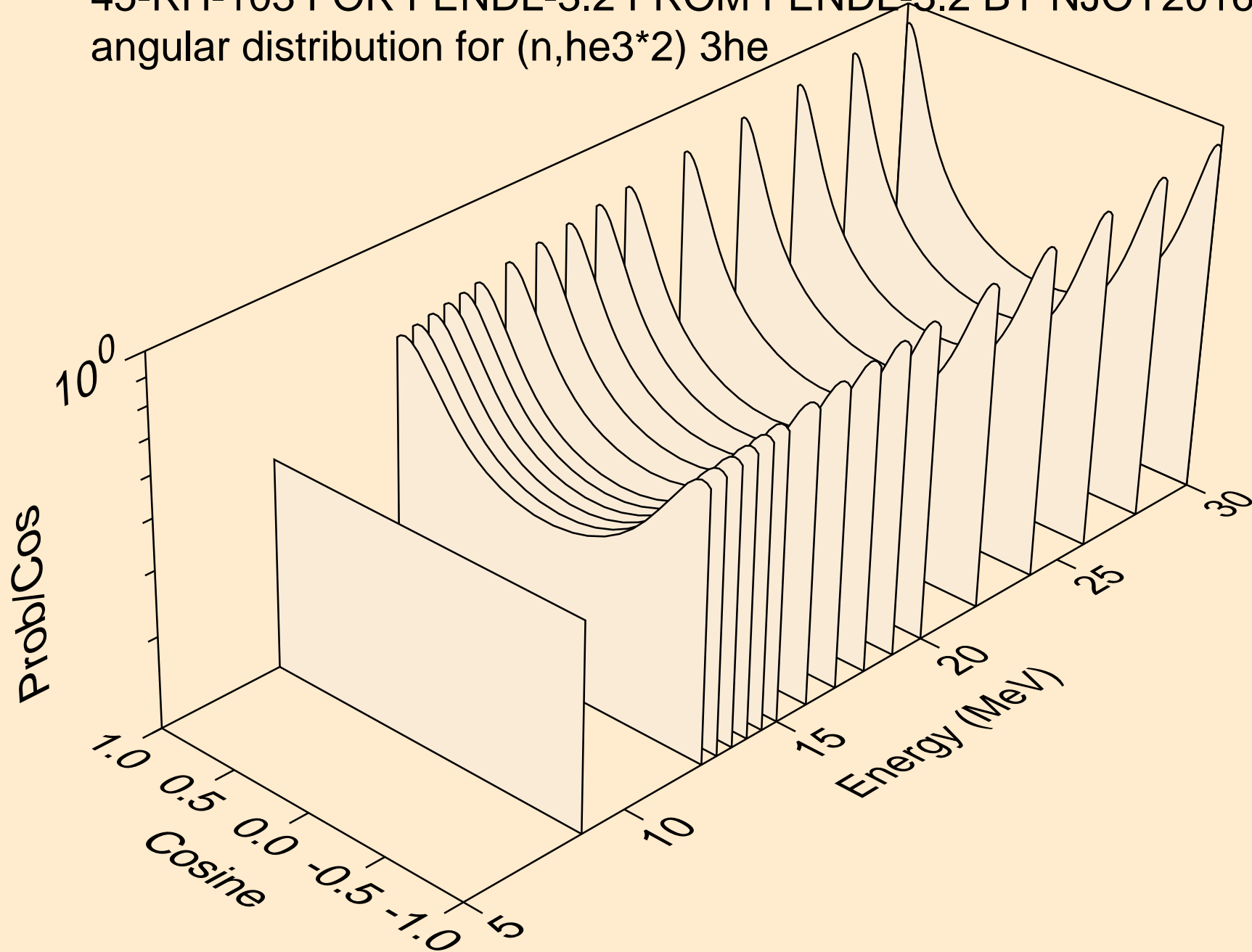

45-RH-103 FOR FENDL-3.2 FROM FENDL-3.2 BY NJOY2016.60+ C
angular distribution for (n,he3*3) 3he

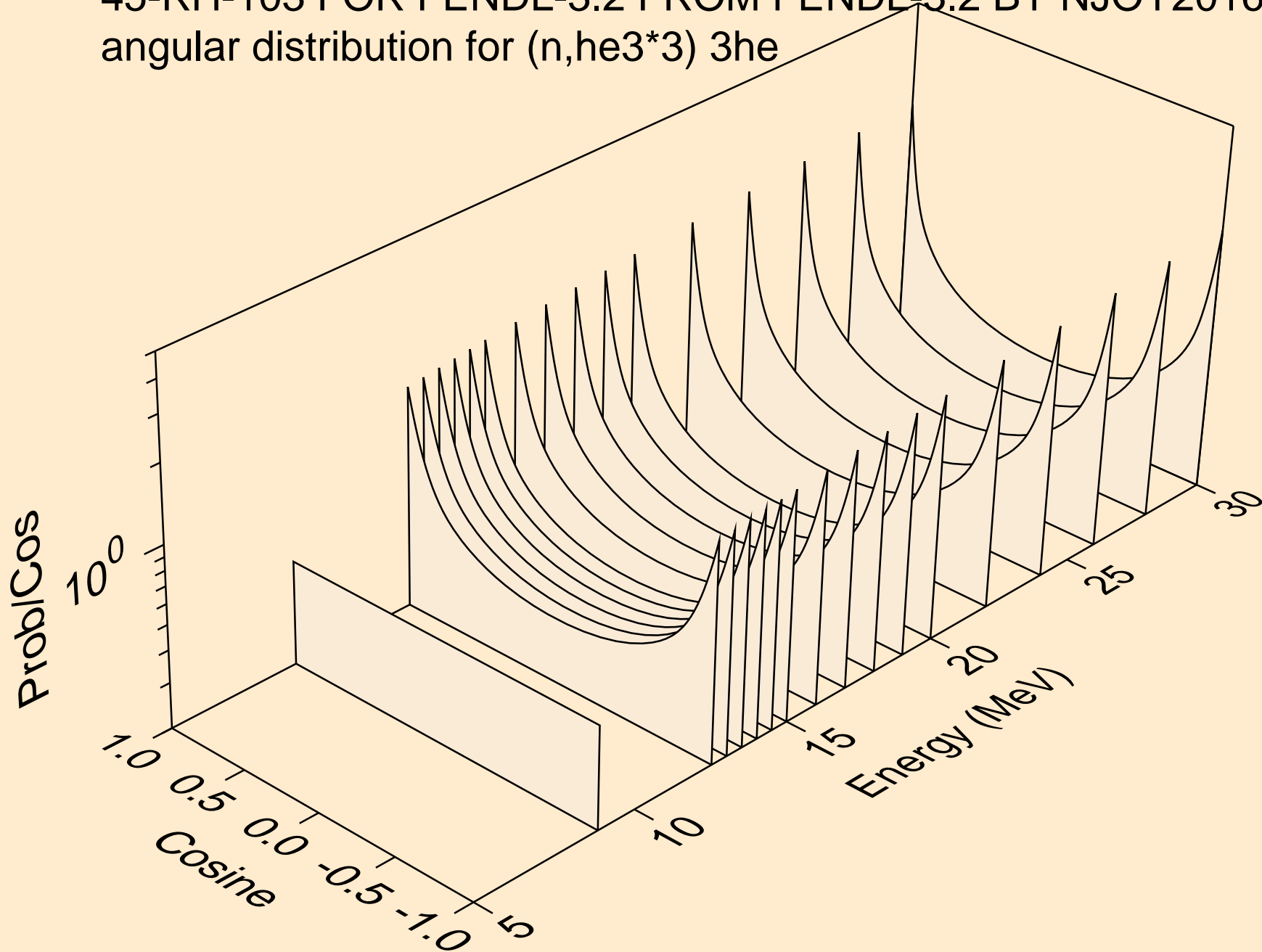

45-RH-103 FOR FENDL-3.2 FROM FENDL-3.2 BY NJOY2016.60+ C
angular distribution for (n,he3*4) 3he

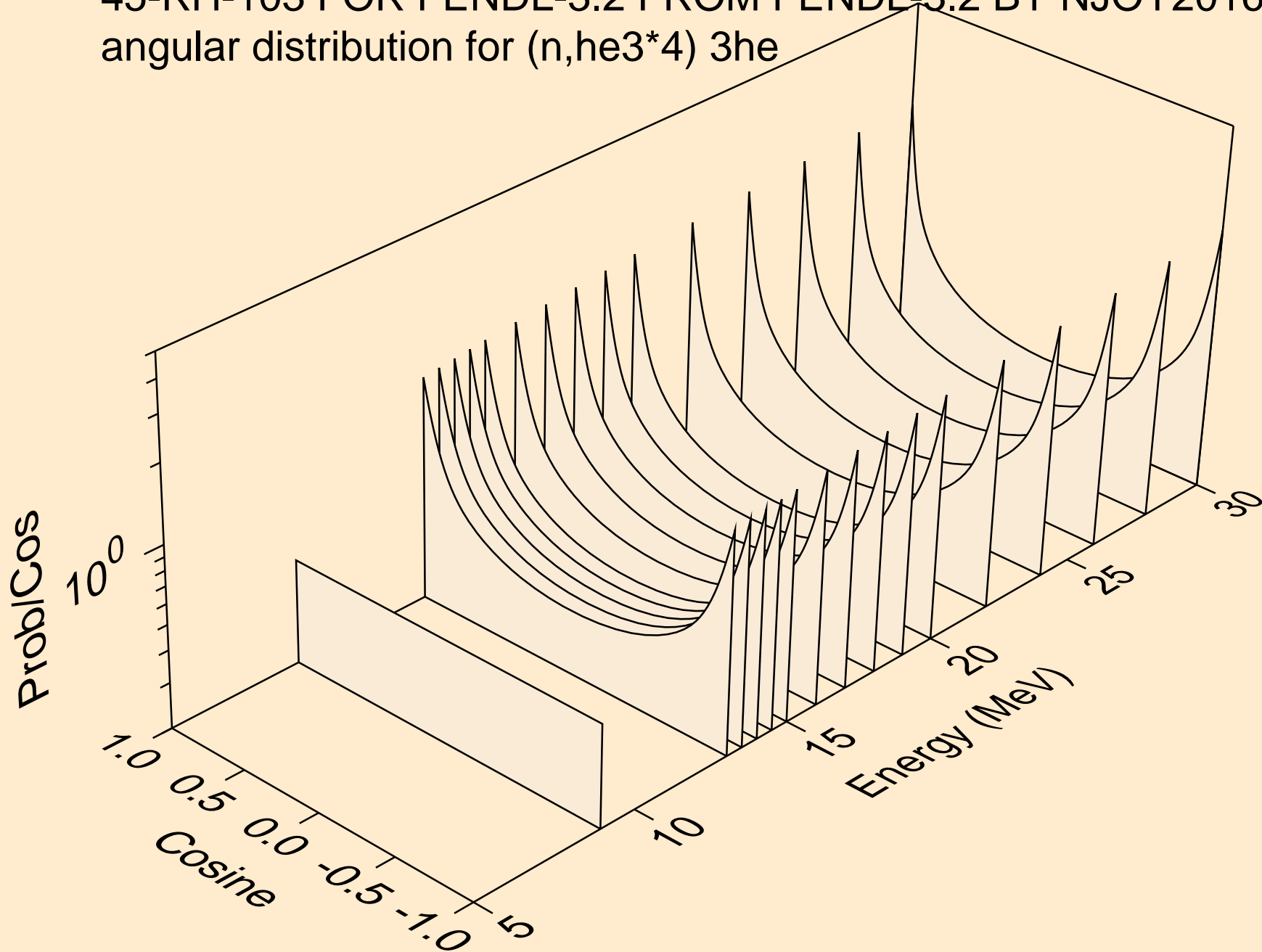

45-RH-103 FOR FENDL-3.2 FROM FENDL-3.2 BY NJOY2016.60+ C
angular distribution for (n,he3*5) 3he

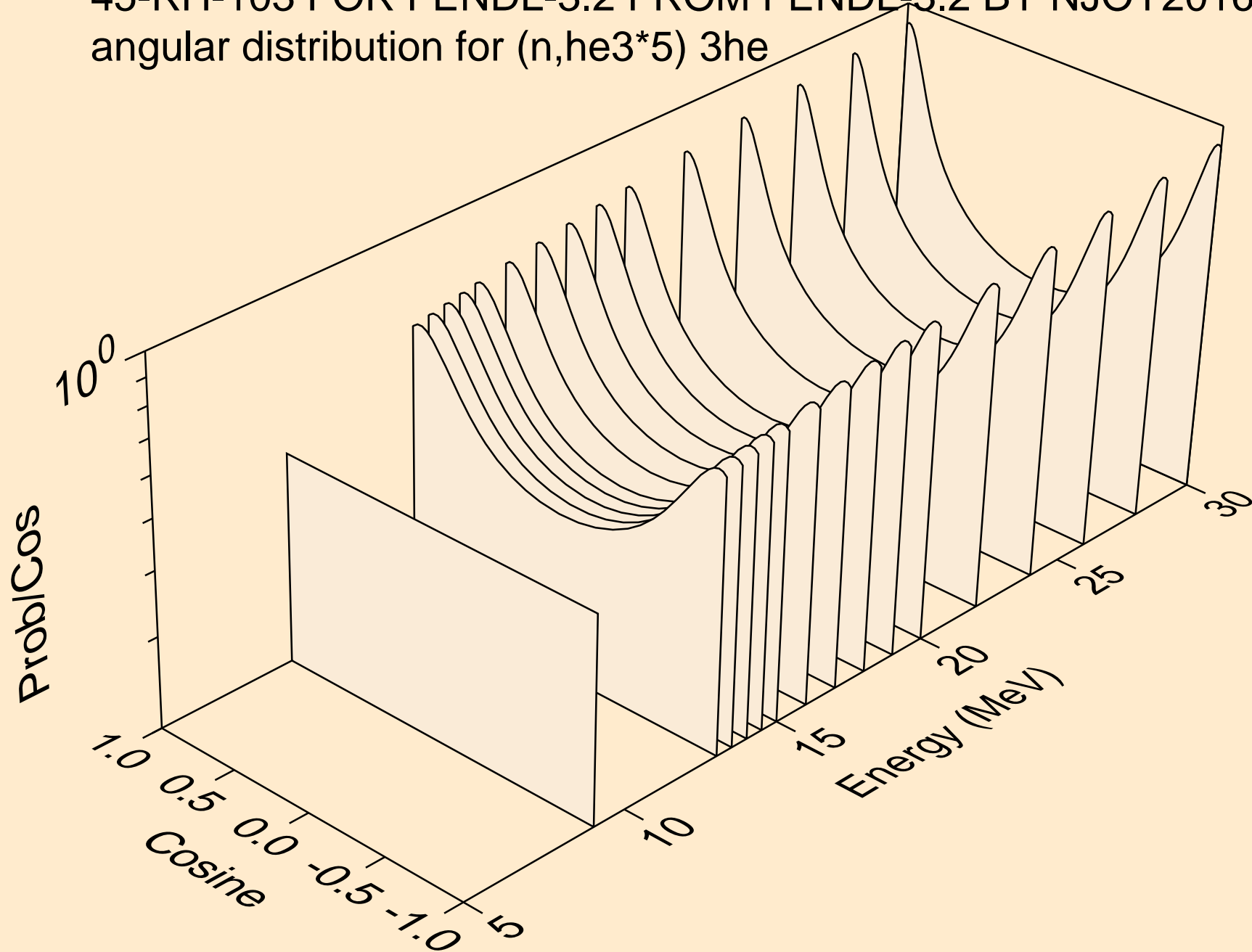

45-RH-103 FOR FENDL-3.2 FROM FENDL-3.2 BY NJOY2016.60+ C
angular distribution for (n,he3*6) 3he

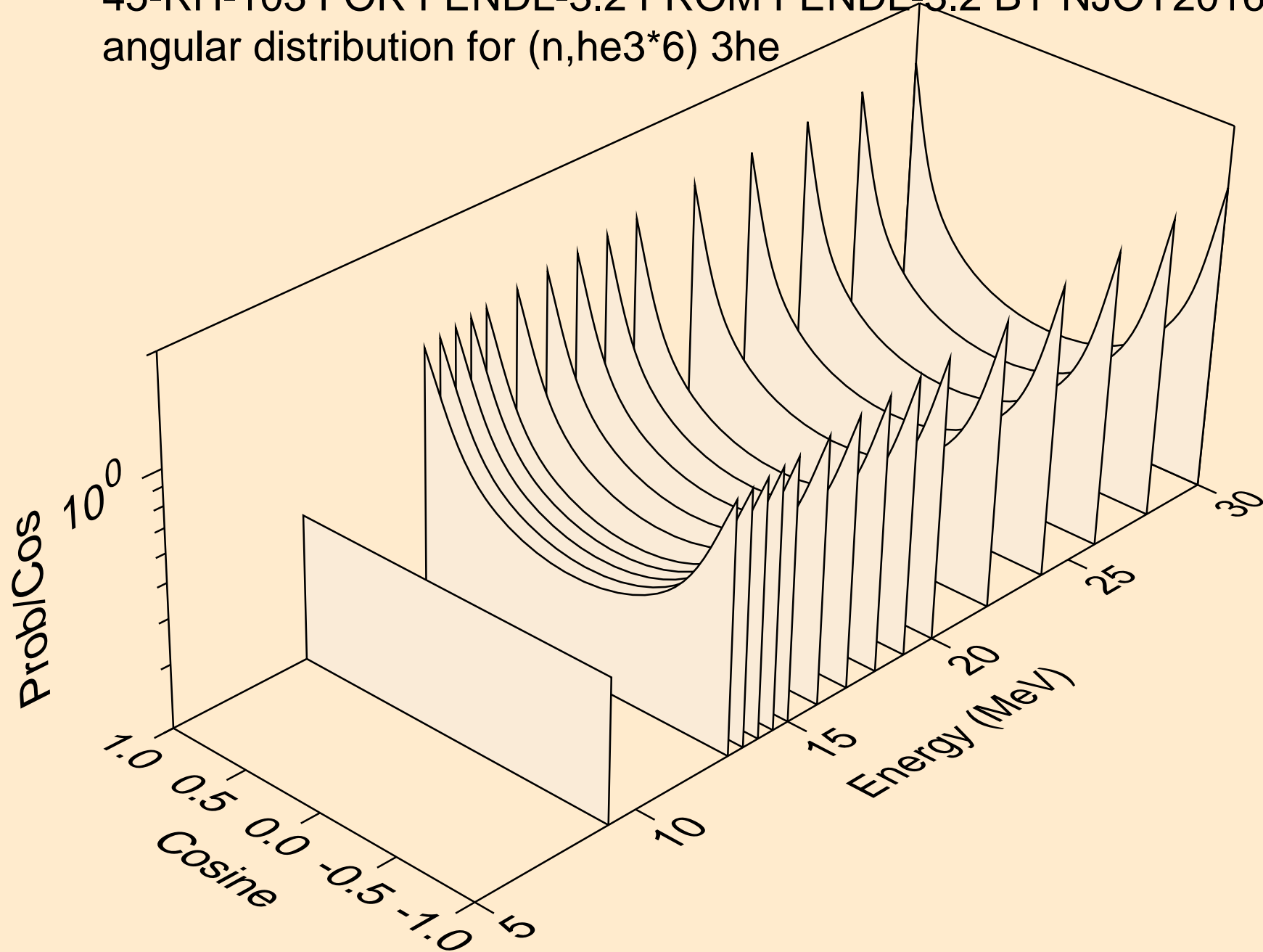

45-RH-103 FOR FENDL-3.2 FROM FENDL-3.2 BY NJOY2016.60+ C
angular distribution for (n,he3*7) 3he

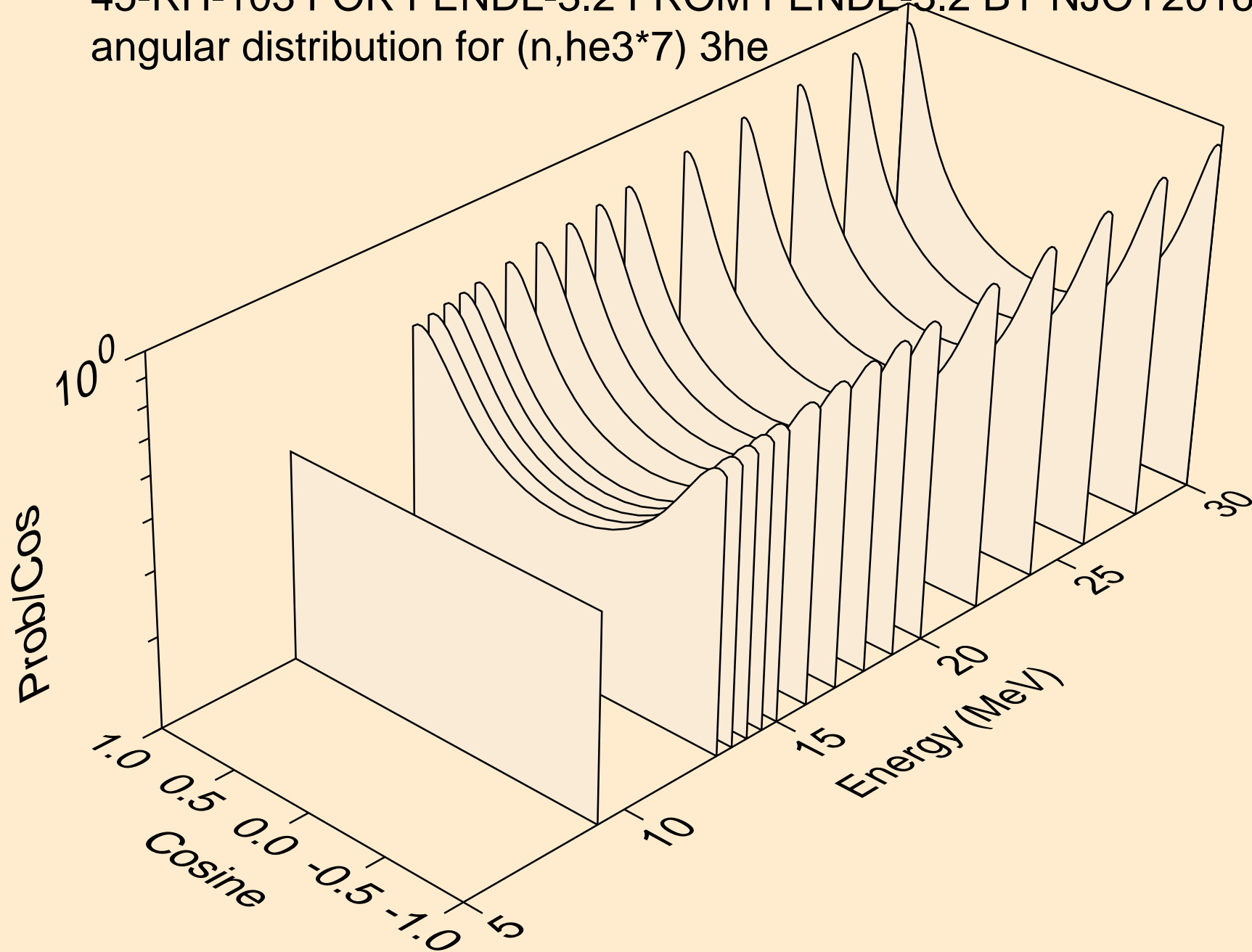

45-RH-103 FOR FENDL-3.2 FROM FENDL-3.2 BY NJOY2016.60+ C
angular distribution for (n,he3*8) 3he

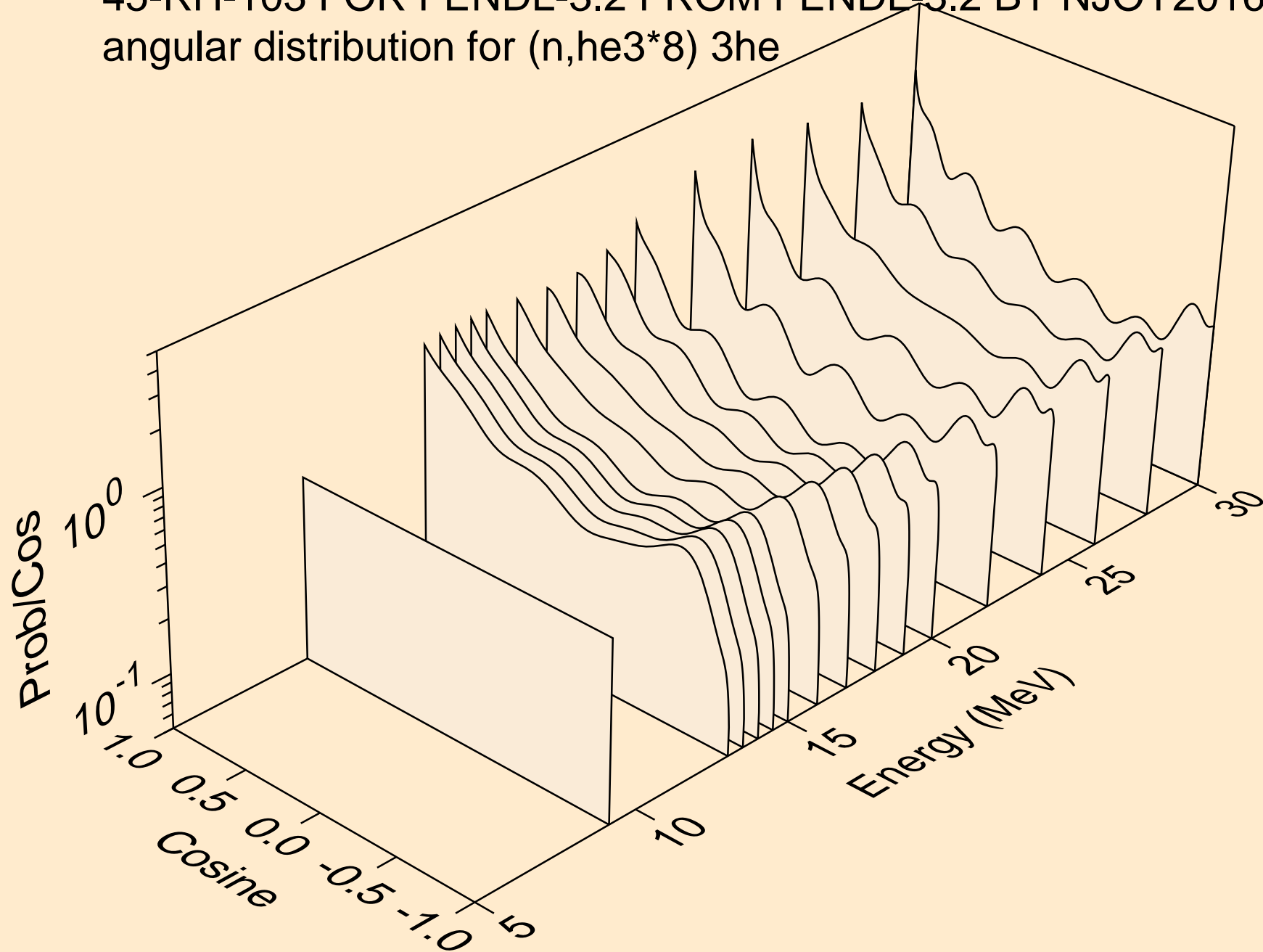

45-RH-103 FOR FENDL-3.2 FROM FENDL-3.2 BY NJOY2016.60+ C
angular distribution for (n,he3*9) 3he

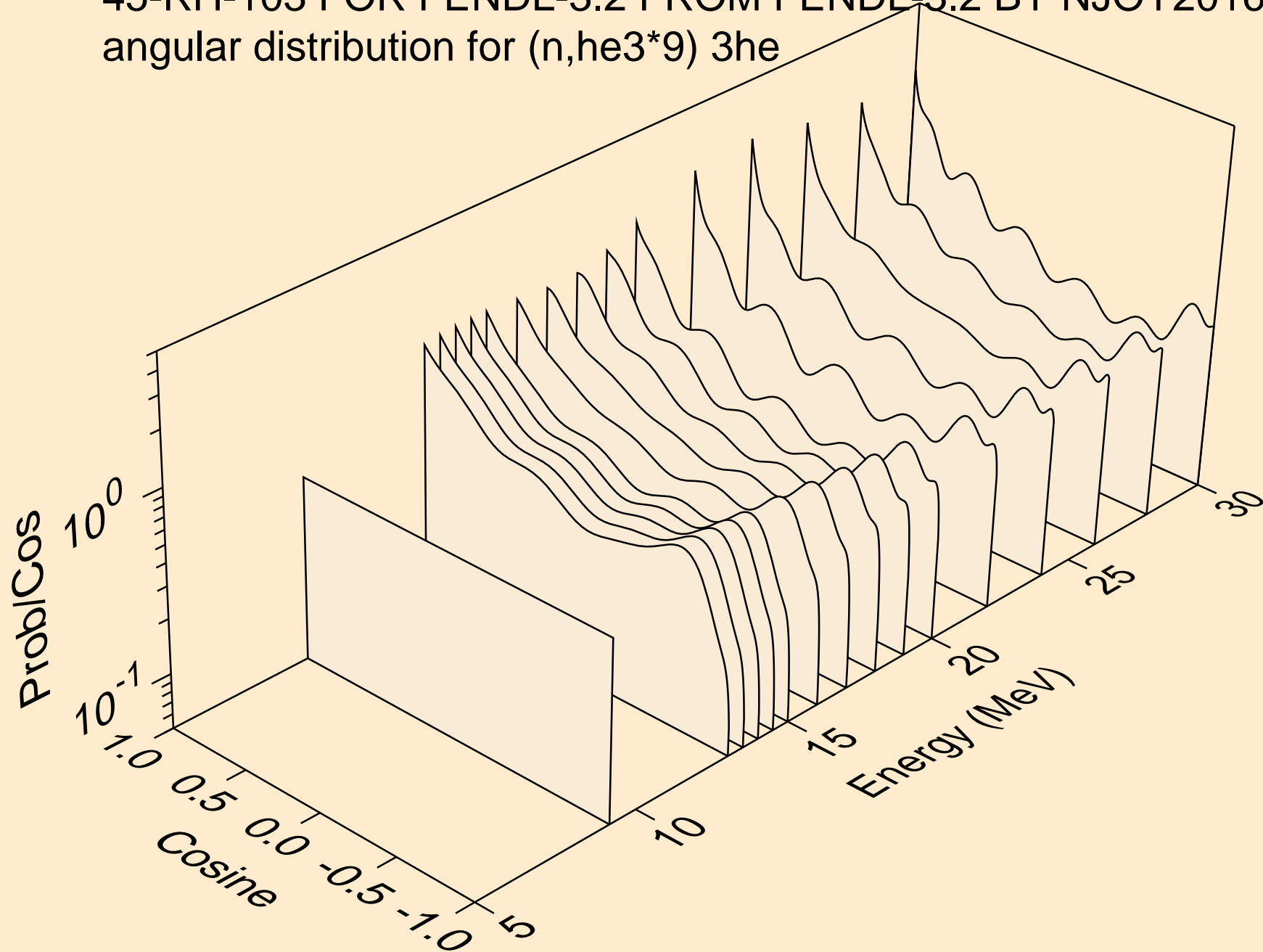

45-RH-103 FOR FENDL-3.2 FROM FENDL-3.2 BY NJOY2016.60+ C
angular distribution for (n,he3*10) 3he

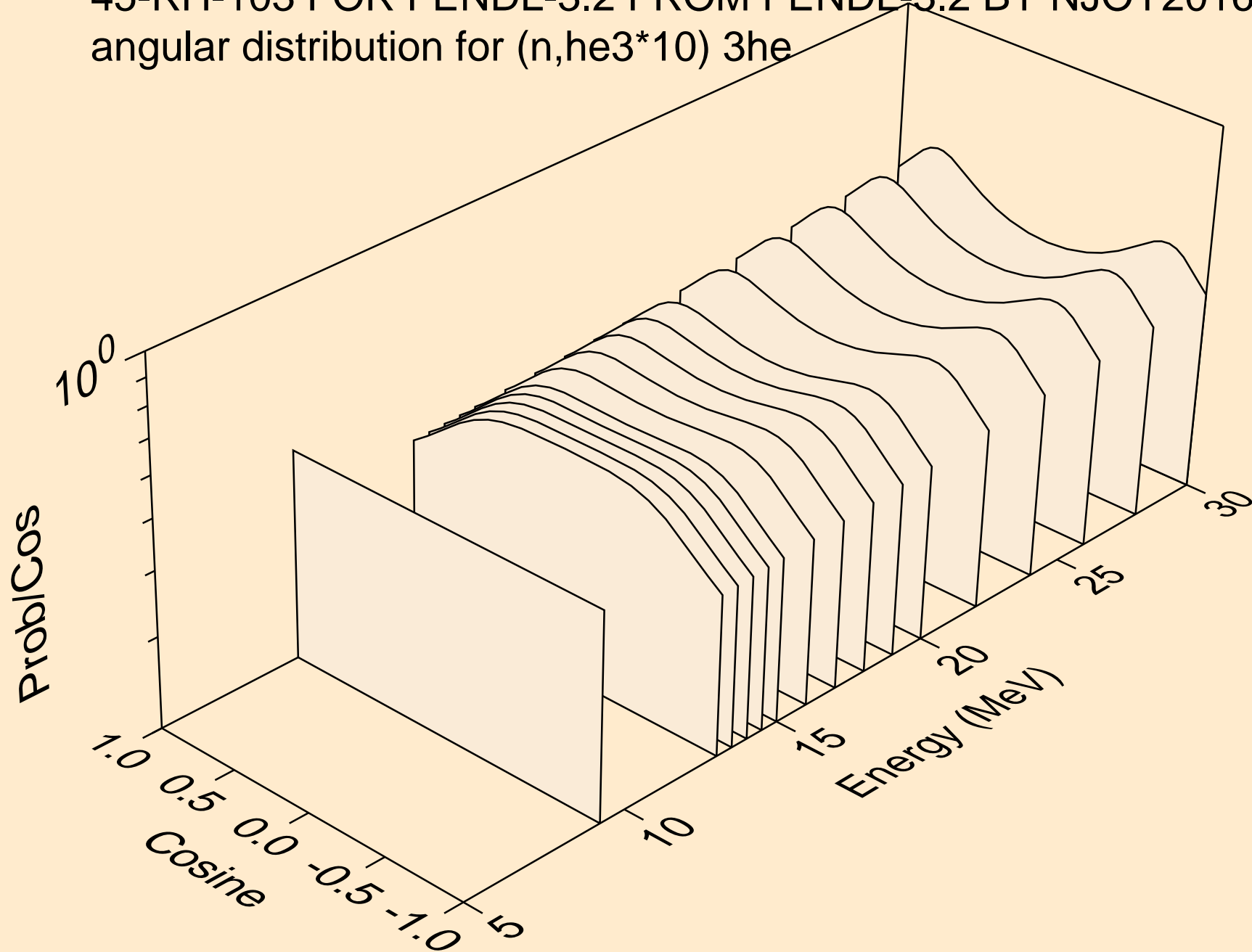

45-RH-103 FOR FENDL-3.2 FROM FENDL-3.2 BY NJOY2016.60+ C
angular distribution for (n,he3*11) 3he

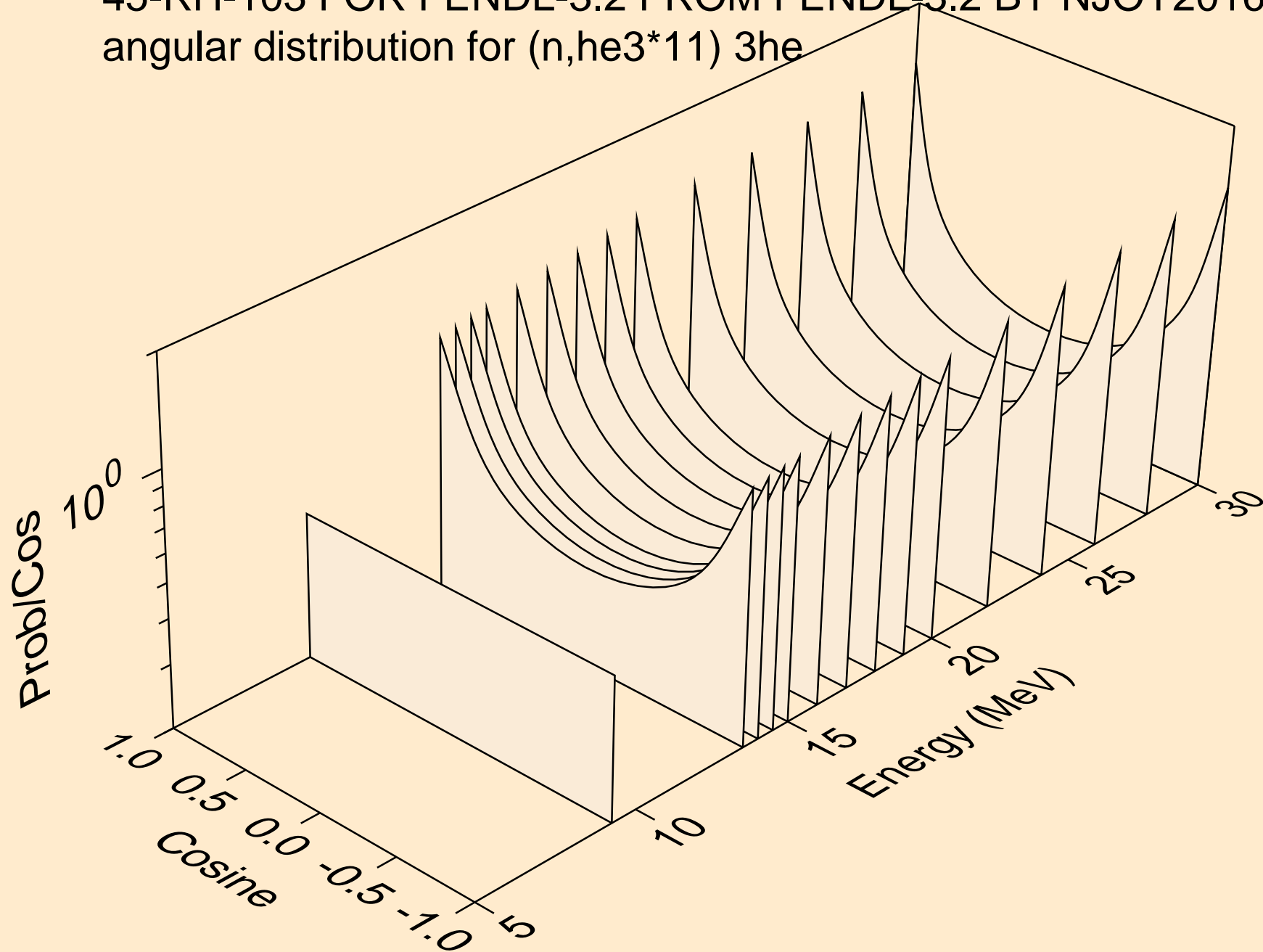

45-RH-103 FOR FENDL-3.2 FROM FENDL-3.2 BY NJOY2016.60+ C
angular distribution for (n,he3*12) 3he

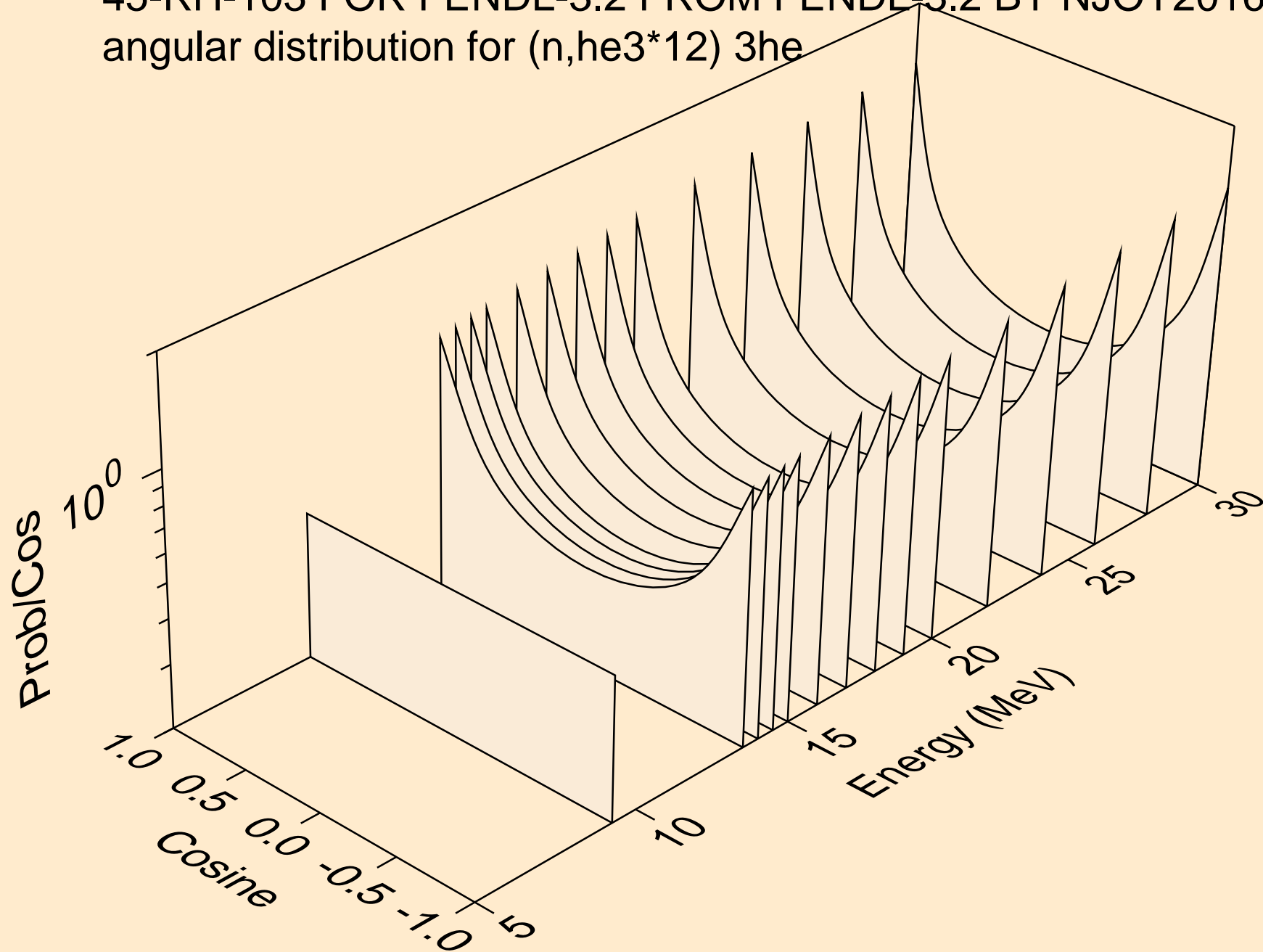

45-RH-103 FOR FENDL-3.2 FROM FENDL-3.2 BY NJOY2016.60+ C
angular distribution for (n,he3*13) 3he

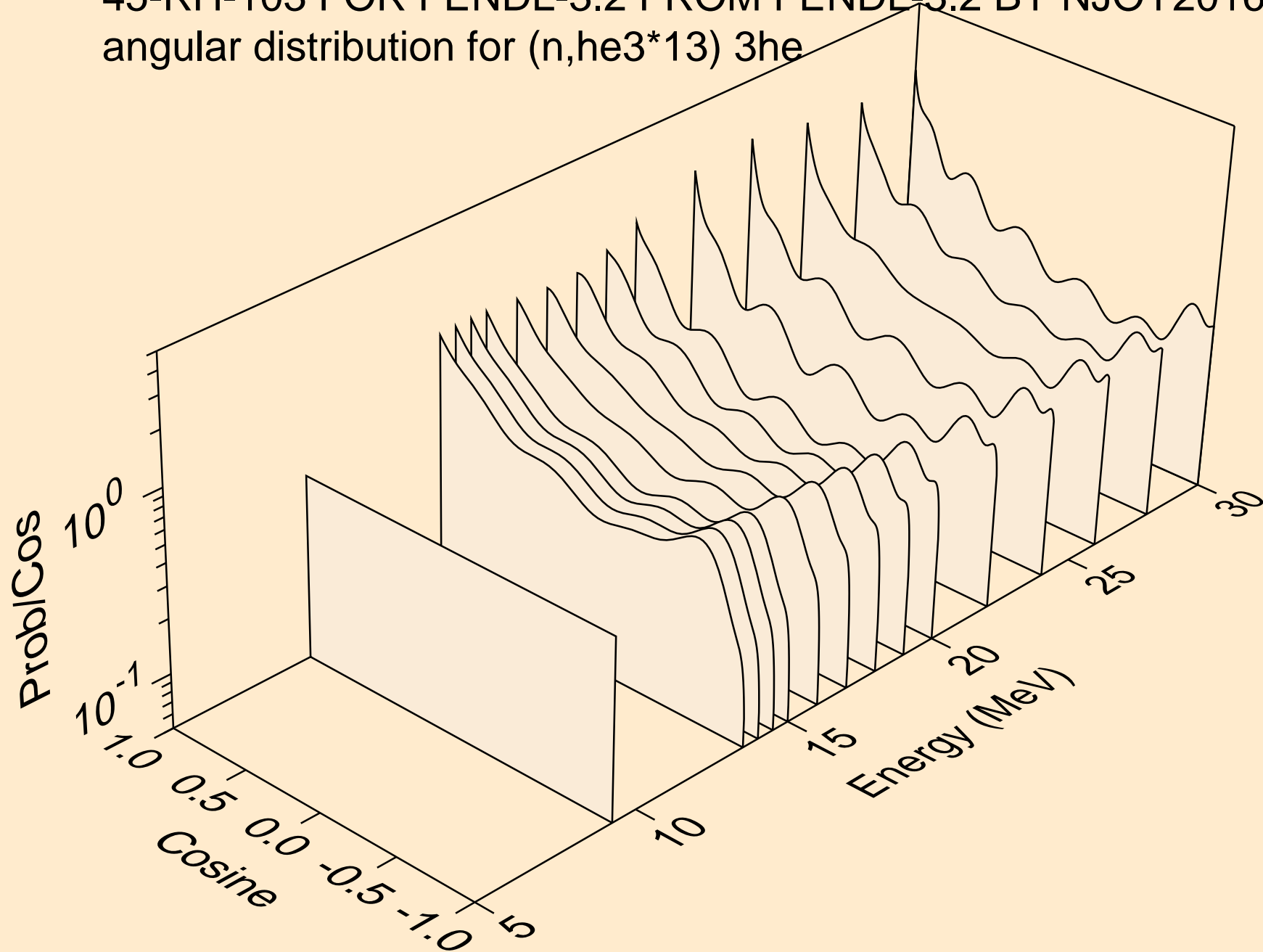

45-RH-103 FOR FENDL-3.2 FROM FENDL-3.2 BY NJOY2016.60+ C
angular distribution for (n,he3*14) 3he

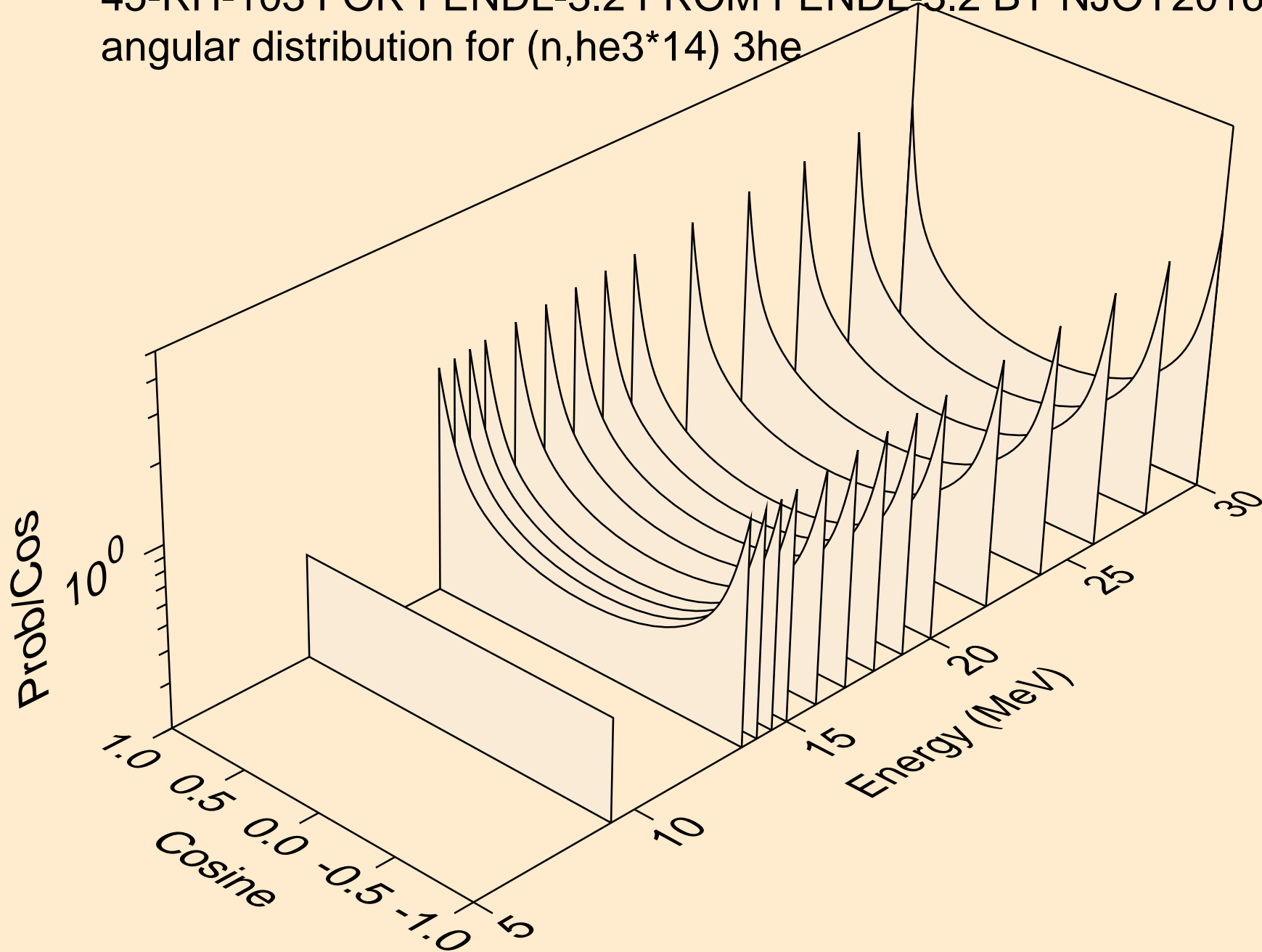

45-RH-103 FOR FENDL-3.2 FROM FENDL-3.2 BY NJOY2016.60+ C
angular distribution for (n,he3*15) 3he

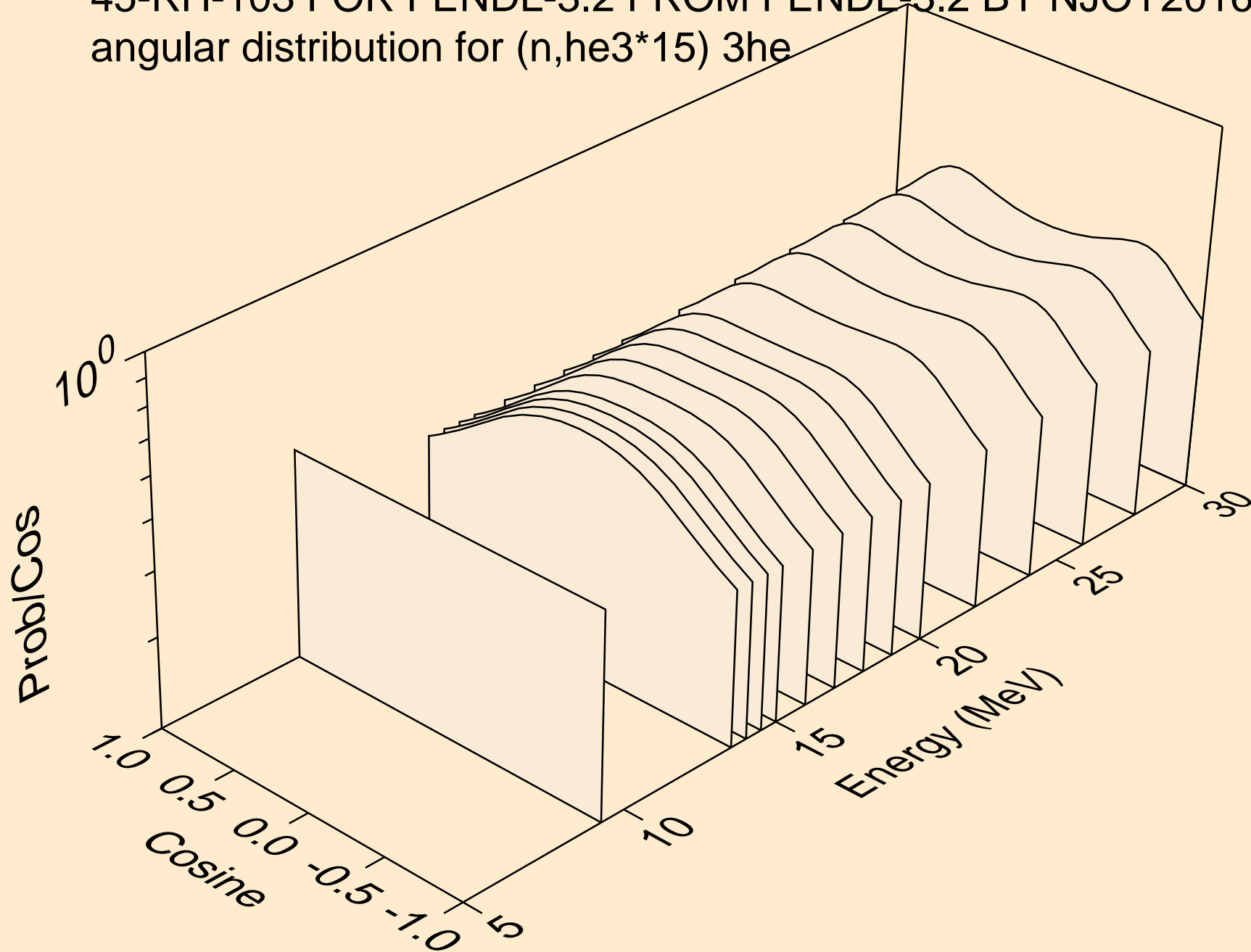

45-RH-103 FOR FENDL-3.2 FROM FENDL-3.2 BY NJOY2016.60+ C
he3s from (n,he3*c)

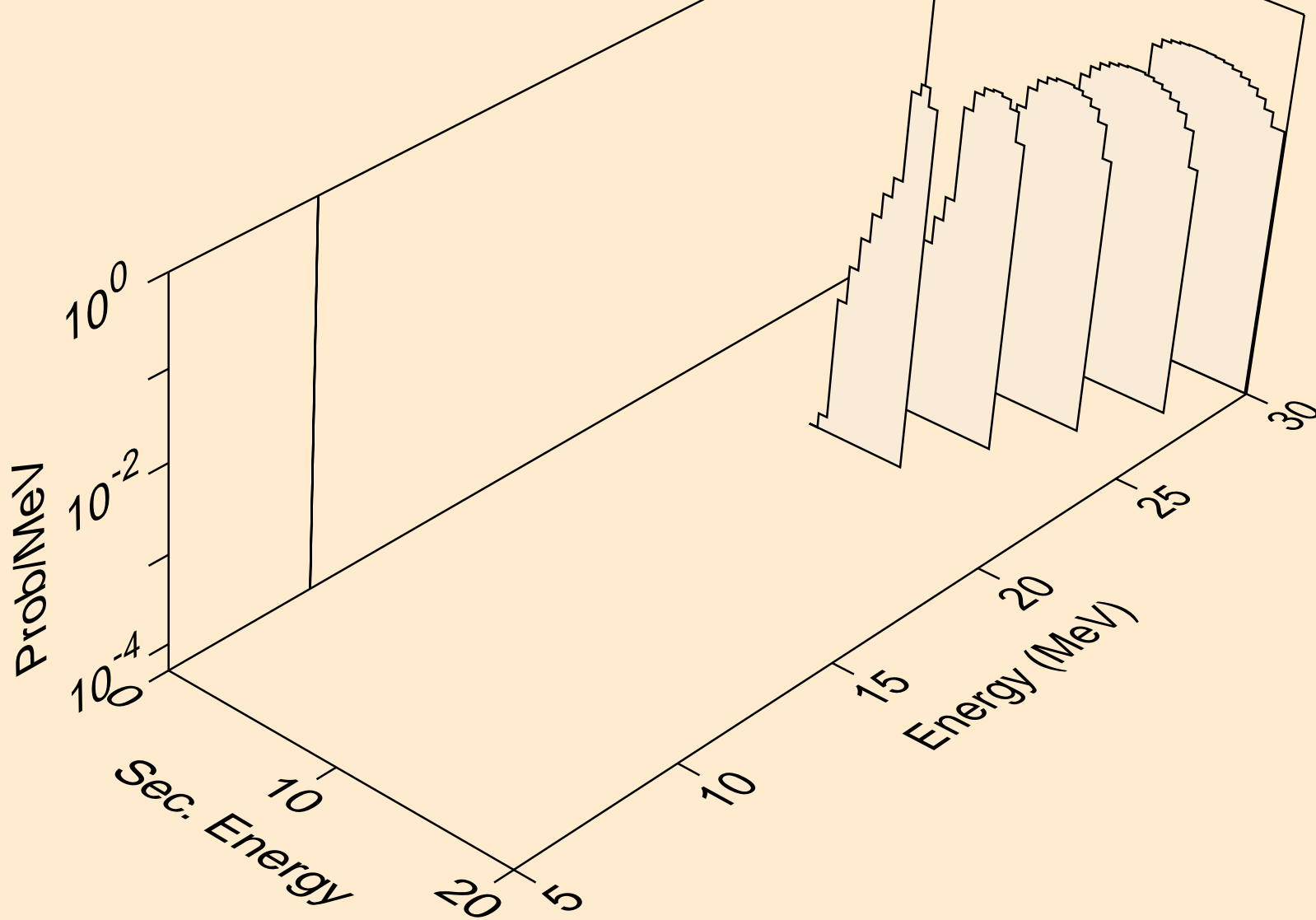

45-RH-103 FOR FENDL-3.2 FROM FENDL-3.2 BY NJOY2016.60+ C
alphas from (n,x)

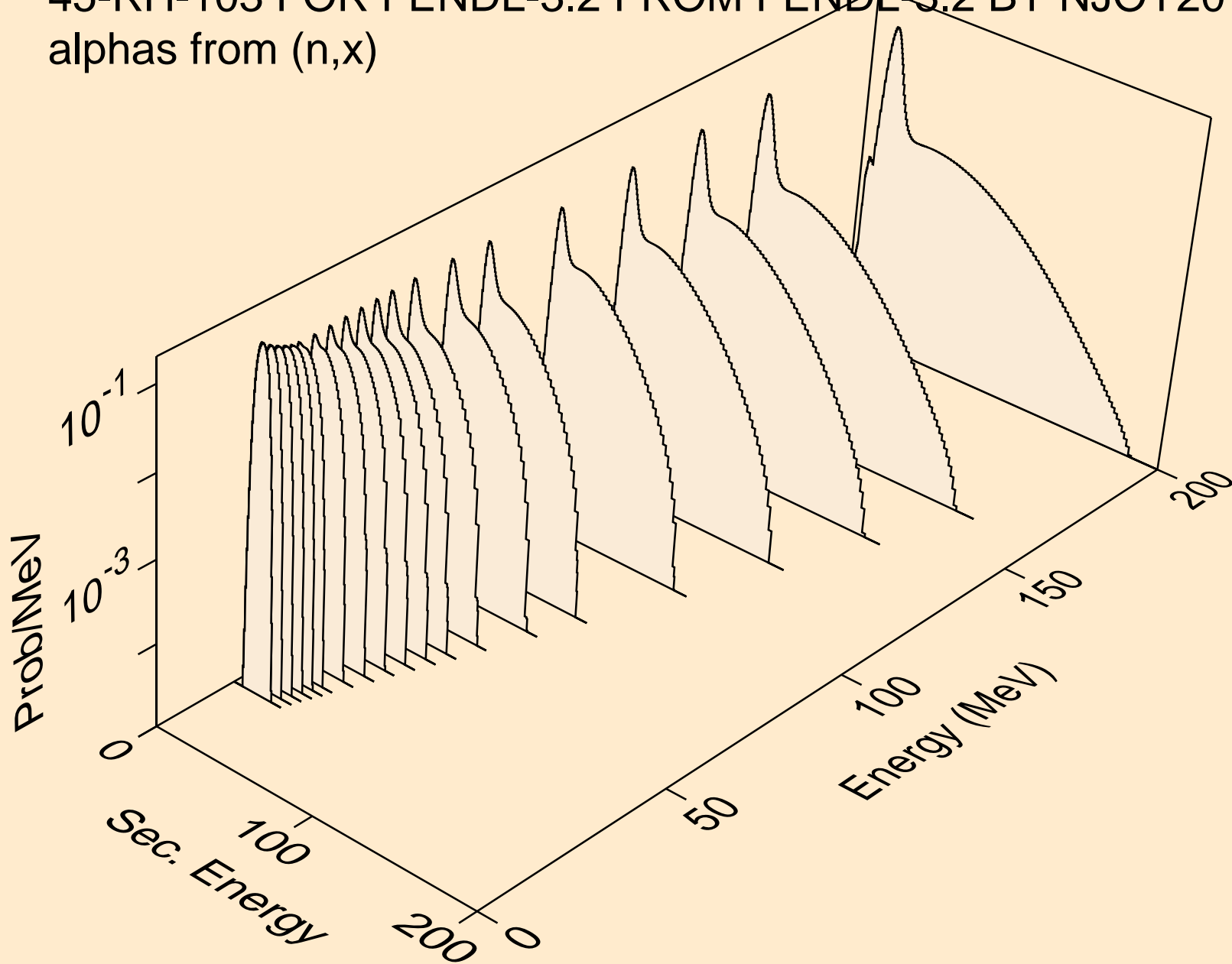

45-RH-103 FOR FENDL-3.2 FROM FENDL-3.2 BY NJOY2016.60+ C
alphas from (n,n*)a

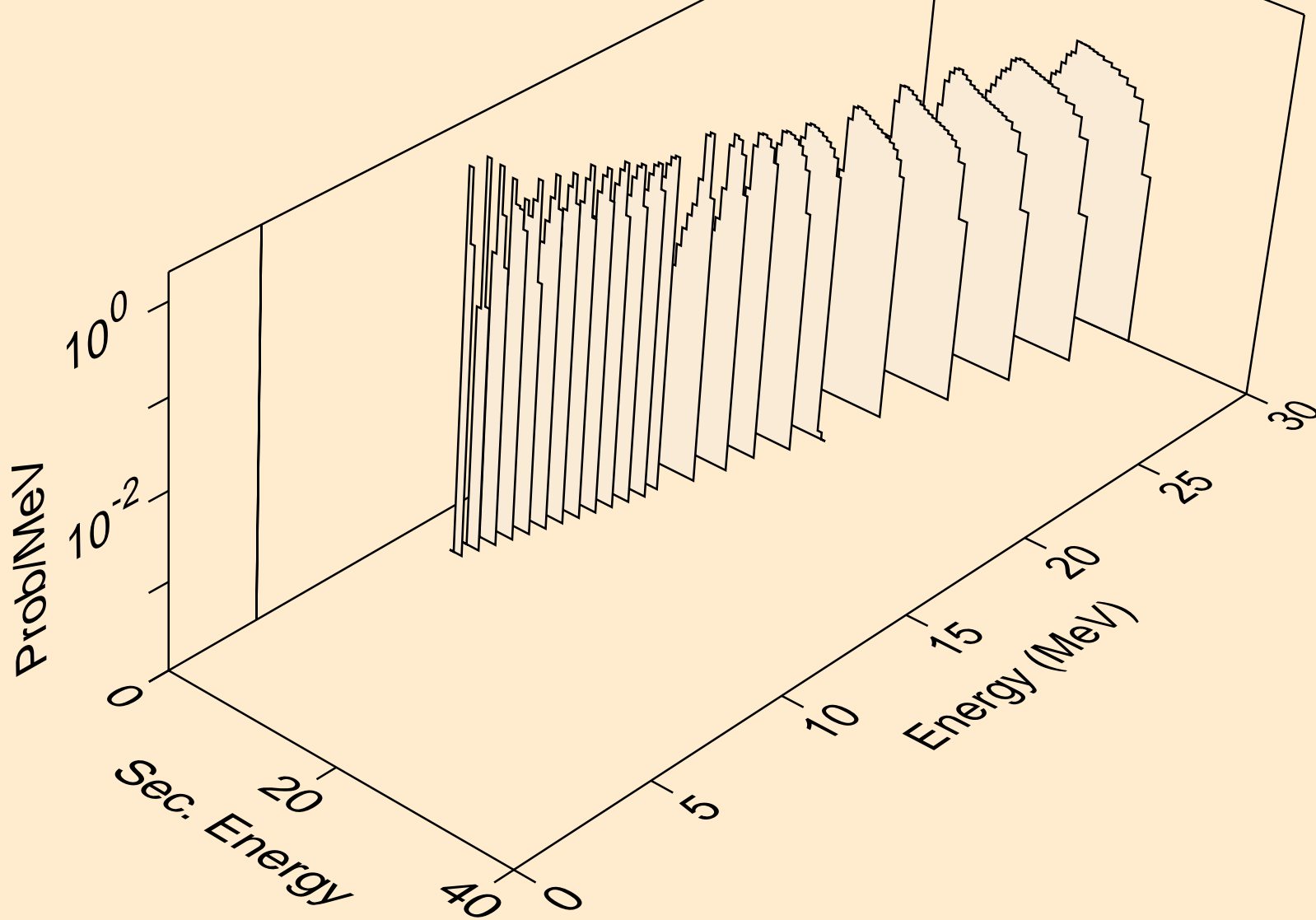

45-RH-103 FOR FENDL-3.2 FROM FENDL-3.2 BY NJOY2016.60+ C
alphas from (n,2n)a

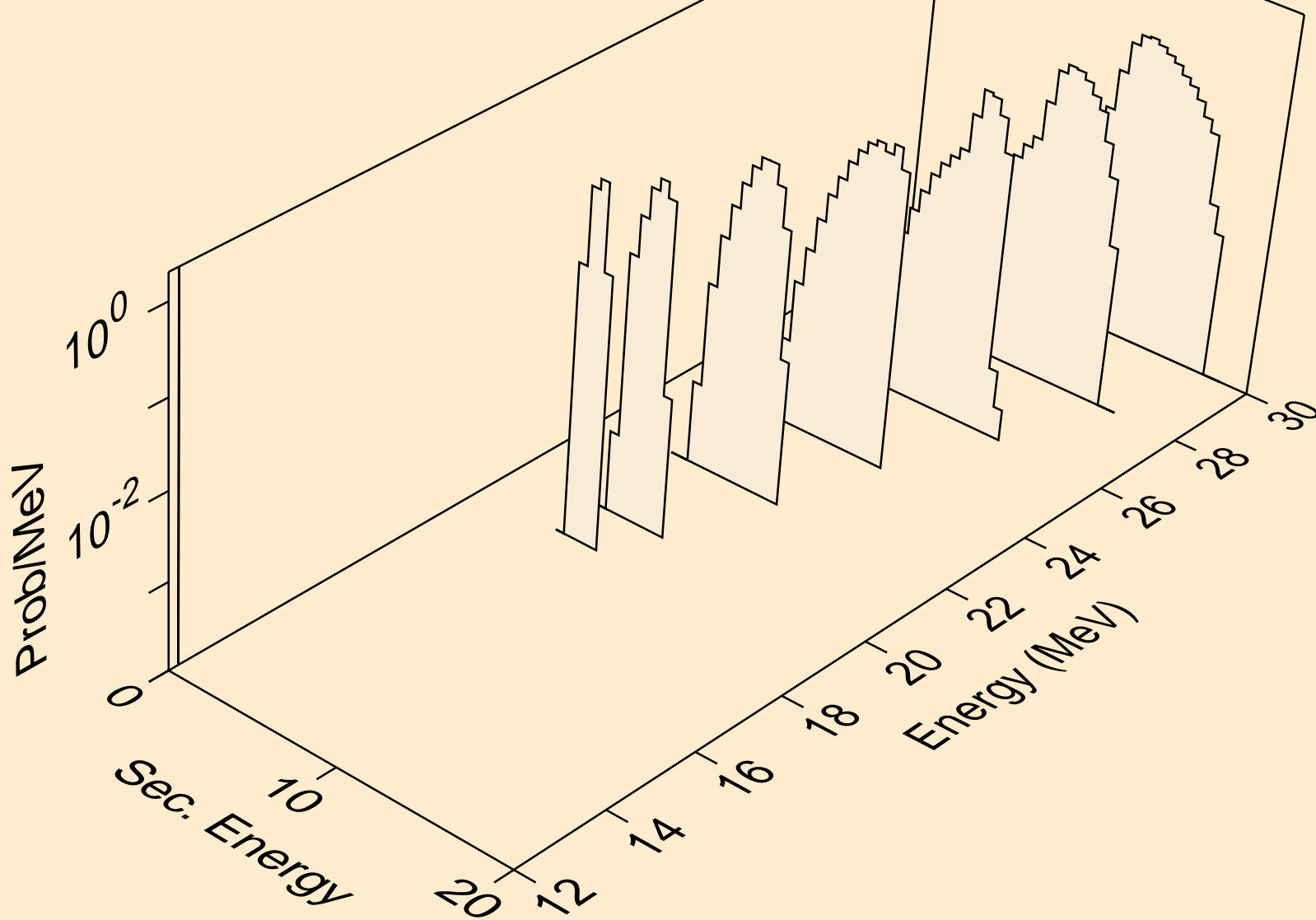

45-RH-103 FOR FENDL-3.2 FROM FENDL-3.2 BY NJOY2016.60+ C
alphas from (n,3n)a

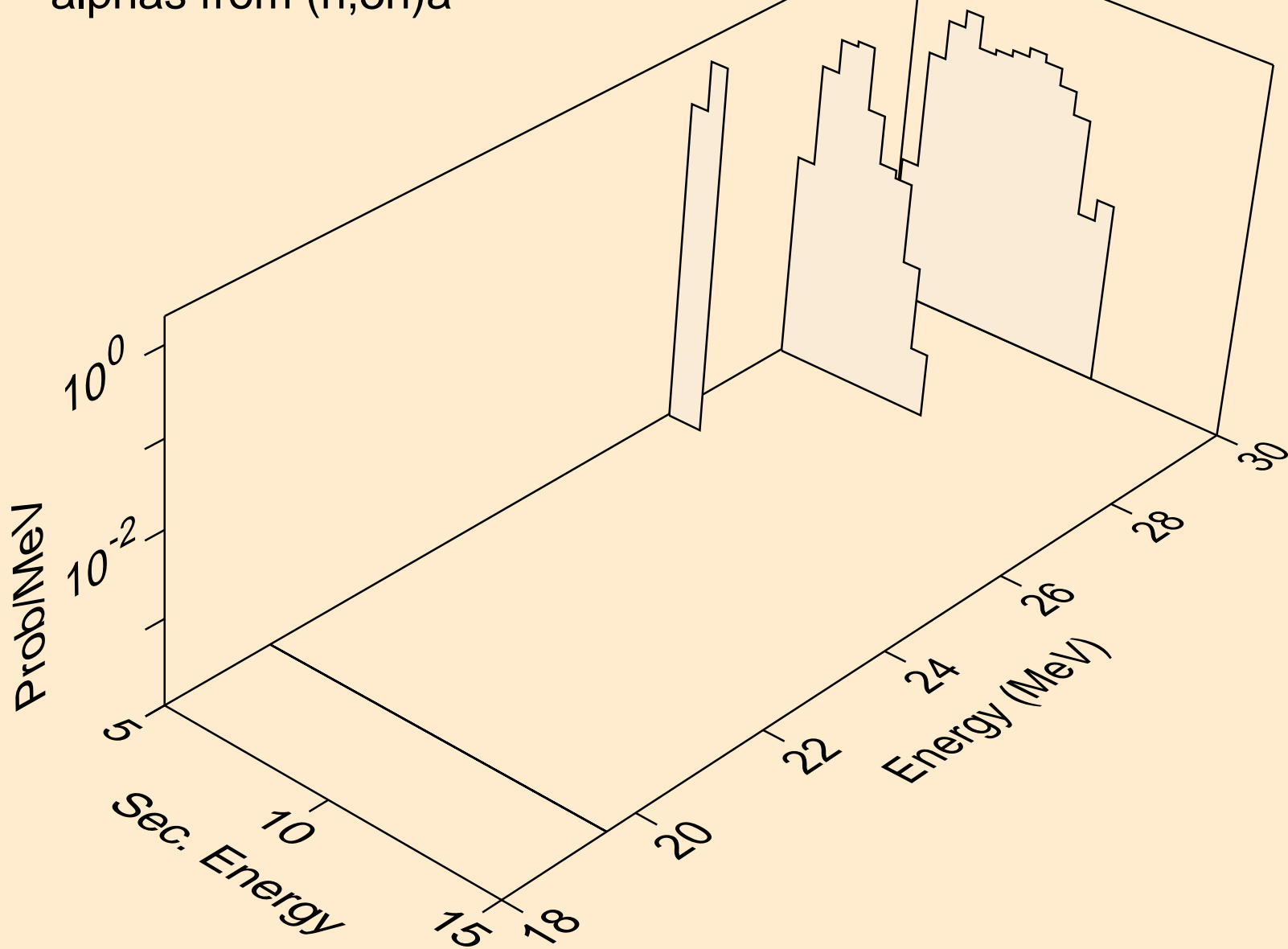

45-RH-103 FOR FENDL-3.2 FROM FENDL-3.2 BY NJOY2016.60+ C
alphas from (n,n*)2a

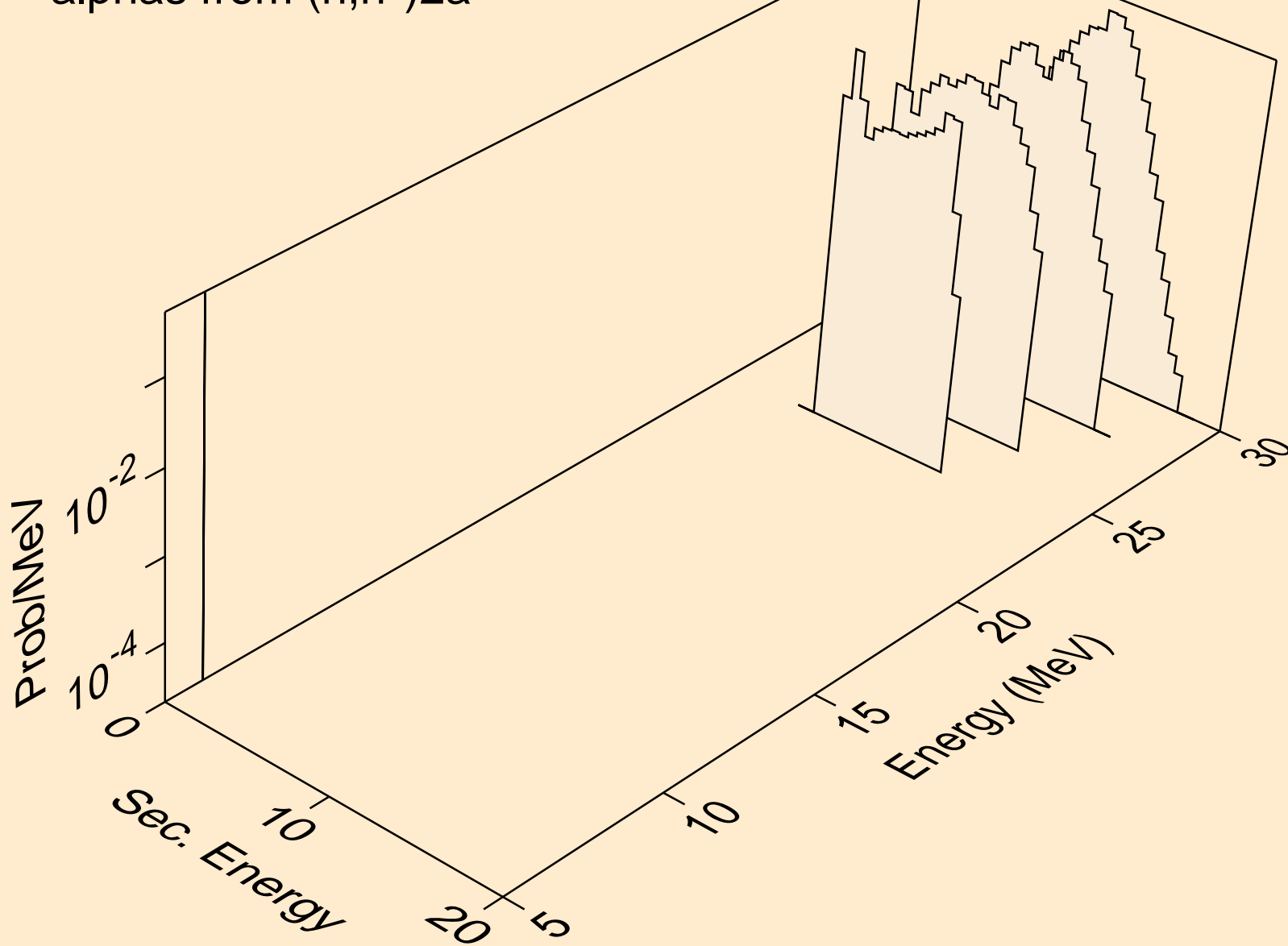

45-RH-103 FOR FENDL-3.2 FROM FENDL-3.2 BY NJOY2016.60+ C
alphas from (n,npa)

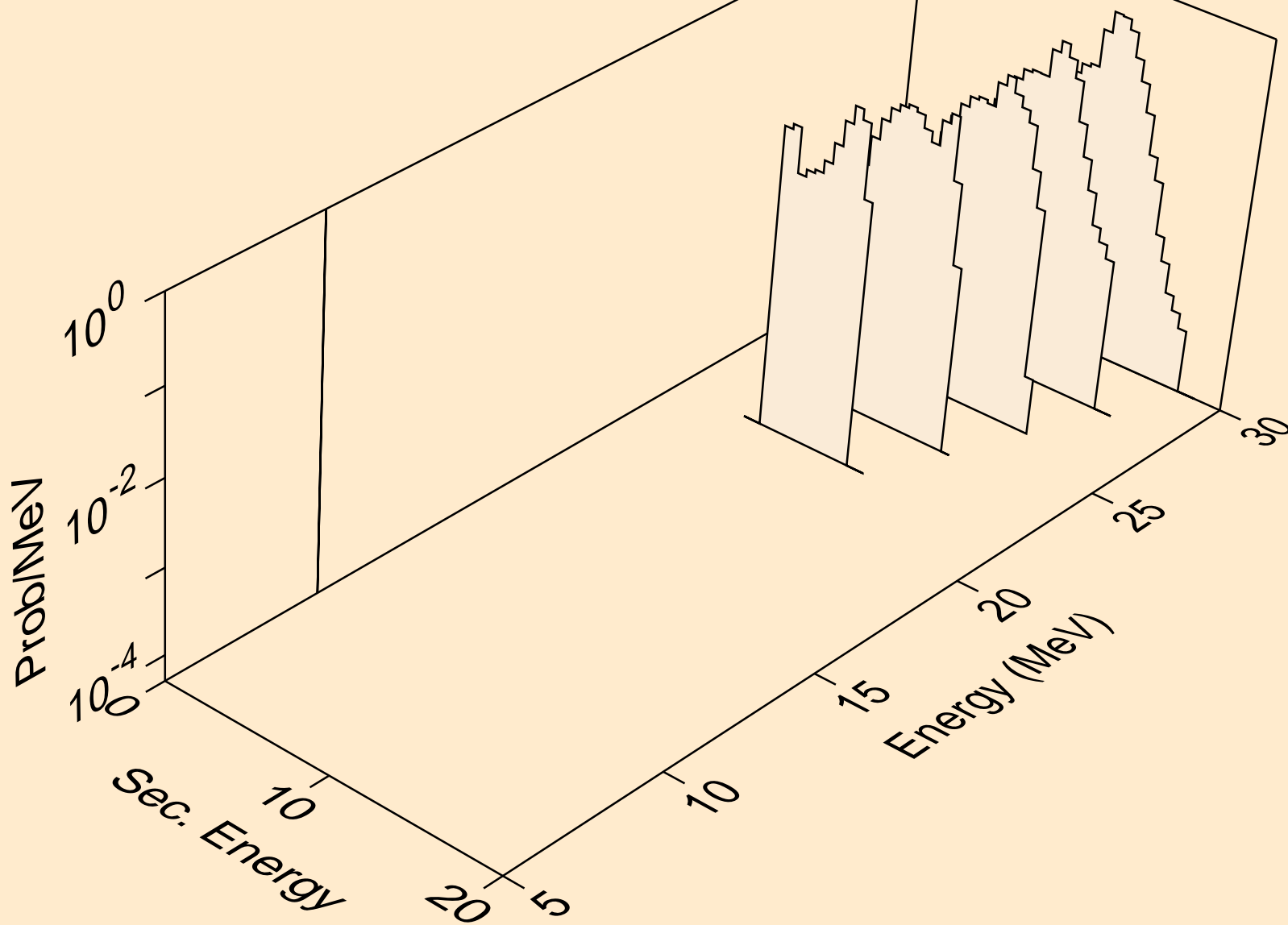

45-RH-103 FOR FENDL-3.2 FROM FENDL-3.2 BY NJOY2016.60+ C
alphas from (n,2a)

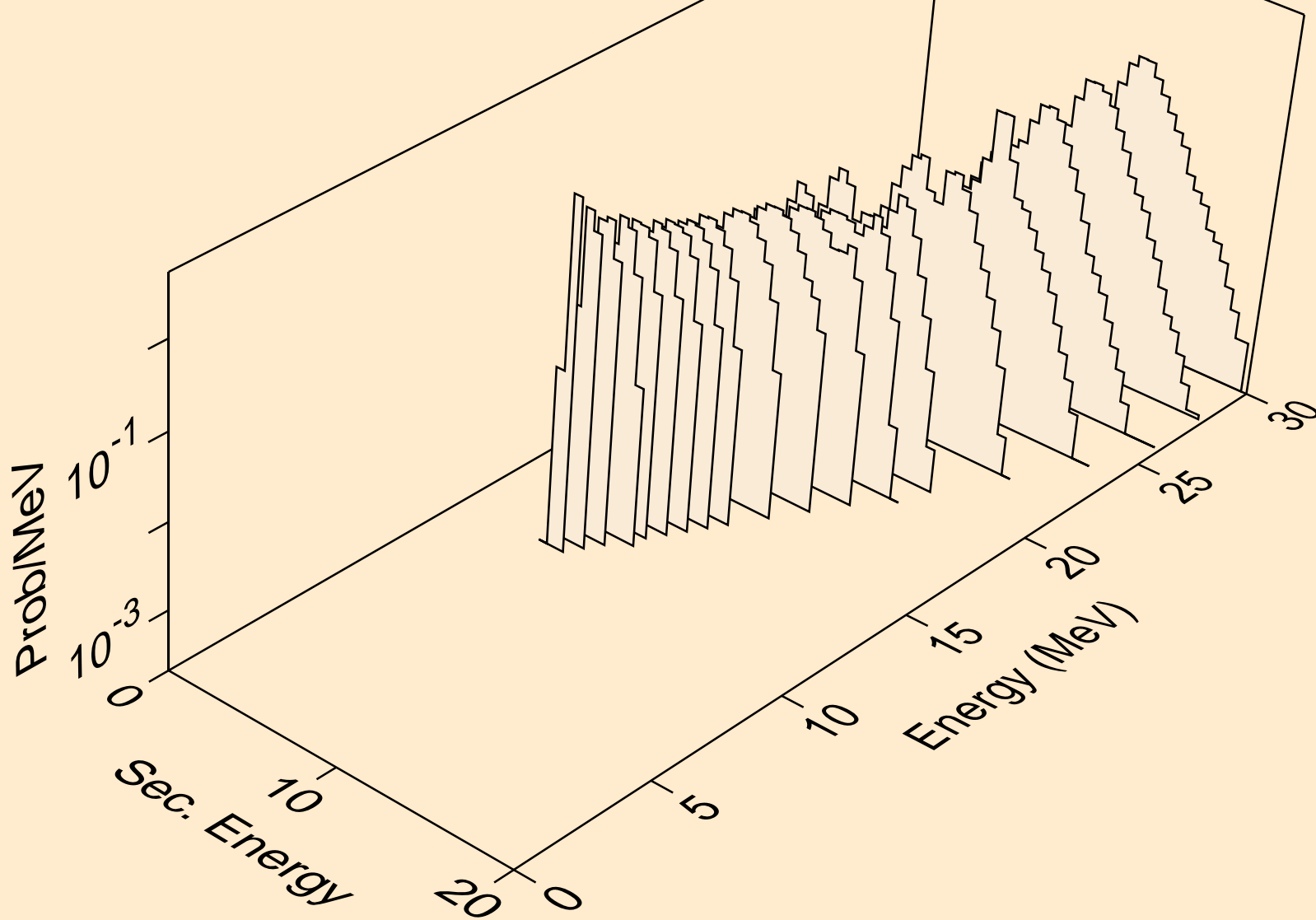

45-RH-103 FOR FENDL-3.2 FROM FENDL-3.2 BY NJOY2016.60+ C
alphas from (n,pa)

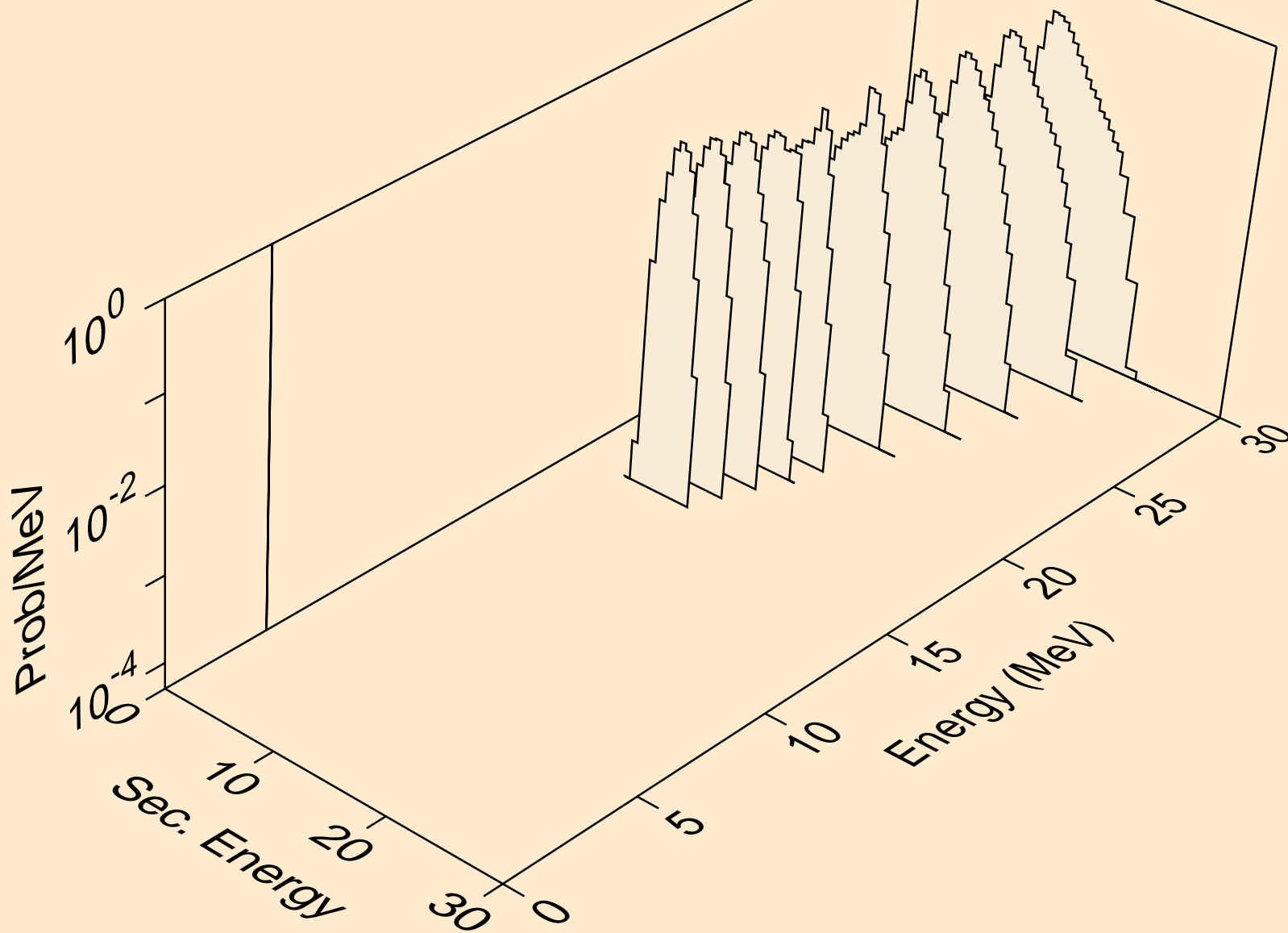

45-RH-103 FOR FENDL-3.2 FROM FENDL-3.2 BY NJOY2016.60+ C
alphas from (n,da)

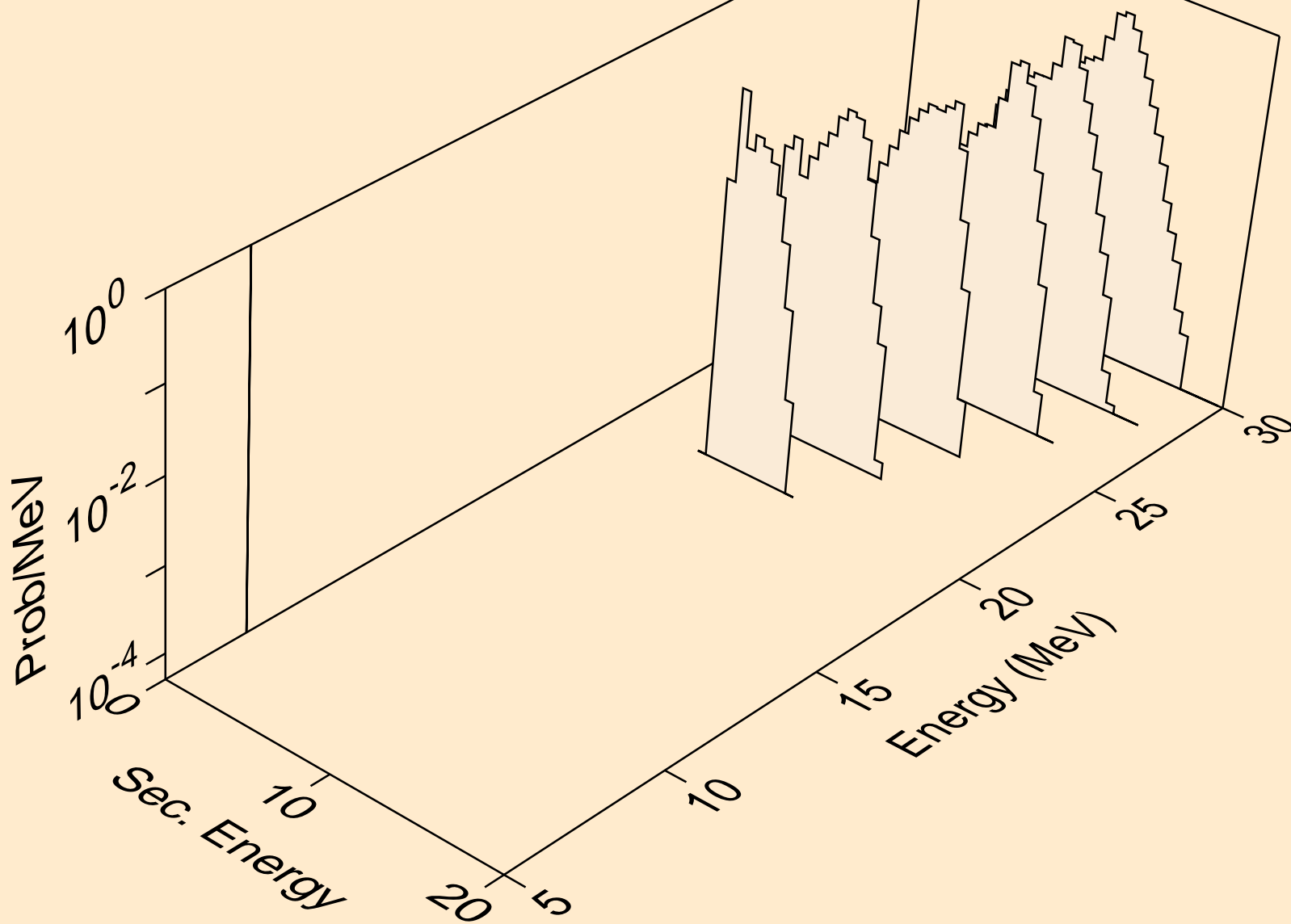

45-RH-103 FOR FENDL-3.2 FROM FENDL-3.2 BY NJOY2016.60+ C
angular distribution for (n,a*0) alpha

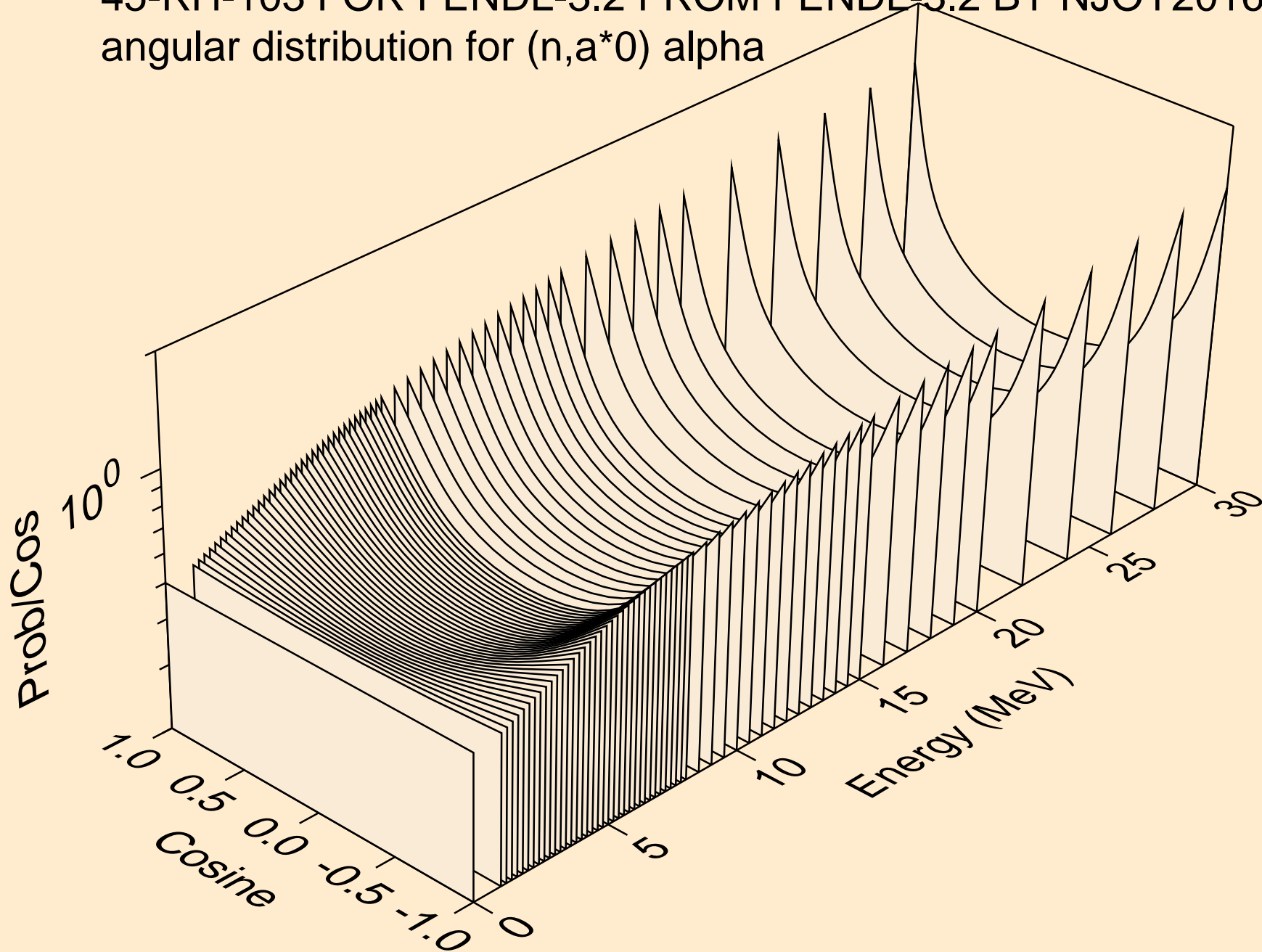

45-RH-103 FOR FENDL-3.2 FROM FENDL-3.2 BY NJOY2016.60+ C
angular distribution for (n,a*1) alpha

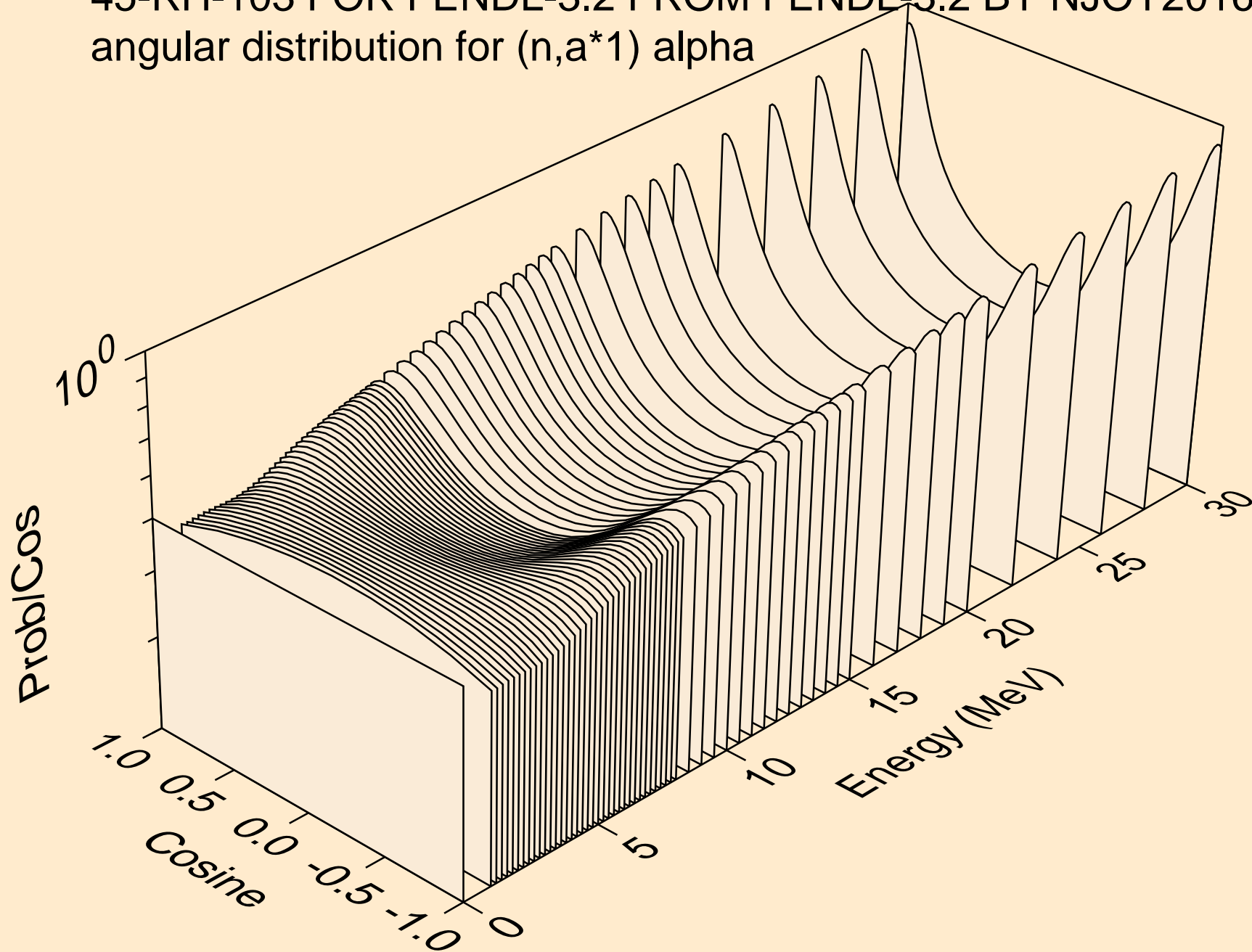

45-RH-103 FOR FENDL-3.2 FROM FENDL-3.2 BY NJOY2016.60+ C
angular distribution for (n,a*2) alpha

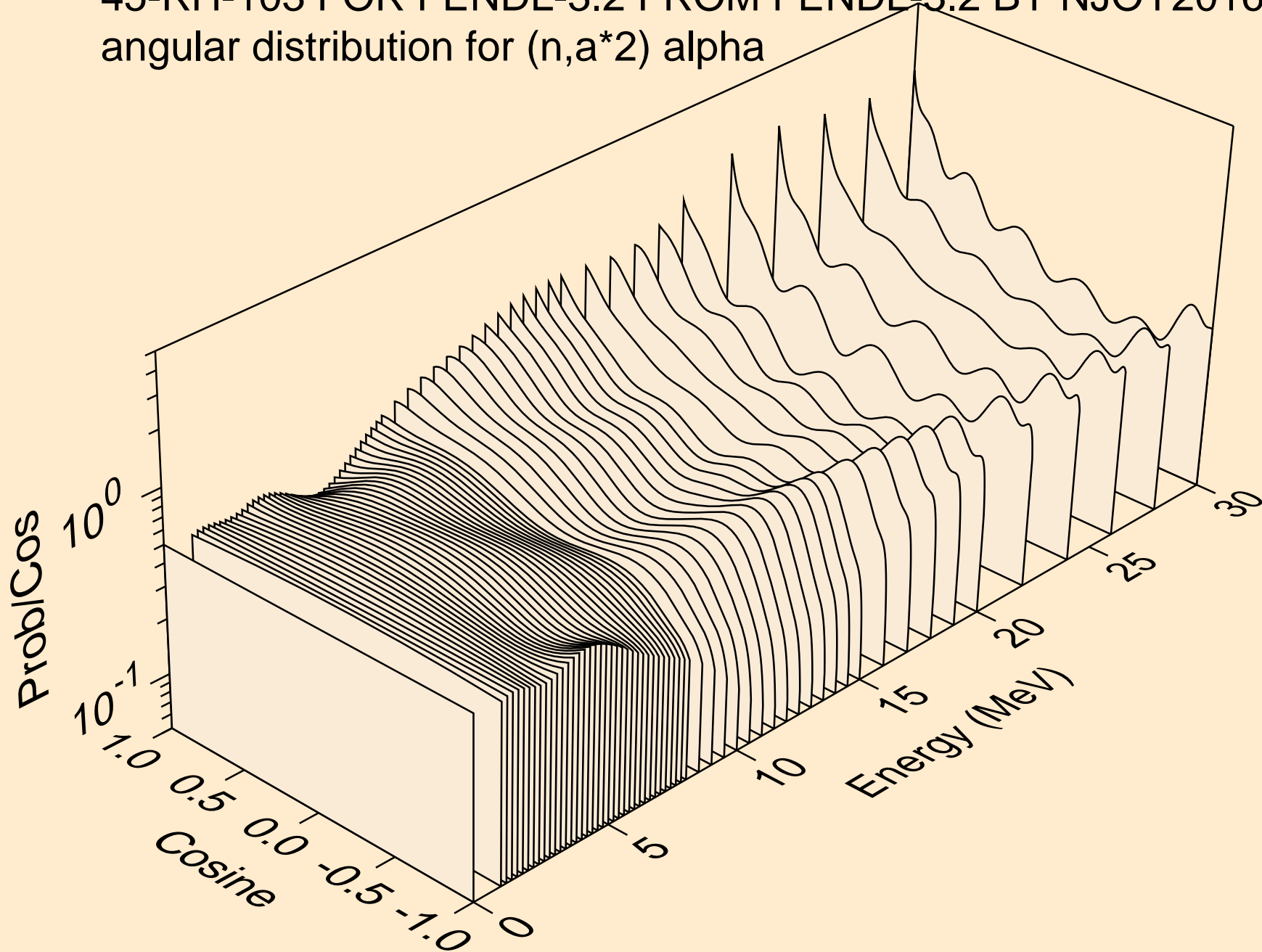

45-RH-103 FOR FENDL-3.2 FROM FENDL-3.2 BY NJOY2016.60+ C
angular distribution for (n,a*3) alpha

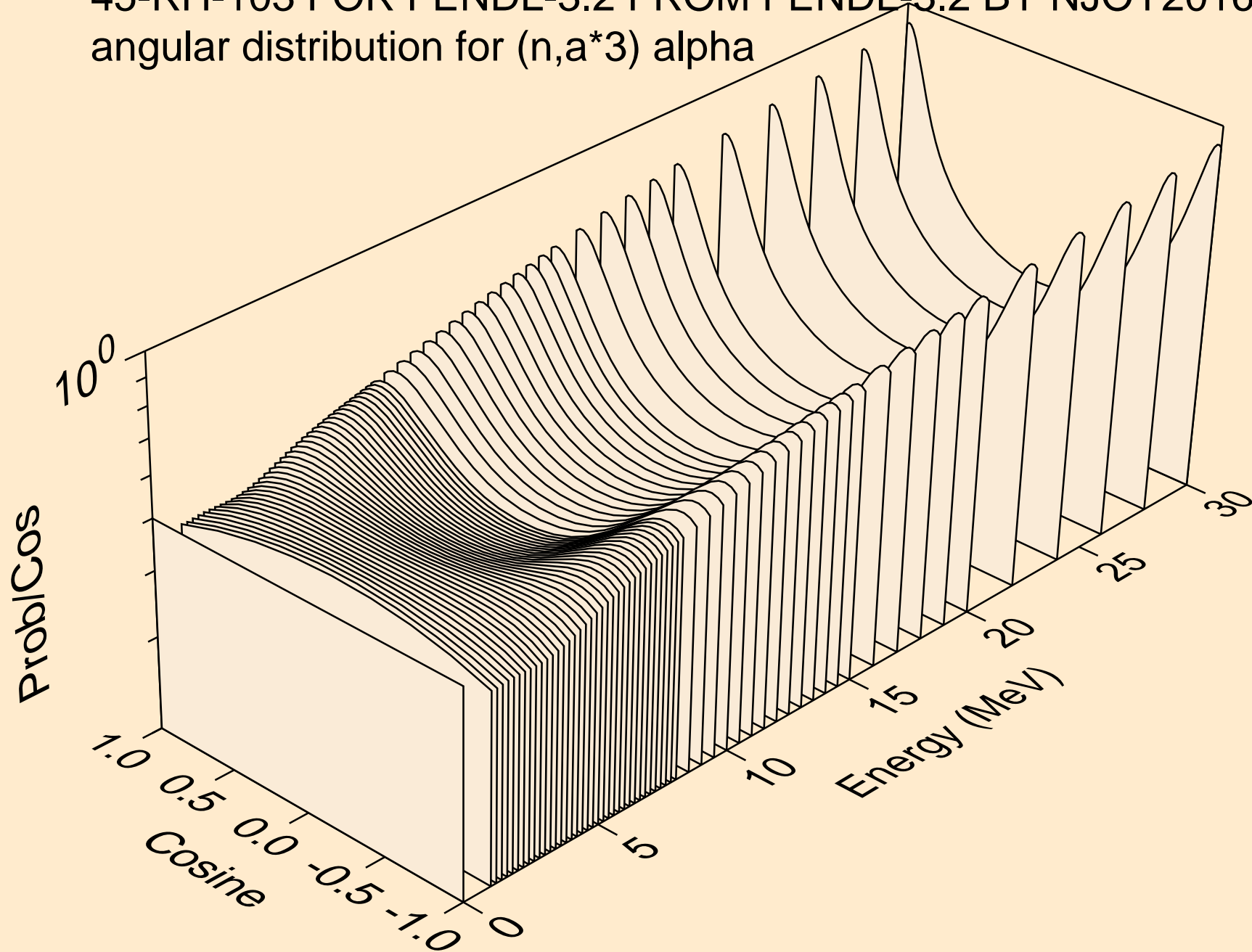

45-RH-103 FOR FENDL-3.2 FROM FENDL-3.2 BY NJOY2016.60+ C
angular distribution for (n,a*4) alpha

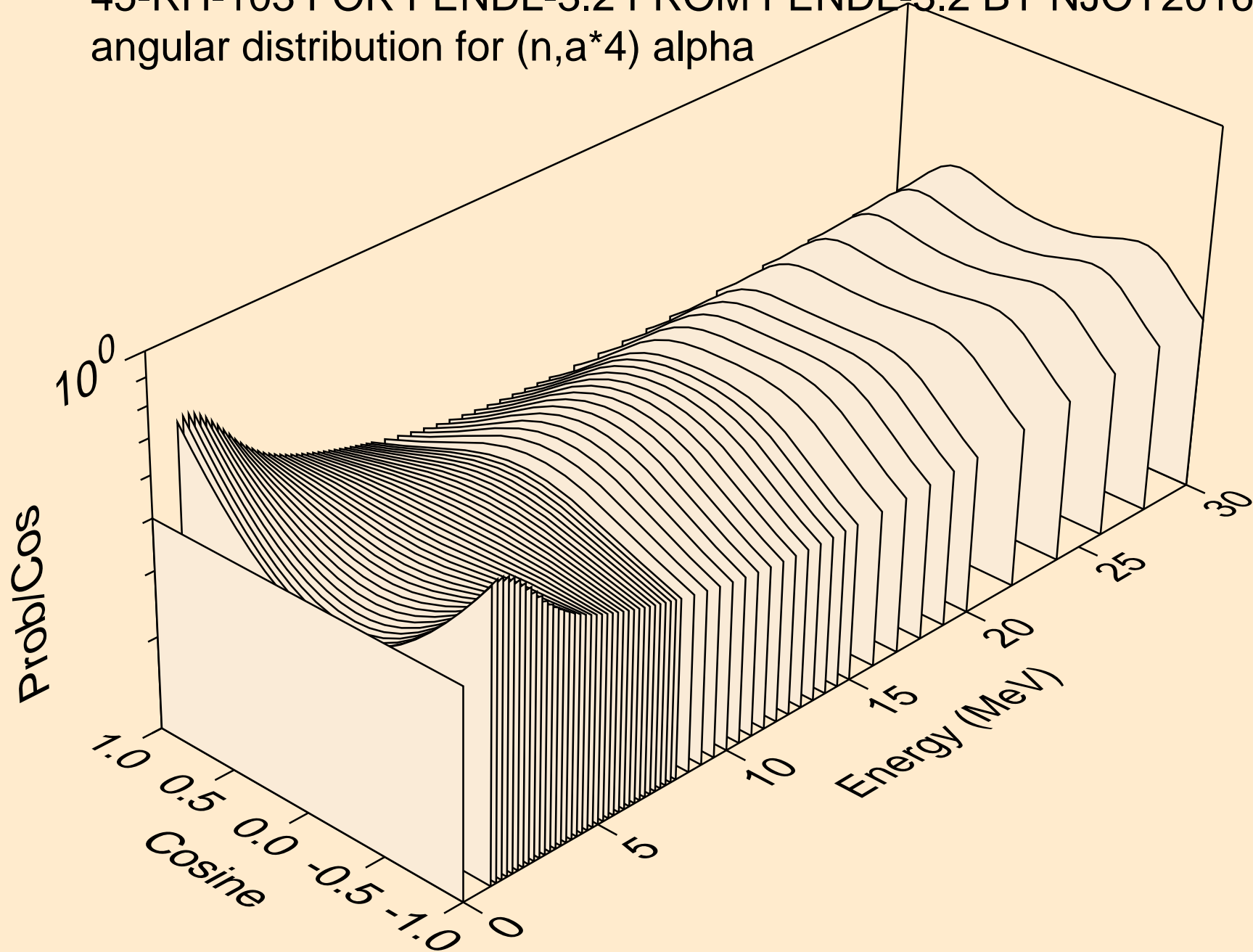

45-RH-103 FOR FENDL-3.2 FROM FENDL-3.2 BY NJOY2016.60+ C
angular distribution for (n,a*5) alpha

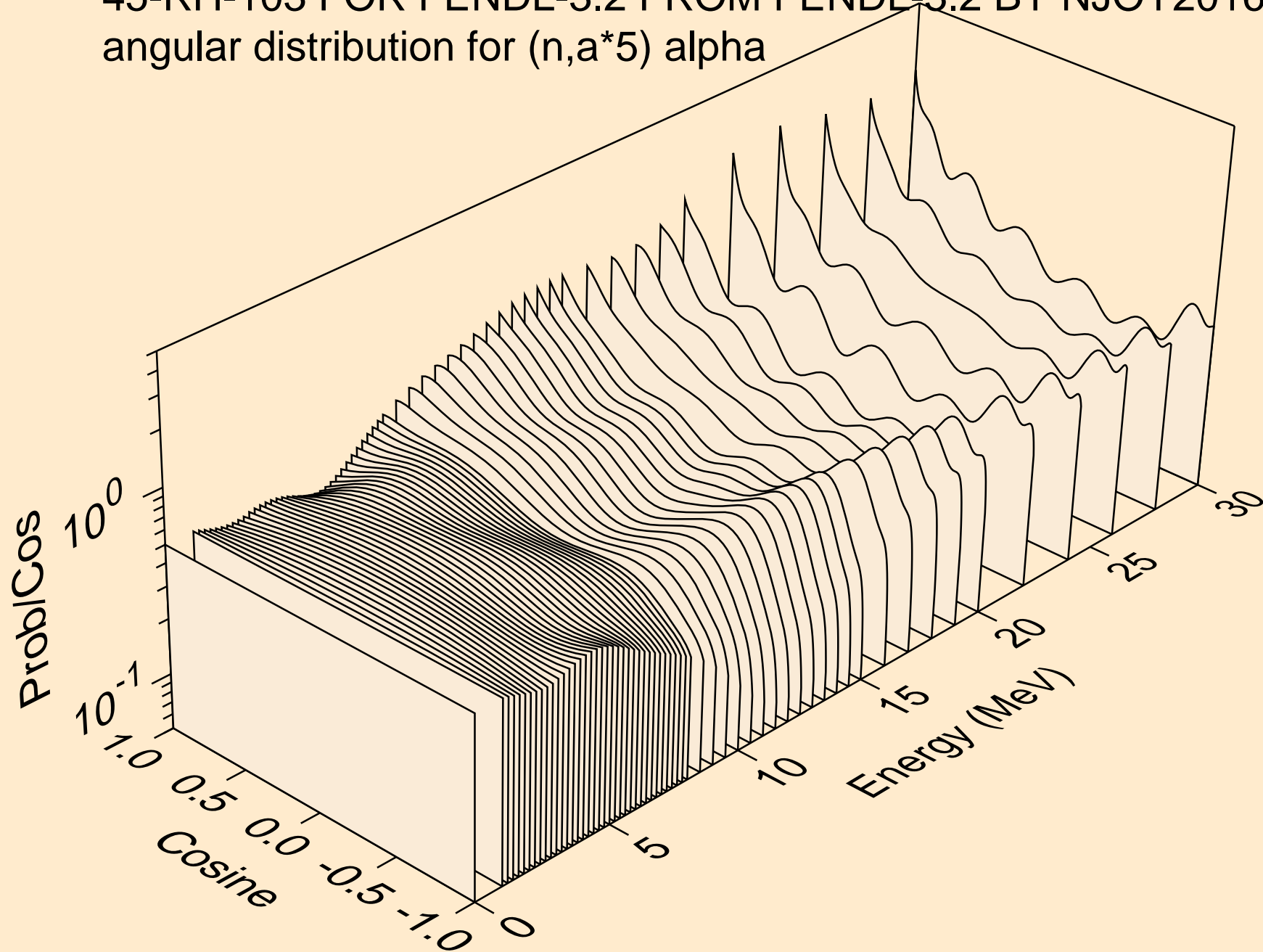

45-RH-103 FOR FENDL-3.2 FROM FENDL-3.2 BY NJOY2016.60+ C
angular distribution for (n,a*6) alpha

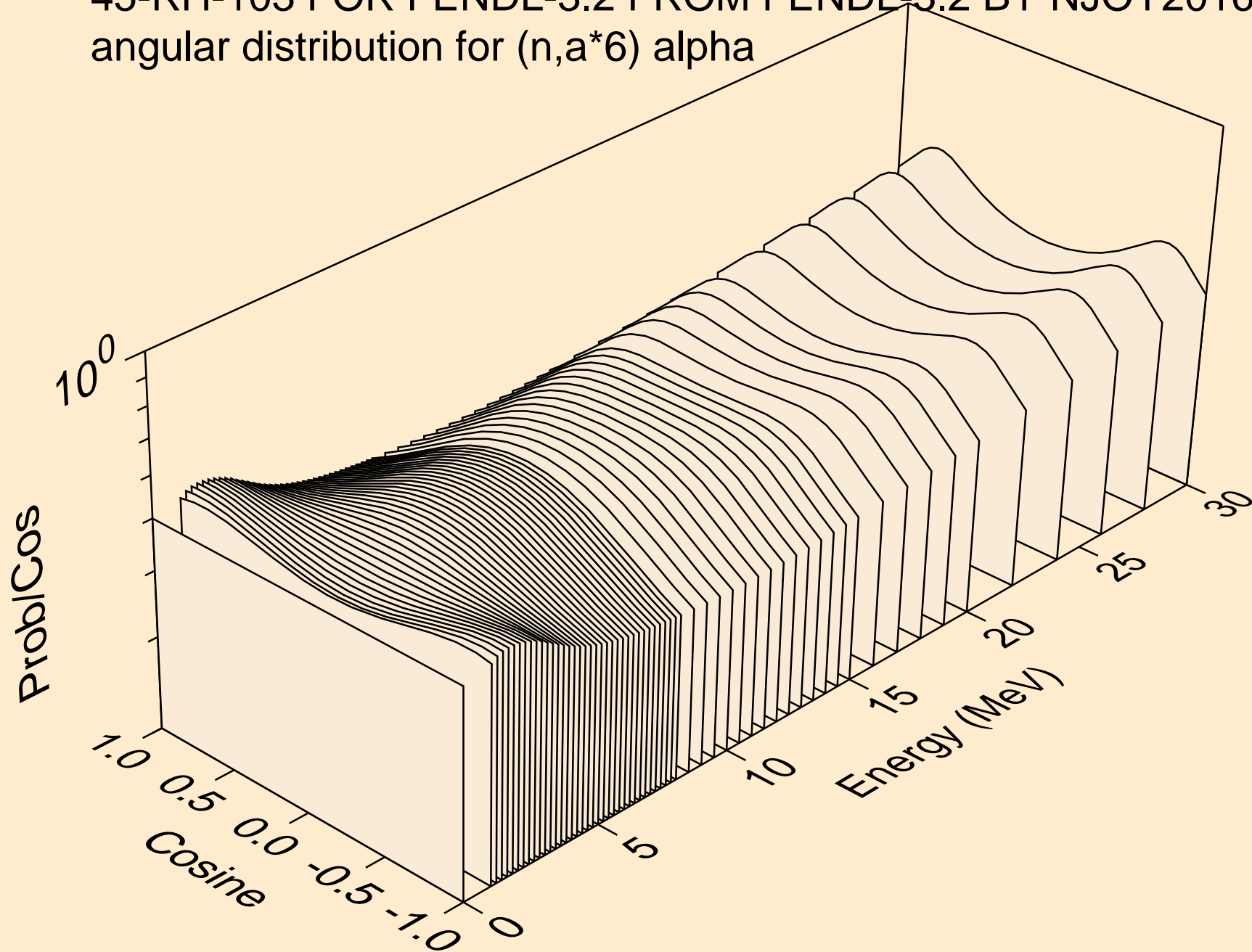

45-RH-103 FOR FENDL-3.2 FROM FENDL-3.2 BY NJOY2016.60+ C
angular distribution for (n,a*7) alpha

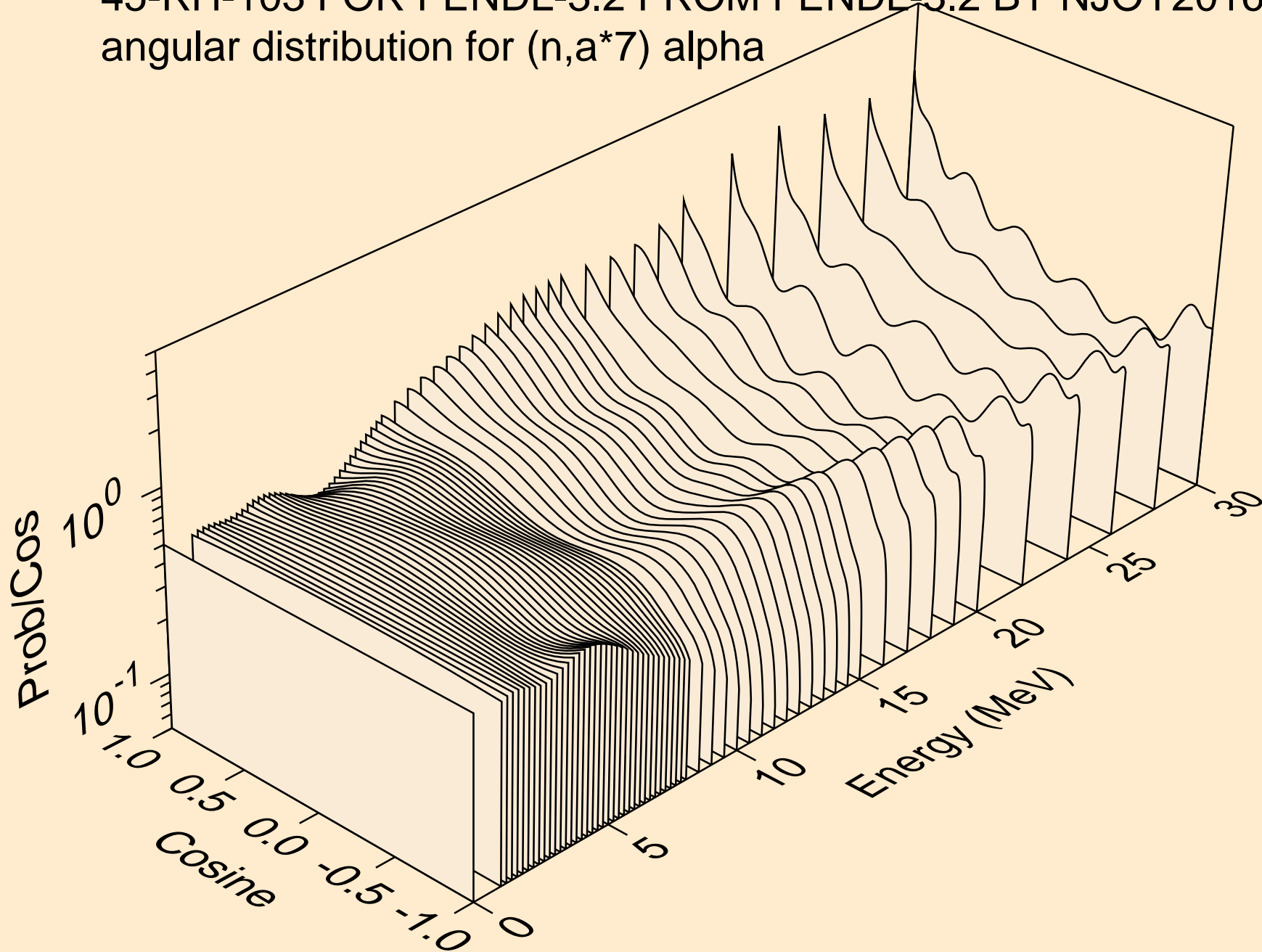

45-RH-103 FOR FENDL-3.2 FROM FENDL-3.2 BY NJOY2016.60+ C
angular distribution for (n,a*8) alpha

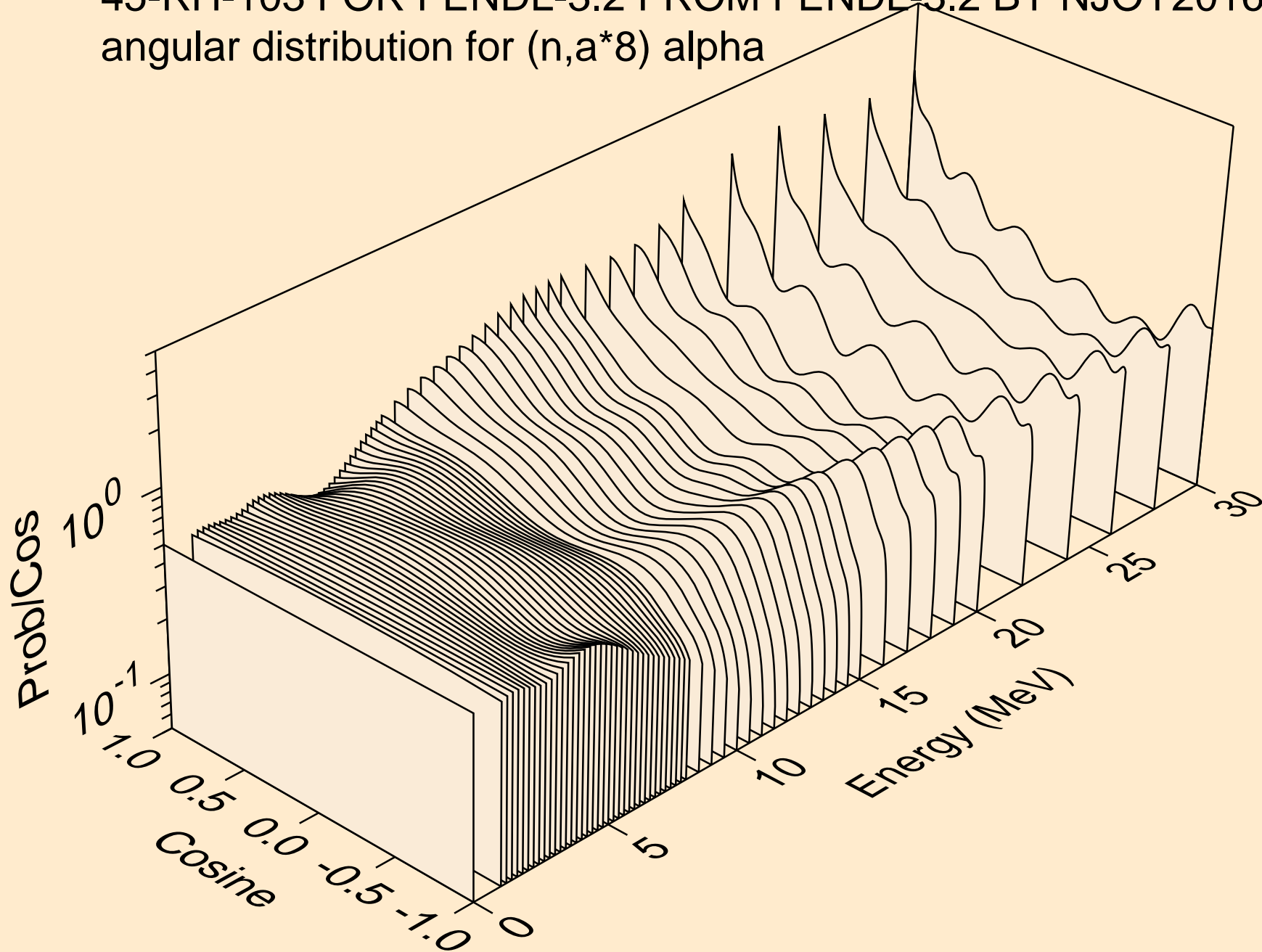

45-RH-103 FOR FENDL-3.2 FROM FENDL-3.2 BY NJOY2016.60+ C
angular distribution for (n,a*9) alpha

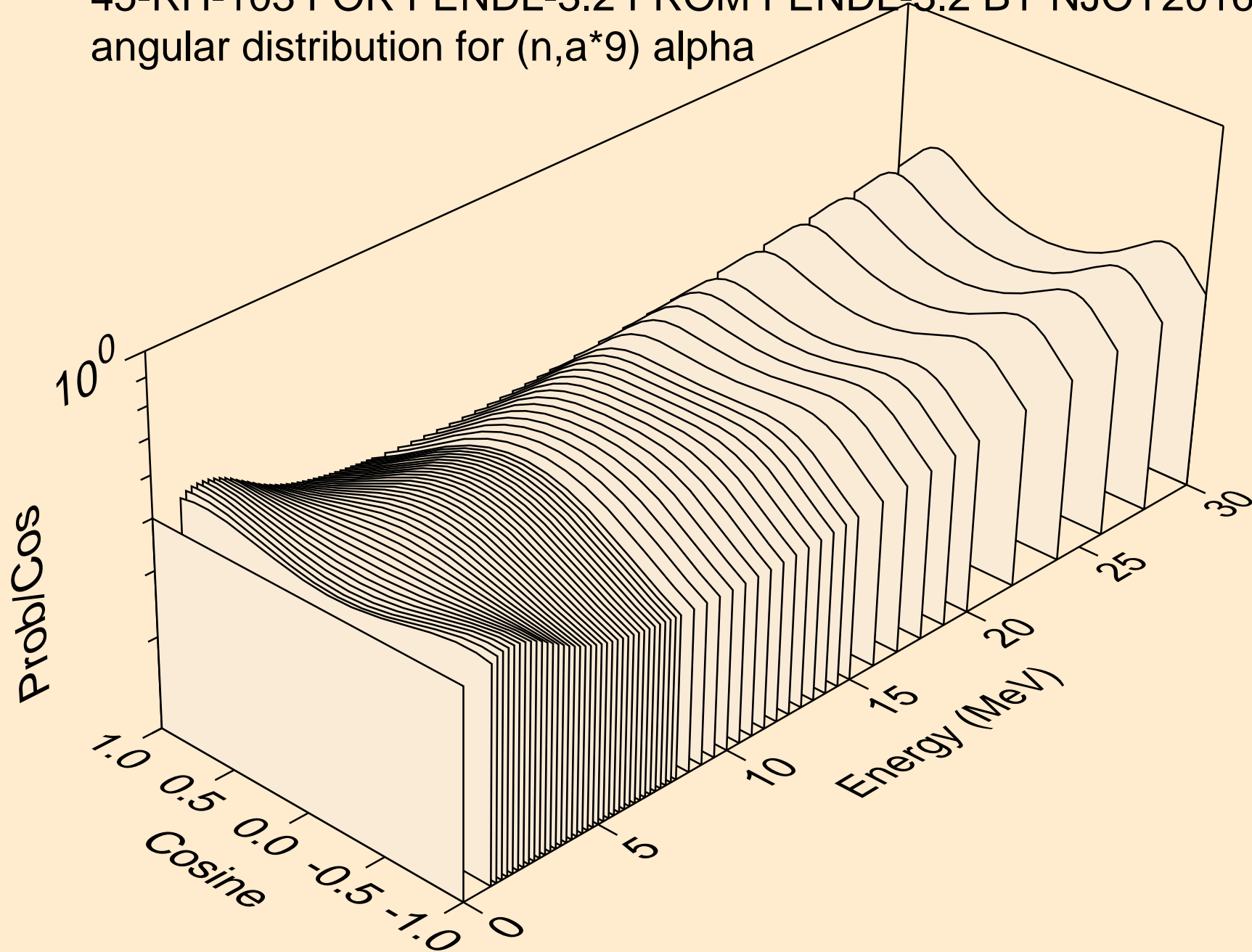

45-RH-103 FOR FENDL-3.2 FROM FENDL-3.2 BY NJOY2016.60+ C
angular distribution for (n,a*10) alpha

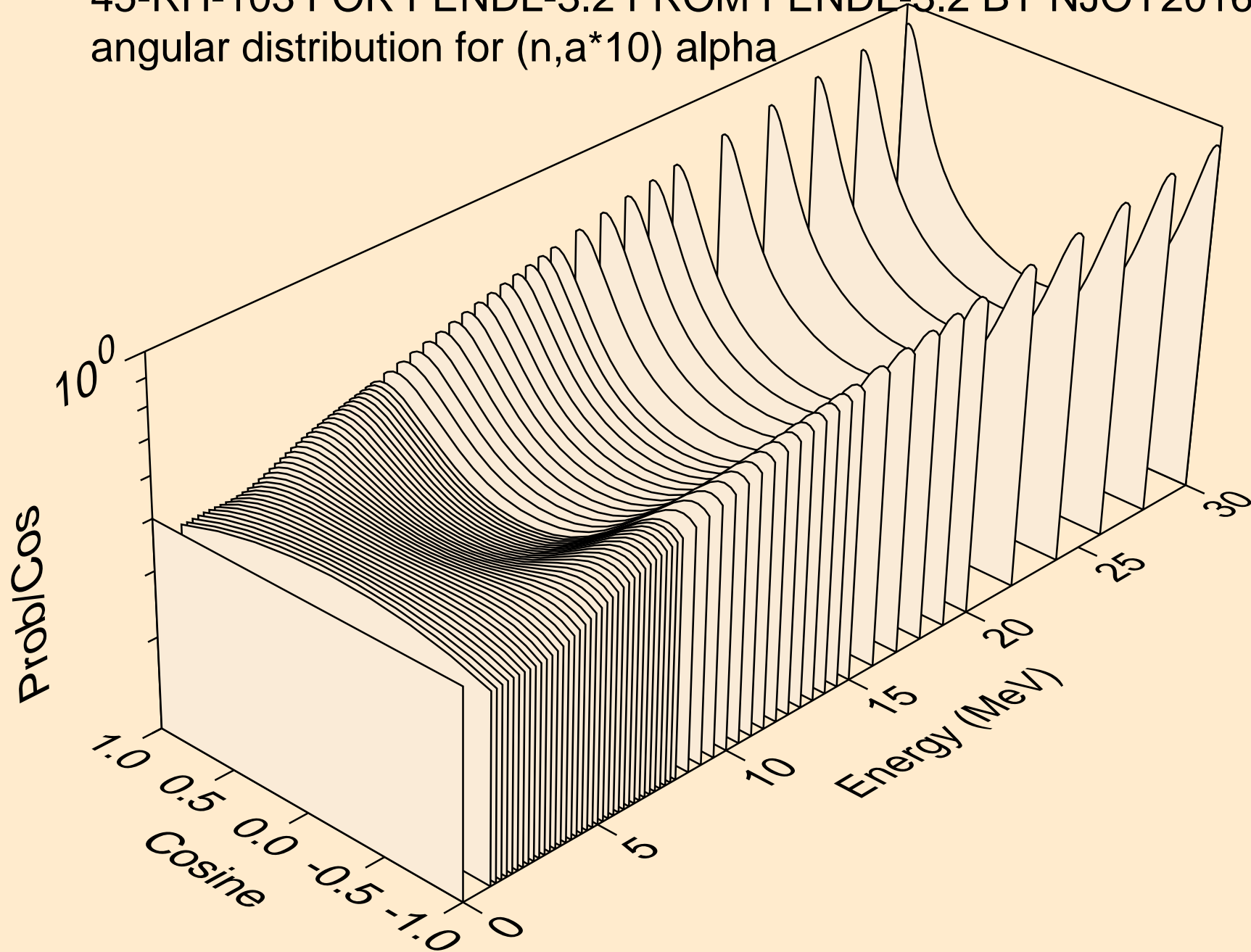

45-RH-103 FOR FENDL-3.2 FROM FENDL-3.2 BY NJOY2016.60+ C
angular distribution for (n,a*11) alpha

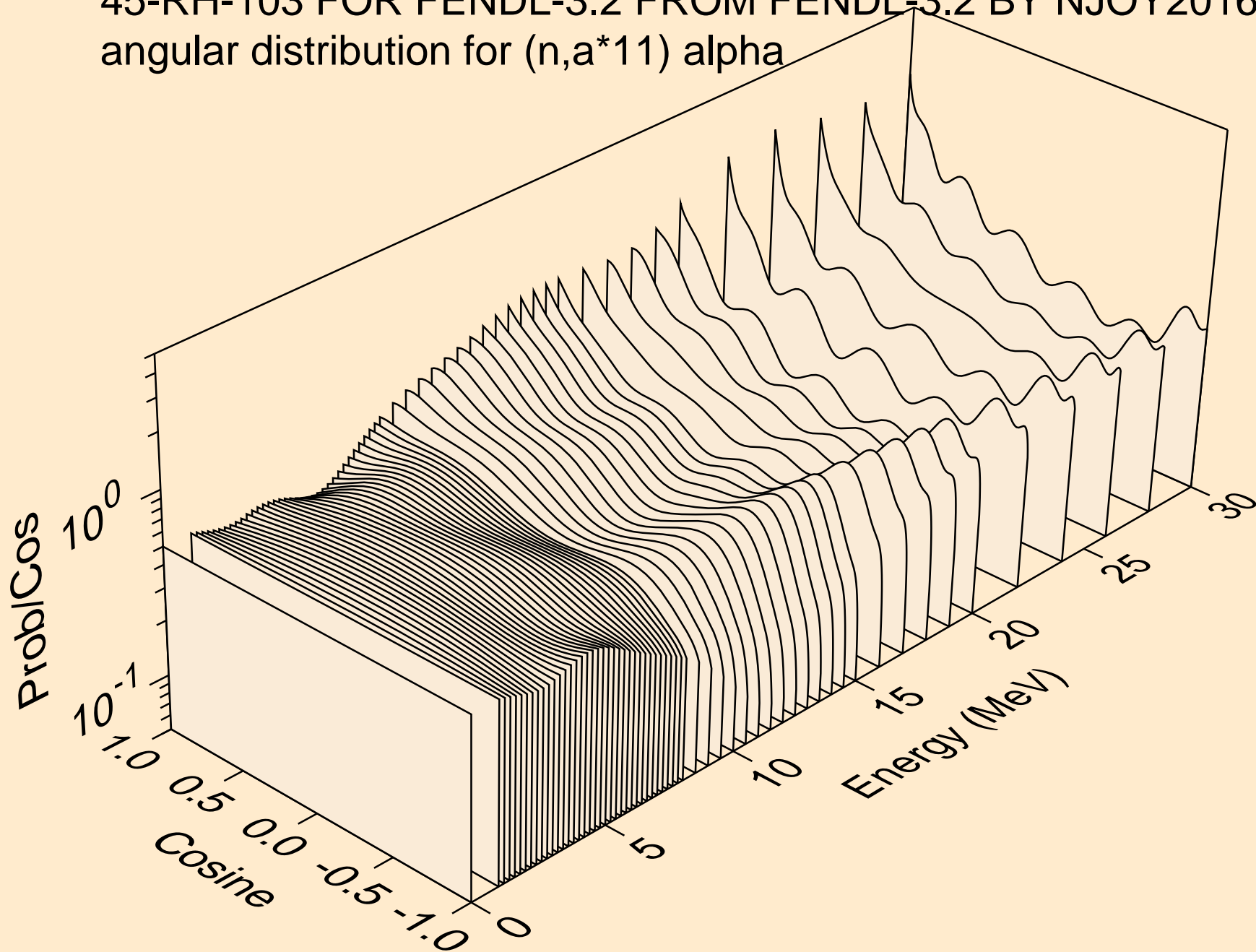

45-RH-103 FOR FENDL-3.2 FROM FENDL-3.2 BY NJOY2016.60+ C
angular distribution for (n,a*12) alpha

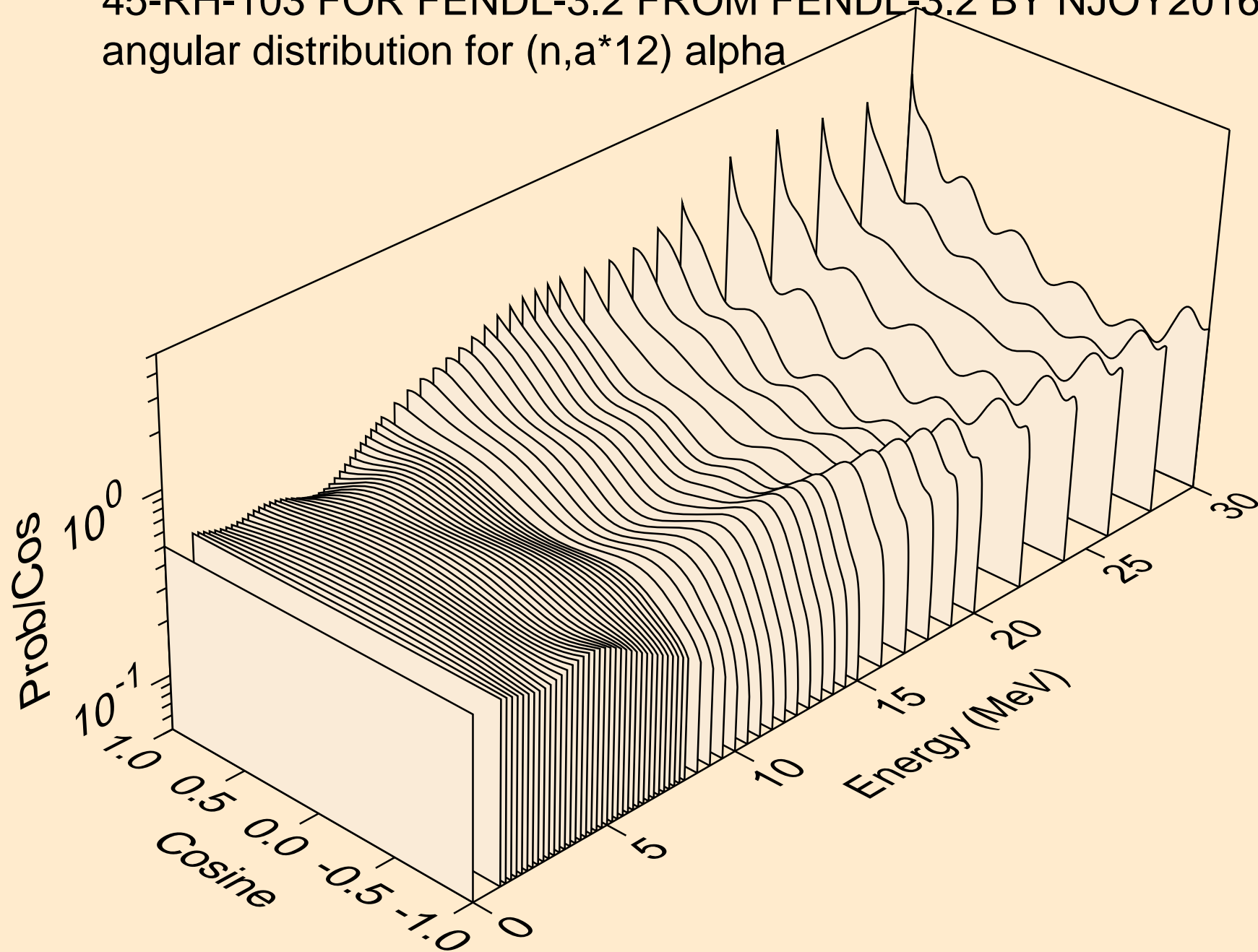

45-RH-103 FOR FENDL-3.2 FROM FENDL-3.2 BY NJOY2016.60+ C
angular distribution for (n,a*13) alpha

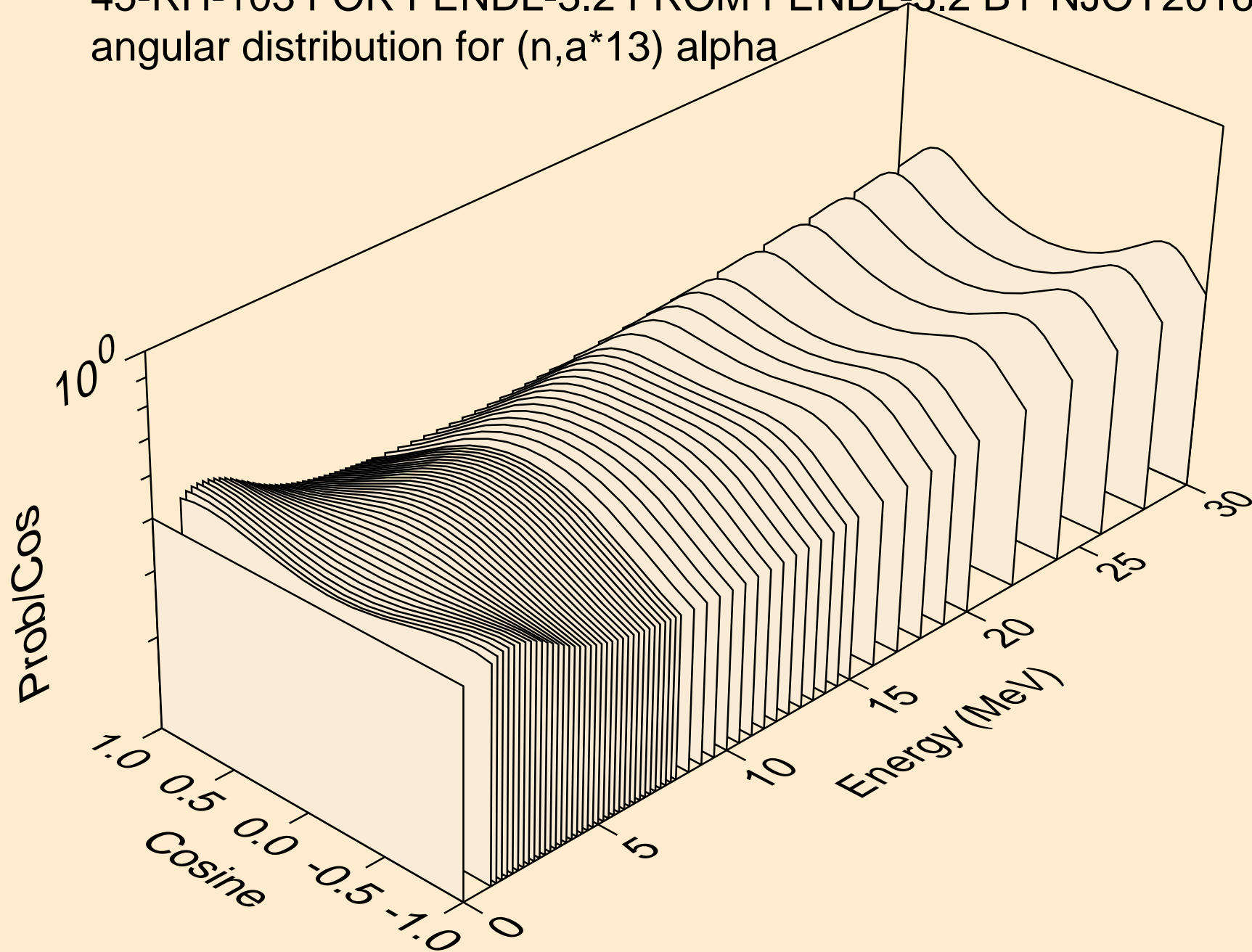

45-RH-103 FOR FENDL-3.2 FROM FENDL-3.2 BY NJOY2016.60+ C
angular distribution for (n,a*14) alpha

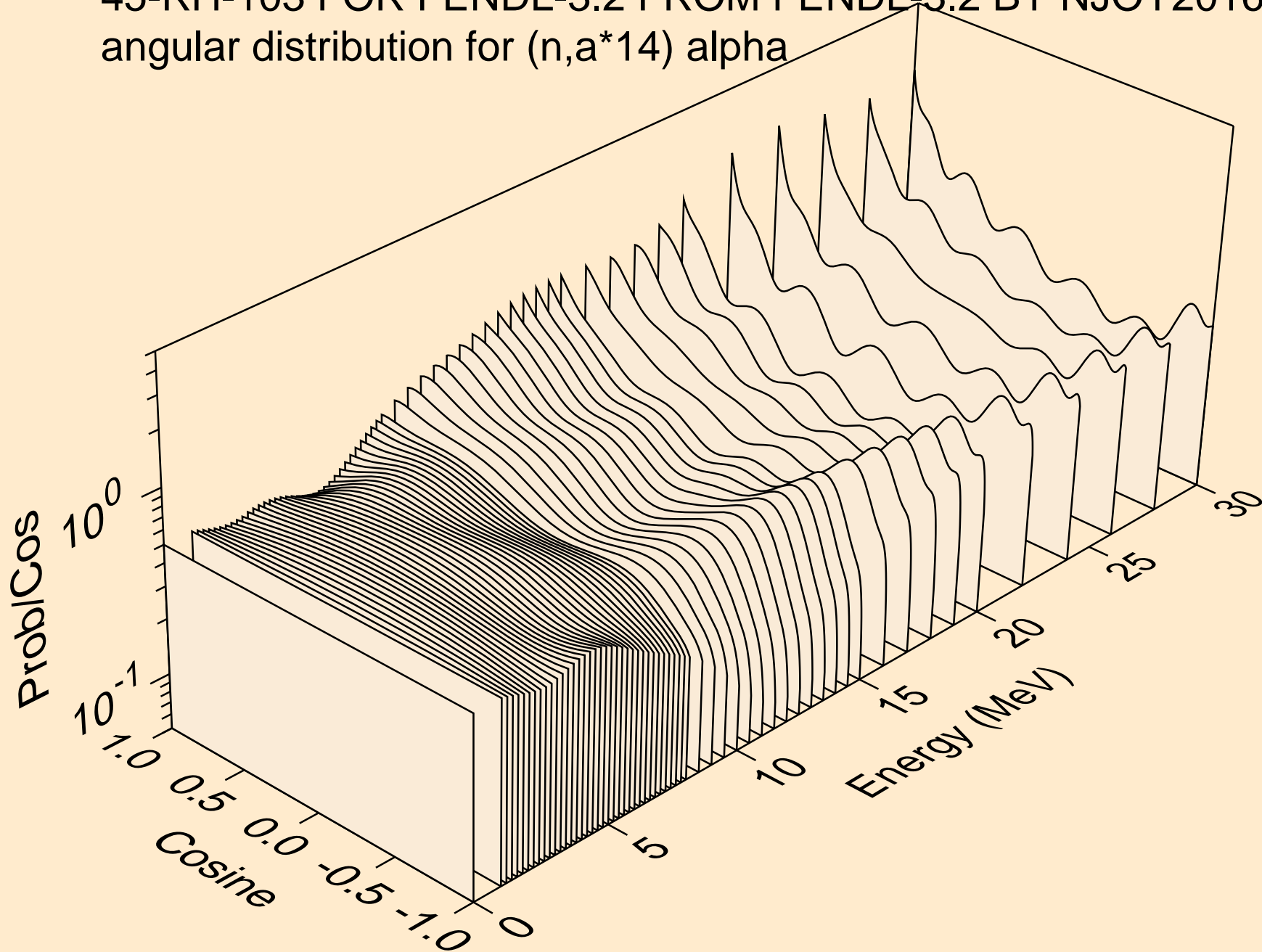

45-RH-103 FOR FENDL-3.2 FROM FENDL-3.2 BY NJOY2016.60+ C
angular distribution for (n,a*15) alpha

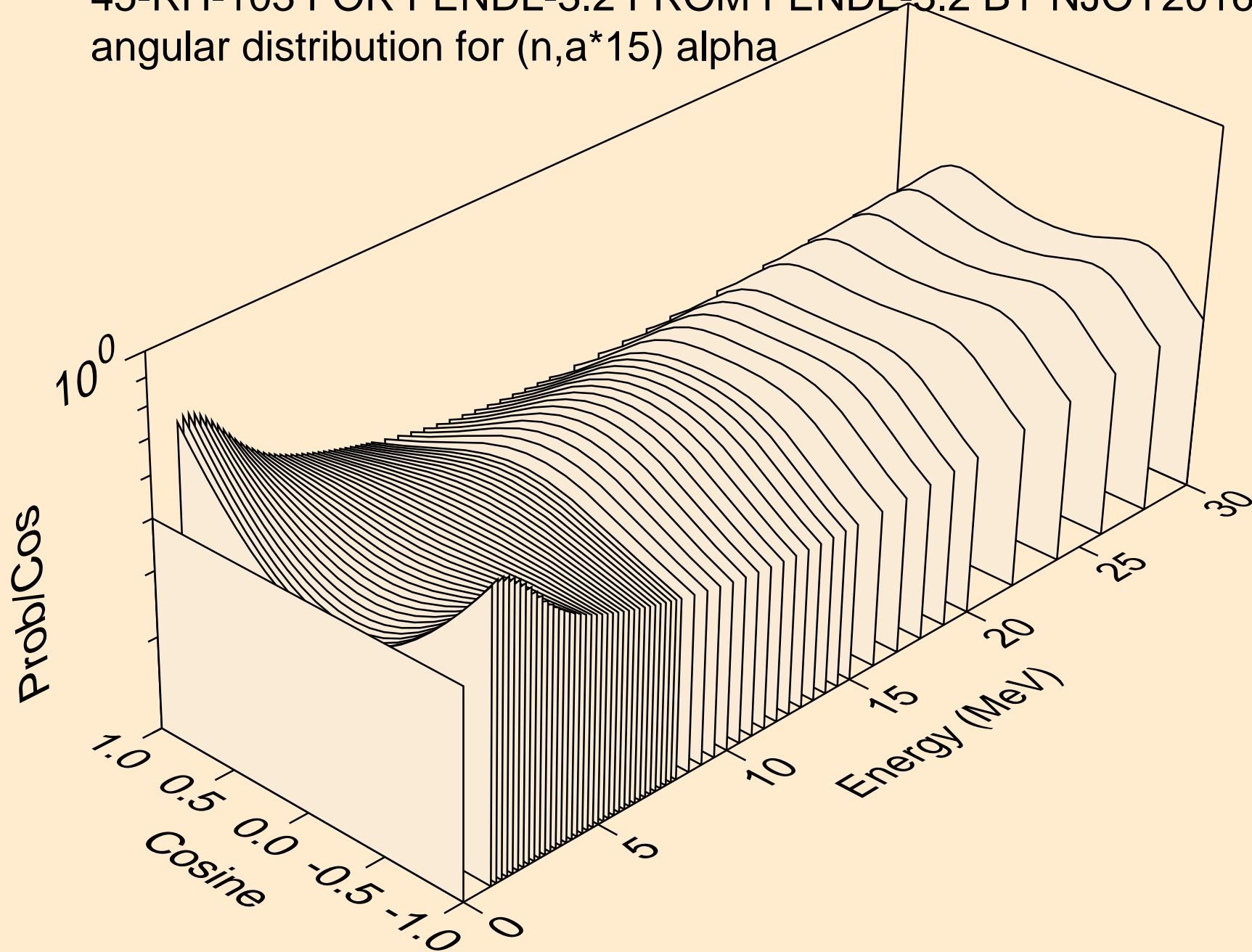

45-RH-103 FOR FENDL-3.2 FROM FENDL-3.2 BY NJOY2016.60+ C
alphas from (n,a*c)

