

50-SN-116 FOR FENDL-3.2 FROM FENDL-3.2 BY NJOY2016.60+ C
Principal cross sections

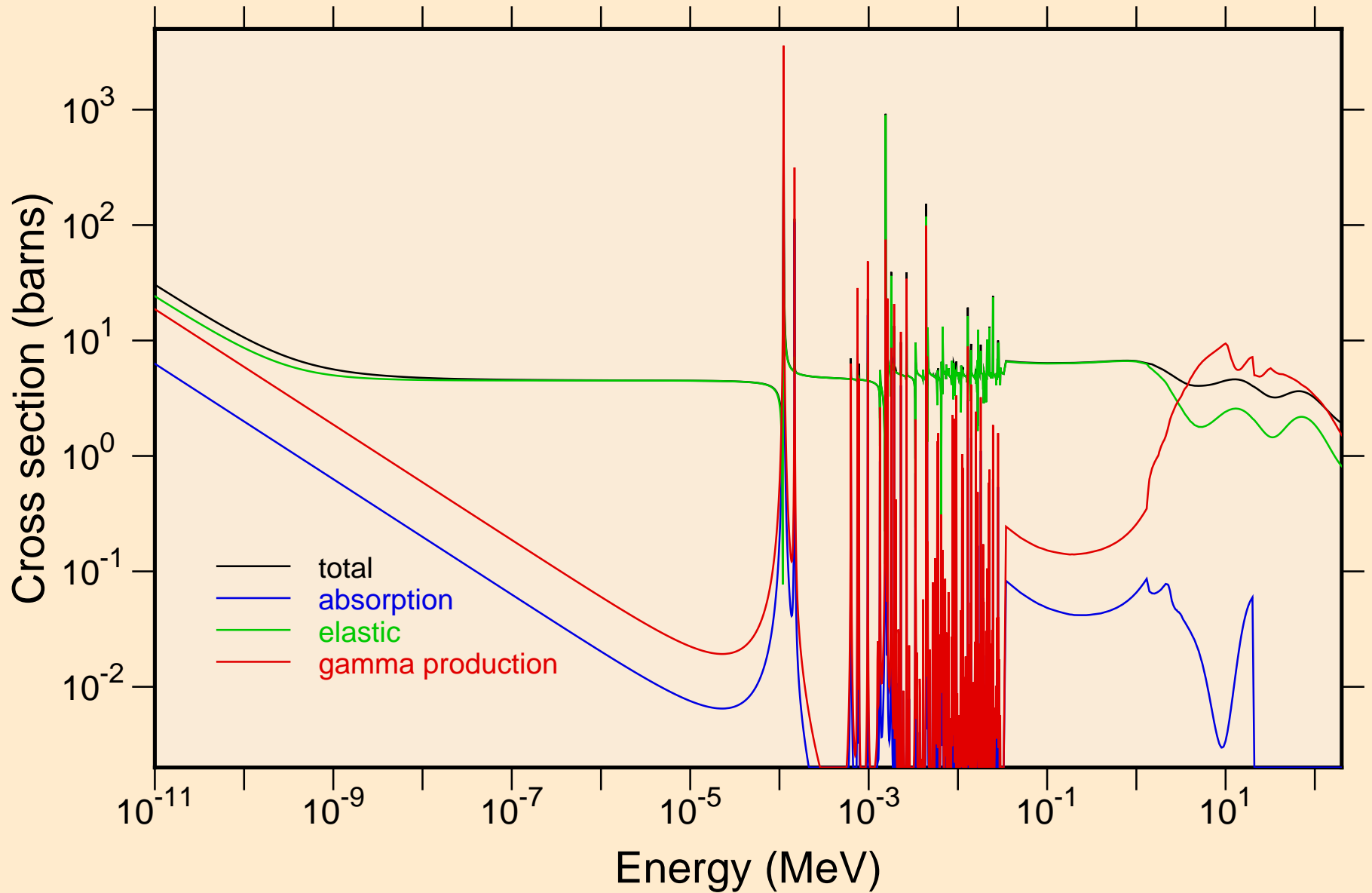

50-SN-116 FOR FENDL-3.2 FROM FENDL-3.2 BY NJOY2016.60+ C
resonance total cross section

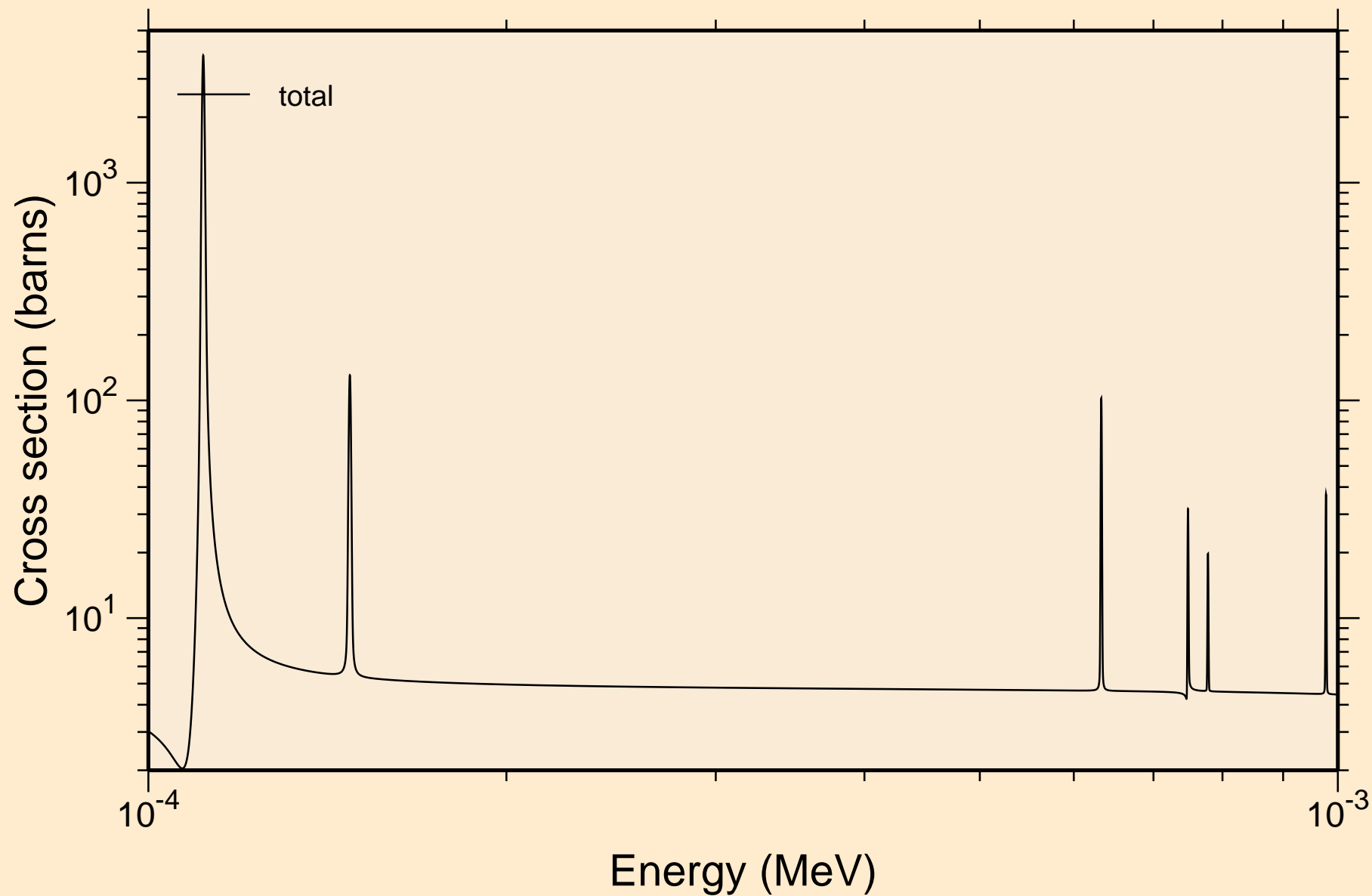

50-SN-116 FOR FENDL-3.2 FROM FENDL-3.2 BY NJOY2016.60+ C
resonance total cross section

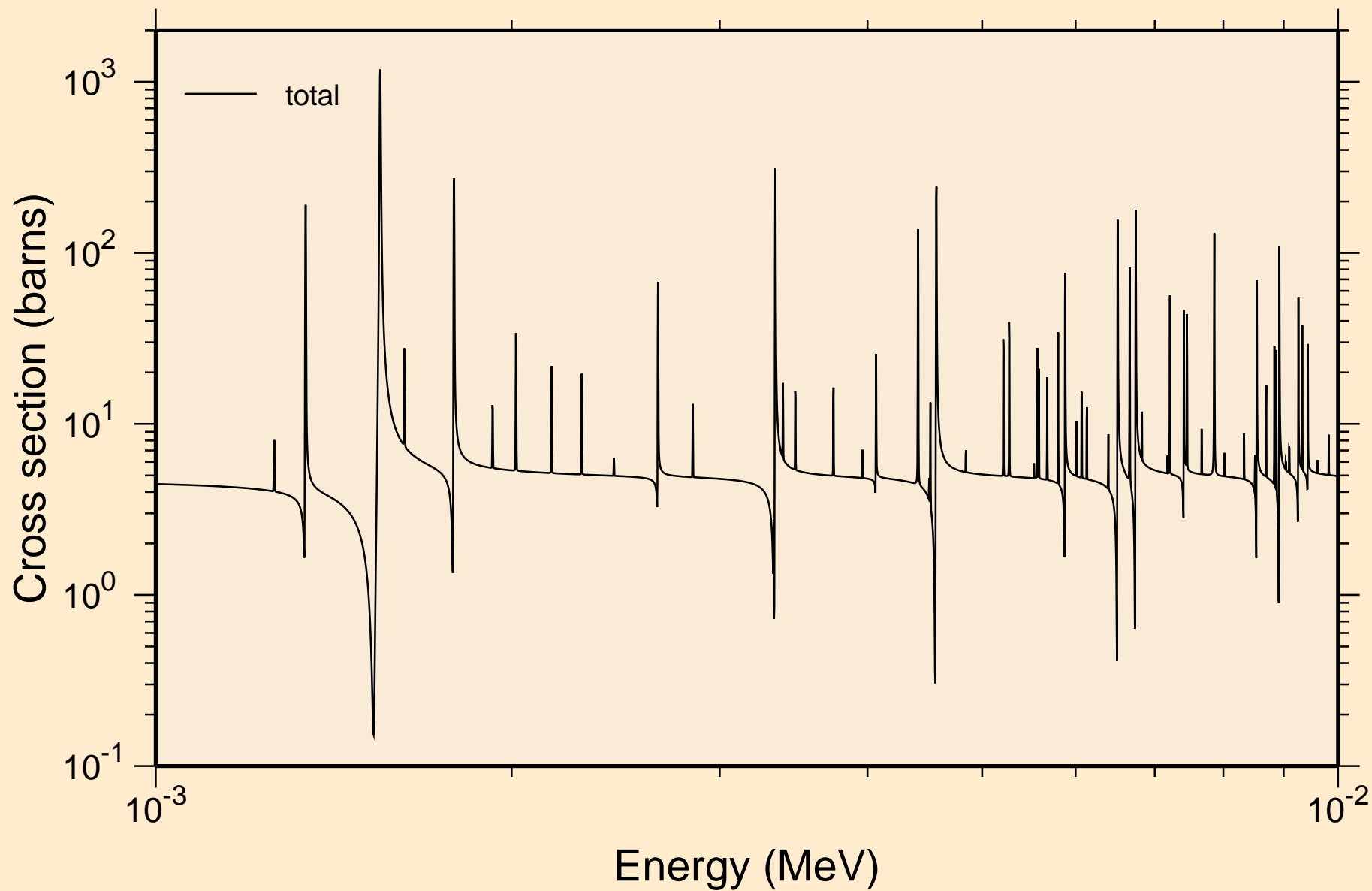

50-SN-116 FOR FENDL-3.2 FROM FENDL-3.2 BY NJOY2016.60+ C
resonance total cross section

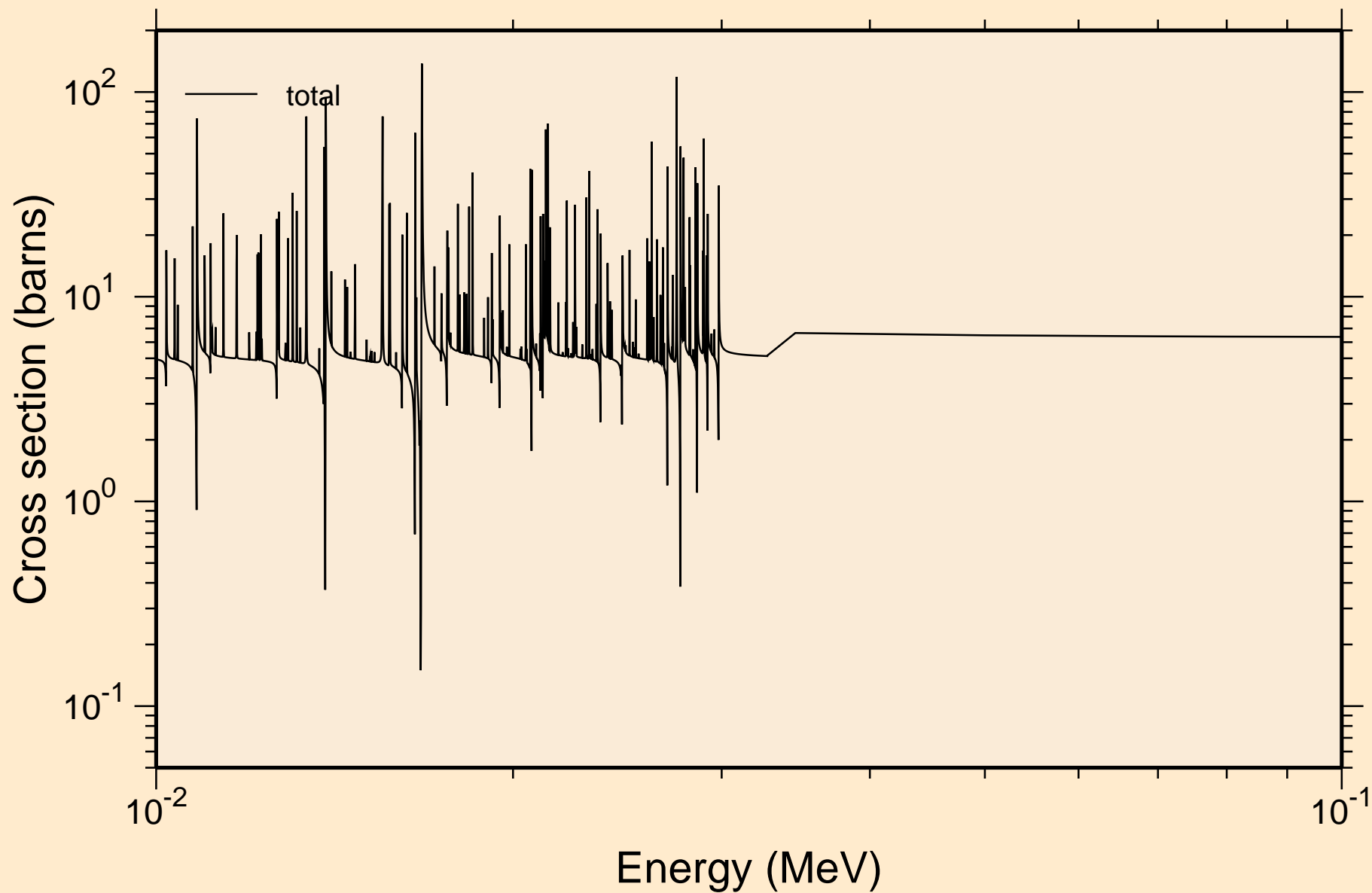

50-SN-116 FOR FENDL-3.2 FROM FENDL-3.2 BY NJOY2016.60+ C
resonance total cross section

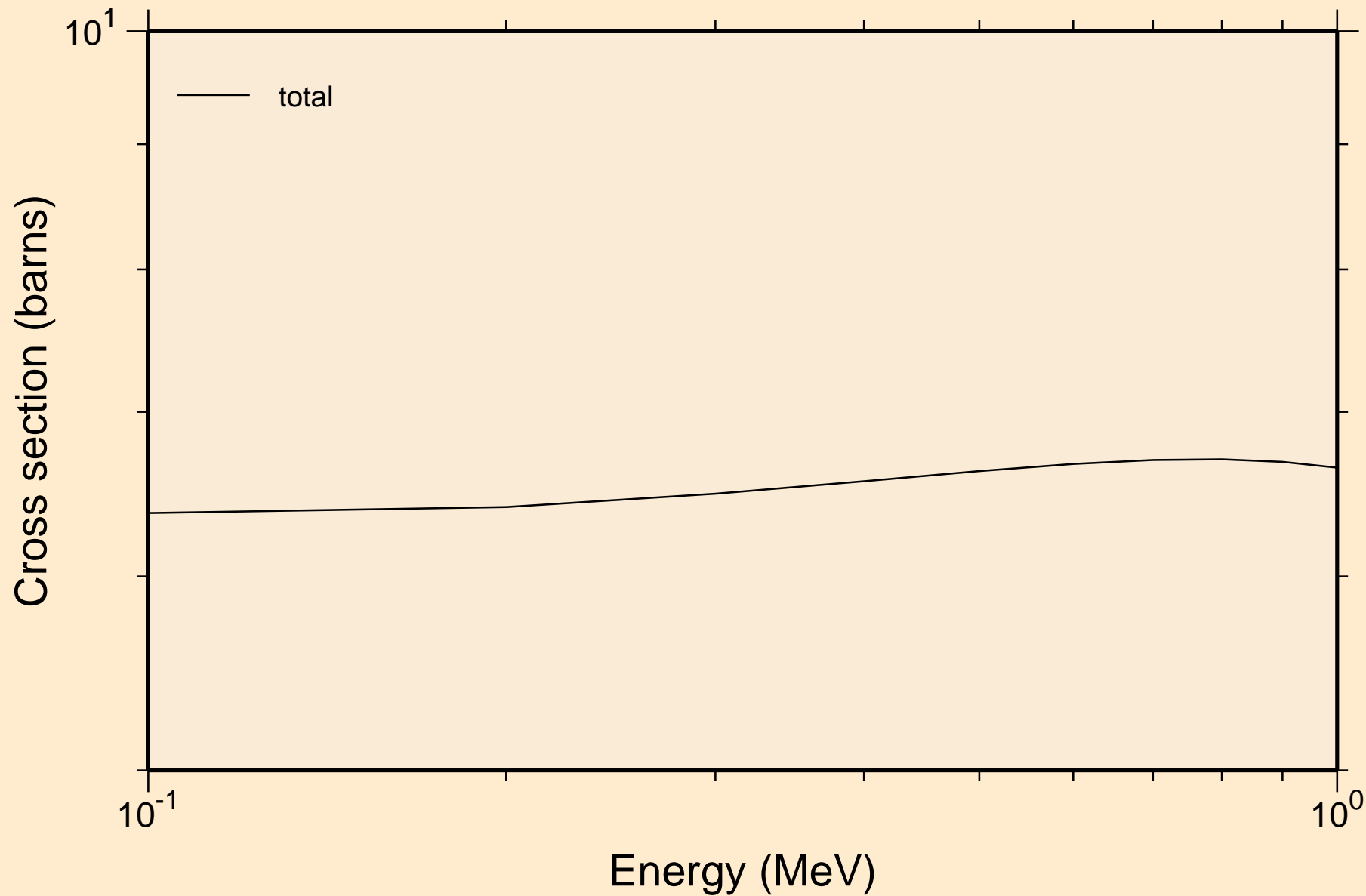

50-SN-116 FOR FENDL-3.2 FROM FENDL-3.2 BY NJOY2016.60+ C
resonance total cross section

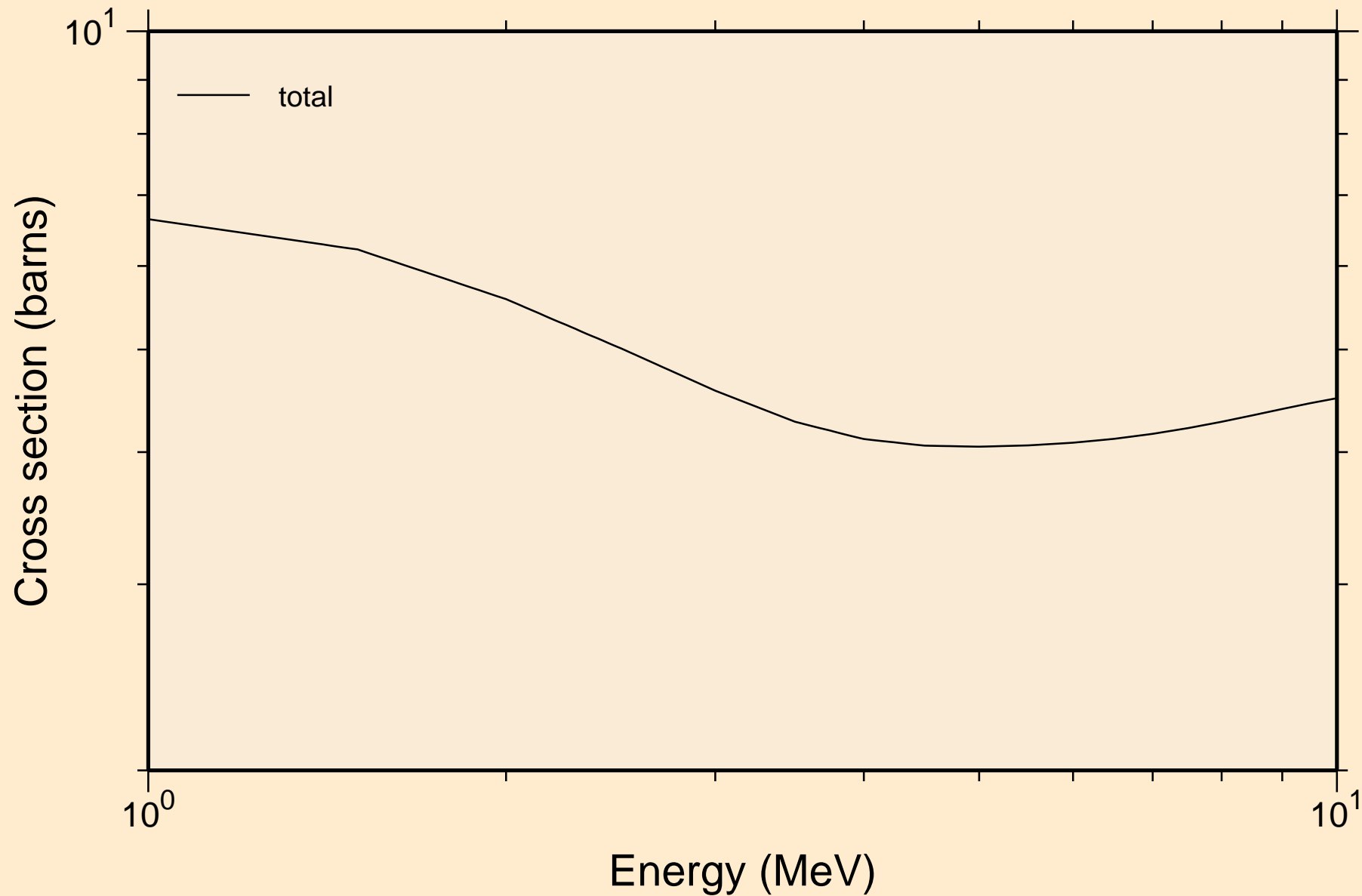

50-SN-116 FOR FENDL-3.2 FROM FENDL-3.2 BY NJOY2016.60+ C
resonance absorption cross sections

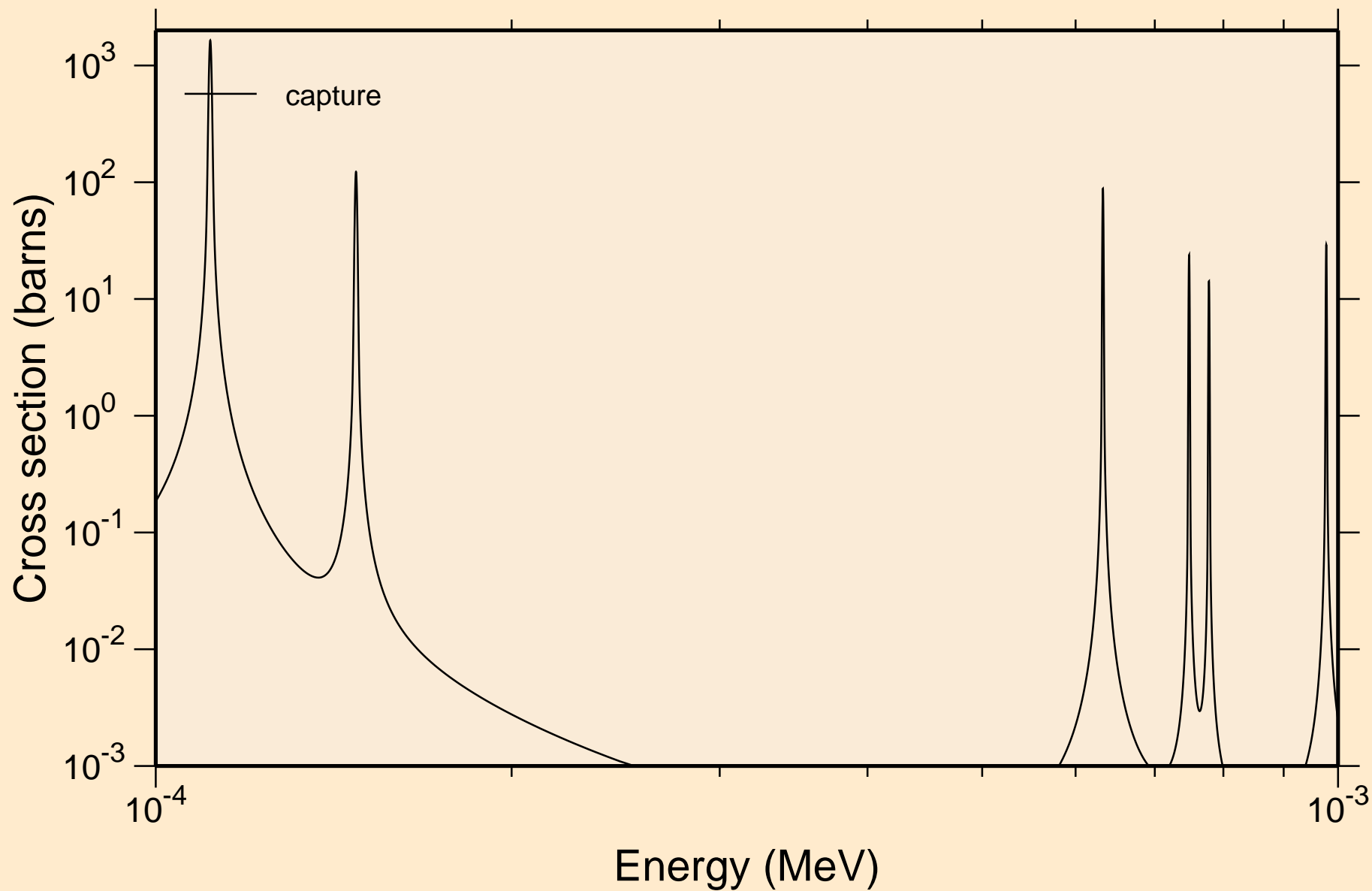

50-SN-116 FOR FENDL-3.2 FROM FENDL-3.2 BY NJOY2016.60+ C
resonance absorption cross sections

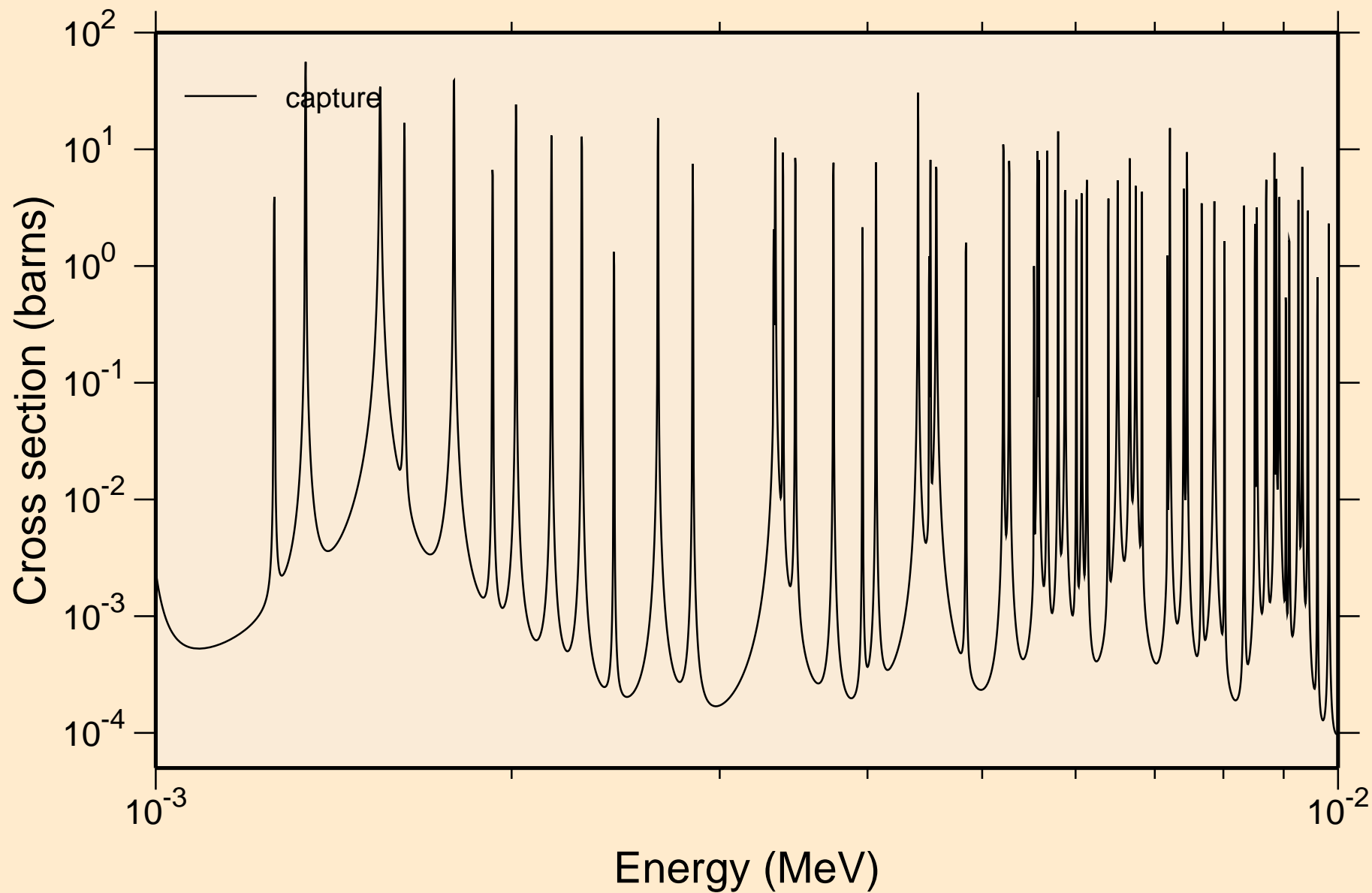

50-SN-116 FOR FENDL-3.2 FROM FENDL-3.2 BY NJOY2016.60+ C
resonance absorption cross sections

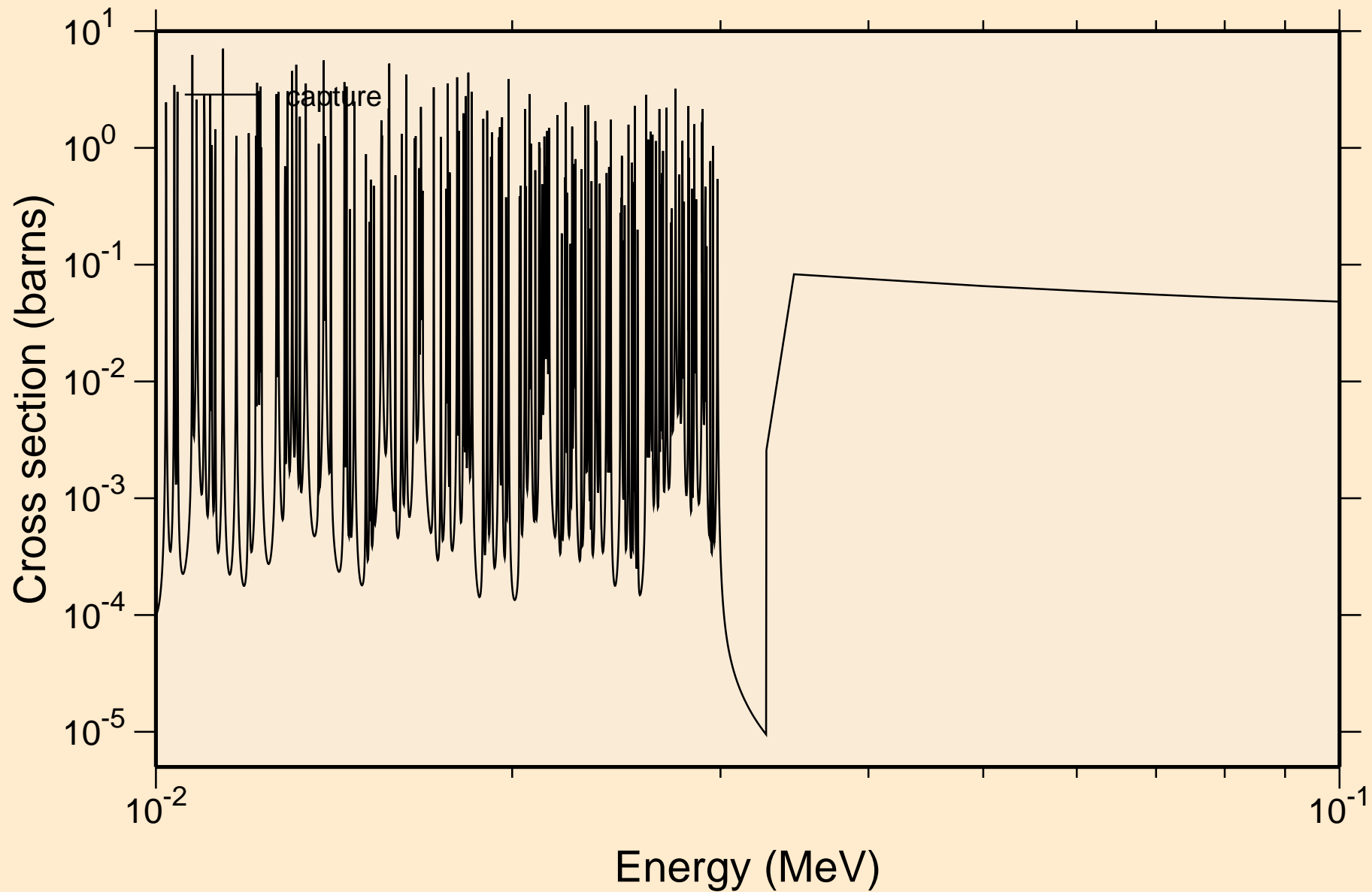

50-SN-116 FOR FENDL-3.2 FROM FENDL-3.2 BY NJOY2016.60+ C
resonance absorption cross sections

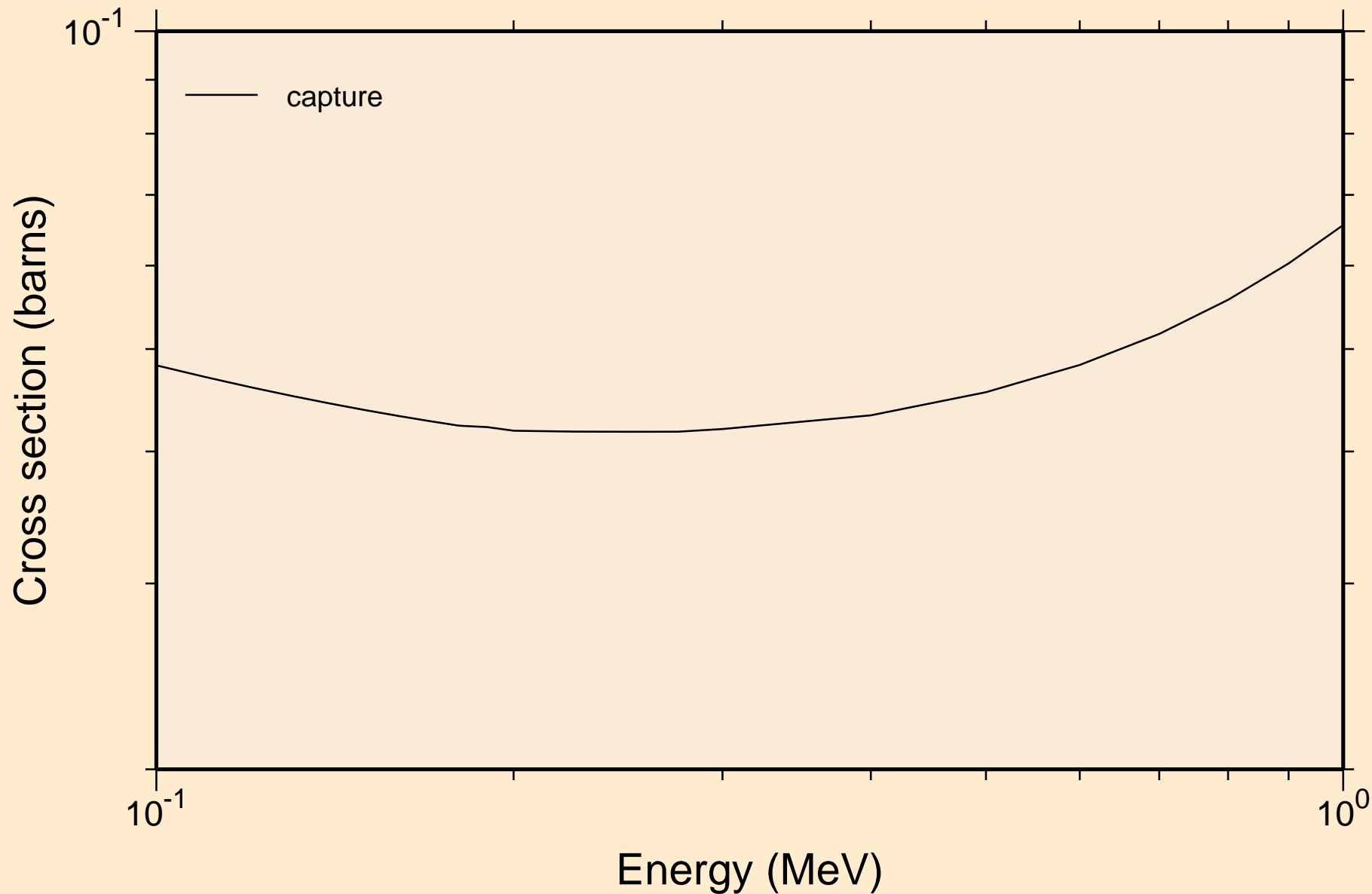

50-SN-116 FOR FENDL-3.2 FROM FENDL-3.2 BY NJOY2016.60+ C
resonance absorption cross sections

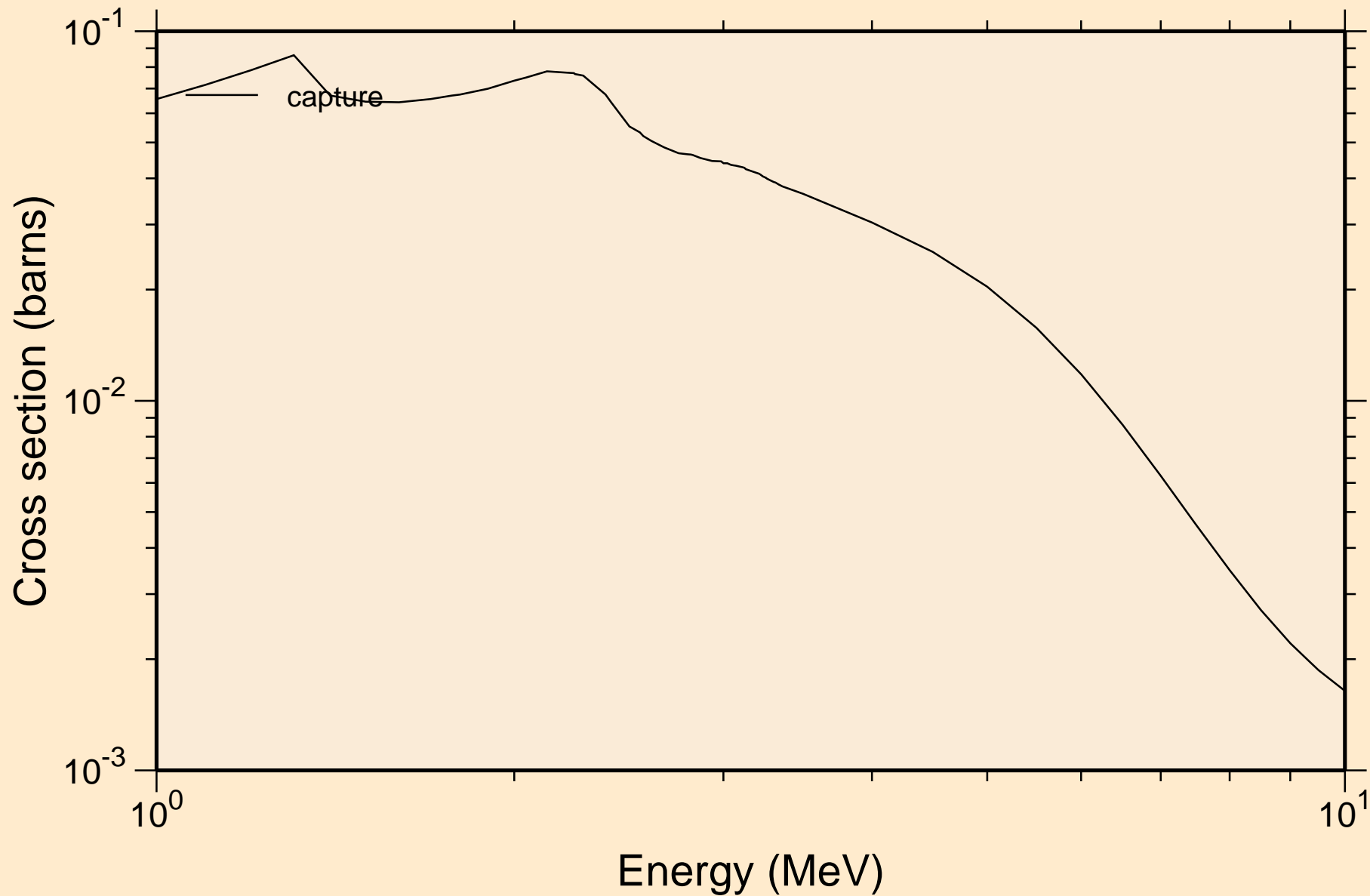

50-SN-116 FOR FENDL-3.2 FROM FENDL-3.2 BY NJOY2016.60+ C
UR total cross section

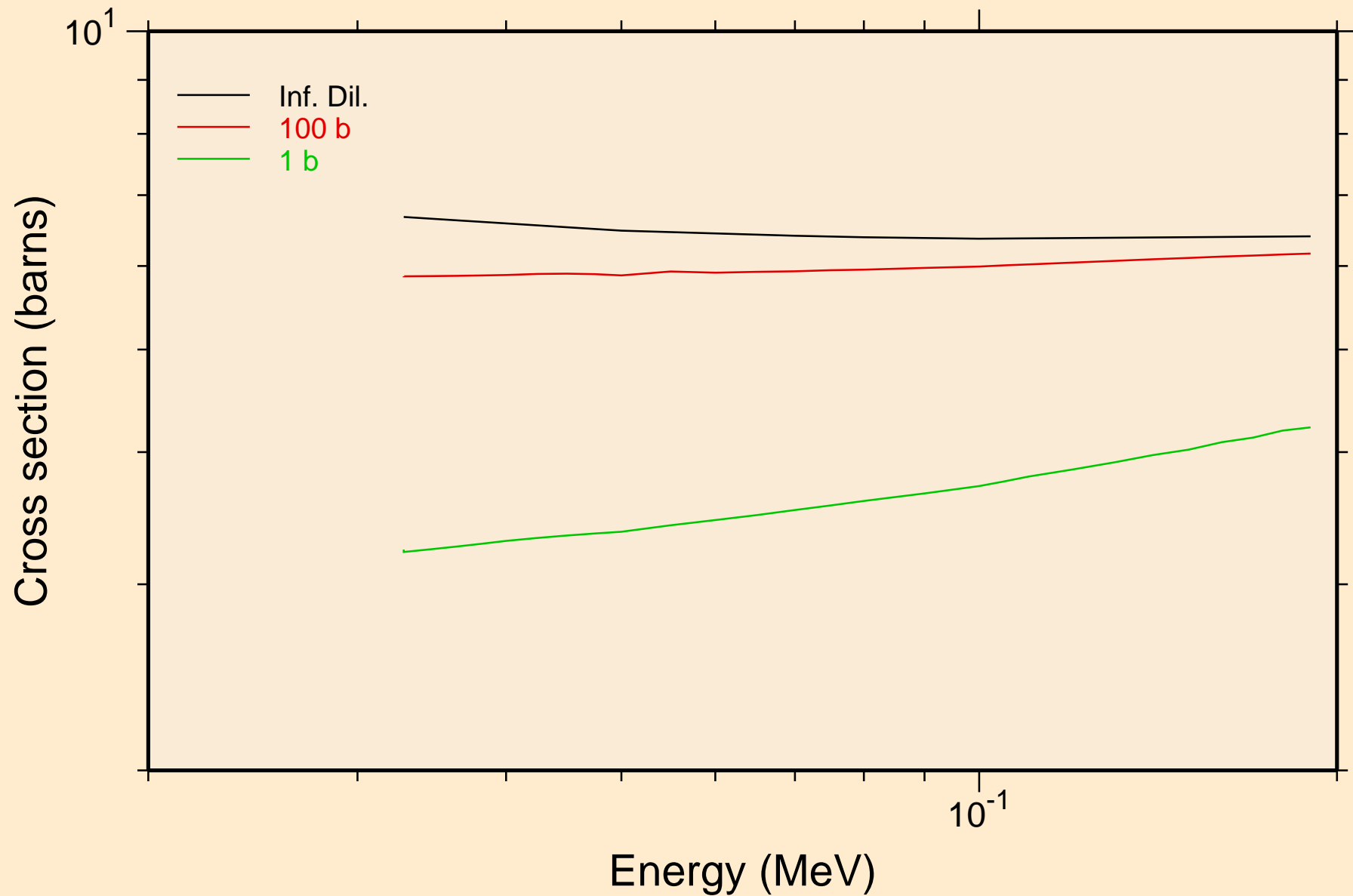

50-SN-116 FOR FENDL-3.2 FROM FENDL-3.2 BY NJOY2016.60+ C
UR elastic cross section

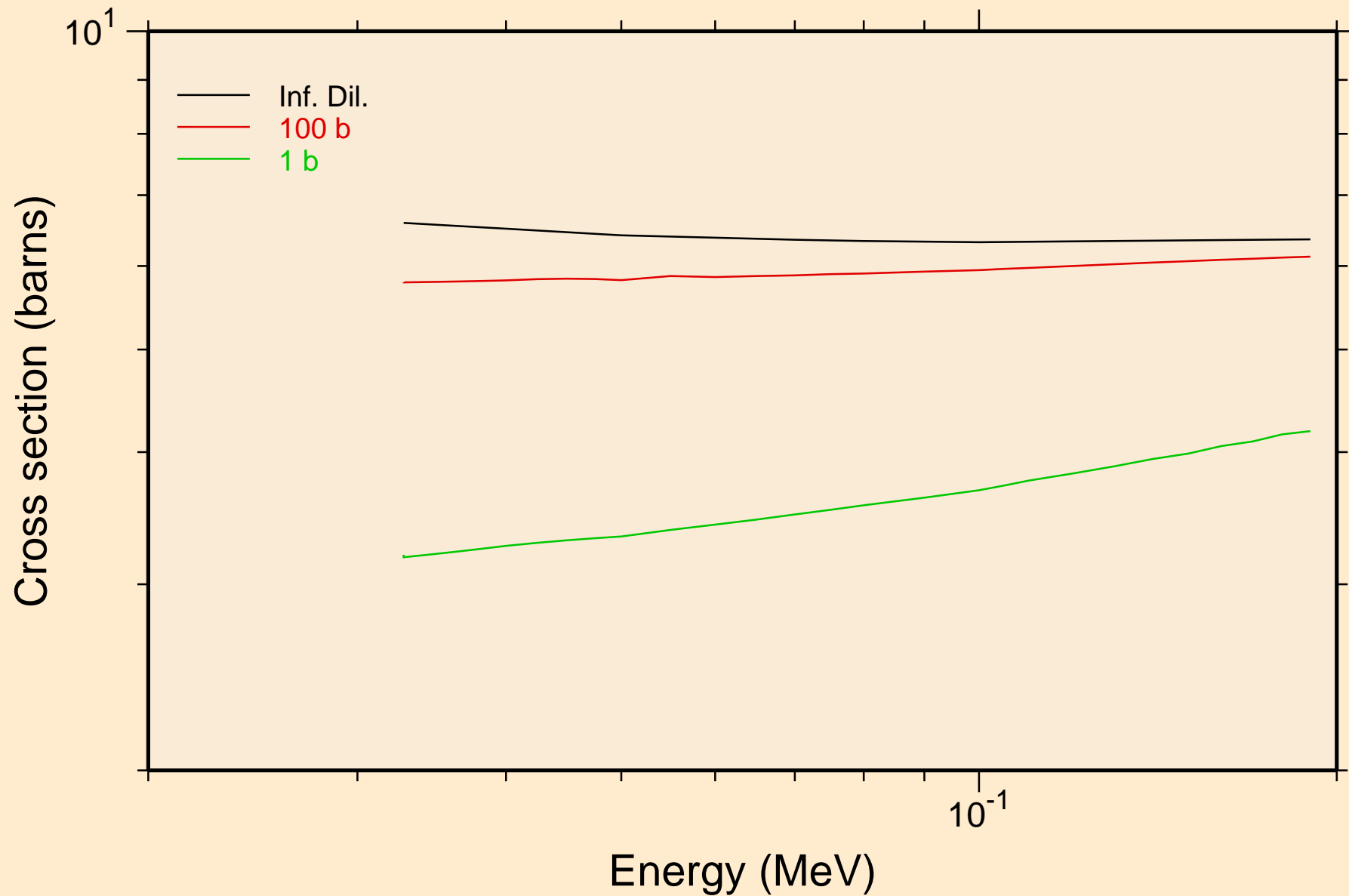

50-SN-116 FOR FENDL-3.2 FROM FENDL-3.2 BY NJOY2016.60+ C
UR capture cross section

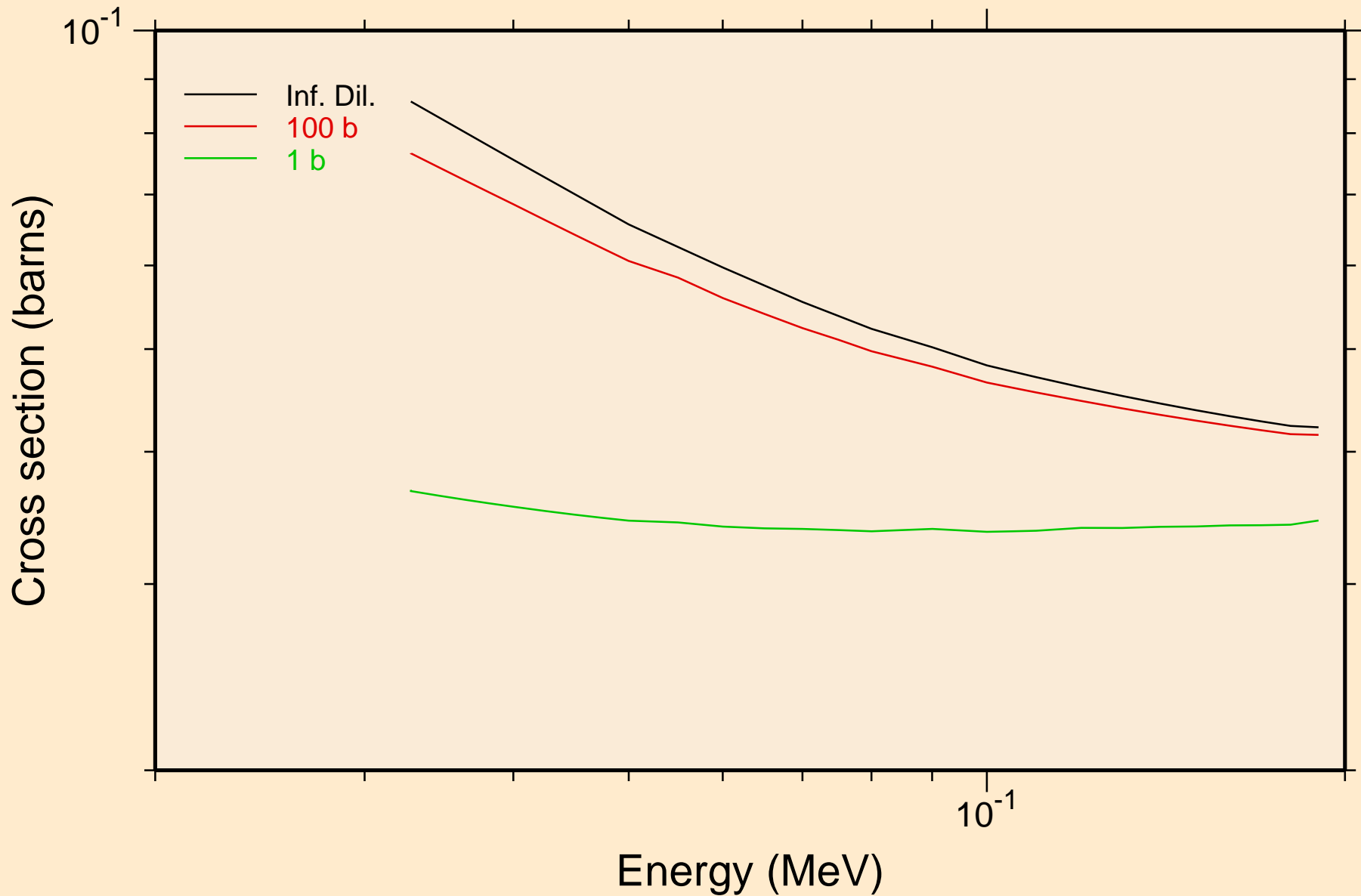

50-SN-116 FOR FENDL-3.2 FROM FENDL-3.2 BY NJOY2016.60+ C
Heating

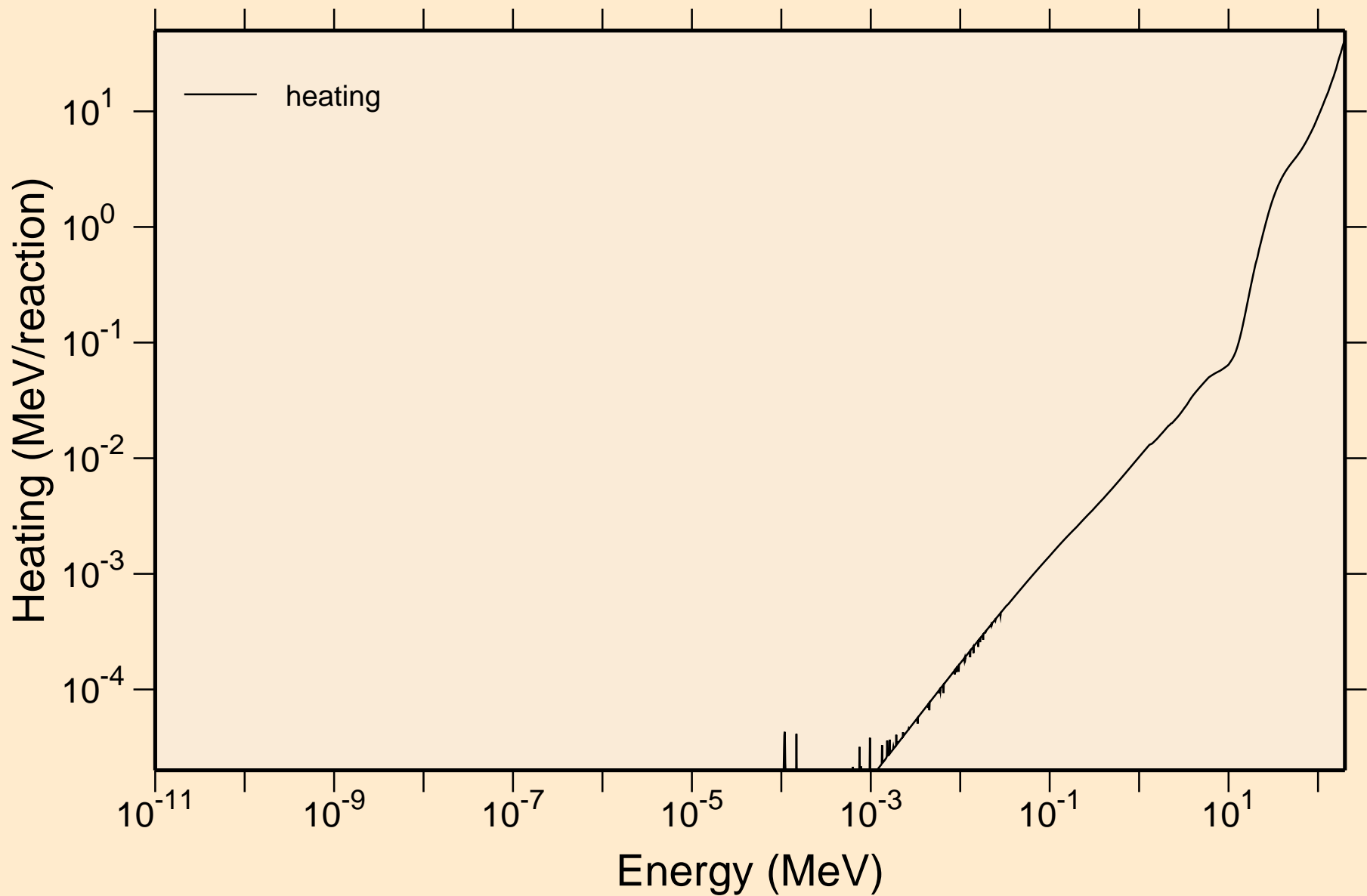

50-SN-116 FOR FENDL-3.2 FROM FENDL-3.2 BY NJOY2016.60+ C Damage

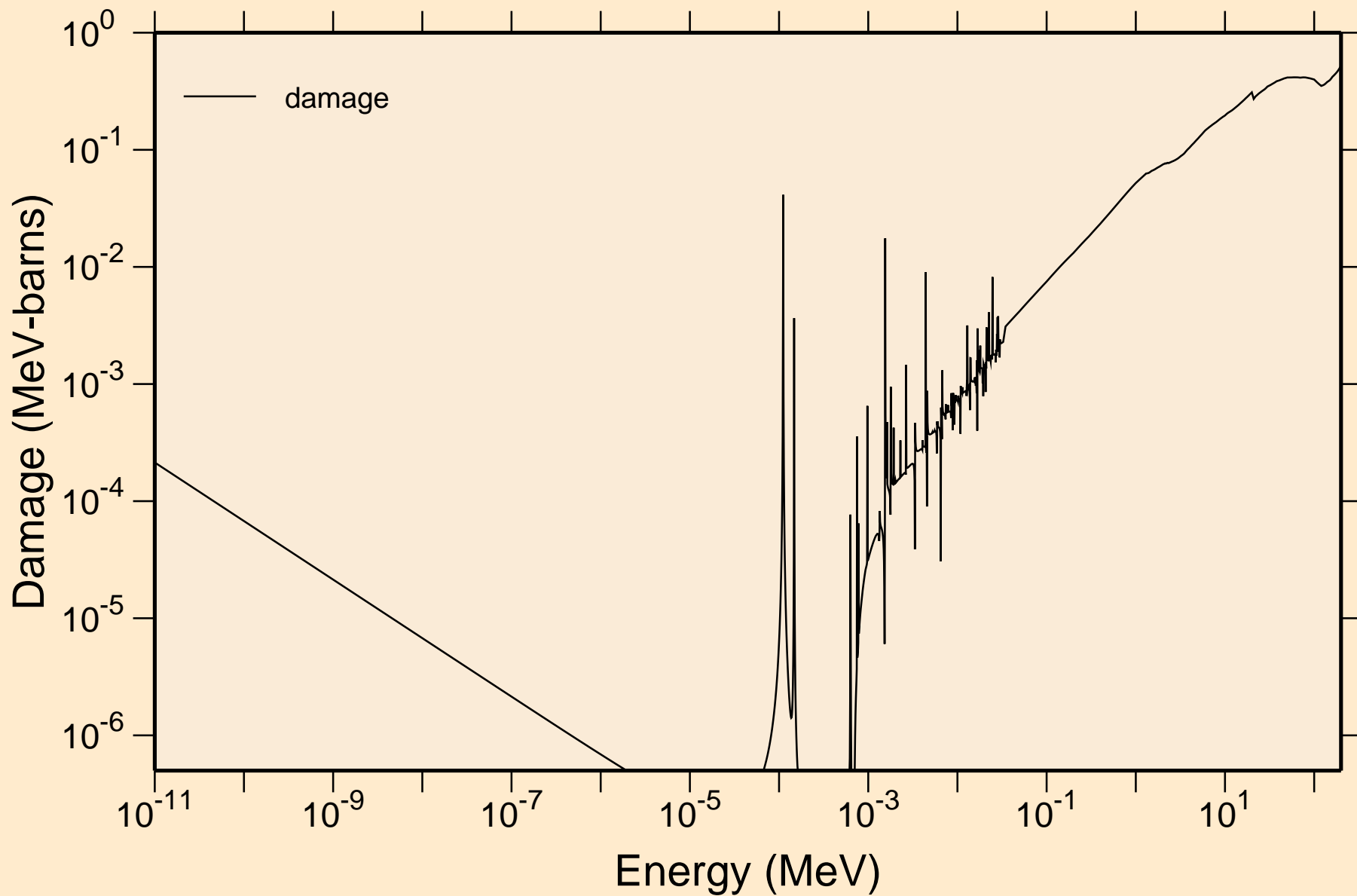

50-SN-116 FOR FENDL-3.2 FROM FENDL-3.2 BY NJOY2016.60+ C
Non-threshold reactions

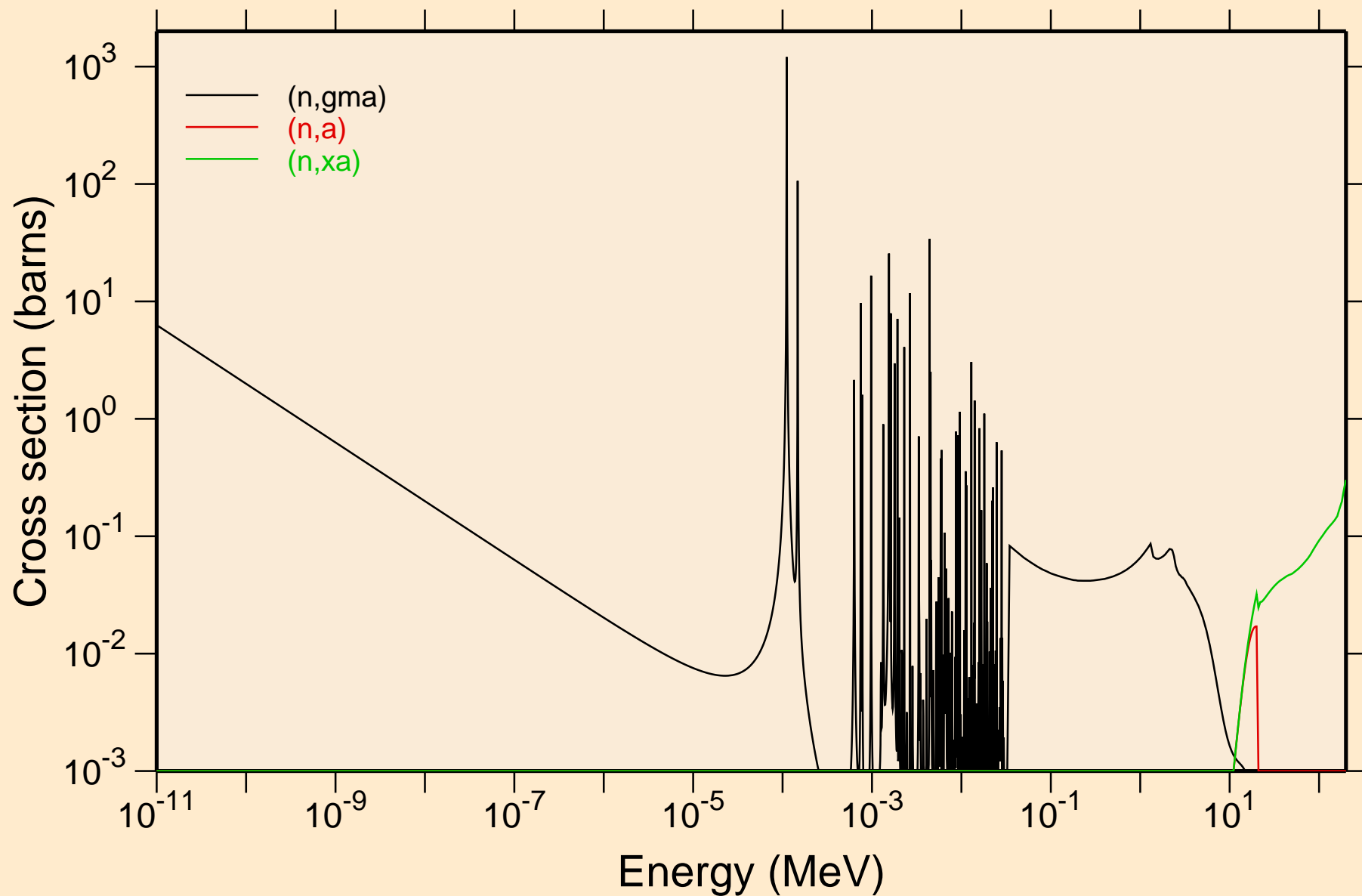

50-SN-116 FOR FENDL-3.2 FROM FENDL-3.2 BY NJOY2016.60+ C
Principal cross sections

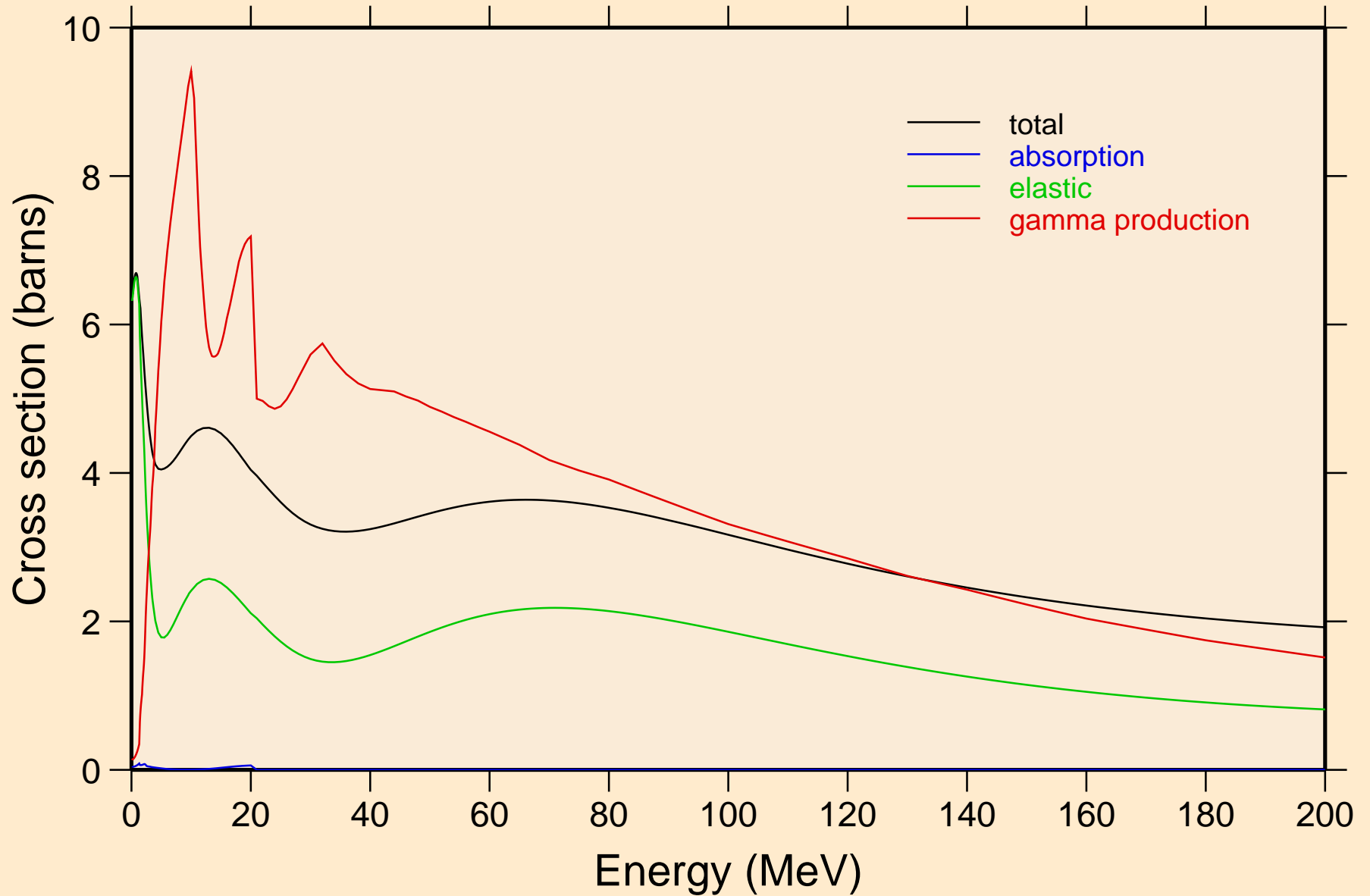

50-SN-116 FOR FENDL-3.2 FROM FENDL-3.2 BY NJOY2016.60+ C
Heating

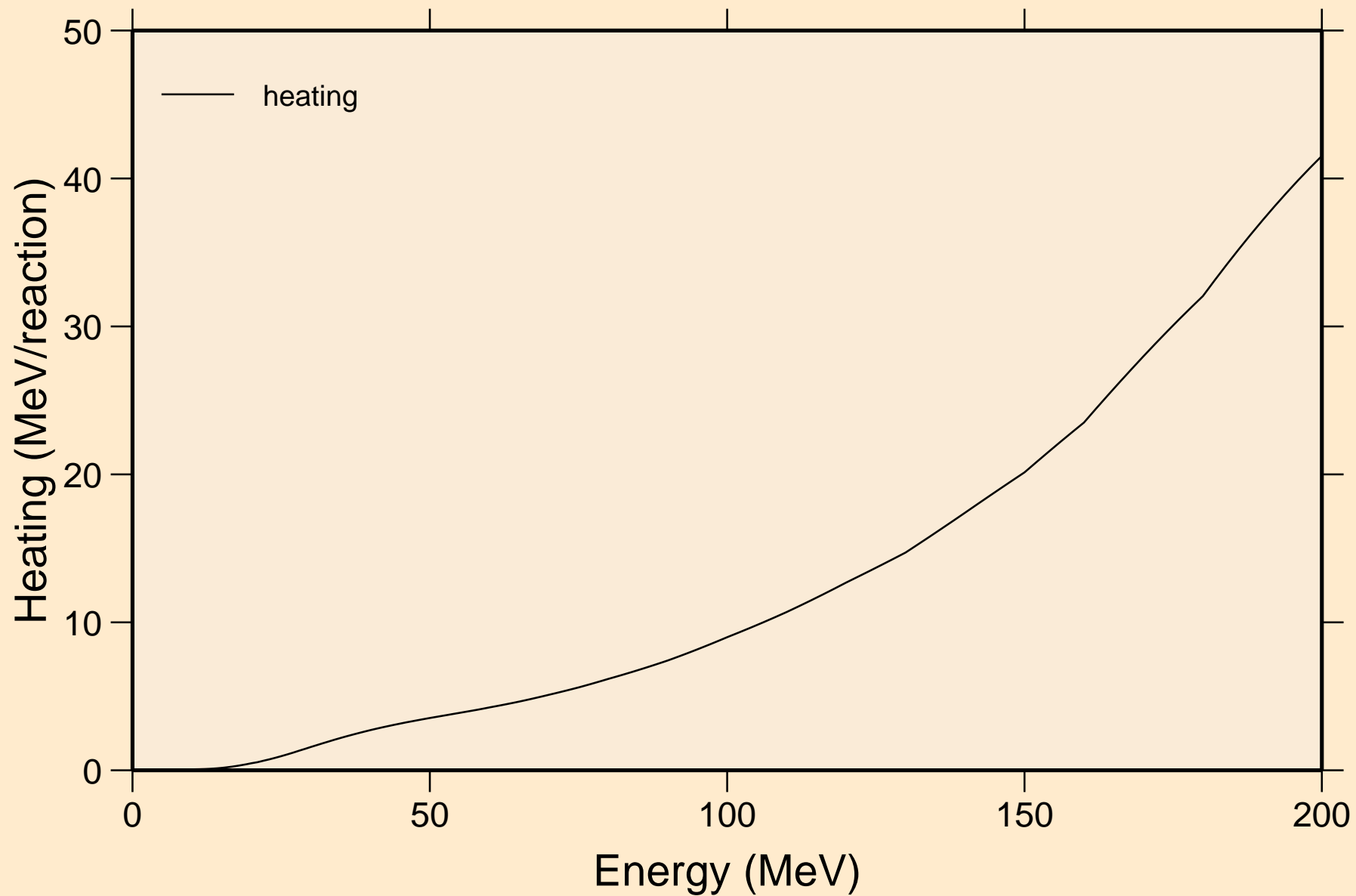

50-SN-116 FOR FENDL-3.2 FROM FENDL-3.2 BY NJOY2016.60+ C
Damage

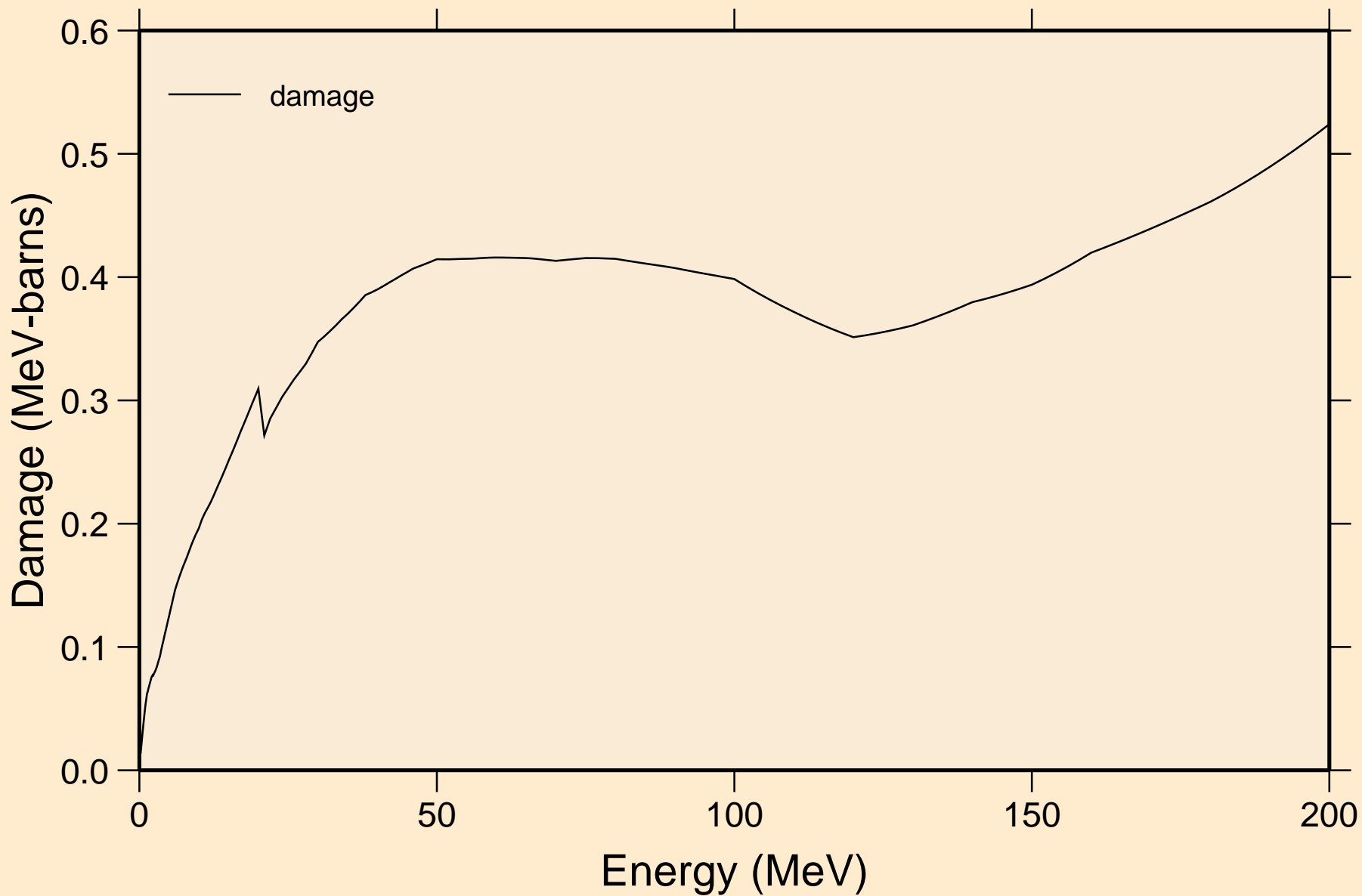

50-SN-116 FOR FENDL-3.2 FROM FENDL-3.2 BY NJOY2016.60+ C
Non-threshold reactions

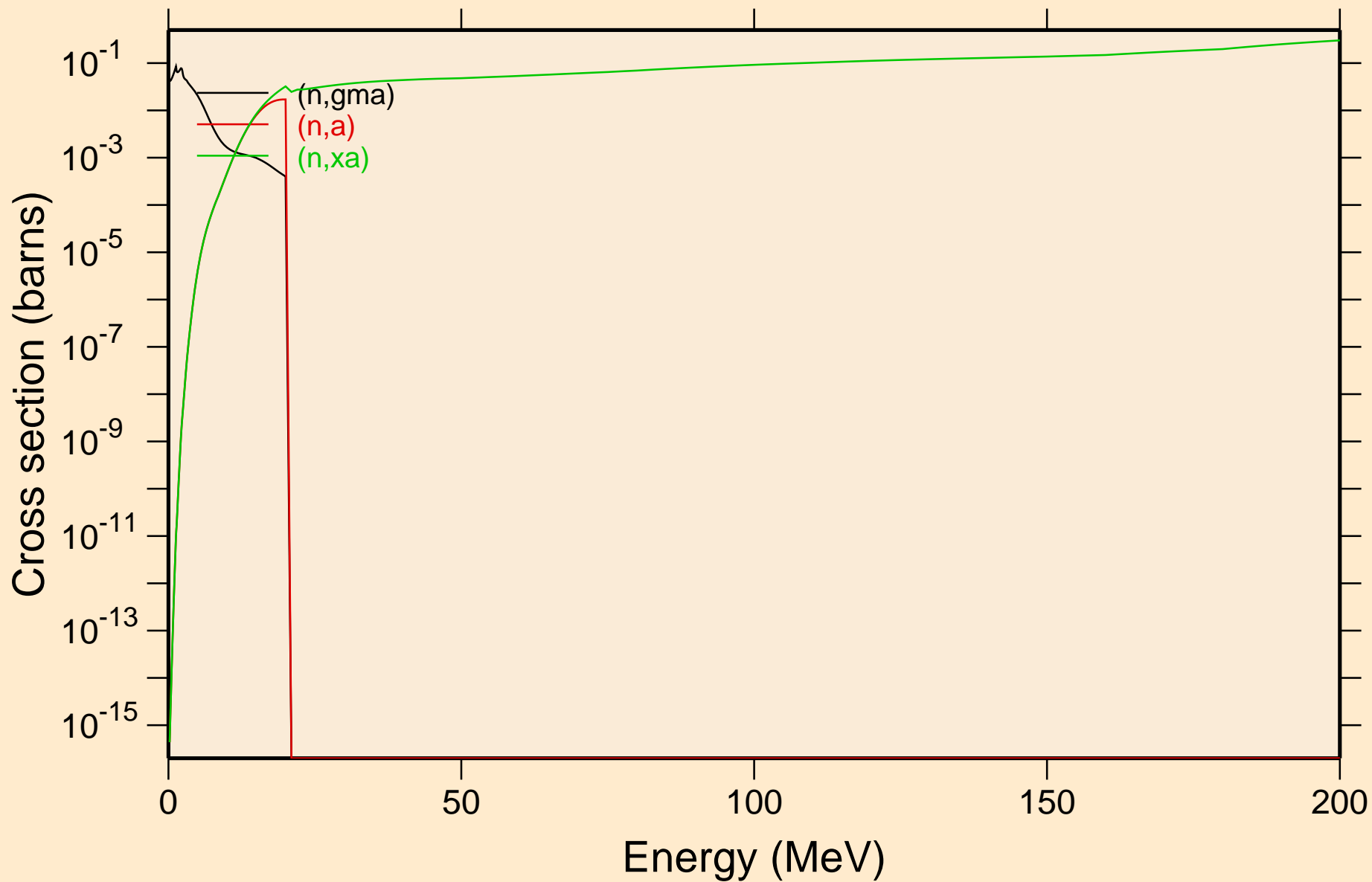

50-SN-116 FOR FENDL-3.2 FROM FENDL-3.2 BY NJOY2016.60+ C
Inelastic levels

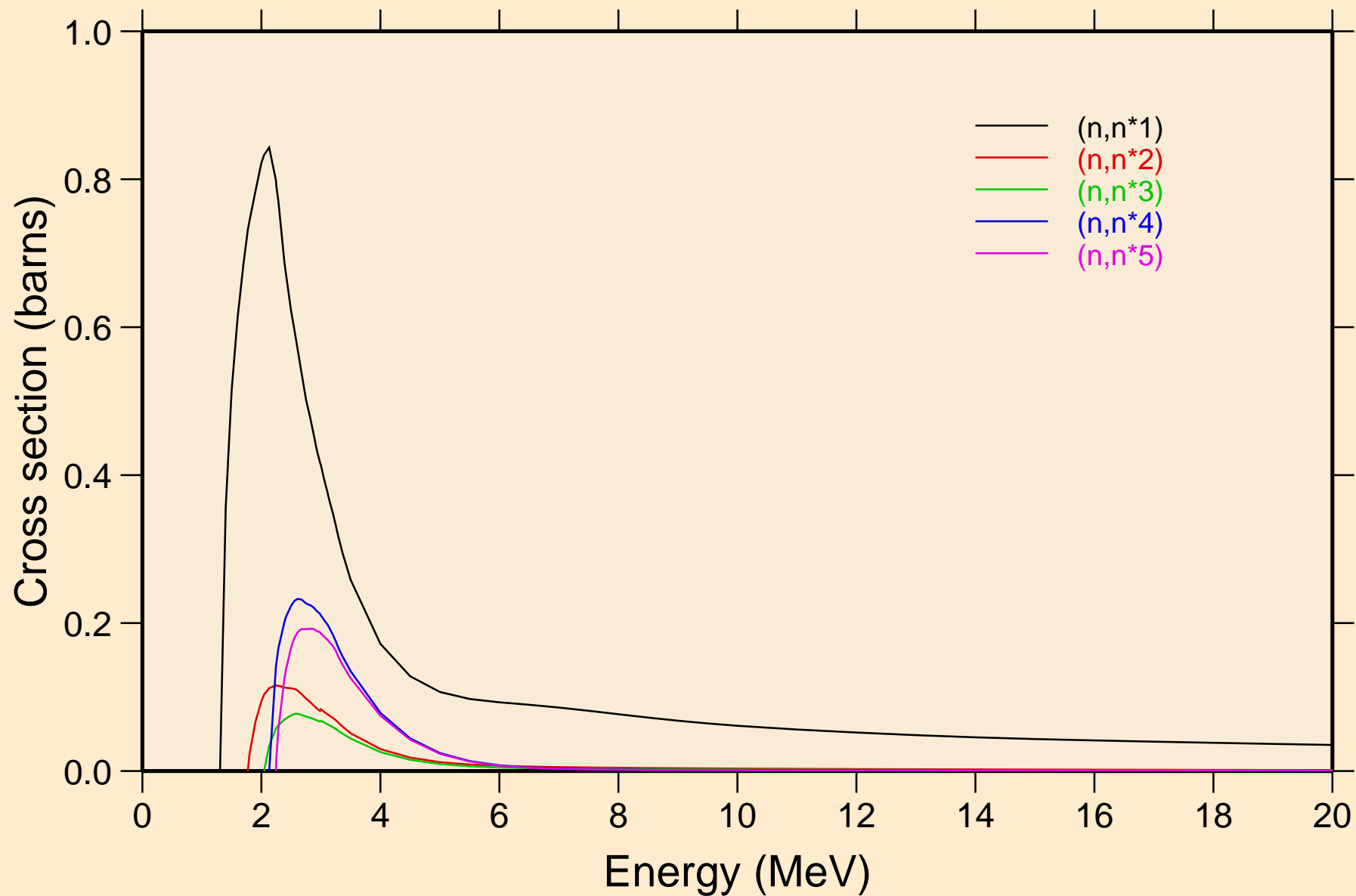

50-SN-116 FOR FENDL-3.2 FROM FENDL-3.2 BY NJOY2016.60+ C
Inelastic levels

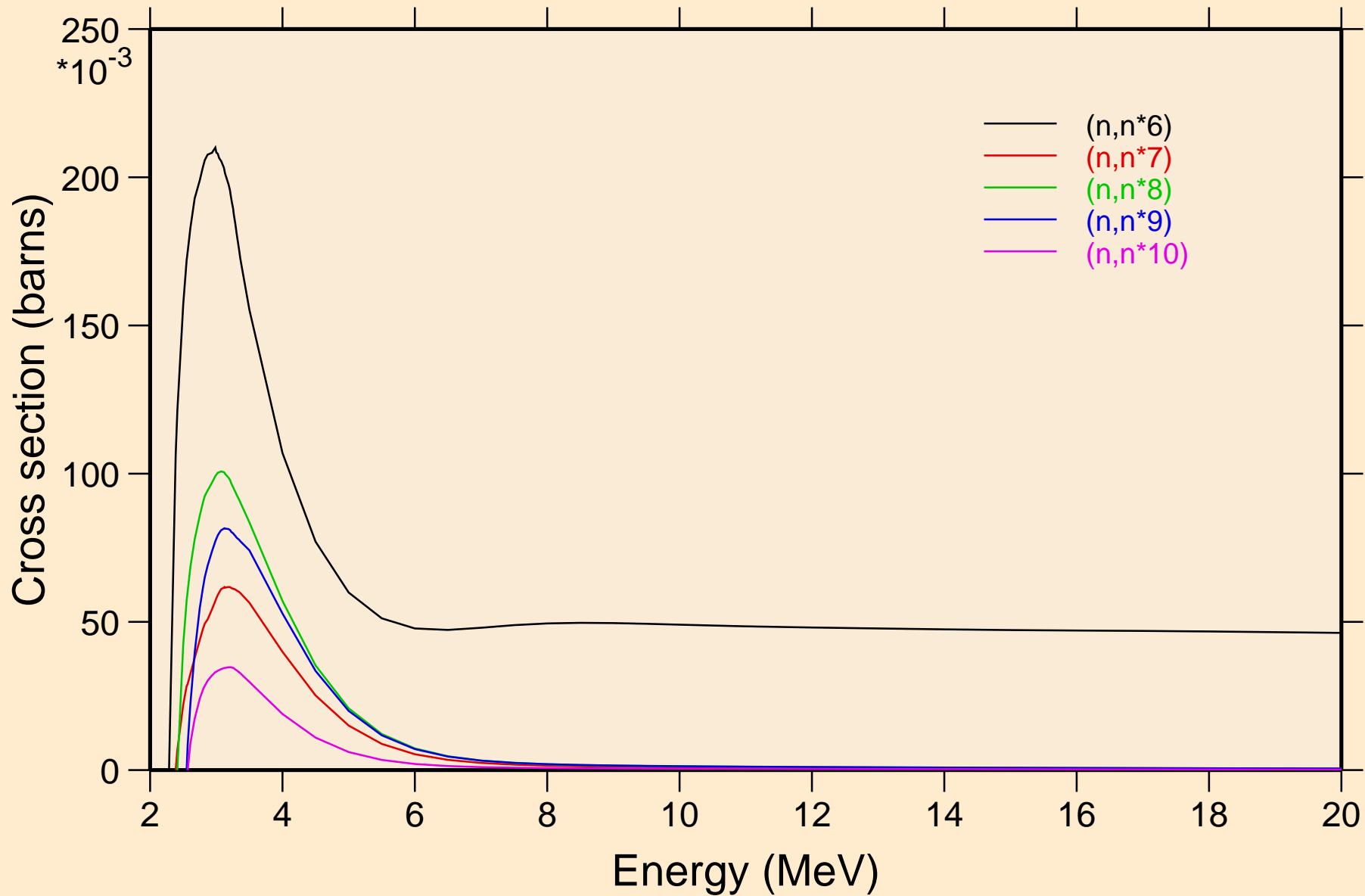

50-SN-116 FOR FENDL-3.2 FROM FENDL-3.2 BY NJOY2016.60+ C
Inelastic levels

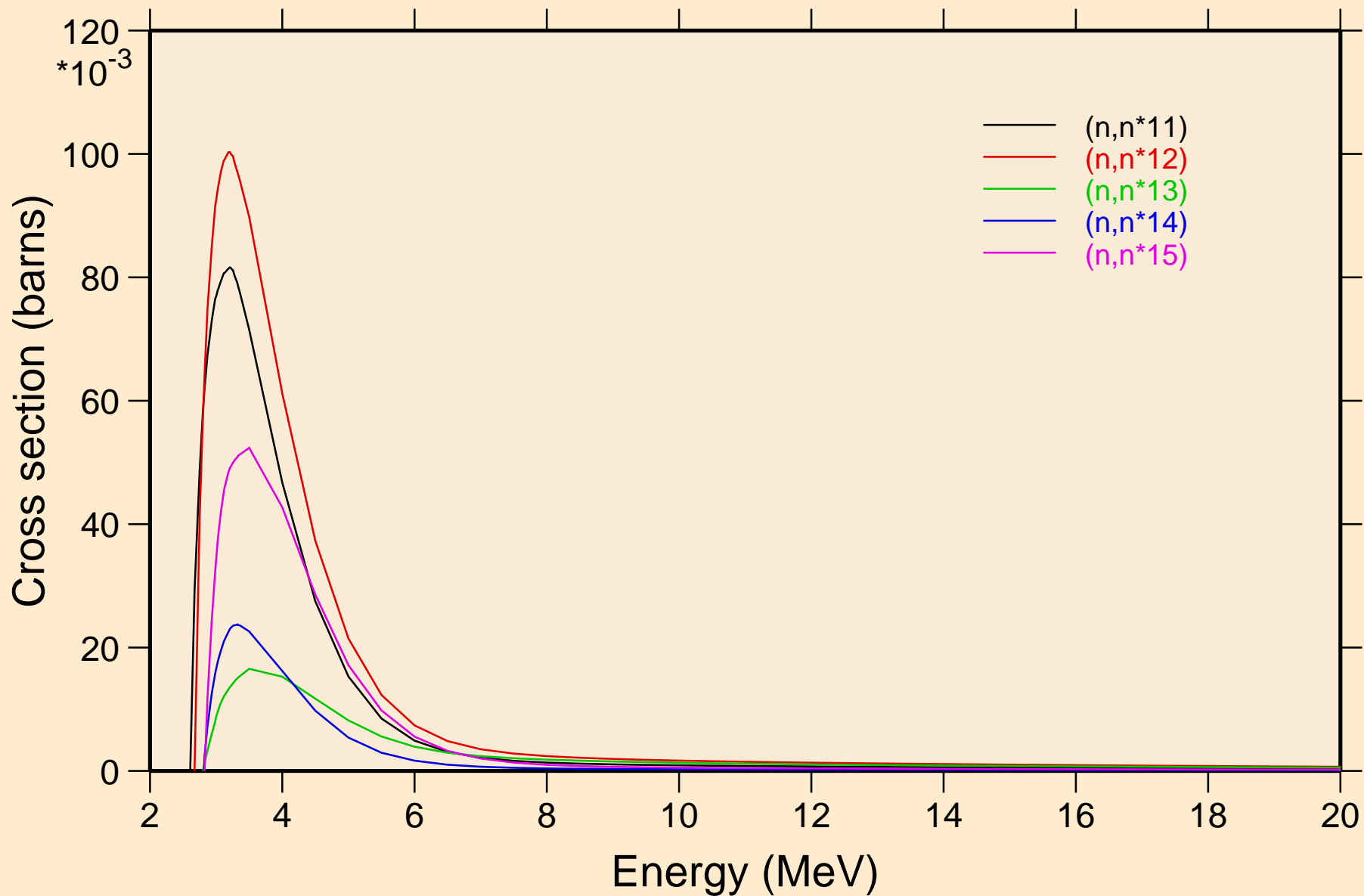

50-SN-116 FOR FENDL-3.2 FROM FENDL-3.2 BY NJOY2016.60+ C
Inelastic levels

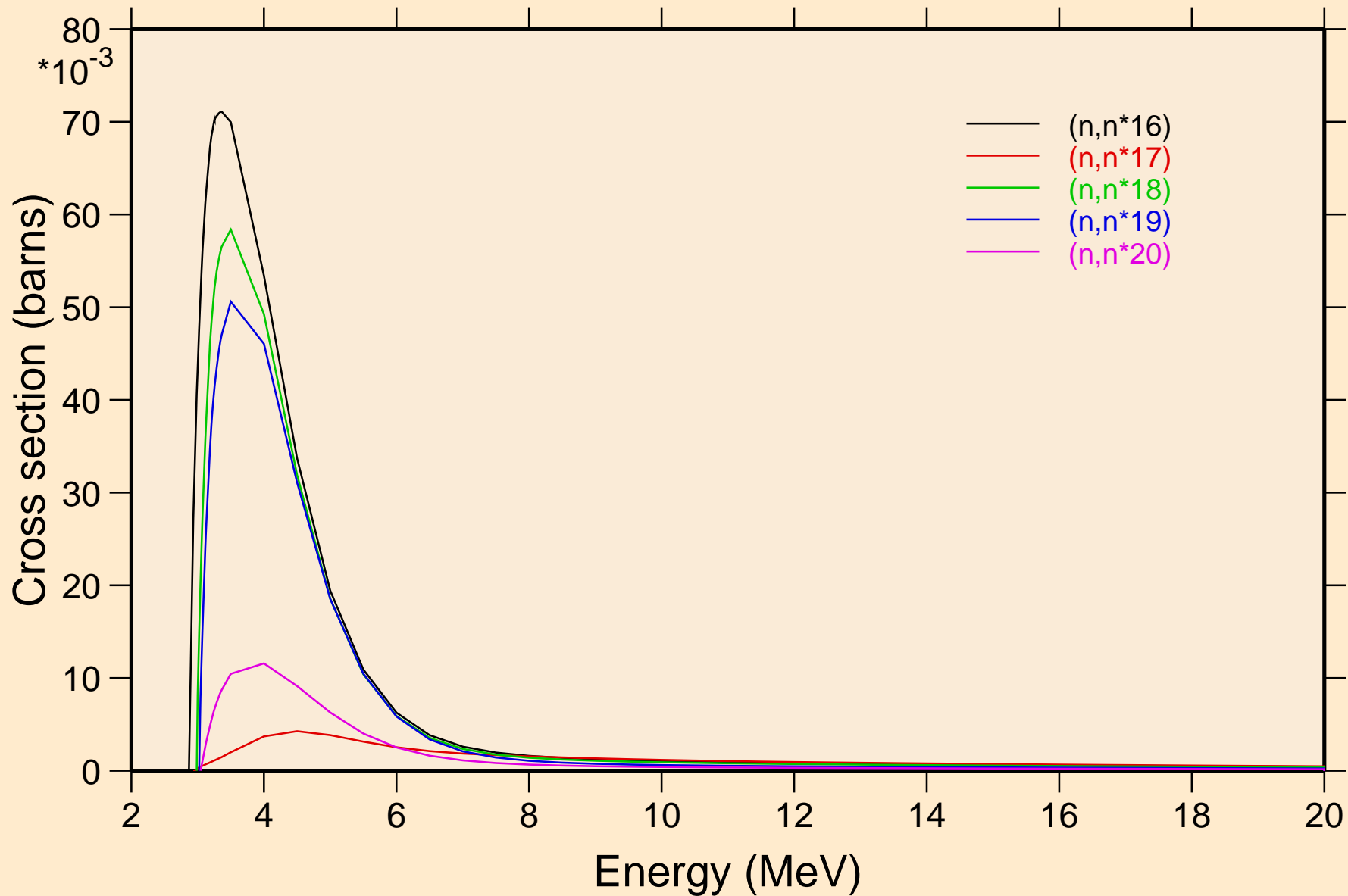

50-SN-116 FOR FENDL-3.2 FROM FENDL-3.2 BY NJOY2016.60+ C Inelastic levels

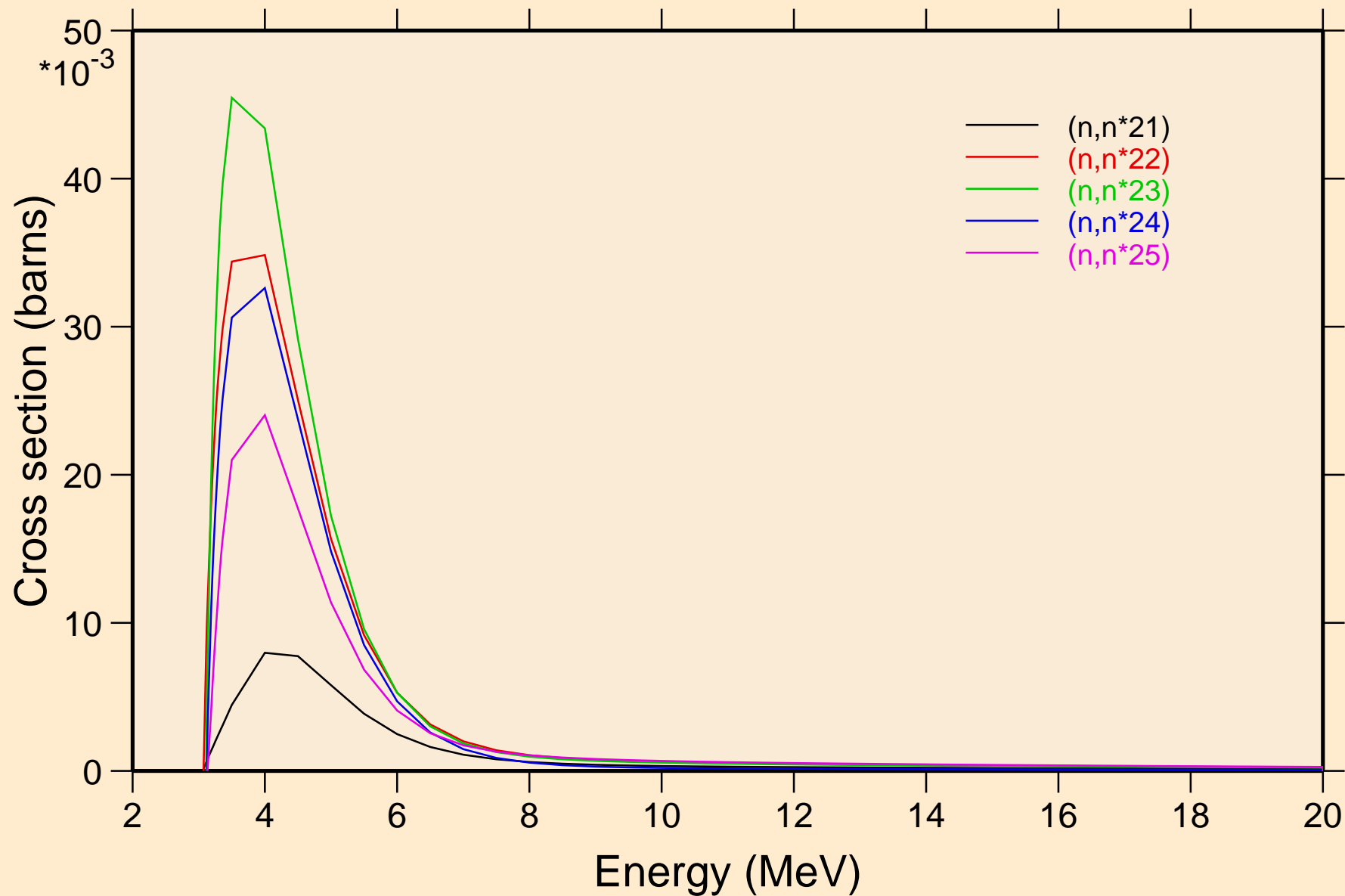

50-SN-116 FOR FENDL-3.2 FROM FENDL-3.2 BY NJOY2016.60+ C Inelastic levels

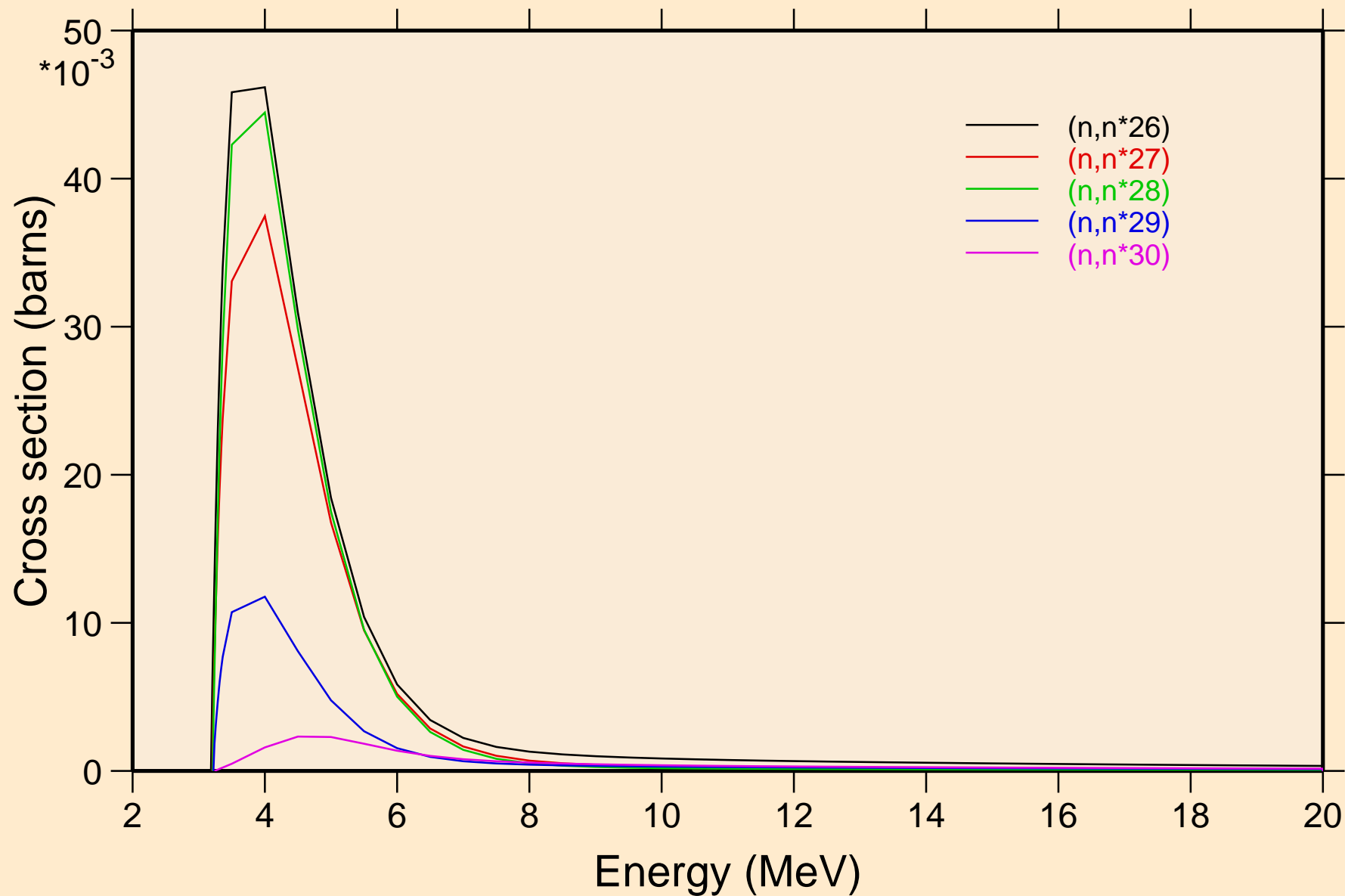

50-SN-116 FOR FENDL-3.2 FROM FENDL-3.2 BY NJOY2016.60+ C Inelastic levels

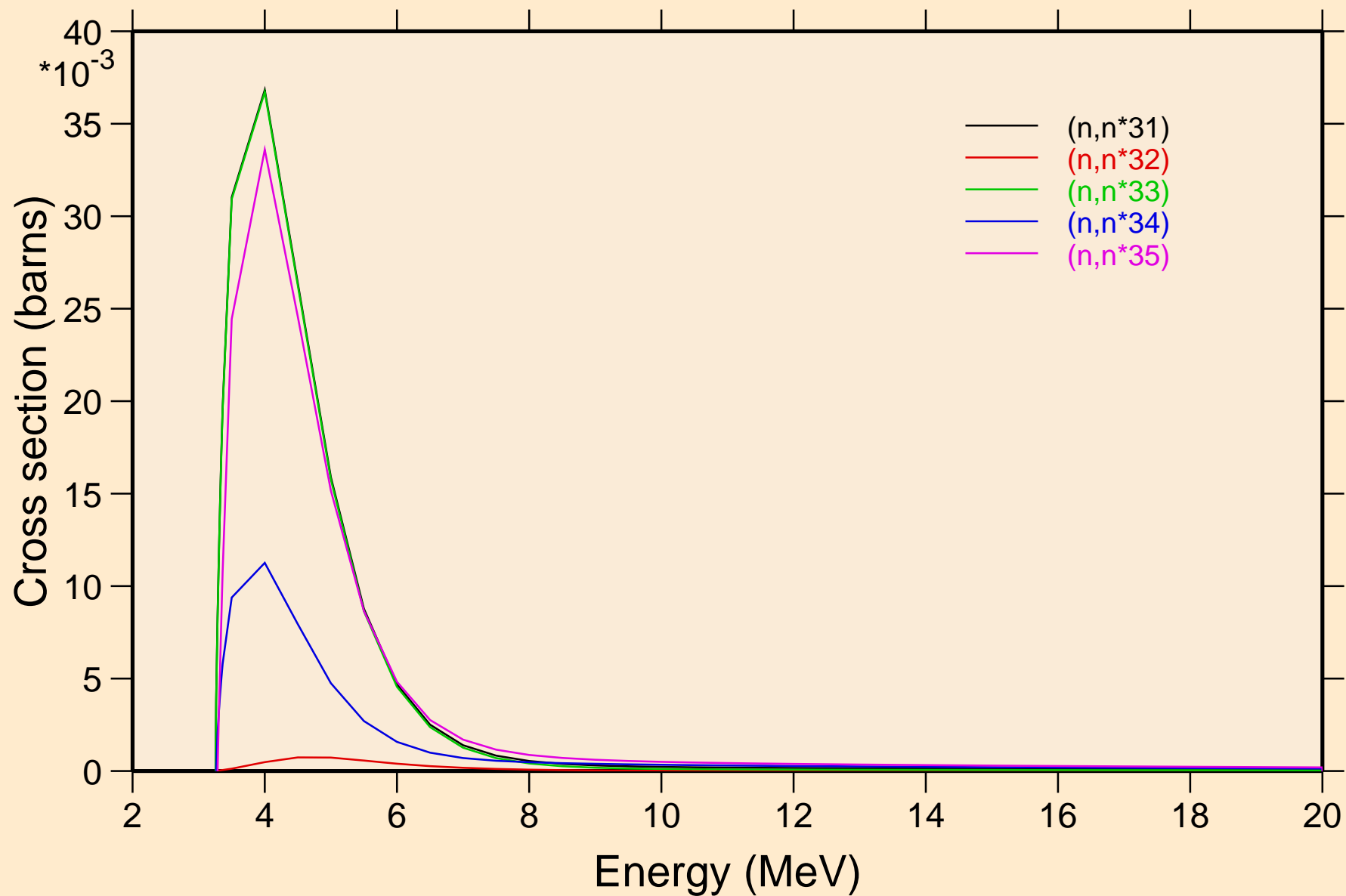

50-SN-116 FOR FENDL-3.2 FROM FENDL-3.2 BY NJOY2016.60+ C Inelastic levels

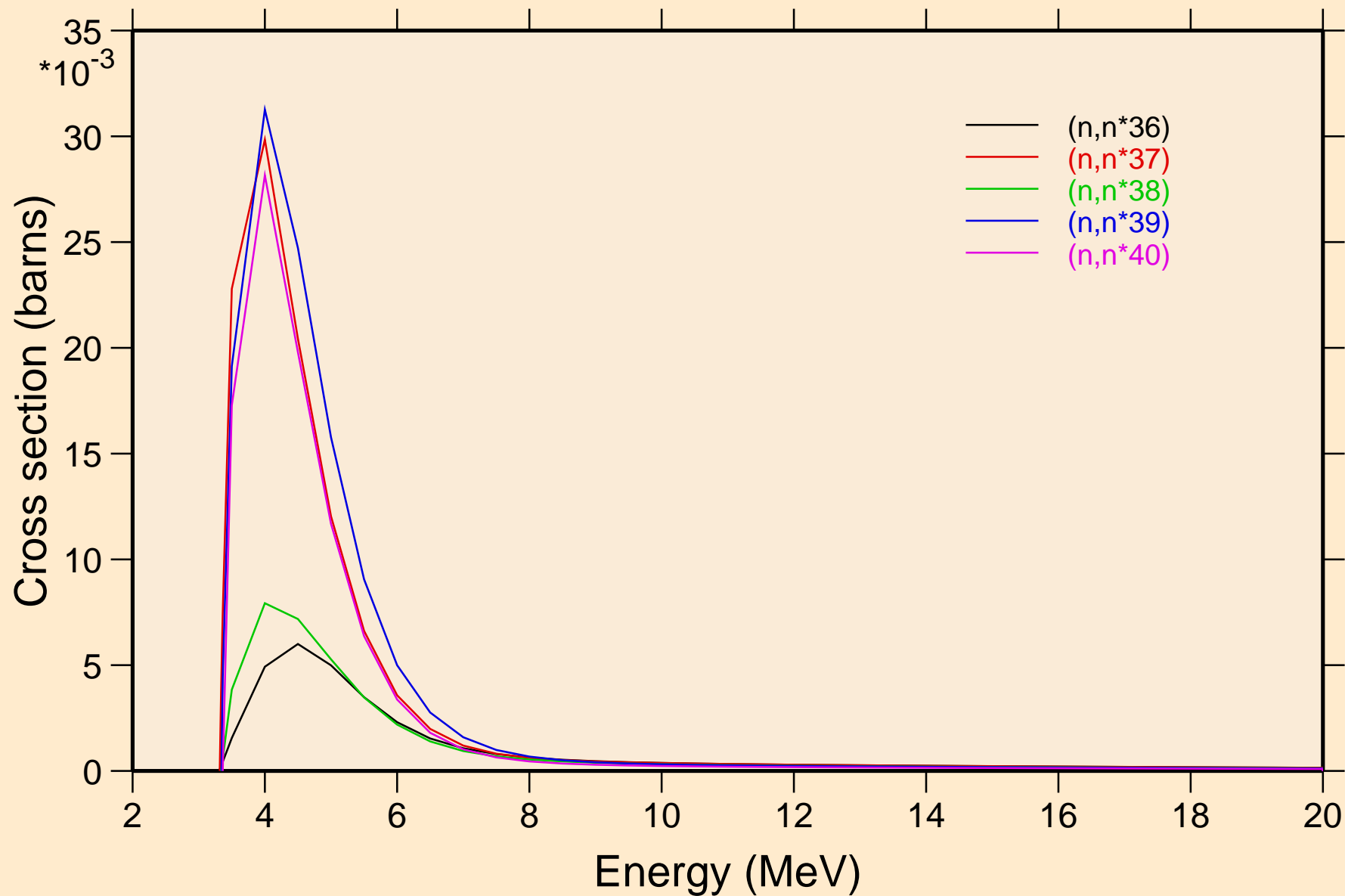

50-SN-116 FOR FENDL-3.2 FROM FENDL-3.2 BY NJOY2016.60+ C
Threshold reactions

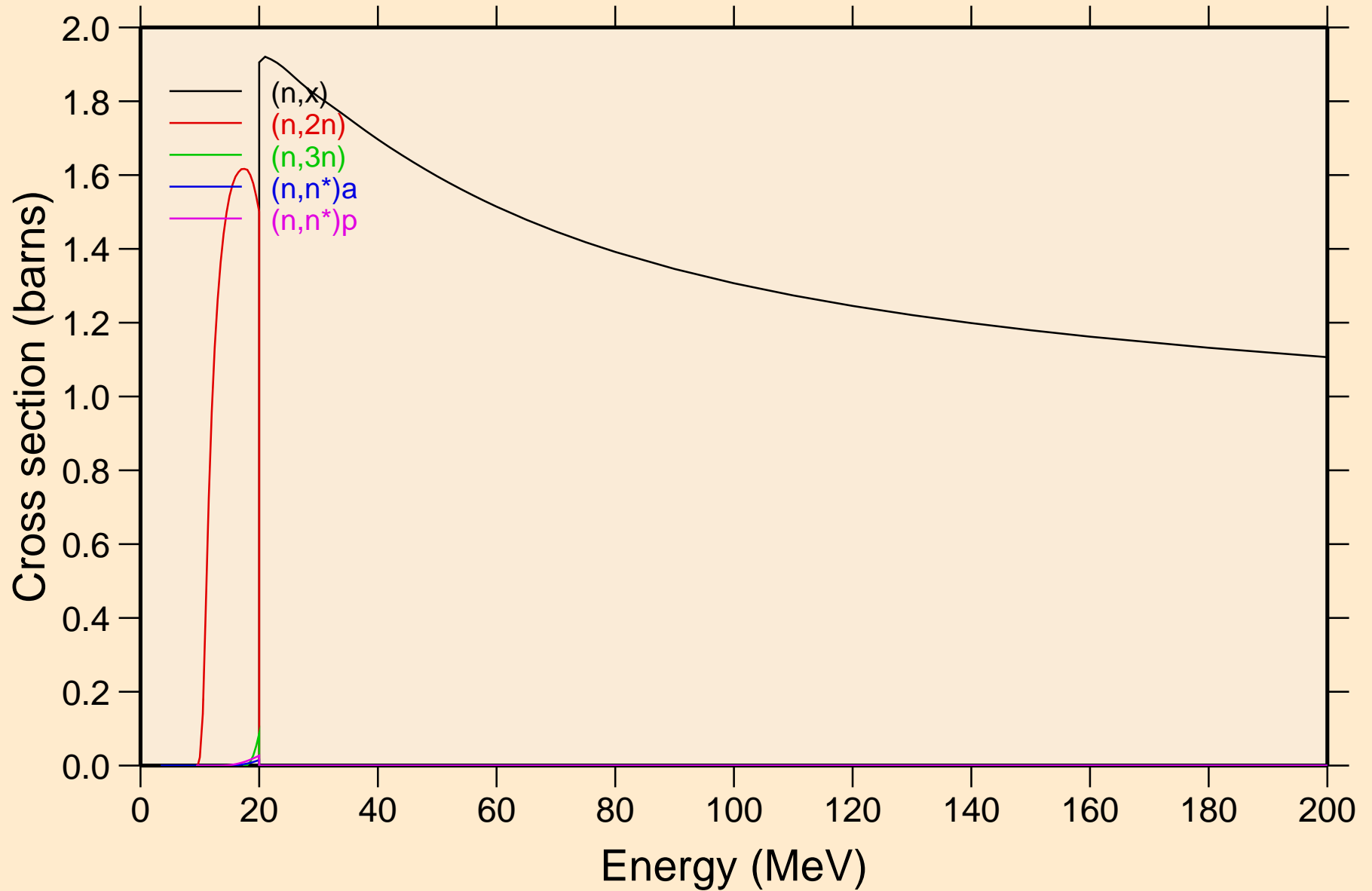

50-SN-116 FOR FENDL-3.2 FROM FENDL-3.2 BY NJOY2016.60+ C
Threshold reactions

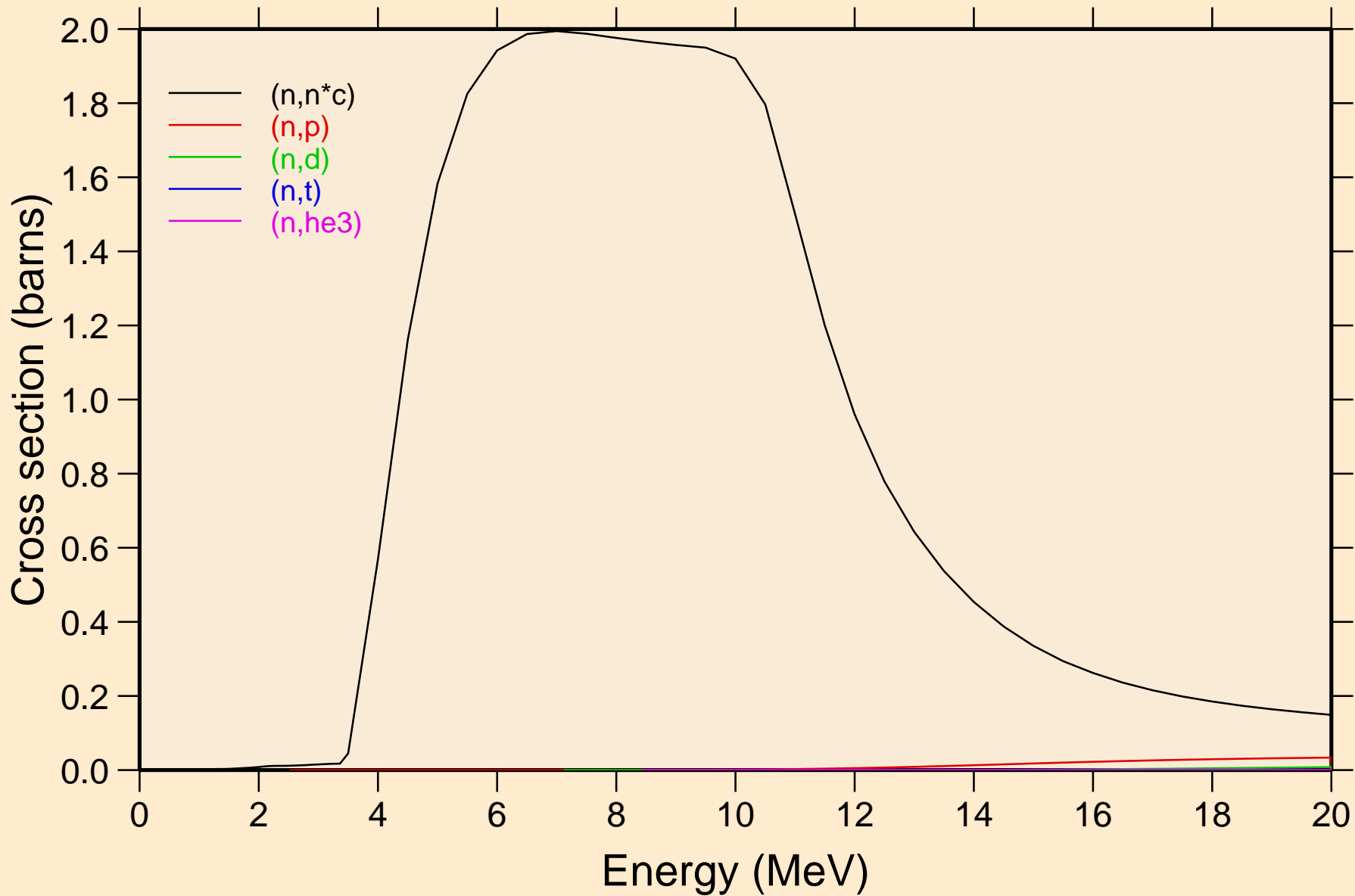

50-SN-116 FOR FENDL-3.2 FROM FENDL-3.2 BY NJOY2016.60+ C

Threshold reactions

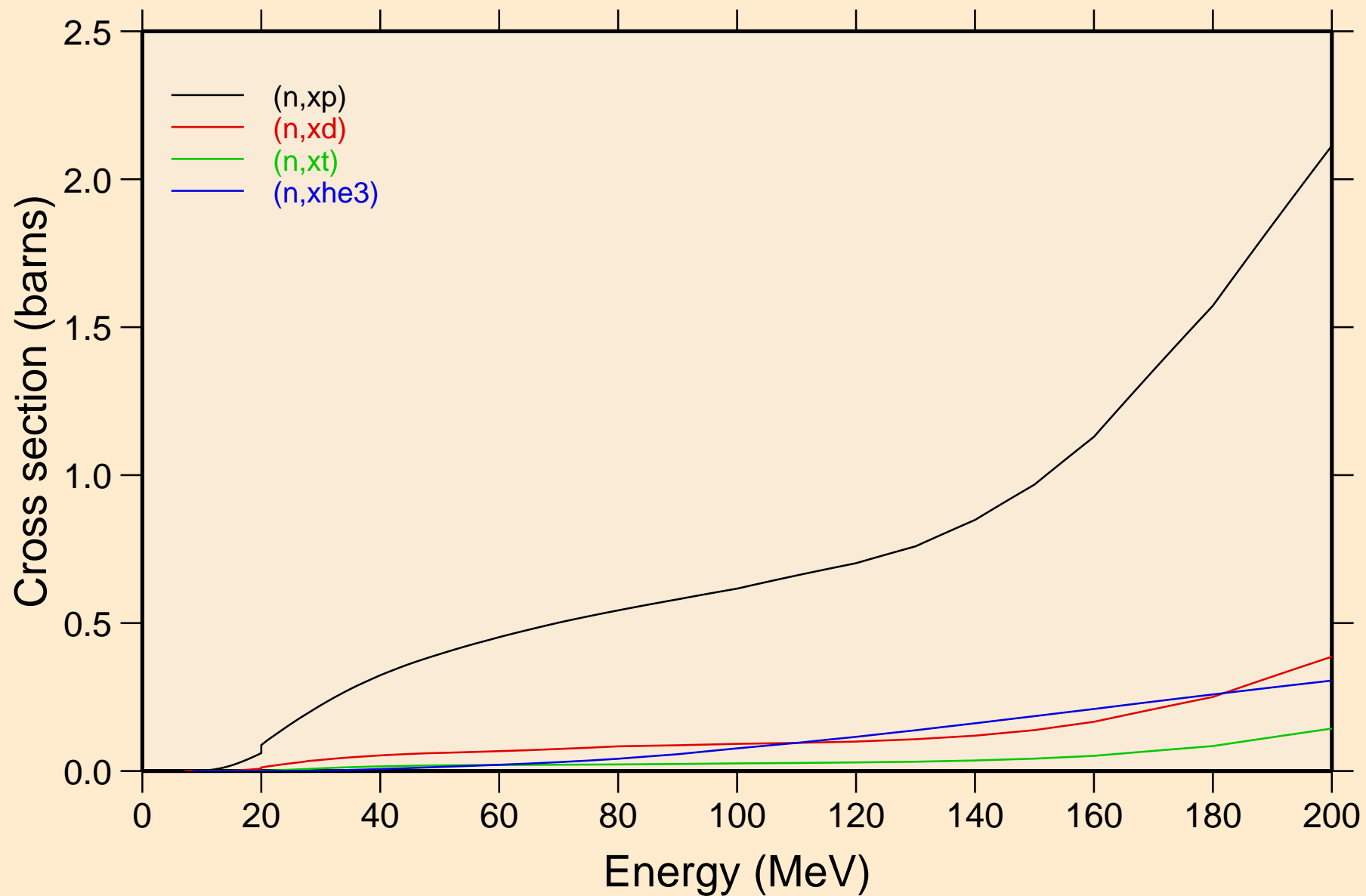

50-SN-116 FOR FENDL-3.2 FROM FENDL-3.2 BY NJOY2016.60+ C
angular distribution for elastic

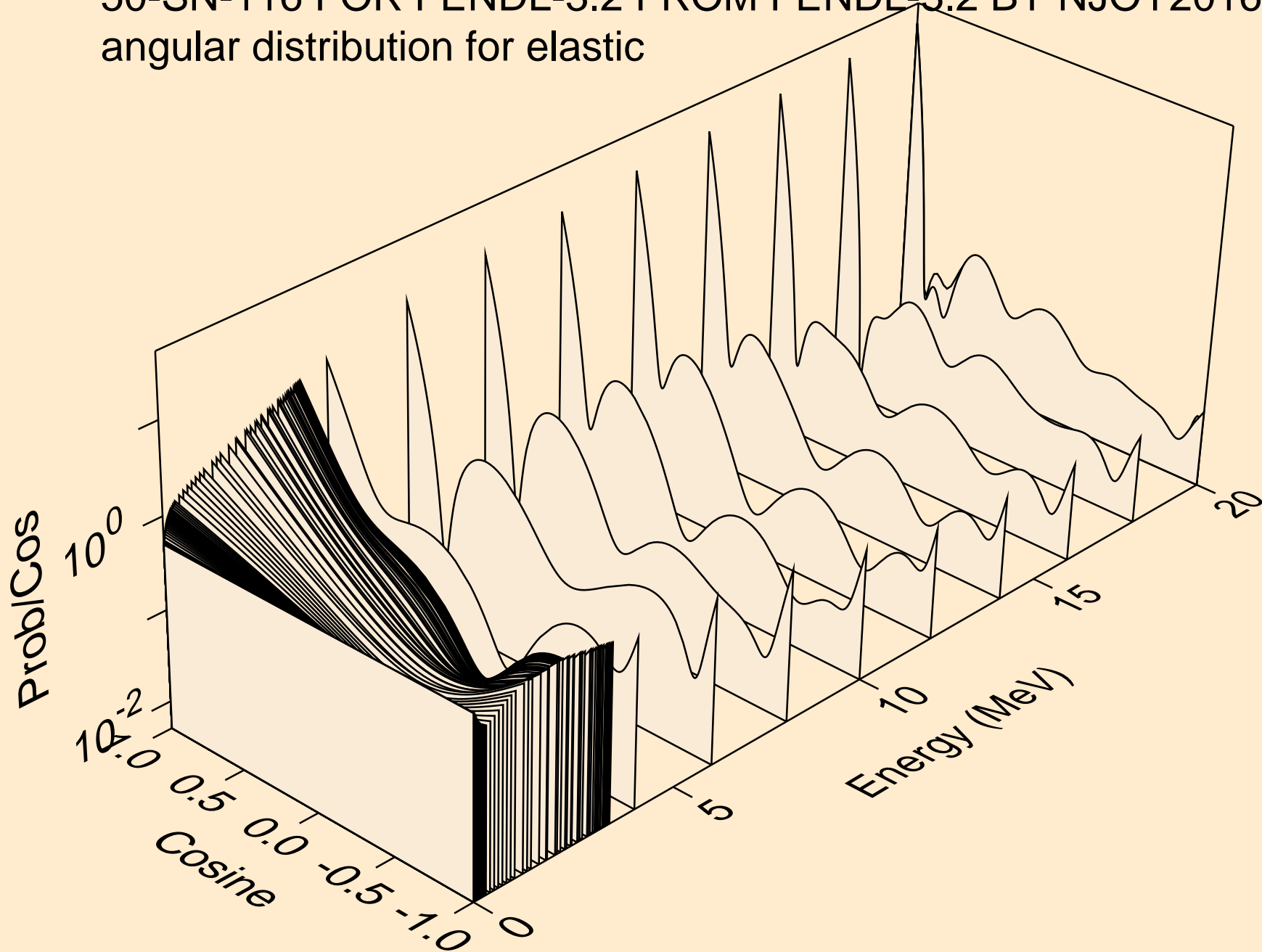

50-SN-116 FOR FENDL-3.2 FROM FENDL-3.2 BY NJOY2016.60+ C
angular distribution for elastic

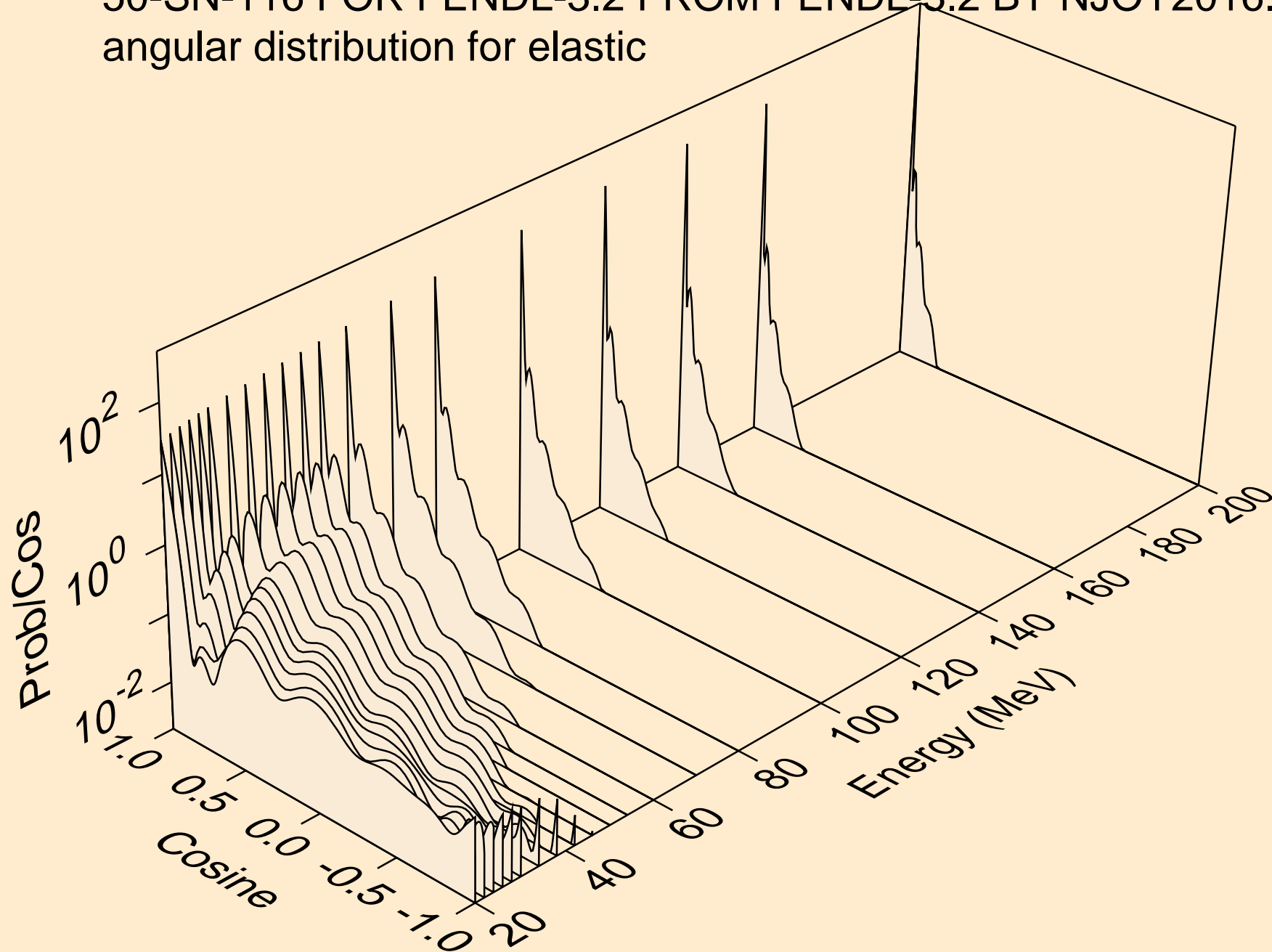

50-SN-116 FOR FENDL-3.2 FROM FENDL-3.2 BY NJOY2016.60+ C
angular distribution for (n,n*1)

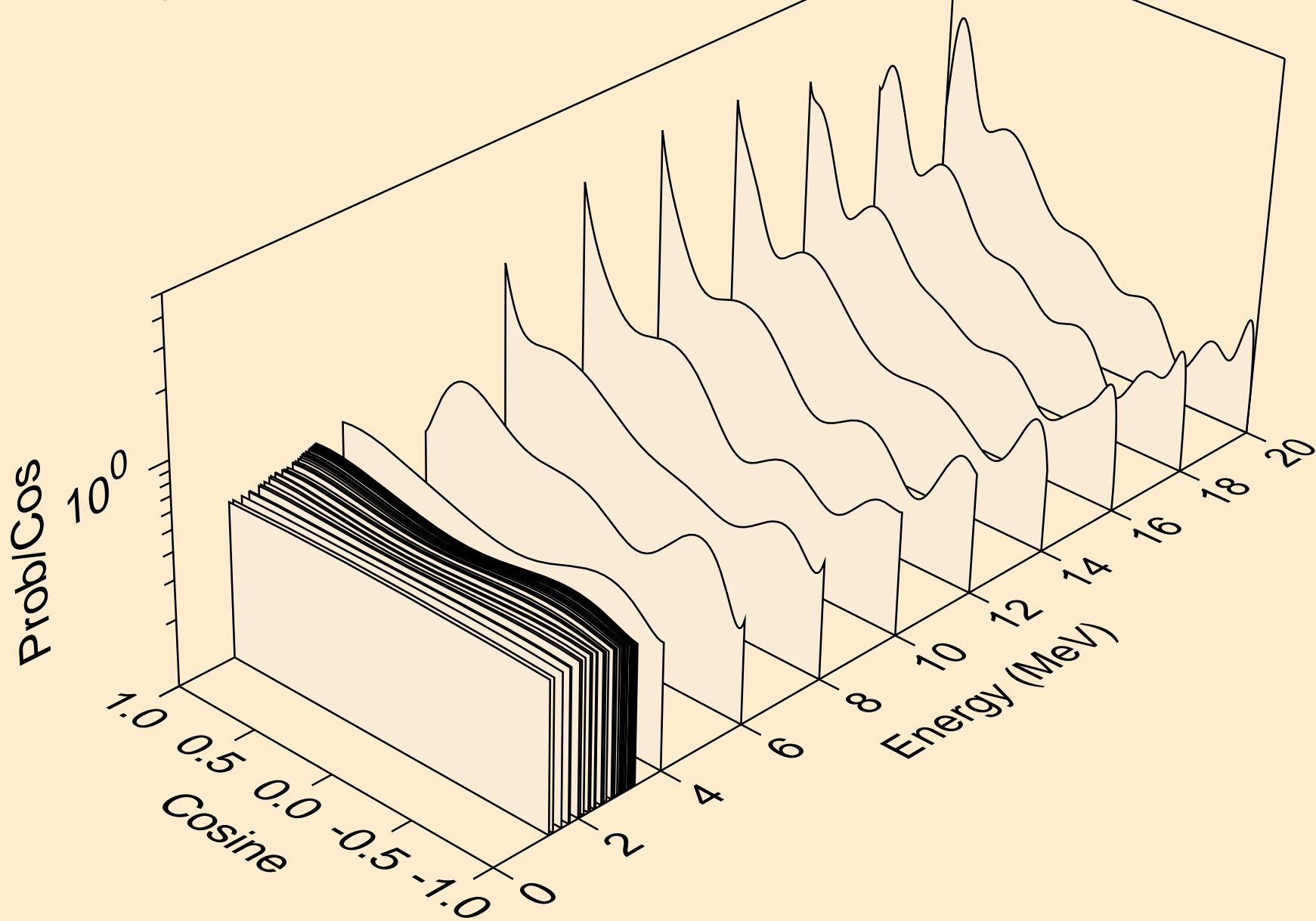

50-SN-116 FOR FENDL-3.2 FROM FENDL-3.2 BY NJOY2016.60+ C
angular distribution for (n,n*2)

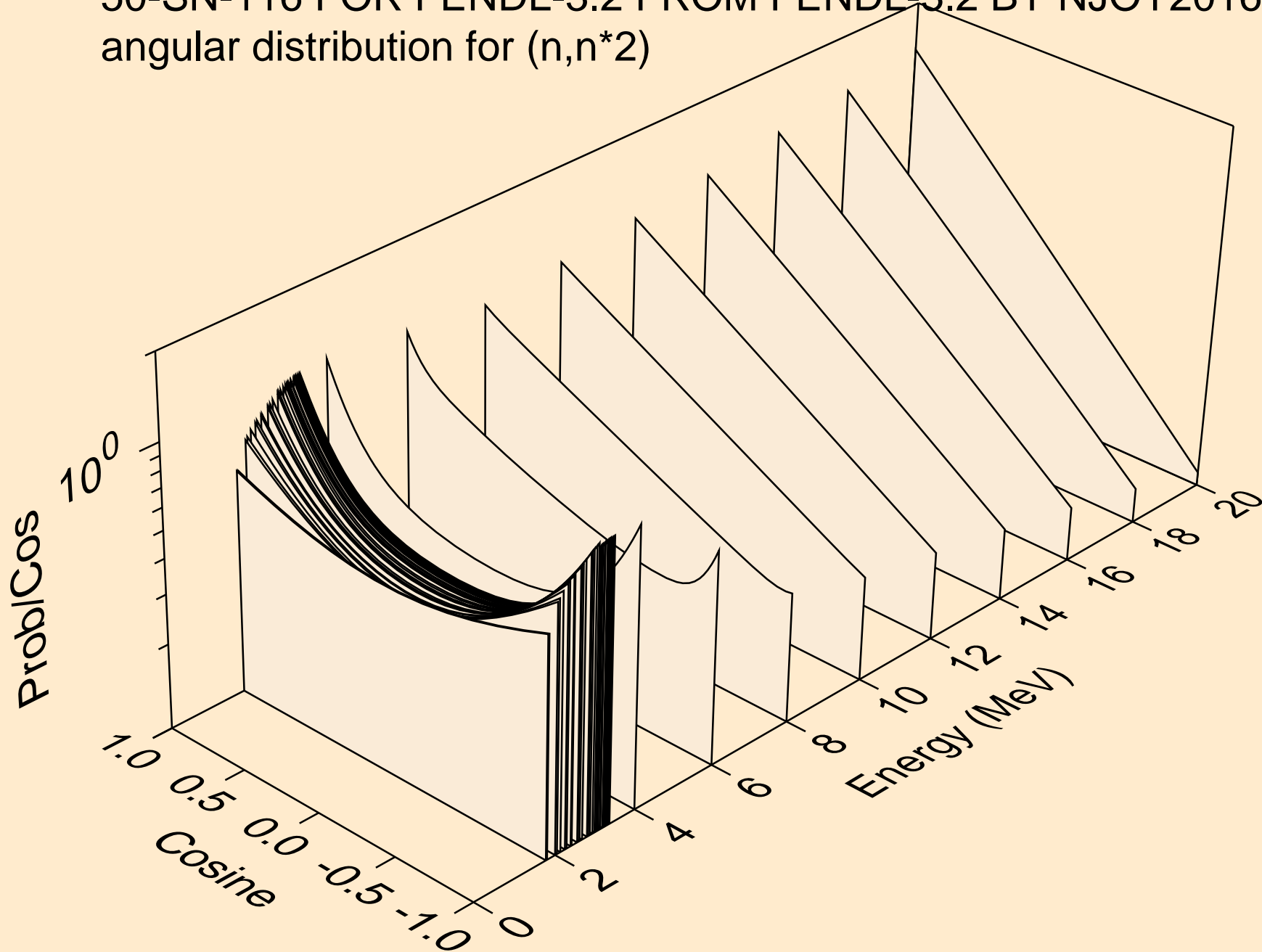

50-SN-116 FOR FENDL-3.2 FROM FENDL-3.2 BY NJOY2016.60+ C
angular distribution for (n,n*3)

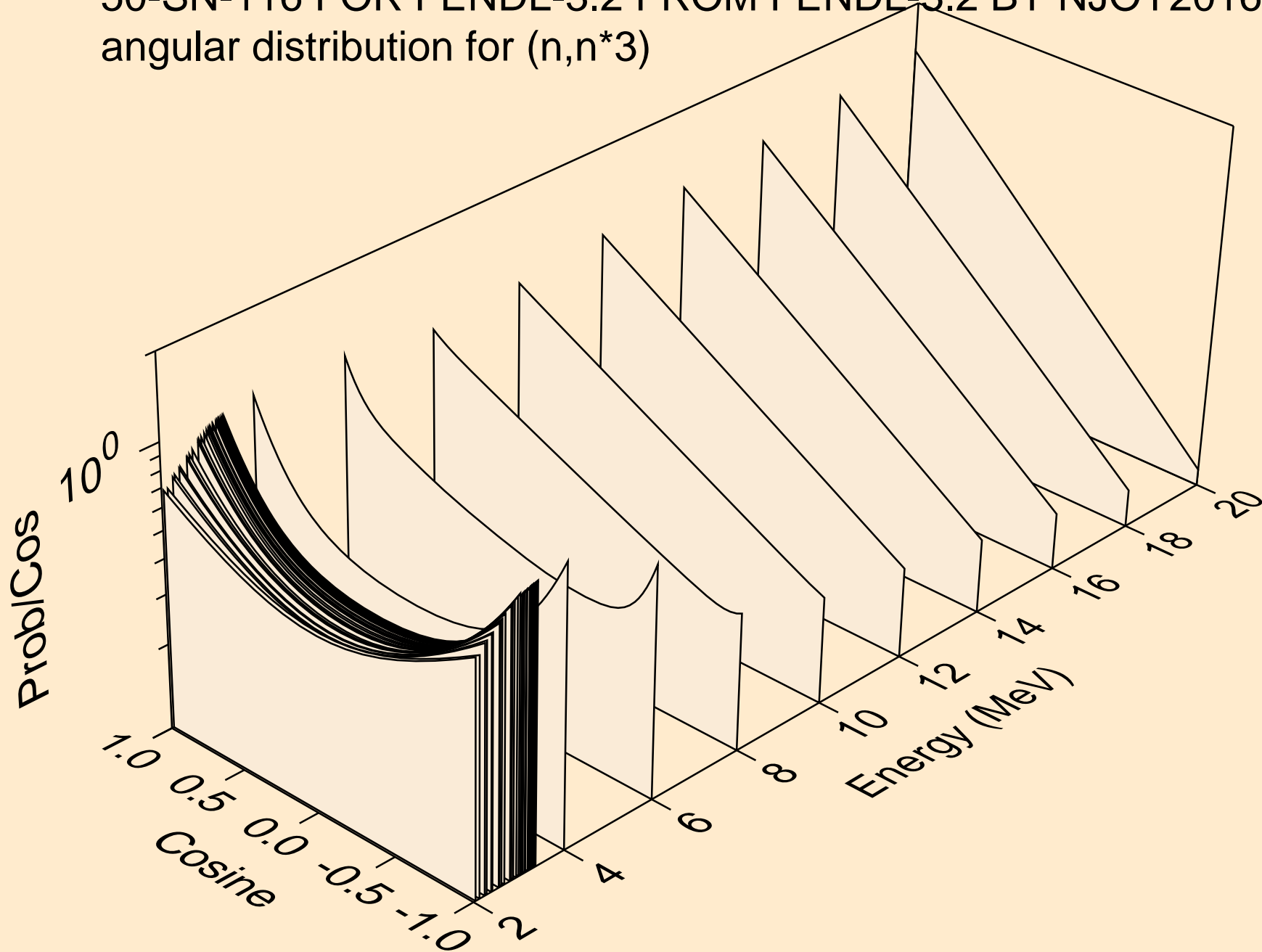

50-SN-116 FOR FENDL-3.2 FROM FENDL-3.2 BY NJOY2016.60+ C
angular distribution for (n,n*4)

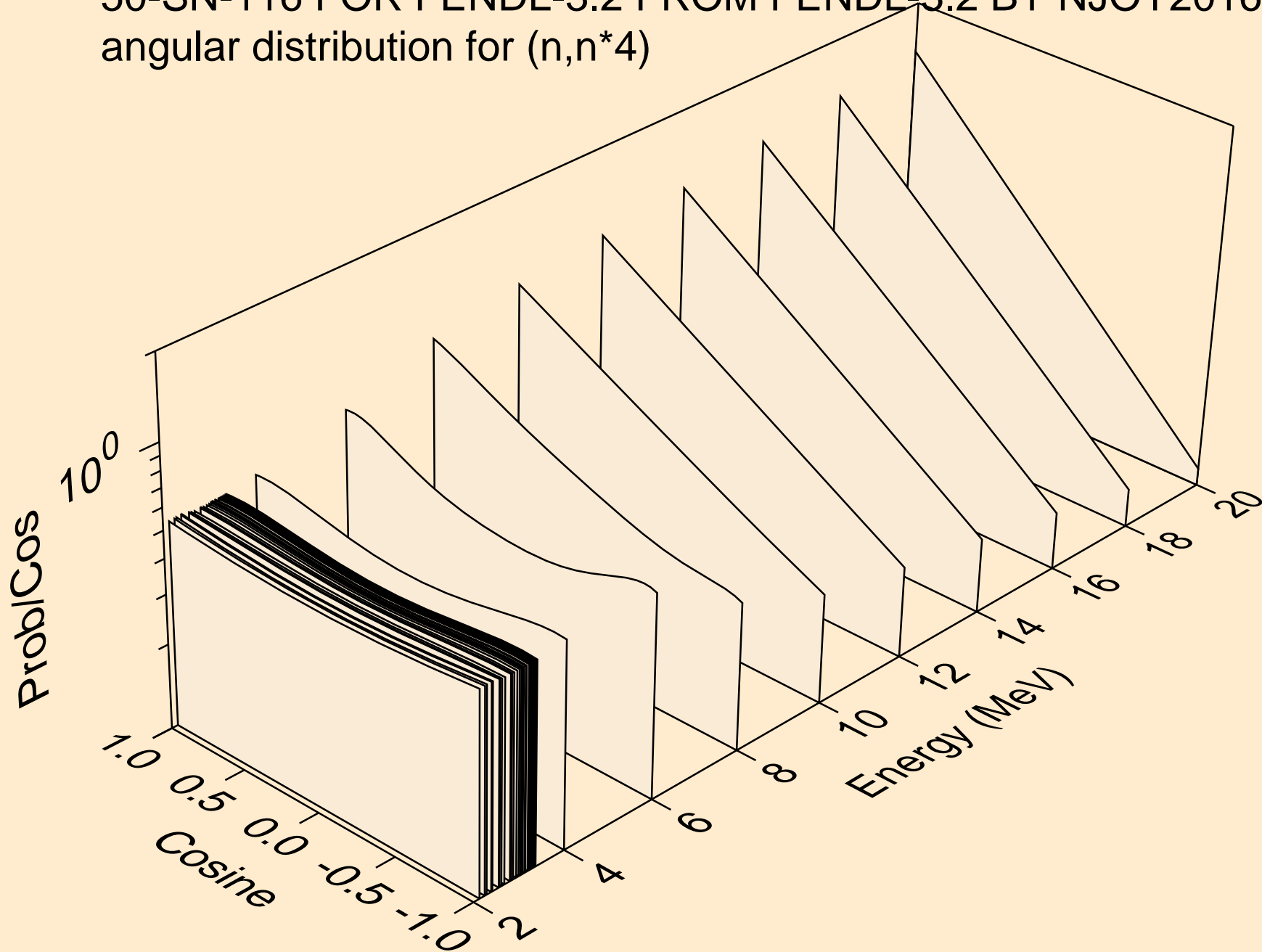

50-SN-116 FOR FENDL-3.2 FROM FENDL-3.2 BY NJOY2016.60+ C
angular distribution for (n,n*5)

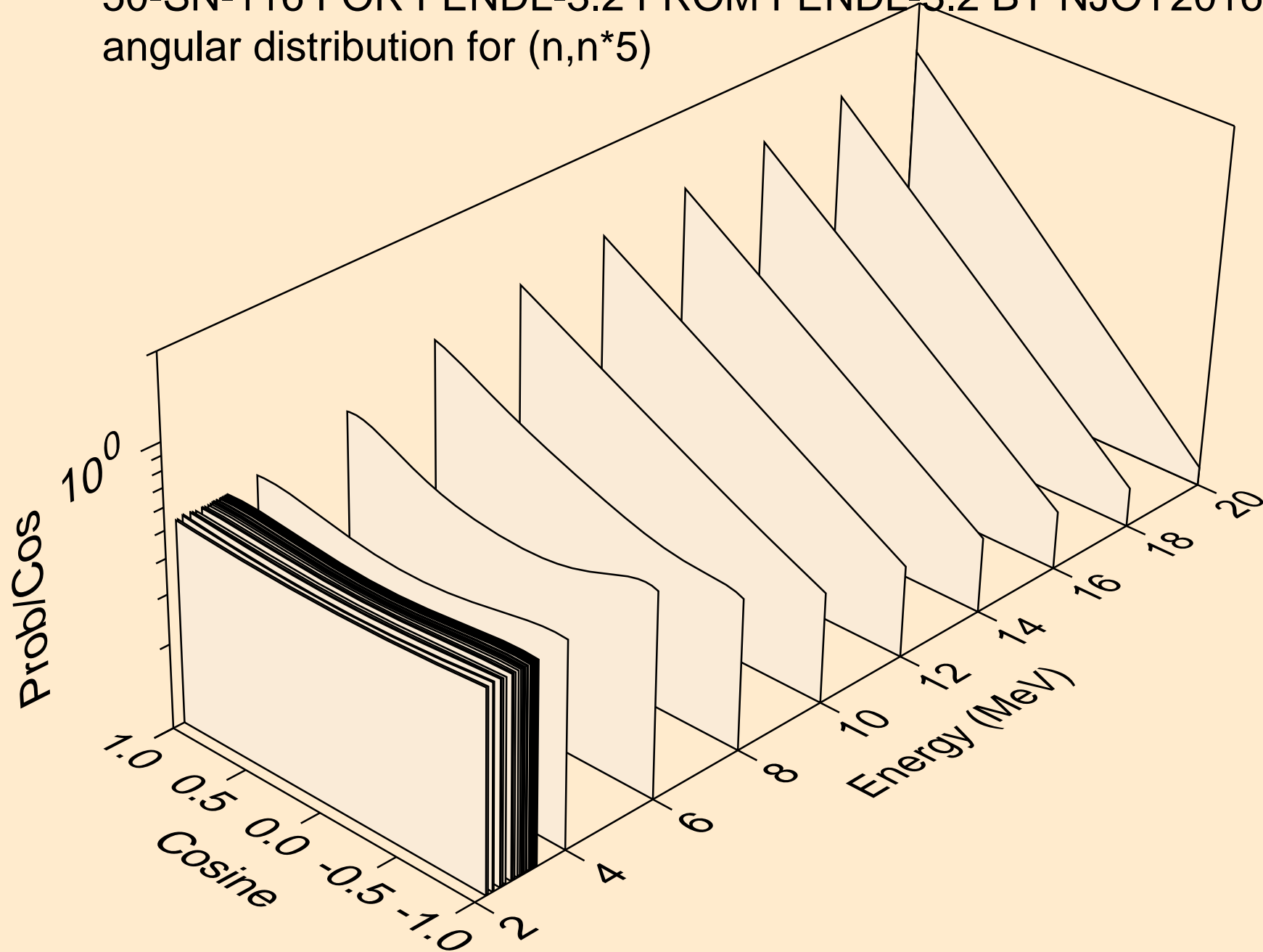

50-SN-116 FOR FENDL-3.2 FROM FENDL-3.2 BY NJOY2016.60+ C
angular distribution for (n,n*6)

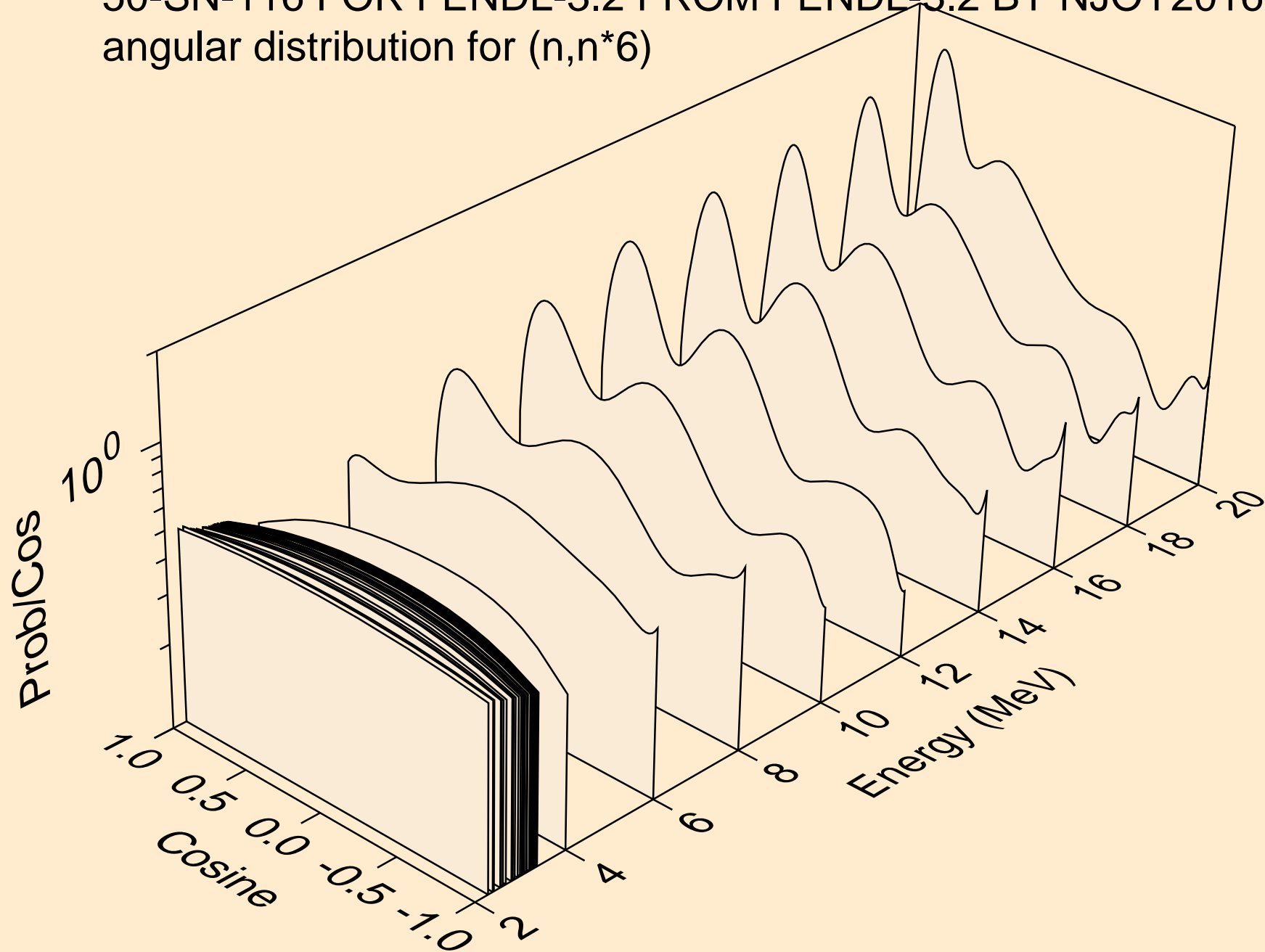

50-SN-116 FOR FENDL-3.2 FROM FENDL-3.2 BY NJOY2016.60+ C
angular distribution for (n,n*7)

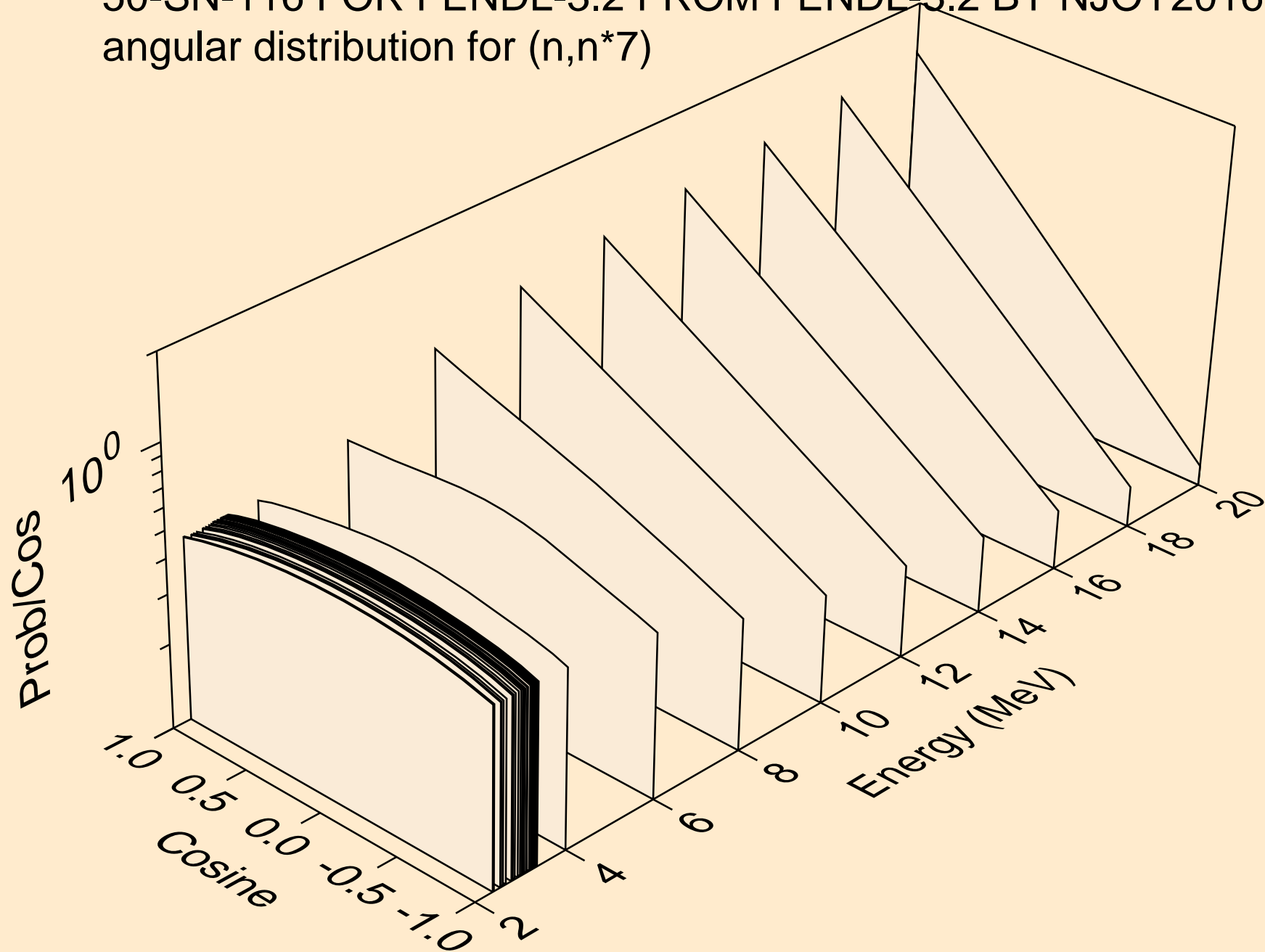

50-SN-116 FOR FENDL-3.2 FROM FENDL-3.2 BY NJOY2016.60+ C
angular distribution for (n,n*8)

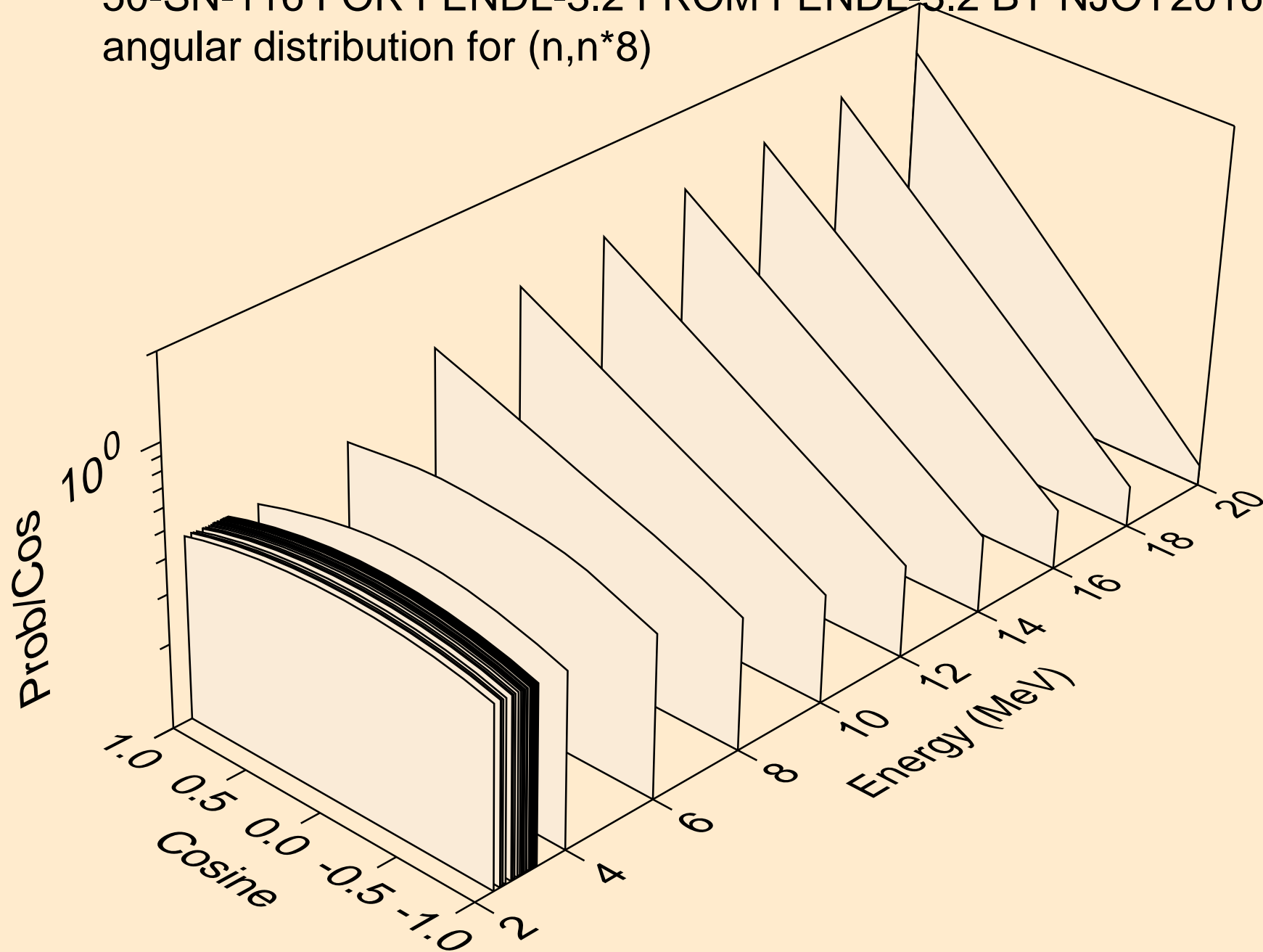

50-SN-116 FOR FENDL-3.2 FROM FENDL-3.2 BY NJOY2016.60+ C
angular distribution for (n,n*9)

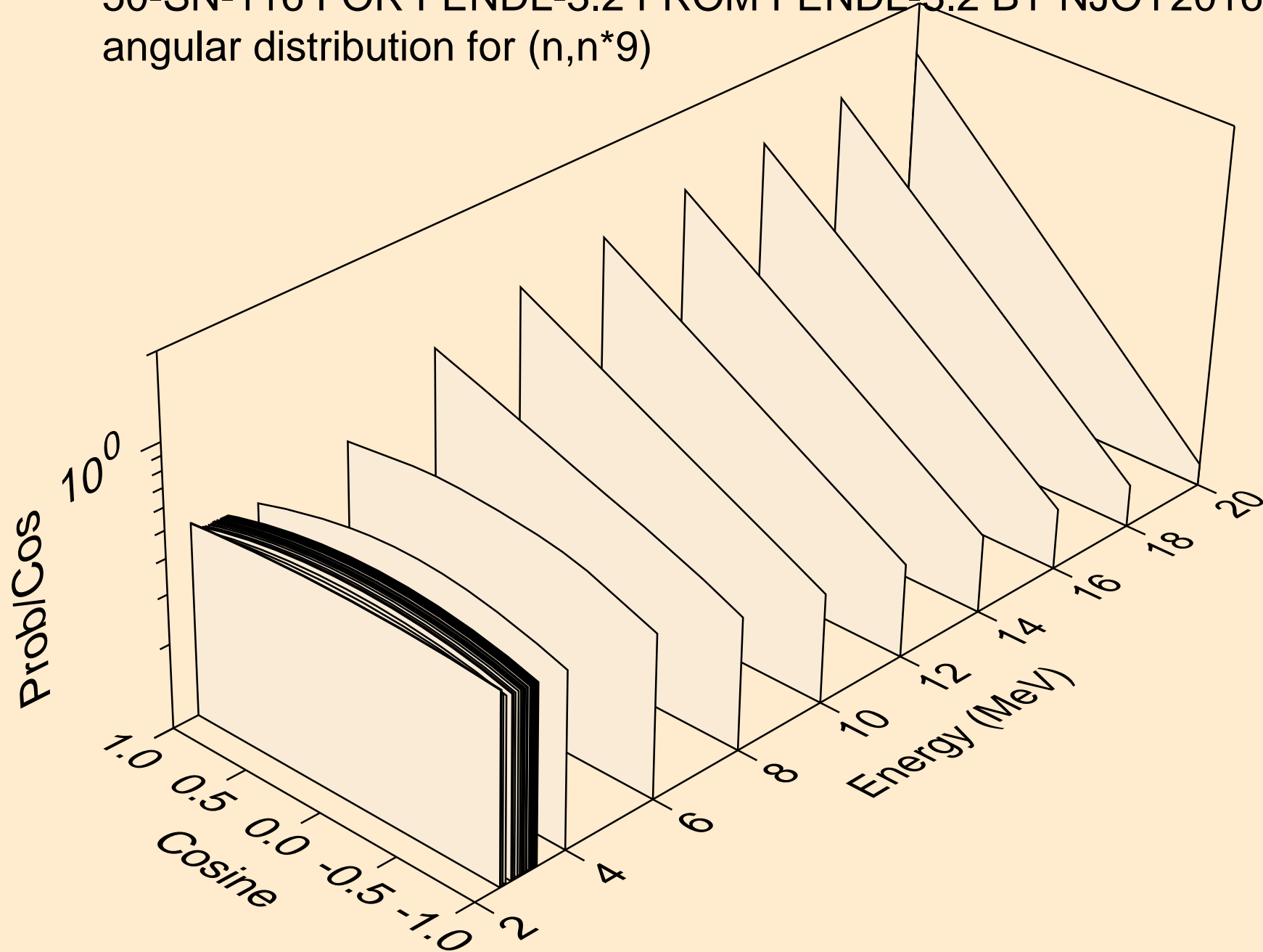

50-SN-116 FOR FENDL-3.2 FROM FENDL-3.2 BY NJOY2016.60+ C
angular distribution for (n,n*10)

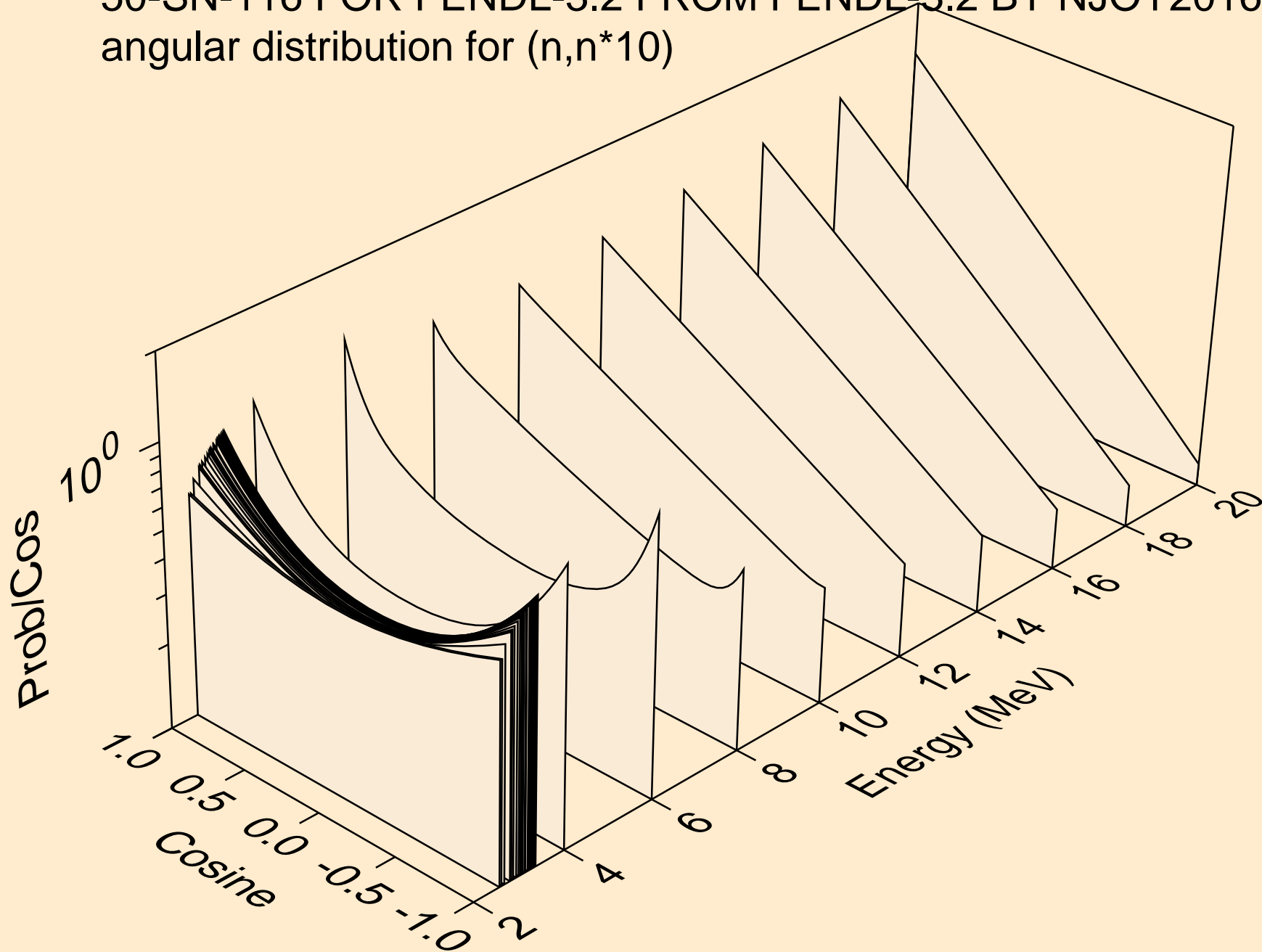

50-SN-116 FOR FENDL-3.2 FROM FENDL-3.2 BY NJOY2016.60+ C
angular distribution for (n,n*11)

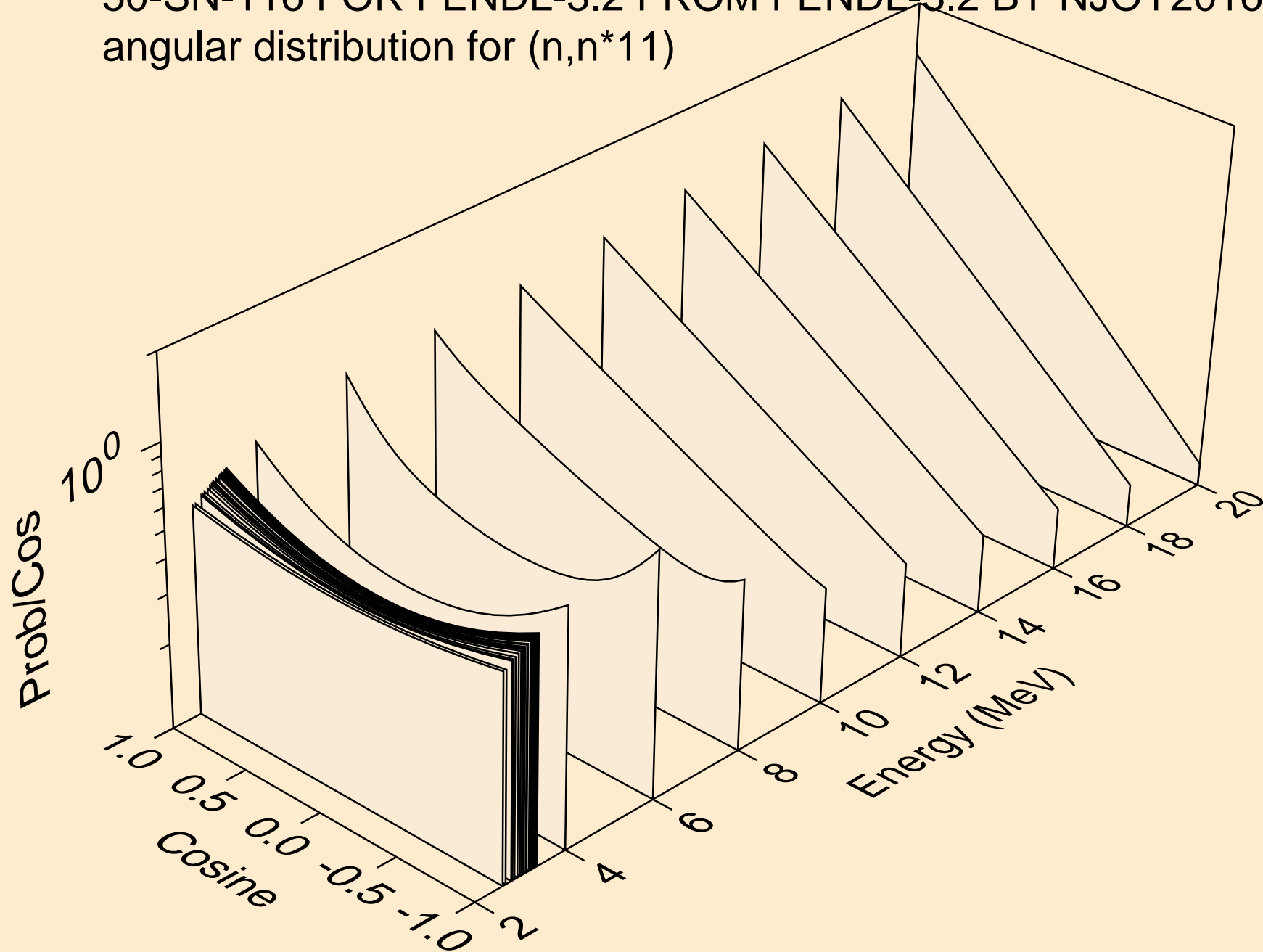

50-SN-116 FOR FENDL-3.2 FROM FENDL-3.2 BY NJOY2016.60+ C
angular distribution for (n,n*12)

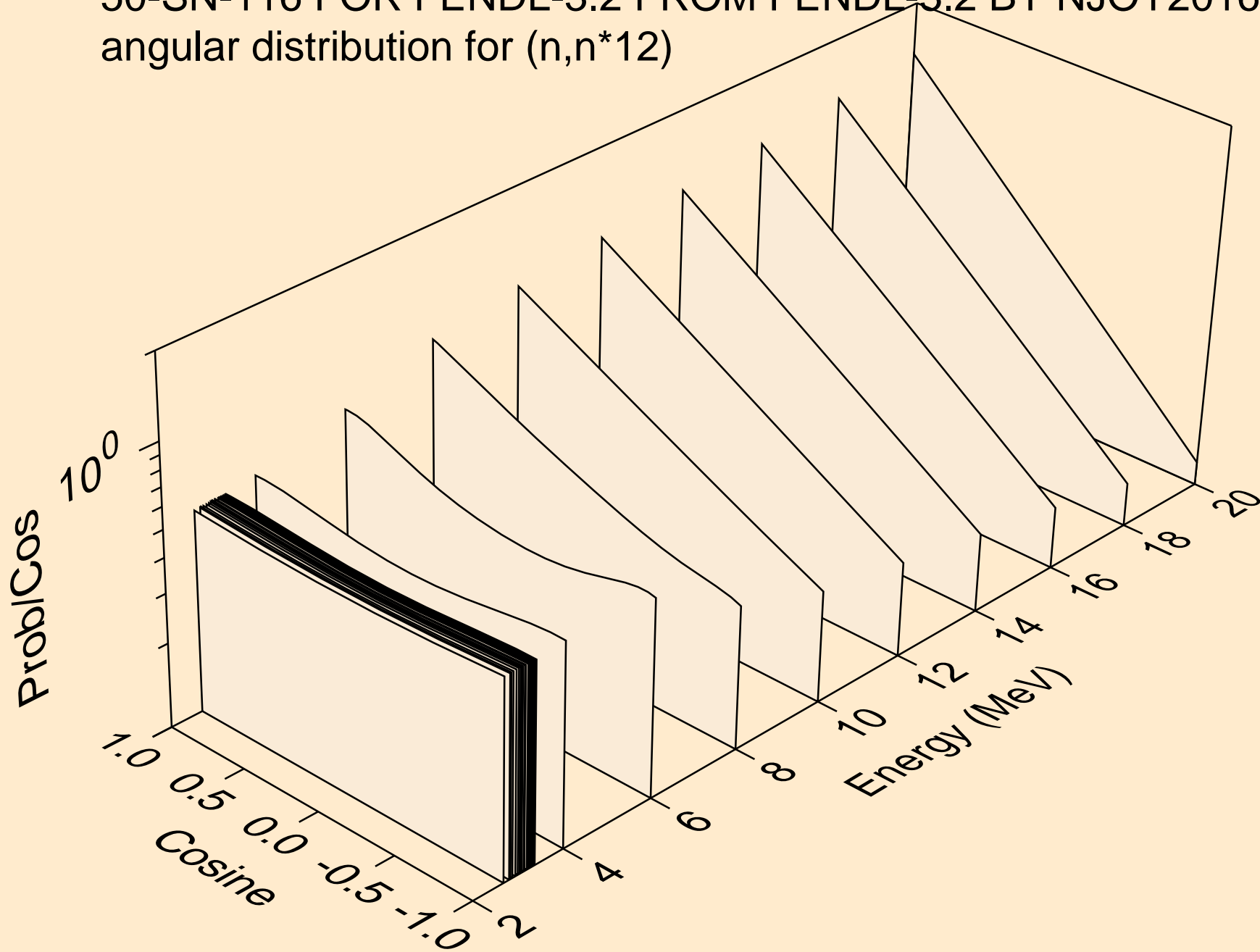

50-SN-116 FOR FENDL-3.2 FROM FENDL-3.2 BY NJOY2016.60+ C
angular distribution for (n,n*13)

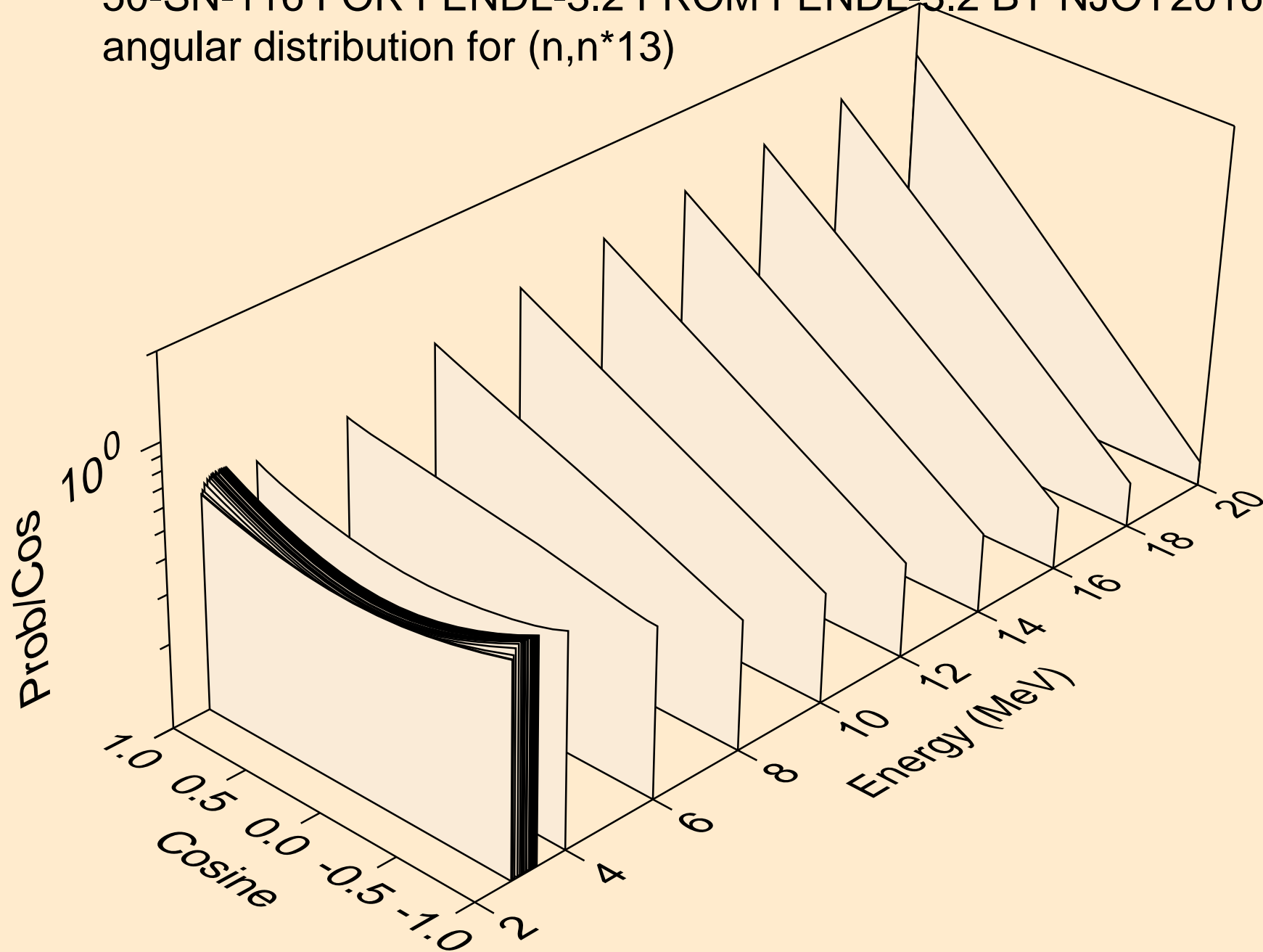

50-SN-116 FOR FENDL-3.2 FROM FENDL-3.2 BY NJOY2016.60+ C
angular distribution for (n,n*14)

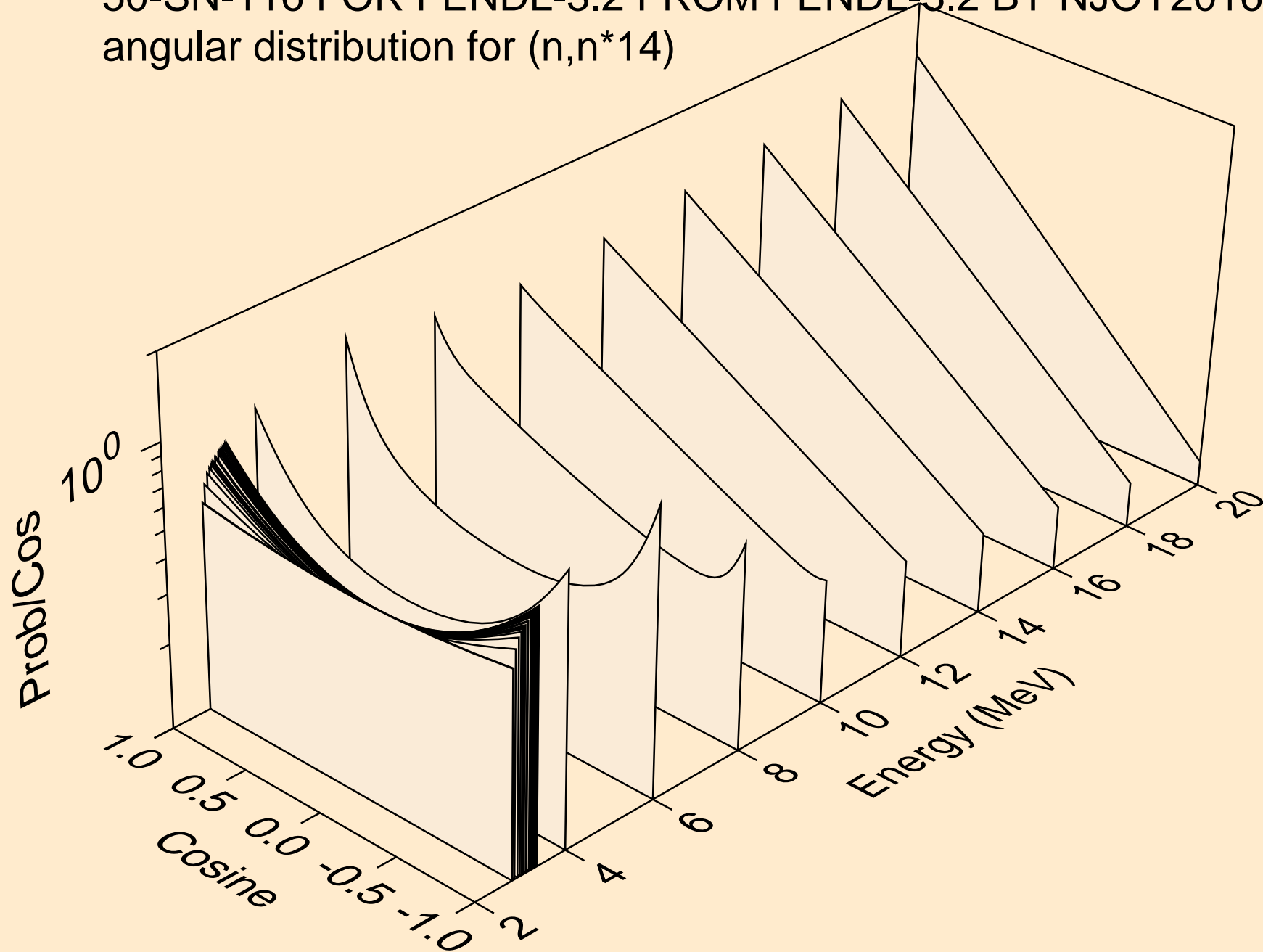

50-SN-116 FOR FENDL-3.2 FROM FENDL-3.2 BY NJOY2016.60+ C
angular distribution for (n,n*15)

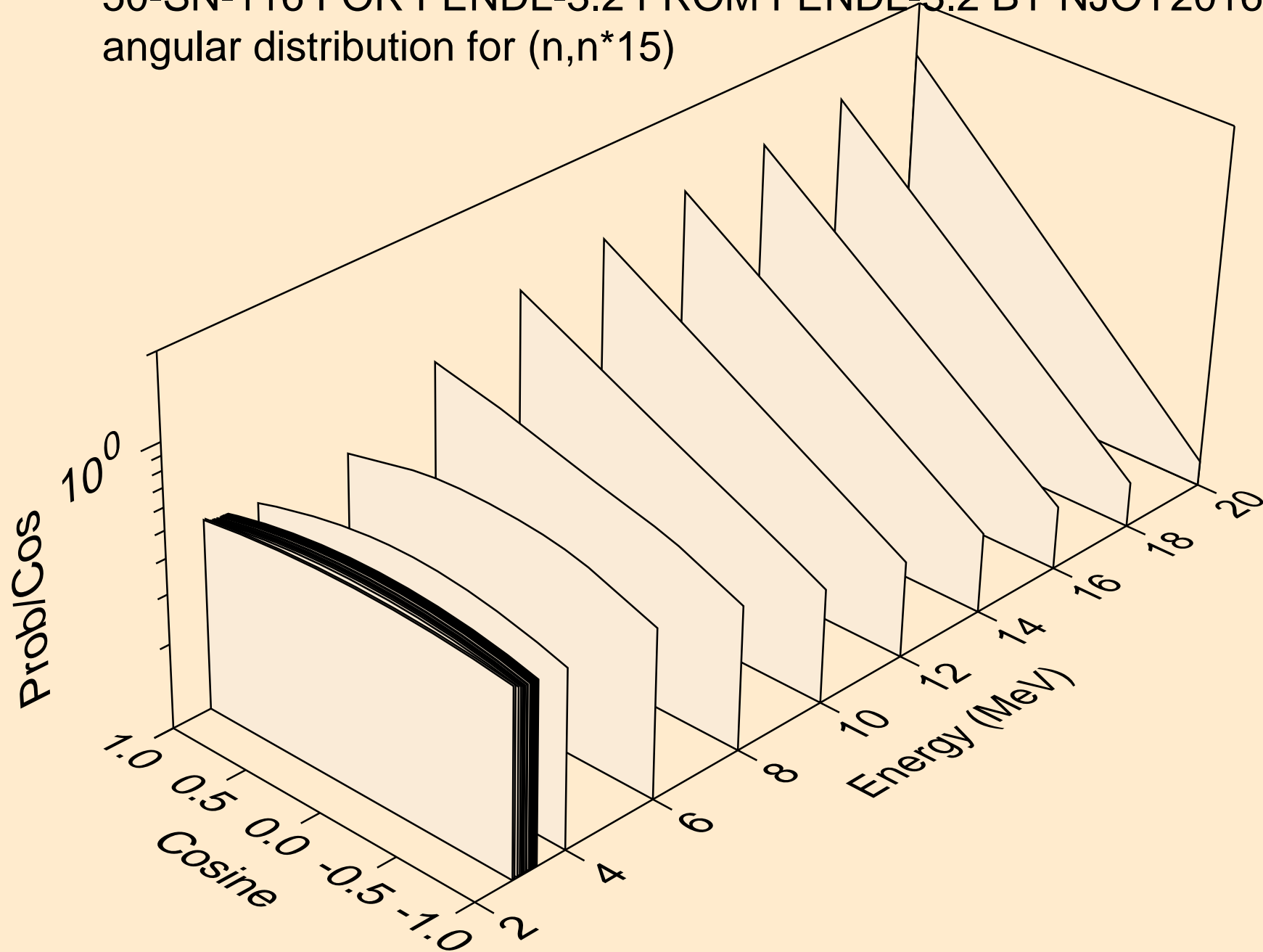

50-SN-116 FOR FENDL-3.2 FROM FENDL-3.2 BY NJOY2016.60+ C
angular distribution for (n,n*16)

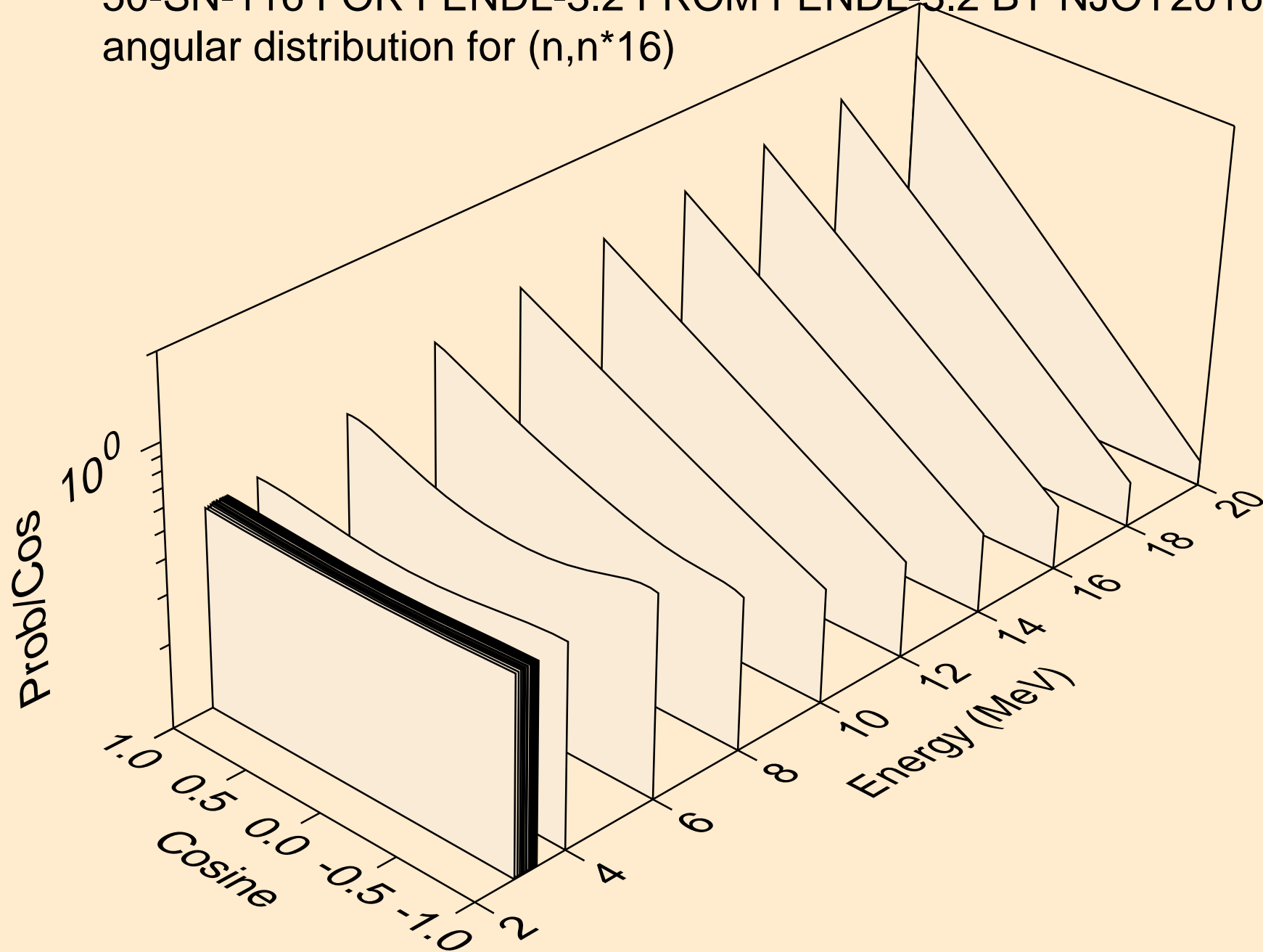

50-SN-116 FOR FENDL-3.2 FROM FENDL-3.2 BY NJOY2016.60+ C
angular distribution for (n,n*17)

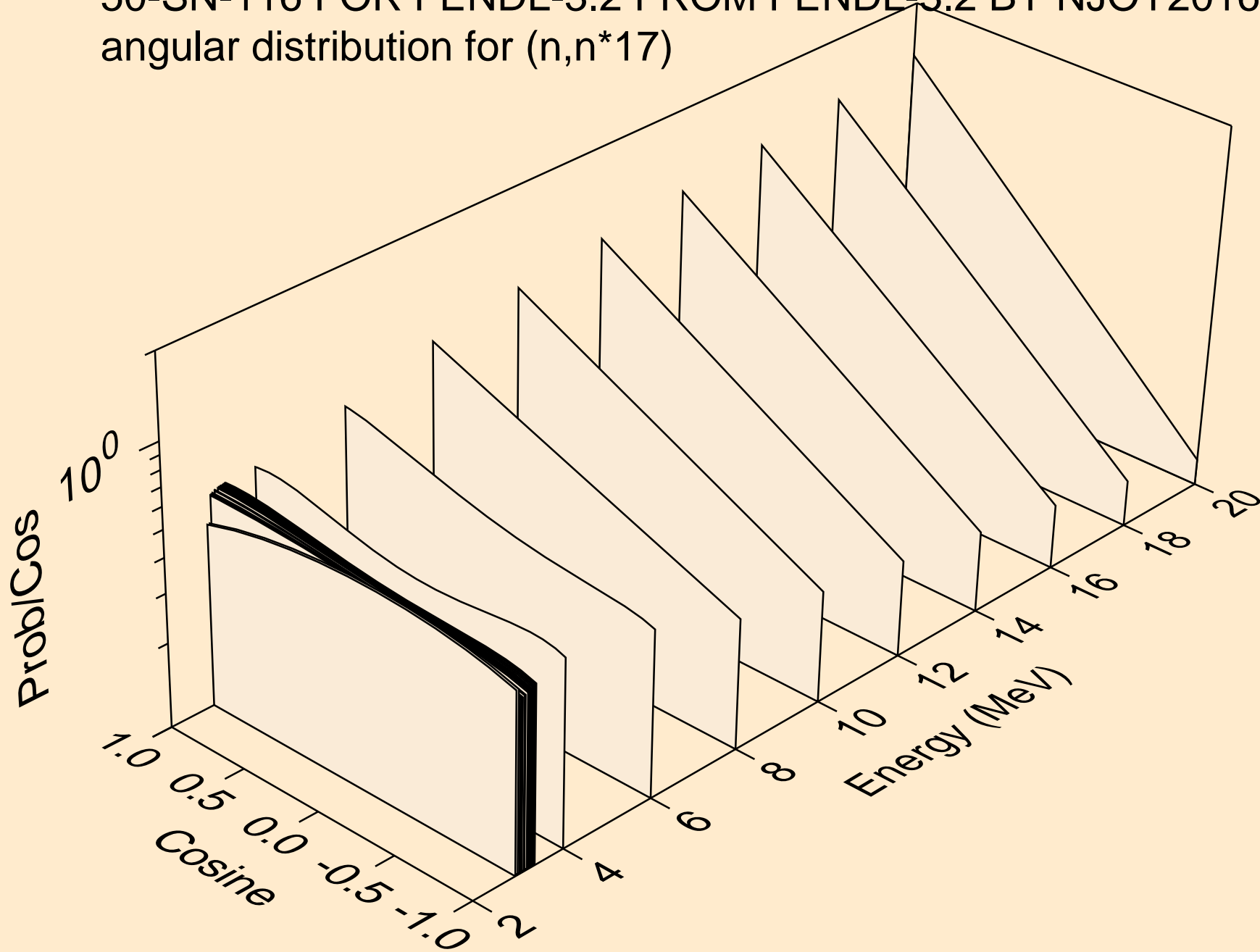

50-SN-116 FOR FENDL-3.2 FROM FENDL-3.2 BY NJOY2016.60+ C
angular distribution for (n,n*18)

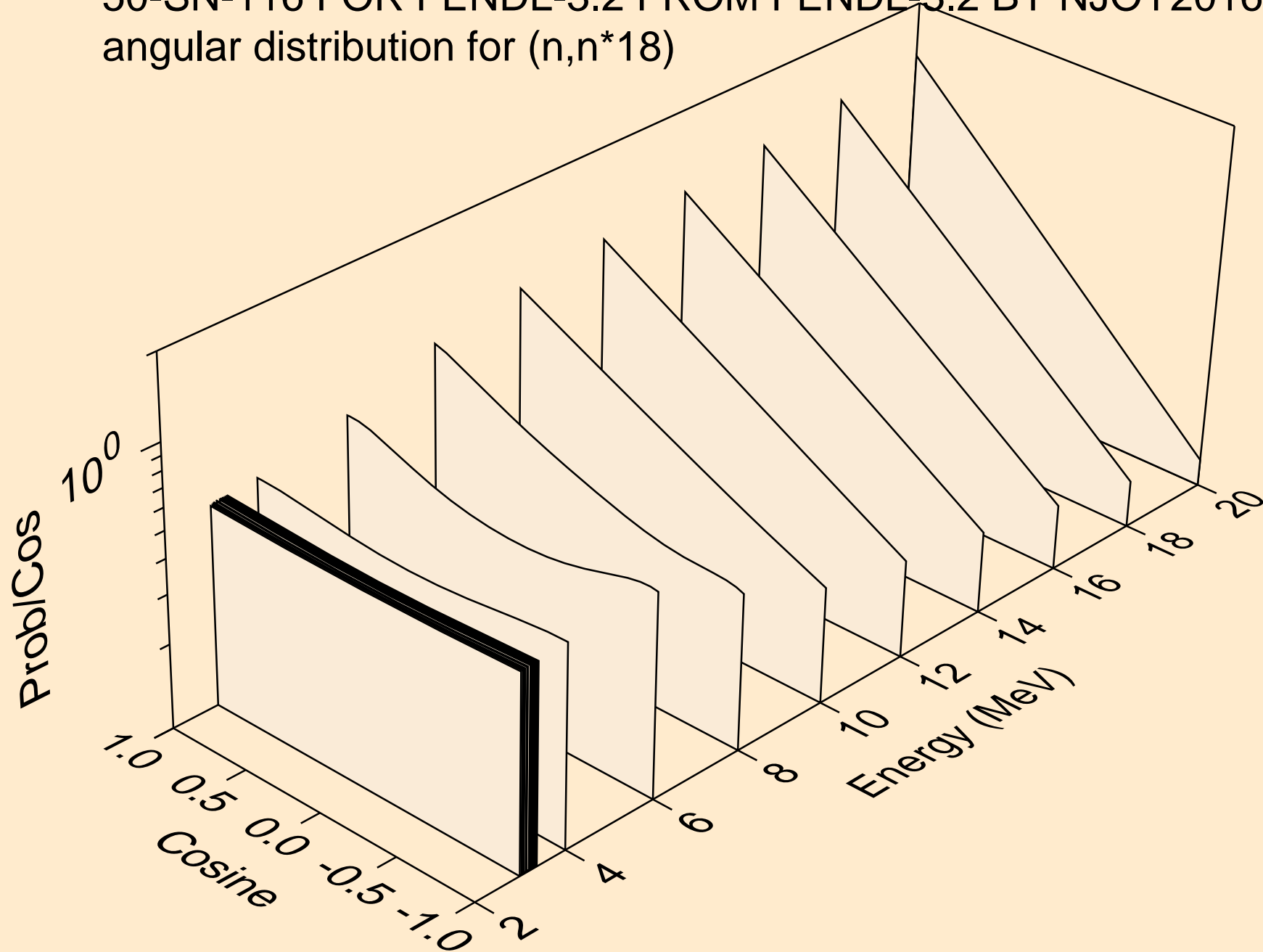

50-SN-116 FOR FENDL-3.2 FROM FENDL-3.2 BY NJOY2016.60+ C
angular distribution for (n,n*19)

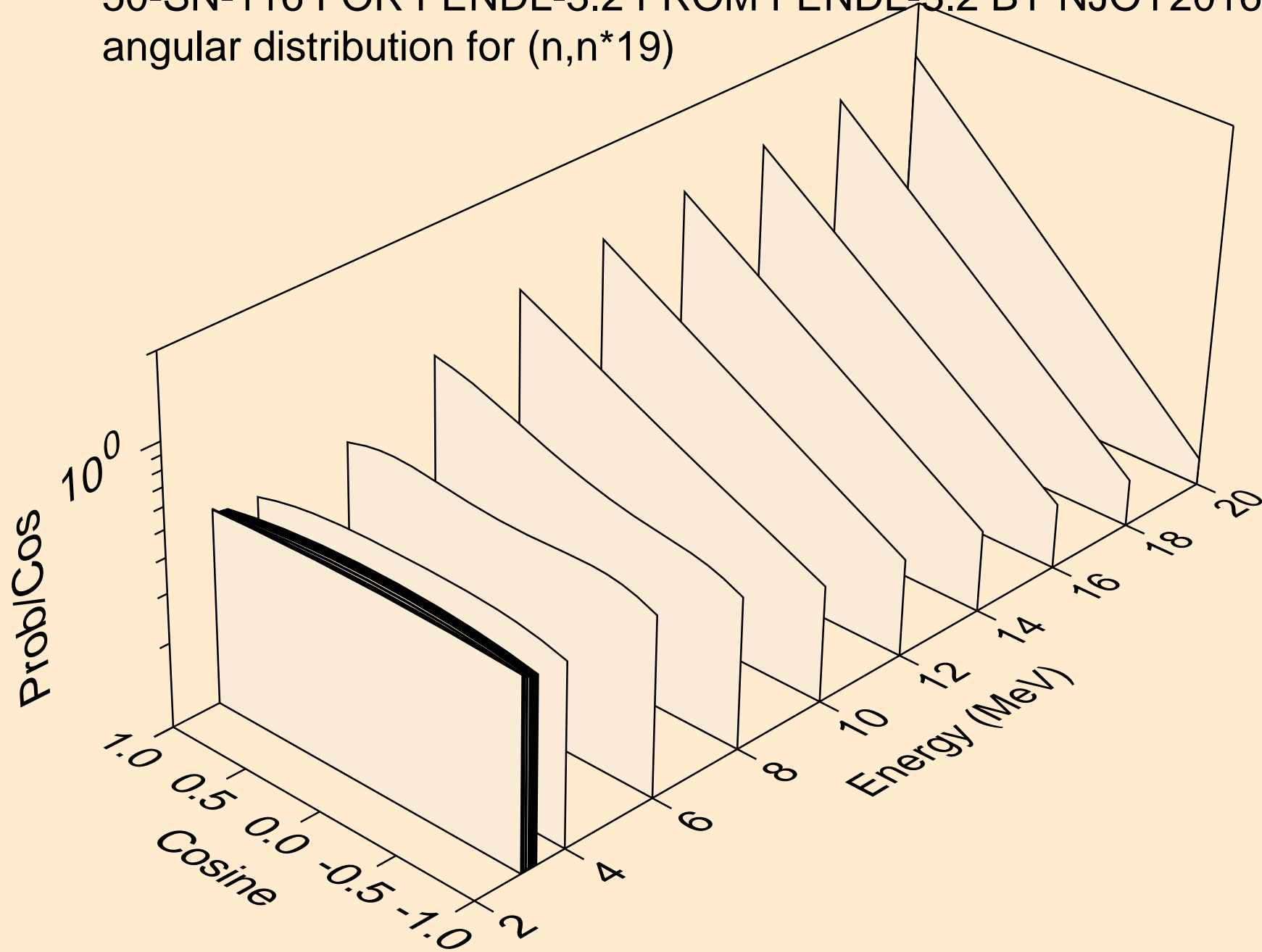

50-SN-116 FOR FENDL-3.2 FROM FENDL-3.2 BY NJOY2016.60+ C
angular distribution for (n,n*20)

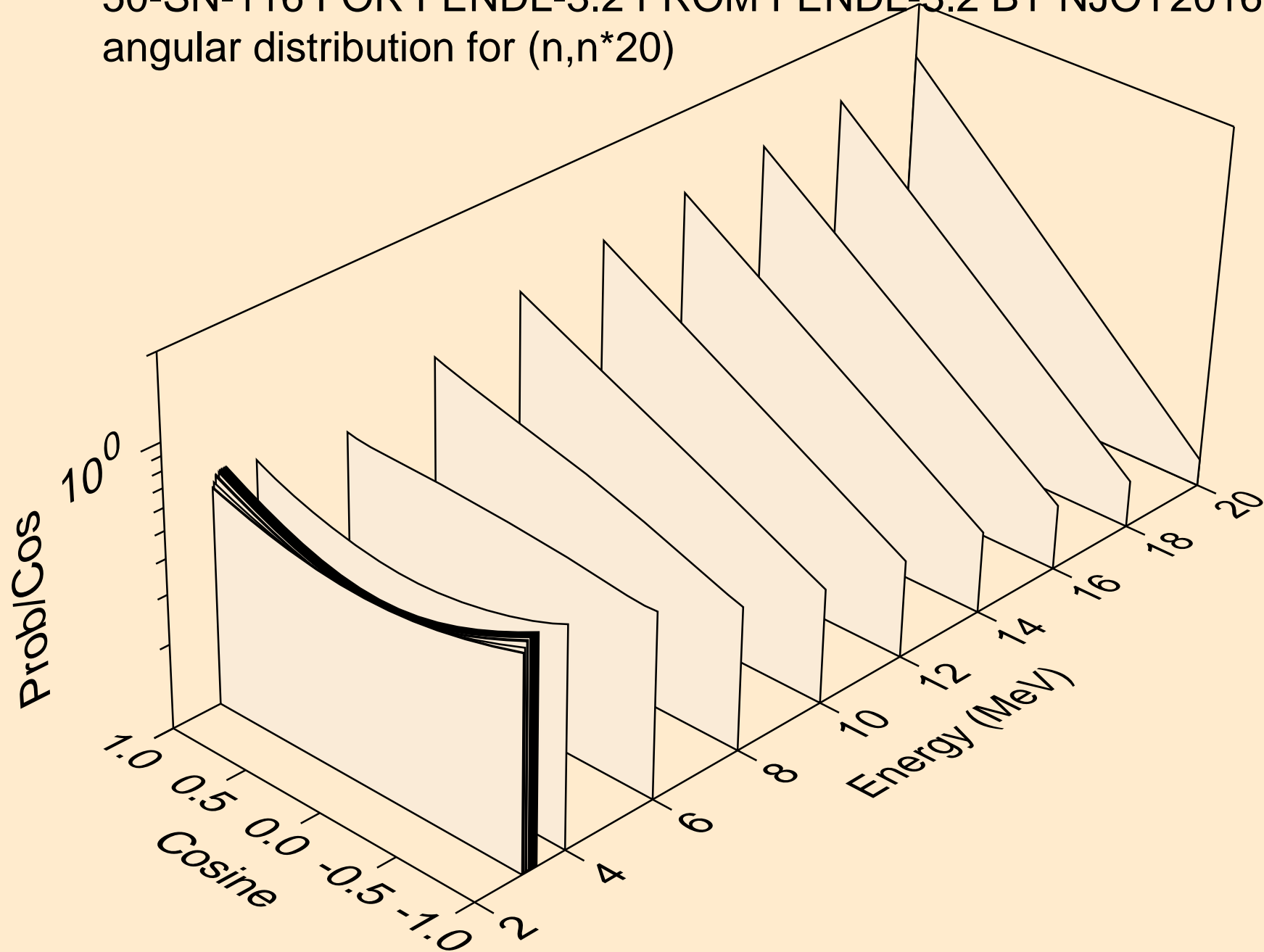

50-SN-116 FOR FENDL-3.2 FROM FENDL-3.2 BY NJOY2016.60+ C
angular distribution for (n,n*21)

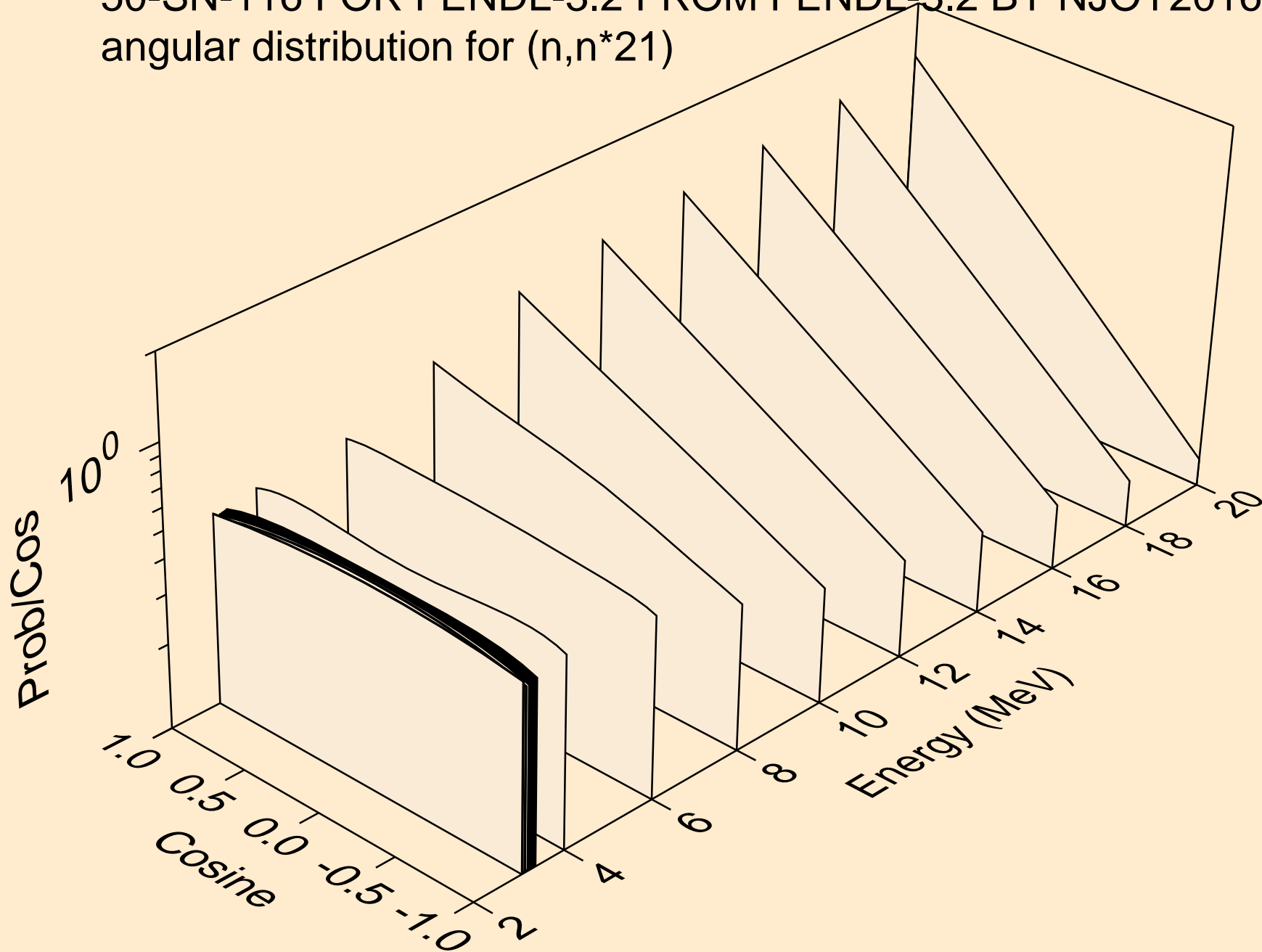

50-SN-116 FOR FENDL-3.2 FROM FENDL-3.2 BY NJOY2016.60+ C
angular distribution for (n,n*22)

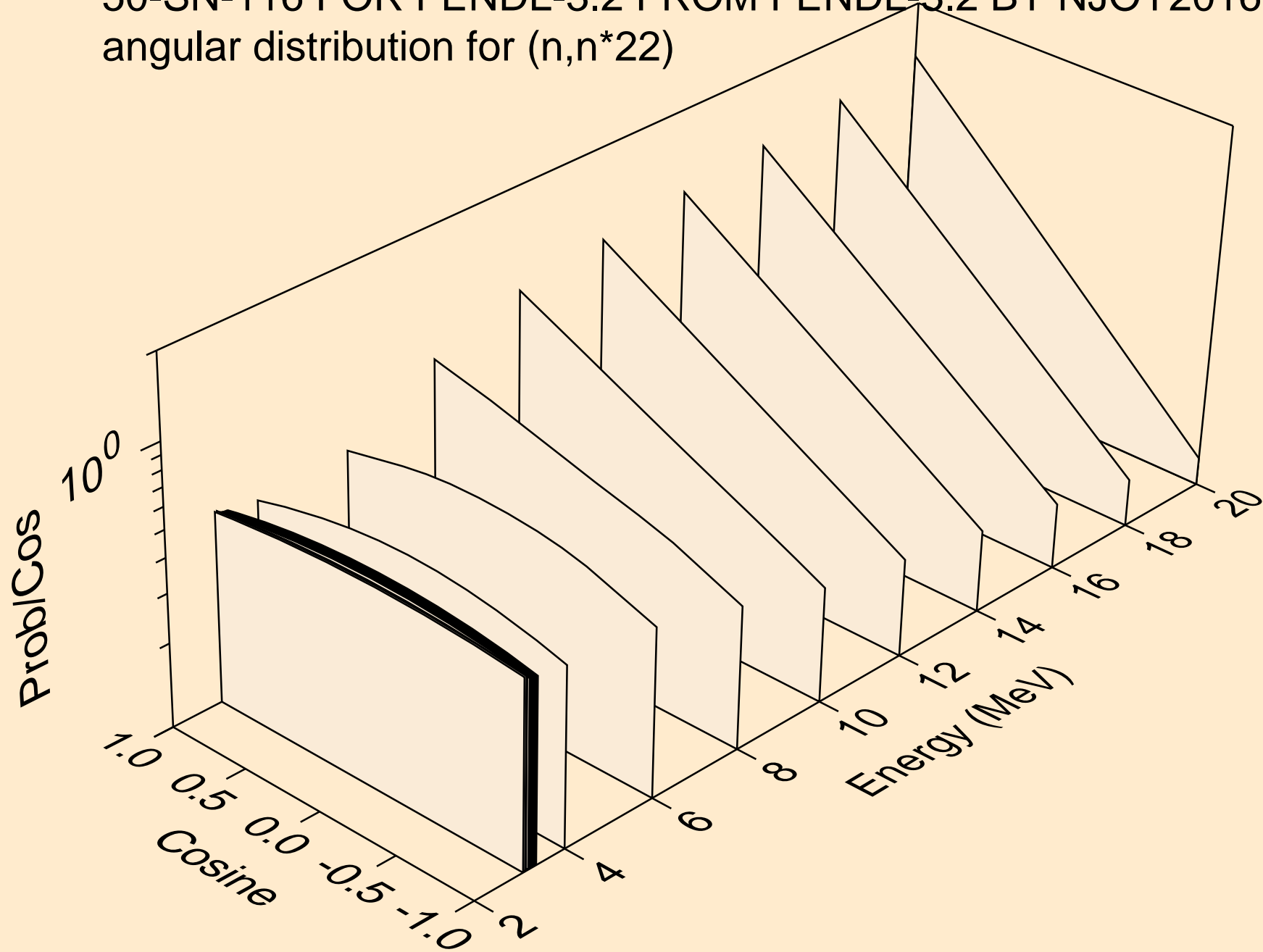

50-SN-116 FOR FENDL-3.2 FROM FENDL-3.2 BY NJOY2016.60+ C
angular distribution for (n,n*23)

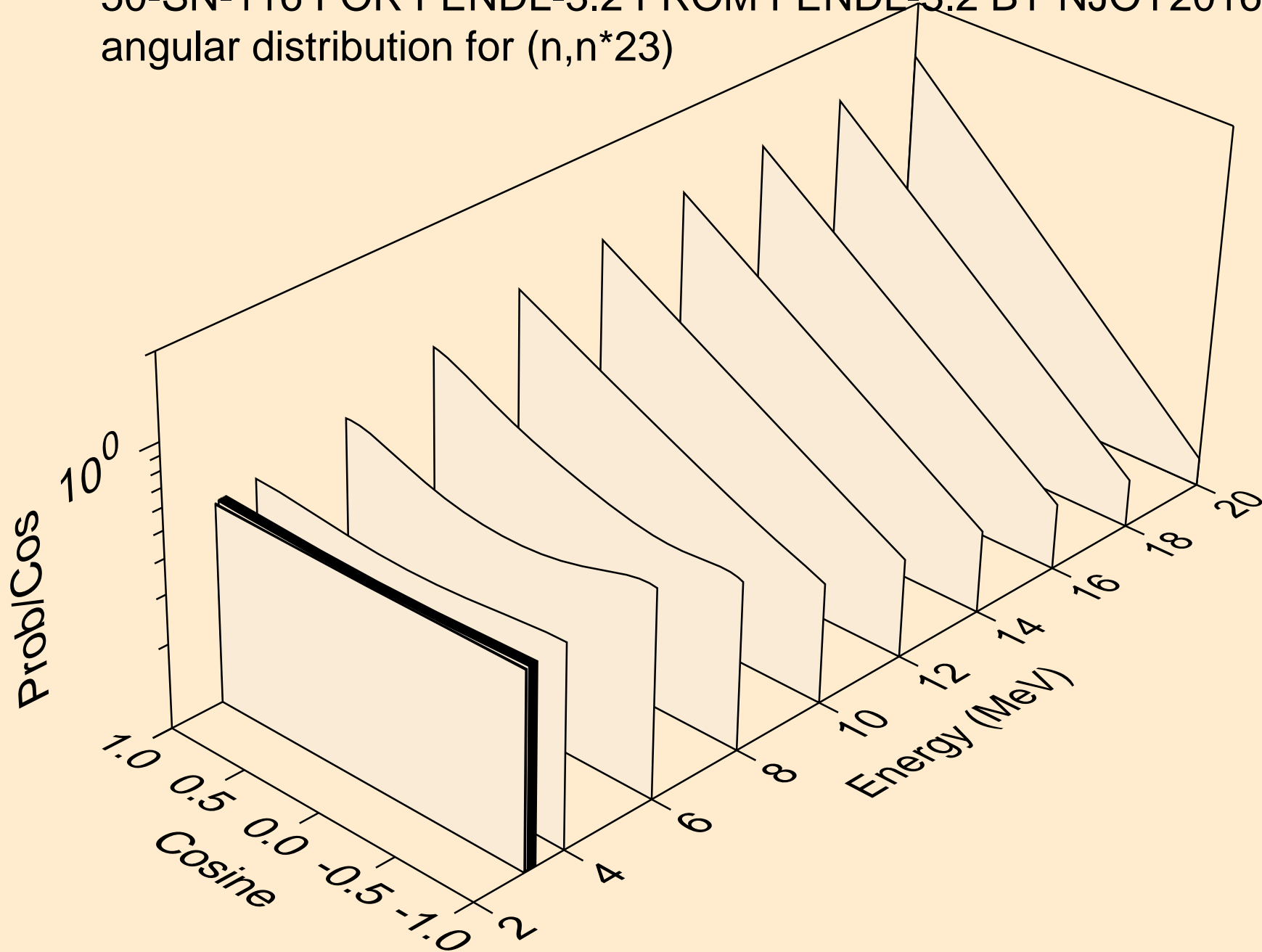

50-SN-116 FOR FENDL-3.2 FROM FENDL-3.2 BY NJOY2016.60+ C
angular distribution for (n,n*24)

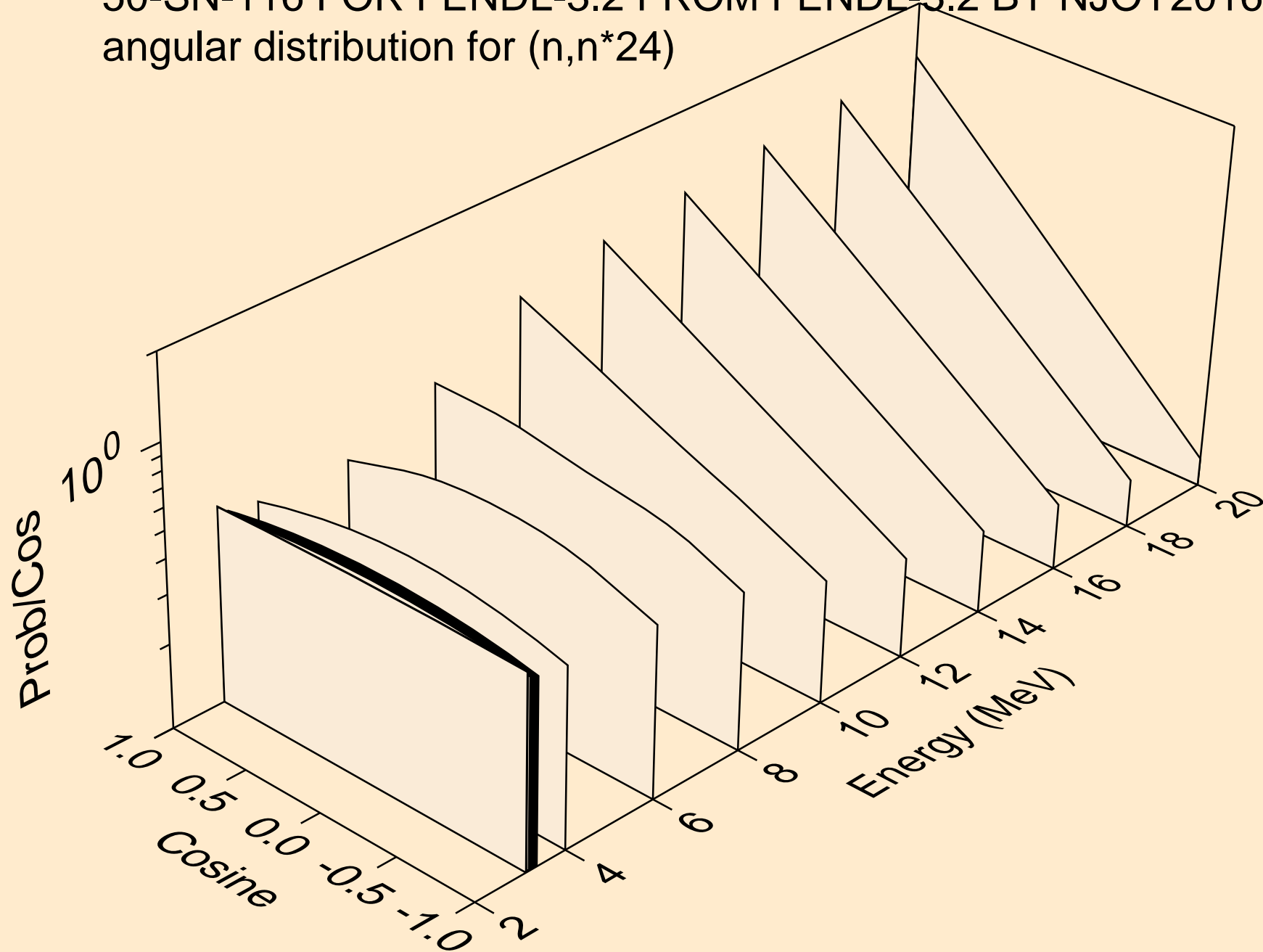

50-SN-116 FOR FENDL-3.2 FROM FENDL-3.2 BY NJOY2016.60+ C
angular distribution for (n,n*25)

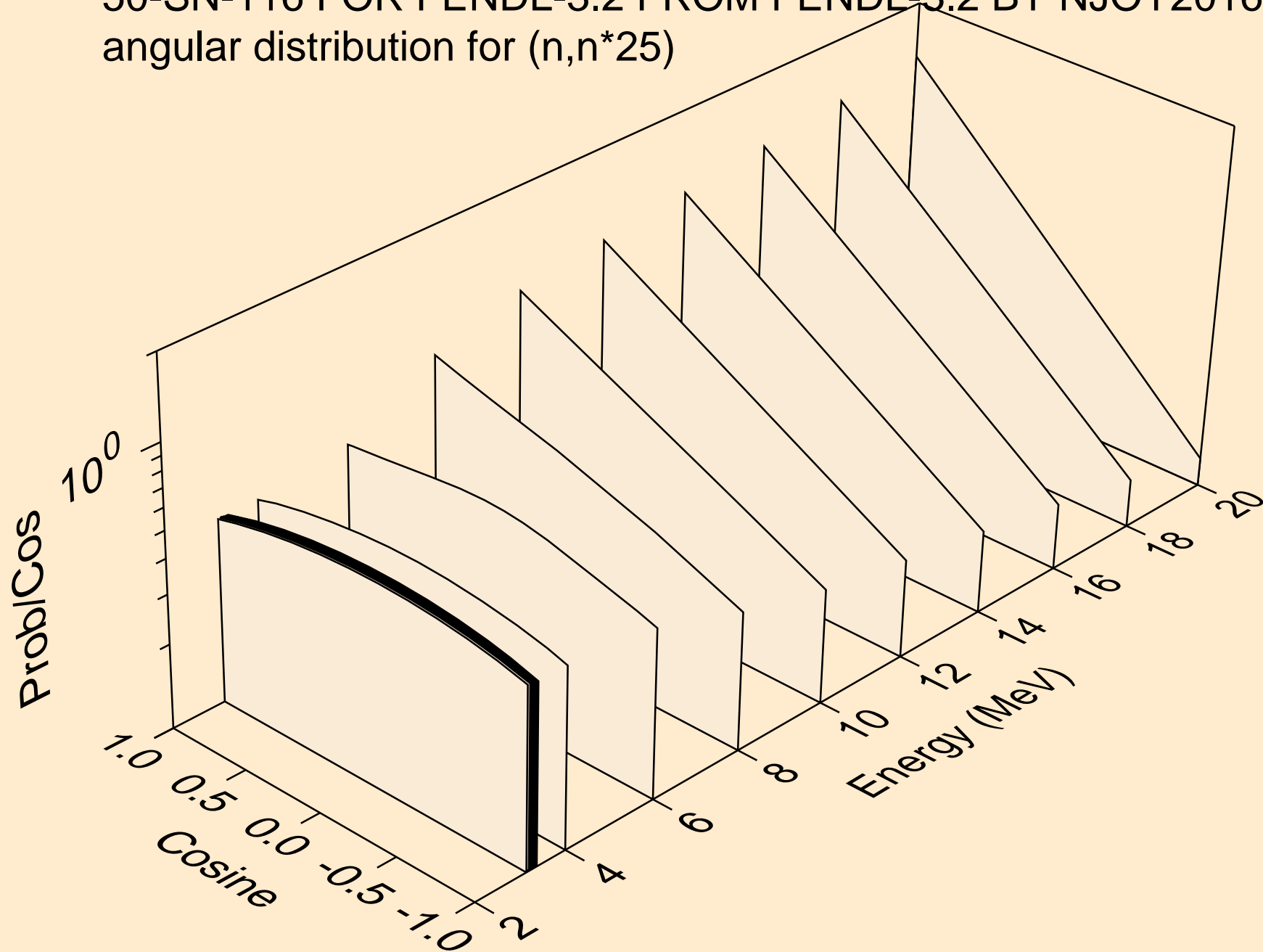

50-SN-116 FOR FENDL-3.2 FROM FENDL-3.2 BY NJOY2016.60+ C
angular distribution for (n,n*26)

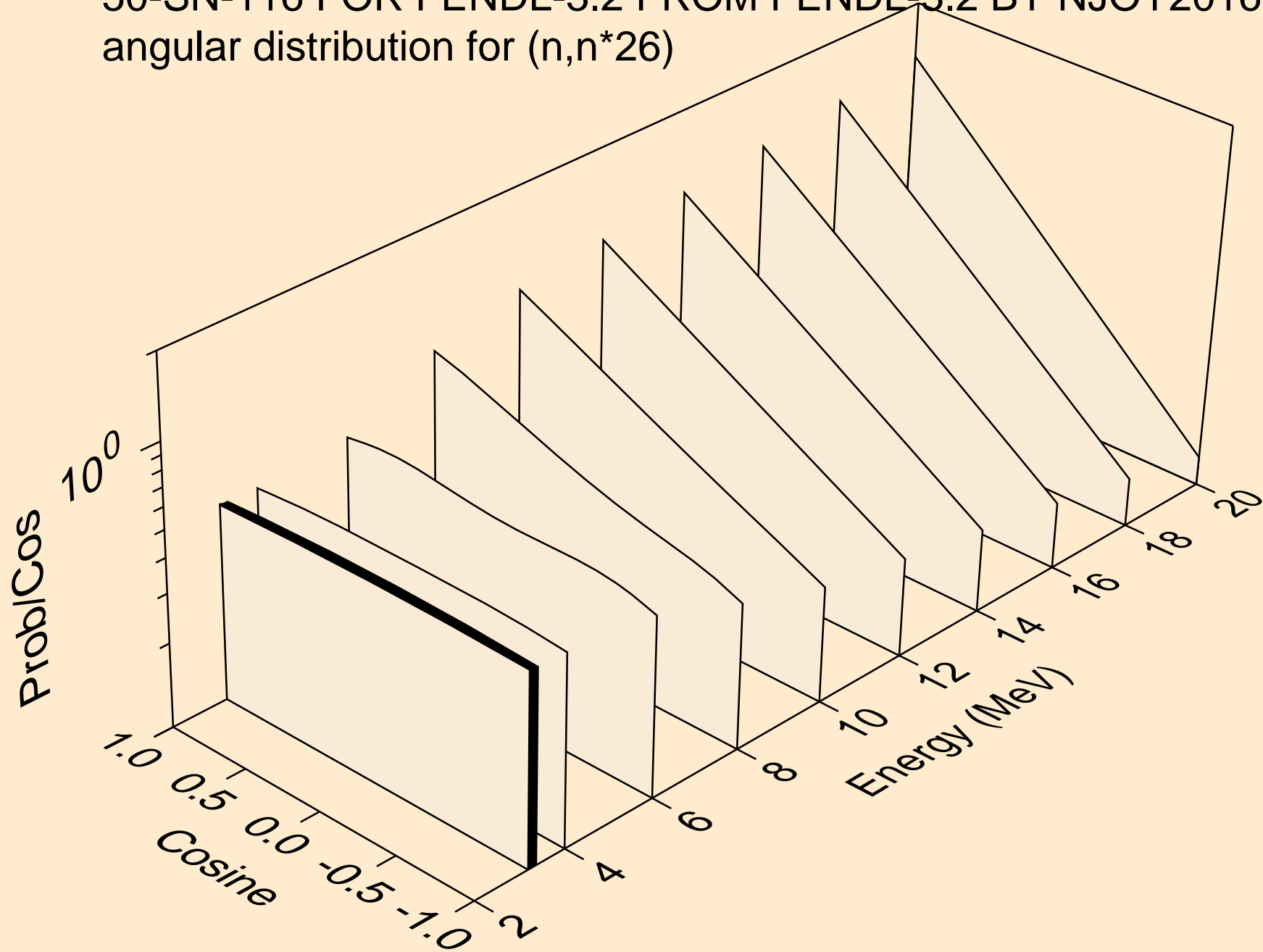

50-SN-116 FOR FENDL-3.2 FROM FENDL-3.2 BY NJOY2016.60+ C
angular distribution for (n,n*27)

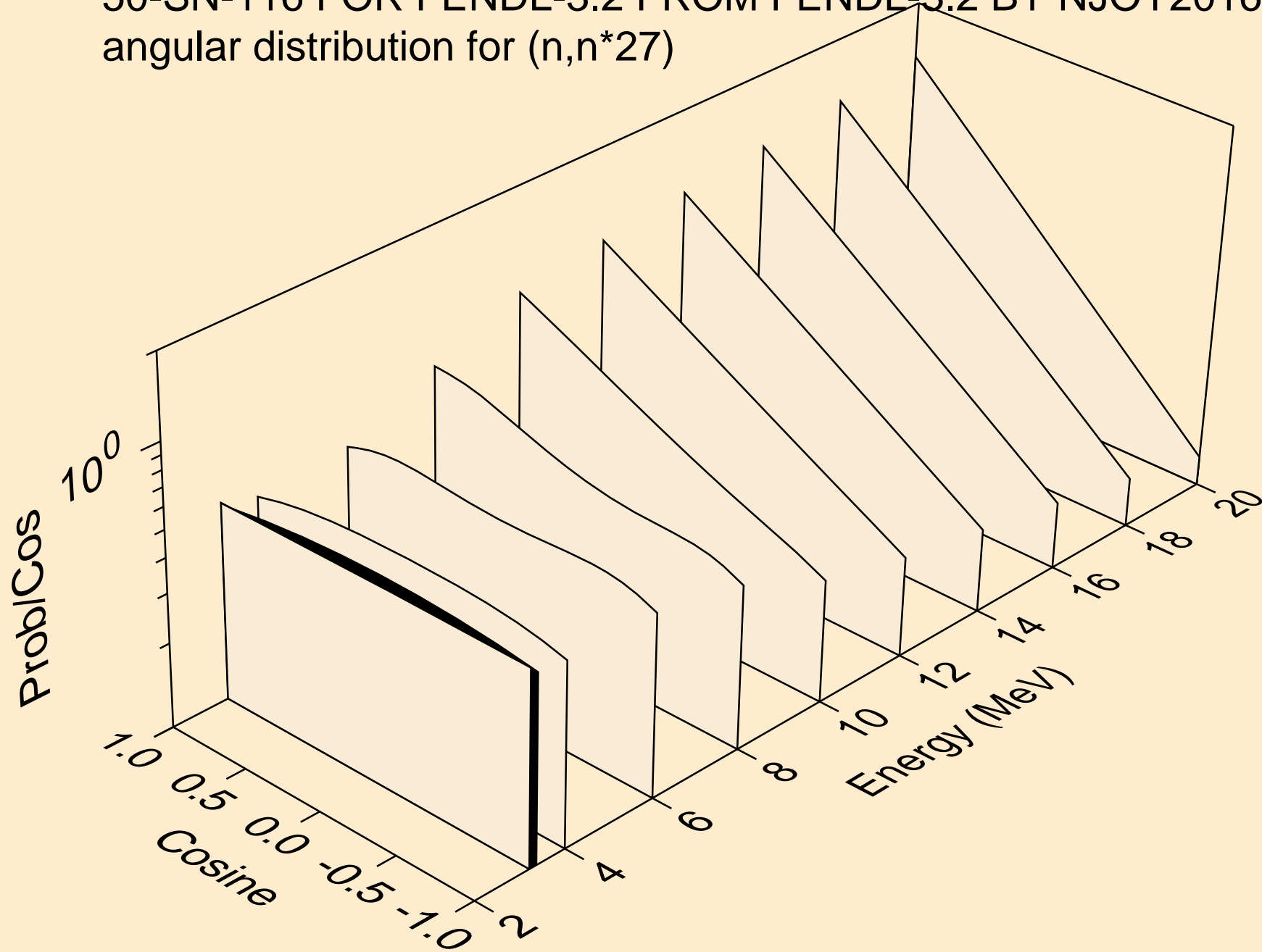

50-SN-116 FOR FENDL-3.2 FROM FENDL-3.2 BY NJOY2016.60+ C
angular distribution for (n,n*28)

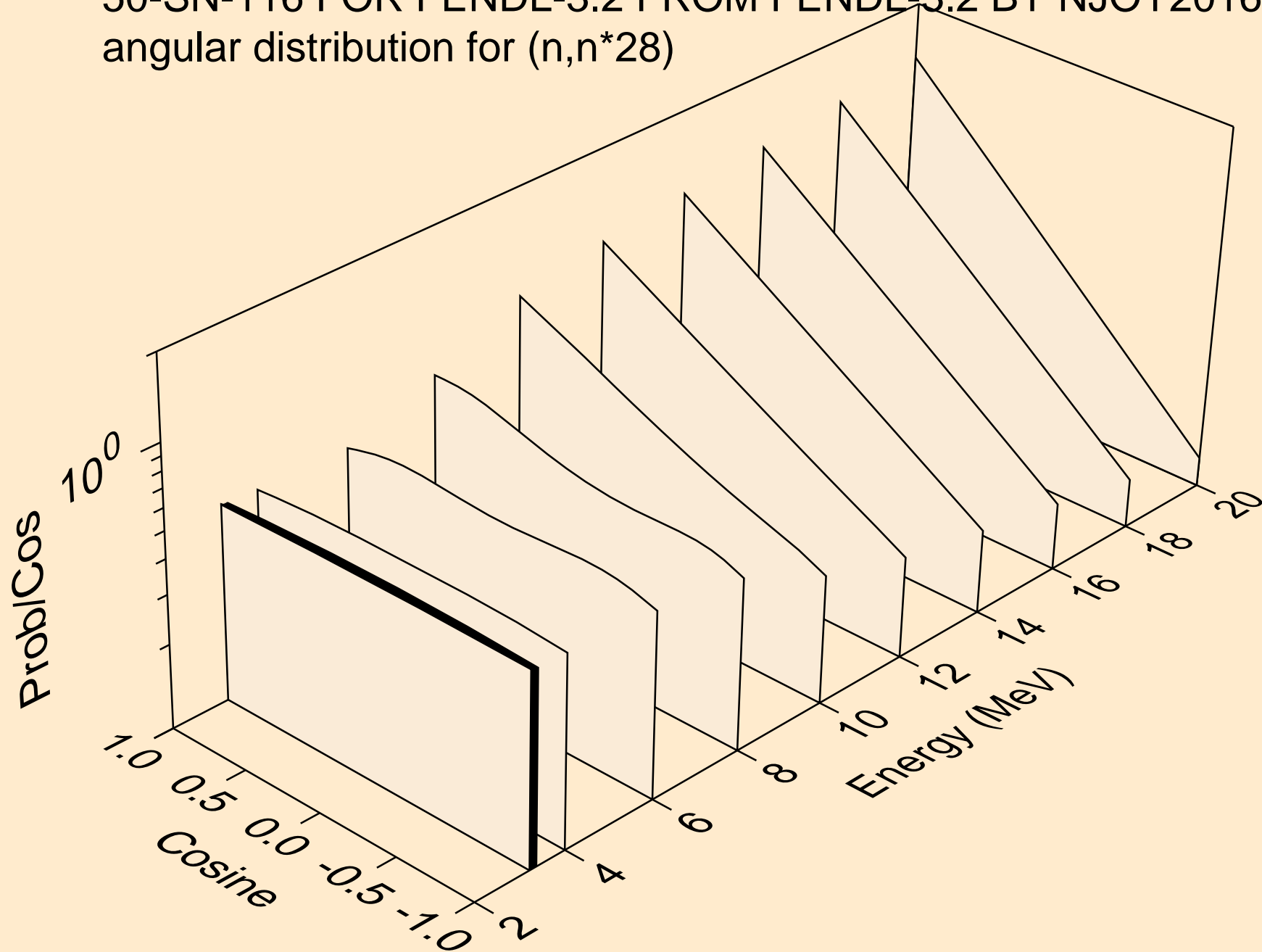

50-SN-116 FOR FENDL-3.2 FROM FENDL-3.2 BY NJOY2016.60+ C
angular distribution for (n,n*29)

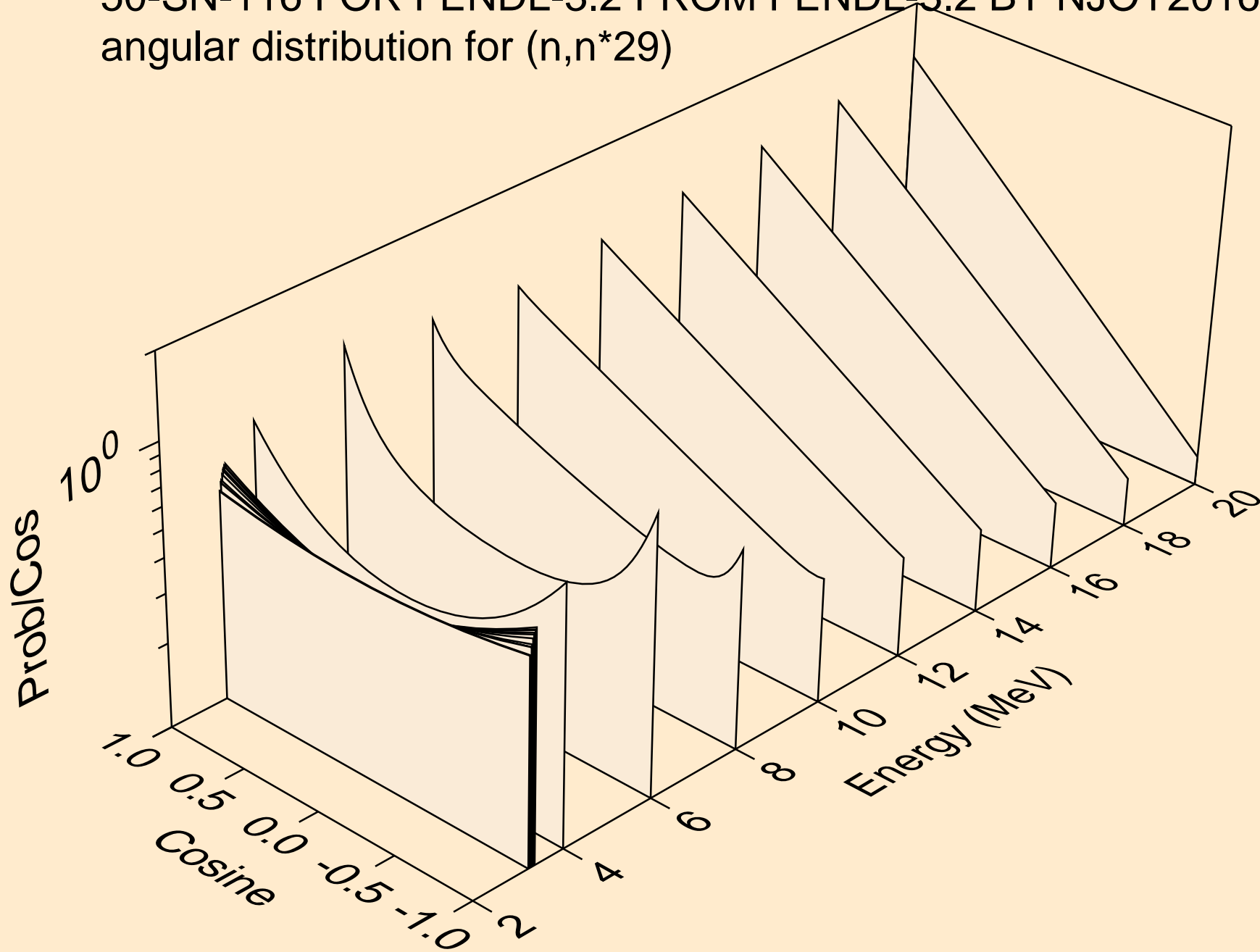

50-SN-116 FOR FENDL-3.2 FROM FENDL-3.2 BY NJOY2016.60+ C
angular distribution for (n,n*30)

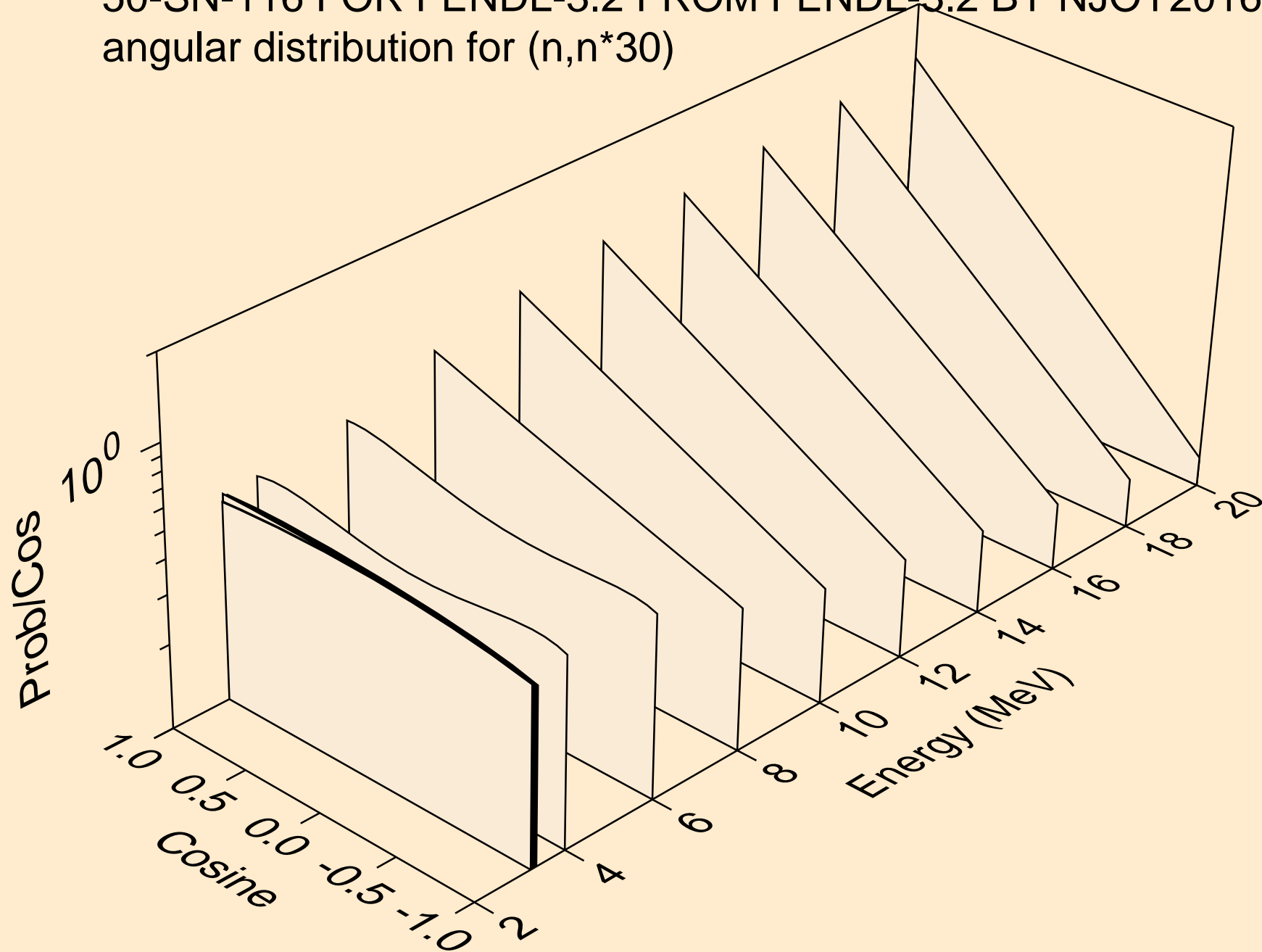

50-SN-116 FOR FENDL-3.2 FROM FENDL-3.2 BY NJOY2016.60+ C
angular distribution for (n,n*31)

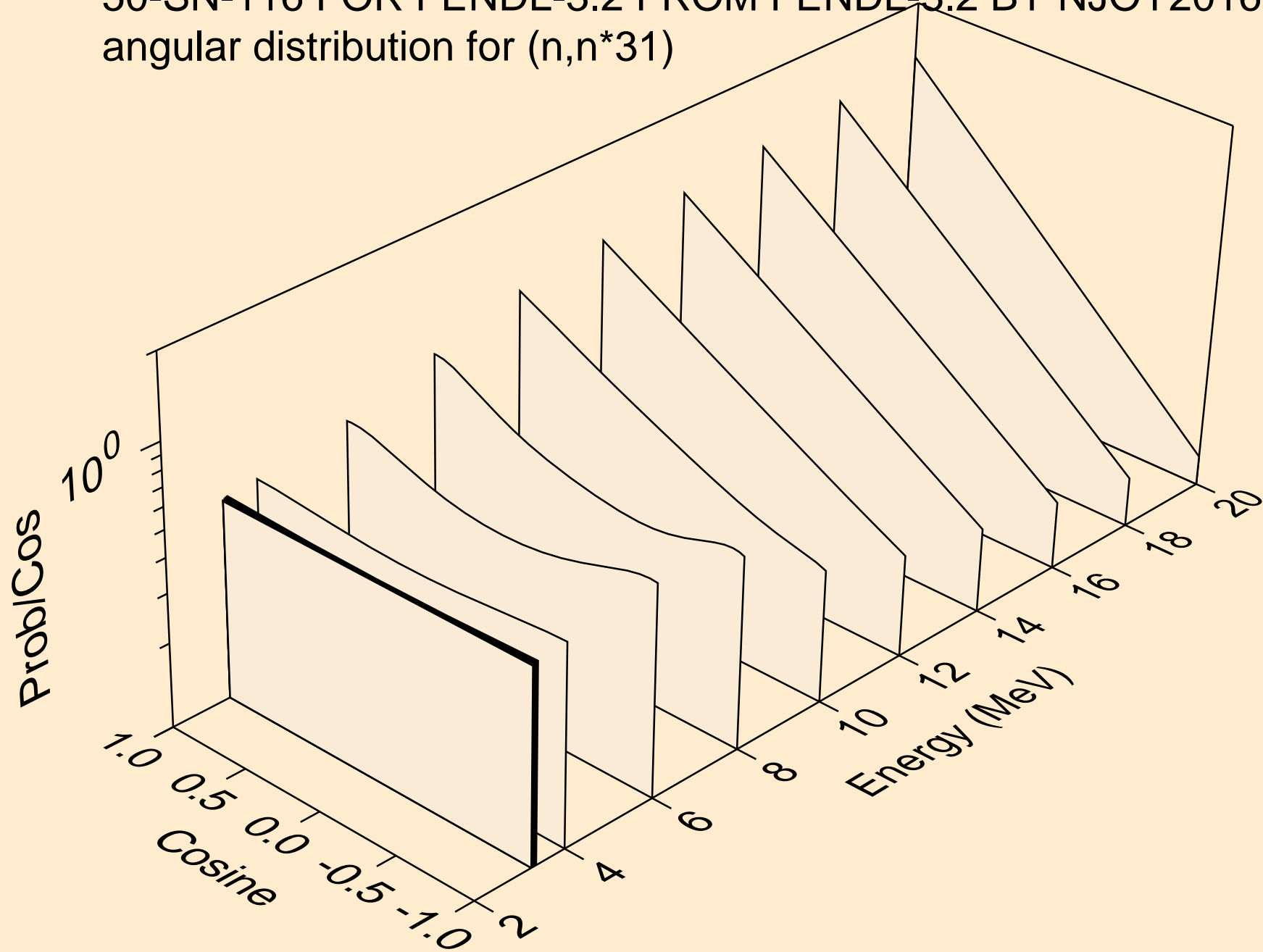

50-SN-116 FOR FENDL-3.2 FROM FENDL-3.2 BY NJOY2016.60+ C
angular distribution for (n,n*32)

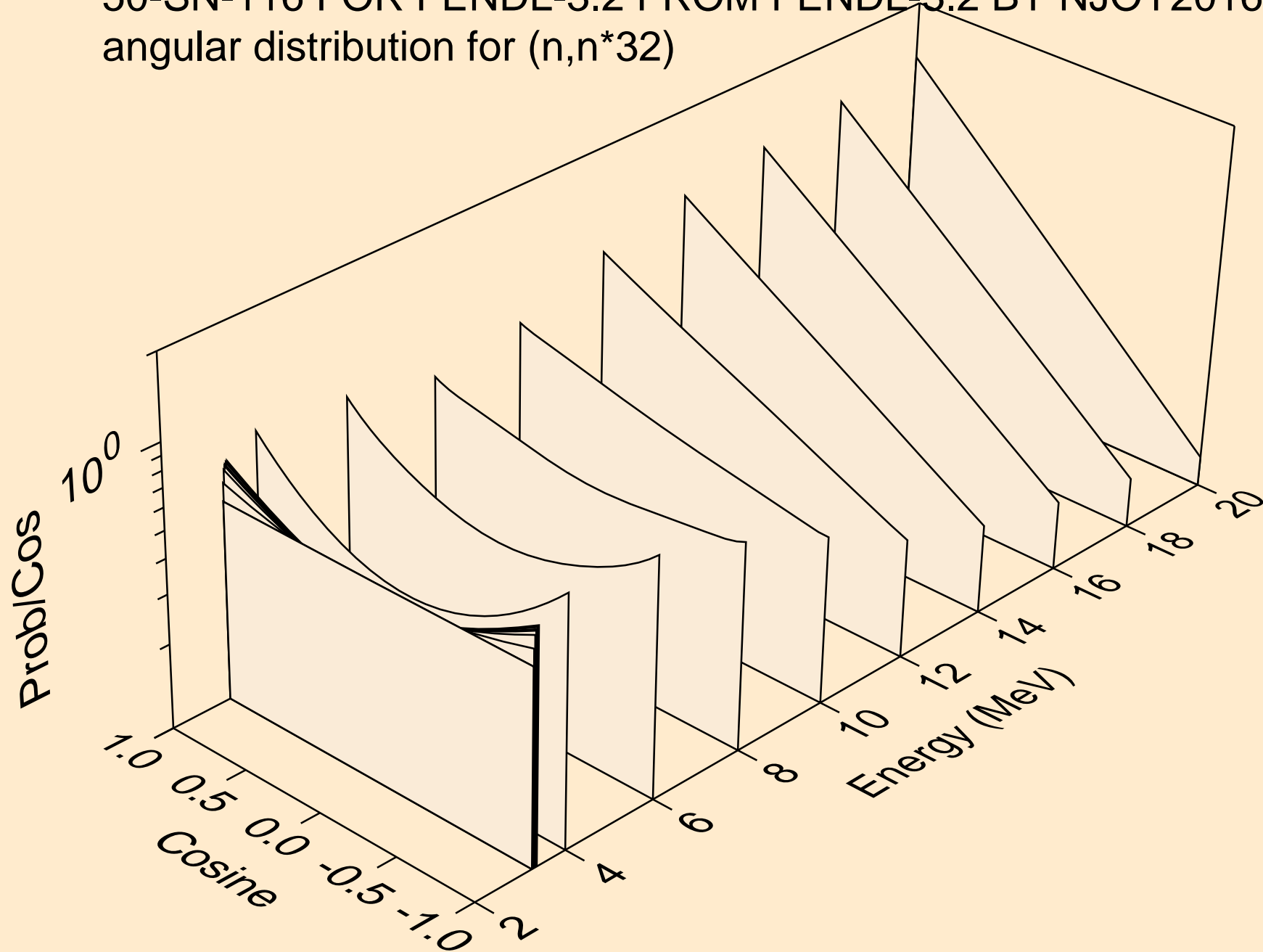

50-SN-116 FOR FENDL-3.2 FROM FENDL-3.2 BY NJOY2016.60+ C
angular distribution for (n,n*33)

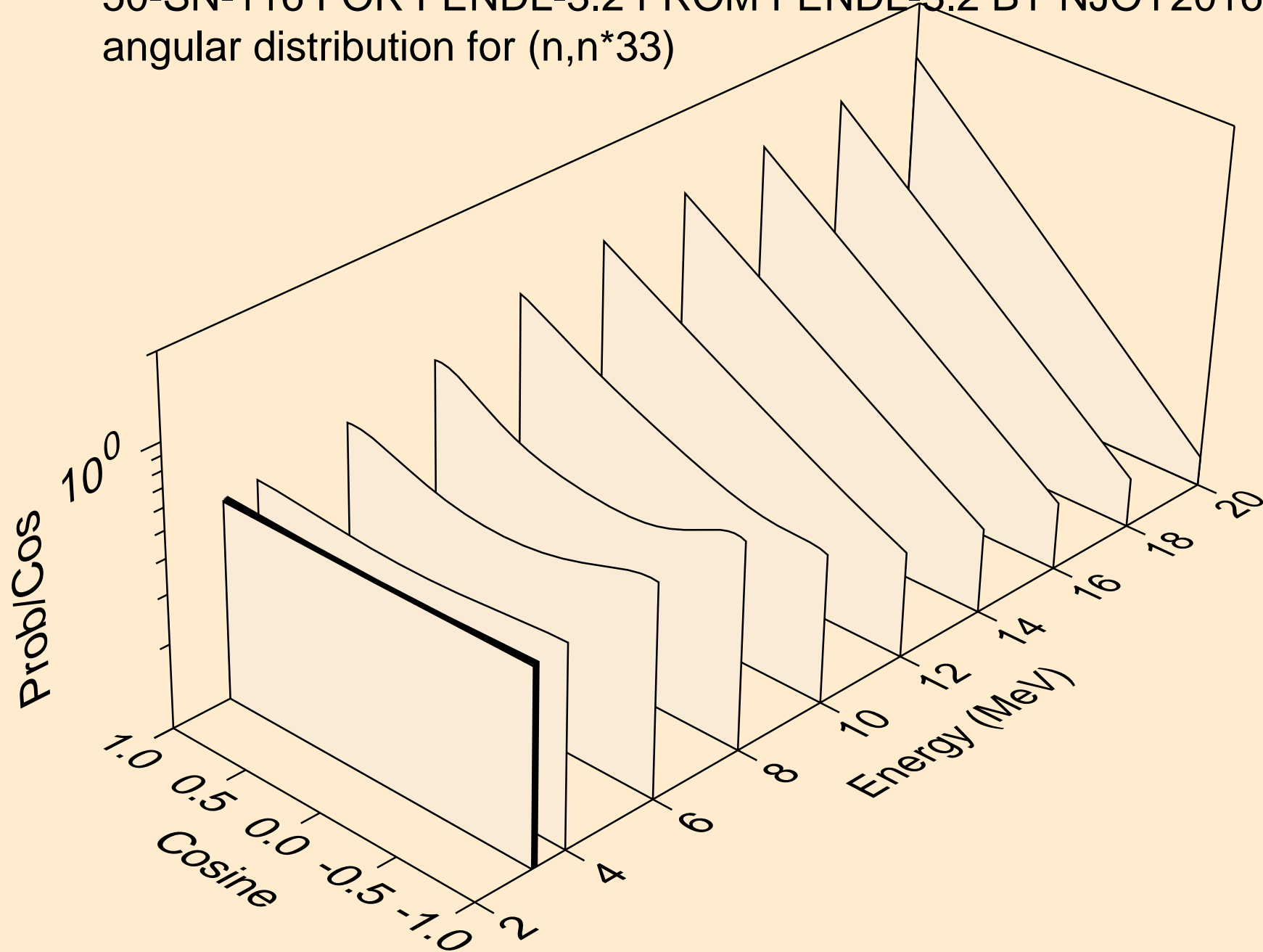

50-SN-116 FOR FENDL-3.2 FROM FENDL-3.2 BY NJOY2016.60+ C
angular distribution for (n,n*34)

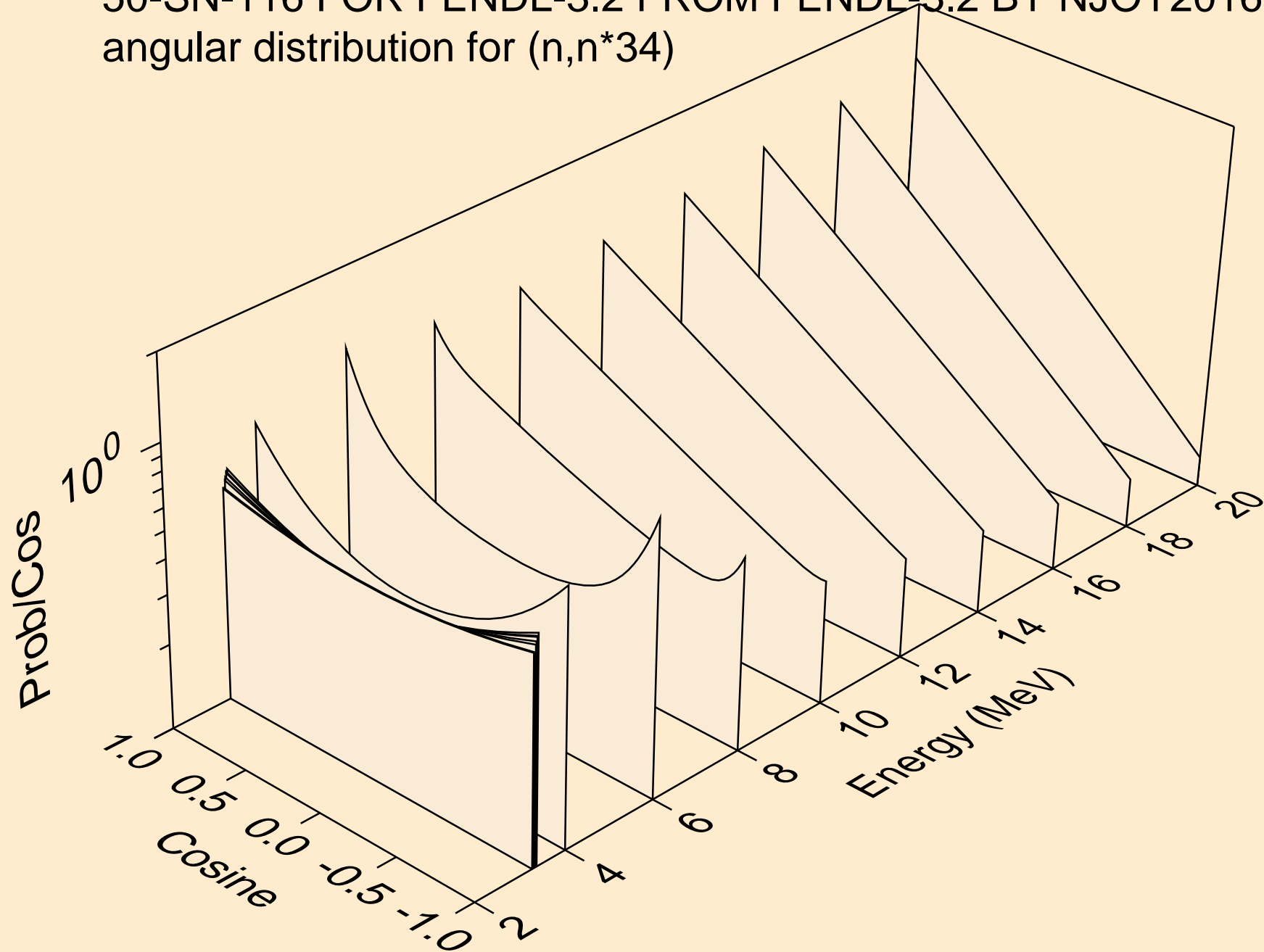

50-SN-116 FOR FENDL-3.2 FROM FENDL-3.2 BY NJOY2016.60+ C
angular distribution for (n,n*35)

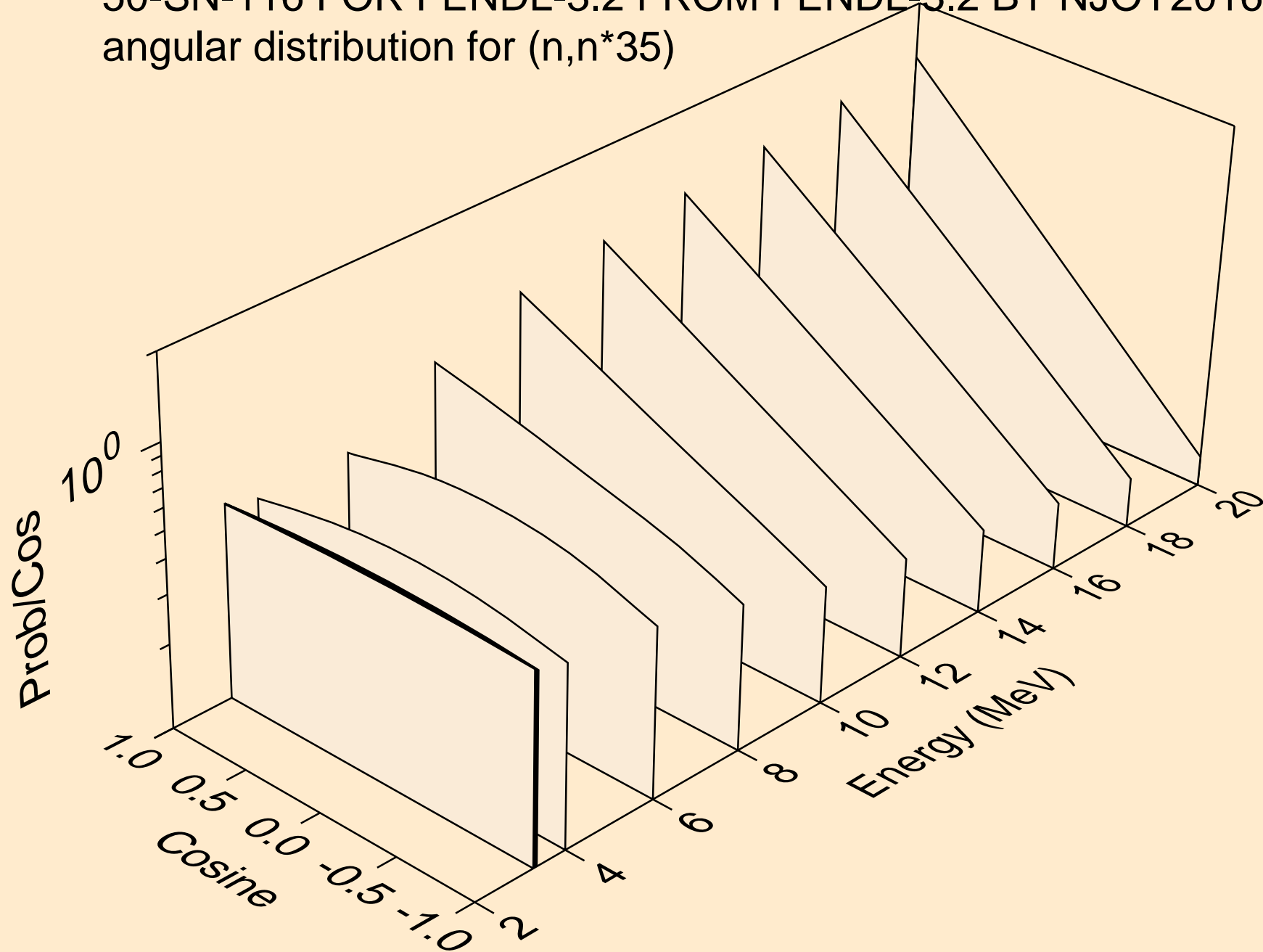

50-SN-116 FOR FENDL-3.2 FROM FENDL-3.2 BY NJOY2016.60+ C
angular distribution for (n,n*36)

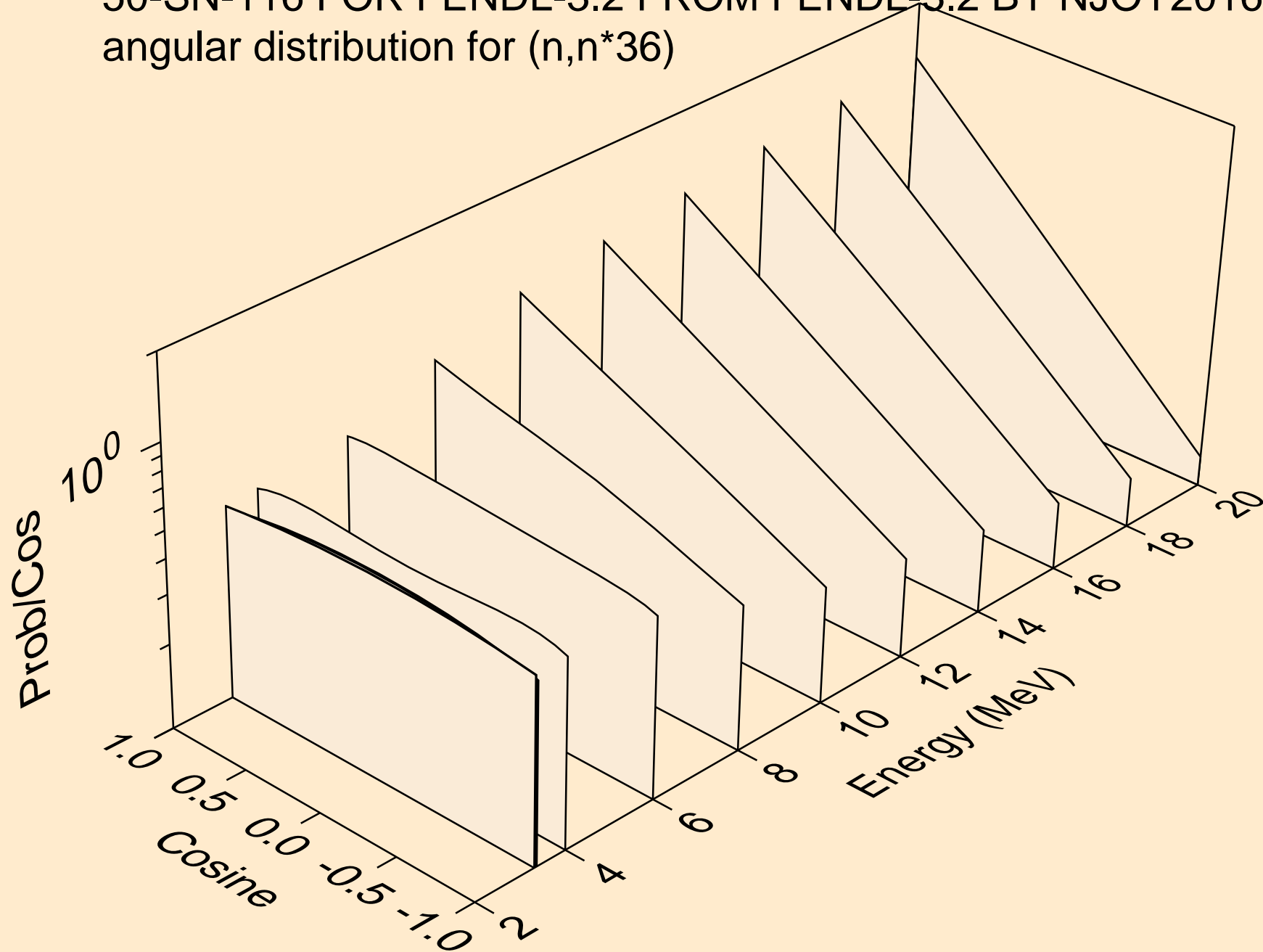

50-SN-116 FOR FENDL-3.2 FROM FENDL-3.2 BY NJOY2016.60+ C
angular distribution for (n,n*37)

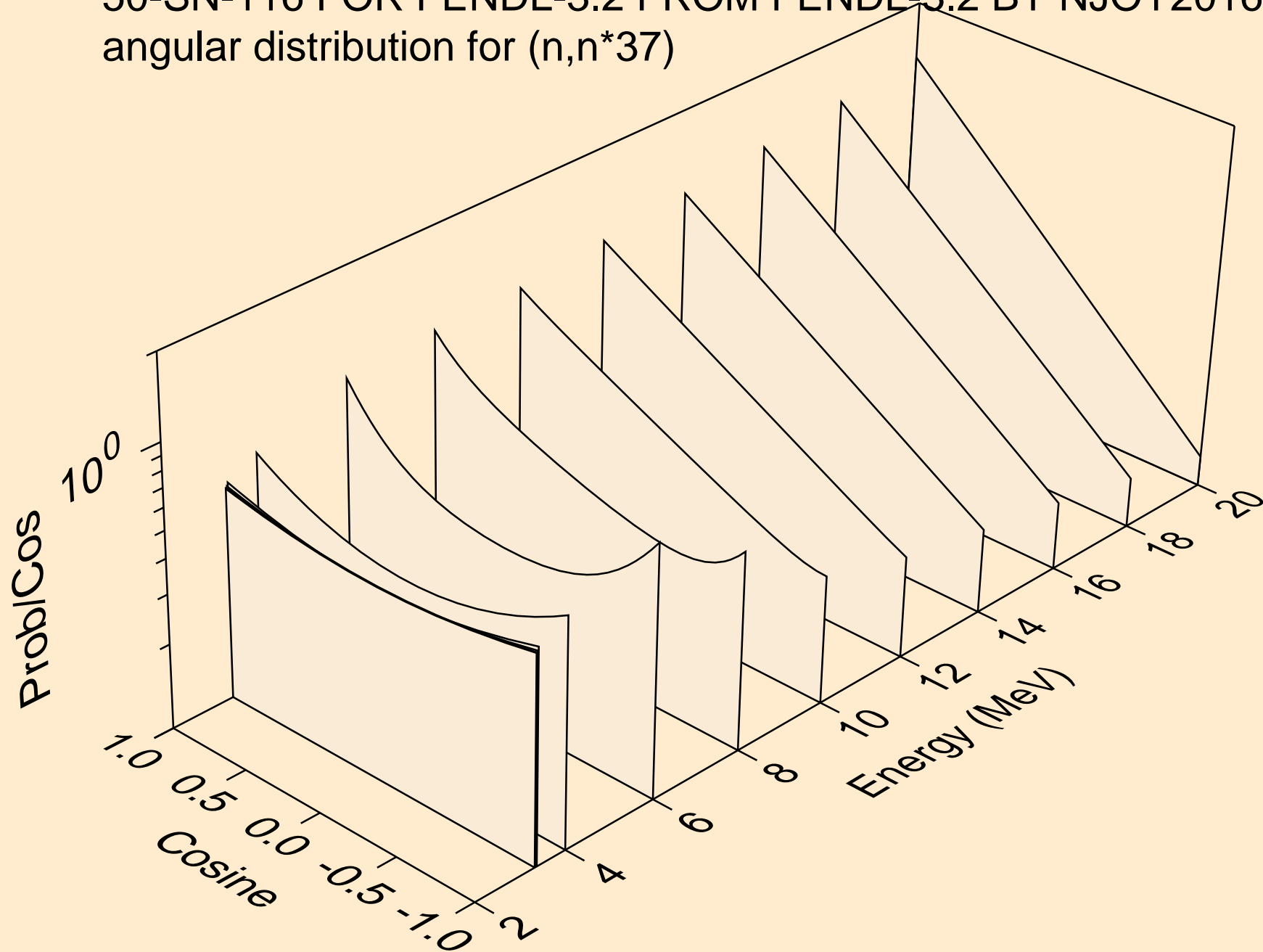

50-SN-116 FOR FENDL-3.2 FROM FENDL-3.2 BY NJOY2016.60+ C
angular distribution for (n,n*38)

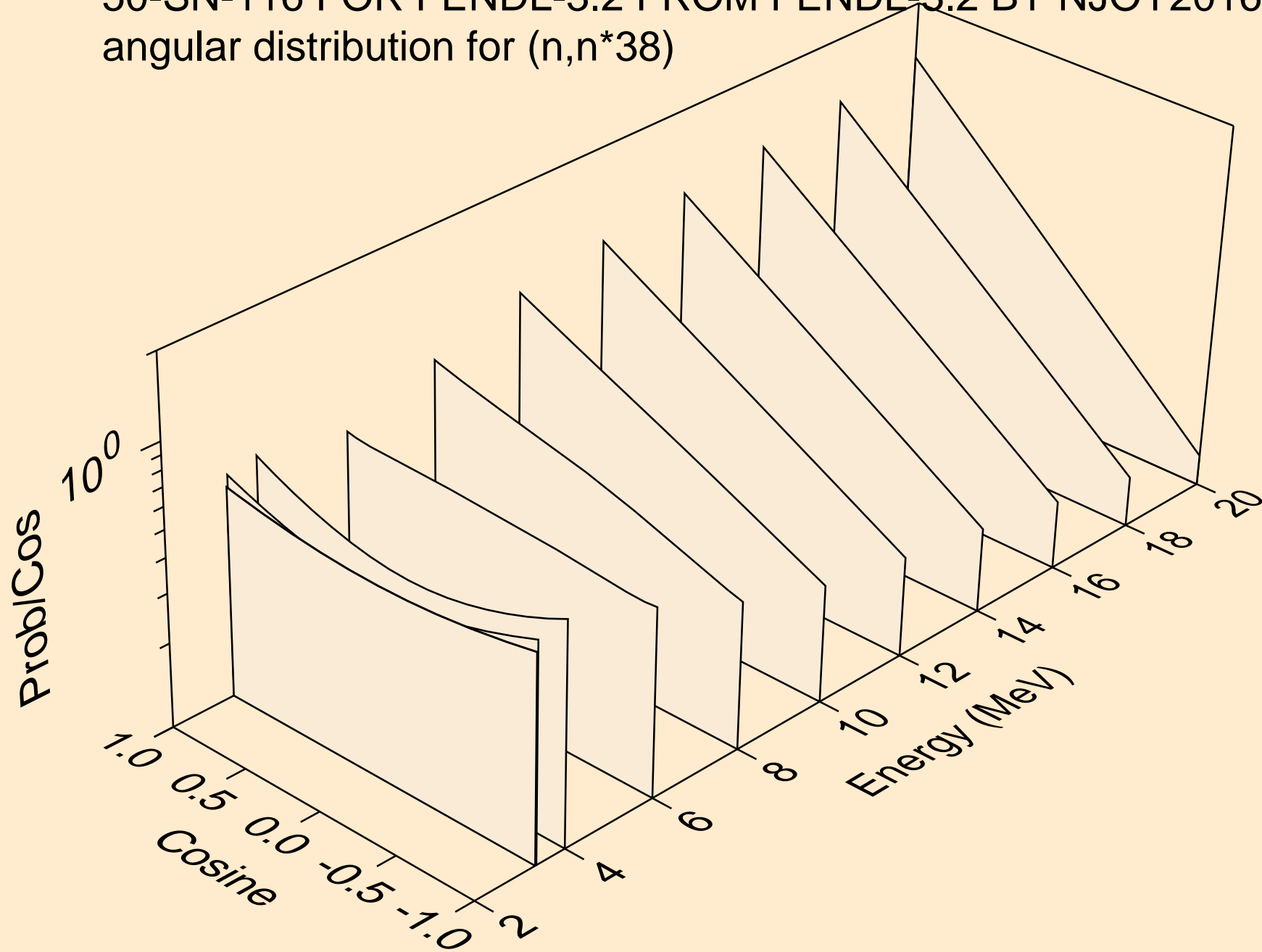

50-SN-116 FOR FENDL-3.2 FROM FENDL-3.2 BY NJOY2016.60+ C
angular distribution for (n,n*39)

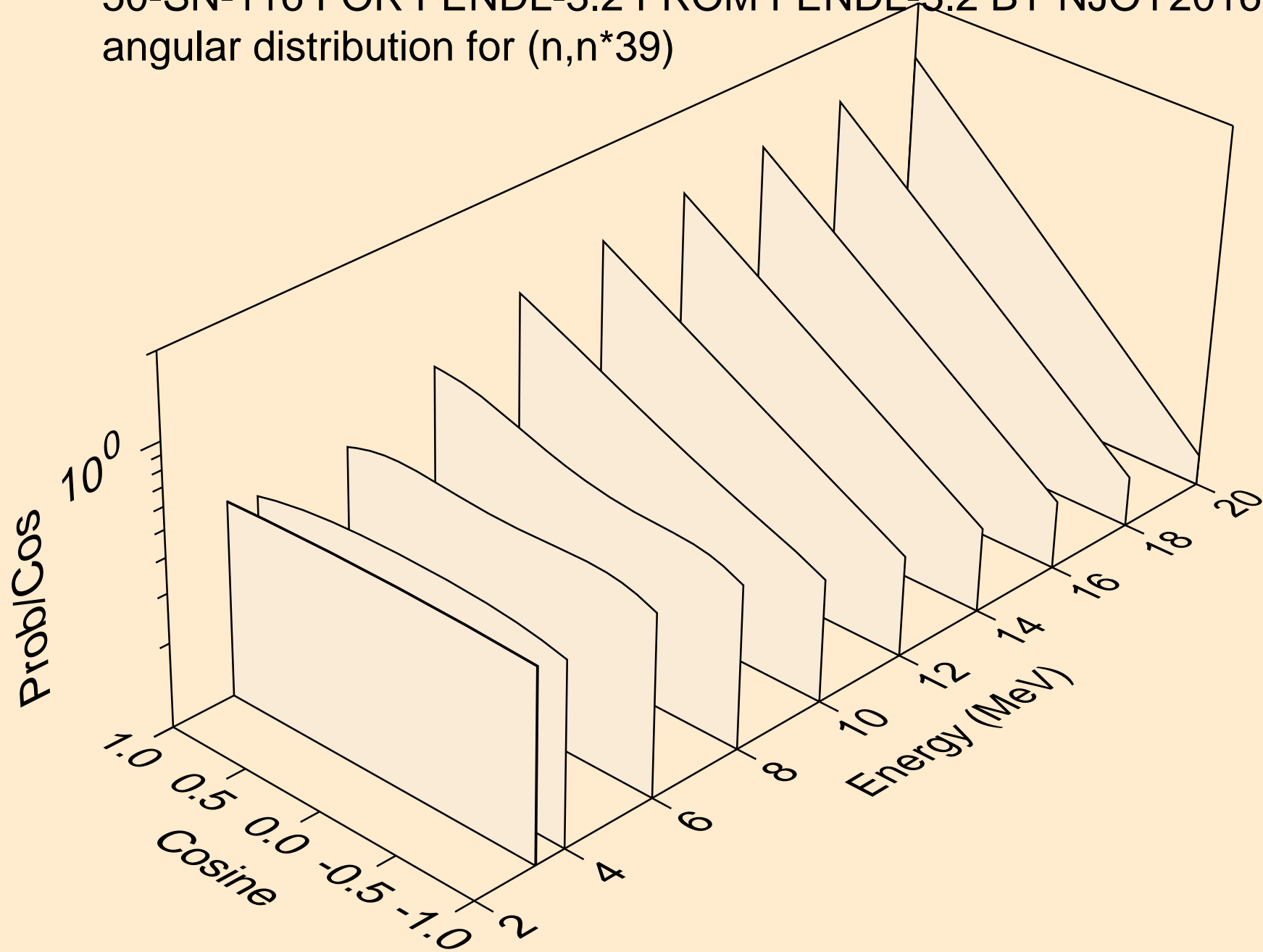

50-SN-116 FOR FENDL-3.2 FROM FENDL-3.2 BY NJOY2016.60+ C
angular distribution for (n,n*40)

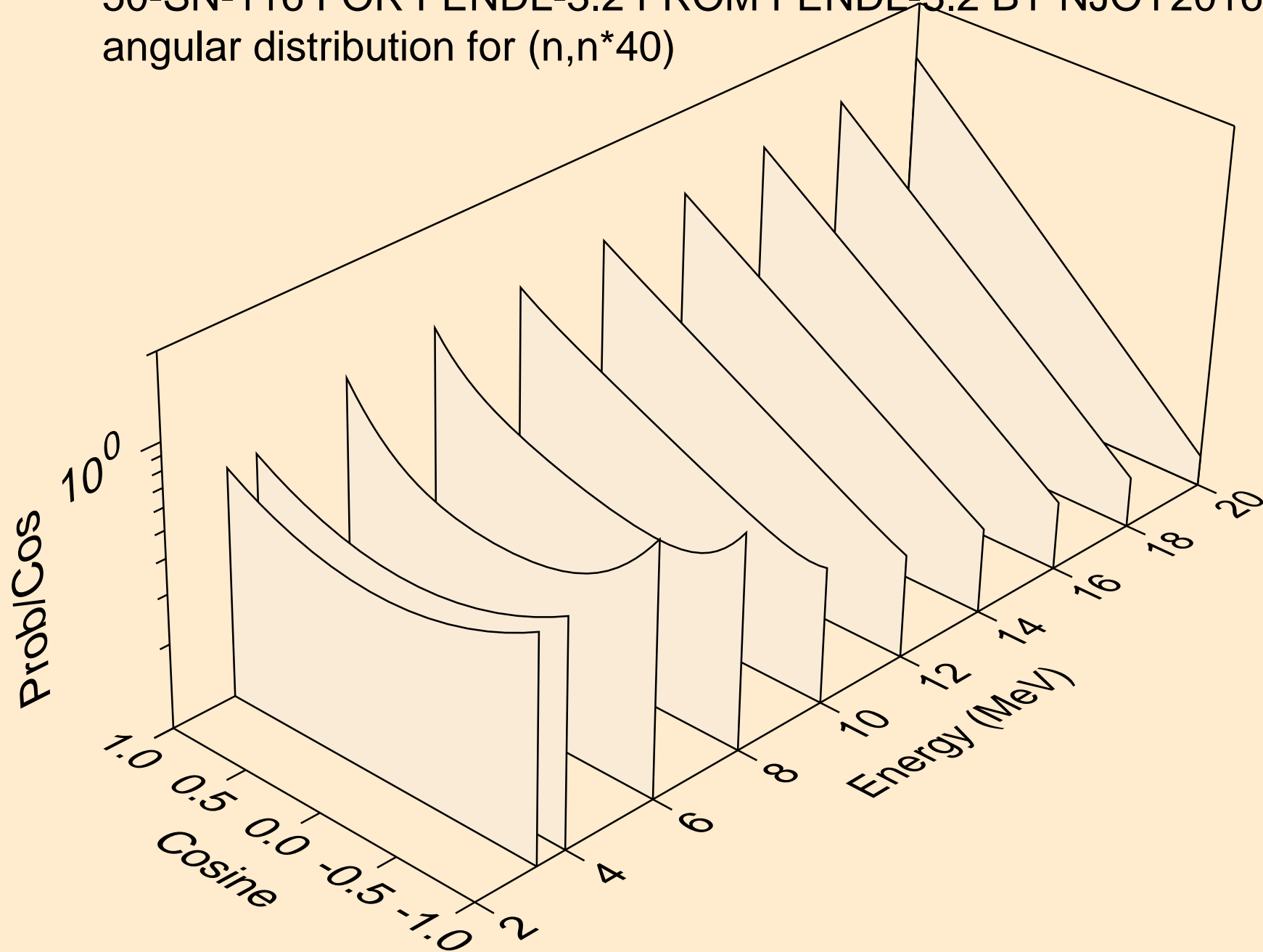

50-SN-116 FOR FENDL-3.2 FROM FENDL-3.2 BY NJOY2016.60+ C
Neutron emission for (n,x)

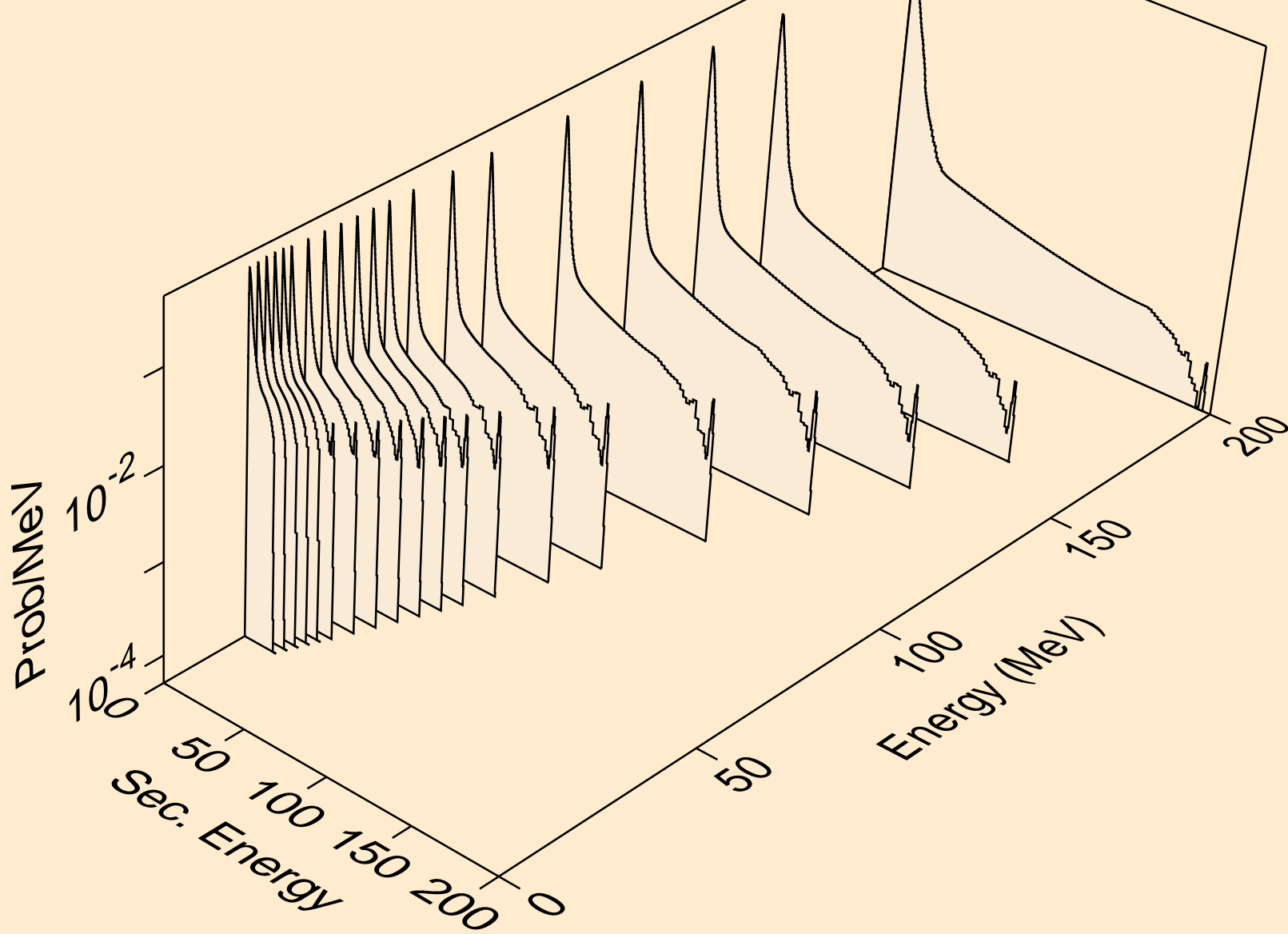

50-SN-116 FOR FENDL-3.2 FROM FENDL-3.2 BY NJOY2016.60+ C
Neutron emission for (n,2n)

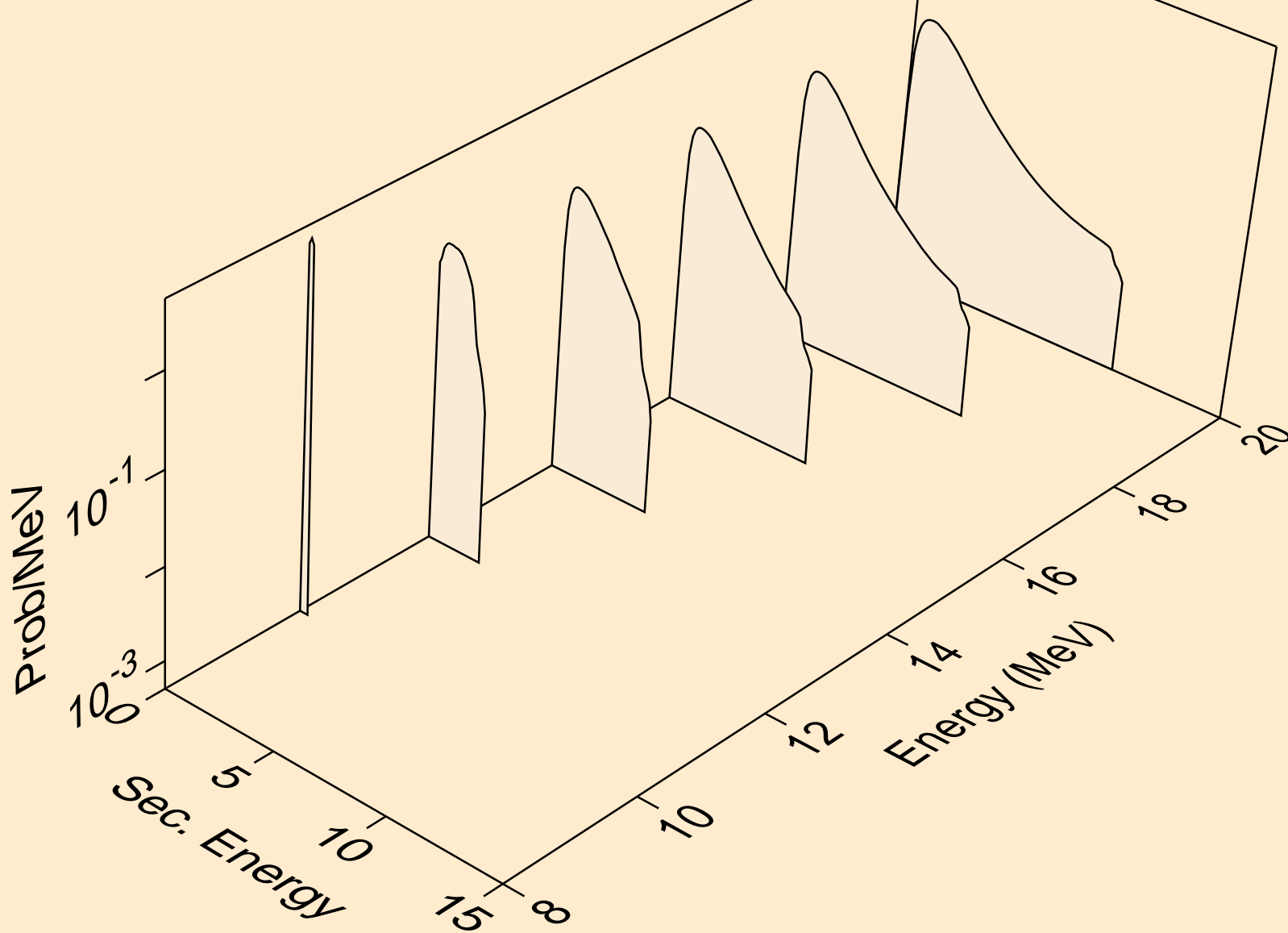

50-SN-116 FOR FENDL-3.2 FROM FENDL-3.2 BY NJOY2016.60+ C
Neutron emission for (n,3n)

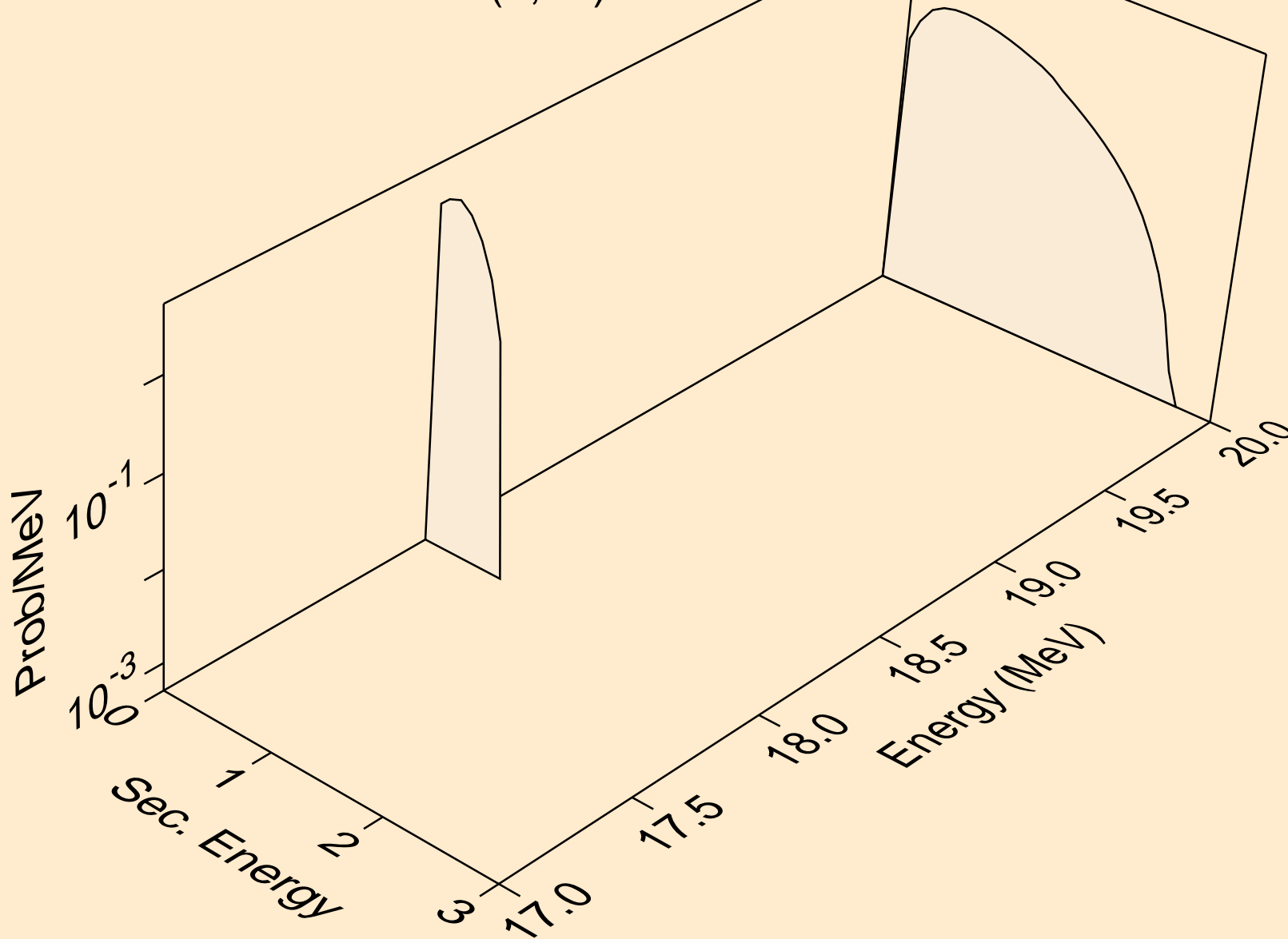

50-SN-116 FOR FENDL-3.2 FROM FENDL-3.2 BY NJOY2016.60+ C
Neutron emission for (n,n*)a

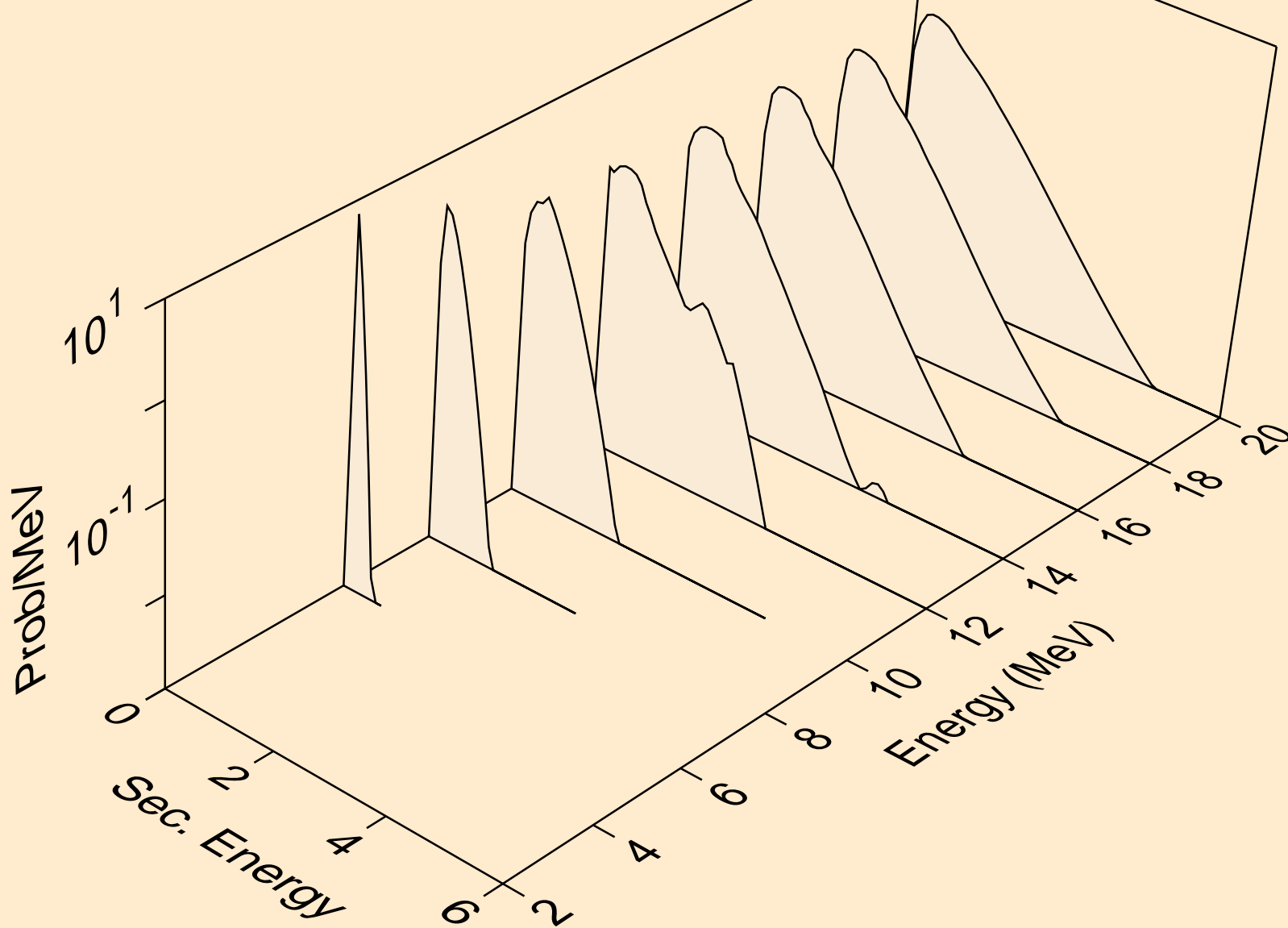

50-SN-116 FOR FENDL-3.2 FROM FENDL-3.2 BY NJOY2016.60+ C
Neutron emission for (n,n*)p

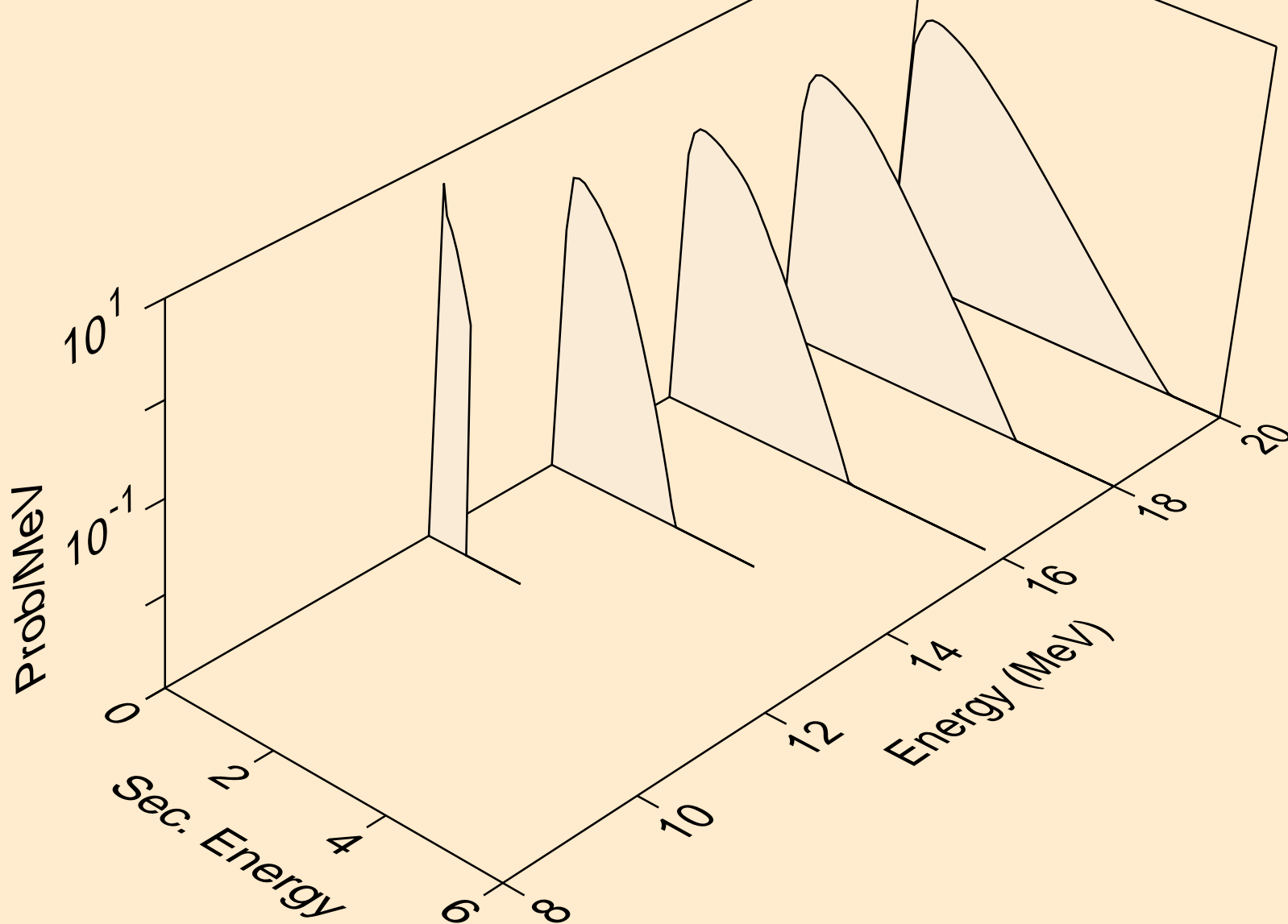

50-SN-116 FOR FENDL-3.2 FROM FENDL-3.2 BY NJOY2016.60+ C
Neutron emission for (n,n*c)

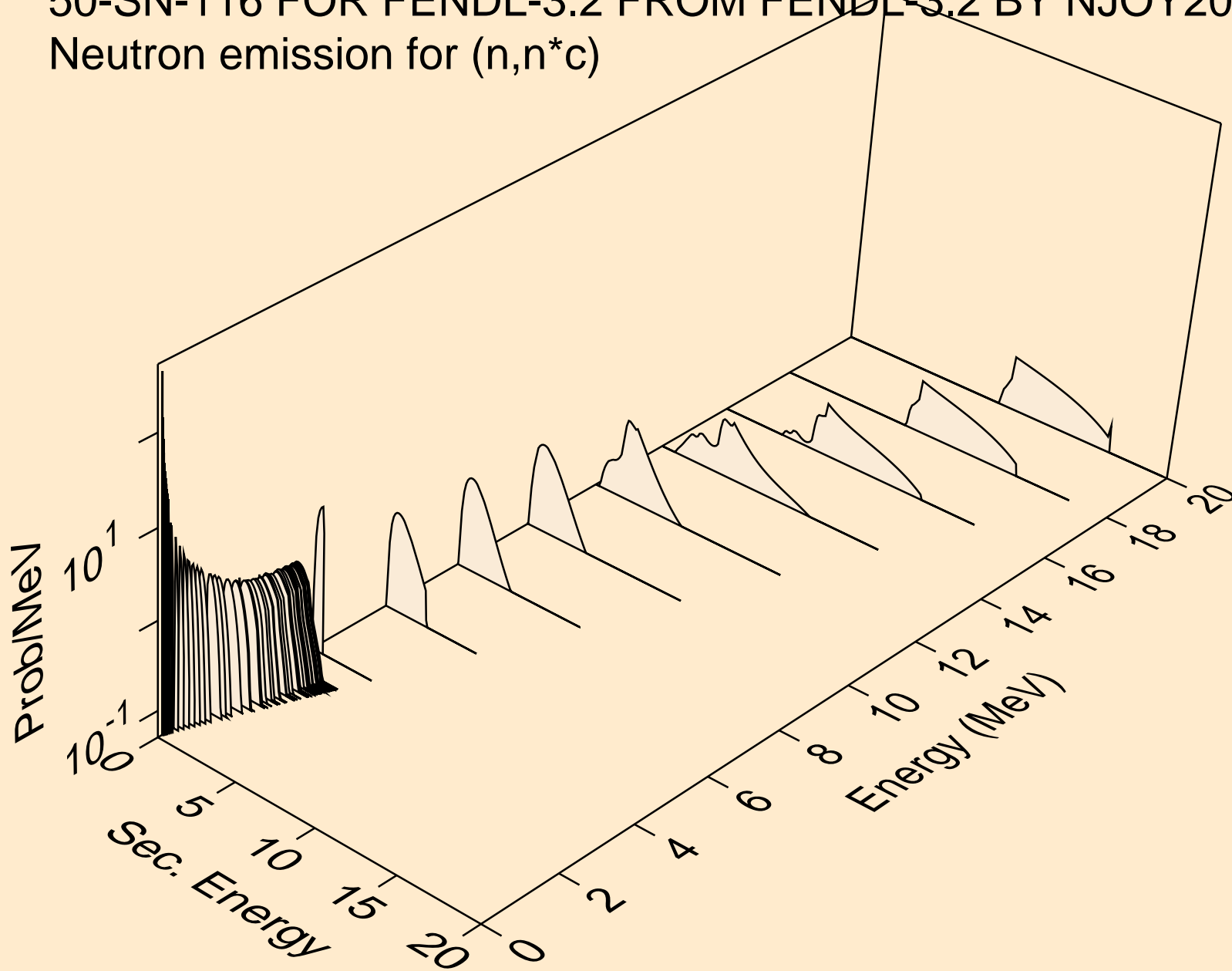

50-SN-116 FOR FENDL-3.2 FROM FENDL-3.2 BY NJOY2016.60+ C
Photon emission for (n,x)

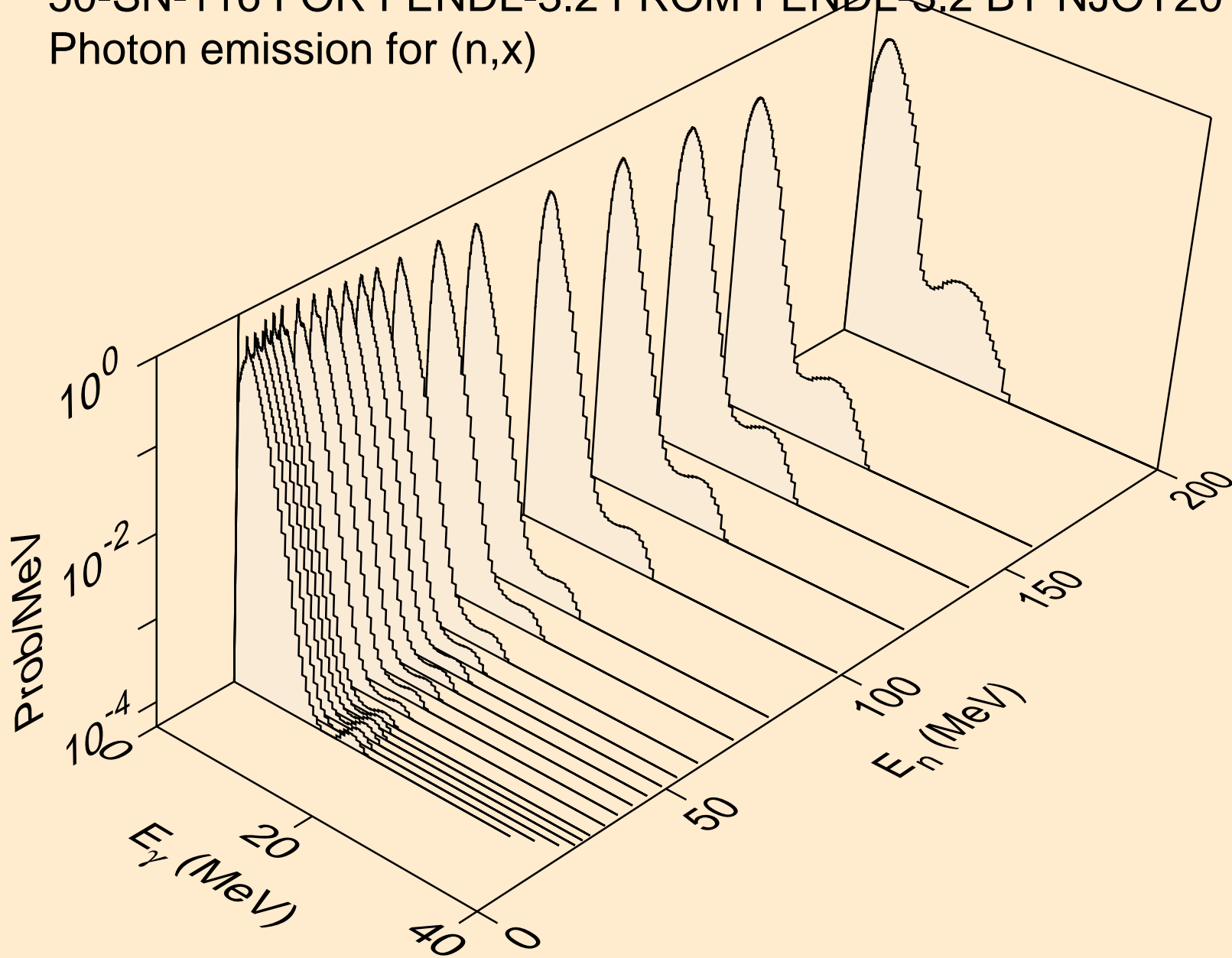

50-SN-116 FOR FENDL-3.2 FROM FENDL-3.2 BY NJOY2016.60+ C
Photon emission for (n,2n)

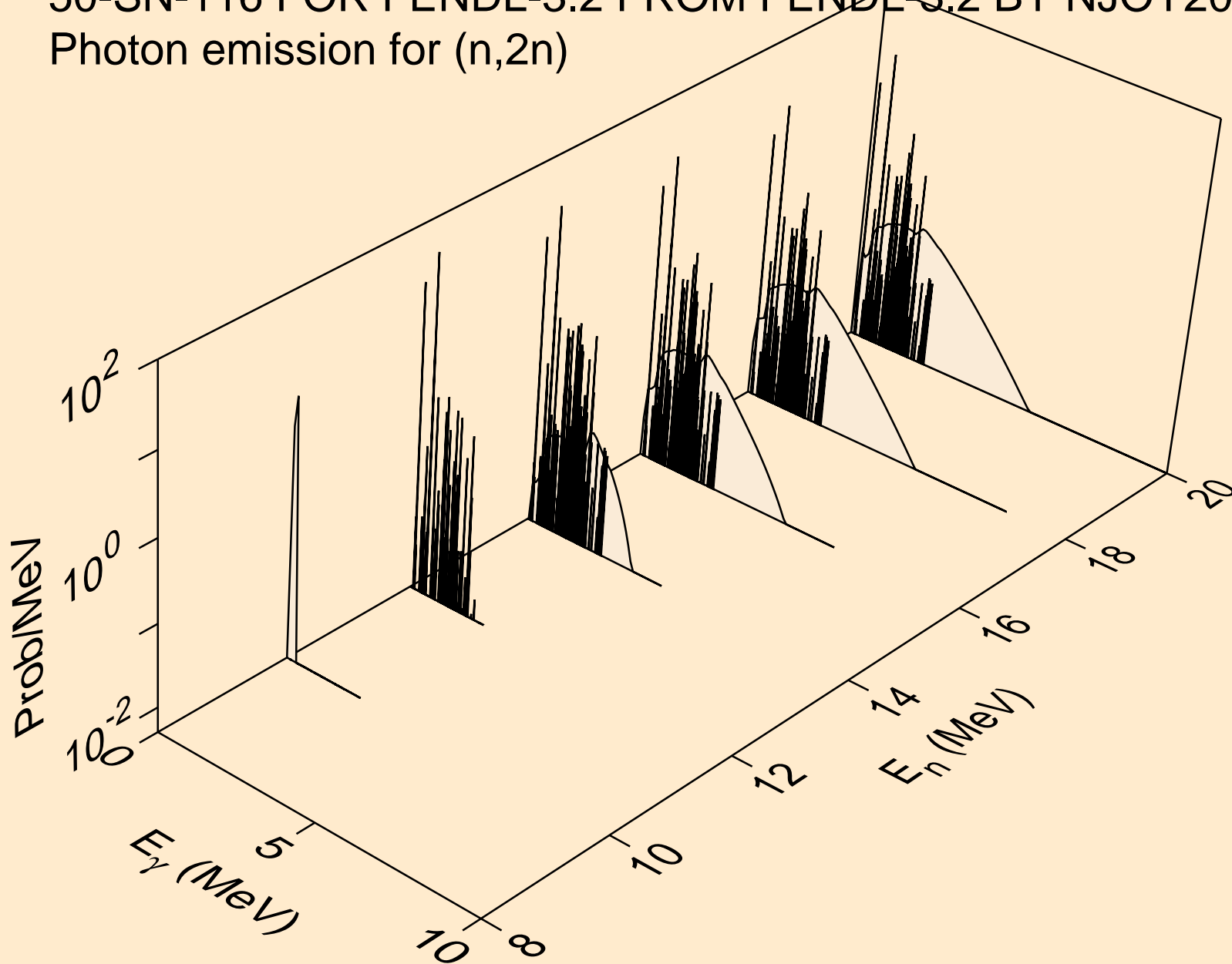

50-SN-116 FOR FENDL-3.2 FROM FENDL-3.2 BY NJOY2016.60+ C
Photon emission for (n,3n)

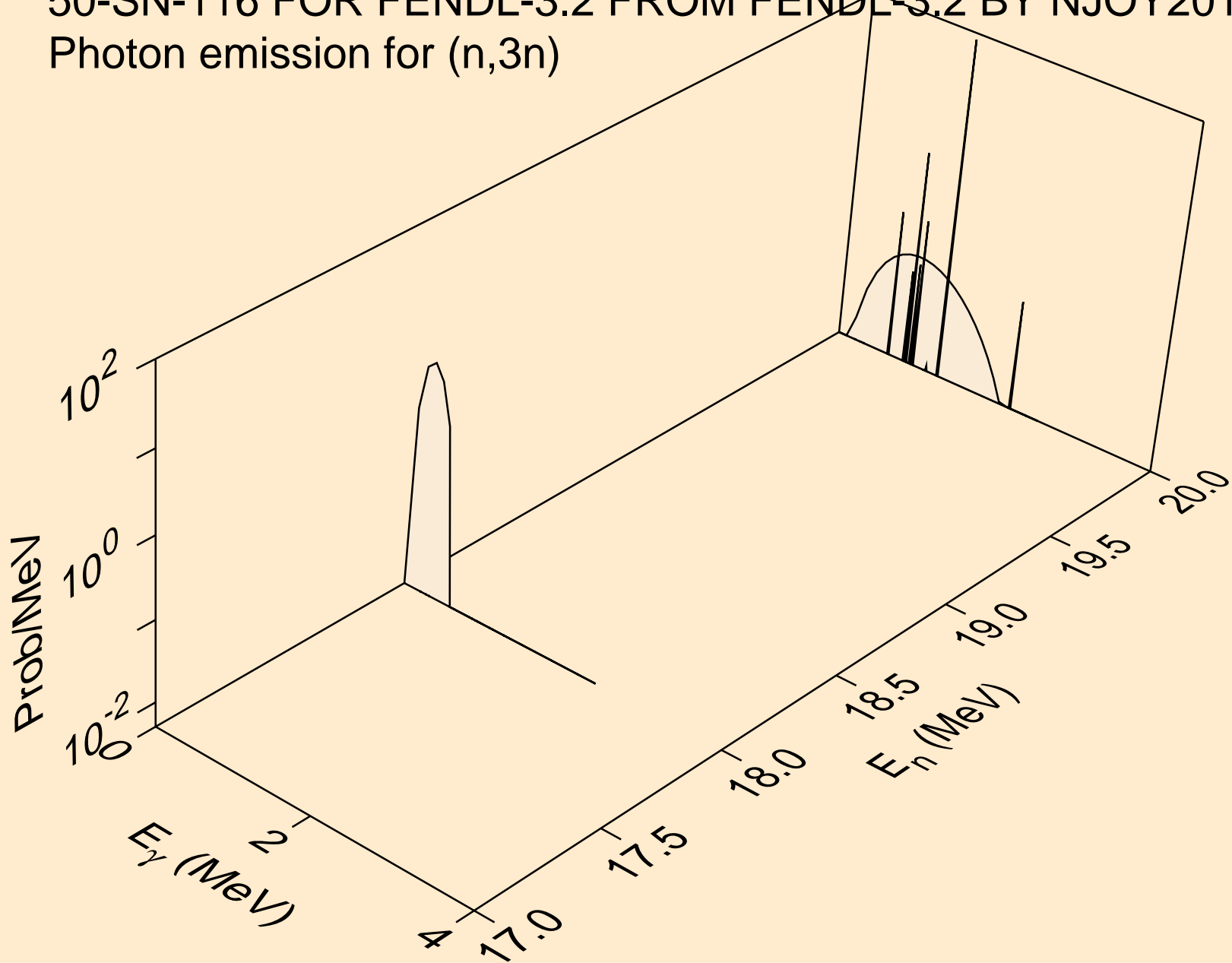

50-SN-116 FOR FENDL-3.2 FROM FENDL-3.2 BY NJOY2016.60+ C
Photon emission for (n,n*)a

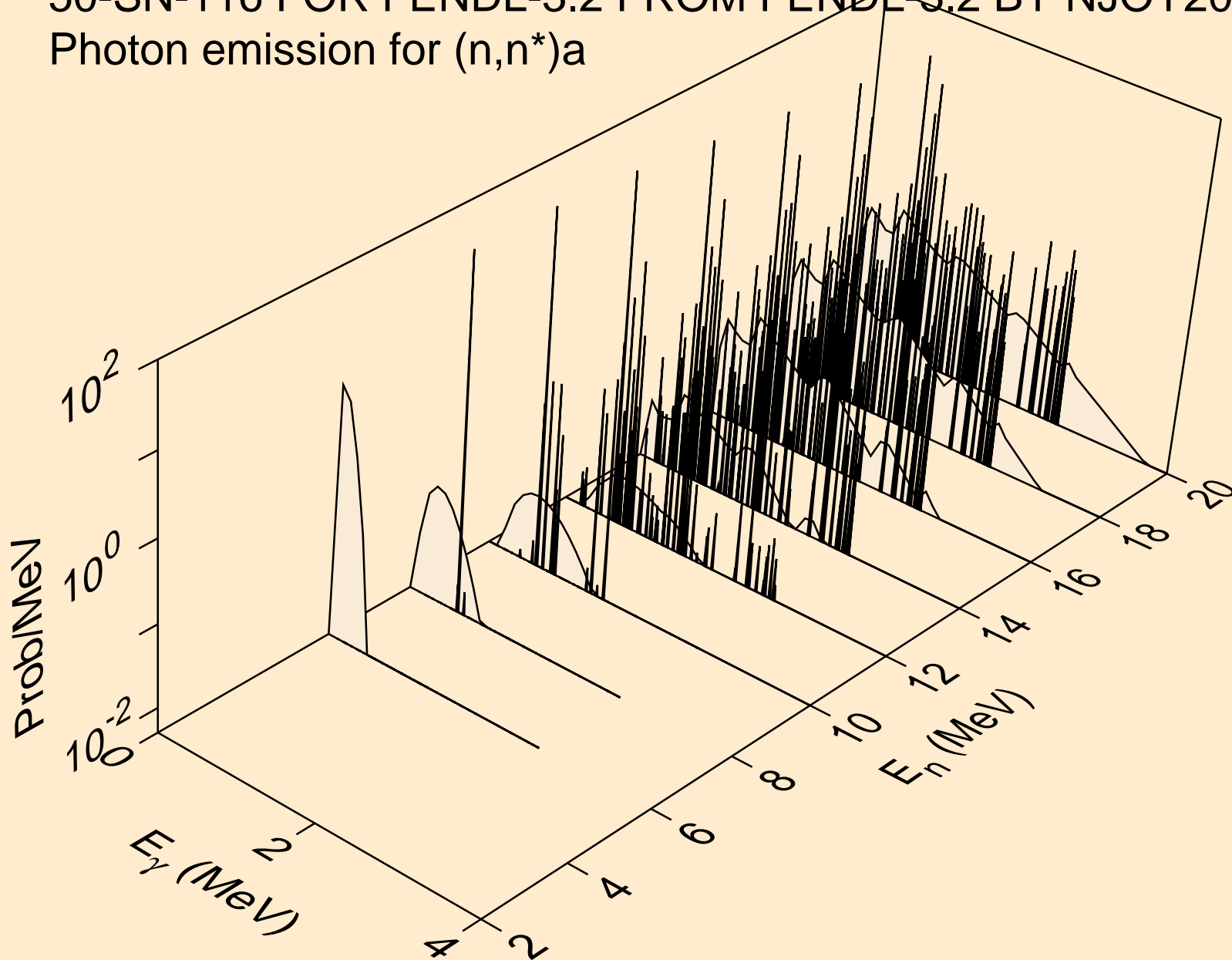

50-SN-116 FOR FENDL-3.2 FROM FENDL-3.2 BY NJOY2016.60+ C
Photon emission for (n,n*)p

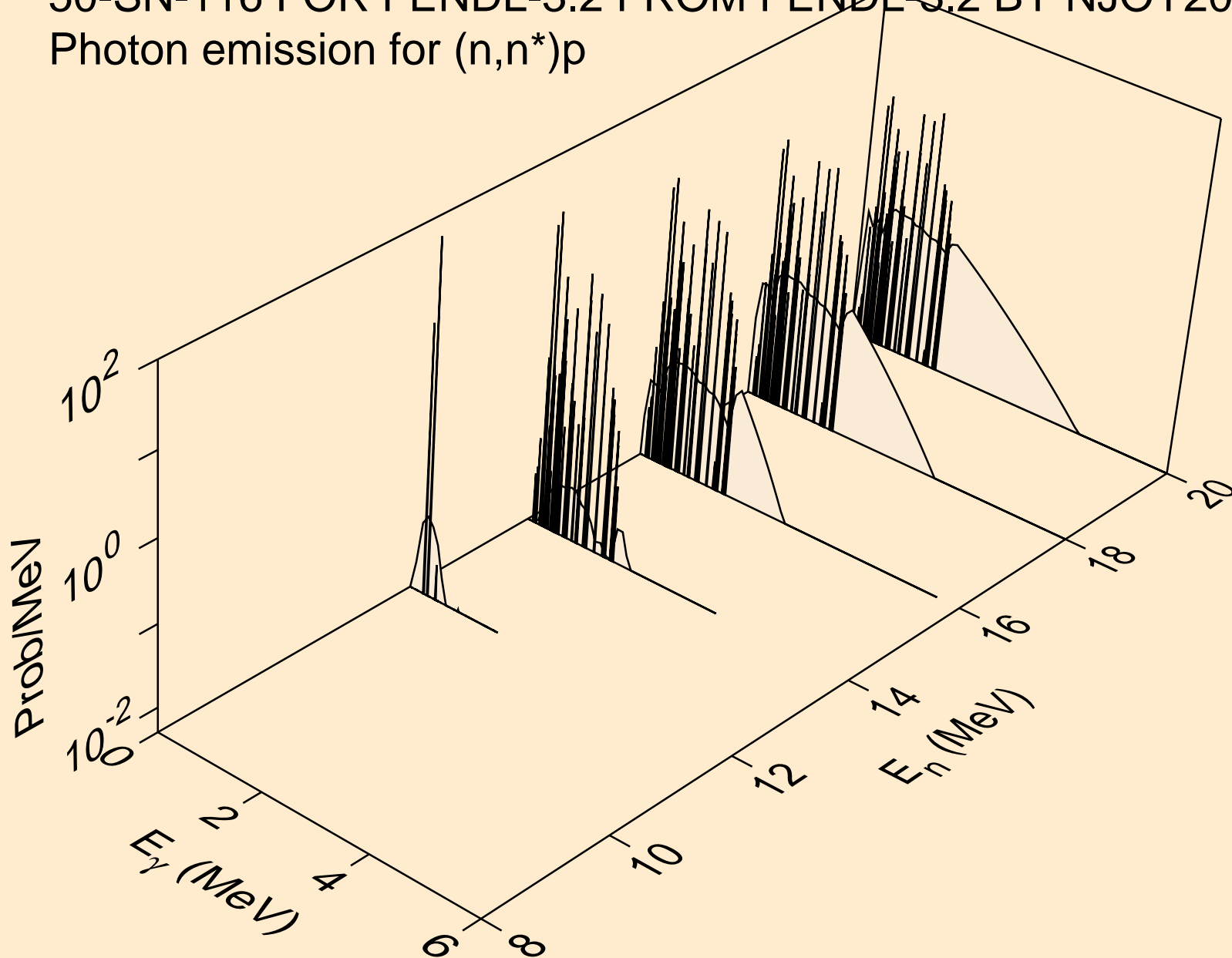

50-SN-116 FOR FENDL-3.2 FROM FENDL-3.2 BY NJOY2016.60+ C
Photon emission for (n,n*1)

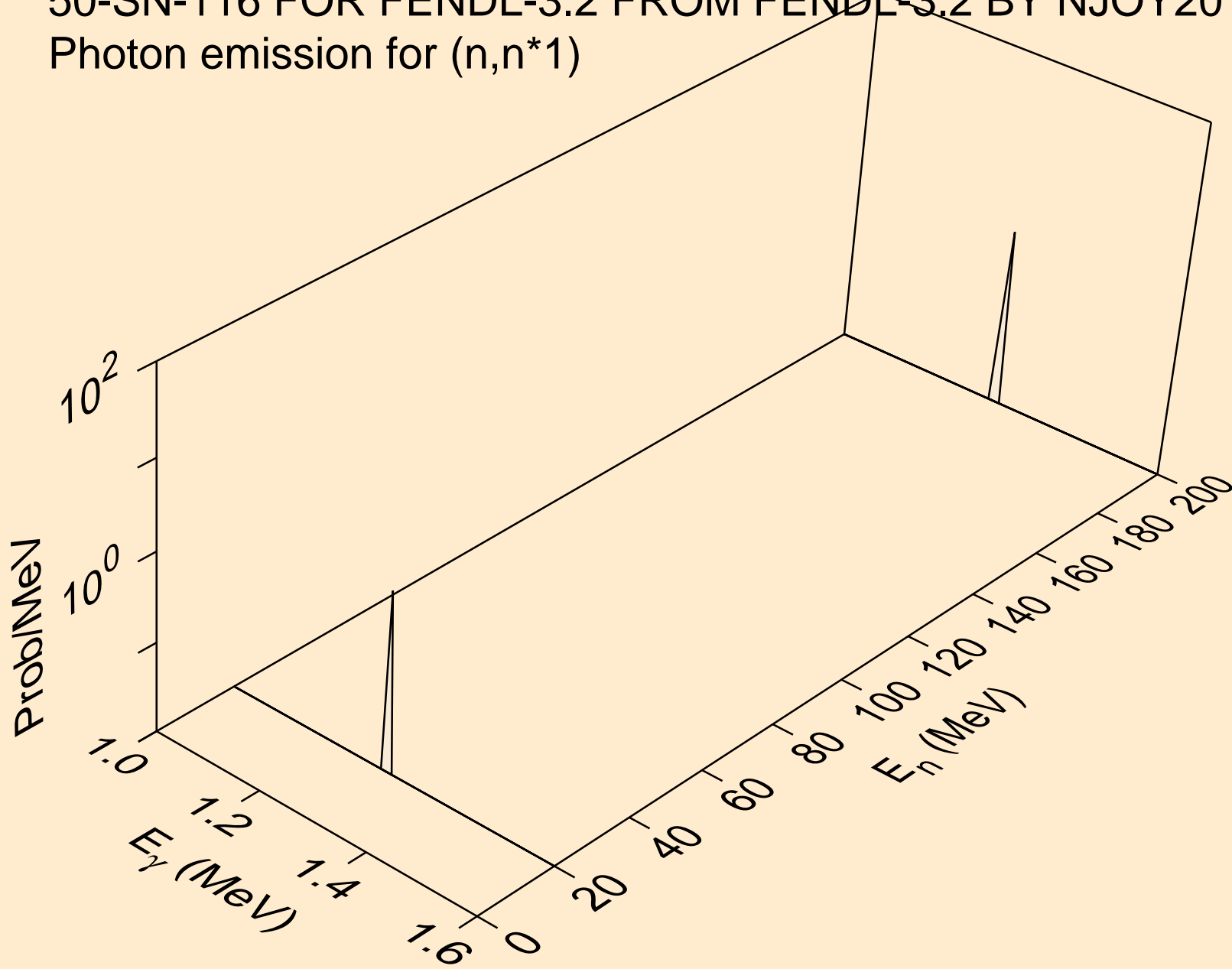

50-SN-116 FOR FENDL-3.2 FROM FENDL-3.2 BY NJOY2016.60+ C
Photon emission for (n,n*2)

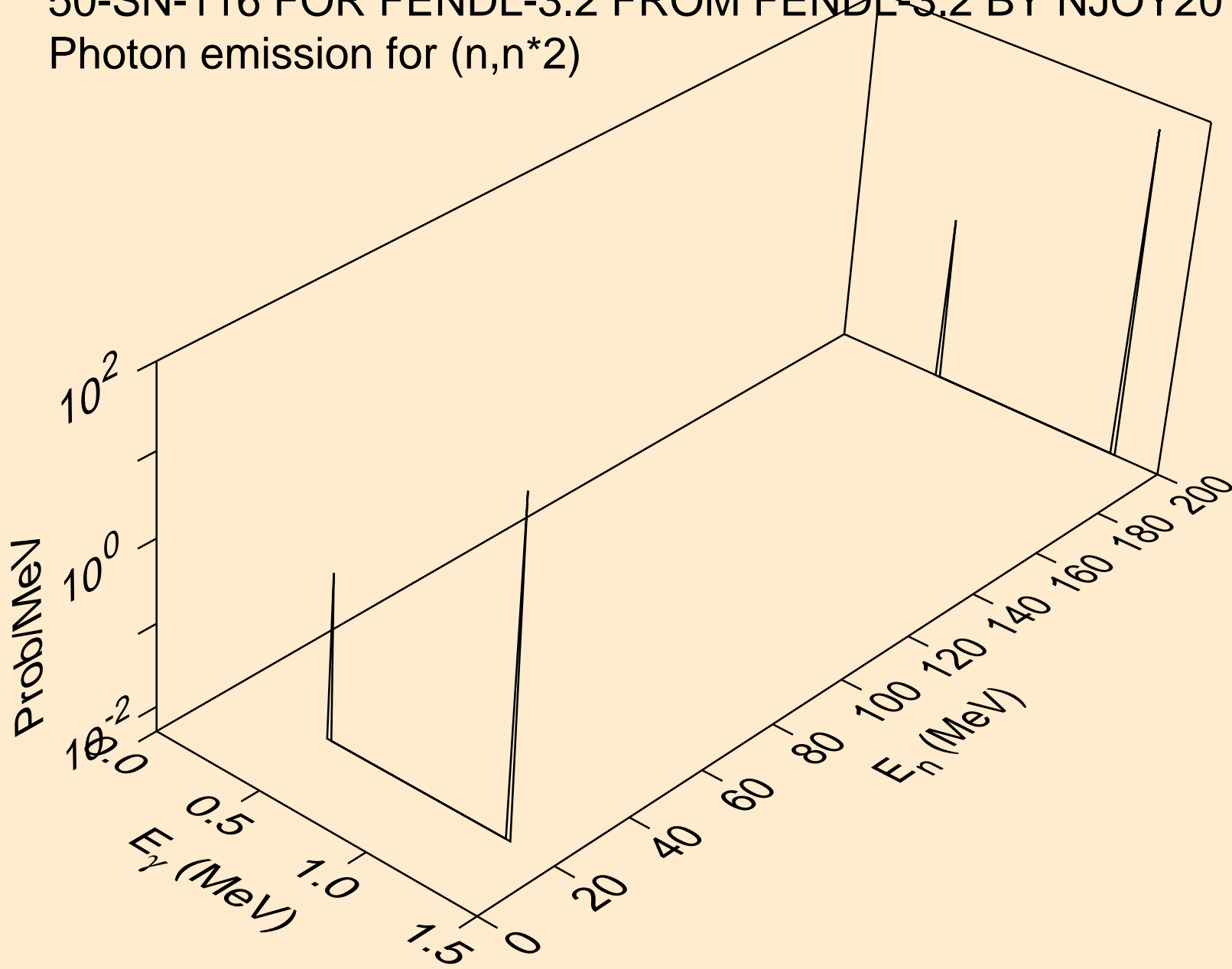

50-SN-116 FOR FENDL-3.2 FROM FENDL-3.2 BY NJOY2016.60+ C
Photon emission for (n,n*3)

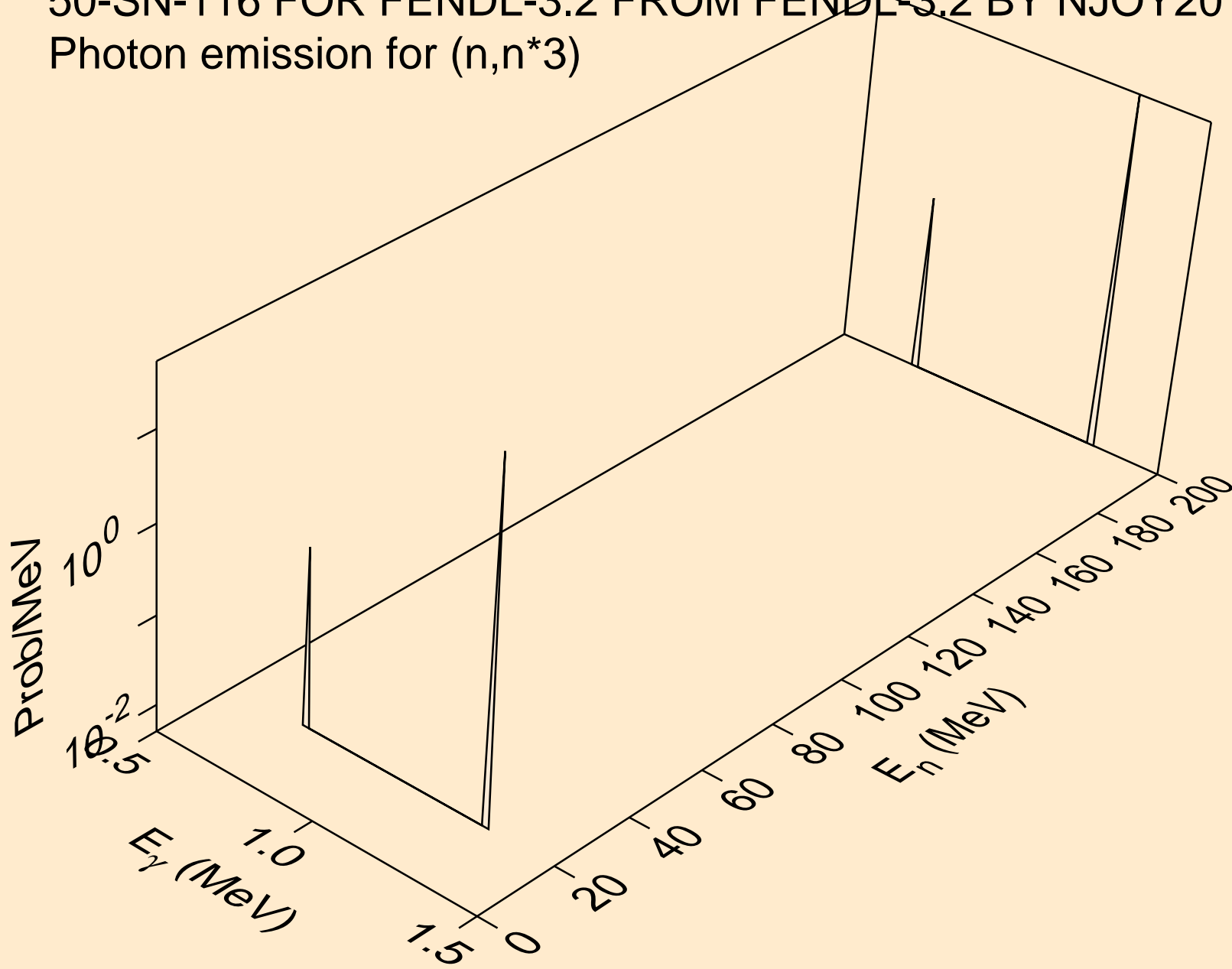

50-SN-116 FOR FENDL-3.2 FROM FENDL-3.2 BY NJOY2016.60+ C
Photon emission for (n,n*4)

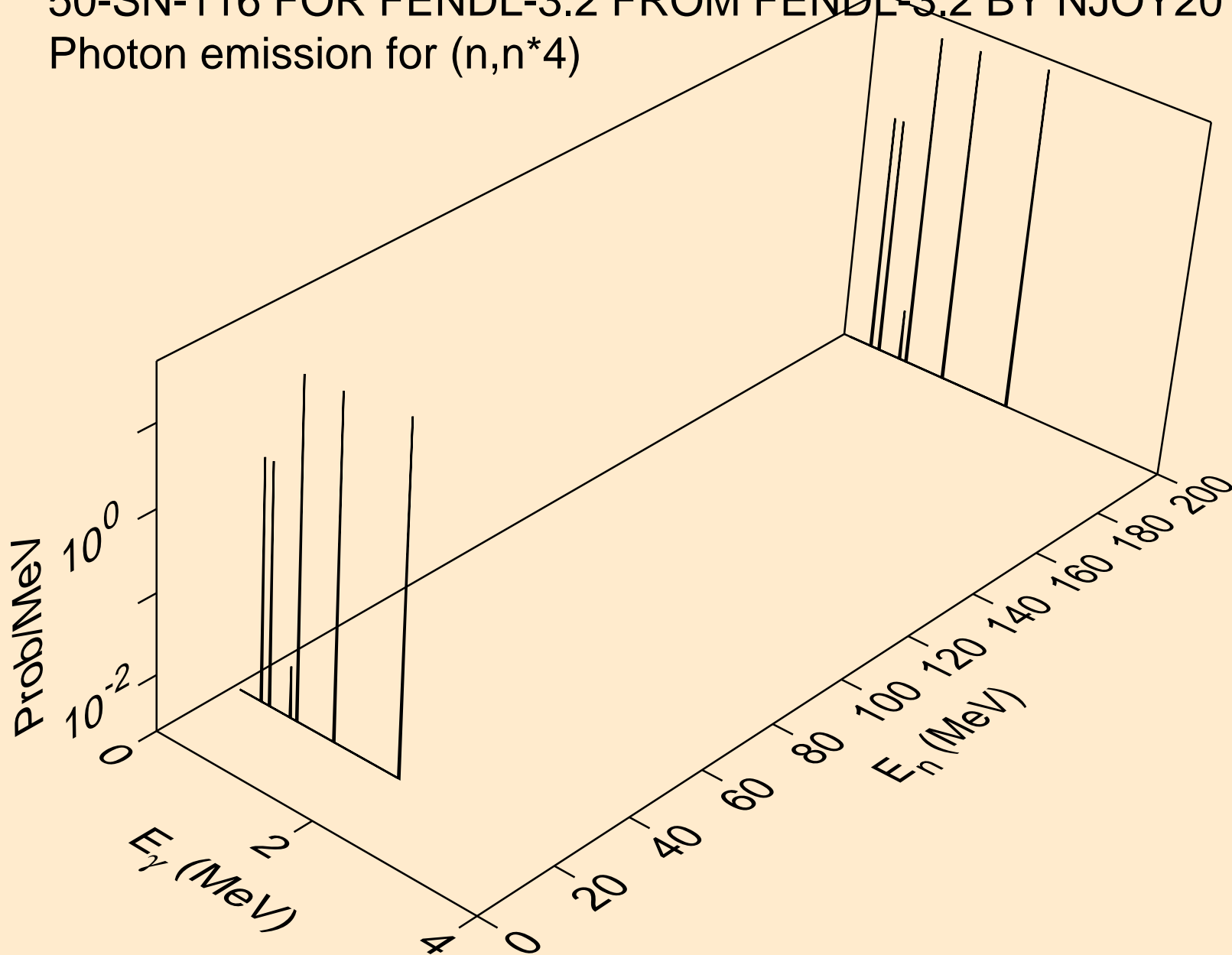

50-SN-116 FOR FENDL-3.2 FROM FENDL-3.2 BY NJOY2016.60+ C
Photon emission for (n,n*5)

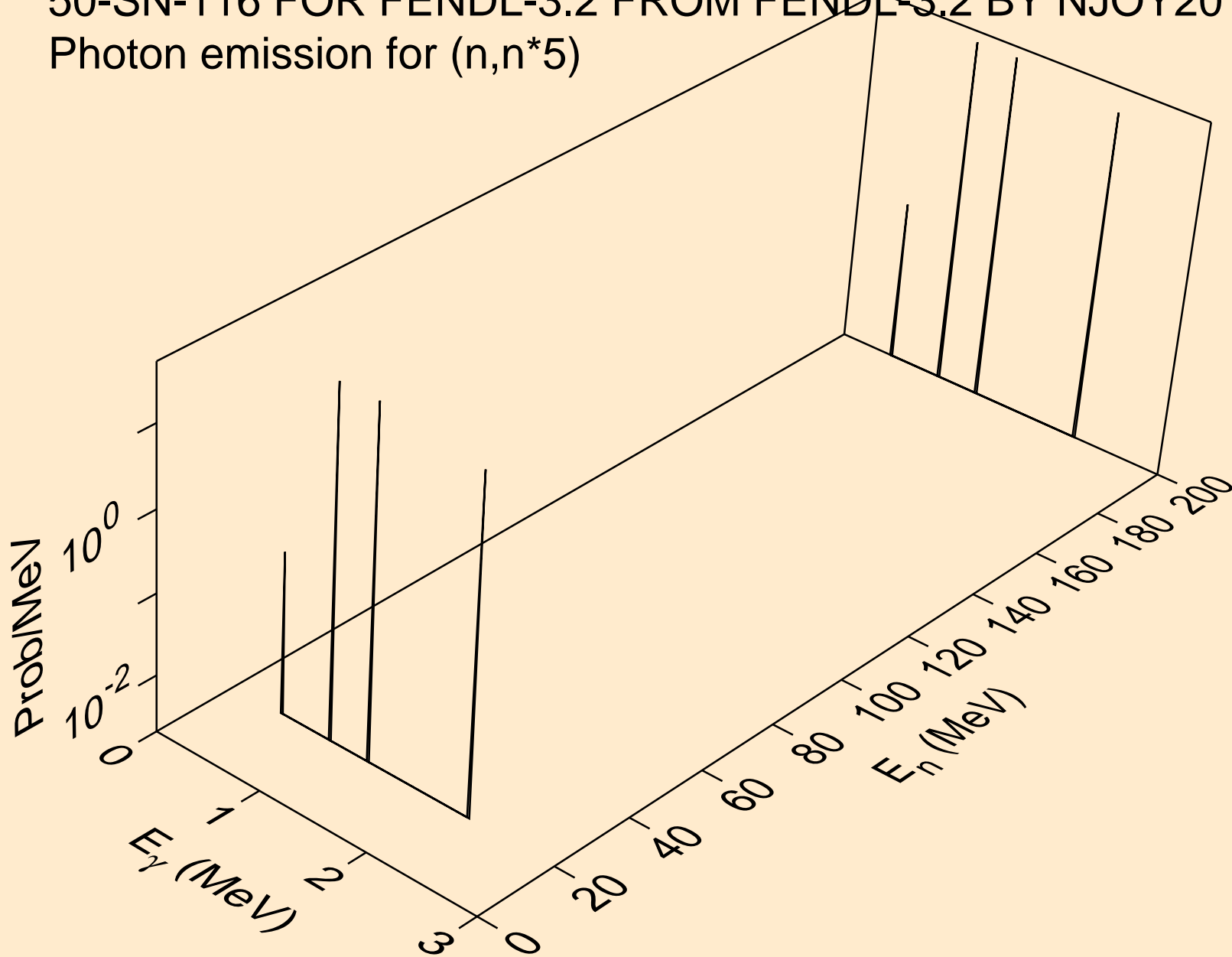

50-SN-116 FOR FENDL-3.2 FROM FENDL-3.2 BY NJOY2016.60+ C
Photon emission for (n,n*6)

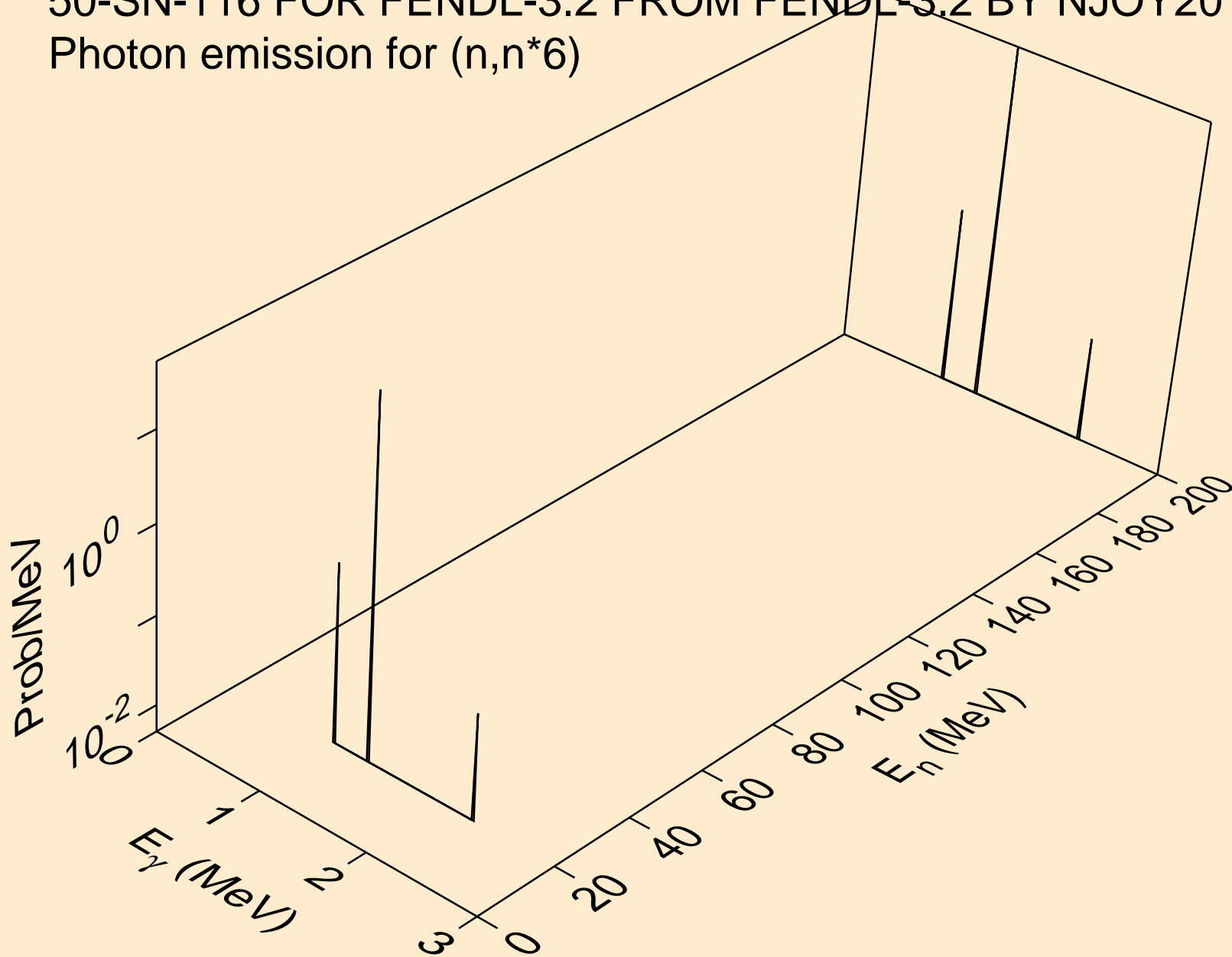

50-SN-116 FOR FENDL-3.2 FROM FENDL-3.2 BY NJOY2016.60+ C
Photon emission for (n,n*7)

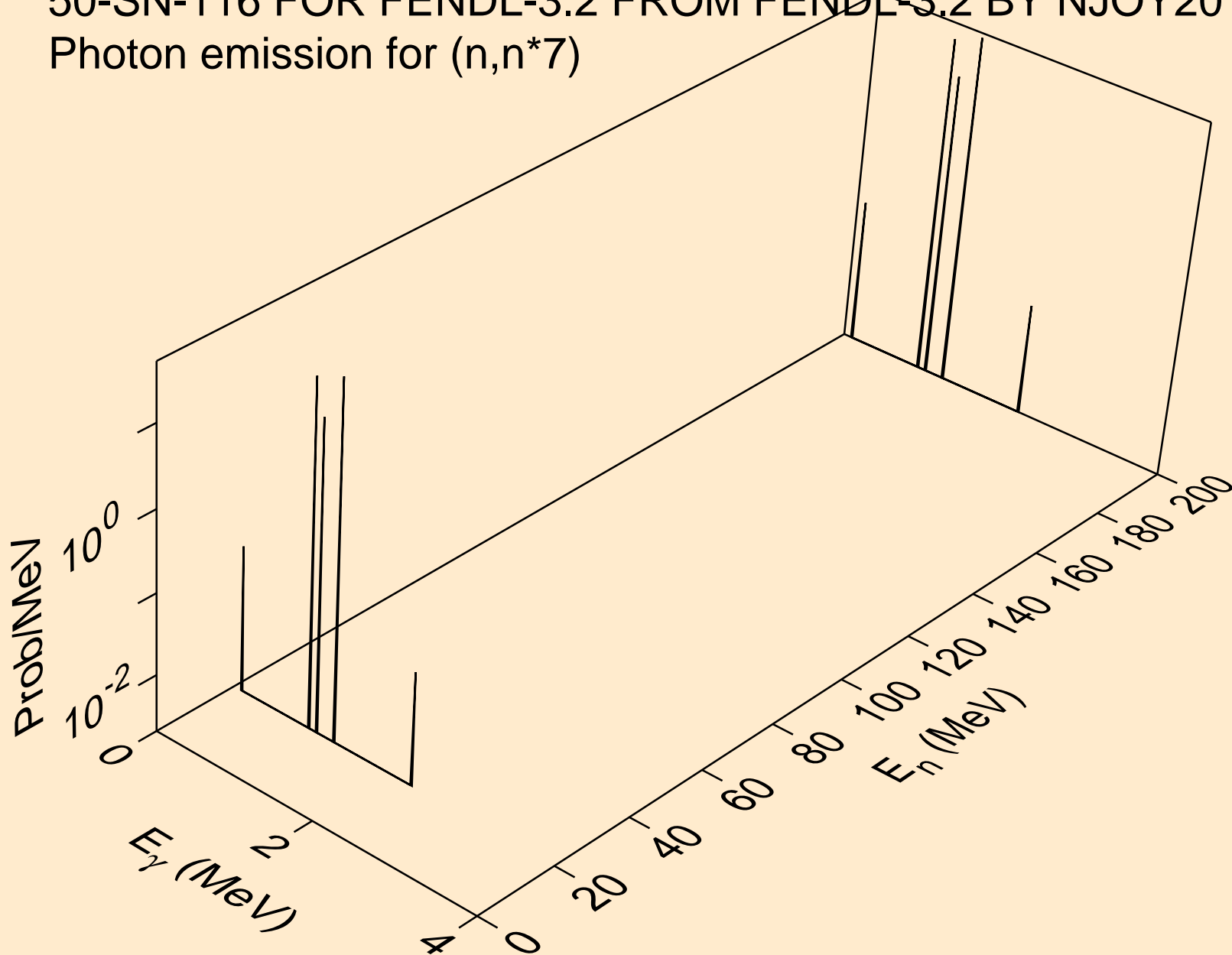

50-SN-116 FOR FENDL-3.2 FROM FENDL-3.2 BY NJOY2016.60+ C
Photon emission for (n,n*8)

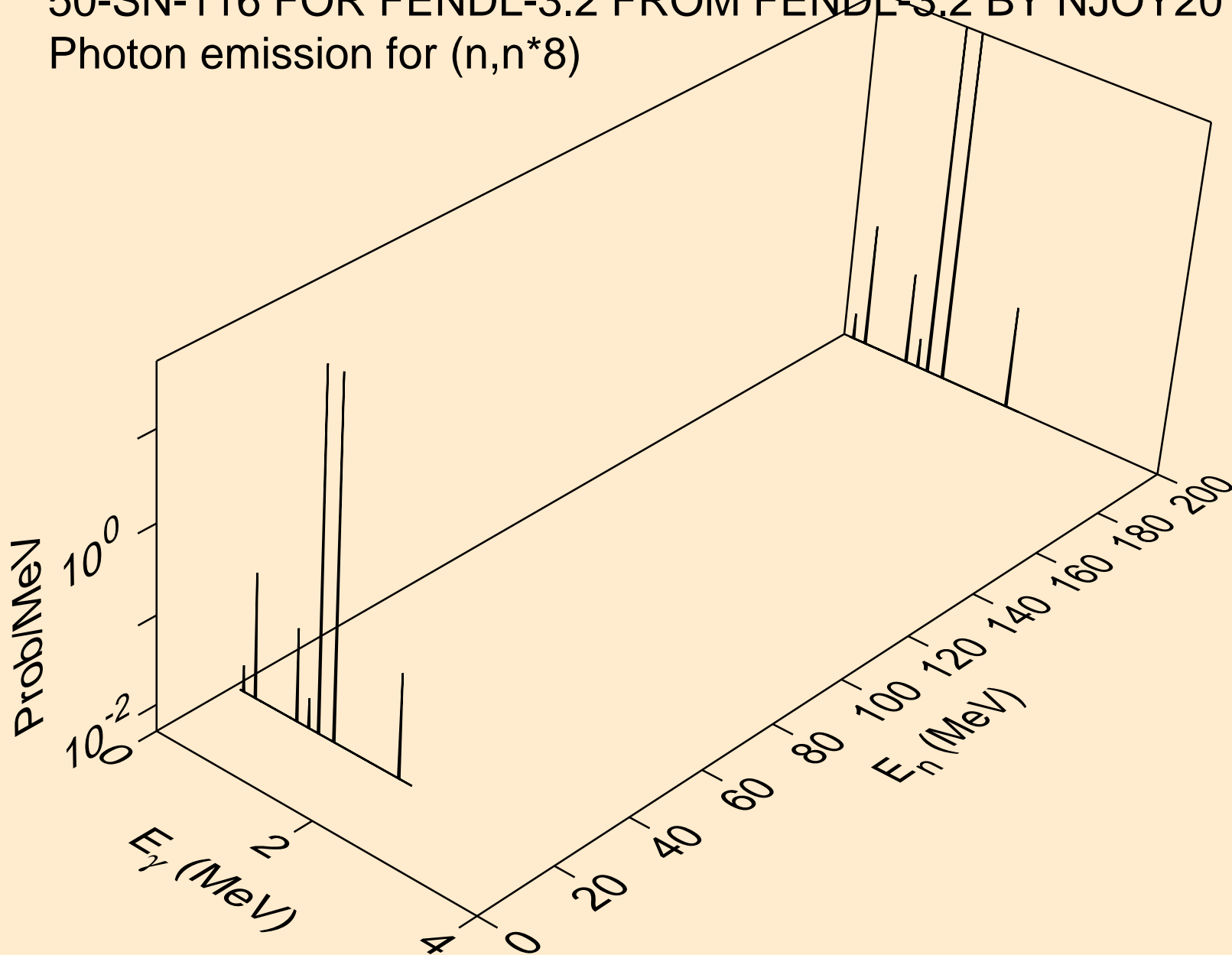

50-SN-116 FOR FENDL-3.2 FROM FENDL-3.2 BY NJOY2016.60+ C
Photon emission for (n,n*9)

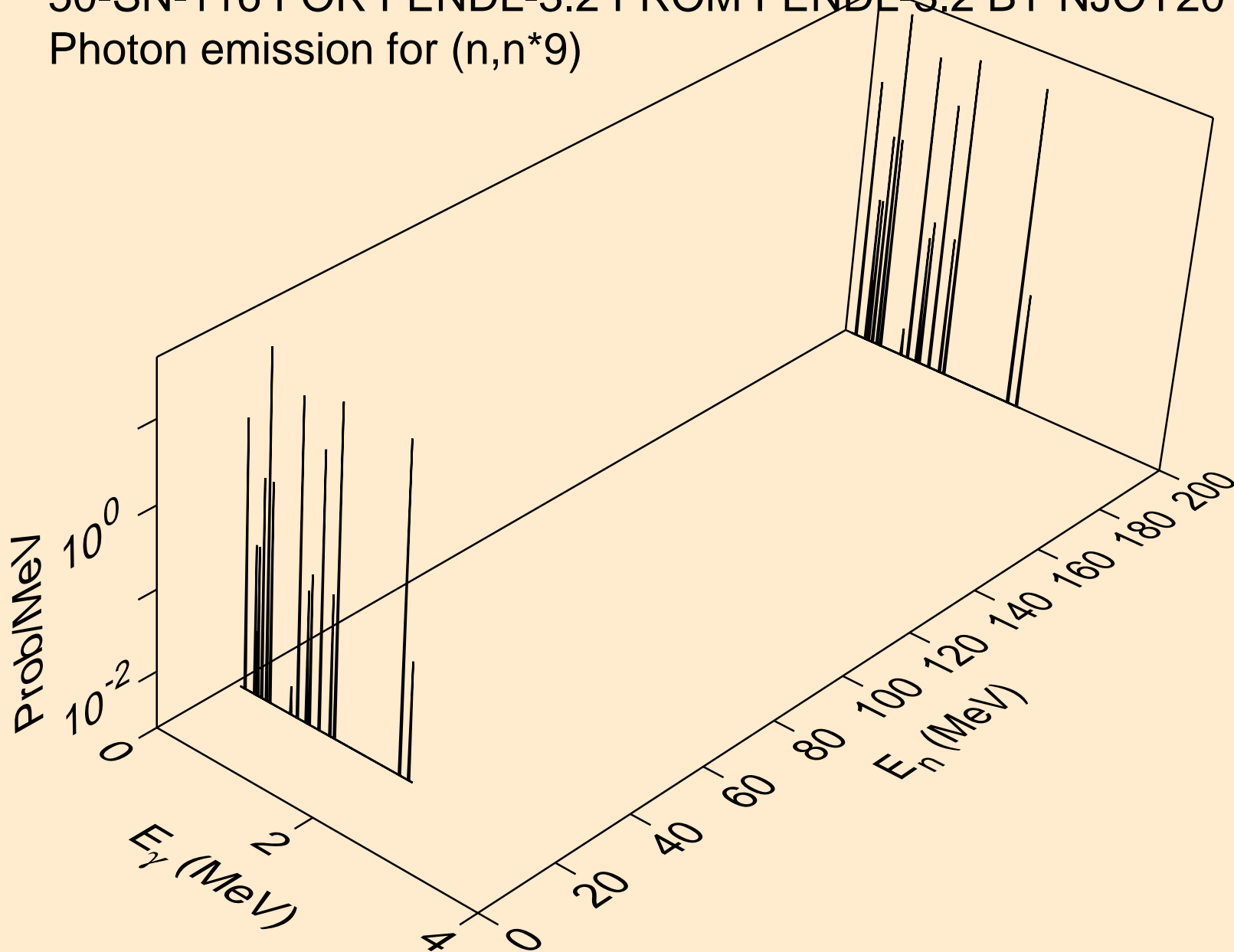

50-SN-116 FOR FENDL-3.2 FROM FENDL-3.2 BY NJOY2016.60+ C
Photon emission for (n,n*10)

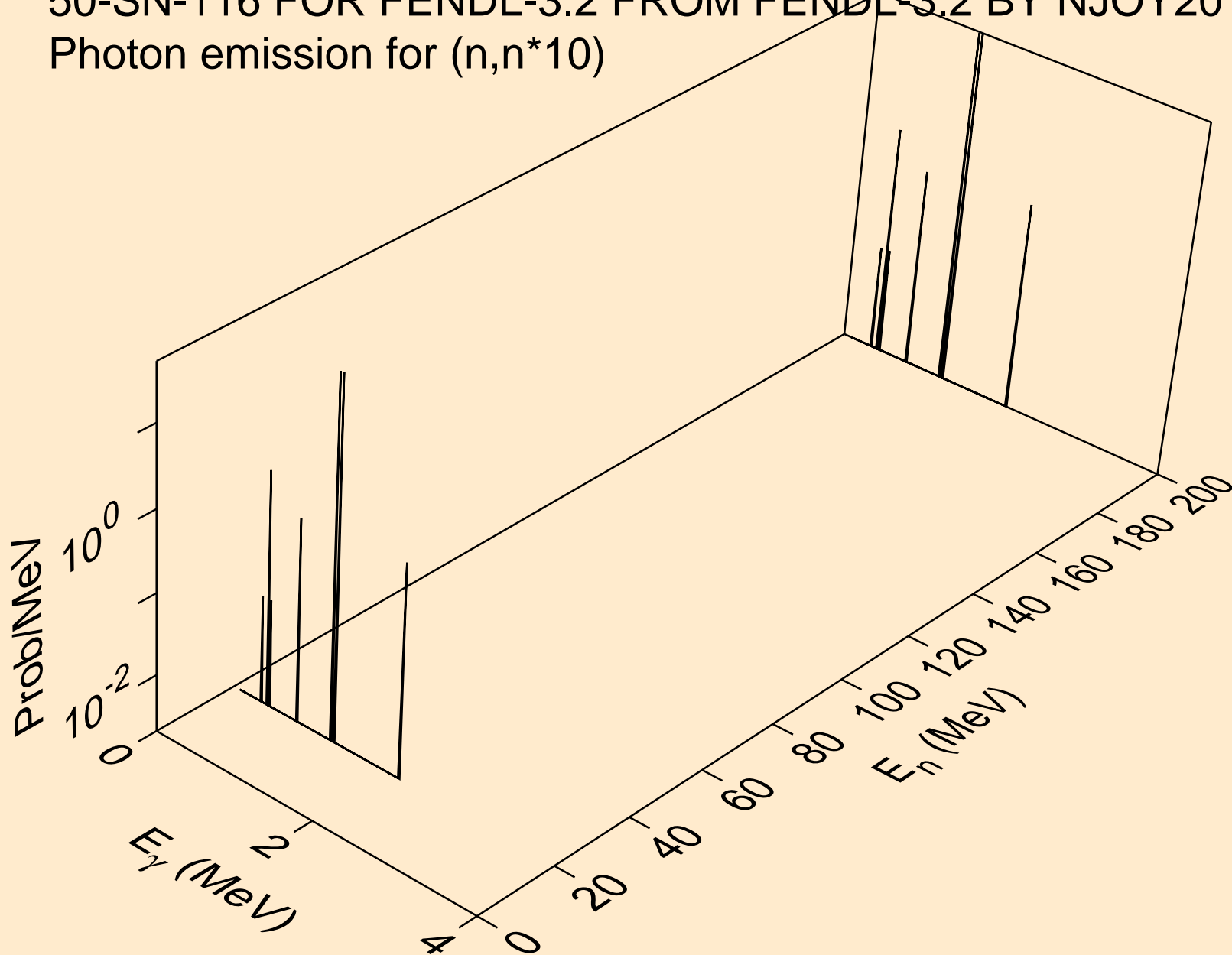

50-SN-116 FOR FENDL-3.2 FROM FENDL-3.2 BY NJOY2016.60+ C
Photon emission for (n,n*11)

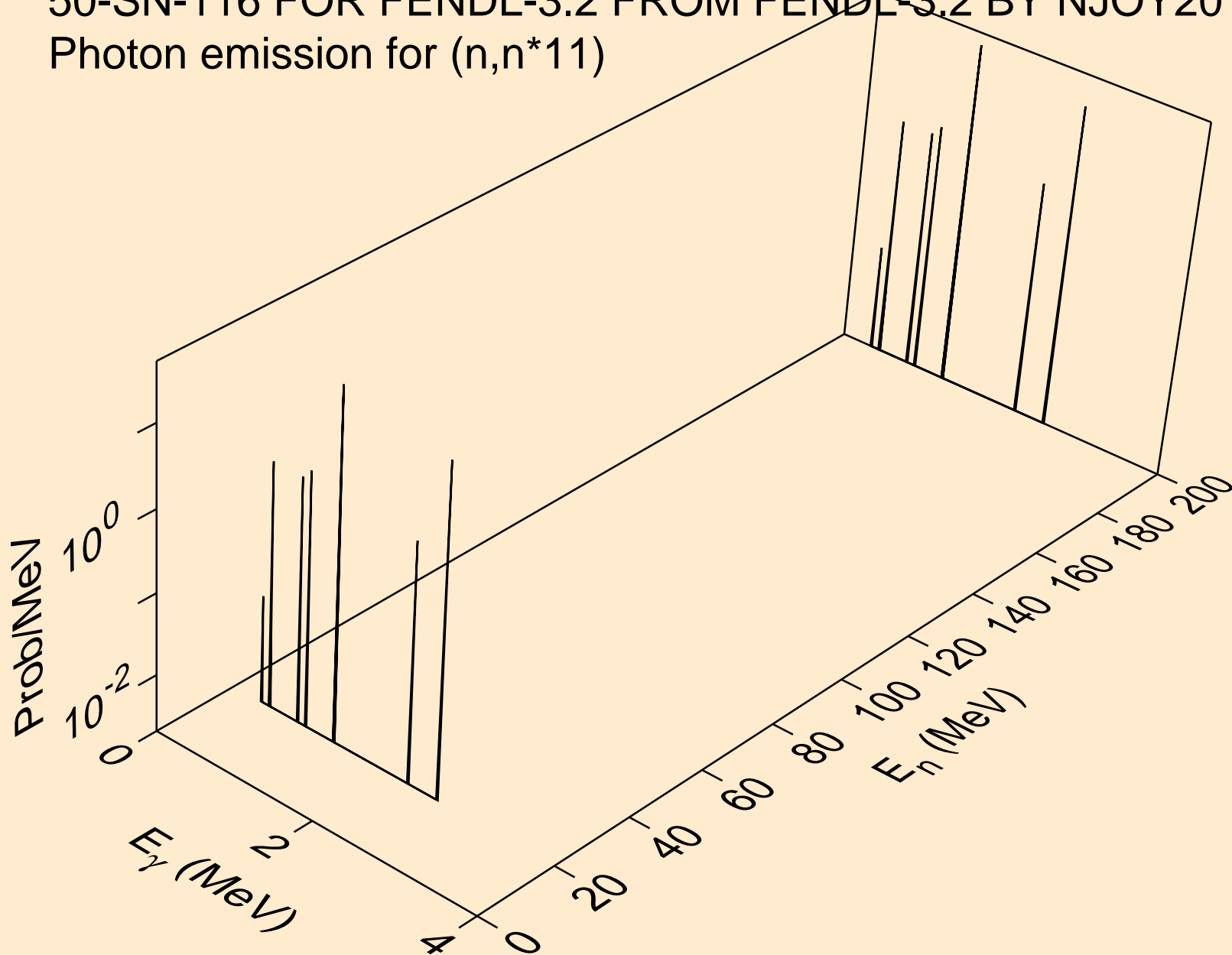

50-SN-116 FOR FENDL-3.2 FROM FENDL-3.2 BY NJOY2016.60+ C
Photon emission for (n,n*12)

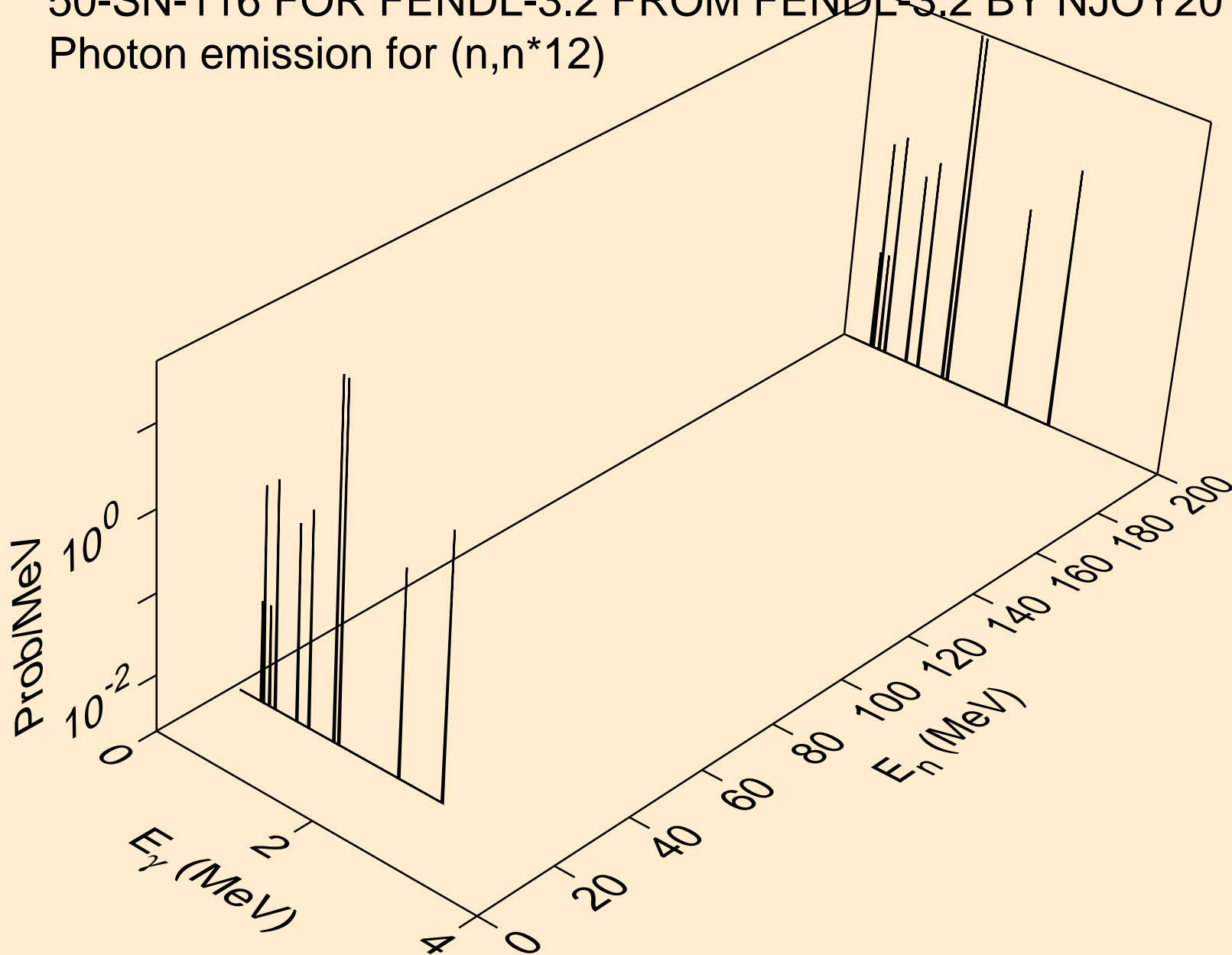

50-SN-116 FOR FENDL-3.2 FROM FENDL-3.2 BY NJOY2016.60+ C
Photon emission for (n,n*13)

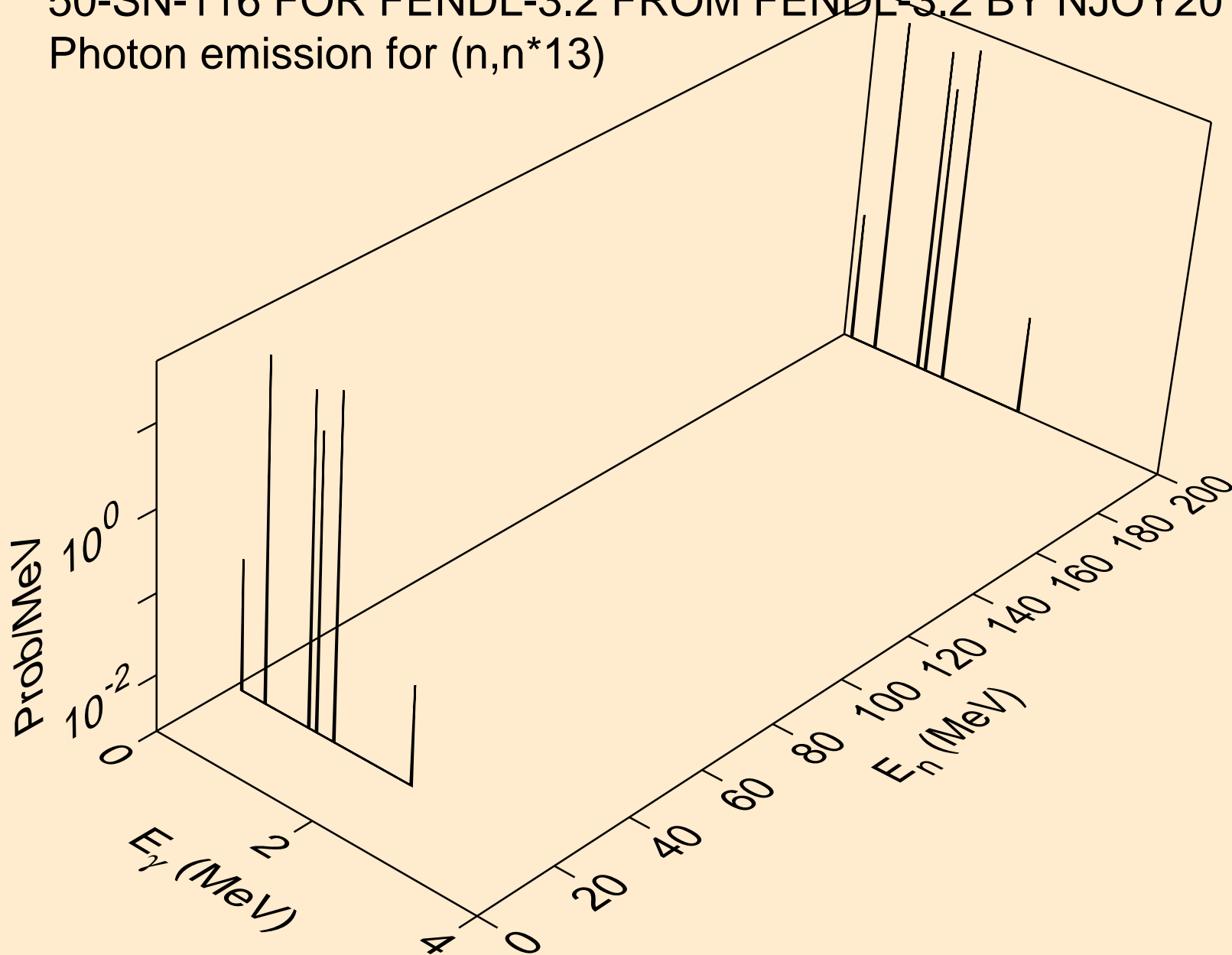

50-SN-116 FOR FENDL-3.2 FROM FENDL-3.2 BY NJOY2016.60+ C
Photon emission for (n,n*14)

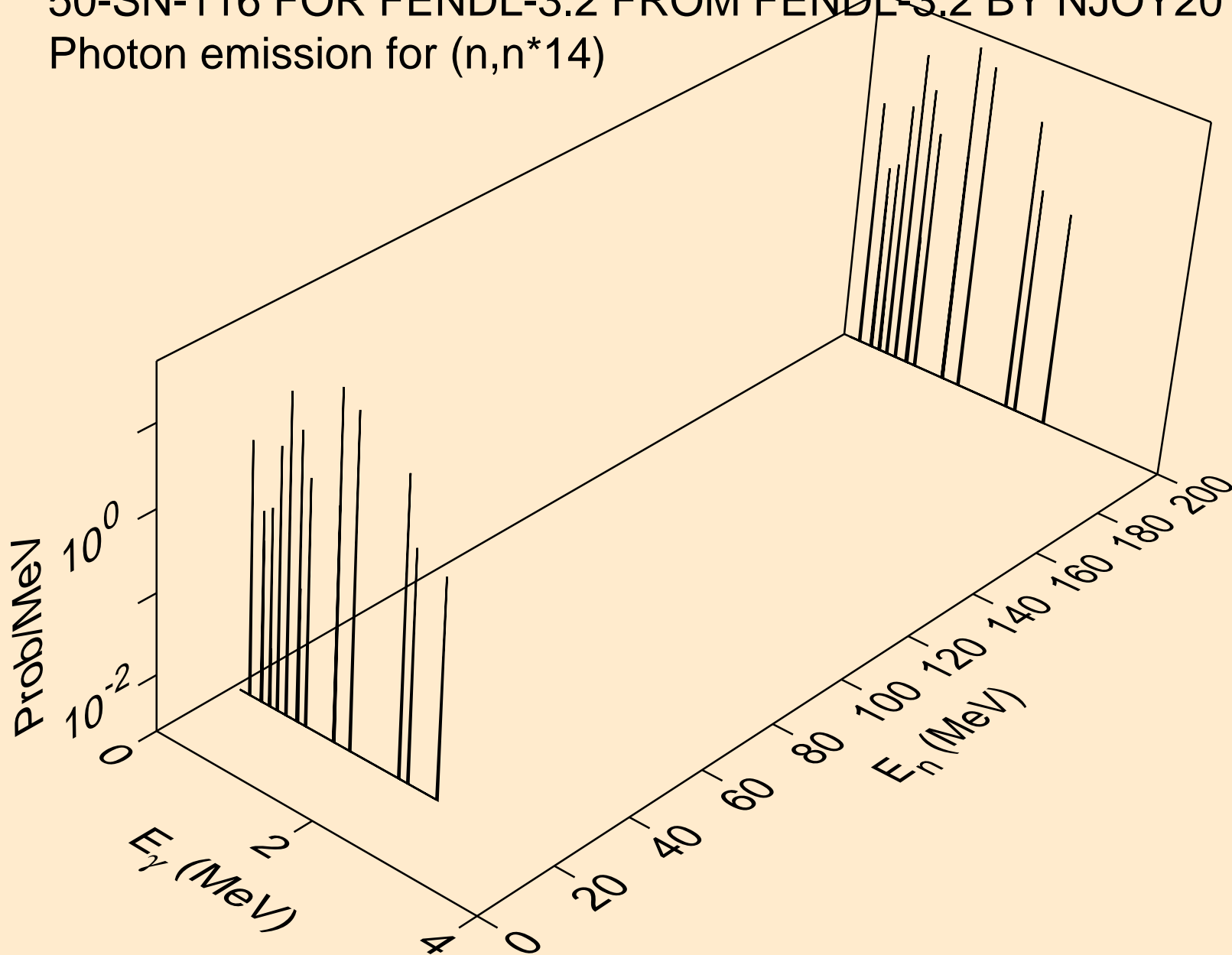

50-SN-116 FOR FENDL-3.2 FROM FENDL-3.2 BY NJOY2016.60+ C
Photon emission for (n,n*15)

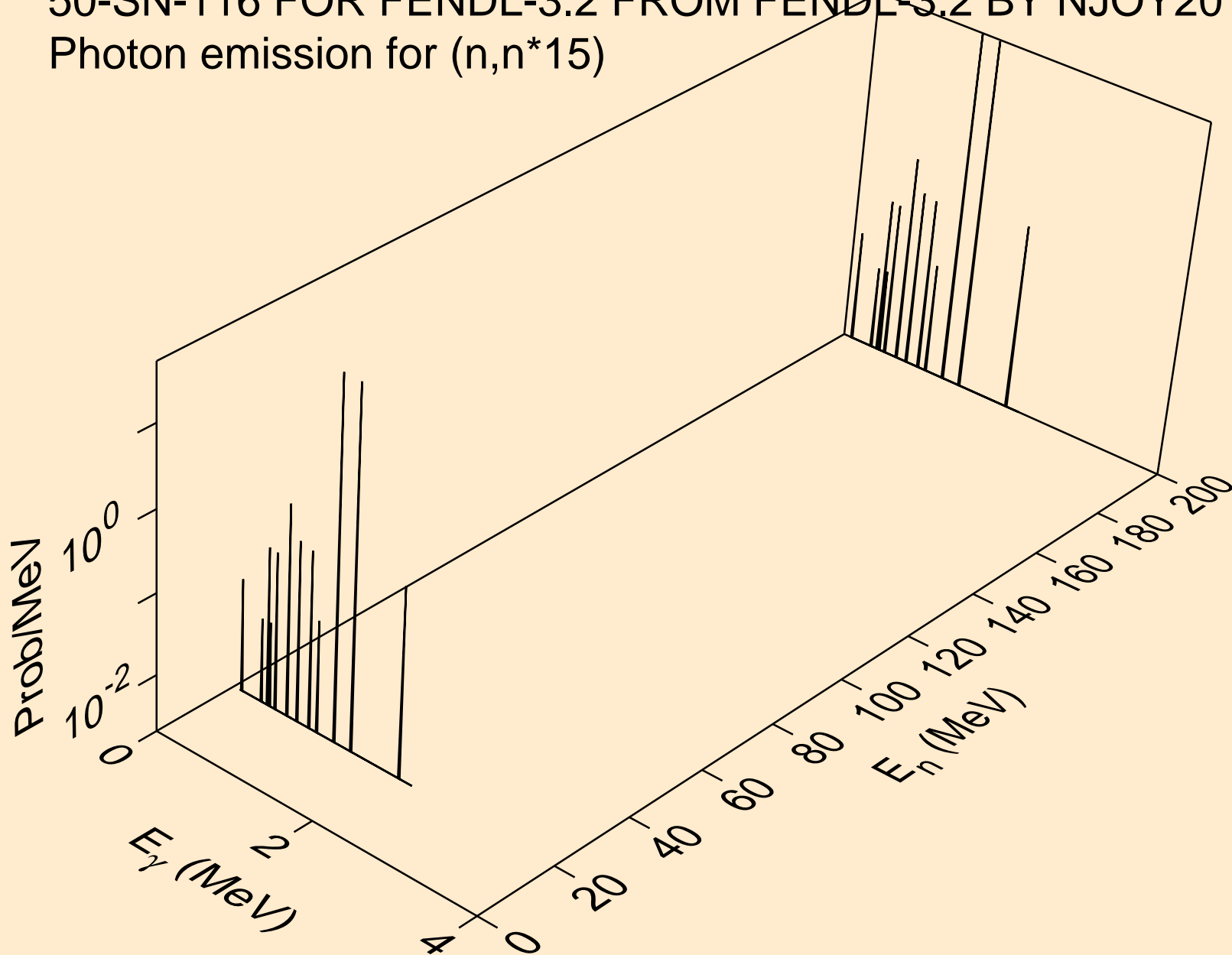

50-SN-116 FOR FENDL-3.2 FROM FENDL-3.2 BY NJOY2016.60+ C
Photon emission for (n,n*16)

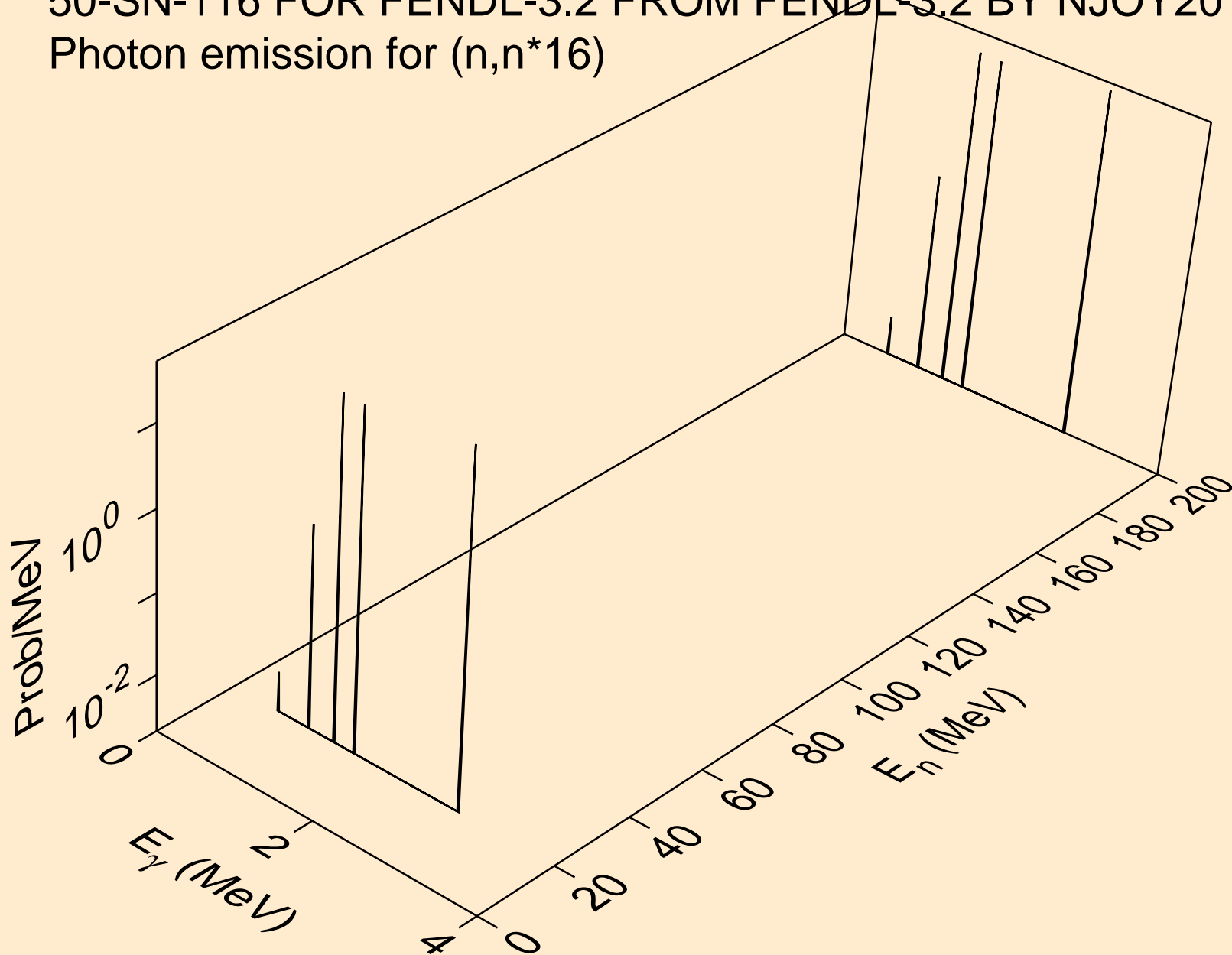

50-SN-116 FOR FENDL-3.2 FROM FENDL-3.2 BY NJOY2016.60+ C
Photon emission for (n,n*17)

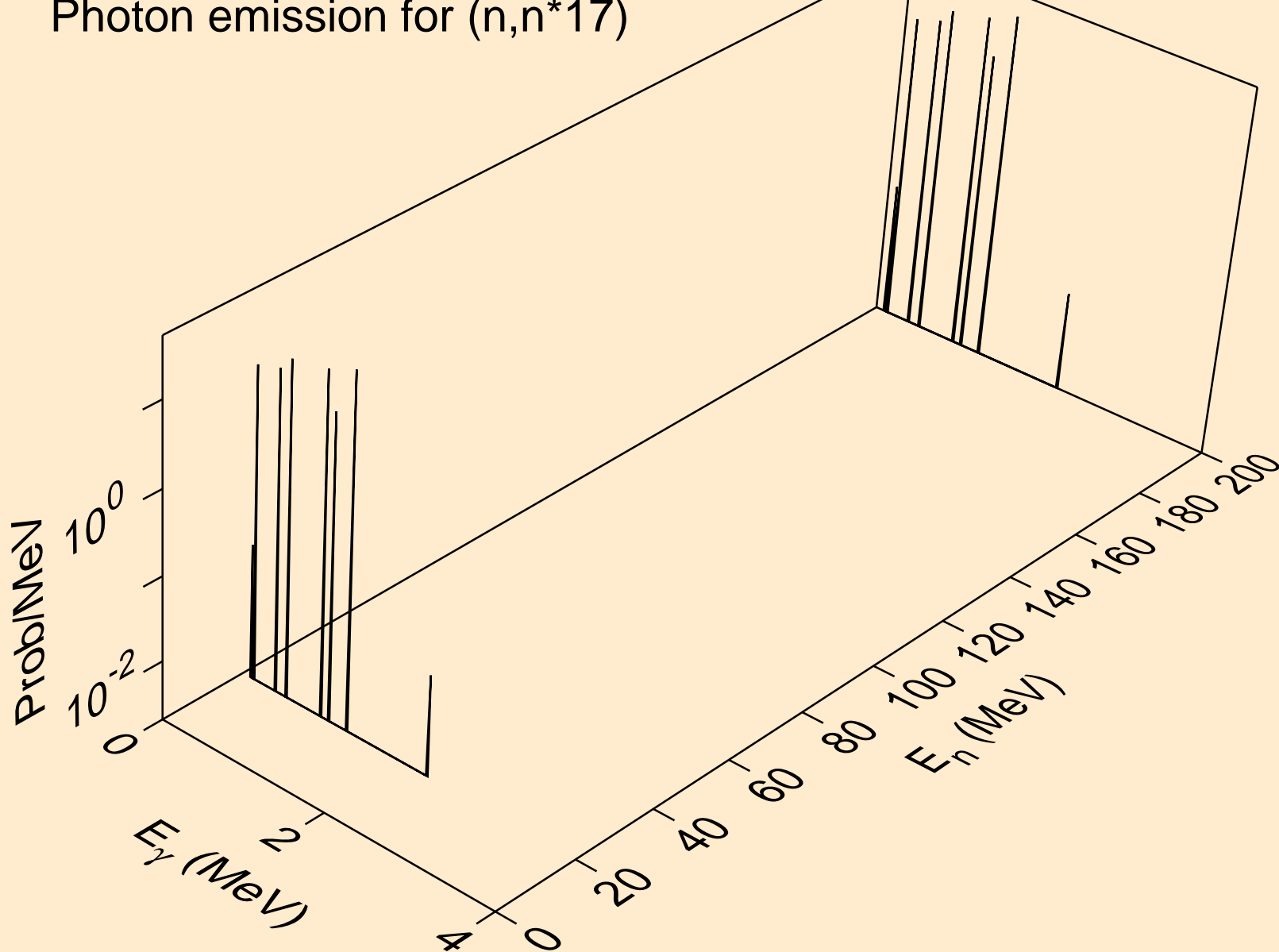

50-SN-116 FOR FENDL-3.2 FROM FENDL-3.2 BY NJOY2016.60+ C
Photon emission for (n,n*18)

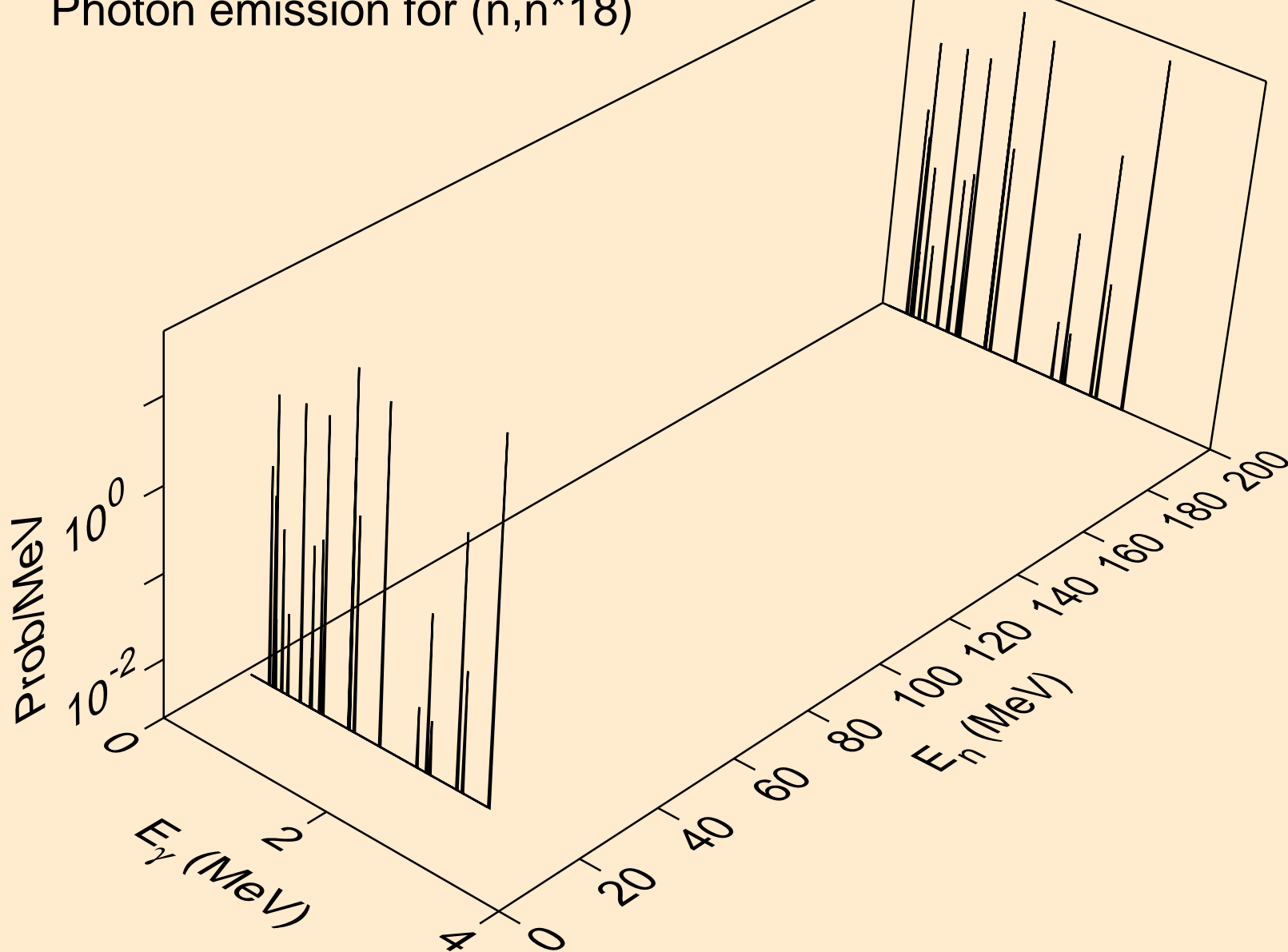

50-SN-116 FOR FENDL-3.2 FROM FENDL-3.2 BY NJOY2016.60+ C
Photon emission for (n,n*19)

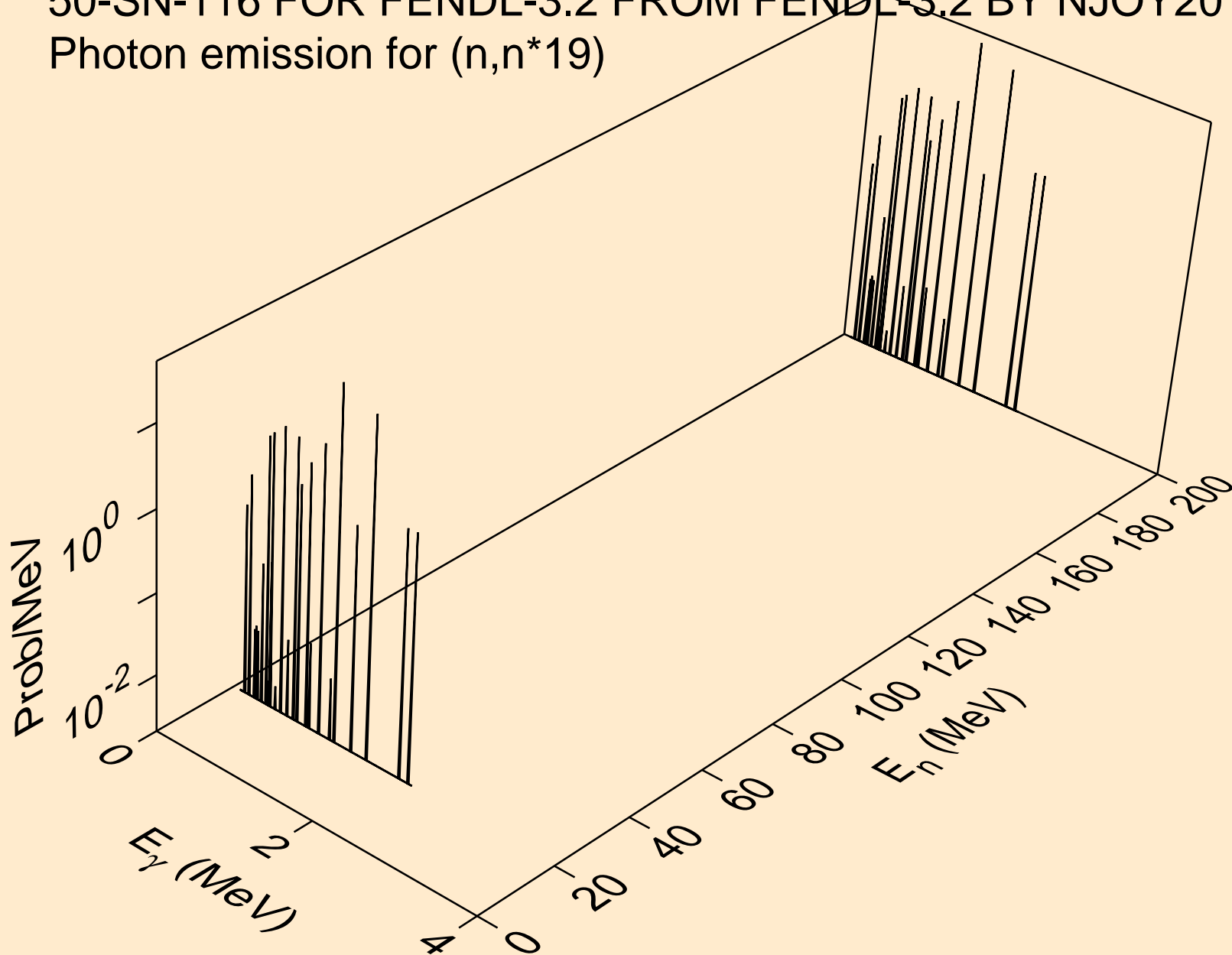

50-SN-116 FOR FENDL-3.2 FROM FENDL-3.2 BY NJOY2016.60+ C
Photon emission for (n,n*20)

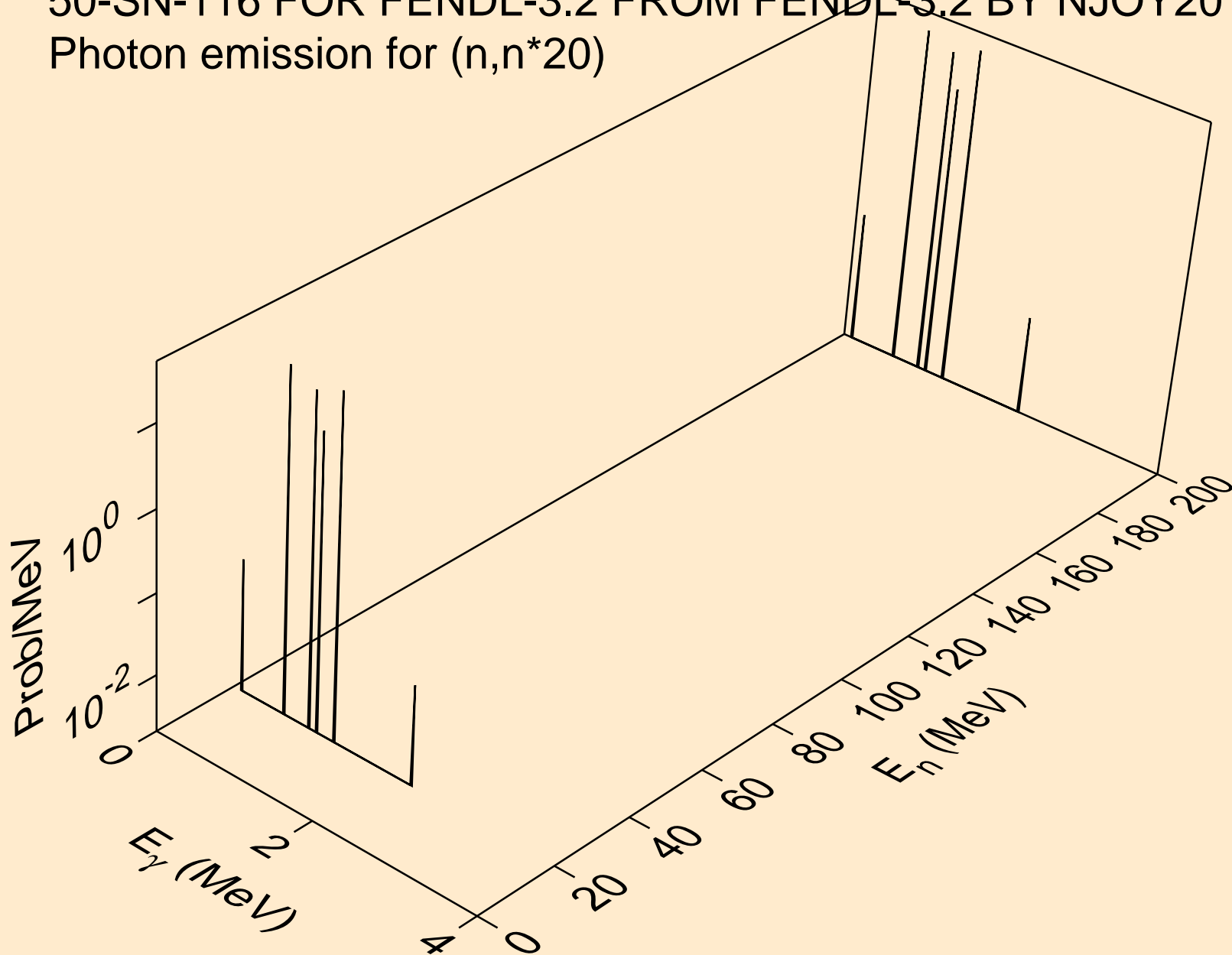

50-SN-116 FOR FENDL-3.2 FROM FENDL-3.2 BY NJOY2016.60+ C
Photon emission for (n,n*21)

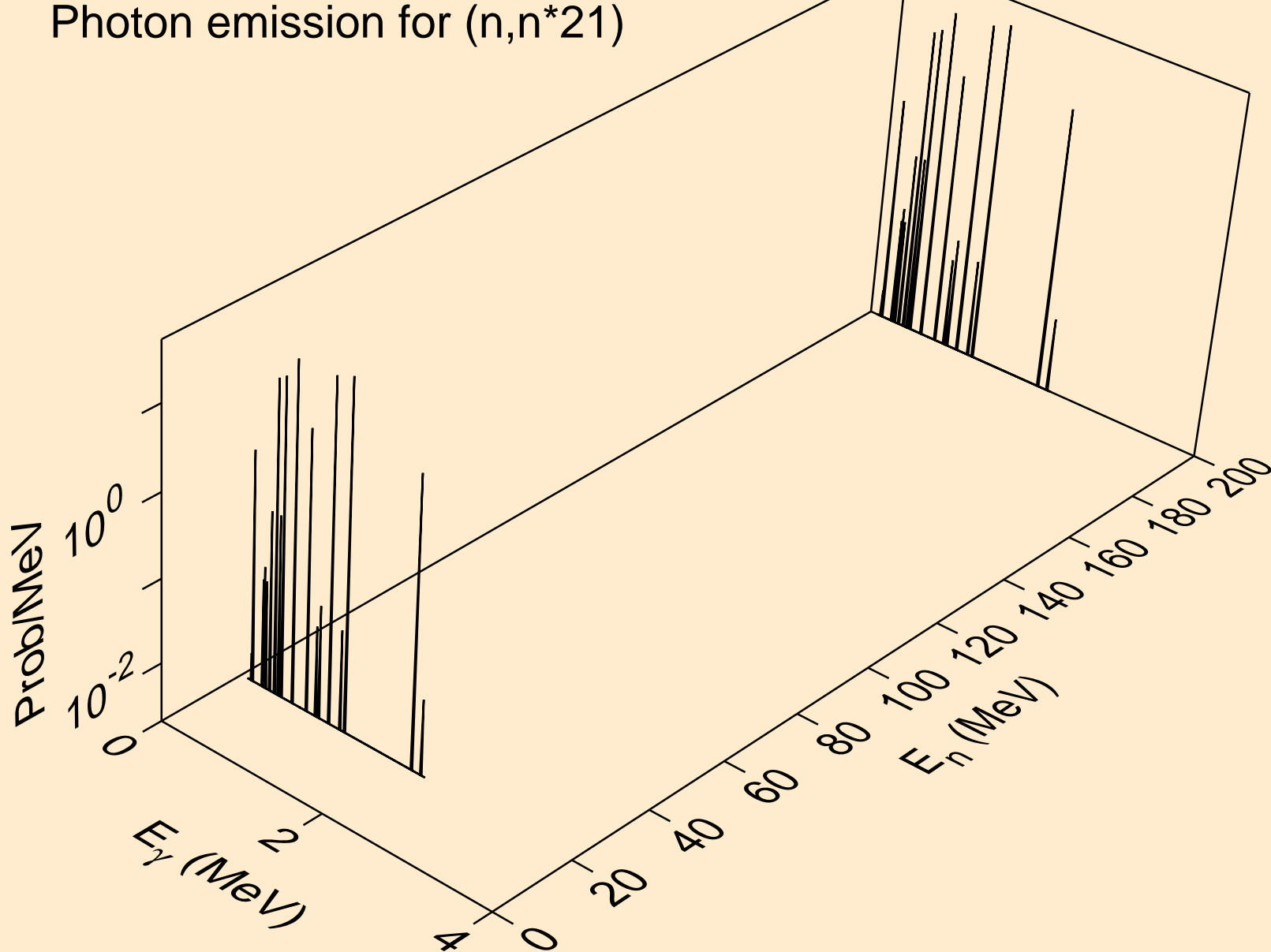

50-SN-116 FOR FENDL-3.2 FROM FENDL-3.2 BY NJOY2016.60+ C
Photon emission for (n,n*22)

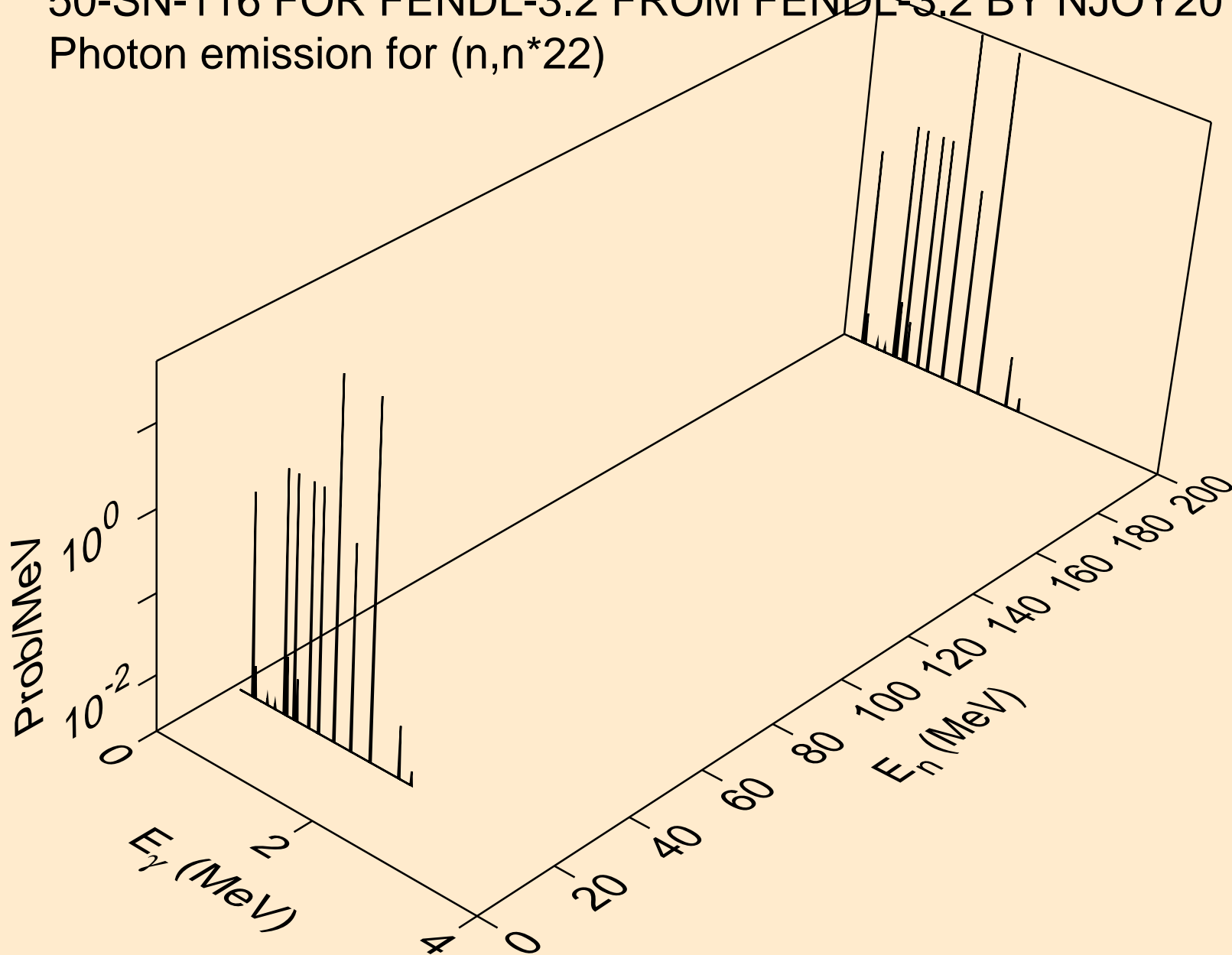

50-SN-116 FOR FENDL-3.2 FROM FENDL-3.2 BY NJOY2016.60+ C
Photon emission for (n,n*23)

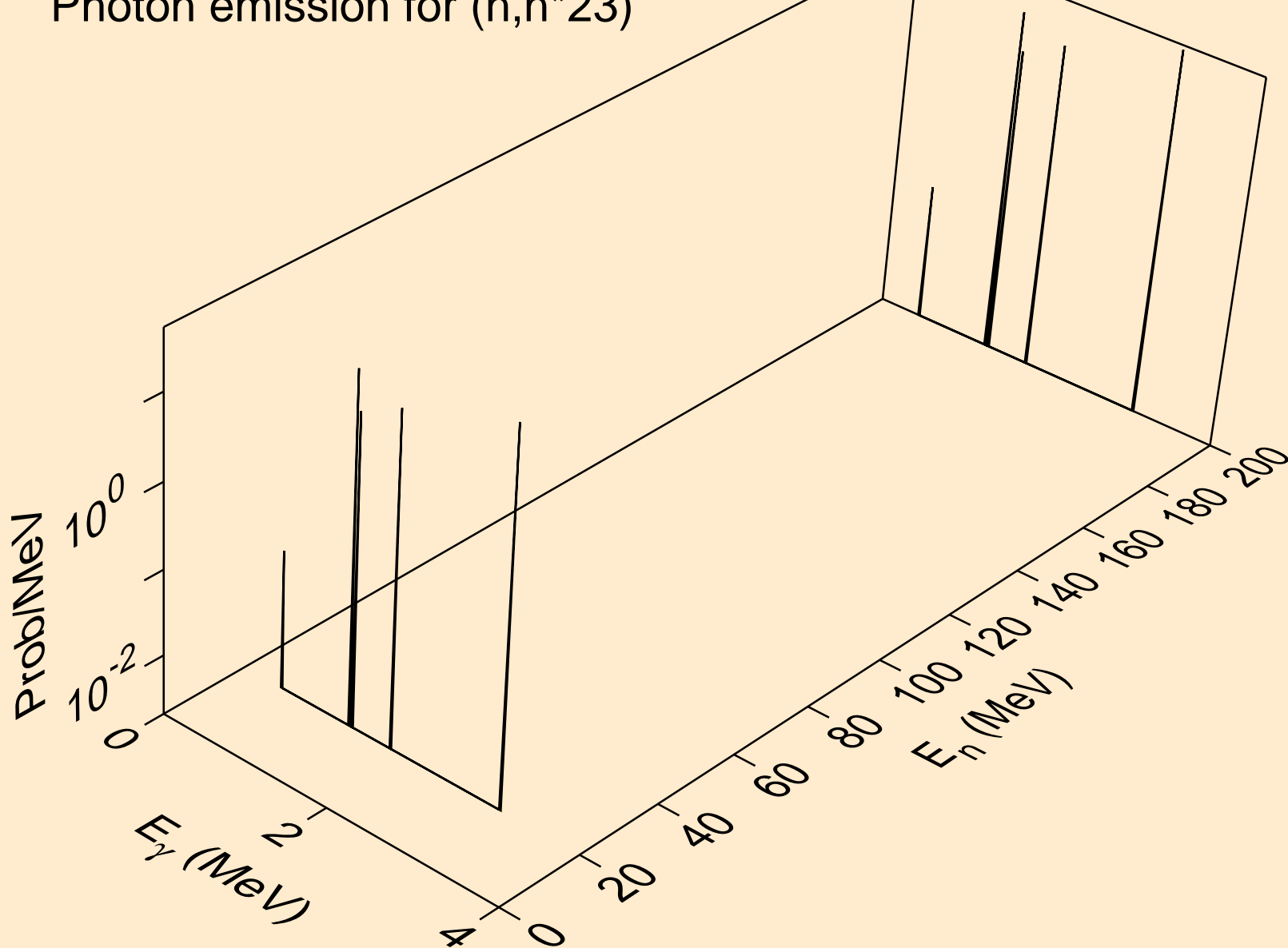

50-SN-116 FOR FENDL-3.2 FROM FENDL-3.2 BY NJOY2016.60+ C
Photon emission for (n,n*24)

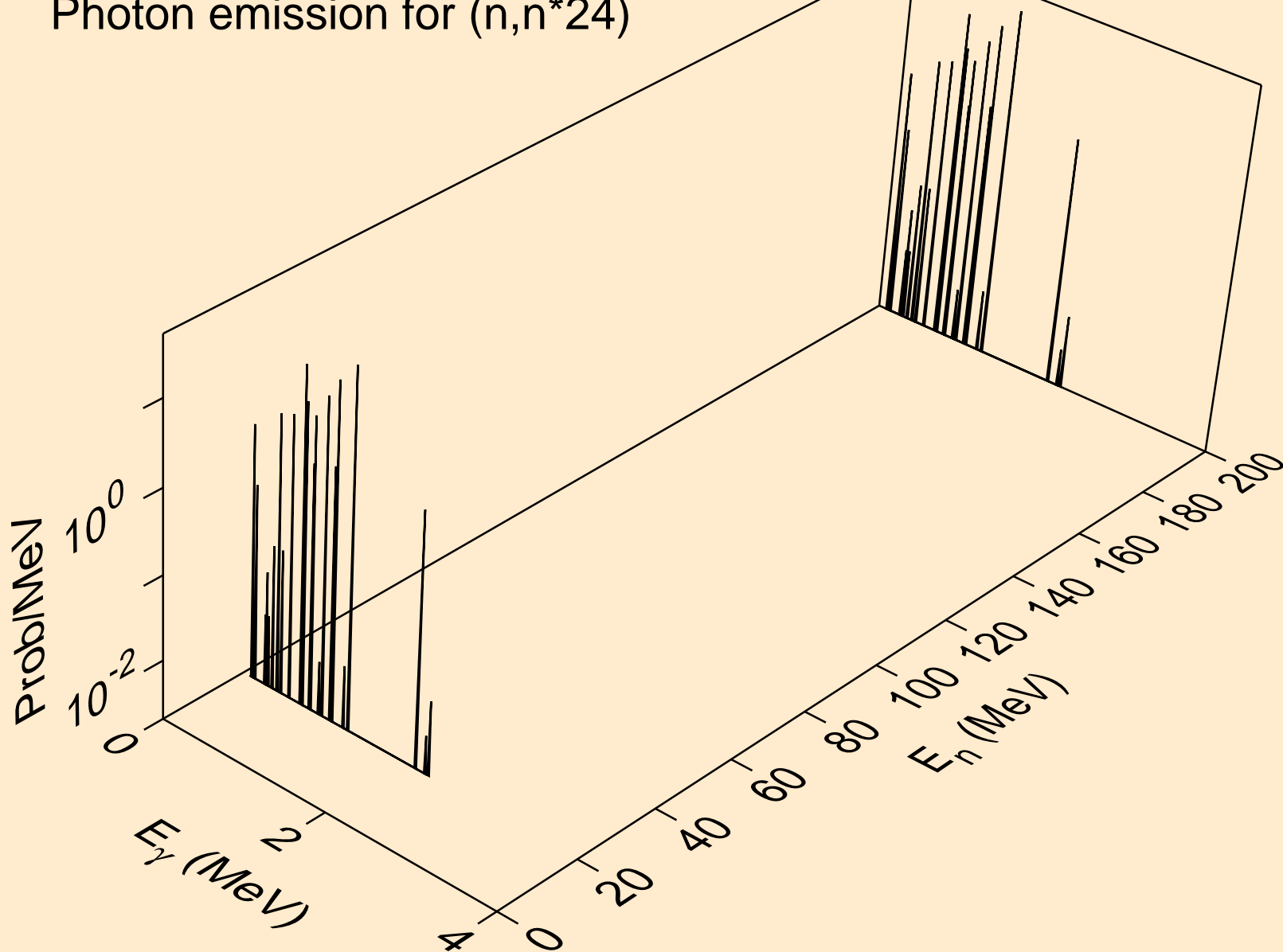

50-SN-116 FOR FENDL-3.2 FROM FENDL-3.2 BY NJOY2016.60+ C
Photon emission for (n,n*25)

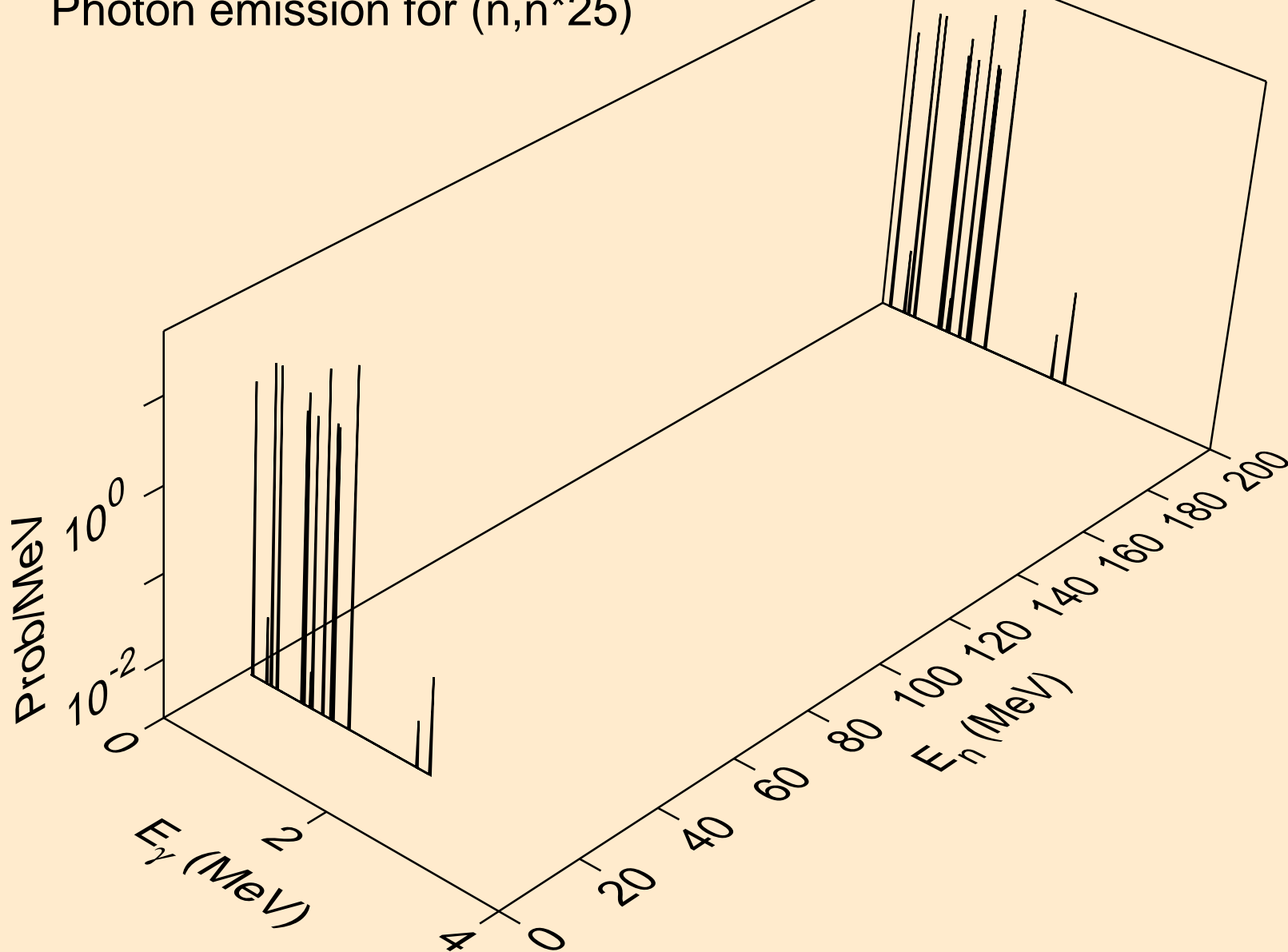

50-SN-116 FOR FENDL-3.2 FROM FENDL-3.2 BY NJOY2016.60+ C
Photon emission for (n,n*26)

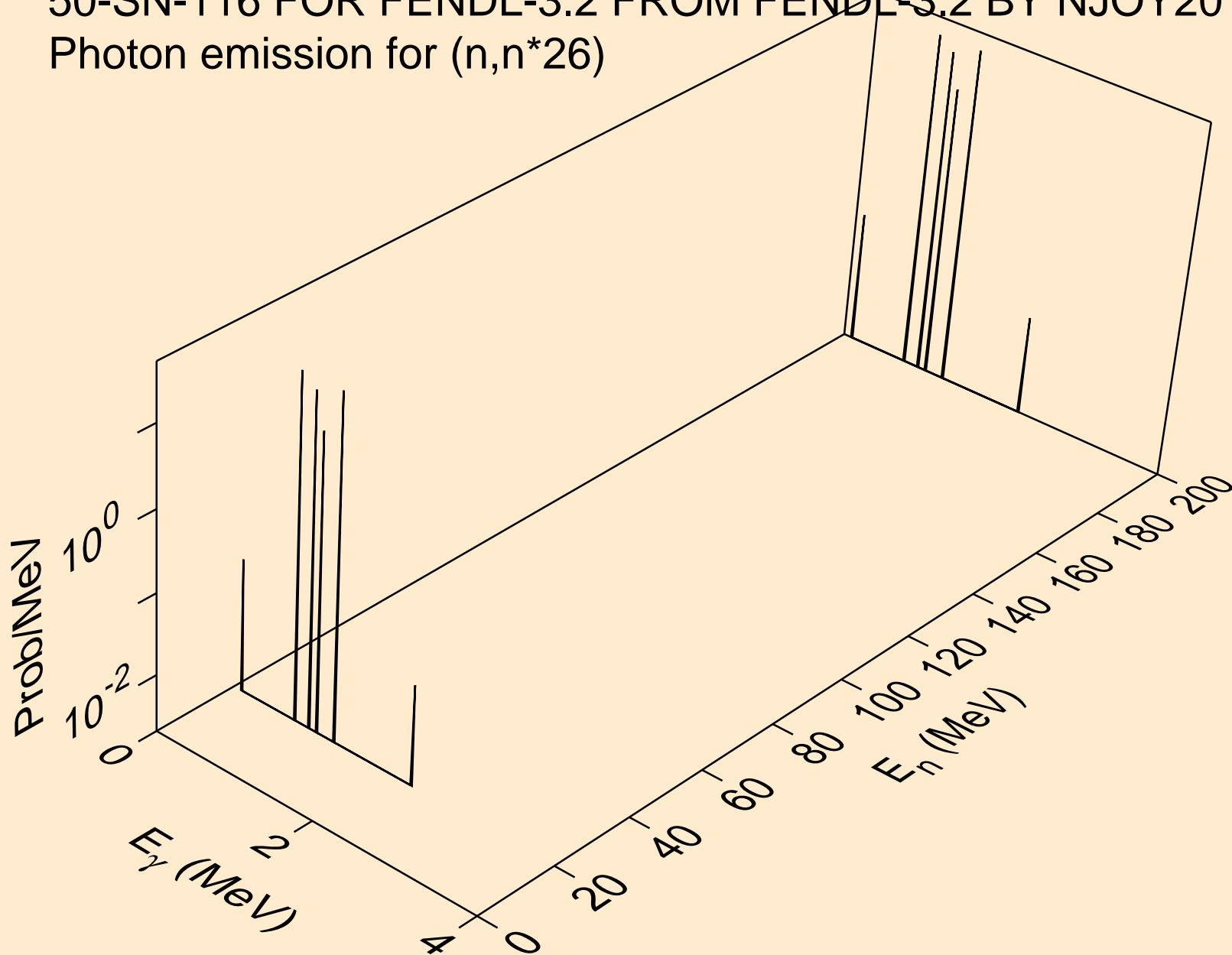

50-SN-116 FOR FENDL-3.2 FROM FENDL-3.2 BY NJOY2016.60+ C
Photon emission for (n,n*27)

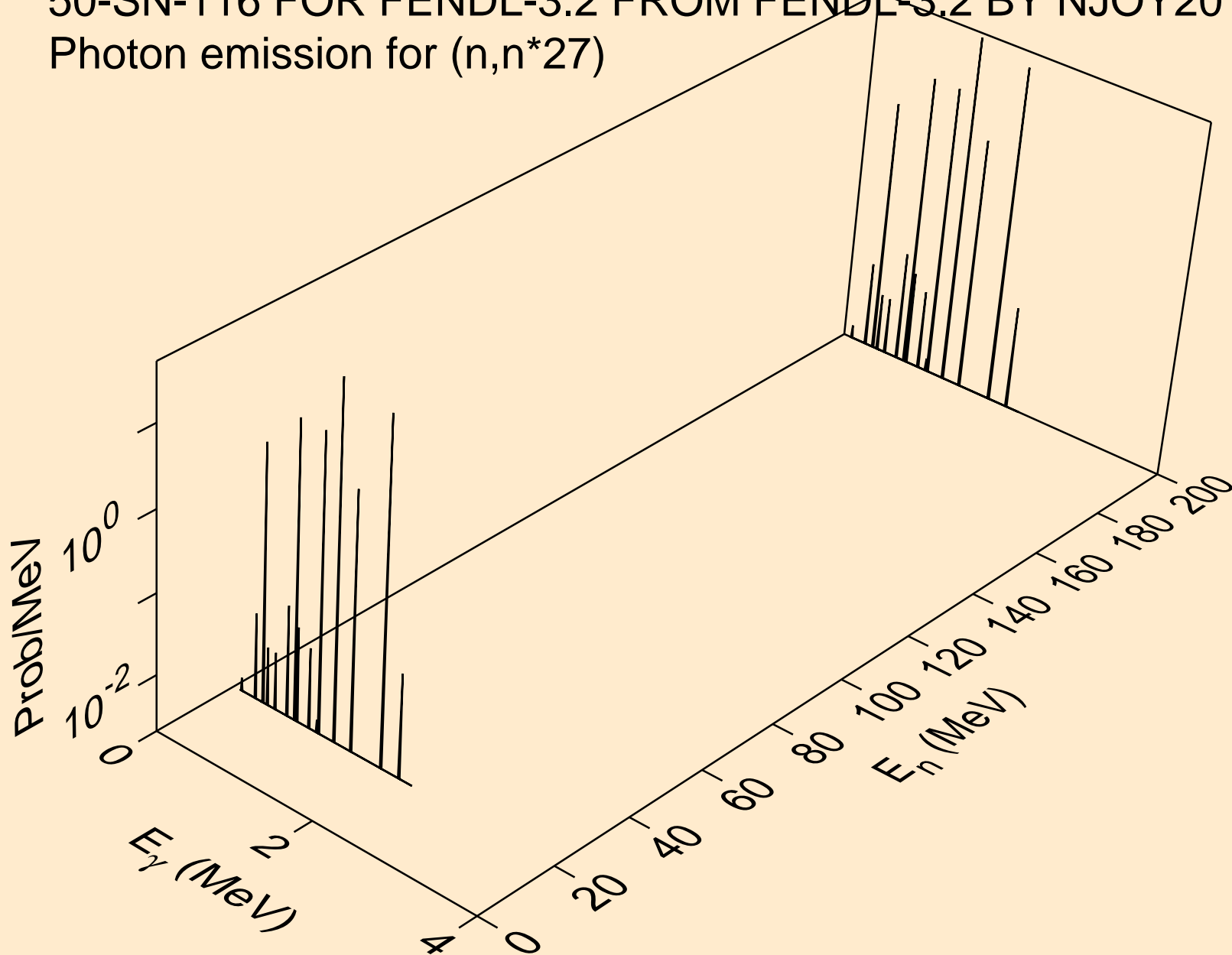

50-SN-116 FOR FENDL-3.2 FROM FENDL-3.2 BY NJOY2016.60+ C
Photon emission for (n,n*28)

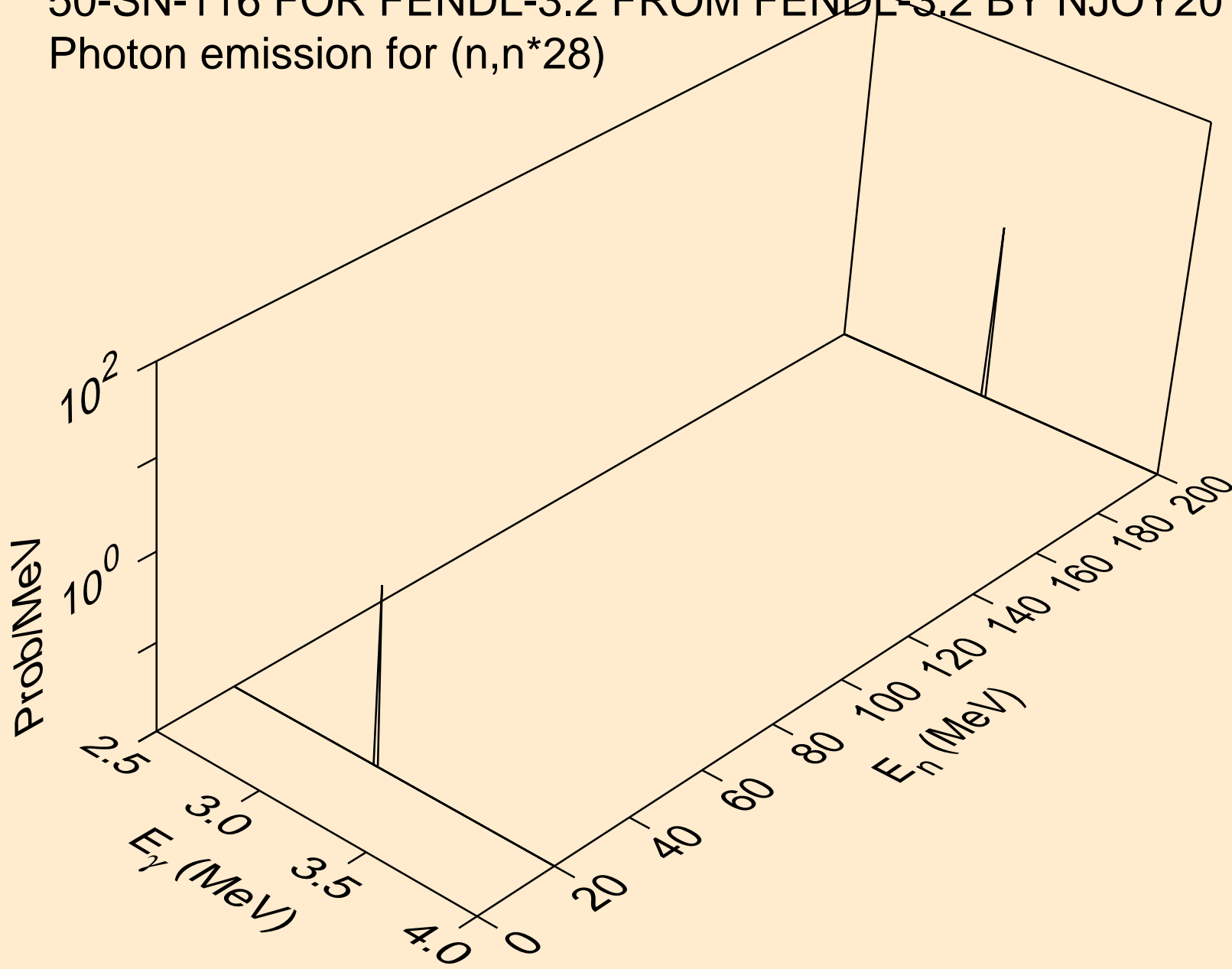

50-SN-116 FOR FENDL-3.2 FROM FENDL-3.2 BY NJOY2016.60+ C
Photon emission for (n,n*29)

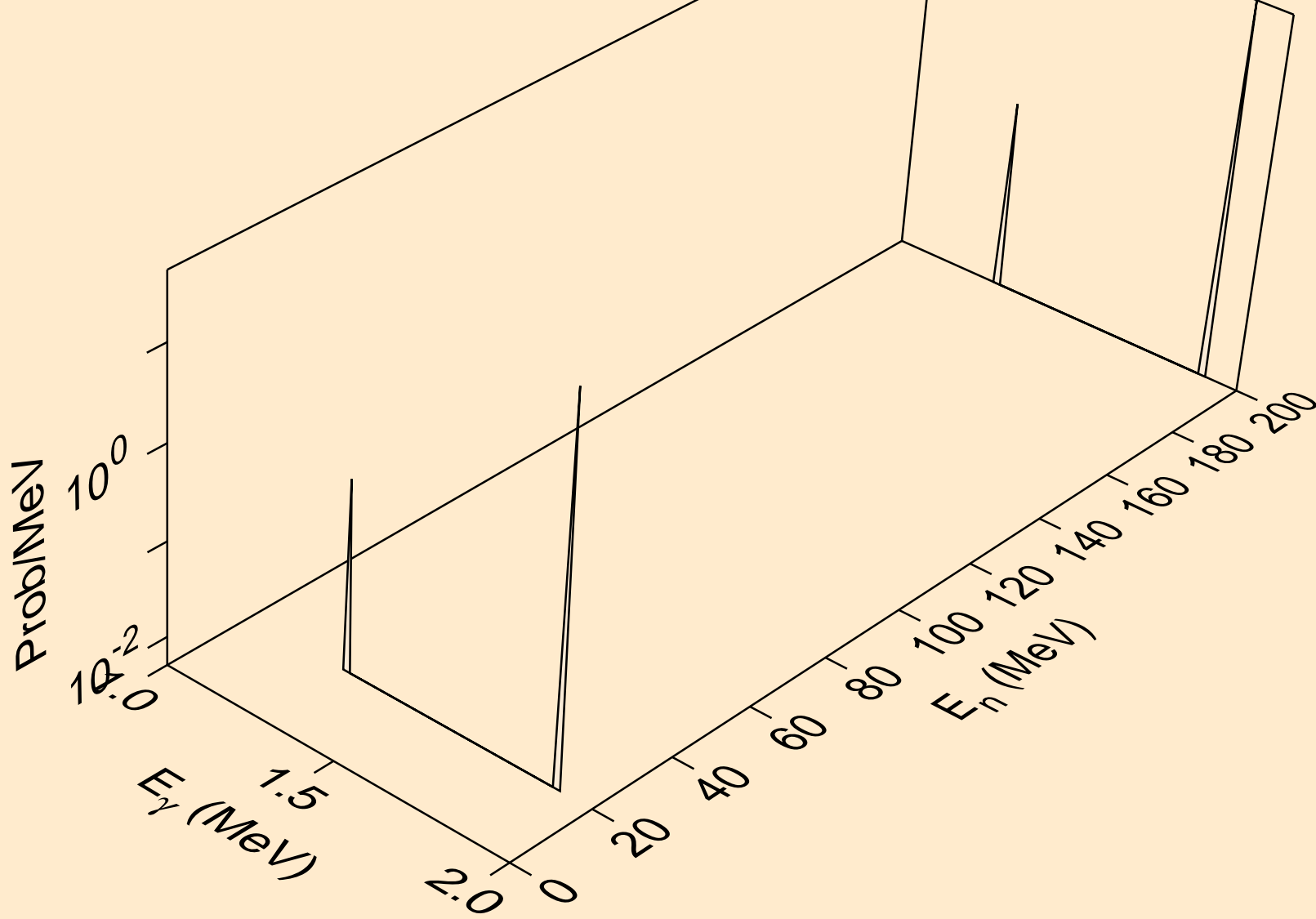

50-SN-116 FOR FENDL-3.2 FROM FENDL-3.2 BY NJOY2016.60+ C
Photon emission for (n,n*30)

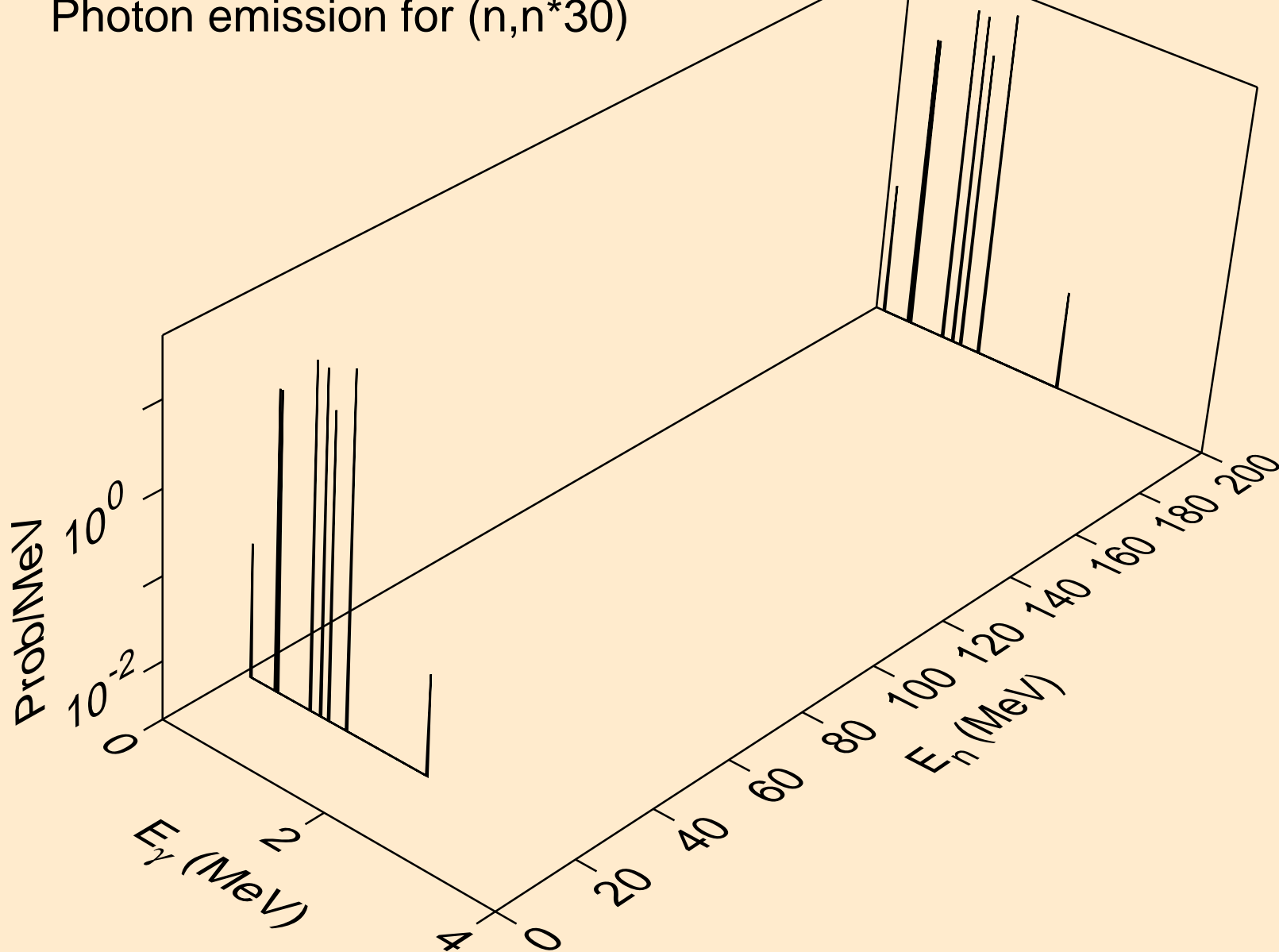

50-SN-116 FOR FENDL-3.2 FROM FENDL-3.2 BY NJOY2016.60+ C
Photon emission for (n,n*31)

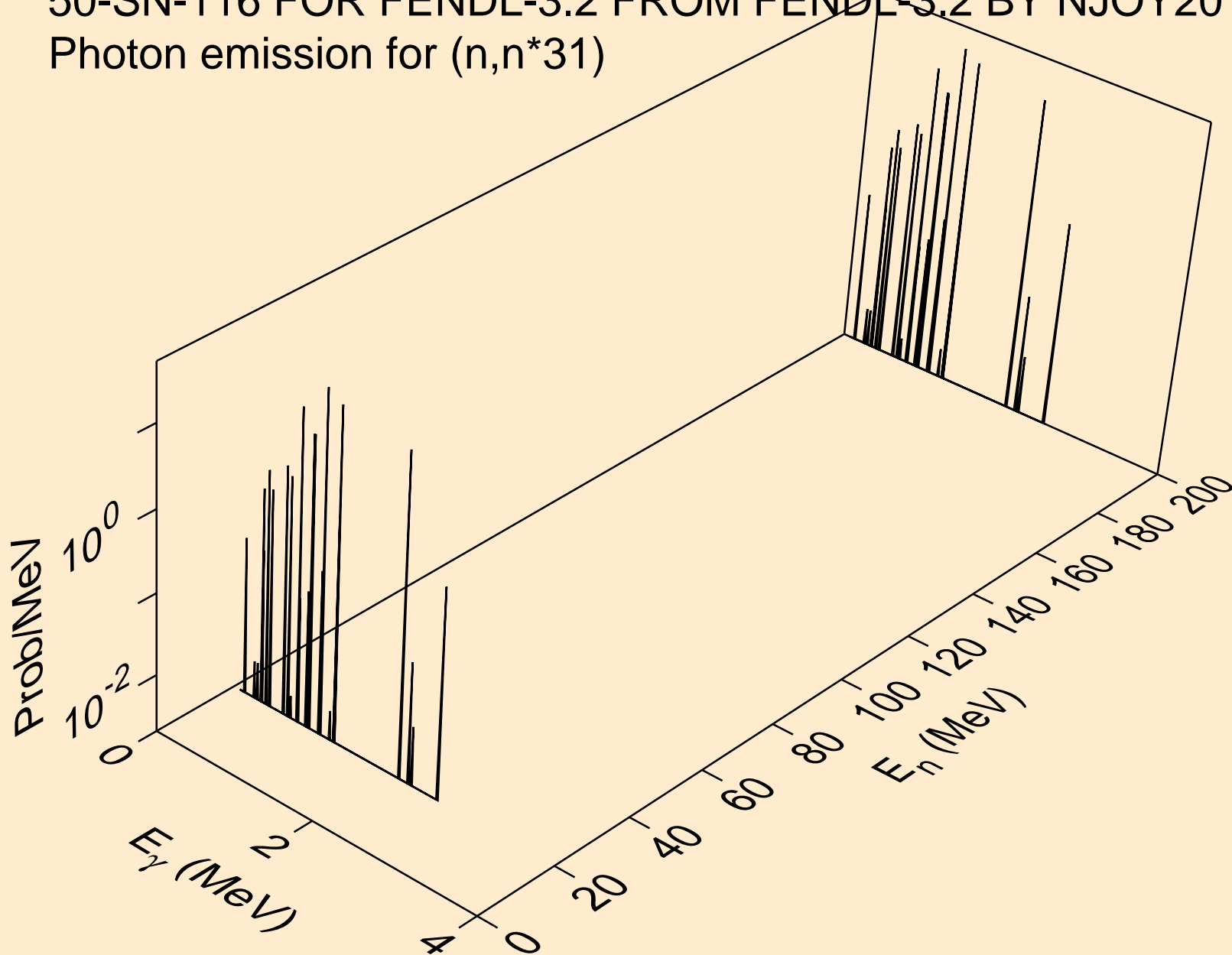

50-SN-116 FOR FENDL-3.2 FROM FENDL-3.2 BY NJOY2016.60+ C
Photon emission for (n,n*32)

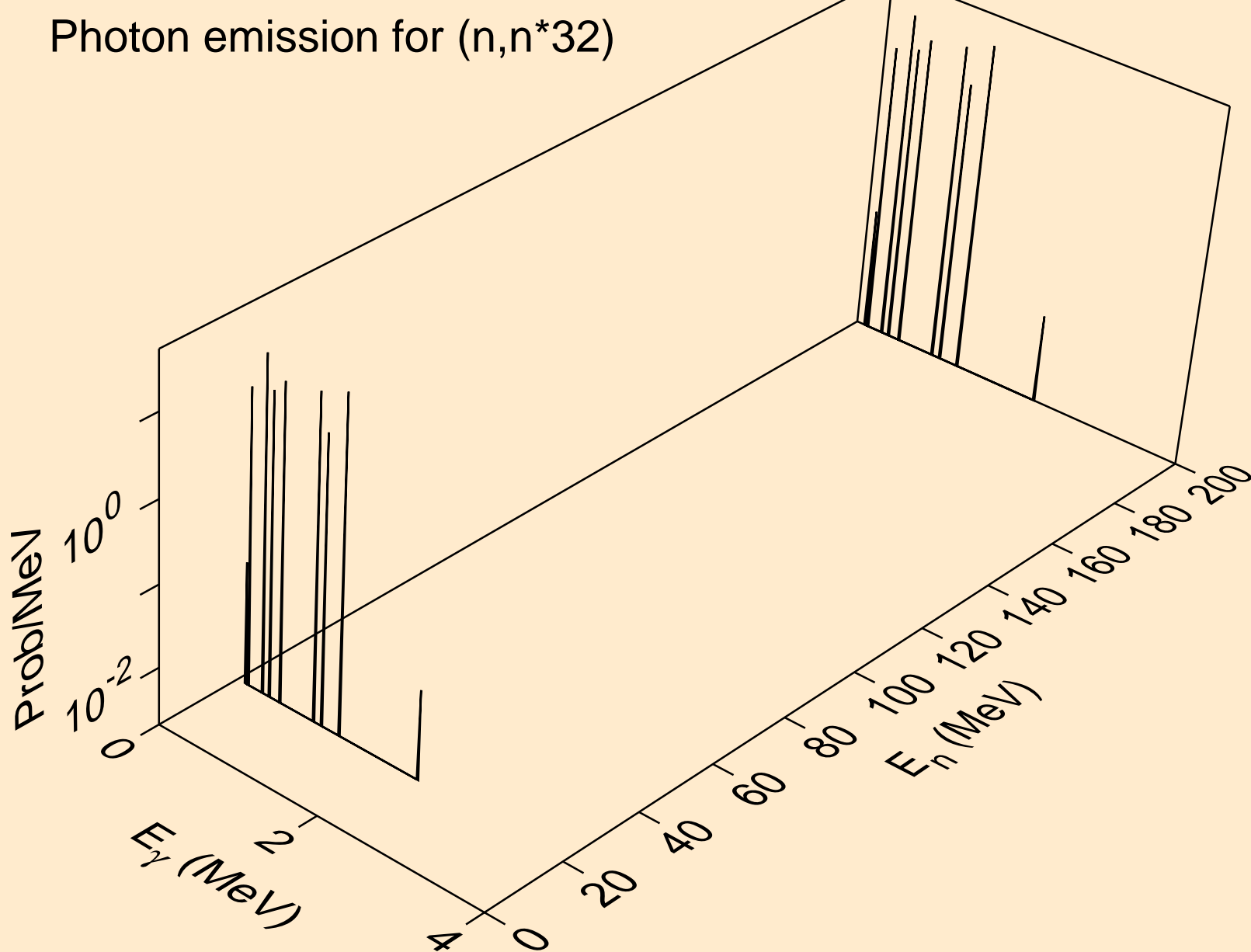

50-SN-116 FOR FENDL-3.2 FROM FENDL-3.2 BY NJOY2016.60+ C
Photon emission for (n,n*33)

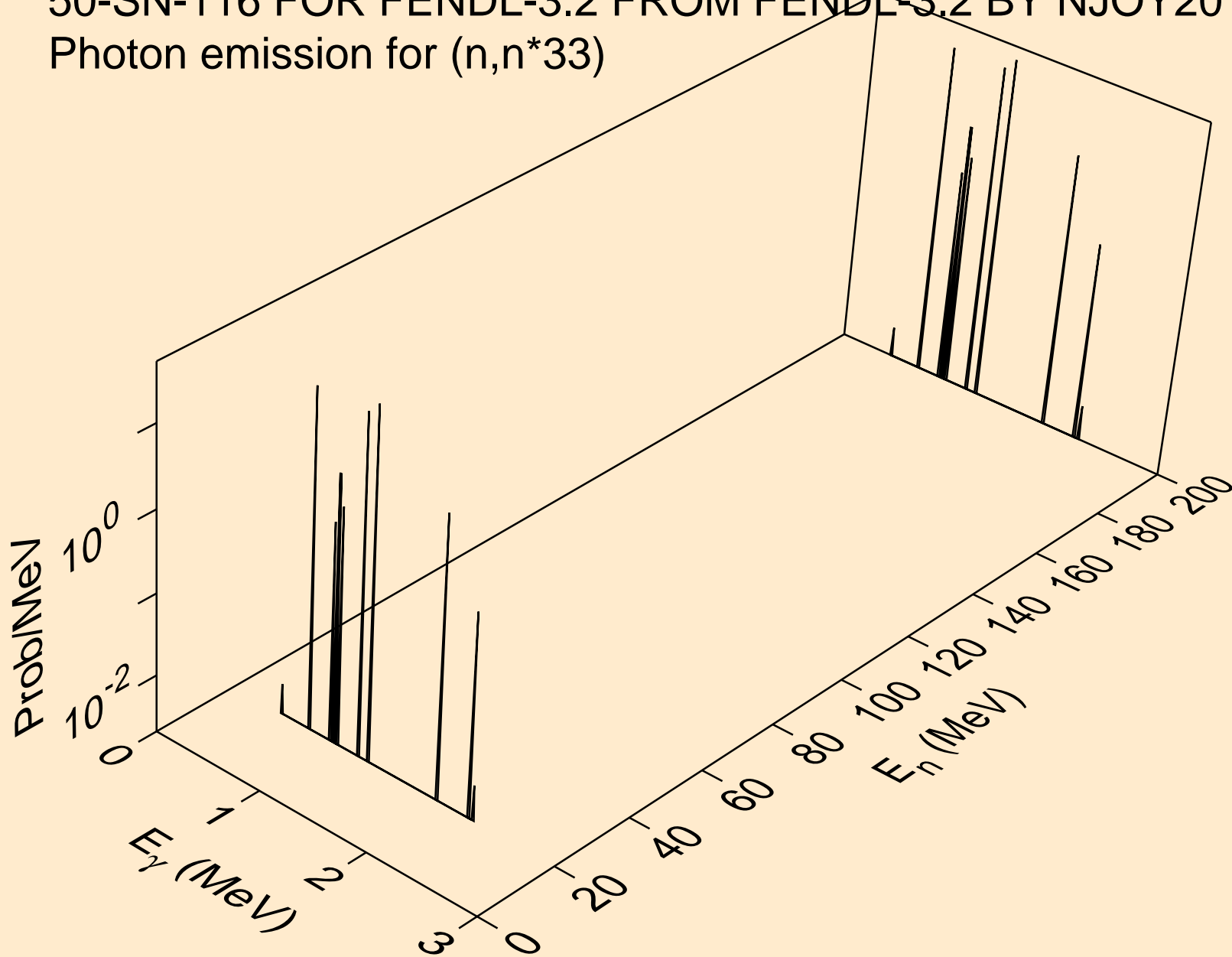

50-SN-116 FOR FENDL-3.2 FROM FENDL-3.2 BY NJOY2016.60+ C
Photon emission for (n,n*34)

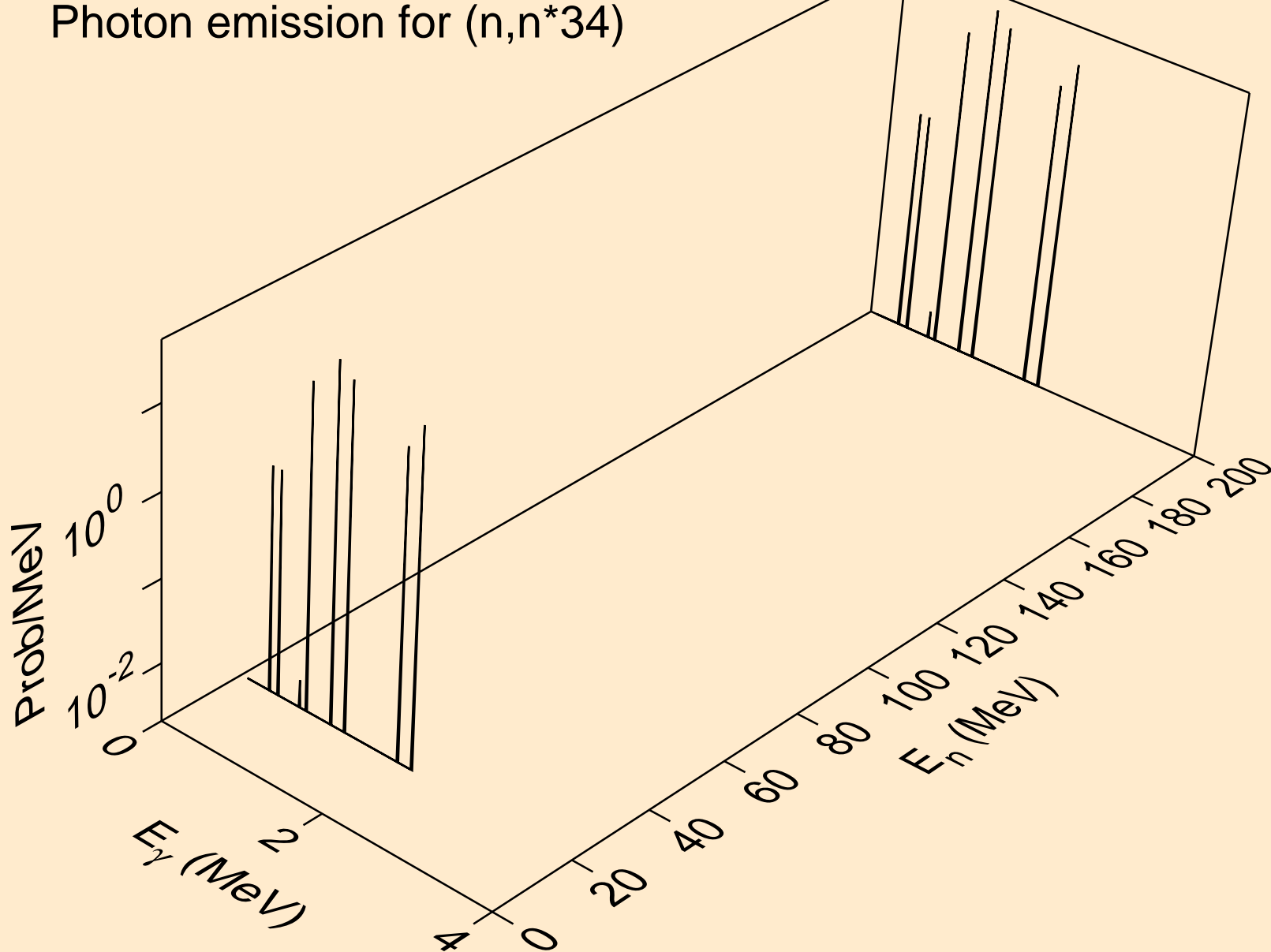

50-SN-116 FOR FENDL-3.2 FROM FENDL-3.2 BY NJOY2016.60+ C
Photon emission for (n,n*35)

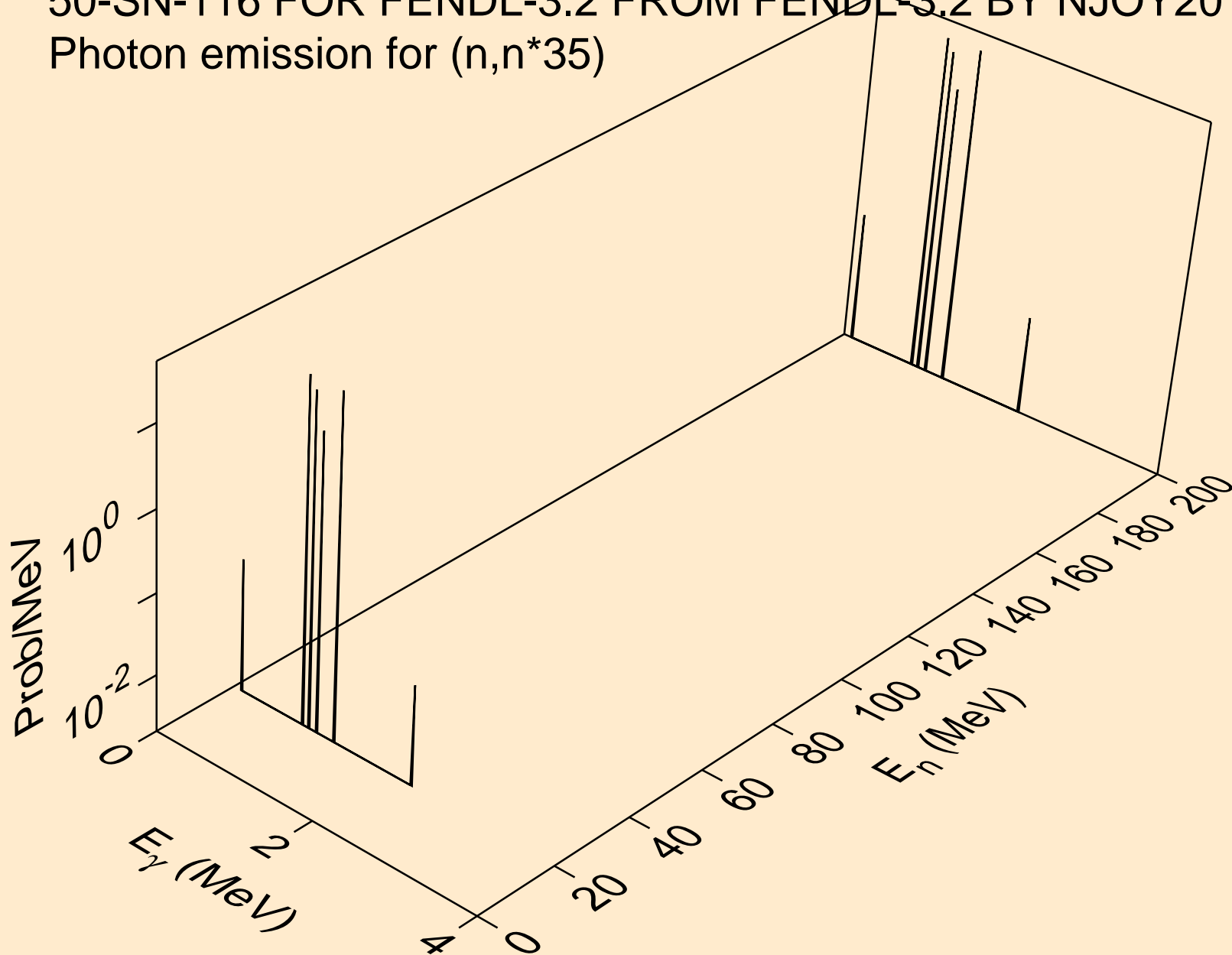

50-SN-116 FOR FENDL-3.2 FROM FENDL-3.2 BY NJOY2016.60+ C
Photon emission for (n,n*36)

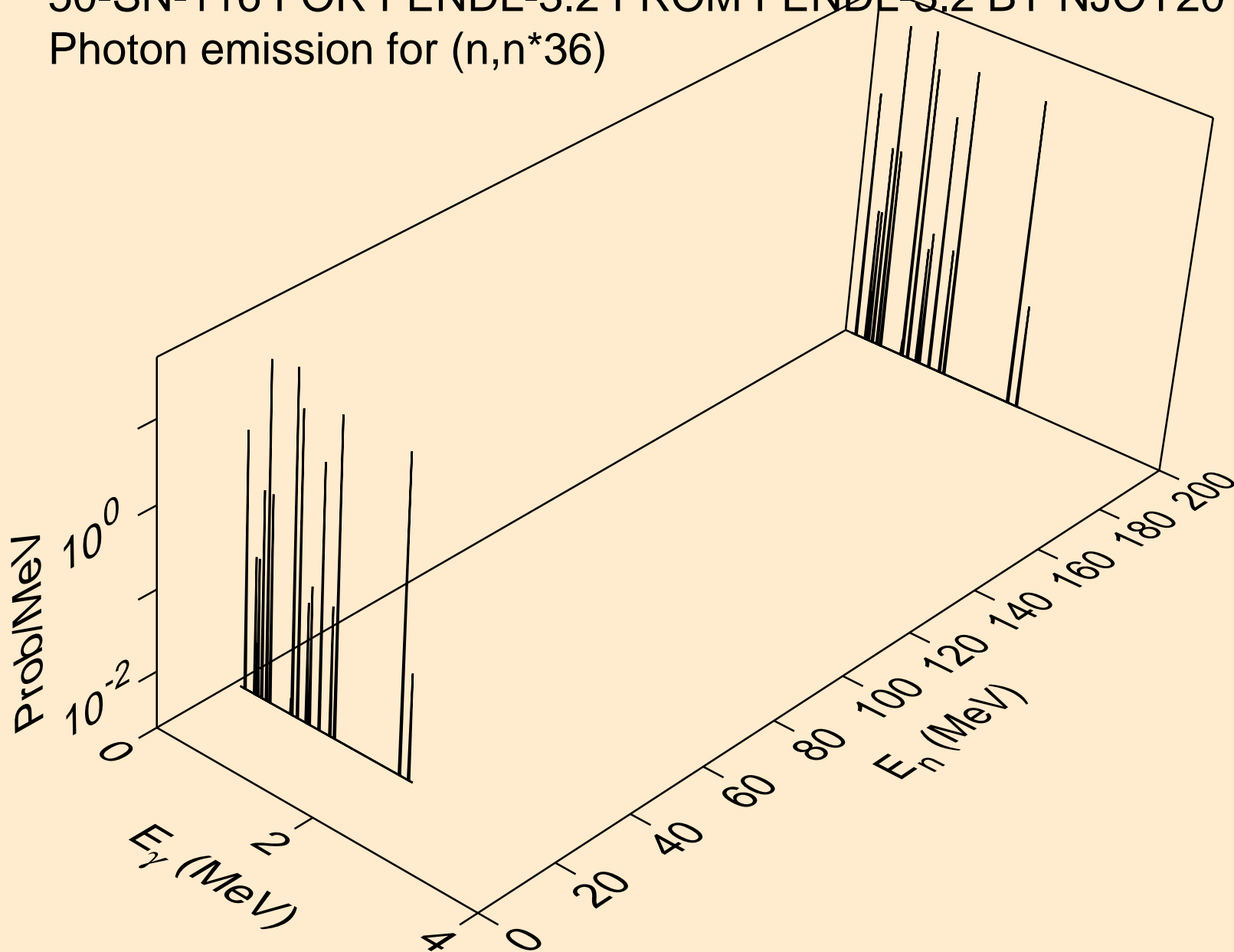

50-SN-116 FOR FENDL-3.2 FROM FENDL-3.2 BY NJOY2016.60+ C
Photon emission for (n,n*37)

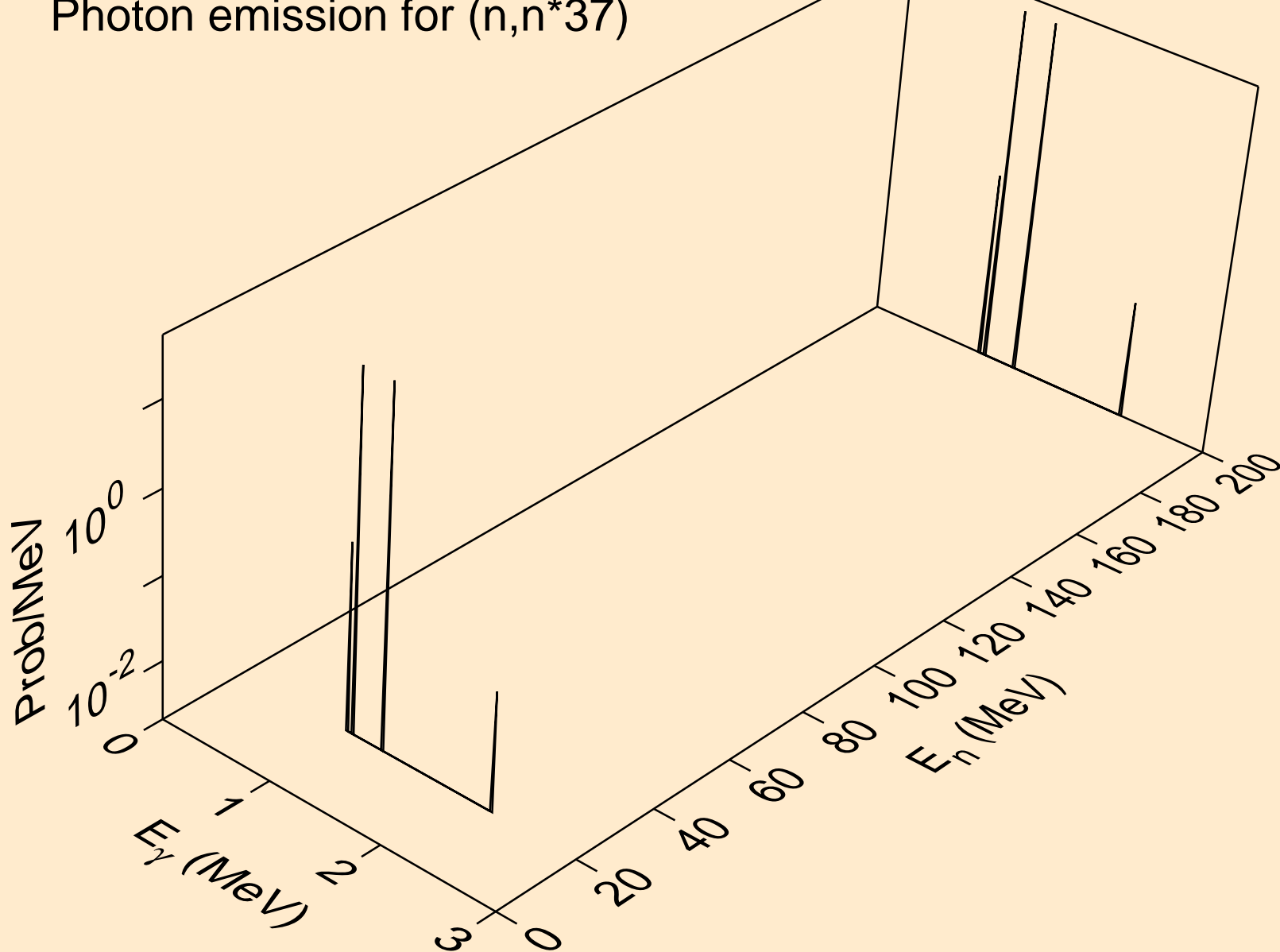

50-SN-116 FOR FENDL-3.2 FROM FENDL-3.2 BY NJOY2016.60+ C
Photon emission for (n,n*38)

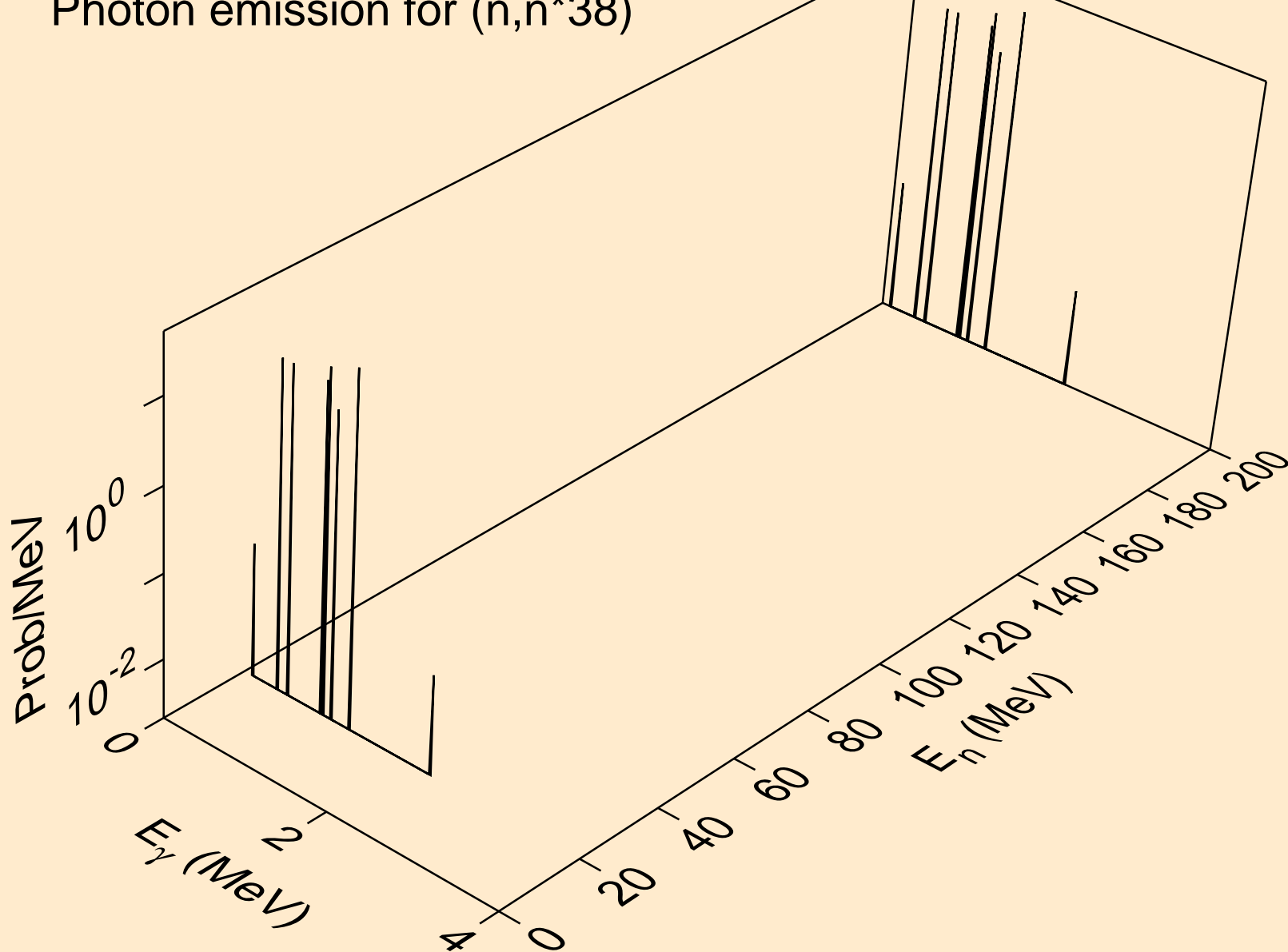

50-SN-116 FOR FENDL-3.2 FROM FENDL-3.2 BY NJOY2016.60+ C
Photon emission for (n,n*39)

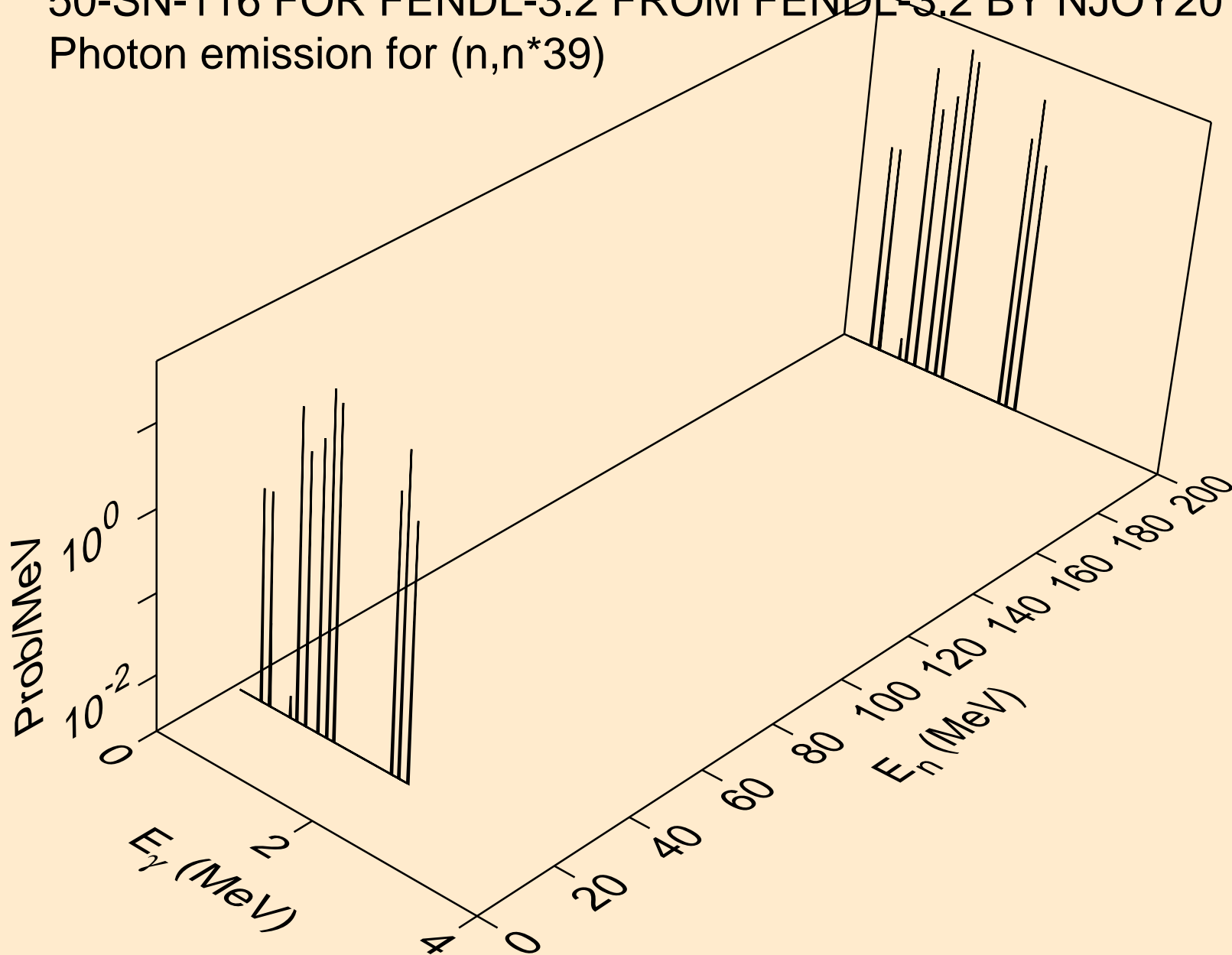

50-SN-116 FOR FENDL-3.2 FROM FENDL-3.2 BY NJOY2016.60+ C
Photon emission for (n,n*40)

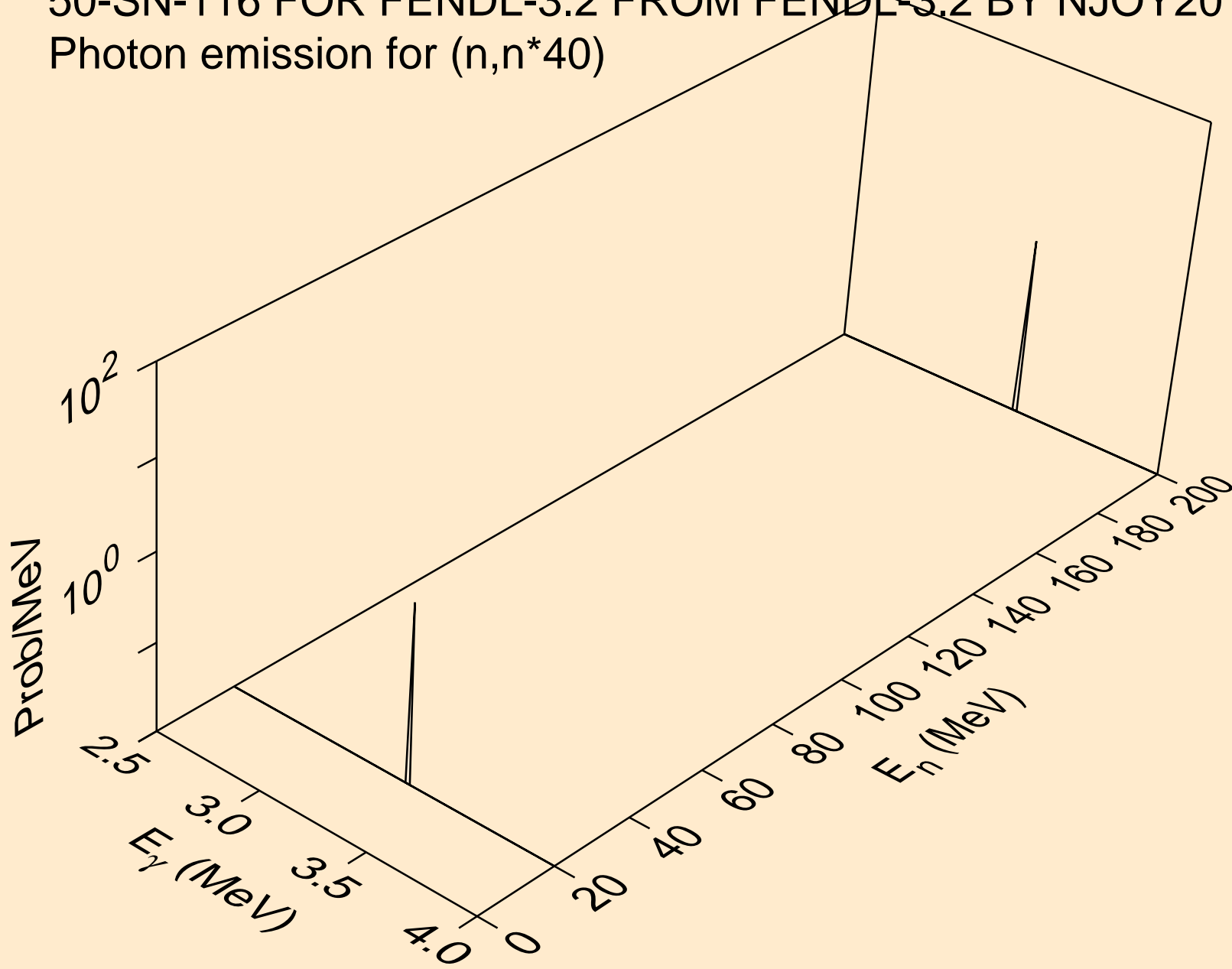

50-SN-116 FOR FENDL-3.2 FROM FENDL-3.2 BY NJOY2016.60+ C
Photon emission for (n,n*c)

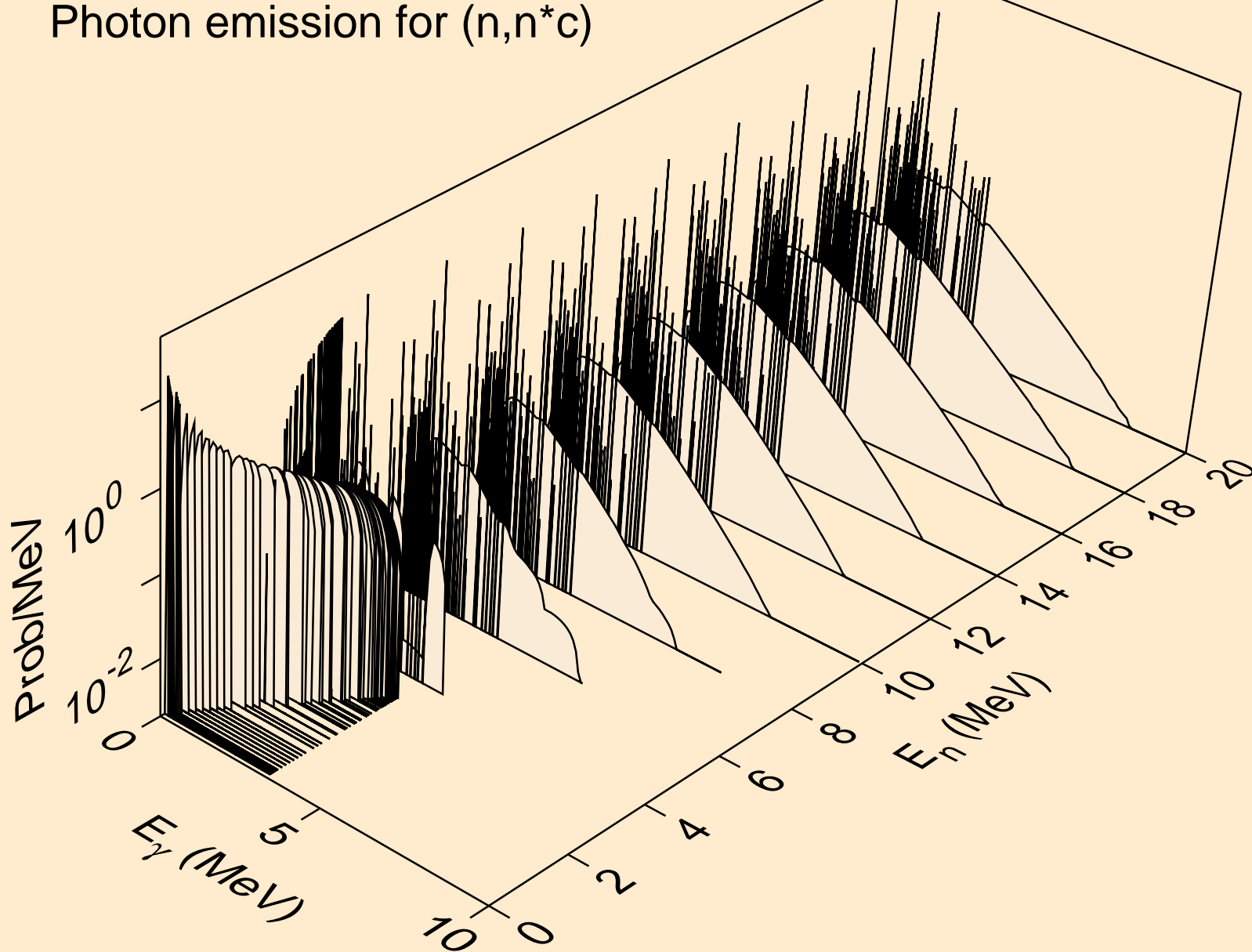

50-SN-116 FOR FENDL-3.2 FROM FENDL-3.2 BY NJOY2016.60+ C
Photon emission for (n,gma)

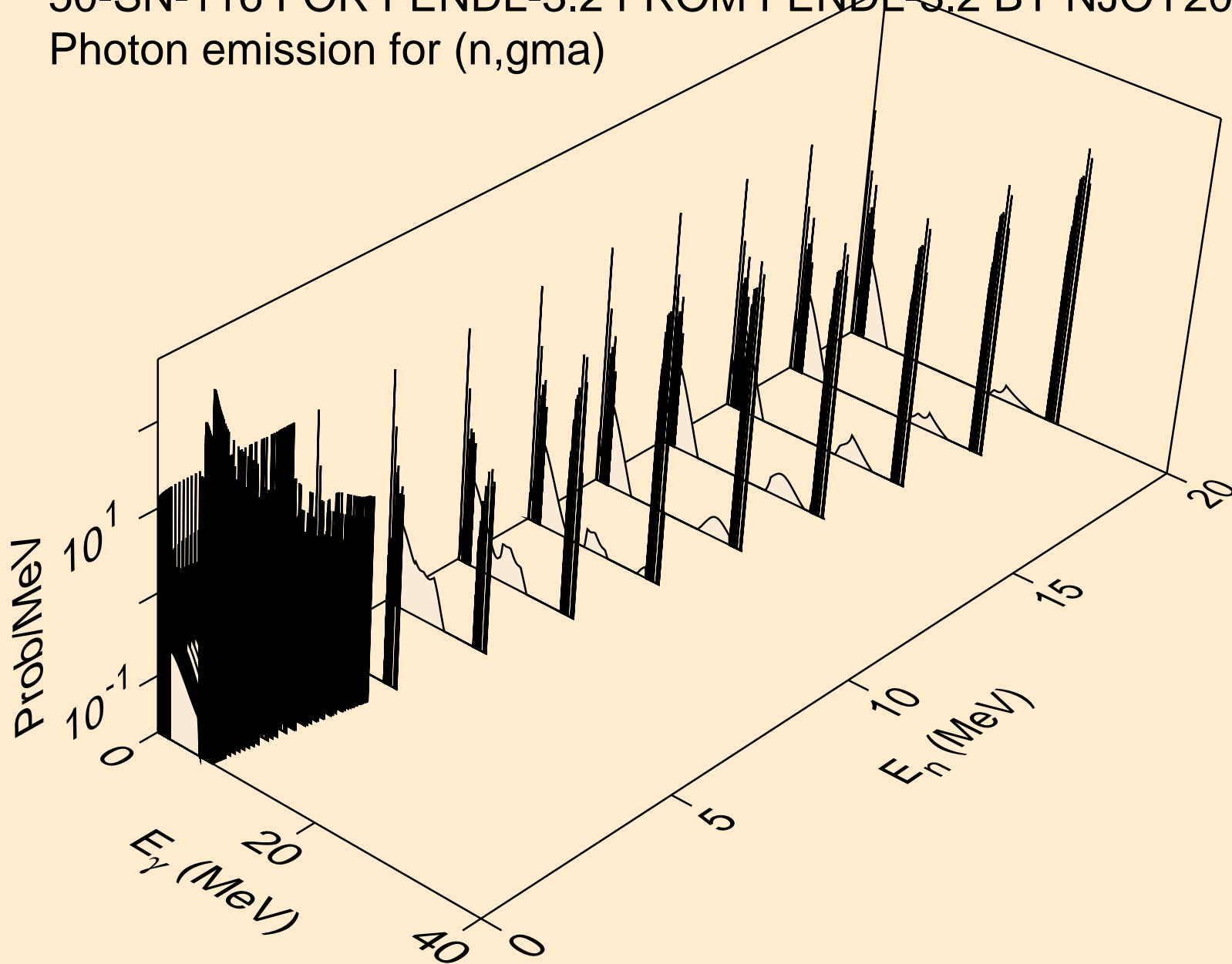

50-SN-116 FOR FENDL-3.2 FROM FENDL-3.2 BY NJOY2016.60+ C
thermal capture photon spectrum

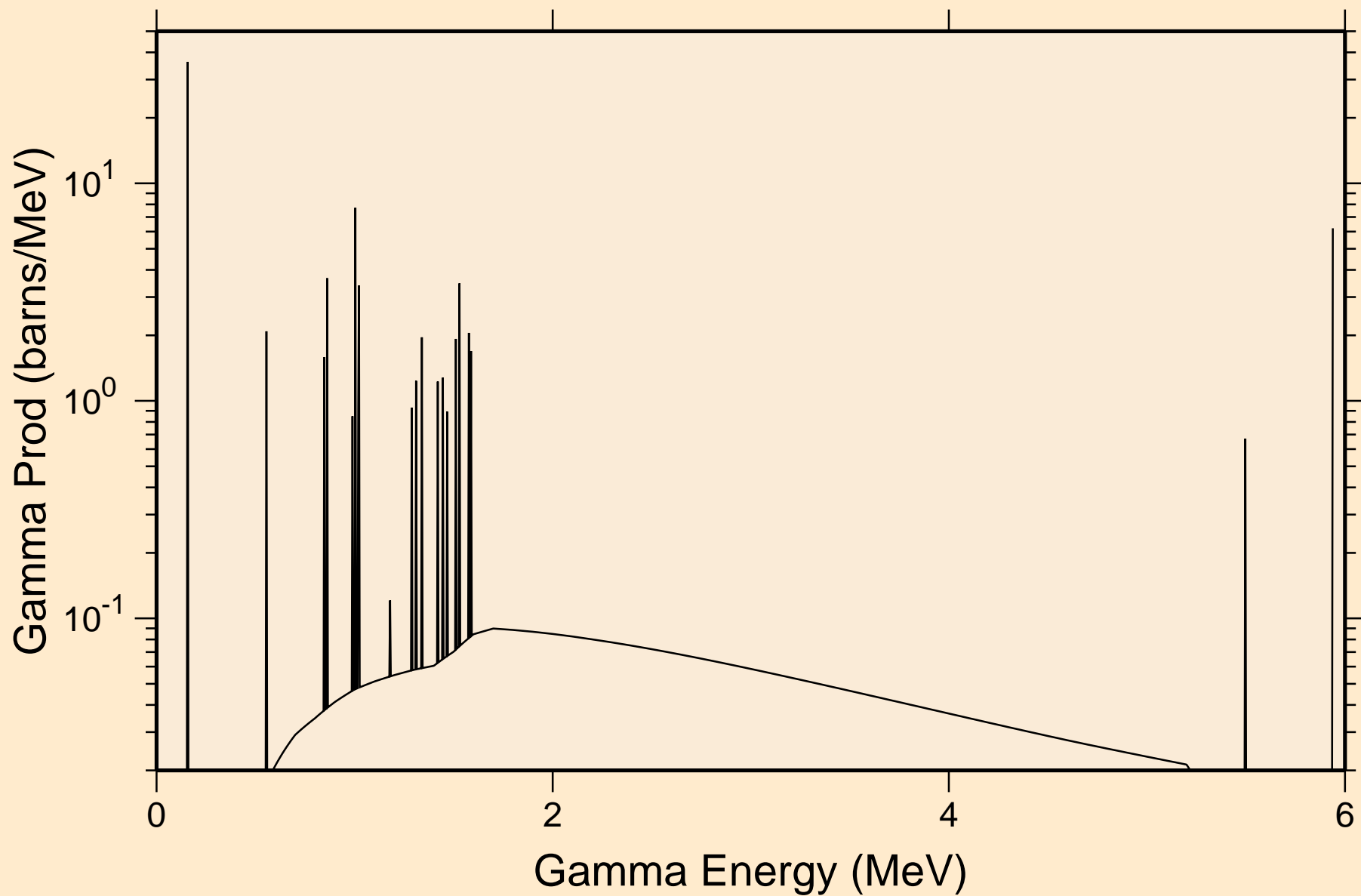

50-SN-116 FOR FENDL-3.2 FROM FENDL-3.2 BY NJOY2016.60+ C
14 MeV photon spectrum

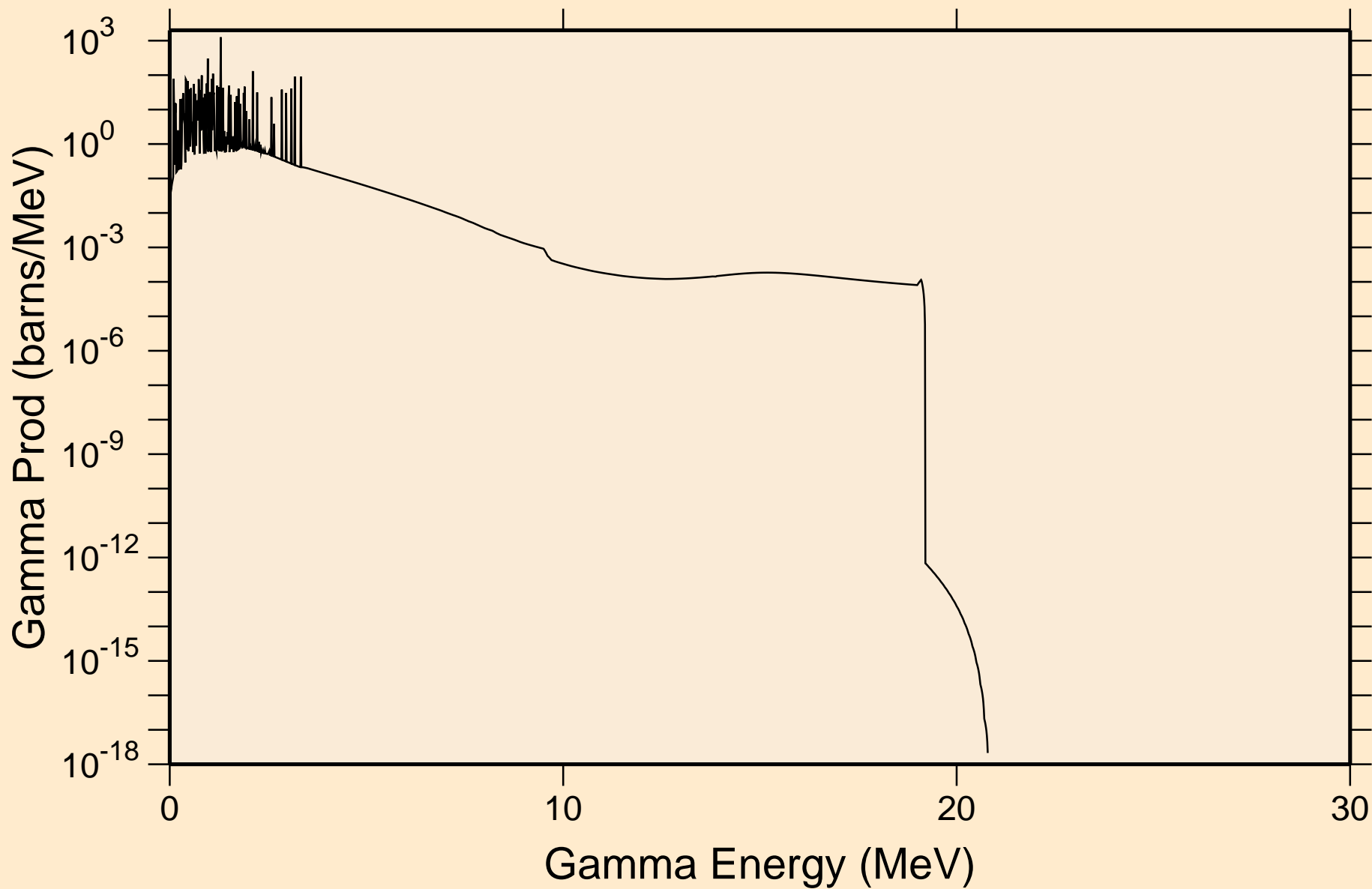

50-SN-116 FOR FENDL-3.2 FROM FENDL-3.2 BY NJOY2016.60+ C

Particle heating contributions

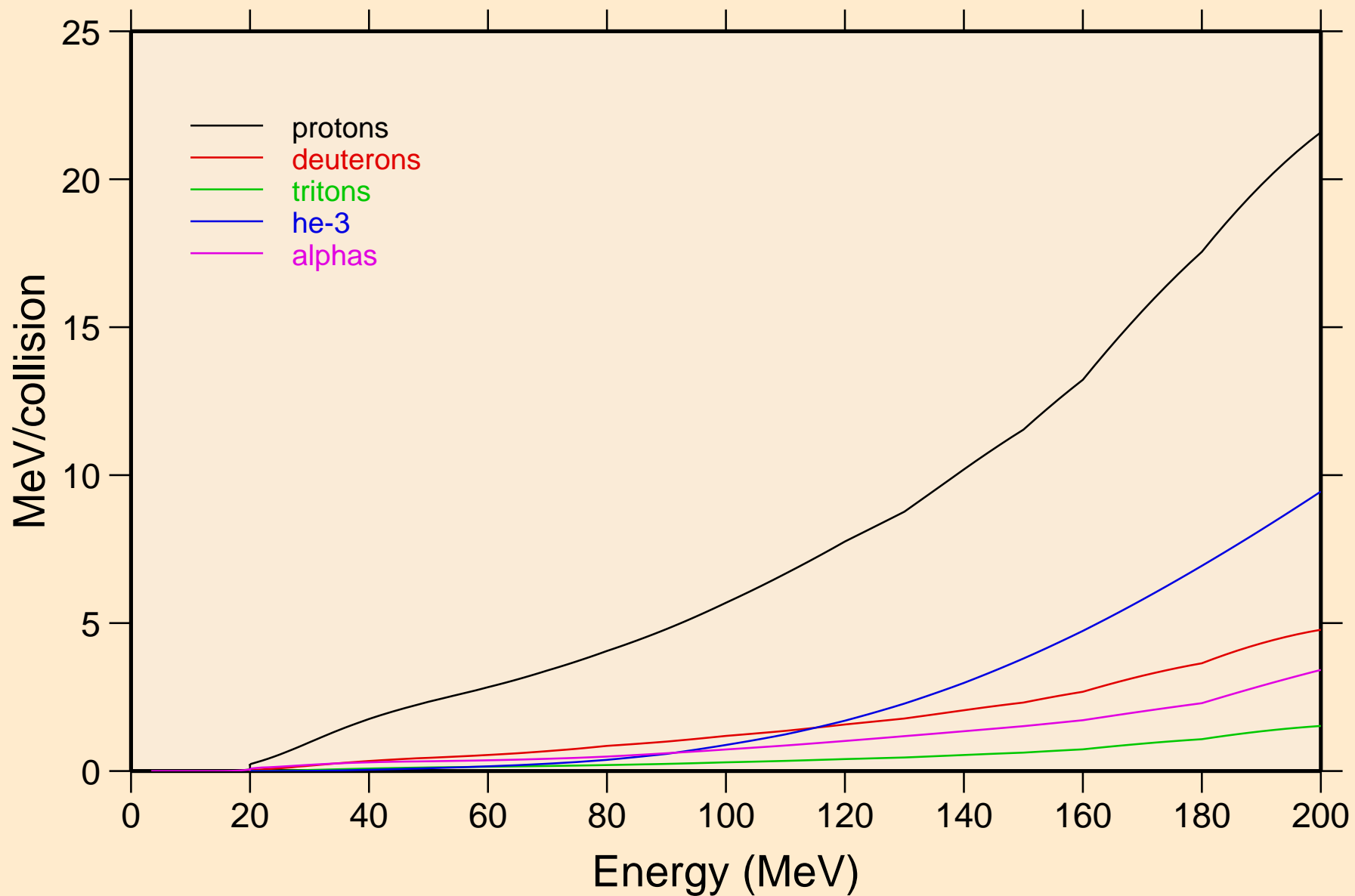

50-SN-116 FOR FENDL-3.2 FROM FENDL-3.2 BY NJOY2016.60+ C
Recoil Heating

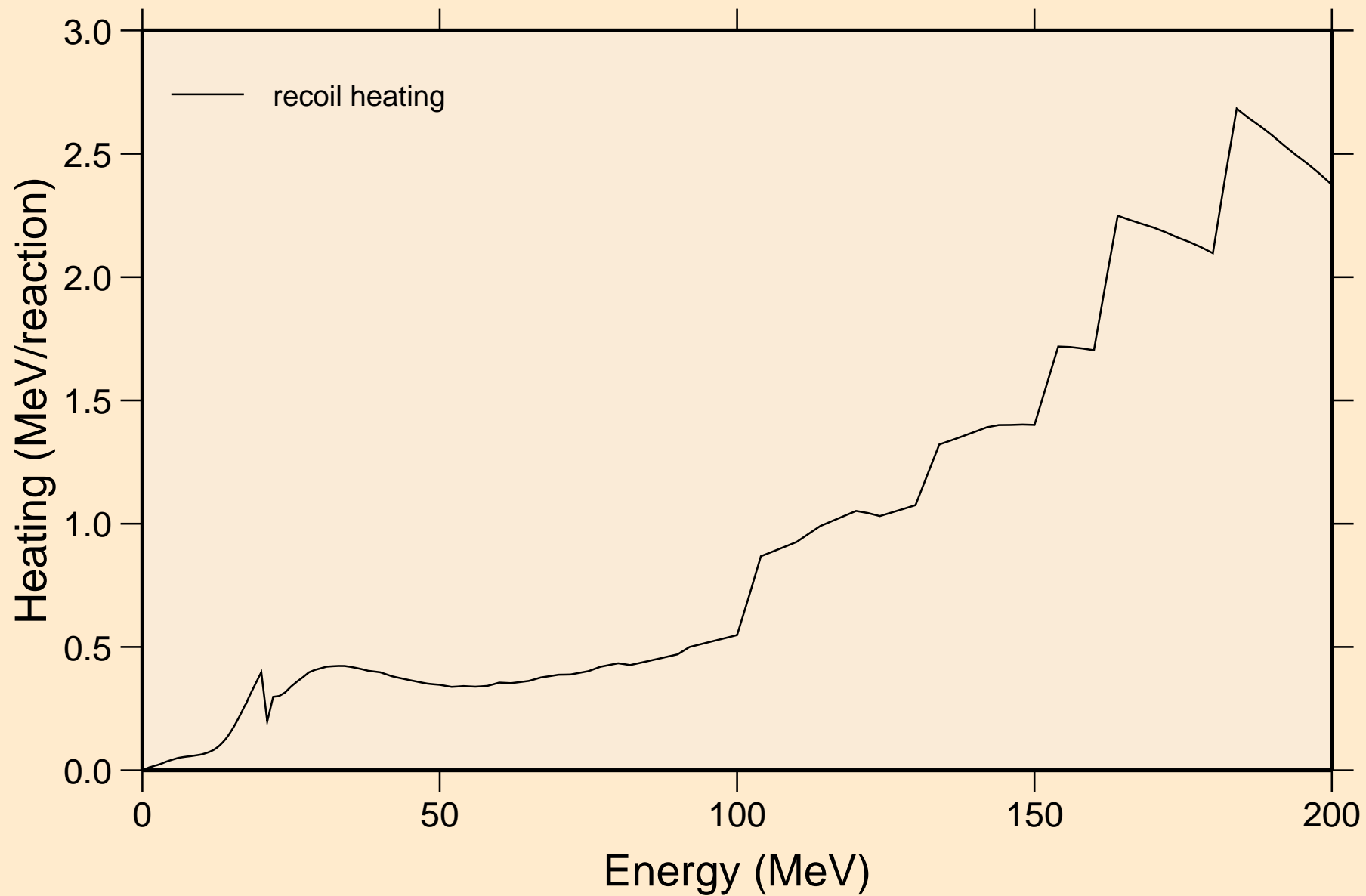

50-SN-116 FOR FENDL-3.2 FROM FENDL-3.2 BY NJOY2016.60+ C
Particle production cross sections

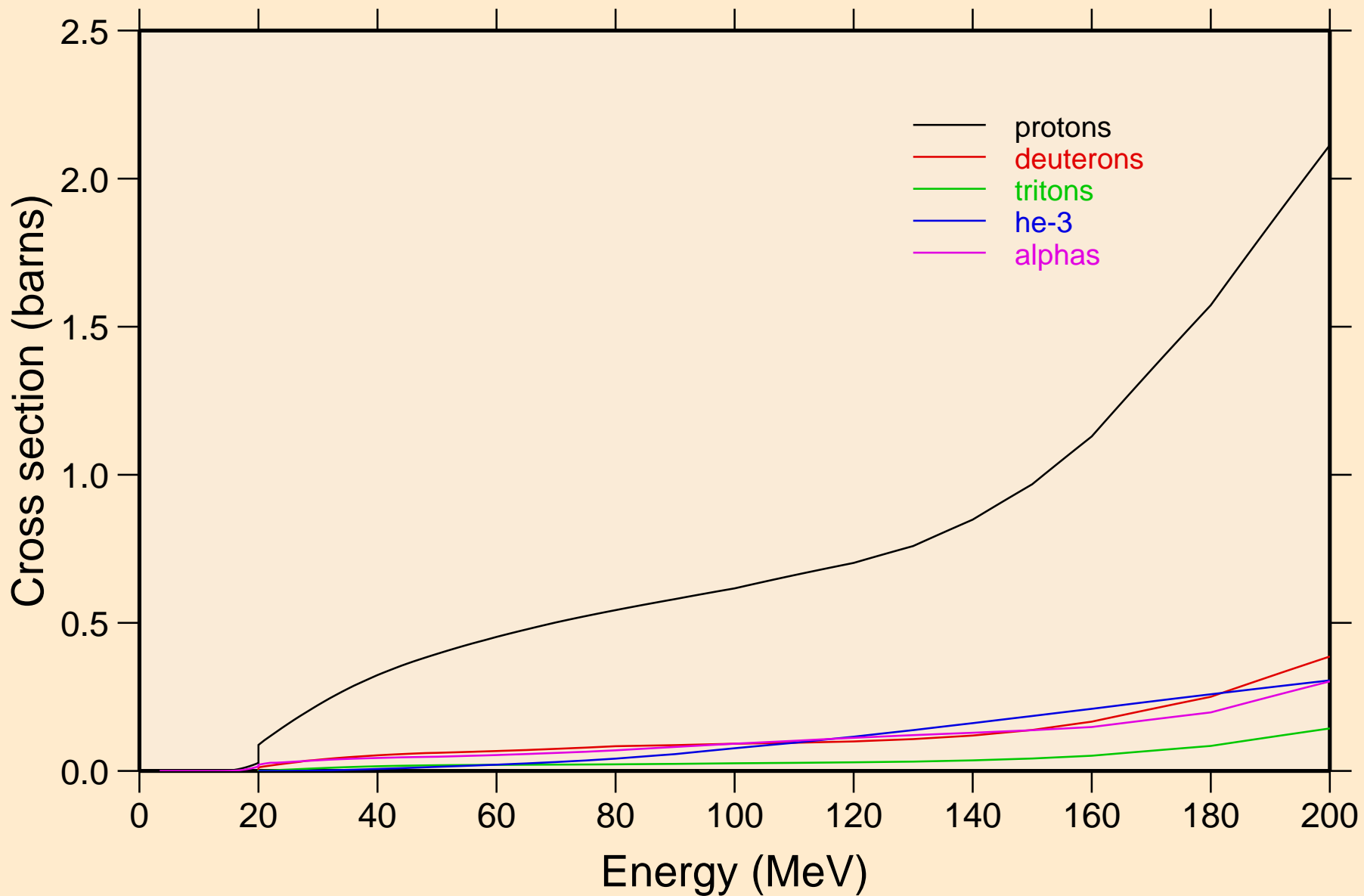

50-SN-116 FOR FENDL-3.2 FROM FENDL-3.2 BY NJOY2016.60+ C
protons from (n,x)

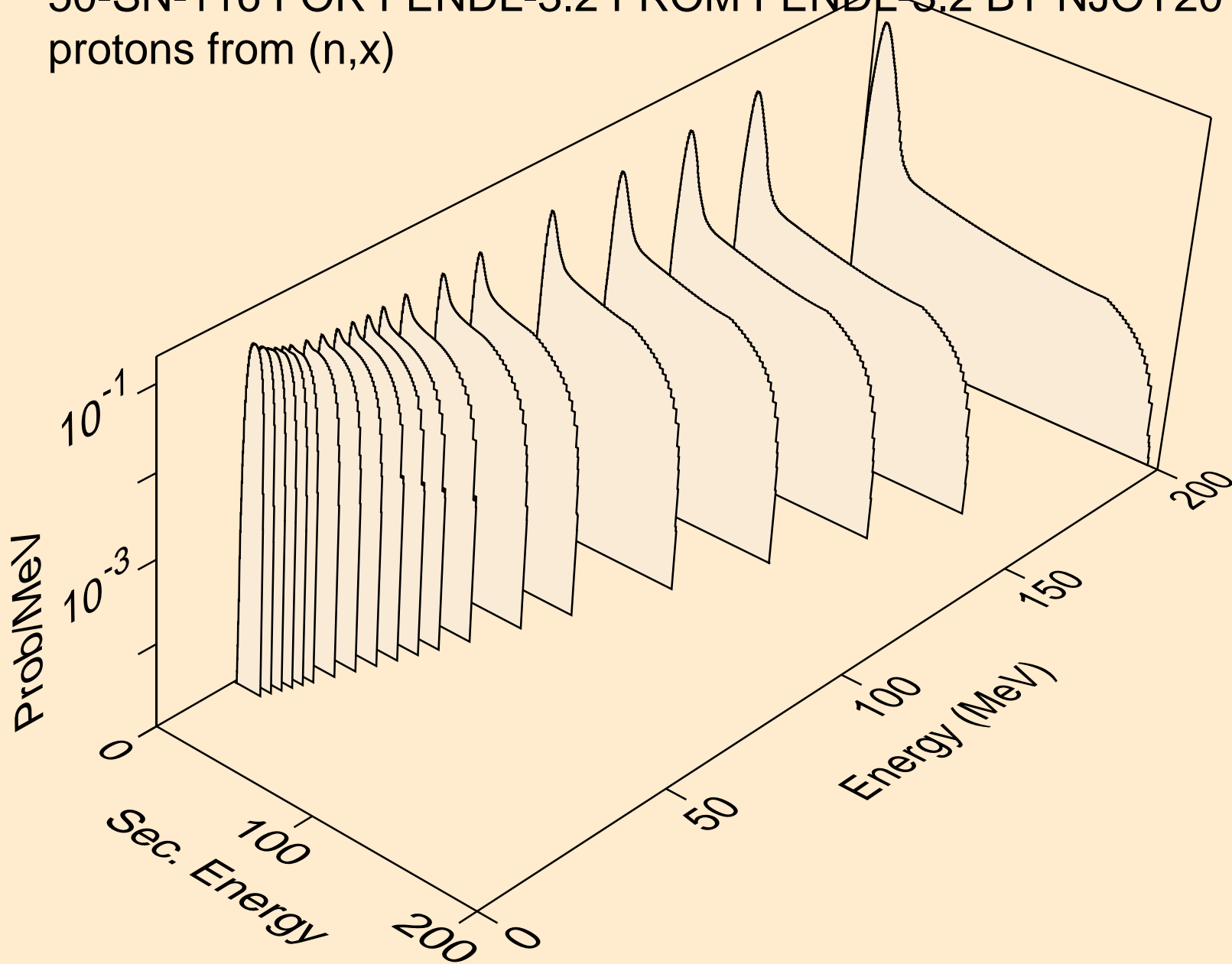

50-SN-116 FOR FENDL-3.2 FROM FENDL-3.2 BY NJOY2016.60+ C
protons from (n,n*)p

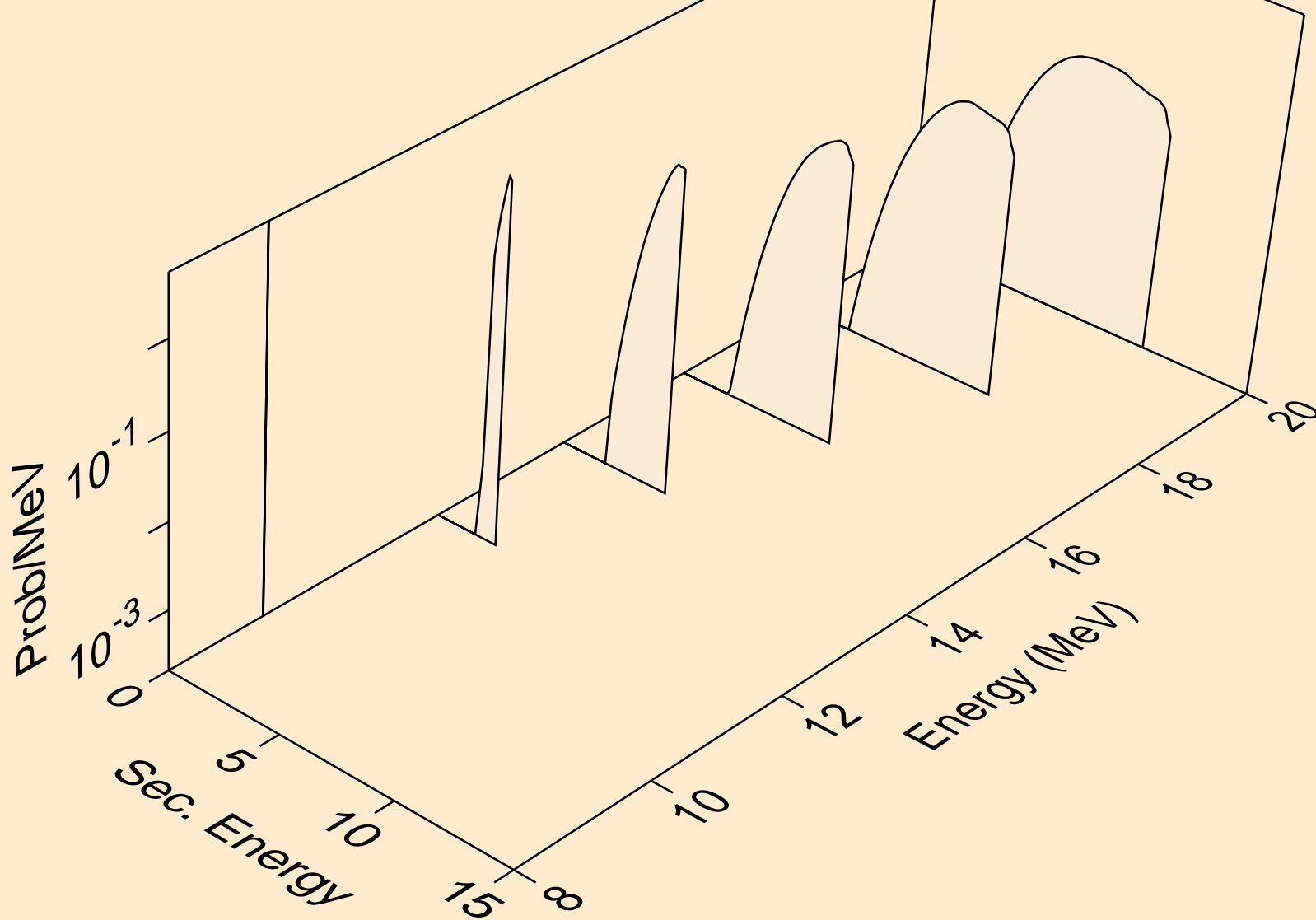

50-SN-116 FOR FENDL-3.2 FROM FENDL-3.2 BY NJOY2016.60+ C
deuterons from (n,x)

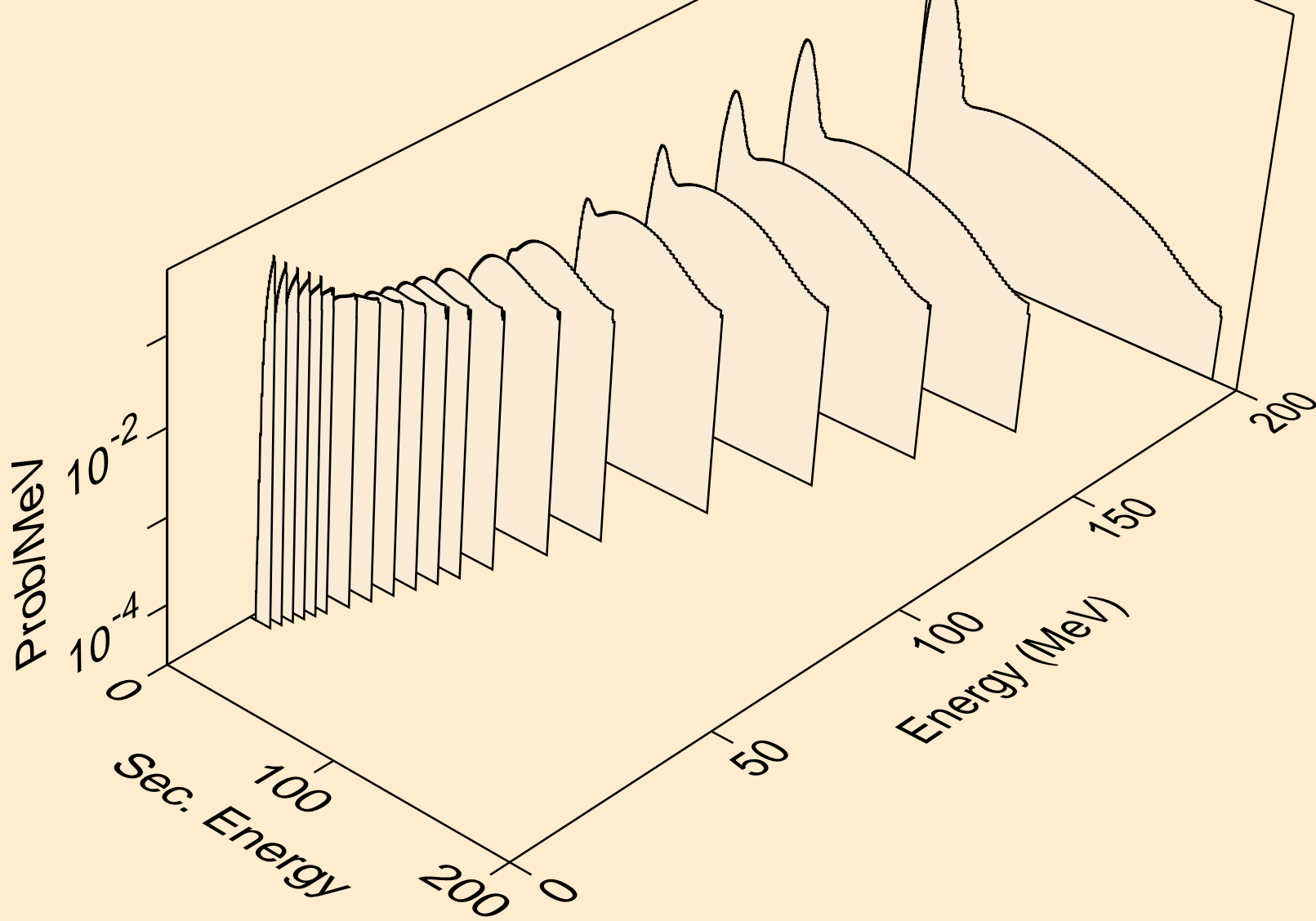

50-SN-116 FOR FENDL-3.2 FROM FENDL-3.2 BY NJOY2016.60+ C
tritons from (n,x)

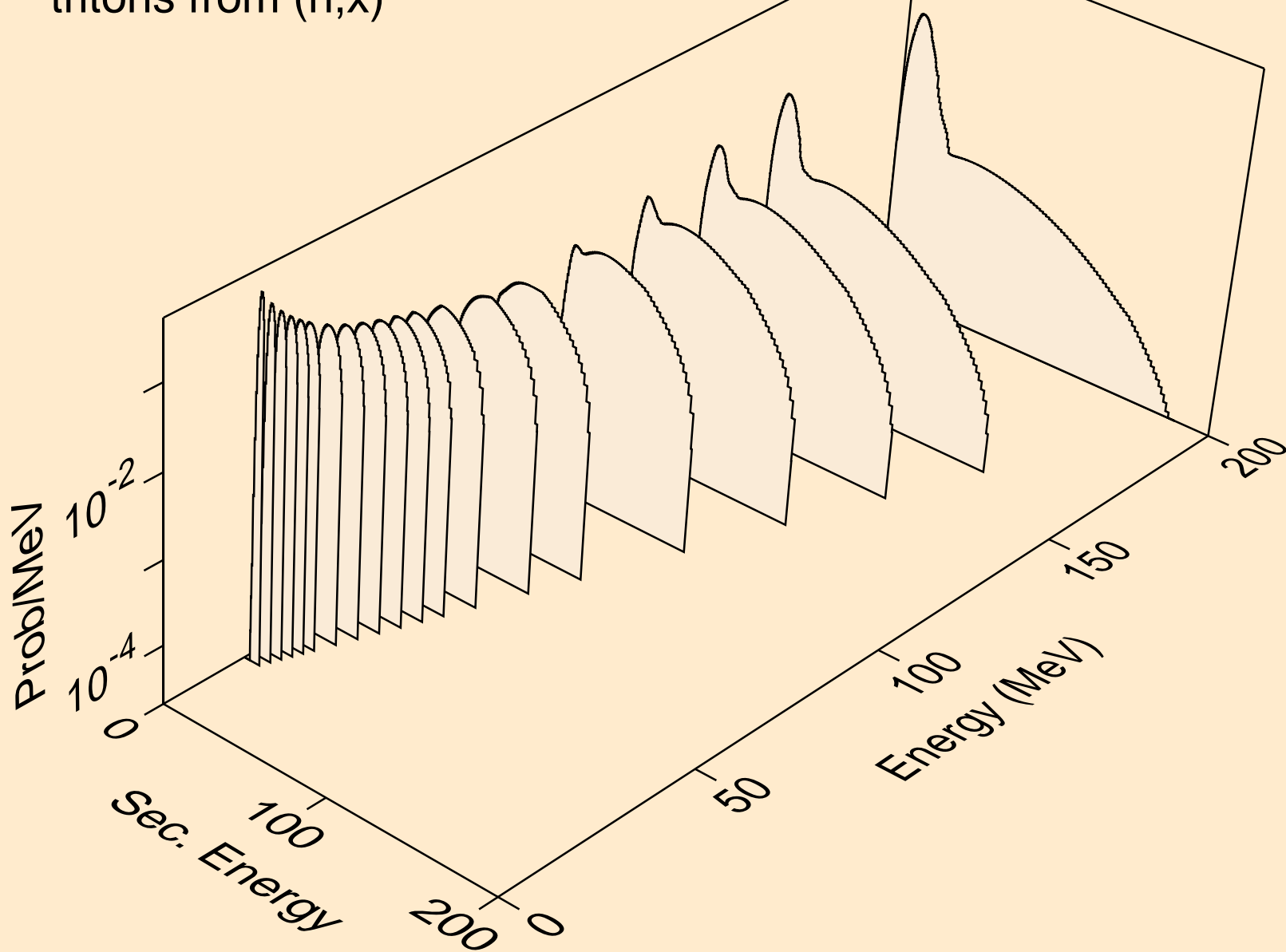

50-SN-116 FOR FENDL-3.2 FROM FENDL-3.2 BY NJOY2016.60+ C
he3s from (n,x)

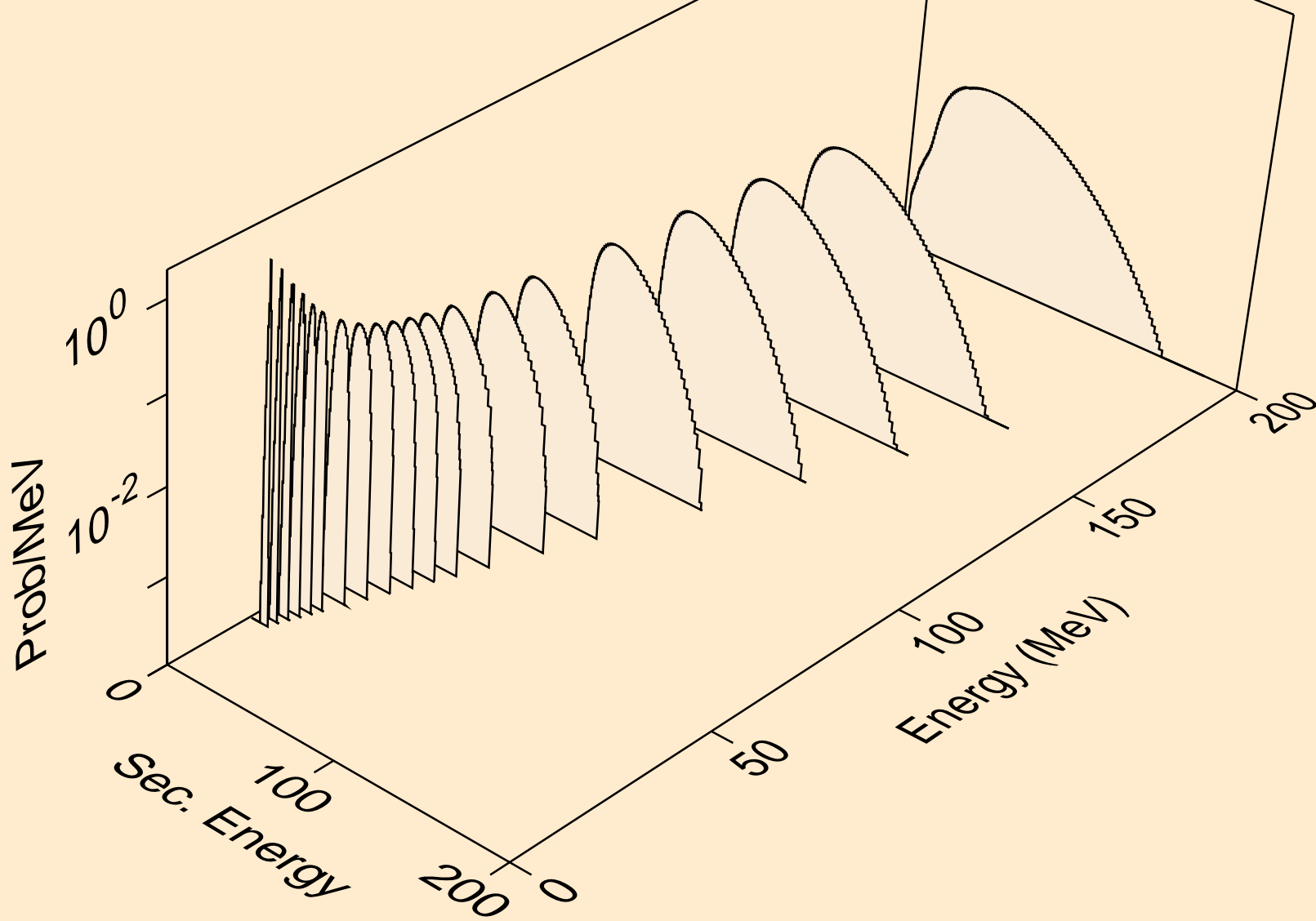

50-SN-116 FOR FENDL-3.2 FROM FENDL-3.2 BY NJOY2016.60+ C
alphas from (n,x)

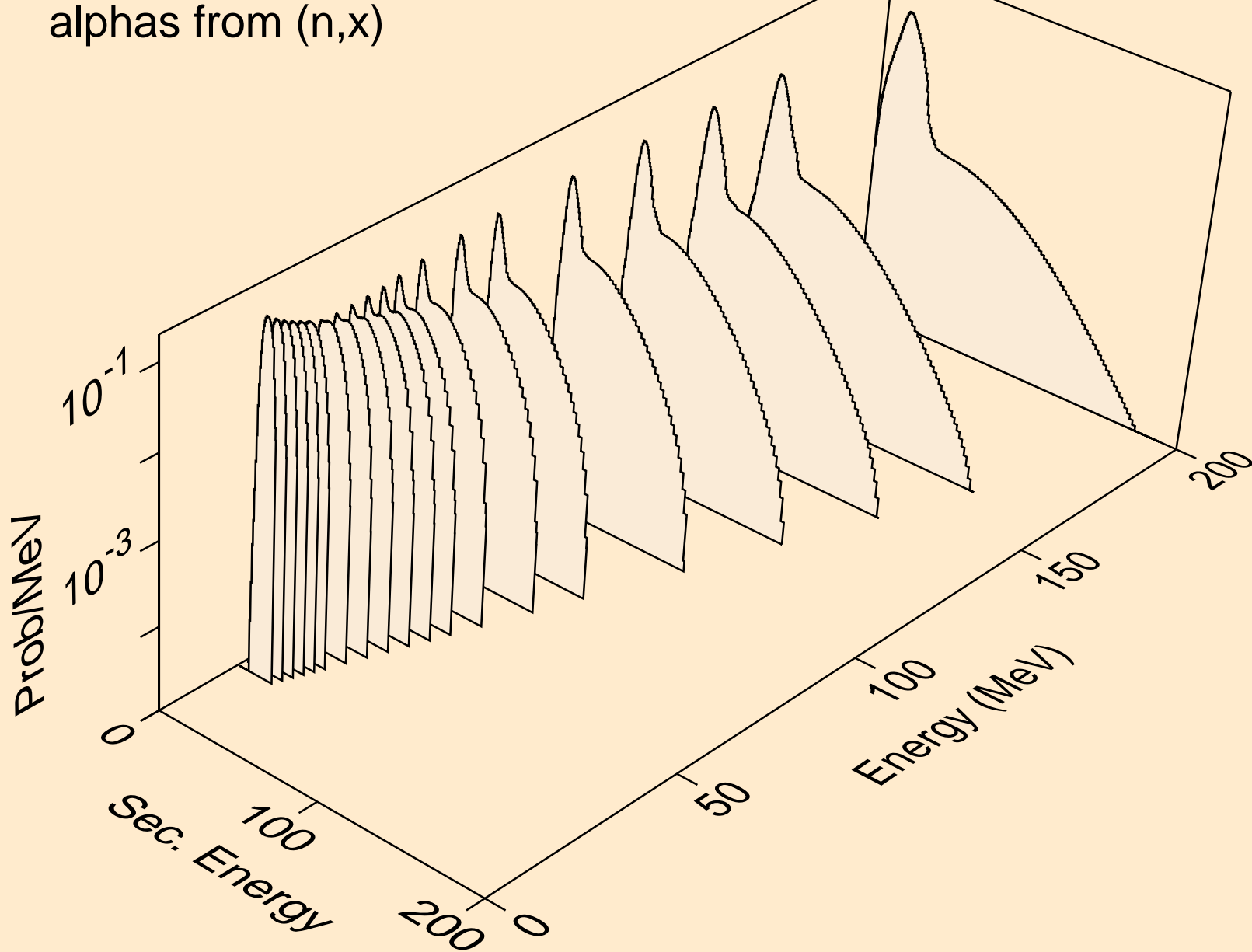

50-SN-116 FOR FENDL-3.2 FROM FENDL-3.2 BY NJOY2016.60+ C
alphas from (n,n*)a

