

50-SN-118 FOR FENDL-3.2 FROM FENDL-3.2 BY NJOY2016.60+ C  
Principal cross sections

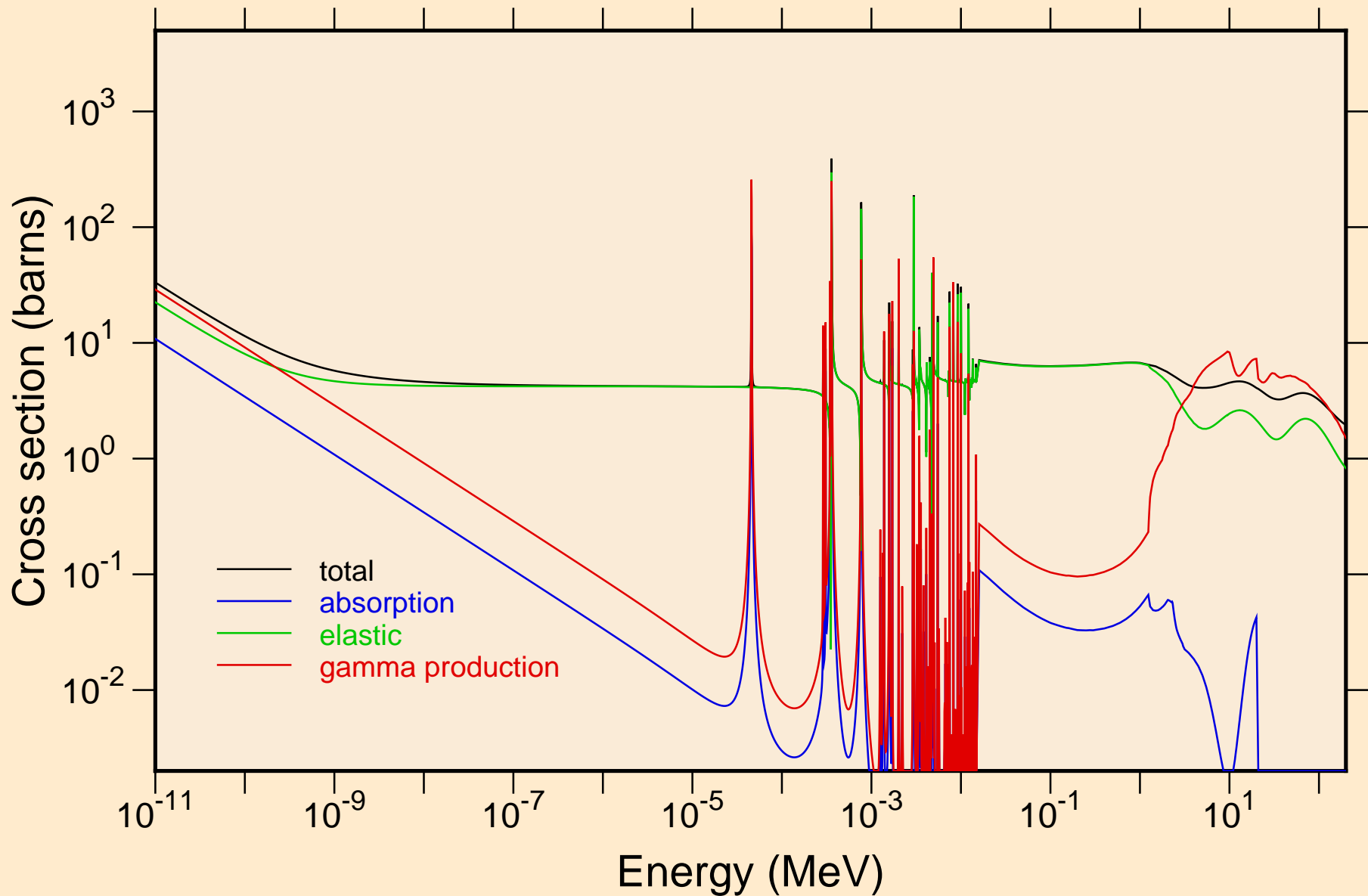

50-SN-118 FOR FENDL-3.2 FROM FENDL-3.2 BY NJOY2016.60+ C  
resonance total cross section

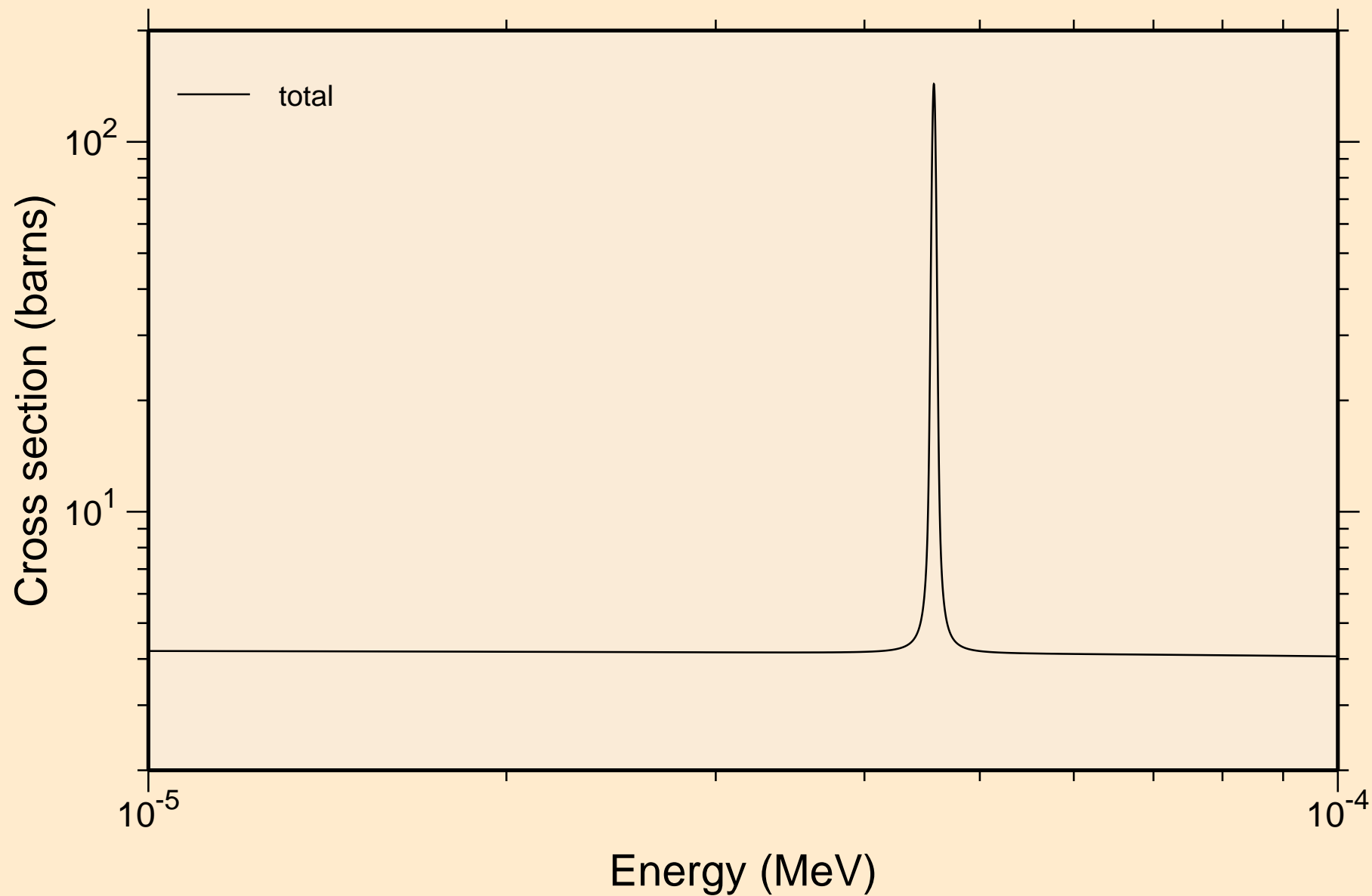

50-SN-118 FOR FENDL-3.2 FROM FENDL-3.2 BY NJOY2016.60+ C  
resonance total cross section

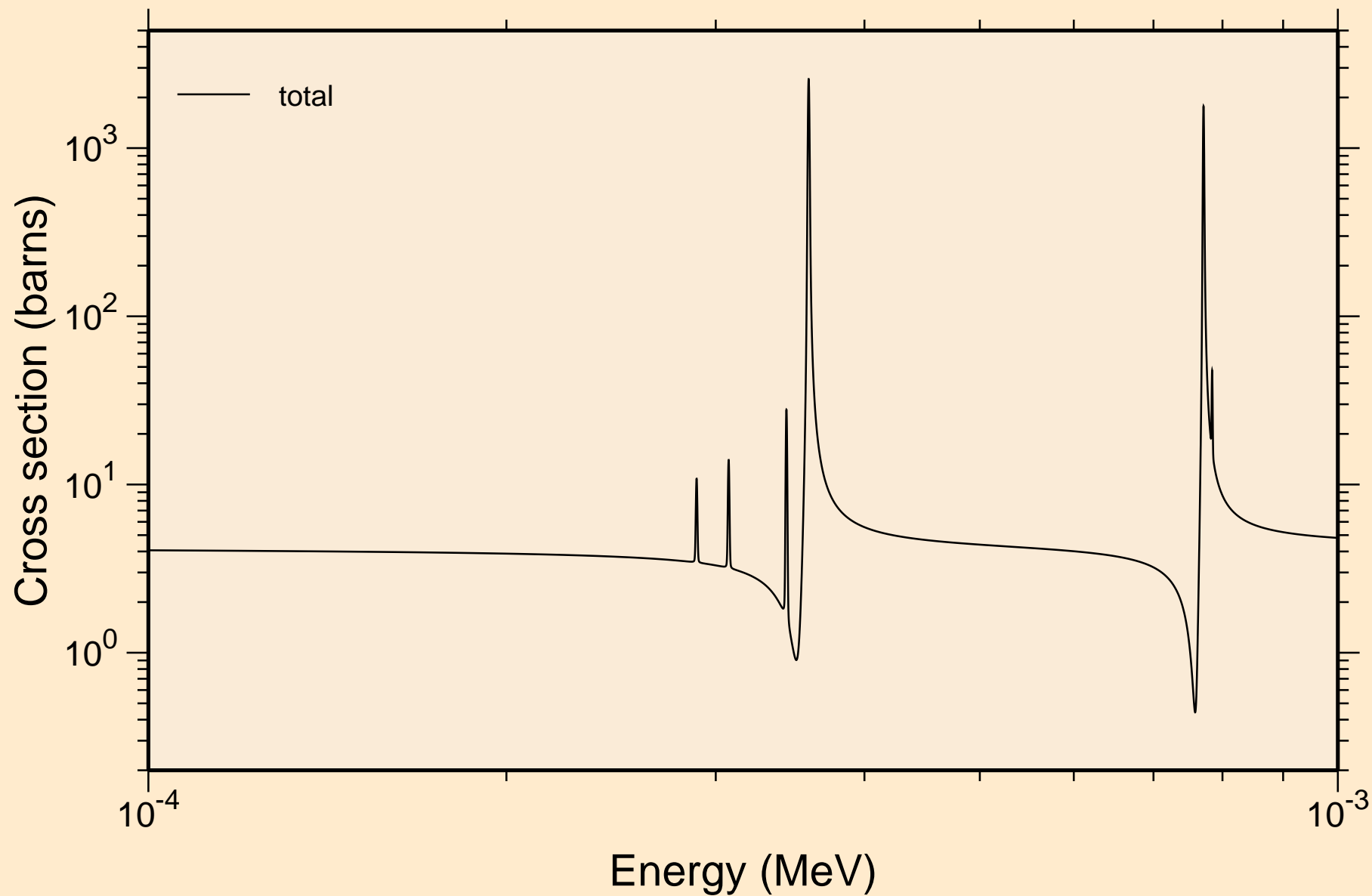

50-SN-118 FOR FENDL-3.2 FROM FENDL-3.2 BY NJOY2016.60+ C  
resonance total cross section

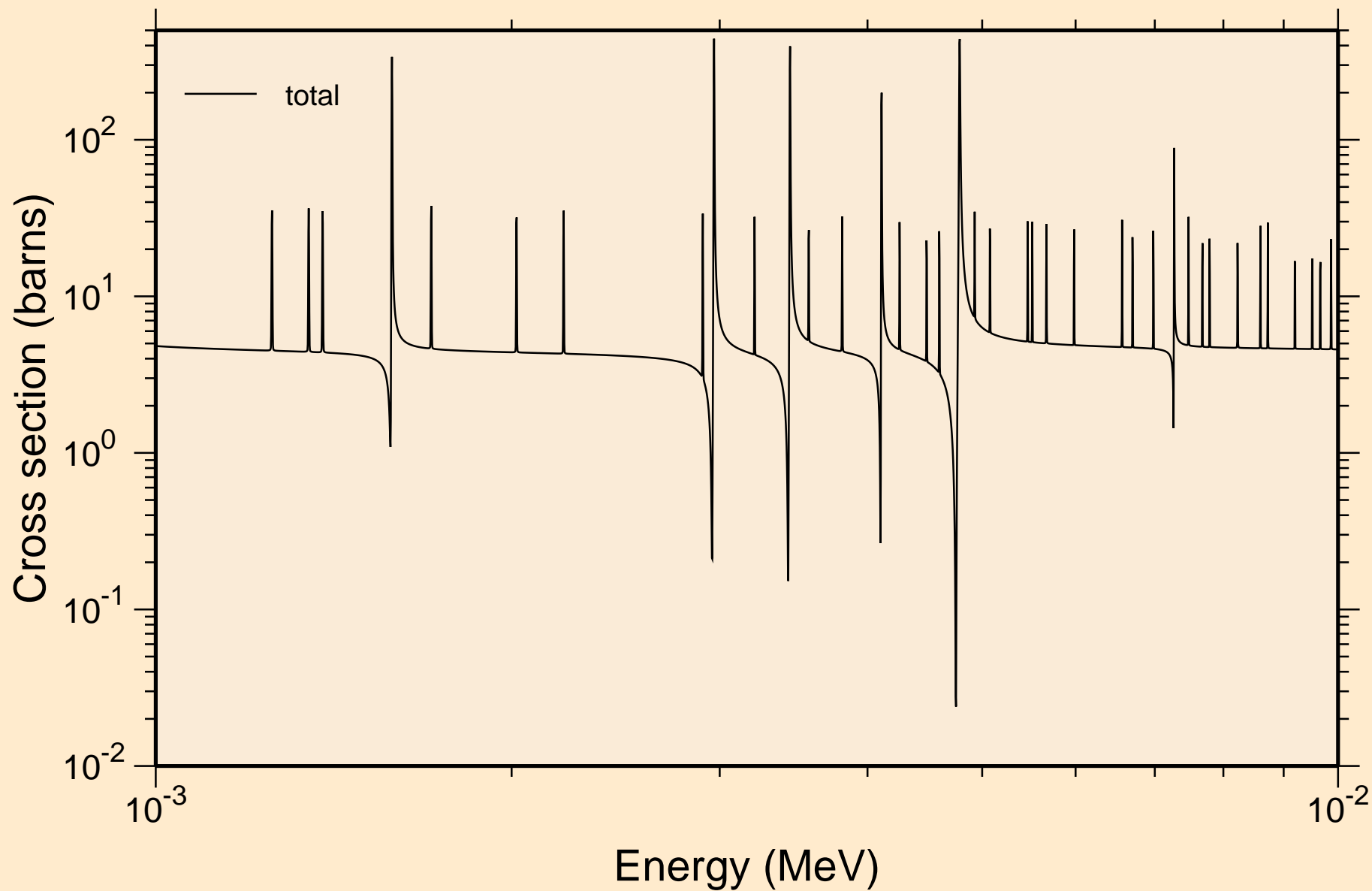

50-SN-118 FOR FENDL-3.2 FROM FENDL-3.2 BY NJOY2016.60+ C  
resonance total cross section

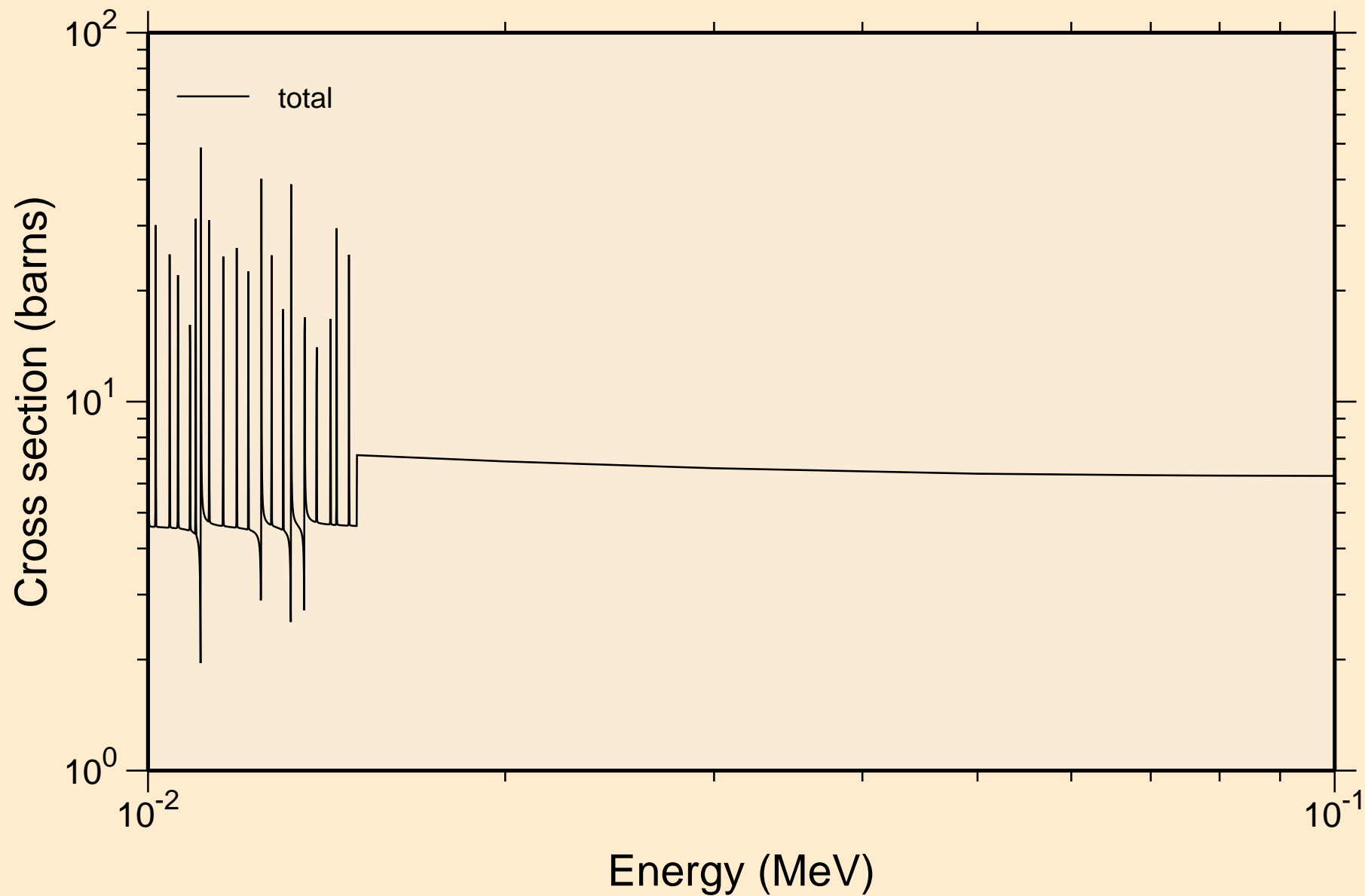

50-SN-118 FOR FENDL-3.2 FROM FENDL-3.2 BY NJOY2016.60+ C  
resonance total cross section

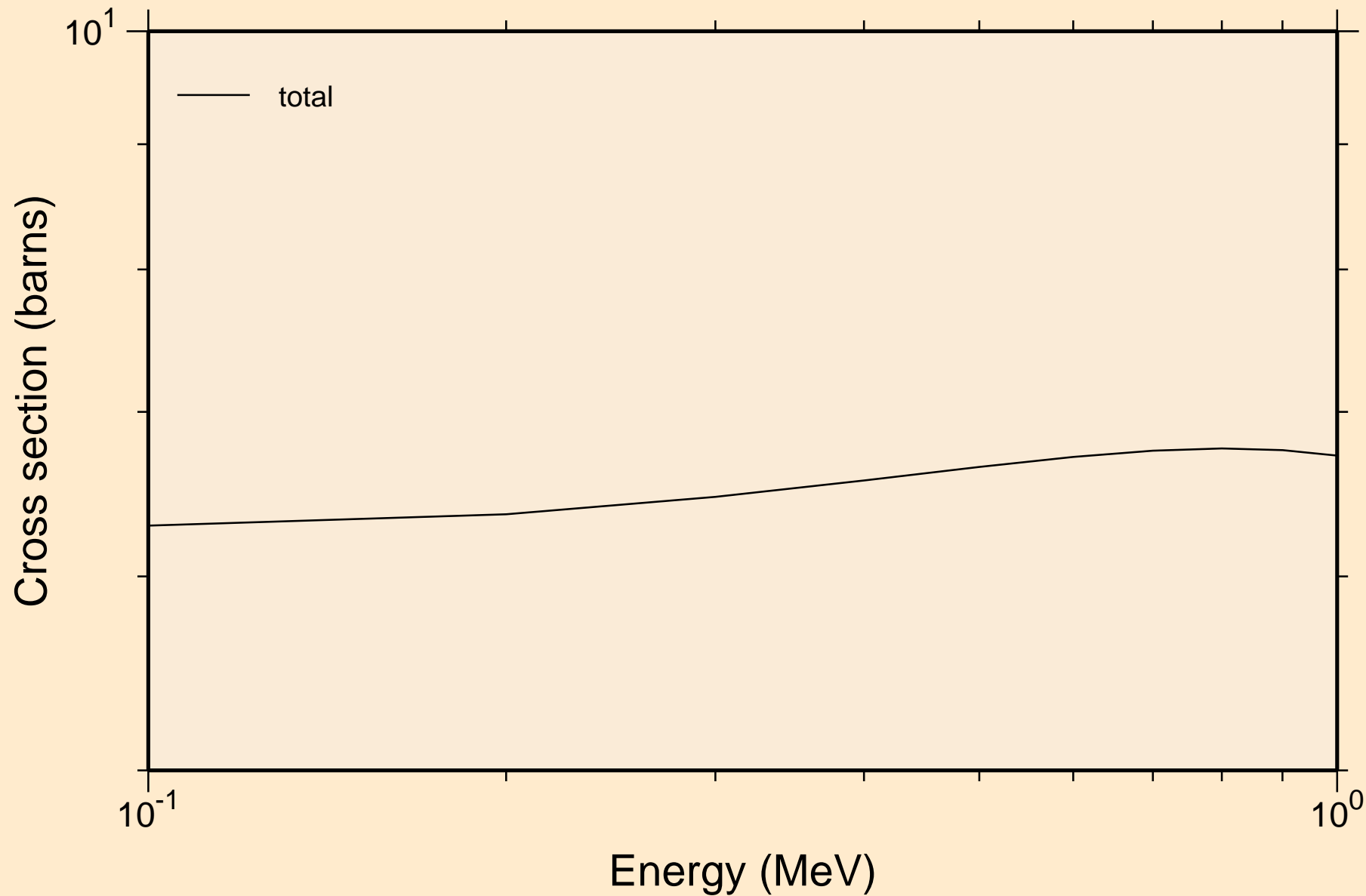

50-SN-118 FOR FENDL-3.2 FROM FENDL-3.2 BY NJOY2016.60+ C  
resonance total cross section

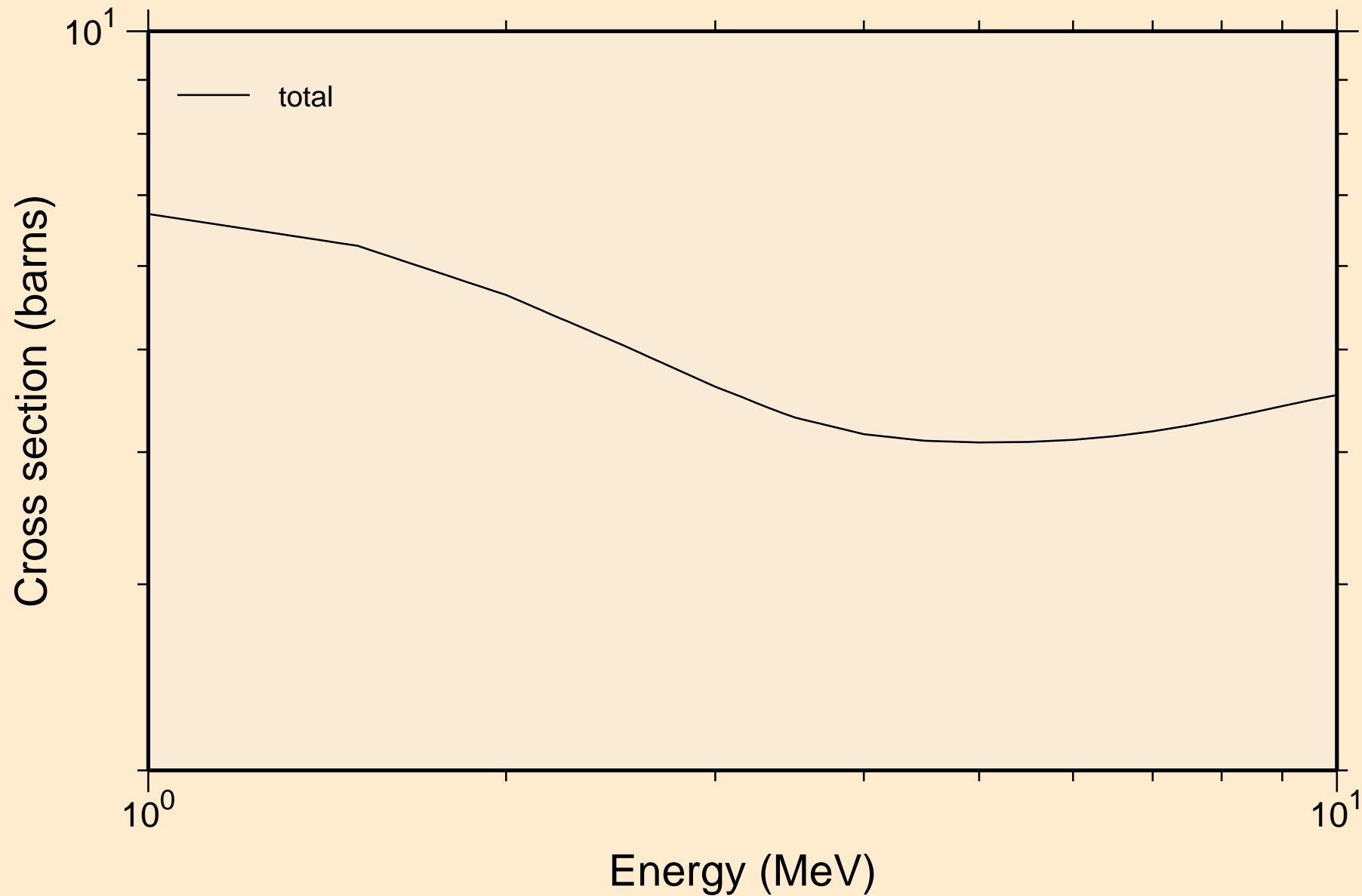

50-SN-118 FOR FENDL-3.2 FROM FENDL-3.2 BY NJOY2016.60+ C  
resonance absorption cross sections

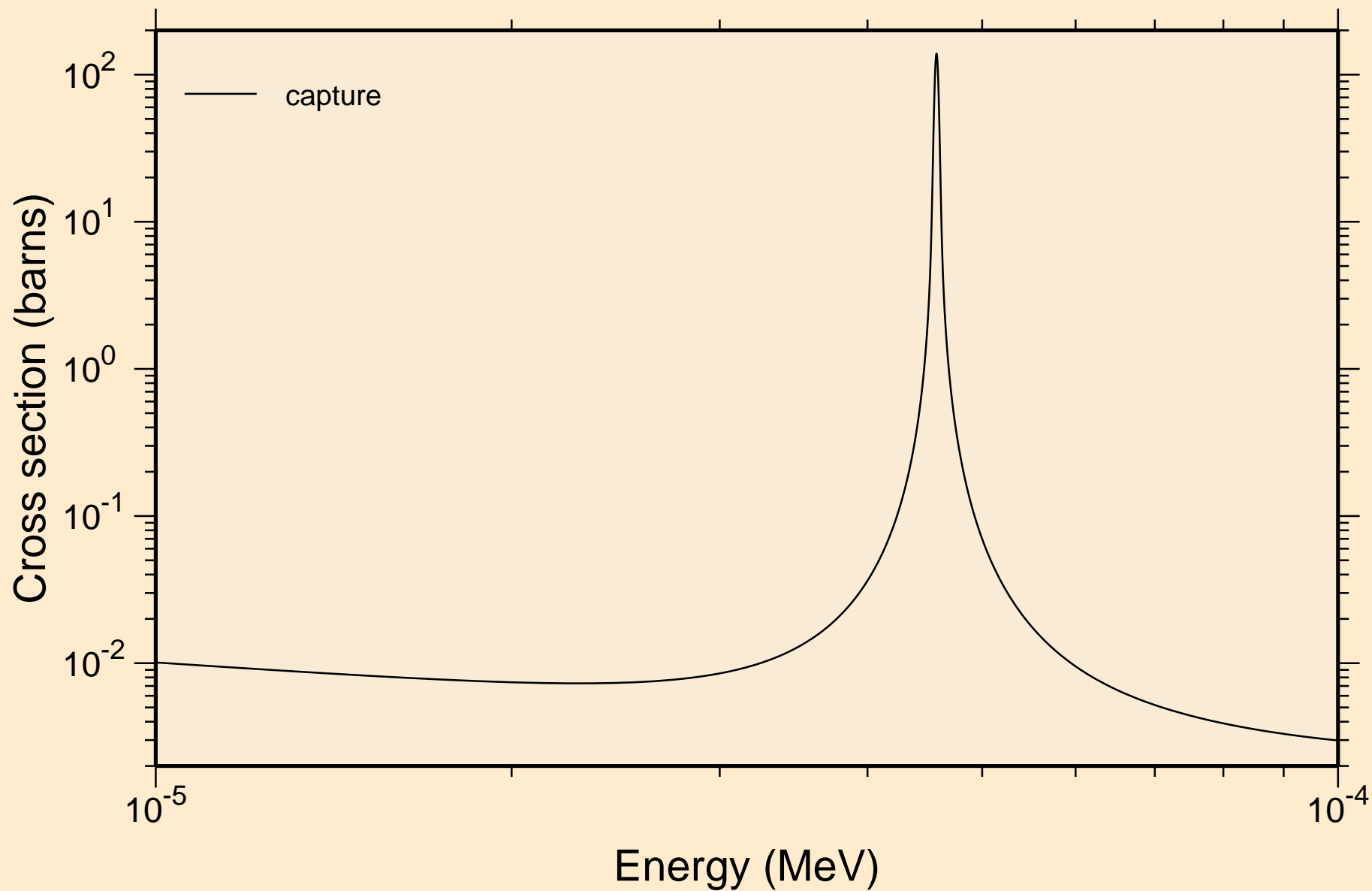



50-SN-118 FOR FENDL-3.2 FROM FENDL-3.2 BY NJOY2016.60+ C  
resonance absorption cross sections

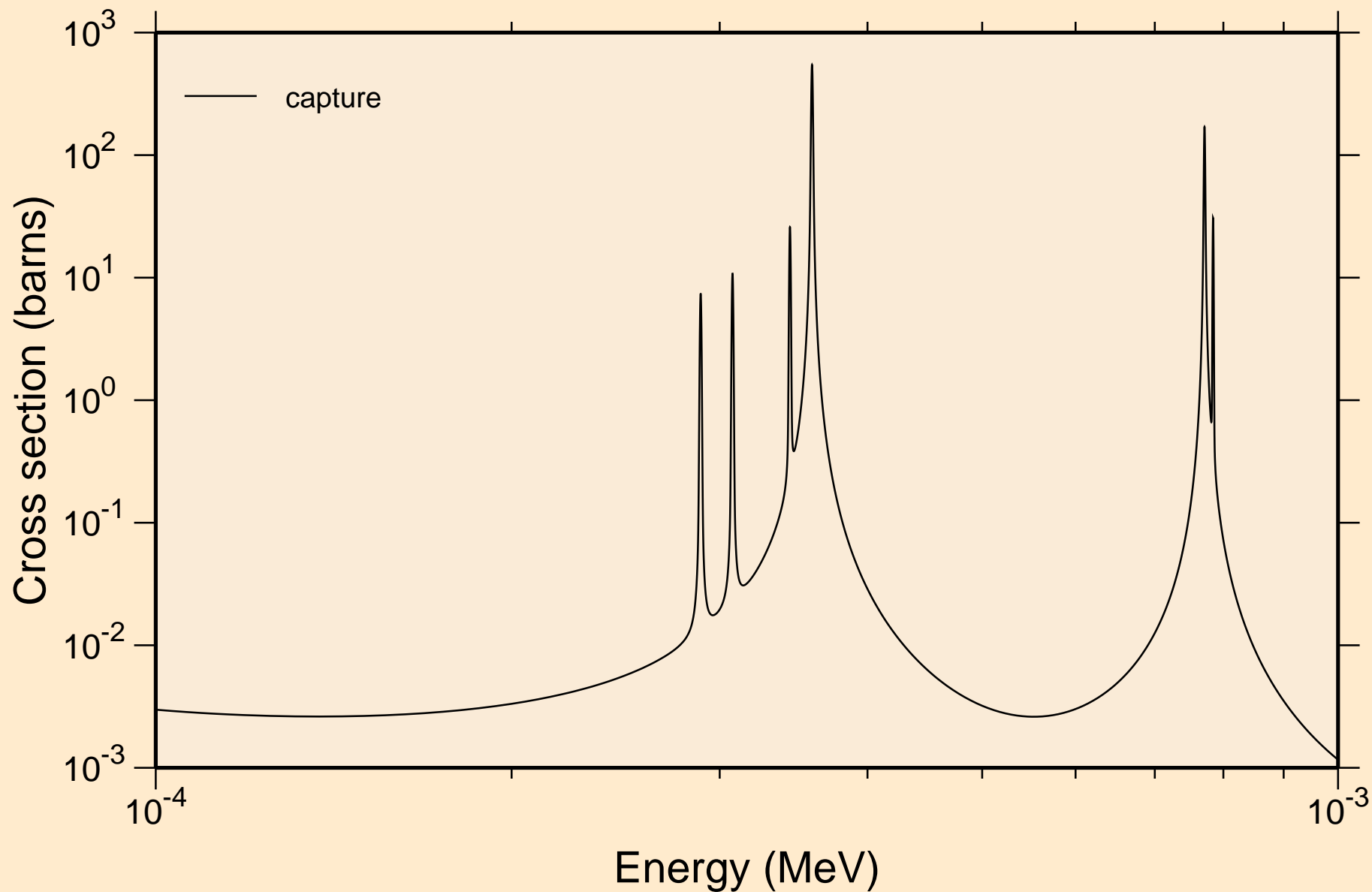

50-SN-118 FOR FENDL-3.2 FROM FENDL-3.2 BY NJOY2016.60+ C  
resonance absorption cross sections

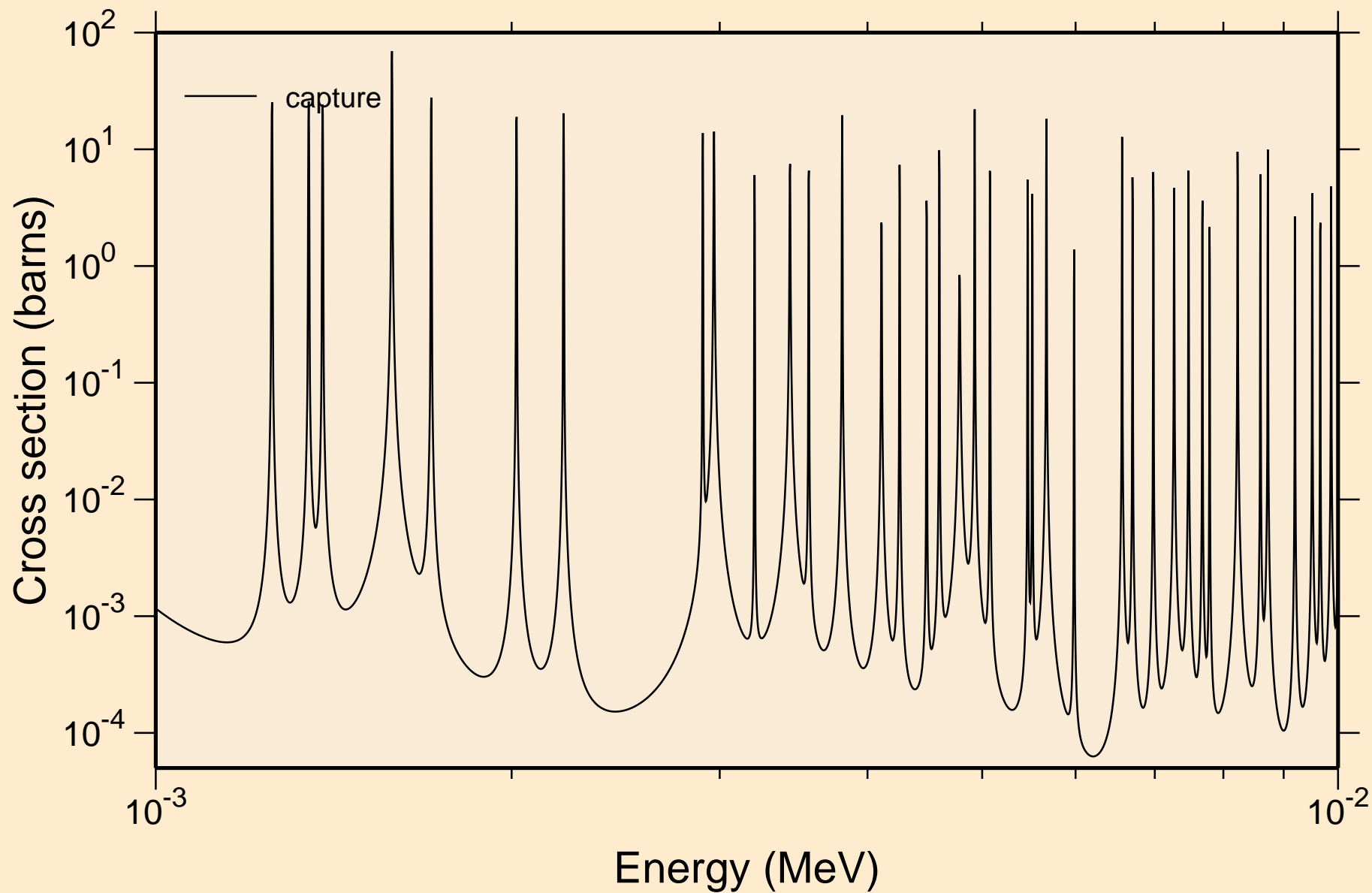

50-SN-118 FOR FENDL-3.2 FROM FENDL-3.2 BY NJOY2016.60+ C  
resonance absorption cross sections

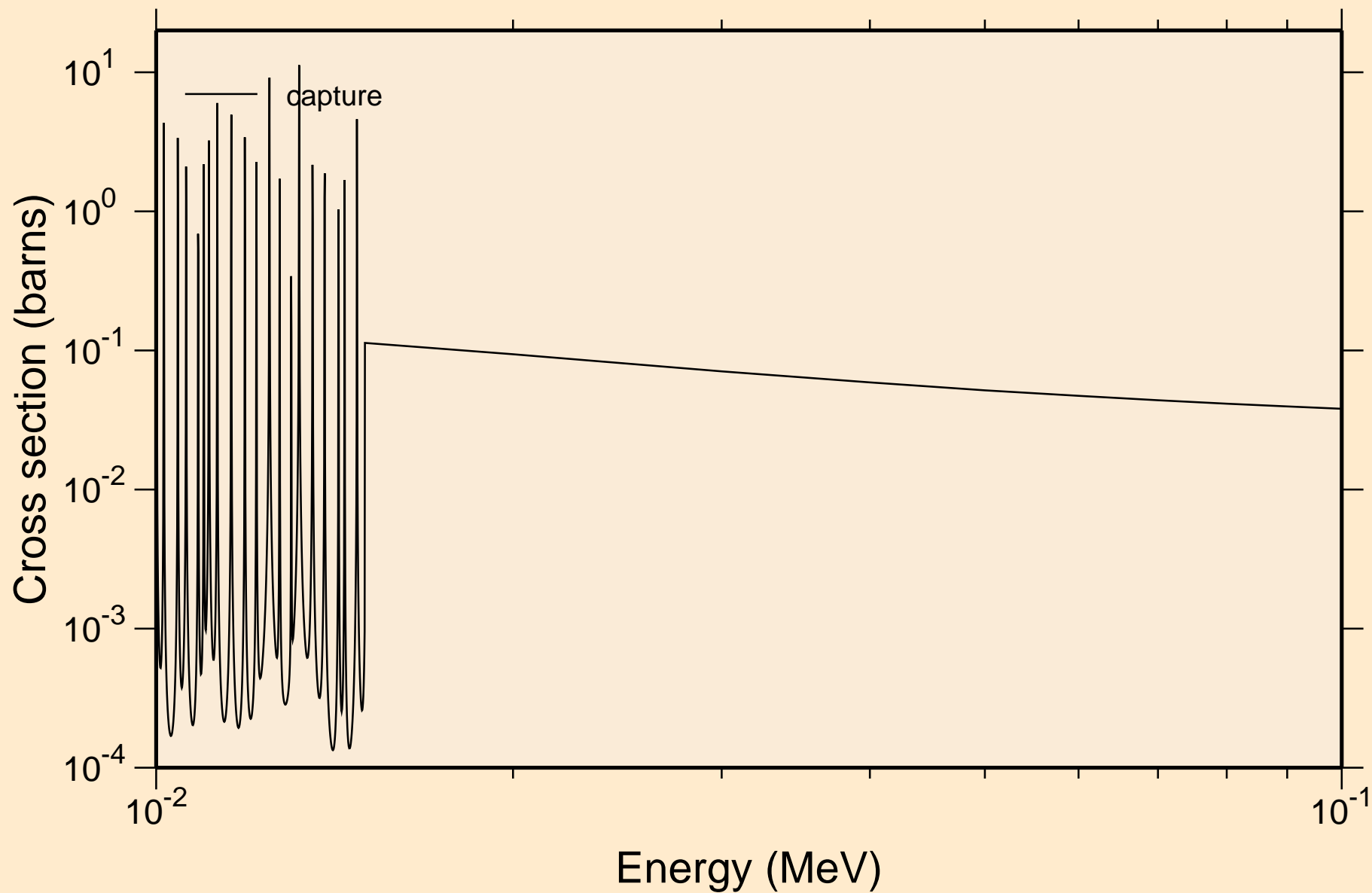

50-SN-118 FOR FENDL-3.2 FROM FENDL-3.2 BY NJOY2016.60+ C  
resonance absorption cross sections

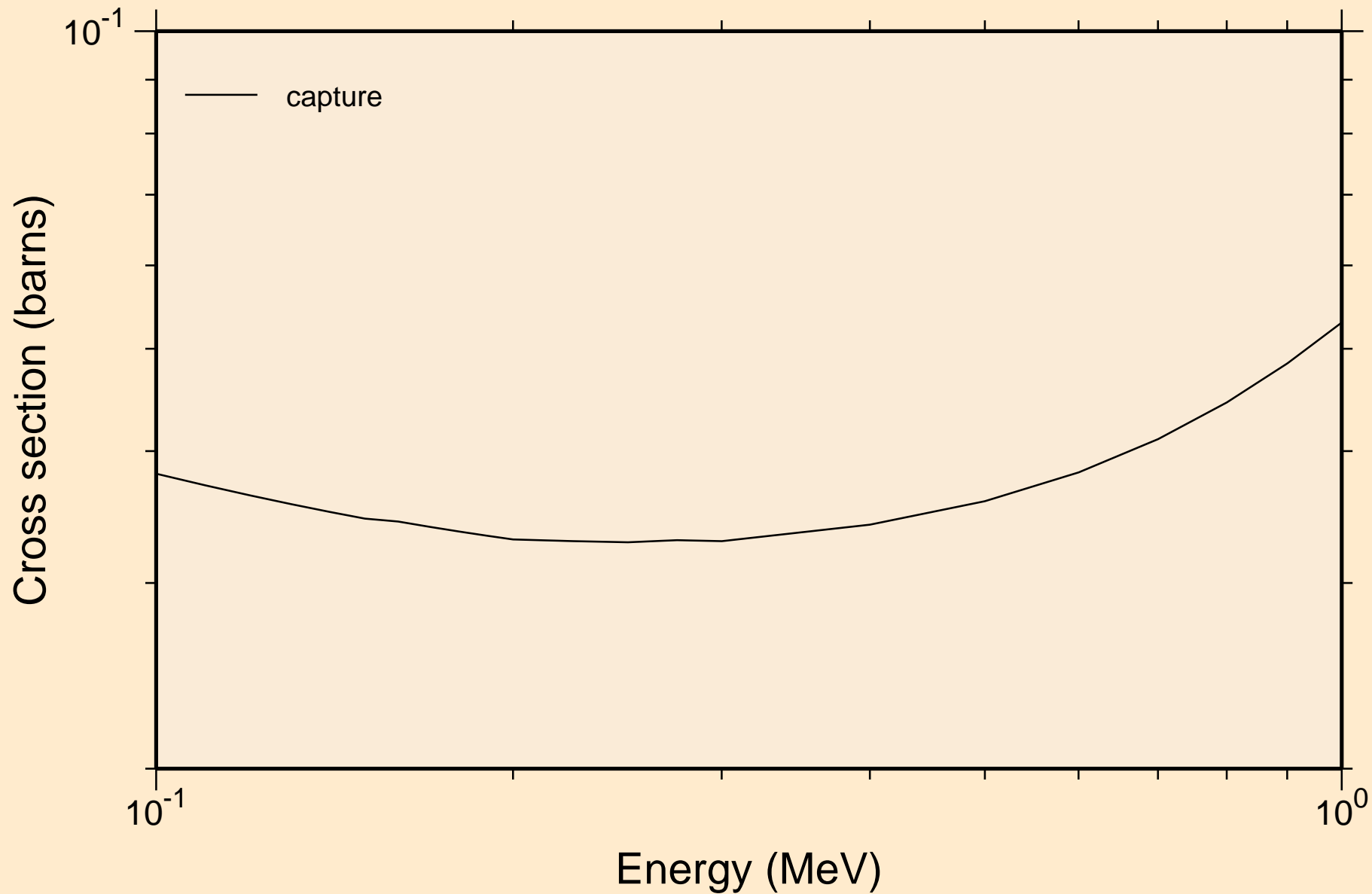

50-SN-118 FOR FENDL-3.2 FROM FENDL-3.2 BY NJOY2016.60+ C  
resonance absorption cross sections

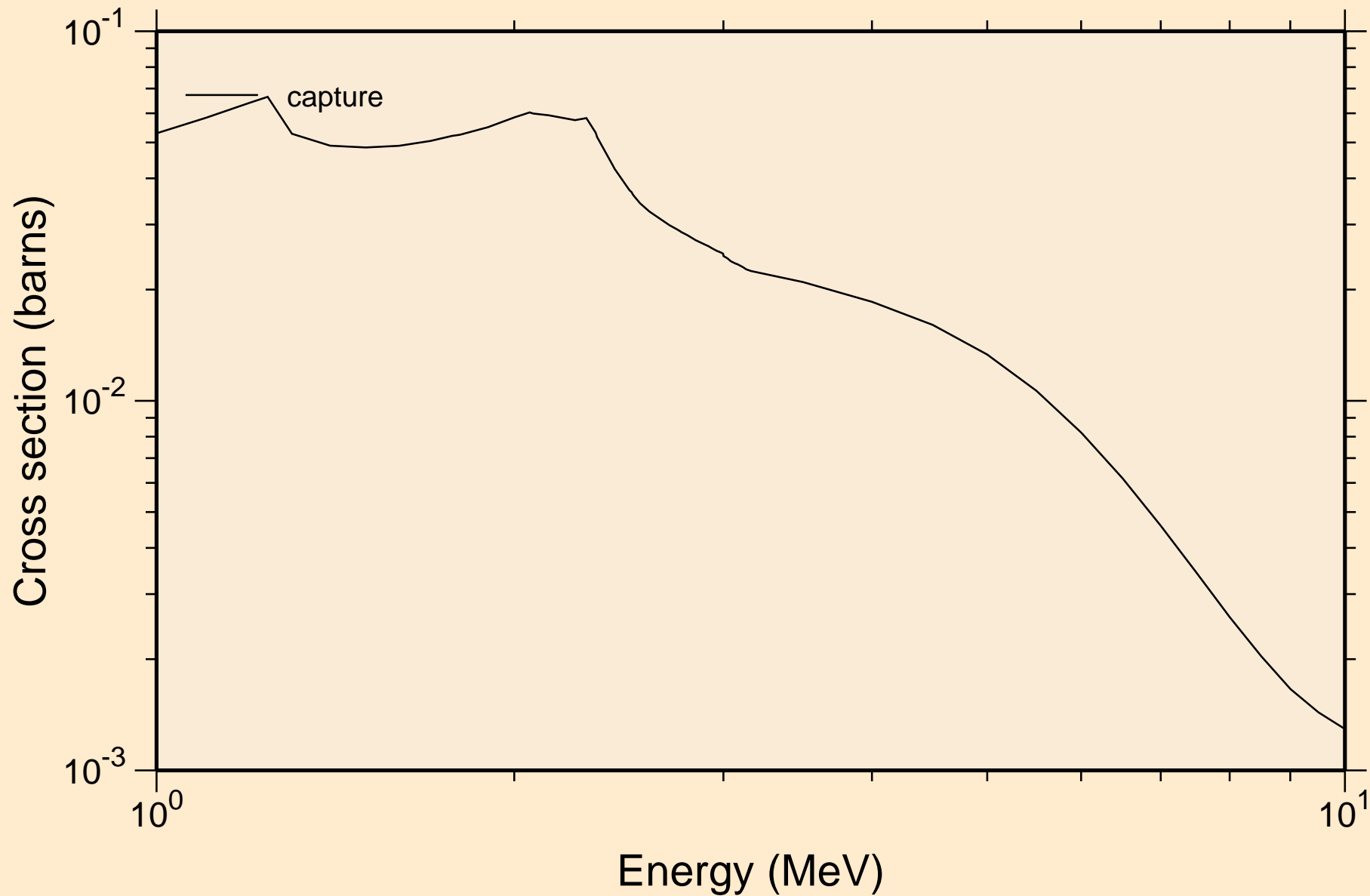

50-SN-118 FOR FENDL-3.2 FROM FENDL-3.2 BY NJOY2016.60+ C  
UR total cross section

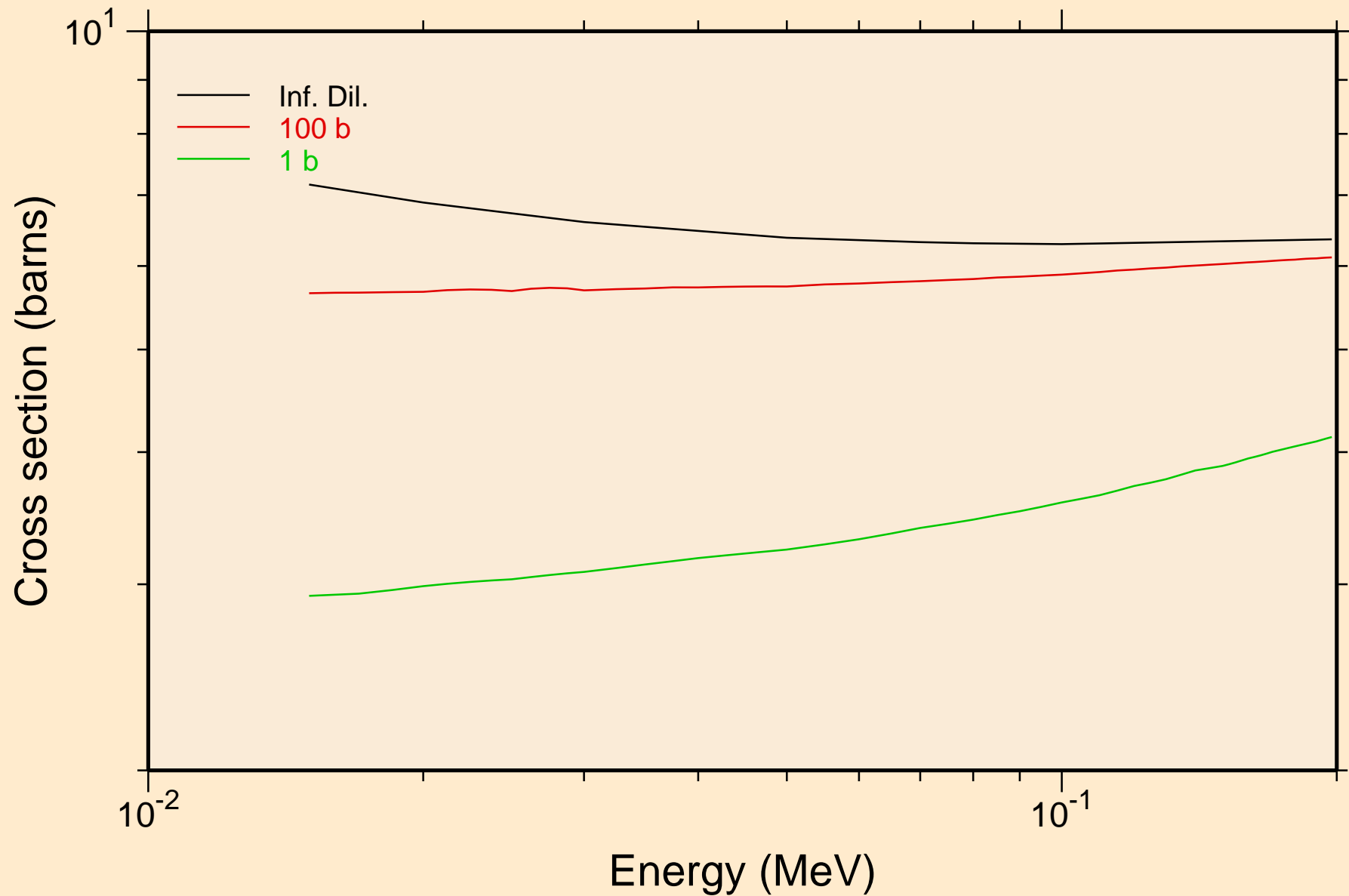

50-SN-118 FOR FENDL-3.2 FROM FENDL-3.2 BY NJOY2016.60+ C  
UR elastic cross section

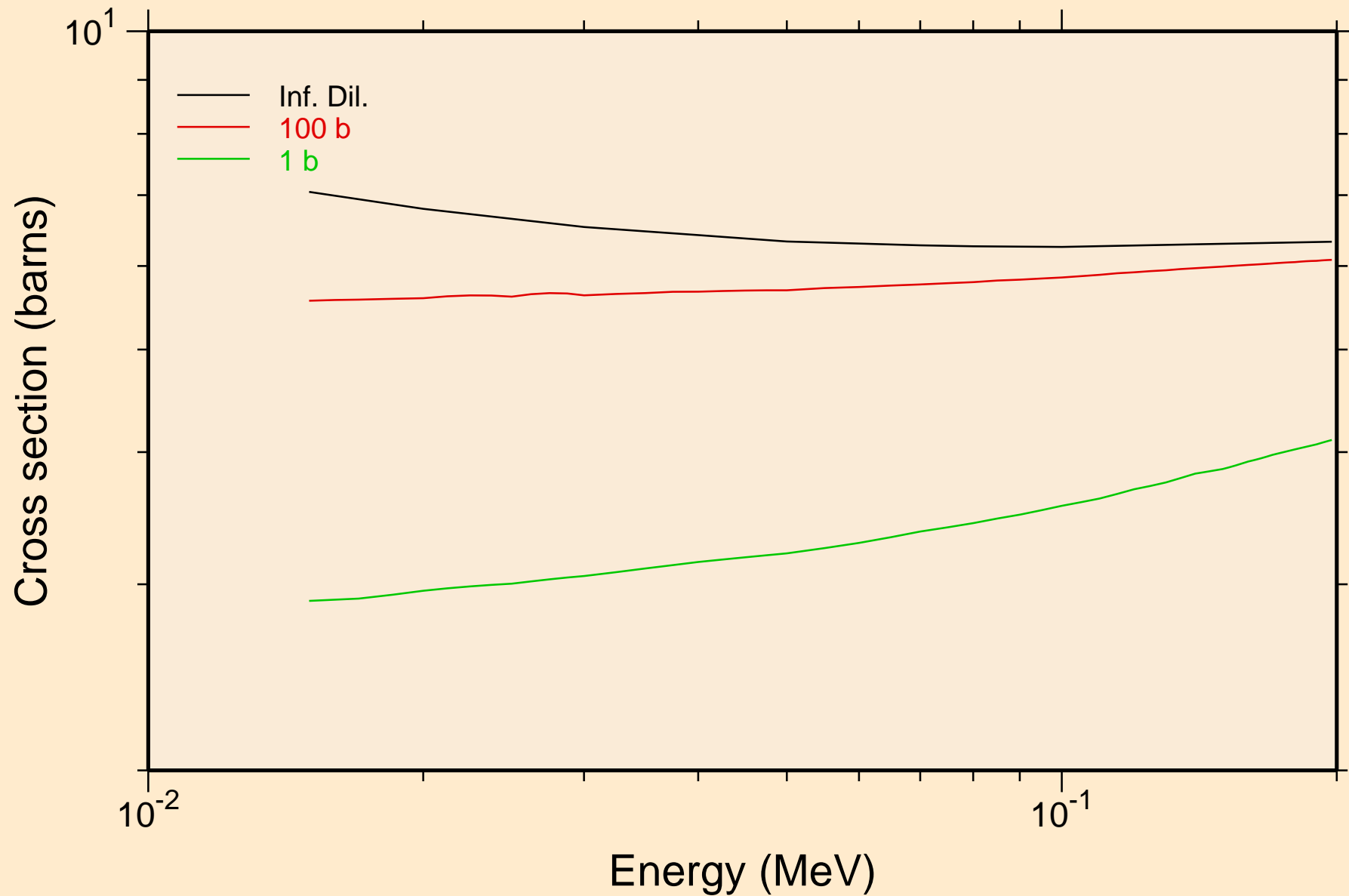

50-SN-118 FOR FENDL-3.2 FROM FENDL-3.2 BY NJOY2016.60+ C  
UR capture cross section

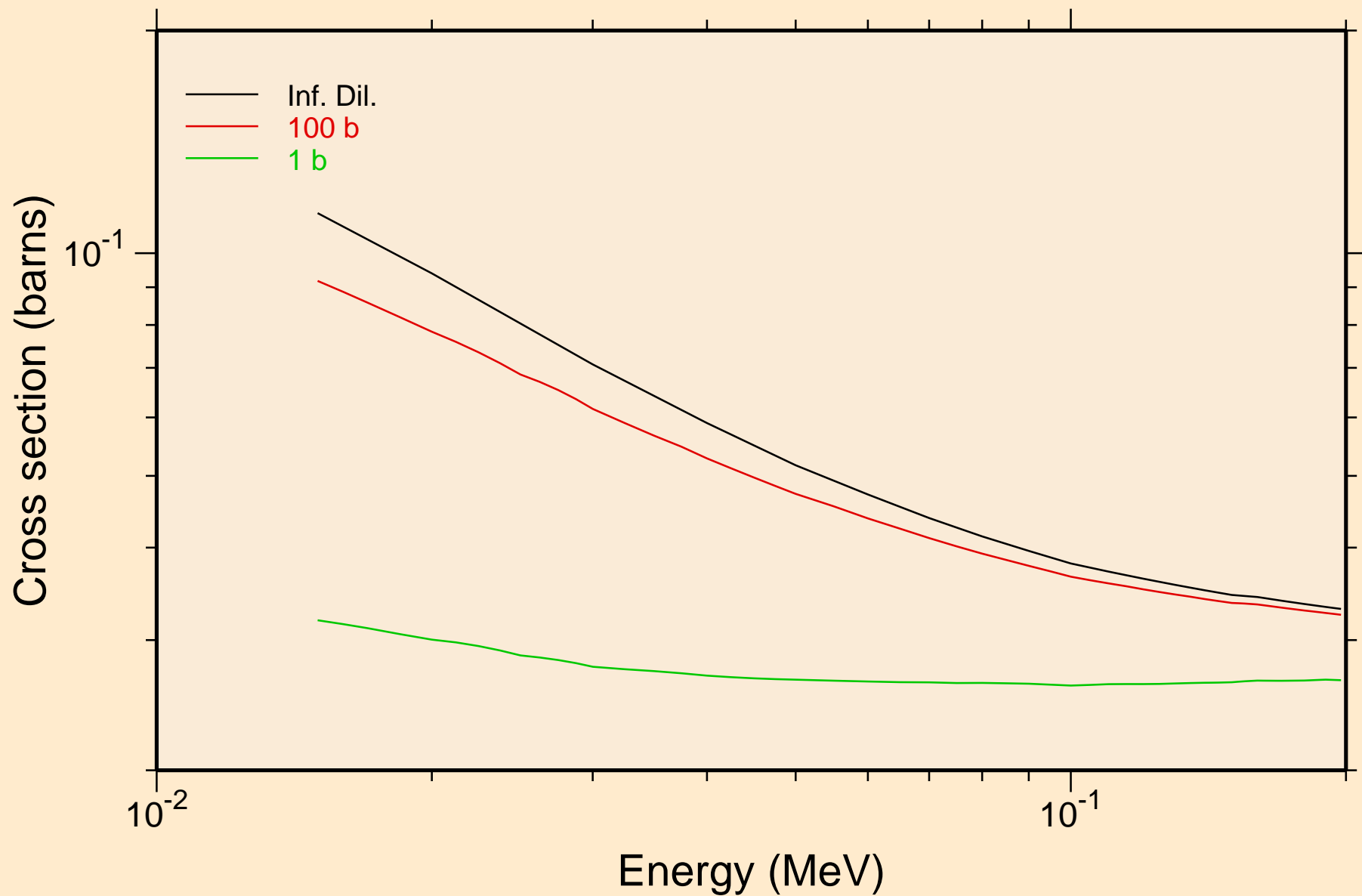



50-SN-118 FOR FENDL-3.2 FROM FENDL-3.2 BY NJOY2016.60+ C  
Heating

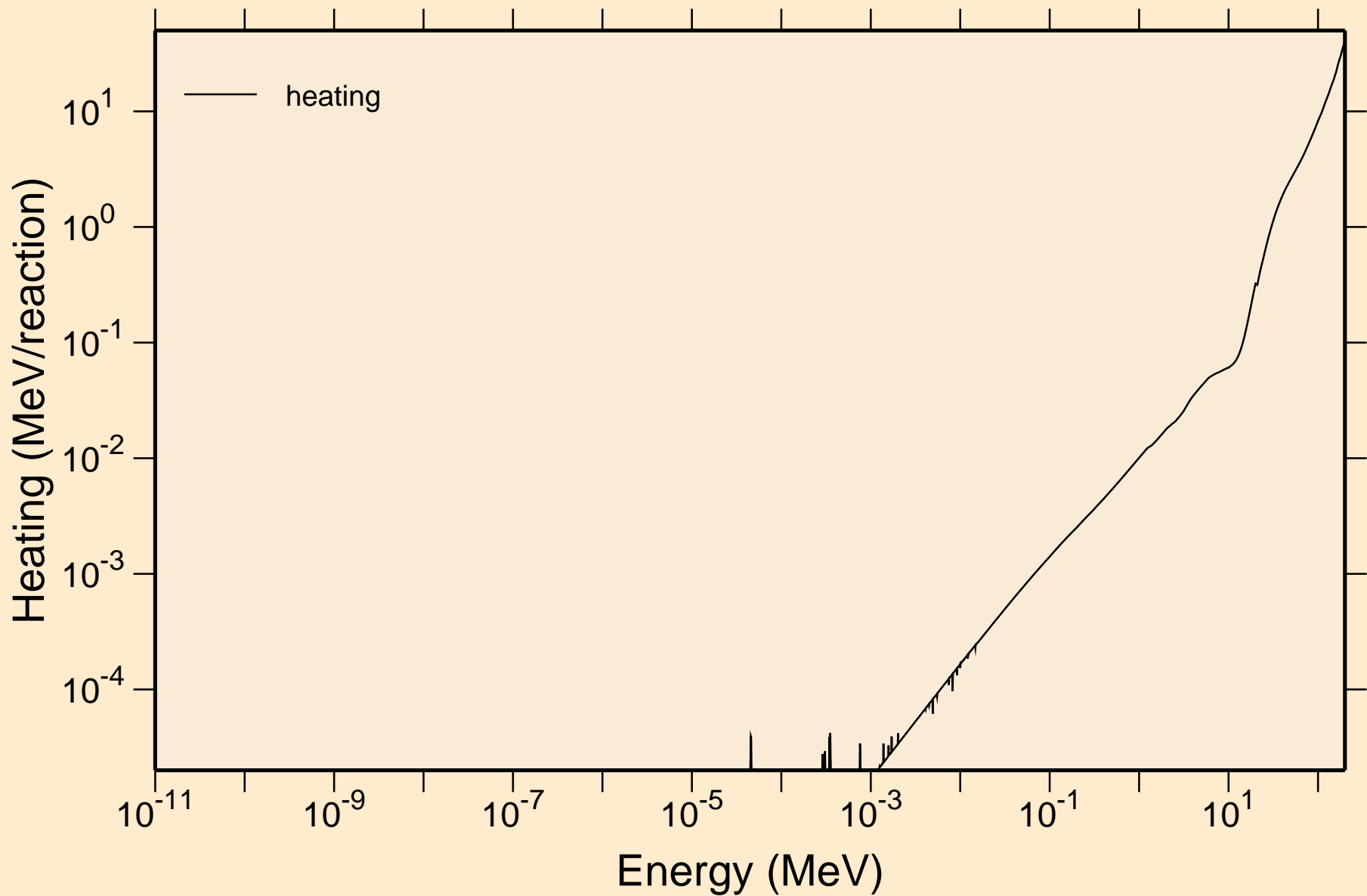

# 50-SN-118 FOR FENDL-3.2 FROM FENDL-3.2 BY NJOY2016.60+ C Damage

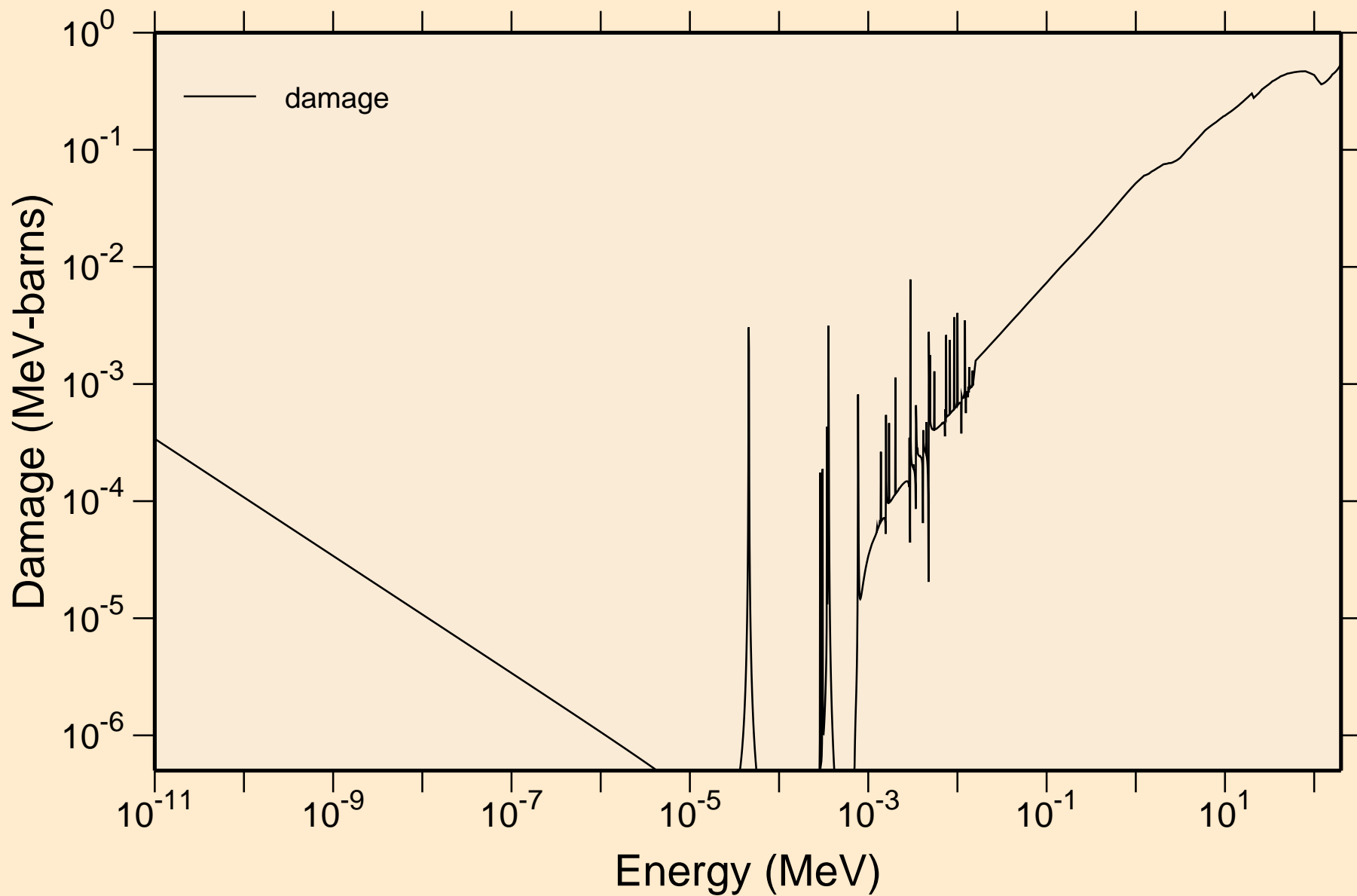

50-SN-118 FOR FENDL-3.2 FROM FENDL-3.2 BY NJOY2016.60+ C  
Non-threshold reactions

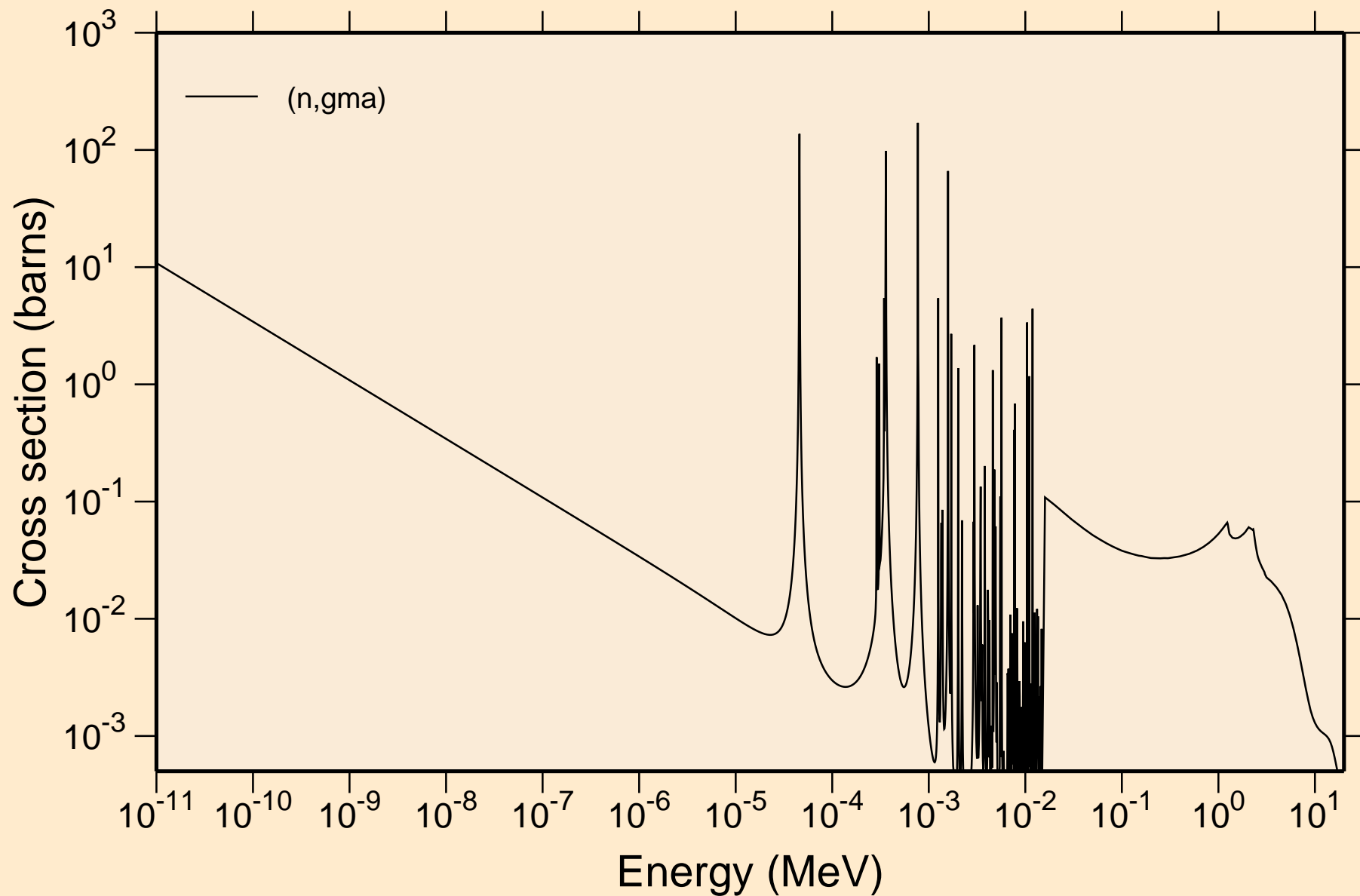

50-SN-118 FOR FENDL-3.2 FROM FENDL-3.2 BY NJOY2016.60+ C  
Principal cross sections

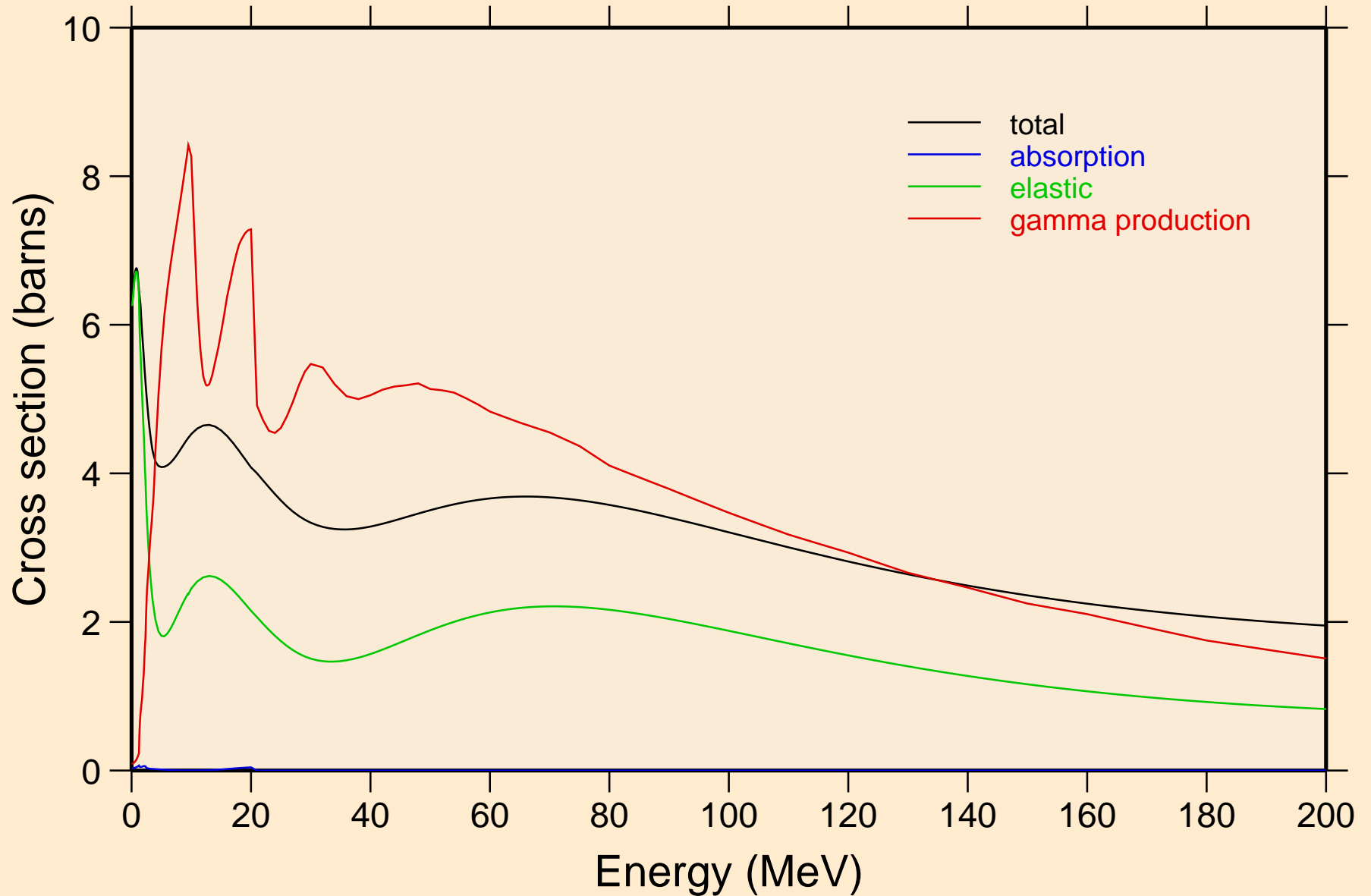

50-SN-118 FOR FENDL-3.2 FROM FENDL-3.2 BY NJOY2016.60+ C  
Heating

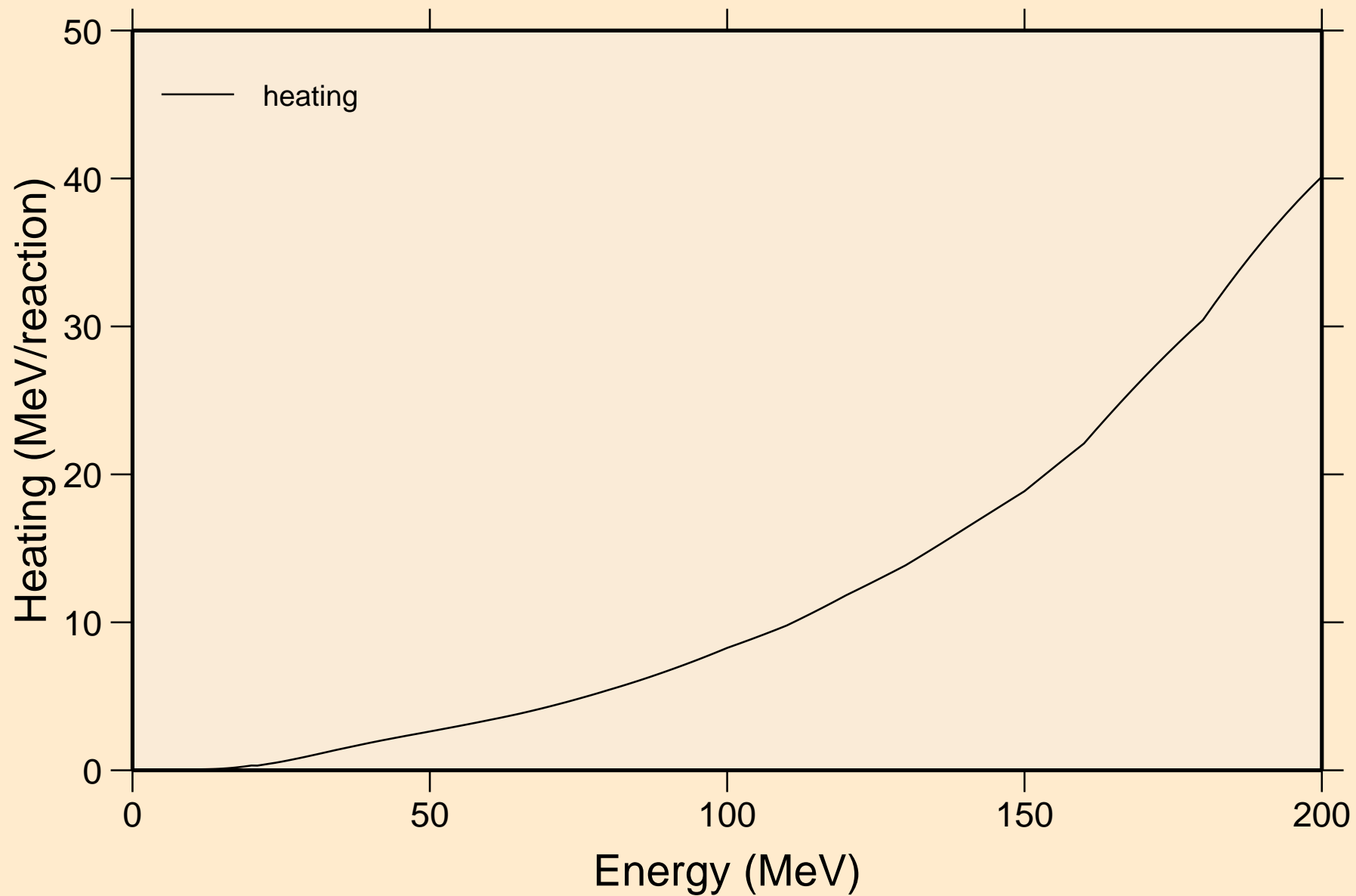

# 50-SN-118 FOR FENDL-3.2 FROM FENDL-3.2 BY NJOY2016.60+ C Damage

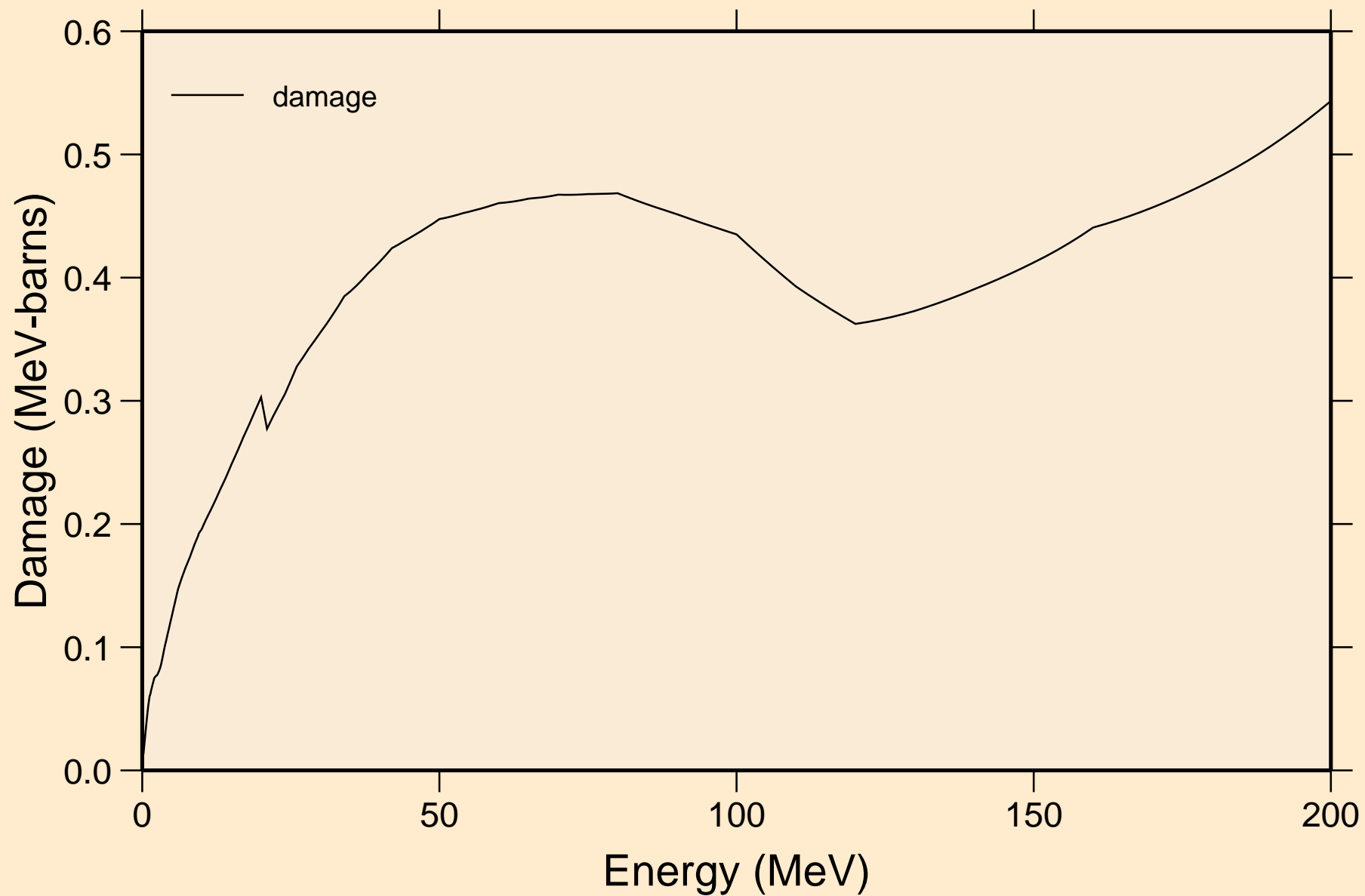

50-SN-118 FOR FENDL-3.2 FROM FENDL-3.2 BY NJOY2016.60+ C  
Non-threshold reactions

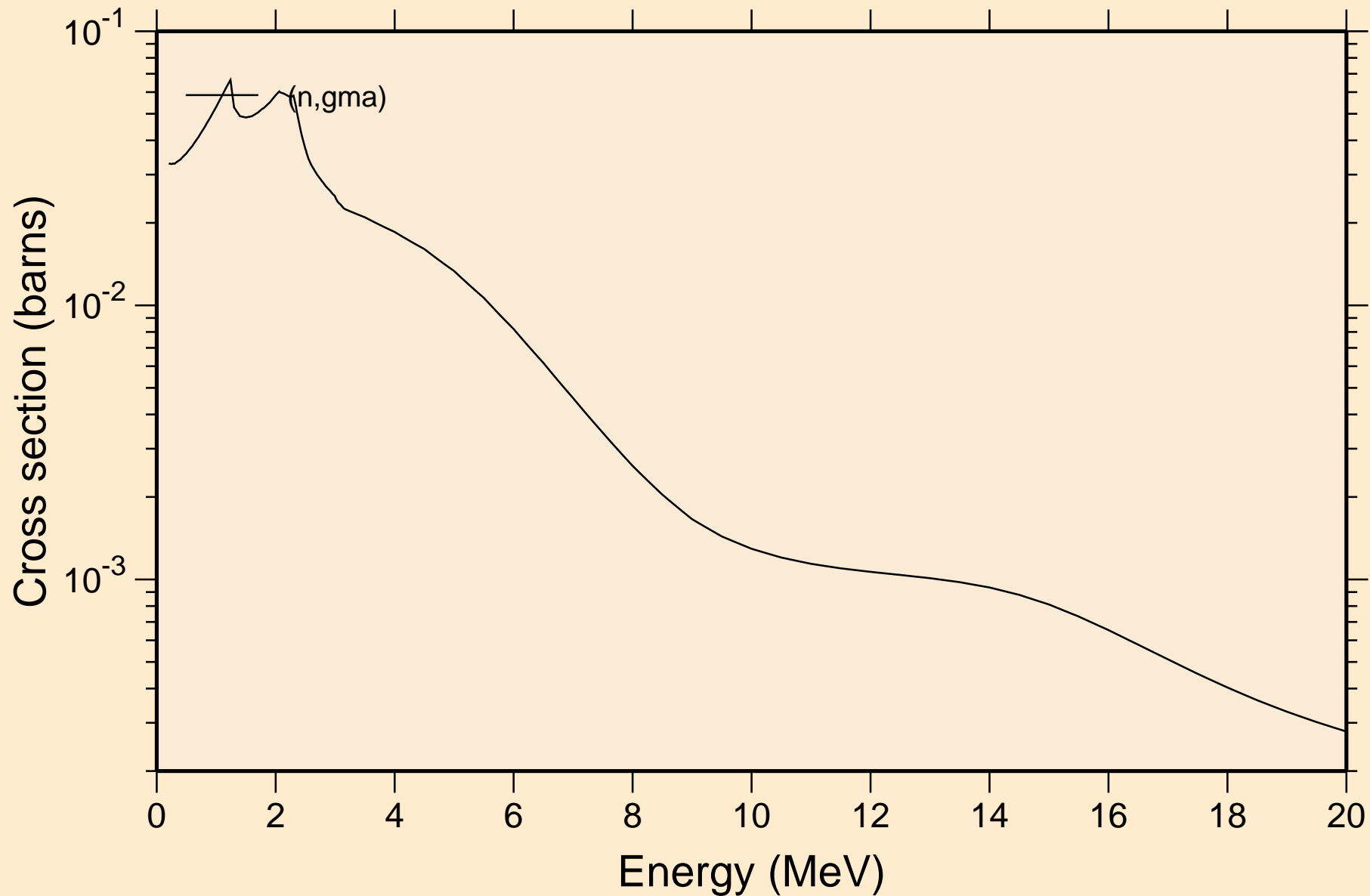

50-SN-118 FOR FENDL-3.2 FROM FENDL-3.2 BY NJOY2016.60+ C  
Inelastic levels

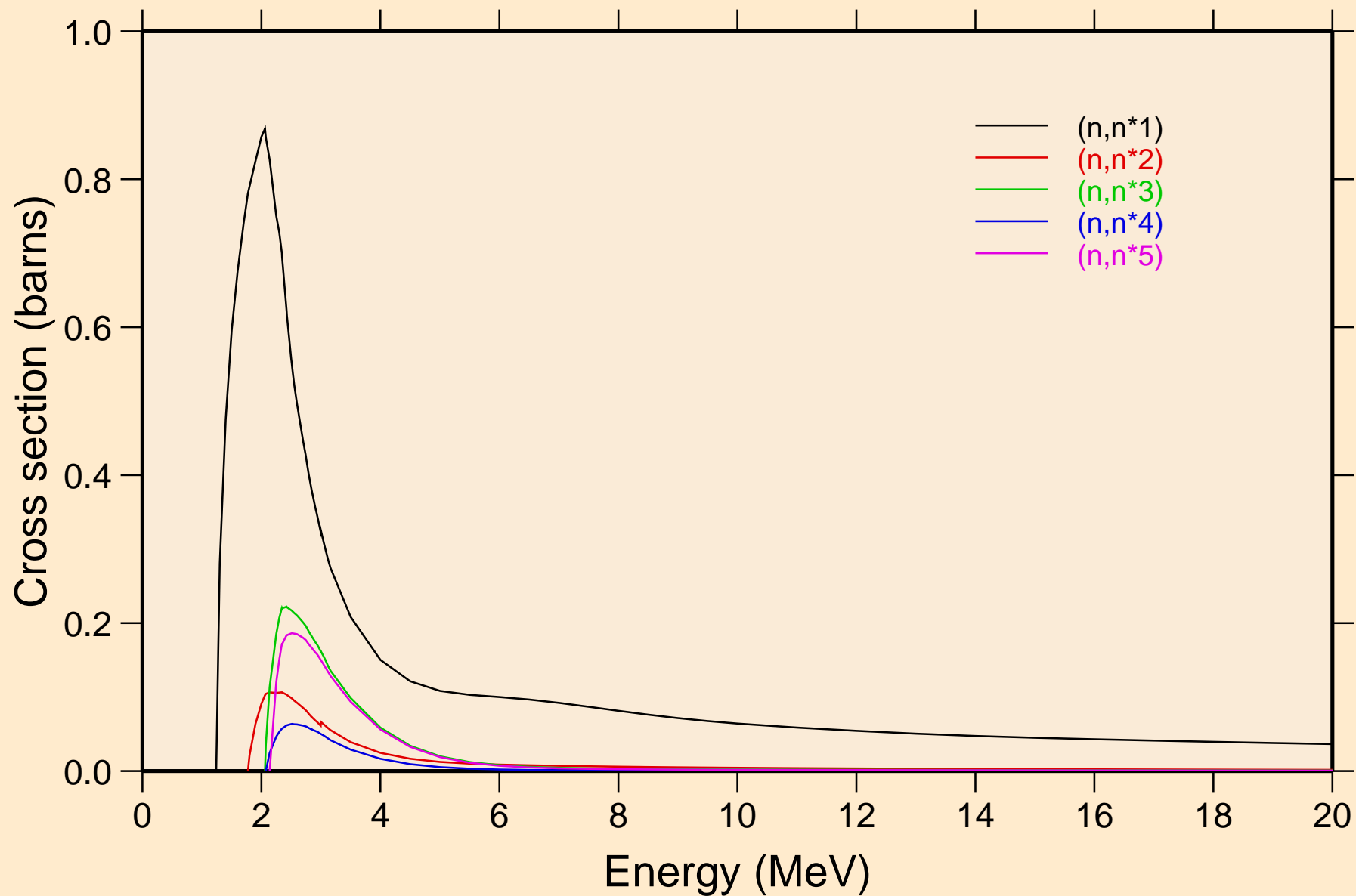



# 50-SN-118 FOR FENDL-3.2 FROM FENDL-3.2 BY NJOY2016.60+ C Inelastic levels

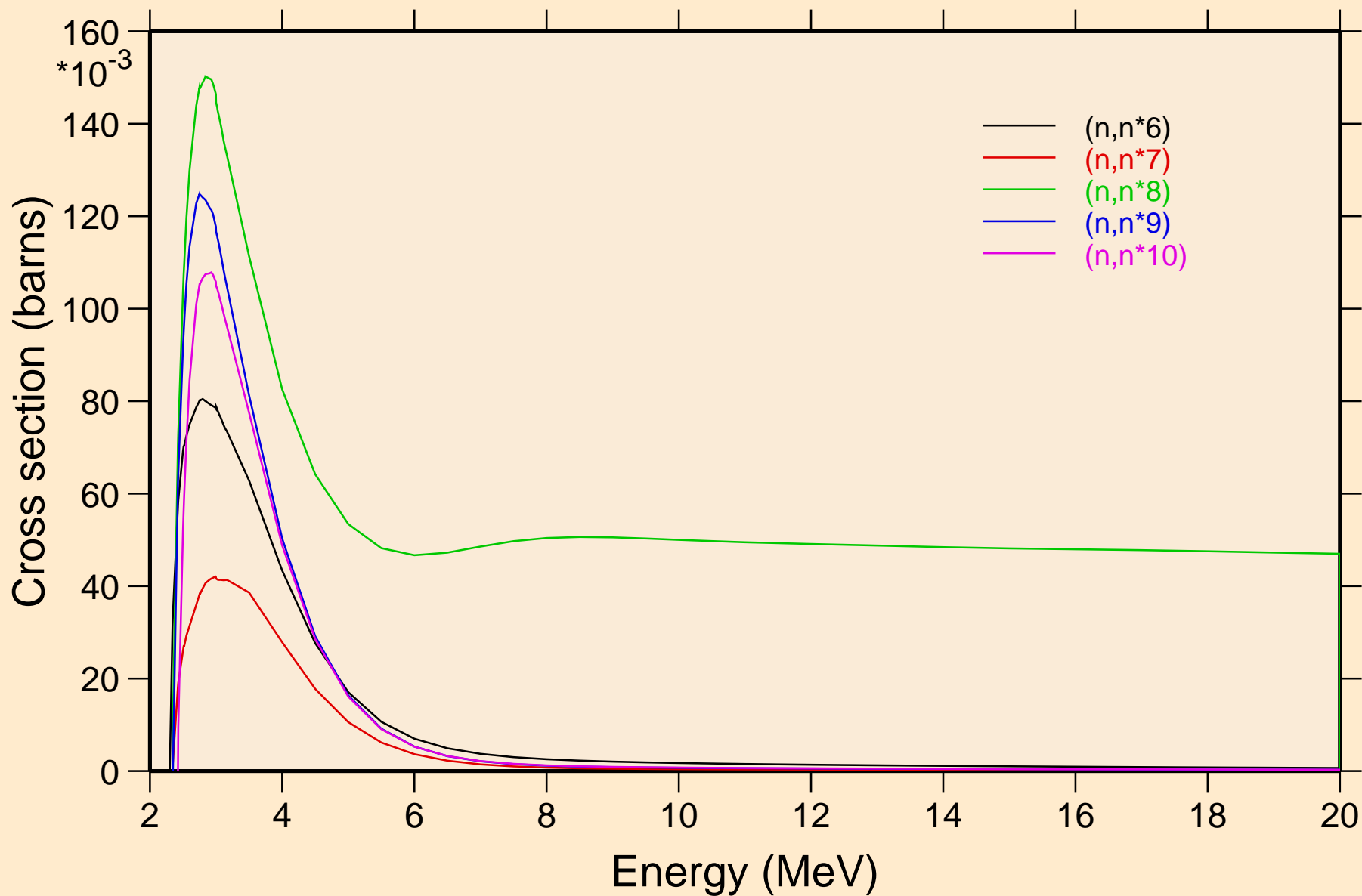

50-SN-118 FOR FENDL-3.2 FROM FENDL-3.2 BY NJOY2016.60+ C  
Inelastic levels

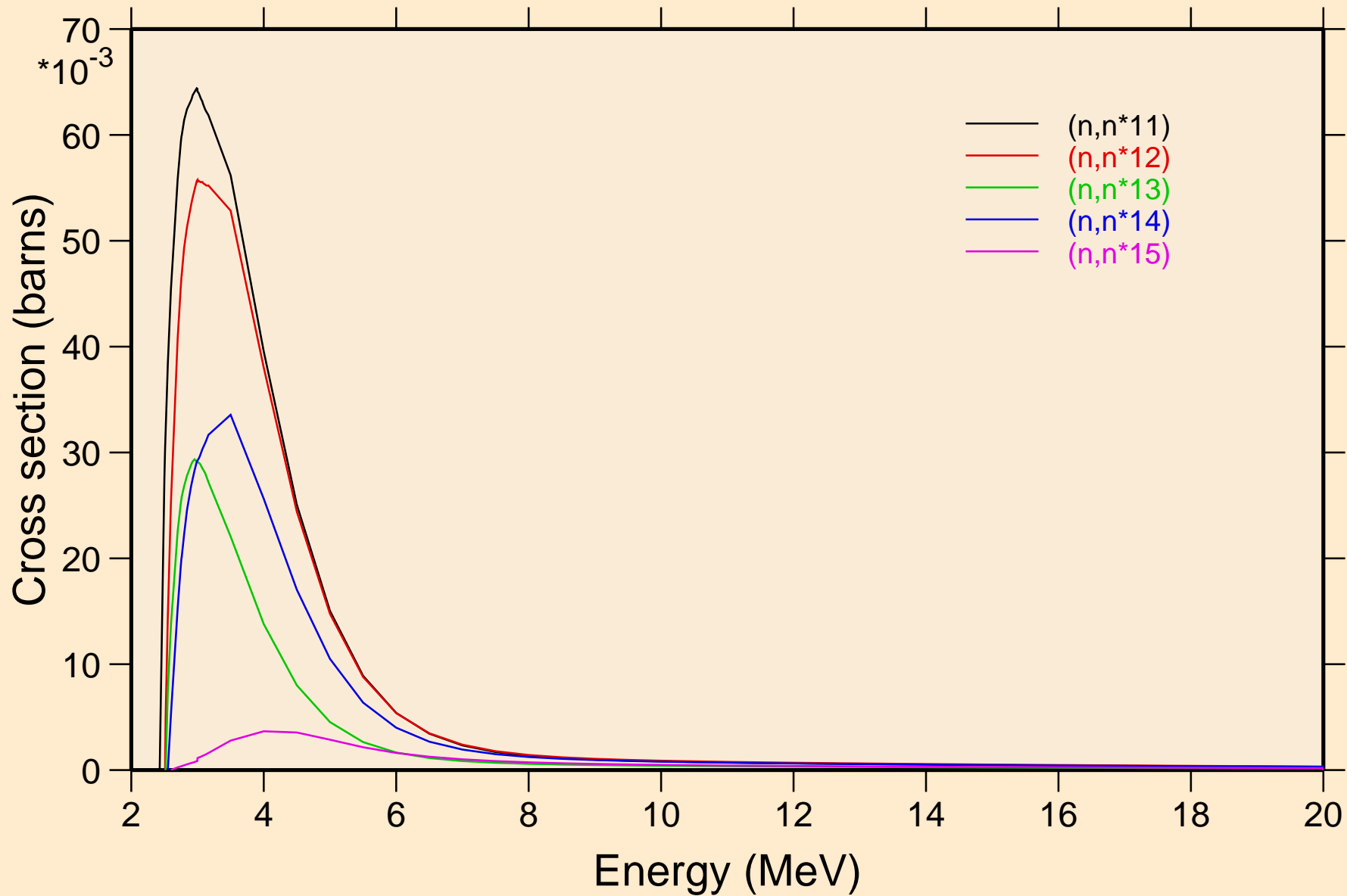

50-SN-118 FOR FENDL-3.2 FROM FENDL-3.2 BY NJOY2016.60+ C  
Inelastic levels

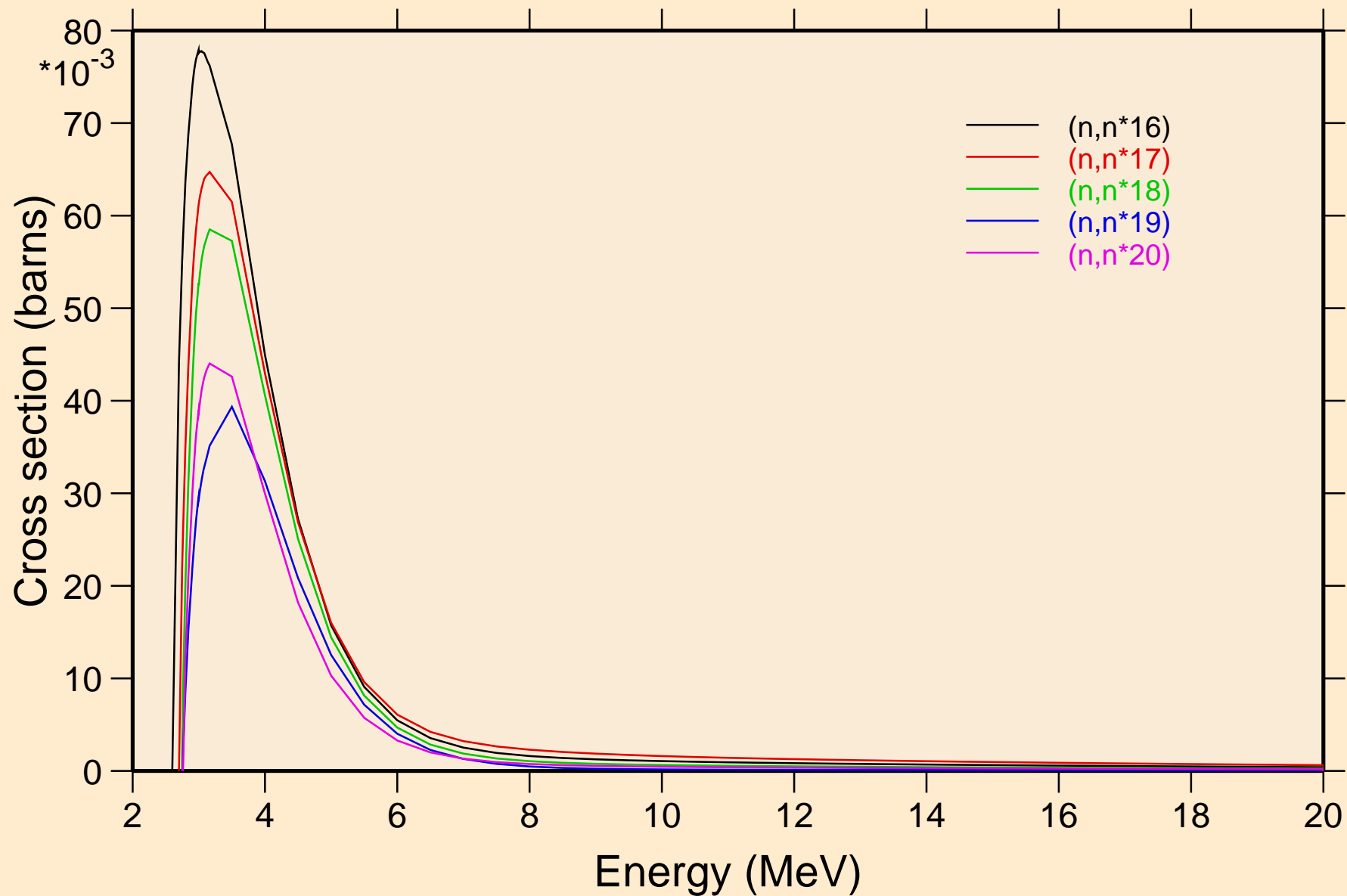

50-SN-118 FOR FENDL-3.2 FROM FENDL-3.2 BY NJOY2016.60+ C  
Inelastic levels

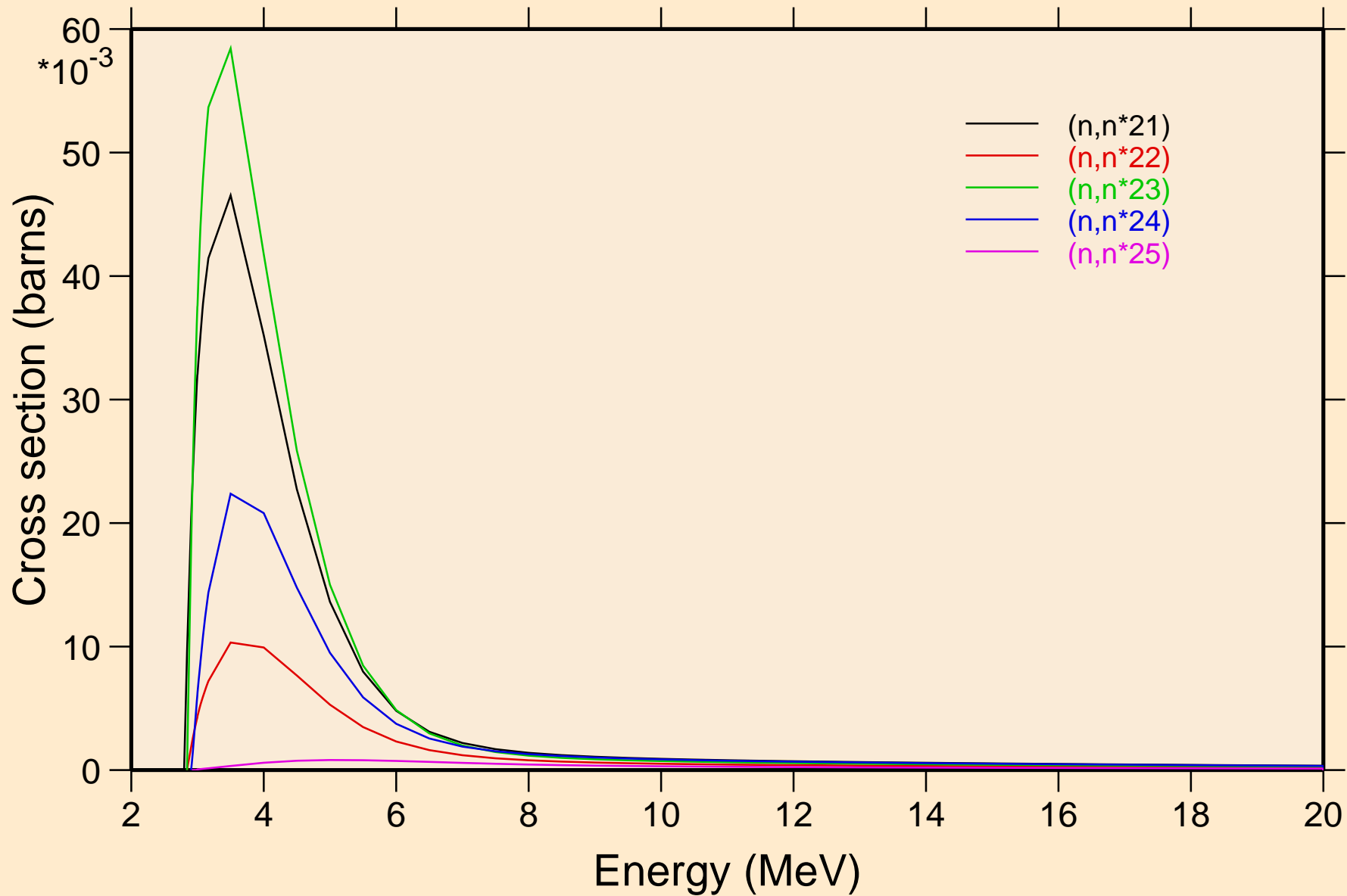

# 50-SN-118 FOR FENDL-3.2 FROM FENDL-3.2 BY NJOY2016.60+ C Inelastic levels

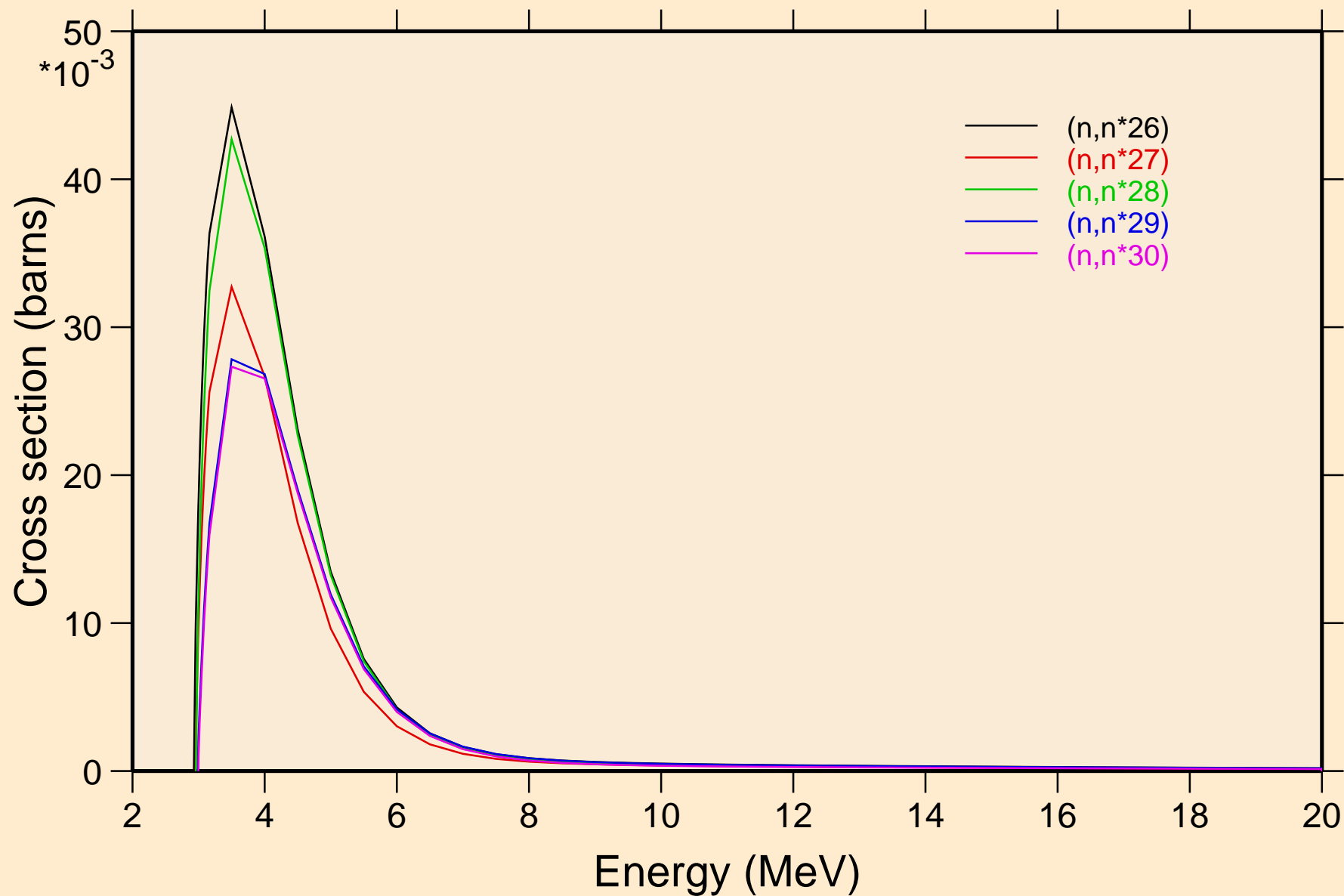

50-SN-118 FOR FENDL-3.2 FROM FENDL-3.2 BY NJOY2016.60+ C  
Inelastic levels

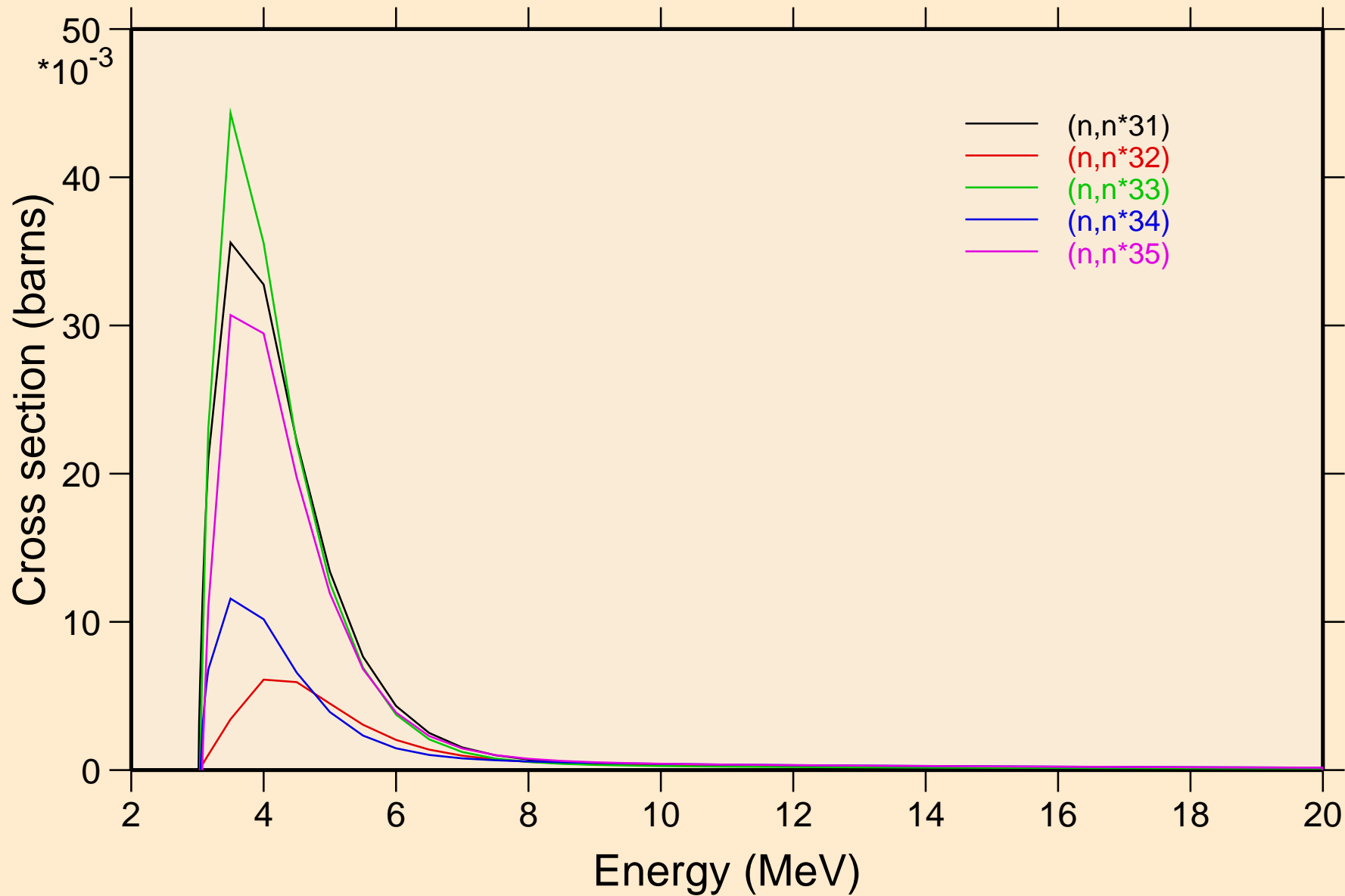

50-SN-118 FOR FENDL-3.2 FROM FENDL-3.2 BY NJOY2016.60+ C  
Inelastic levels

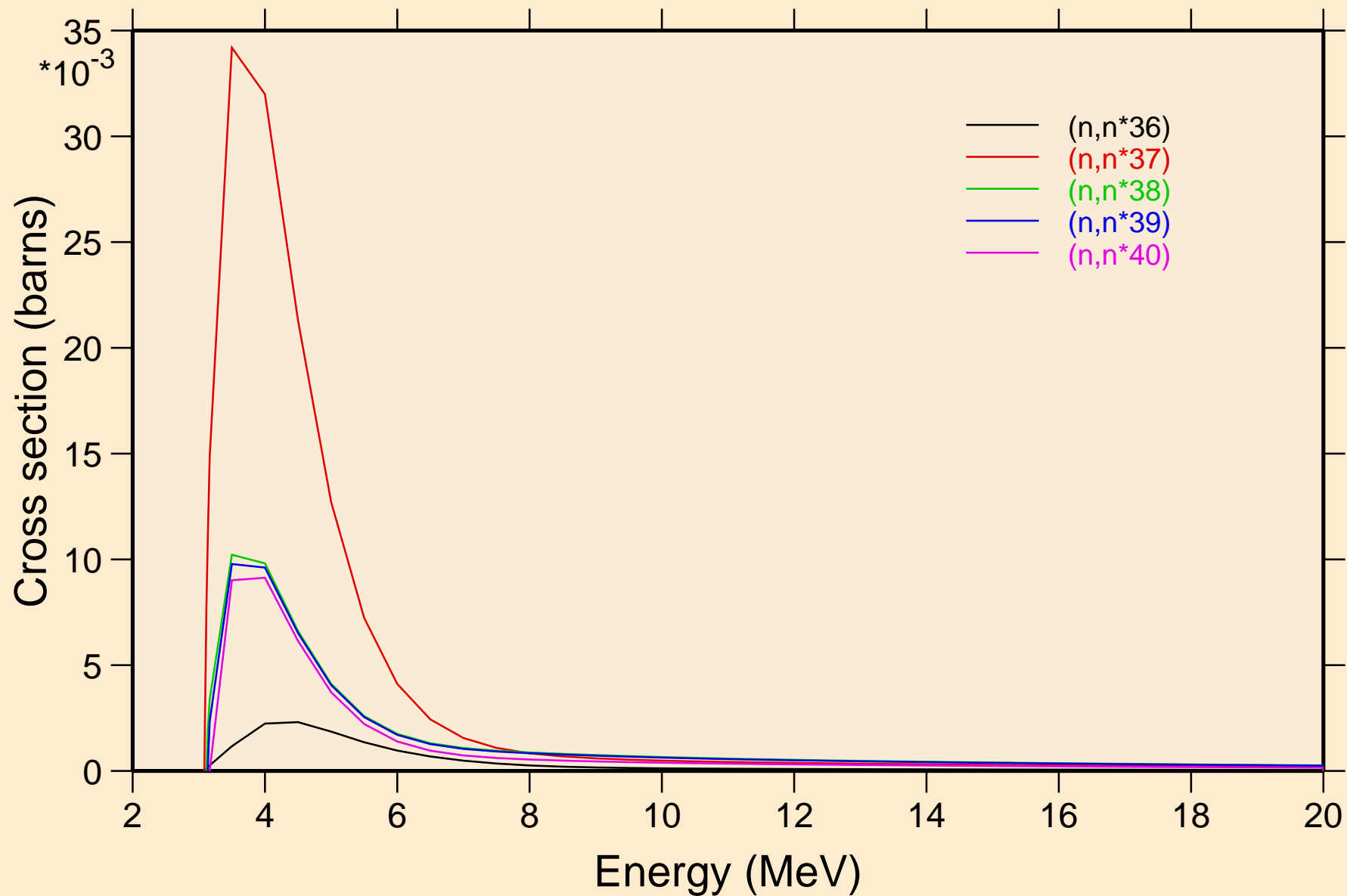

50-SN-118 FOR FENDL-3.2 FROM FENDL-3.2 BY NJOY2016.60+ C  
Threshold reactions

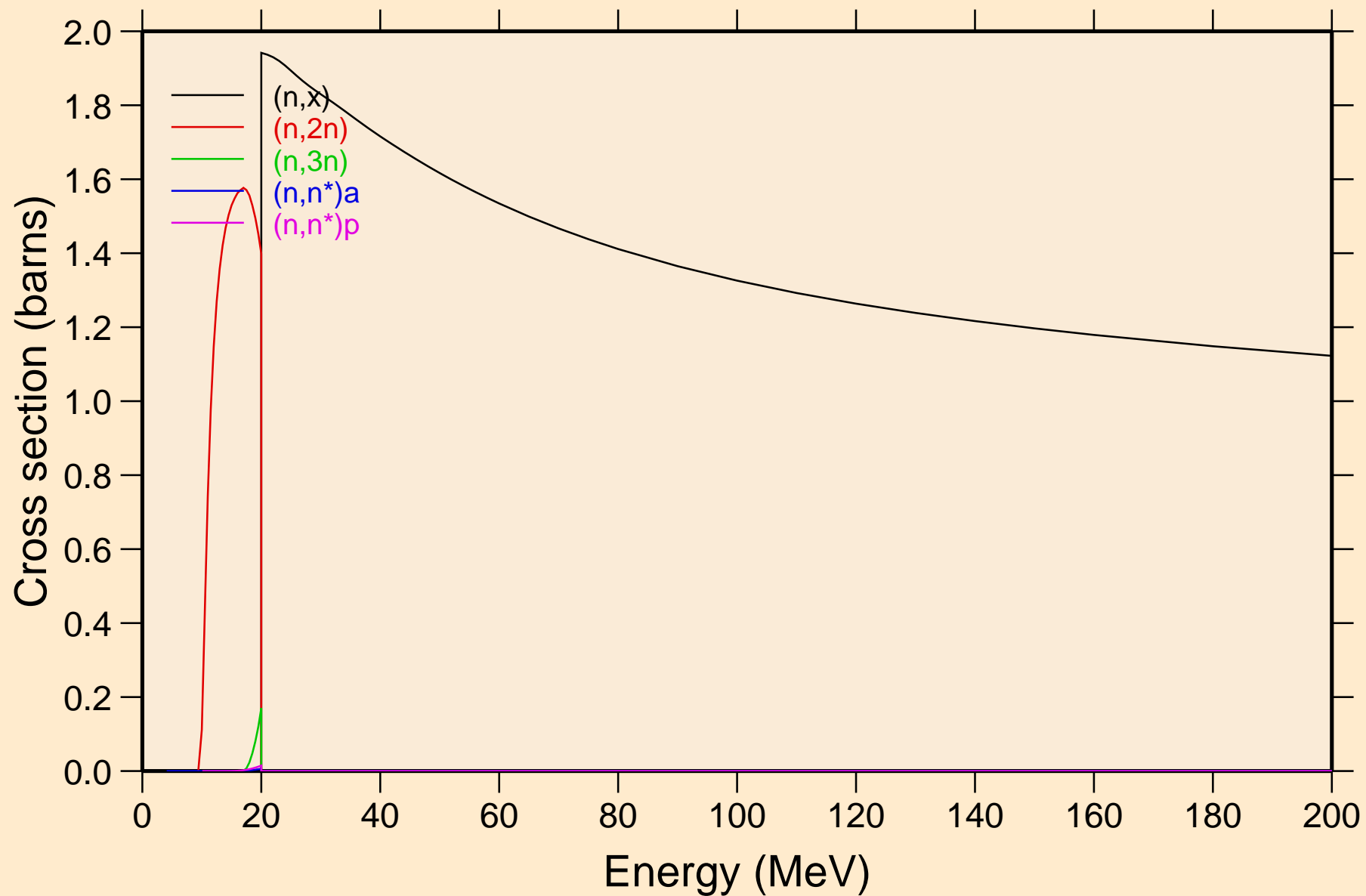



50-SN-118 FOR FENDL-3.2 FROM FENDL-3.2 BY NJOY2016.60+ C  
Threshold reactions

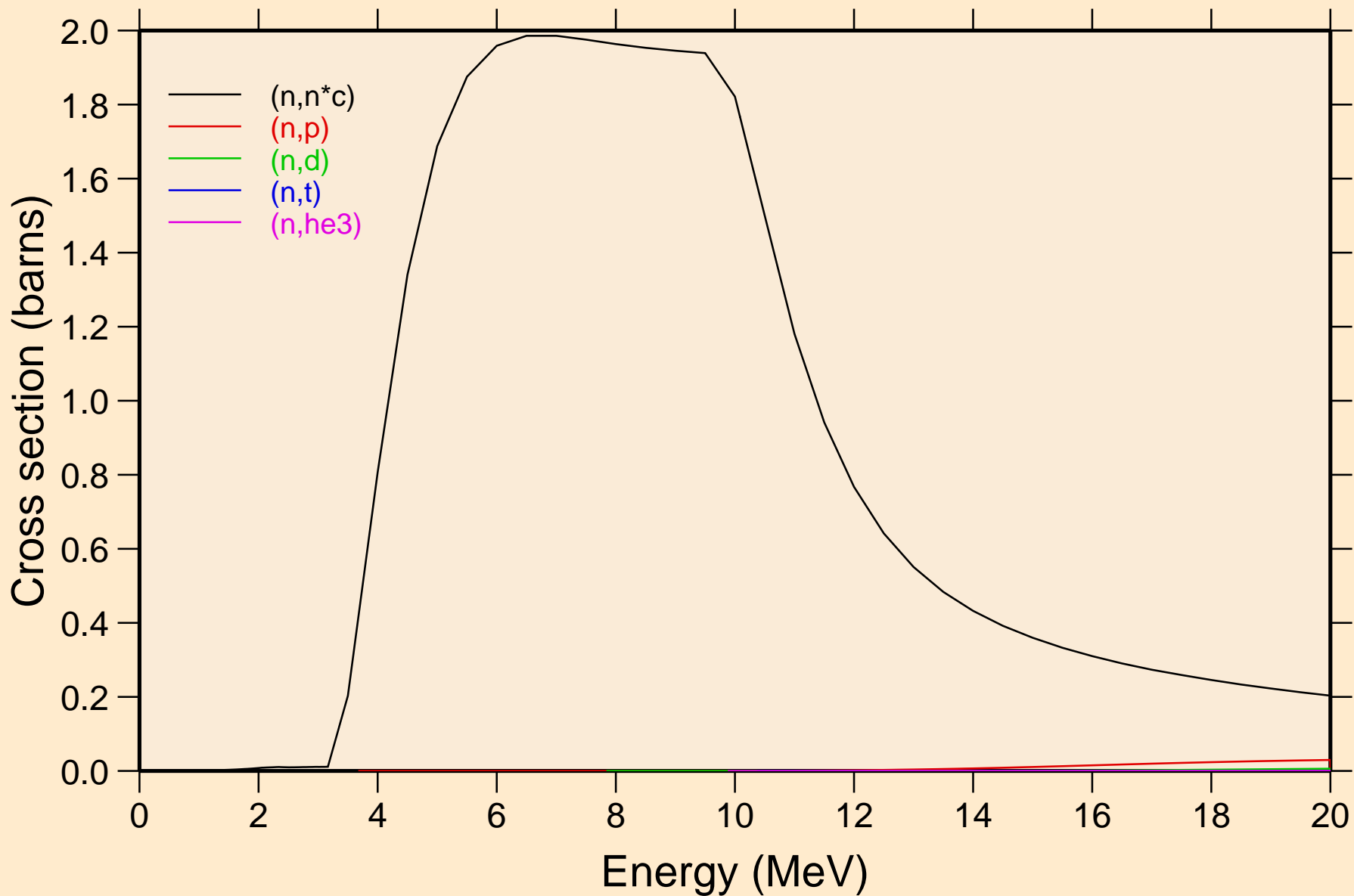

50-SN-118 FOR FENDL-3.2 FROM FENDL-3.2 BY NJOY2016.60+ C  
Threshold reactions

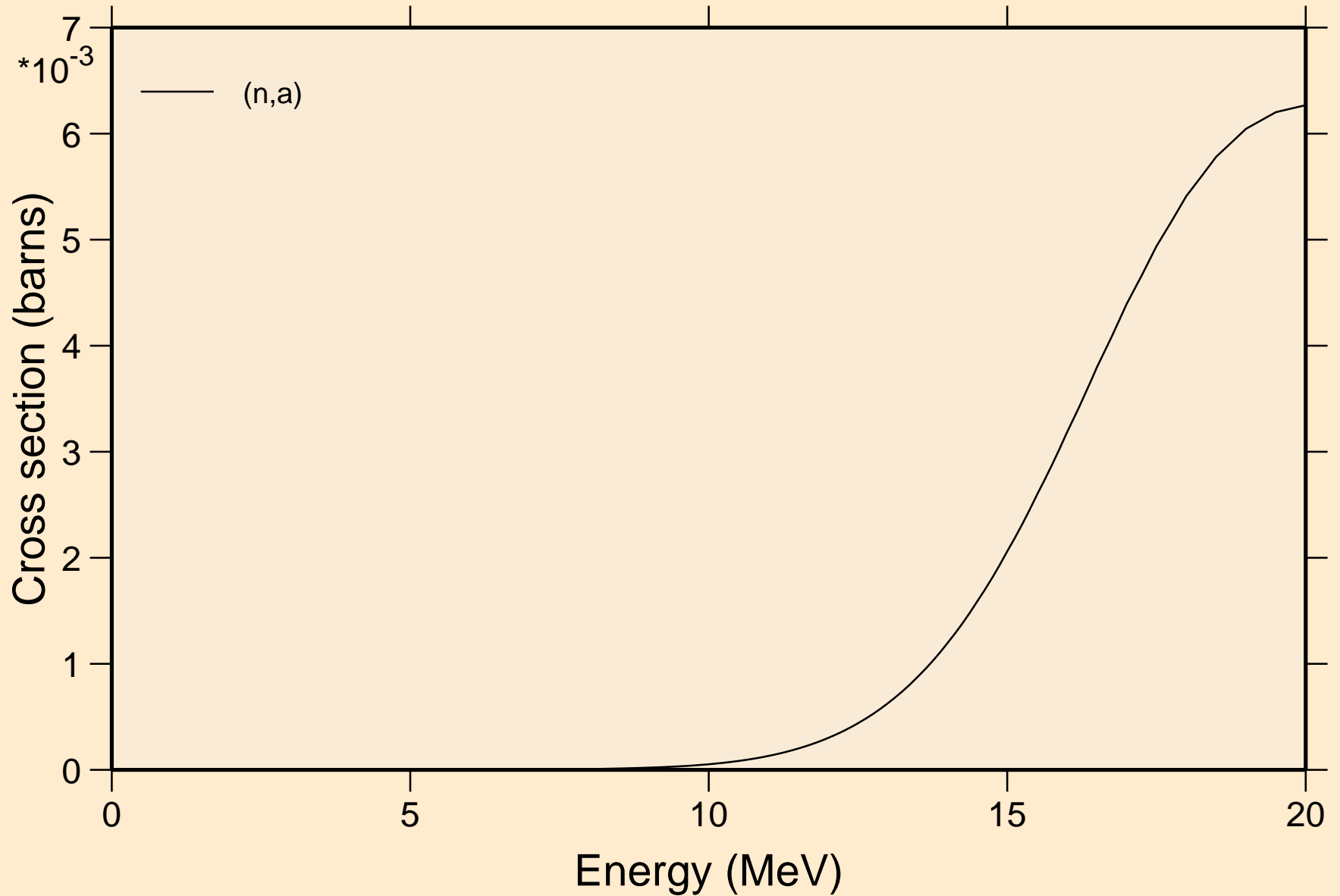

50-SN-118 FOR FENDL-3.2 FROM FENDL-3.2 BY NJOY2016.60+ C  
Threshold reactions

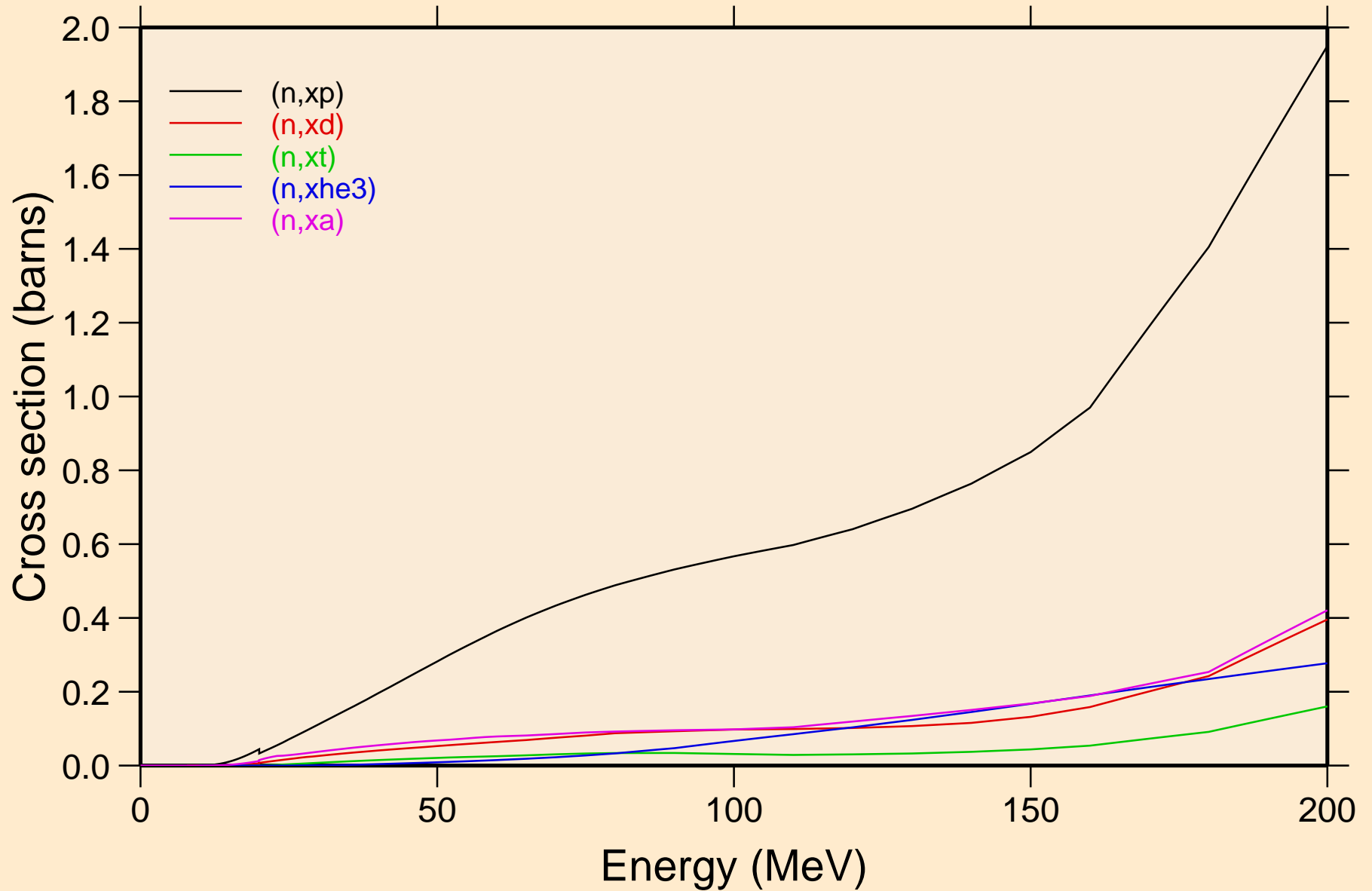

50-SN-118 FOR FENDL-3.2 FROM FENDL-3.2 BY NJOY2016.60+ C  
angular distribution for elastic

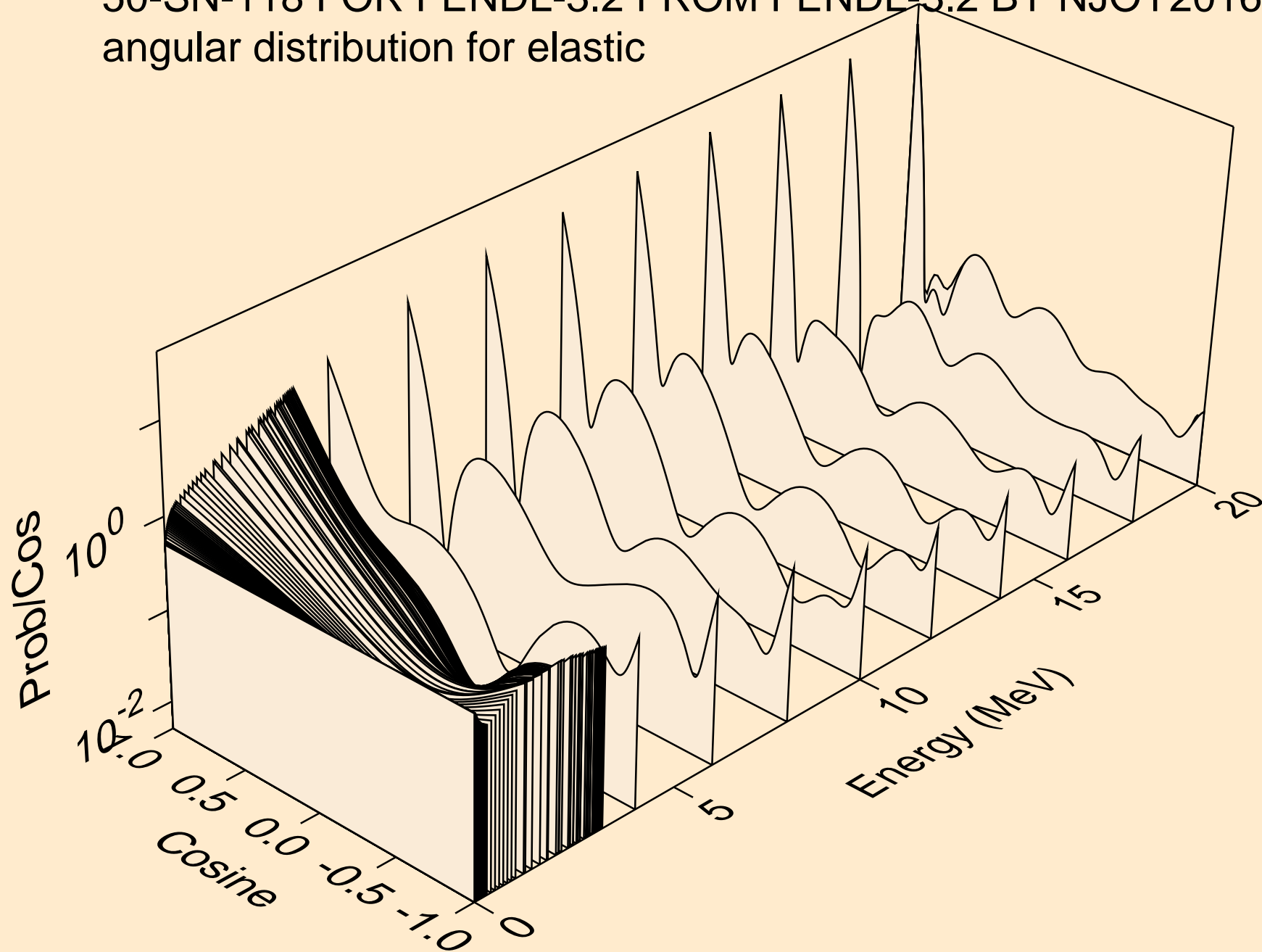

50-SN-118 FOR FENDL-3.2 FROM FENDL-3.2 BY NJOY2016.60+ C  
angular distribution for elastic

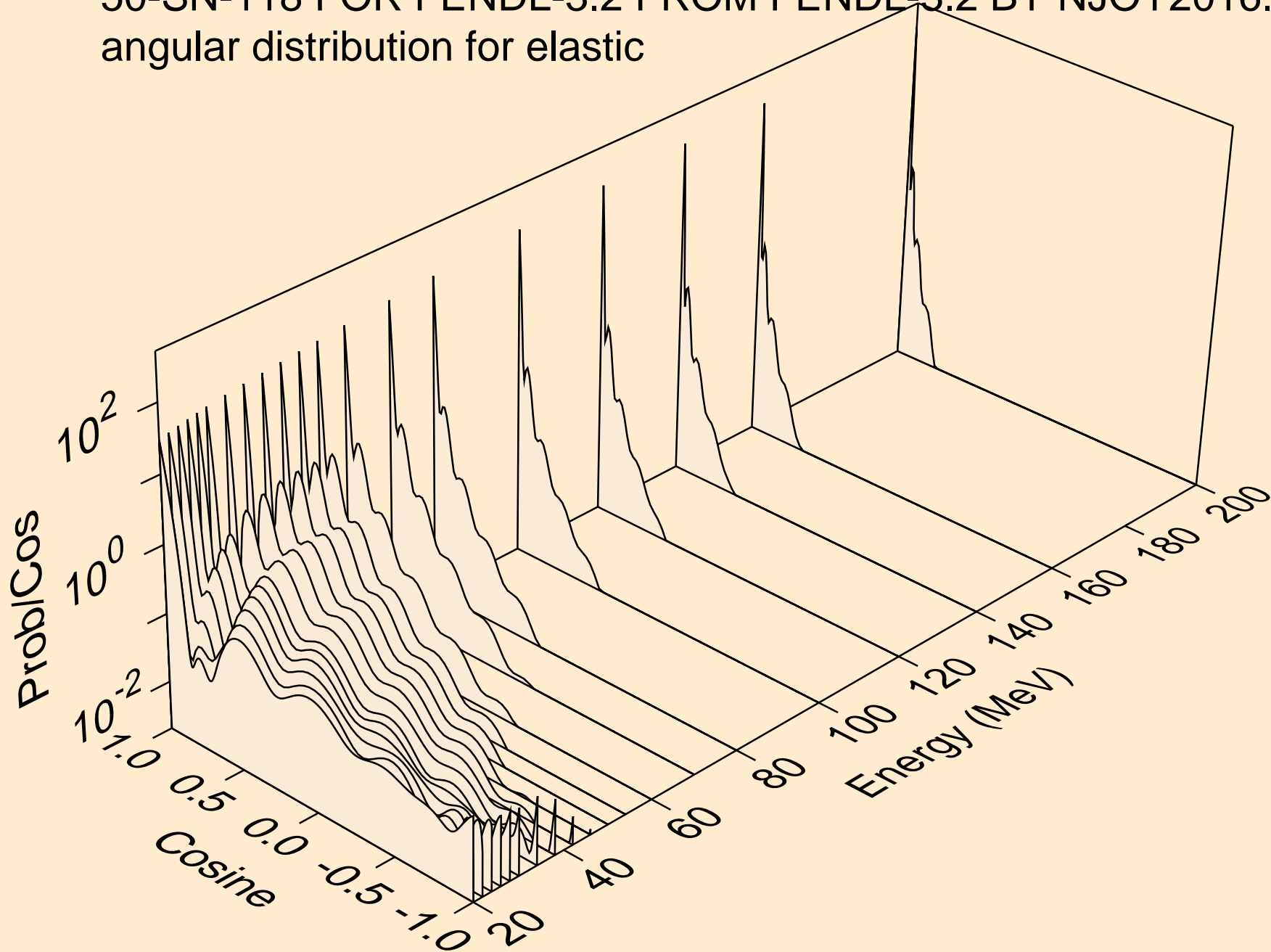

50-SN-118 FOR FENDL-3.2 FROM FENDL-3.2 BY NJOY2016.60+ C  
angular distribution for (n,n\*1)

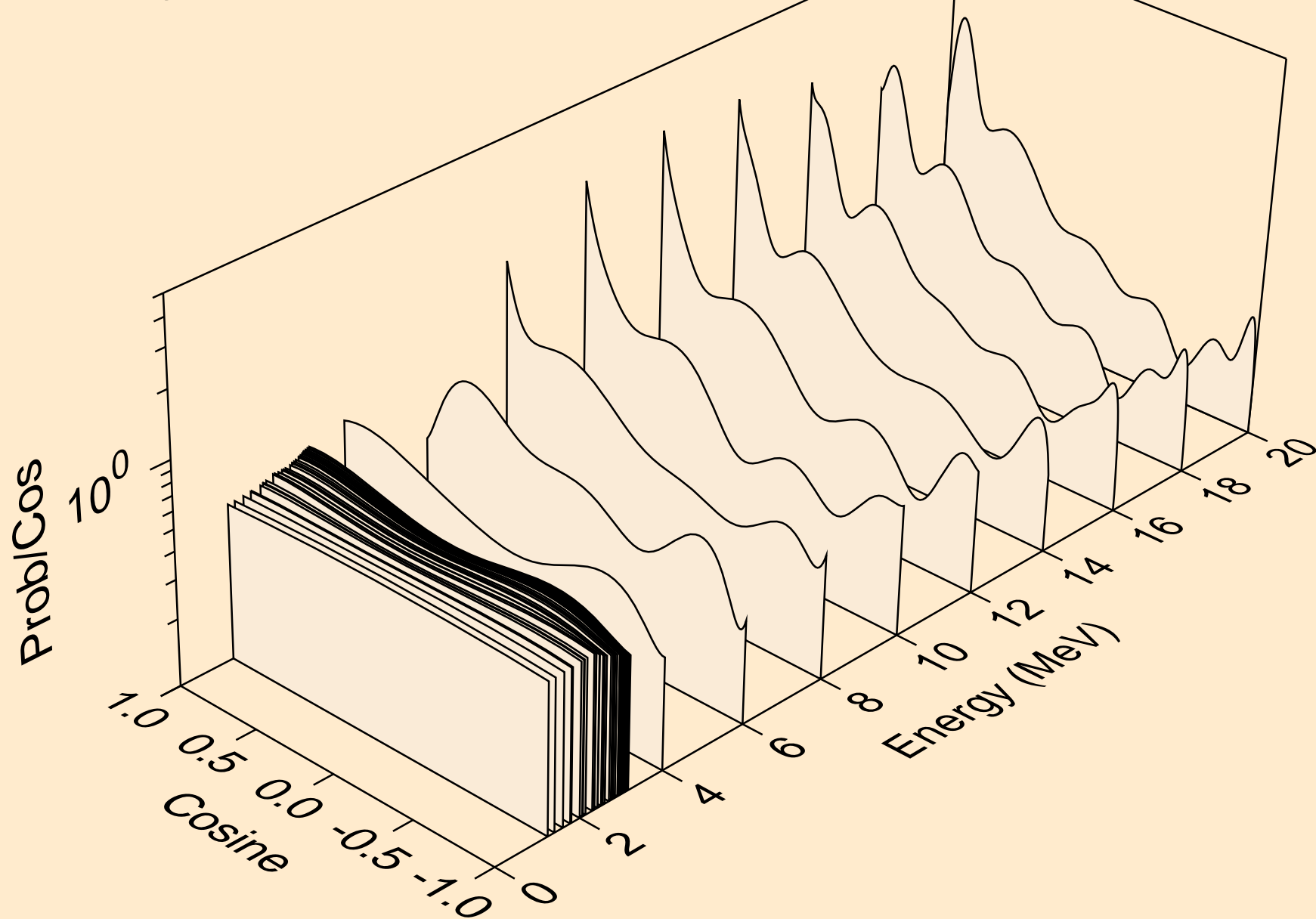

50-SN-118 FOR FENDL-3.2 FROM FENDL-3.2 BY NJOY2016.60+ C  
angular distribution for (n,n\*2)

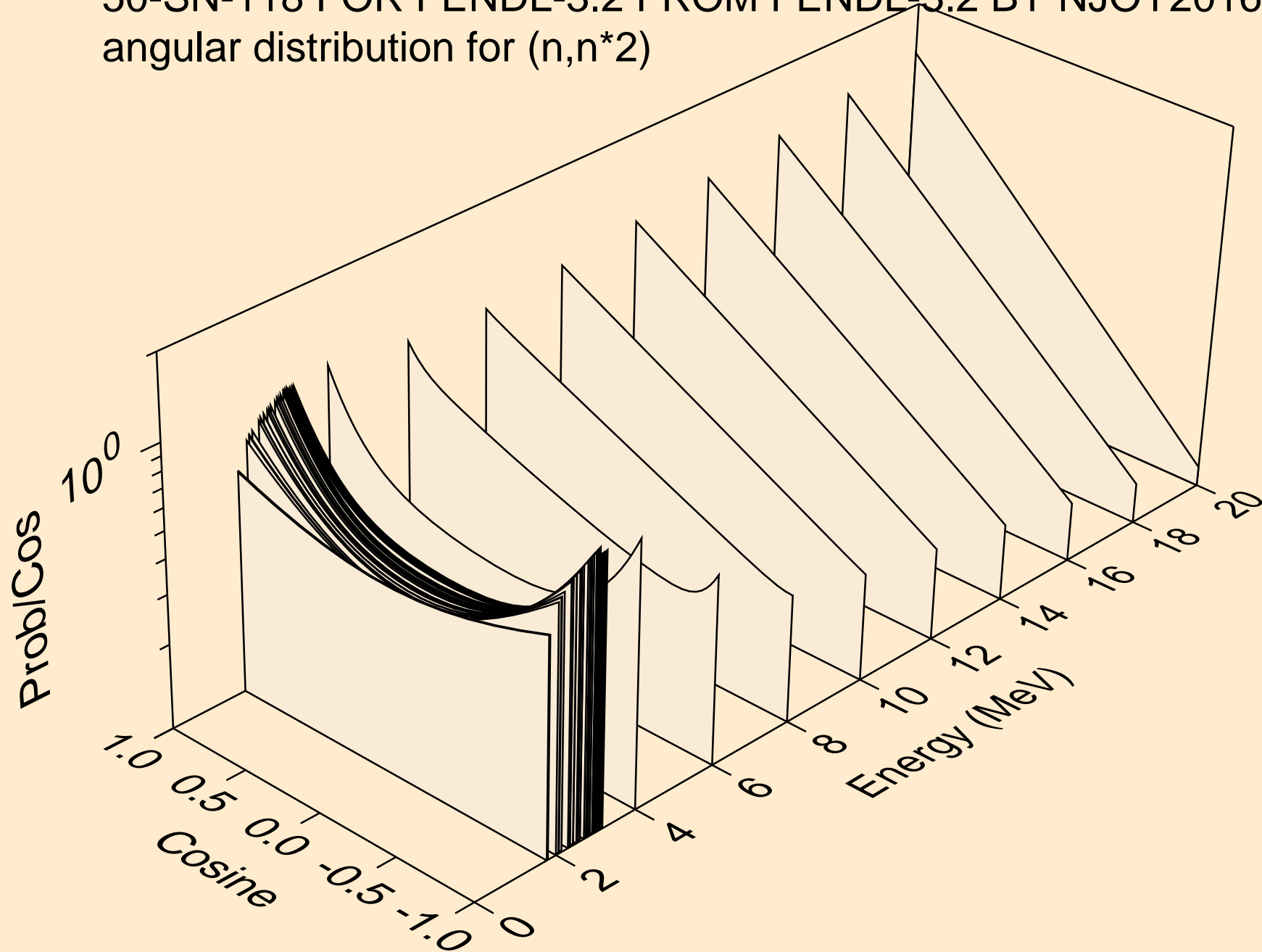

50-SN-118 FOR FENDL-3.2 FROM FENDL-3.2 BY NJOY2016.60+ C  
angular distribution for (n,n\*3)

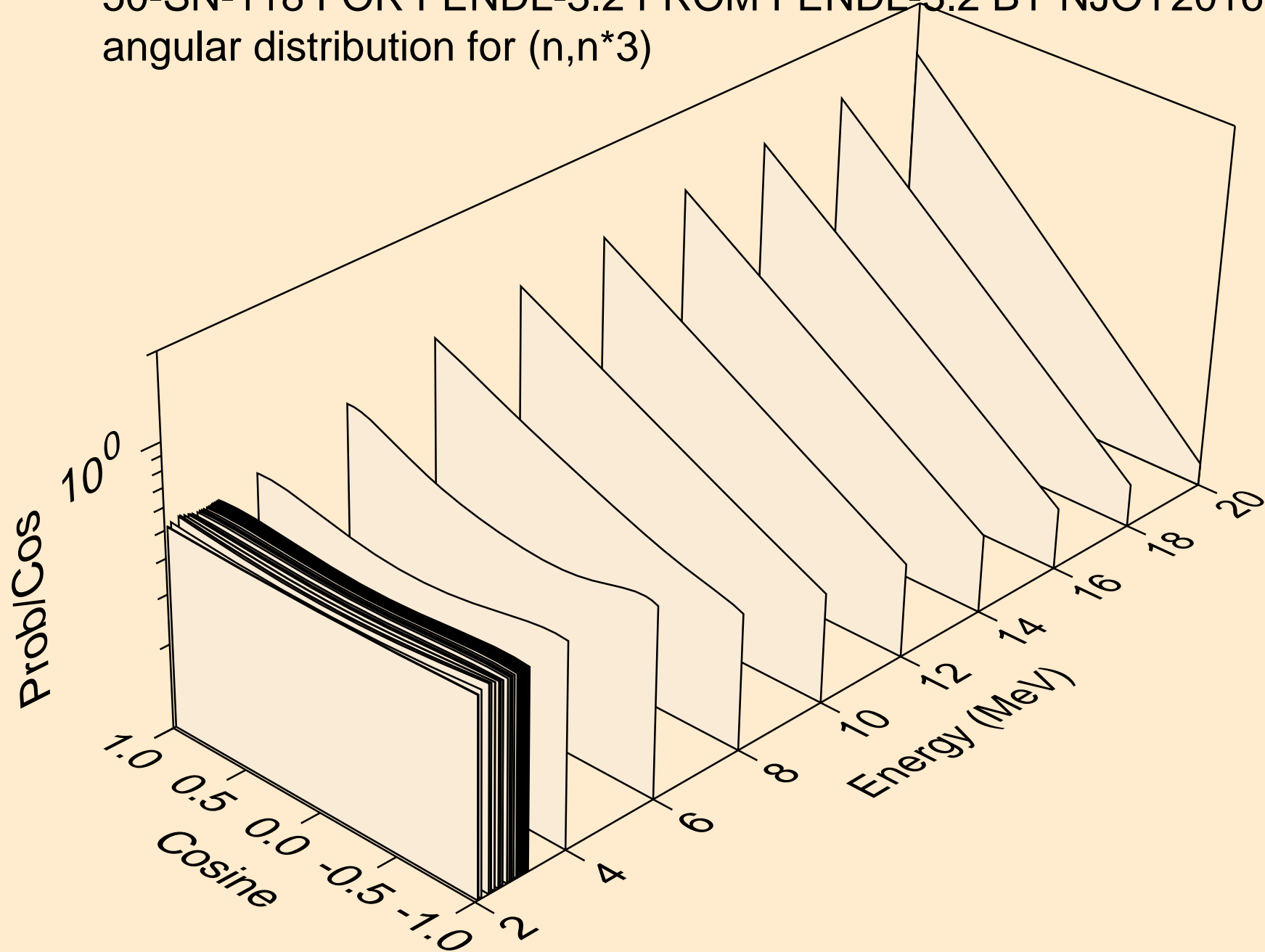



50-SN-118 FOR FENDL-3.2 FROM FENDL-3.2 BY NJOY2016.60+ C  
angular distribution for (n,n\*4)

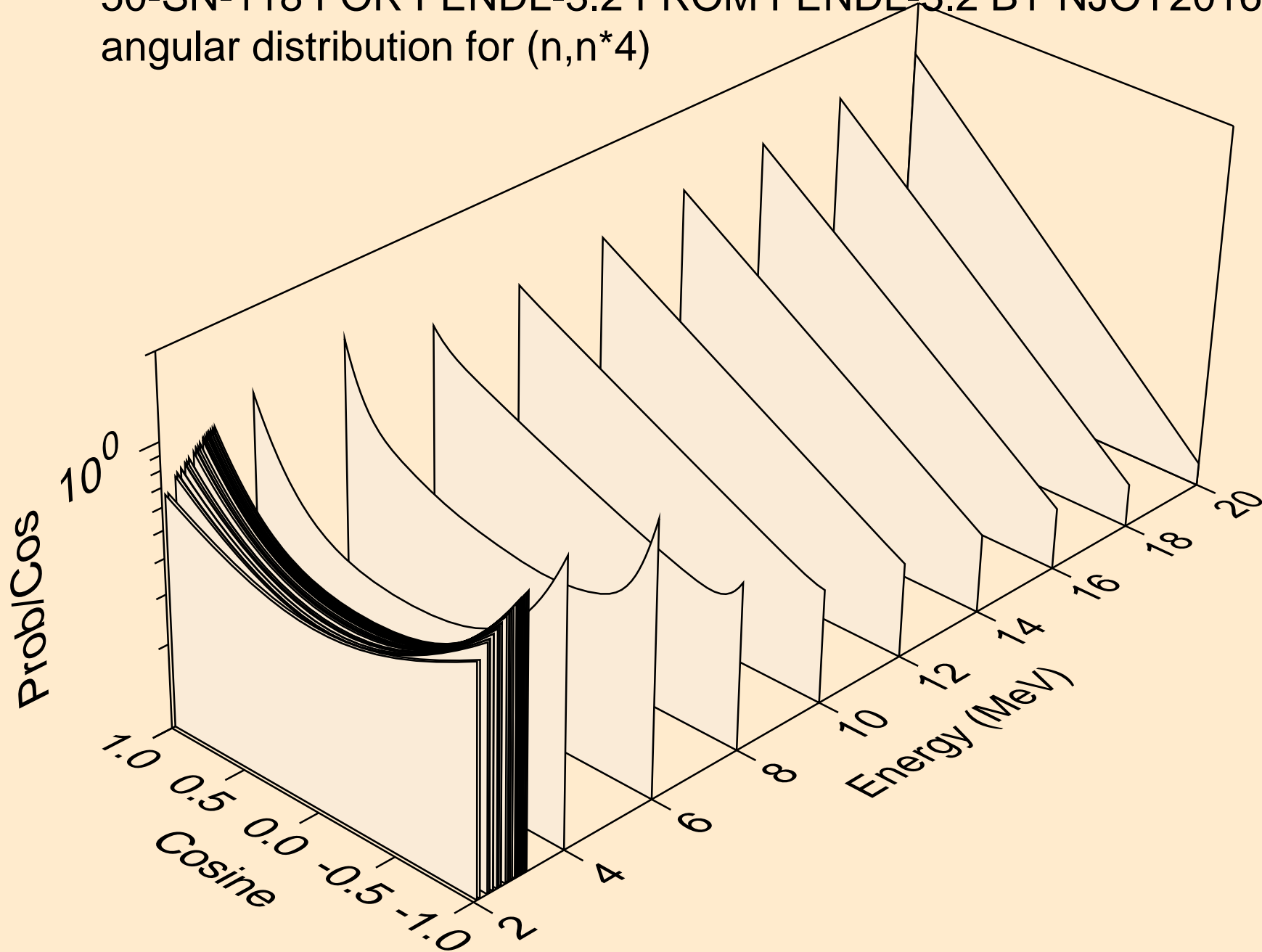

50-SN-118 FOR FENDL-3.2 FROM FENDL-3.2 BY NJOY2016.60+ C  
angular distribution for (n,n\*5)

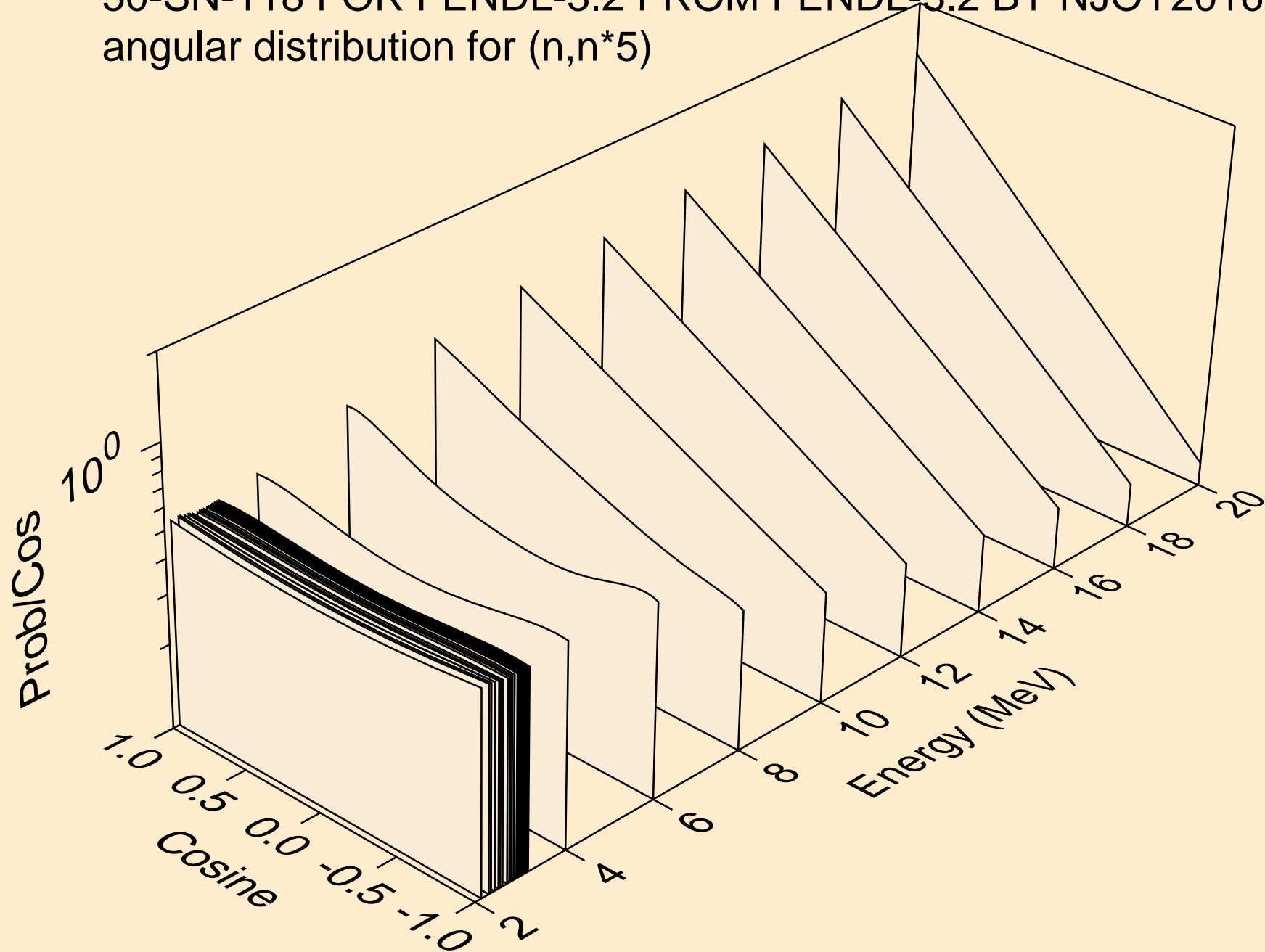

50-SN-118 FOR FENDL-3.2 FROM FENDL-3.2 BY NJOY2016.60+ C  
angular distribution for (n,n\*6)

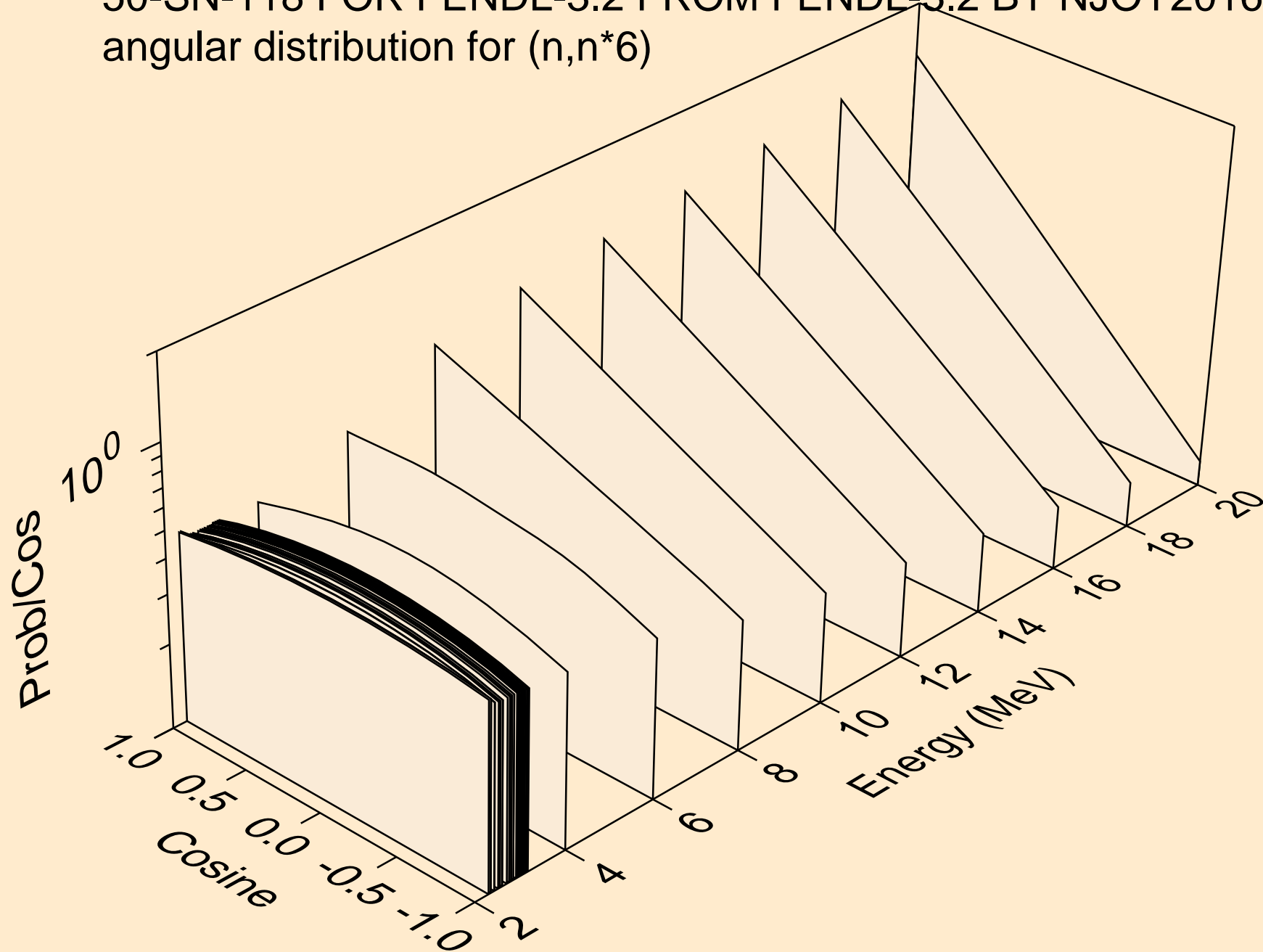

50-SN-118 FOR FENDL-3.2 FROM FENDL-3.2 BY NJOY2016.60+ C  
angular distribution for (n,n\*7)

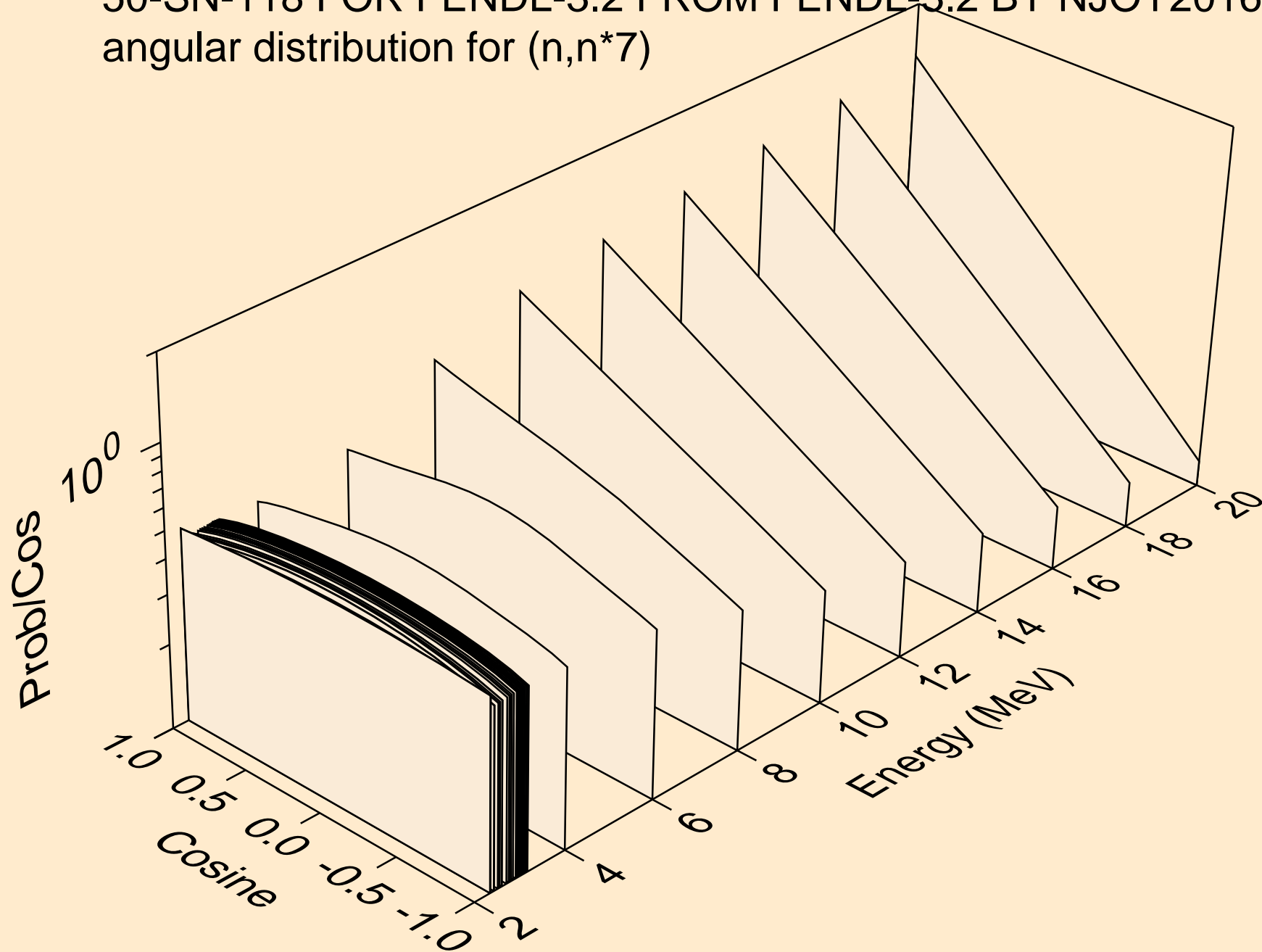

50-SN-118 FOR FENDL-3.2 FROM FENDL-3.2 BY NJOY2016.60+ C  
angular distribution for (n,n\*8)

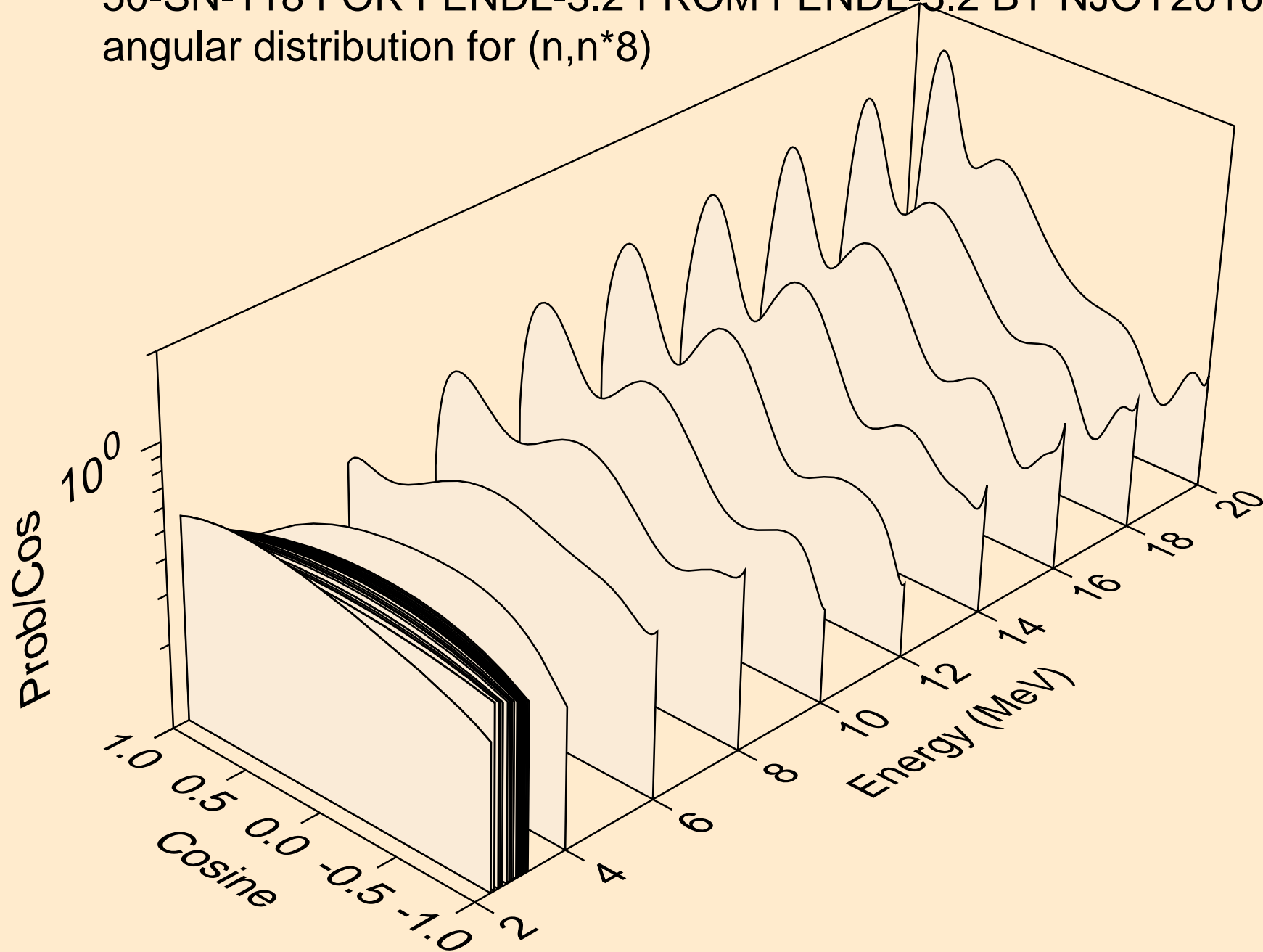

50-SN-118 FOR FENDL-3.2 FROM FENDL-3.2 BY NJOY2016.60+ C  
angular distribution for (n,n\*9)

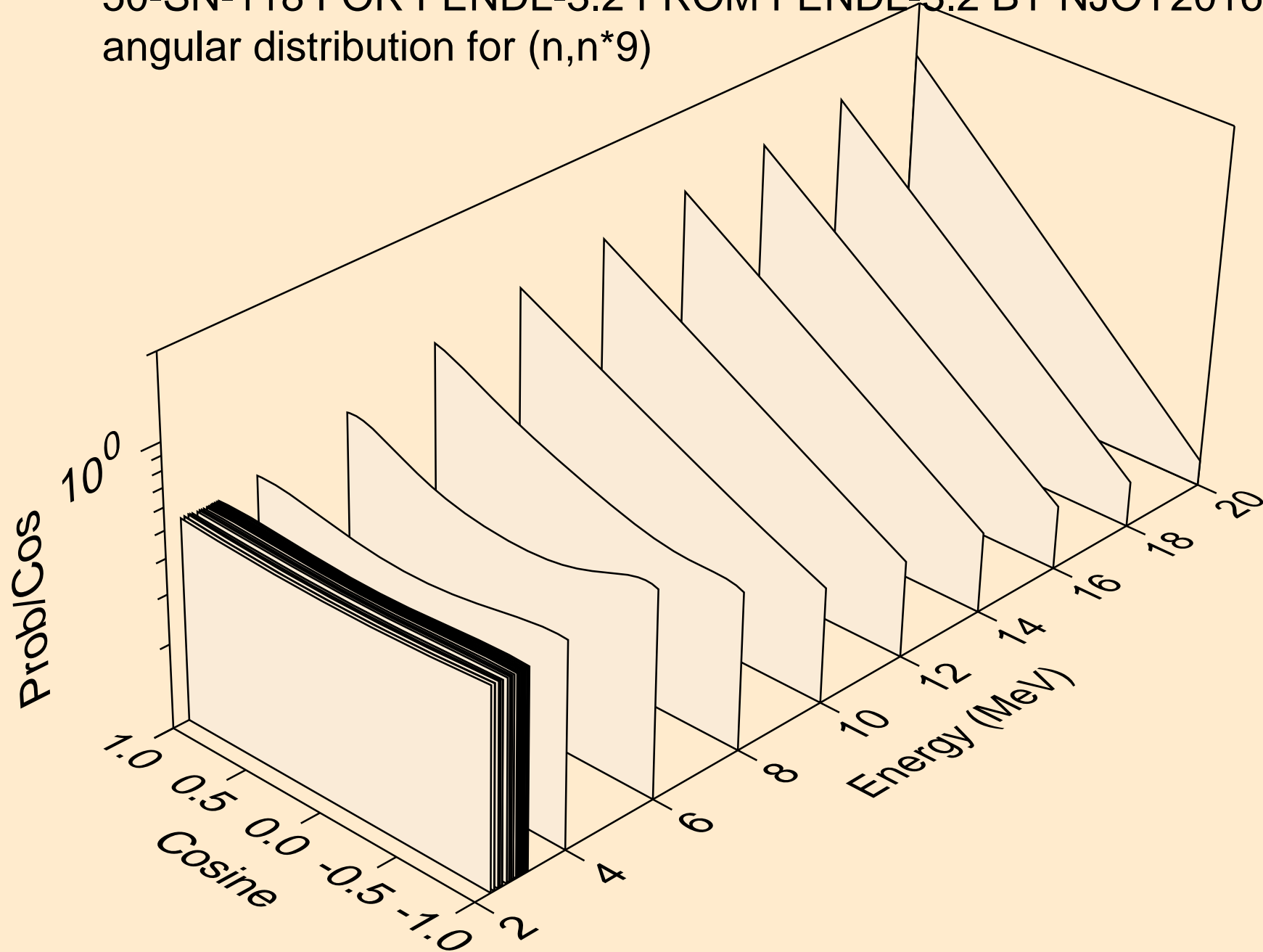

50-SN-118 FOR FENDL-3.2 FROM FENDL-3.2 BY NJOY2016.60+ C  
angular distribution for (n,n\*10)

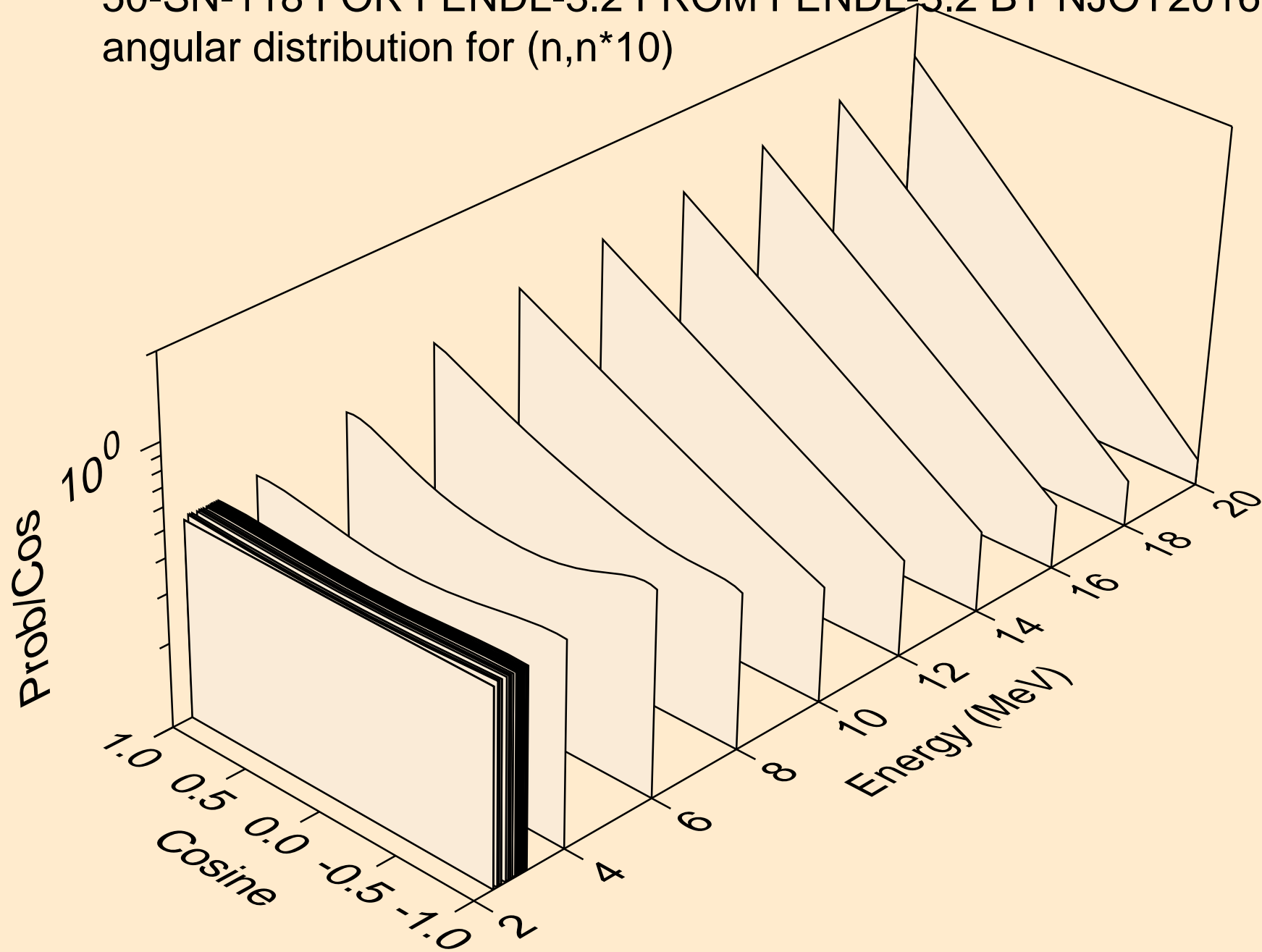

50-SN-118 FOR FENDL-3.2 FROM FENDL-3.2 BY NJOY2016.60+ C  
angular distribution for (n,n\*11)

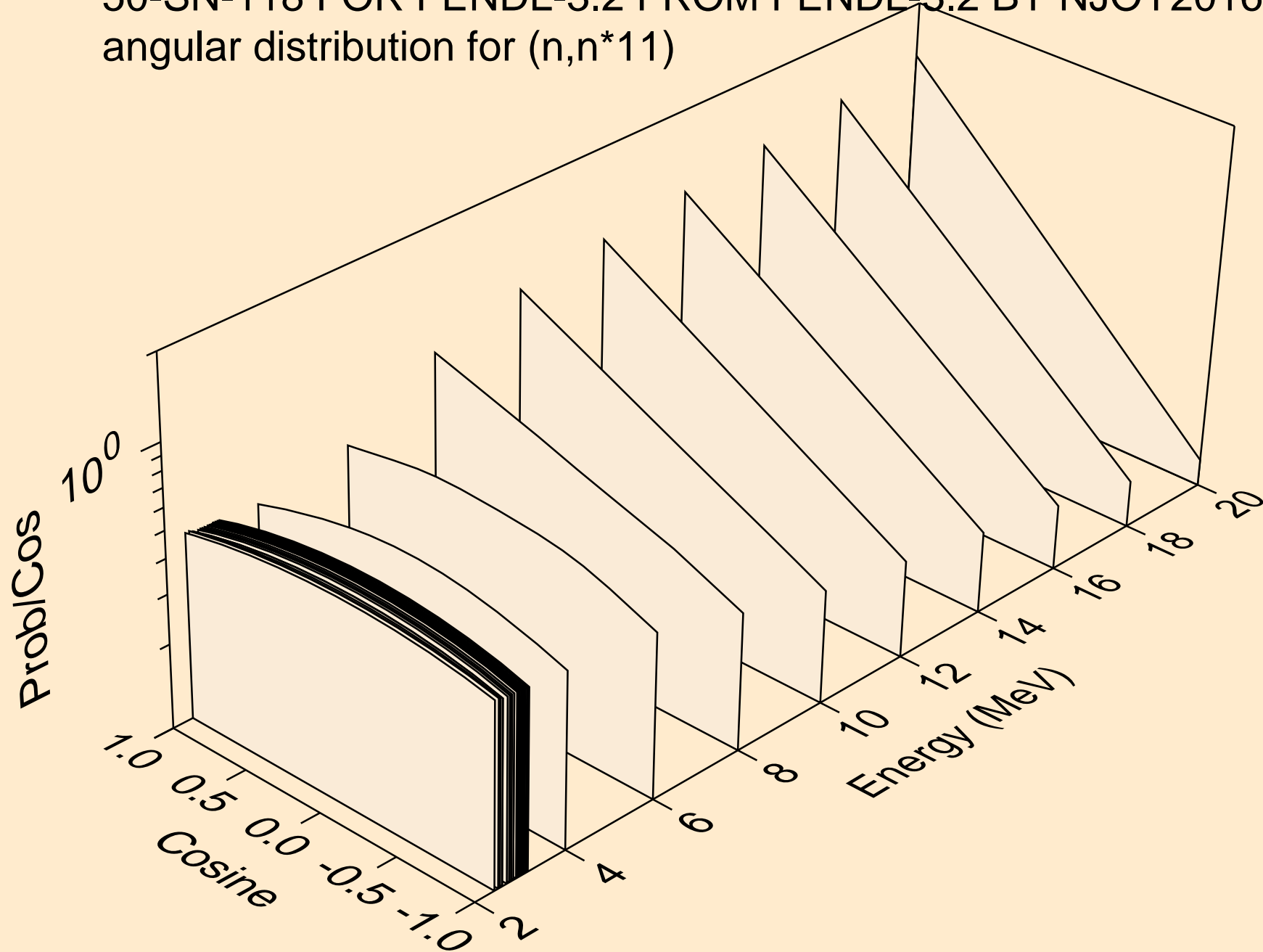



50-SN-118 FOR FENDL-3.2 FROM FENDL-3.2 BY NJOY2016.60+ C  
angular distribution for (n,n\*12)

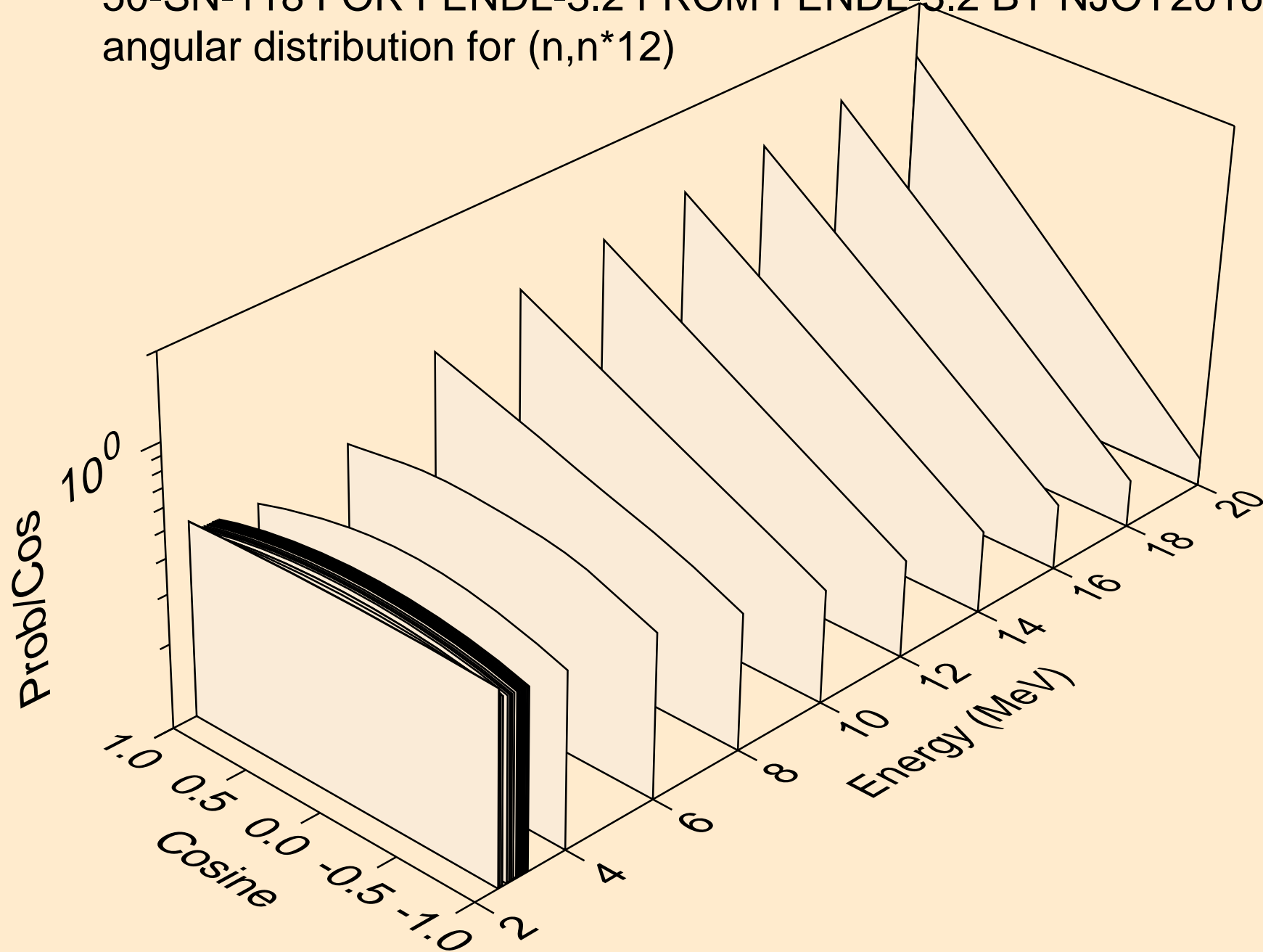

50-SN-118 FOR FENDL-3.2 FROM FENDL-3.2 BY NJOY2016.60+ C  
angular distribution for (n,n\*13)

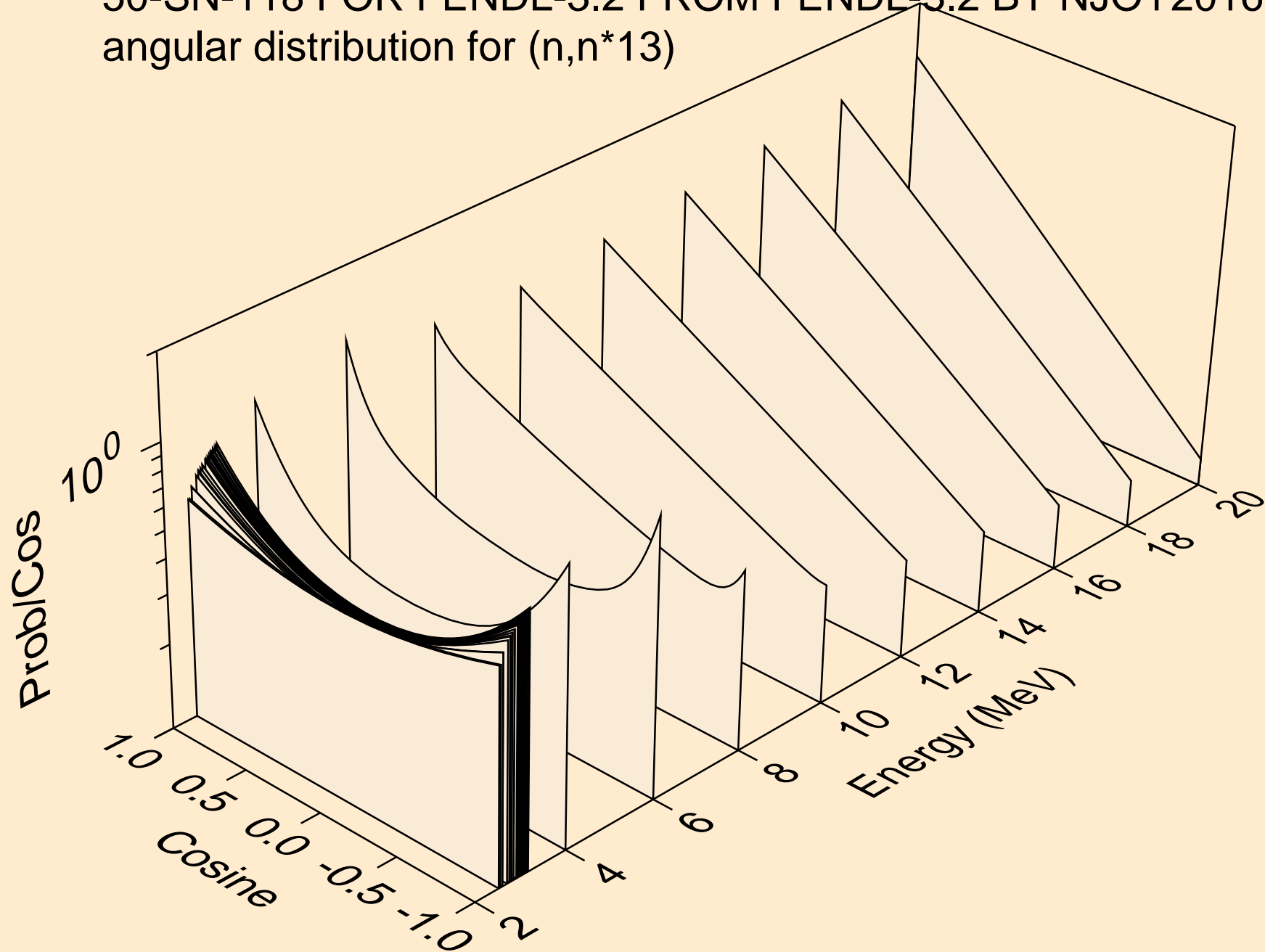

50-SN-118 FOR FENDL-3.2 FROM FENDL-3.2 BY NJOY2016.60+ C  
angular distribution for (n,n\*14)

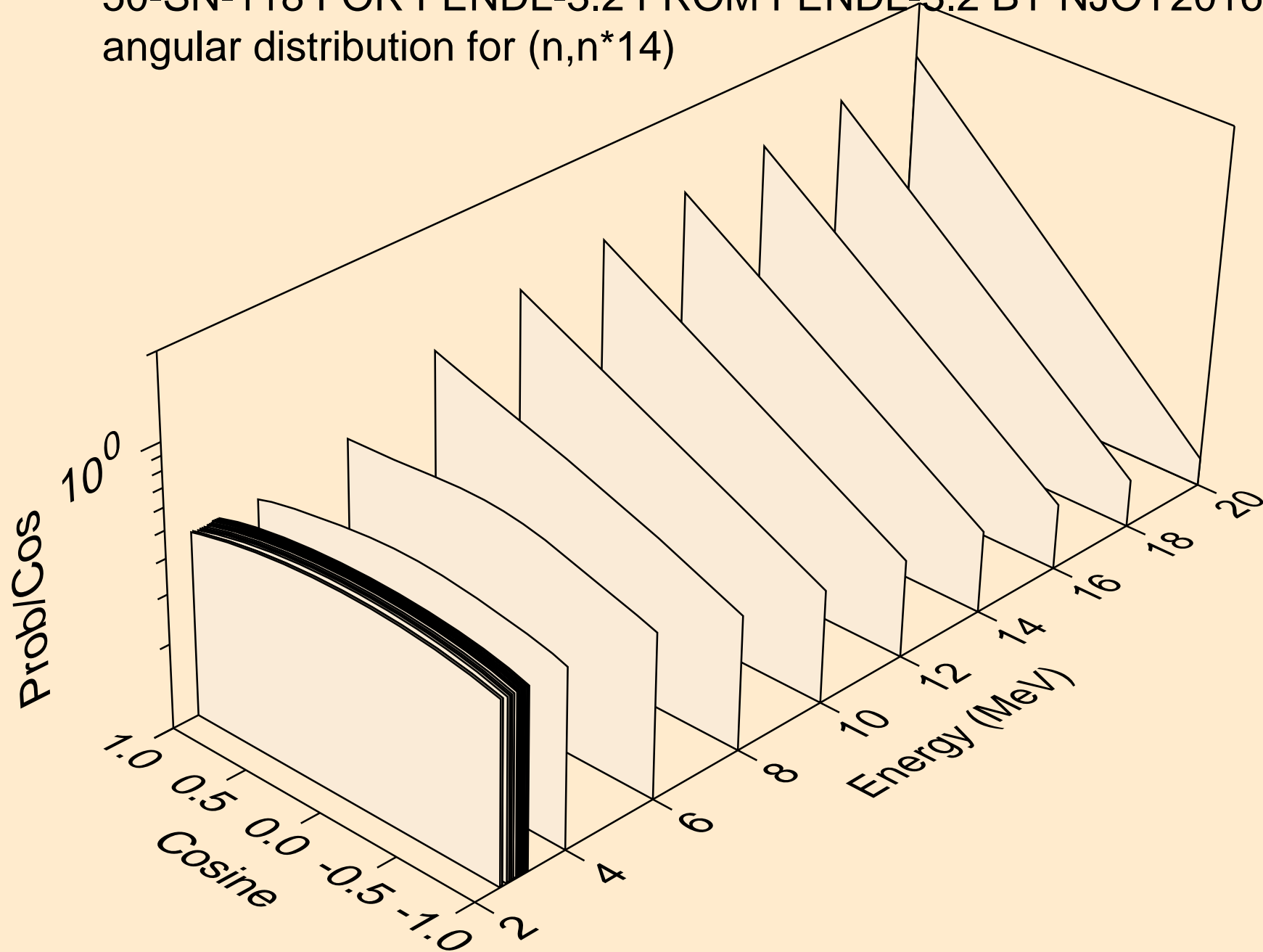

50-SN-118 FOR FENDL-3.2 FROM FENDL-3.2 BY NJOY2016.60+ C  
angular distribution for (n,n\*15)

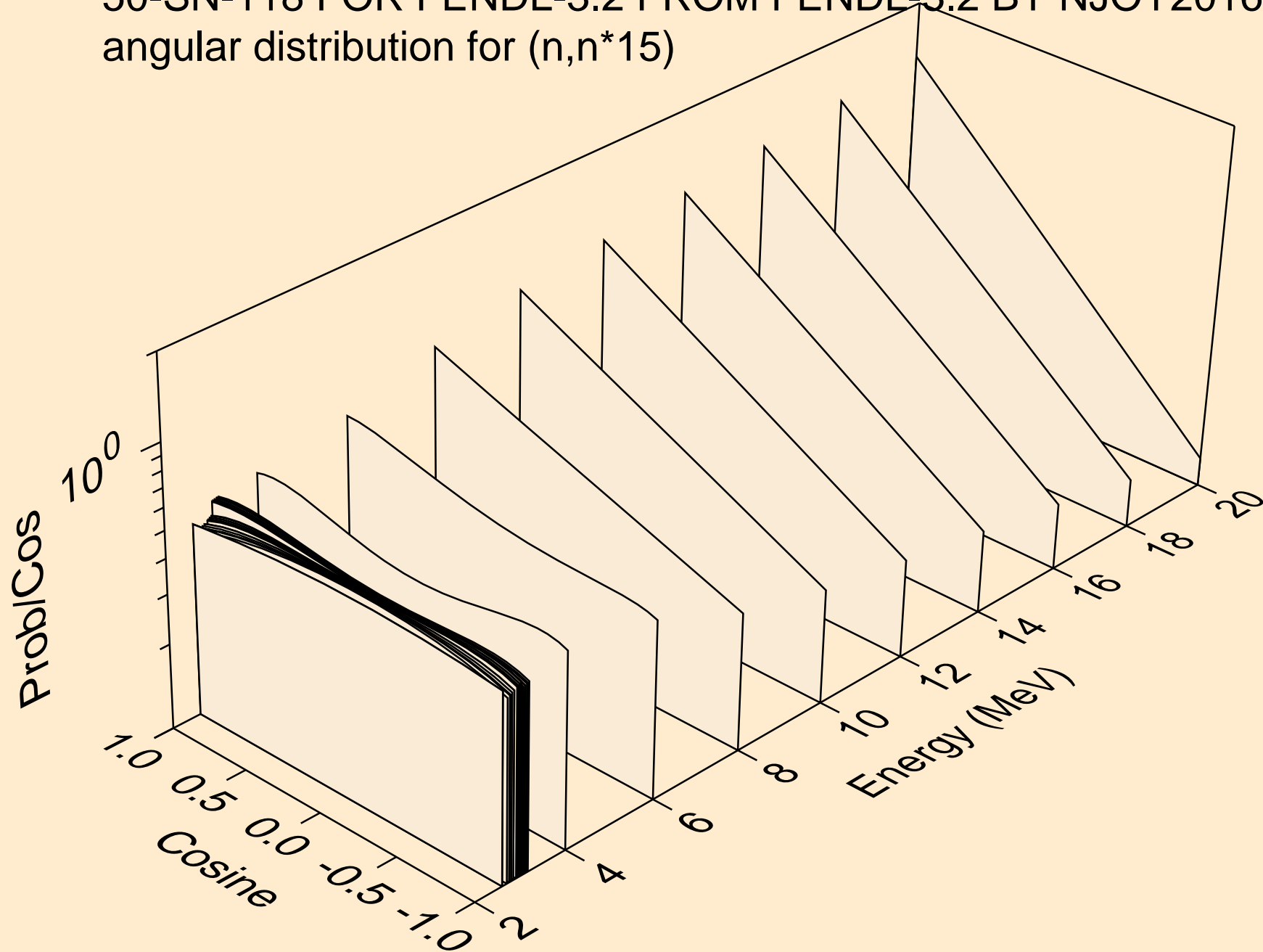

50-SN-118 FOR FENDL-3.2 FROM FENDL-3.2 BY NJOY2016.60+ C  
angular distribution for (n,n\*16)

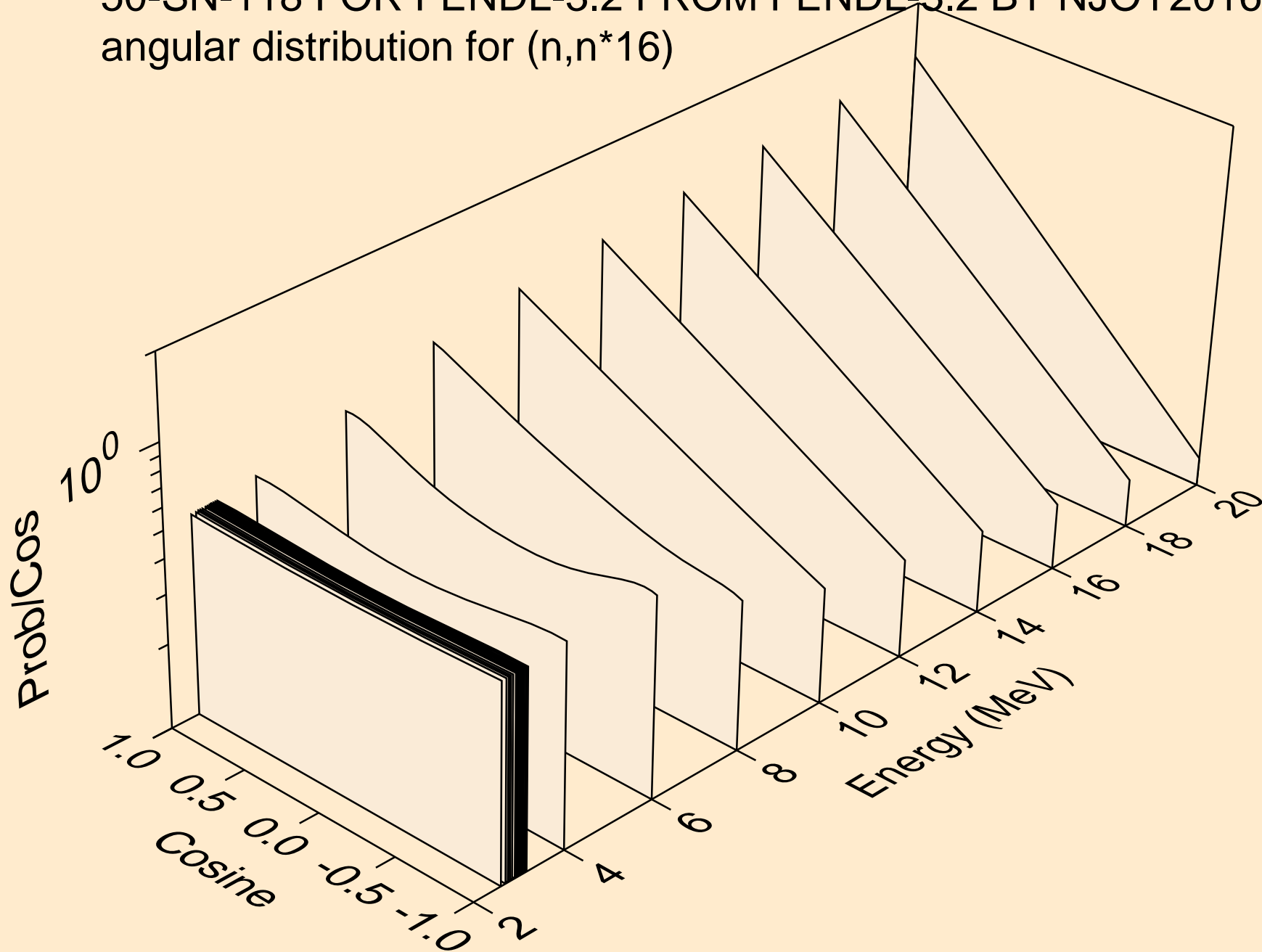

50-SN-118 FOR FENDL-3.2 FROM FENDL-3.2 BY NJOY2016.60+ C  
angular distribution for (n,n\*17)

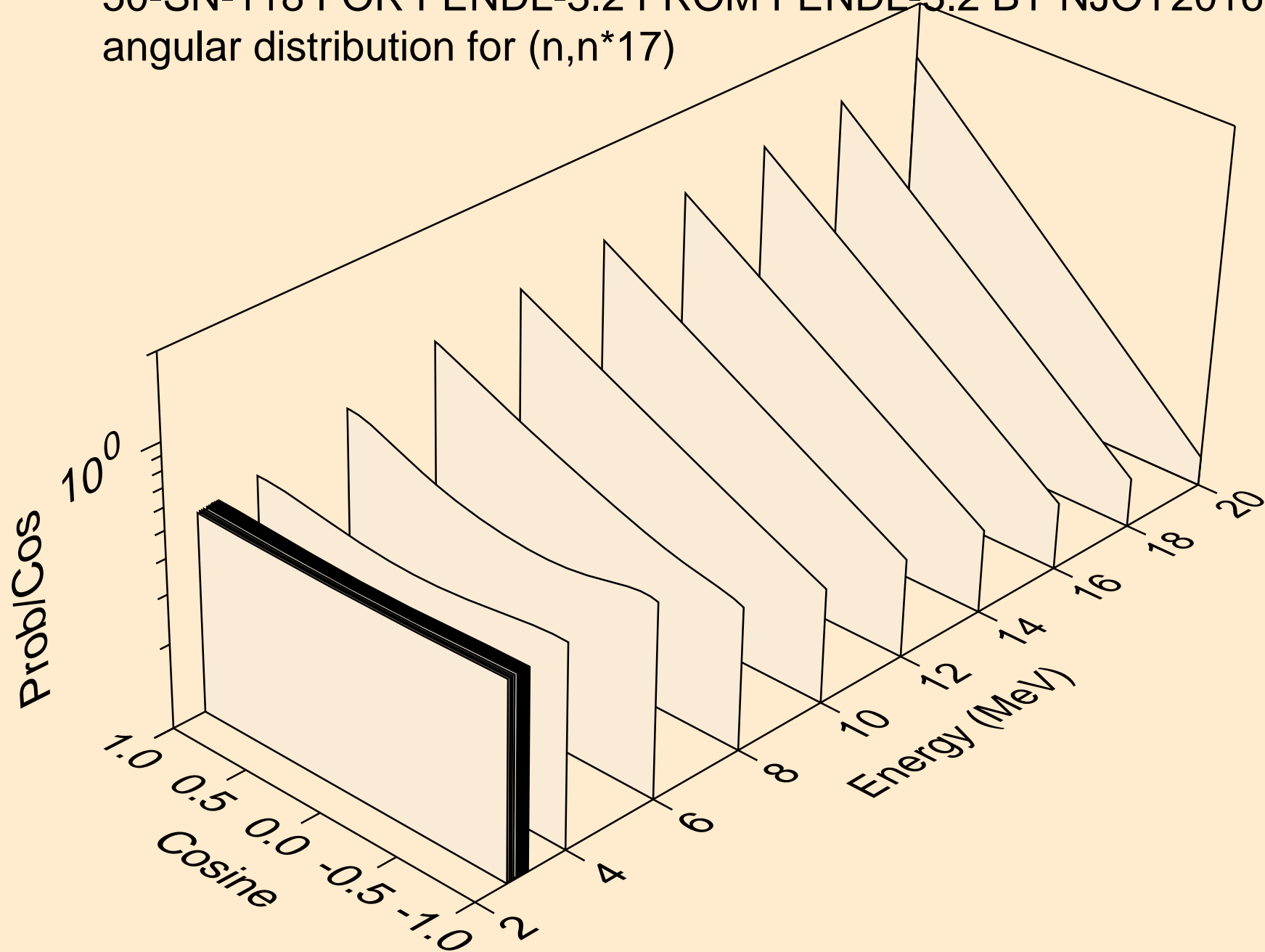

50-SN-118 FOR FENDL-3.2 FROM FENDL-3.2 BY NJOY2016.60+ C  
angular distribution for (n,n\*18)

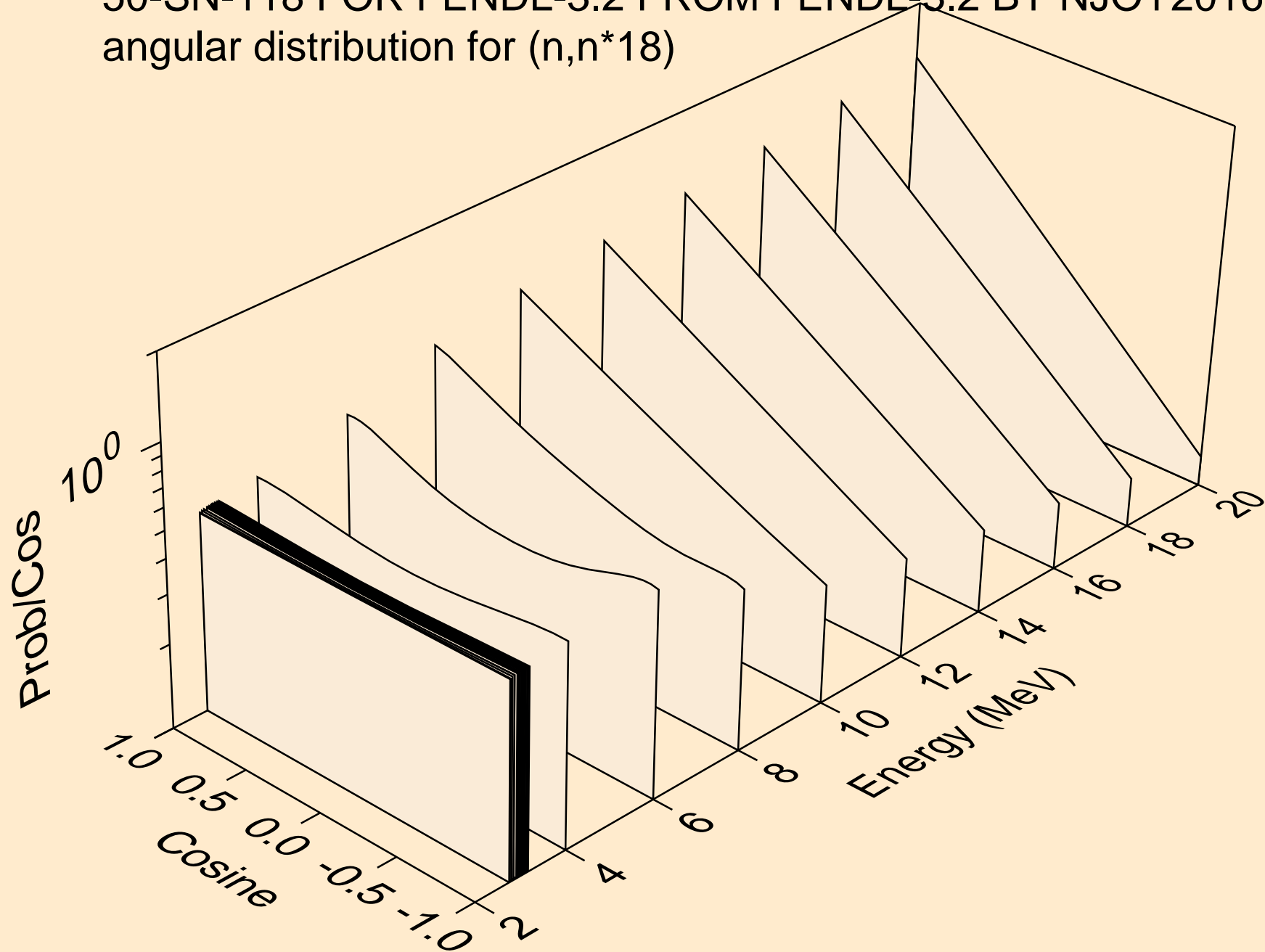

50-SN-118 FOR FENDL-3.2 FROM FENDL-3.2 BY NJOY2016.60+ C  
angular distribution for (n,n\*19)

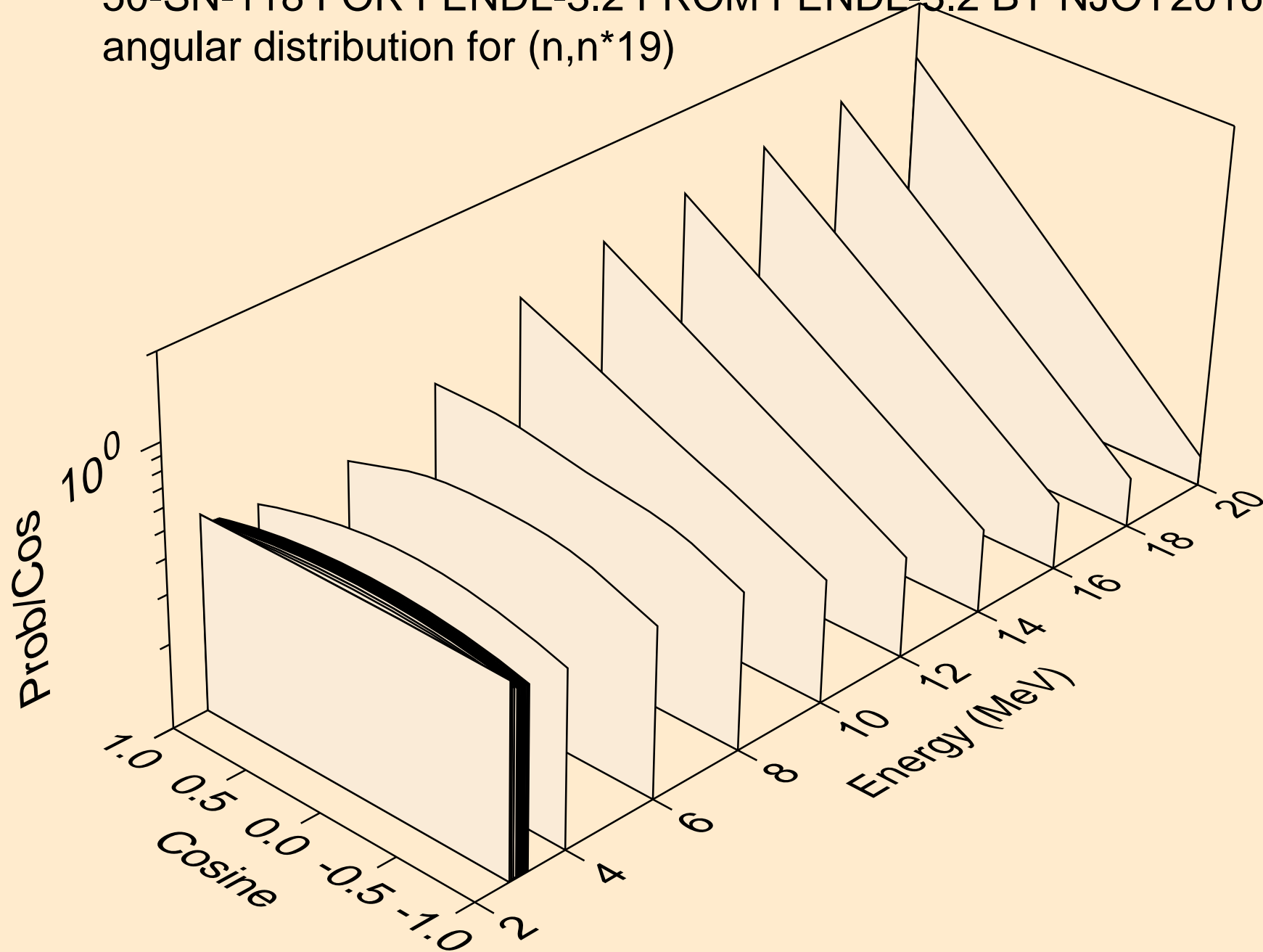



50-SN-118 FOR FENDL-3.2 FROM FENDL-3.2 BY NJOY2016.60+ C  
angular distribution for (n,n\*20)

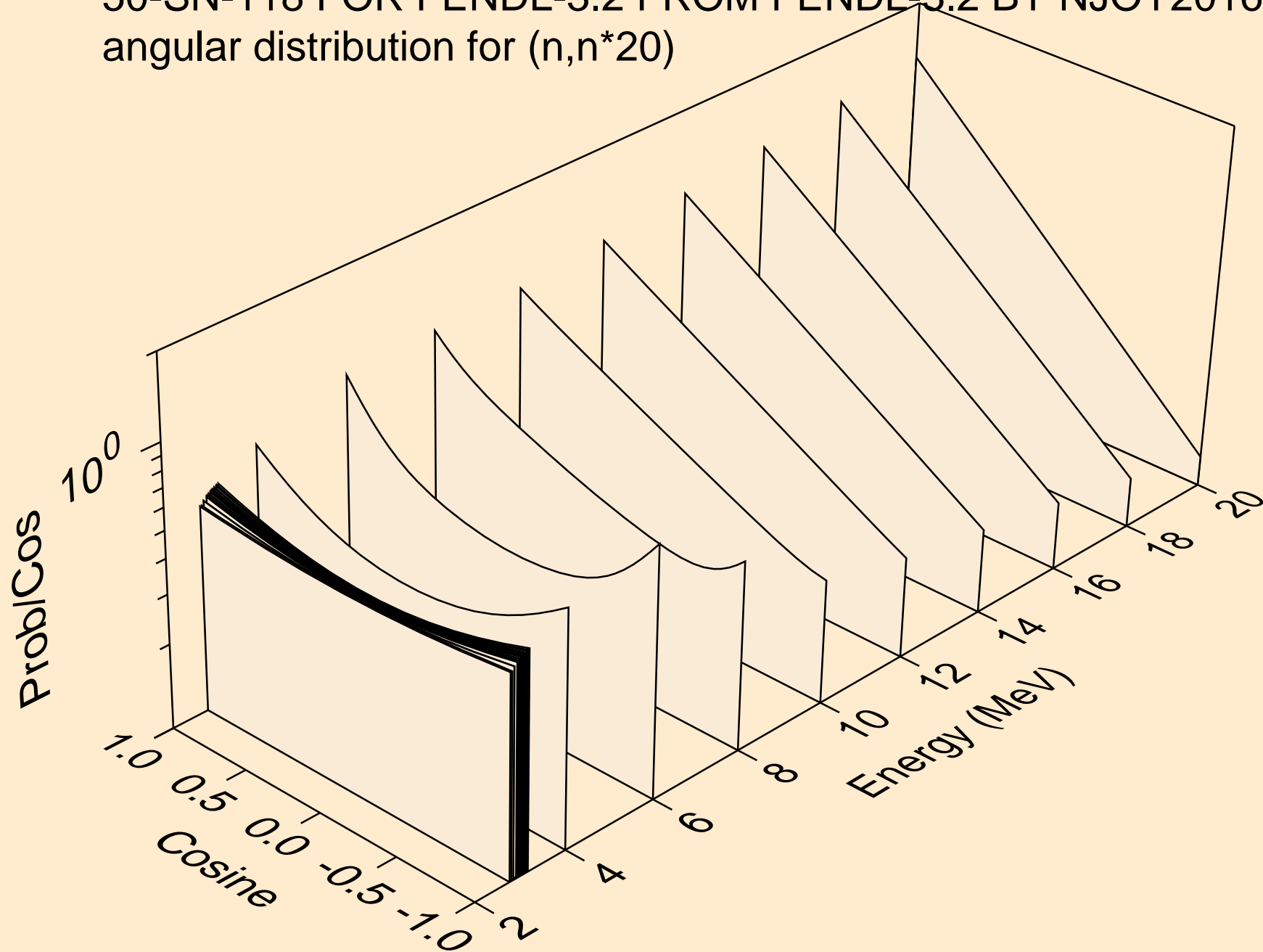

50-SN-118 FOR FENDL-3.2 FROM FENDL-3.2 BY NJOY2016.60+ C  
angular distribution for (n,n\*21)

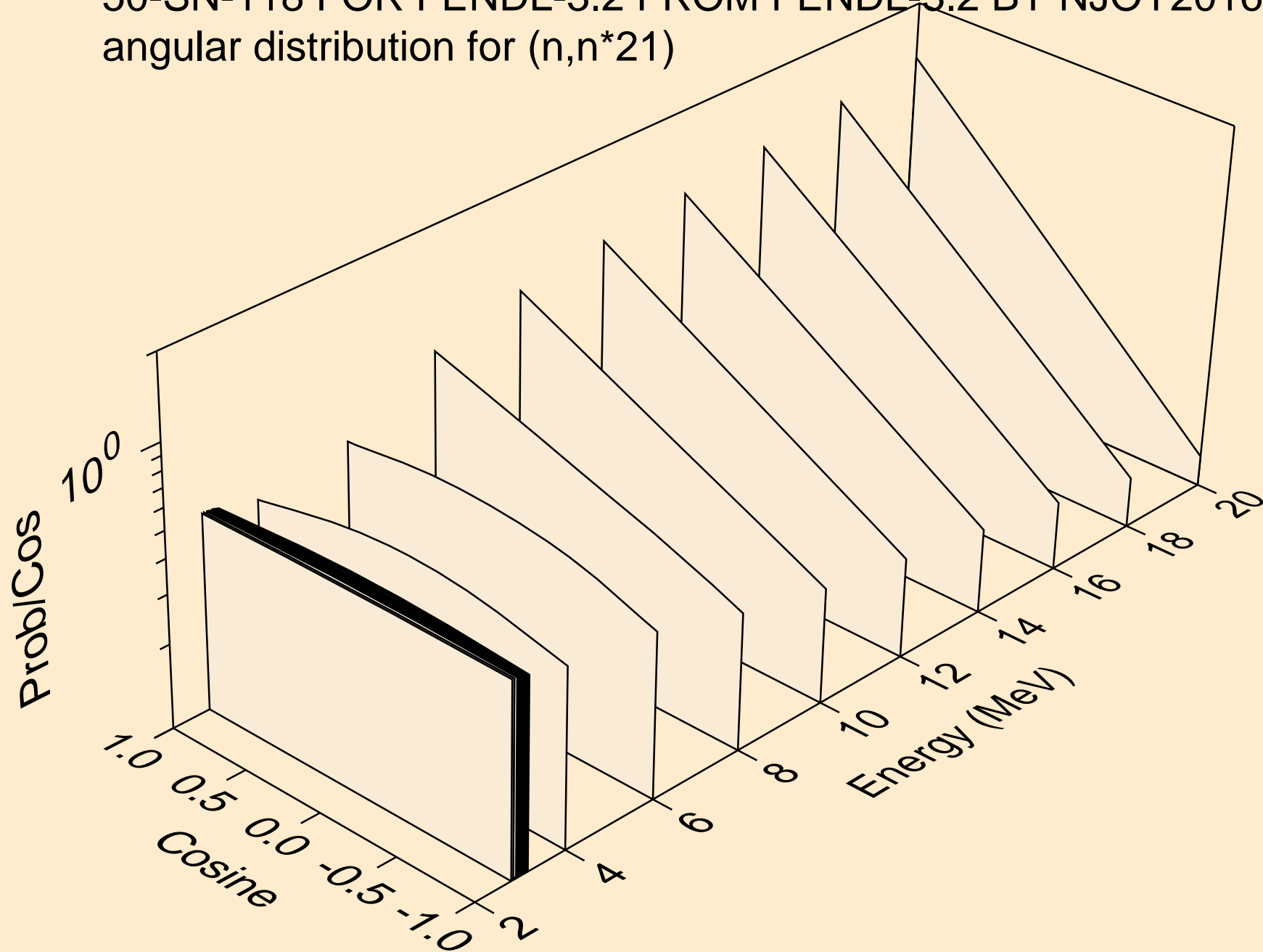

50-SN-118 FOR FENDL-3.2 FROM FENDL-3.2 BY NJOY2016.60+ C  
angular distribution for (n,n\*22)

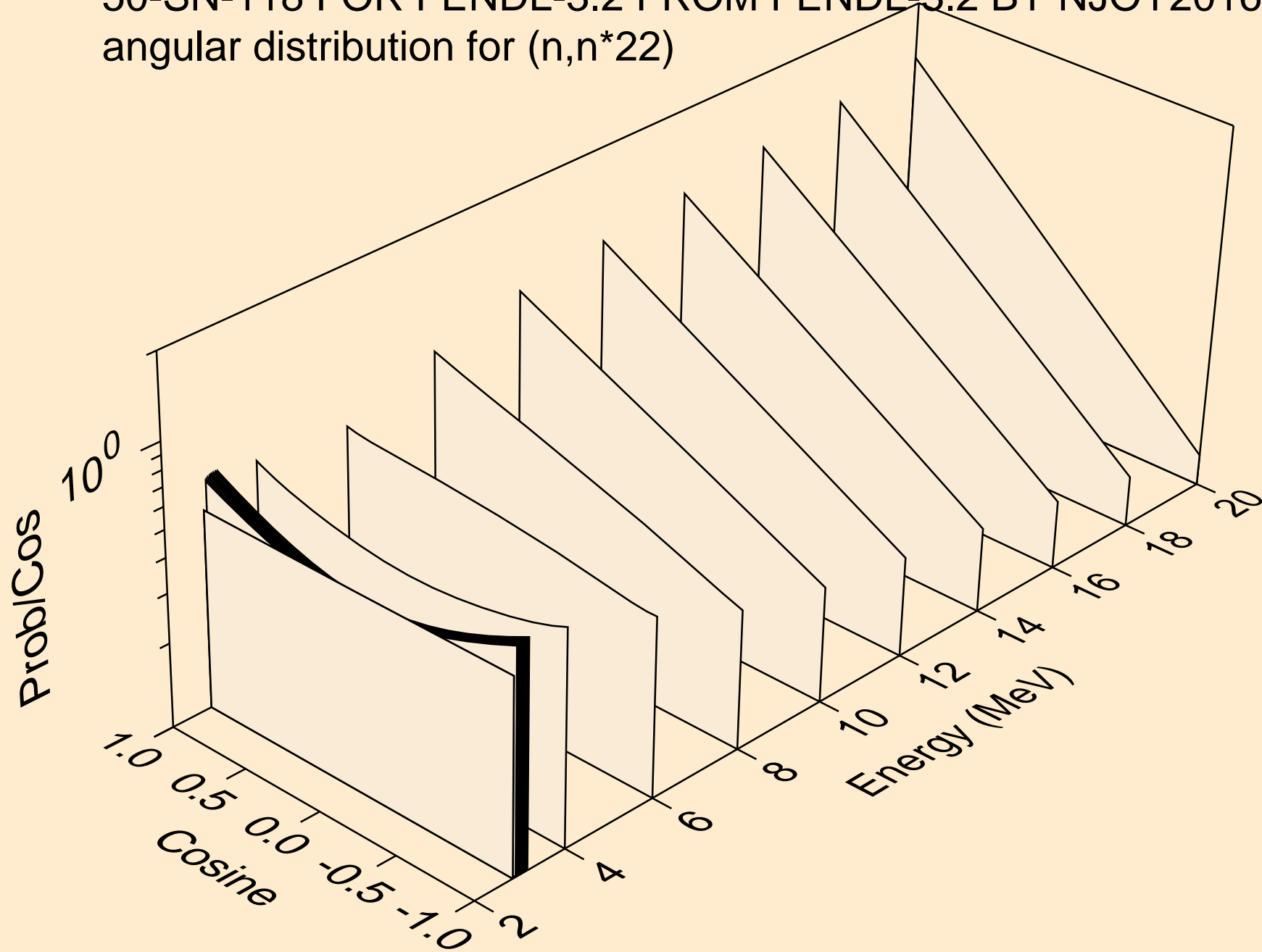

50-SN-118 FOR FENDL-3.2 FROM FENDL-3.2 BY NJOY2016.60+ C  
angular distribution for (n,n\*23)

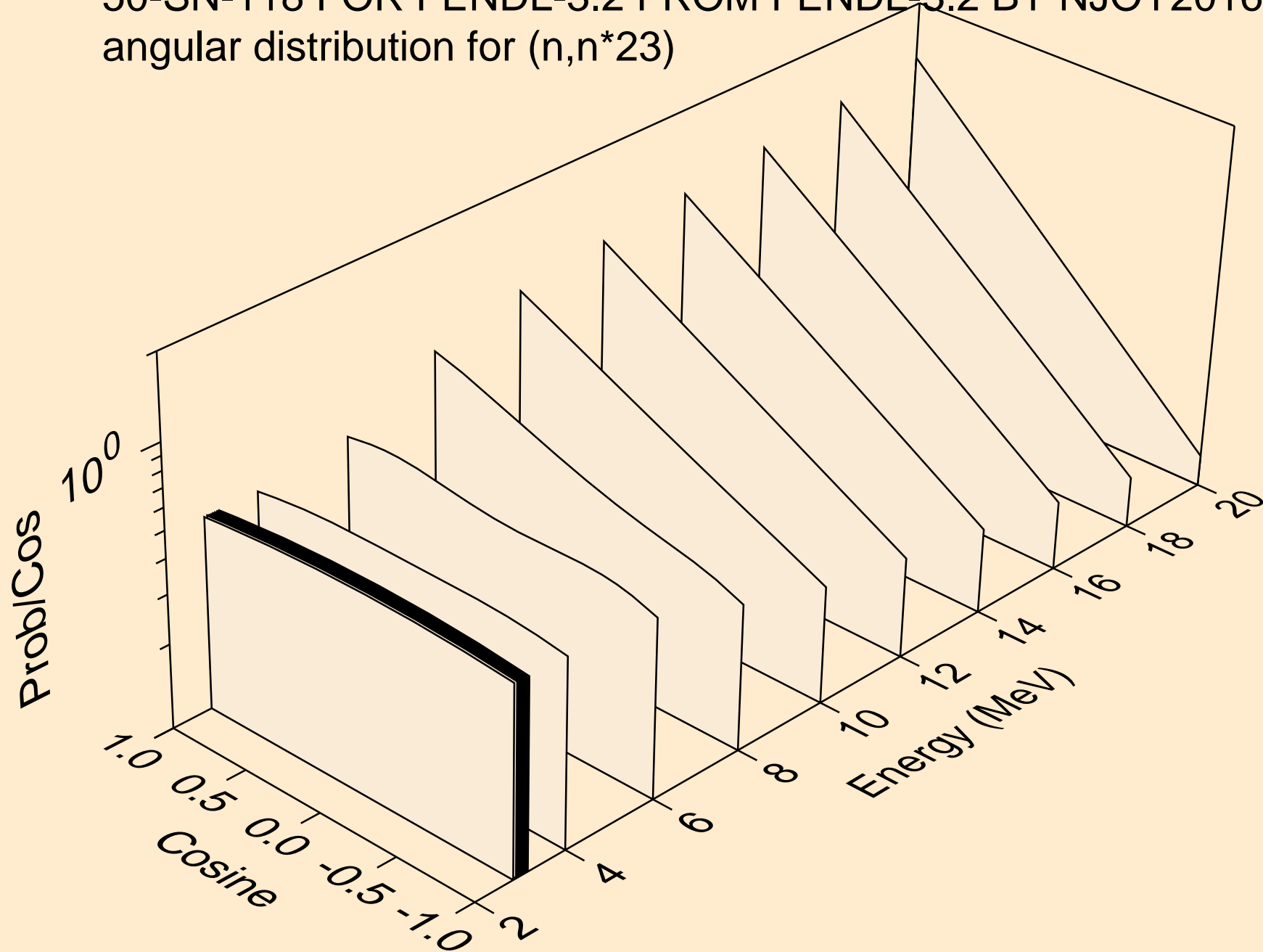

50-SN-118 FOR FENDL-3.2 FROM FENDL-3.2 BY NJOY2016.60+ C  
angular distribution for (n,n\*24)

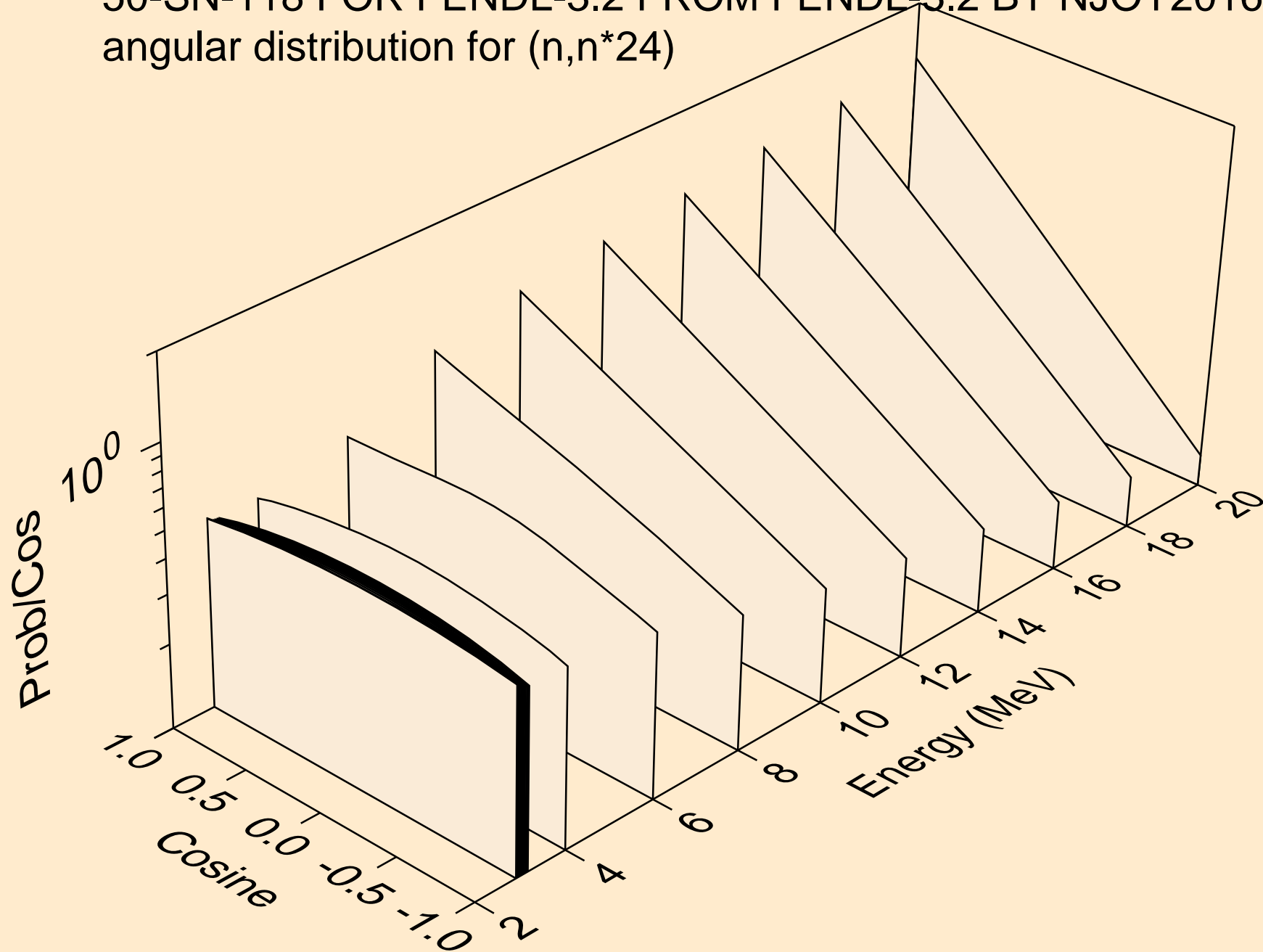

50-SN-118 FOR FENDL-3.2 FROM FENDL-3.2 BY NJOY2016.60+ C  
angular distribution for (n,n\*25)

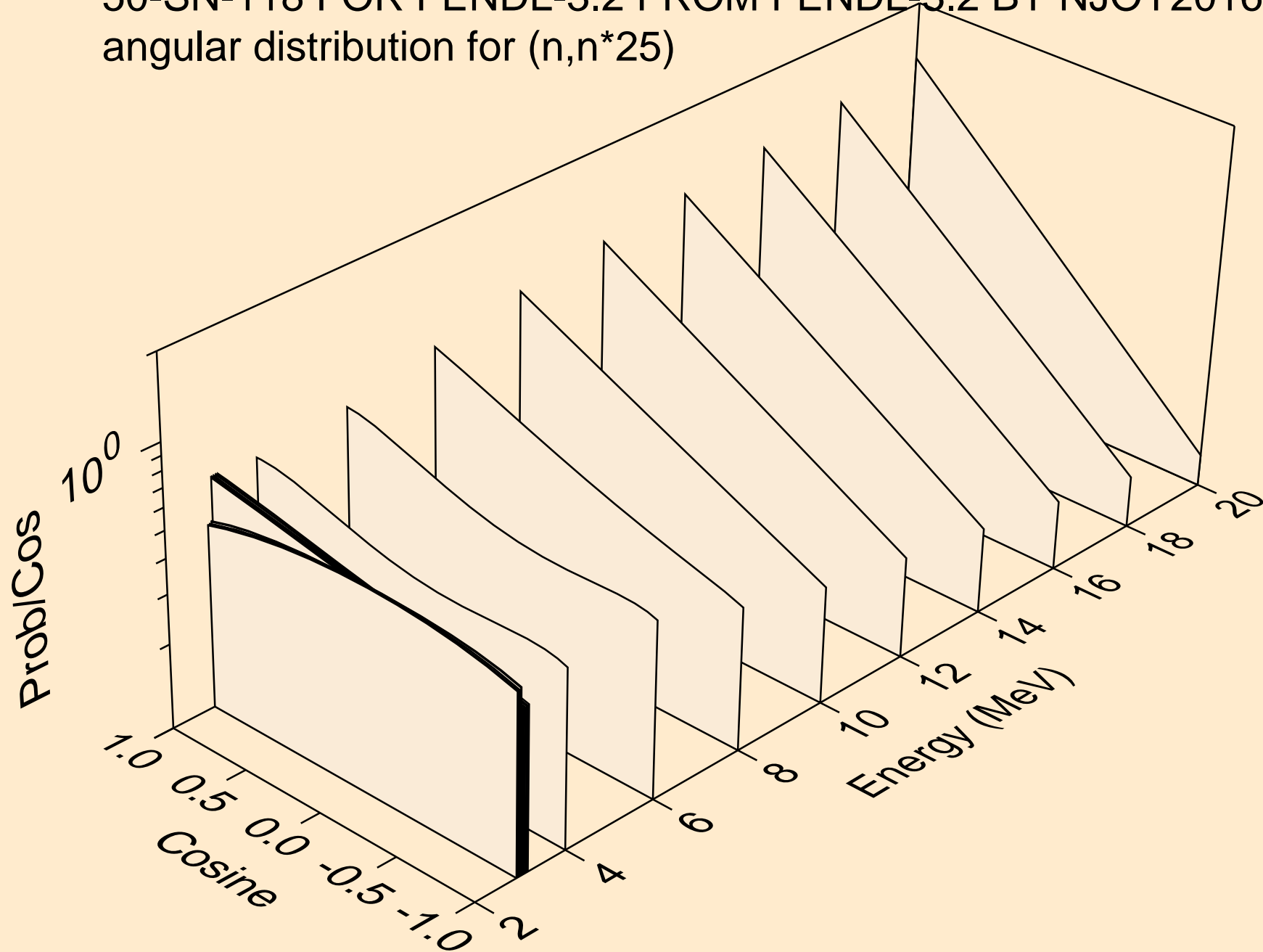

50-SN-118 FOR FENDL-3.2 FROM FENDL-3.2 BY NJOY2016.60+ C  
angular distribution for (n,n\*26)

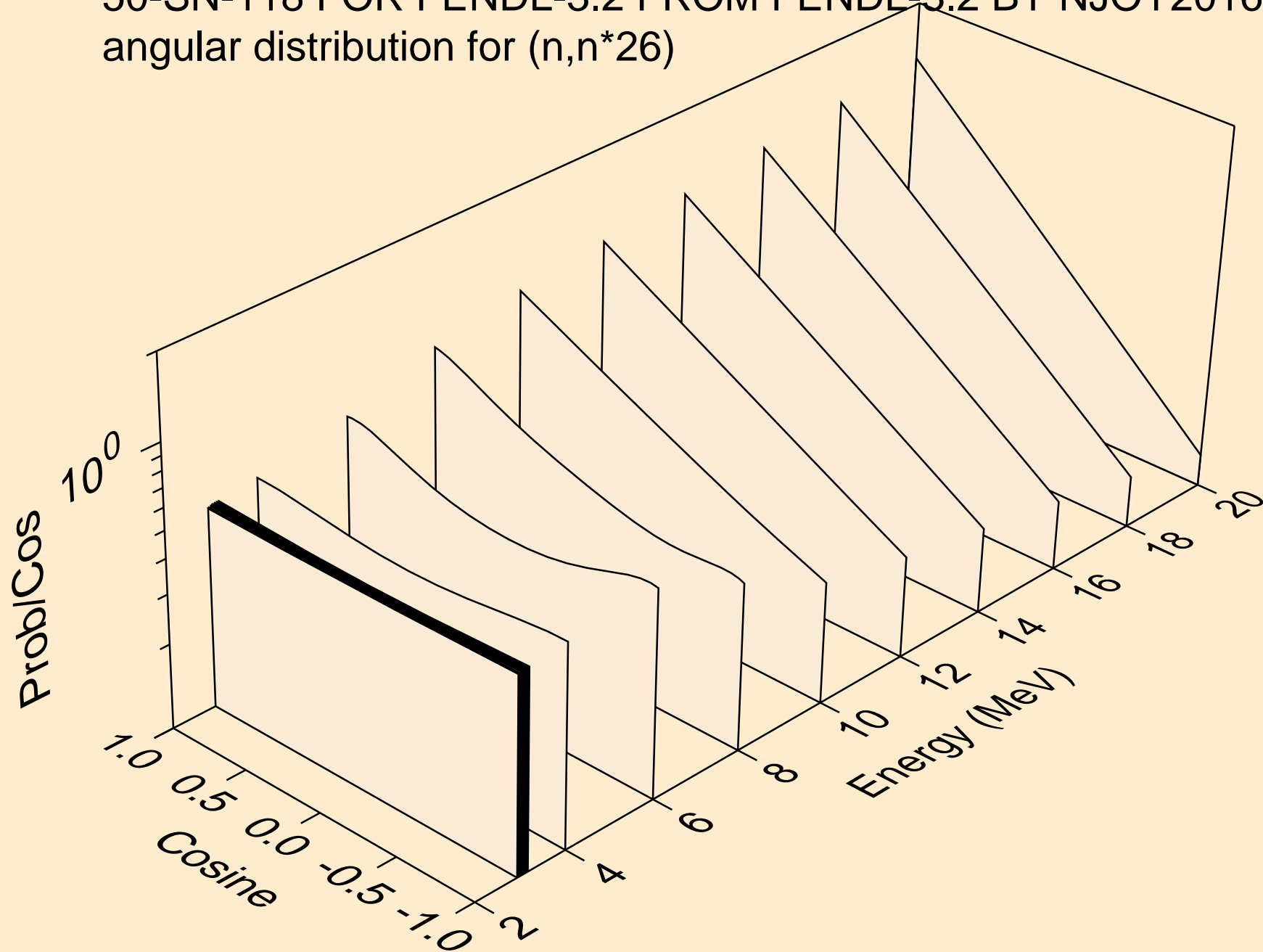

50-SN-118 FOR FENDL-3.2 FROM FENDL-3.2 BY NJOY2016.60+ C  
angular distribution for (n,n\*27)

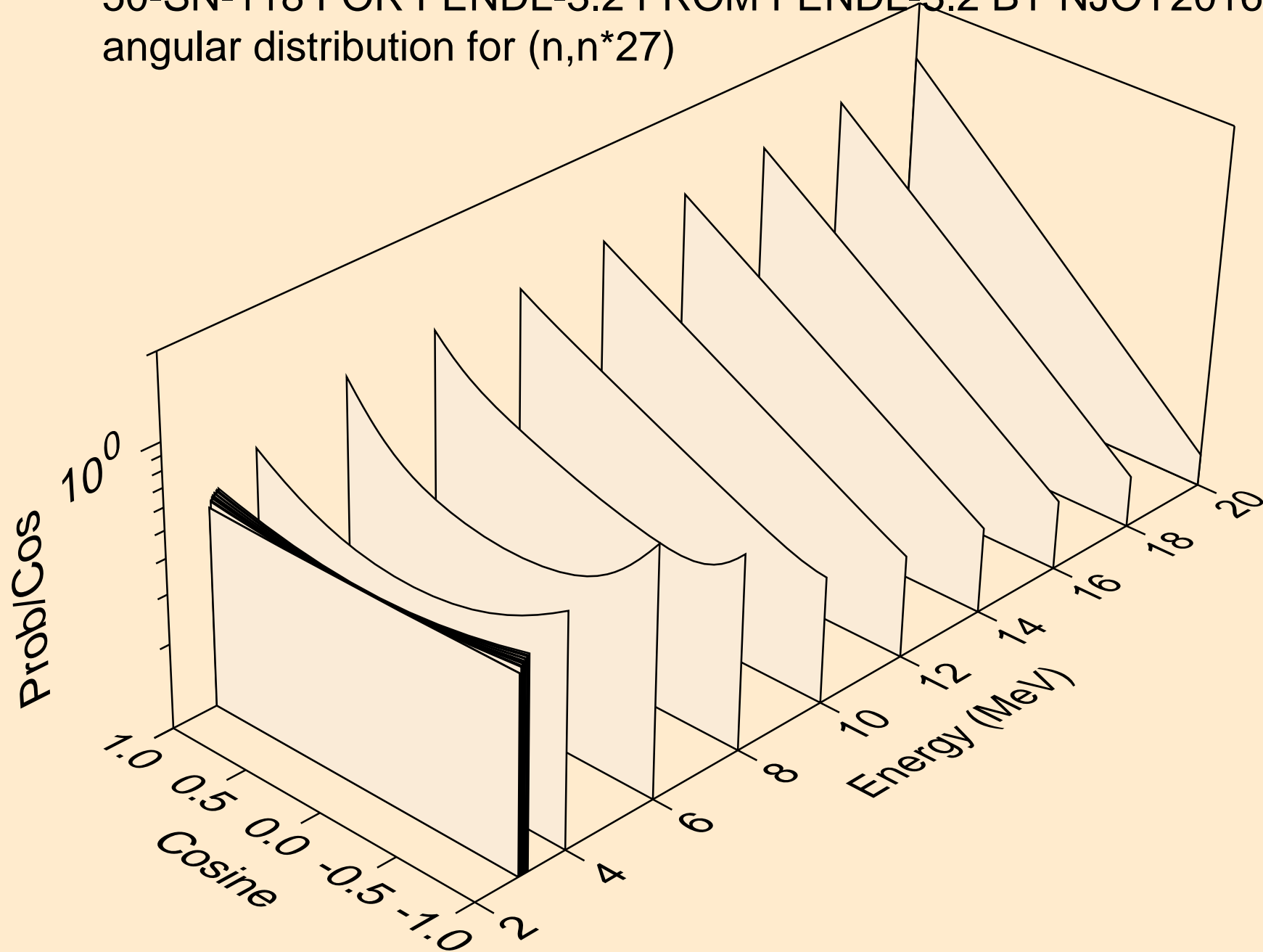



50-SN-118 FOR FENDL-3.2 FROM FENDL-3.2 BY NJOY2016.60+ C  
angular distribution for (n,n\*28)

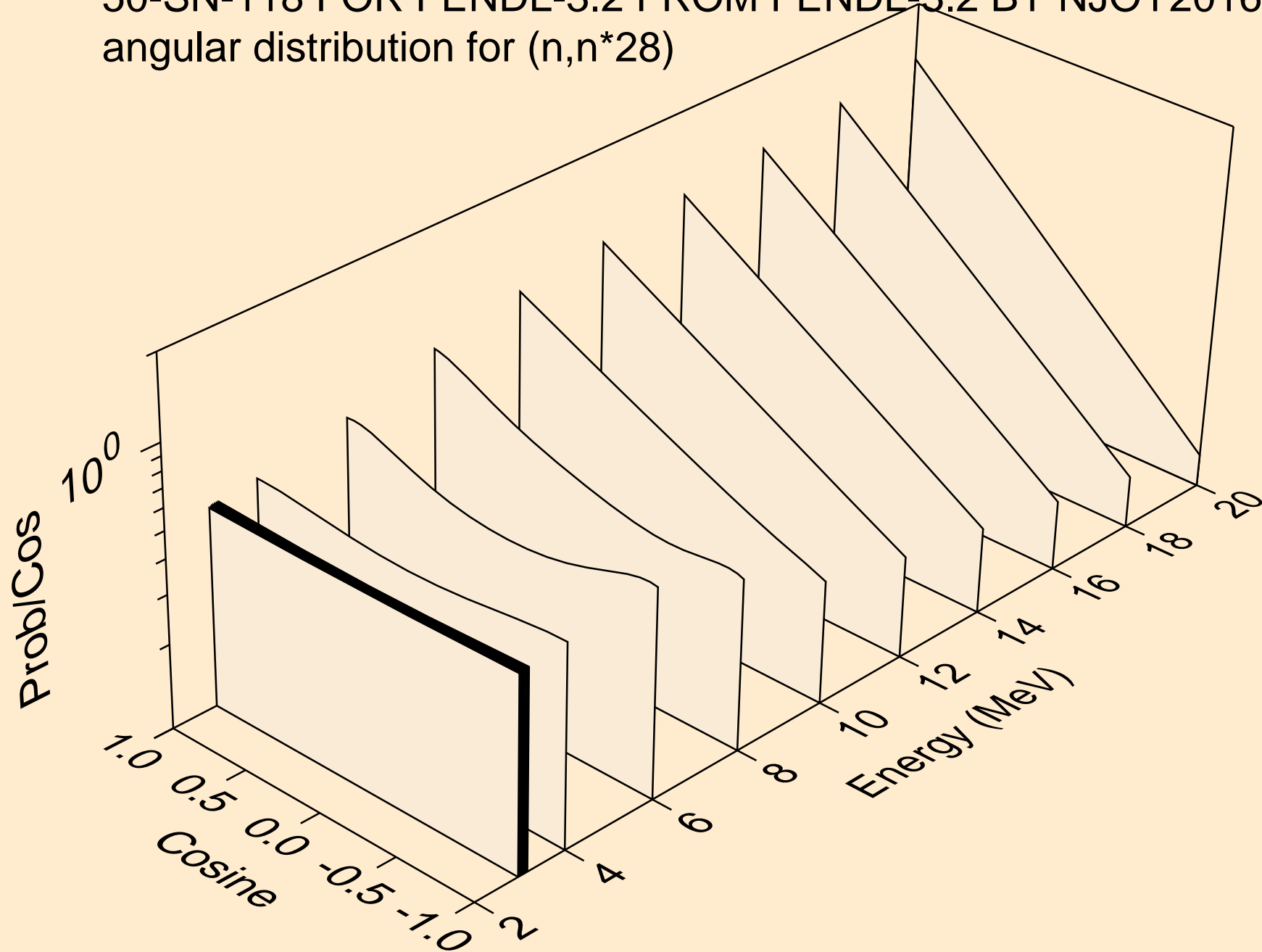

50-SN-118 FOR FENDL-3.2 FROM FENDL-3.2 BY NJOY2016.60+ C  
angular distribution for (n,n\*29)

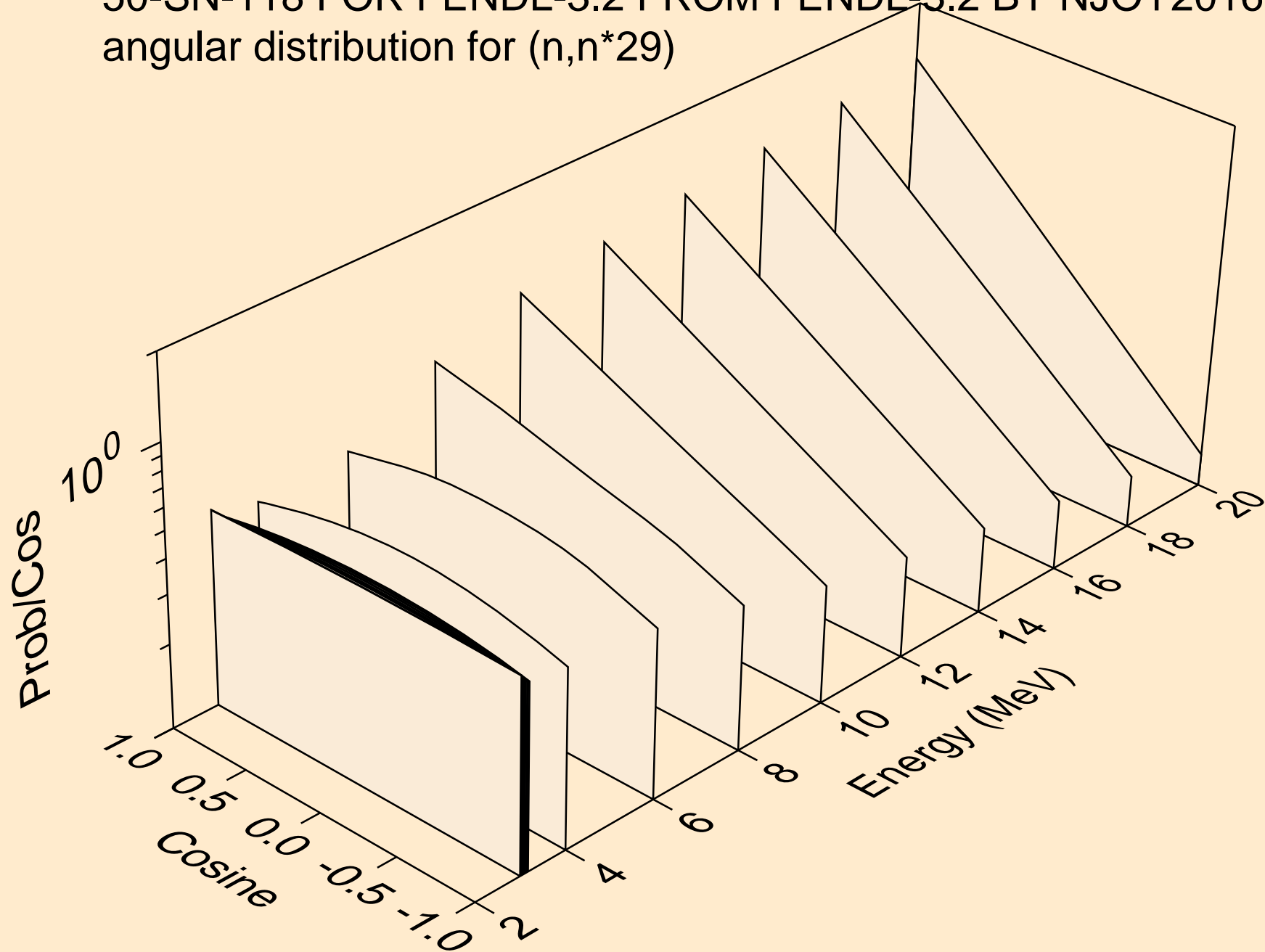

50-SN-118 FOR FENDL-3.2 FROM FENDL-3.2 BY NJOY2016.60+ C  
angular distribution for (n,n\*30)

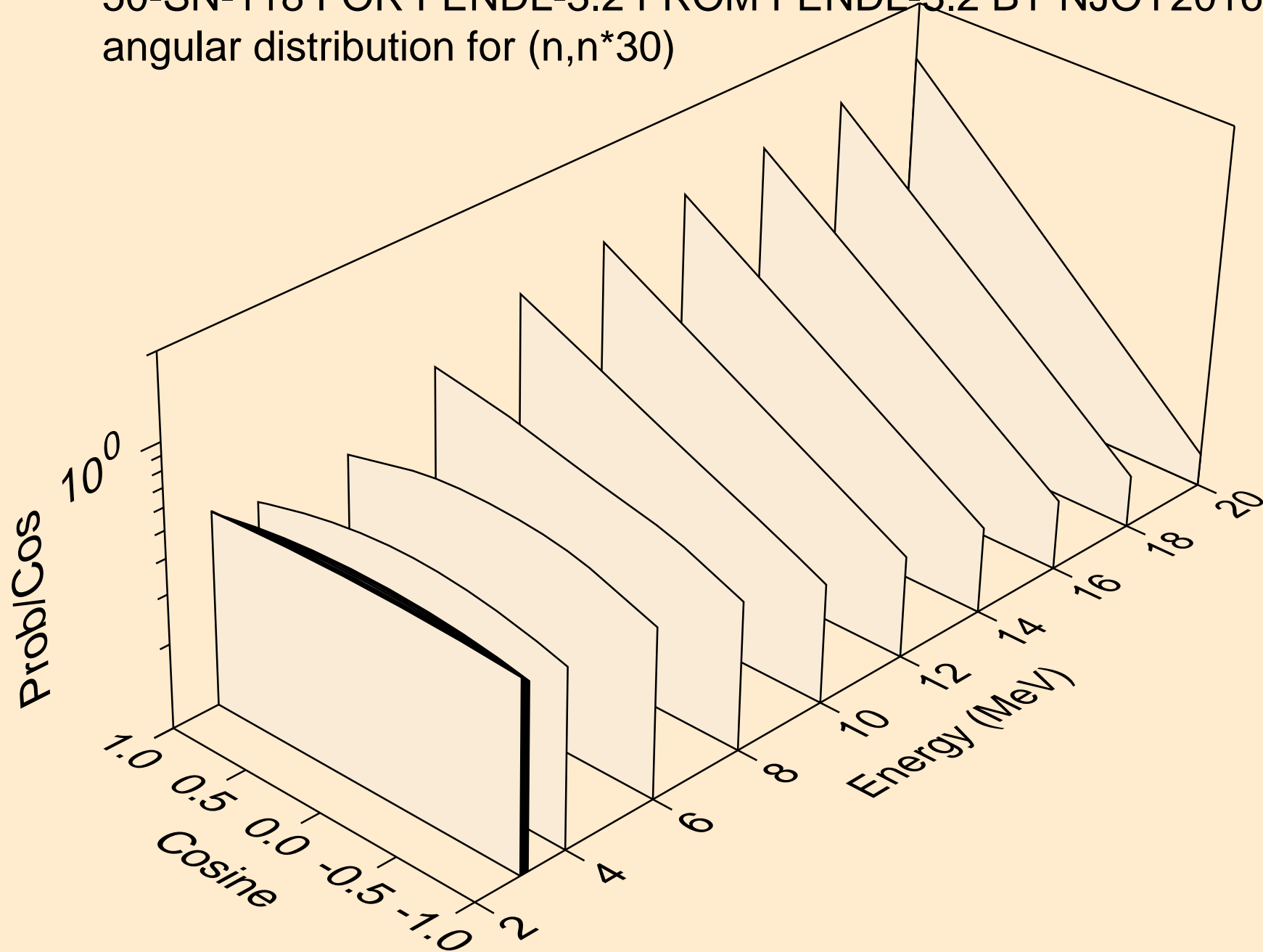

50-SN-118 FOR FENDL-3.2 FROM FENDL-3.2 BY NJOY2016.60+ C  
angular distribution for (n,n\*31)

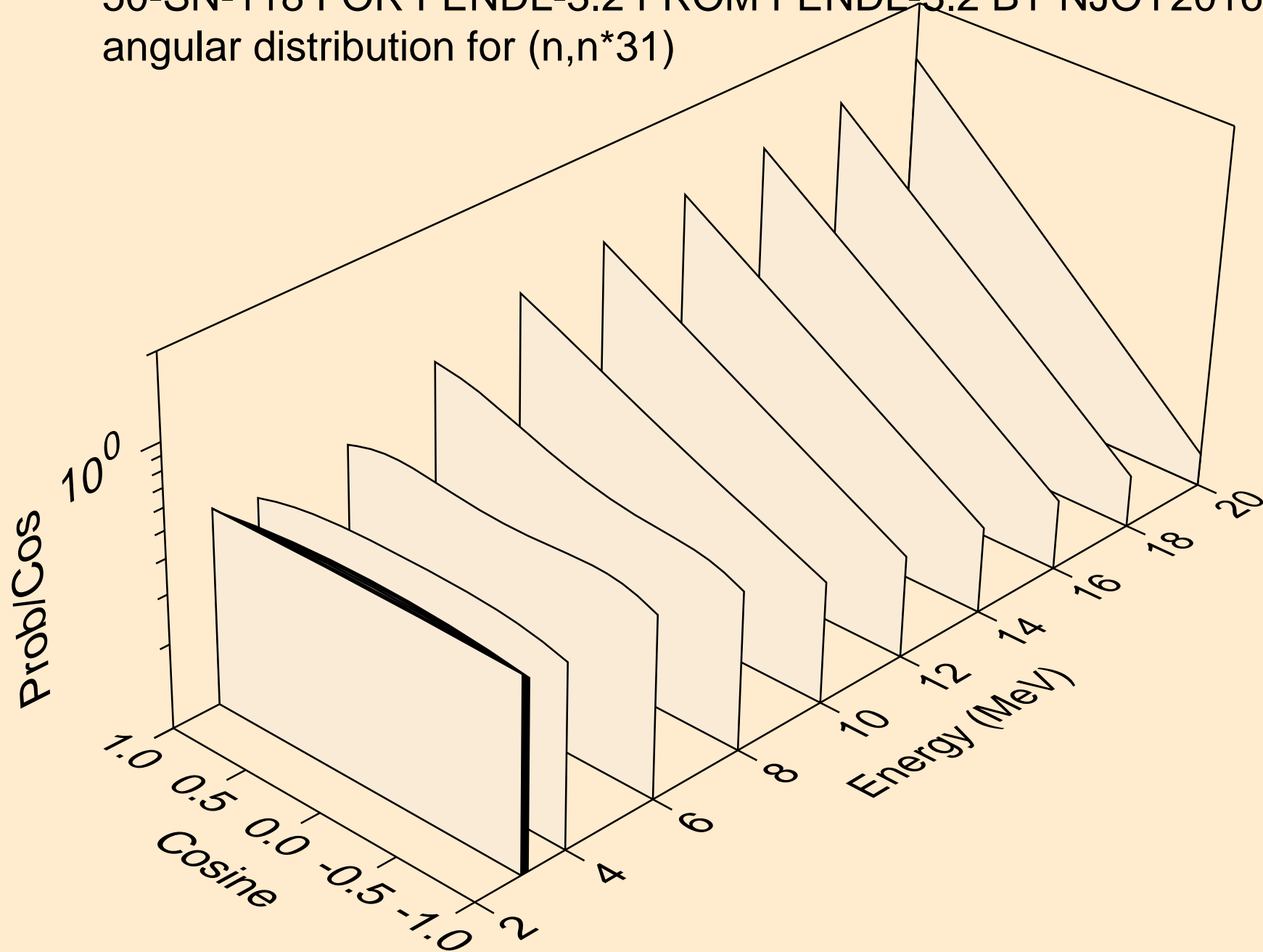

50-SN-118 FOR FENDL-3.2 FROM FENDL-3.2 BY NJOY2016.60+ C  
angular distribution for (n,n\*32)

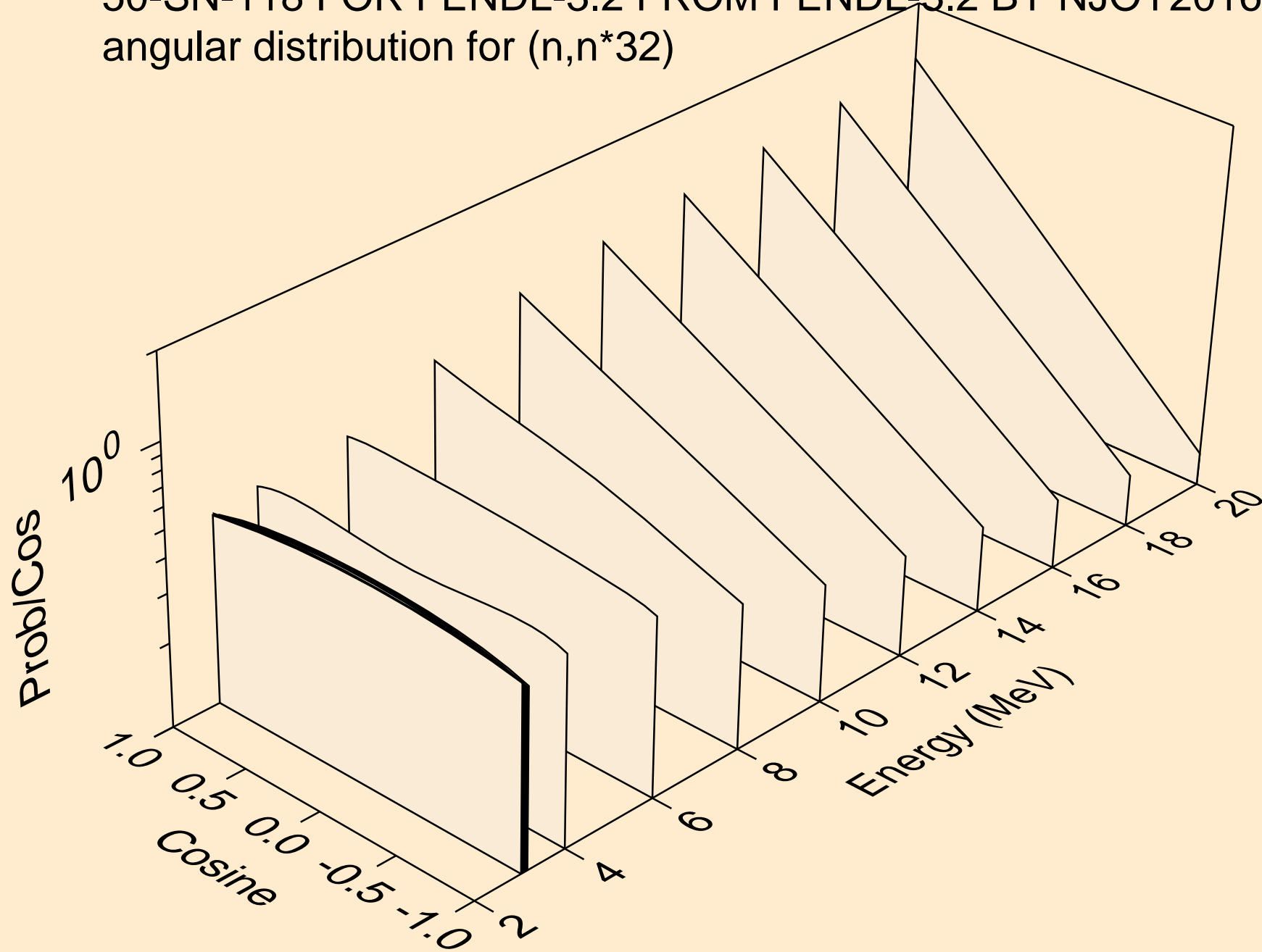

50-SN-118 FOR FENDL-3.2 FROM FENDL-3.2 BY NJOY2016.60+ C  
angular distribution for (n,n\*33)

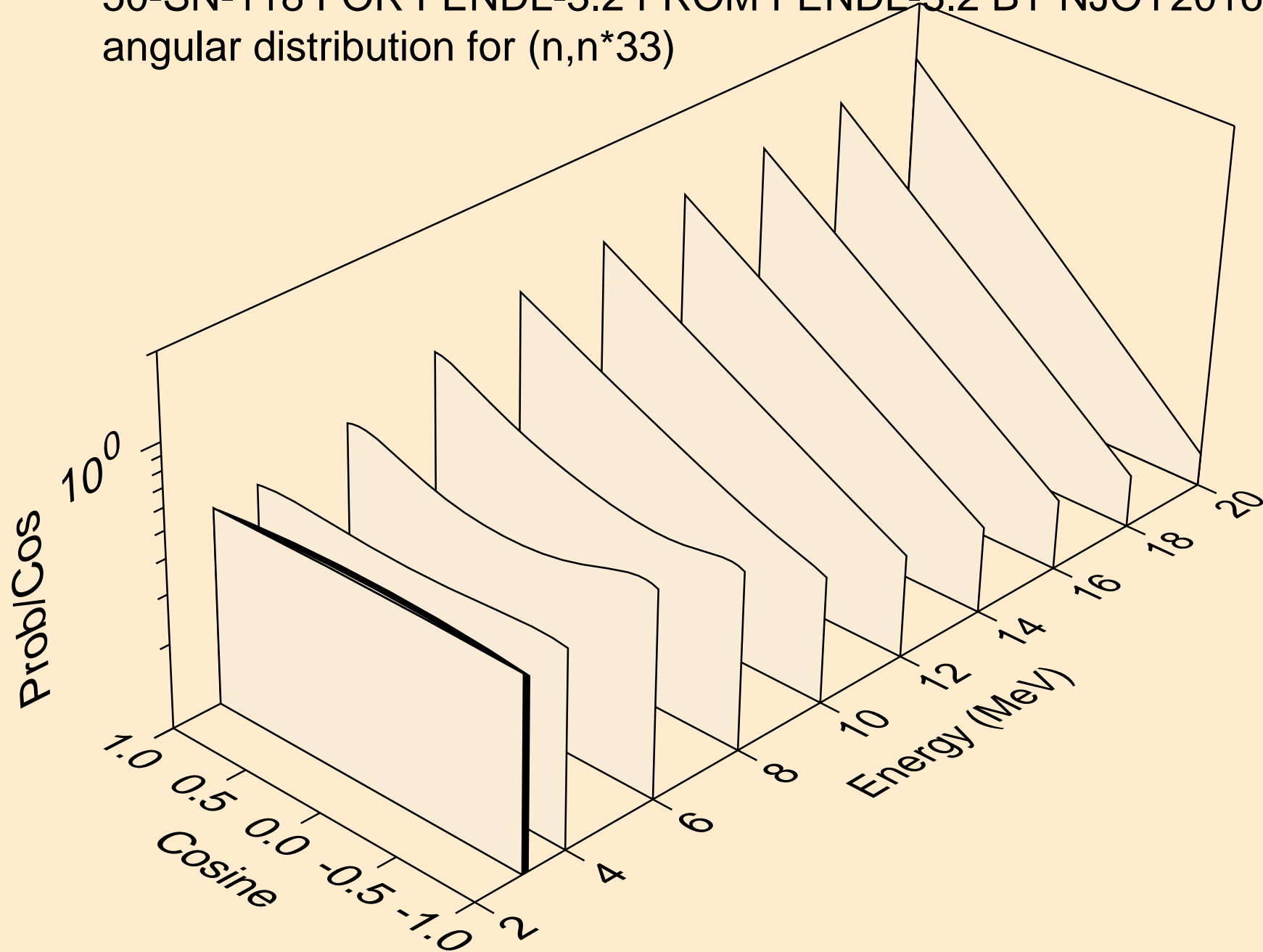

50-SN-118 FOR FENDL-3.2 FROM FENDL-3.2 BY NJOY2016.60+ C  
angular distribution for (n,n\*34)

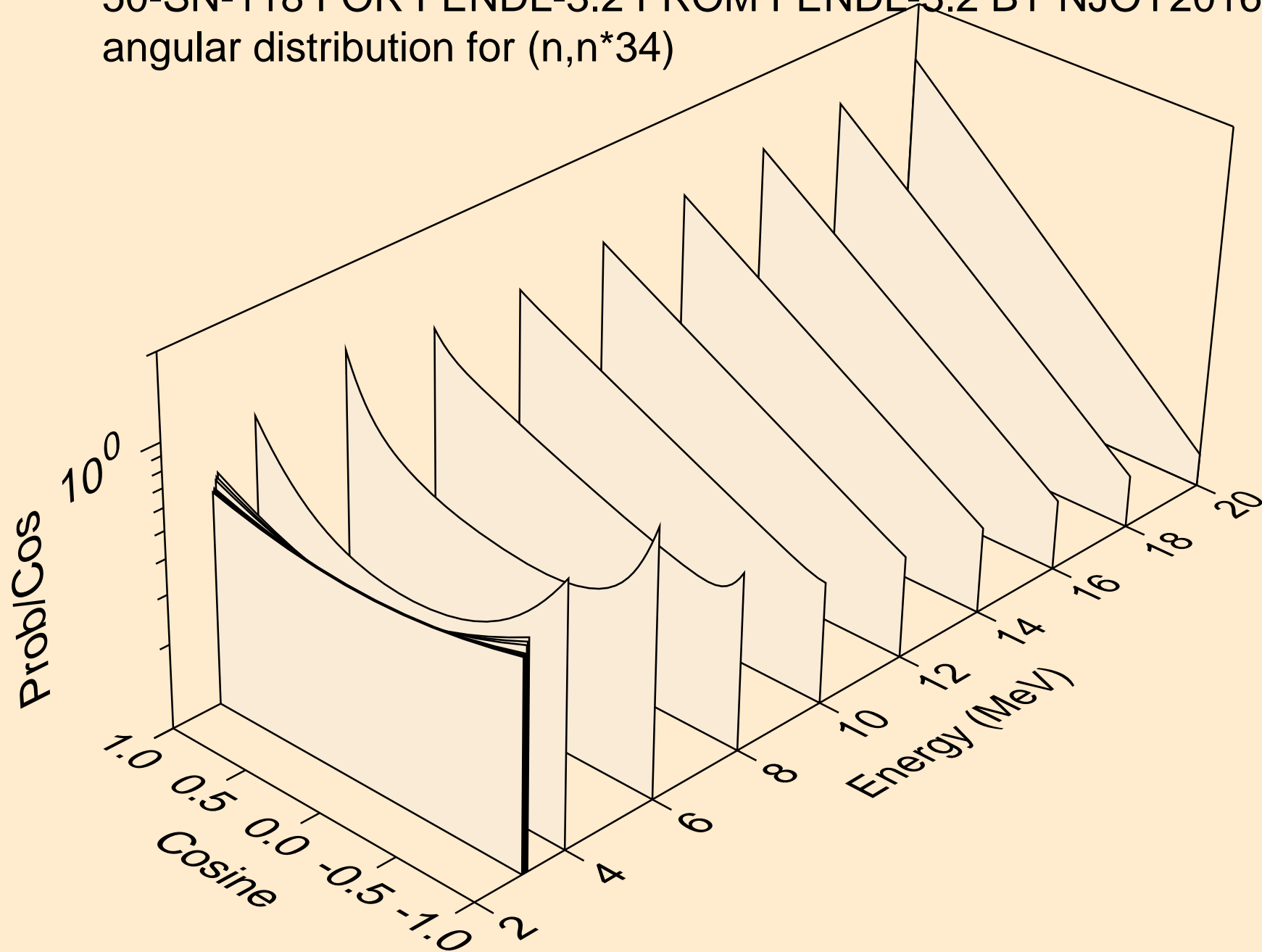

50-SN-118 FOR FENDL-3.2 FROM FENDL-3.2 BY NJOY2016.60+ C  
angular distribution for (n,n\*35)

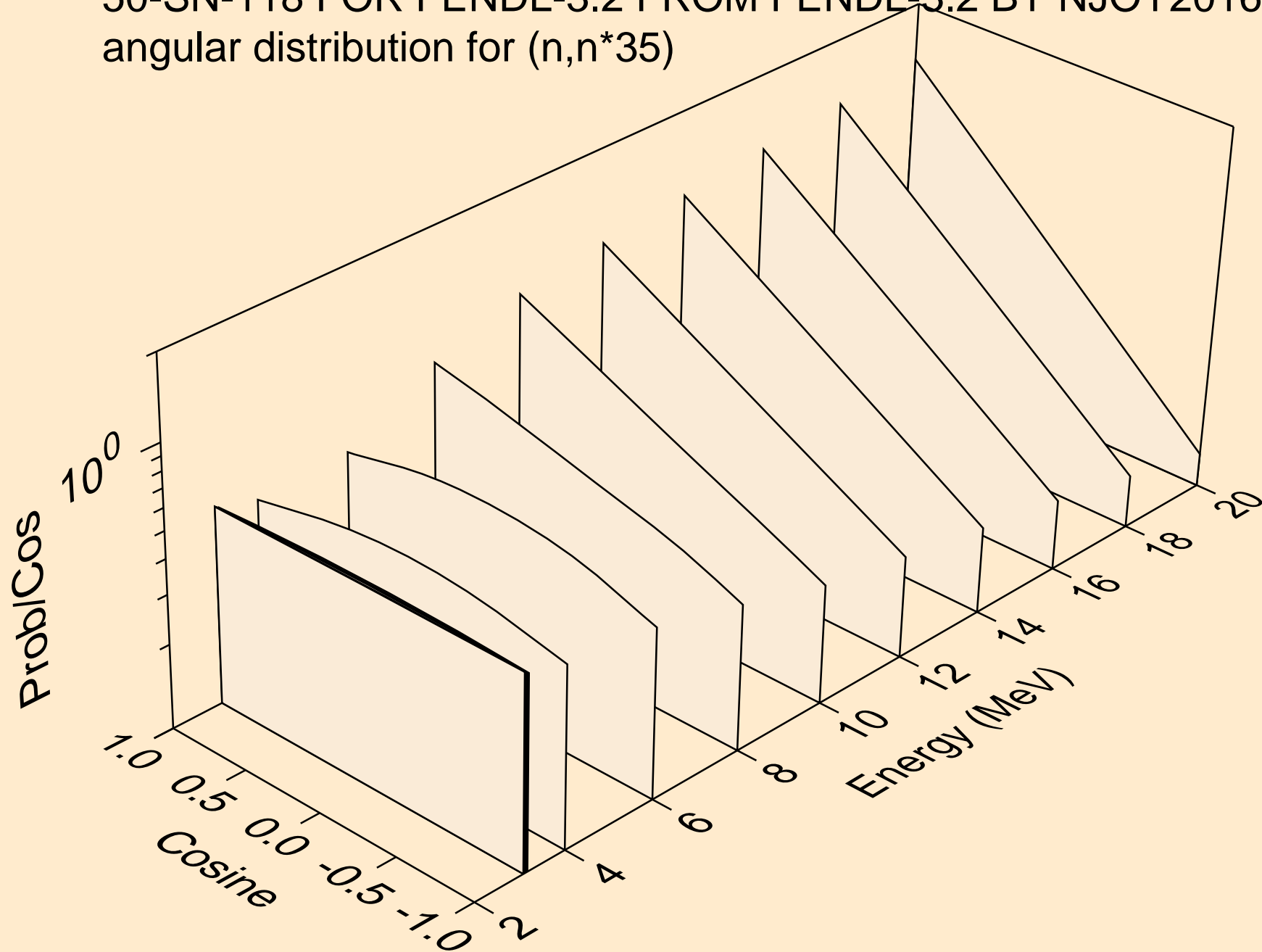



50-SN-118 FOR FENDL-3.2 FROM FENDL-3.2 BY NJOY2016.60+ C  
angular distribution for (n,n\*36)

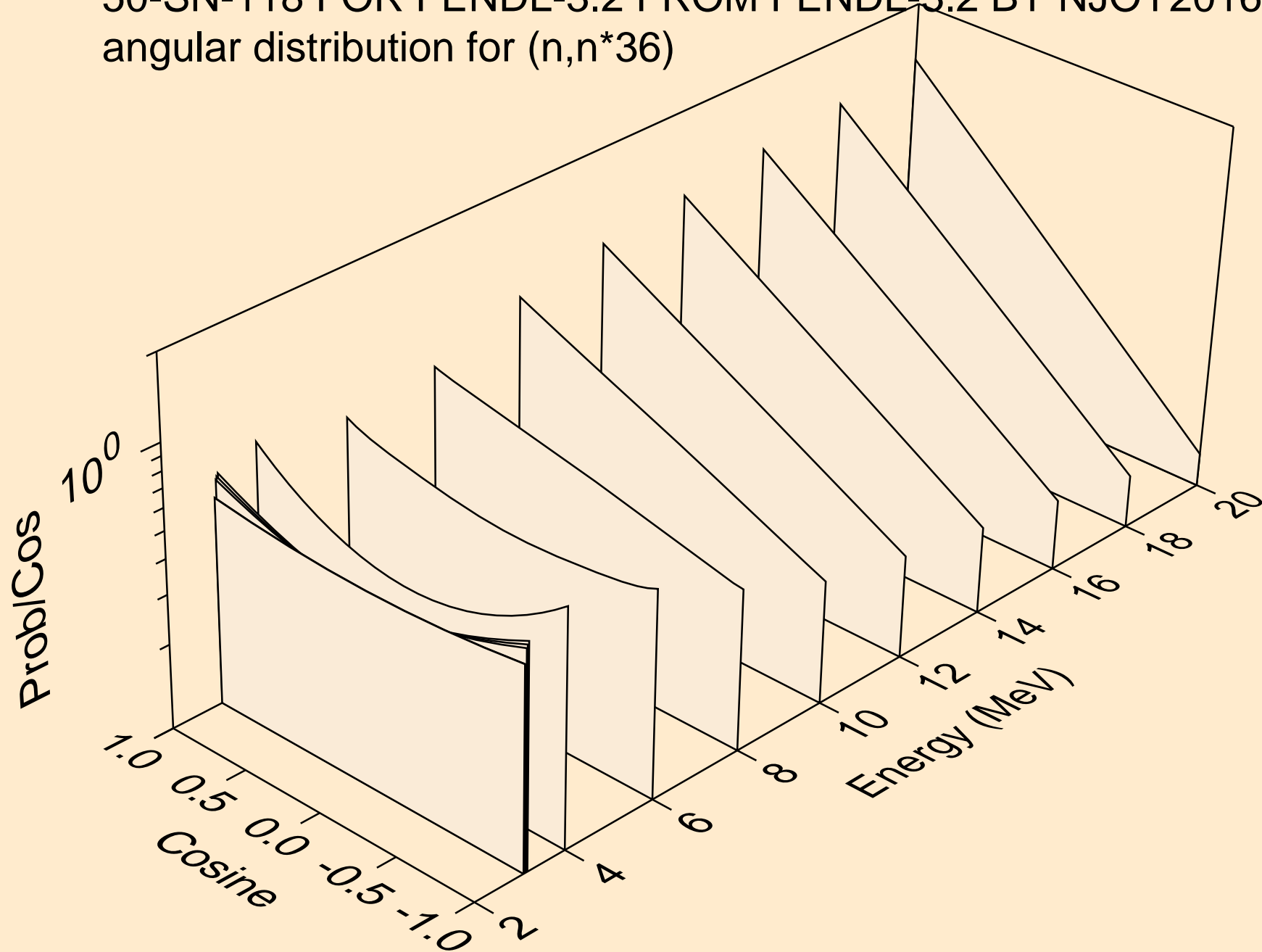

50-SN-118 FOR FENDL-3.2 FROM FENDL-3.2 BY NJOY2016.60+ C  
angular distribution for (n,n\*37)

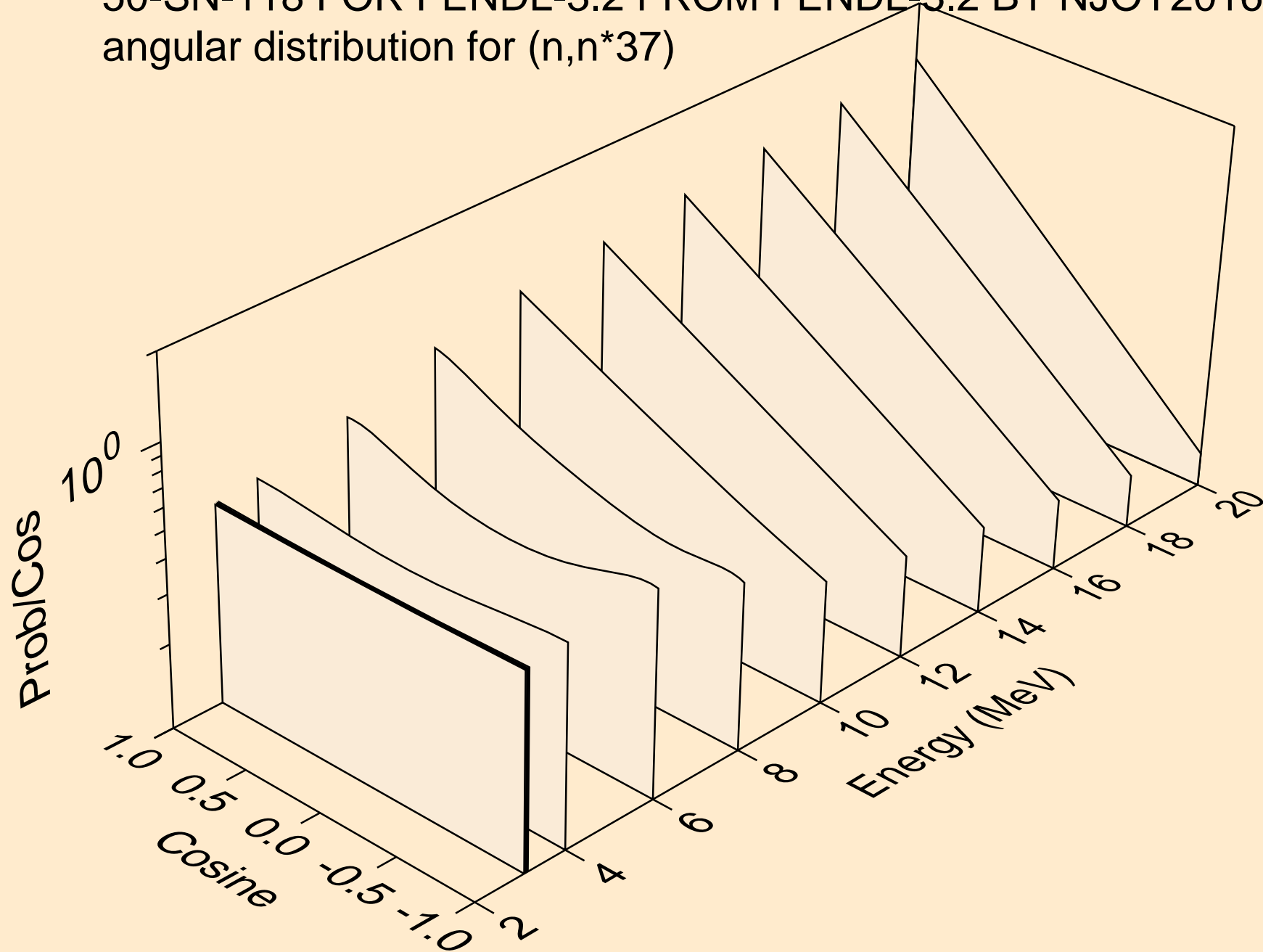

50-SN-118 FOR FENDL-3.2 FROM FENDL-3.2 BY NJOY2016.60+ C  
angular distribution for (n,n\*38)

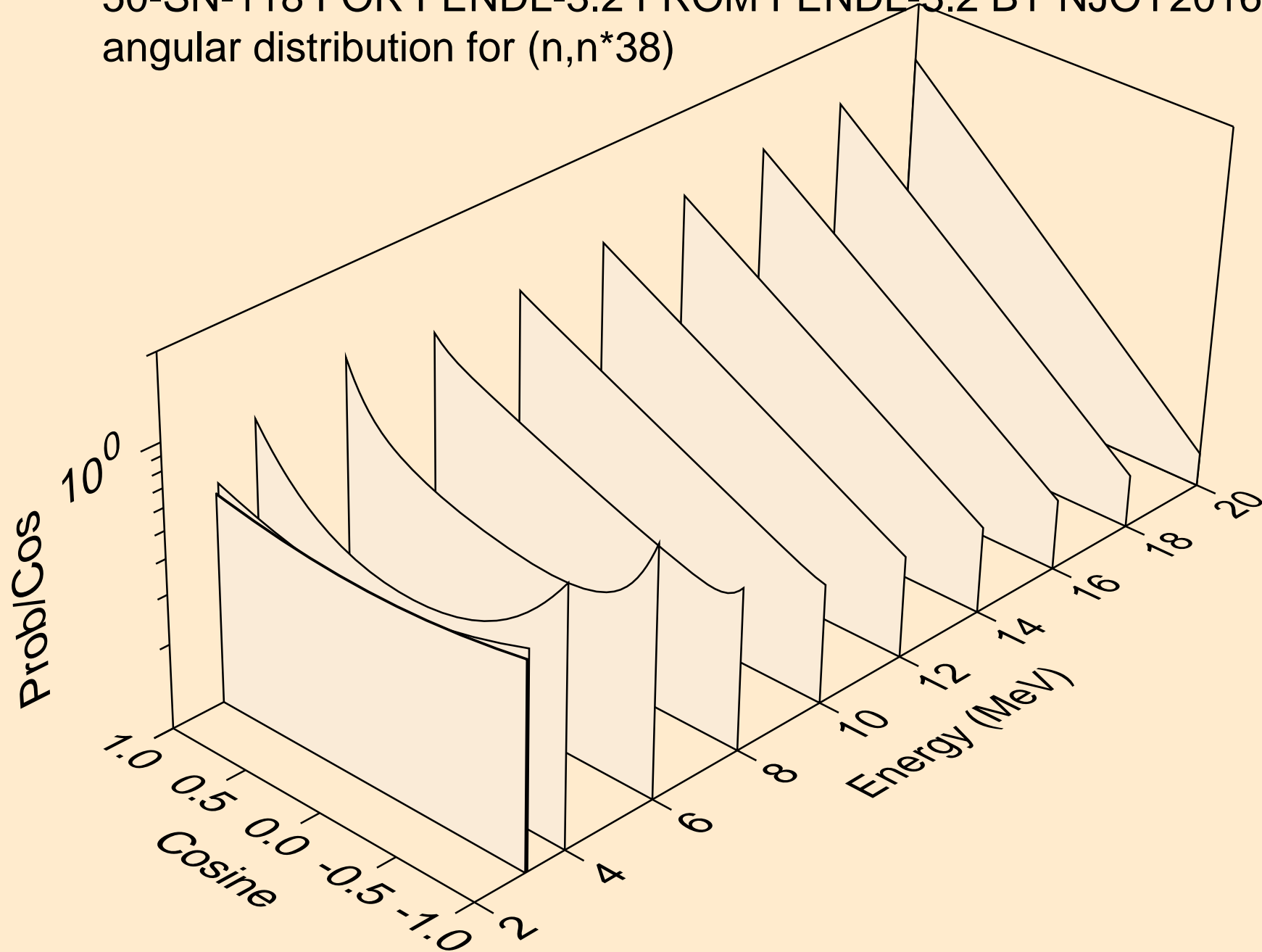

50-SN-118 FOR FENDL-3.2 FROM FENDL-3.2 BY NJOY2016.60+ C  
angular distribution for (n,n\*39)

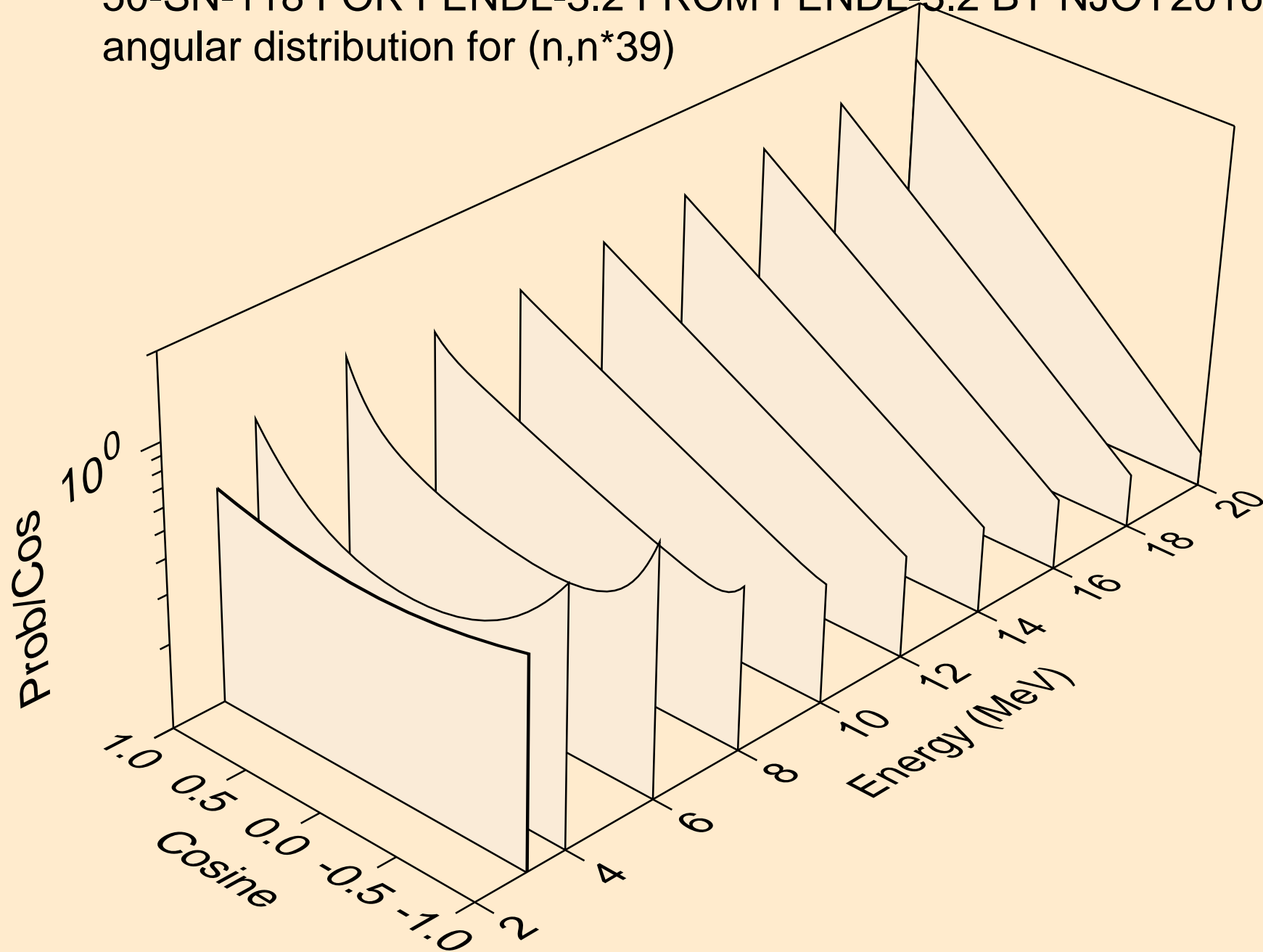

50-SN-118 FOR FENDL-3.2 FROM FENDL-3.2 BY NJOY2016.60+ C  
angular distribution for (n,n\*40)

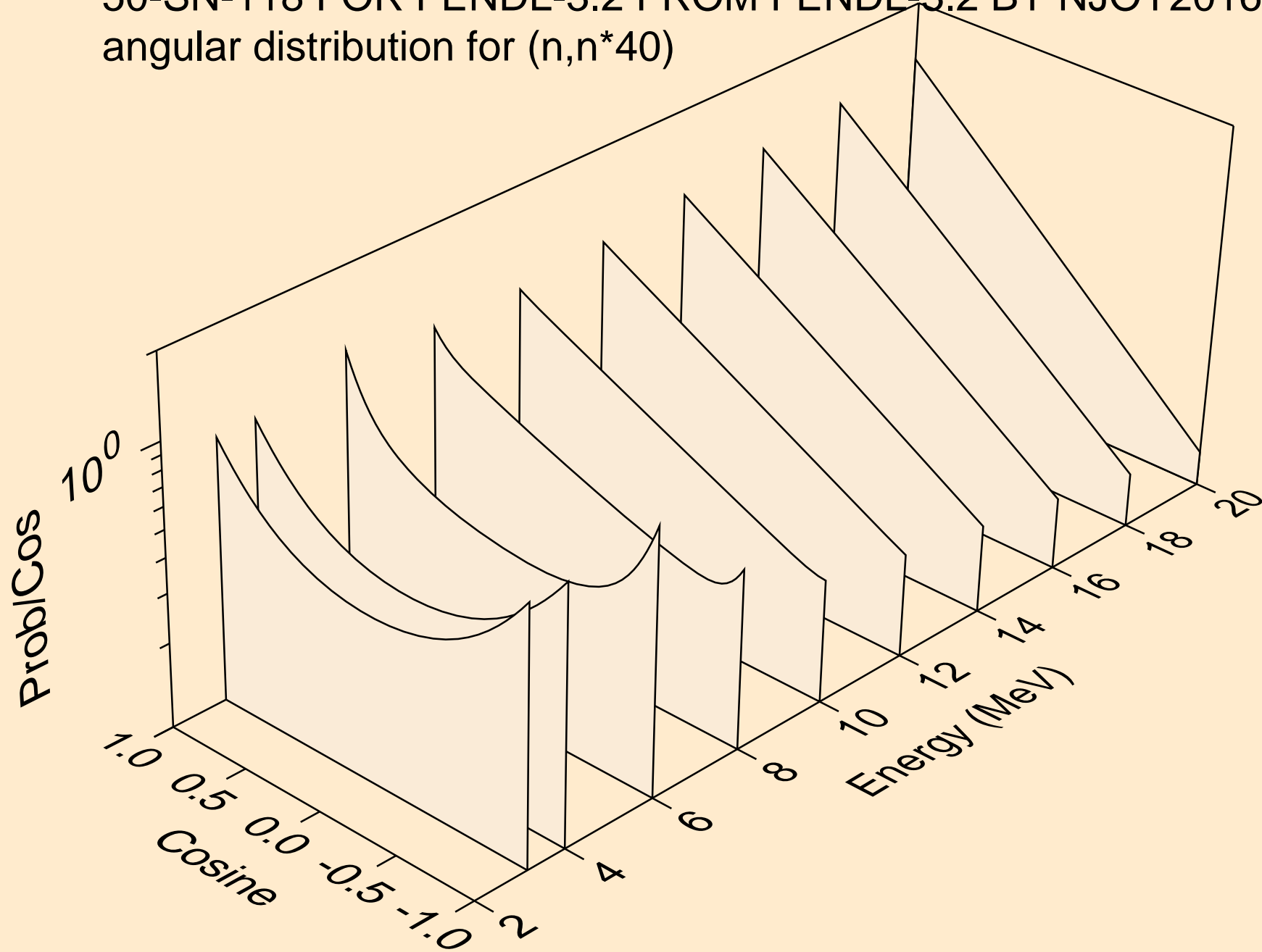

50-SN-118 FOR FENDL-3.2 FROM FENDL-3.2 BY NJOY2016.60+ C  
Neutron emission for (n,x)

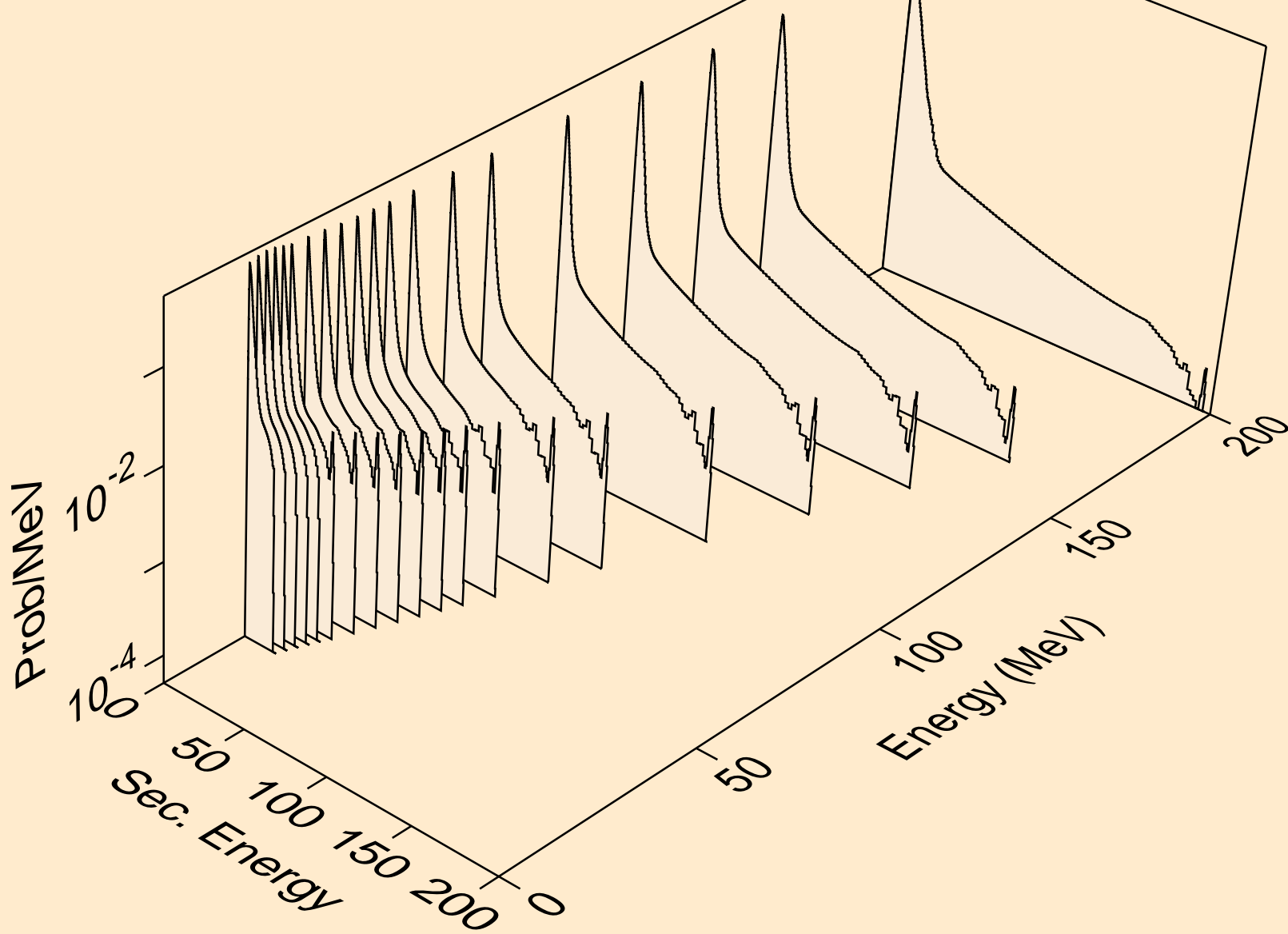

50-SN-118 FOR FENDL-3.2 FROM FENDL-3.2 BY NJOY2016.60+ C  
Neutron emission for (n,2n)

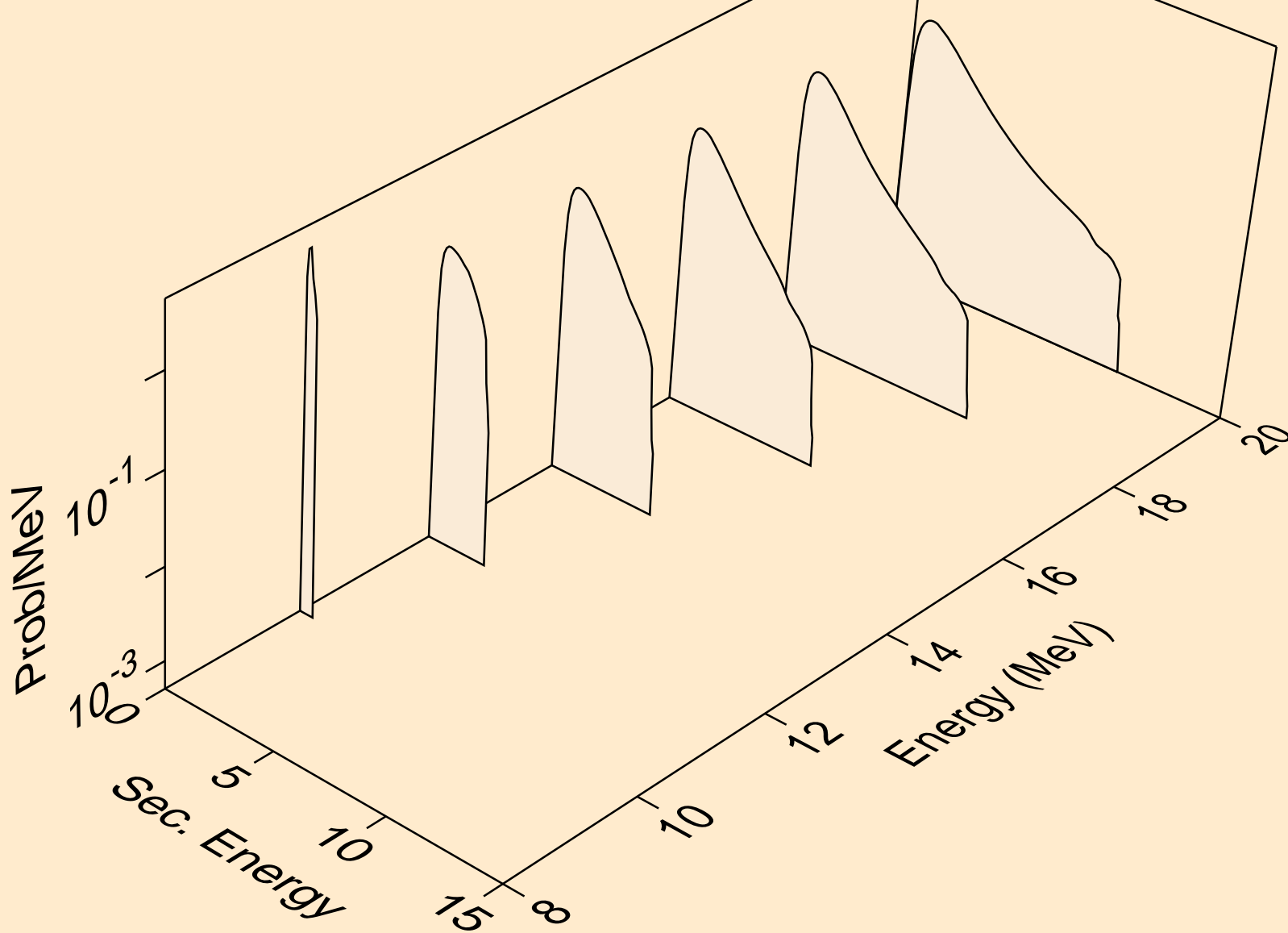

50-SN-118 FOR FENDL-3.2 FROM FENDL-3.2 BY NJOY2016.60+ C  
Neutron emission for (n,3n)

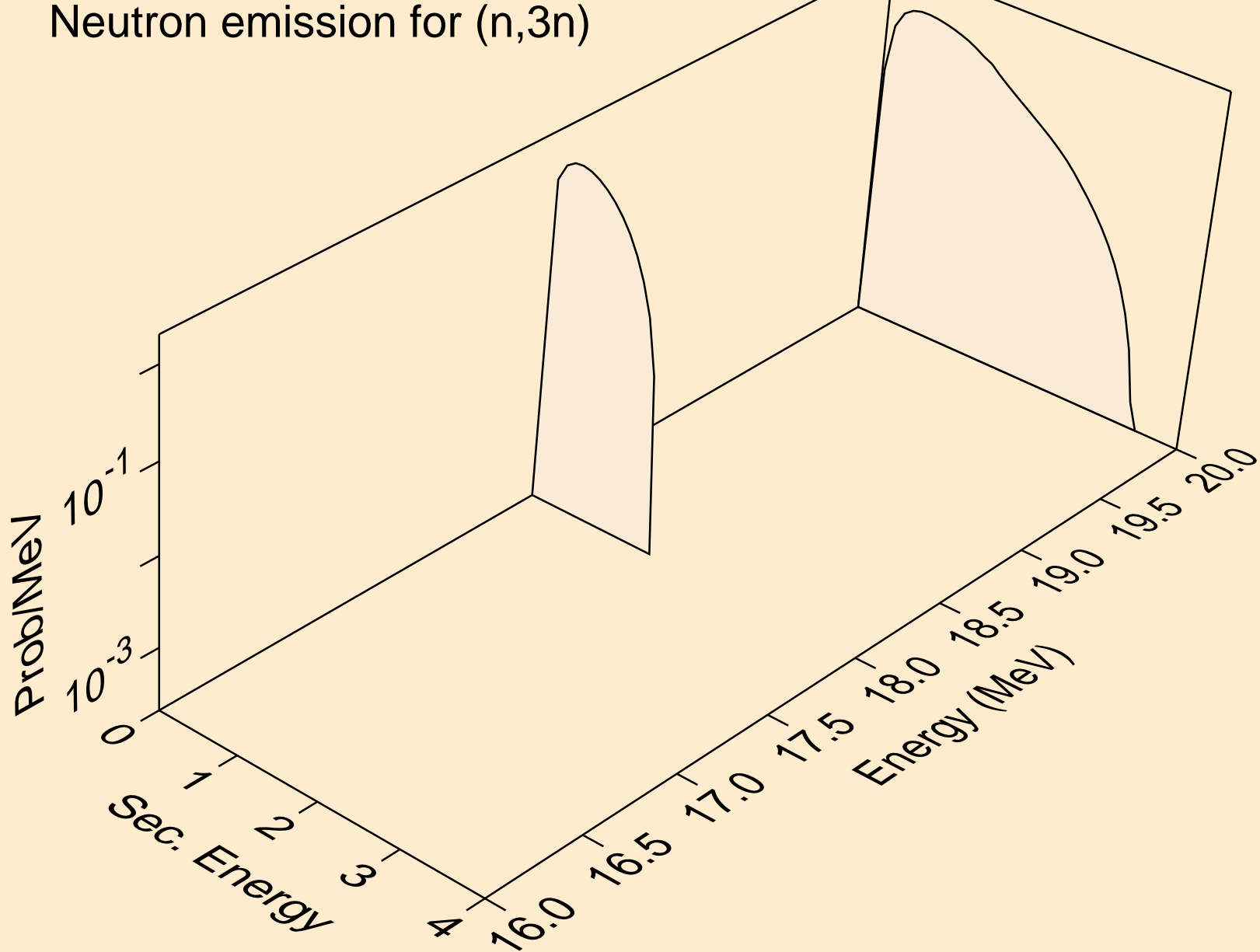



50-SN-118 FOR FENDL-3.2 FROM FENDL-3.2 BY NJOY2016.60+ C  
Neutron emission for (n,n\*)a

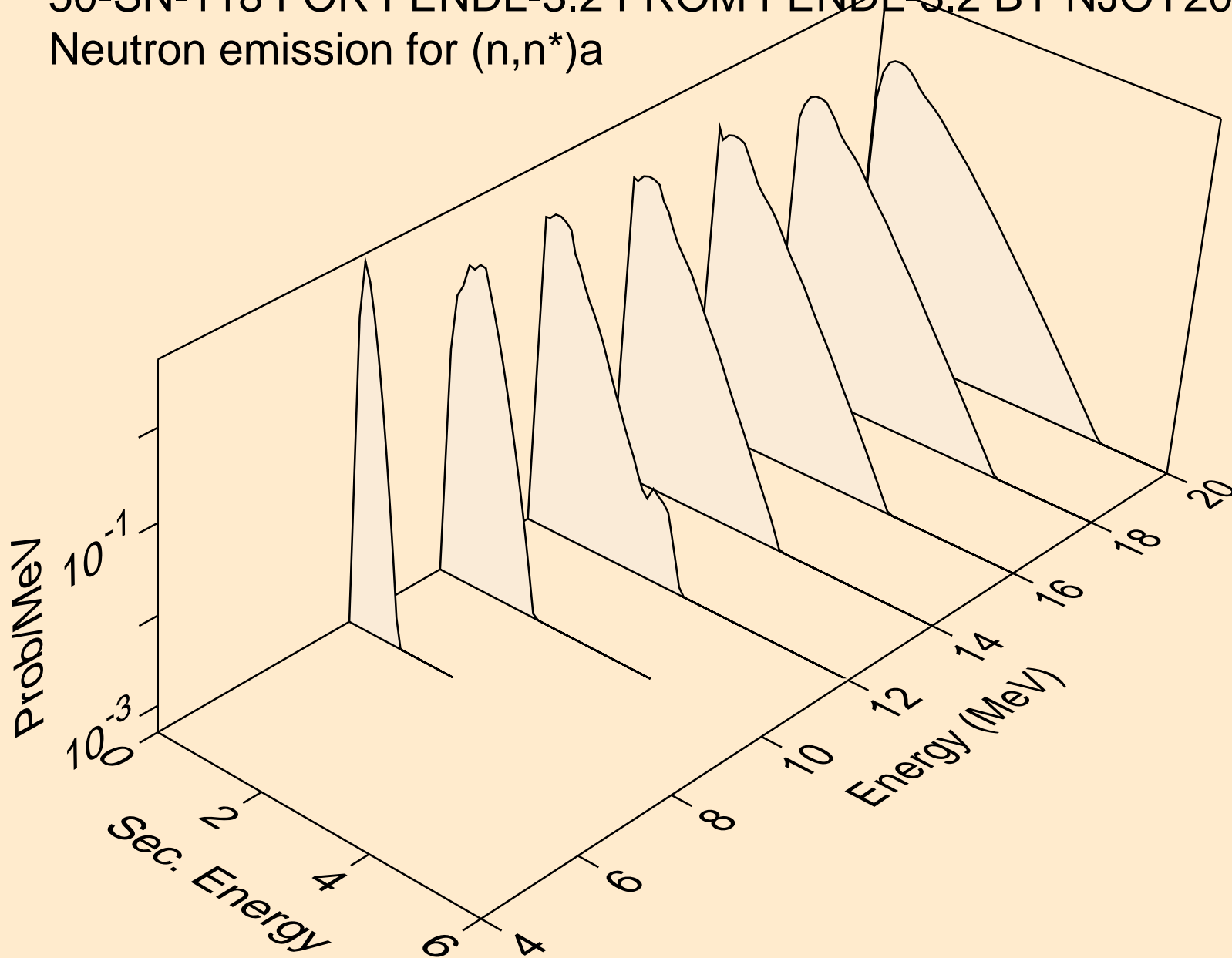

50-SN-118 FOR FENDL-3.2 FROM FENDL-3.2 BY NJOY2016.60+ C  
Neutron emission for (n,n\*)p

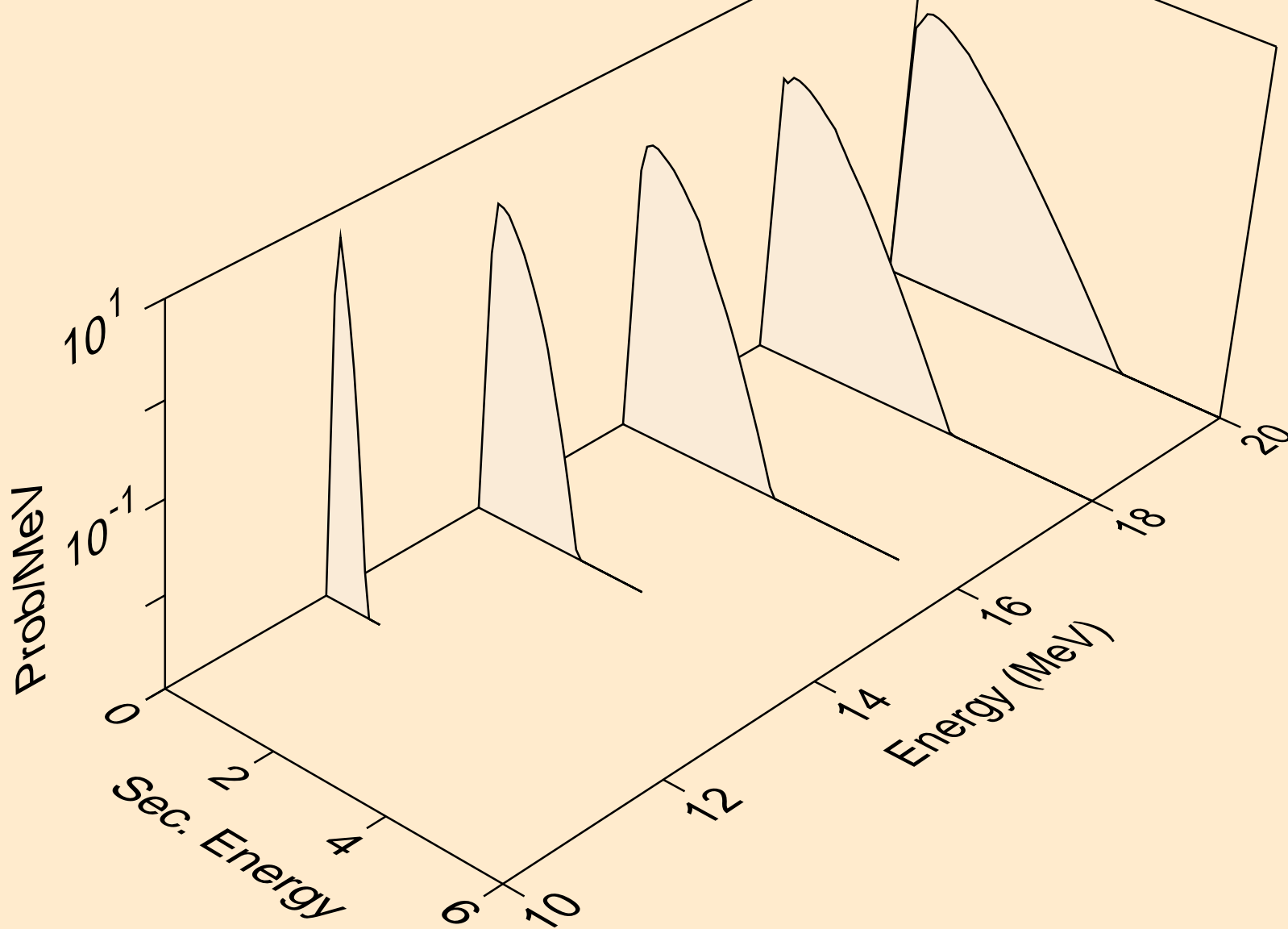

50-SN-118 FOR FENDL-3.2 FROM FENDL-3.2 BY NJOY2016.60+ C  
Neutron emission for (n,n\*c)

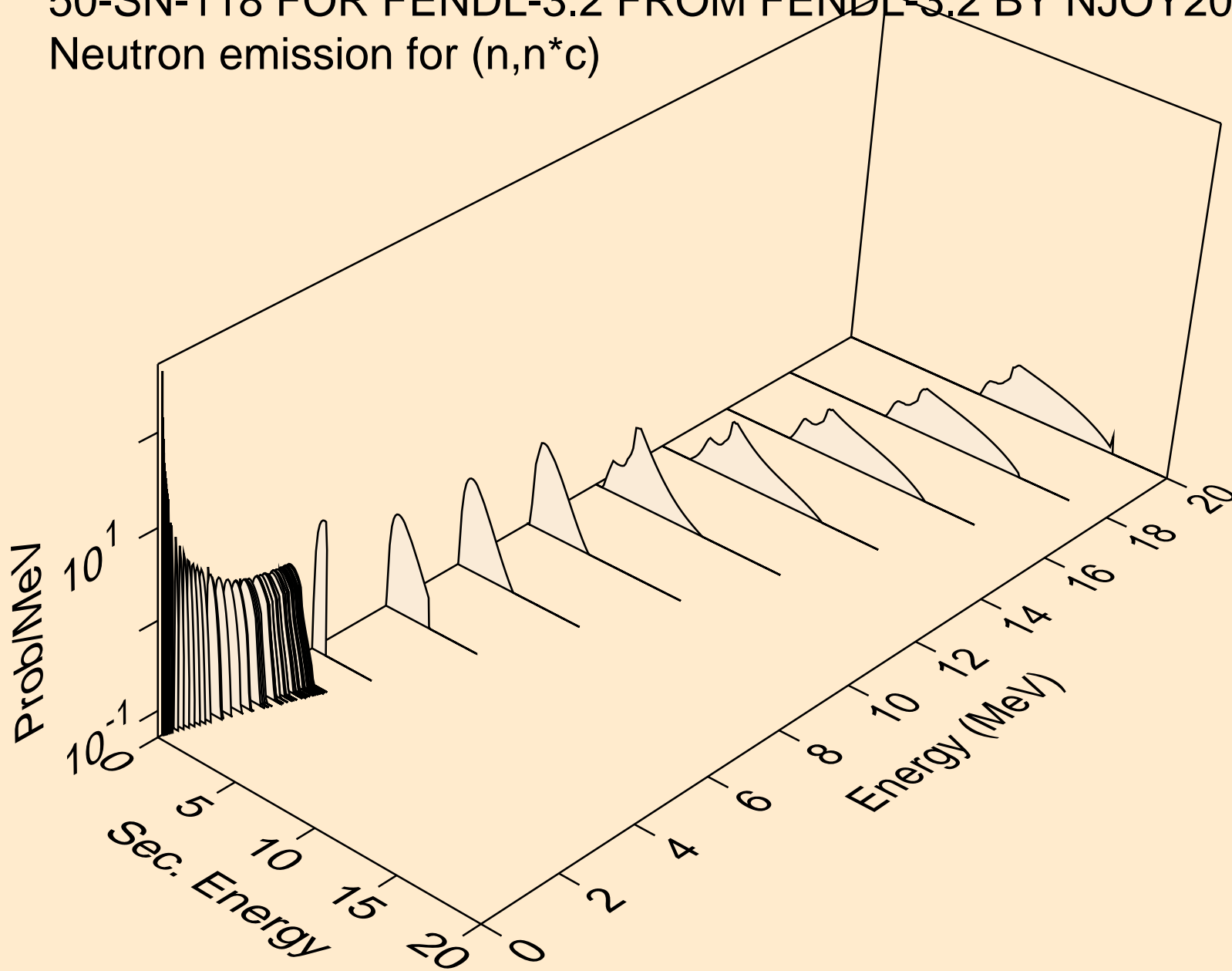

50-SN-118 FOR FENDL-3.2 FROM FENDL-3.2 BY NJOY2016.60+ C  
Photon emission for (n,x)

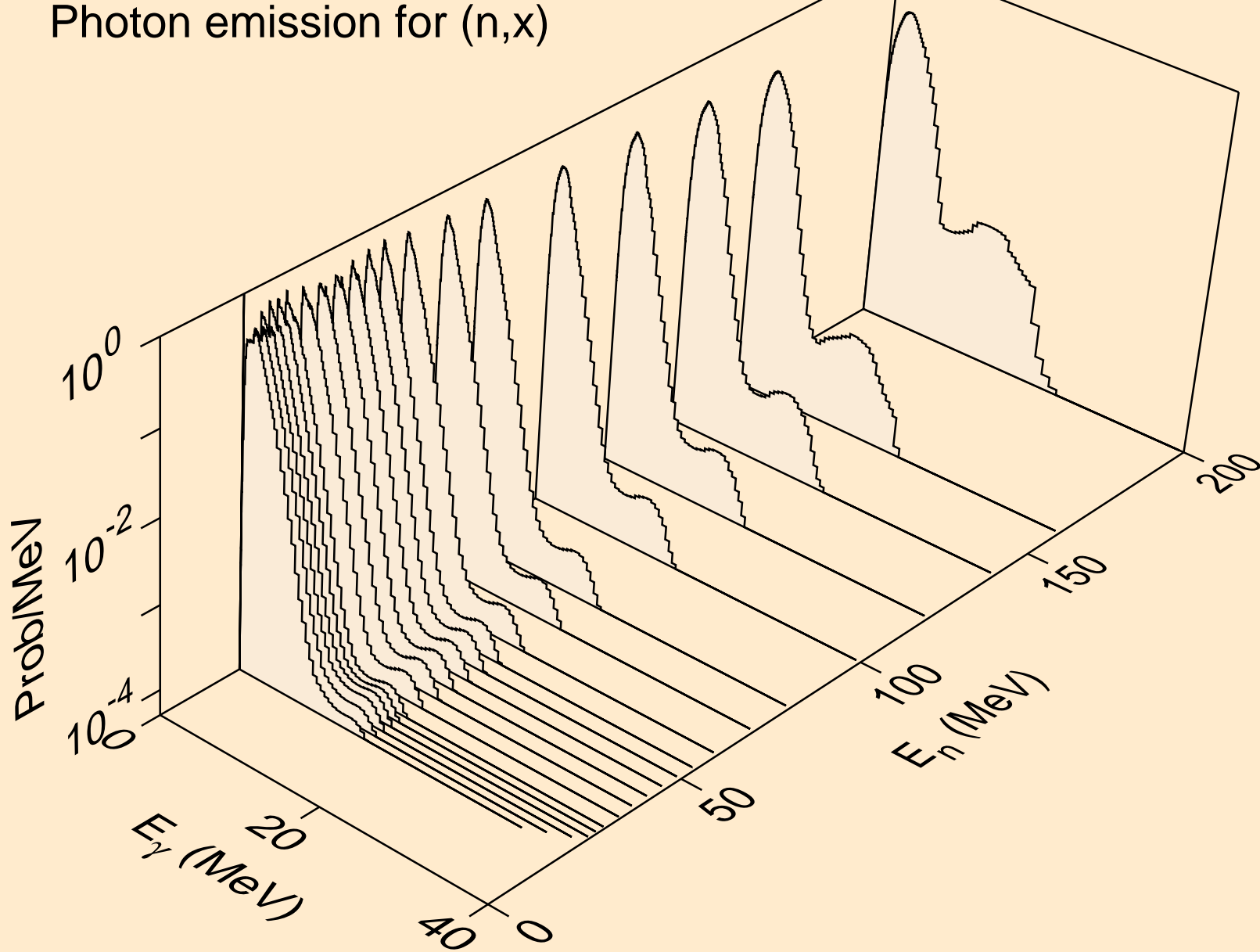

50-SN-118 FOR FENDL-3.2 FROM FENDL-3.2 BY NJOY2016.60+ C  
Photon emission for (n,2n)

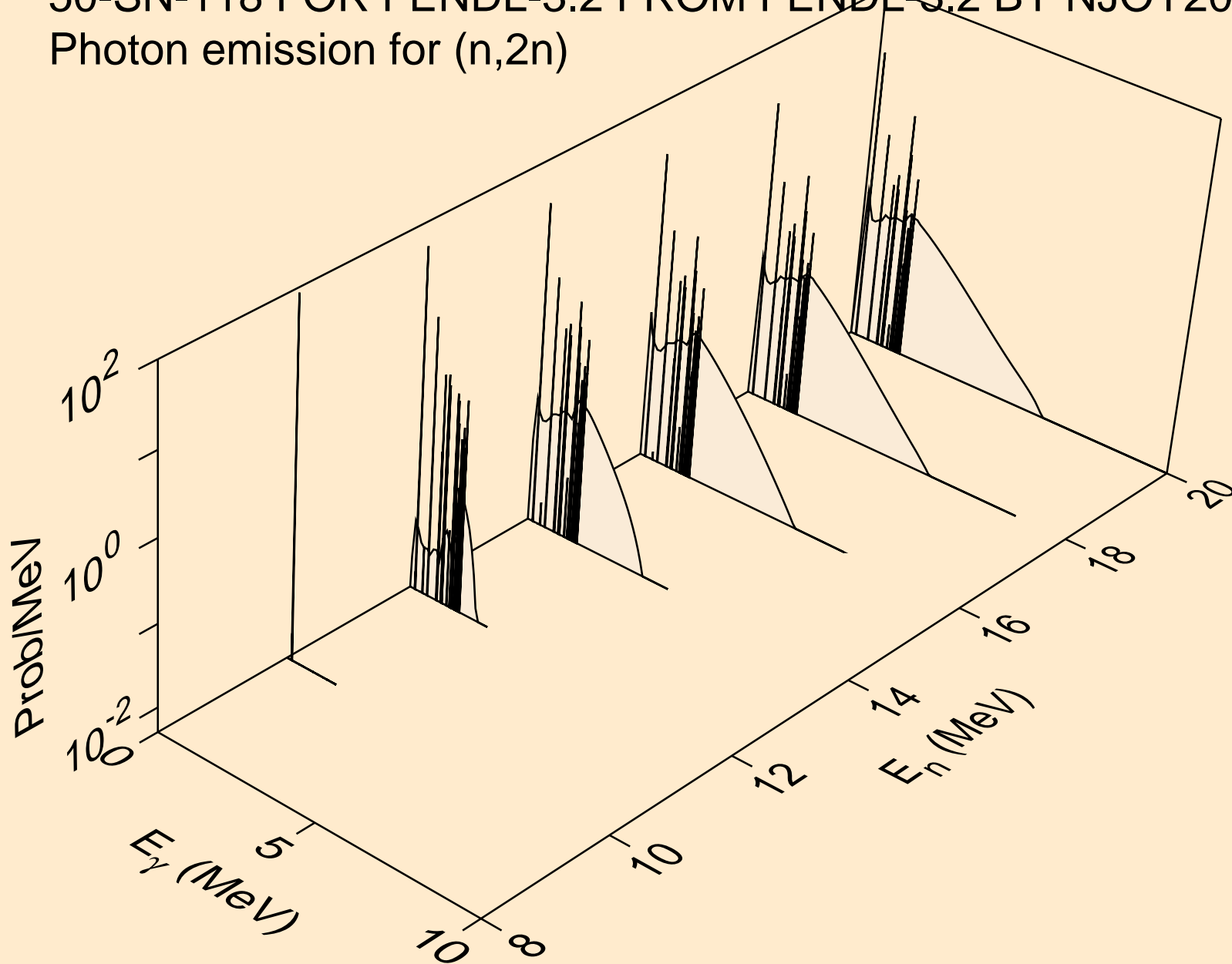

50-SN-118 FOR FENDL-3.2 FROM FENDL-3.2 BY NJOY2016.60+ C  
Photon emission for (n,3n)

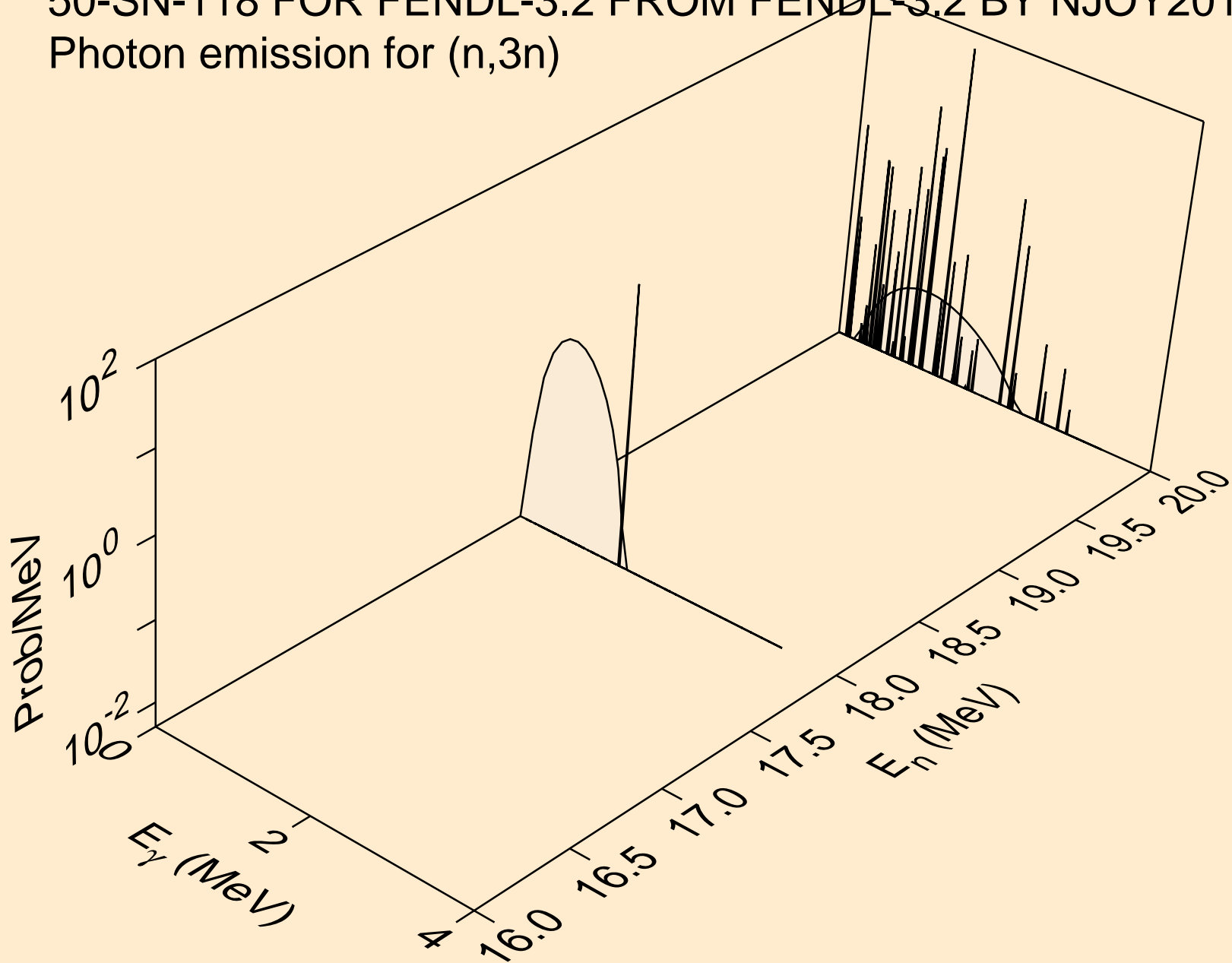

50-SN-118 FOR FENDL-3.2 FROM FENDL-3.2 BY NJOY2016.60+ C  
Photon emission for (n,n\*)a

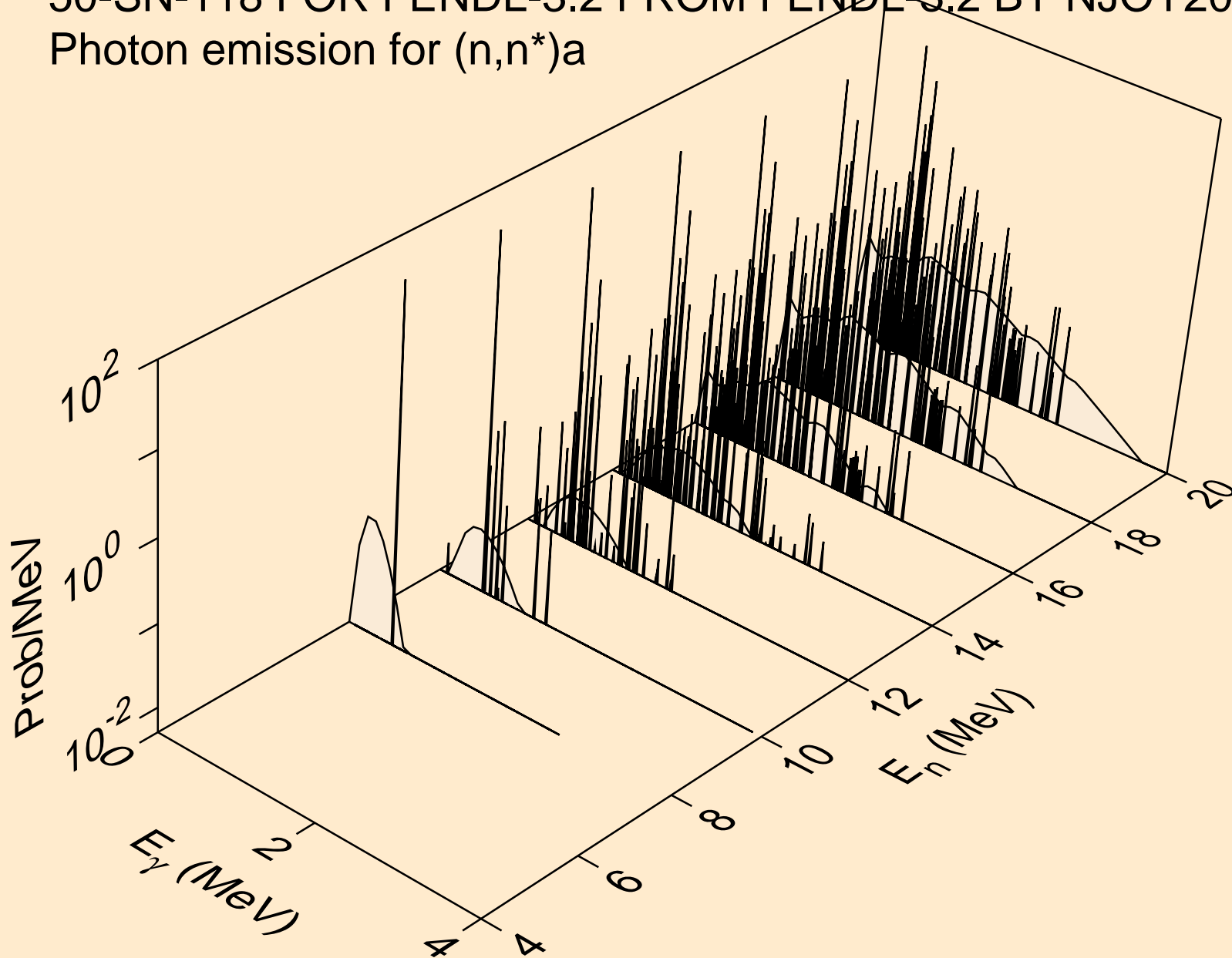

50-SN-118 FOR FENDL-3.2 FROM FENDL-3.2 BY NJOY2016.60+ C  
Photon emission for (n,n\*)p

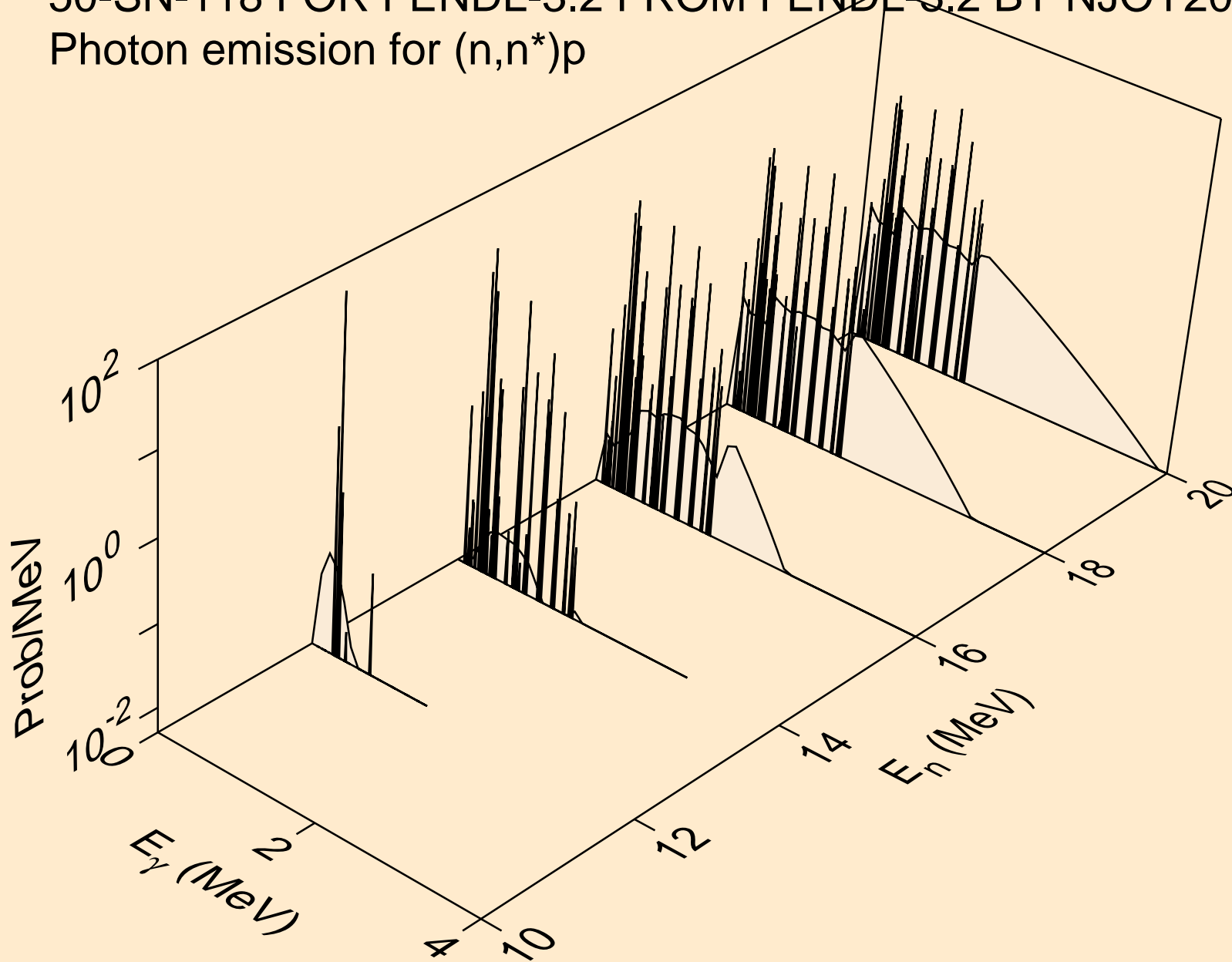



50-SN-118 FOR FENDL-3.2 FROM FENDL-3.2 BY NJOY2016.60+ C  
Photon emission for (n,n\*1)

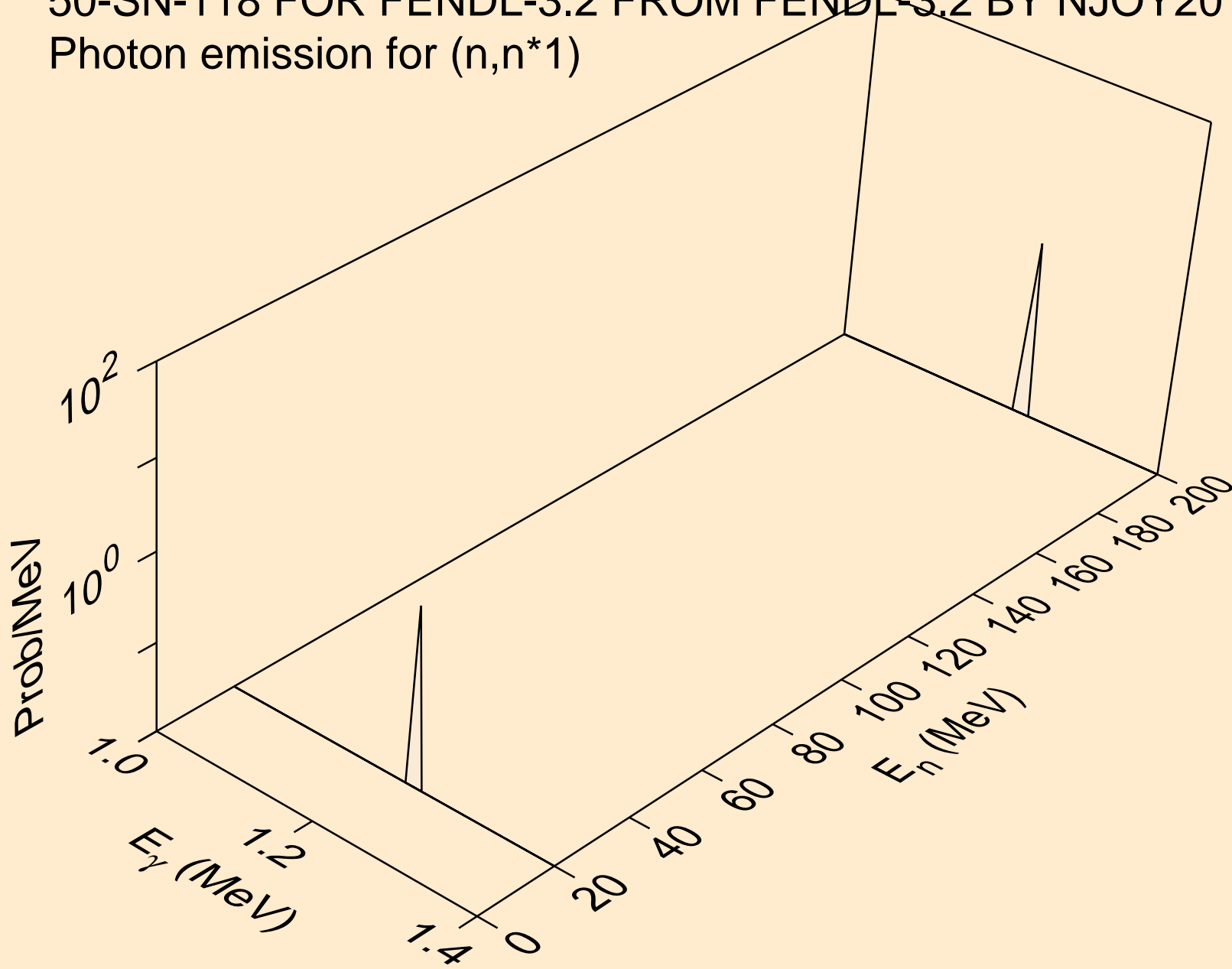

50-SN-118 FOR FENDL-3.2 FROM FENDL-3.2 BY NJOY2016.60+ C  
Photon emission for (n,n\*2)

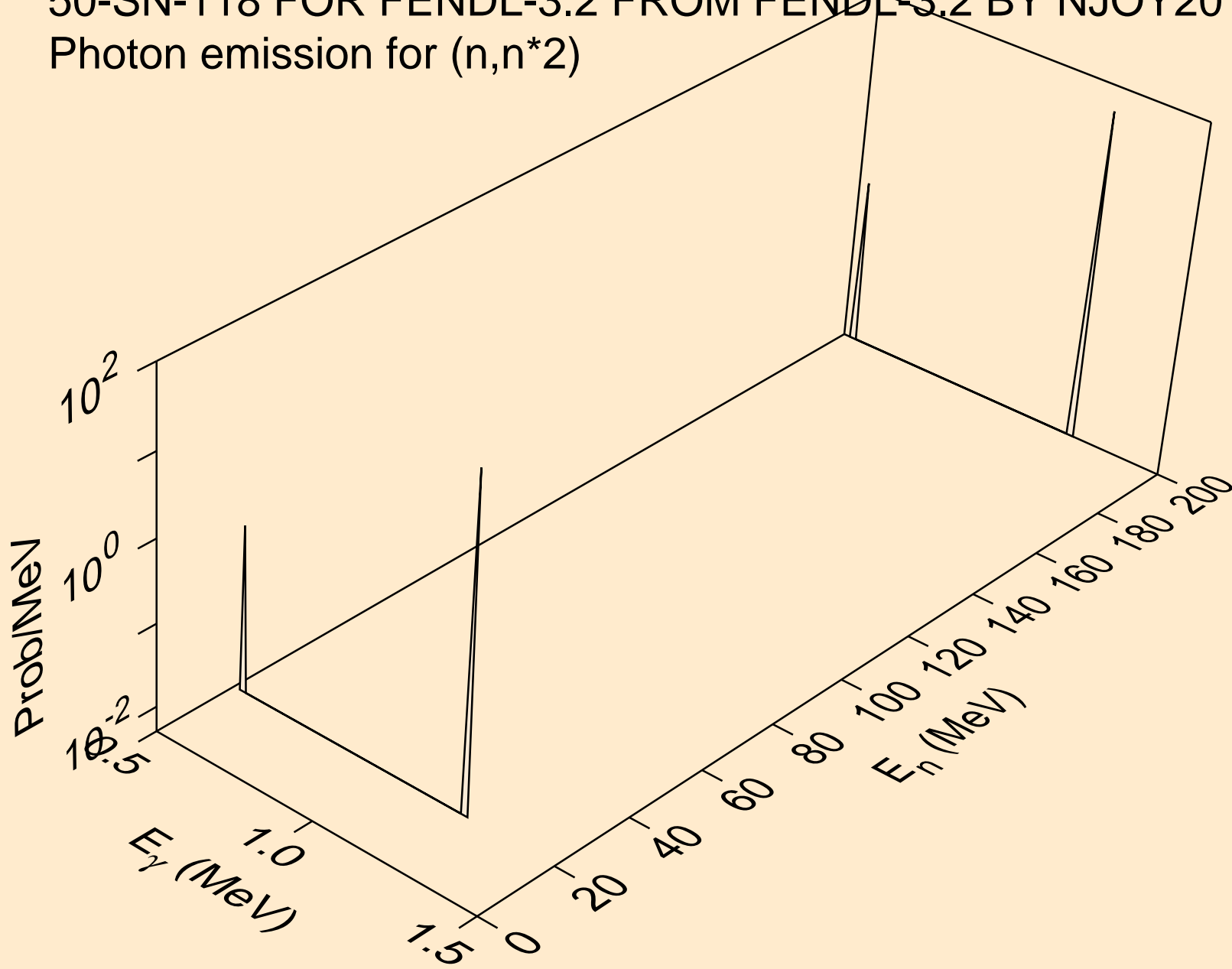

50-SN-118 FOR FENDL-3.2 FROM FENDL-3.2 BY NJOY2016.60+ C  
Photon emission for (n,n\*3)

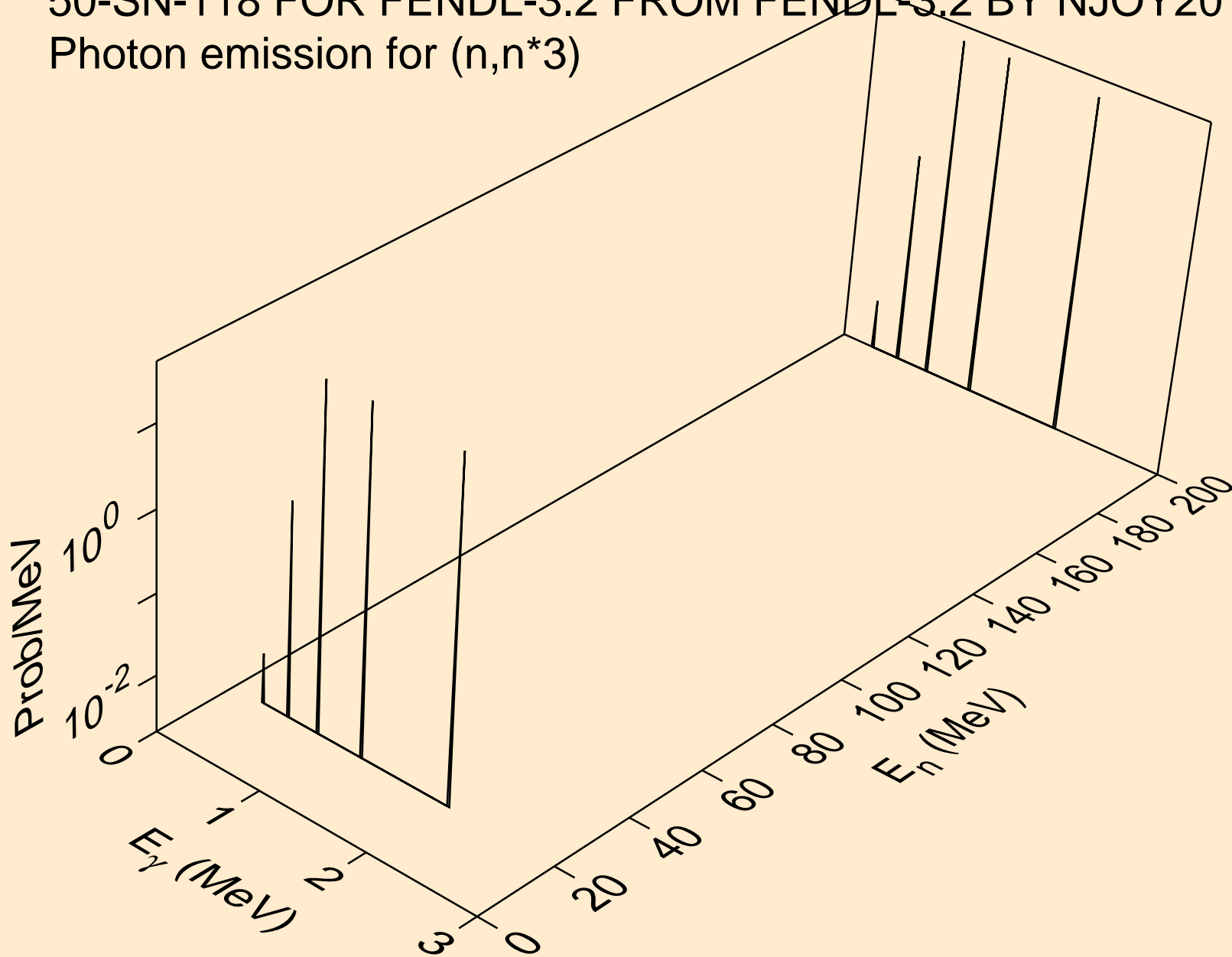

50-SN-118 FOR FENDL-3.2 FROM FENDL-3.2 BY NJOY2016.60+ C  
Photon emission for (n,n\*4)

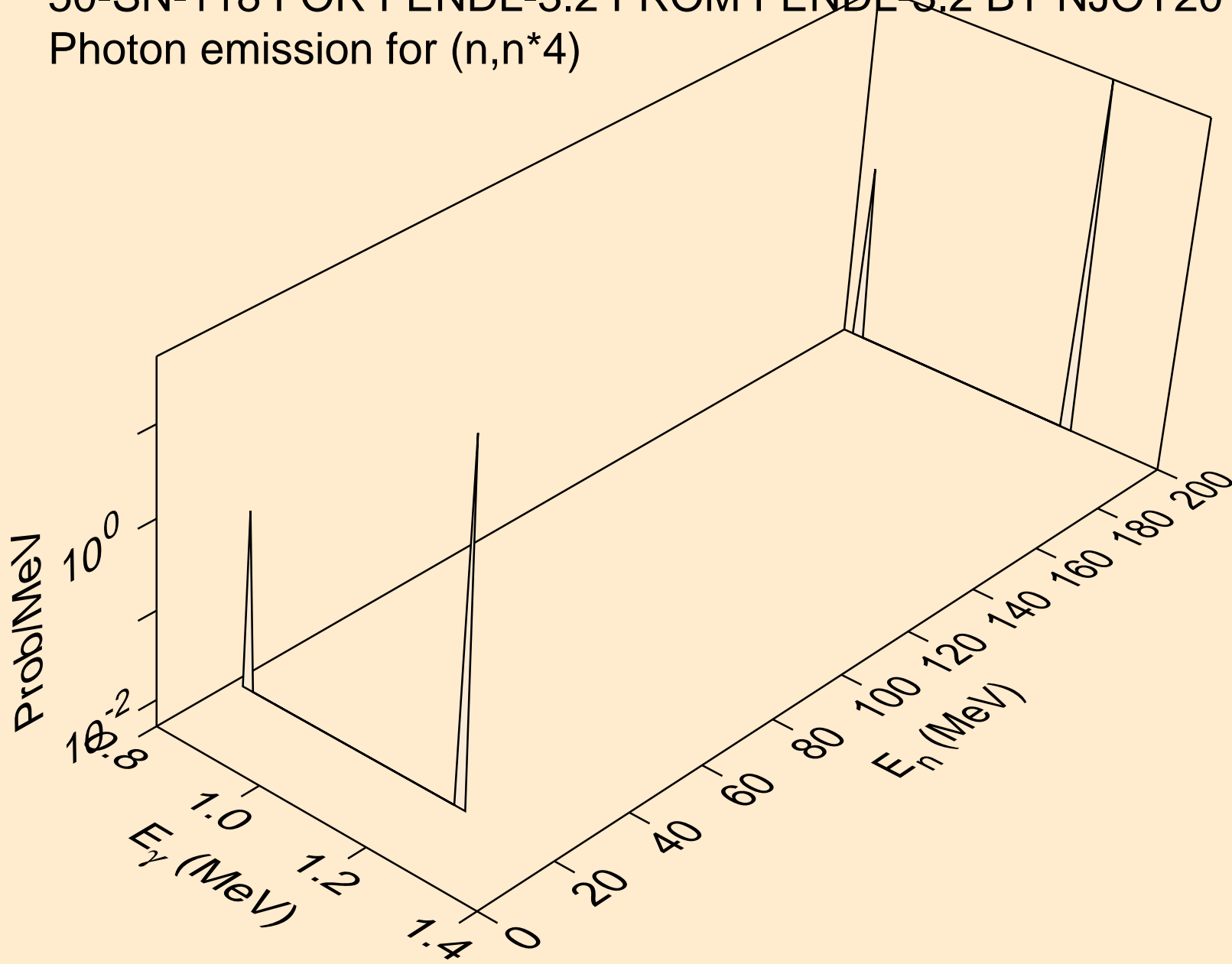

50-SN-118 FOR FENDL-3.2 FROM FENDL-3.2 BY NJOY2016.60+ C  
Photon emission for (n,n\*5)

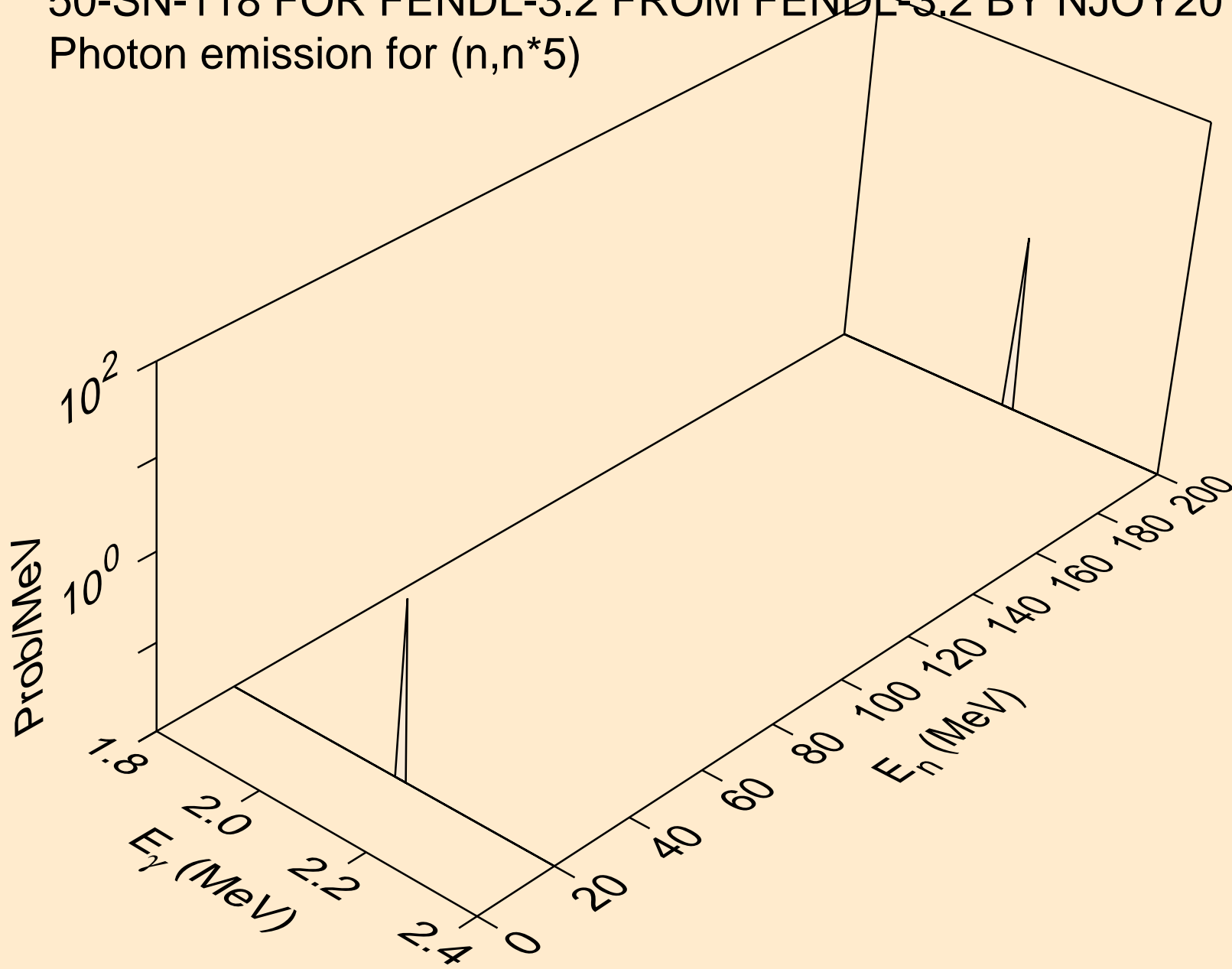

50-SN-118 FOR FENDL-3.2 FROM FENDL-3.2 BY NJOY2016.60+ C  
Photon emission for (n,n\*6)

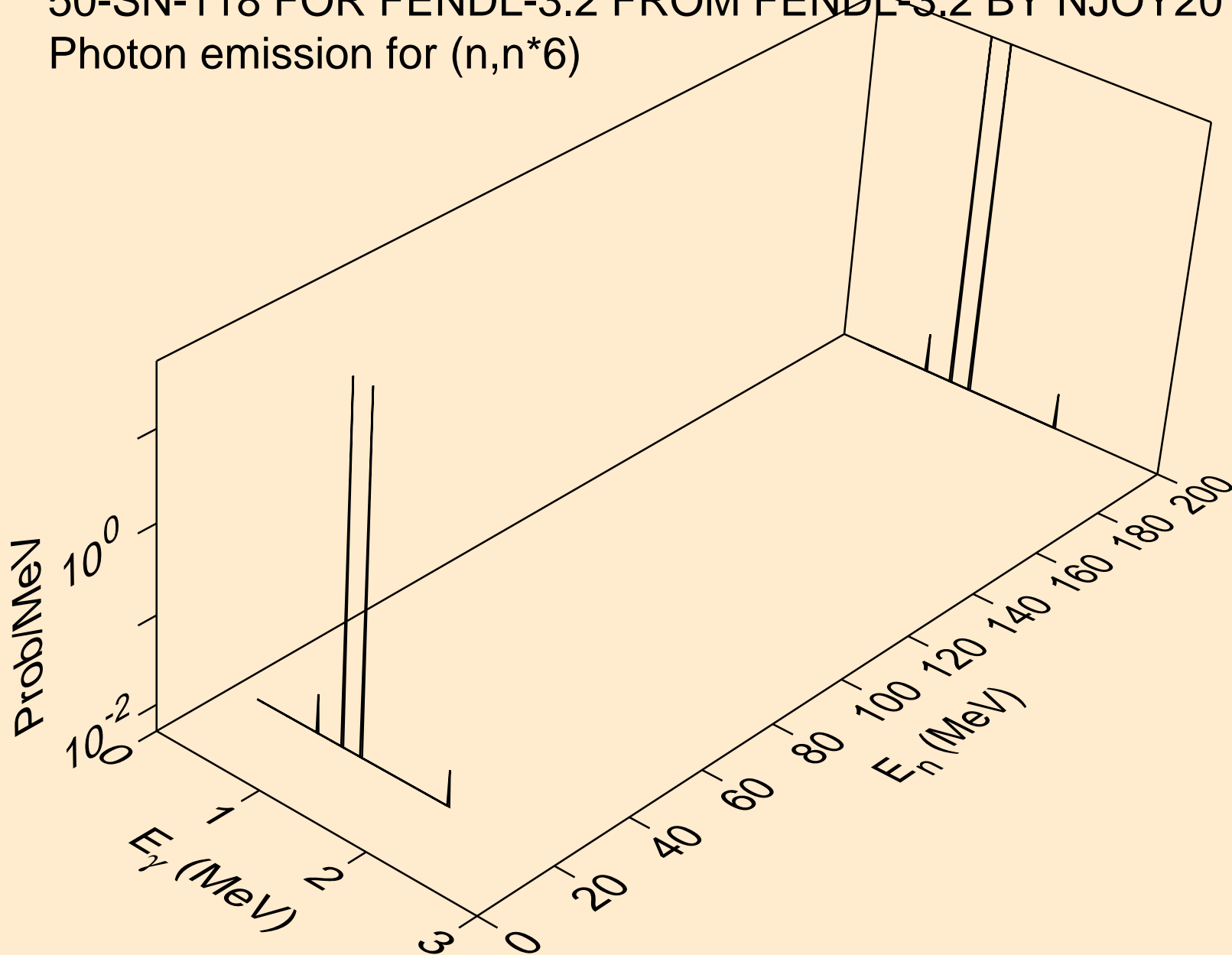

50-SN-118 FOR FENDL-3.2 FROM FENDL-3.2 BY NJOY2016.60+ C  
Photon emission for (n,n\*7)

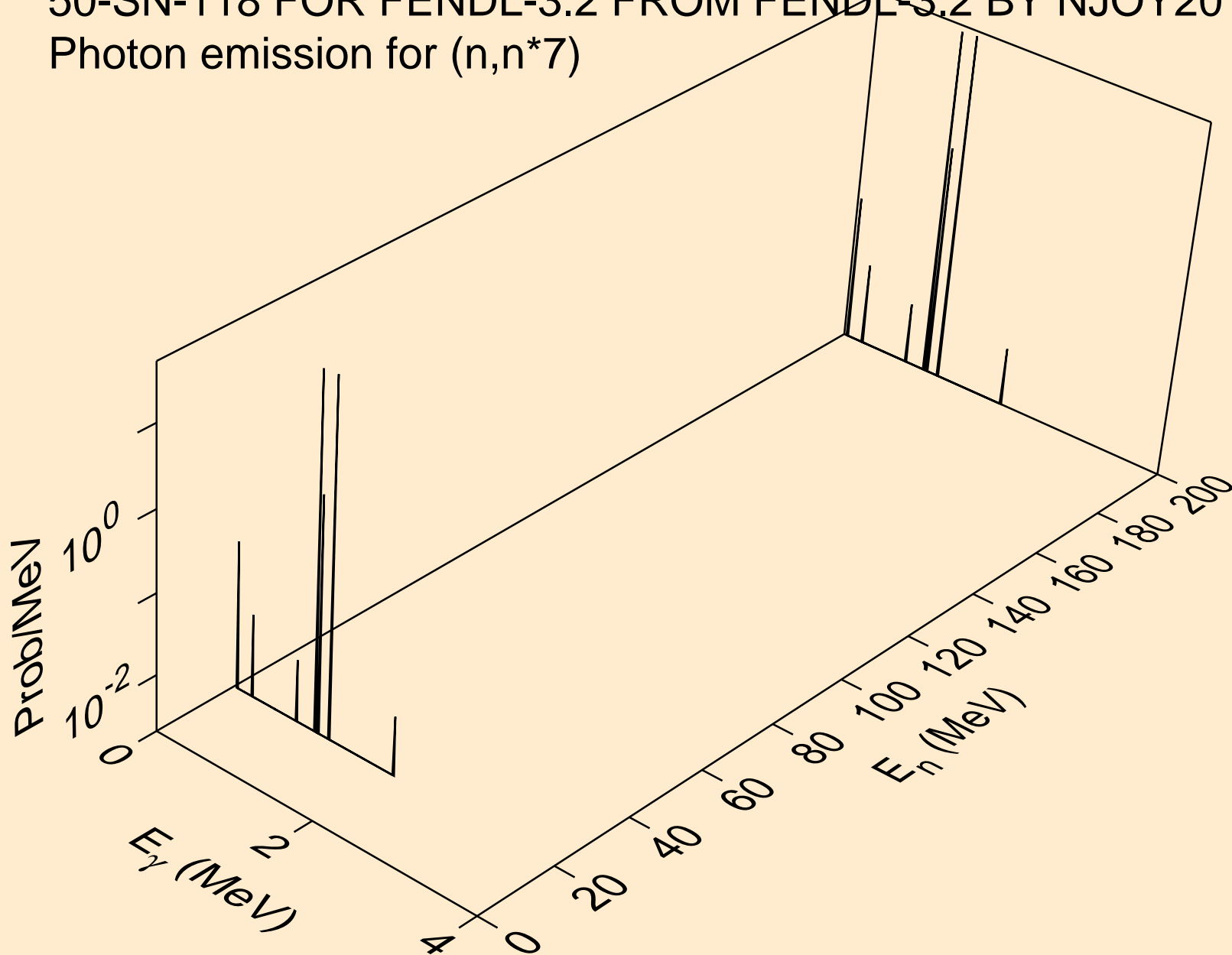

50-SN-118 FOR FENDL-3.2 FROM FENDL-3.2 BY NJOY2016.60+ C  
Photon emission for (n,n\*8)

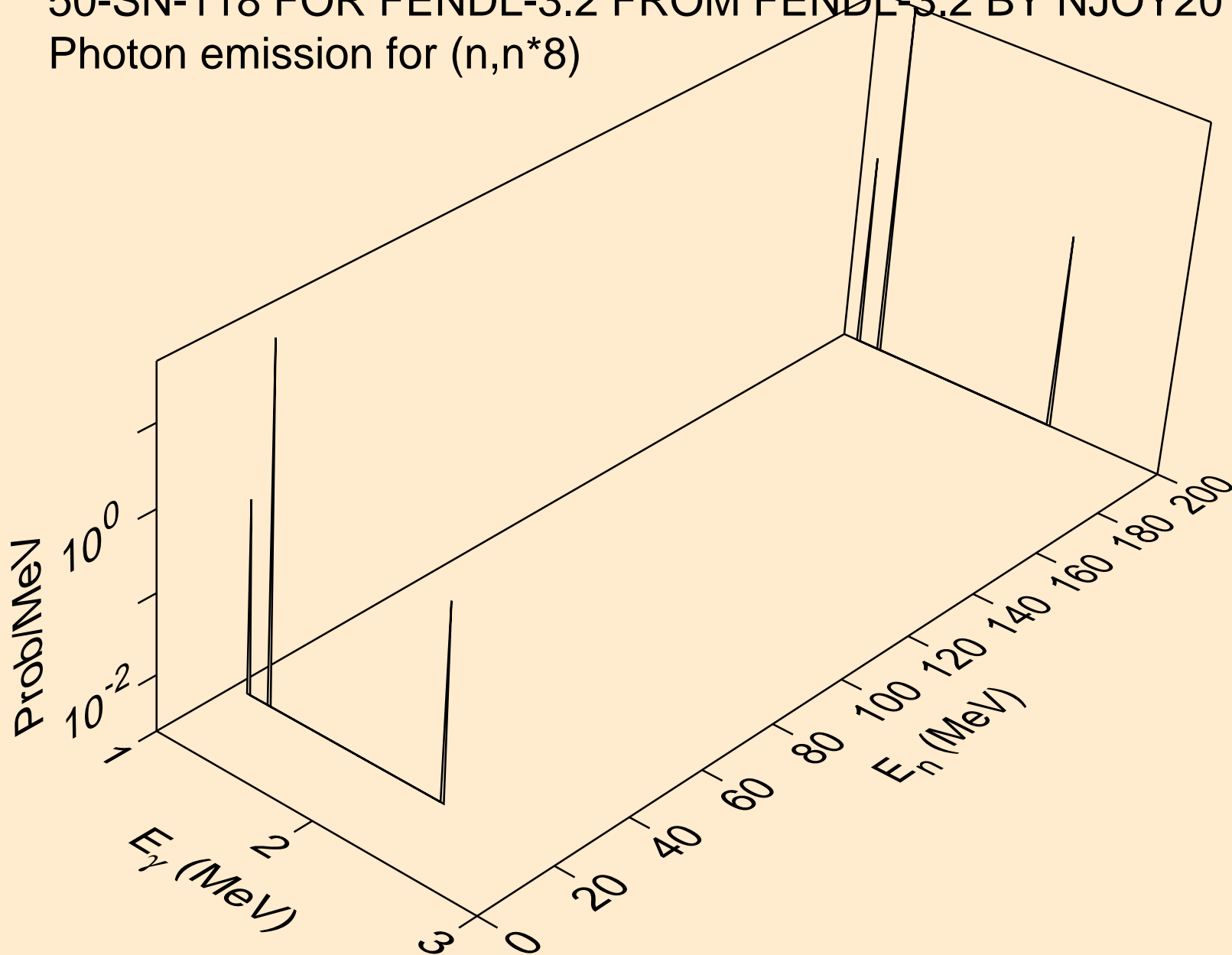



50-SN-118 FOR FENDL-3.2 FROM FENDL-3.2 BY NJOY2016.60+ C  
Photon emission for (n,n\*9)

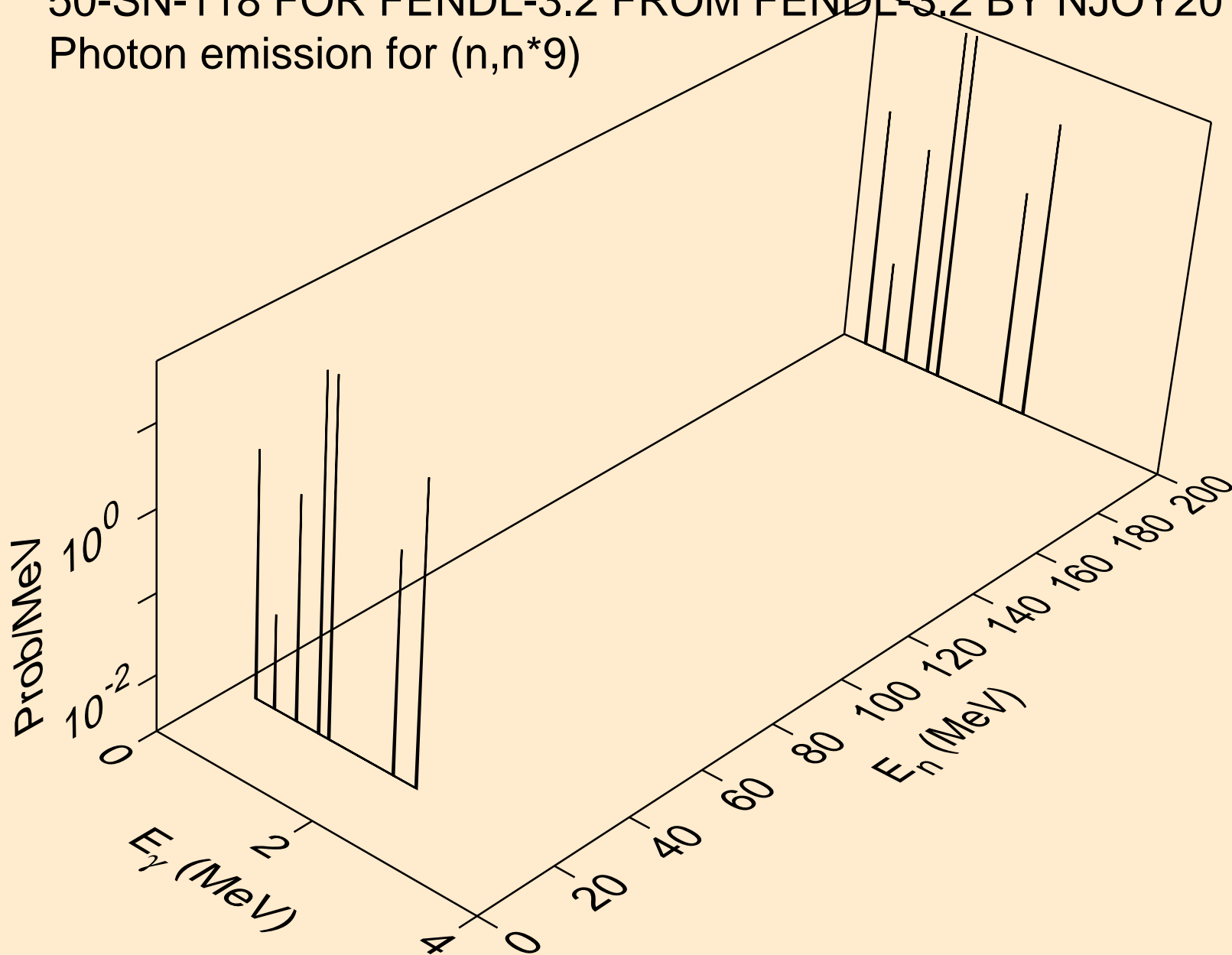

50-SN-118 FOR FENDL-3.2 FROM FENDL-3.2 BY NJOY2016.60+ C  
Photon emission for (n,n\*10)

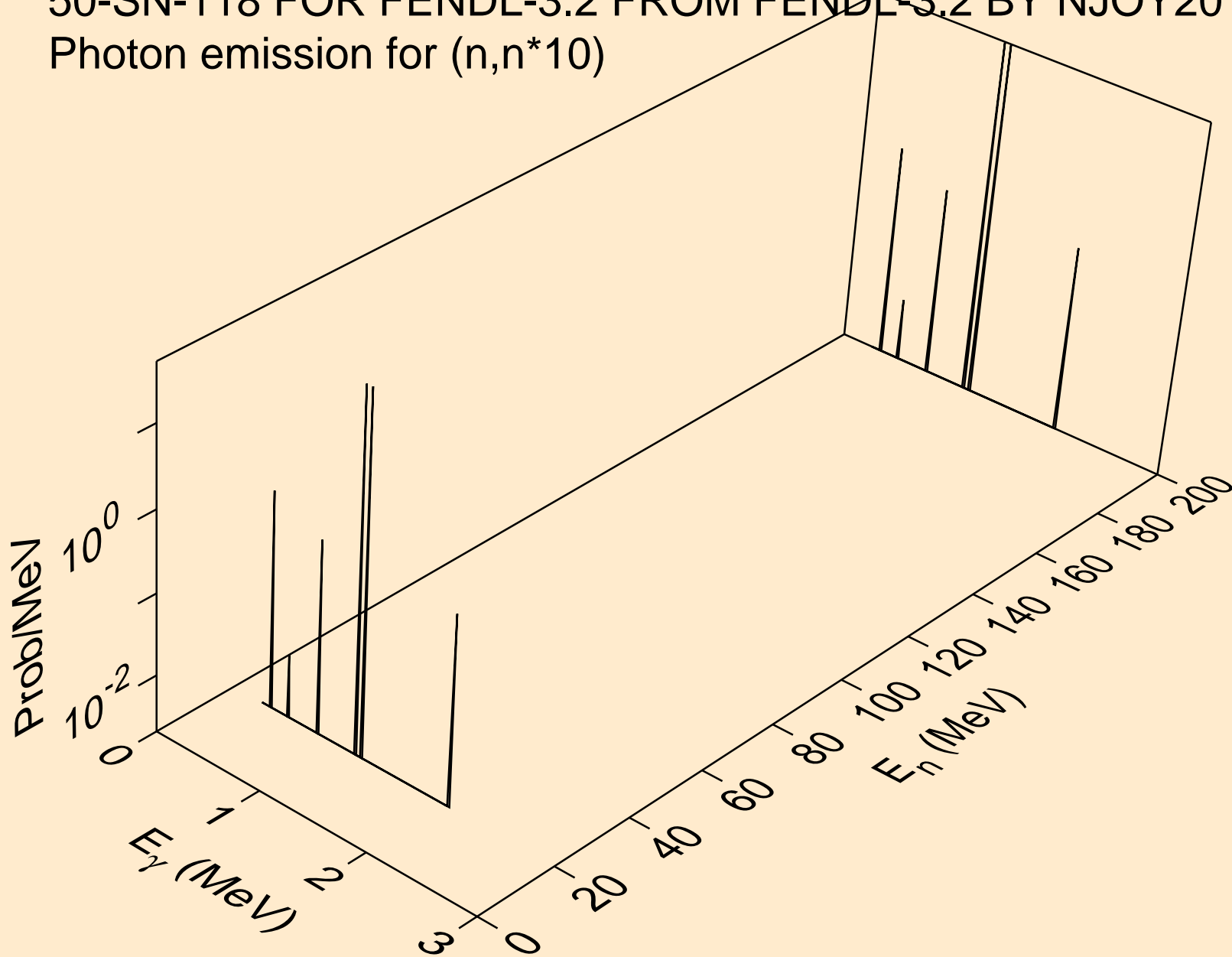

50-SN-118 FOR FENDL-3.2 FROM FENDL-3.2 BY NJOY2016.60+ C  
Photon emission for (n,n\*11)

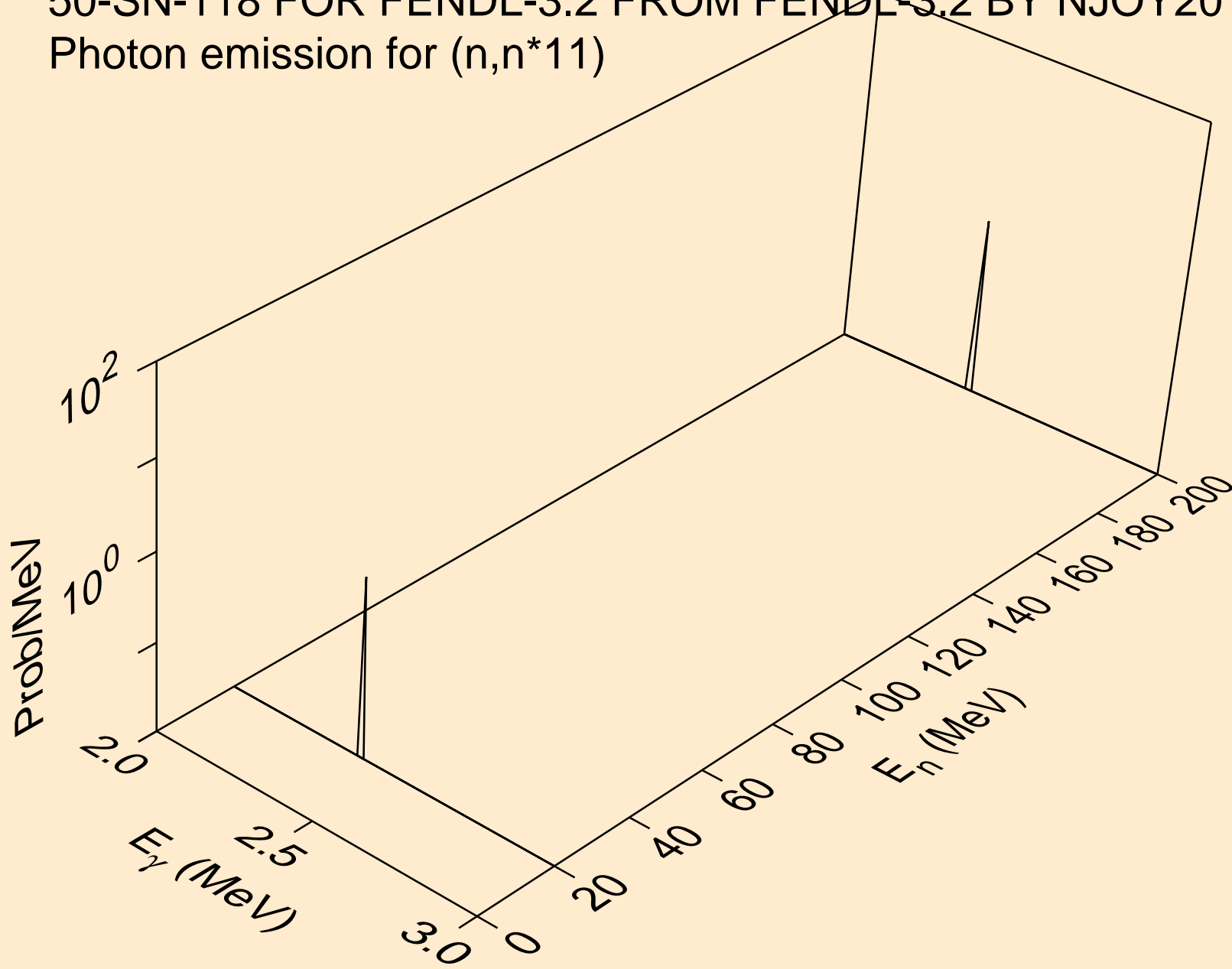

50-SN-118 FOR FENDL-3.2 FROM FENDL-3.2 BY NJOY2016.60+ C  
Photon emission for (n,n\*12)

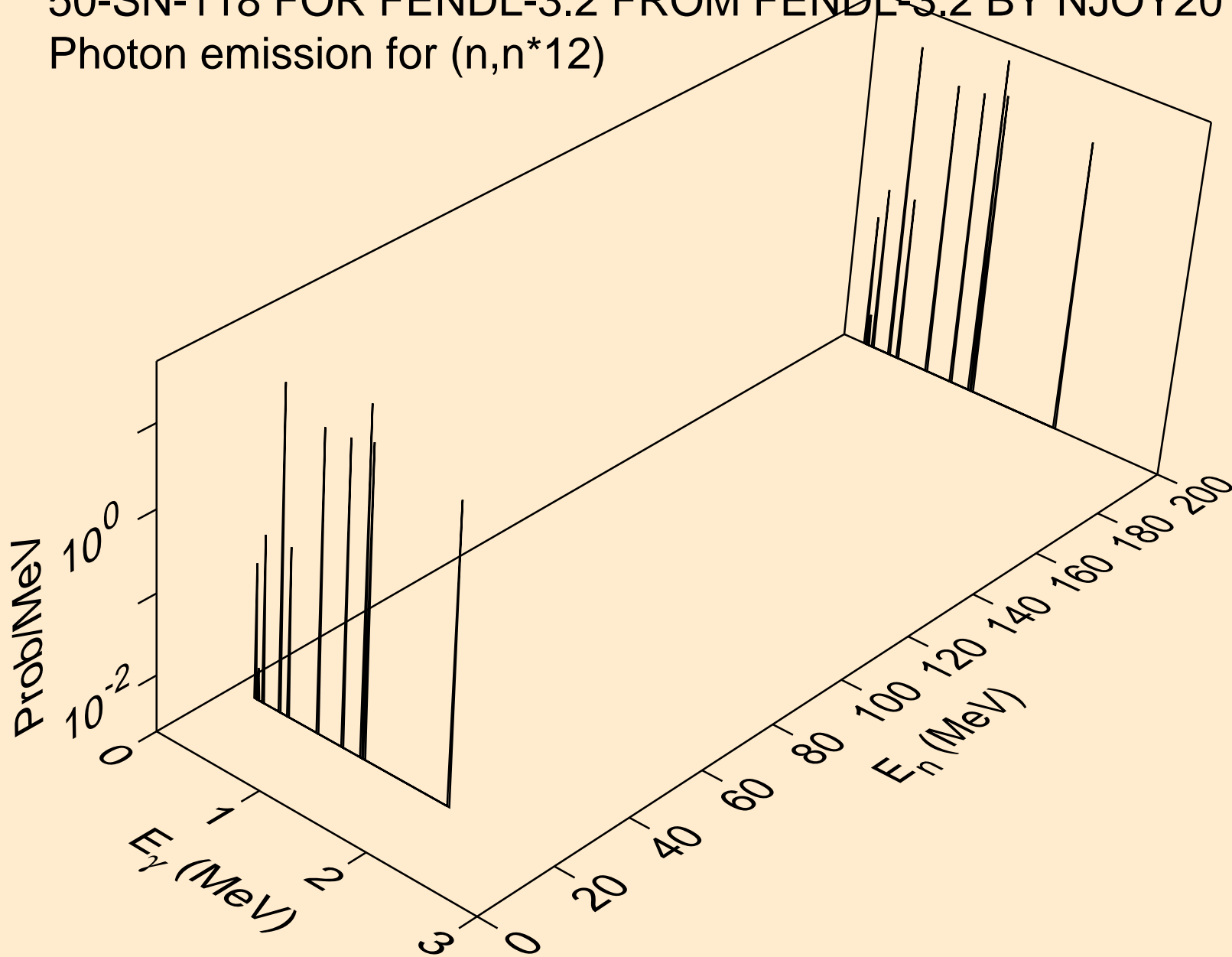

50-SN-118 FOR FENDL-3.2 FROM FENDL-3.2 BY NJOY2016.60+ C  
Photon emission for (n,n\*13)

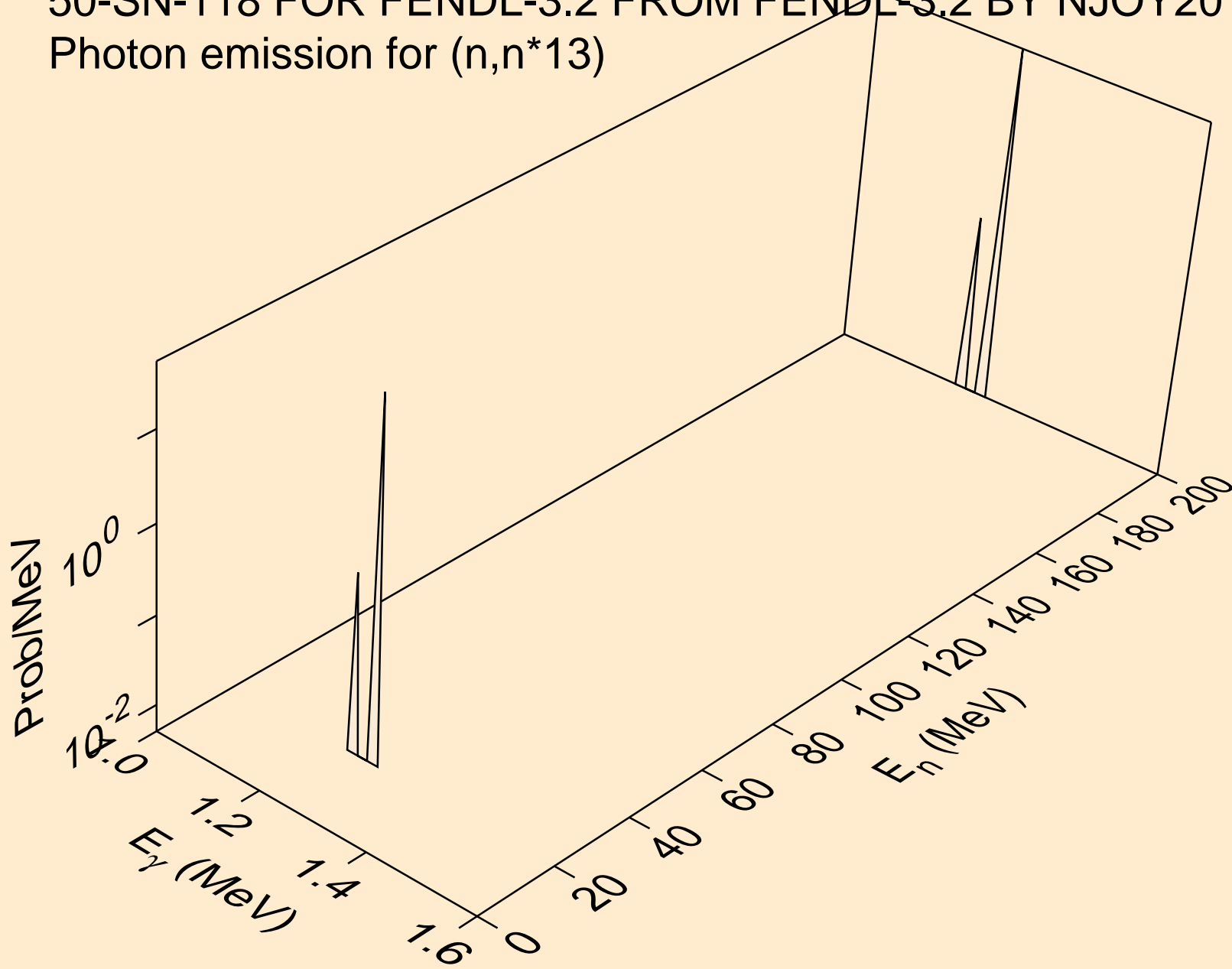

50-SN-118 FOR FENDL-3.2 FROM FENDL-3.2 BY NJOY2016.60+ C  
Photon emission for (n,n\*14)

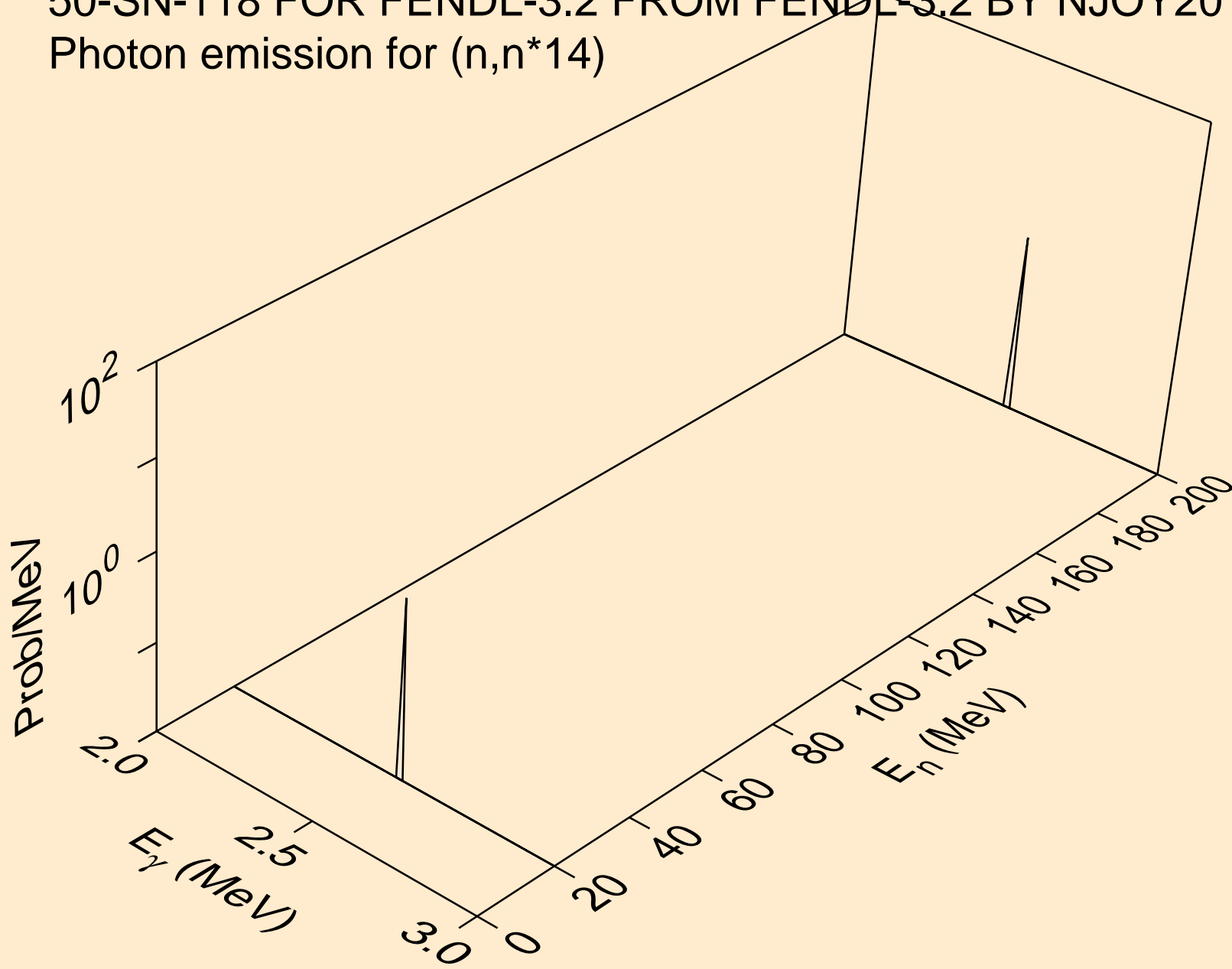

50-SN-118 FOR FENDL-3.2 FROM FENDL-3.2 BY NJOY2016.60+ C  
Photon emission for (n,n\*15)

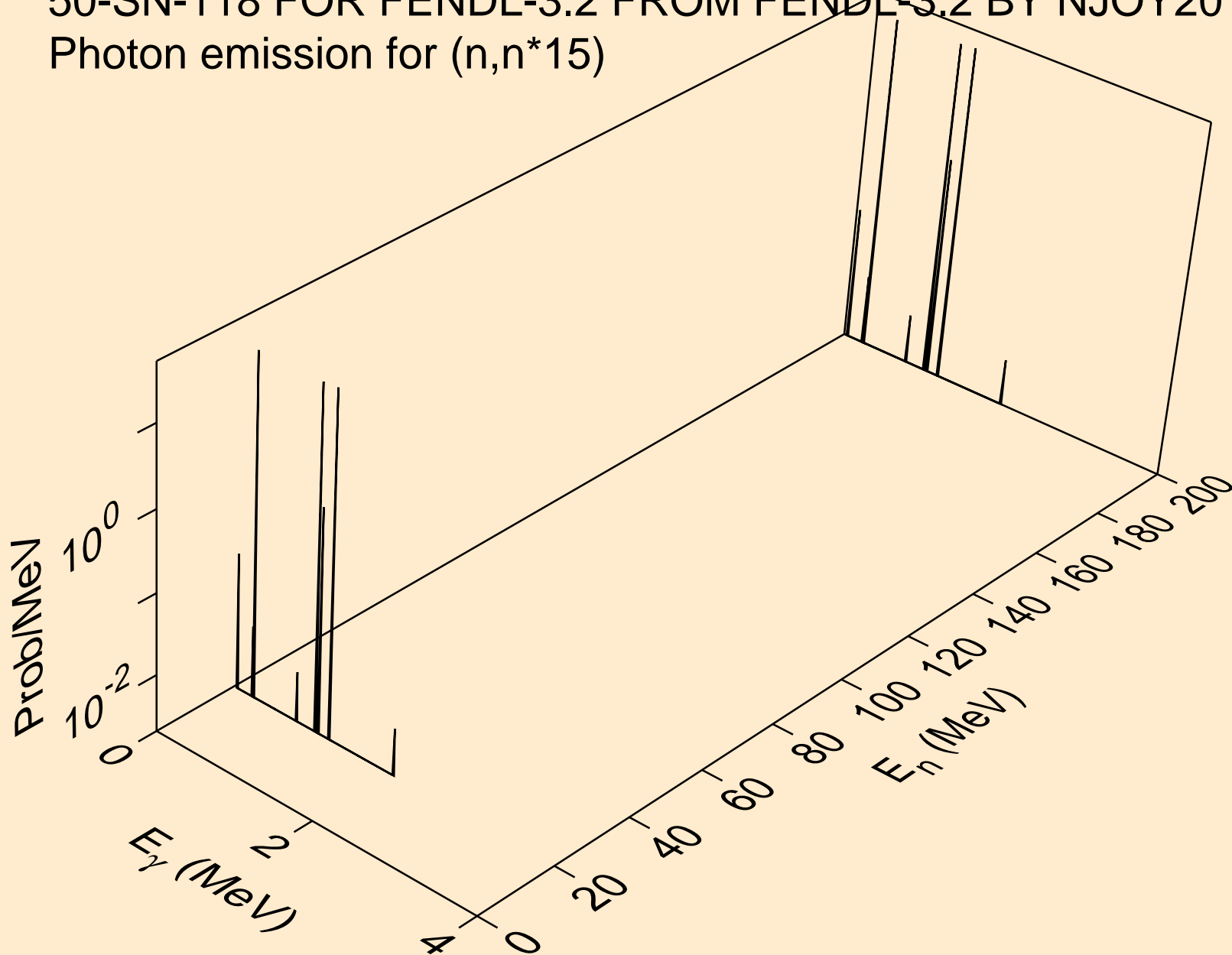

50-SN-118 FOR FENDL-3.2 FROM FENDL-3.2 BY NJOY2016.60+ C  
Photon emission for (n,n\*16)

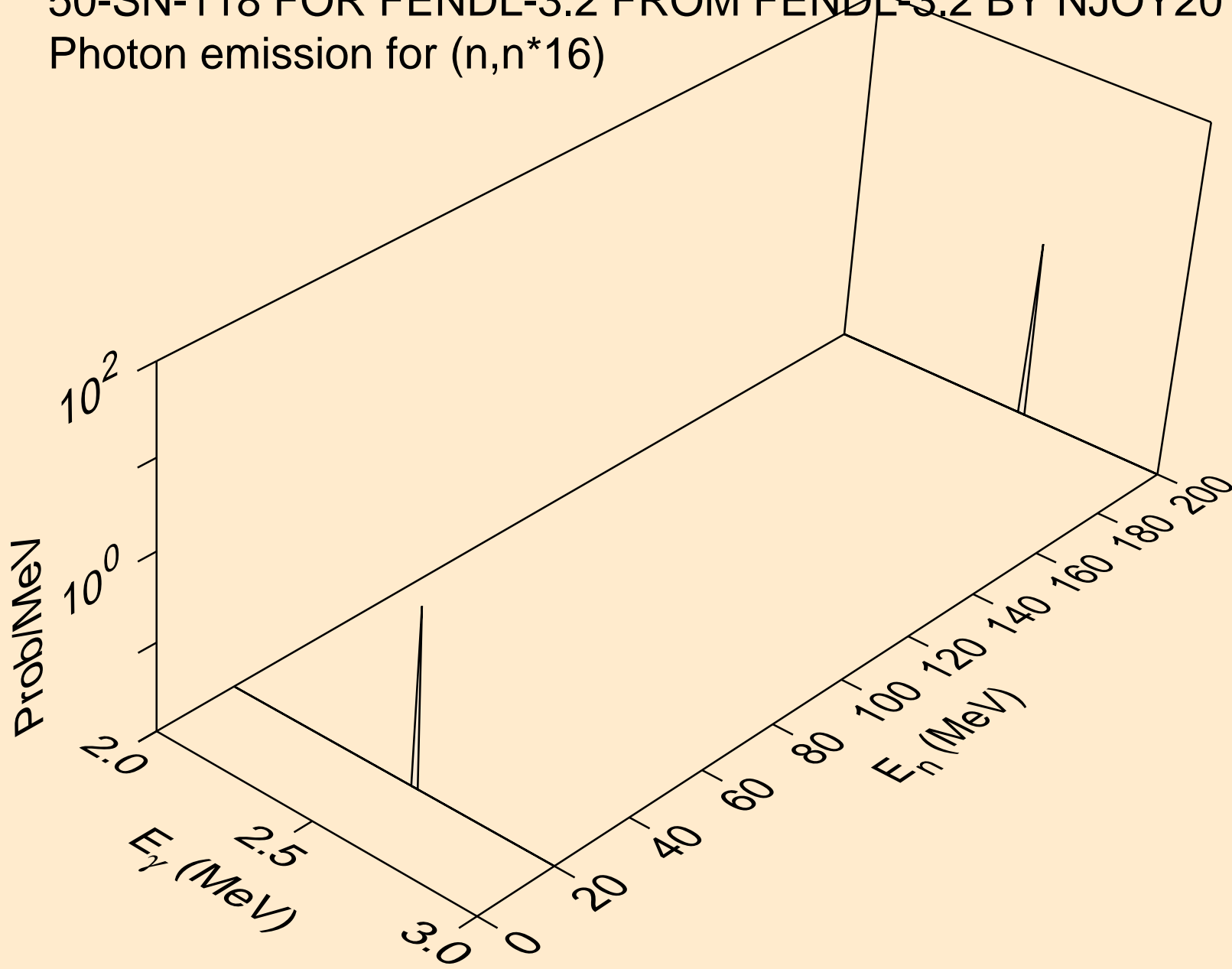



50-SN-118 FOR FENDL-3.2 FROM FENDL-3.2 BY NJOY2016.60+ C  
Photon emission for (n,n\*17)

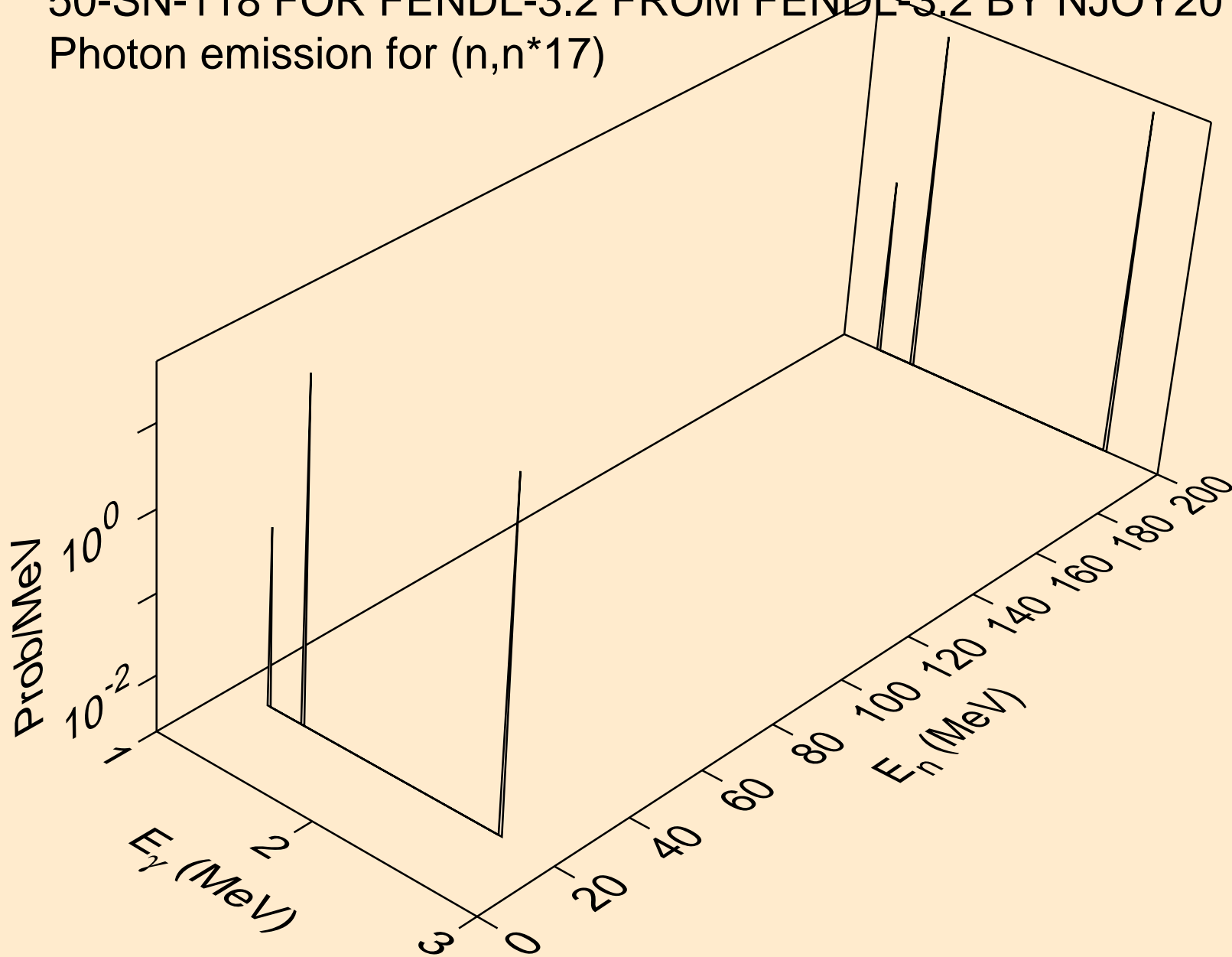

50-SN-118 FOR FENDL-3.2 FROM FENDL-3.2 BY NJOY2016.60+ C  
Photon emission for (n,n\*18)

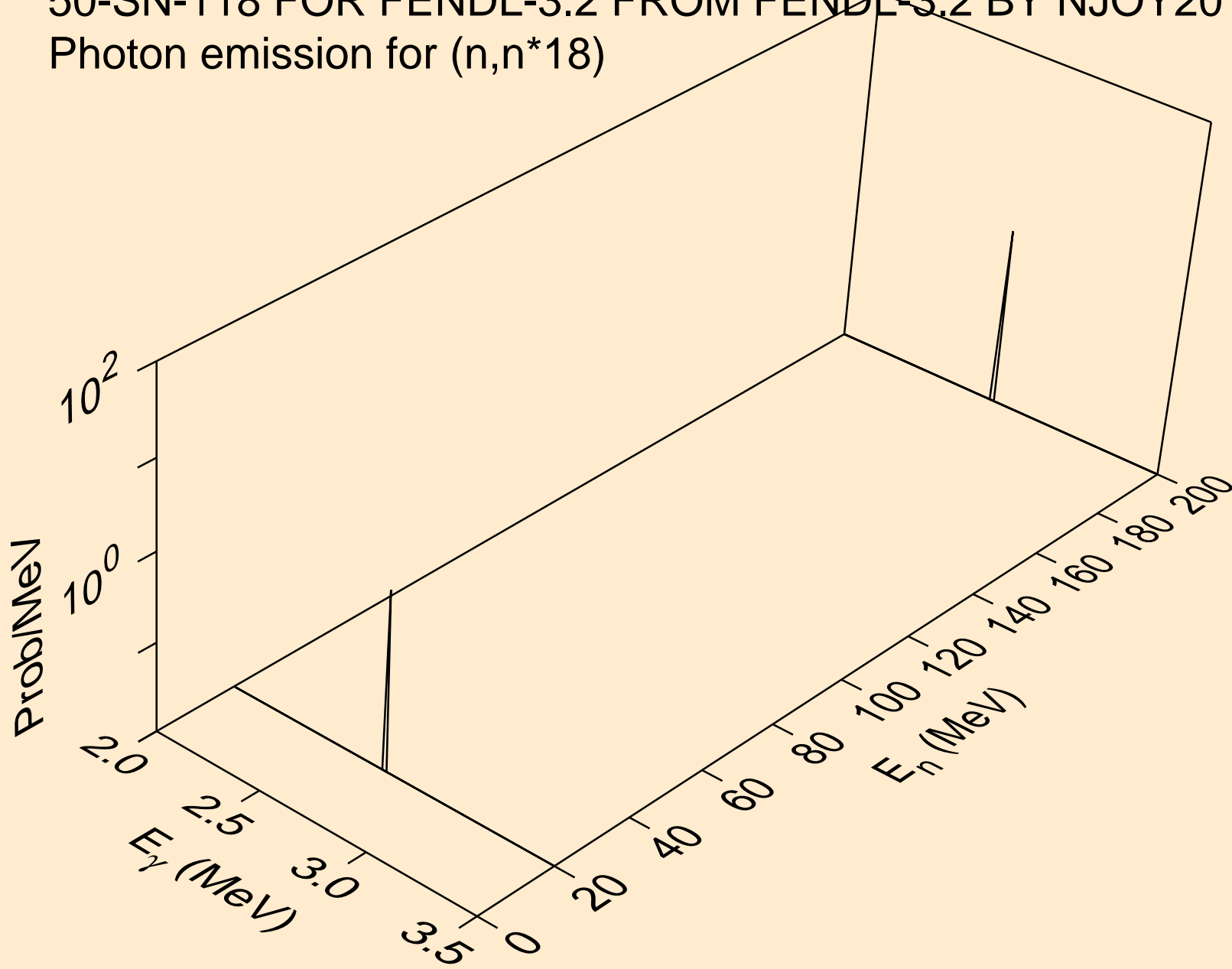

50-SN-118 FOR FENDL-3.2 FROM FENDL-3.2 BY NJOY2016.60+ C  
Photon emission for (n,n\*19)

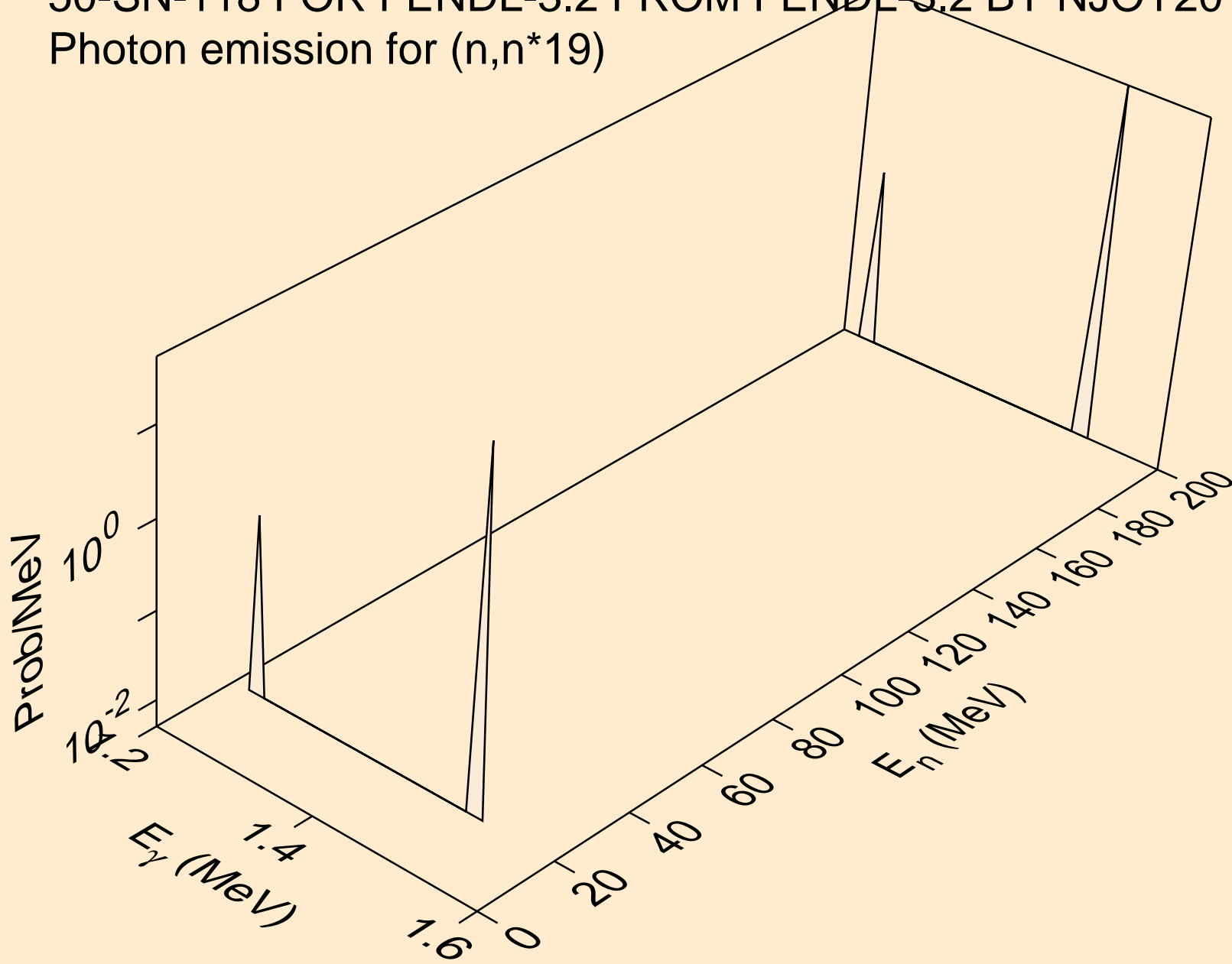

50-SN-118 FOR FENDL-3.2 FROM FENDL-3.2 BY NJOY2016.60+ C  
Photon emission for (n,n\*20)

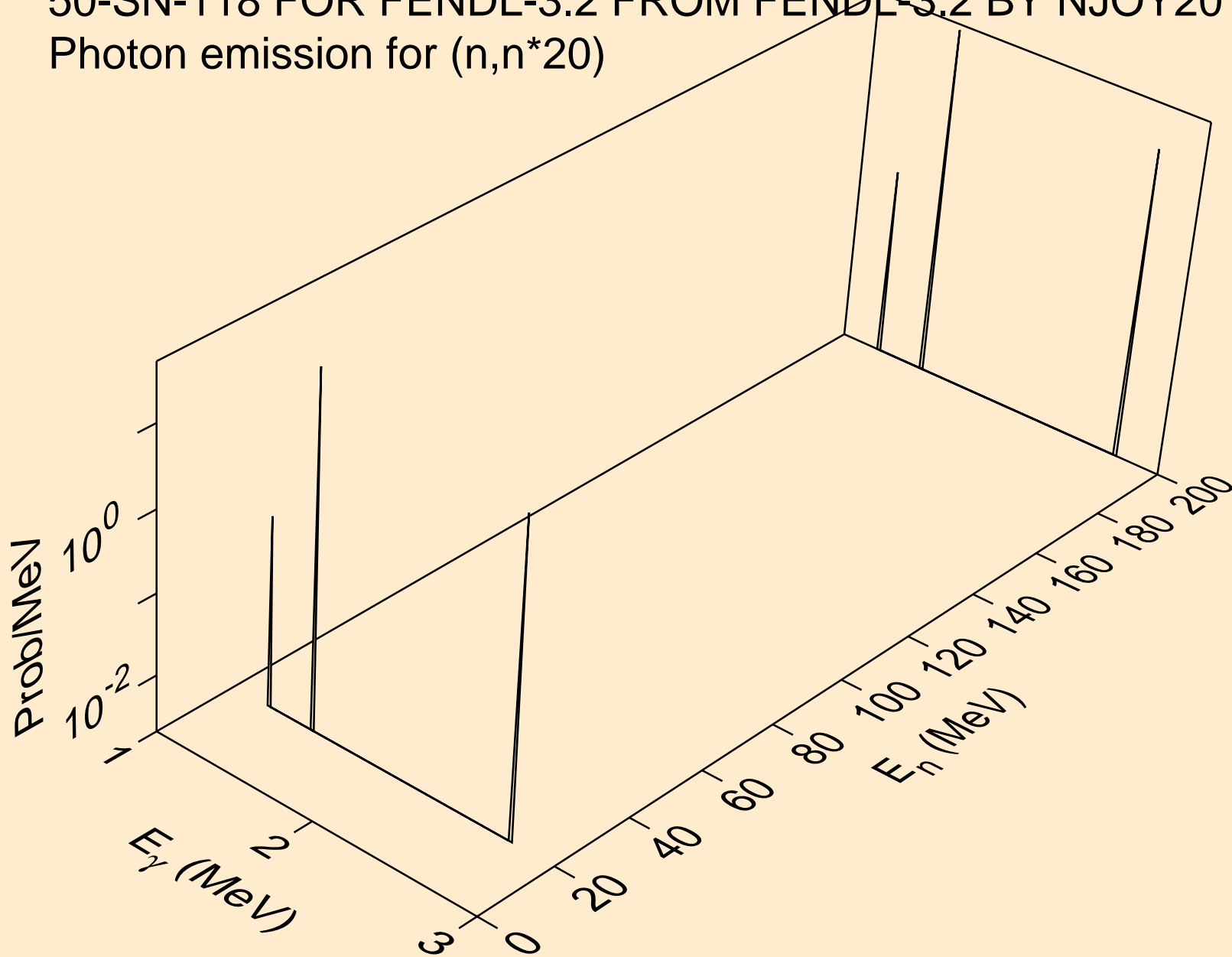

50-SN-118 FOR FENDL-3.2 FROM FENDL-3.2 BY NJOY2016.60+ C  
Photon emission for (n,n\*21)

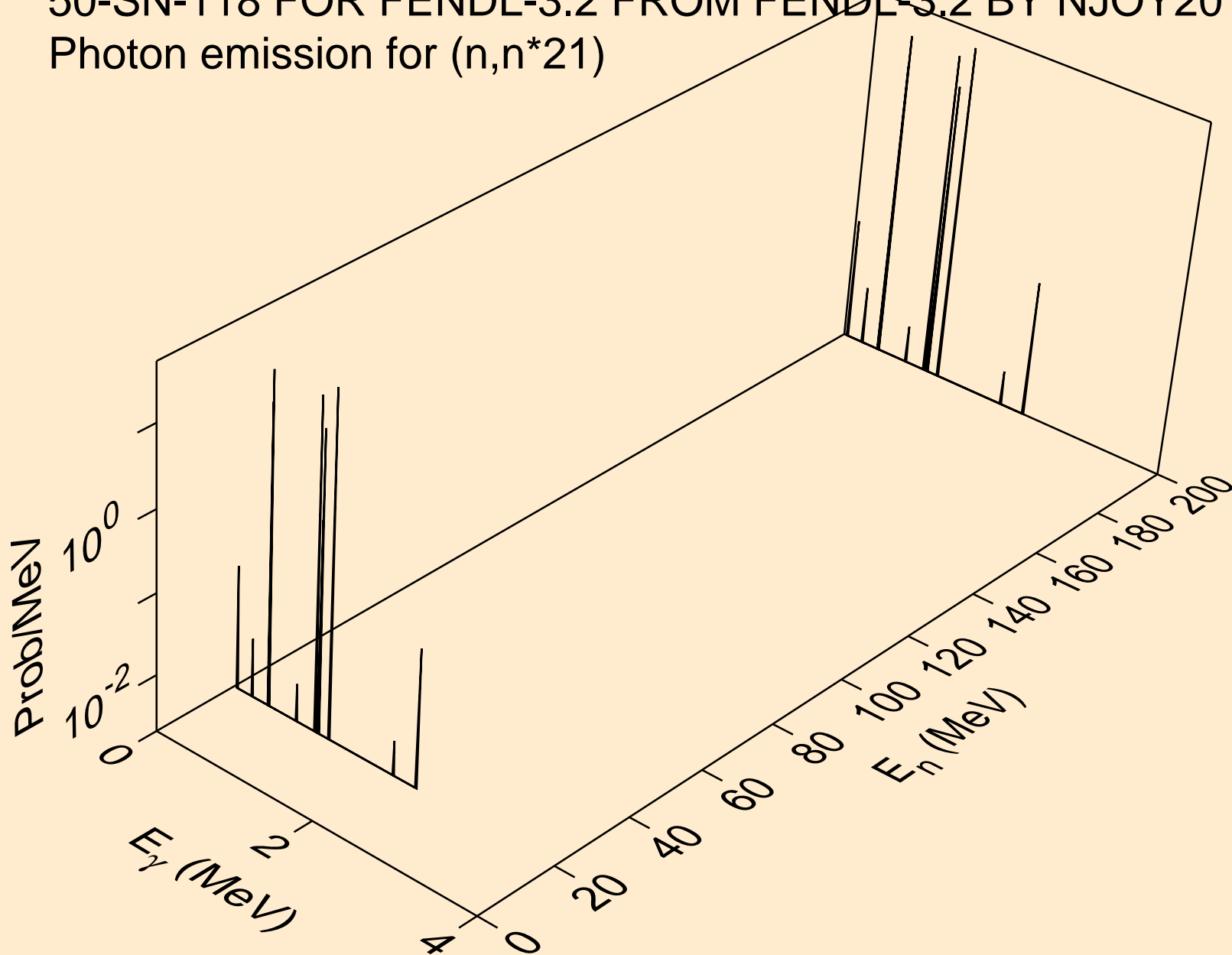

50-SN-118 FOR FENDL-3.2 FROM FENDL-3.2 BY NJOY2016.60+ C  
Photon emission for (n,n\*22)

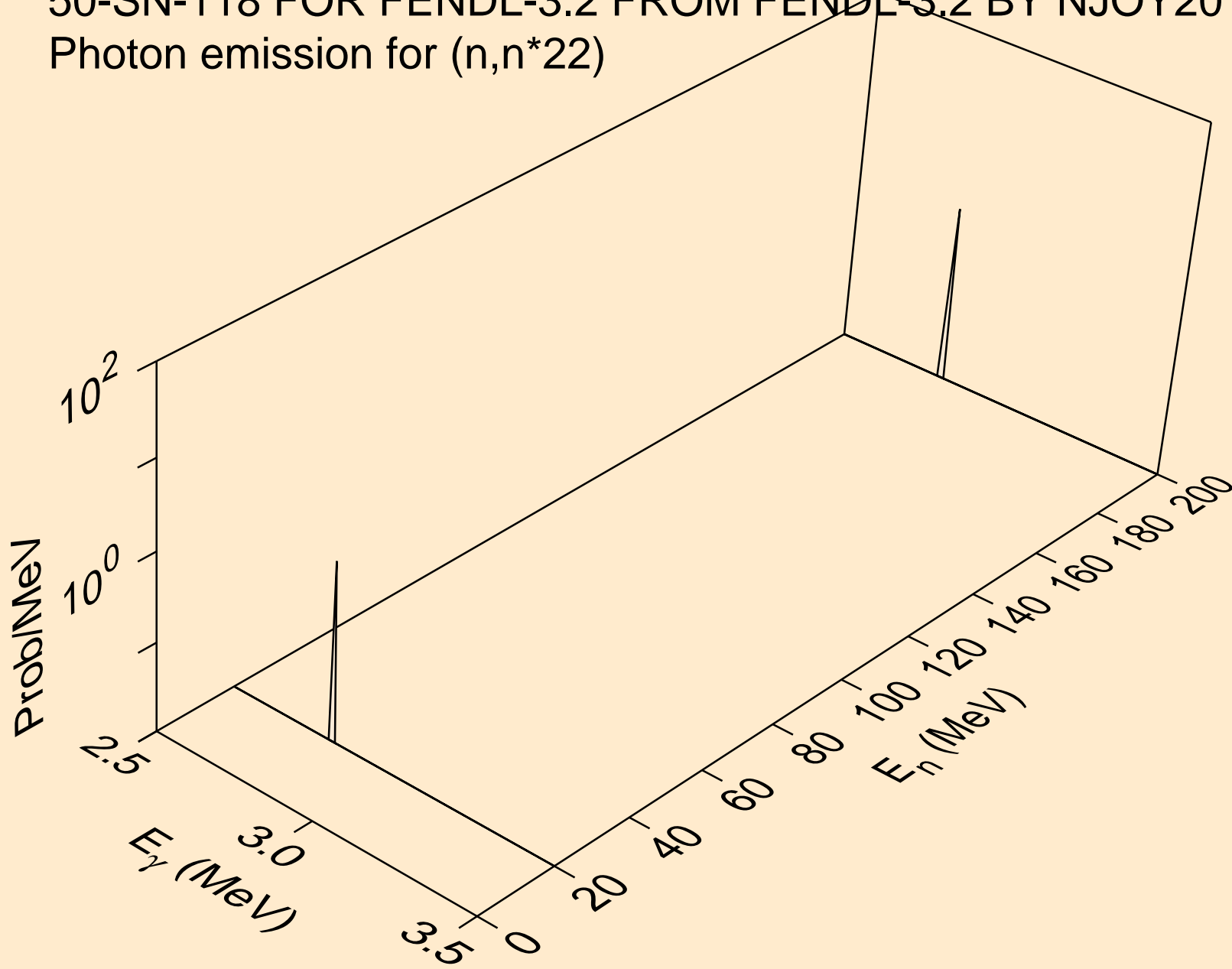

50-SN-118 FOR FENDL-3.2 FROM FENDL-3.2 BY NJOY2016.60+ C  
Photon emission for (n,n\*23)

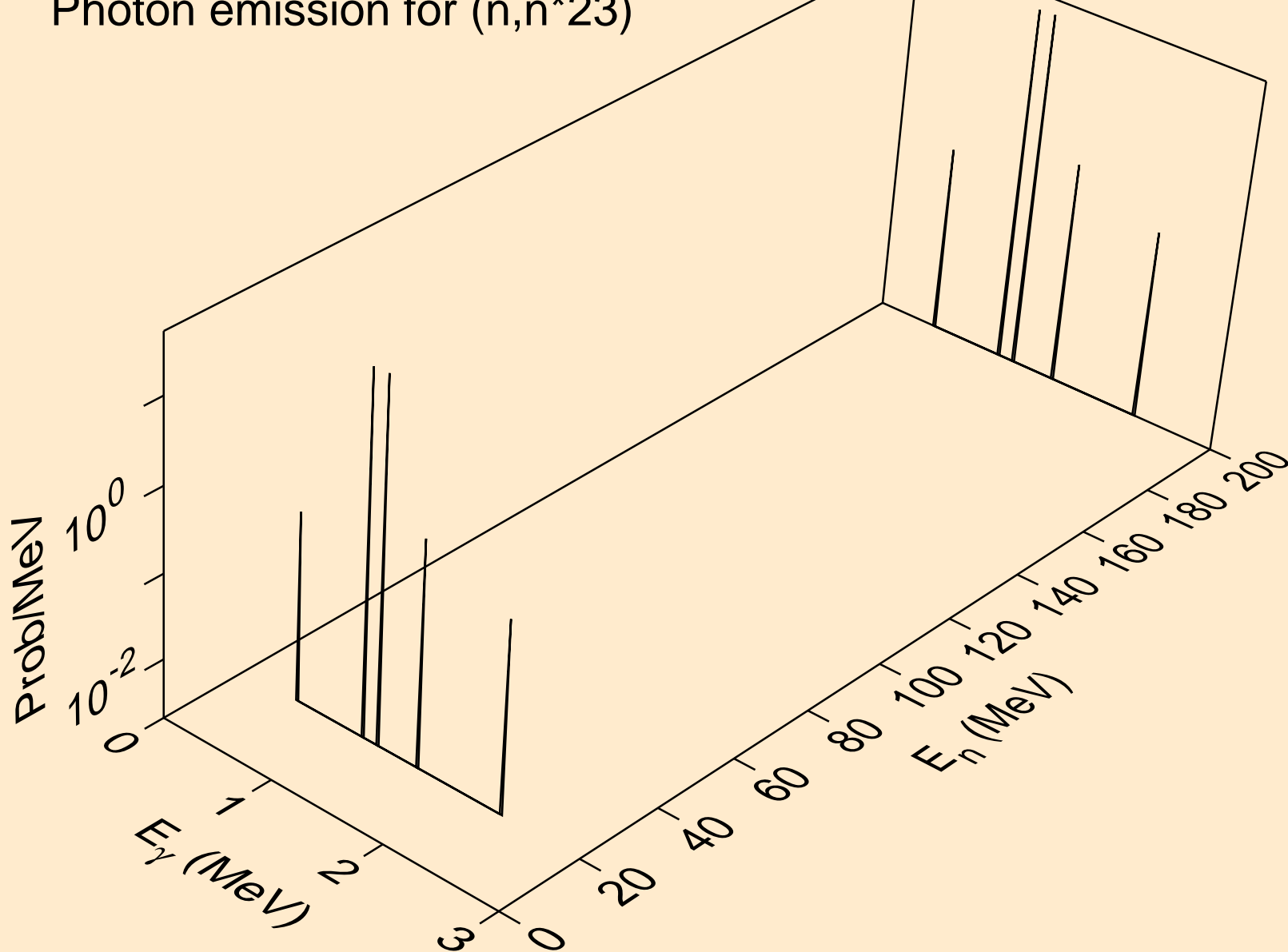

50-SN-118 FOR FENDL-3.2 FROM FENDL-3.2 BY NJOY2016.60+ C  
Photon emission for (n,n\*24)

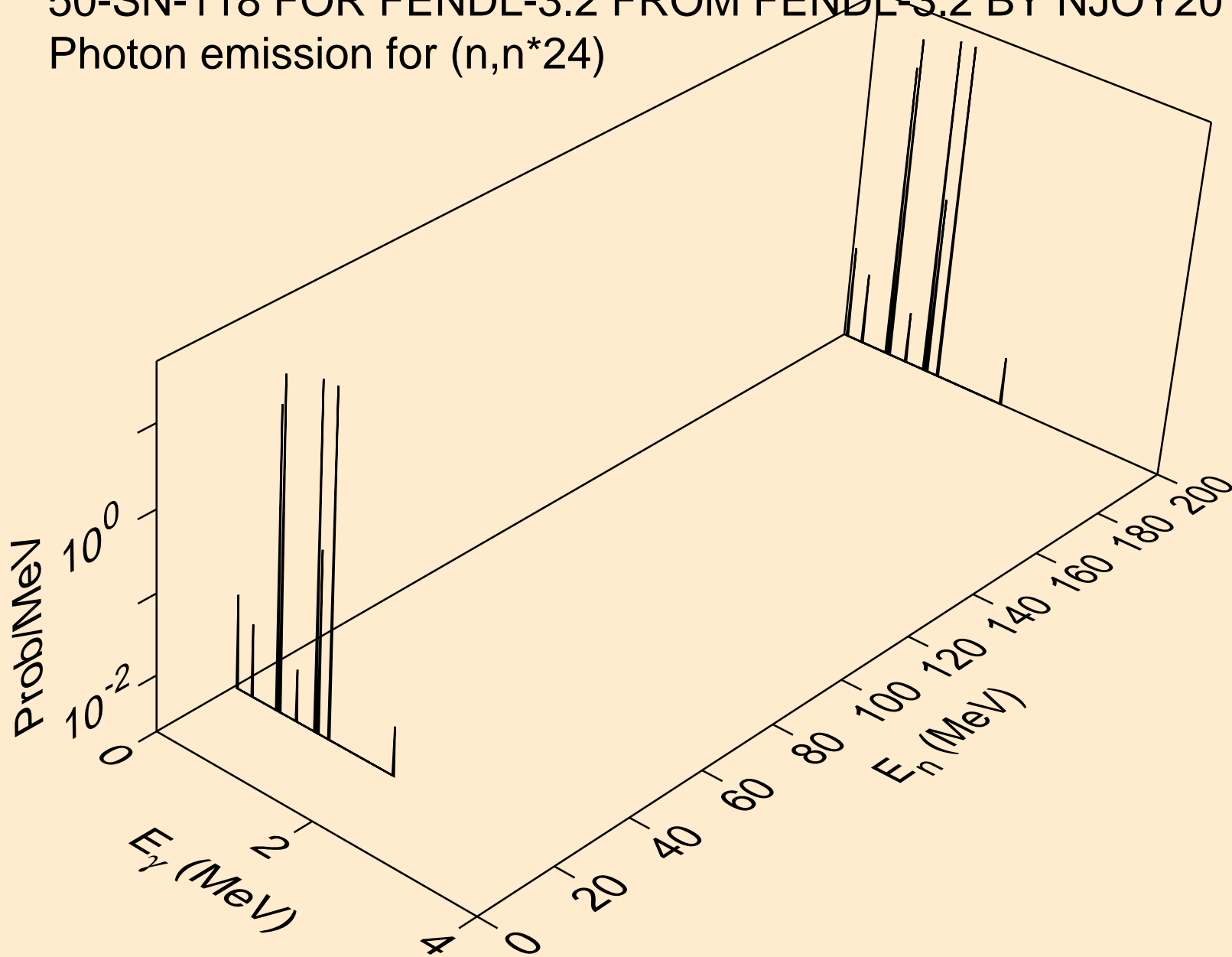



50-SN-118 FOR FENDL-3.2 FROM FENDL-3.2 BY NJOY2016.60+ C  
Photon emission for (n,n\*25)

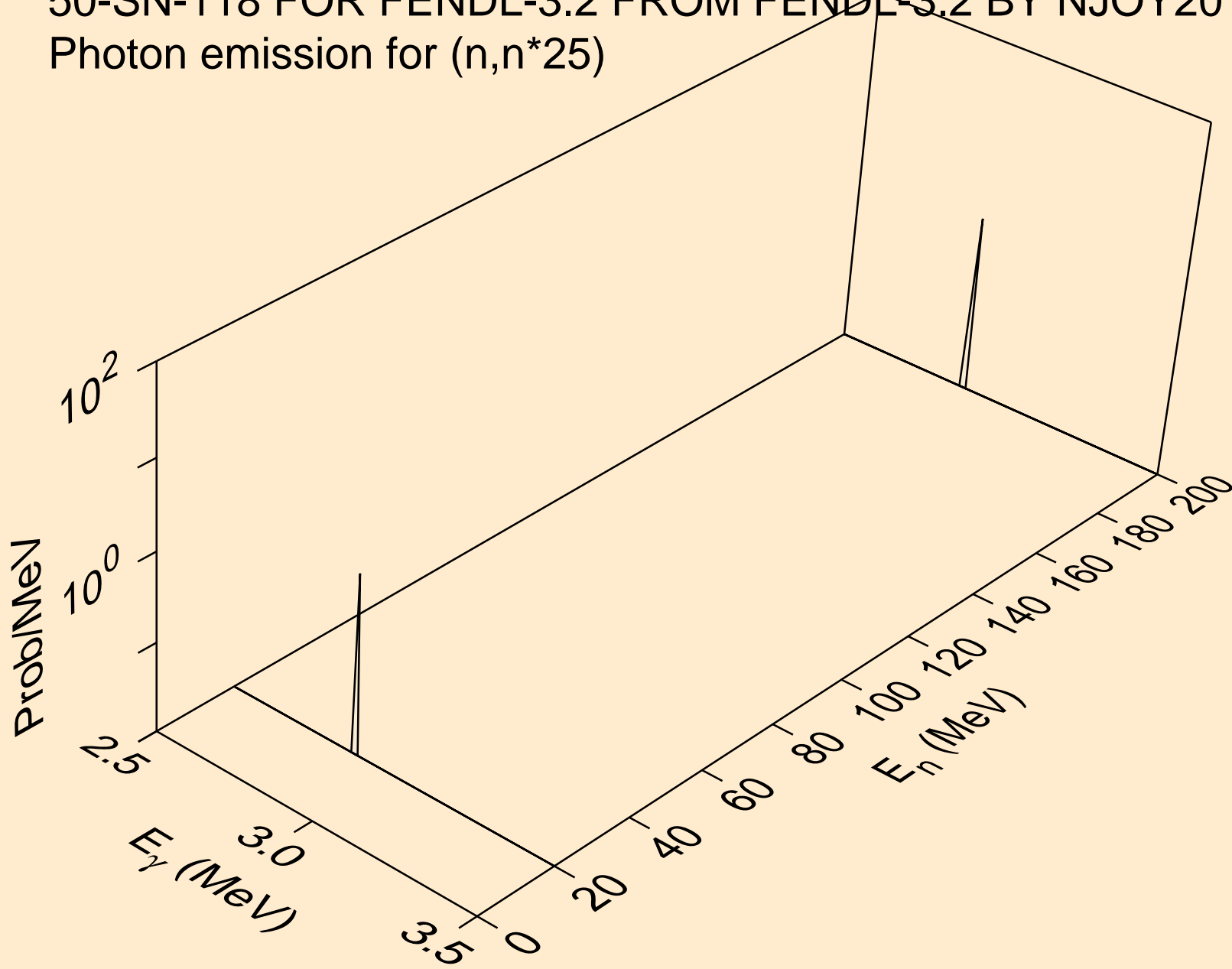

50-SN-118 FOR FENDL-3.2 FROM FENDL-3.2 BY NJOY2016.60+ C  
Photon emission for (n,n\*26)

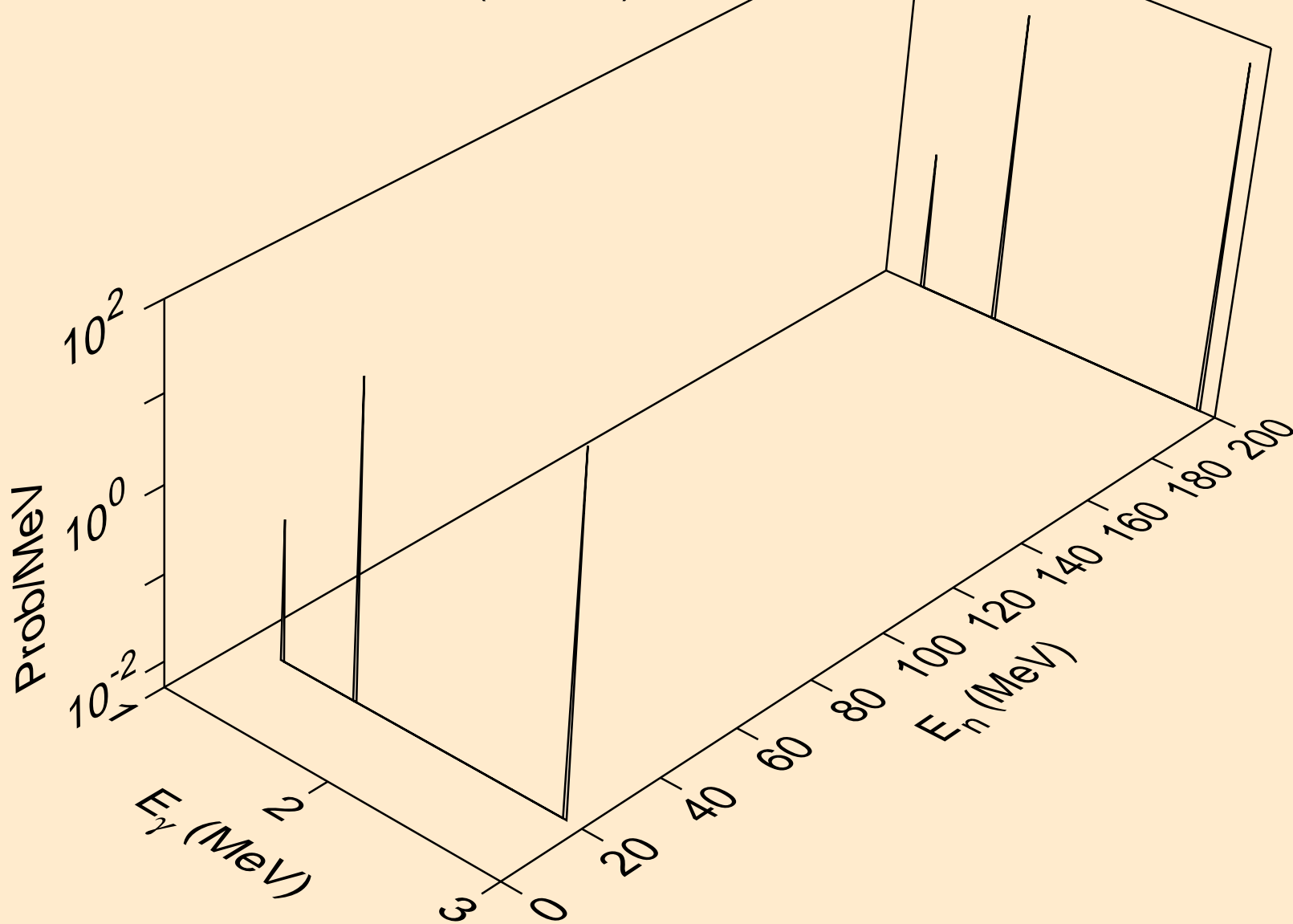

50-SN-118 FOR FENDL-3.2 FROM FENDL-3.2 BY NJOY2016.60+ C  
Photon emission for (n,n\*27)

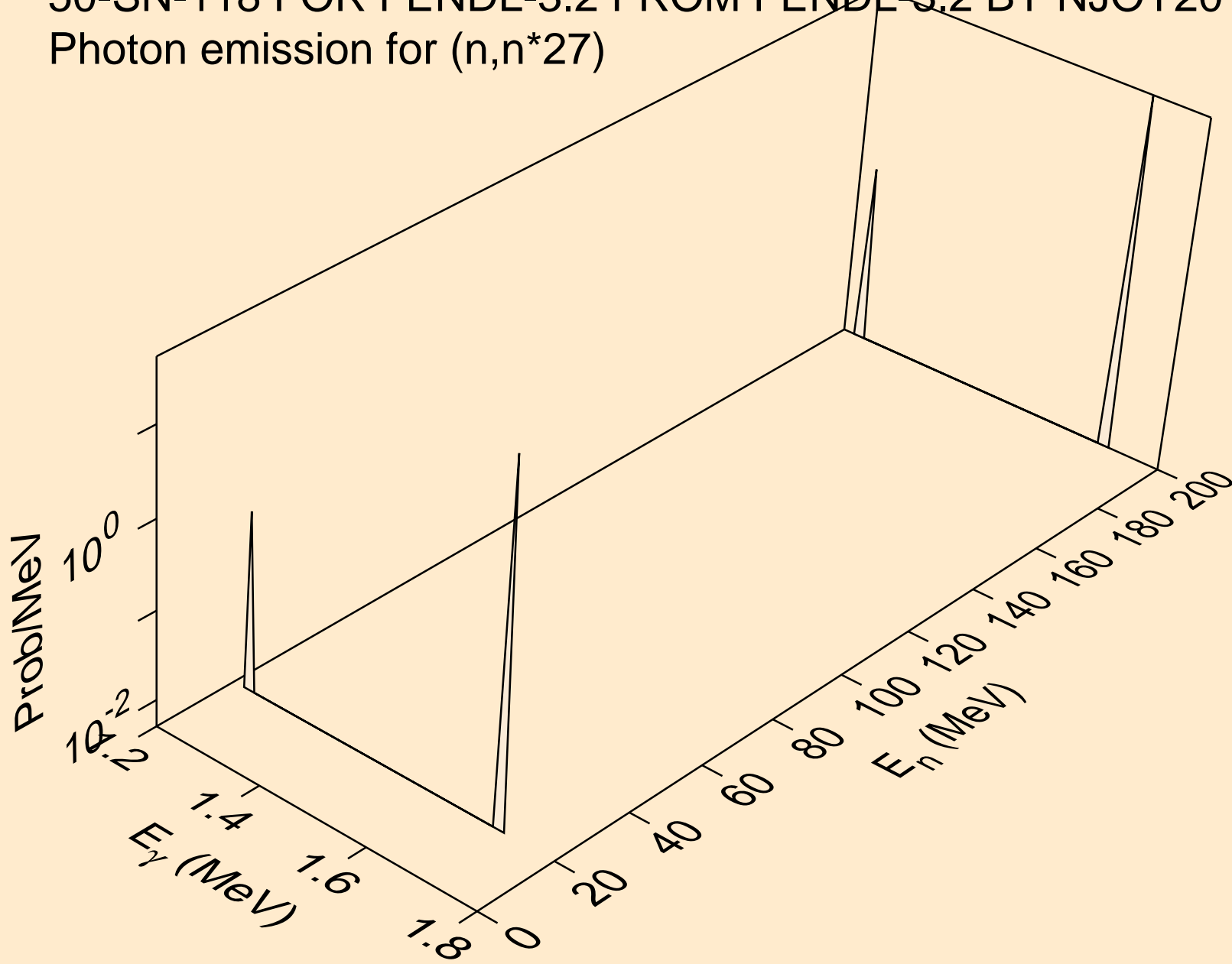

50-SN-118 FOR FENDL-3.2 FROM FENDL-3.2 BY NJOY2016.60+ C  
Photon emission for (n,n\*28)

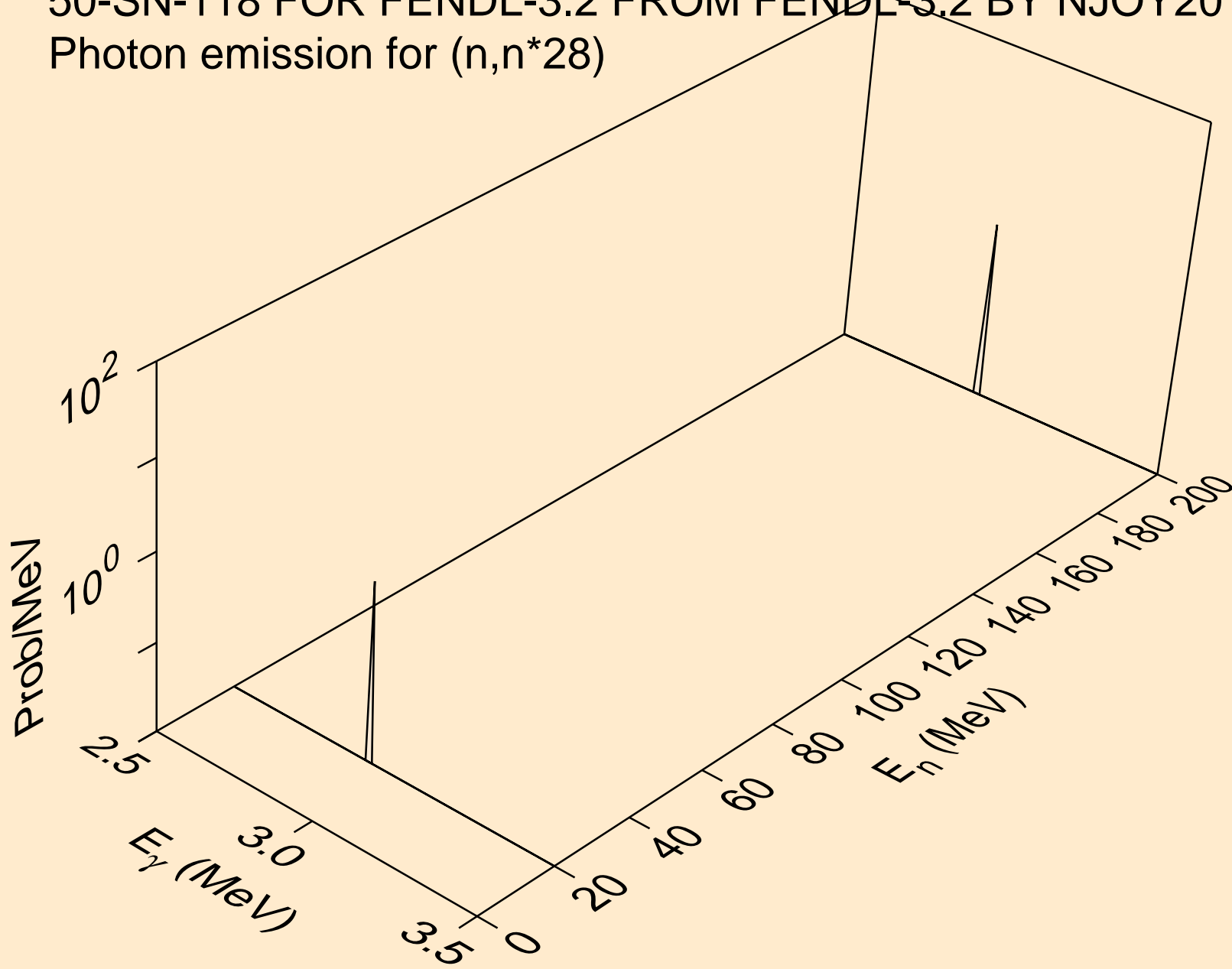

50-SN-118 FOR FENDL-3.2 FROM FENDL-3.2 BY NJOY2016.60+ C  
Photon emission for (n,n\*29)

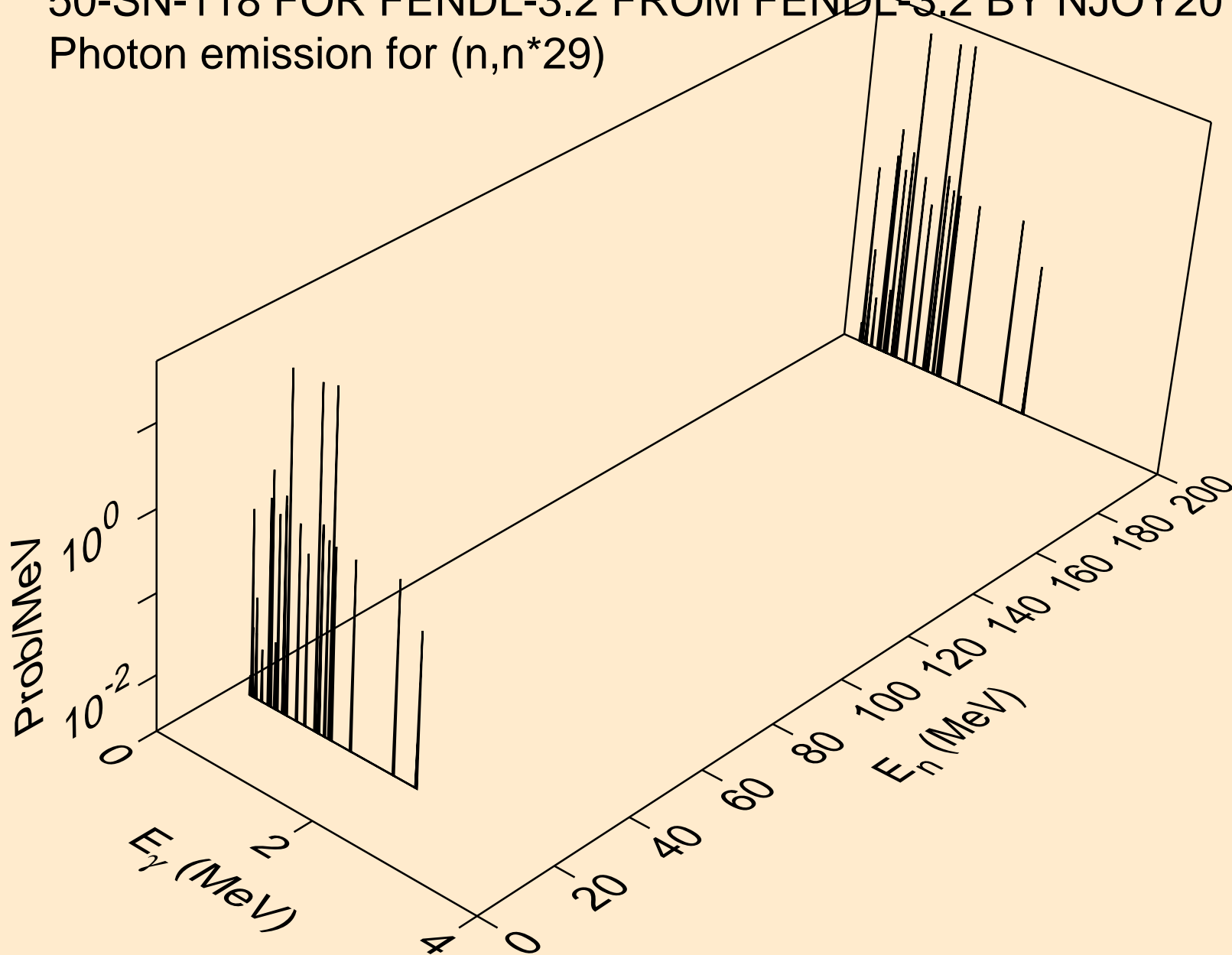

50-SN-118 FOR FENDL-3.2 FROM FENDL-3.2 BY NJOY2016.60+ C  
Photon emission for (n,n\*30)

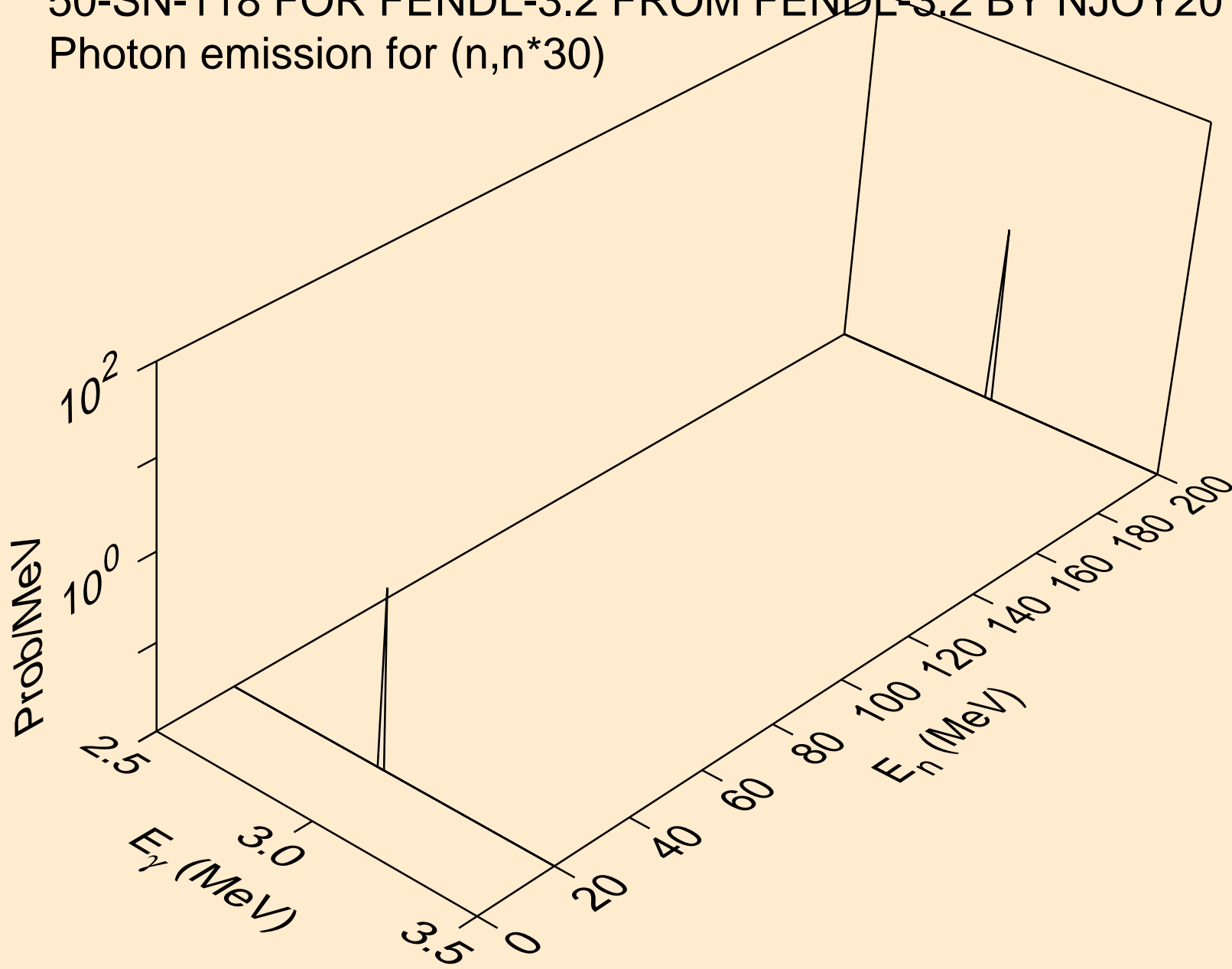

50-SN-118 FOR FENDL-3.2 FROM FENDL-3.2 BY NJOY2016.60+ C  
Photon emission for (n,n\*31)

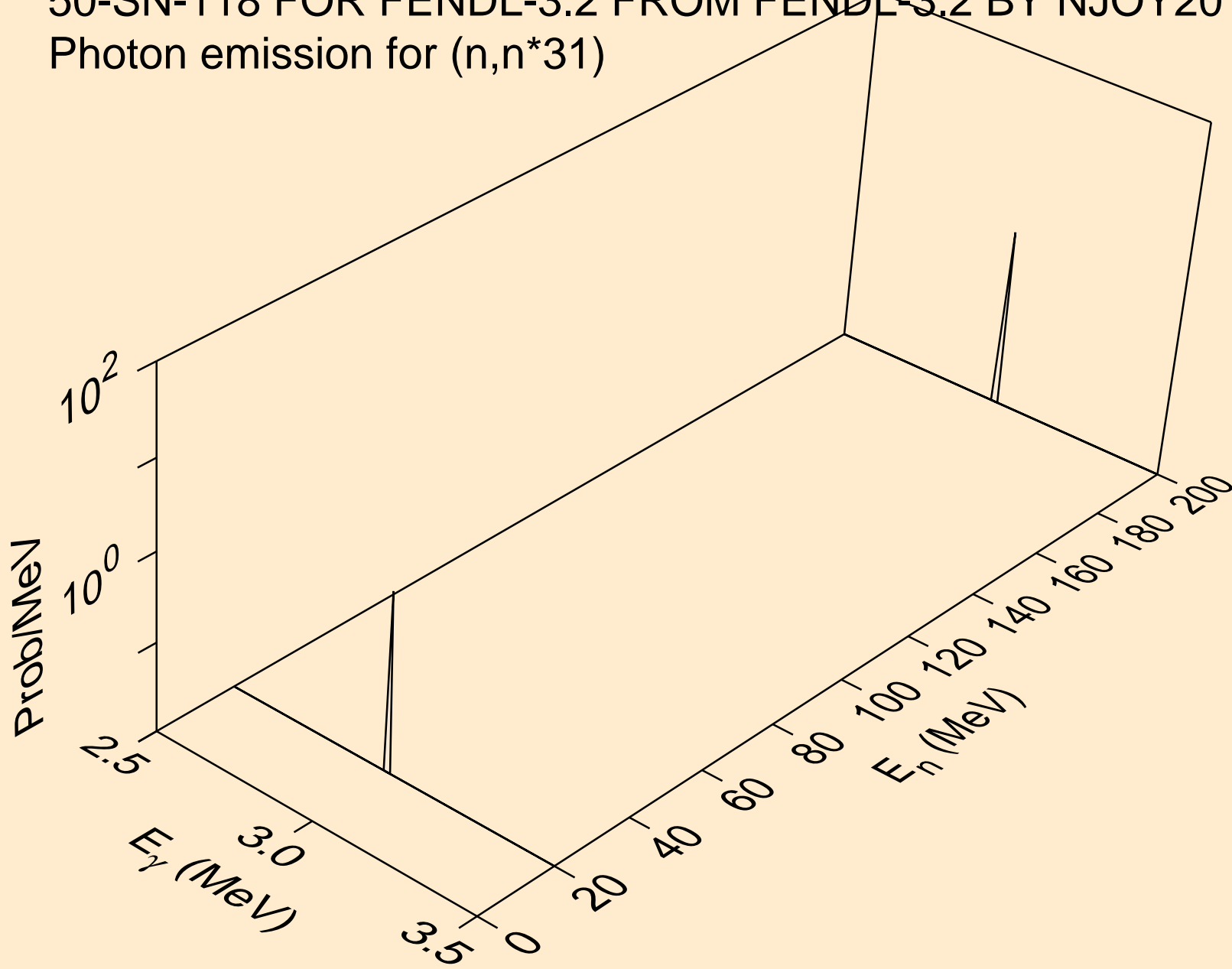

50-SN-118 FOR FENDL-3.2 FROM FENDL-3.2 BY NJOY2016.60+ C  
Photon emission for (n,n\*32)

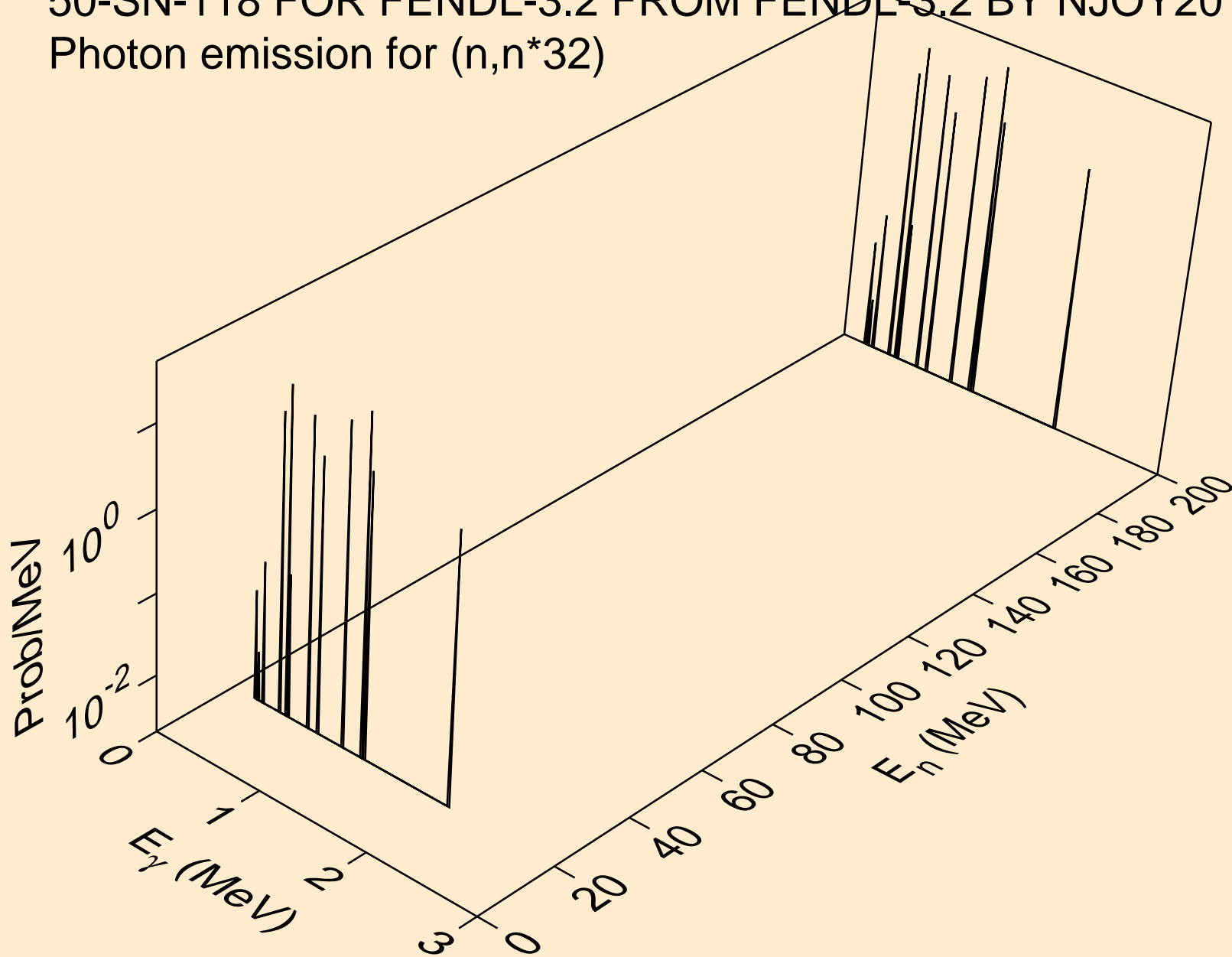



50-SN-118 FOR FENDL-3.2 FROM FENDL-3.2 BY NJOY2016.60+ C  
Photon emission for (n,n\*33)

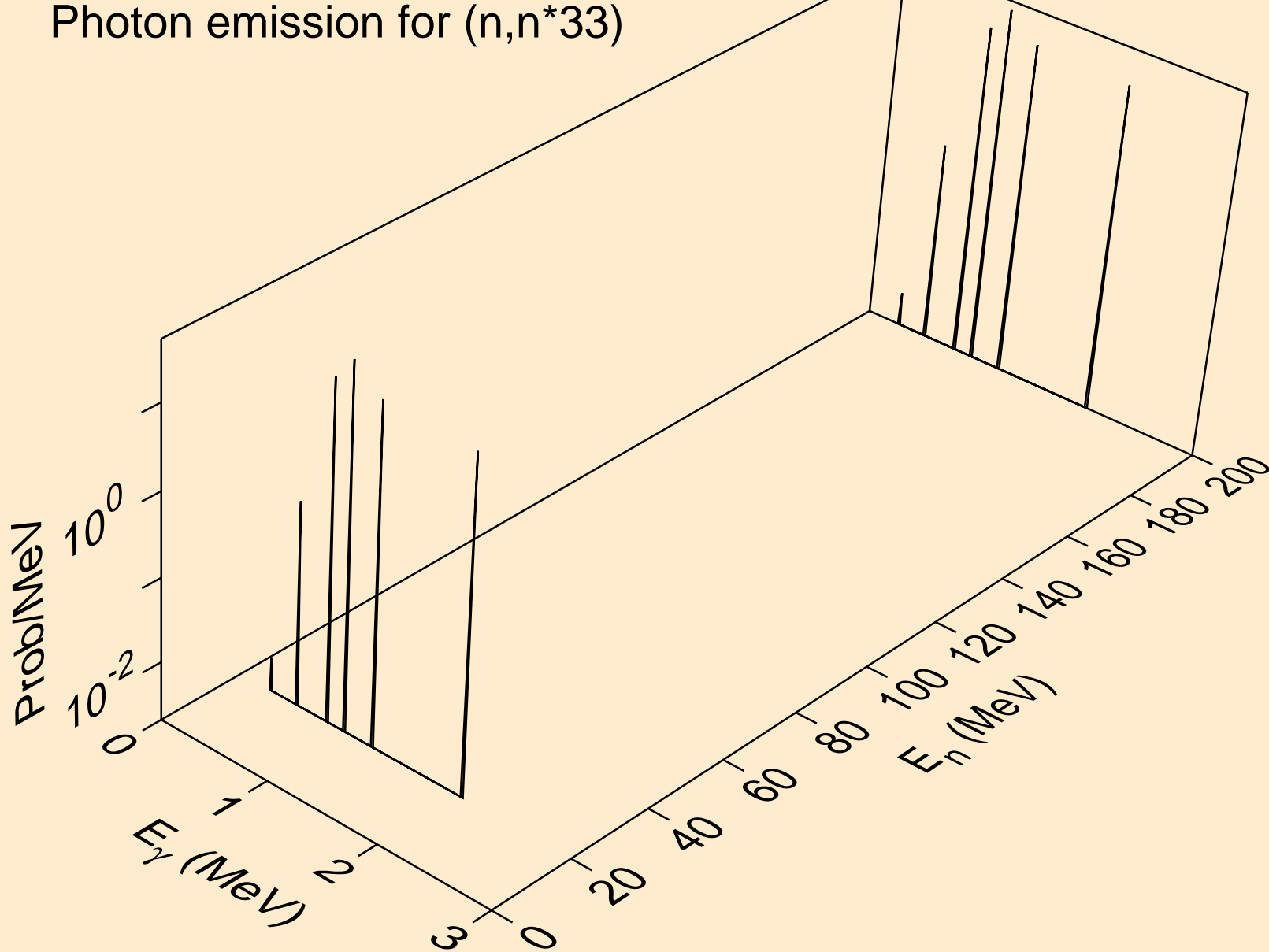

50-SN-118 FOR FENDL-3.2 FROM FENDL-3.2 BY NJOY2016.60+ C  
Photon emission for (n,n\*34)

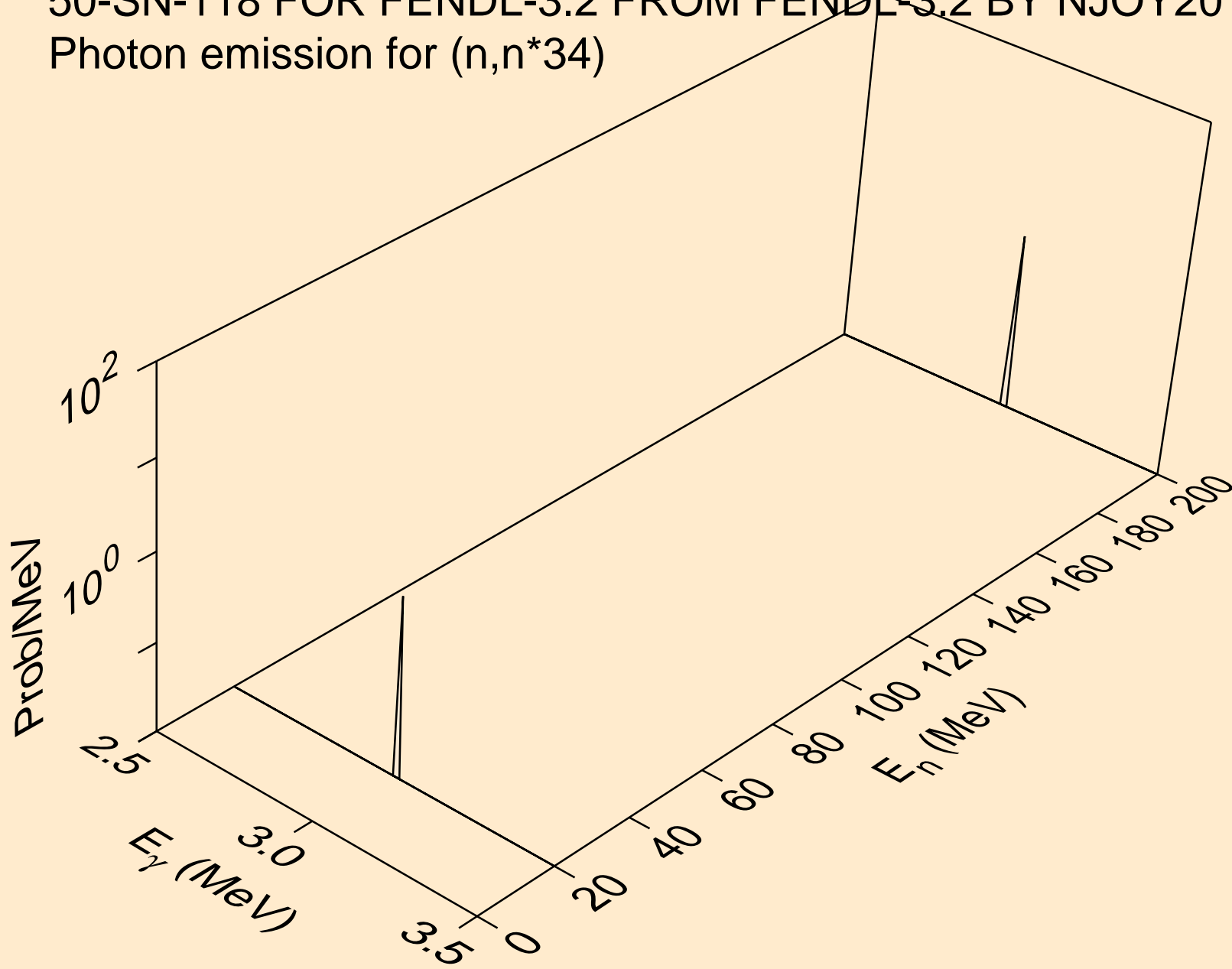

50-SN-118 FOR FENDL-3.2 FROM FENDL-3.2 BY NJOY2016.60+ C  
Photon emission for (n,n\*35)

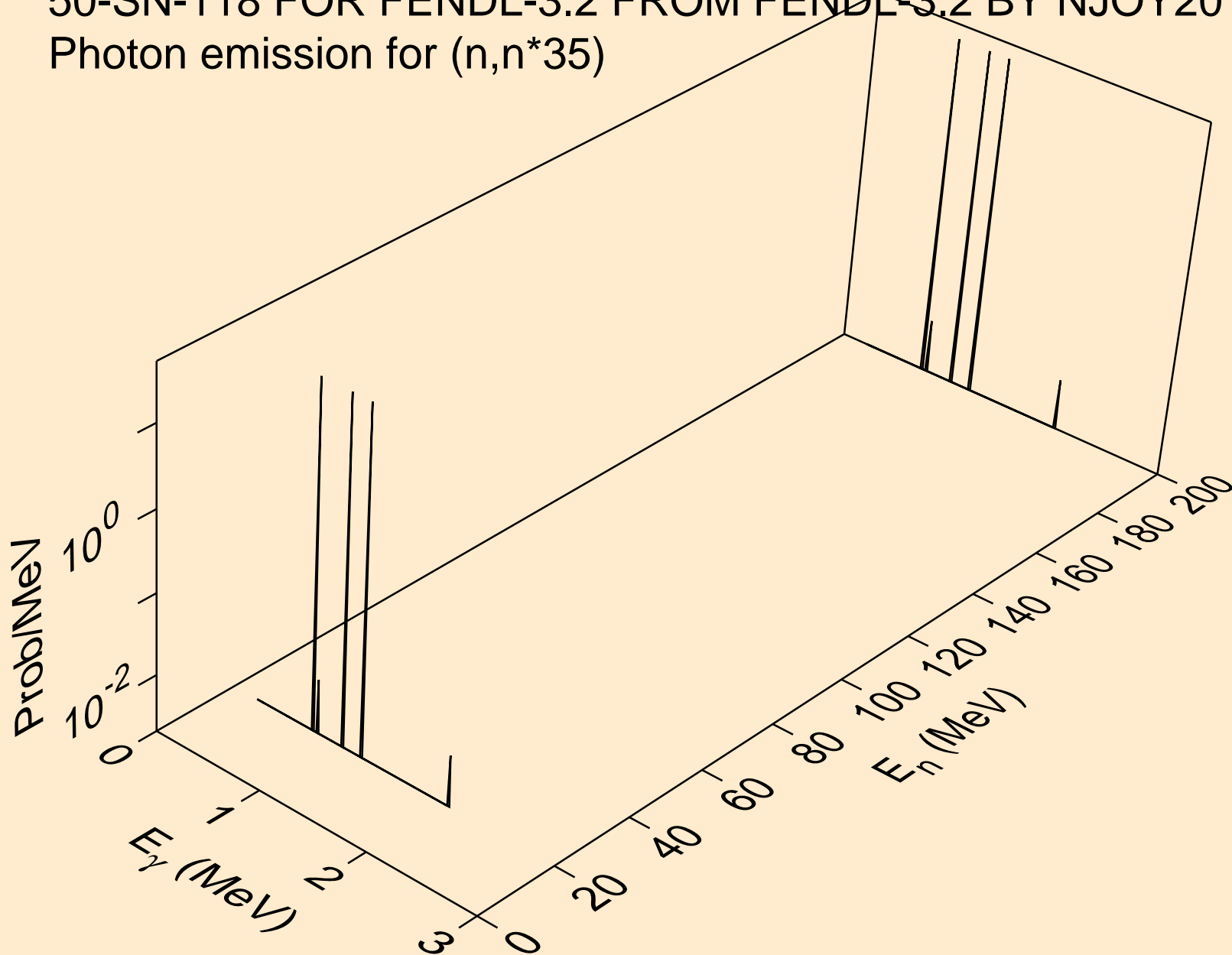

50-SN-118 FOR FENDL-3.2 FROM FENDL-3.2 BY NJOY2016.60+ C  
Photon emission for (n,n\*36)

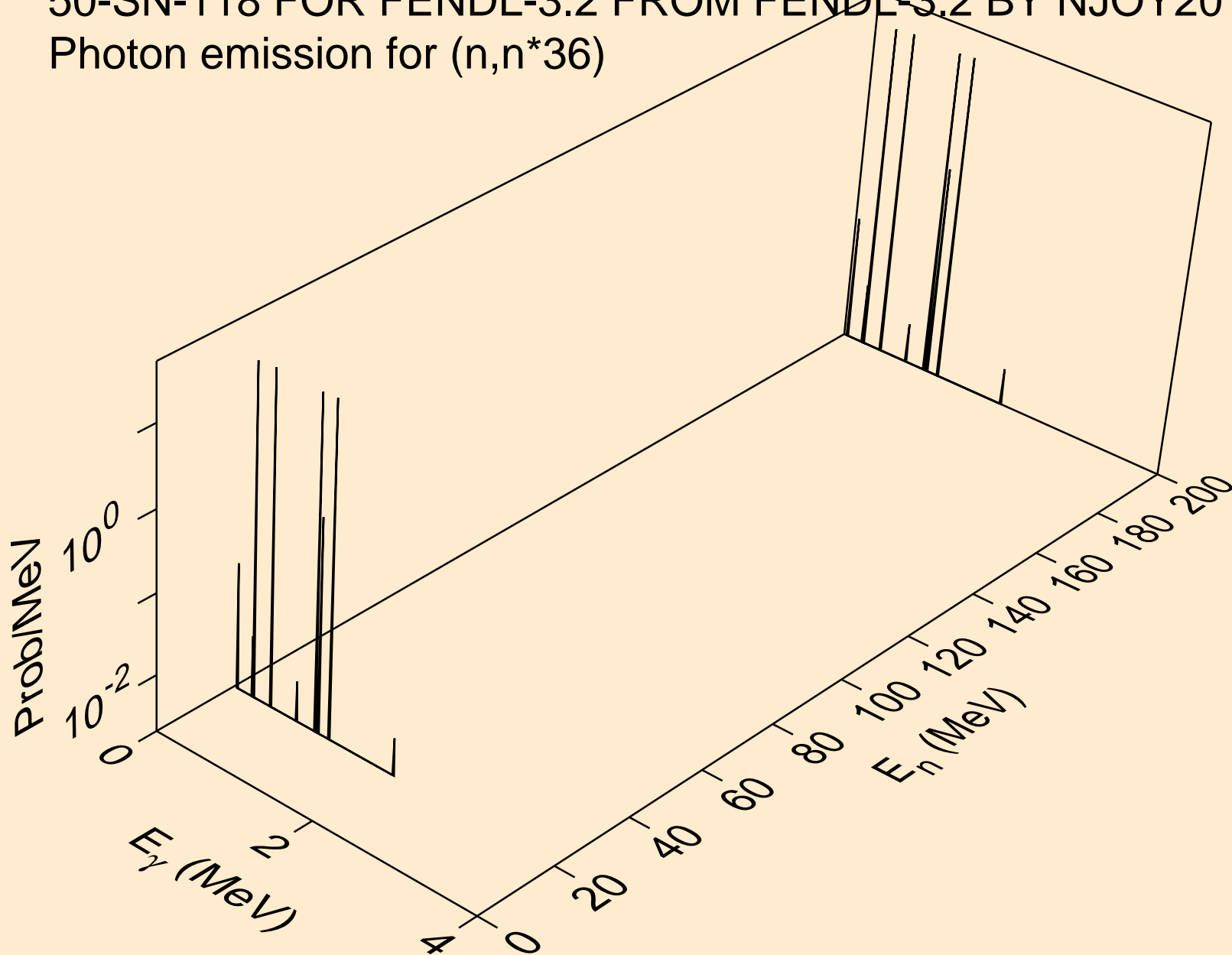

50-SN-118 FOR FENDL-3.2 FROM FENDL-3.2 BY NJOY2016.60+ C  
Photon emission for (n,n\*37)

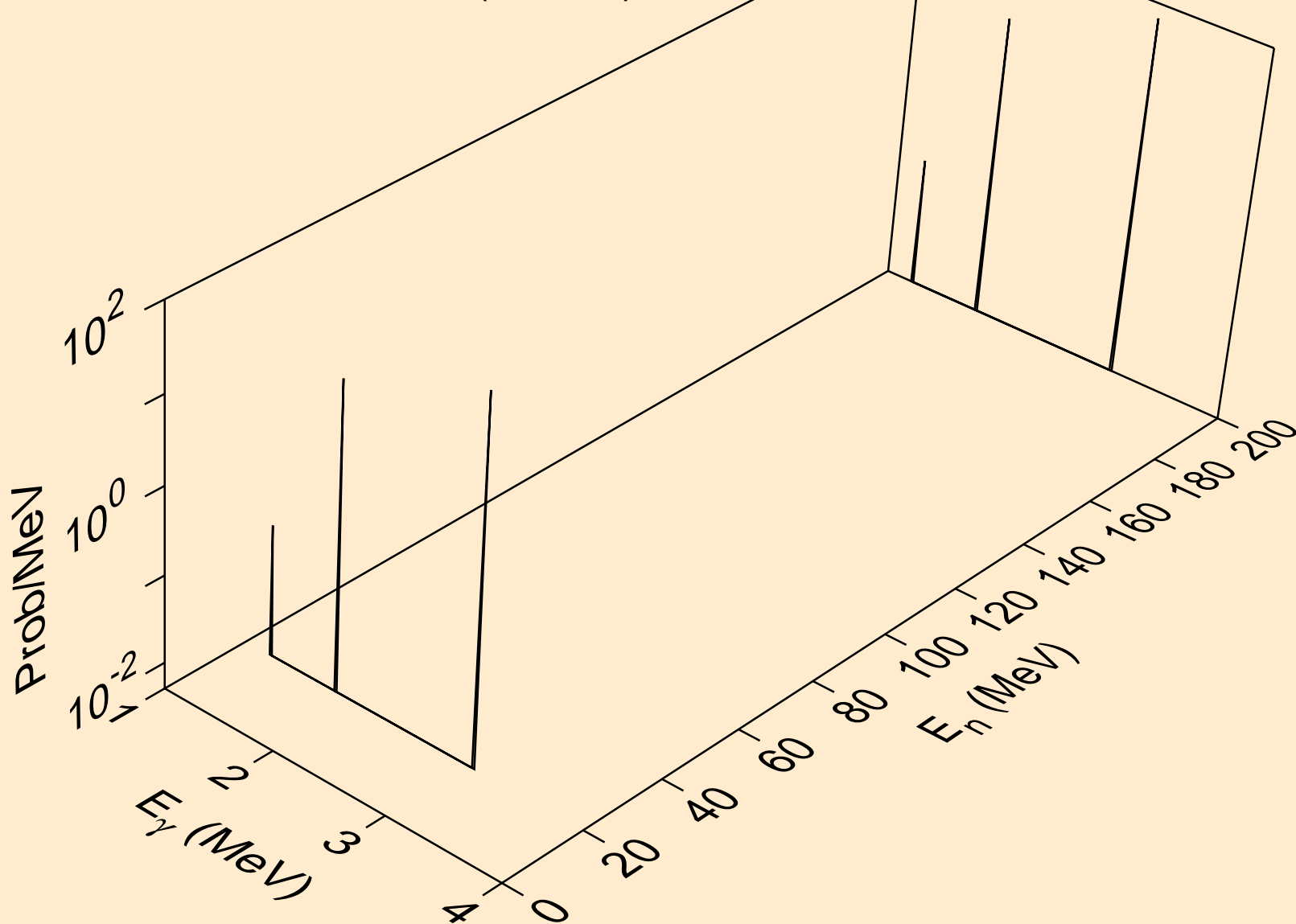

50-SN-118 FOR FENDL-3.2 FROM FENDL-3.2 BY NJOY2016.60+ C  
Photon emission for (n,n\*38)

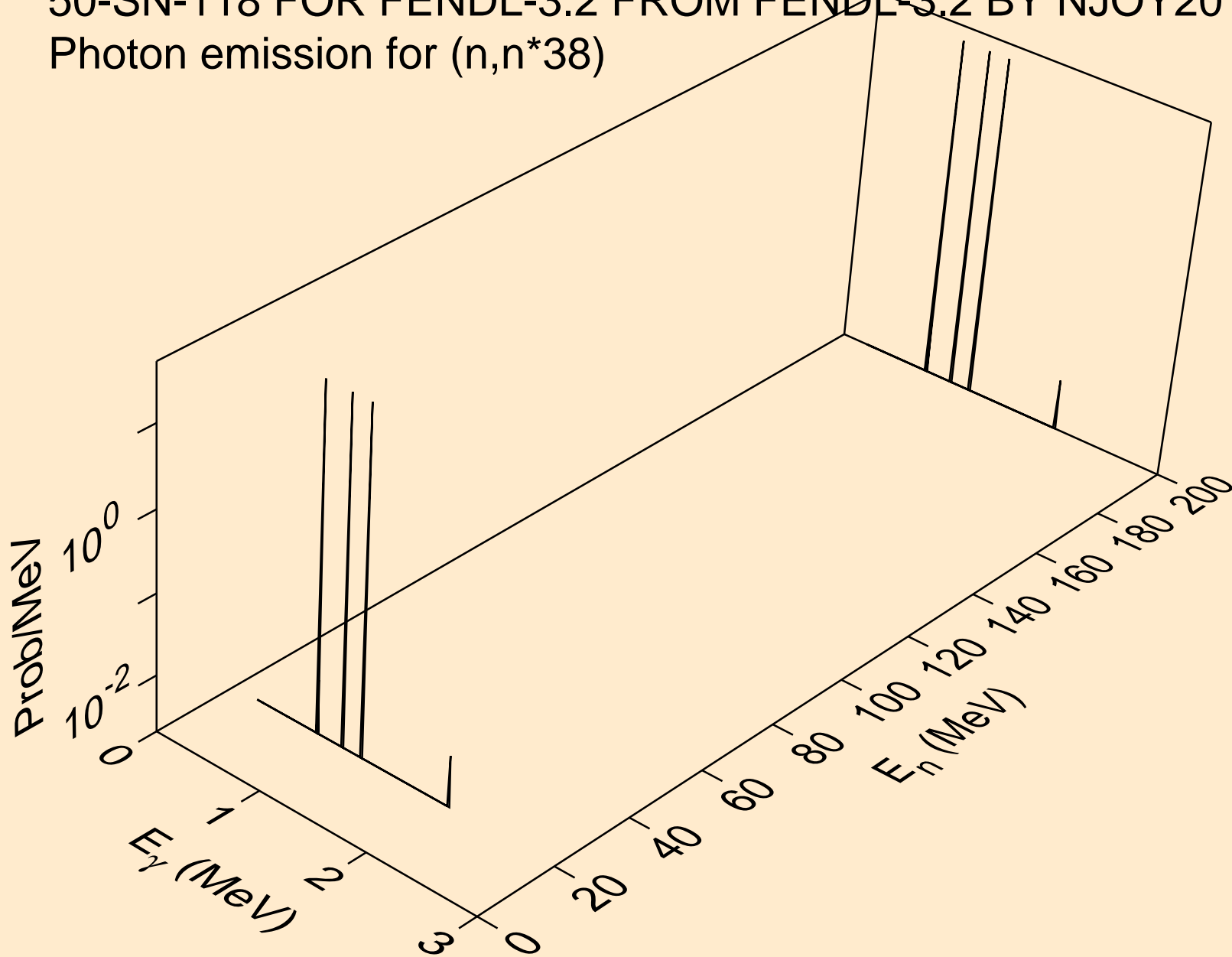

50-SN-118 FOR FENDL-3.2 FROM FENDL-3.2 BY NJOY2016.60+ C  
Photon emission for (n,n\*39)

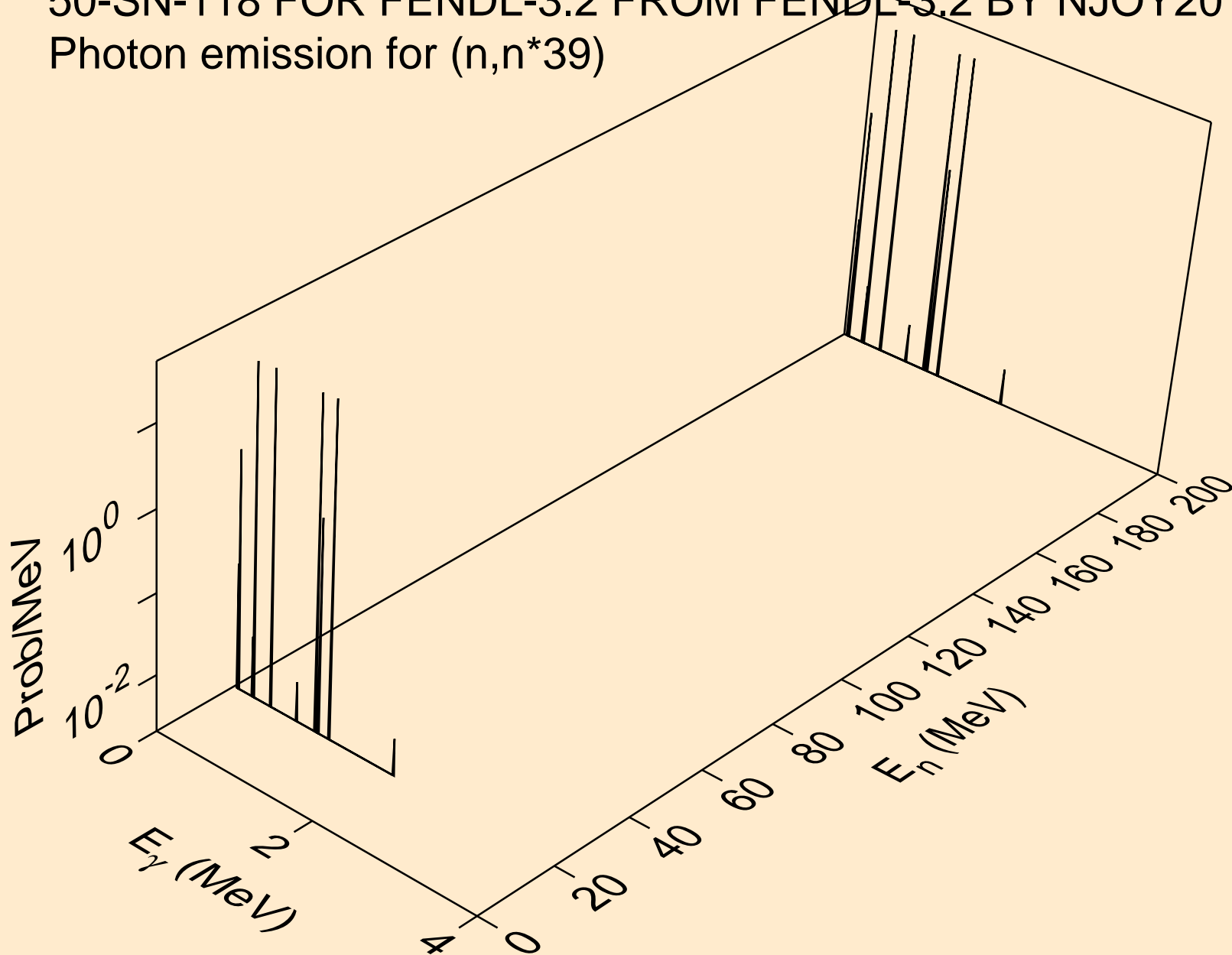

50-SN-118 FOR FENDL-3.2 FROM FENDL-3.2 BY NJOY2016.60+ C  
Photon emission for (n,n\*40)

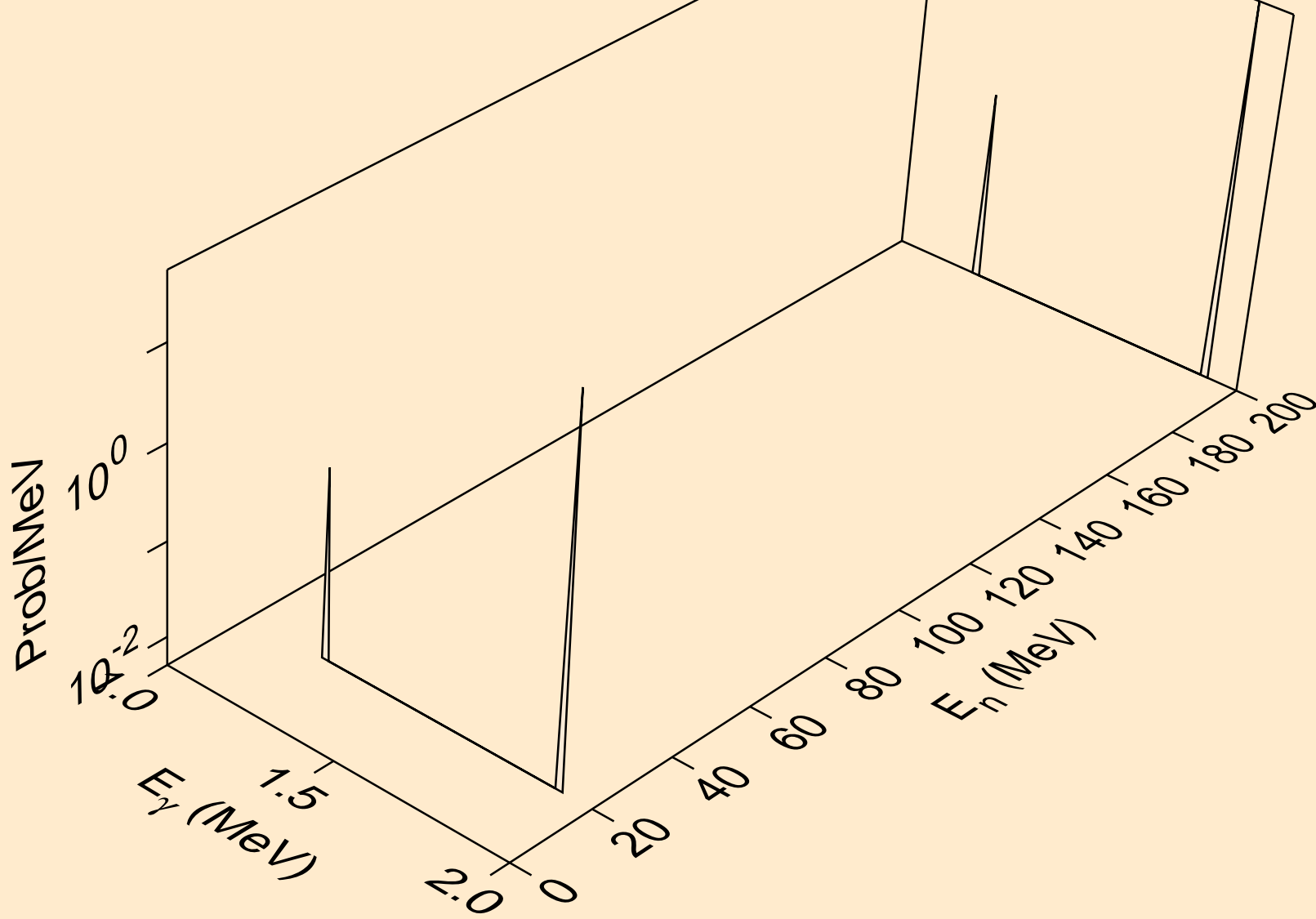



50-SN-118 FOR FENDL-3.2 FROM FENDL-3.2 BY NJOY2016.60+ C  
Photon emission for (n,n\*c)

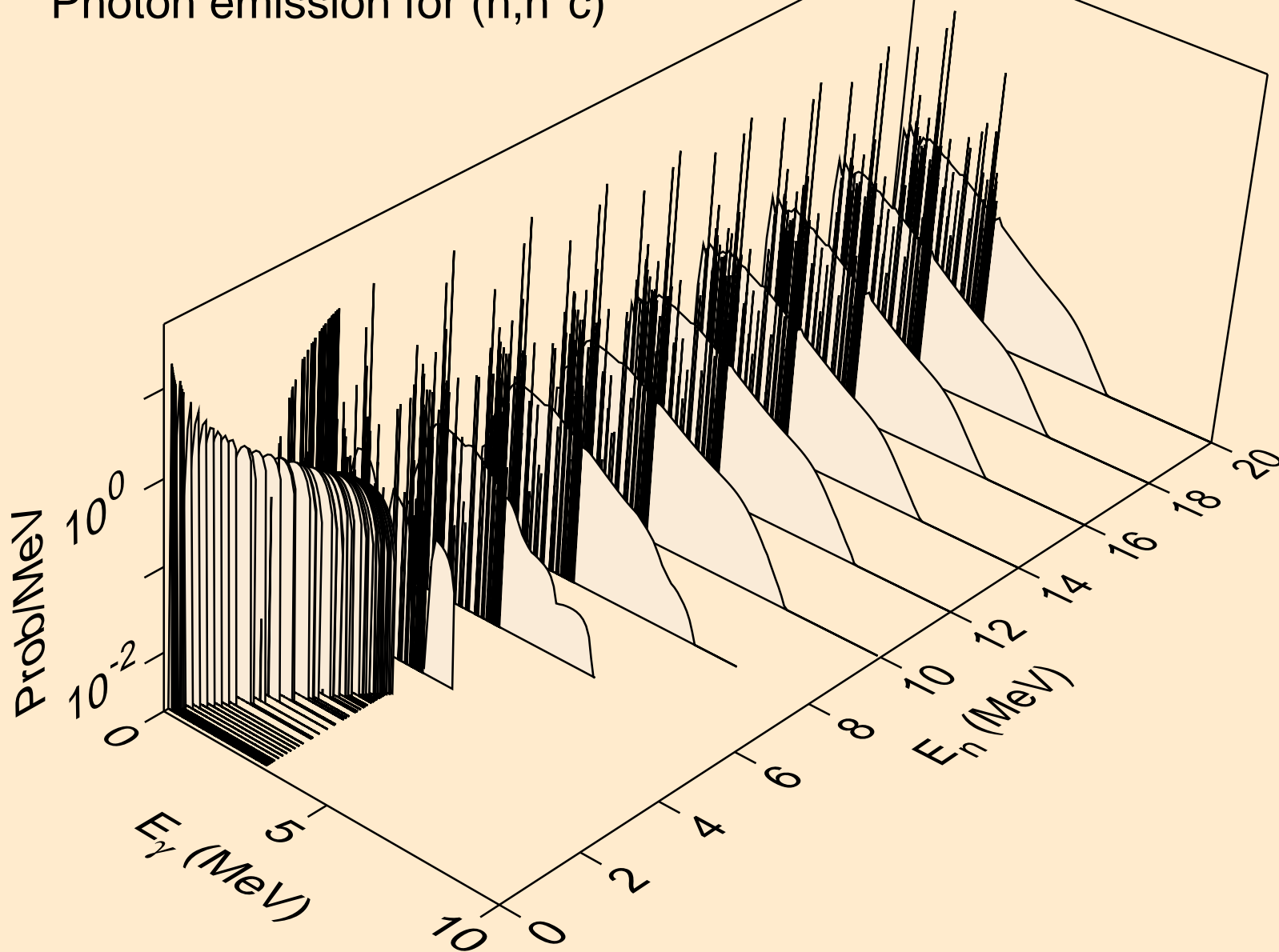

50-SN-118 FOR FENDL-3.2 FROM FENDL-3.2 BY NJOY2016.60+ C  
Photon emission for (n,gma)

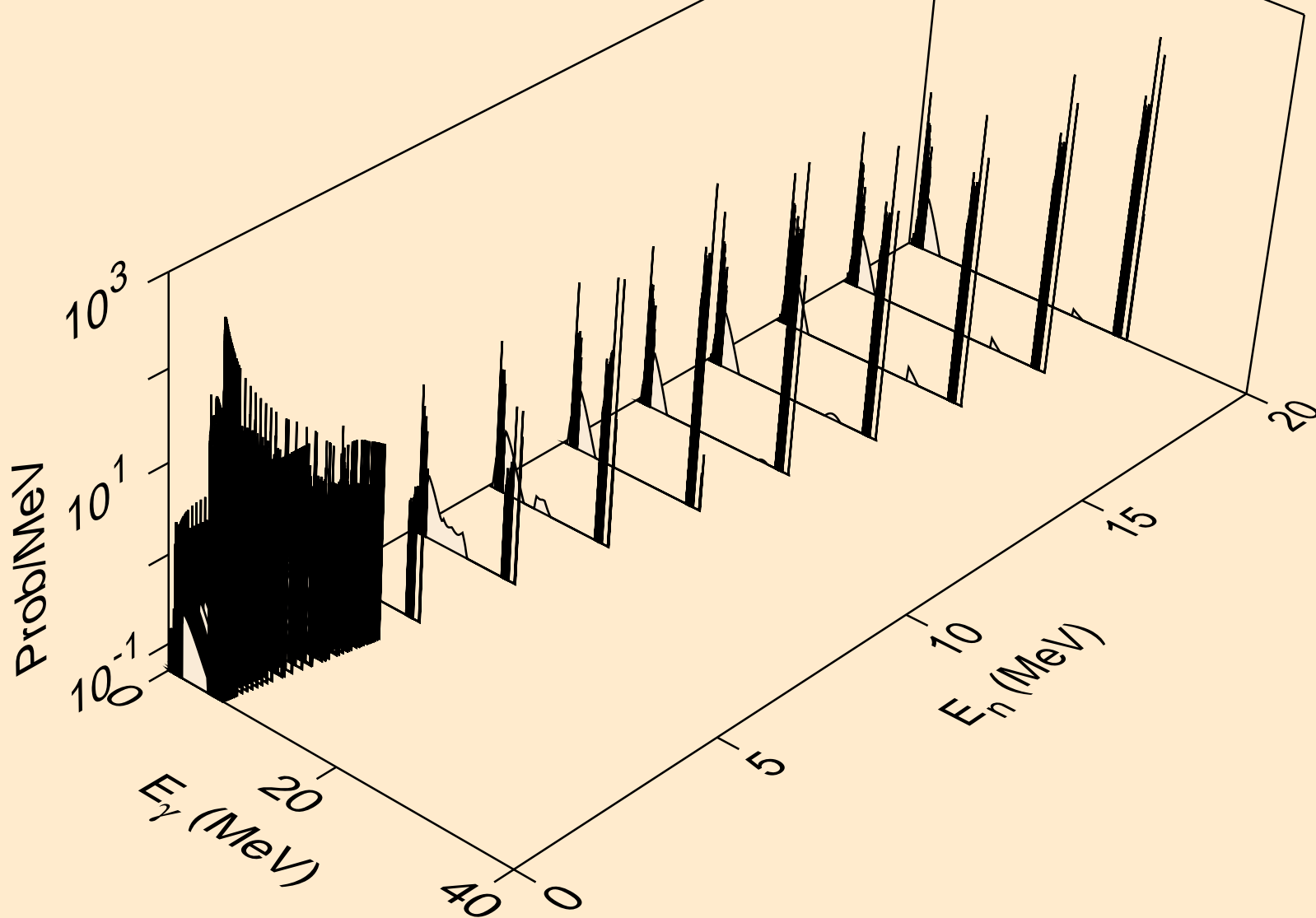

50-SN-118 FOR FENDL-3.2 FROM FENDL-3.2 BY NJOY2016.60+ C  
thermal capture photon spectrum

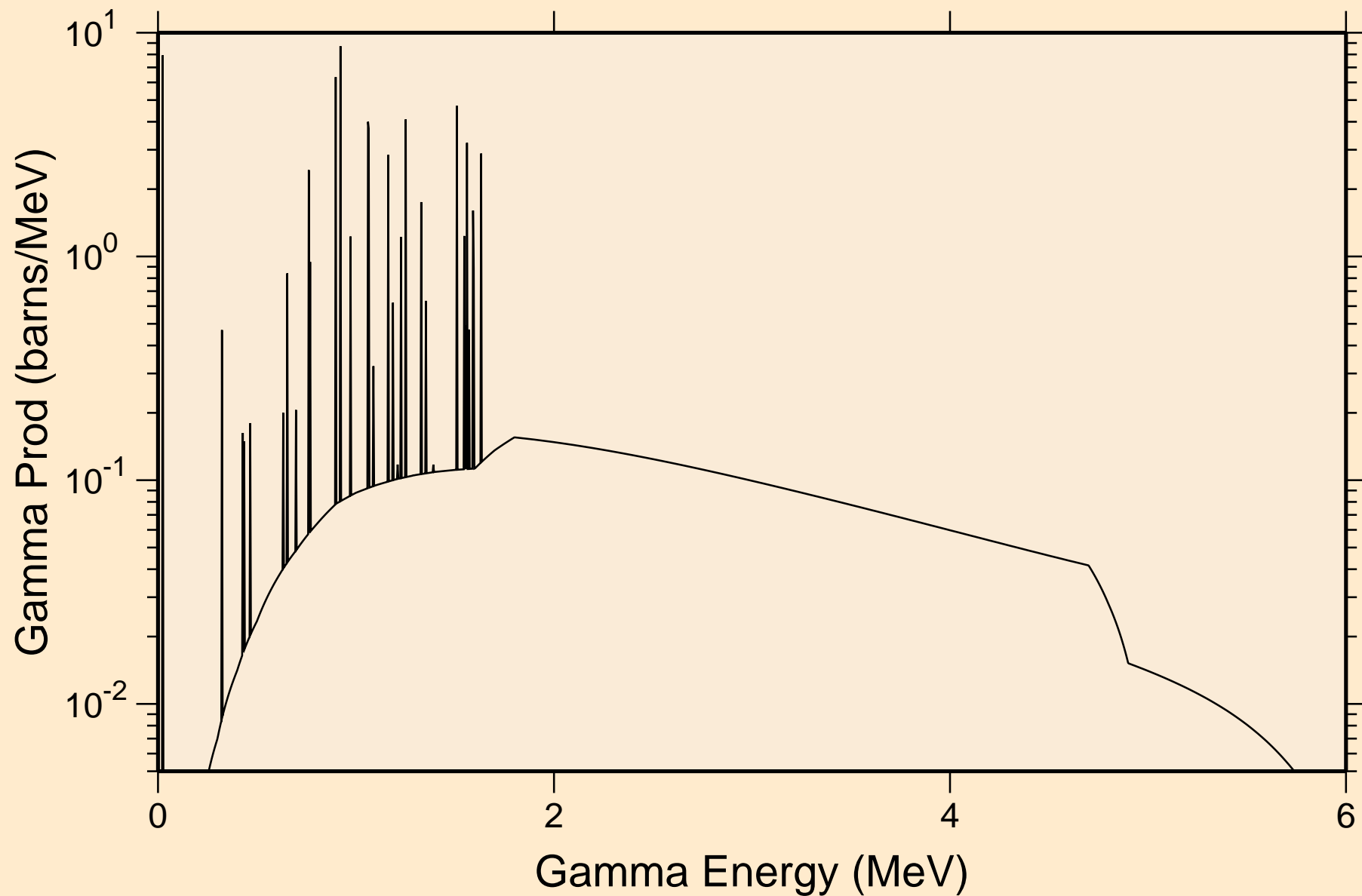

50-SN-118 FOR FENDL-3.2 FROM FENDL-3.2 BY NJOY2016.60+ C  
14 MeV photon spectrum

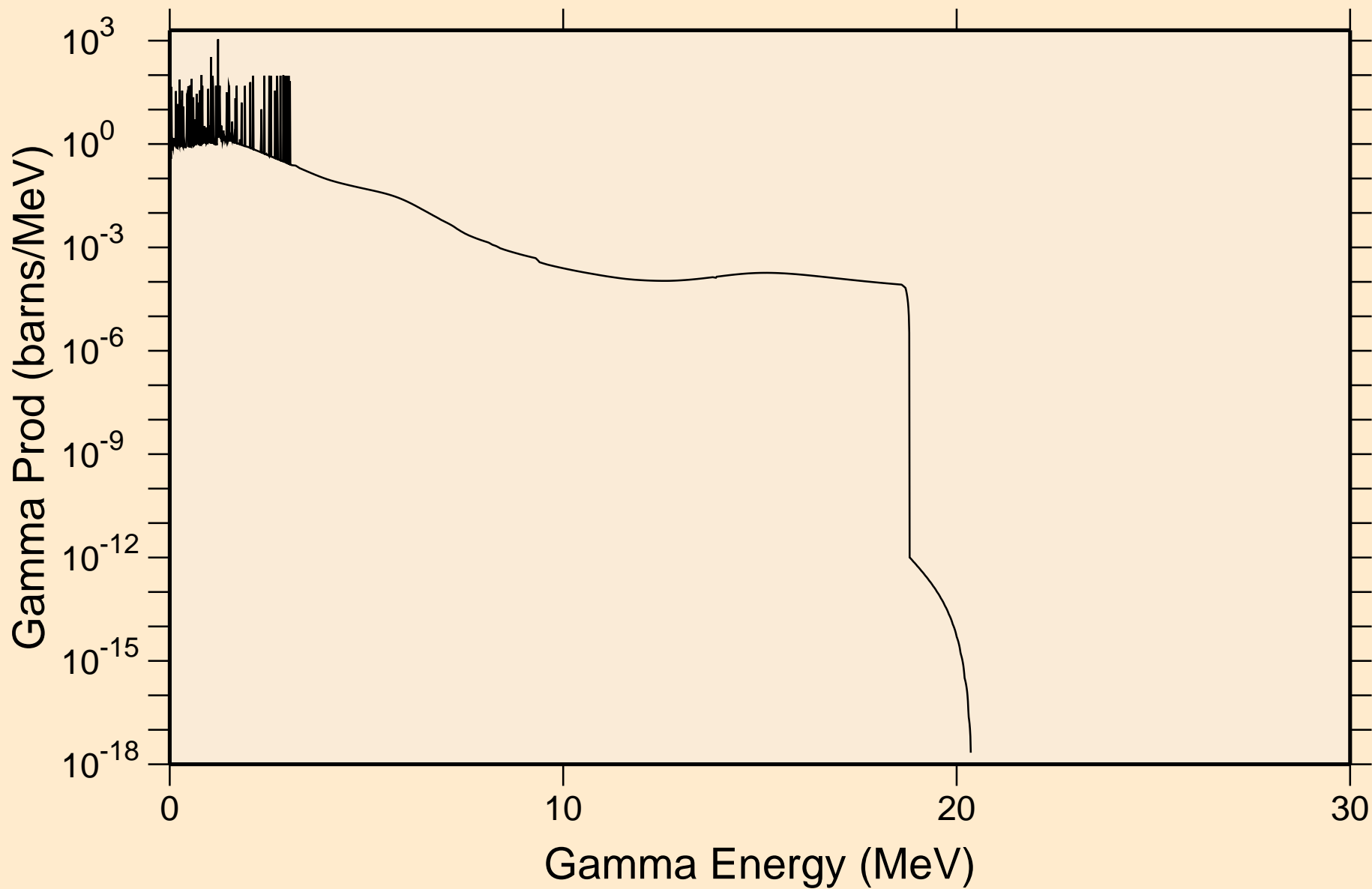

# 50-SN-118 FOR FENDL-3.2 FROM FENDL-3.2 BY NJOY2016.60+ C

## Particle heating contributions

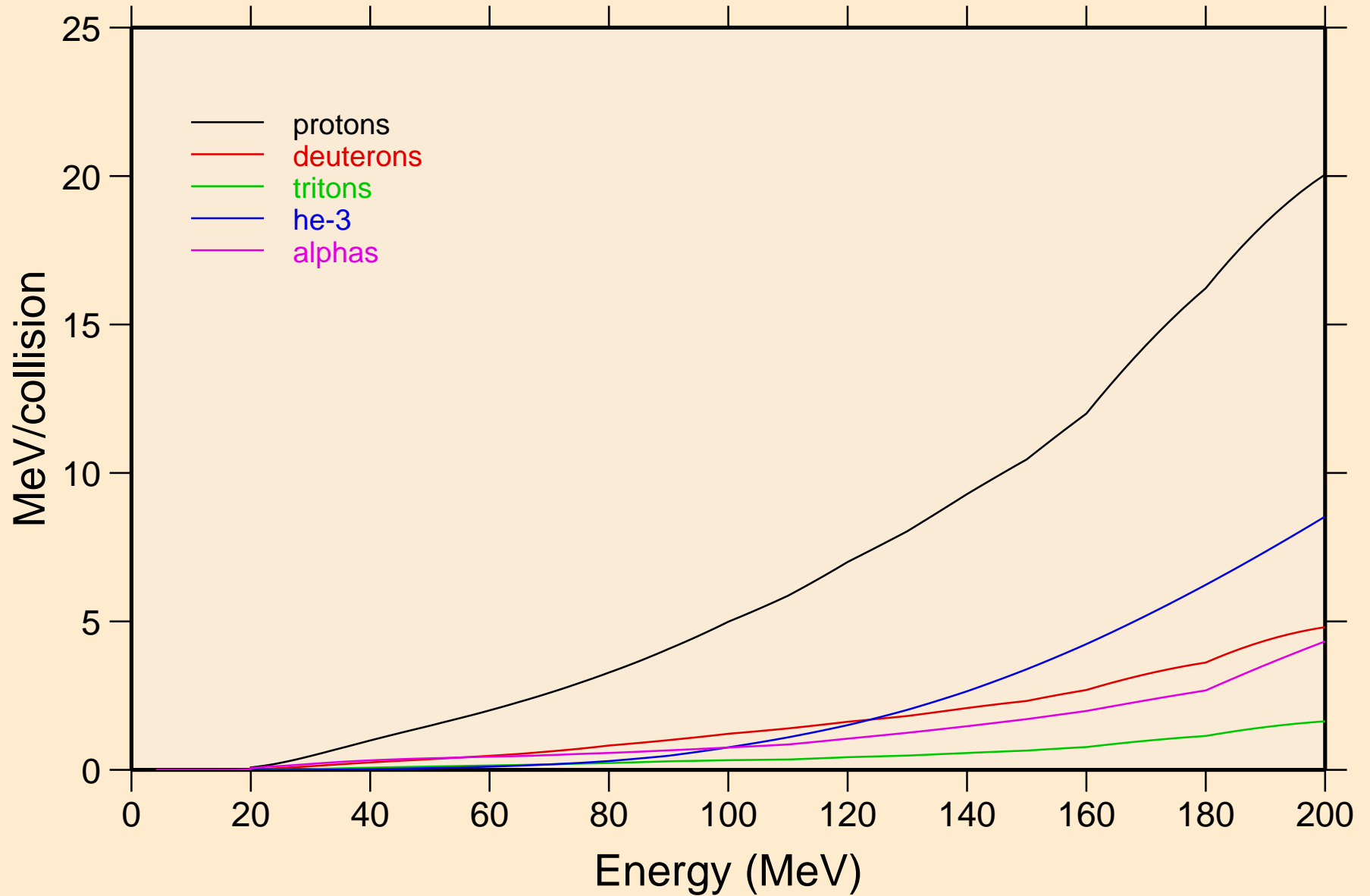

# 50-SN-118 FOR FENDL-3.2 FROM FENDL-3.2 BY NJOY2016.60+ C Recoil Heating

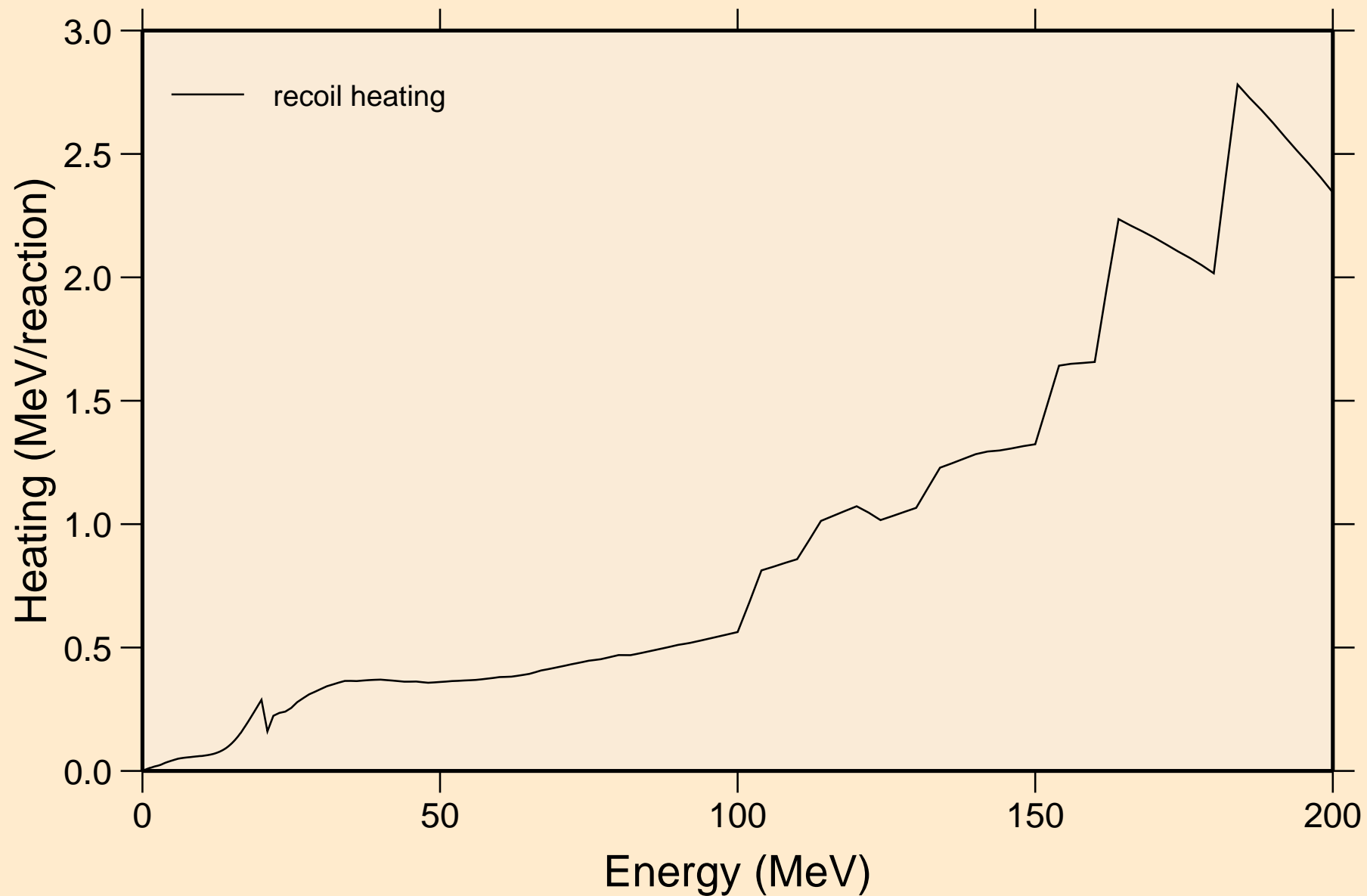

50-SN-118 FOR FENDL-3.2 FROM FENDL-3.2 BY NJOY2016.60+ C  
Particle production cross sections

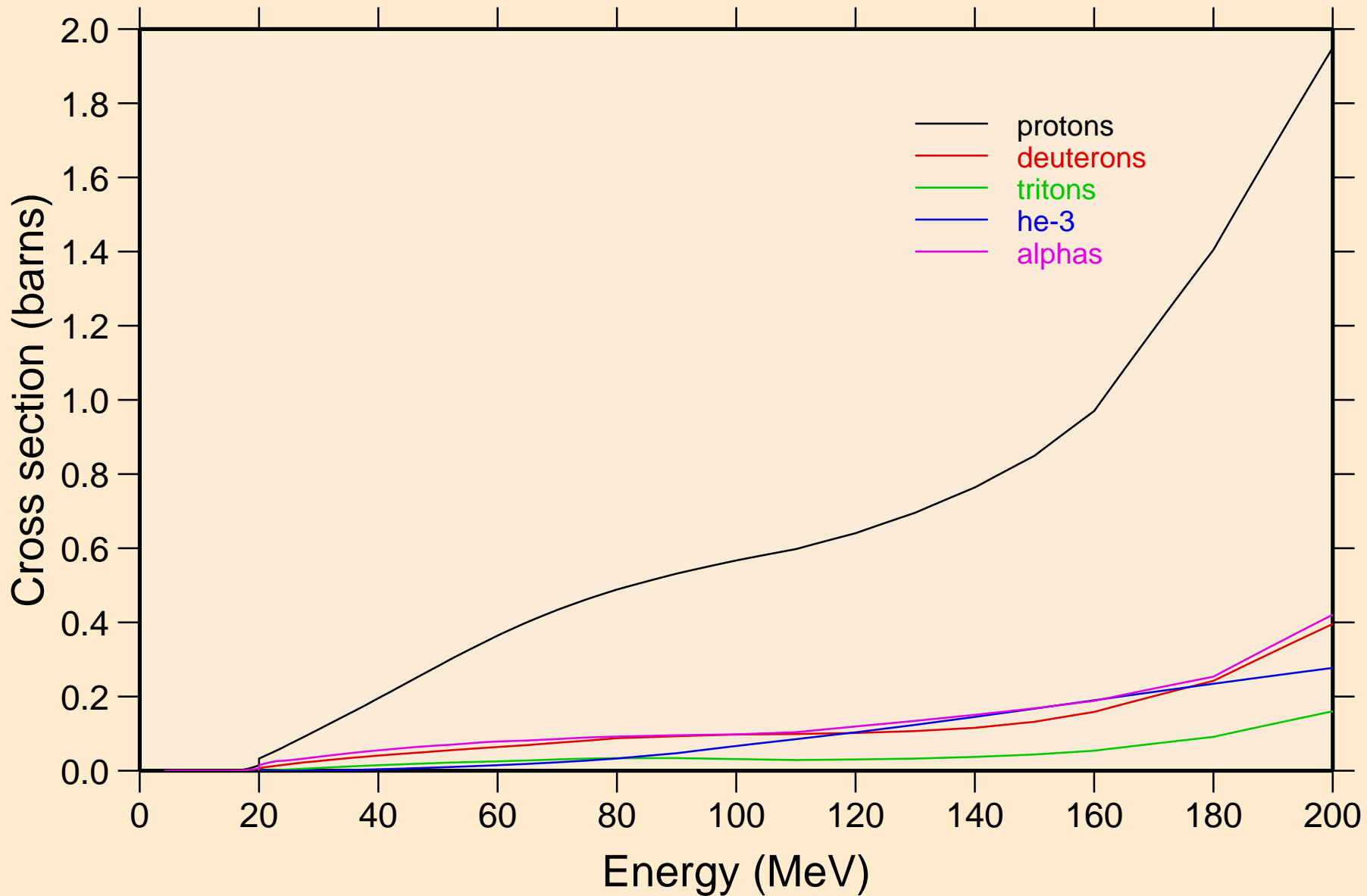

50-SN-118 FOR FENDL-3.2 FROM FENDL-3.2 BY NJOY2016.60+ C  
protons from (n,x)

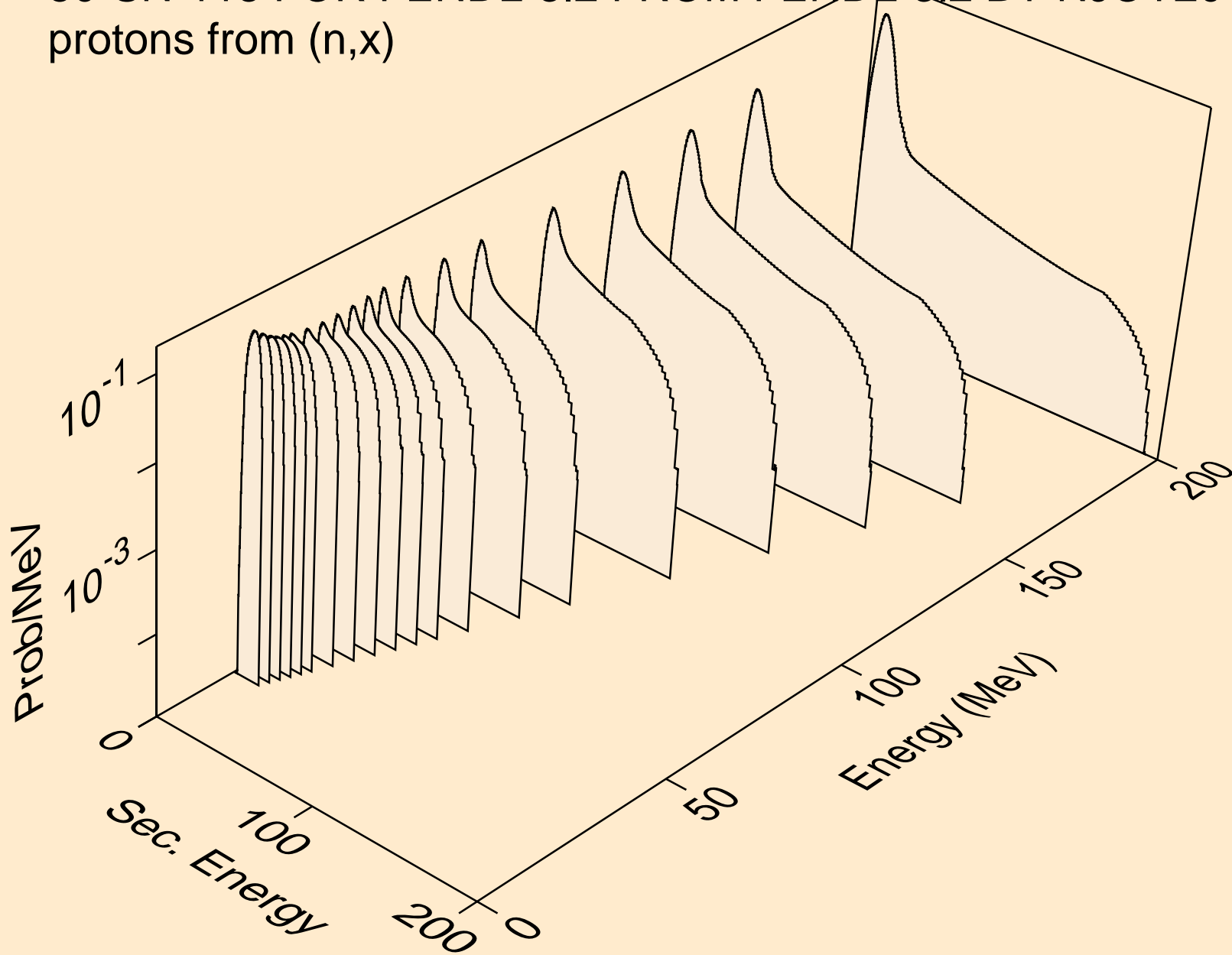



50-SN-118 FOR FENDL-3.2 FROM FENDL-3.2 BY NJOY2016.60+ C  
protons from (n,n\*)p

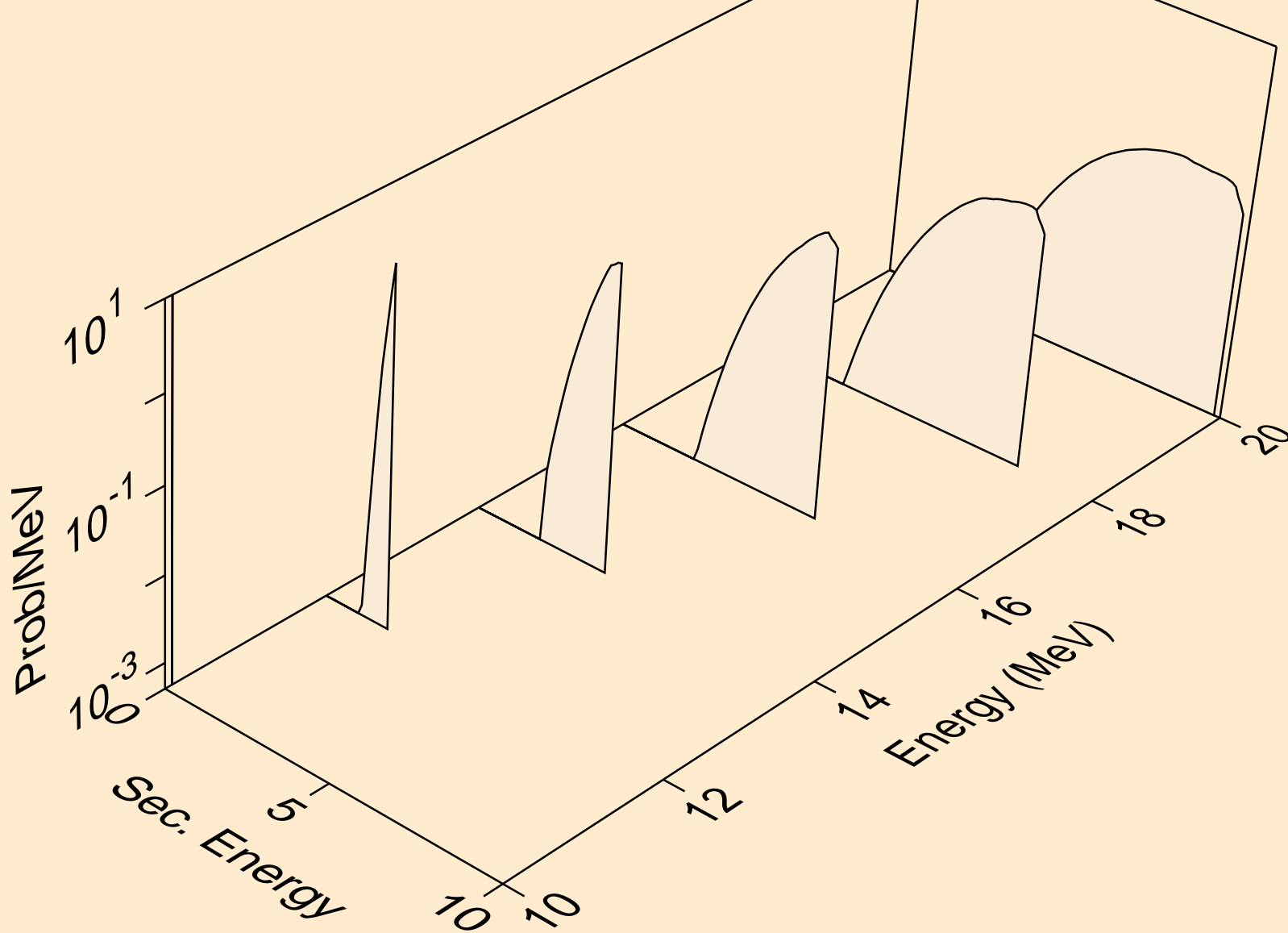

50-SN-118 FOR FENDL-3.2 FROM FENDL-3.2 BY NJOY2016.60+ C  
deuterons from (n,x)

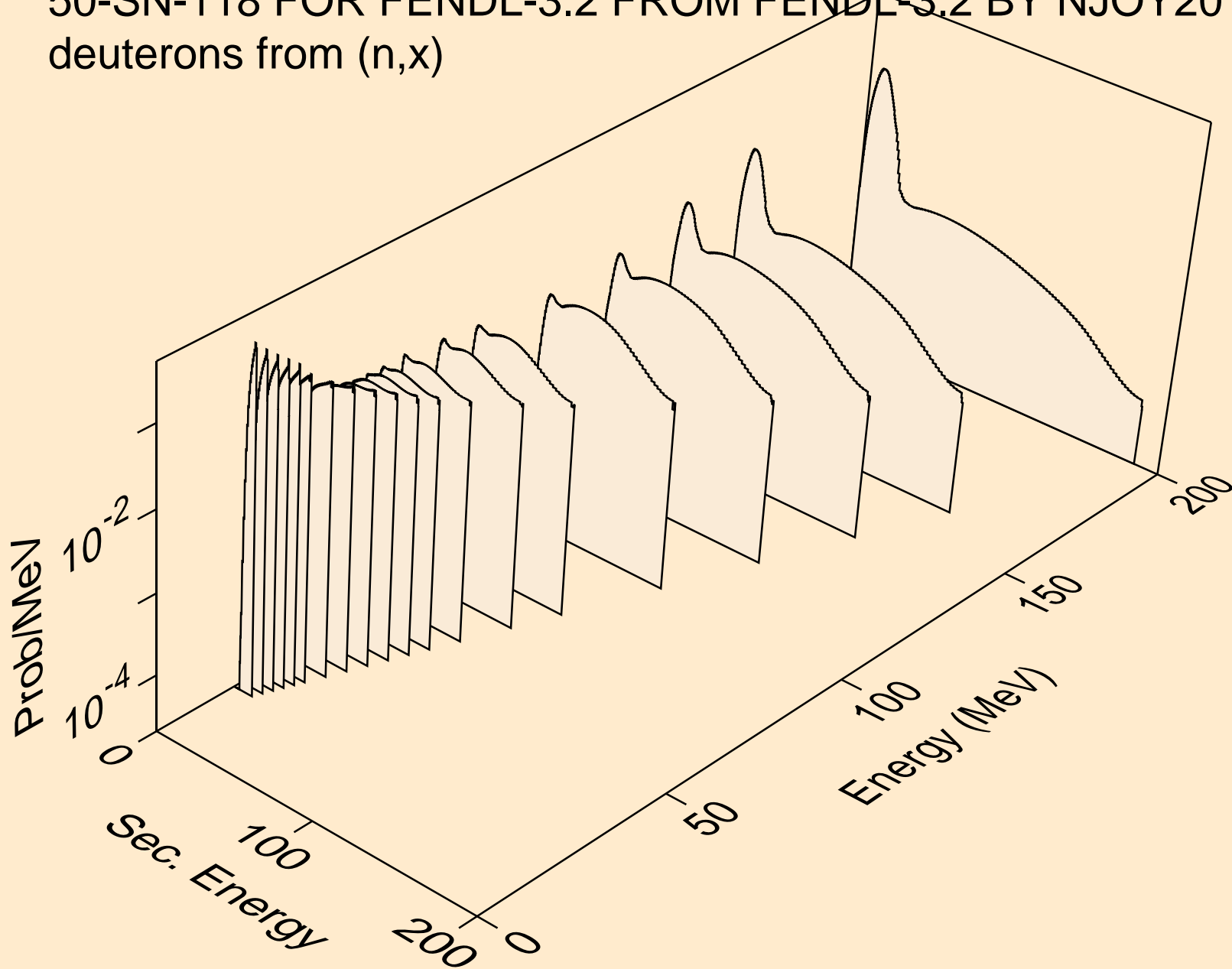

50-SN-118 FOR FENDL-3.2 FROM FENDL-3.2 BY NJOY2016.60+ C  
tritons from (n,x)

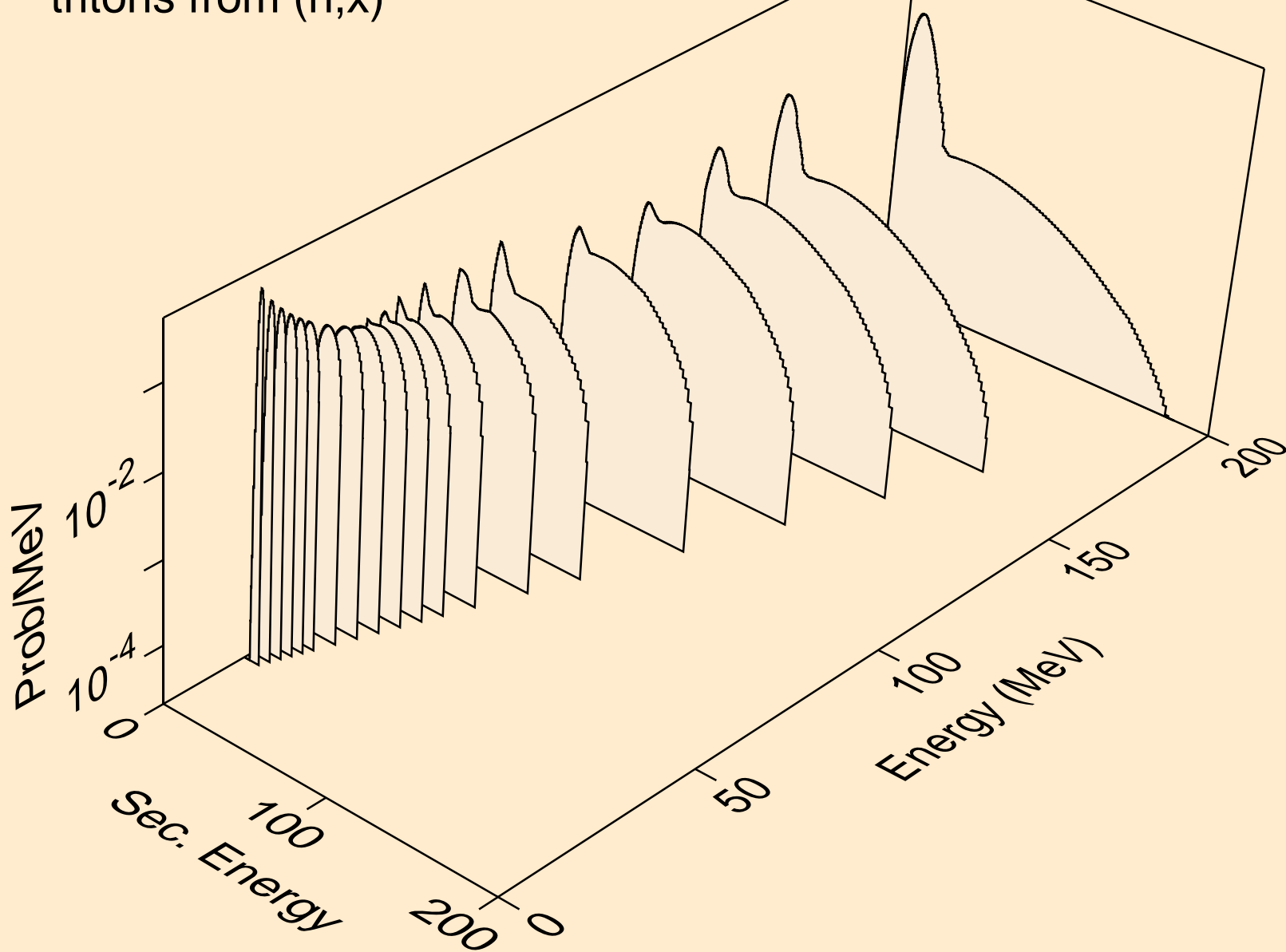

50-SN-118 FOR FENDL-3.2 FROM FENDL-3.2 BY NJOY2016.60+ C  
he3s from (n,x)

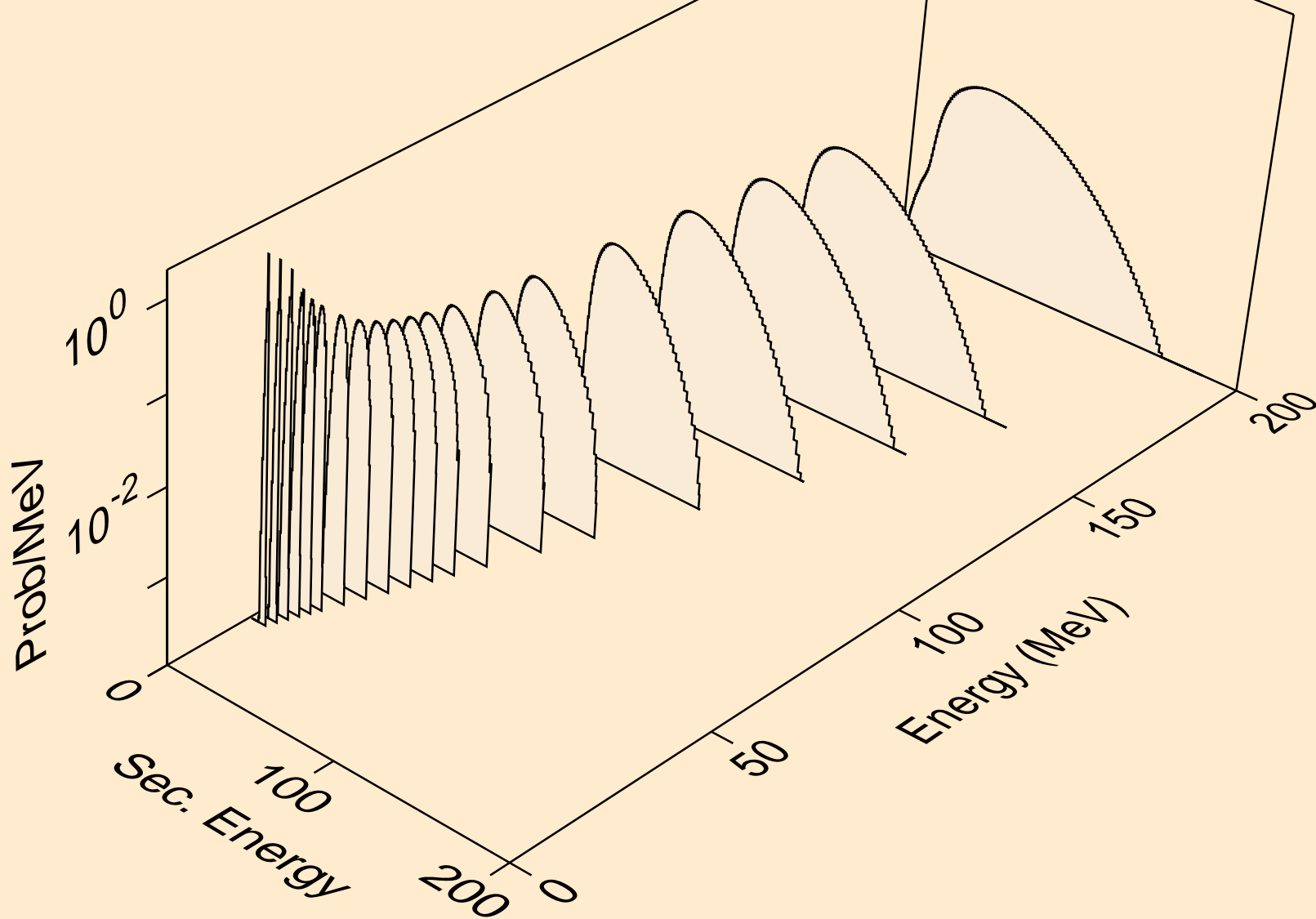

50-SN-118 FOR FENDL-3.2 FROM FENDL-3.2 BY NJOY2016.60+ C  
alphas from (n,x)

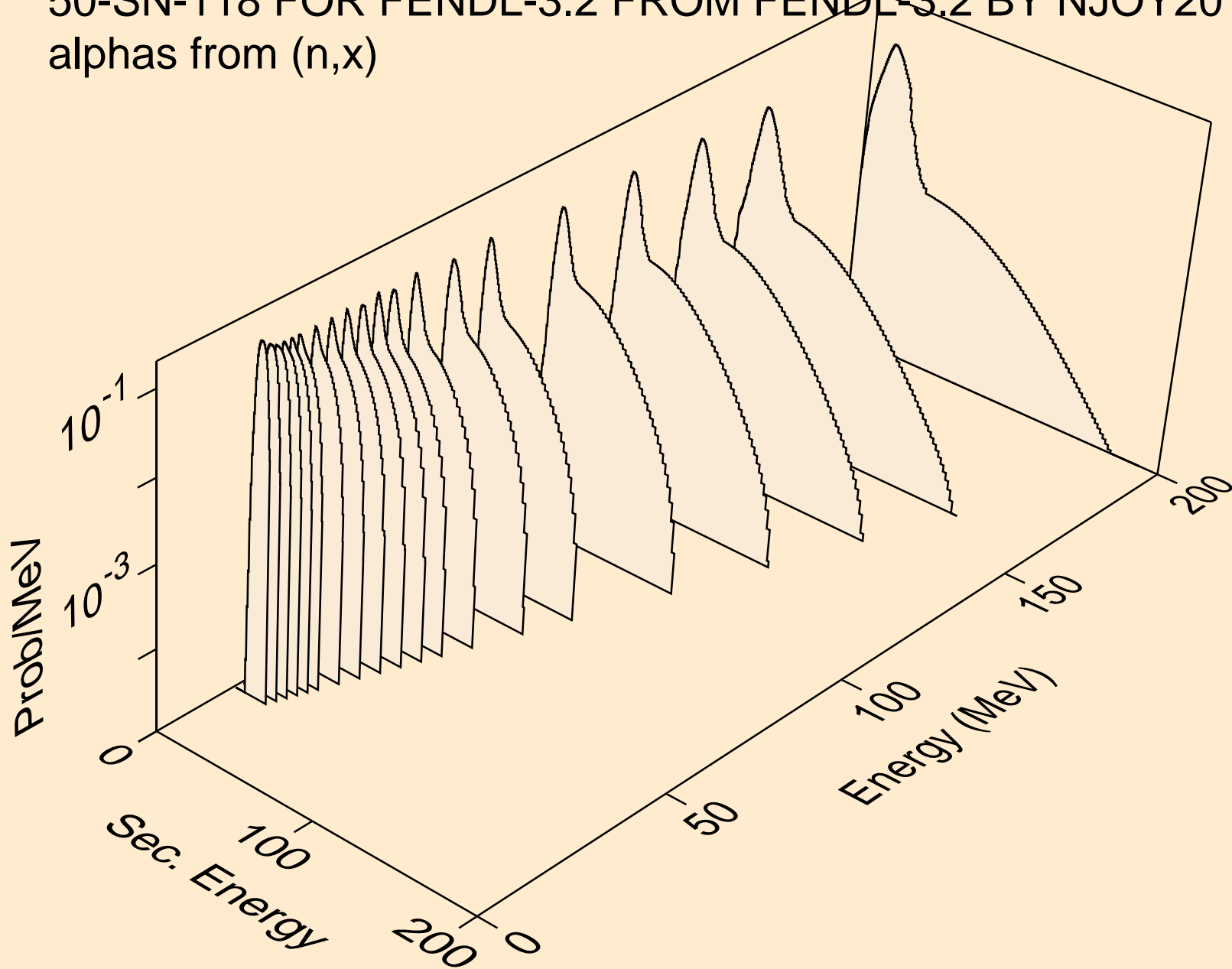

50-SN-118 FOR FENDL-3.2 FROM FENDL-3.2 BY NJOY2016.60+ C  
alphas from (n,n\*)a

