

51-SB-123 FOR FENDL-3.2 FROM FENDL-3.2 BY NJOY2016.60+ C
Principal cross sections

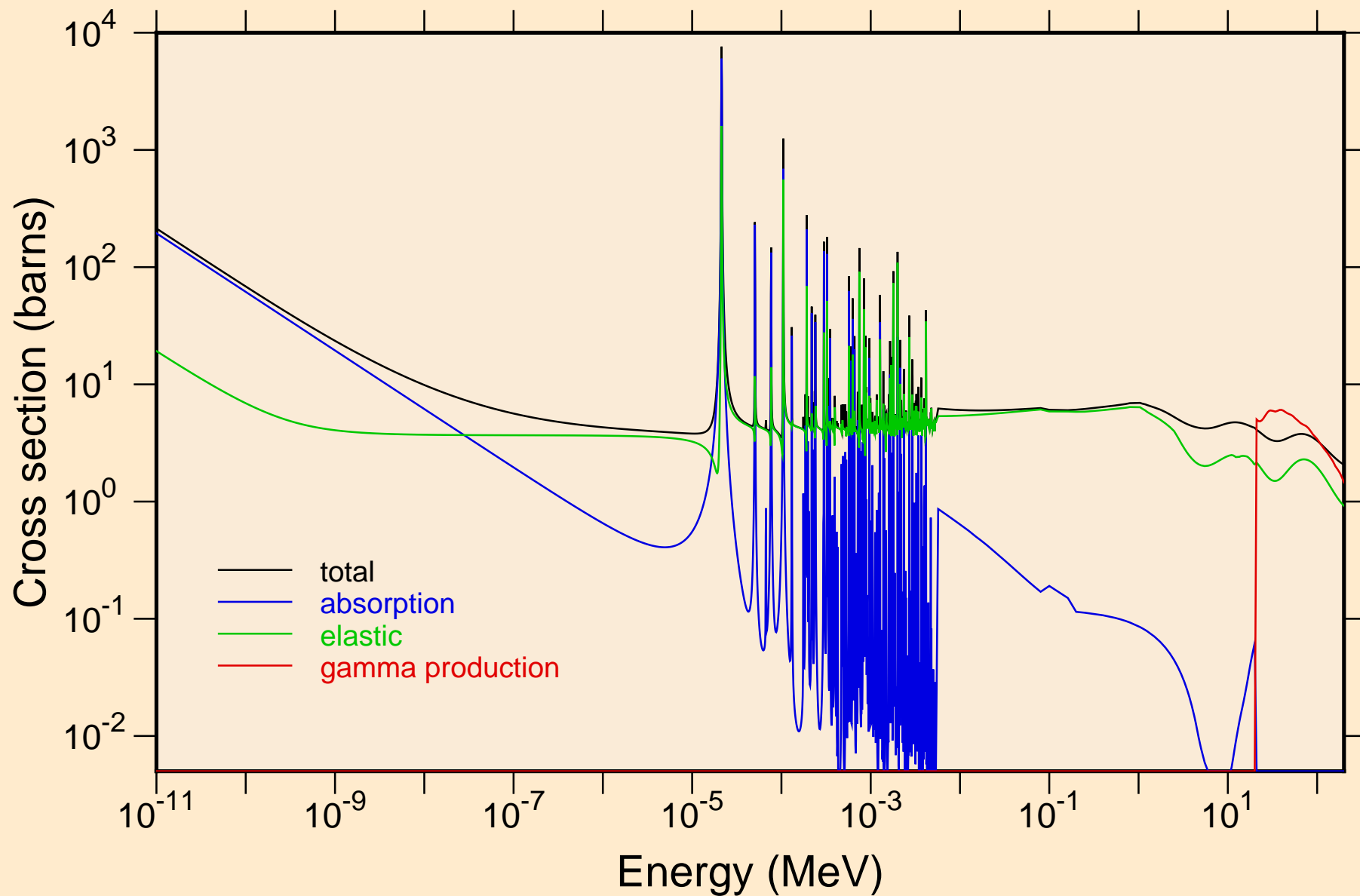

51-SB-123 FOR FENDL-3.2 FROM FENDL-3.2 BY NJOY2016.60+ C
resonance total cross section

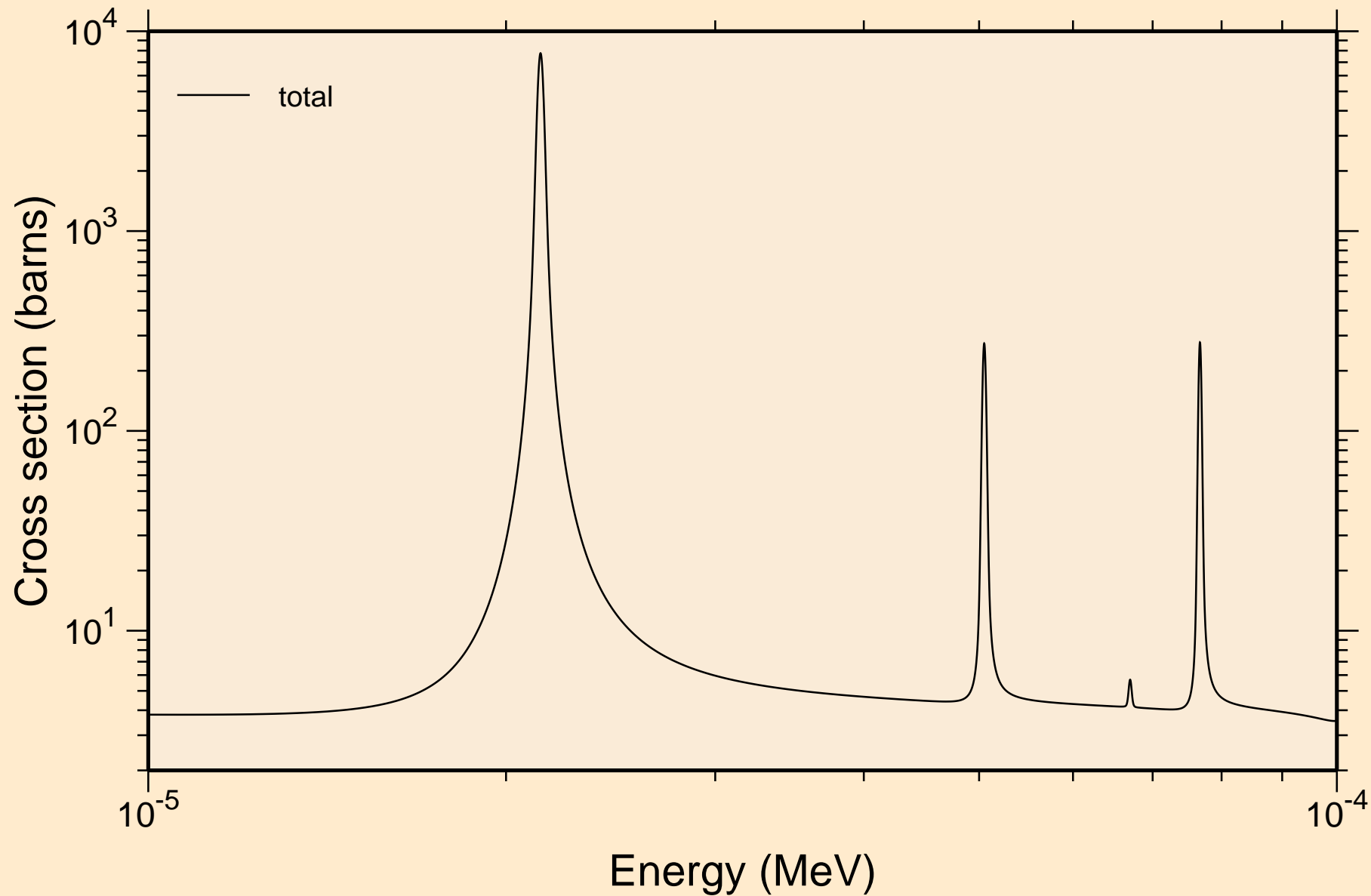

51-SB-123 FOR FENDL-3.2 FROM FENDL-3.2 BY NJOY2016.60+ C
resonance total cross section

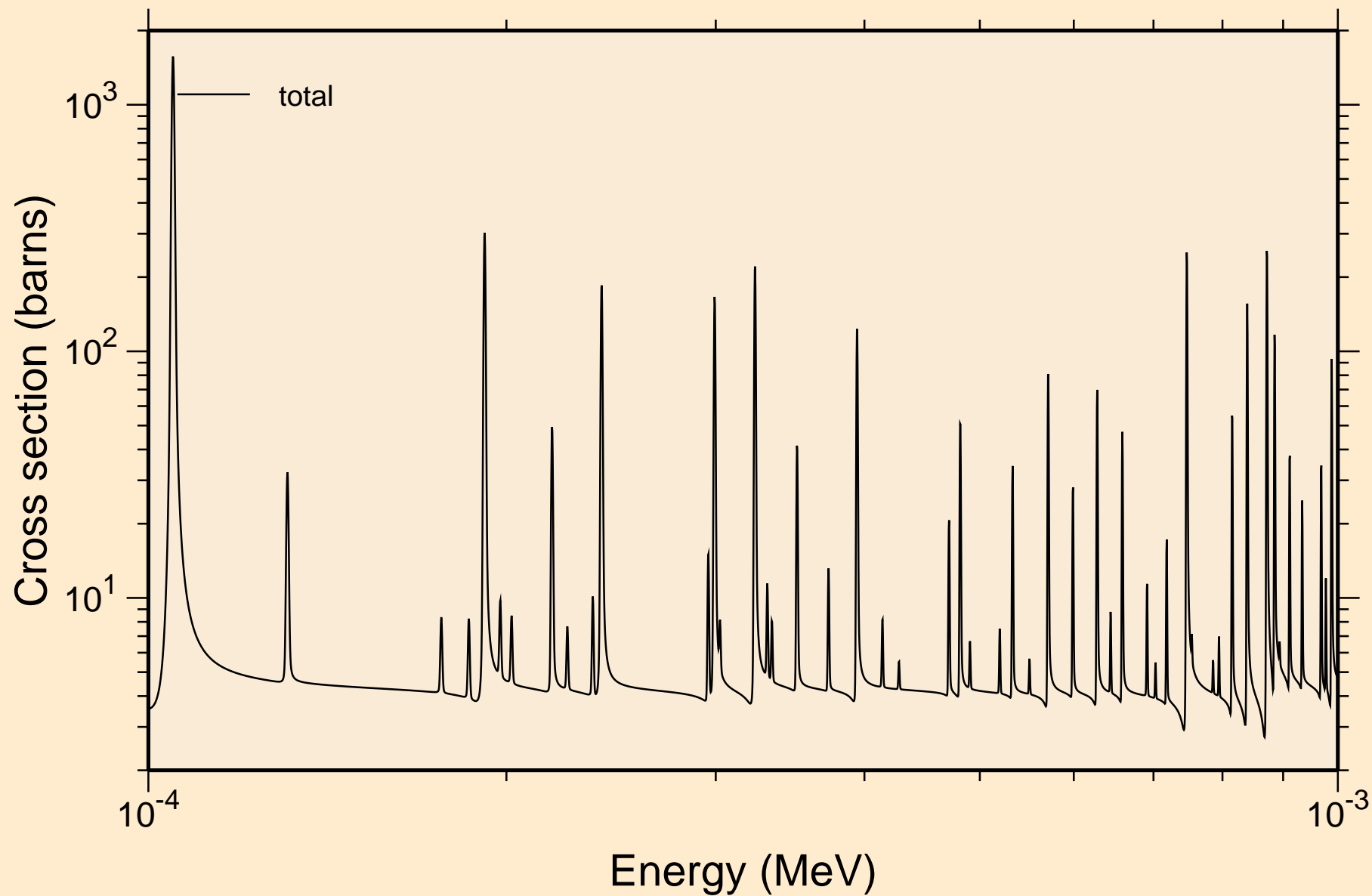

51-SB-123 FOR FENDL-3.2 FROM FENDL-3.2 BY NJOY2016.60+ C
resonance total cross section

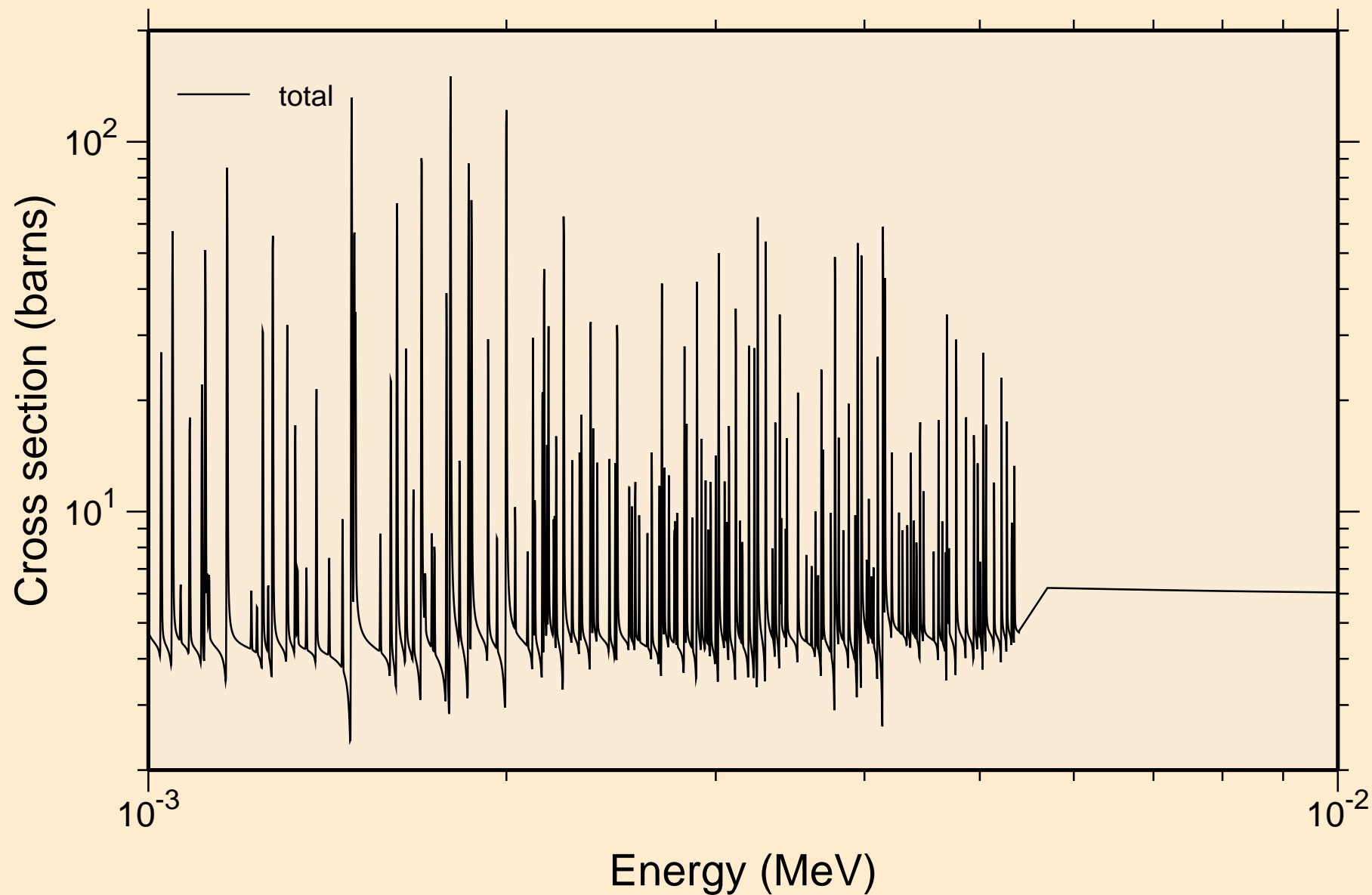

51-SB-123 FOR FENDL-3.2 FROM FENDL-3.2 BY NJOY2016.60+ C
resonance absorption cross sections

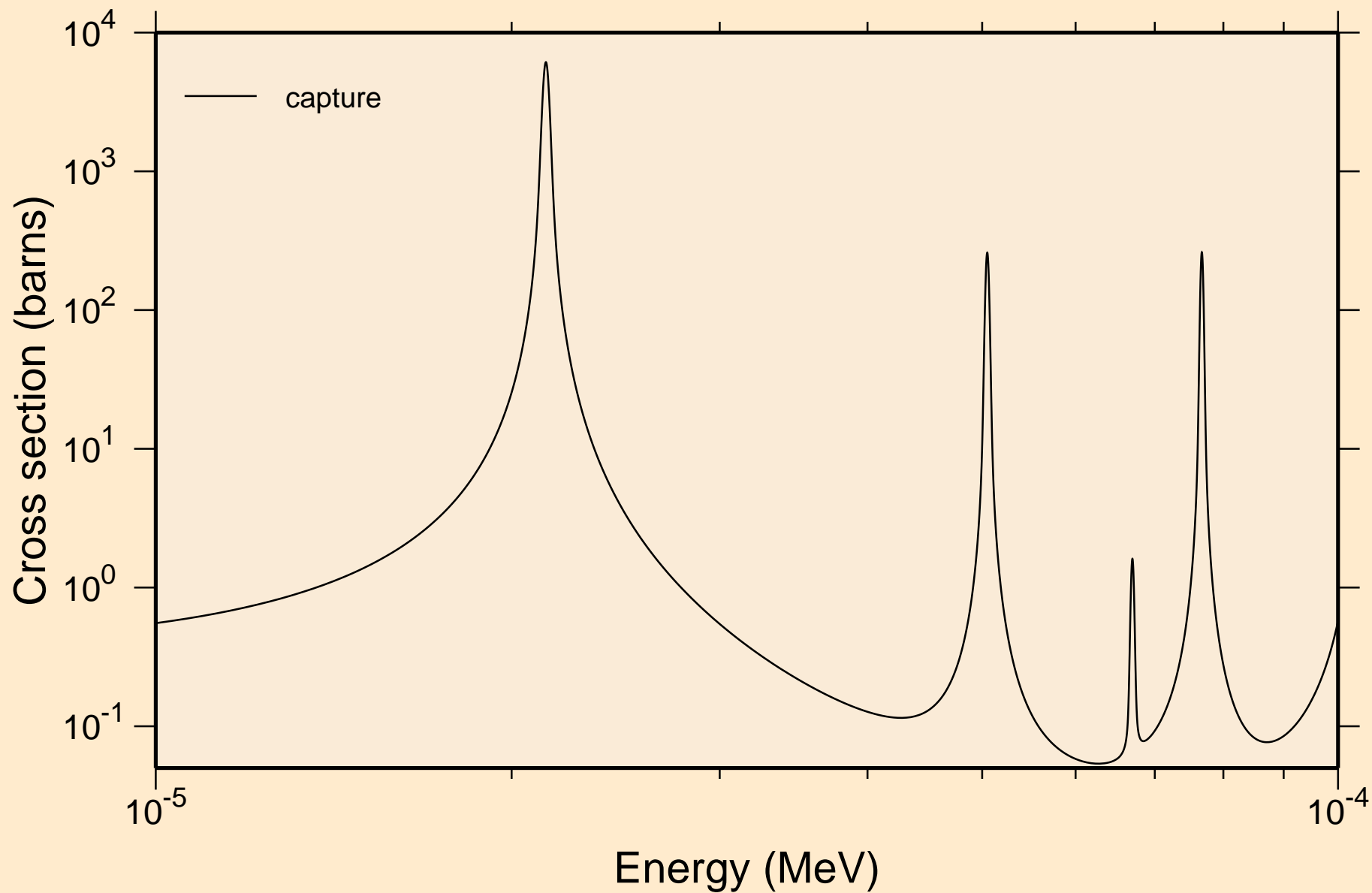

51-SB-123 FOR FENDL-3.2 FROM FENDL-3.2 BY NJOY2016.60+ C
resonance absorption cross sections

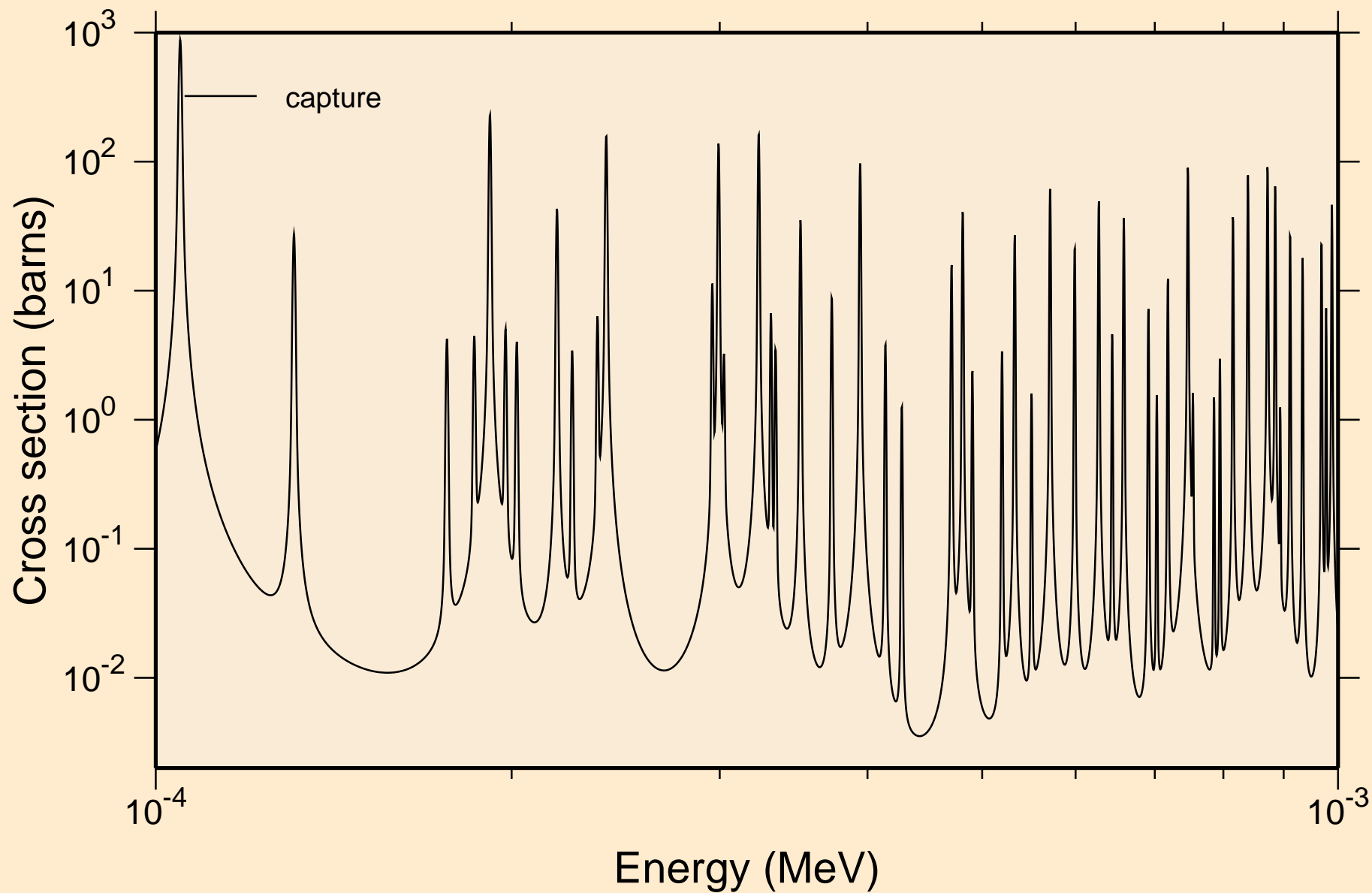

51-SB-123 FOR FENDL-3.2 FROM FENDL-3.2 BY NJOY2016.60+ C
resonance absorption cross sections

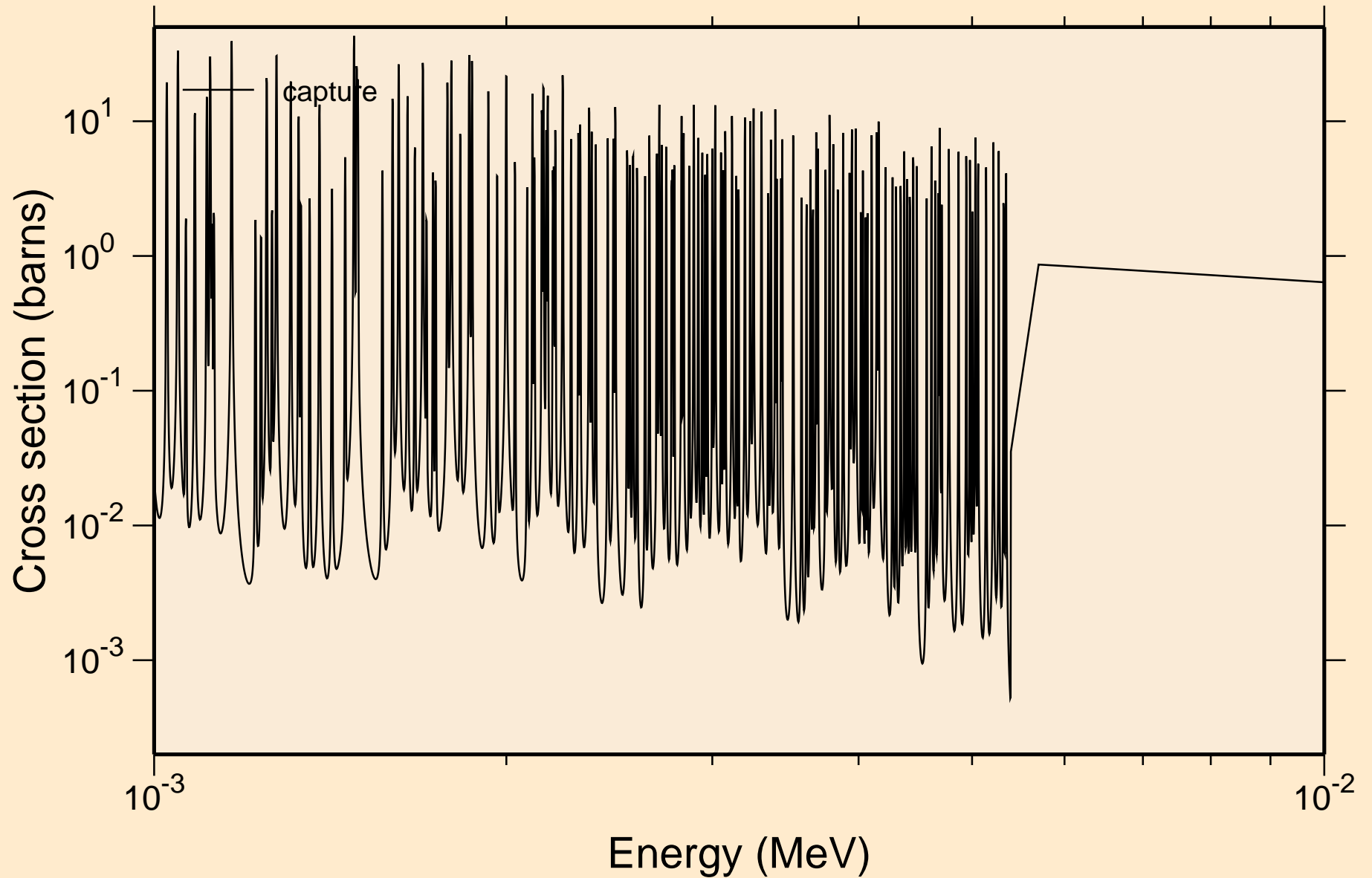

51-SB-123 FOR FENDL-3.2 FROM FENDL-3.2 BY NJOY2016.60+ C
resonance absorption cross sections

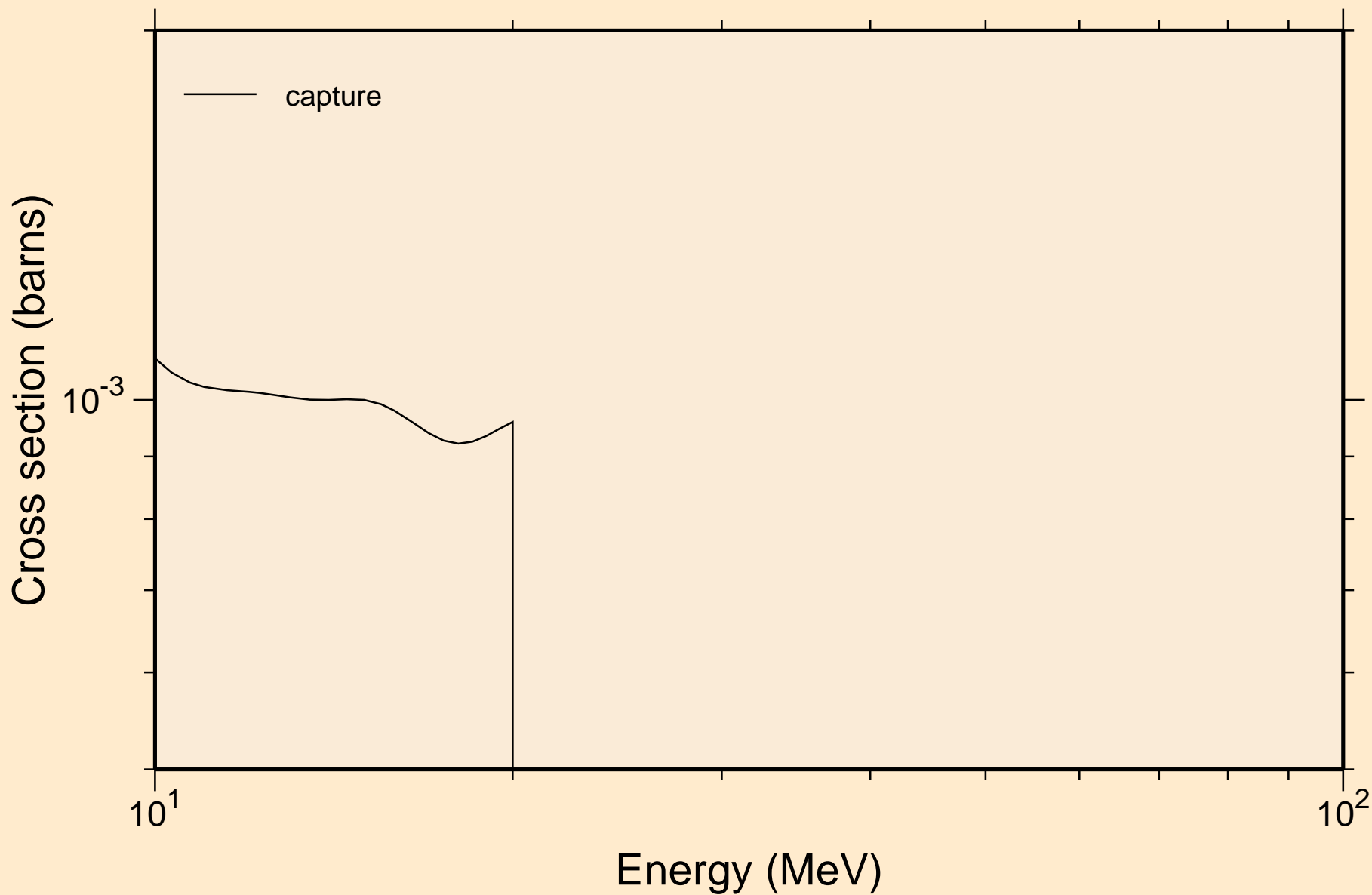

51-SB-123 FOR FENDL-3.2 FROM FENDL-3.2 BY NJOY2016.60+ C
UR total cross section

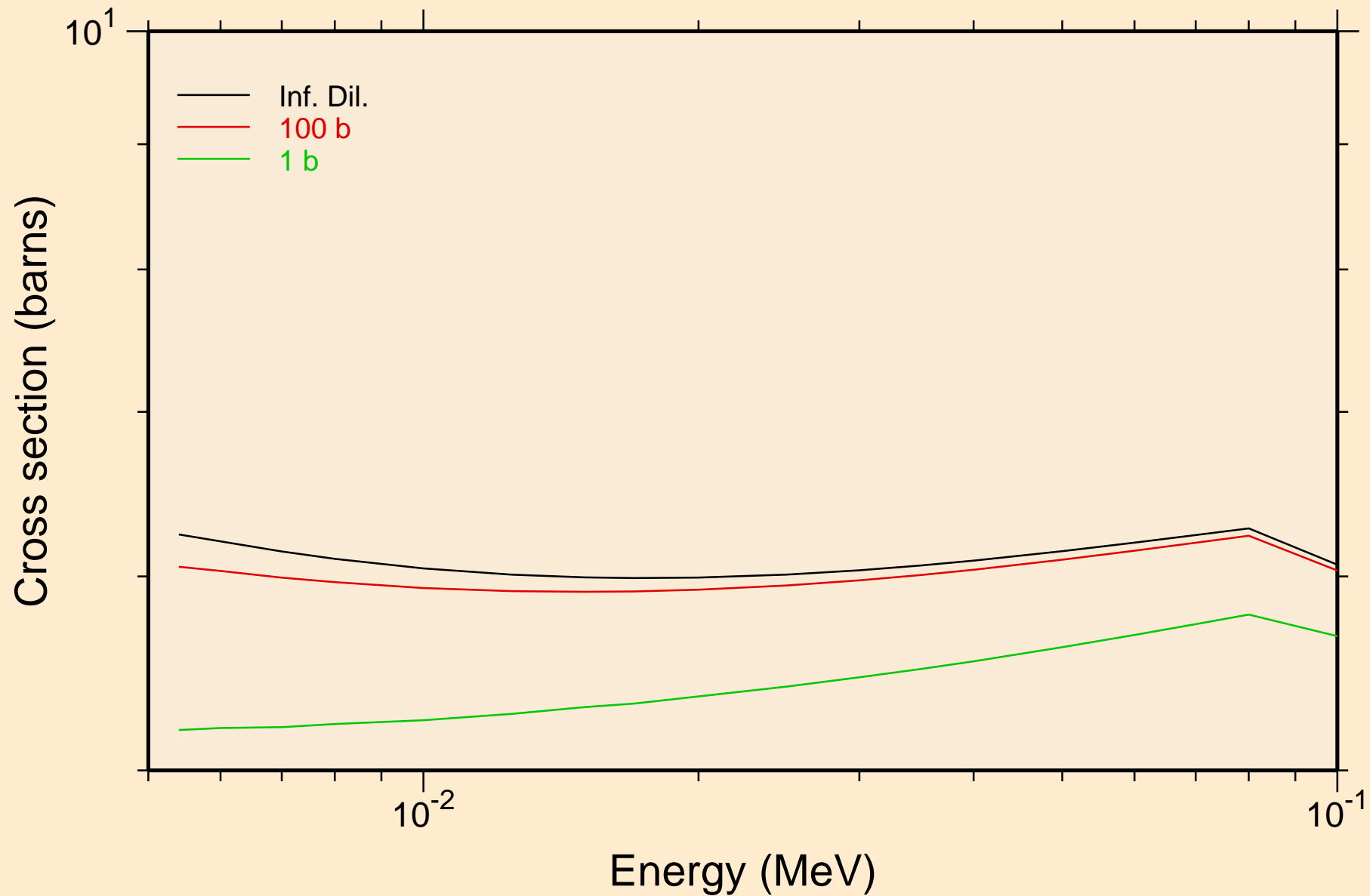

51-SB-123 FOR FENDL-3.2 FROM FENDL-3.2 BY NJOY2016.60+ C
UR elastic cross section

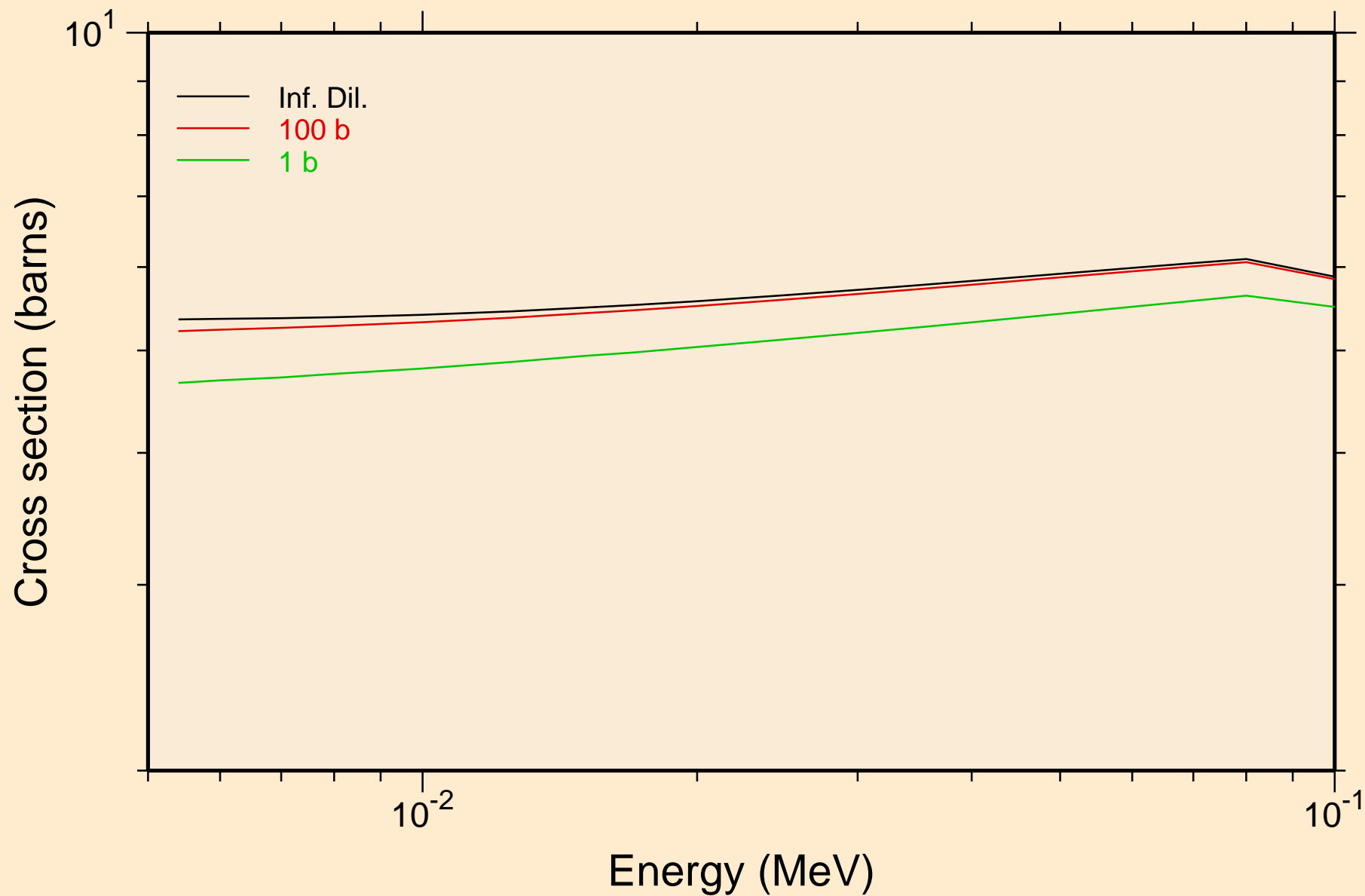

51-SB-123 FOR FENDL-3.2 FROM FENDL-3.2 BY NJOY2016.60+ C
UR capture cross section

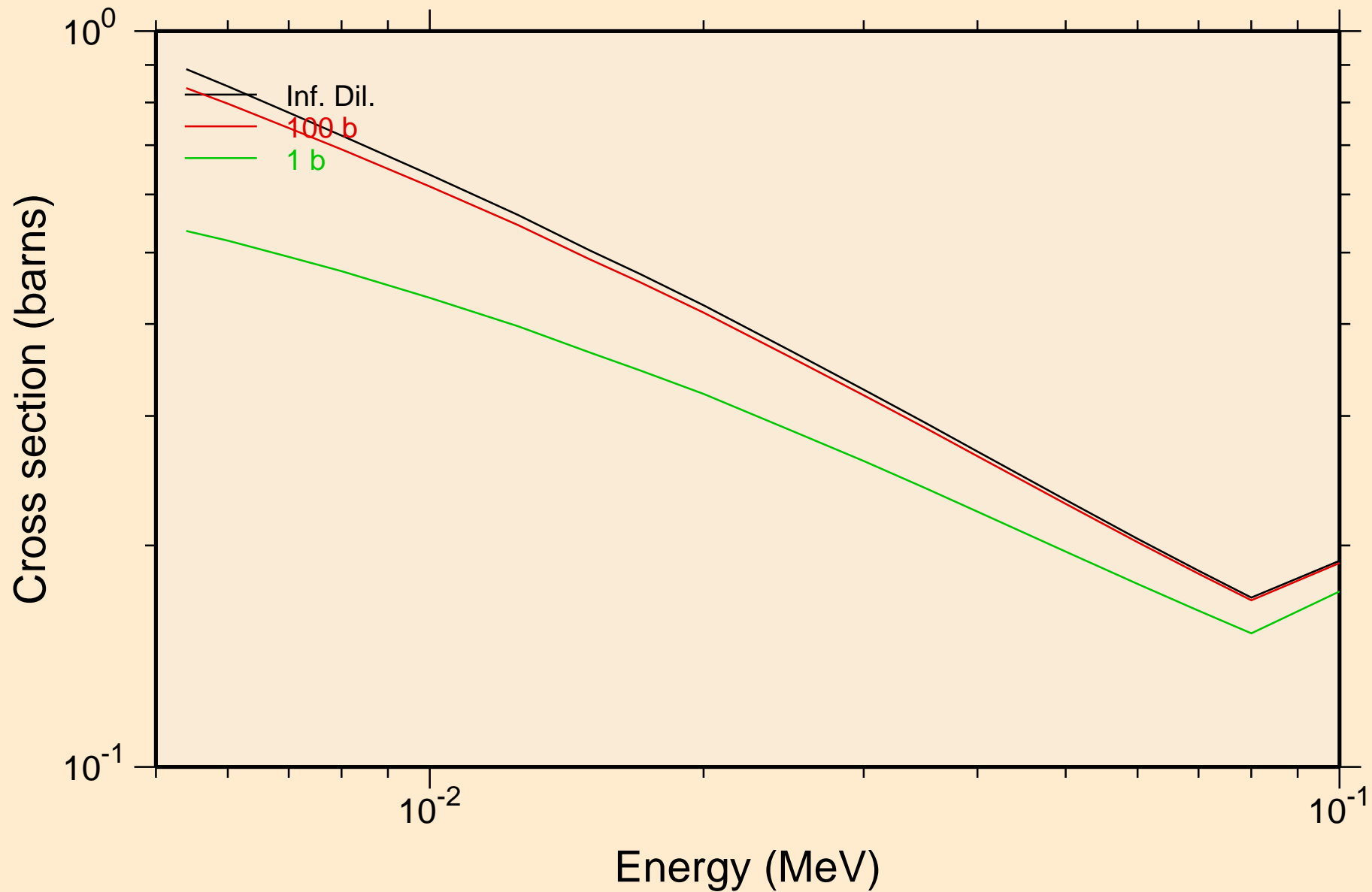

51-SB-123 FOR FENDL-3.2 FROM FENDL-3.2 BY NJOY2016.60+ C
Heating

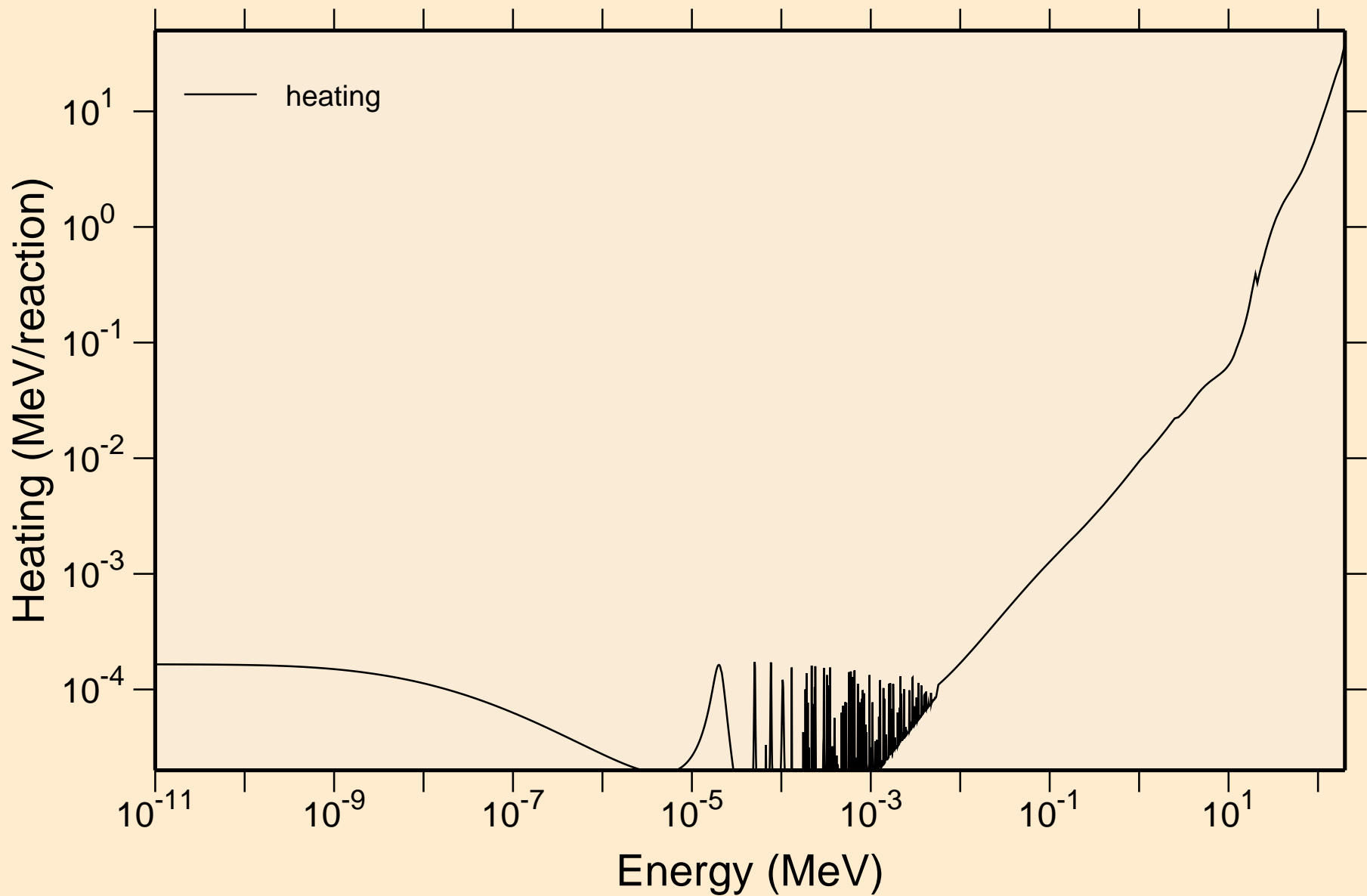

51-SB-123 FOR FENDL-3.2 FROM FENDL-3.2 BY NJOY2016.60+ C Damage

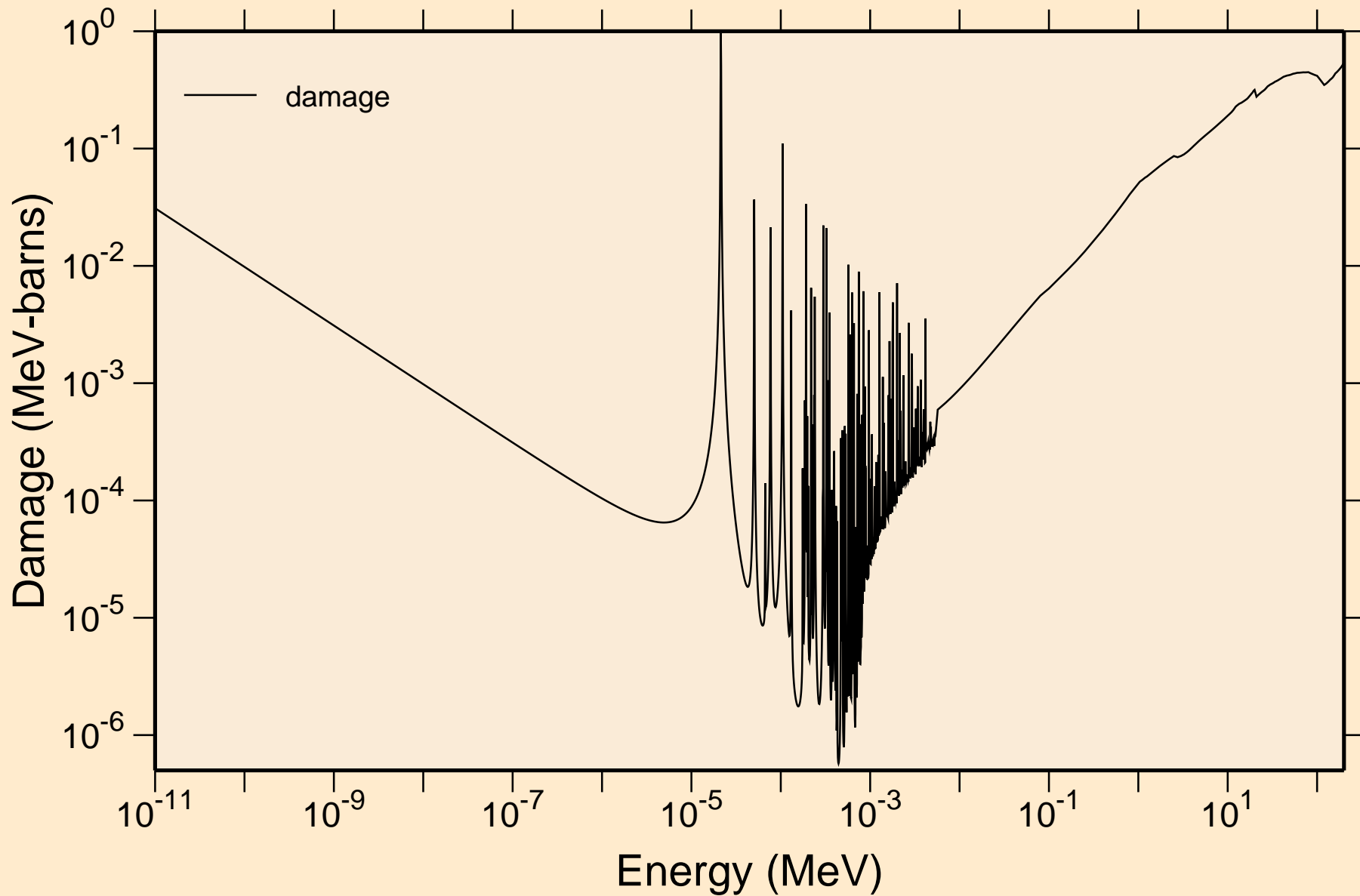

51-SB-123 FOR FENDL-3.2 FROM FENDL-3.2 BY NJOY2016.60+ C
Non-threshold reactions

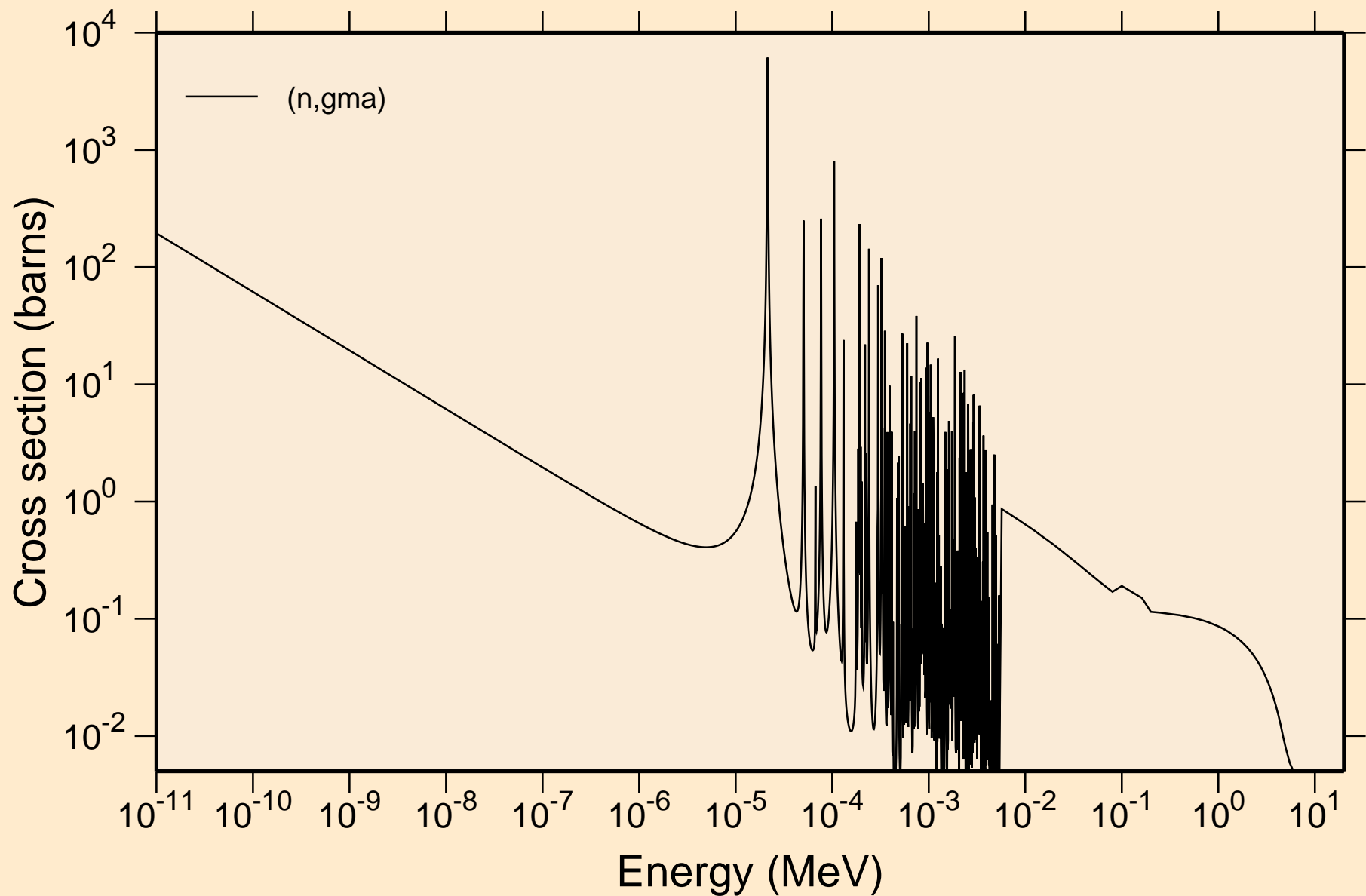

51-SB-123 FOR FENDL-3.2 FROM FENDL-3.2 BY NJOY2016.60+ C
Principal cross sections

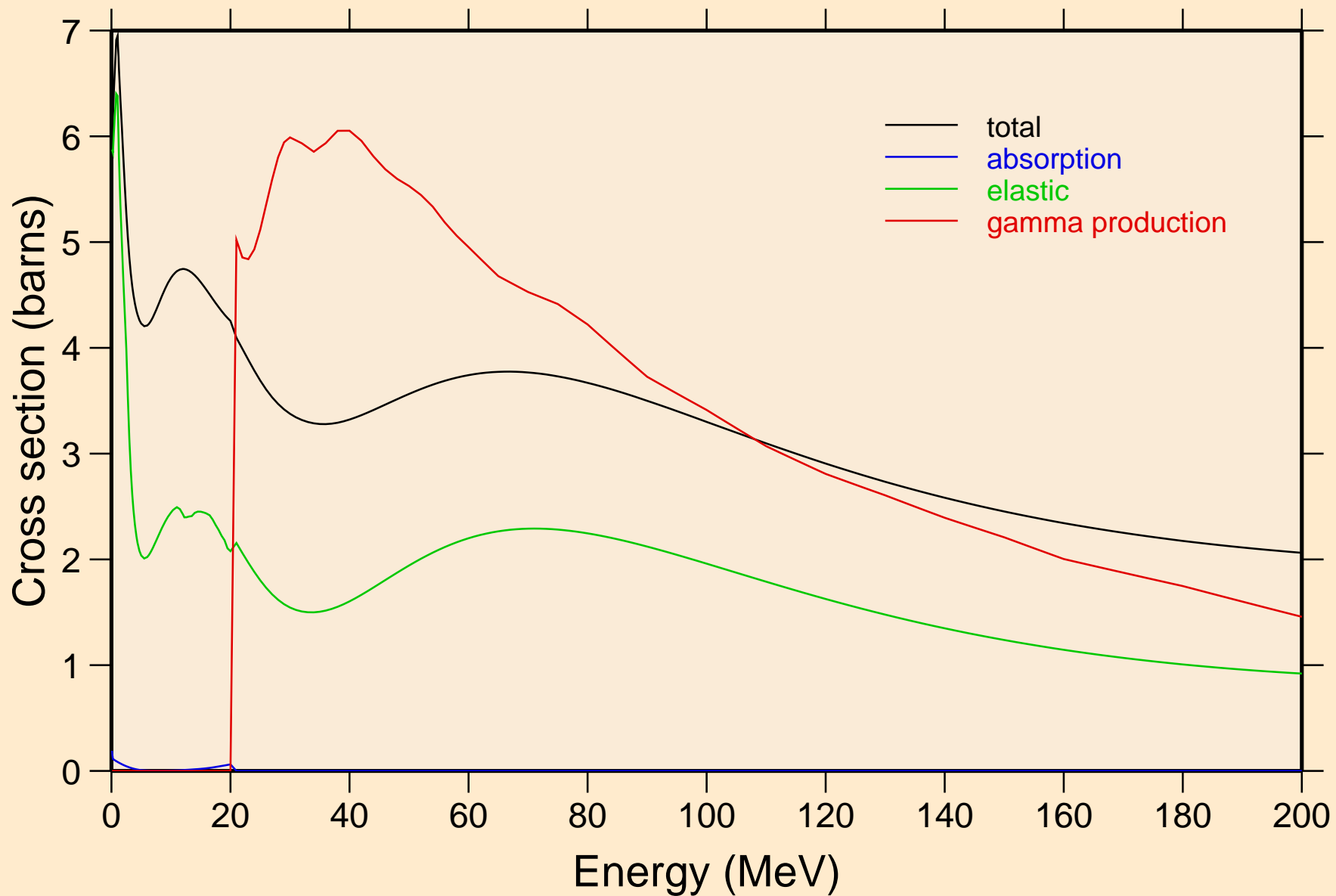

51-SB-123 FOR FENDL-3.2 FROM FENDL-3.2 BY NJOY2016.60+ C Heating

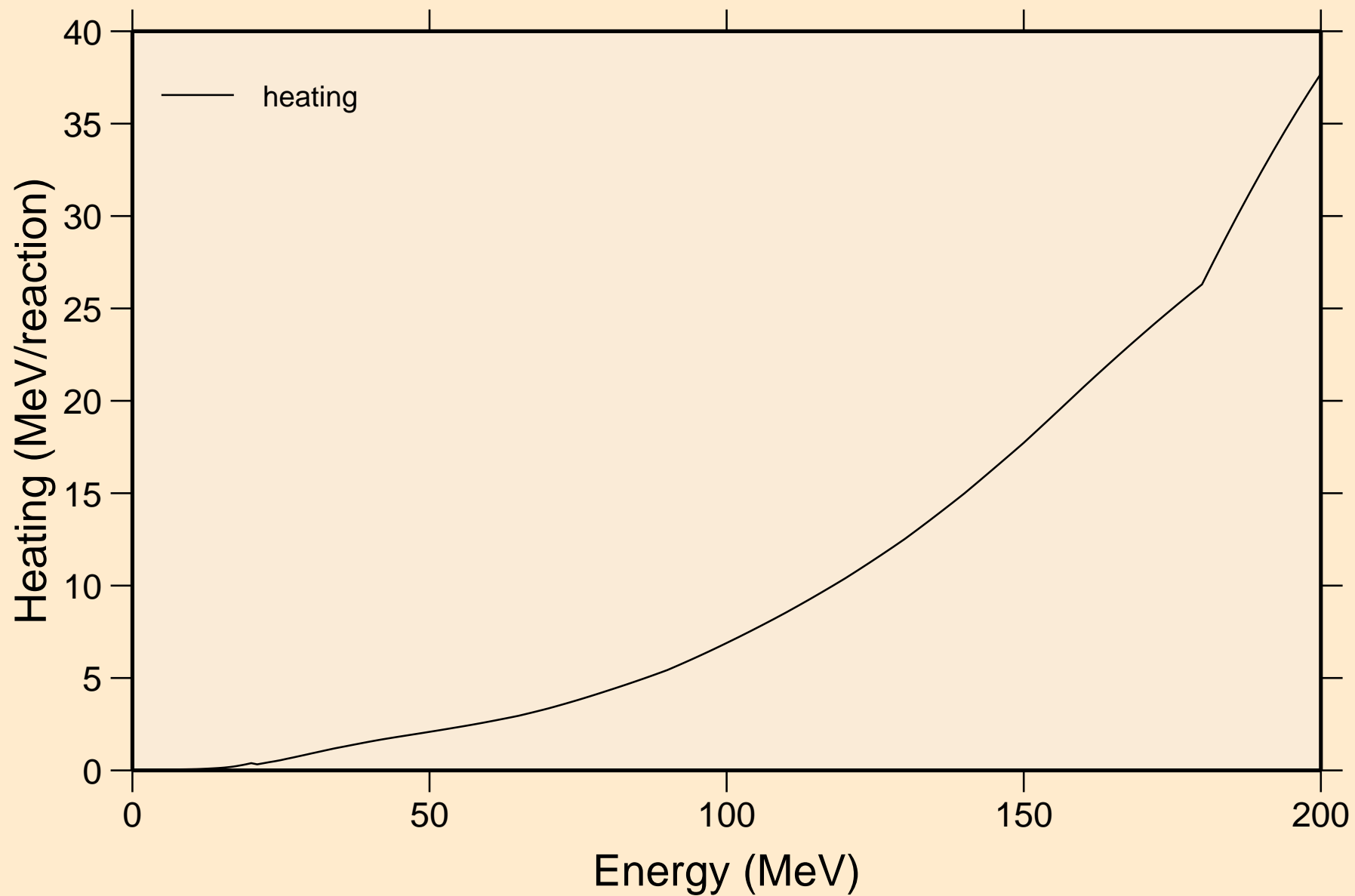

51-SB-123 FOR FENDL-3.2 FROM FENDL-3.2 BY NJOY2016.60+ C Damage

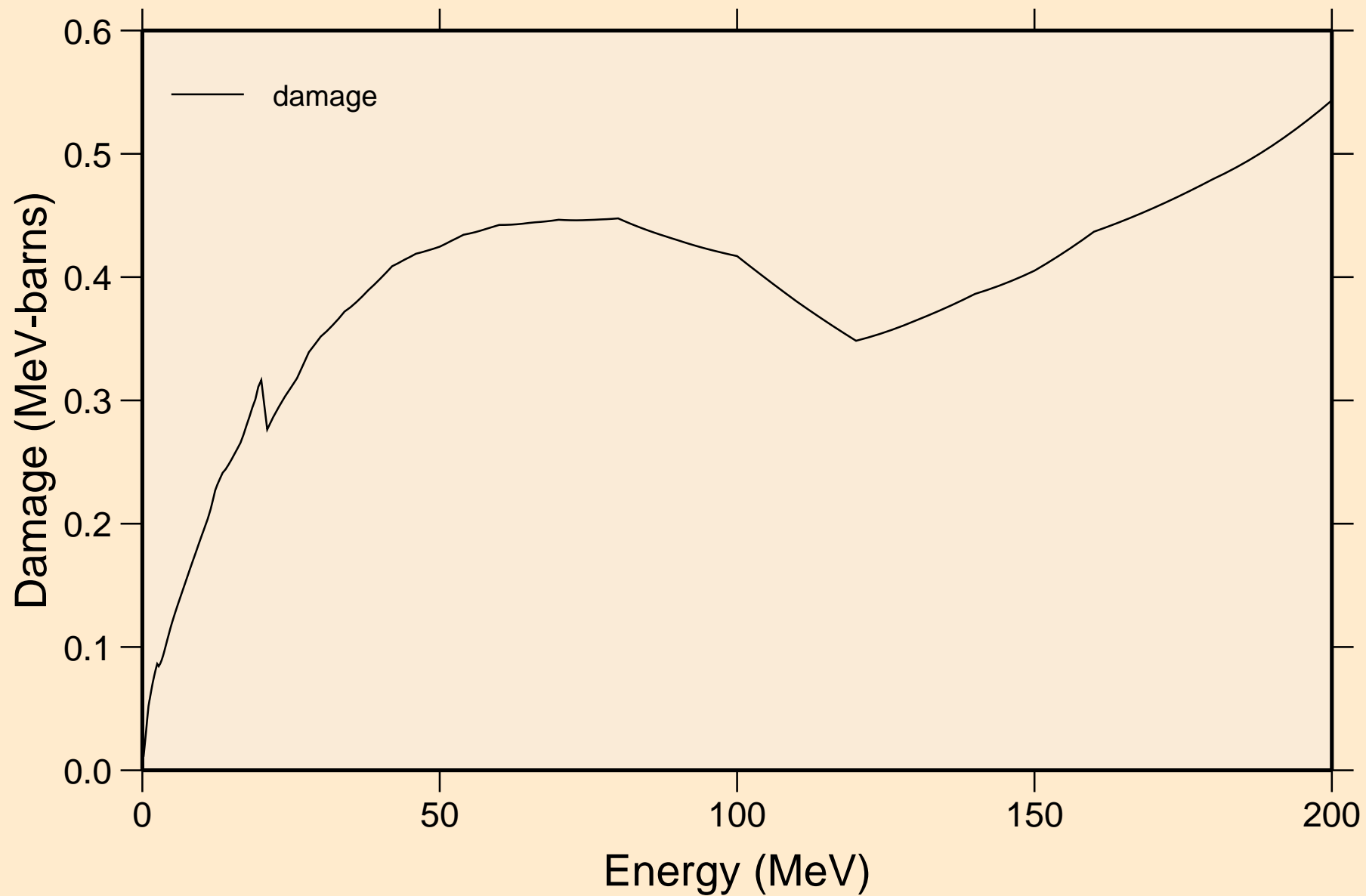

51-SB-123 FOR FENDL-3.2 FROM FENDL-3.2 BY NJOY2016.60+ C
Non-threshold reactions

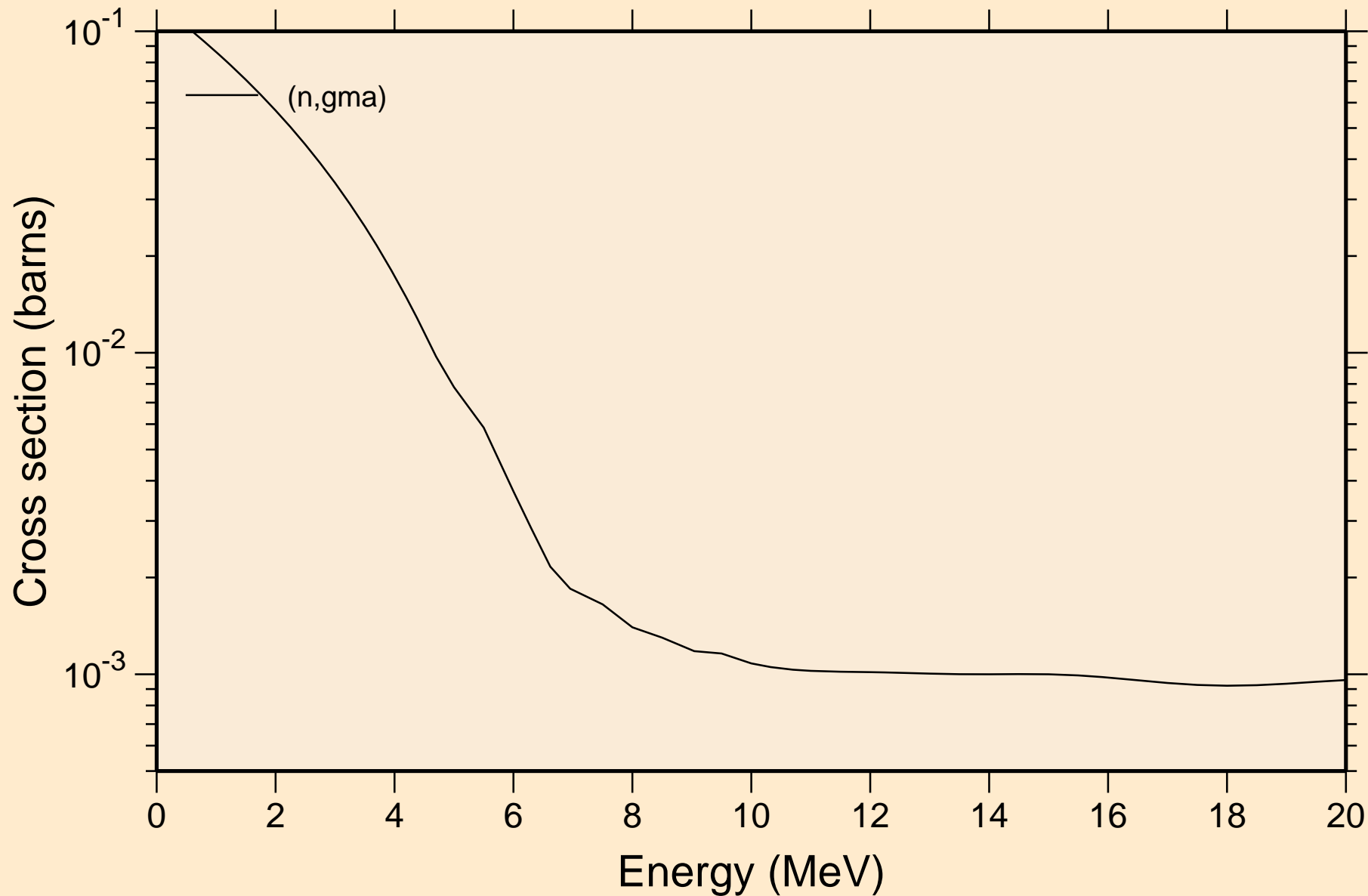

51-SB-123 FOR FENDL-3.2 FROM FENDL-3.2 BY NJOY2016.60+ C
Inelastic levels

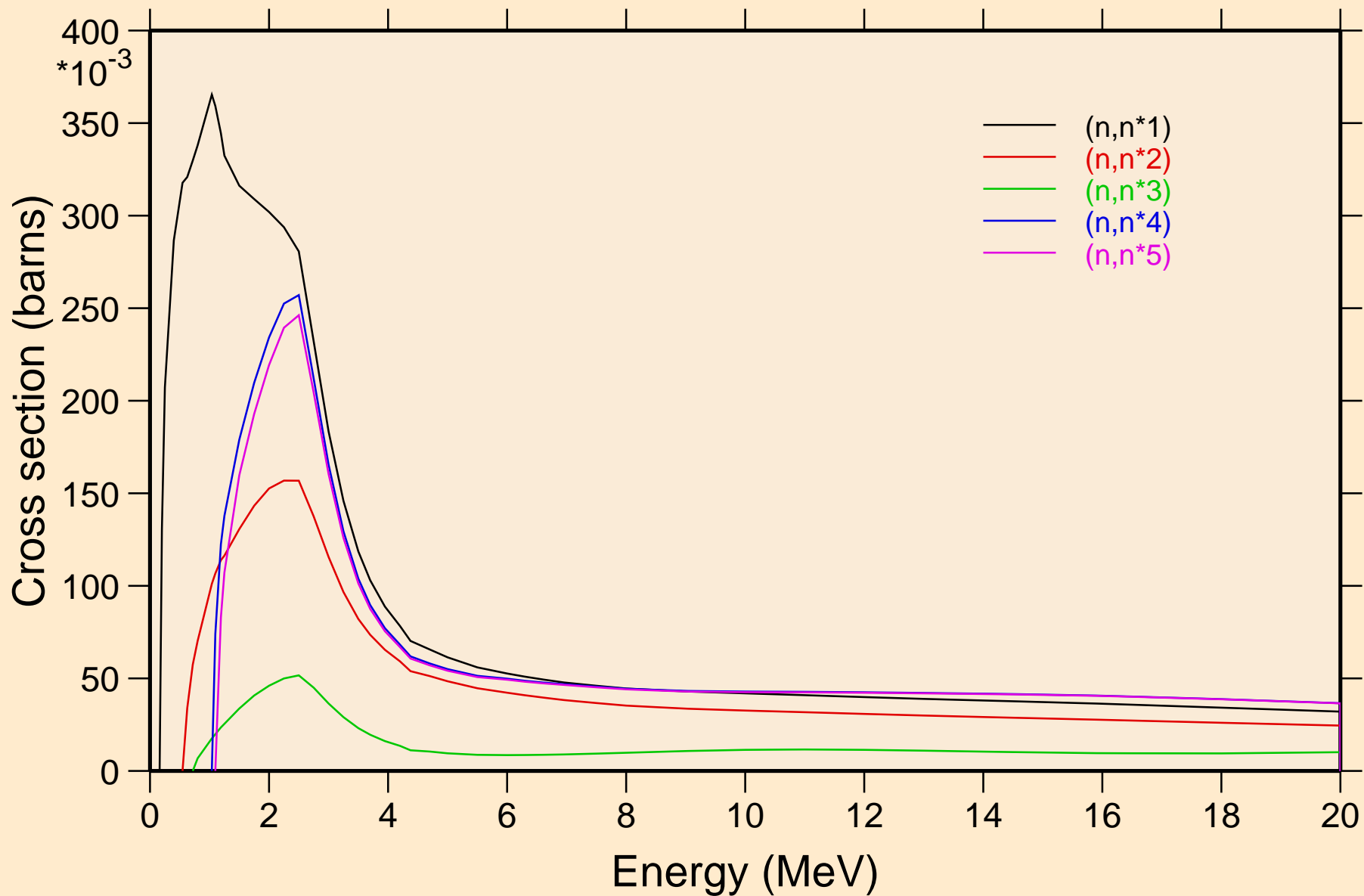

51-SB-123 FOR FENDL-3.2 FROM FENDL-3.2 BY NJOY2016.60+ C
Inelastic levels

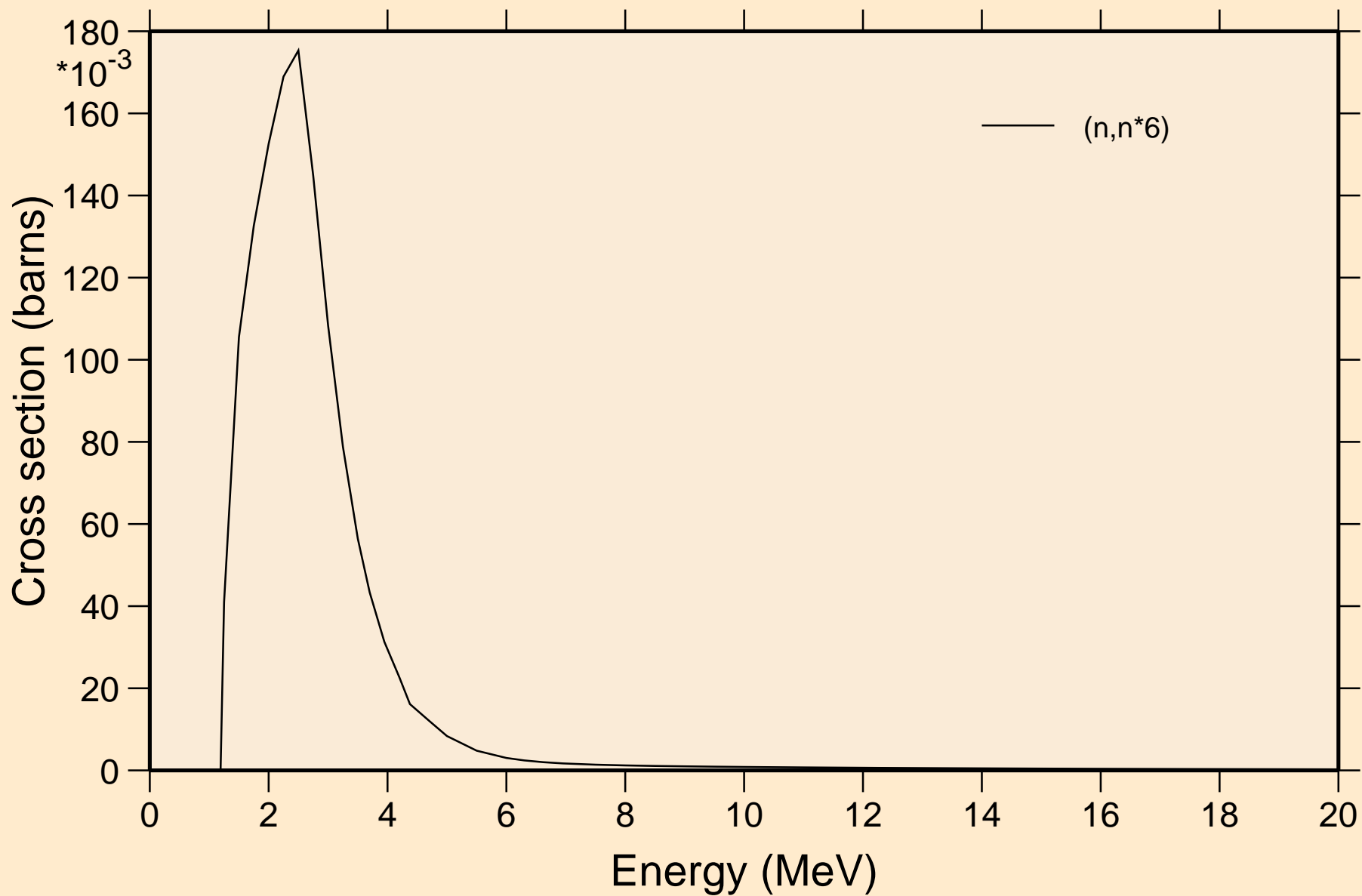

51-SB-123 FOR FENDL-3.2 FROM FENDL-3.2 BY NJOY2016.60+ C
Threshold reactions

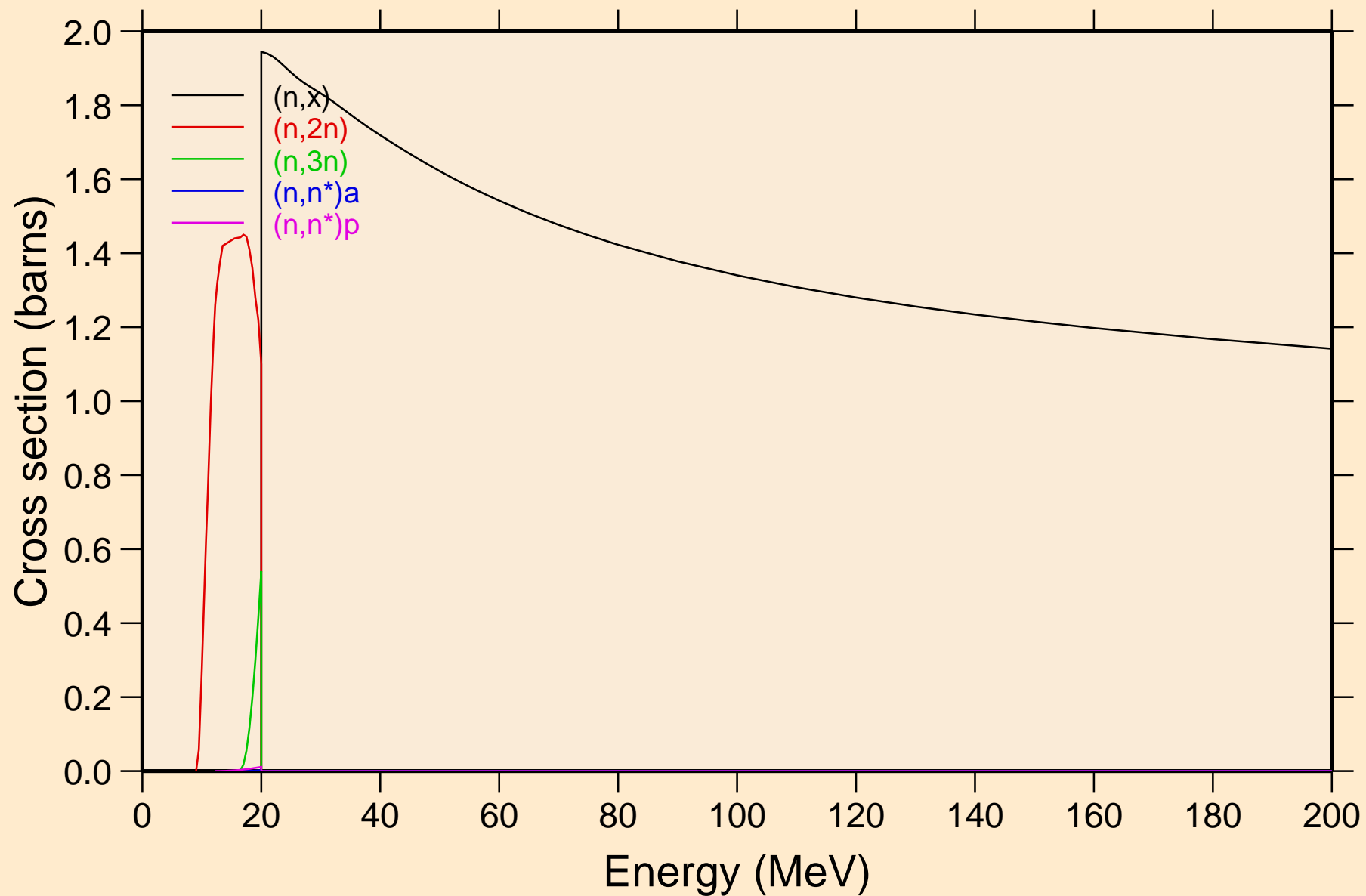

51-SB-123 FOR FENDL-3.2 FROM FENDL-3.2 BY NJOY2016.60+ C
Threshold reactions

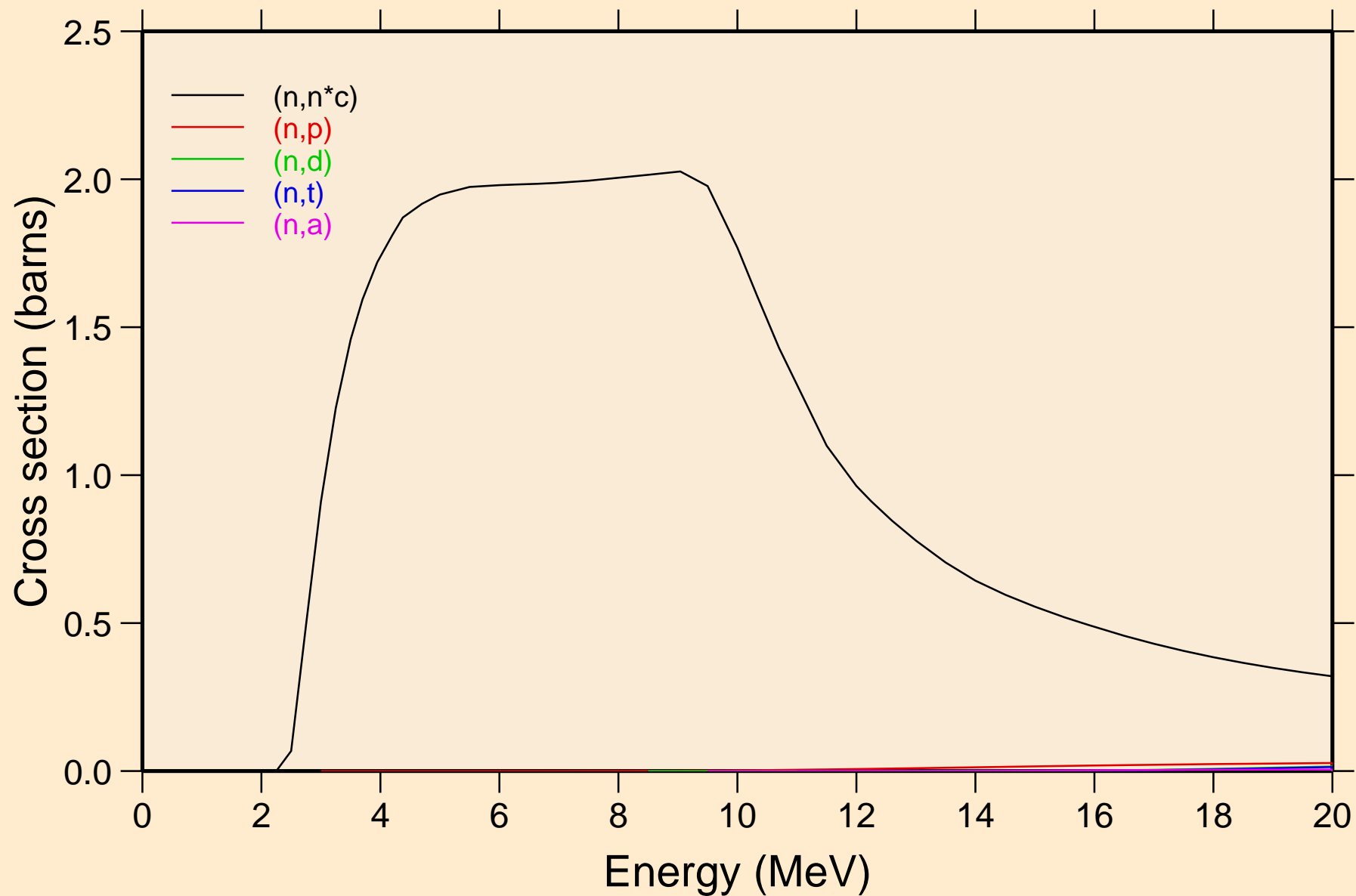

51-SB-123 FOR FENDL-3.2 FROM FENDL-3.2 BY NJOY2016.60+ C
Threshold reactions

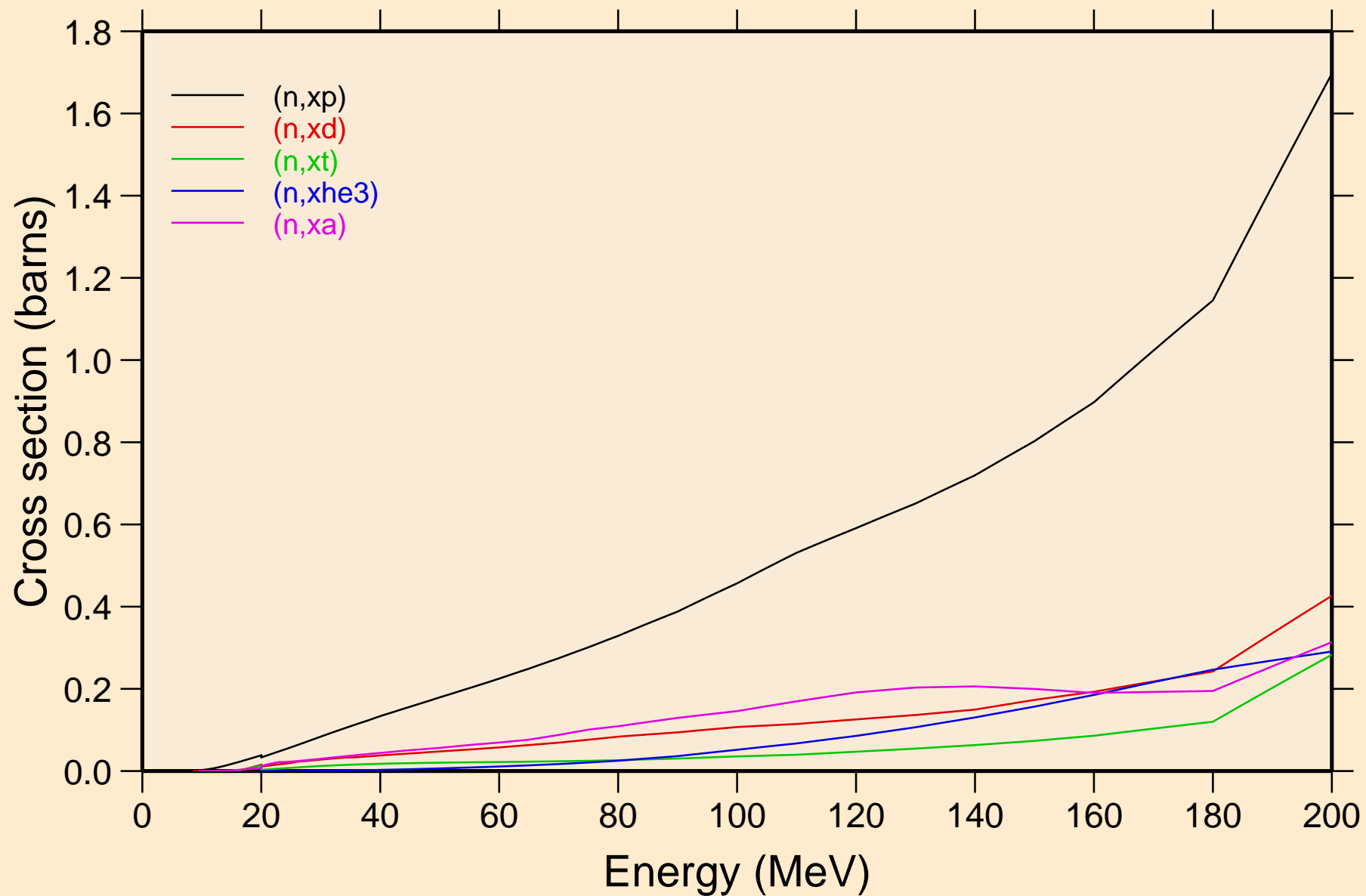

51-SB-123 FOR FENDL-3.2 FROM FENDL-3.2 BY NJOY2016.60+ C
angular distribution for elastic

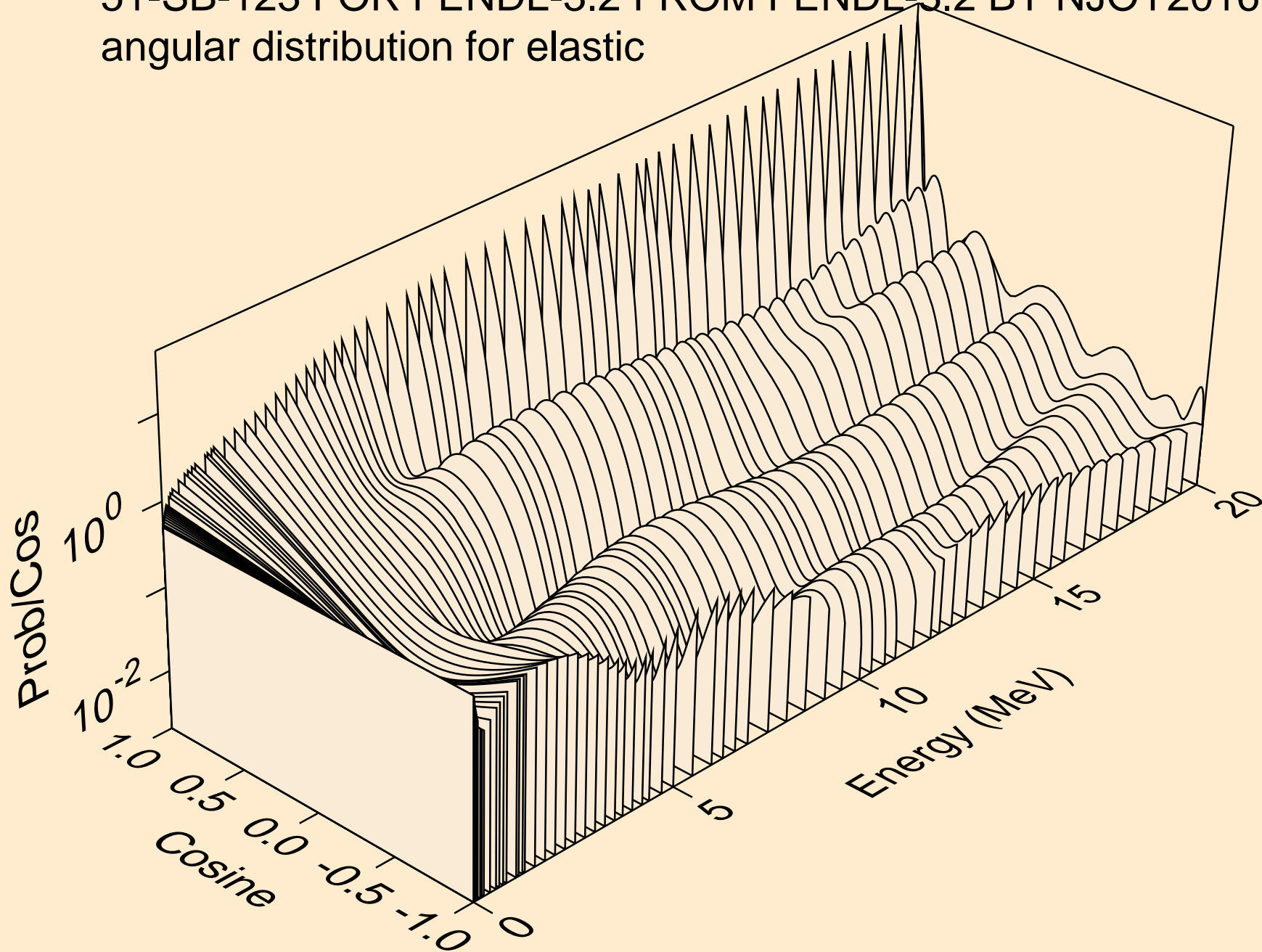

51-SB-123 FOR FENDL-3.2 FROM FENDL-3.2 BY NJOY2016.60+ C
angular distribution for elastic

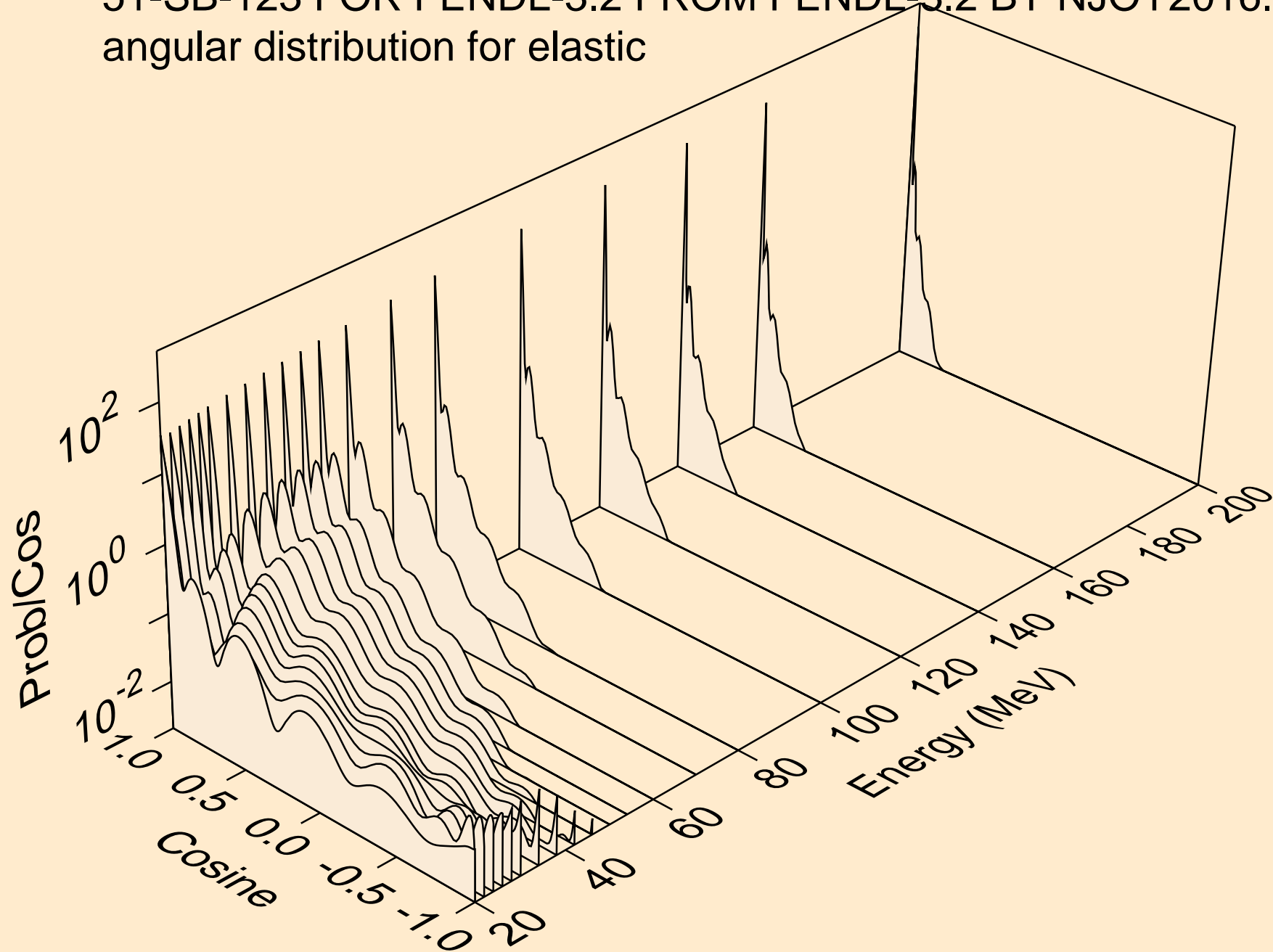

51-SB-123 FOR FENDL-3.2 FROM FENDL-3.2 BY NJOY2016.60+ C
angular distribution for (n,2n)

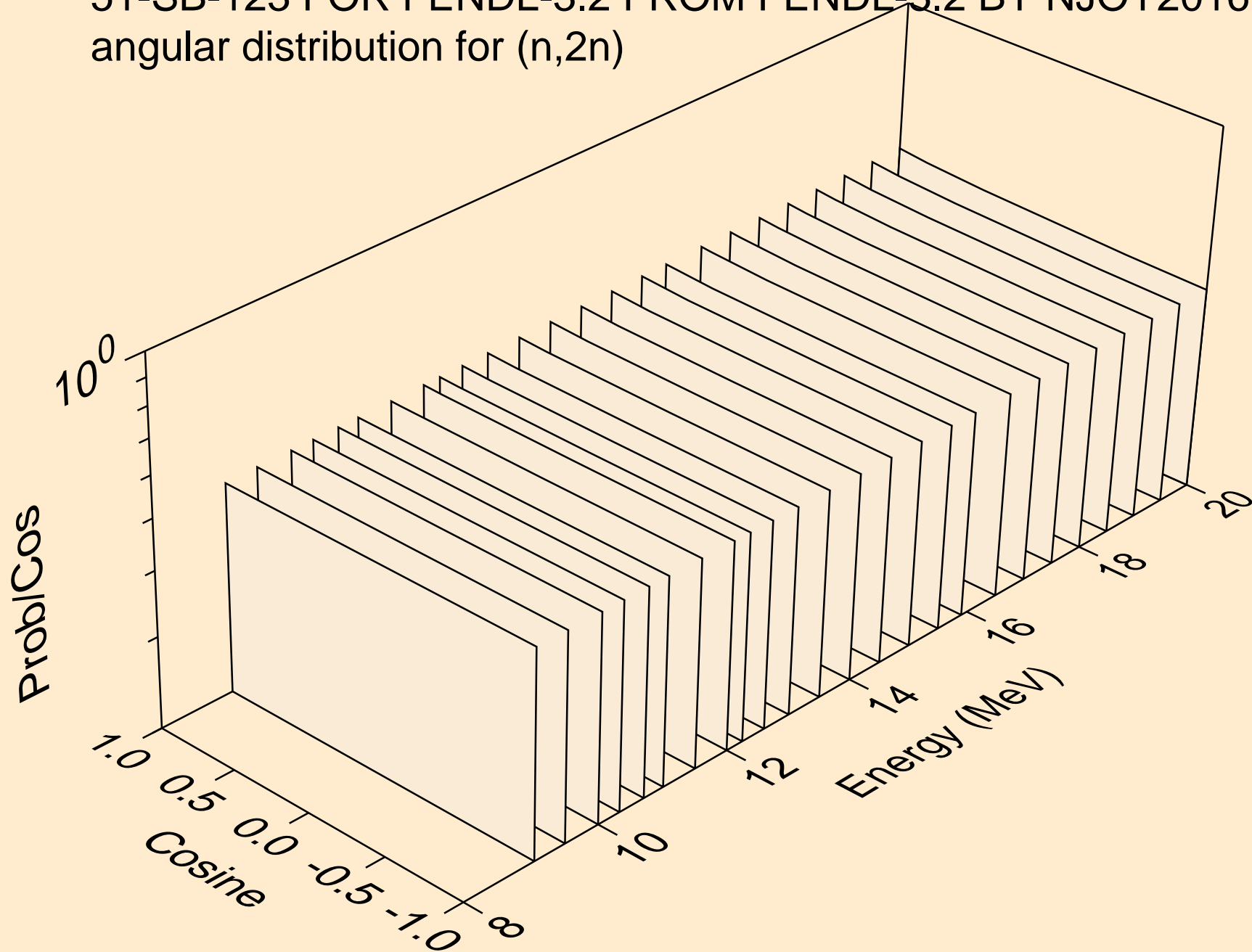

51-SB-123 FOR FENDL-3.2 FROM FENDL-3.2 BY NJOY2016.60+ C
angular distribution for (n,3n)

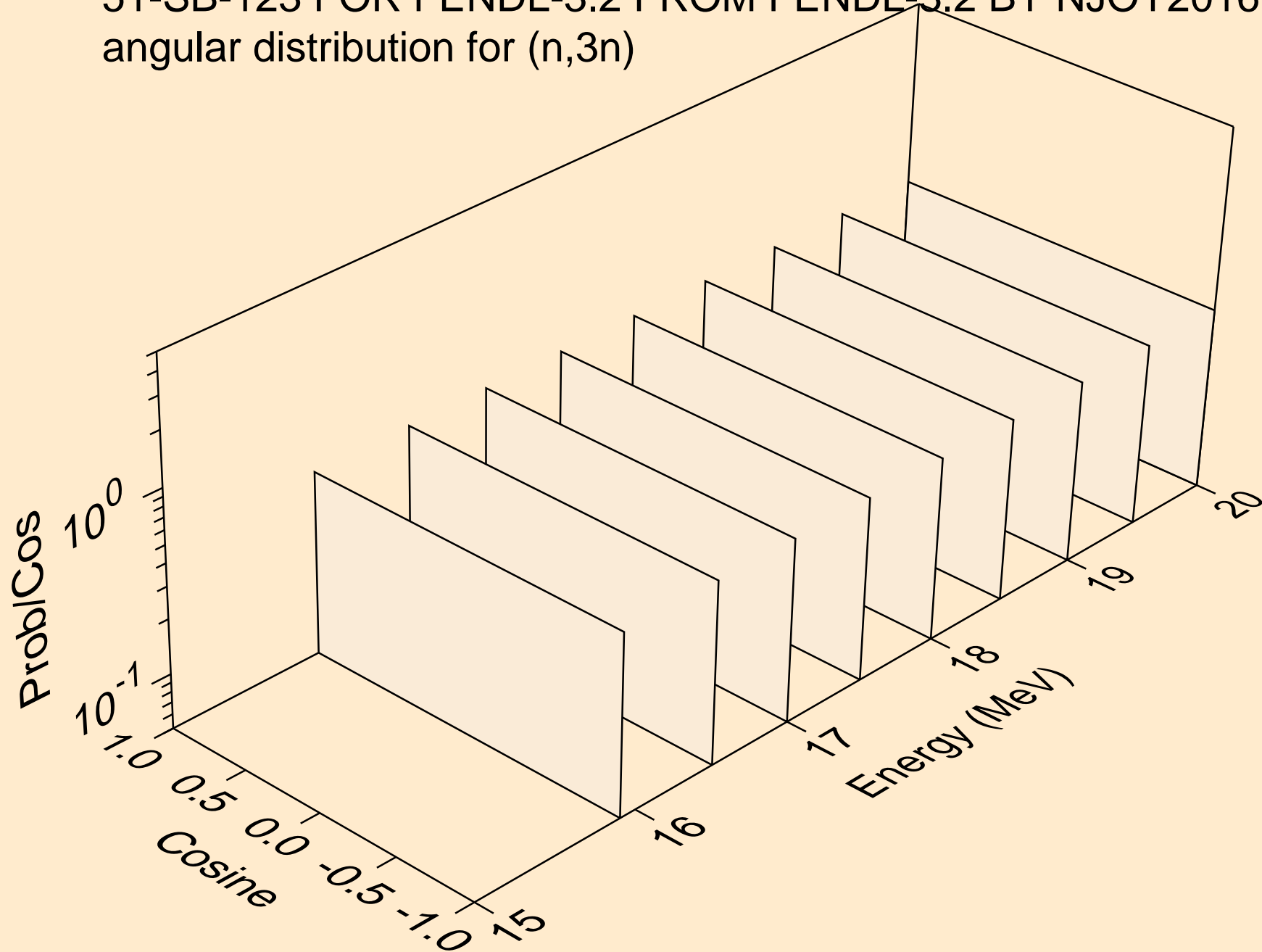

51-SB-123 FOR FENDL-3.2 FROM FENDL-3.2 BY NJOY2016.60+ C
angular distribution for (n,n*)a

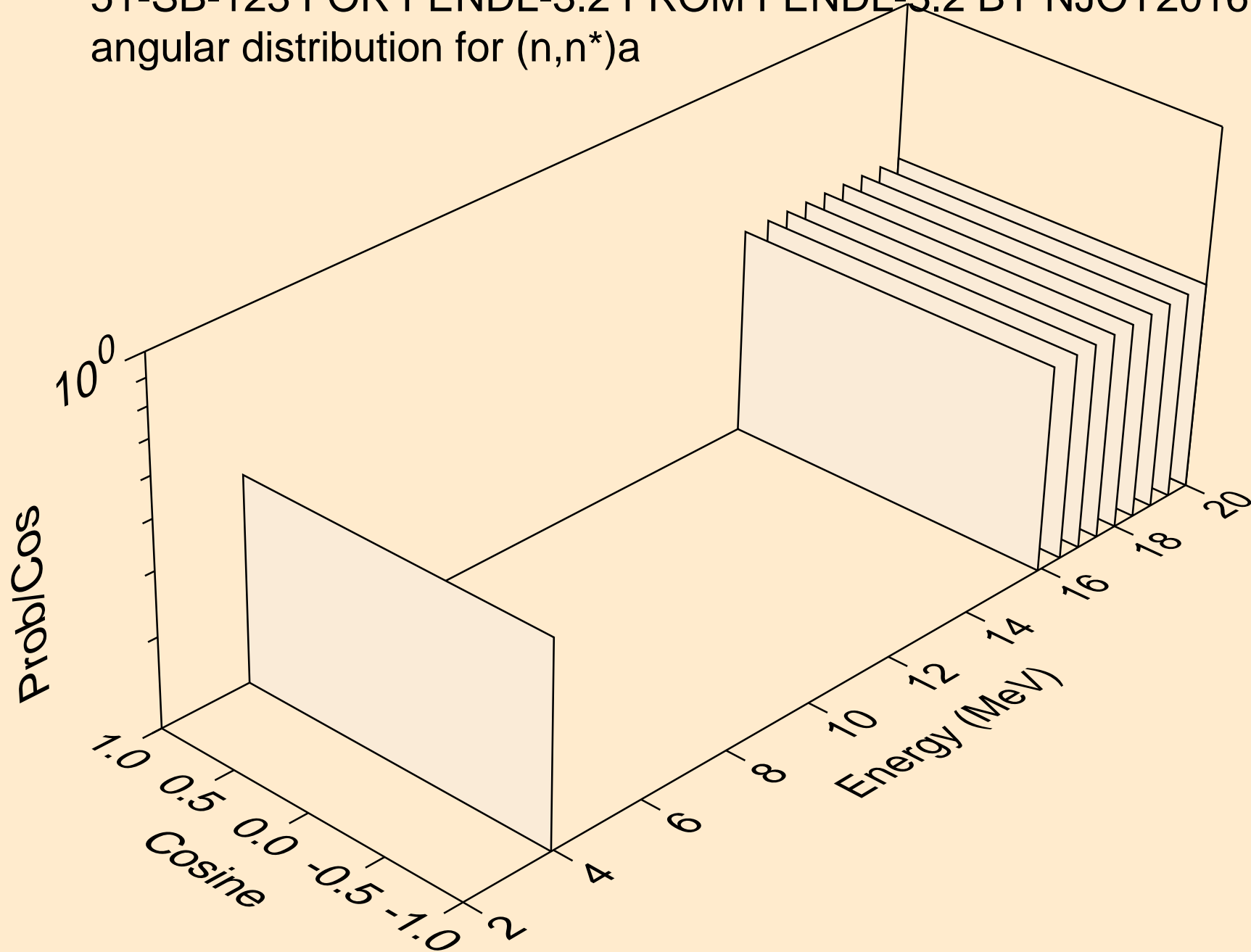

51-SB-123 FOR FENDL-3.2 FROM FENDL-3.2 BY NJOY2016.60+ C
angular distribution for (n,n*)p

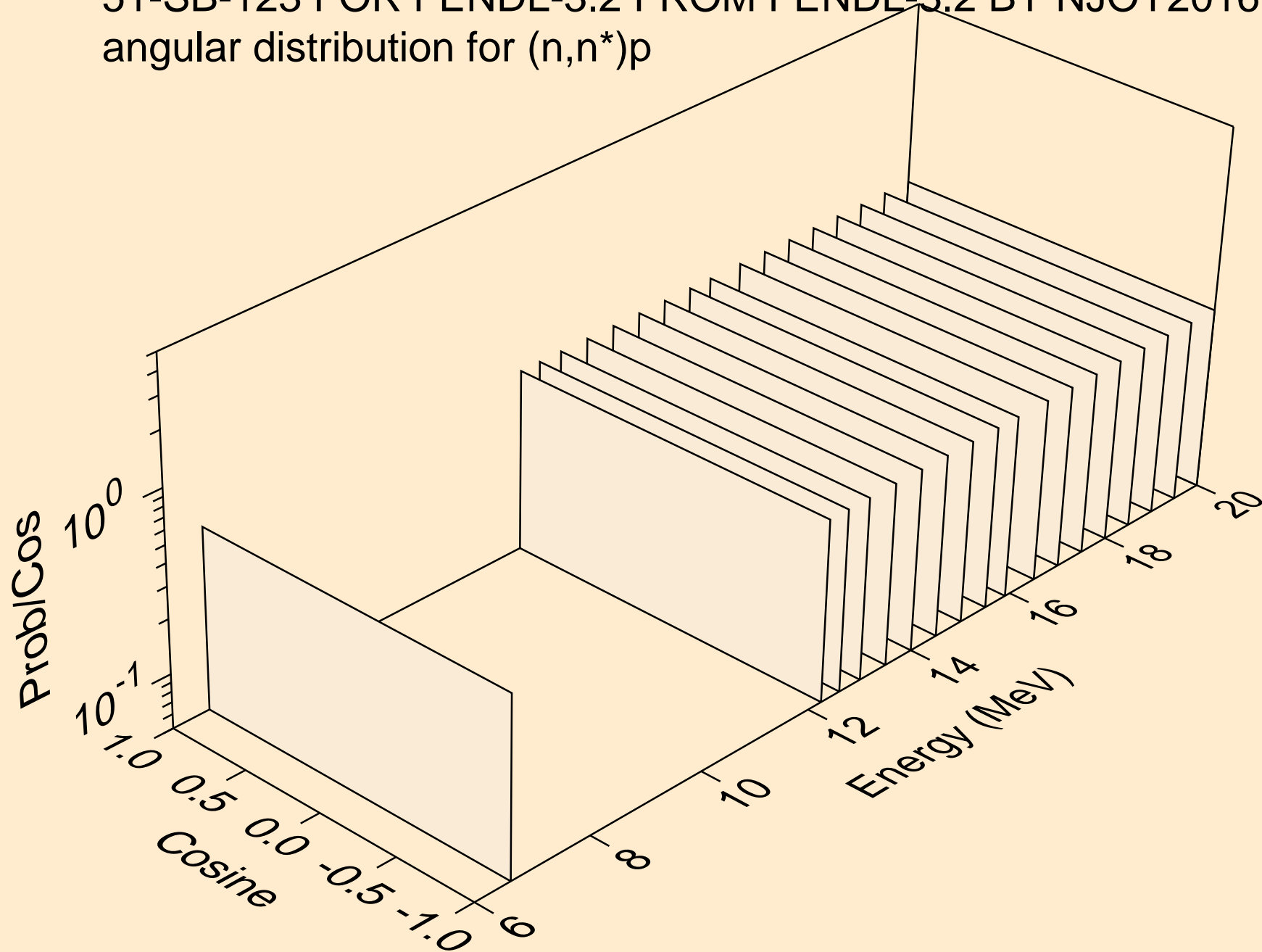

51-SB-123 FOR FENDL-3.2 FROM FENDL-3.2 BY NJOY2016.60+ C
angular distribution for (n,n*1)

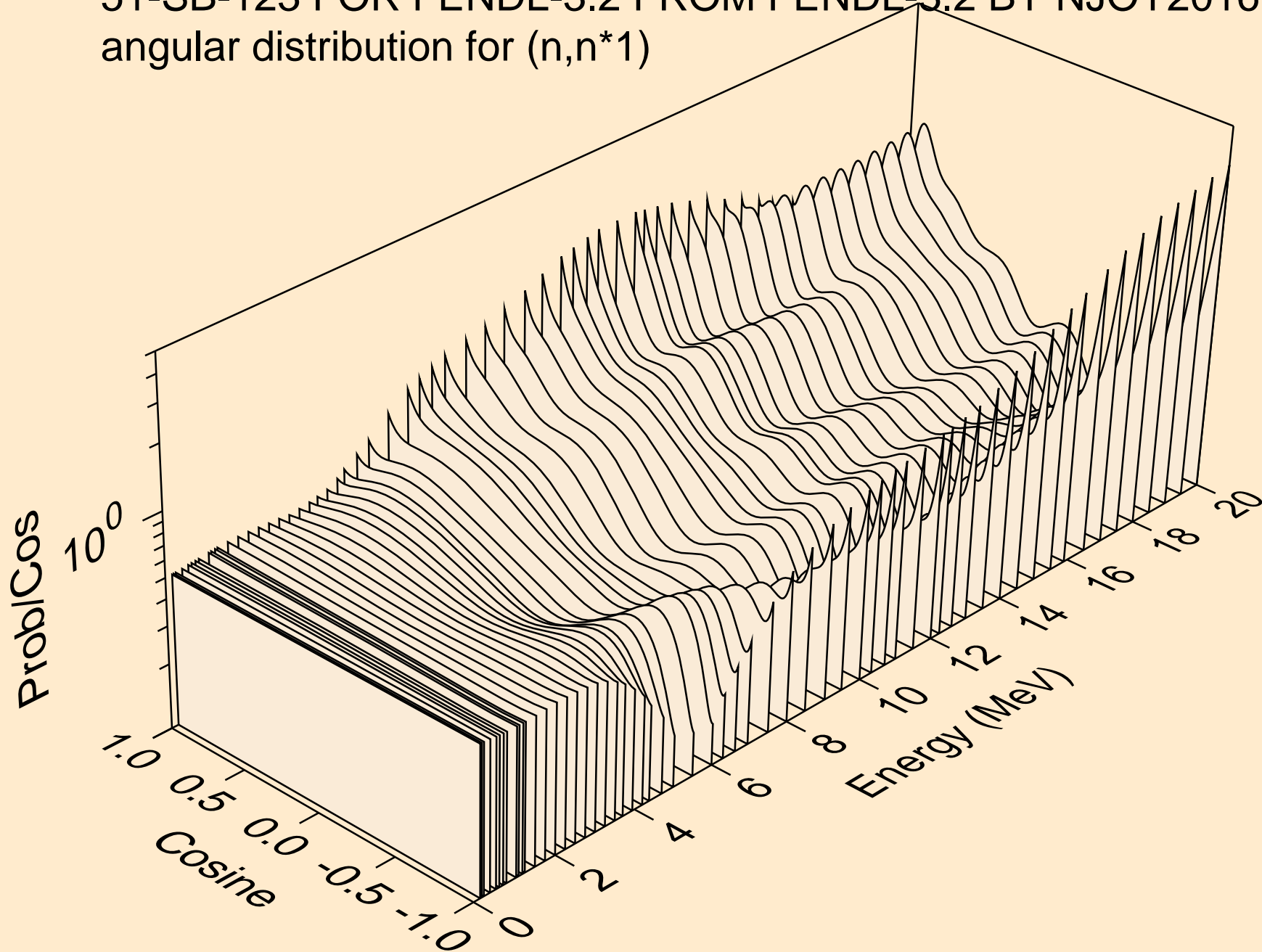

51-SB-123 FOR FENDL-3.2 FROM FENDL-3.2 BY NJOY2016.60+ C
angular distribution for (n,n*2)

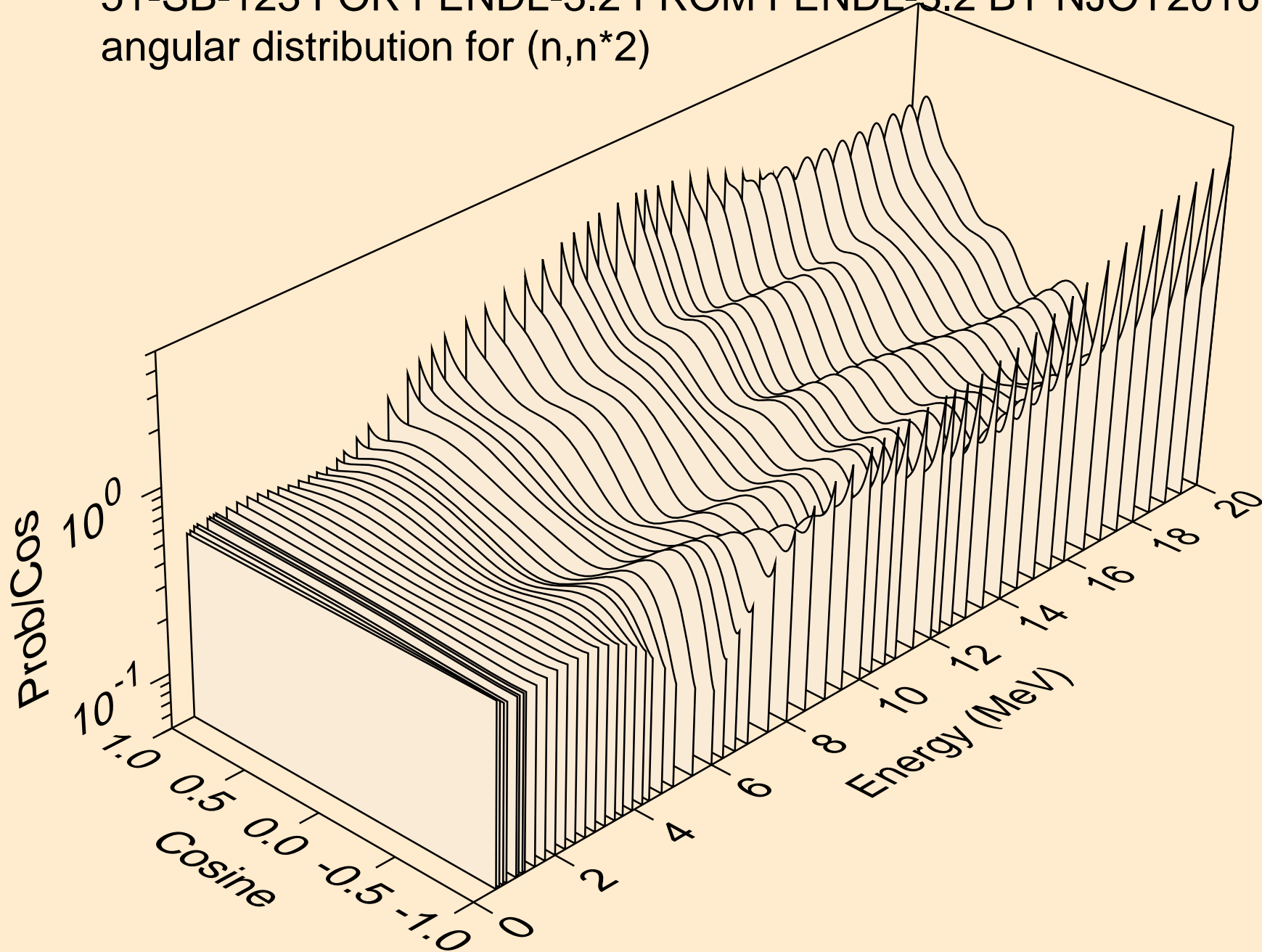

51-SB-123 FOR FENDL-3.2 FROM FENDL-3.2 BY NJOY2016.60+ C
angular distribution for (n,n*3)

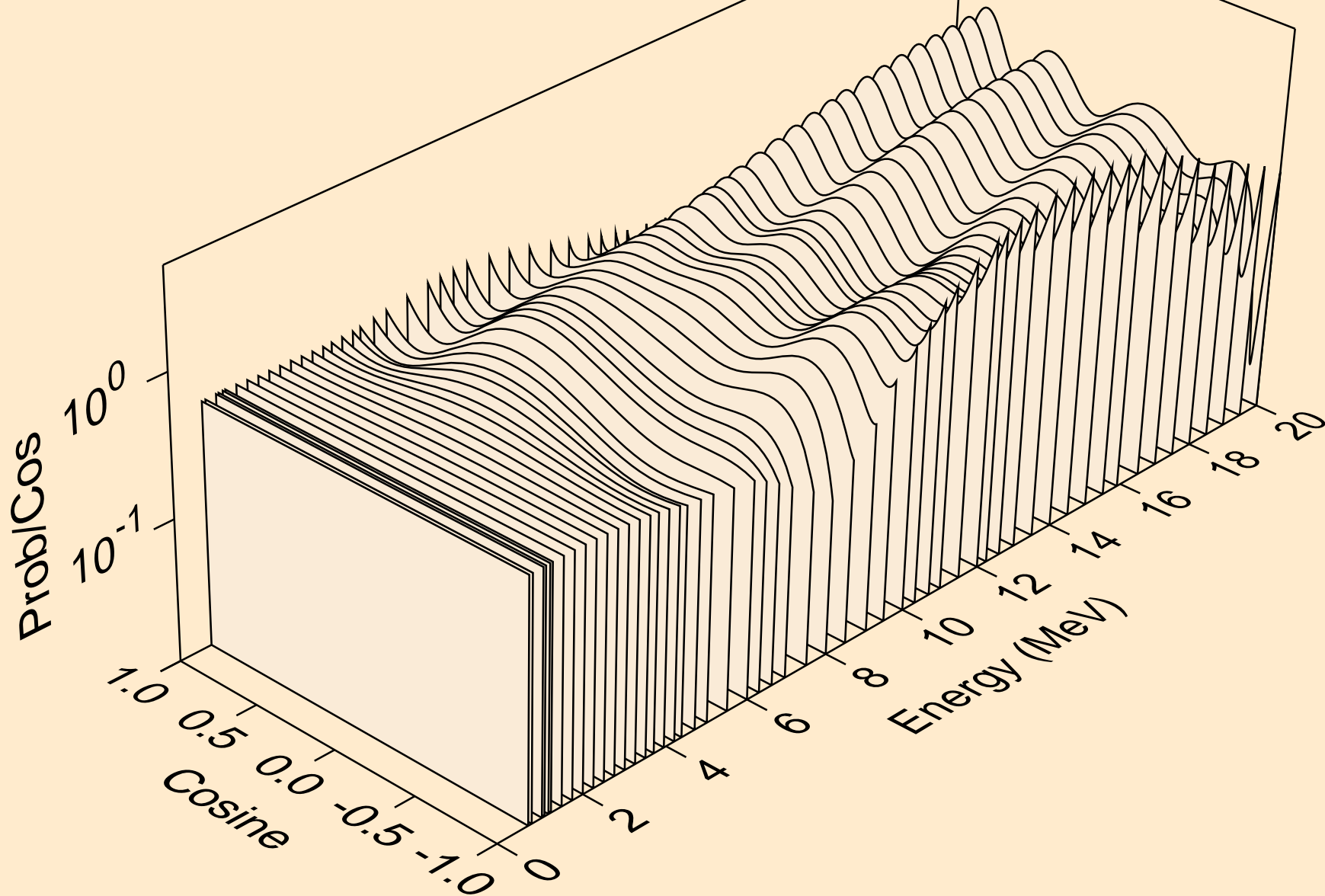

51-SB-123 FOR FENDL-3.2 FROM FENDL-3.2 BY NJOY2016.60+ C
angular distribution for (n,n*4)

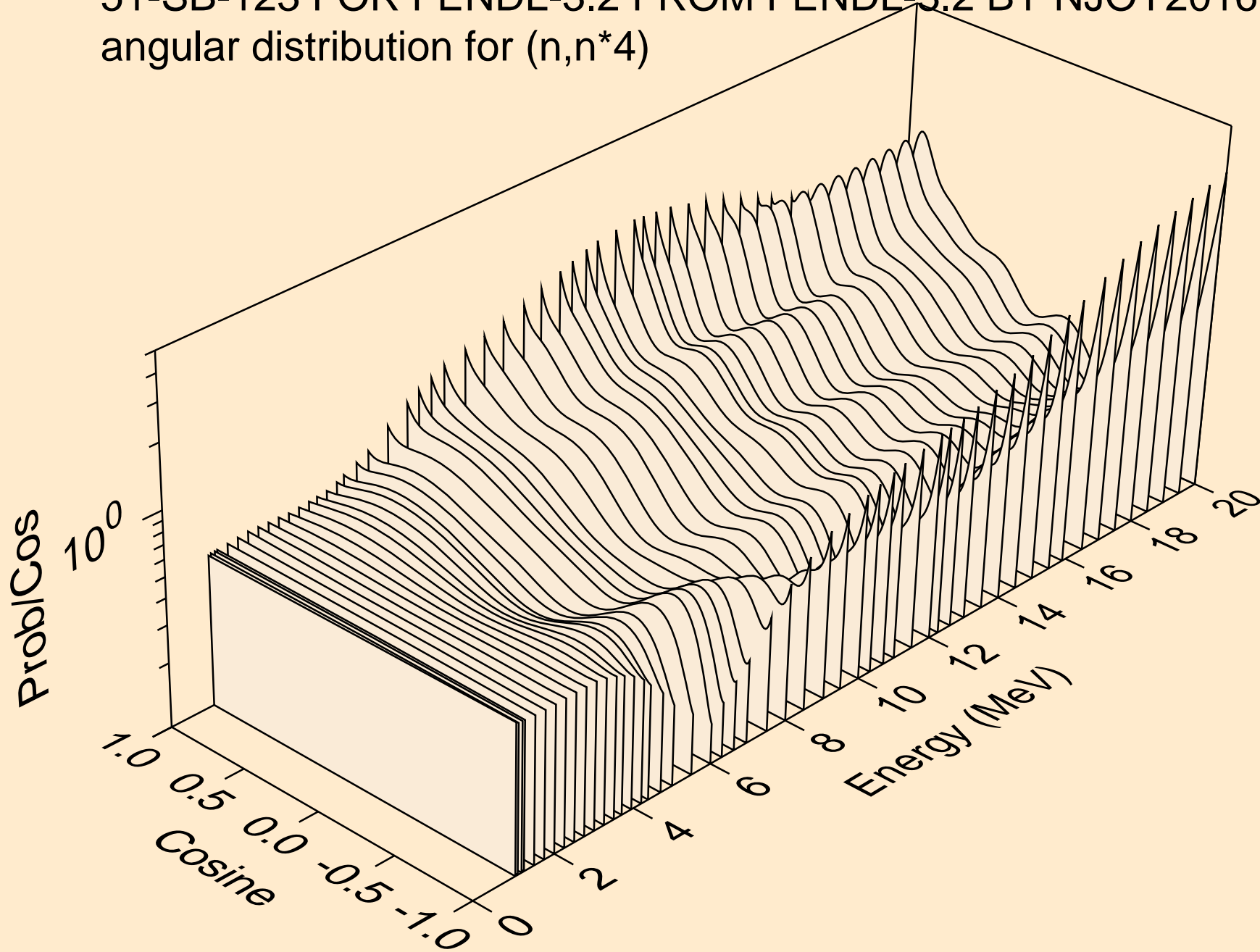

51-SB-123 FOR FENDL-3.2 FROM FENDL-3.2 BY NJOY2016.60+ C
angular distribution for (n,n*5)

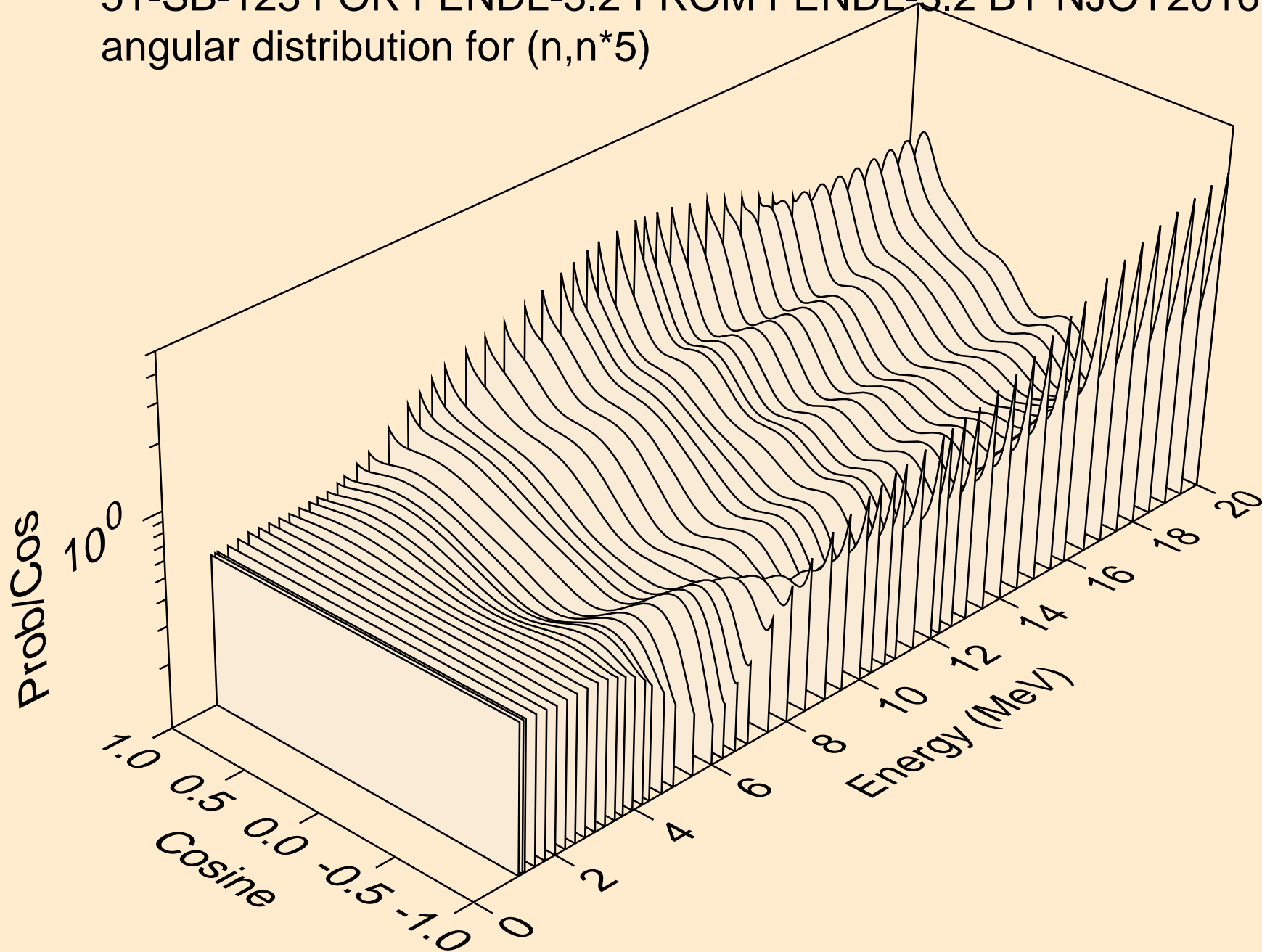

51-SB-123 FOR FENDL-3.2 FROM FENDL-3.2 BY NJOY2016.60+ C
angular distribution for (n,n*6)

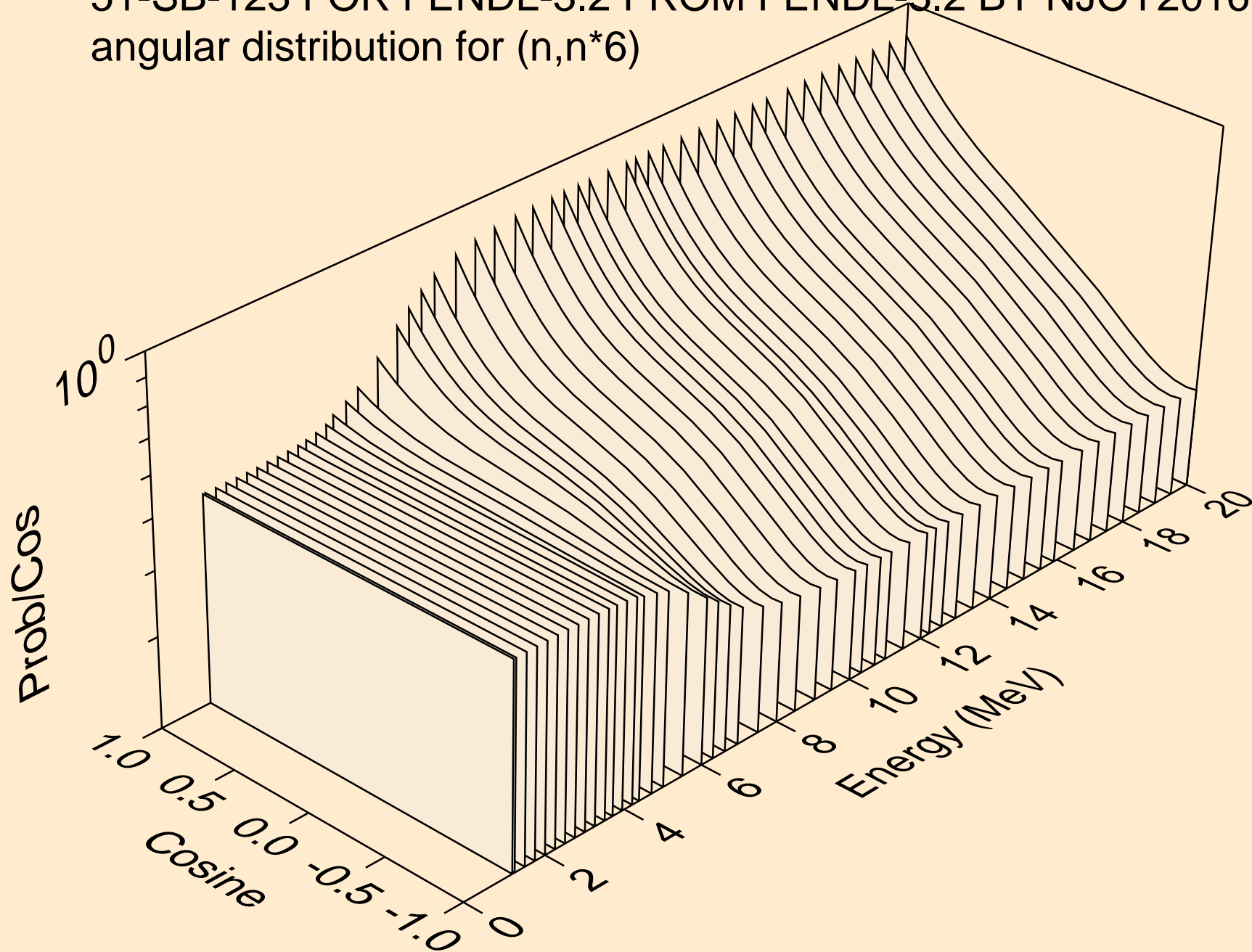

51-SB-123 FOR FENDL-3.2 FROM FENDL-3.2 BY NJOY2016.60+ C
angular distribution for (n,n*c)

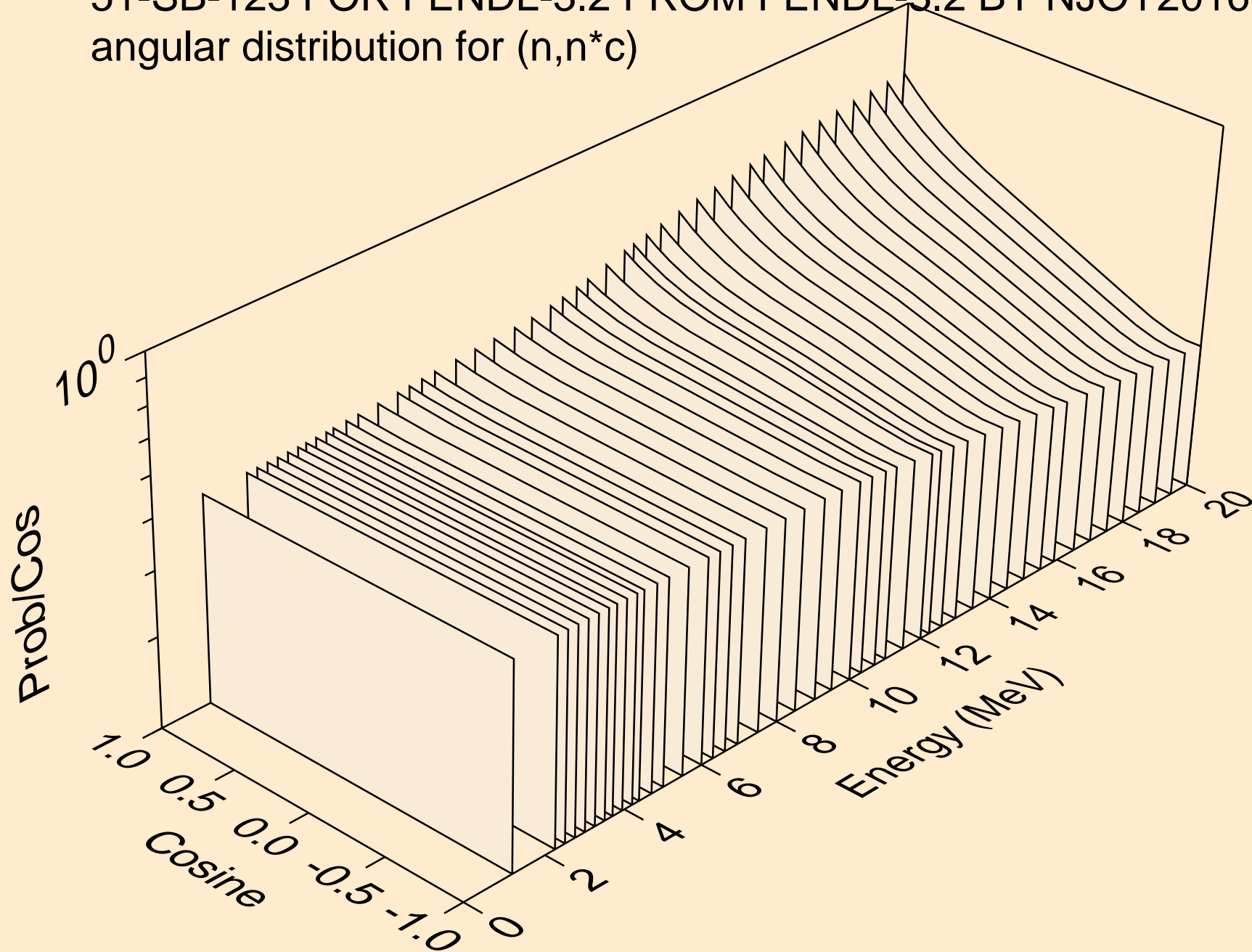

51-SB-123 FOR FENDL-3.2 FROM FENDL-3.2 BY NJOY2016.60+ C
Neutron emission for (n,x)

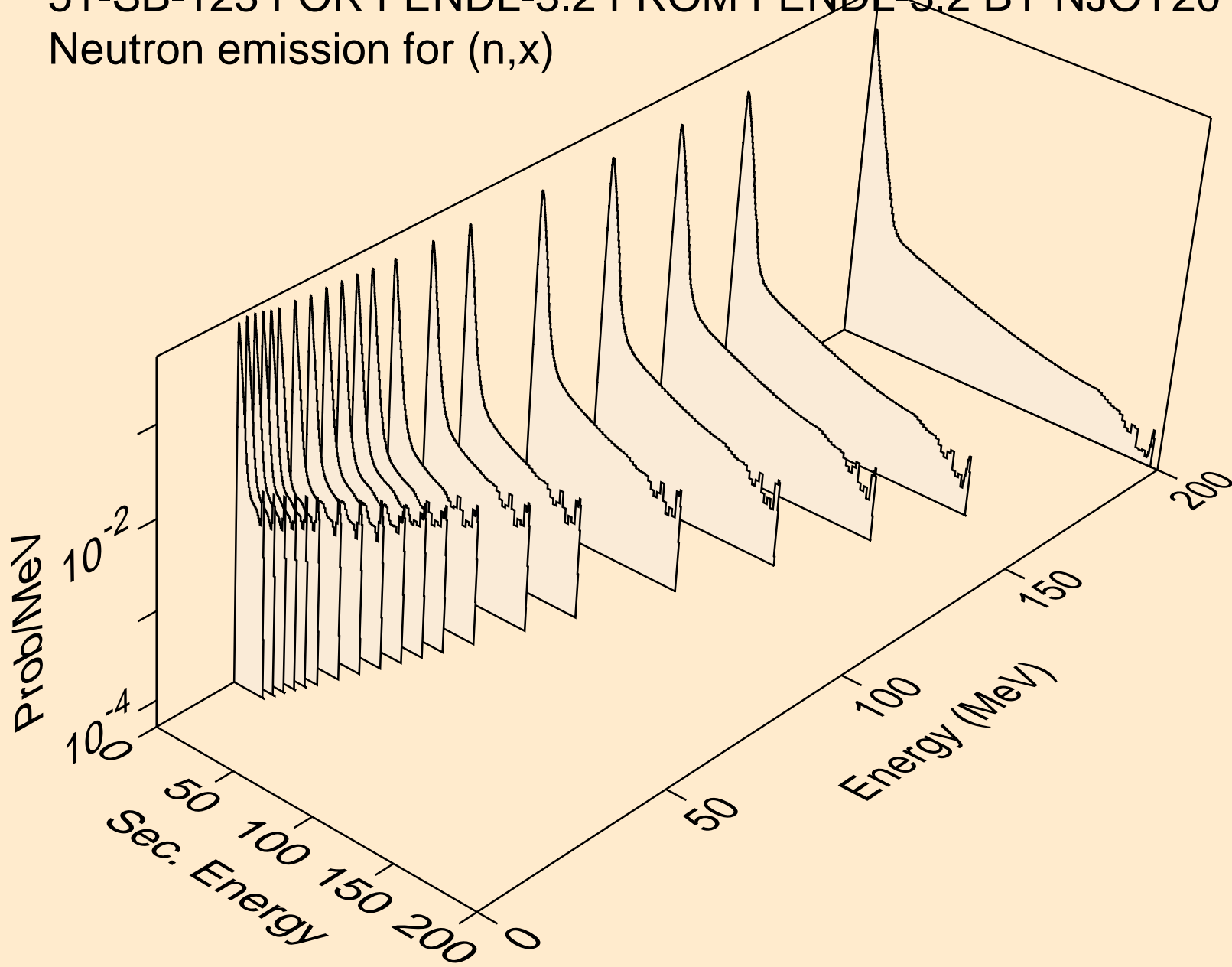

51-SB-123 FOR FENDL-3.2 FROM FENDL-3.2 BY NJOY2016.60+ C
Neutron emission for (n,2n)

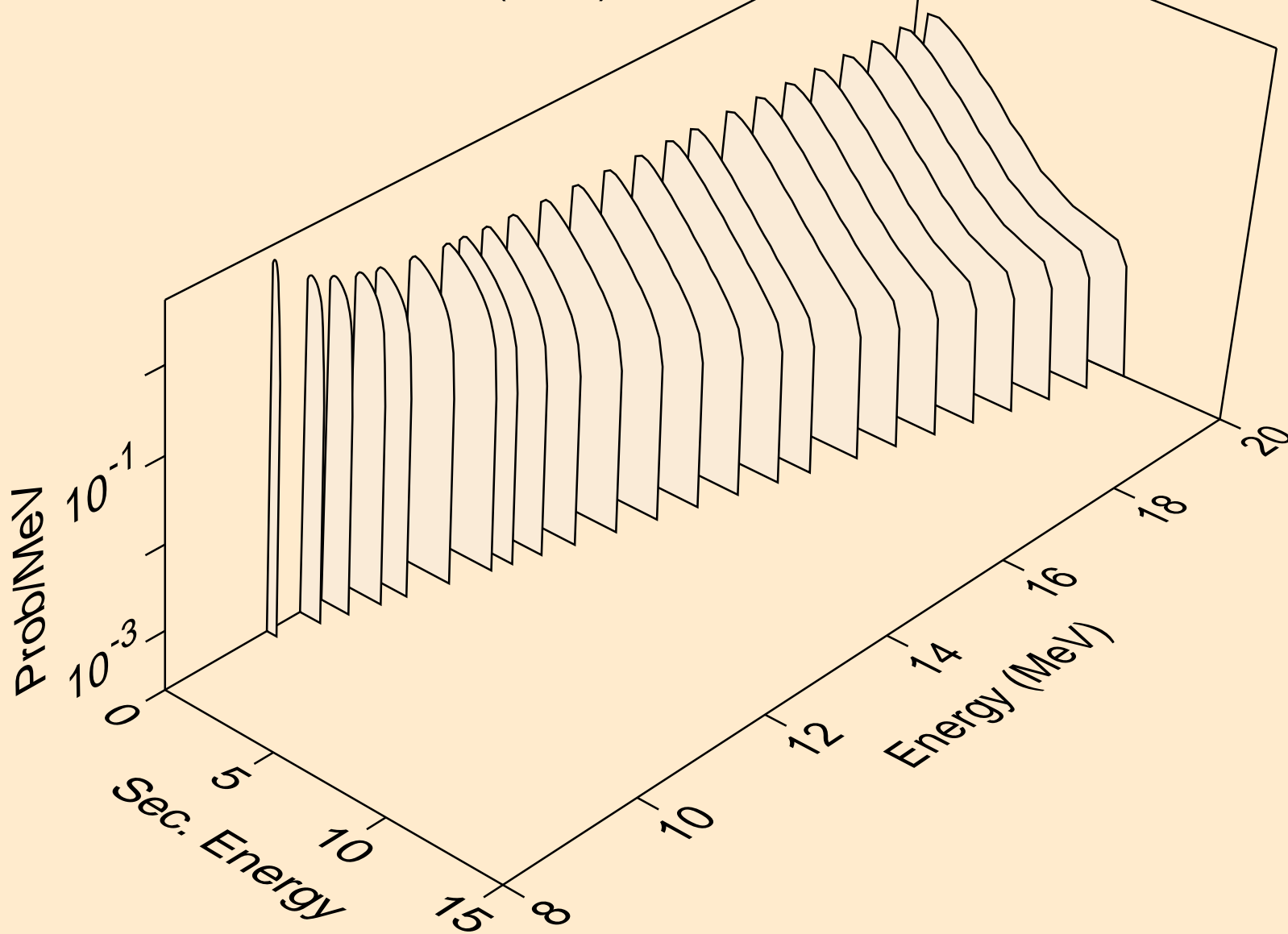

51-SB-123 FOR FENDL-3.2 FROM FENDL-3.2 BY NJOY2016.60+ C
Neutron emission for (n,3n)

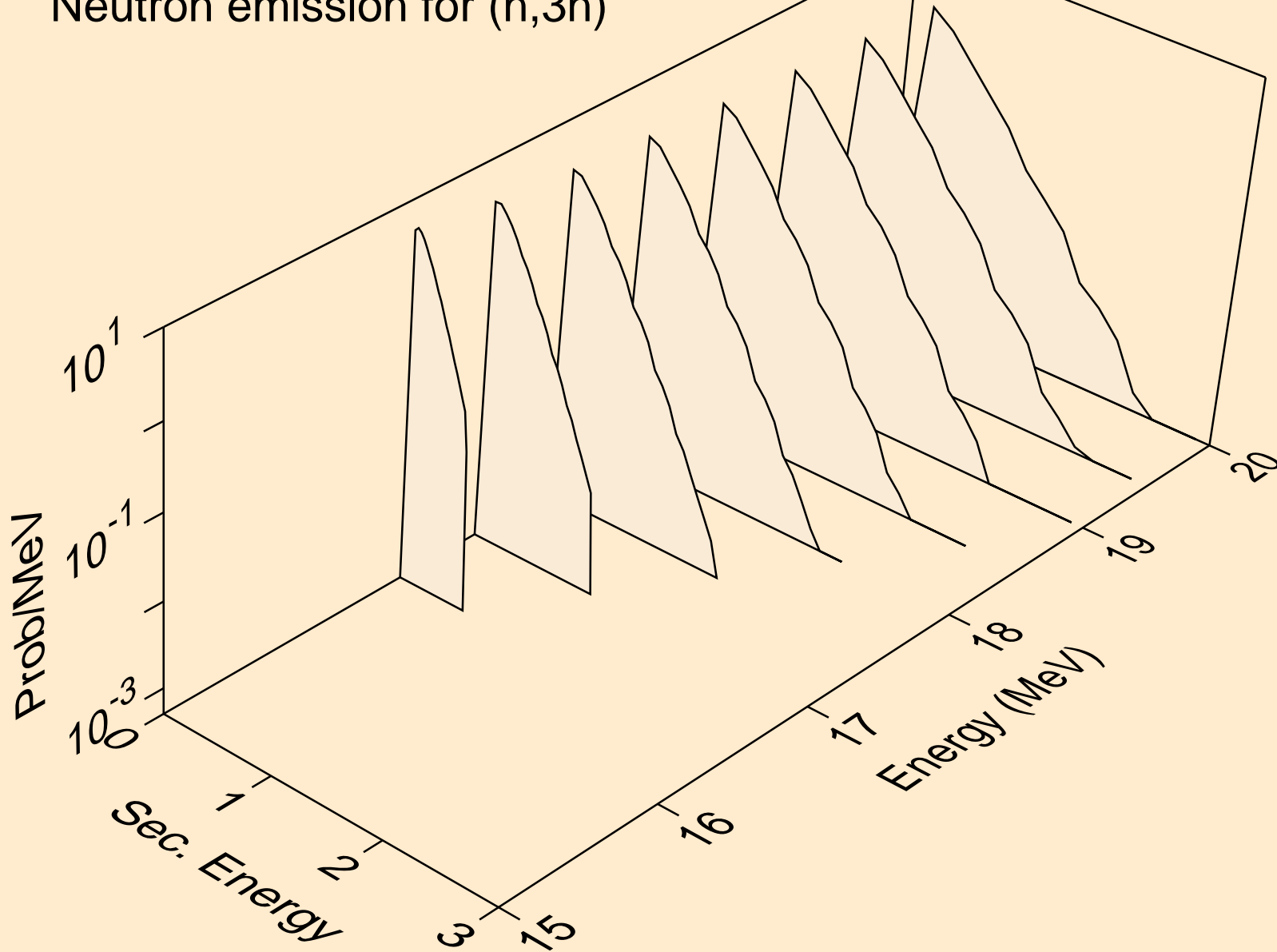

51-SB-123 FOR FENDL-3.2 FROM FENDL-3.2 BY NJOY2016.60+ C
Neutron emission for (n,n*)a

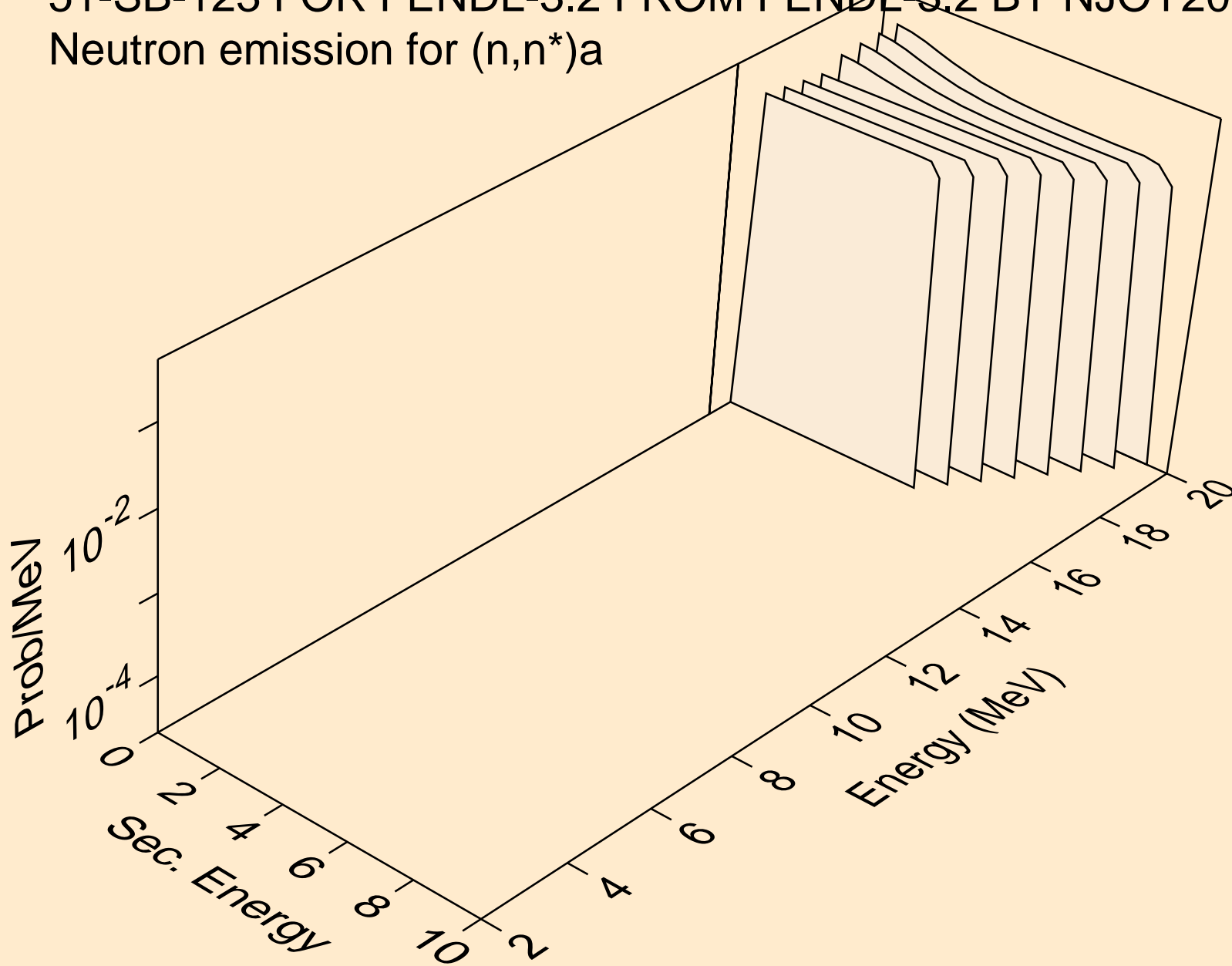

51-SB-123 FOR FENDL-3.2 FROM FENDL-3.2 BY NJOY2016.60+ C
Neutron emission for (n,n*)p

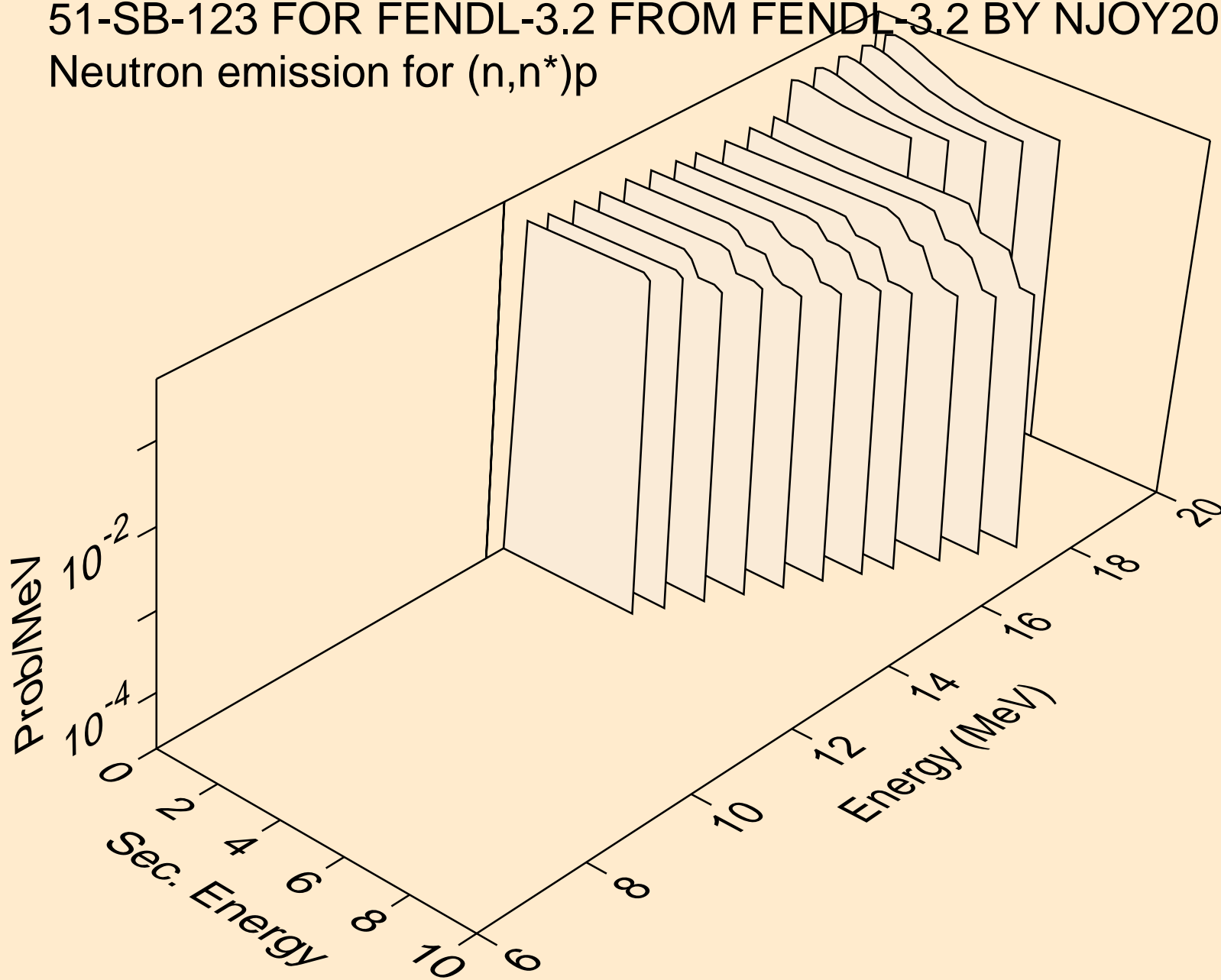

51-SB-123 FOR FENDL-3.2 FROM FENDL-3.2 BY NJOY2016.60+ C
Neutron emission for (n,n*c)

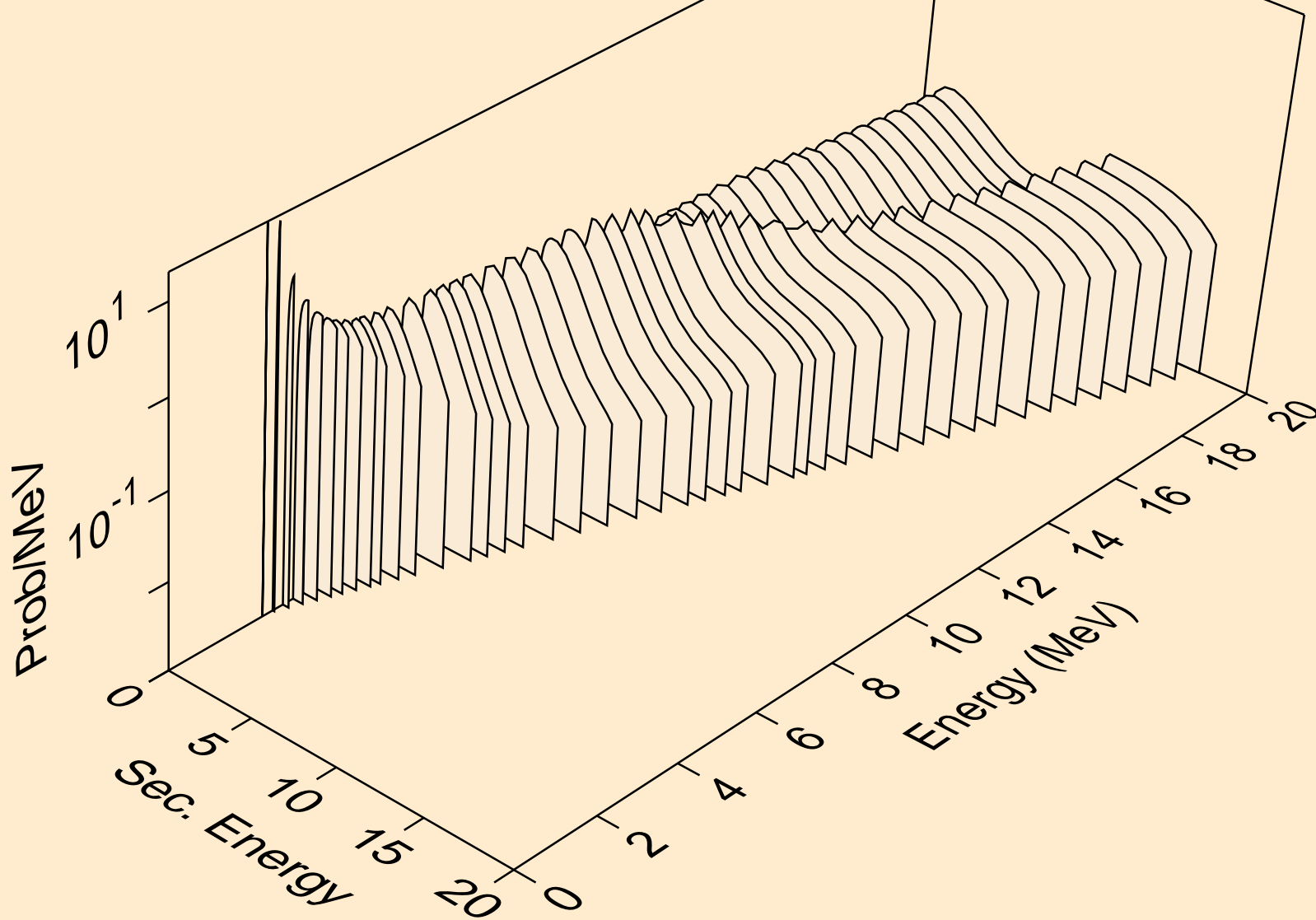

51-SB-123 FOR FENDL-3.2 FROM FENDL-3.2 BY NJOY2016.60+ C
Photon emission for (n,x)

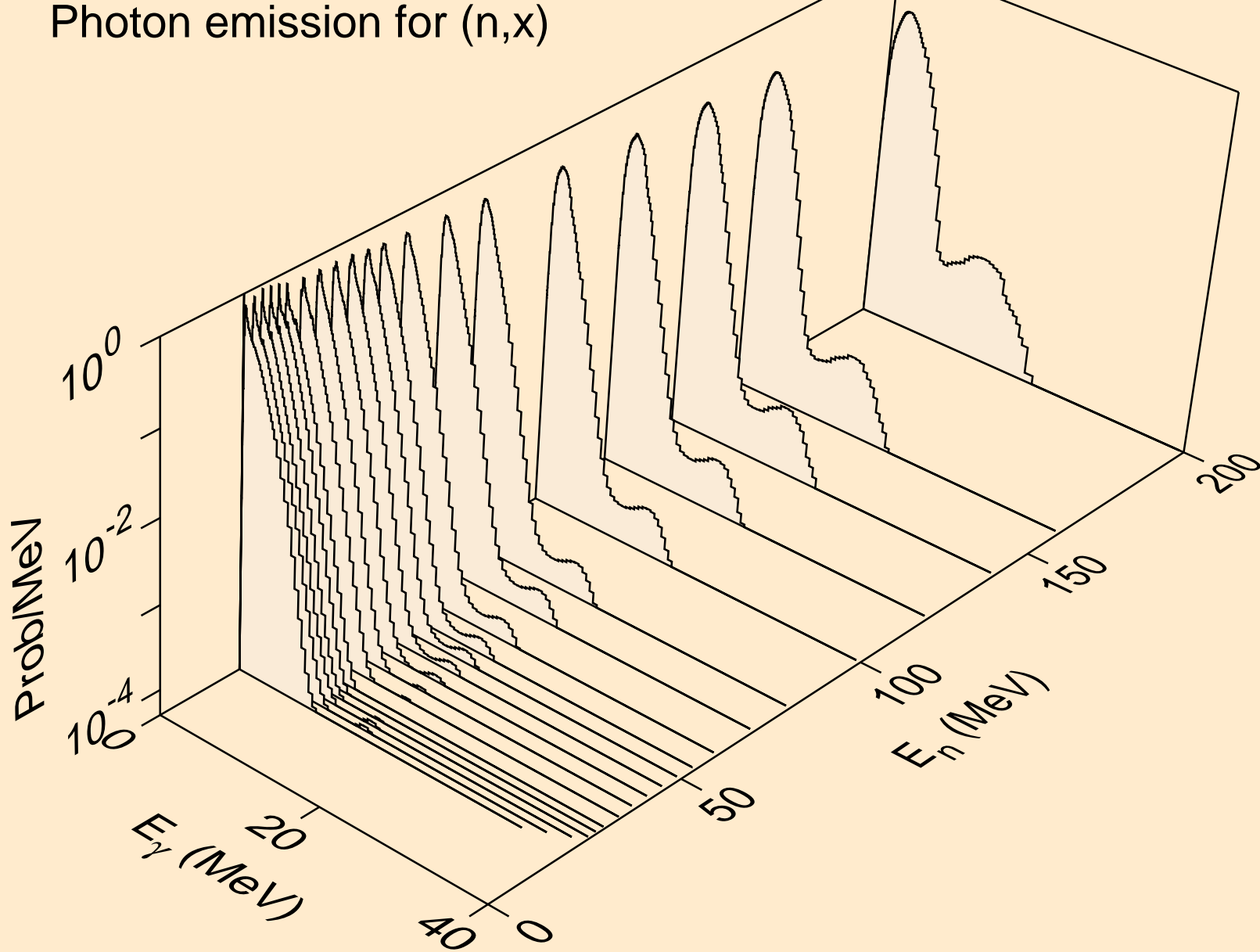

51-SB-123 FOR FENDL-3.2 FROM FENDL-3.2 BY NJOY2016.60+ C
Particle heating contributions

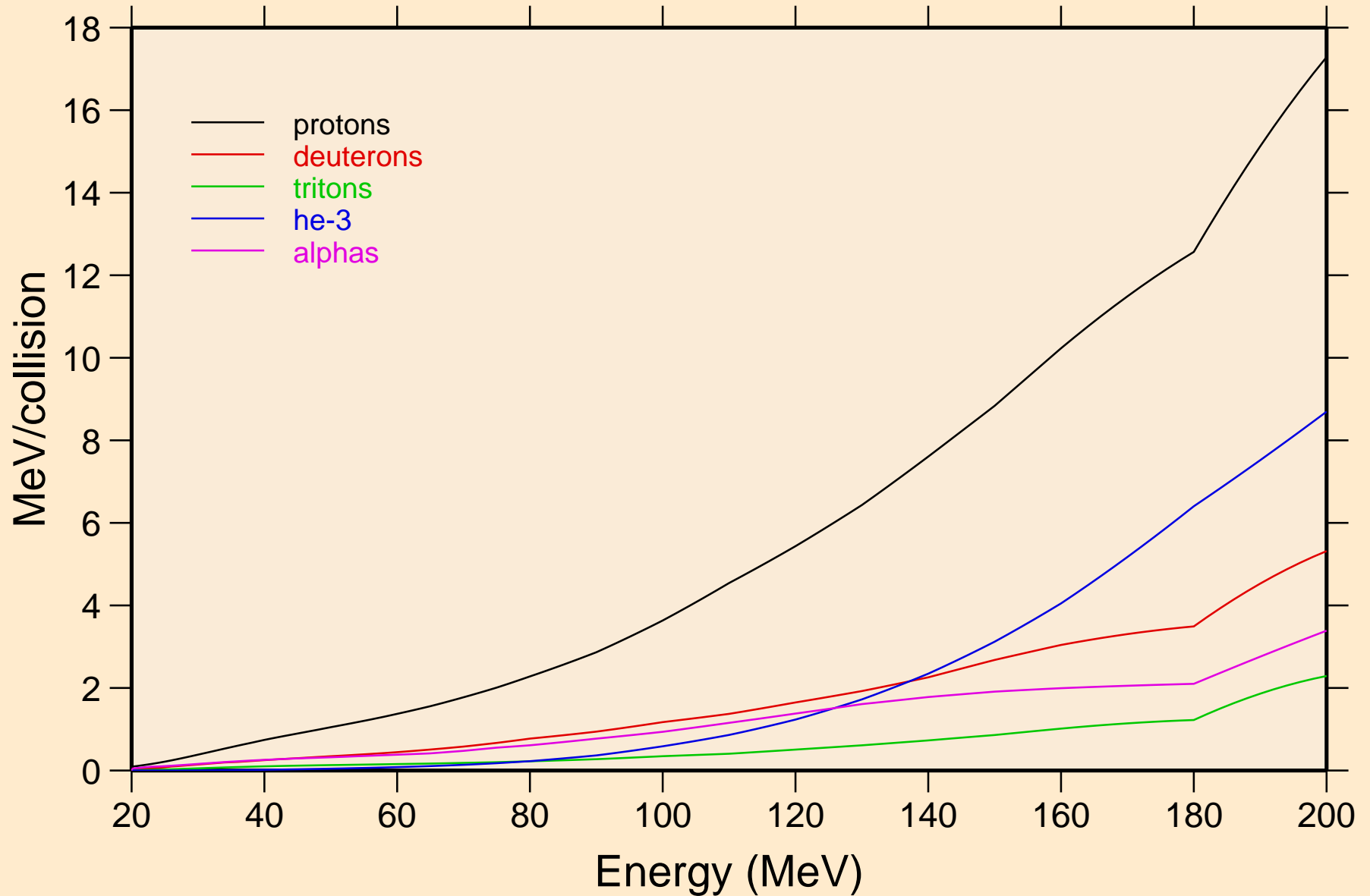

51-SB-123 FOR FENDL-3.2 FROM FENDL-3.2 BY NJOY2016.60+ C
Recoil Heating

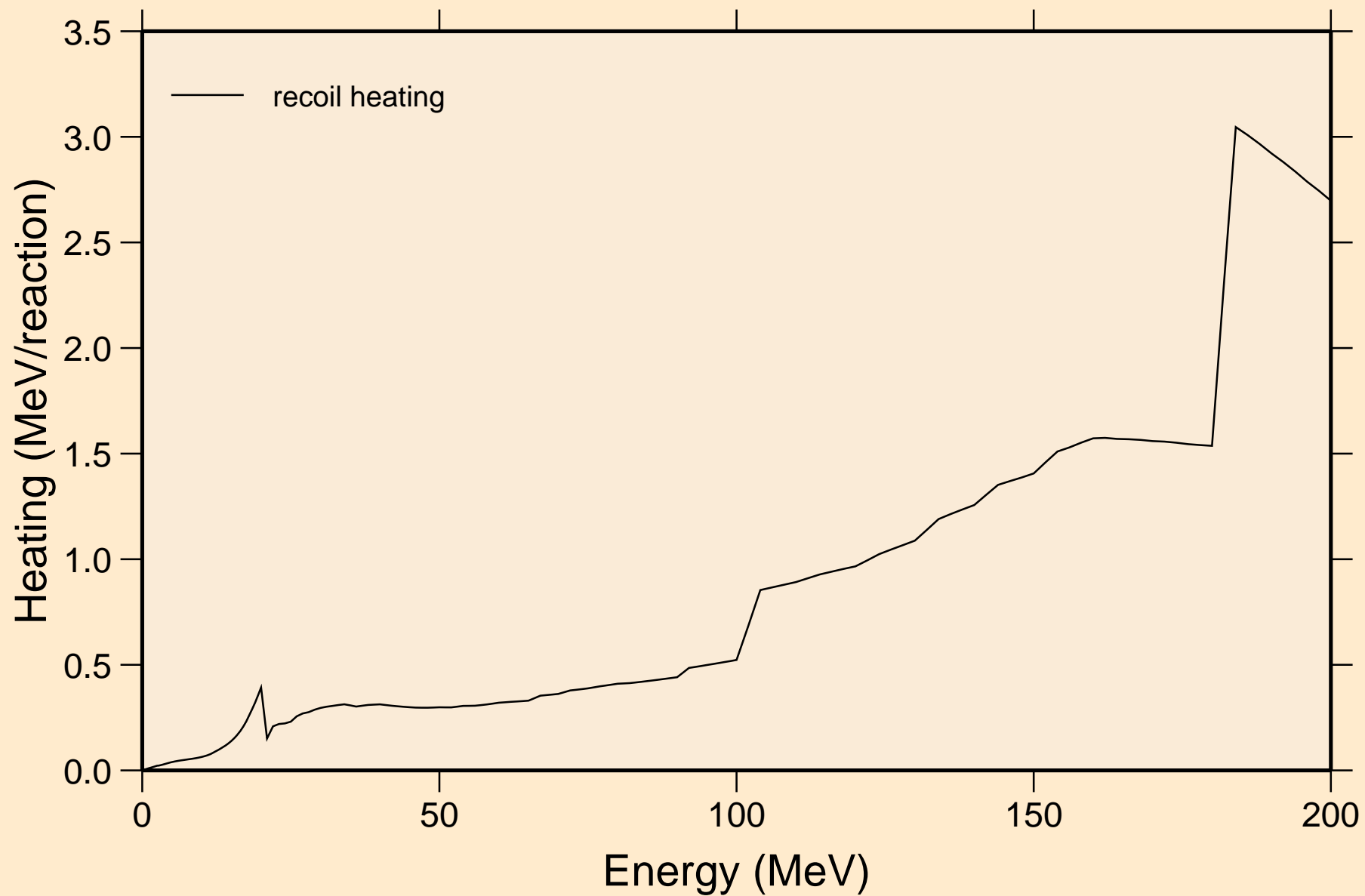

51-SB-123 FOR FENDL-3.2 FROM FENDL-3.2 BY NJOY2016.60+ C
Particle production cross sections

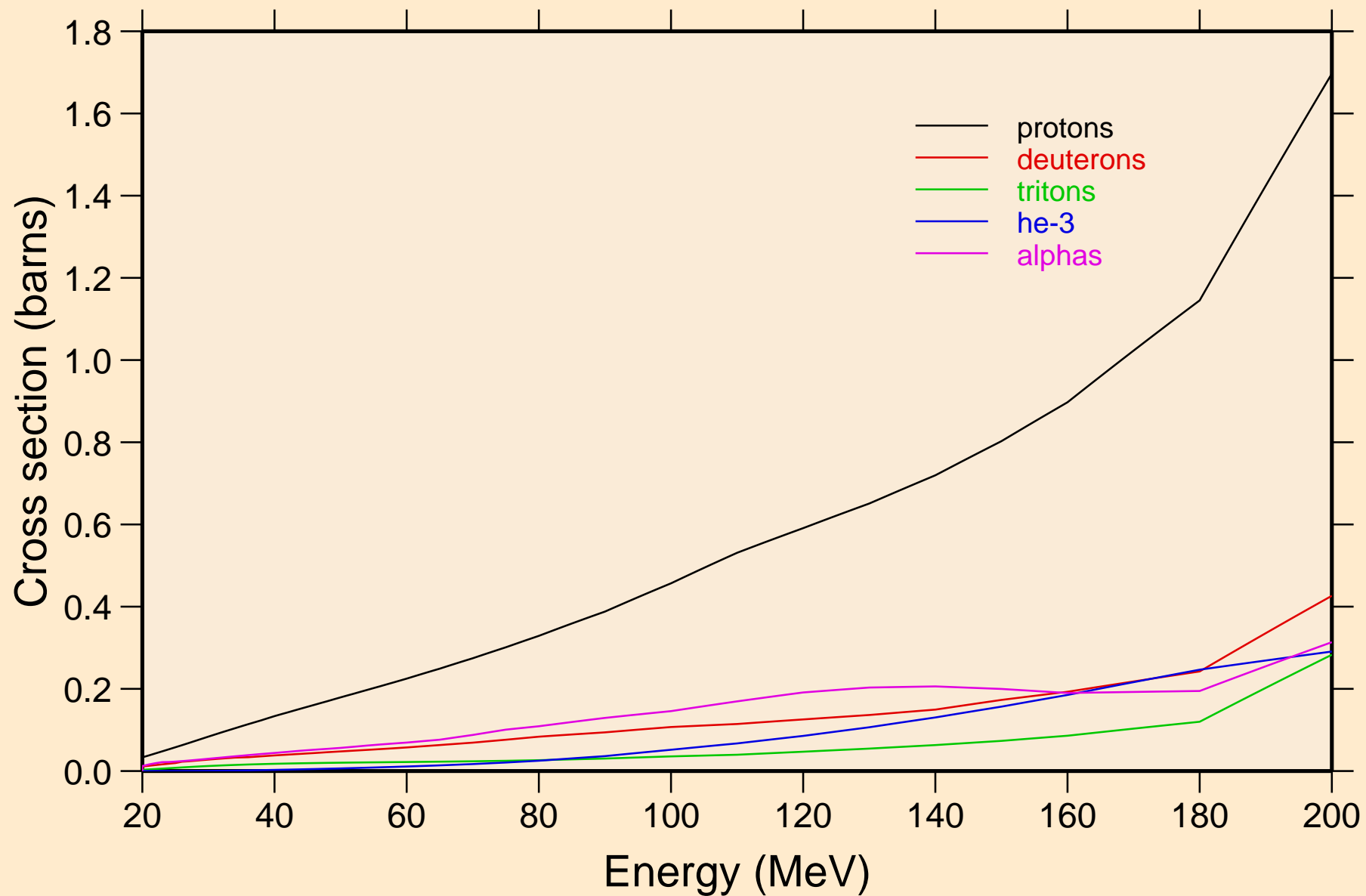

51-SB-123 FOR FENDL-3.2 FROM FENDL-3.2 BY NJOY2016.60+ C
protons from (n,x)

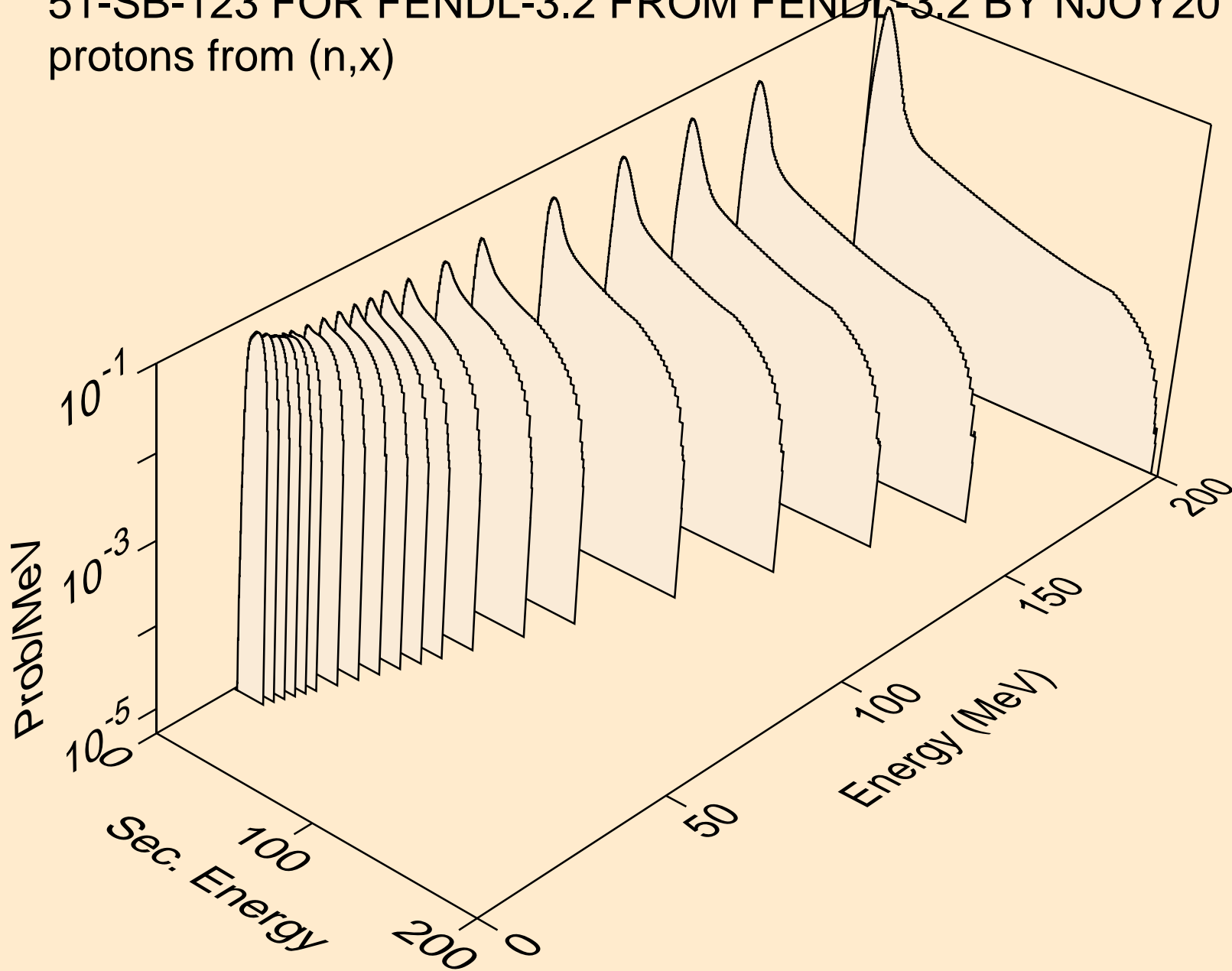

51-SB-123 FOR FENDL-3.2 FROM FENDL-3.2 BY NJOY2016.60+ C
deuterons from (n,x)

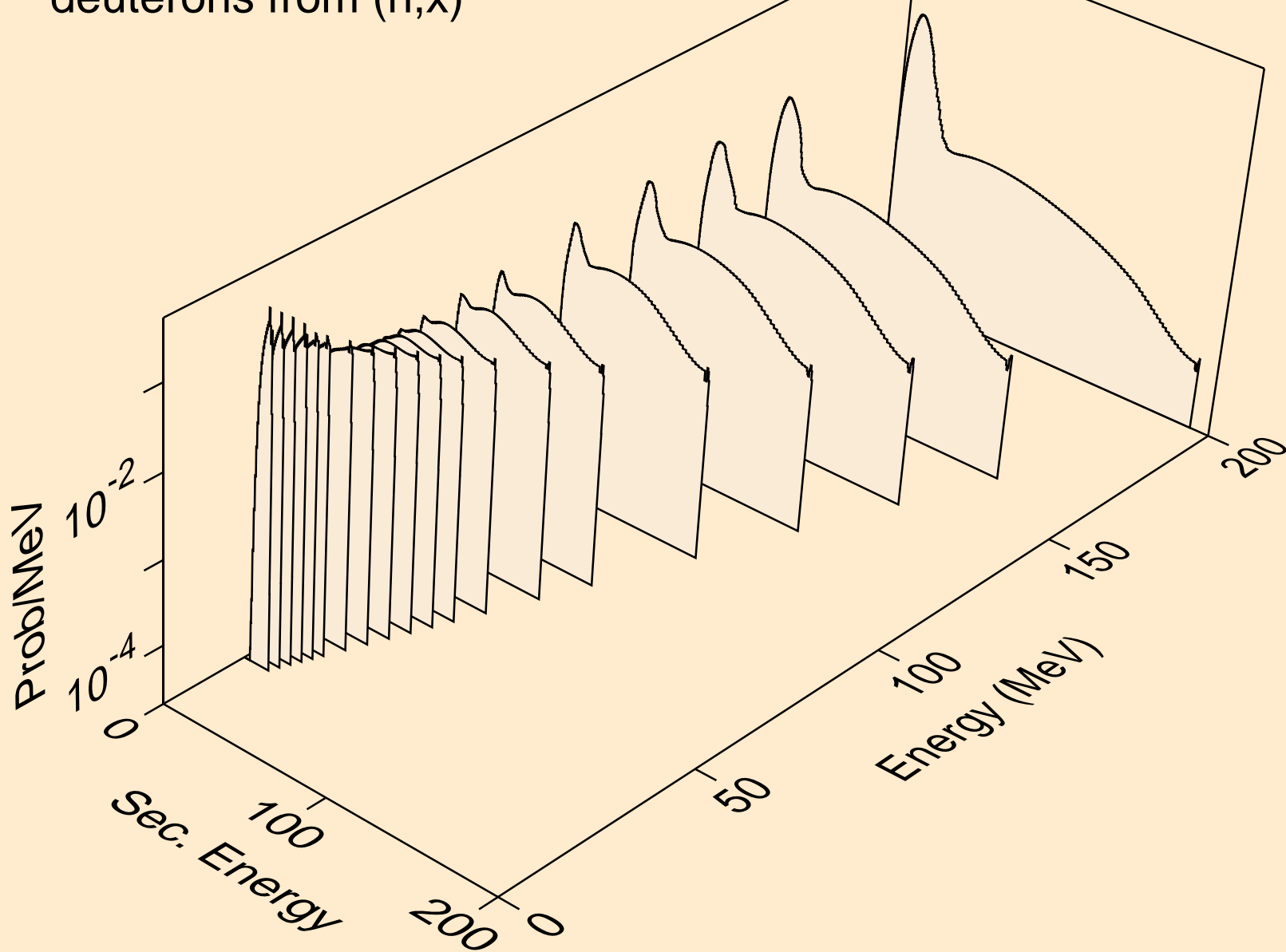

51-SB-123 FOR FENDL-3.2 FROM FENDL-3.2 BY NJOY2016.60+ C
tritons from (n,x)

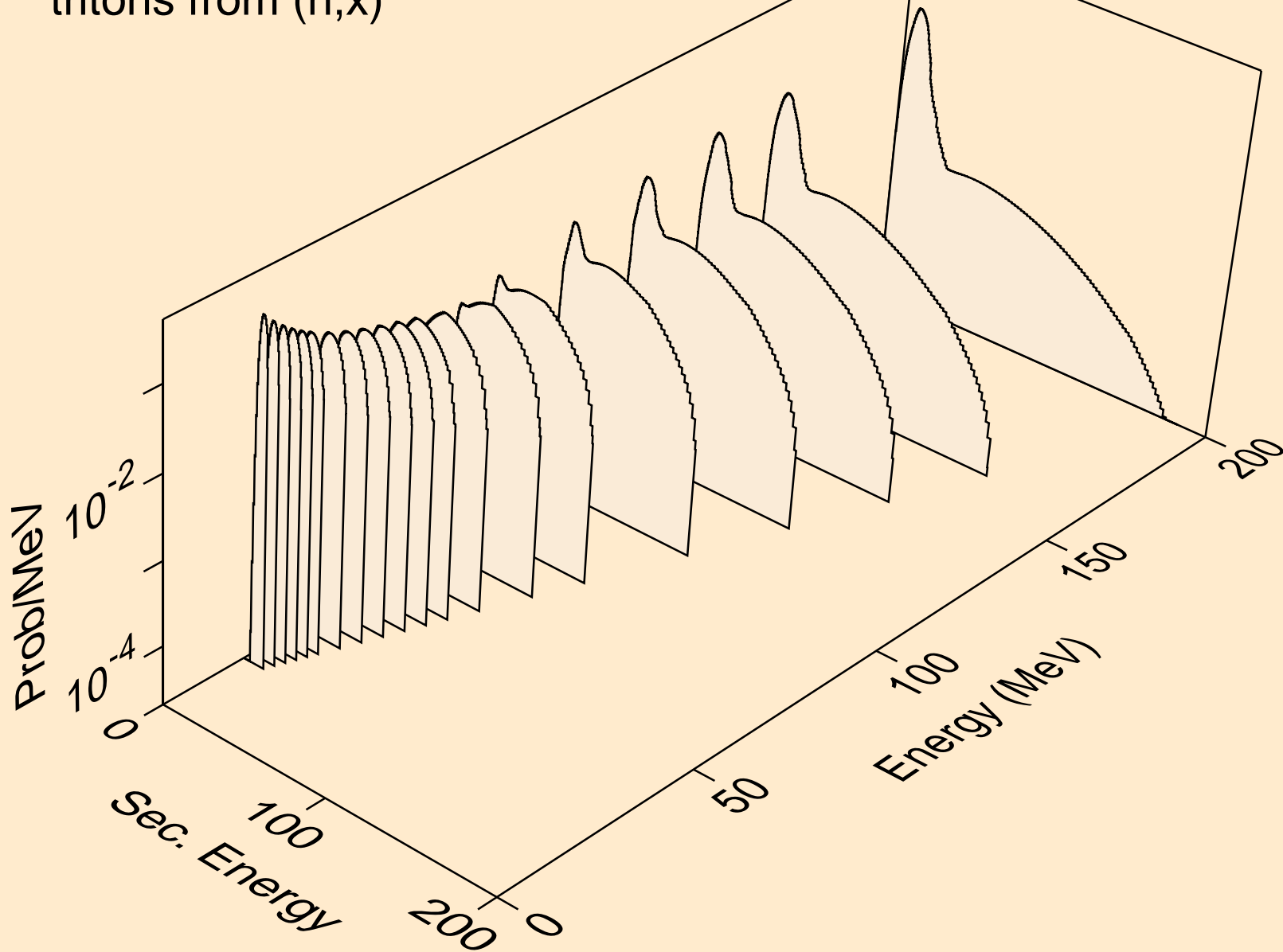

51-SB-123 FOR FENDL-3.2 FROM FENDL-3.2 BY NJOY2016.60+ C
he3s from (n,x)

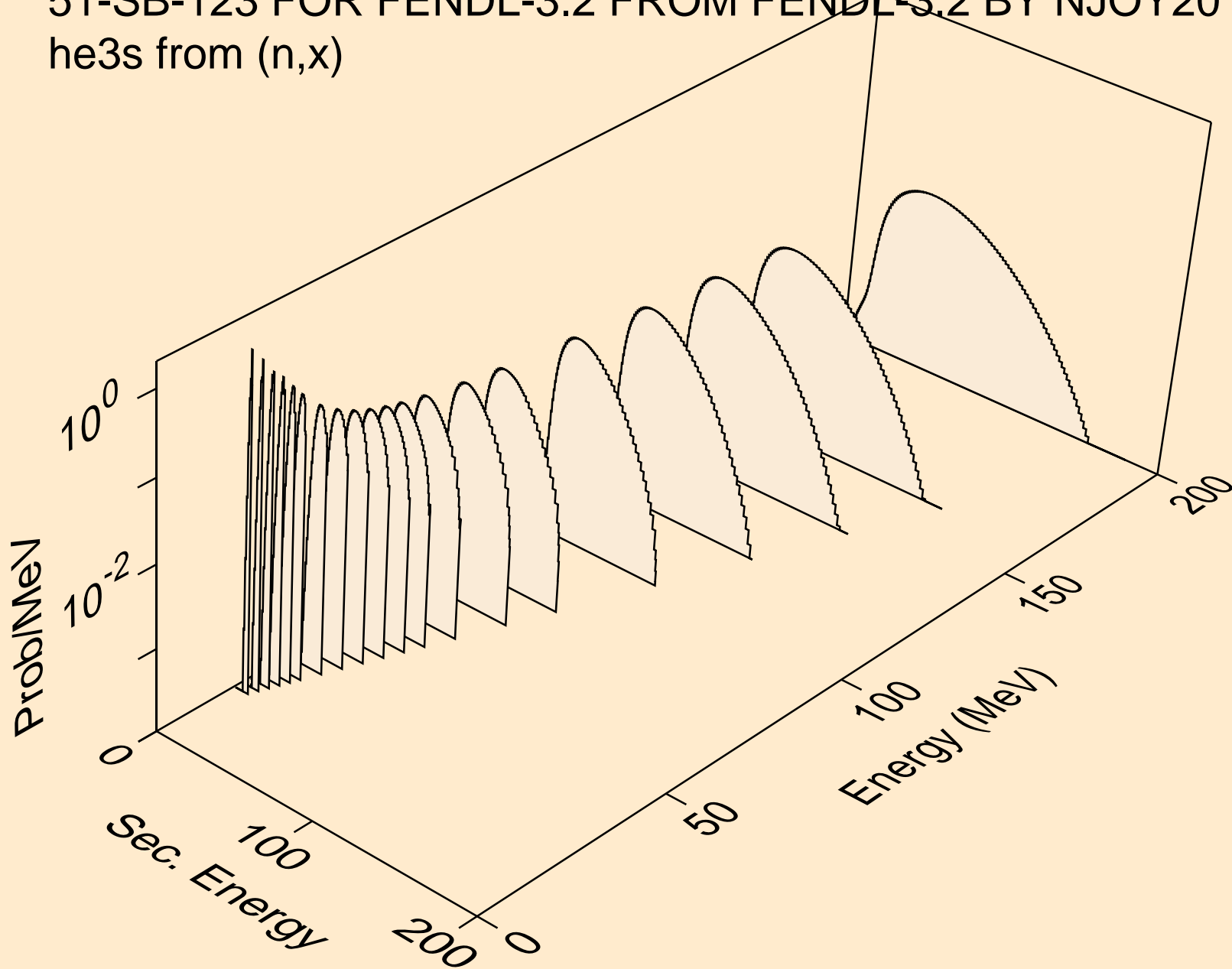

51-SB-123 FOR FENDL-3.2 FROM FENDL-3.2 BY NJOY2016.60+ C
alphas from (n,x)

