

57-LA-138 FOR FENDL-3.2 PROCESSED BY NJOY2016.60+ ON
Principal cross sections

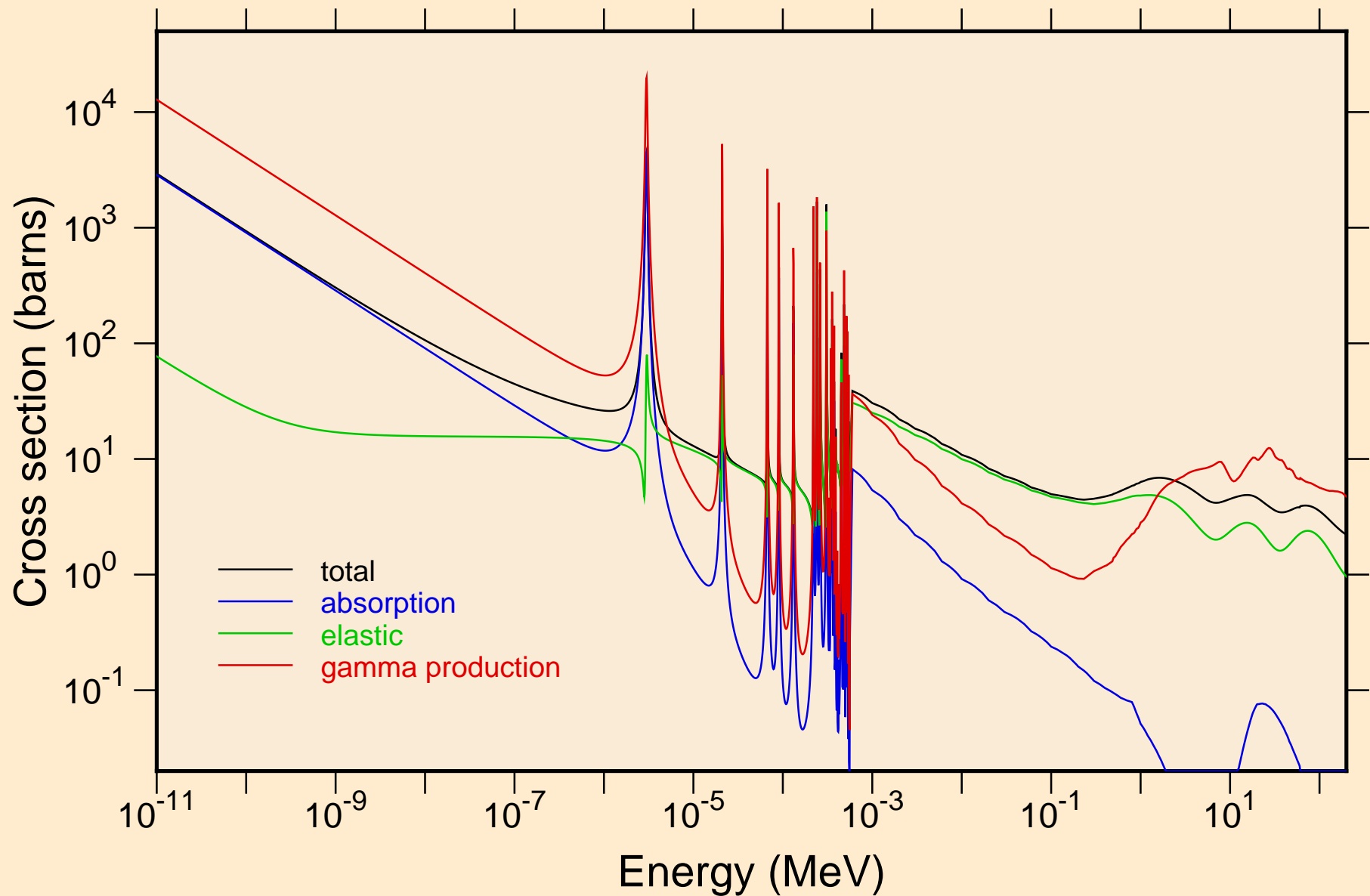

57-LA-138 FOR FENDL-3.2 PROCESSED BY NJOY2016.60+ ON
resonance total cross section

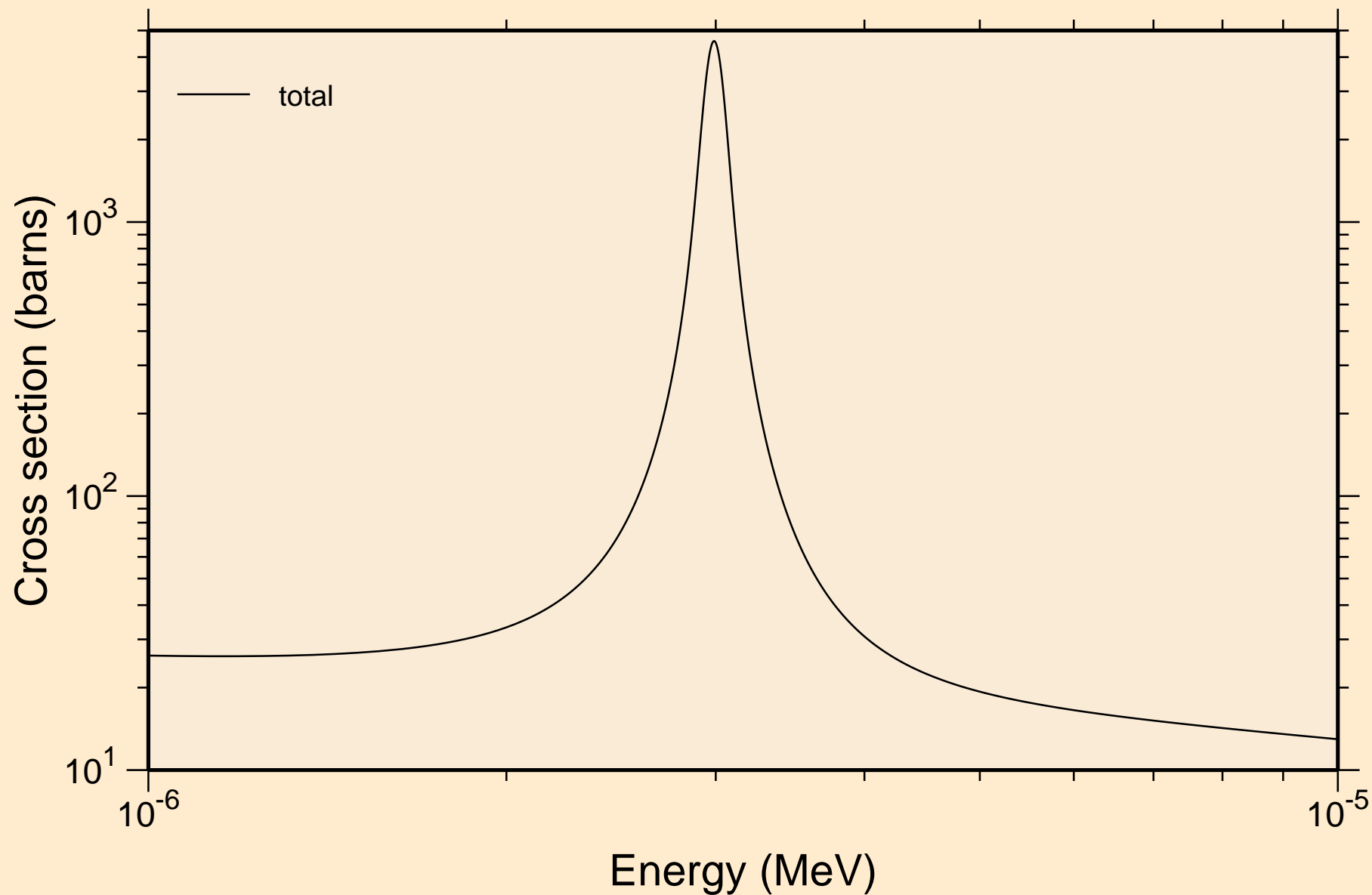

57-LA-138 FOR FENDL-3.2 PROCESSED BY NJOY2016.60+ ON
resonance total cross section

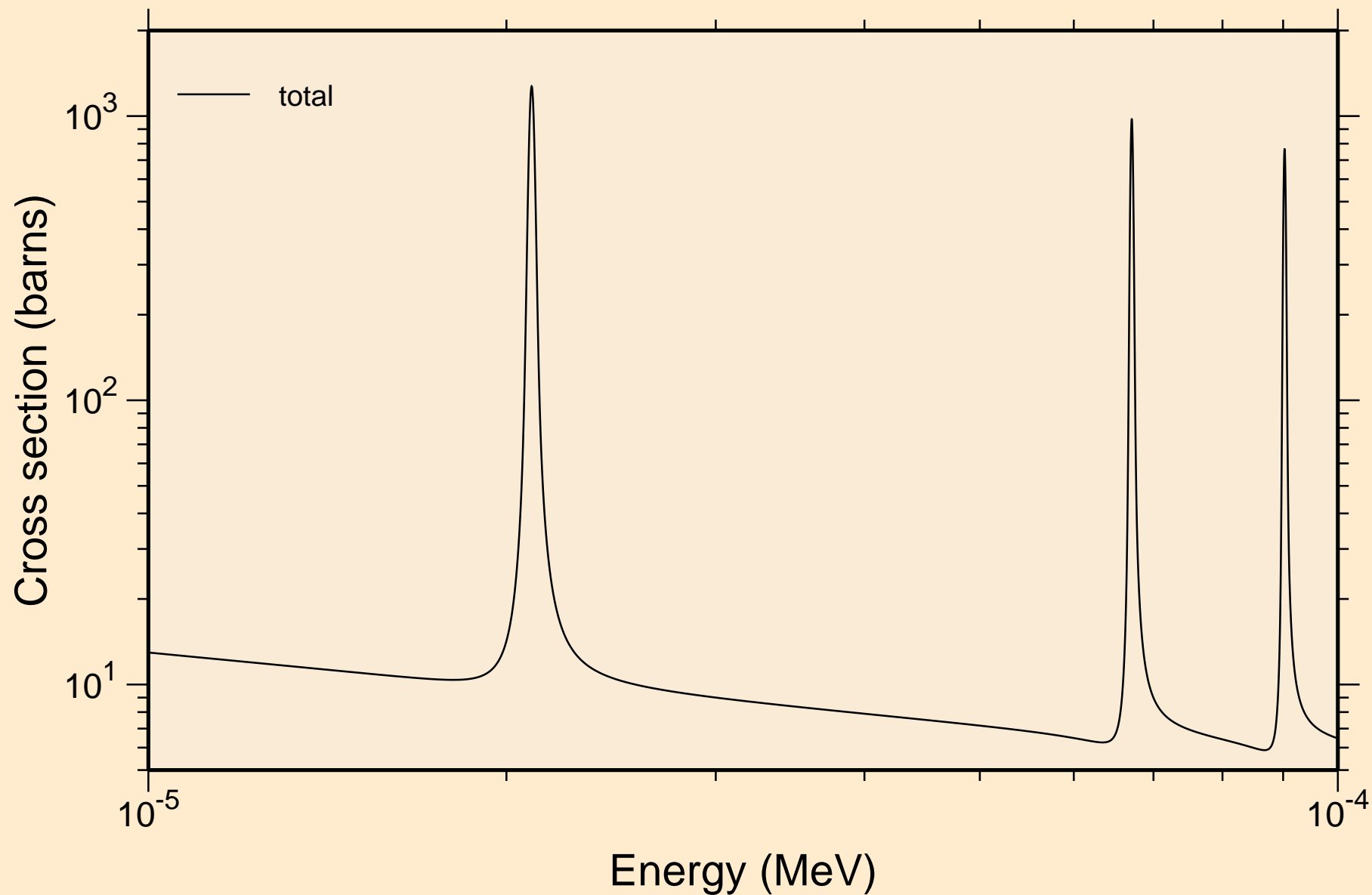

57-LA-138 FOR FENDL-3.2 PROCESSED BY NJOY2016.60+ ON
resonance total cross section

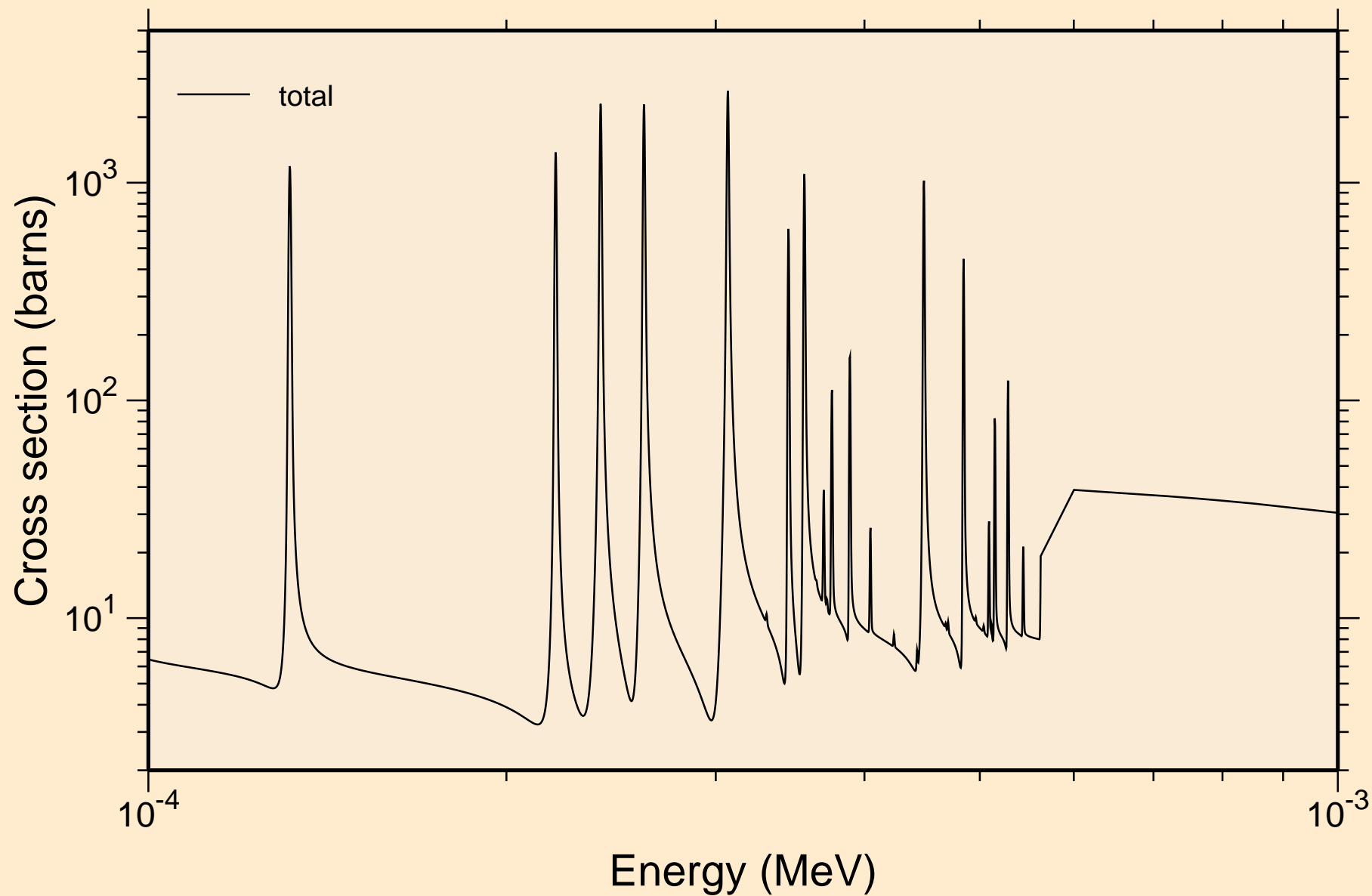

57-LA-138 FOR FENDL-3.2 PROCESSED BY NJOY2016.60+ ON
resonance total cross section

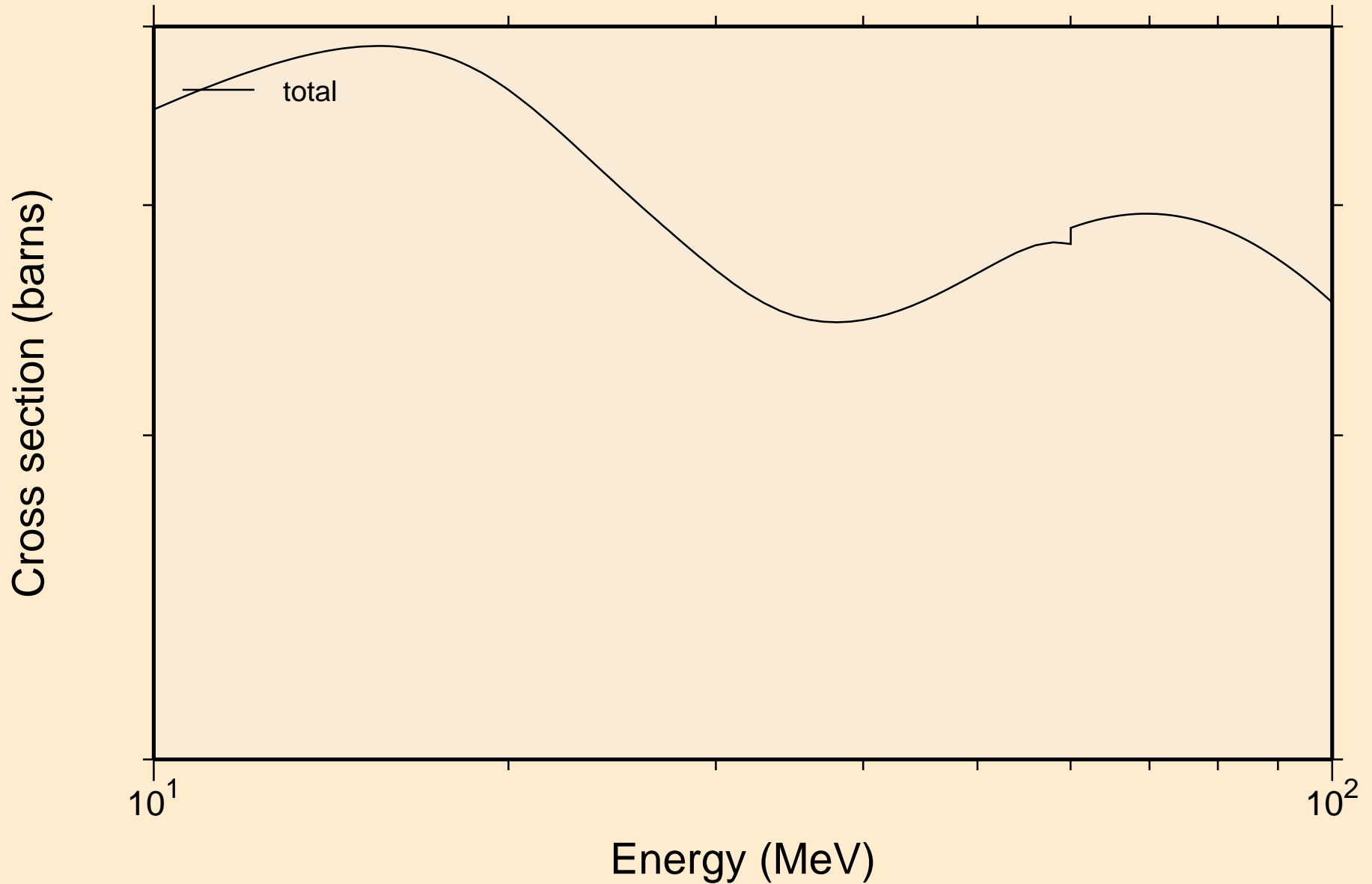

57-LA-138 FOR FENDL-3.2 PROCESSED BY NJOY2016.60+ ON
resonance absorption cross sections

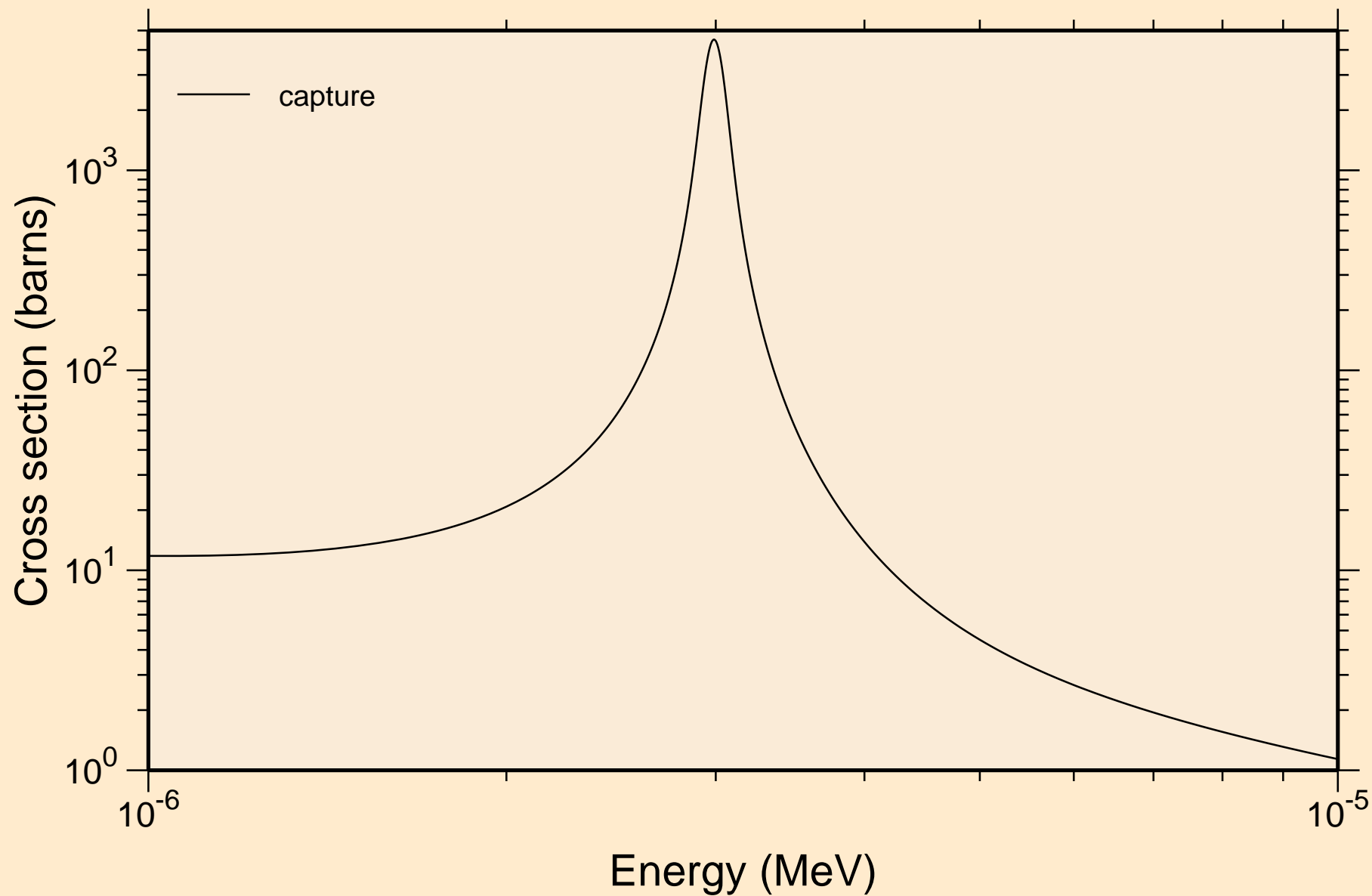

57-LA-138 FOR FENDL-3.2 PROCESSED BY NJOY2016.60+ ON
resonance absorption cross sections

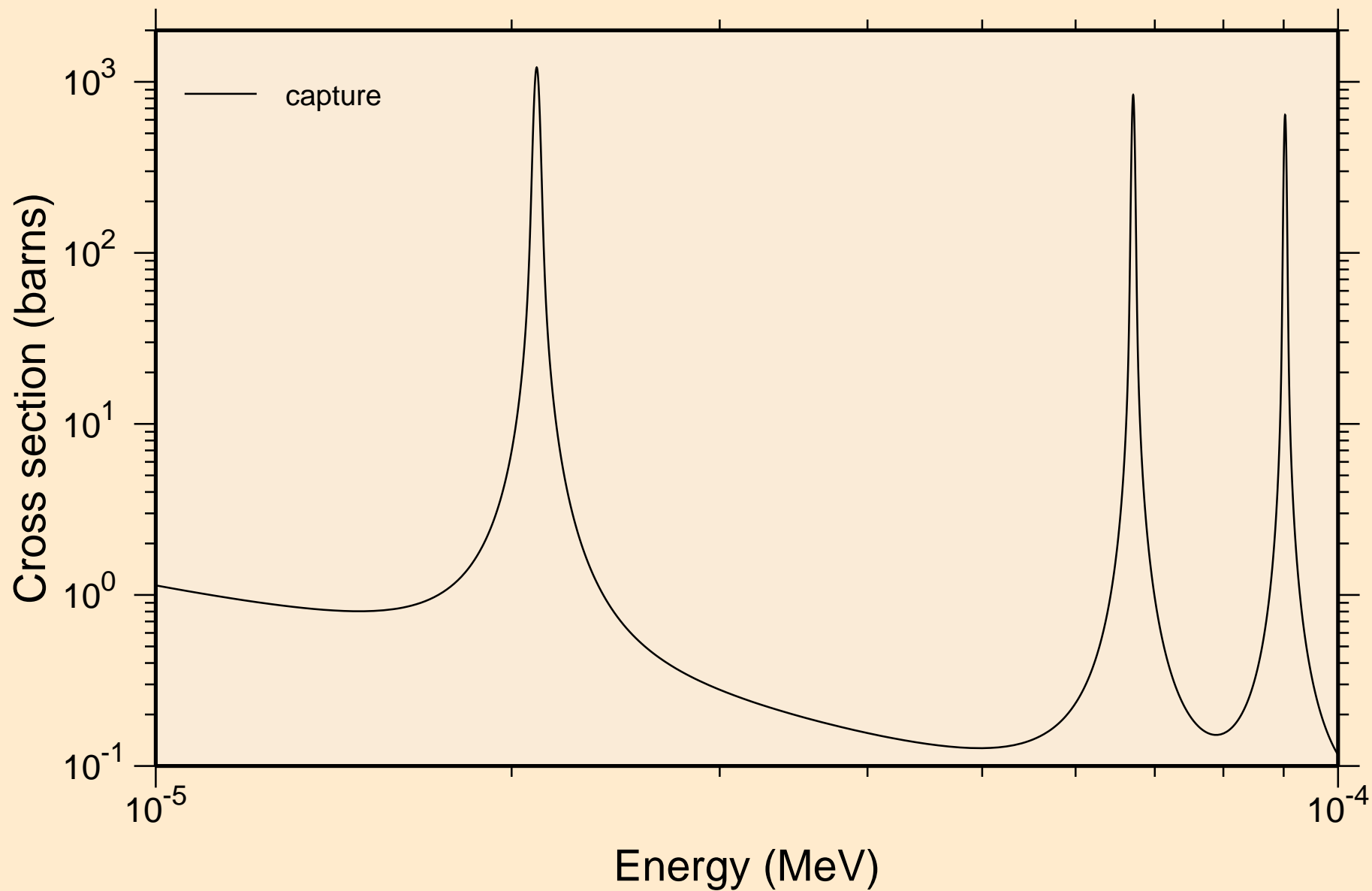

57-LA-138 FOR FENDL-3.2 PROCESSED BY NJOY2016.60+ ON
resonance absorption cross sections

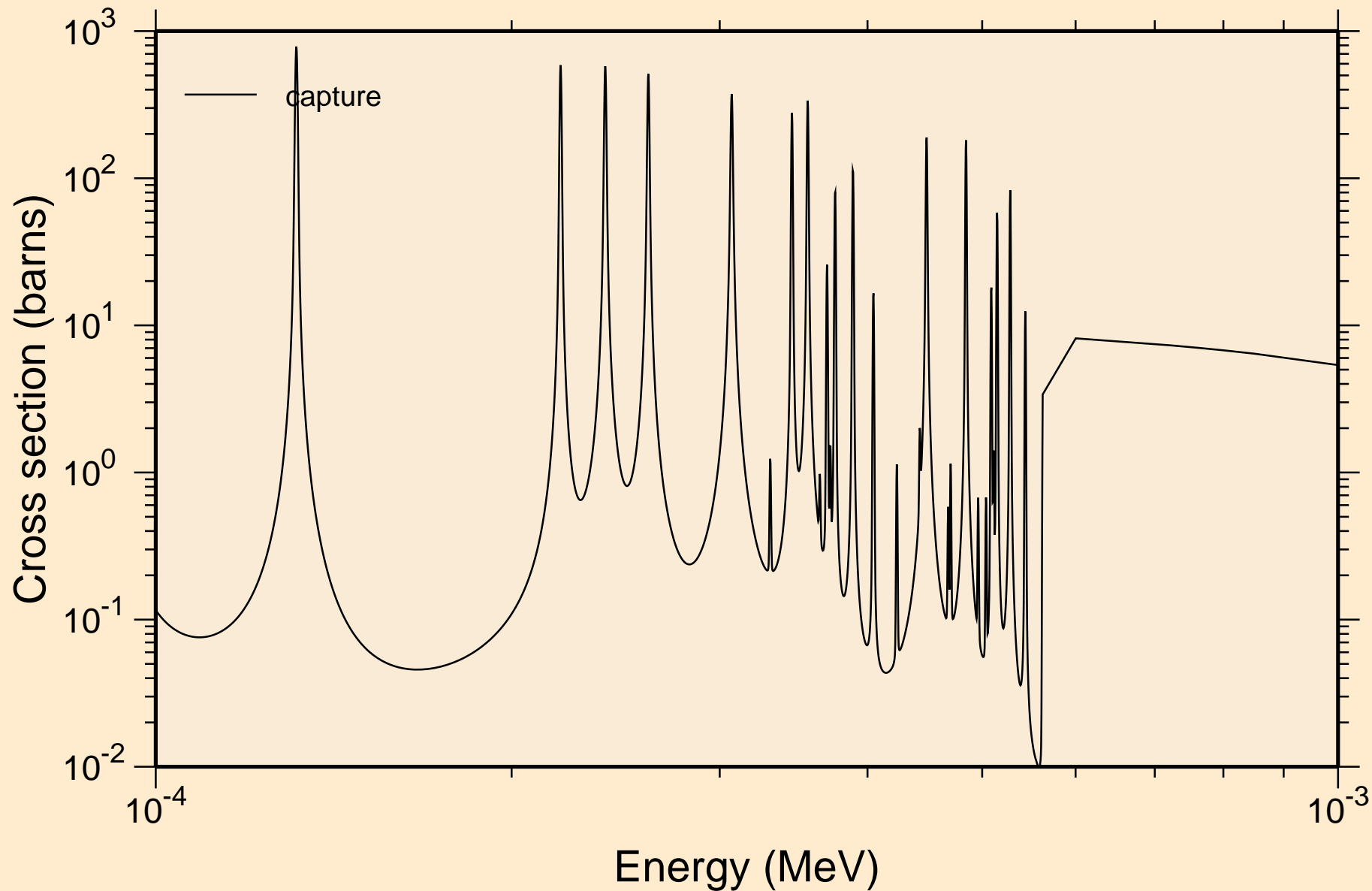

57-LA-138 FOR FENDL-3.2 PROCESSED BY NJOY2016.60+ ON
resonance absorption cross sections

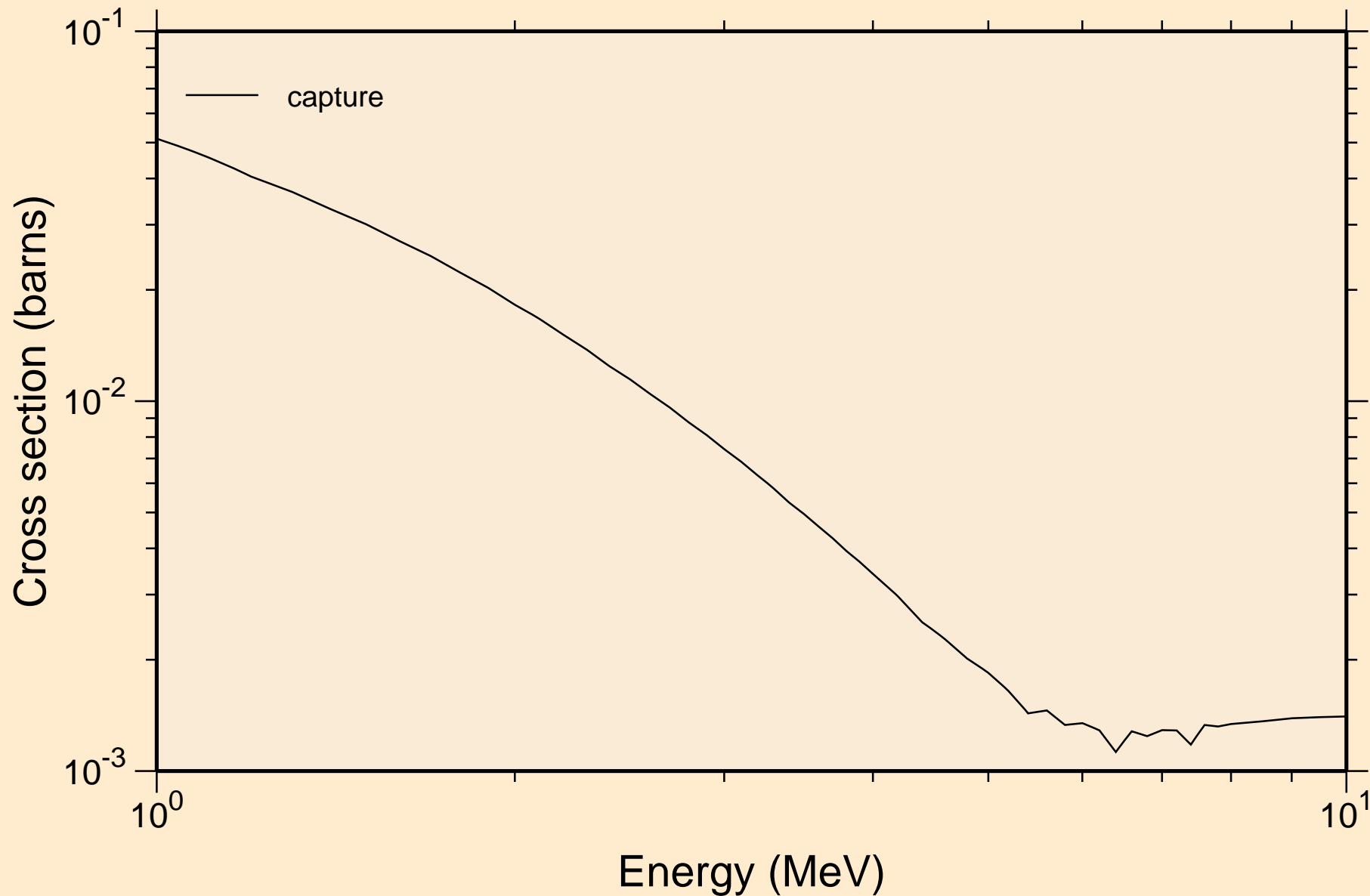

57-LA-138 FOR FENDL-3.2 PROCESSED BY NJOY2016.60+ ON
UR total cross section

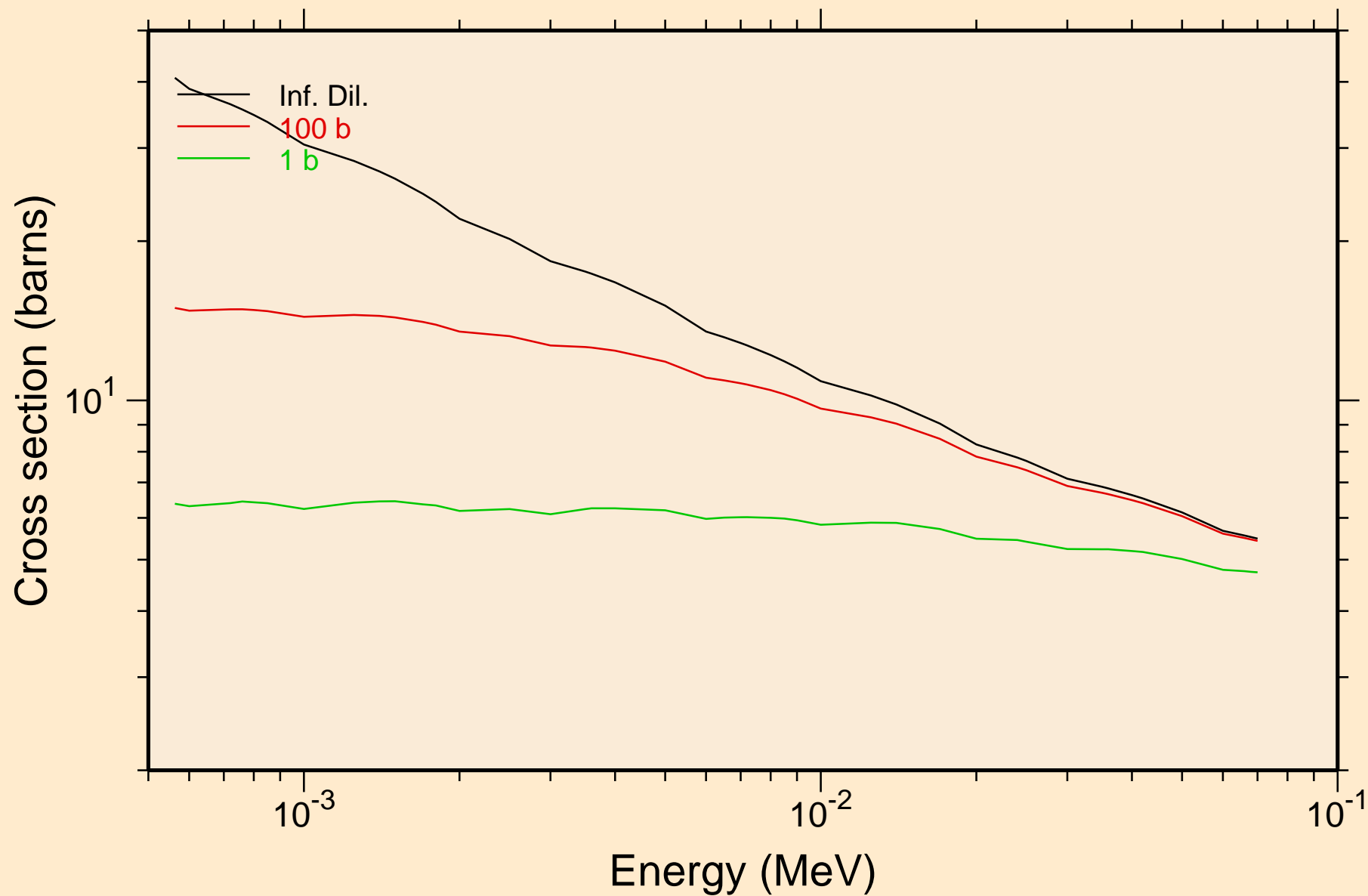

57-LA-138 FOR FENDL-3.2 PROCESSED BY NJOY2016.60+ ON
UR elastic cross section

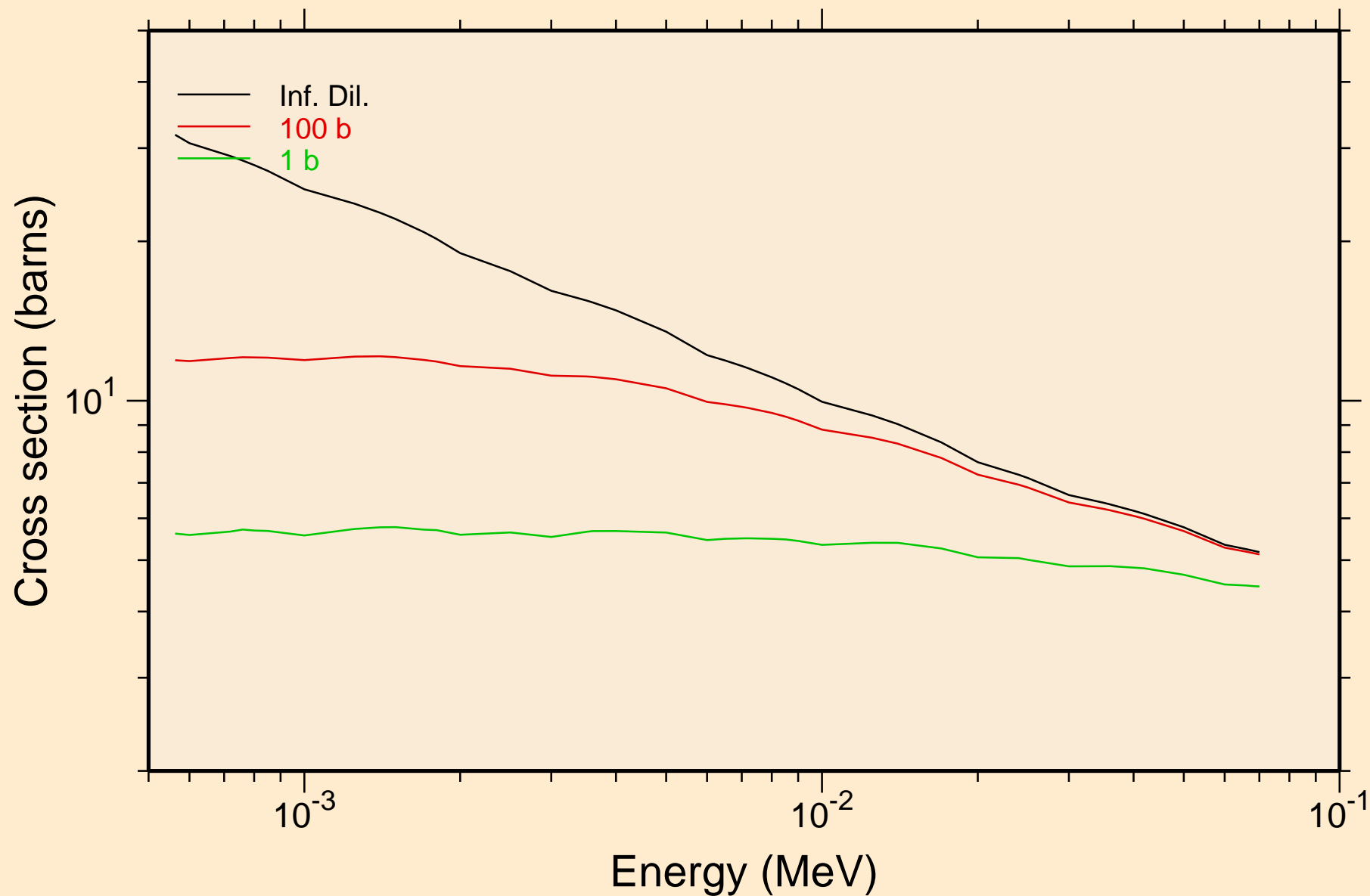

57-LA-138 FOR FENDL-3.2 PROCESSED BY NJOY2016.60+ ON
UR capture cross section

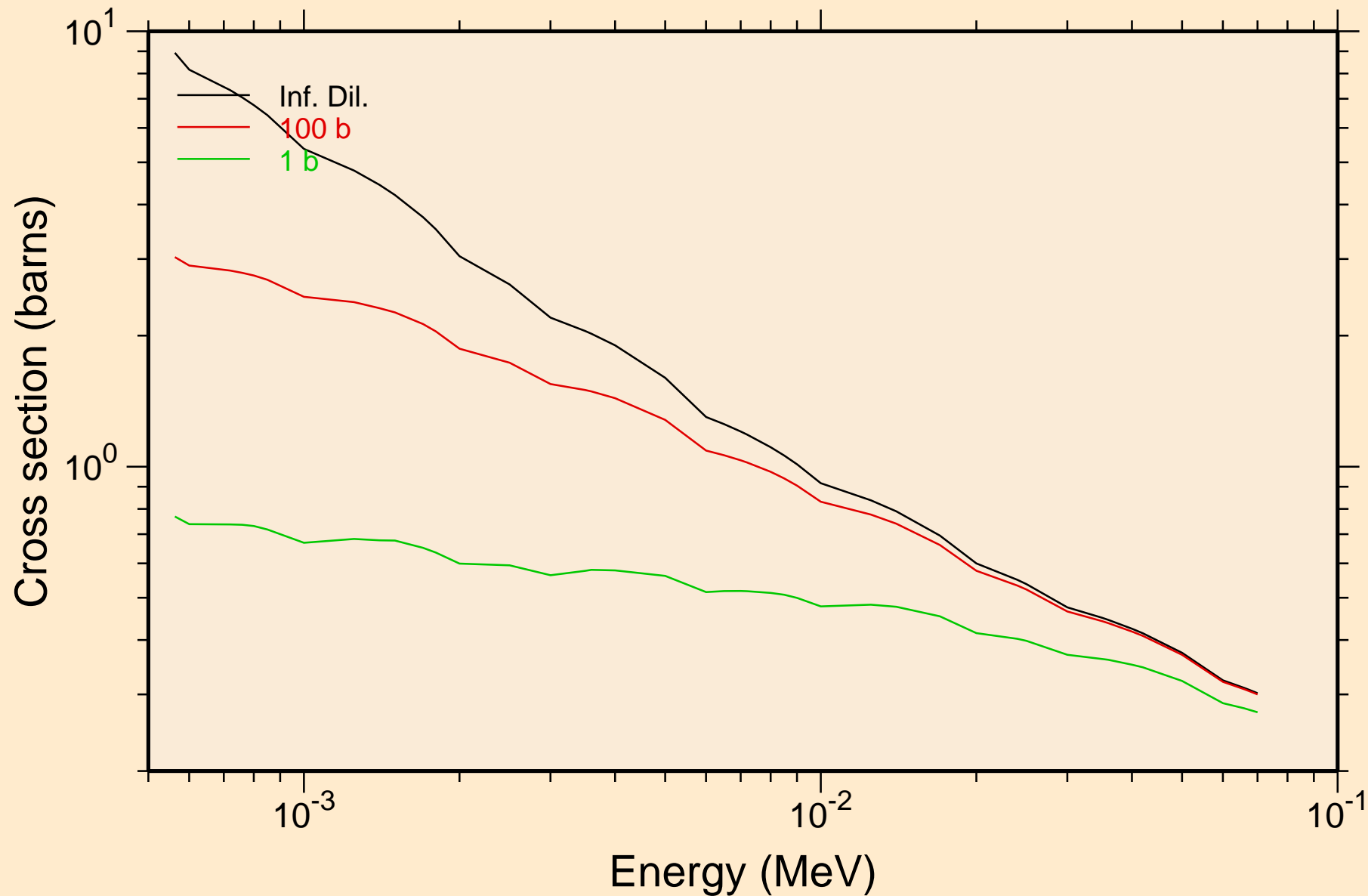

57-LA-138 FOR FENDL-3.2 PROCESSED BY NJOY2016.60+ ON Heating

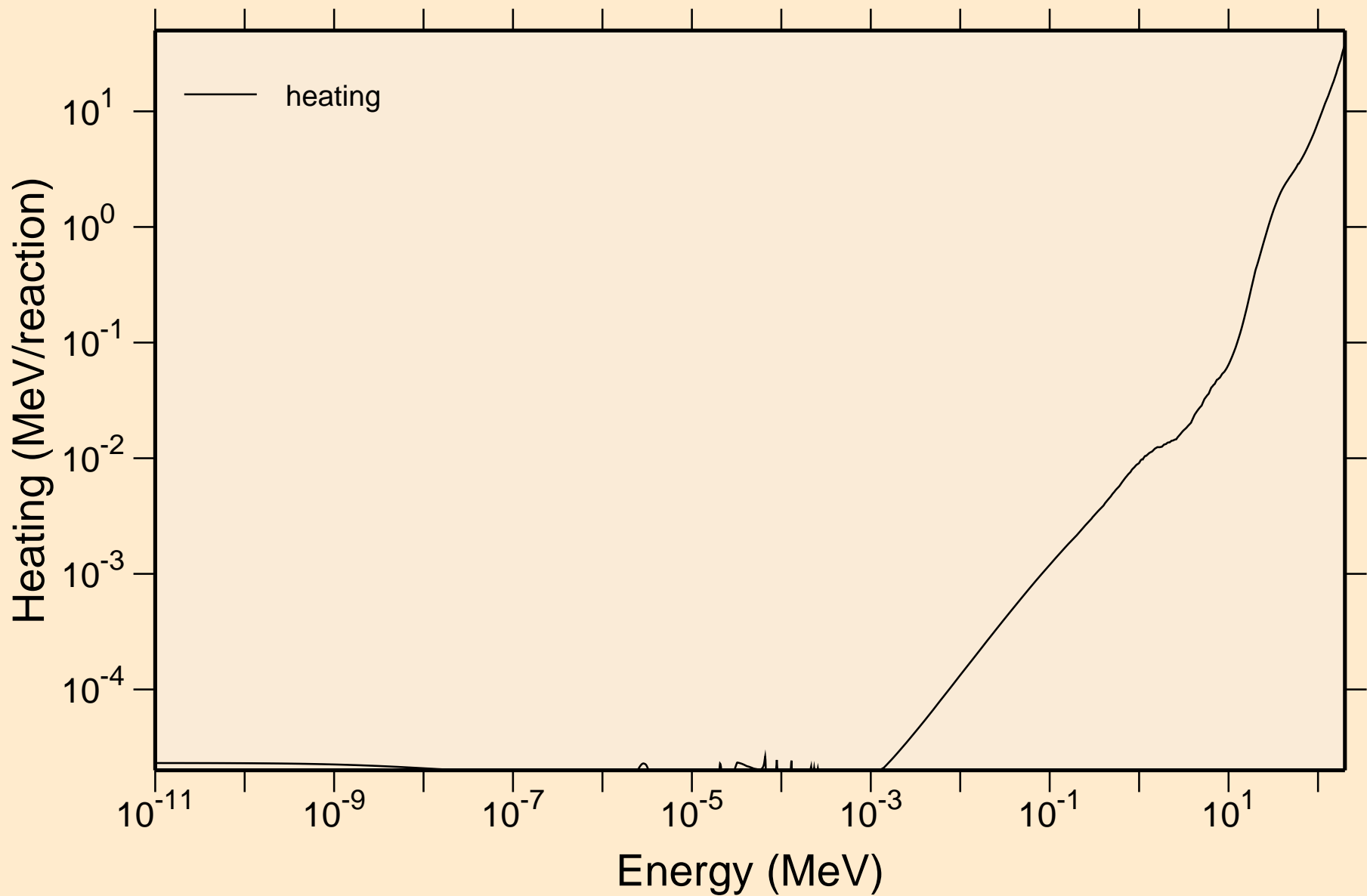

57-LA-138 FOR FENDL-3.2 PROCESSED BY NJOY2016.60+ ON
Damage

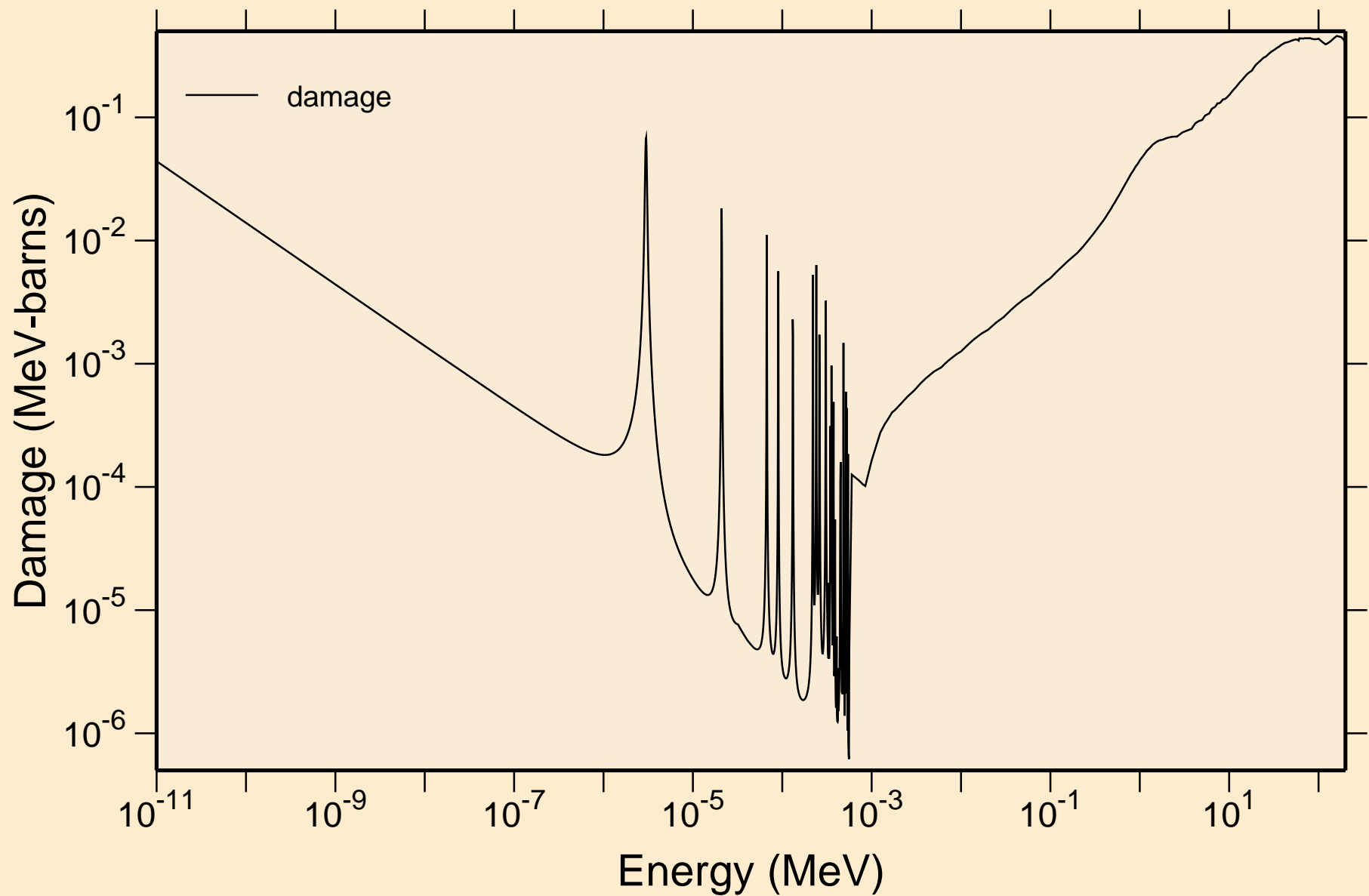

57-LA-138 FOR FENDL-3.2 PROCESSED BY NJOY2016.60+ ON
Non-threshold reactions

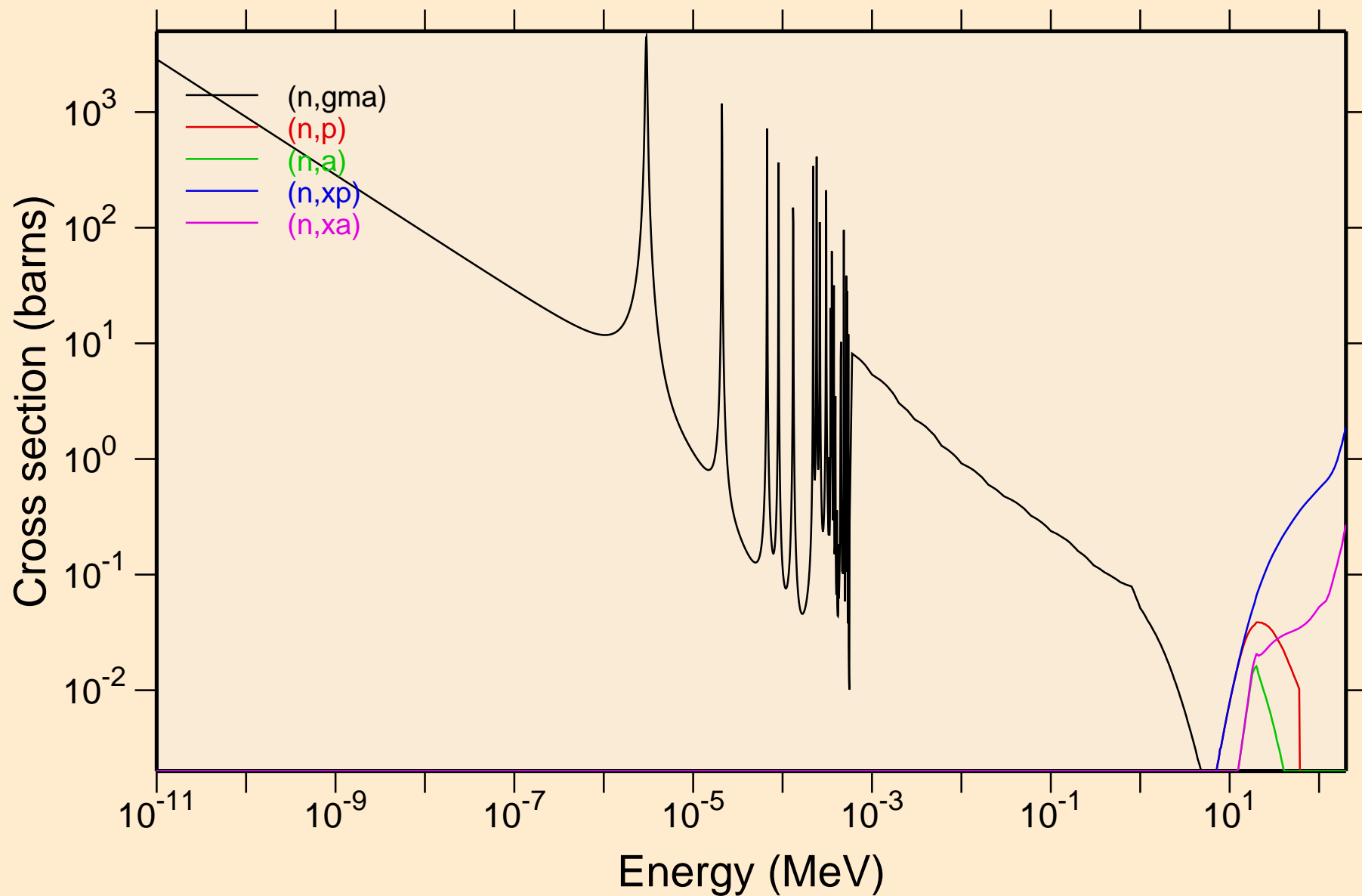

57-LA-138 FOR FENDL-3.2 PROCESSED BY NJOY2016.60+ ON
Principal cross sections

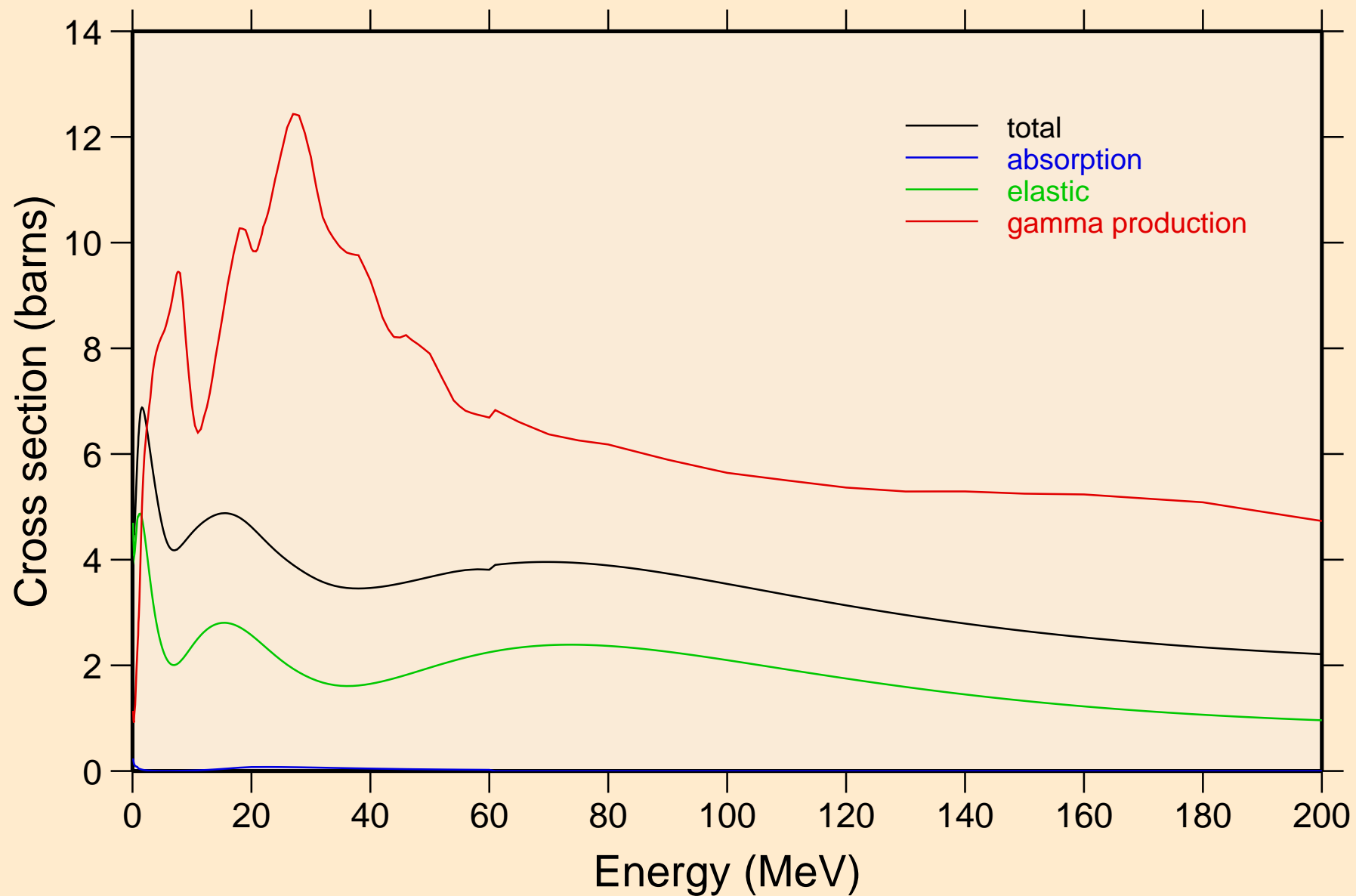

57-LA-138 FOR FENDL-3.2 PROCESSED BY NJOY2016.60+ ON Heating

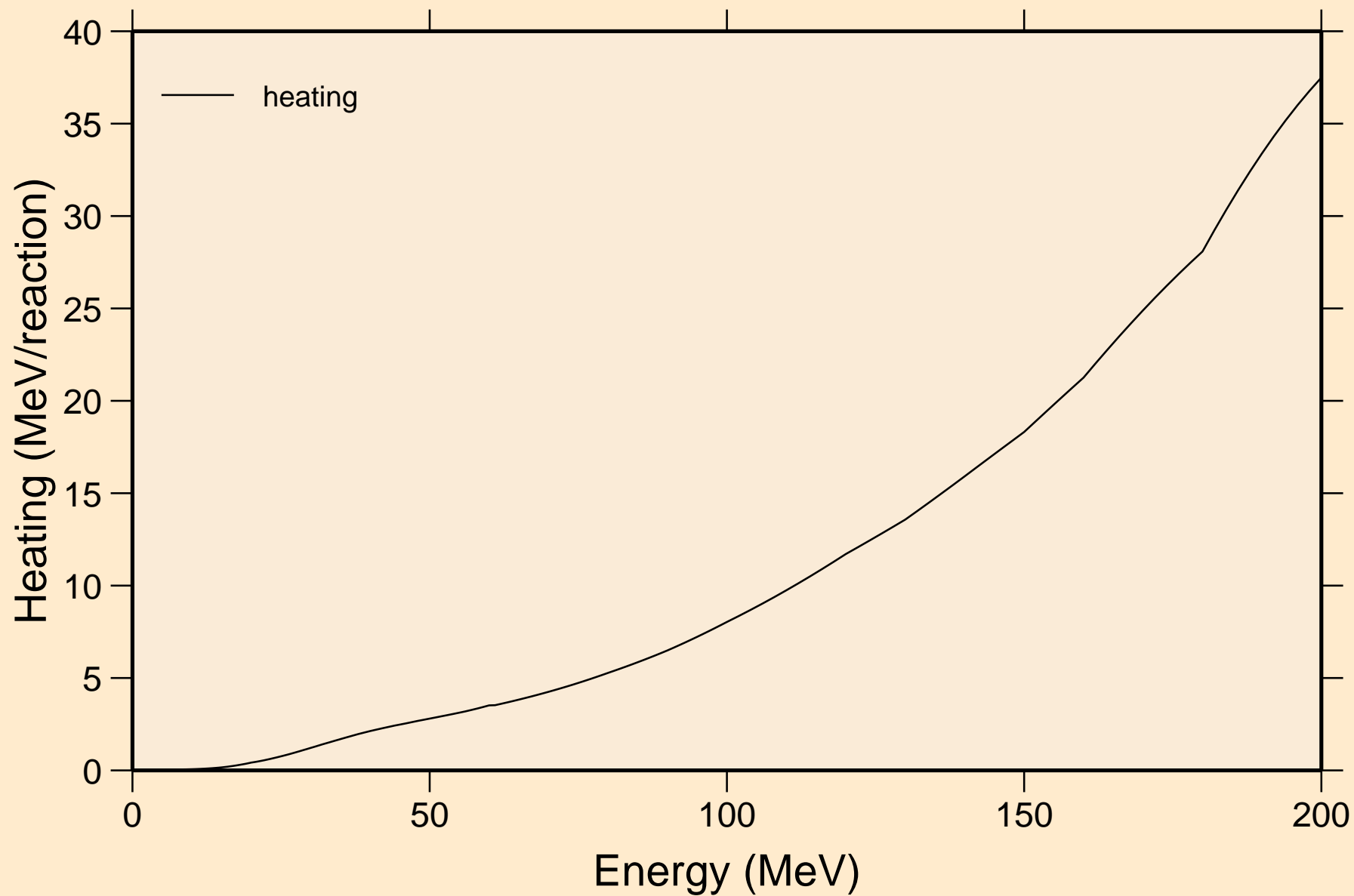

57-LA-138 FOR FENDL-3.2 PROCESSED BY NJOY2016.60+ ON
Damage

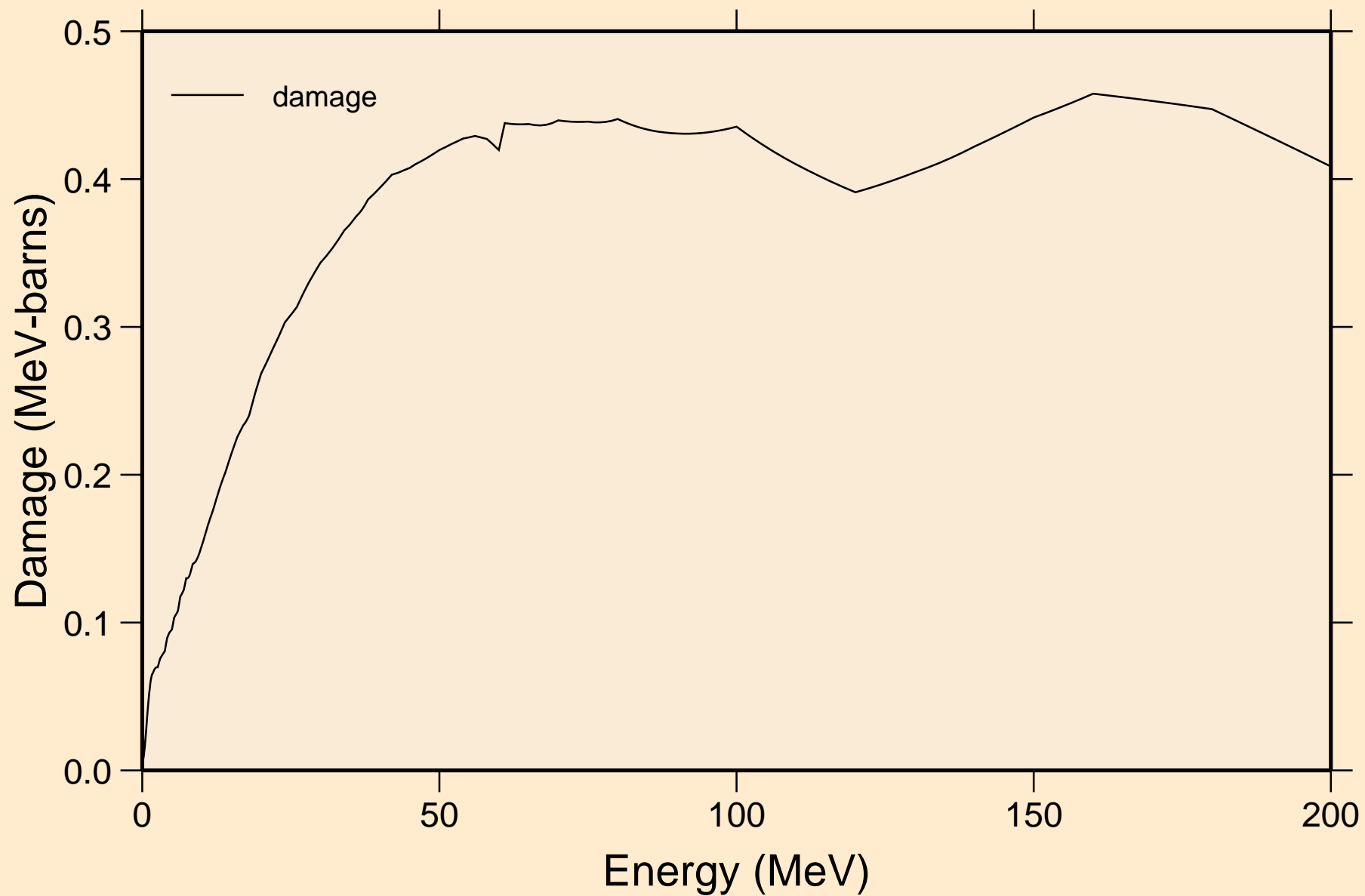

57-LA-138 FOR FENDL-3.2 PROCESSED BY NJOY2016.60+ ON
Non-threshold reactions

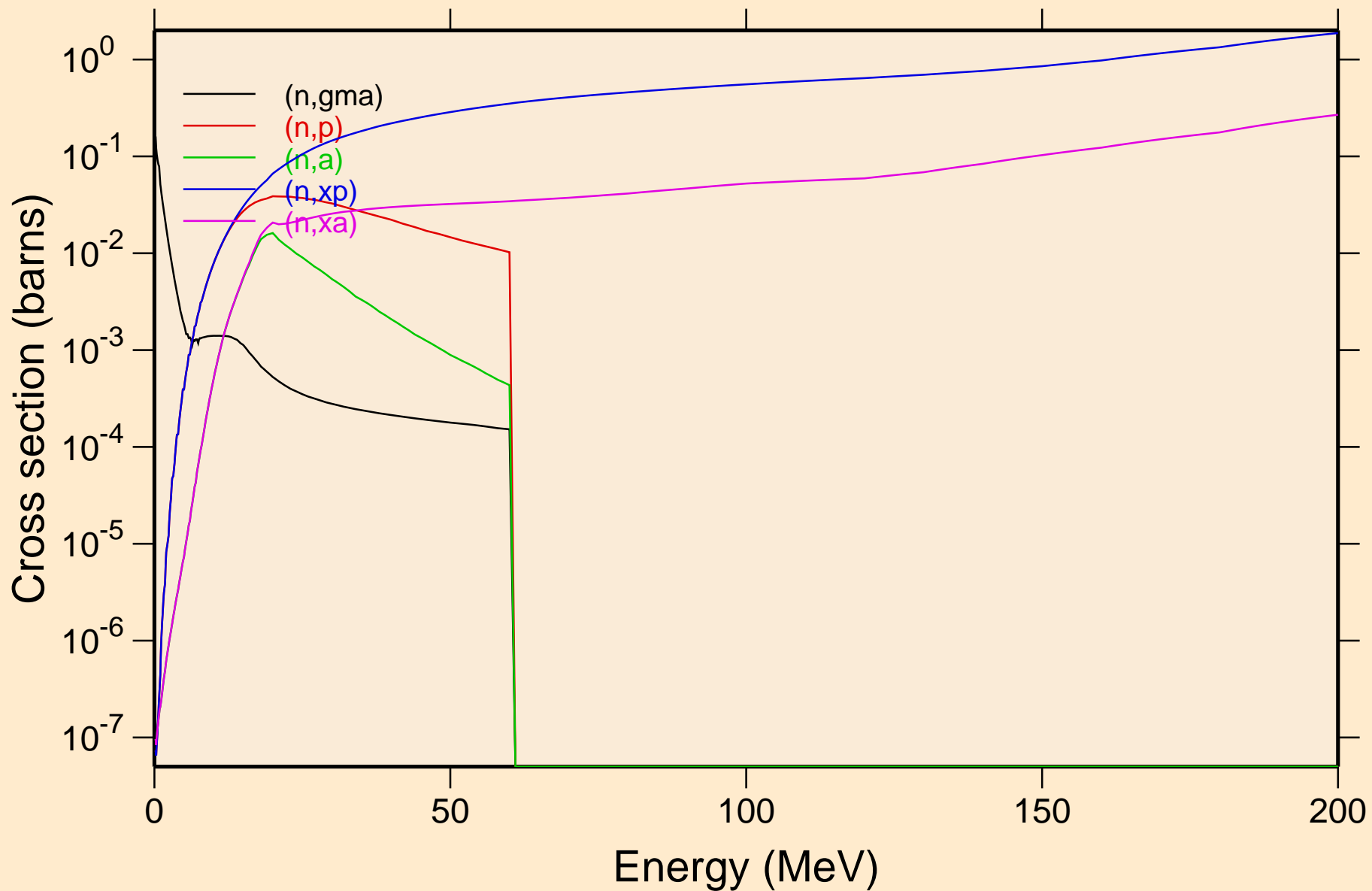

57-LA-138 FOR FENDL-3.2 PROCESSED BY NJOY2016.60+ ON
Inelastic levels

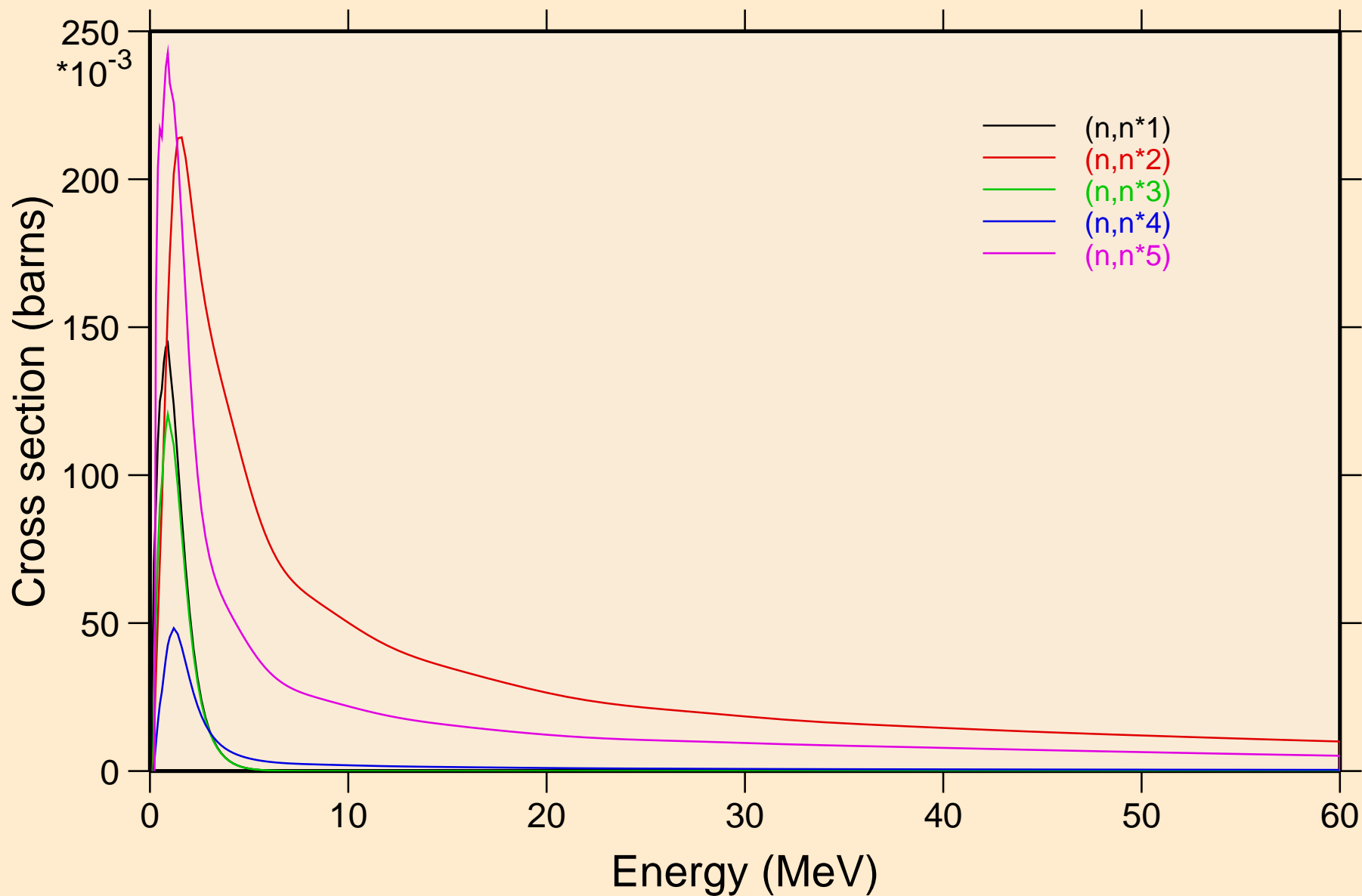

57-LA-138 FOR FENDL-3.2 PROCESSED BY NJOY2016.60+ ON
Inelastic levels

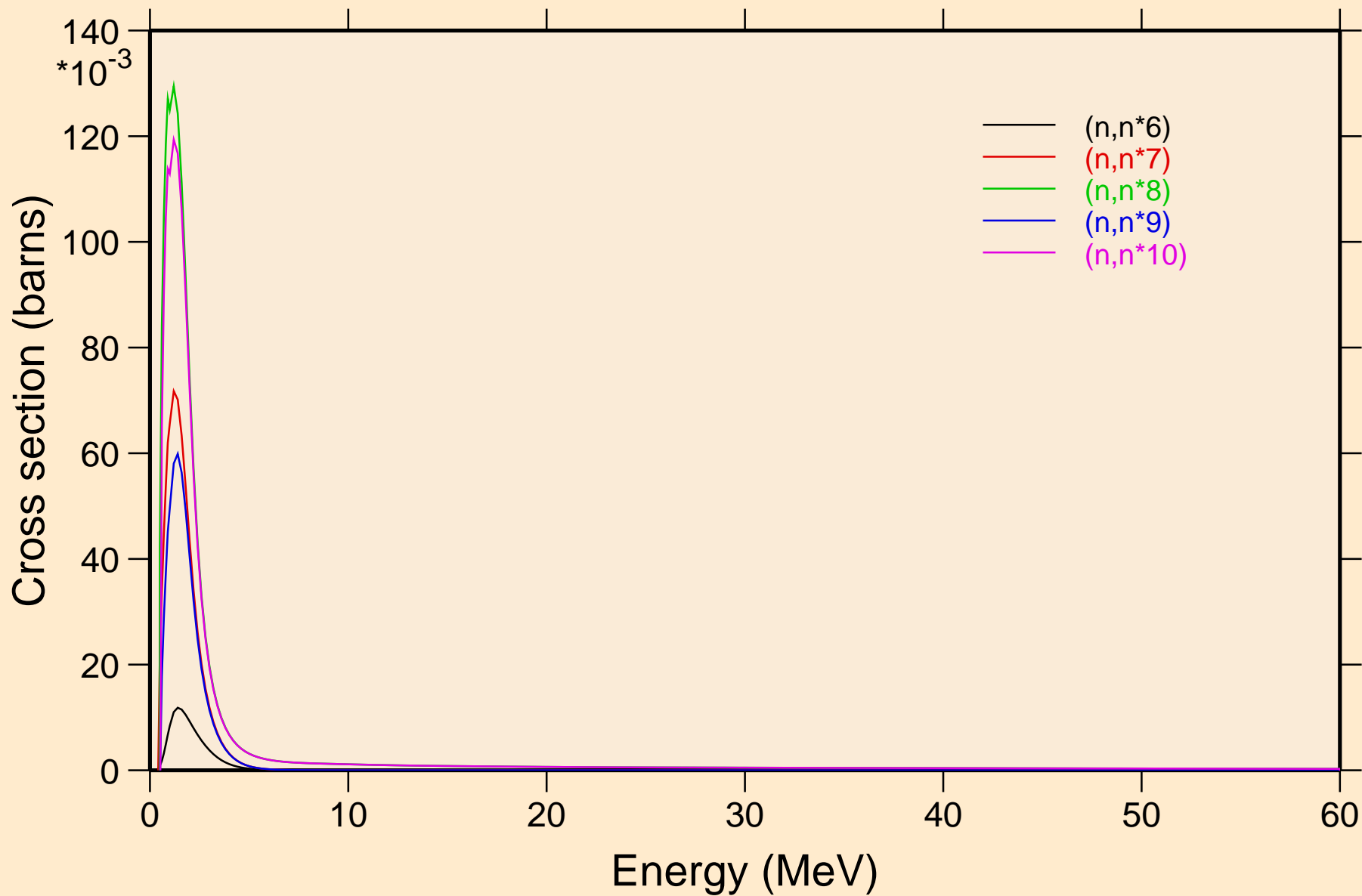

57-LA-138 FOR FENDL-3.2 PROCESSED BY NJOY2016.60+ ON
Inelastic levels

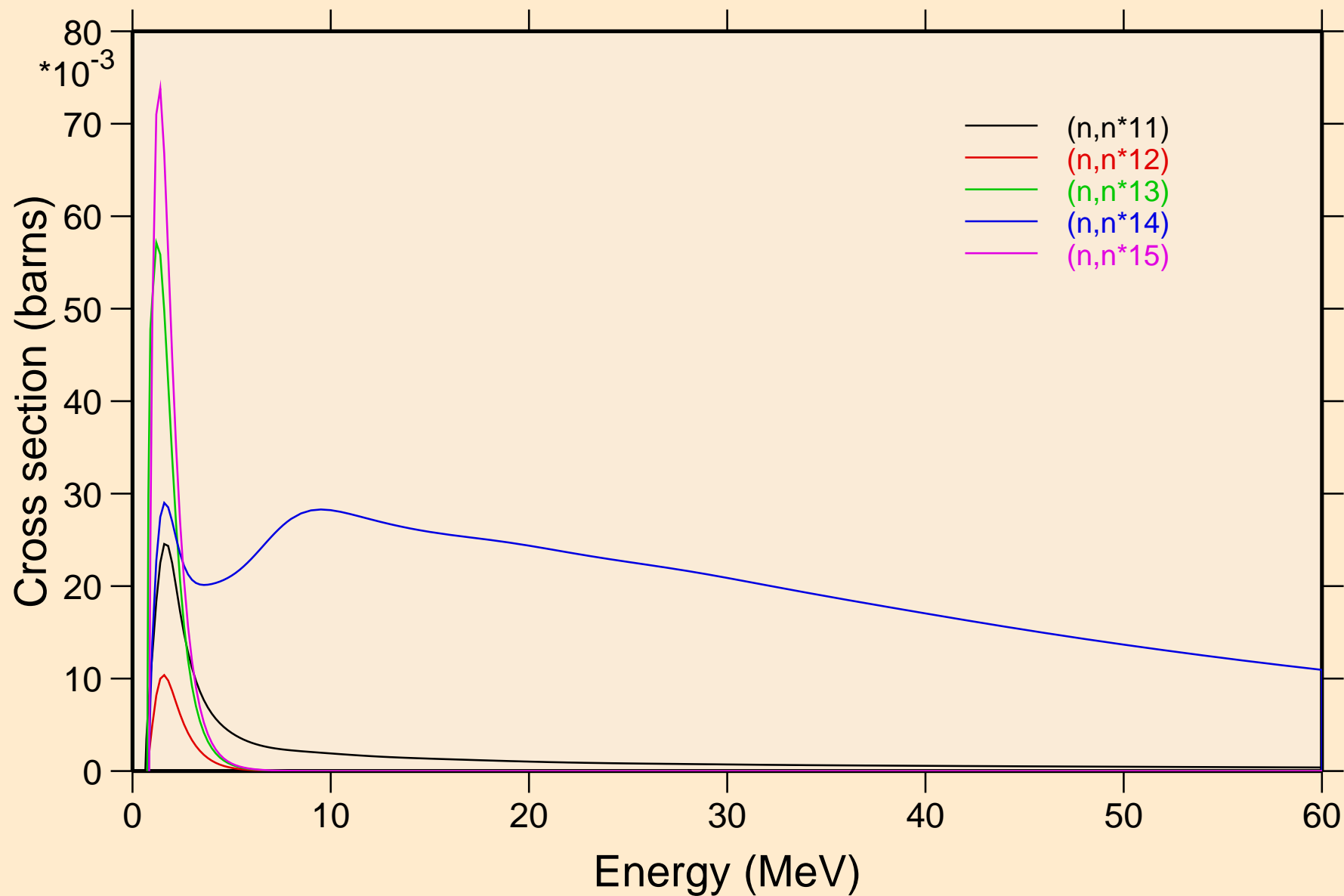

57-LA-138 FOR FENDL-3.2 PROCESSED BY NJOY2016.60+ ON
Inelastic levels

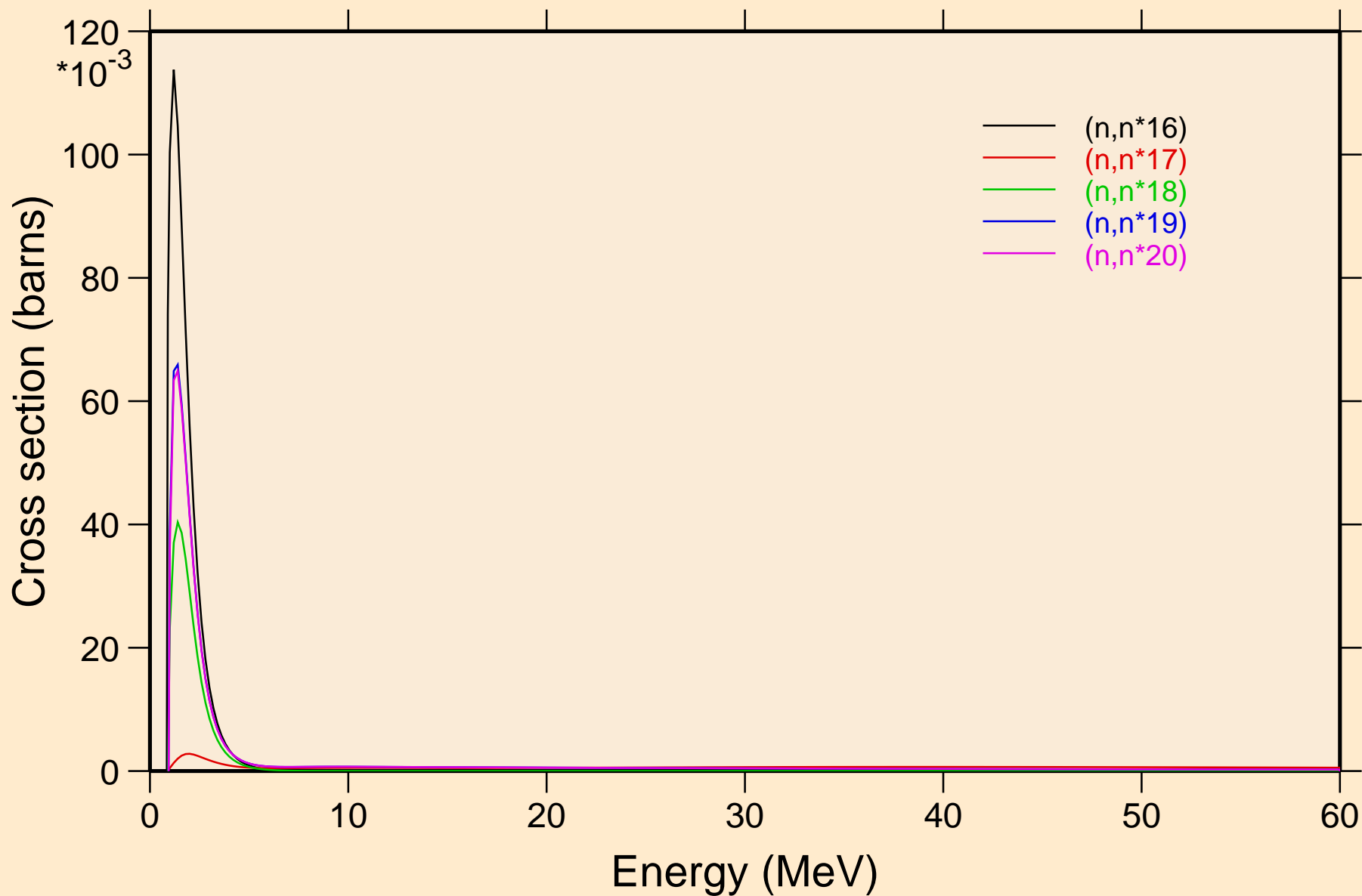

57-LA-138 FOR FENDL-3.2 PROCESSED BY NJOY2016.60+ ON
Inelastic levels

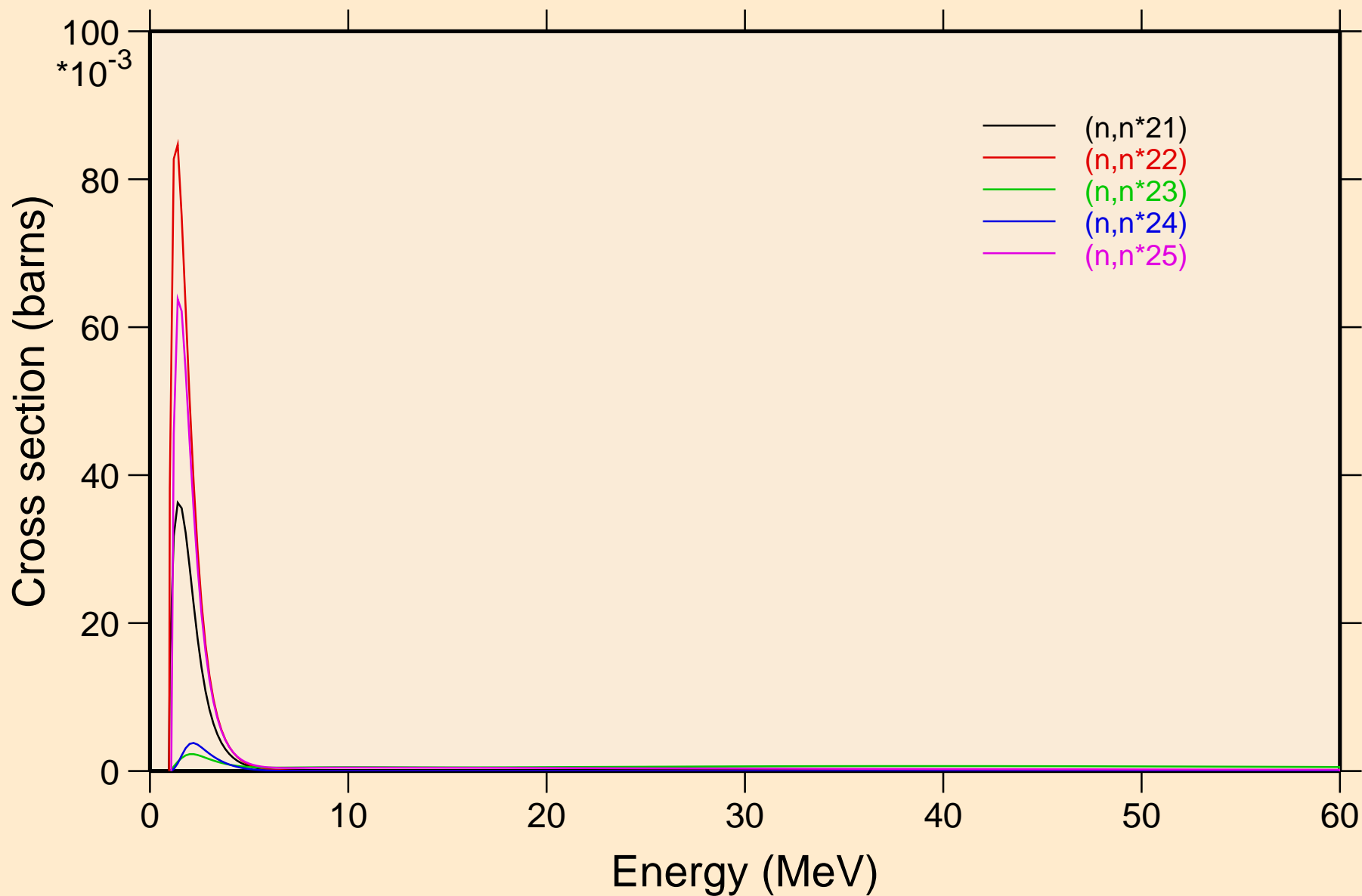

57-LA-138 FOR FENDL-3.2 PROCESSED BY NJOY2016.60+ ON
Inelastic levels

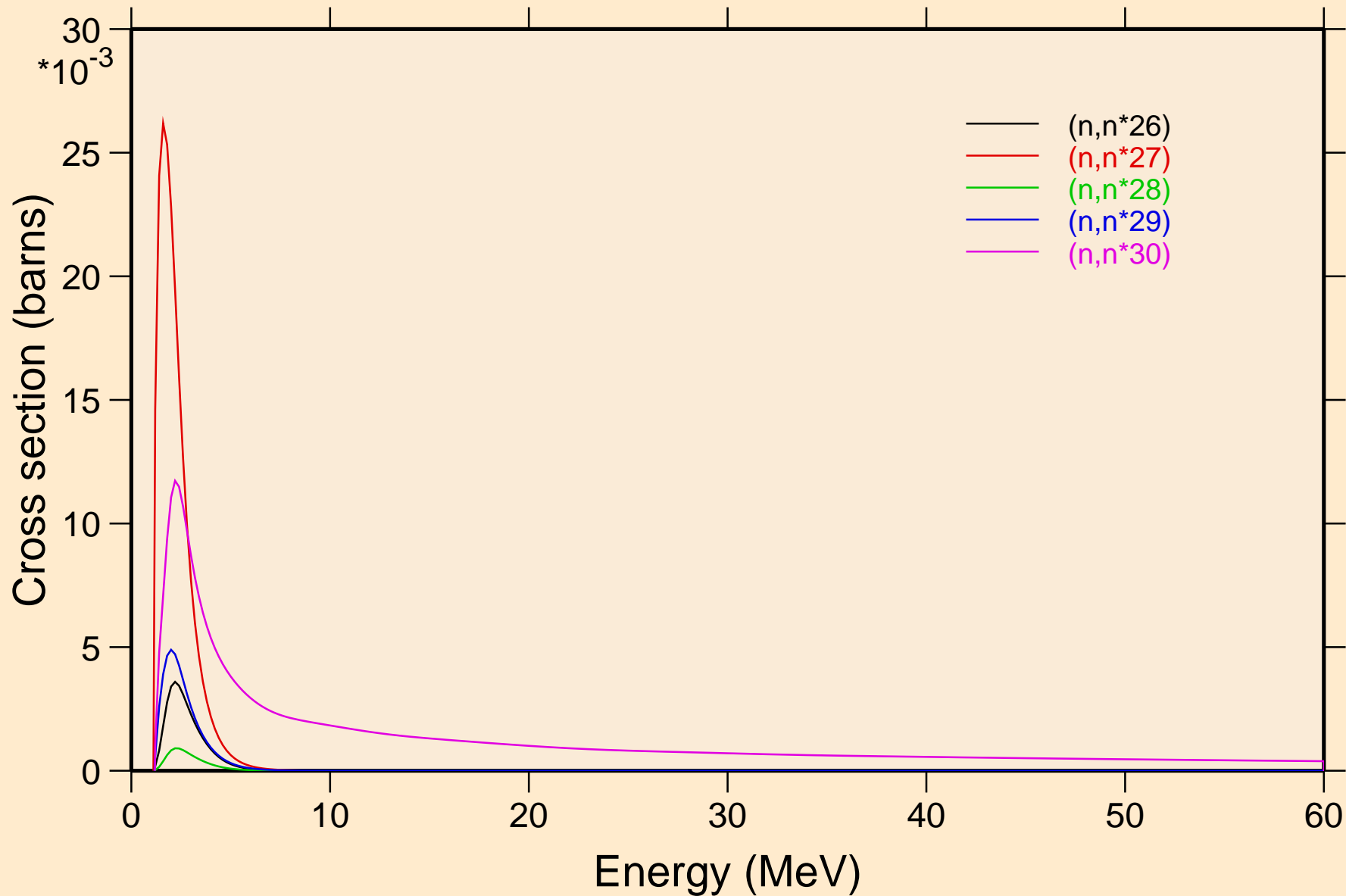

57-LA-138 FOR FENDL-3.2 PROCESSED BY NJOY2016.60+ ON
Threshold reactions

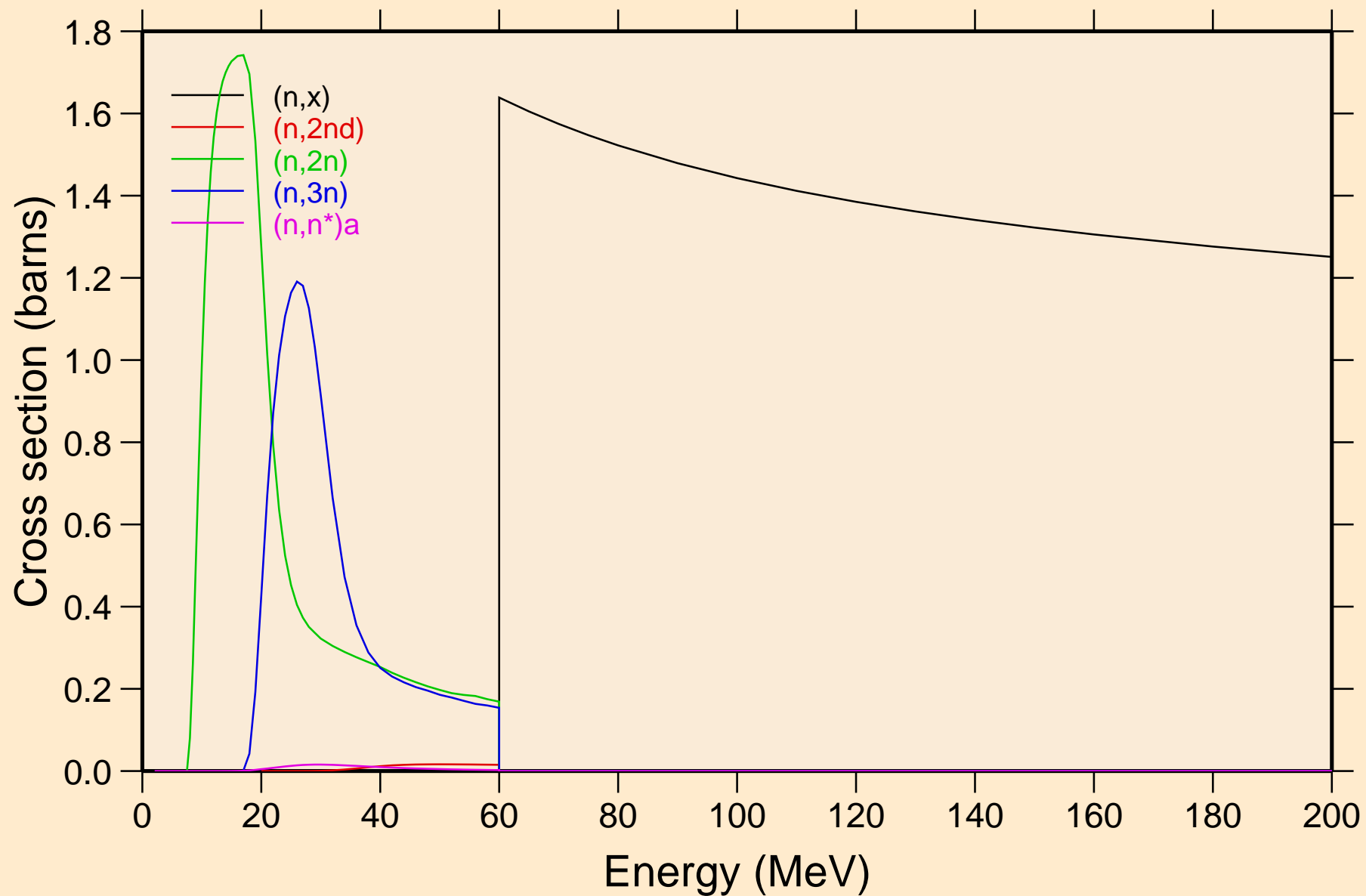

57-LA-138 FOR FENDL-3.2 PROCESSED BY NJOY2016.60+ ON
Threshold reactions

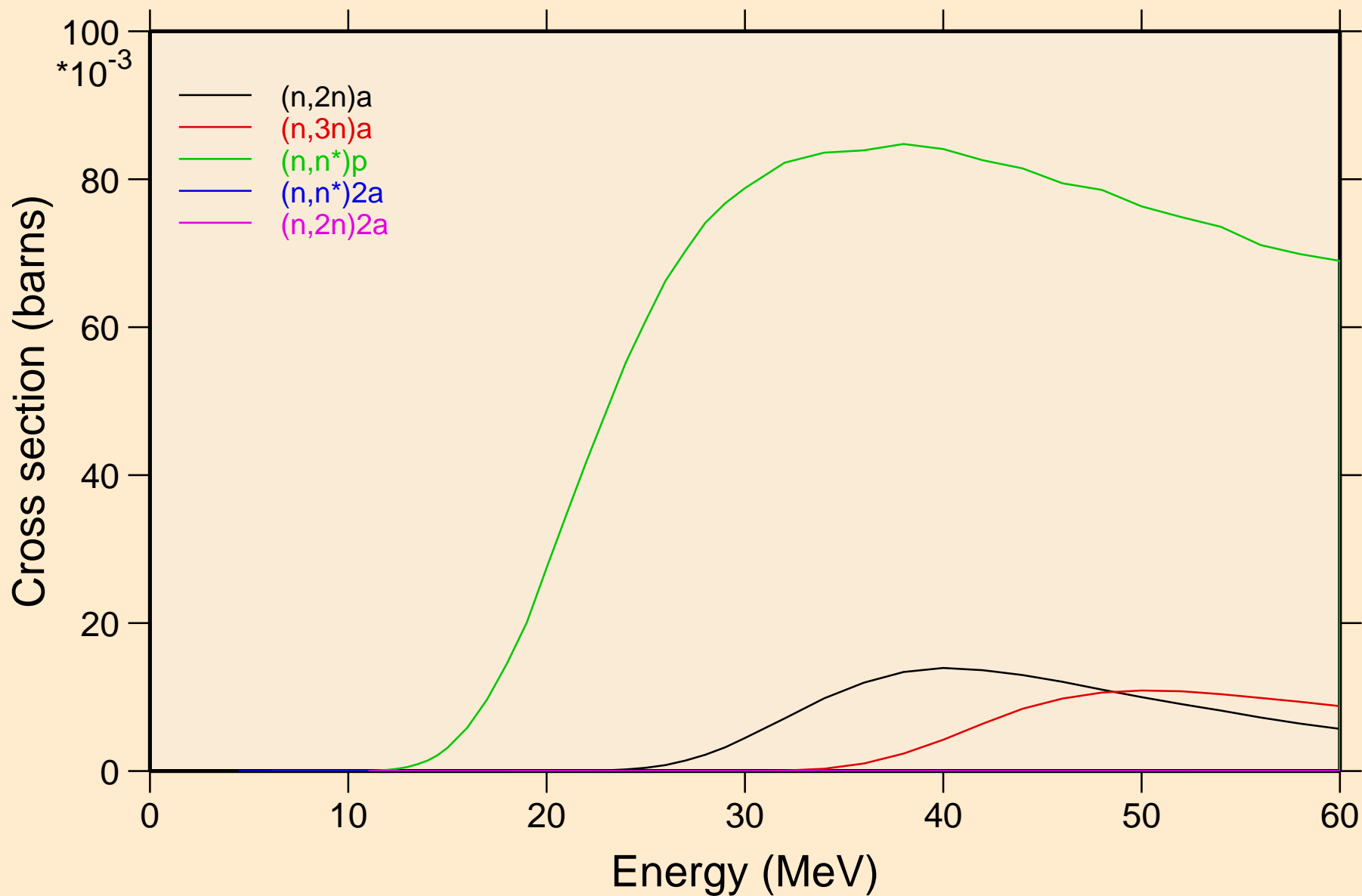

57-LA-138 FOR FENDL-3.2 PROCESSED BY NJOY2016.60+ ON
Threshold reactions

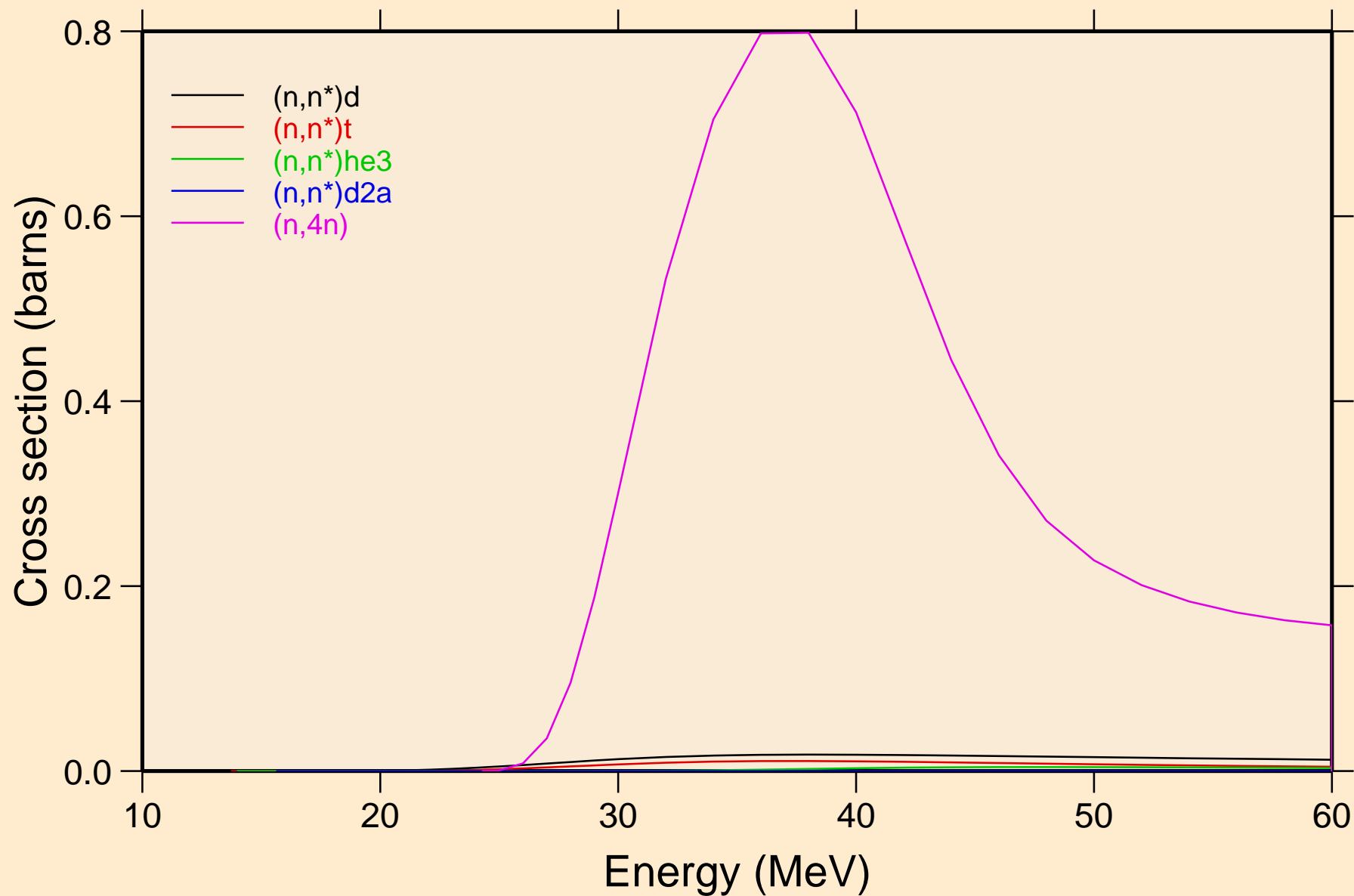

57-LA-138 FOR FENDL-3.2 PROCESSED BY NJOY2016.60+ ON
Threshold reactions

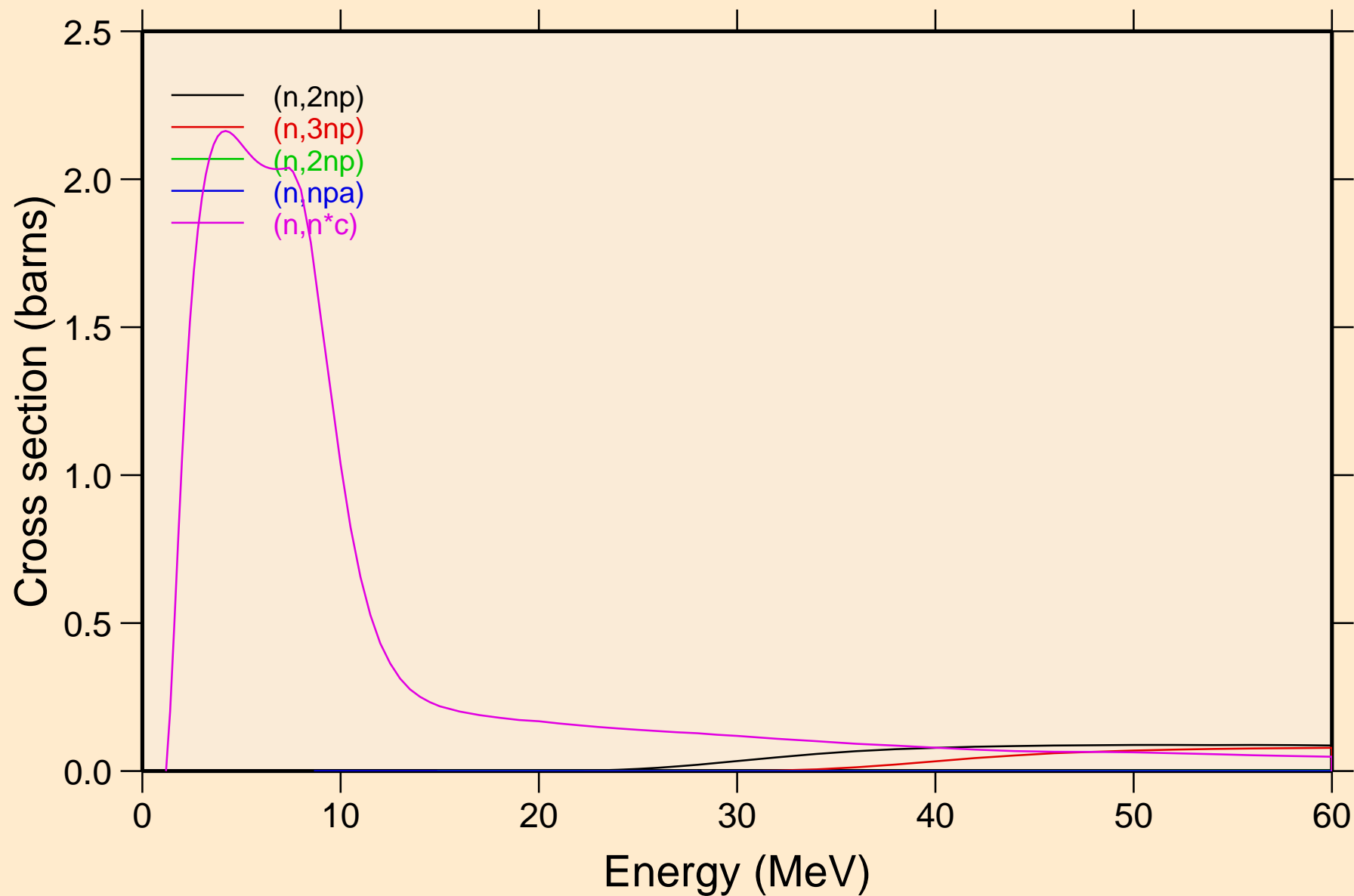

57-LA-138 FOR FENDL-3.2 PROCESSED BY NJOY2016.60+ ON
Threshold reactions

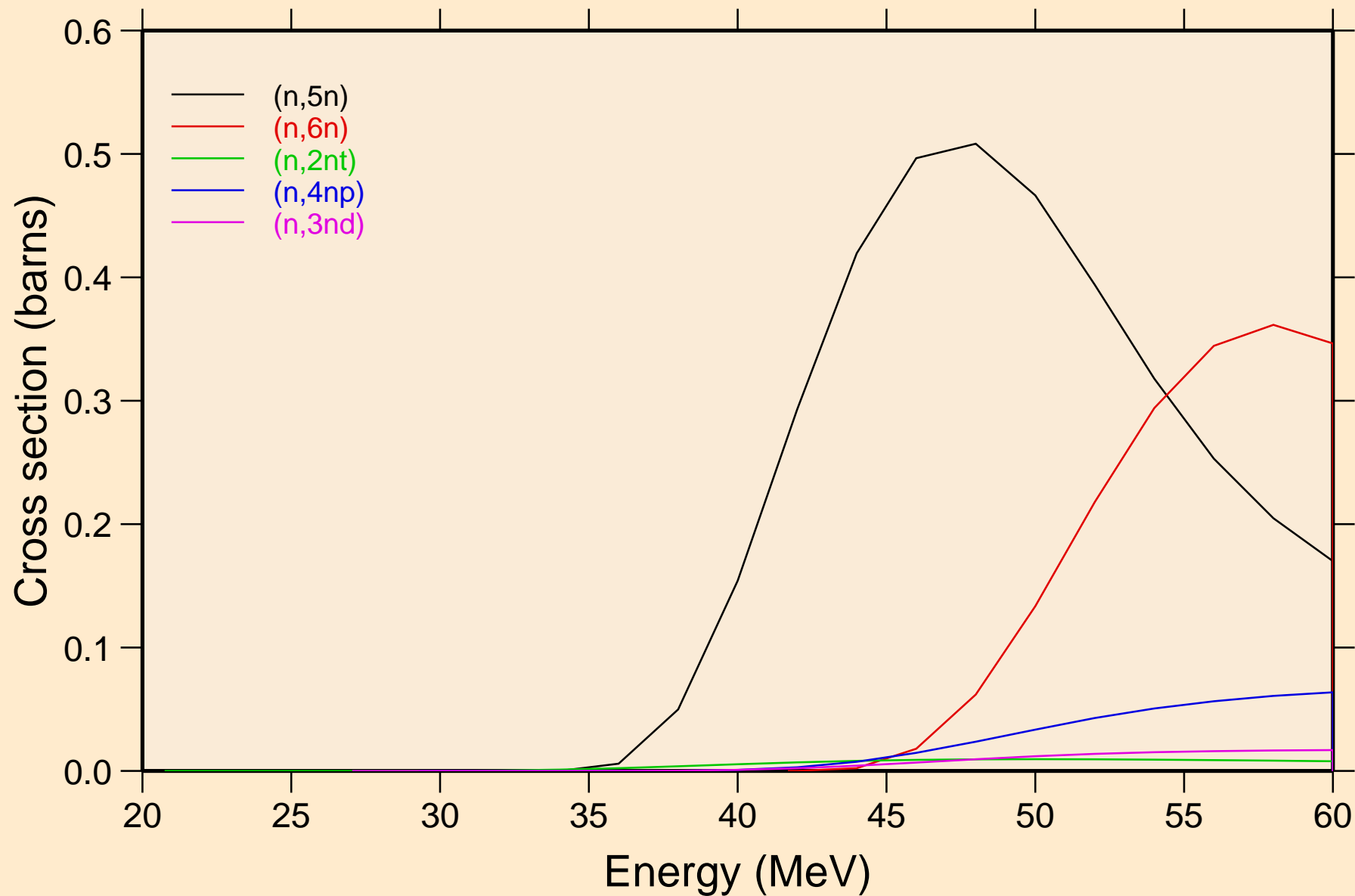

57-LA-138 FOR FENDL-3.2 PROCESSED BY NJOY2016.60+ ON
Threshold reactions

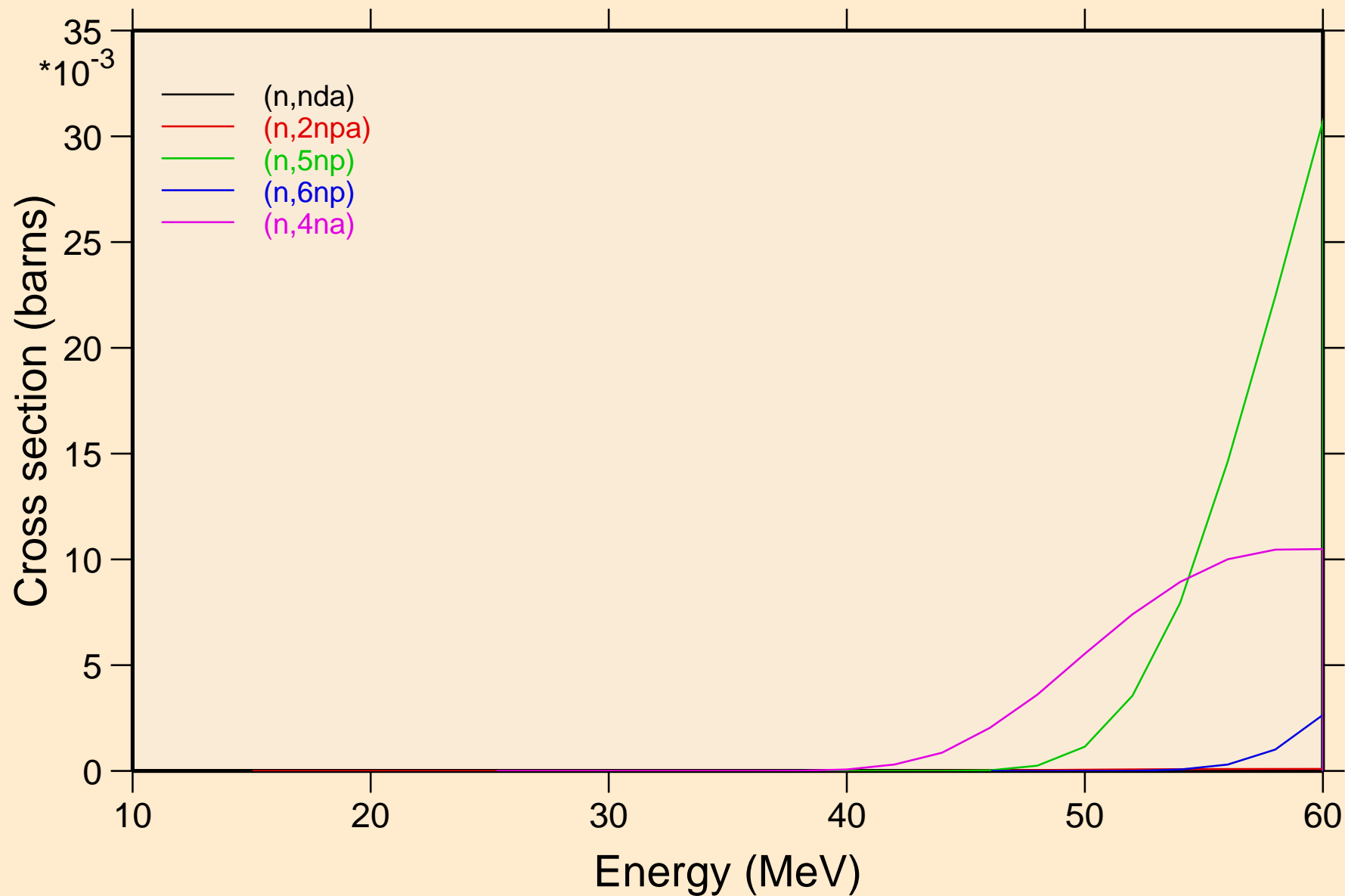

57-LA-138 FOR FENDL-3.2 PROCESSED BY NJOY2016.60+ ON
Threshold reactions

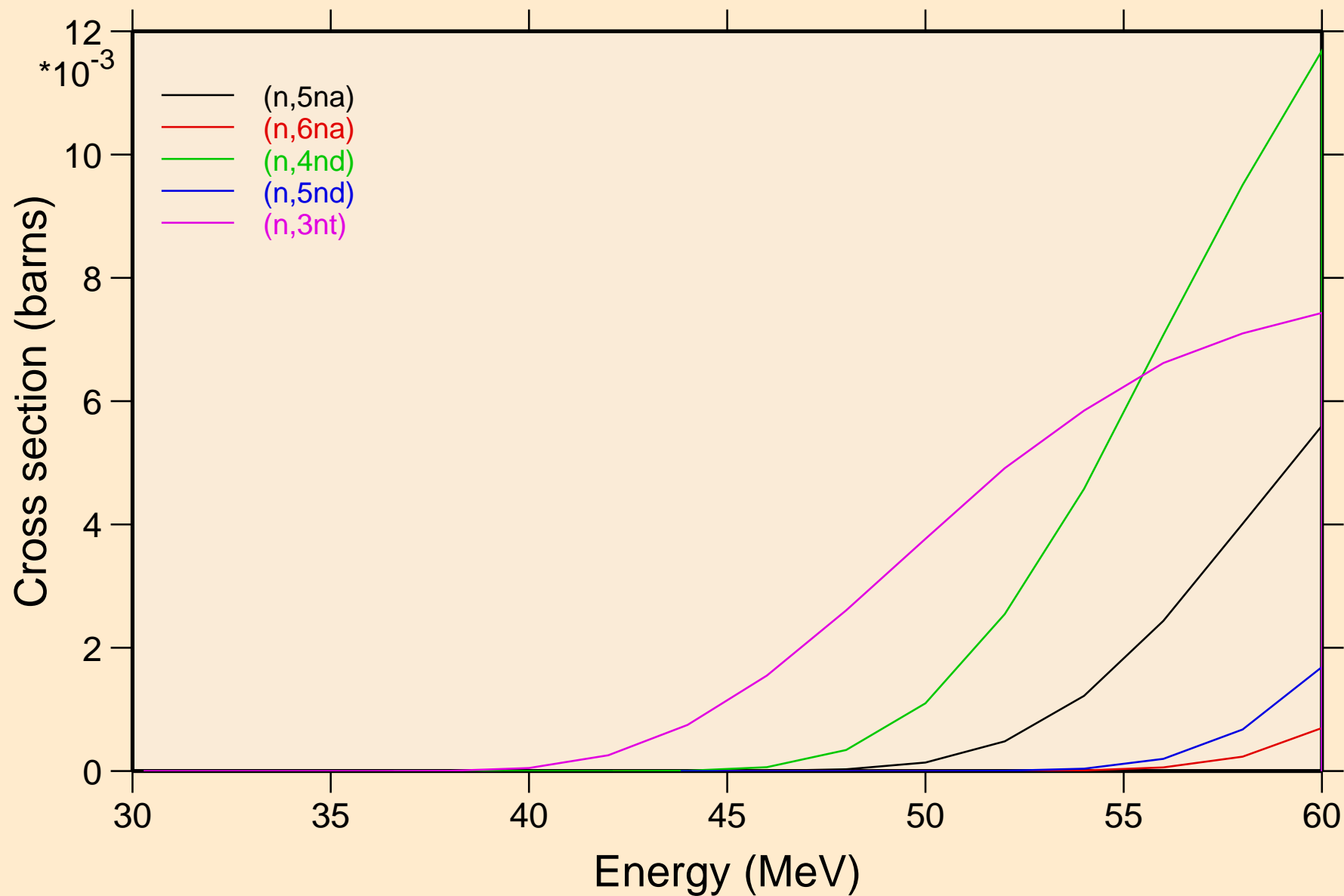

57-LA-138 FOR FENDL-3.2 PROCESSED BY NJOY2016.60+ ON
Threshold reactions

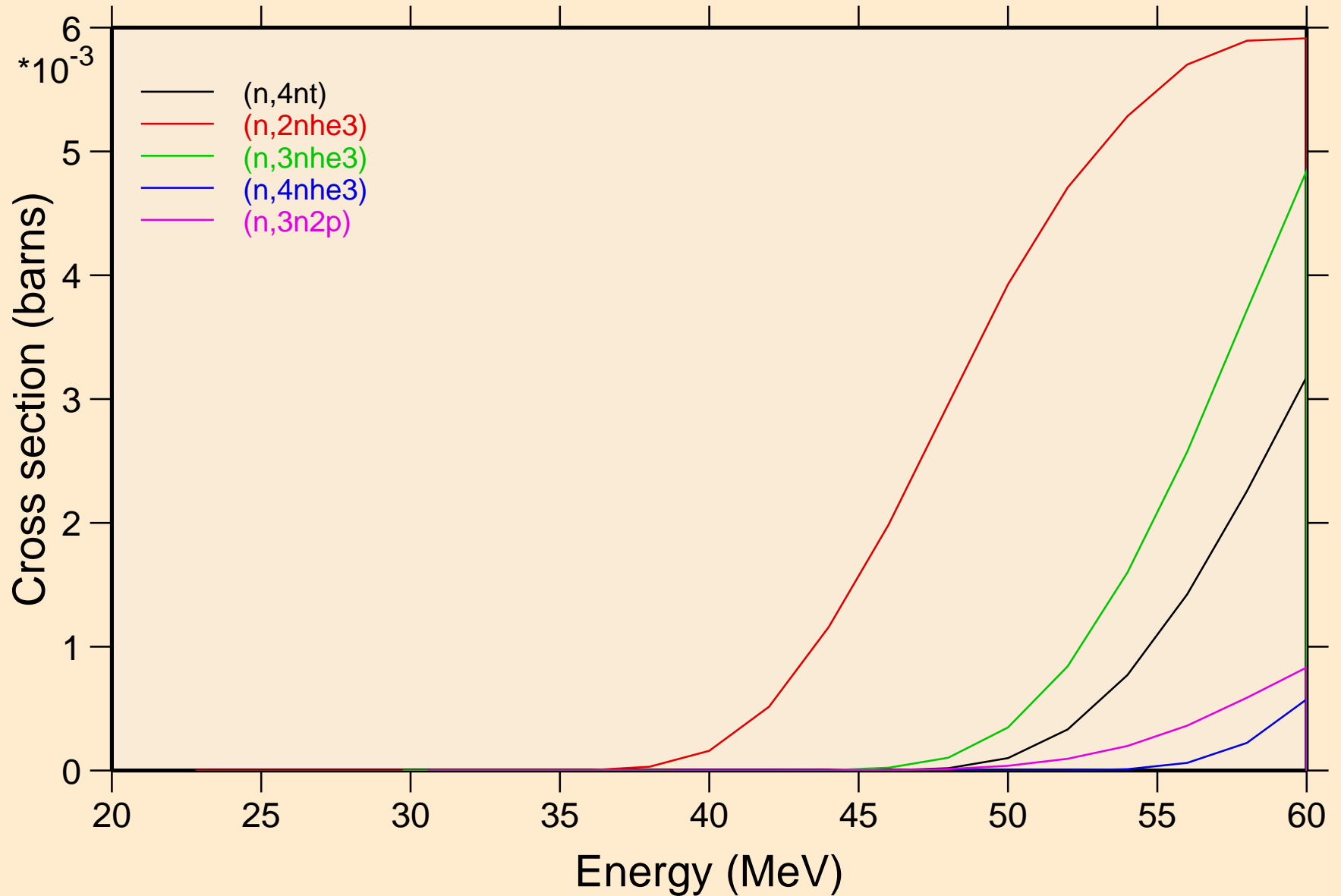

57-LA-138 FOR FENDL-3.2 PROCESSED BY NJOY2016.60+ ON
Threshold reactions

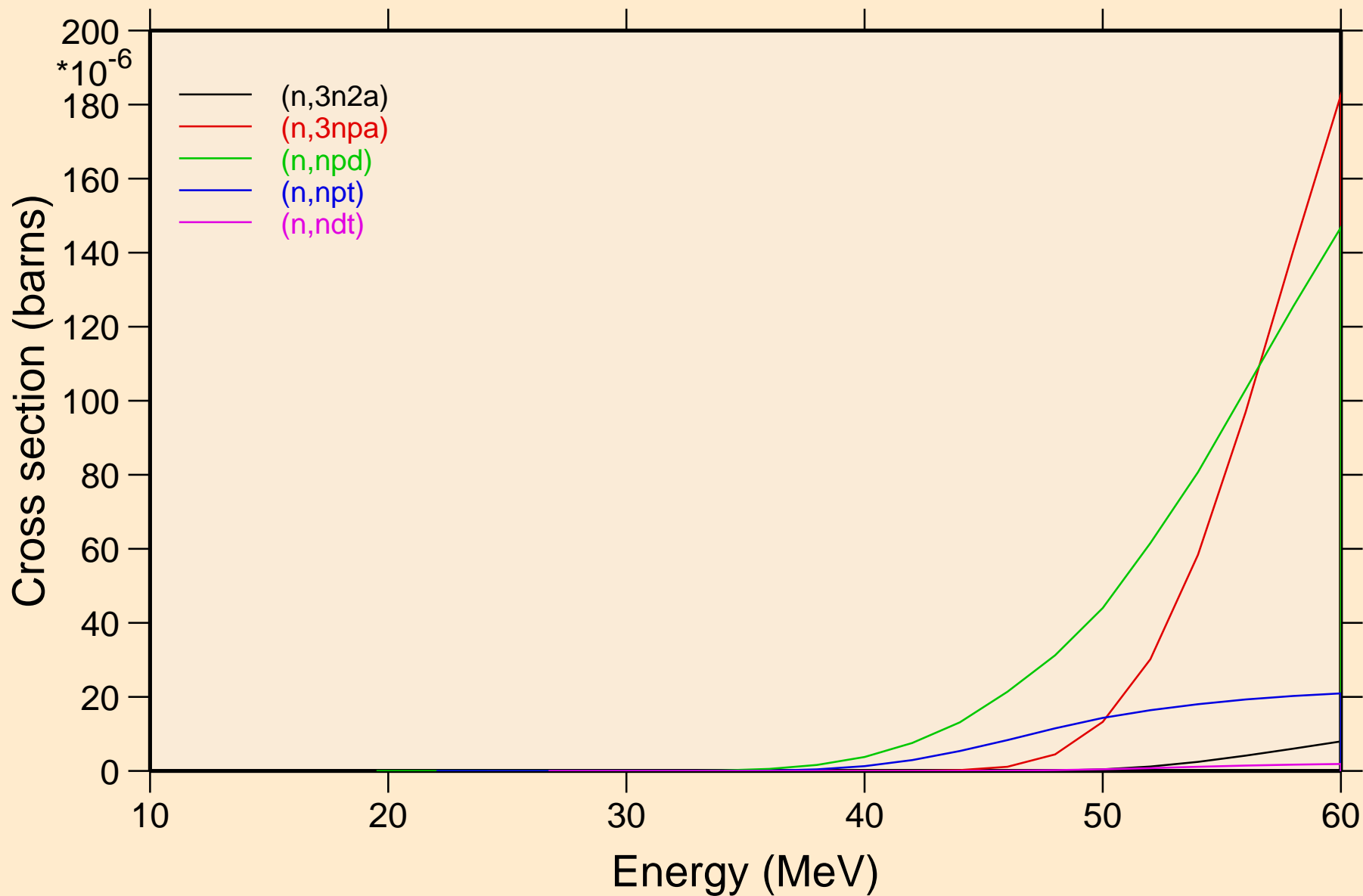

57-LA-138 FOR FENDL-3.2 PROCESSED BY NJOY2016.60+ ON
Threshold reactions

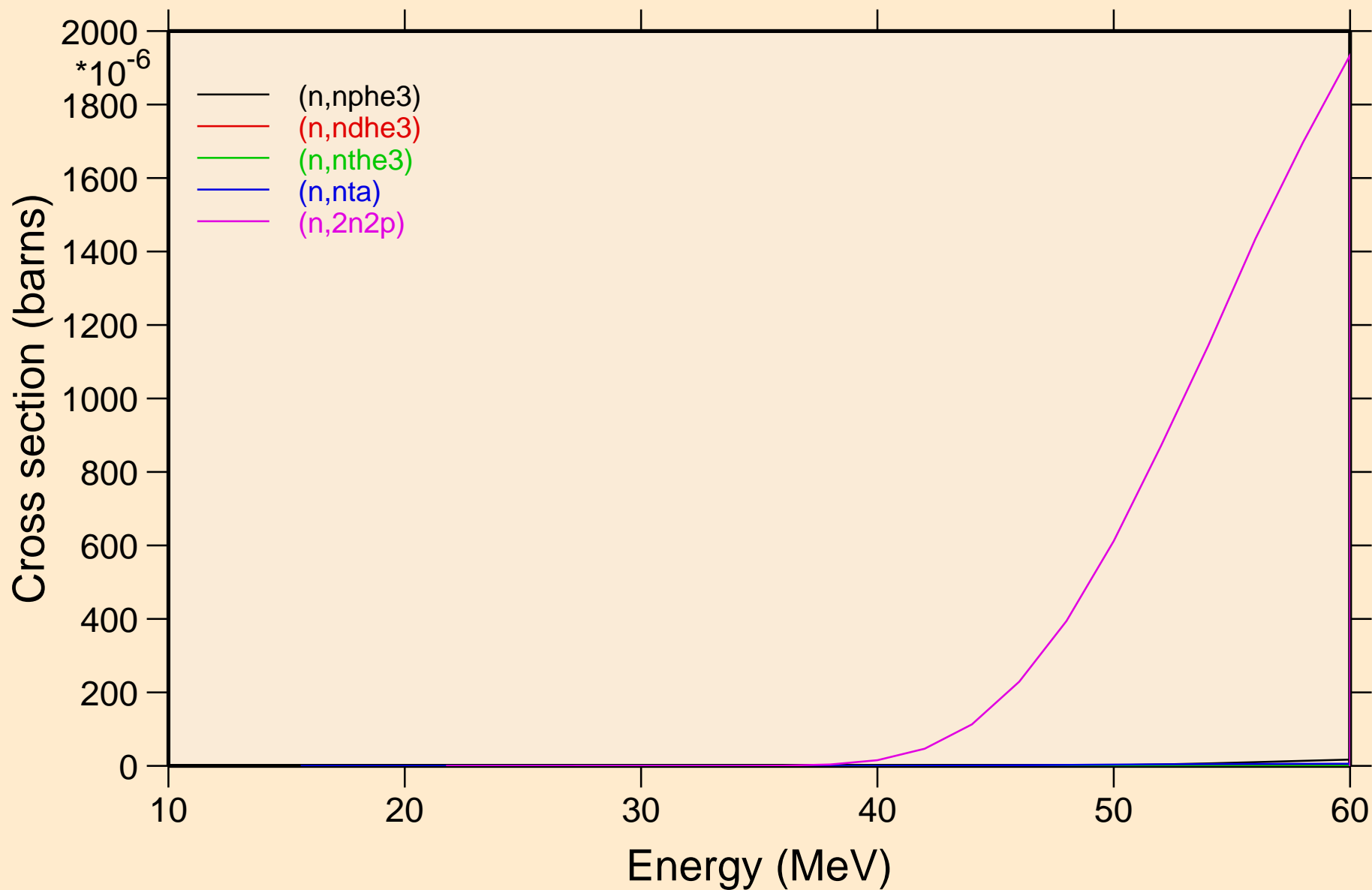

57-LA-138 FOR FENDL-3.2 PROCESSED BY NJOY2016.60+ ON
Threshold reactions

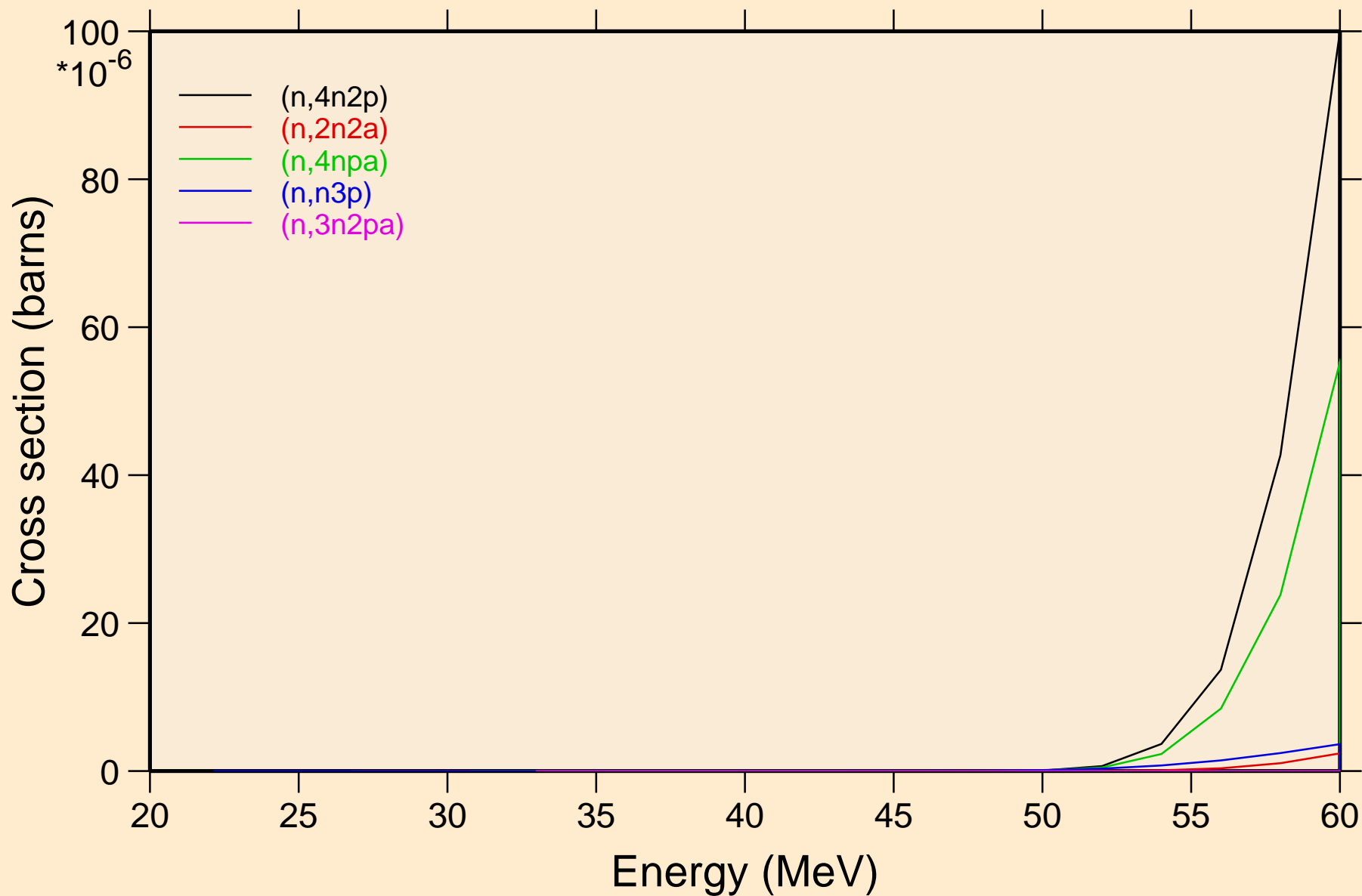

57-LA-138 FOR FENDL-3.2 PROCESSED BY NJOY2016.60+ ON
Threshold reactions

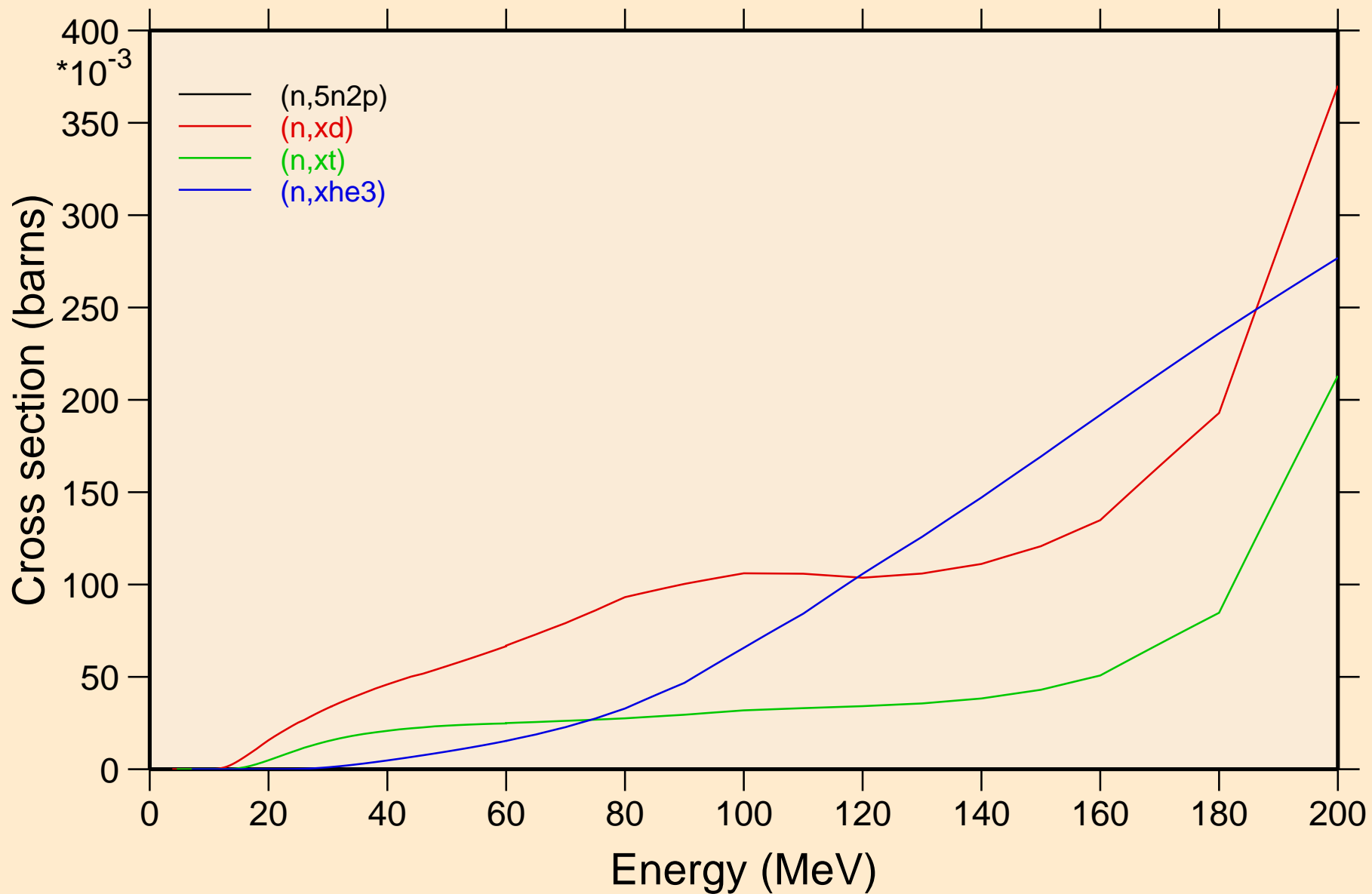

57-LA-138 FOR FENDL-3.2 PROCESSED BY NJOY2016.60+ ON
angular distribution for elastic

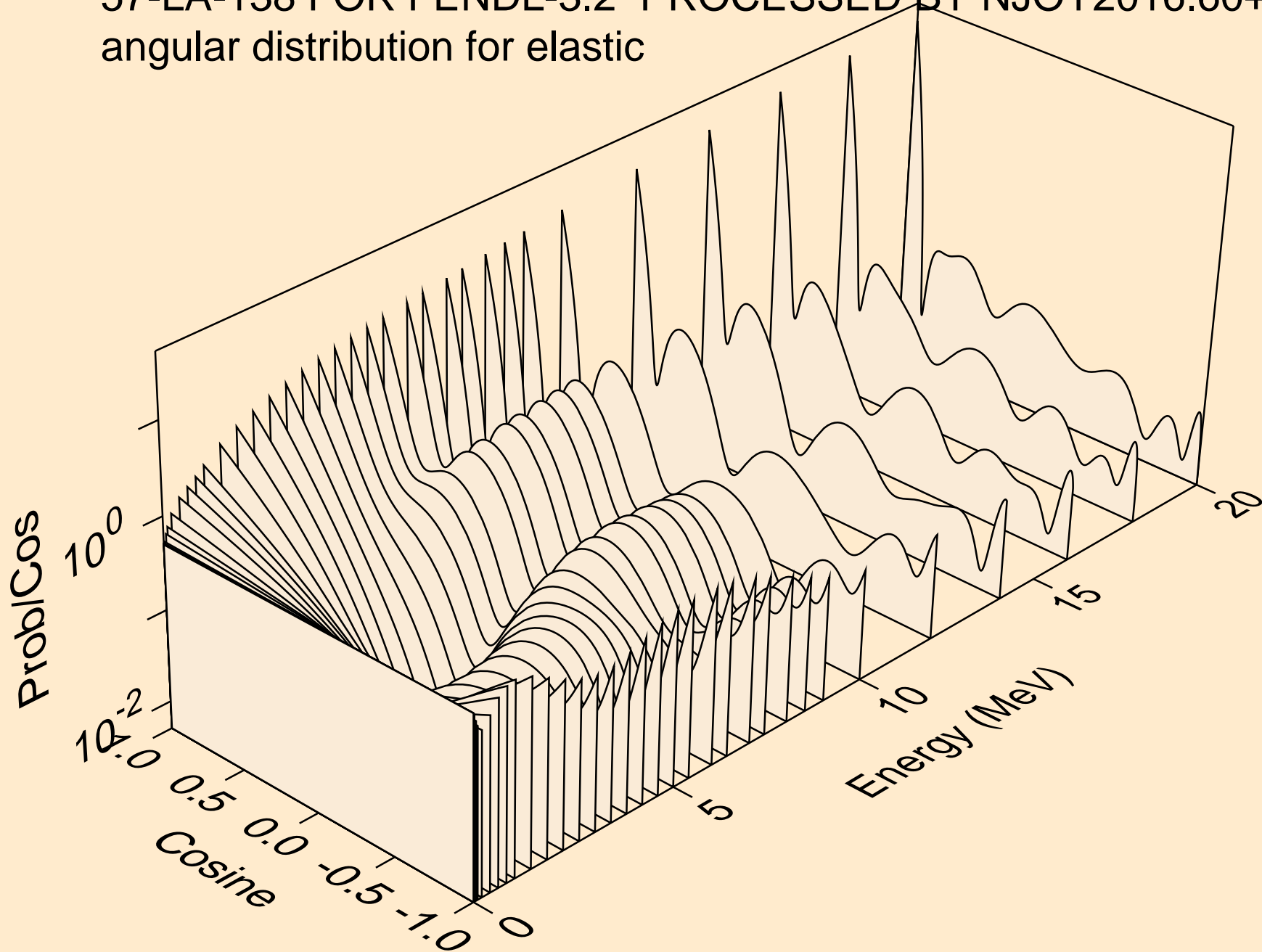

57-LA-138 FOR FENDL-3.2 PROCESSED BY NJOY2016.60+ ON
angular distribution for elastic

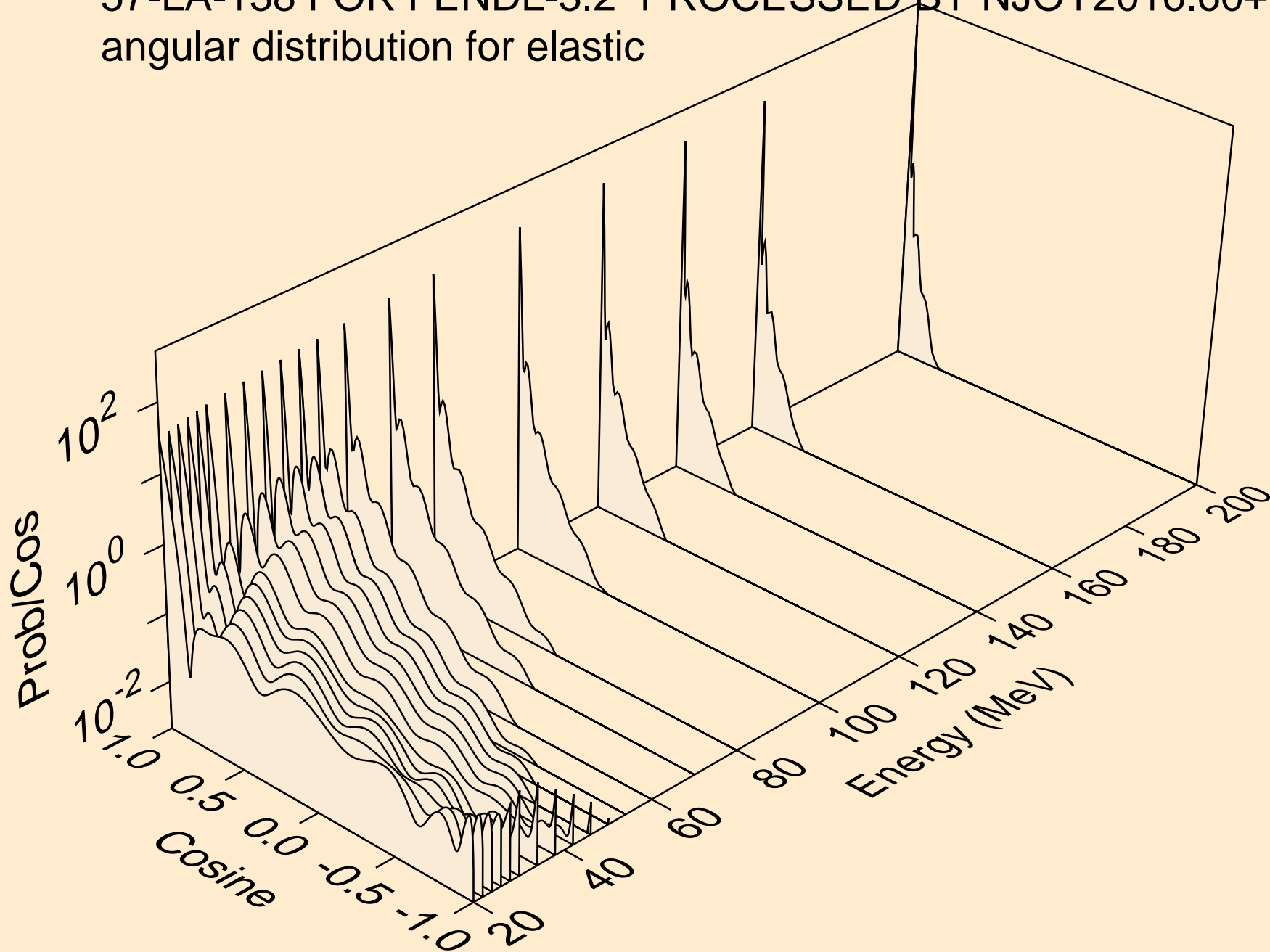

57-LA-138 FOR FENDL-3.2 PROCESSED BY NJOY2016.60+ ON
angular distribution for (n,n*1)

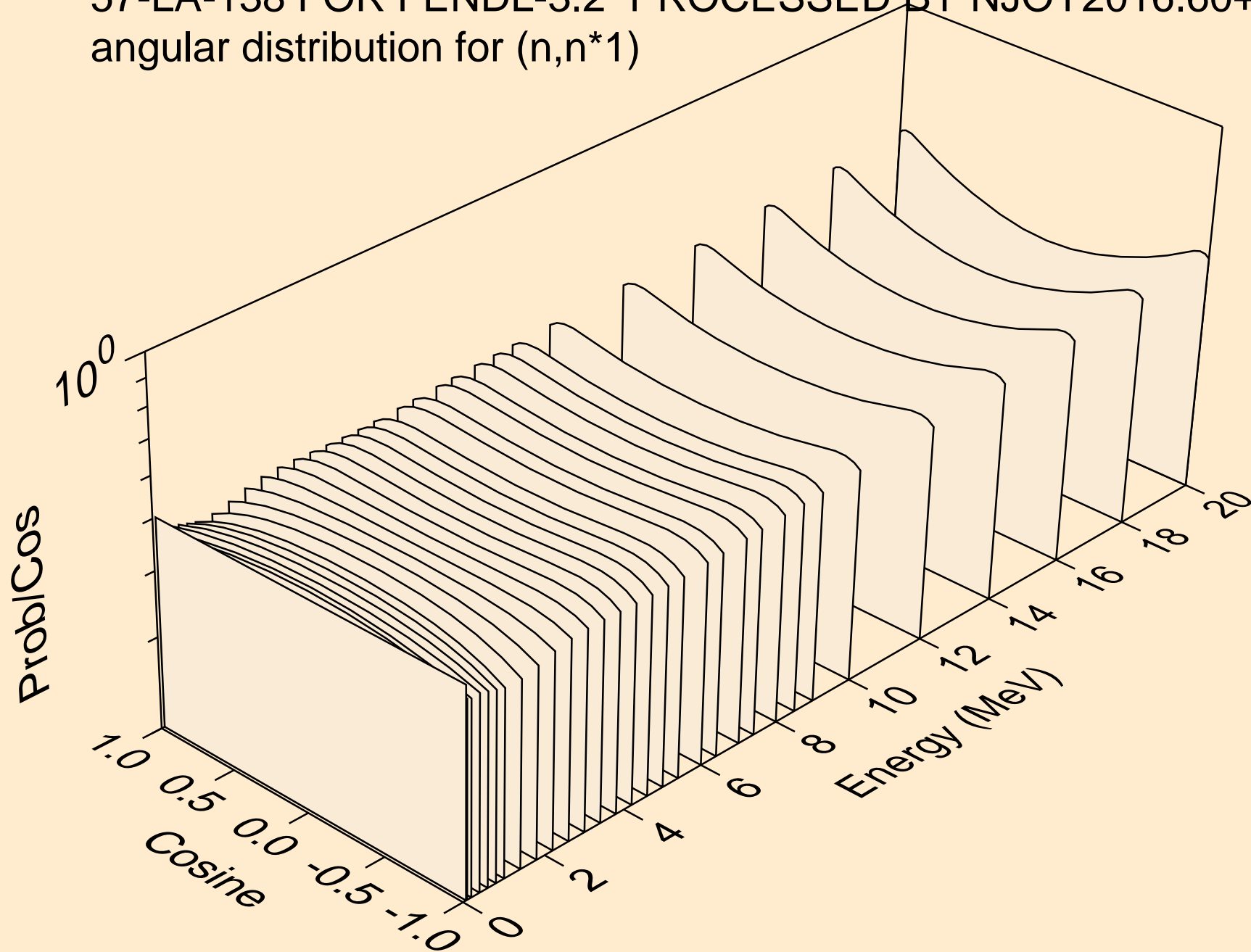

57-LA-138 FOR FENDL-3.2 PROCESSED BY NJOY2016.60+ ON
angular distribution for (n,n*1)

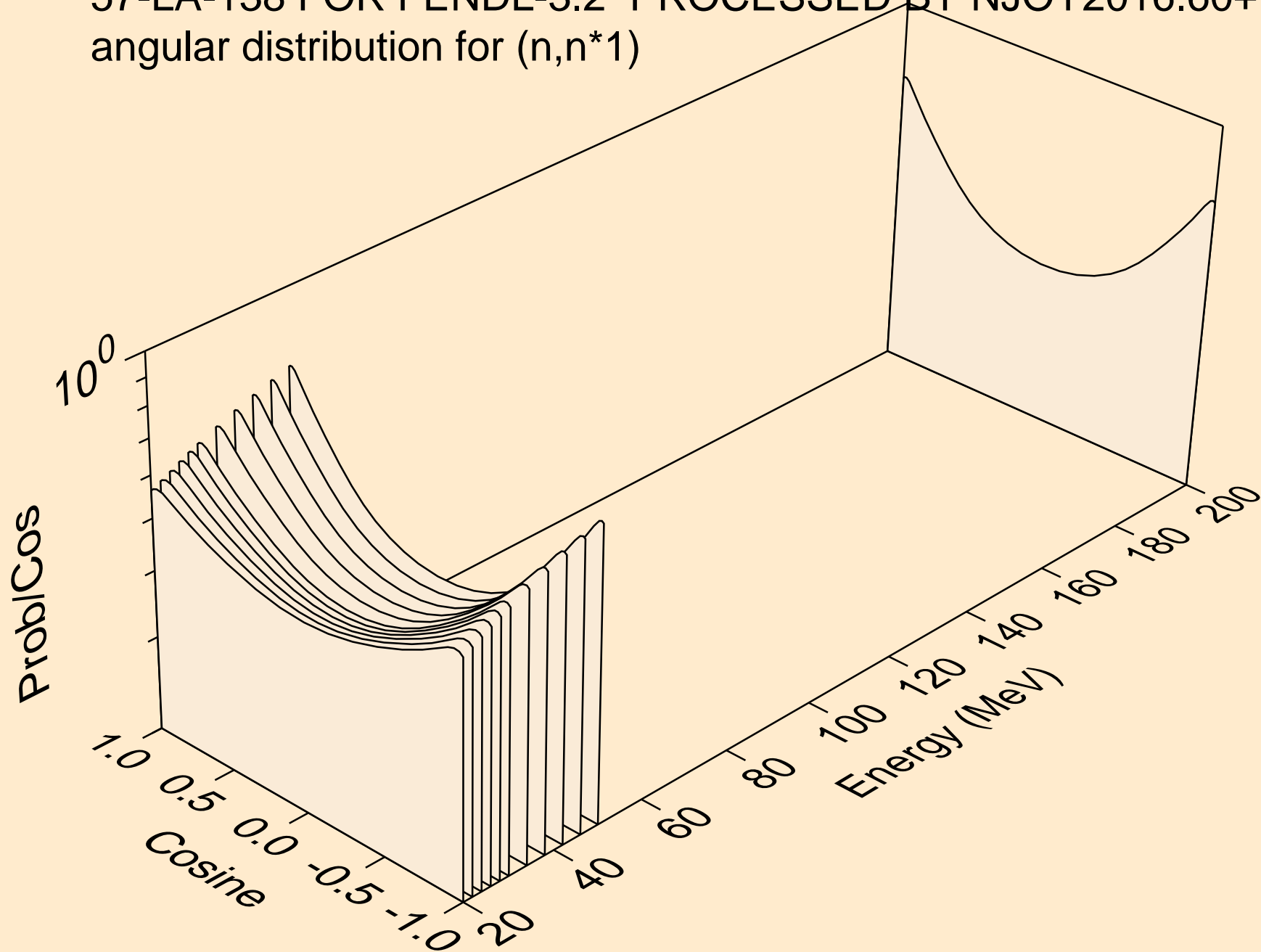

57-LA-138 FOR FENDL-3.2 PROCESSED BY NJOY2016.60+ ON
angular distribution for (n,n*2)

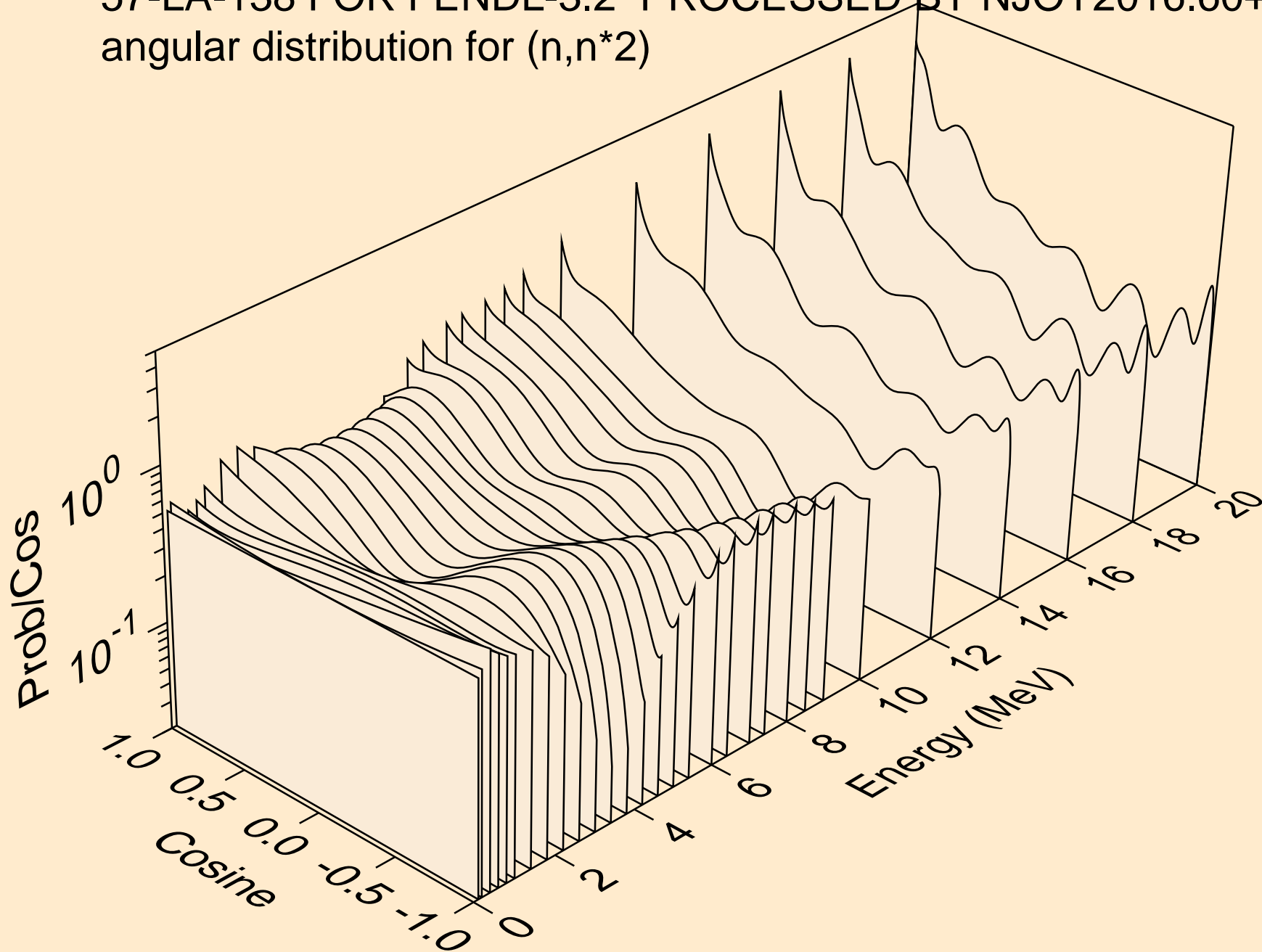

57-LA-138 FOR FENDL-3.2 PROCESSED BY NJOY2016.60+ ON
angular distribution for (n,n*2)

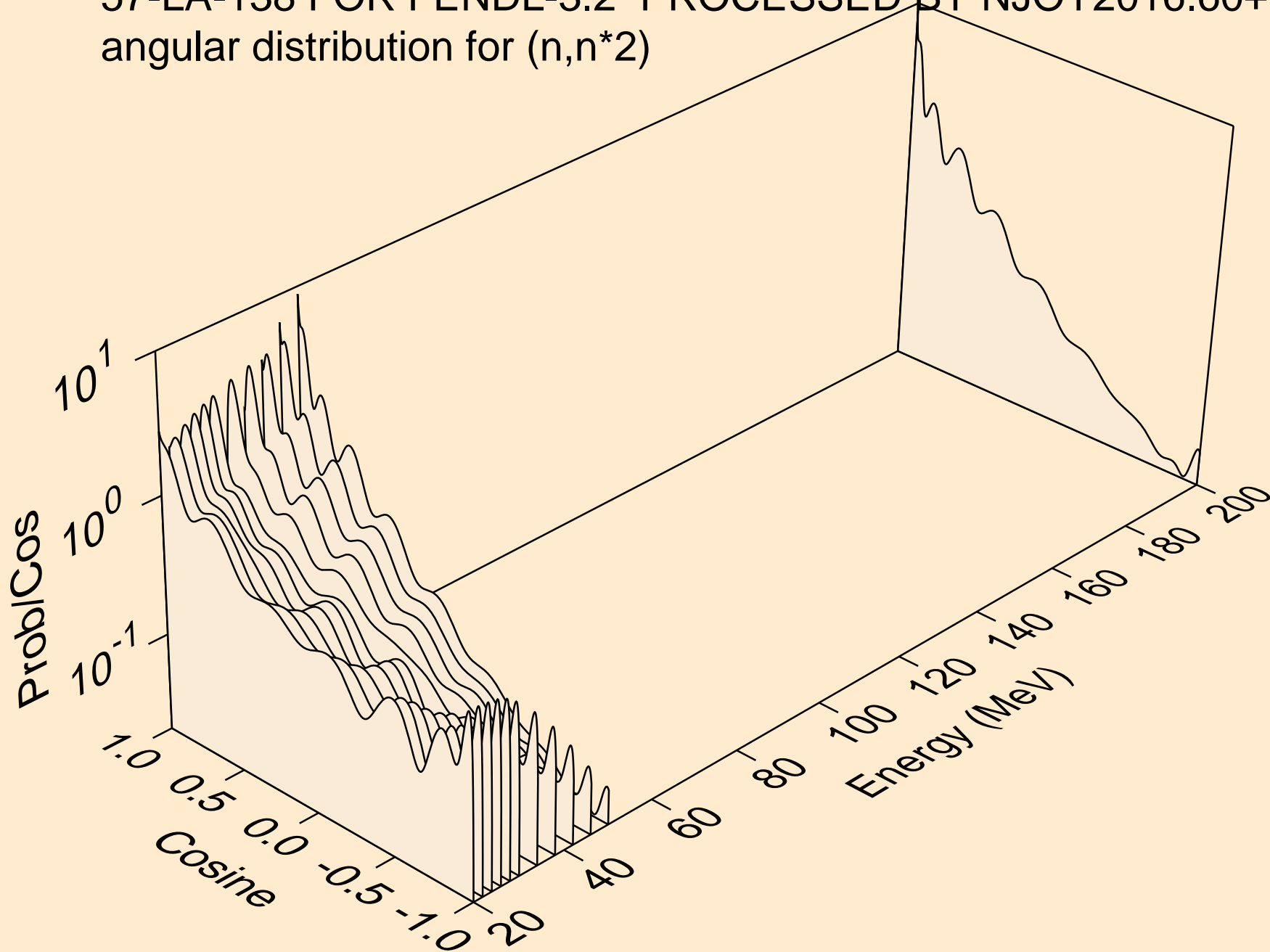

57-LA-138 FOR FENDL-3.2 PROCESSED BY NJOY2016.60+ ON
angular distribution for (n,n*3)

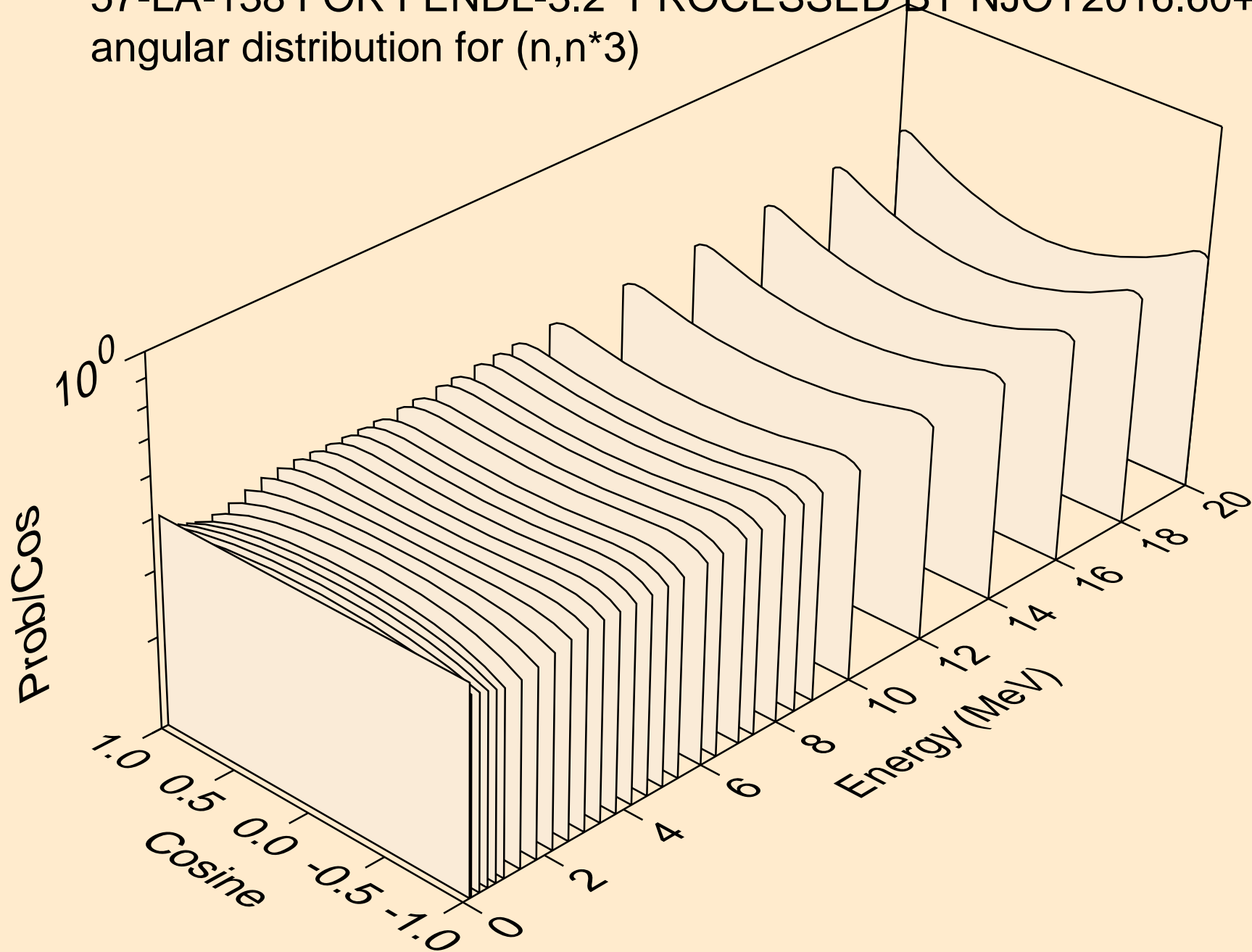

57-LA-138 FOR FENDL-3.2 PROCESSED BY NJOY2016.60+ ON
angular distribution for (n,n*3)

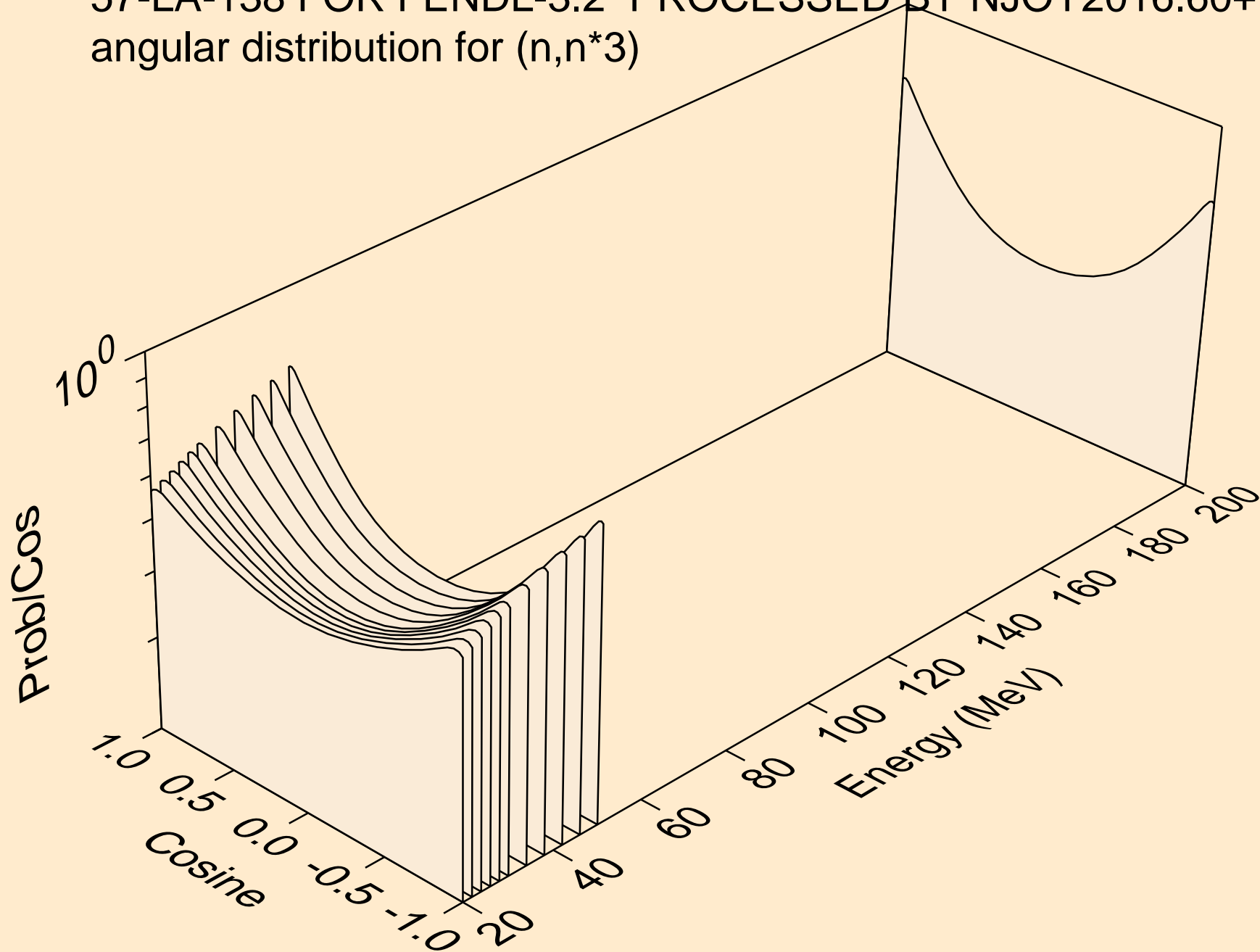

57-LA-138 FOR FENDL-3.2 PROCESSED BY NJOY2016.60+ ON
angular distribution for (n,n*4)

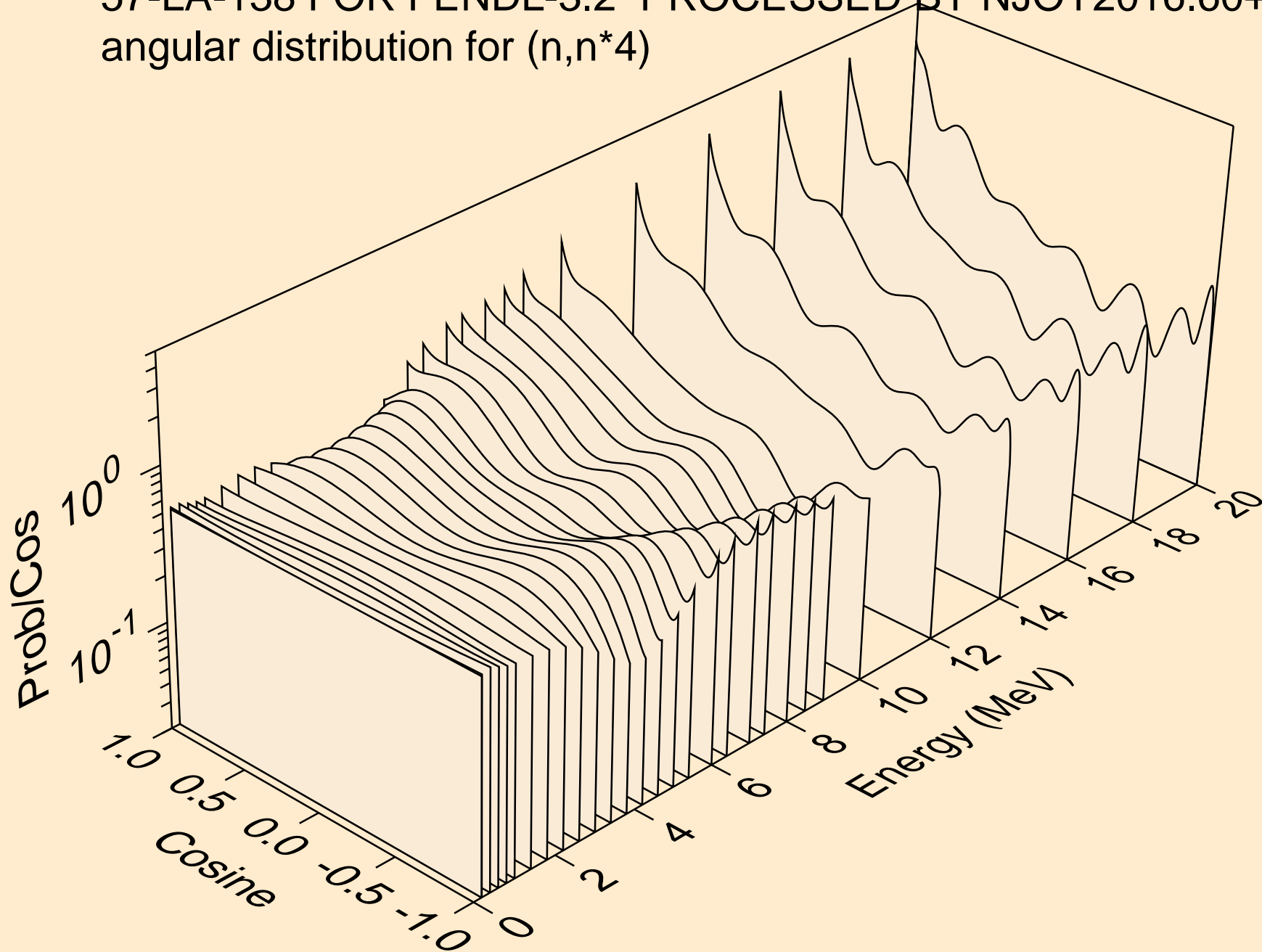

57-LA-138 FOR FENDL-3.2 PROCESSED BY NJOY2016.60+ ON
angular distribution for (n,n*4)

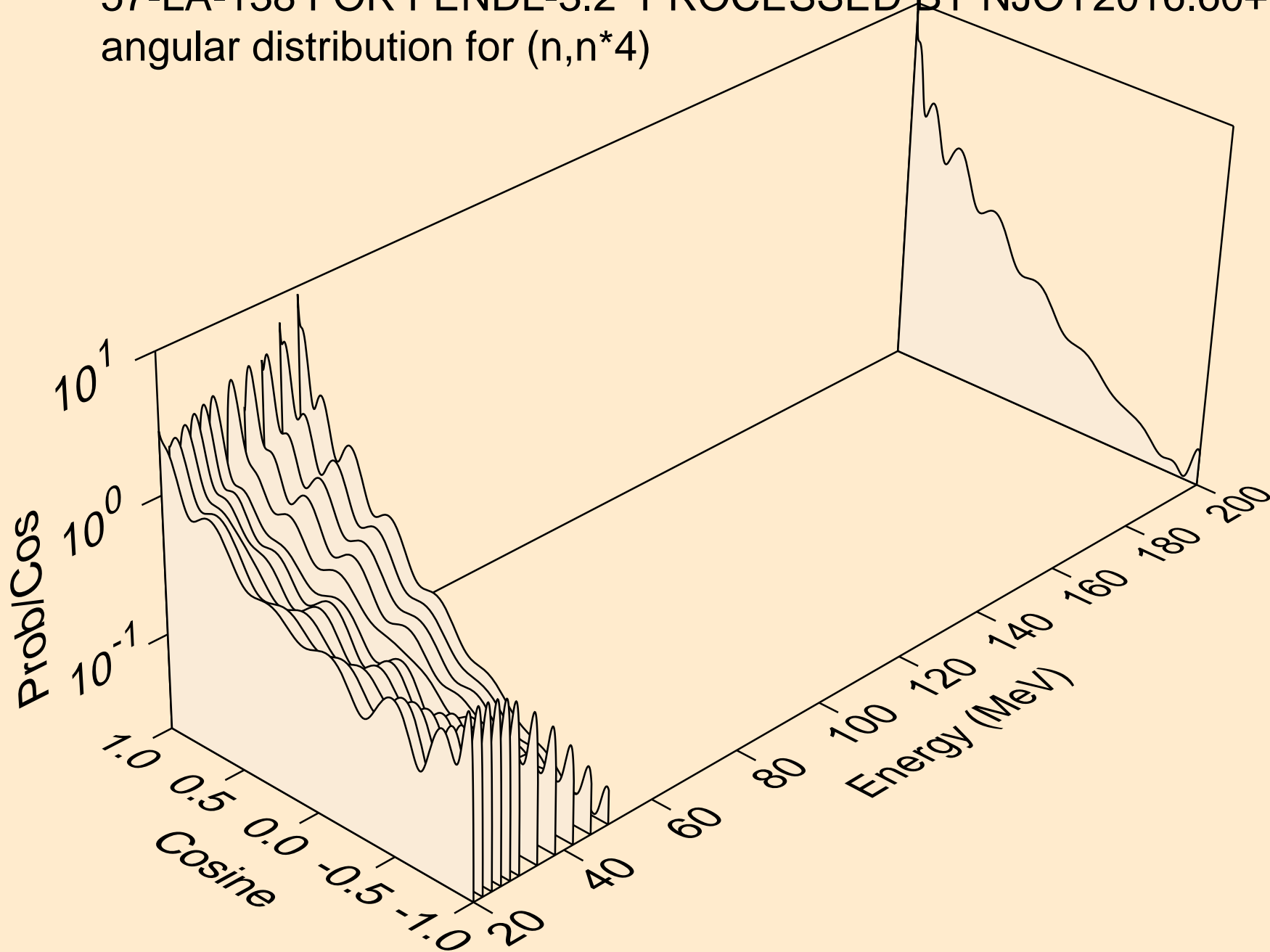

57-LA-138 FOR FENDL-3.2 PROCESSED BY NJOY2016.60+ ON
angular distribution for (n,n*5)

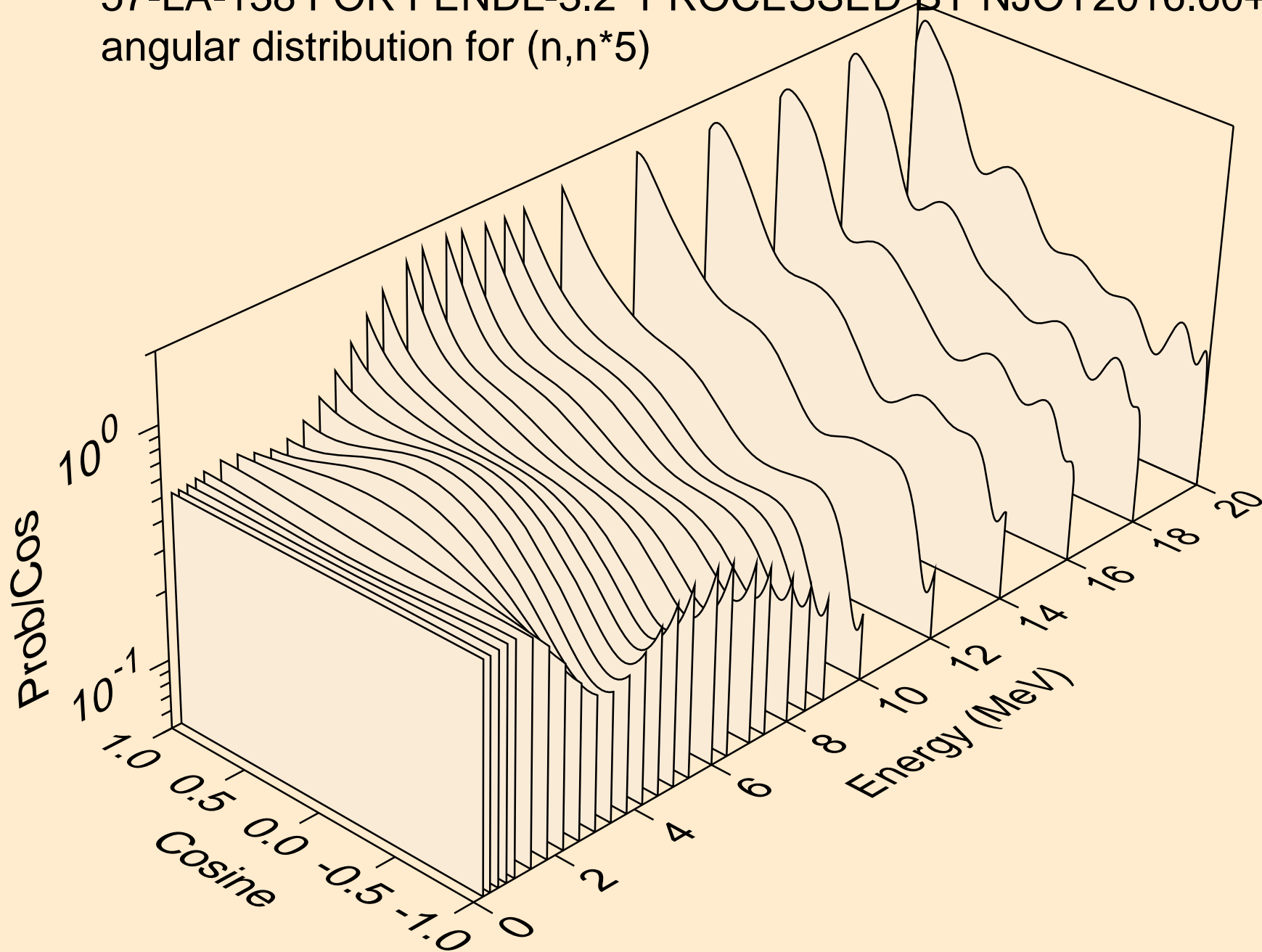

57-LA-138 FOR FENDL-3.2 PROCESSED BY NJOY2016.60+ ON
angular distribution for (n,n*5)

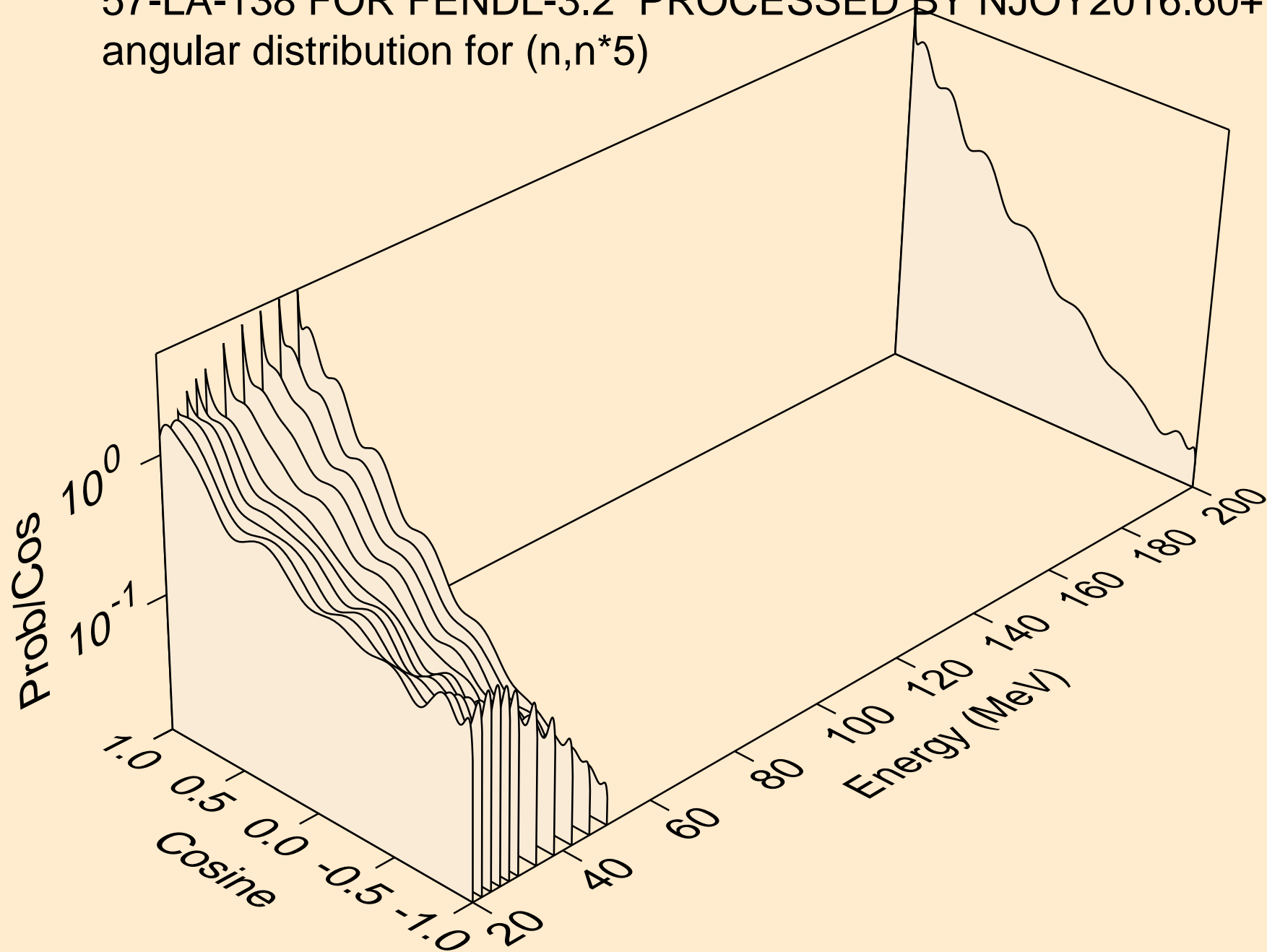

57-LA-138 FOR FENDL-3.2 PROCESSED BY NJOY2016.60+ ON
angular distribution for (n,n*6)

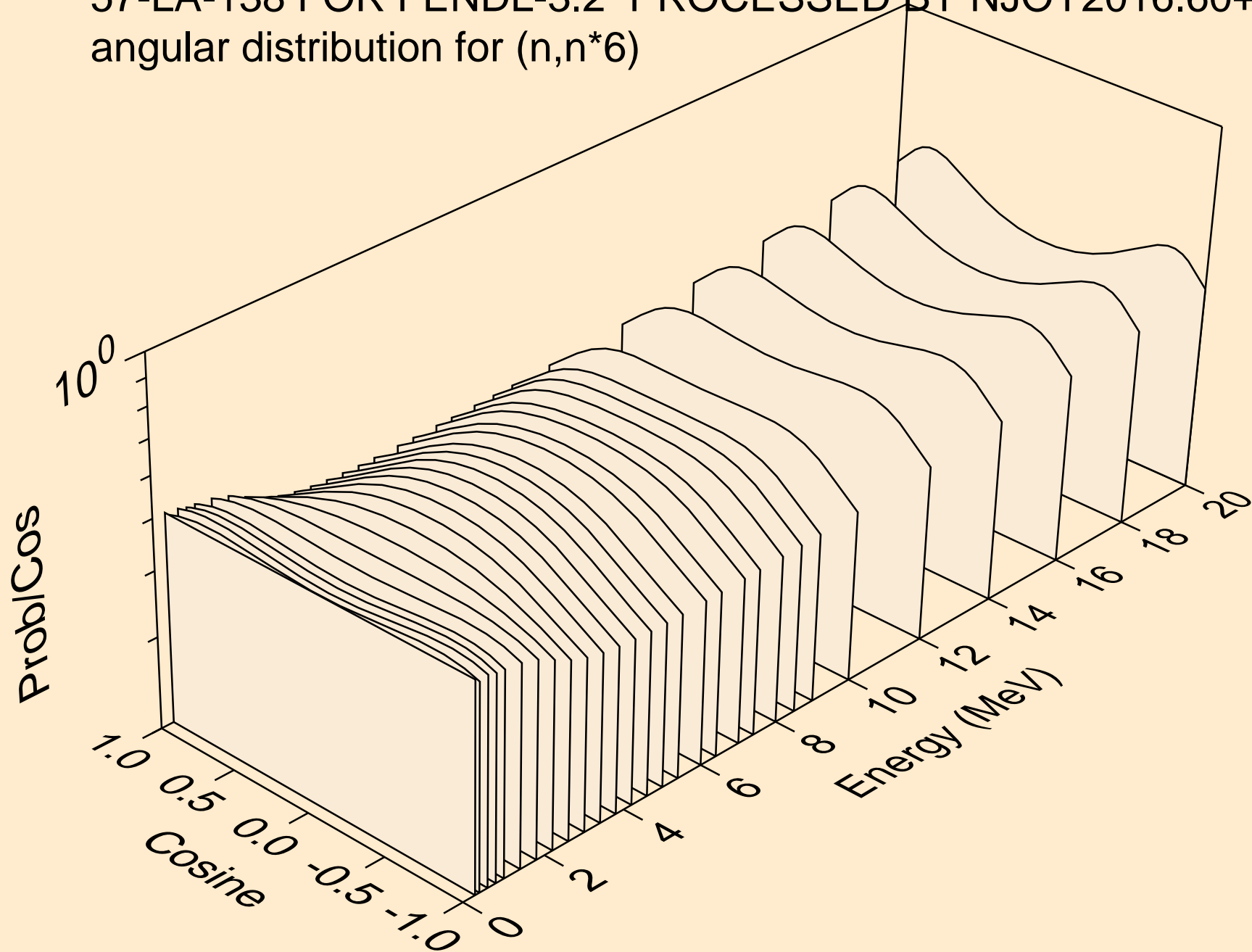

57-LA-138 FOR FENDL-3.2 PROCESSED BY NJOY2016.60+ ON
angular distribution for (n,n*6)

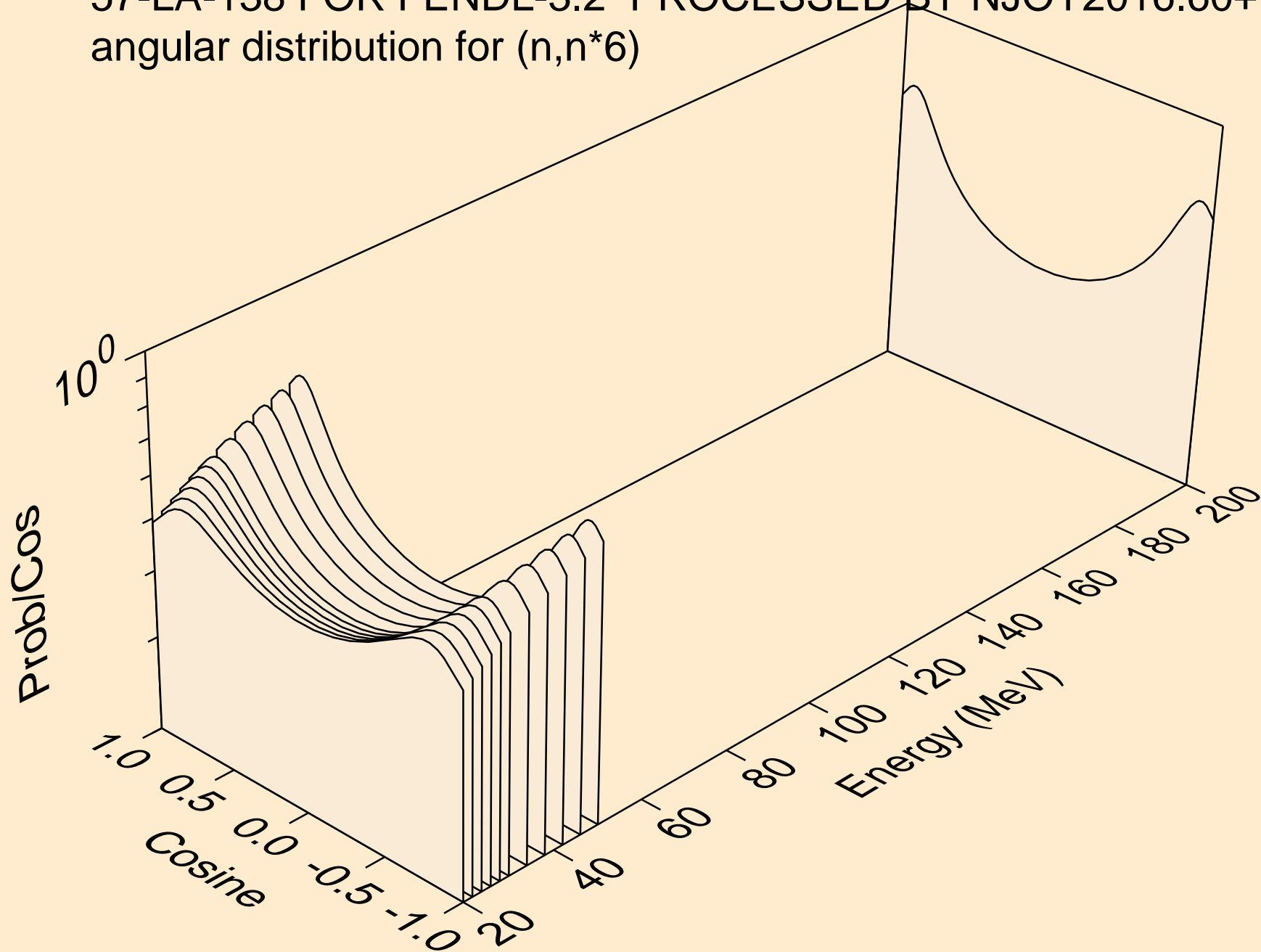

57-LA-138 FOR FENDL-3.2 PROCESSED BY NJOY2016.60+ ON
angular distribution for (n,n*7)

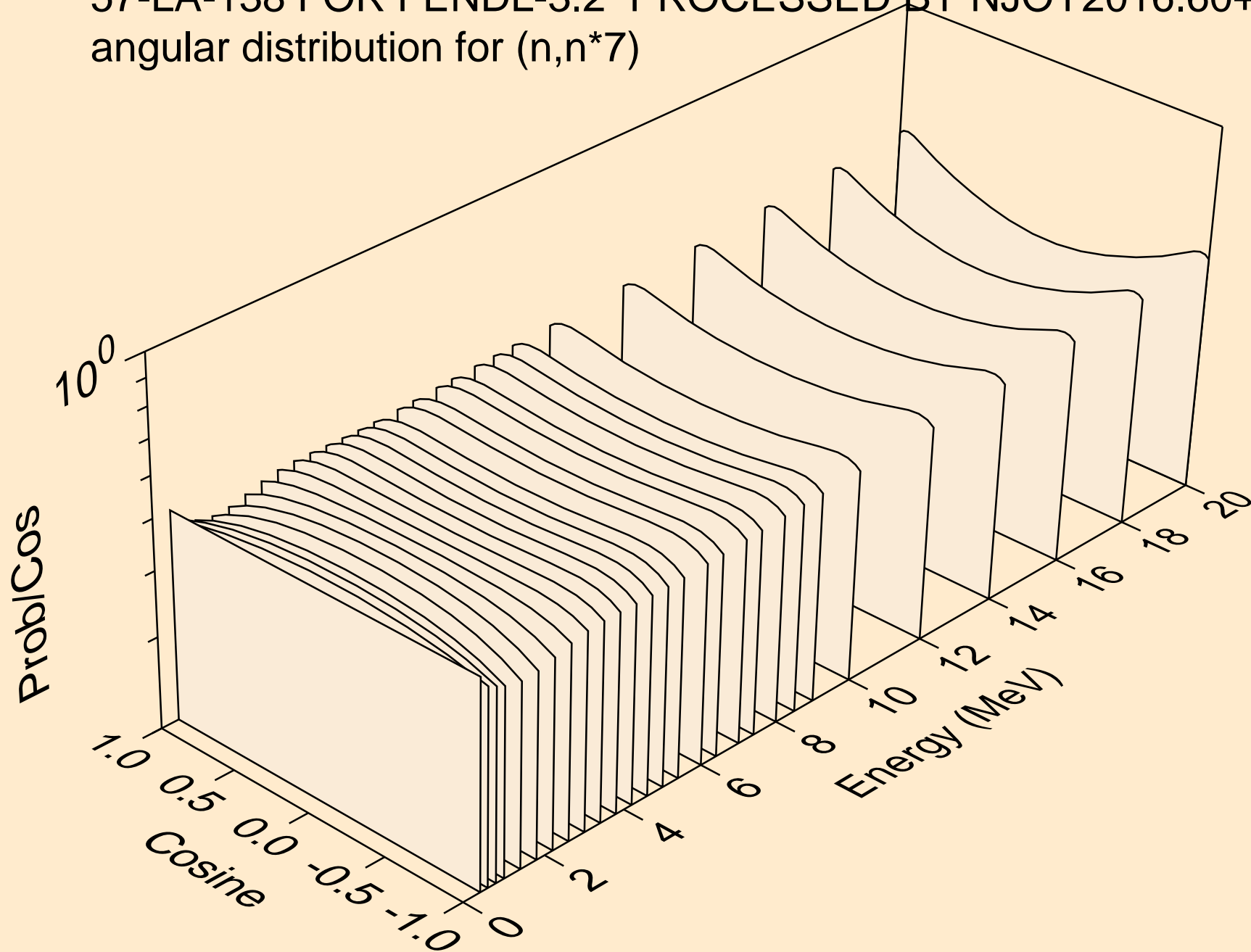

57-LA-138 FOR FENDL-3.2 PROCESSED BY NJOY2016.60+ ON
angular distribution for (n,n*7)

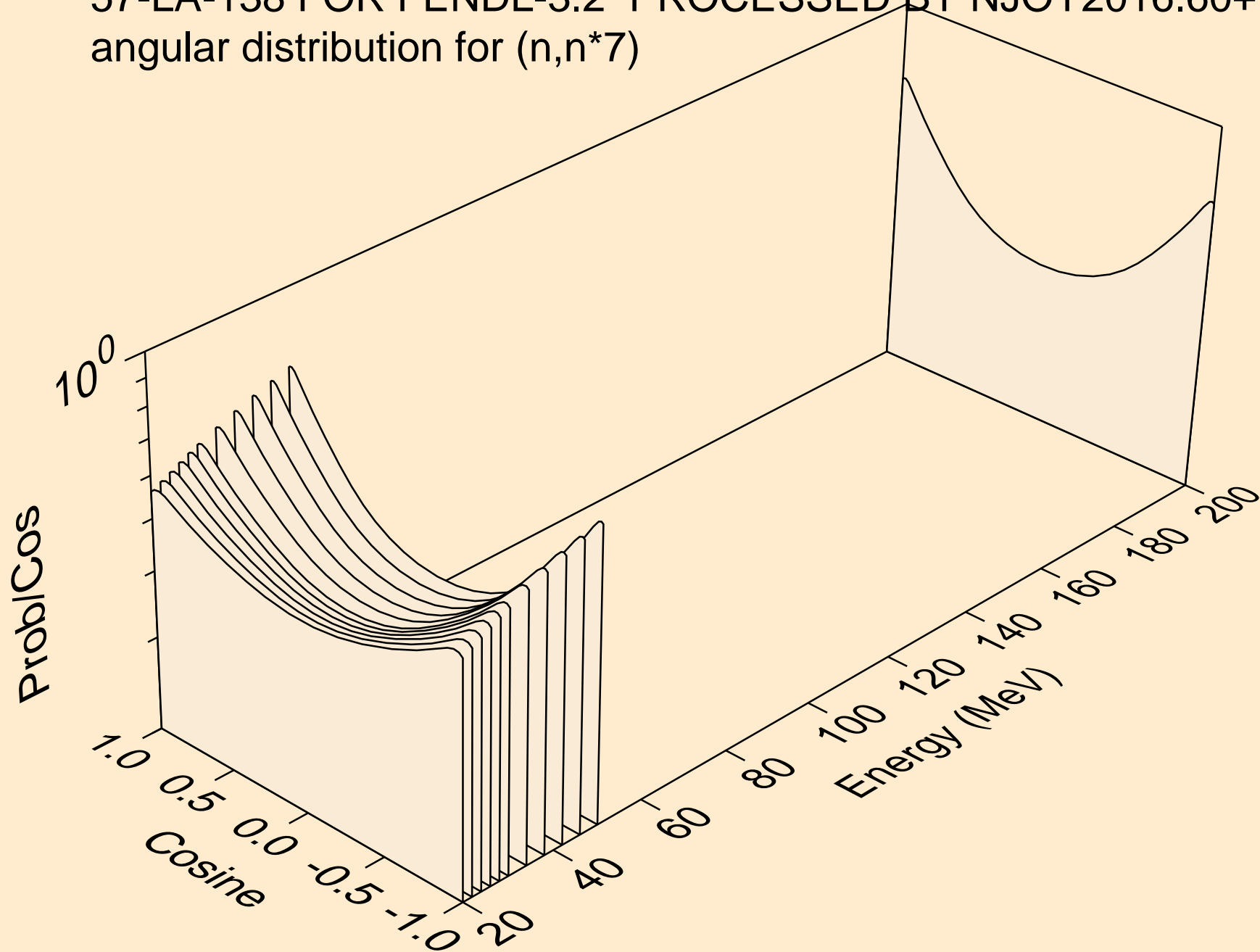

57-LA-138 FOR FENDL-3.2 PROCESSED BY NJOY2016.60+ ON
angular distribution for (n,n*8)

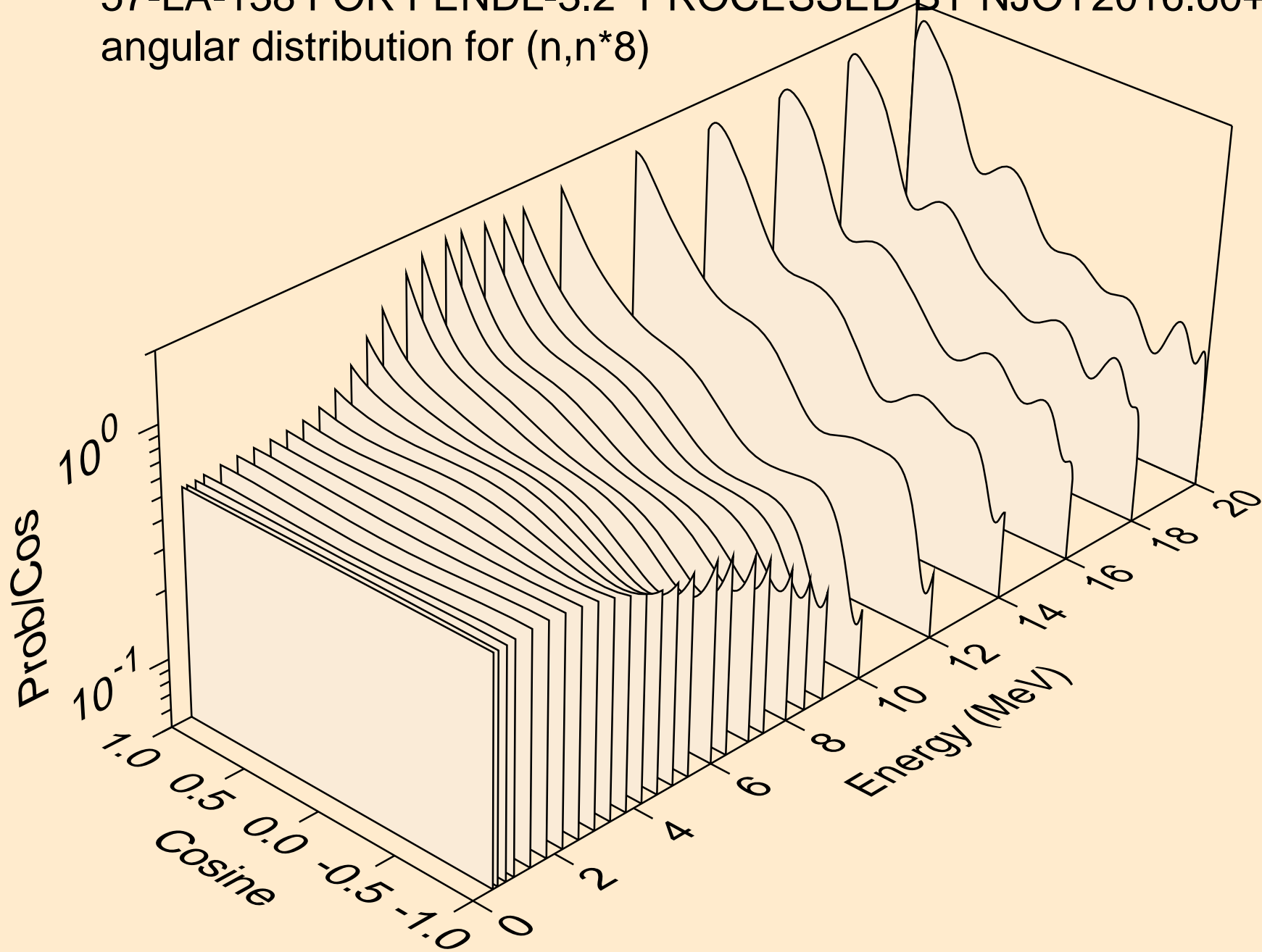

57-LA-138 FOR FENDL-3.2 PROCESSED BY NJOY2016.60+ ON
angular distribution for (n,n*8)

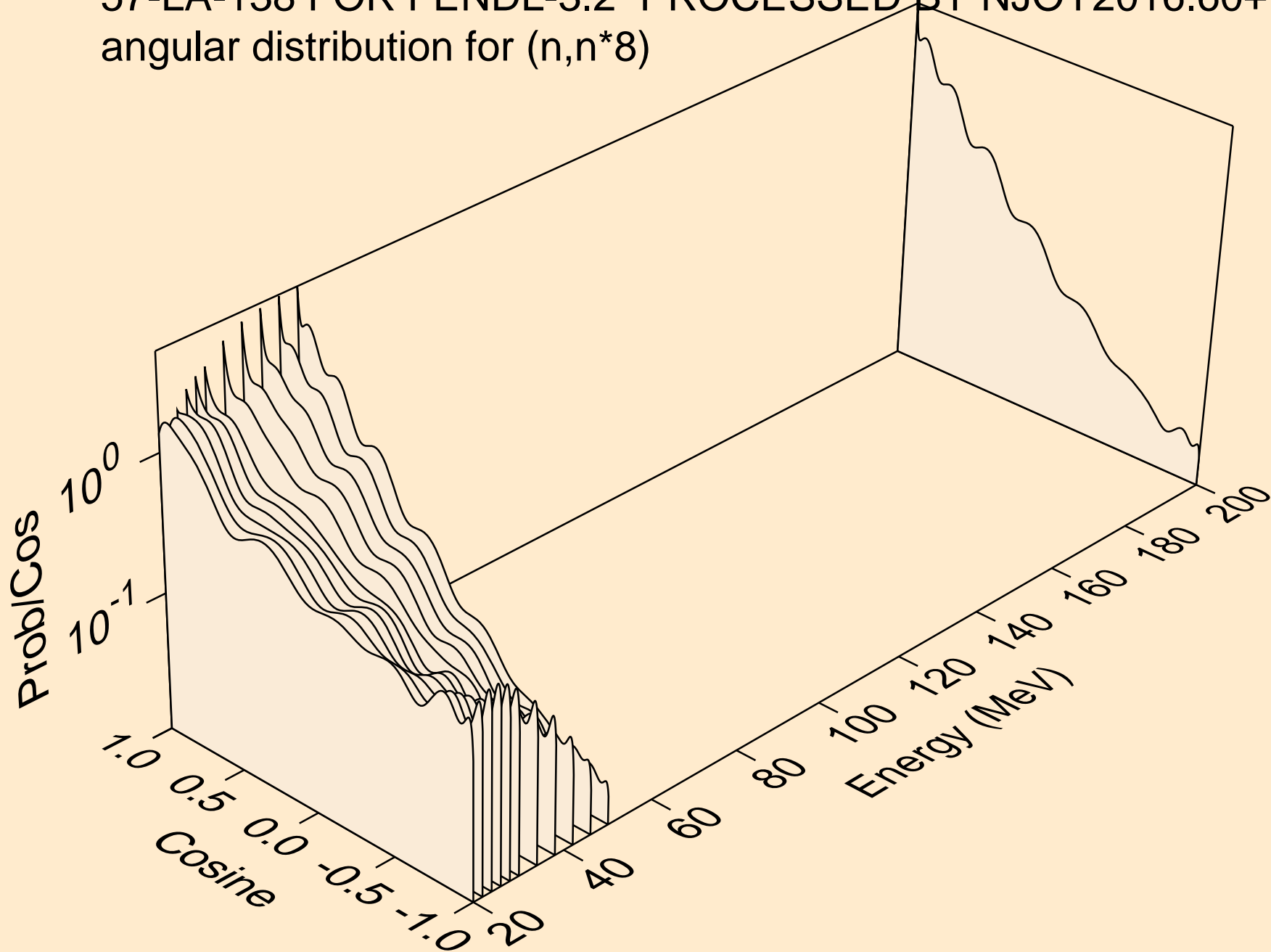

57-LA-138 FOR FENDL-3.2 PROCESSED BY NJOY2016.60+ ON
angular distribution for (n,n*9)

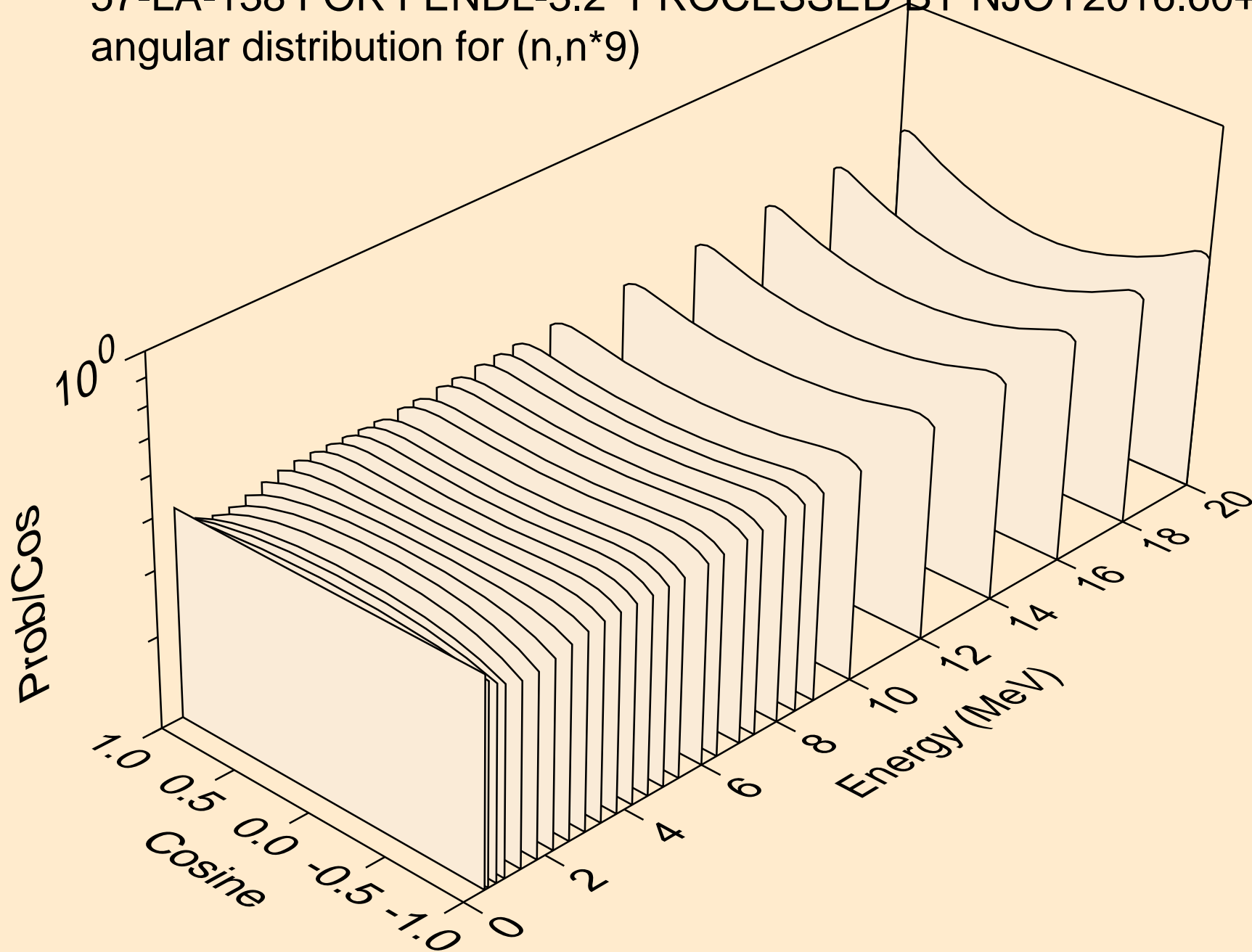

57-LA-138 FOR FENDL-3.2 PROCESSED BY NJOY2016.60+ ON
angular distribution for (n,n*9)

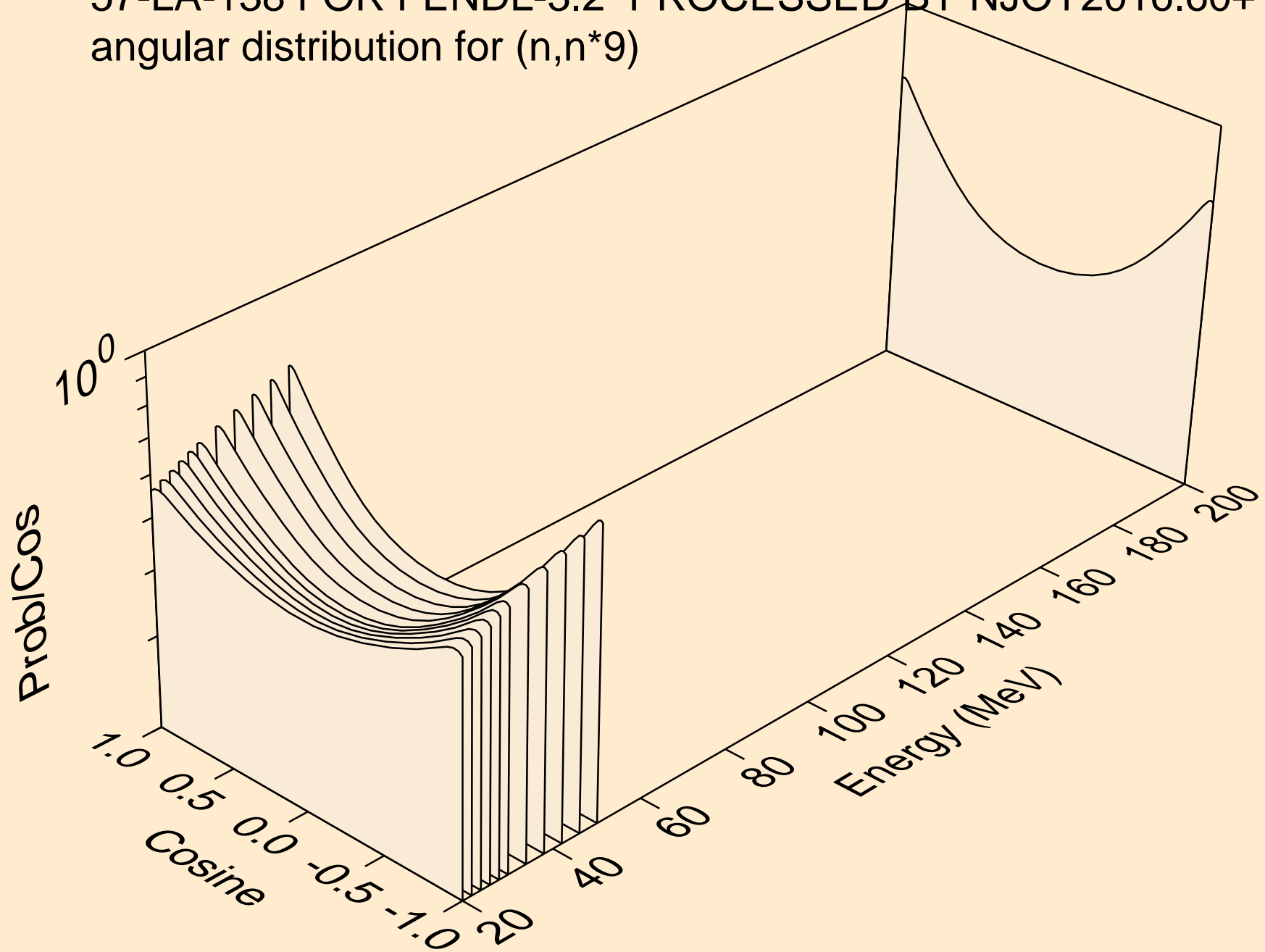

57-LA-138 FOR FENDL-3.2 PROCESSED BY NJOY2016.60+ ON
angular distribution for (n,n*10)

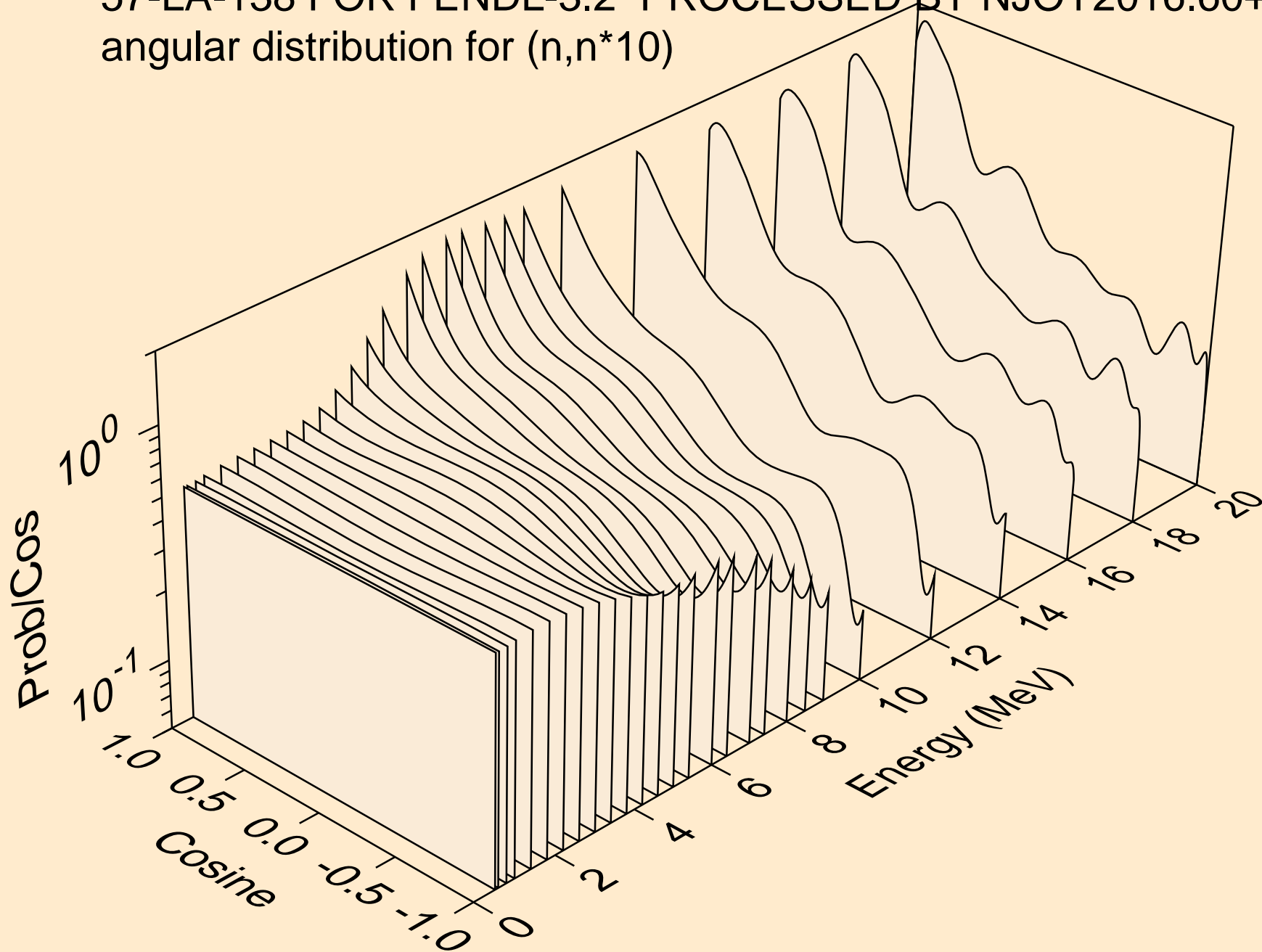

57-LA-138 FOR FENDL-3.2 PROCESSED BY NJOY2016.60+ ON
angular distribution for (n,n*10)

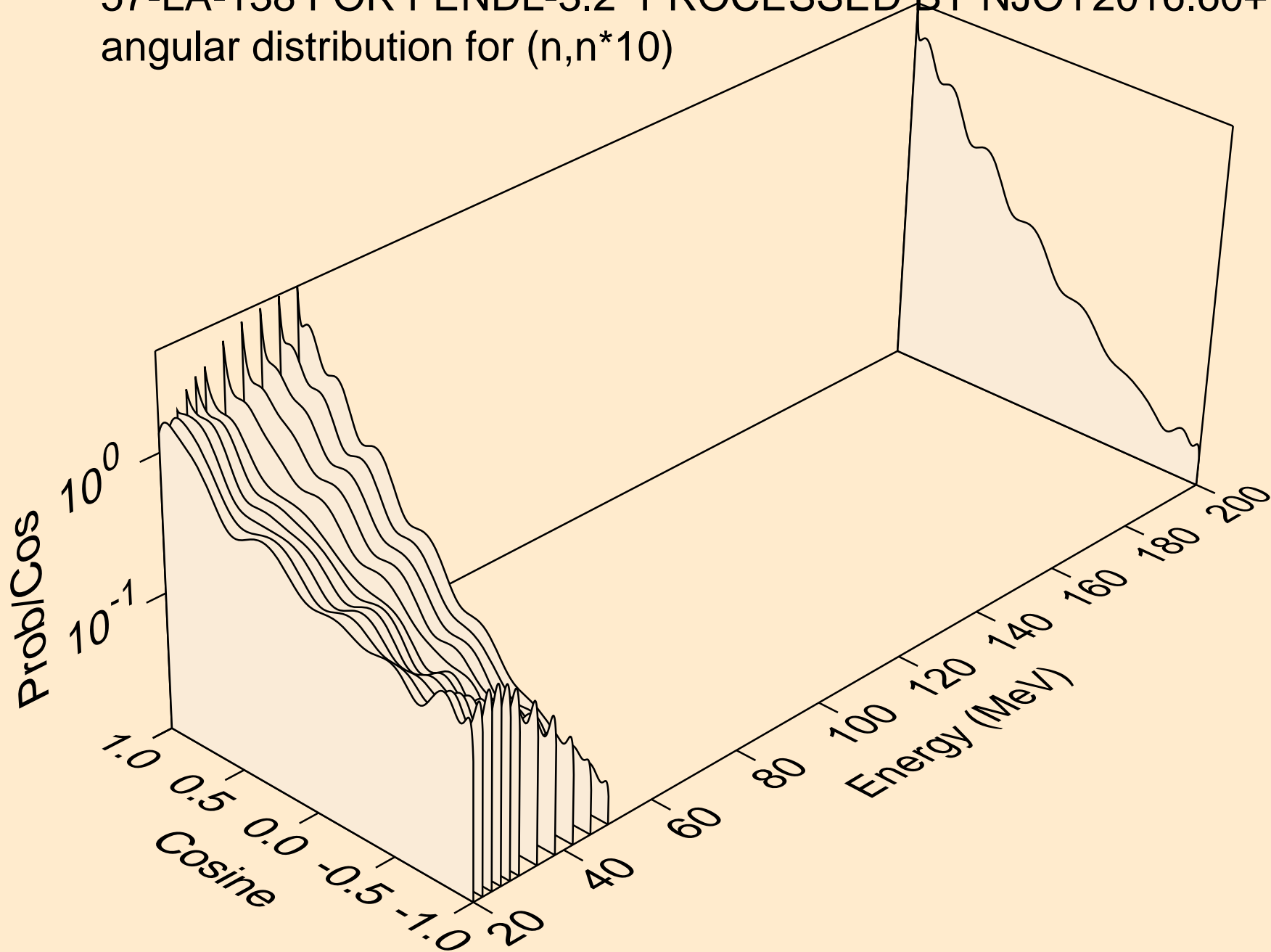

57-LA-138 FOR FENDL-3.2 PROCESSED BY NJOY2016.60+ ON
angular distribution for (n,n*11)

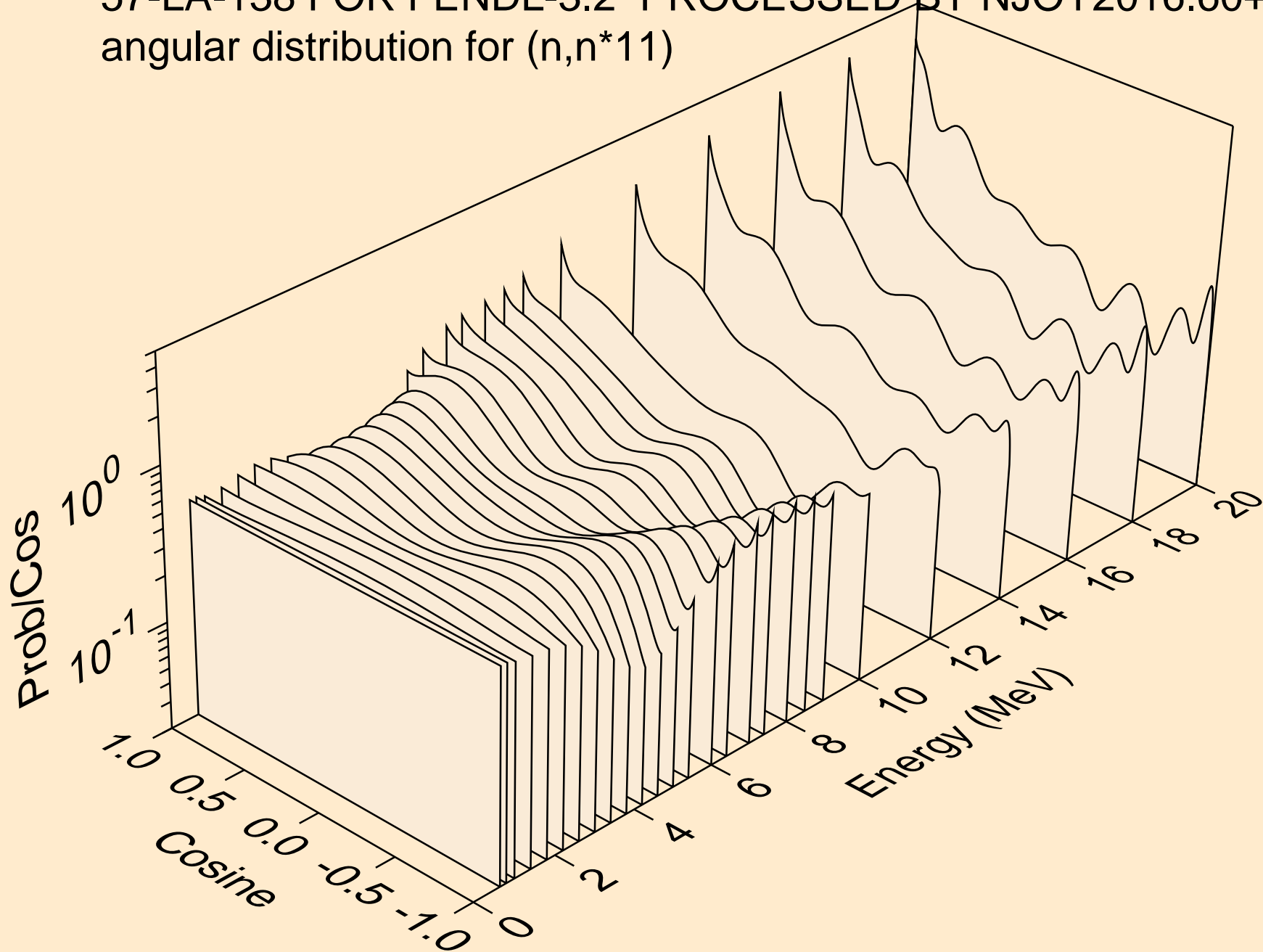

57-LA-138 FOR FENDL-3.2 PROCESSED BY NJOY2016.60+ ON
angular distribution for (n,n*11)

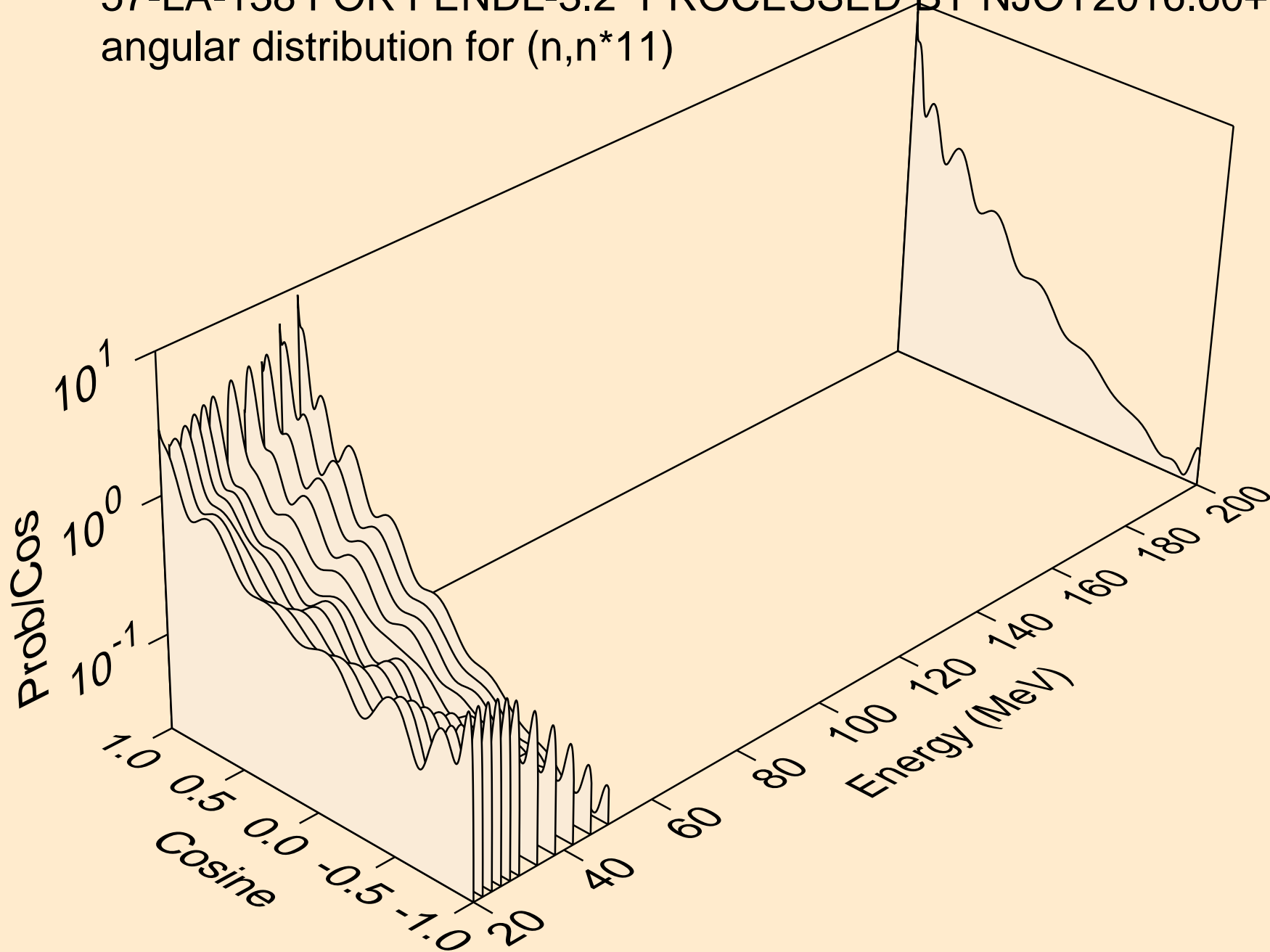

57-LA-138 FOR FENDL-3.2 PROCESSED BY NJOY2016.60+ ON
angular distribution for (n,n*12)

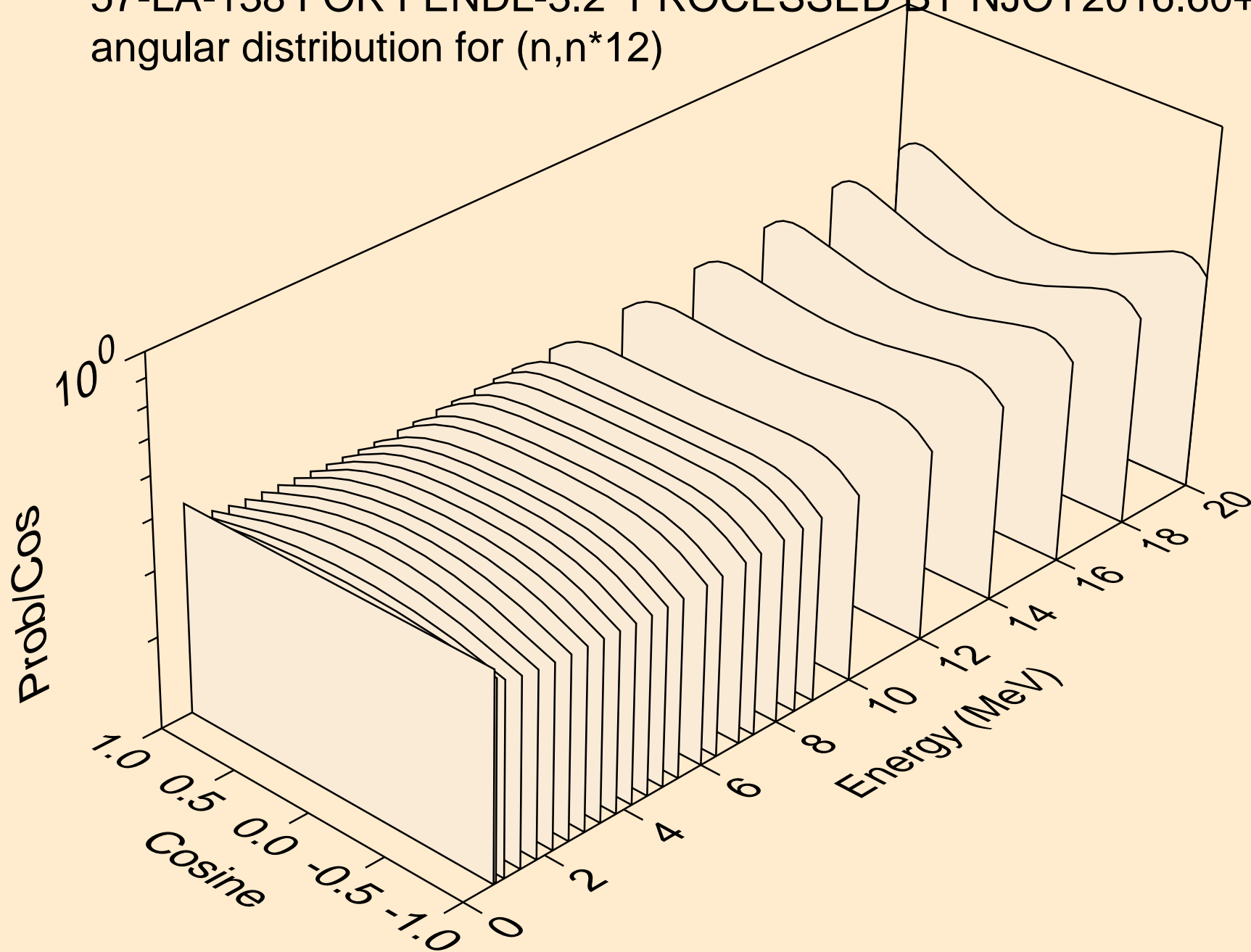

57-LA-138 FOR FENDL-3.2 PROCESSED BY NJOY2016.60+ ON
angular distribution for (n,n*12)

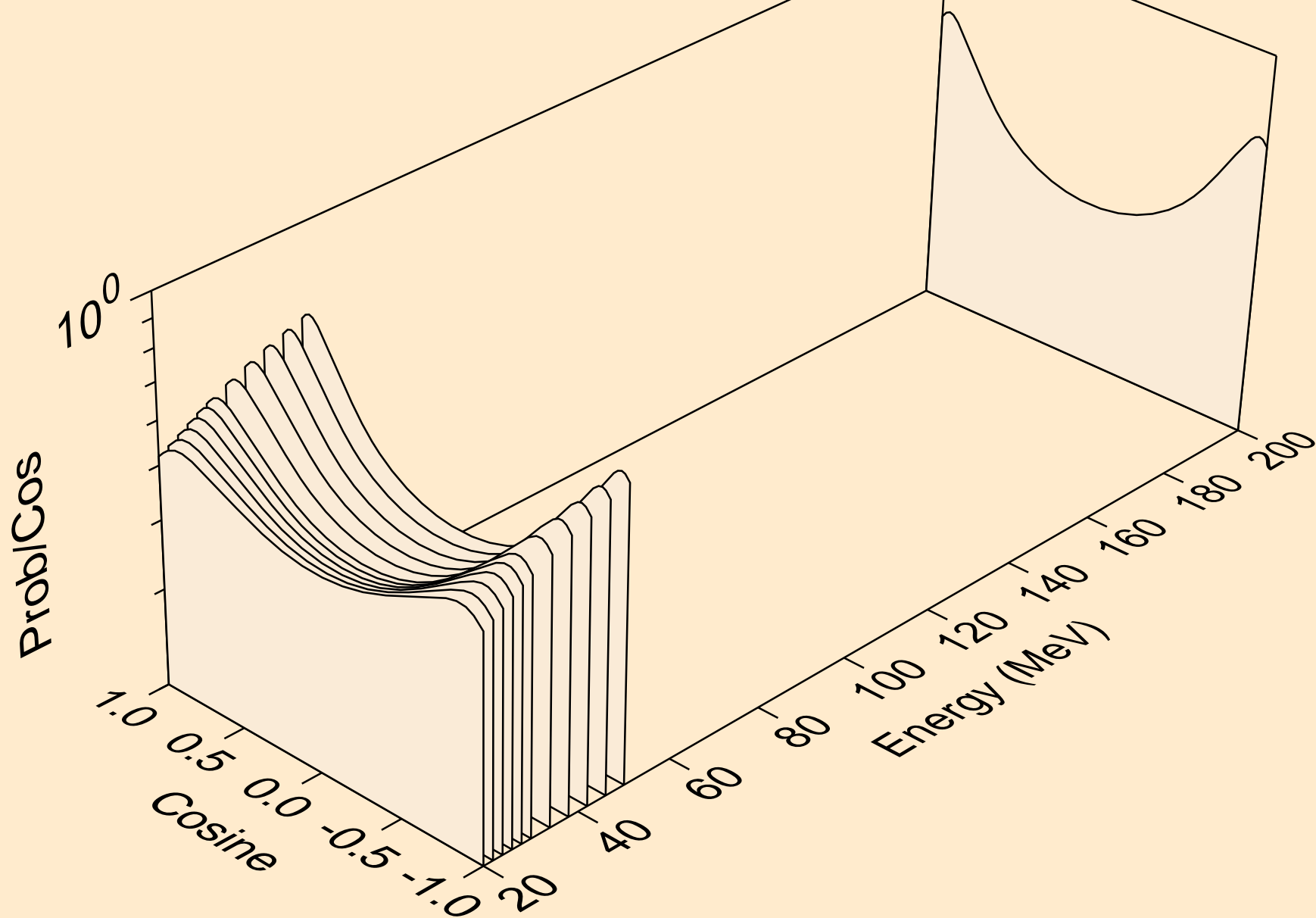

57-LA-138 FOR FENDL-3.2 PROCESSED BY NJOY2016.60+ ON
angular distribution for (n,n*13)

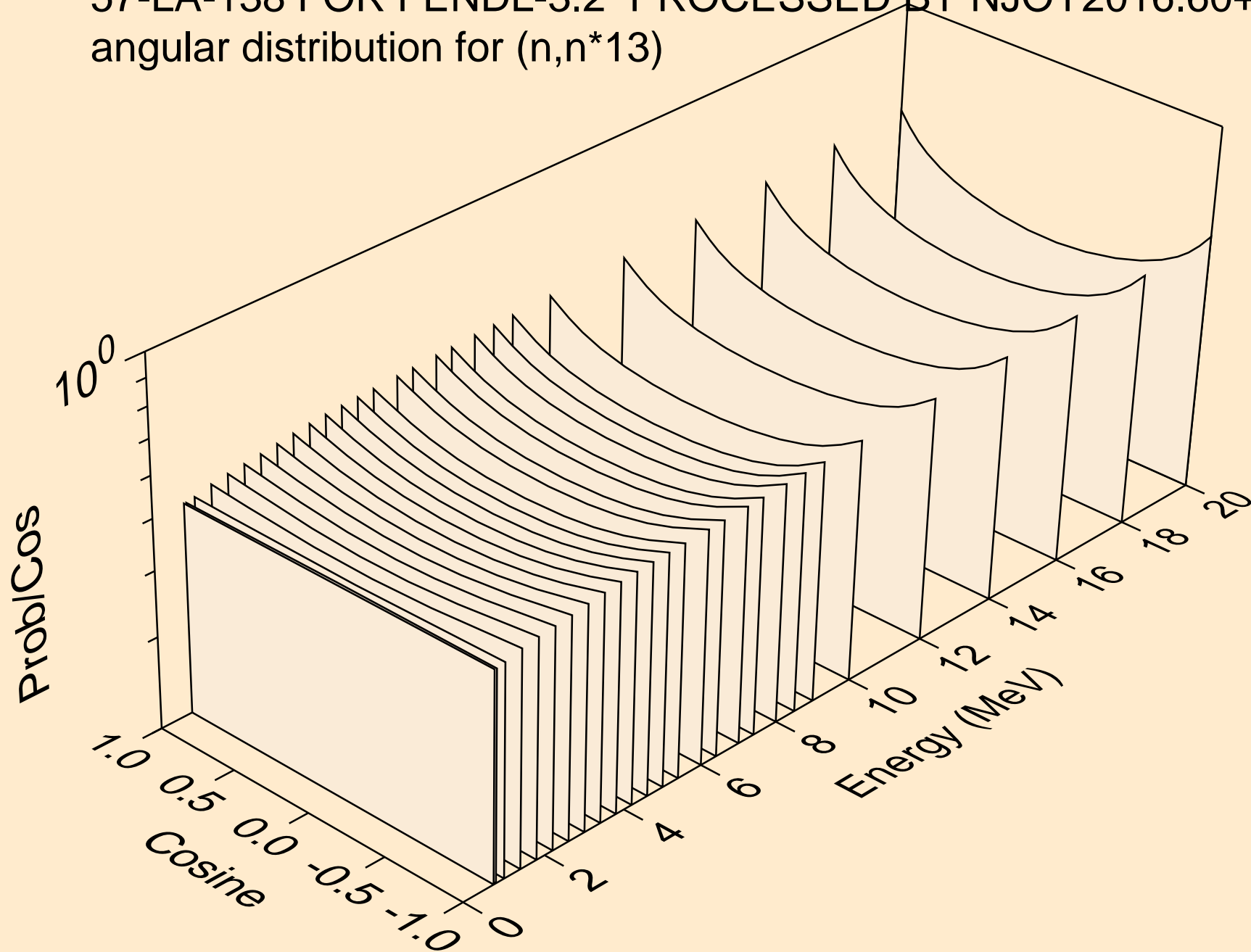

57-LA-138 FOR FENDL-3.2 PROCESSED BY NJOY2016.60+ ON
angular distribution for (n,n*13)

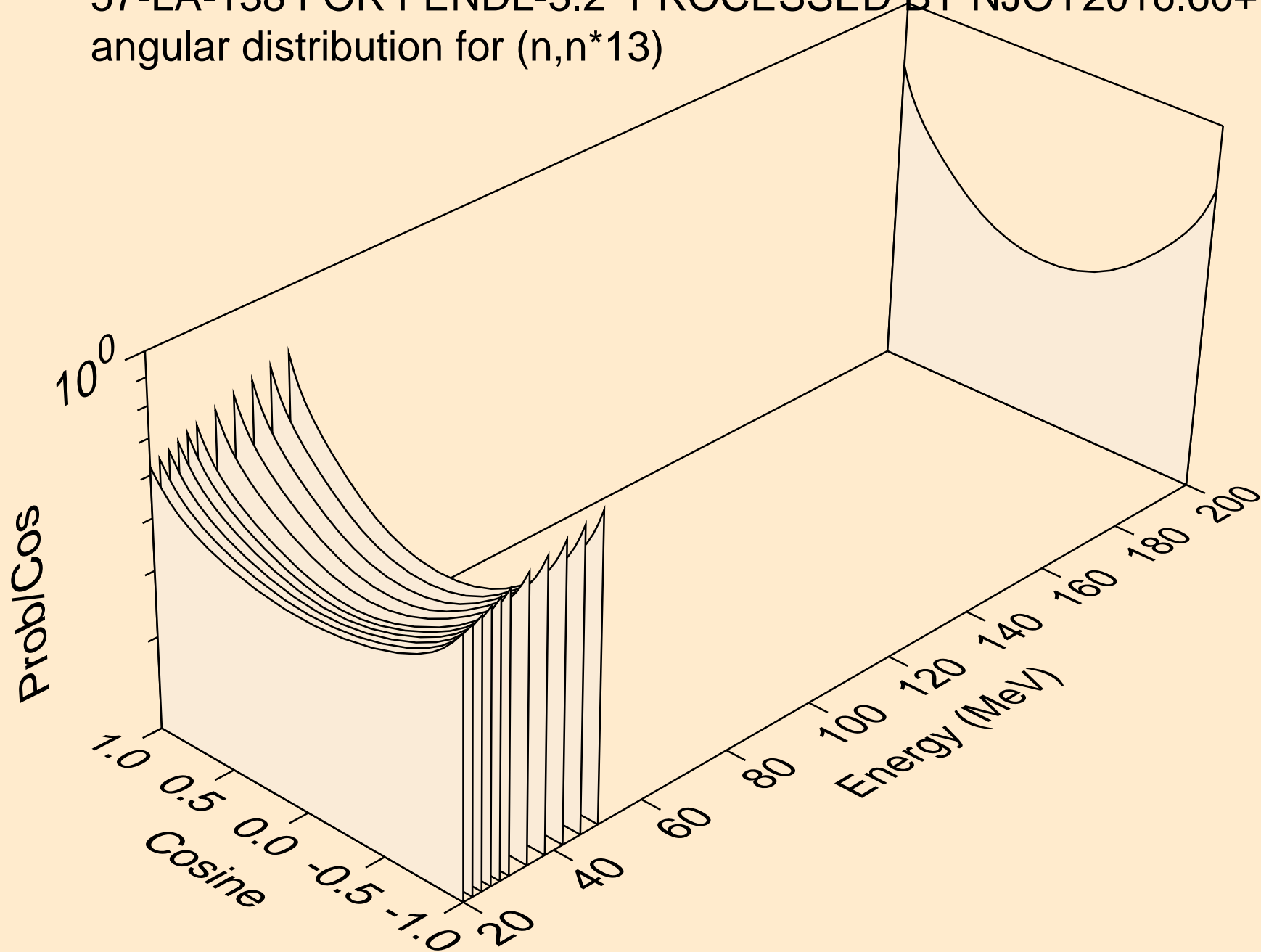

57-LA-138 FOR FENDL-3.2 PROCESSED BY NJOY2016.60+ ON
angular distribution for (n,n*14)

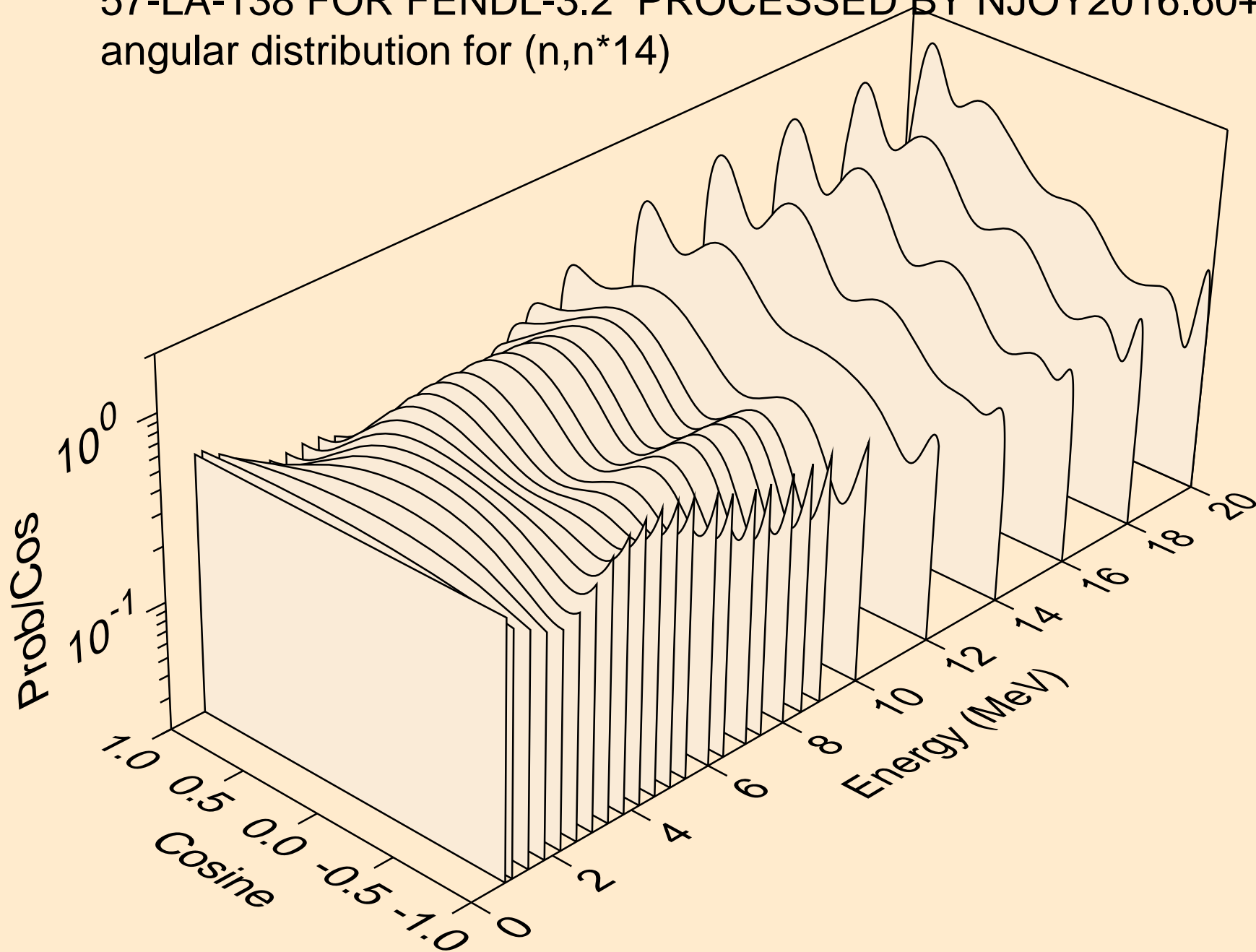

57-LA-138 FOR FENDL-3.2 PROCESSED BY NJOY2016.60+ ON
angular distribution for (n,n*14)

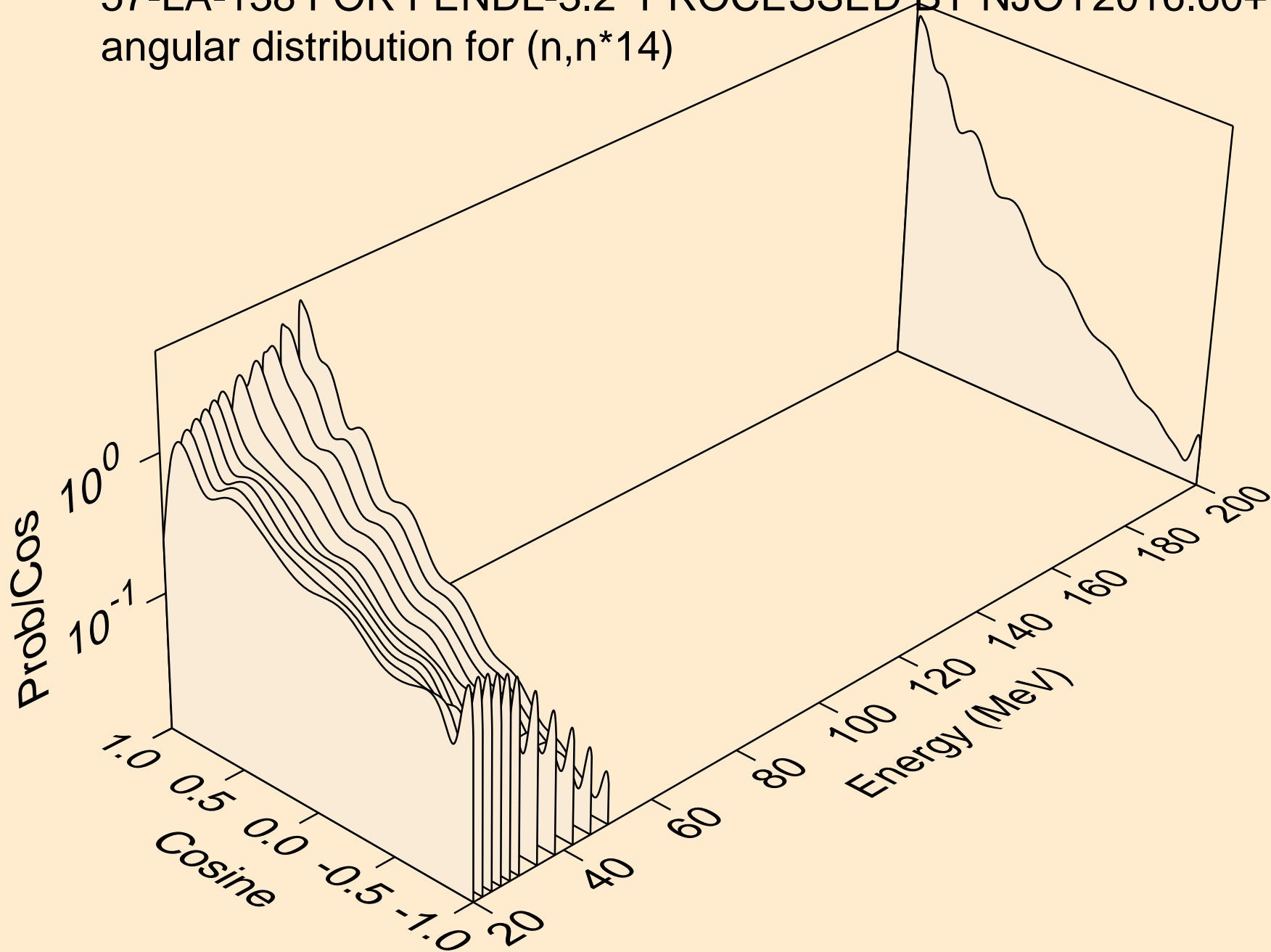

57-LA-138 FOR FENDL-3.2 PROCESSED BY NJOY2016.60+ ON
angular distribution for (n,n*15)

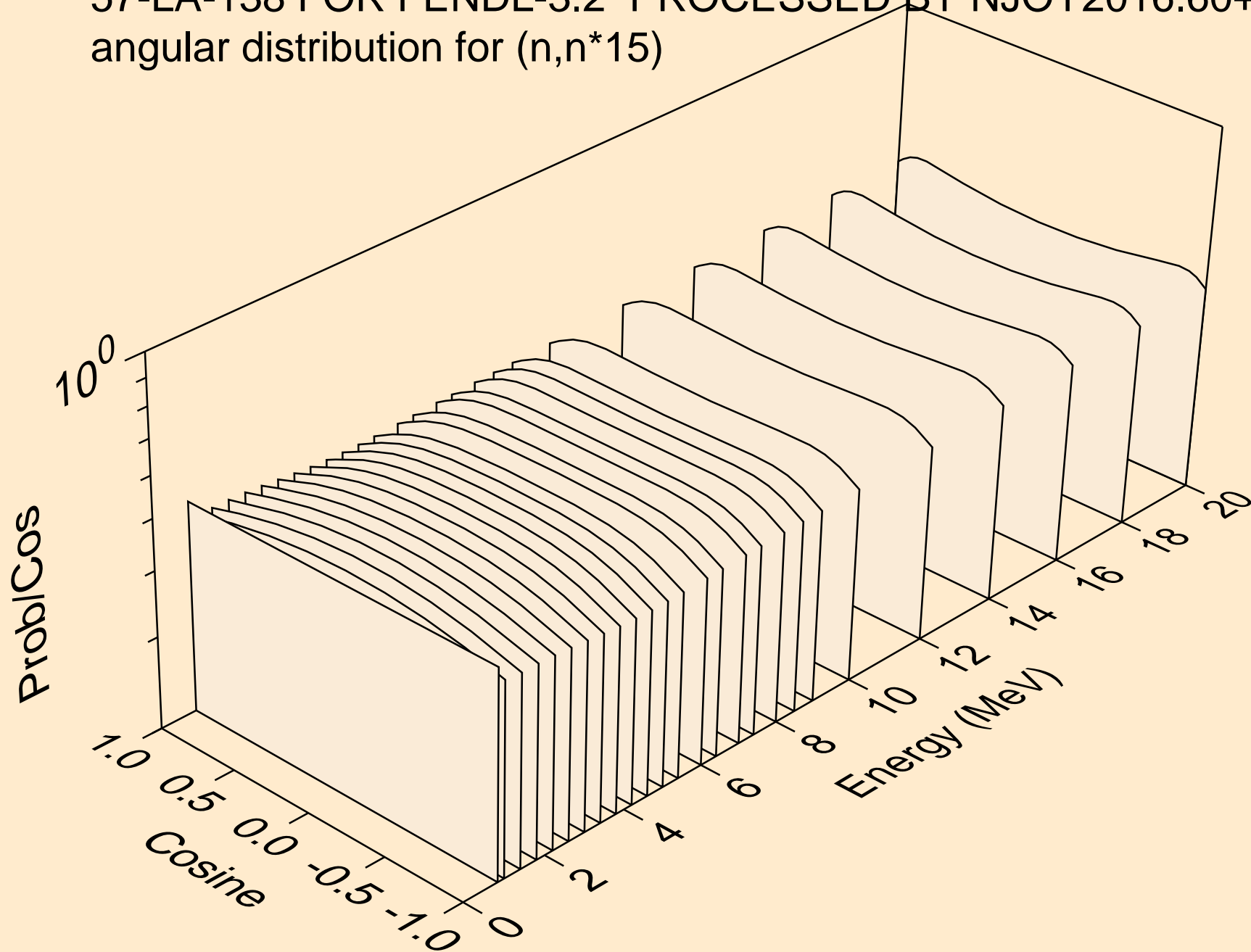

57-LA-138 FOR FENDL-3.2 PROCESSED BY NJOY2016.60+ ON
angular distribution for (n,n*15)

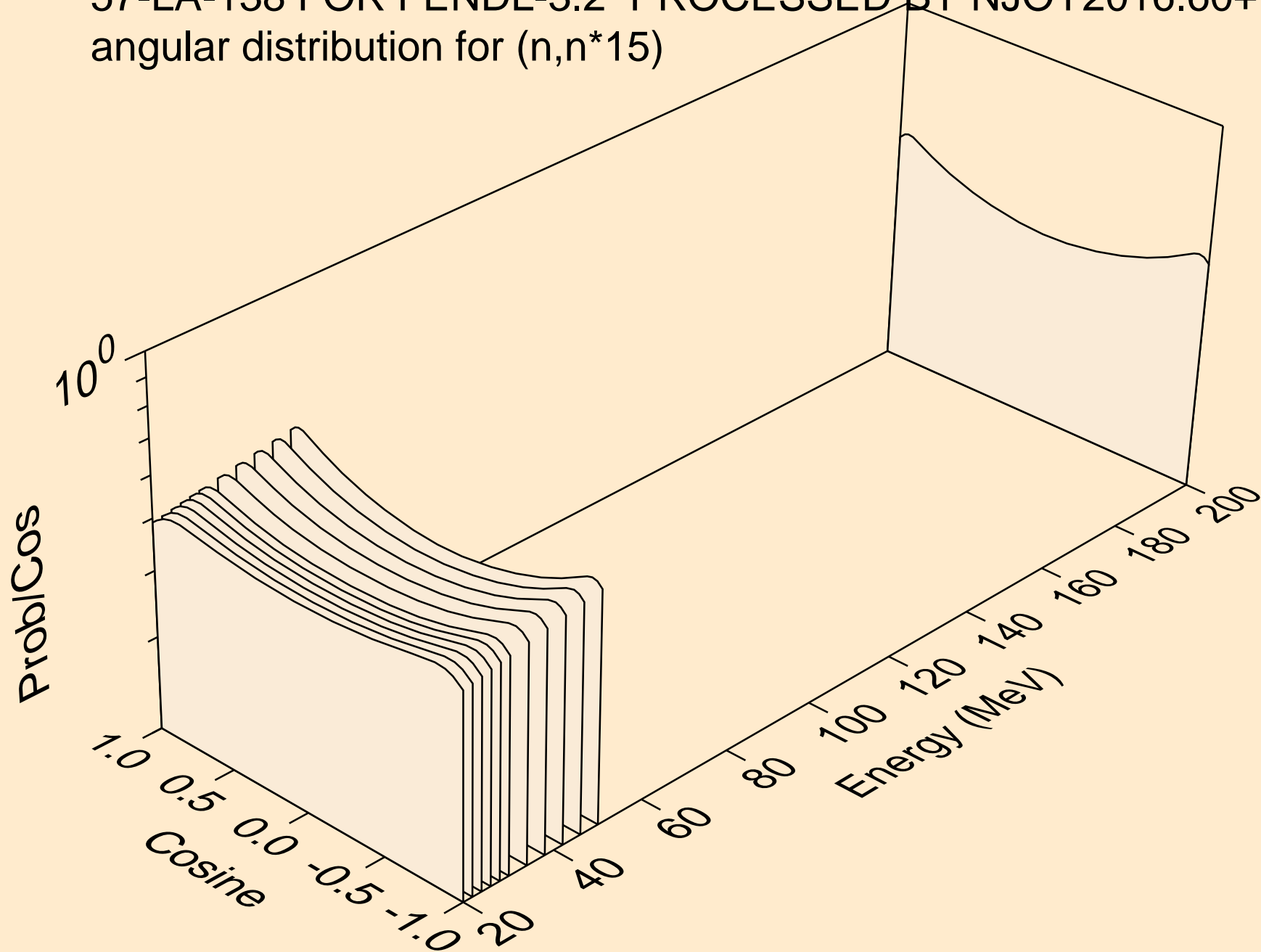

57-LA-138 FOR FENDL-3.2 PROCESSED BY NJOY2016.60+ ON
angular distribution for (n,n*16)

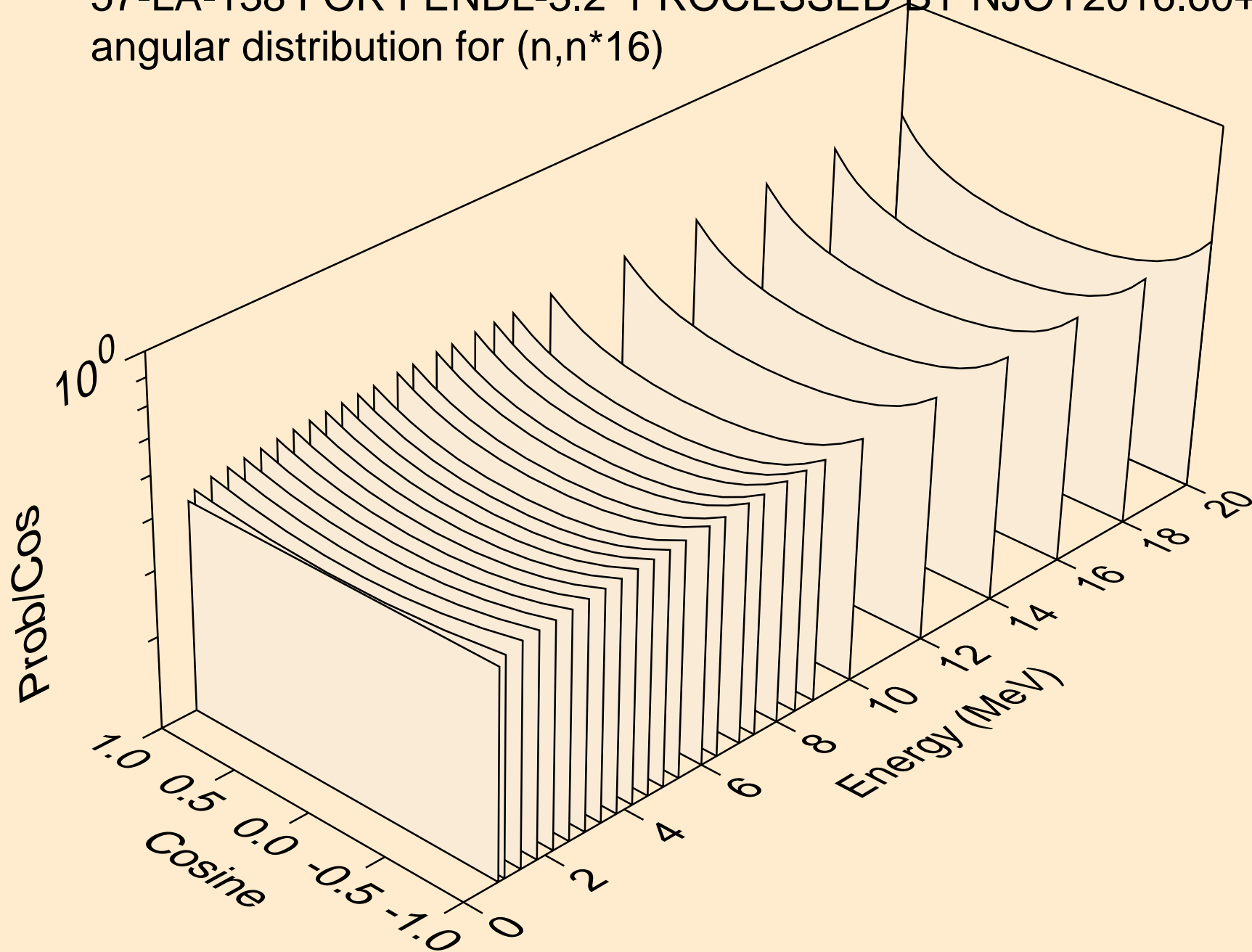

57-LA-138 FOR FENDL-3.2 PROCESSED BY NJOY2016.60+ ON
angular distribution for (n,n*16)

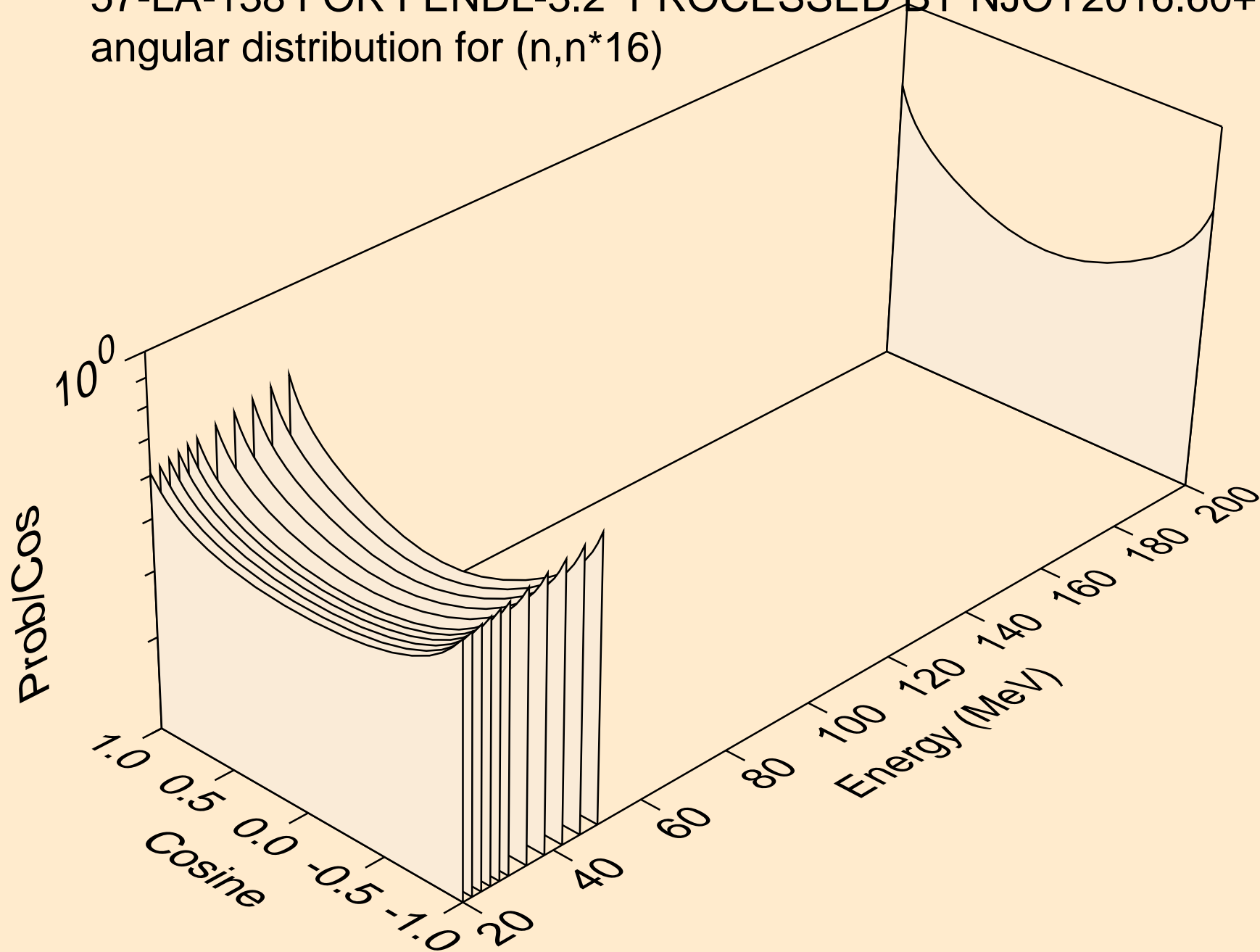

57-LA-138 FOR FENDL-3.2 PROCESSED BY NJOY2016.60+ ON
angular distribution for (n,n*17)

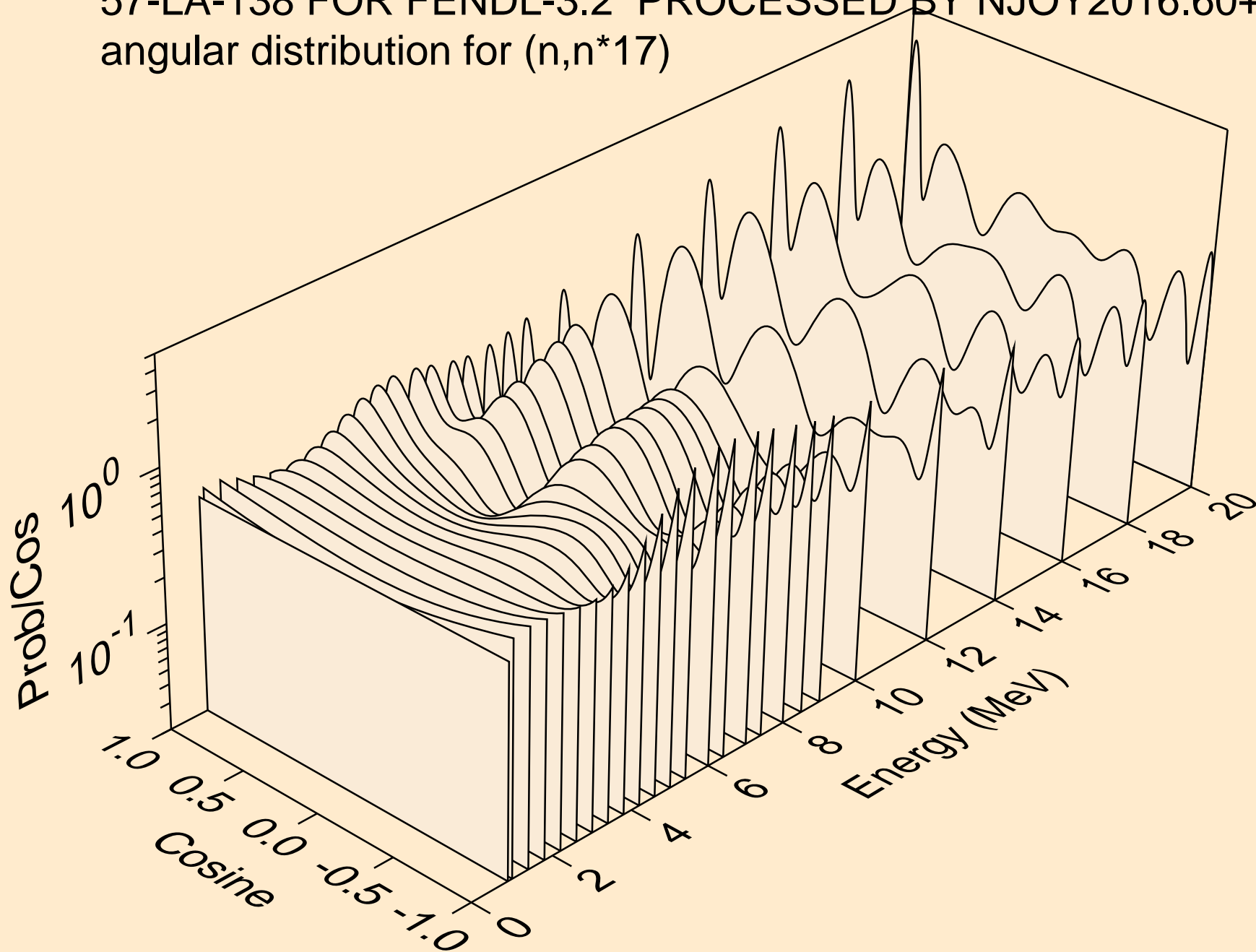

57-LA-138 FOR FENDL-3.2 PROCESSED BY NJOY2016.60+ ON
angular distribution for (n,n*17)

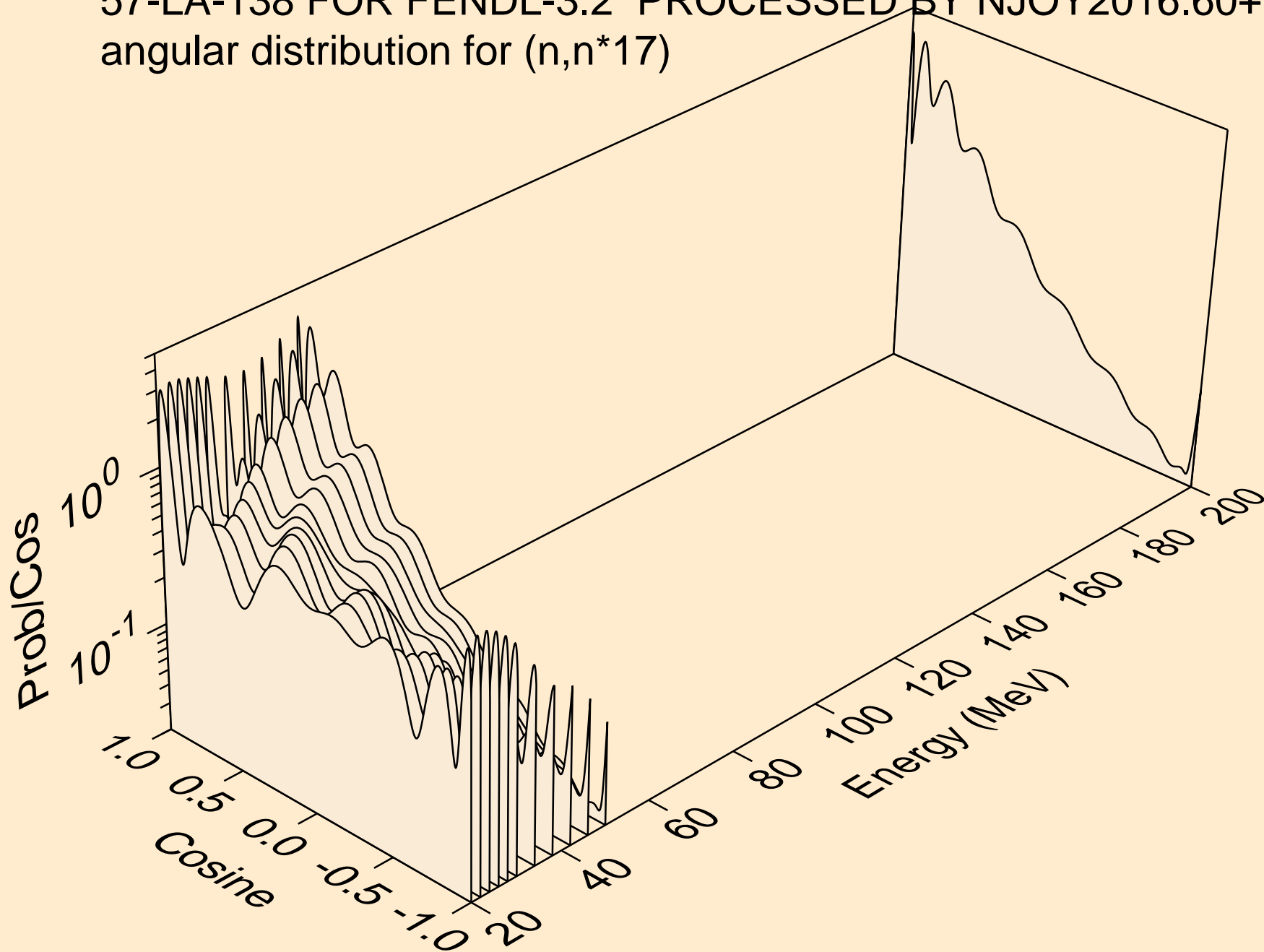

57-LA-138 FOR FENDL-3.2 PROCESSED BY NJOY2016.60+ ON
angular distribution for (n,n*18)

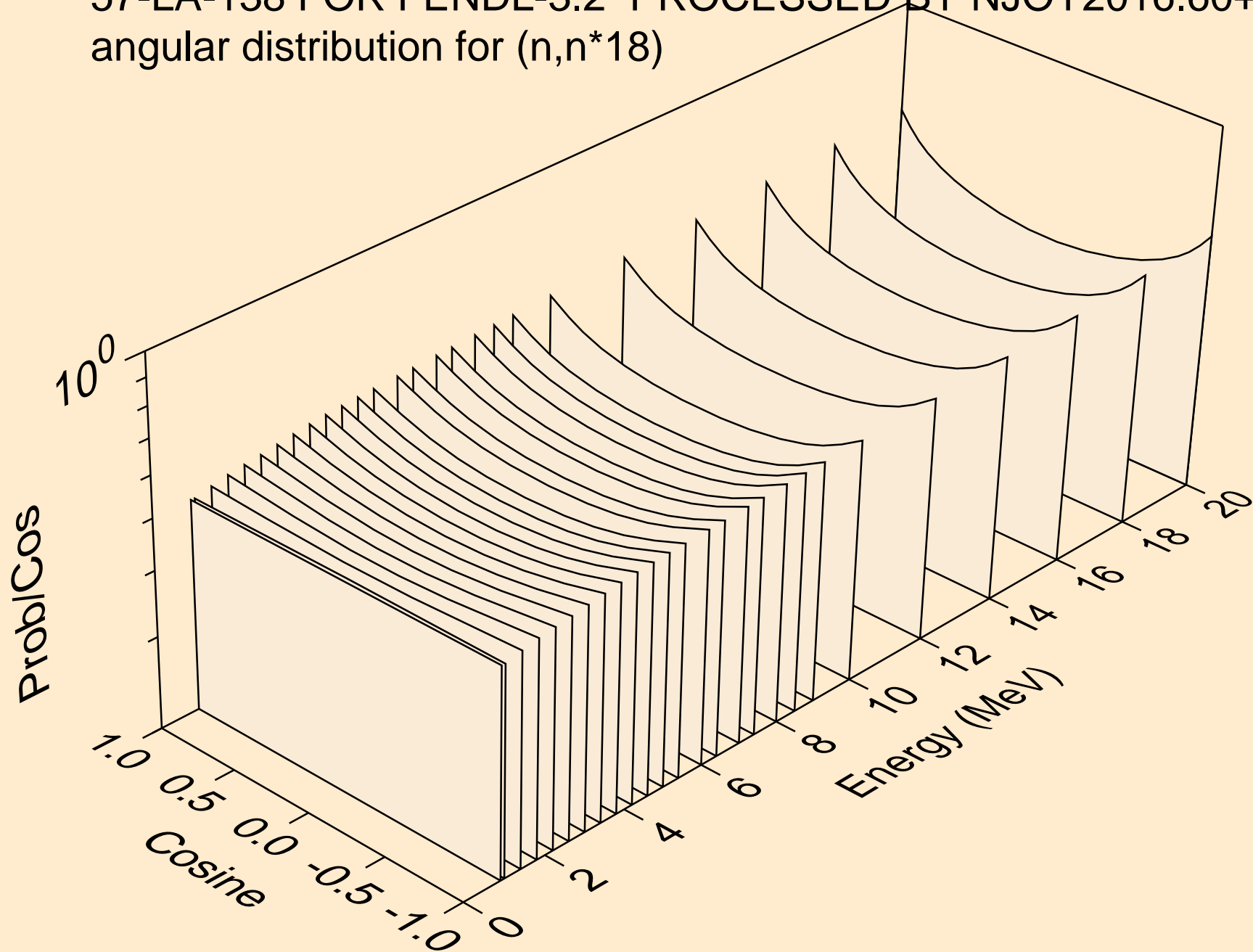

57-LA-138 FOR FENDL-3.2 PROCESSED BY NJOY2016.60+ ON
angular distribution for (n,n*18)

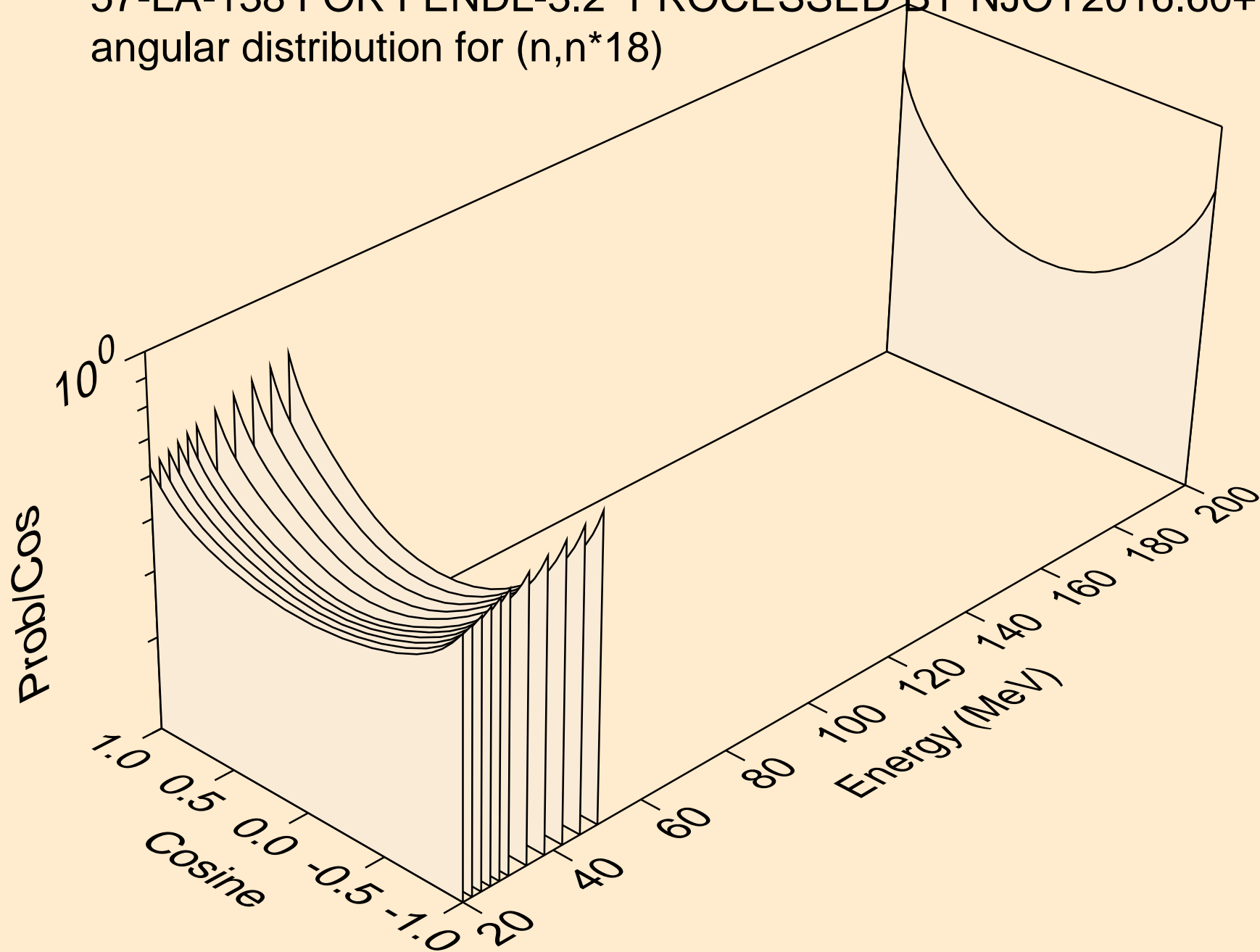

57-LA-138 FOR FENDL-3.2 PROCESSED BY NJOY2016.60+ ON
angular distribution for (n,n*19)

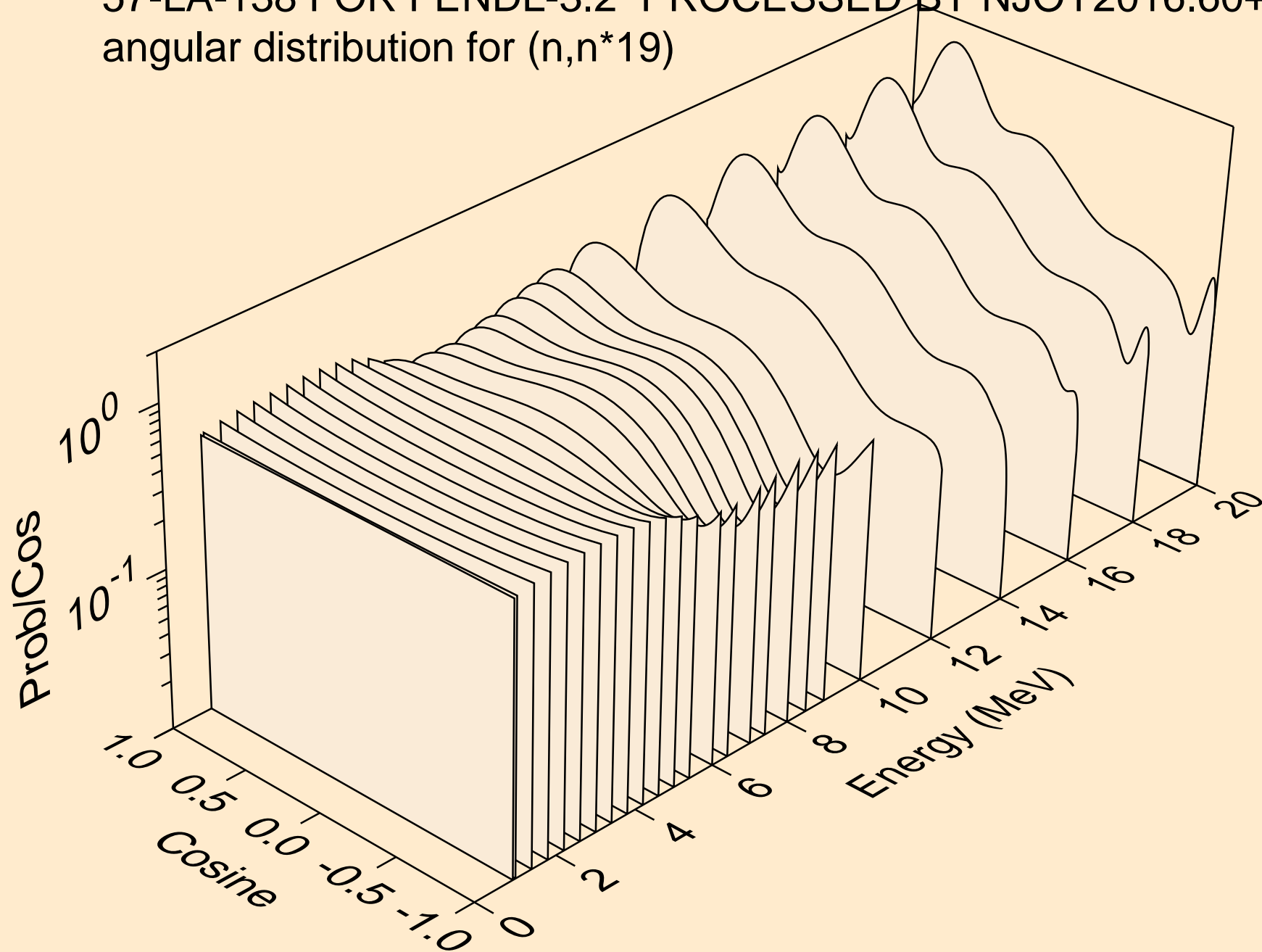

57-LA-138 FOR FENDL-3.2 PROCESSED BY NJOY2016.60+ ON
angular distribution for (n,n*19)

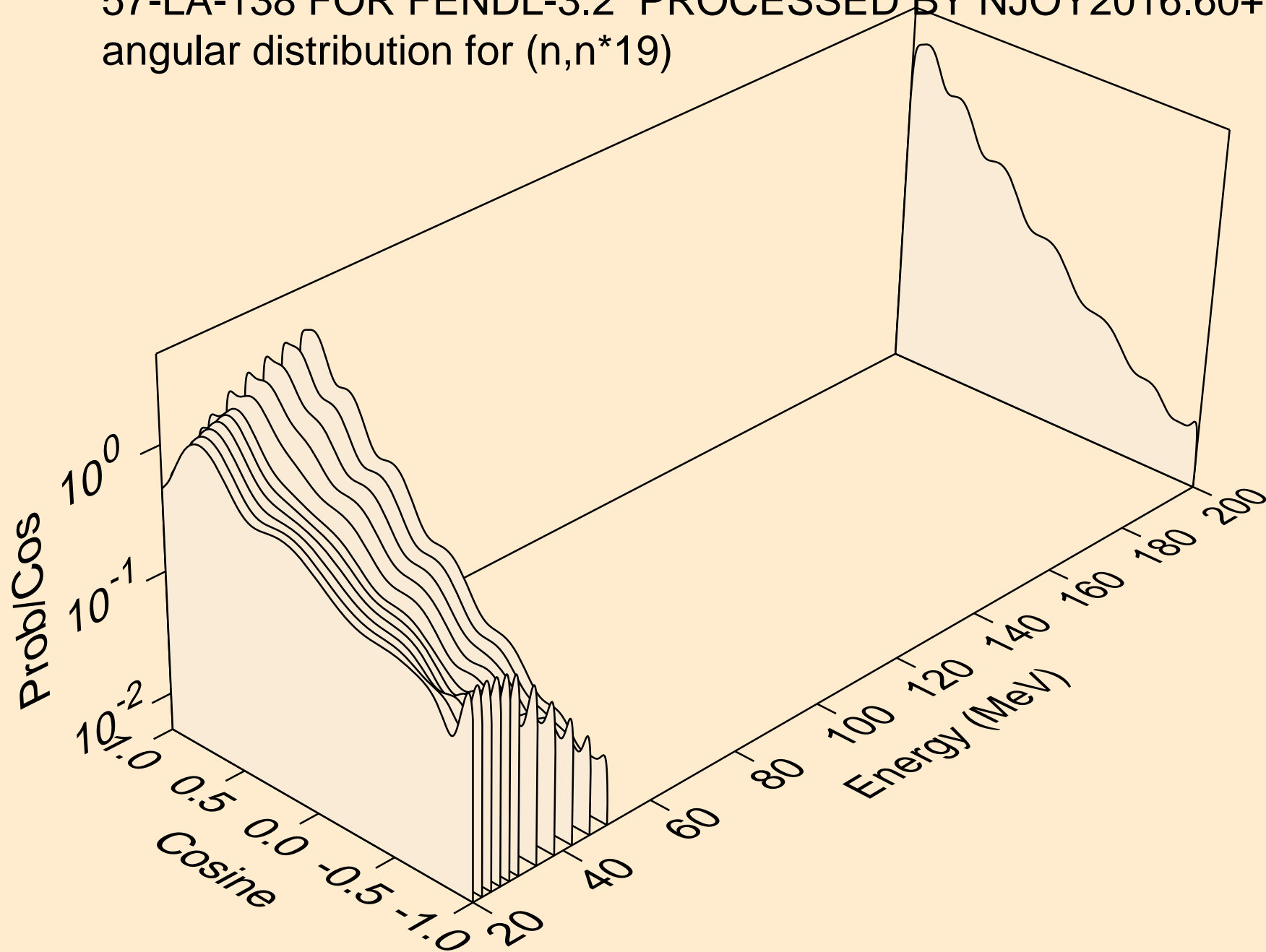

57-LA-138 FOR FENDL-3.2 PROCESSED BY NJOY2016.60+ ON
angular distribution for (n,n*20)

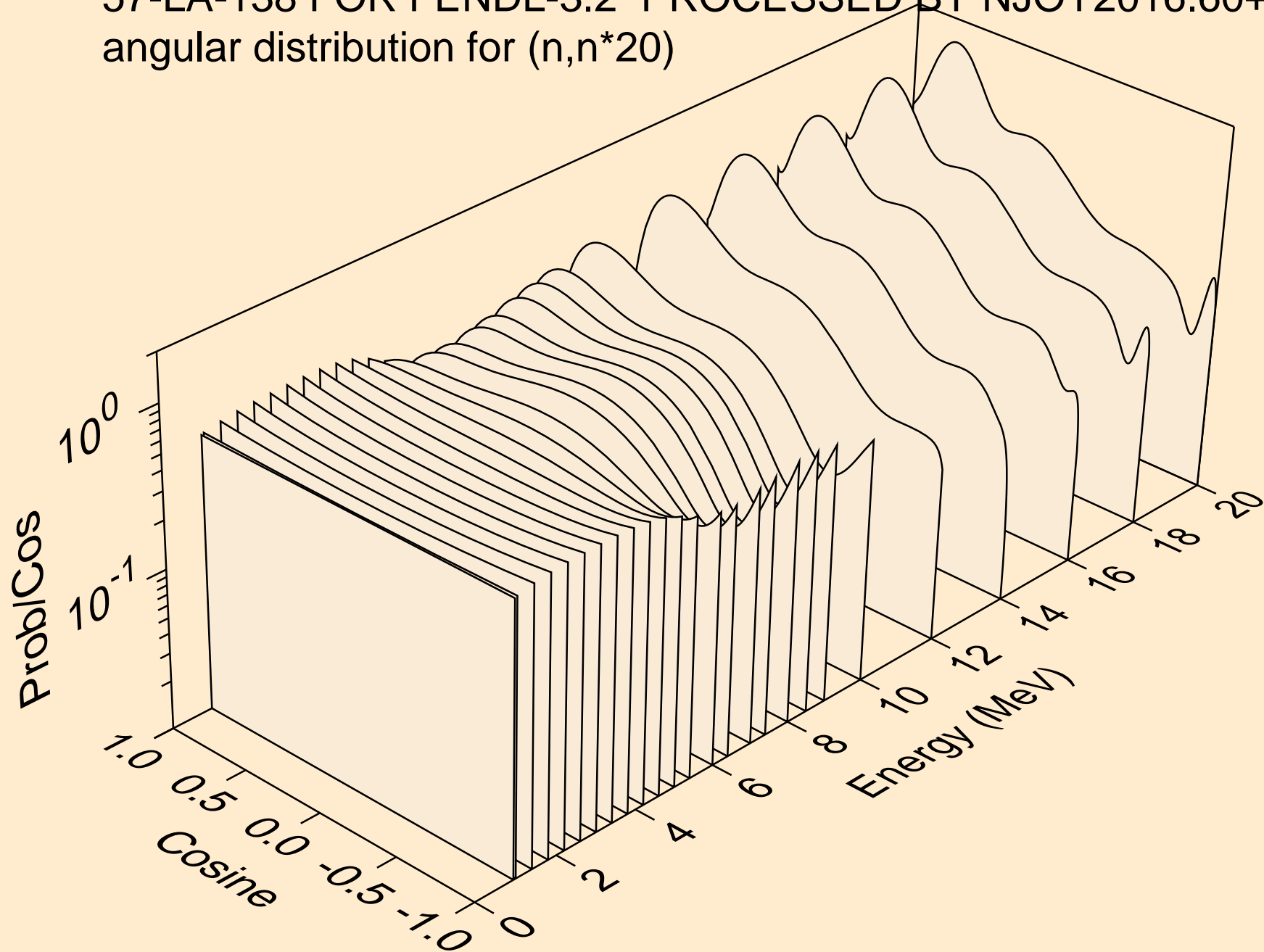

57-LA-138 FOR FENDL-3.2 PROCESSED BY NJOY2016.60+ ON
angular distribution for (n,n*20)

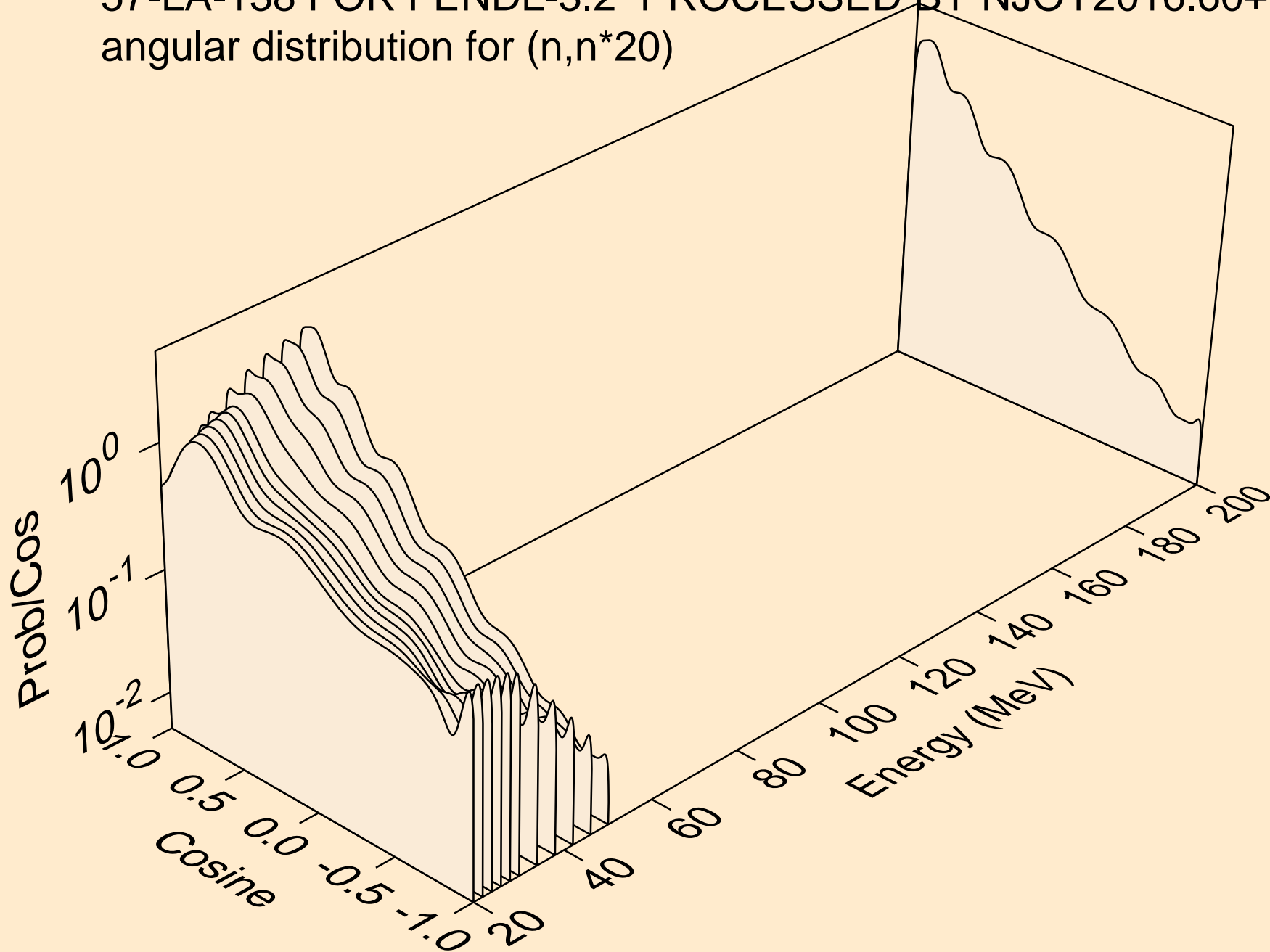

57-LA-138 FOR FENDL-3.2 PROCESSED BY NJOY2016.60+ ON
angular distribution for (n,n*21)

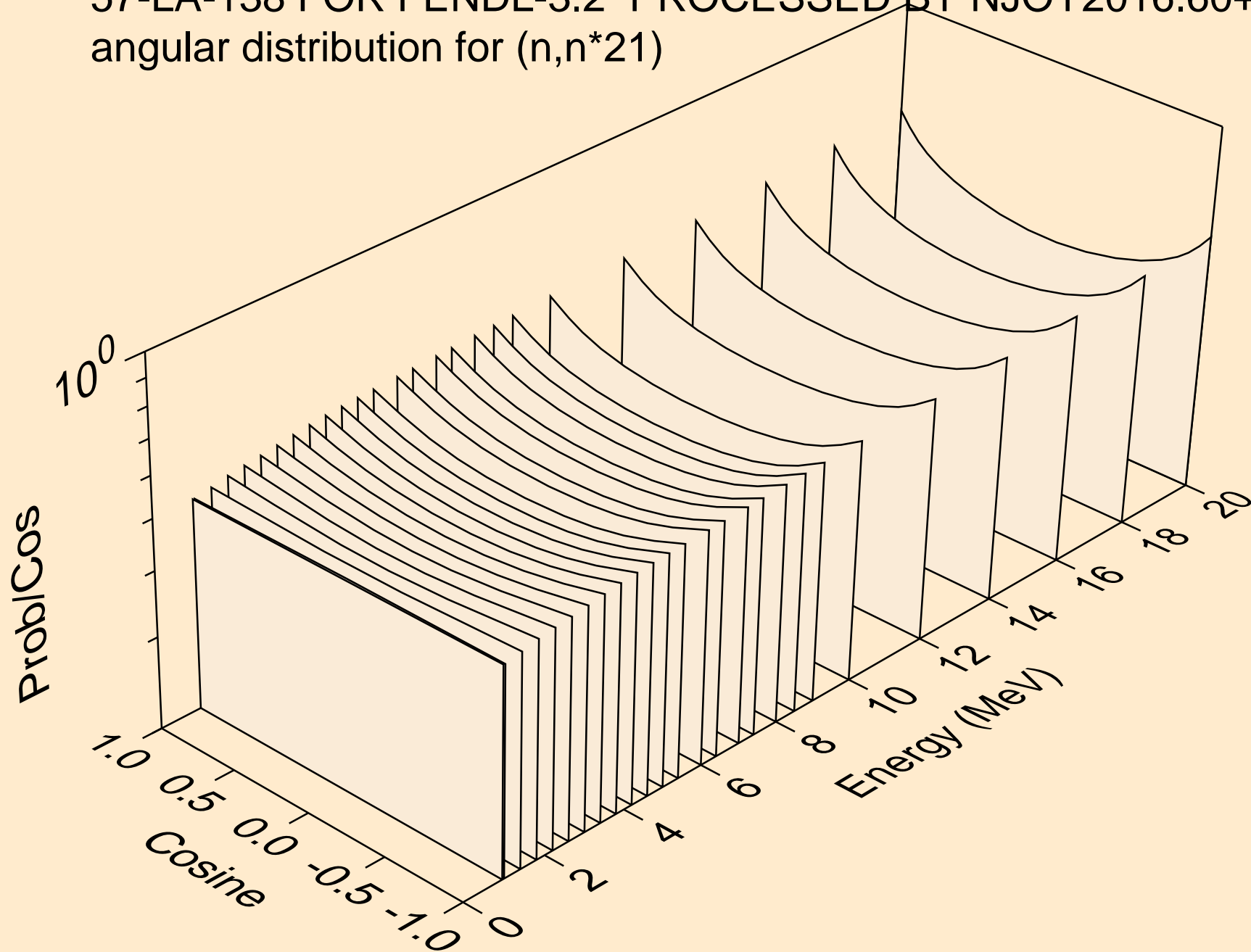

57-LA-138 FOR FENDL-3.2 PROCESSED BY NJOY2016.60+ ON
angular distribution for (n,n*21)

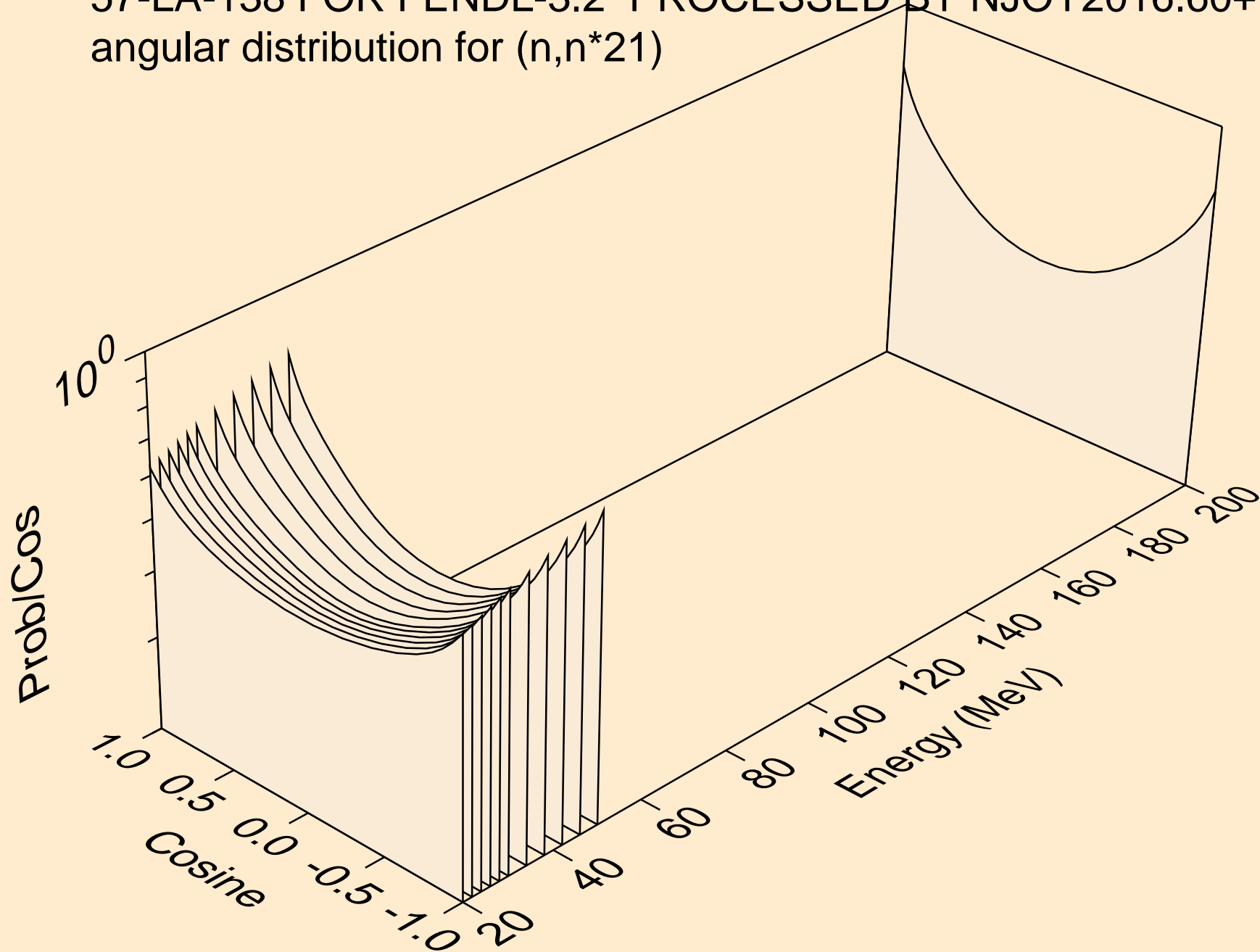

57-LA-138 FOR FENDL-3.2 PROCESSED BY NJOY2016.60+ ON
angular distribution for (n,n*22)

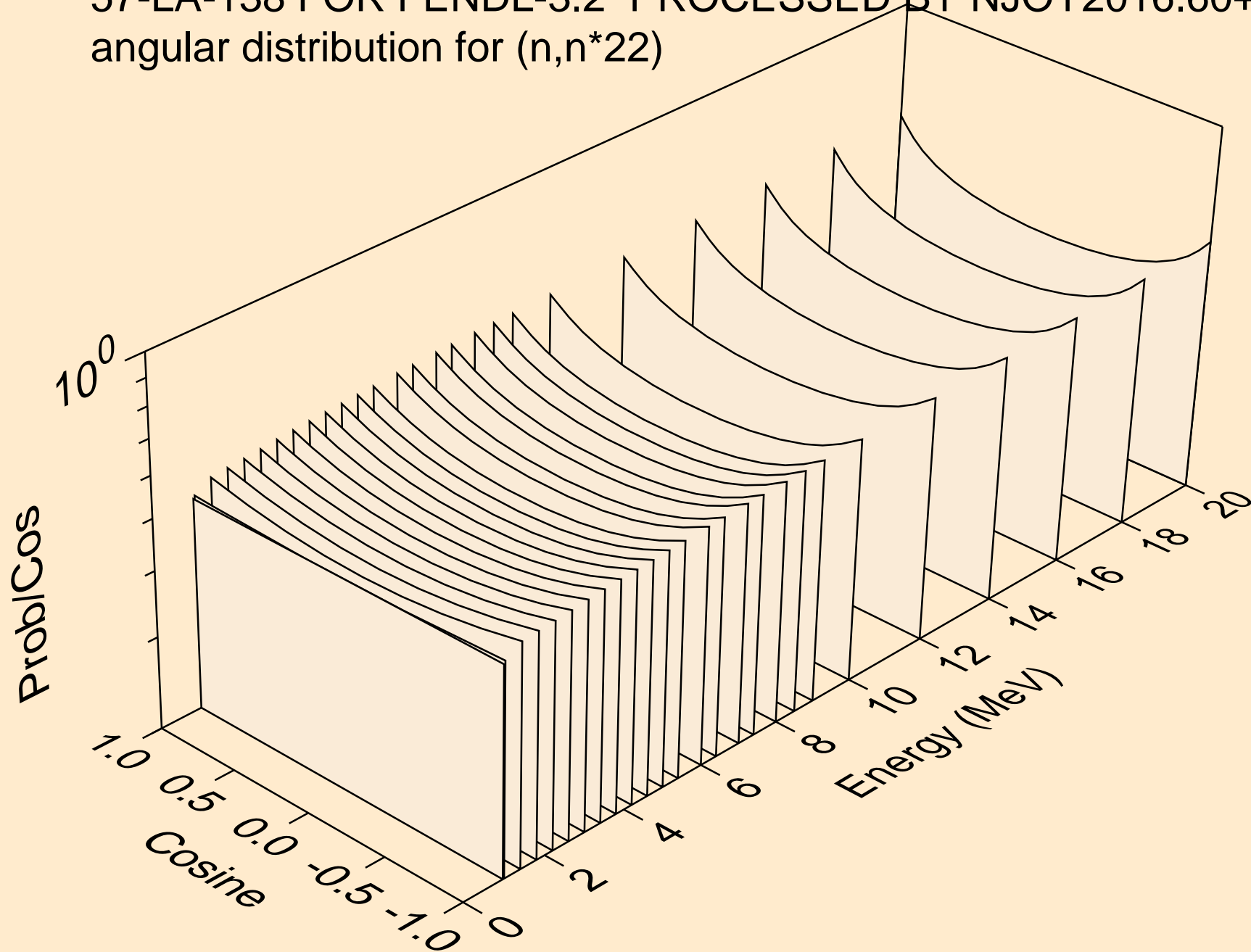

57-LA-138 FOR FENDL-3.2 PROCESSED BY NJOY2016.60+ ON
angular distribution for (n,n*22)

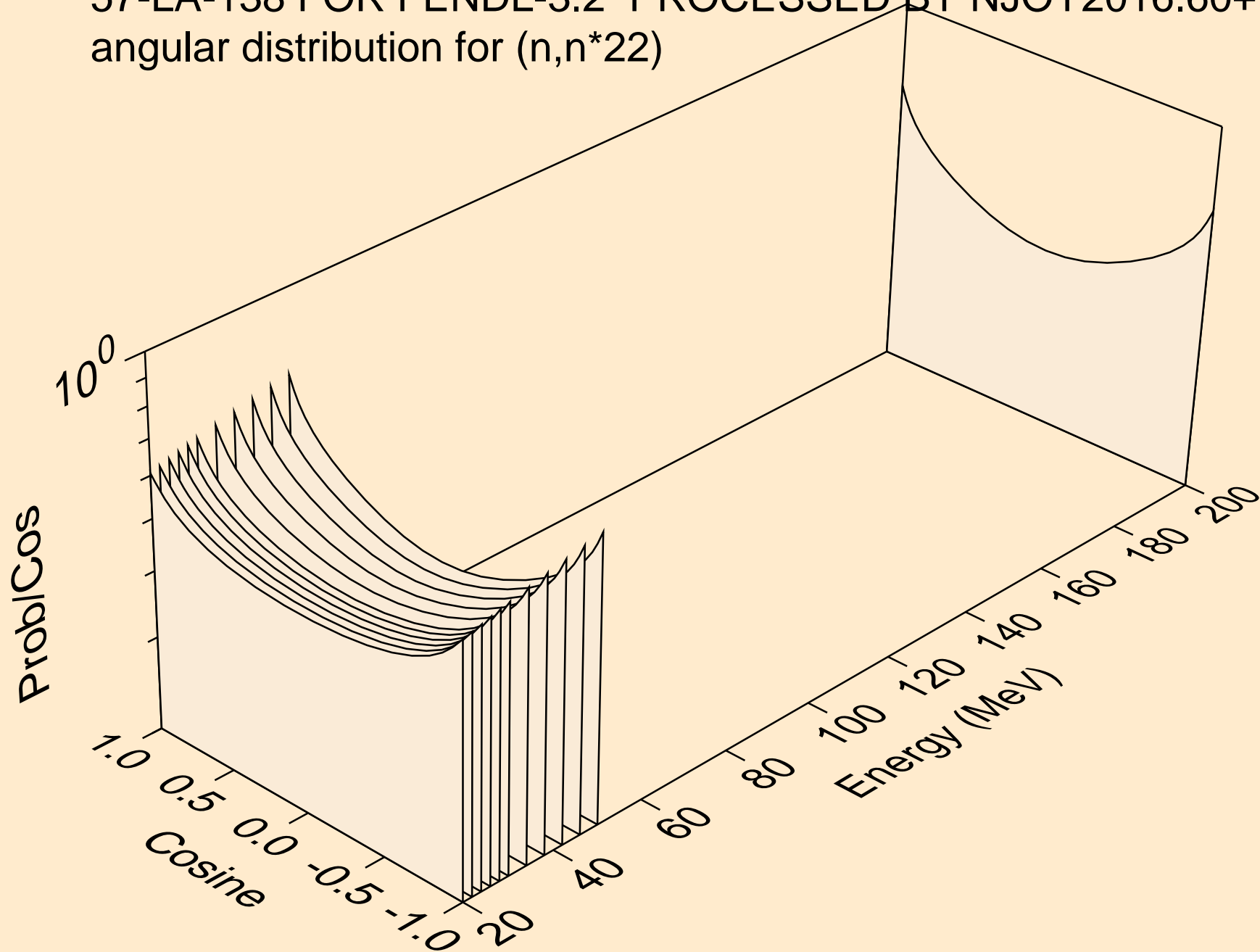

57-LA-138 FOR FENDL-3.2 PROCESSED BY NJOY2016.60+ ON
angular distribution for (n,n*23)

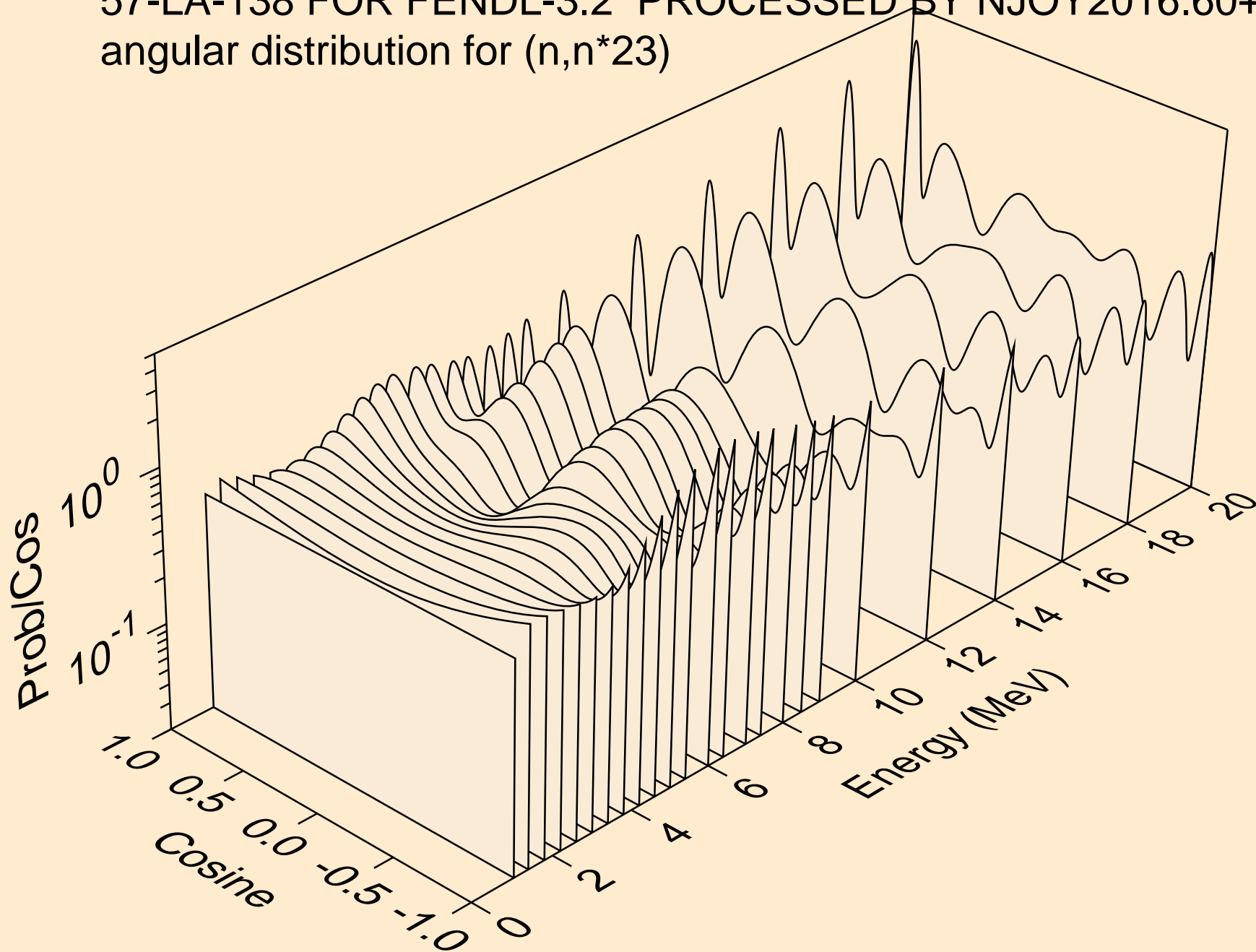

57-LA-138 FOR FENDL-3.2 PROCESSED BY NJOY2016.60+ ON
angular distribution for (n,n*23)

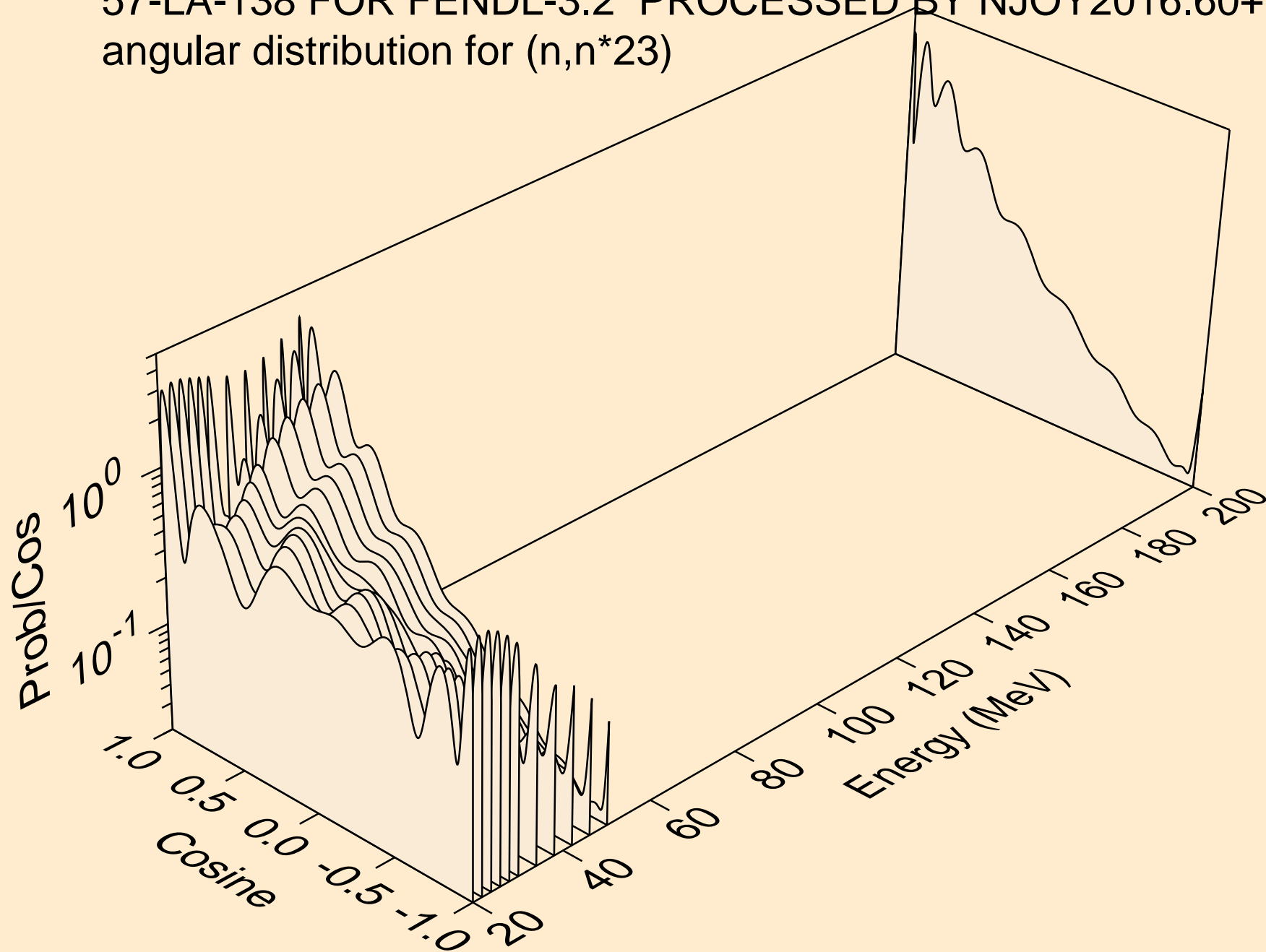

57-LA-138 FOR FENDL-3.2 PROCESSED BY NJOY2016.60+ ON
angular distribution for (n,n*24)

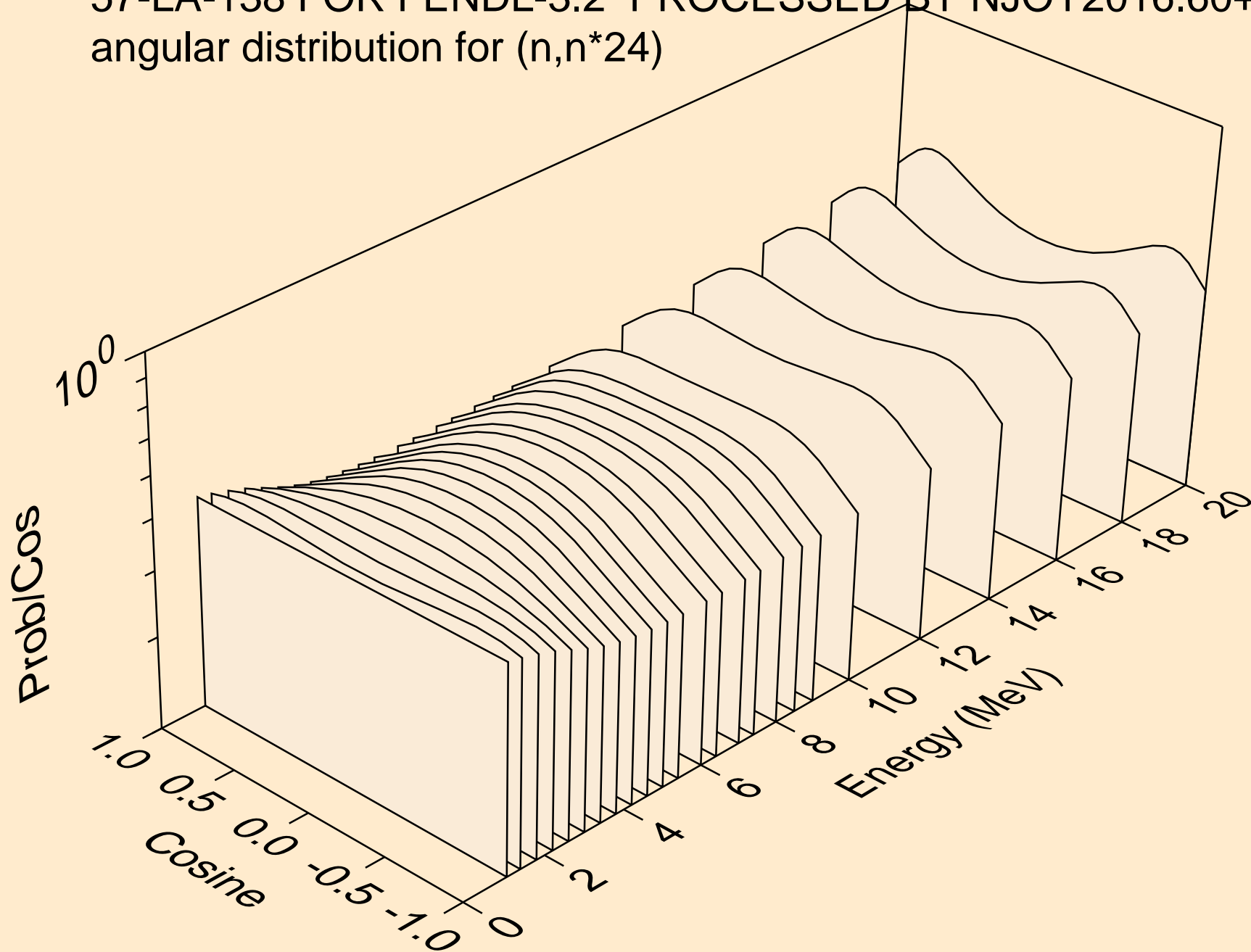

57-LA-138 FOR FENDL-3.2 PROCESSED BY NJOY2016.60+ ON
angular distribution for (n,n*24)

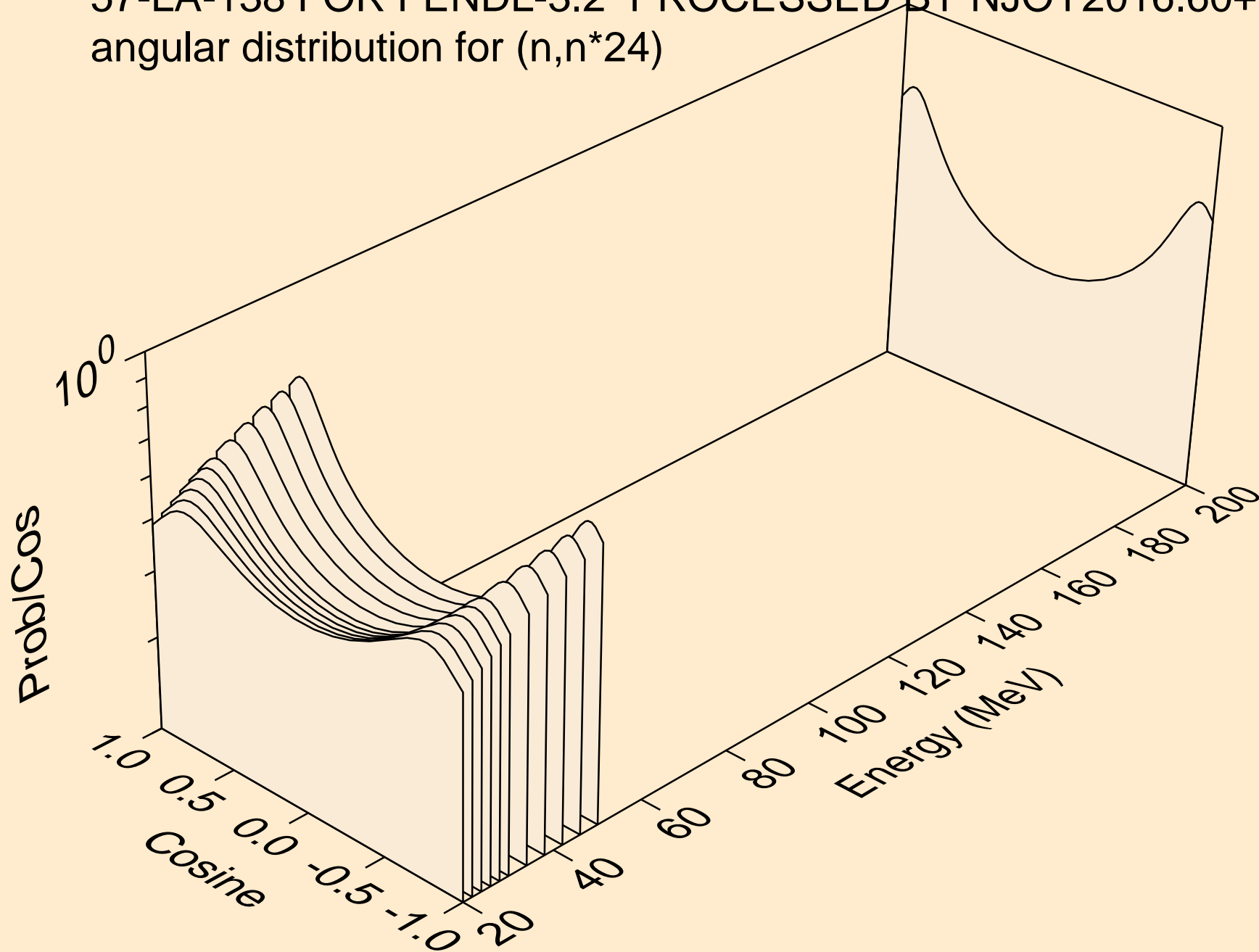

57-LA-138 FOR FENDL-3.2 PROCESSED BY NJOY2016.60+ ON
angular distribution for (n,n*25)

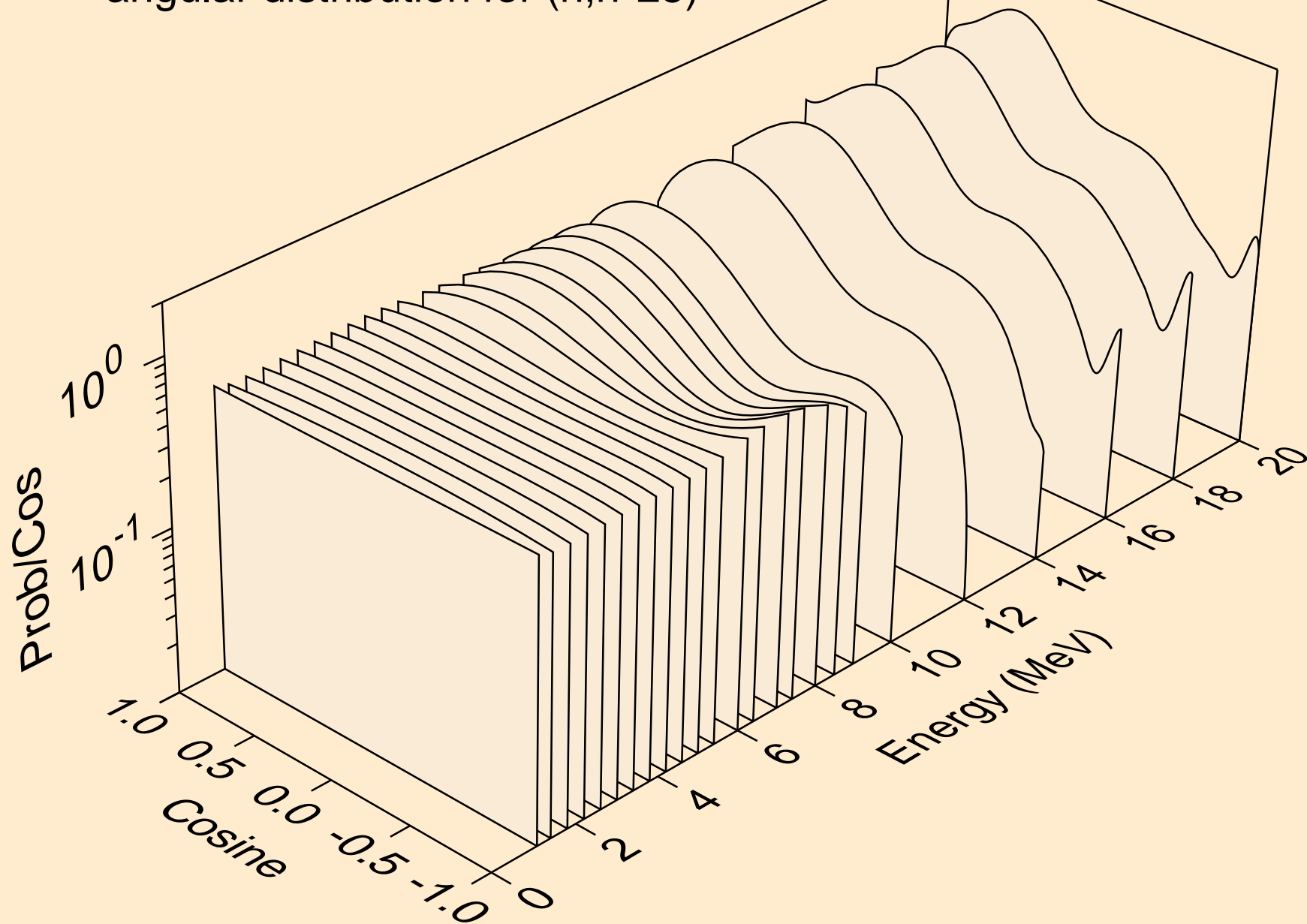

57-LA-138 FOR FENDL-3.2 PROCESSED BY NJOY2016.60+ ON
angular distribution for (n,n*25)

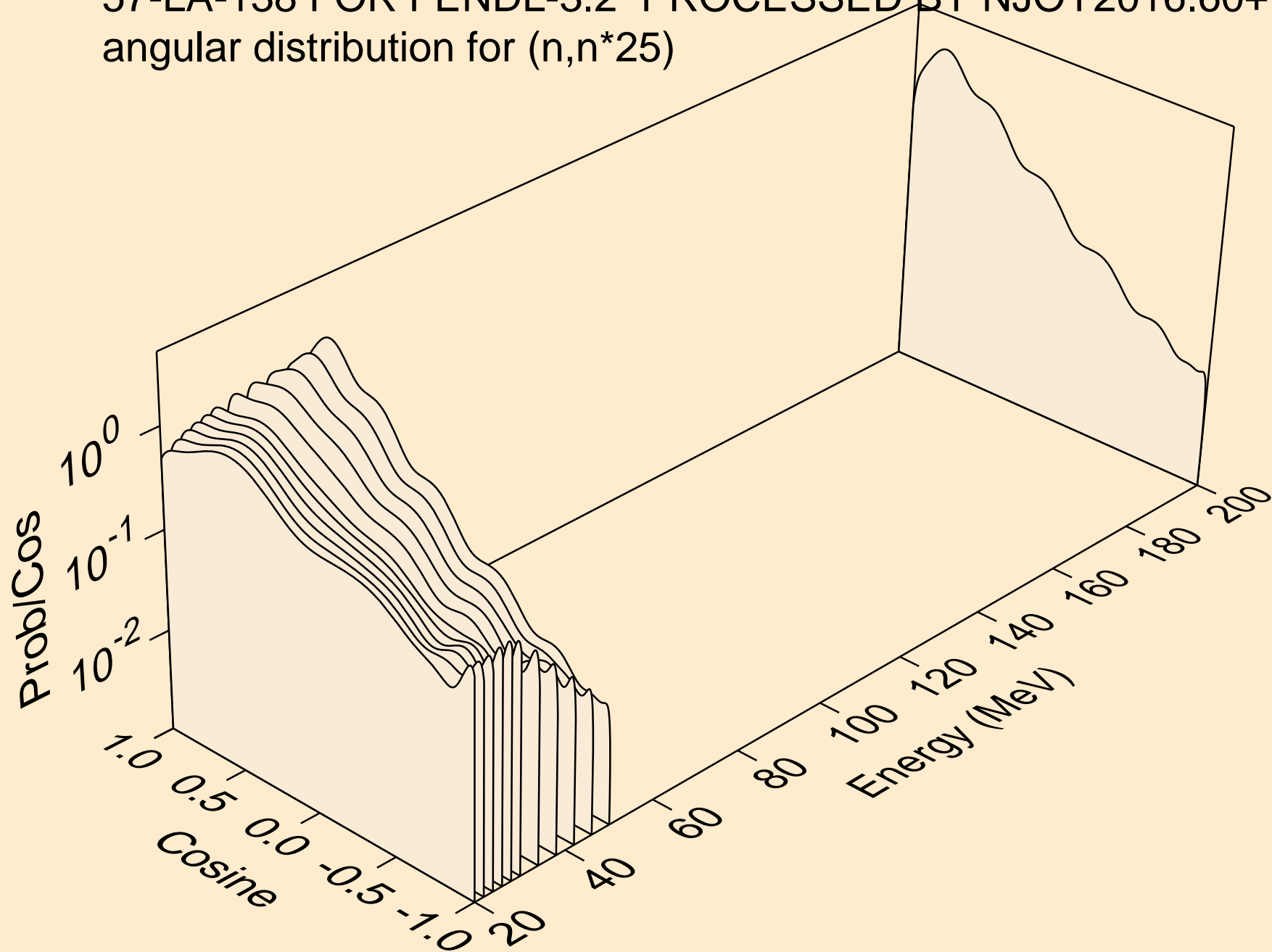

57-LA-138 FOR FENDL-3.2 PROCESSED BY NJOY2016.60+ ON
angular distribution for (n,n*26)

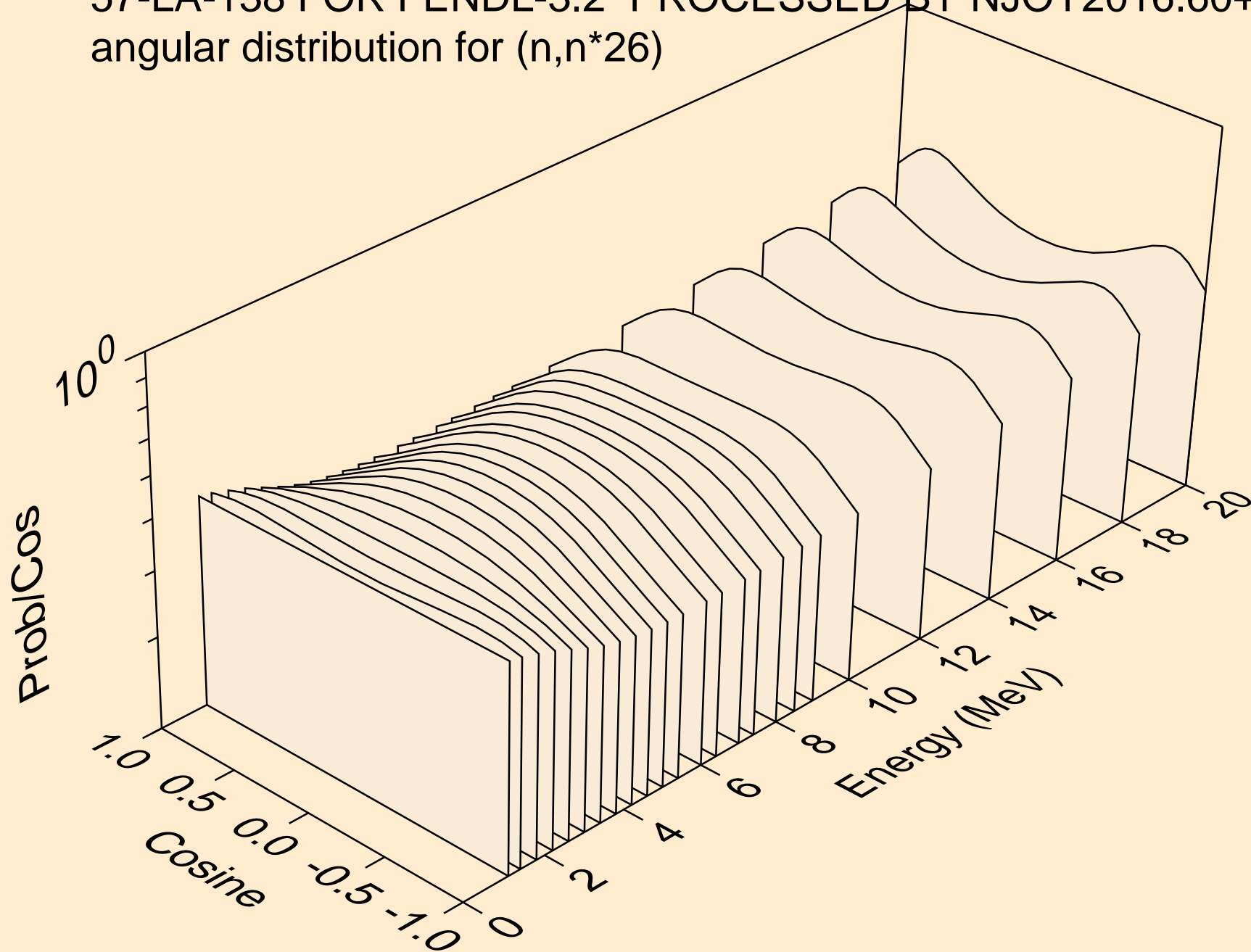

57-LA-138 FOR FENDL-3.2 PROCESSED BY NJOY2016.60+ ON
angular distribution for (n,n*26)

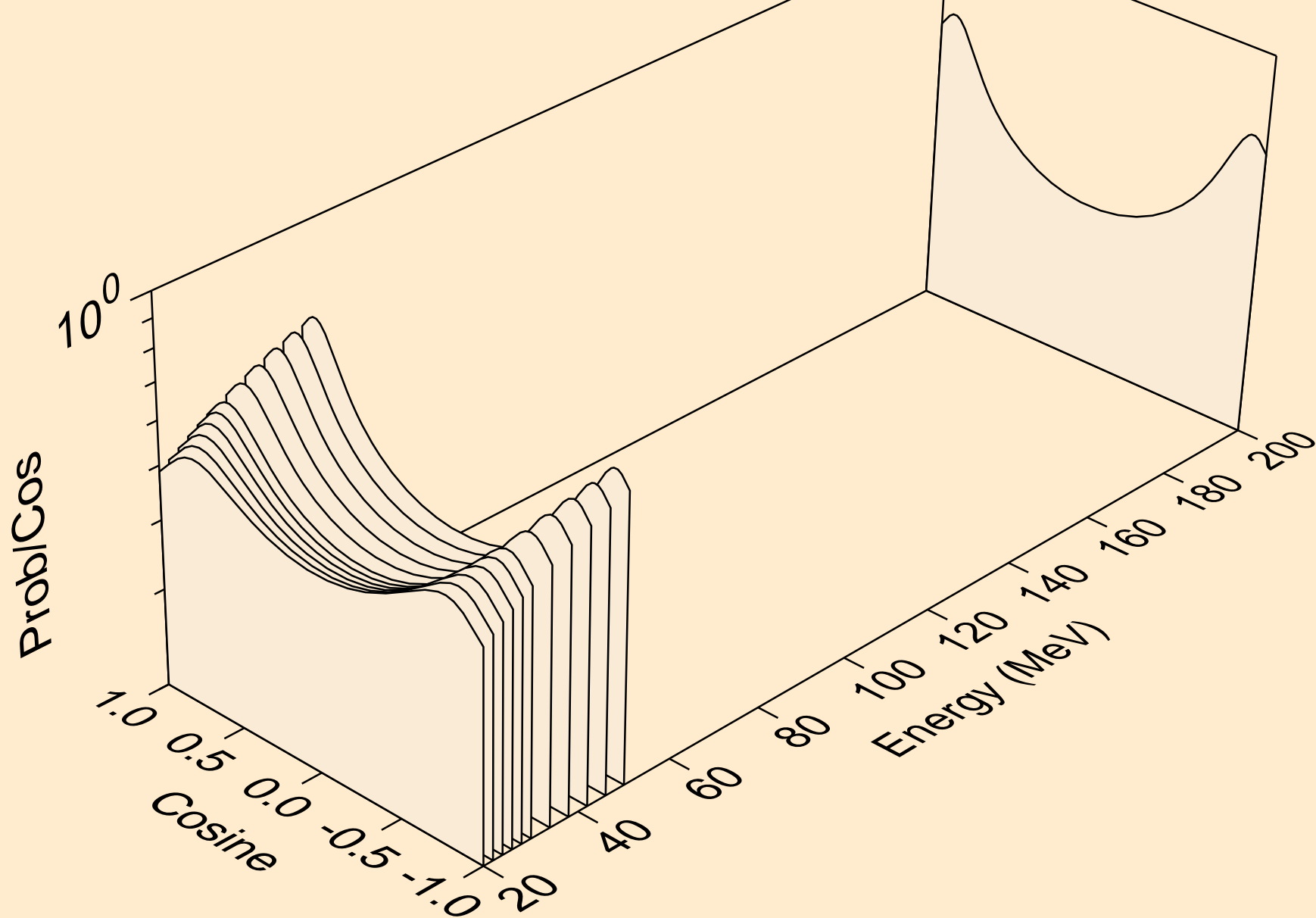

57-LA-138 FOR FENDL-3.2 PROCESSED BY NJOY2016.60+ ON
angular distribution for (n,n*27)

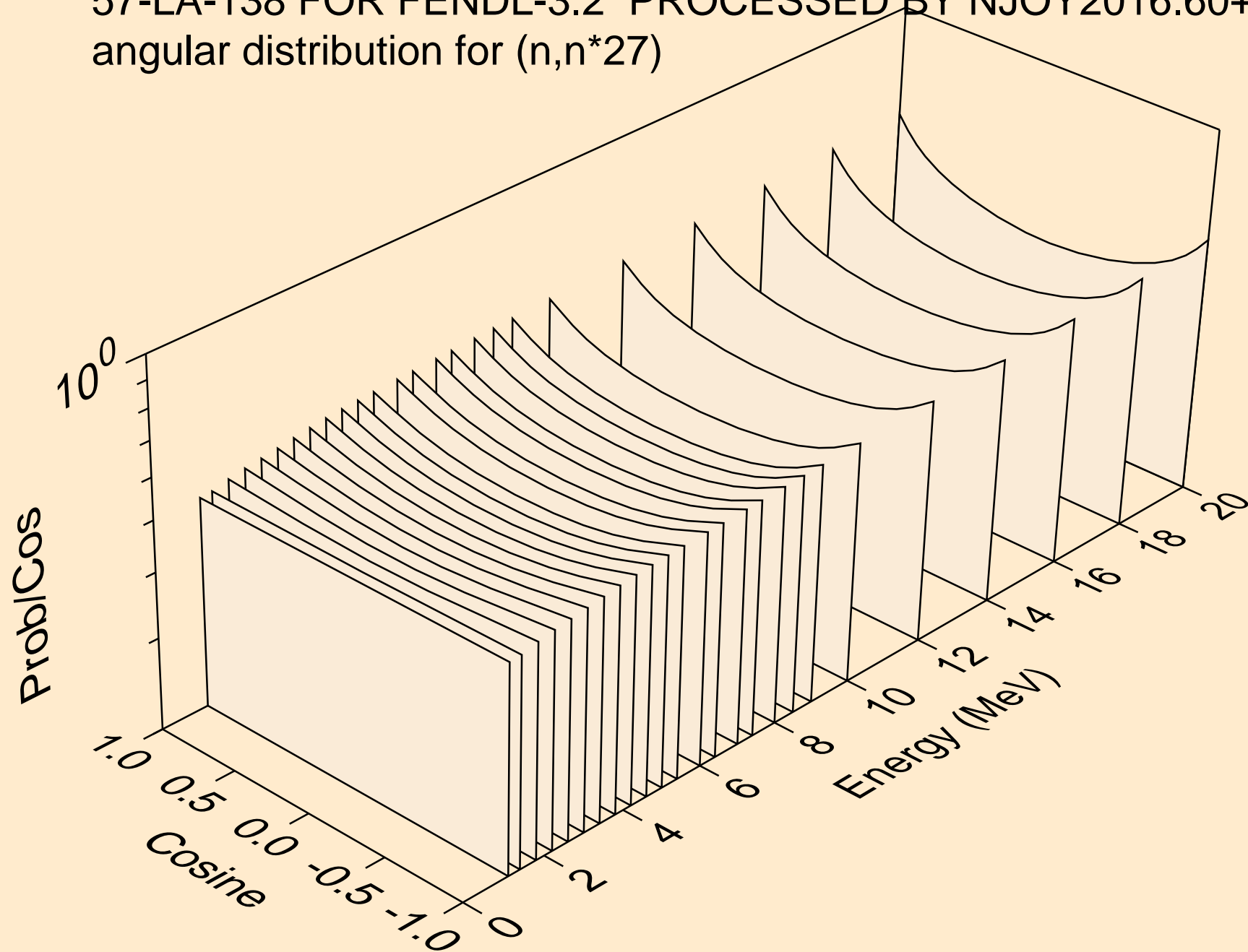

57-LA-138 FOR FENDL-3.2 PROCESSED BY NJOY2016.60+ ON
angular distribution for (n,n*27)

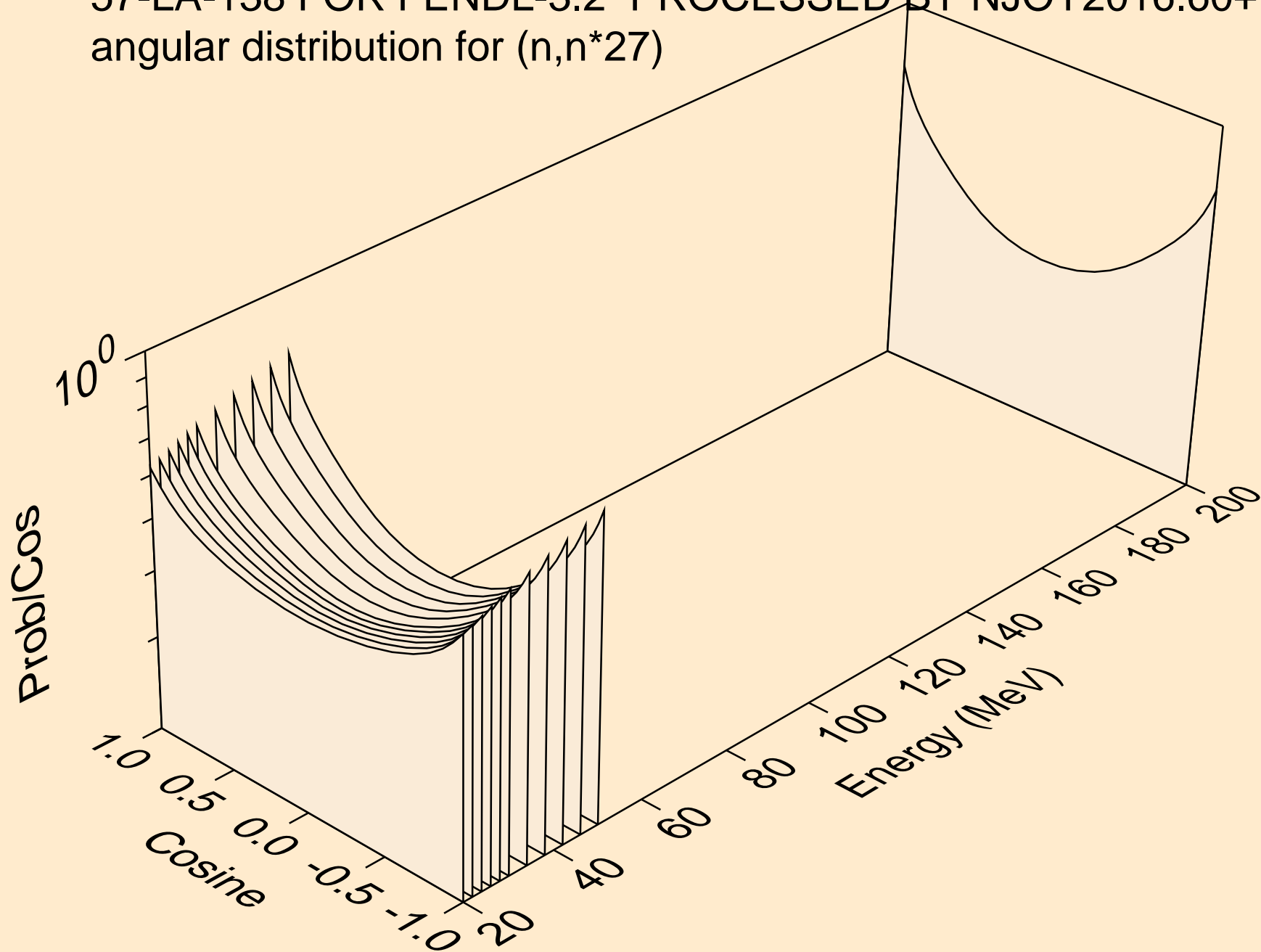

57-LA-138 FOR FENDL-3.2 PROCESSED BY NJOY2016.60+ ON
angular distribution for (n,n*28)

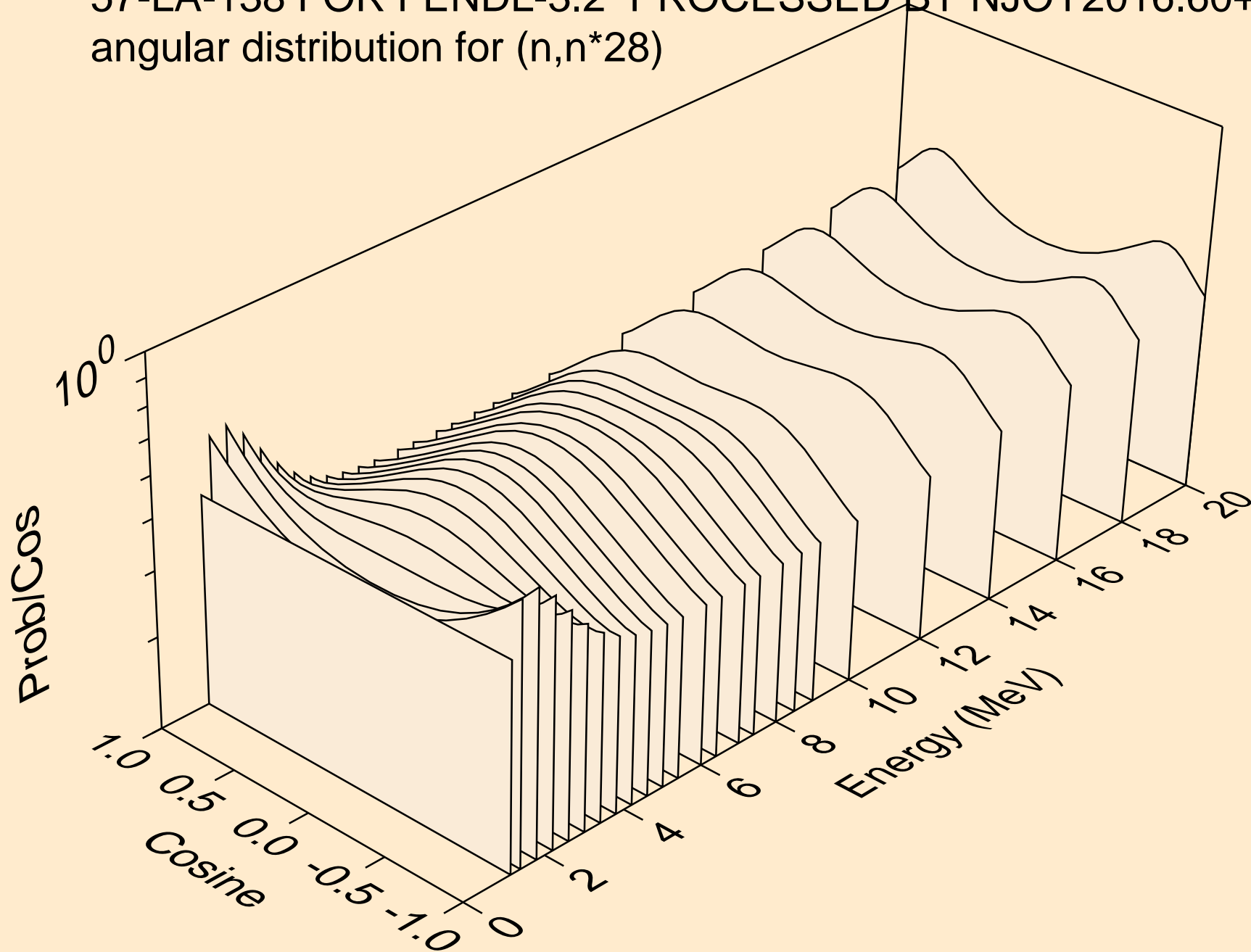

57-LA-138 FOR FENDL-3.2 PROCESSED BY NJOY2016.60+ ON
angular distribution for (n,n*28)

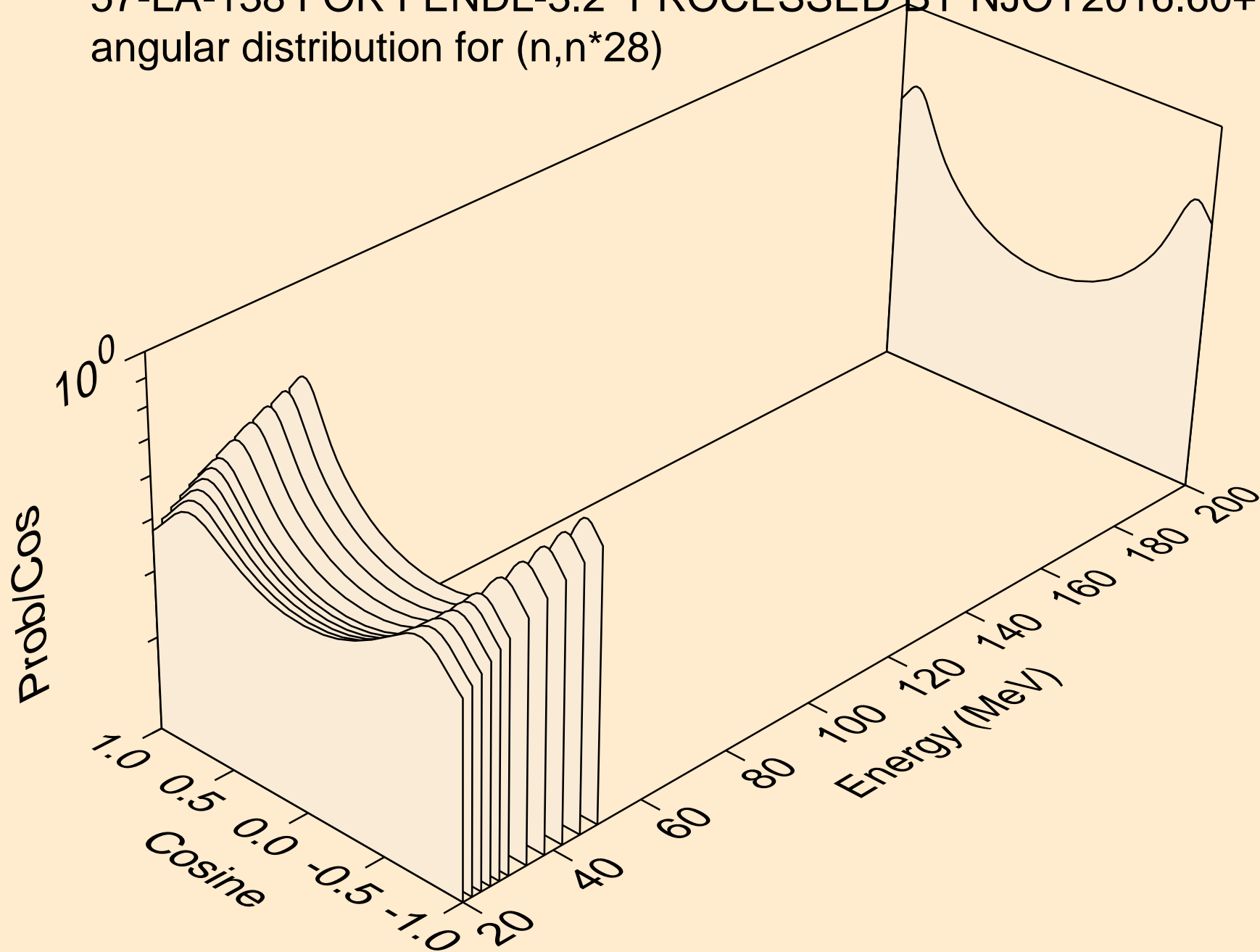

57-LA-138 FOR FENDL-3.2 PROCESSED BY NJOY2016.60+ ON
angular distribution for (n,n*29)

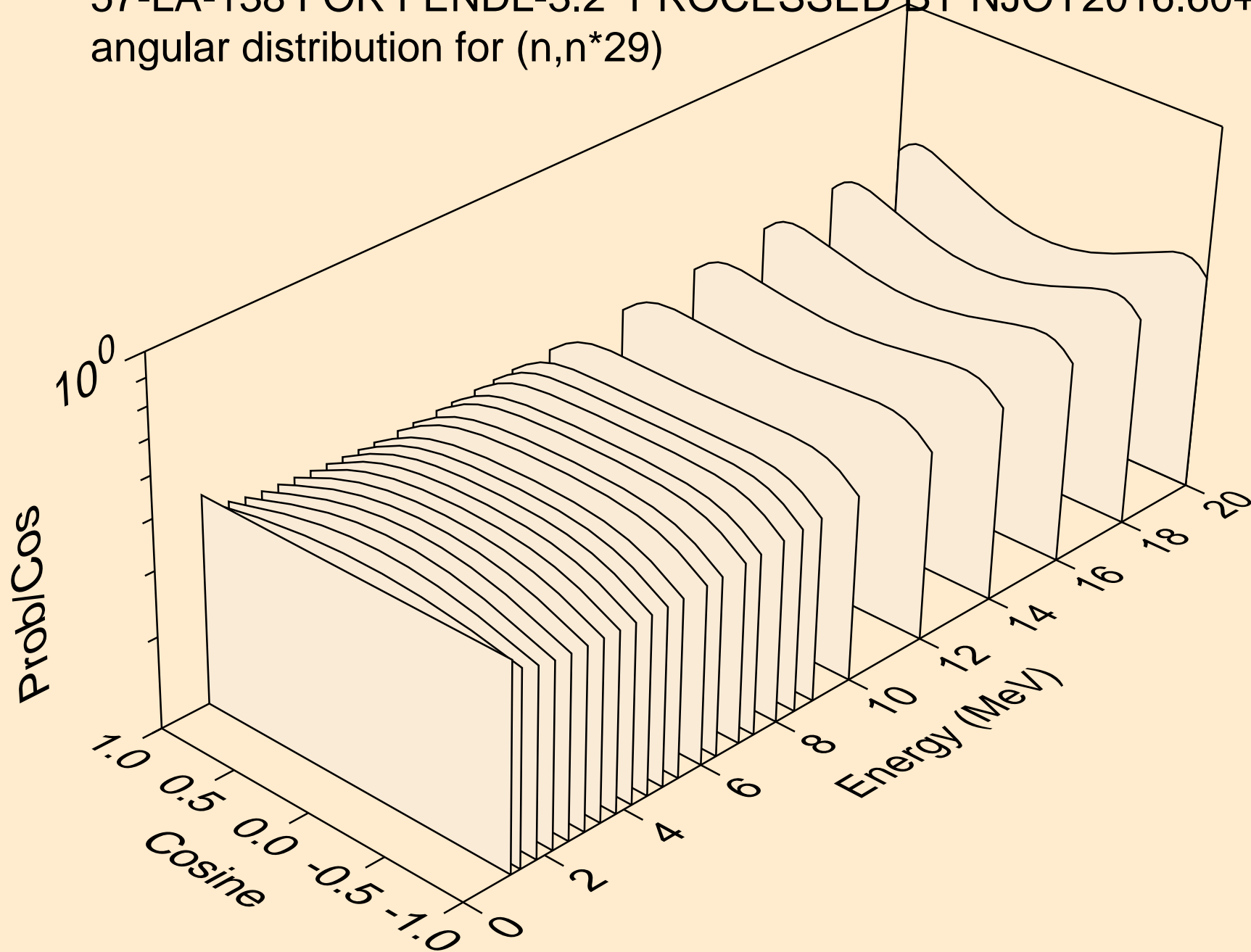

57-LA-138 FOR FENDL-3.2 PROCESSED BY NJOY2016.60+ ON
angular distribution for (n,n*29)

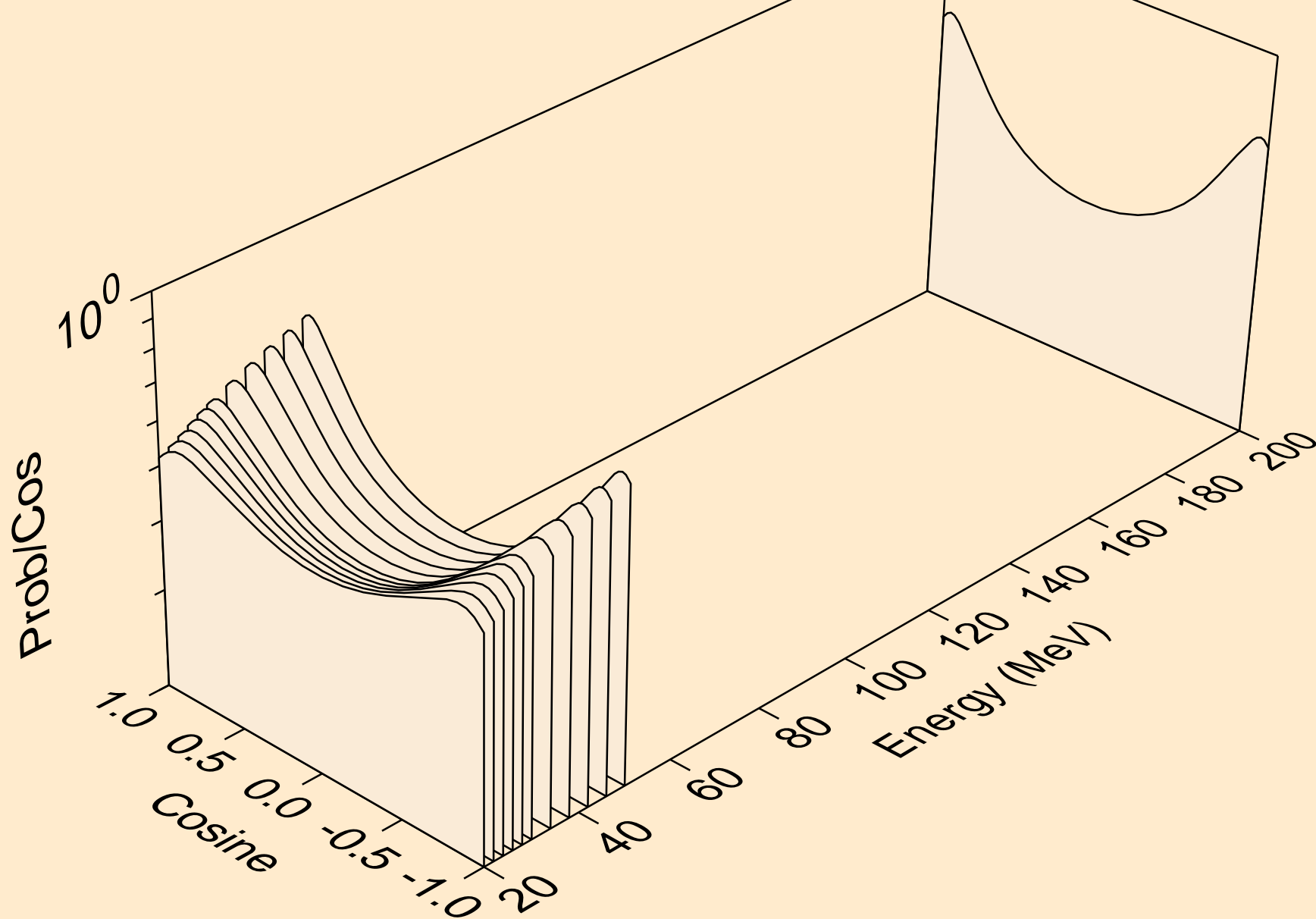

57-LA-138 FOR FENDL-3.2 PROCESSED BY NJOY2016.60+ ON
angular distribution for (n,n*30)

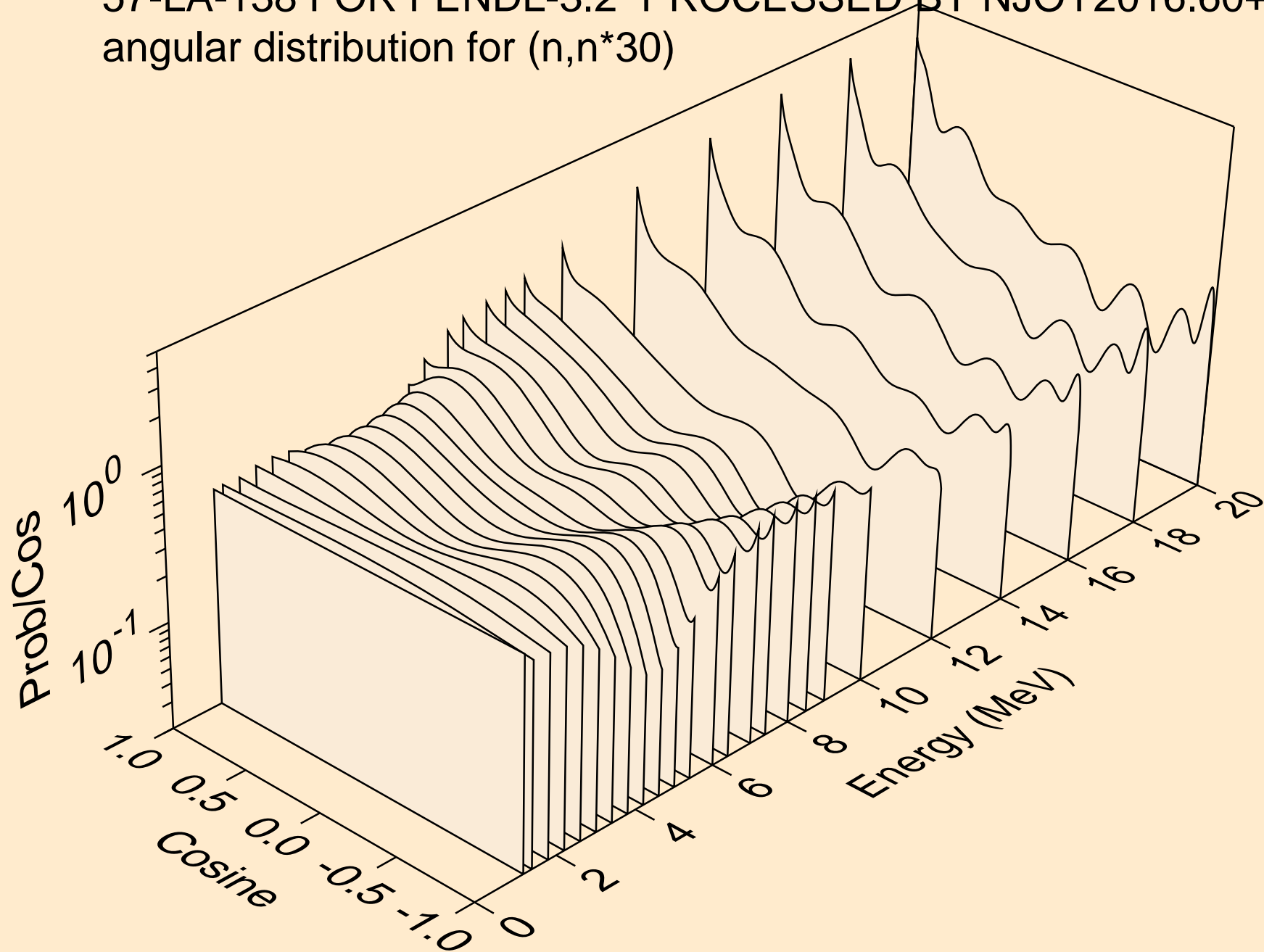

57-LA-138 FOR FENDL-3.2 PROCESSED BY NJOY2016.60+ ON
angular distribution for (n,n*30)

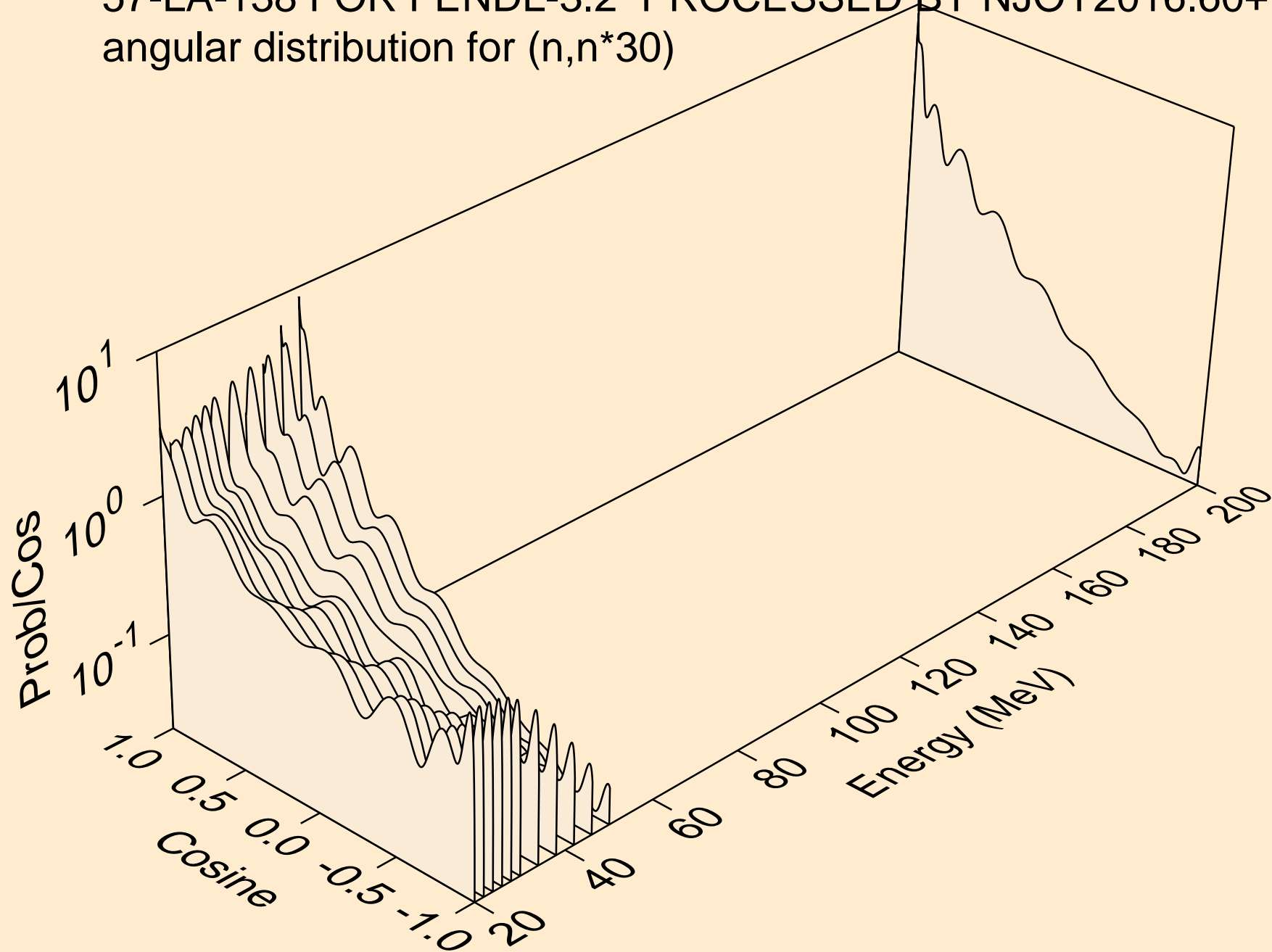

57-LA-138 FOR FENDL-3.2 PROCESSED BY NJOY2016.60+ ON
Neutron emission for (n,x)

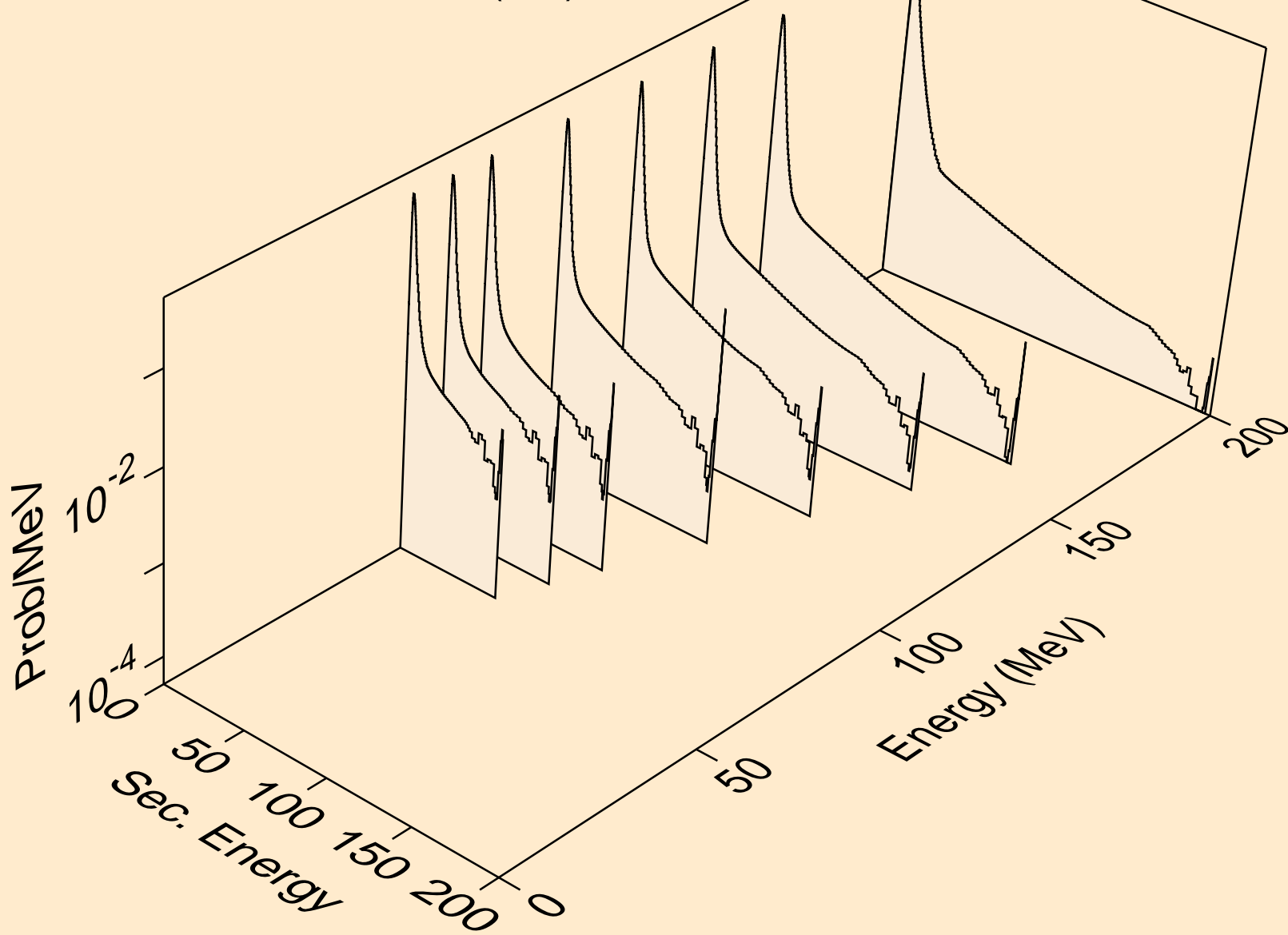

57-LA-138 FOR FENDL-3.2 PROCESSED BY NJOY2016.60+ ON
Neutron emission for (n,2nd)

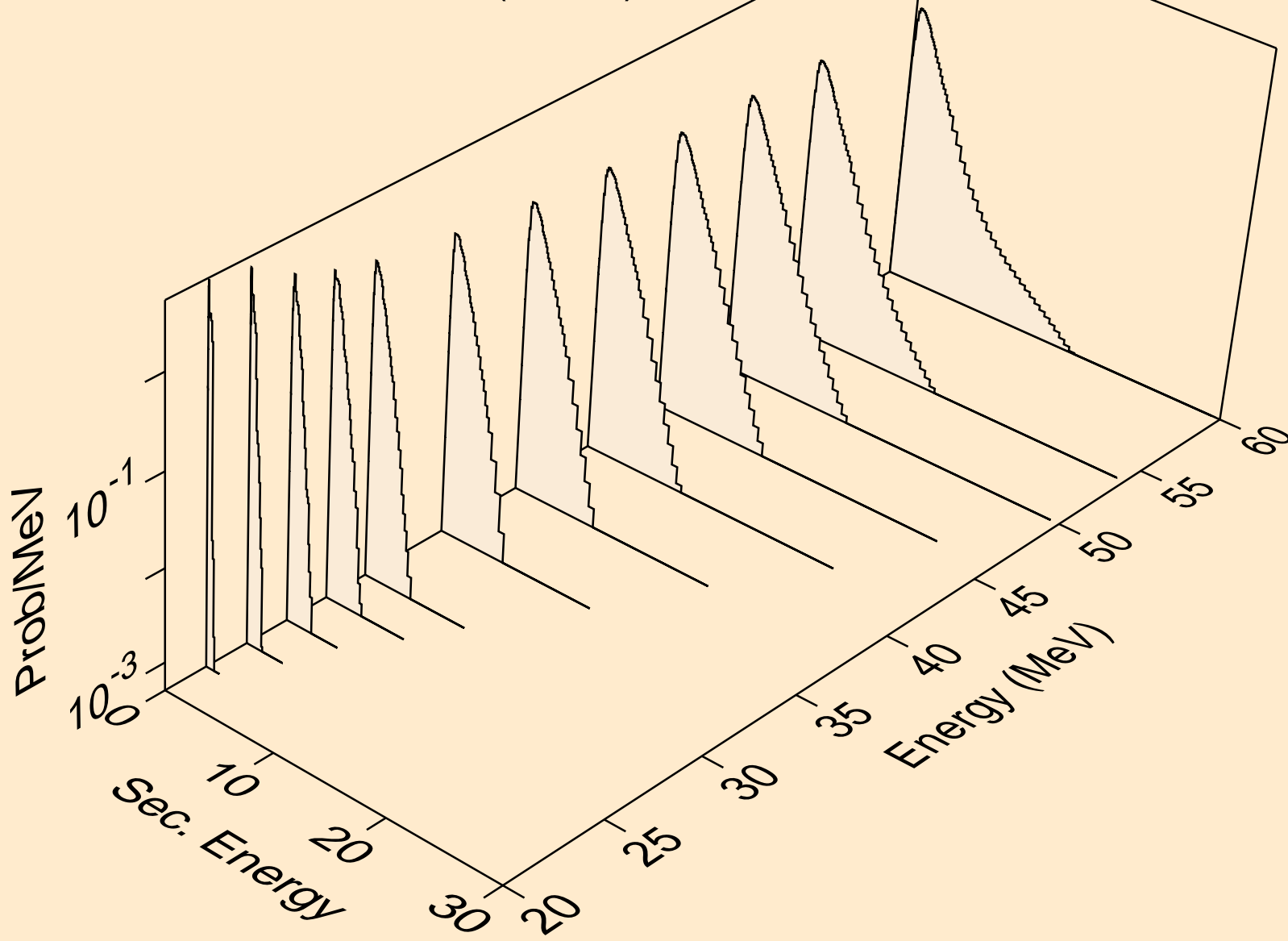

57-LA-138 FOR FENDL-3.2 PROCESSED BY NJOY2016.60+ ON
Neutron emission for (n,2n)

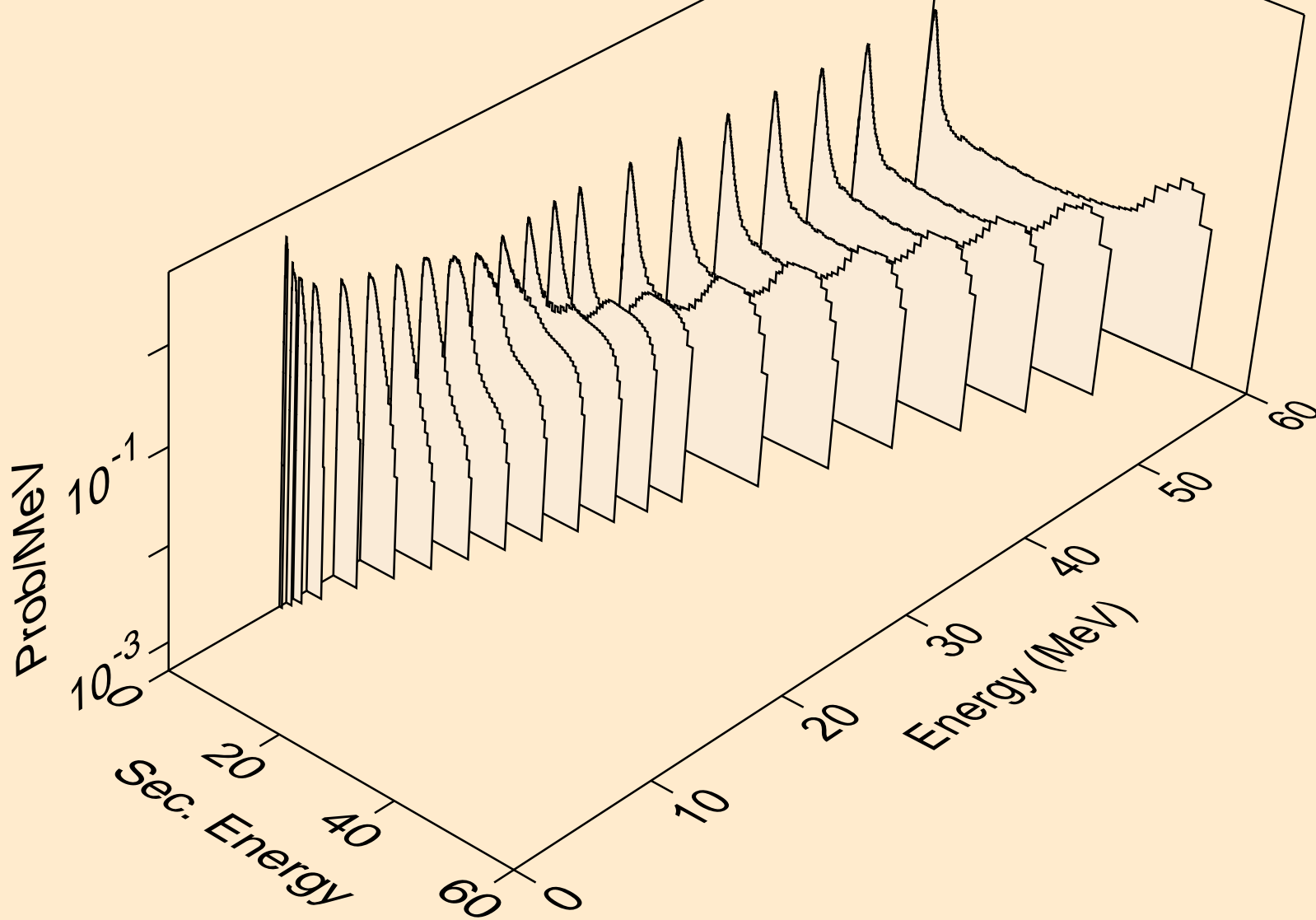

57-LA-138 FOR FENDL-3.2 PROCESSED BY NJOY2016.60+ ON
Neutron emission for (n,3n)

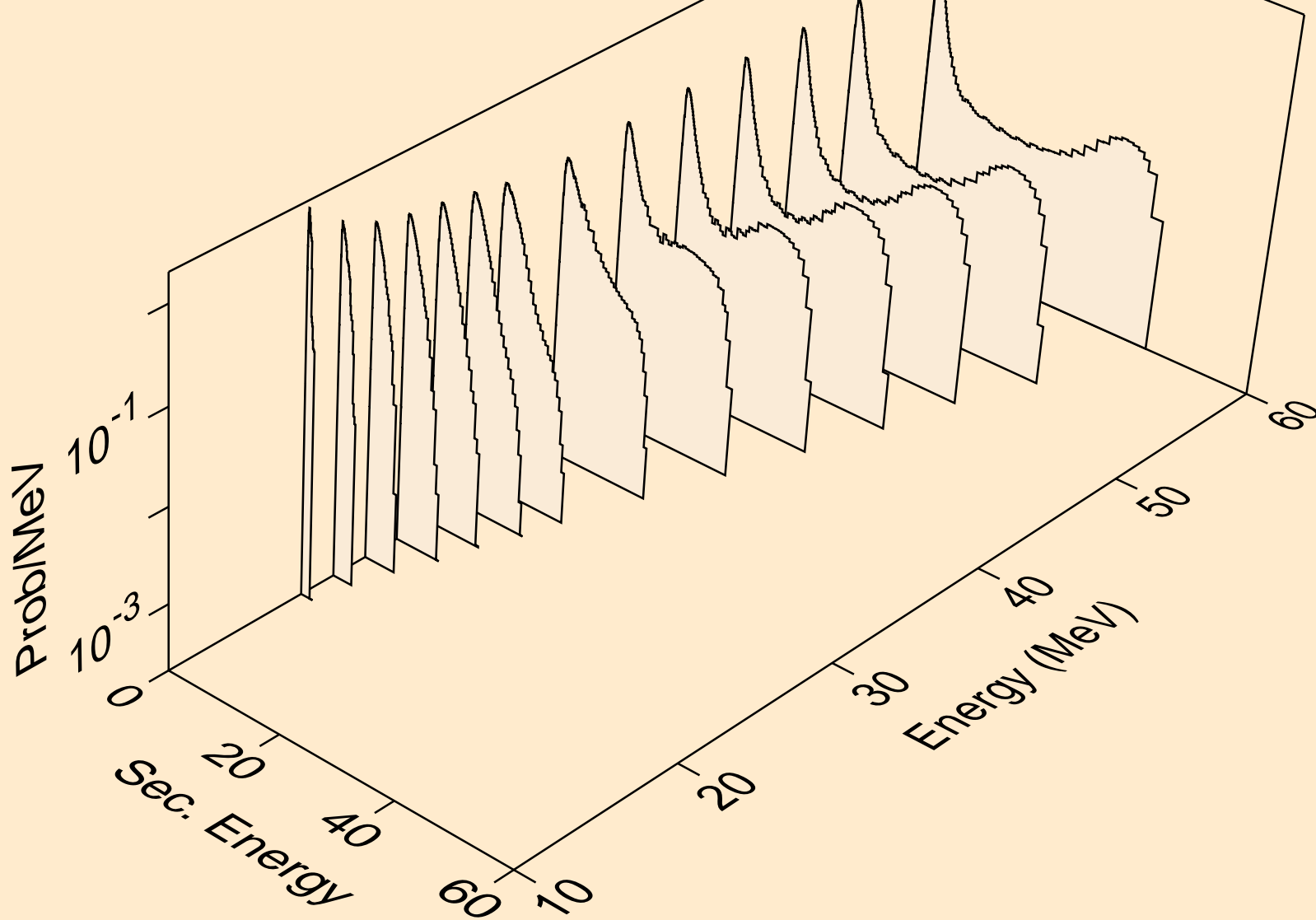

57-LA-138 FOR FENDL-3.2 PROCESSED BY NJOY2016.60+ ON
Neutron emission for (n,n*)a

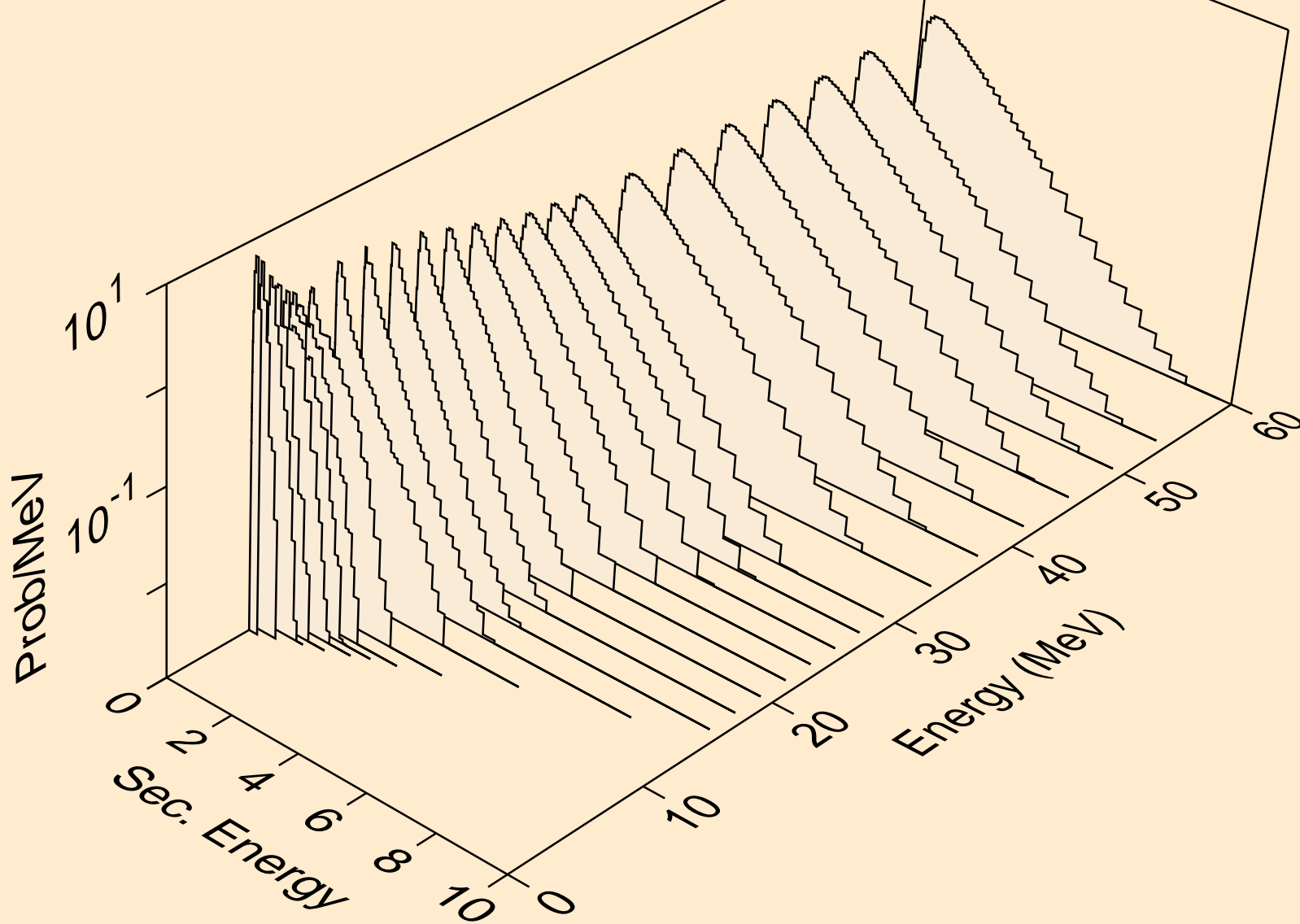

57-LA-138 FOR FENDL-3.2 PROCESSED BY NJOY2016.60+ ON
Neutron emission for (n,2n)a

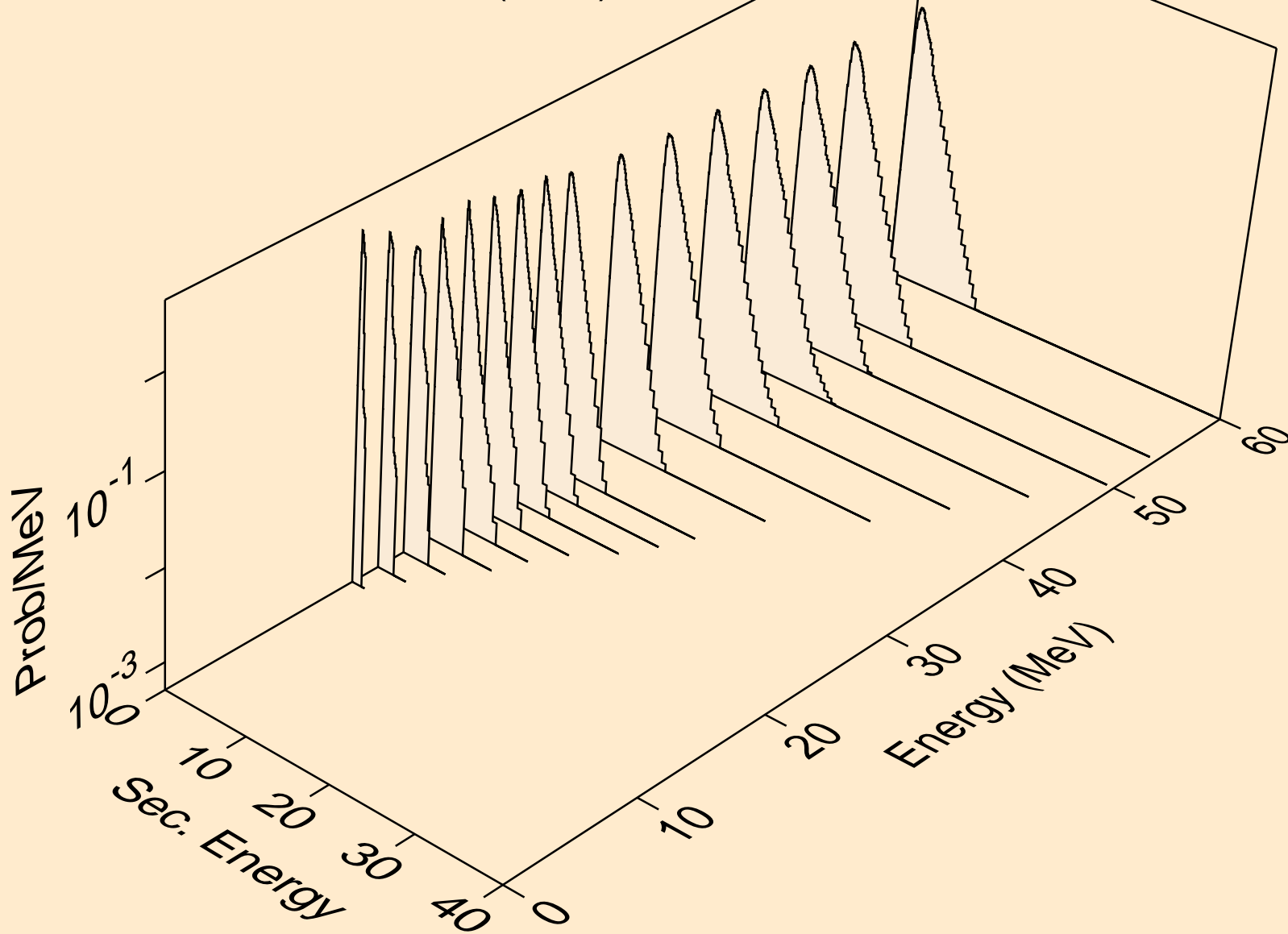

57-LA-138 FOR FENDL-3.2 PROCESSED BY NJOY2016.60+ ON
Neutron emission for (n,3n)a

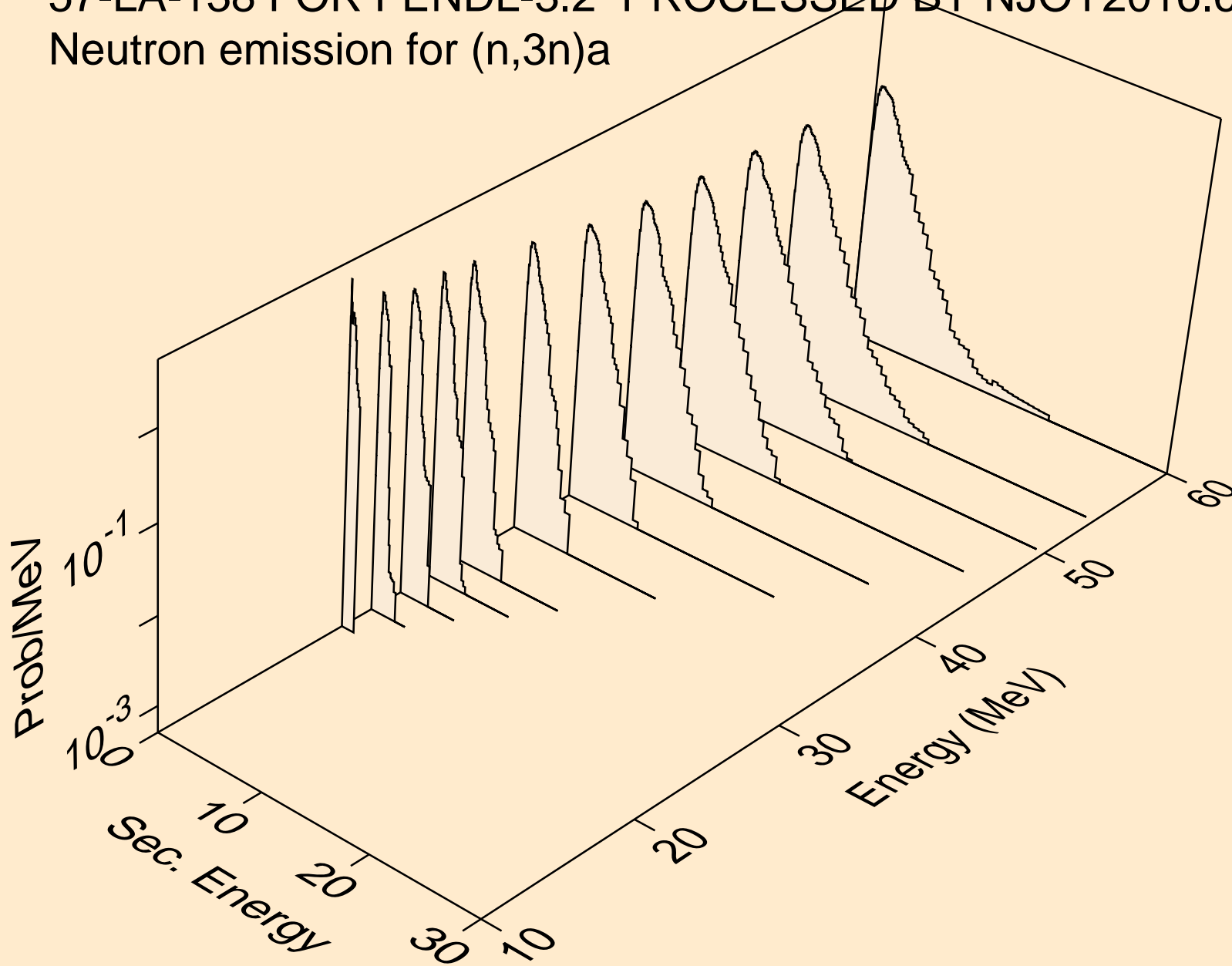

57-LA-138 FOR FENDL-3.2 PROCESSED BY NJOY2016.60+ ON
Neutron emission for (n,n*)p

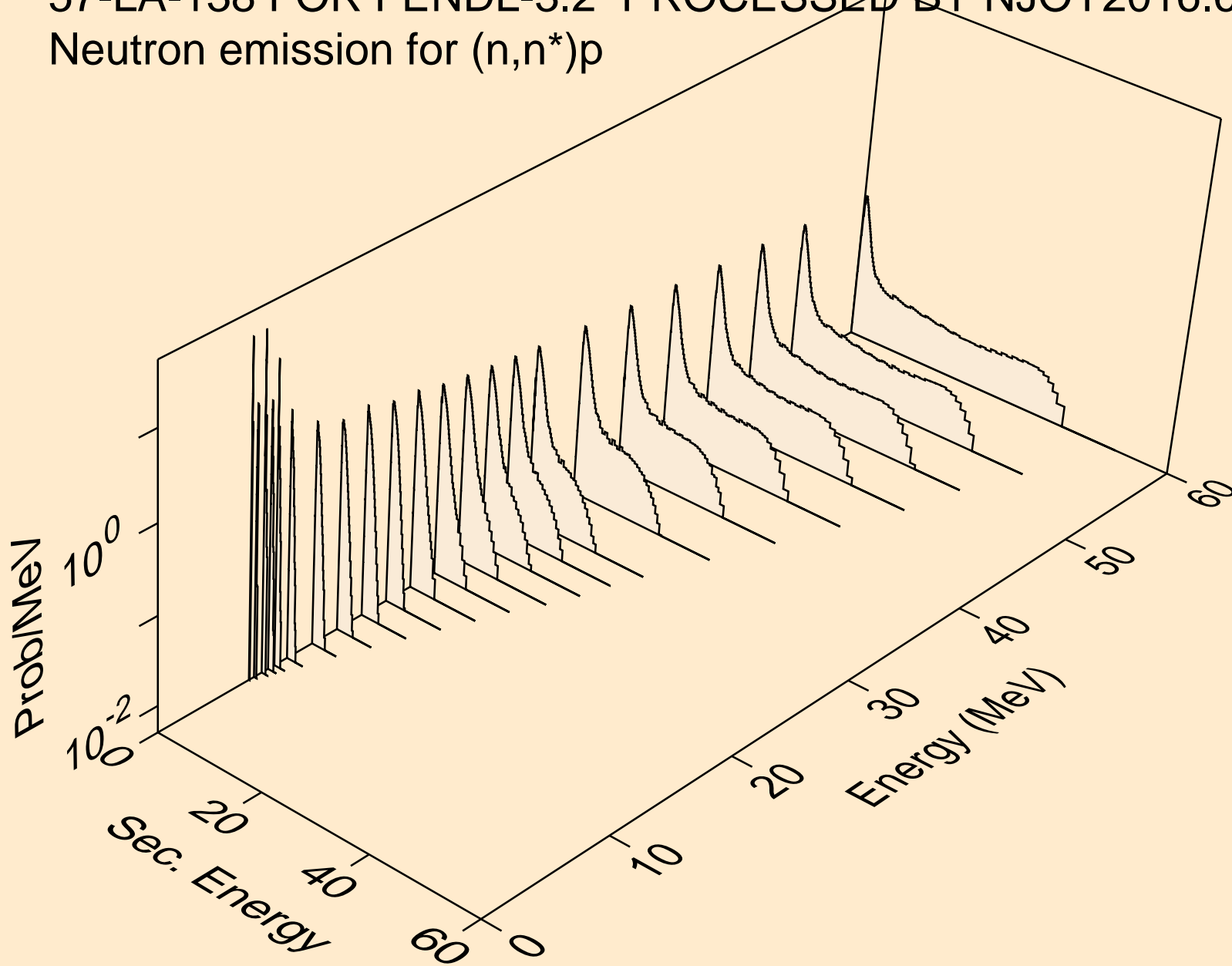

57-LA-138 FOR FENDL-3.2 PROCESSED BY NJOY2016.60+ ON
Neutron emission for (n,n*)2a

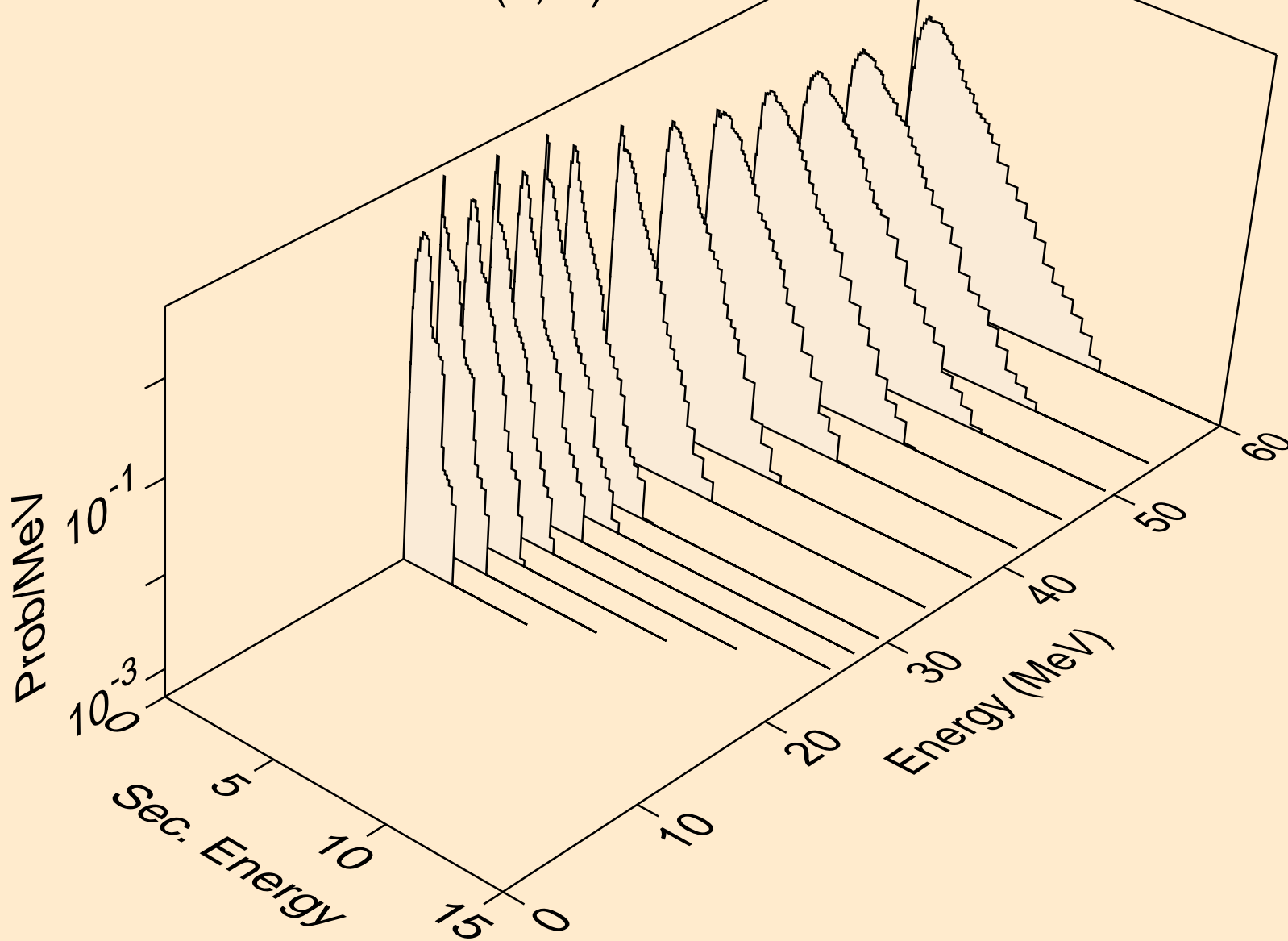

57-LA-138 FOR FENDL-3.2 PROCESSED BY NJOY2016.60+ ON
Neutron emission for (n,2n)2a

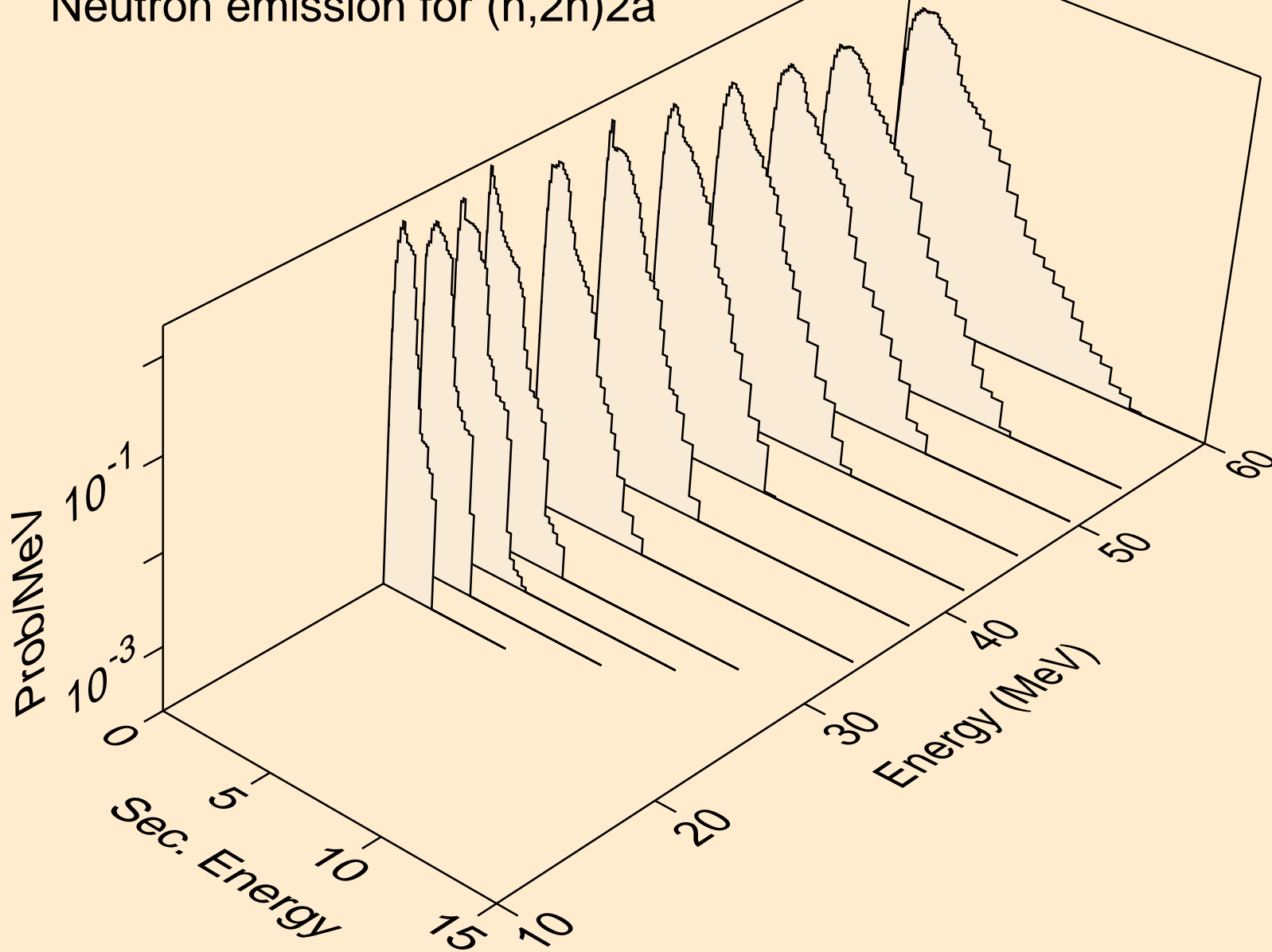

57-LA-138 FOR FENDL-3.2 PROCESSED BY NJOY2016.60+ ON
Neutron emission for (n,n*)d

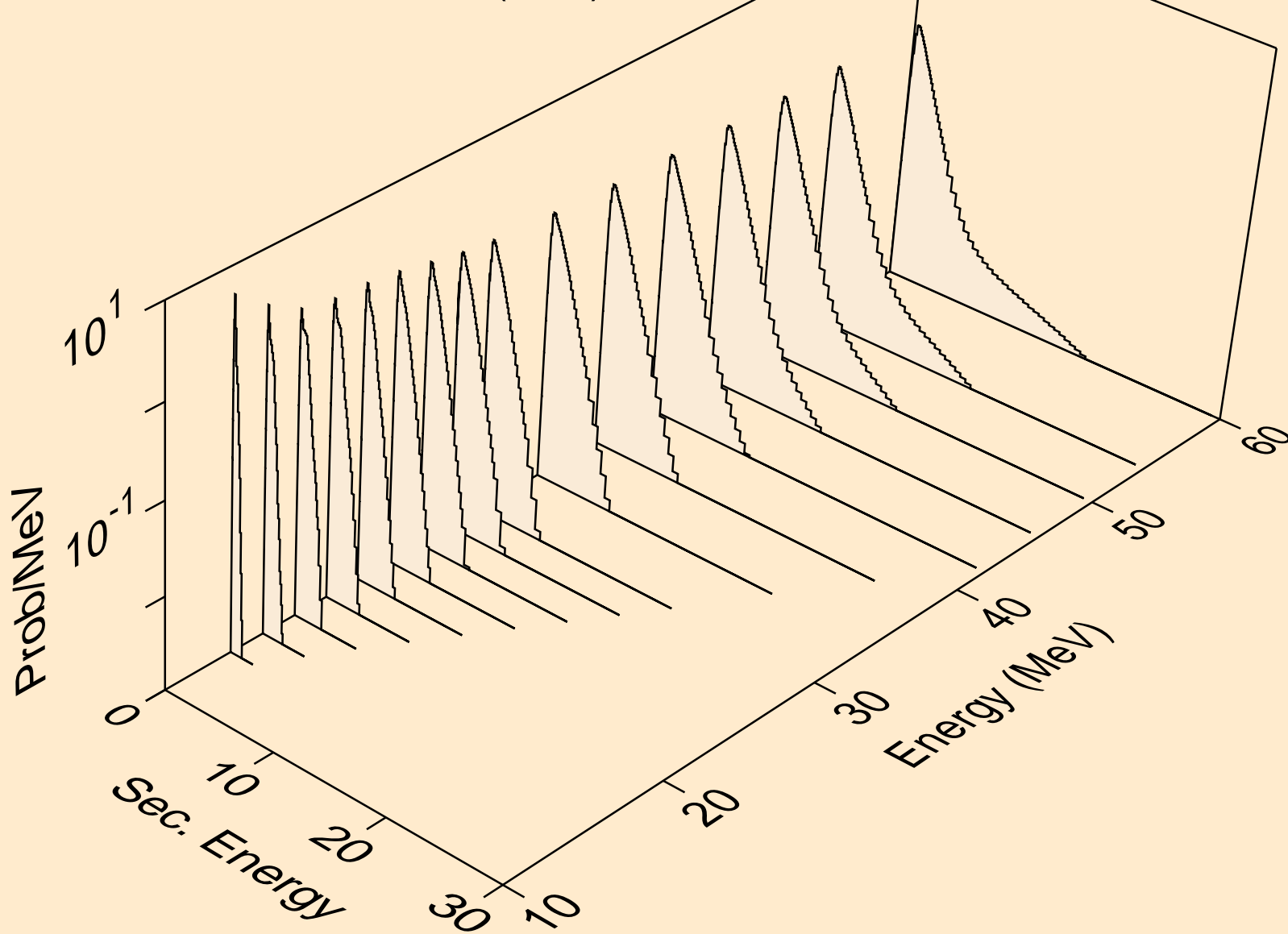

57-LA-138 FOR FENDL-3.2 PROCESSED BY NJOY2016.60+ ON
Neutron emission for (n,n*)t

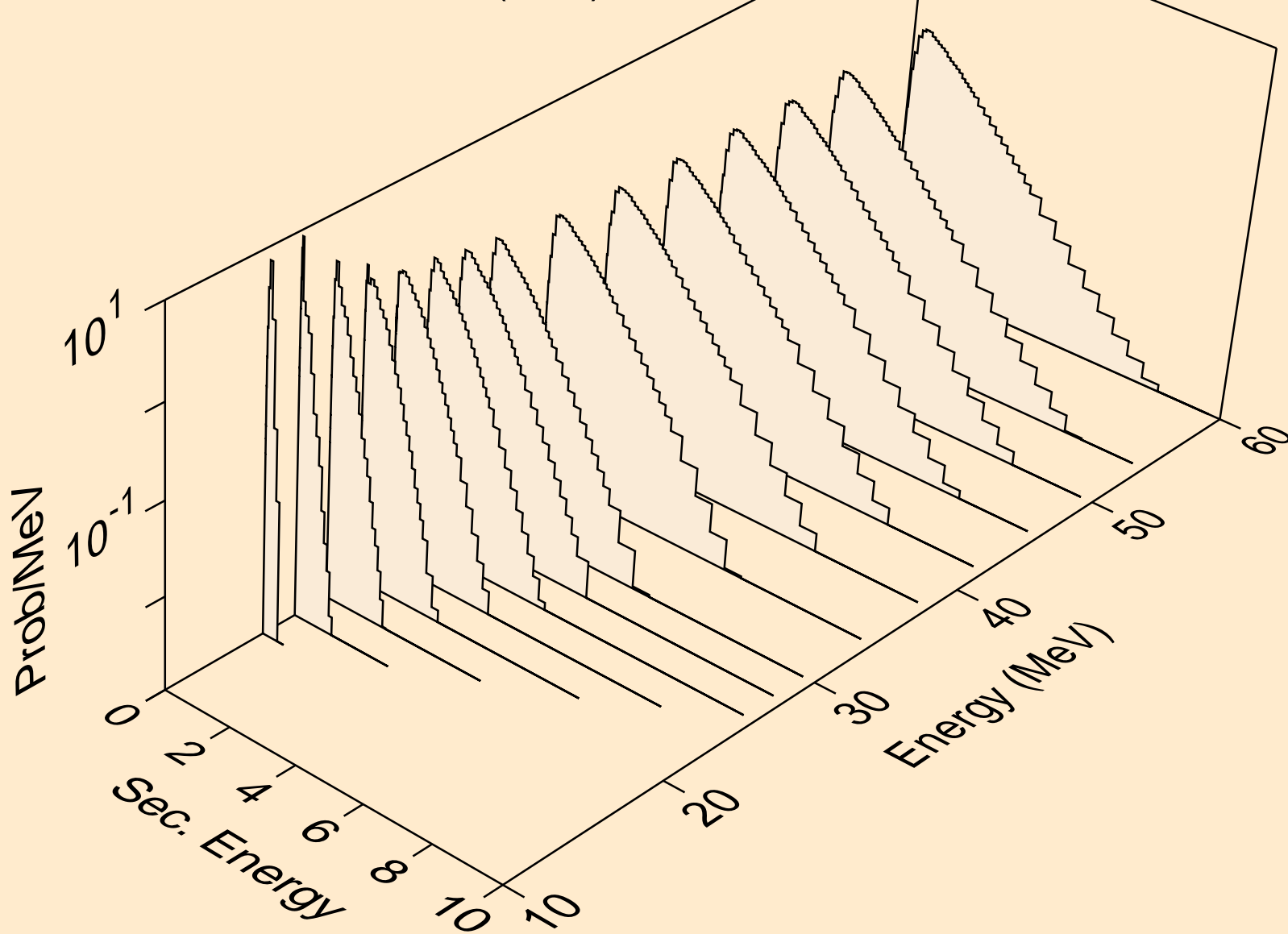

57-LA-138 FOR FENDL-3.2 PROCESSED BY NJOY2016.60+ ON
Neutron emission for (n,n*)he3

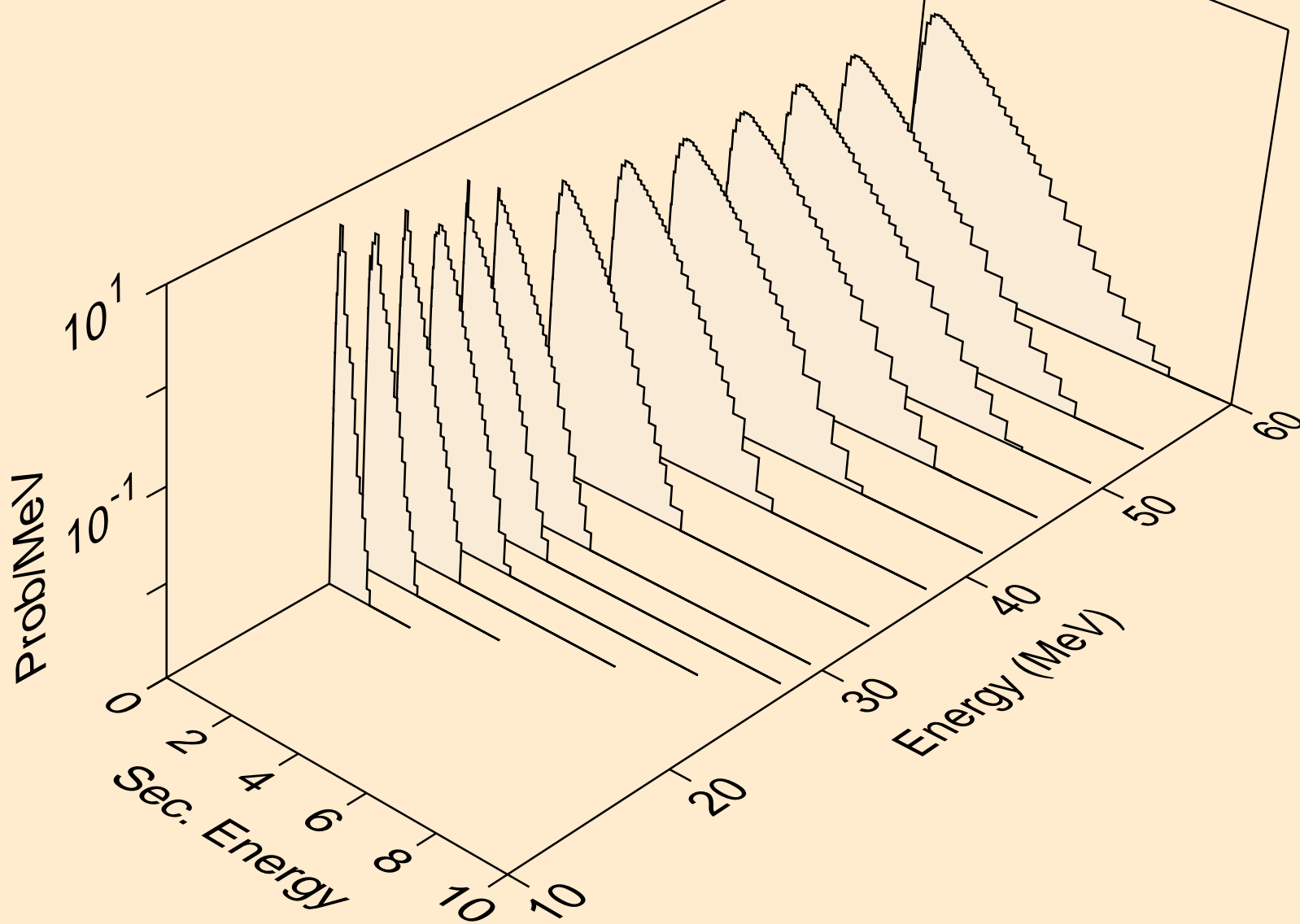

57-LA-138 FOR FENDL-3.2 PROCESSED BY NJOY2016.60+ ON
Neutron emission for (n,n*)d2a

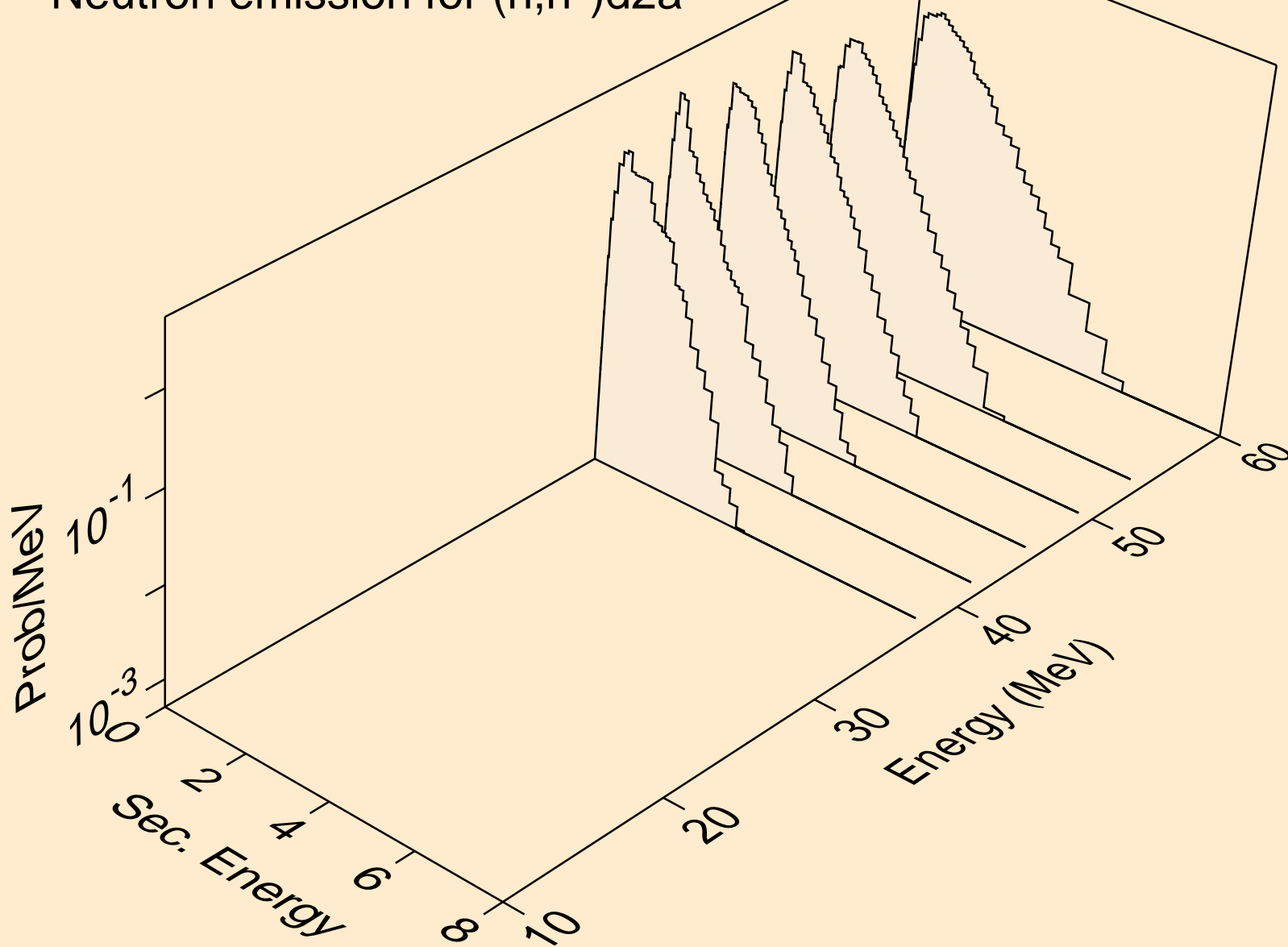

57-LA-138 FOR FENDL-3.2 PROCESSED BY NJOY2016.60+ ON
Neutron emission for (n,4n)

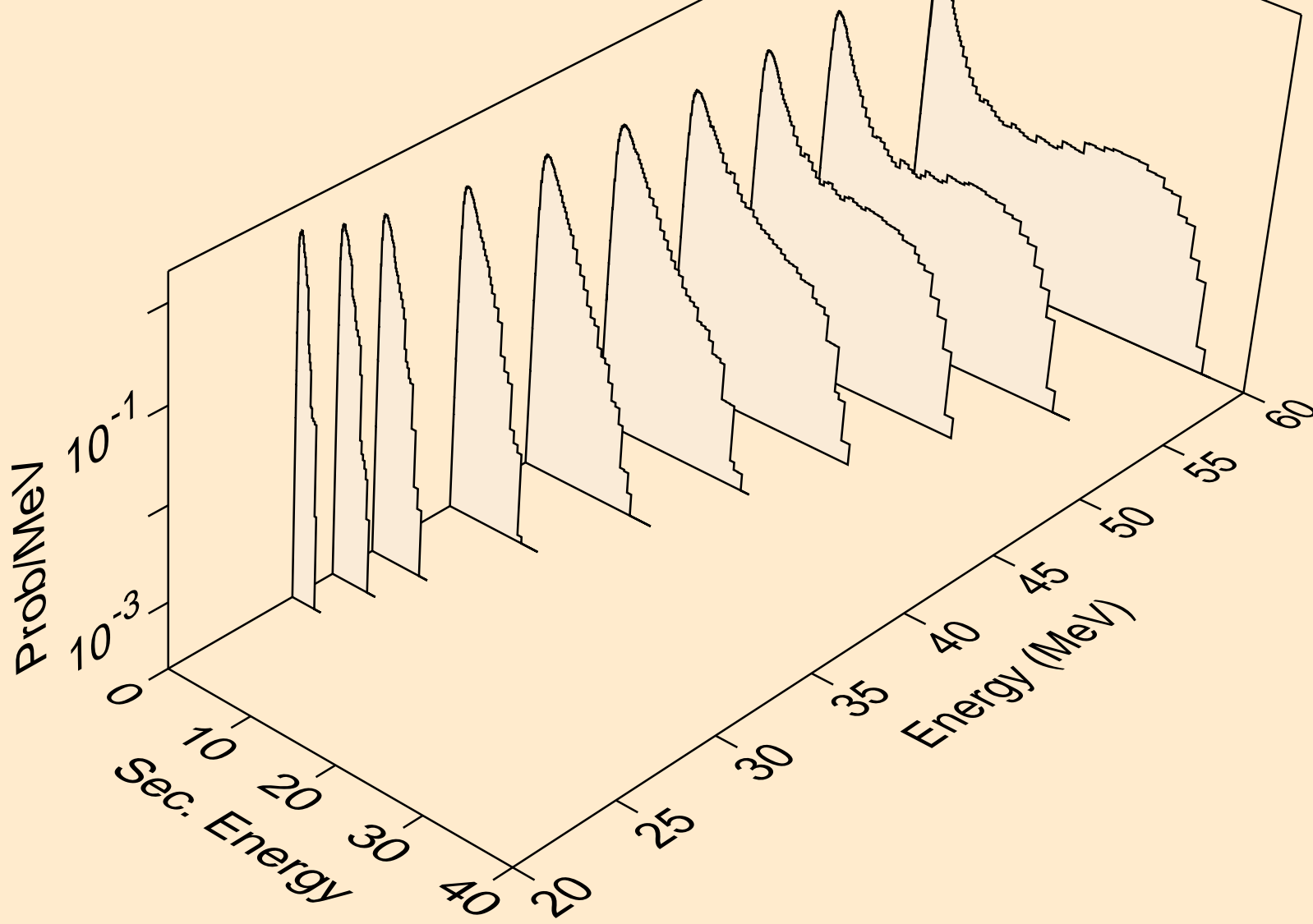

57-LA-138 FOR FENDL-3.2 PROCESSED BY NJOY2016.60+ ON
Neutron emission for (n,2np)

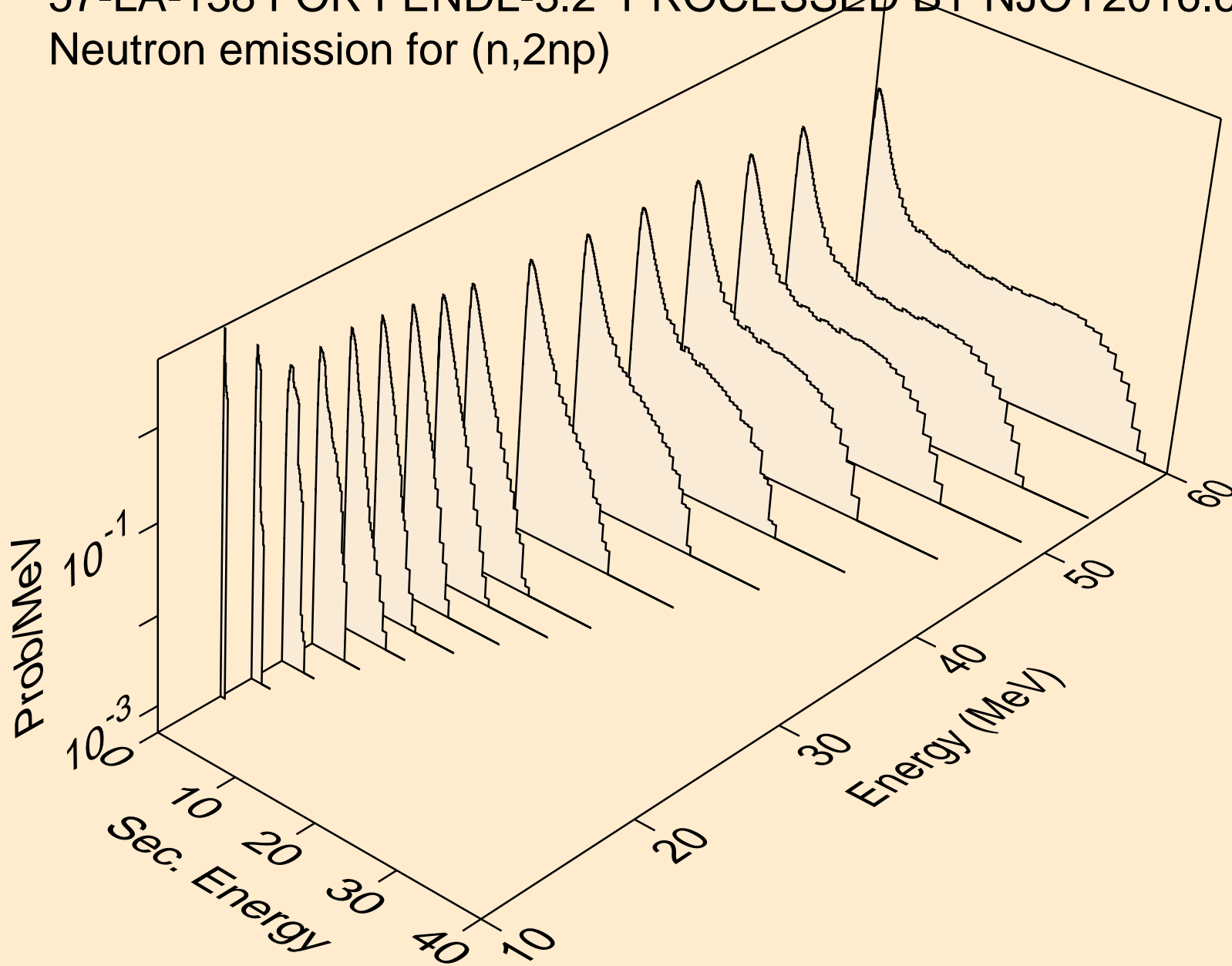

57-LA-138 FOR FENDL-3.2 PROCESSED BY NJOY2016.60+ ON
Neutron emission for (n,3np)

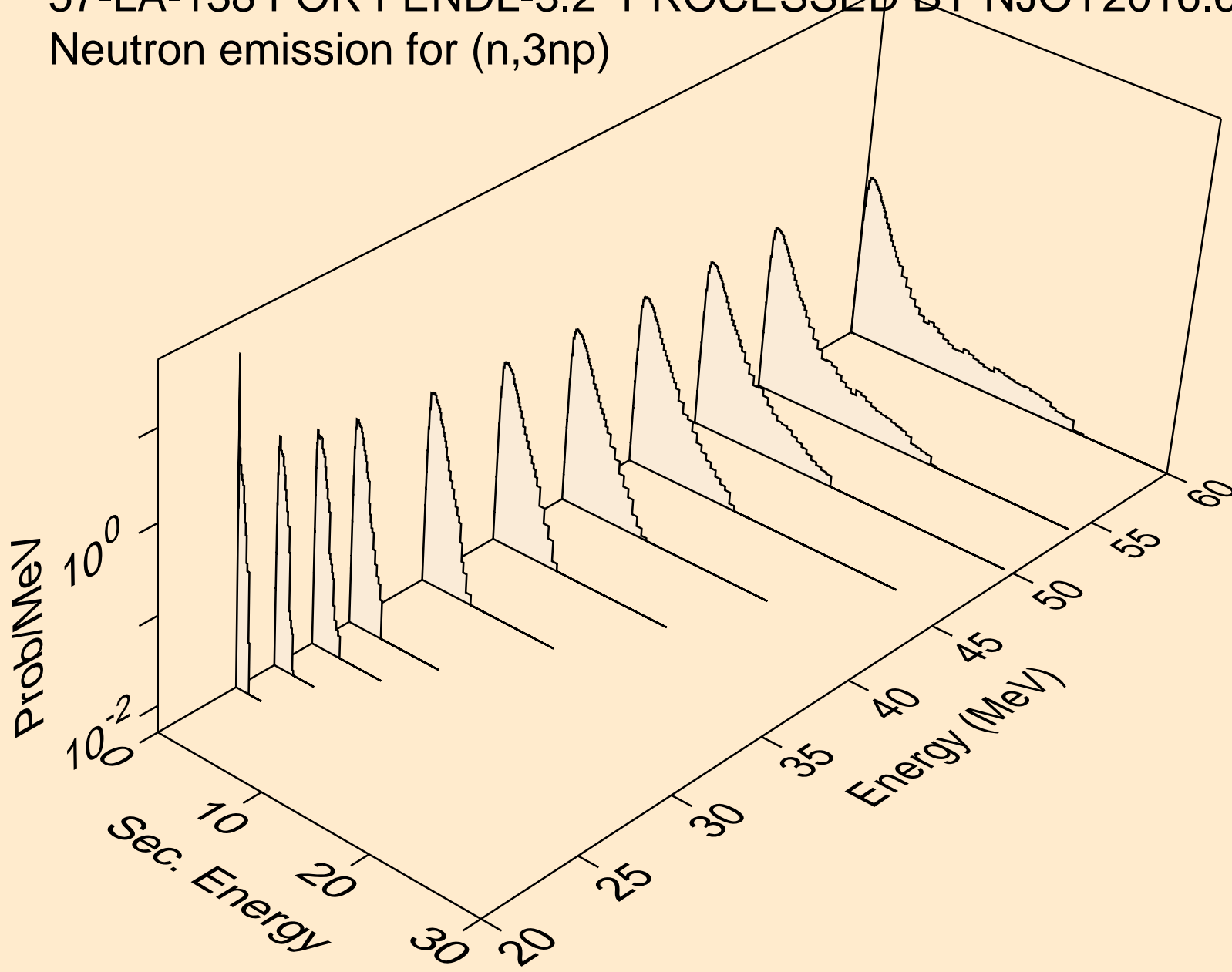

57-LA-138 FOR FENDL-3.2 PROCESSED BY NJOY2016.60+ ON
Neutron emission for (n,2np)

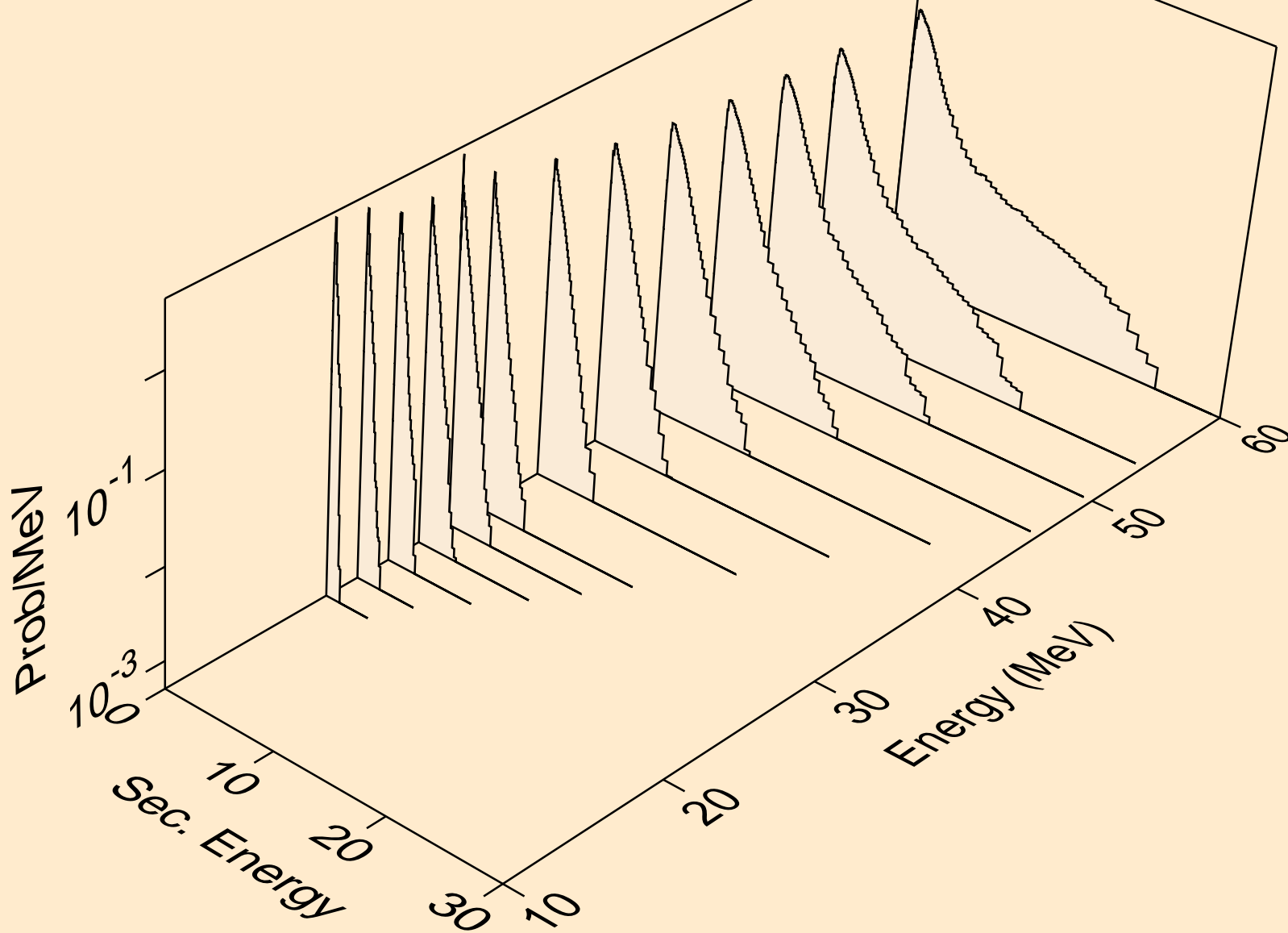

57-LA-138 FOR FENDL-3.2 PROCESSED BY NJOY2016.60+ ON
Neutron emission for (n,npa)

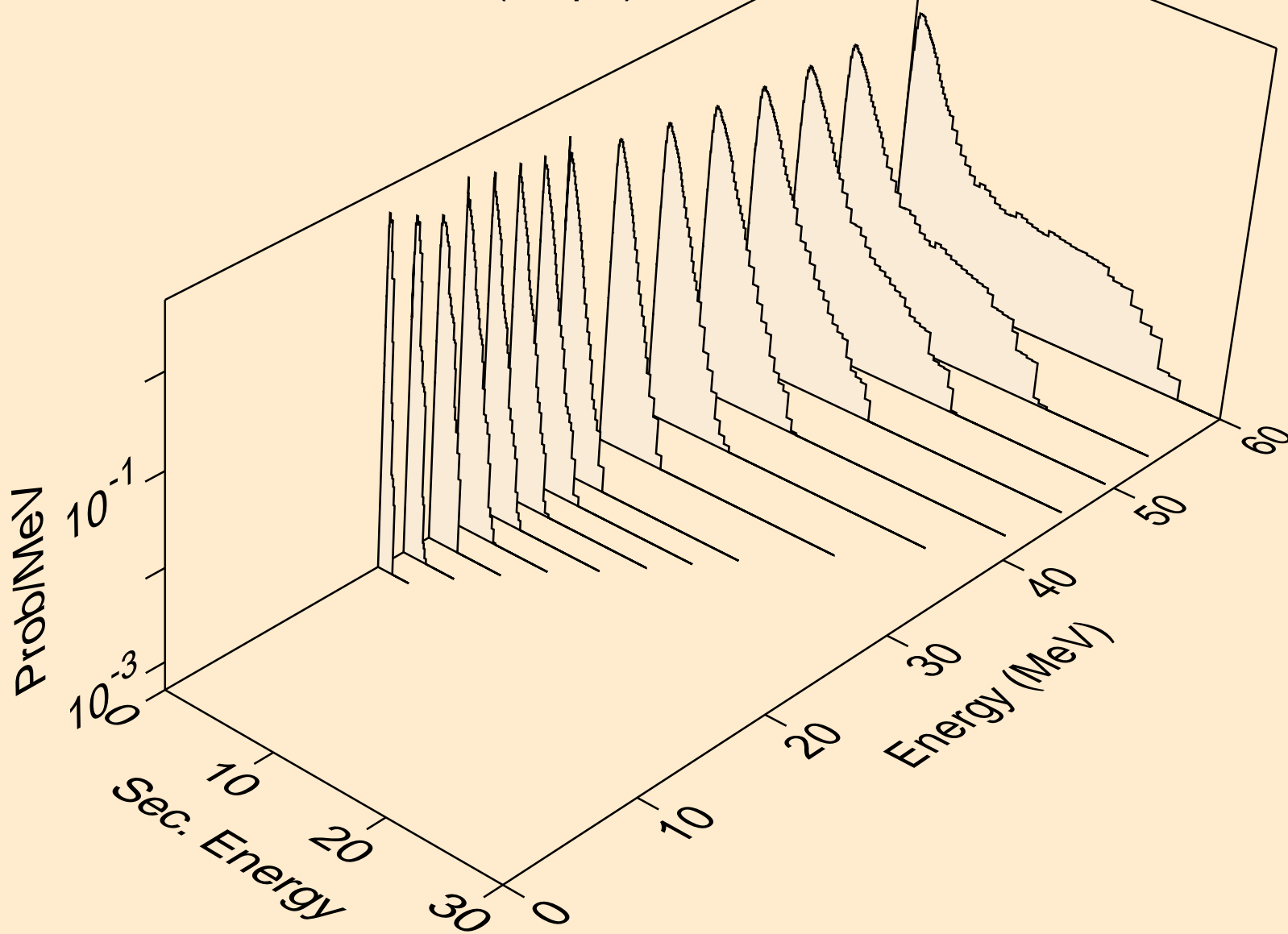

57-LA-138 FOR FENDL-3.2 PROCESSED BY NJOY2016.60+ ON
Neutron emission for (n,n*c)

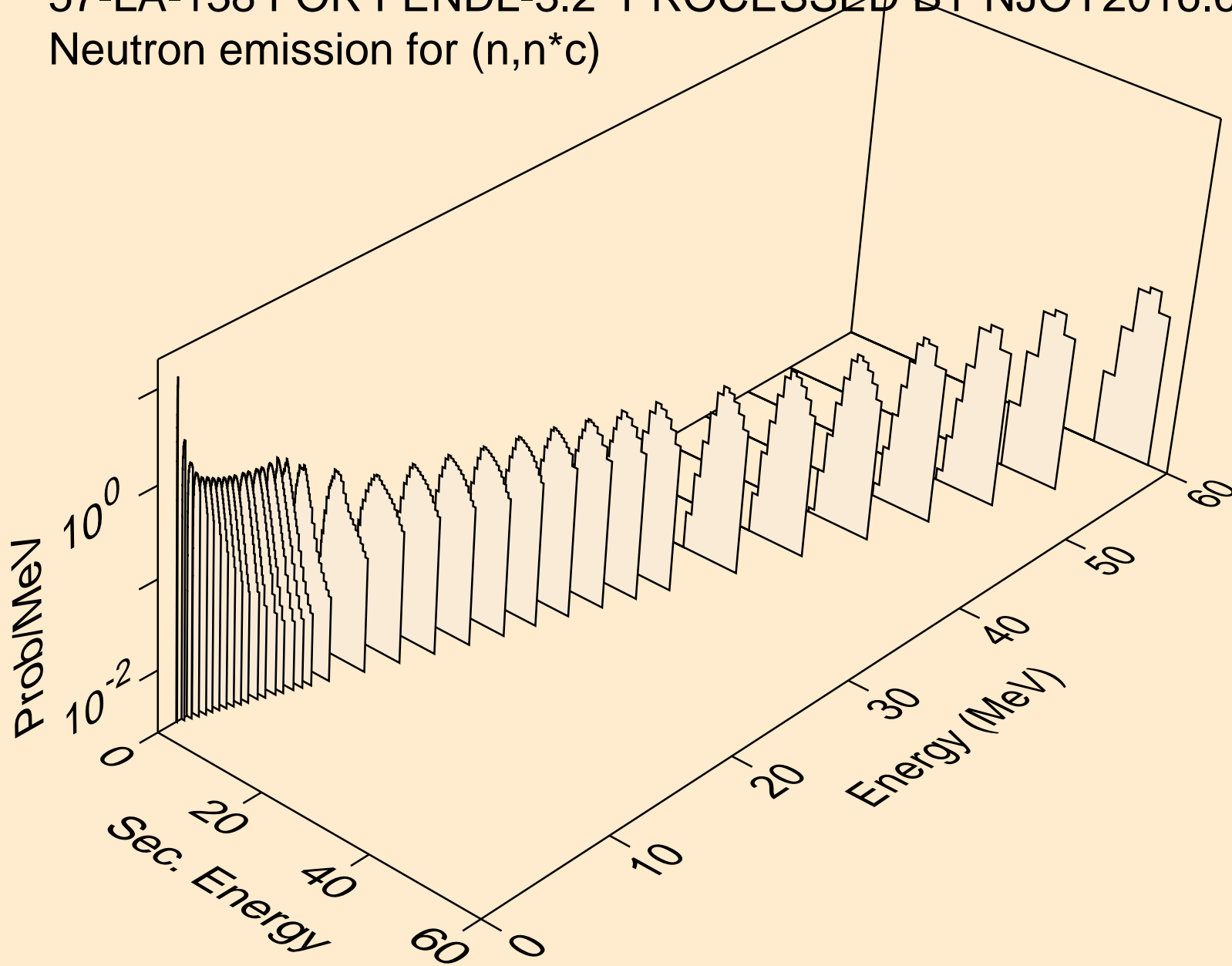

57-LA-138 FOR FENDL-3.2 PROCESSED BY NJOY2016.60+ ON
Neutron emission for (n,5n)

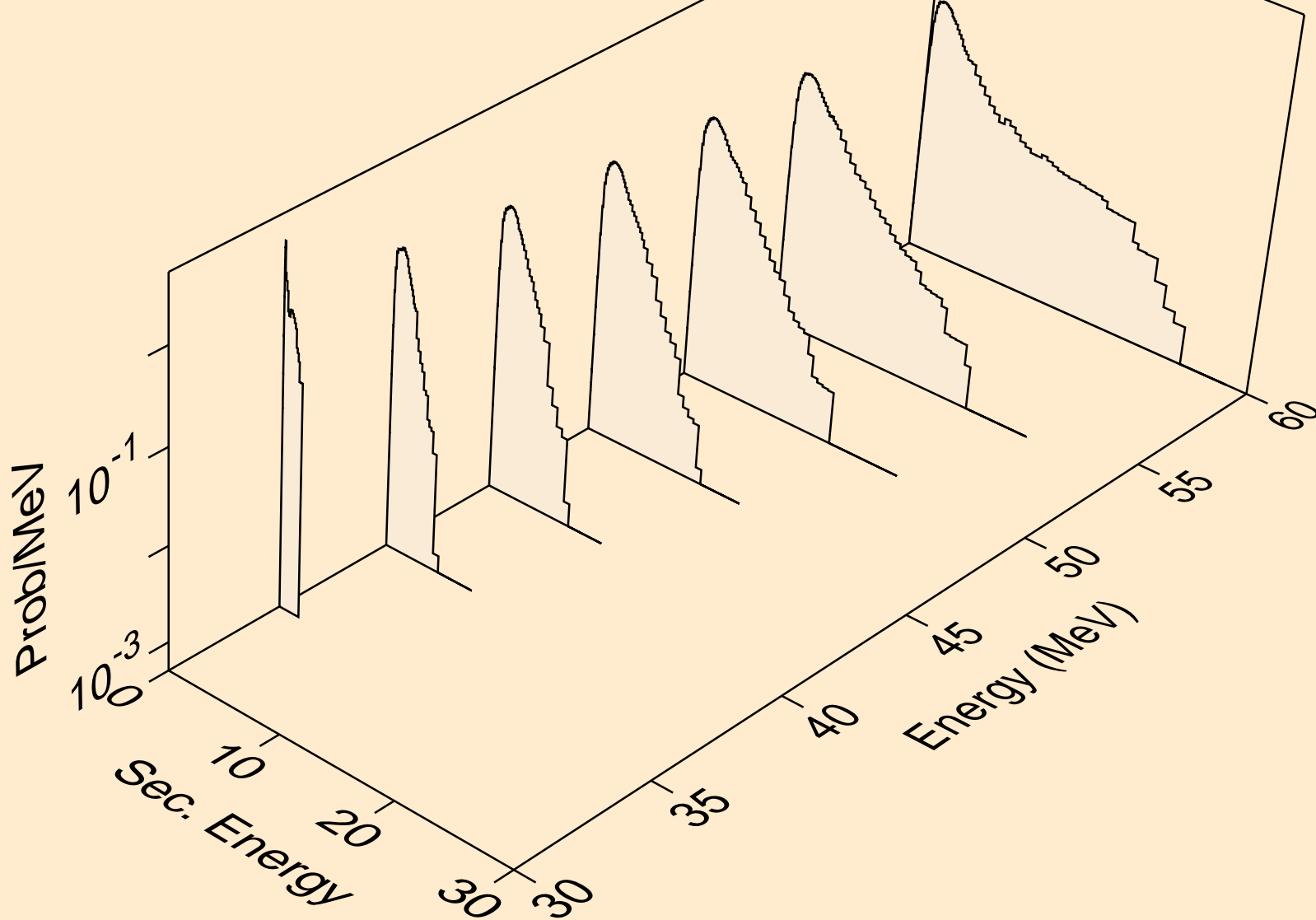

57-LA-138 FOR FENDL-3.2 PROCESSED BY NJOY2016.60+ ON
Neutron emission for (n,6n)

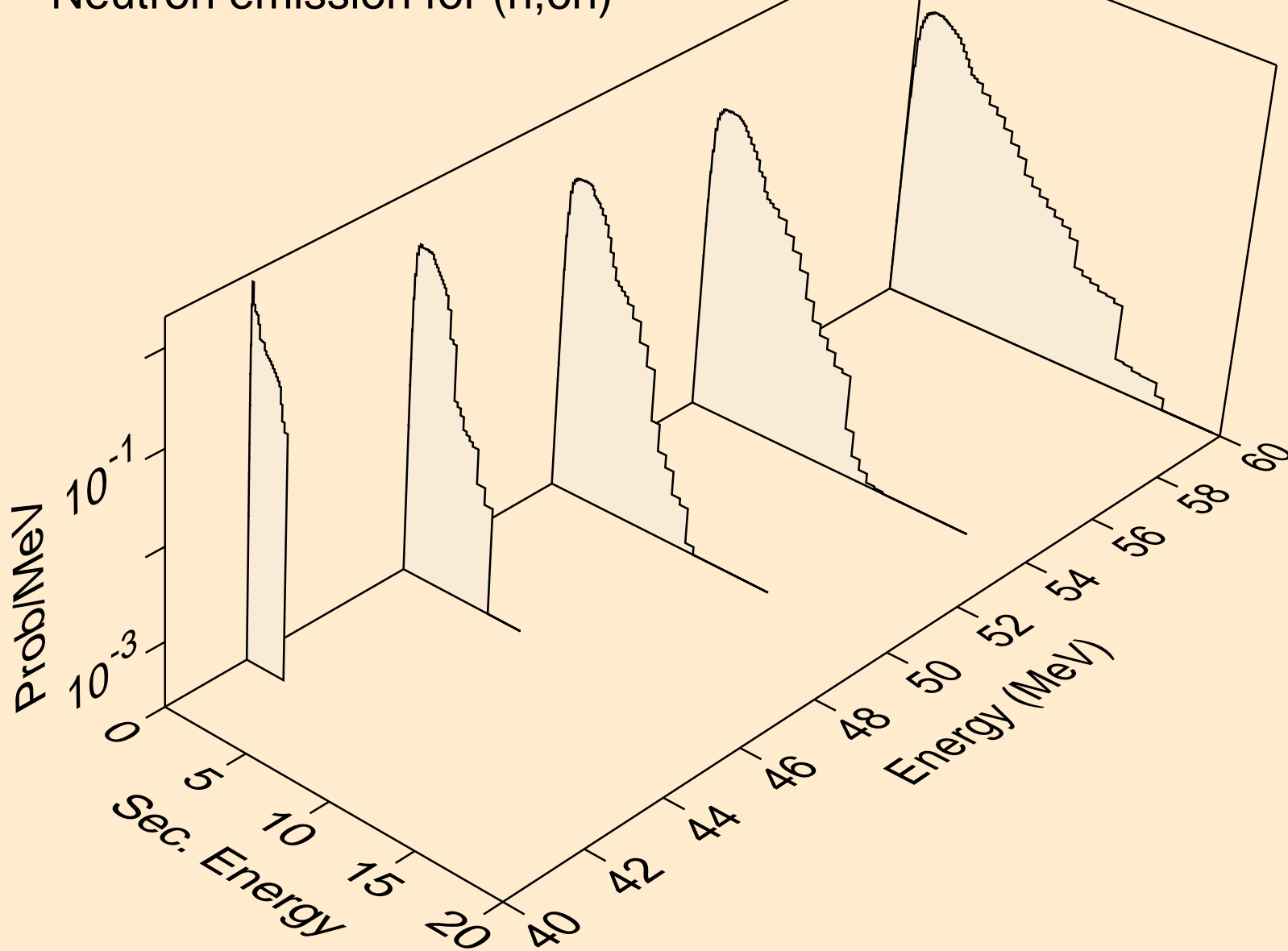

57-LA-138 FOR FENDL-3.2 PROCESSED BY NJOY2016.60+ ON
Neutron emission for (n,2nt)

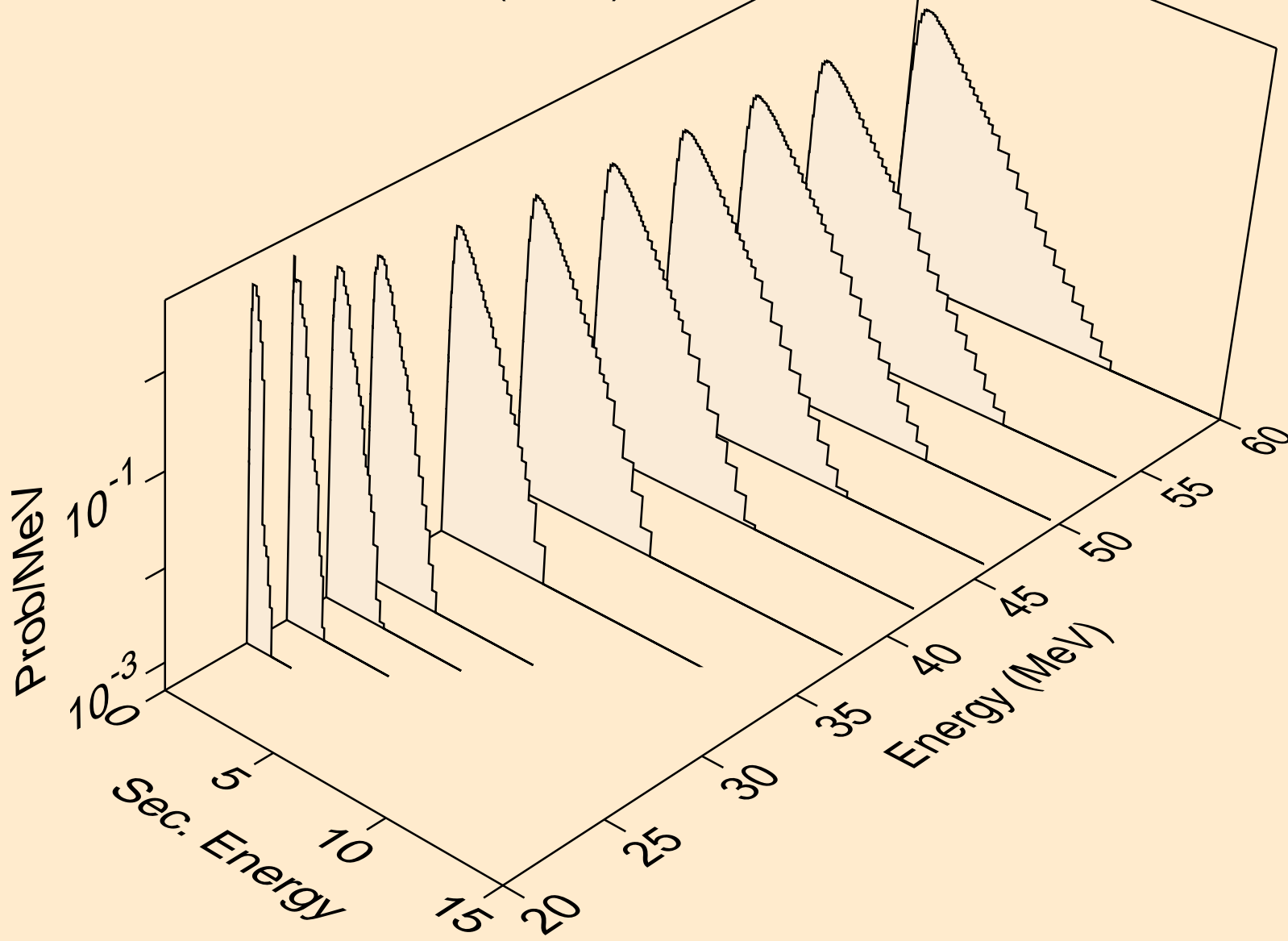

57-LA-138 FOR FENDL-3.2 PROCESSED BY NJOY2016.60+ ON
Neutron emission for (n,4np)

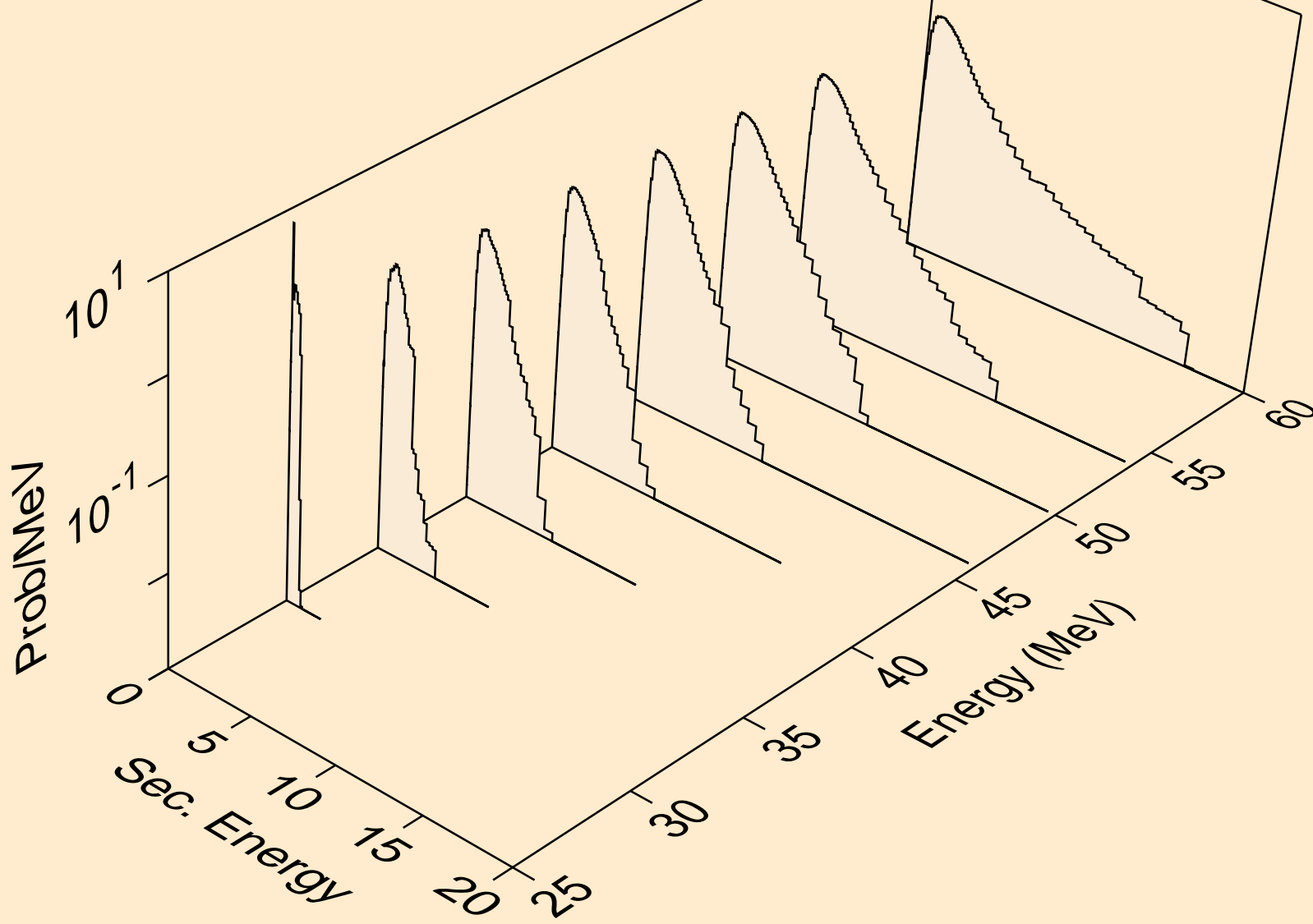

57-LA-138 FOR FENDL-3.2 PROCESSED BY NJOY2016.60+ ON
Neutron emission for (n,3nd)

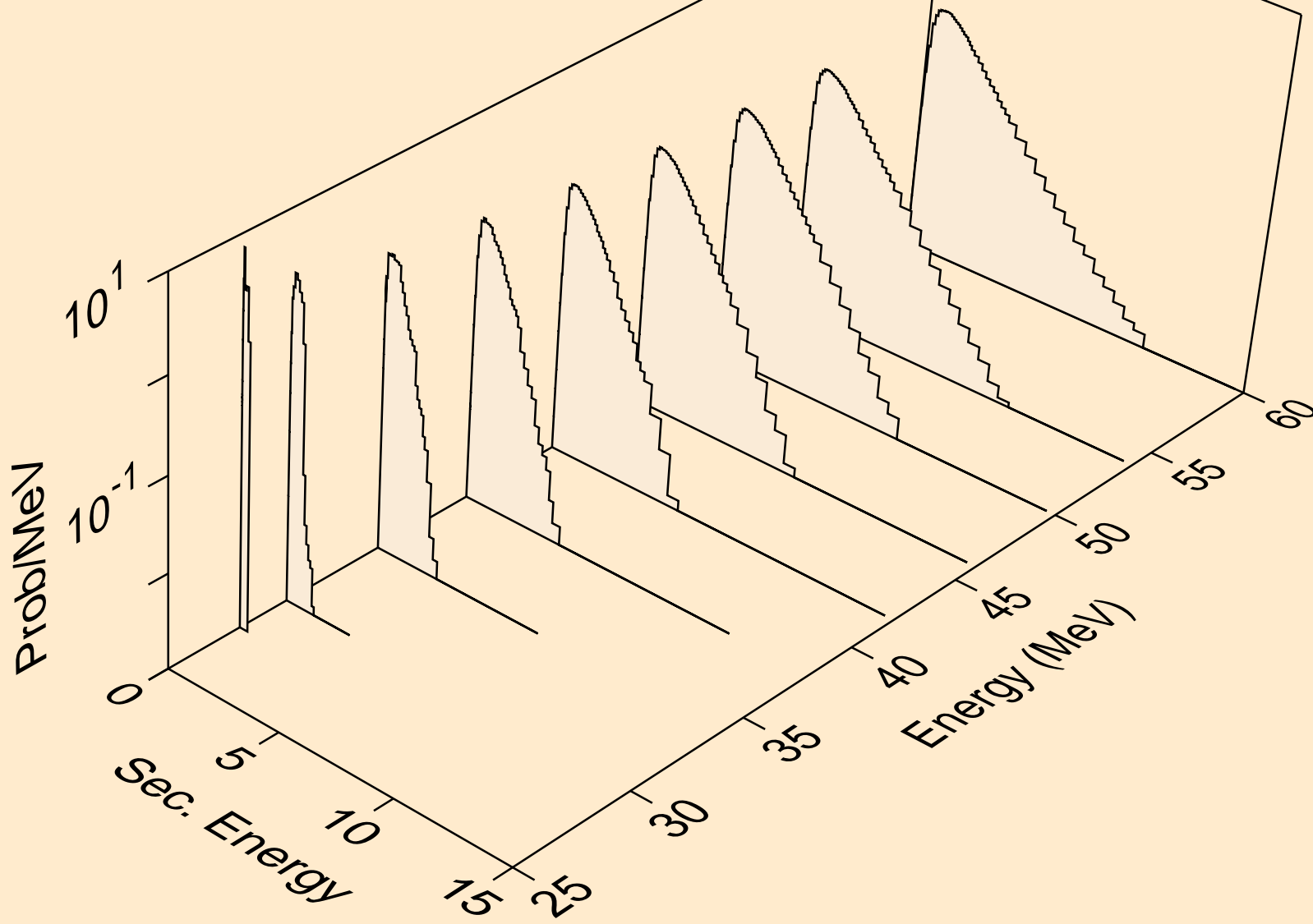

57-LA-138 FOR FENDL-3.2 PROCESSED BY NJOY2016.60+ ON
Neutron emission for (n,nda)

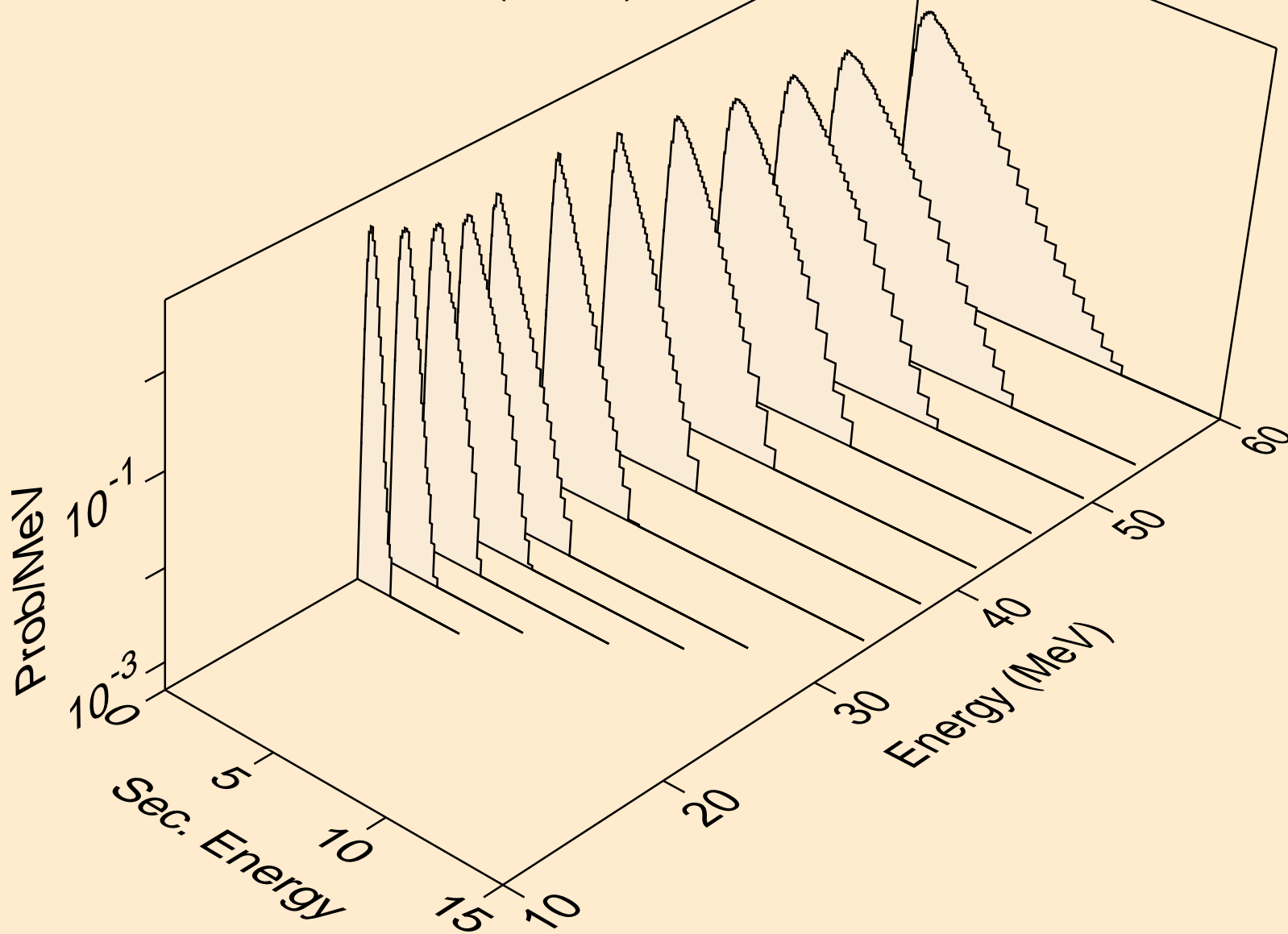

57-LA-138 FOR FENDL-3.2 PROCESSED BY NJOY2016.60+ ON
Neutron emission for (n,2npa)

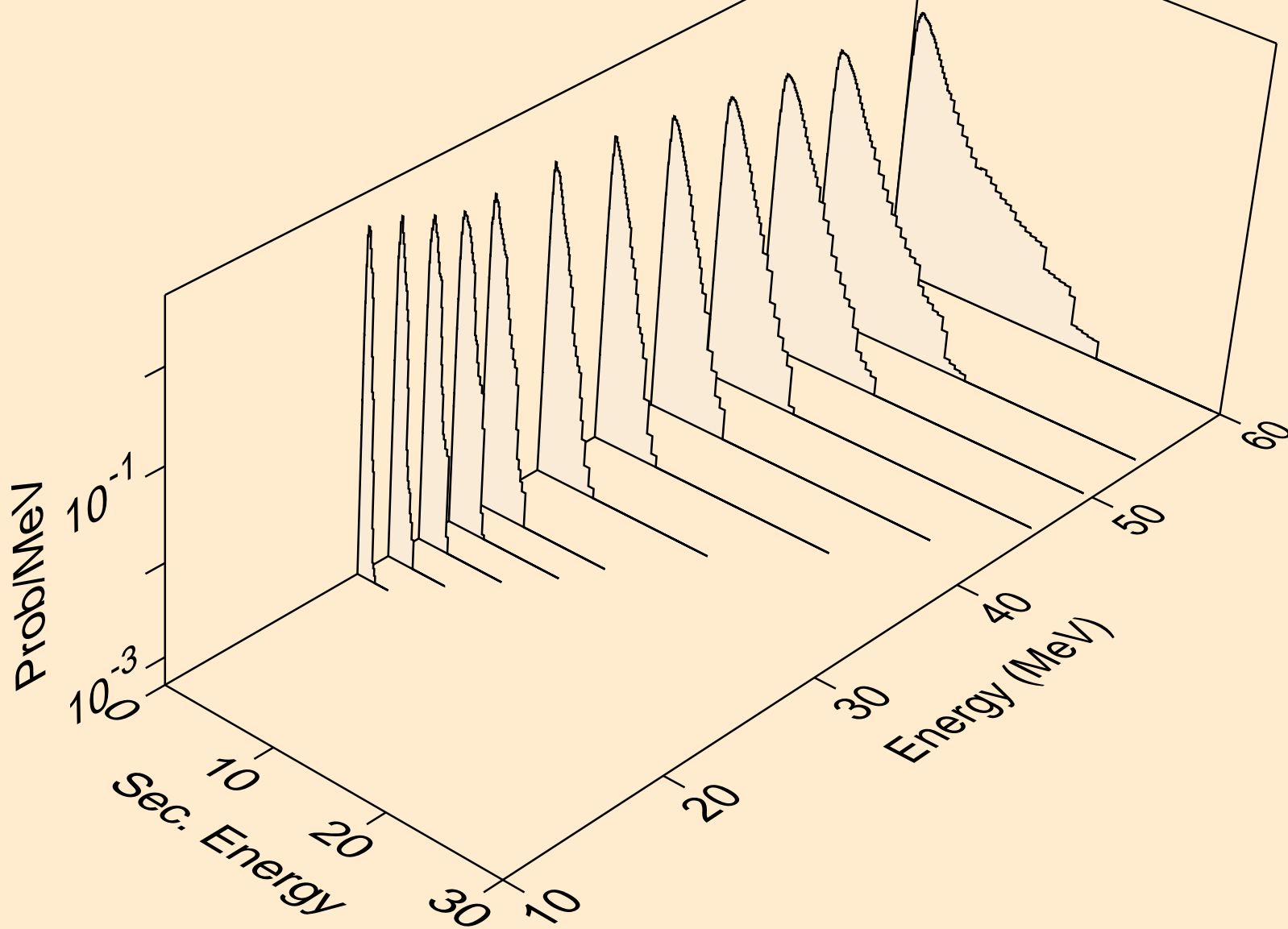

57-LA-138 FOR FENDL-3.2 PROCESSED BY NJOY2016.60+ ON
Neutron emission for (n,5np)

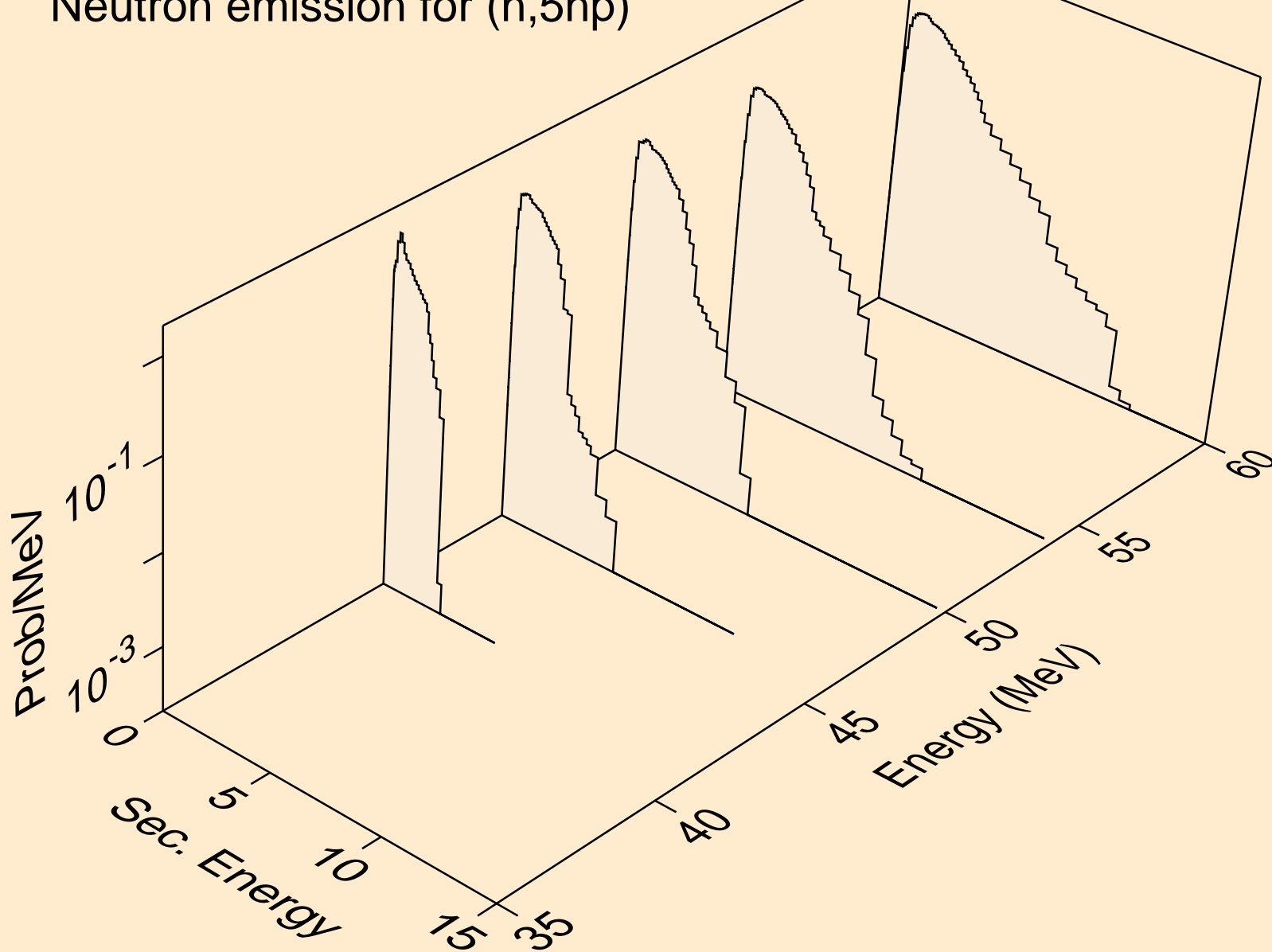

57-LA-138 FOR FENDL-3.2 PROCESSED BY NJOY2016.60+ ON
Neutron emission for (n,6np)

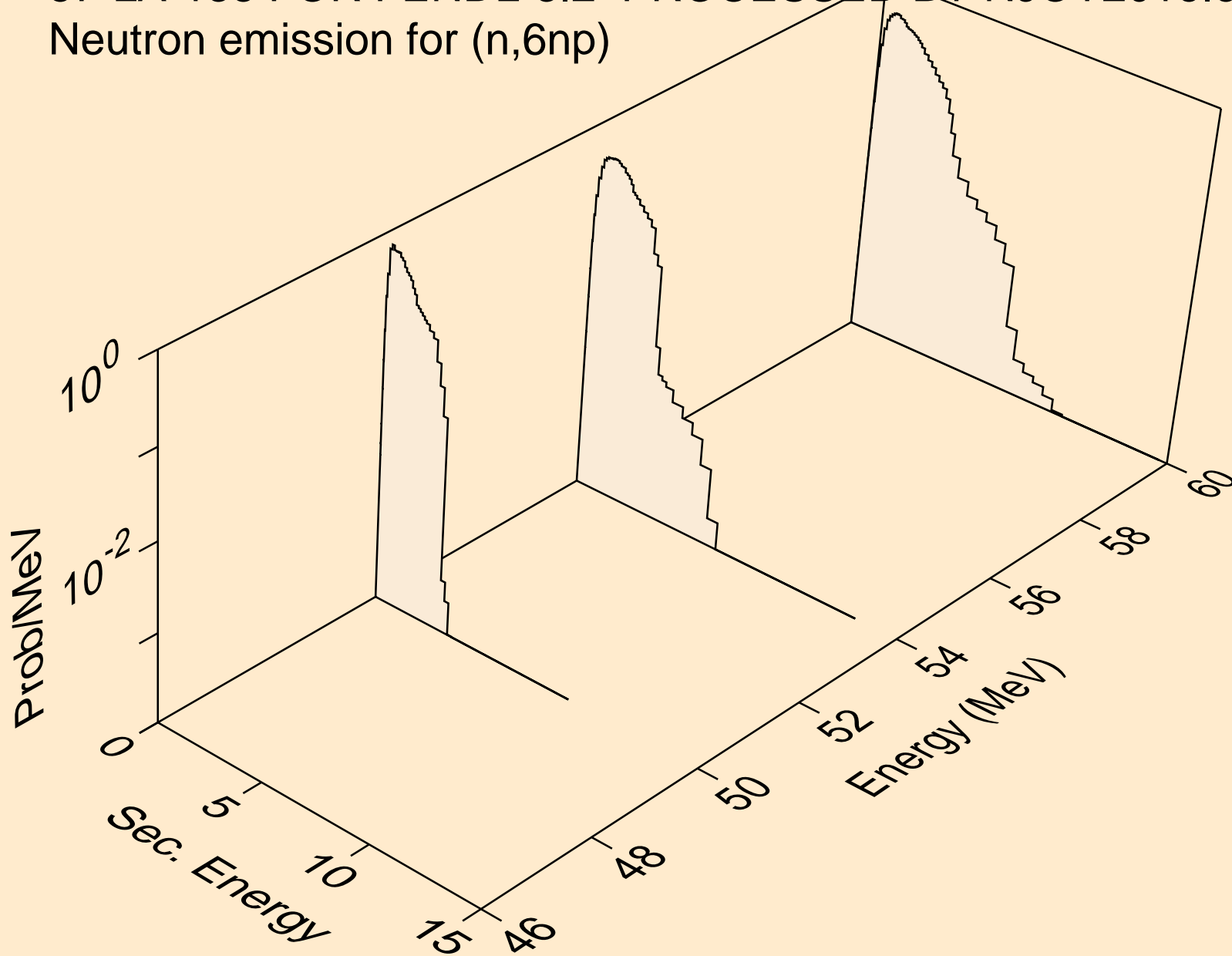

57-LA-138 FOR FENDL-3.2 PROCESSED BY NJOY2016.60+ ON
Neutron emission for (n,4na)

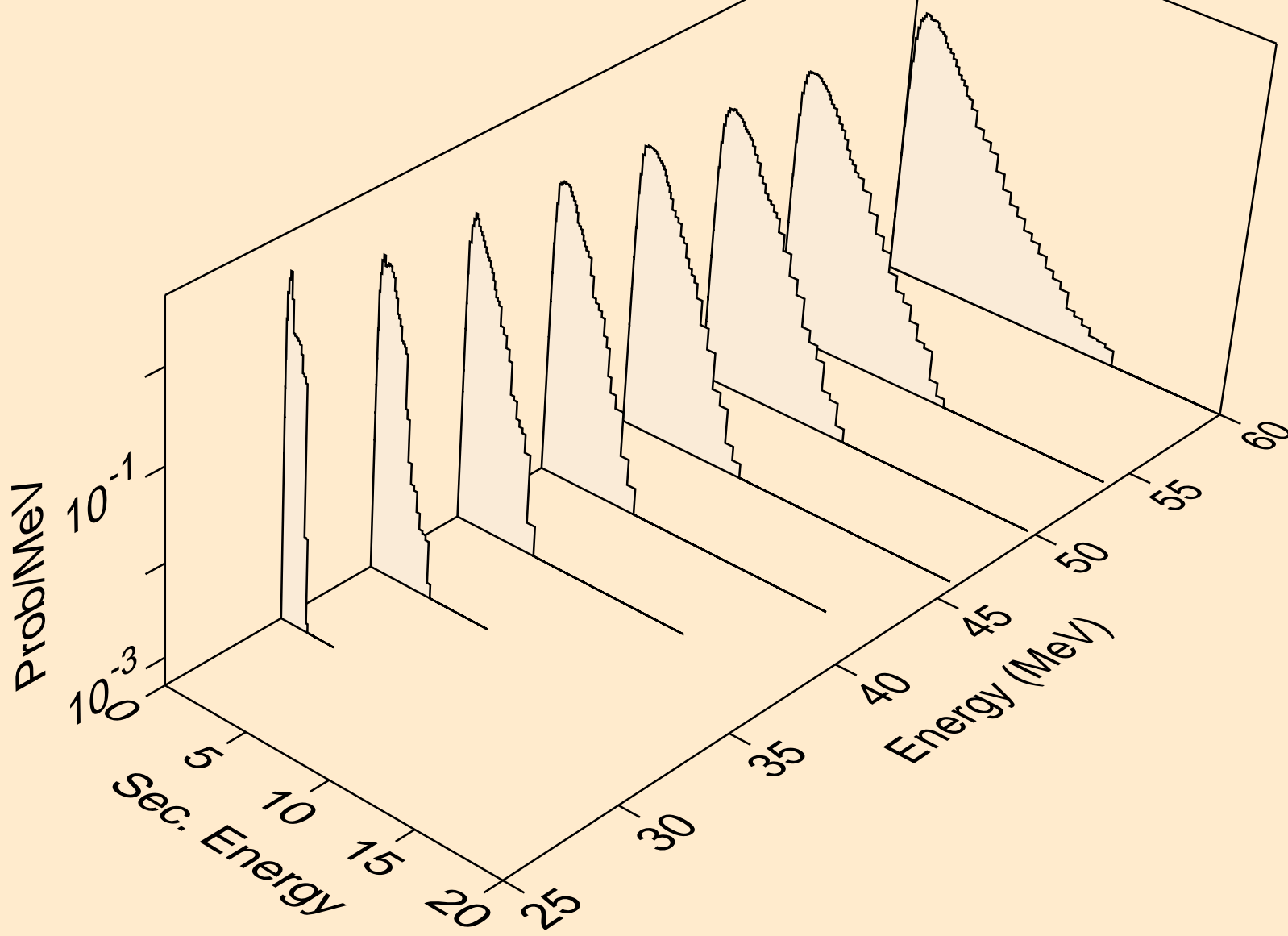

57-LA-138 FOR FENDL-3.2 PROCESSED BY NJOY2016.60+ ON
Neutron emission for (n,5na)

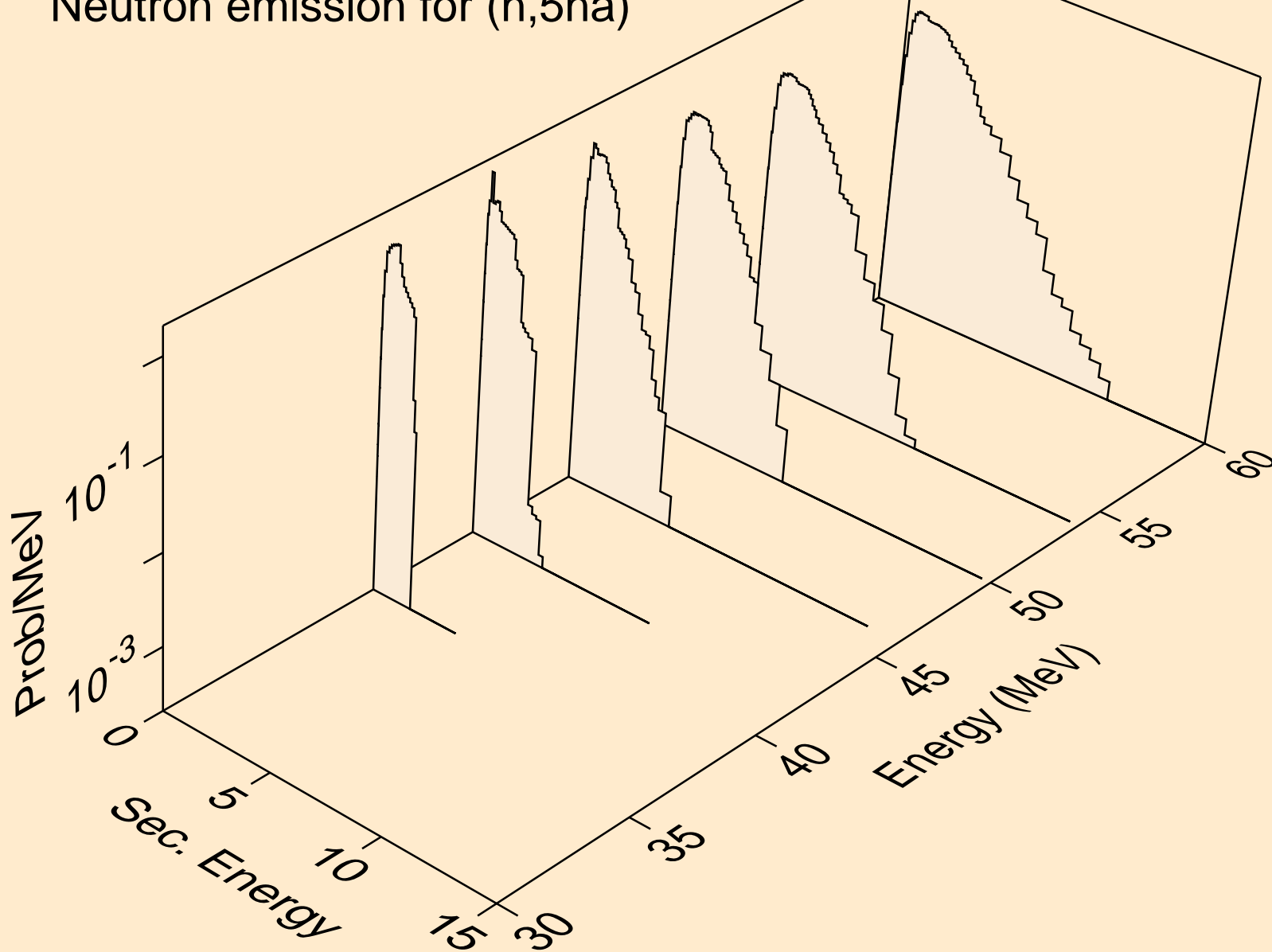

57-LA-138 FOR FENDL-3.2 PROCESSED BY NJOY2016.60+ ON
Neutron emission for (n,6na)

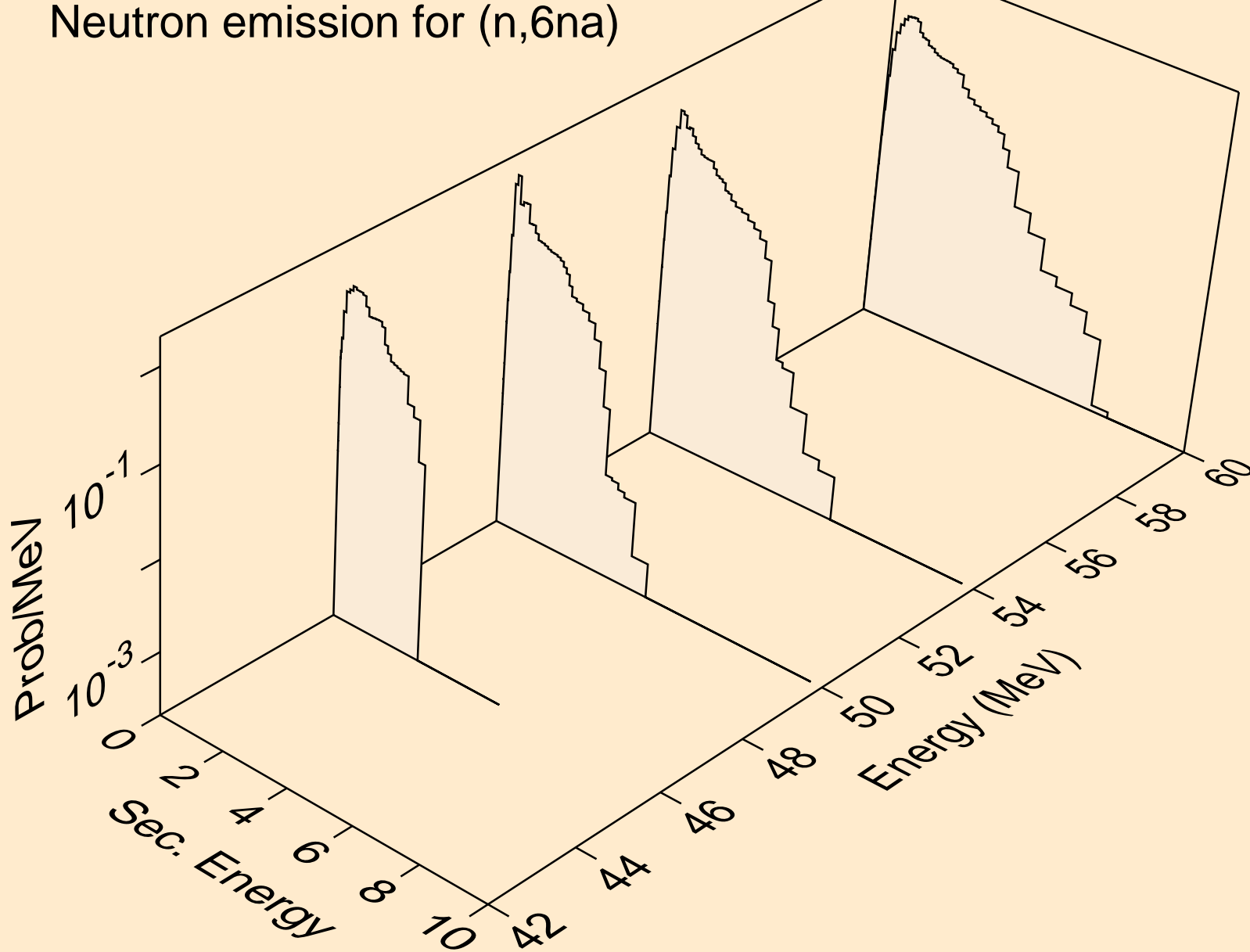

57-LA-138 FOR FENDL-3.2 PROCESSED BY NJOY2016.60+ ON
Neutron emission for (n,4nd)

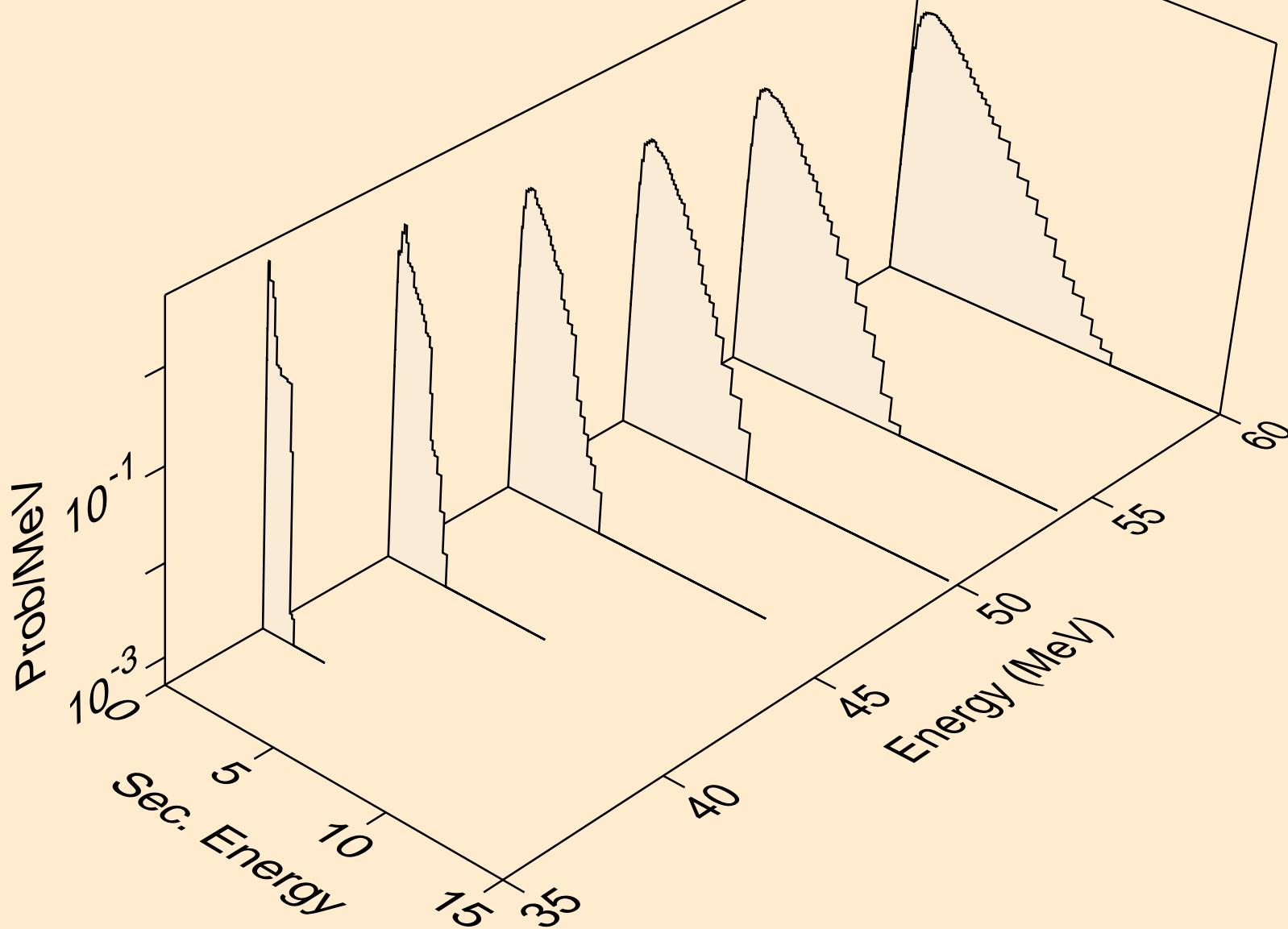

57-LA-138 FOR FENDL-3.2 PROCESSED BY NJOY2016.60+ ON
Neutron emission for (n,5nd)

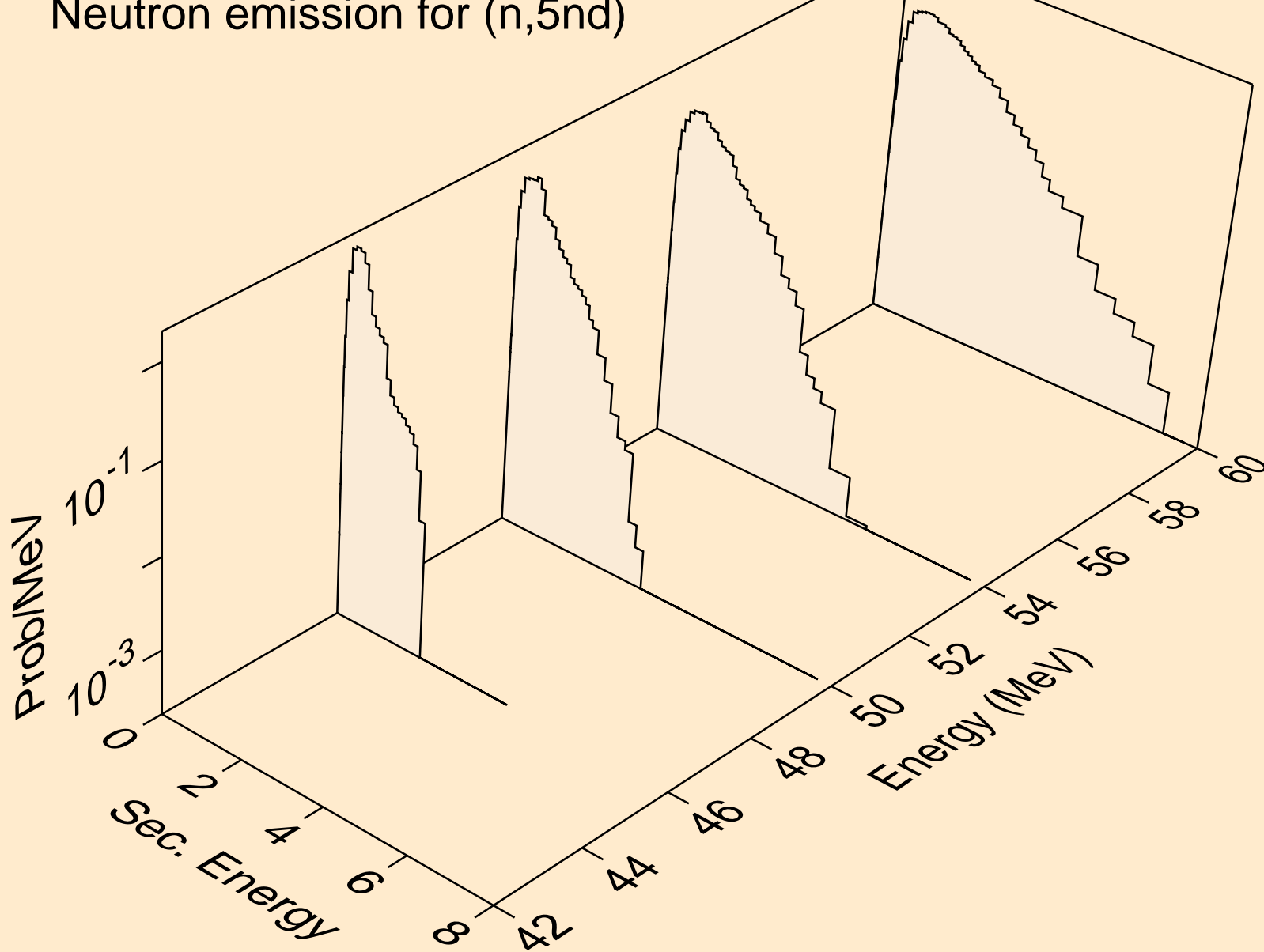

57-LA-138 FOR FENDL-3.2 PROCESSED BY NJOY2016.60+ ON
Neutron emission for (n,3nt)

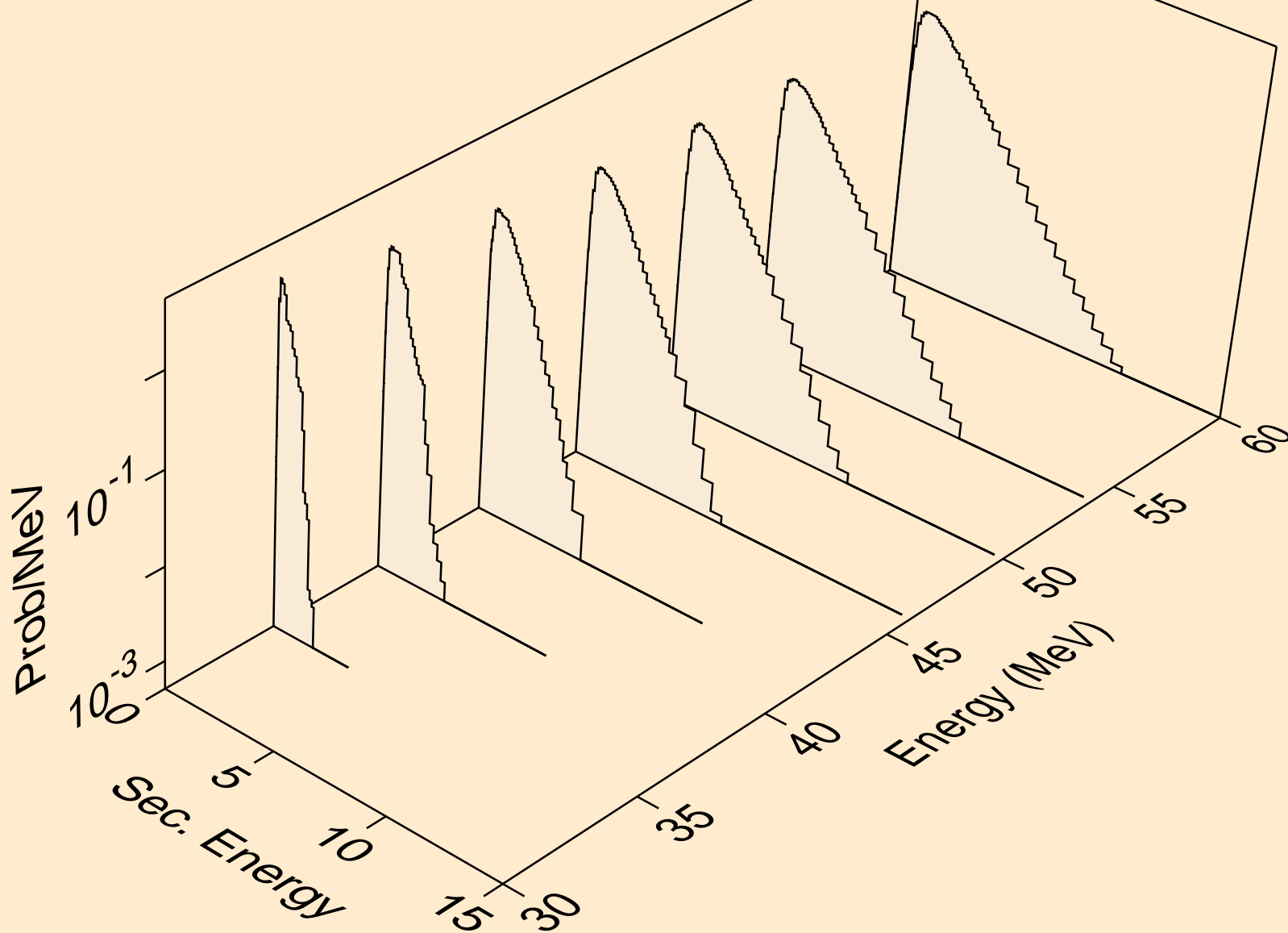

57-LA-138 FOR FENDL-3.2 PROCESSED BY NJOY2016.60+ ON
Neutron emission for (n,4nt)

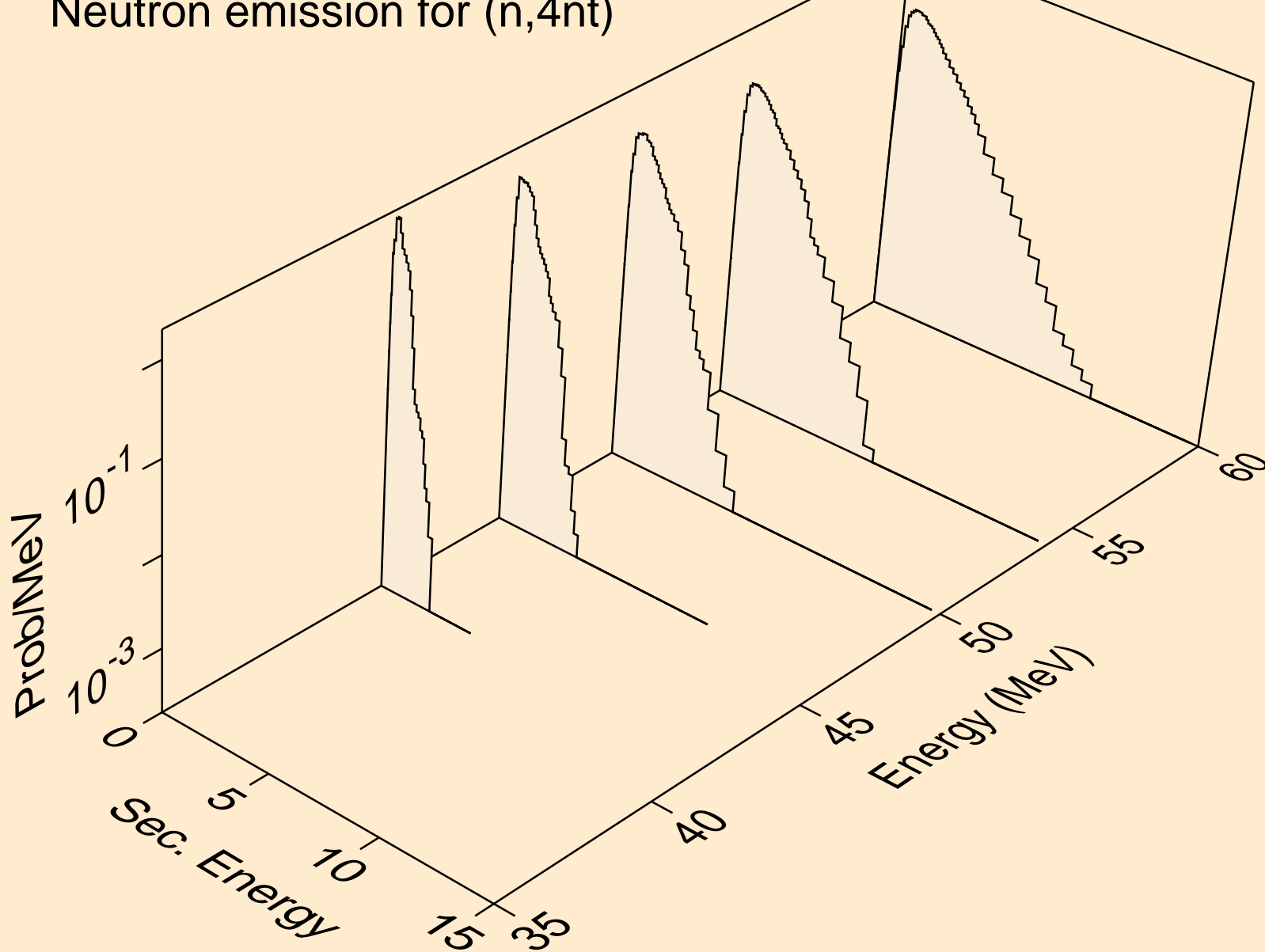

57-LA-138 FOR FENDL-3.2 PROCESSED BY NJOY2016.60+ ON
Neutron emission for (n,2n)he3

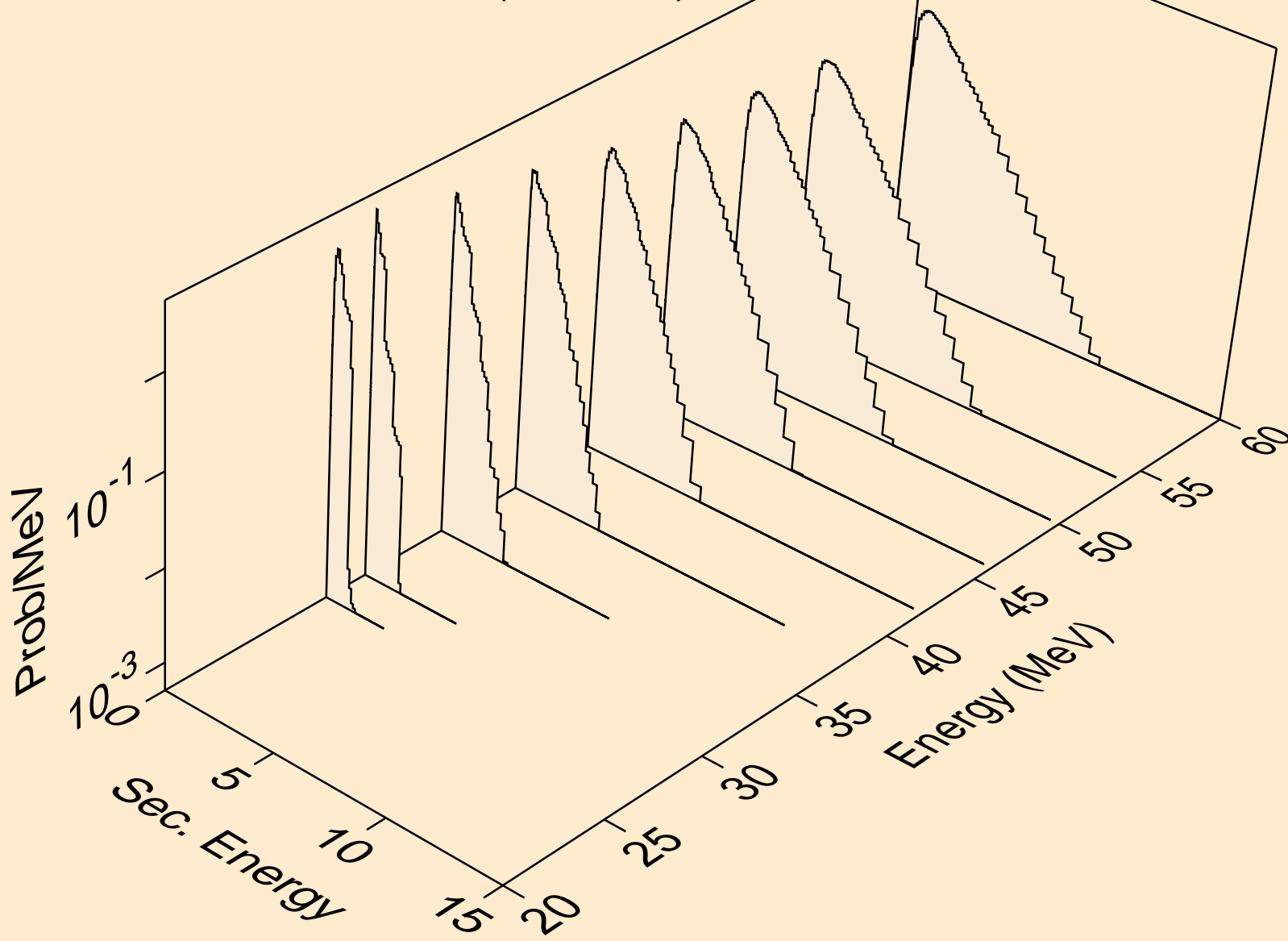

57-LA-138 FOR FENDL-3.2 PROCESSED BY NJOY2016.60+ ON
Neutron emission for (n,3n)he3

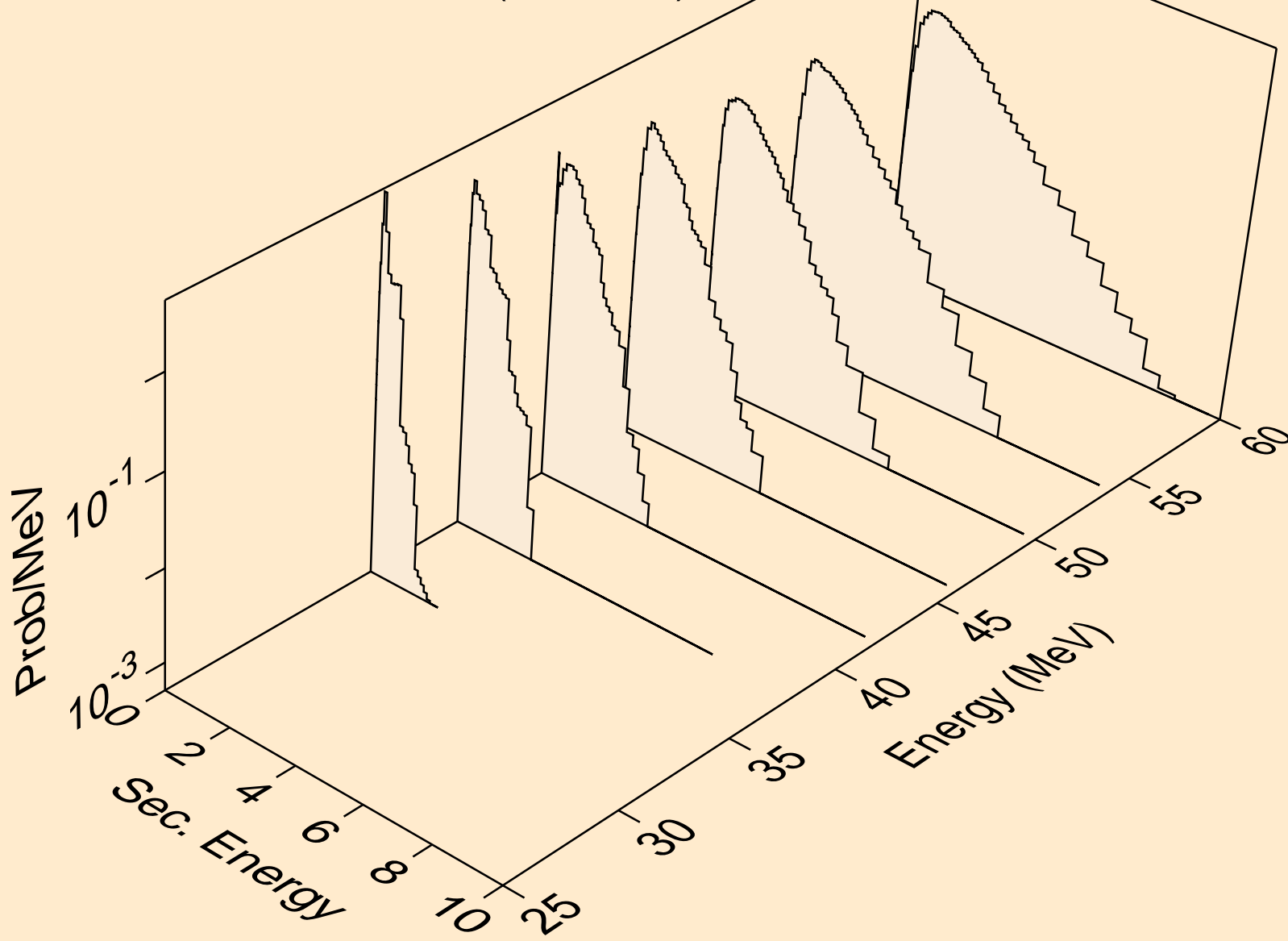

57-LA-138 FOR FENDL-3.2 PROCESSED BY NJOY2016.60+ ON
Neutron emission for (n,4n)he3

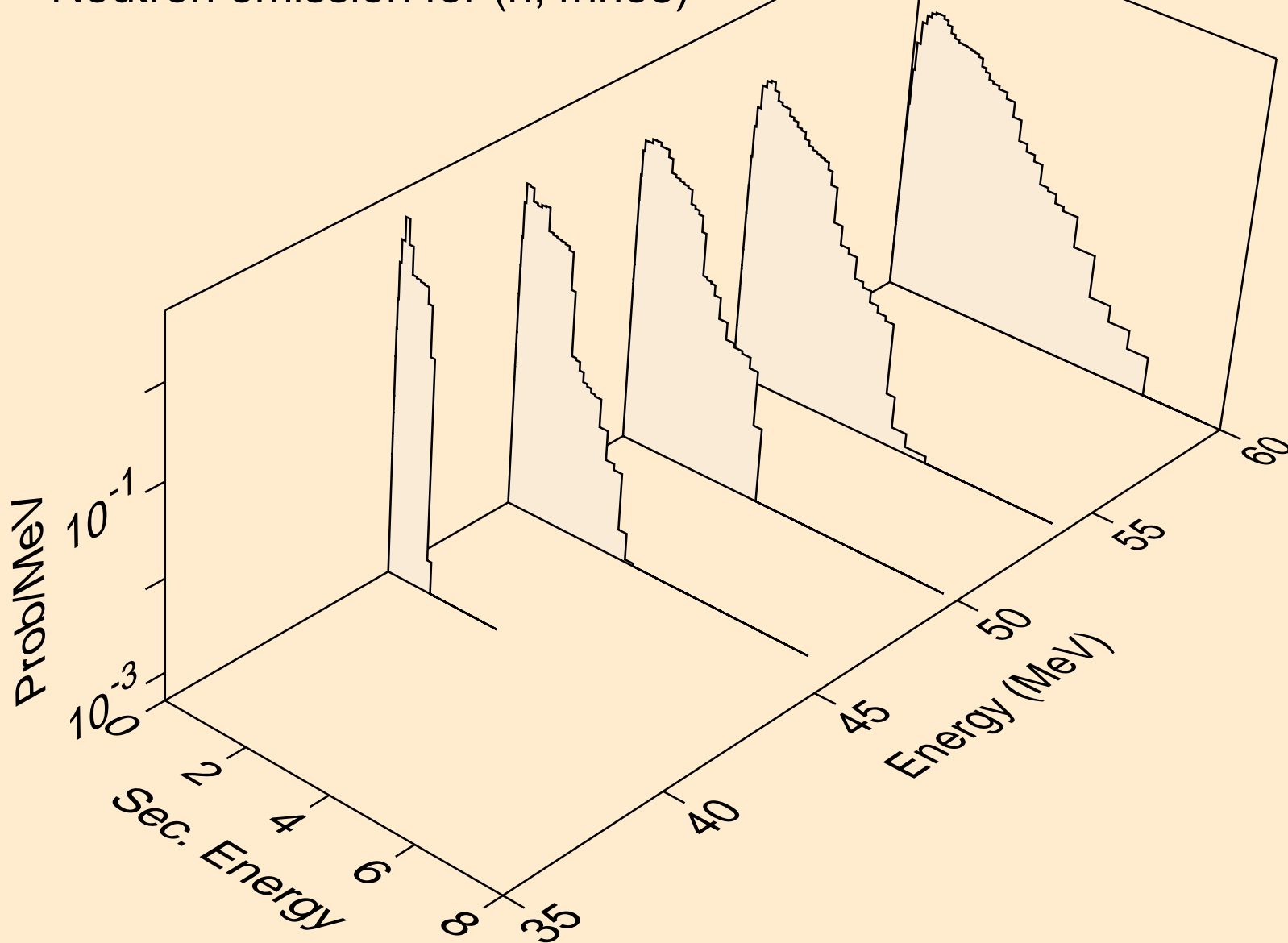

57-LA-138 FOR FENDL-3.2 PROCESSED BY NJOY2016.60+ ON
Neutron emission for (n,3n2p)

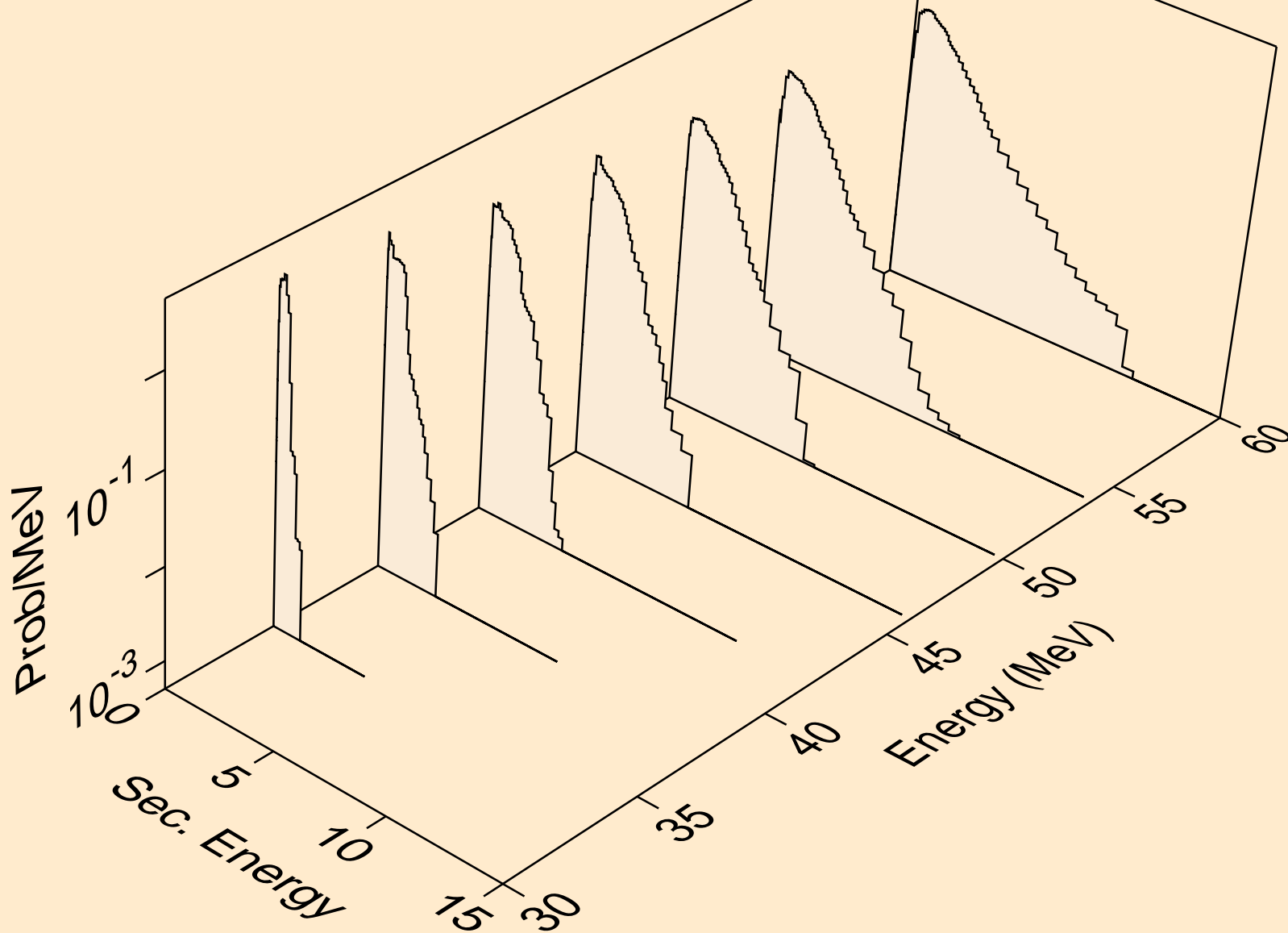

57-LA-138 FOR FENDL-3.2 PROCESSED BY NJOY2016.60+ ON
Neutron emission for (n,3n2a)

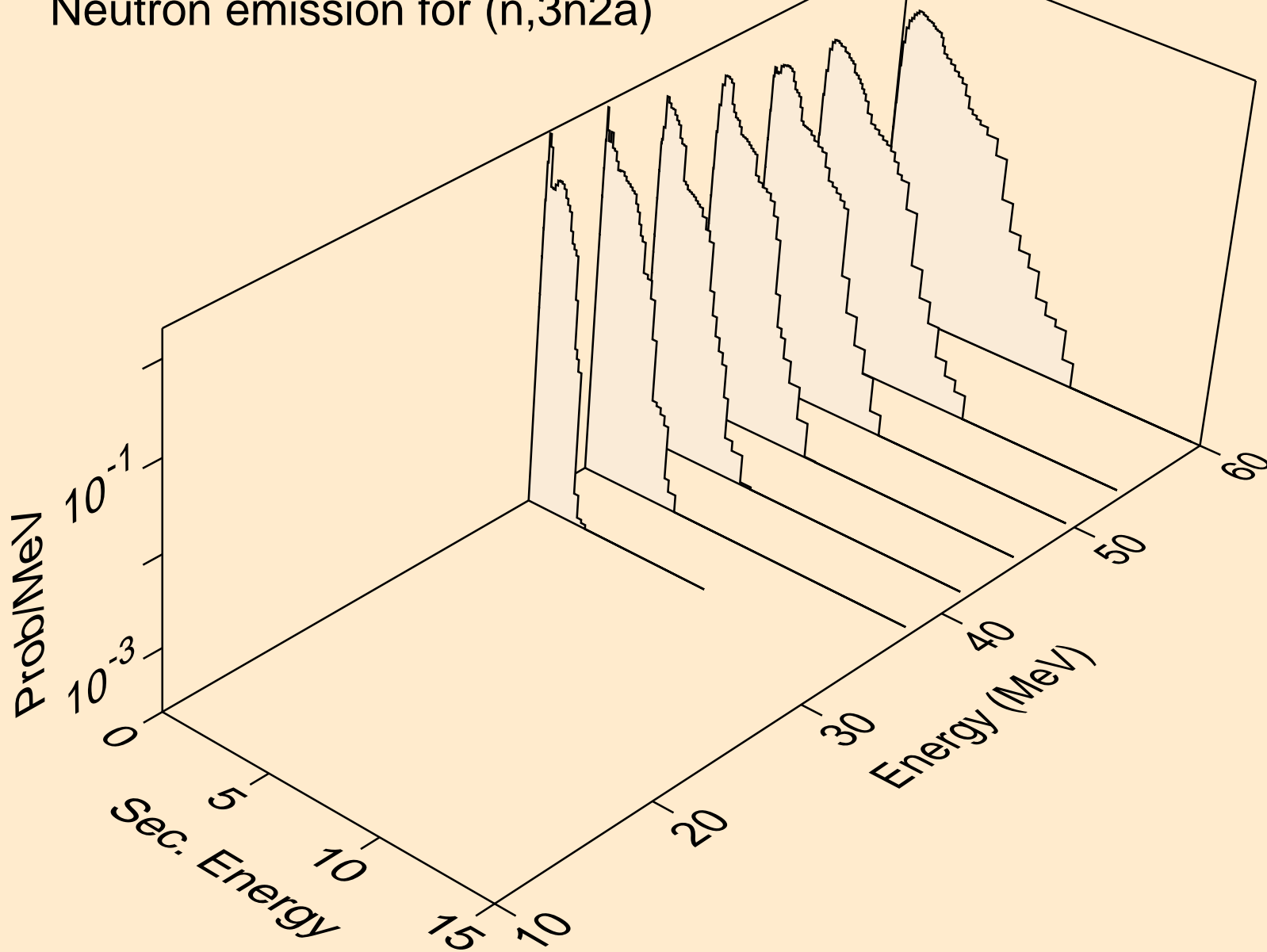

57-LA-138 FOR FENDL-3.2 PROCESSED BY NJOY2016.60+ ON
Neutron emission for (n,3npa)

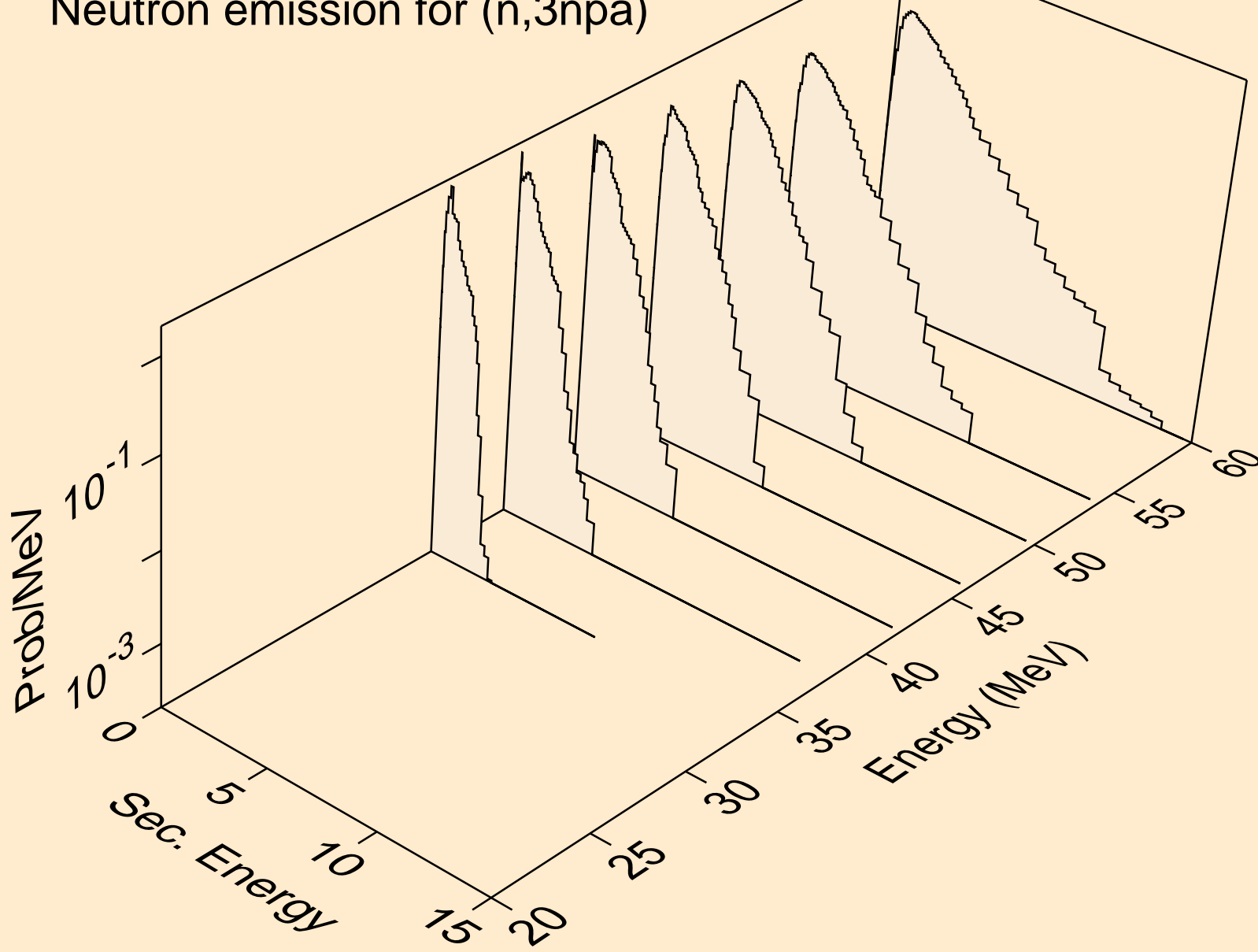

57-LA-138 FOR FENDL-3.2 PROCESSED BY NJOY2016.60+ ON
Neutron emission for (n,npd)

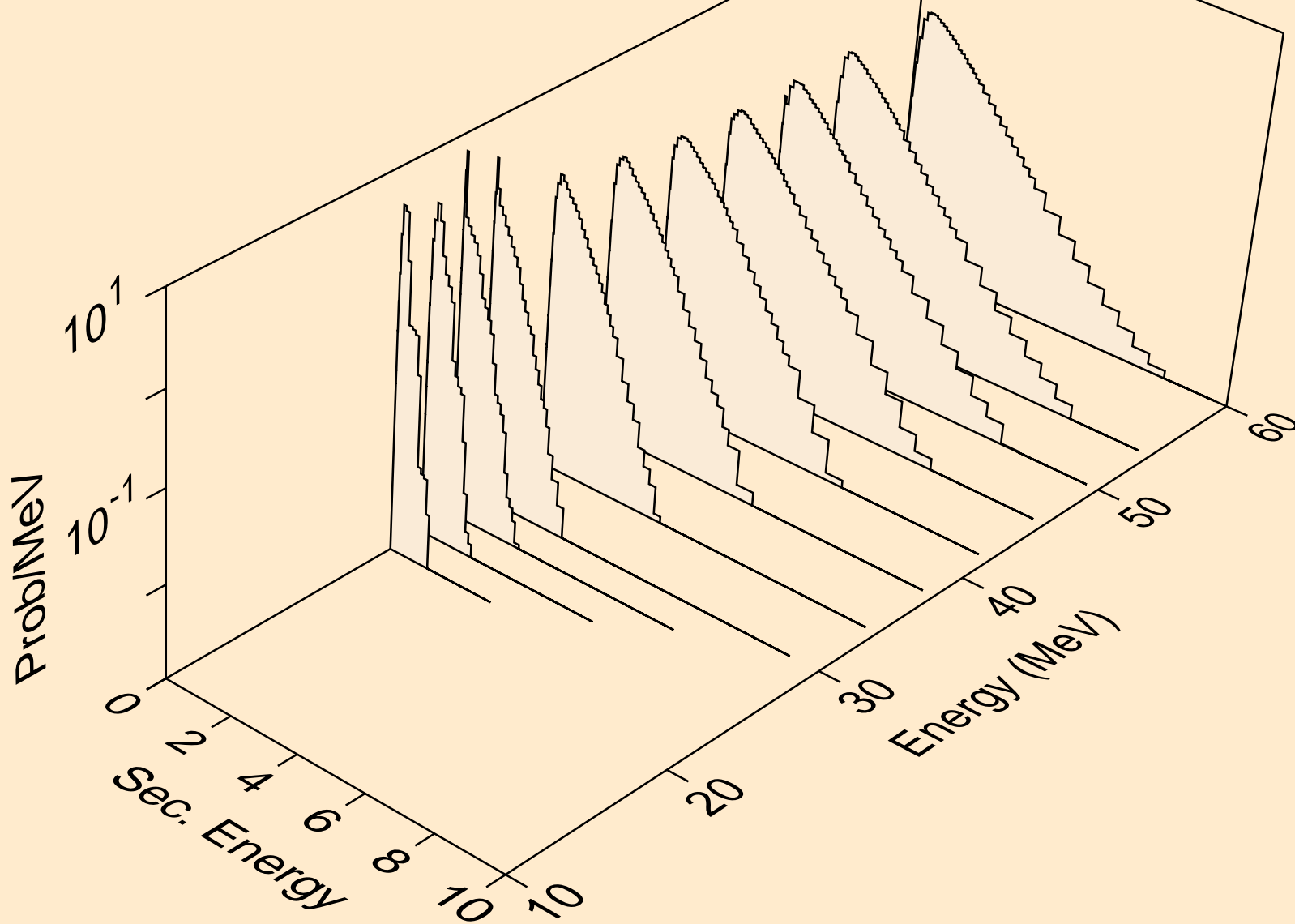

57-LA-138 FOR FENDL-3.2 PROCESSED BY NJOY2016.60+ ON
Neutron emission for (n,npt)

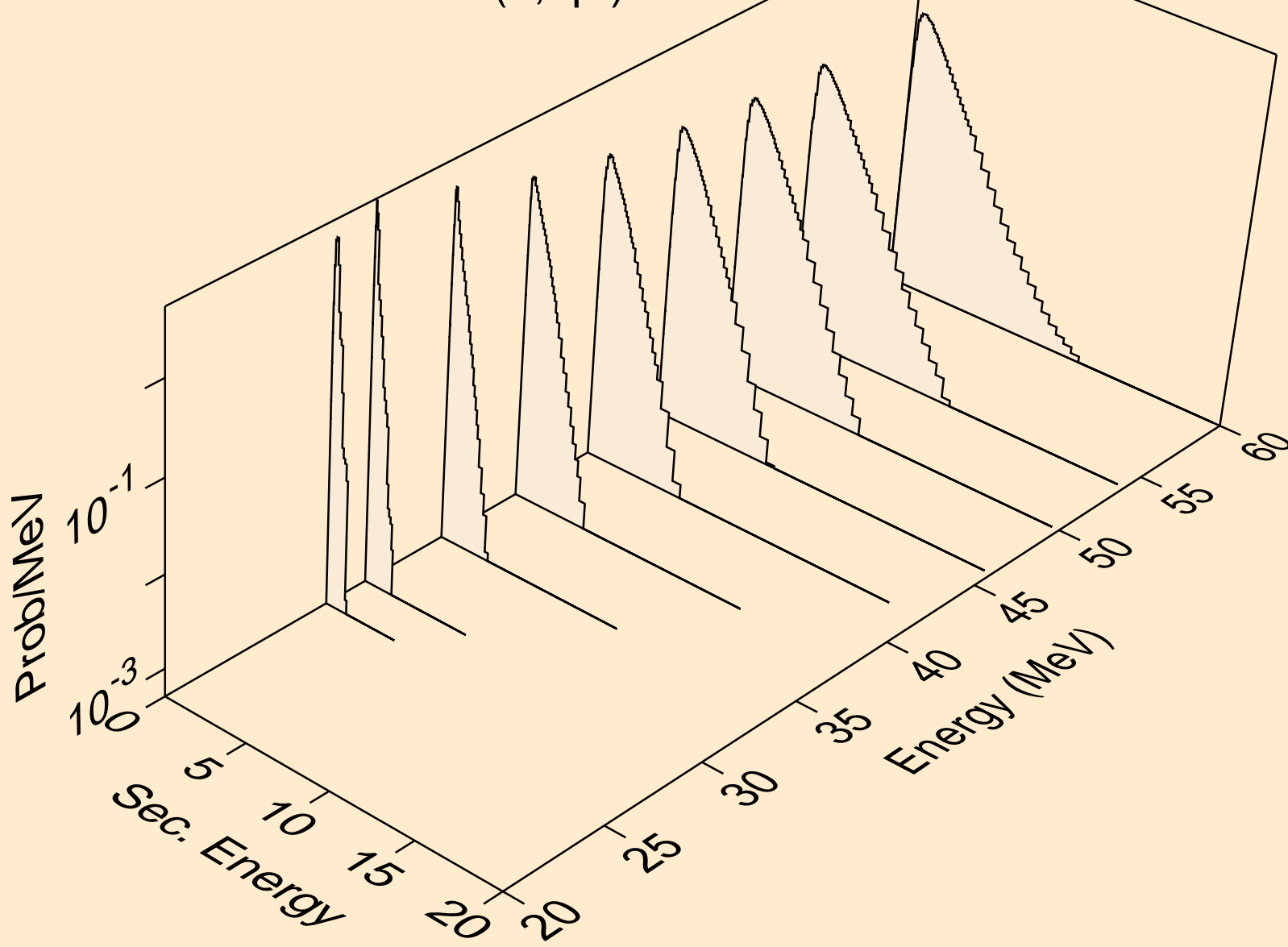

57-LA-138 FOR FENDL-3.2 PROCESSED BY NJOY2016.60+ ON
Neutron emission for (n,ndt)

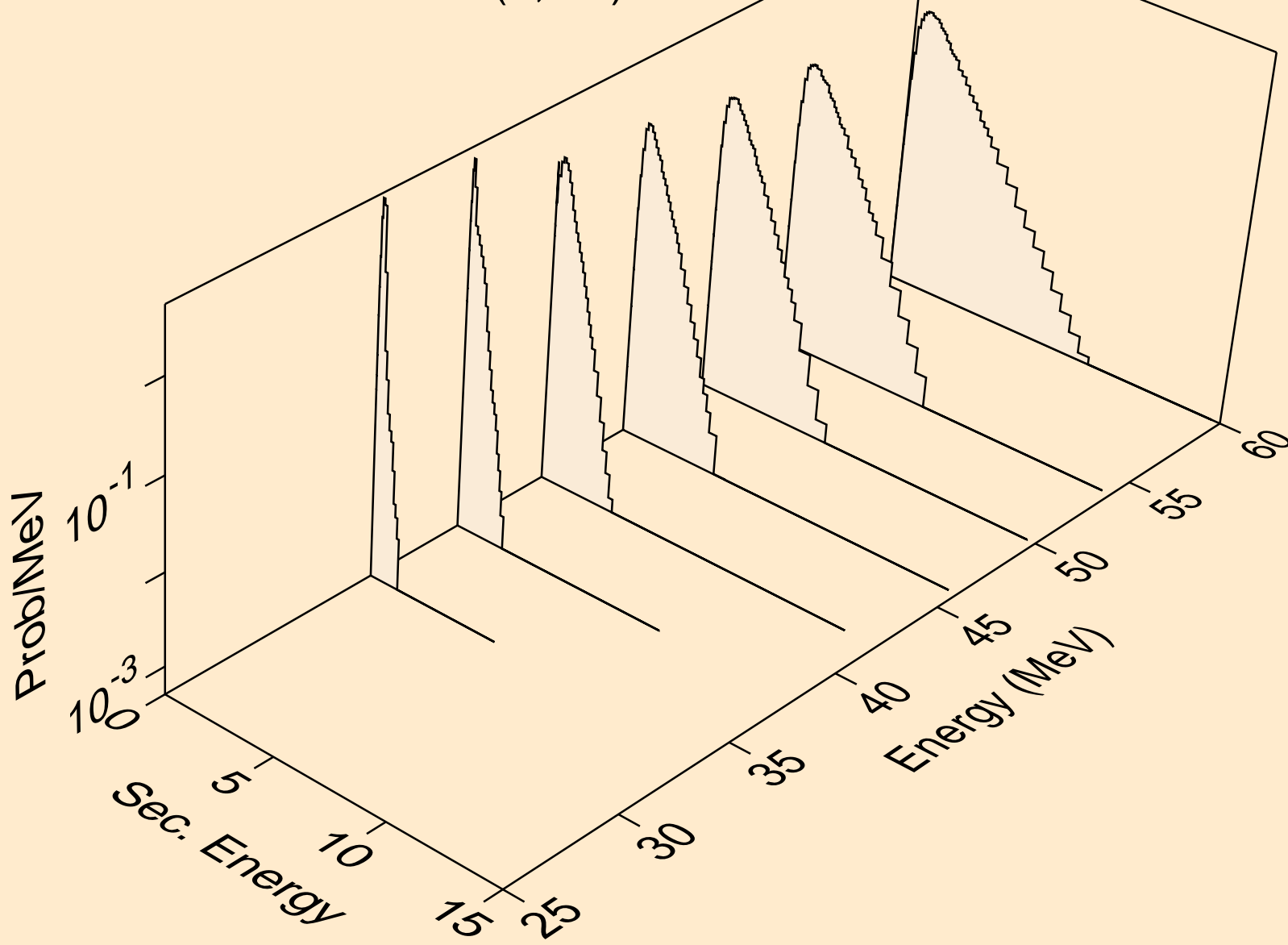

57-LA-138 FOR FENDL-3.2 PROCESSED BY NJOY2016.60+ ON
Neutron emission for (n,nphe3)

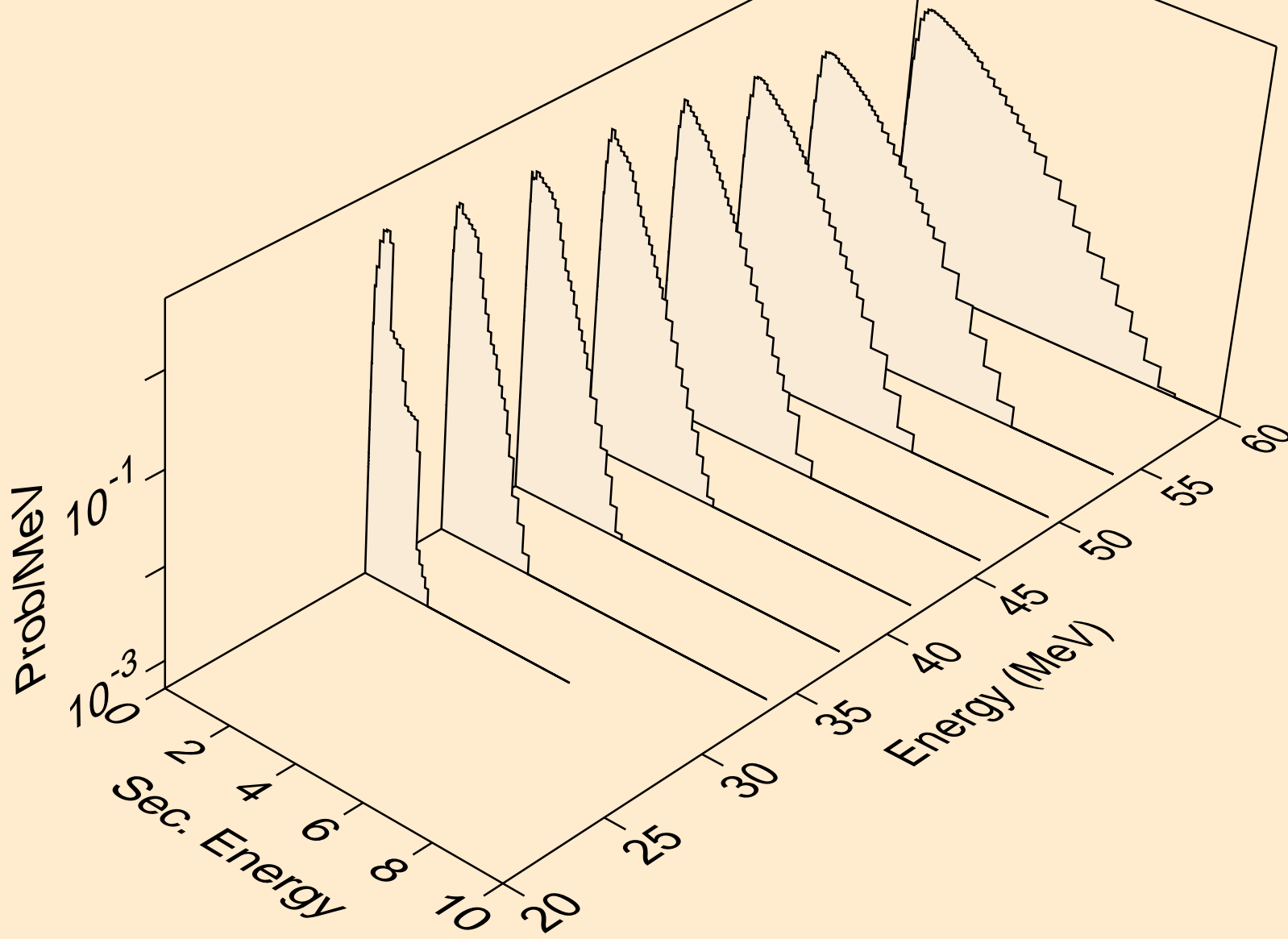

57-LA-138 FOR FENDL-3.2 PROCESSED BY NJOY2016.60+ ON
Neutron emission for (n,ndhe3)

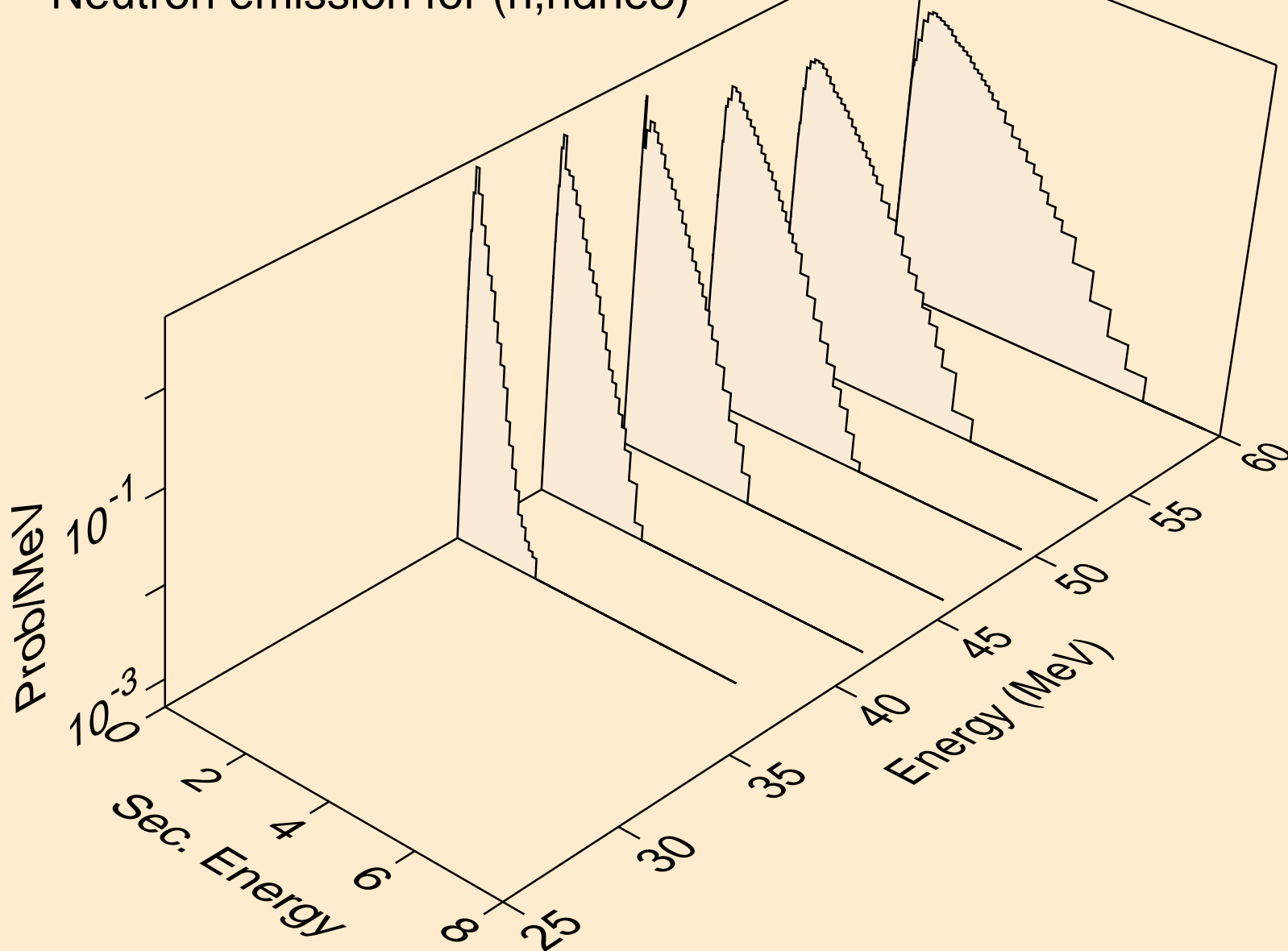

57-LA-138 FOR FENDL-3.2 PROCESSED BY NJOY2016.60+ ON
Neutron emission for (n,nthe3)

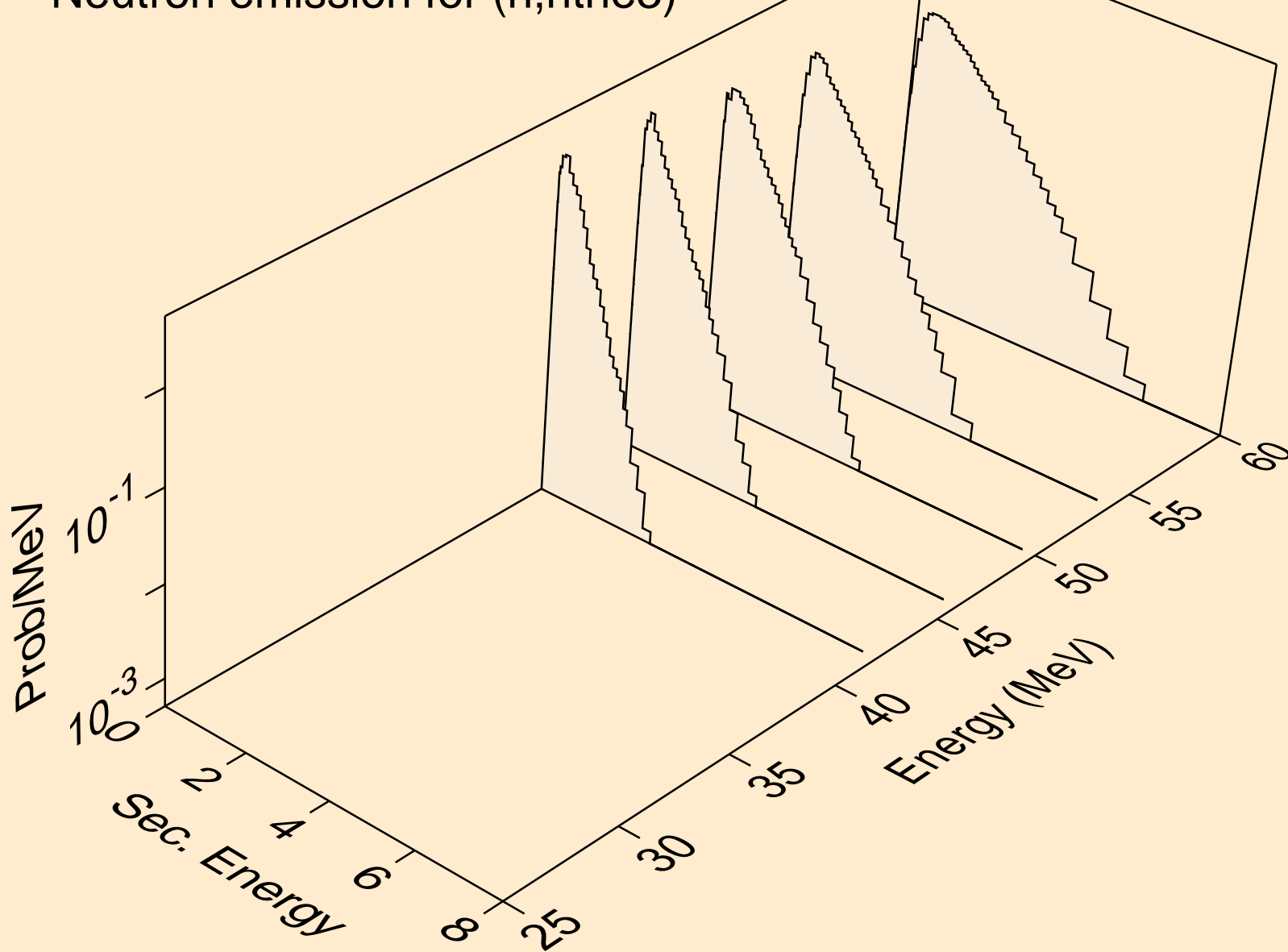

57-LA-138 FOR FENDL-3.2 PROCESSED BY NJOY2016.60+ ON
Neutron emission for (n,nta)

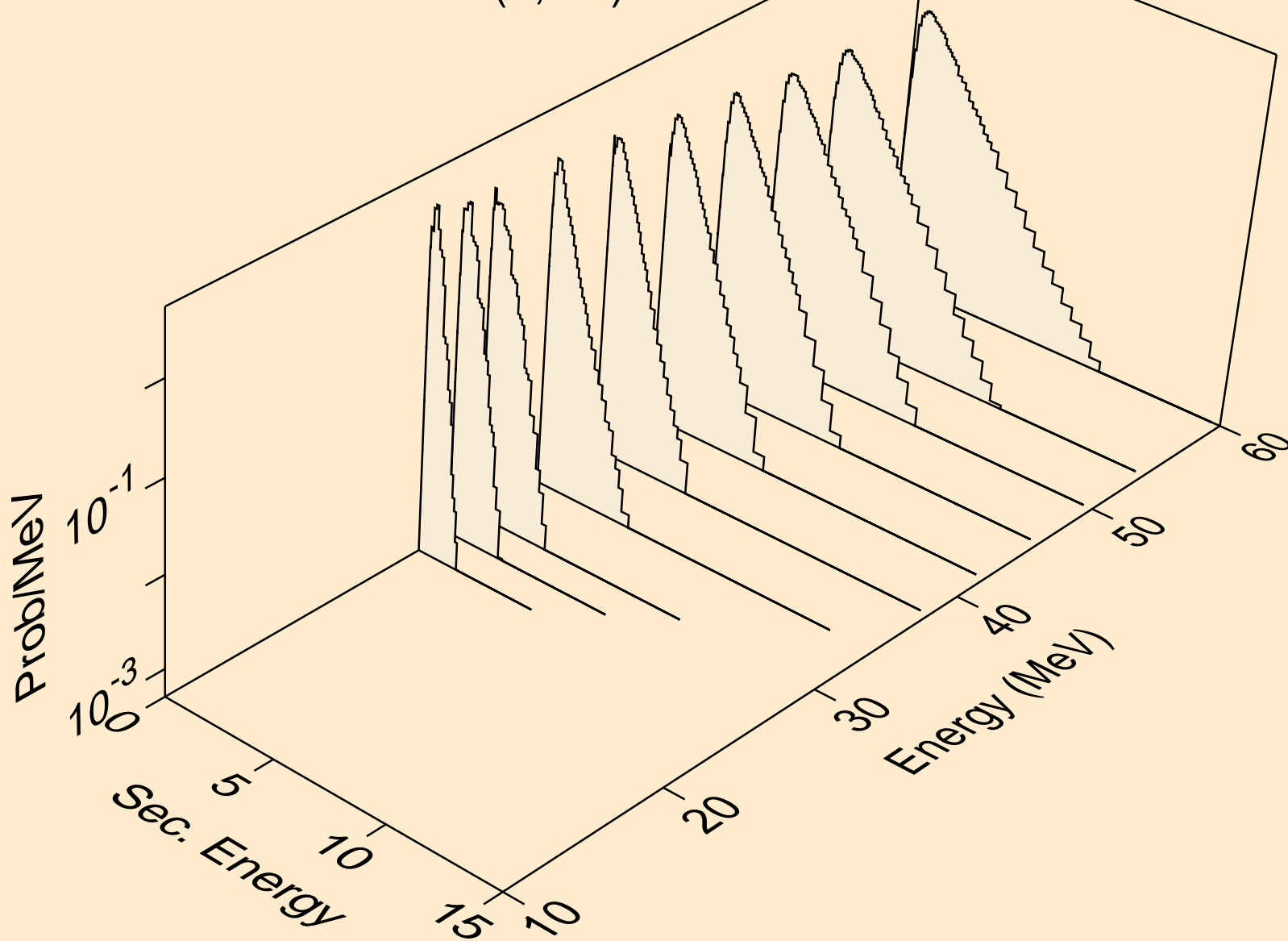

57-LA-138 FOR FENDL-3.2 PROCESSED BY NJOY2016.60+ ON
Neutron emission for (n,2n2p)

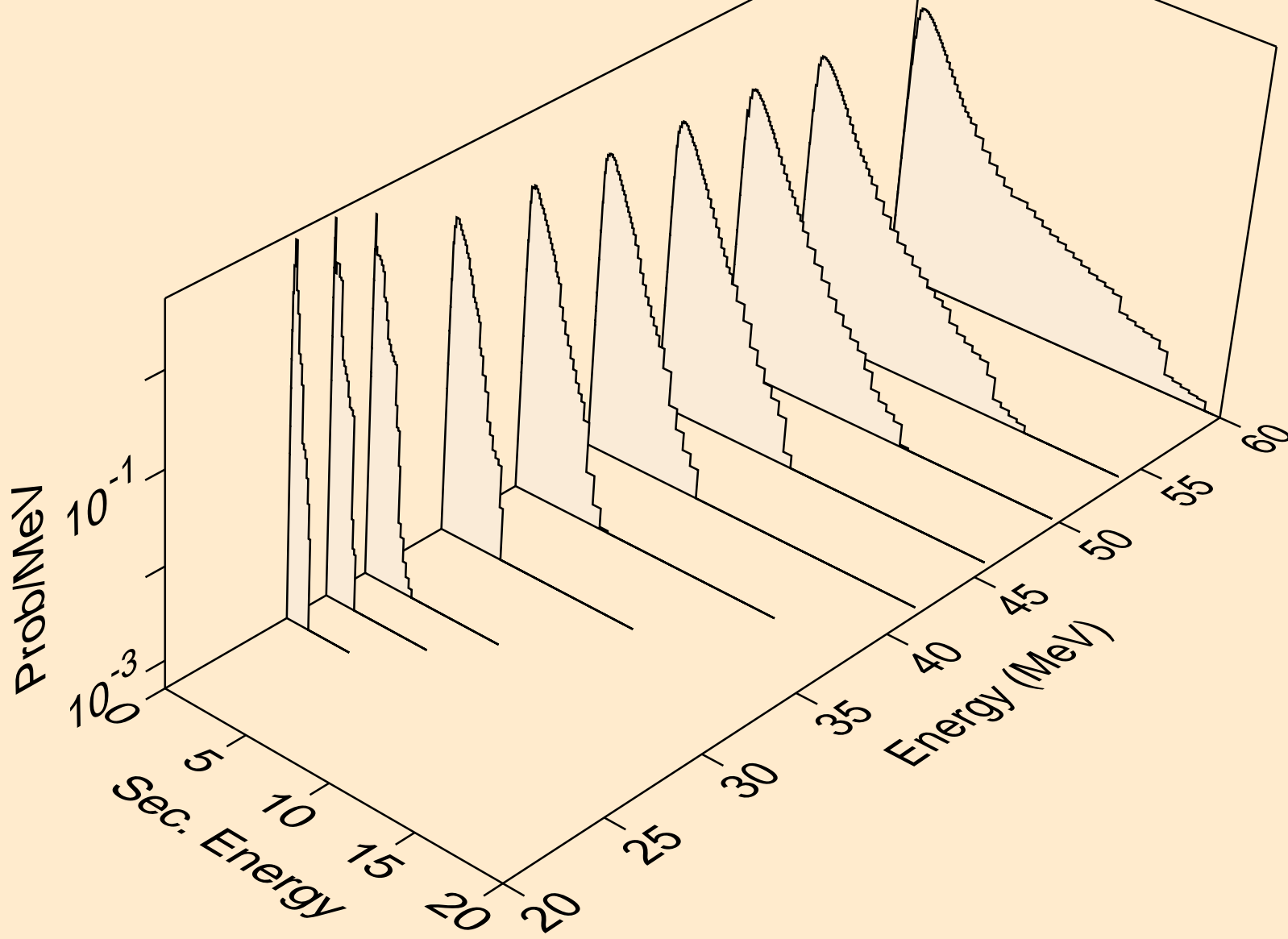

57-LA-138 FOR FENDL-3.2 PROCESSED BY NJOY2016.60+ ON
Neutron emission for (n,4n2p)

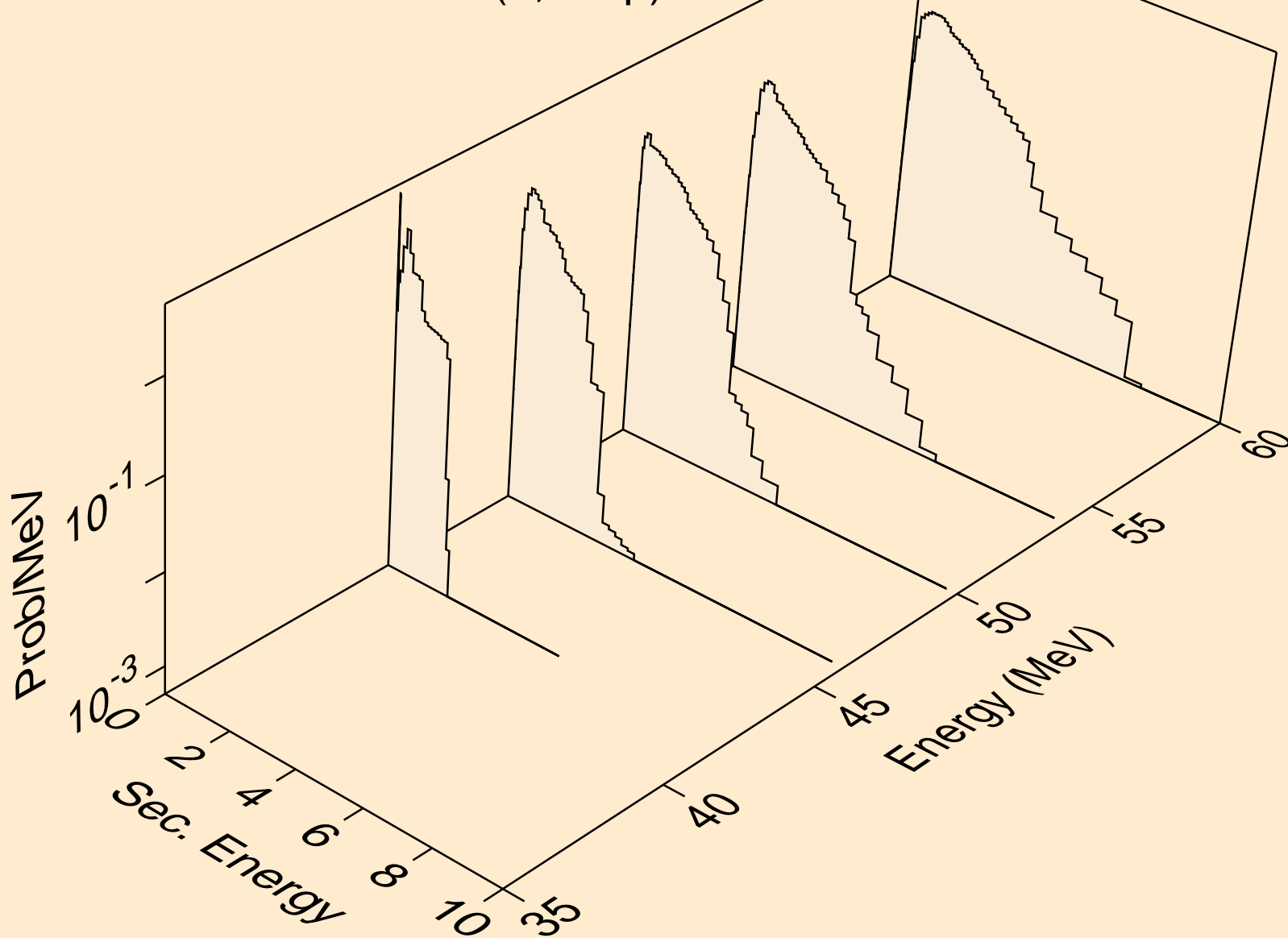

57-LA-138 FOR FENDL-3.2 PROCESSED BY NJOY2016.60+ ON
Neutron emission for (n,2n2a)

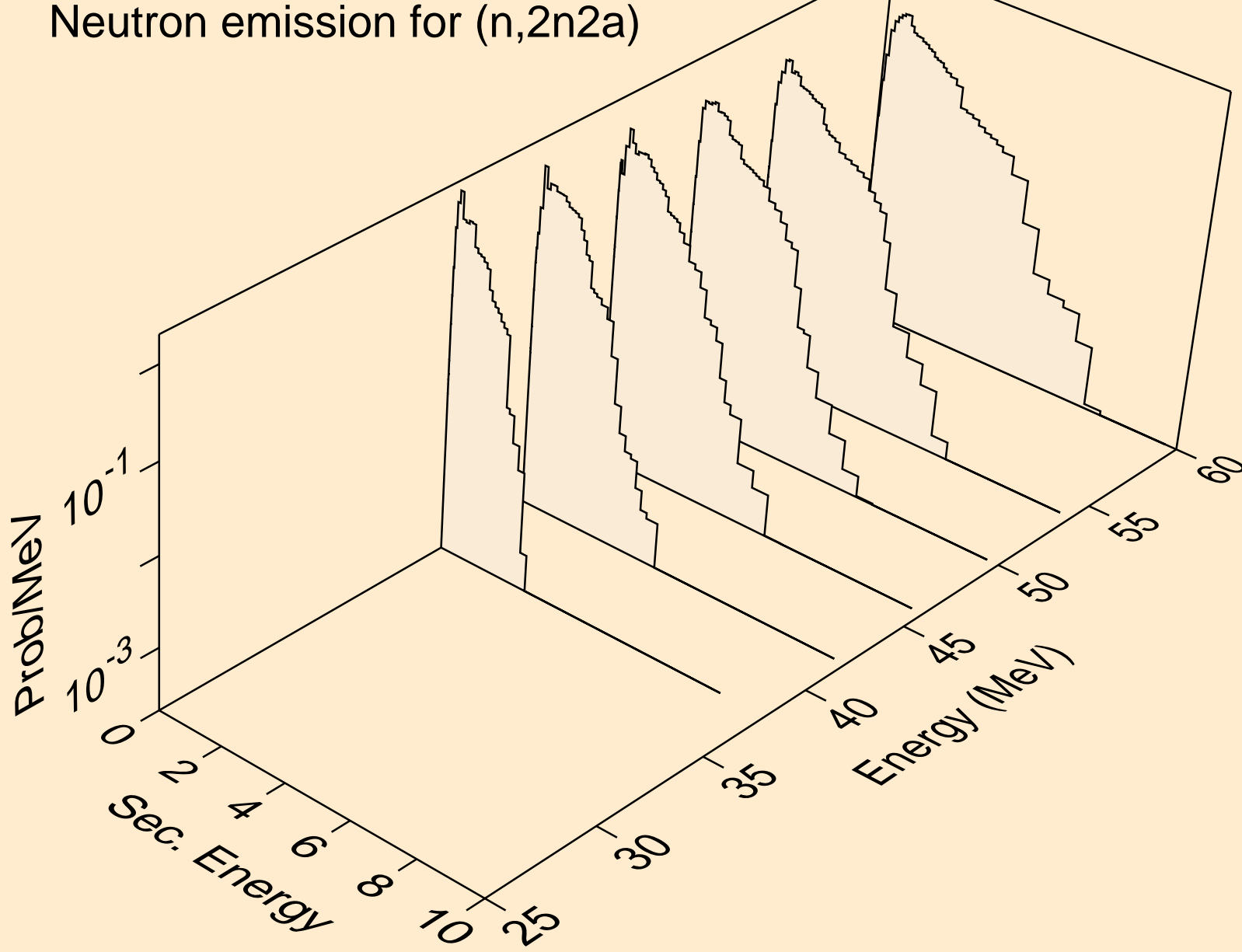

57-LA-138 FOR FENDL-3.2 PROCESSED BY NJOY2016.60+ ON
Neutron emission for (n,4npa)

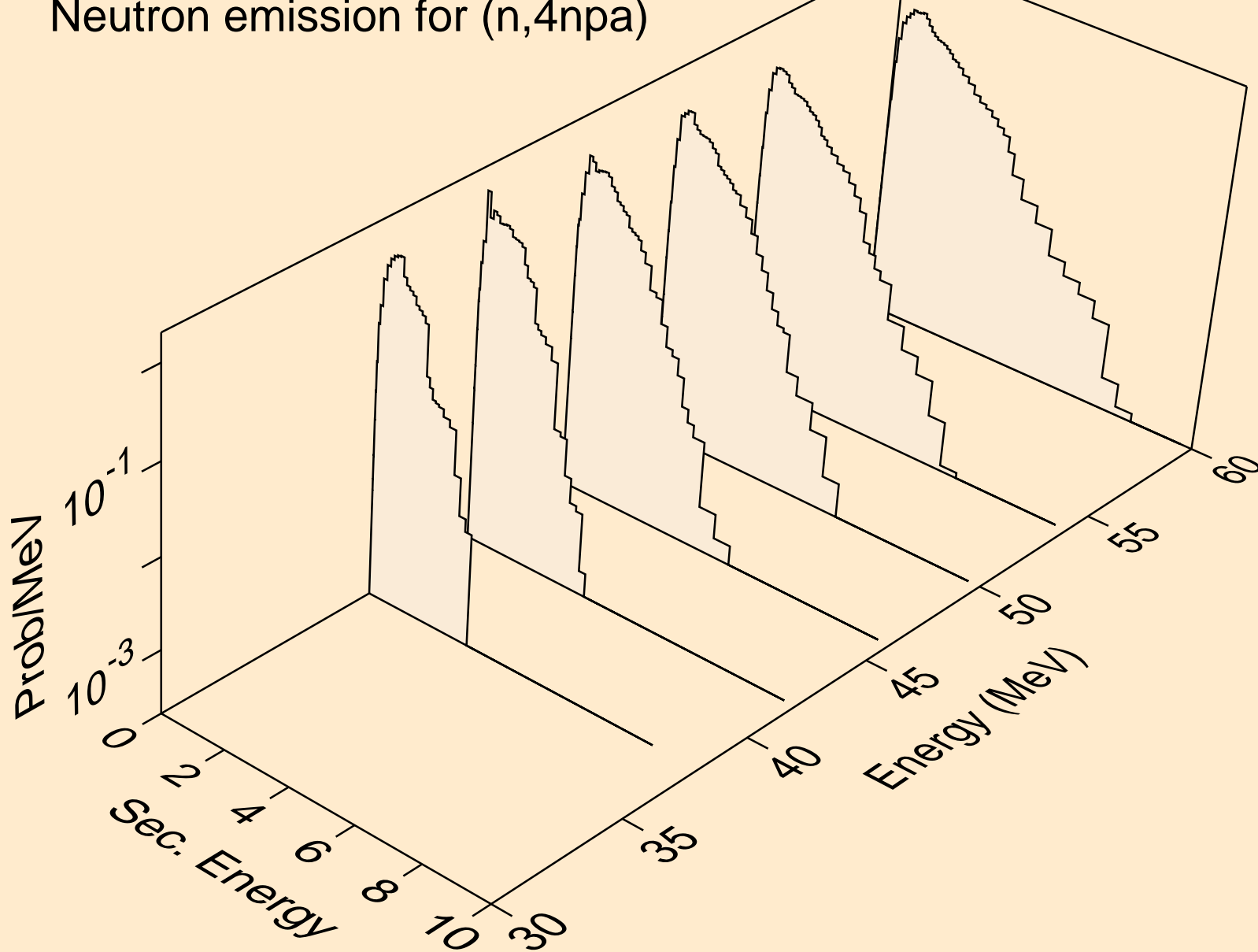

57-LA-138 FOR FENDL-3.2 PROCESSED BY NJOY2016.60+ ON
Neutron emission for (n,n3p)

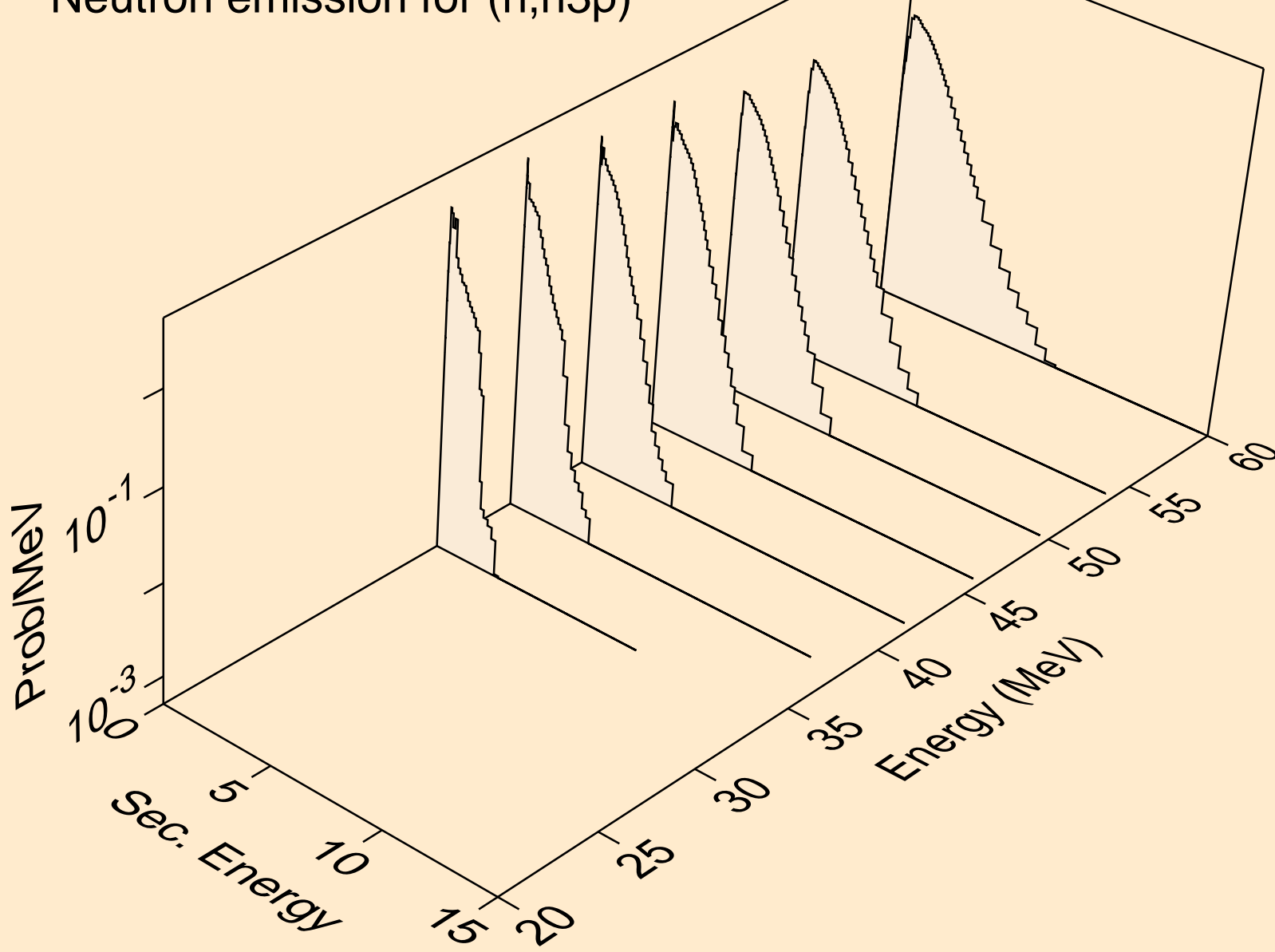

57-LA-138 FOR FENDL-3.2 PROCESSED BY NJOY2016.60+ ON
Neutron emission for (n,3n2pa)

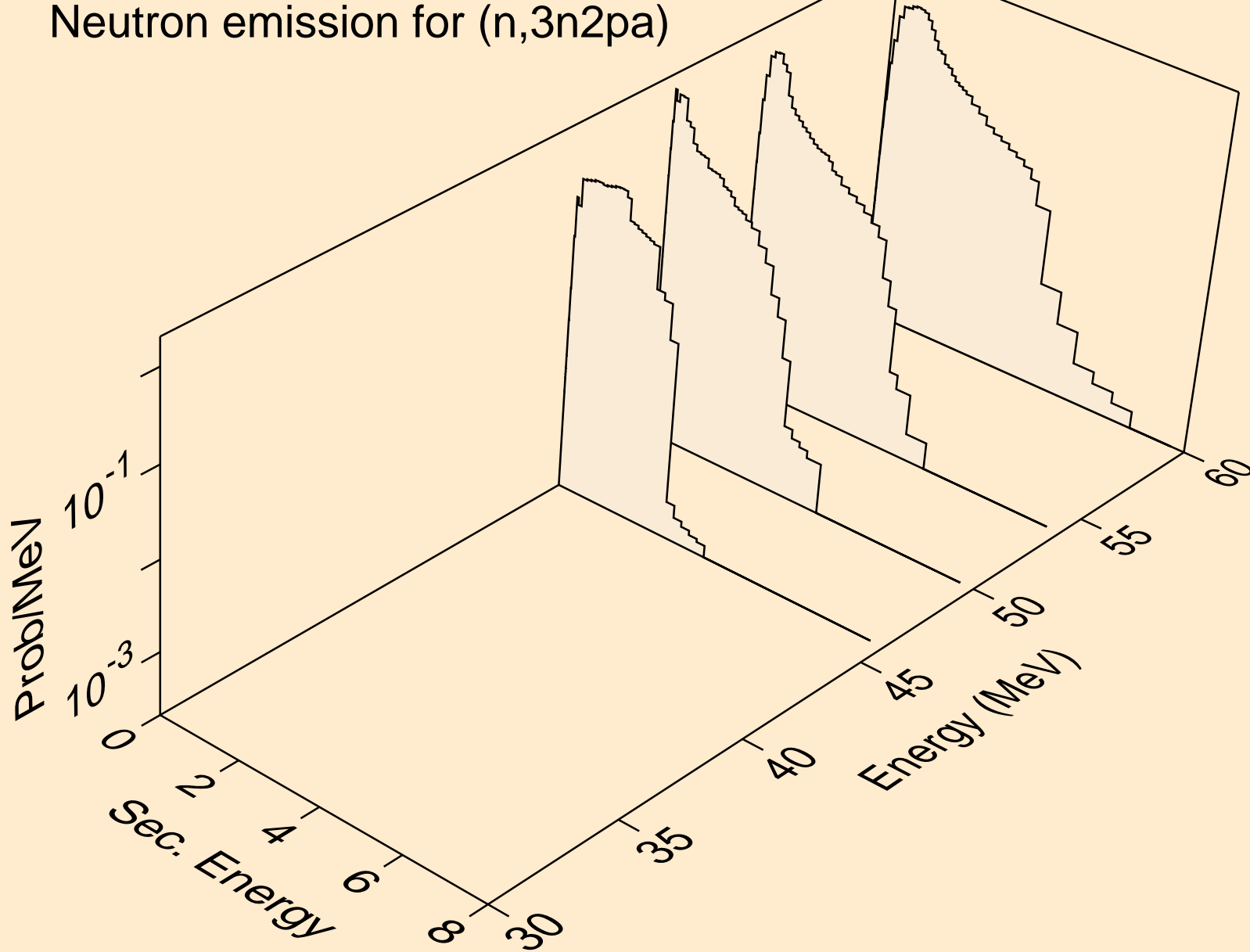

57-LA-138 FOR FENDL-3.2 PROCESSED BY NJOY2016.60+ ON
Neutron emission for (n,5n2p)

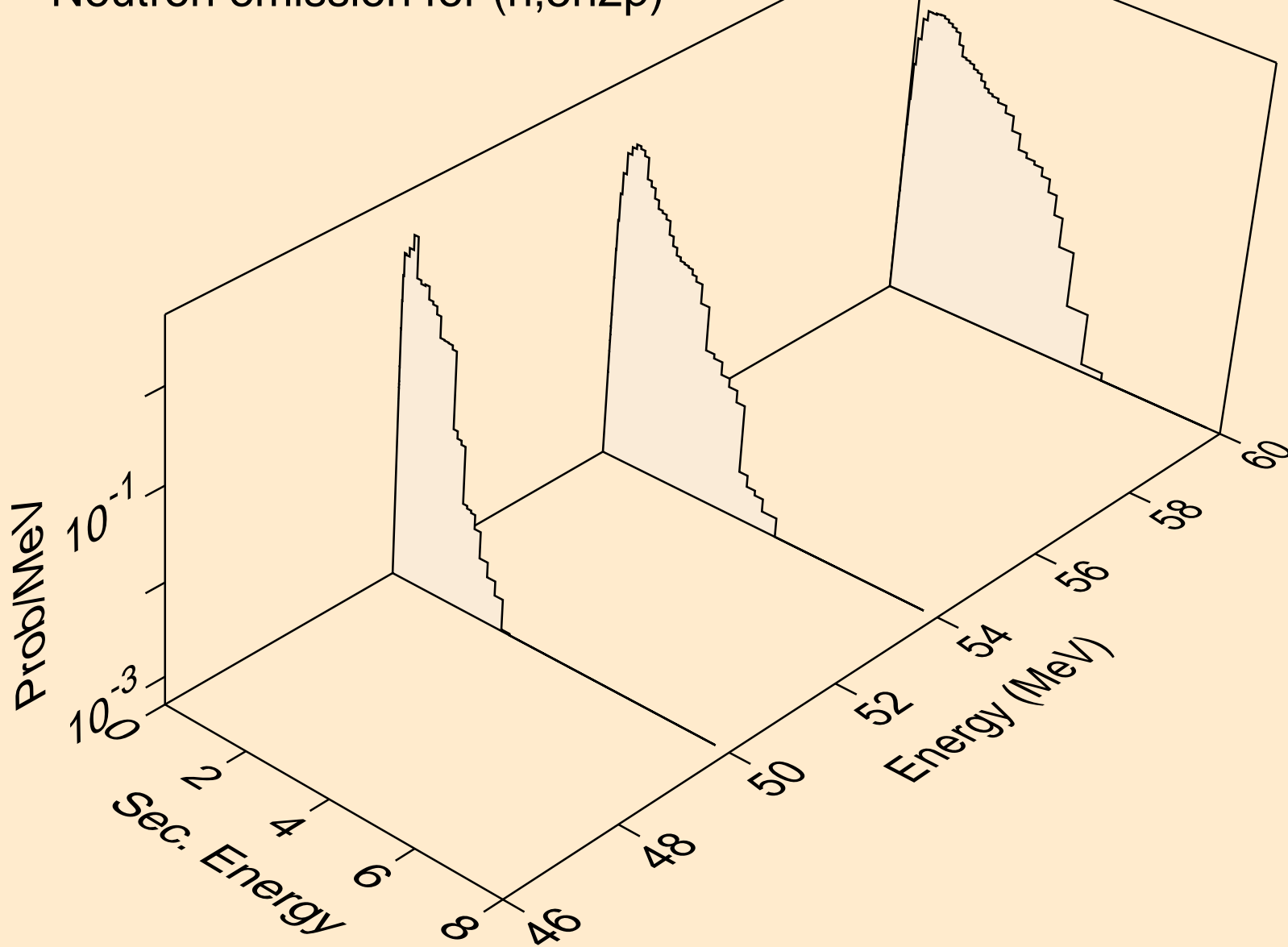

57-LA-138 FOR FENDL-3.2 PROCESSED BY NJOY2016.60+ ON
Photon emission for (n,x)

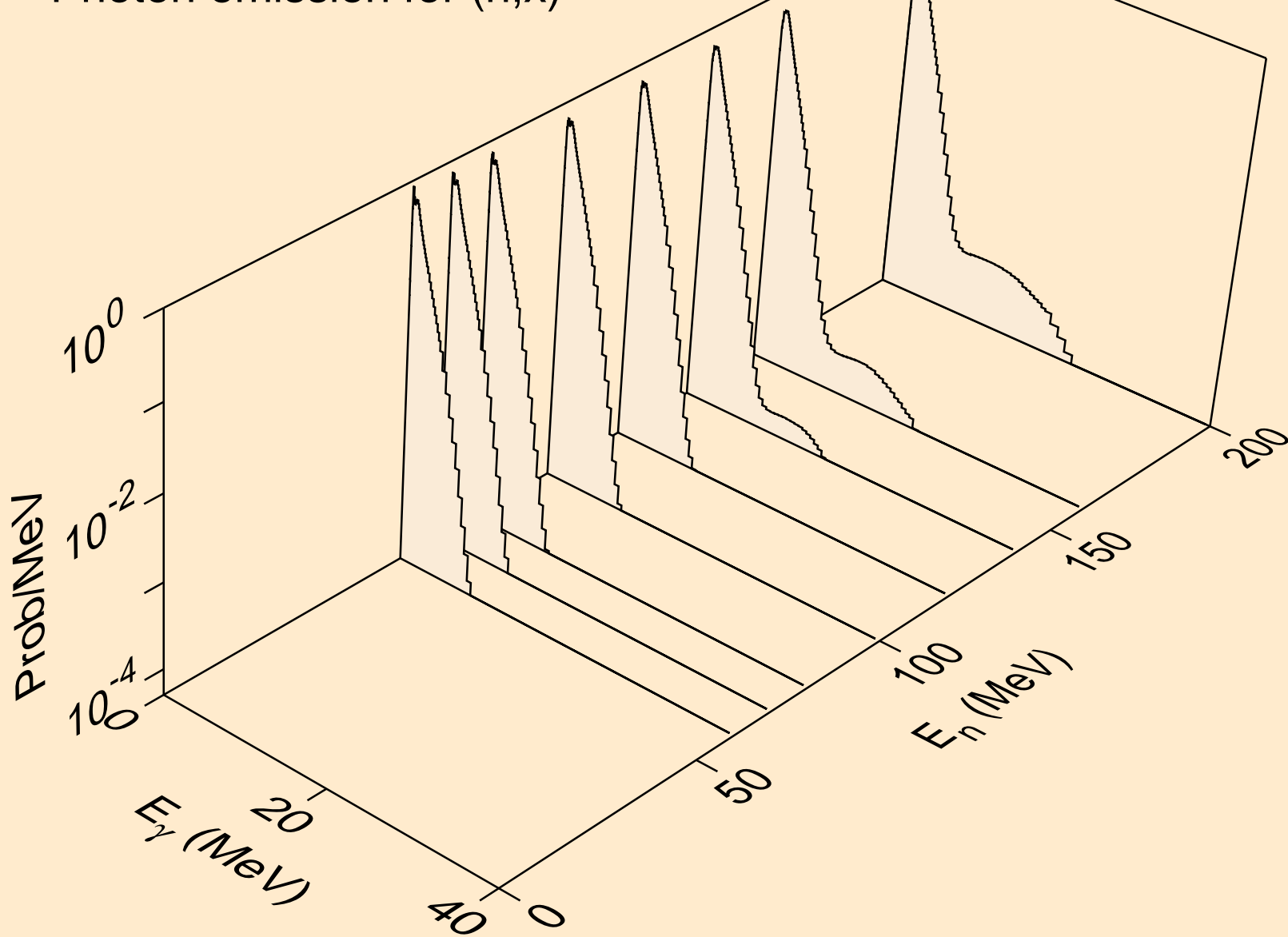

57-LA-138 FOR FENDL-3.2 PROCESSED BY NJOY2016.60+ ON
Photon emission for (n,2nd)

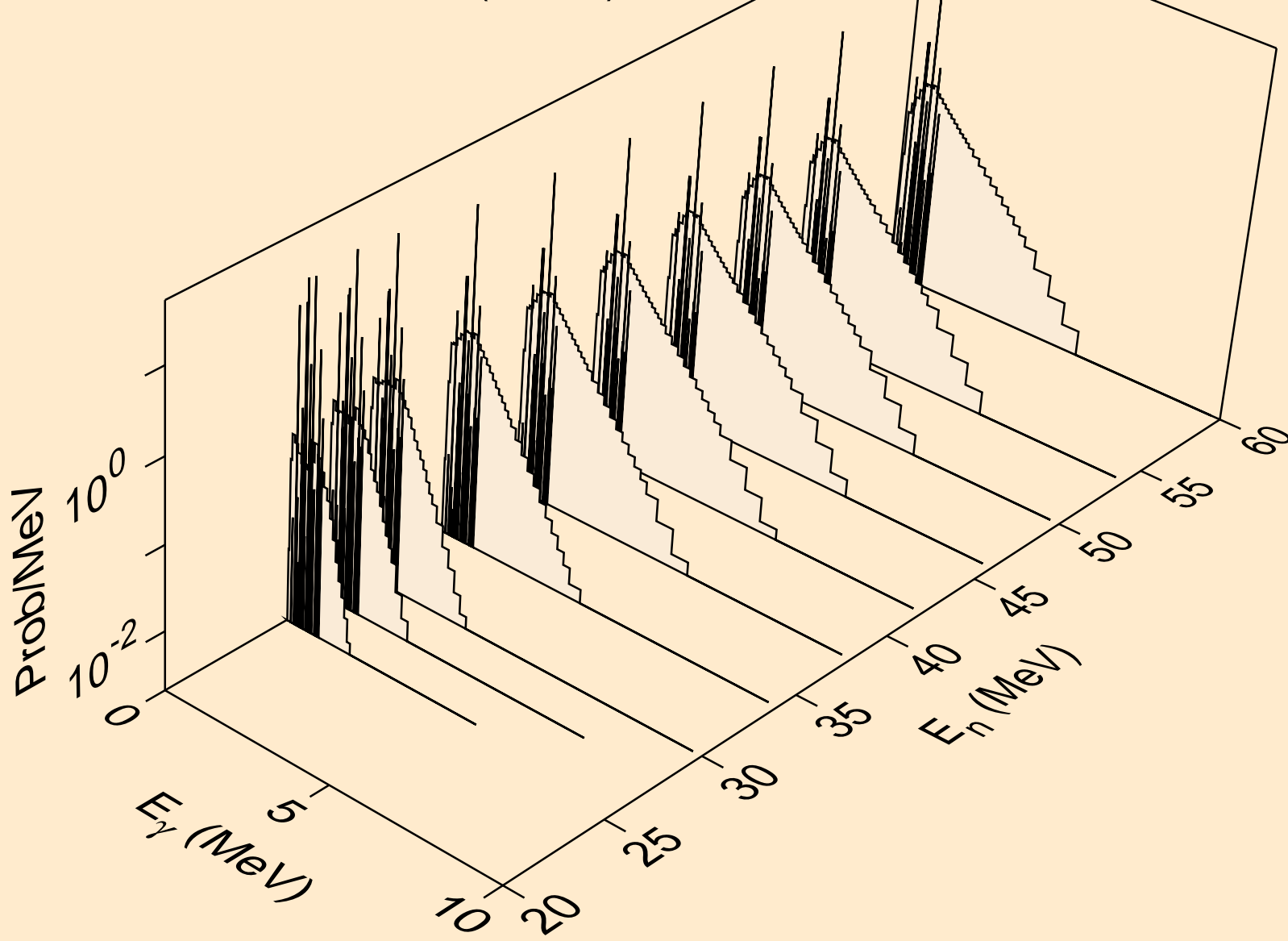

57-LA-138 FOR FENDL-3.2 PROCESSED BY NJOY2016.60+ ON
Photon emission for (n,2n)

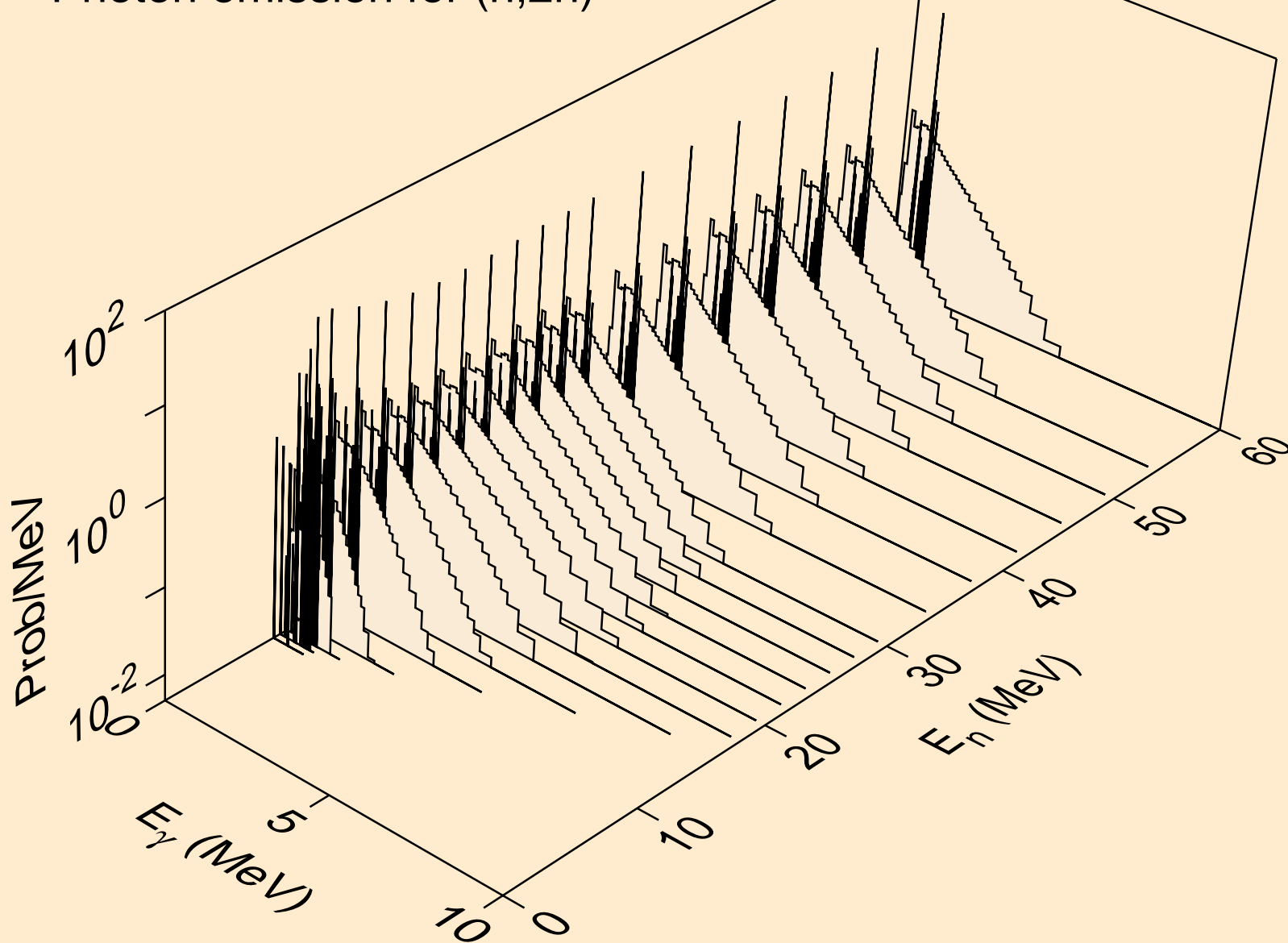

57-LA-138 FOR FENDL-3.2 PROCESSED BY NJOY2016.60+ ON
Photon emission for (n,3n)

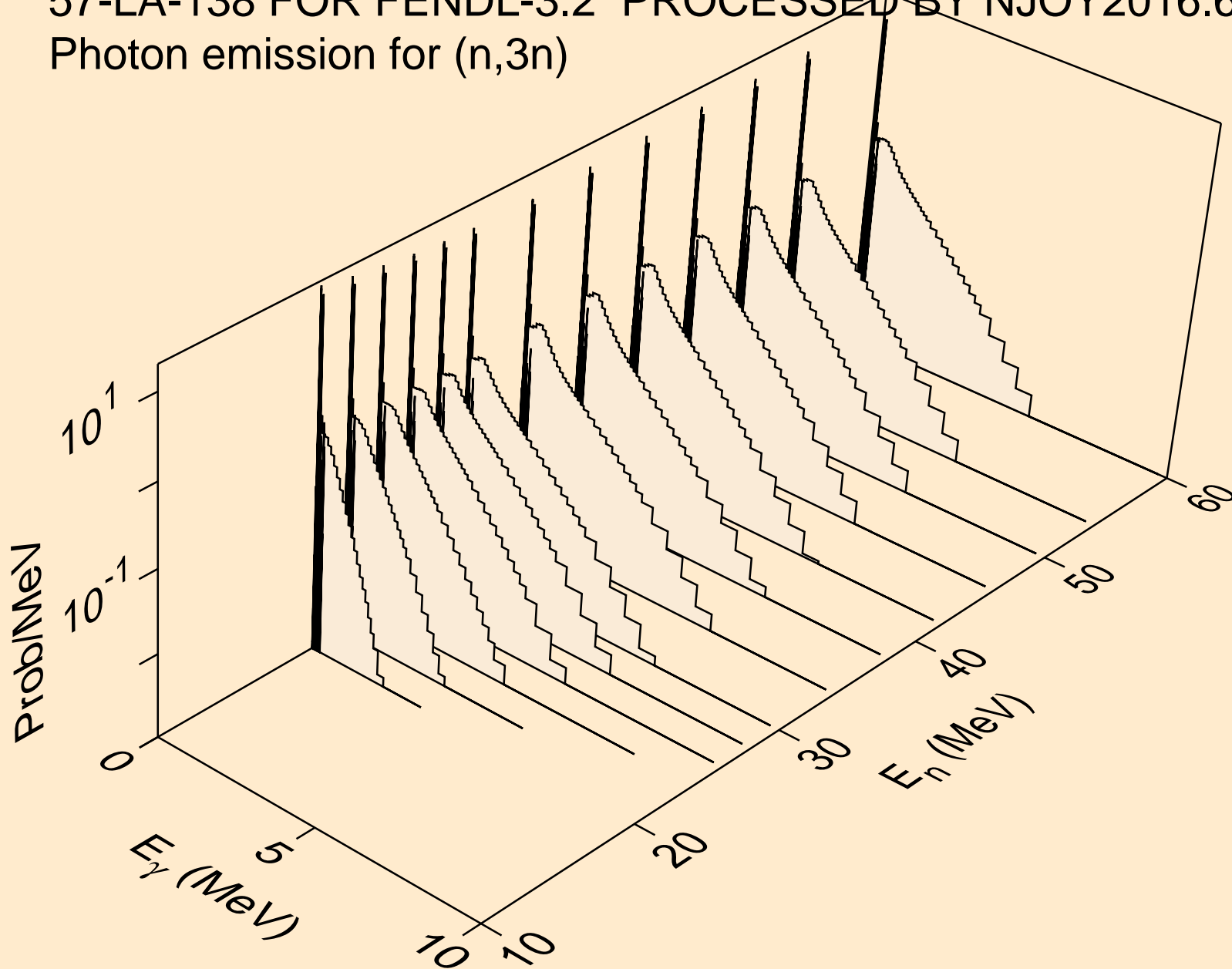

57-LA-138 FOR FENDL-3.2 PROCESSED BY NJOY2016.60+ ON
Photon emission for (n,n*)a

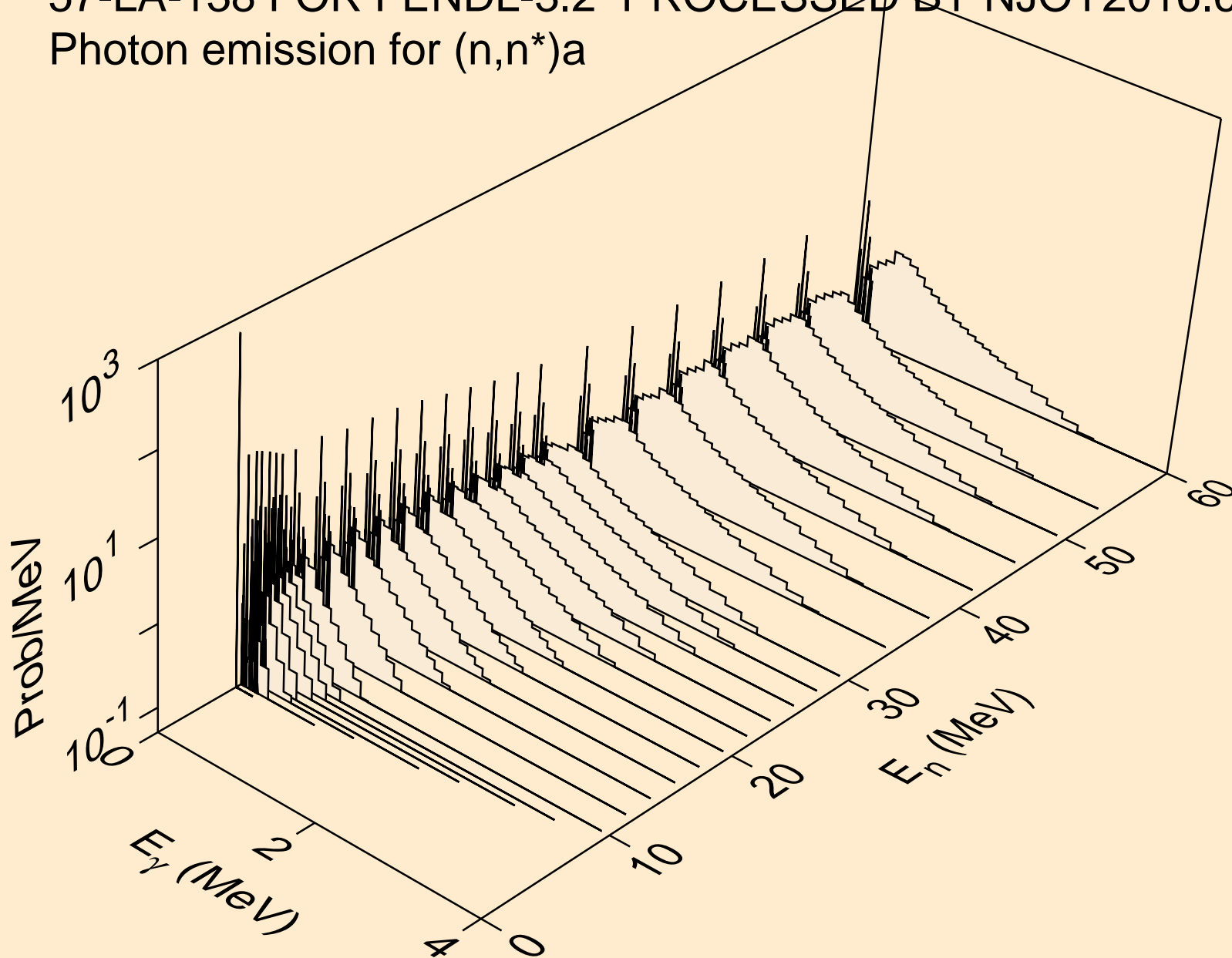

57-LA-138 FOR FENDL-3.2 PROCESSED BY NJOY2016.60+ ON
Photon emission for (n,2n)a

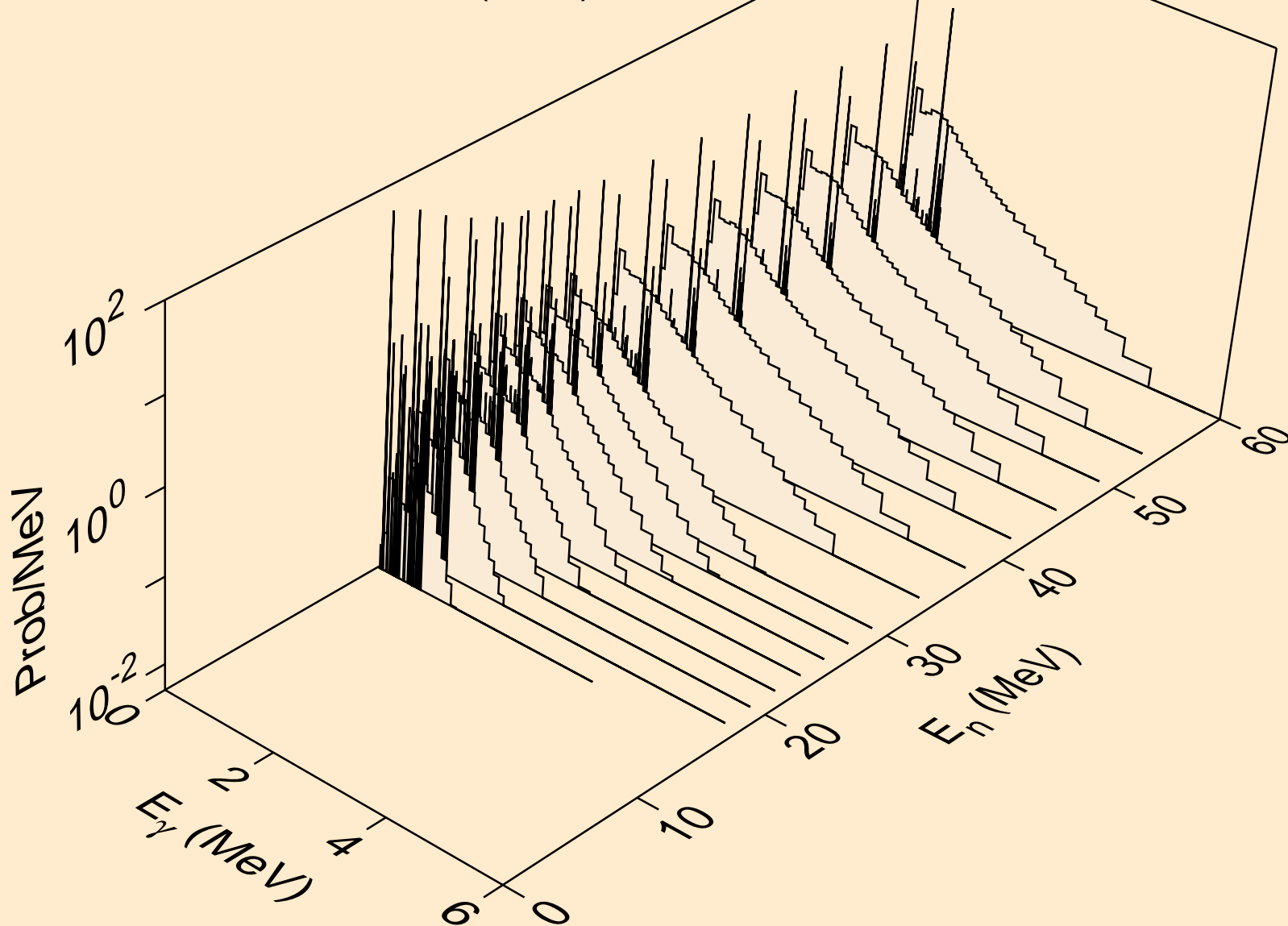

57-LA-138 FOR FENDL-3.2 PROCESSED BY NJOY2016.60+ ON
Photon emission for (n,3n)a

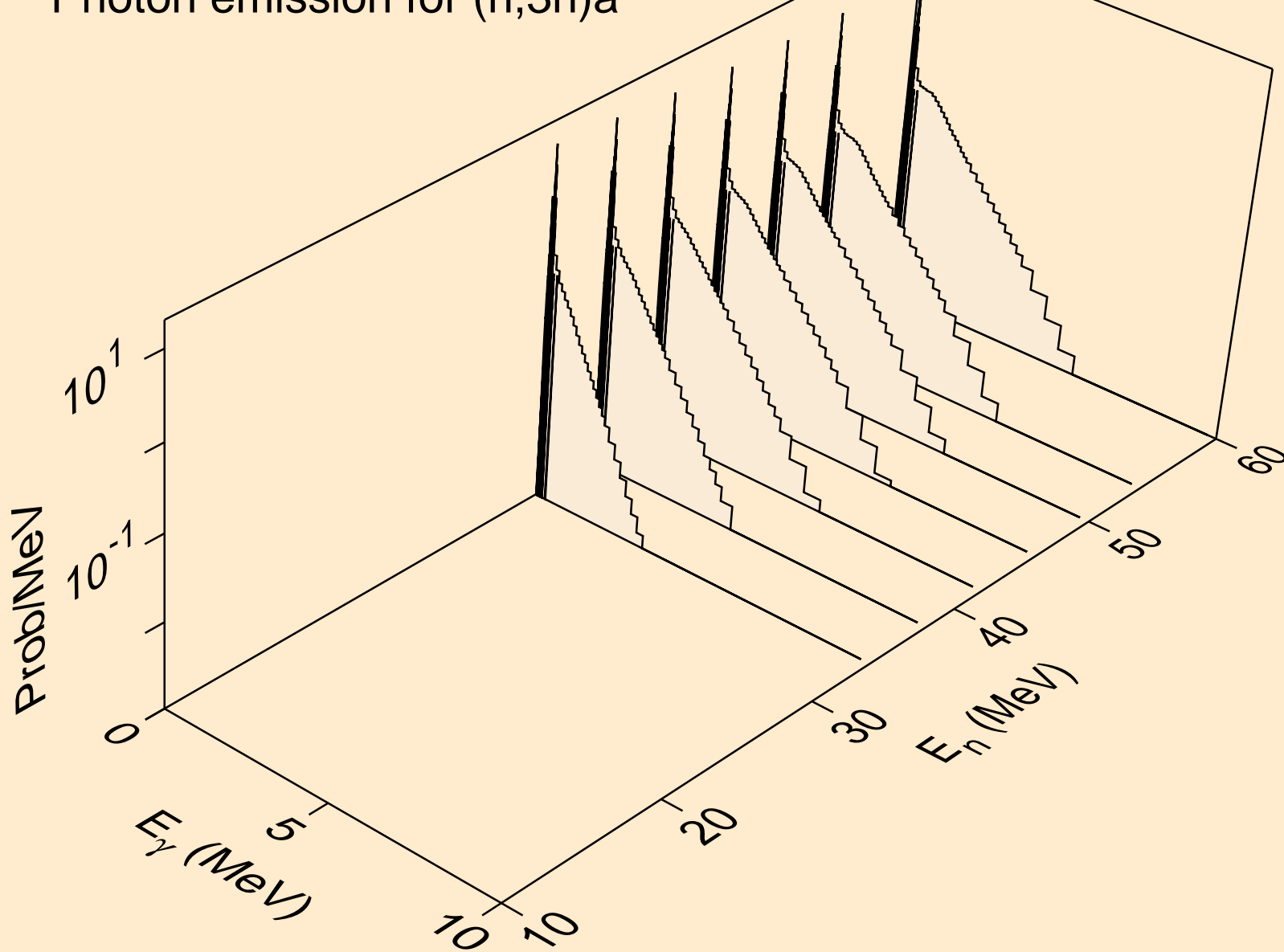

57-LA-138 FOR FENDL-3.2 PROCESSED BY NJOY2016.60+ ON
Photon emission for (n,n*)p

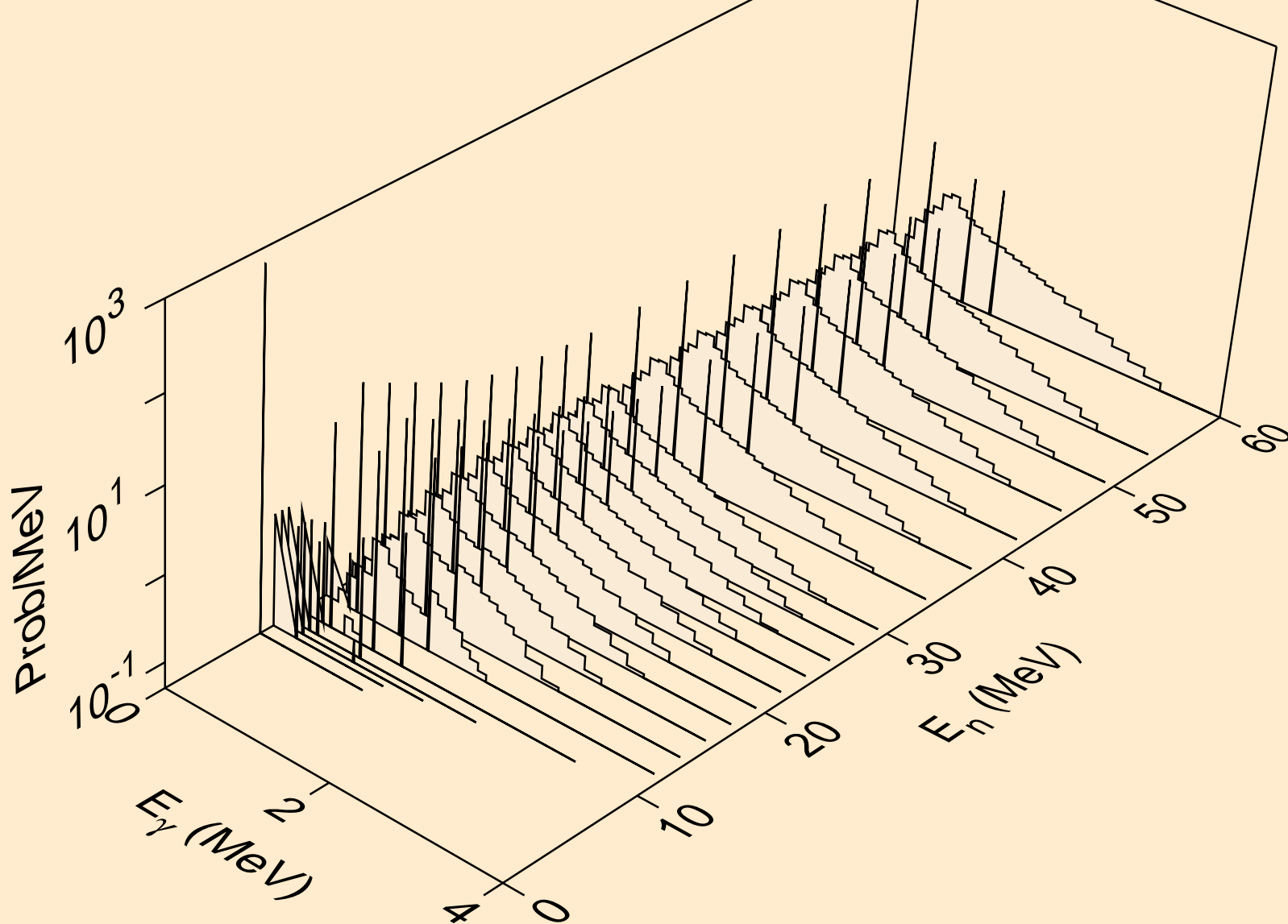

57-LA-138 FOR FENDL-3.2 PROCESSED BY NJOY2016.60+ ON
Photon emission for (n,n*)2a

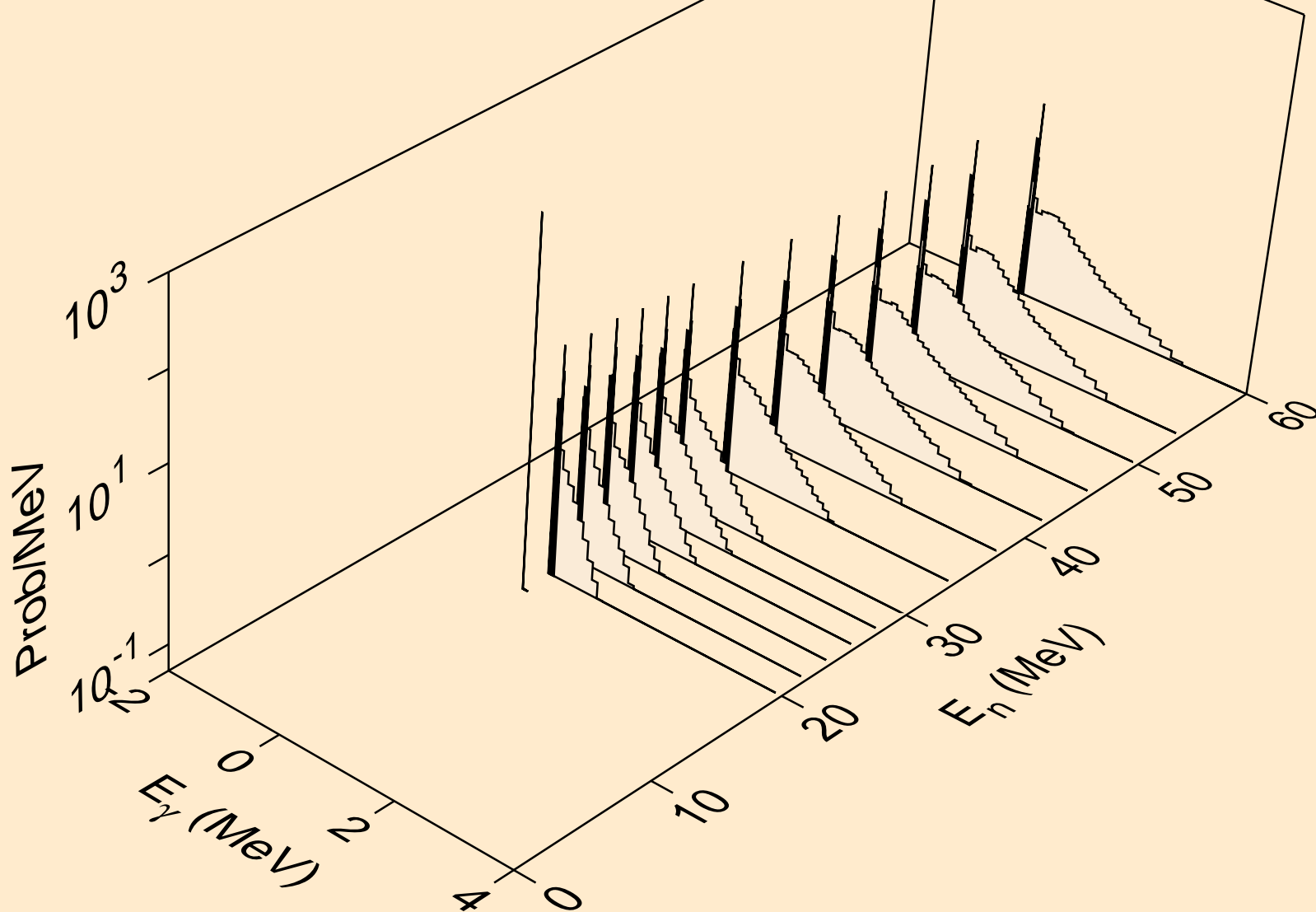

57-LA-138 FOR FENDL-3.2 PROCESSED BY NJOY2016.60+ ON
Photon emission for (n,2n)2a

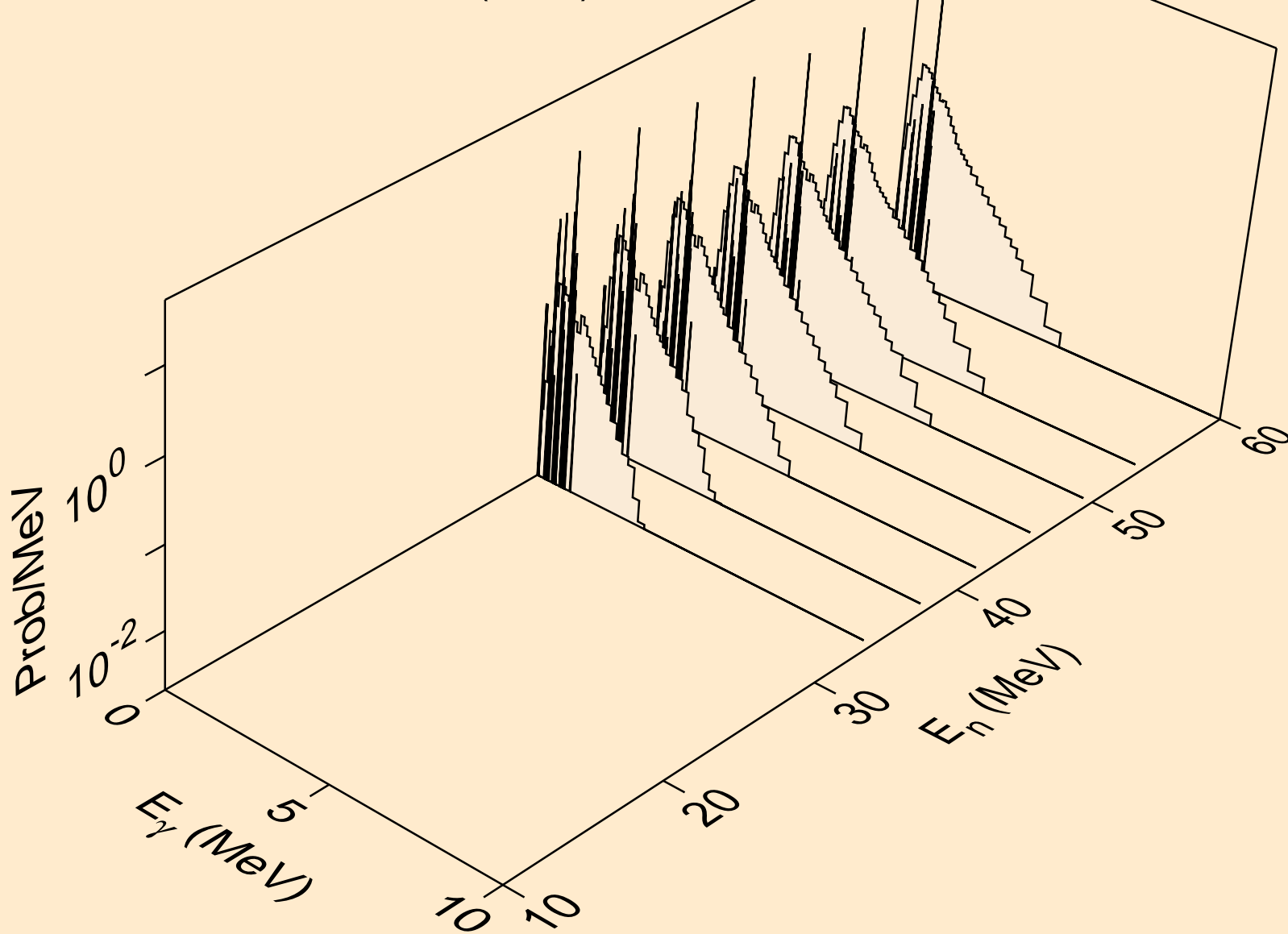

57-LA-138 FOR FENDL-3.2 PROCESSED BY NJOY2016.60+ ON
Photon emission for (n,n*)d

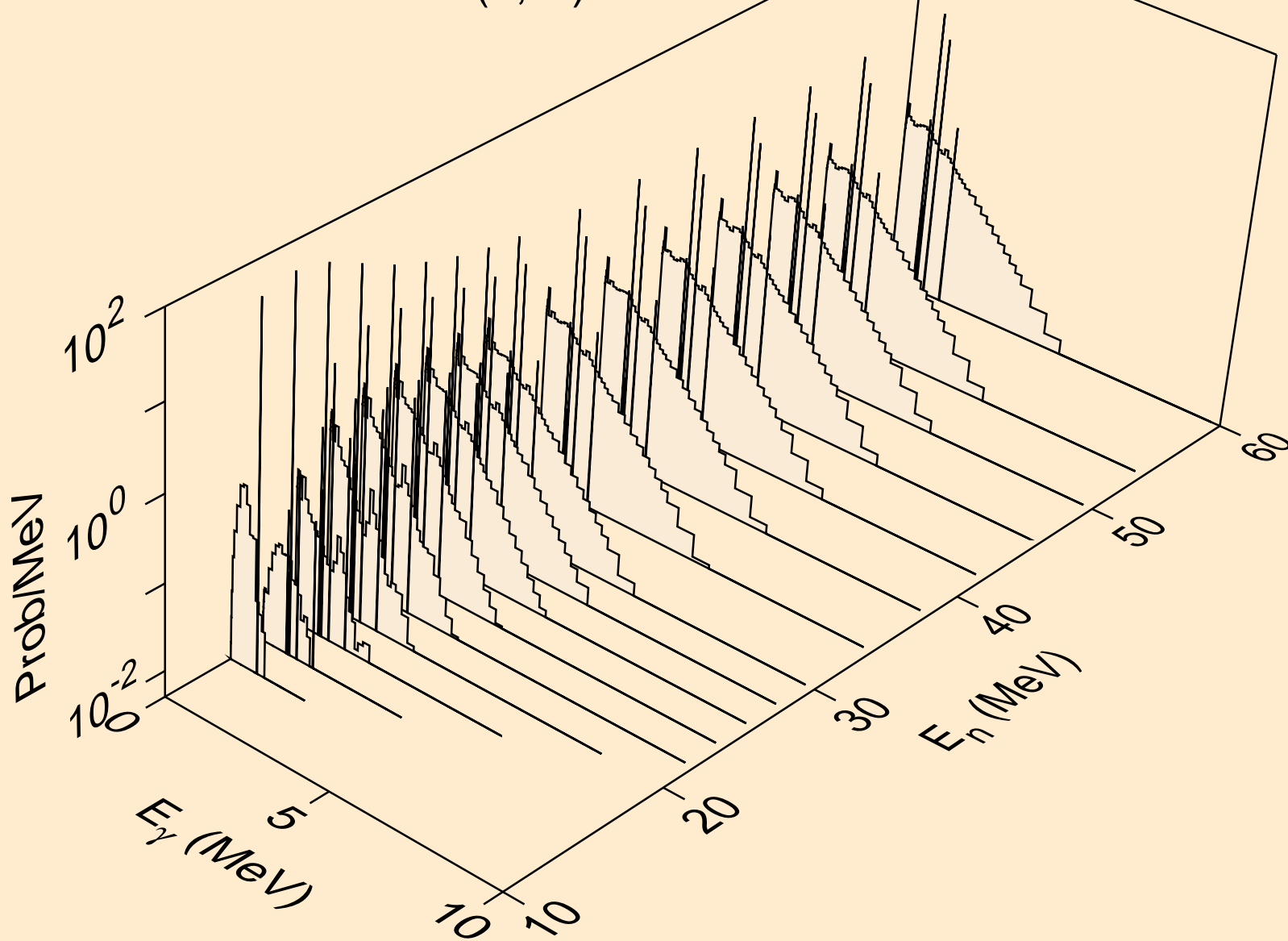

57-LA-138 FOR FENDL-3.2 PROCESSED BY NJOY2016.60+ ON
Photon emission for (n,n*)t

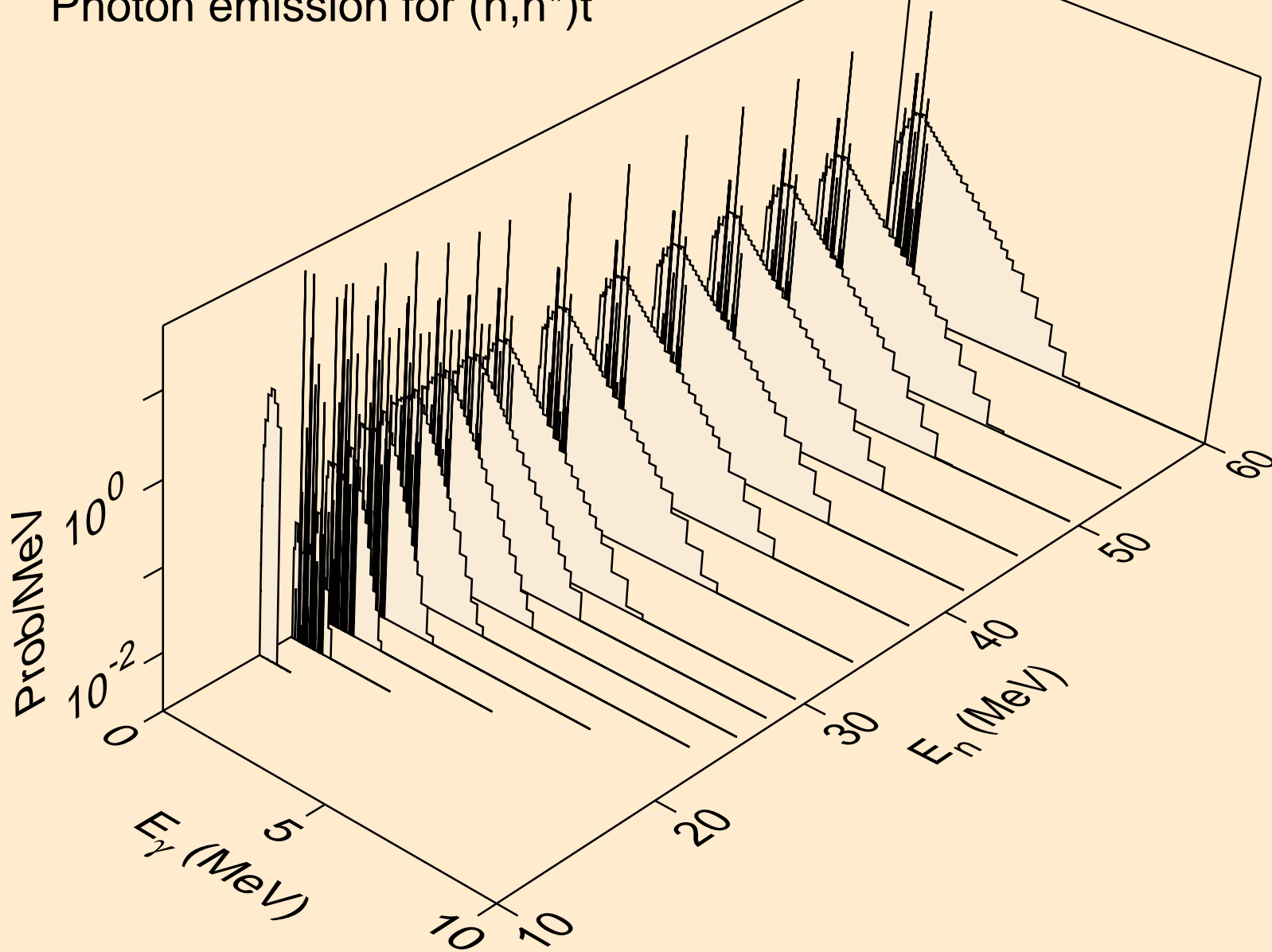

57-LA-138 FOR FENDL-3.2 PROCESSED BY NJOY2016.60+ ON
Photon emission for (n,n*)he3

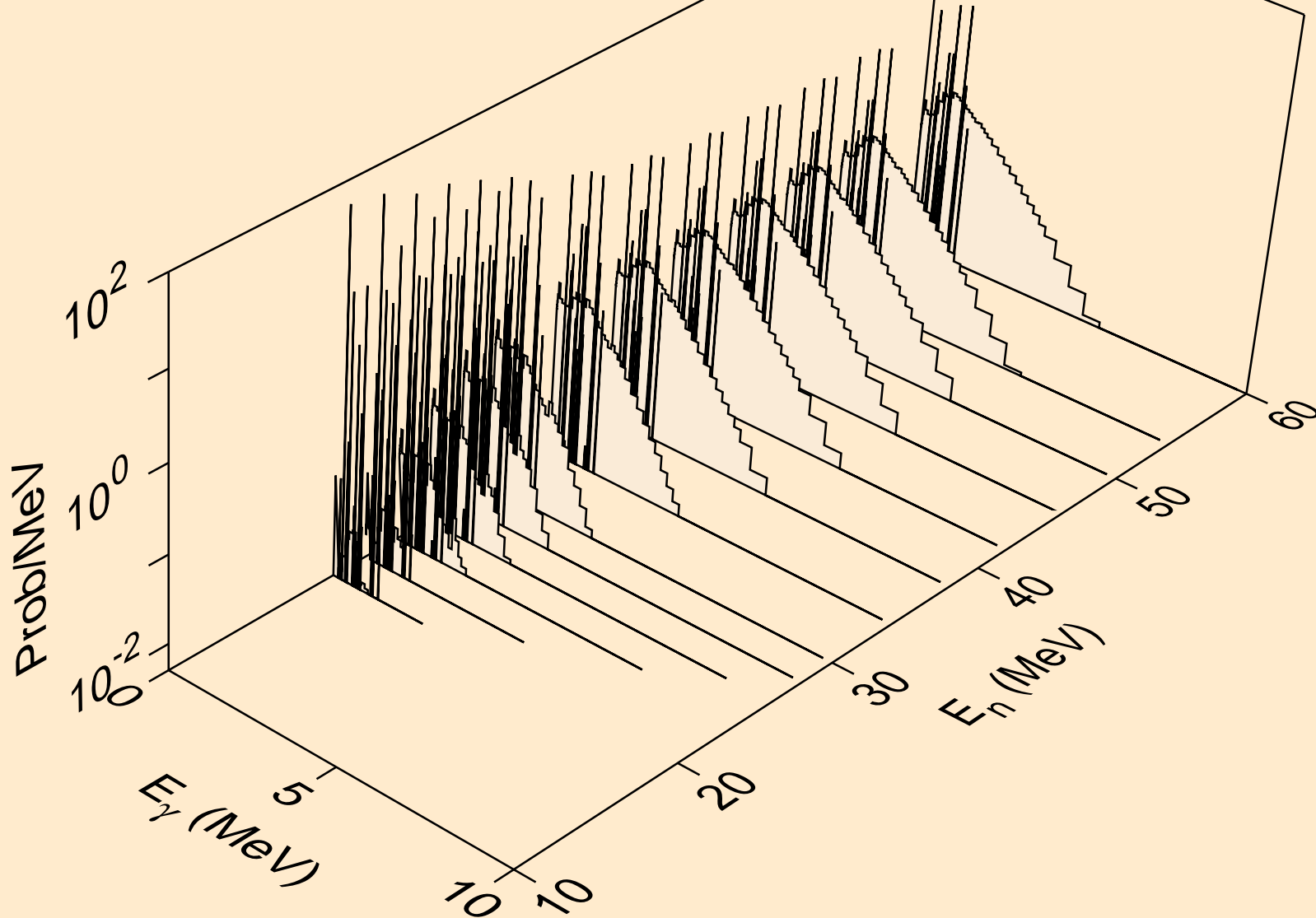

57-LA-138 FOR FENDL-3.2 PROCESSED BY NJOY2016.60+ ON
Photon emission for (n,n*)d2a

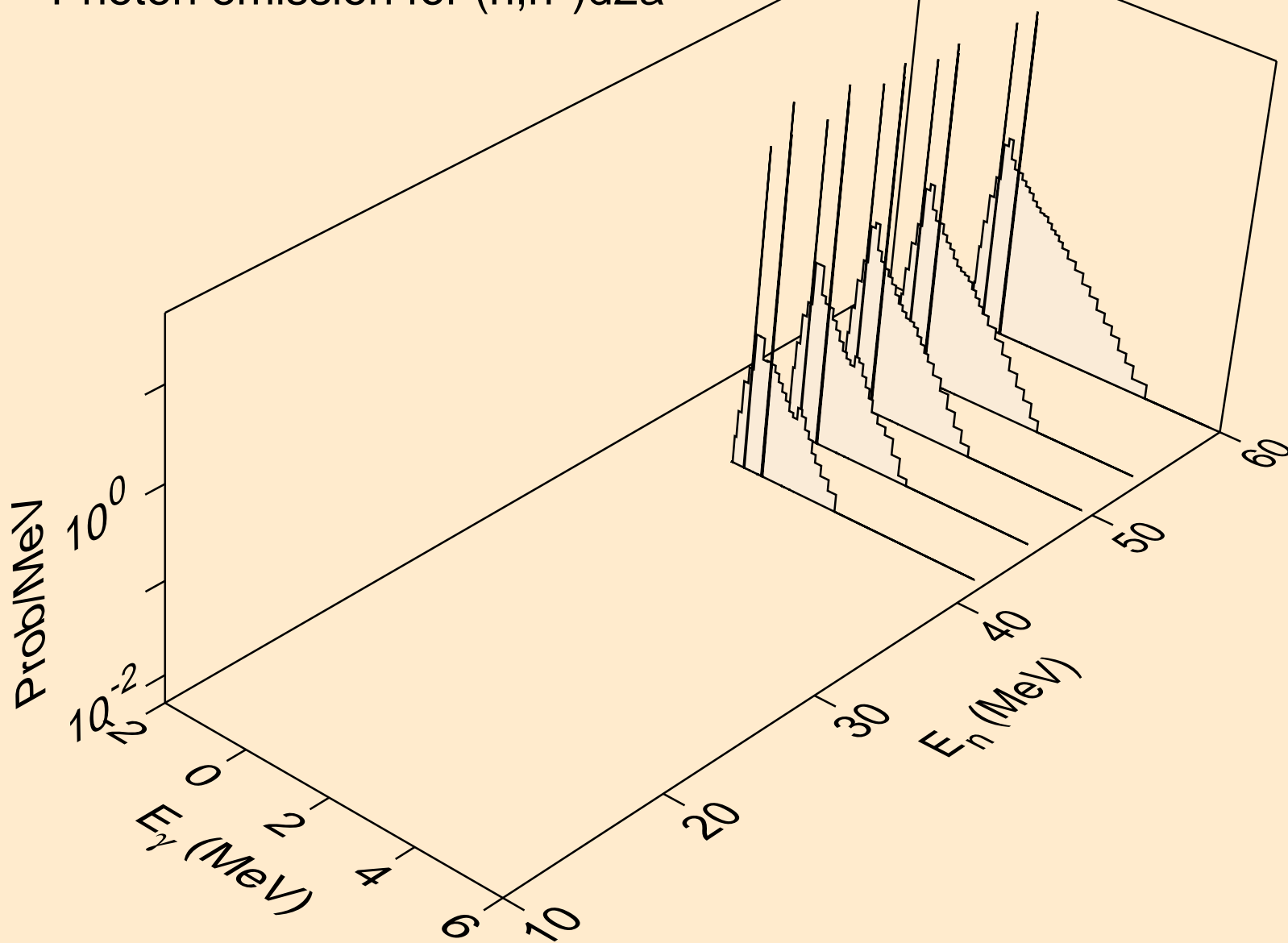

57-LA-138 FOR FENDL-3.2 PROCESSED BY NJOY2016.60+ ON
Photon emission for (n,4n)

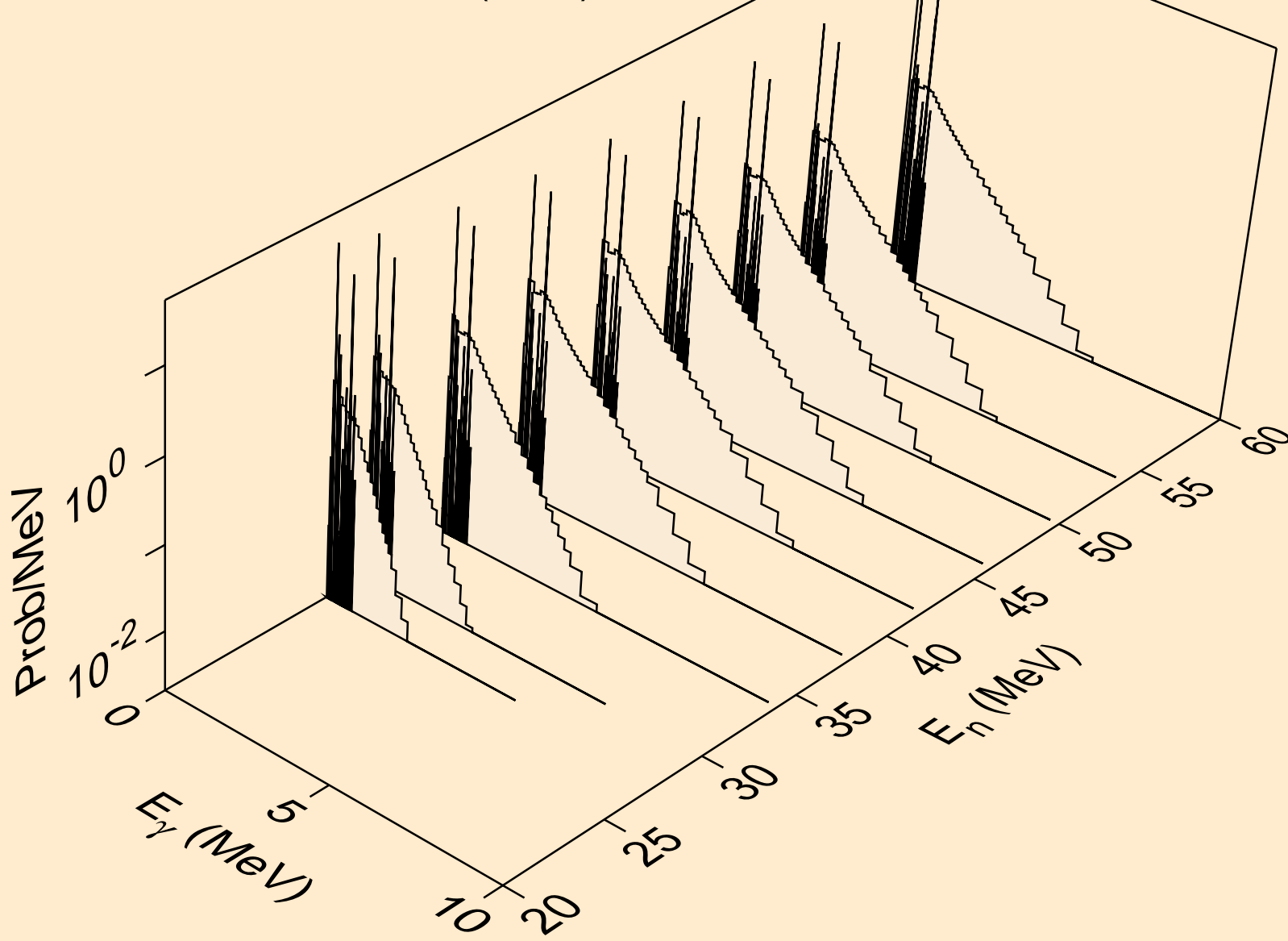

57-LA-138 FOR FENDL-3.2 PROCESSED BY NJOY2016.60+ ON
Photon emission for (n,2np)

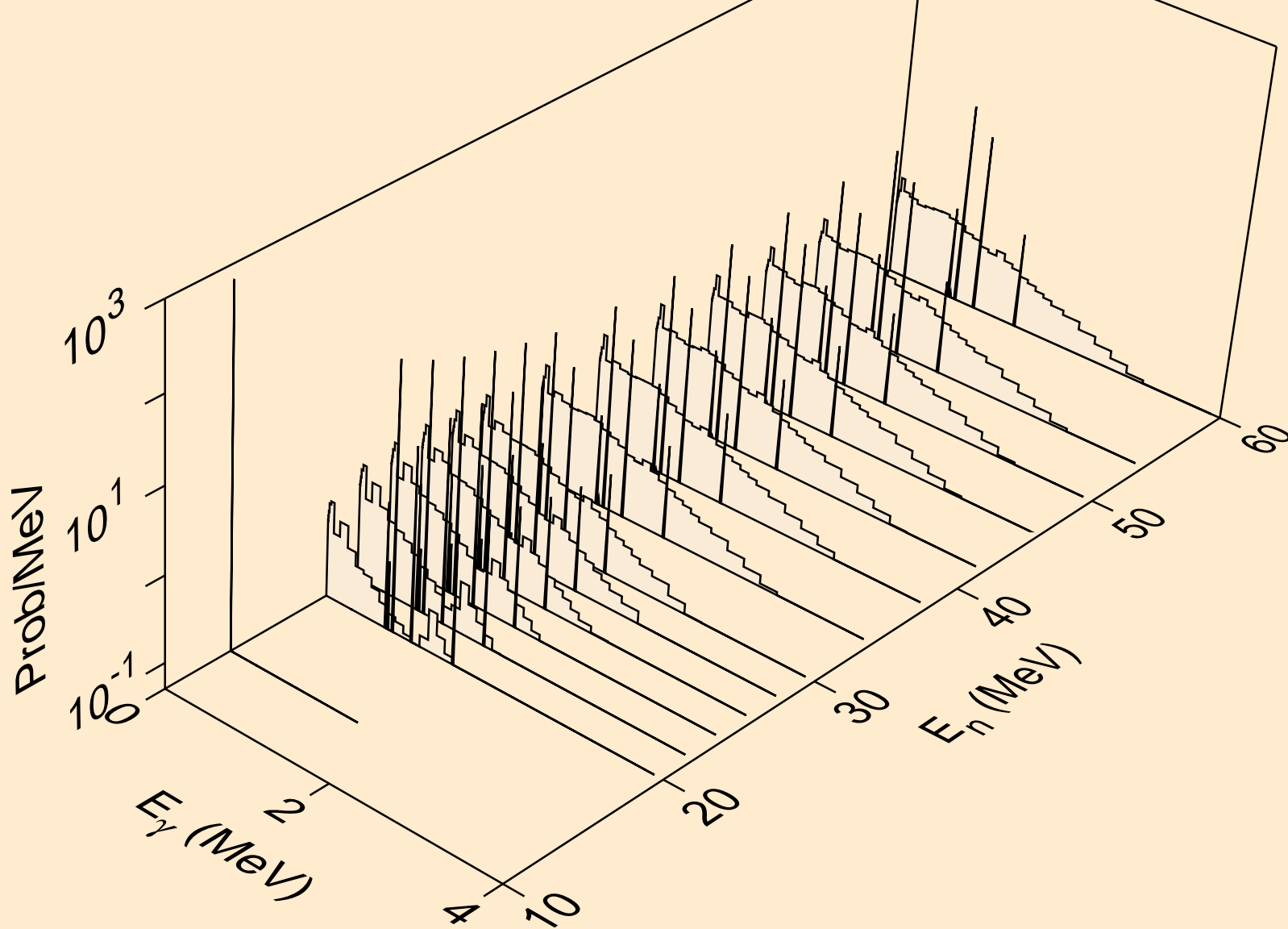

57-LA-138 FOR FENDL-3.2 PROCESSED BY NJOY2016.60+ ON
Photon emission for (n,3np)

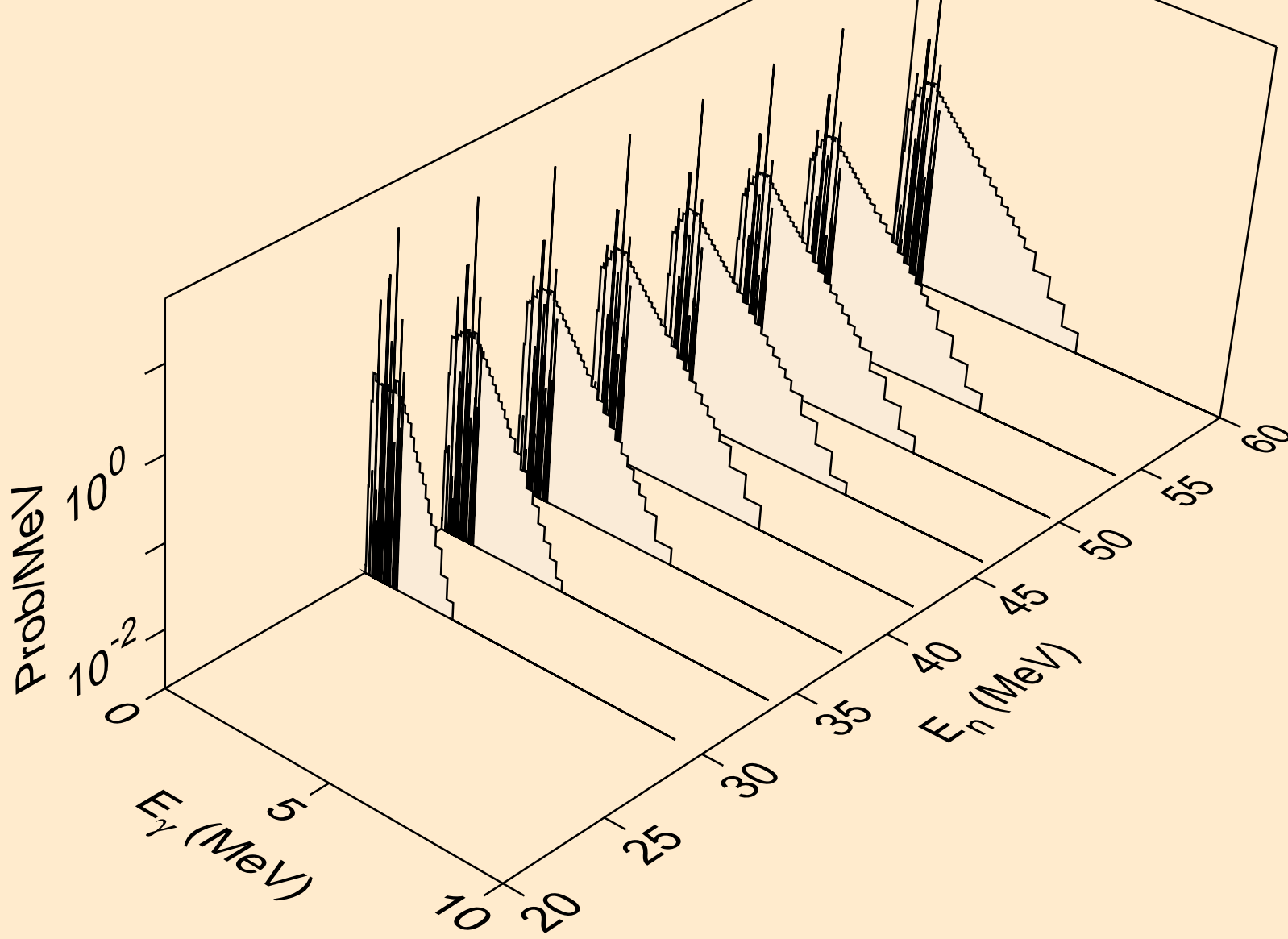

57-LA-138 FOR FENDL-3.2 PROCESSED BY NJOY2016.60+ ON
Photon emission for (n,2np)

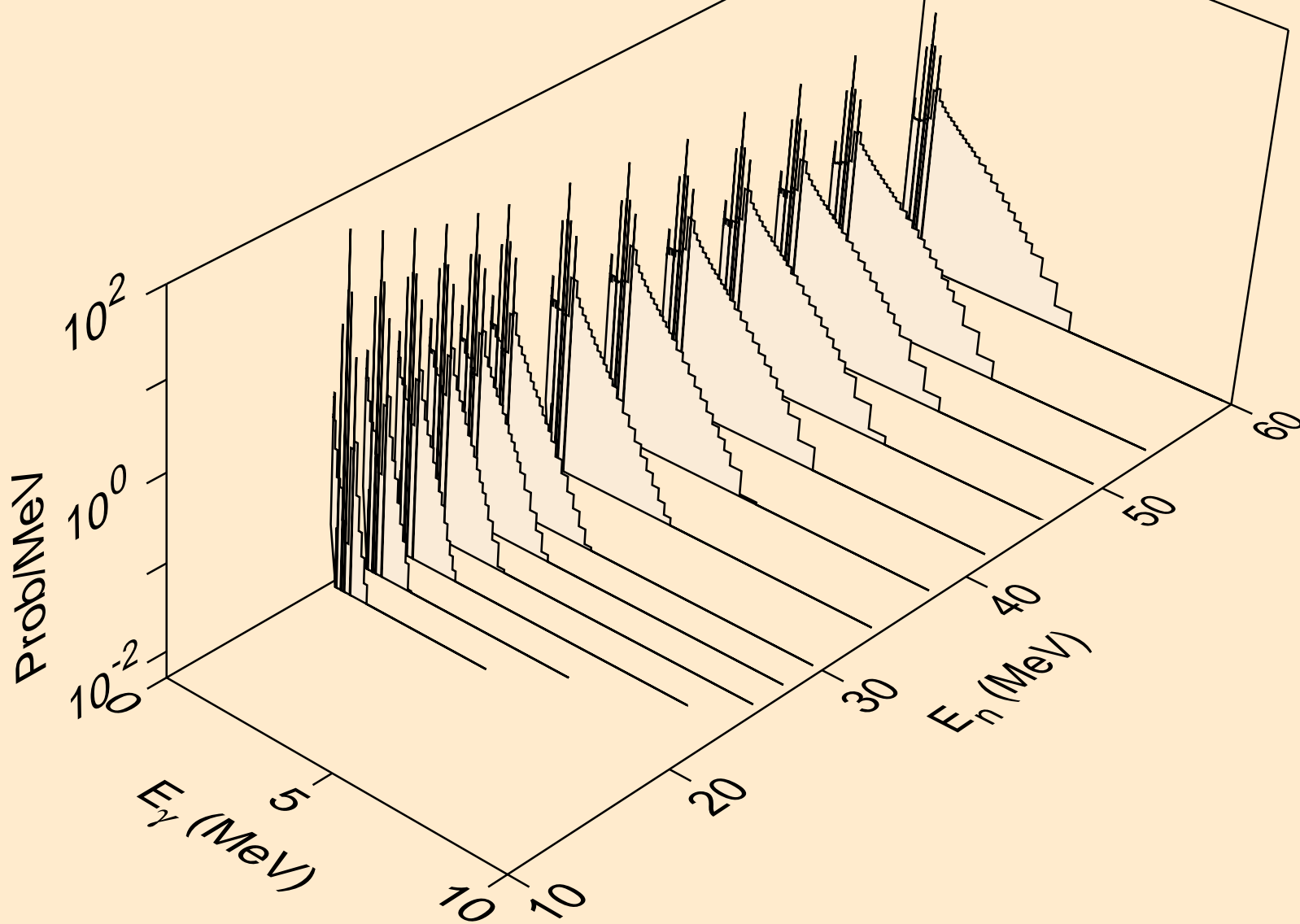

57-LA-138 FOR FENDL-3.2 PROCESSED BY NJOY2016.60+ ON
Photon emission for (n,npa)

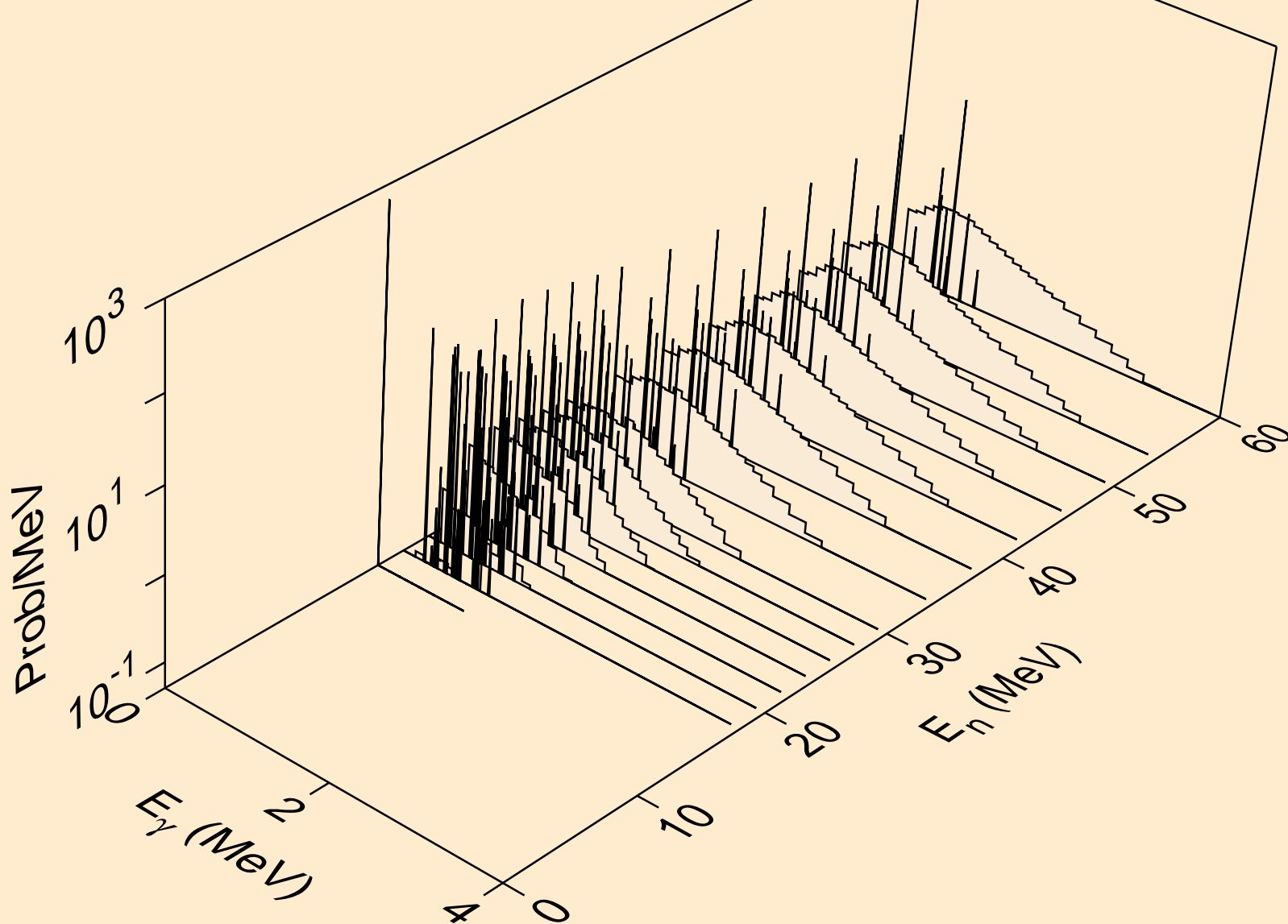

57-LA-138 FOR FENDL-3.2 PROCESSED BY NJOY2016.60+ ON
Photon emission for (n,n*c)

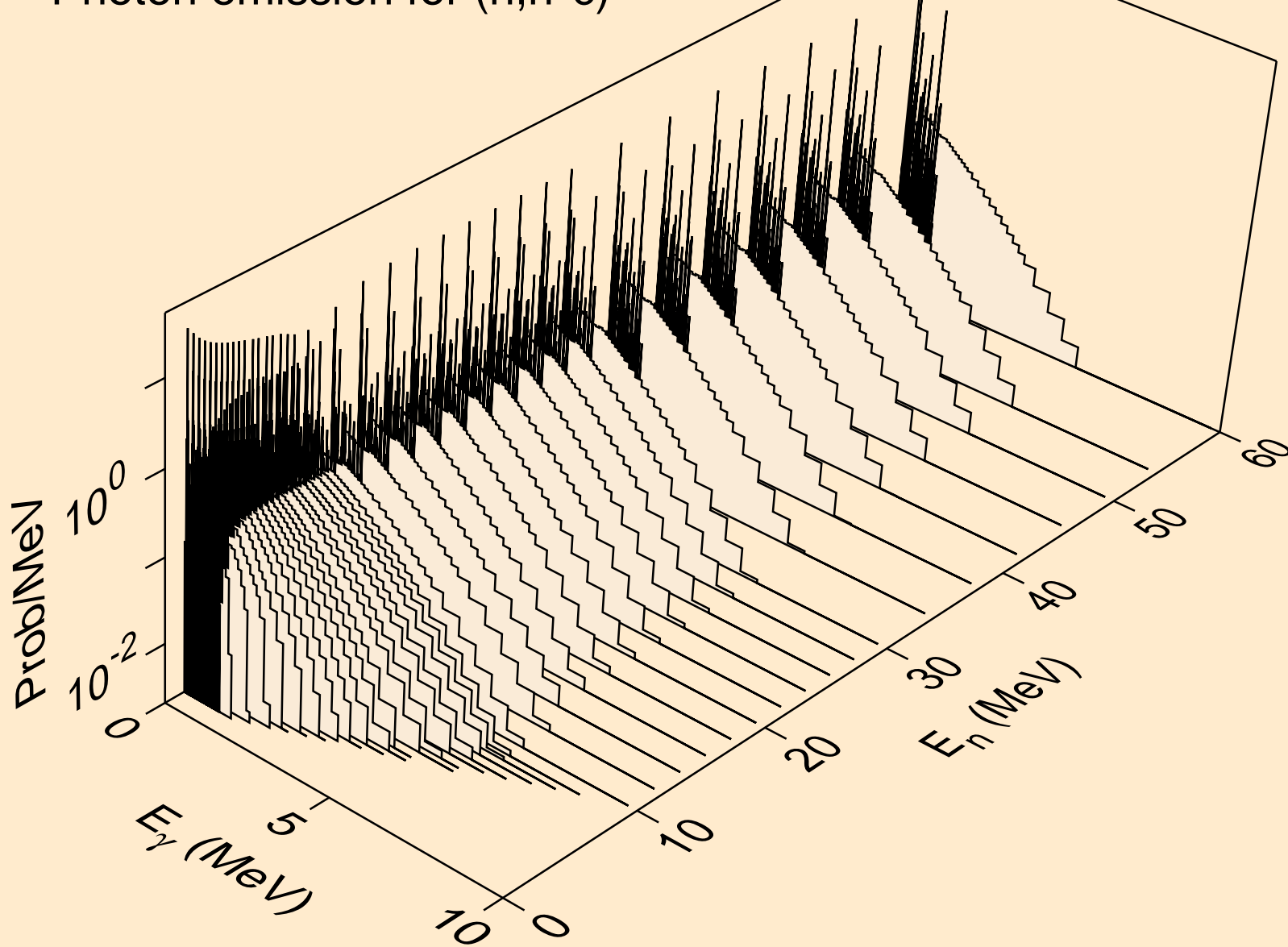

57-LA-138 FOR FENDL-3.2 PROCESSED BY NJOY2016.60+ ON
Photon emission for (n,gma)

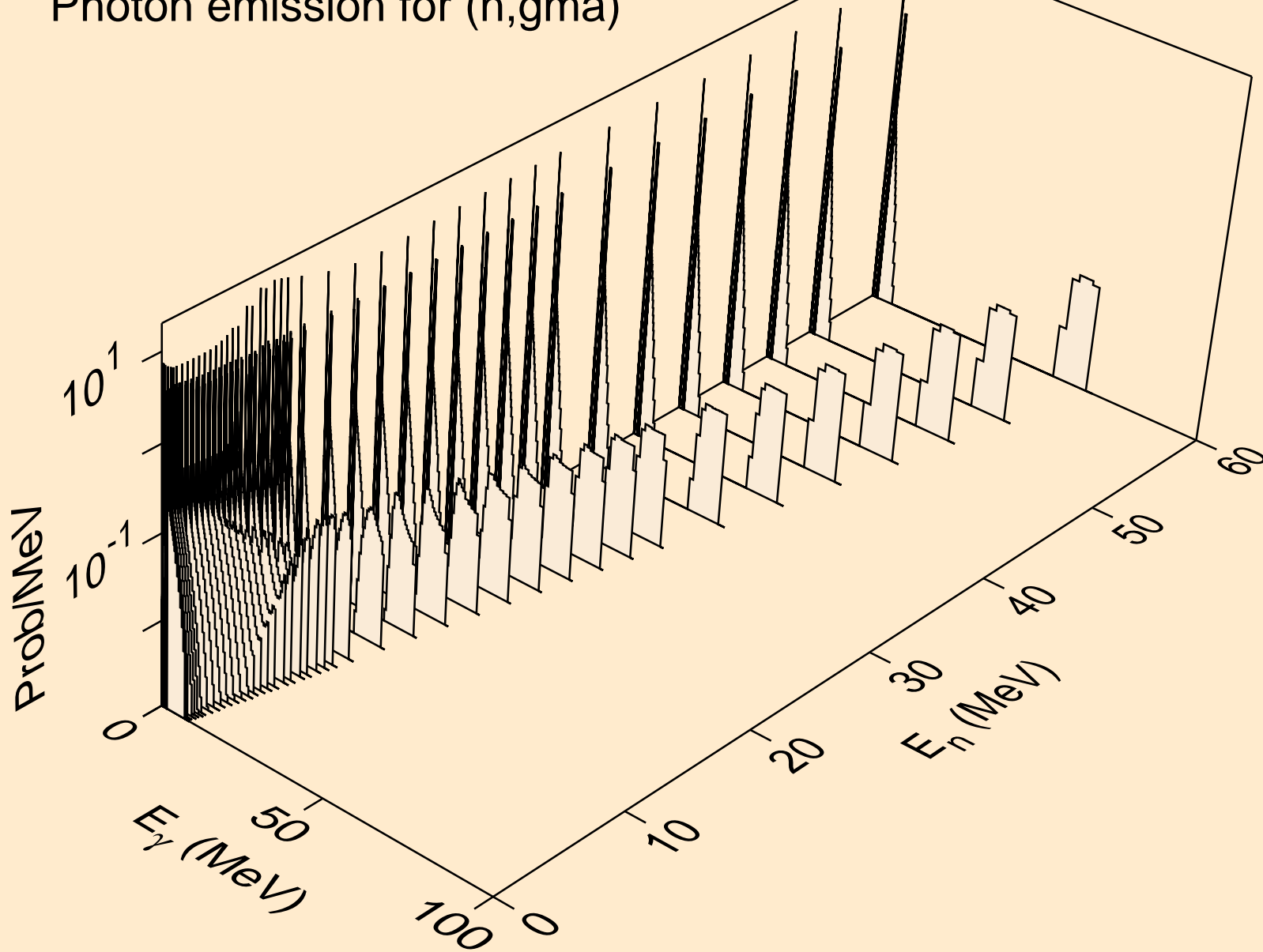

57-LA-138 FOR FENDL-3.2 PROCESSED BY NJOY2016.60+ ON
Photon emission for (n,p)

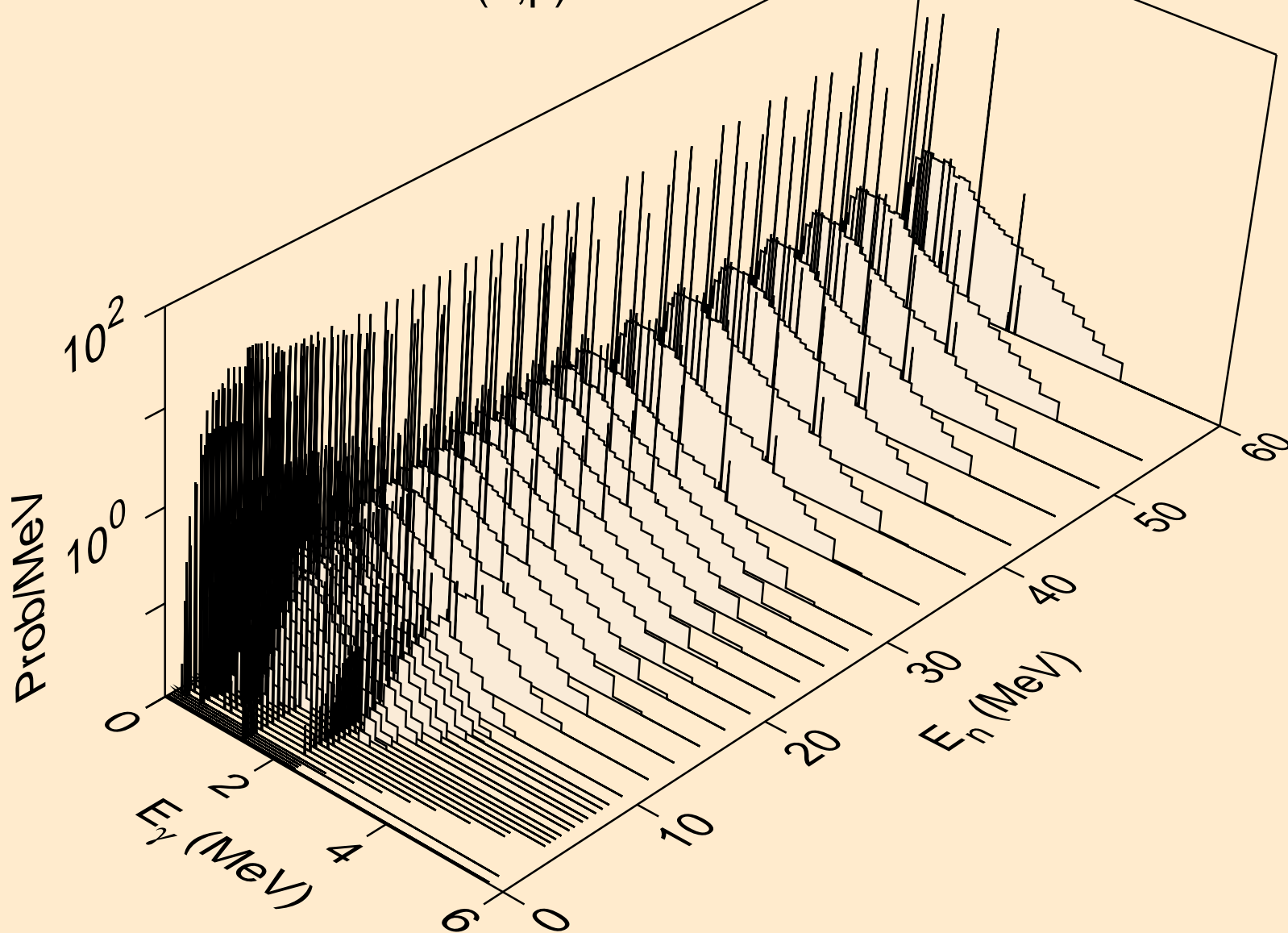

57-LA-138 FOR FENDL-3.2 PROCESSED BY NJOY2016.60+ ON
Photon emission for (n,d)

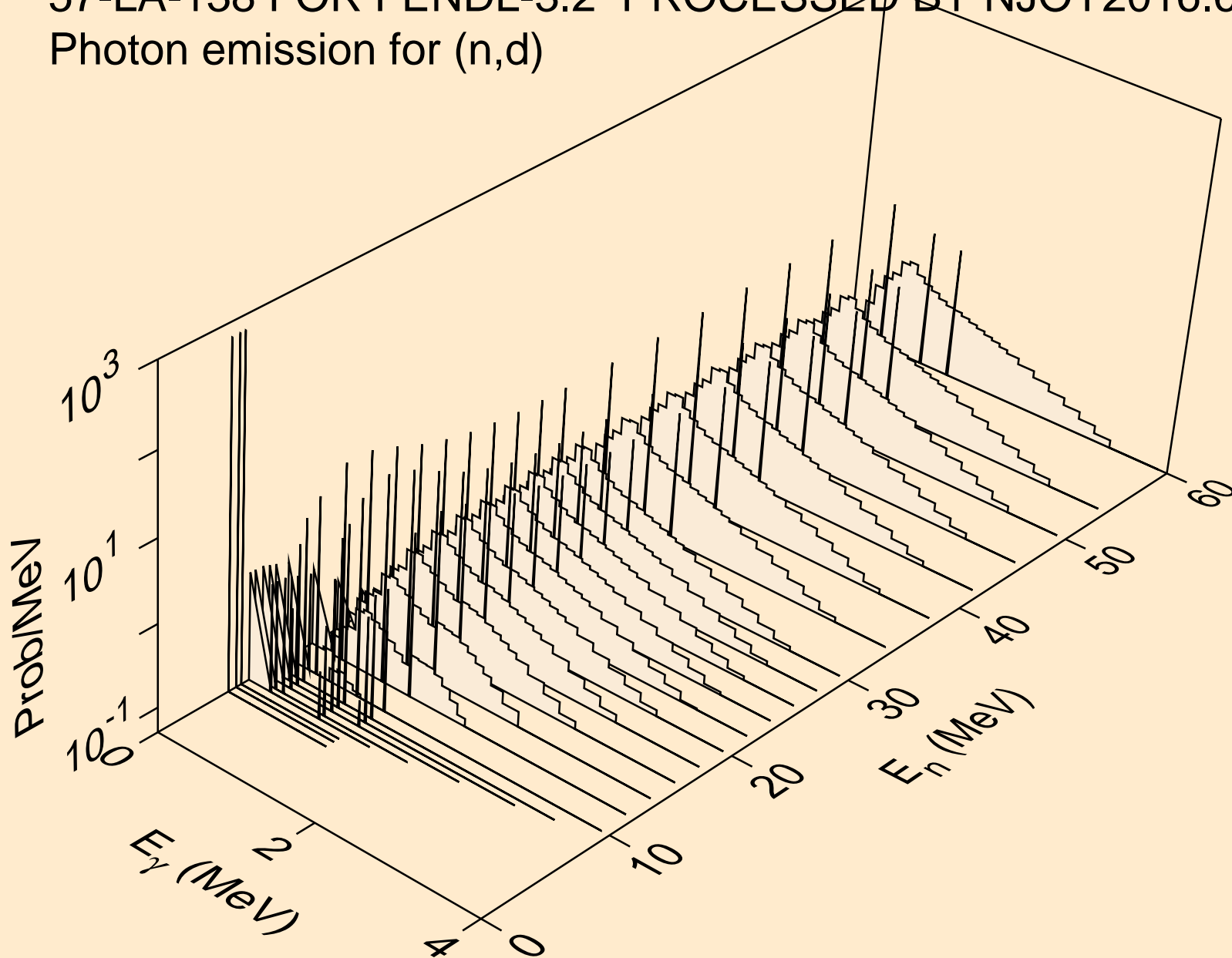

57-LA-138 FOR FENDL-3.2 PROCESSED BY NJOY2016.60+ ON
Photon emission for (n,t)

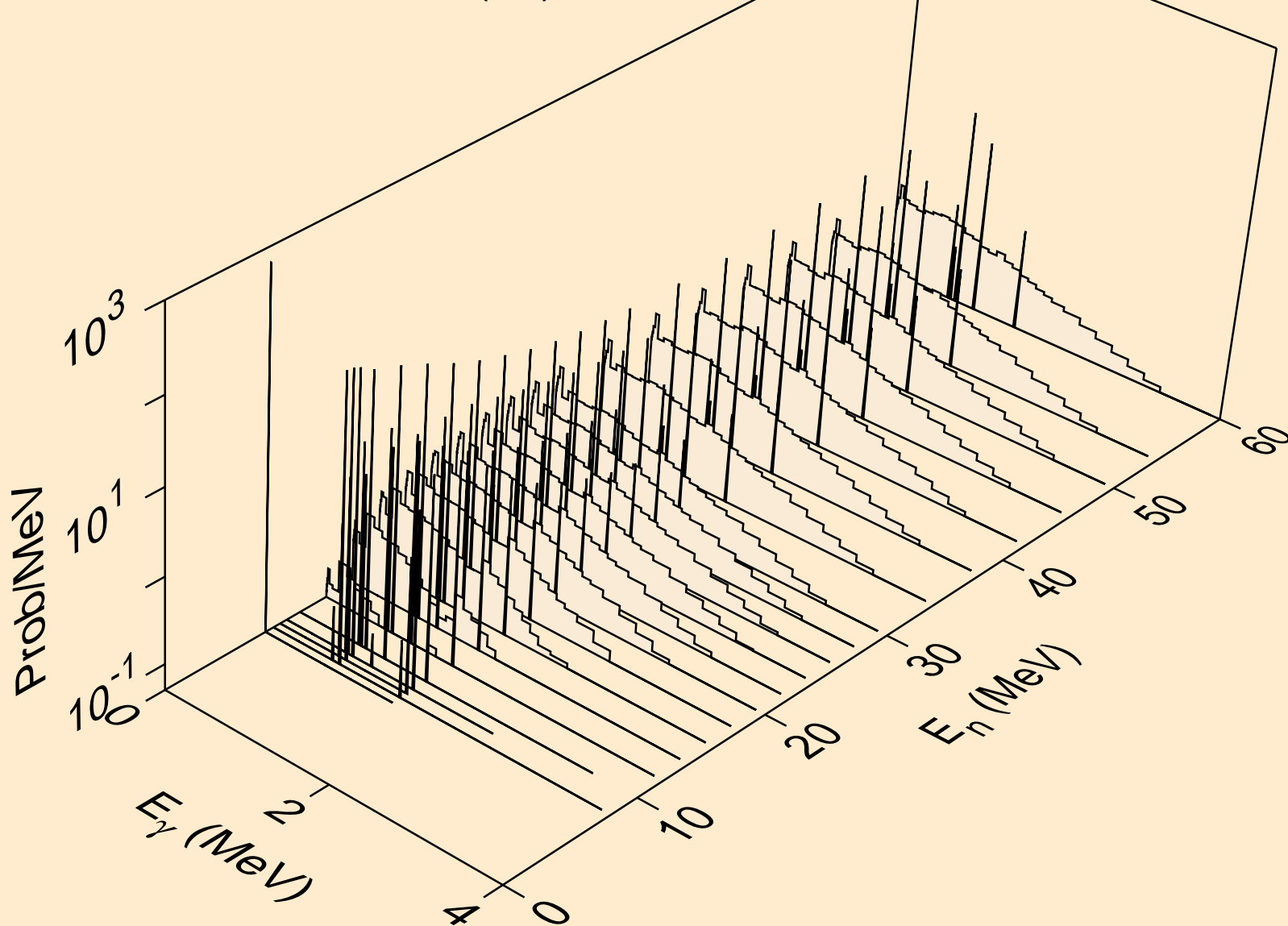

57-LA-138 FOR FENDL-3.2 PROCESSED BY NJOY2016.60+ ON
Photon emission for (n,he3)

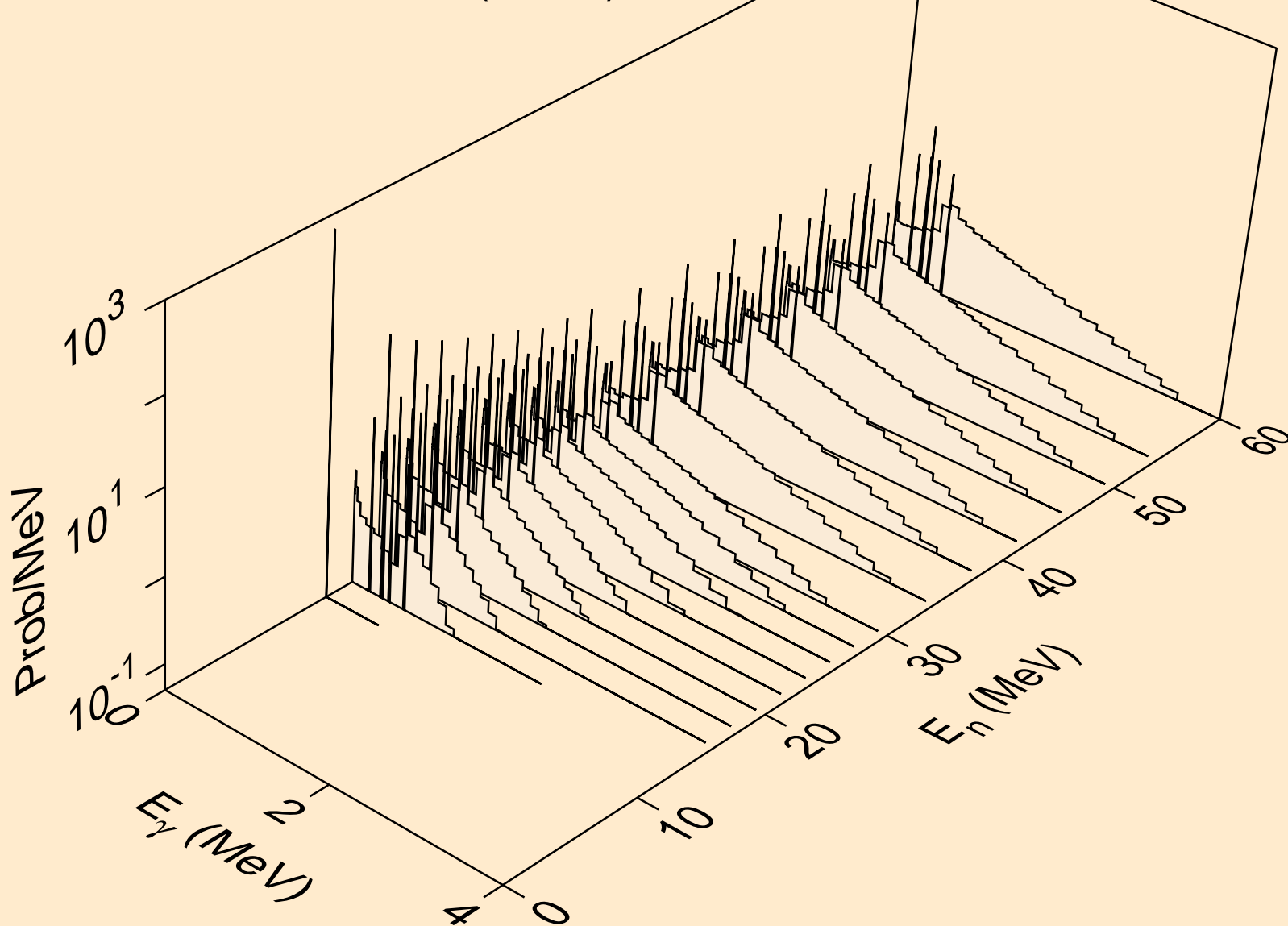

57-LA-138 FOR FENDL-3.2 PROCESSED BY NJOY2016.60+ ON
Photon emission for (n,a)

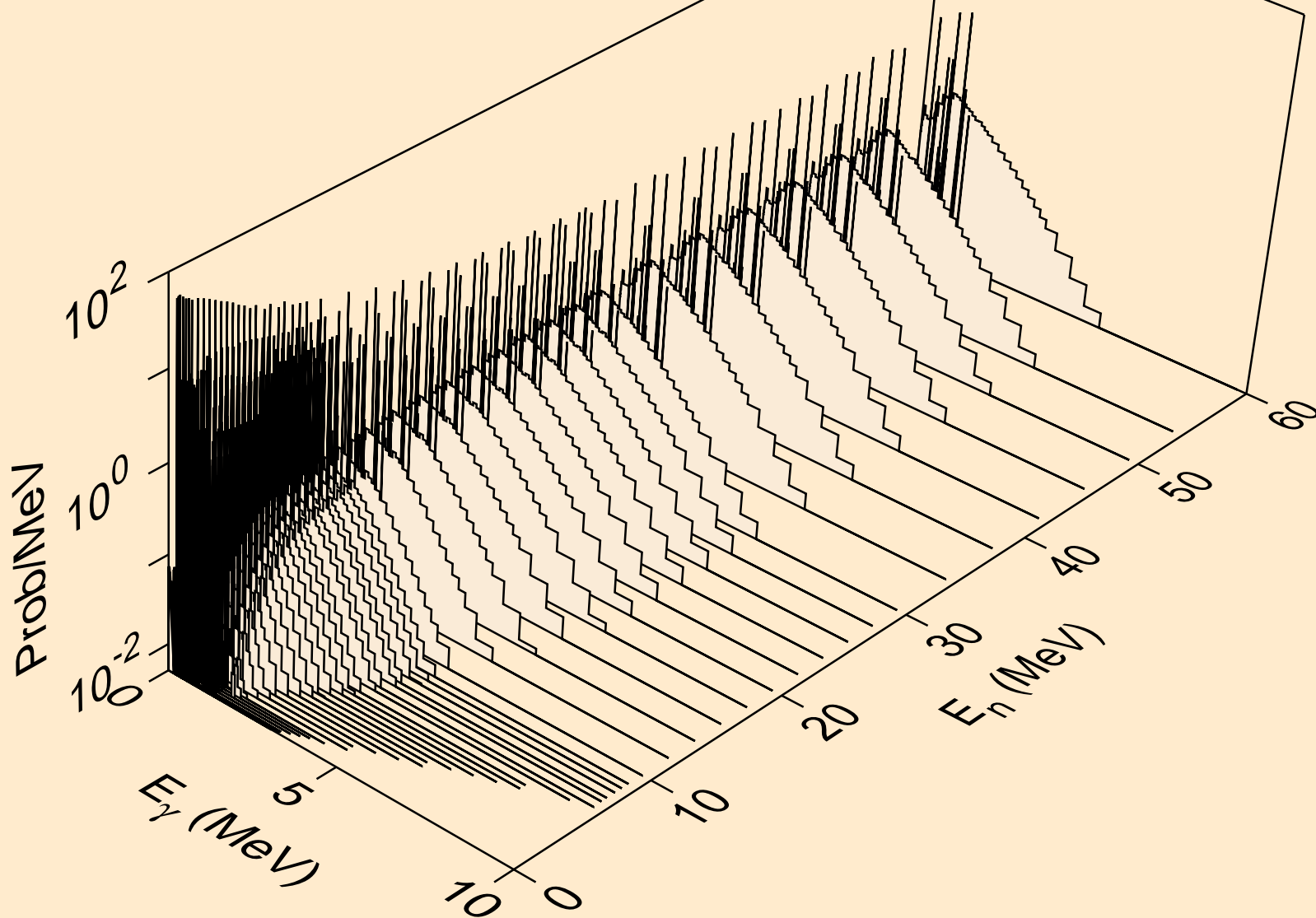

57-LA-138 FOR FENDL-3.2 PROCESSED BY NJOY2016.60+ ON
Photon emission for (n,2a)

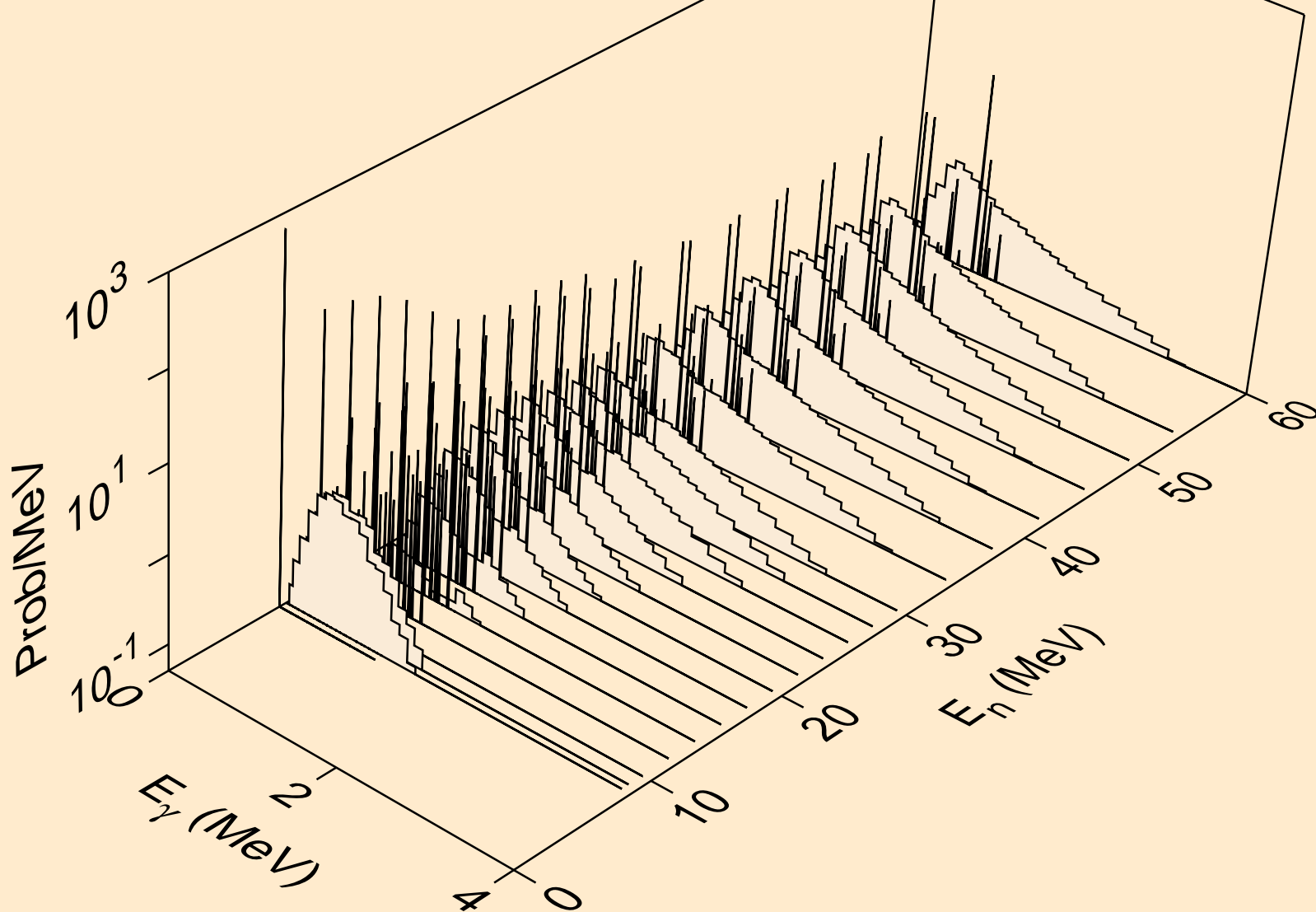

57-LA-138 FOR FENDL-3.2 PROCESSED BY NJOY2016.60+ ON
Photon emission for (n,2p)

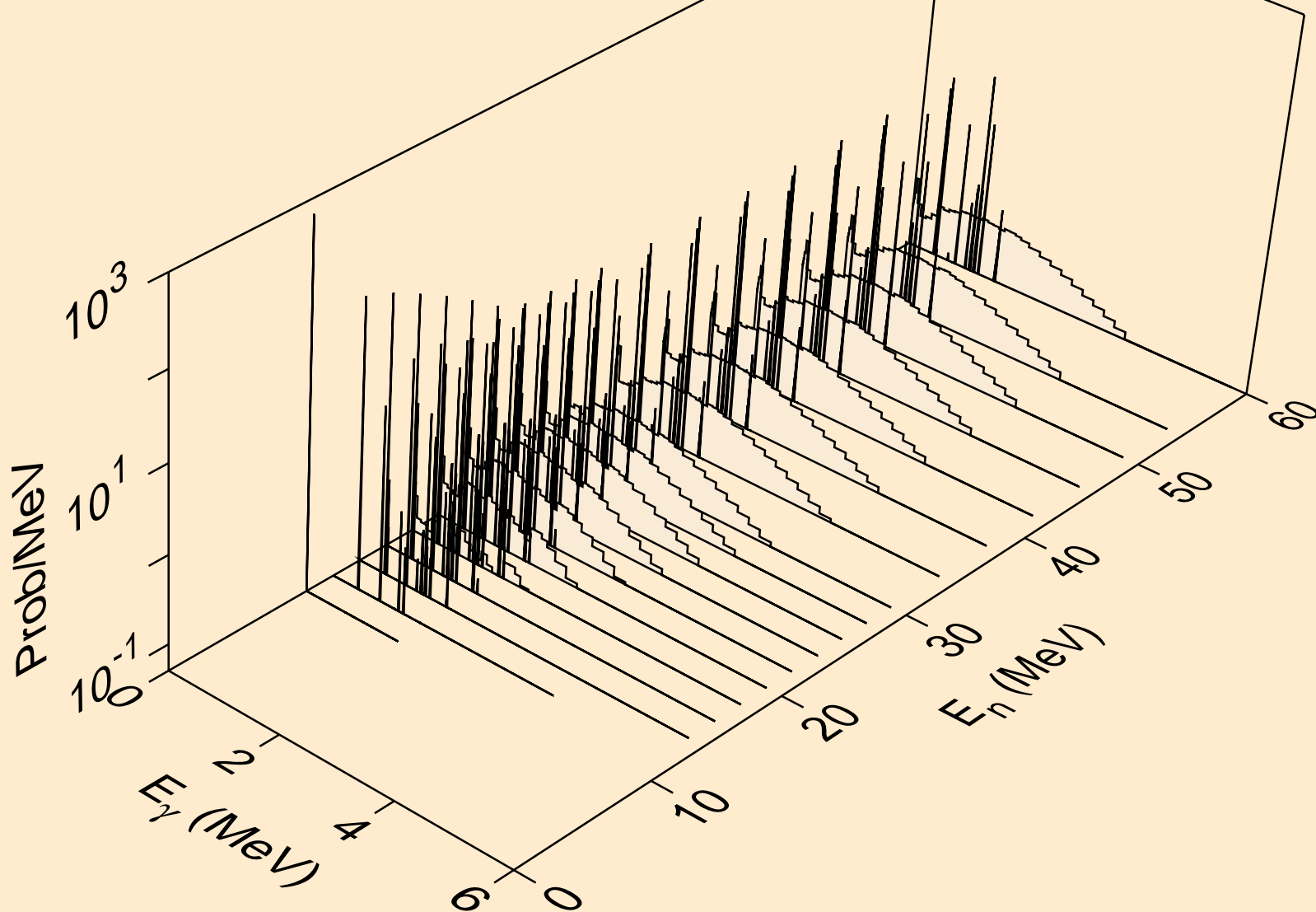

57-LA-138 FOR FENDL-3.2 PROCESSED BY NJOY2016.60+ ON
Photon emission for (n,pa)

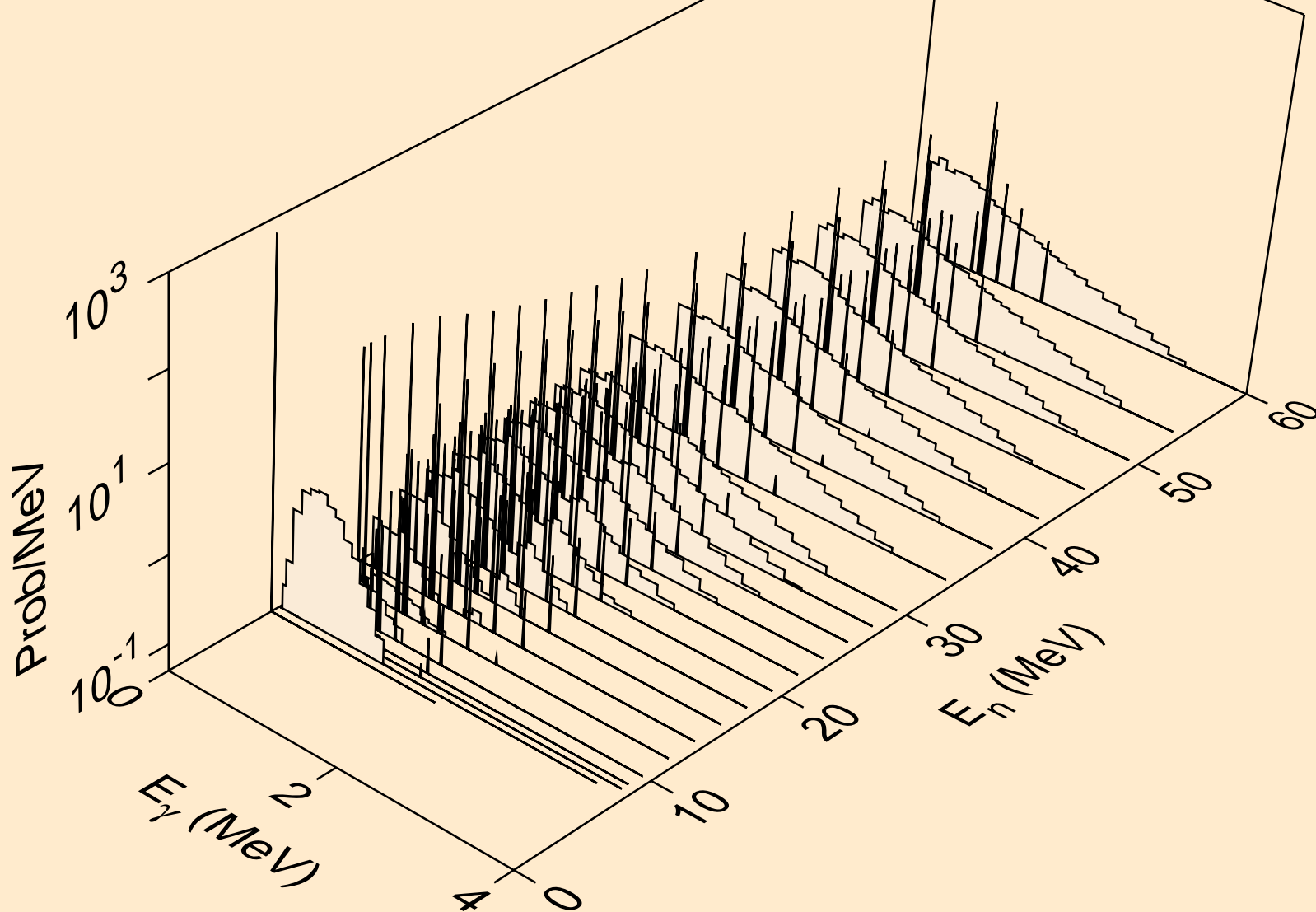

57-LA-138 FOR FENDL-3.2 PROCESSED BY NJOY2016.60+ ON
Photon emission for (n,d2a)

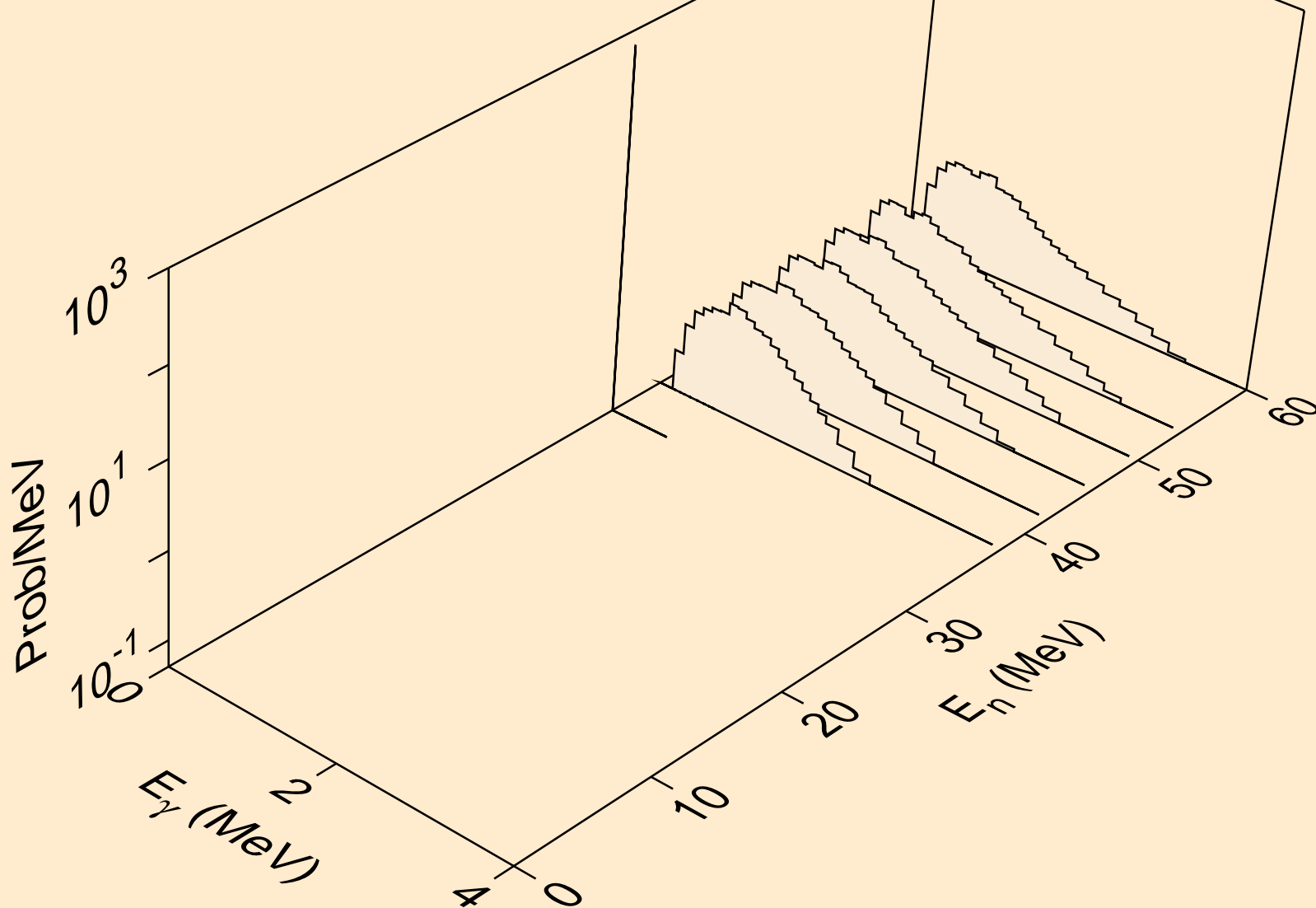

57-LA-138 FOR FENDL-3.2 PROCESSED BY NJOY2016.60+ ON
Photon emission for (n,pd)

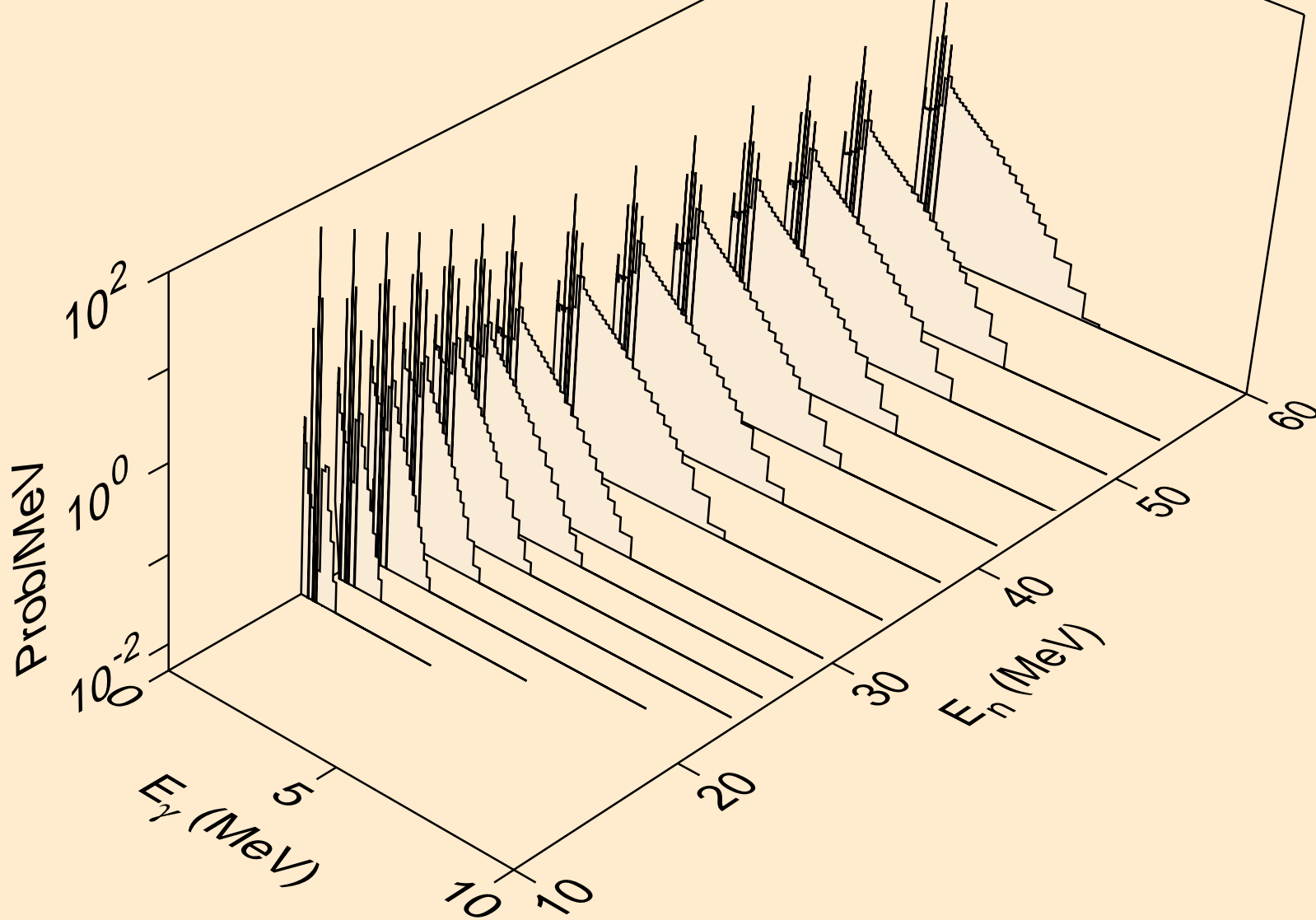

57-LA-138 FOR FENDL-3.2 PROCESSED BY NJOY2016.60+ ON
Photon emission for (n,pt)

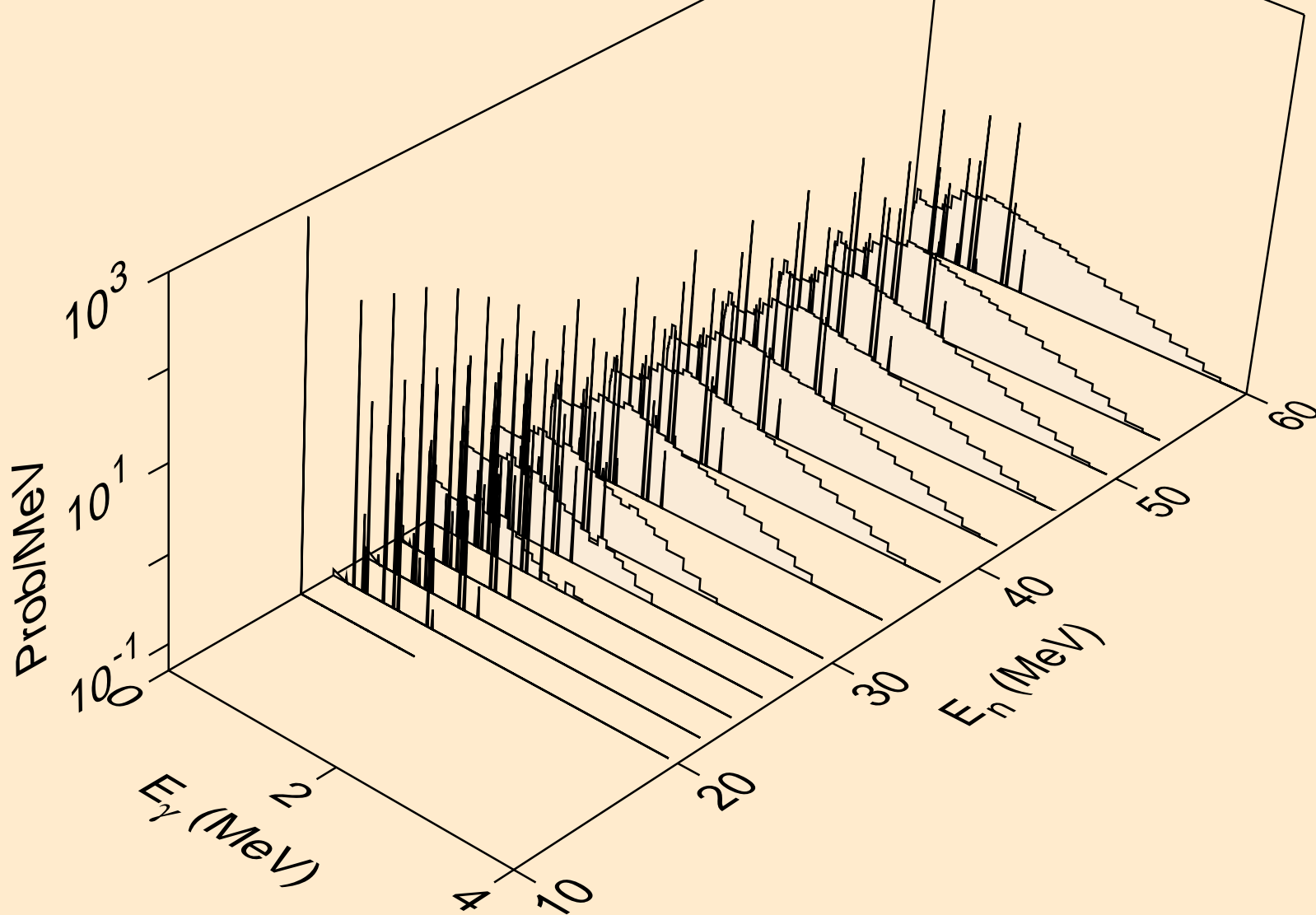

57-LA-138 FOR FENDL-3.2 PROCESSED BY NJOY2016.60+ ON
Photon emission for (n,da)

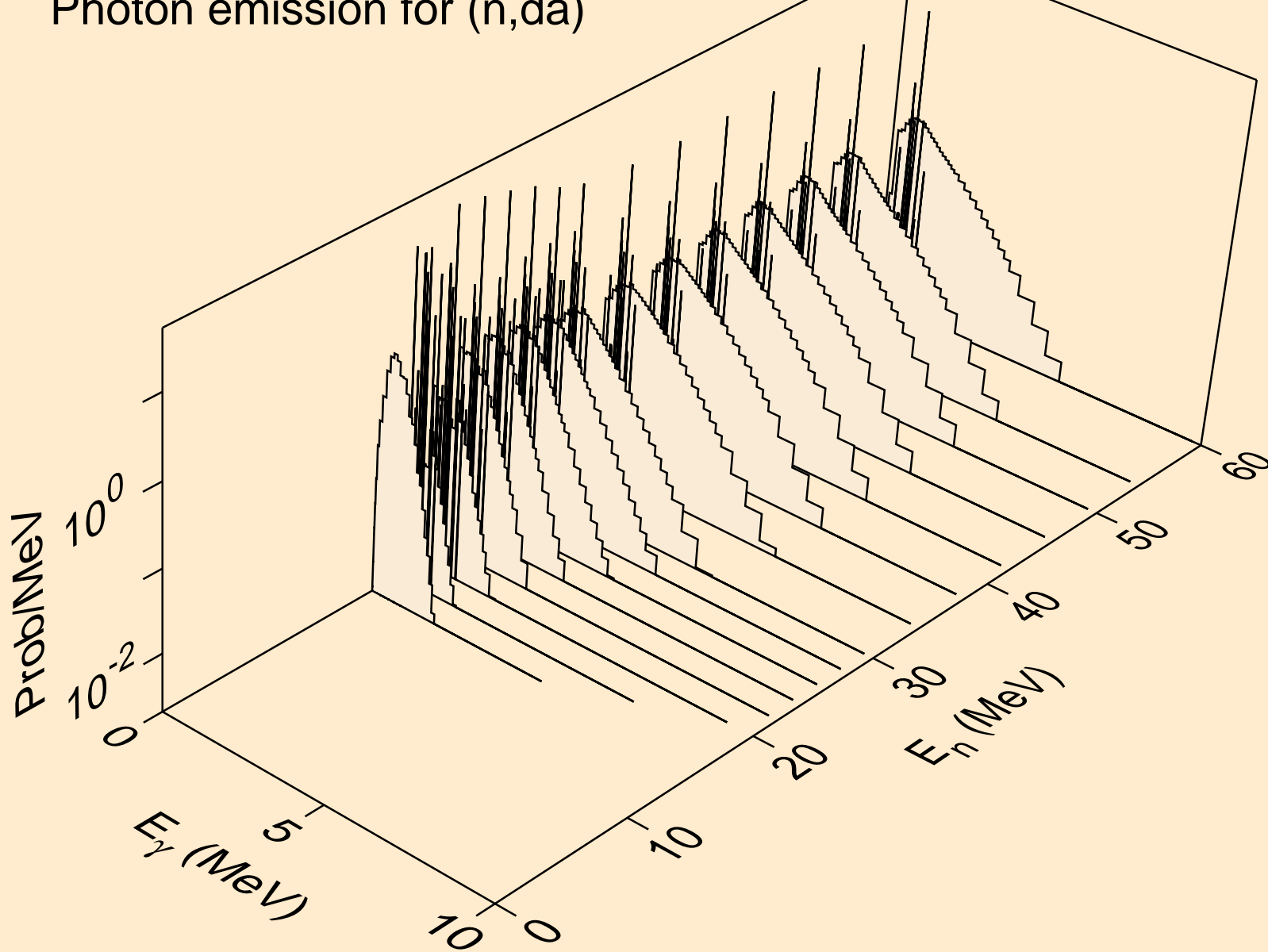

57-LA-138 FOR FENDL-3.2 PROCESSED BY NJOY2016.60+ ON
Photon emission for (n,5n)

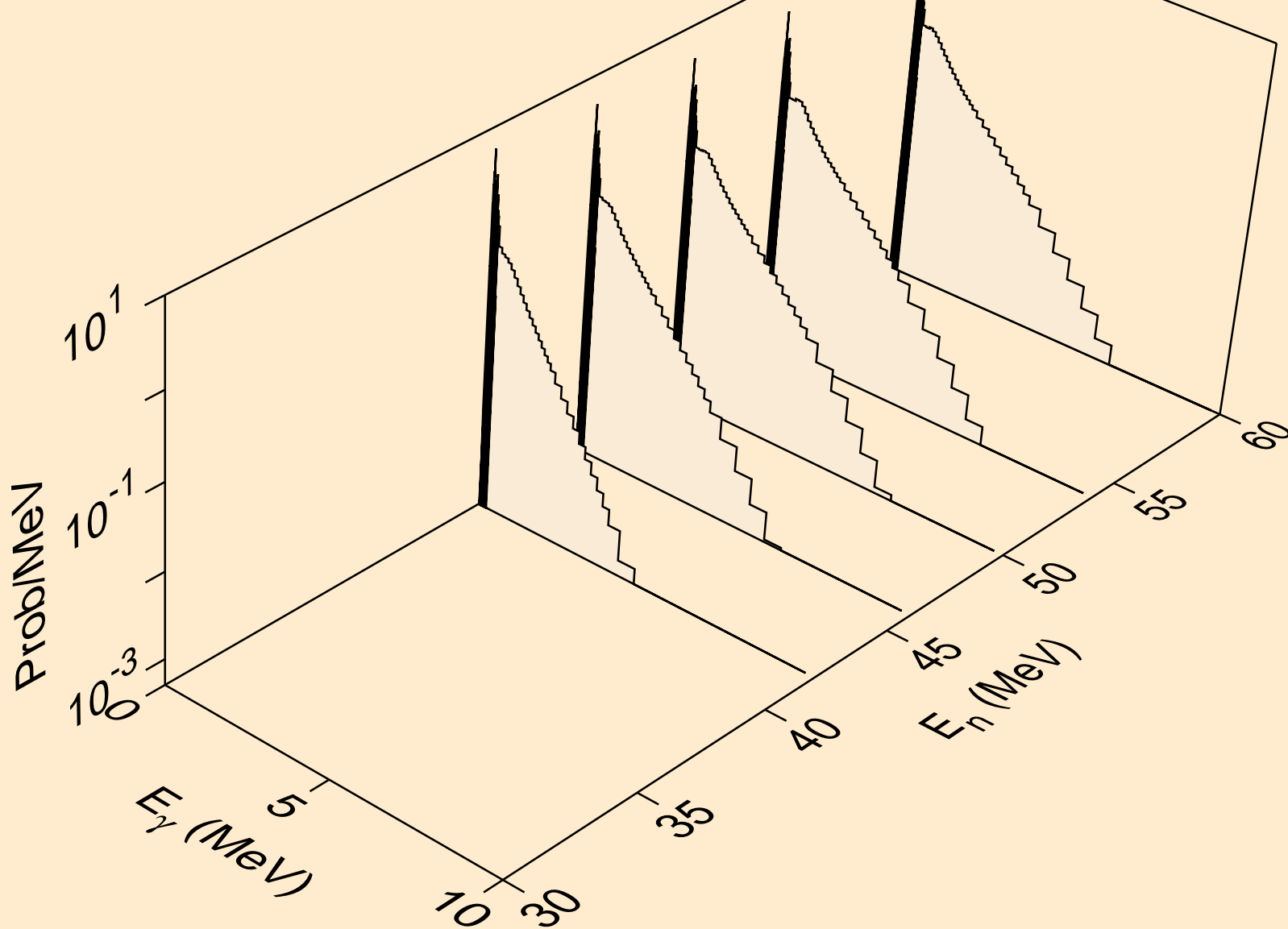

57-LA-138 FOR FENDL-3.2 PROCESSED BY NJOY2016.60+ ON
Photon emission for (n,6n)

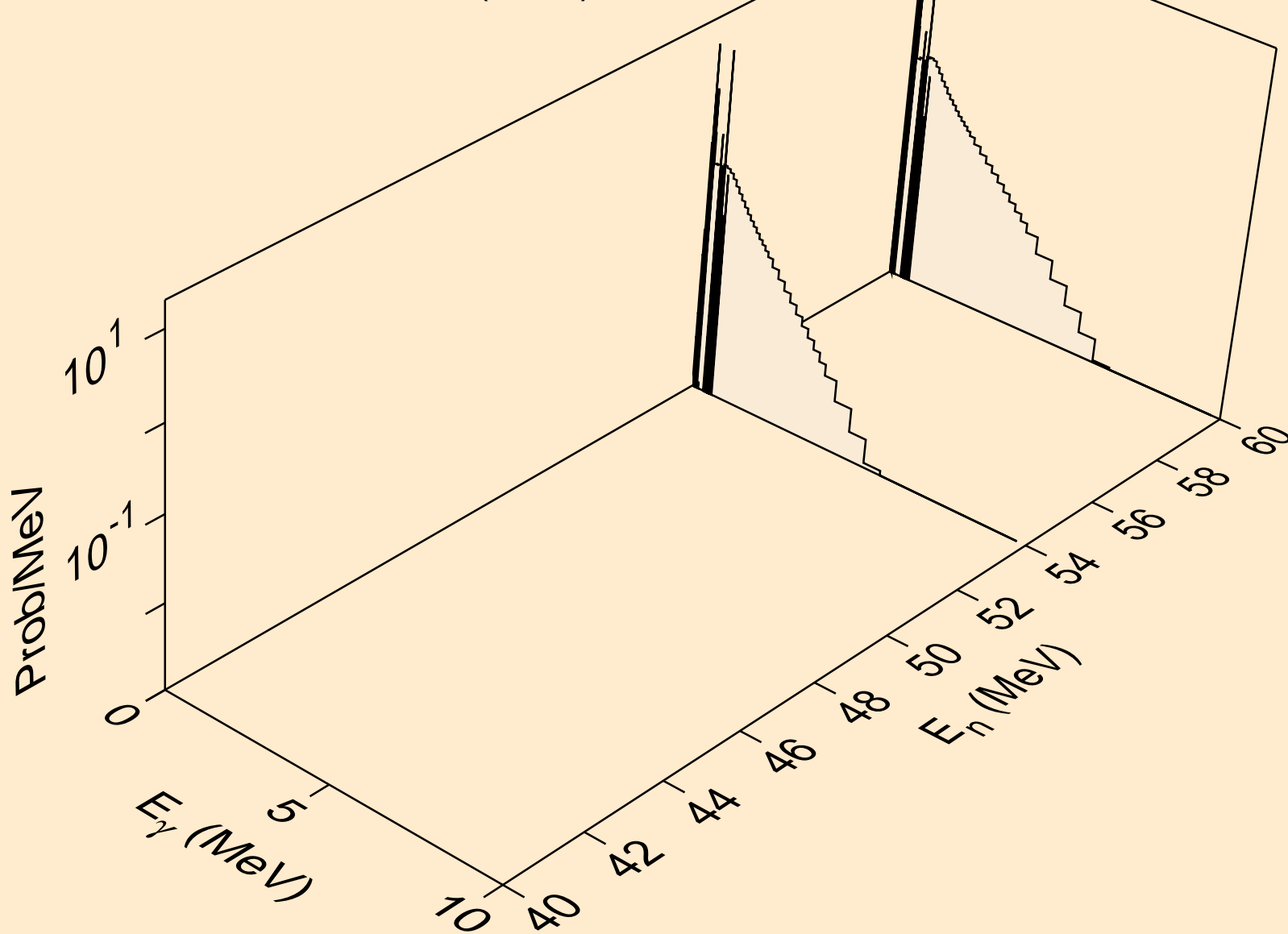

57-LA-138 FOR FENDL-3.2 PROCESSED BY NJOY2016.60+ ON
Photon emission for (n,2nt)

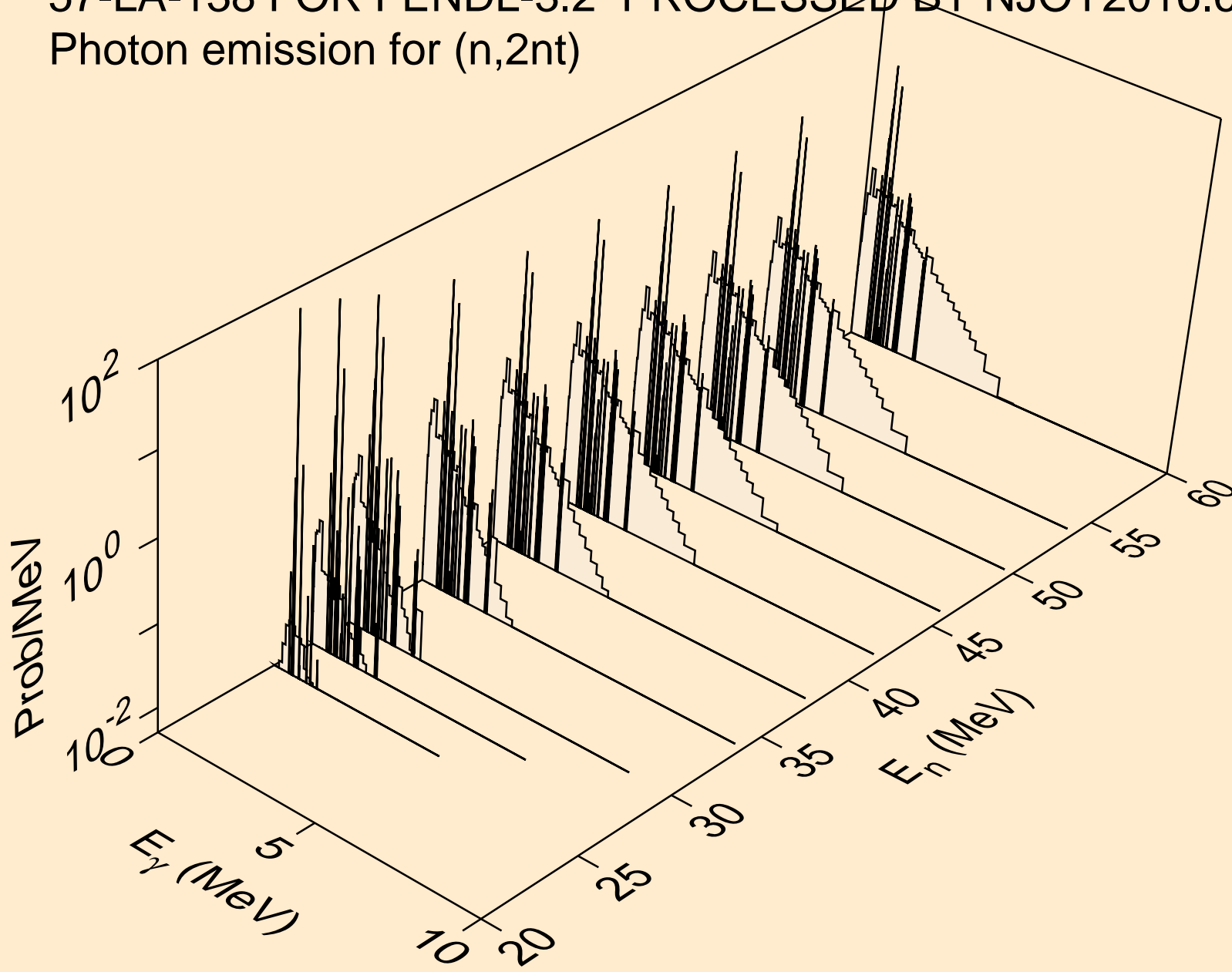

57-LA-138 FOR FENDL-3.2 PROCESSED BY NJOY2016.60+ ON
Photon emission for (n,ta)

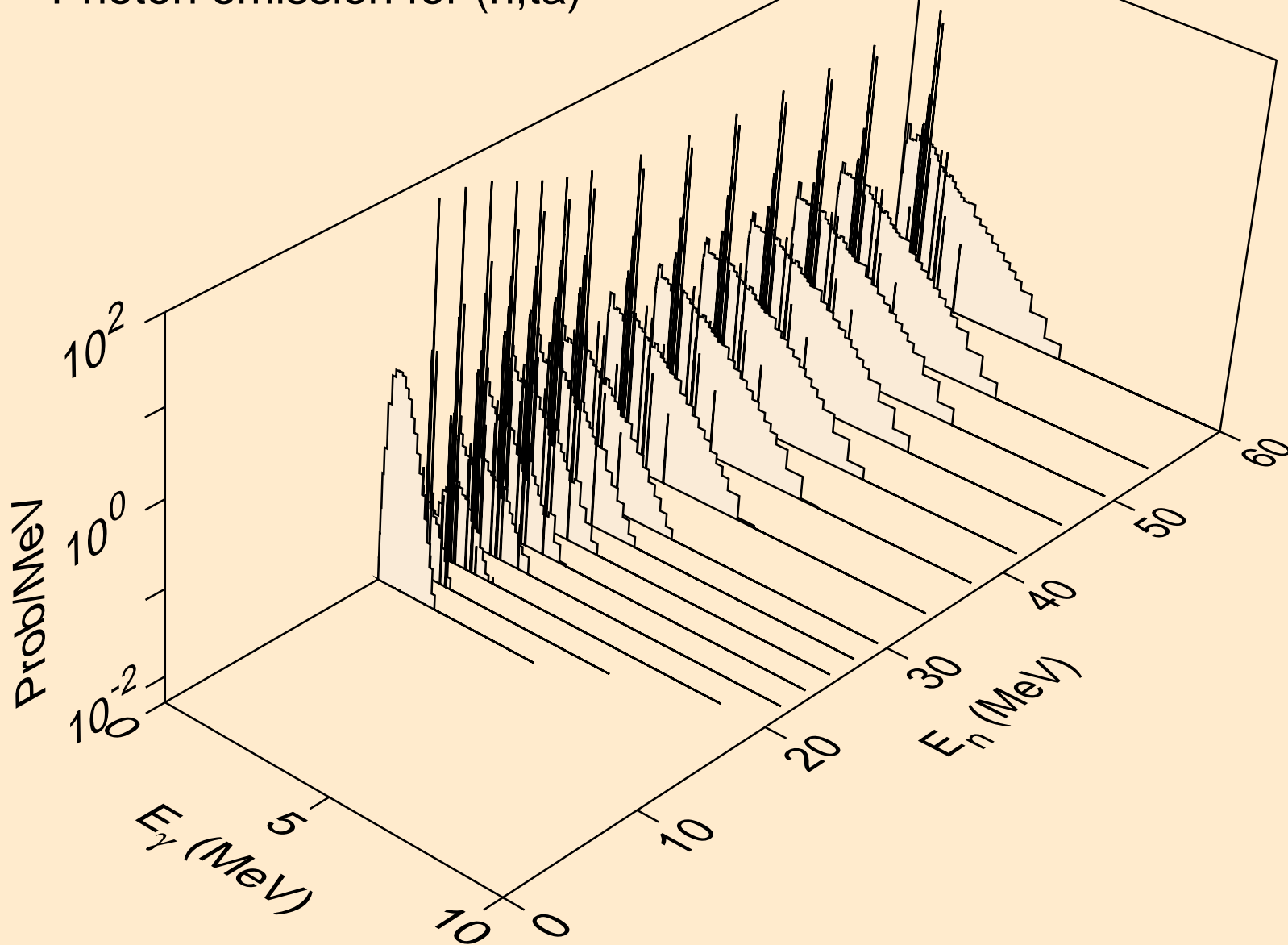

57-LA-138 FOR FENDL-3.2 PROCESSED BY NJOY2016.60+ ON
Photon emission for (n,4np)

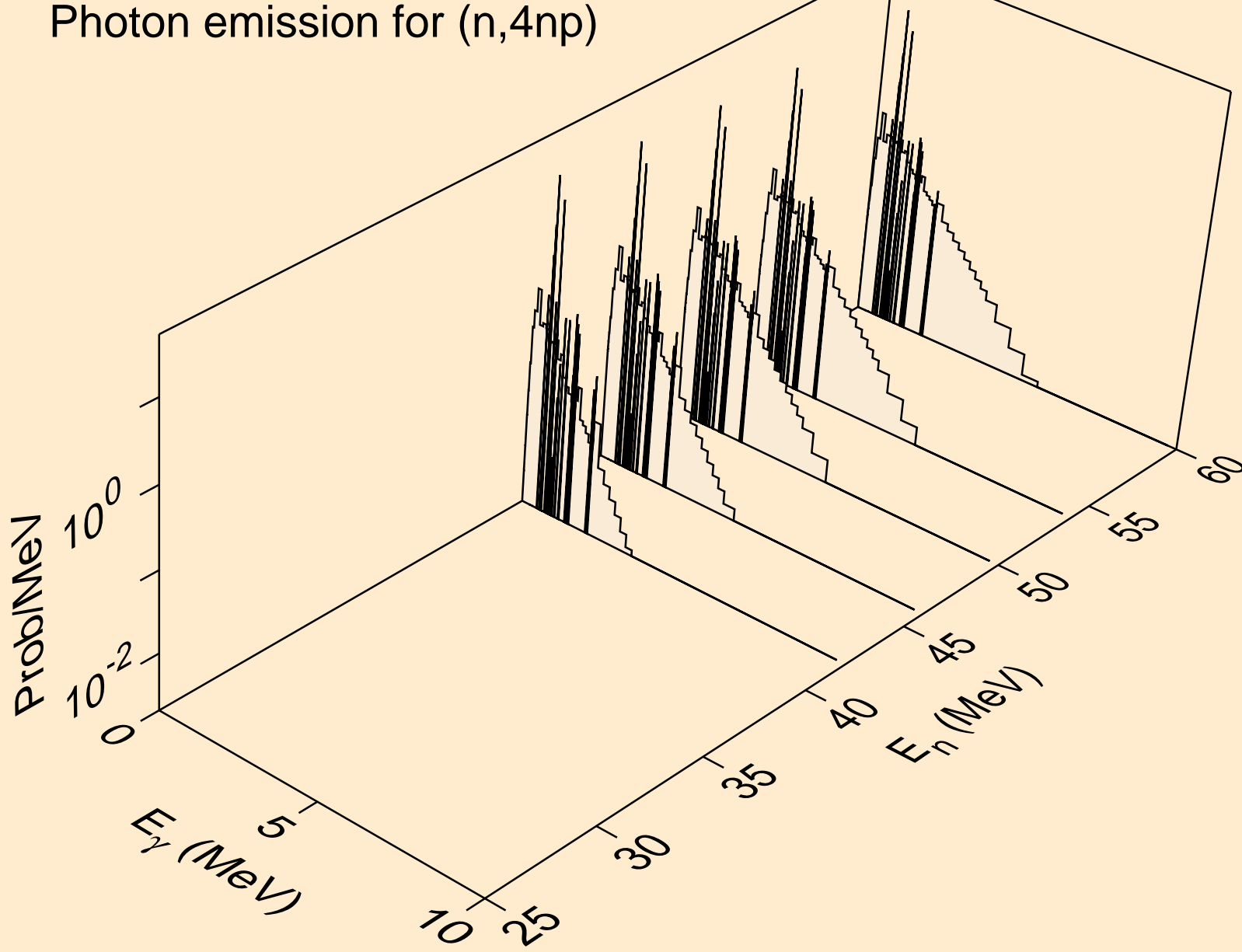

57-LA-138 FOR FENDL-3.2 PROCESSED BY NJOY2016.60+ ON
Photon emission for (n,3nd)

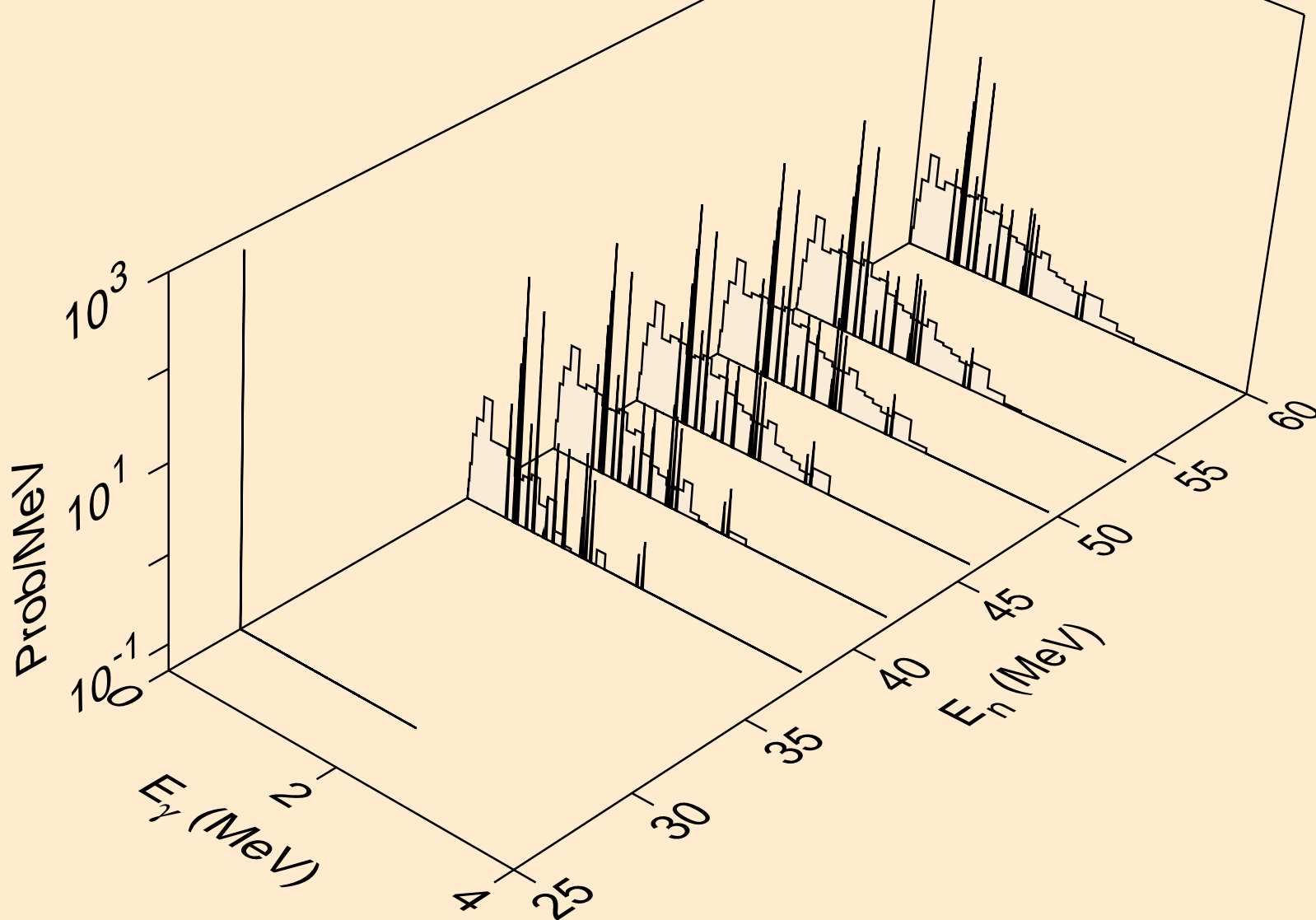

57-LA-138 FOR FENDL-3.2 PROCESSED BY NJOY2016.60+ ON
Photon emission for (n,nda)

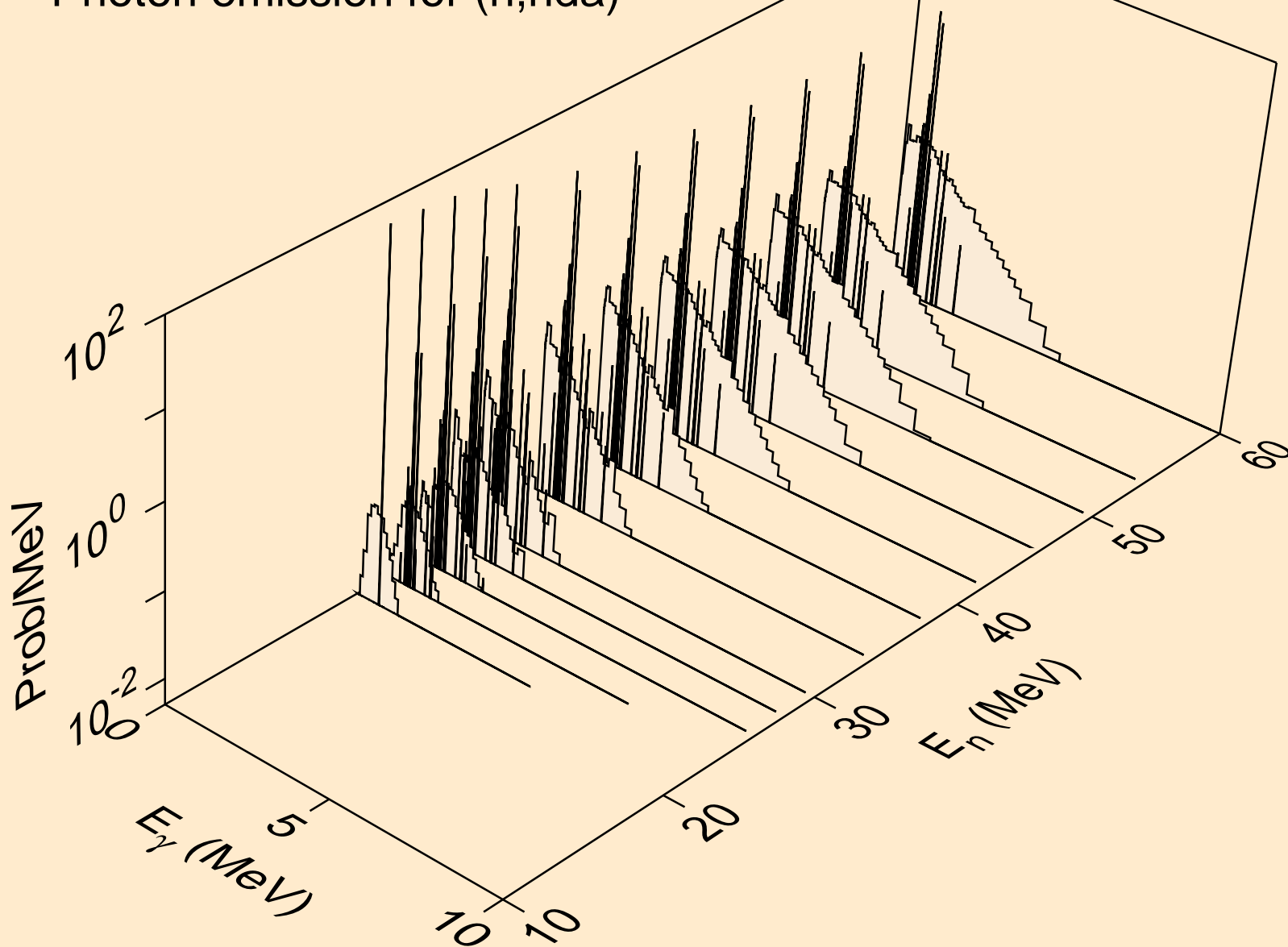

57-LA-138 FOR FENDL-3.2 PROCESSED BY NJOY2016.60+ ON
Photon emission for (n,2npa)

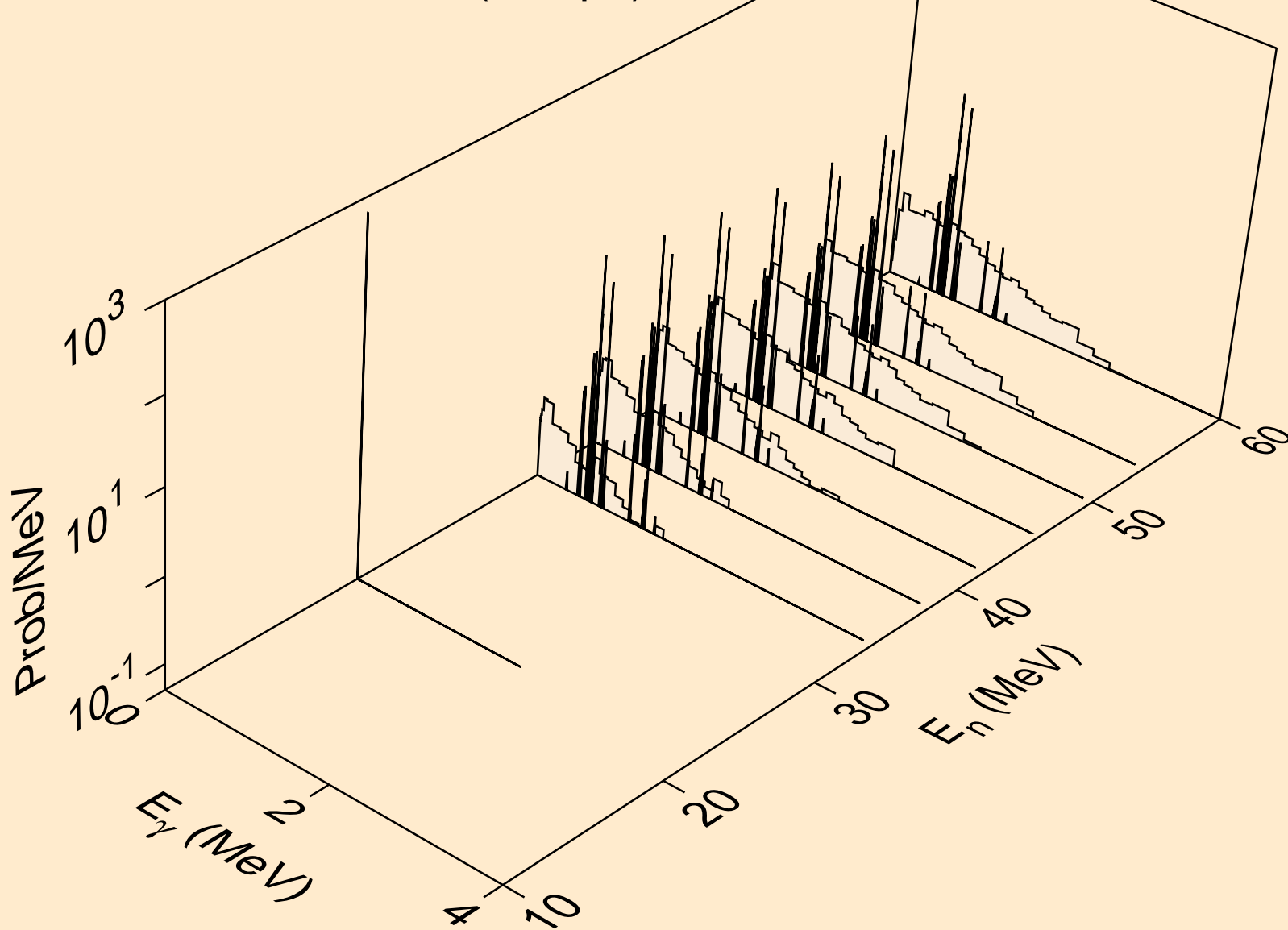

57-LA-138 FOR FENDL-3.2 PROCESSED BY NJOY2016.60+ ON
Photon emission for (n,5np)

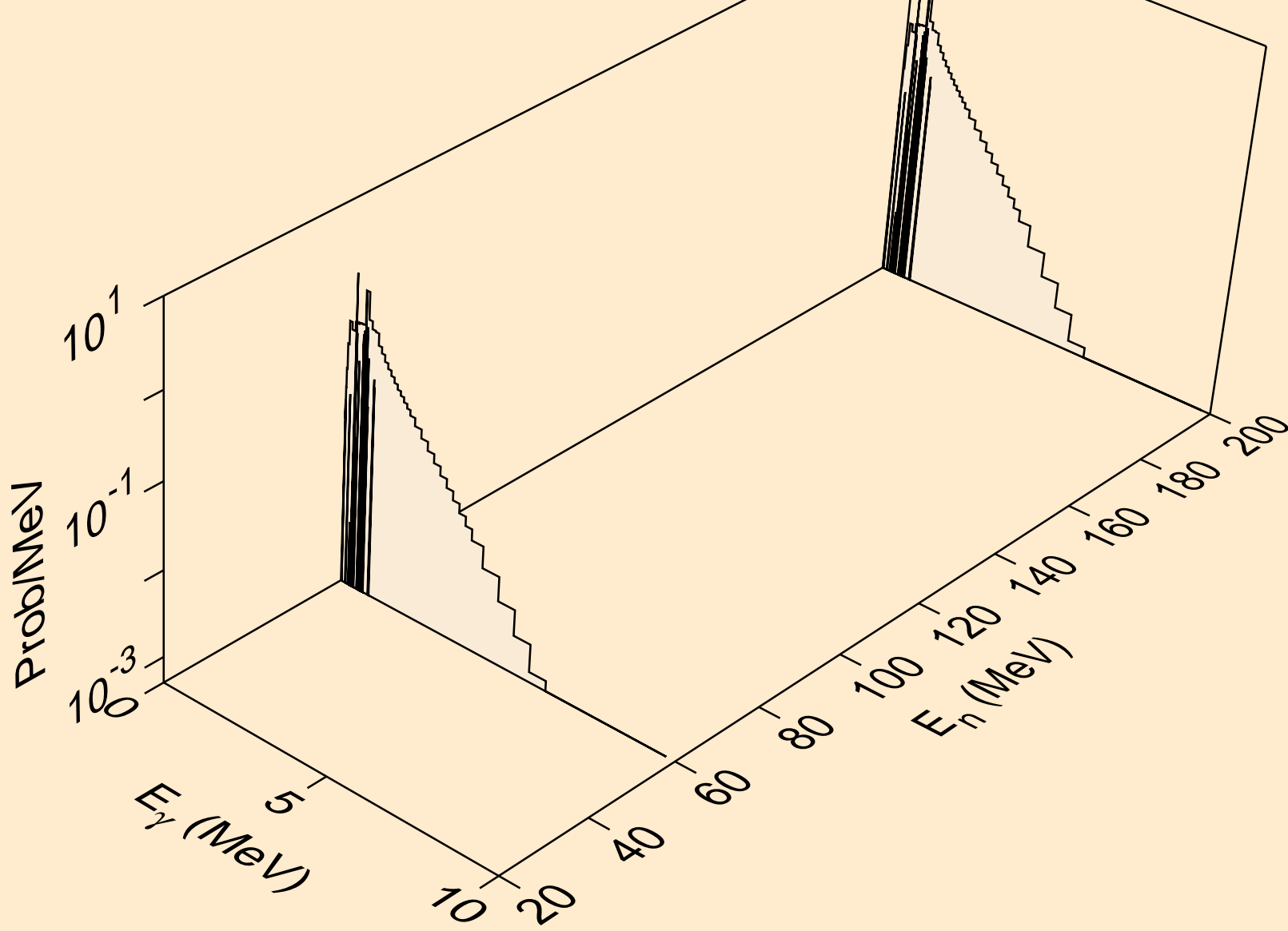

57-LA-138 FOR FENDL-3.2 PROCESSED BY NJOY2016.60+ ON
Photon emission for (n,6np)

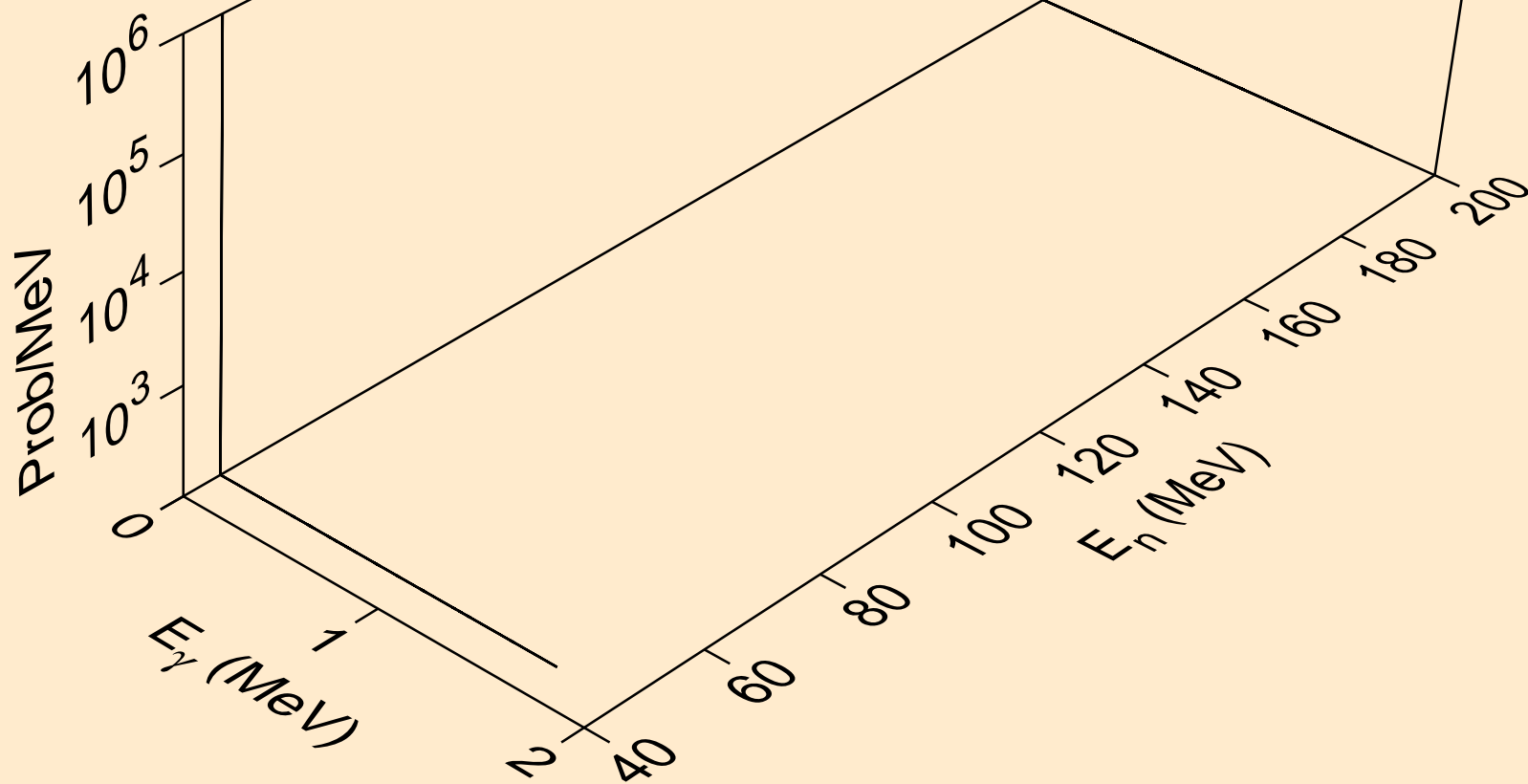

57-LA-138 FOR FENDL-3.2 PROCESSED BY NJOY2016.60+ ON
Photon emission for (n,4na)

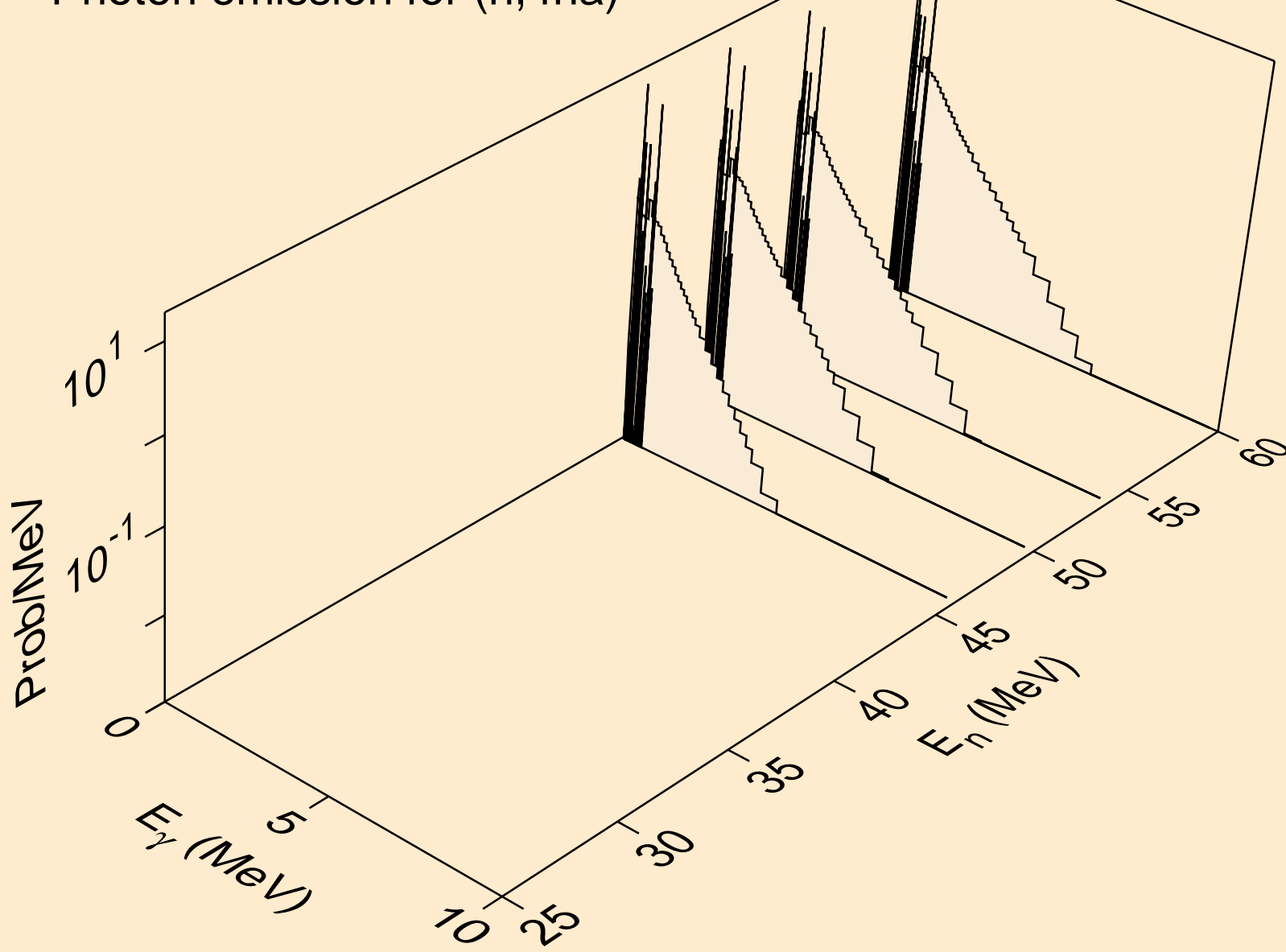

57-LA-138 FOR FENDL-3.2 PROCESSED BY NJOY2016.60+ ON
Photon emission for (n,5na)

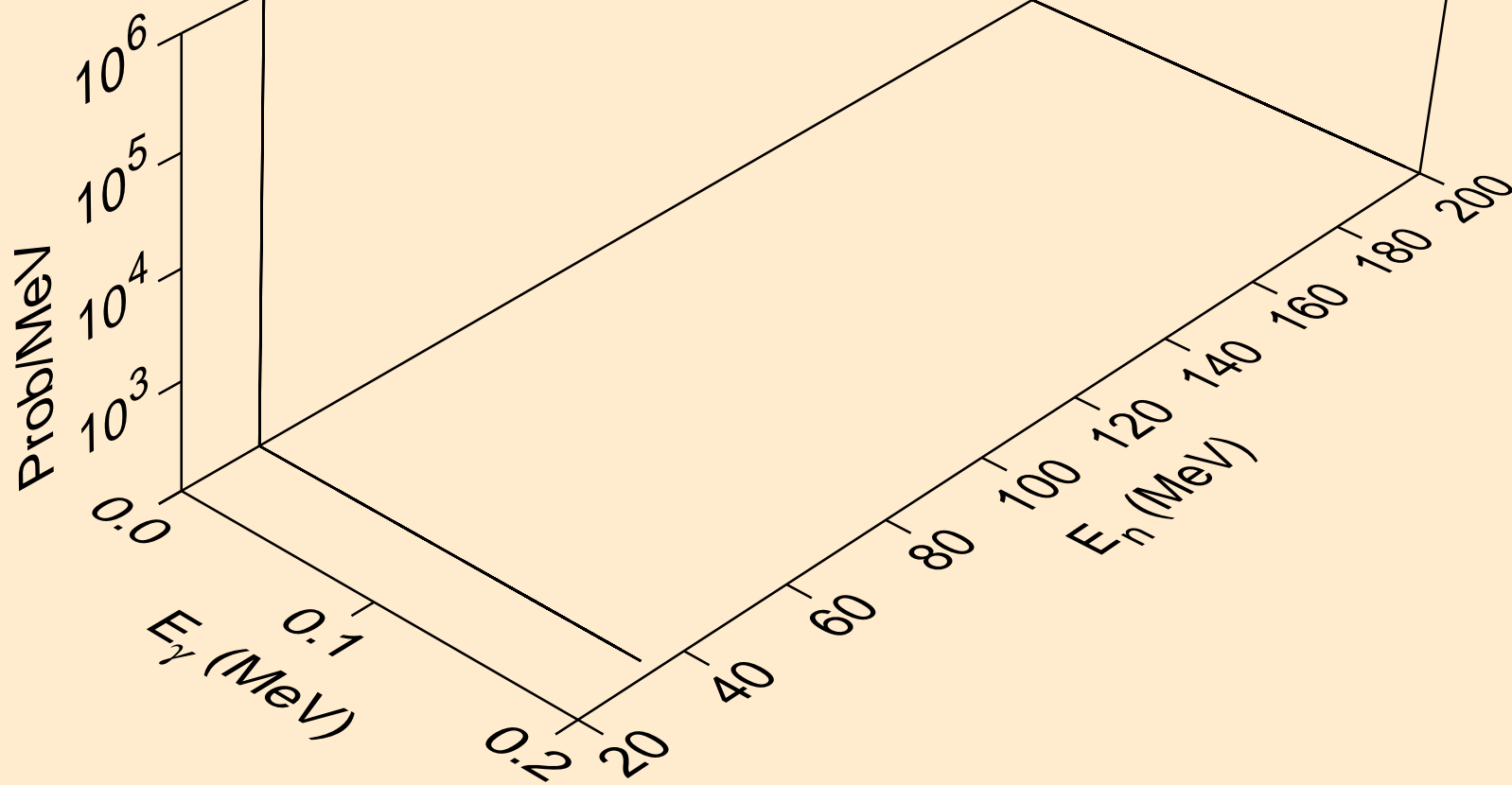

57-LA-138 FOR FENDL-3.2 PROCESSED BY NJOY2016.60+ ON
Photon emission for (n,6na)

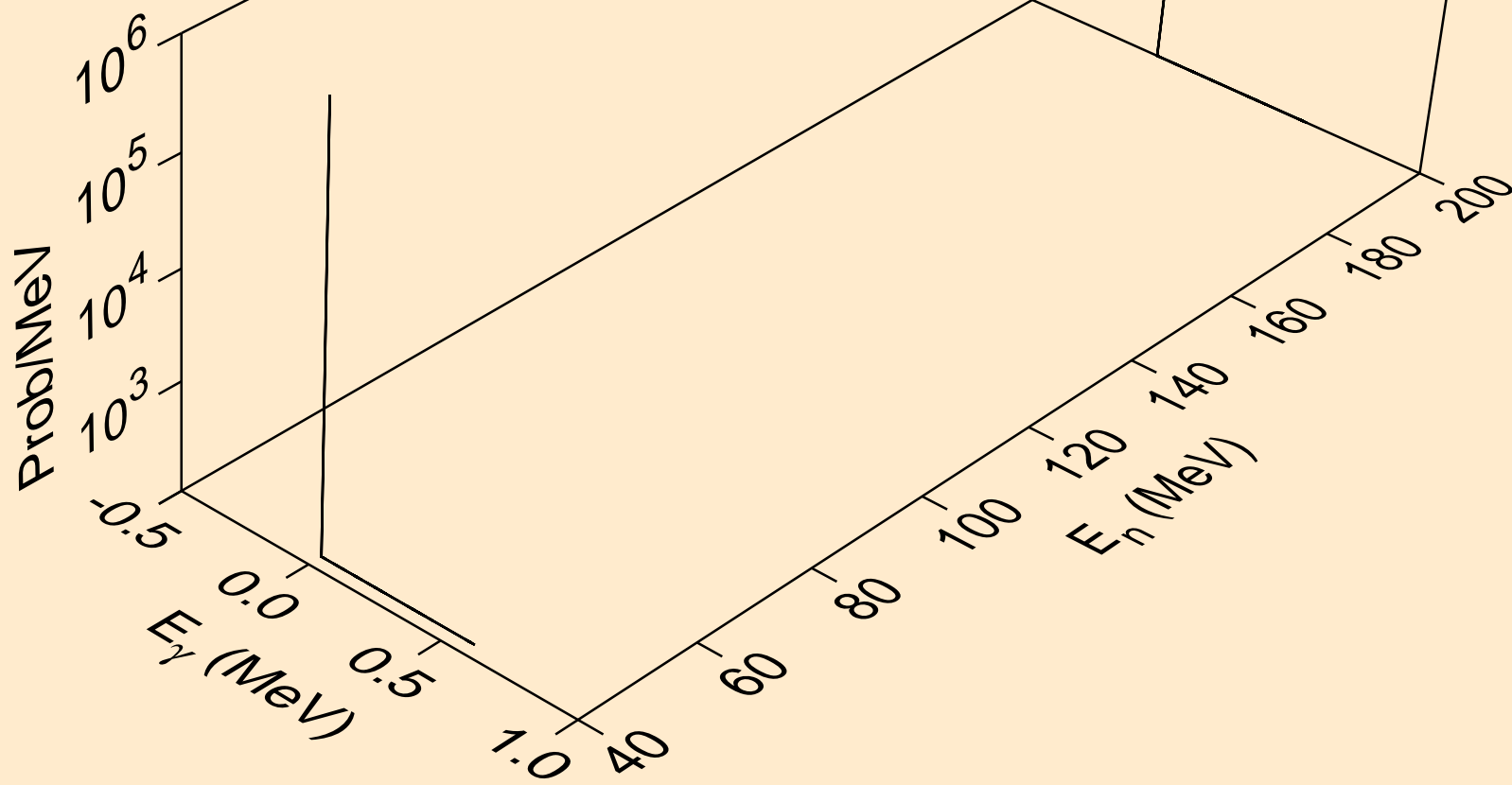

57-LA-138 FOR FENDL-3.2 PROCESSED BY NJOY2016.60+ ON
Photon emission for (n,4nd)

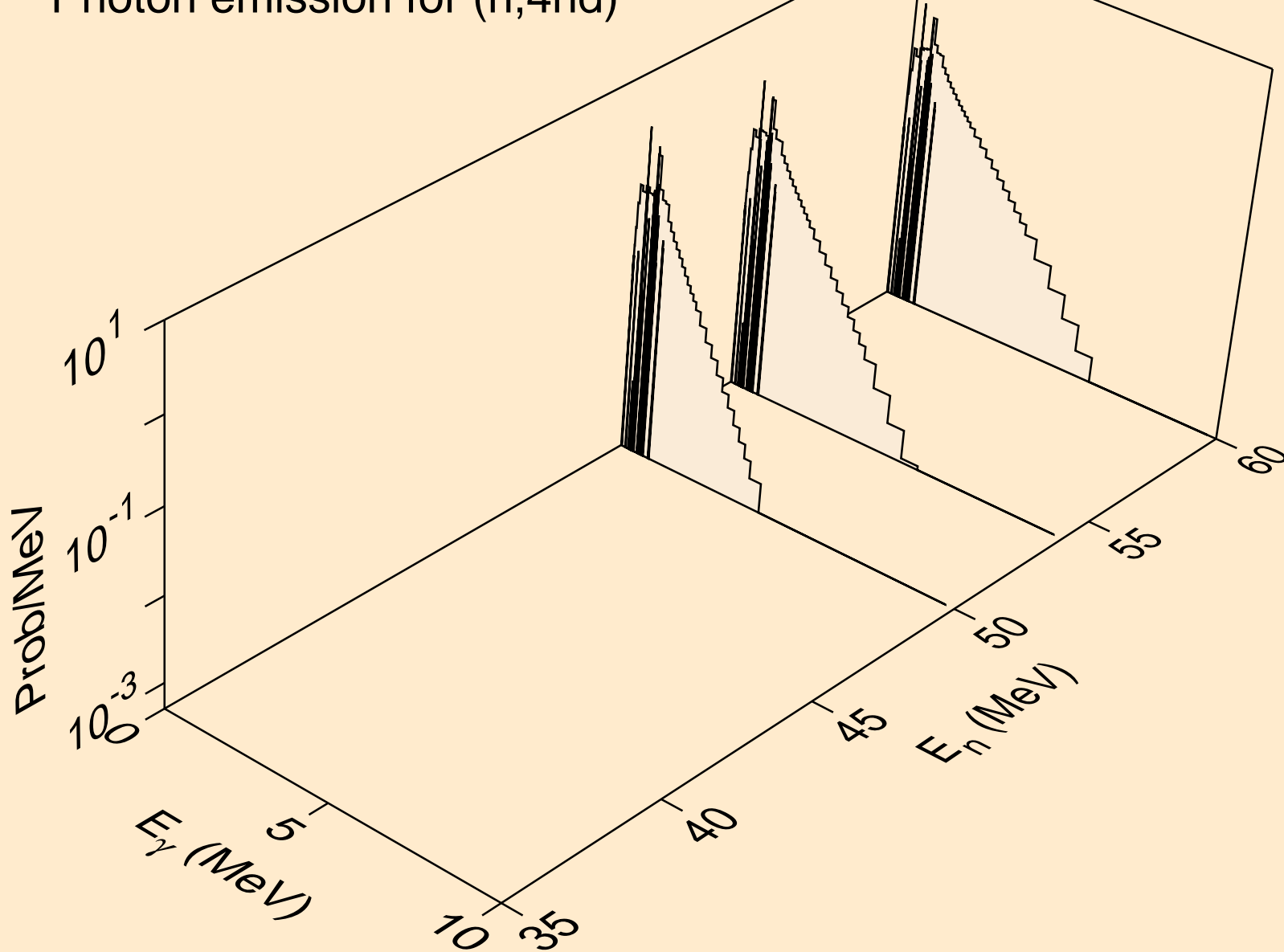

57-LA-138 FOR FENDL-3.2 PROCESSED BY NJOY2016.60+ ON
Photon emission for (n,5nd)

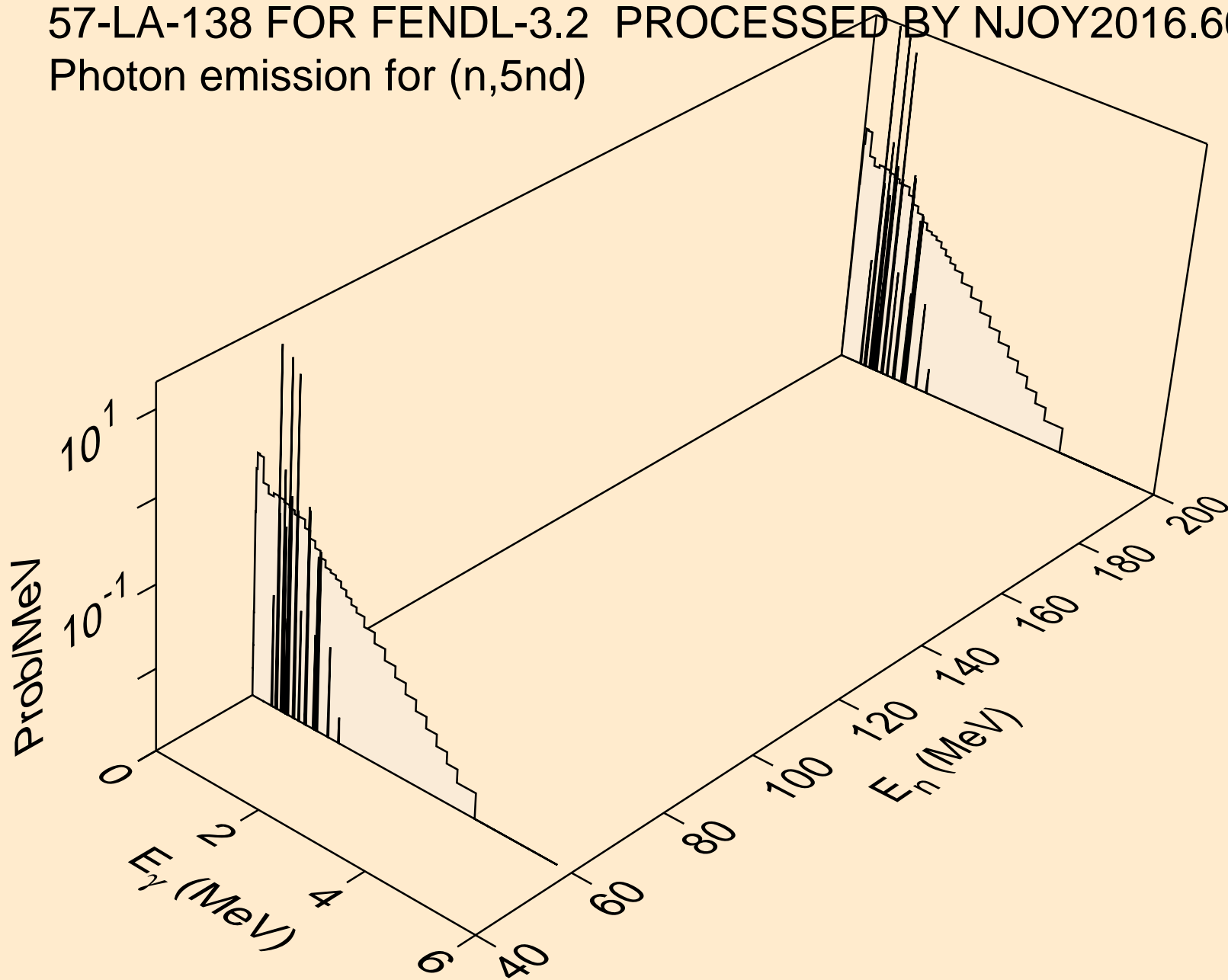

57-LA-138 FOR FENDL-3.2 PROCESSED BY NJOY2016.60+ ON
Photon emission for (n,3nt)

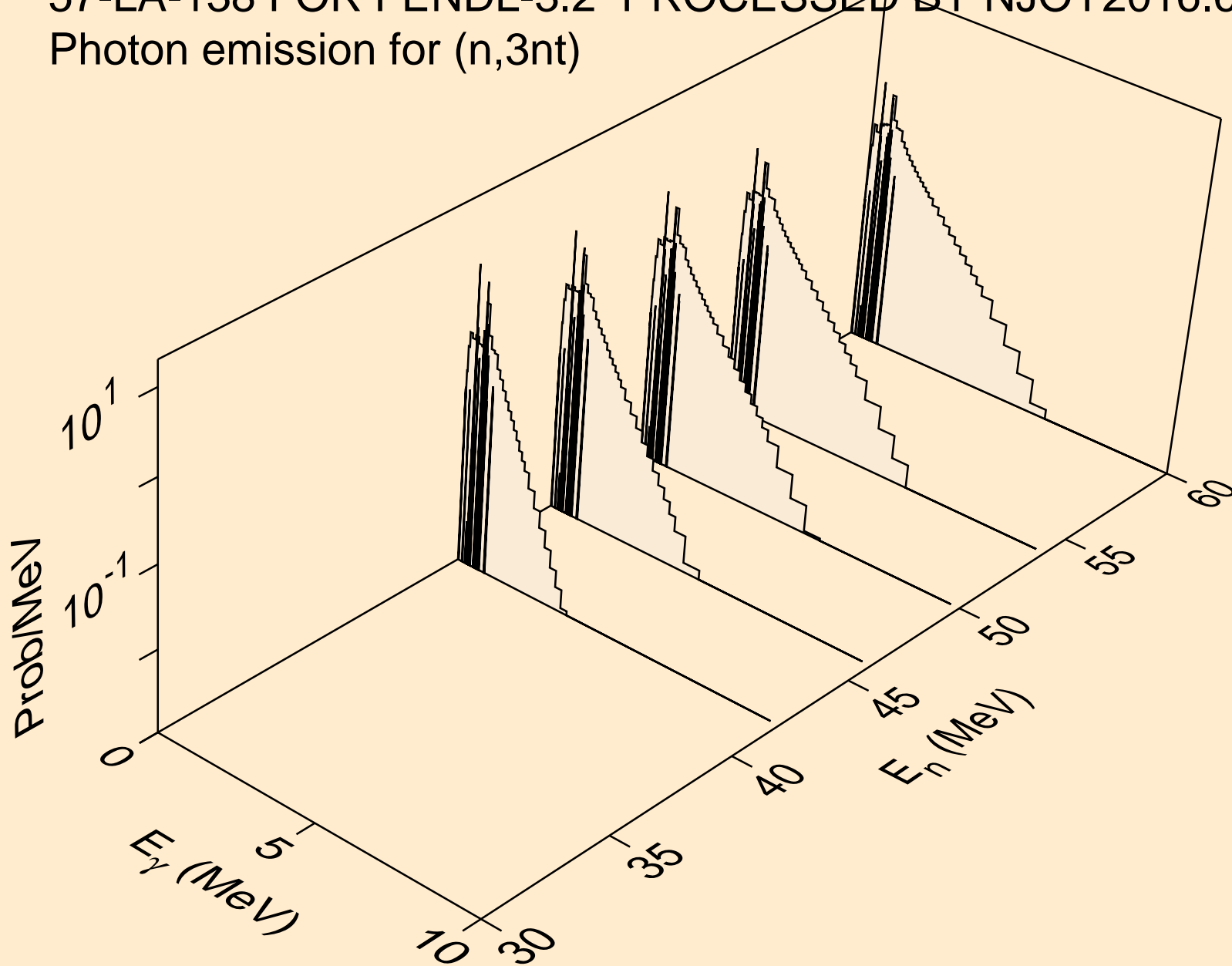

57-LA-138 FOR FENDL-3.2 PROCESSED BY NJOY2016.60+ ON
Photon emission for (n,4nt)

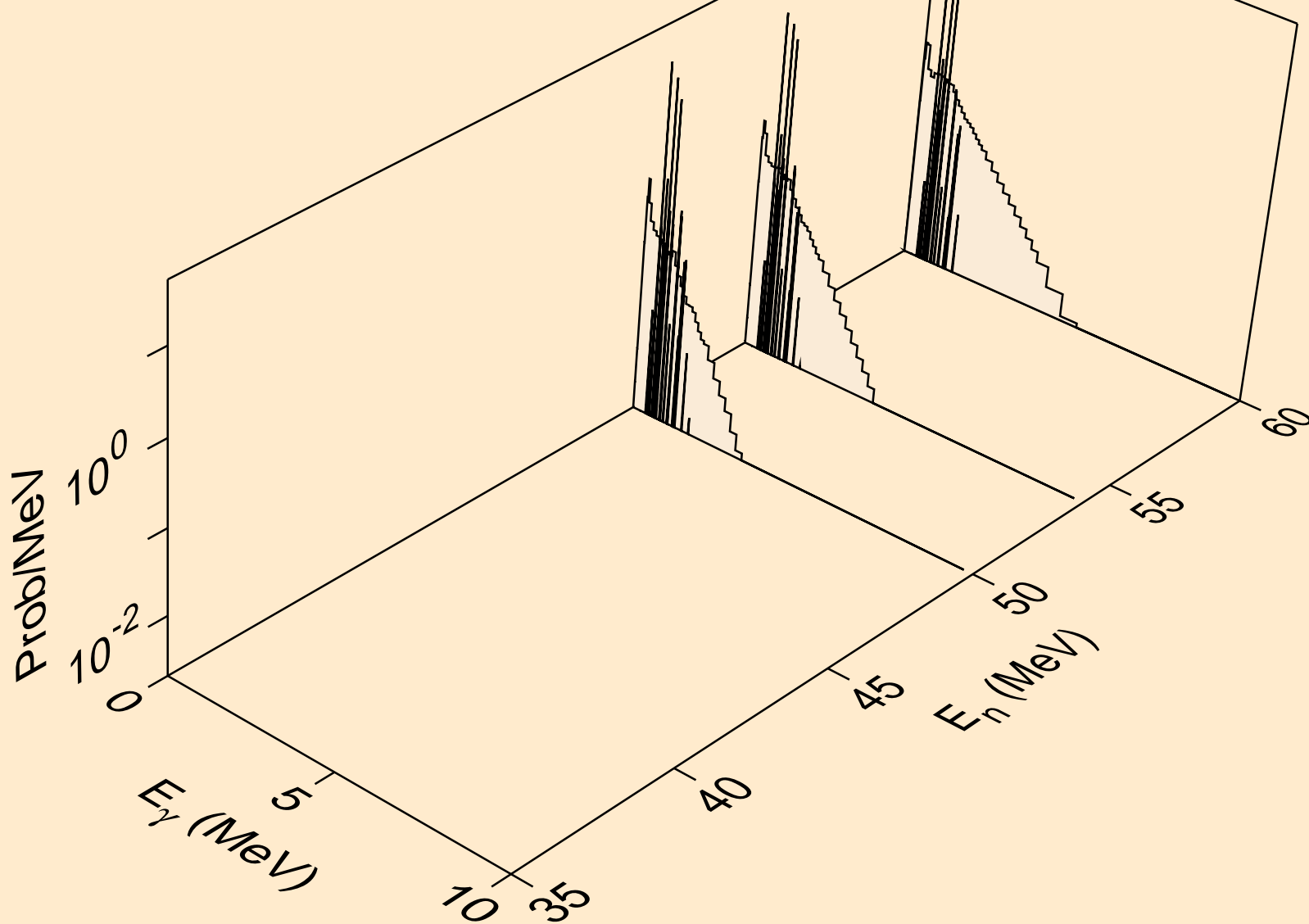

57-LA-138 FOR FENDL-3.2 PROCESSED BY NJOY2016.60+ ON
Photon emission for (n,2n)he3

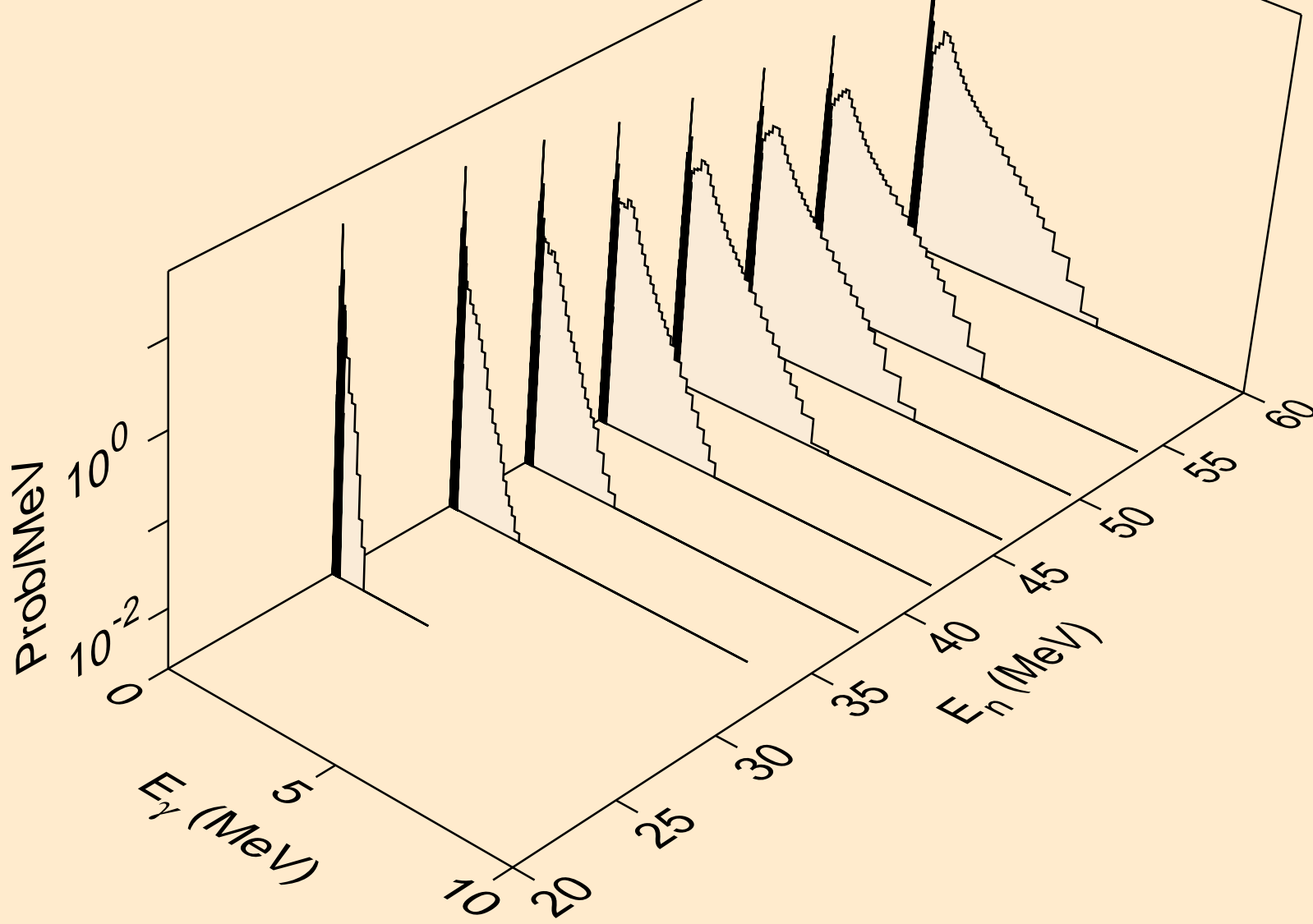

57-LA-138 FOR FENDL-3.2 PROCESSED BY NJOY2016.60+ ON
Photon emission for (n,3n)he3

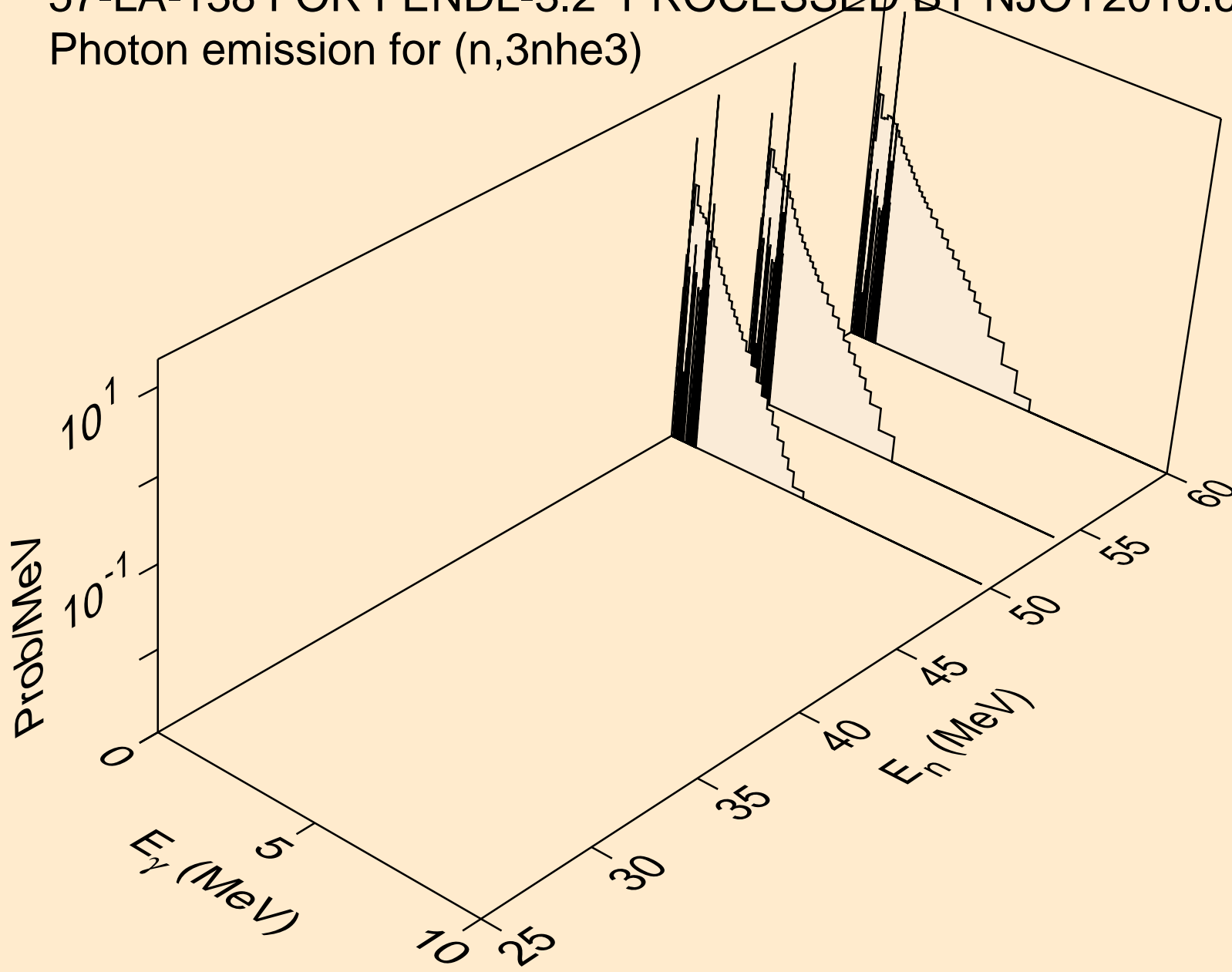

57-LA-138 FOR FENDL-3.2 PROCESSED BY NJOY2016.60+ ON
Photon emission for (n,4n)he3

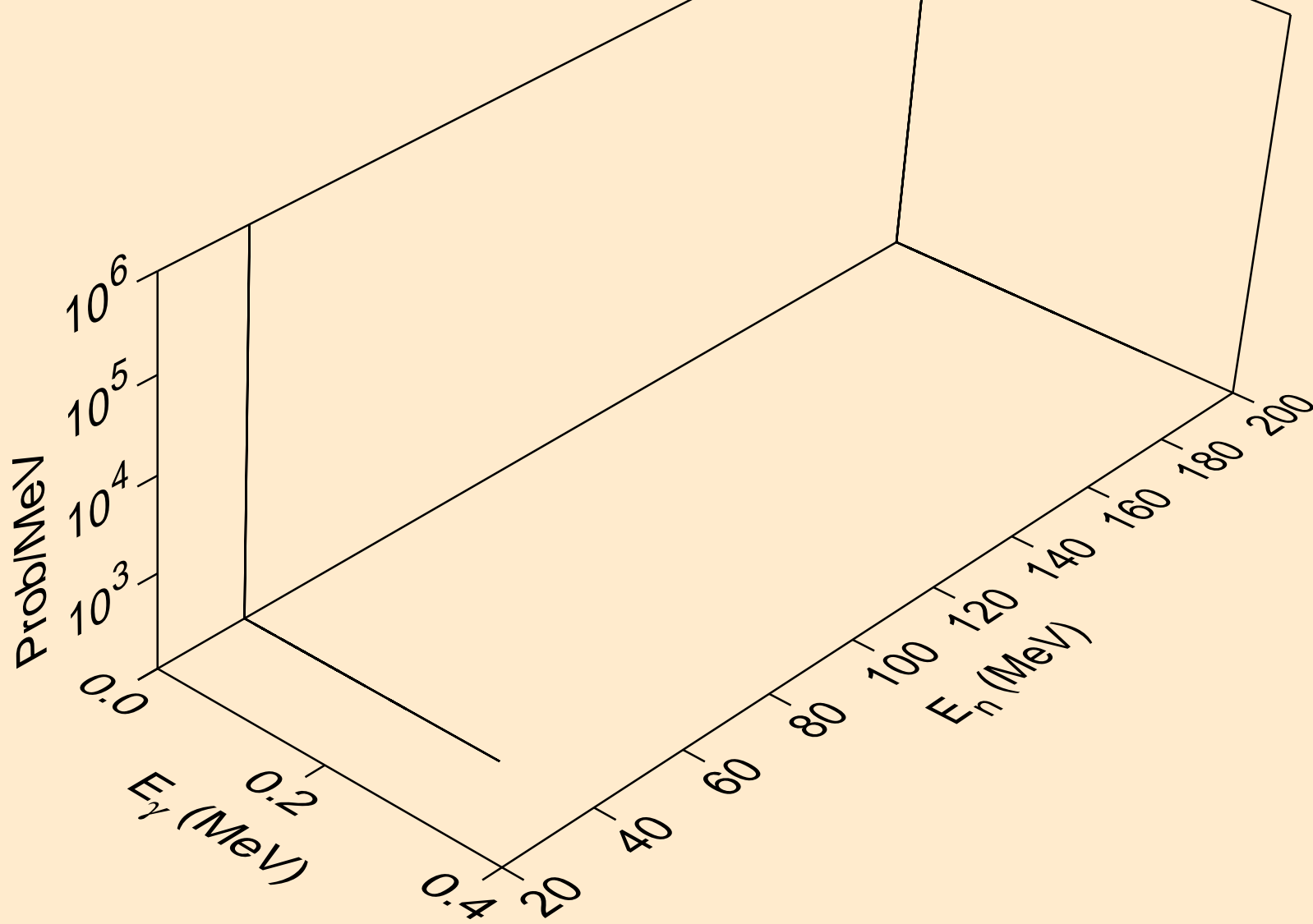

57-LA-138 FOR FENDL-3.2 PROCESSED BY NJOY2016.60+ ON
Photon emission for (n,3n2p)

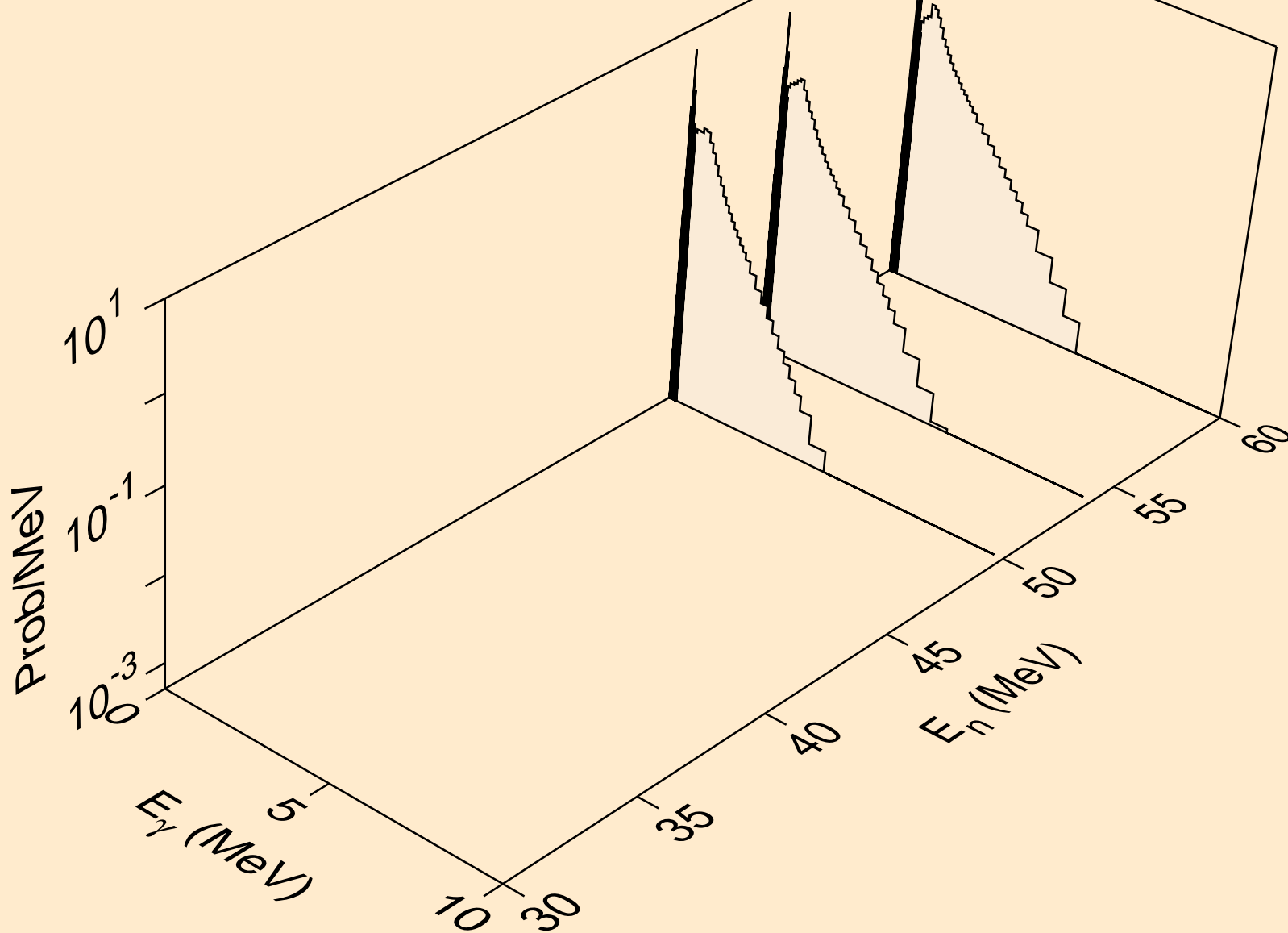

57-LA-138 FOR FENDL-3.2 PROCESSED BY NJOY2016.60+ ON
Photon emission for (n,3n2a)

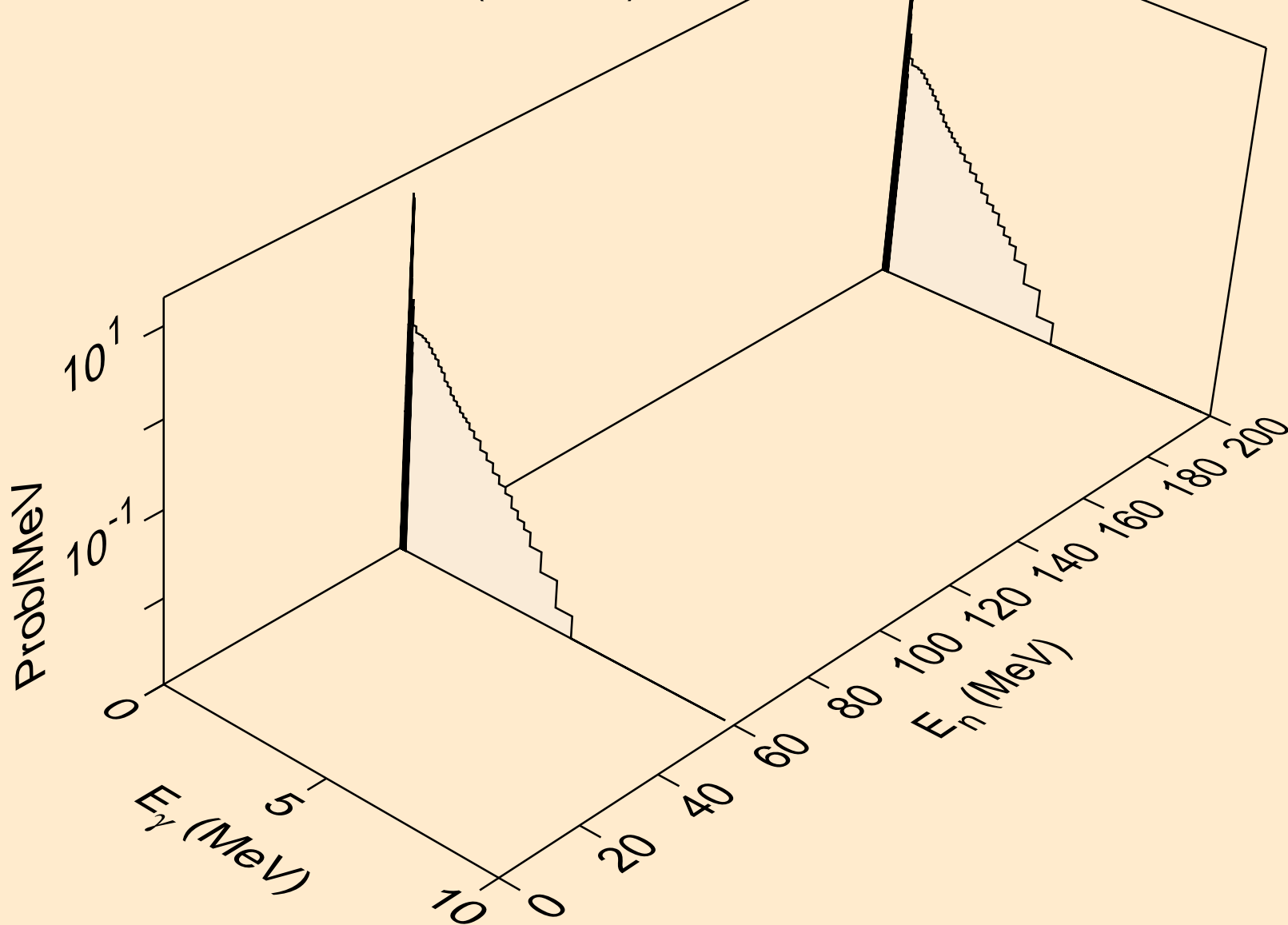

57-LA-138 FOR FENDL-3.2 PROCESSED BY NJOY2016.60+ ON
Photon emission for (n,3npa)

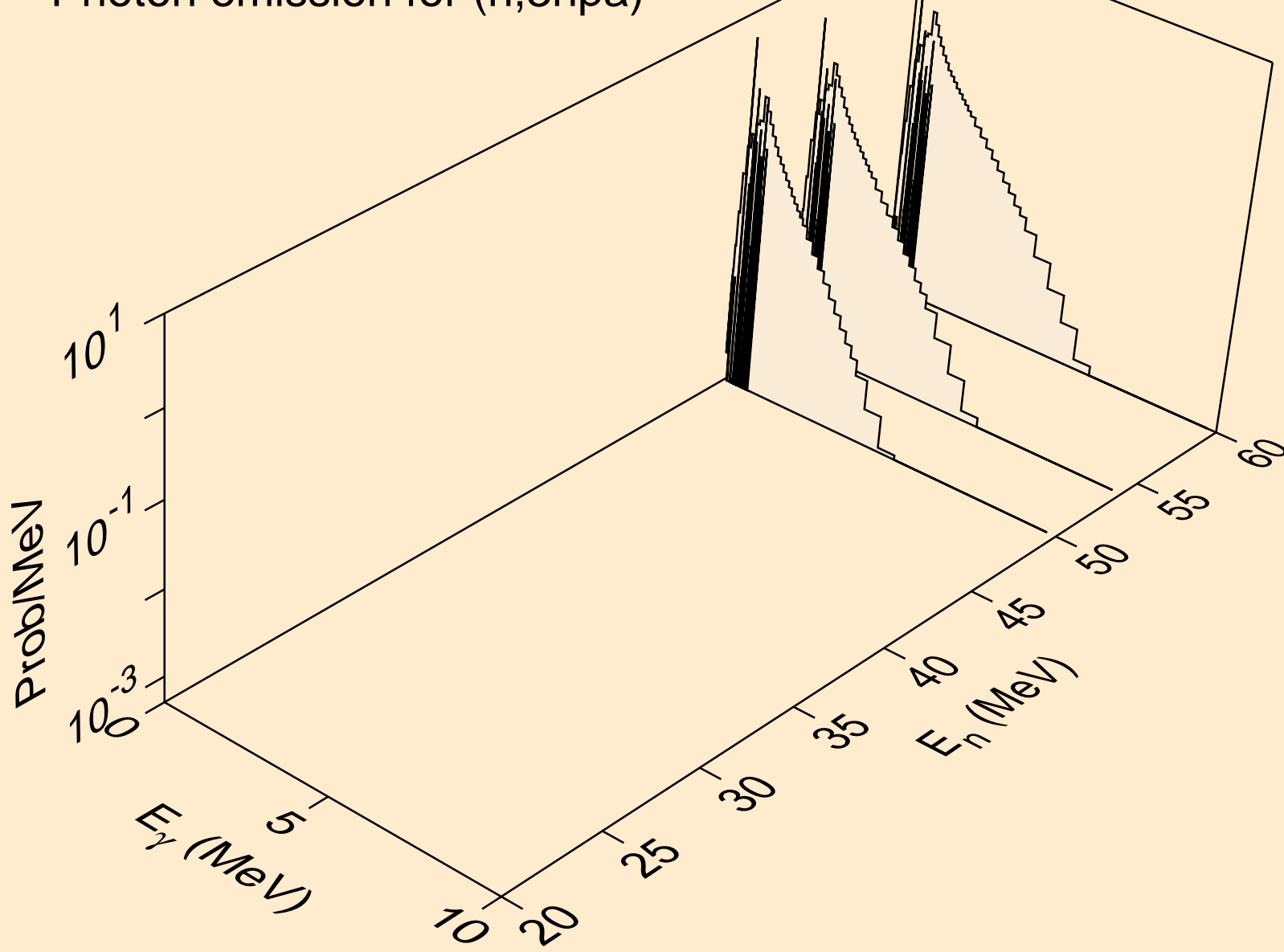

57-LA-138 FOR FENDL-3.2 PROCESSED BY NJOY2016.60+ ON
Photon emission for (n,dt)

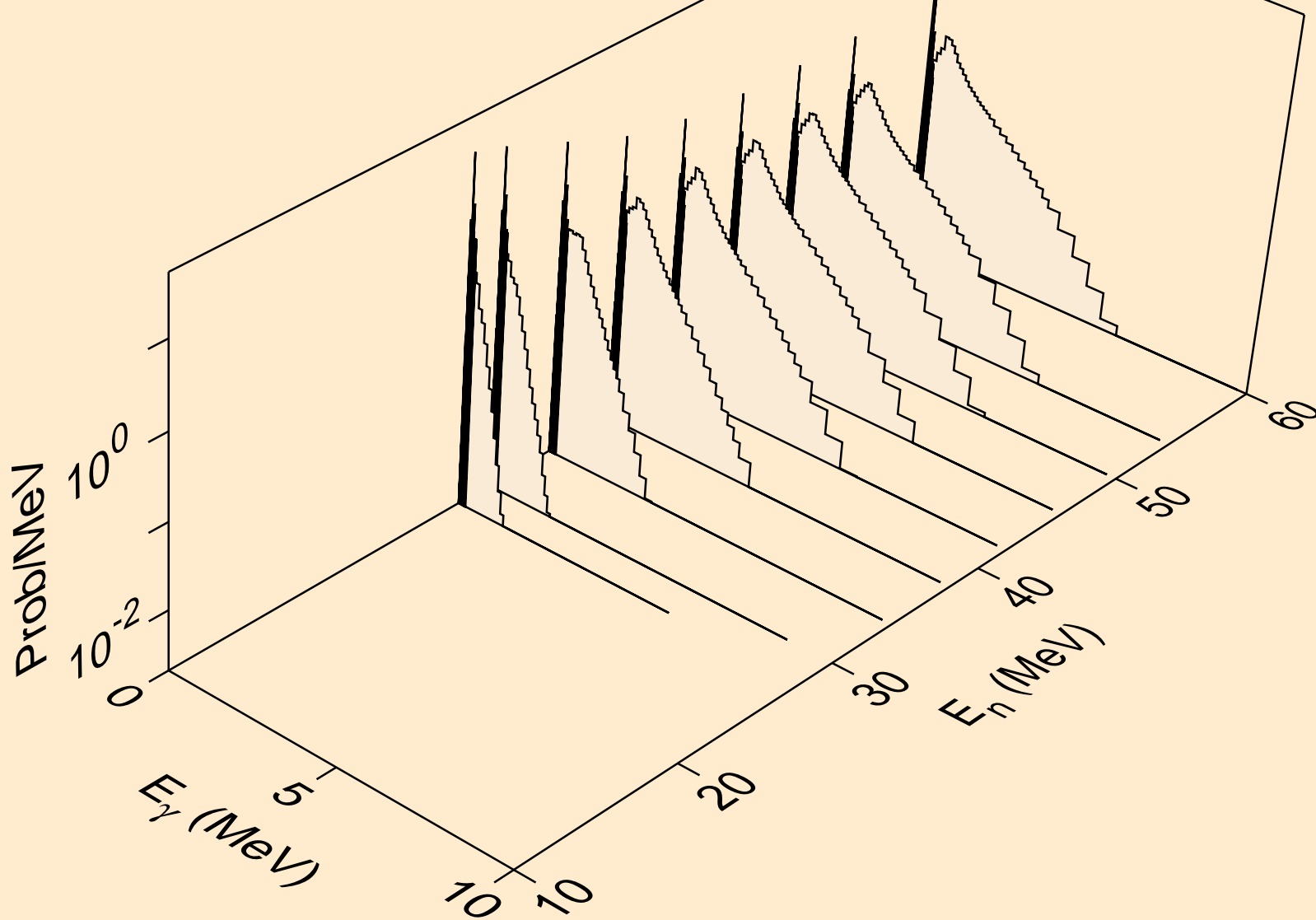

57-LA-138 FOR FENDL-3.2 PROCESSED BY NJOY2016.60+ ON
Photon emission for (n,npd)

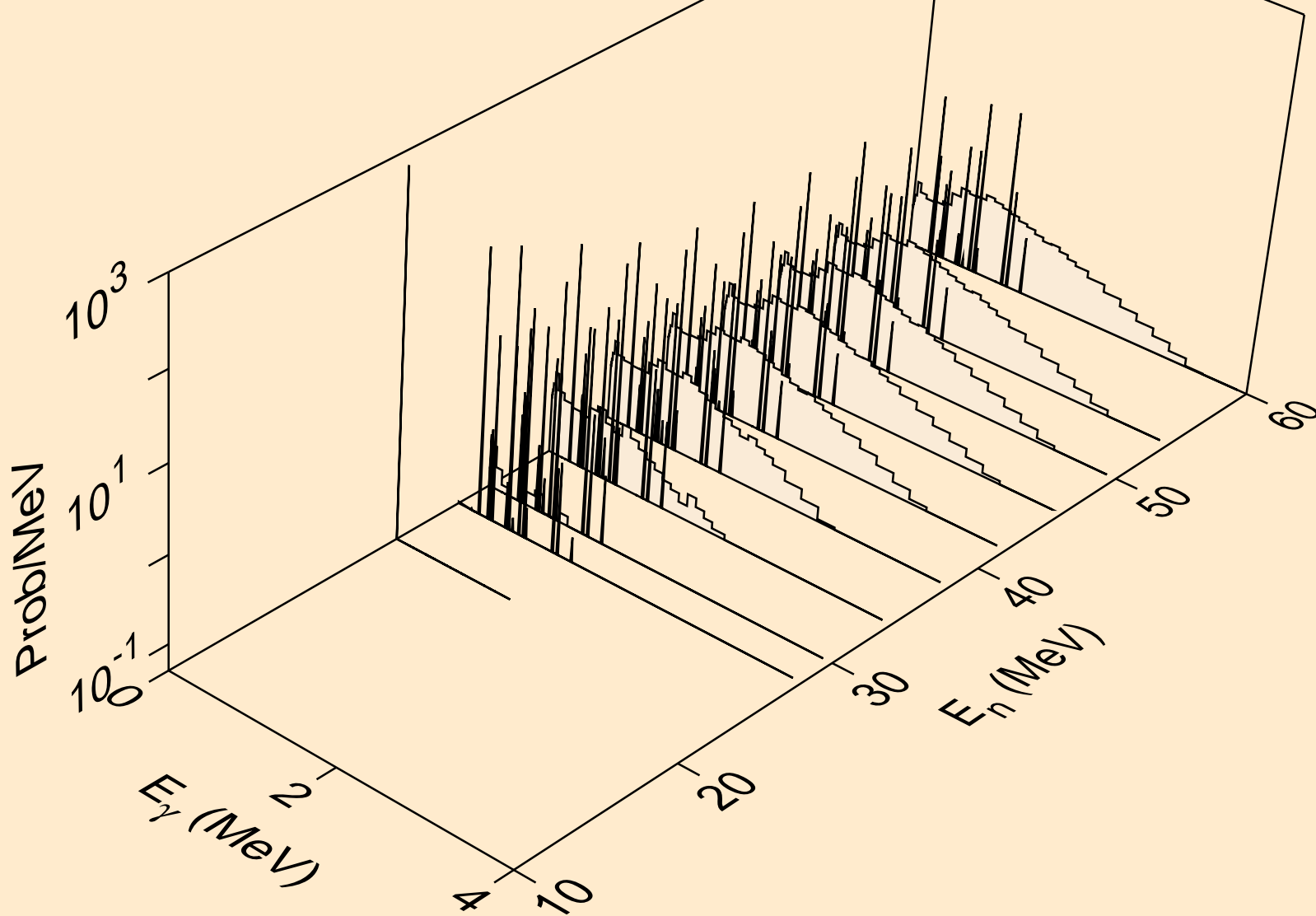

57-LA-138 FOR FENDL-3.2 PROCESSED BY NJOY2016.60+ ON
Photon emission for (n,npt)

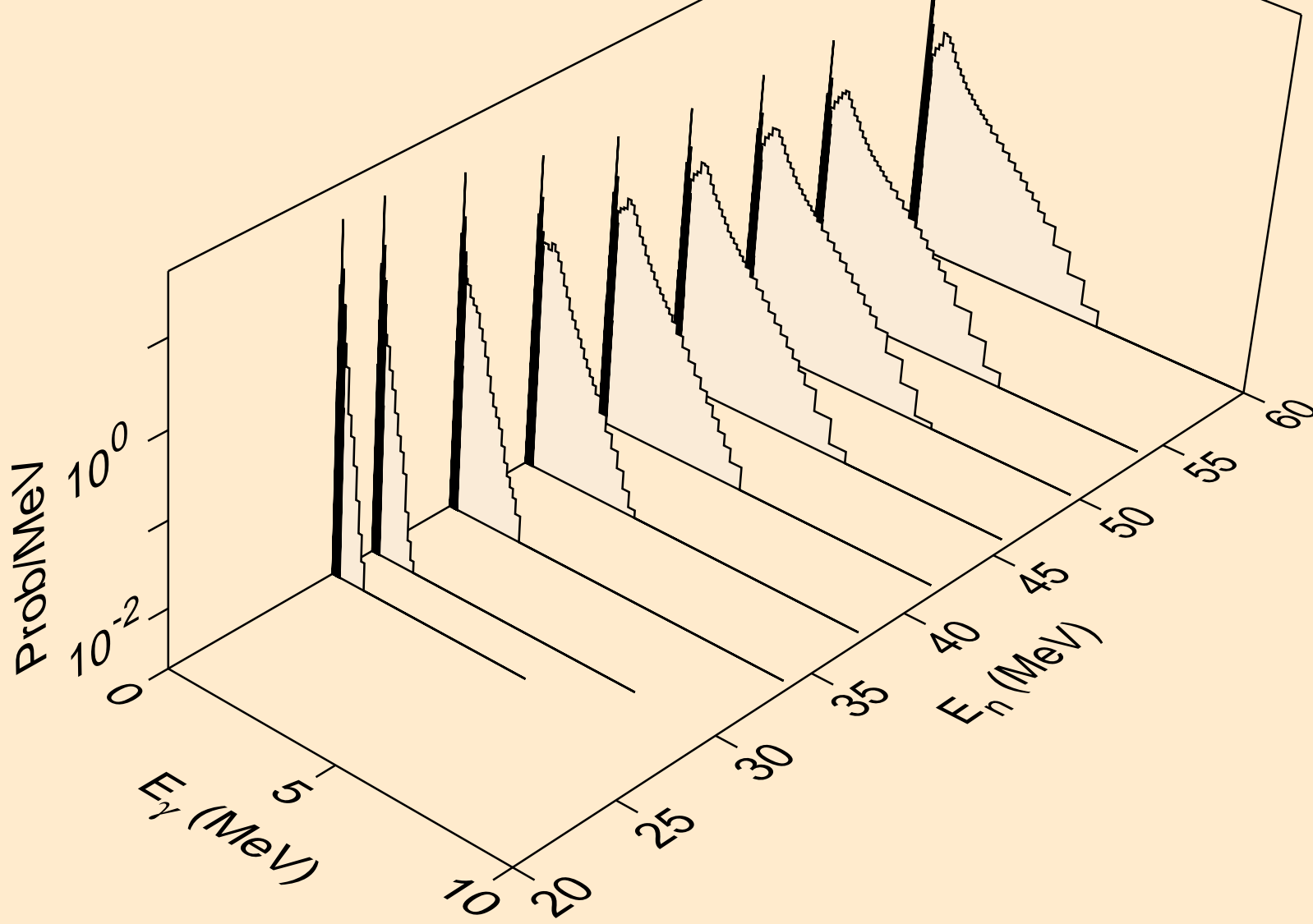

57-LA-138 FOR FENDL-3.2 PROCESSED BY NJOY2016.60+ ON
Photon emission for (n,ndt)

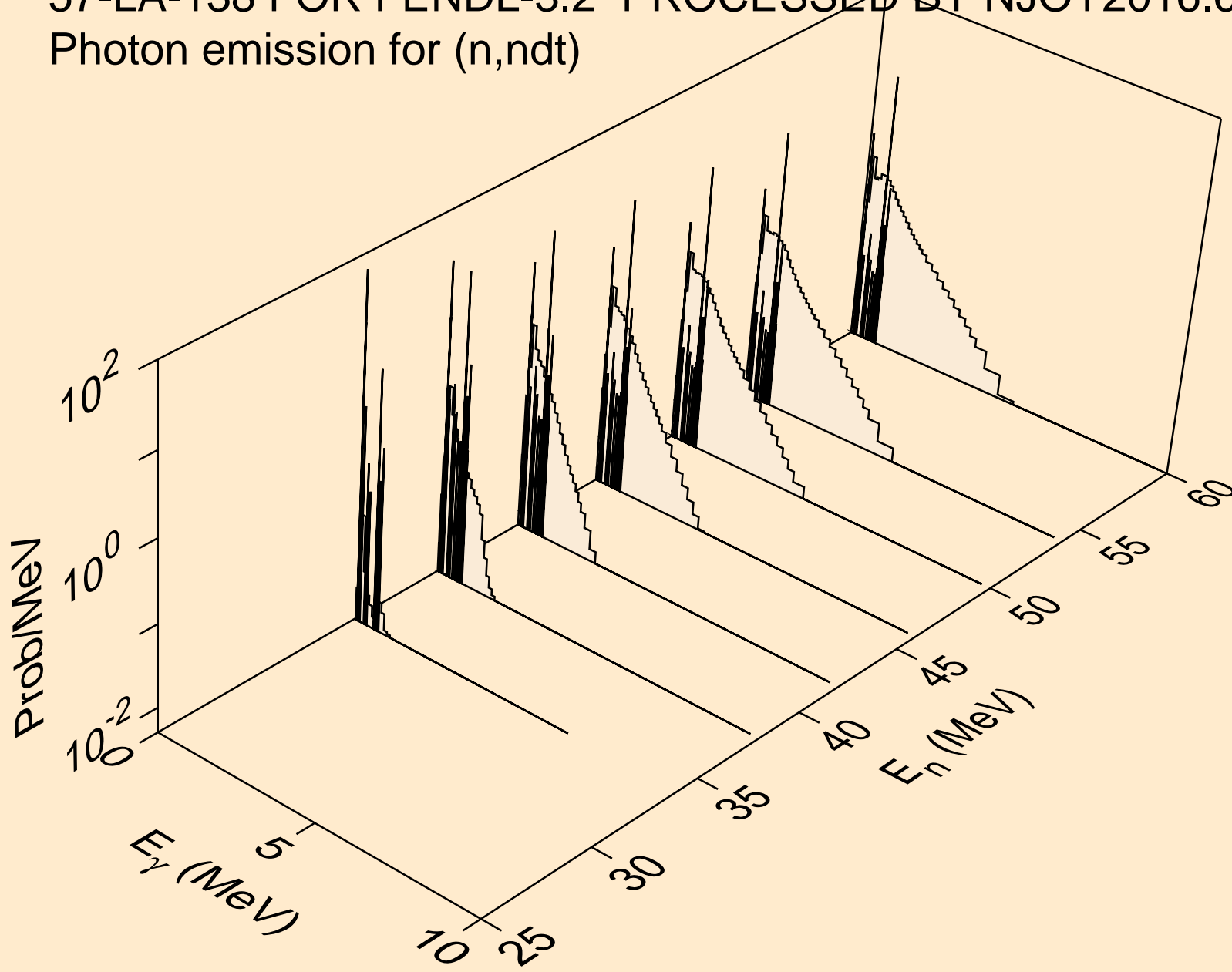

57-LA-138 FOR FENDL-3.2 PROCESSED BY NJOY2016.60+ ON
Photon emission for (n,nphe3)

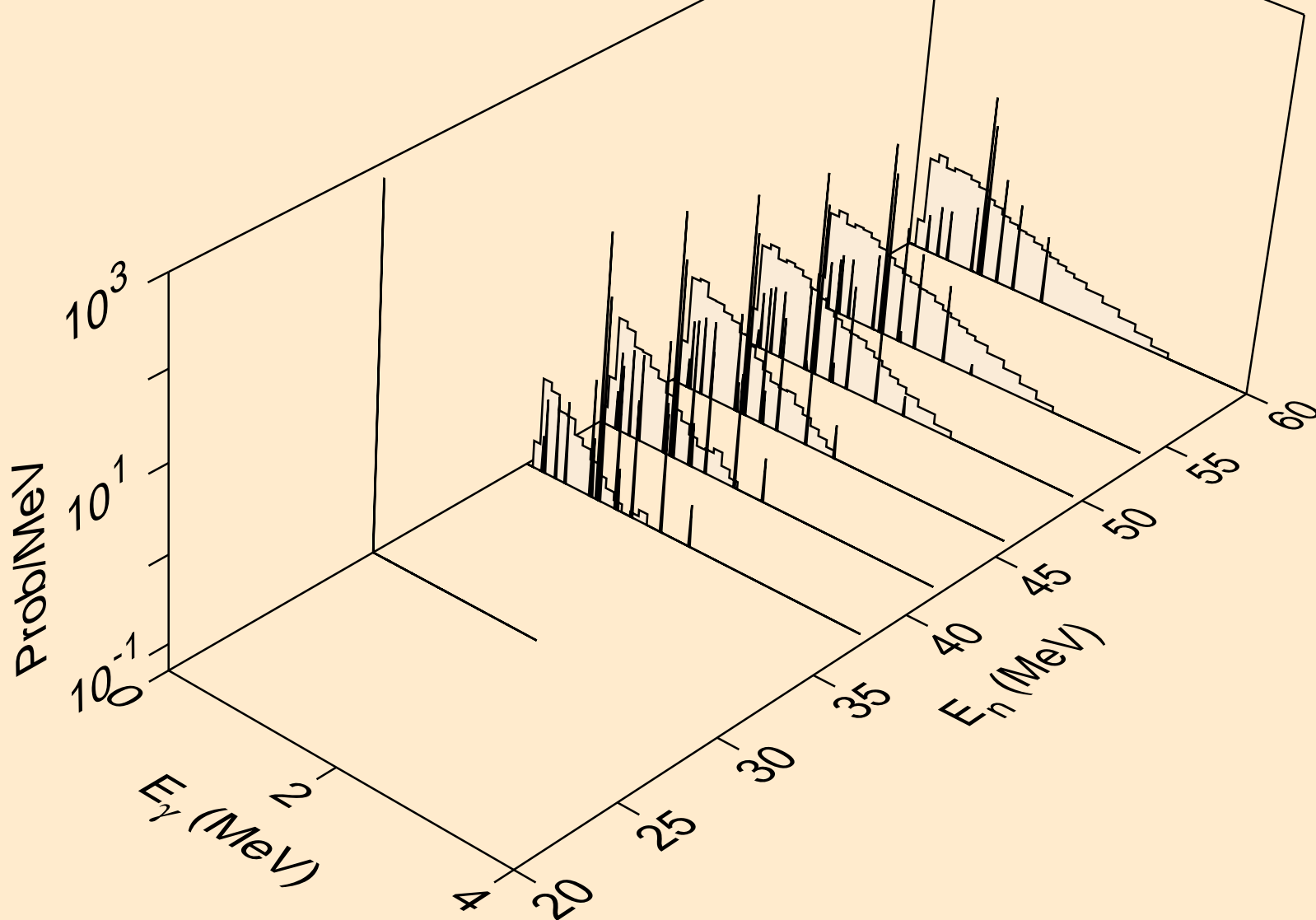

57-LA-138 FOR FENDL-3.2 PROCESSED BY NJOY2016.60+ ON
Photon emission for (n,ndhe3)

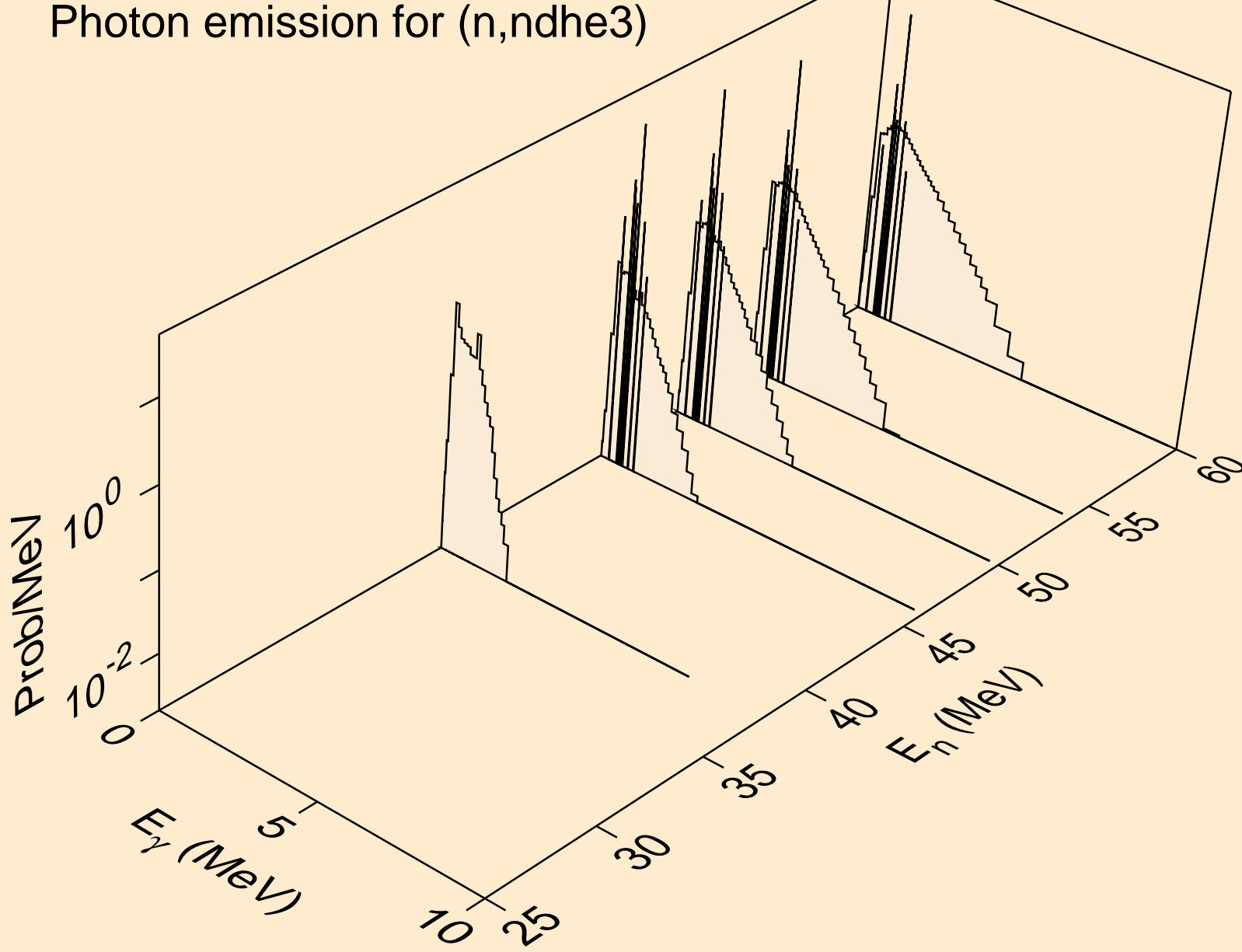

57-LA-138 FOR FENDL-3.2 PROCESSED BY NJOY2016.60+ ON
Photon emission for (n,nthe3)

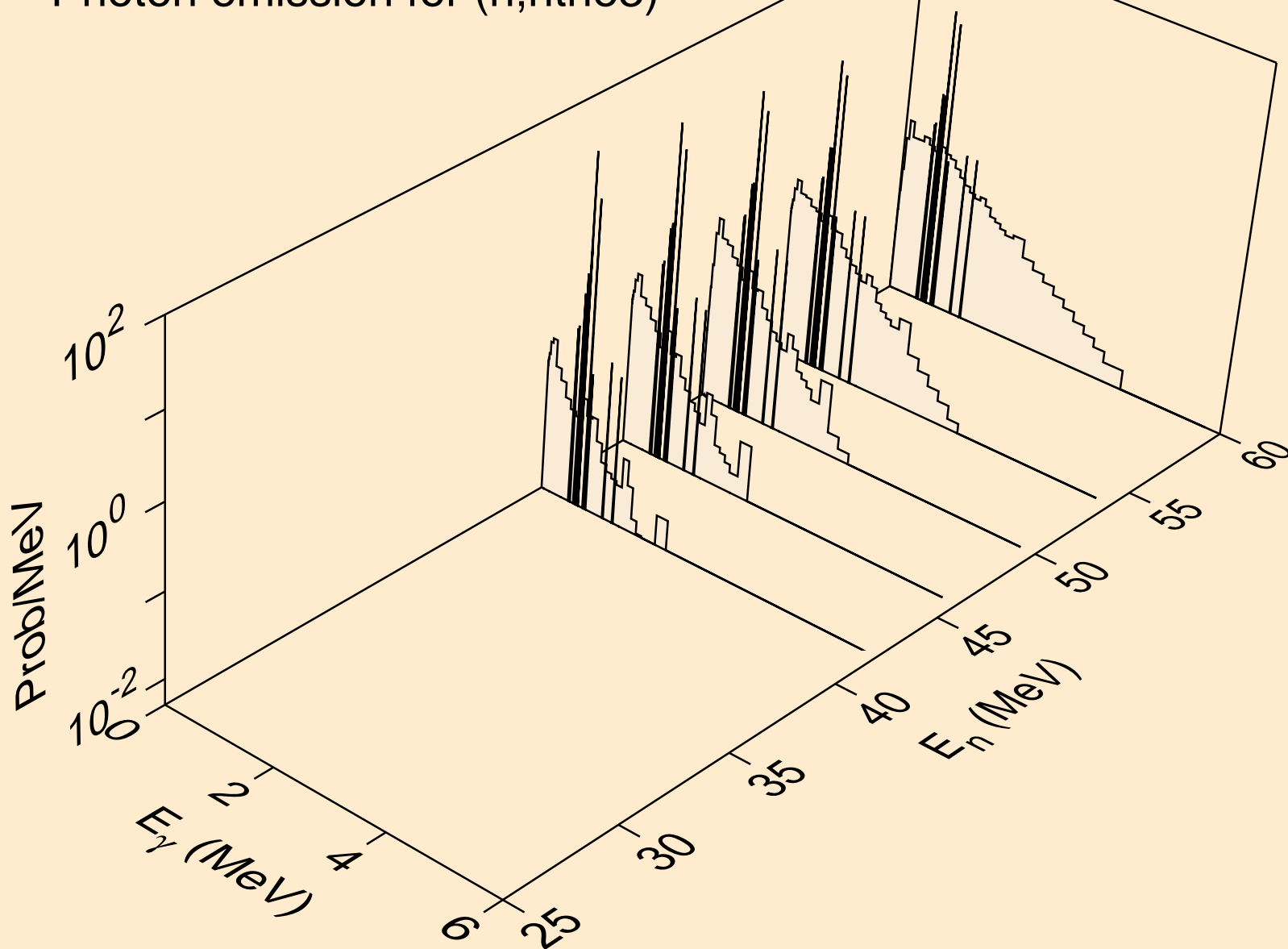

57-LA-138 FOR FENDL-3.2 PROCESSED BY NJOY2016.60+ ON
Photon emission for (n,nta)

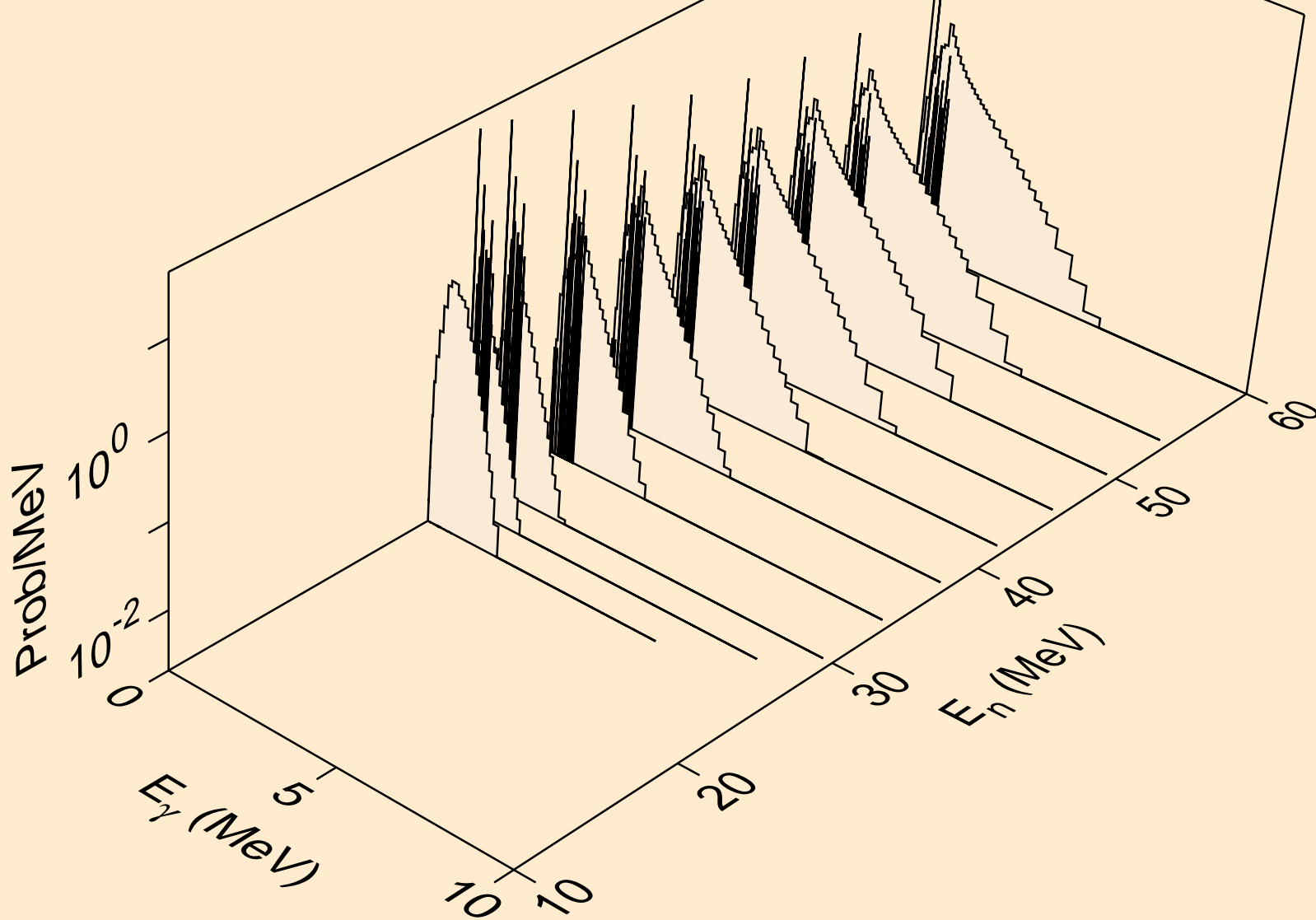

57-LA-138 FOR FENDL-3.2 PROCESSED BY NJOY2016.60+ ON
Photon emission for (n,2n2p)

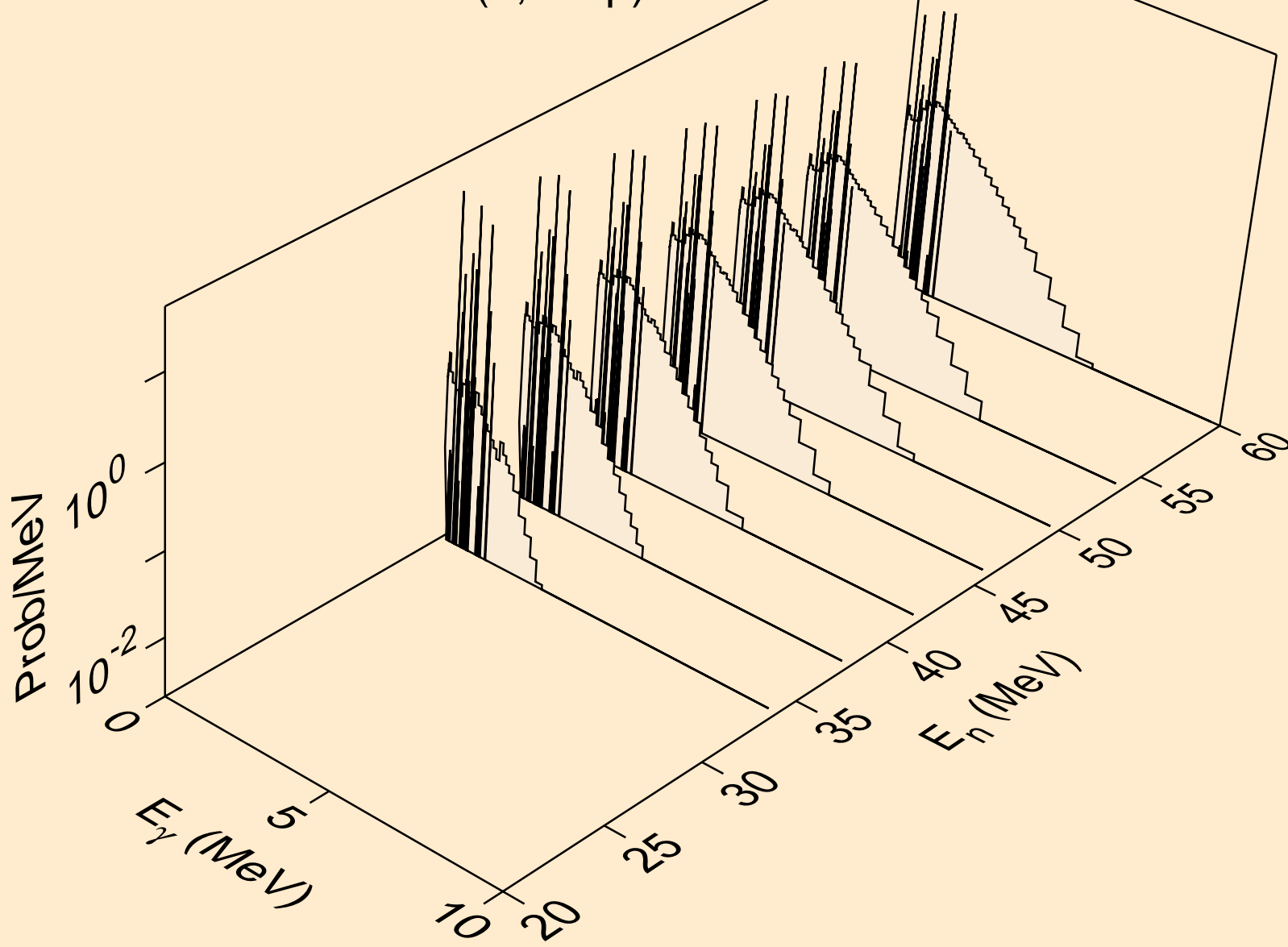

57-LA-138 FOR FENDL-3.2 PROCESSED BY NJOY2016.60+ ON
Photon emission for (n,phe3)

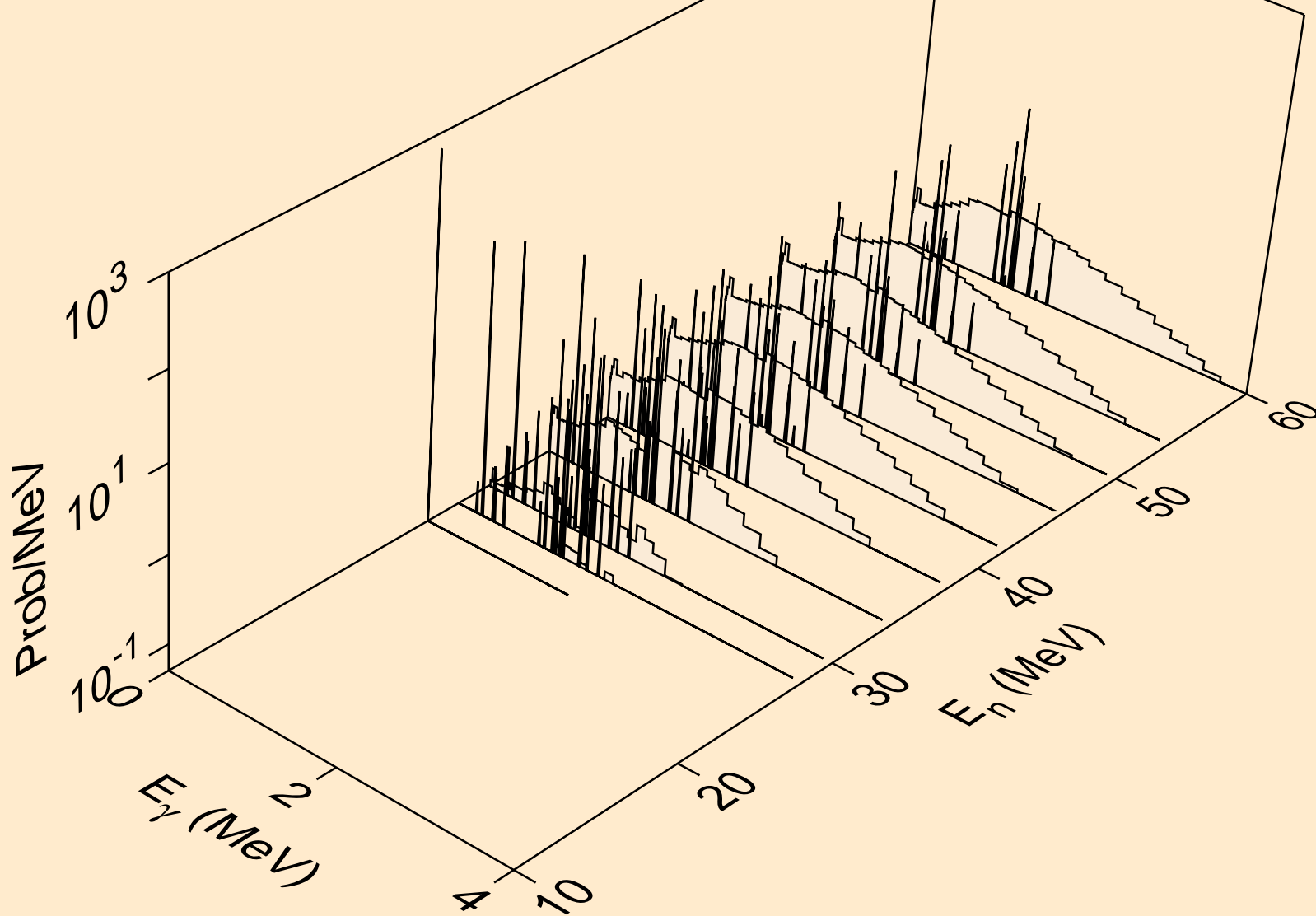

57-LA-138 FOR FENDL-3.2 PROCESSED BY NJOY2016.60+ ON
Photon emission for (n,dhe3)

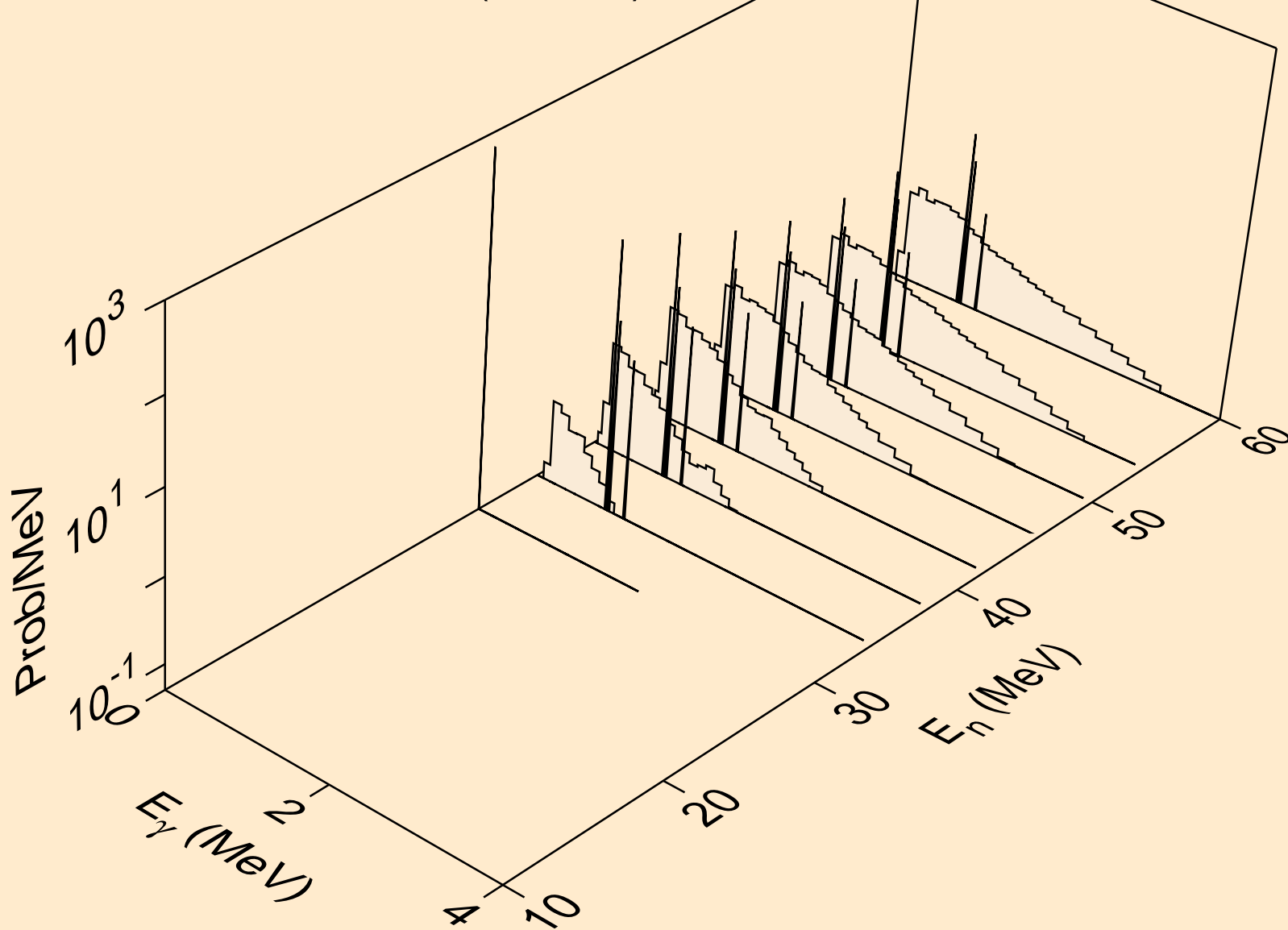

57-LA-138 FOR FENDL-3.2 PROCESSED BY NJOY2016.60+ ON
Photon emission for (n,he3a)

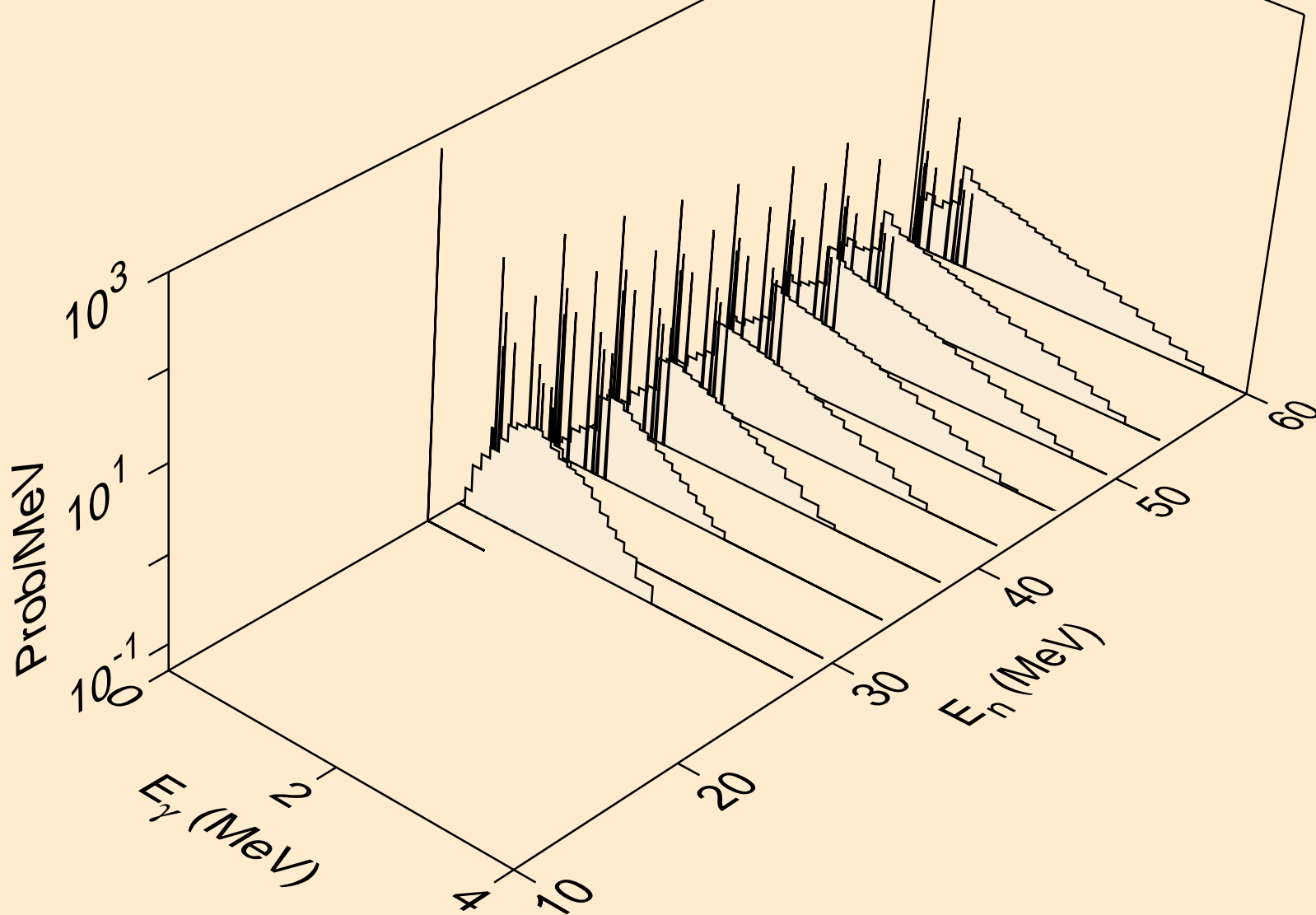

57-LA-138 FOR FENDL-3.2 PROCESSED BY NJOY2016.60+ ON
Photon emission for (n,4n2p)

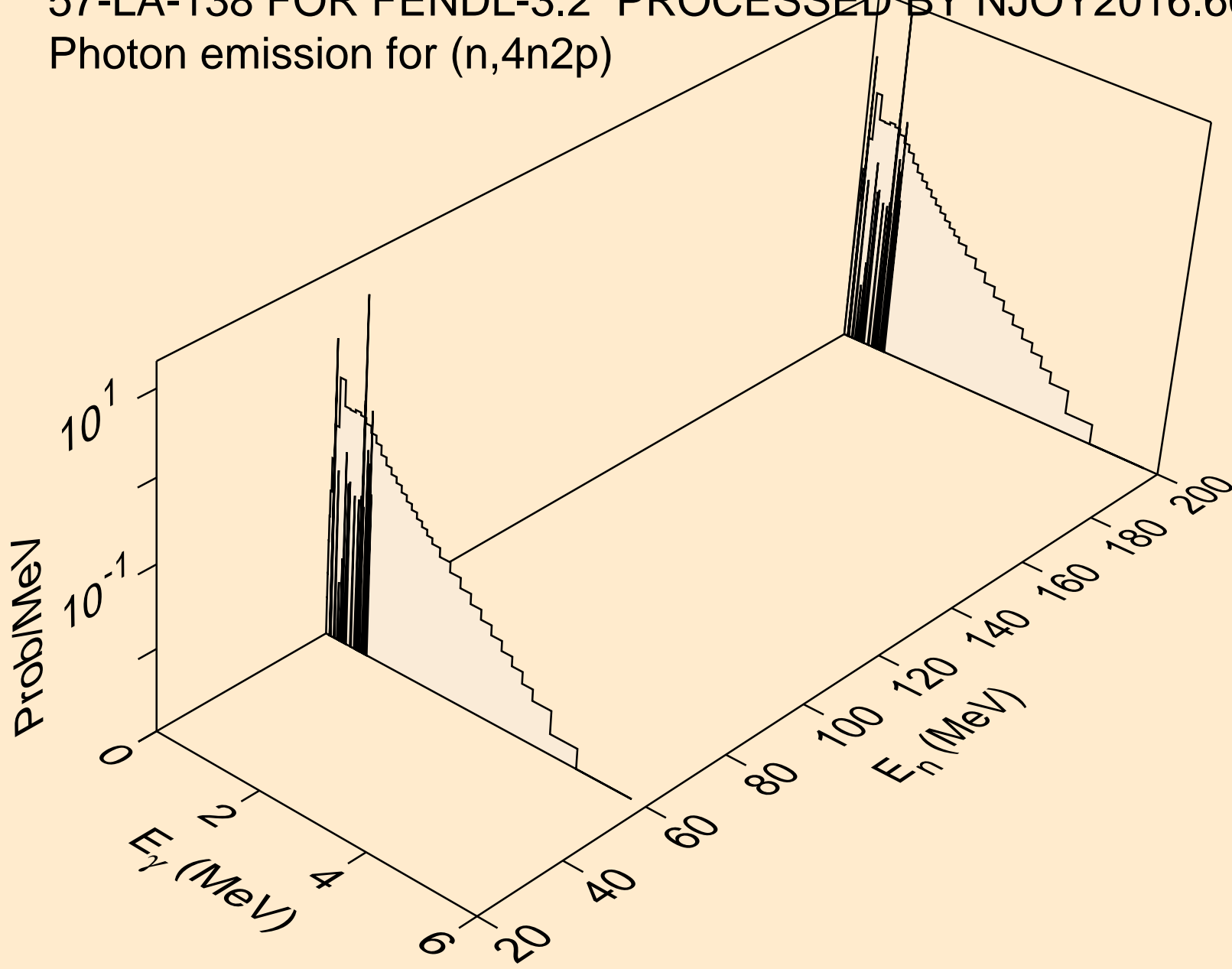

57-LA-138 FOR FENDL-3.2 PROCESSED BY NJOY2016.60+ ON
Photon emission for (n,2n2a)

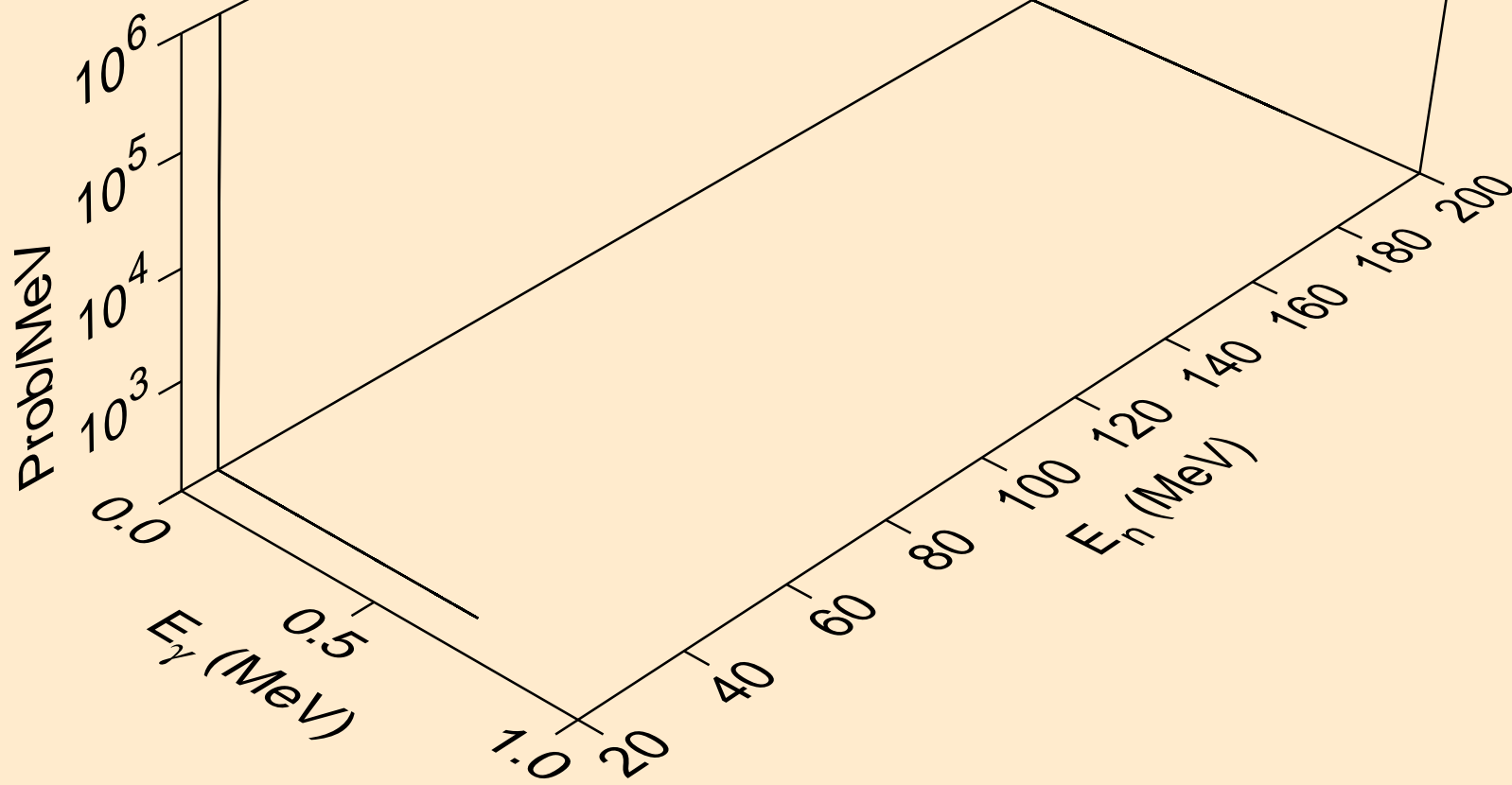

57-LA-138 FOR FENDL-3.2 PROCESSED BY NJOY2016.60+ ON
Photon emission for (n,4npa)

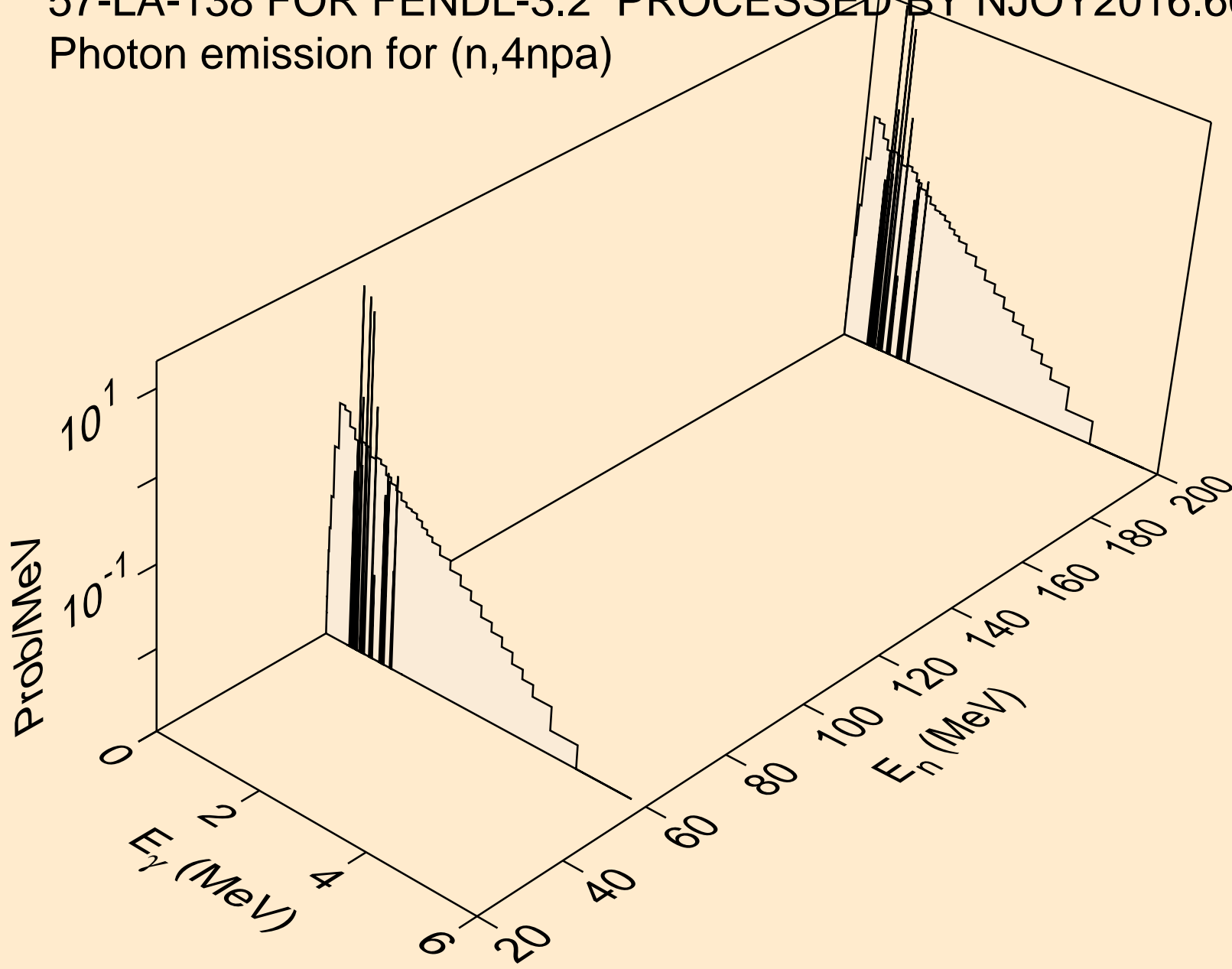

57-LA-138 FOR FENDL-3.2 PROCESSED BY NJOY2016.60+ ON
Photon emission for (n,3p)

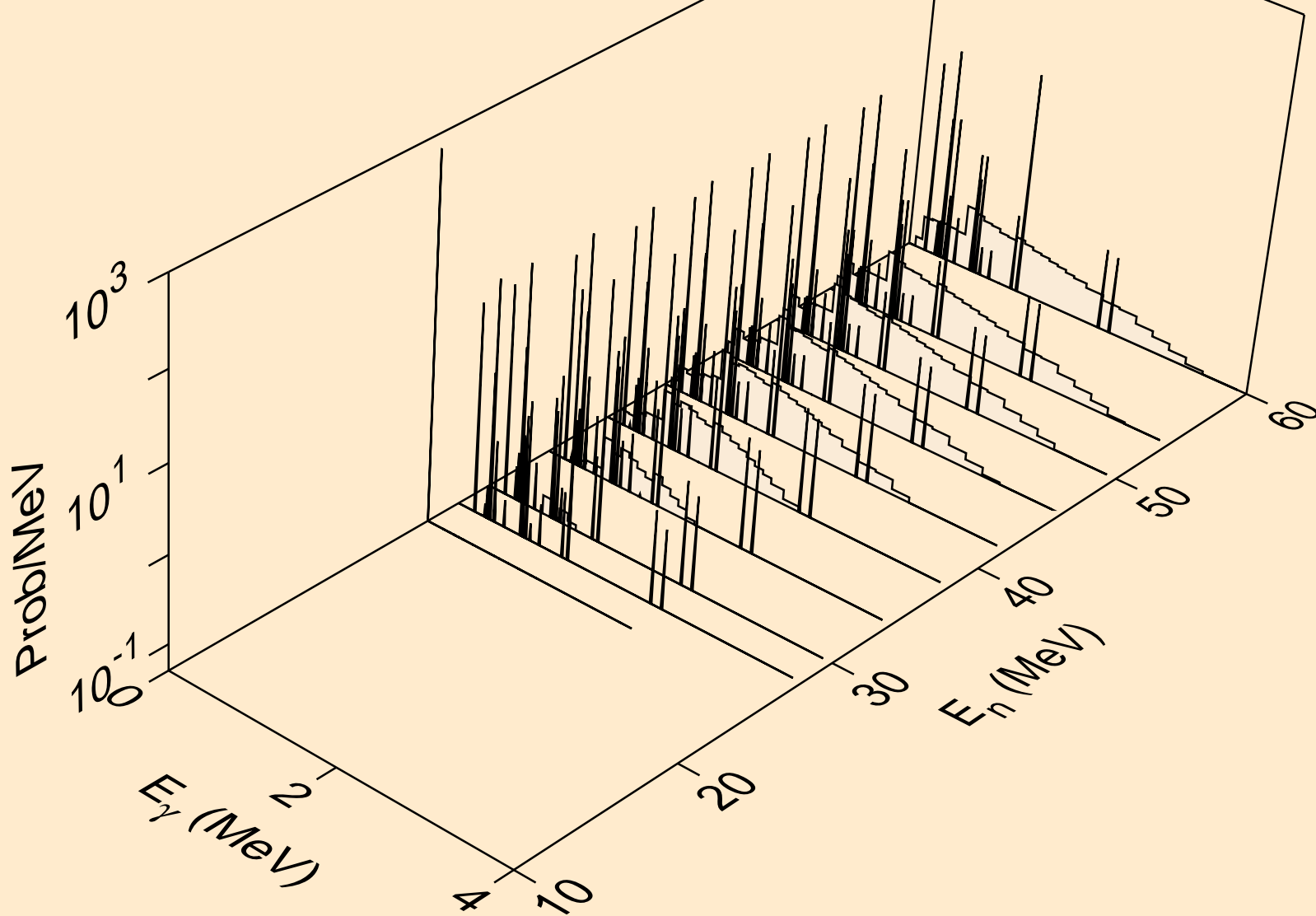

57-LA-138 FOR FENDL-3.2 PROCESSED BY NJOY2016.60+ ON
Photon emission for (n,n3p)

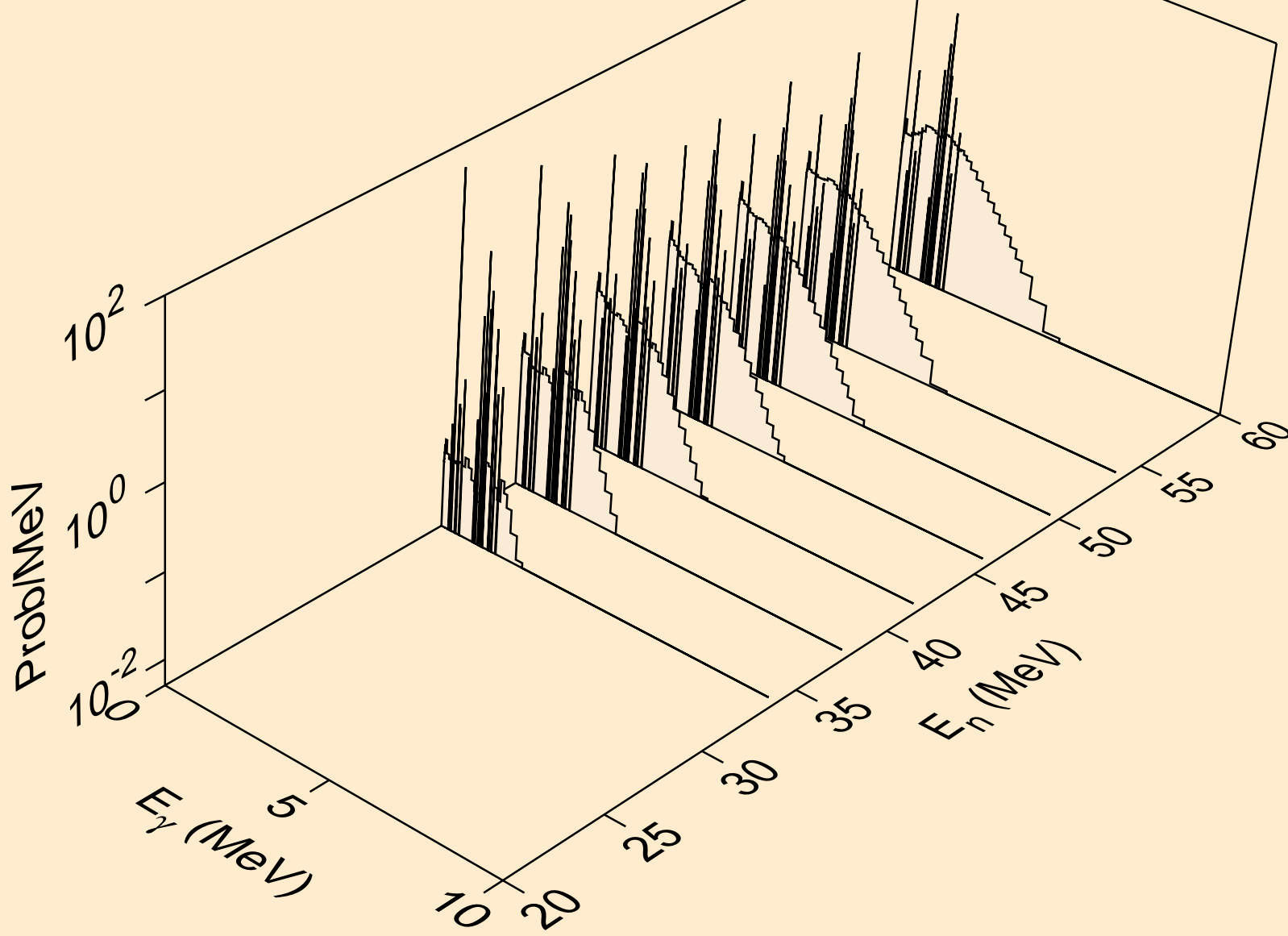

57-LA-138 FOR FENDL-3.2 PROCESSED BY NJOY2016.60+ ON
Photon emission for (n,3n2pa)

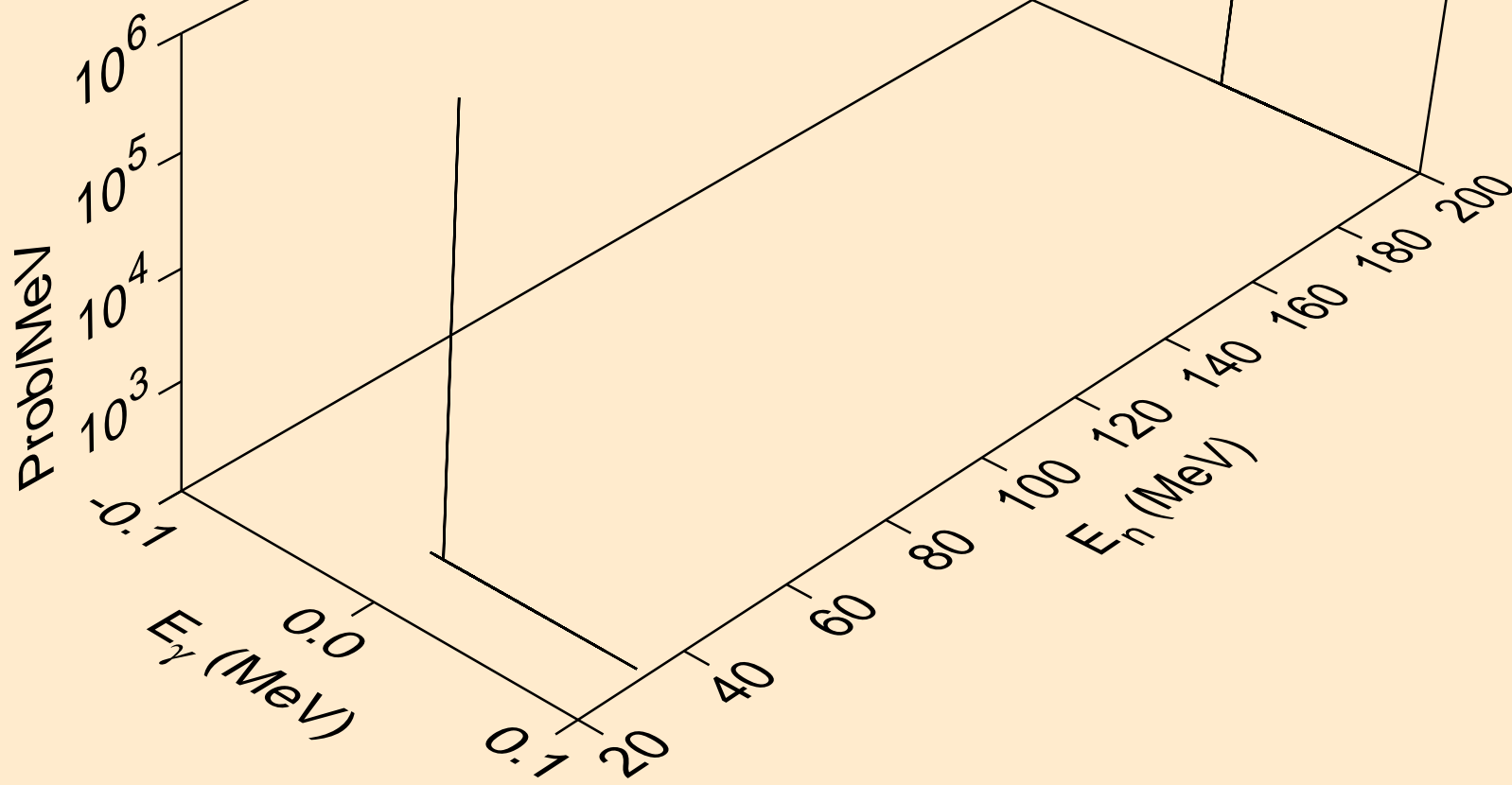

57-LA-138 FOR FENDL-3.2 PROCESSED BY NJOY2016.60+ ON
Photon emission for (n,5n2p)

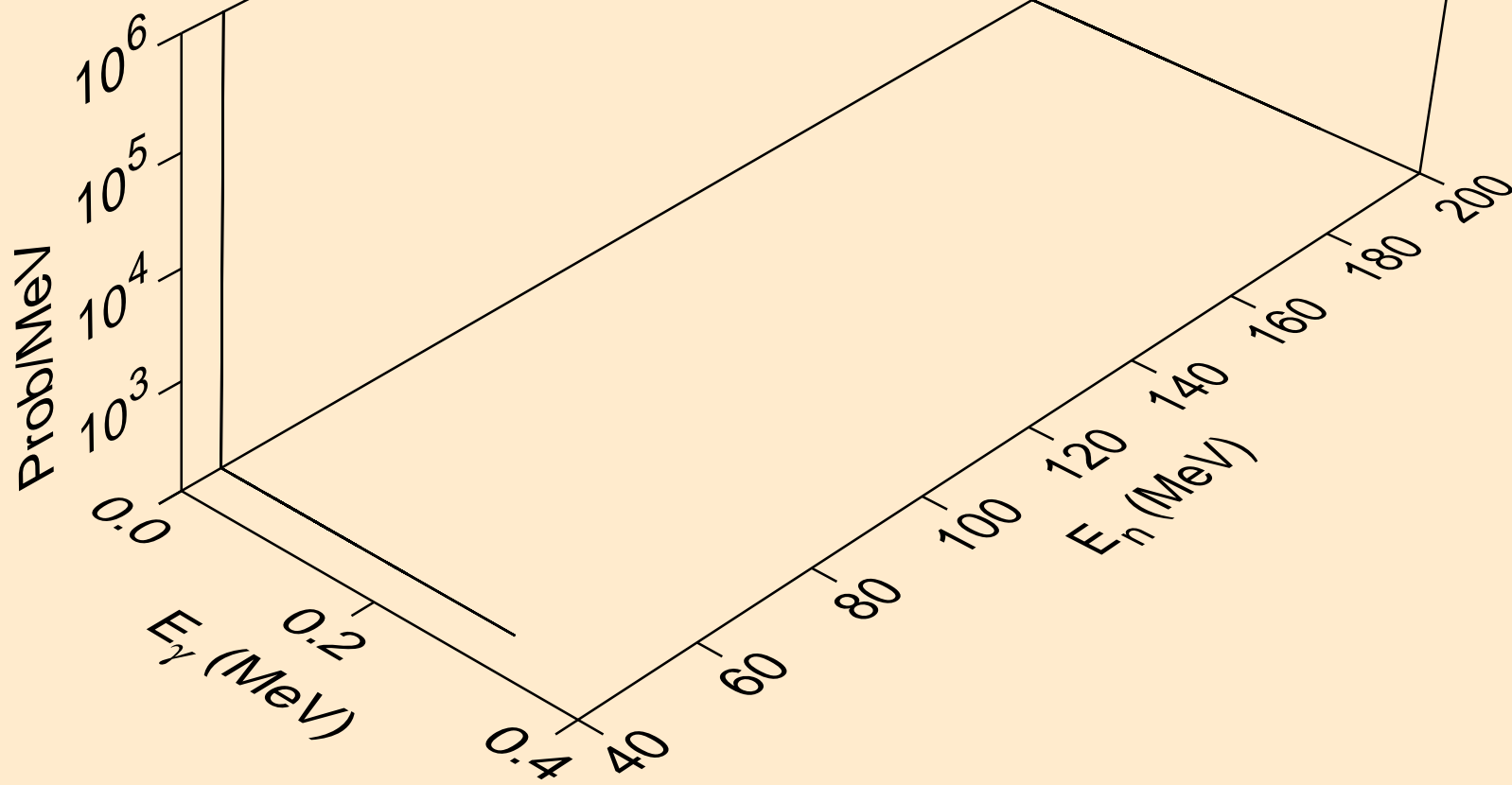

57-LA-138 FOR FENDL-3.2 PROCESSED BY NJOY2016.60+ ON thermal capture photon spectrum

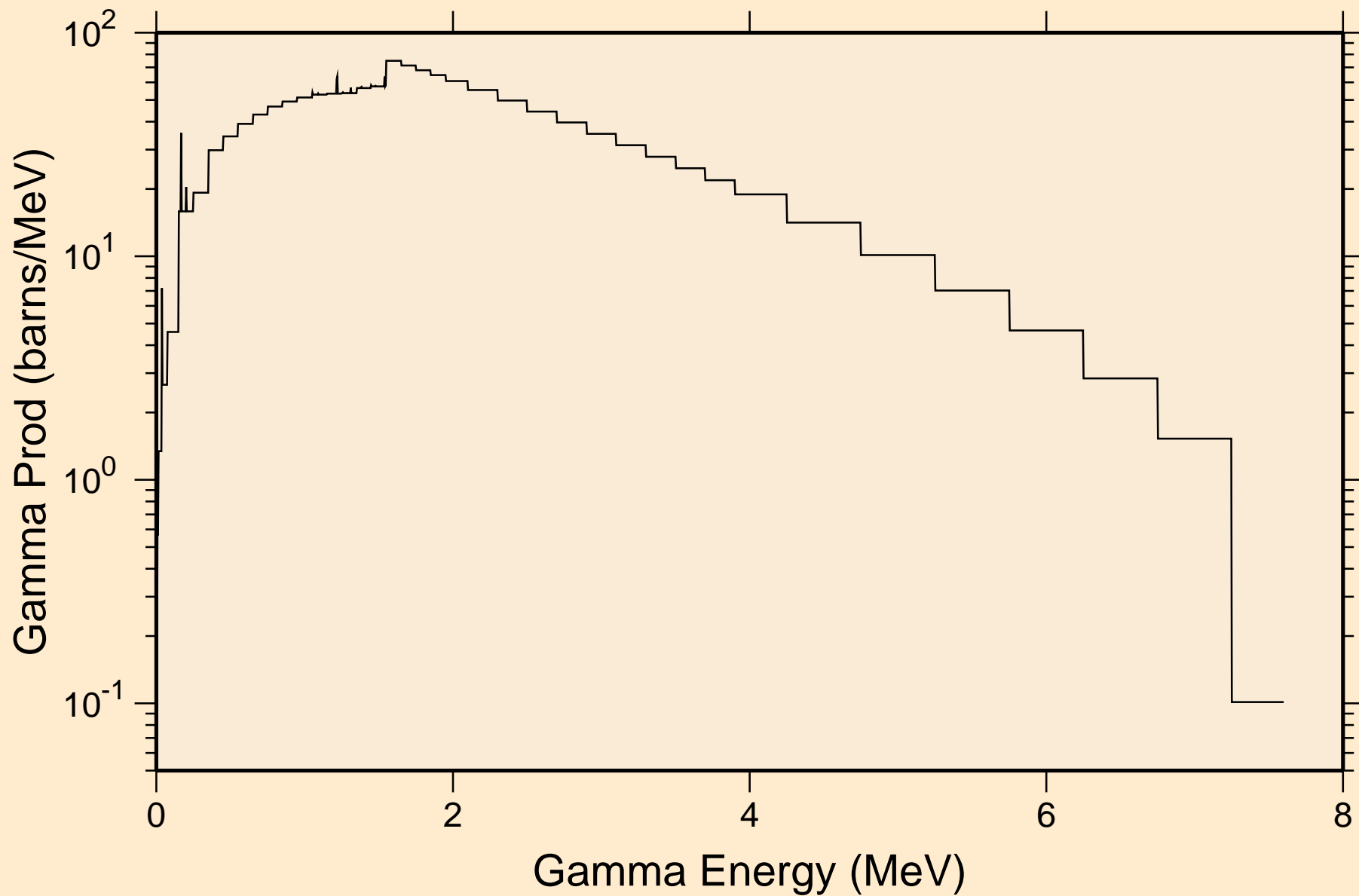

57-LA-138 FOR FENDL-3.2 PROCESSED BY NJOY2016.60+ ON
14 MeV photon spectrum

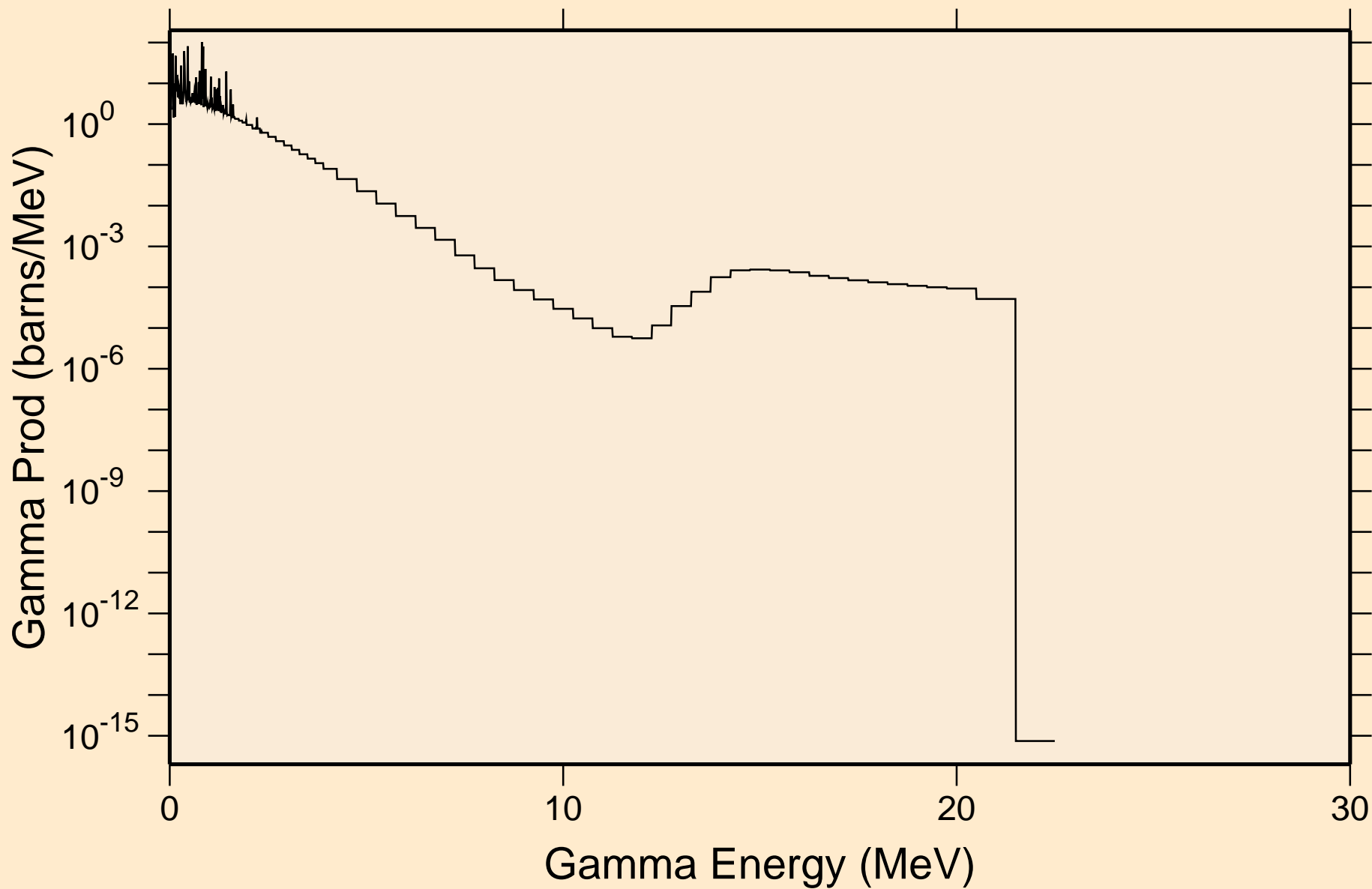

57-LA-138 FOR FENDL-3.2 PROCESSED BY NJOY2016.60+ ON Particle heating contributions

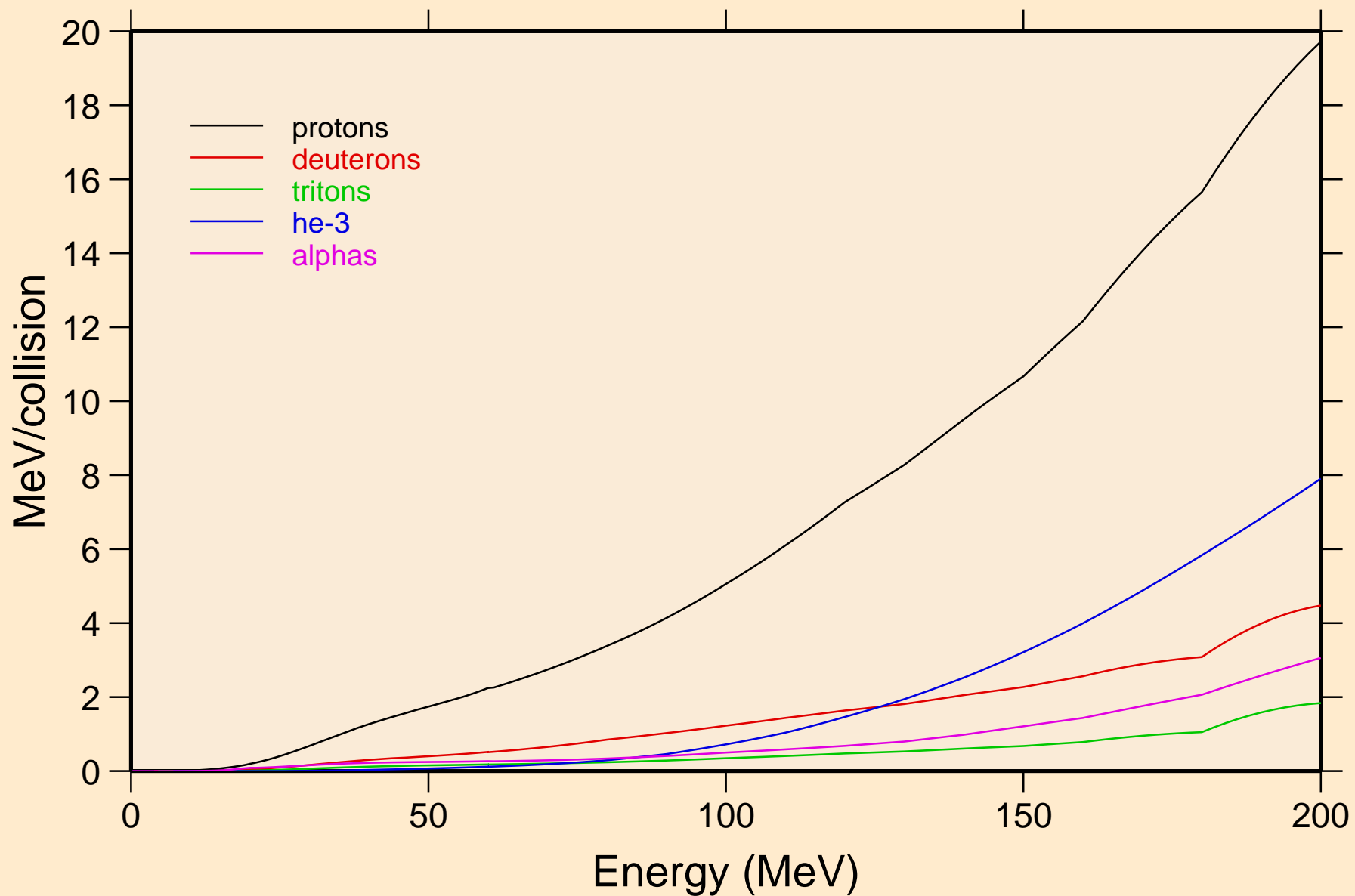

57-LA-138 FOR FENDL-3.2 PROCESSED BY NJOY2016.60+ ON
Recoil Heating

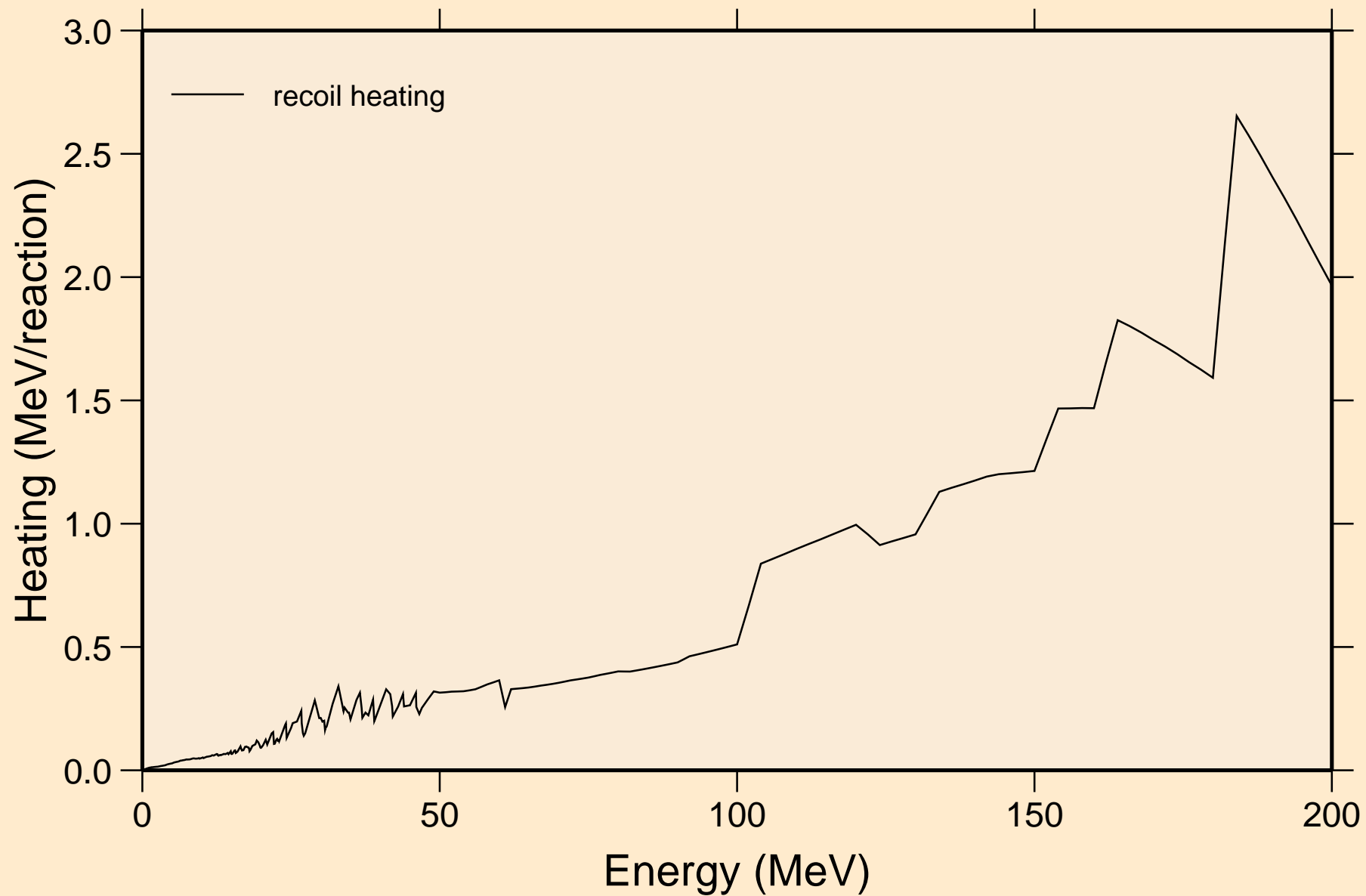

57-LA-138 FOR FENDL-3.2 PROCESSED BY NJOY2016.60+ ON
Particle production cross sections

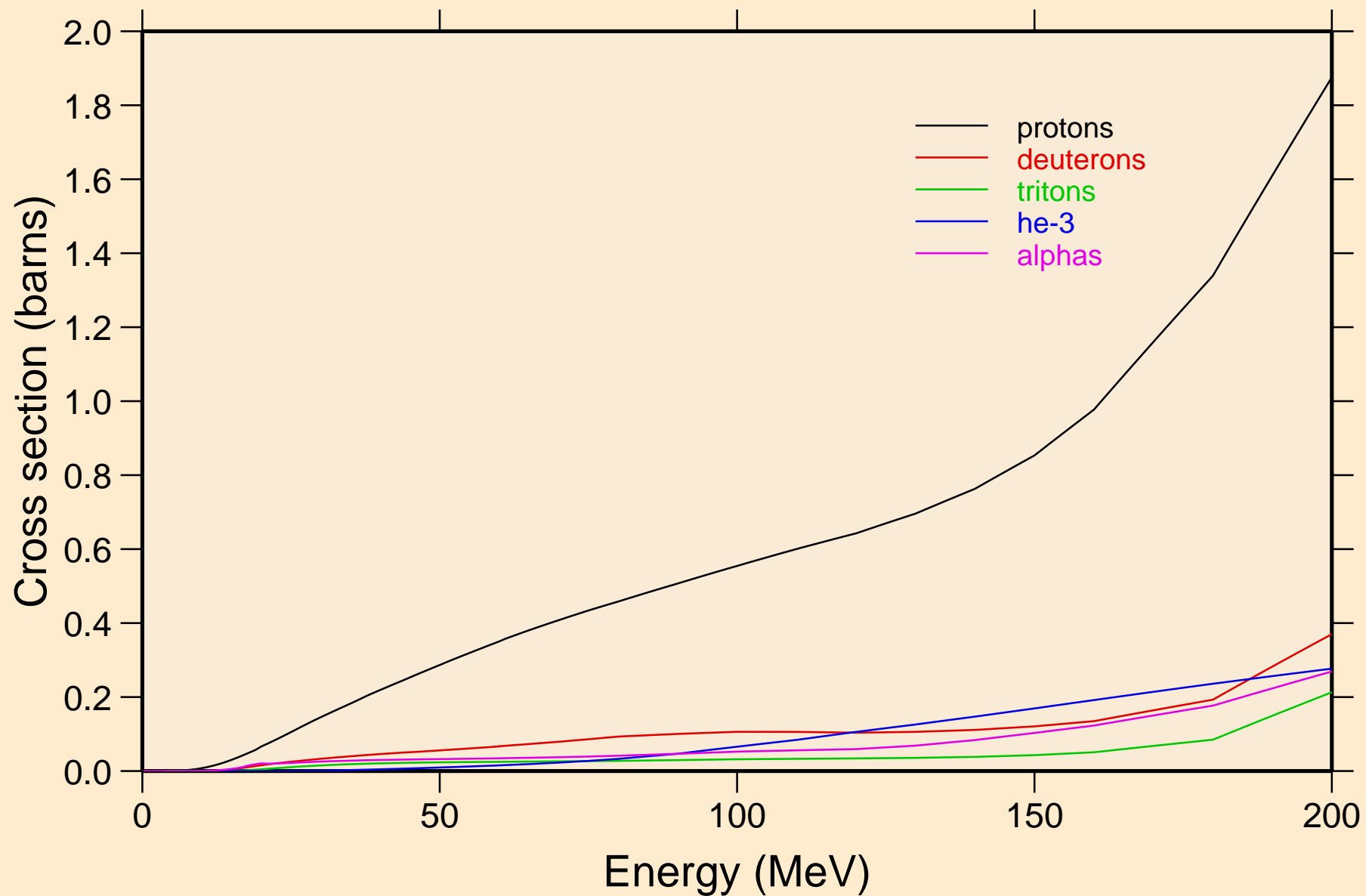

57-LA-138 FOR FENDL-3.2 PROCESSED BY NJOY2016.60+ ON
protons from (n,x)

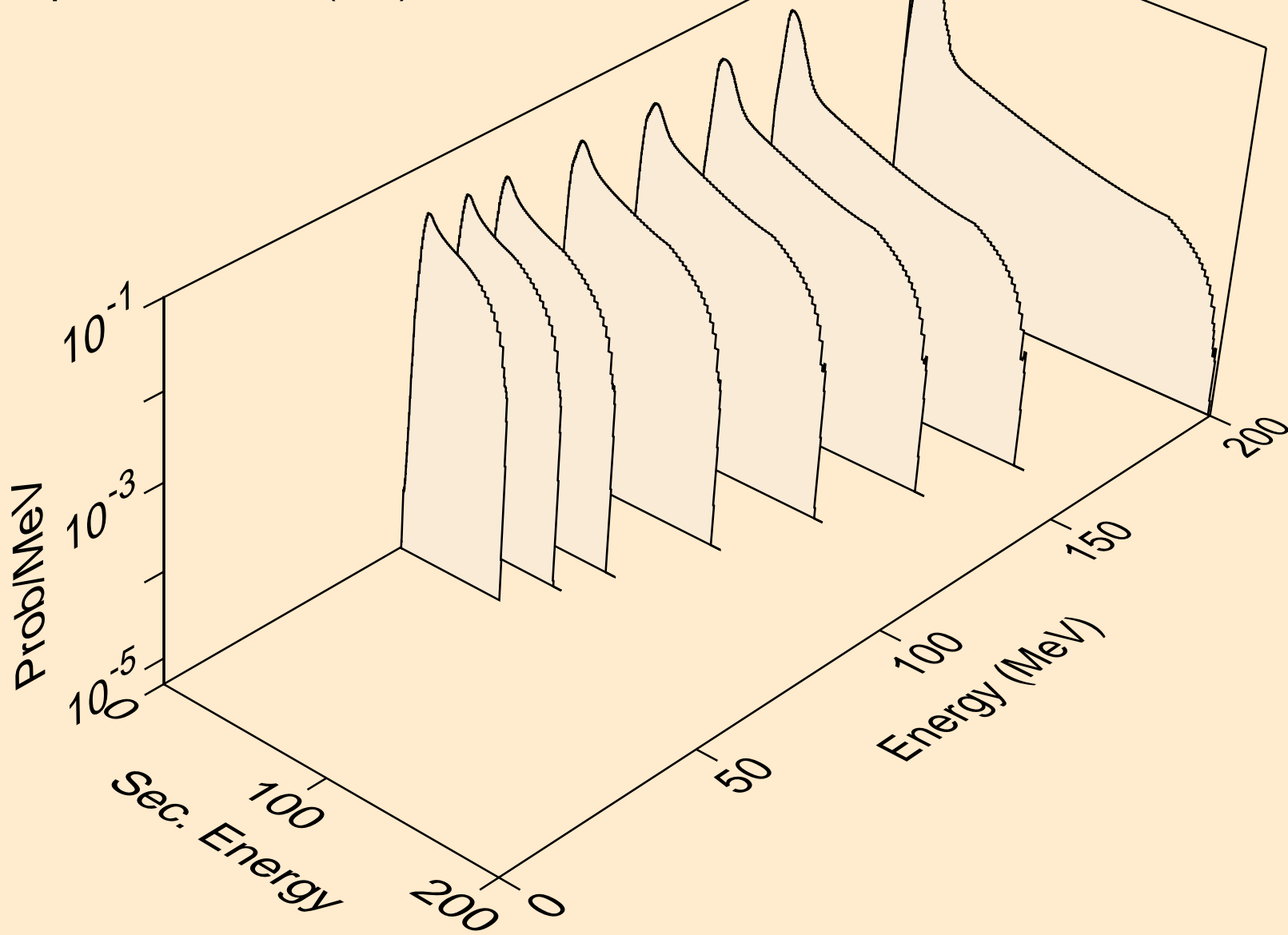

57-LA-138 FOR FENDL-3.2 PROCESSED BY NJOY2016.60+ ON
protons from (n,n*)p

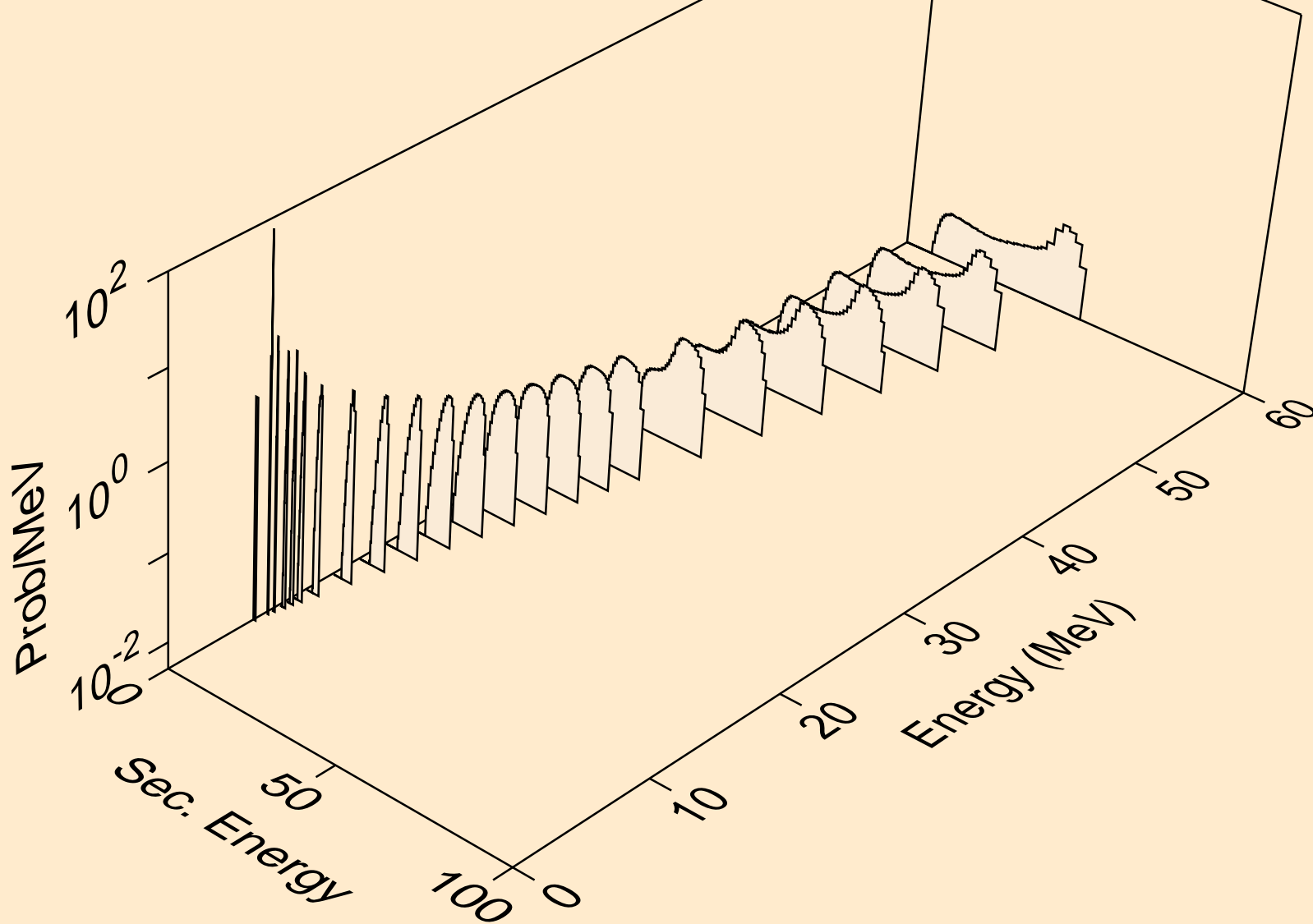

57-LA-138 FOR FENDL-3.2 PROCESSED BY NJOY2016.60+ ON
protons from (n,2np)

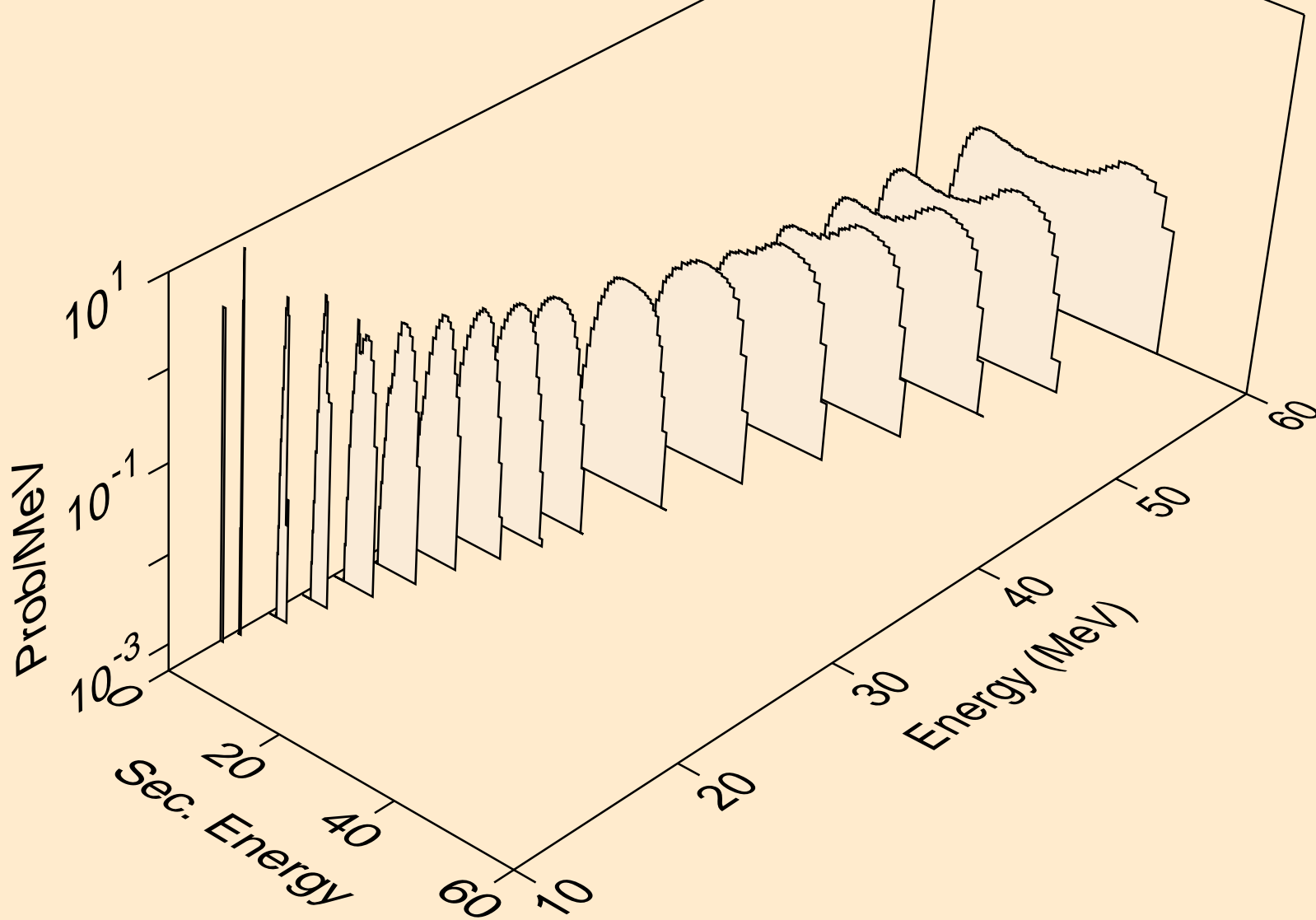

57-LA-138 FOR FENDL-3.2 PROCESSED BY NJOY2016.60+ ON
protons from (n,3np)

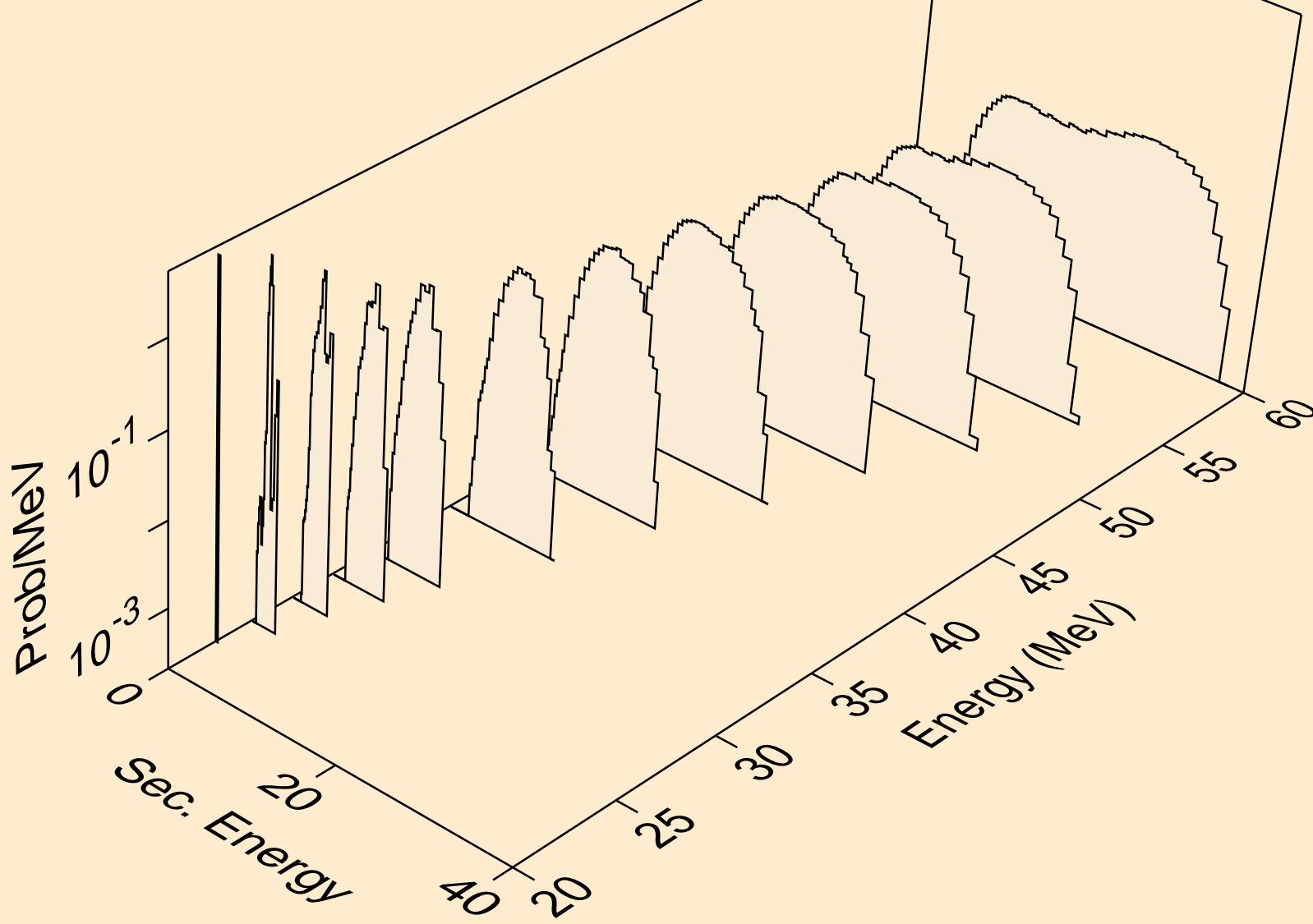

57-LA-138 FOR FENDL-3.2 PROCESSED BY NJOY2016.60+ ON
protons from (n,2np)

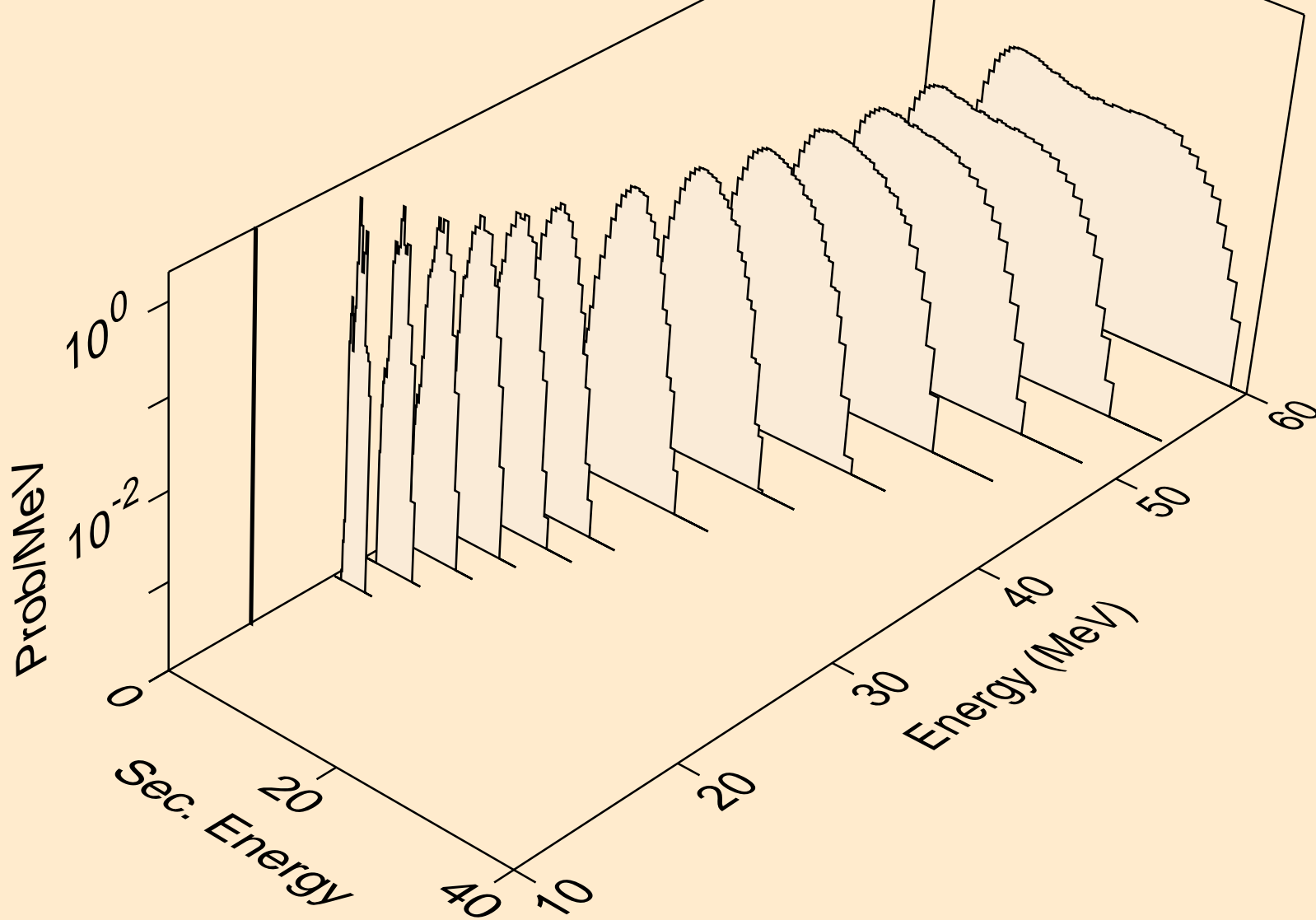

57-LA-138 FOR FENDL-3.2 PROCESSED BY NJOY2016.60+ ON
protons from (n,npa)

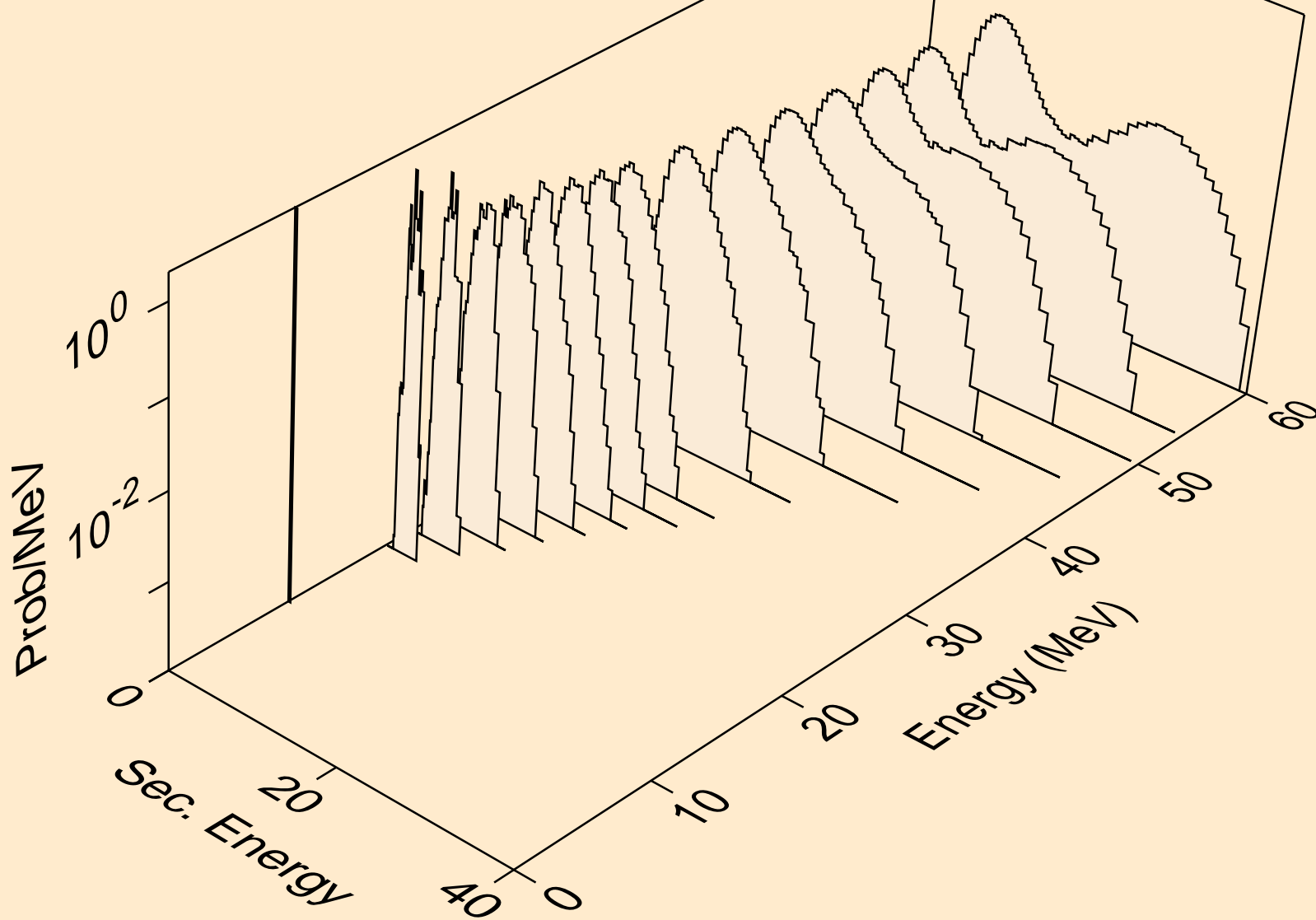

57-LA-138 FOR FENDL-3.2 PROCESSED BY NJOY2016.60+ ON
protons from (n,p)

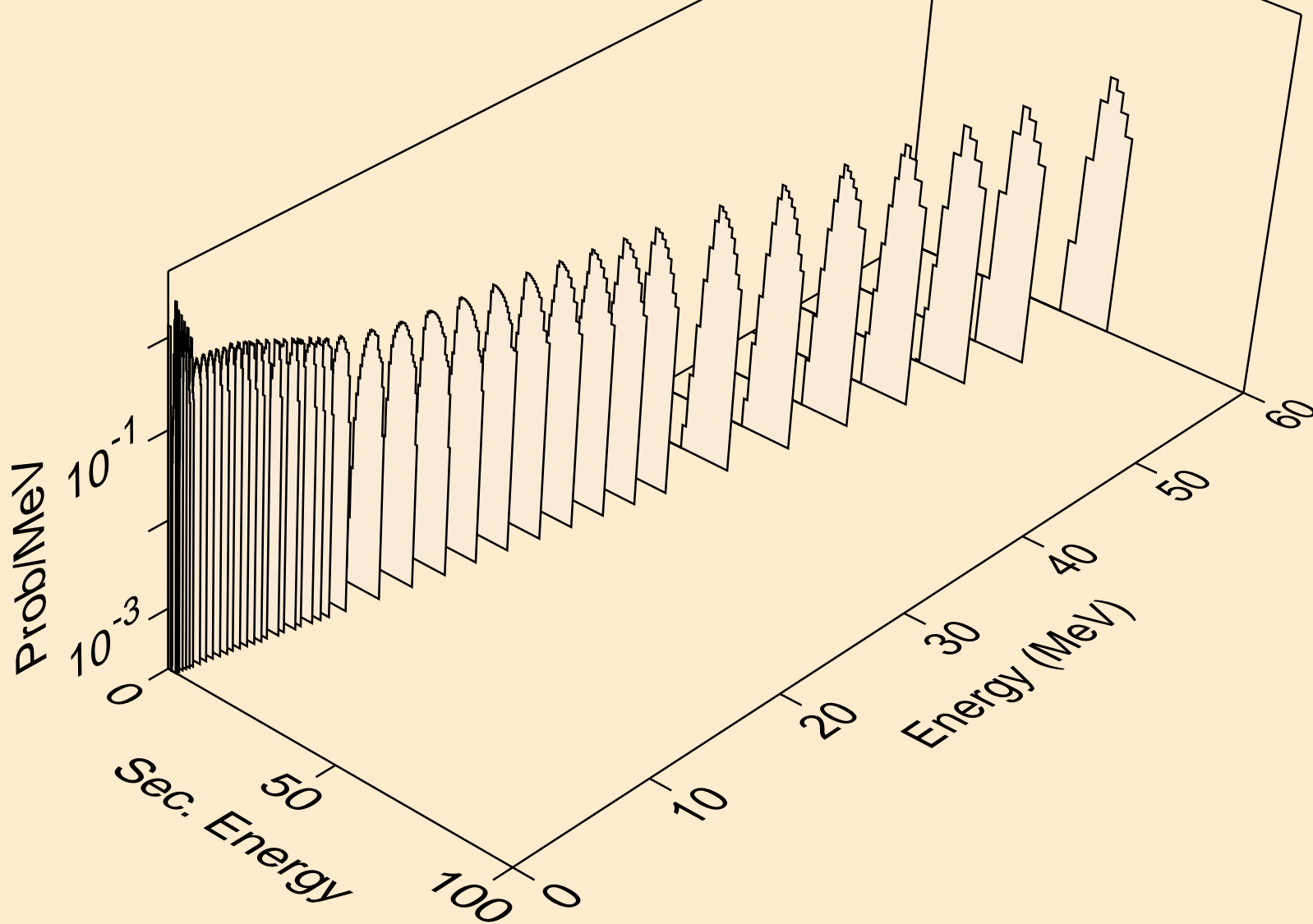

57-LA-138 FOR FENDL-3.2 PROCESSED BY NJOY2016.60+ ON
protons from (n,2p)

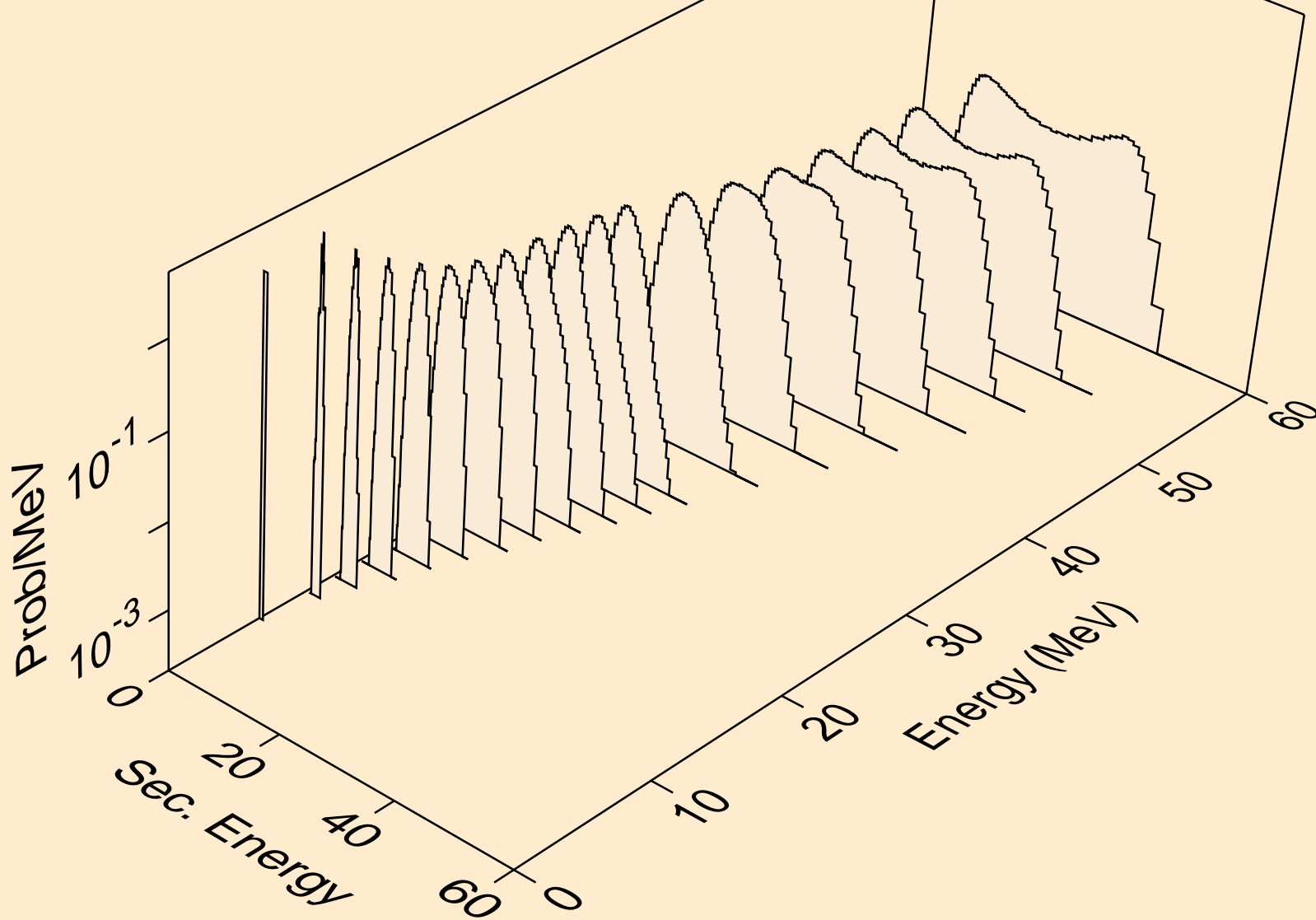

57-LA-138 FOR FENDL-3.2 PROCESSED BY NJOY2016.60+ ON
protons from (n,pa)

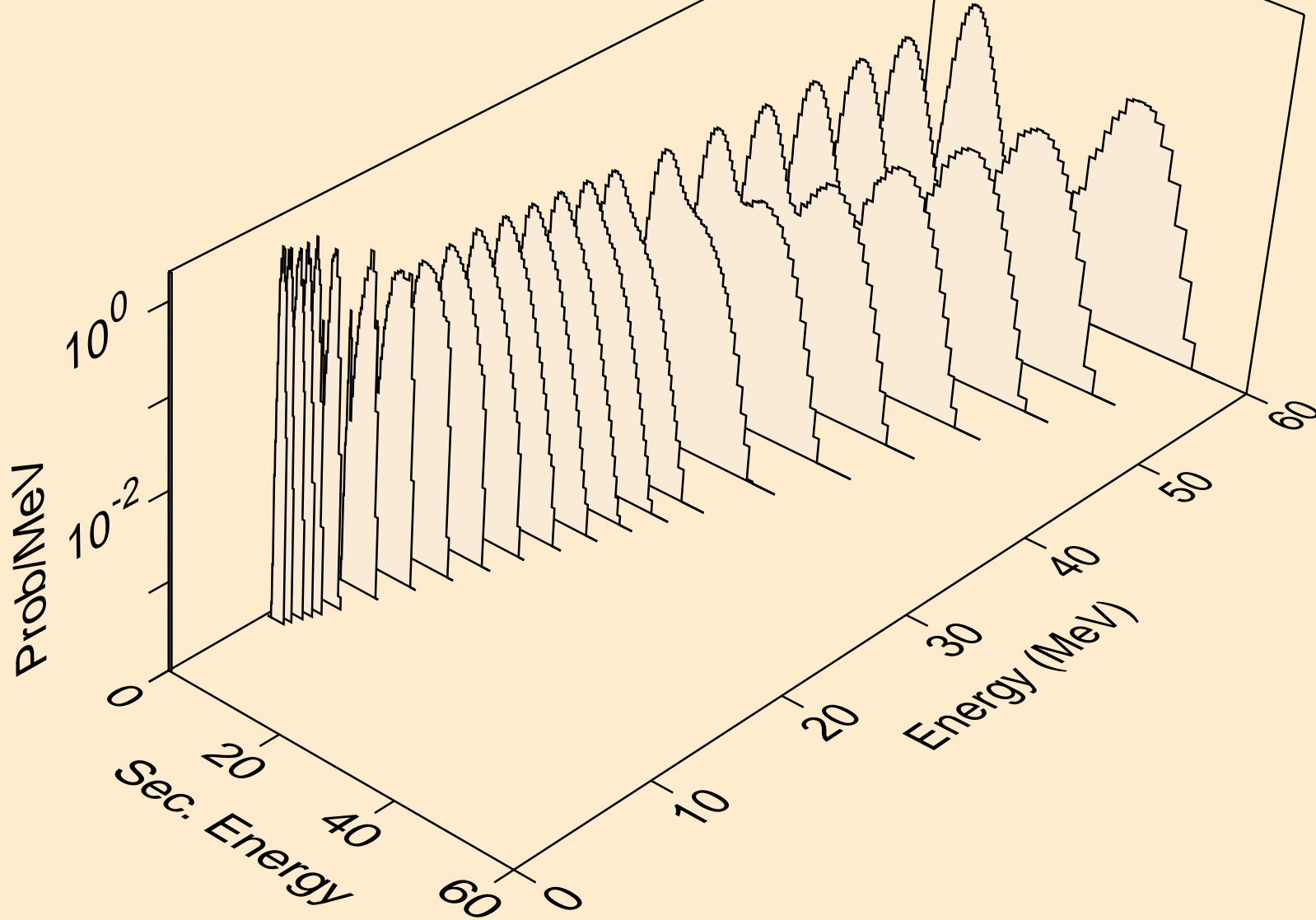

57-LA-138 FOR FENDL-3.2 PROCESSED BY NJOY2016.60+ ON
protons from (n,pd)

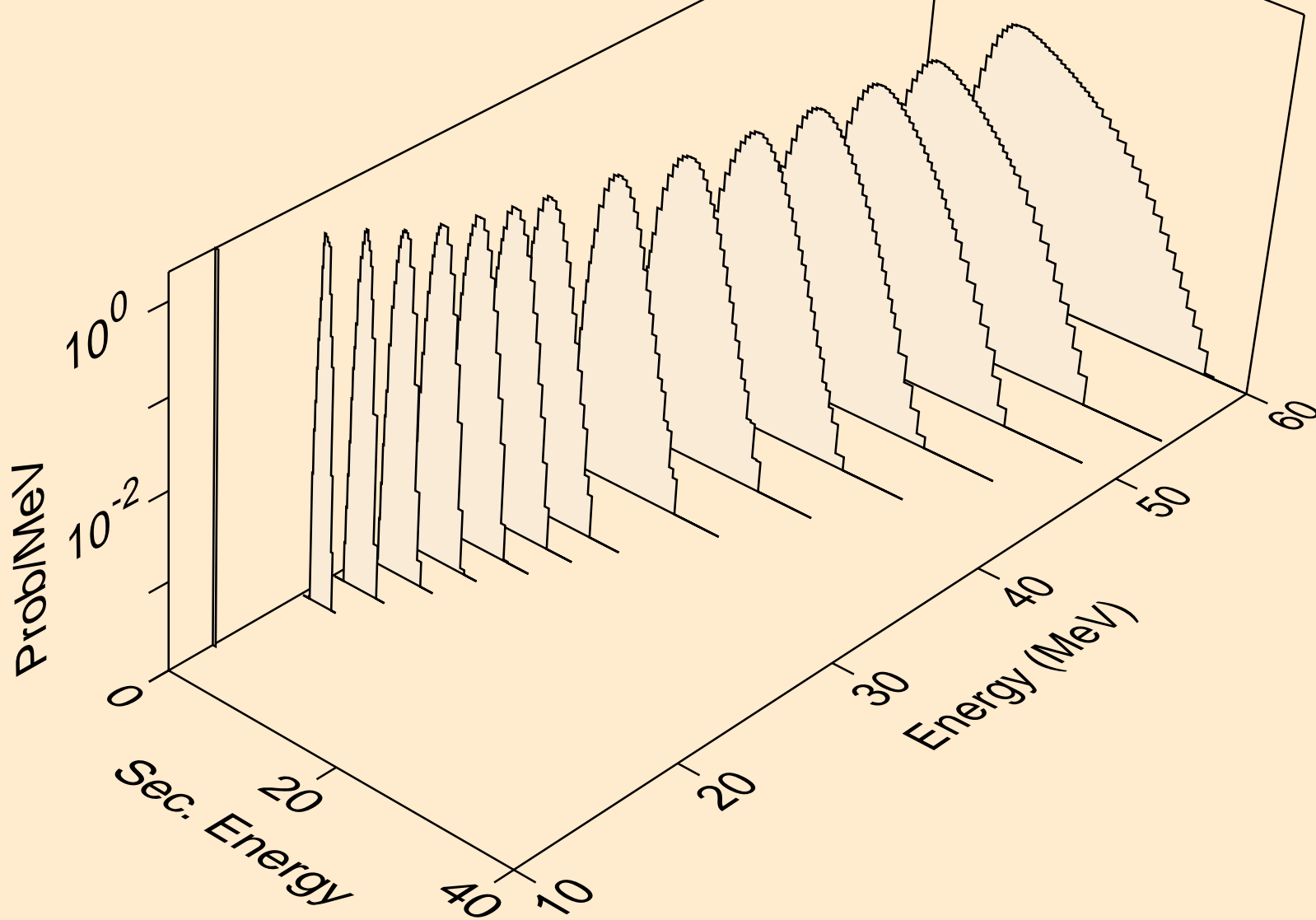

57-LA-138 FOR FENDL-3.2 PROCESSED BY NJOY2016.60+ ON
protons from (n,pt)

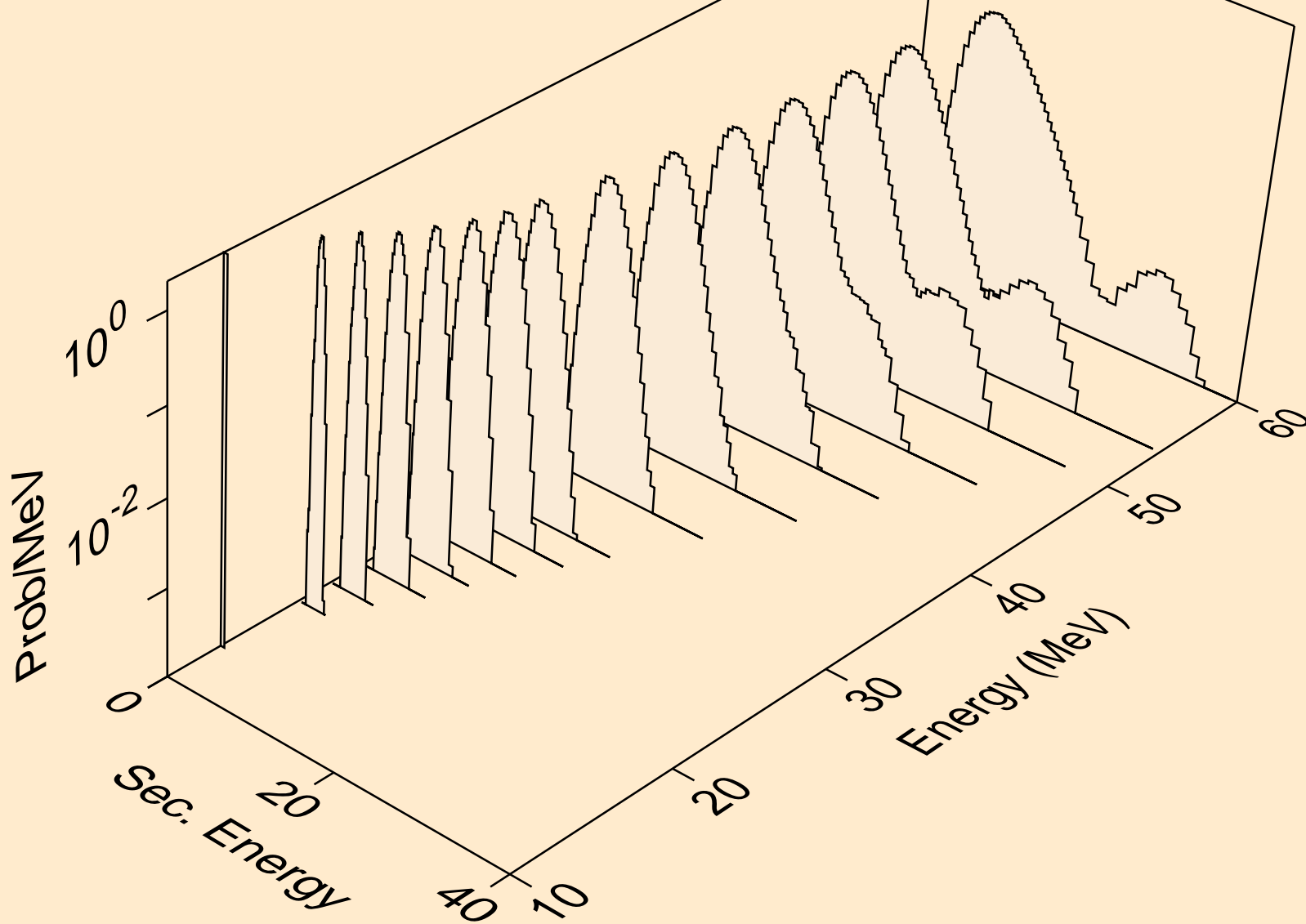

57-LA-138 FOR FENDL-3.2 PROCESSED BY NJOY2016.60+ ON
protons from (n,4np)

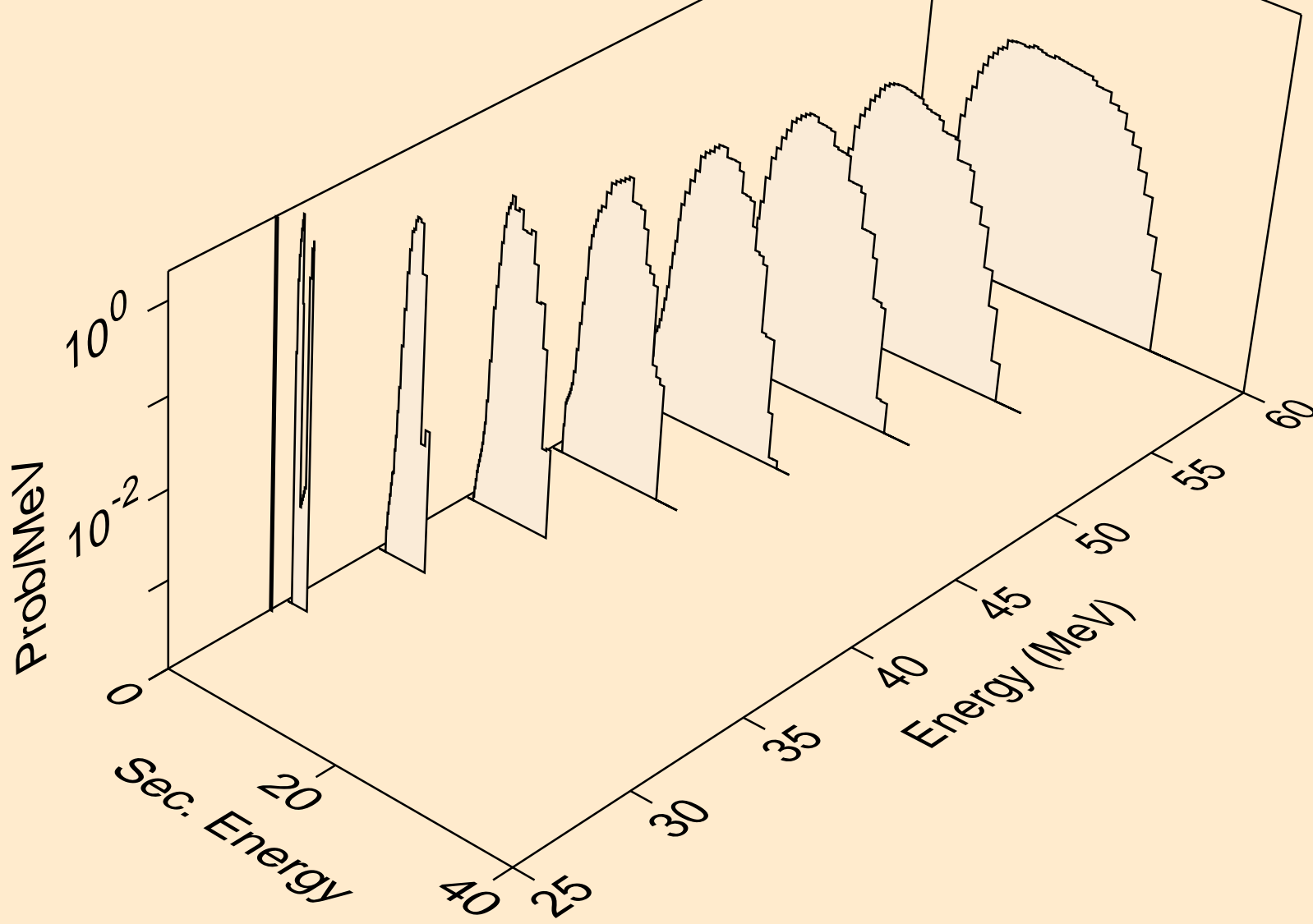

57-LA-138 FOR FENDL-3.2 PROCESSED BY NJOY2016.60+ ON
protons from (n,2npa)

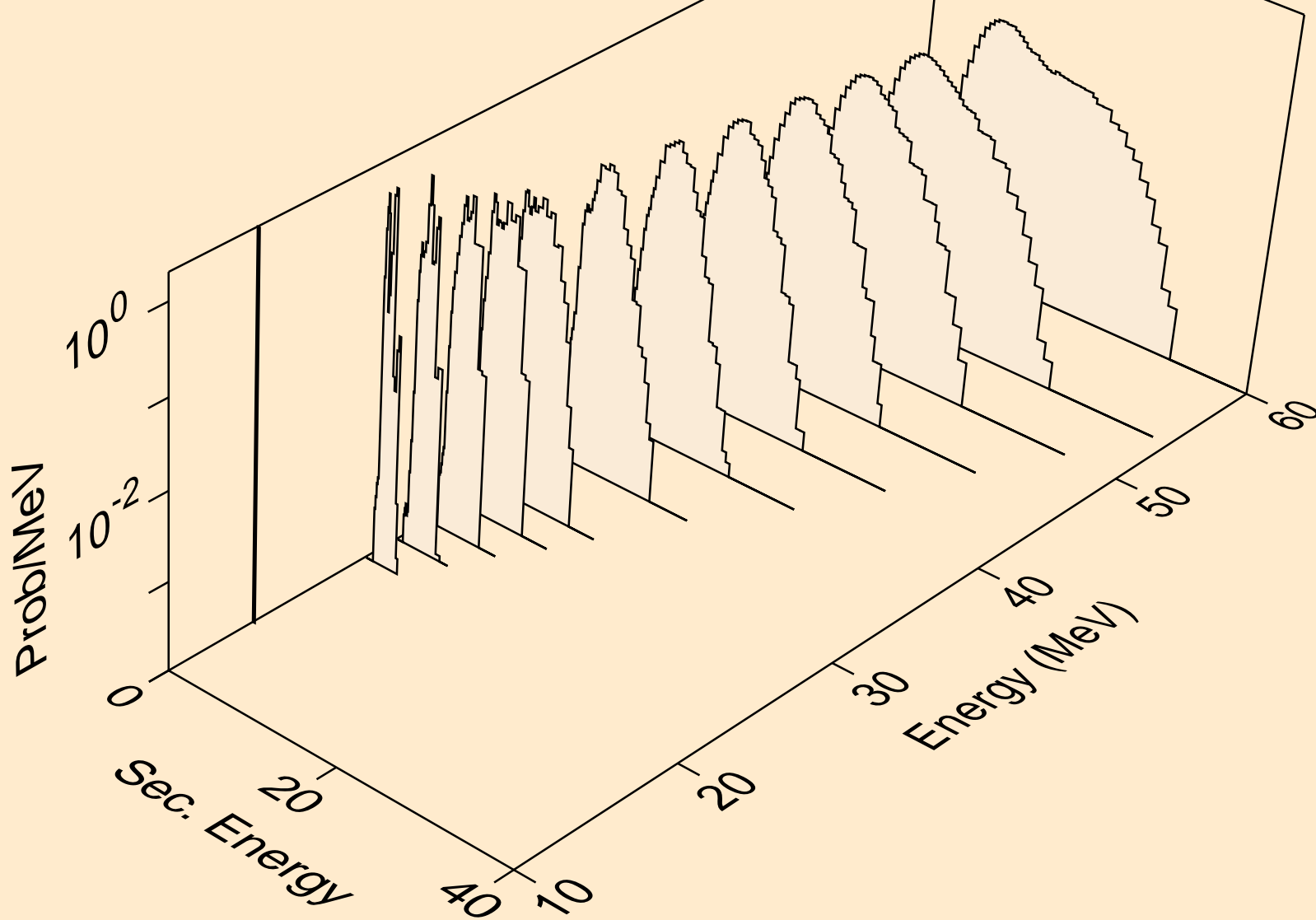

57-LA-138 FOR FENDL-3.2 PROCESSED BY NJOY2016.60+ ON
protons from (n,5np)

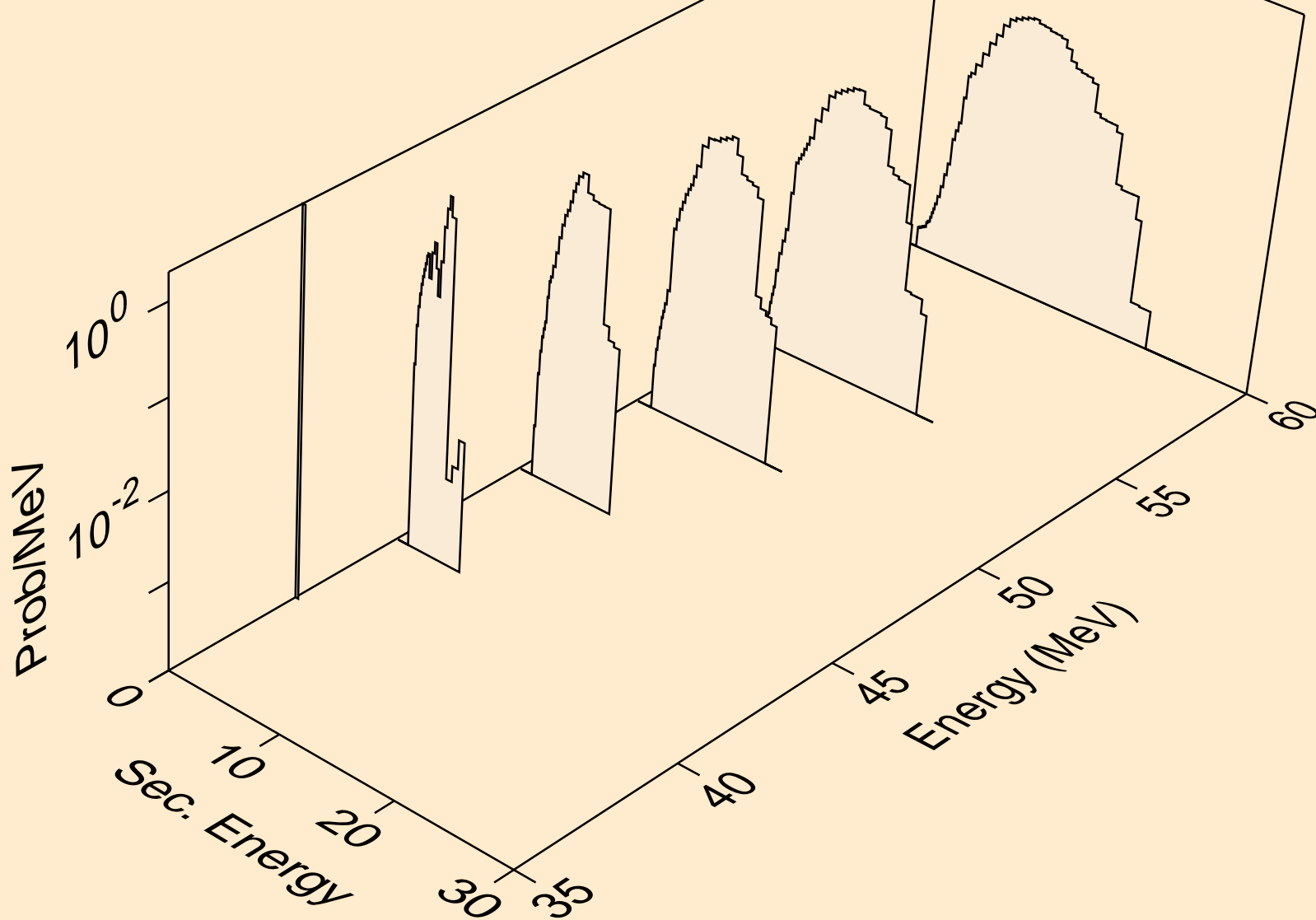

57-LA-138 FOR FENDL-3.2 PROCESSED BY NJOY2016.60+ ON
protons from (n,6np)

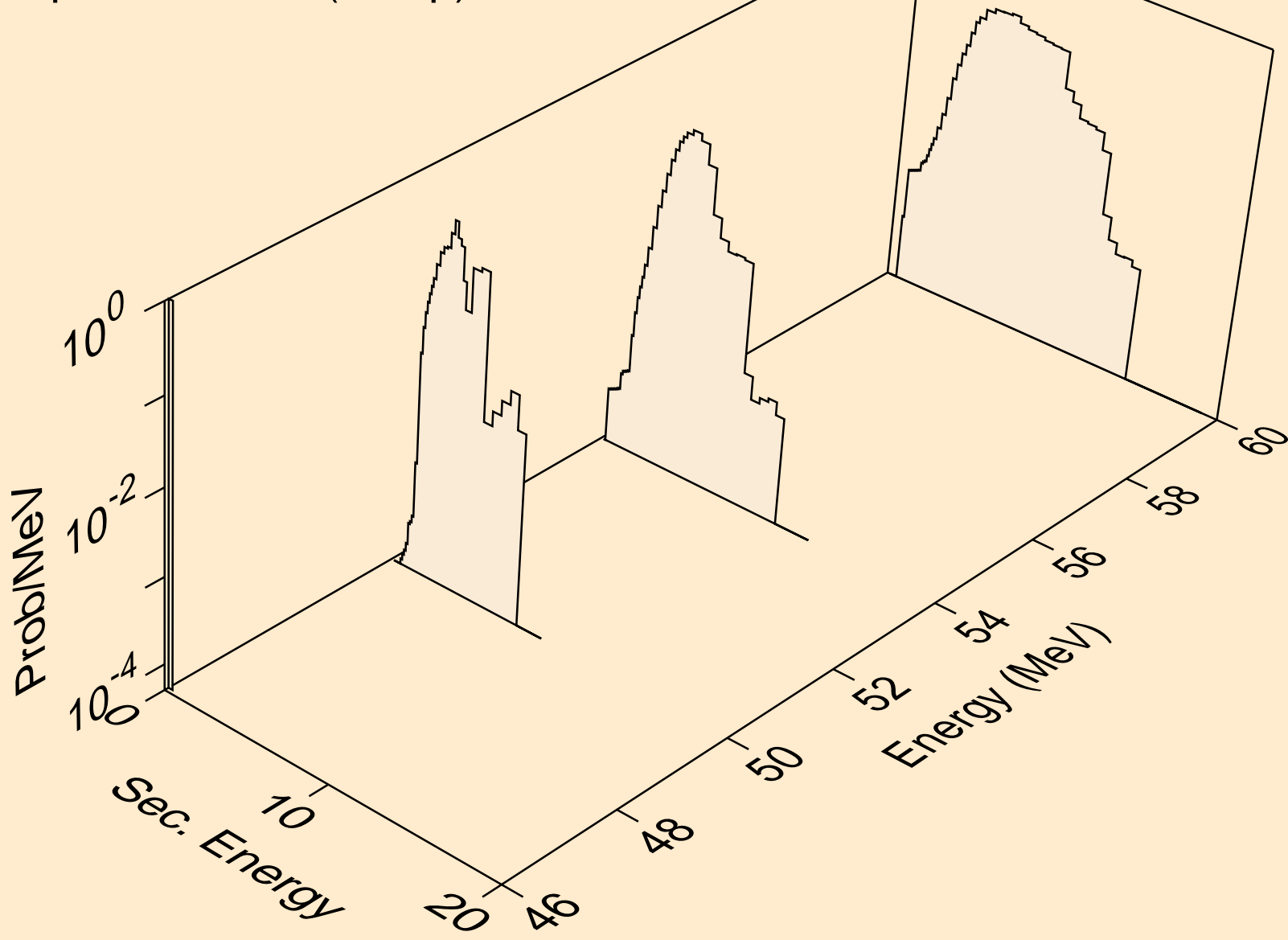

57-LA-138 FOR FENDL-3.2 PROCESSED BY NJOY2016.60+ ON
protons from (n,3n2p)

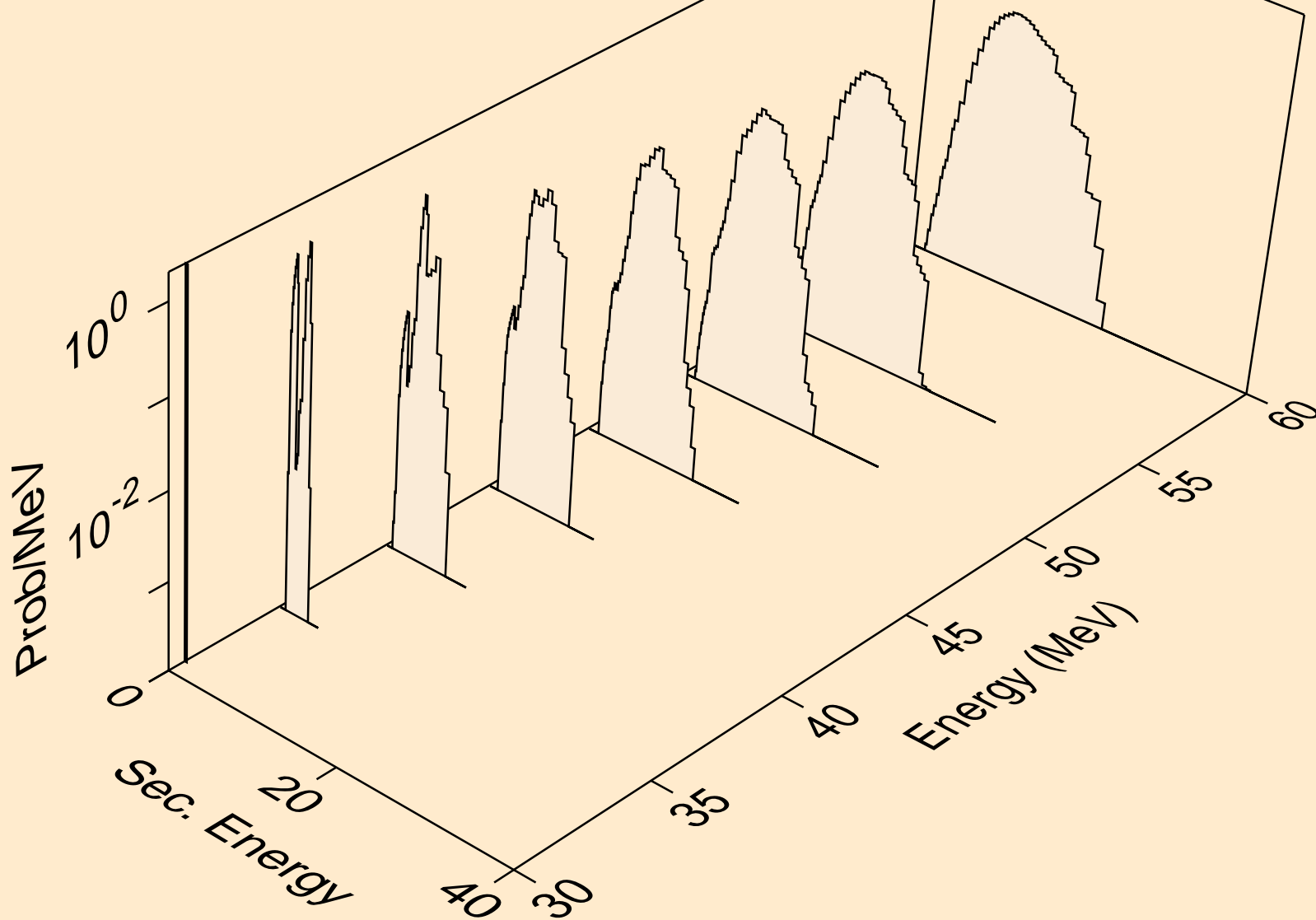

57-LA-138 FOR FENDL-3.2 PROCESSED BY NJOY2016.60+ ON
protons from (n,3npa)

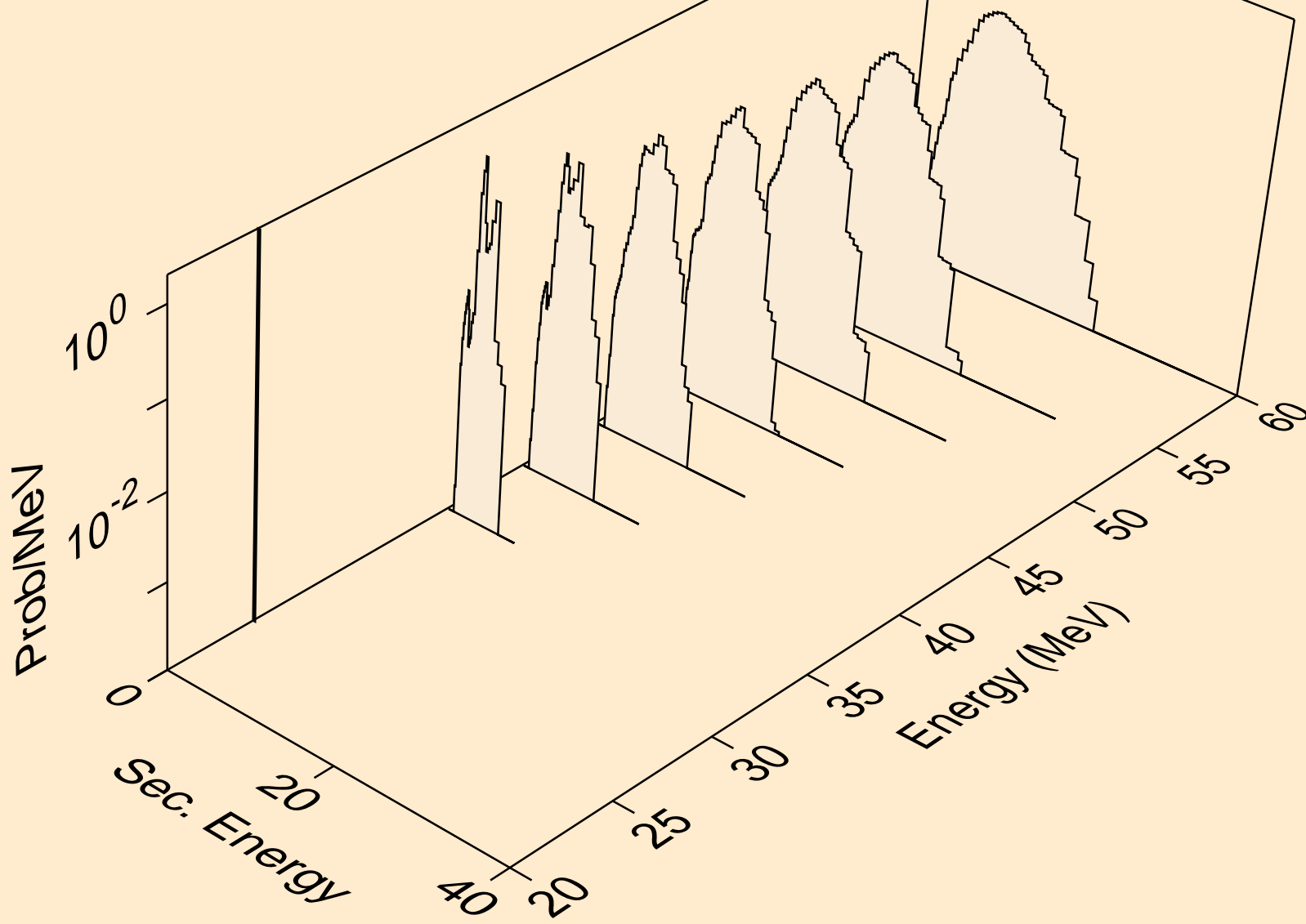

57-LA-138 FOR FENDL-3.2 PROCESSED BY NJOY2016.60+ ON
protons from (n,npd)

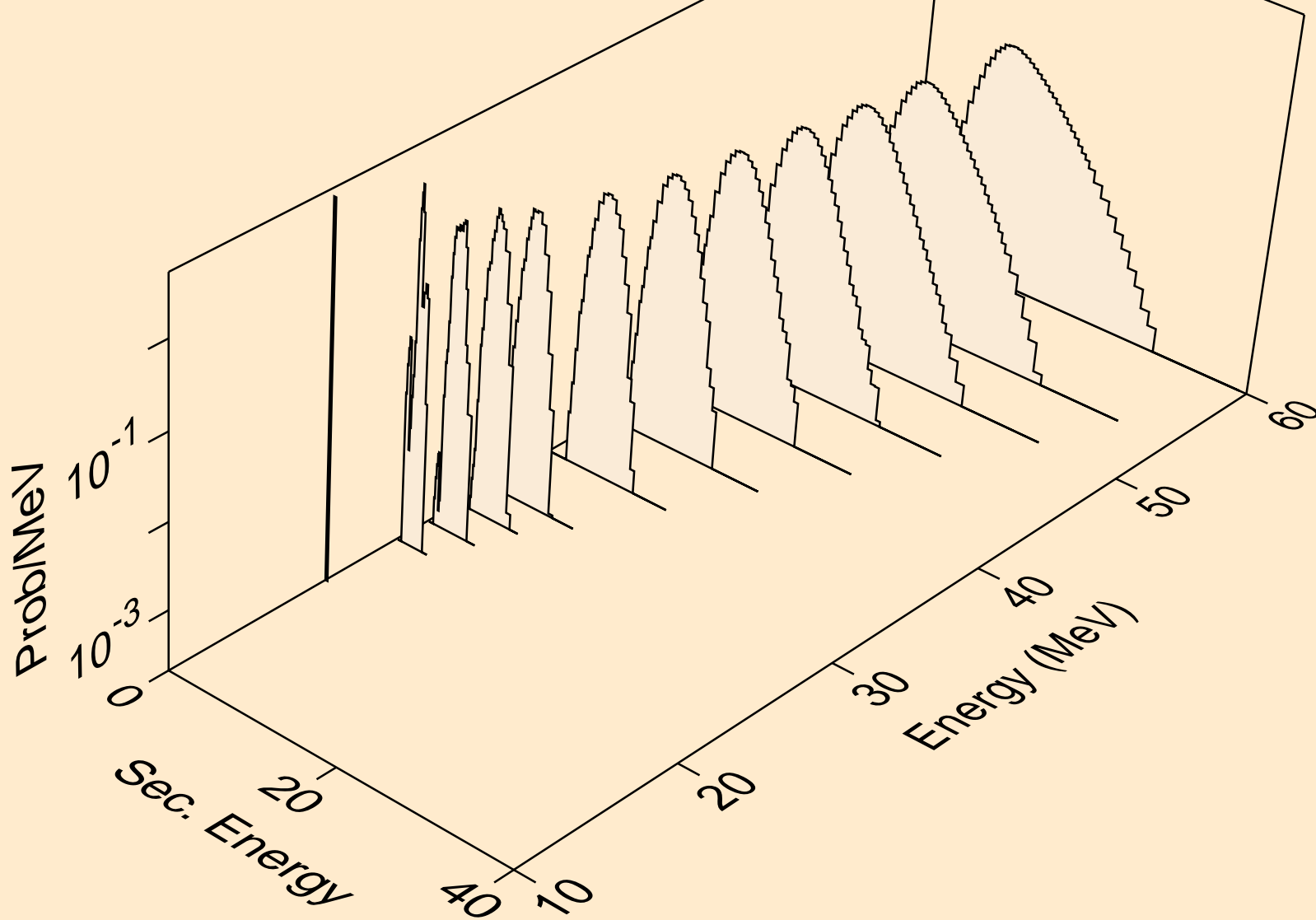

57-LA-138 FOR FENDL-3.2 PROCESSED BY NJOY2016.60+ ON
protons from (n,npt)

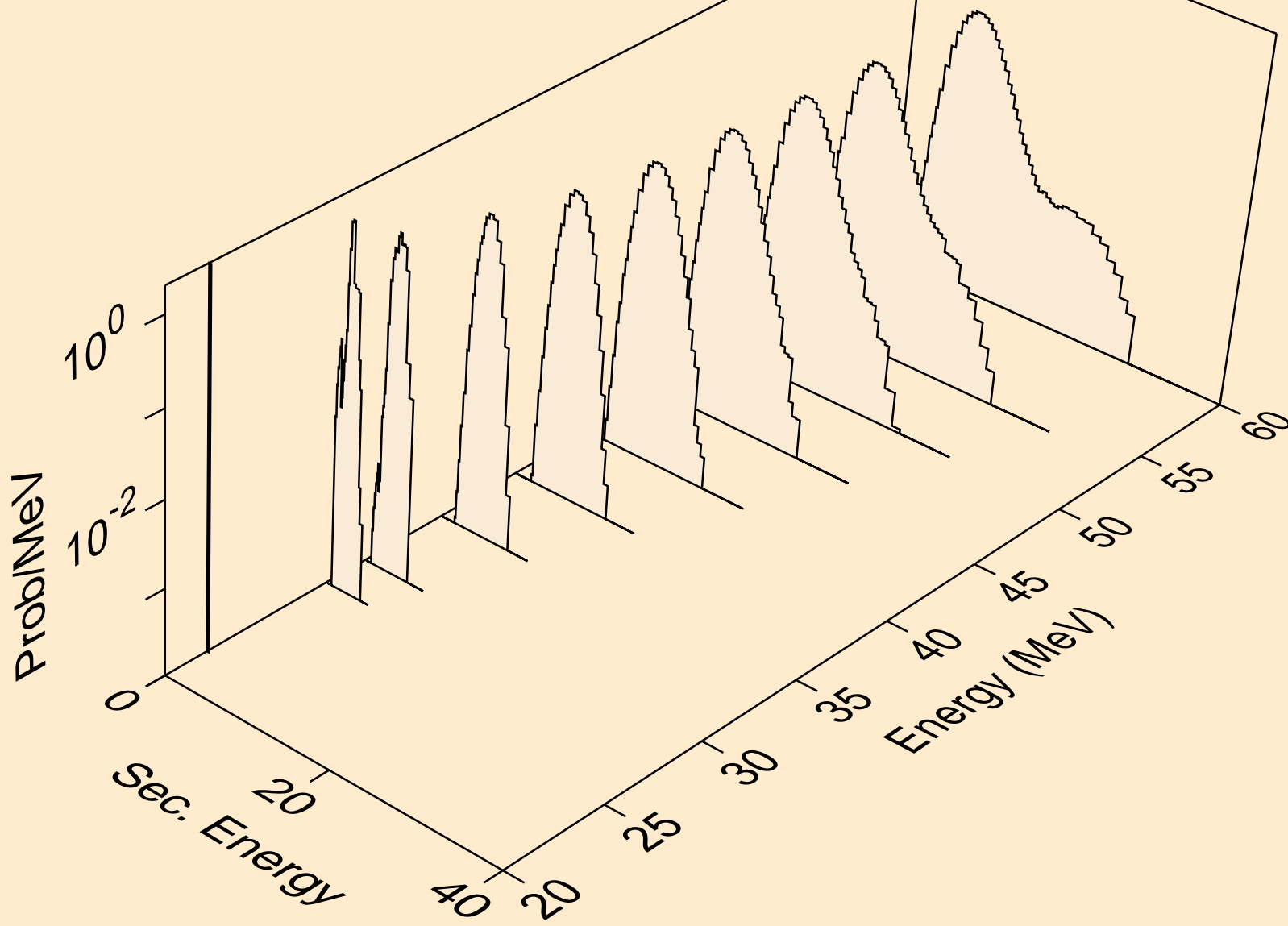

57-LA-138 FOR FENDL-3.2 PROCESSED BY NJOY2016.60+ ON
protons from (n,nphe3)

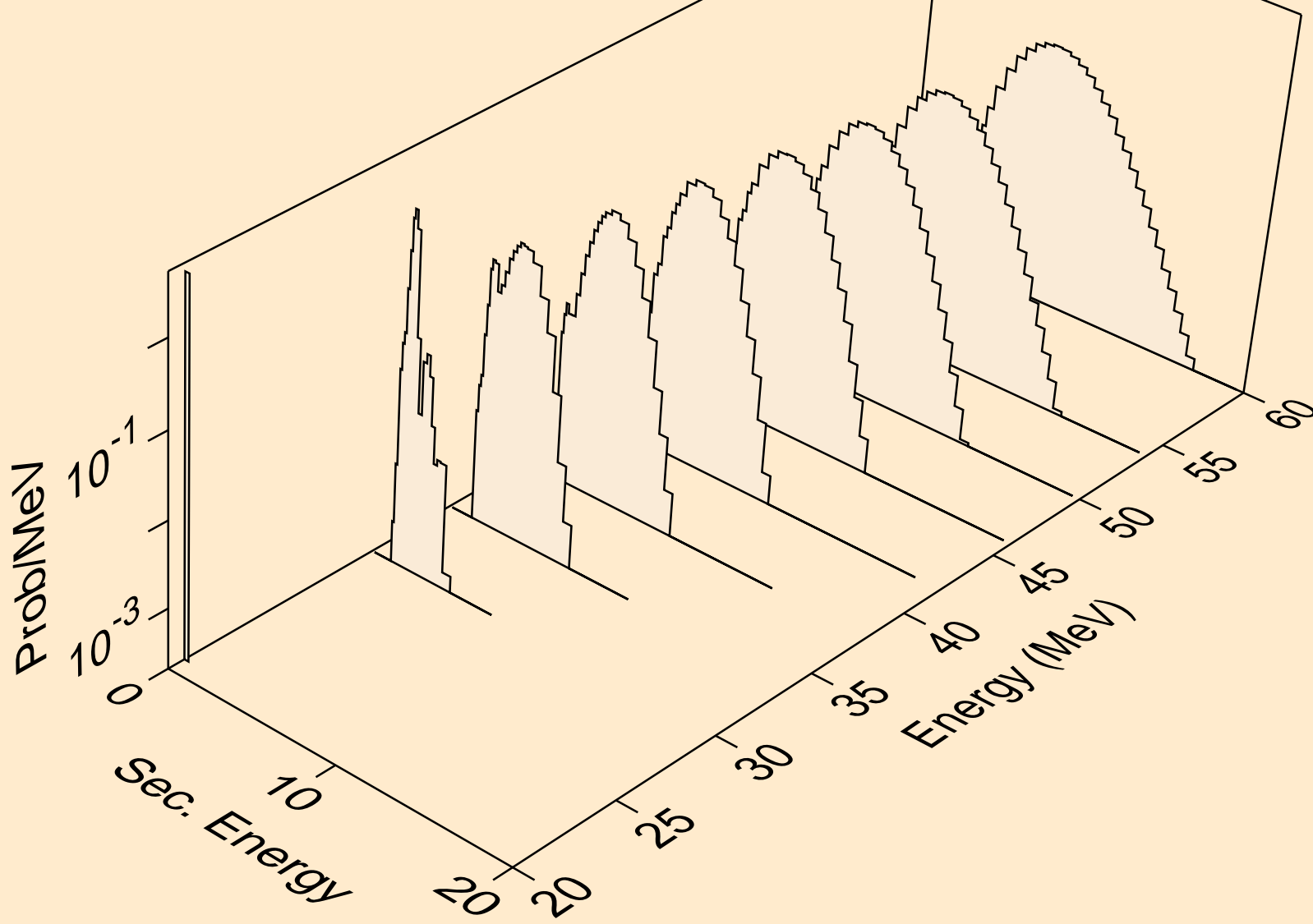

57-LA-138 FOR FENDL-3.2 PROCESSED BY NJOY2016.60+ ON
protons from (n,2n2p)

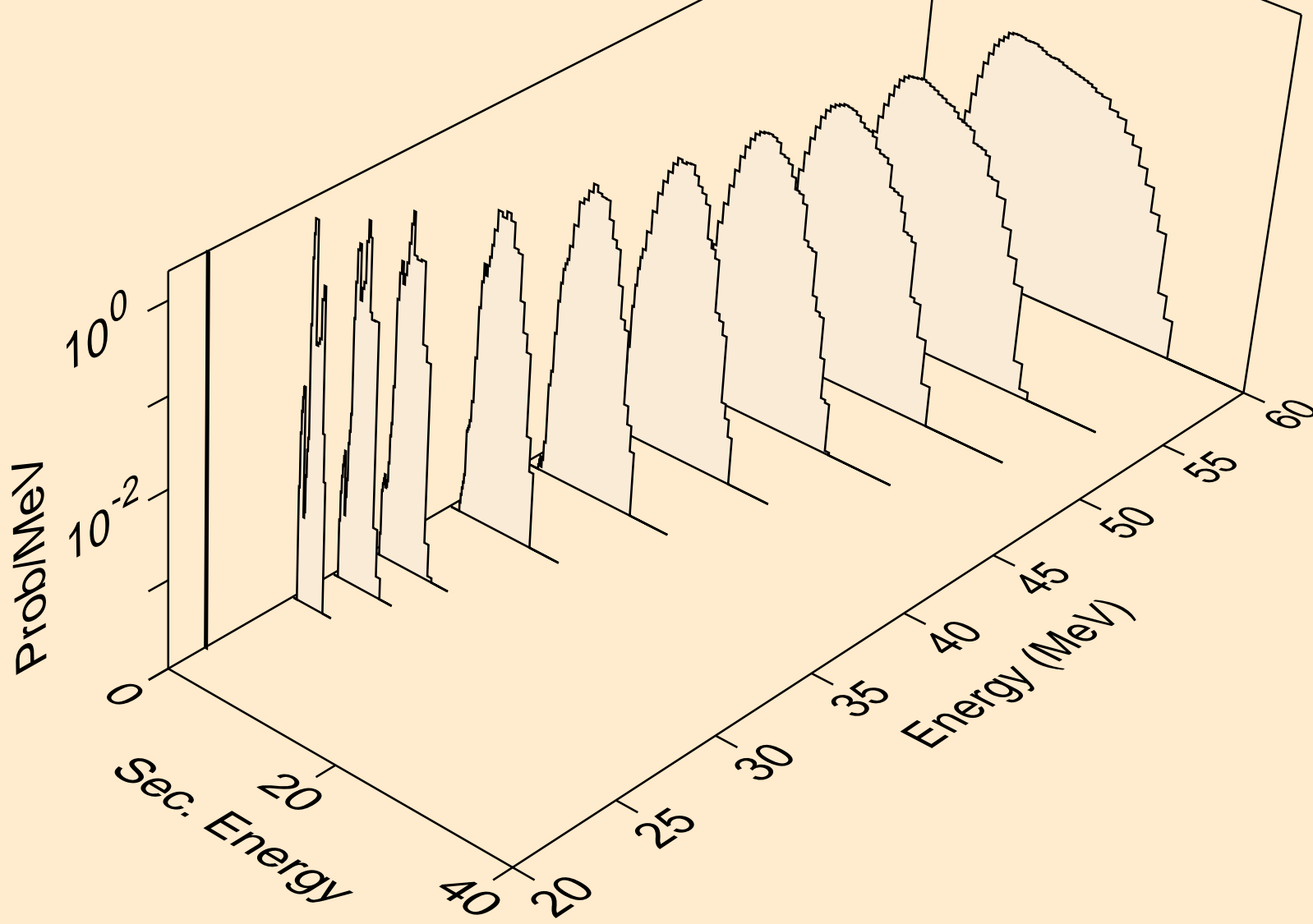

57-LA-138 FOR FENDL-3.2 PROCESSED BY NJOY2016.60+ ON
protons from (n,phe3)

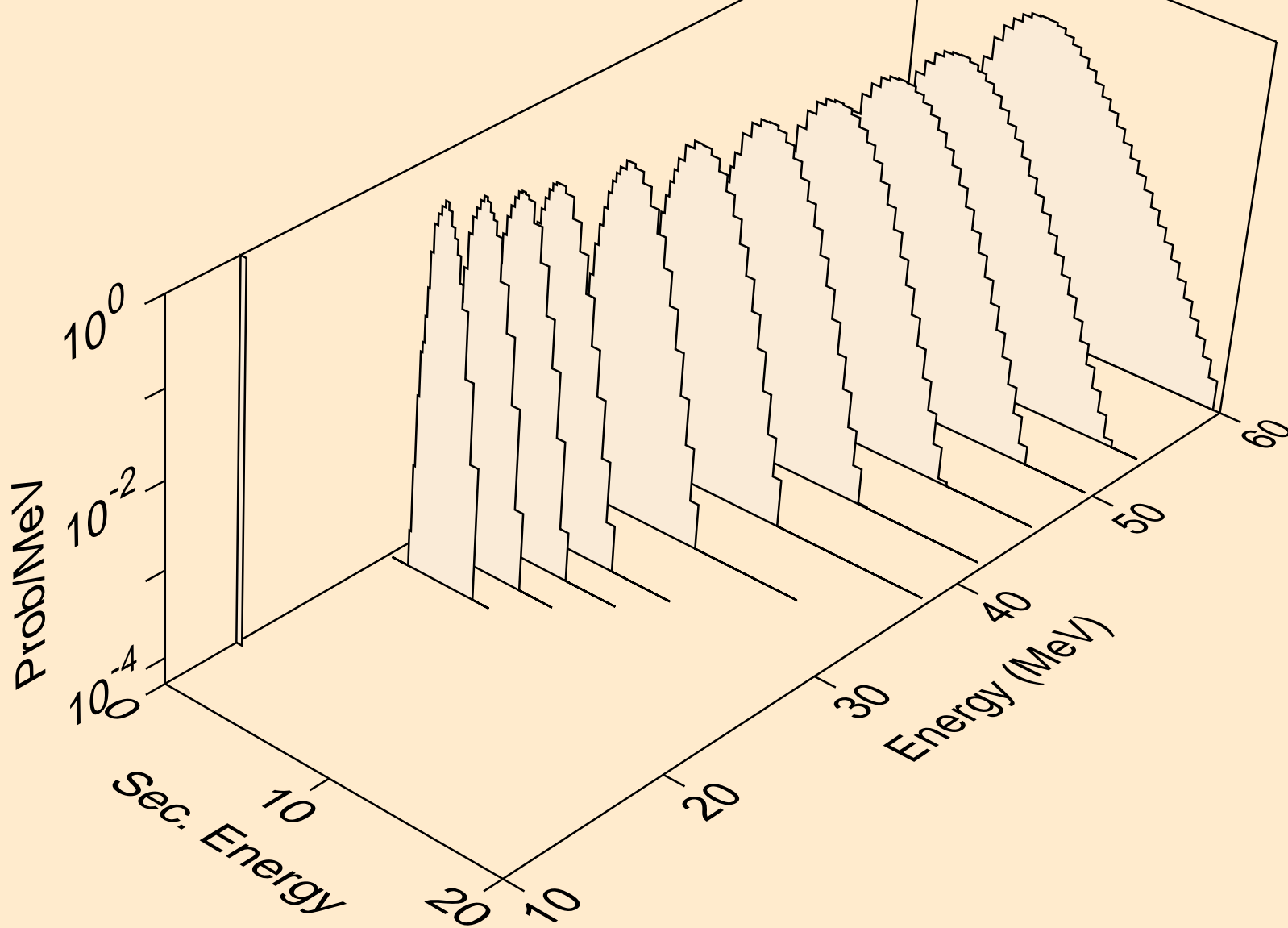

57-LA-138 FOR FENDL-3.2 PROCESSED BY NJOY2016.60+ ON
protons from (n,4n2p)

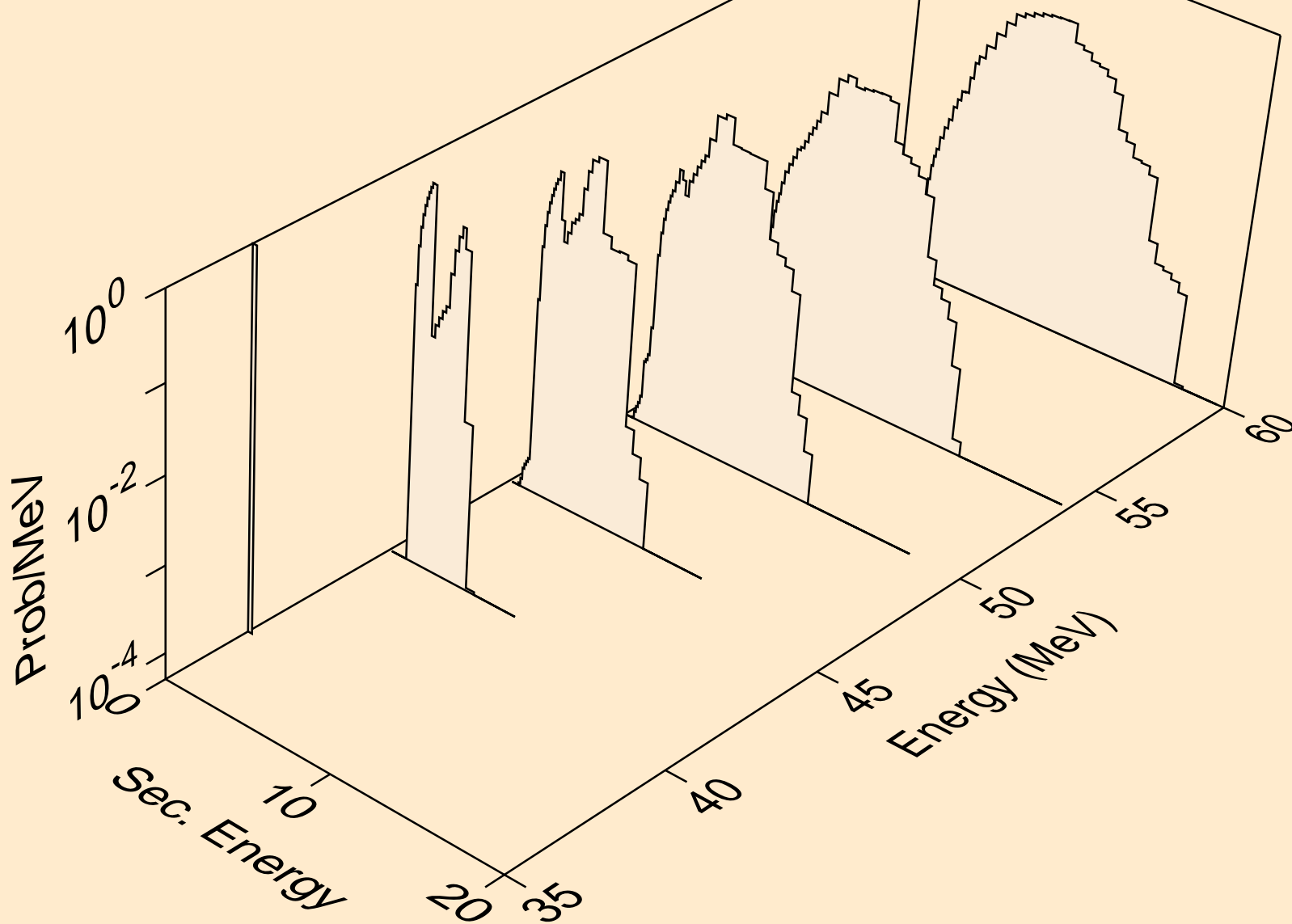

57-LA-138 FOR FENDL-3.2 PROCESSED BY NJOY2016.60+ ON
protons from (n,4npa)

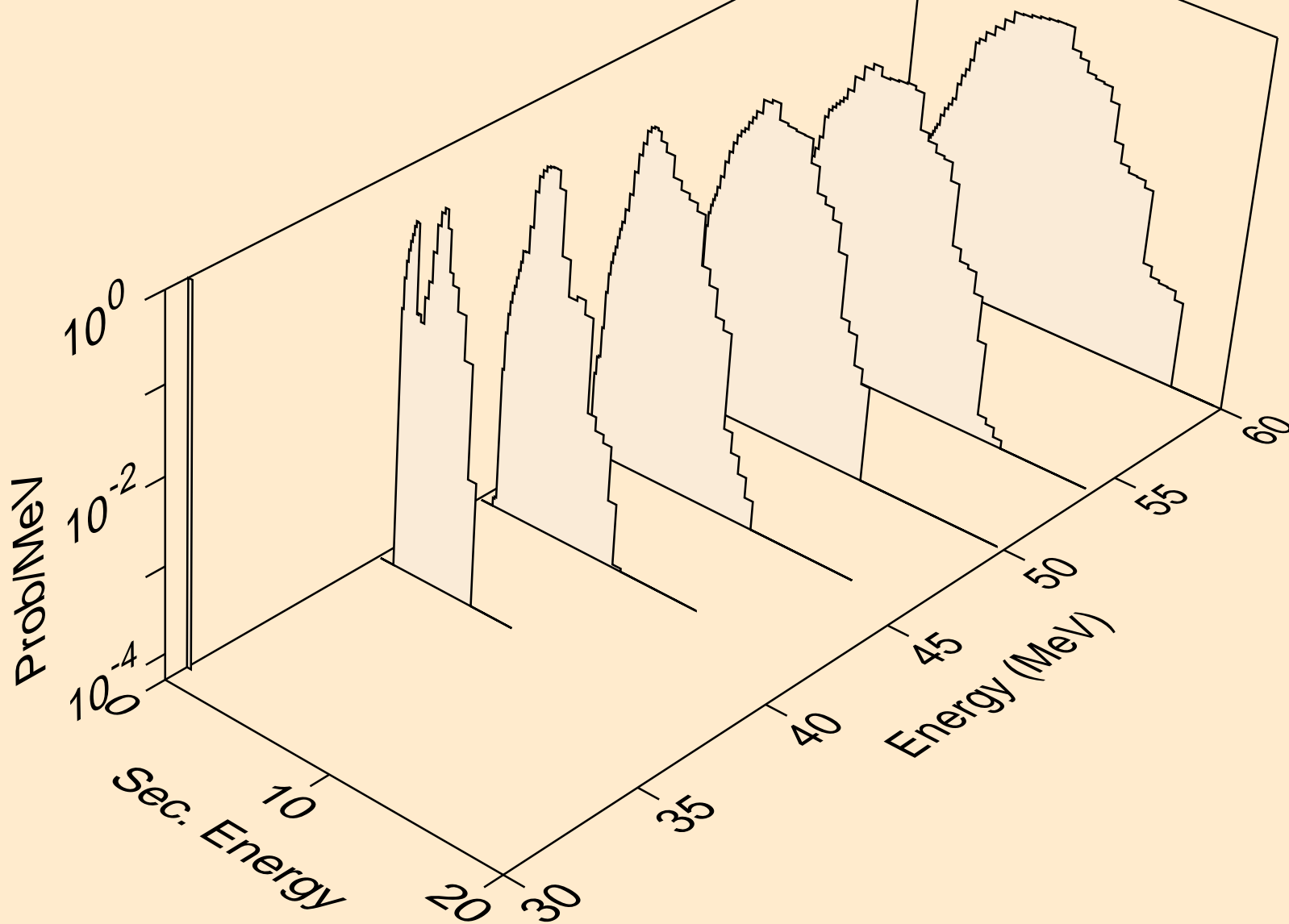

57-LA-138 FOR FENDL-3.2 PROCESSED BY NJOY2016.60+ ON
protons from (n,3p)

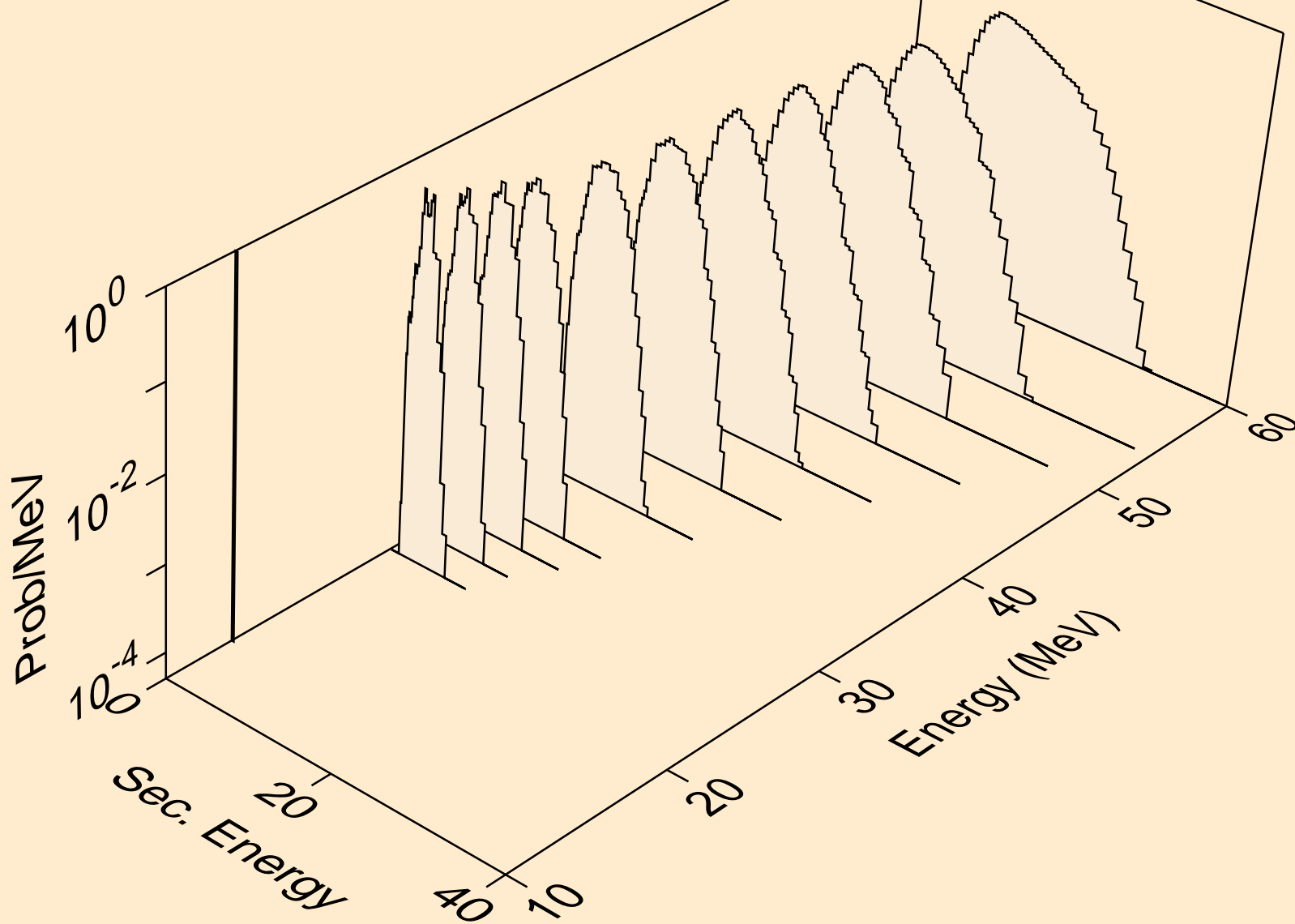

57-LA-138 FOR FENDL-3.2 PROCESSED BY NJOY2016.60+ ON
protons from (n,n3p)

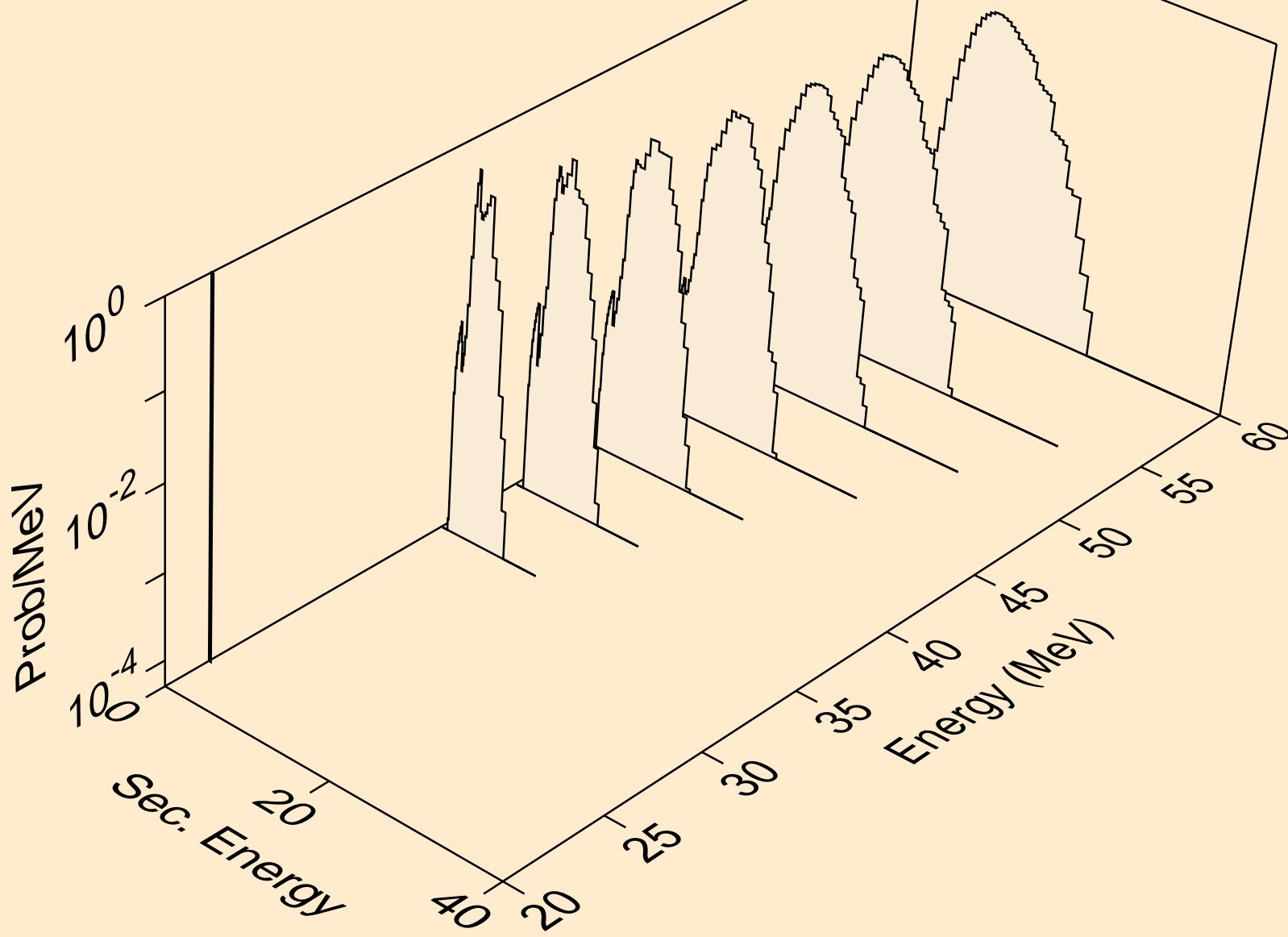

57-LA-138 FOR FENDL-3.2 PROCESSED BY NJOY2016.60+ ON
protons from (n,3n2pa)

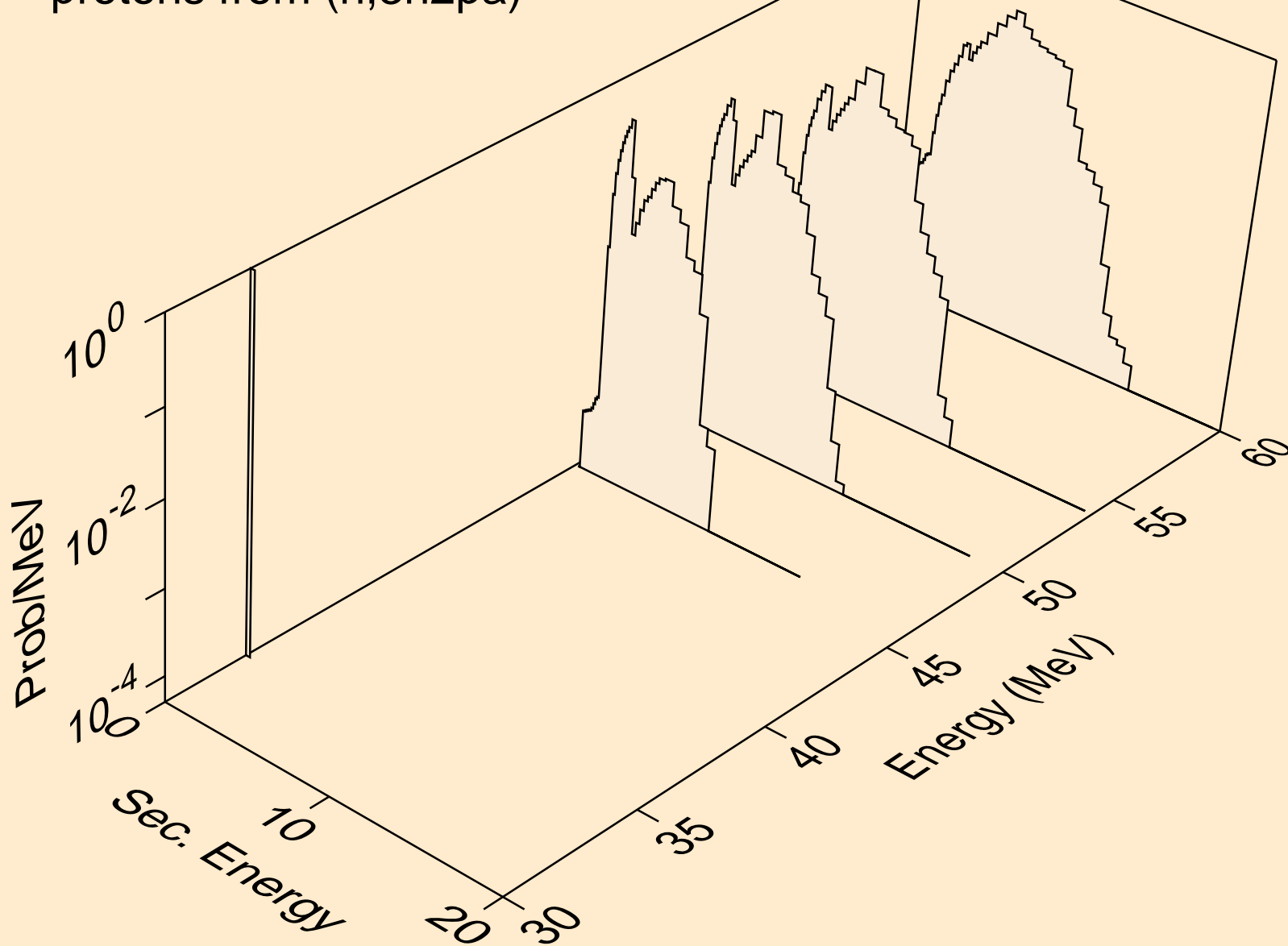

57-LA-138 FOR FENDL-3.2 PROCESSED BY NJOY2016.60+ ON
protons from (n,5n2p)

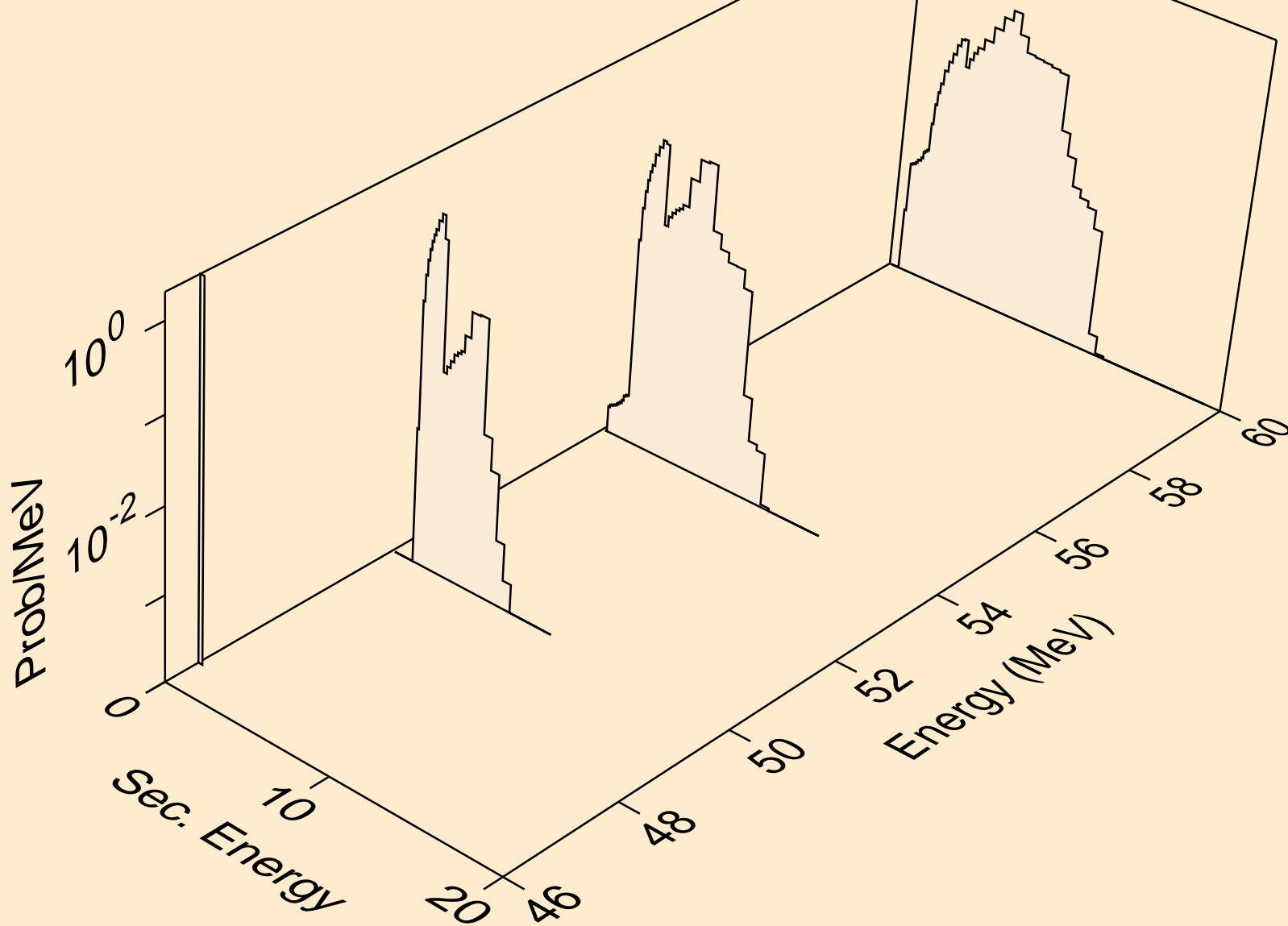

57-LA-138 FOR FENDL-3.2 PROCESSED BY NJOY2016.60+ ON
deuterons from (n,x)

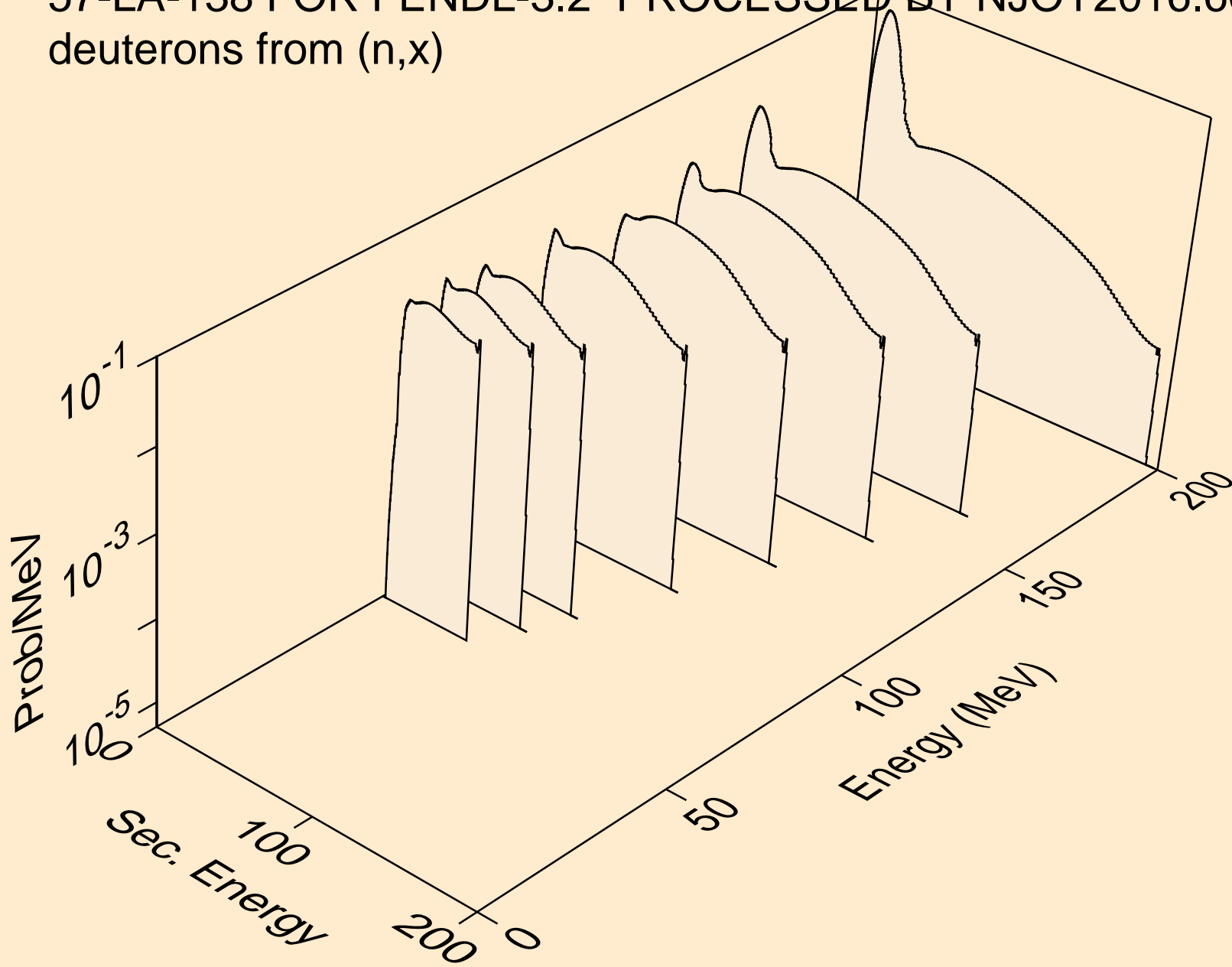

57-LA-138 FOR FENDL-3.2 PROCESSED BY NJOY2016.60+ ON
deuterons from (n,2nd)

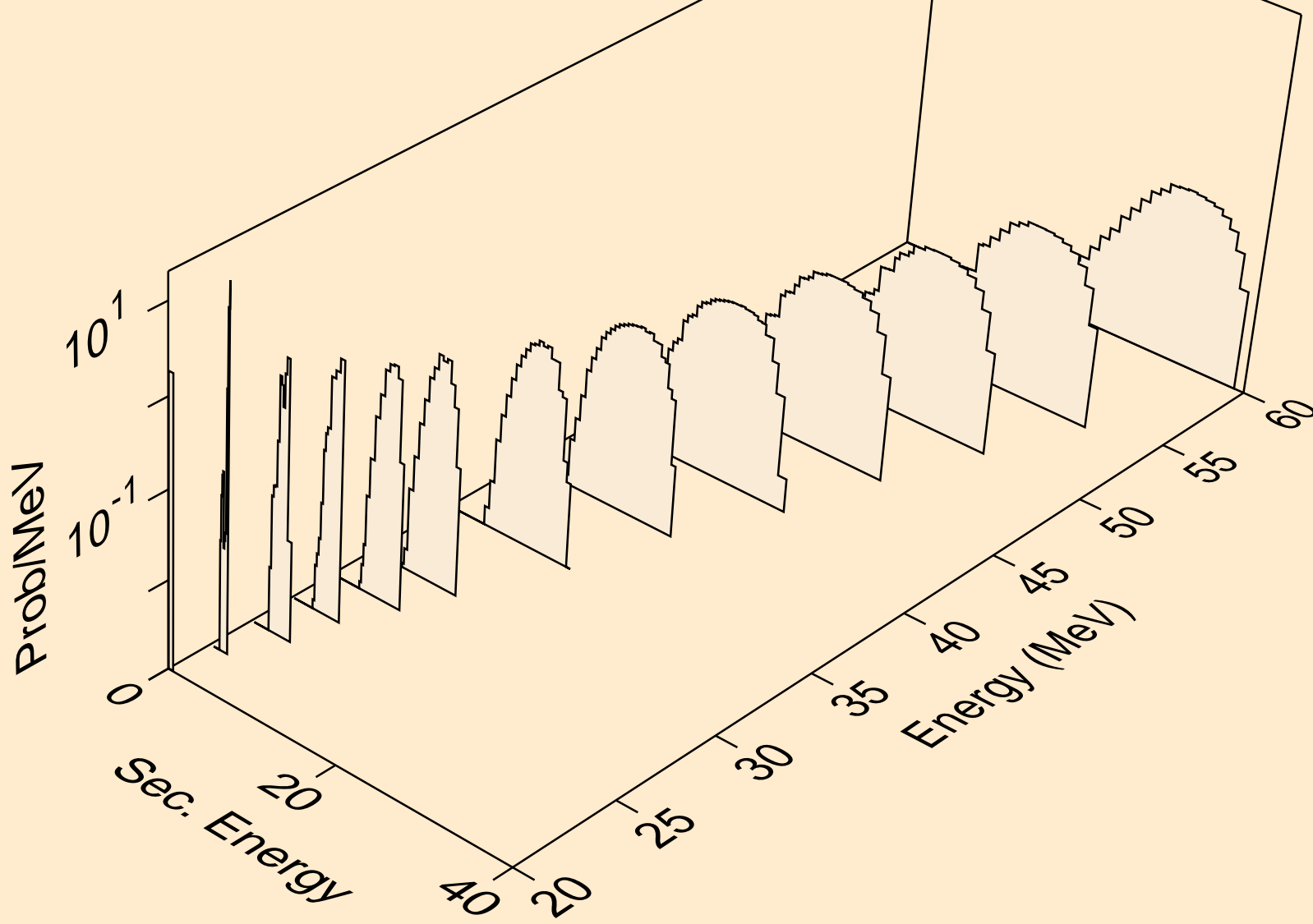

57-LA-138 FOR FENDL-3.2 PROCESSED BY NJOY2016.60+ ON
deuterons from (n,n*)d

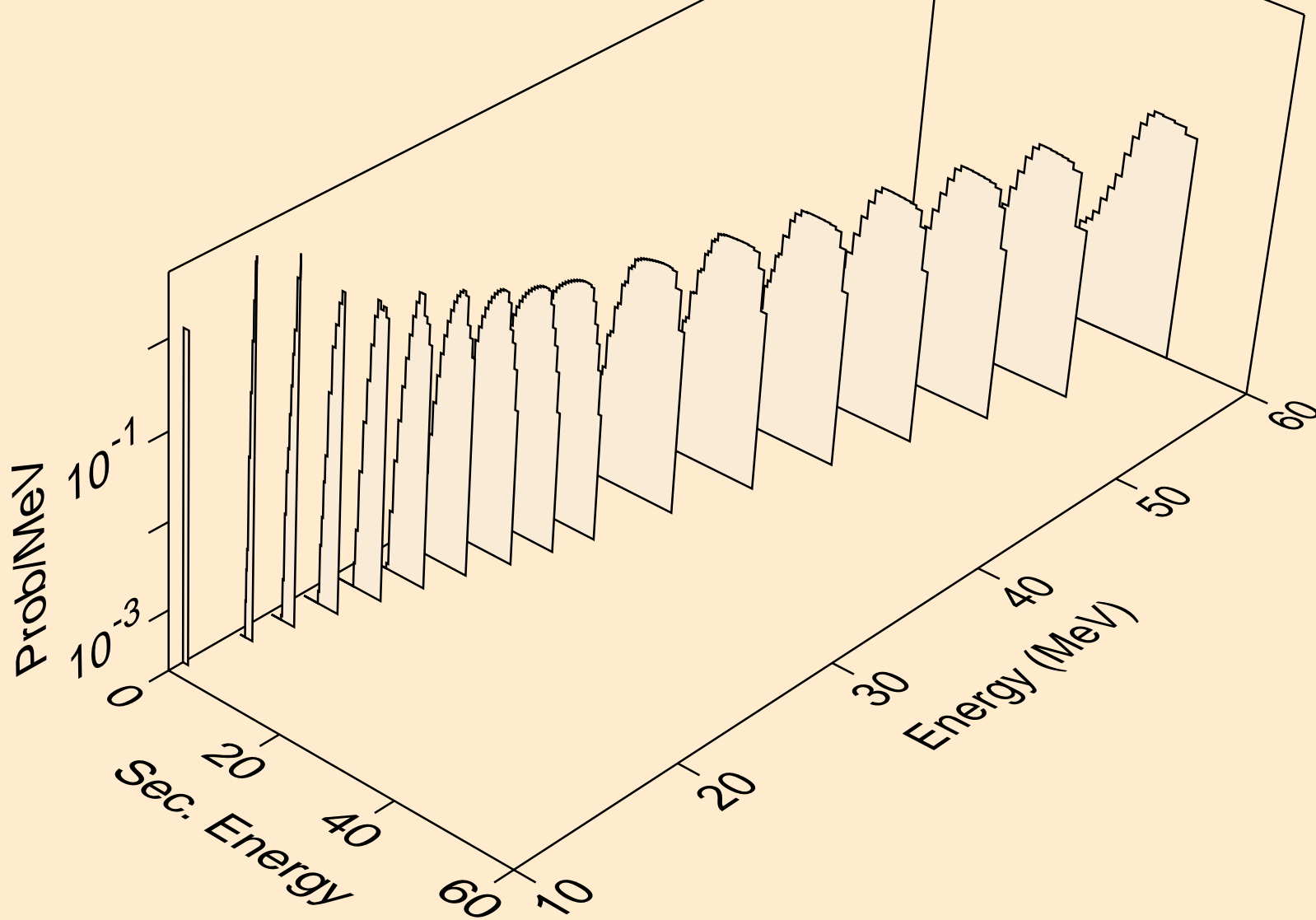

57-LA-138 FOR FENDL-3.2 PROCESSED BY NJOY2016.60+ ON
deuterons from (n,n*)d2a

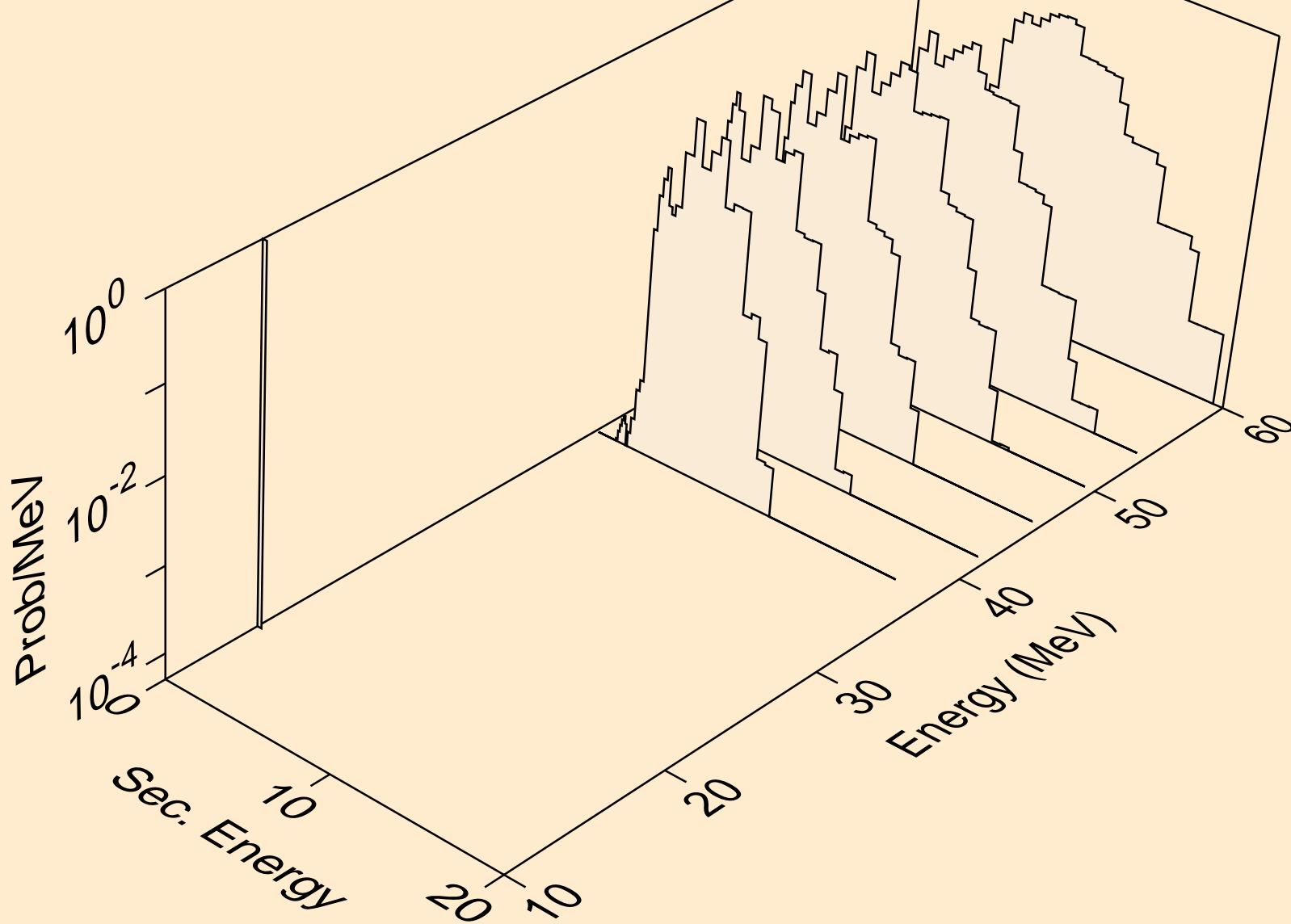

57-LA-138 FOR FENDL-3.2 PROCESSED BY NJOY2016.60+ ON
deuterons from (n,d)

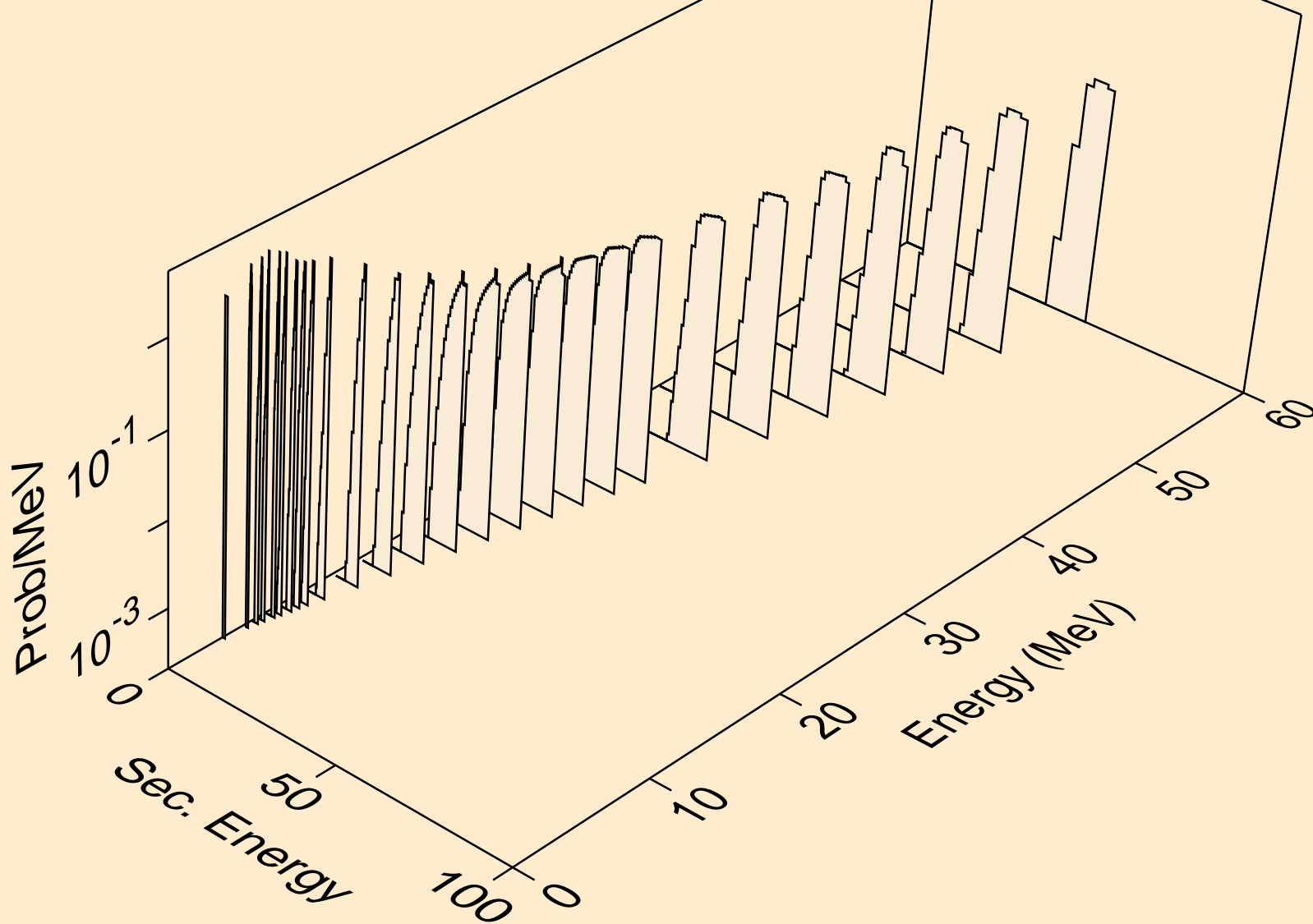

57-LA-138 FOR FENDL-3.2 PROCESSED BY NJOY2016.60+ ON
deuterons from (n,d2a)

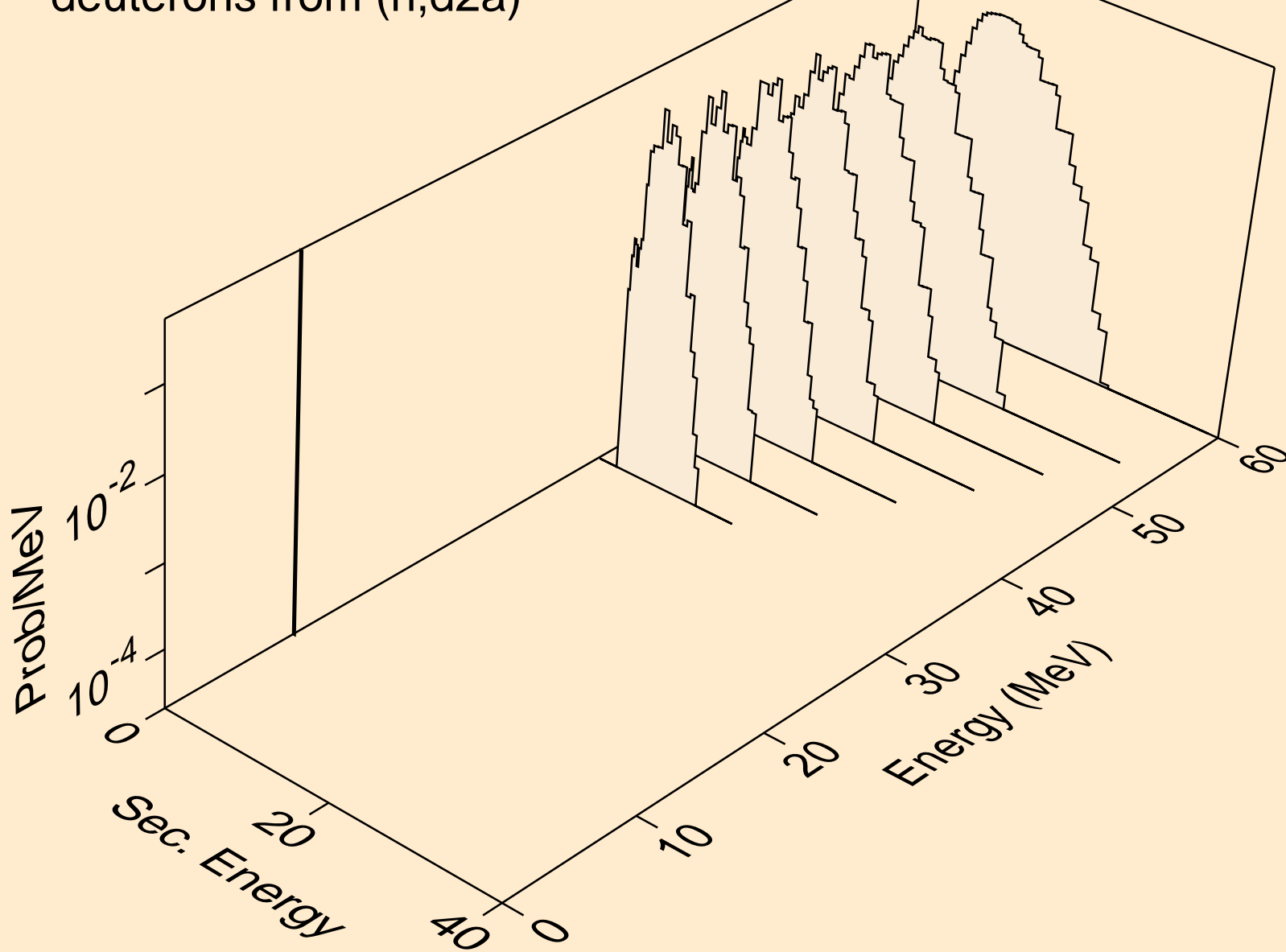

57-LA-138 FOR FENDL-3.2 PROCESSED BY NJOY2016.60+ ON
deuterons from (n,pd)

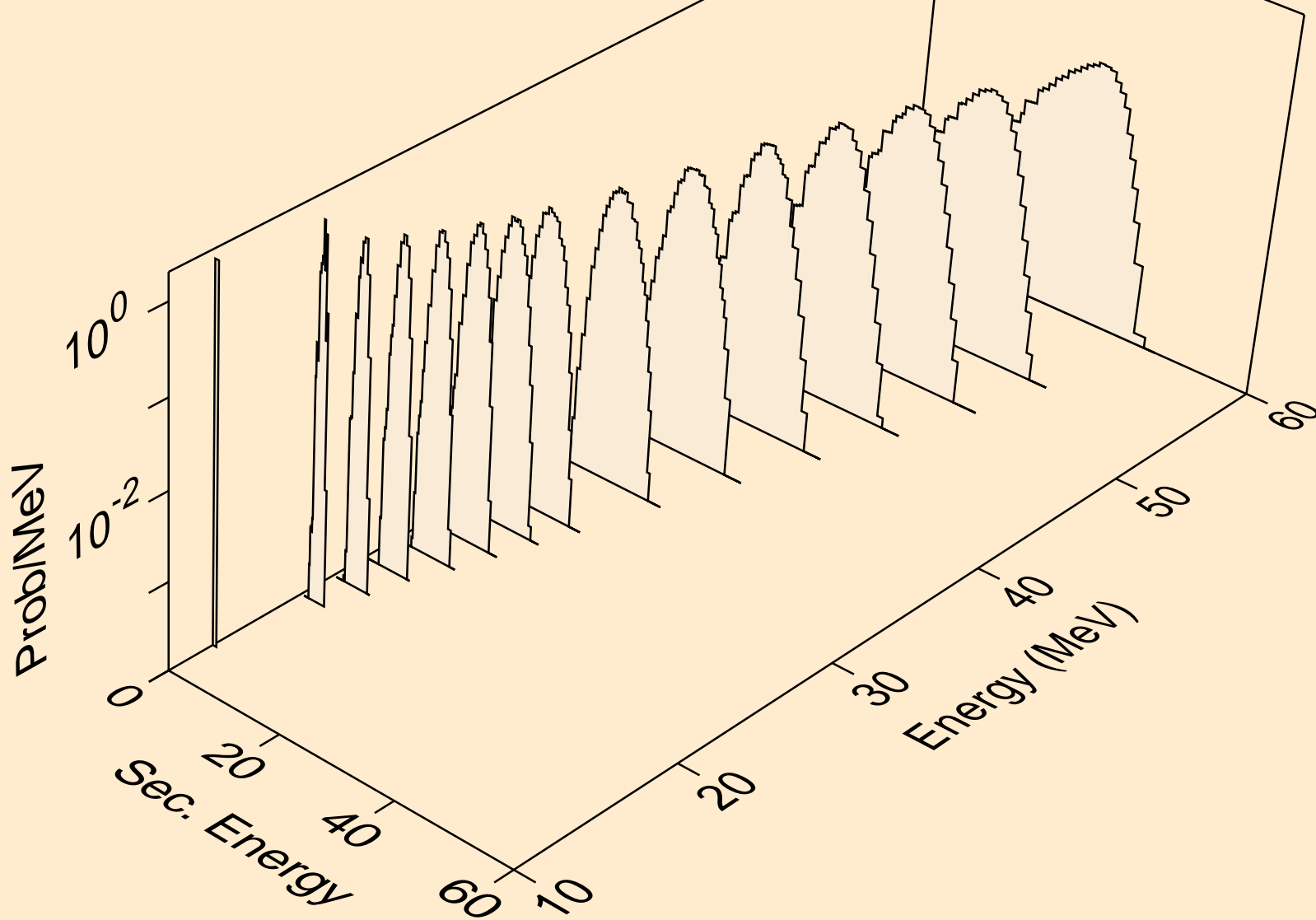

57-LA-138 FOR FENDL-3.2 PROCESSED BY NJOY2016.60+ ON
deuterons from (n,da)

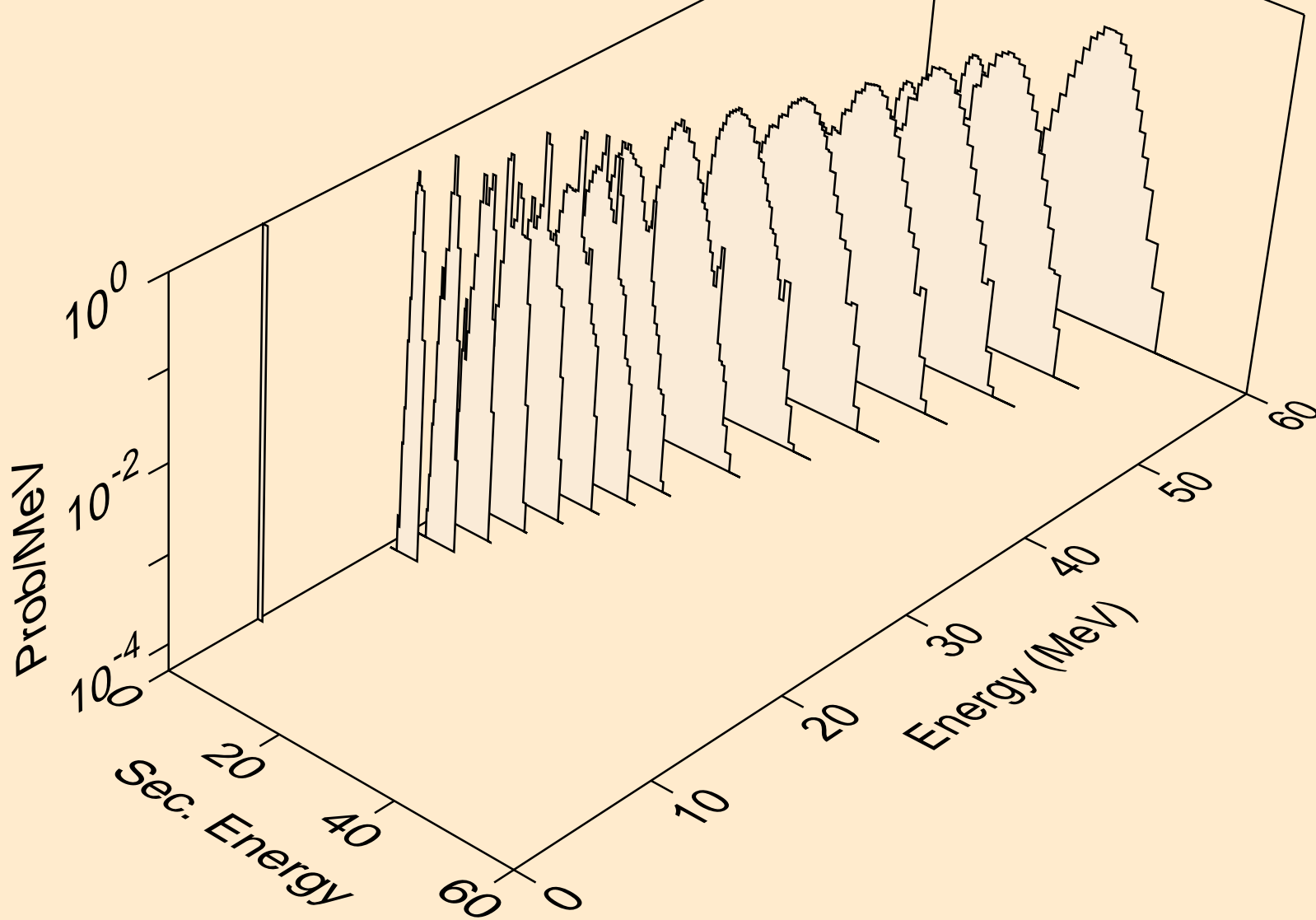

57-LA-138 FOR FENDL-3.2 PROCESSED BY NJOY2016.60+ ON
deuterons from (n,3nd)

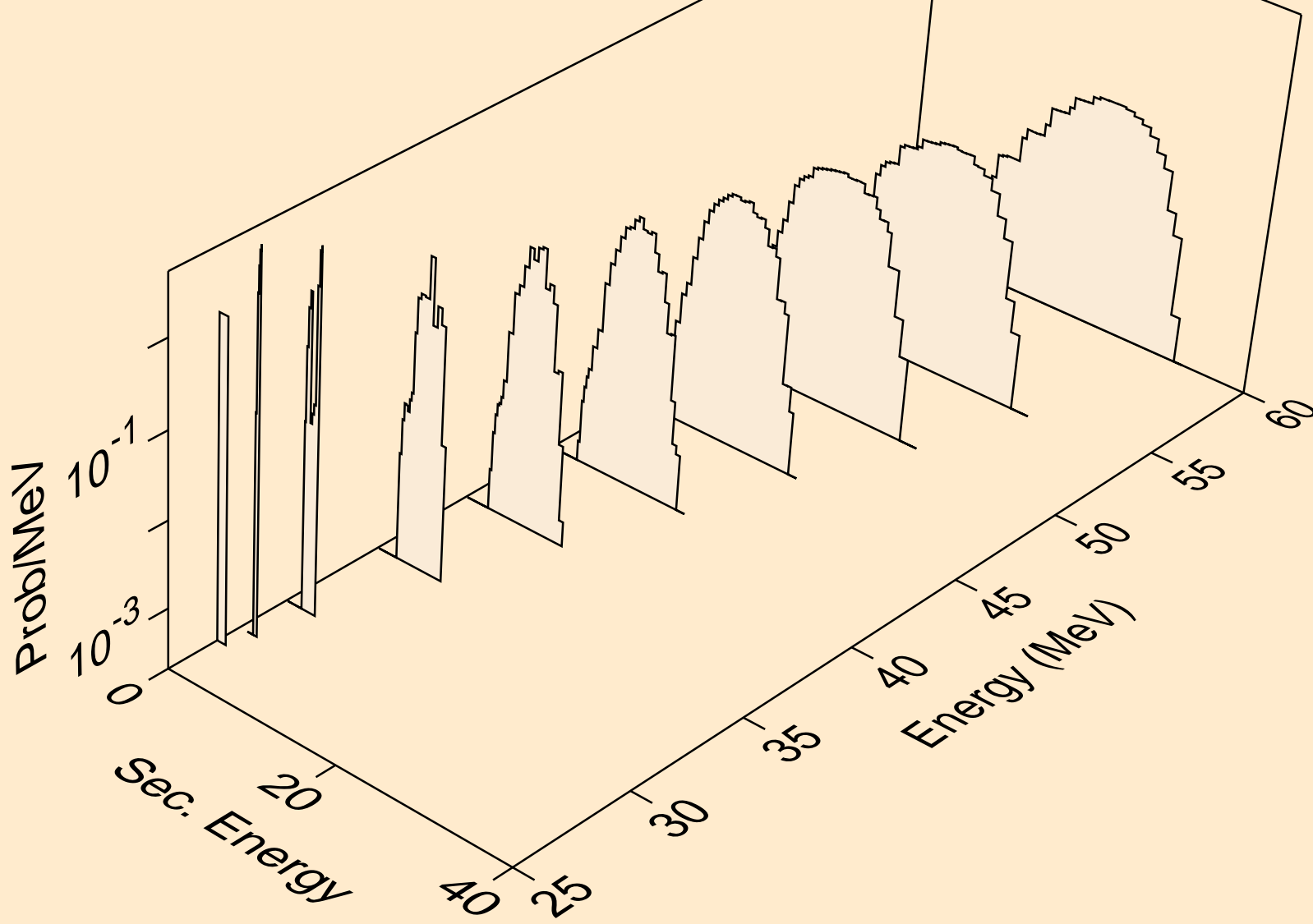

57-LA-138 FOR FENDL-3.2 PROCESSED BY NJOY2016.60+ ON
deuterons from (n,nda)

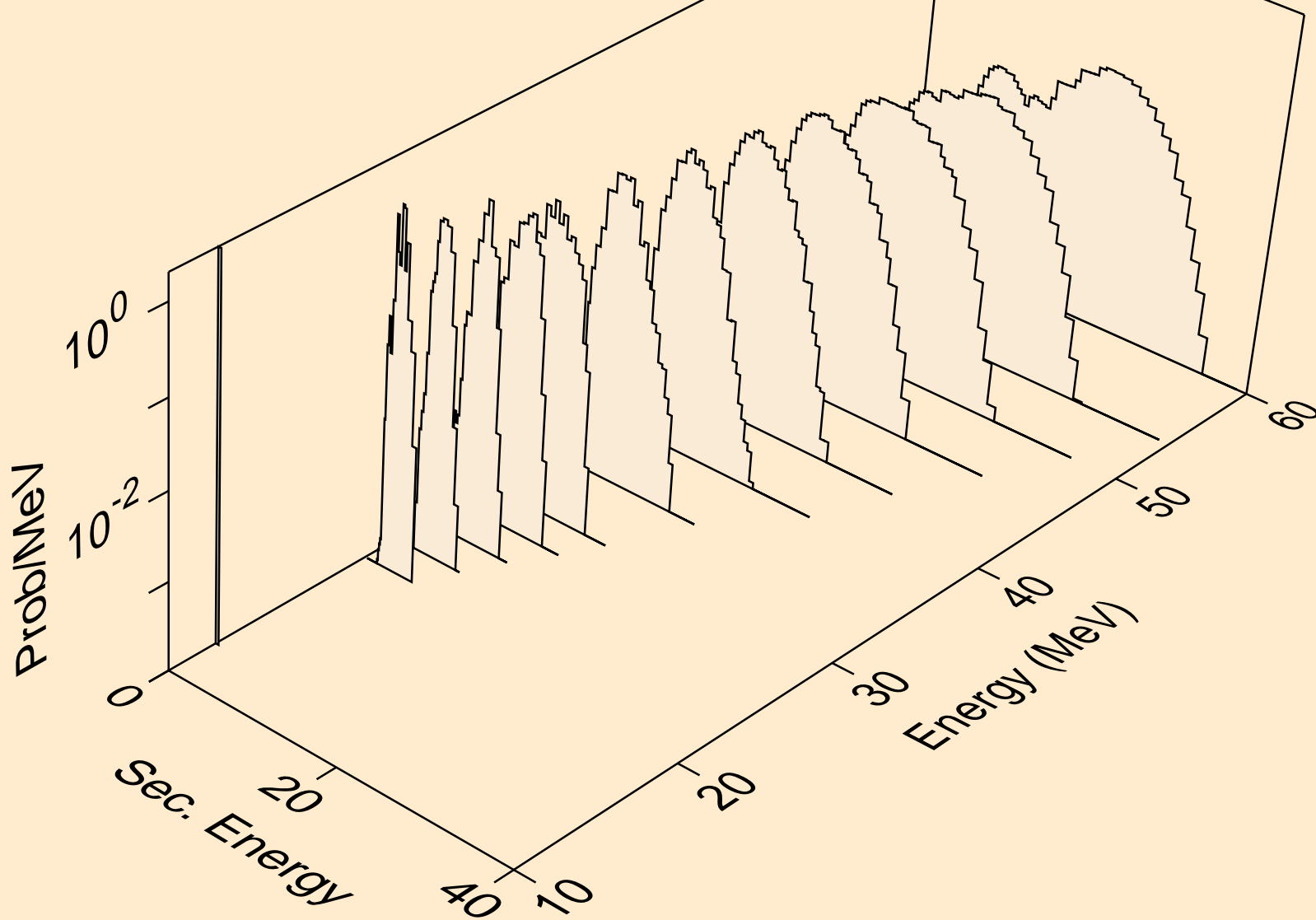

57-LA-138 FOR FENDL-3.2 PROCESSED BY NJOY2016.60+ ON
deuterons from (n,4nd)

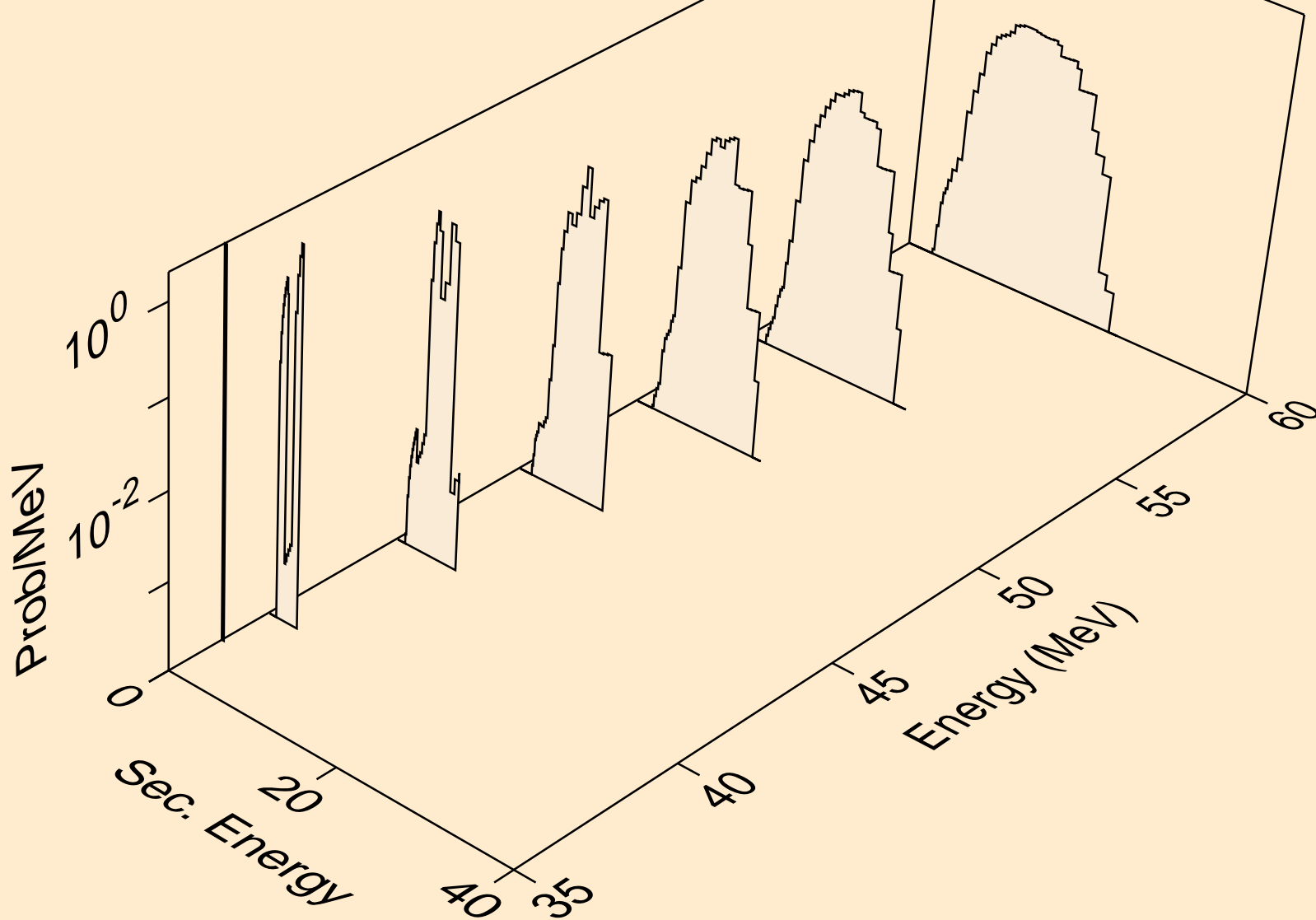

57-LA-138 FOR FENDL-3.2 PROCESSED BY NJOY2016.60+ ON
deuterons from (n,5nd)

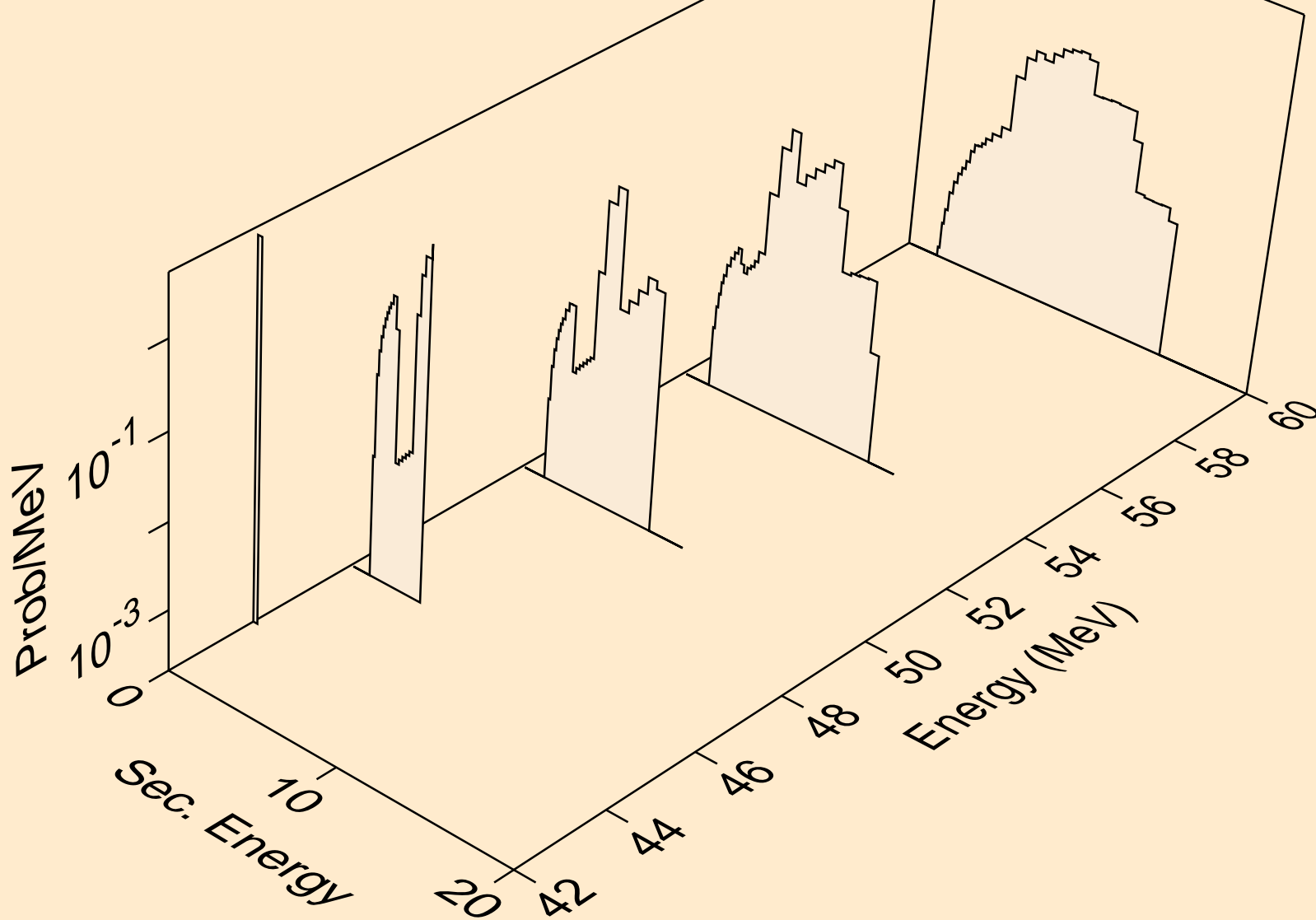

57-LA-138 FOR FENDL-3.2 PROCESSED BY NJOY2016.60+ ON
deuterons from (n,dt)

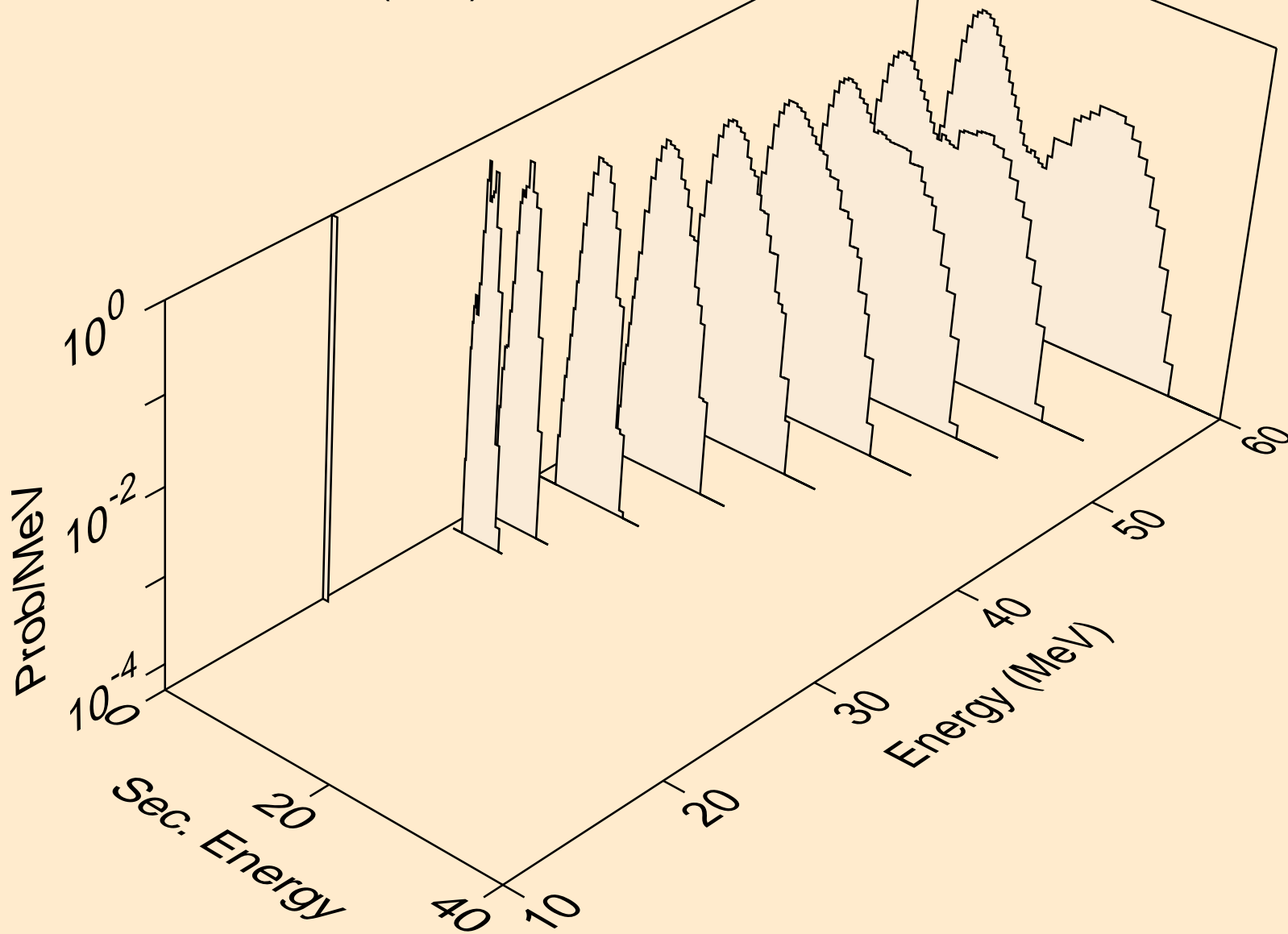

57-LA-138 FOR FENDL-3.2 PROCESSED BY NJOY2016.60+ ON
deuterons from (n,npd)

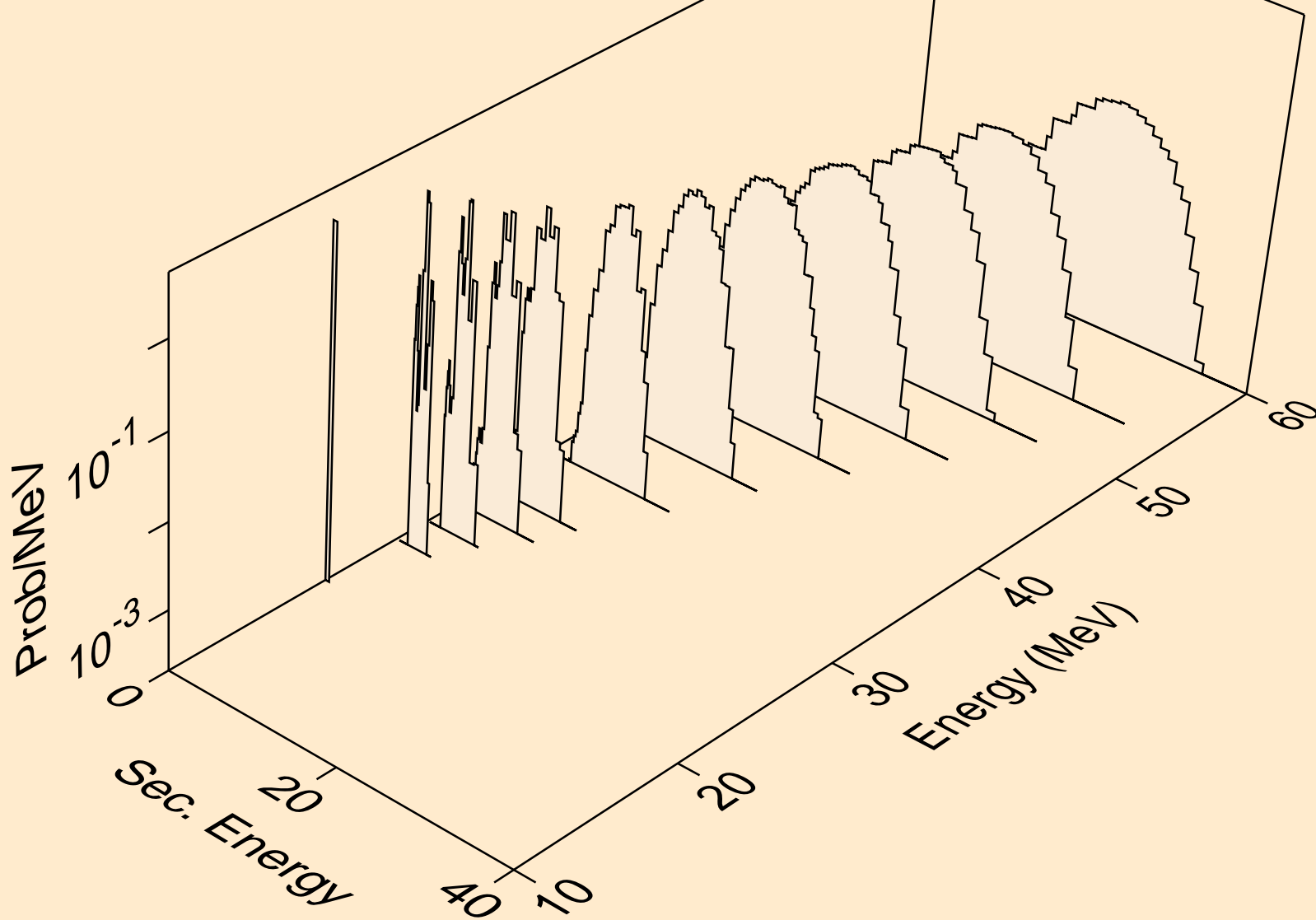

57-LA-138 FOR FENDL-3.2 PROCESSED BY NJOY2016.60+ ON
deuterons from (n,ndt)

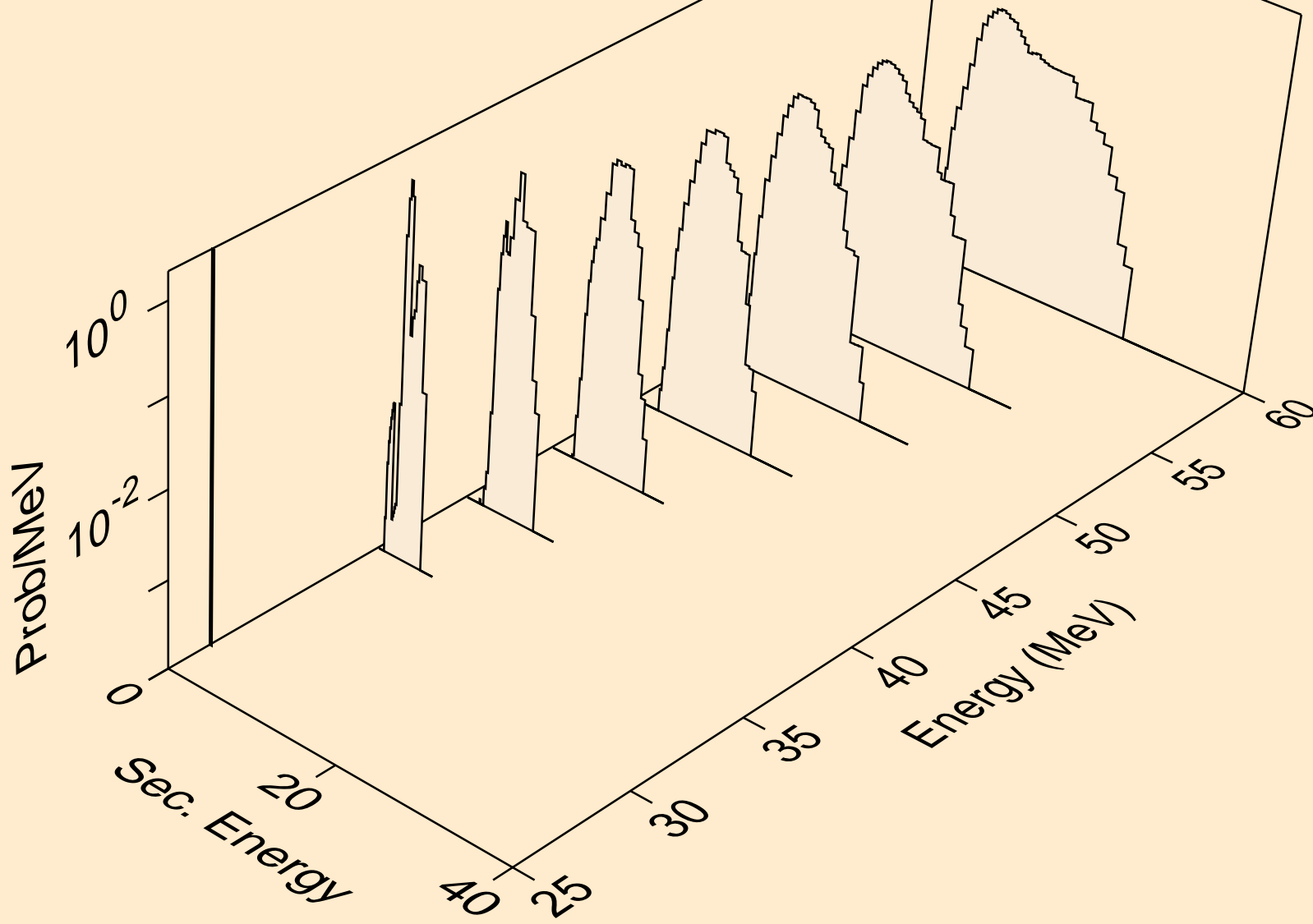

57-LA-138 FOR FENDL-3.2 PROCESSED BY NJOY2016.60+ ON
deuterons from (n,ndhe3)

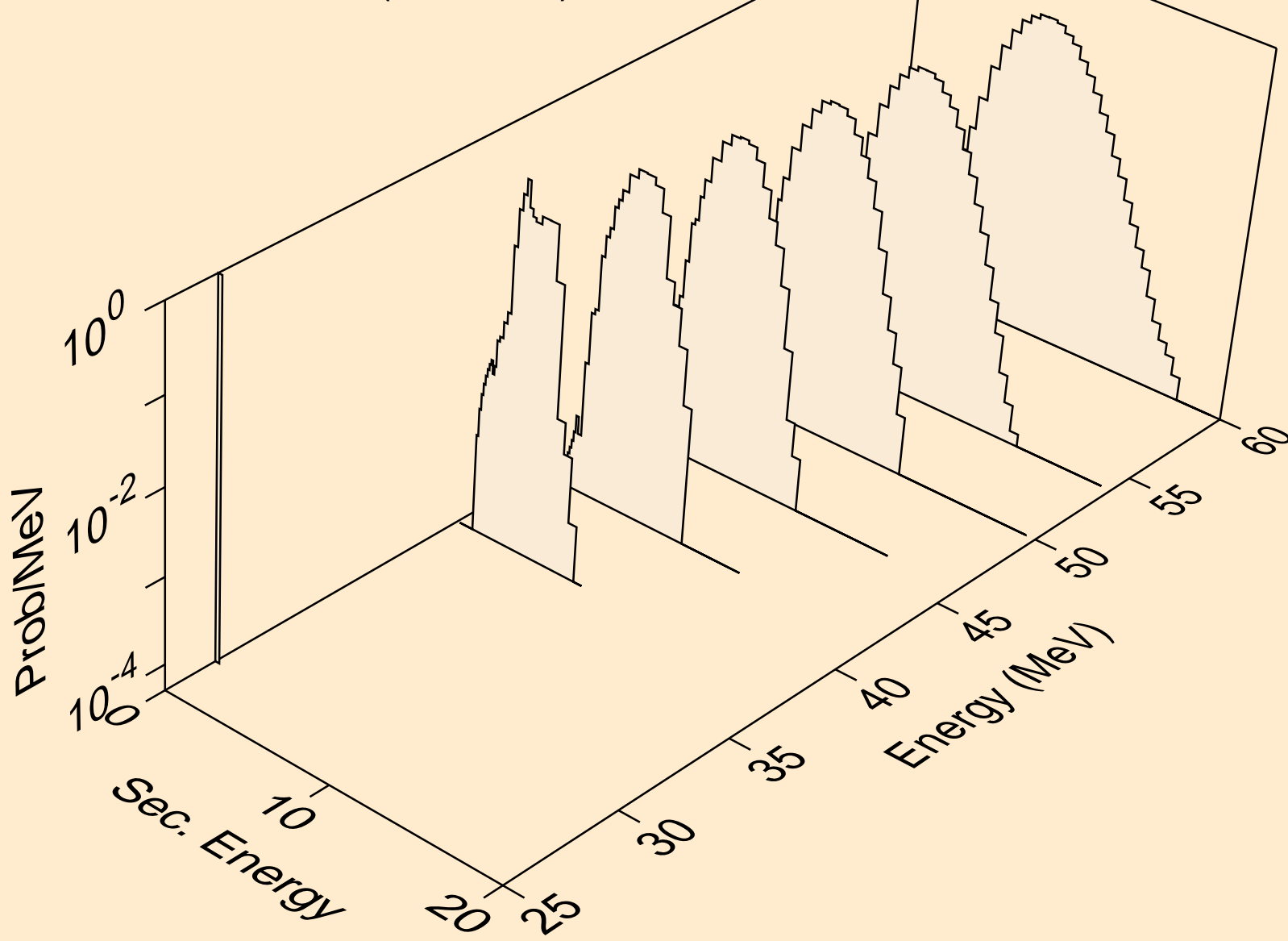

57-LA-138 FOR FENDL-3.2 PROCESSED BY NJOY2016.60+ ON
deuterons from (n,dhe3)

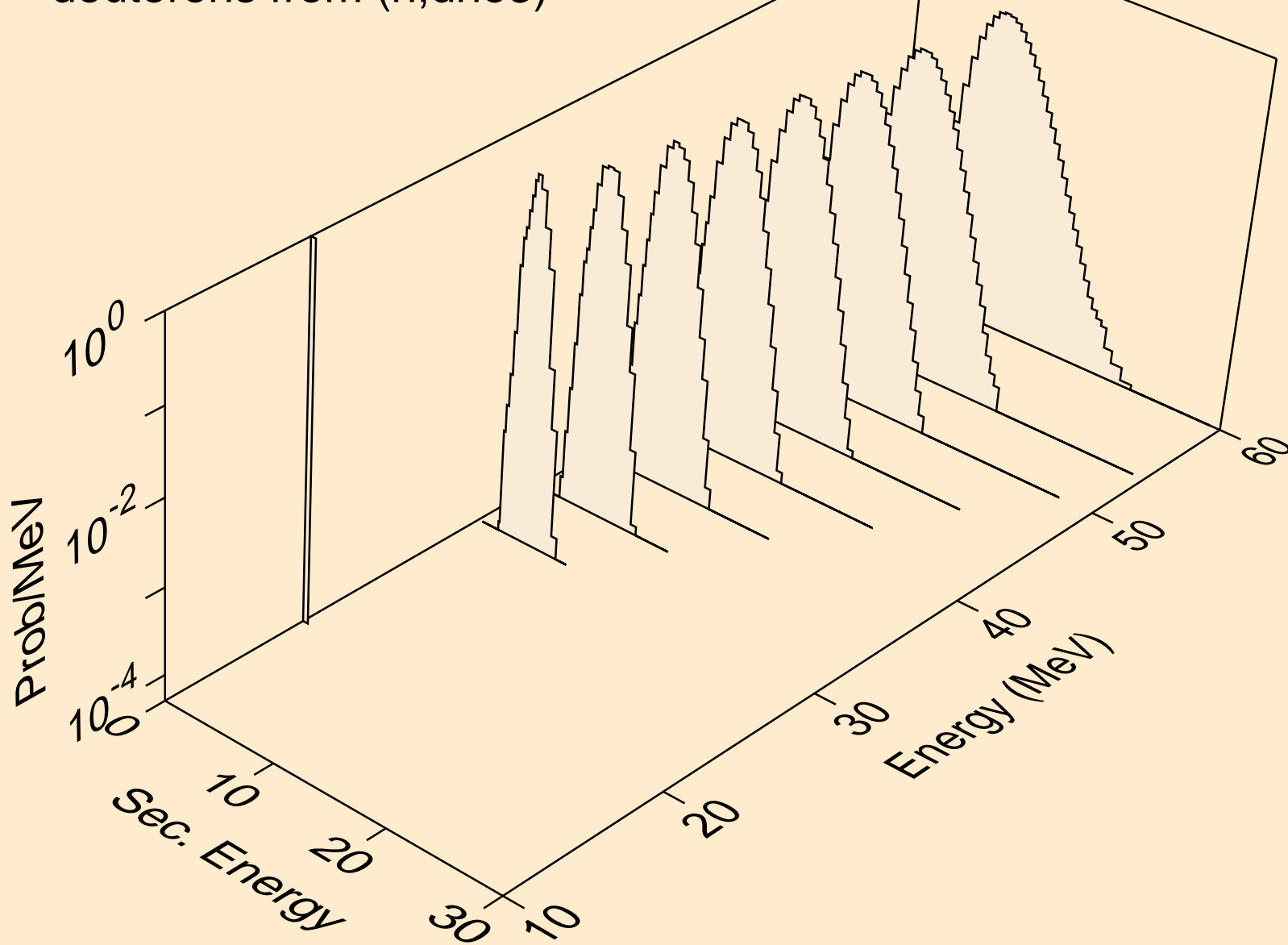

57-LA-138 FOR FENDL-3.2 PROCESSED BY NJOY2016.60+ ON
tritons from (n,x)

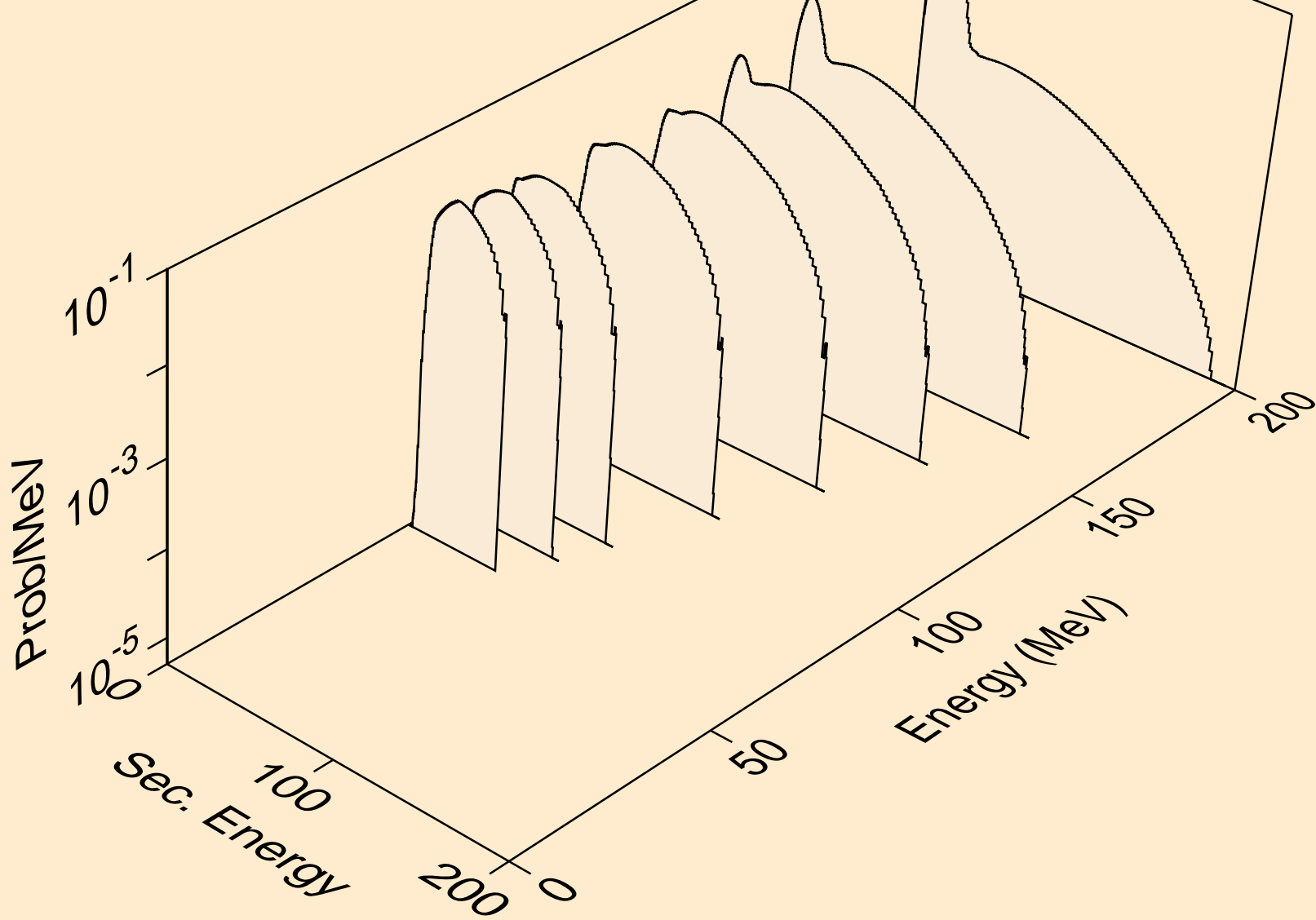

57-LA-138 FOR FENDL-3.2 PROCESSED BY NJOY2016.60+ ON
tritons from (n,n*)t

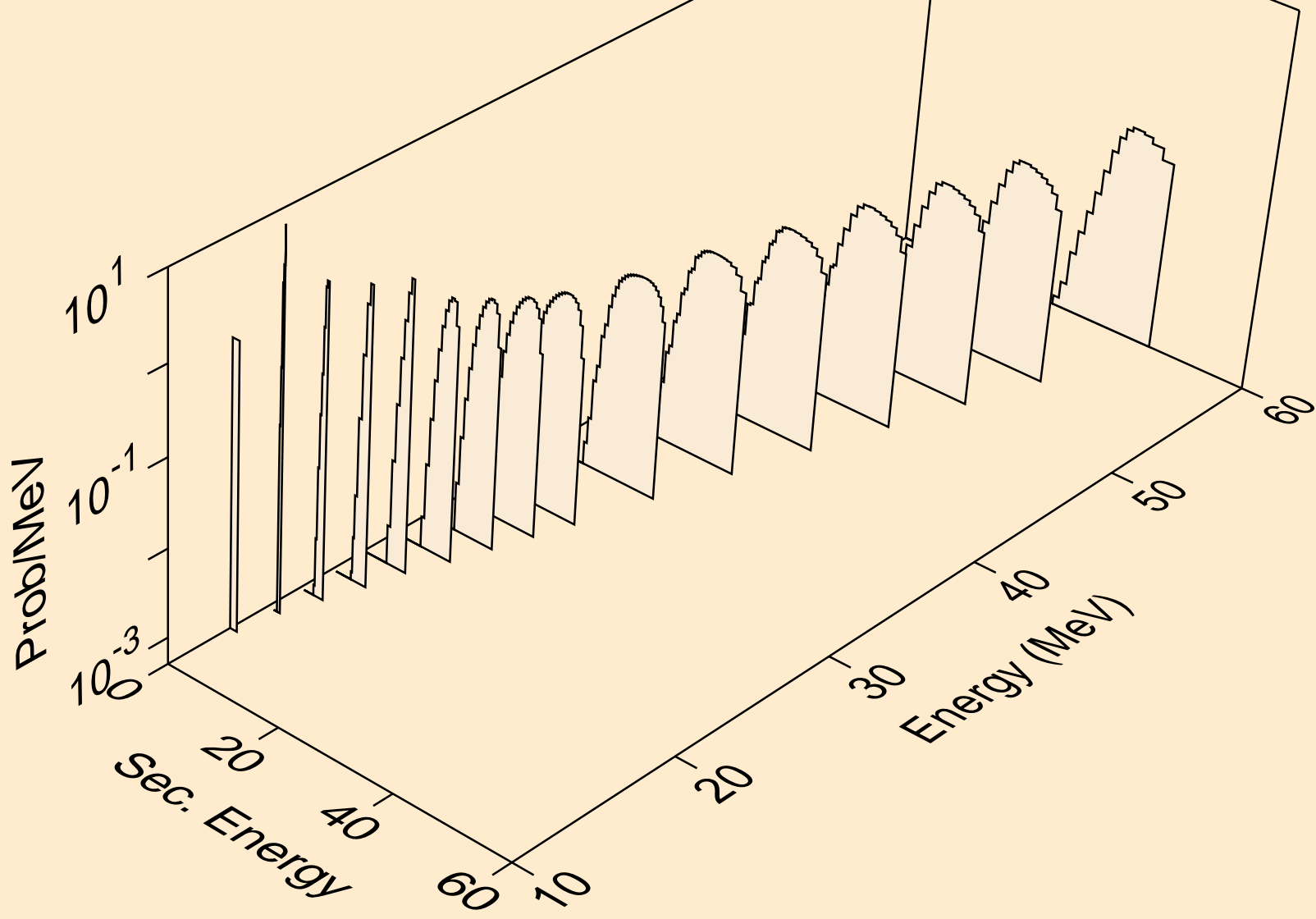

57-LA-138 FOR FENDL-3.2 PROCESSED BY NJOY2016.60+ ON
tritons from (n,t)

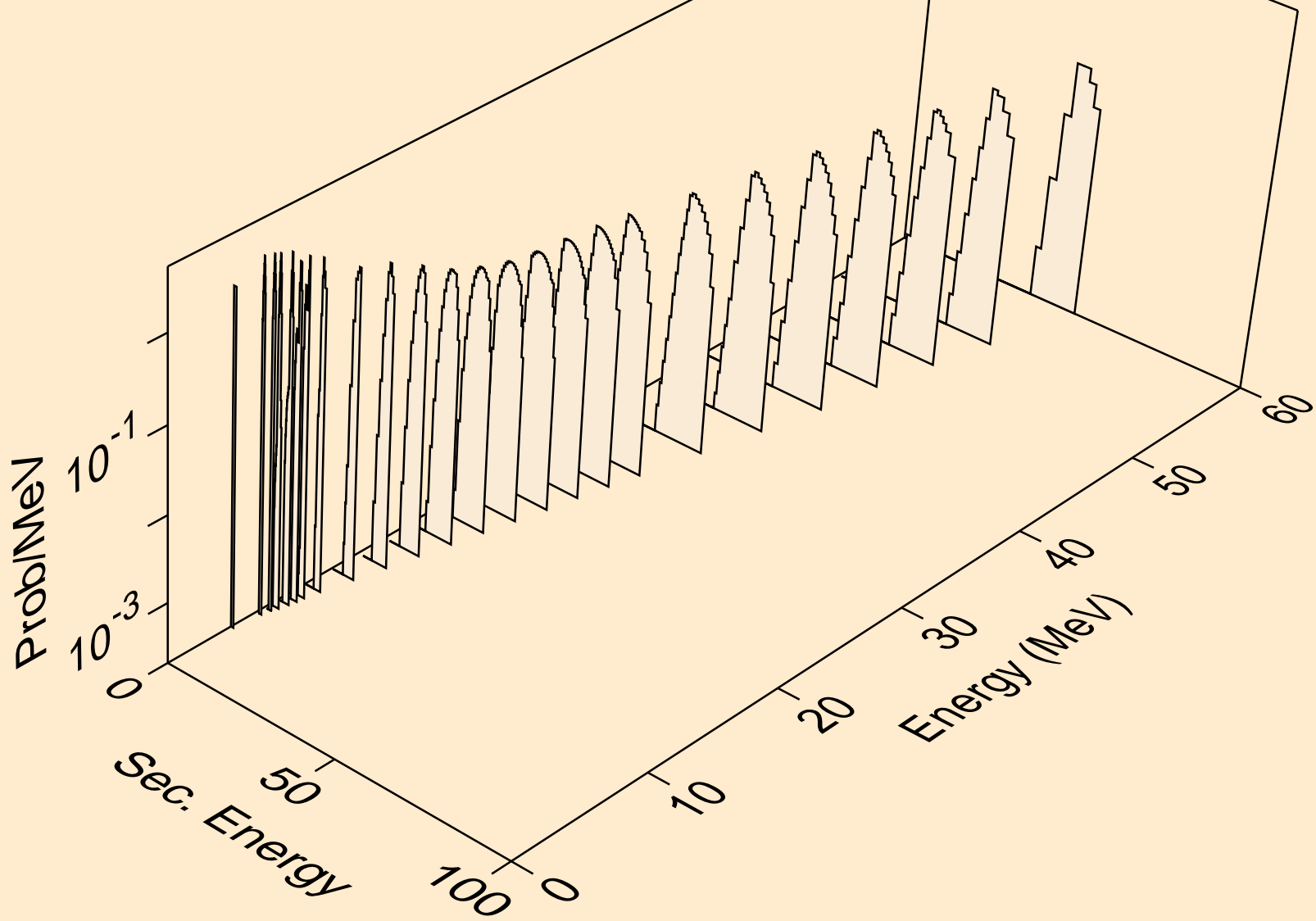

57-LA-138 FOR FENDL-3.2 PROCESSED BY NJOY2016.60+ ON
tritons from (n,pt)

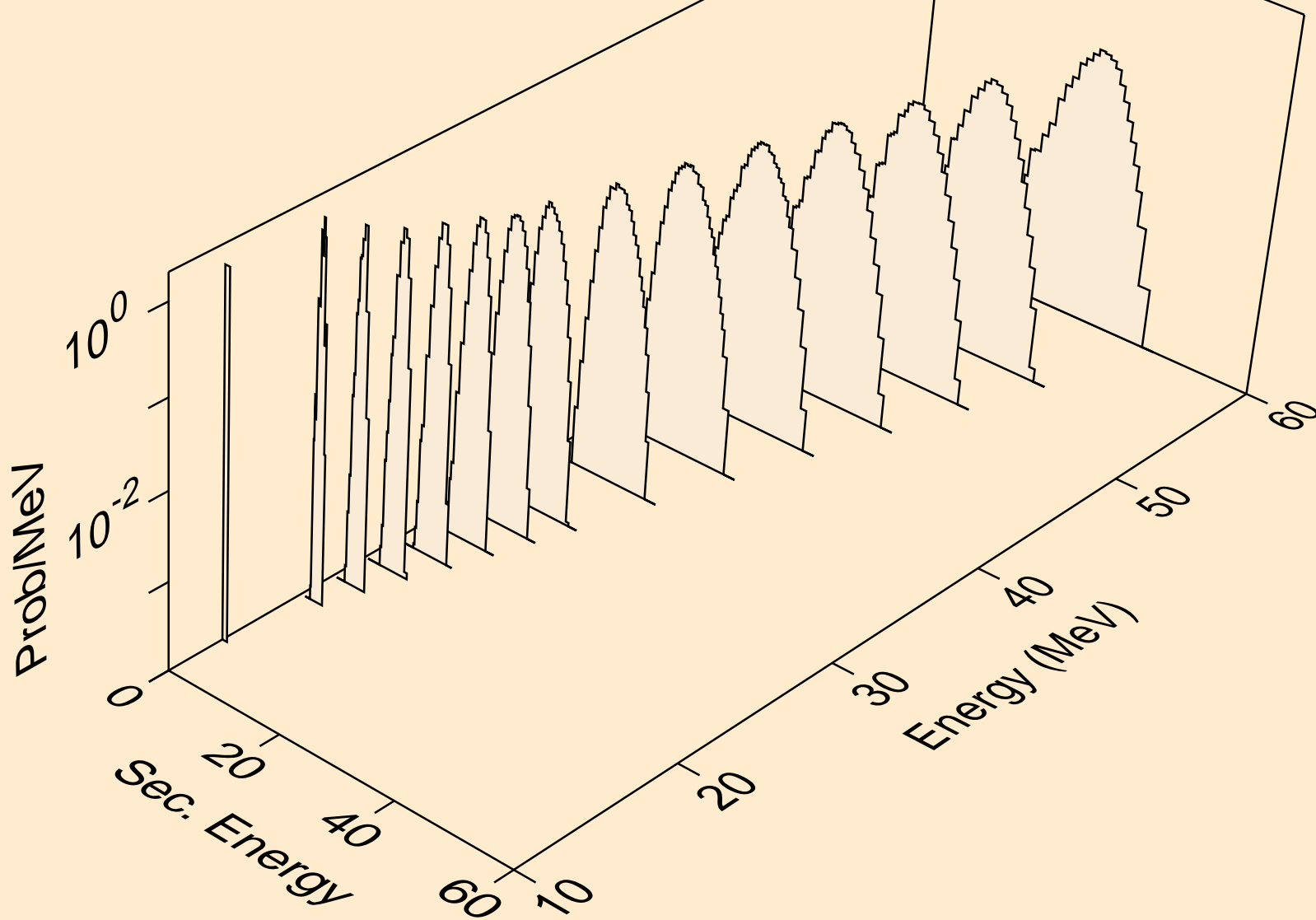

57-LA-138 FOR FENDL-3.2 PROCESSED BY NJOY2016.60+ ON
tritons from (n,2nt)

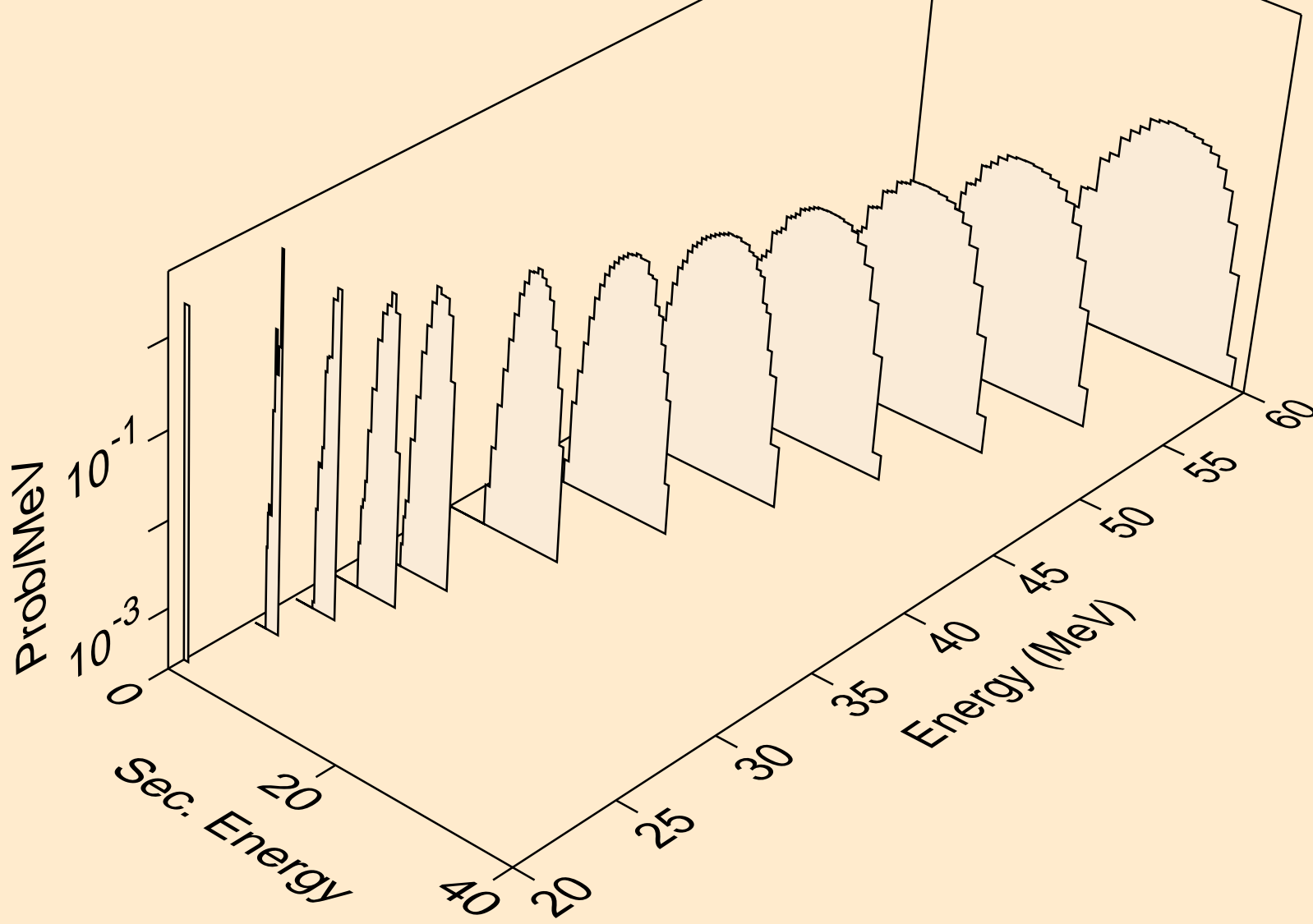

57-LA-138 FOR FENDL-3.2 PROCESSED BY NJOY2016.60+ ON
tritons from (n,ta)

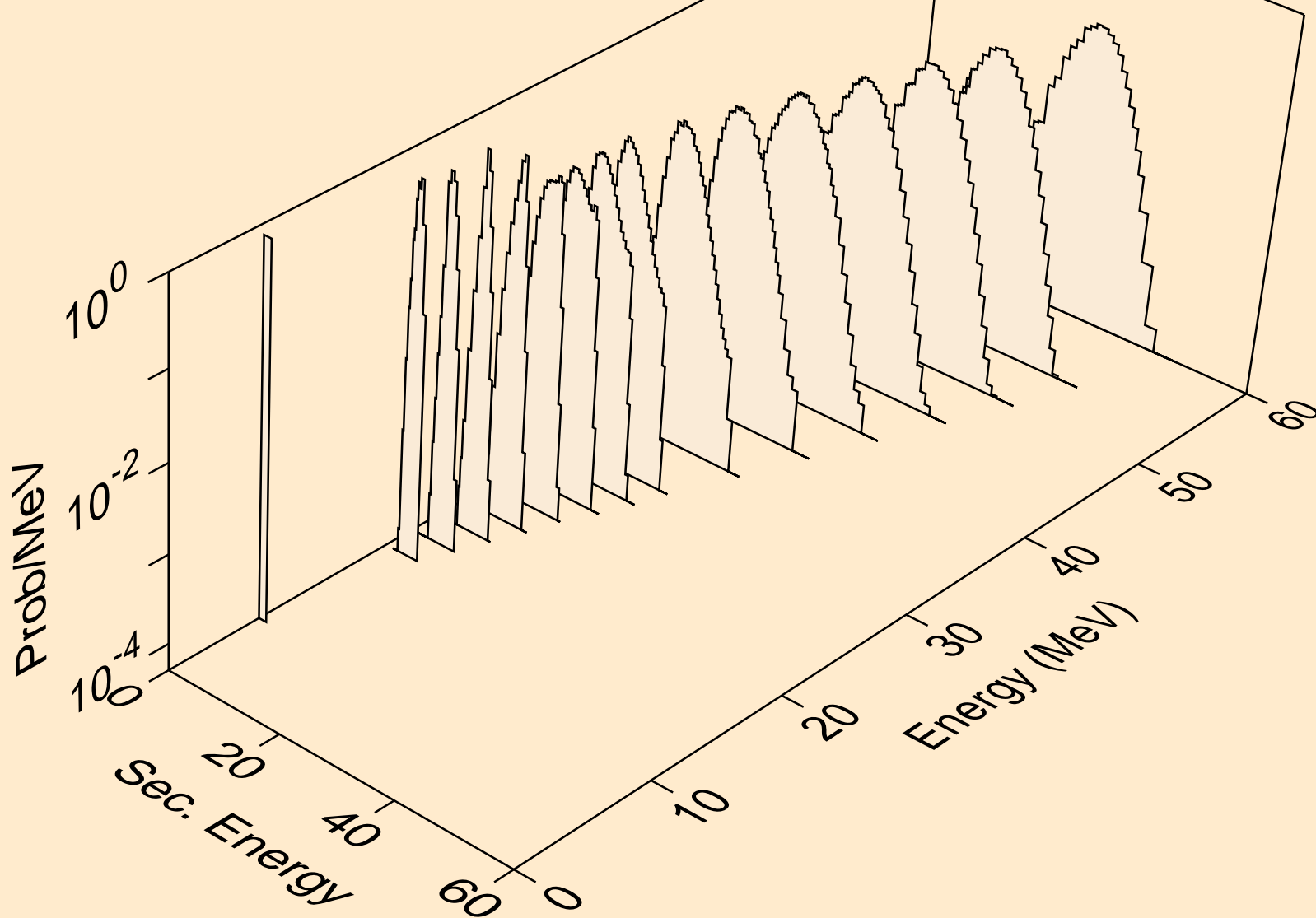

57-LA-138 FOR FENDL-3.2 PROCESSED BY NJOY2016.60+ ON
tritons from (n,3nt)

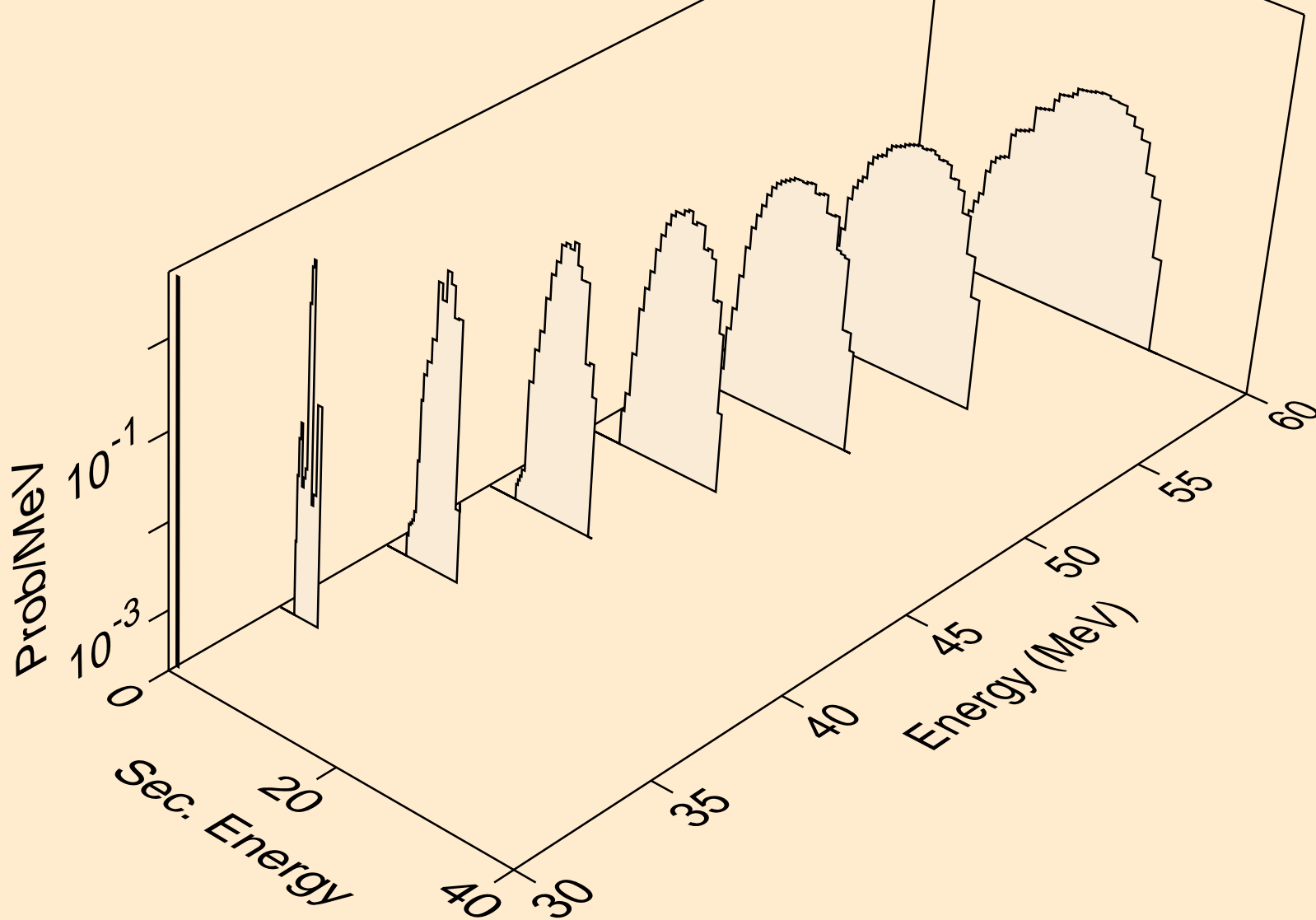

57-LA-138 FOR FENDL-3.2 PROCESSED BY NJOY2016.60+ ON
tritons from (n,4nt)

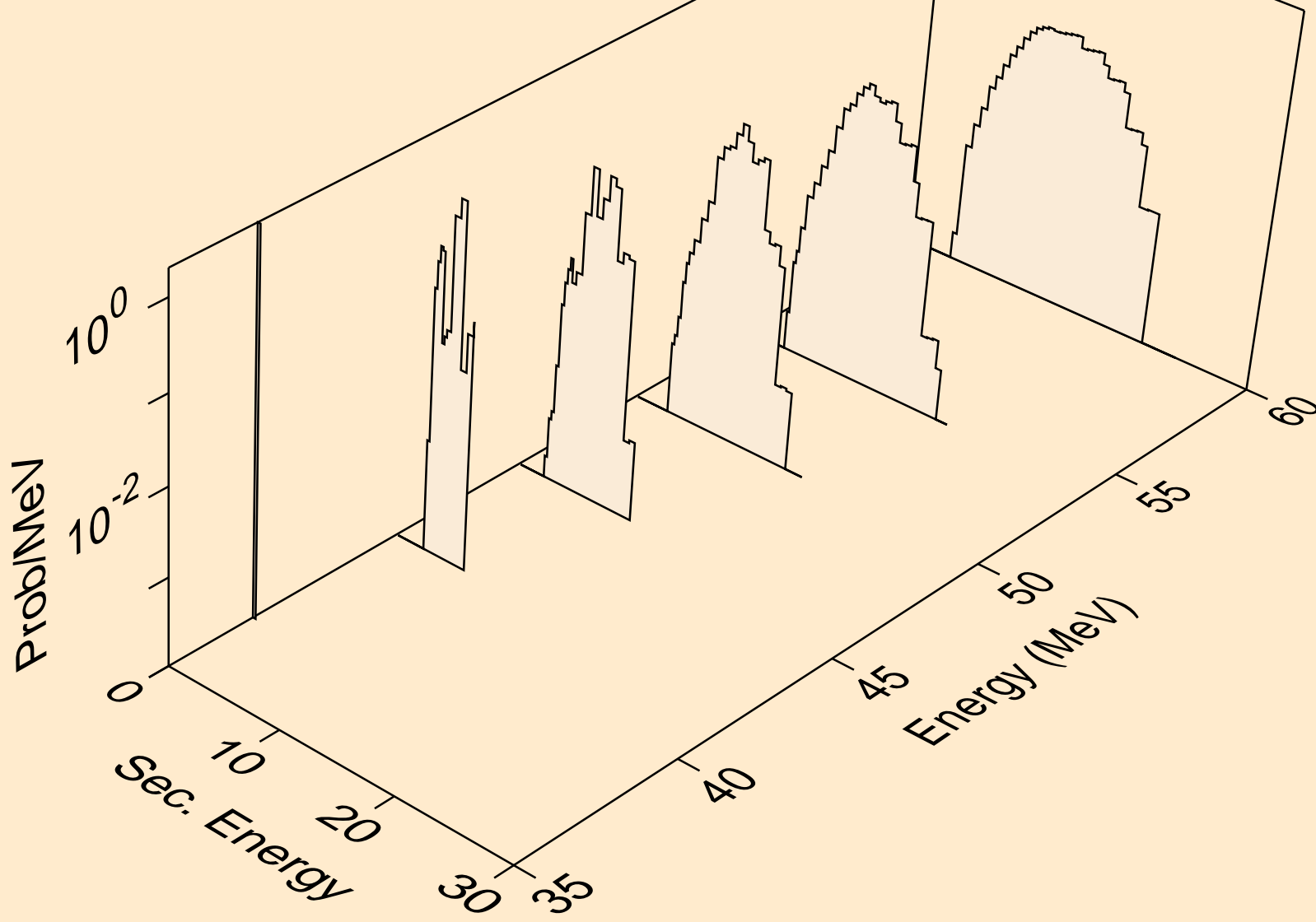

57-LA-138 FOR FENDL-3.2 PROCESSED BY NJOY2016.60+ ON
tritons from (n,dt)

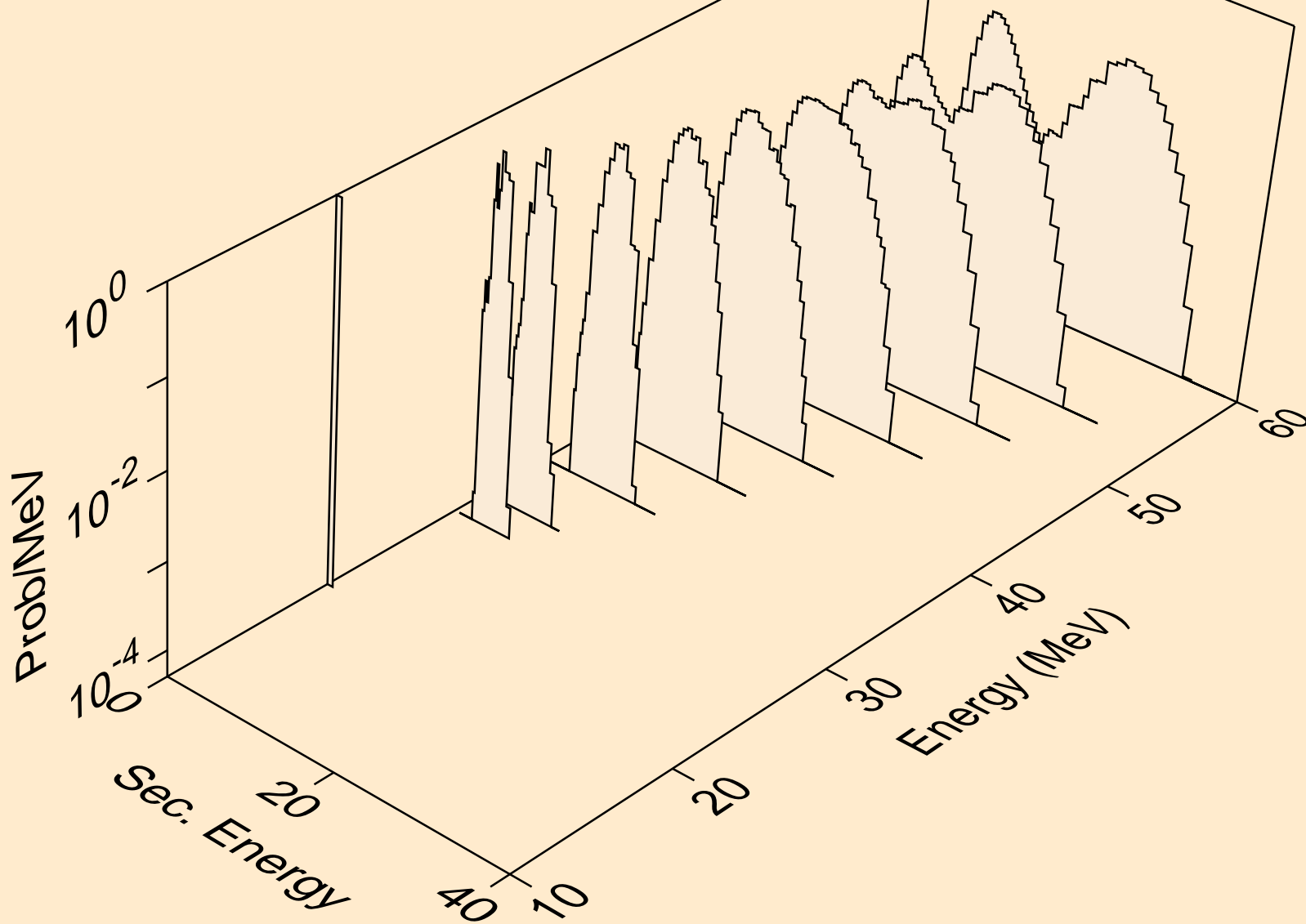

57-LA-138 FOR FENDL-3.2 PROCESSED BY NJOY2016.60+ ON
tritons from (n,npt)

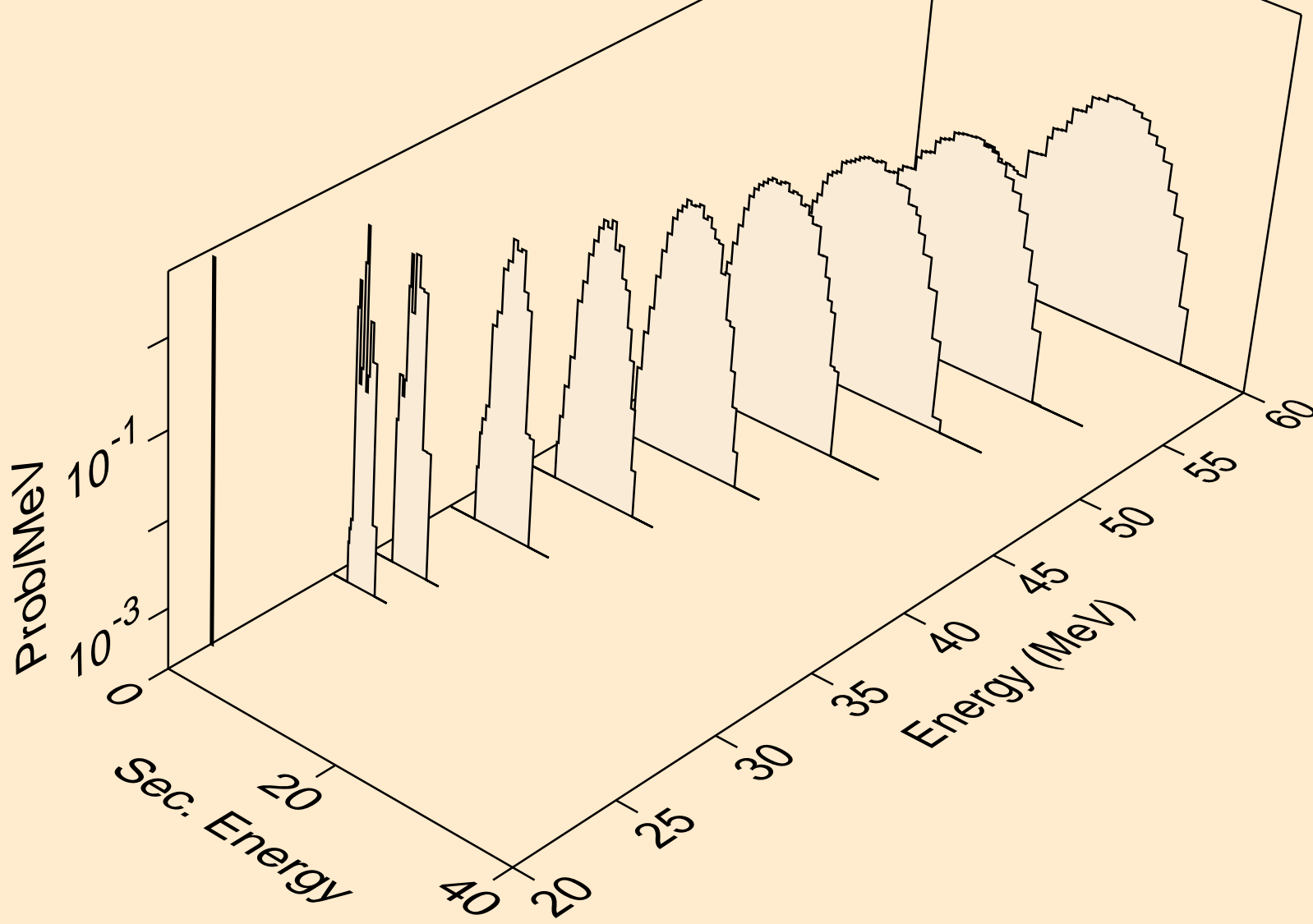

57-LA-138 FOR FENDL-3.2 PROCESSED BY NJOY2016.60+ ON
tritons from (n,ndt)

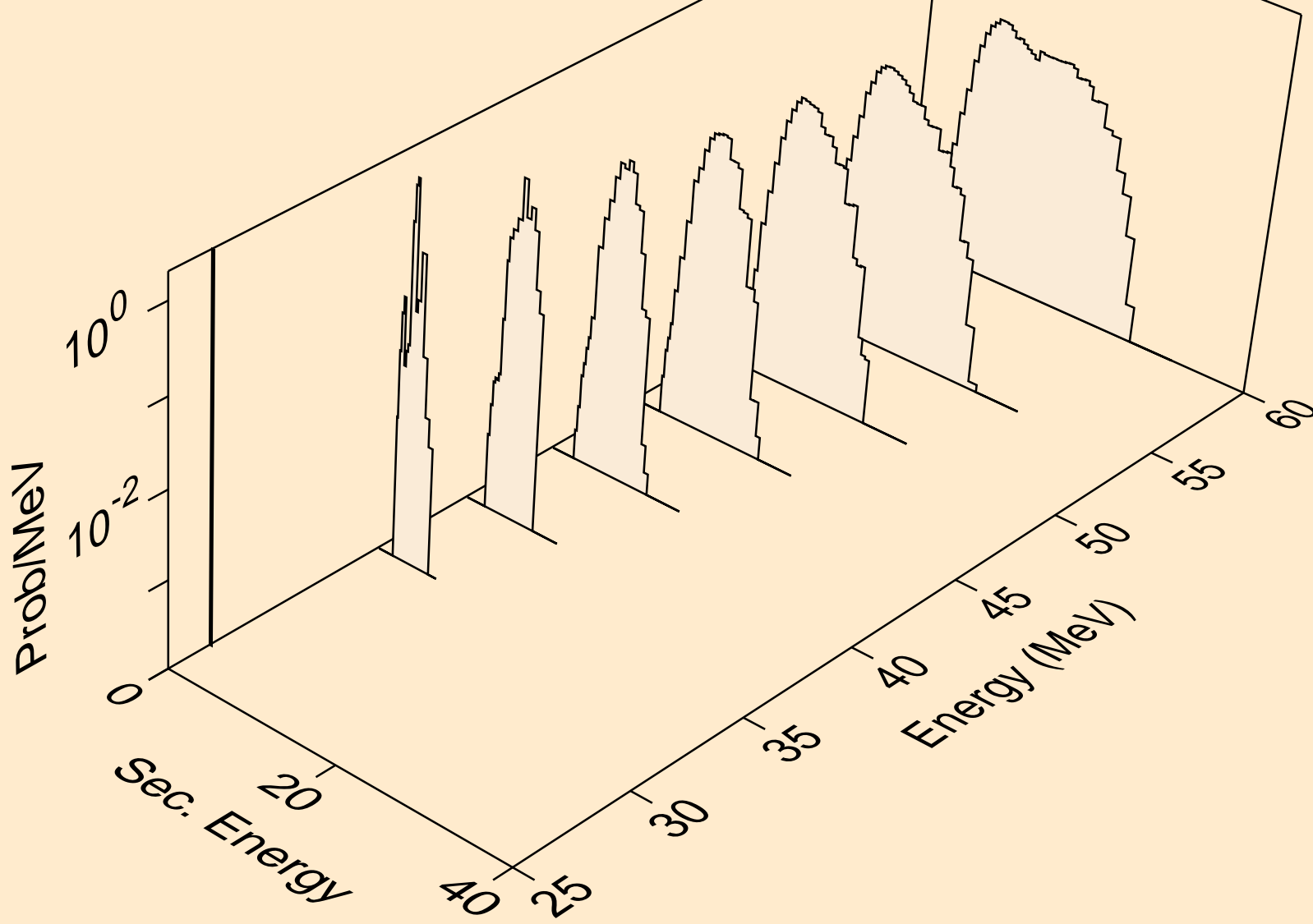

57-LA-138 FOR FENDL-3.2 PROCESSED BY NJOY2016.60+ ON
tritons from (n,nthe3)

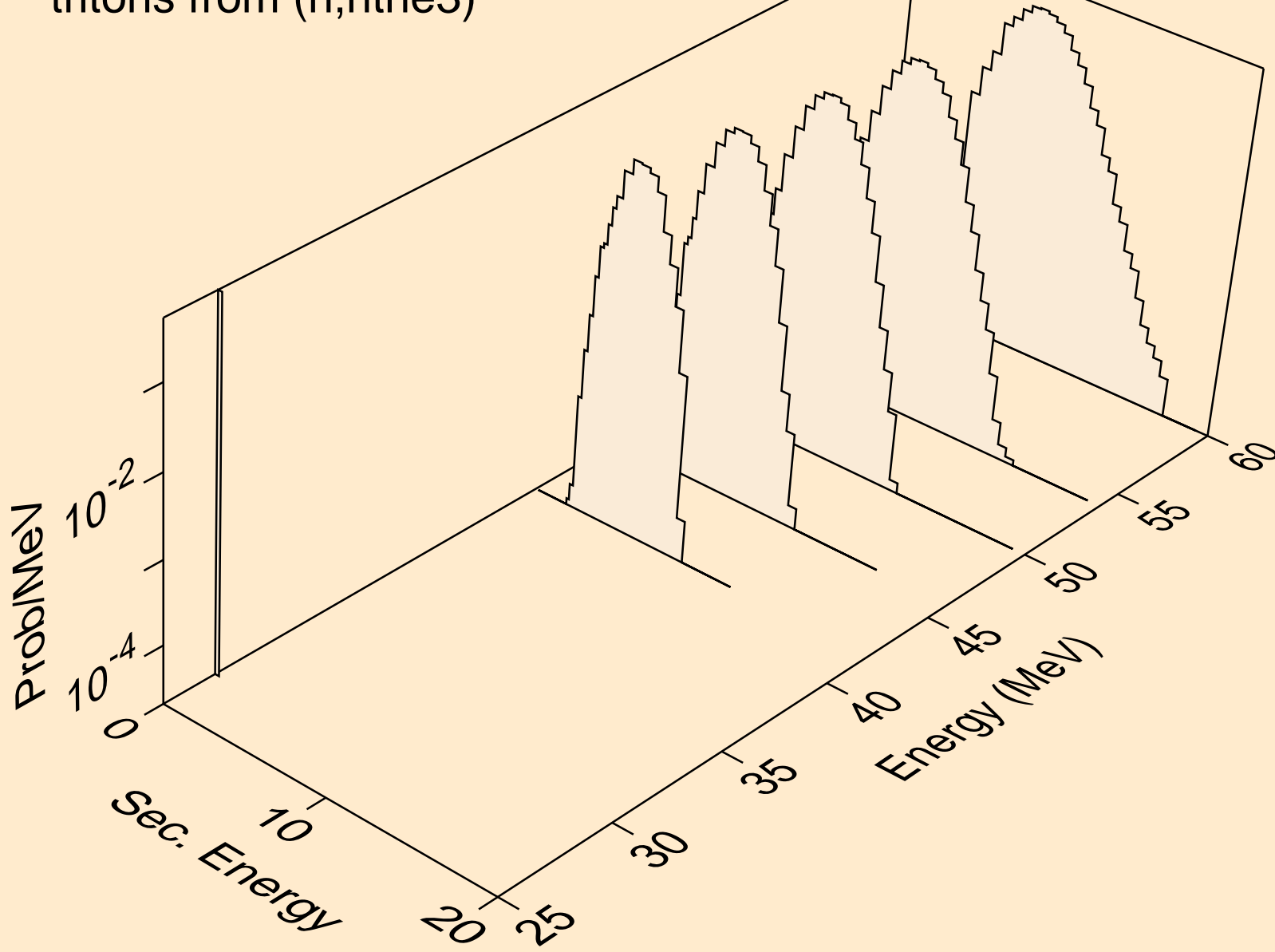

57-LA-138 FOR FENDL-3.2 PROCESSED BY NJOY2016.60+ ON
tritons from (n,nta)

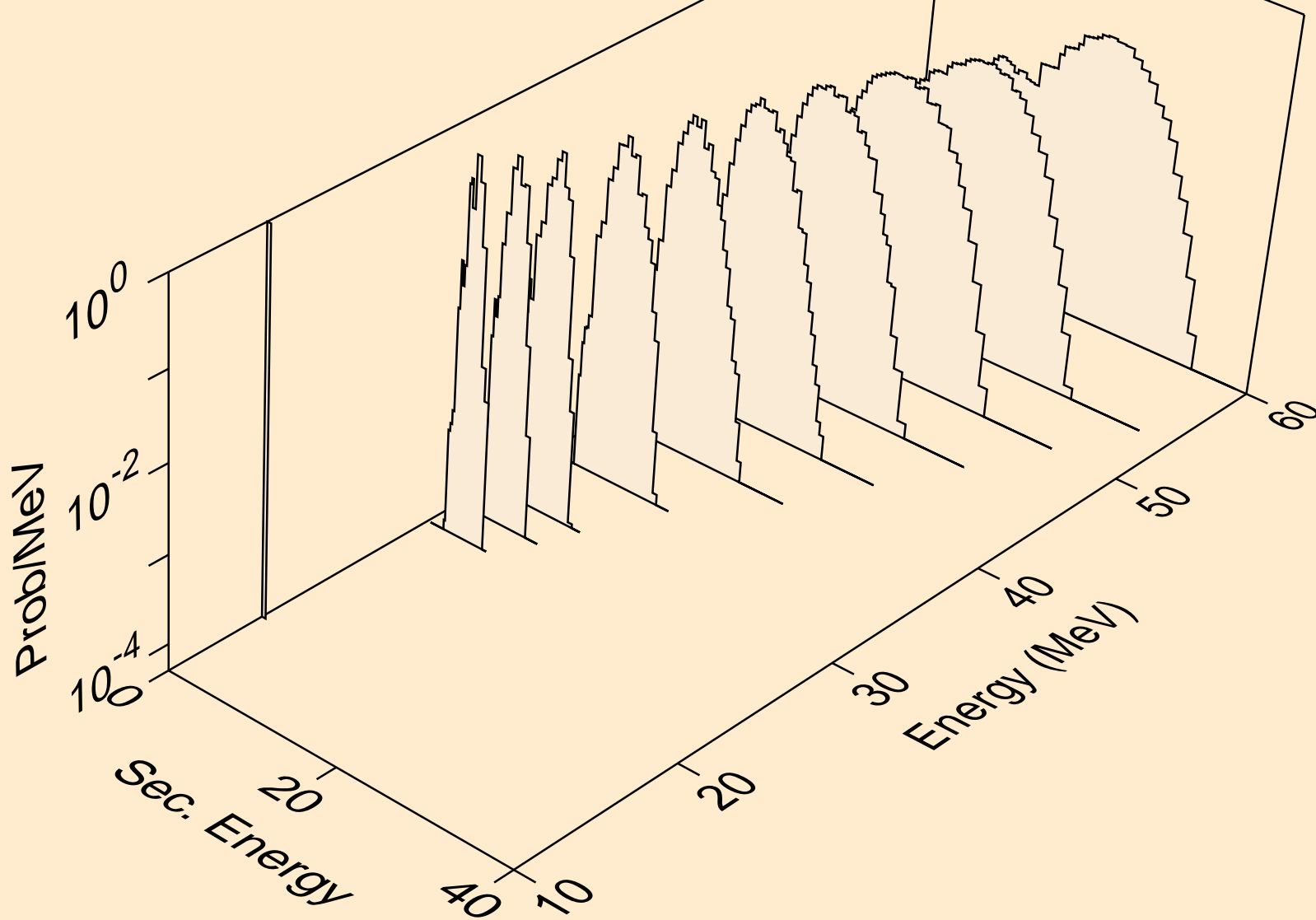

57-LA-138 FOR FENDL-3.2 PROCESSED BY NJOY2016.60+ ON
he3s from (n,x)

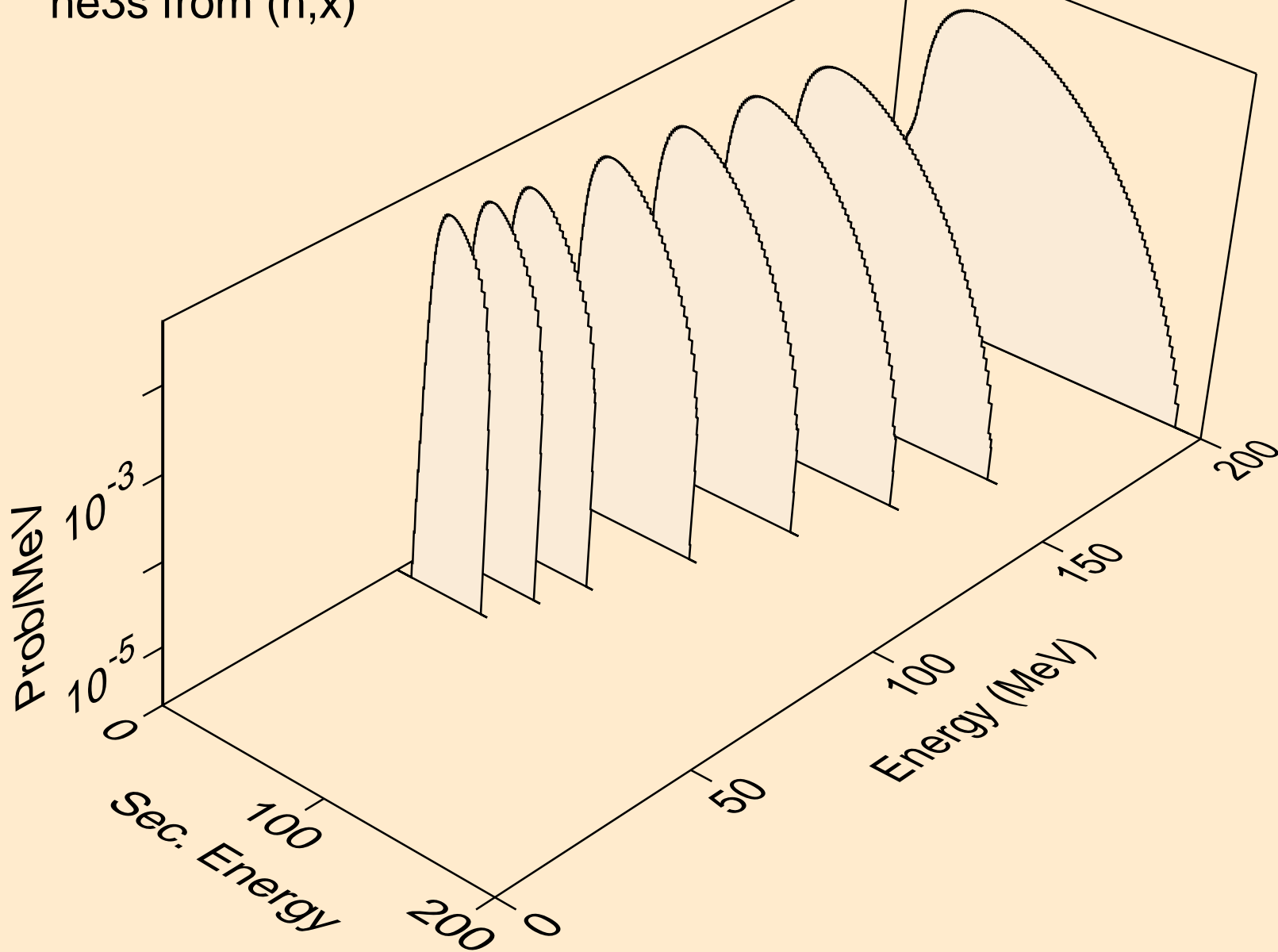

57-LA-138 FOR FENDL-3.2 PROCESSED BY NJOY2016.60+ ON
he3s from (n,n*)he3

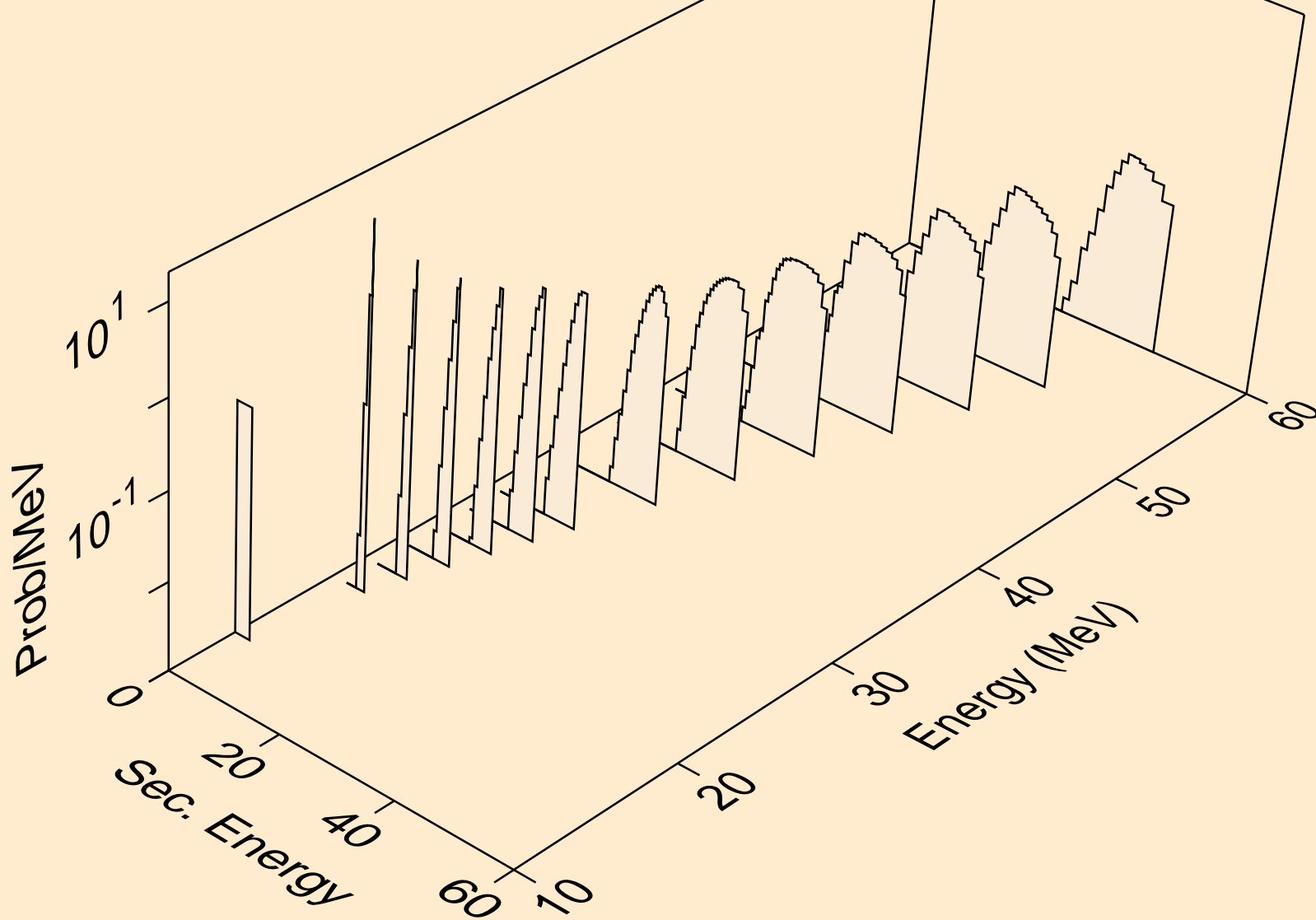

57-LA-138 FOR FENDL-3.2 PROCESSED BY NJOY2016.60+ ON
he3s from (n,he3)

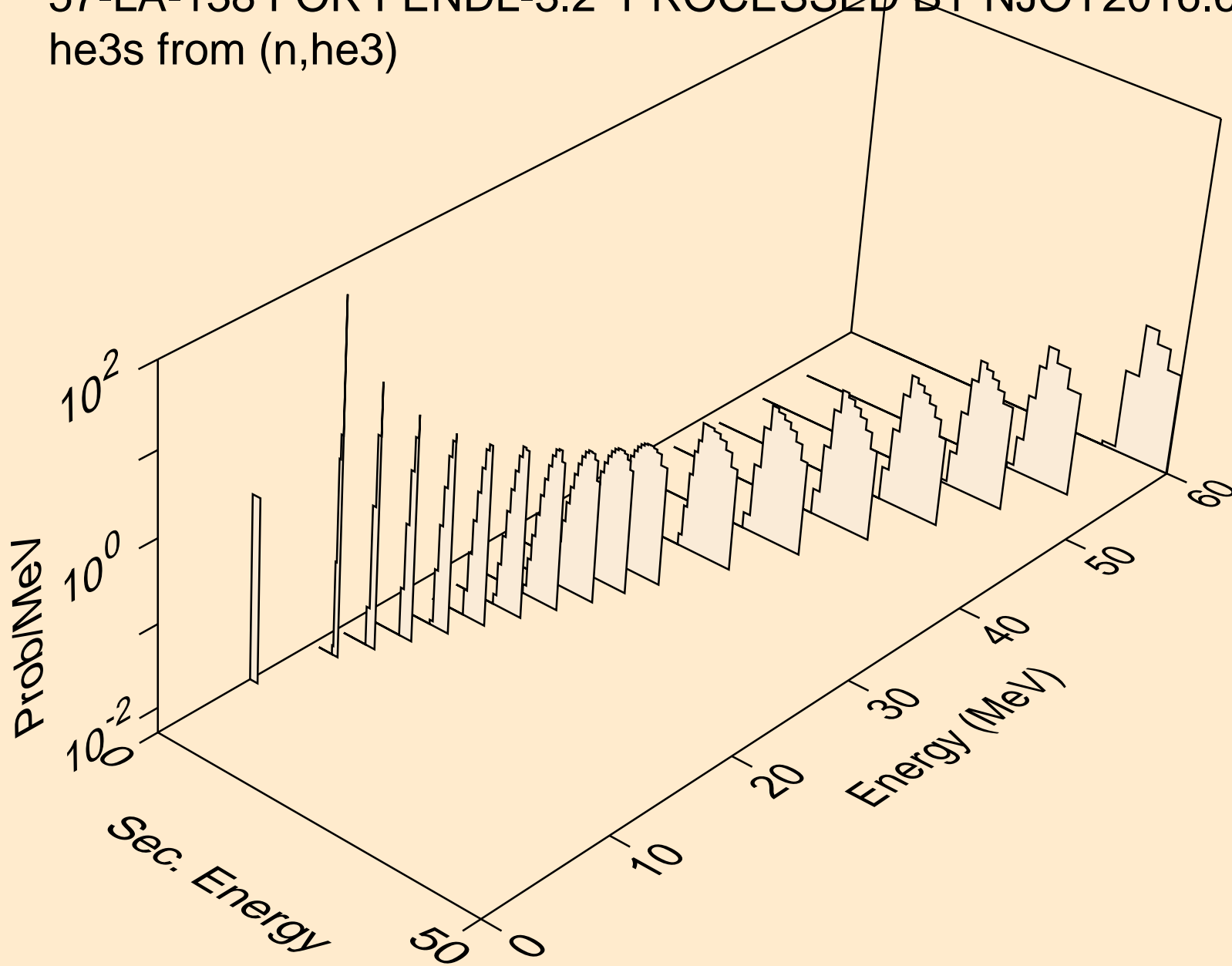

57-LA-138 FOR FENDL-3.2 PROCESSED BY NJOY2016.60+ ON
he3s from (n,2n)he3

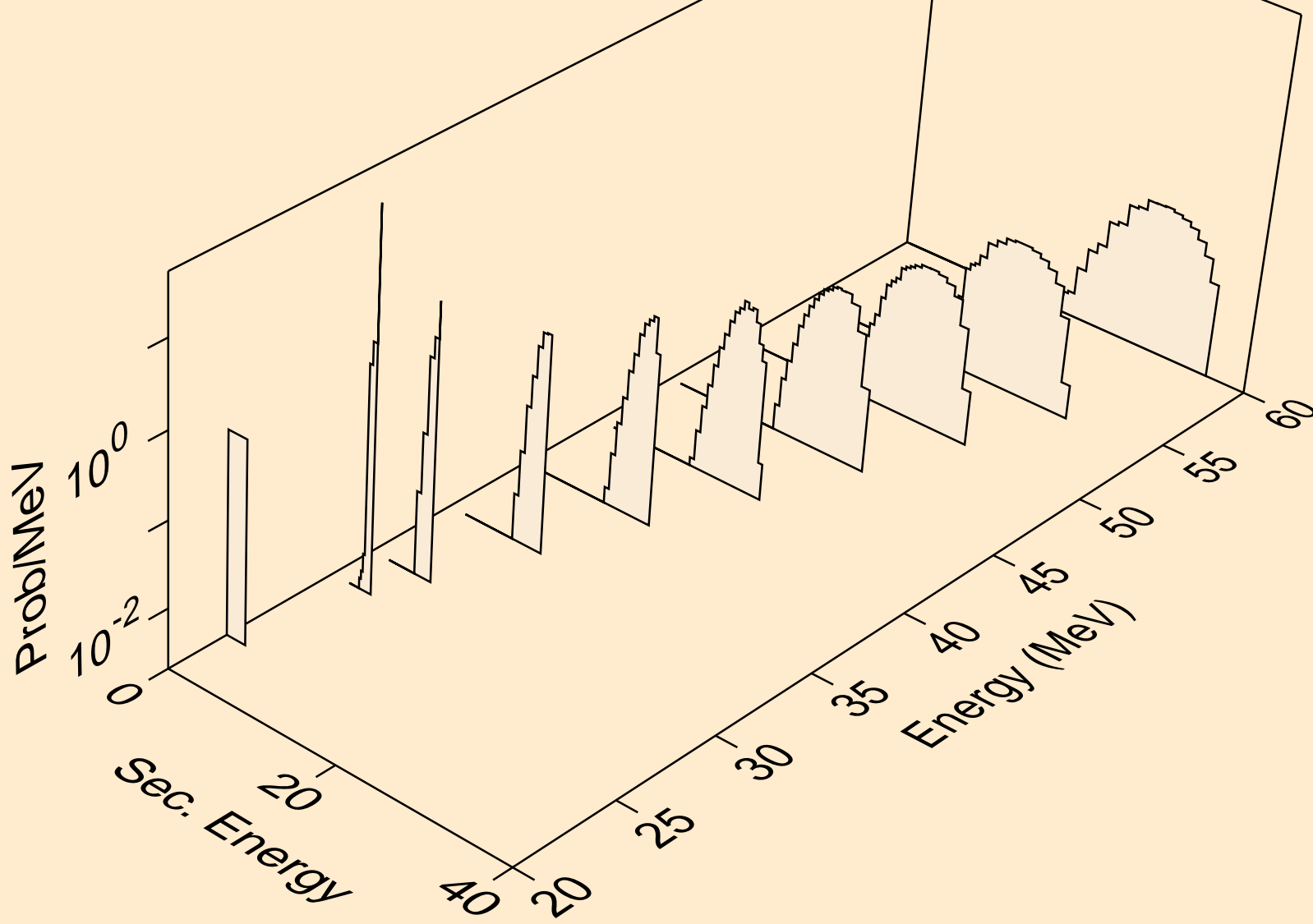

57-LA-138 FOR FENDL-3.2 PROCESSED BY NJOY2016.60+ ON
he3s from (n,3nhe3)

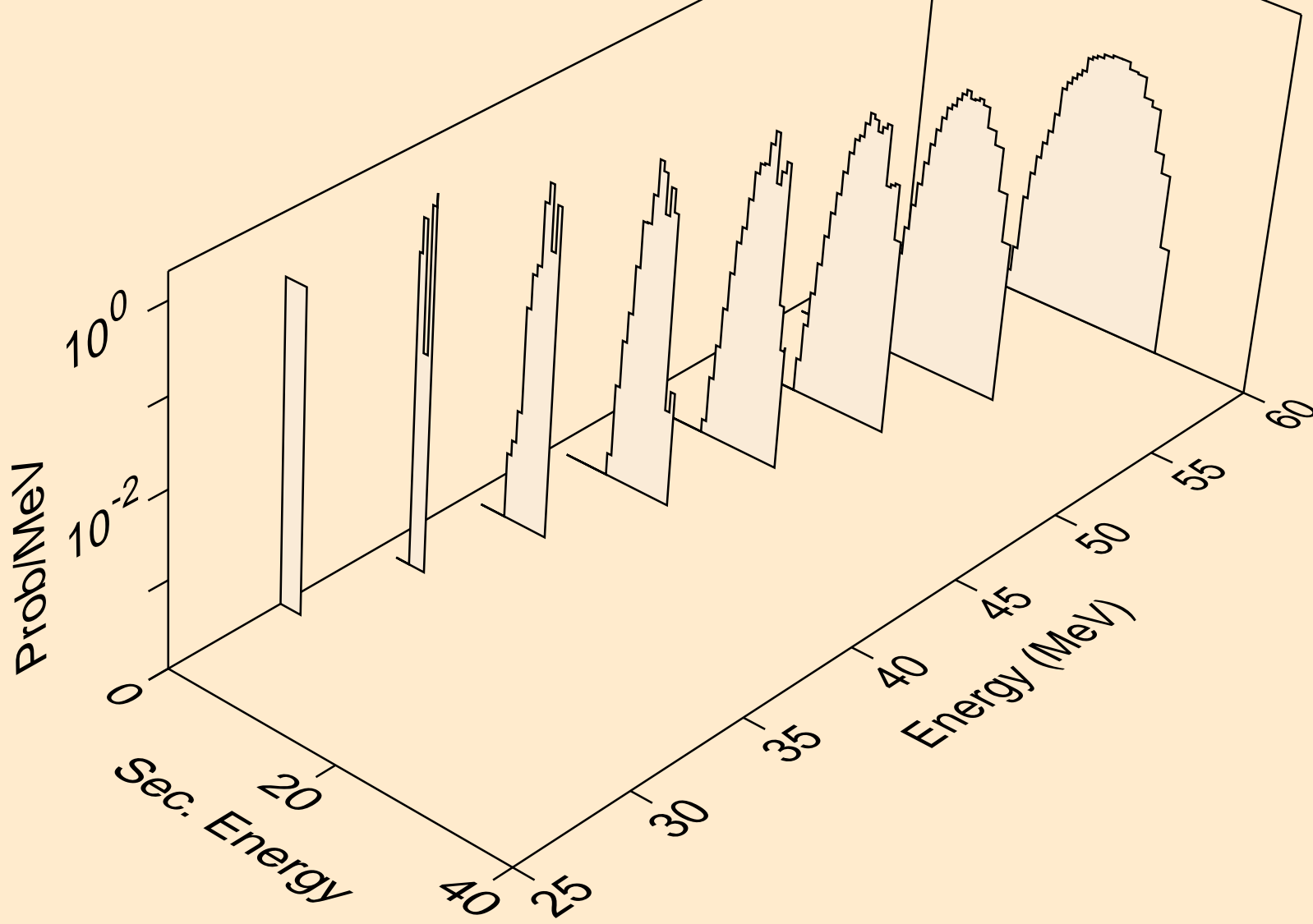

57-LA-138 FOR FENDL-3.2 PROCESSED BY NJOY2016.60+ ON
he3s from (n,4n)he3)

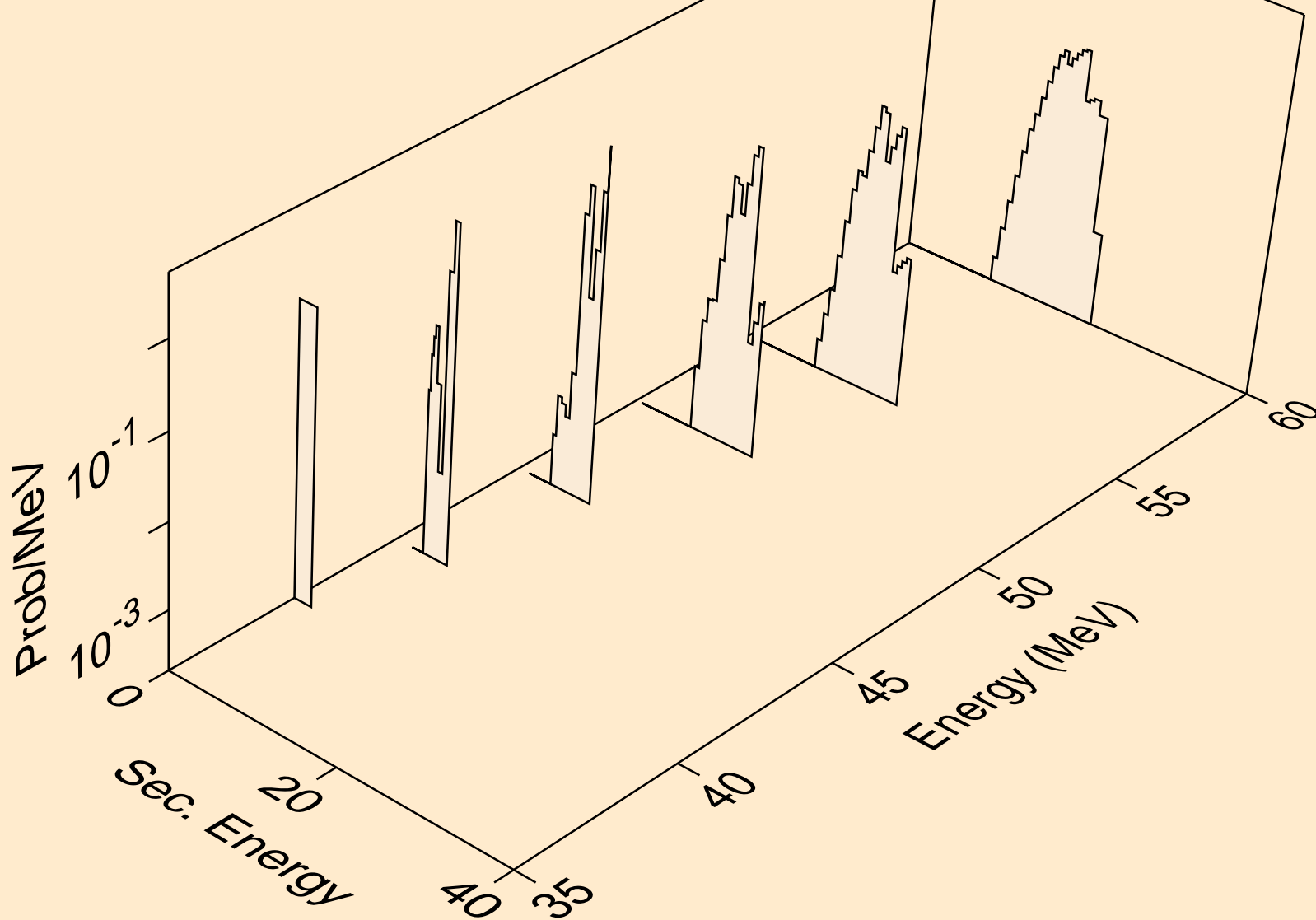

57-LA-138 FOR FENDL-3.2 PROCESSED BY NJOY2016.60+ ON
he3s from (n,nphe3)

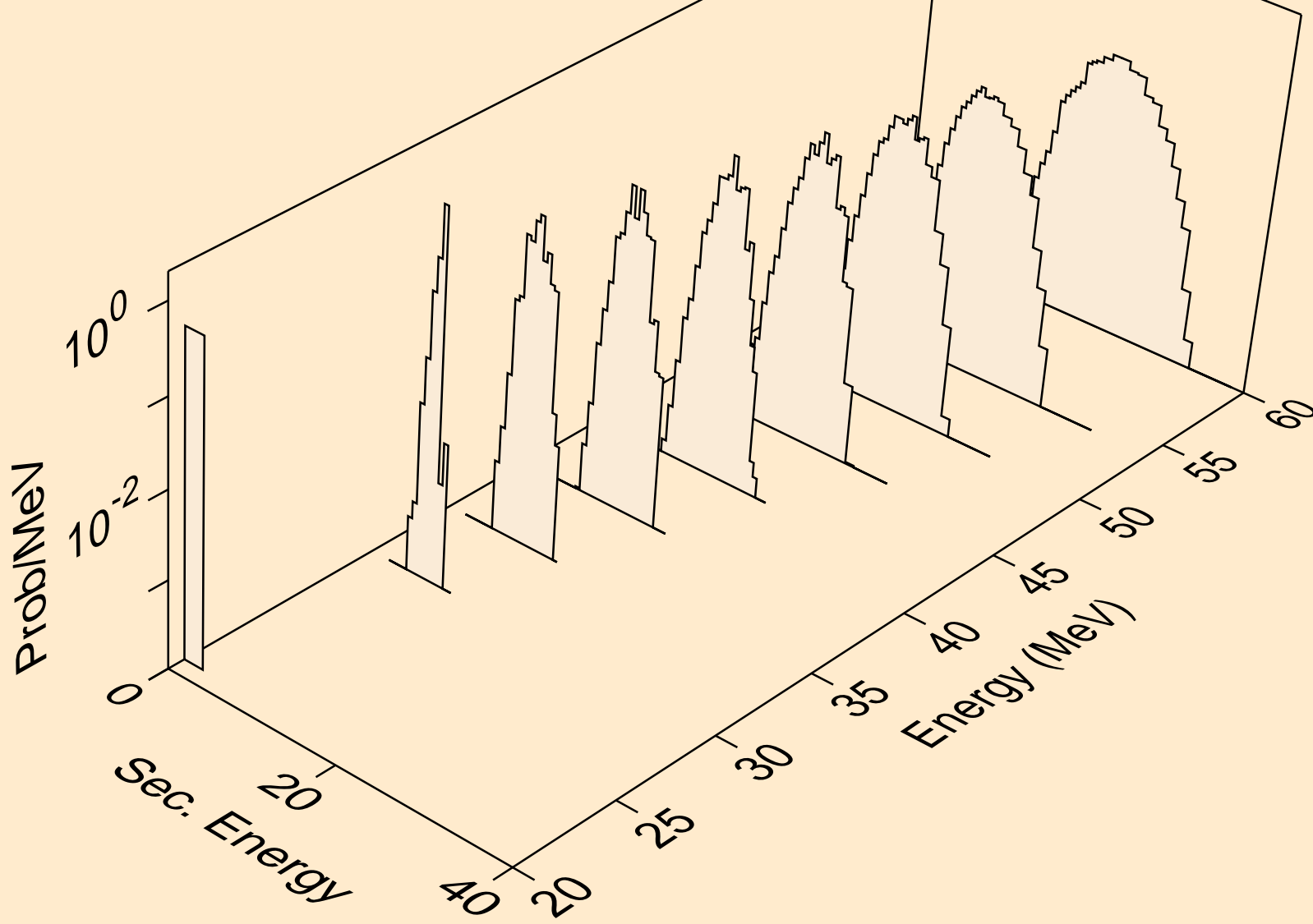

57-LA-138 FOR FENDL-3.2 PROCESSED BY NJOY2016.60+ ON
he3s from (n,ndhe3)

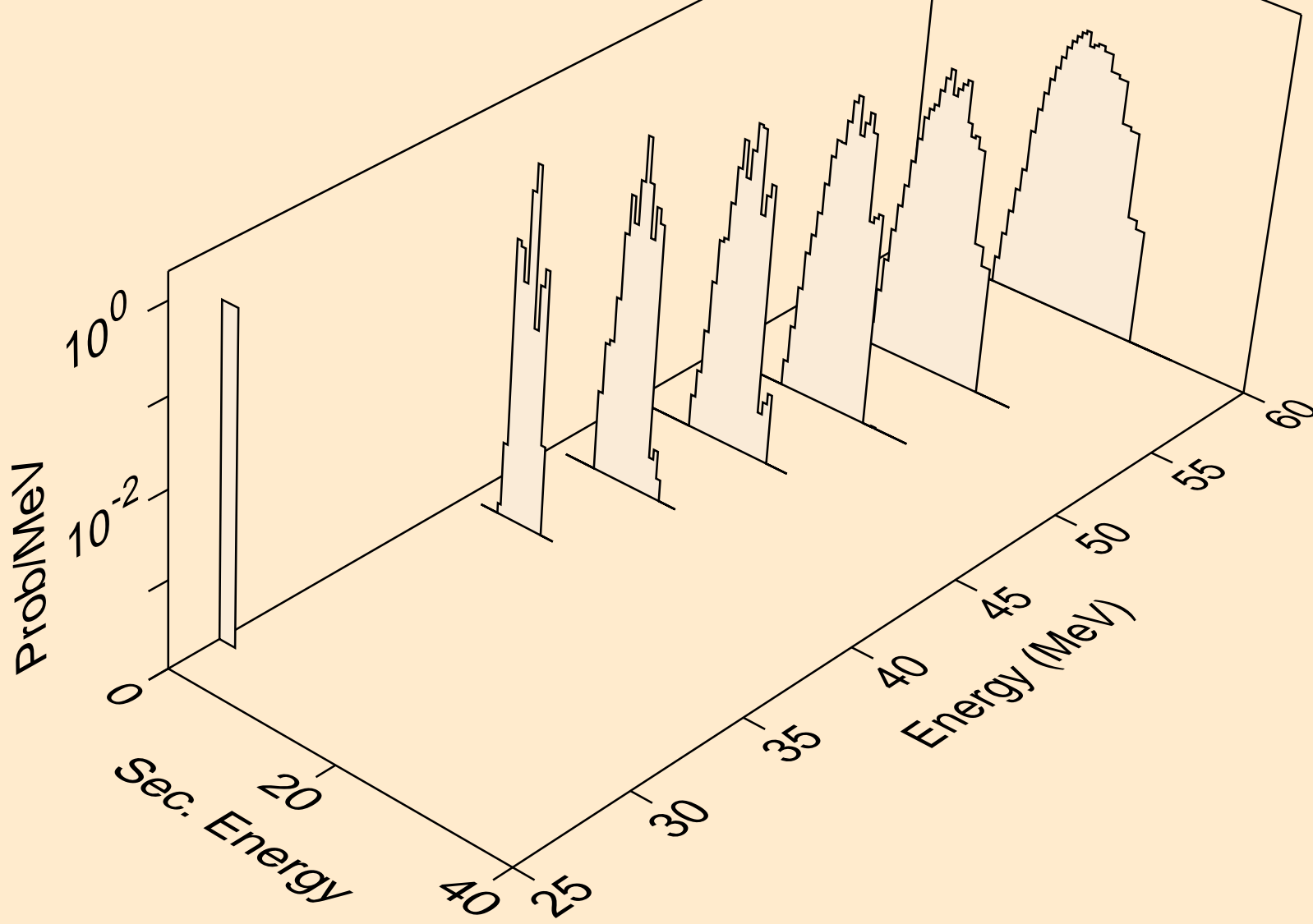

57-LA-138 FOR FENDL-3.2 PROCESSED BY NJOY2016.60+ ON
he3s from (n,nthe3)

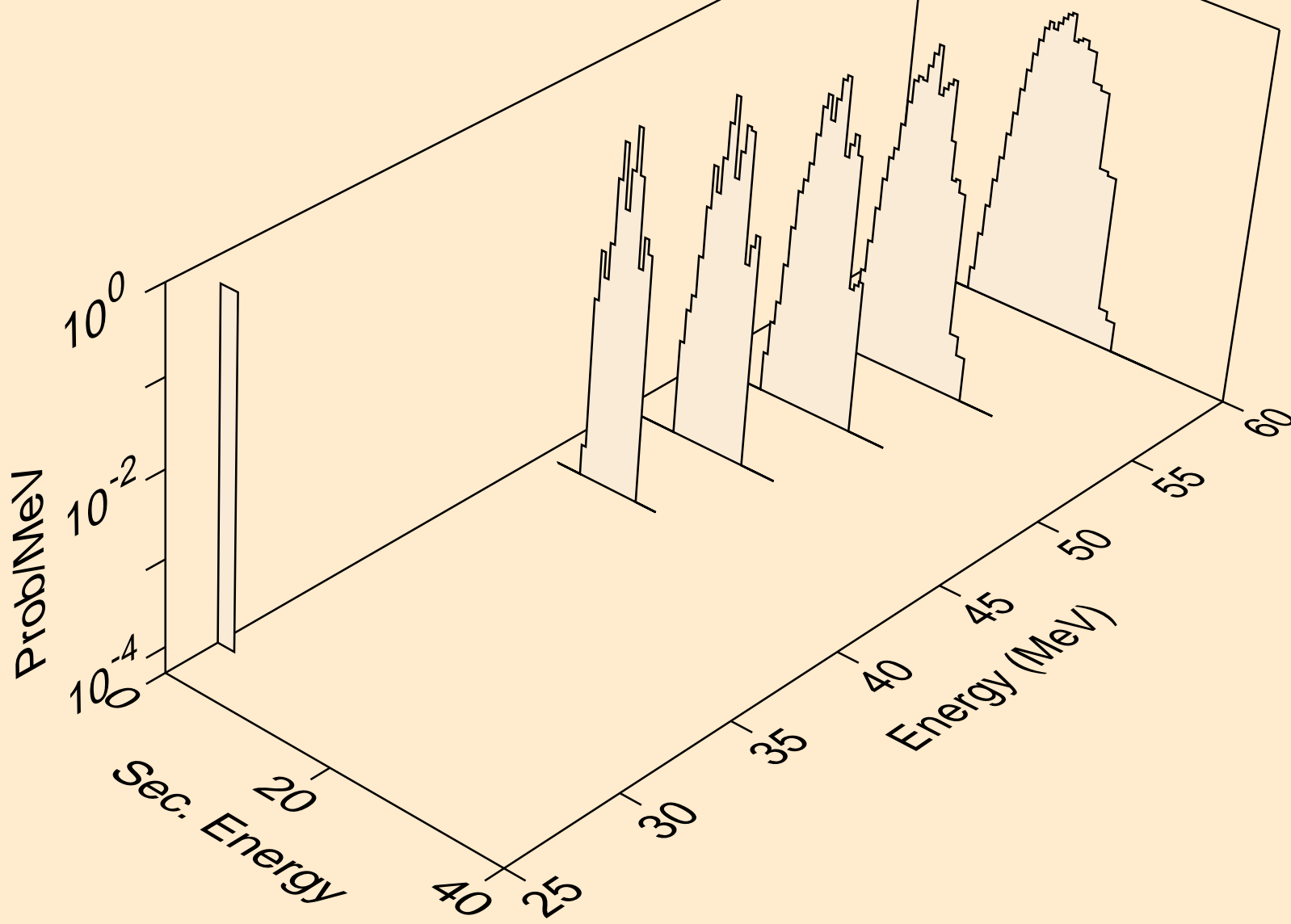

57-LA-138 FOR FENDL-3.2 PROCESSED BY NJOY2016.60+ ON
he3s from (n,phe3)

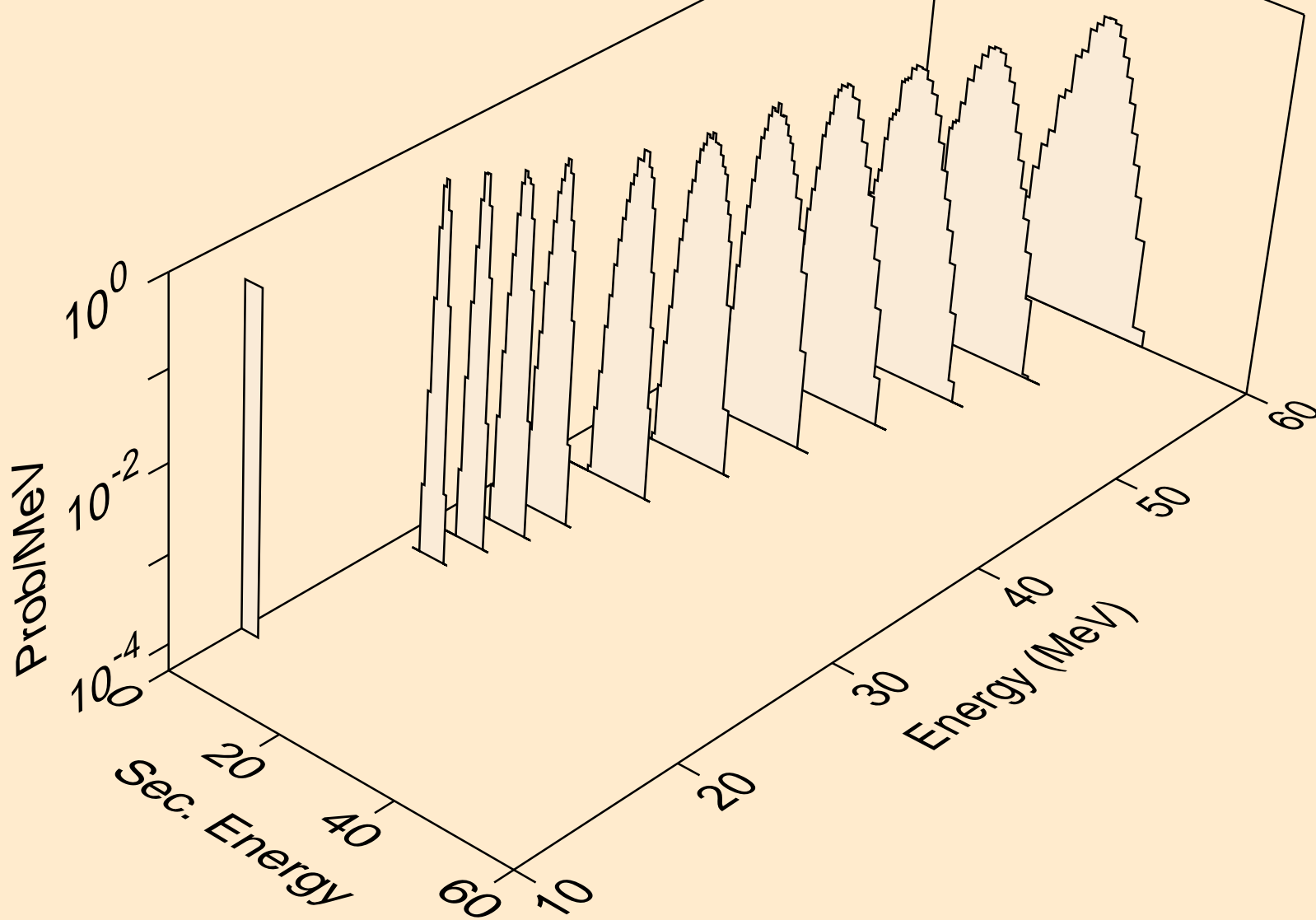

57-LA-138 FOR FENDL-3.2 PROCESSED BY NJOY2016.60+ ON
he3s from (n,d)he3)

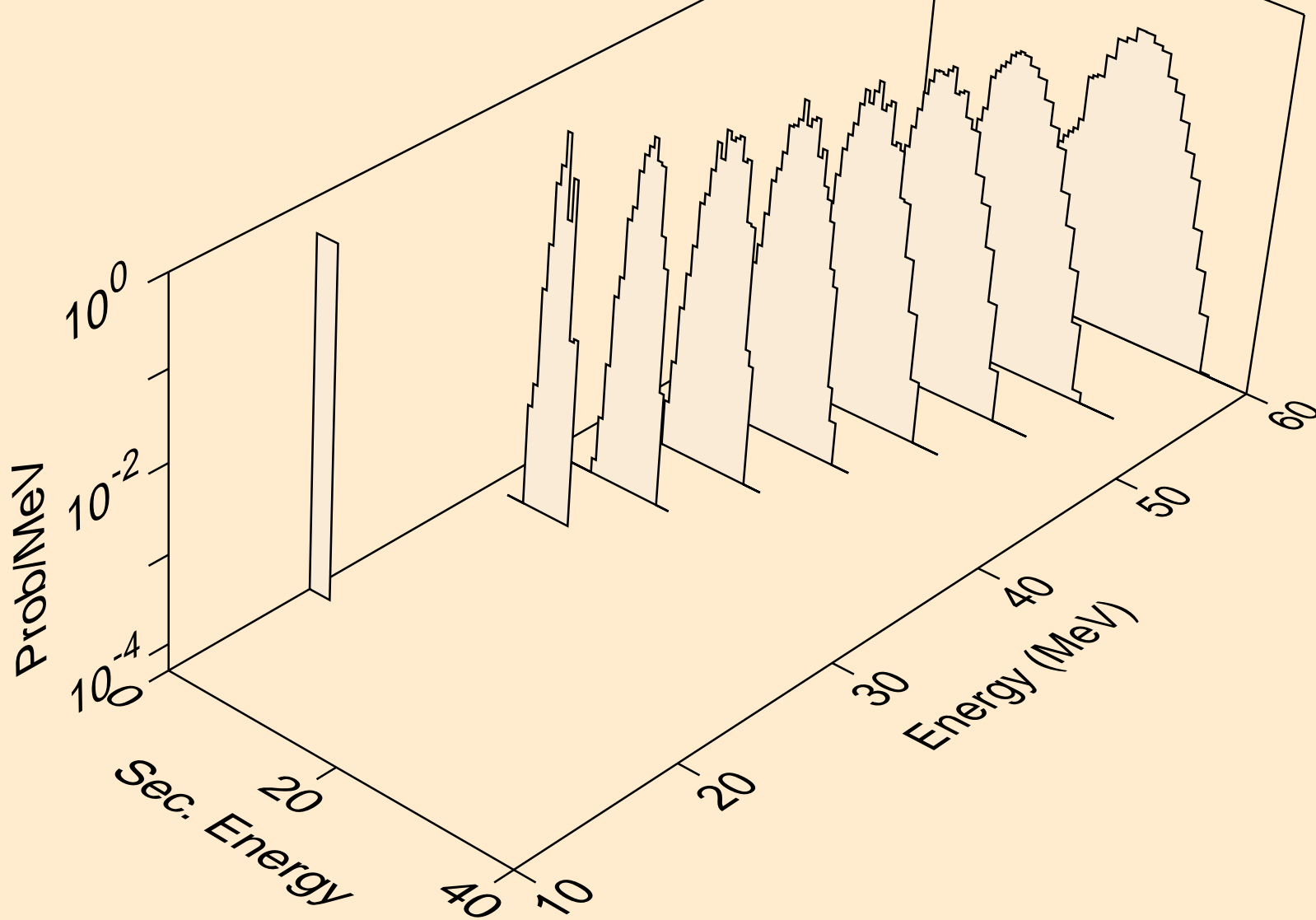

57-LA-138 FOR FENDL-3.2 PROCESSED BY NJOY2016.60+ ON
he3s from (n,he3a)

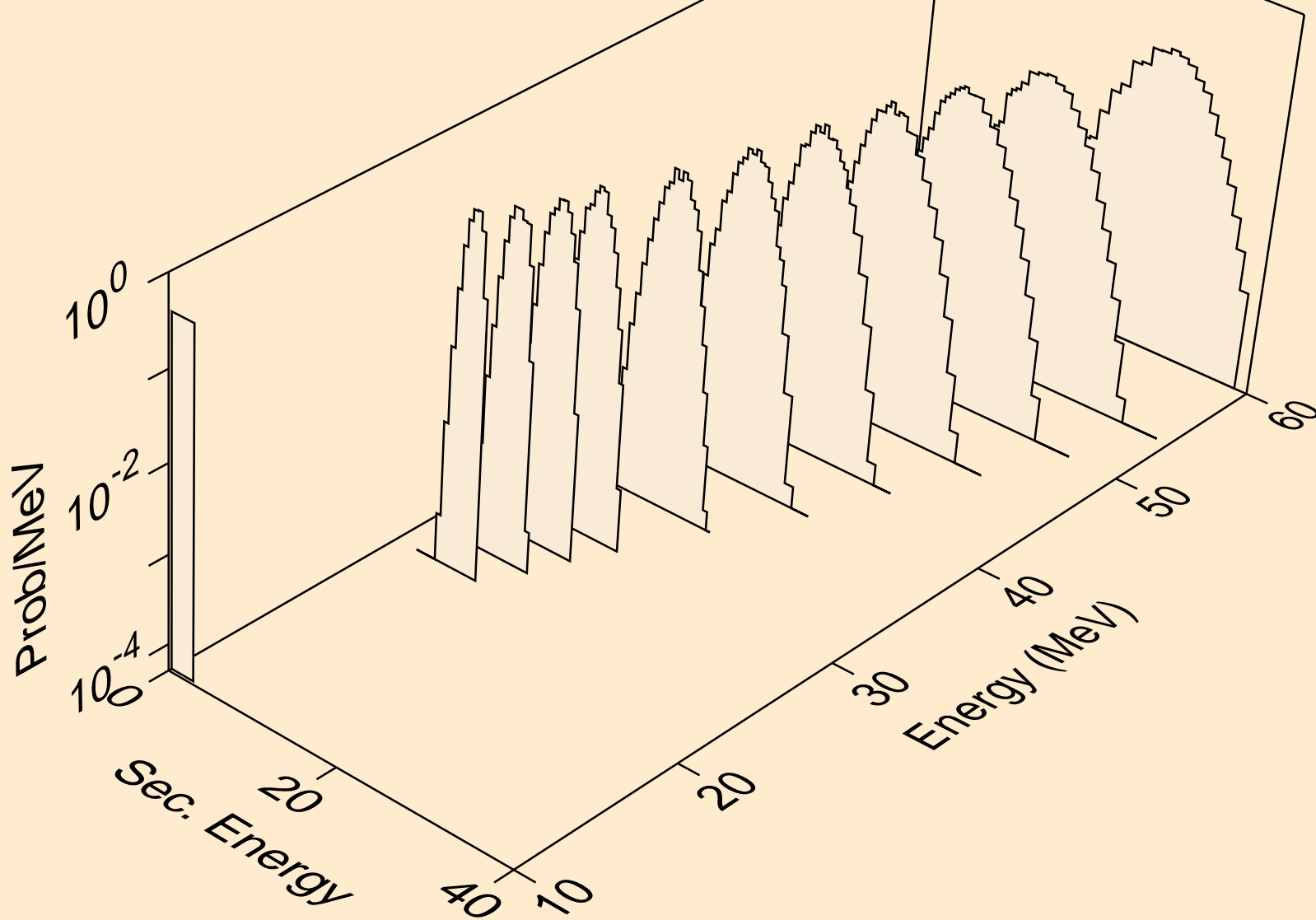

57-LA-138 FOR FENDL-3.2 PROCESSED BY NJOY2016.60+ ON
alphas from (n,x)

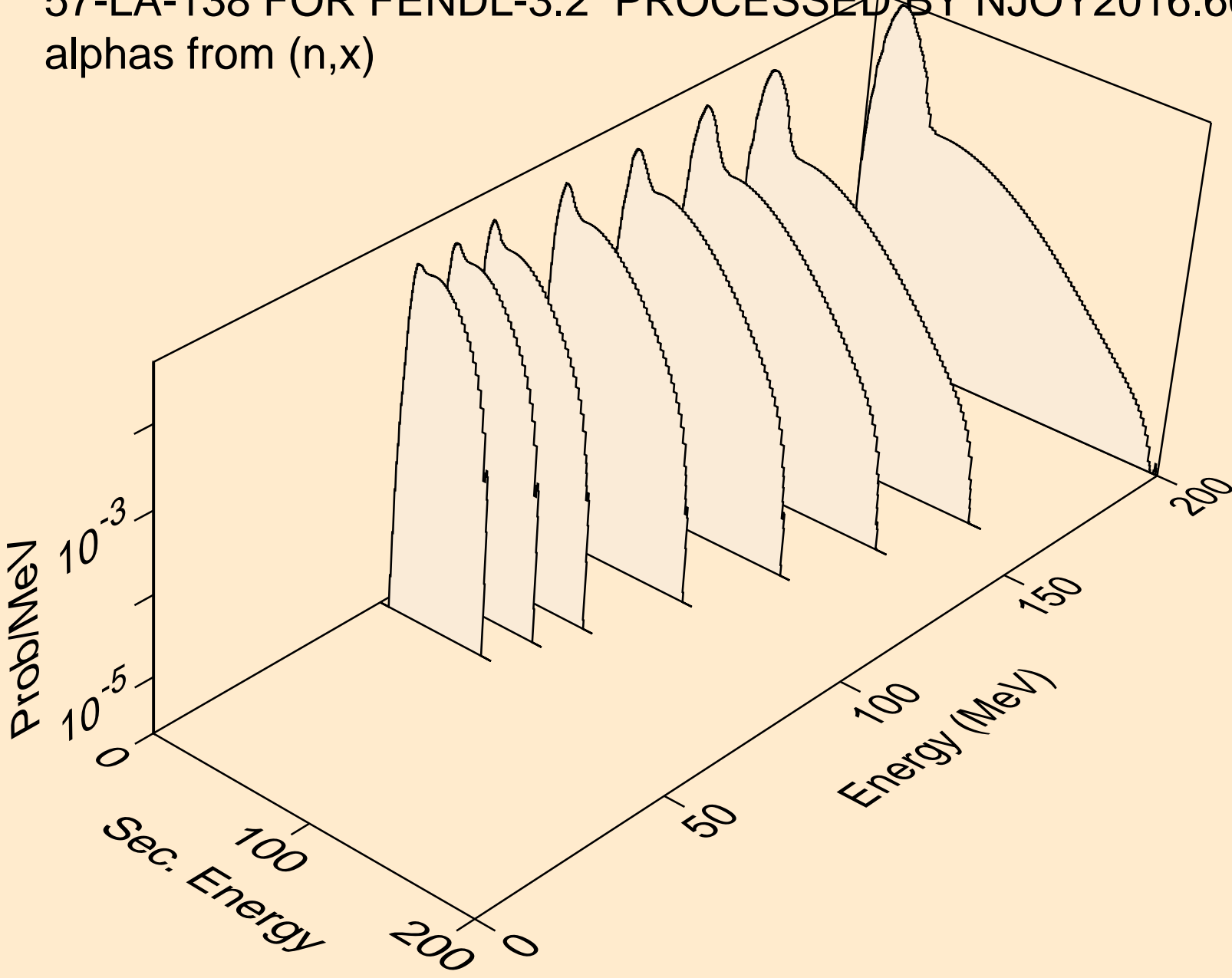

57-LA-138 FOR FENDL-3.2 PROCESSED BY NJOY2016.60+ ON
alphas from (n,n*)a

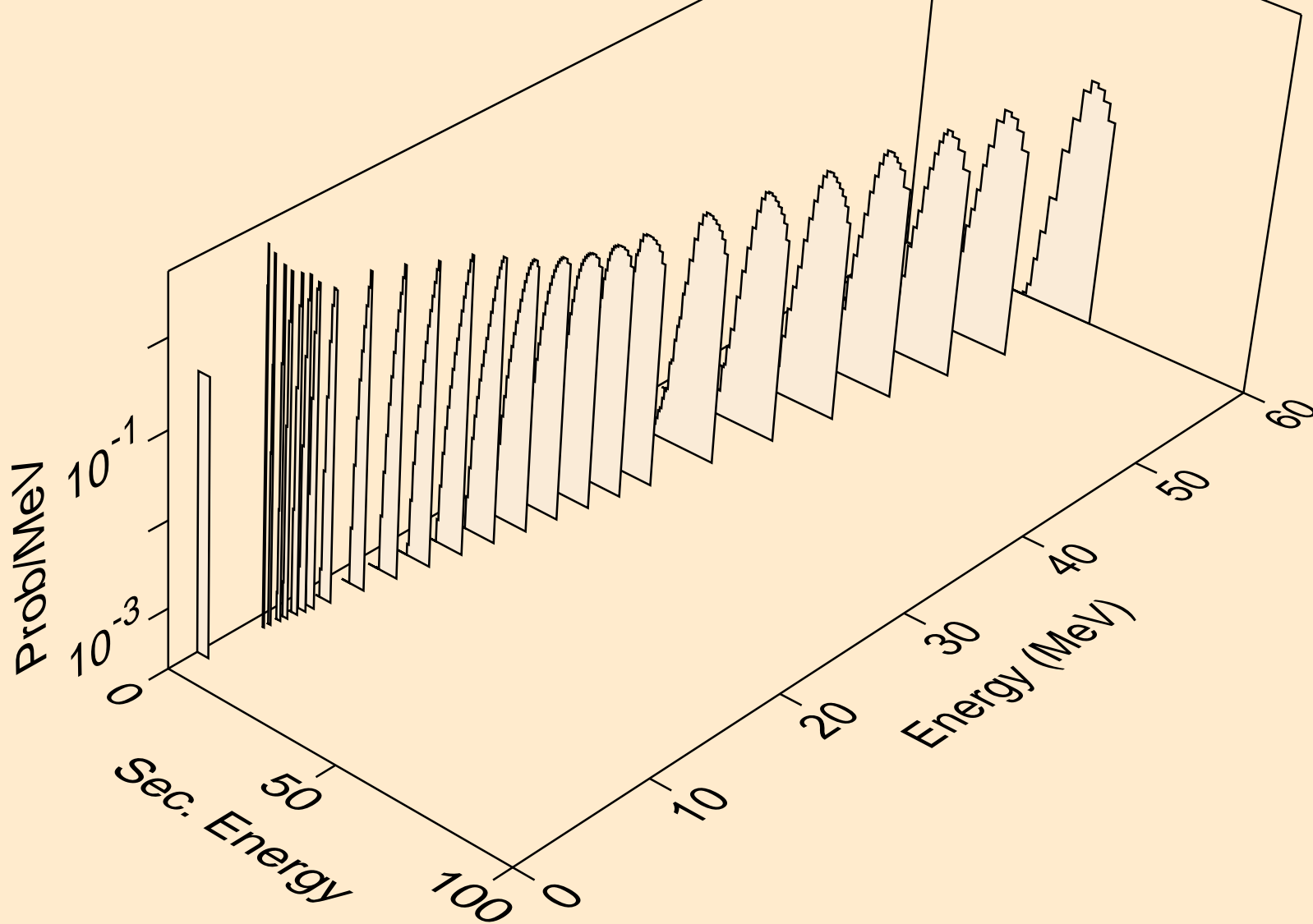

57-LA-138 FOR FENDL-3.2 PROCESSED BY NJOY2016.60+ ON
alphas from (n,2n)a

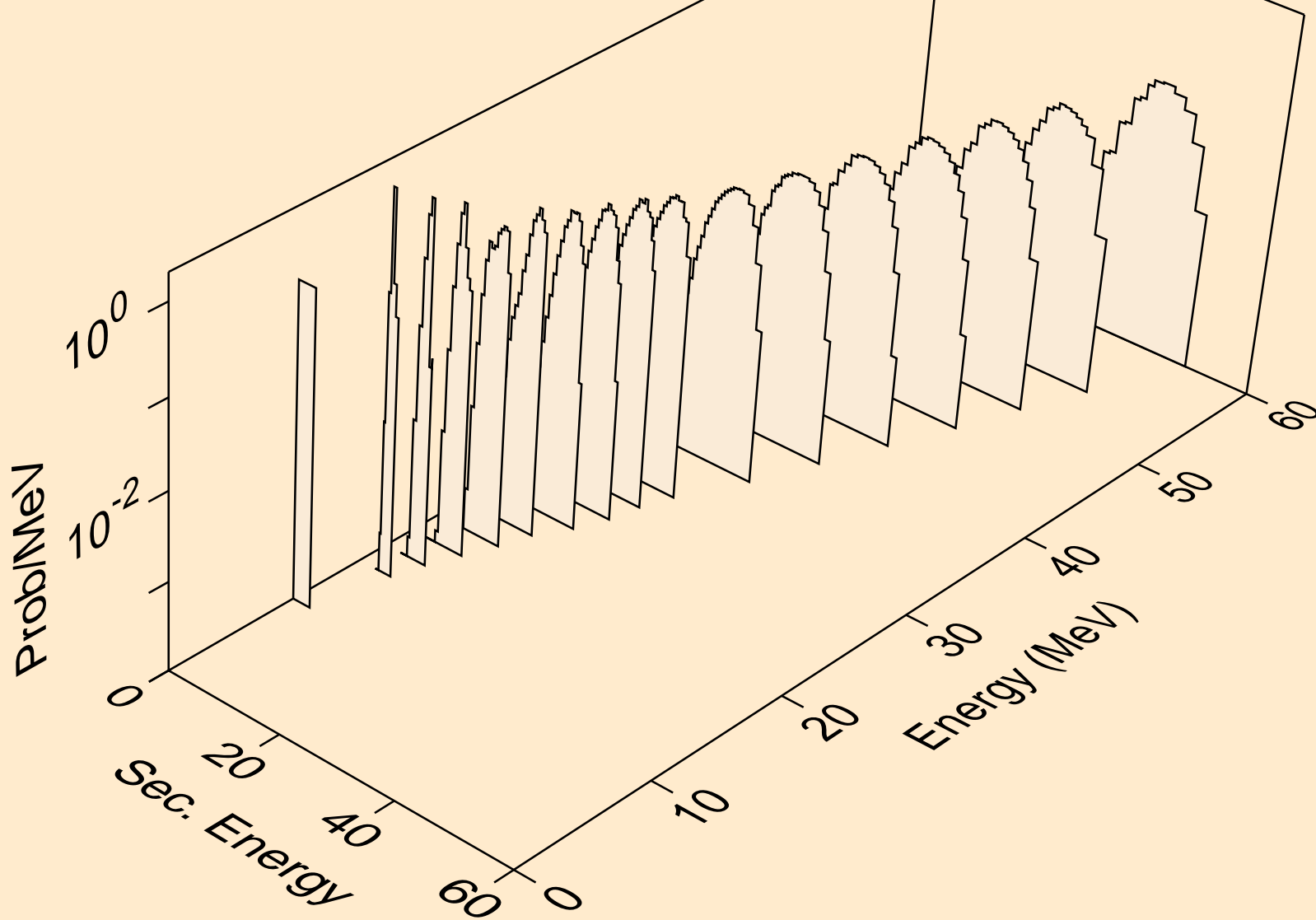

57-LA-138 FOR FENDL-3.2 PROCESSED BY NJOY2016.60+ ON
alphas from (n,3n)a

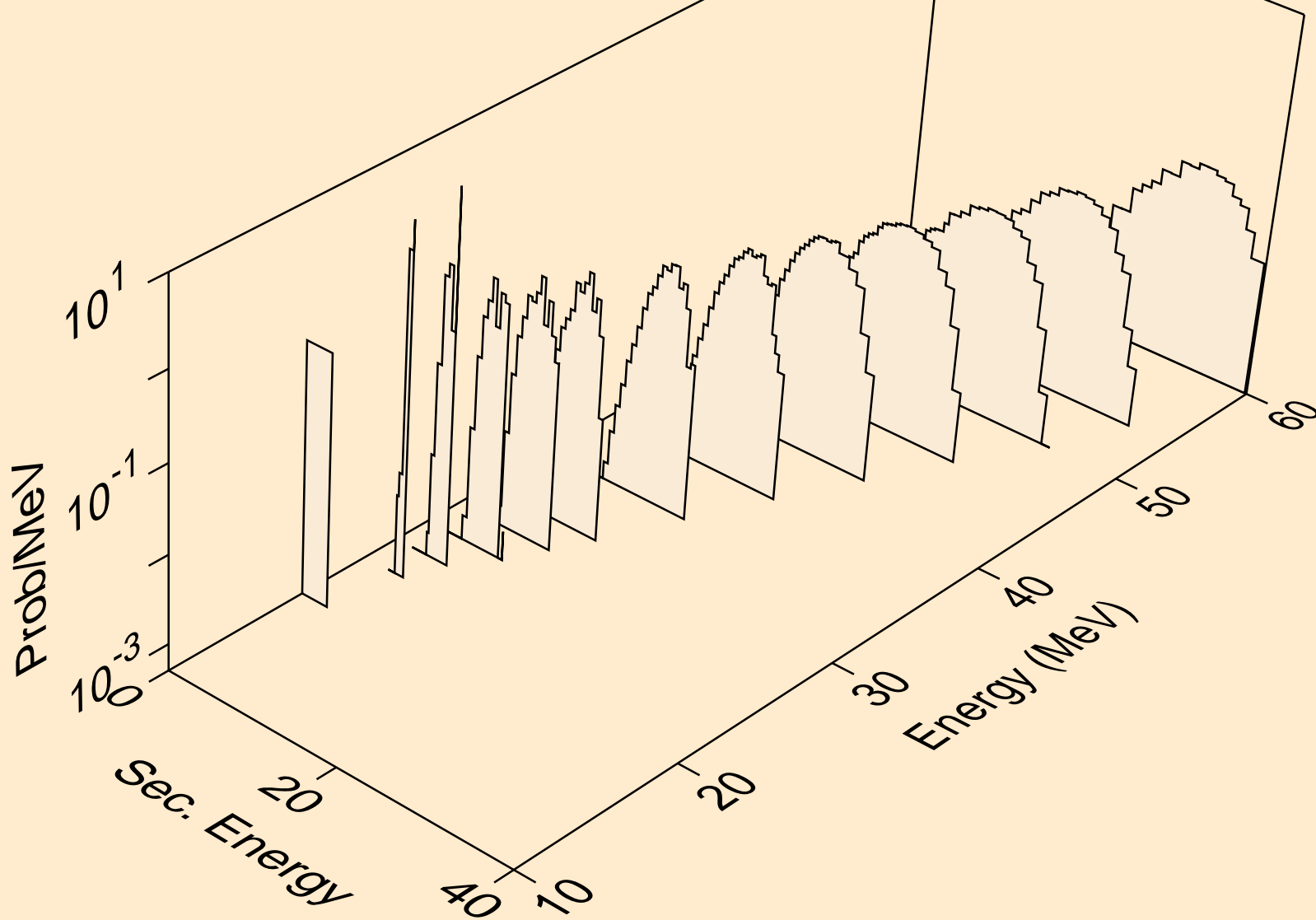

57-LA-138 FOR FENDL-3.2 PROCESSED BY NJOY2016.60+ ON
alphas from (n,n*)2a

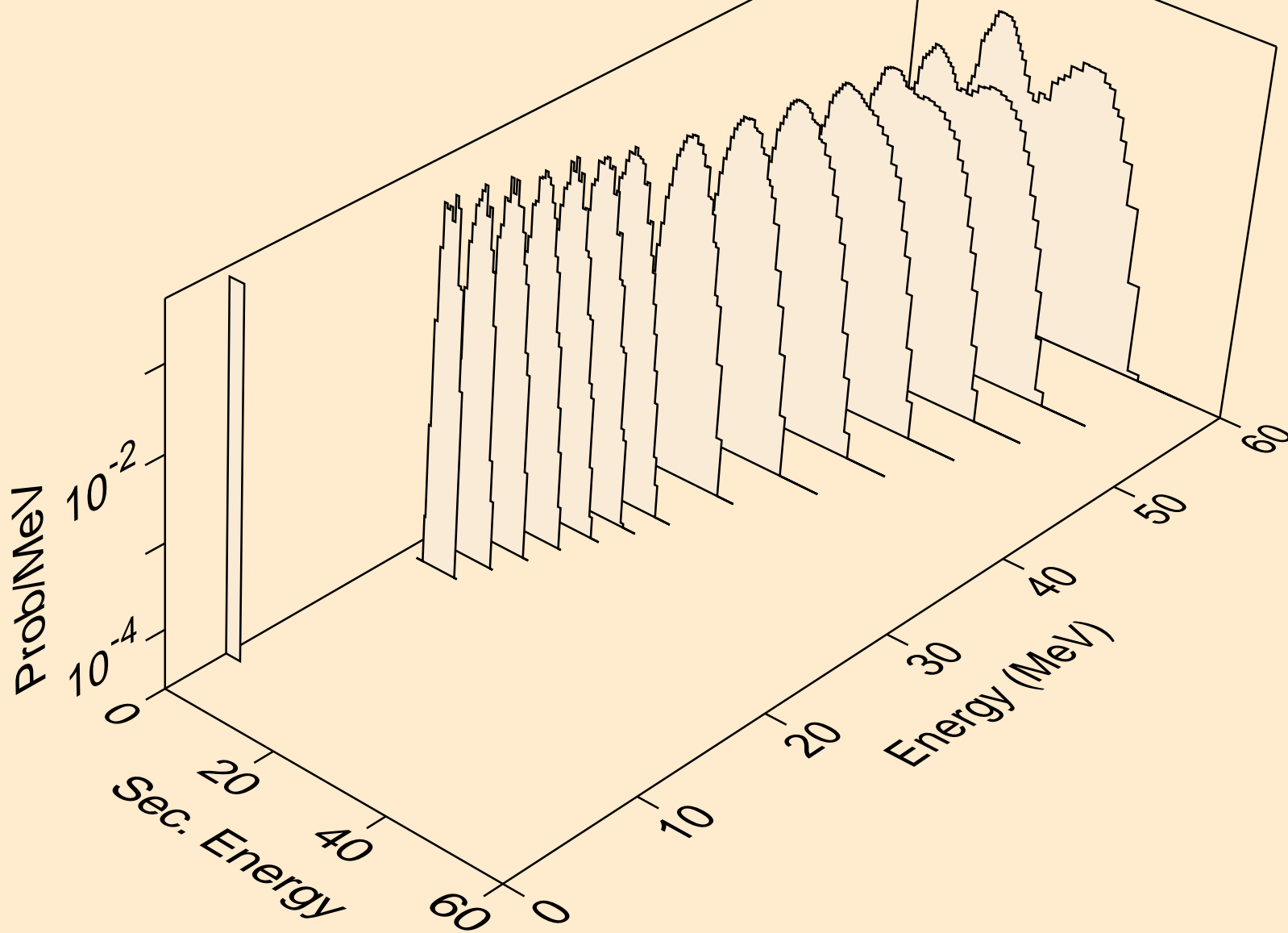

57-LA-138 FOR FENDL-3.2 PROCESSED BY NJOY2016.60+ ON
alphas from (n,2n)2a

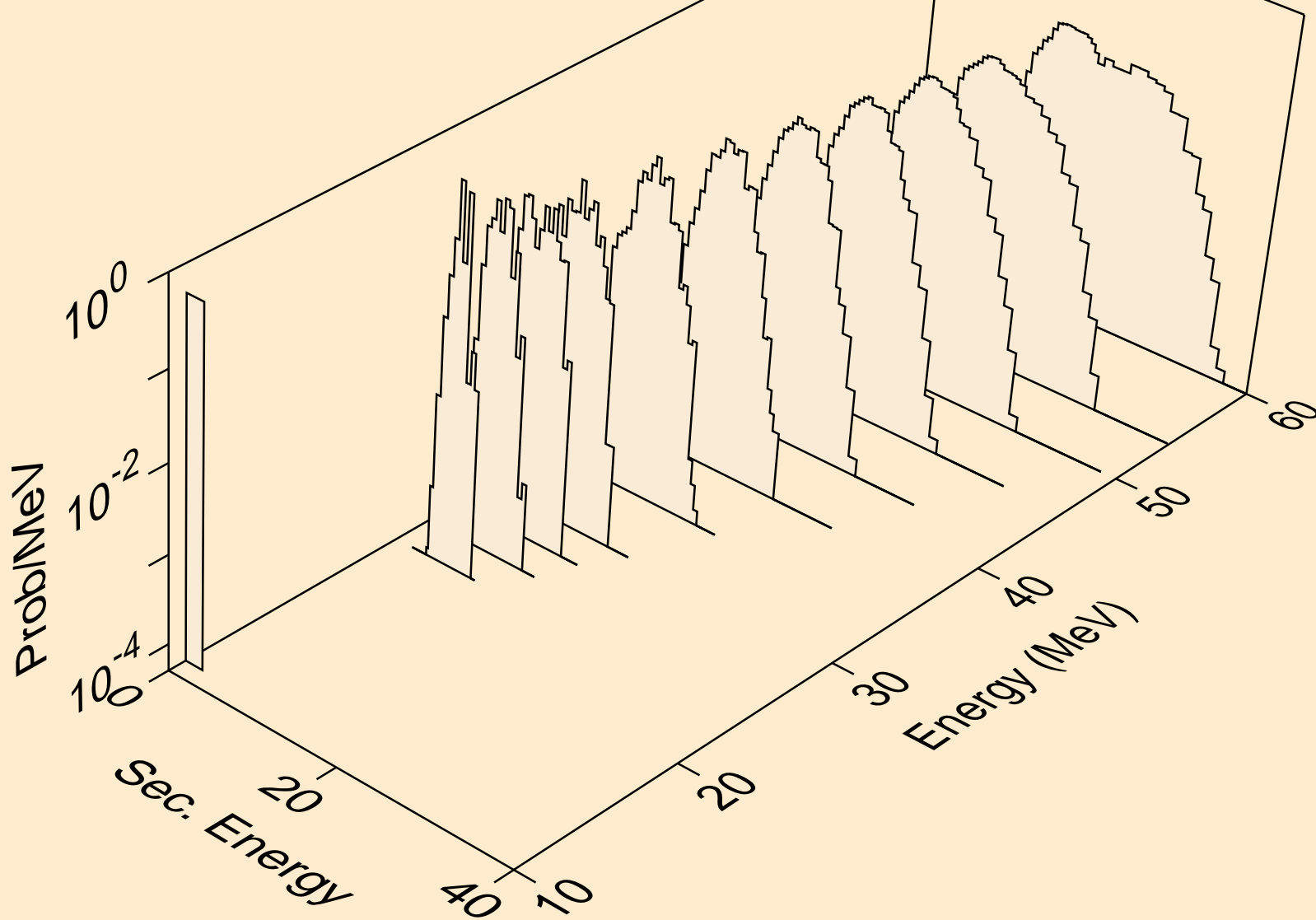

57-LA-138 FOR FENDL-3.2 PROCESSED BY NJOY2016.60+ ON
alphas from (n,n*)d2a

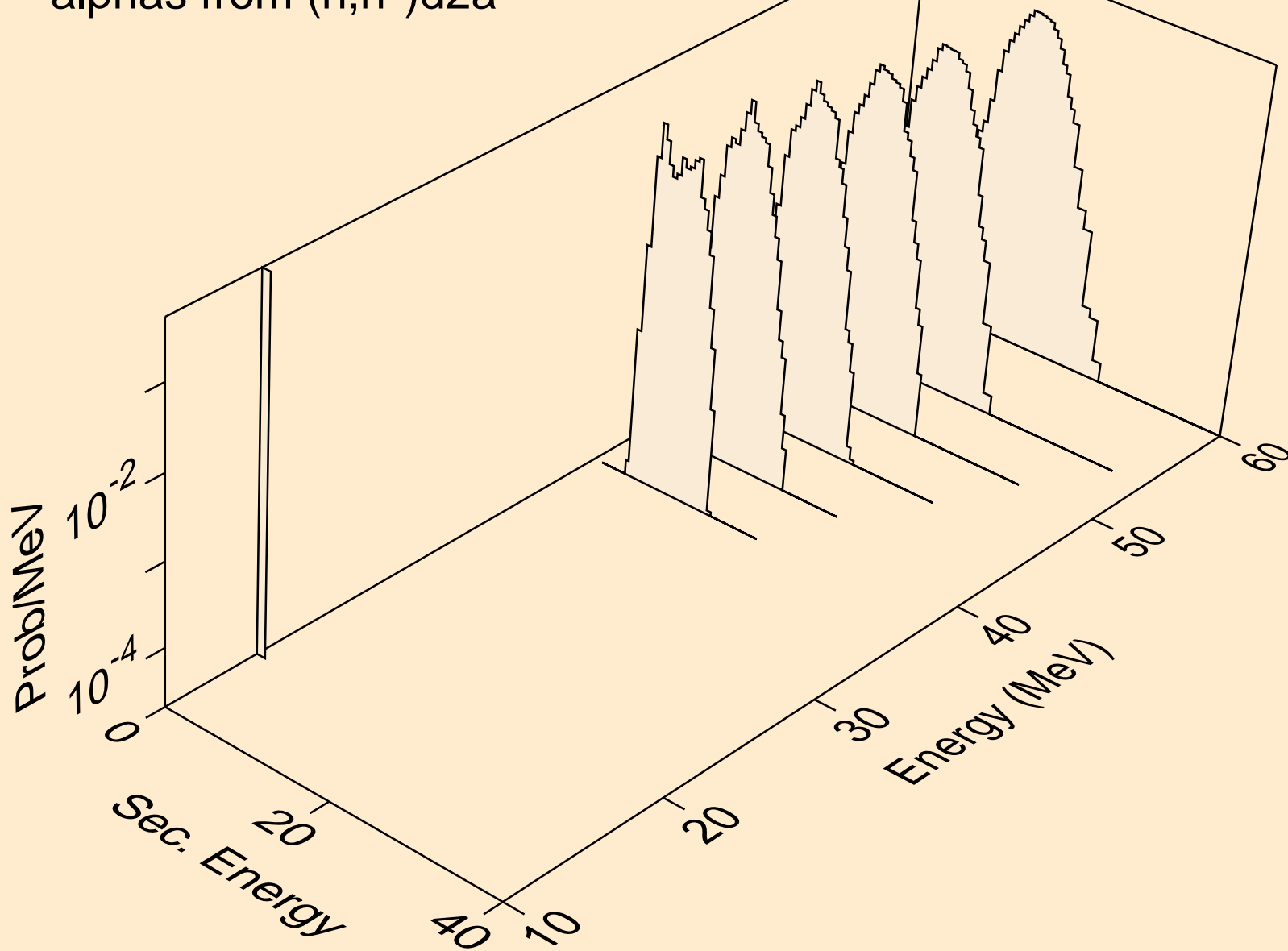

57-LA-138 FOR FENDL-3.2 PROCESSED BY NJOY2016.60+ ON
alphas from (n,npa)

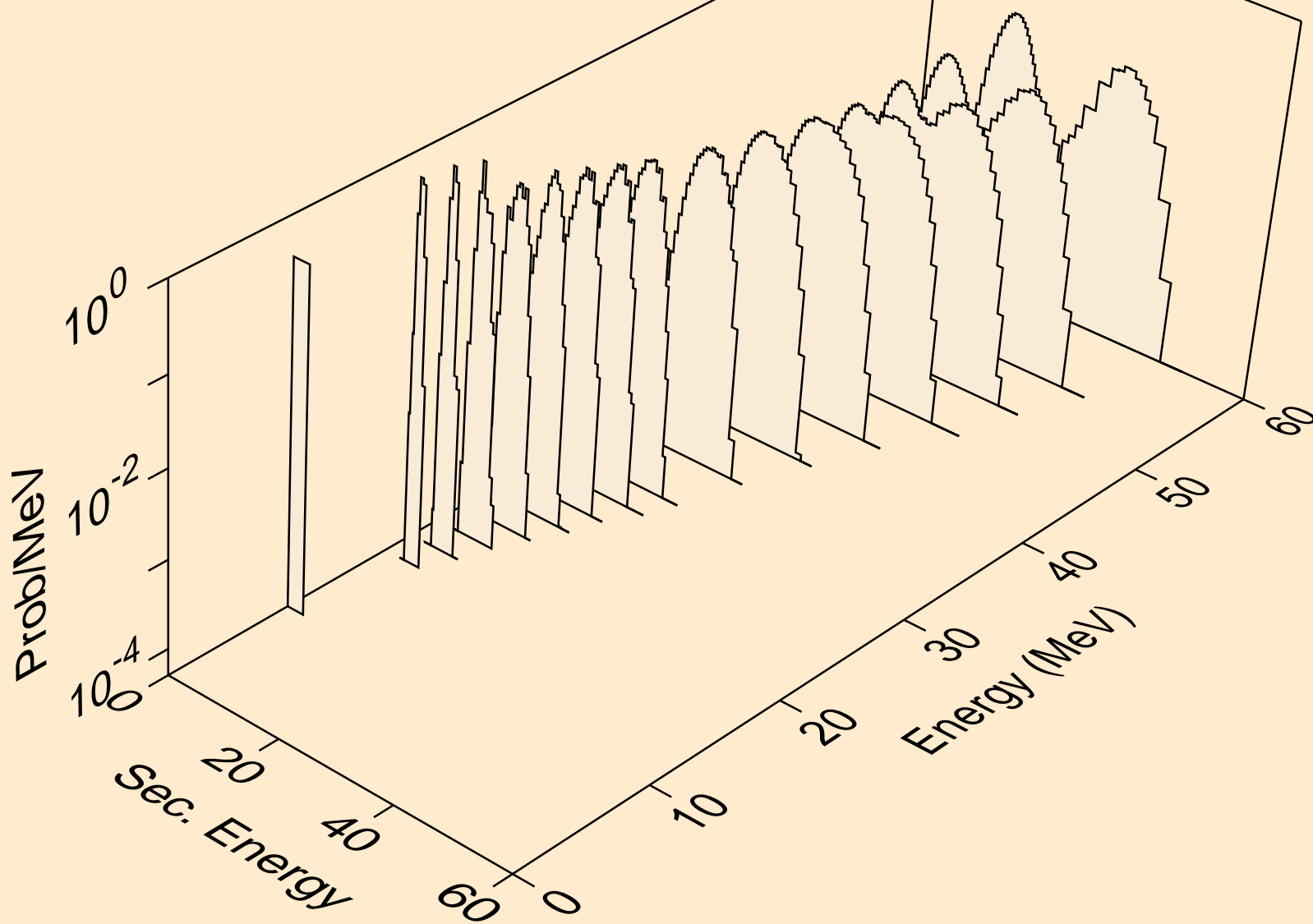

57-LA-138 FOR FENDL-3.2 PROCESSED BY NJOY2016.60+ ON
alphas from (n,a)

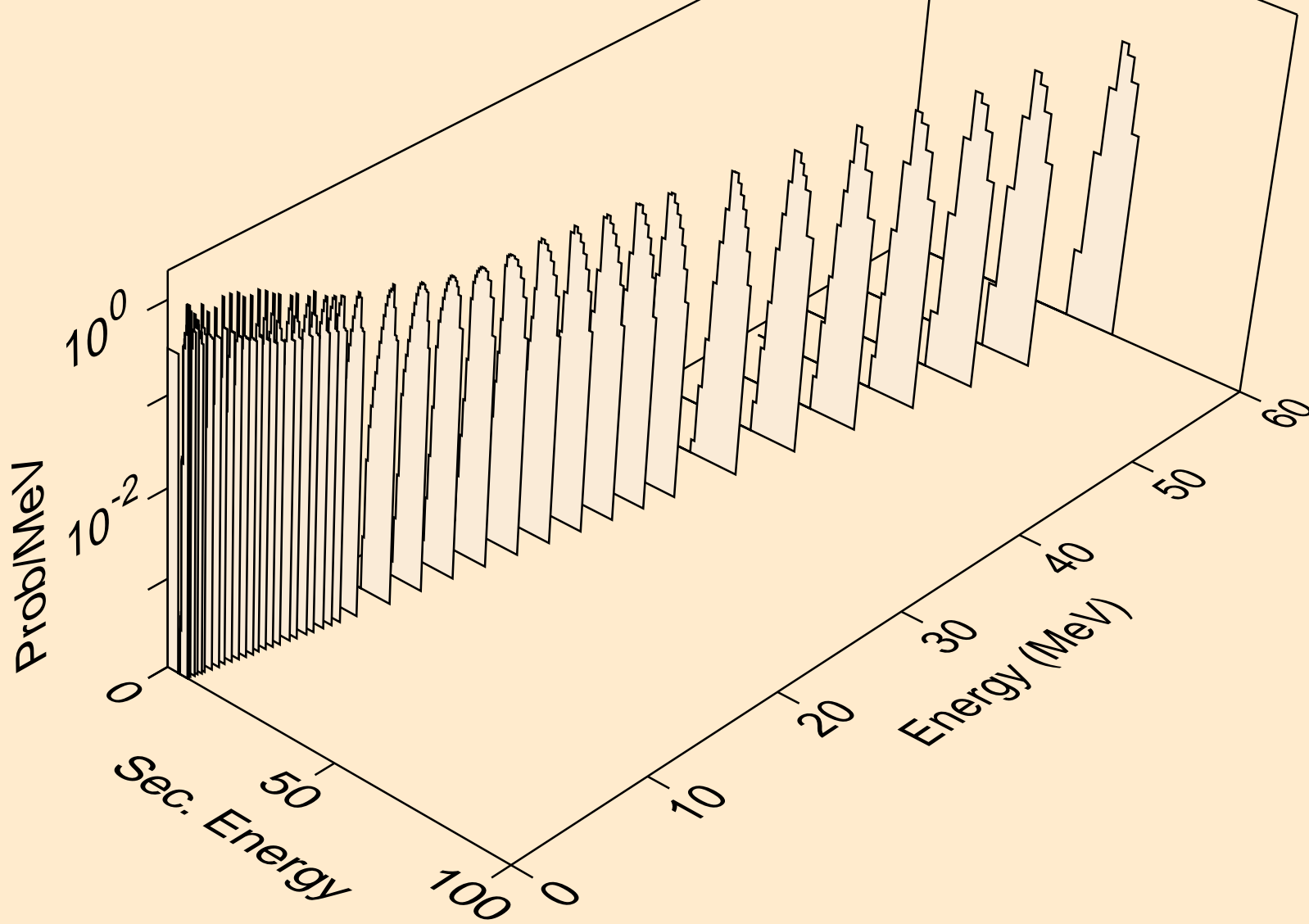

57-LA-138 FOR FENDL-3.2 PROCESSED BY NJOY2016.60+ ON
alphas from (n,2a)

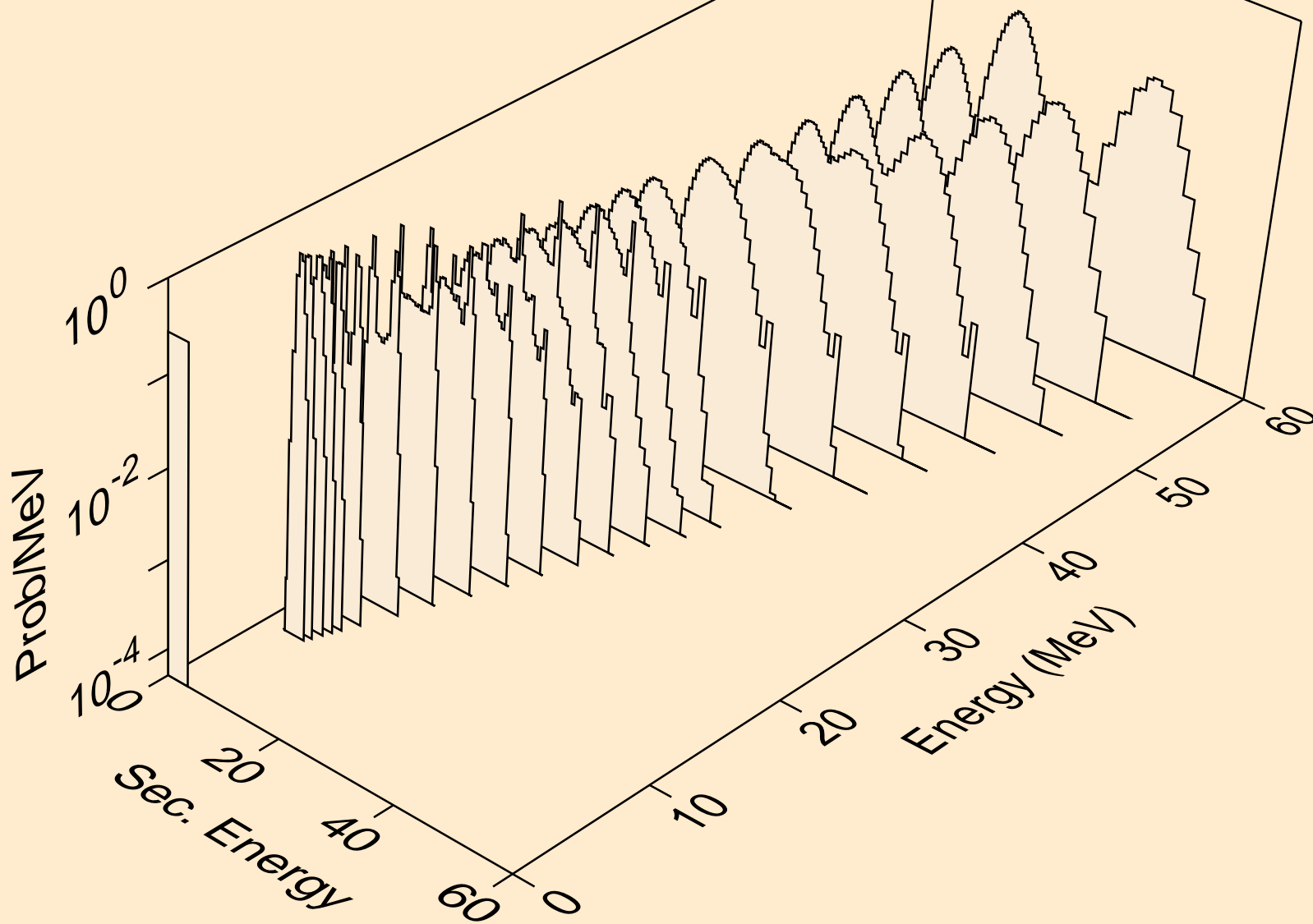

57-LA-138 FOR FENDL-3.2 PROCESSED BY NJOY2016.60+ ON
alphas from (n,pa)

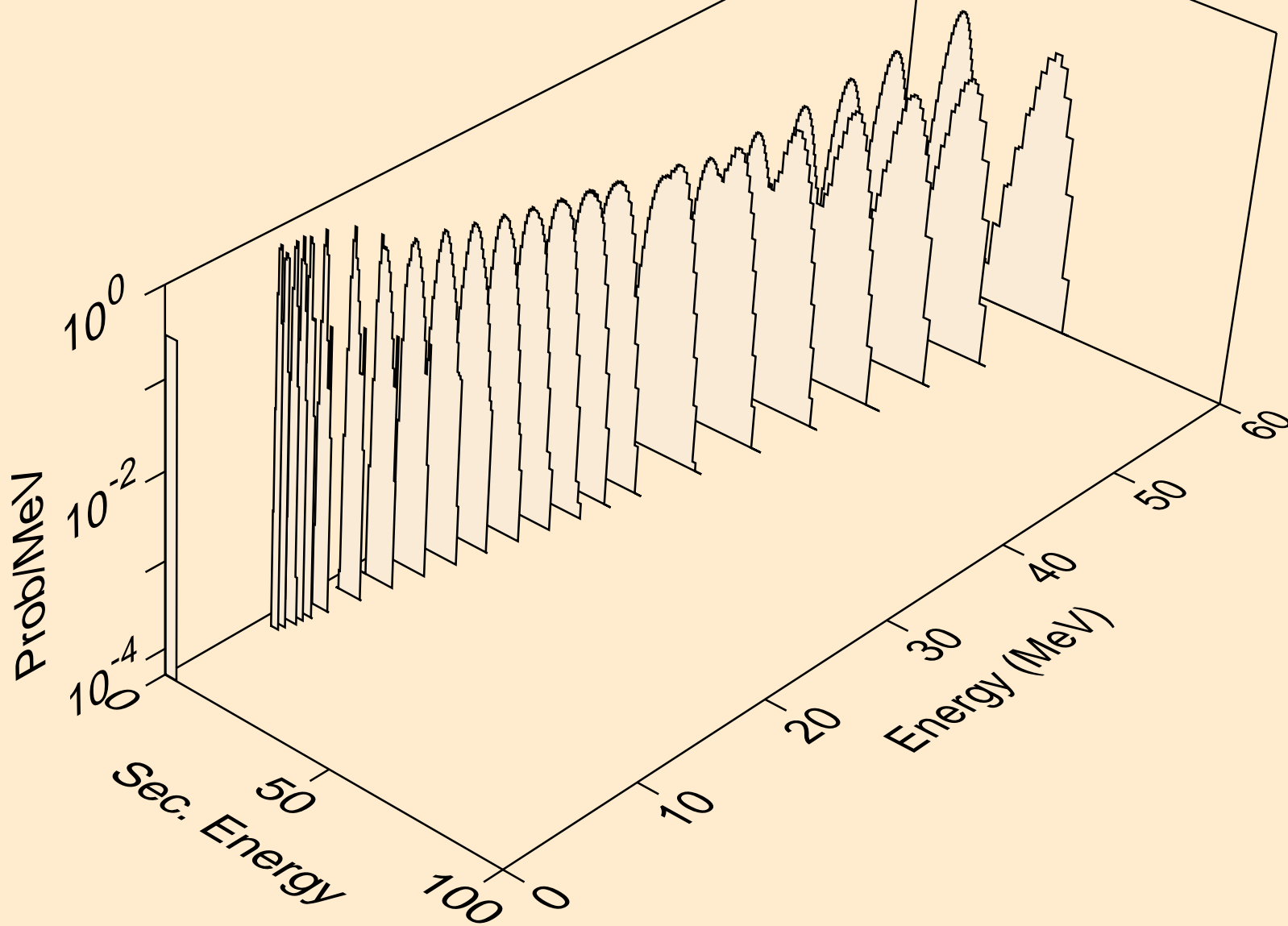

57-LA-138 FOR FENDL-3.2 PROCESSED BY NJOY2016.60+ ON
alphas from (n,d2a)

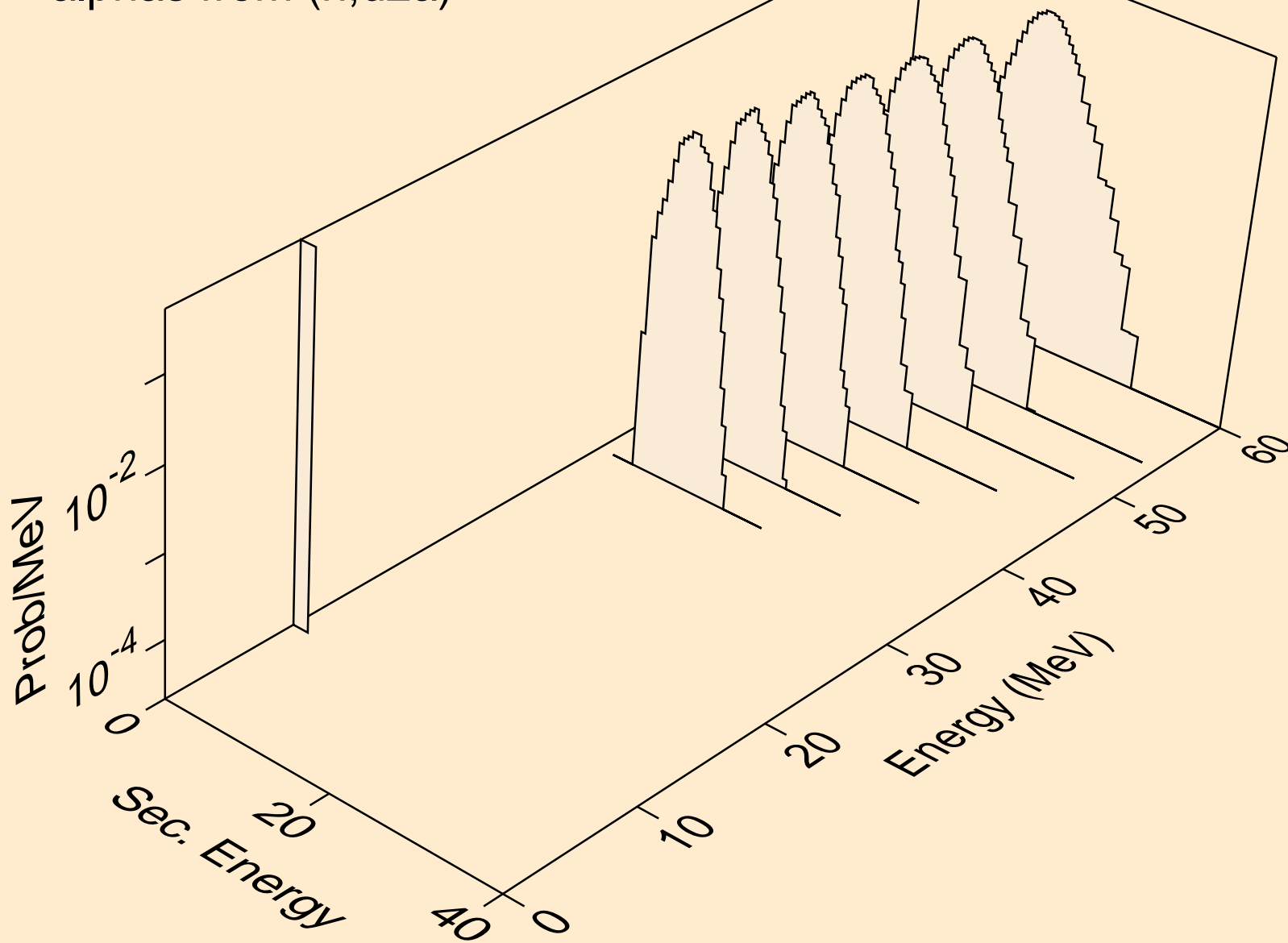

57-LA-138 FOR FENDL-3.2 PROCESSED BY NJOY2016.60+ ON
alphas from (n,da)

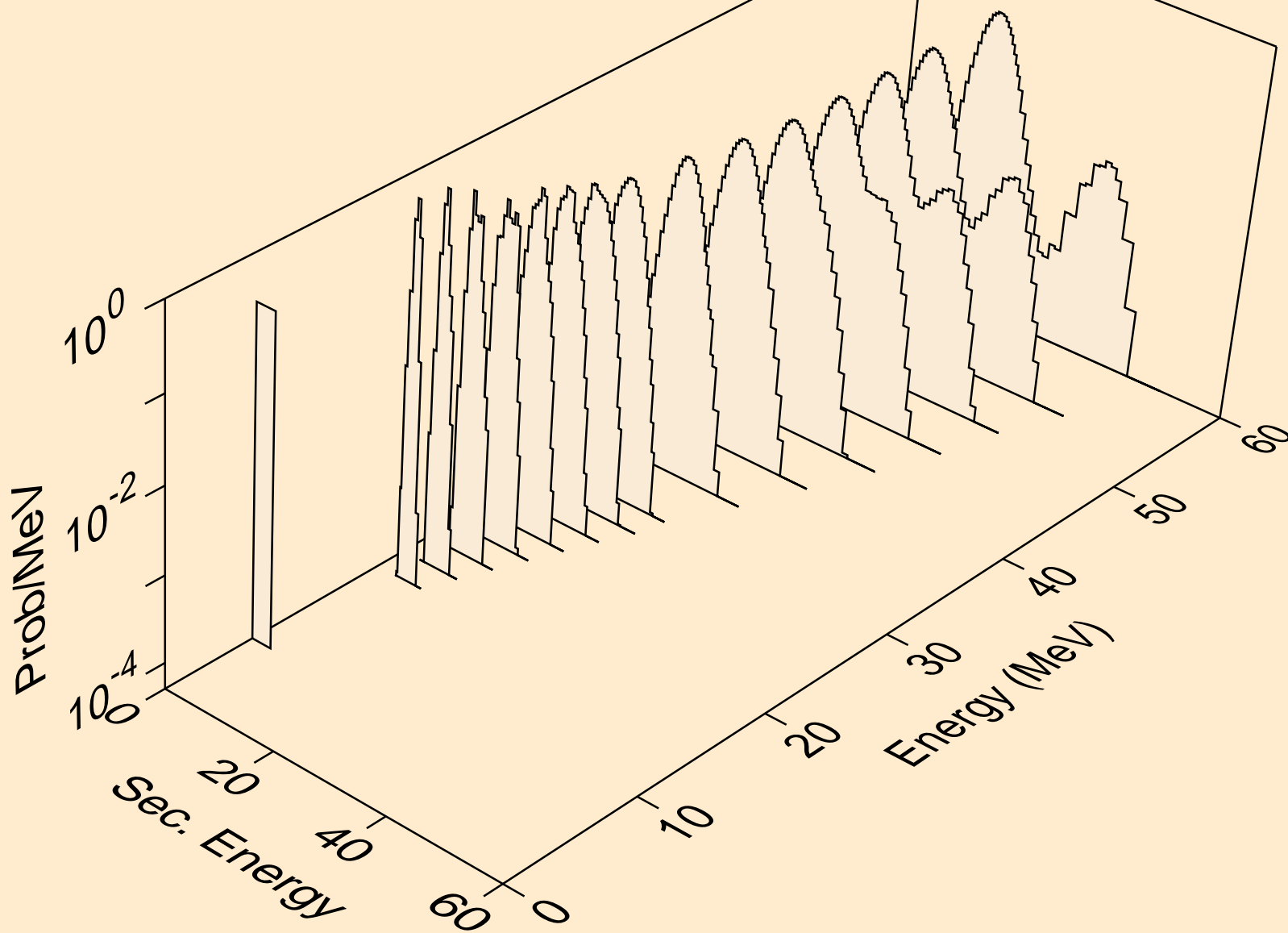

57-LA-138 FOR FENDL-3.2 PROCESSED BY NJOY2016.60+ ON
alphas from (n,ta)

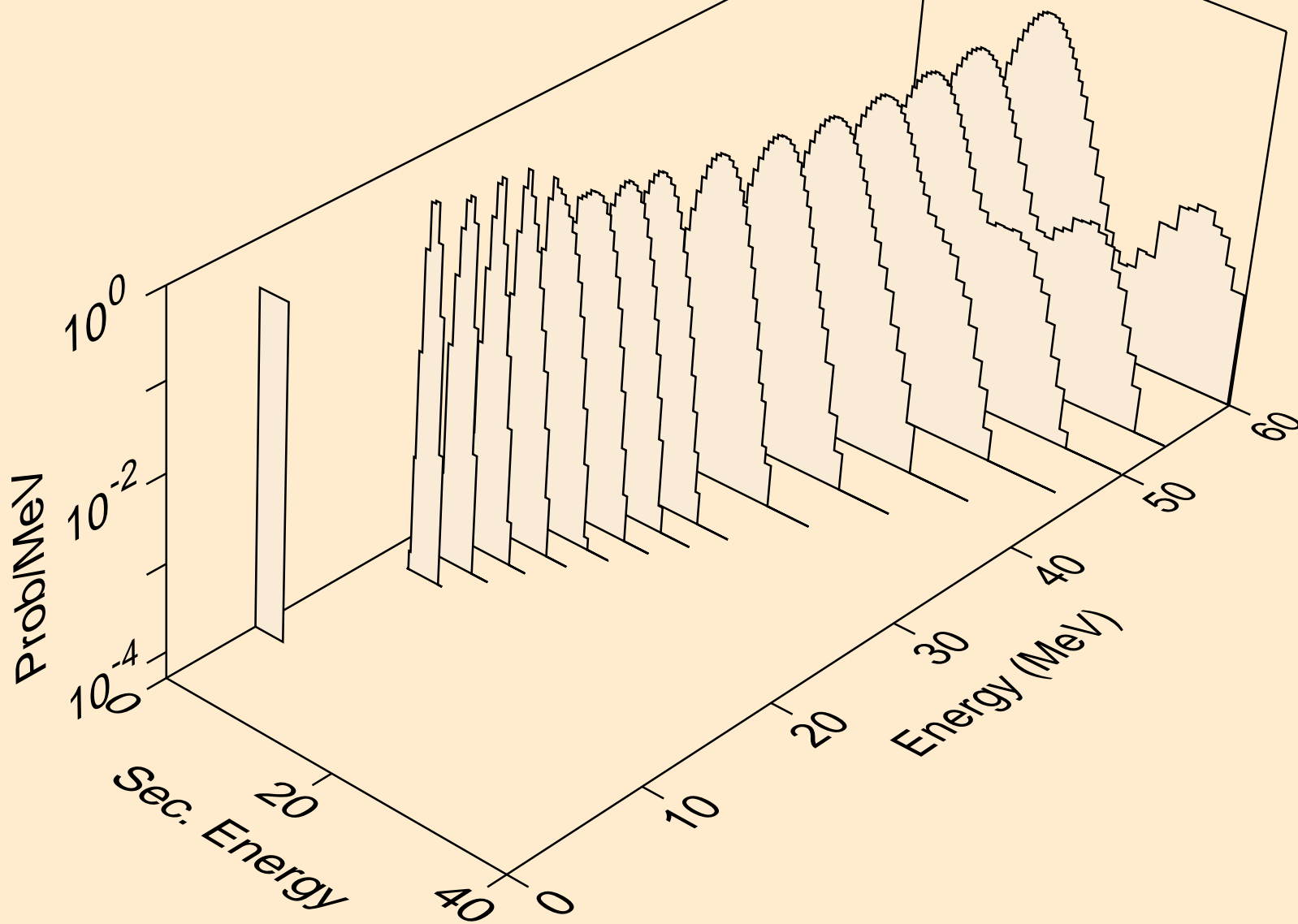

57-LA-138 FOR FENDL-3.2 PROCESSED BY NJOY2016.60+ ON
alphas from (n,nda)

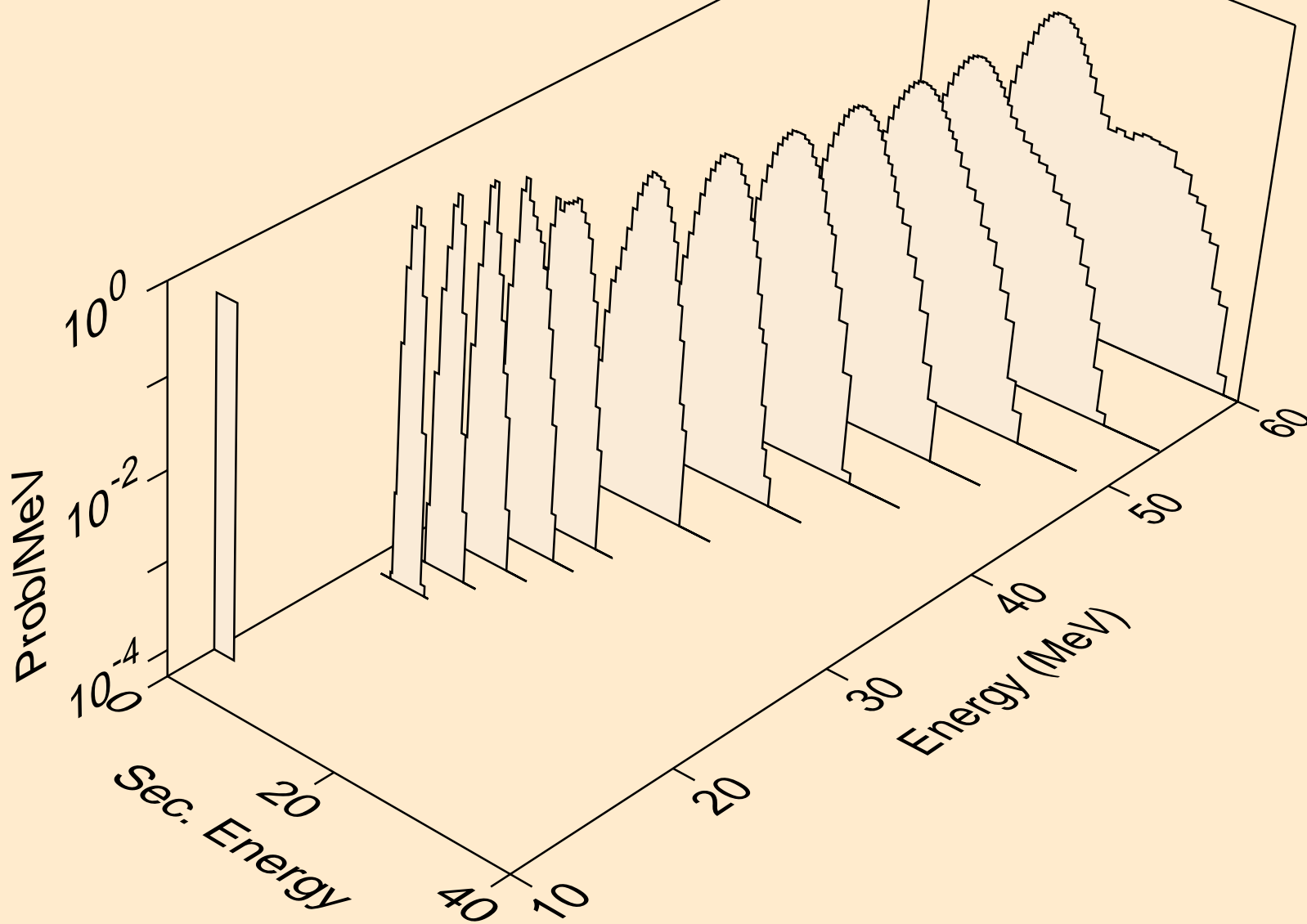

57-LA-138 FOR FENDL-3.2 PROCESSED BY NJOY2016.60+ ON
alphas from (n,2npa)

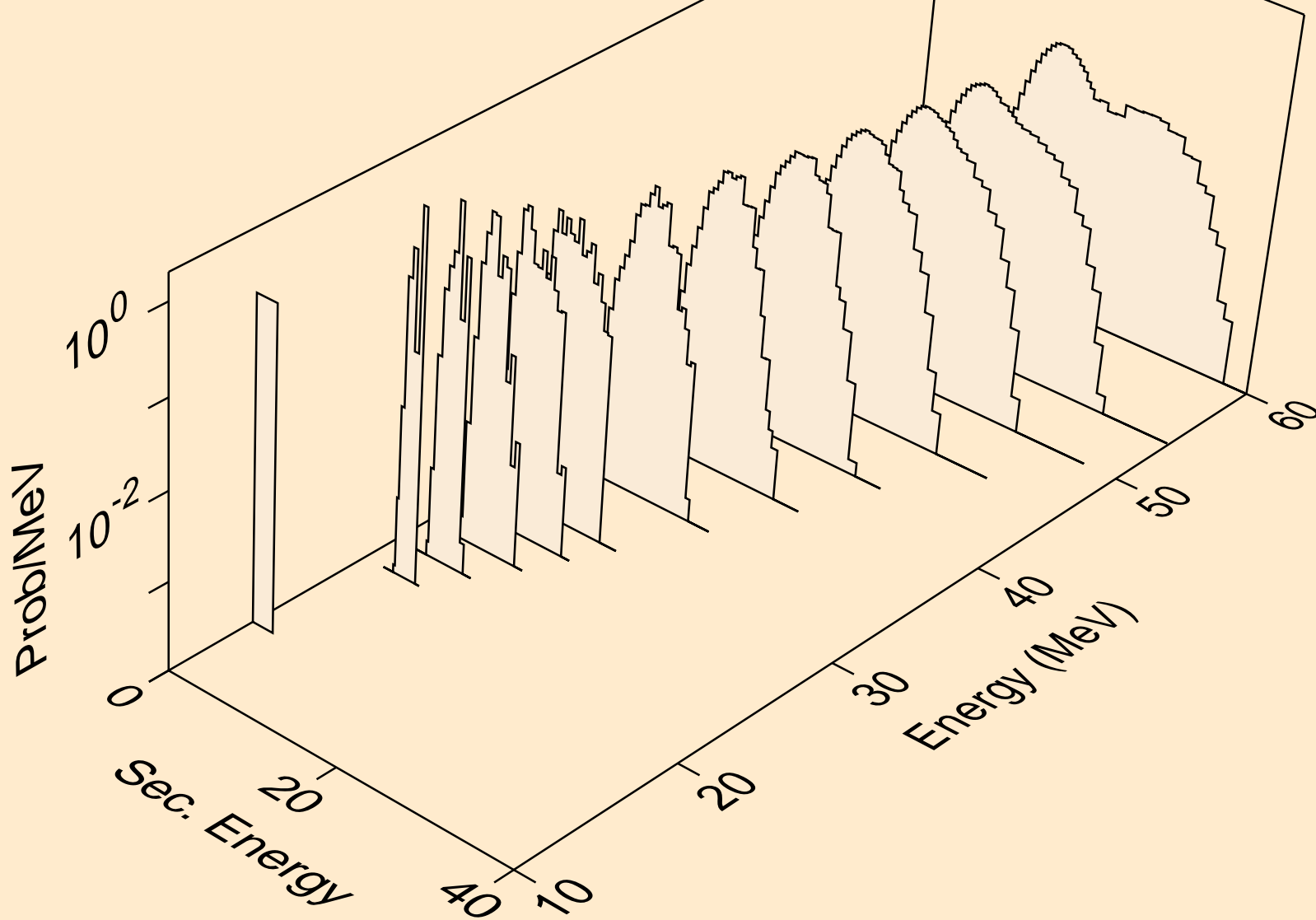

57-LA-138 FOR FENDL-3.2 PROCESSED BY NJOY2016.60+ ON
alphas from (n,4na)

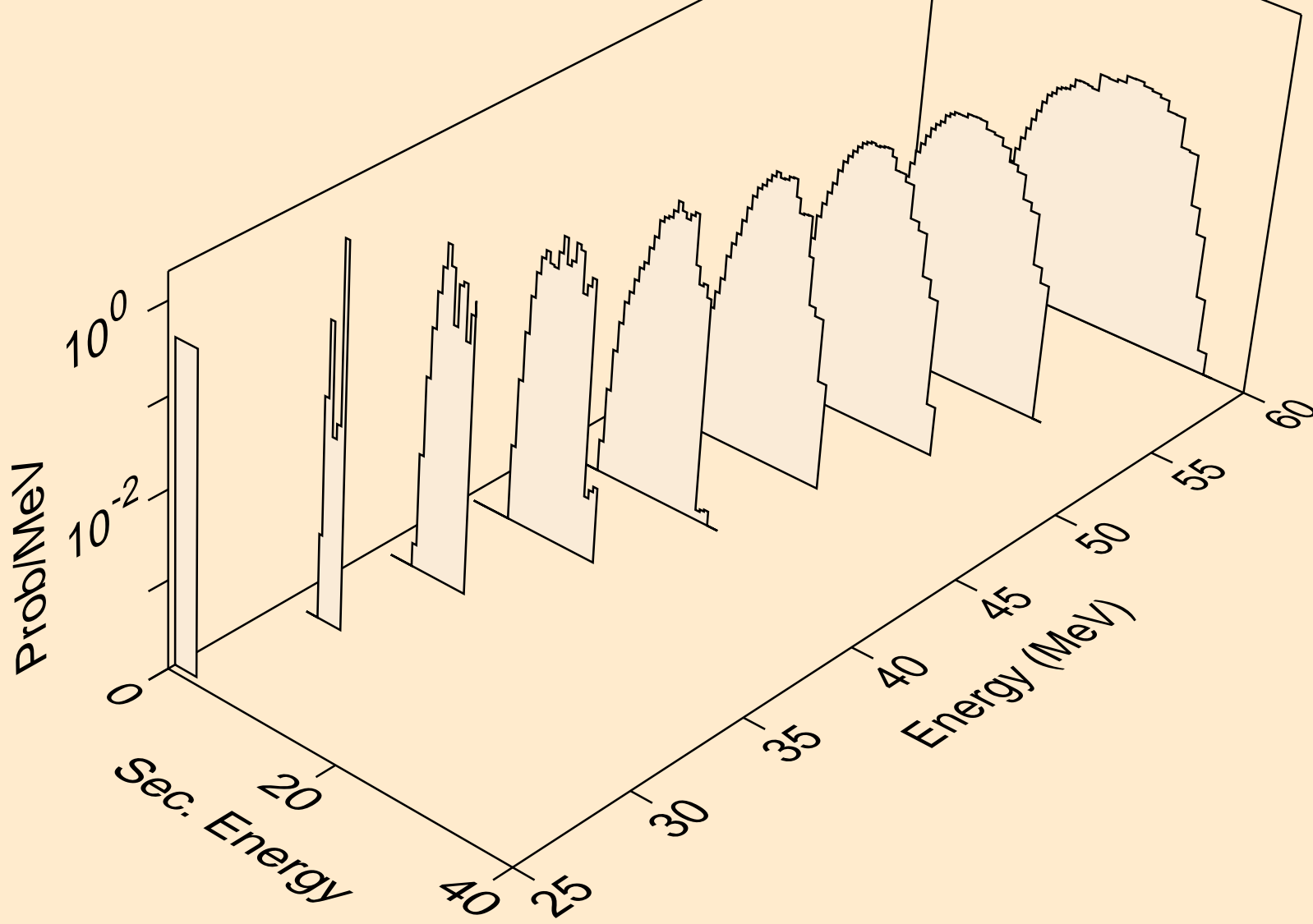

57-LA-138 FOR FENDL-3.2 PROCESSED BY NJOY2016.60+ ON
alphas from (n,5na)

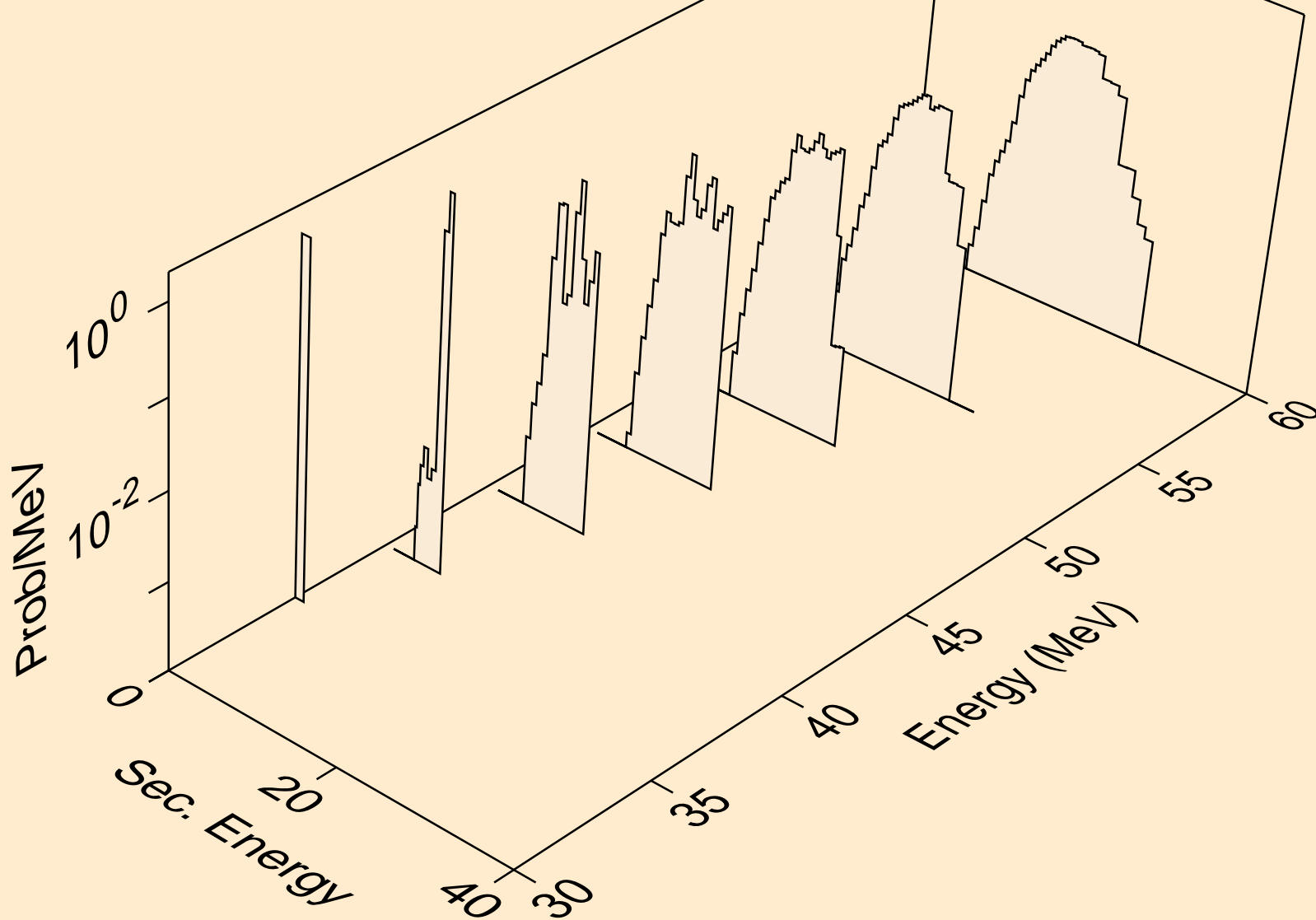

57-LA-138 FOR FENDL-3.2 PROCESSED BY NJOY2016.60+ ON
alphas from (n,6na)

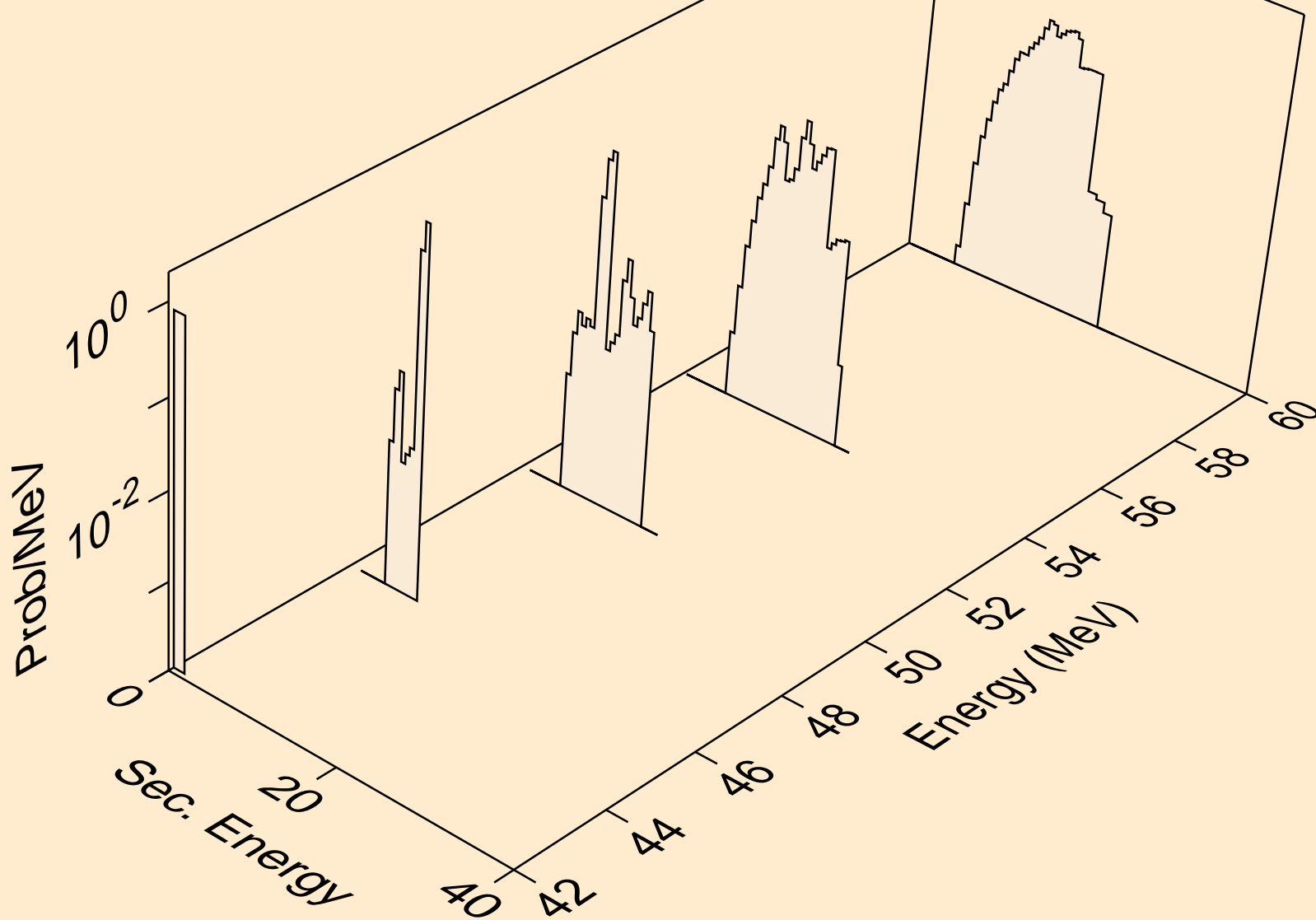

57-LA-138 FOR FENDL-3.2 PROCESSED BY NJOY2016.60+ ON
alphas from (n,3n2a)

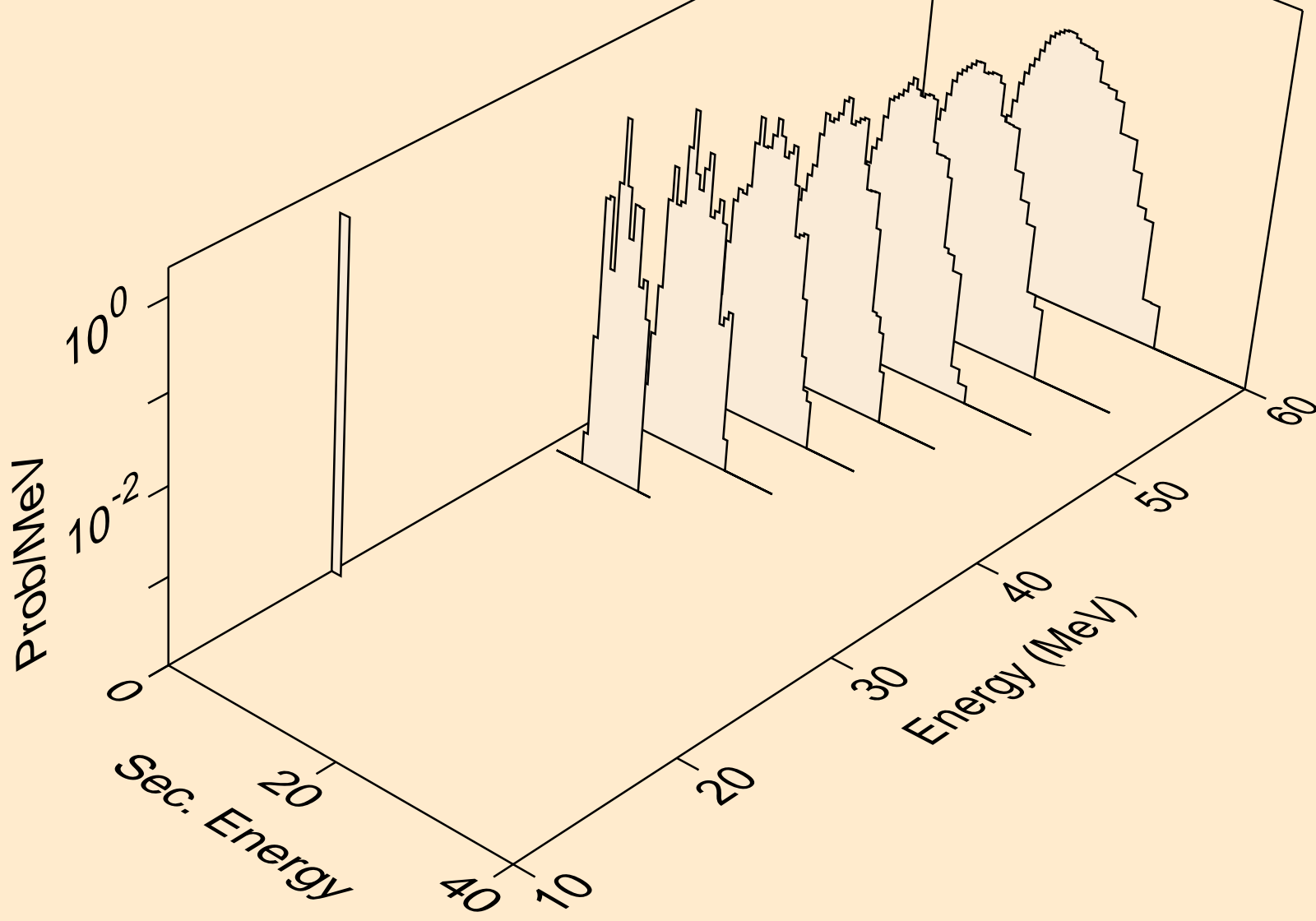

57-LA-138 FOR FENDL-3.2 PROCESSED BY NJOY2016.60+ ON
alphas from (n,3npa)

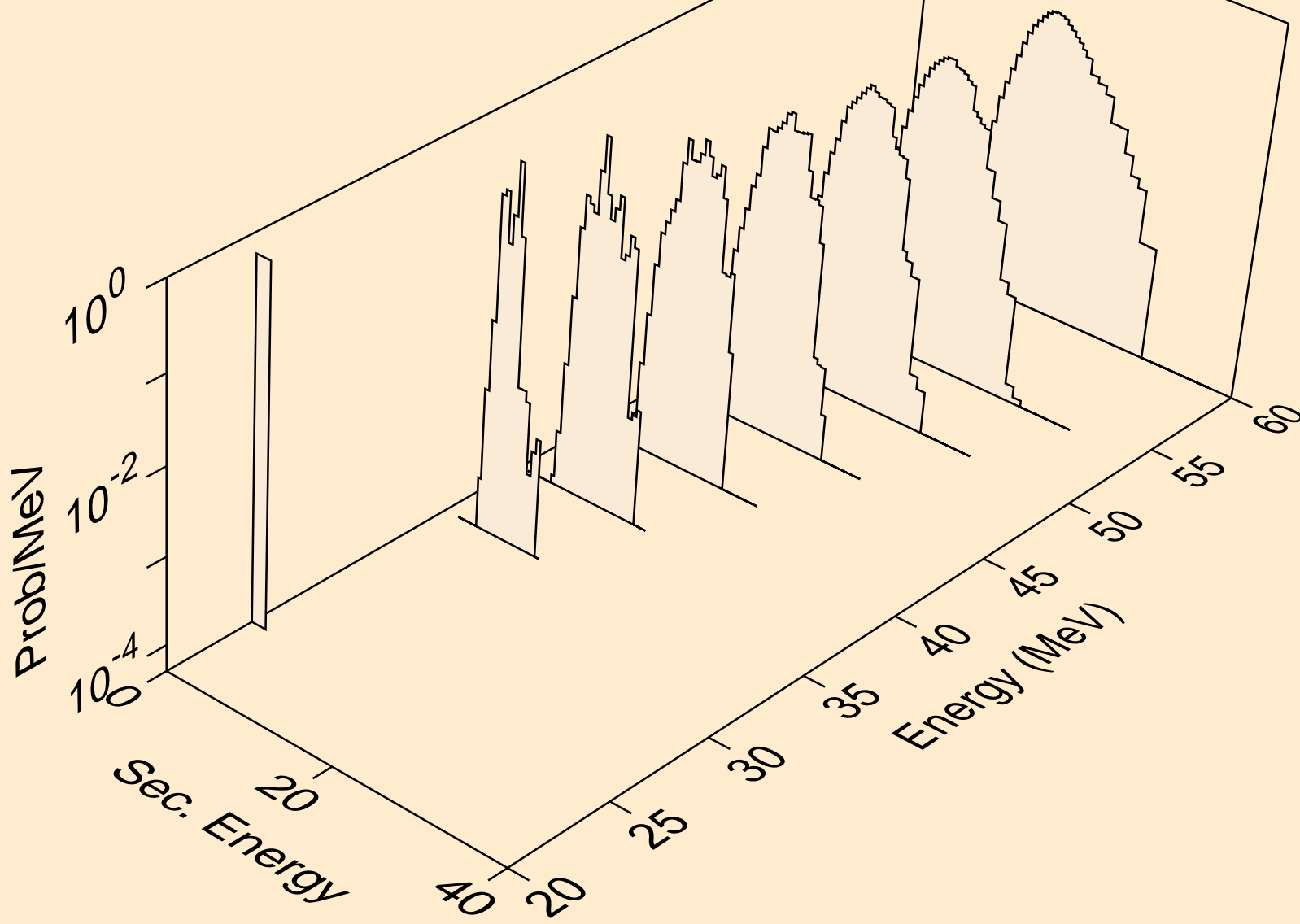

57-LA-138 FOR FENDL-3.2 PROCESSED BY NJOY2016.60+ ON
alphas from (n,nta)

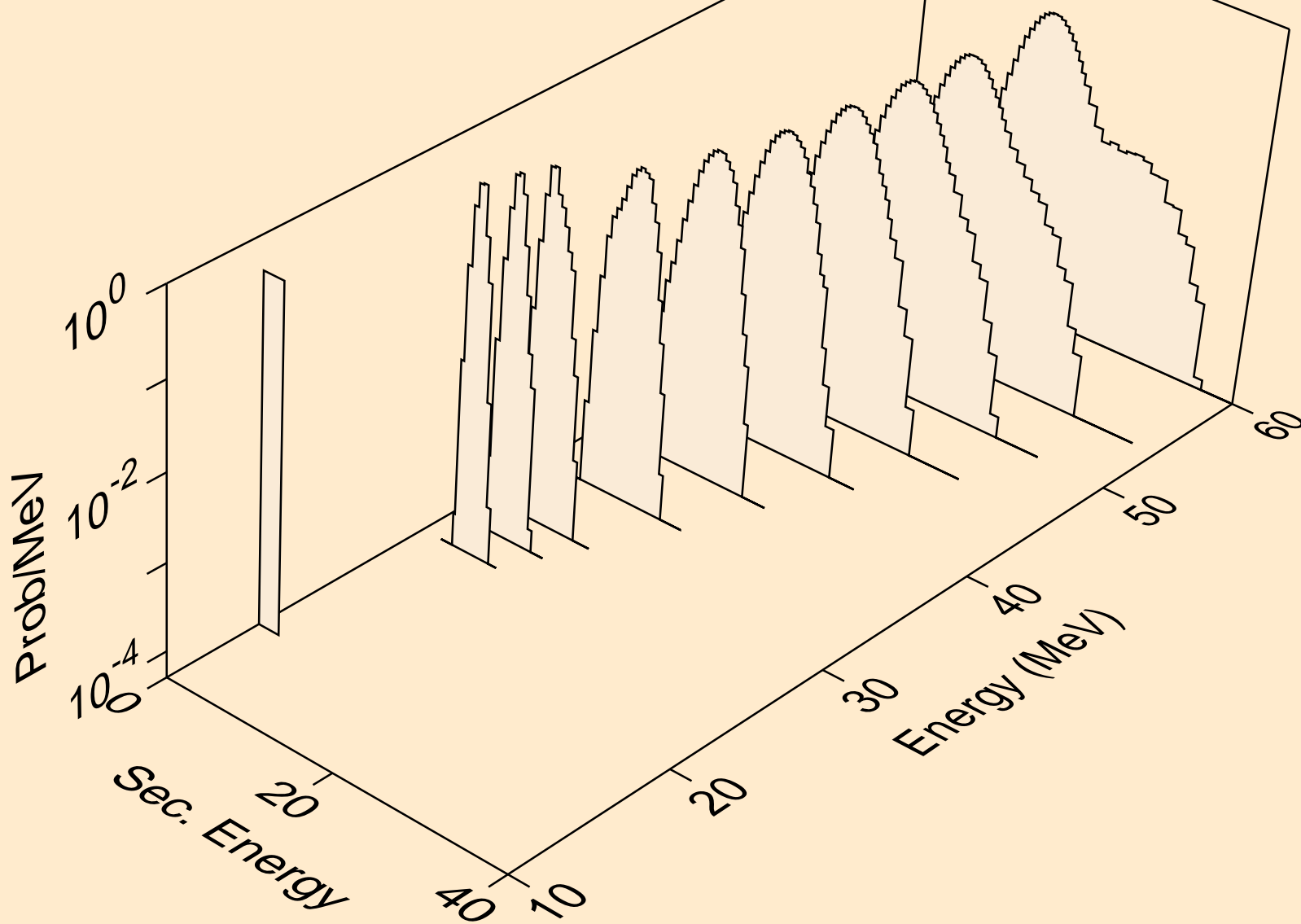

57-LA-138 FOR FENDL-3.2 PROCESSED BY NJOY2016.60+ ON
alphas from (n,he3a)

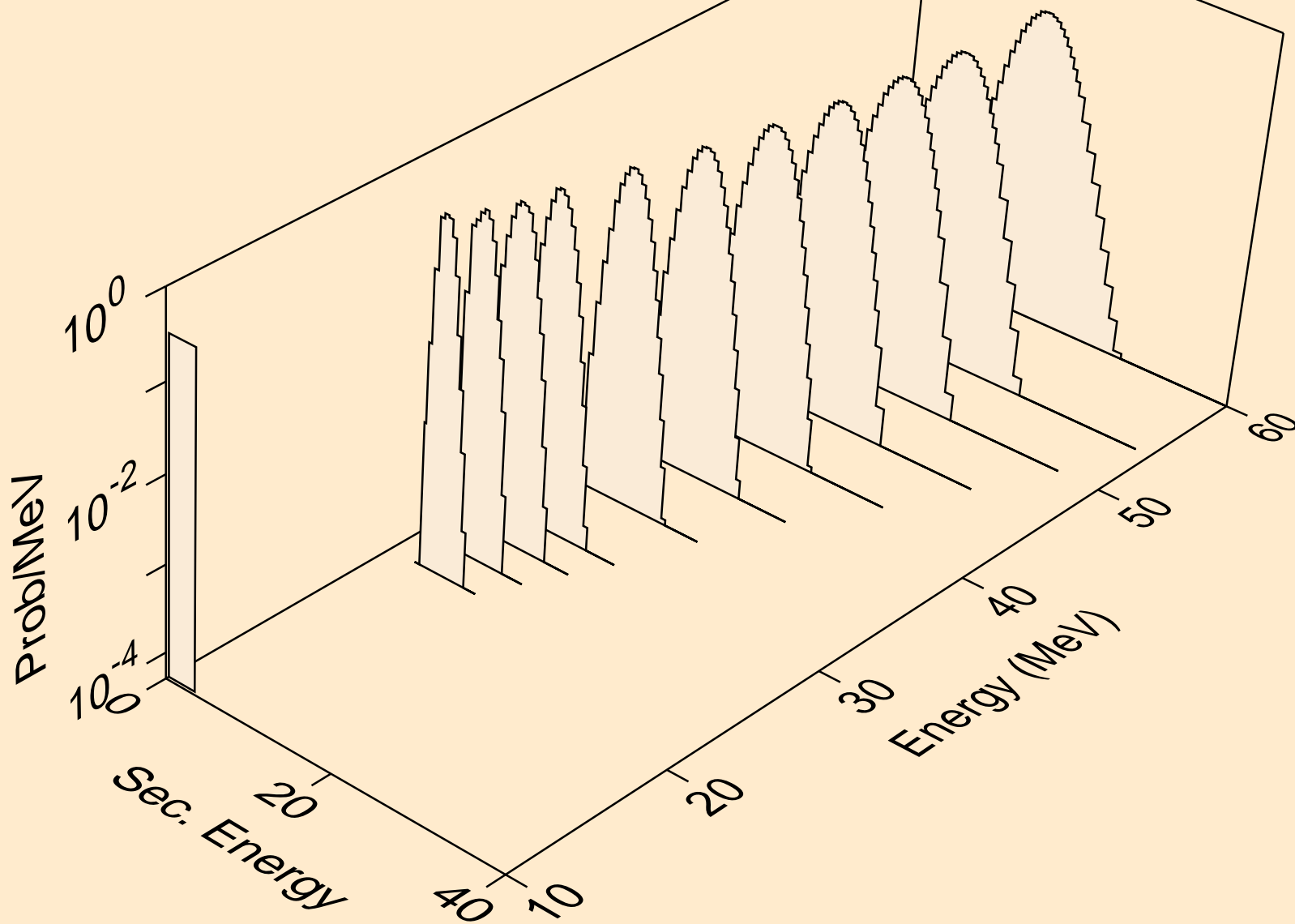

57-LA-138 FOR FENDL-3.2 PROCESSED BY NJOY2016.60+ ON
alphas from (n,2n2a)

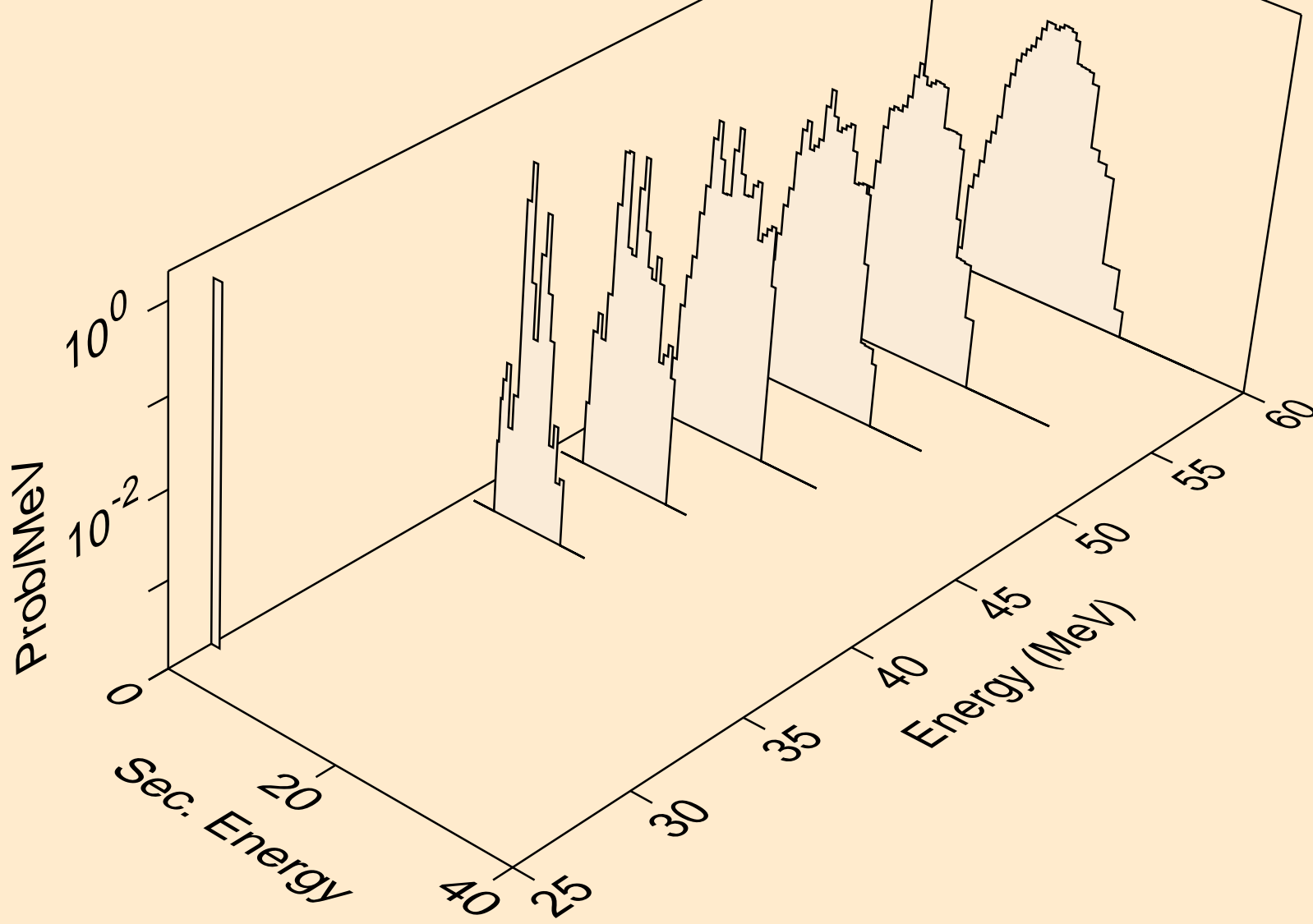

57-LA-138 FOR FENDL-3.2 PROCESSED BY NJOY2016.60+ ON
alphas from (n,4npa)

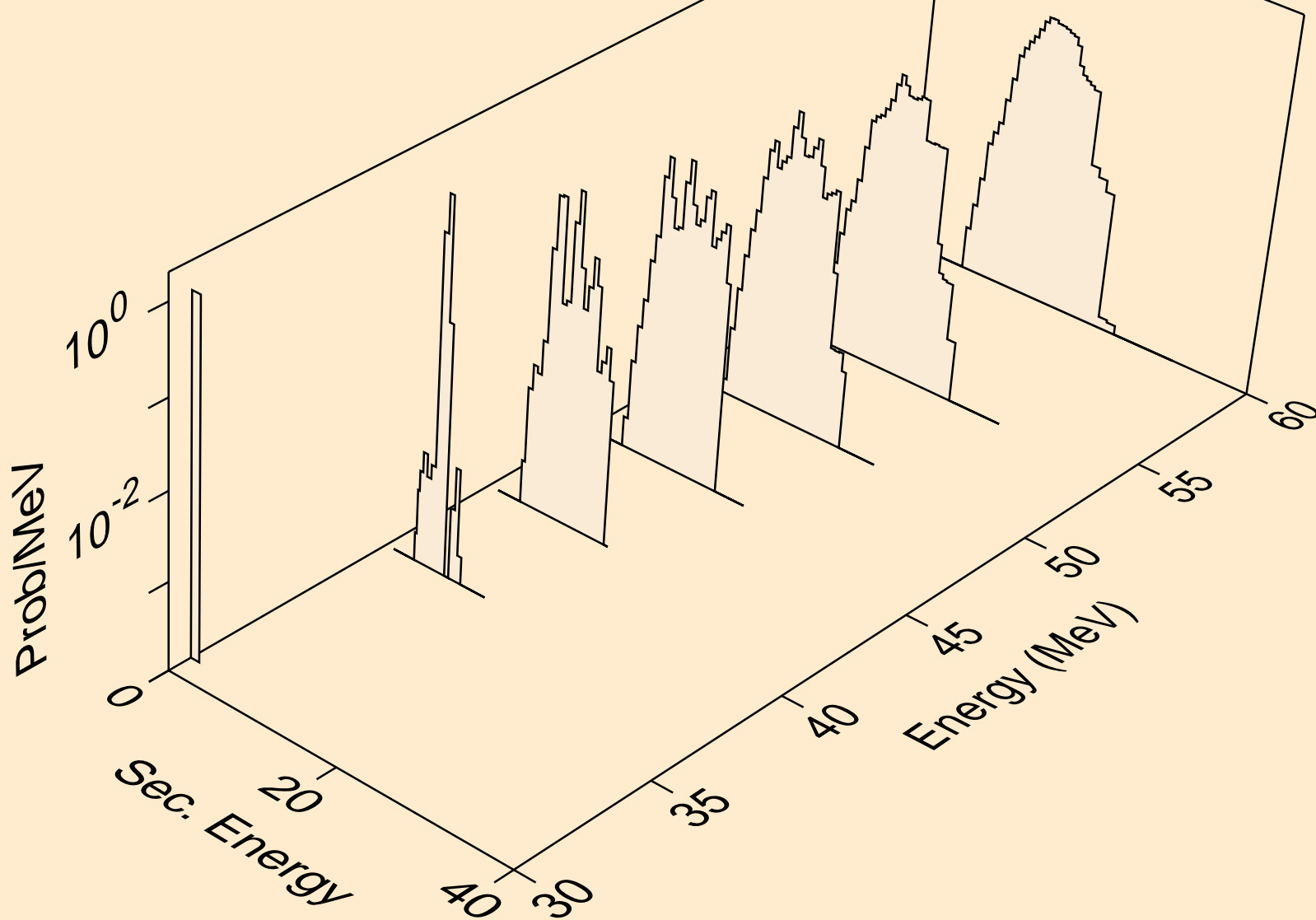

57-LA-138 FOR FENDL-3.2 PROCESSED BY NJOY2016.60+ ON
alphas from (n,3n2pa)

