

62-SM-147 FOR FENDL-3.2 FROM TENDL-2019 BY NJOY2016.60-
Principal cross sections

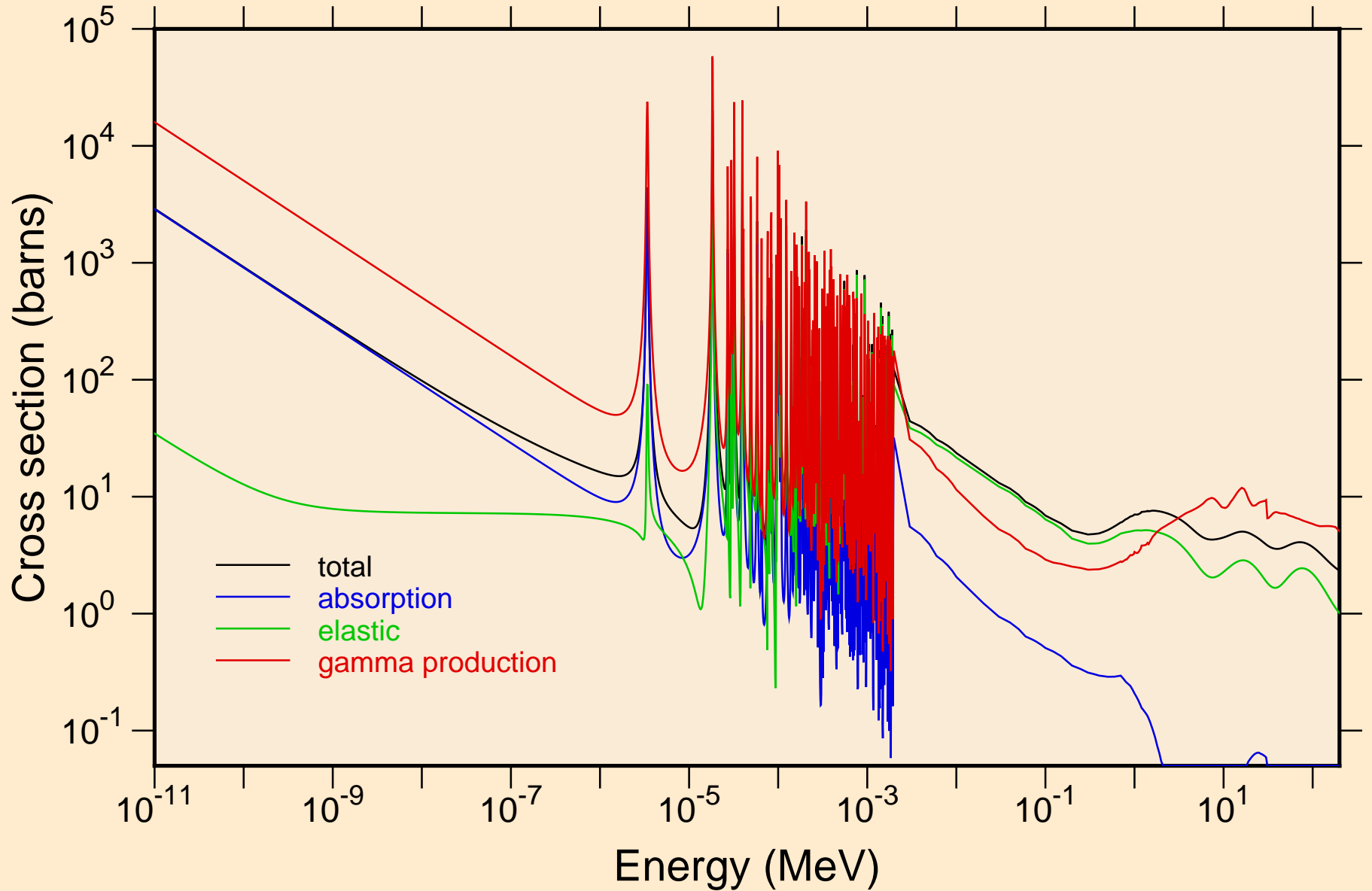

62-SM-147 FOR FENDL-3.2 FROM TENDL-2019 BY NJOY2016.60-
resonance total cross section

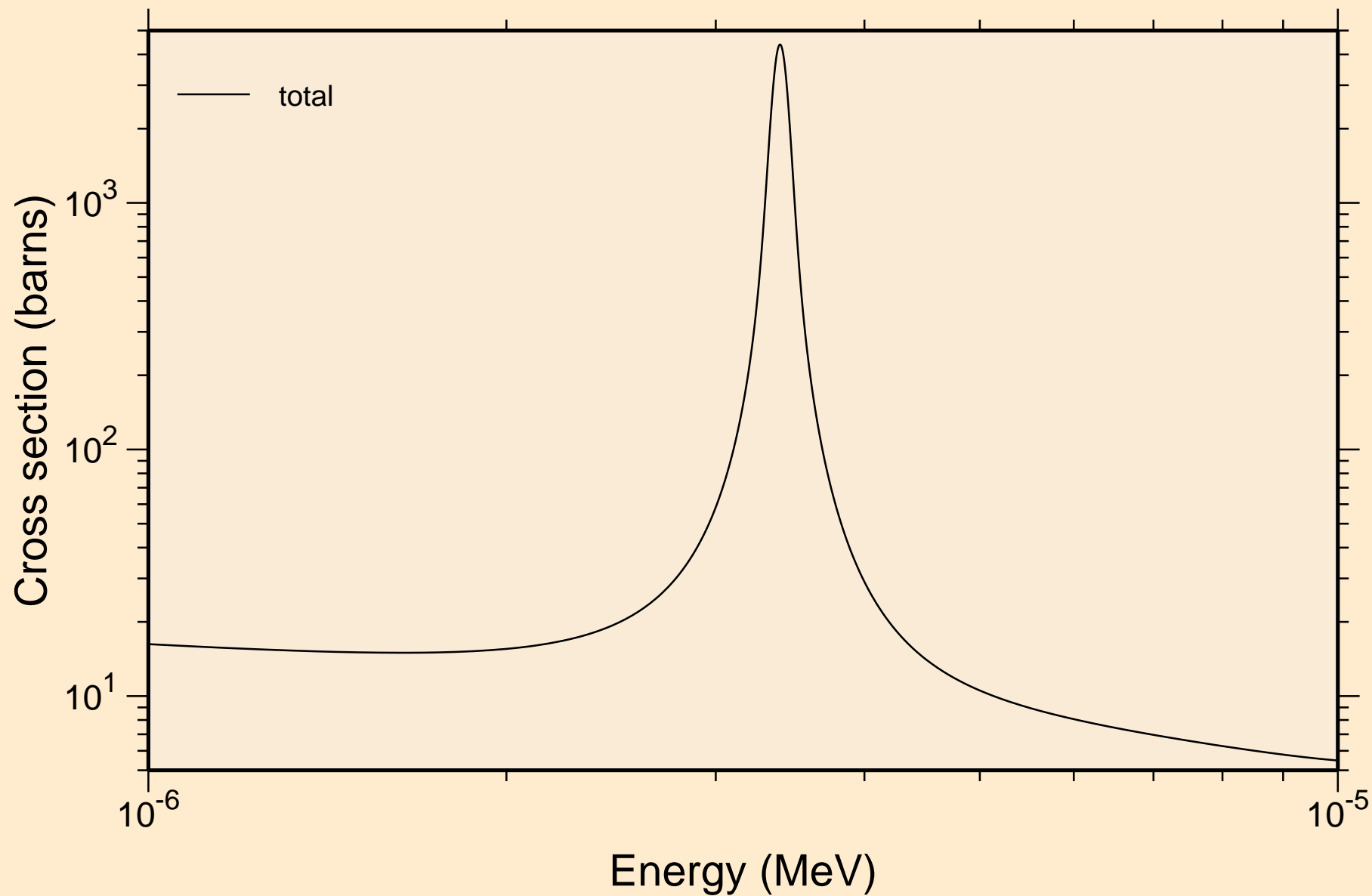

62-SM-147 FOR FENDL-3.2 FROM TENDL-2019 BY NJOY2016.60-
resonance total cross section

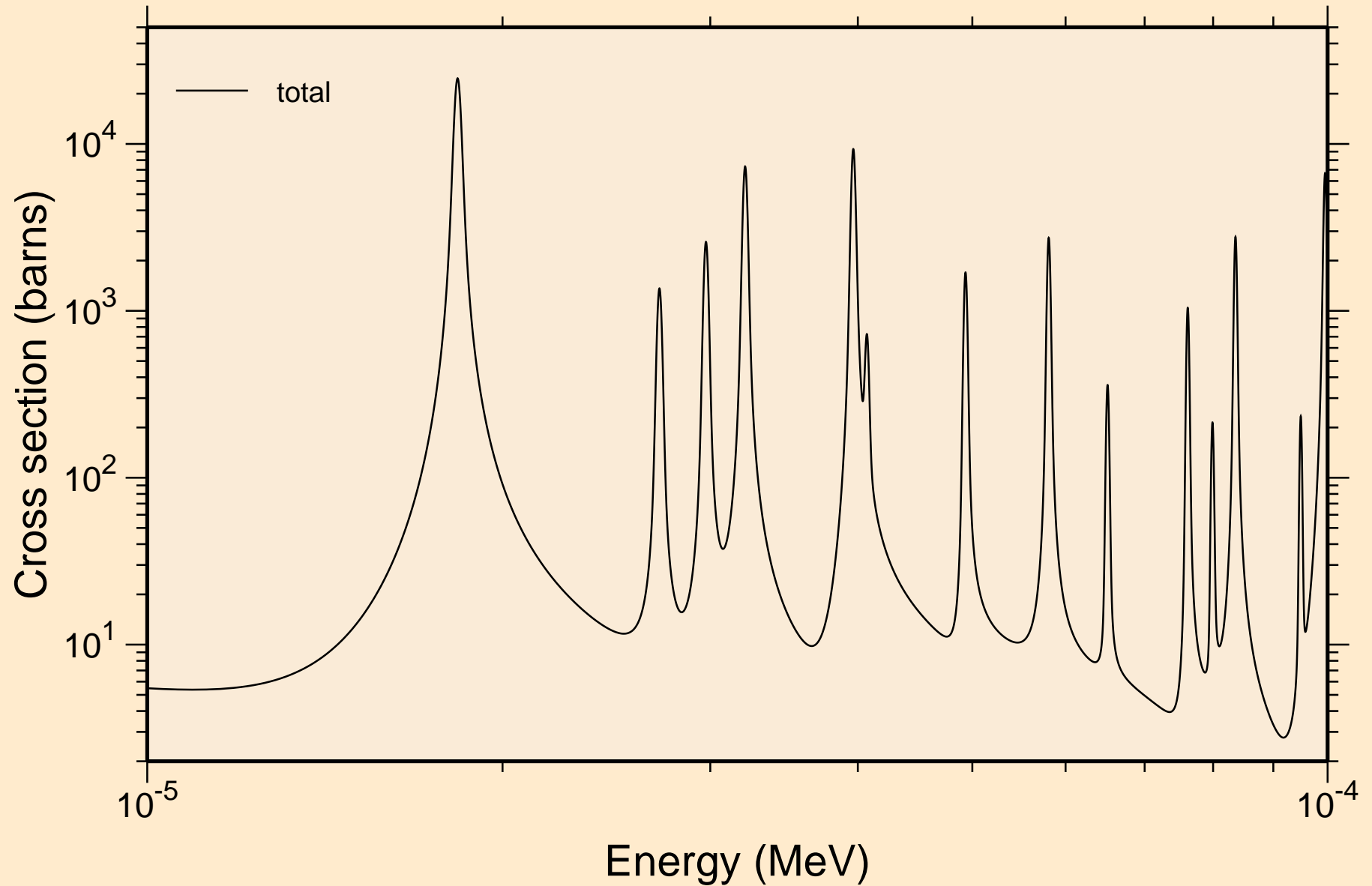

62-SM-147 FOR FENDL-3.2 FROM TENDL-2019 BY NJOY2016.60-
resonance total cross section

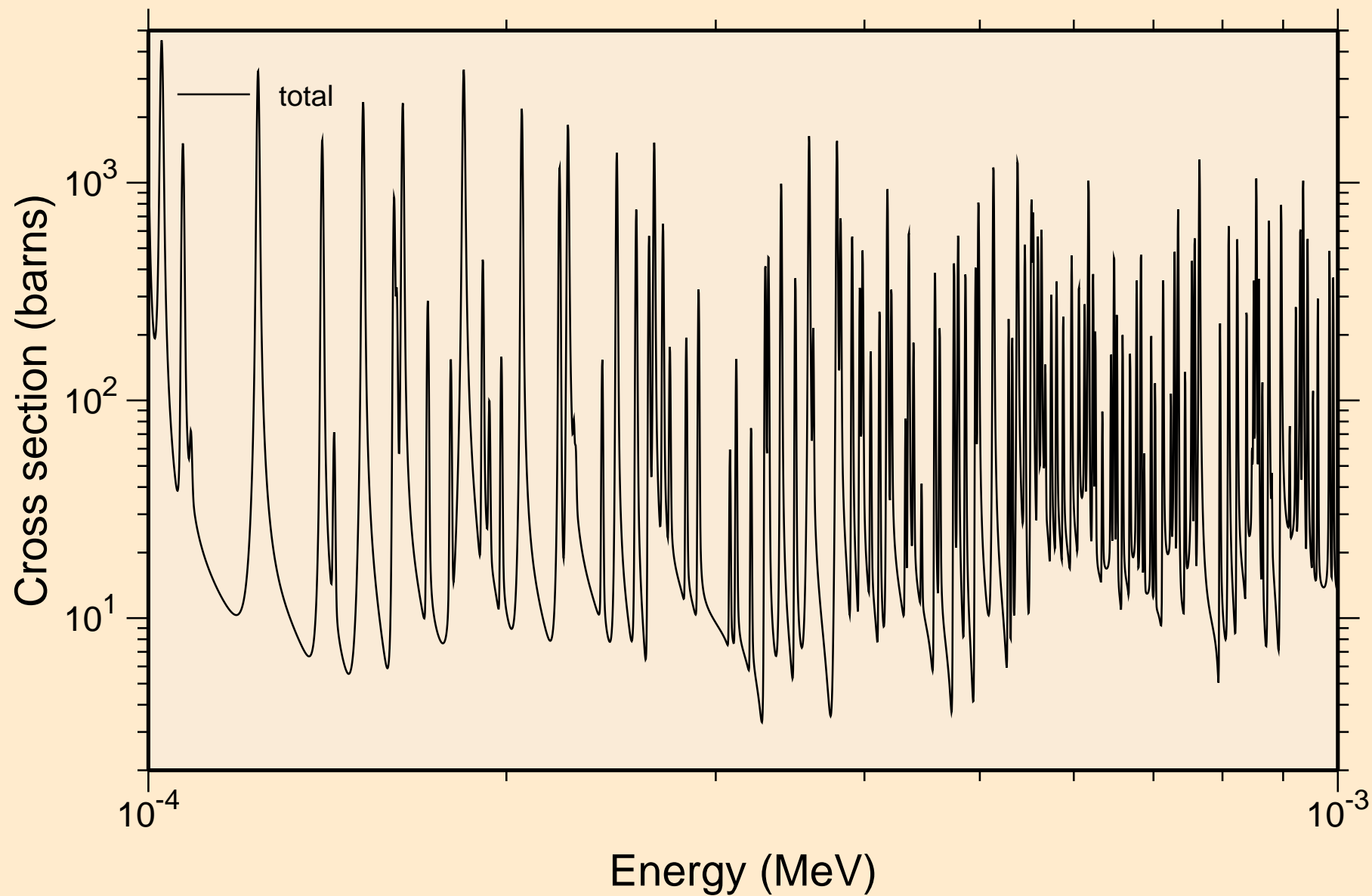

62-SM-147 FOR FENDL-3.2 FROM TENDL-2019 BY NJOY2016.60-
resonance total cross section

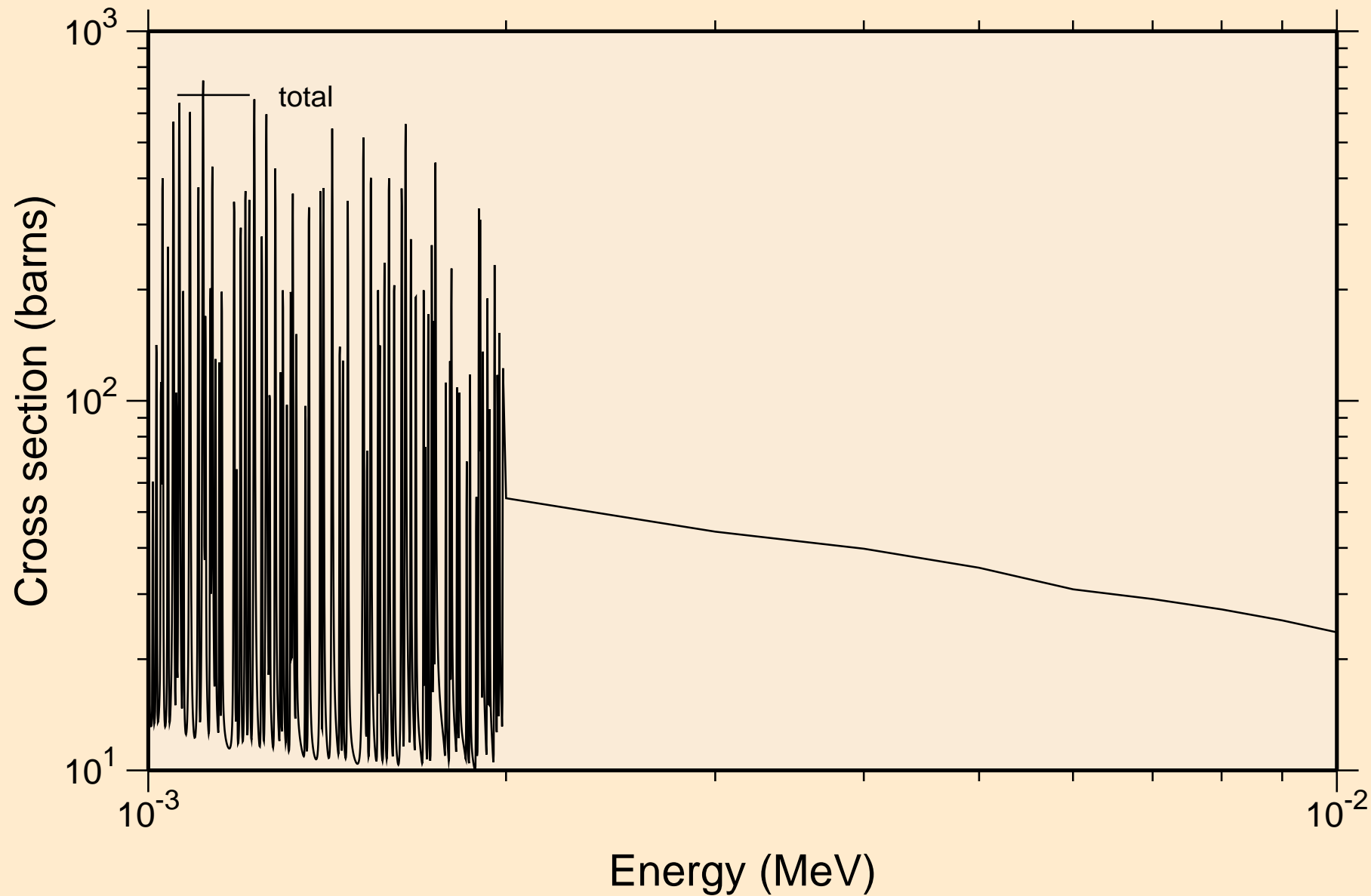

62-SM-147 FOR FENDL-3.2 FROM TENDL-2019 BY NJOY2016.60-
resonance total cross section

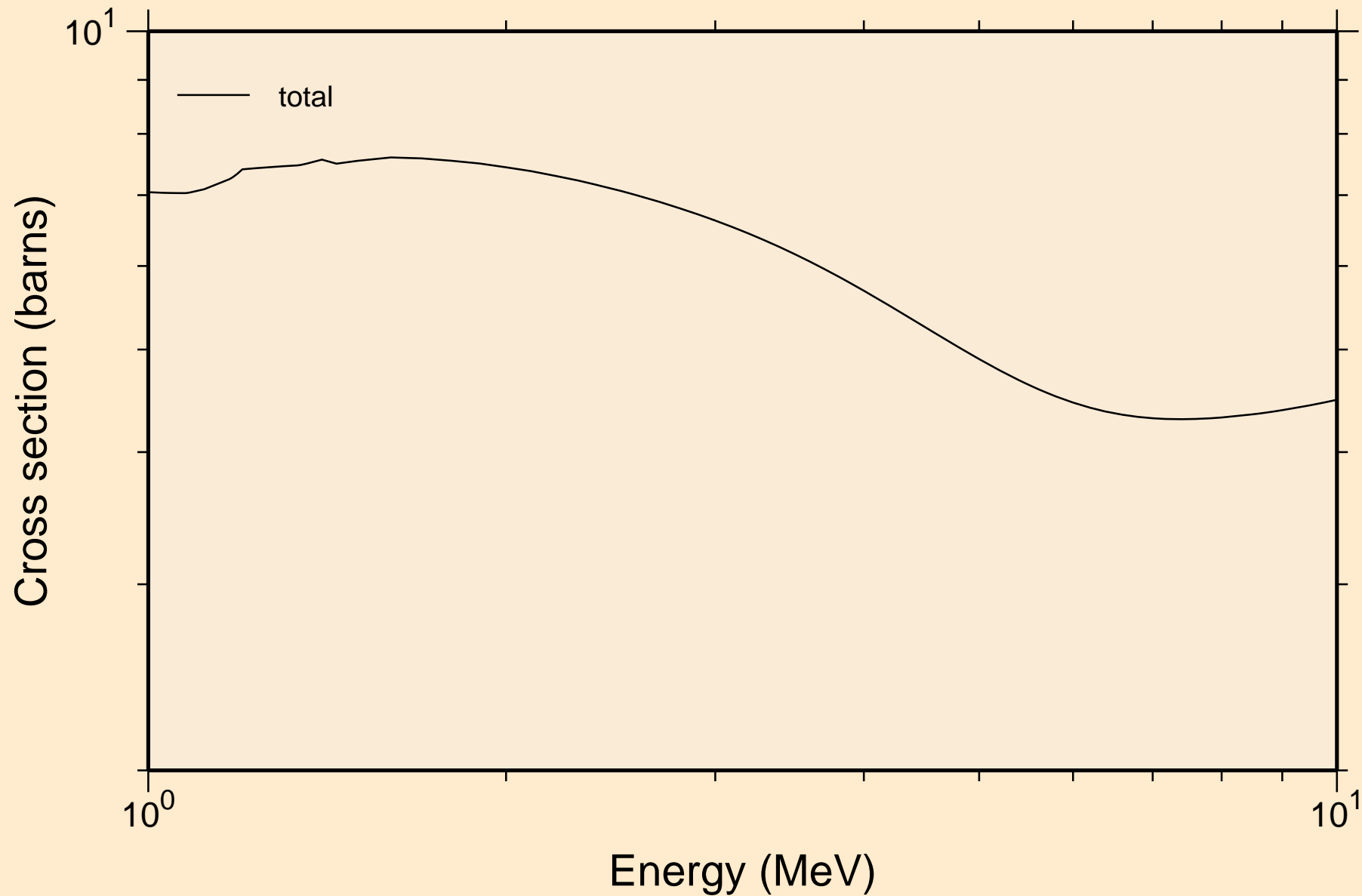

62-SM-147 FOR FENDL-3.2 FROM TENDL-2019 BY NJOY2016.60-
resonance absorption cross sections

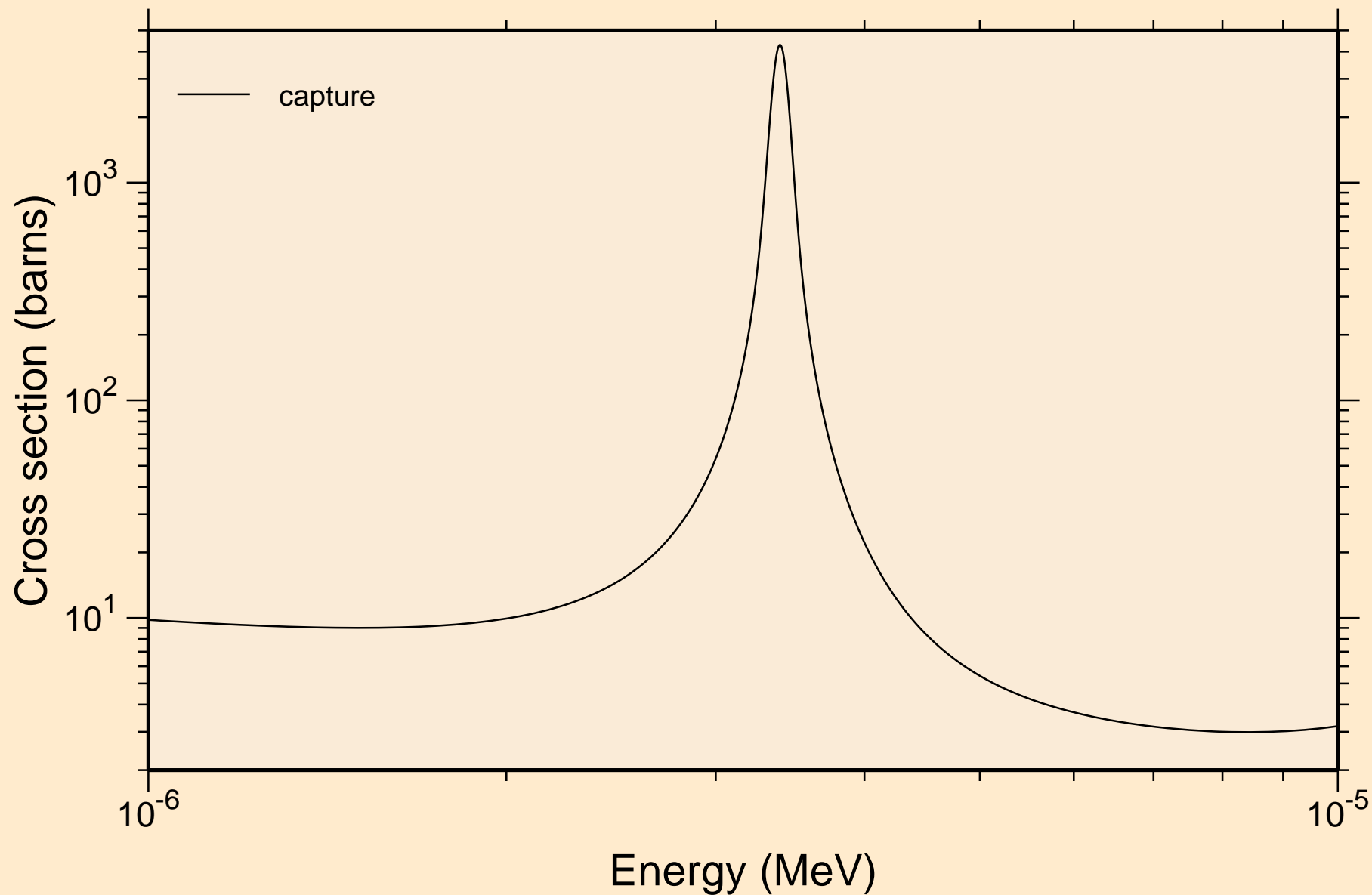

62-SM-147 FOR FENDL-3.2 FROM TENDL-2019 BY NJOY2016.60-
resonance absorption cross sections

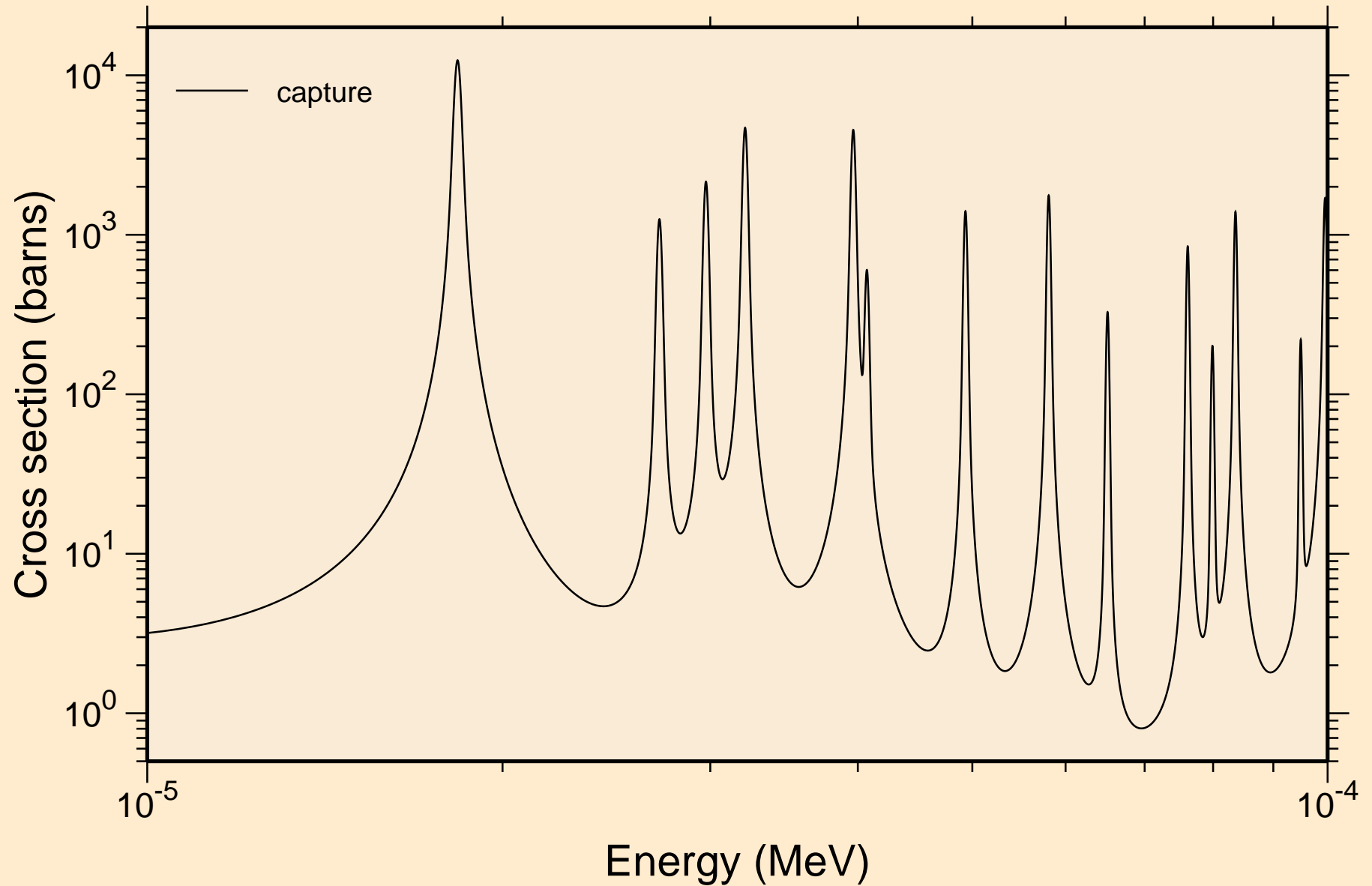

62-SM-147 FOR FENDL-3.2 FROM TENDL-2019 BY NJOY2016.60-
resonance absorption cross sections

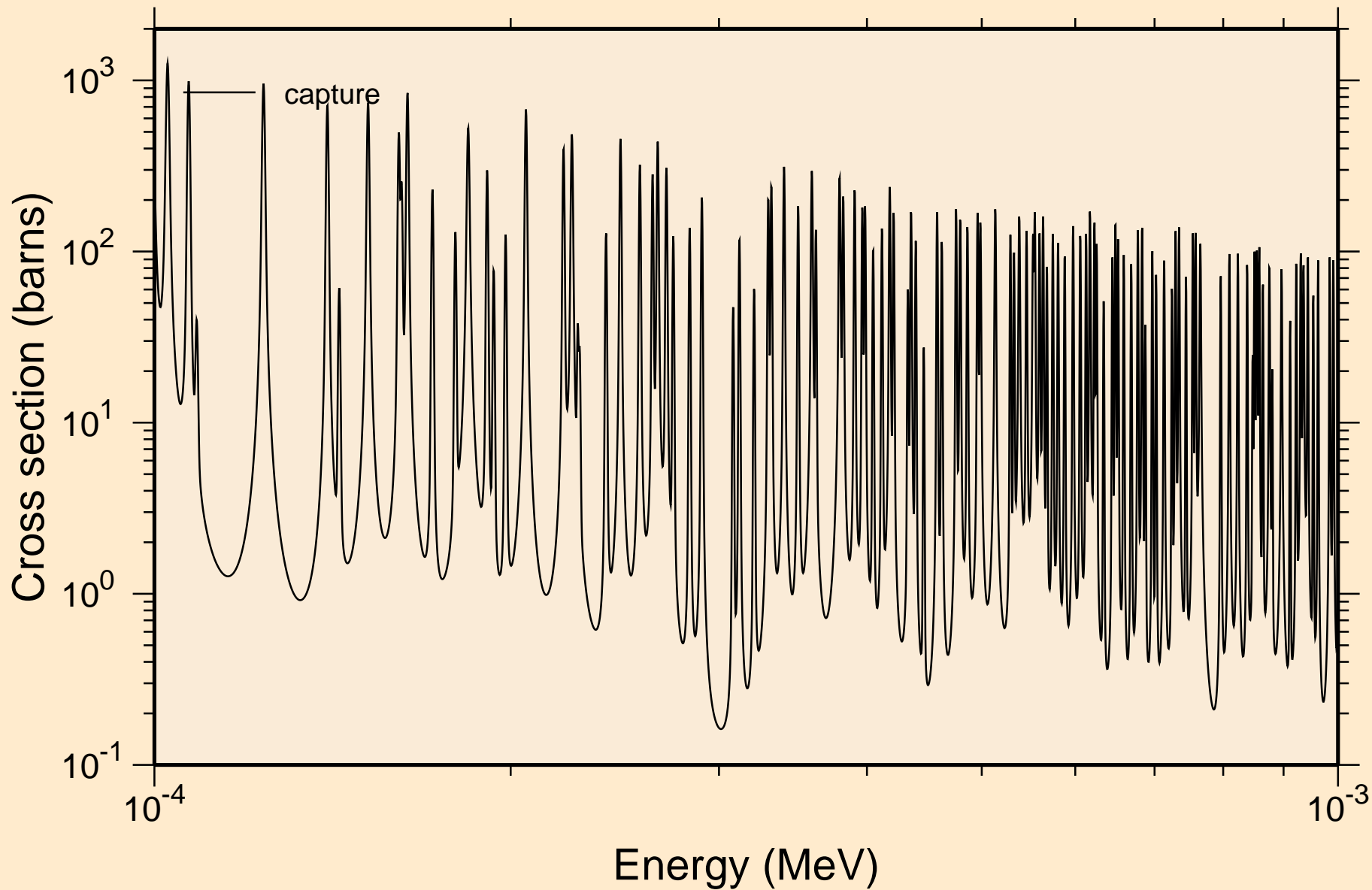

62-SM-147 FOR FENDL-3.2 FROM TENDL-2019 BY NJOY2016.60-
resonance absorption cross sections

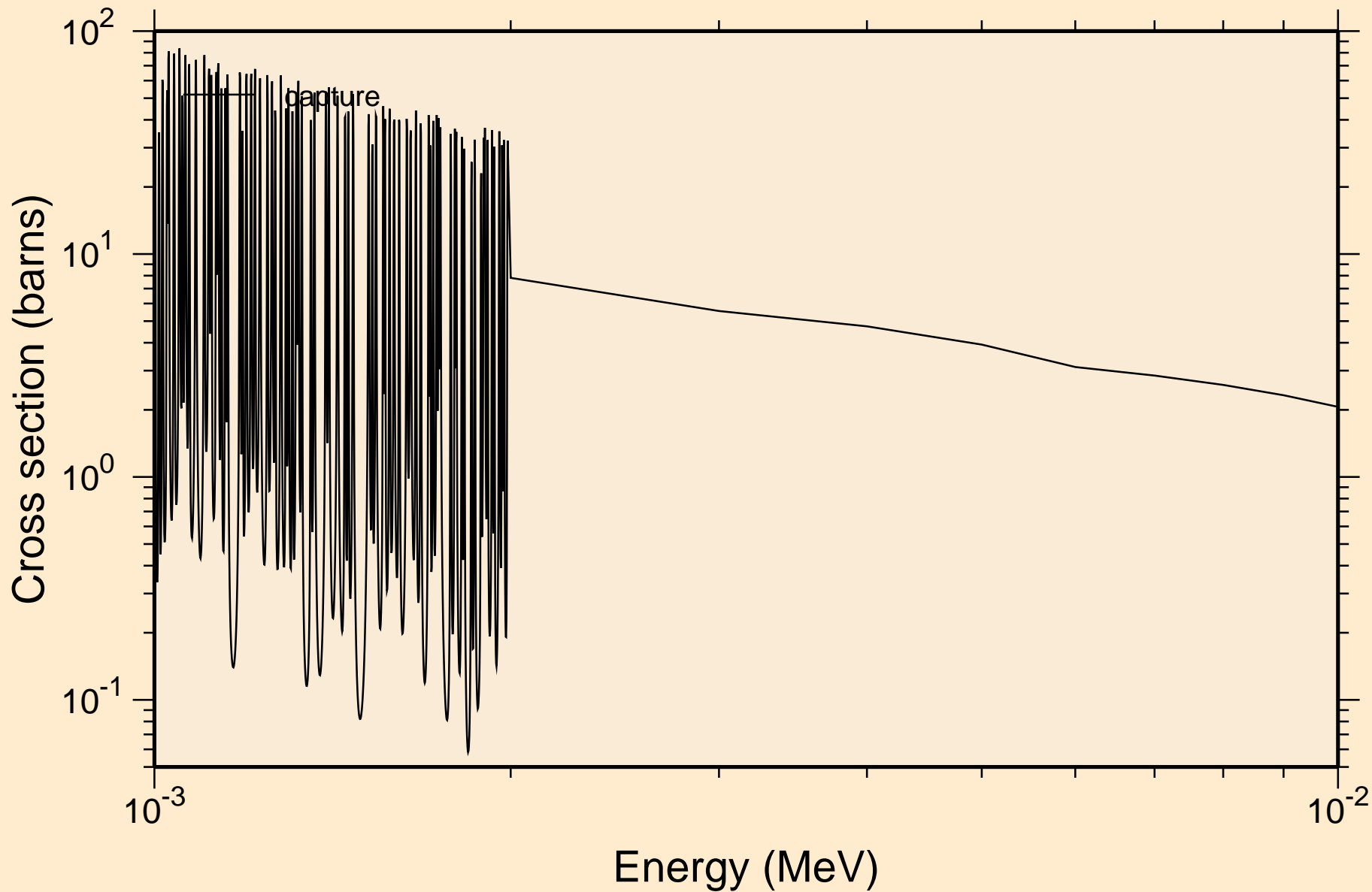

62-SM-147 FOR FENDL-3.2 FROM TENDL-2019 BY NJOY2016.60-
resonance absorption cross sections

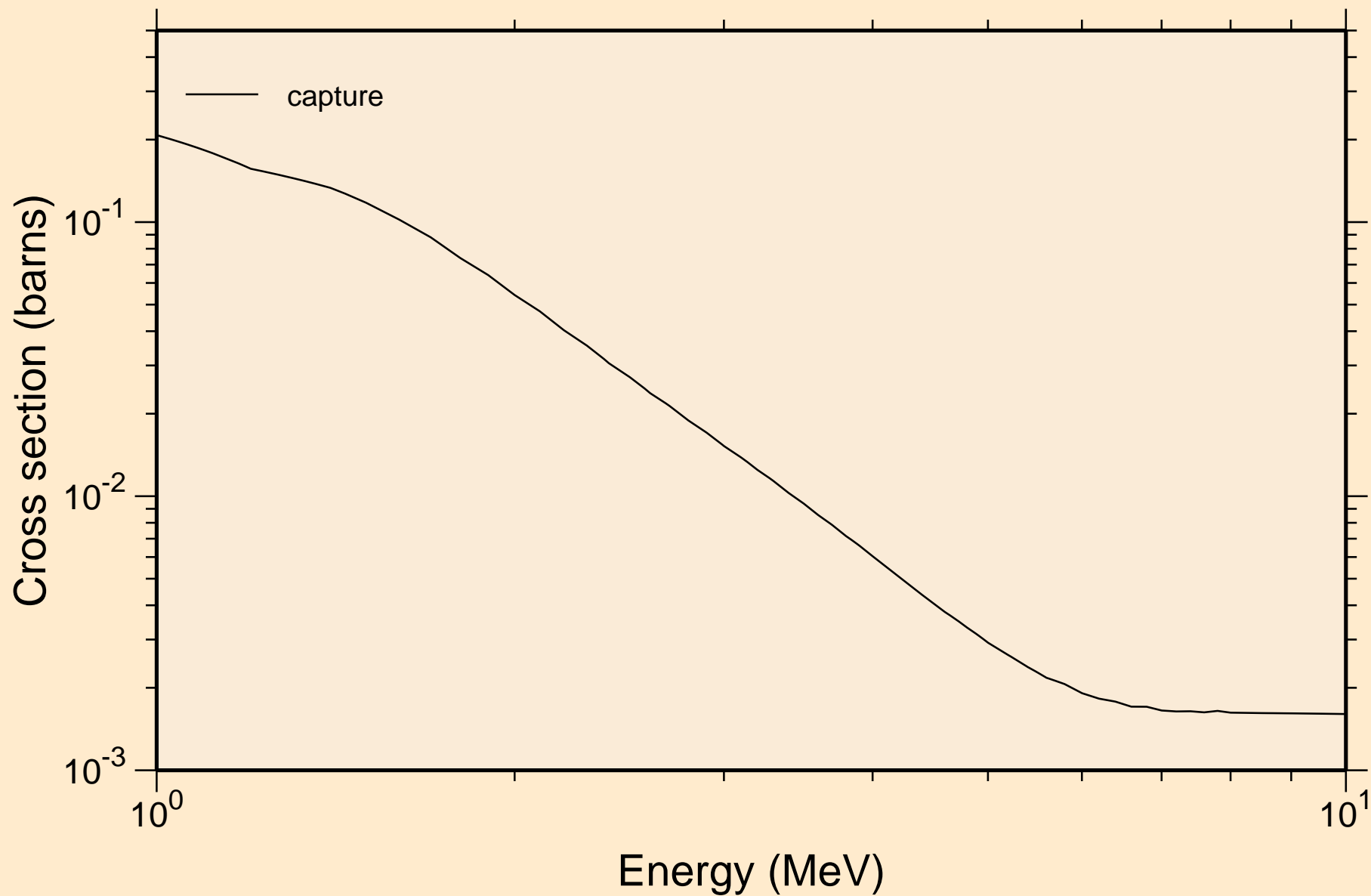

62-SM-147 FOR FENDL-3.2 FROM TENDL-2019 BY NJOY2016.60-
Heating

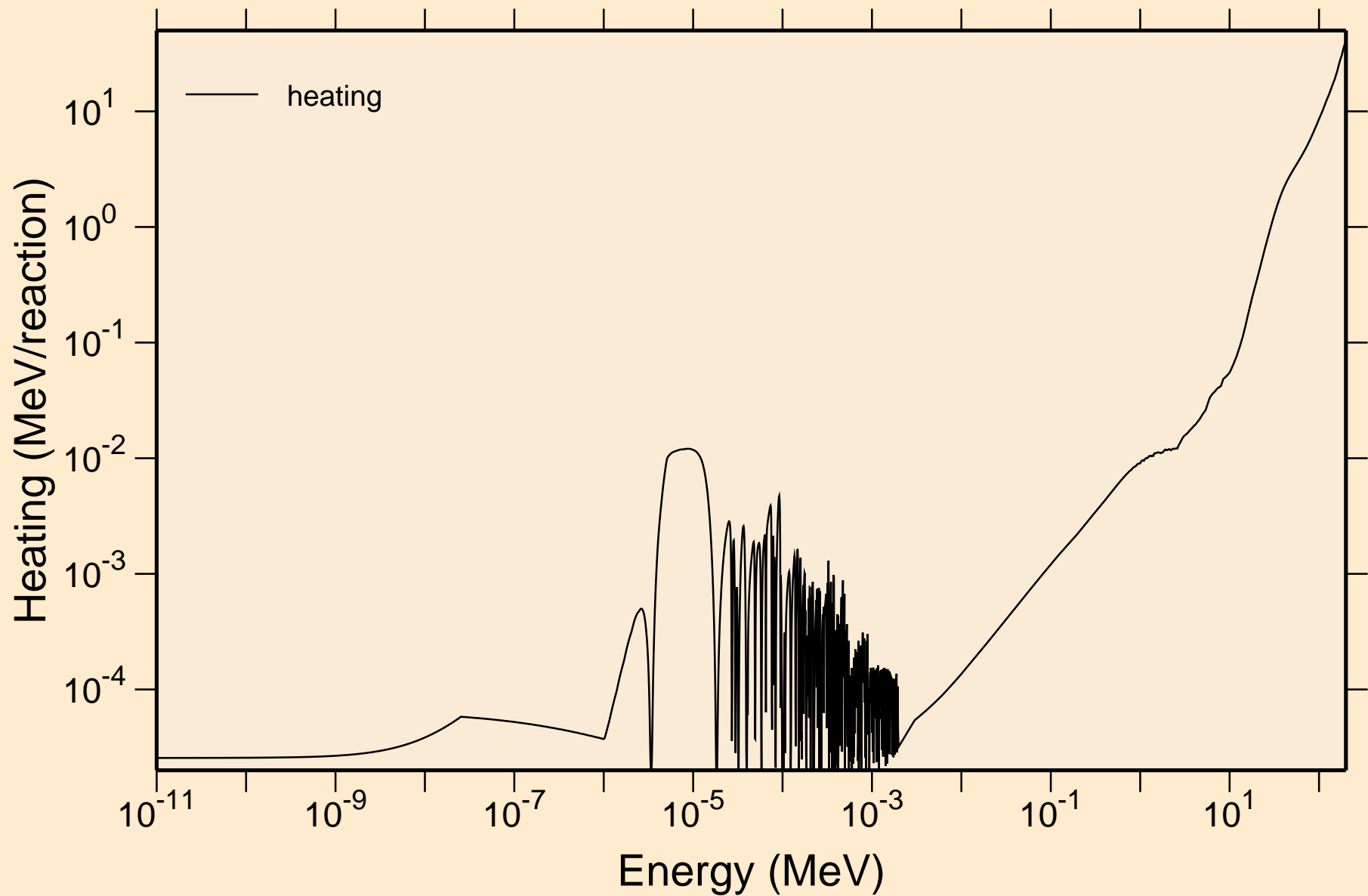

62-SM-147 FOR FENDL-3.2 FROM TENDL-2019 BY NJOY2016.60-
Damage

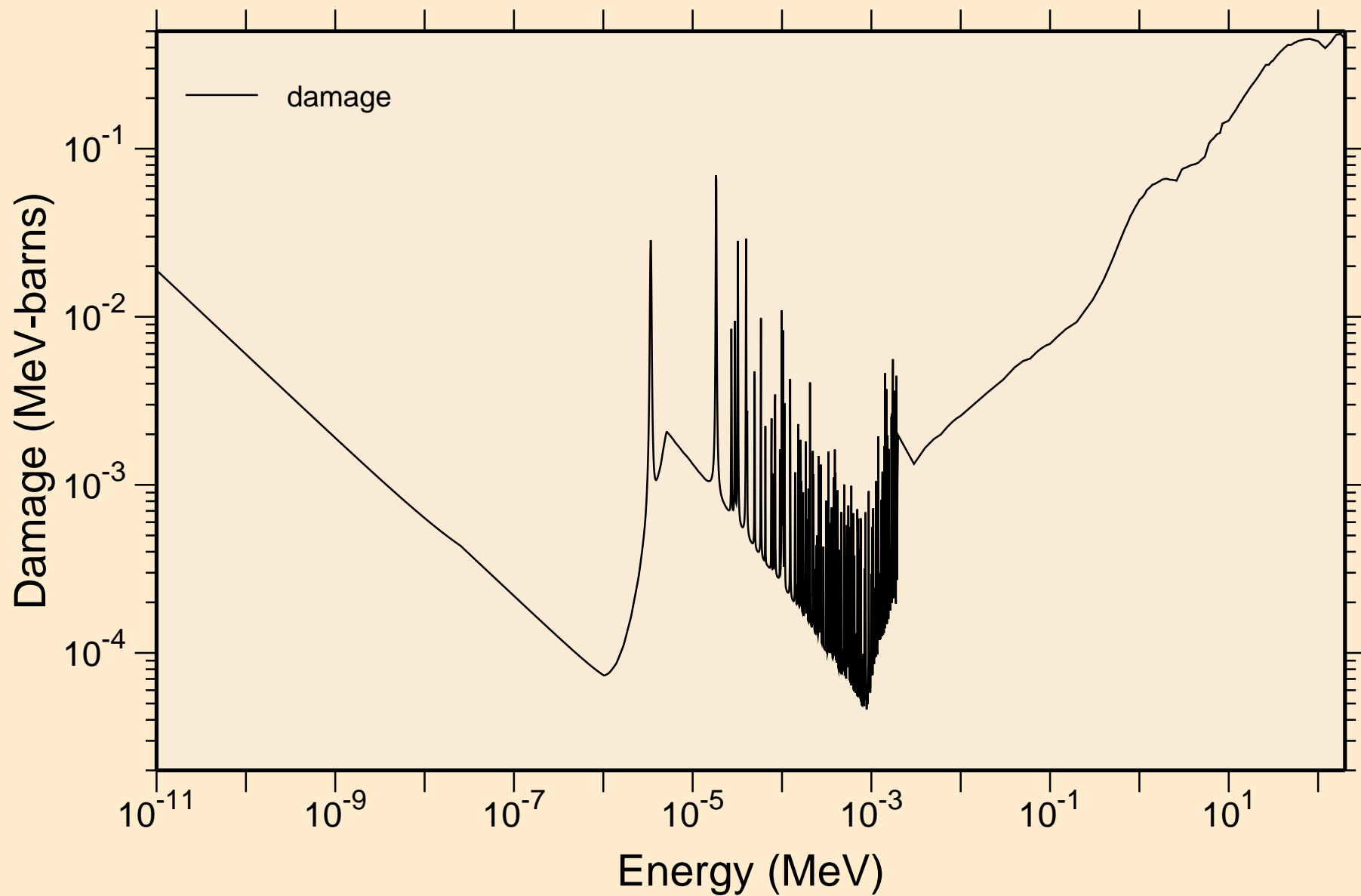

62-SM-147 FOR FENDL-3.2 FROM TENDL-2019 BY NJOY2016.60-
Non-threshold reactions

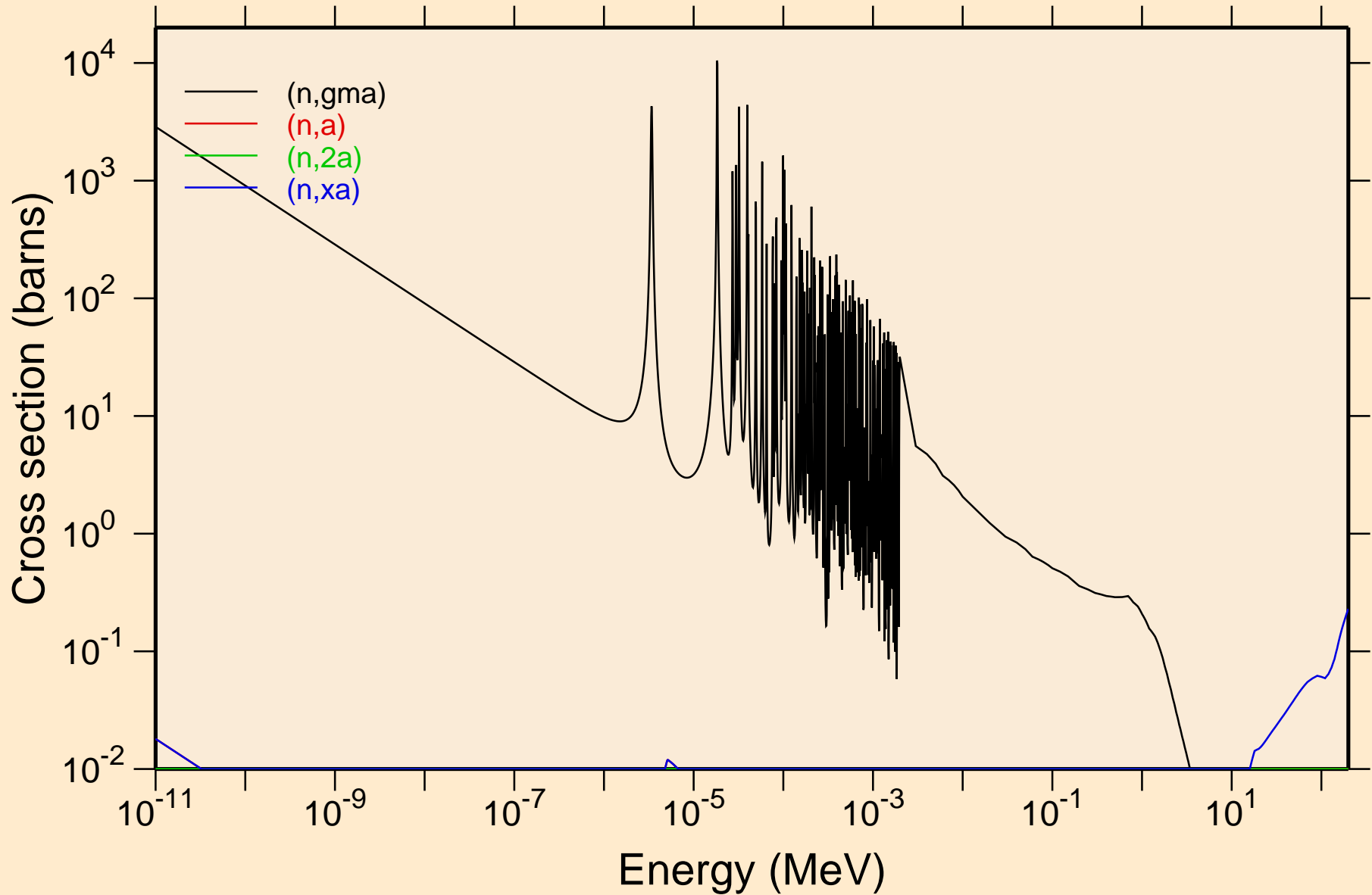

62-SM-147 FOR FENDL-3.2 FROM TENDL-2019 BY NJOY2016.60-
Principal cross sections

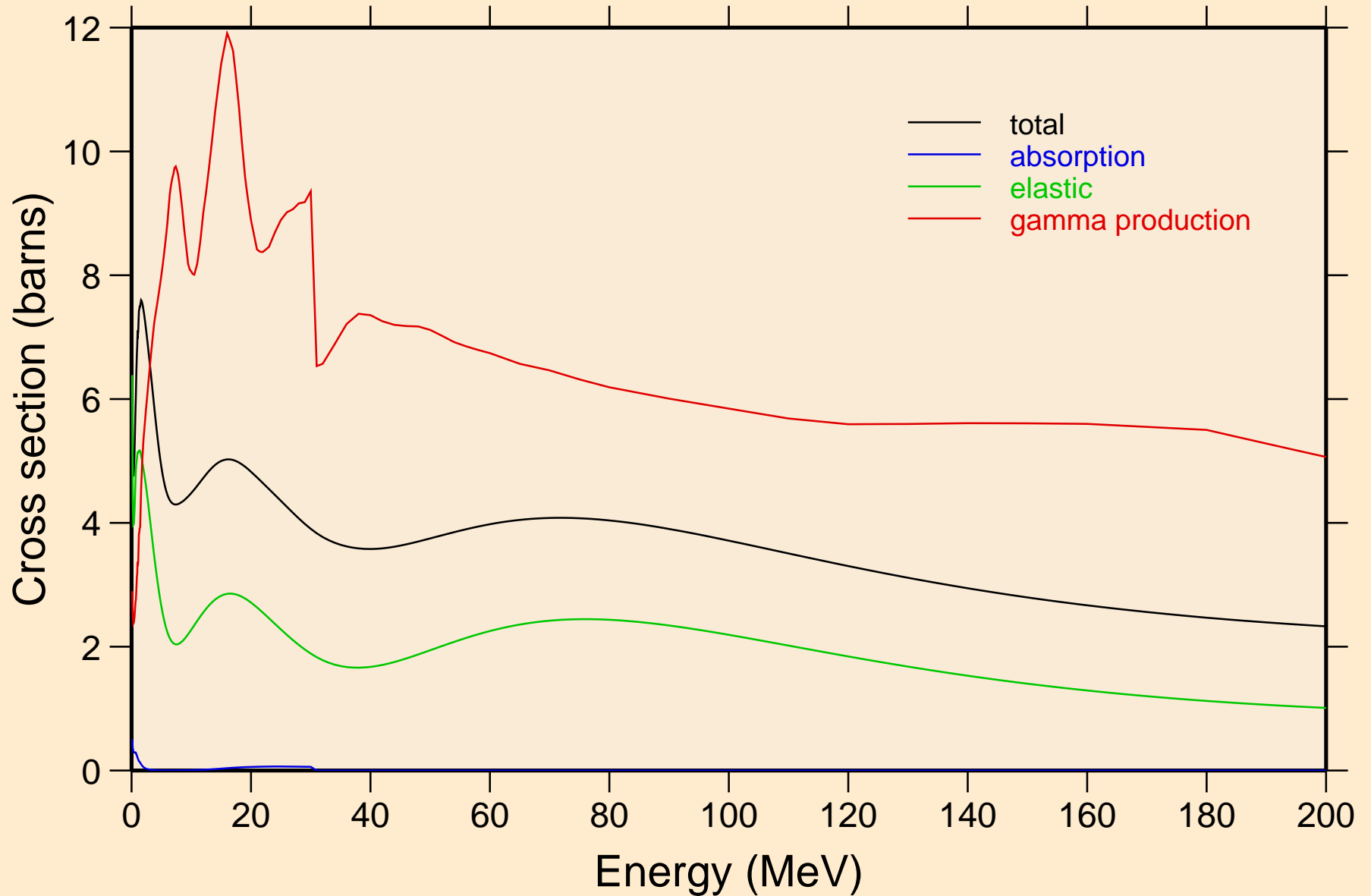

62-SM-147 FOR FENDL-3.2 FROM TENDL-2019 BY NJOY2016.60-
Heating

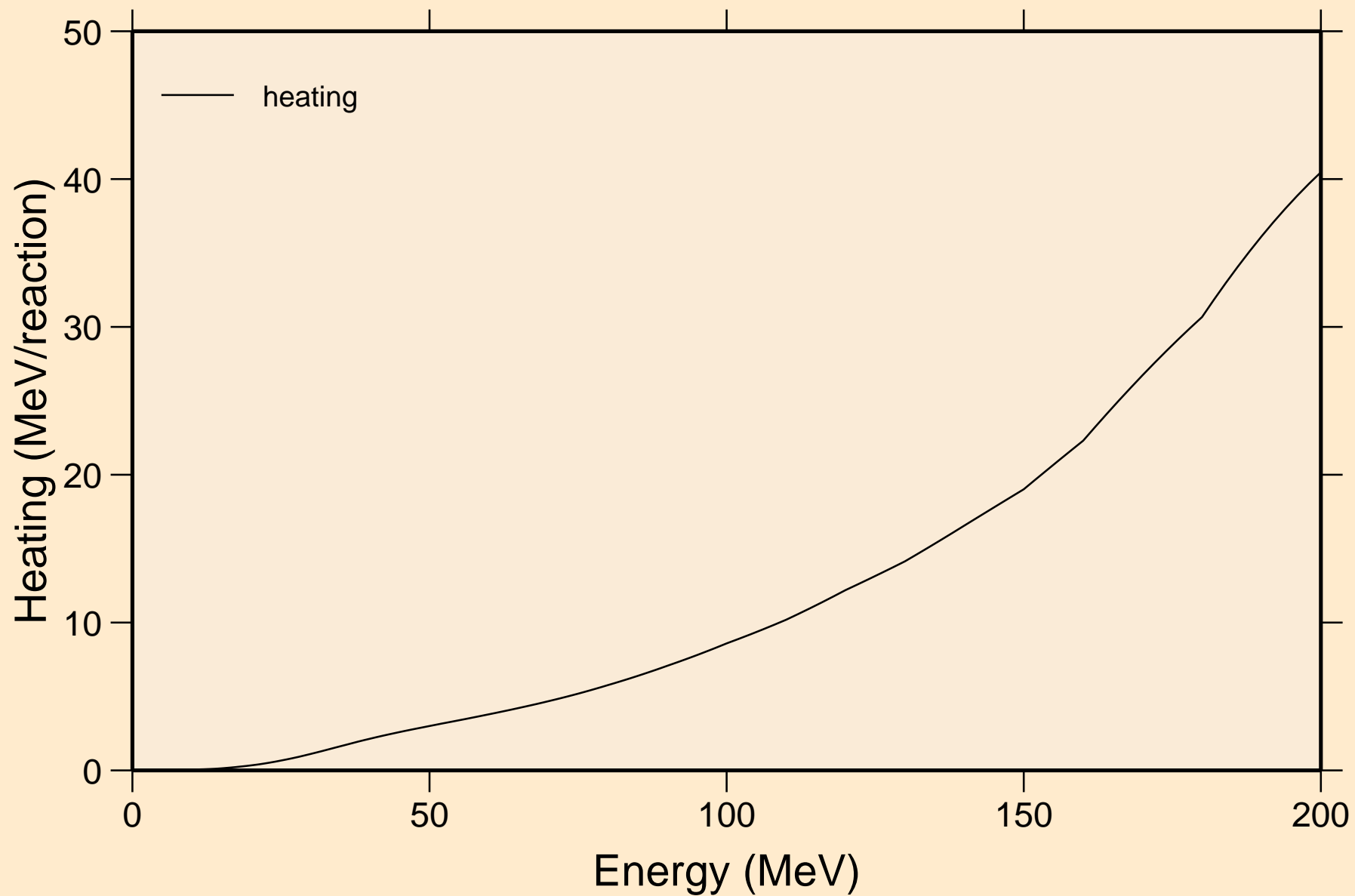

62-SM-147 FOR FENDL-3.2 FROM TENDL-2019 BY NJOY2016.60-
Damage

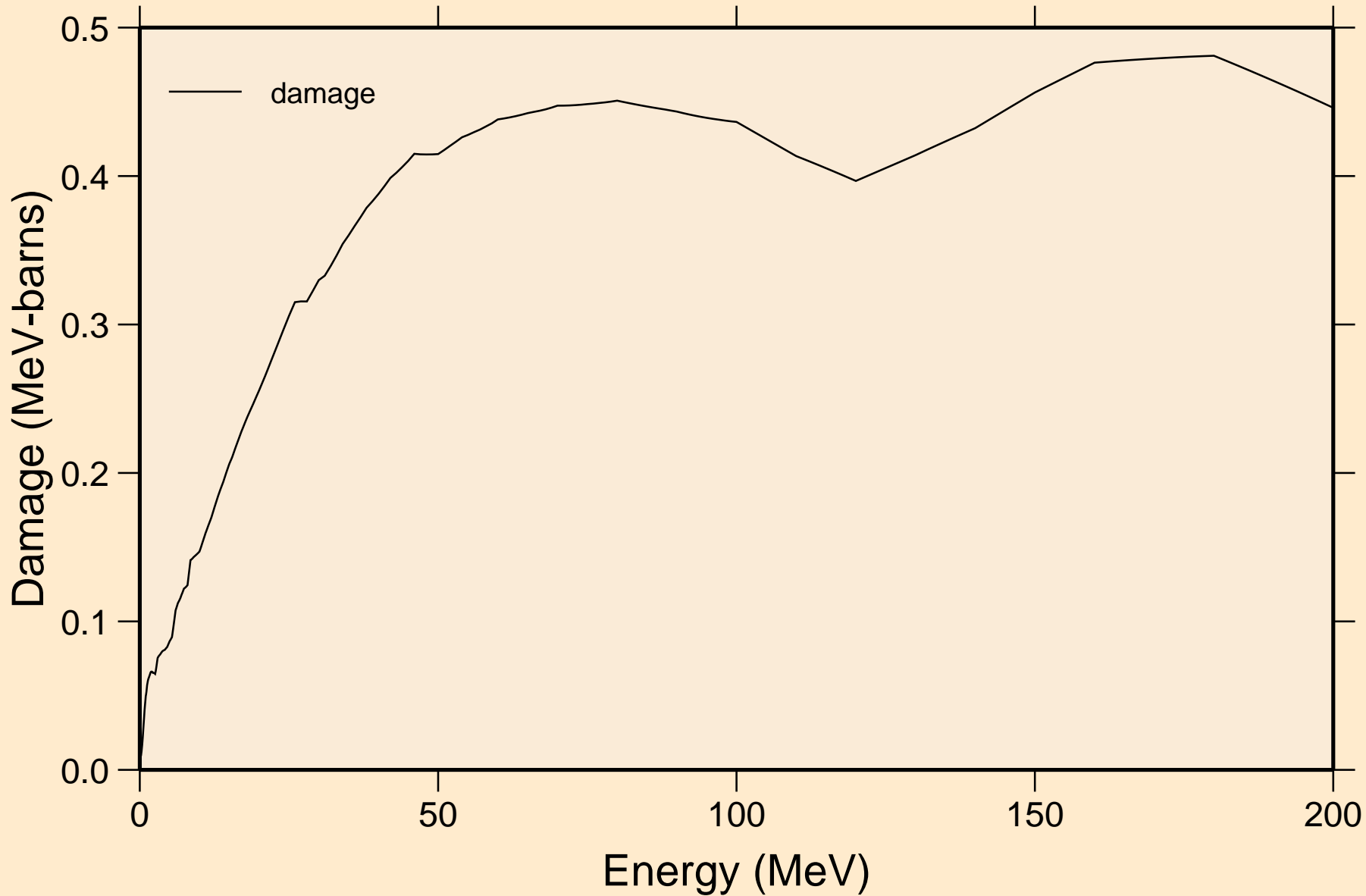

62-SM-147 FOR FENDL-3.2 FROM TENDL-2019 BY NJOY2016.60-
Non-threshold reactions

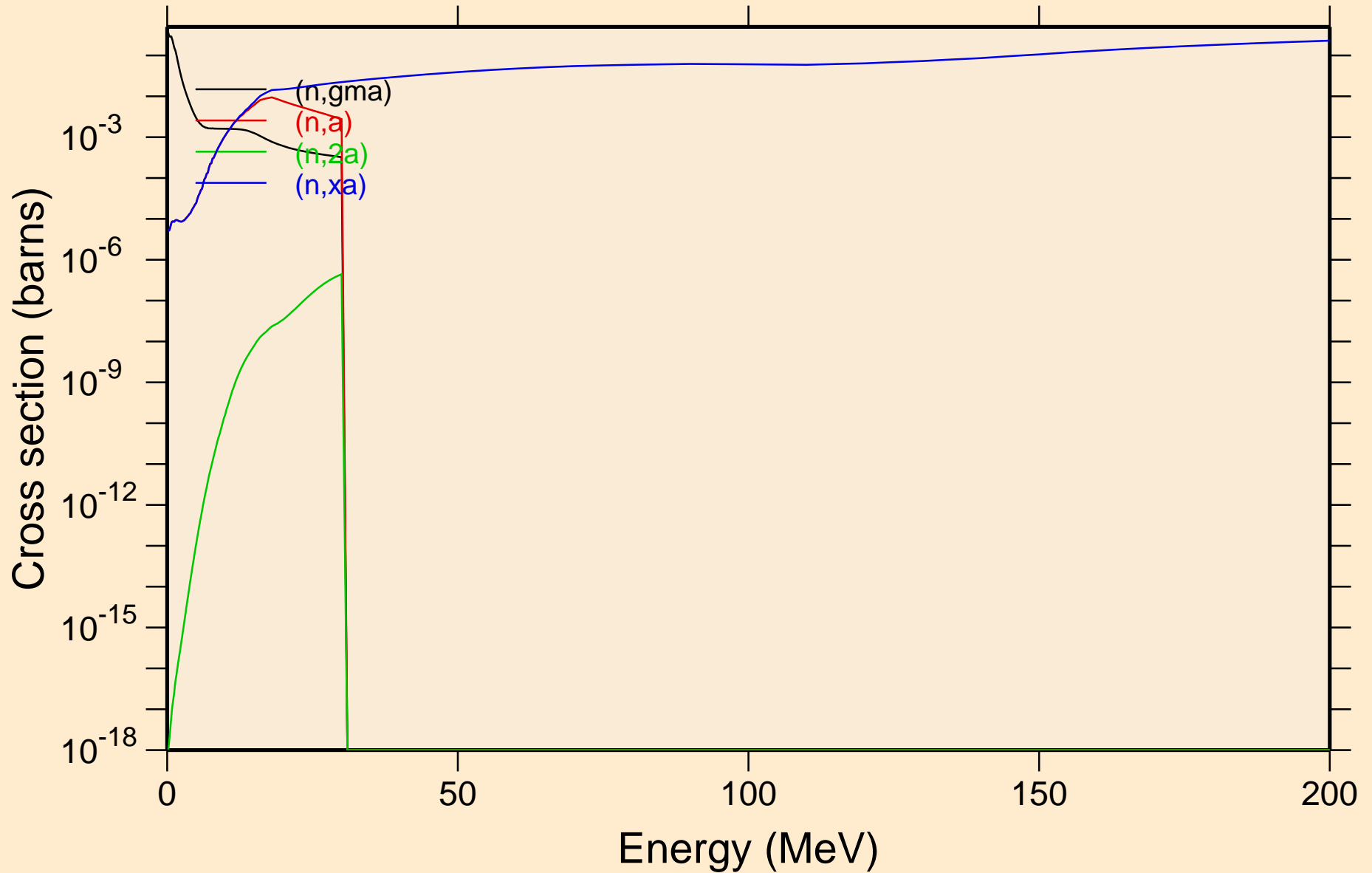

62-SM-147 FOR FENDL-3.2 FROM TENDL-2019 BY NJOY2016.60-
Inelastic levels

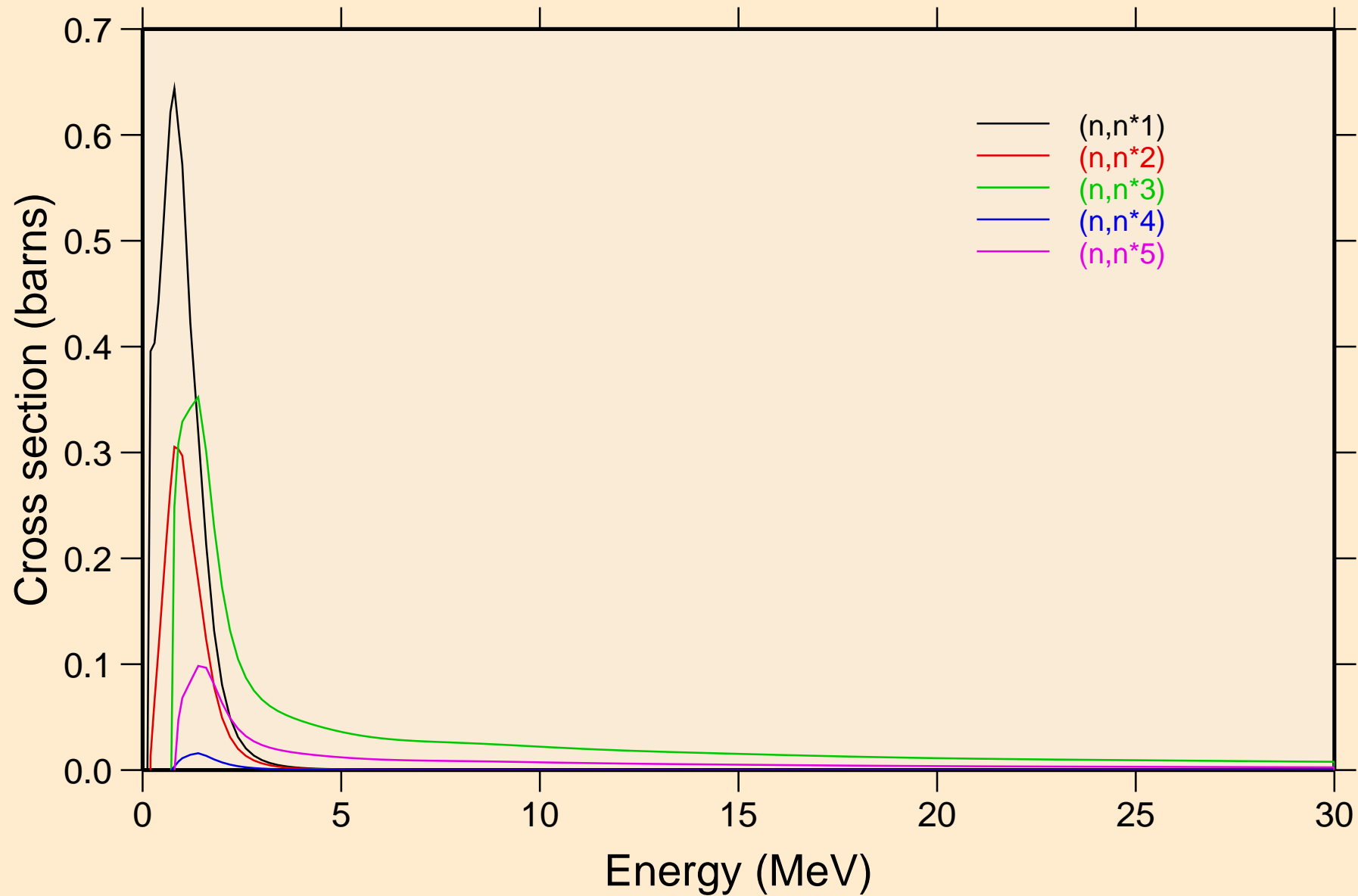

62-SM-147 FOR FENDL-3.2 FROM TENDL-2019 BY NJOY2016.60-
Inelastic levels

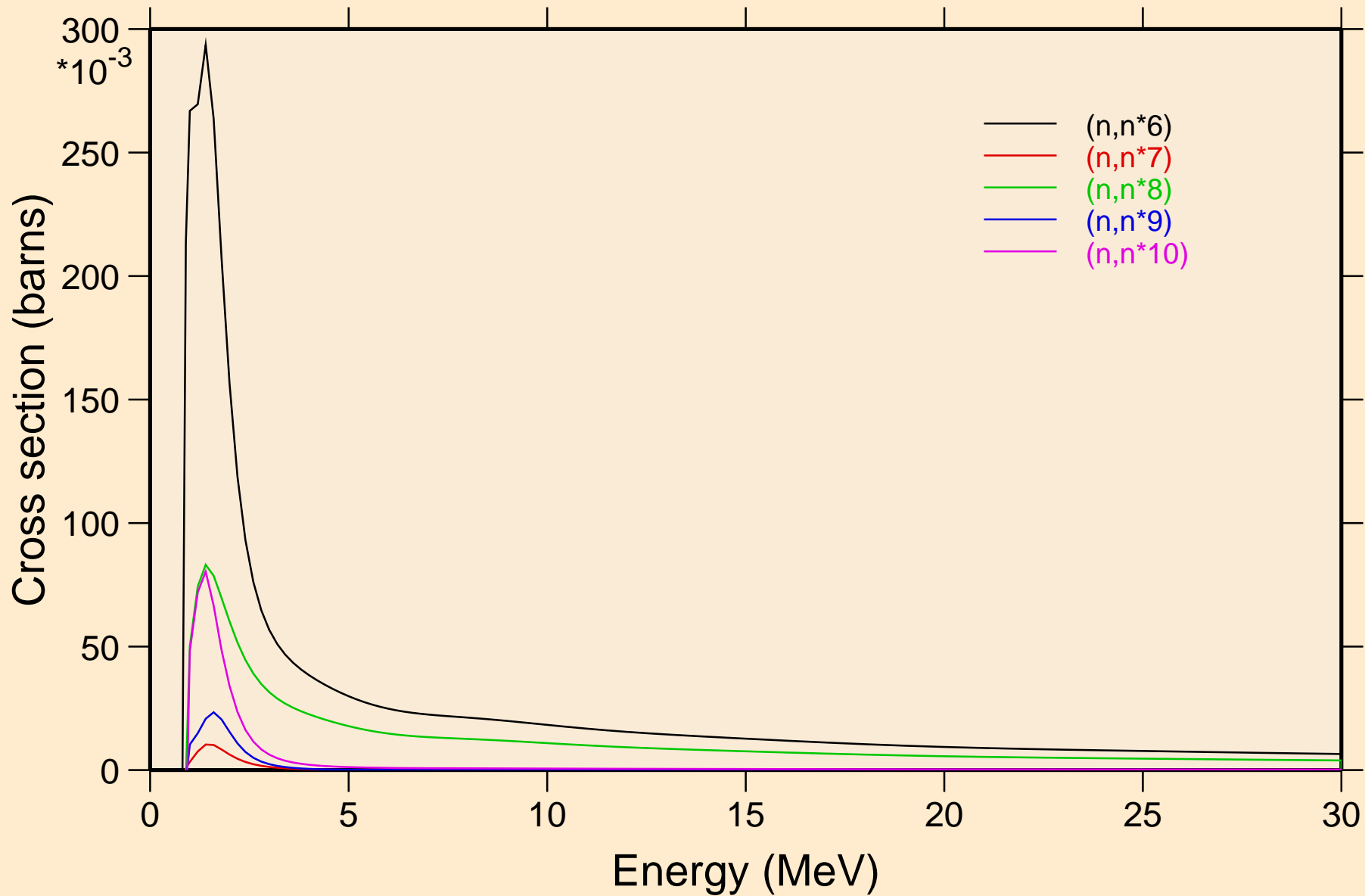

62-SM-147 FOR FENDL-3.2 FROM TENDL-2019 BY NJOY2016.60-
Inelastic levels

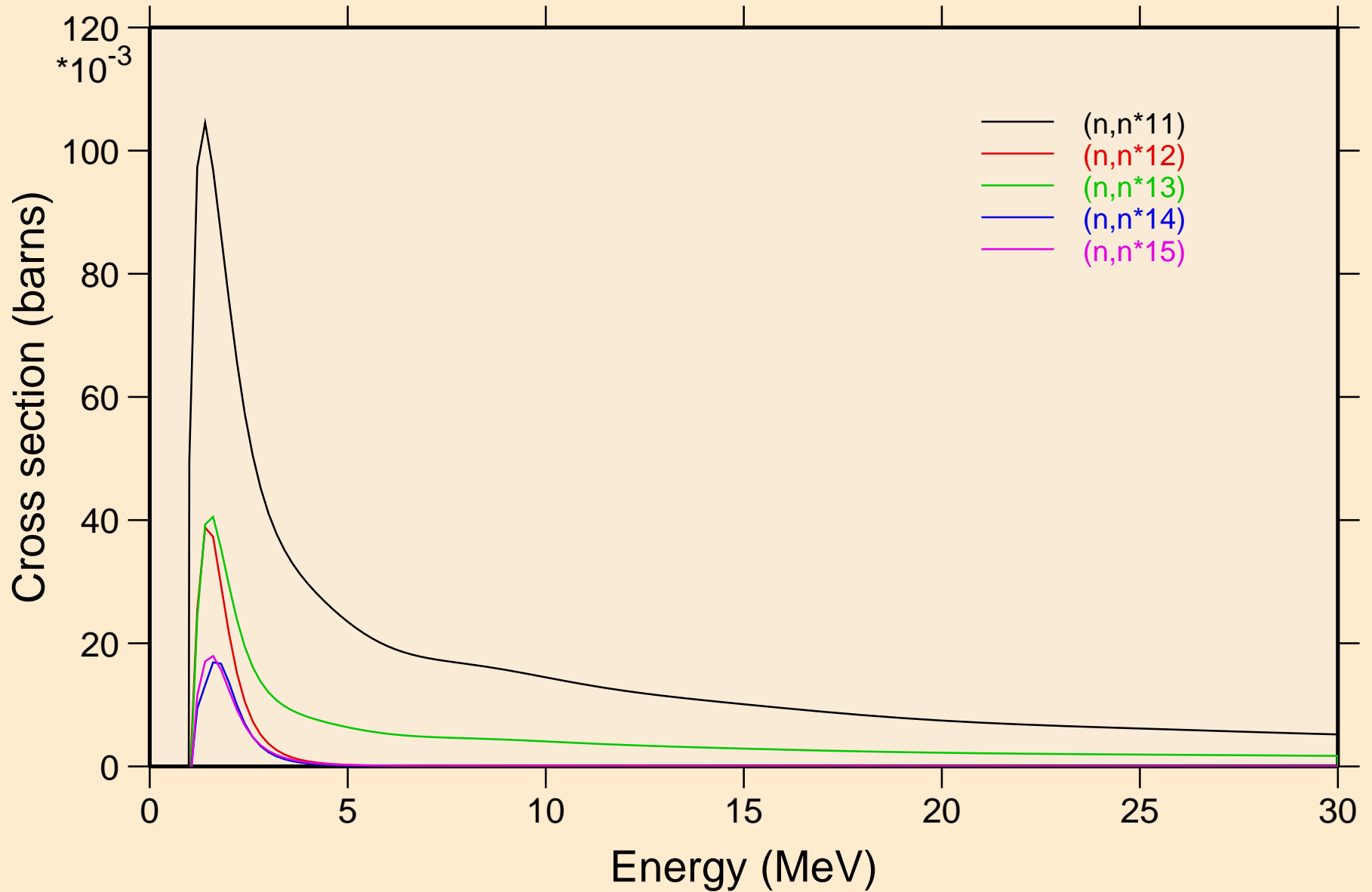

62-SM-147 FOR FENDL-3.2 FROM TENDL-2019 BY NJOY2016.60-
Inelastic levels

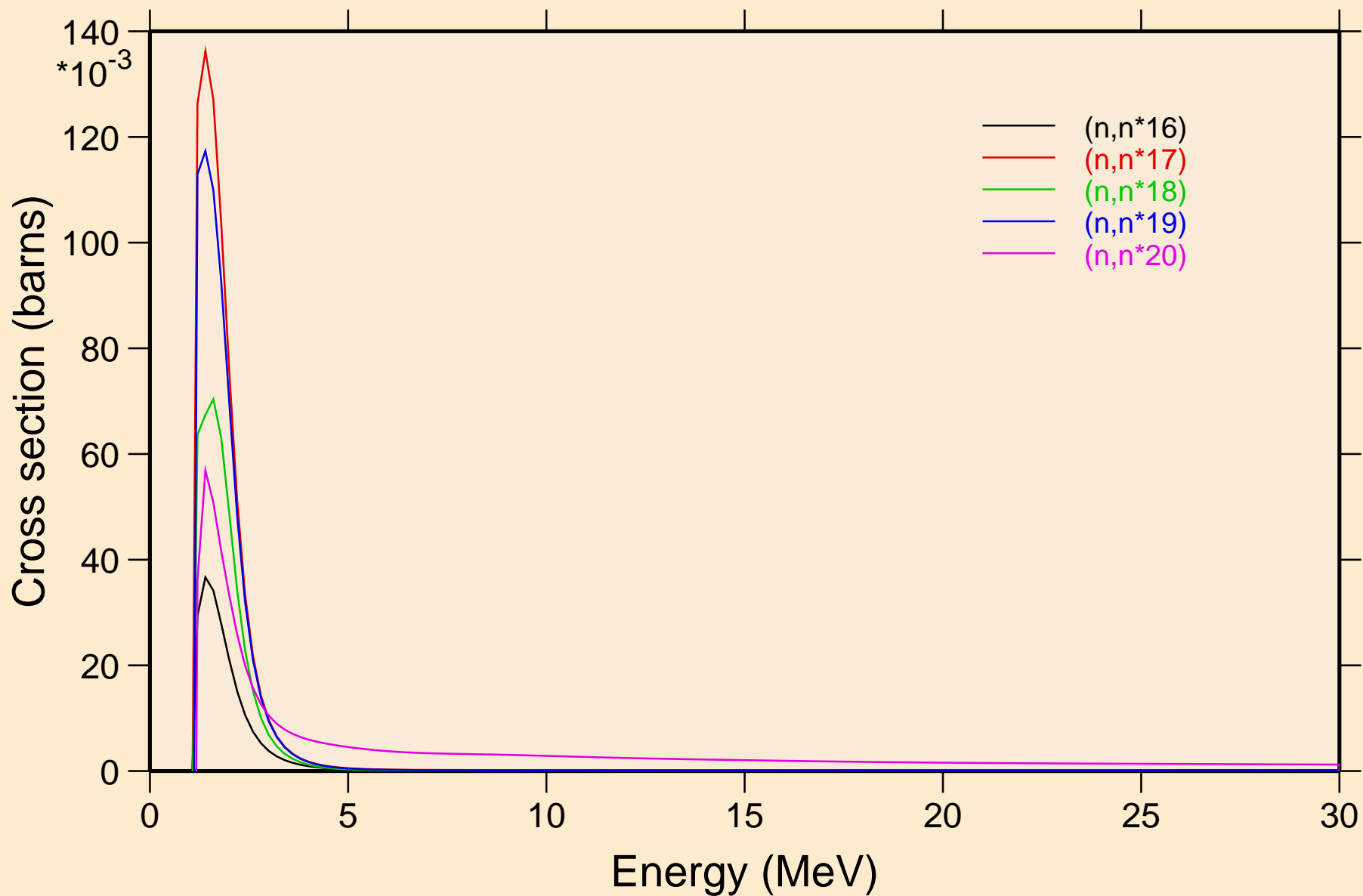

62-SM-147 FOR FENDL-3.2 FROM TENDL-2019 BY NJOY2016.60-
Inelastic levels

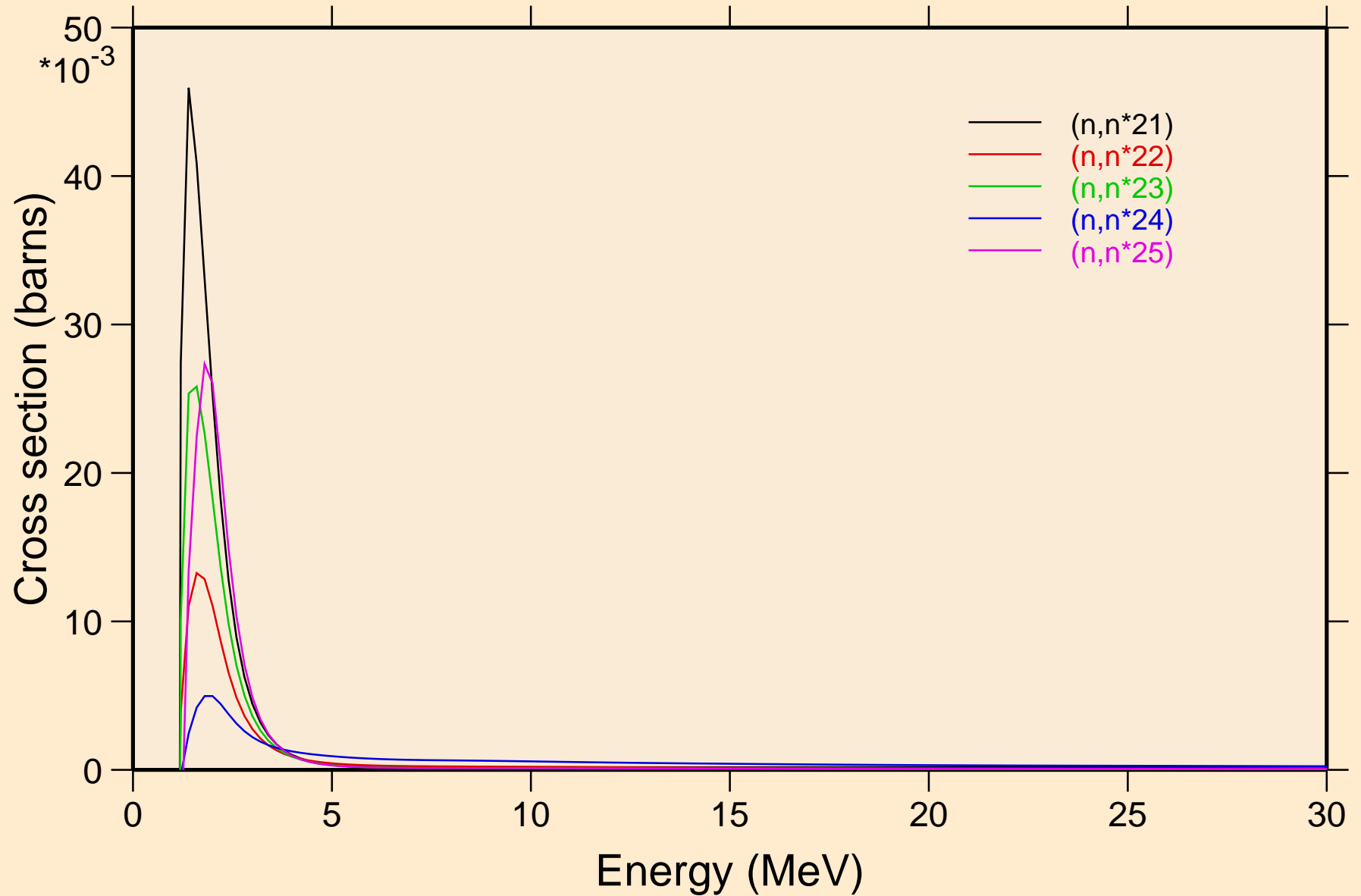

62-SM-147 FOR FENDL-3.2 FROM TENDL-2019 BY NJOY2016.60-
Inelastic levels

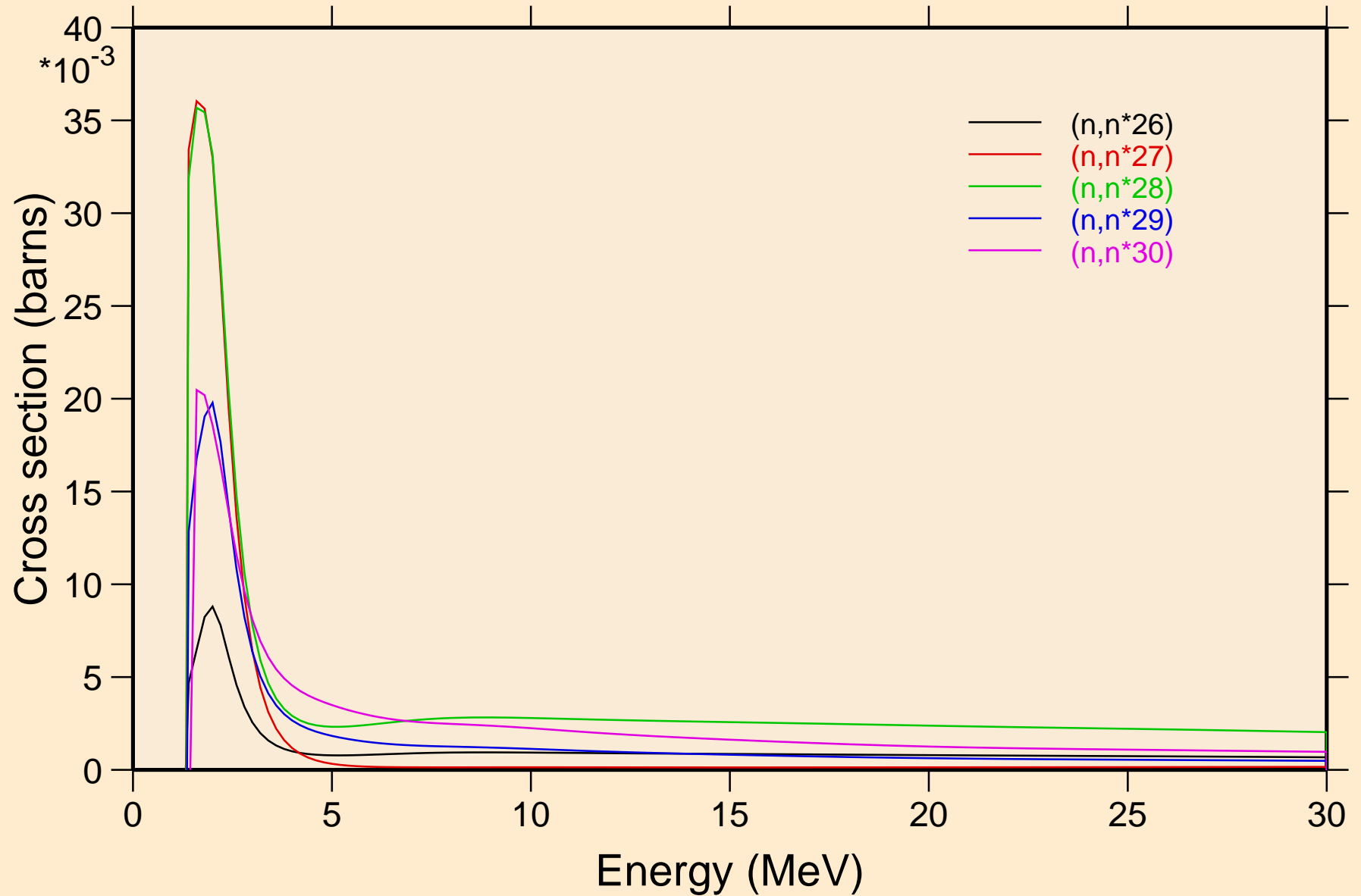

62-SM-147 FOR FENDL-3.2 FROM TENDL-2019 BY NJOY2016.60-
Threshold reactions

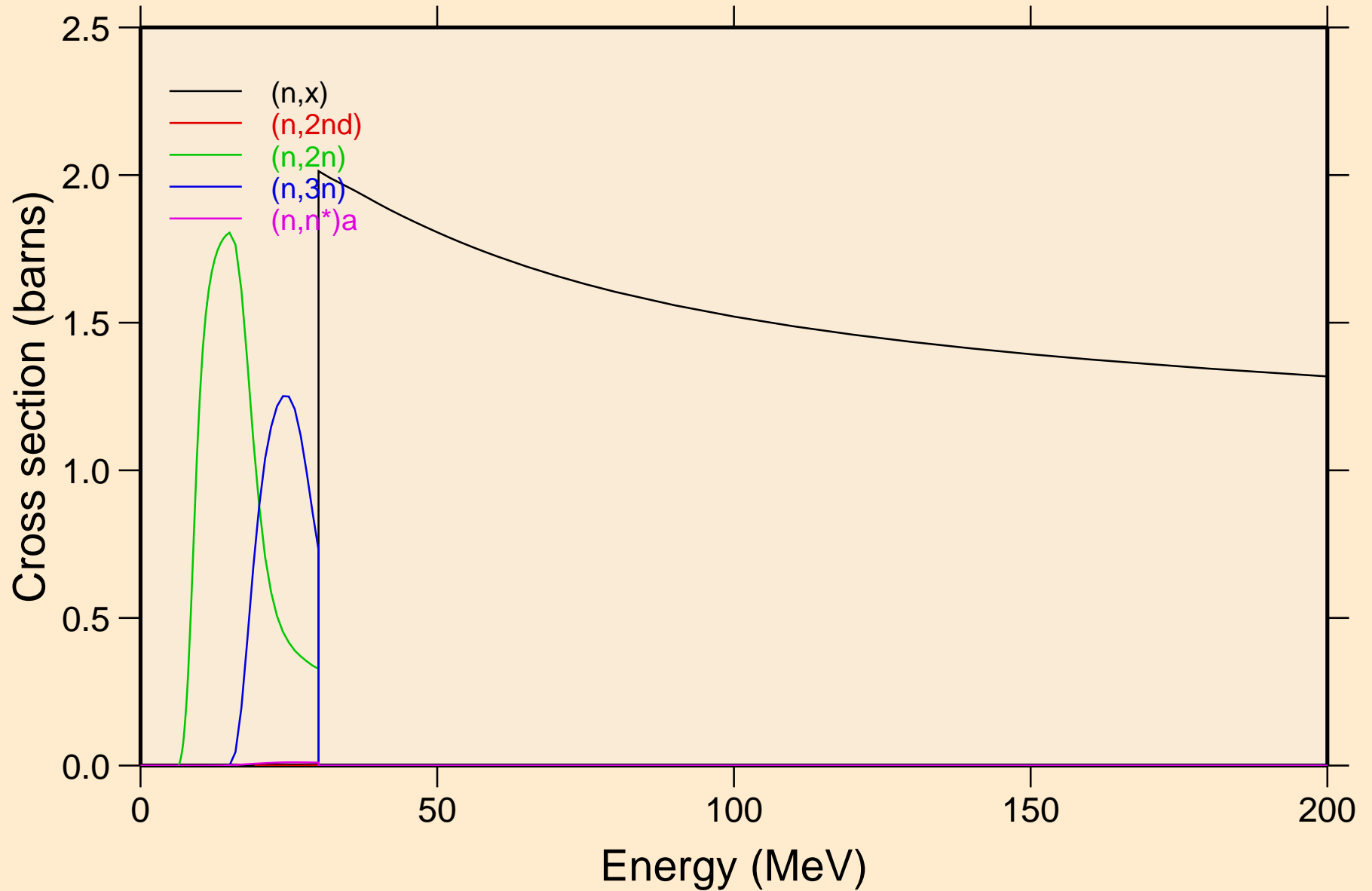

62-SM-147 FOR FENDL-3.2 FROM TENDL-2019 BY NJOY2016.60-
Threshold reactions

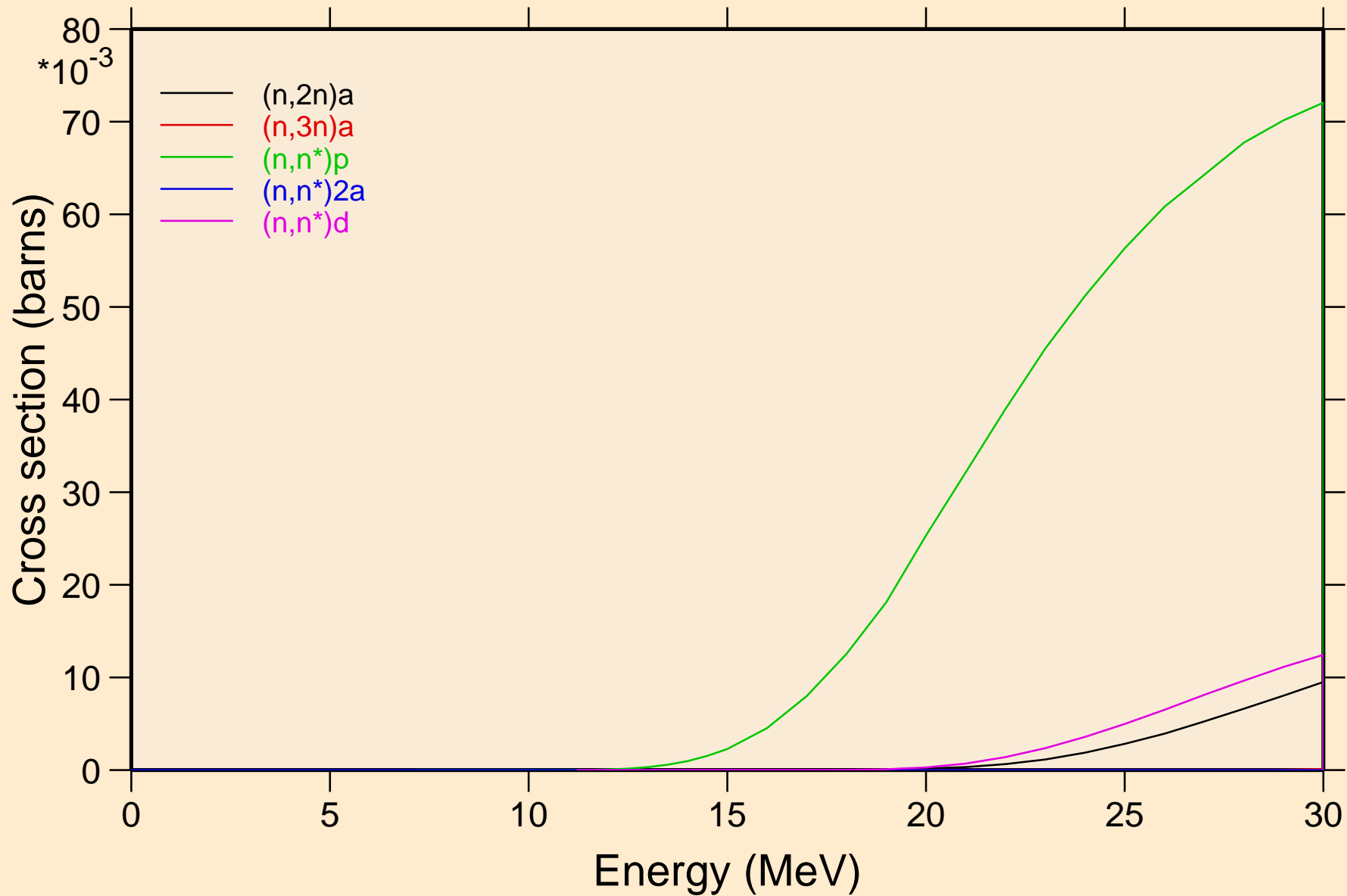

62-SM-147 FOR FENDL-3.2 FROM TENDL-2019 BY NJOY2016.60-
Threshold reactions

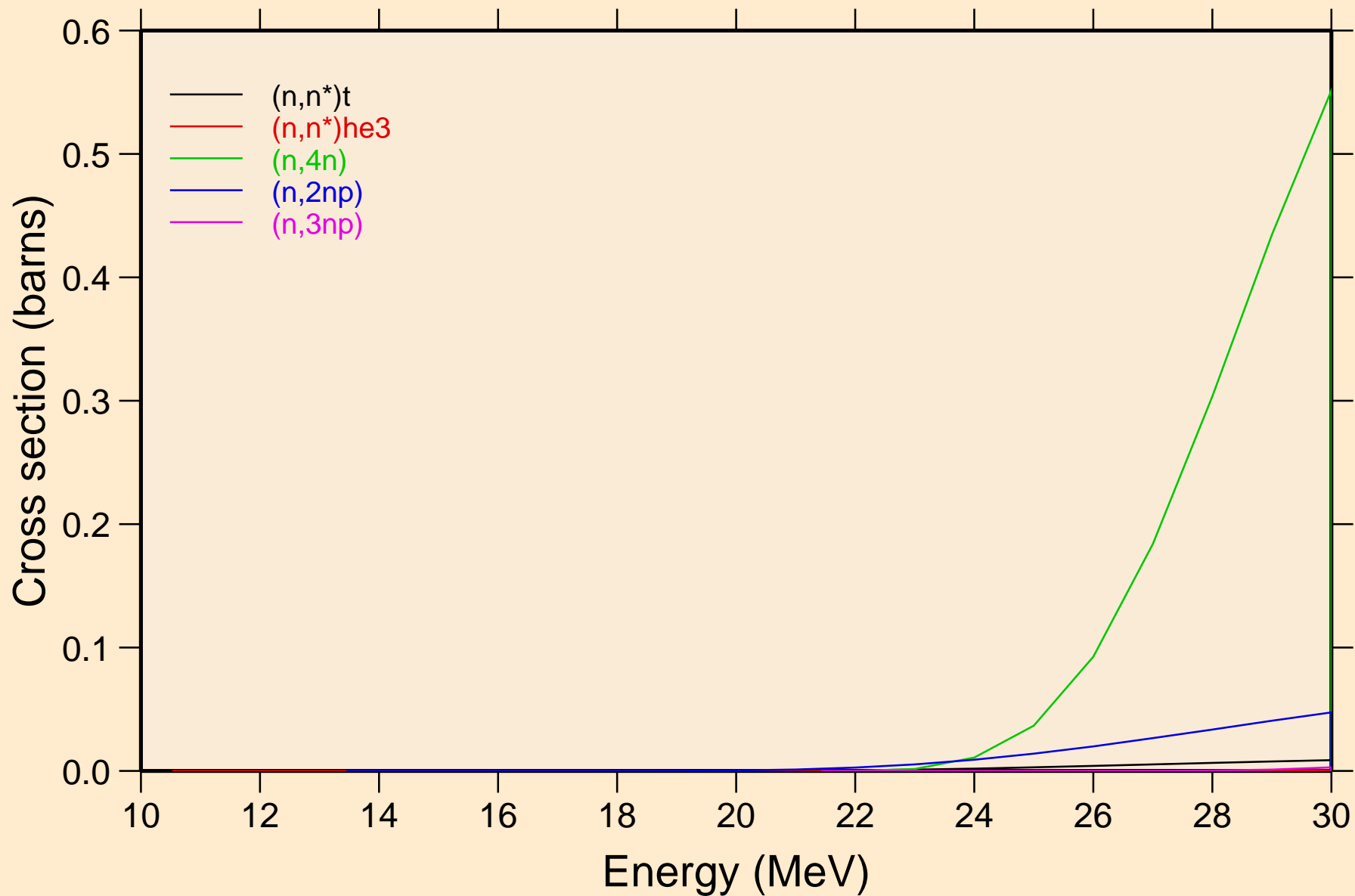

62-SM-147 FOR FENDL-3.2 FROM TENDL-2019 BY NJOY2016.60-
Threshold reactions

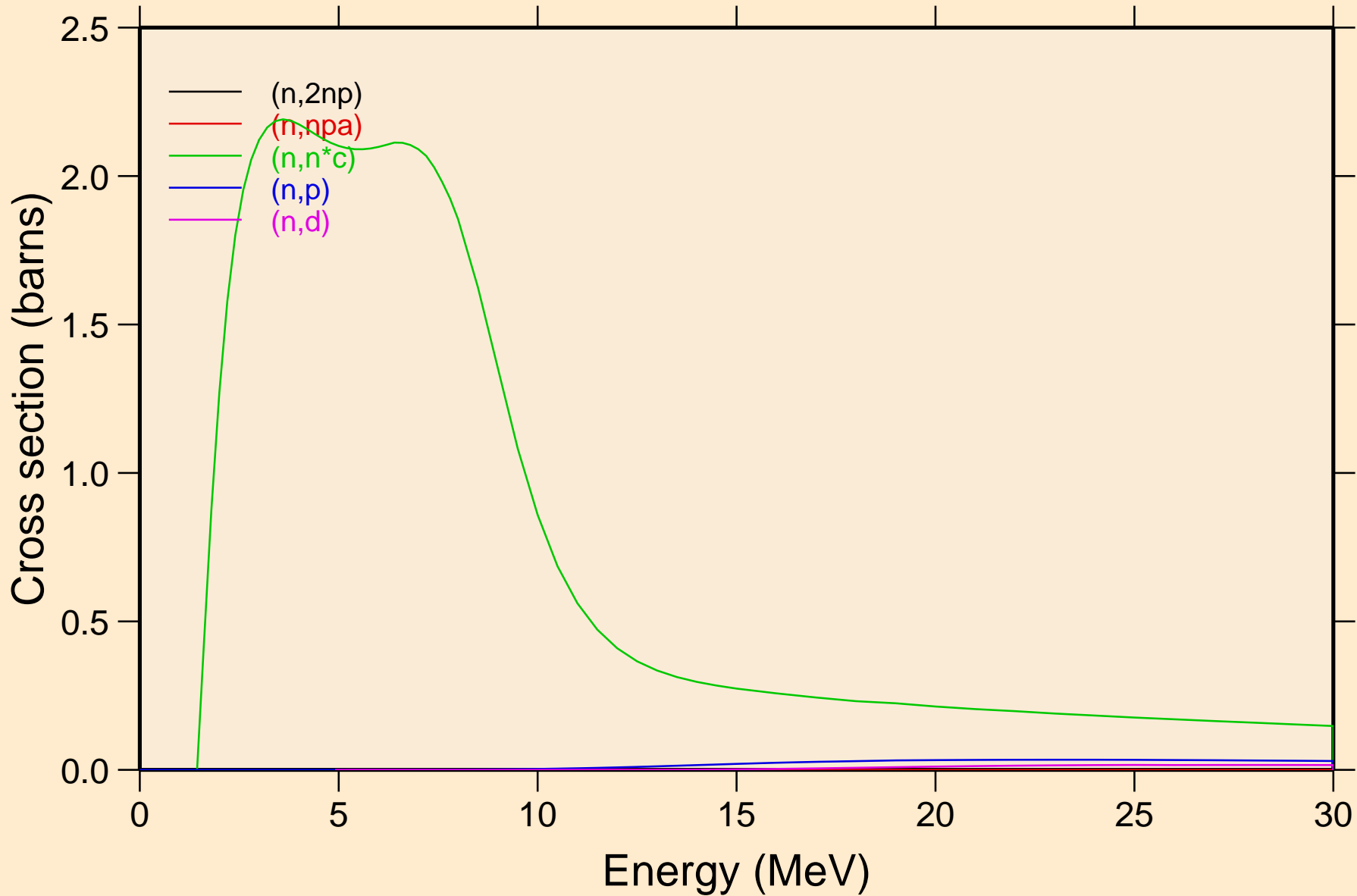

62-SM-147 FOR FENDL-3.2 FROM TENDL-2019 BY NJOY2016.60-
Threshold reactions

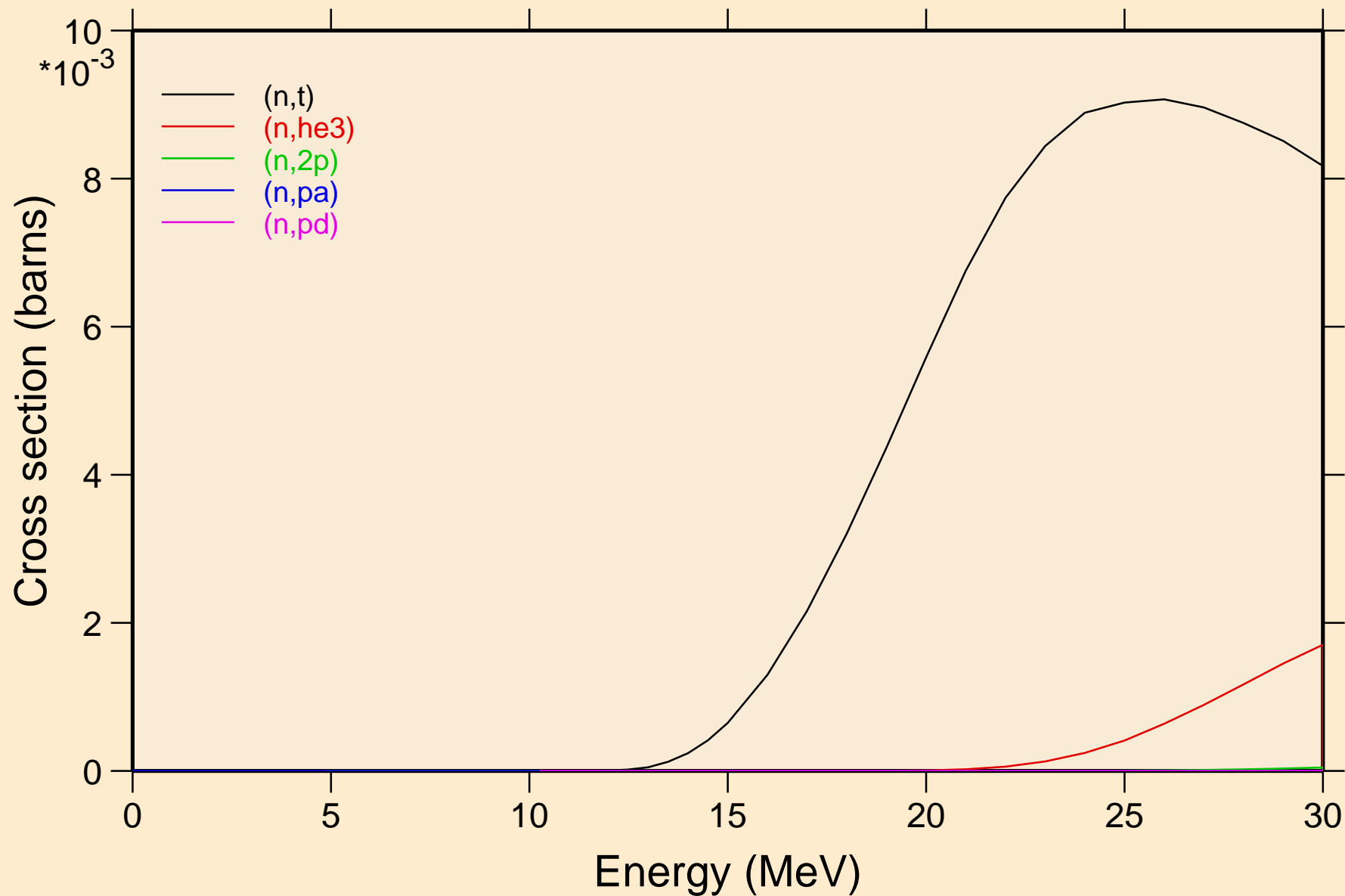

62-SM-147 FOR FENDL-3.2 FROM TENDL-2019 BY NJOY2016.60-
Threshold reactions

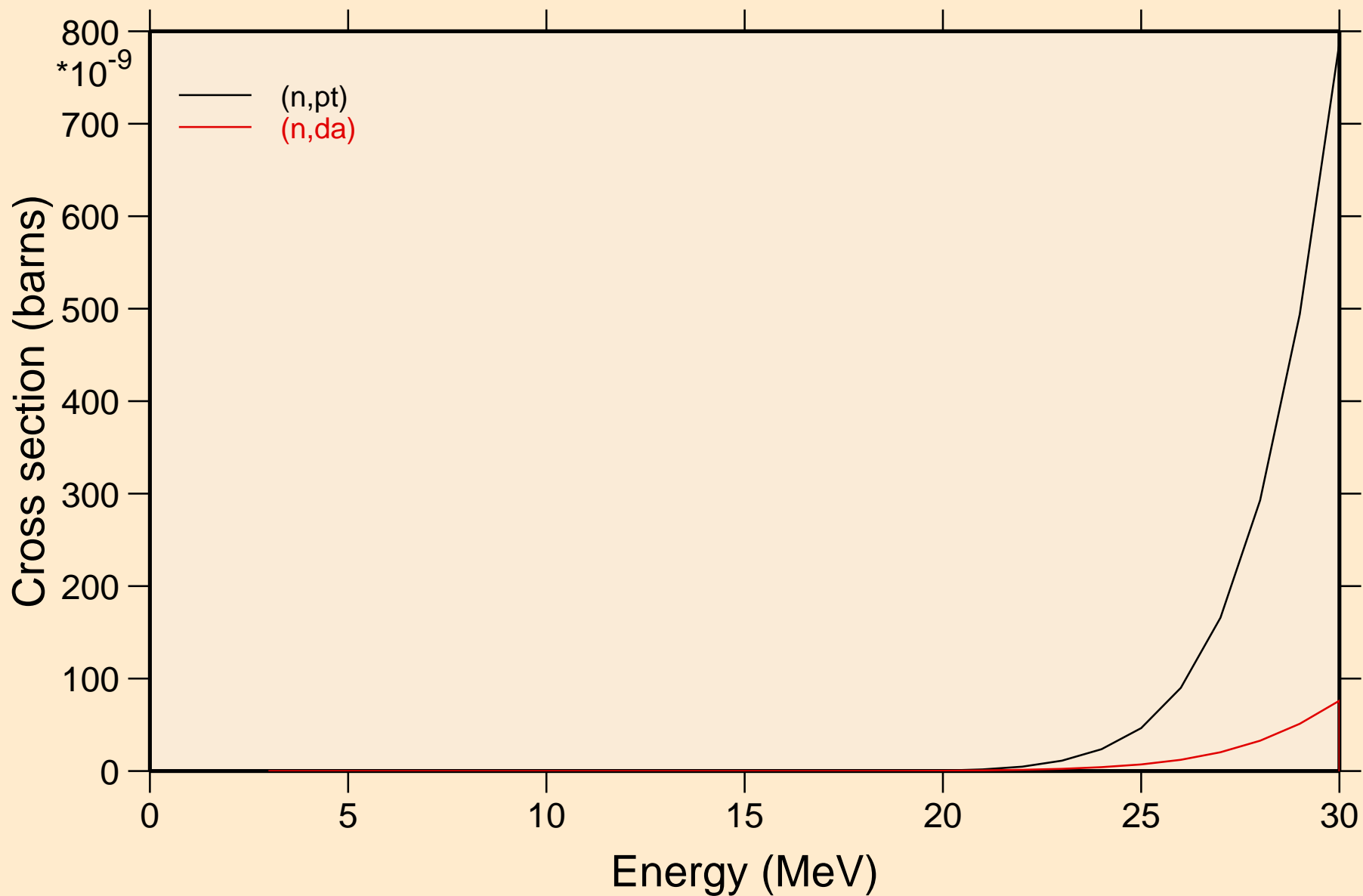

62-SM-147 FOR FENDL-3.2 FROM TENDL-2019 BY NJOY2016.60-
Threshold reactions

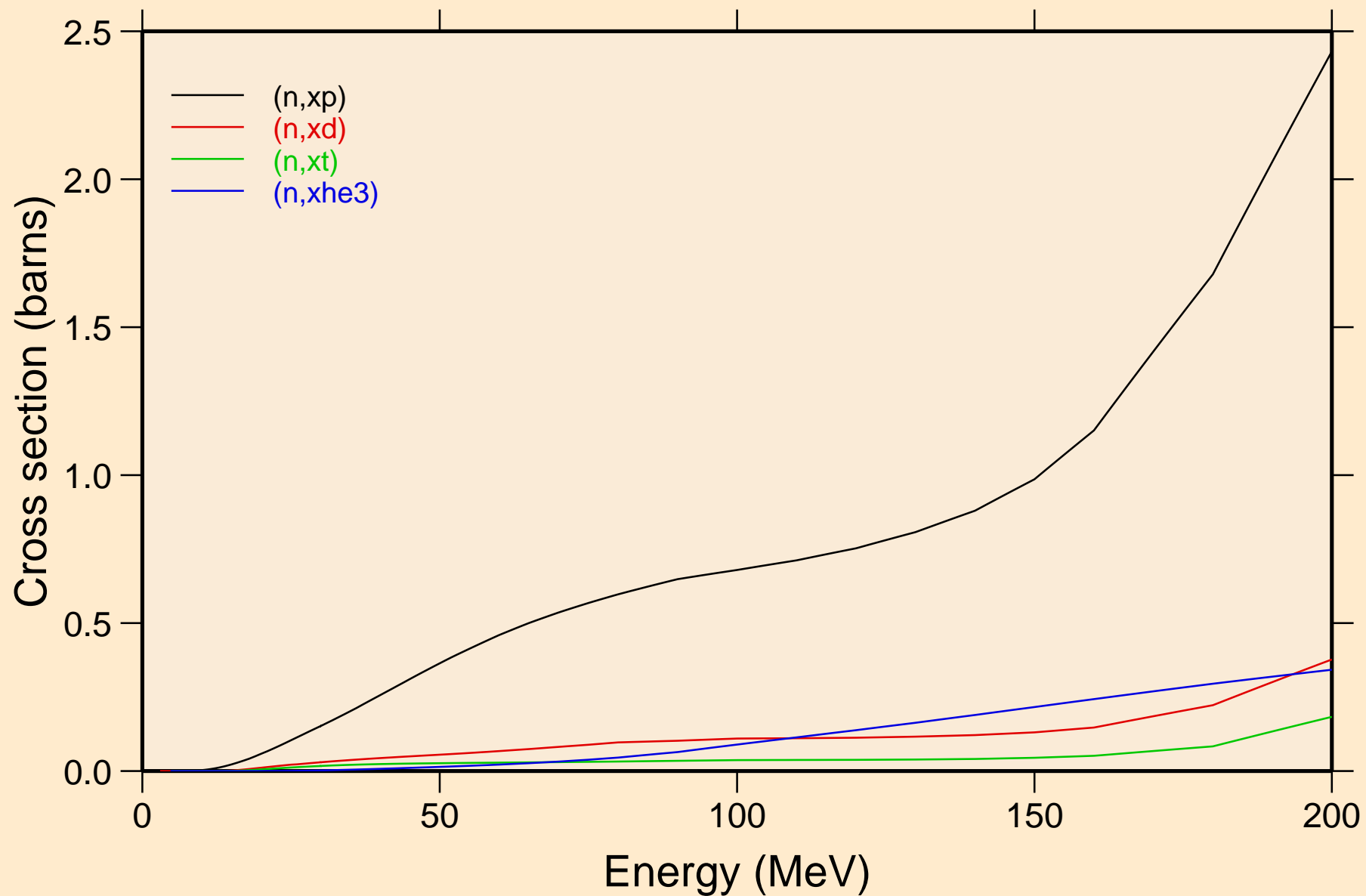

62-SM-147 FOR FENDL-3.2 FROM TENDL-2019 BY NJOY2016.60-
angular distribution for elastic

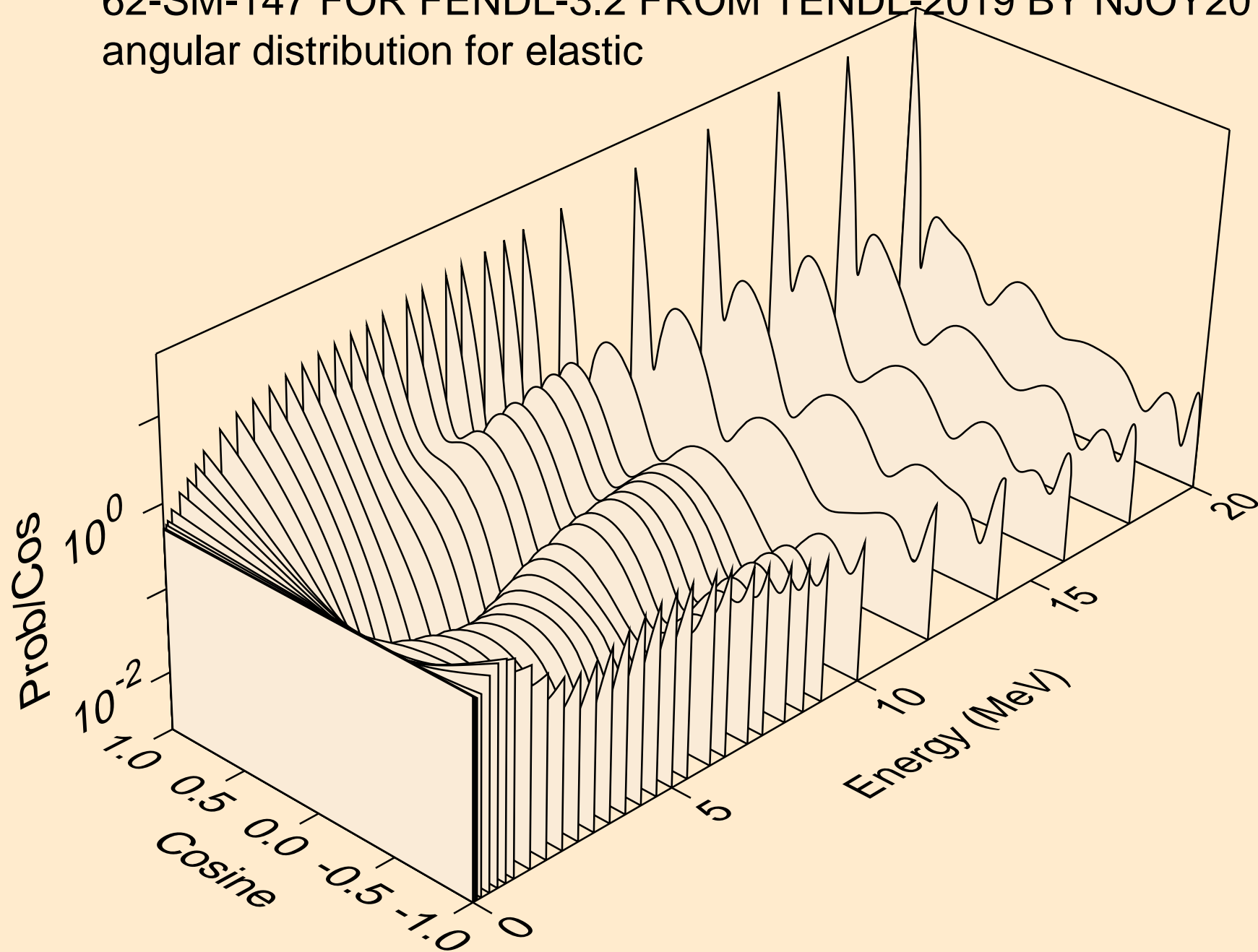

62-SM-147 FOR FENDL-3.2 FROM TENDL-2019 BY NJOY2016.60-
angular distribution for elastic

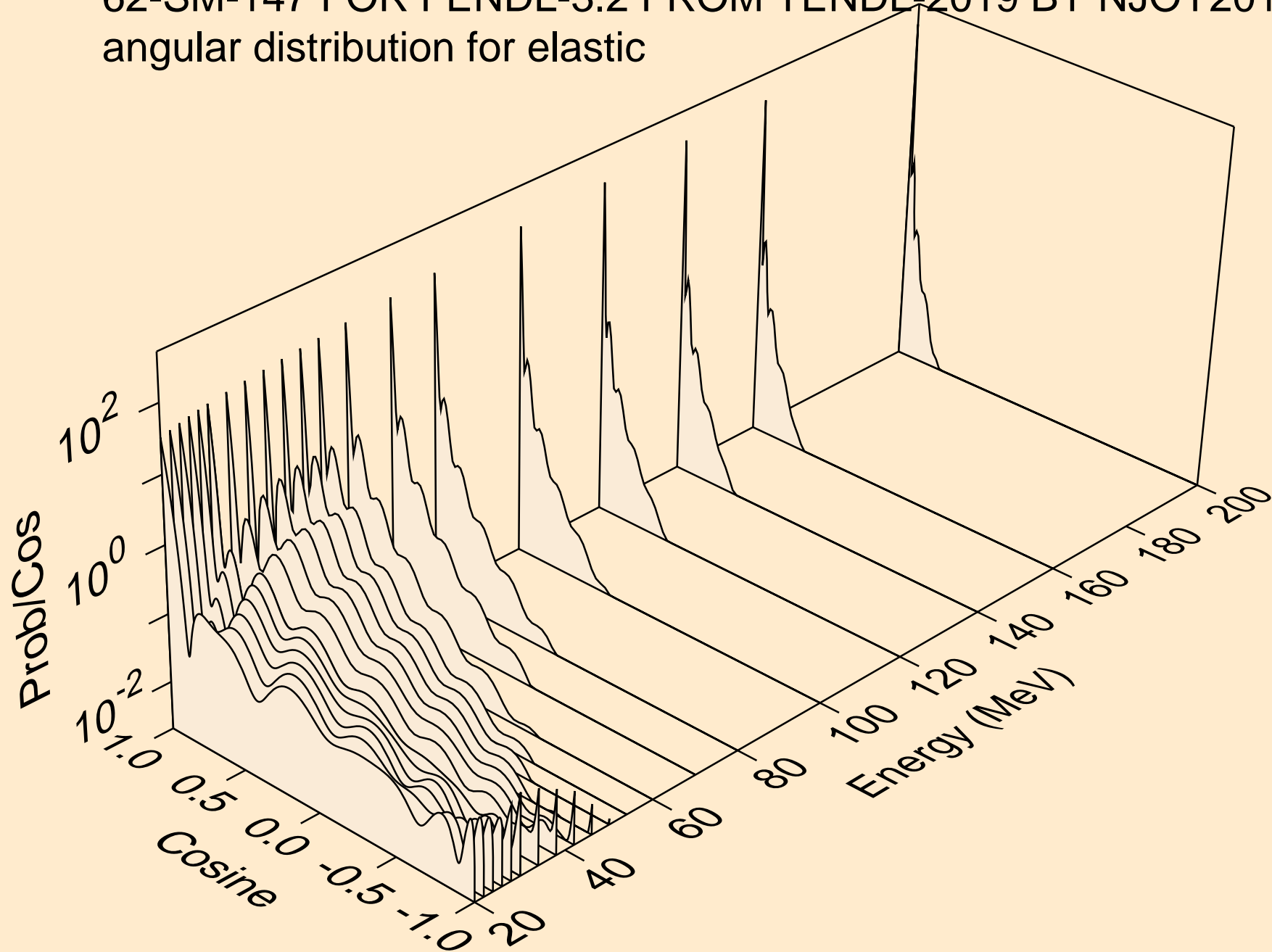

62-SM-147 FOR FENDL-3.2 FROM TENDL-2019 BY NJOY2016.60-
angular distribution for (n,n*1)

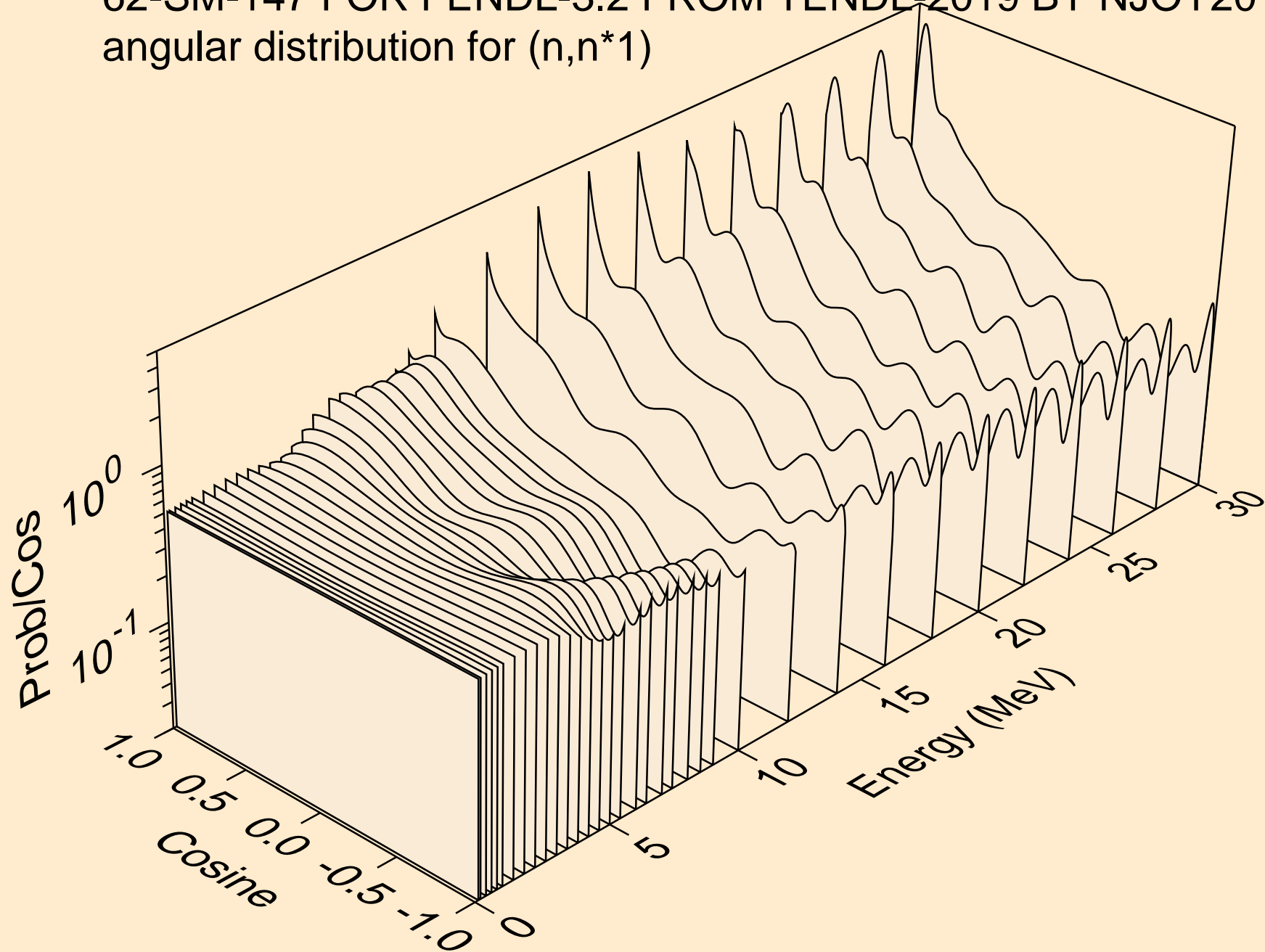

62-SM-147 FOR FENDL-3.2 FROM TENDL-2019 BY NJOY2016.60-
angular distribution for (n,n*2)

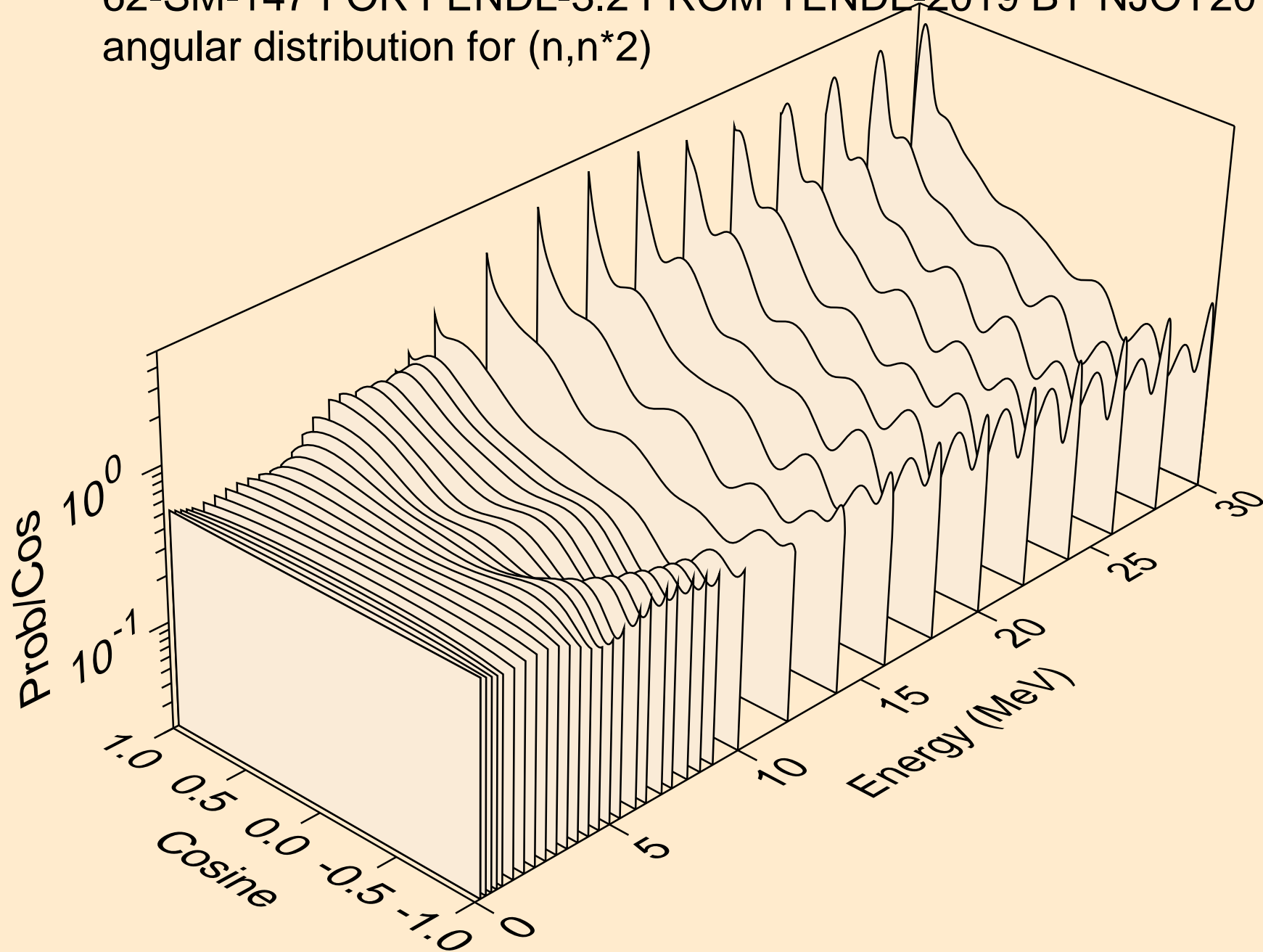

62-SM-147 FOR FENDL-3.2 FROM TENDL-2019 BY NJOY2016.60-
angular distribution for (n,n*3)

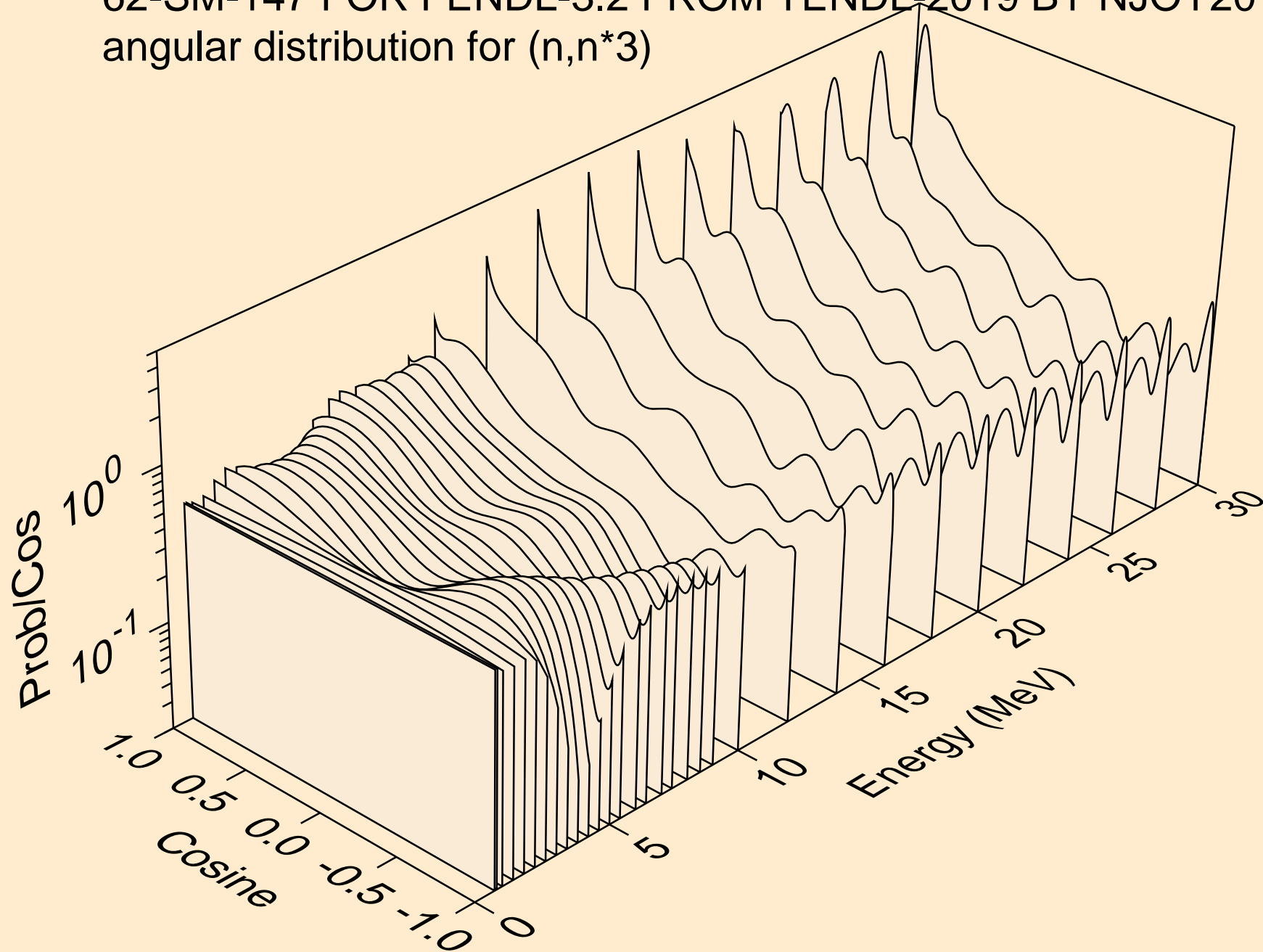

62-SM-147 FOR FENDL-3.2 FROM TENDL-2019 BY NJOY2016.60-
angular distribution for (n,n*4)

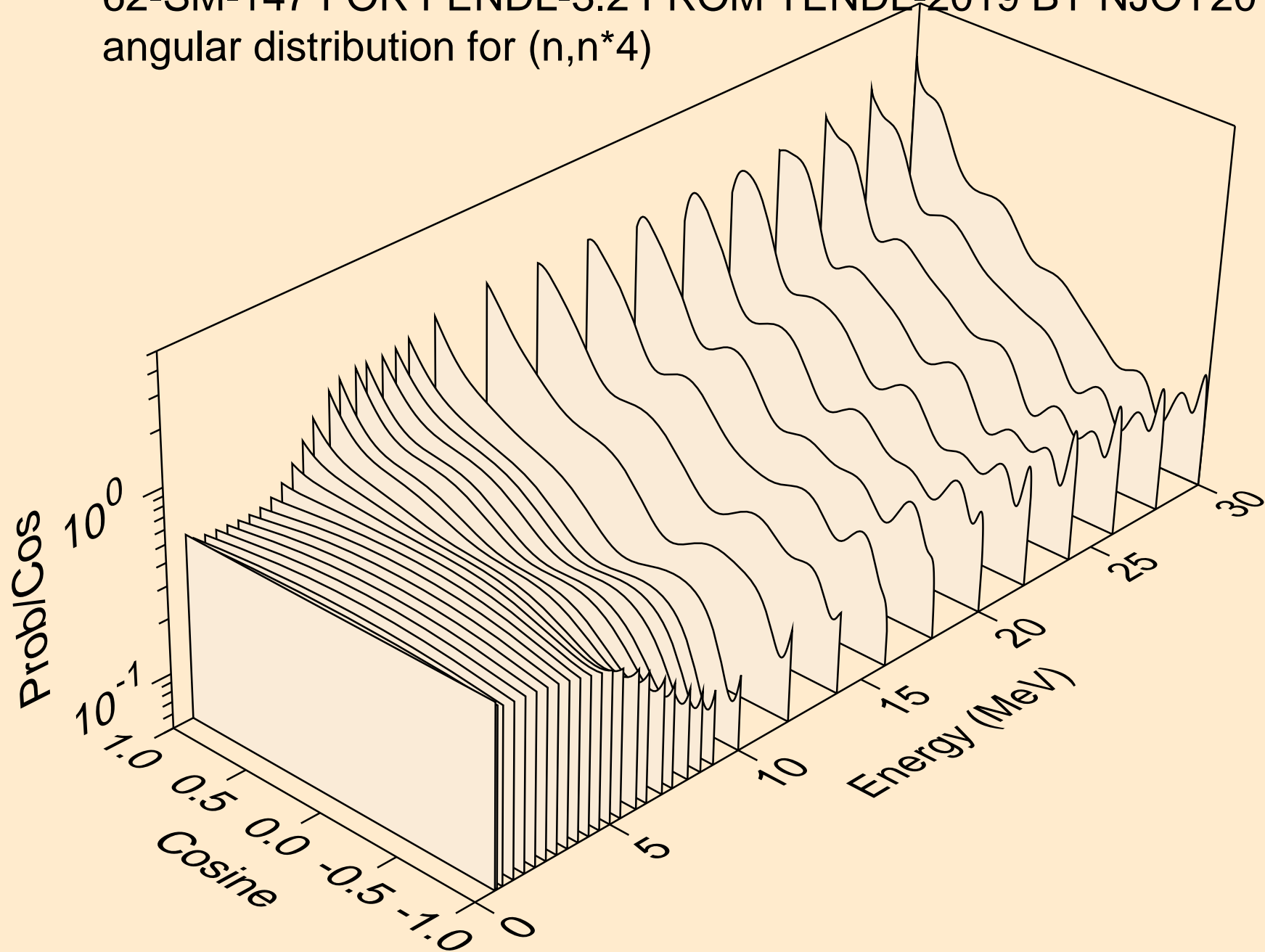

62-SM-147 FOR FENDL-3.2 FROM TENDL-2019 BY NJOY2016.60-
angular distribution for (n,n*5)

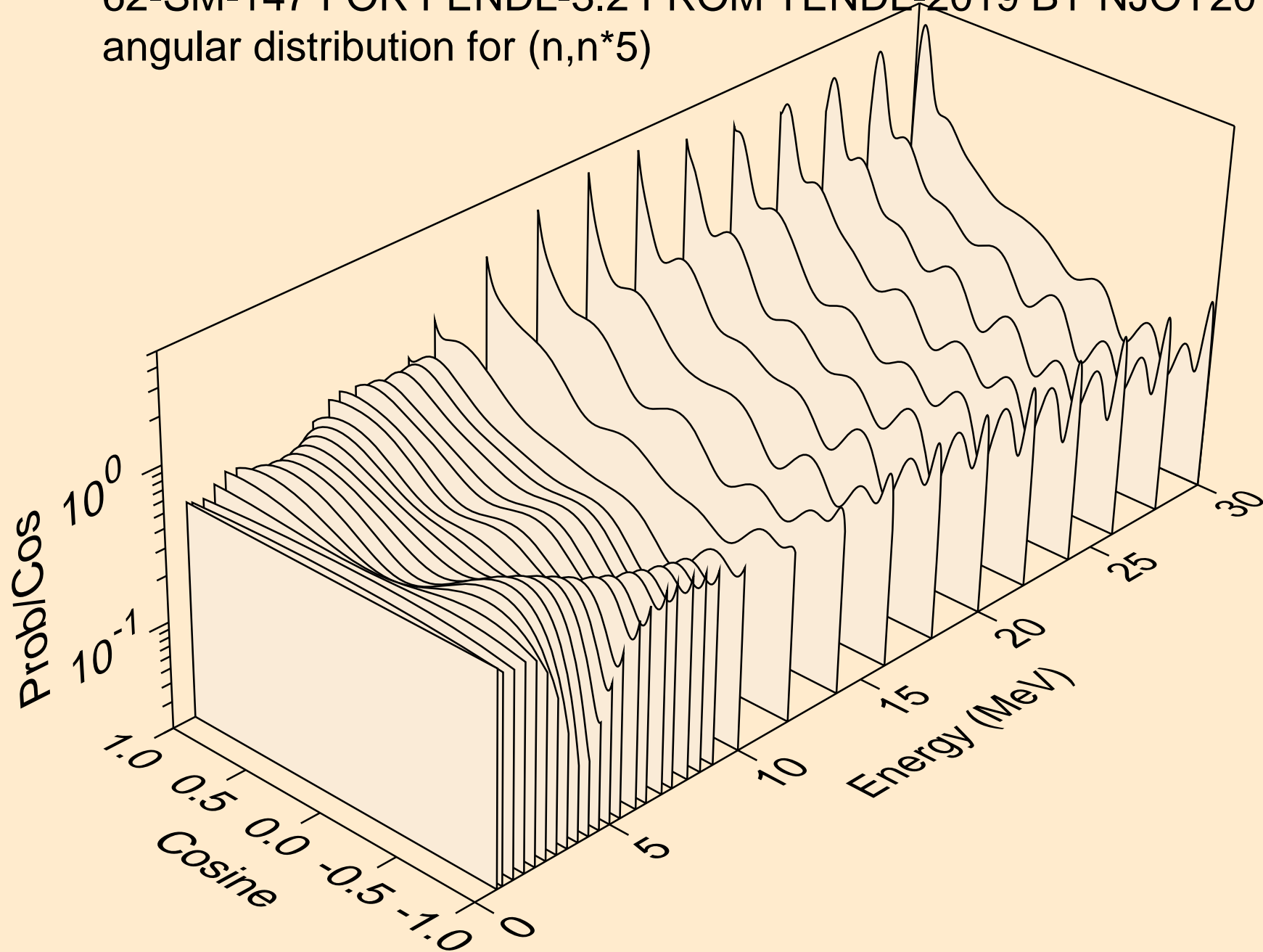

62-SM-147 FOR FENDL-3.2 FROM TENDL-2019 BY NJOY2016.60-
angular distribution for (n,n*6)

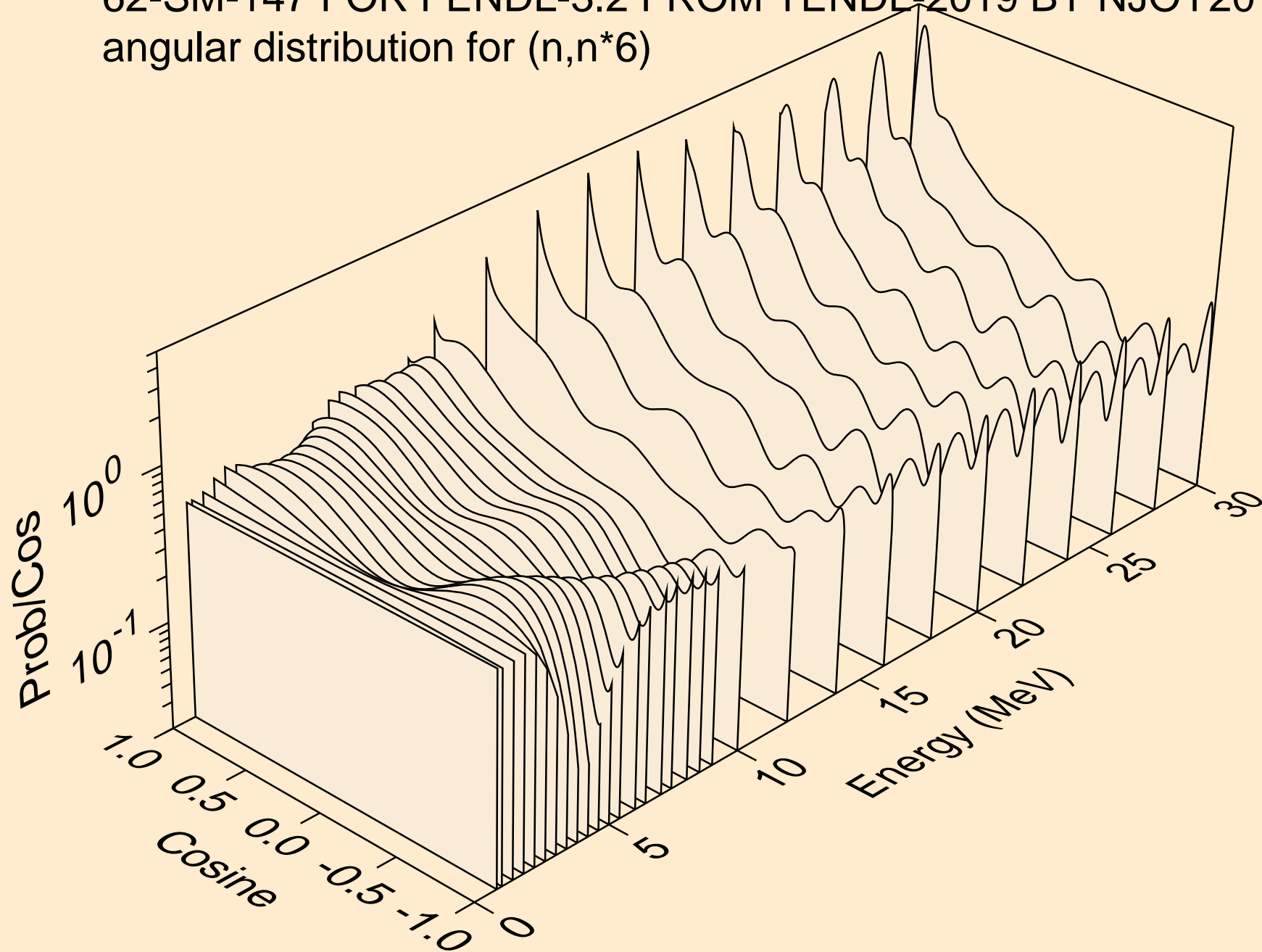

62-SM-147 FOR FENDL-3.2 FROM TENDL-2019 BY NJOY2016.60-
angular distribution for (n,n*7)

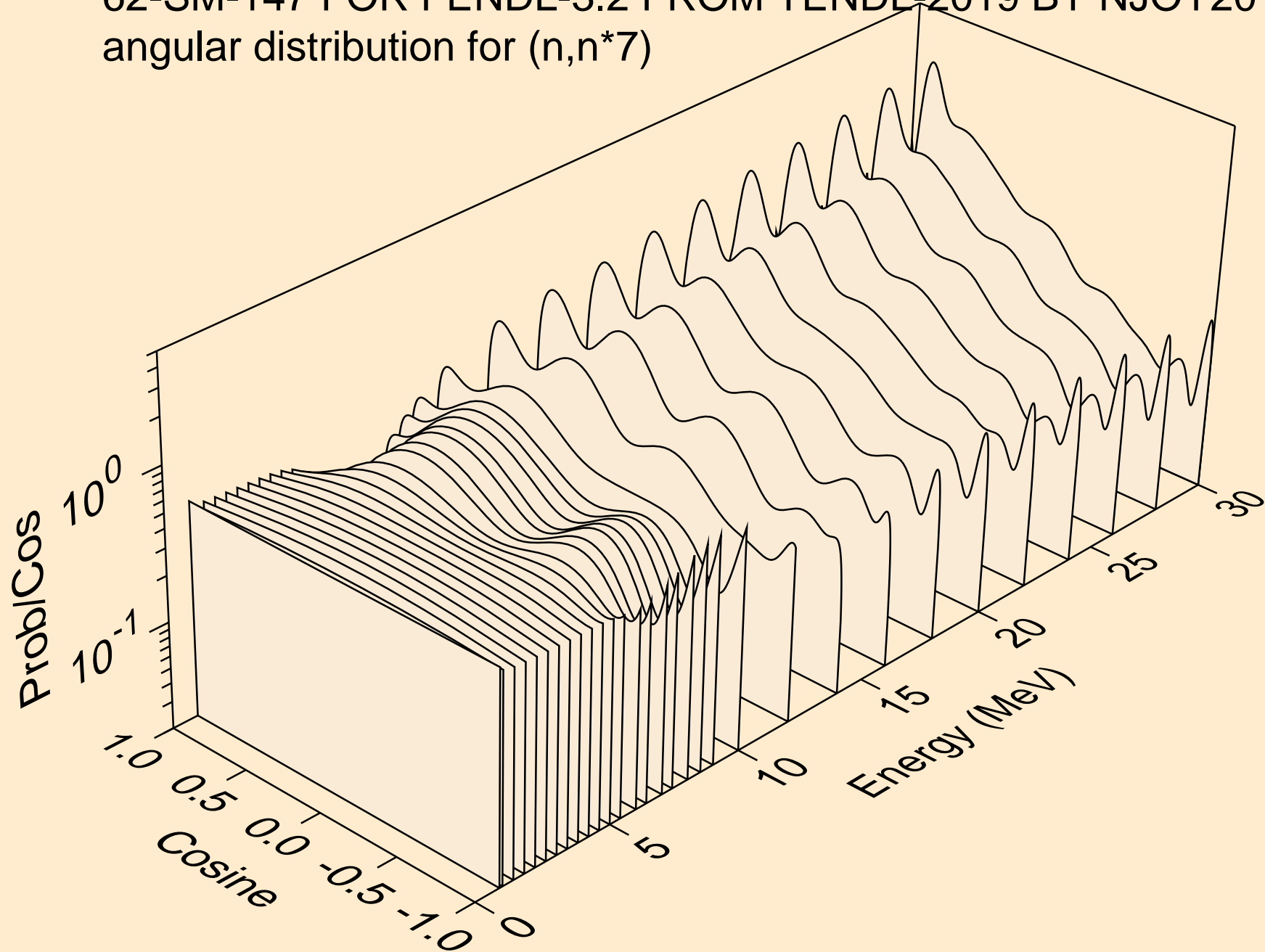

62-SM-147 FOR FENDL-3.2 FROM TENDL-2019 BY NJOY2016.60-
angular distribution for (n,n*8)

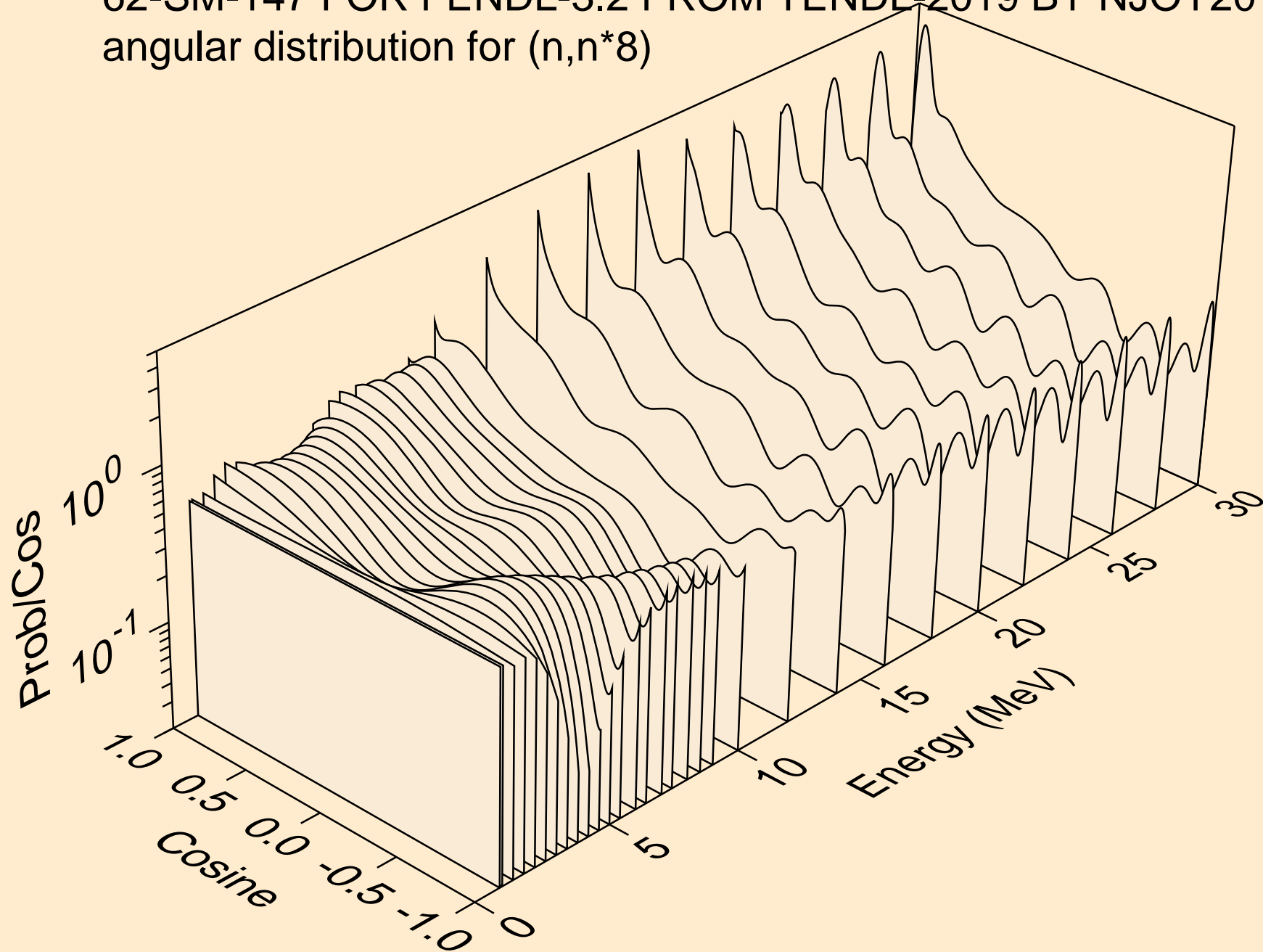

62-SM-147 FOR FENDL-3.2 FROM TENDL-2019 BY NJOY2016.60-
angular distribution for (n,n*9)

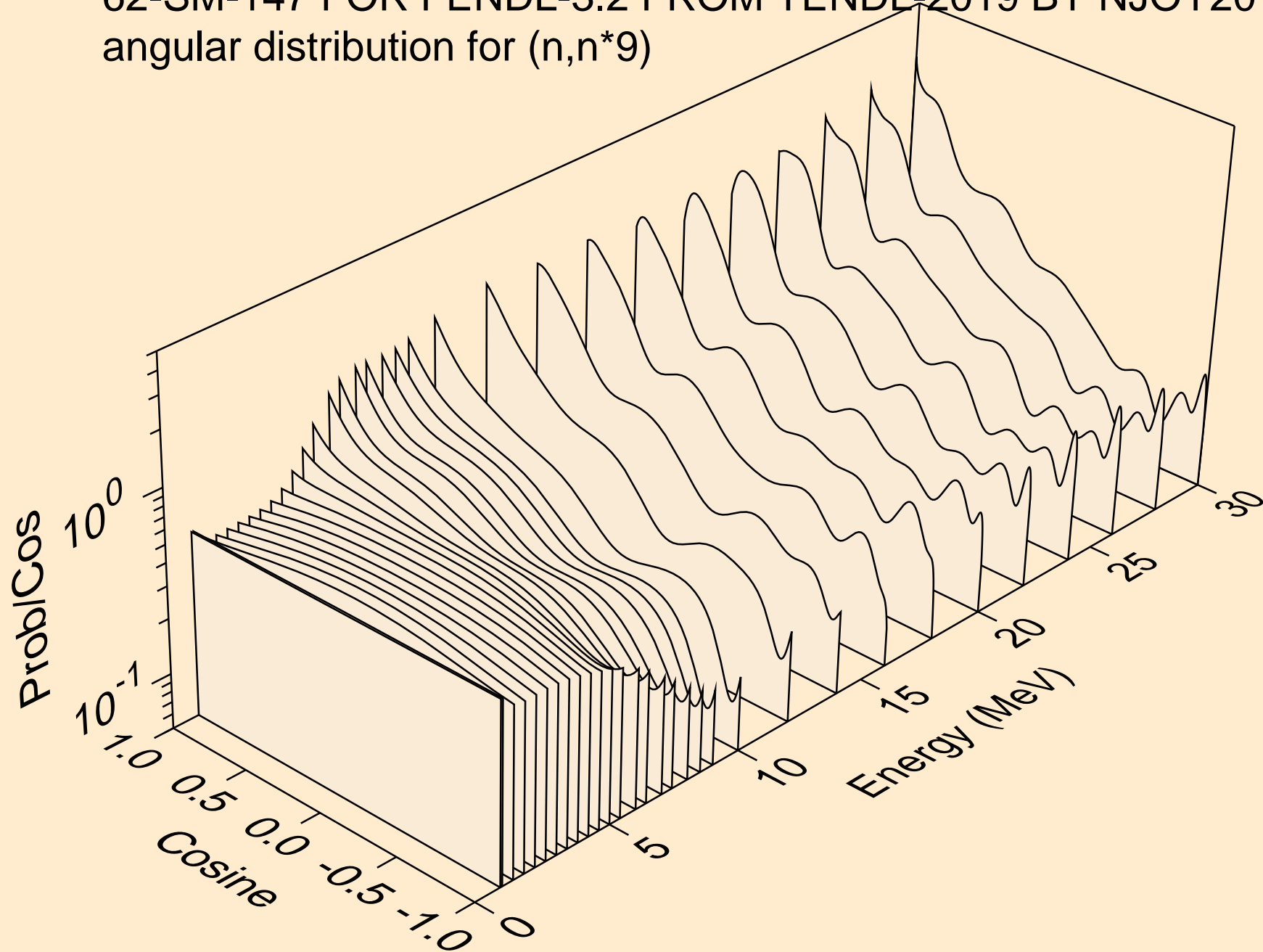

62-SM-147 FOR FENDL-3.2 FROM TENDL-2019 BY NJOY2016.60-
angular distribution for (n,n*10)

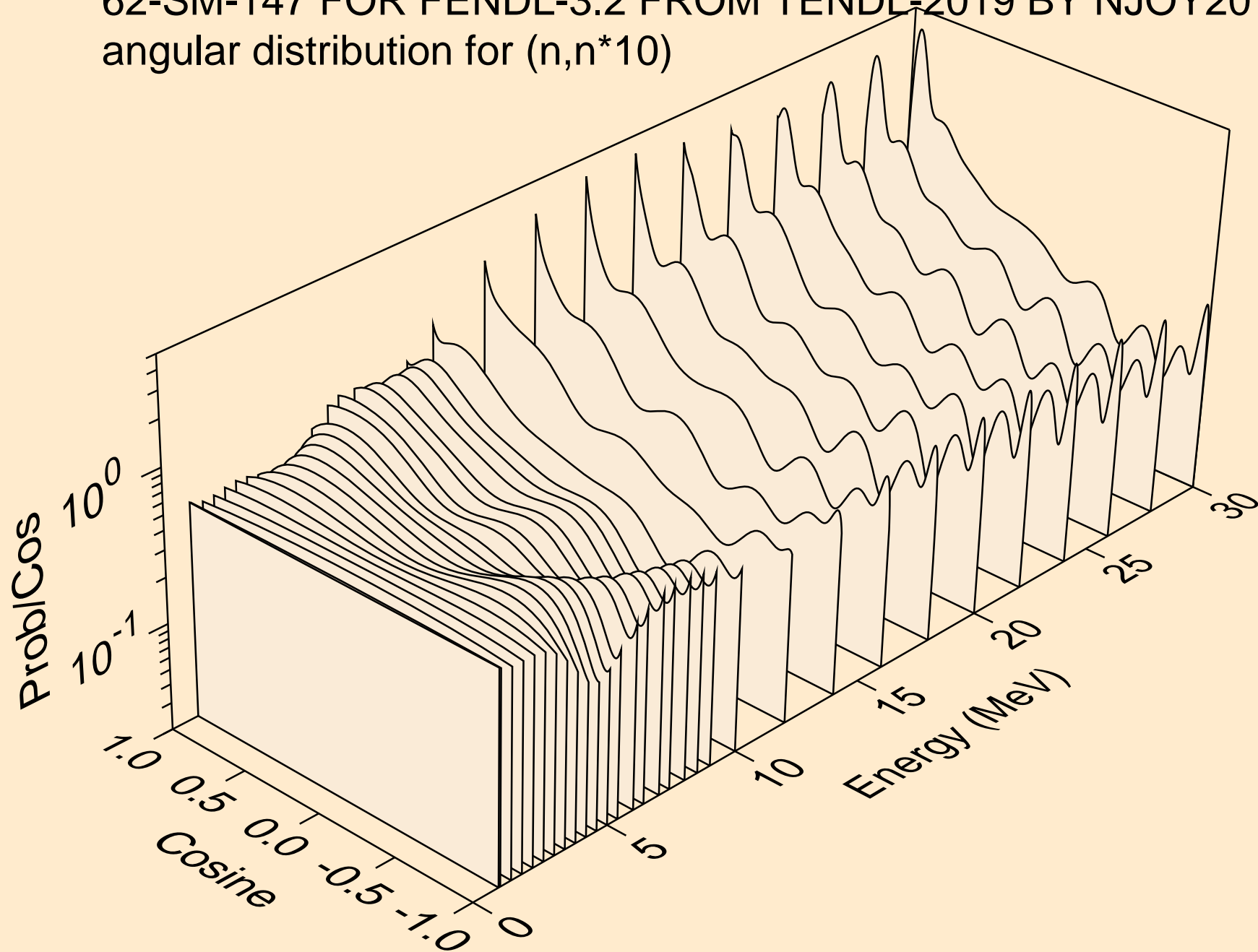

62-SM-147 FOR FENDL-3.2 FROM TENDL-2019 BY NJOY2016.60-
angular distribution for (n,n*11)

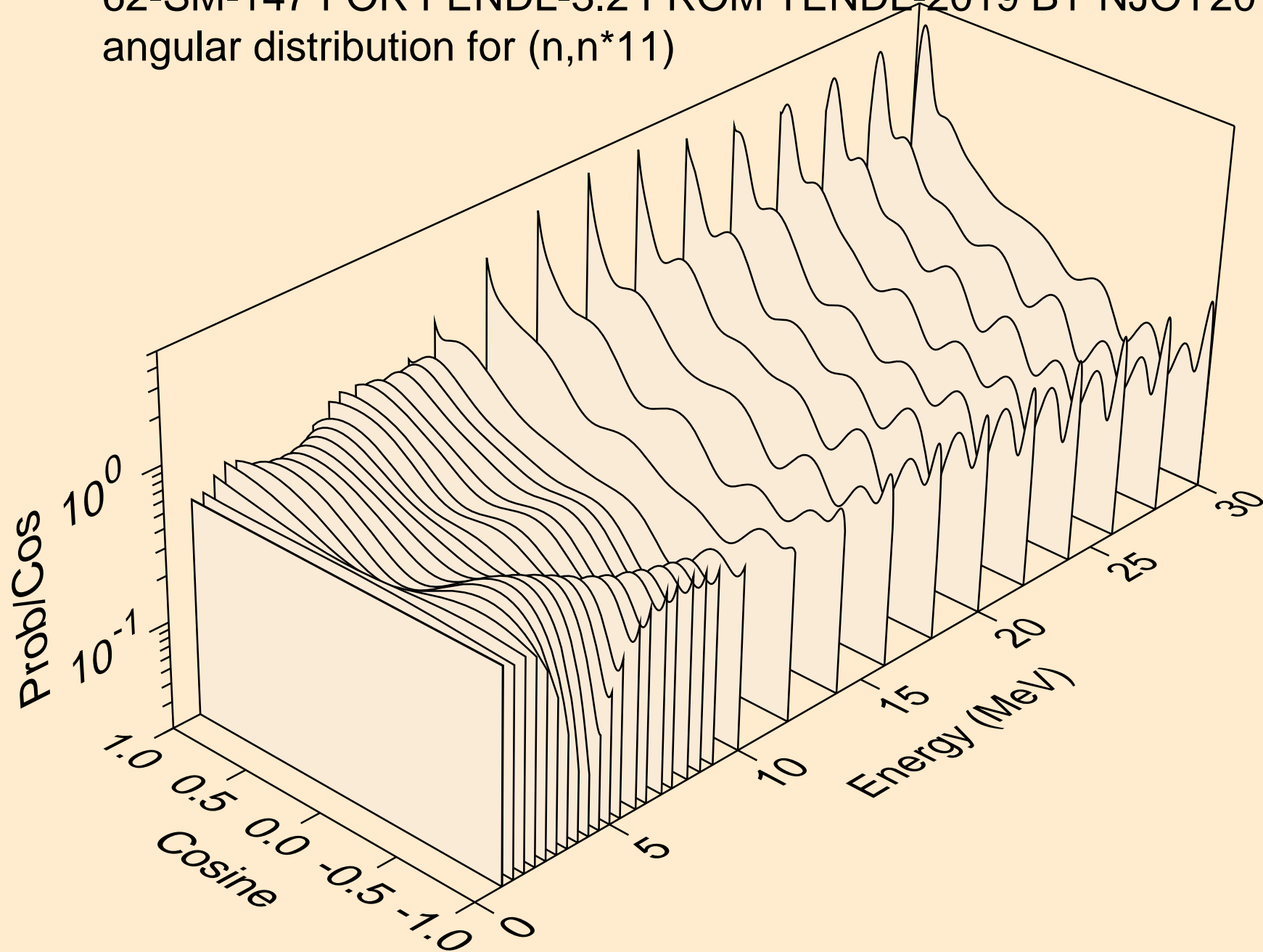

62-SM-147 FOR FENDL-3.2 FROM TENDL-2019 BY NJOY2016.60-
angular distribution for (n,n*12)

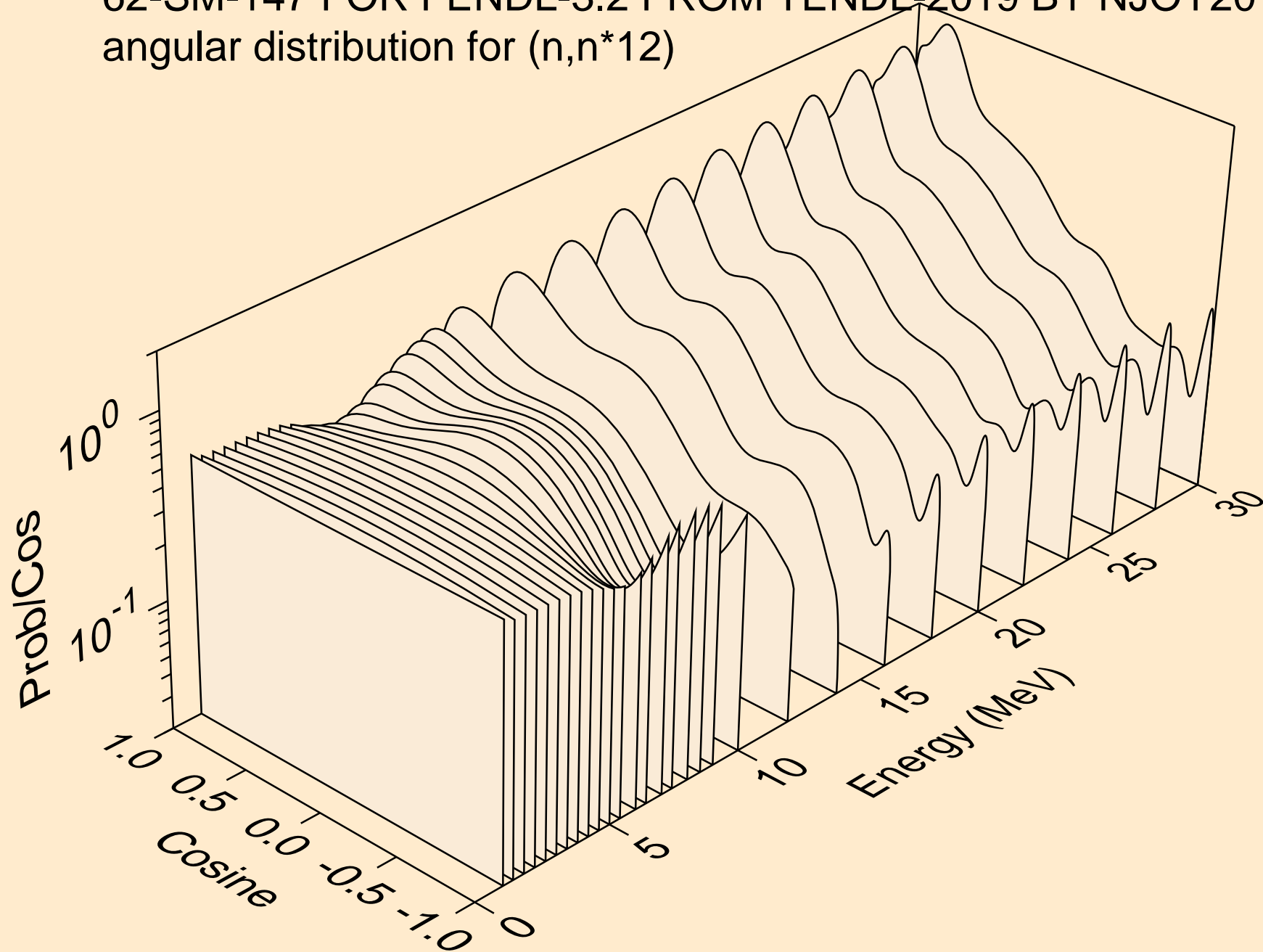

62-SM-147 FOR FENDL-3.2 FROM TENDL-2019 BY NJOY2016.60-
angular distribution for (n,n*13)

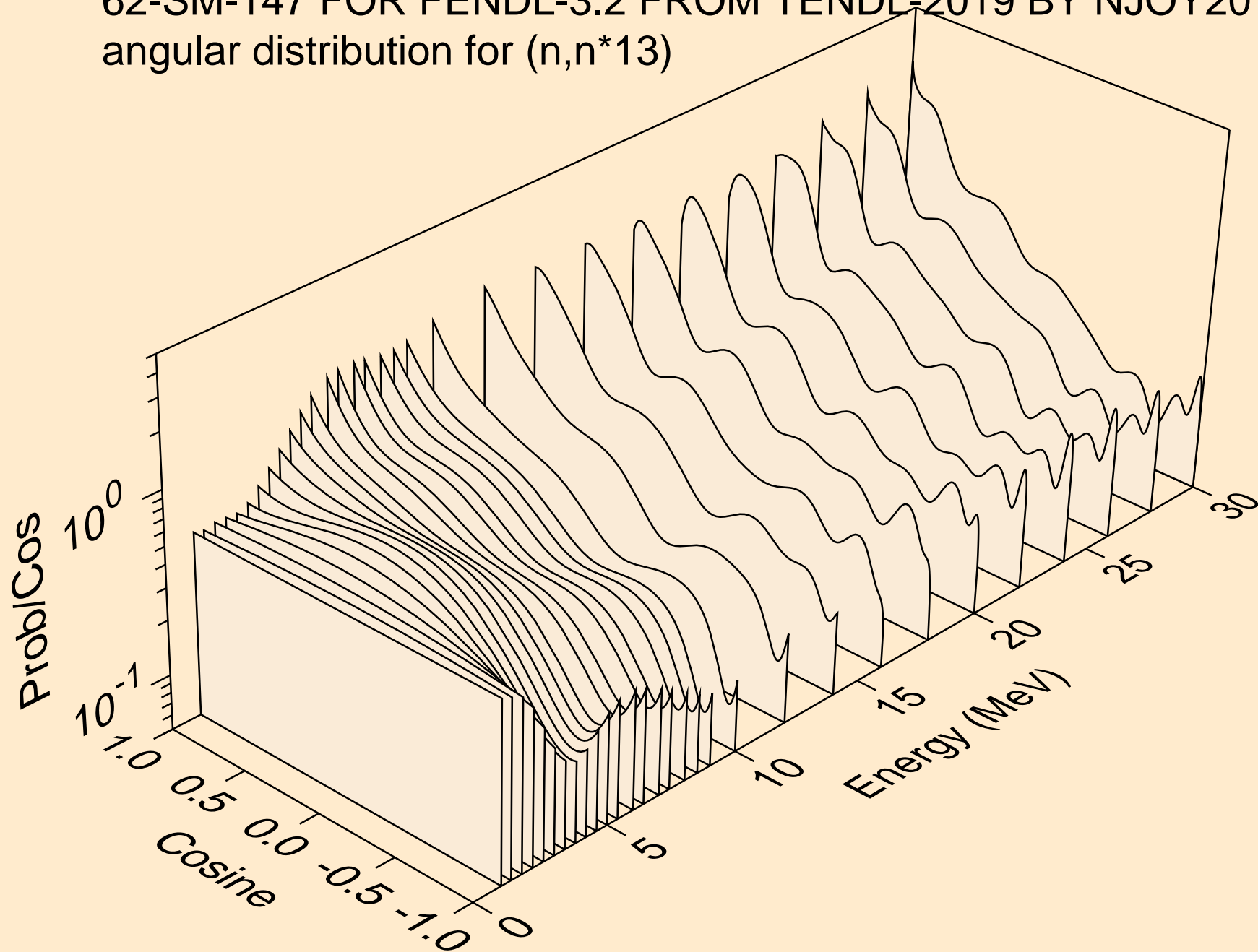

62-SM-147 FOR FENDL-3.2 FROM TENDL-2019 BY NJOY2016.60-
angular distribution for (n,n*14)

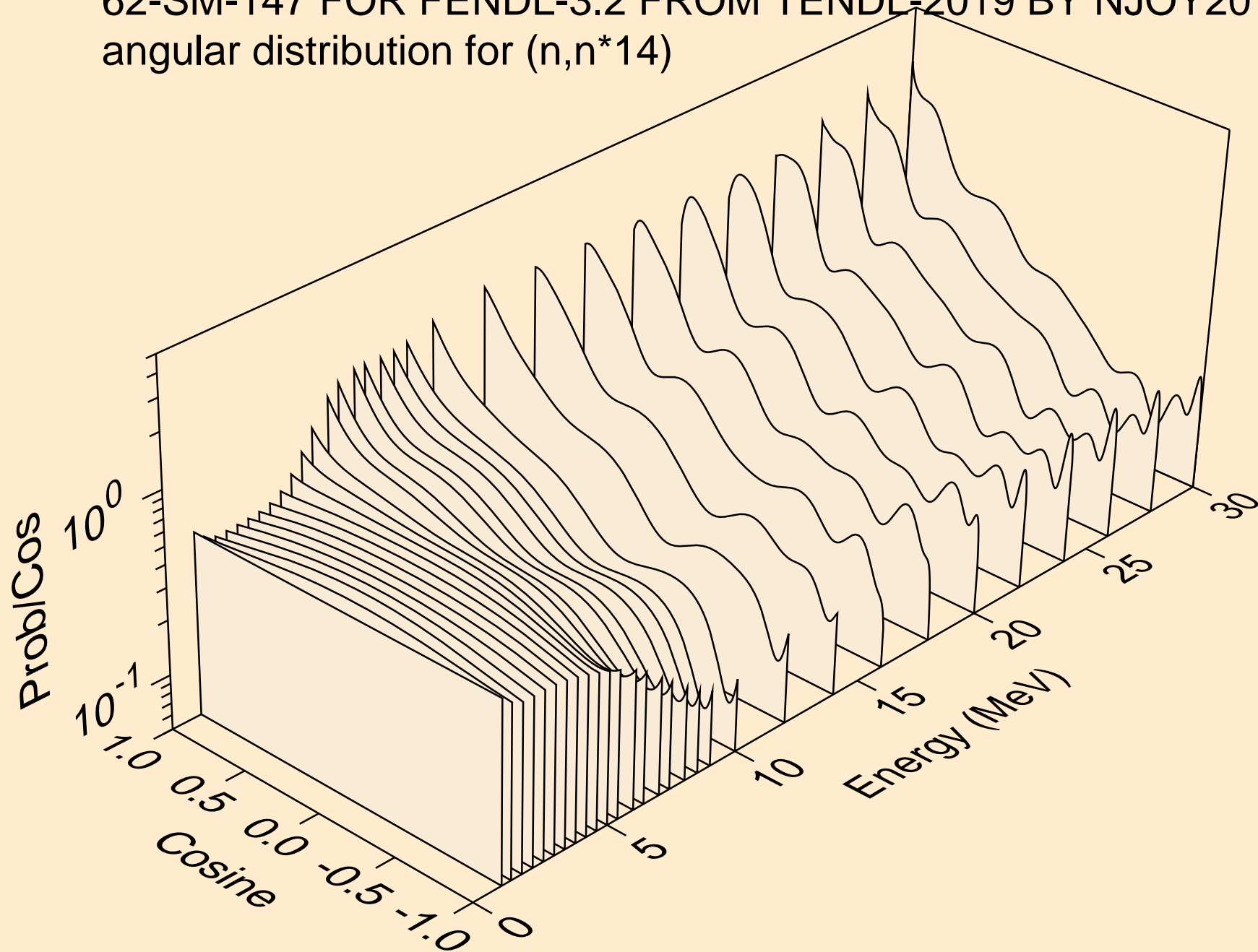

62-SM-147 FOR FENDL-3.2 FROM TENDL-2019 BY NJOY2016.60-
angular distribution for (n,n*15)

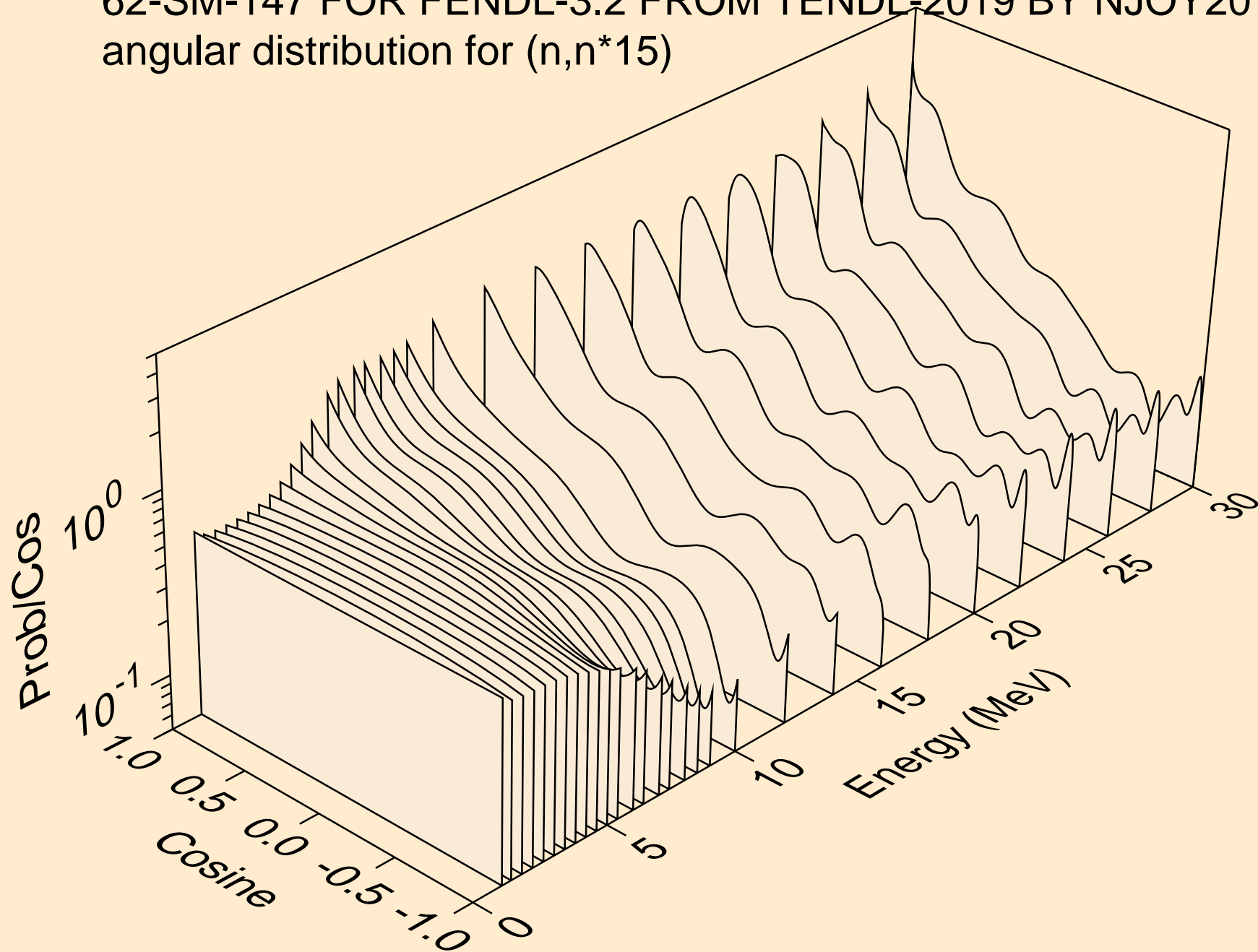

62-SM-147 FOR FENDL-3.2 FROM TENDL-2019 BY NJOY2016.60-
angular distribution for (n,n*16)

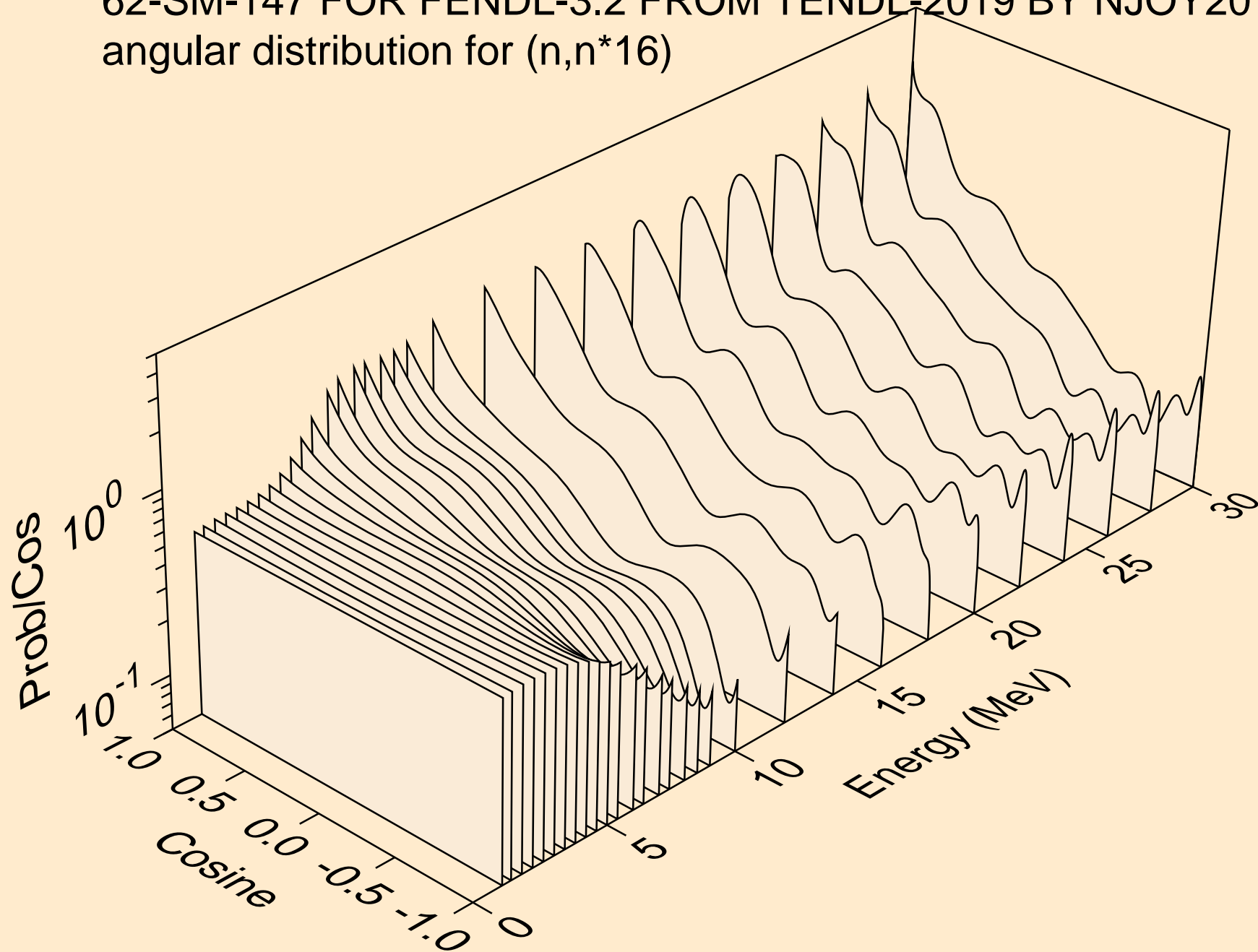

62-SM-147 FOR FENDL-3.2 FROM TENDL-2019 BY NJOY2016.60-
angular distribution for (n,n*17)

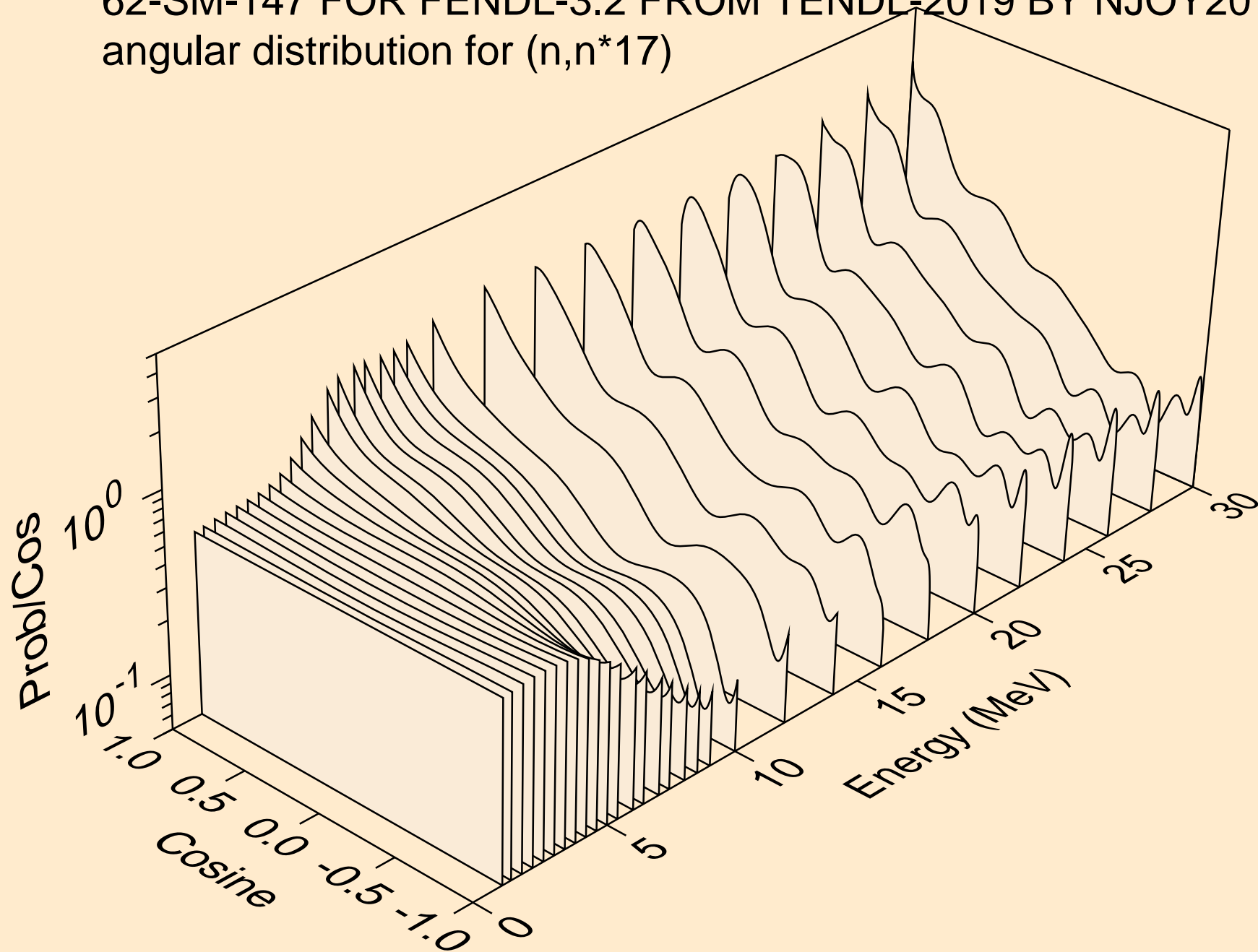

62-SM-147 FOR FENDL-3.2 FROM TENDL-2019 BY NJOY2016.60-
angular distribution for (n,n*18)

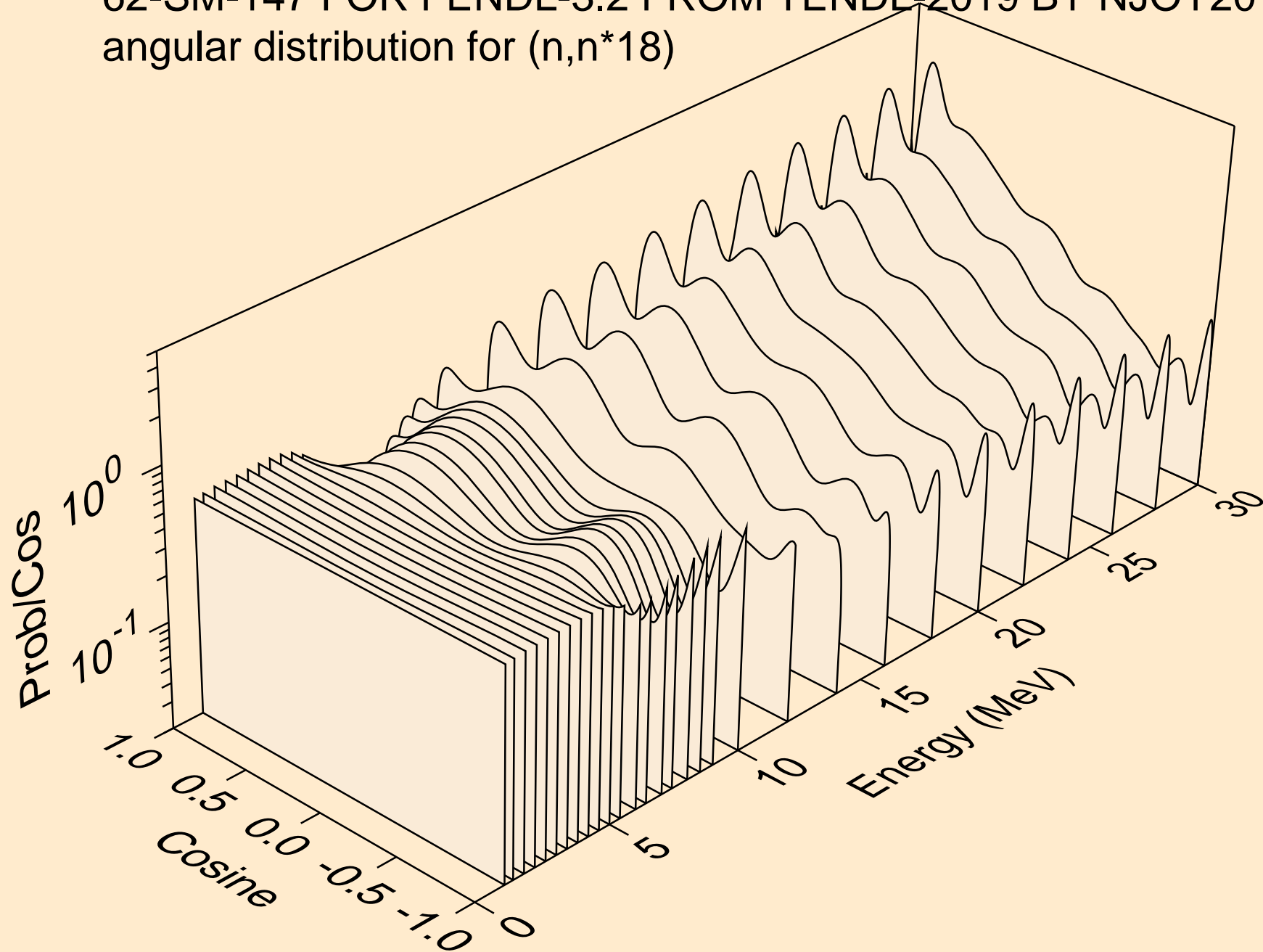

62-SM-147 FOR FENDL-3.2 FROM TENDL-2019 BY NJOY2016.60-
angular distribution for (n,n*19)

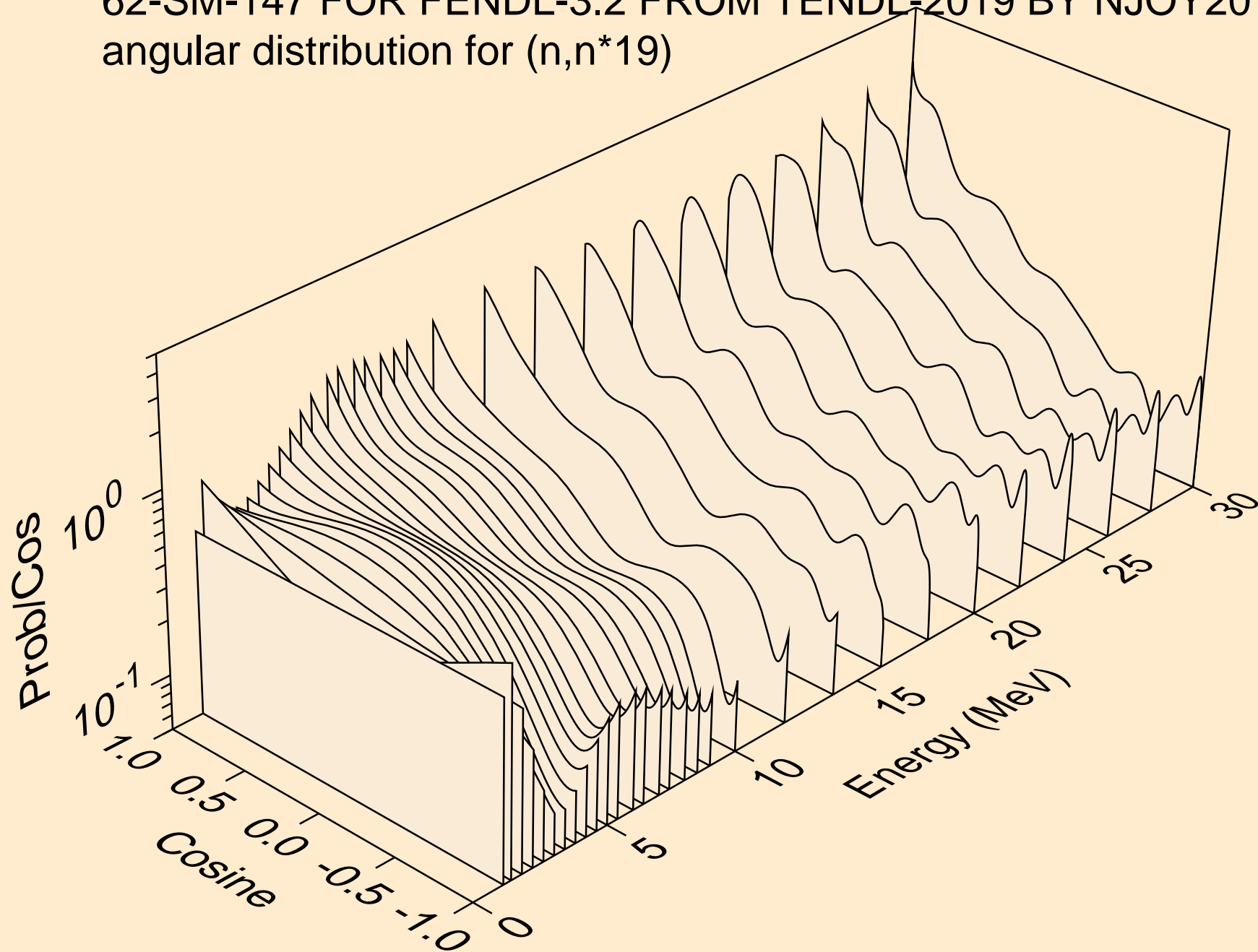

62-SM-147 FOR FENDL-3.2 FROM TENDL-2019 BY NJOY2016.60-
angular distribution for (n,n*20)

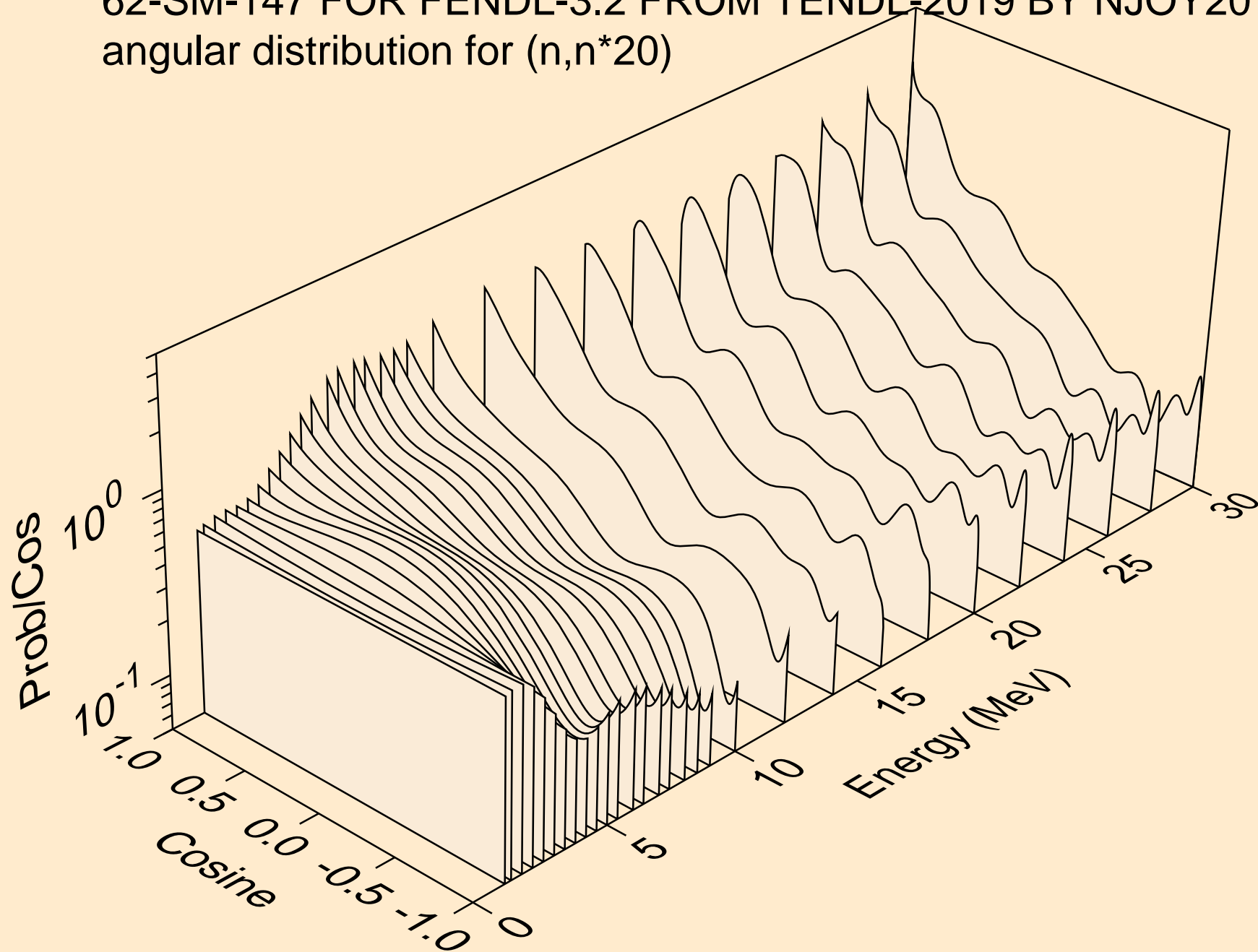

62-SM-147 FOR FENDL-3.2 FROM TENDL-2019 BY NJOY2016.60-
angular distribution for (n,n*21)

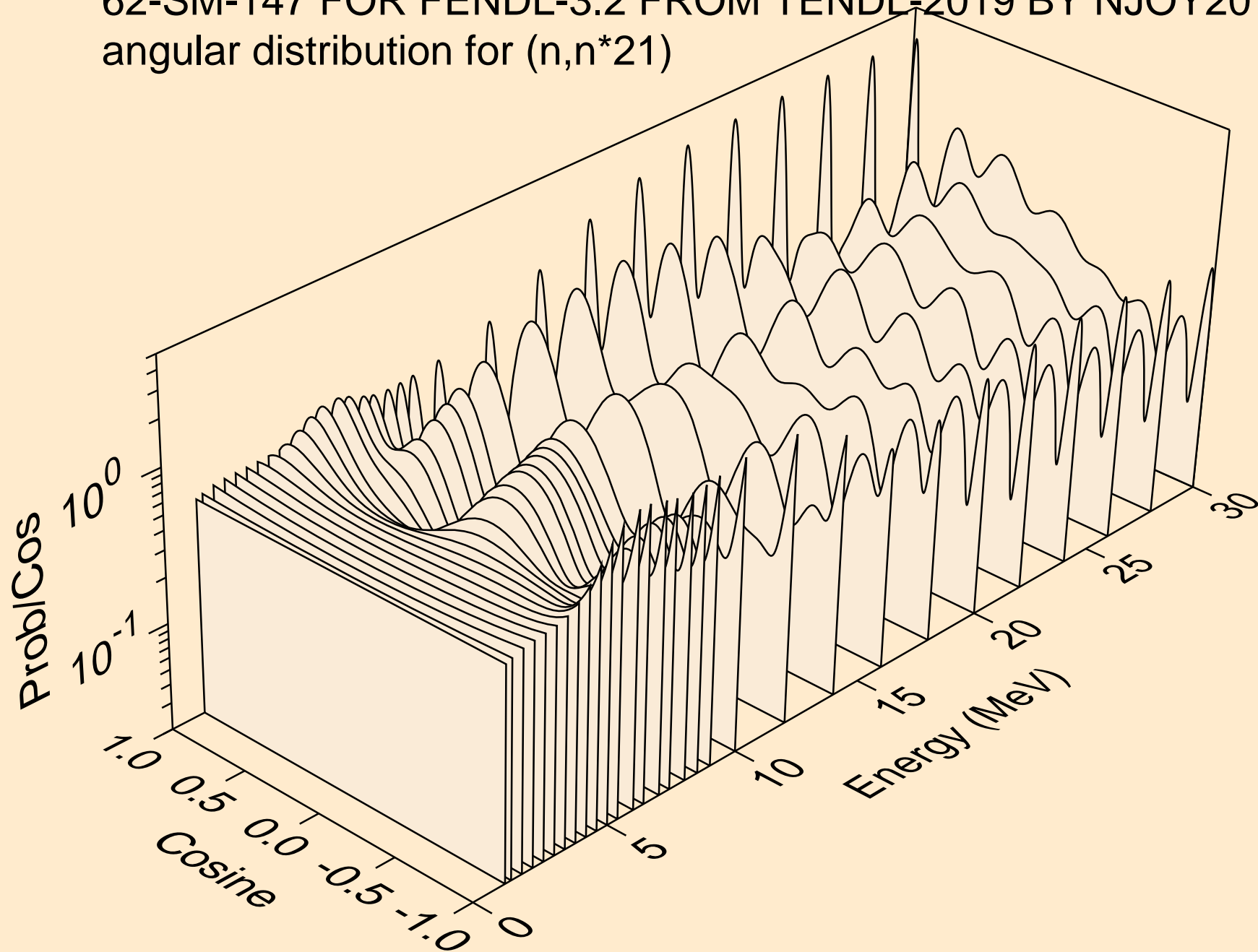

62-SM-147 FOR FENDL-3.2 FROM TENDL-2019 BY NJOY2016.60-
angular distribution for (n,n*22)

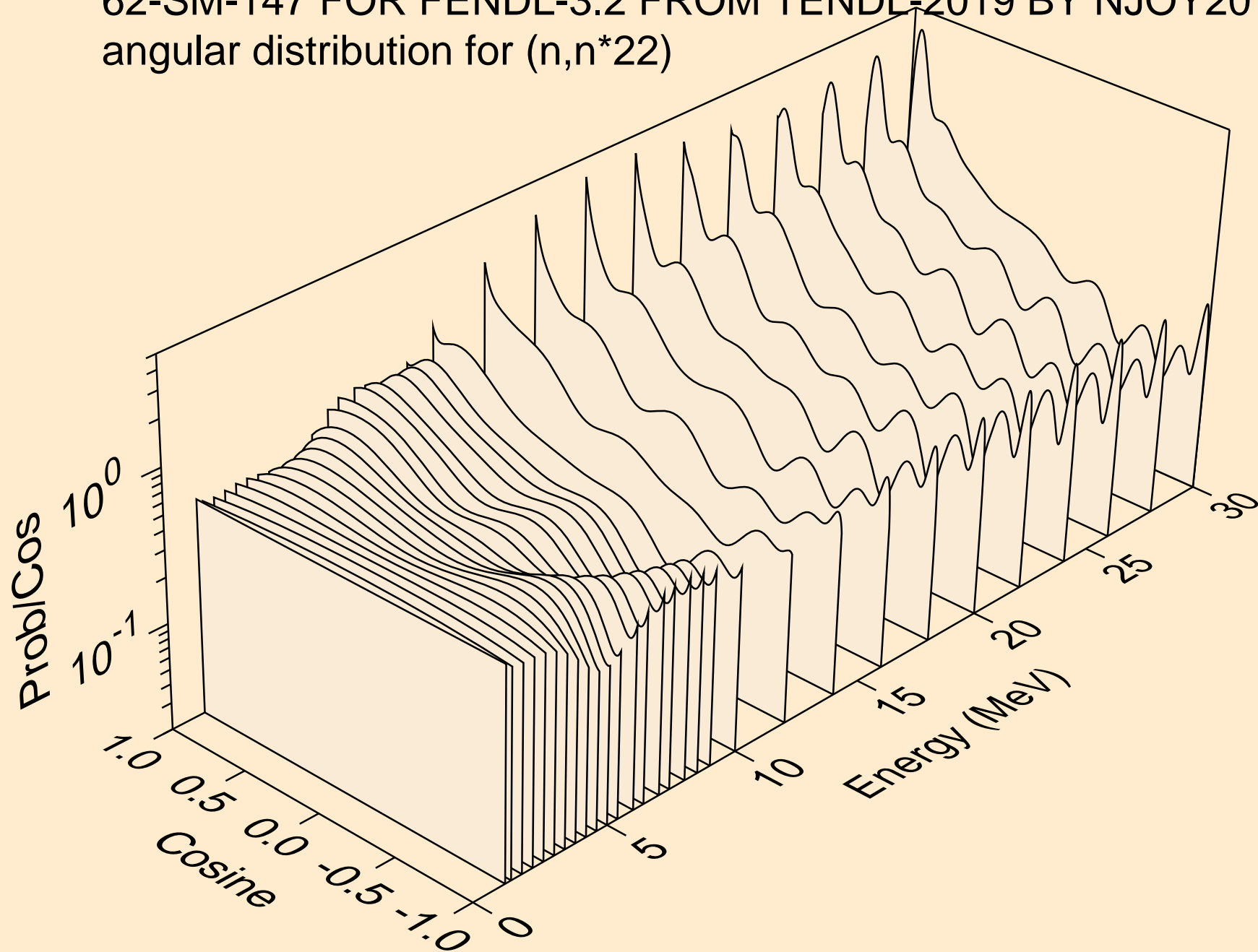

62-SM-147 FOR FENDL-3.2 FROM TENDL-2019 BY NJOY2016.60-
angular distribution for (n,n*23)

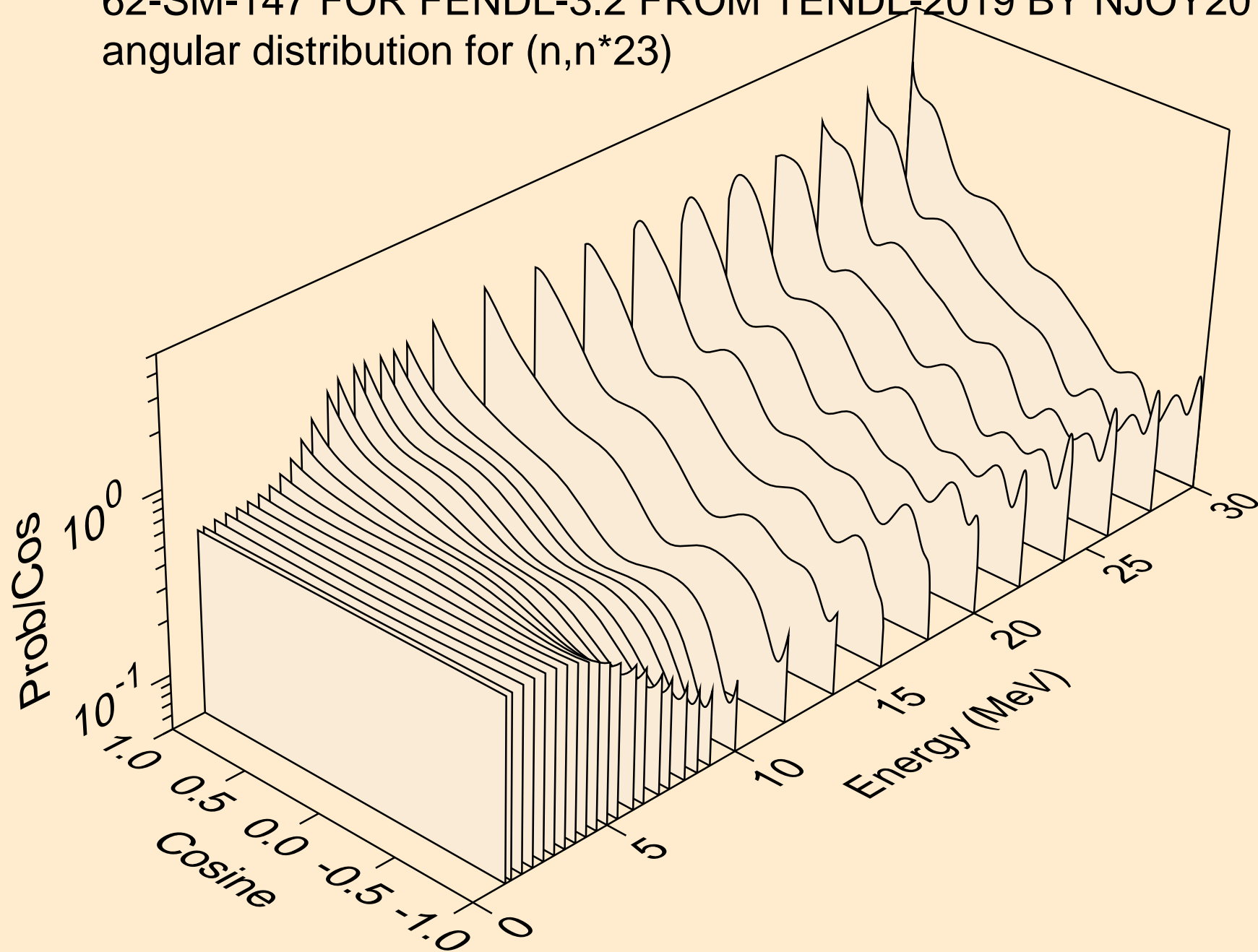

62-SM-147 FOR FENDL-3.2 FROM TENDL-2019 BY NJOY2016.60-
angular distribution for (n,n*24)

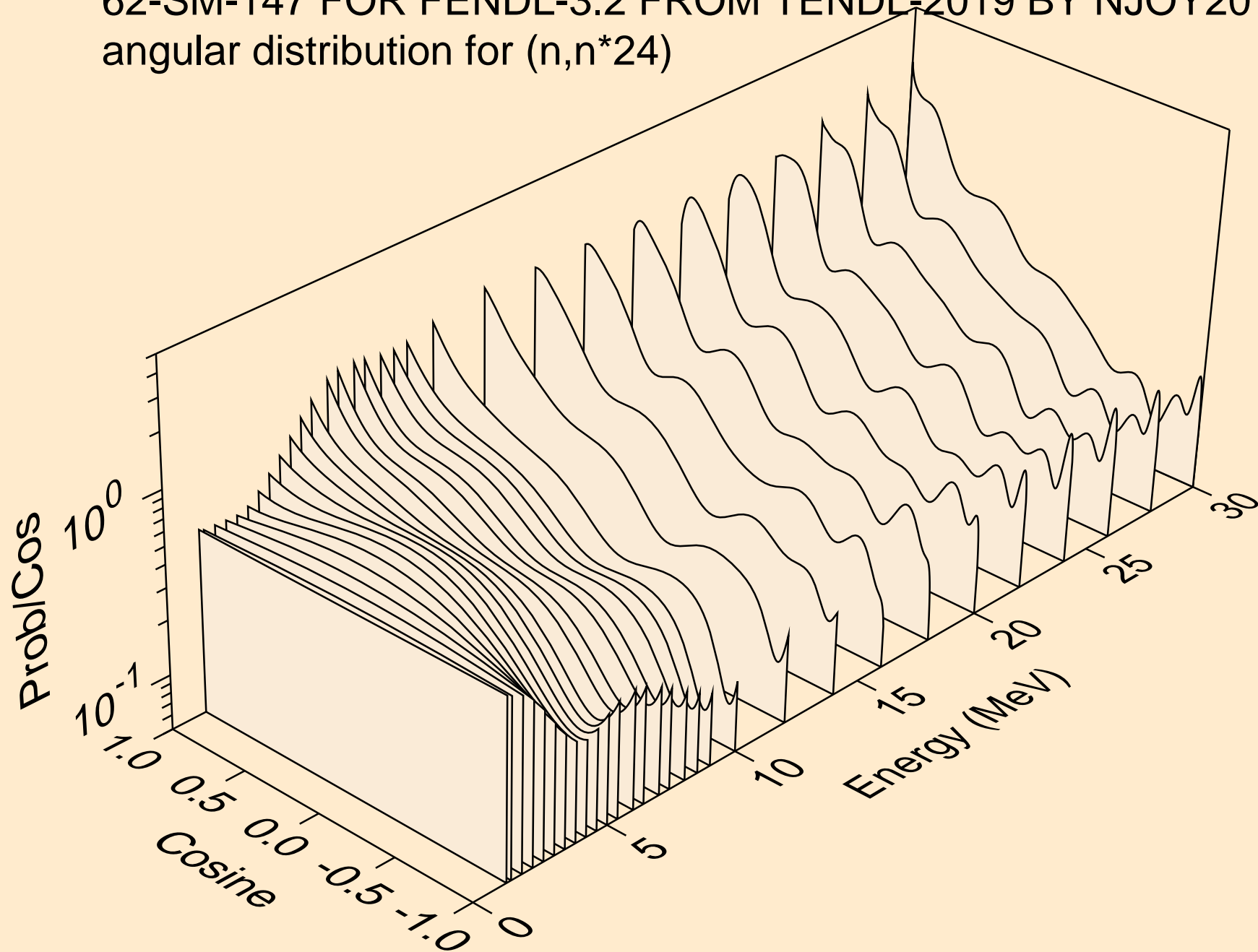

62-SM-147 FOR FENDL-3.2 FROM TENDL-2019 BY NJOY2016.60-
angular distribution for (n,n*25)

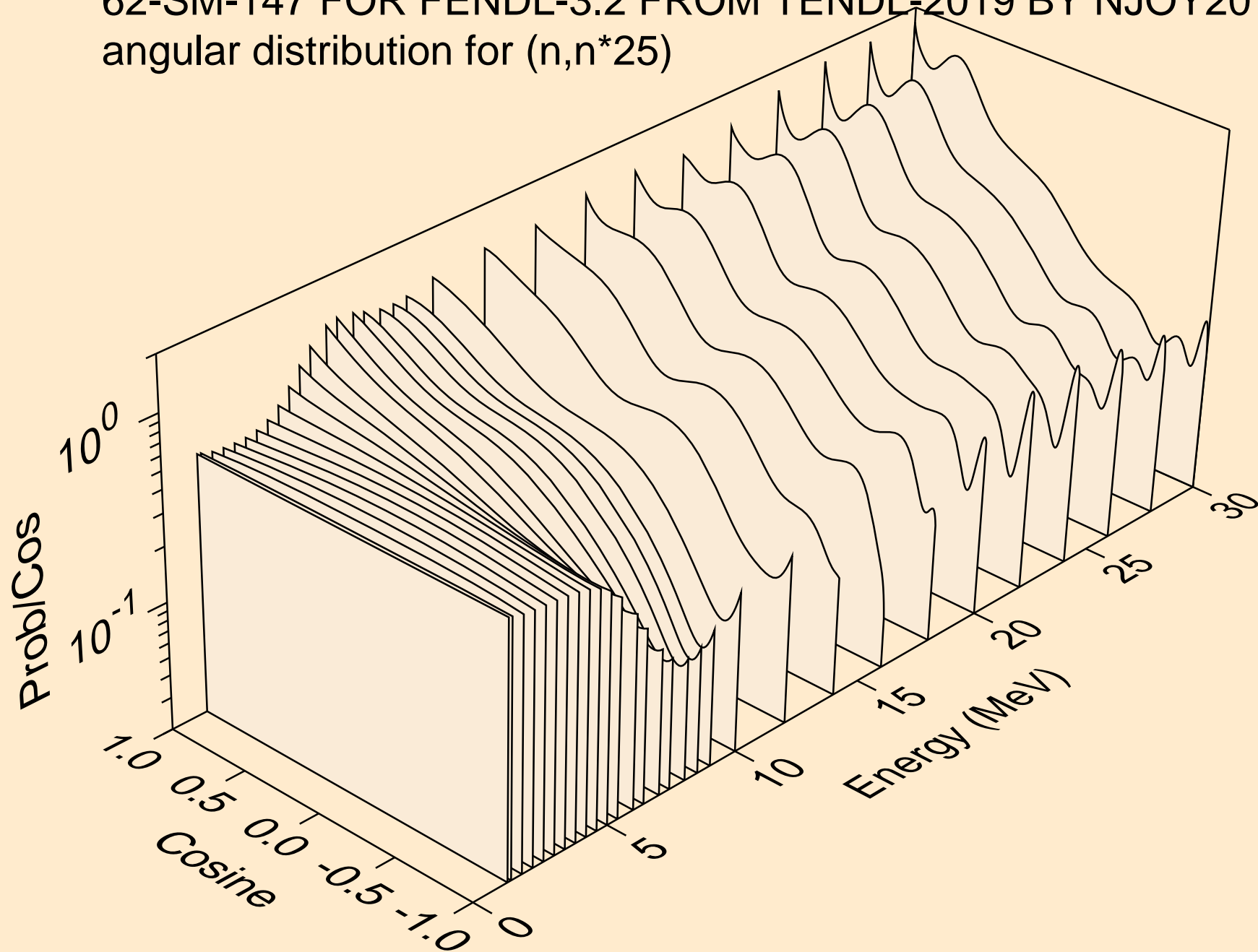

62-SM-147 FOR FENDL-3.2 FROM TENDL-2019 BY NJOY2016.60-
angular distribution for (n,n*26)

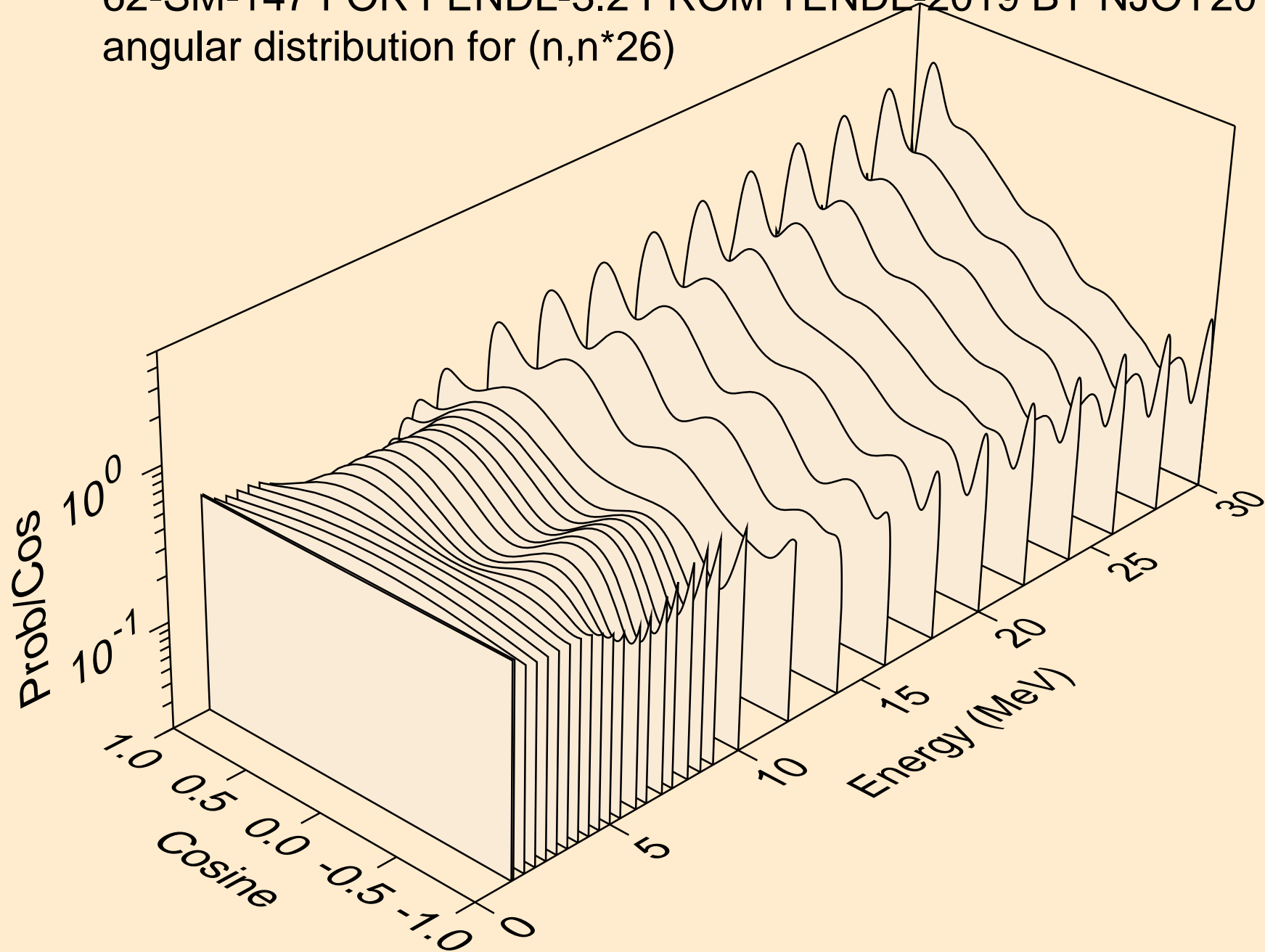

62-SM-147 FOR FENDL-3.2 FROM TENDL-2019 BY NJOY2016.60-
angular distribution for (n,n*27)

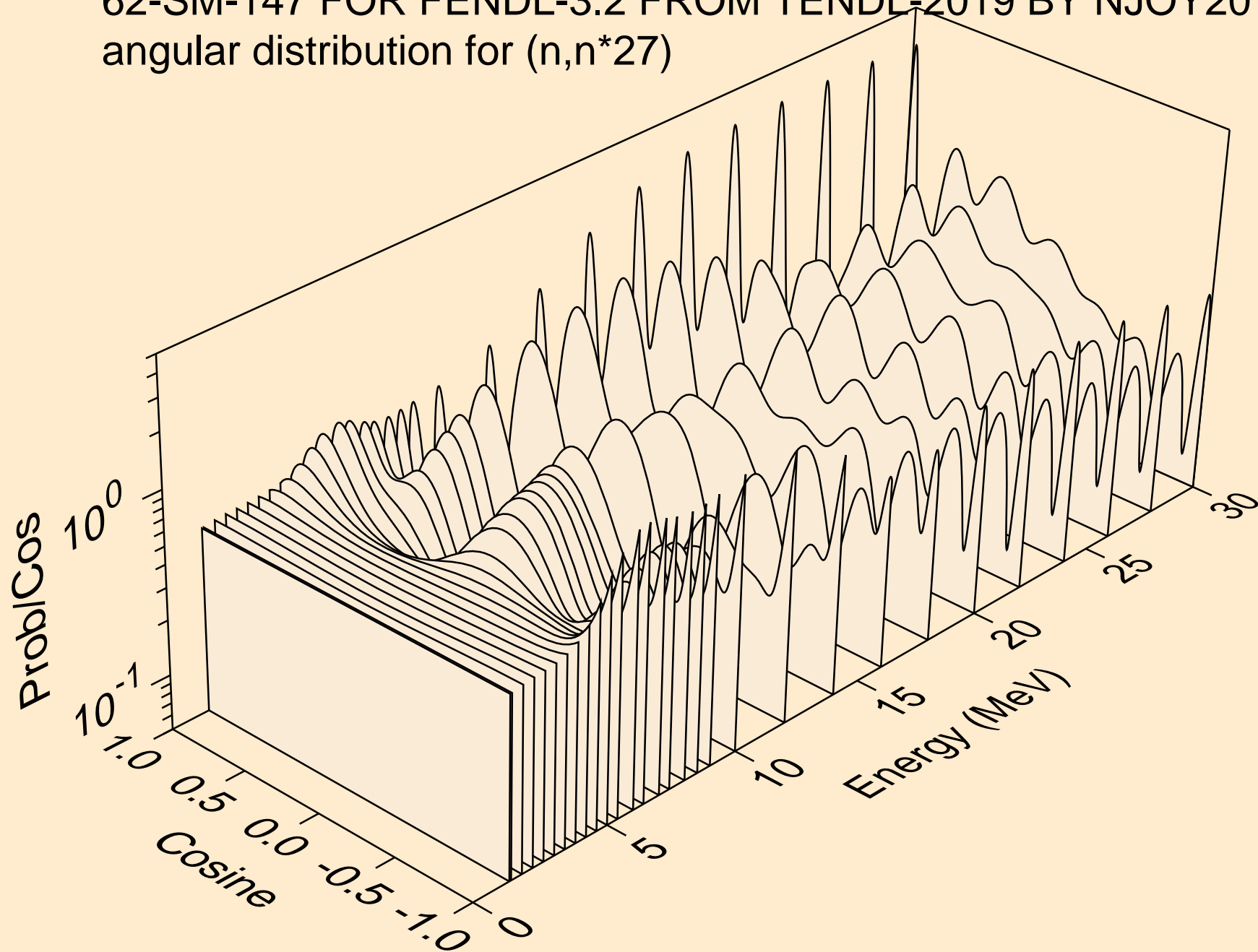

62-SM-147 FOR FENDL-3.2 FROM TENDL-2019 BY NJOY2016.60-
angular distribution for (n,n*28)

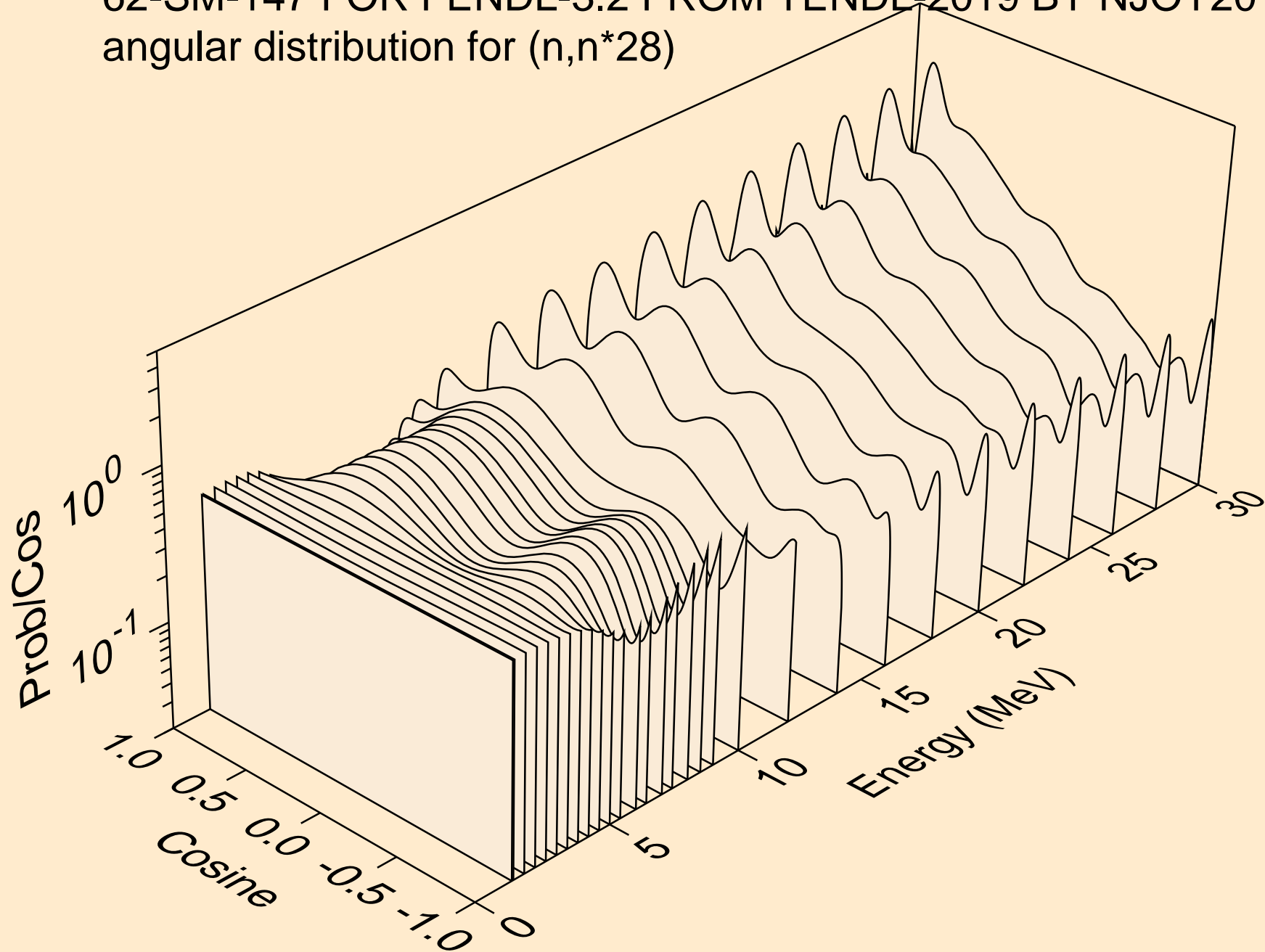

62-SM-147 FOR FENDL-3.2 FROM TENDL-2019 BY NJOY2016.60-
angular distribution for (n,n*29)

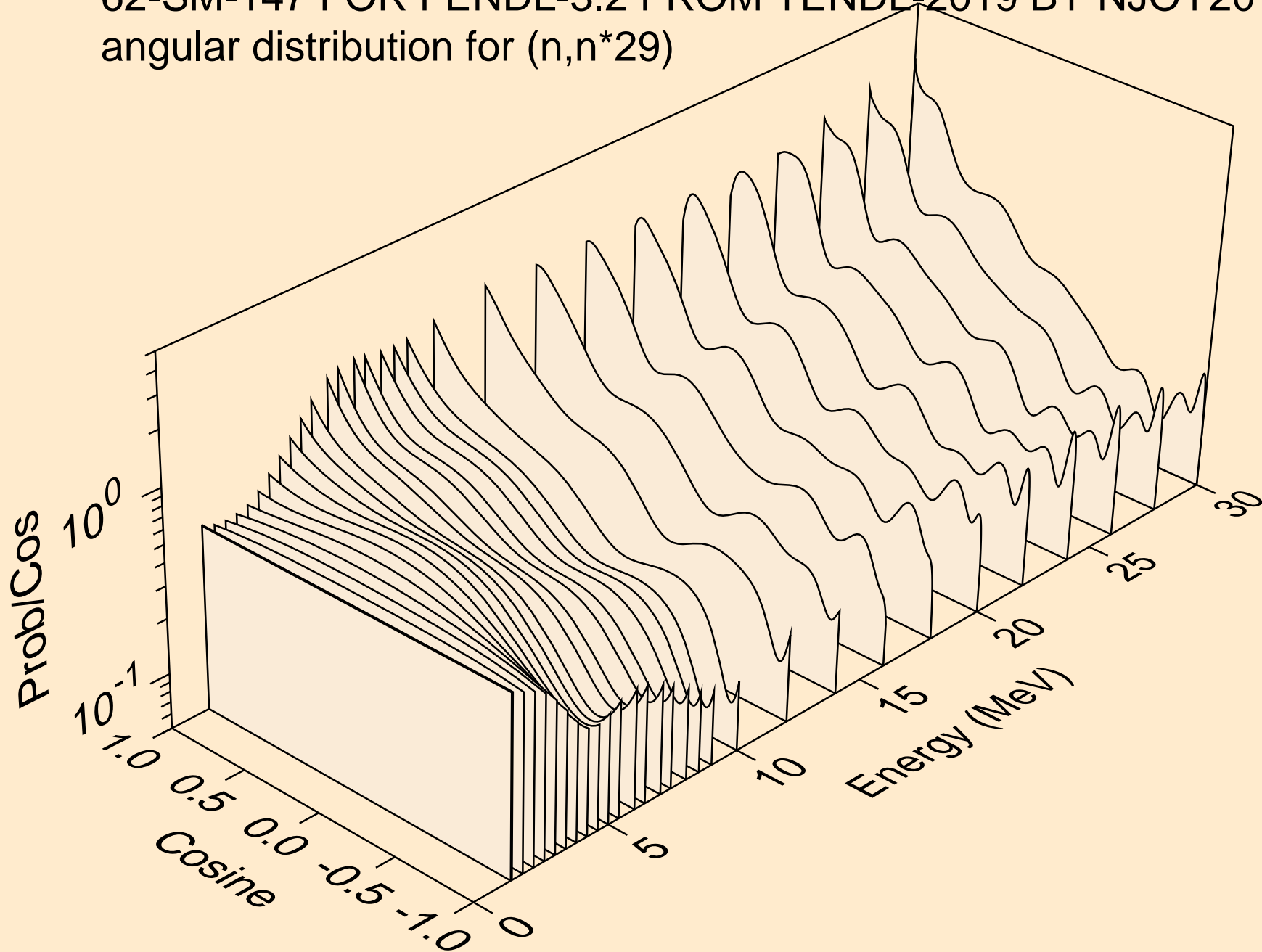

62-SM-147 FOR FENDL-3.2 FROM TENDL-2019 BY NJOY2016.60-
angular distribution for (n,n*30)

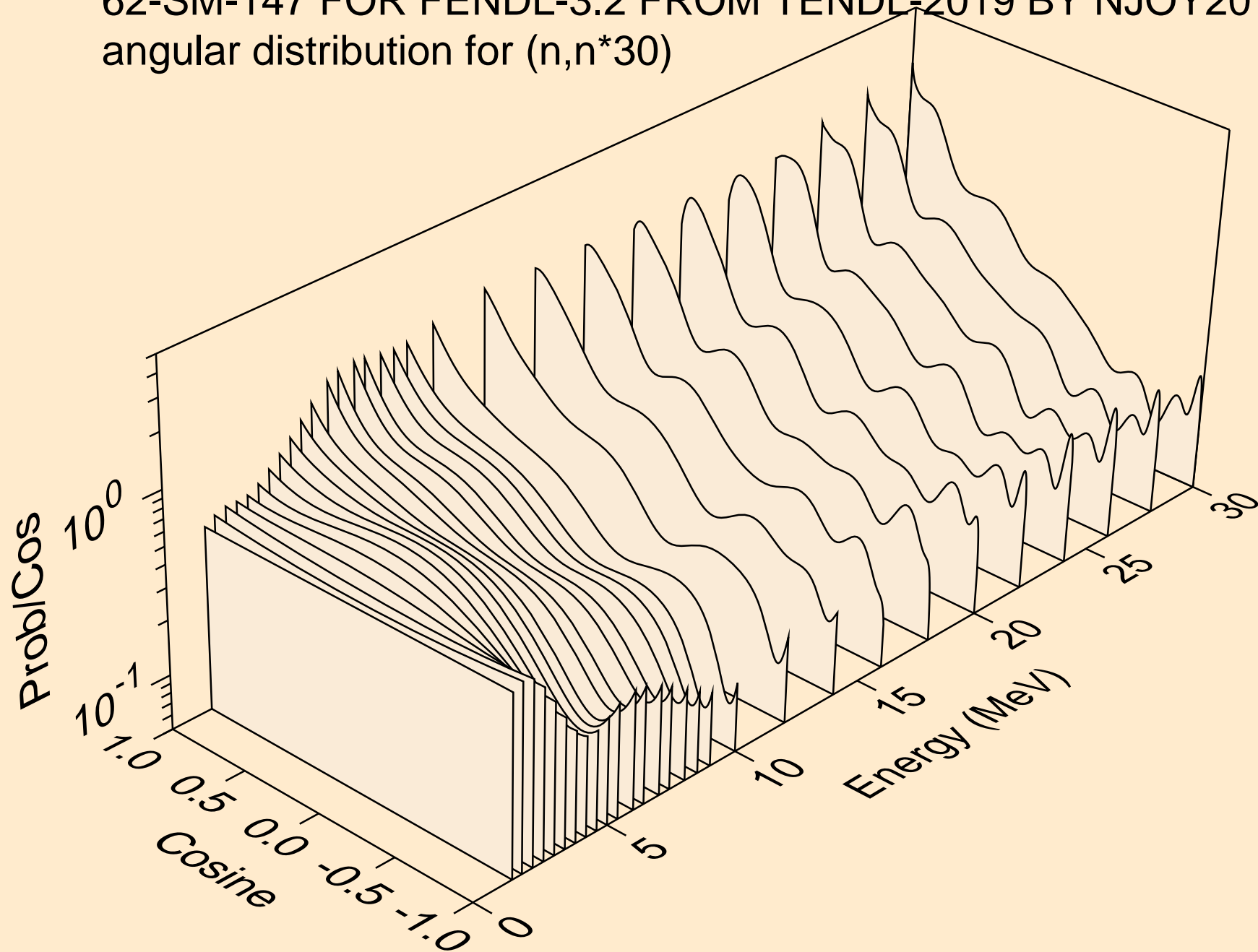

62-SM-147 FOR FENDL-3.2 FROM TENDL-2019 BY NJOY2016.60-
Neutron emission for (n,x)

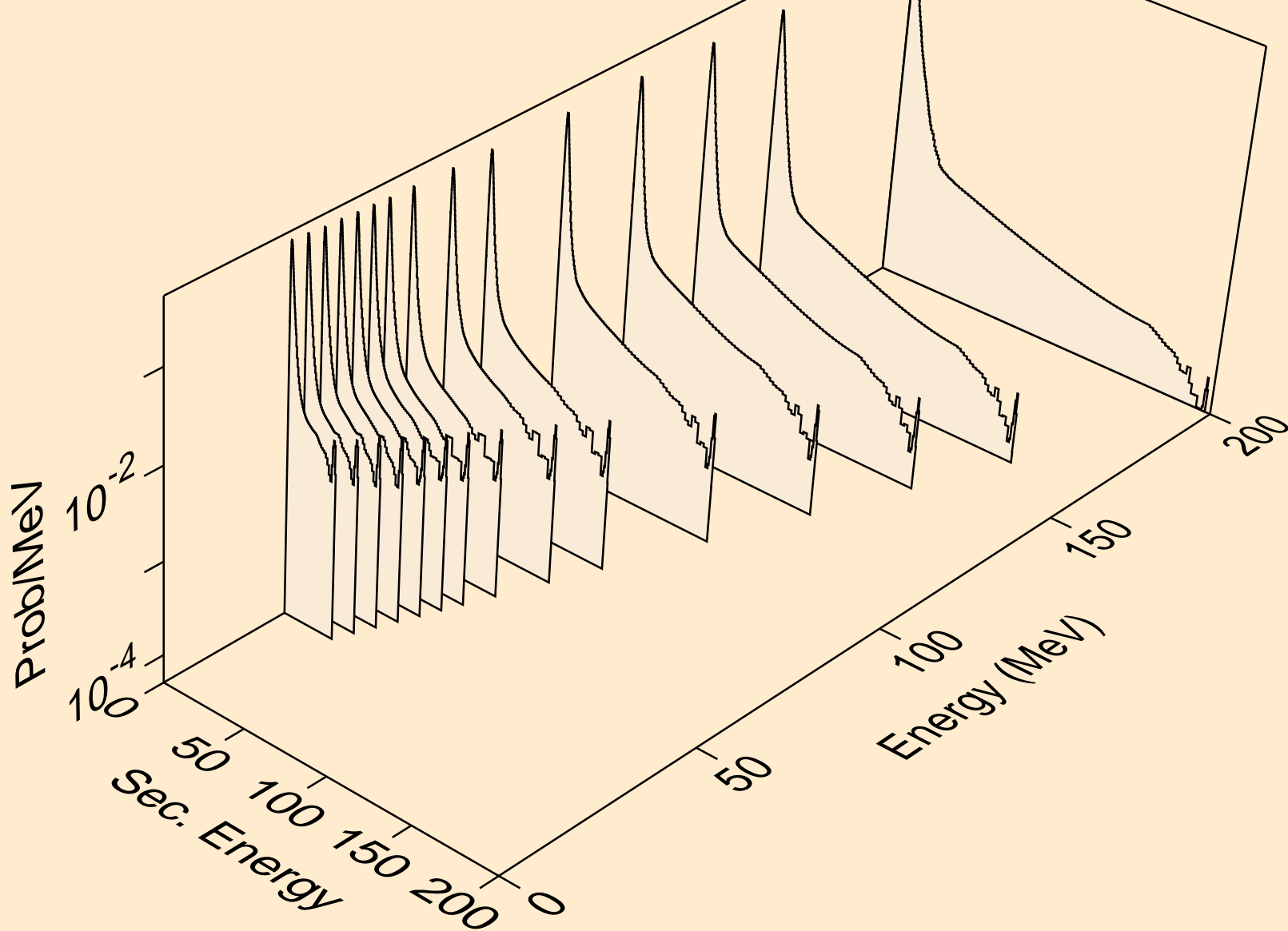

62-SM-147 FOR FENDL-3.2 FROM TENDL-2019 BY NJOY2016.60-
Neutron emission for (n,2nd)

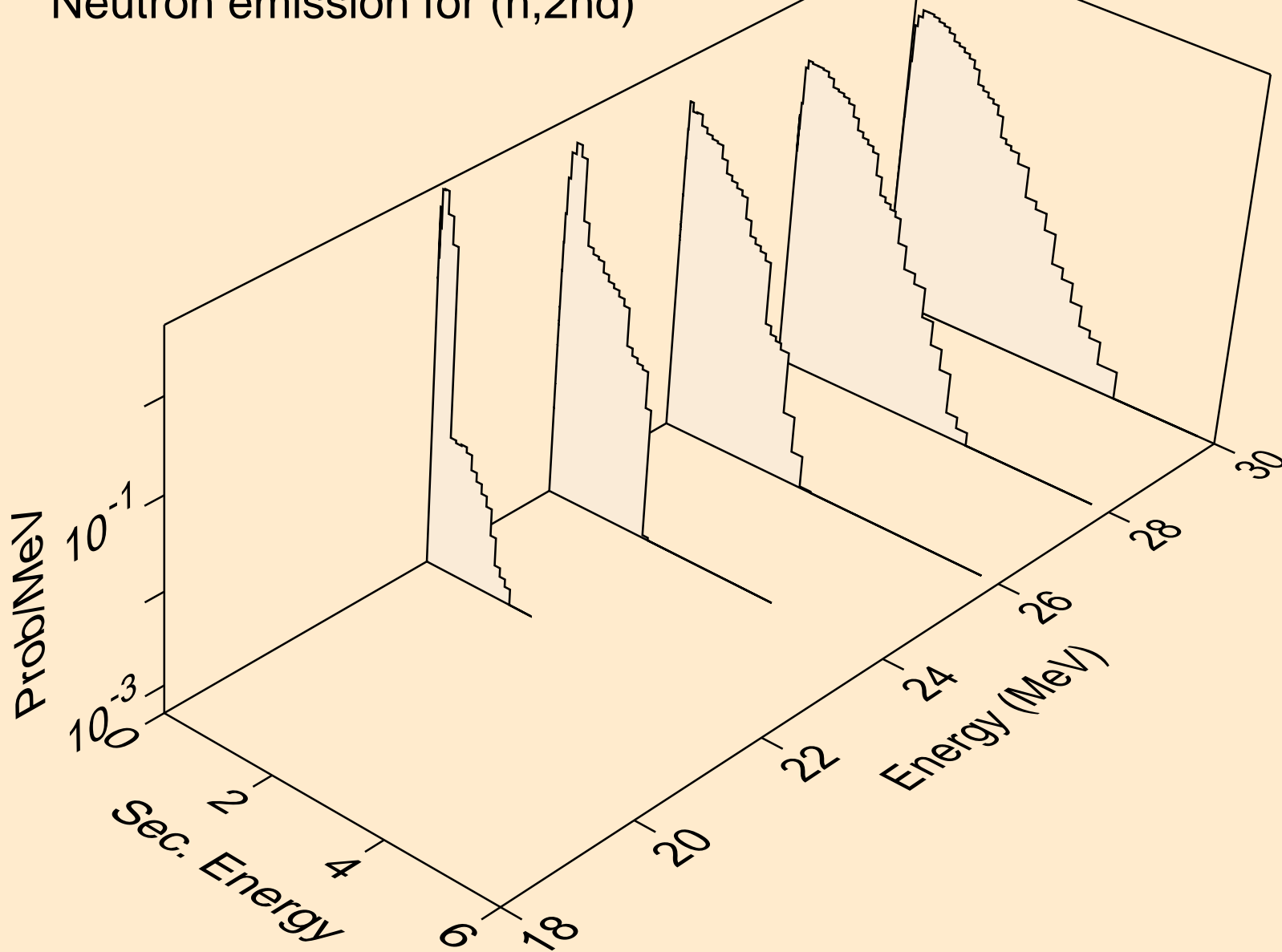

62-SM-147 FOR FENDL-3.2 FROM TENDL-2019 BY NJOY2016.60-
Neutron emission for (n,2n)

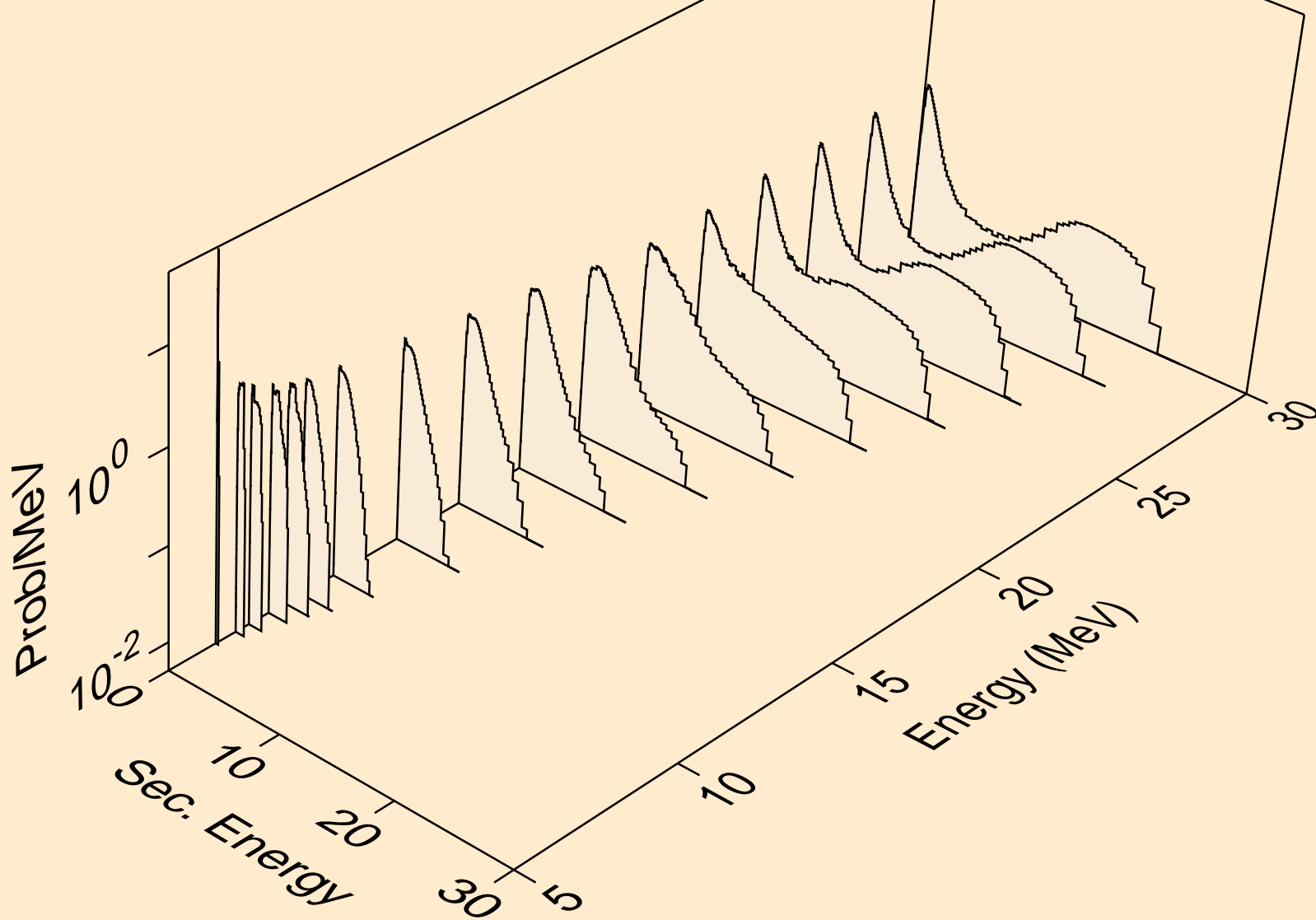

62-SM-147 FOR FENDL-3.2 FROM TENDL-2019 BY NJOY2016.60-
Neutron emission for (n,3n)

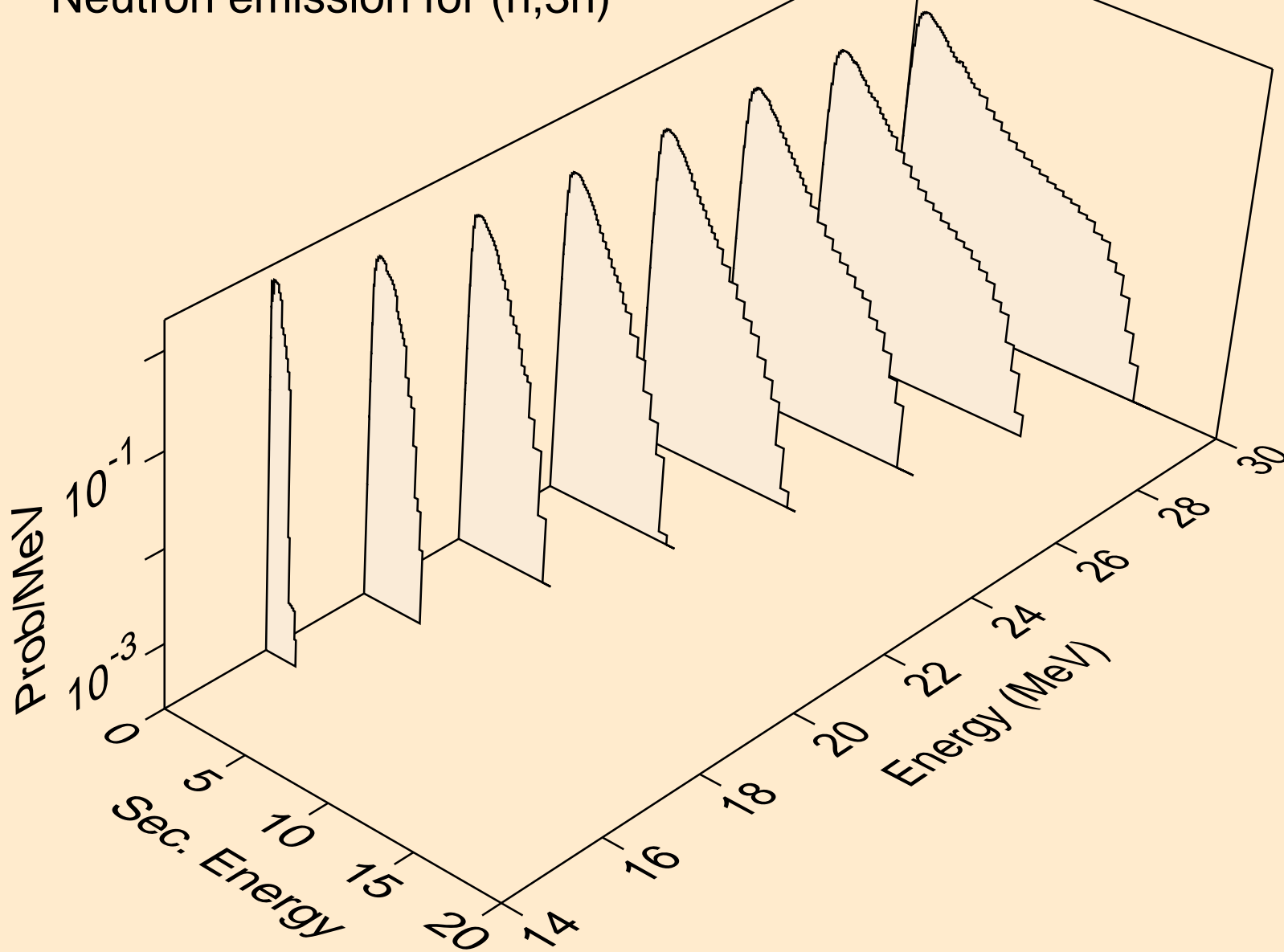

62-SM-147 FOR FENDL-3.2 FROM TENDL-2019 BY NJOY2016.60-
Neutron emission for (n,n*)a

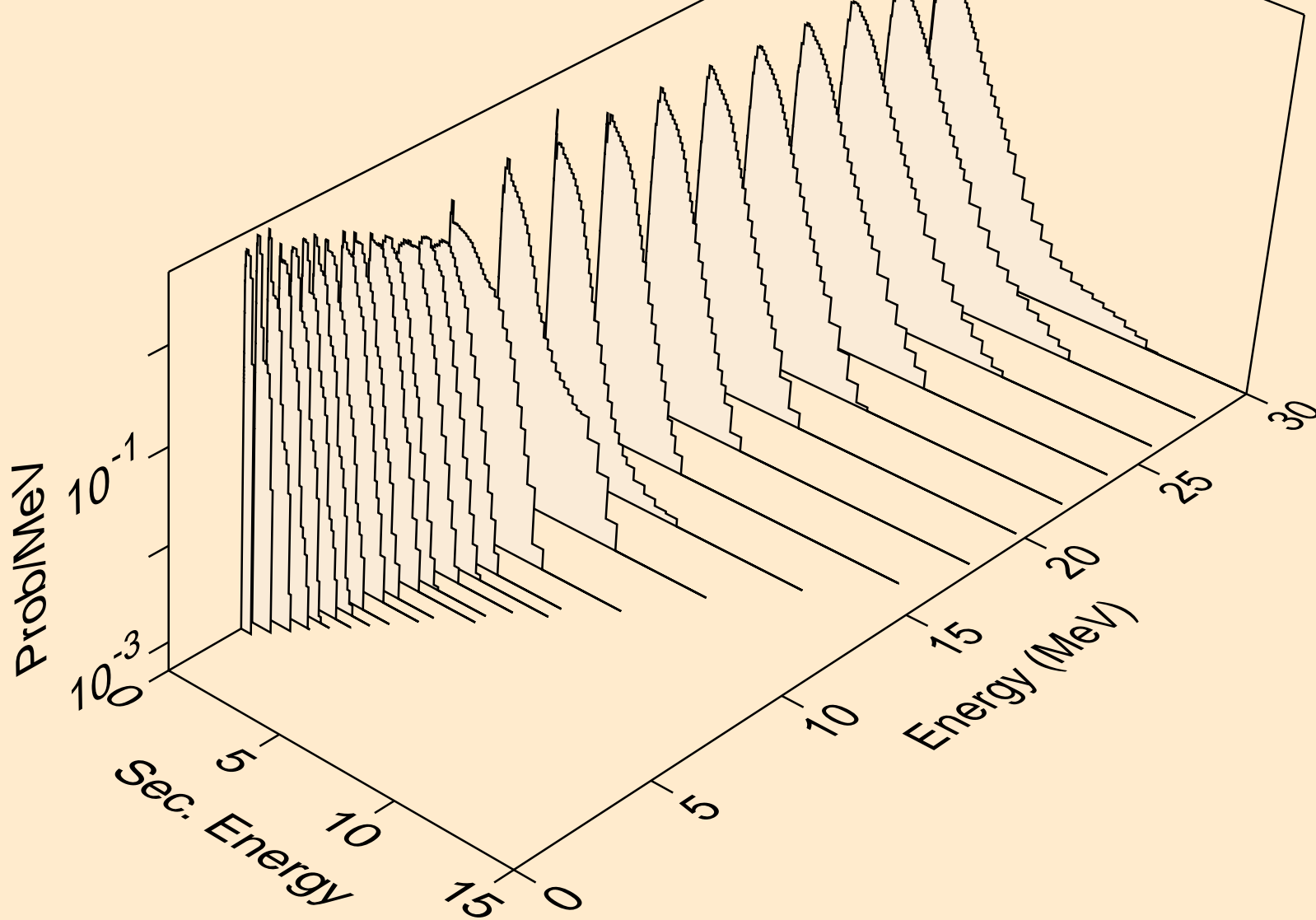

62-SM-147 FOR FENDL-3.2 FROM TENDL-2019 BY NJOY2016.60-
Neutron emission for (n,2n)a

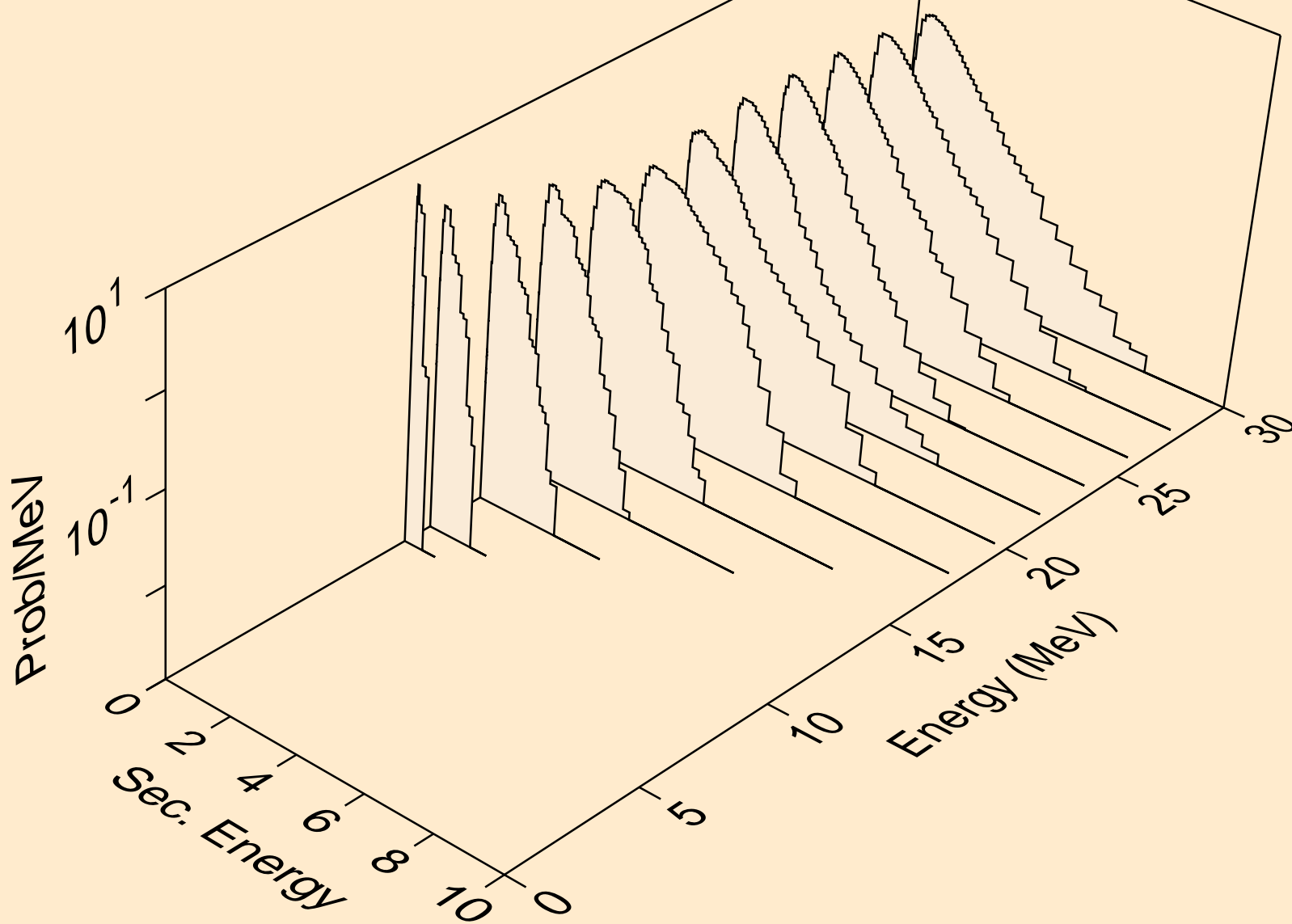

62-SM-147 FOR FENDL-3.2 FROM TENDL-2019 BY NJOY2016.60-
Neutron emission for (n,3n)a

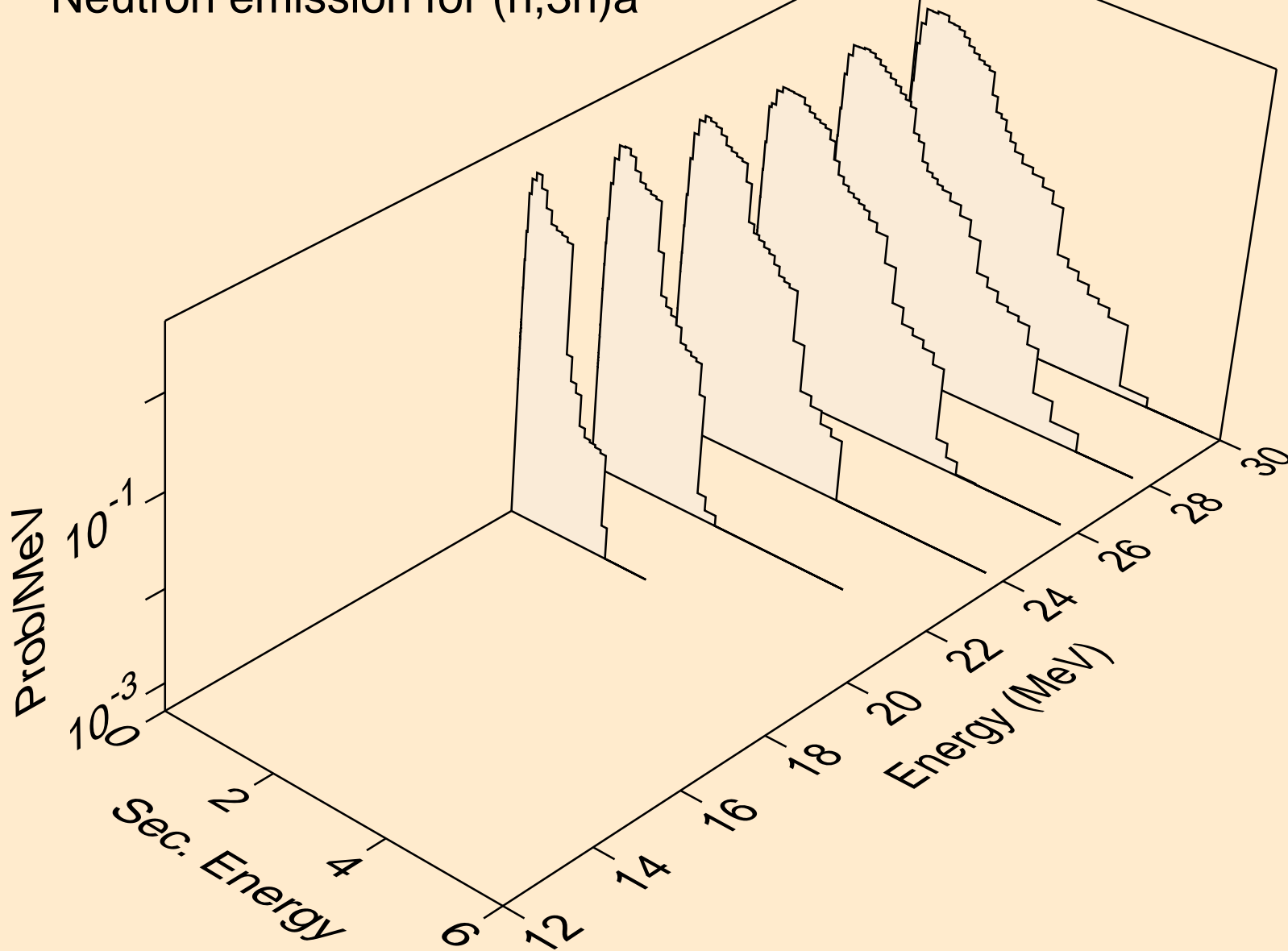

62-SM-147 FOR FENDL-3.2 FROM TENDL-2019 BY NJOY2016.60-
Neutron emission for (n,n*)p

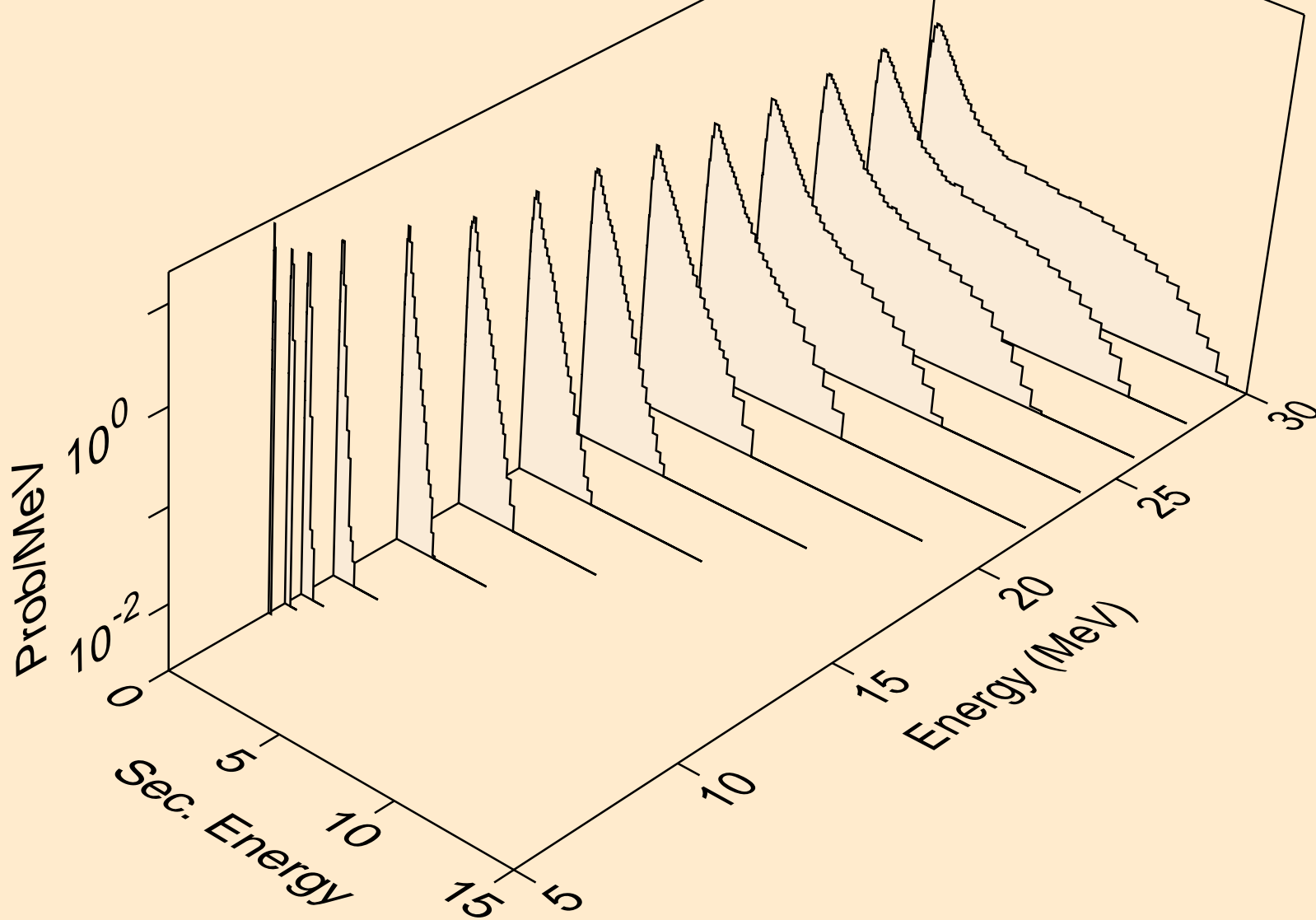

62-SM-147 FOR FENDL-3.2 FROM TENDL-2019 BY NJOY2016.60-
Neutron emission for (n,n*)2a

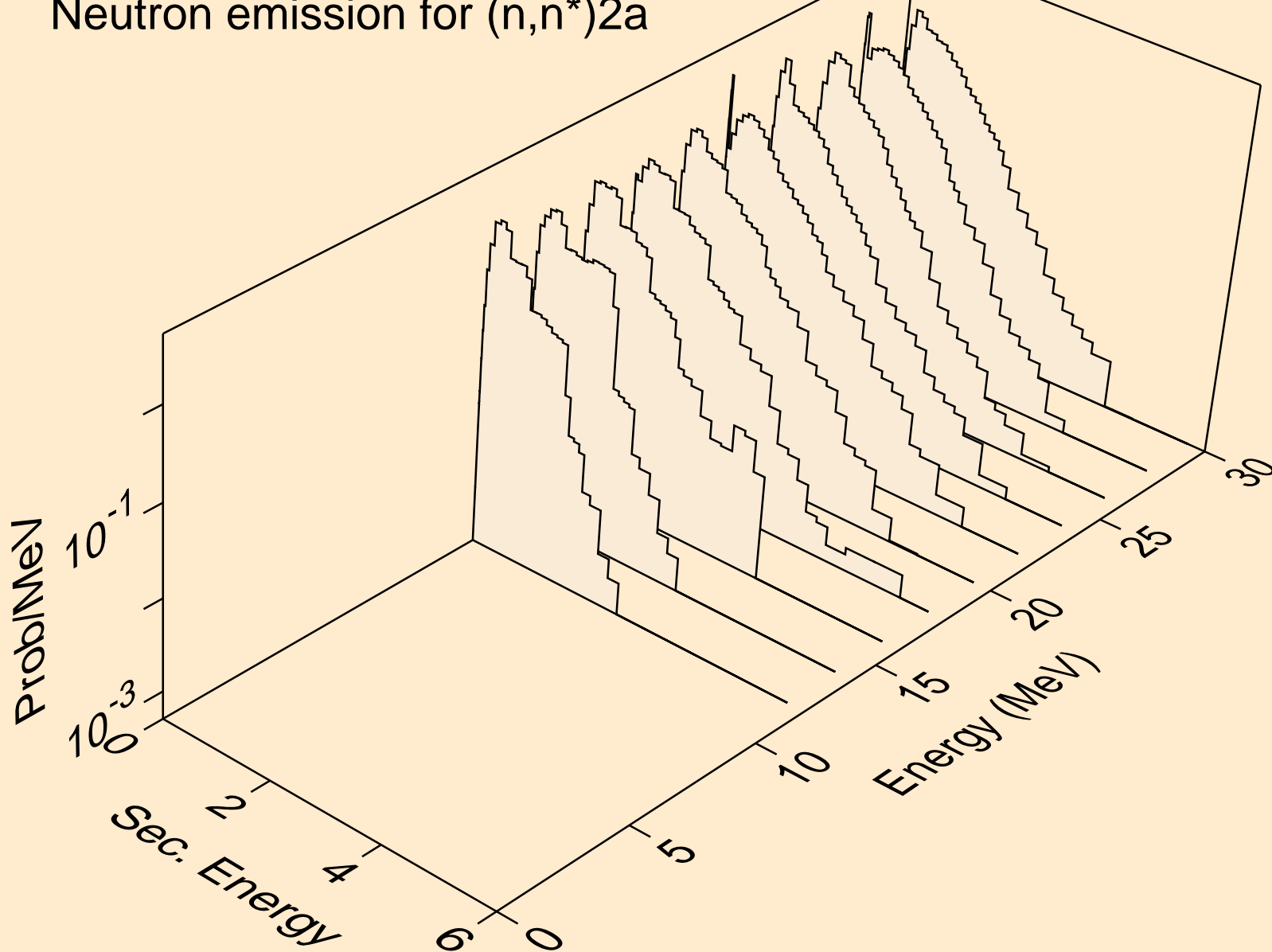

62-SM-147 FOR FENDL-3.2 FROM TENDL-2019 BY NJOY2016.60-
Neutron emission for (n,n*)d

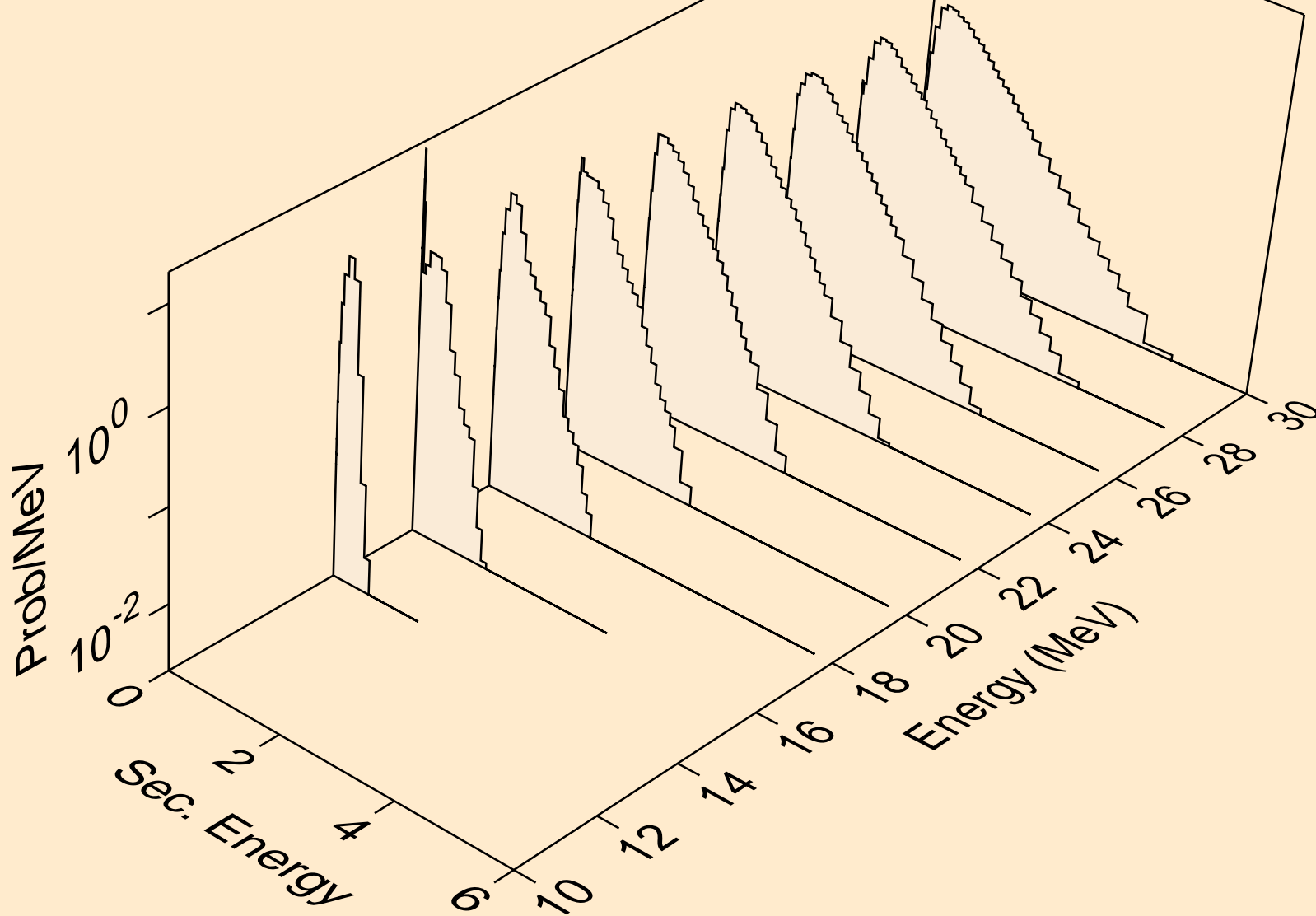

62-SM-147 FOR FENDL-3.2 FROM TENDL-2019 BY NJOY2016.60-
Neutron emission for (n,n*)t

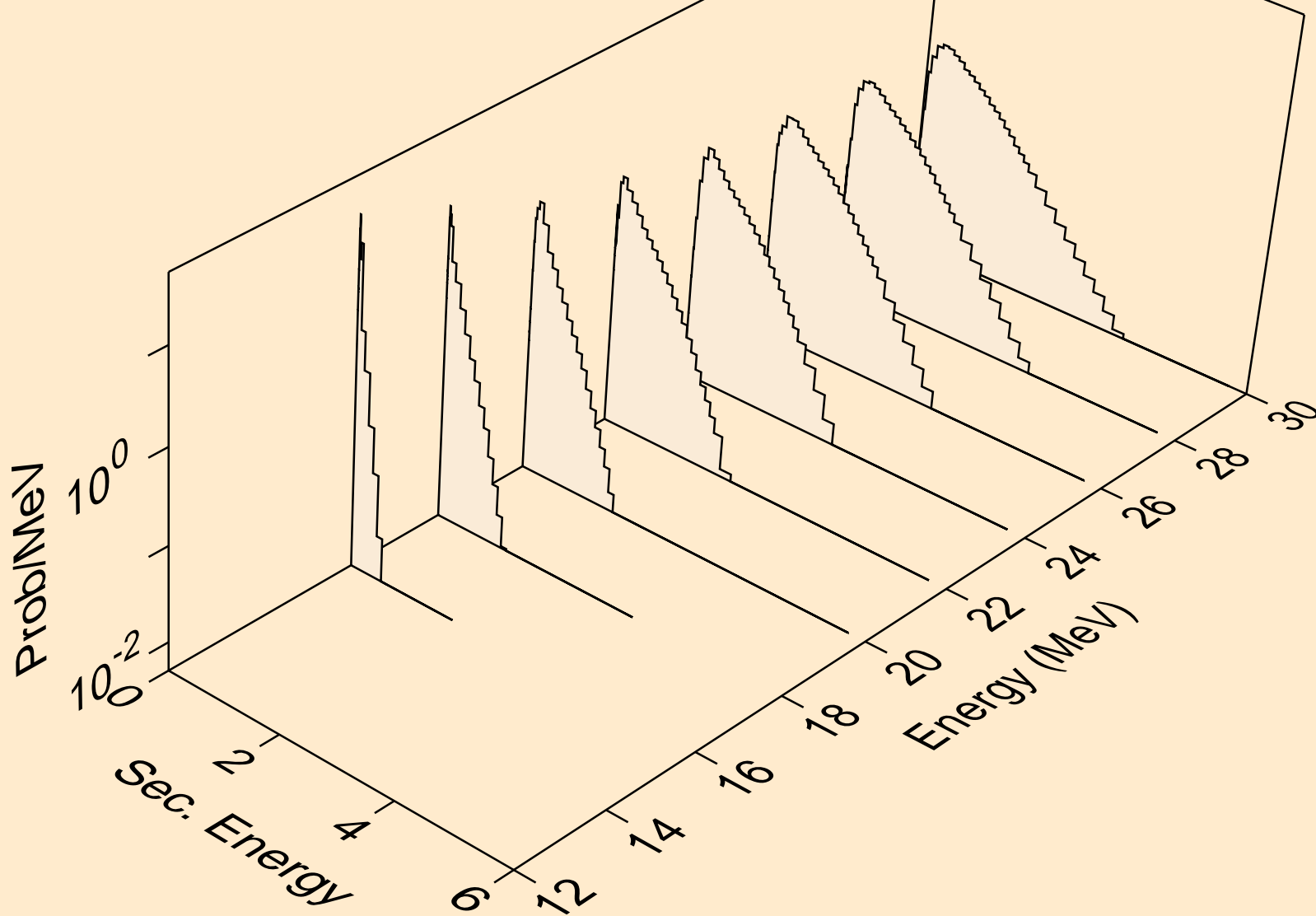

62-SM-147 FOR FENDL-3.2 FROM TENDL-2019 BY NJOY2016.60-
Neutron emission for (n,n*)he3

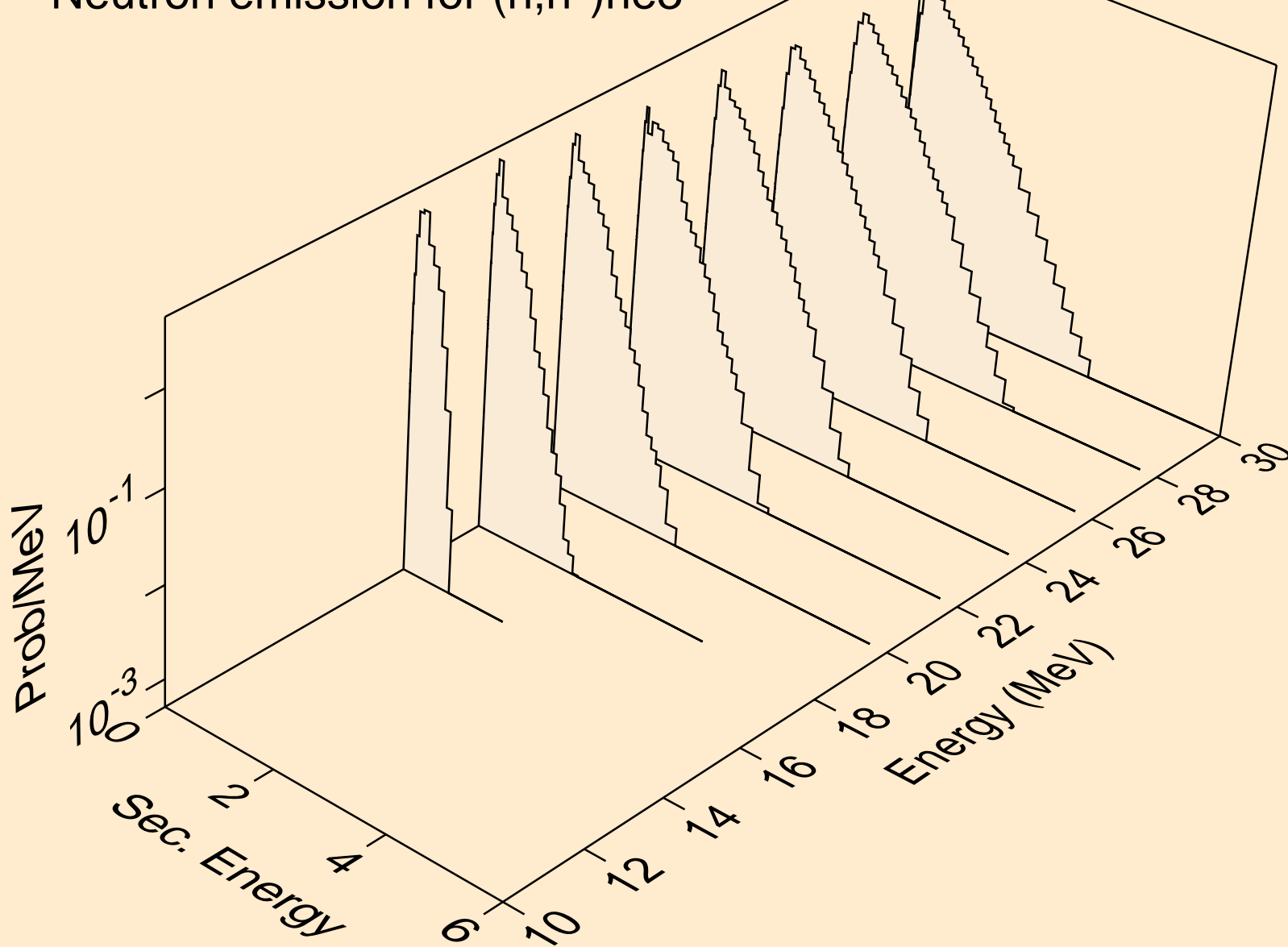

62-SM-147 FOR FENDL-3.2 FROM TENDL-2019 BY NJOY2016.60-
Neutron emission for (n,4n)

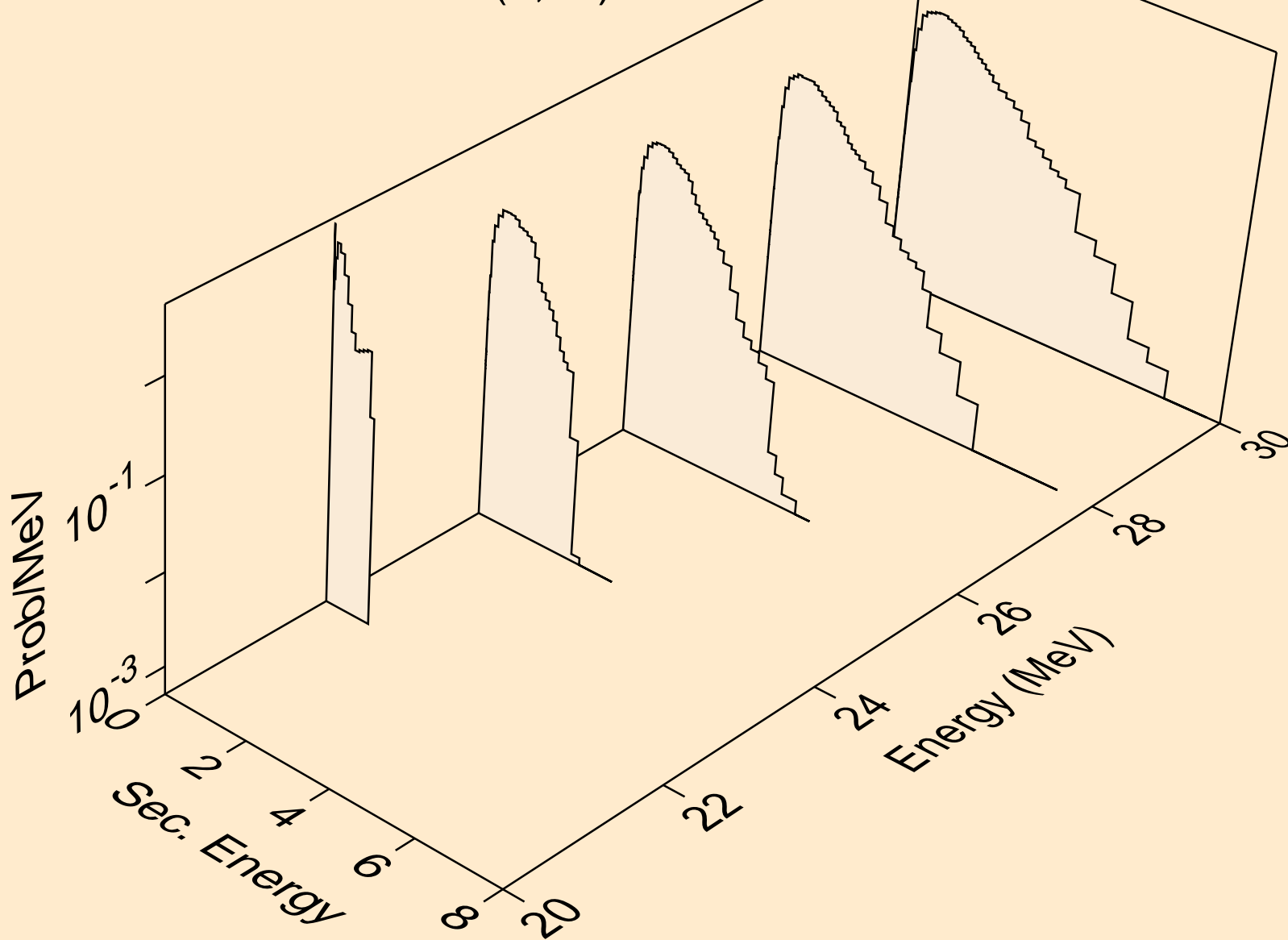

62-SM-147 FOR FENDL-3.2 FROM TENDL-2019 BY NJOY2016.60-
Neutron emission for (n,2np)

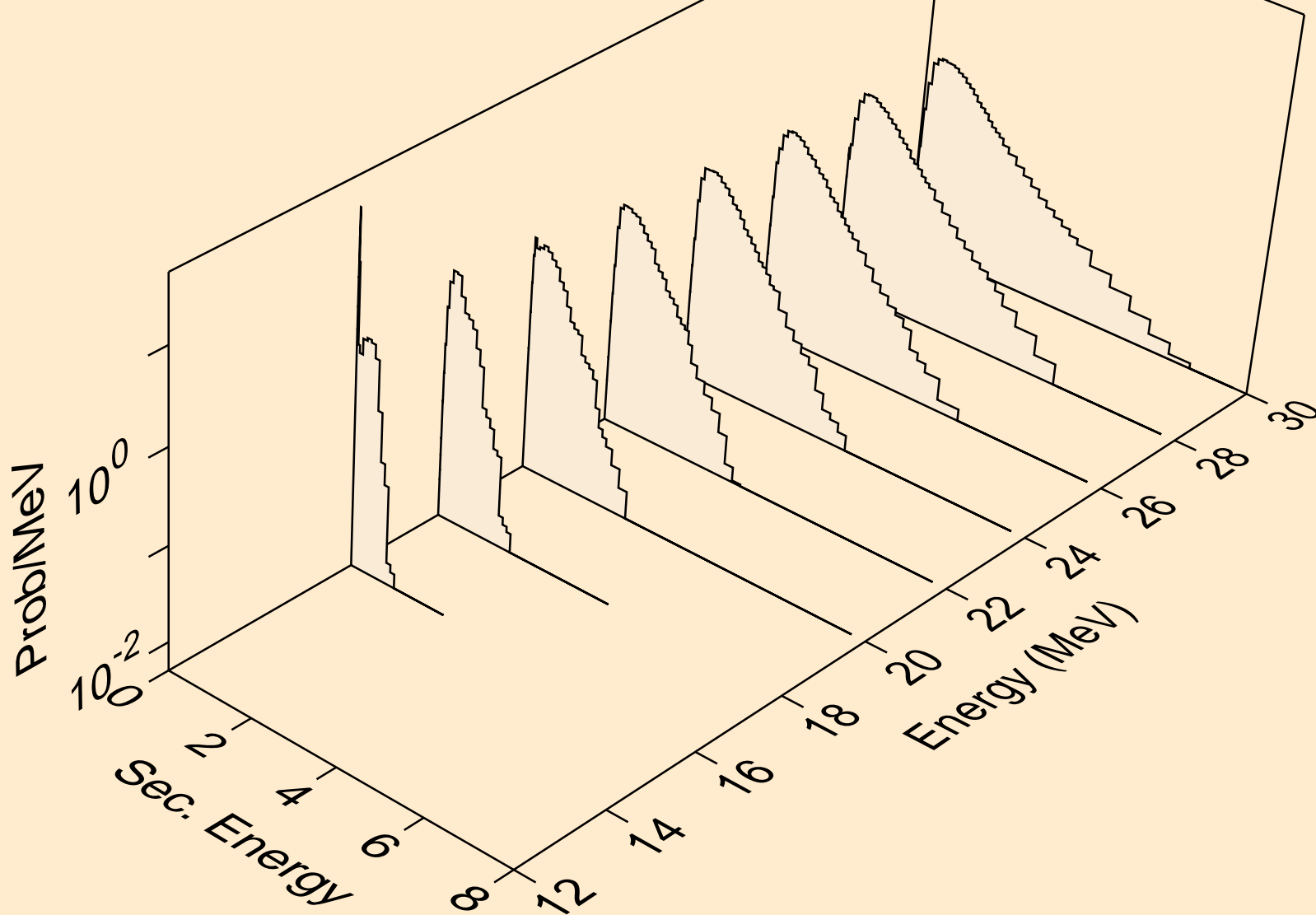

62-SM-147 FOR FENDL-3.2 FROM TENDL-2019 BY NJOY2016.60-
Neutron emission for (n,3np)

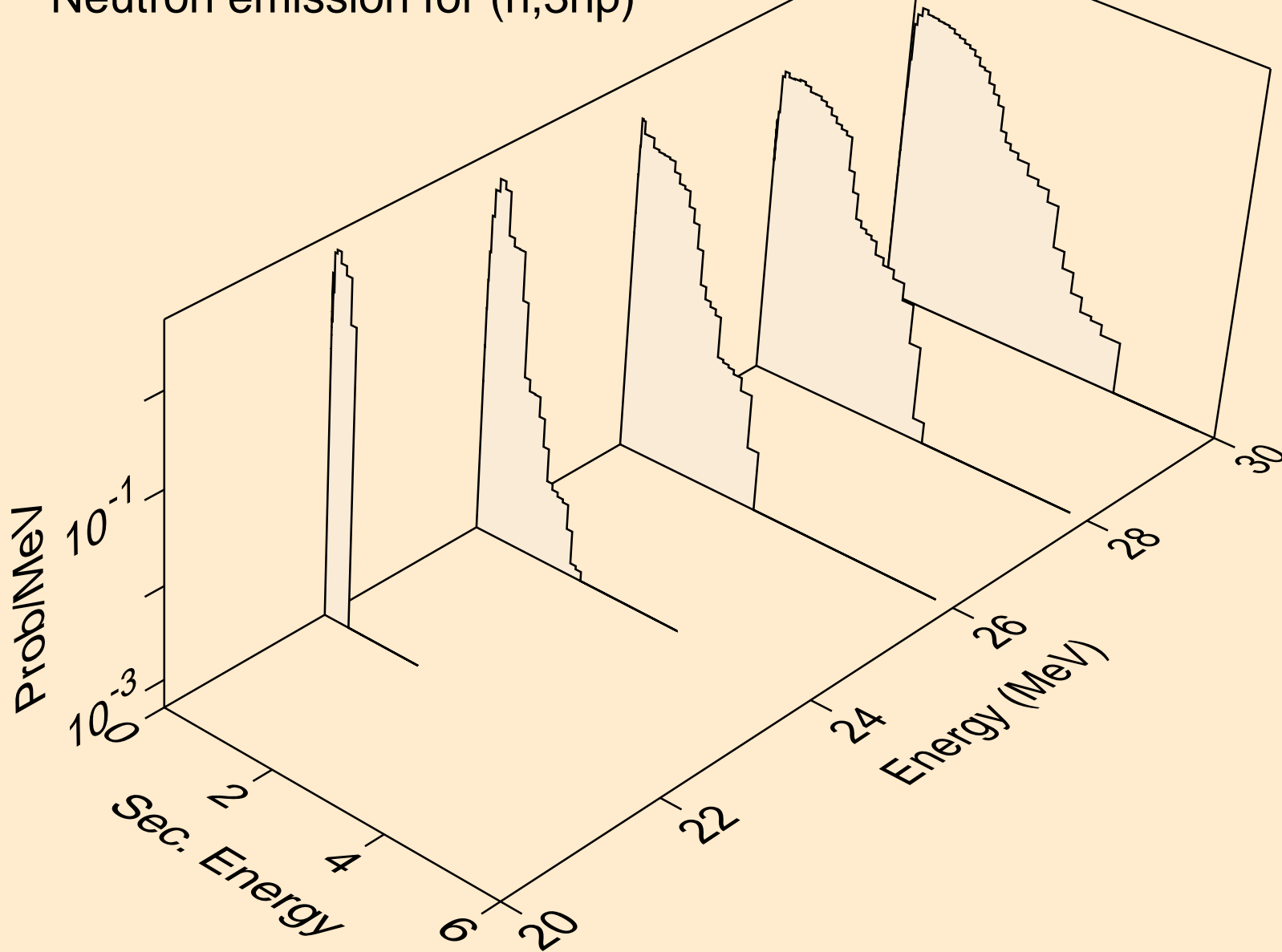

62-SM-147 FOR FENDL-3.2 FROM TENDL-2019 BY NJOY2016.60-
Neutron emission for (n,2np)

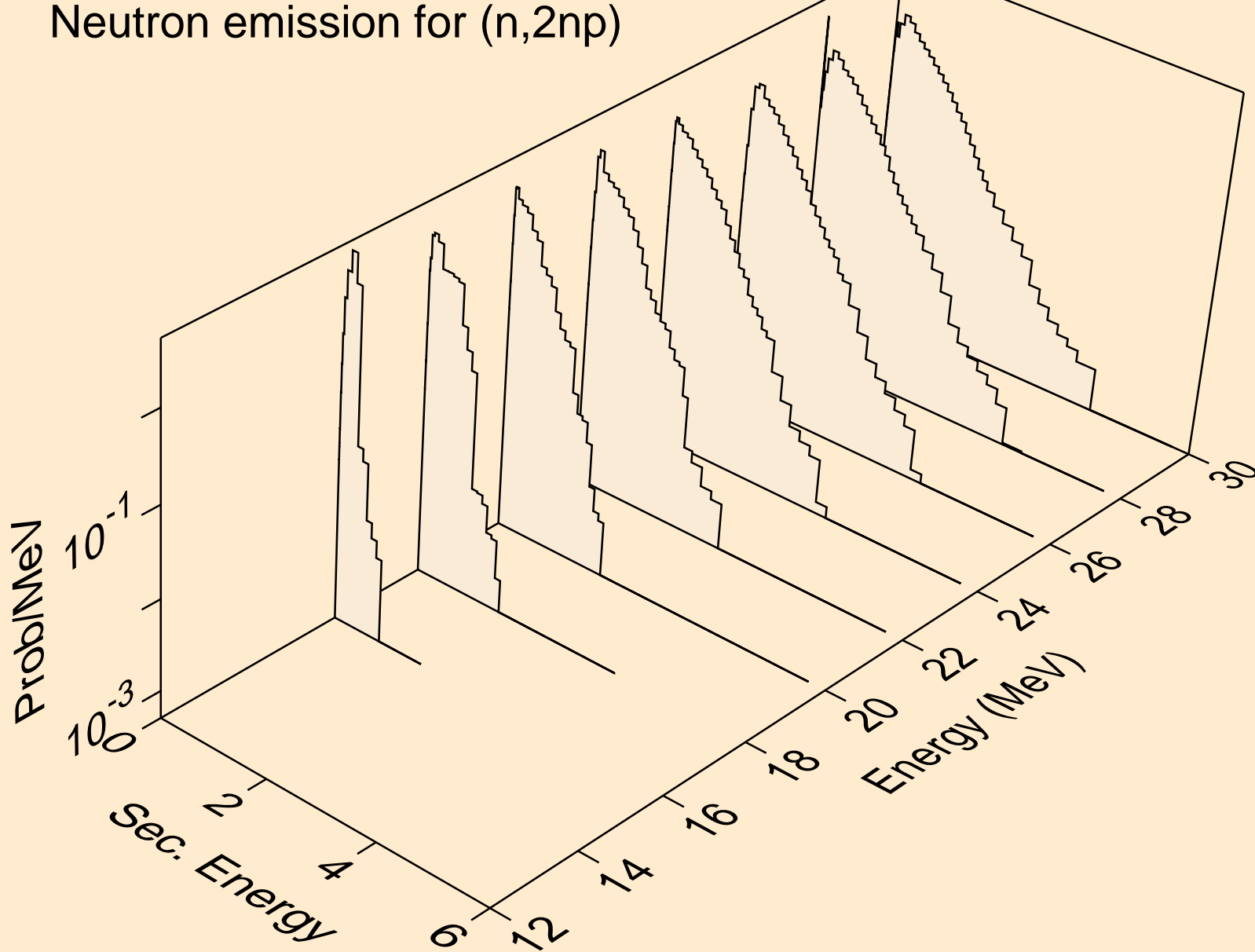

62-SM-147 FOR FENDL-3.2 FROM TENDL-2019 BY NJOY2016.60-
Neutron emission for (n,npa)

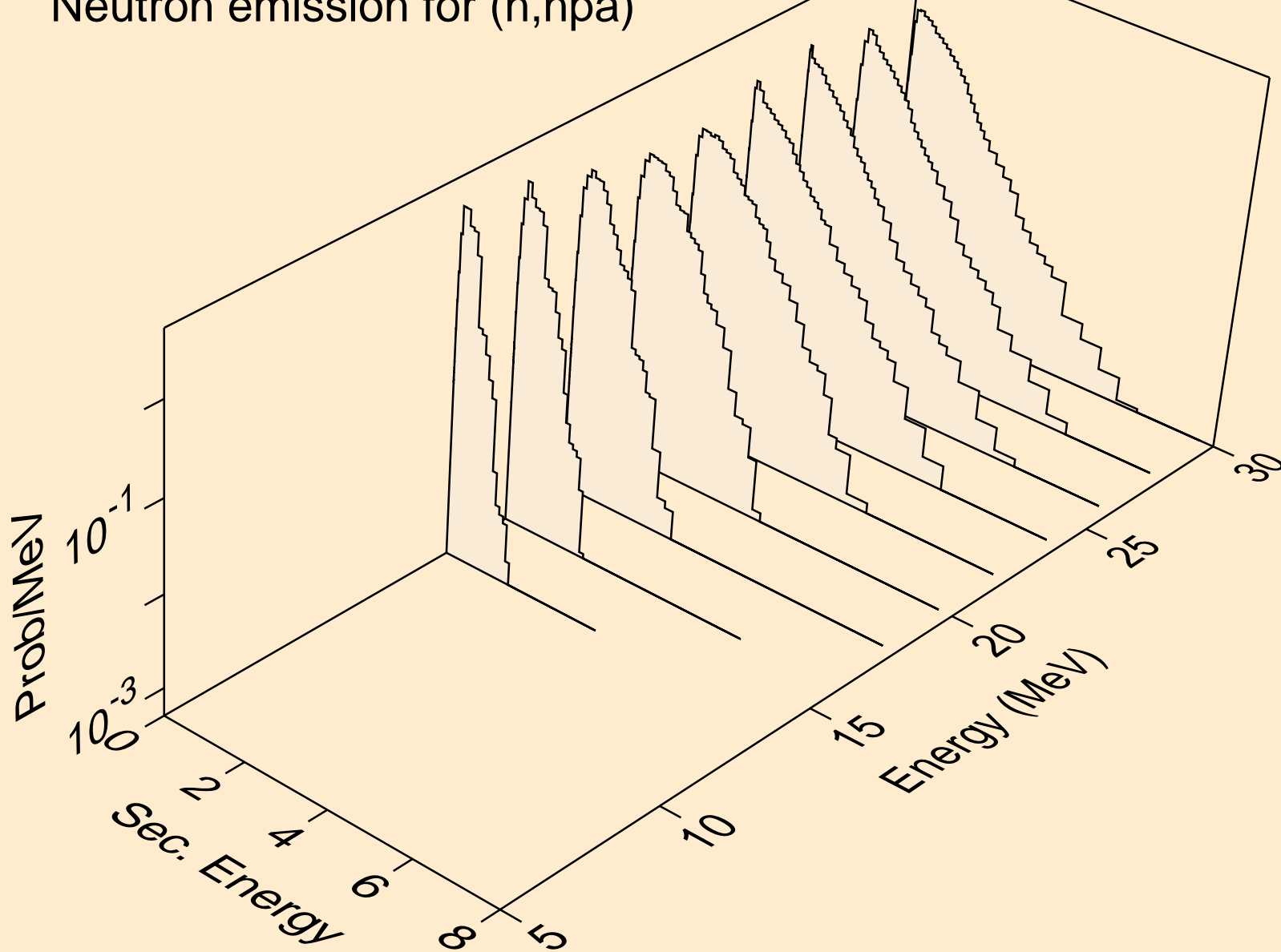

62-SM-147 FOR FENDL-3.2 FROM TENDL-2019 BY NJOY2016.60-
Neutron emission for (n,n*c)

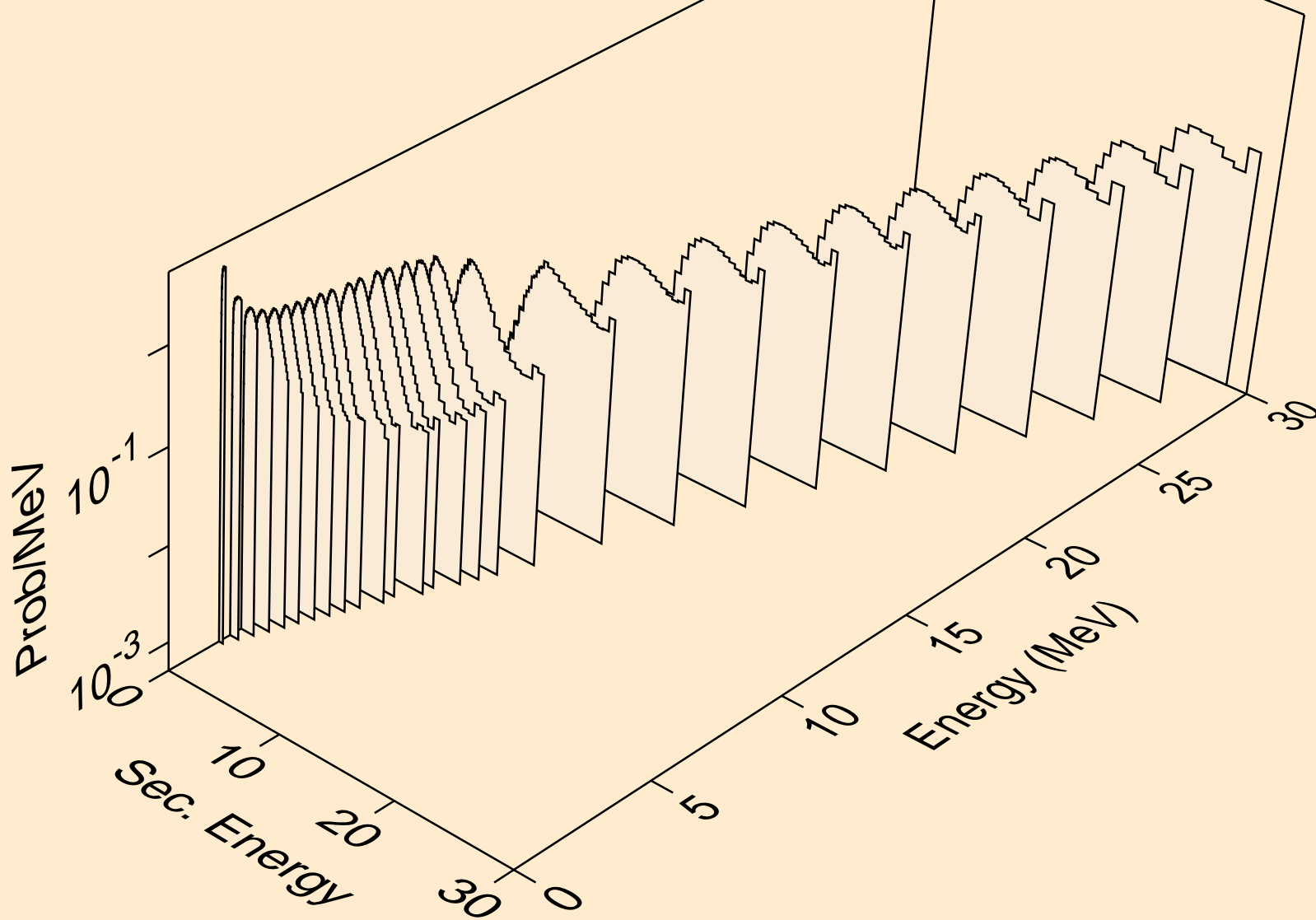

62-SM-147 FOR FENDL-3.2 FROM TENDL-2019 BY NJOY2016.60-
Photon emission for (n,x)

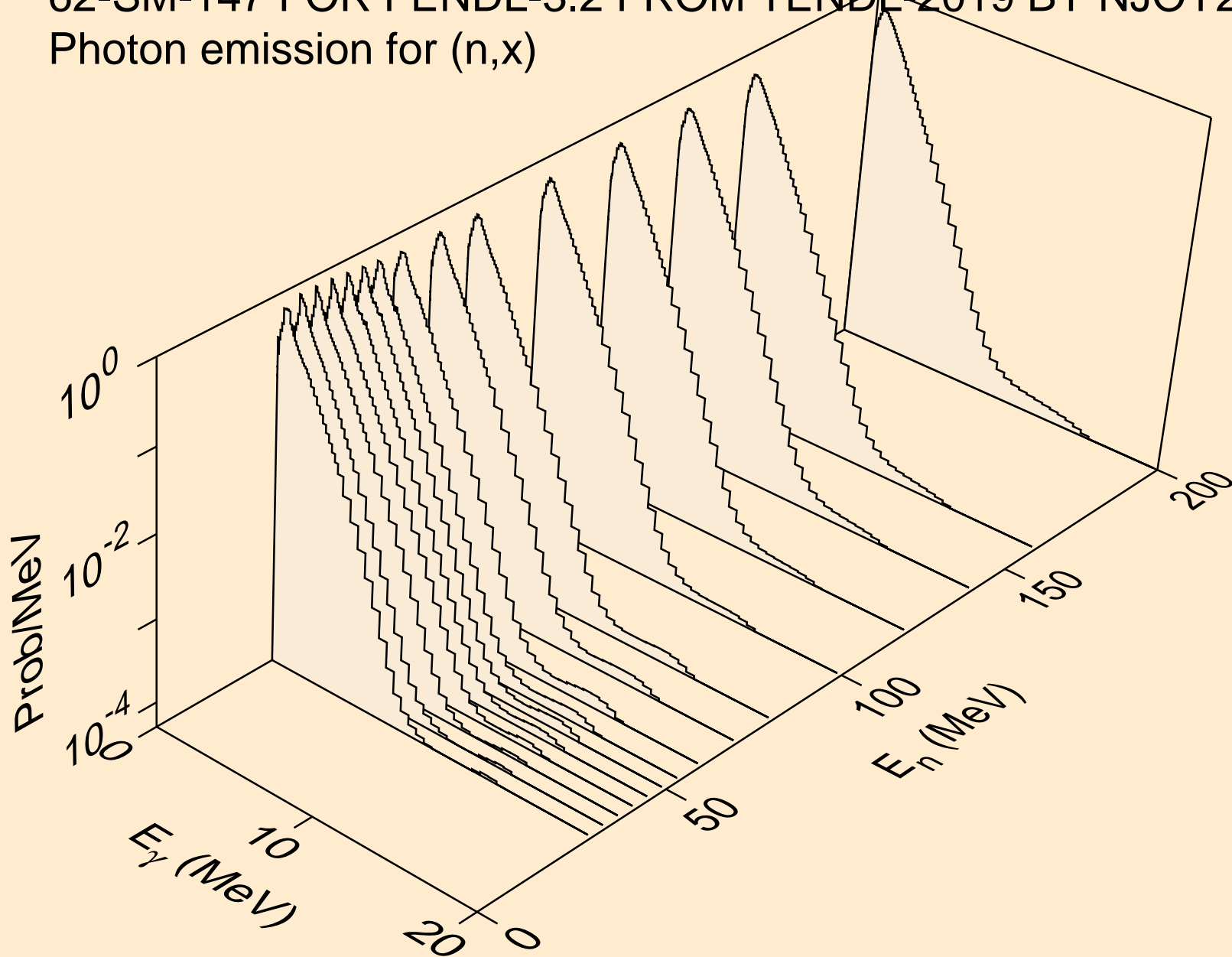

62-SM-147 FOR FENDL-3.2 FROM TENDL-2019 BY NJOY2016.60-
Photon emission for (n,2nd)

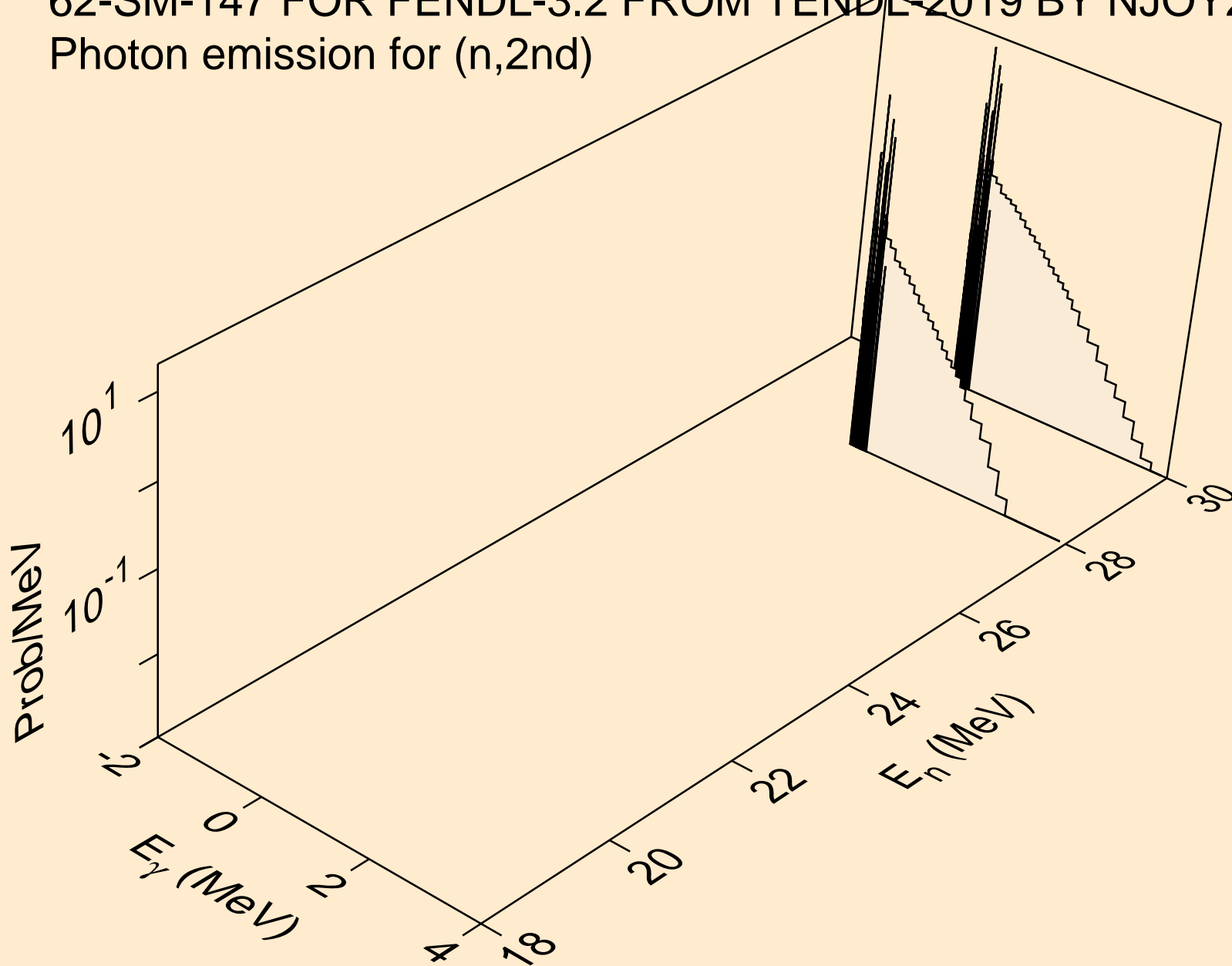

62-SM-147 FOR FENDL-3.2 FROM TENDL-2019 BY NJOY2016.60-
Photon emission for (n,2n)

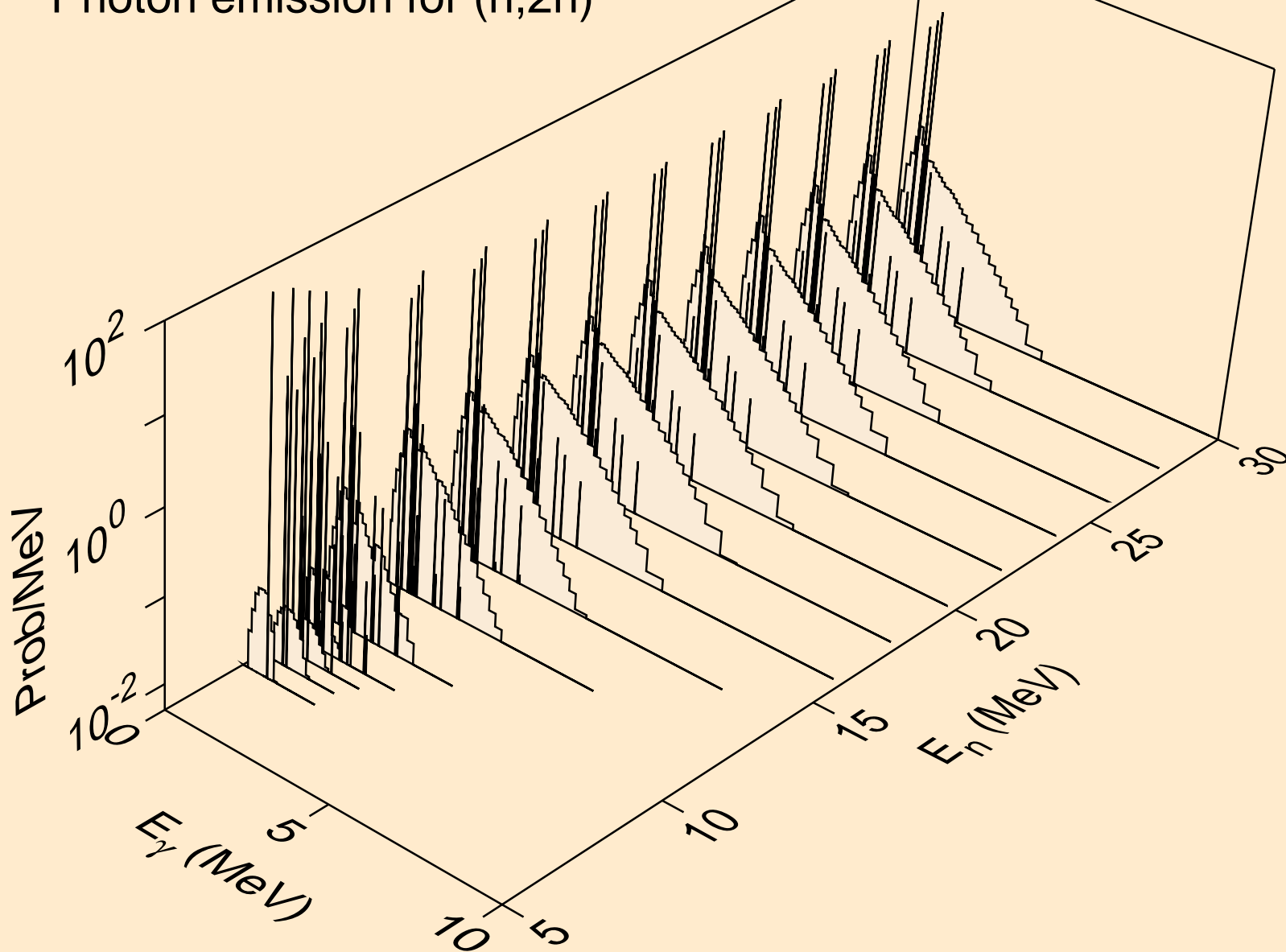

62-SM-147 FOR FENDL-3.2 FROM TENDL-2019 BY NJOY2016.60-
Photon emission for (n,3n)

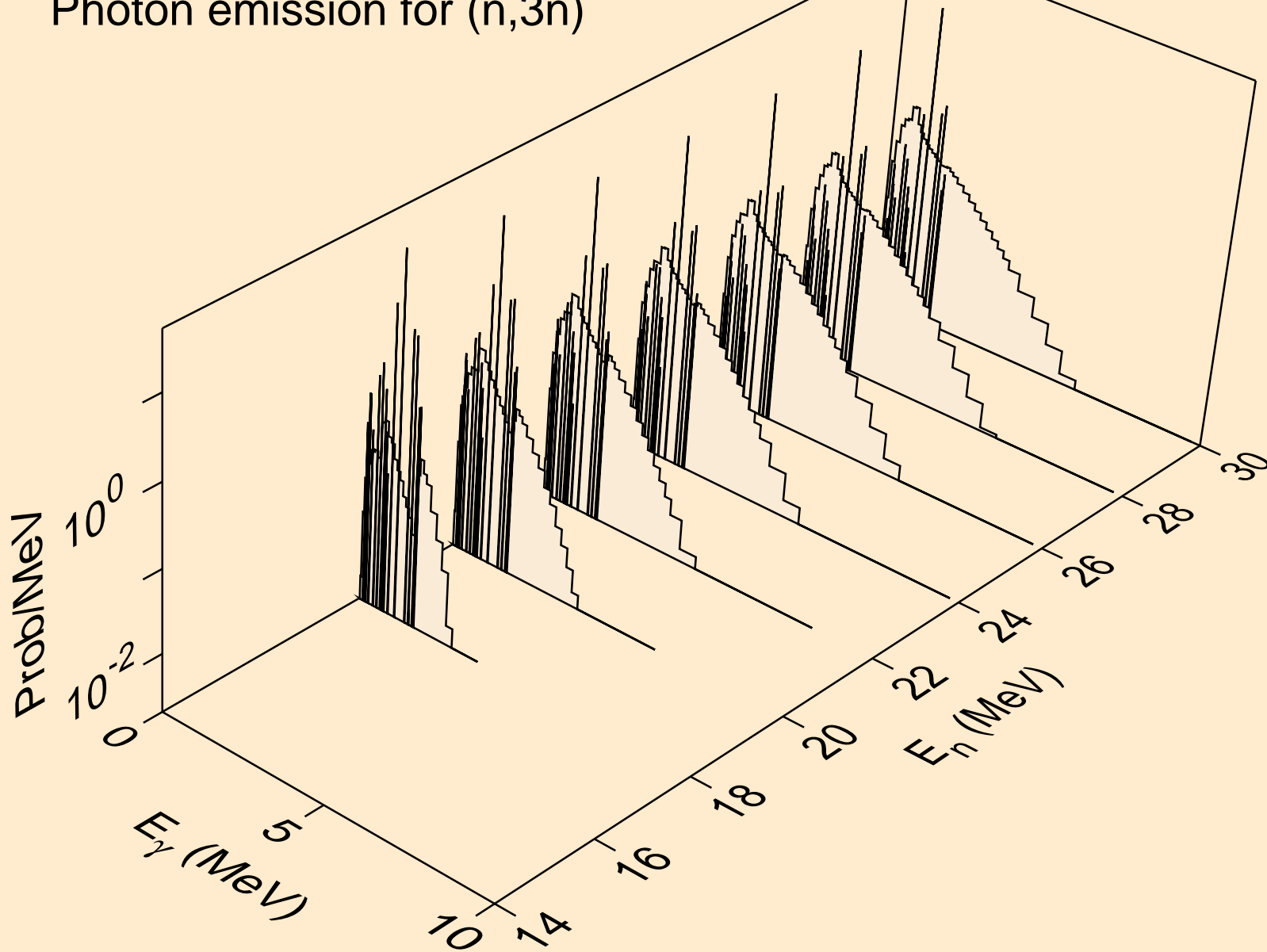

62-SM-147 FOR FENDL-3.2 FROM TENDL-2019 BY NJOY2016.60-
Photon emission for (n,n*)a

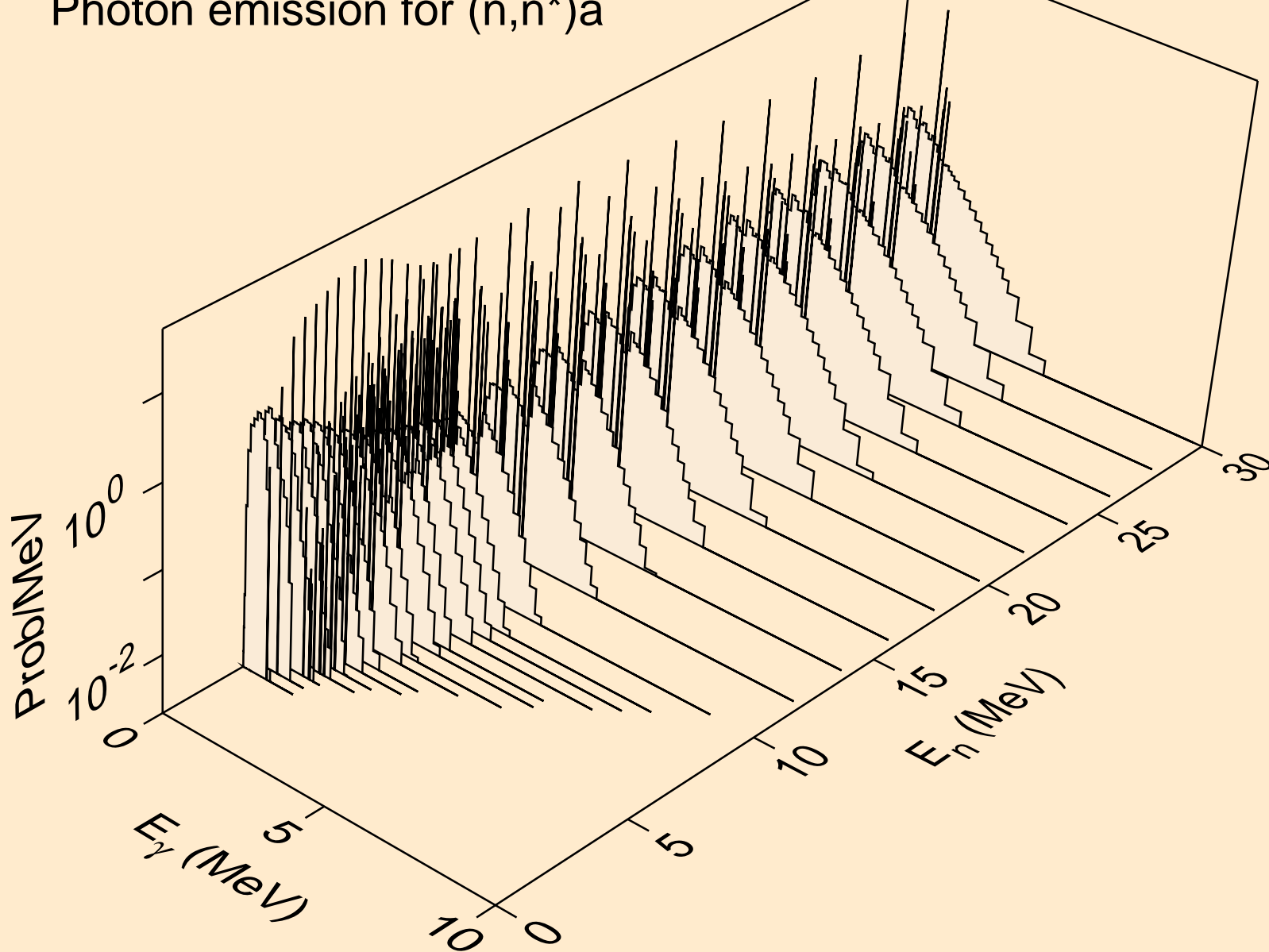

62-SM-147 FOR FENDL-3.2 FROM TENDL-2019 BY NJOY2016.60-
Photon emission for (n,2n)a

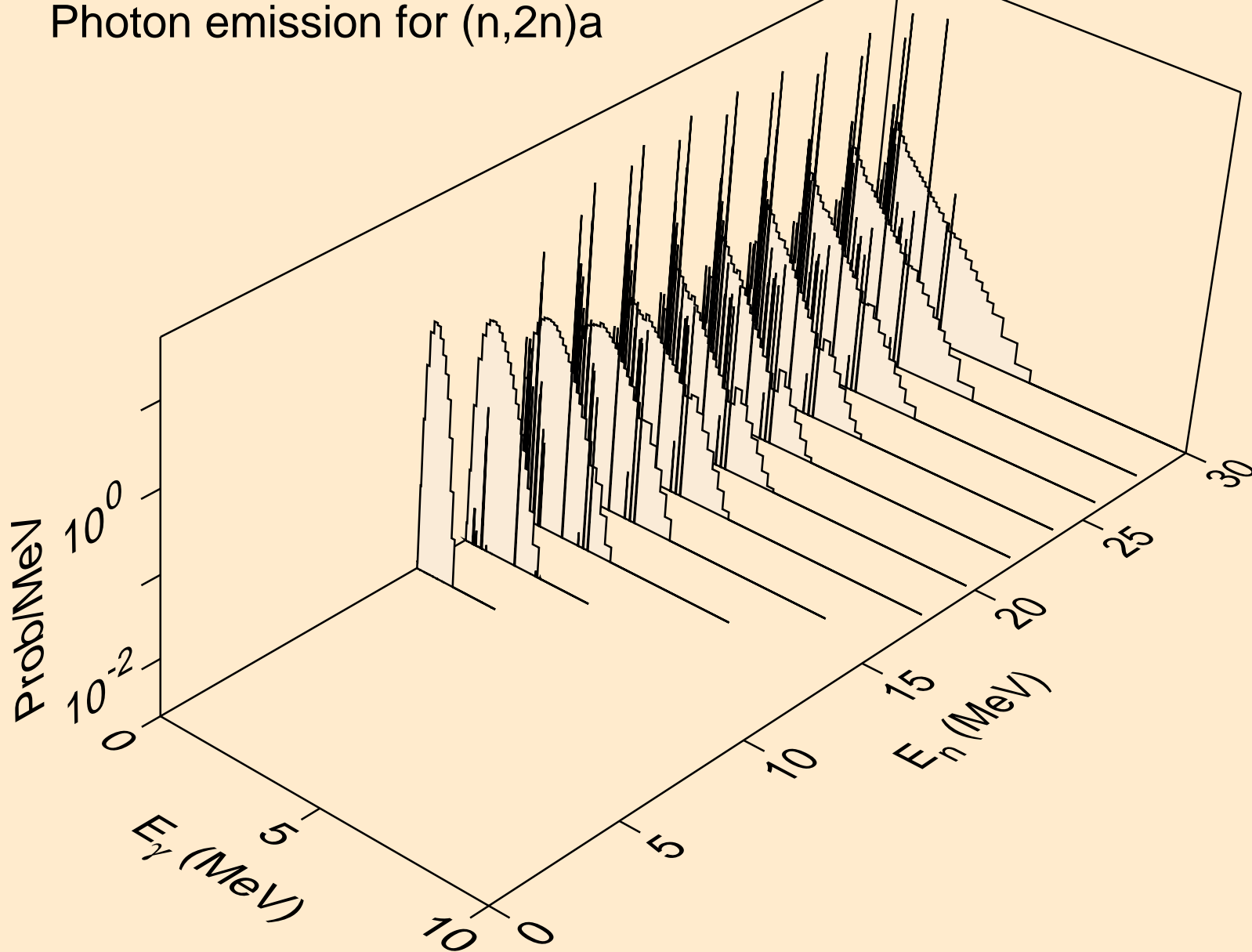

62-SM-147 FOR FENDL-3.2 FROM TENDL-2019 BY NJOY2016.60-
Photon emission for (n,3n)a

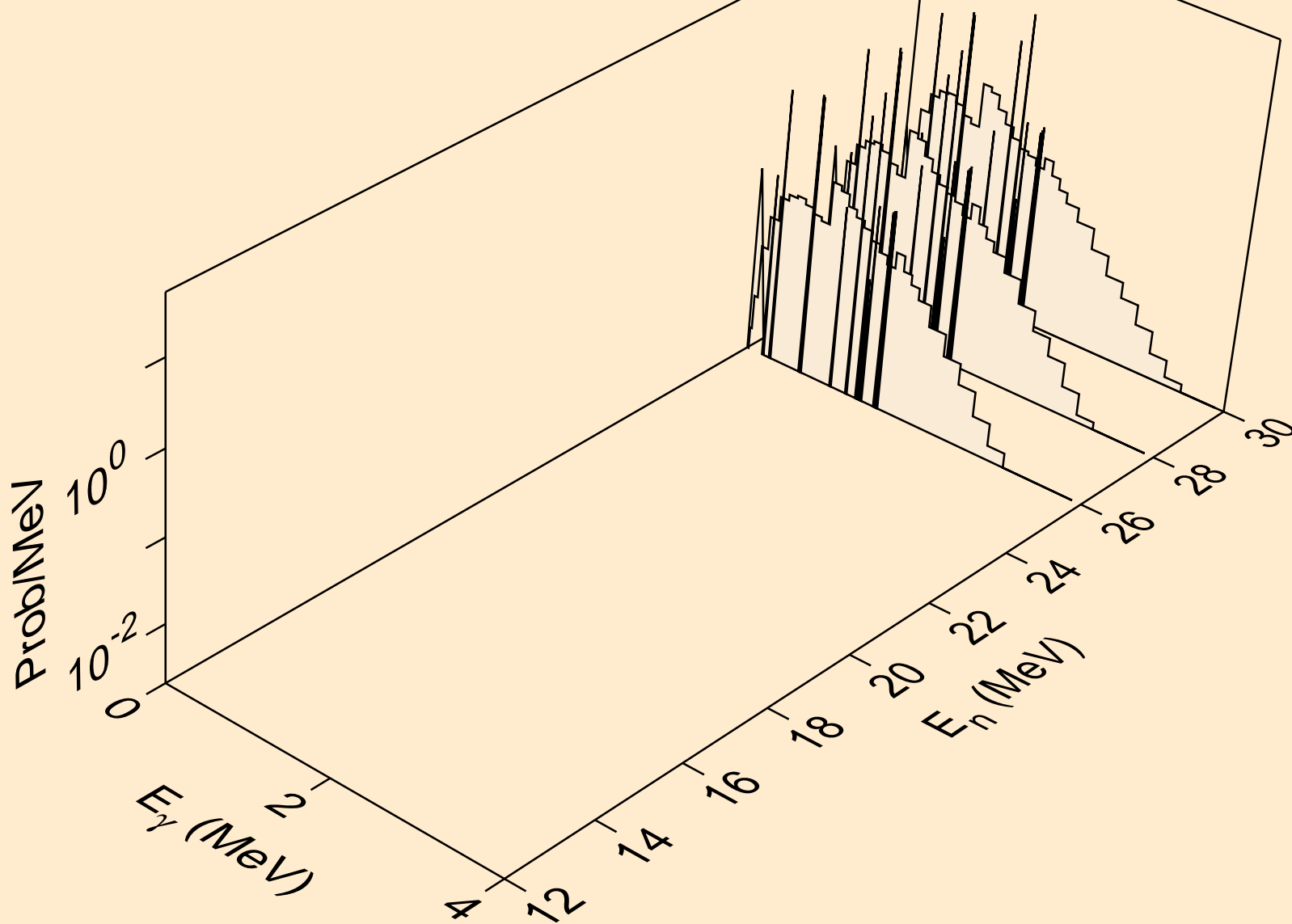

62-SM-147 FOR FENDL-3.2 FROM TENDL-2019 BY NJOY2016.60-
Photon emission for (n,n*)p

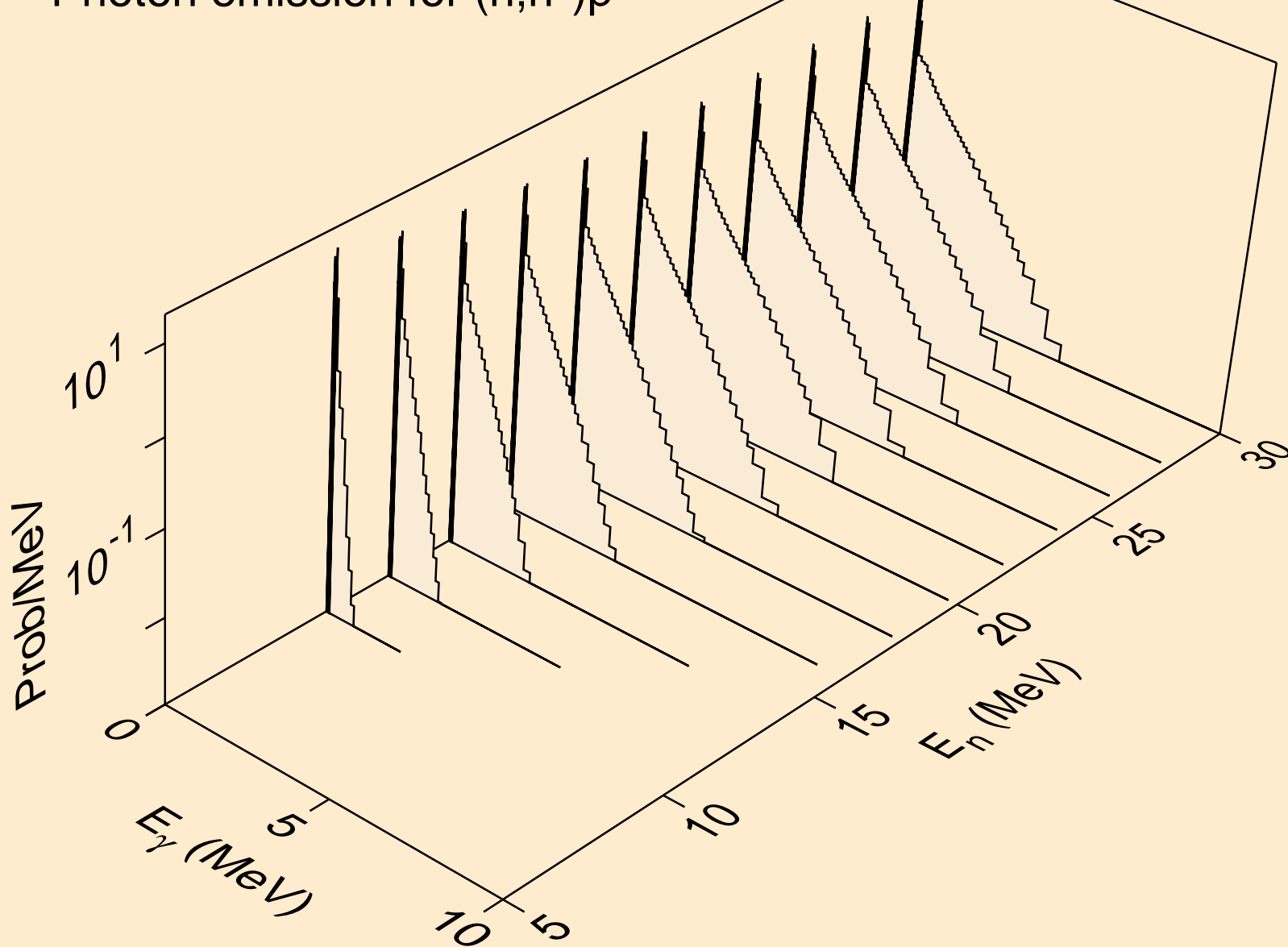

62-SM-147 FOR FENDL-3.2 FROM TENDL-2019 BY NJOY2016.60-
Photon emission for (n,n*)2a

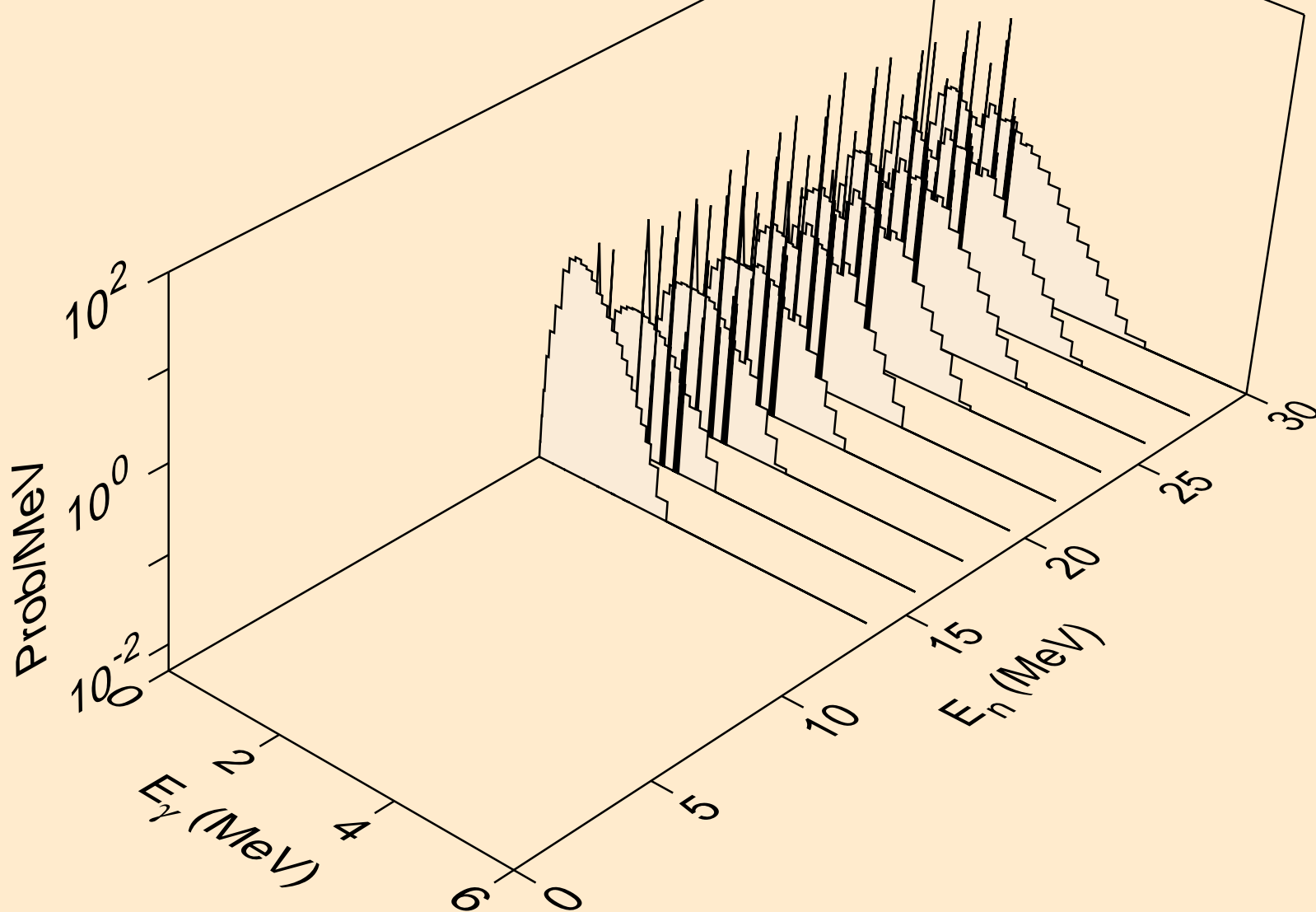

62-SM-147 FOR FENDL-3.2 FROM TENDL-2019 BY NJOY2016.60-
Photon emission for (n,n*)d

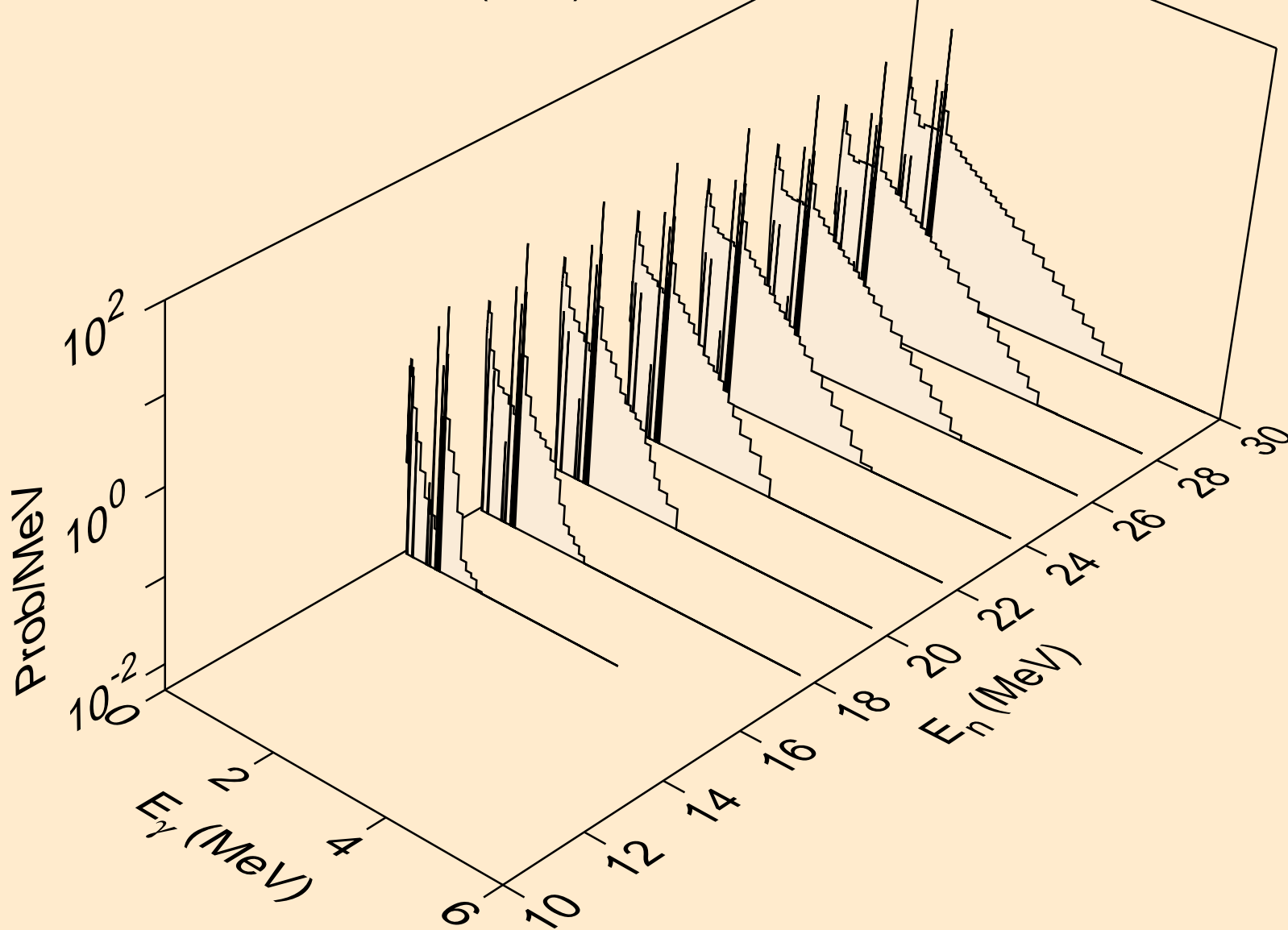

62-SM-147 FOR FENDL-3.2 FROM TENDL-2019 BY NJOY2016.60-
Photon emission for (n,n*)t

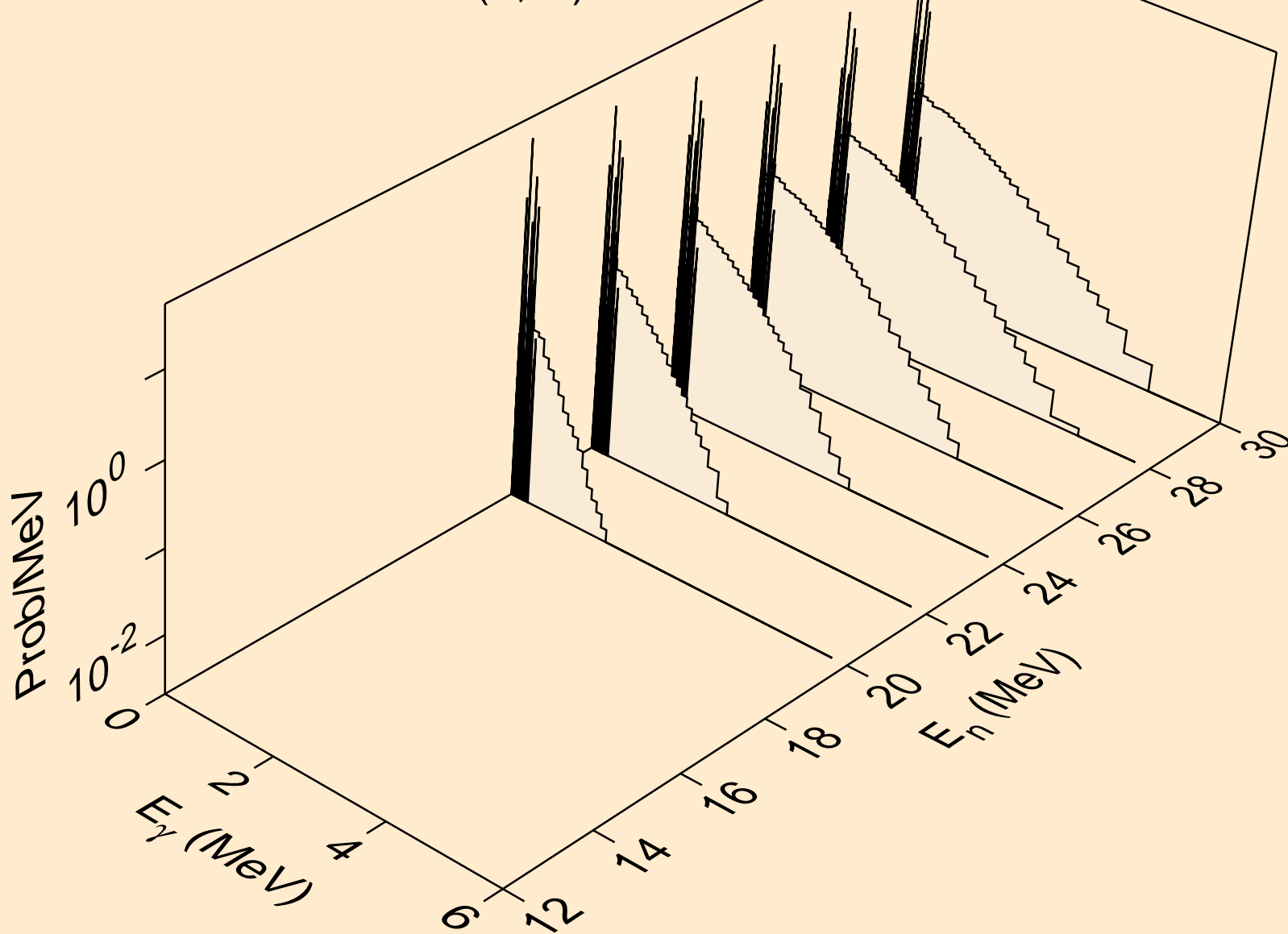

62-SM-147 FOR FENDL-3.2 FROM TENDL-2019 BY NJOY2016.60-
Photon emission for (n,n*)he3

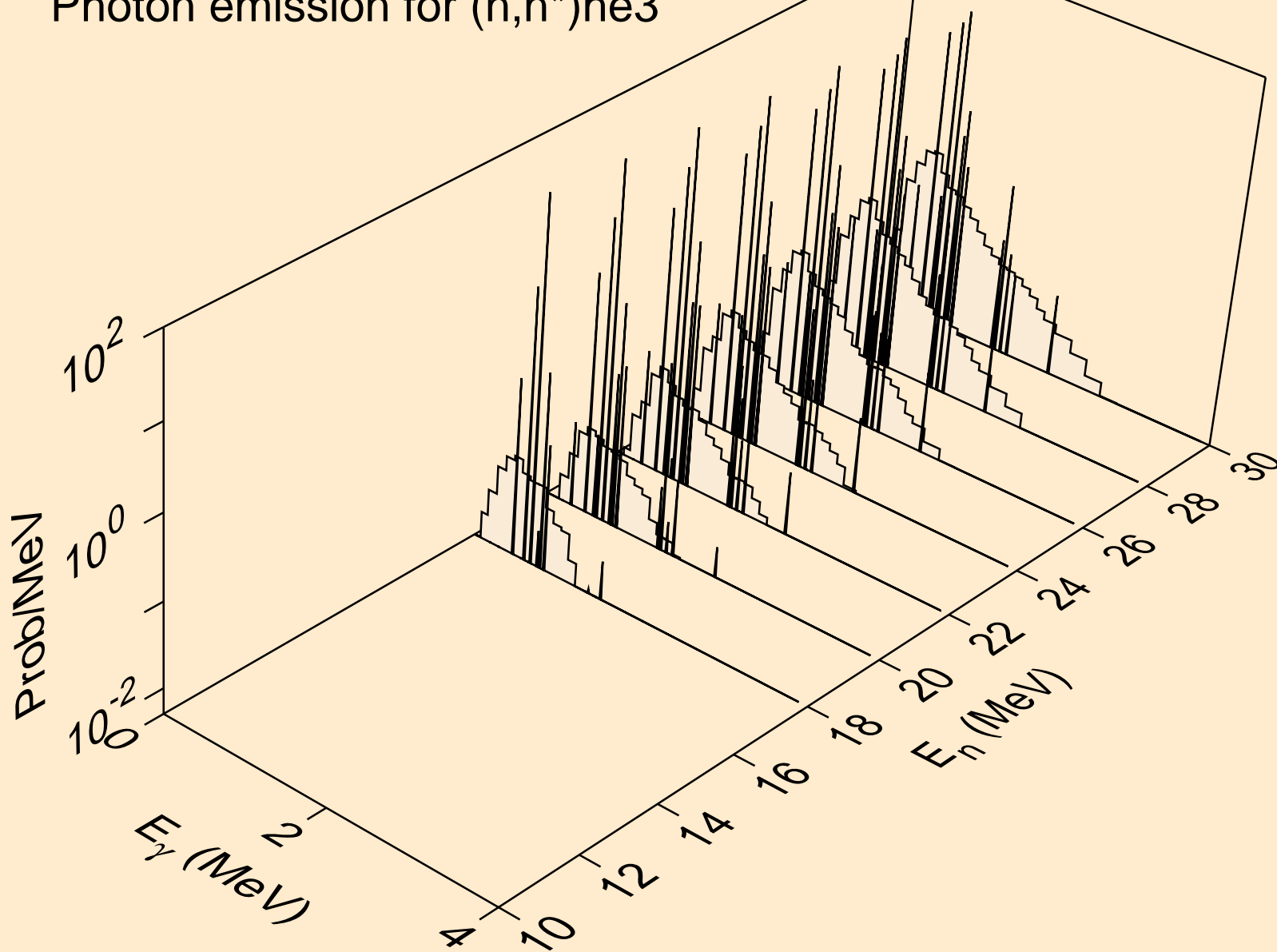

62-SM-147 FOR FENDL-3.2 FROM TENDL-2019 BY NJOY2016.60-
Photon emission for (n,4n)

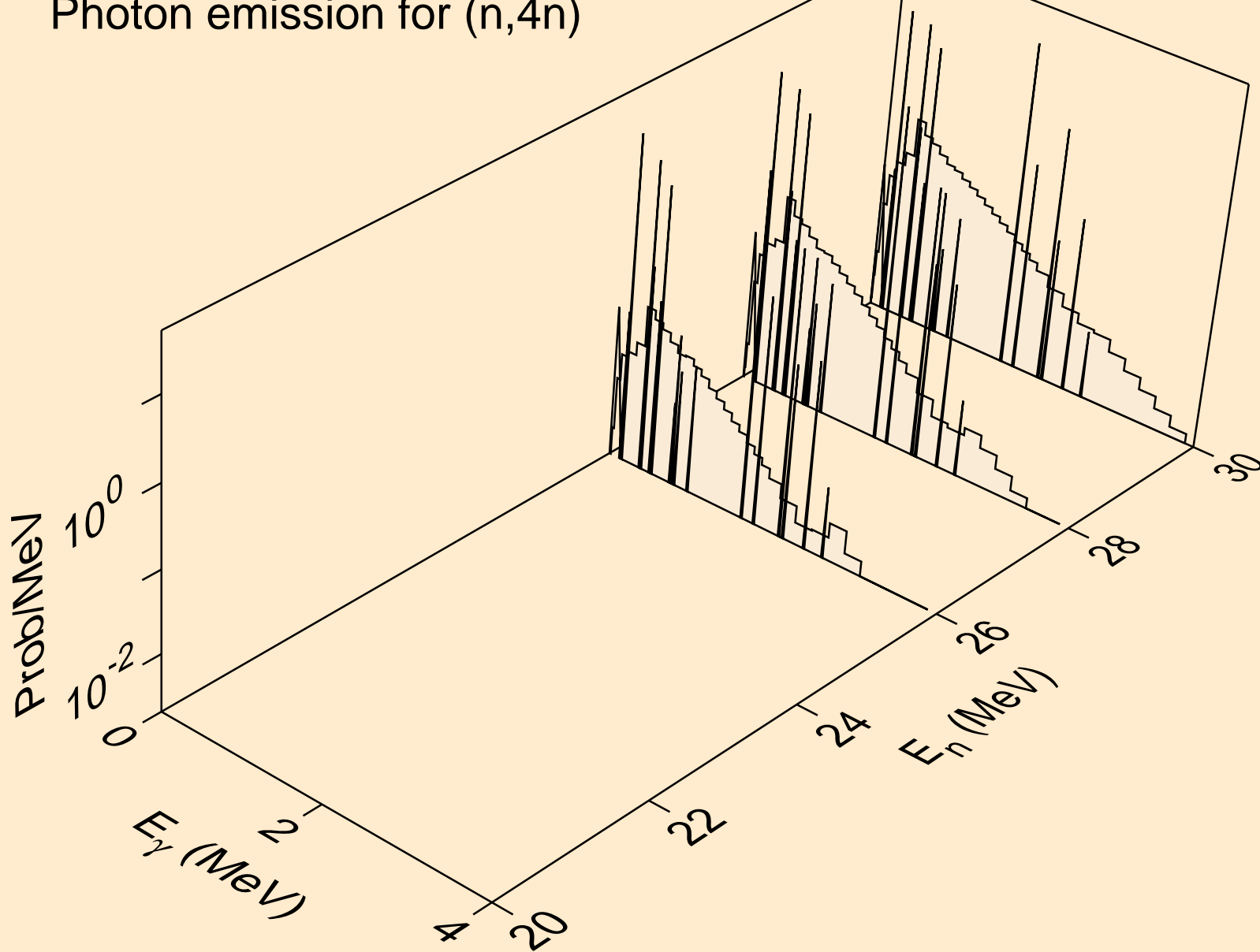

62-SM-147 FOR FENDL-3.2 FROM TENDL-2019 BY NJOY2016.60-
Photon emission for (n,2np)

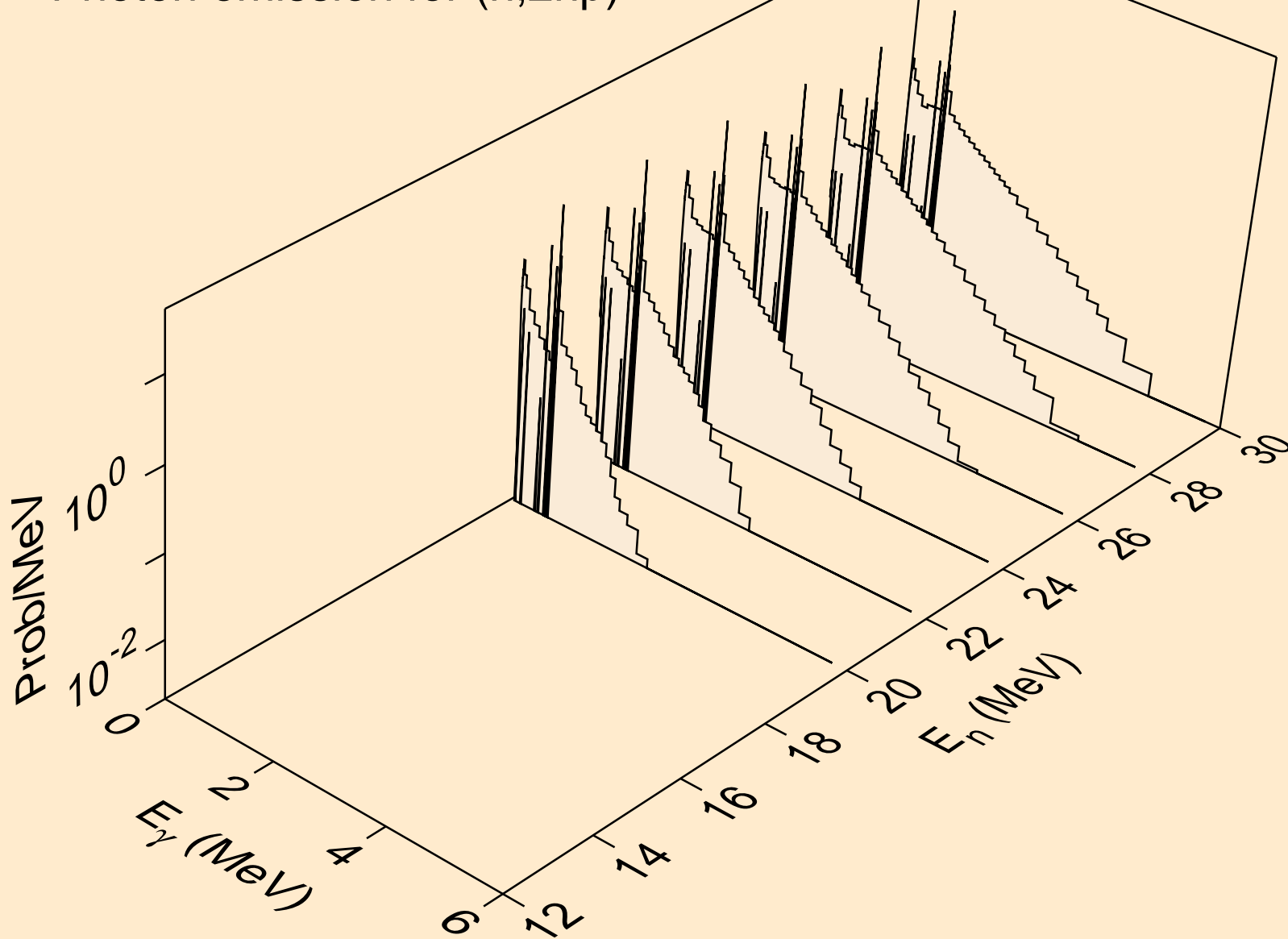

62-SM-147 FOR FENDL-3.2 FROM TENDL-2019 BY NJOY2016.60-
Photon emission for (n,3np)

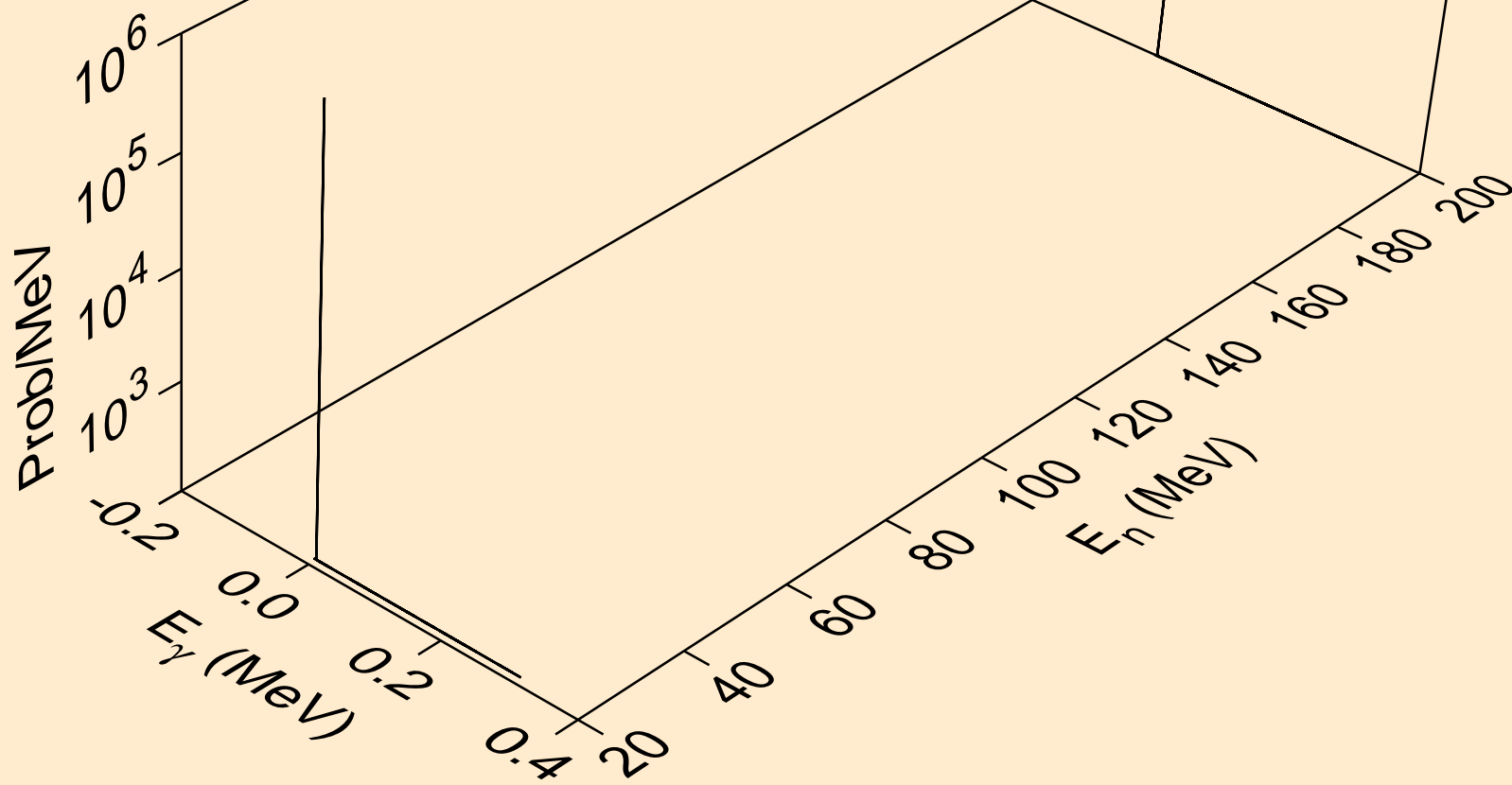

62-SM-147 FOR FENDL-3.2 FROM TENDL-2019 BY NJOY2016.60-
Photon emission for (n,2np)

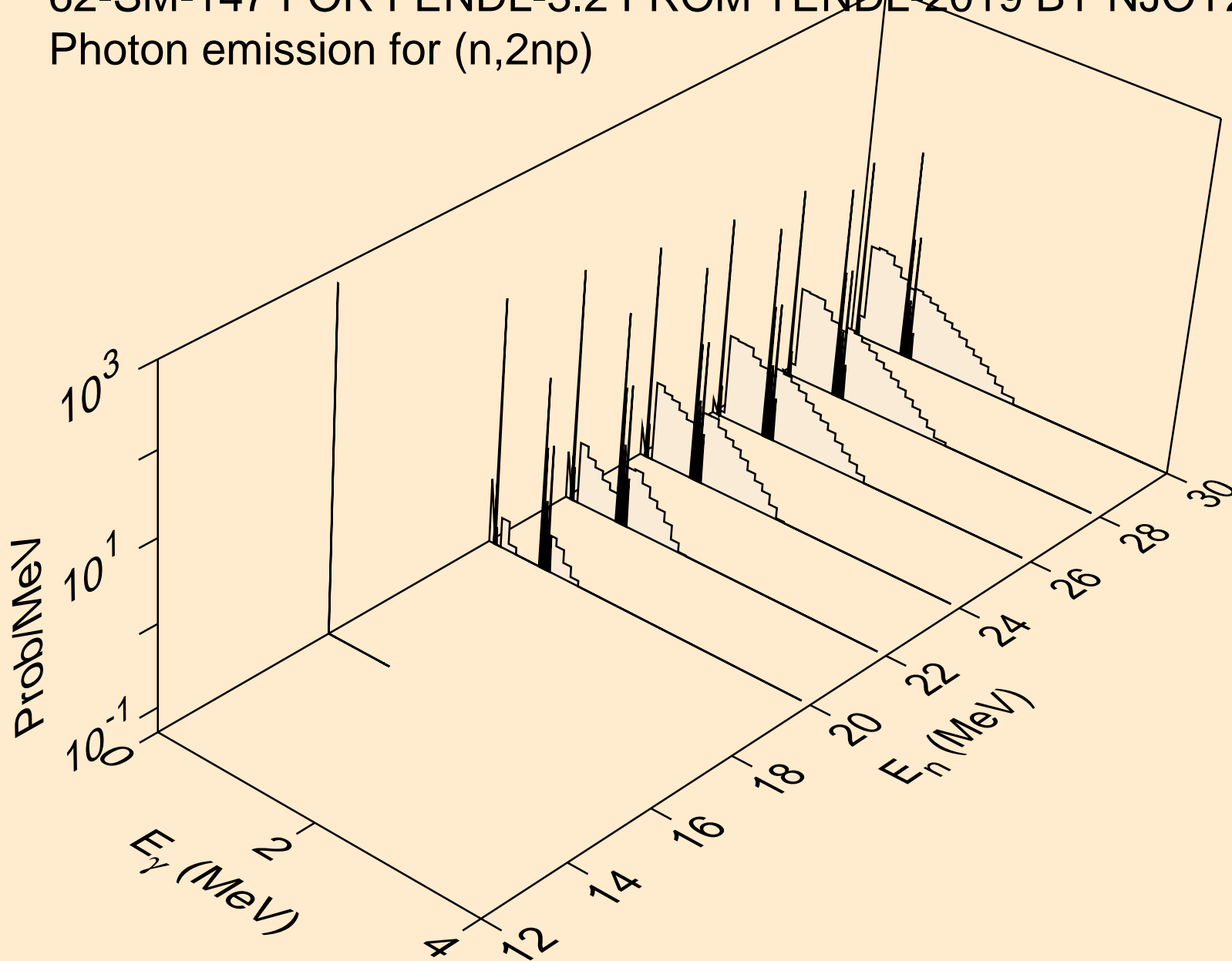

62-SM-147 FOR FENDL-3.2 FROM TENDL-2019 BY NJOY2016.60-
Photon emission for (n,npa)

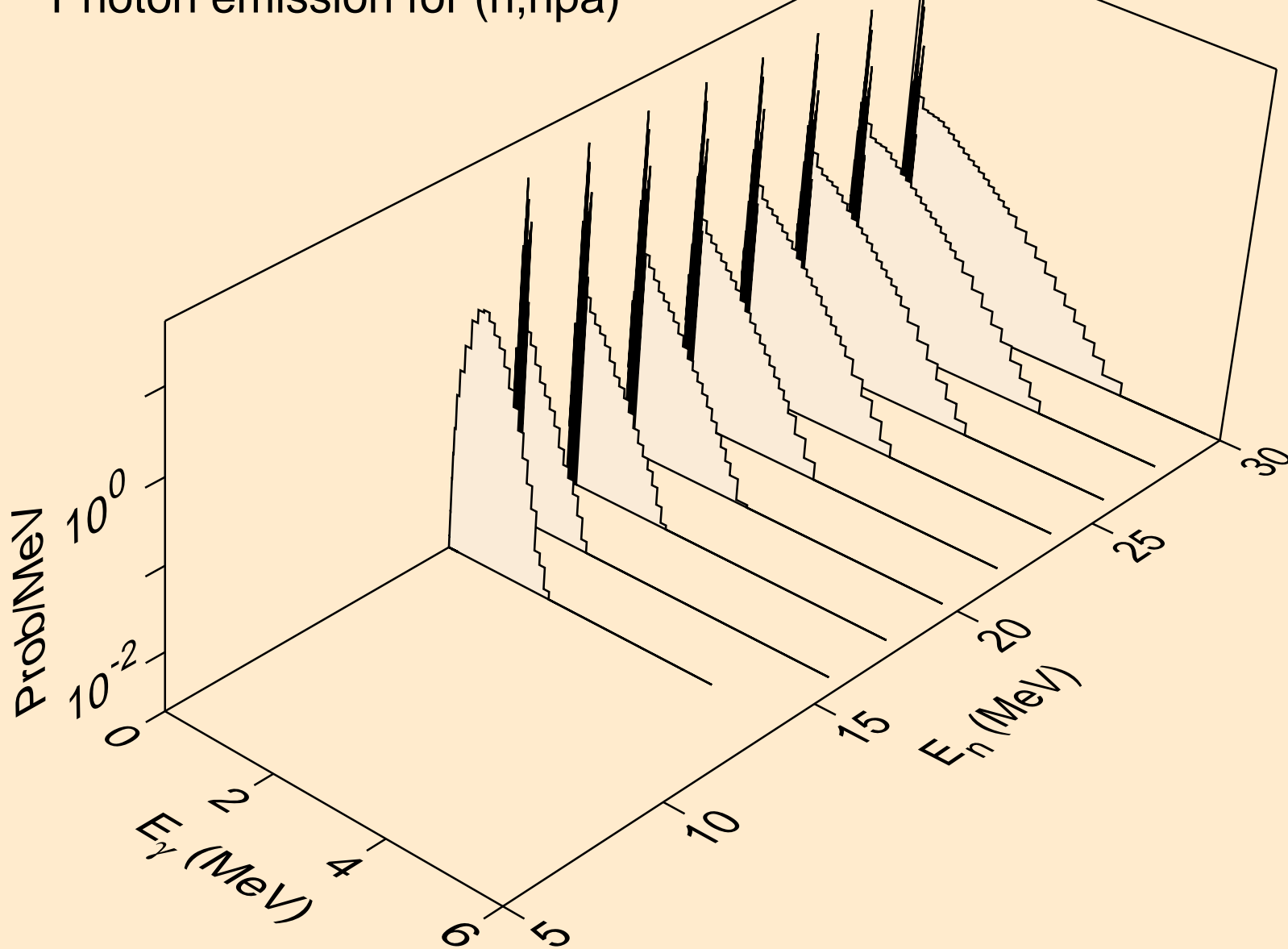

62-SM-147 FOR FENDL-3.2 FROM TENDL-2019 BY NJOY2016.60-
Photon emission for (n,n*c)

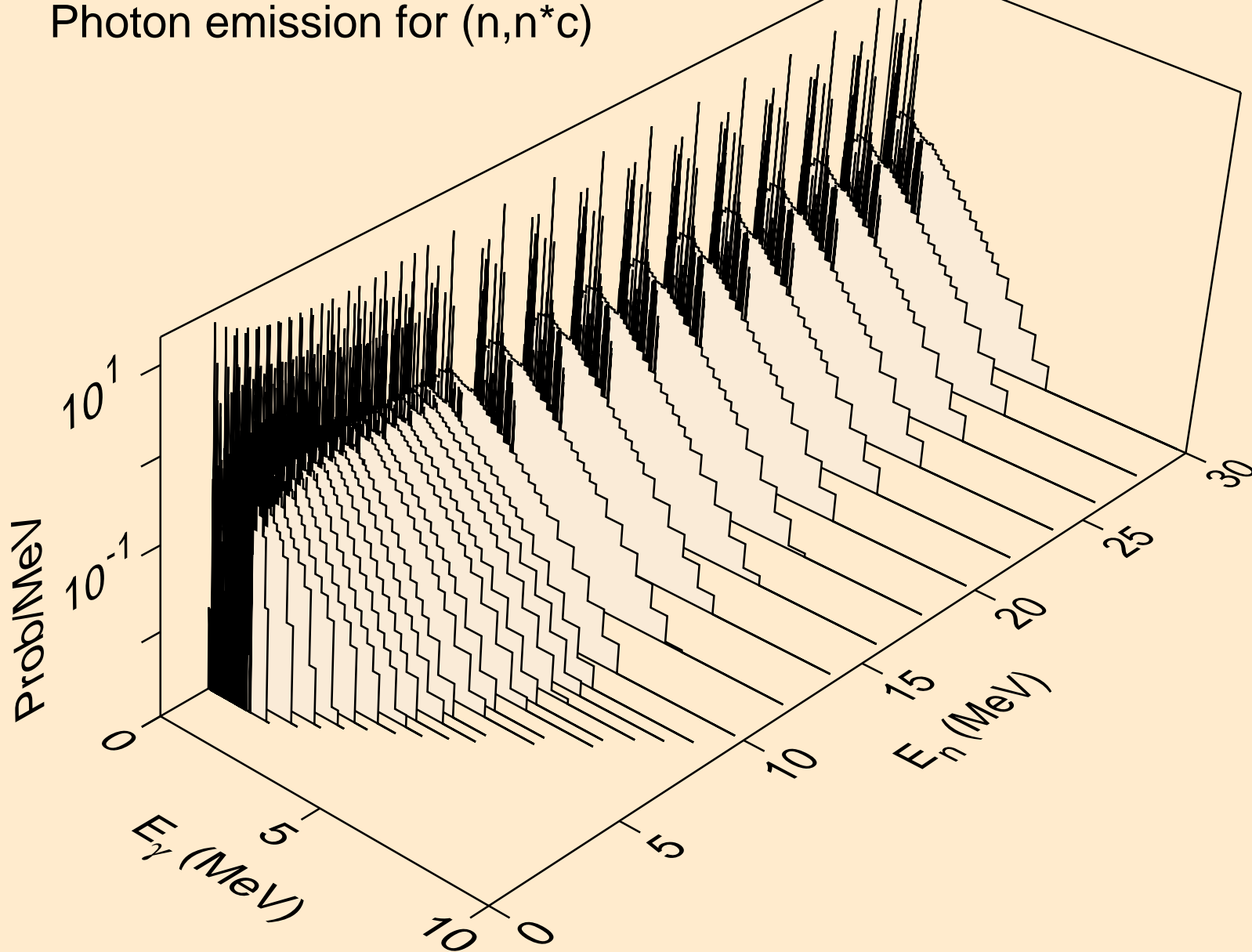

62-SM-147 FOR FENDL-3.2 FROM TENDL-2019 BY NJOY2016.60-
Photon emission for (n,gma)

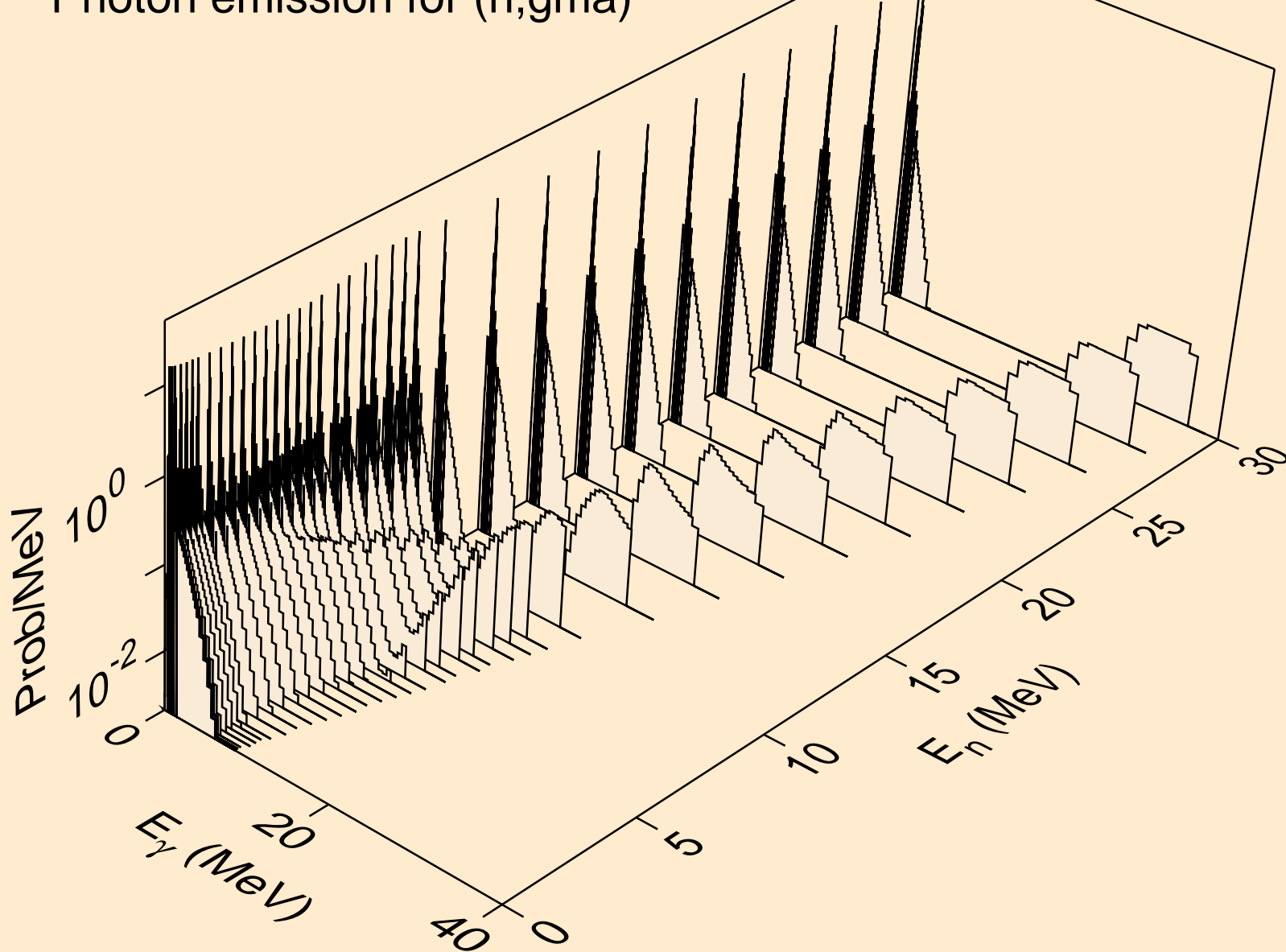

62-SM-147 FOR FENDL-3.2 FROM TENDL-2019 BY NJOY2016.60-
Photon emission for (n,p)

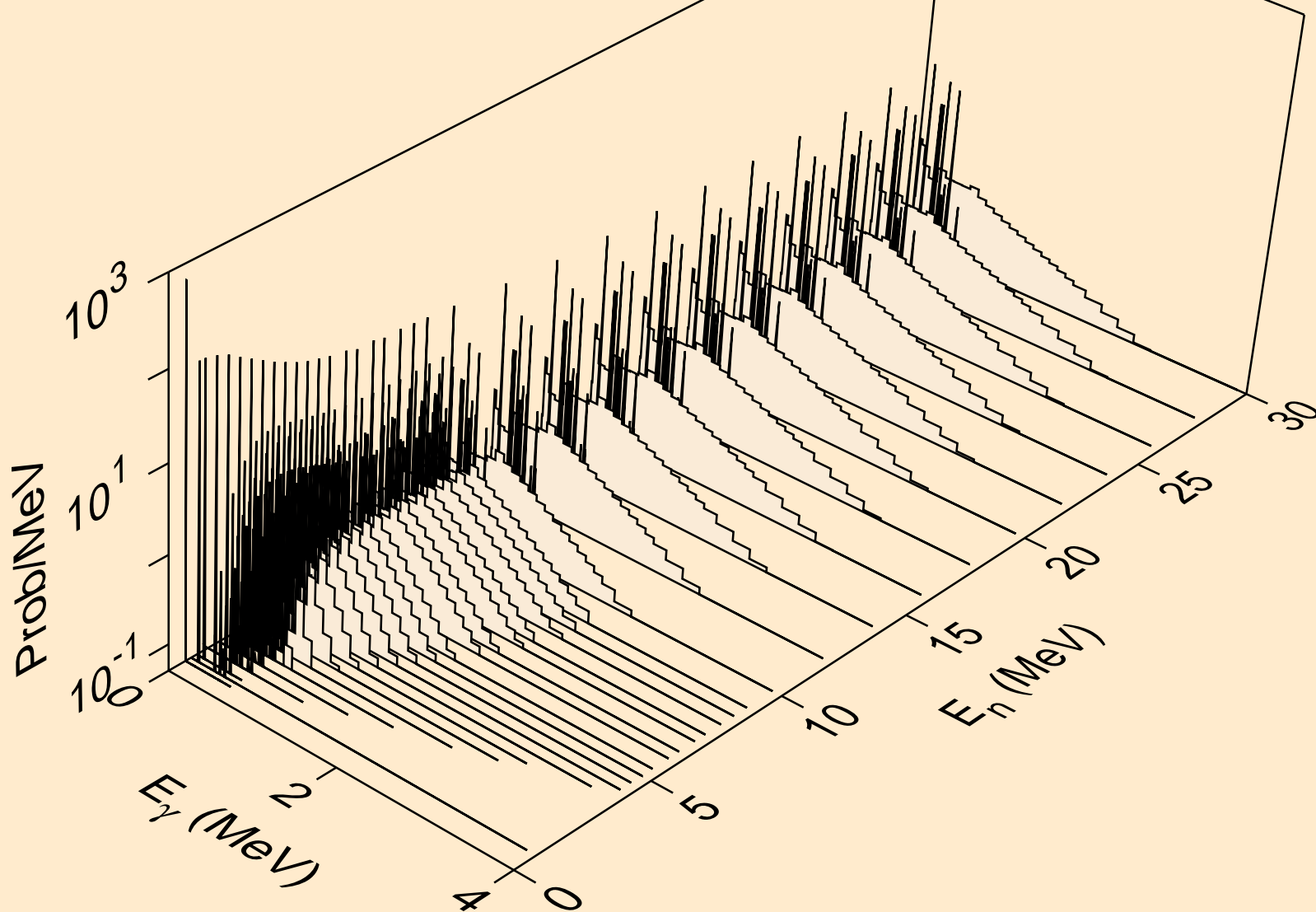

62-SM-147 FOR FENDL-3.2 FROM TENDL-2019 BY NJOY2016.60-
Photon emission for (n,d)

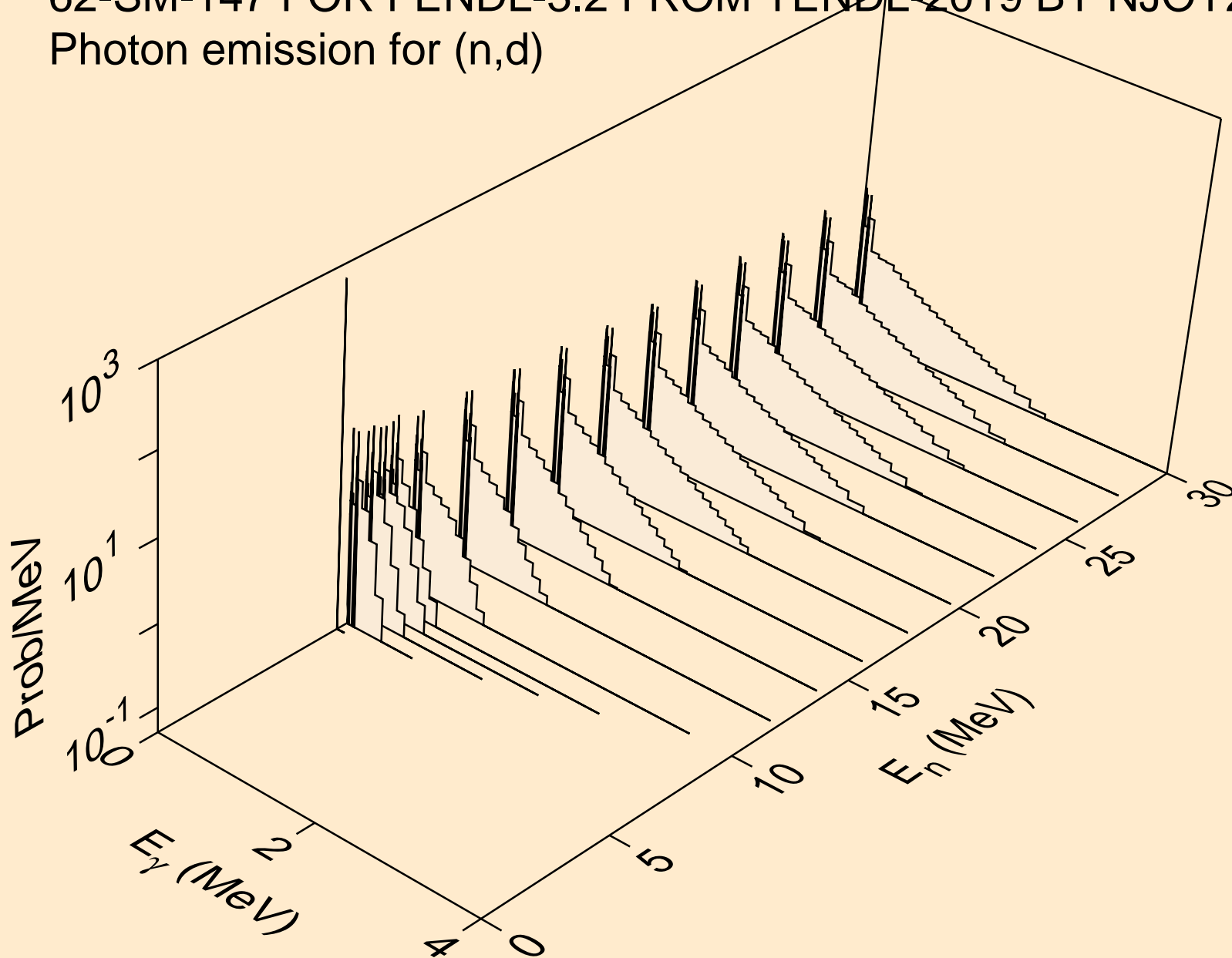

62-SM-147 FOR FENDL-3.2 FROM TENDL-2019 BY NJOY2016.60-
Photon emission for (n,t)

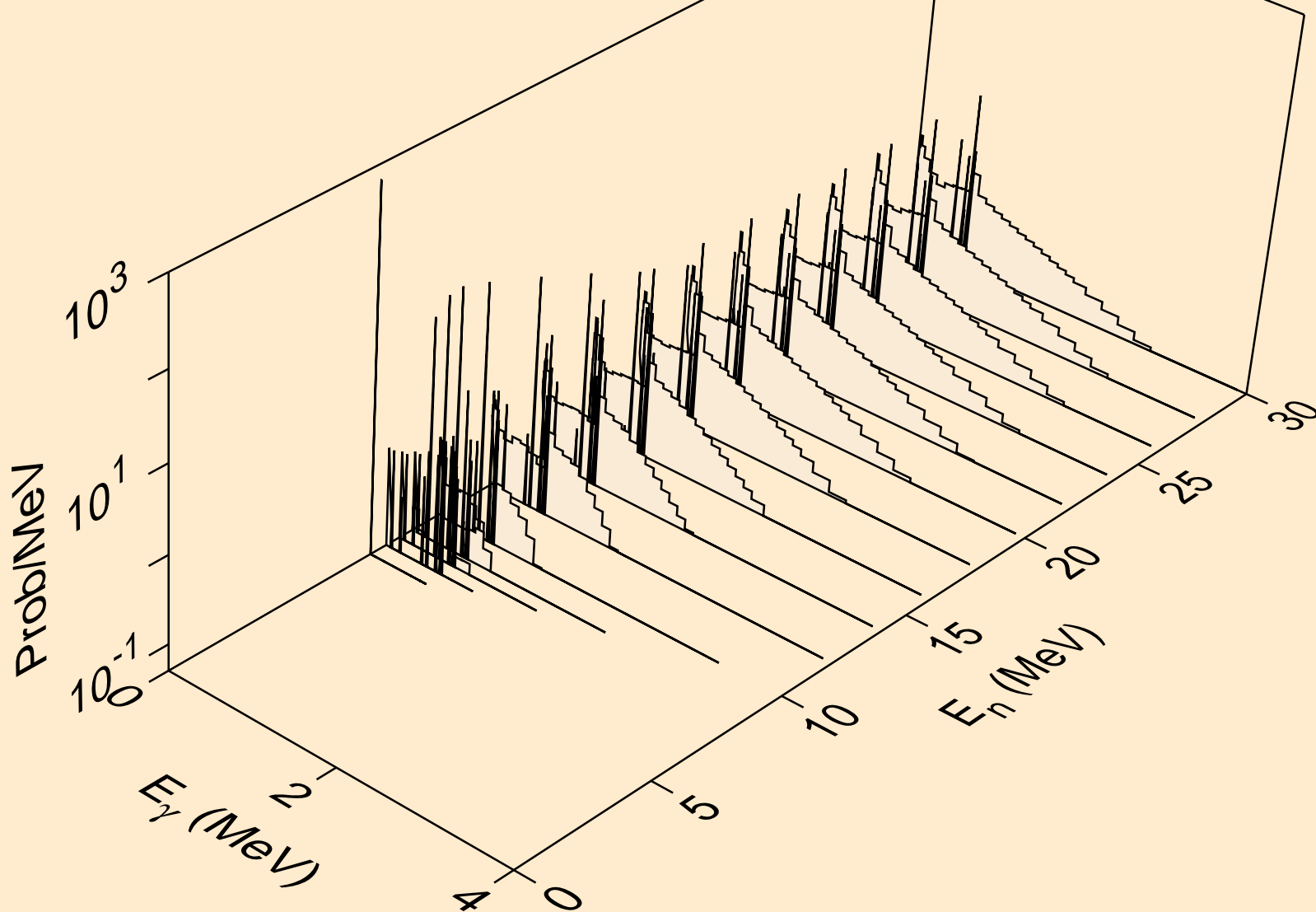

62-SM-147 FOR FENDL-3.2 FROM TENDL-2019 BY NJOY2016.60-
Photon emission for (n,he3)

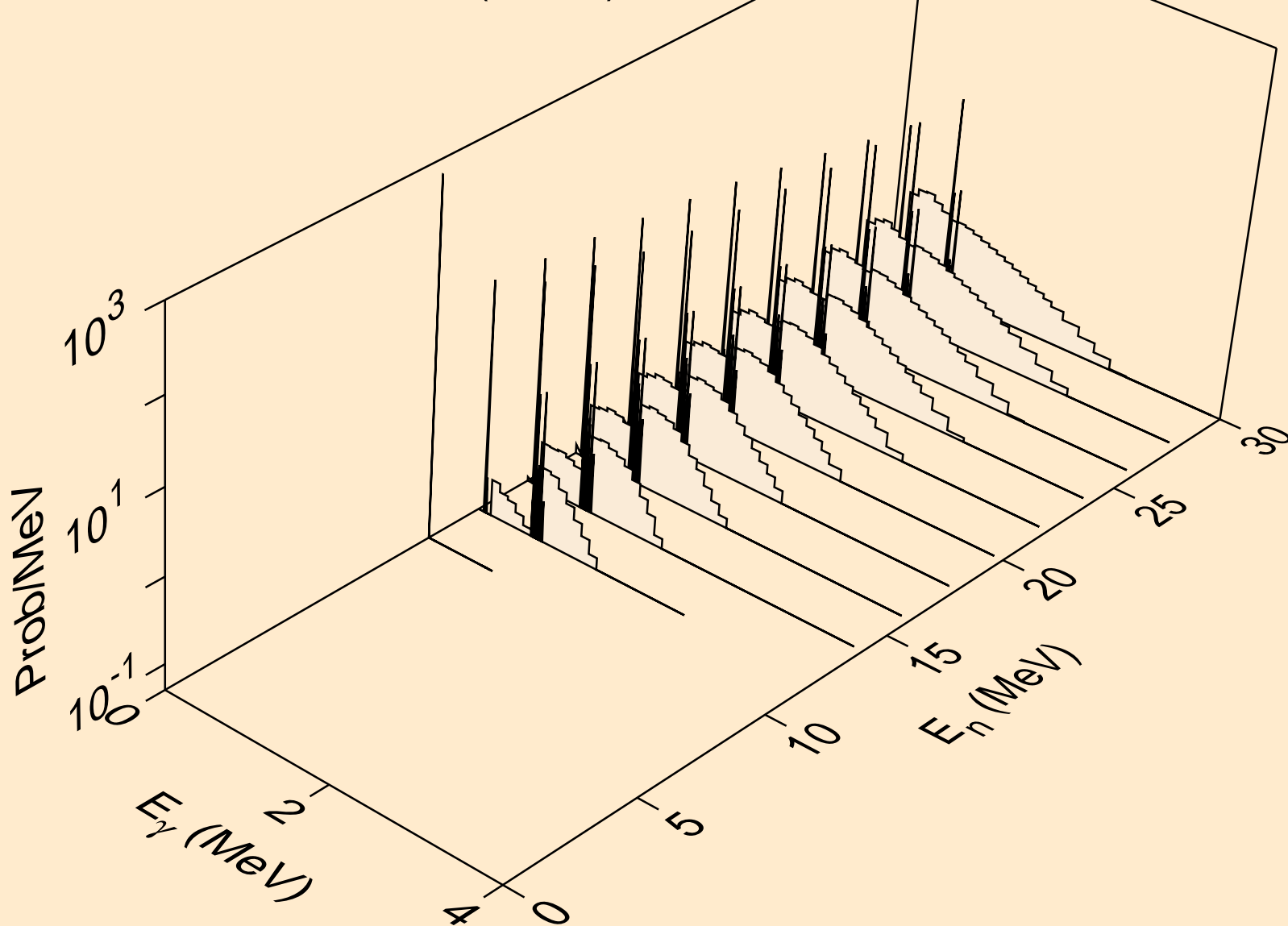

62-SM-147 FOR FENDL-3.2 FROM TENDL-2019 BY NJOY2016.60-
Photon emission for (n,a)

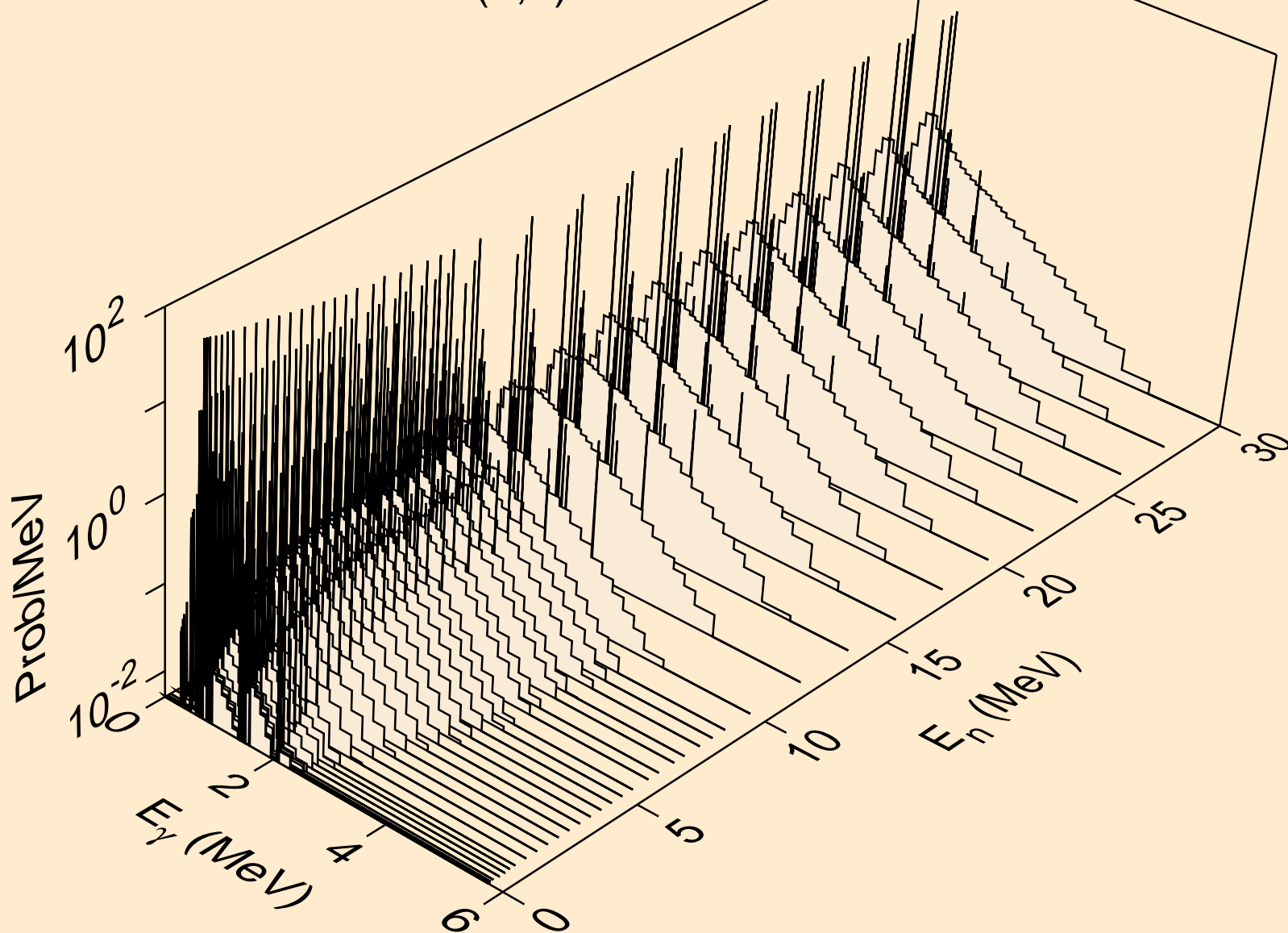

62-SM-147 FOR FENDL-3.2 FROM TENDL-2019 BY NJOY2016.60-
Photon emission for (n,2a)

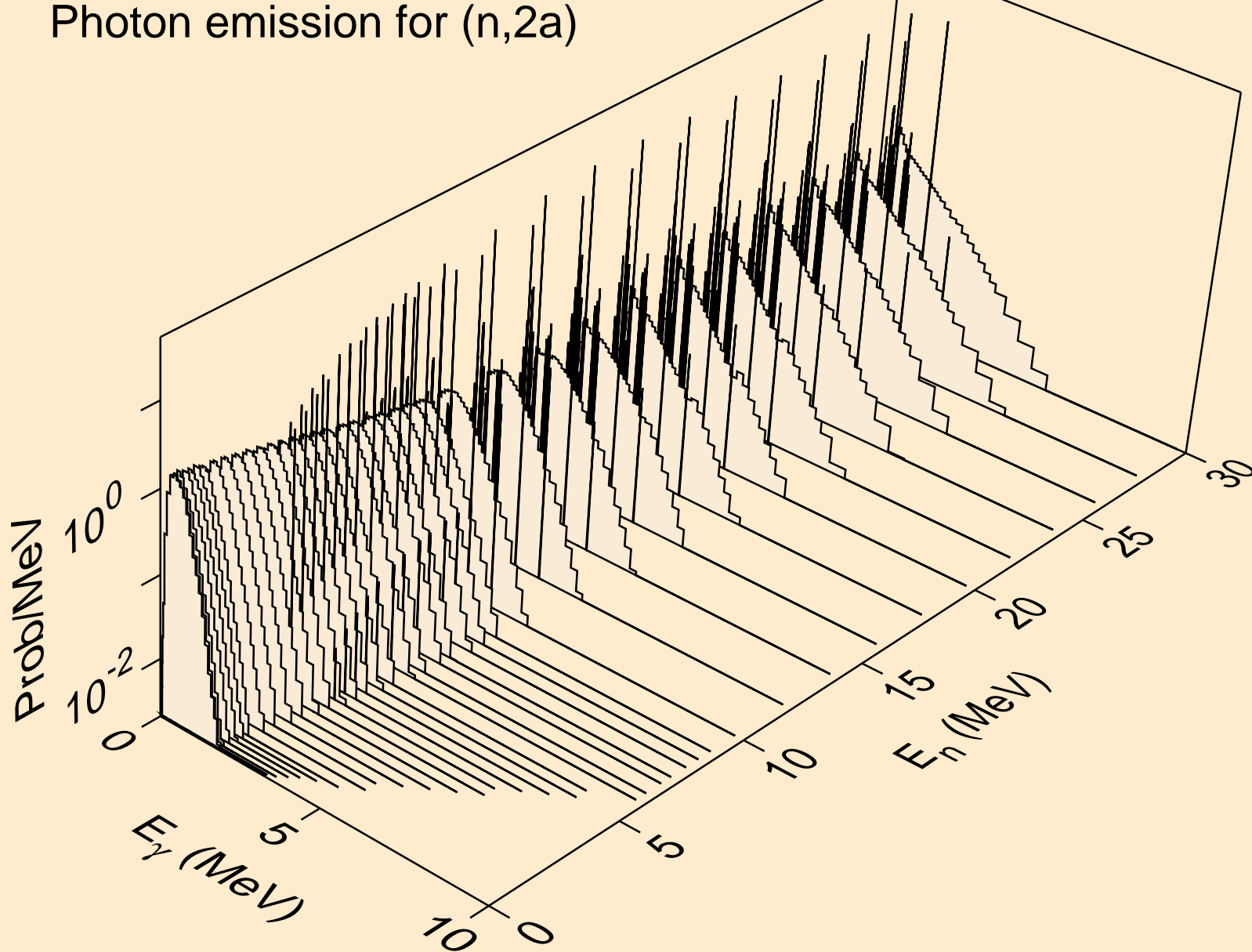

62-SM-147 FOR FENDL-3.2 FROM TENDL-2019 BY NJOY2016.60-
Photon emission for (n,2p)

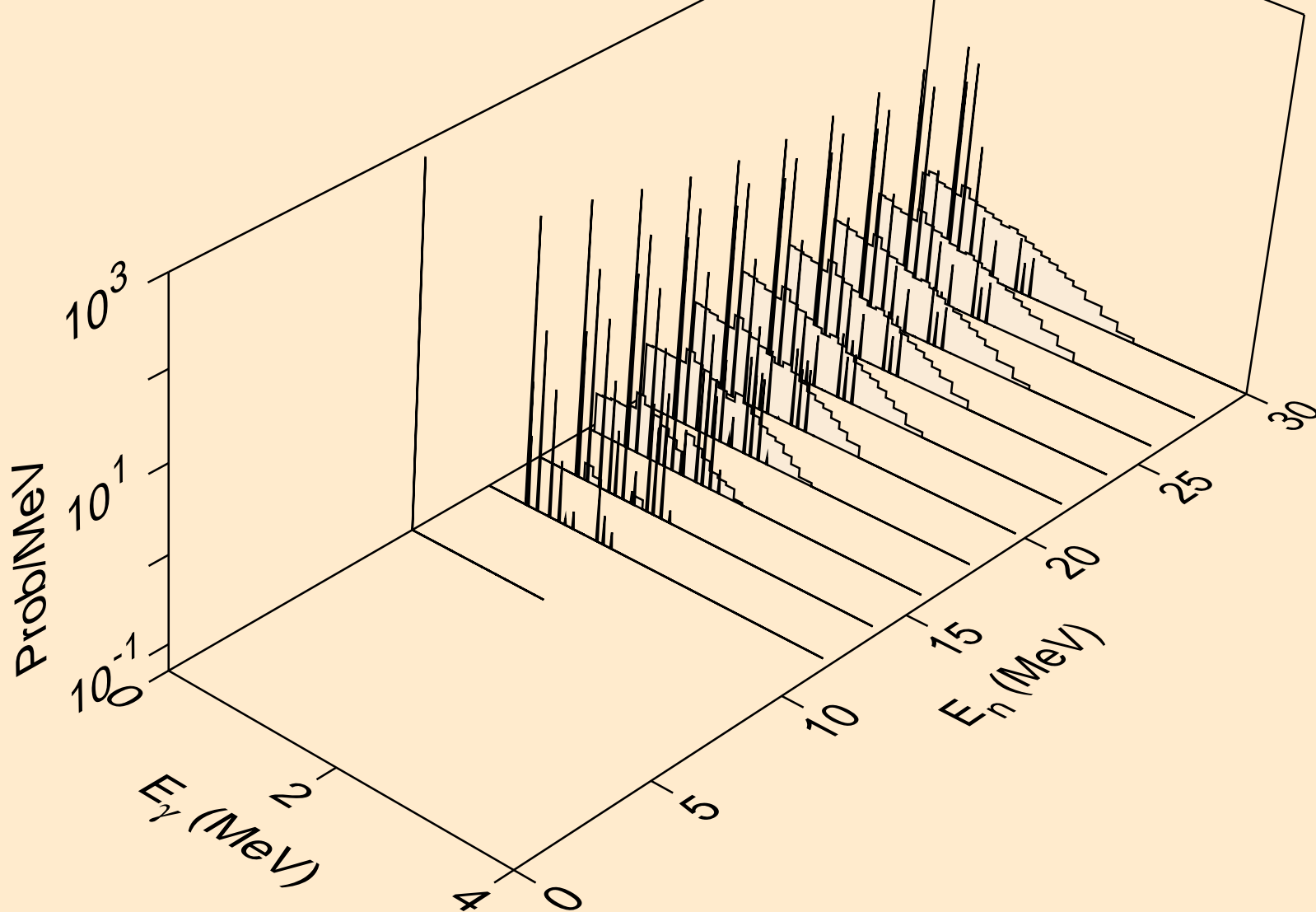

62-SM-147 FOR FENDL-3.2 FROM TENDL-2019 BY NJOY2016.60-
Photon emission for (n,pa)

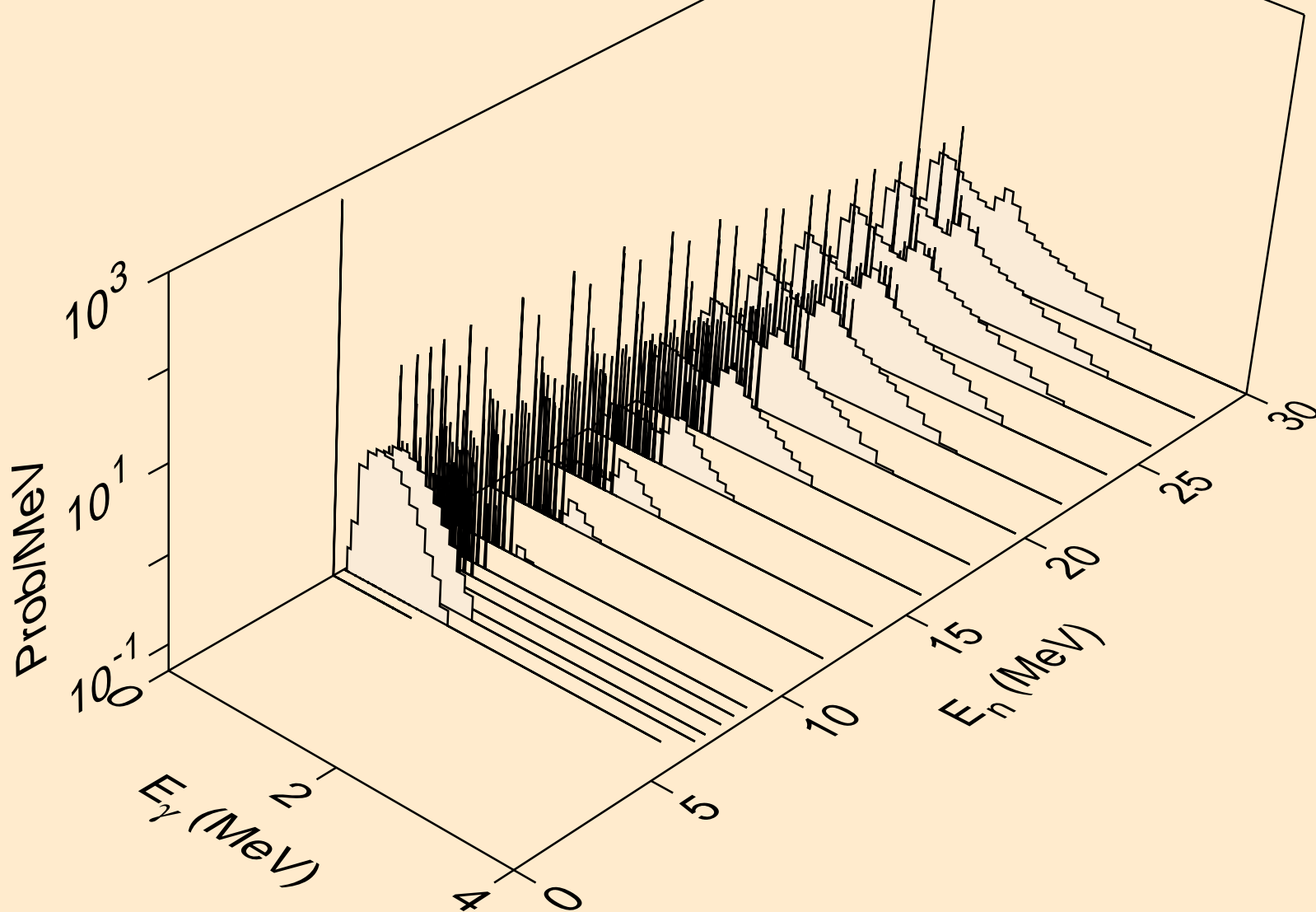

62-SM-147 FOR FENDL-3.2 FROM TENDL-2019 BY NJOY2016.60-
Photon emission for (n,pd)

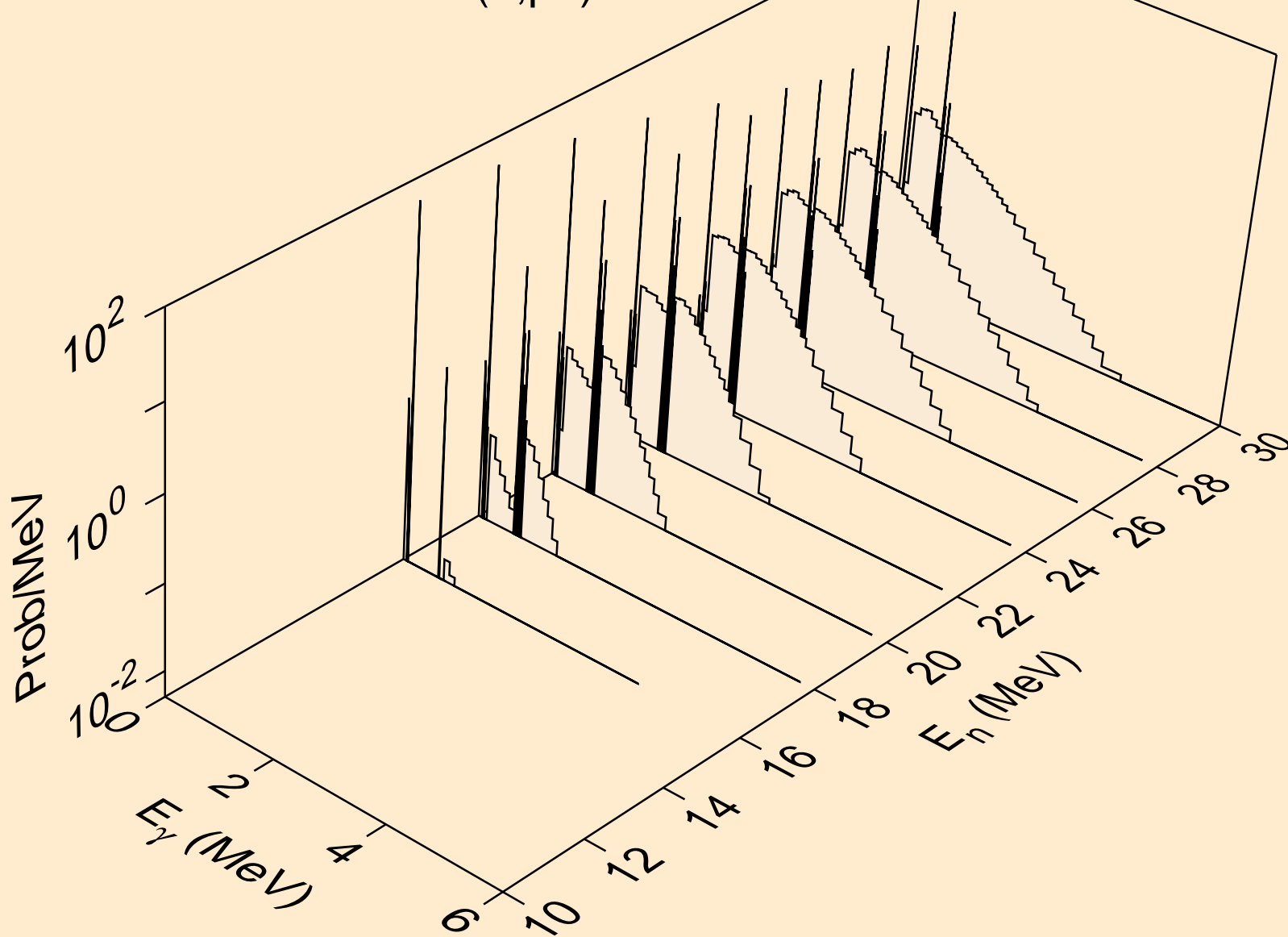

62-SM-147 FOR FENDL-3.2 FROM TENDL-2019 BY NJOY2016.60-
Photon emission for (n,pt)

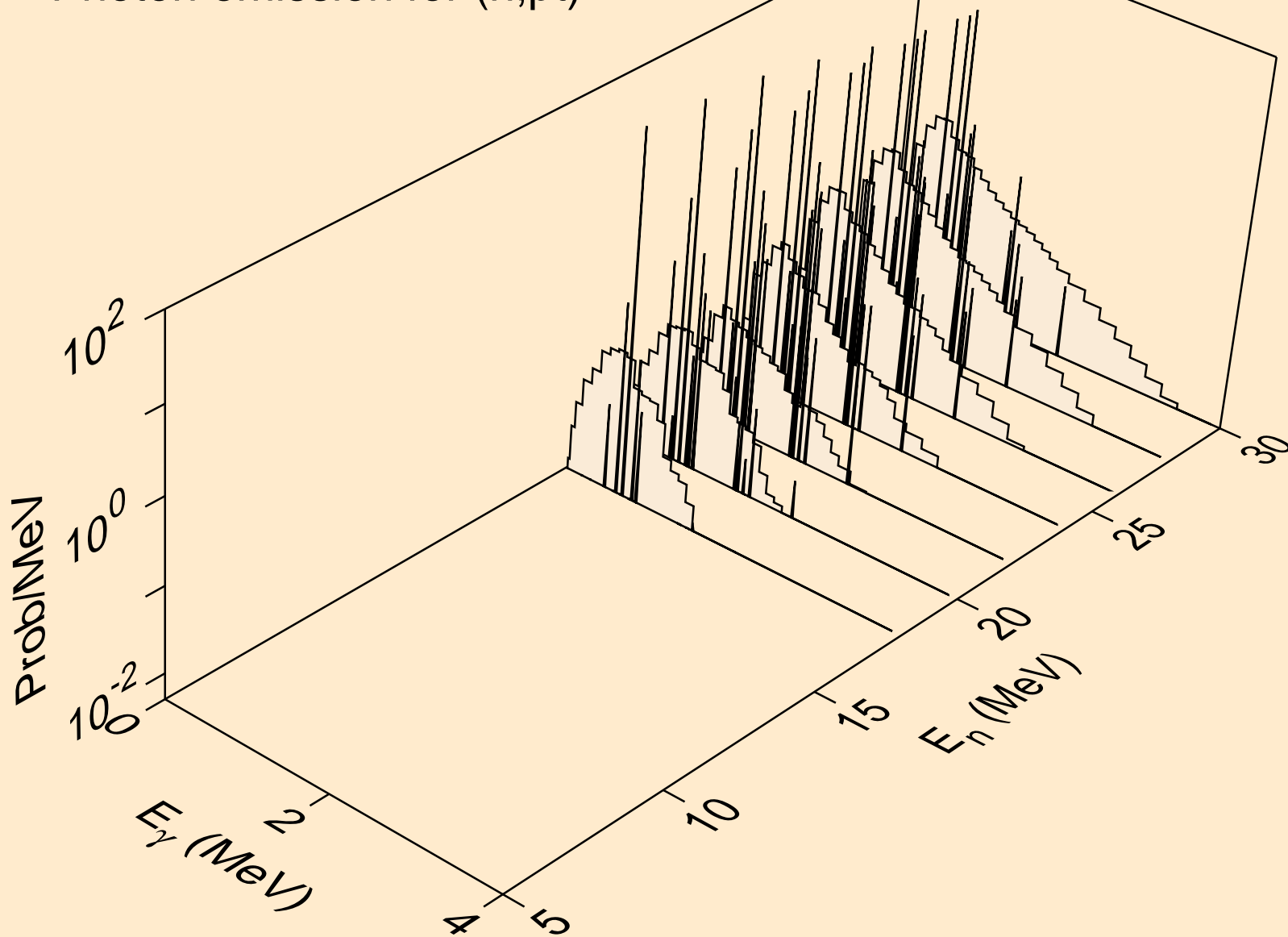

62-SM-147 FOR FENDL-3.2 FROM TENDL-2019 BY NJOY2016.60-
Photon emission for (n,da)

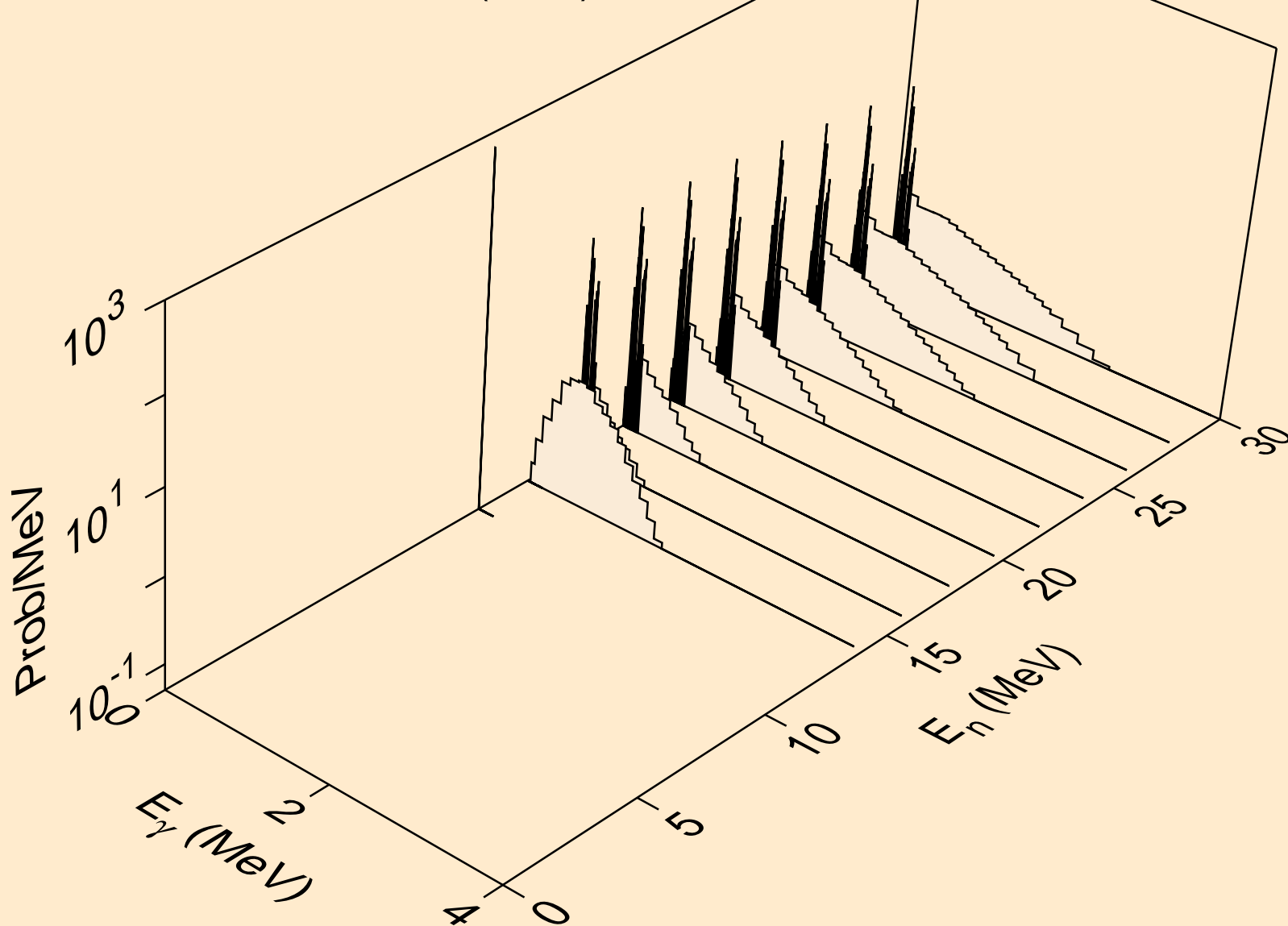

62-SM-147 FOR FENDL-3.2 FROM TENDL-2019 BY NJOY2016.60-
thermal capture photon spectrum

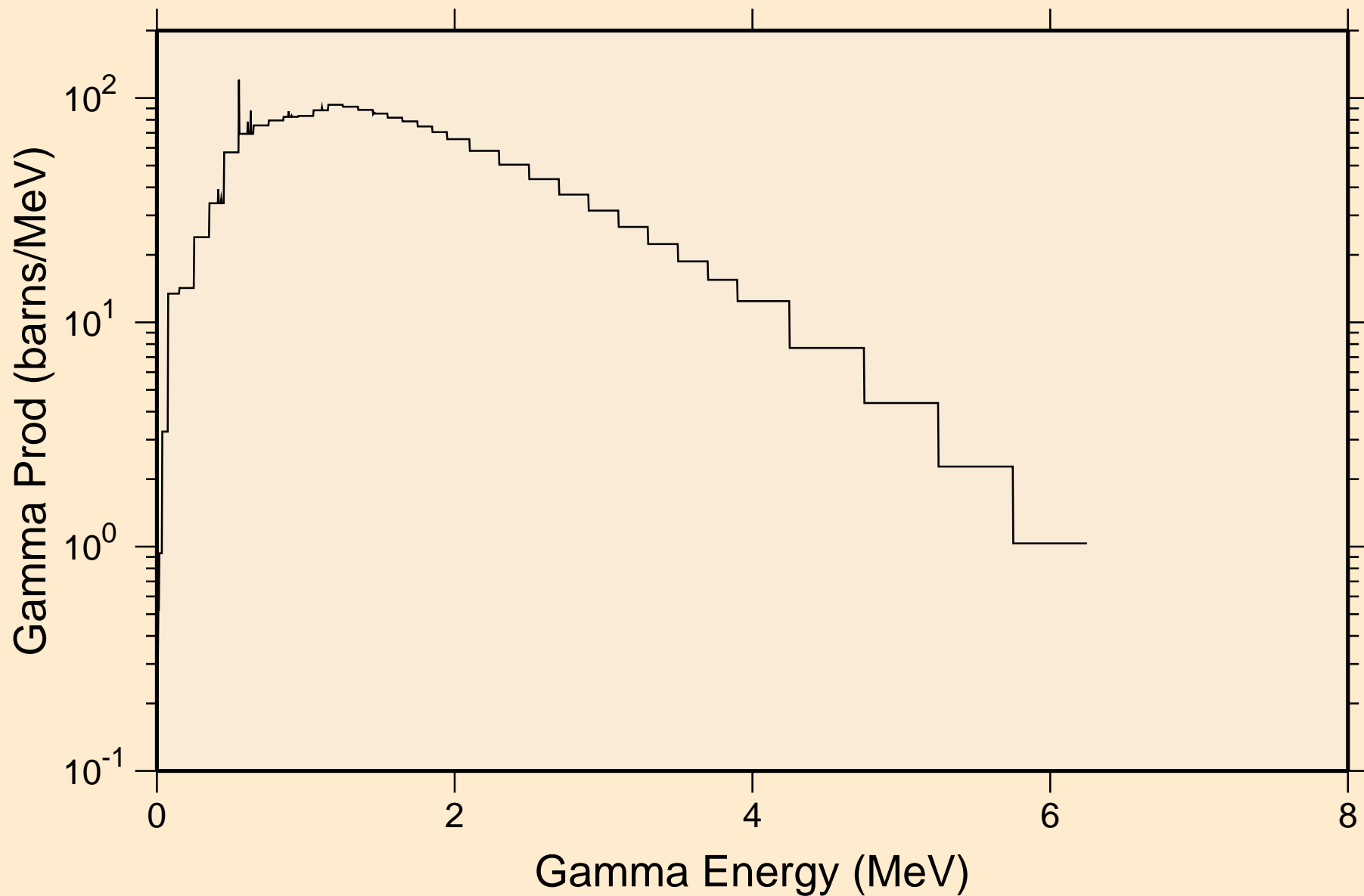

62-SM-147 FOR FENDL-3.2 FROM TENDL-2019 BY NJOY2016.60-
14 MeV photon spectrum

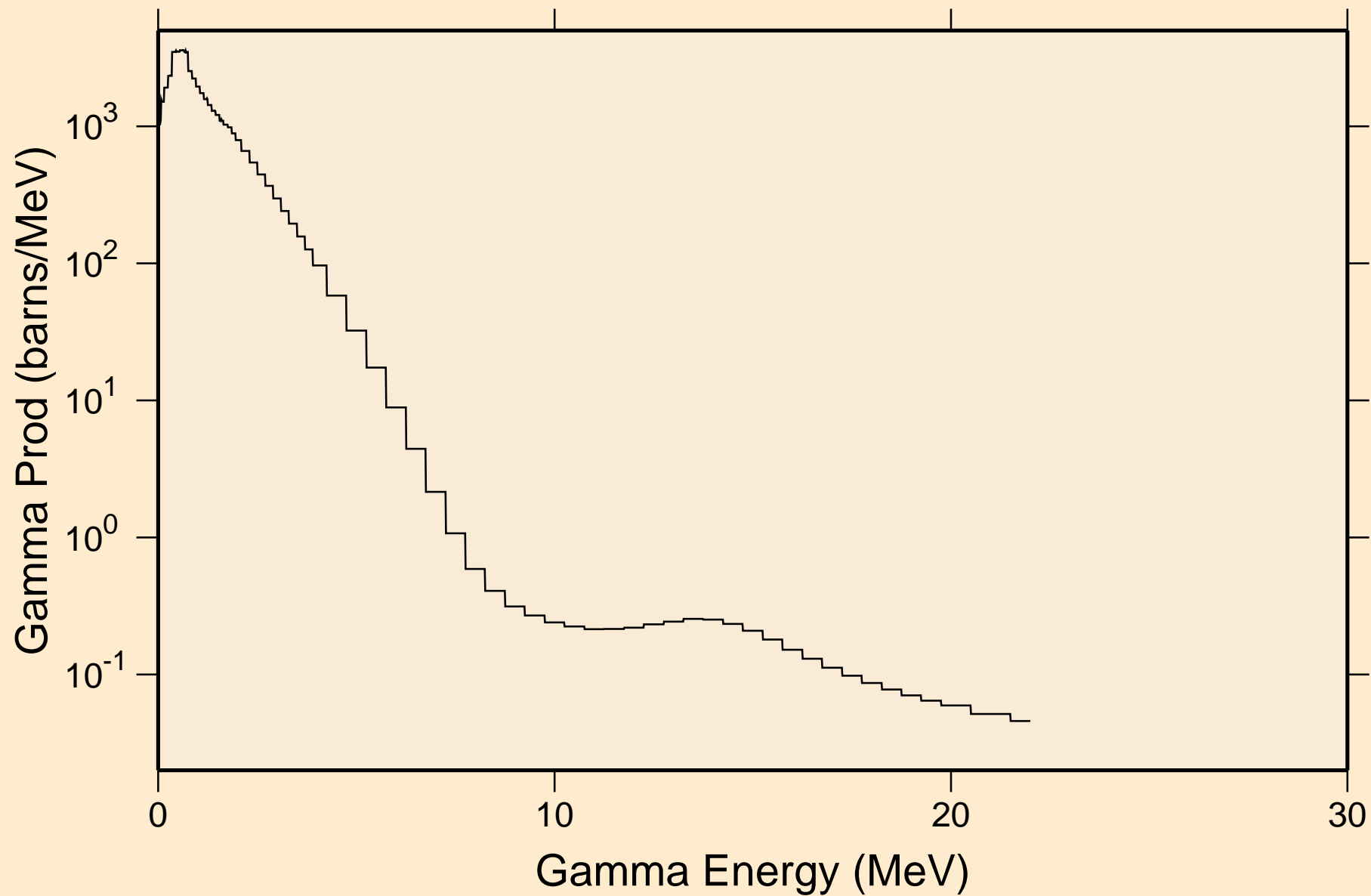

62-SM-147 FOR FENDL-3.2 FROM TENDL-2019 BY NJOY2016.60-
Particle heating contributions

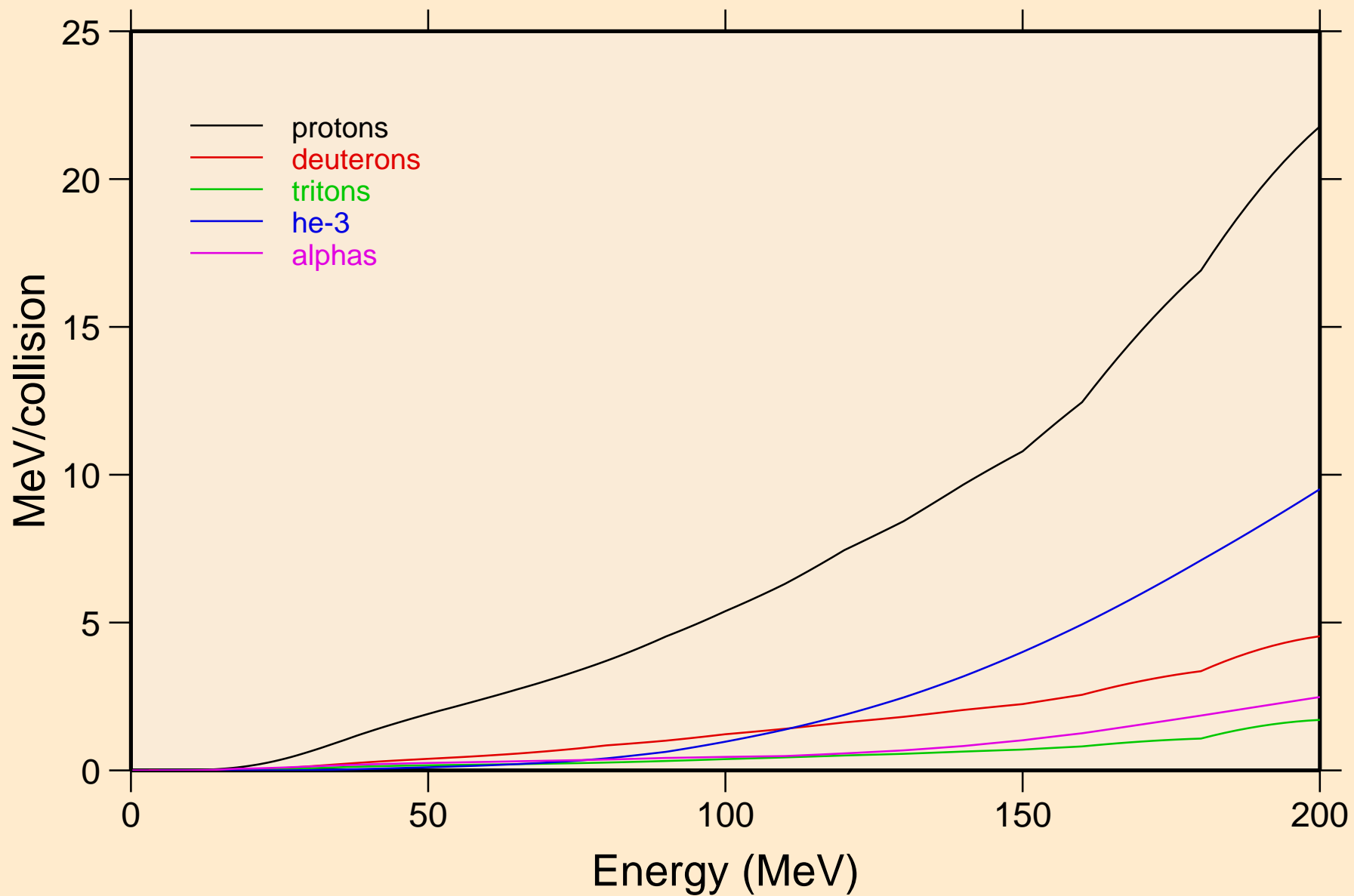

62-SM-147 FOR FENDL-3.2 FROM TENDL-2019 BY NJOY2016.60-
Recoil Heating

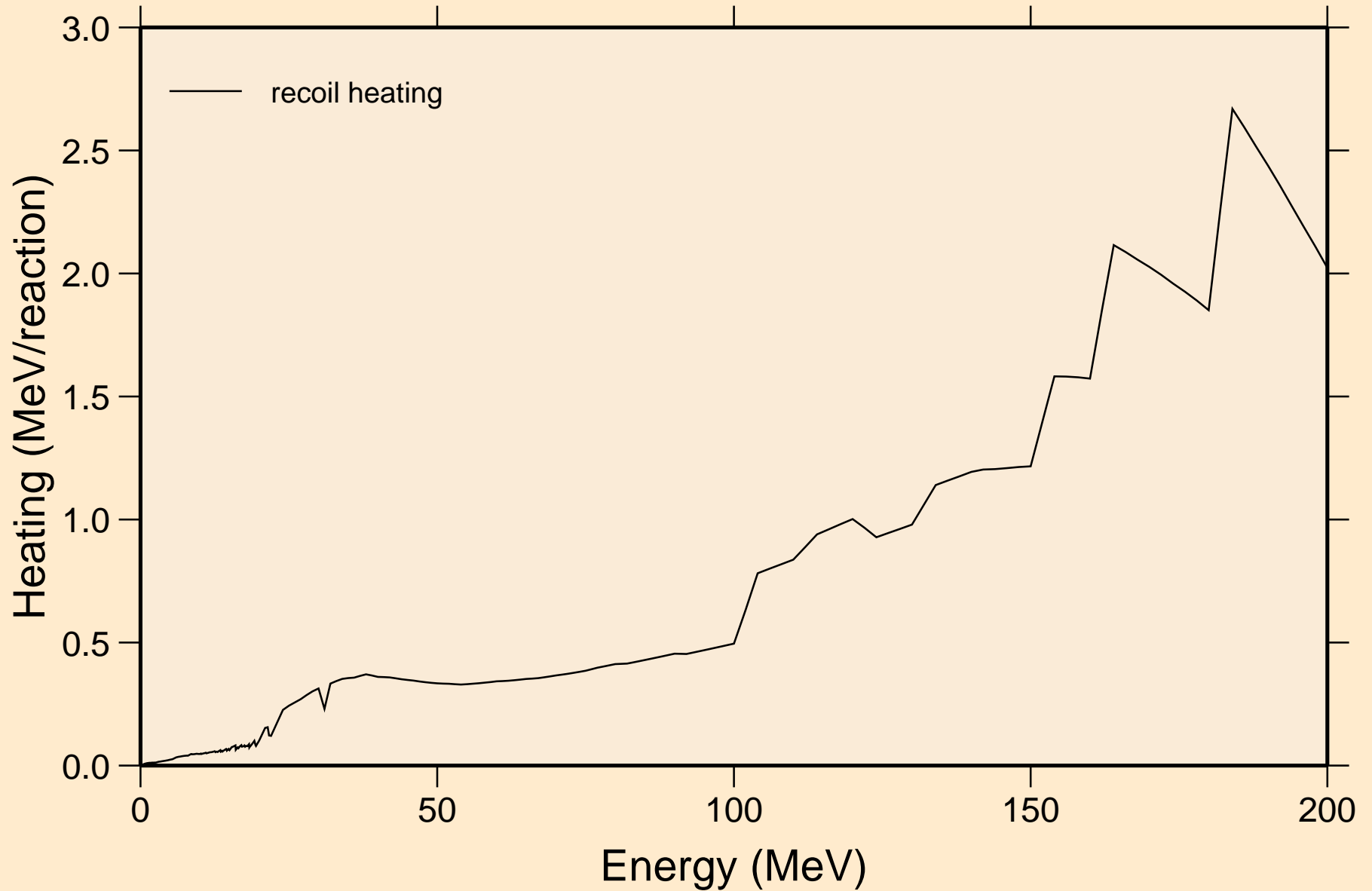

62-SM-147 FOR FENDL-3.2 FROM TENDL-2019 BY NJOY2016.60-
Particle production cross sections

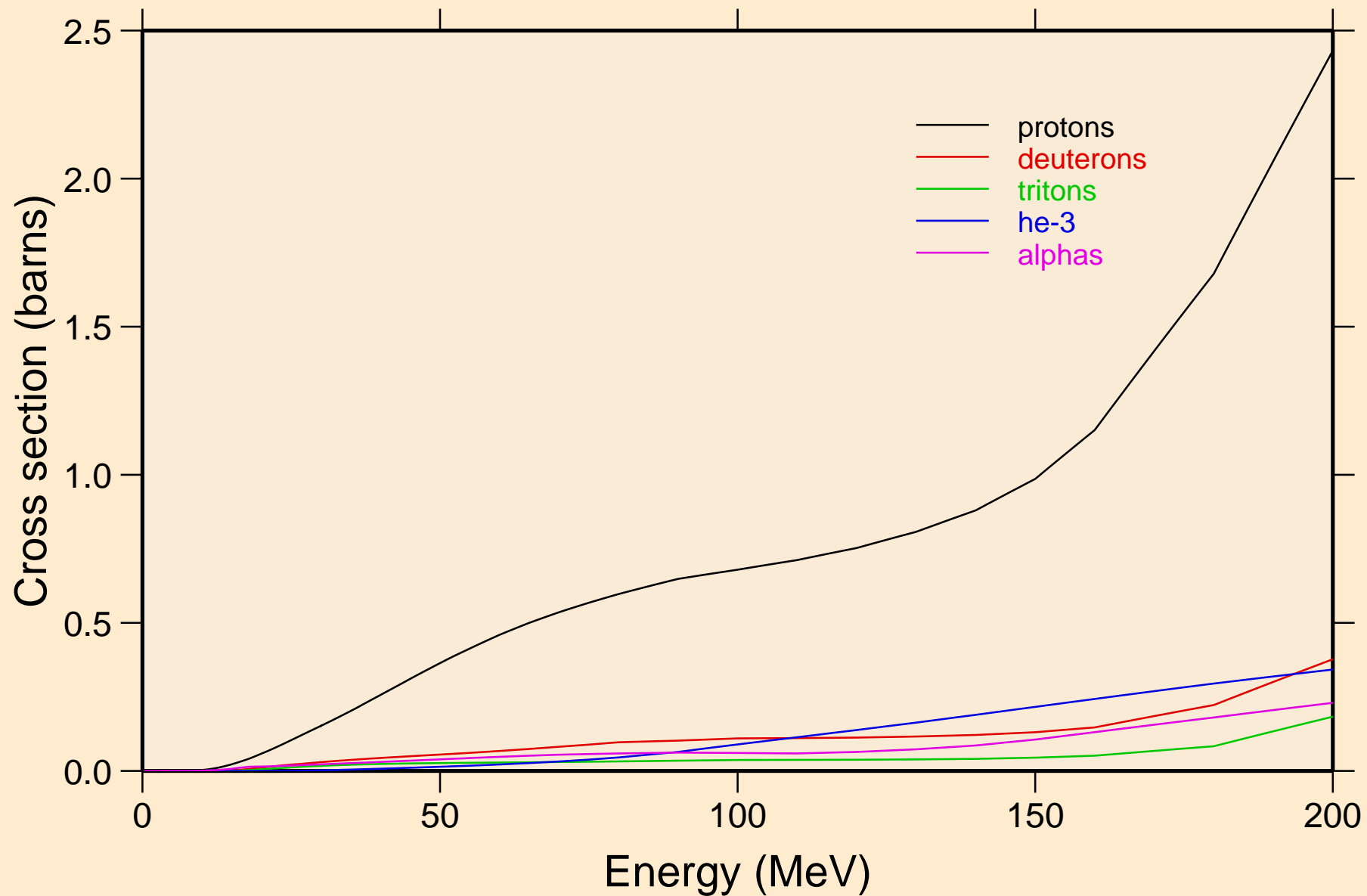

62-SM-147 FOR FENDL-3.2 FROM TENDL-2019 BY NJOY2016.60-
protons from (n,x)

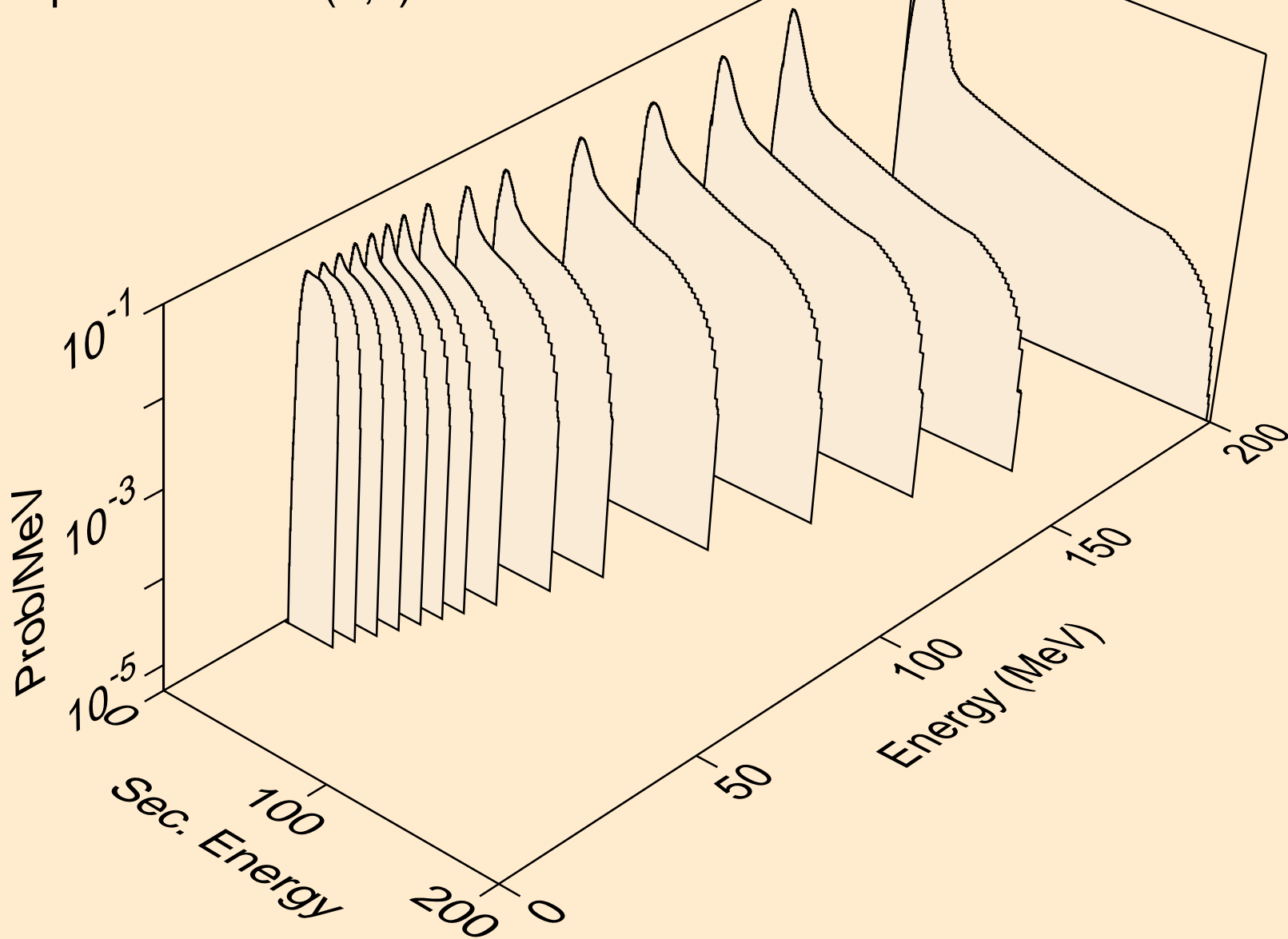

62-SM-147 FOR FENDL-3.2 FROM TENDL-2019 BY NJOY2016.60-
protons from (n,n*)p

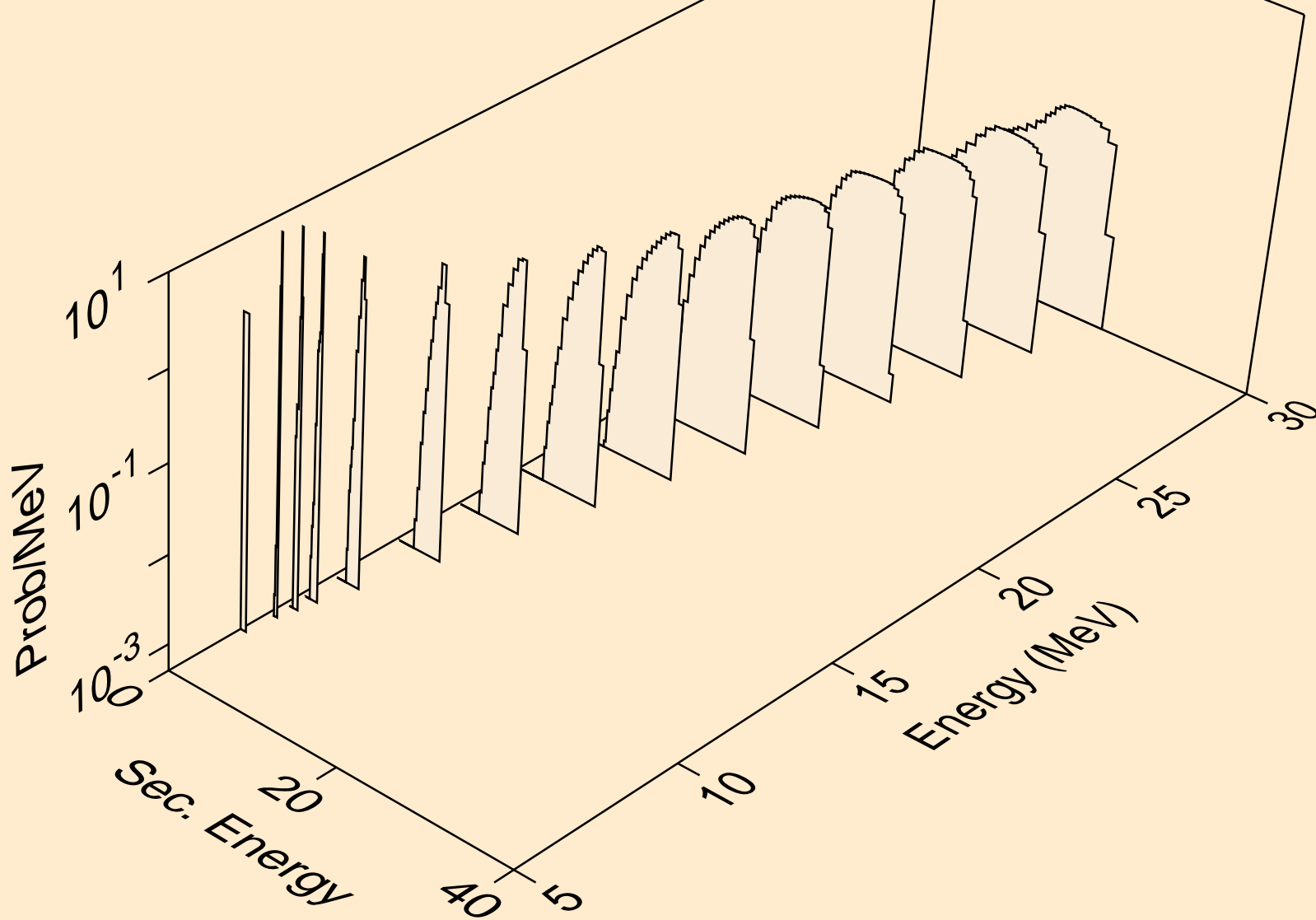

62-SM-147 FOR FENDL-3.2 FROM TENDL-2019 BY NJOY2016.60-
protons from (n,2np)

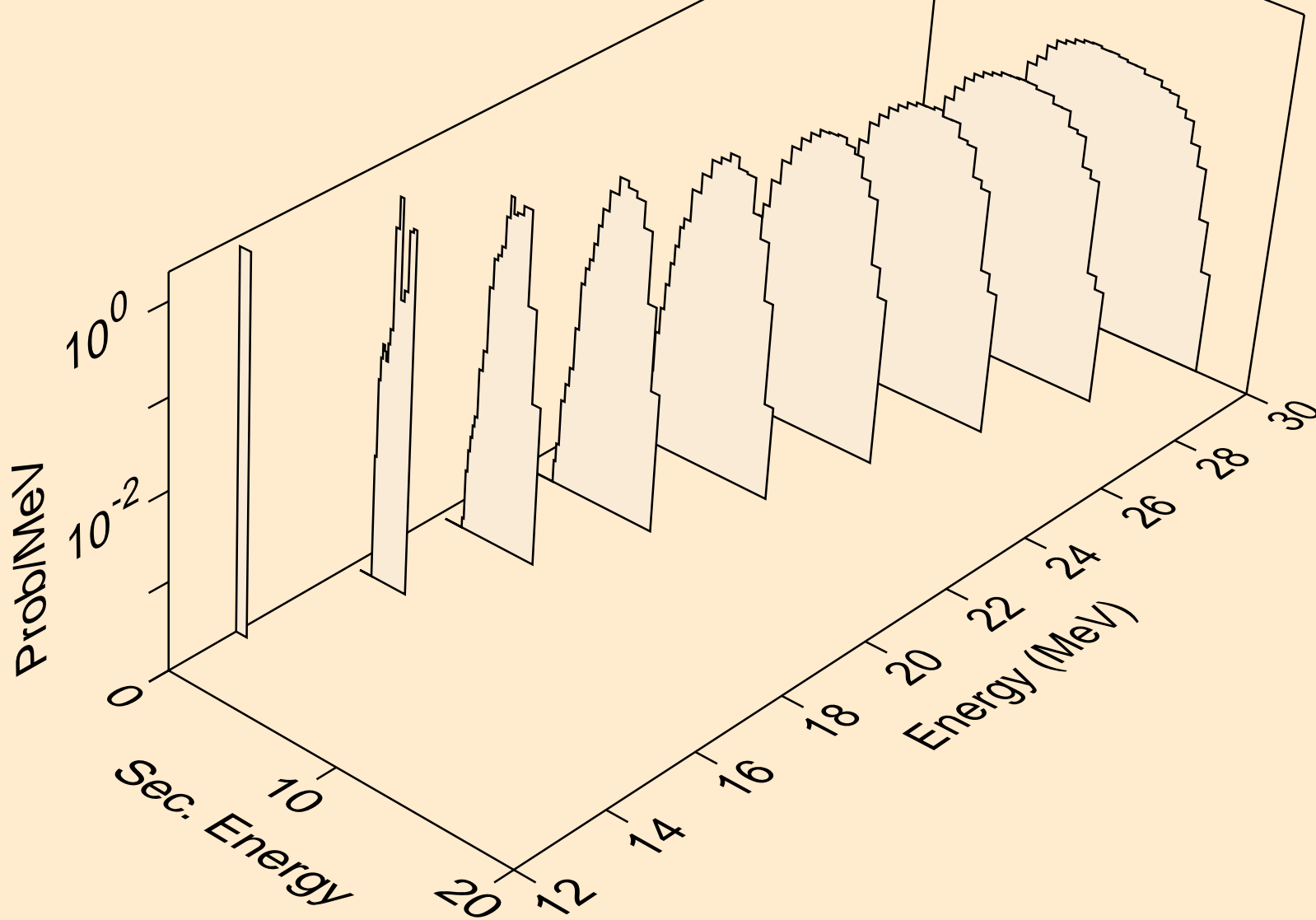

62-SM-147 FOR FENDL-3.2 FROM TENDL-2019 BY NJOY2016.60-
protons from (n,3np)

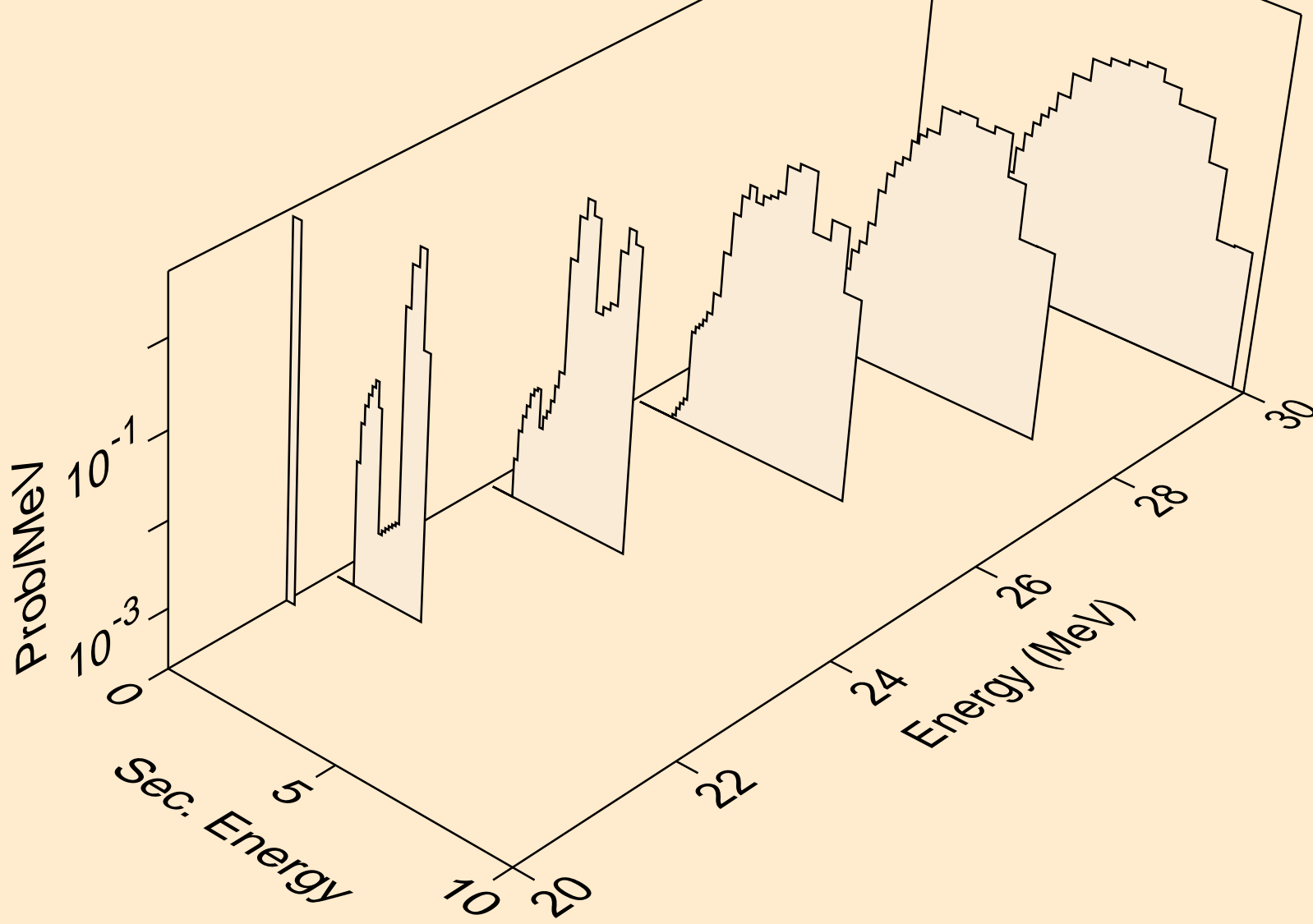

62-SM-147 FOR FENDL-3.2 FROM TENDL-2019 BY NJOY2016.60-
protons from (n,2np)

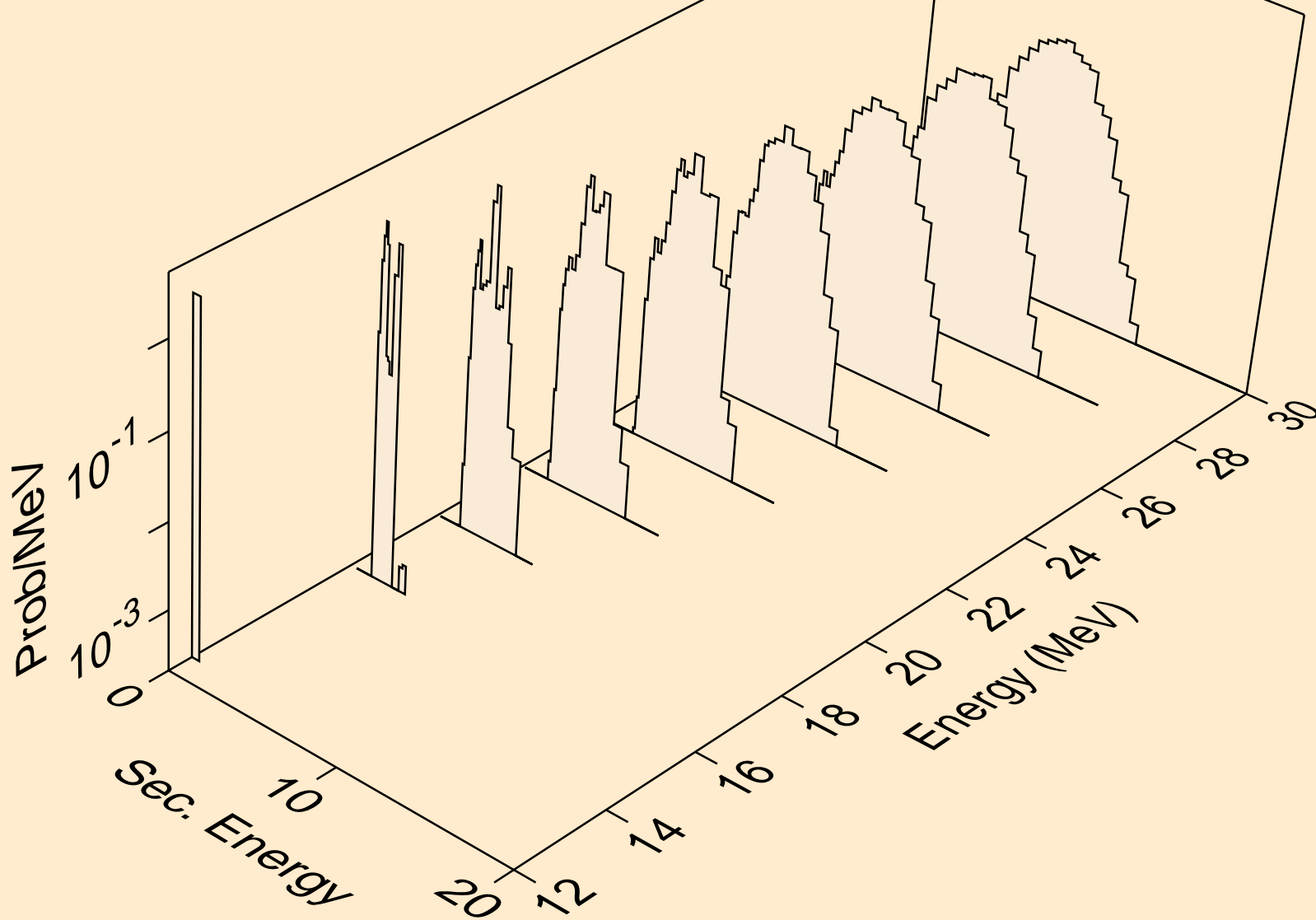

62-SM-147 FOR FENDL-3.2 FROM TENDL-2019 BY NJOY2016.60-
protons from (n,npa)

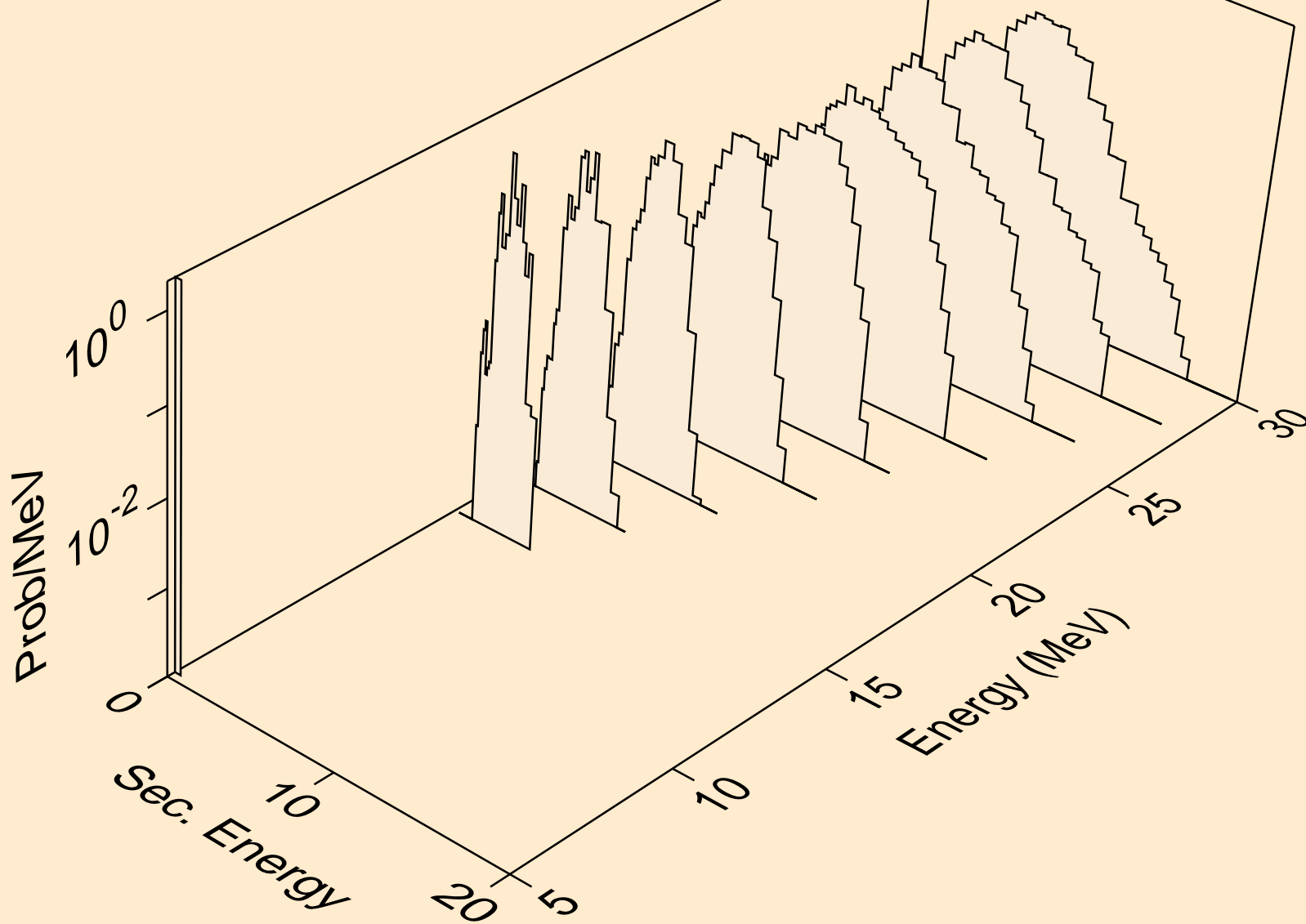

62-SM-147 FOR FENDL-3.2 FROM TENDL-2019 BY NJOY2016.60-
protons from (n,p)

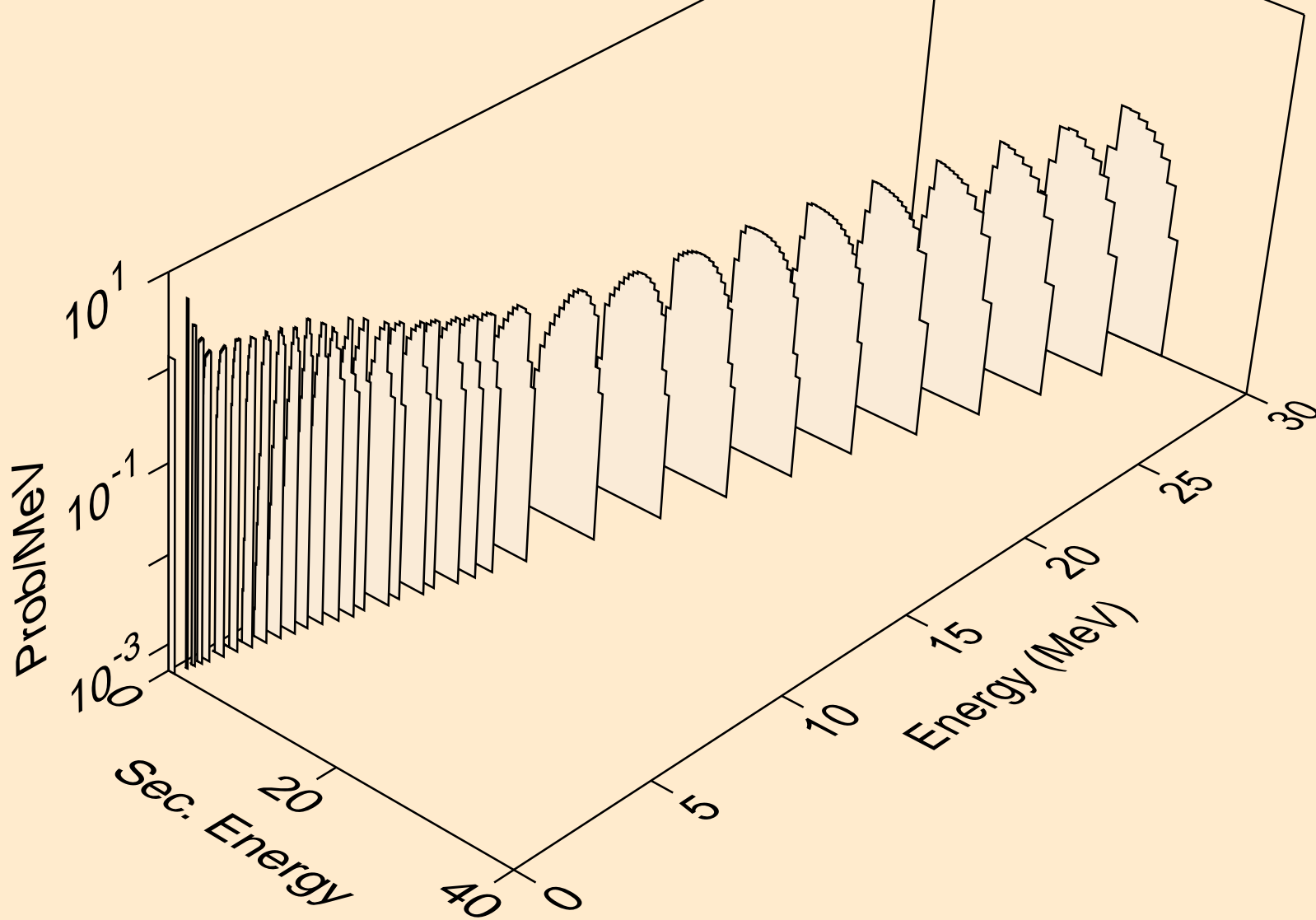

62-SM-147 FOR FENDL-3.2 FROM TENDL-2019 BY NJOY2016.60-
protons from (n,2p)

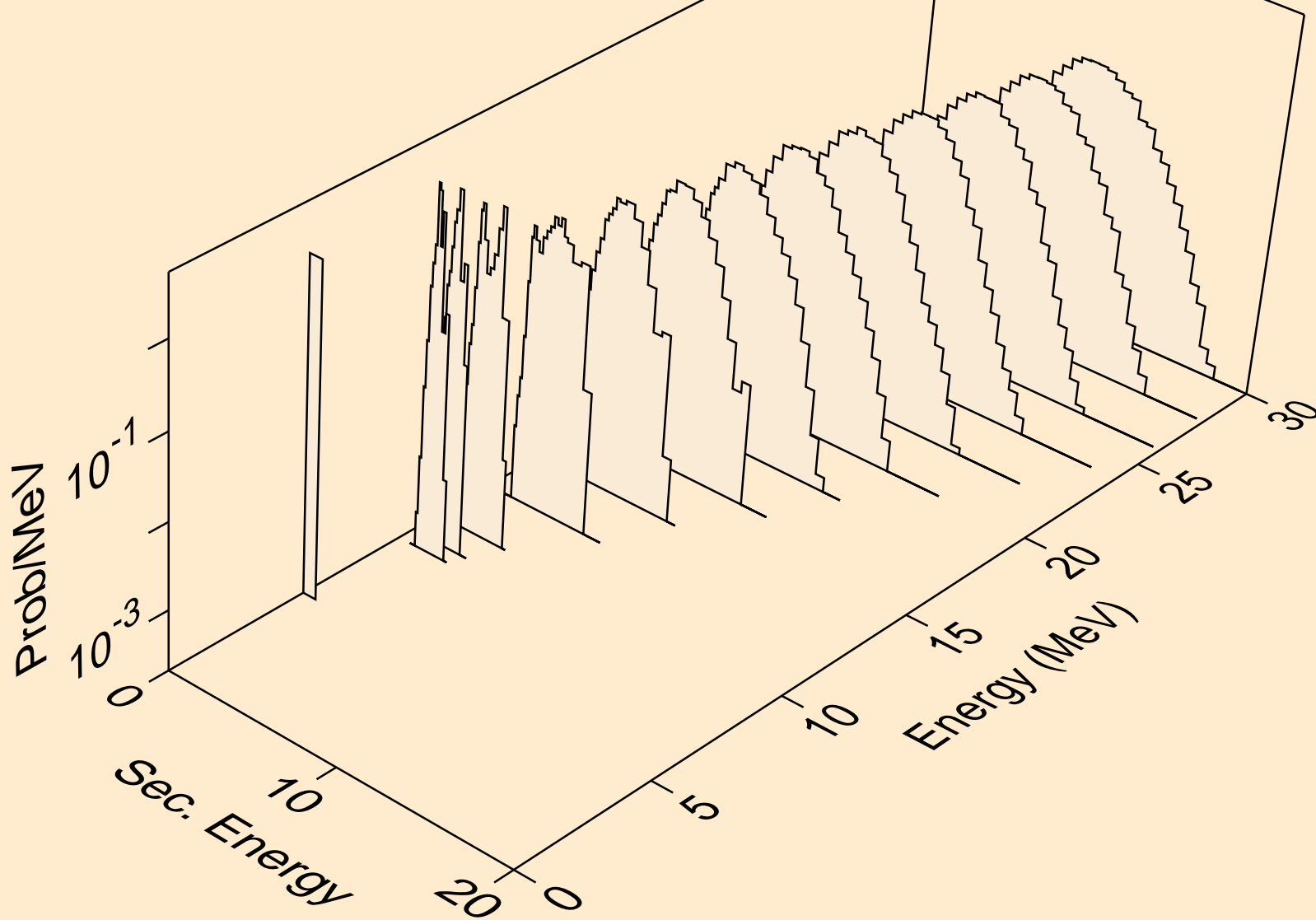

62-SM-147 FOR FENDL-3.2 FROM TENDL-2019 BY NJOY2016.60-
protons from (n,pa)

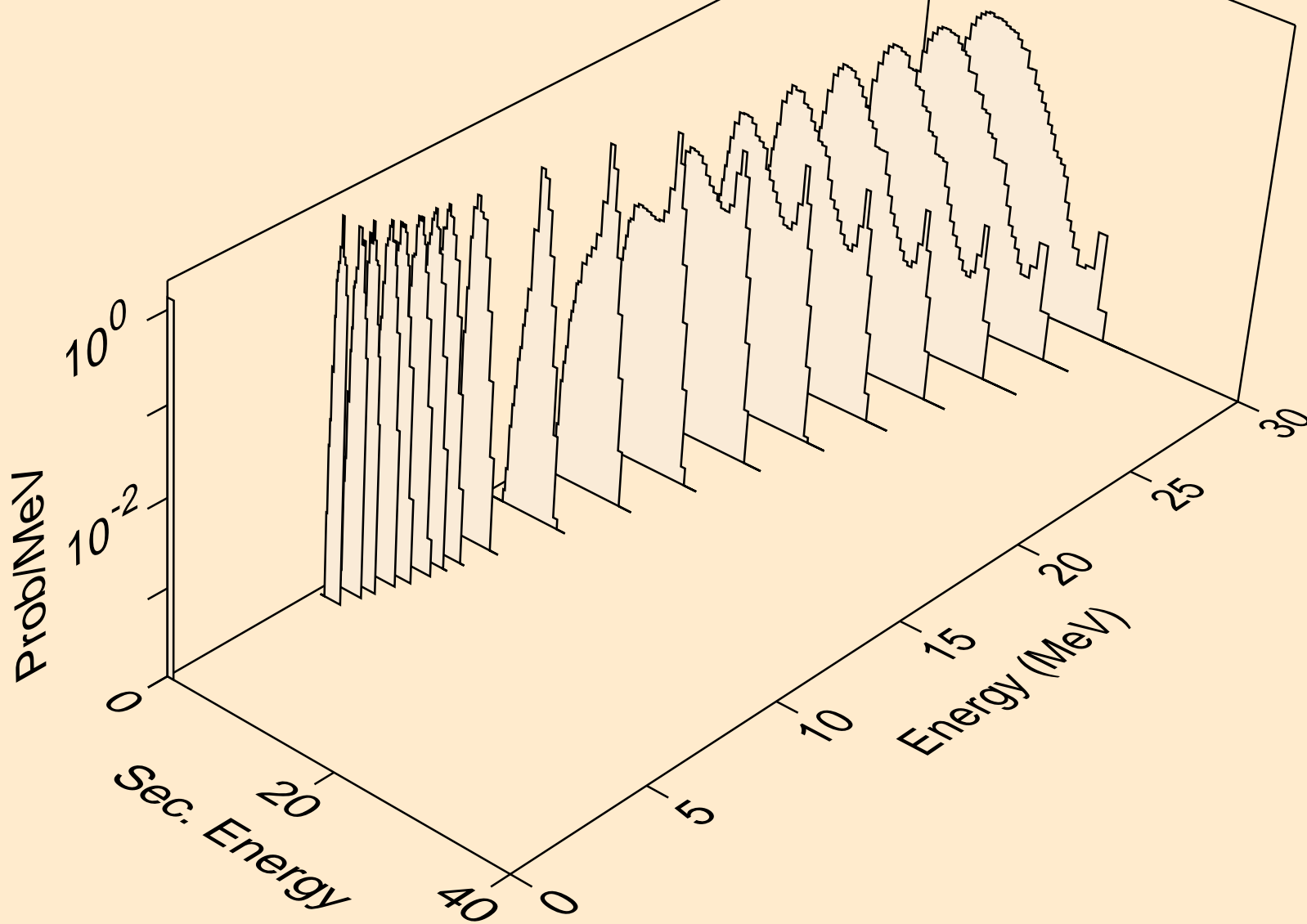

62-SM-147 FOR FENDL-3.2 FROM TENDL-2019 BY NJOY2016.60-
protons from (n,pd)

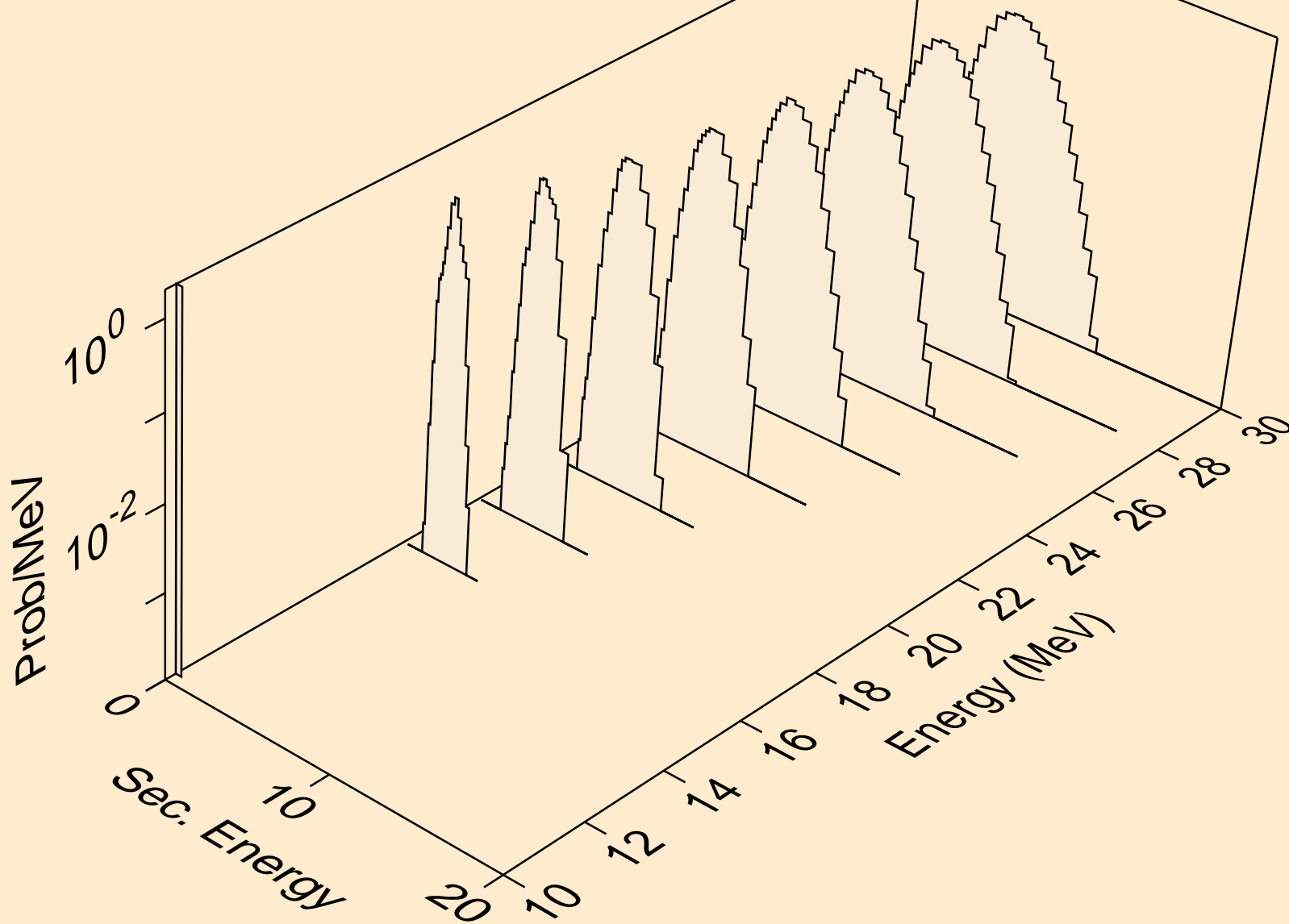

62-SM-147 FOR FENDL-3.2 FROM TENDL-2019 BY NJOY2016.60-
protons from (n,pt)

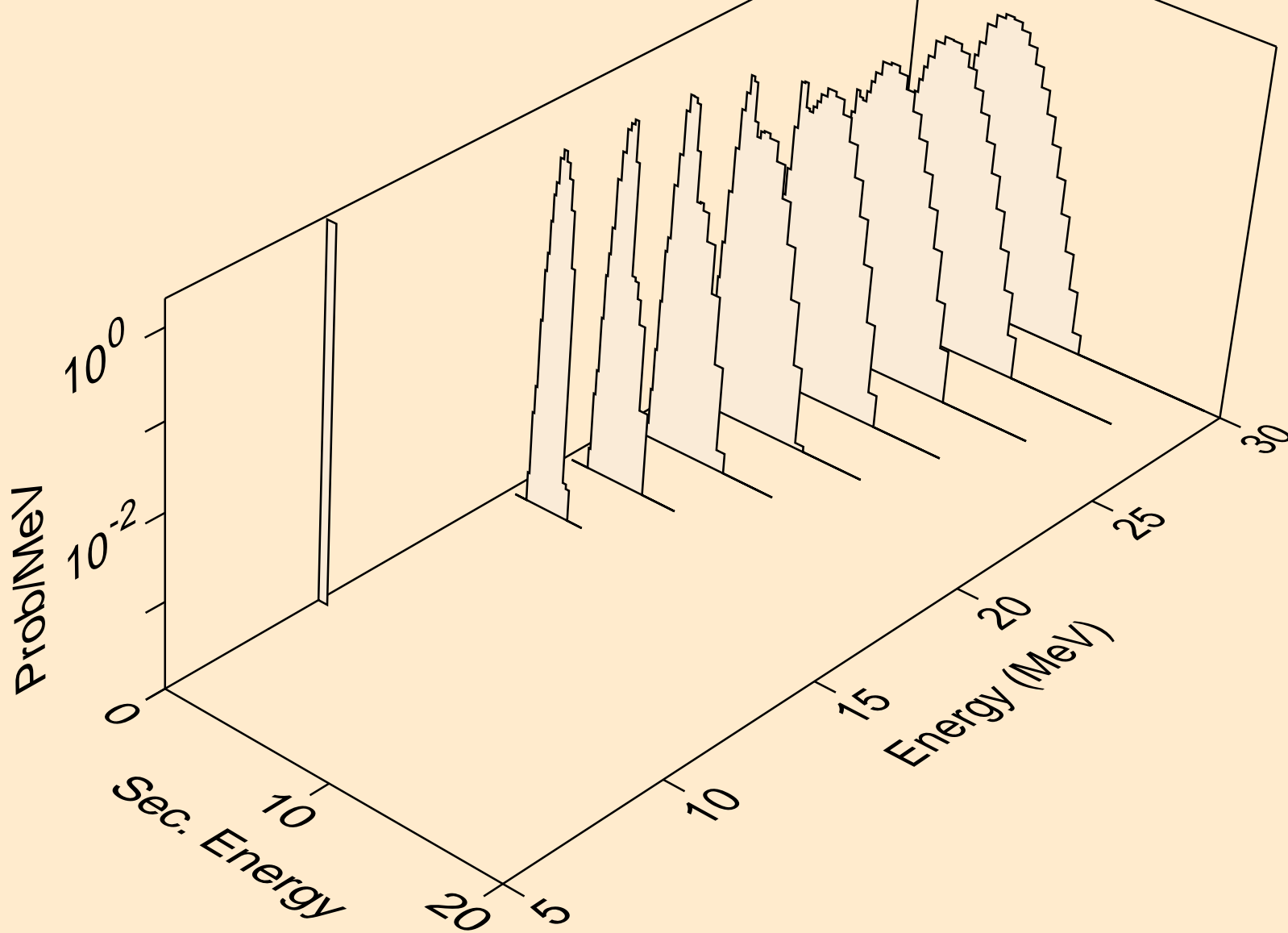

62-SM-147 FOR FENDL-3.2 FROM TENDL-2019 BY NJOY2016.60-
deuterons from (n,x)

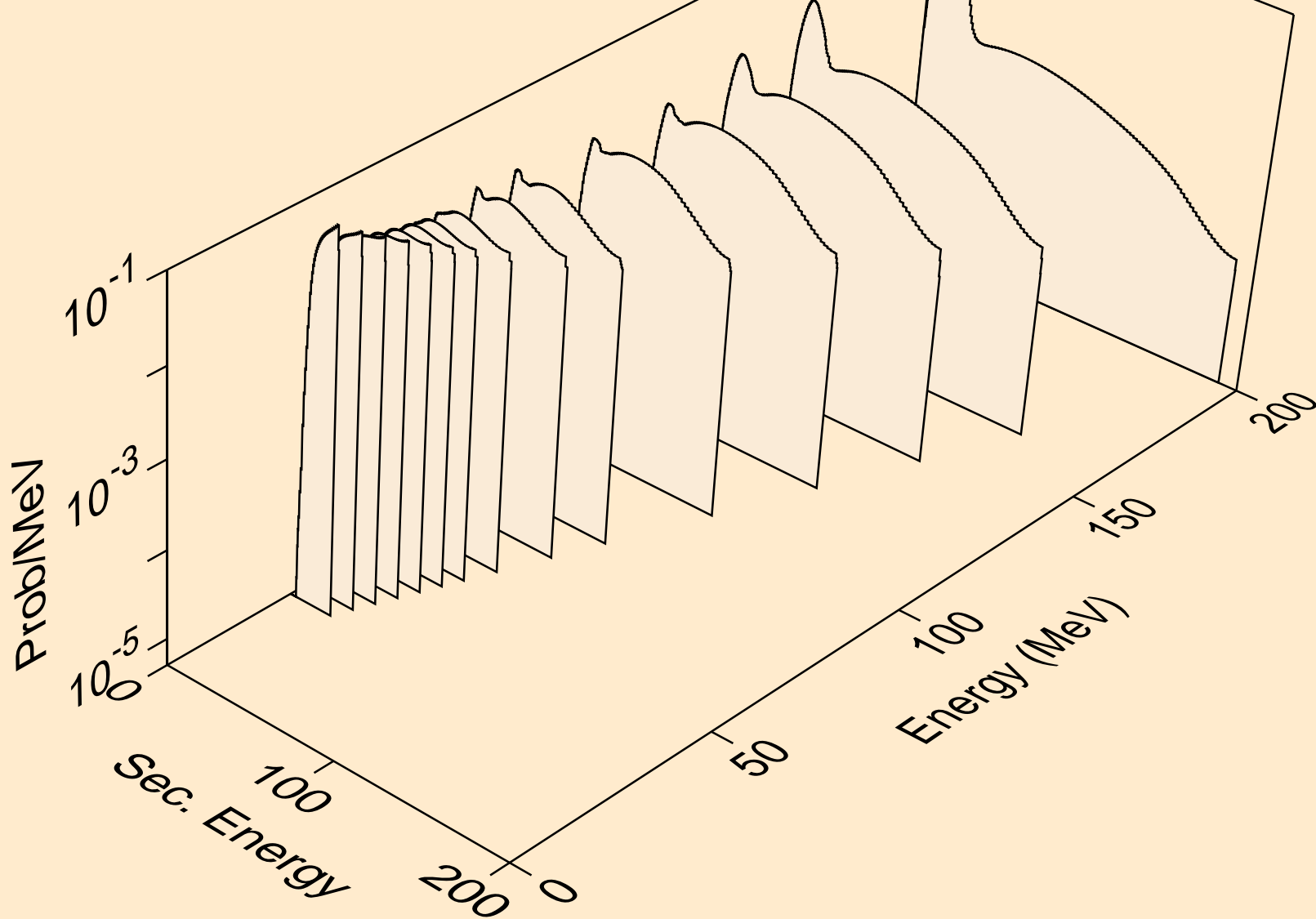

62-SM-147 FOR FENDL-3.2 FROM TENDL-2019 BY NJOY2016.60-
deuterons from (n,2nd)

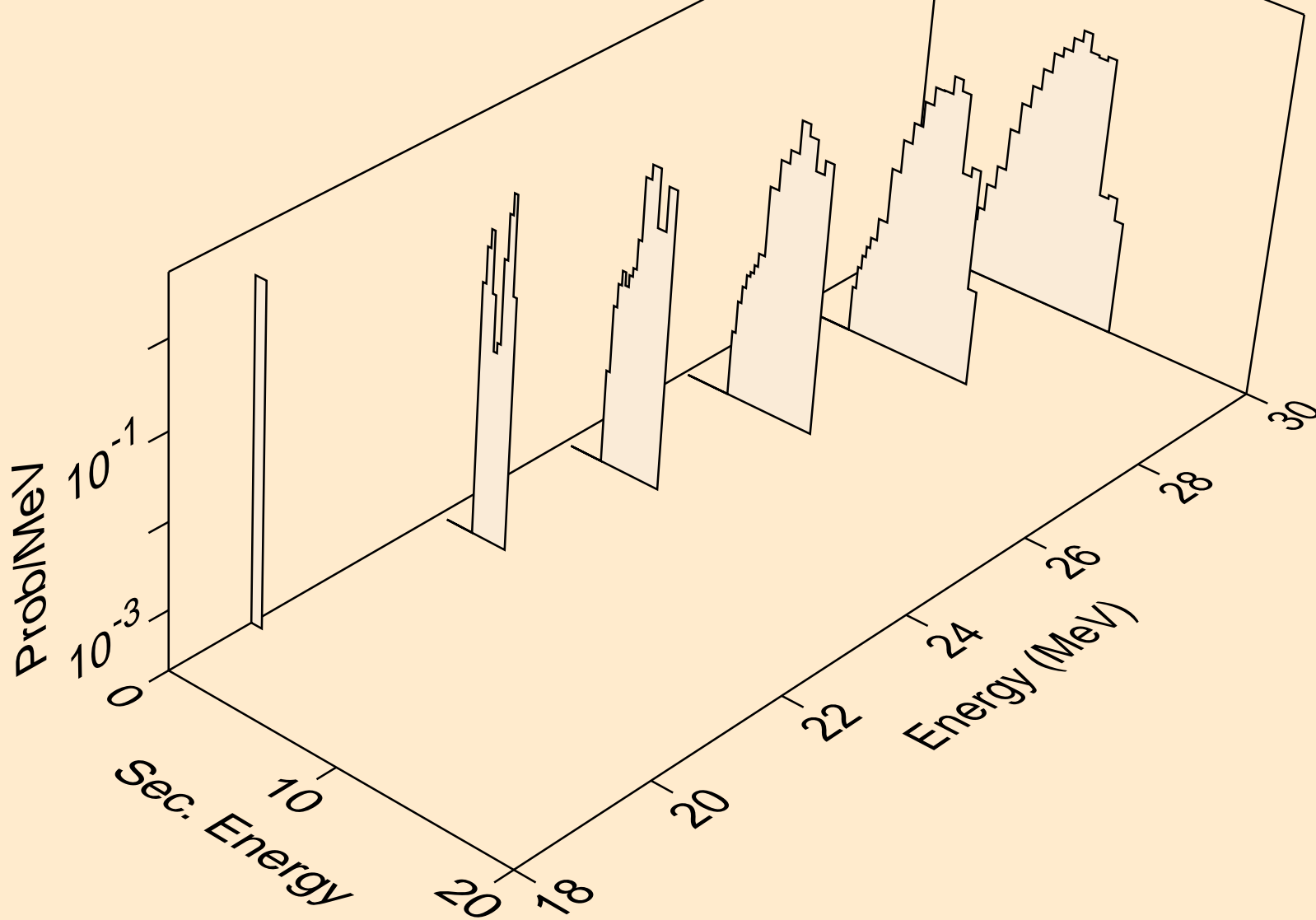

62-SM-147 FOR FENDL-3.2 FROM TENDL-2019 BY NJOY2016.60-
deuterons from (n,n*)d

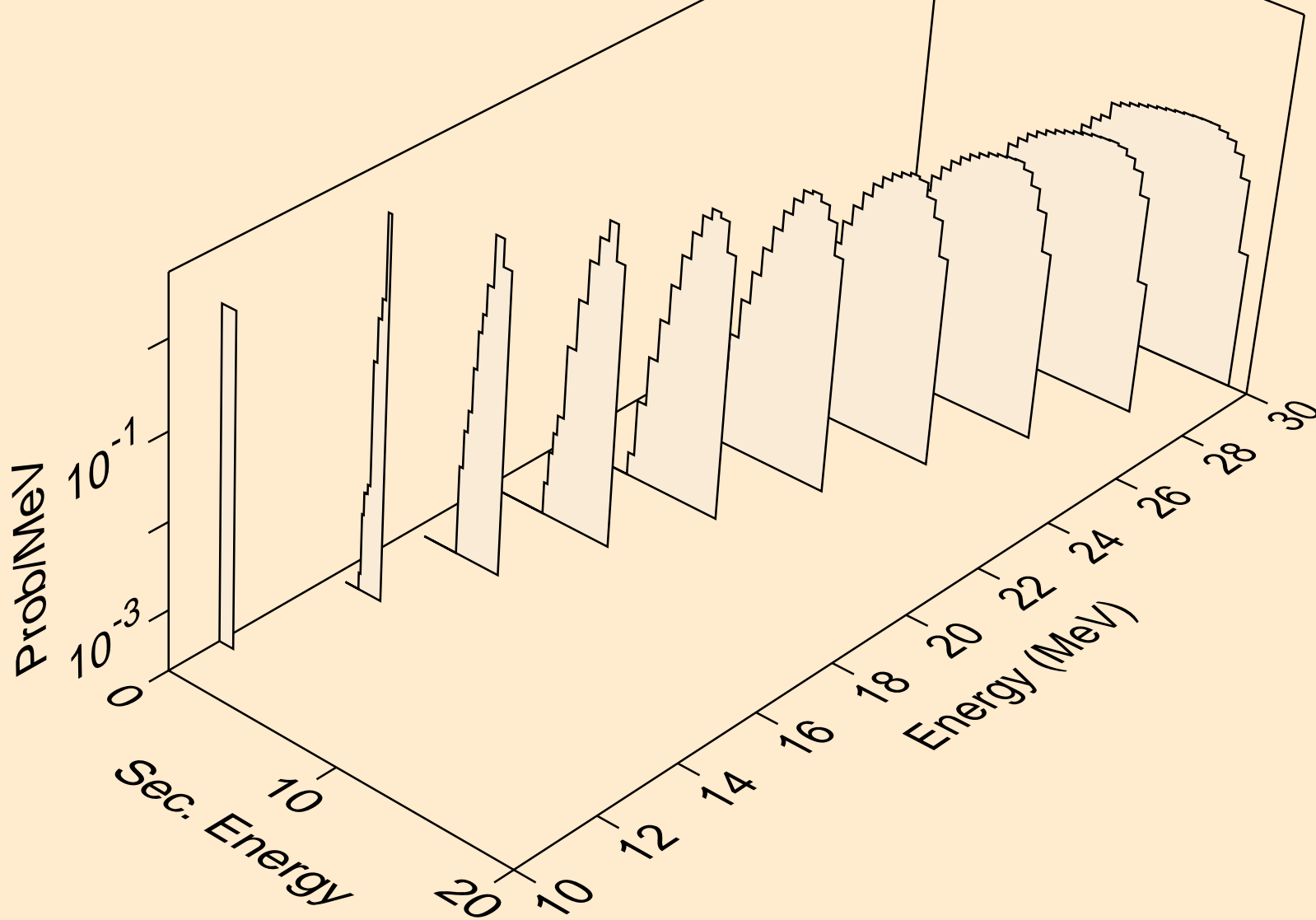

62-SM-147 FOR FENDL-3.2 FROM TENDL-2019 BY NJOY2016.60-
deuterons from (n,d)

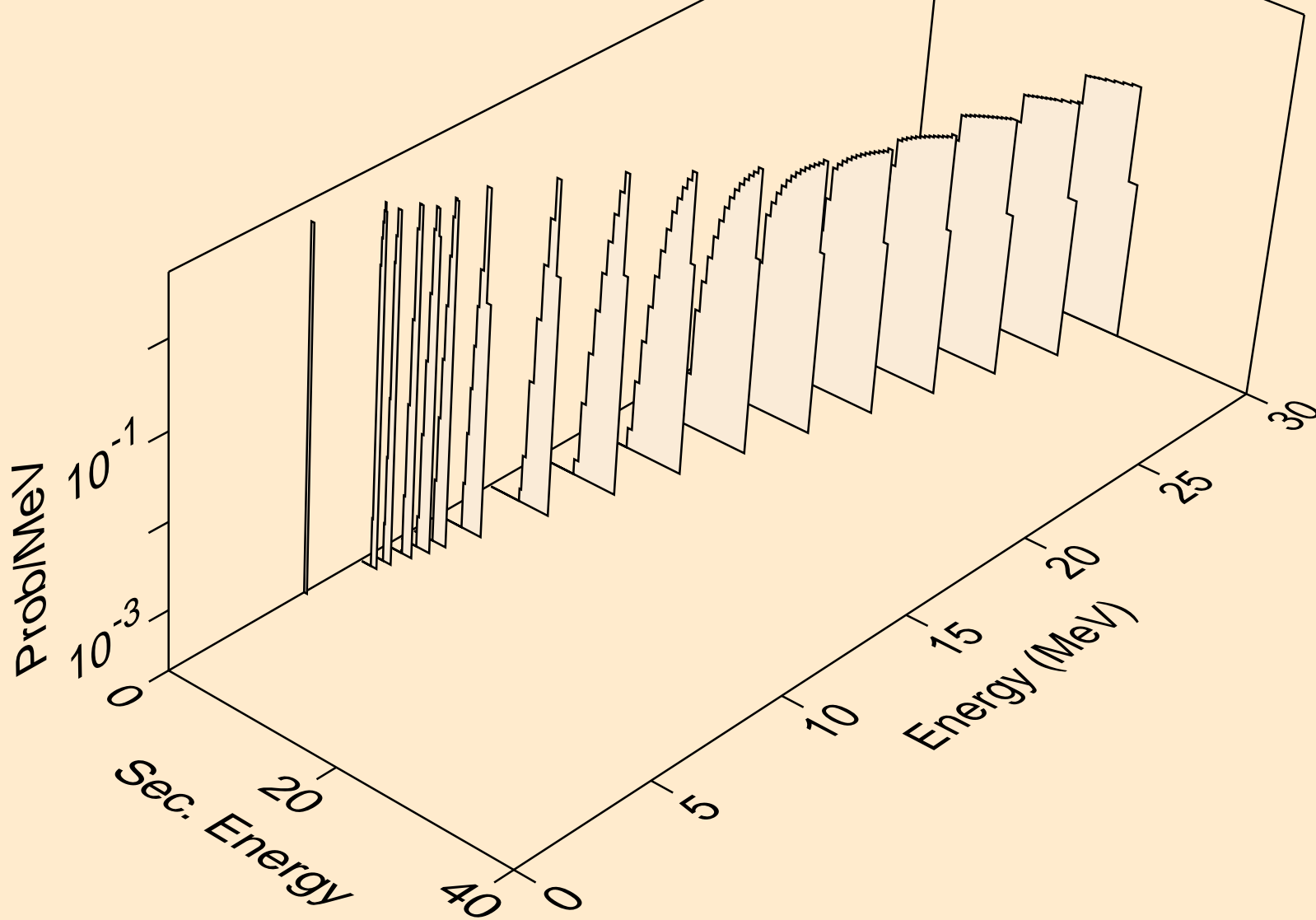

62-SM-147 FOR FENDL-3.2 FROM TENDL-2019 BY NJOY2016.60-
deuterons from (n,pd)

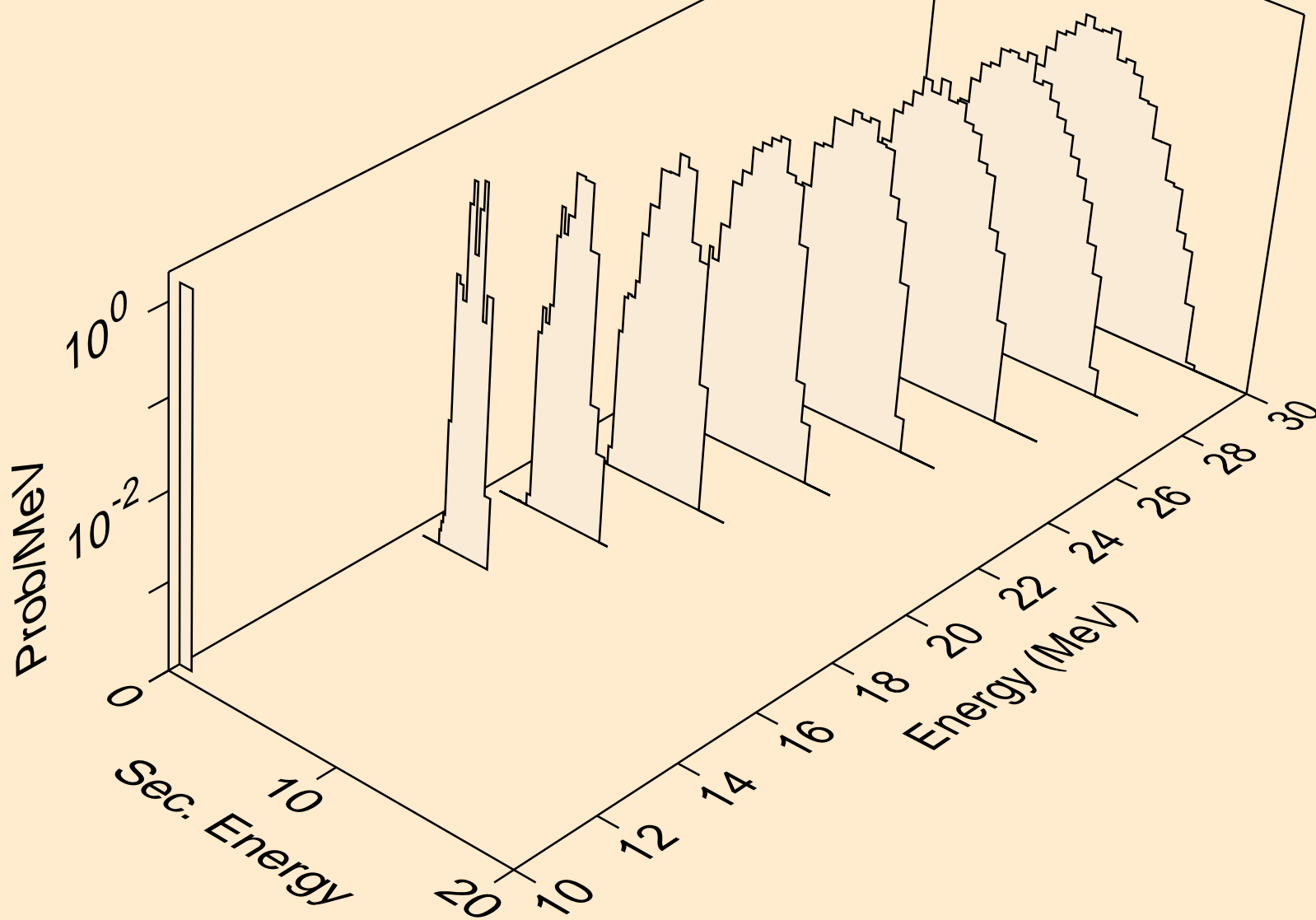

62-SM-147 FOR FENDL-3.2 FROM TENDL-2019 BY NJOY2016.60-
deuterons from (n,da)

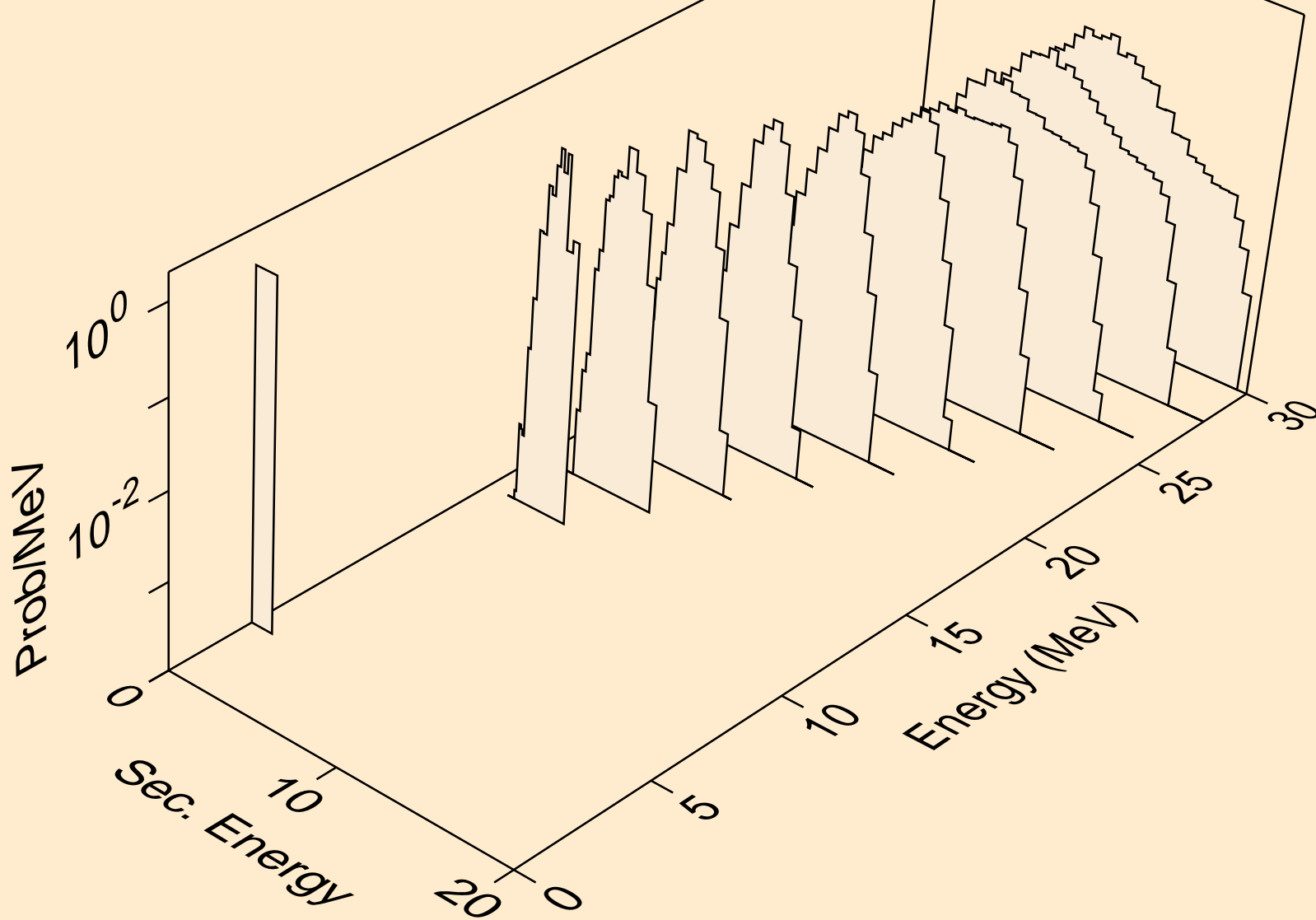

62-SM-147 FOR FENDL-3.2 FROM TENDL-2019 BY NJOY2016.60-
tritons from (n,x)

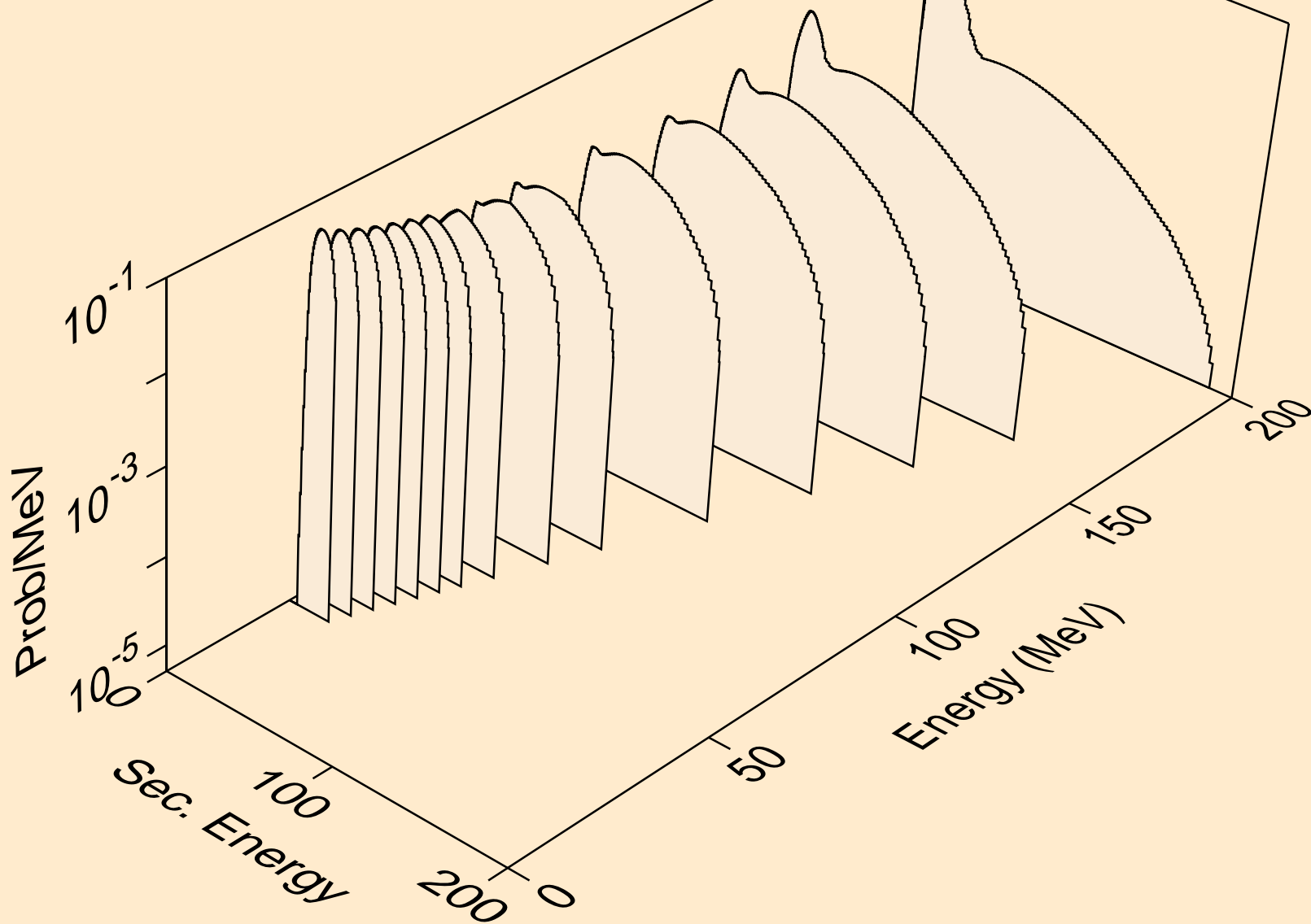

62-SM-147 FOR FENDL-3.2 FROM TENDL-2019 BY NJOY2016.60-
tritons from (n,n*)t

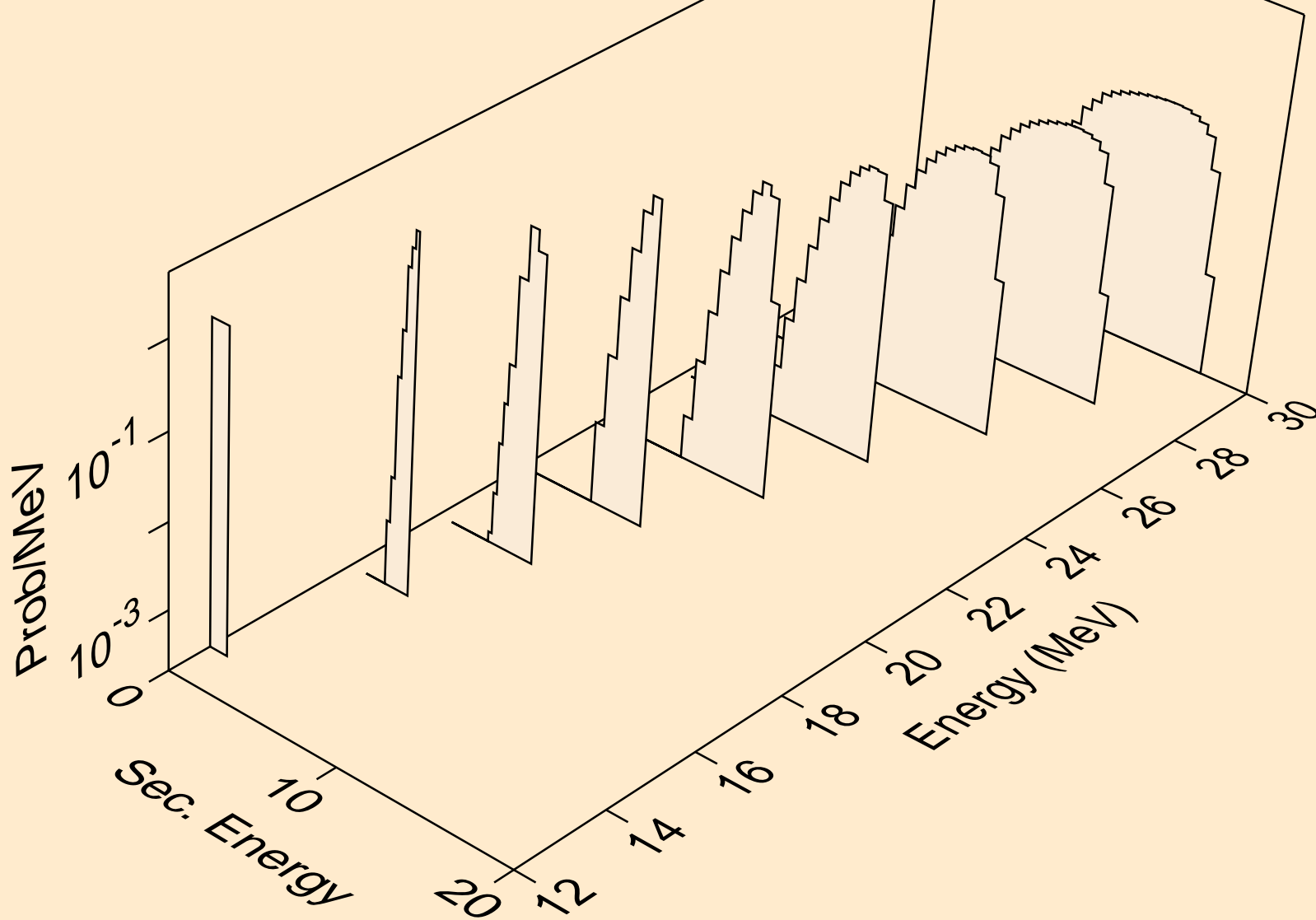

62-SM-147 FOR FENDL-3.2 FROM TENDL-2019 BY NJOY2016.60-
tritons from (n,t)

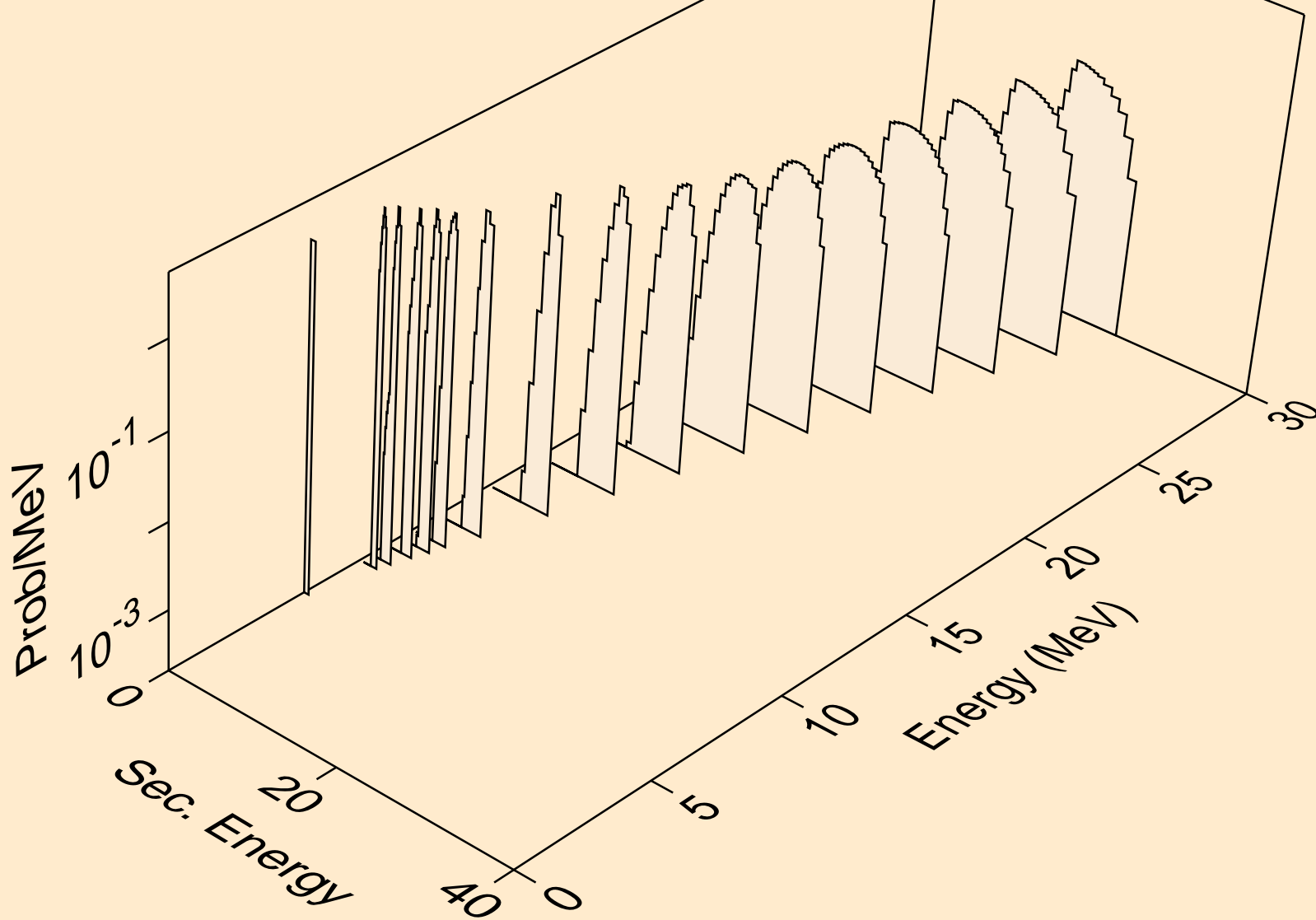

62-SM-147 FOR FENDL-3.2 FROM TENDL-2019 BY NJOY2016.60-
tritons from (n,pt)

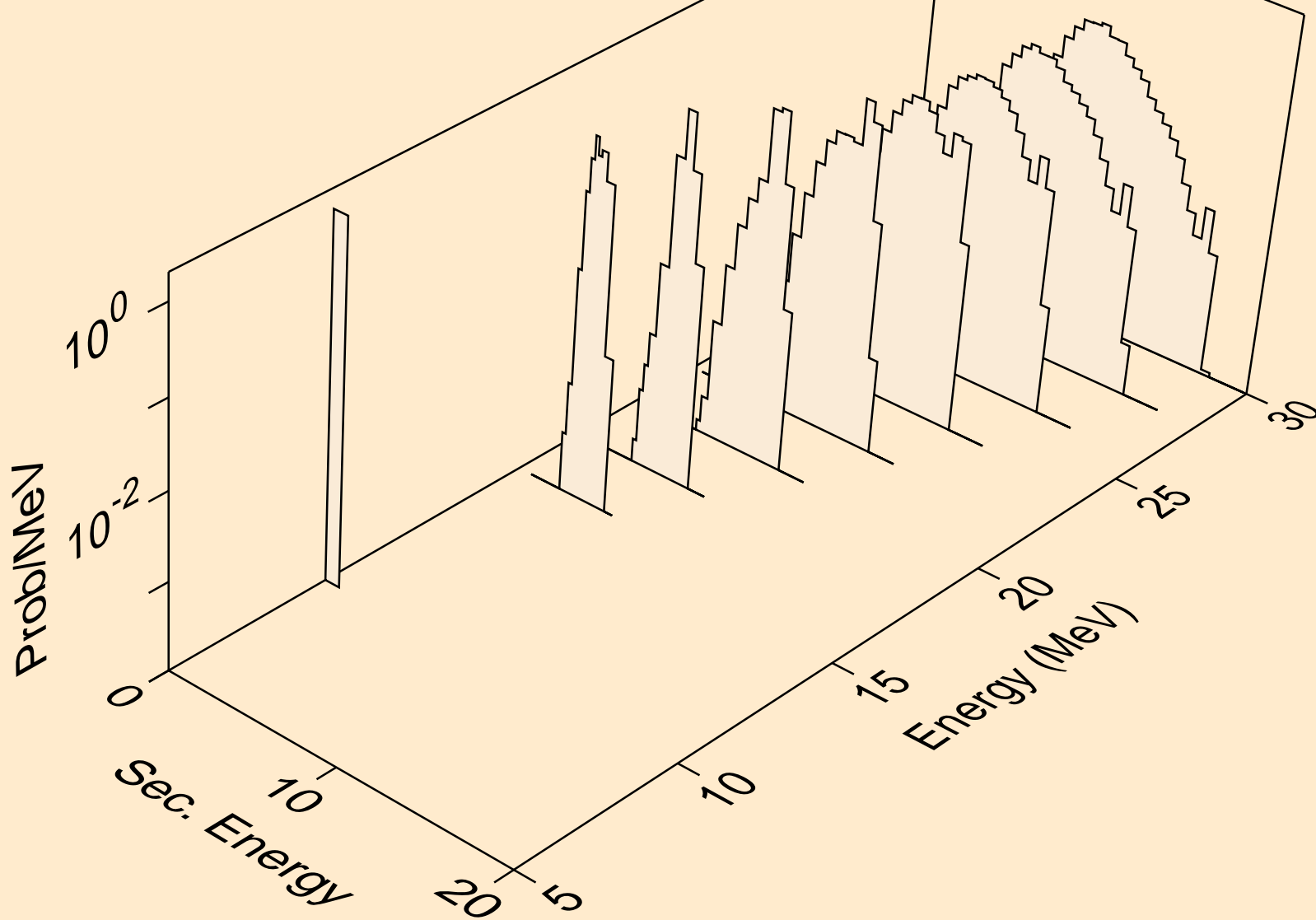

62-SM-147 FOR FENDL-3.2 FROM TENDL-2019 BY NJOY2016.60-
he3s from (n,x)

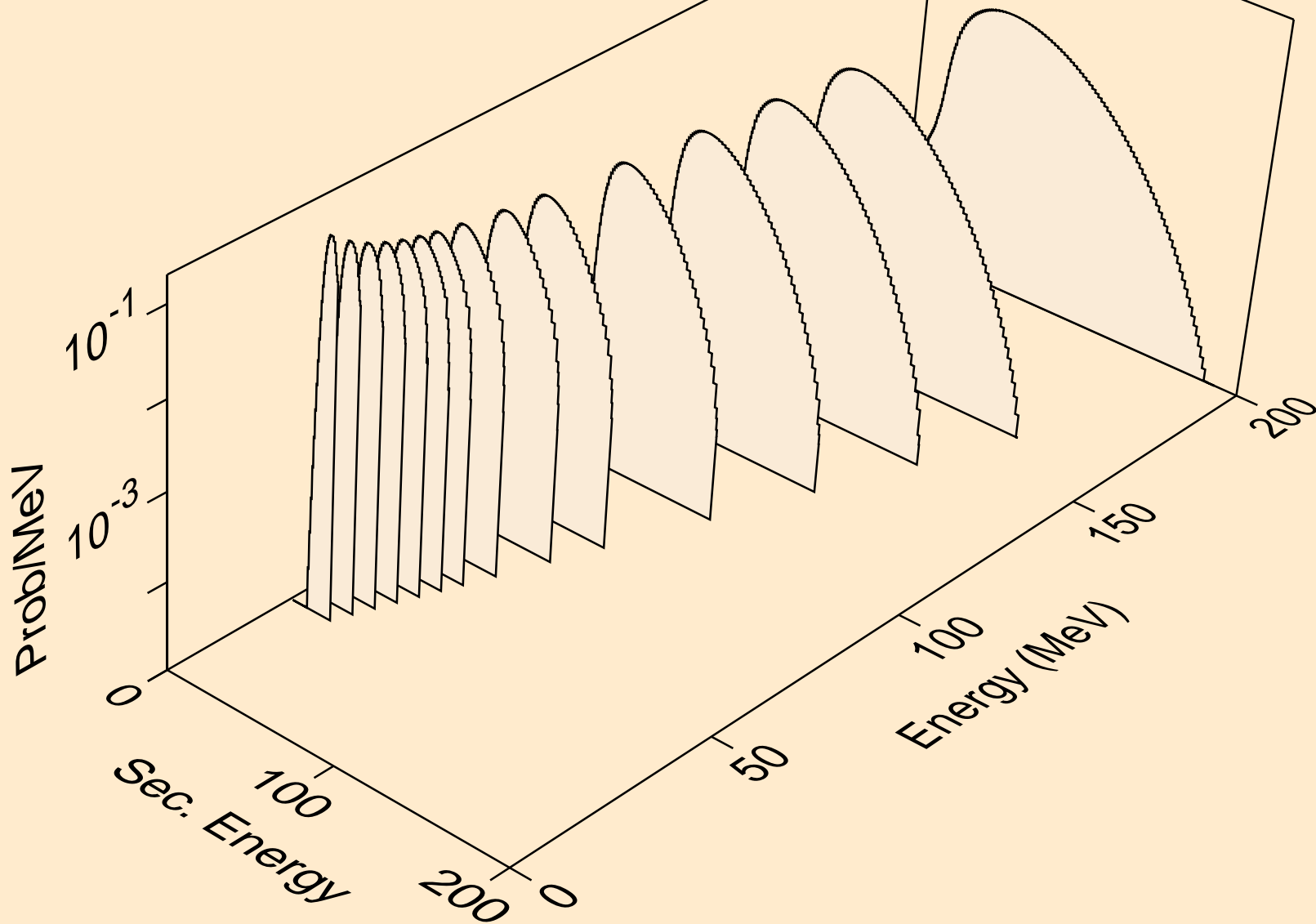

62-SM-147 FOR FENDL-3.2 FROM TENDL-2019 BY NJOY2016.60-
he3s from (n,n*)he3

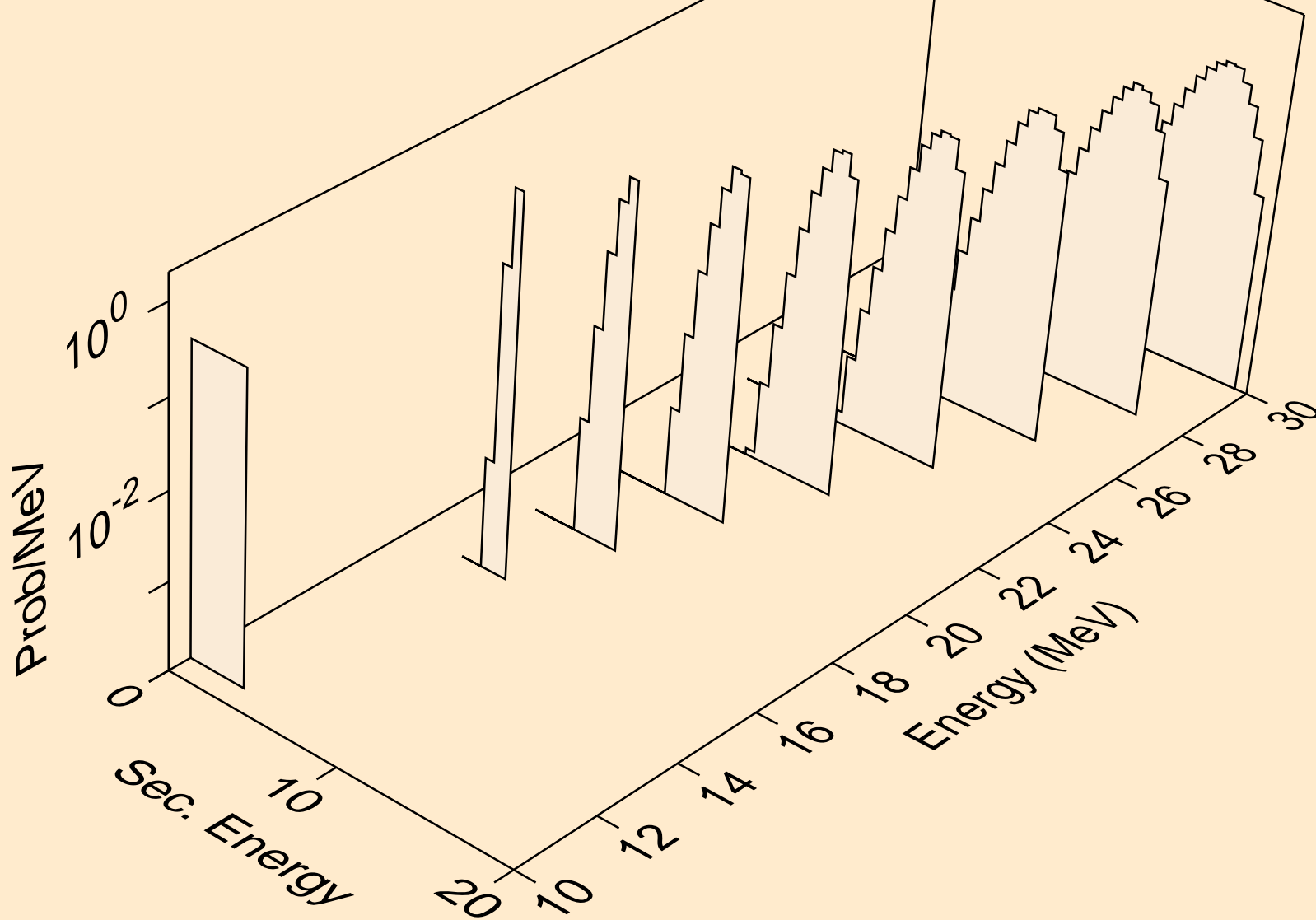

62-SM-147 FOR FENDL-3.2 FROM TENDL-2019 BY NJOY2016.60-
he3s from (n,he3)

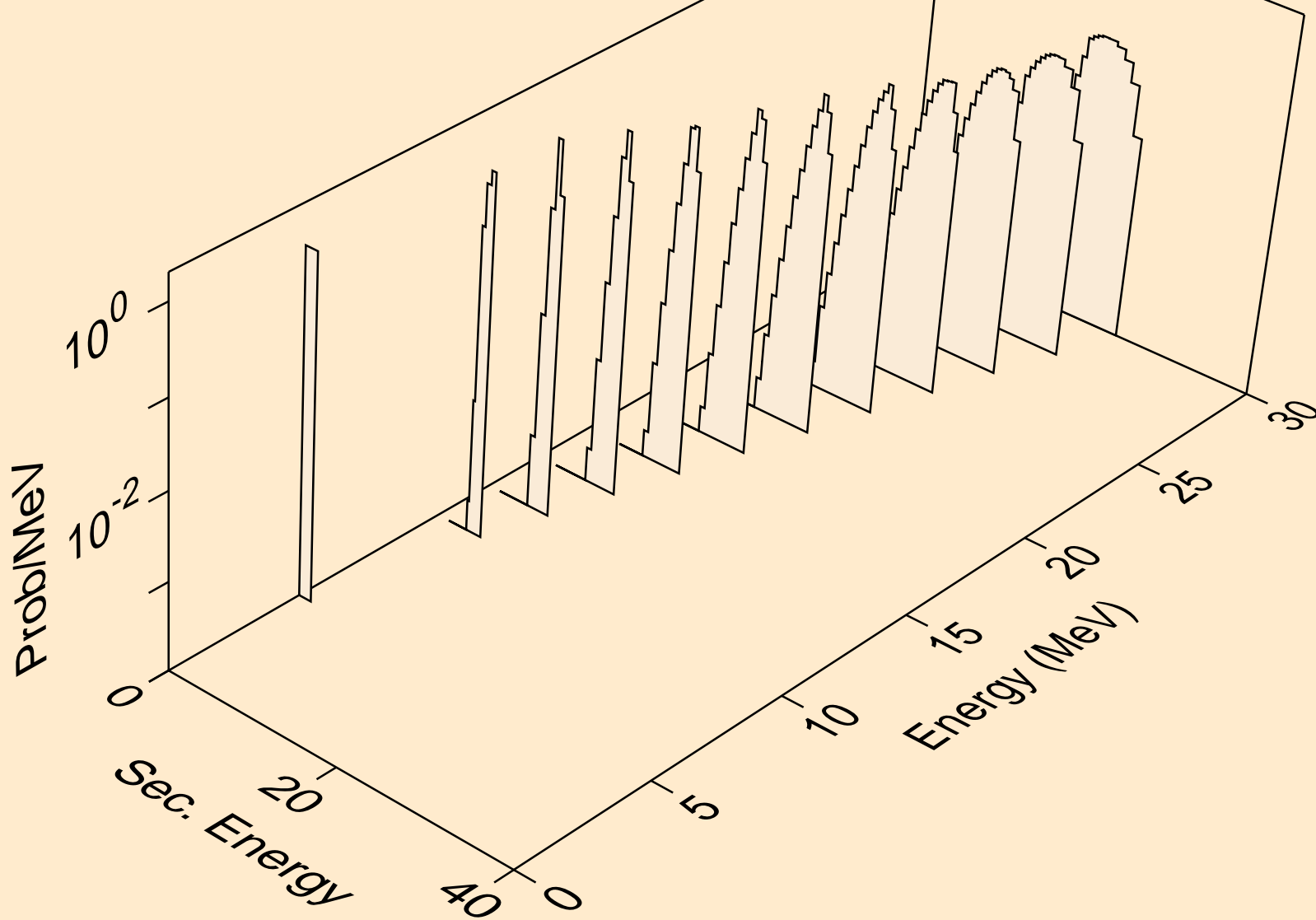

62-SM-147 FOR FENDL-3.2 FROM TENDL-2019 BY NJOY2016.60-
alphas from (n,x)

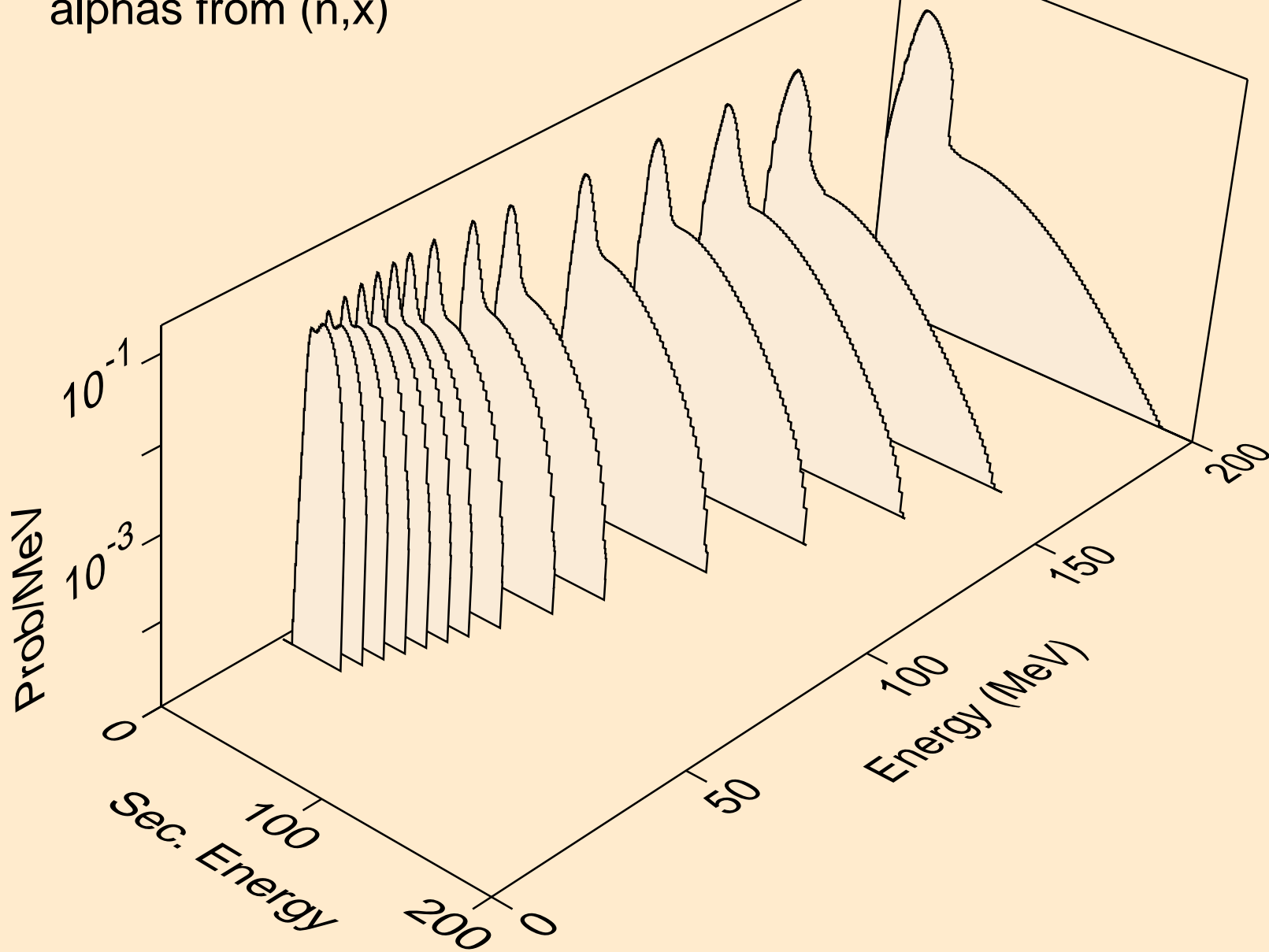

62-SM-147 FOR FENDL-3.2 FROM TENDL-2019 BY NJOY2016.60-
alphas from (n,n*)a

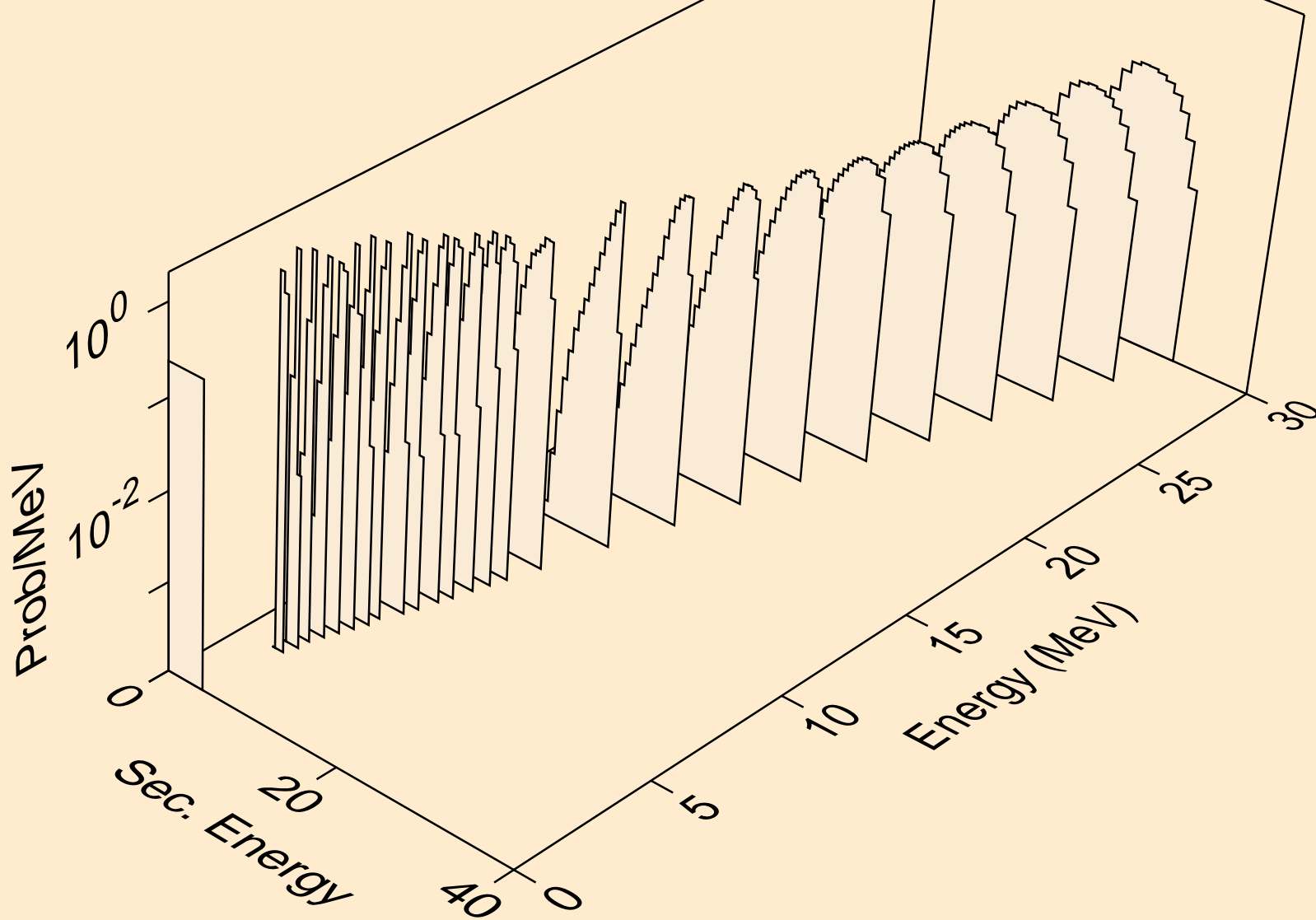

62-SM-147 FOR FENDL-3.2 FROM TENDL-2019 BY NJOY2016.60-
alphas from (n,2n)a

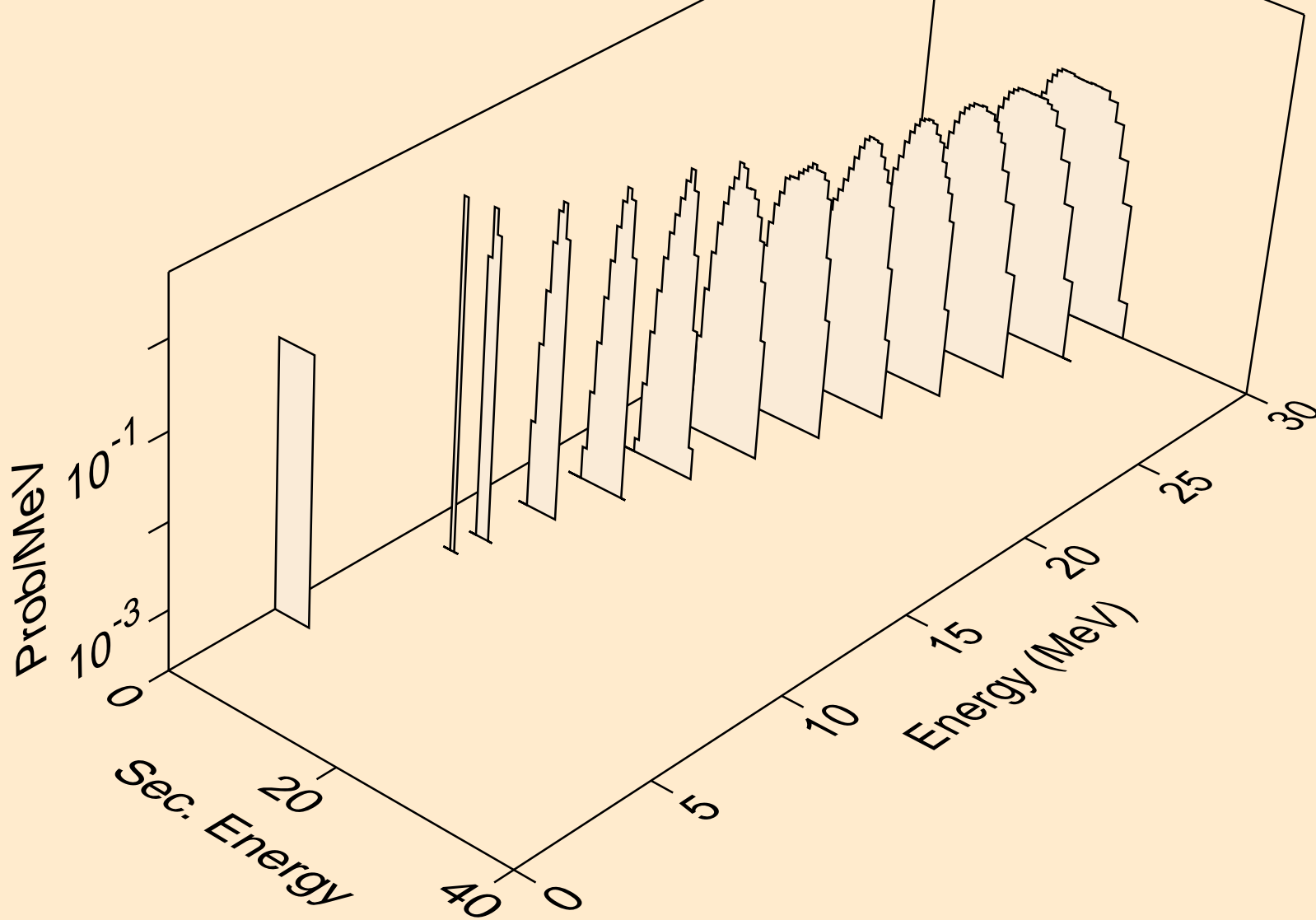

62-SM-147 FOR FENDL-3.2 FROM TENDL-2019 BY NJOY2016.60-
alphas from (n,3n)a

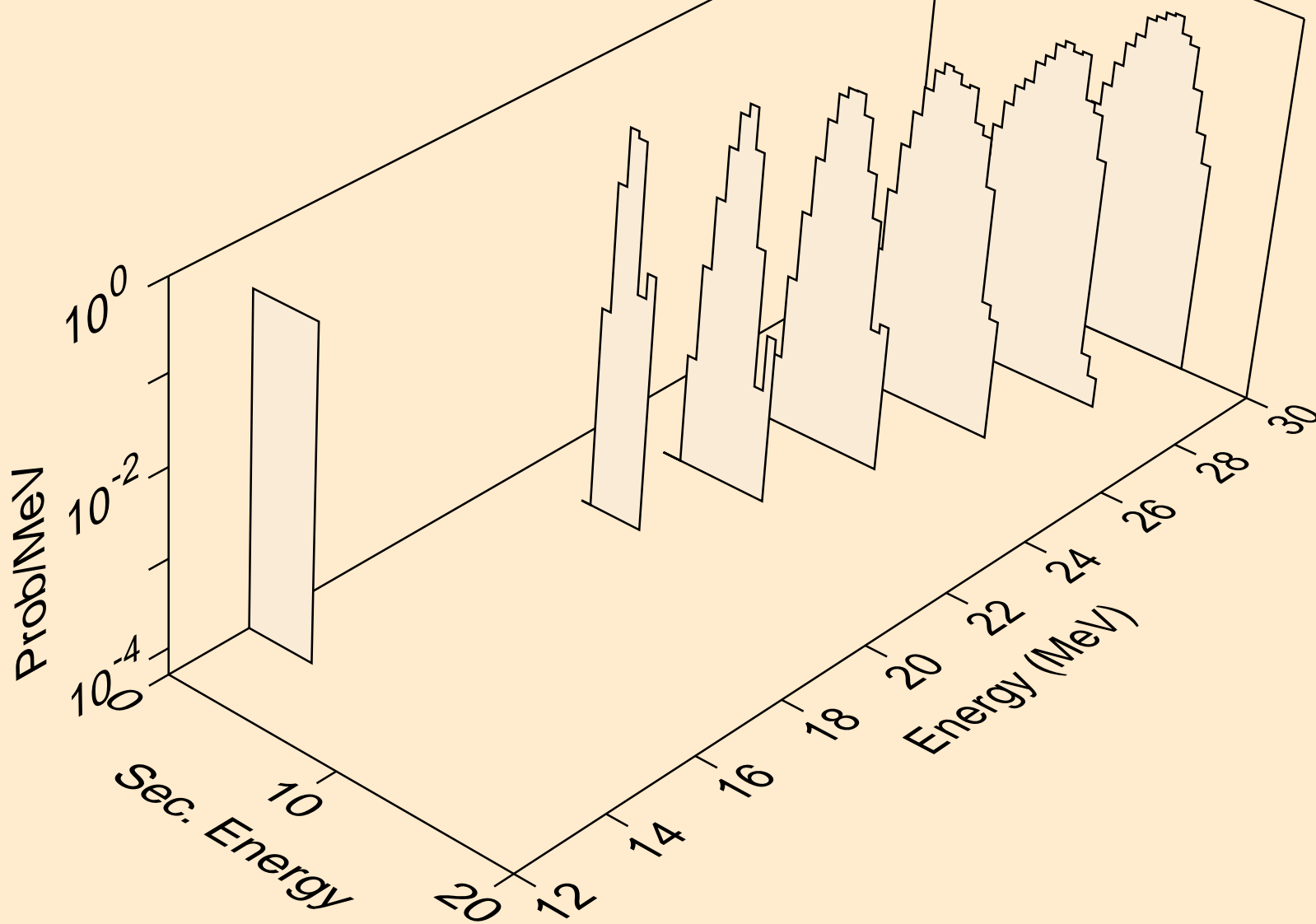

62-SM-147 FOR FENDL-3.2 FROM TENDL-2019 BY NJOY2016.60-
alphas from (n,n*)2a

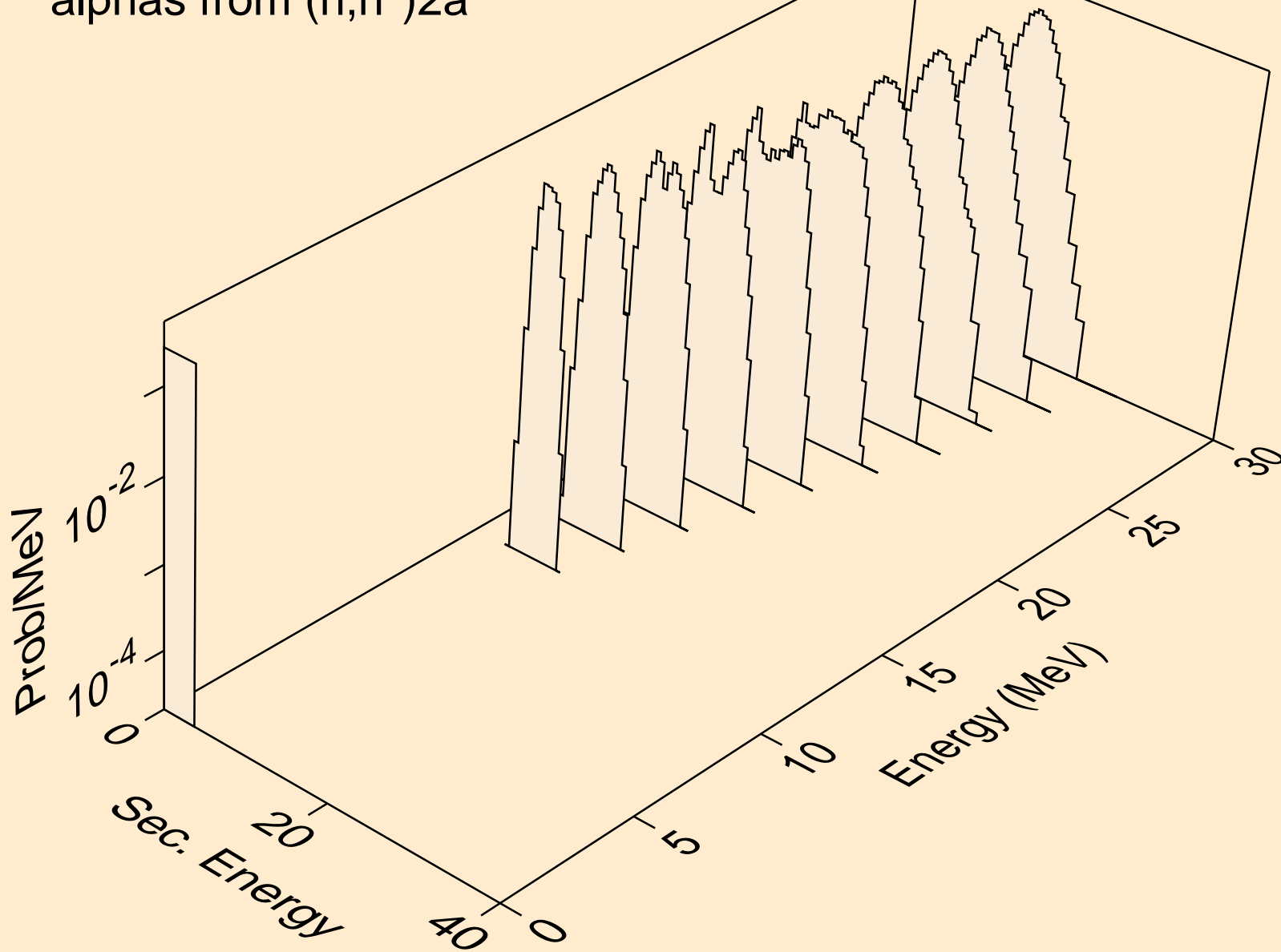

62-SM-147 FOR FENDL-3.2 FROM TENDL-2019 BY NJOY2016.60-
alphas from (n,npa)

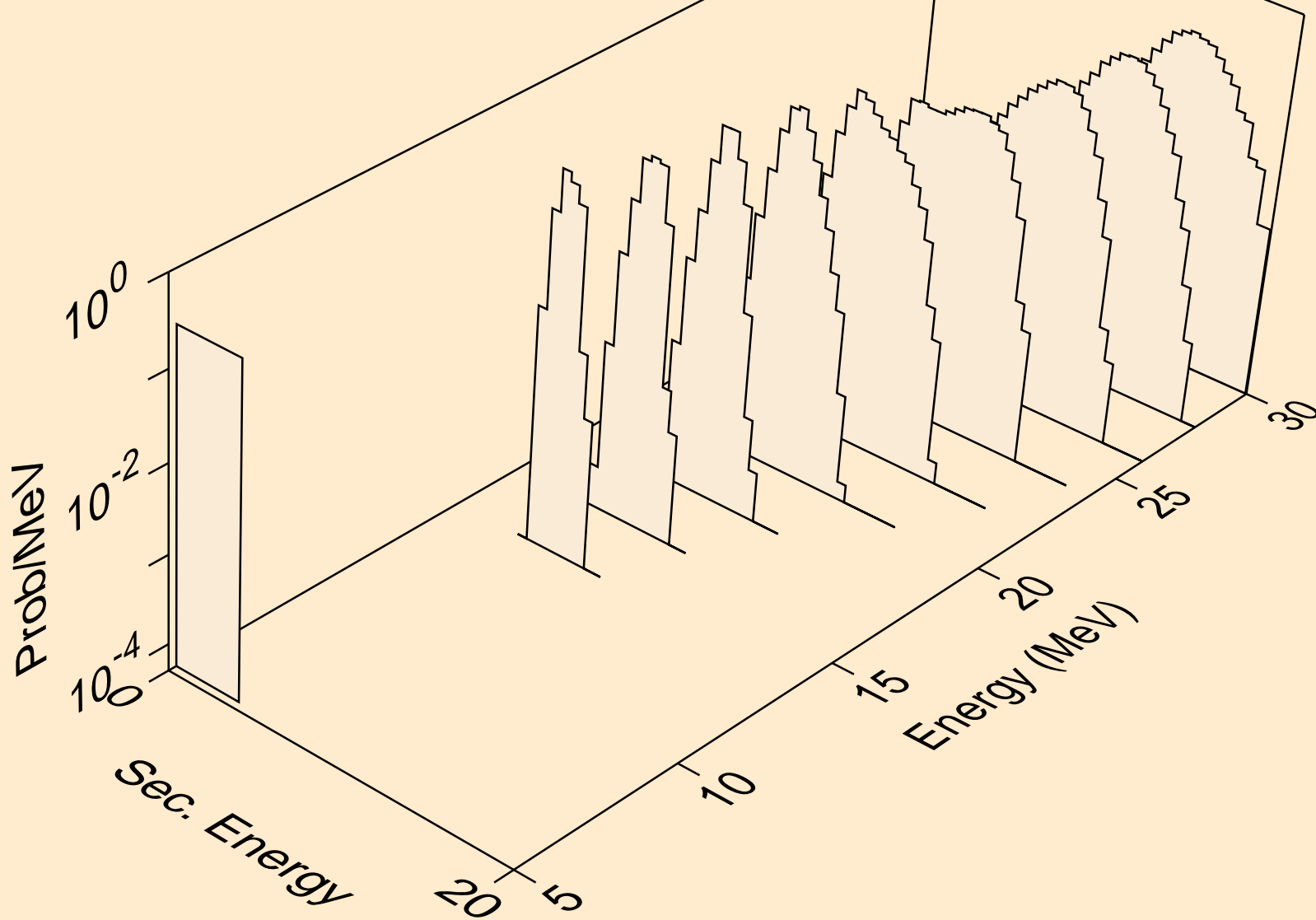

62-SM-147 FOR FENDL-3.2 FROM TENDL-2019 BY NJOY2016.60-
alphas from (n,a)

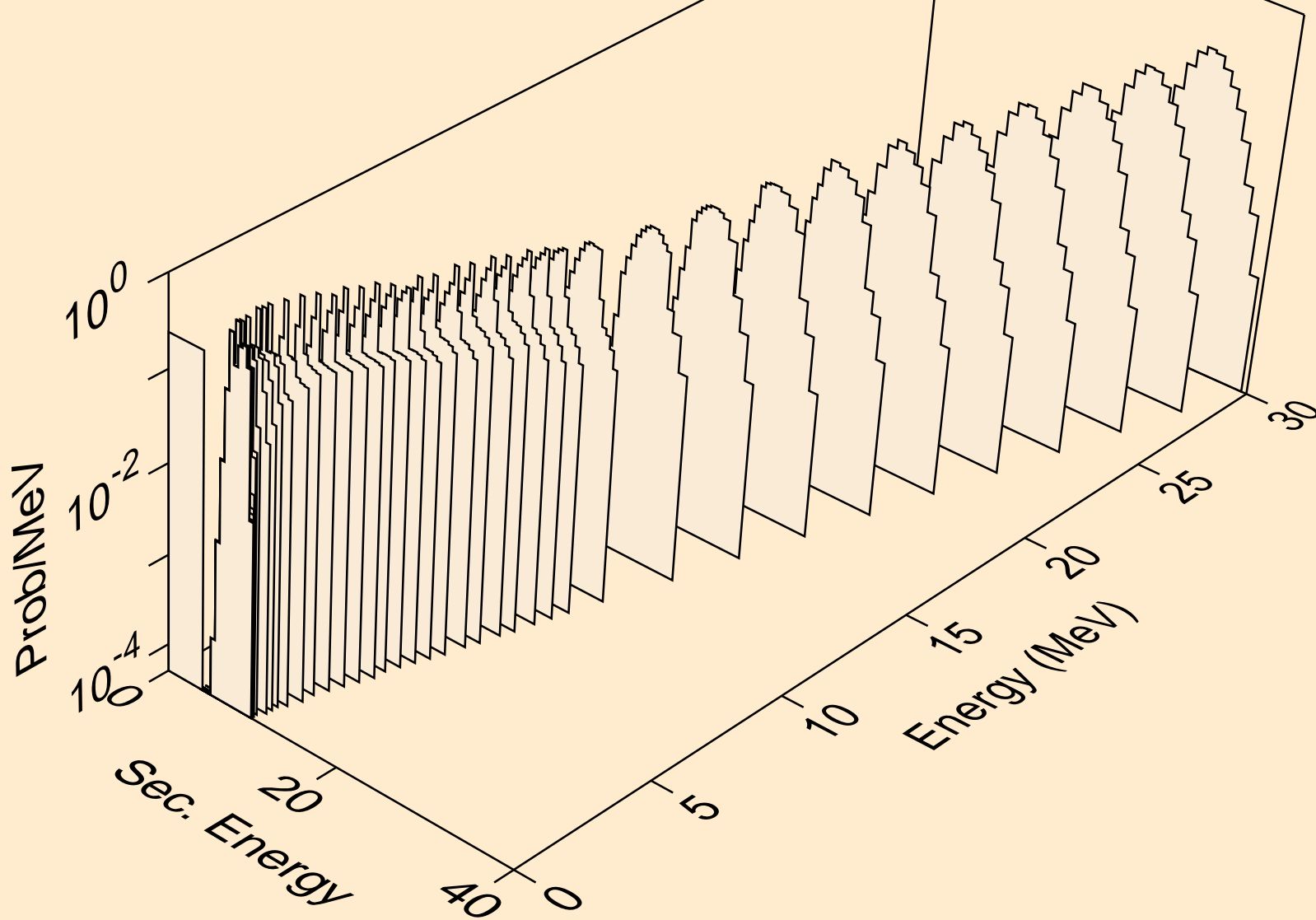

62-SM-147 FOR FENDL-3.2 FROM TENDL-2019 BY NJOY2016.60-
alphas from (n,2a)

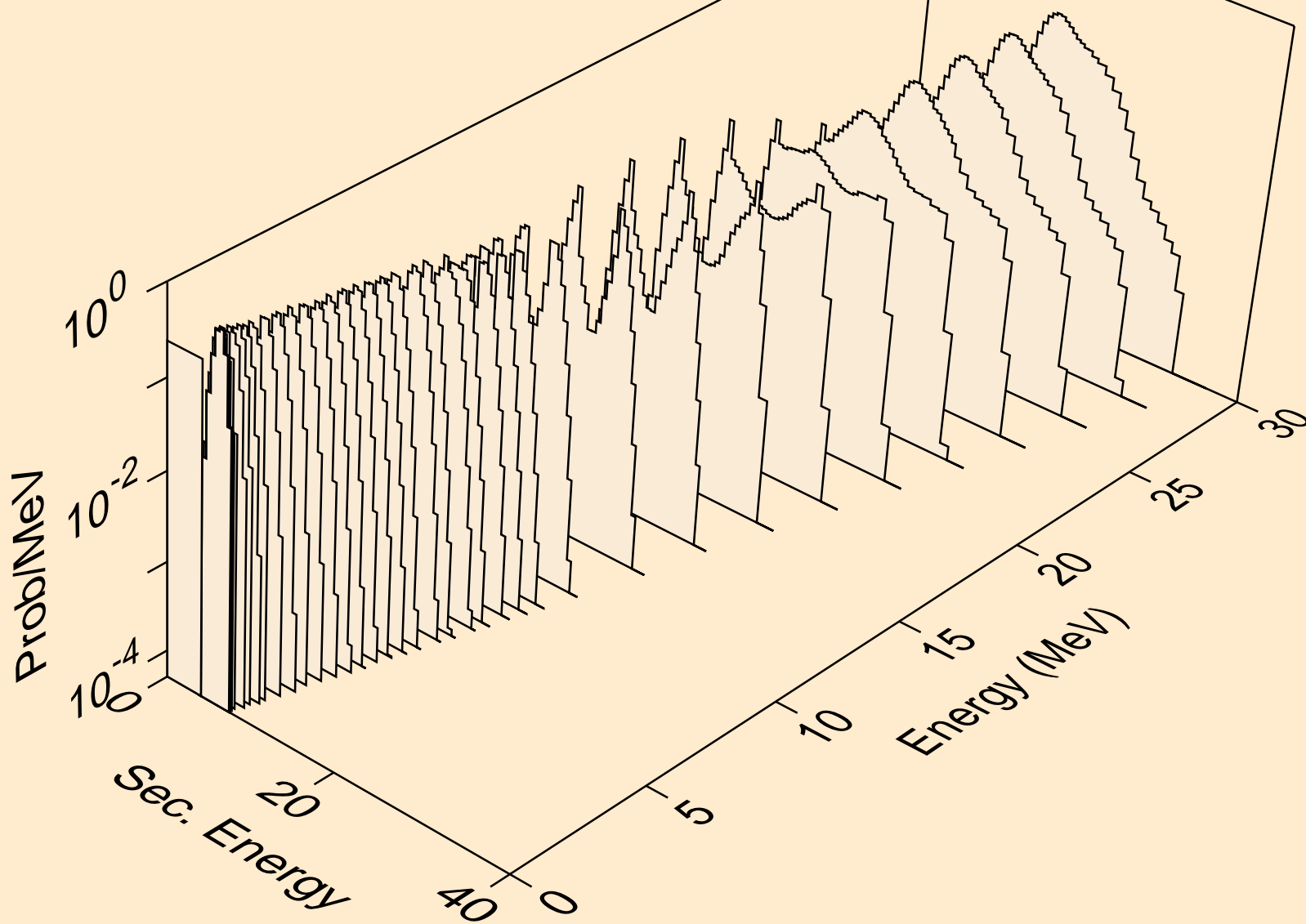

62-SM-147 FOR FENDL-3.2 FROM TENDL-2019 BY NJOY2016.60-
alphas from (n,pa)

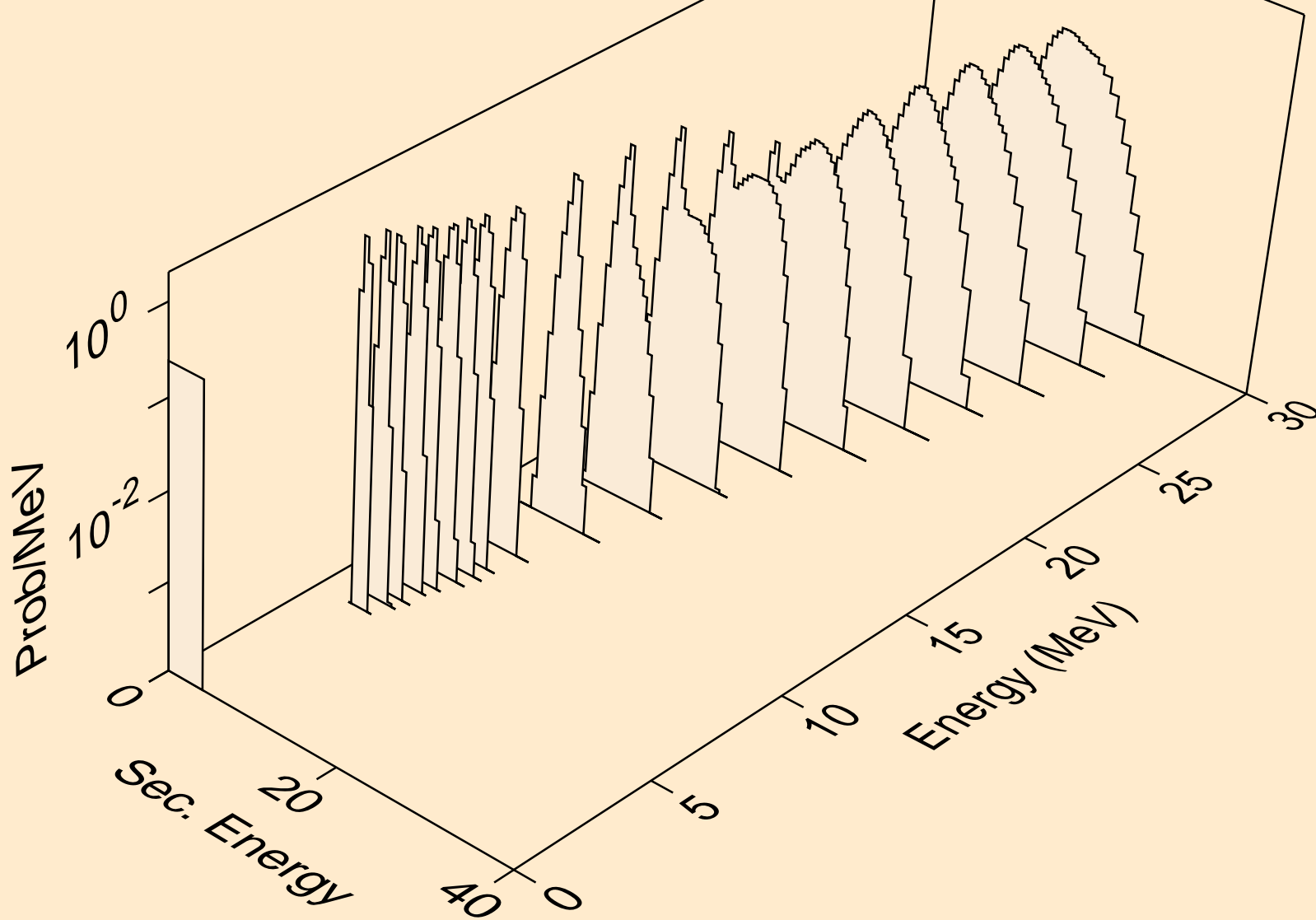

62-SM-147 FOR FENDL-3.2 FROM TENDL-2019 BY NJOY2016.60-
alphas from (n,da)

