

64-GD-158 FOR FENDL-3.2 FROM FENDL-3.2 BY NJOY2016.60+ C
Principal cross sections

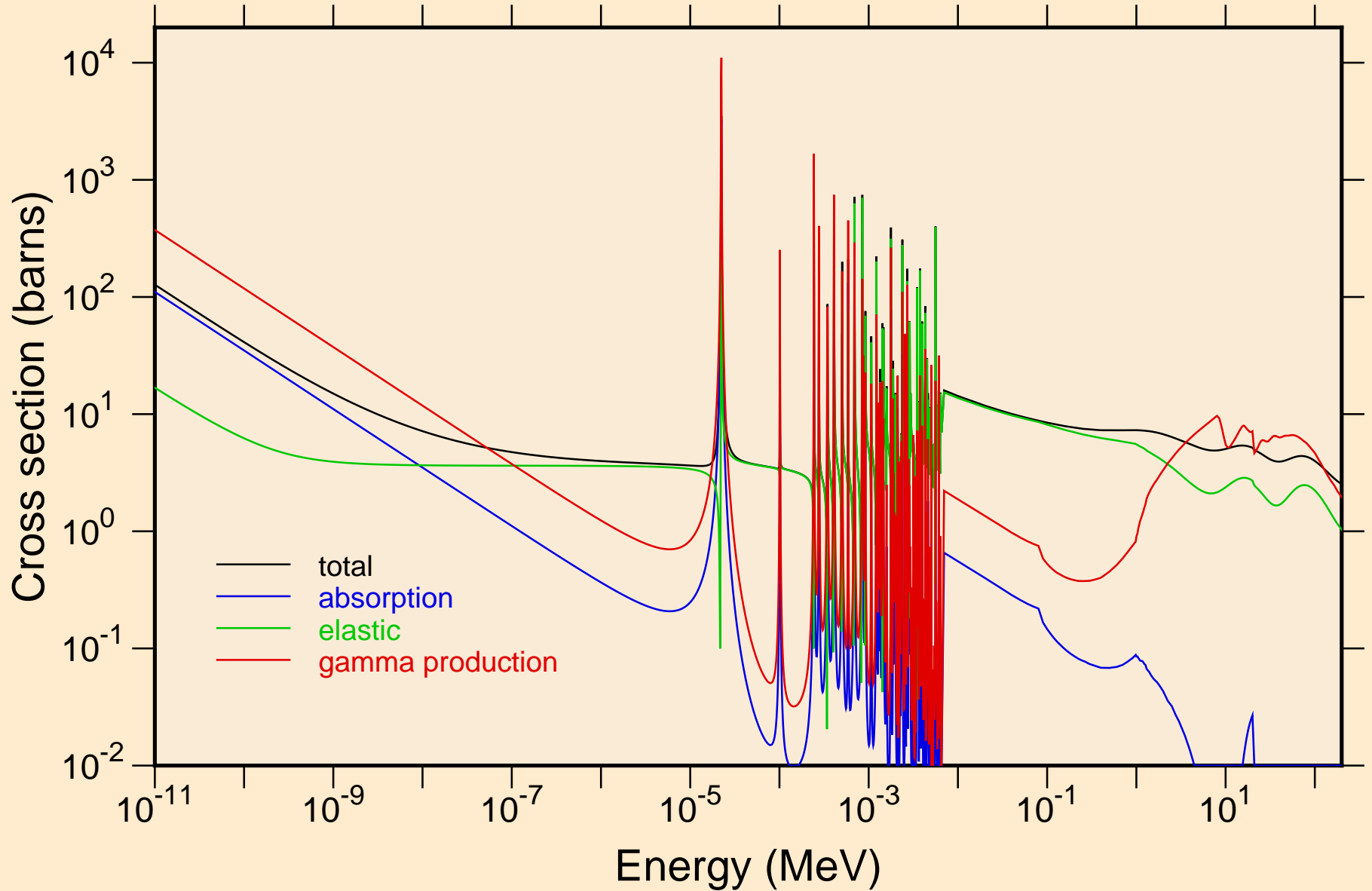

64-GD-158 FOR FENDL-3.2 FROM FENDL-3.2 BY NJOY2016.60+ C
resonance total cross section

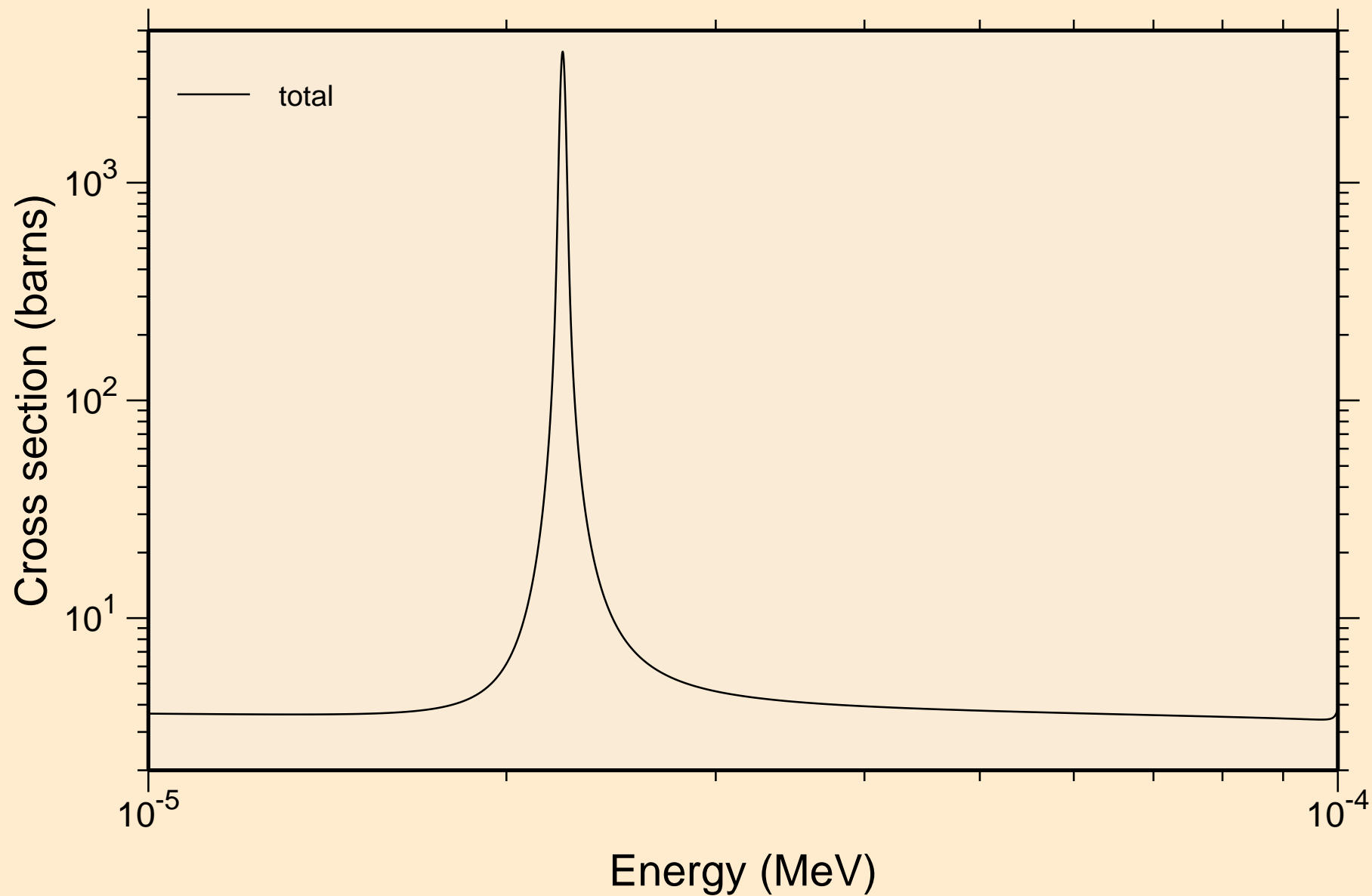

64-GD-158 FOR FENDL-3.2 FROM FENDL-3.2 BY NJOY2016.60+ C
resonance total cross section

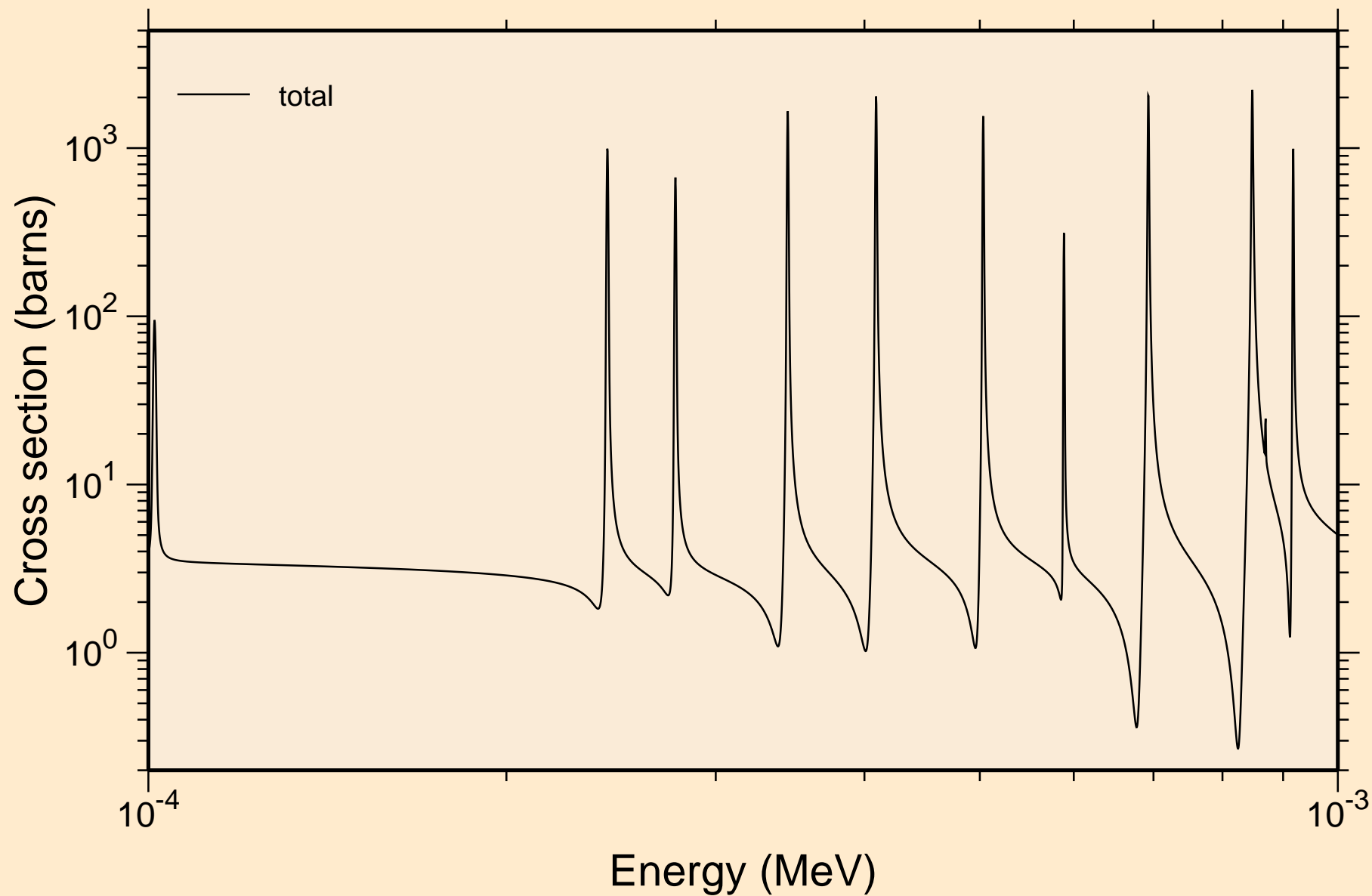

64-GD-158 FOR FENDL-3.2 FROM FENDL-3.2 BY NJOY2016.60+ C
resonance total cross section

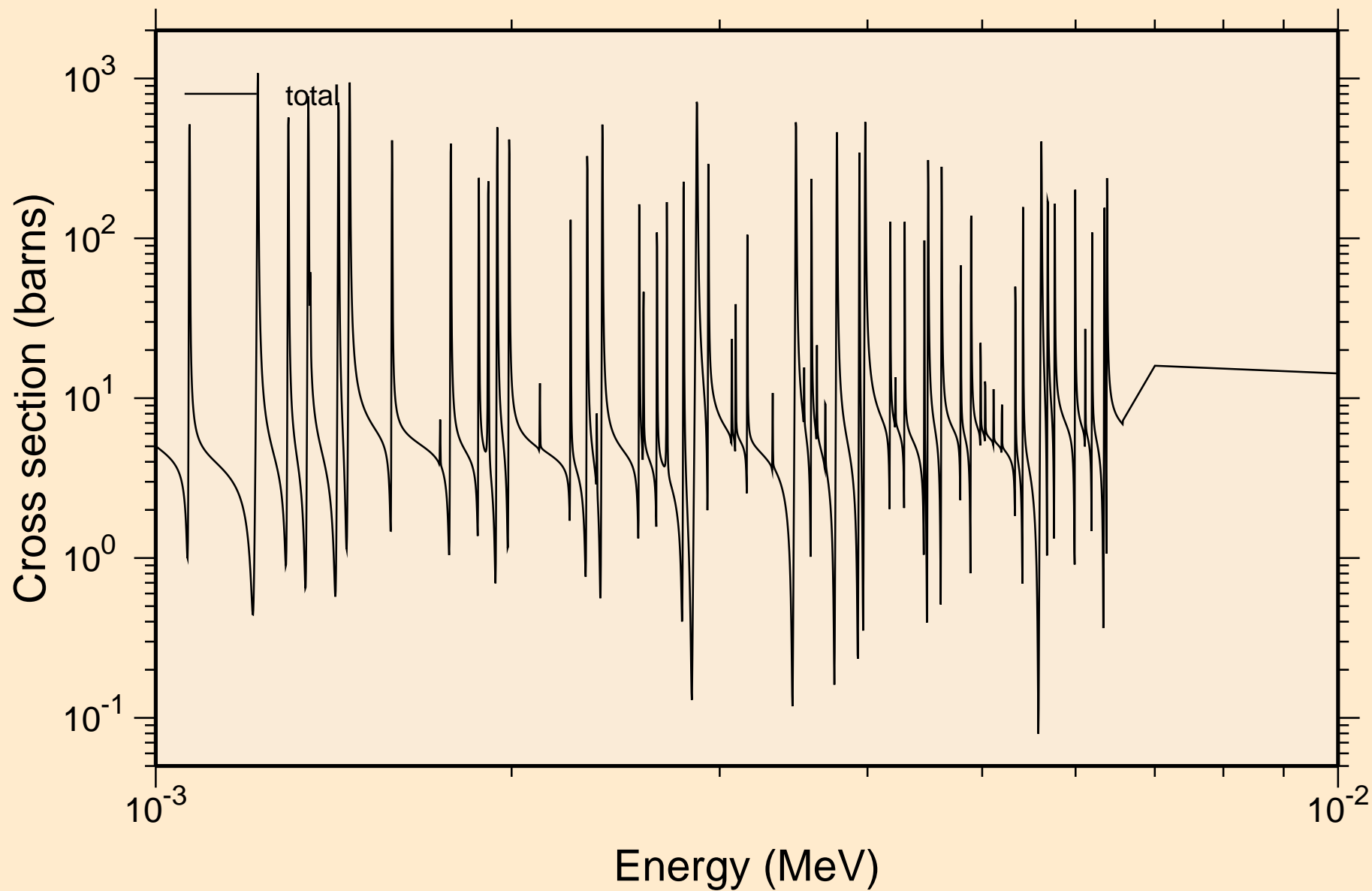

64-GD-158 FOR FENDL-3.2 FROM FENDL-3.2 BY NJOY2016.60+ C
resonance total cross section

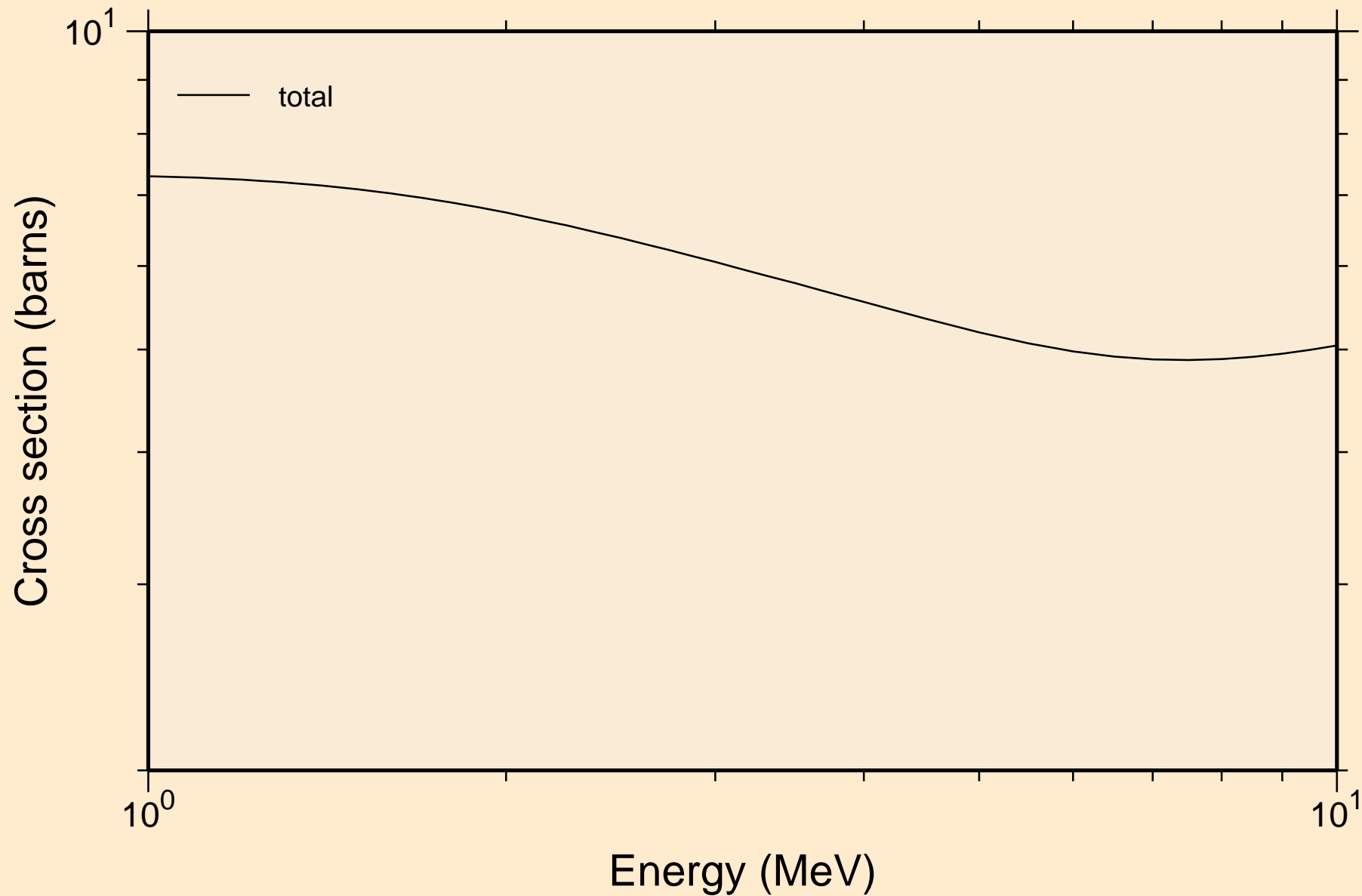

64-GD-158 FOR FENDL-3.2 FROM FENDL-3.2 BY NJOY2016.60+ C
resonance absorption cross sections

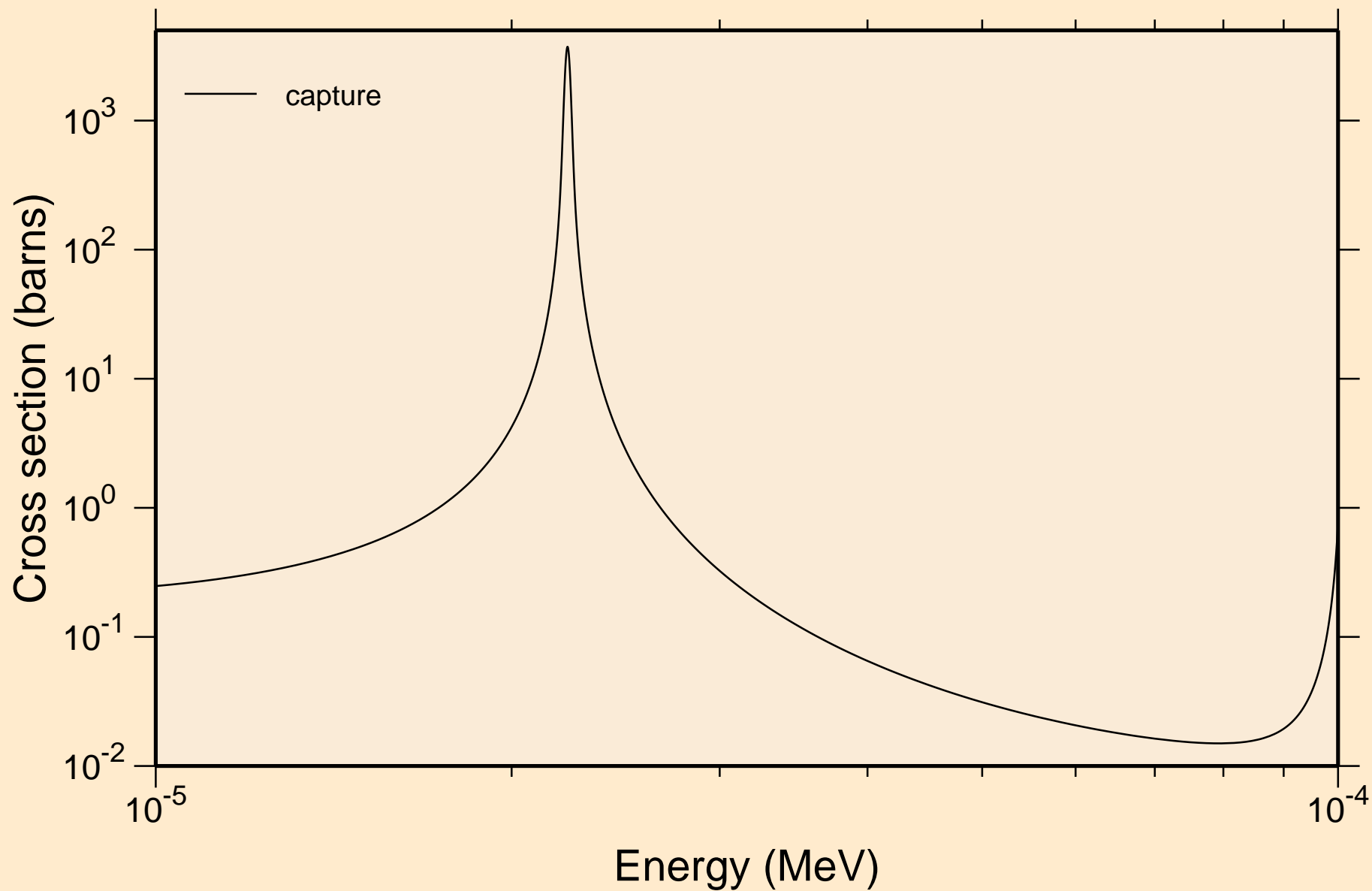

64-GD-158 FOR FENDL-3.2 FROM FENDL-3.2 BY NJOY2016.60+ C
resonance absorption cross sections

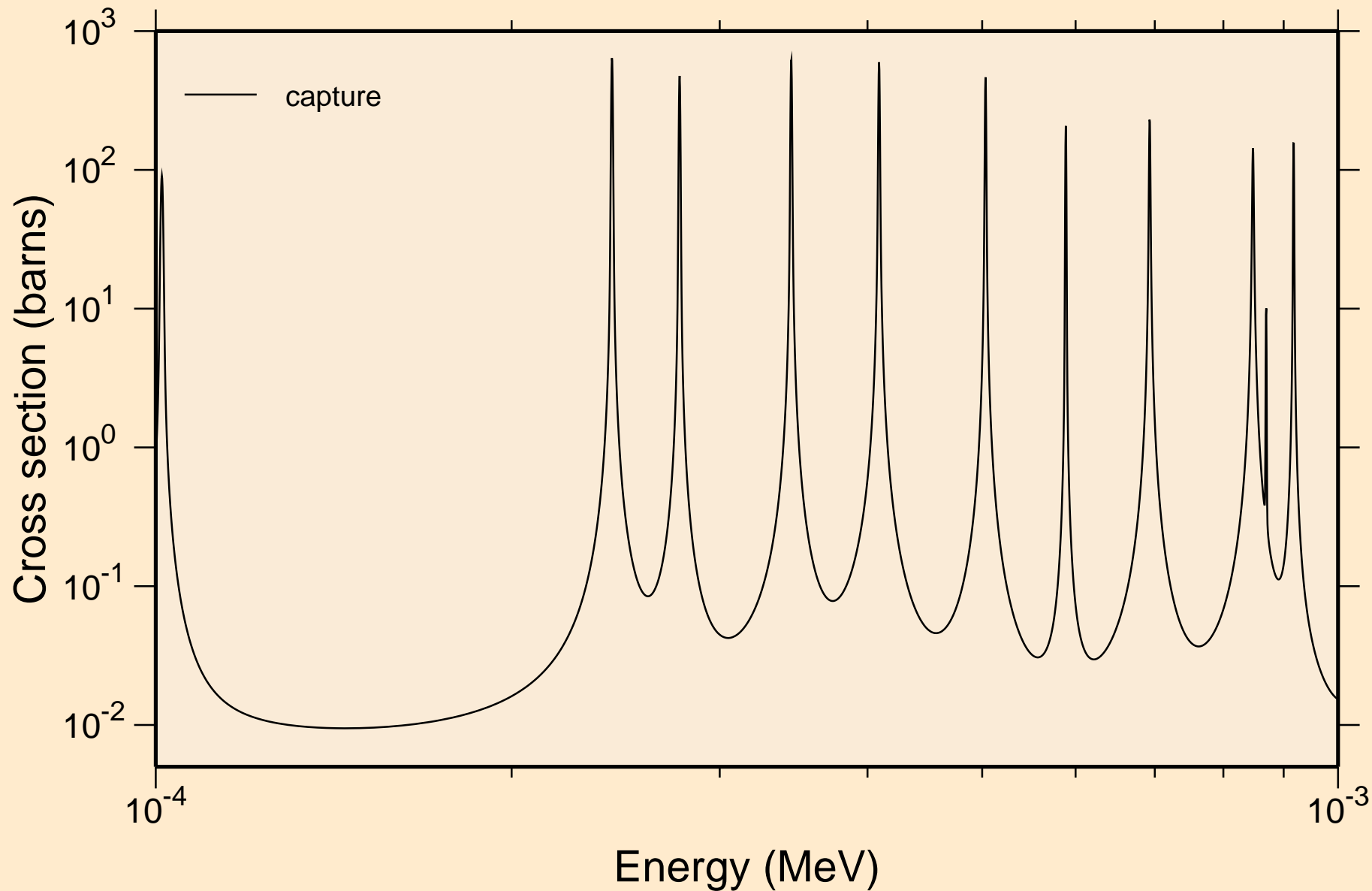

64-GD-158 FOR FENDL-3.2 FROM FENDL-3.2 BY NJOY2016.60+ C
resonance absorption cross sections

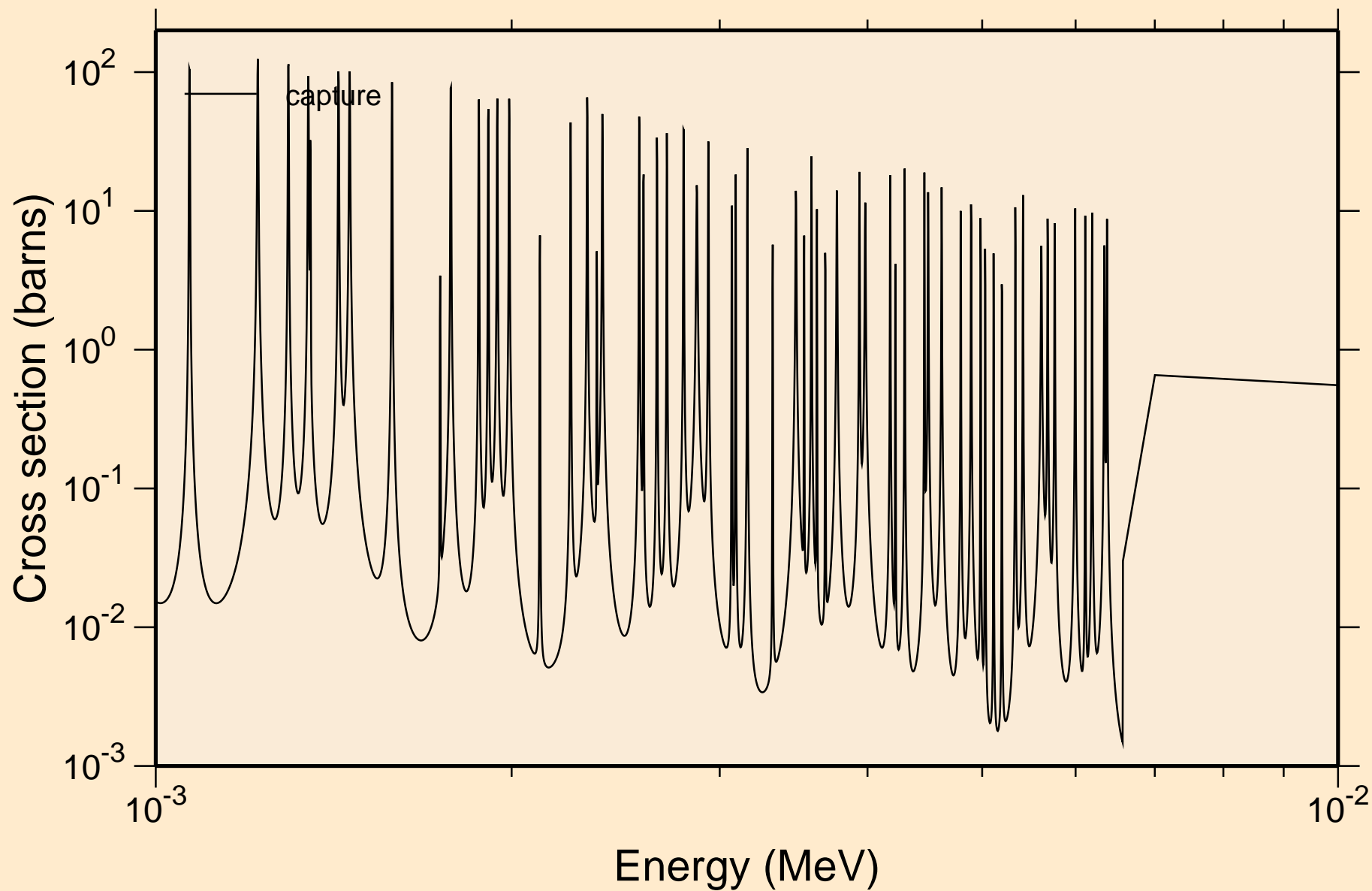

64-GD-158 FOR FENDL-3.2 FROM FENDL-3.2 BY NJOY2016.60+ C
resonance absorption cross sections

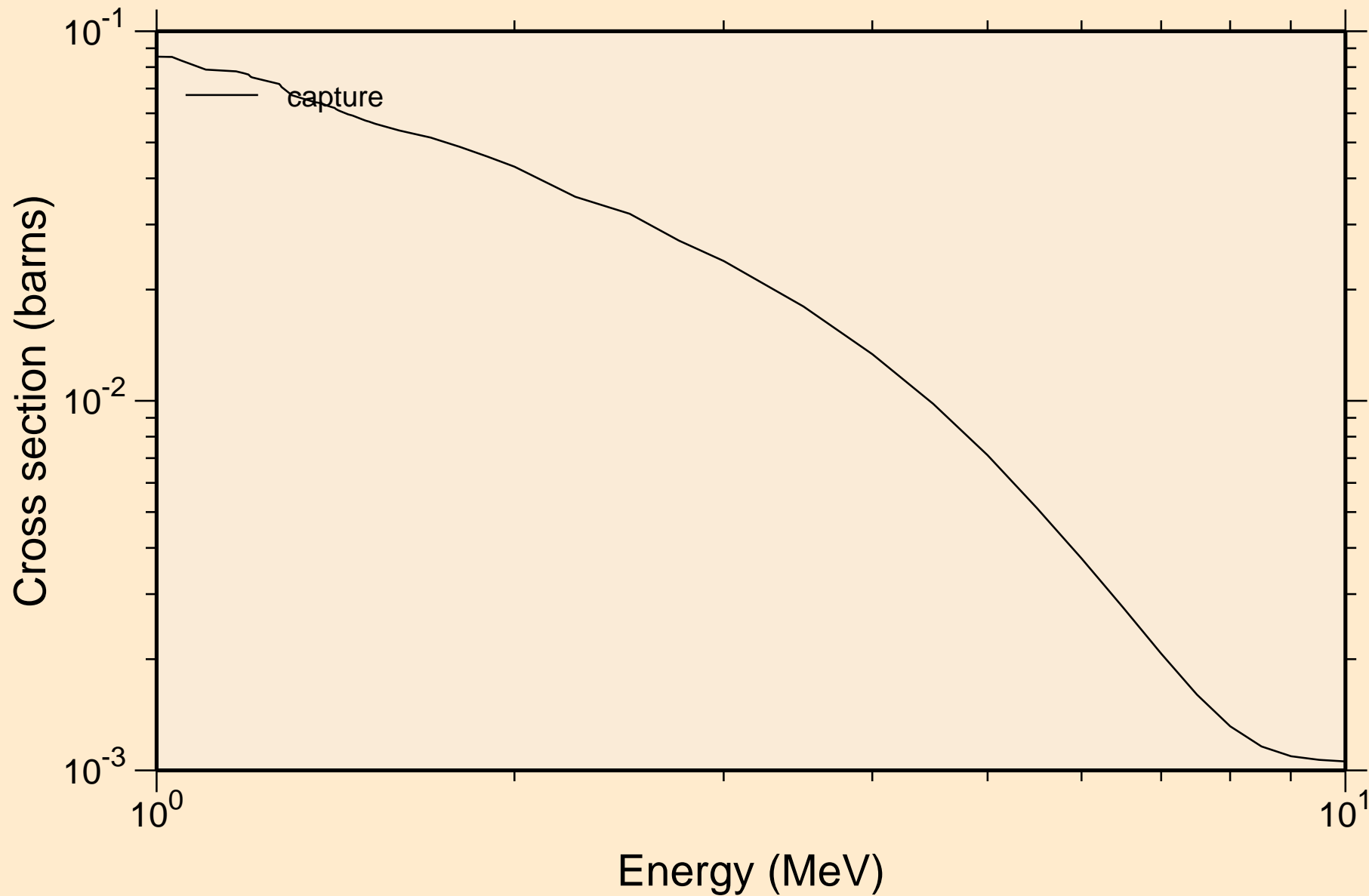

64-GD-158 FOR FENDL-3.2 FROM FENDL-3.2 BY NJOY2016.60+ C
UR total cross section

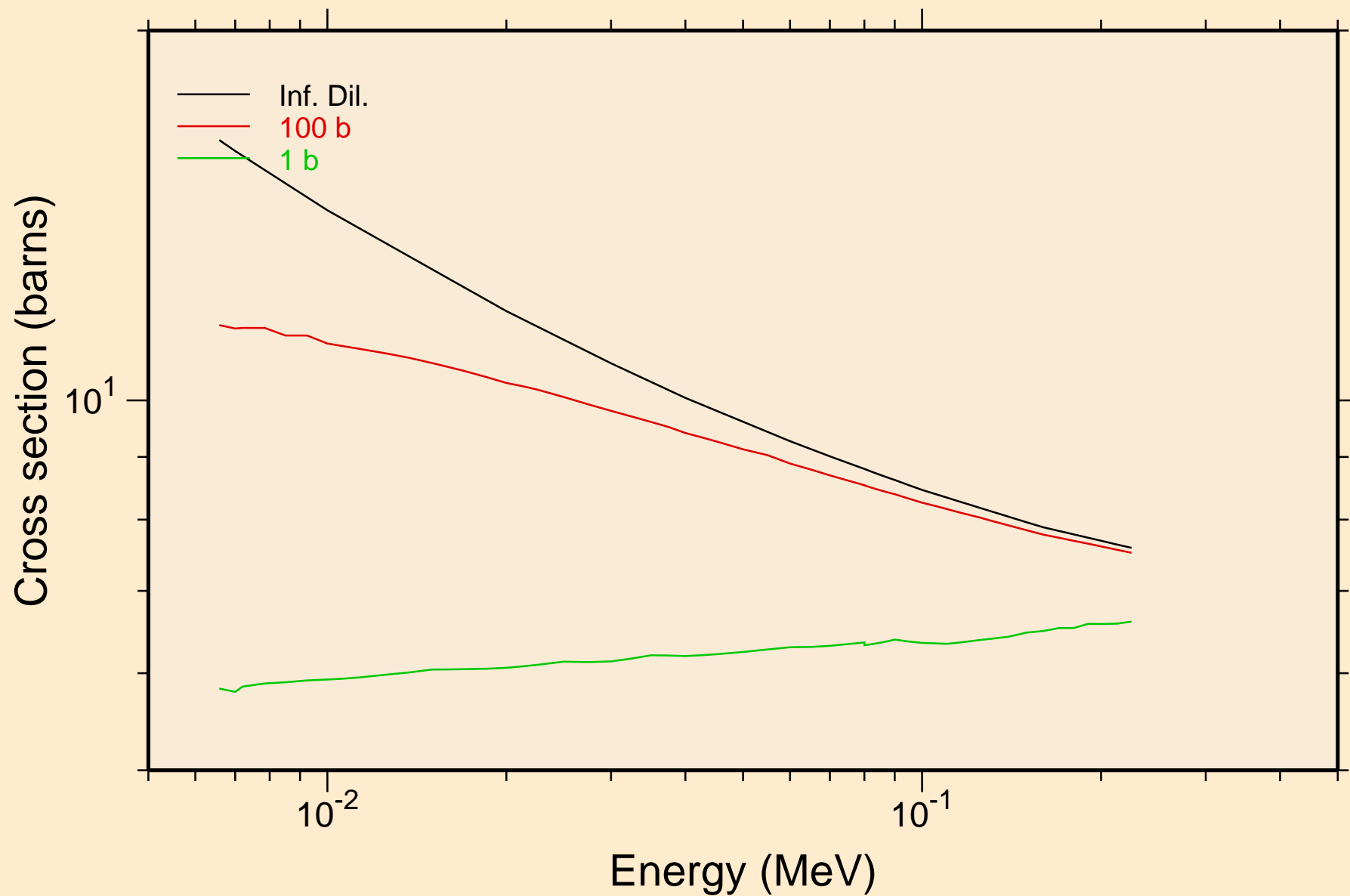

64-GD-158 FOR FENDL-3.2 FROM FENDL-3.2 BY NJOY2016.60+ C
UR elastic cross section

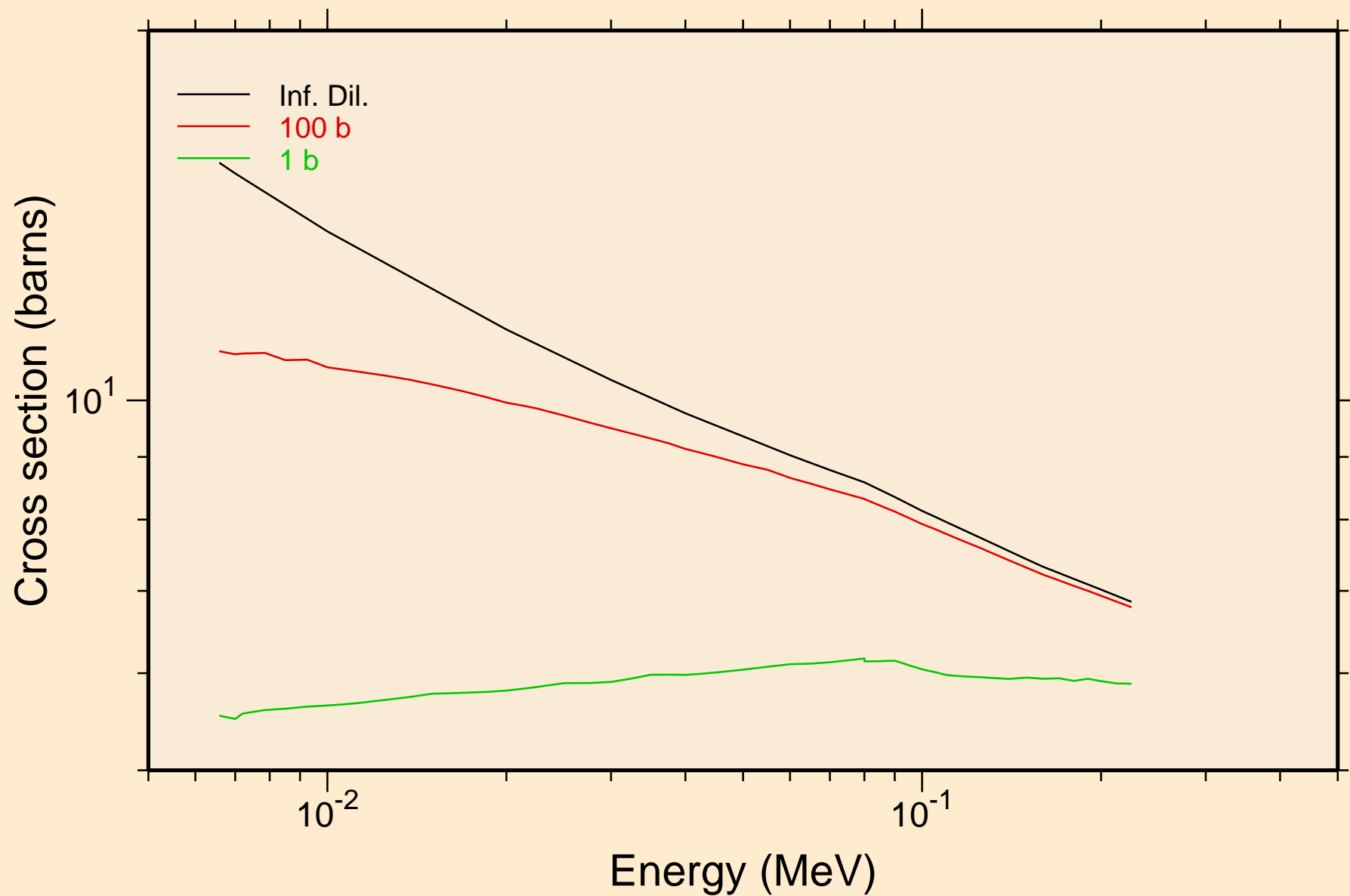

64-GD-158 FOR FENDL-3.2 FROM FENDL-3.2 BY NJOY2016.60+ C
UR capture cross section

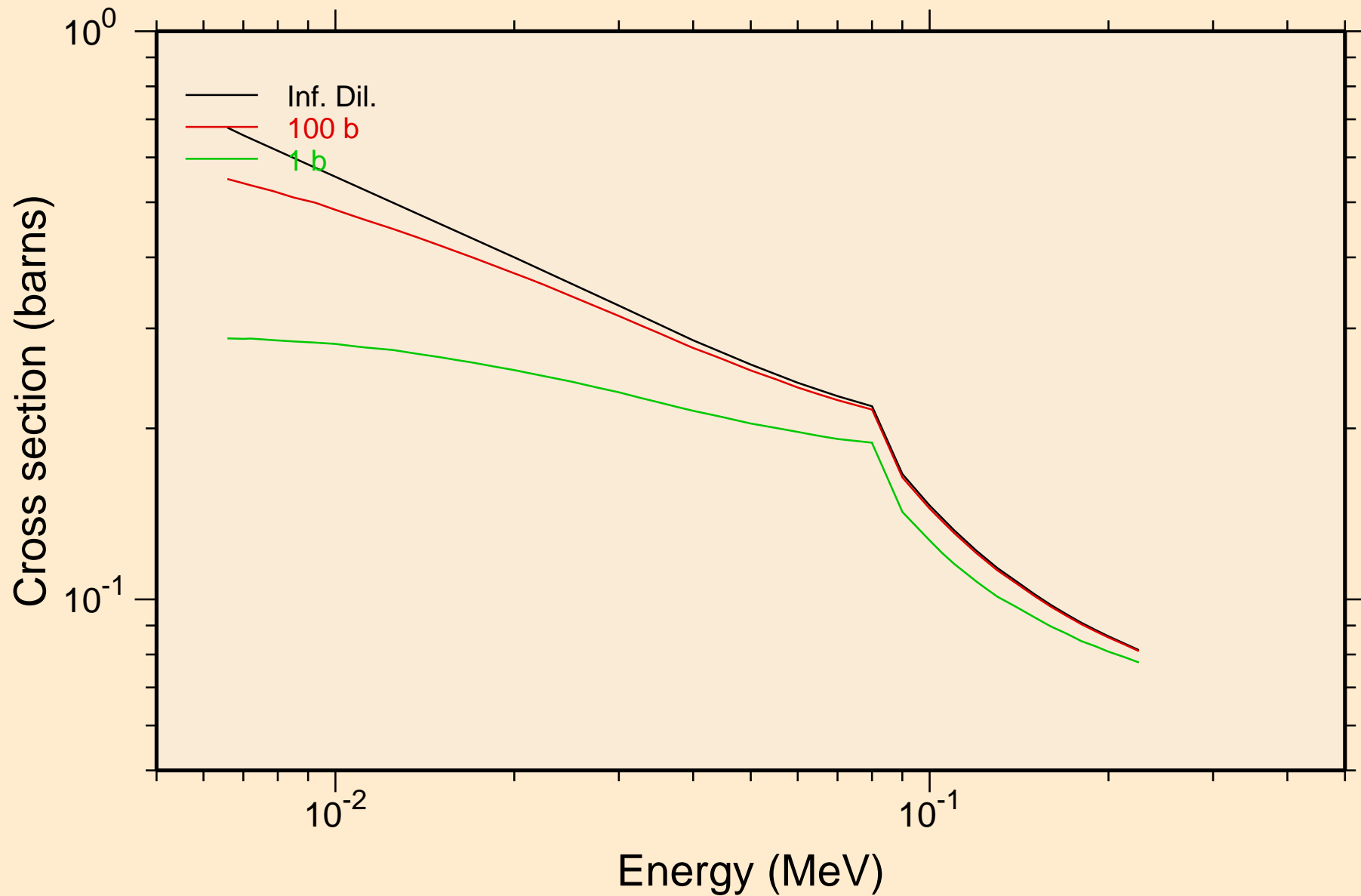

64-GD-158 FOR FENDL-3.2 FROM FENDL-3.2 BY NJOY2016.60+ C
Heating

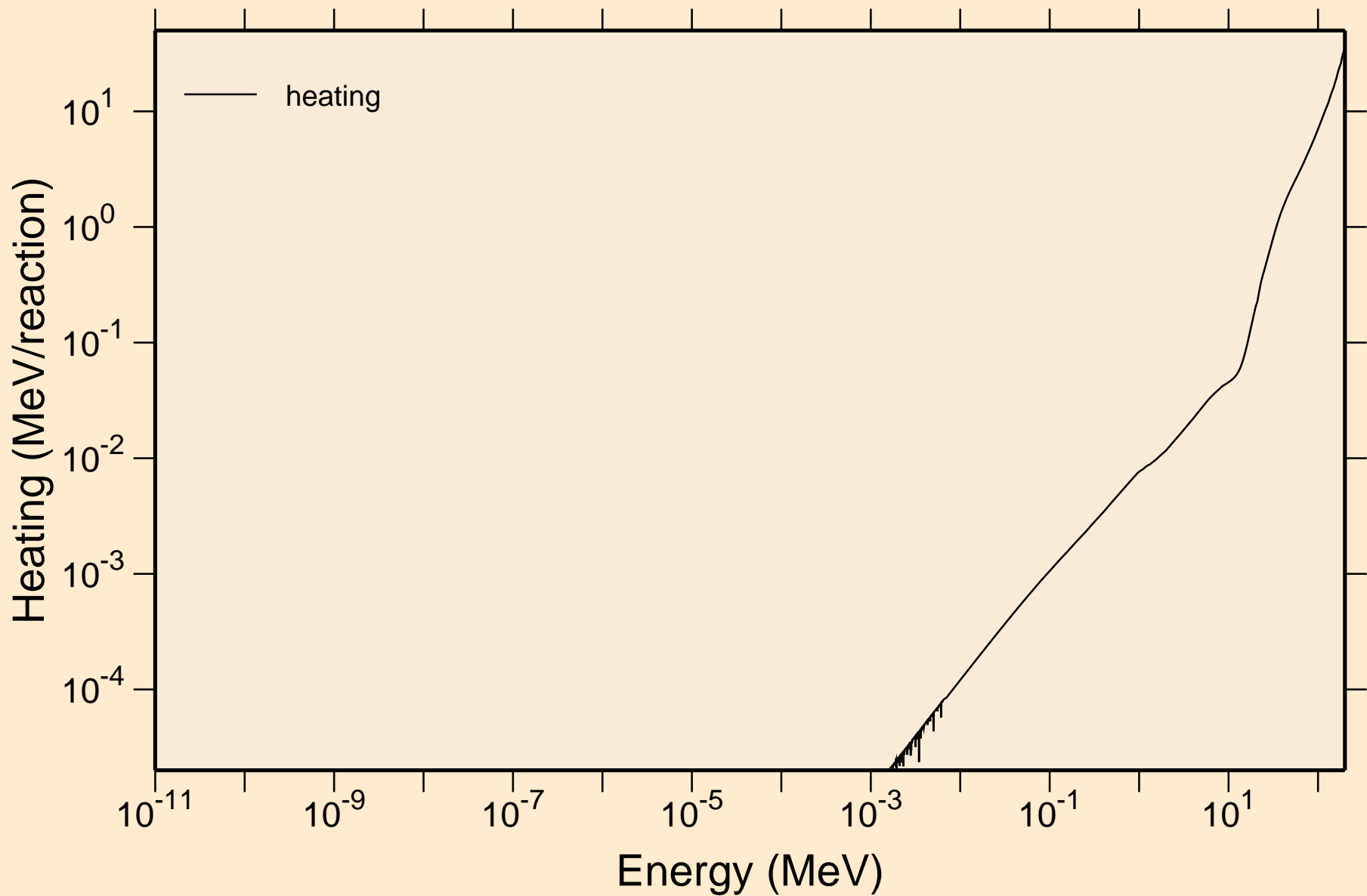

64-GD-158 FOR FENDL-3.2 FROM FENDL-3.2 BY NJOY2016.60+ C Damage

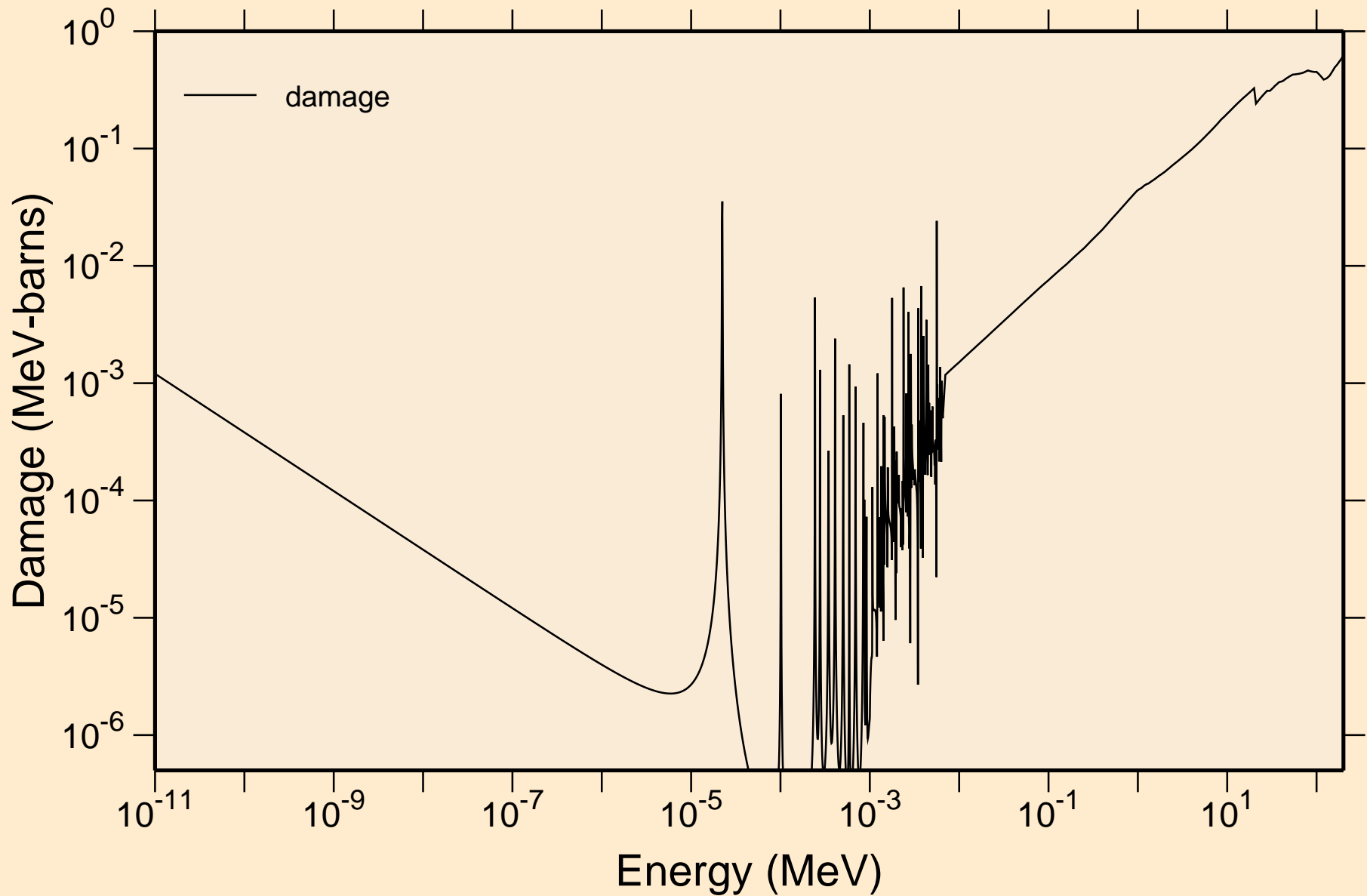

64-GD-158 FOR FENDL-3.2 FROM FENDL-3.2 BY NJOY2016.60+ C
Non-threshold reactions

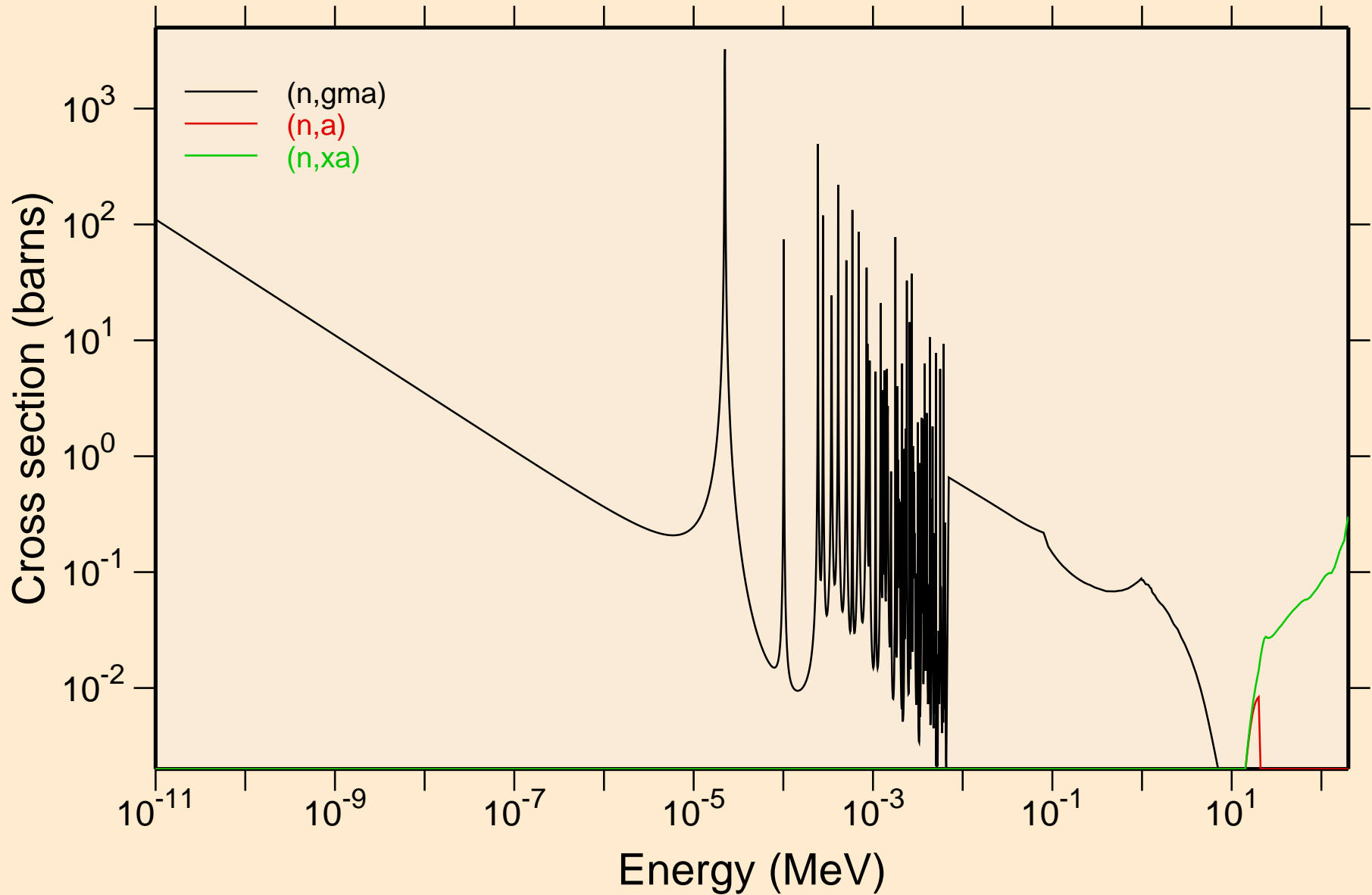

64-GD-158 FOR FENDL-3.2 FROM FENDL-3.2 BY NJOY2016.60+ C
Principal cross sections

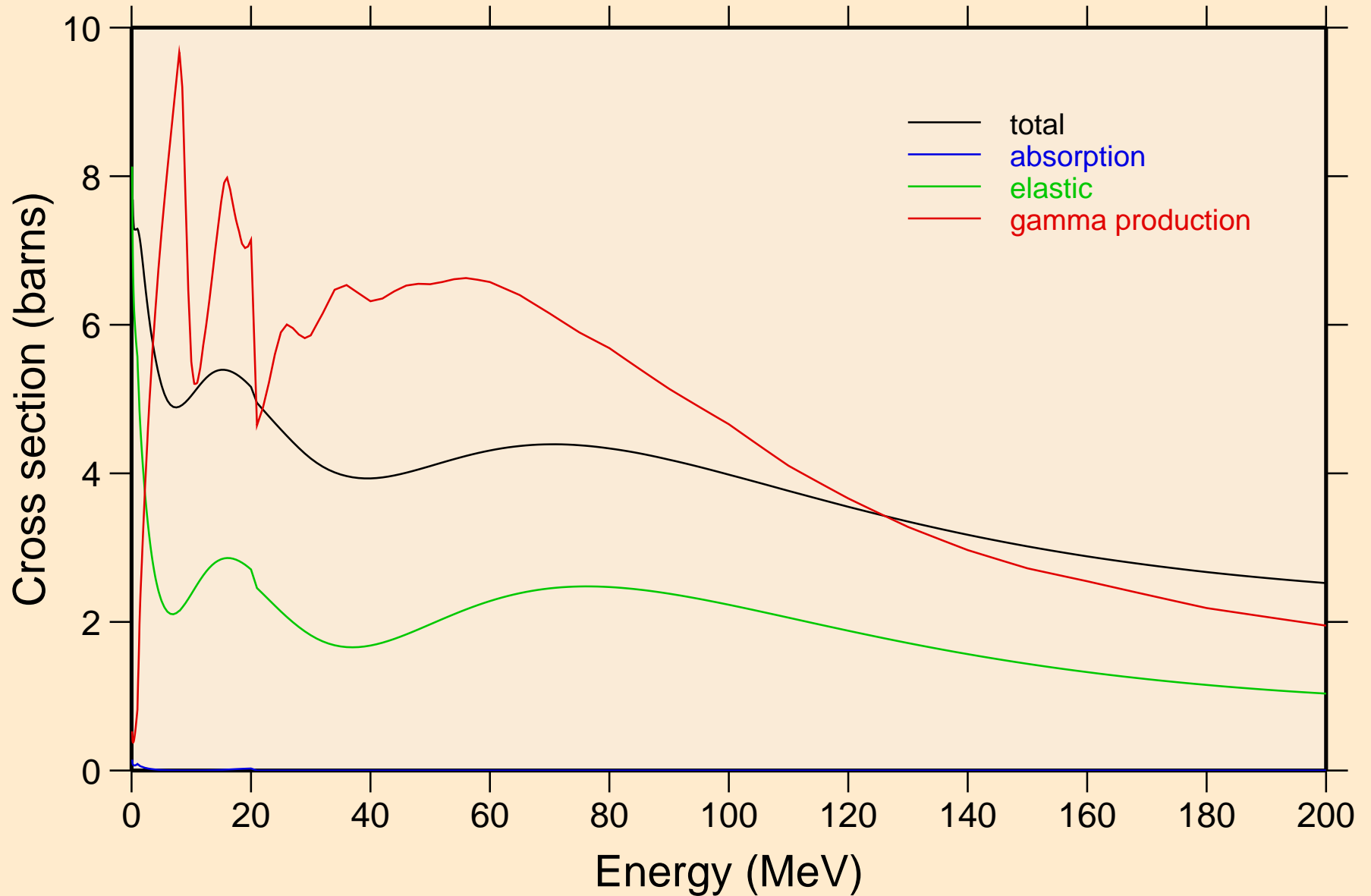

64-GD-158 FOR FENDL-3.2 FROM FENDL-3.2 BY NJOY2016.60+ C Heating

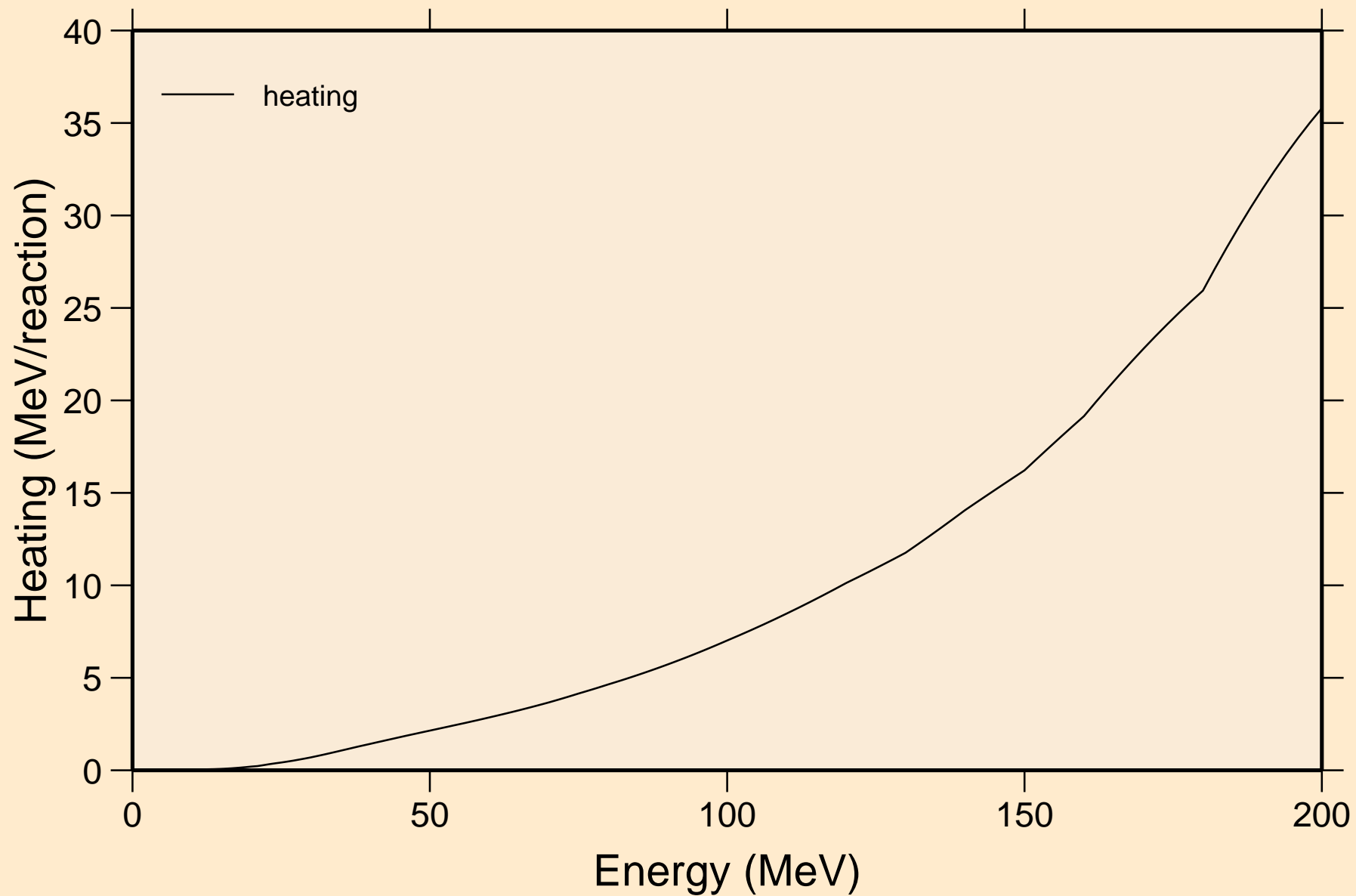

64-GD-158 FOR FENDL-3.2 FROM FENDL-3.2 BY NJOY2016.60+ C Damage

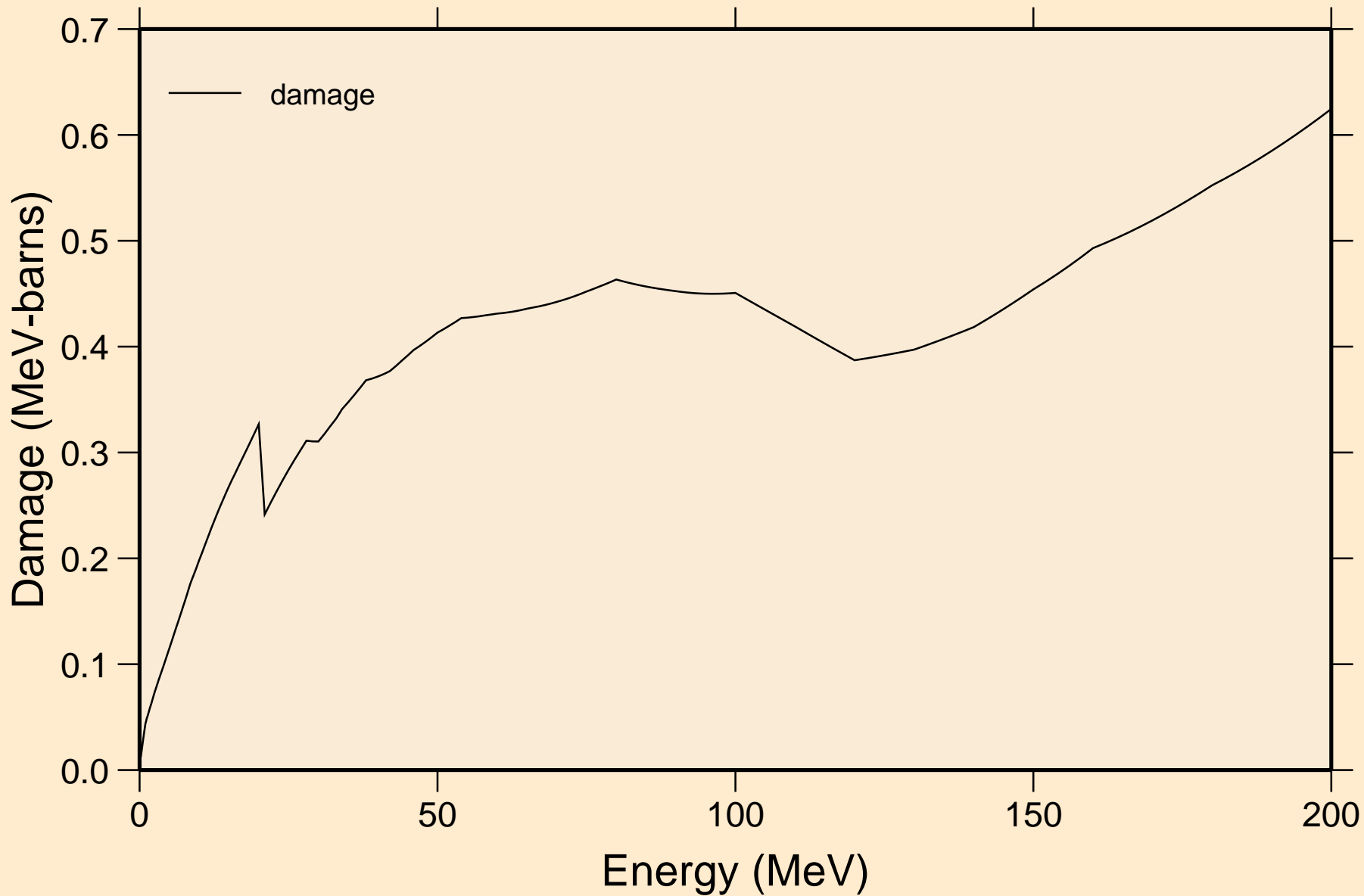

64-GD-158 FOR FENDL-3.2 FROM FENDL-3.2 BY NJOY2016.60+ C
Non-threshold reactions

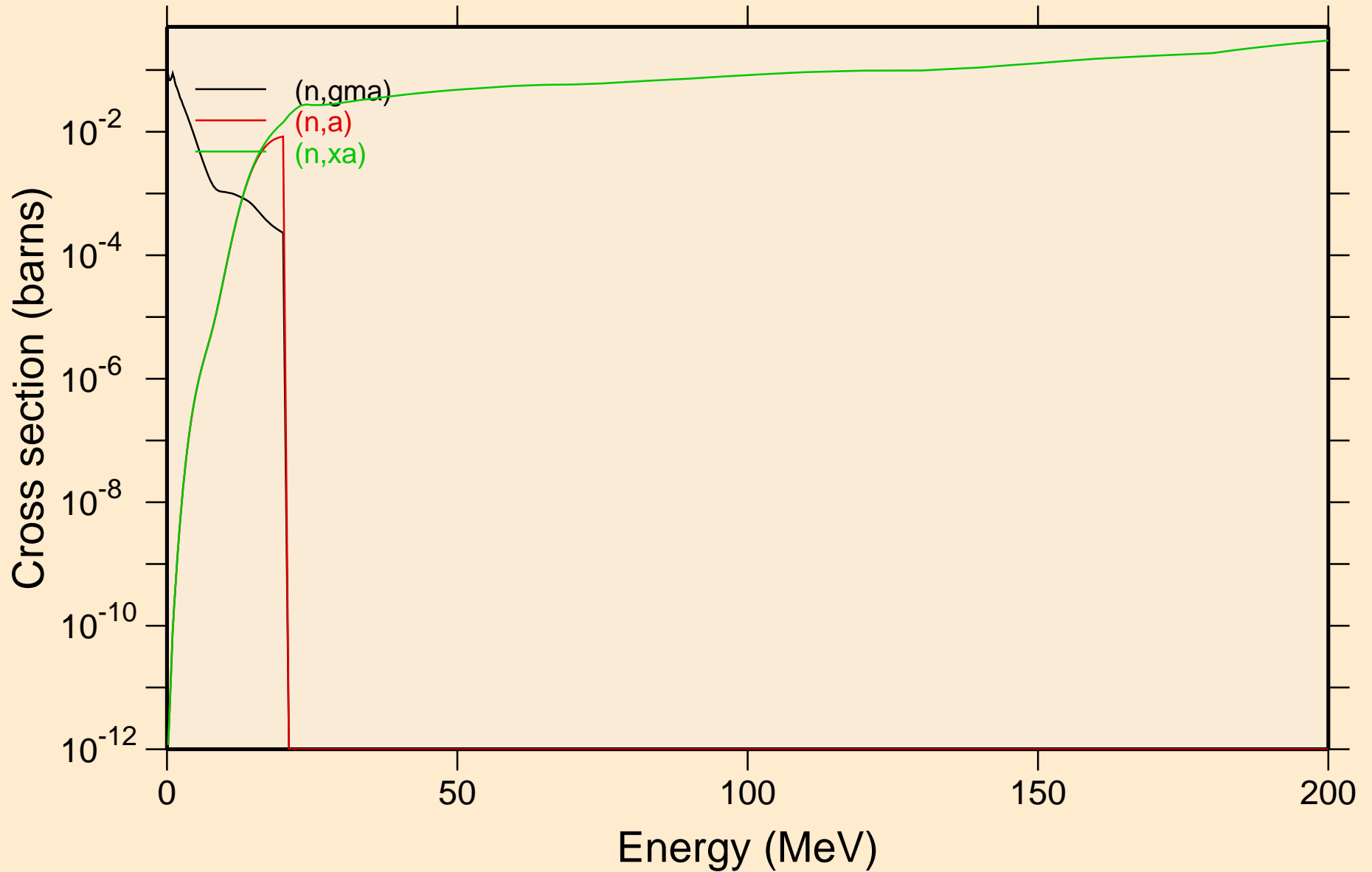

64-GD-158 FOR FENDL-3.2 FROM FENDL-3.2 BY NJOY2016.60+ C Inelastic levels

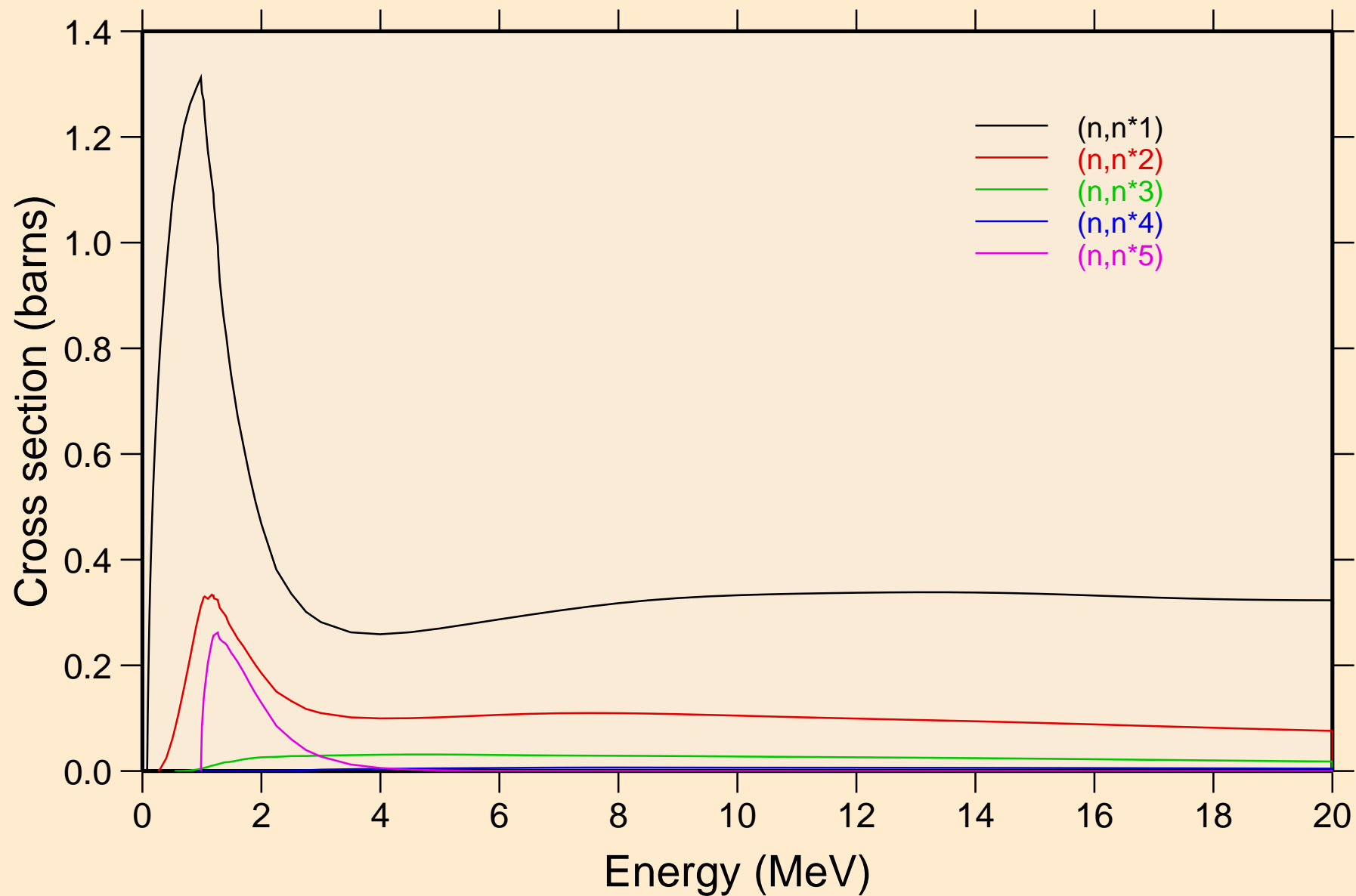

64-GD-158 FOR FENDL-3.2 FROM FENDL-3.2 BY NJOY2016.60+ C
Inelastic levels

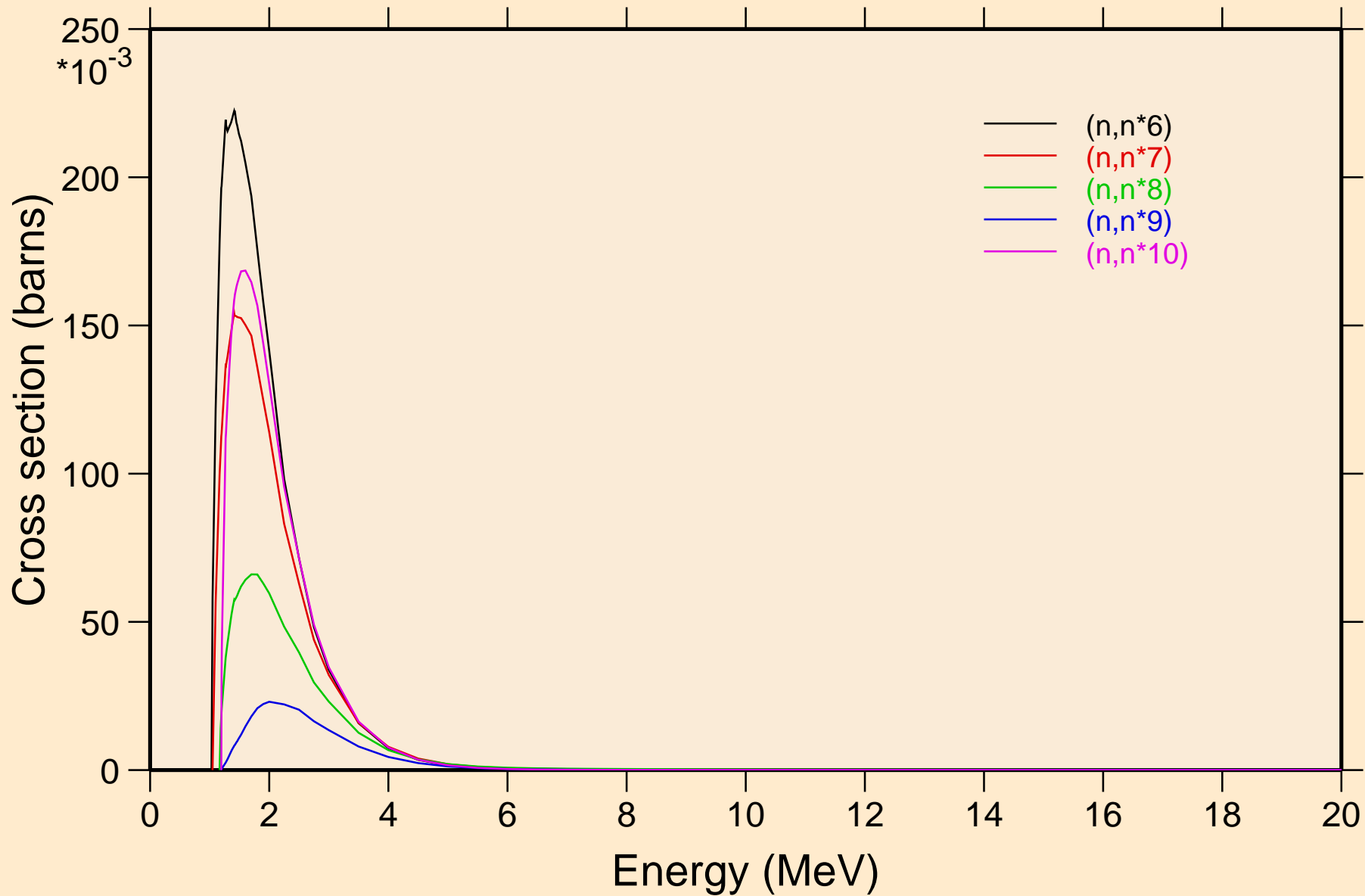

64-GD-158 FOR FENDL-3.2 FROM FENDL-3.2 BY NJOY2016.60+ C
Inelastic levels

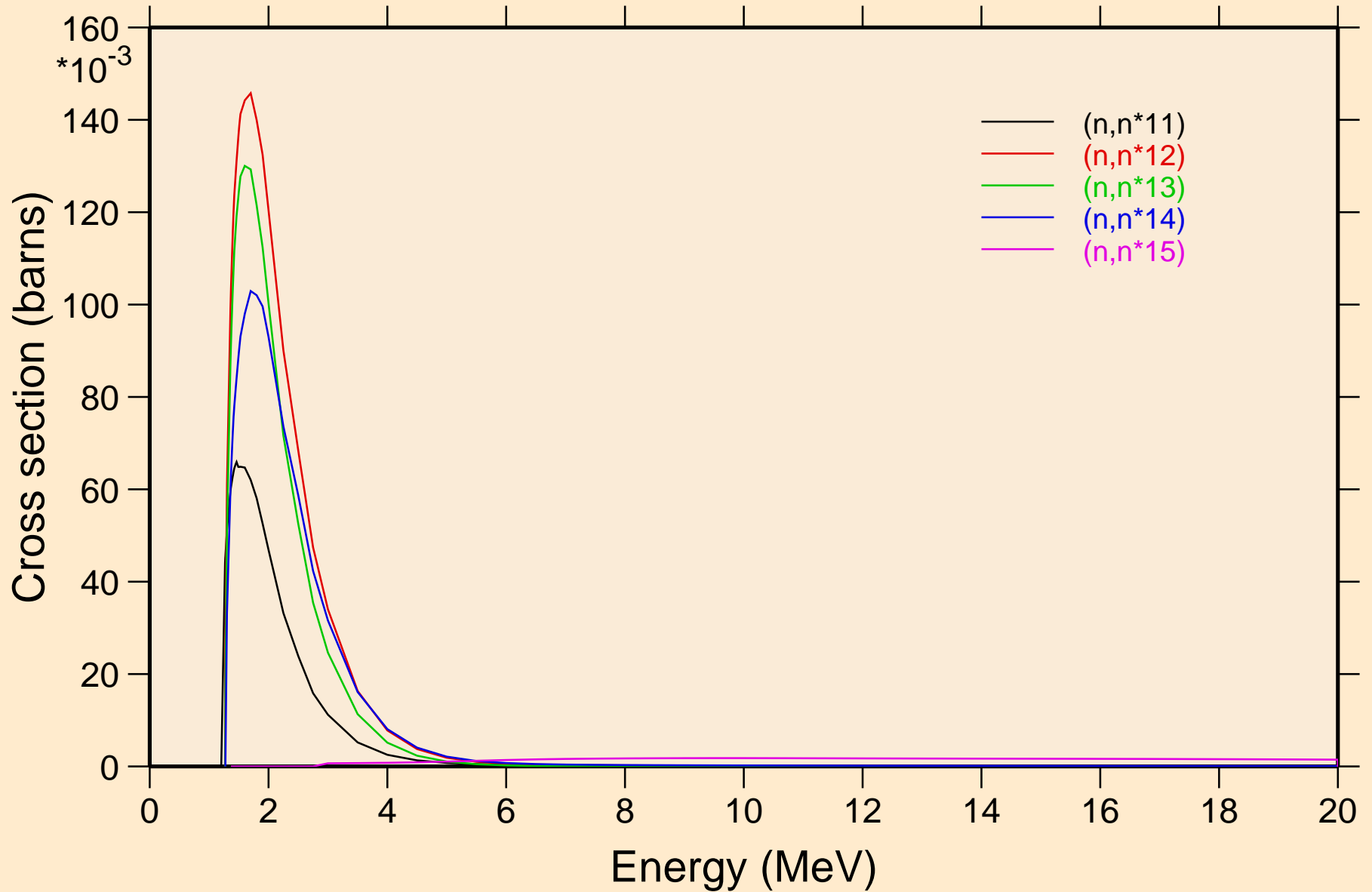

64-GD-158 FOR FENDL-3.2 FROM FENDL-3.2 BY NJOY2016.60+ C Inelastic levels

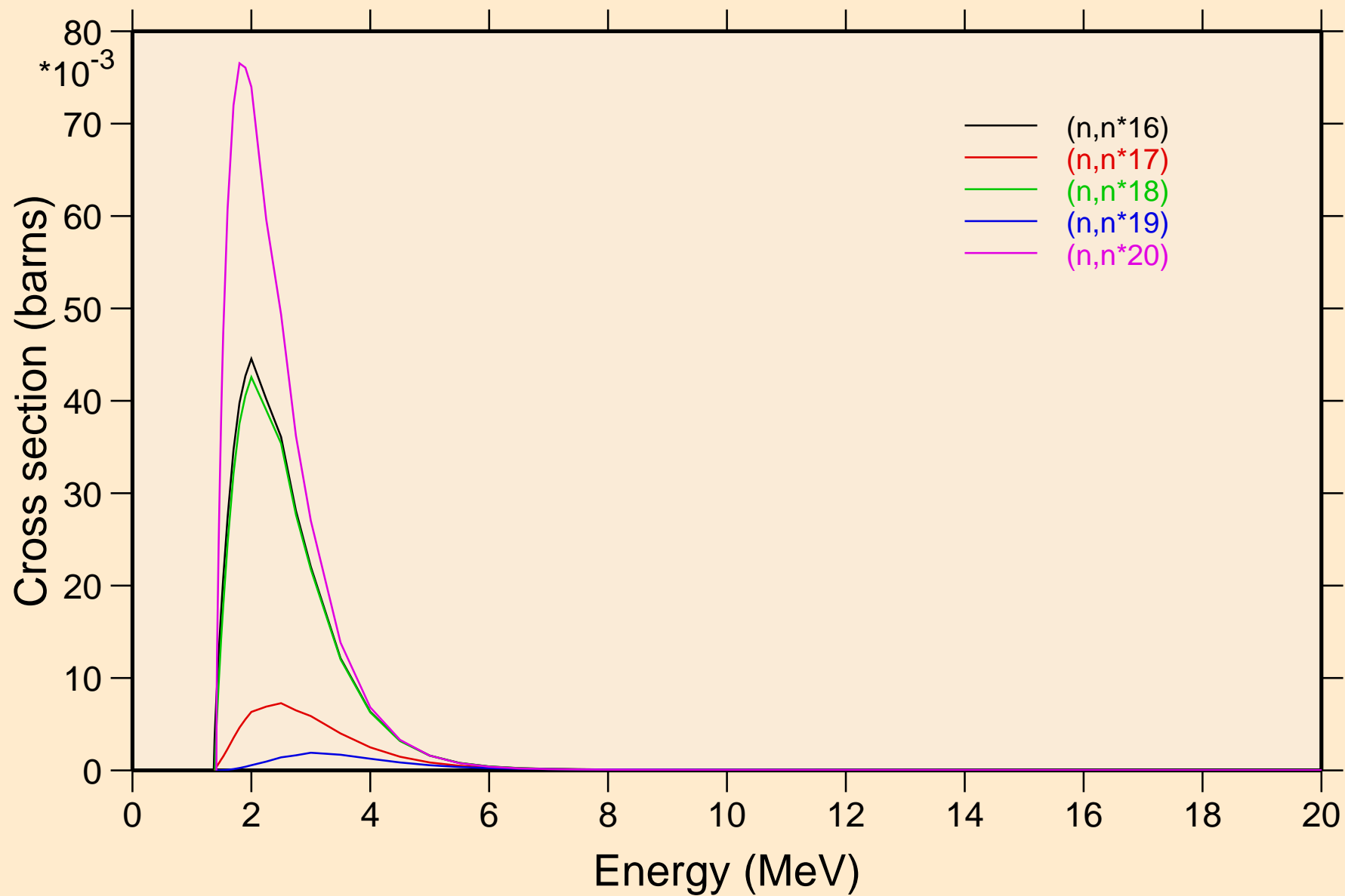

64-GD-158 FOR FENDL-3.2 FROM FENDL-3.2 BY NJOY2016.60+ C
Inelastic levels

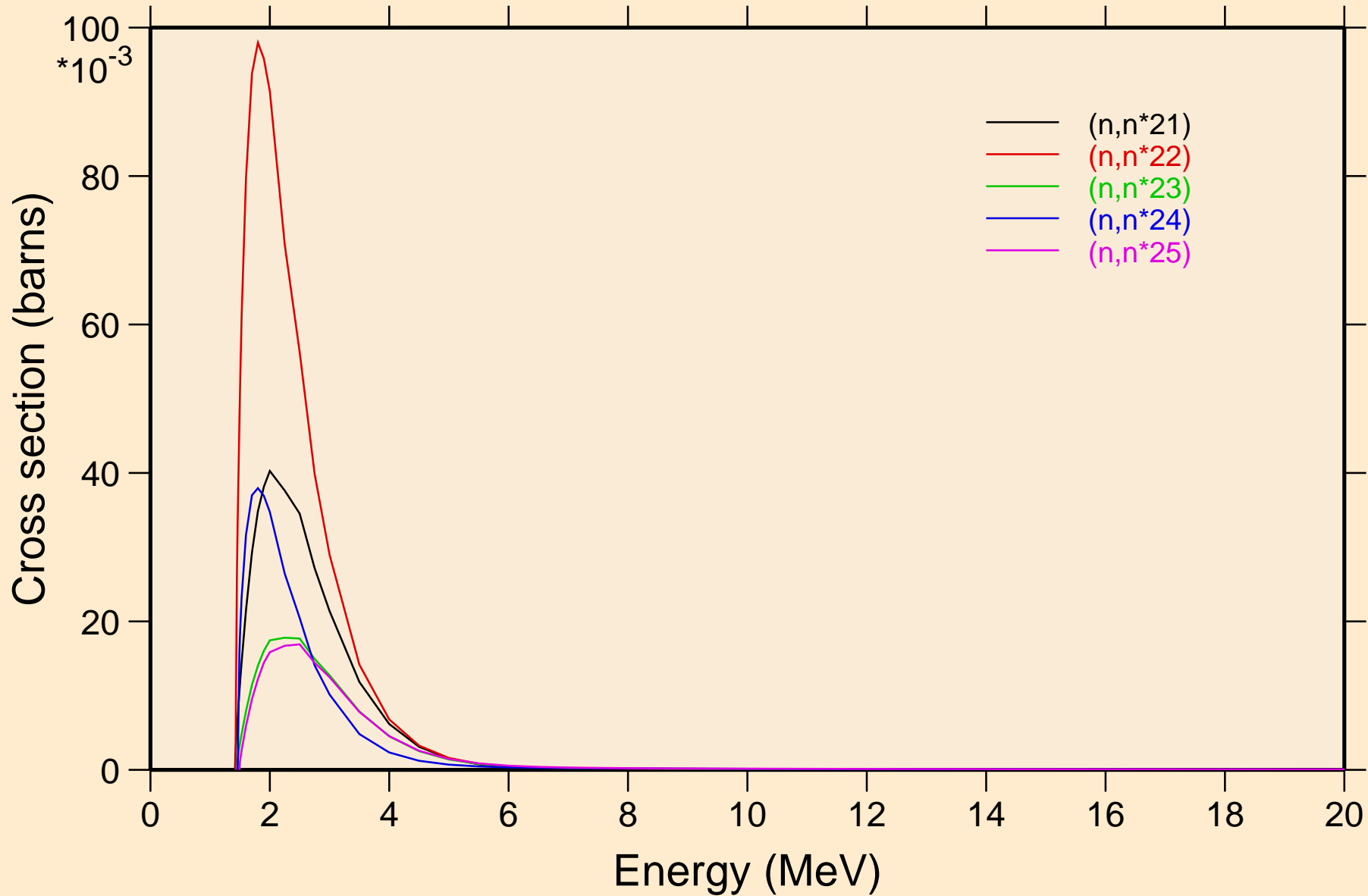

64-GD-158 FOR FENDL-3.2 FROM FENDL-3.2 BY NJOY2016.60+ C
Inelastic levels

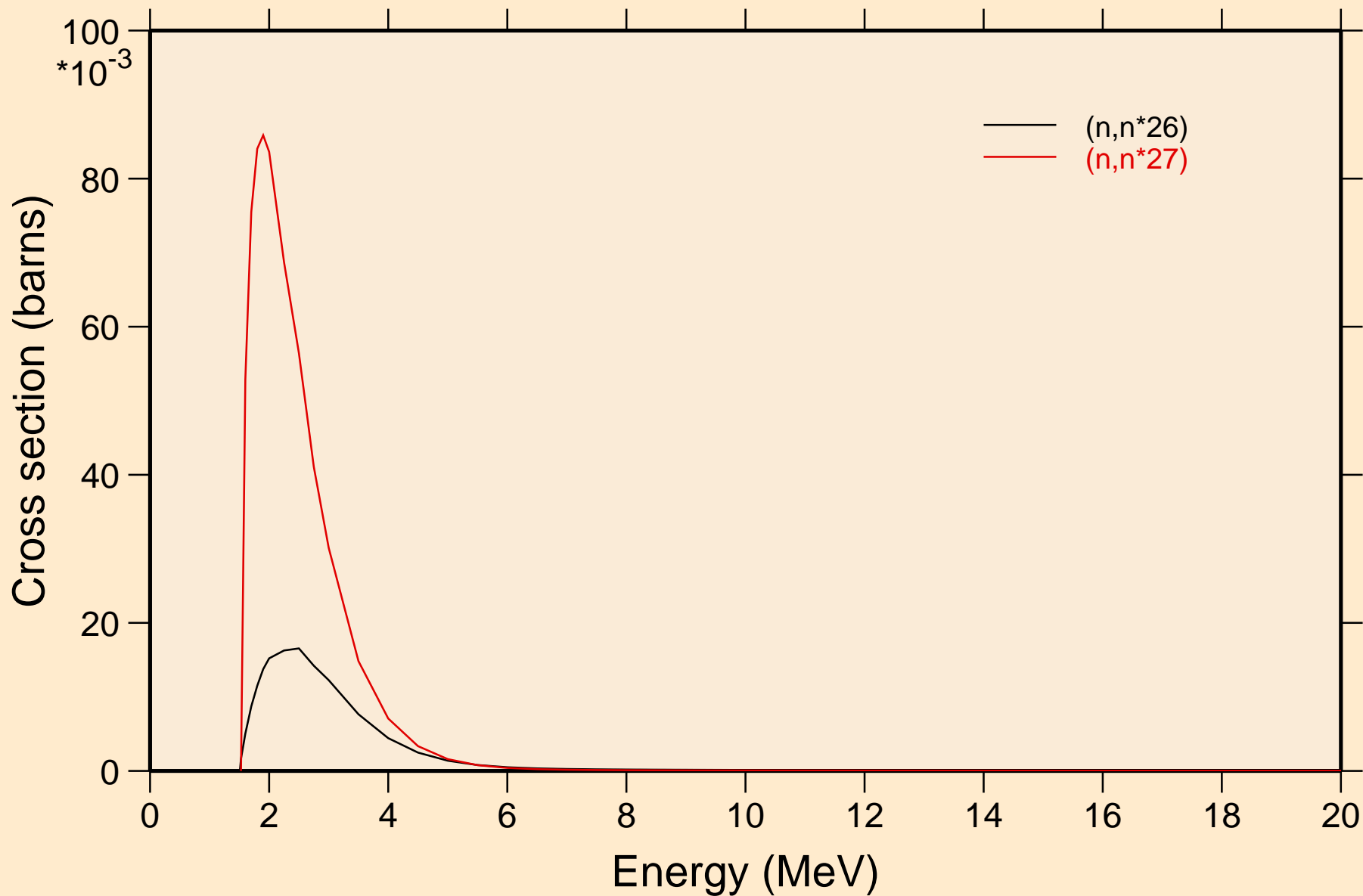

64-GD-158 FOR FENDL-3.2 FROM FENDL-3.2 BY NJOY2016.60+ C

Threshold reactions

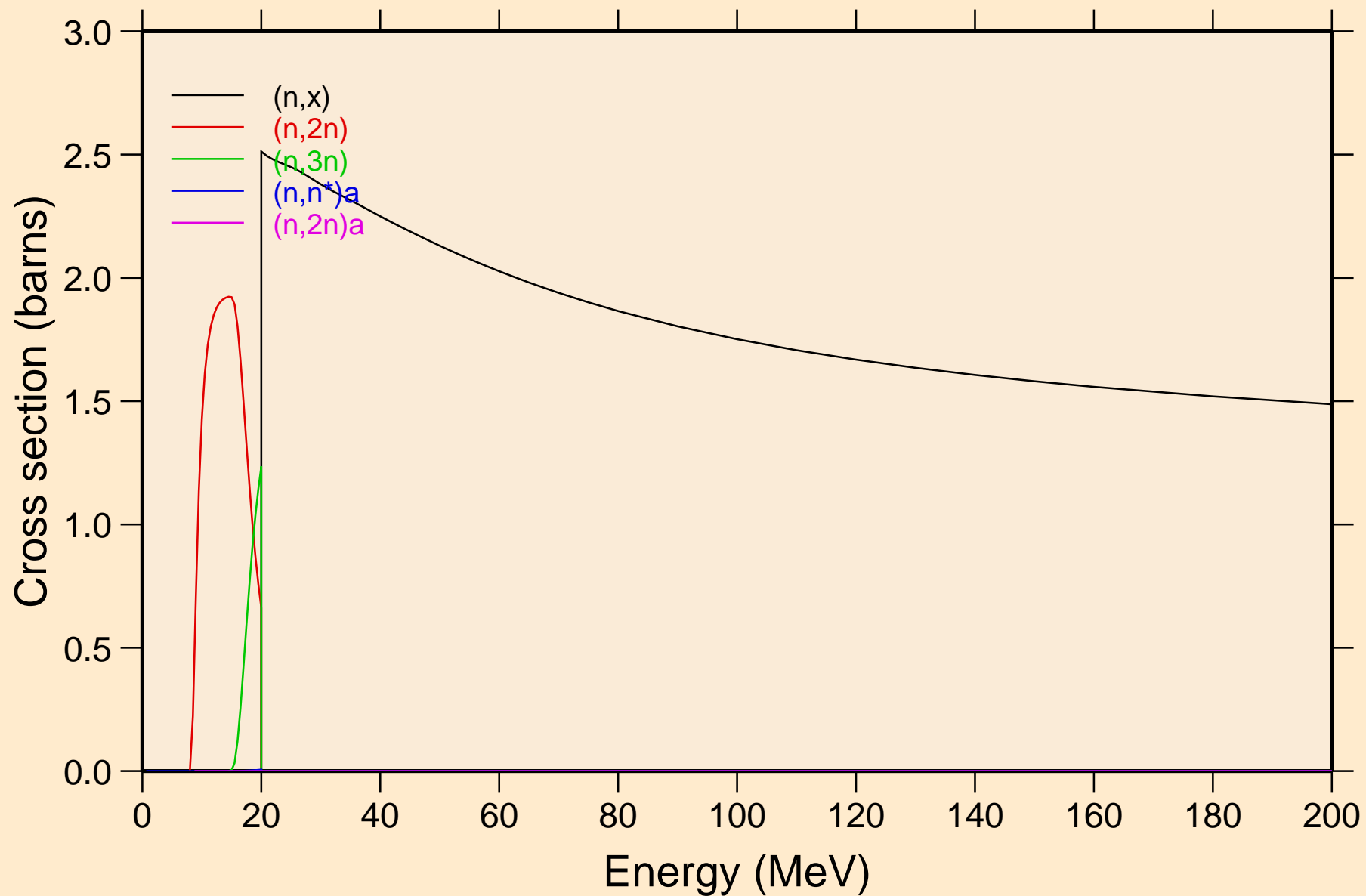

64-GD-158 FOR FENDL-3.2 FROM FENDL-3.2 BY NJOY2016.60+ C
Threshold reactions

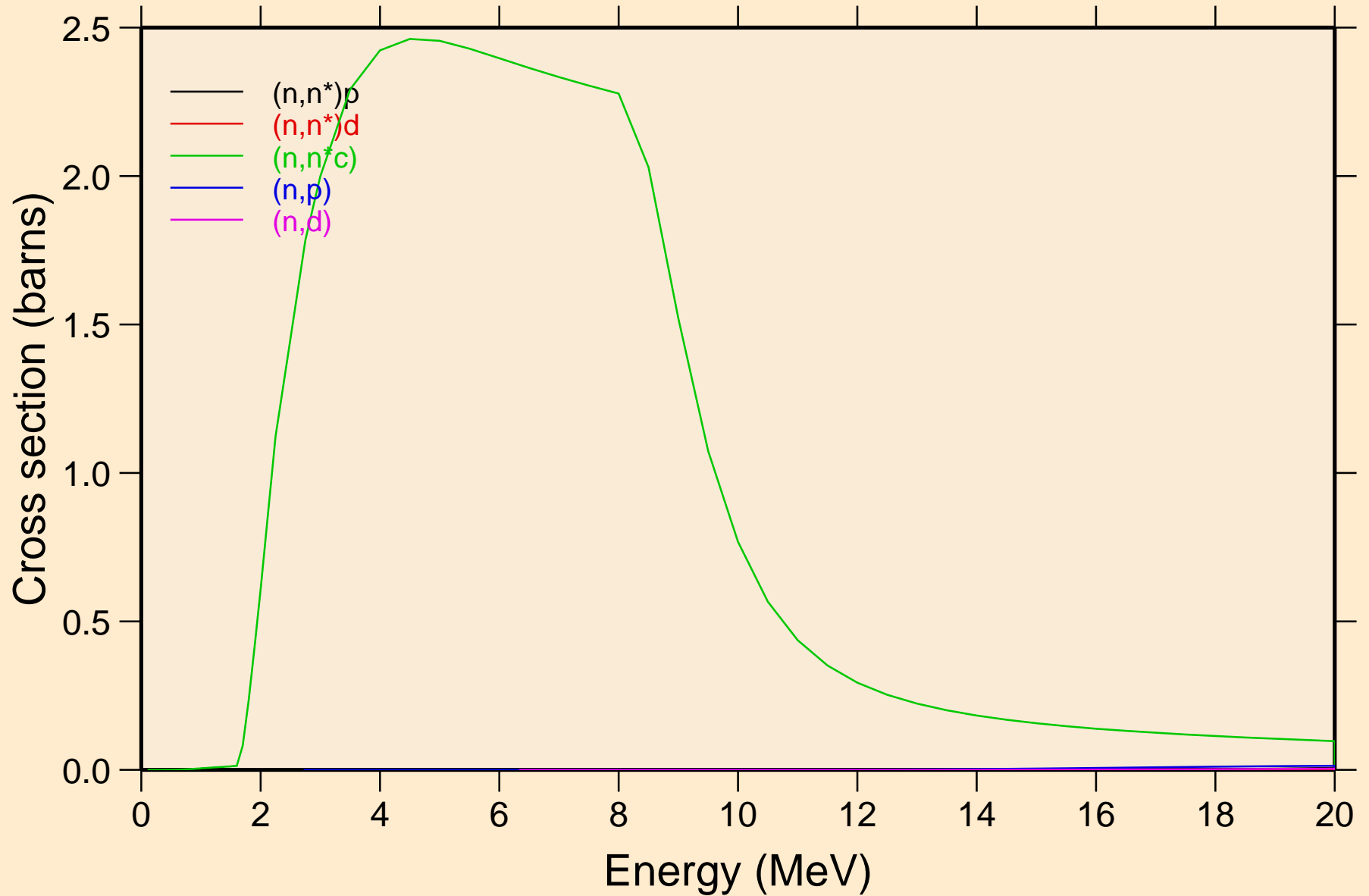

64-GD-158 FOR FENDL-3.2 FROM FENDL-3.2 BY NJOY2016.60+ C
Threshold reactions

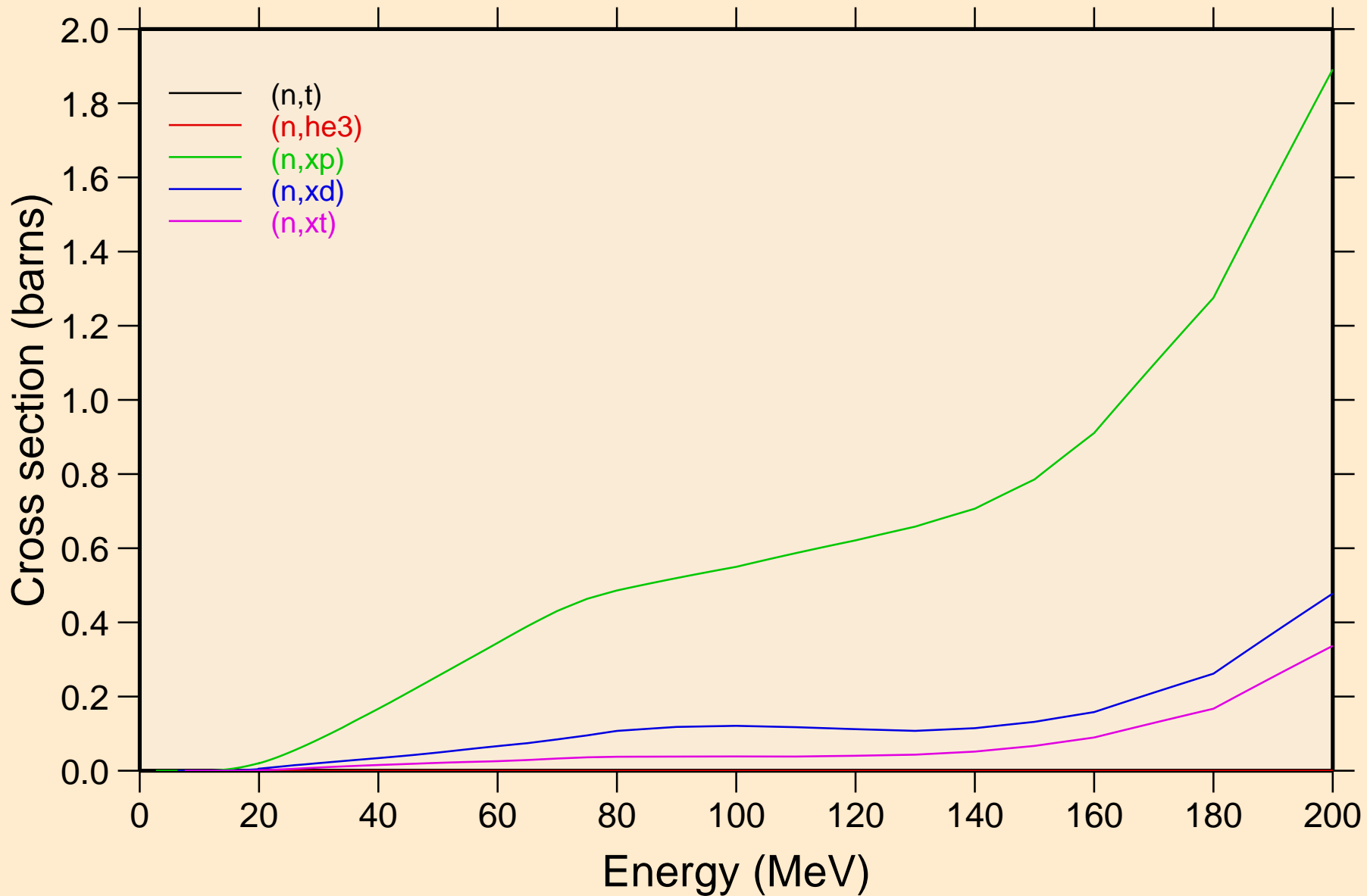

64-GD-158 FOR FENDL-3.2 FROM FENDL-3.2 BY NJOY2016.60+ C
Threshold reactions

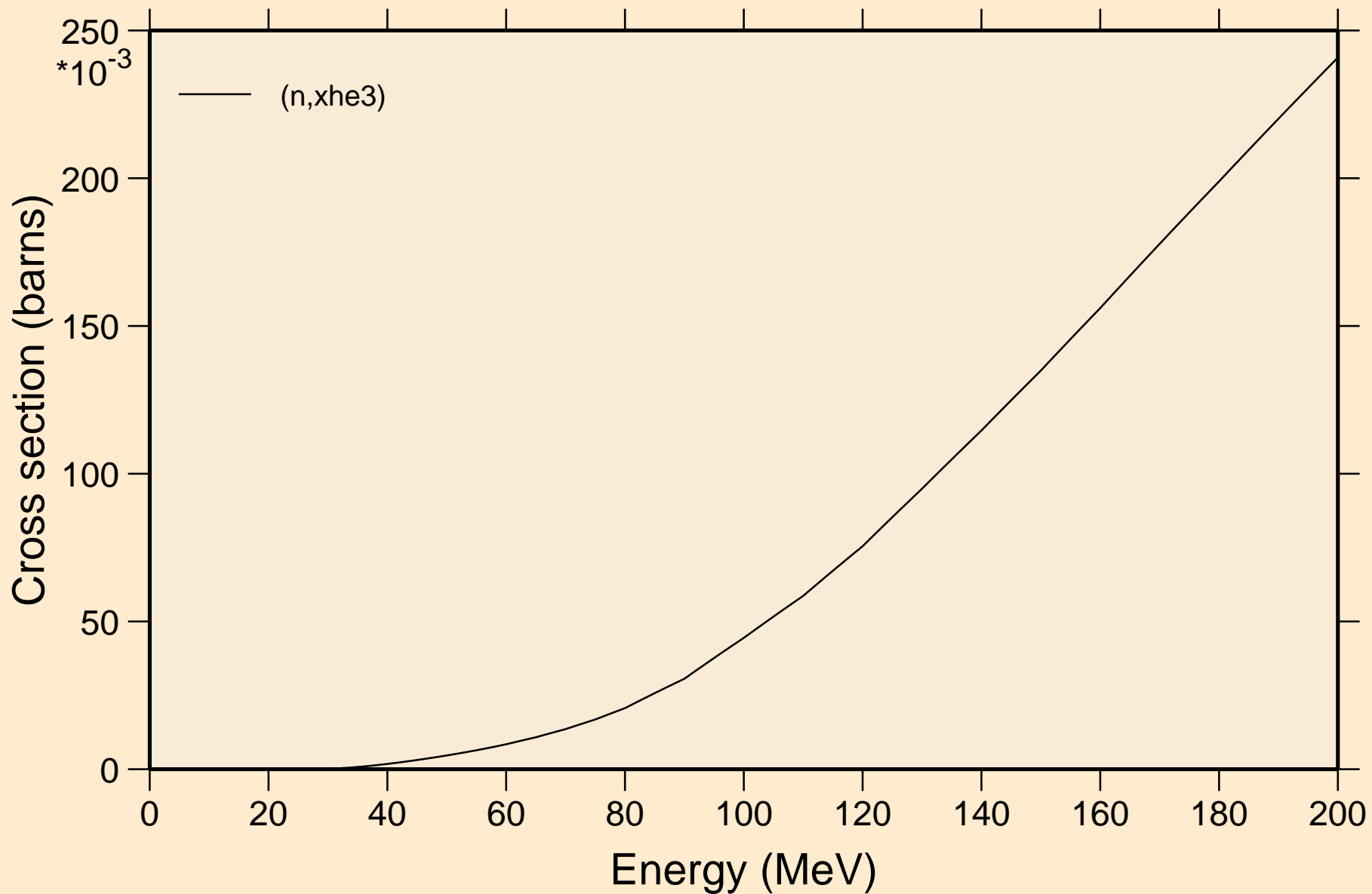

64-GD-158 FOR FENDL-3.2 FROM FENDL-3.2 BY NJOY2016.60+ C
angular distribution for elastic

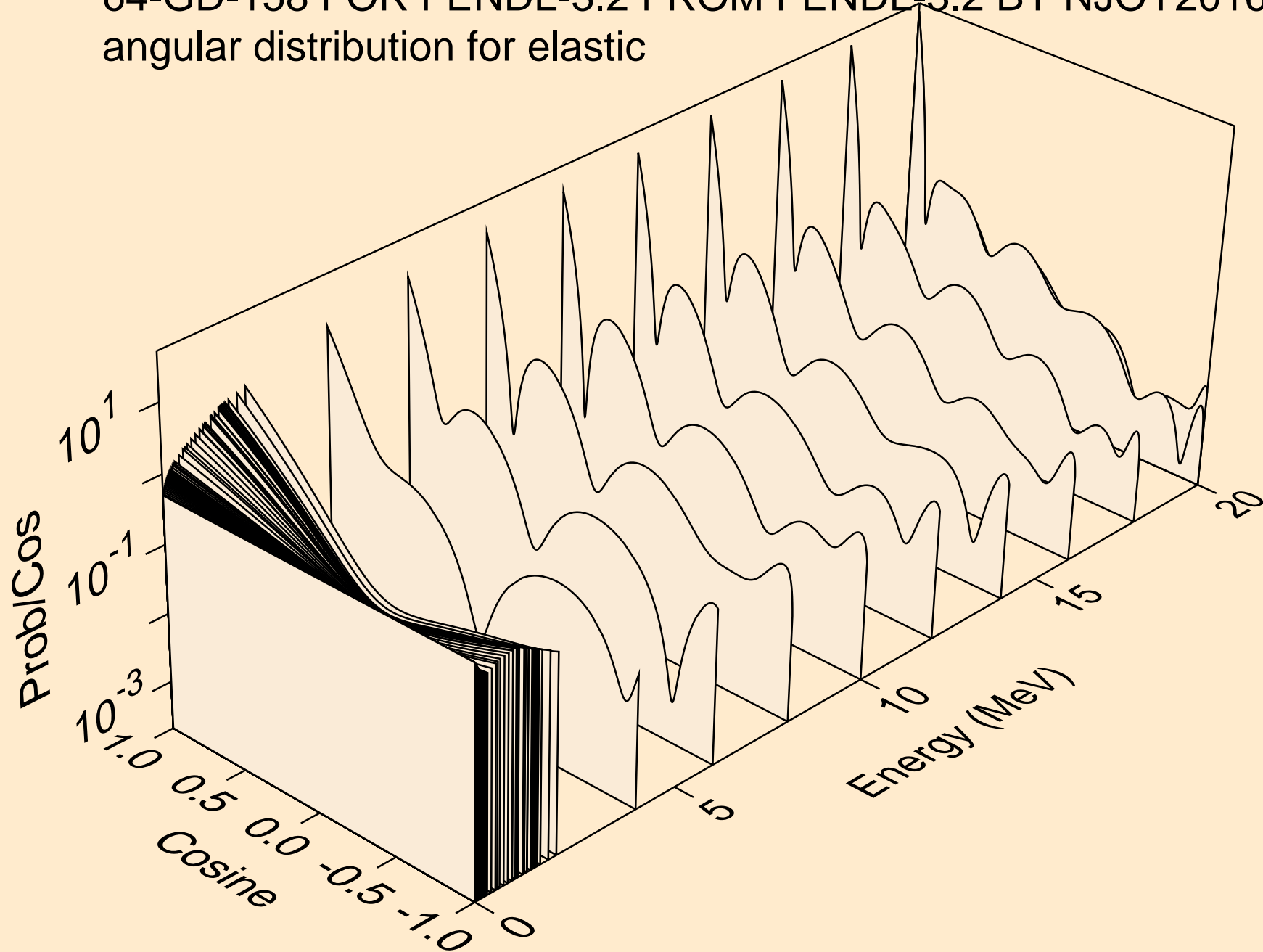

64-GD-158 FOR FENDL-3.2 FROM FENDL-3.2 BY NJOY2016.60+ C
angular distribution for elastic

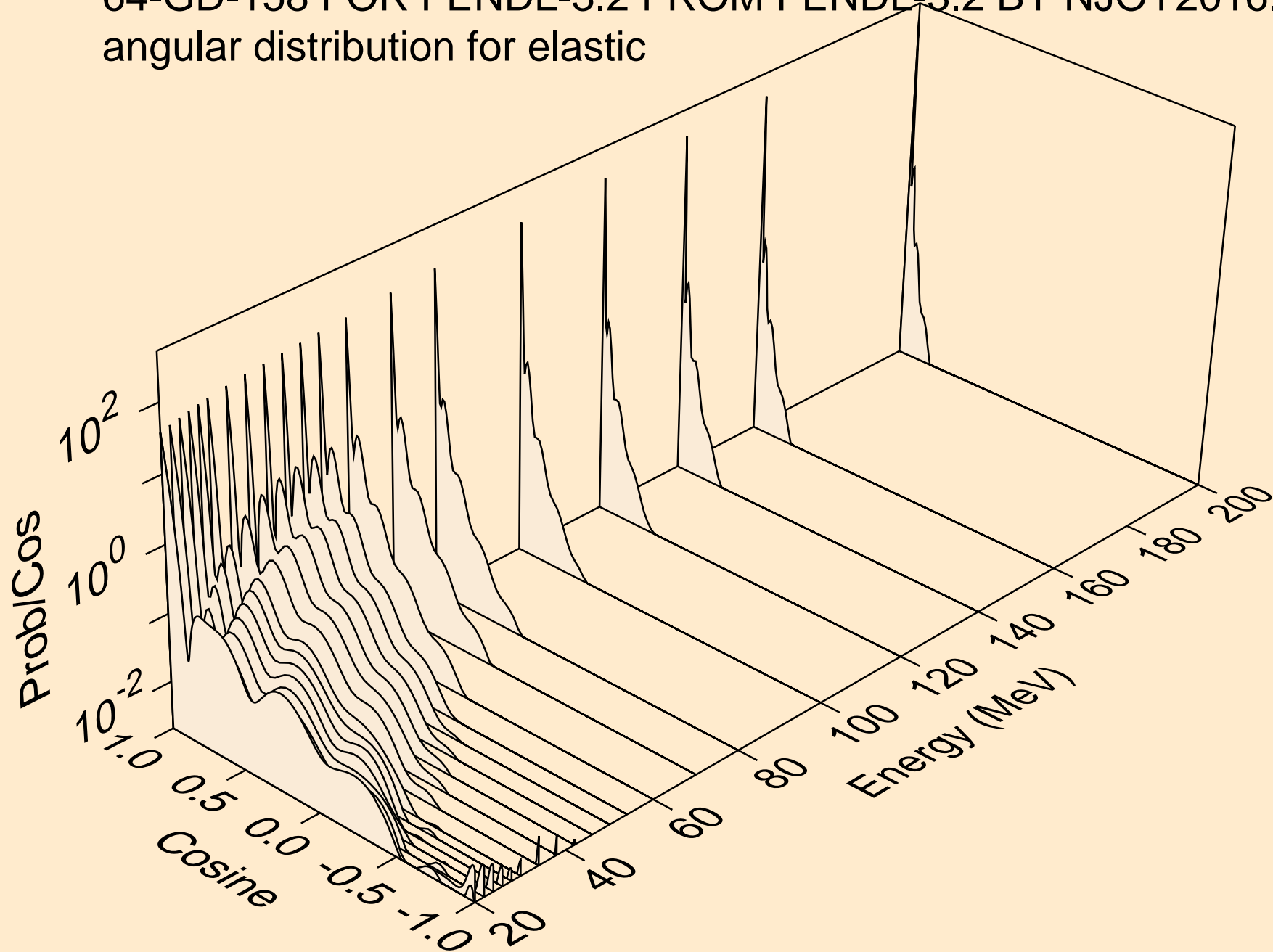

64-GD-158 FOR FENDL-3.2 FROM FENDL-3.2 BY NJOY2016.60+ C
angular distribution for (n,n*1)

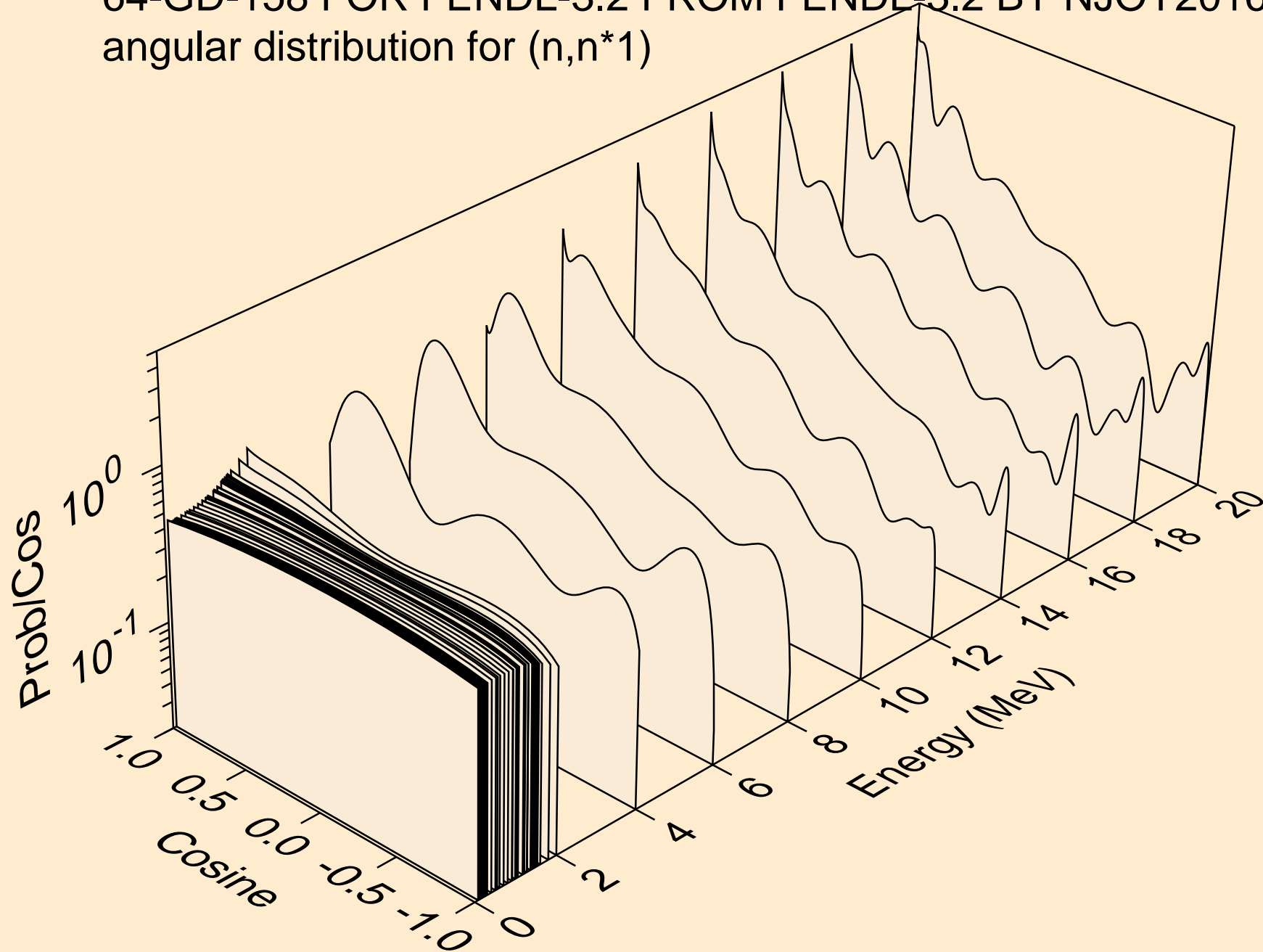

64-GD-158 FOR FENDL-3.2 FROM FENDL-3.2 BY NJOY2016.60+ C
angular distribution for (n,n*2)

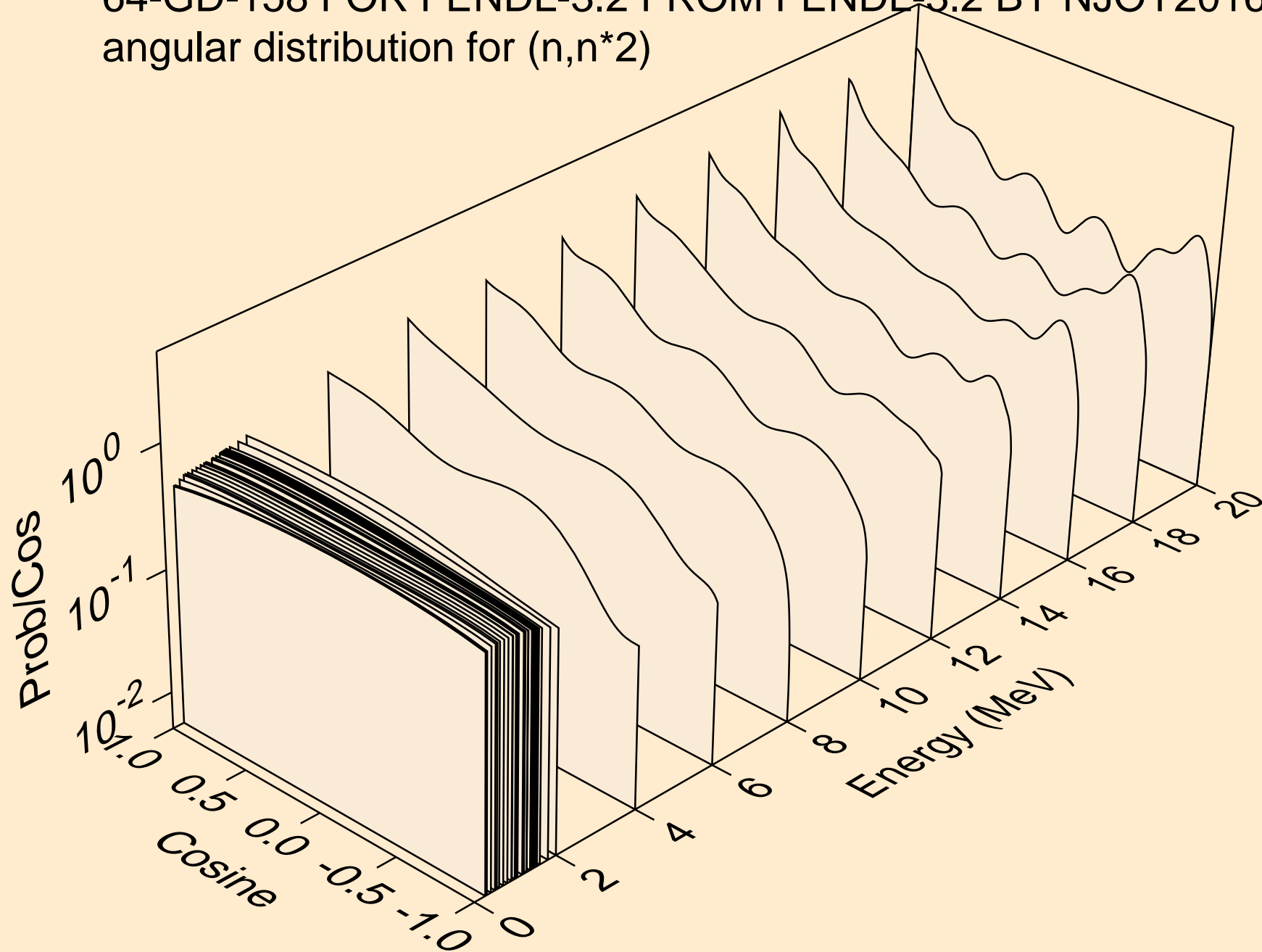

64-GD-158 FOR FENDL-3.2 FROM FENDL-3.2 BY NJOY2016.60+ C
angular distribution for (n,n*3)

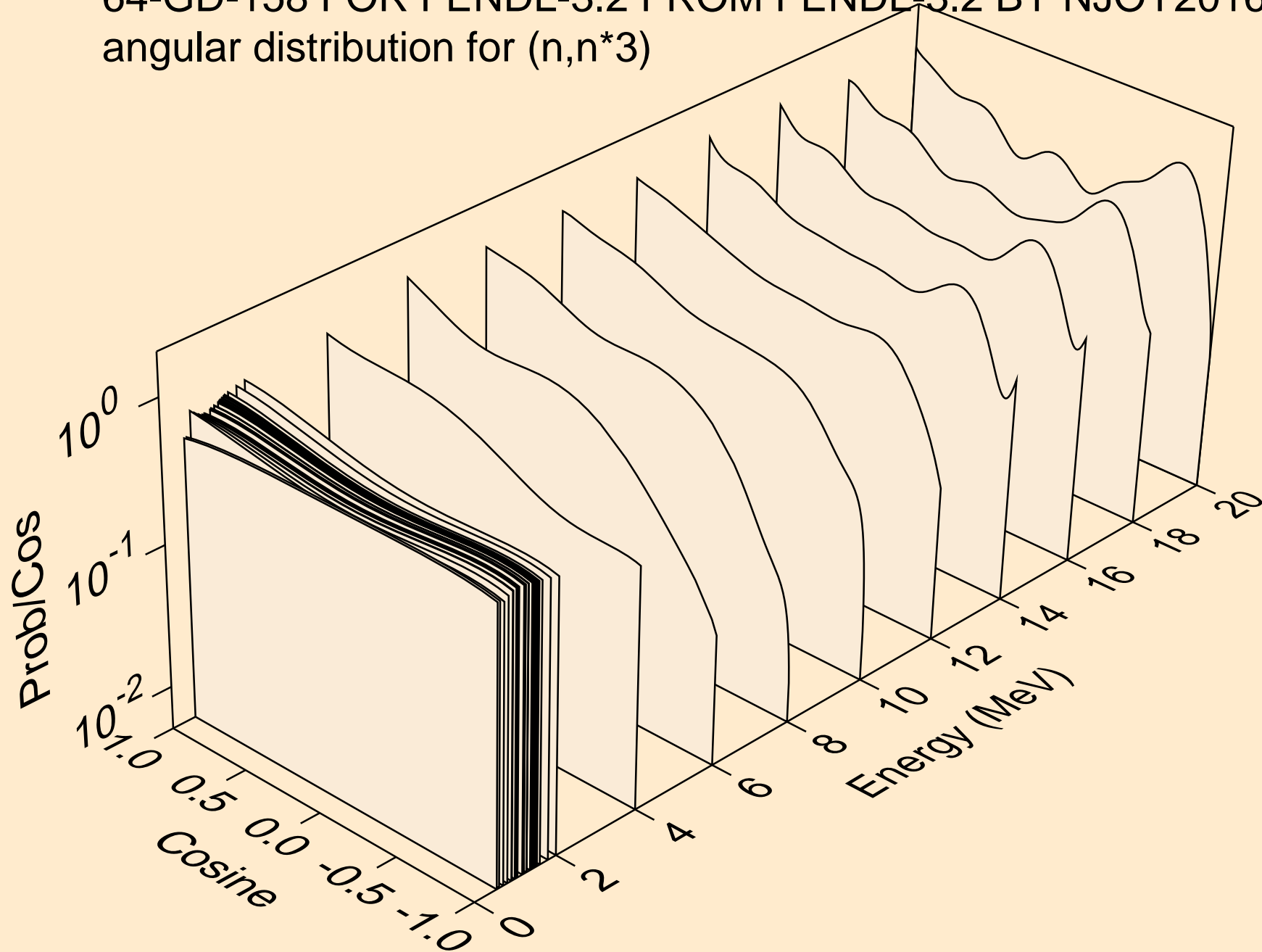

64-GD-158 FOR FENDL-3.2 FROM FENDL-3.2 BY NJOY2016.60+ C
angular distribution for (n,n*4)

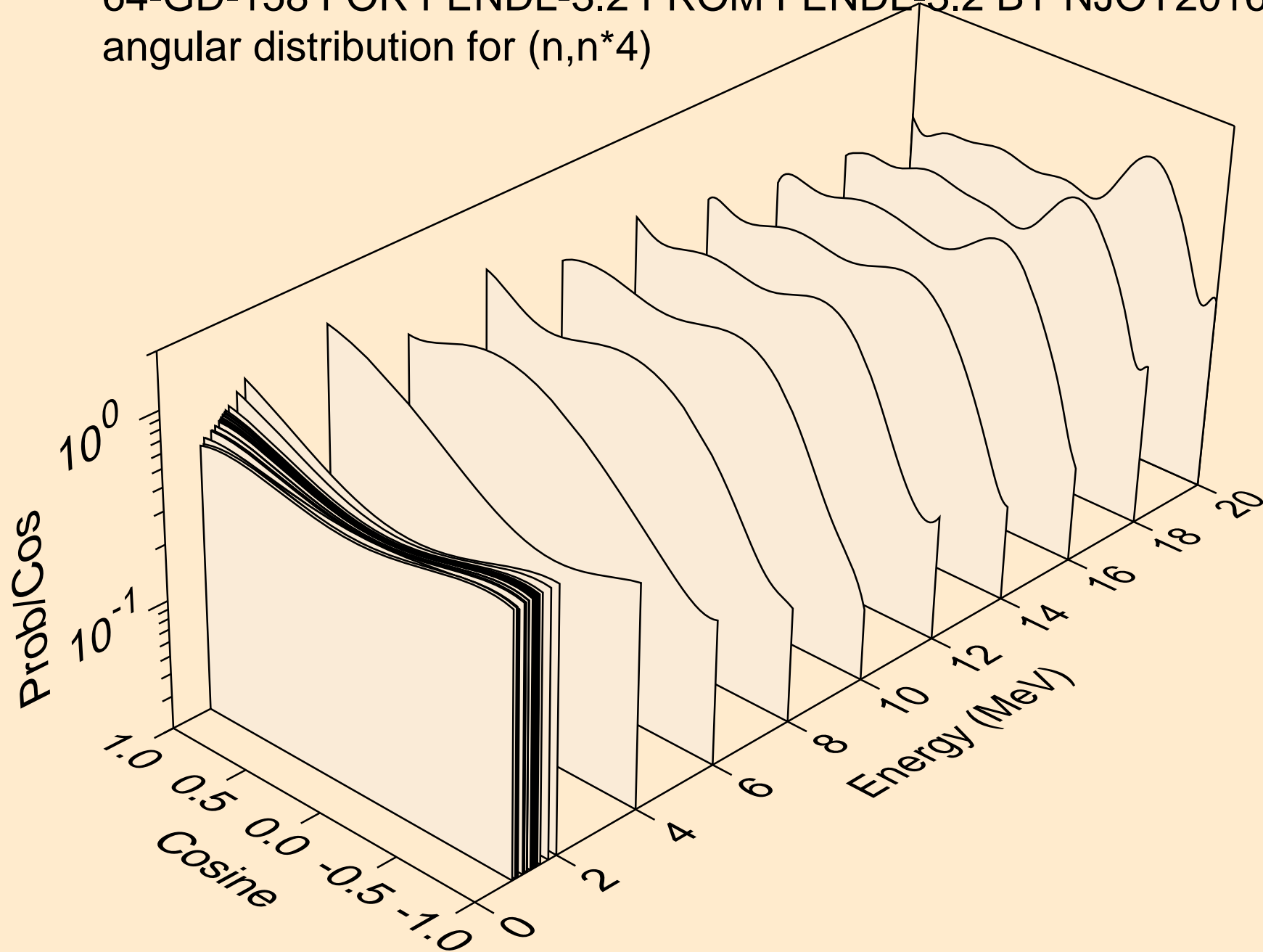

64-GD-158 FOR FENDL-3.2 FROM FENDL-3.2 BY NJOY2016.60+ C
angular distribution for (n,n*5)

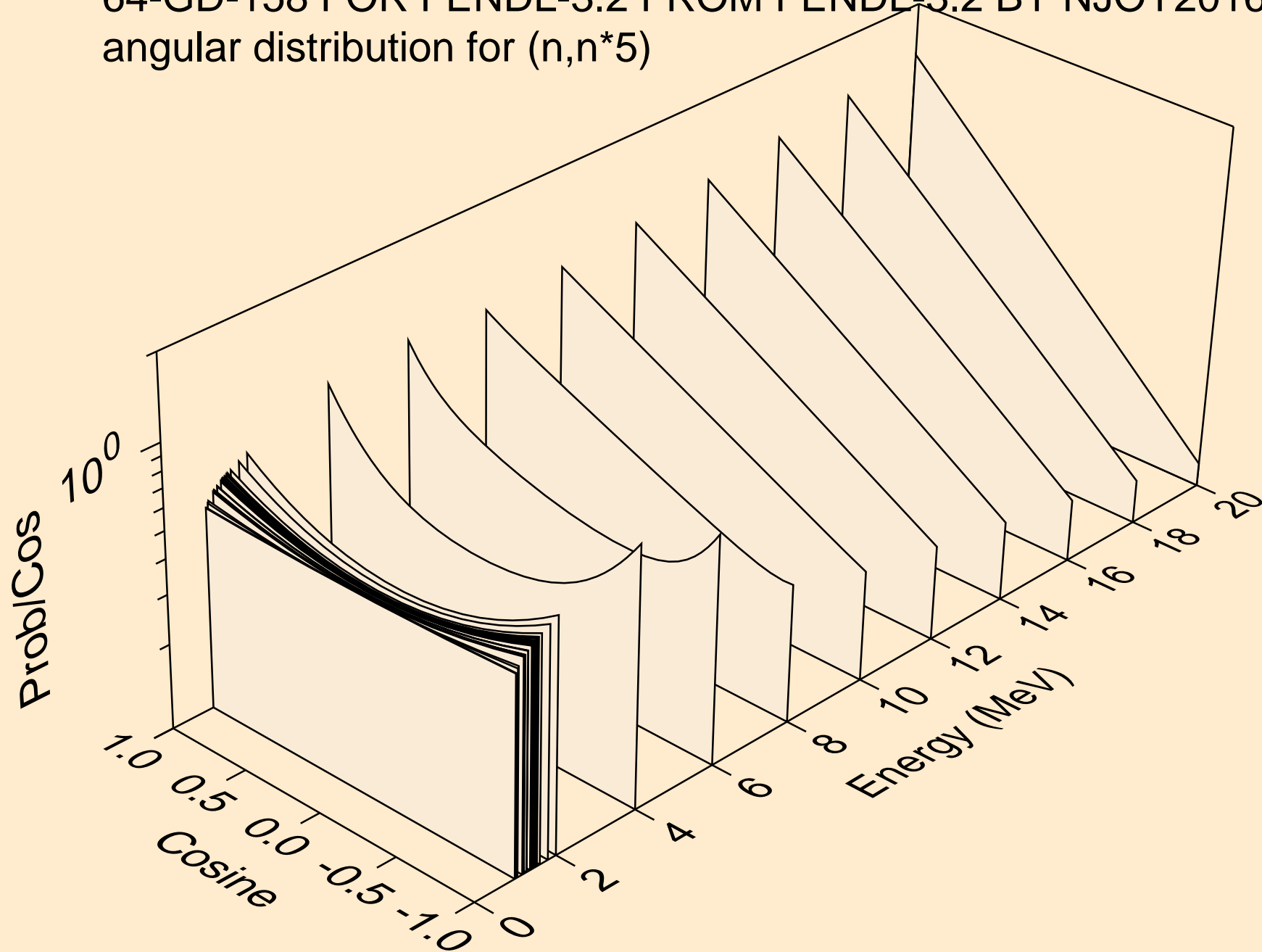

64-GD-158 FOR FENDL-3.2 FROM FENDL-3.2 BY NJOY2016.60+ C
angular distribution for (n,n*6)

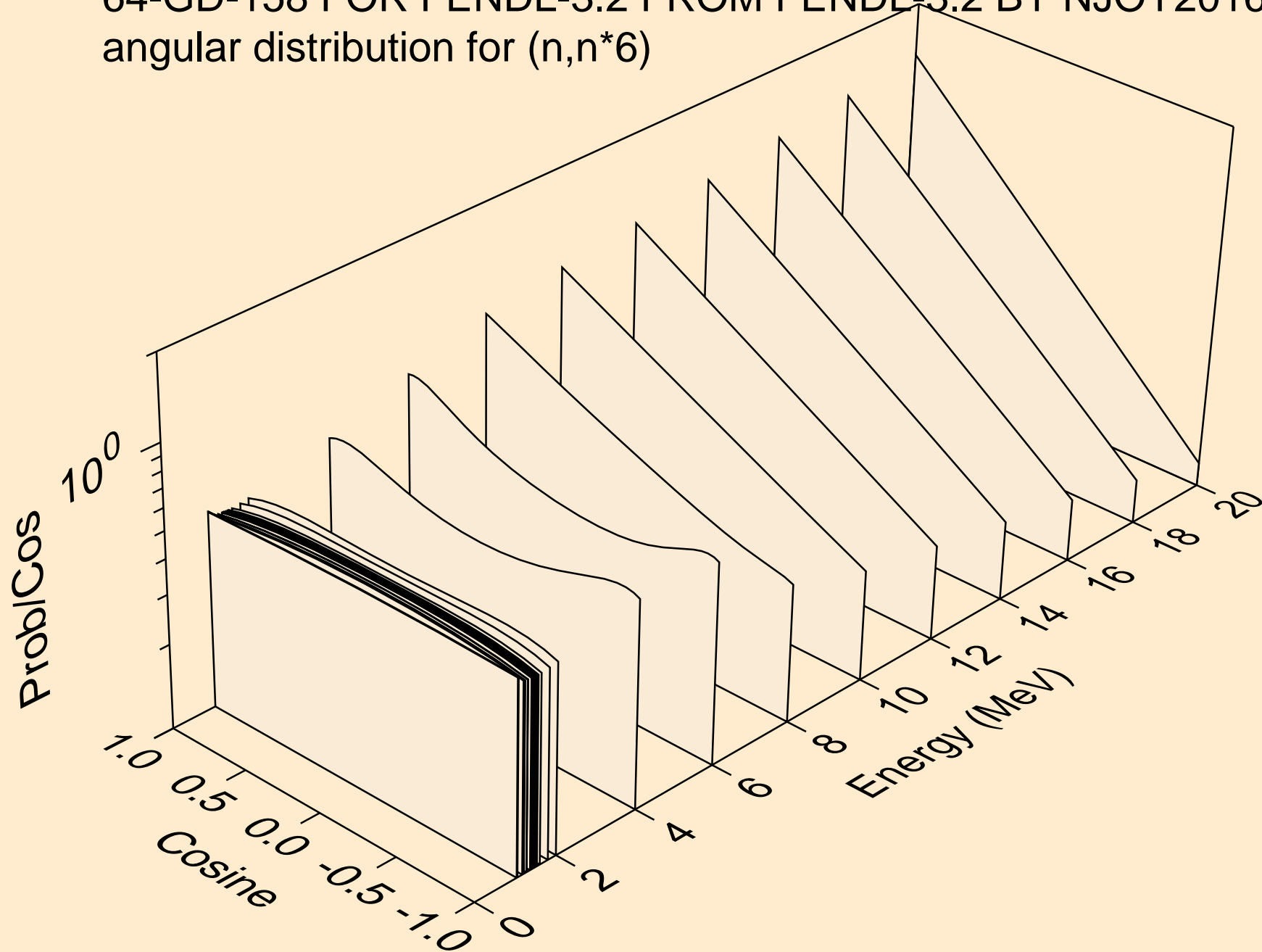

64-GD-158 FOR FENDL-3.2 FROM FENDL-3.2 BY NJOY2016.60+ C
angular distribution for (n,n*7)

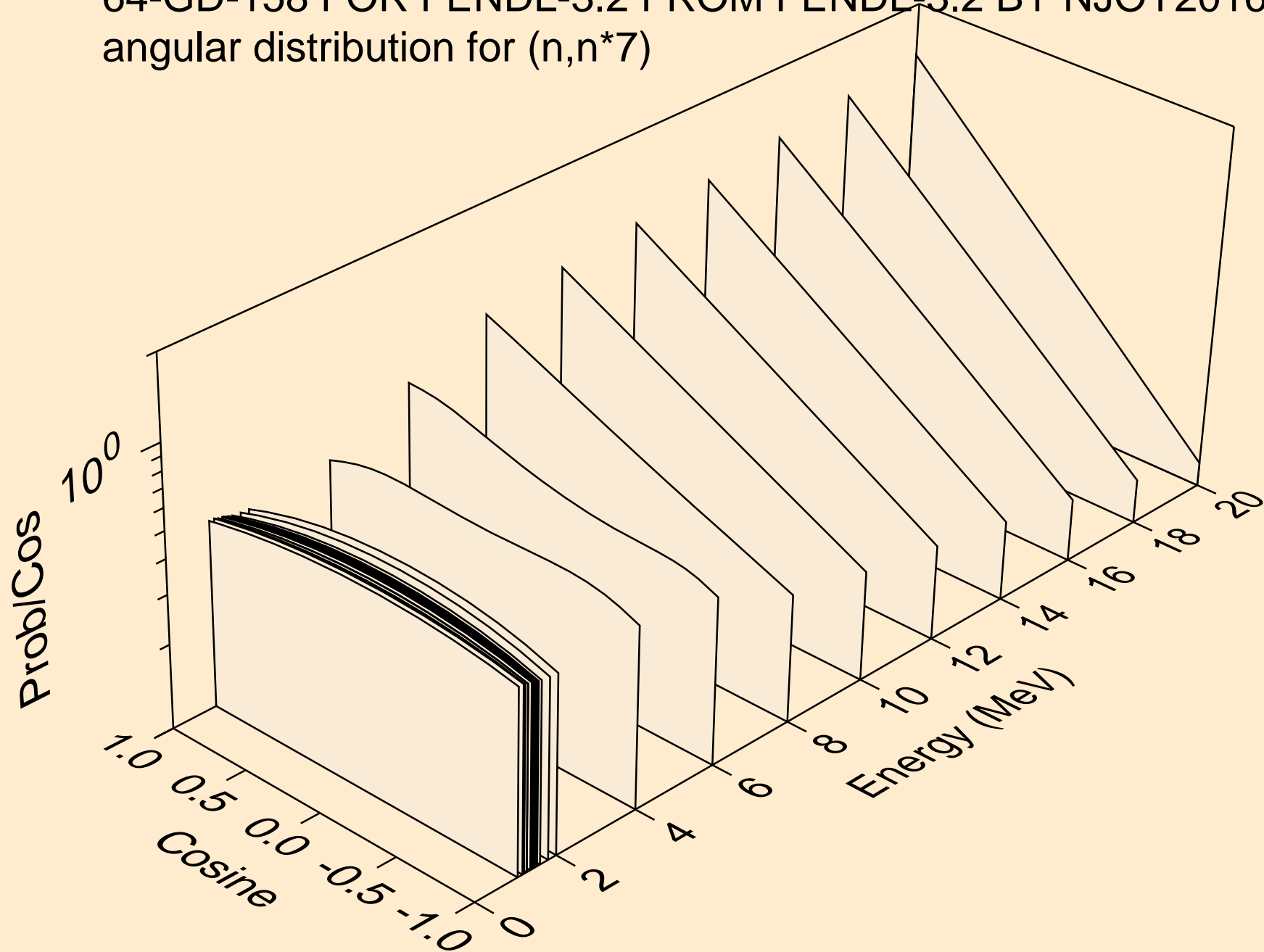

64-GD-158 FOR FENDL-3.2 FROM FENDL-3.2 BY NJOY2016.60+ C
angular distribution for (n,n*8)

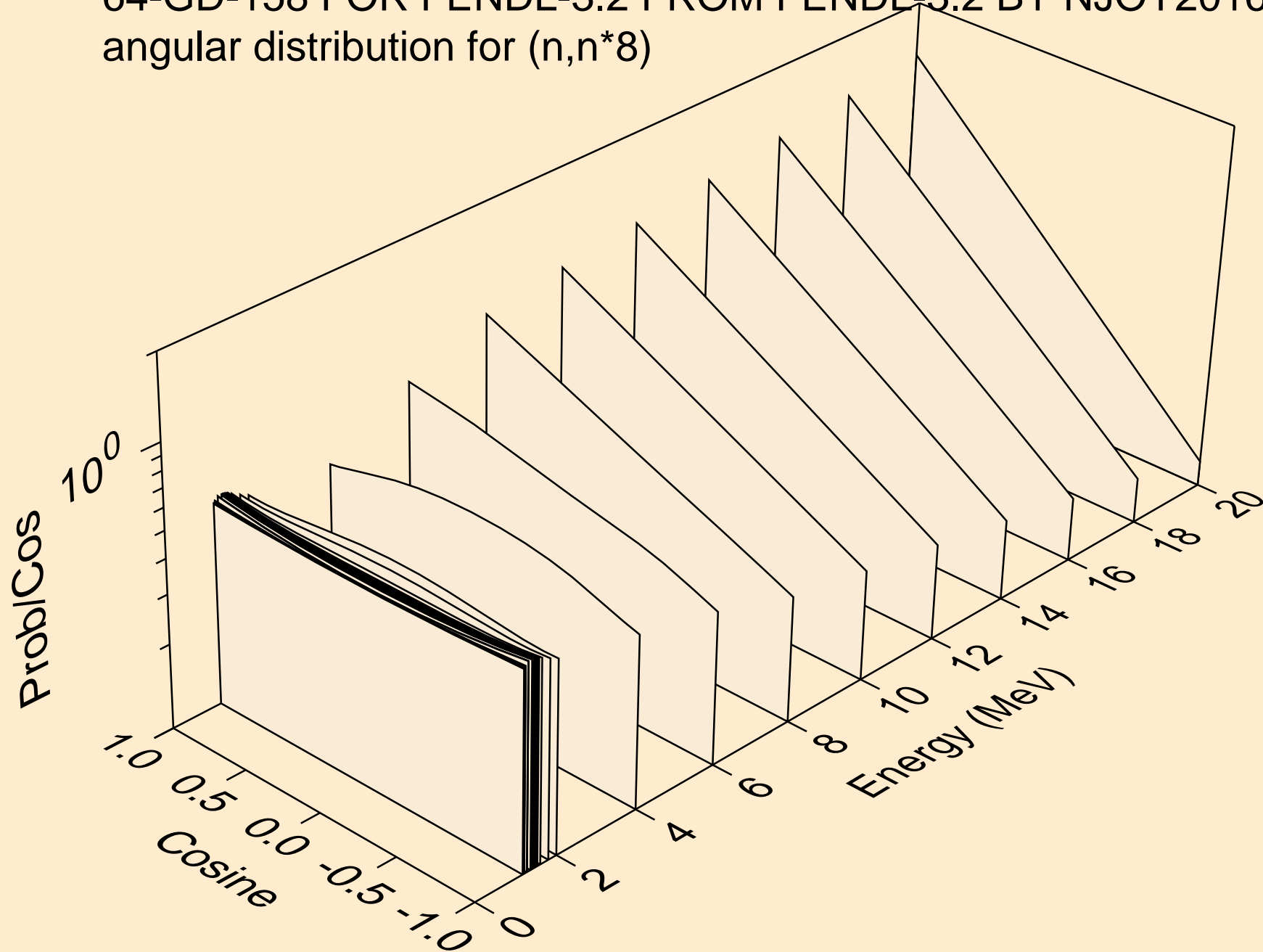

64-GD-158 FOR FENDL-3.2 FROM FENDL-3.2 BY NJOY2016.60+ C
angular distribution for (n,n*9)

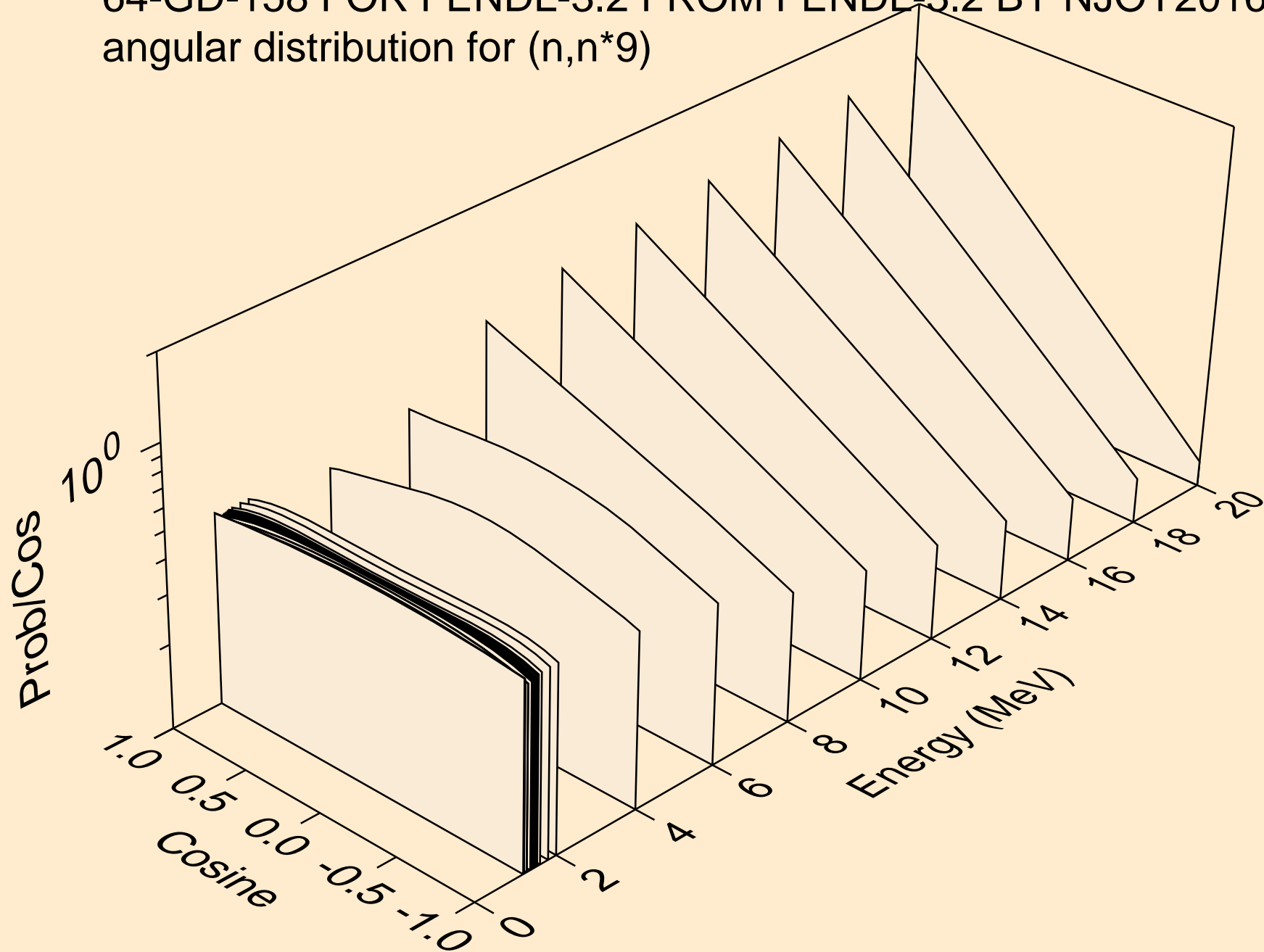

64-GD-158 FOR FENDL-3.2 FROM FENDL-3.2 BY NJOY2016.60+ C
angular distribution for (n,n*10)

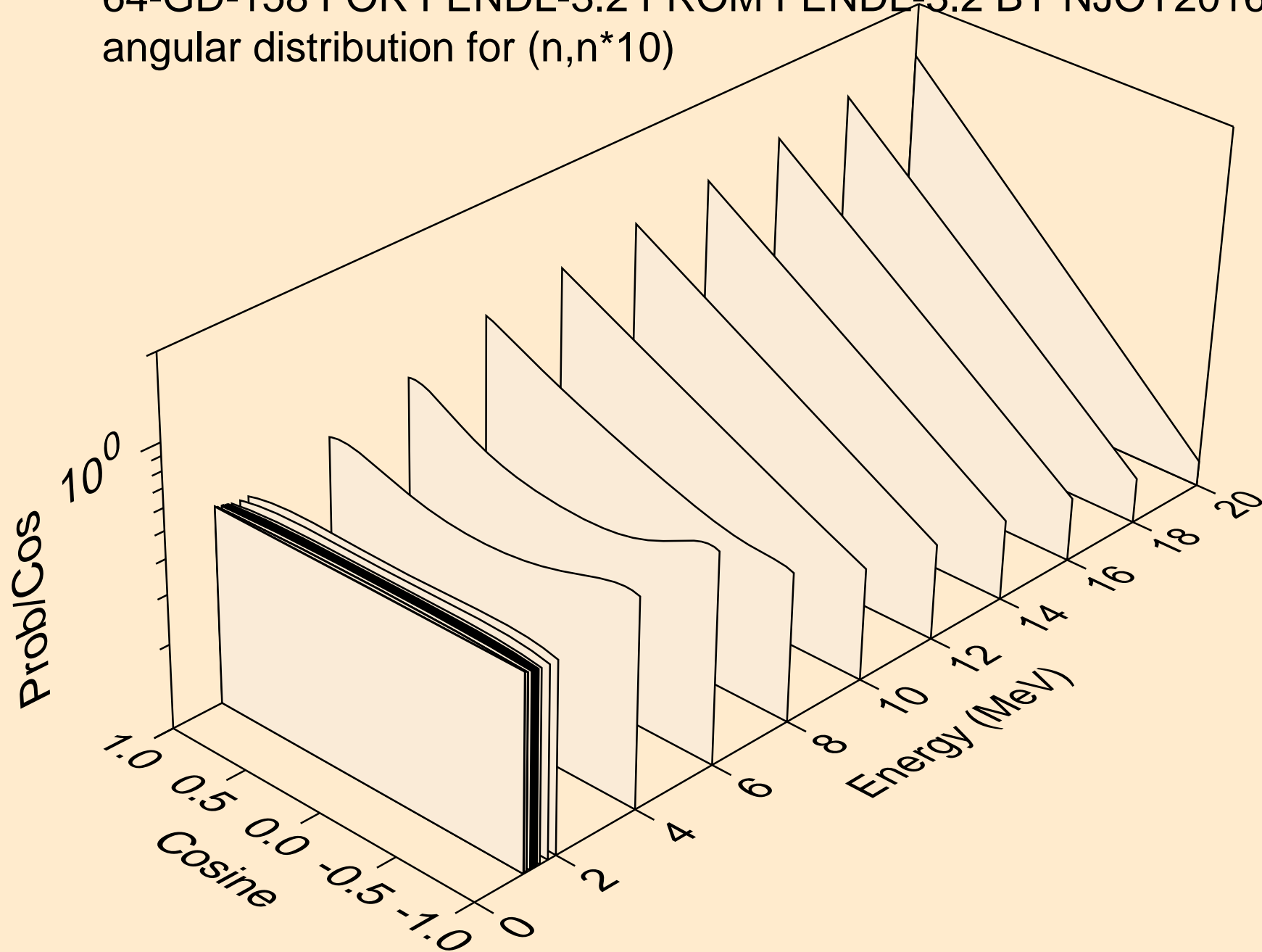

64-GD-158 FOR FENDL-3.2 FROM FENDL-3.2 BY NJOY2016.60+ C
angular distribution for (n,n*11)

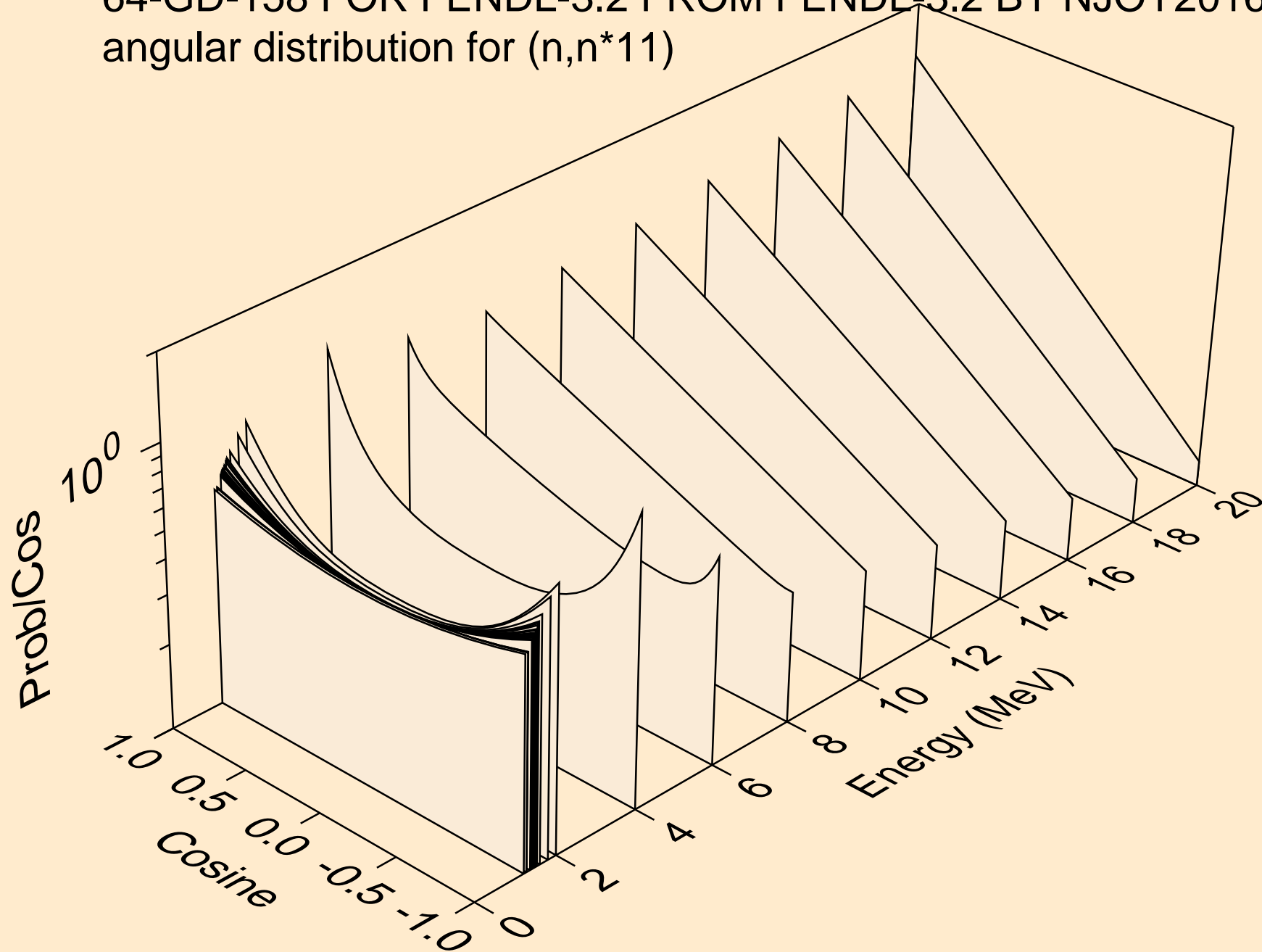

64-GD-158 FOR FENDL-3.2 FROM FENDL-3.2 BY NJOY2016.60+ C
angular distribution for (n,n*12)

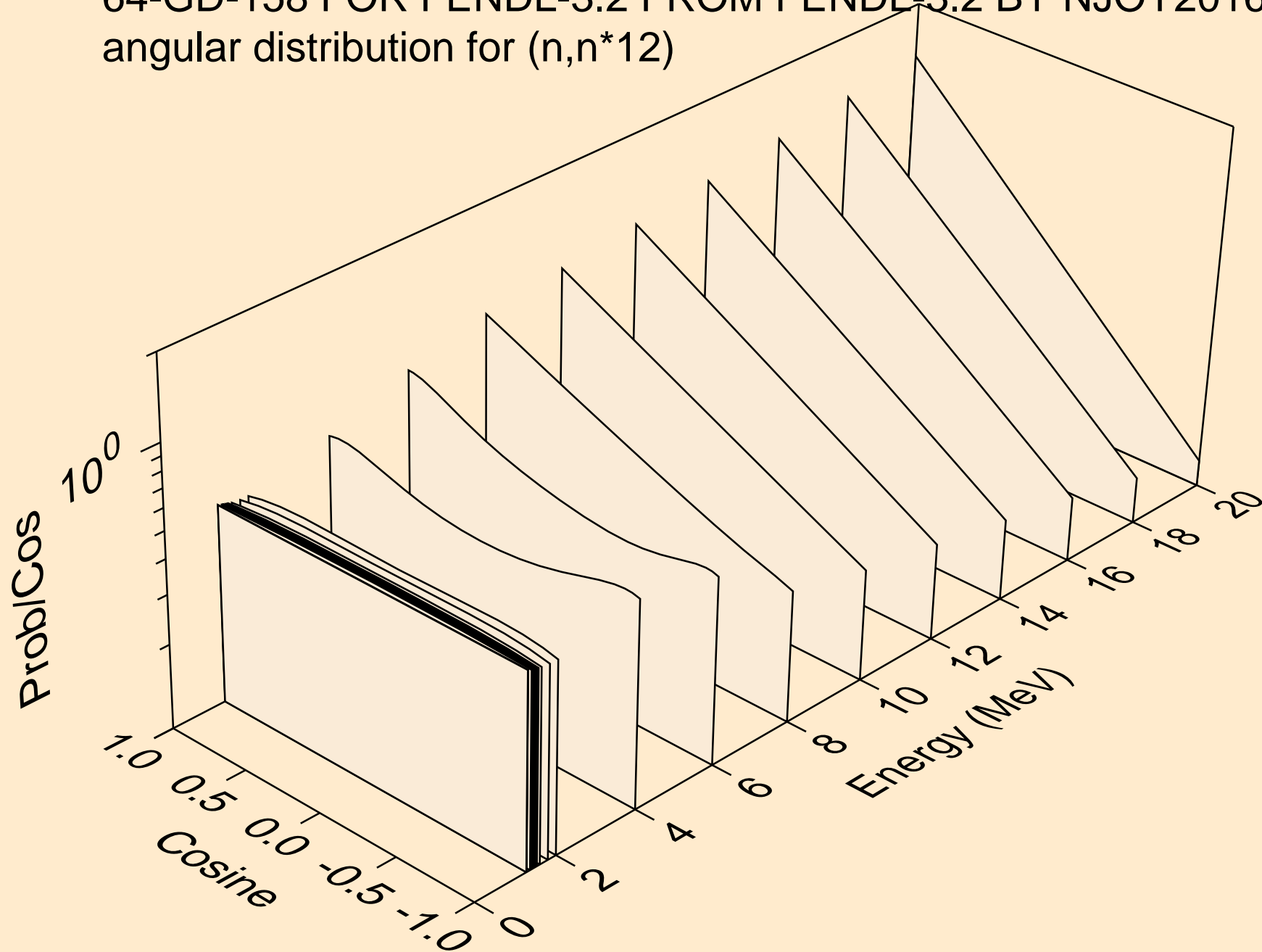

64-GD-158 FOR FENDL-3.2 FROM FENDL-3.2 BY NJOY2016.60+ C
angular distribution for (n,n*13)

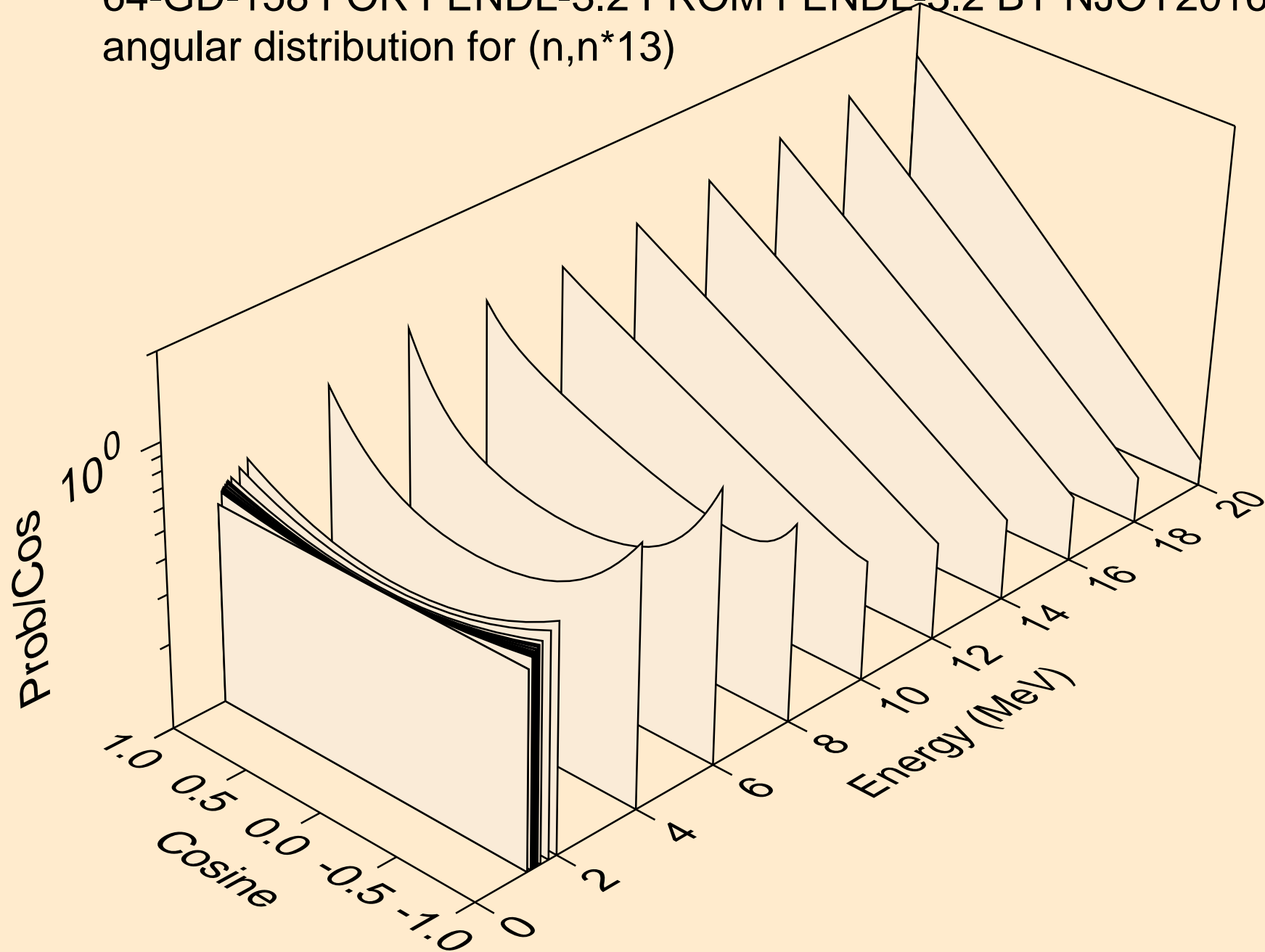

64-GD-158 FOR FENDL-3.2 FROM FENDL-3.2 BY NJOY2016.60+ C
angular distribution for (n,n*14)

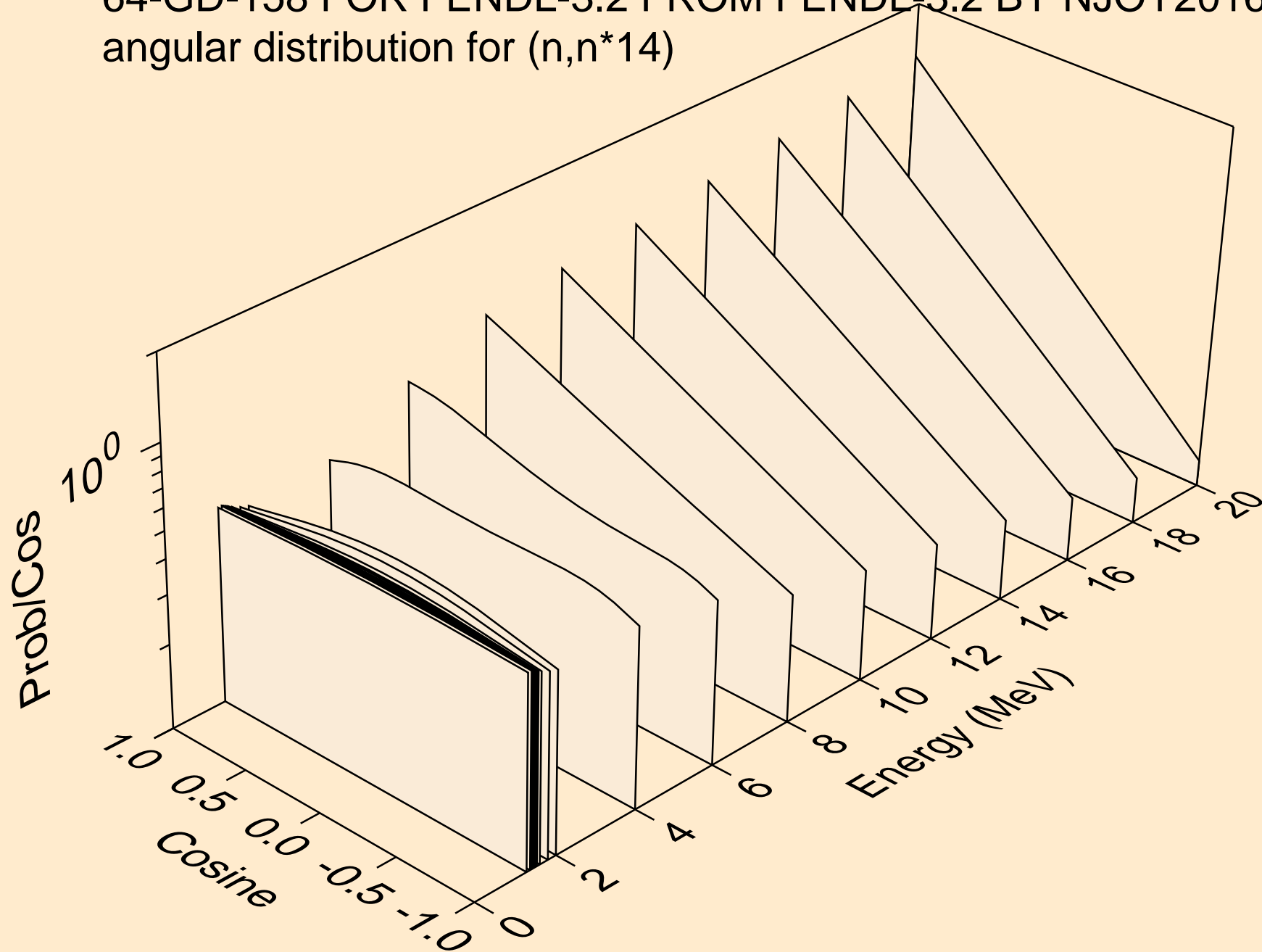

64-GD-158 FOR FENDL-3.2 FROM FENDL-3.2 BY NJOY2016.60+ C
angular distribution for (n,n*15)

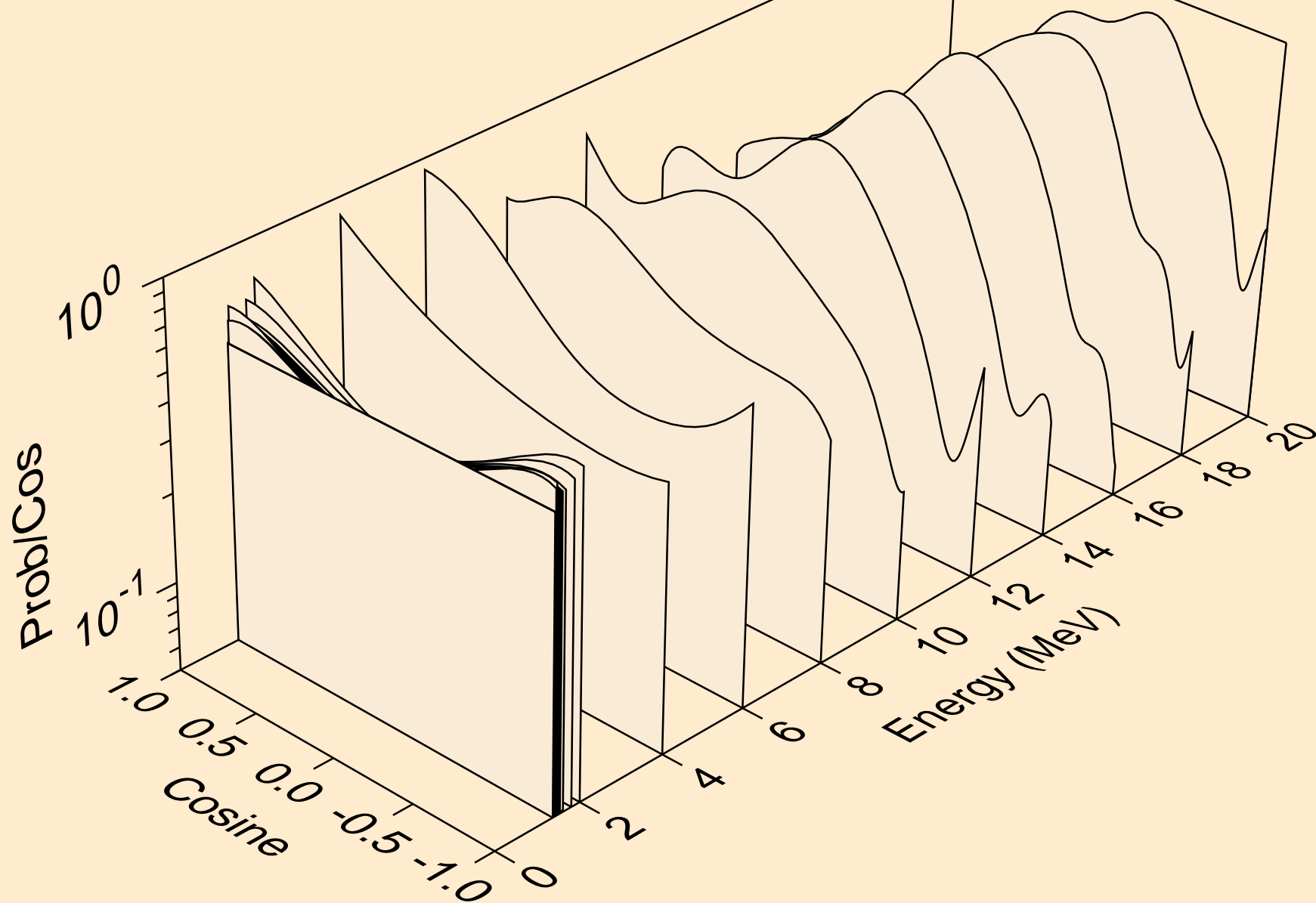

64-GD-158 FOR FENDL-3.2 FROM FENDL-3.2 BY NJOY2016.60+ C
angular distribution for (n,n*16)

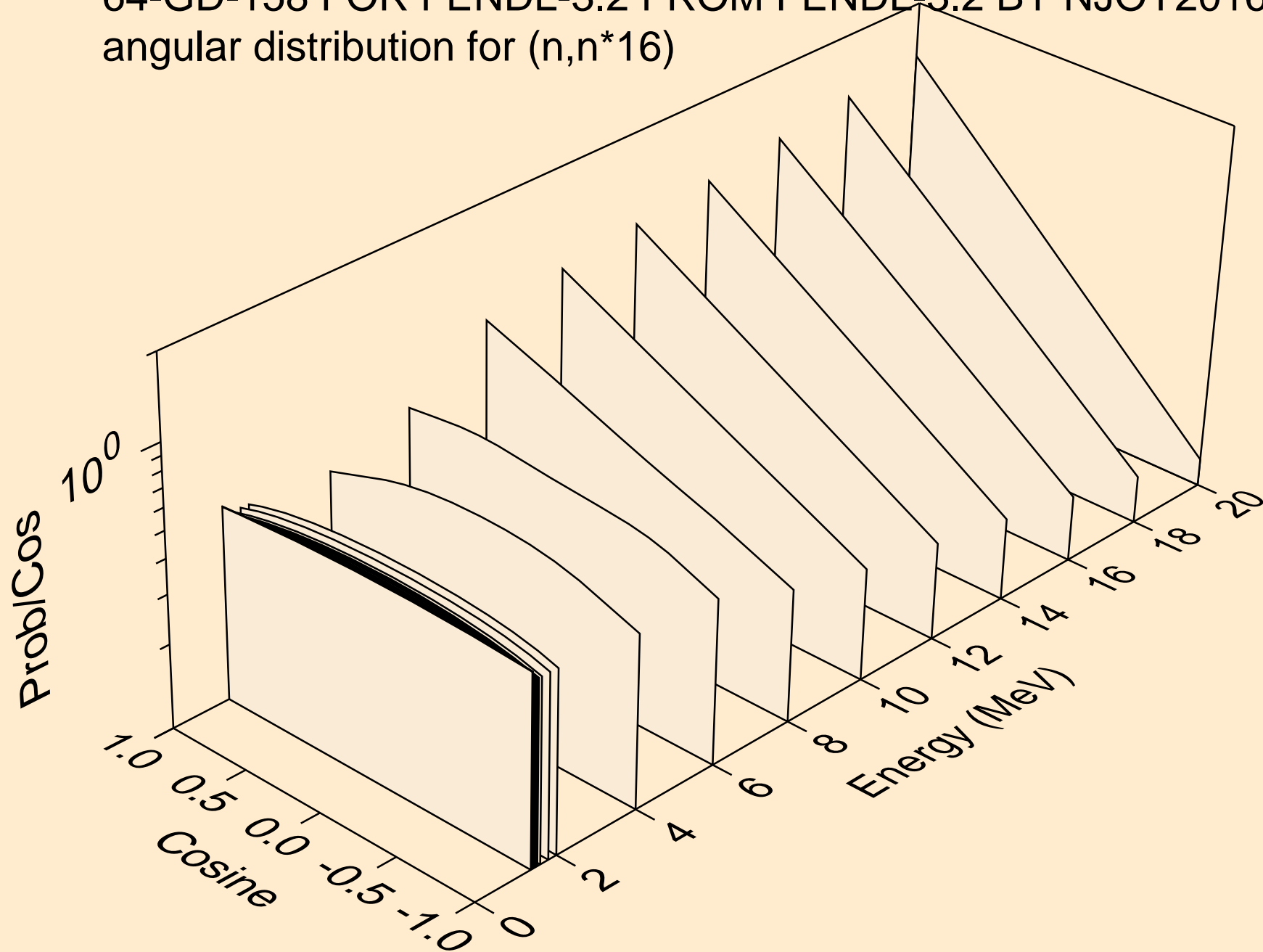

64-GD-158 FOR FENDL-3.2 FROM FENDL-3.2 BY NJOY2016.60+ C
angular distribution for (n,n*17)

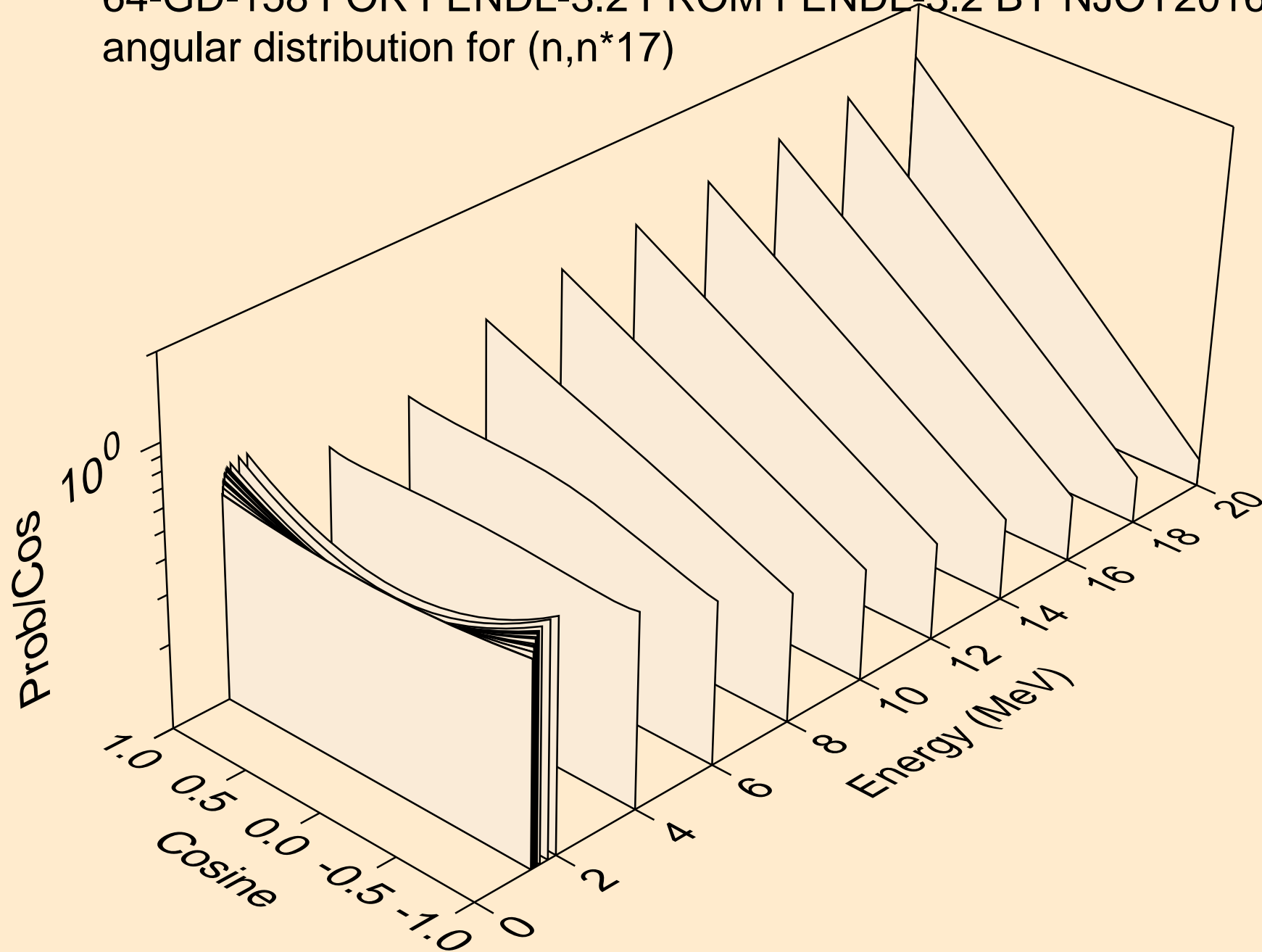

64-GD-158 FOR FENDL-3.2 FROM FENDL-3.2 BY NJOY2016.60+ C
angular distribution for (n,n*18)

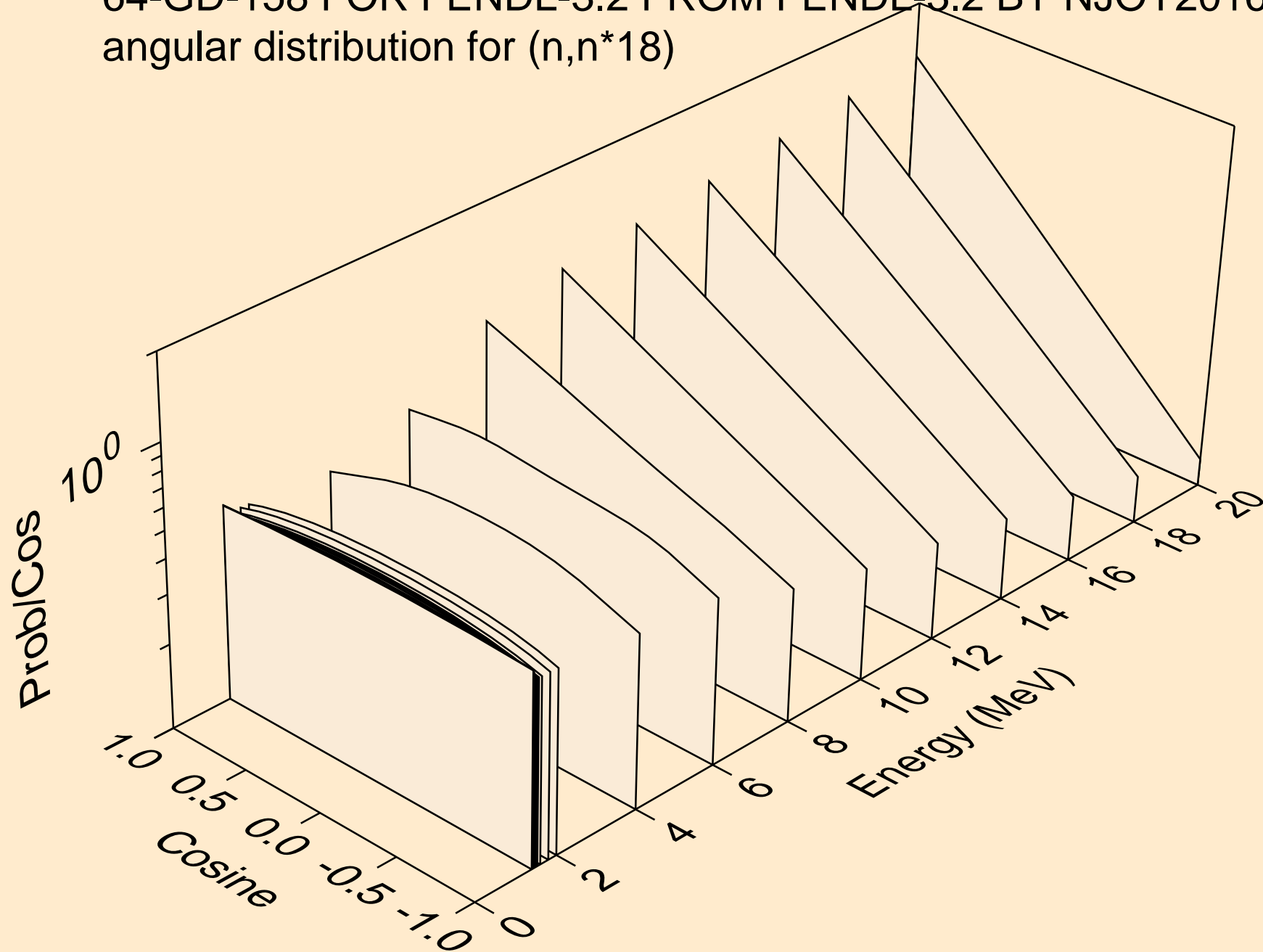

64-GD-158 FOR FENDL-3.2 FROM FENDL-3.2 BY NJOY2016.60+ C
angular distribution for (n,n*19)

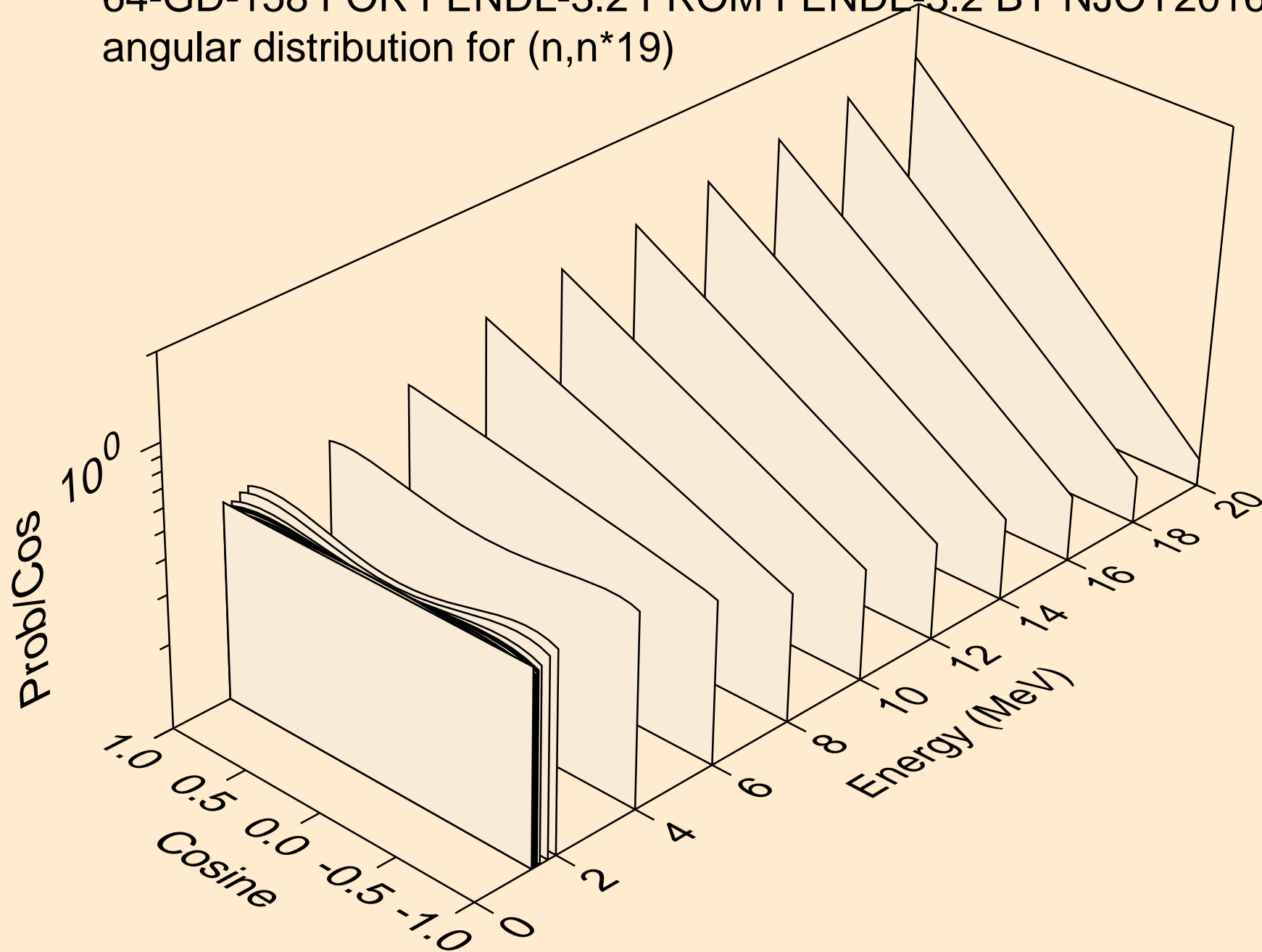

64-GD-158 FOR FENDL-3.2 FROM FENDL-3.2 BY NJOY2016.60+ C
angular distribution for (n,n*20)

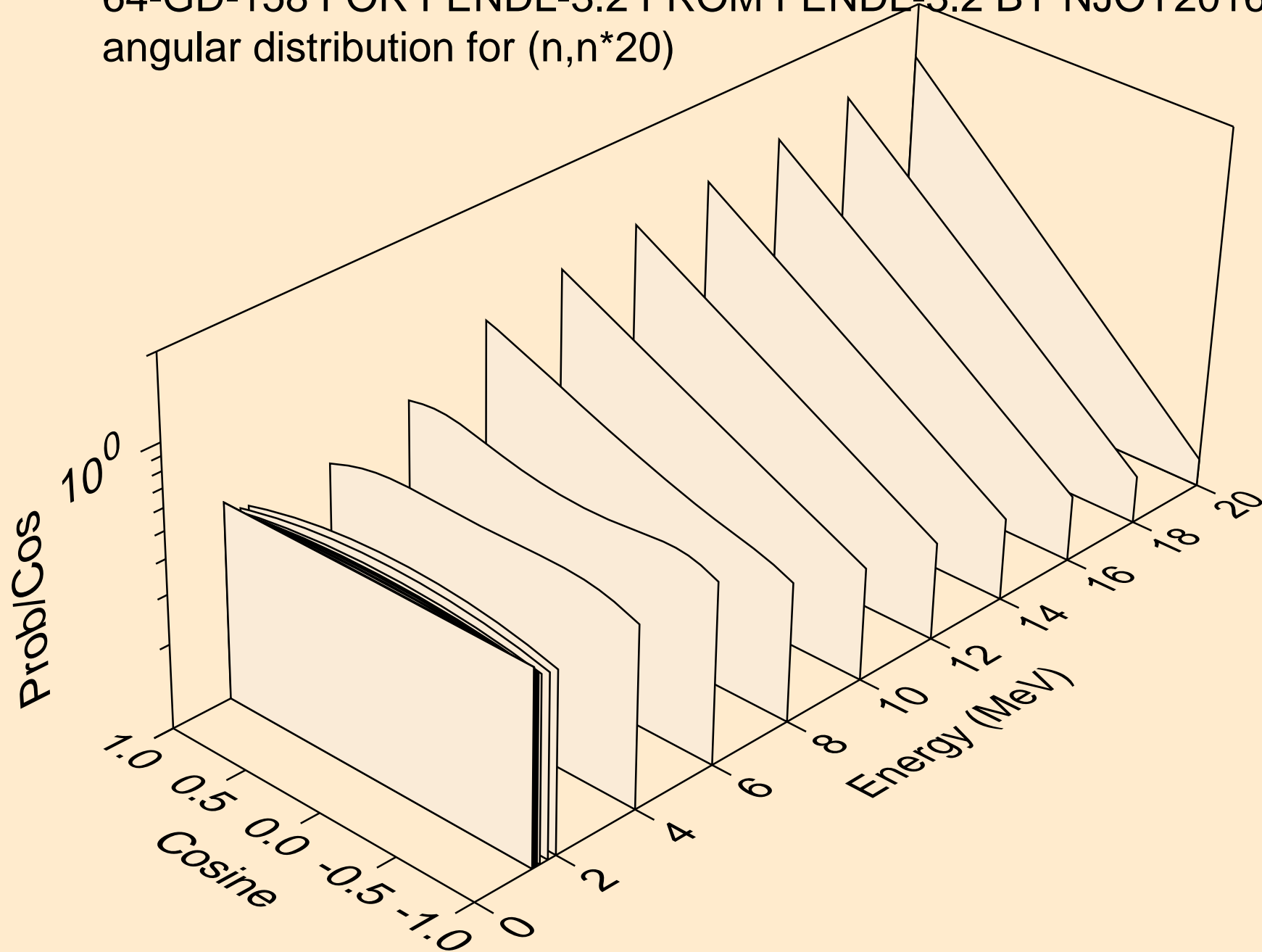

64-GD-158 FOR FENDL-3.2 FROM FENDL-3.2 BY NJOY2016.60+ C
angular distribution for (n,n*21)

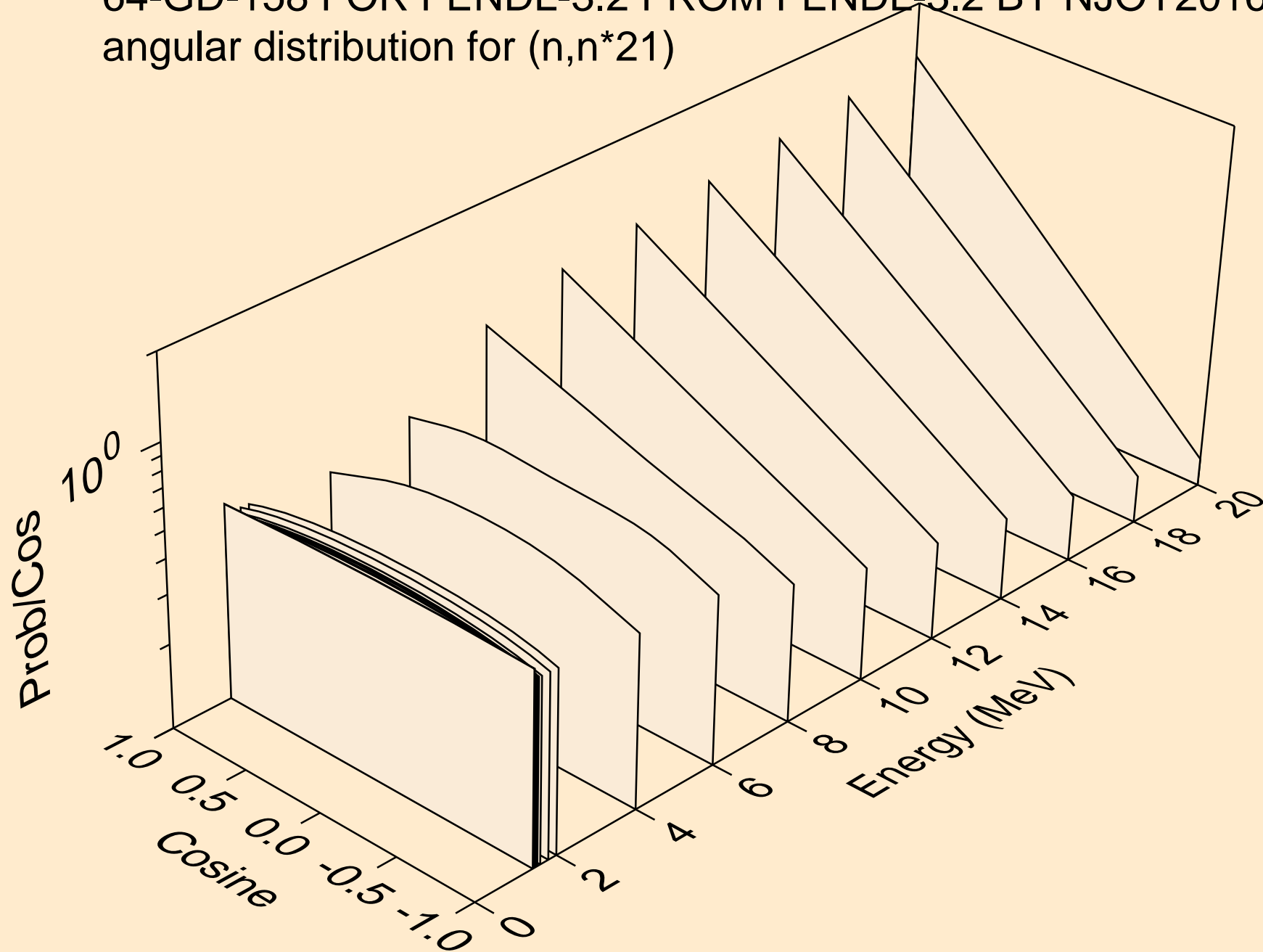

64-GD-158 FOR FENDL-3.2 FROM FENDL-3.2 BY NJOY2016.60+ C
angular distribution for (n,n*22)

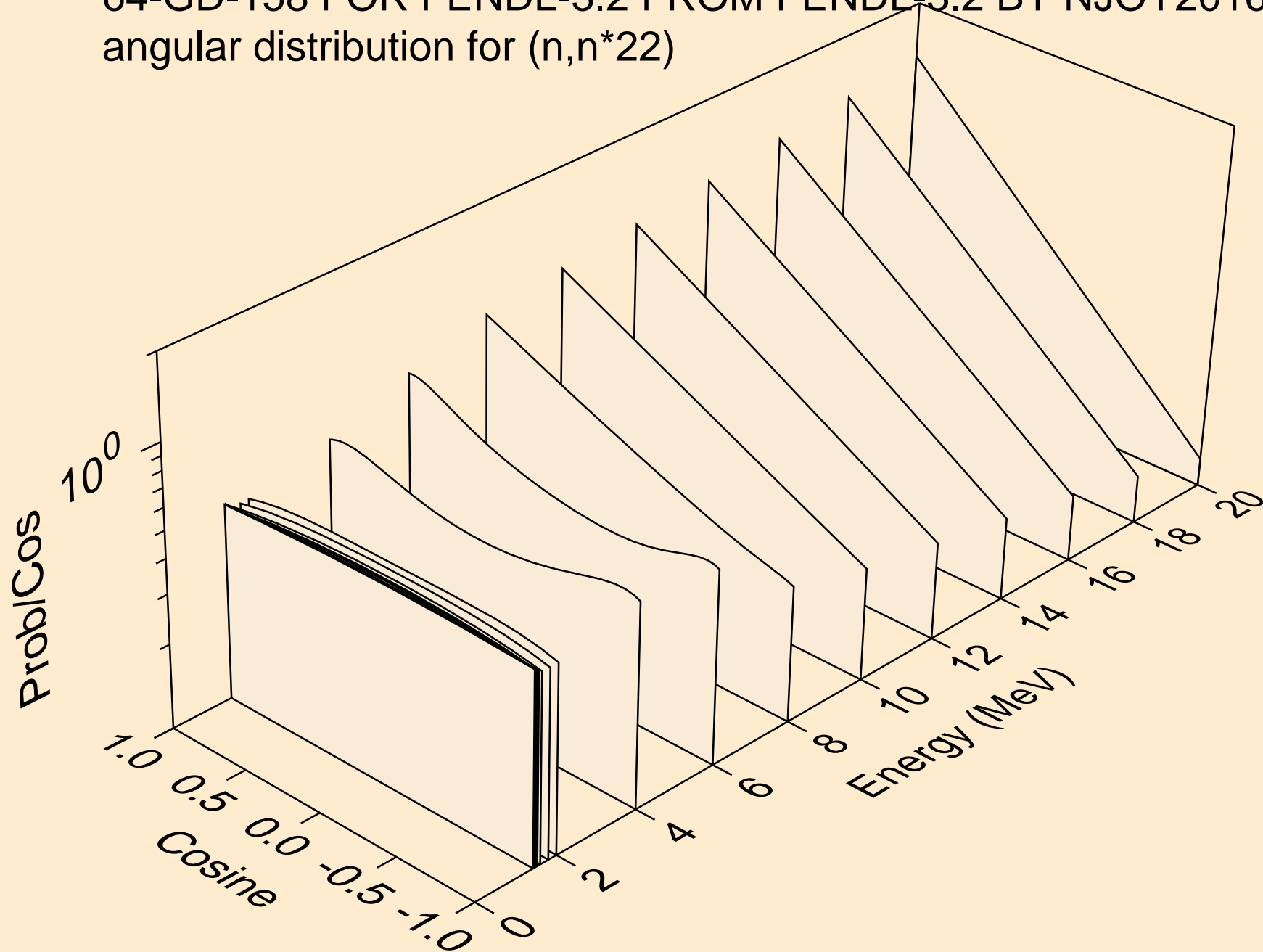

64-GD-158 FOR FENDL-3.2 FROM FENDL-3.2 BY NJOY2016.60+ C
angular distribution for (n,n*23)

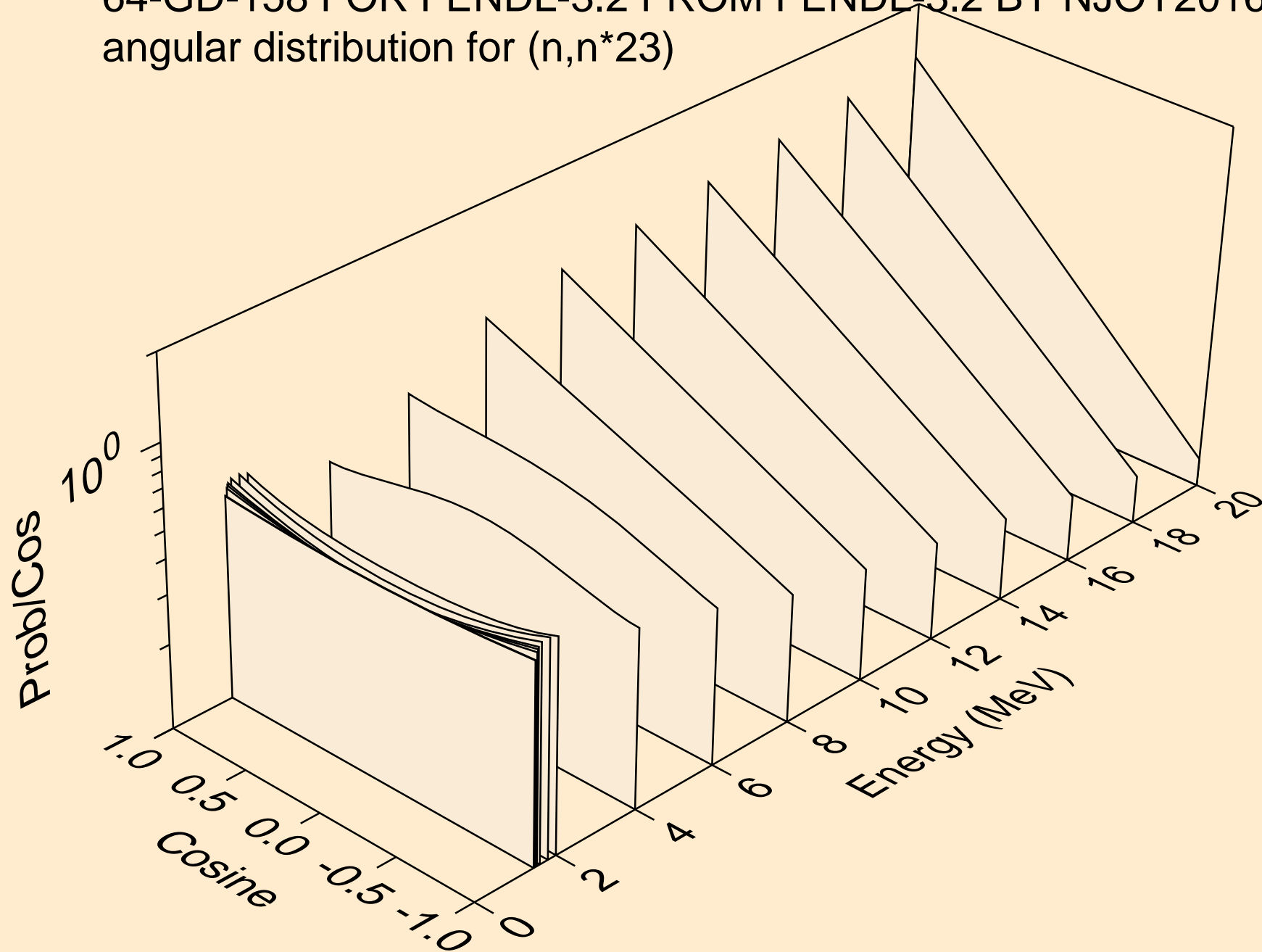

64-GD-158 FOR FENDL-3.2 FROM FENDL-3.2 BY NJOY2016.60+ C
angular distribution for (n,n*24)

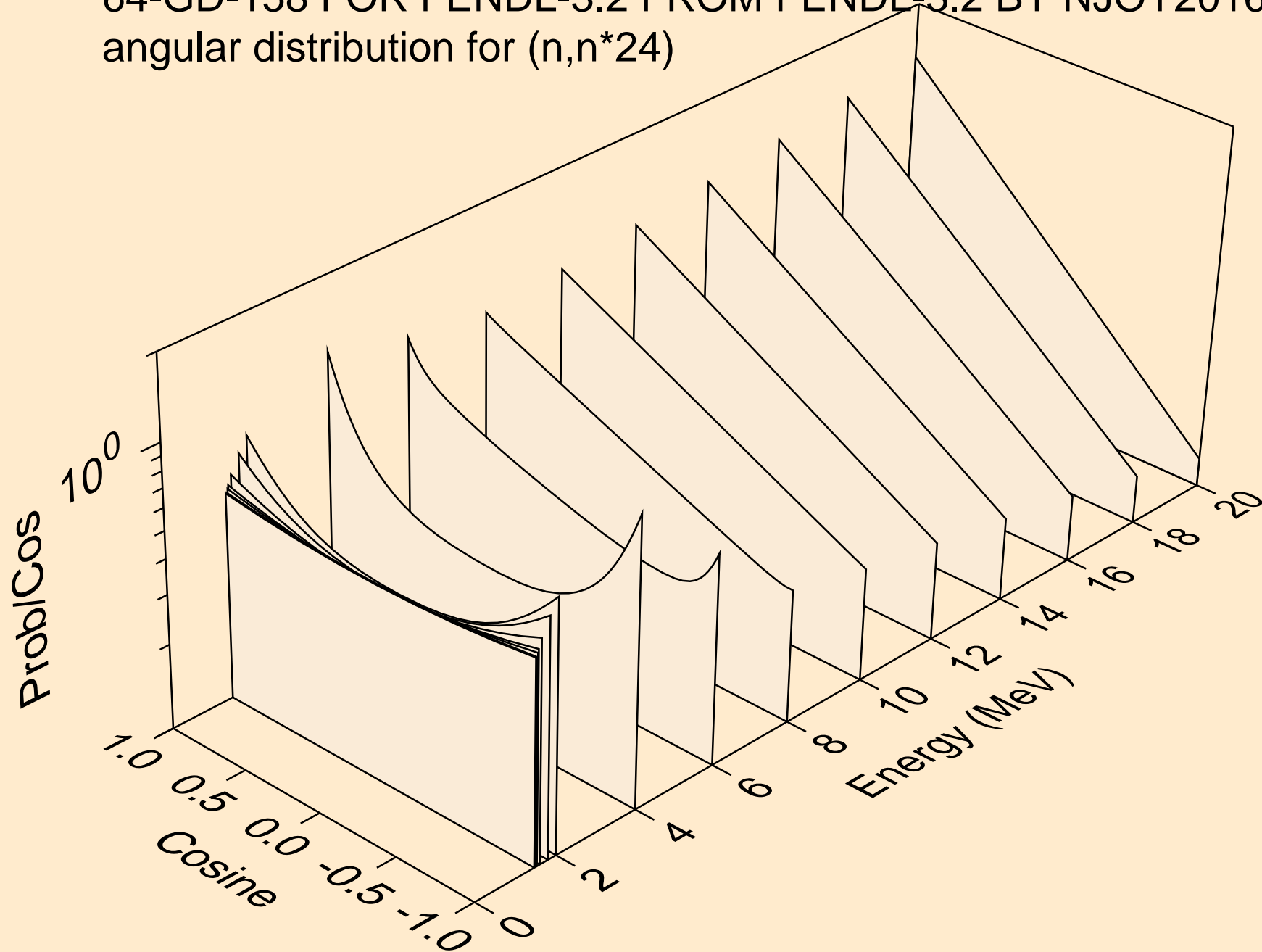

64-GD-158 FOR FENDL-3.2 FROM FENDL-3.2 BY NJOY2016.60+ C
angular distribution for (n,n*25)

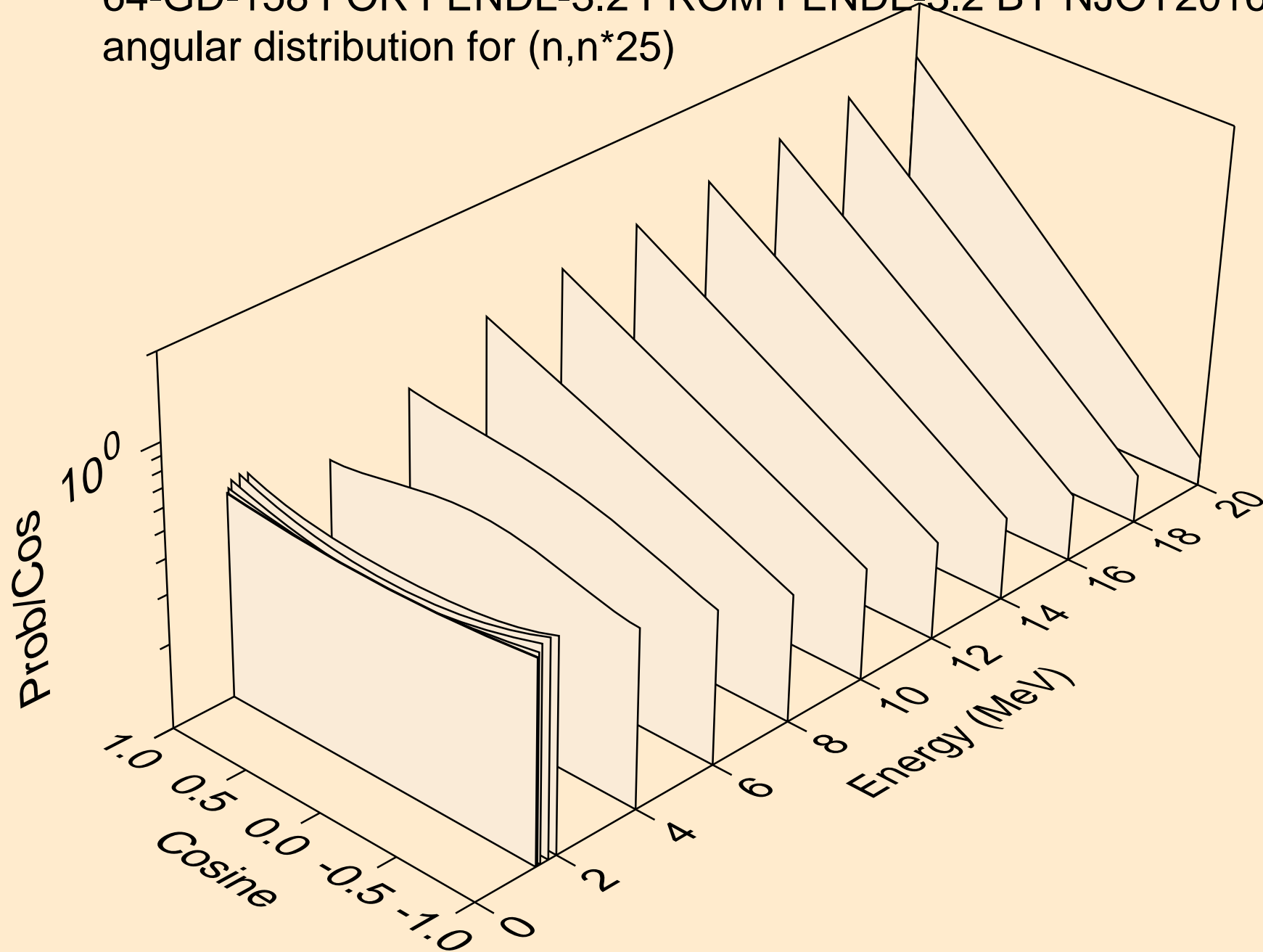

64-GD-158 FOR FENDL-3.2 FROM FENDL-3.2 BY NJOY2016.60+ C
angular distribution for (n,n*26)

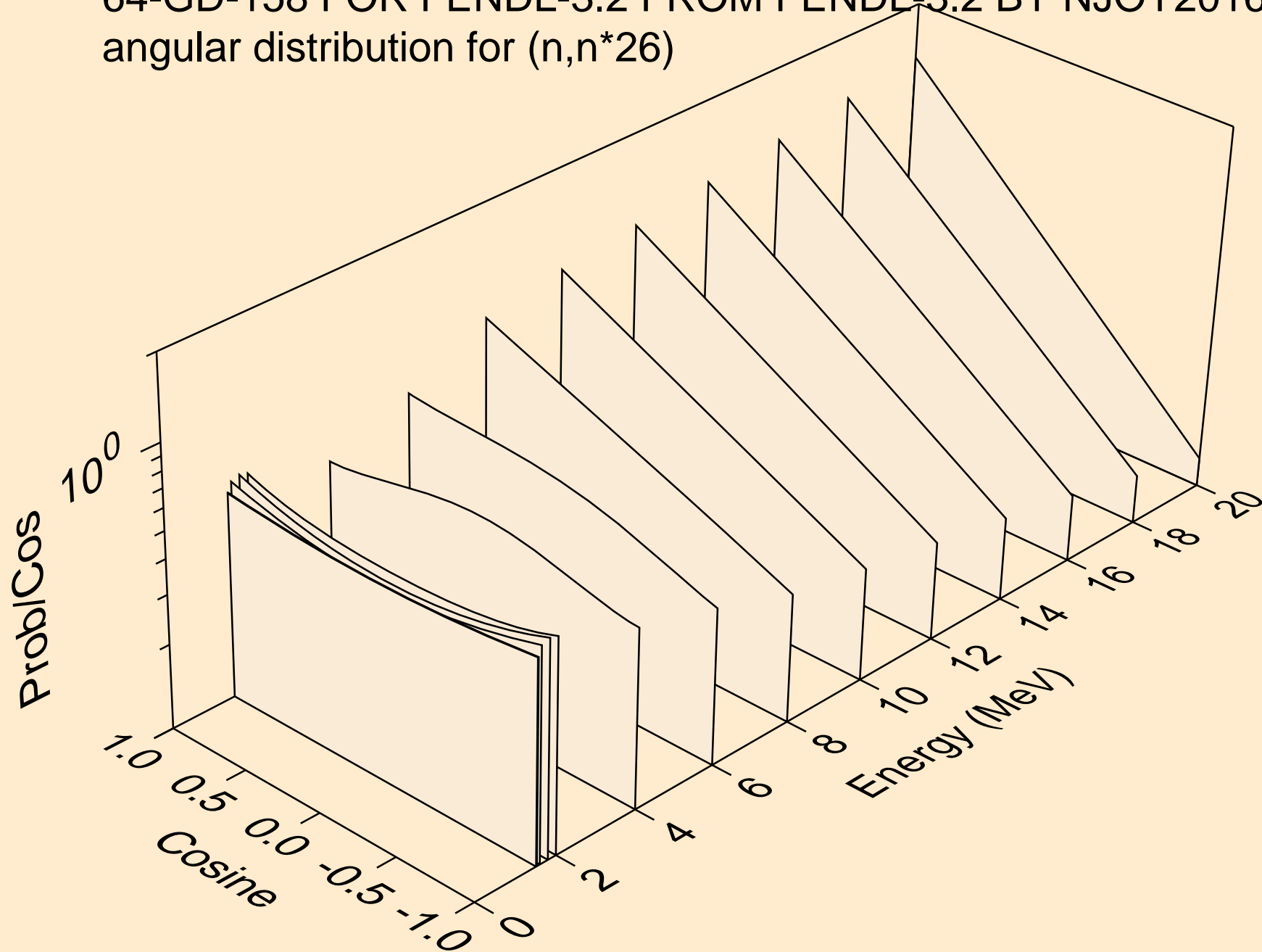

64-GD-158 FOR FENDL-3.2 FROM FENDL-3.2 BY NJOY2016.60+ C
angular distribution for (n,n*27)

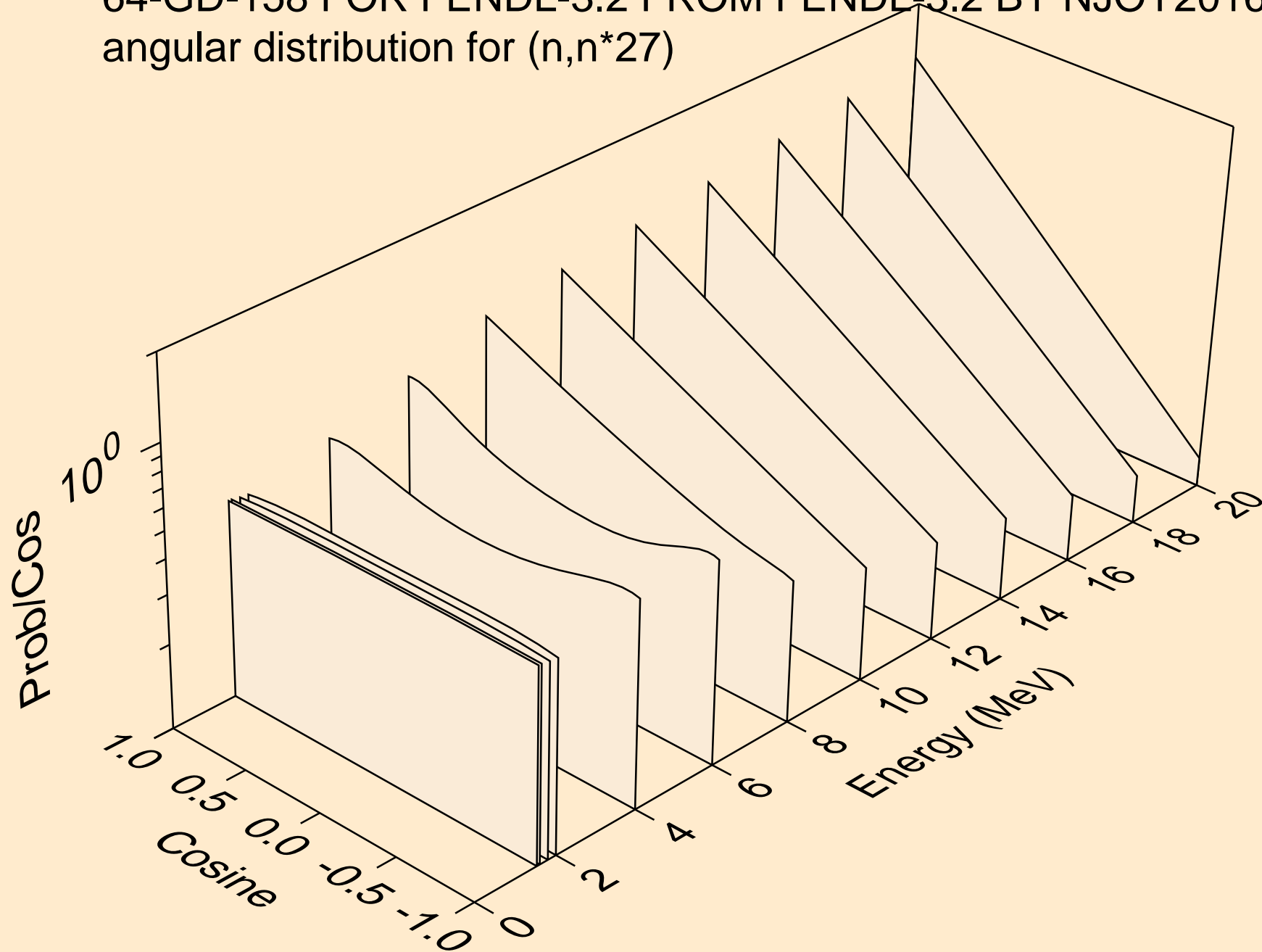

64-GD-158 FOR FENDL-3.2 FROM FENDL-3.2 BY NJOY2016.60+ C
Neutron emission for (n,x)

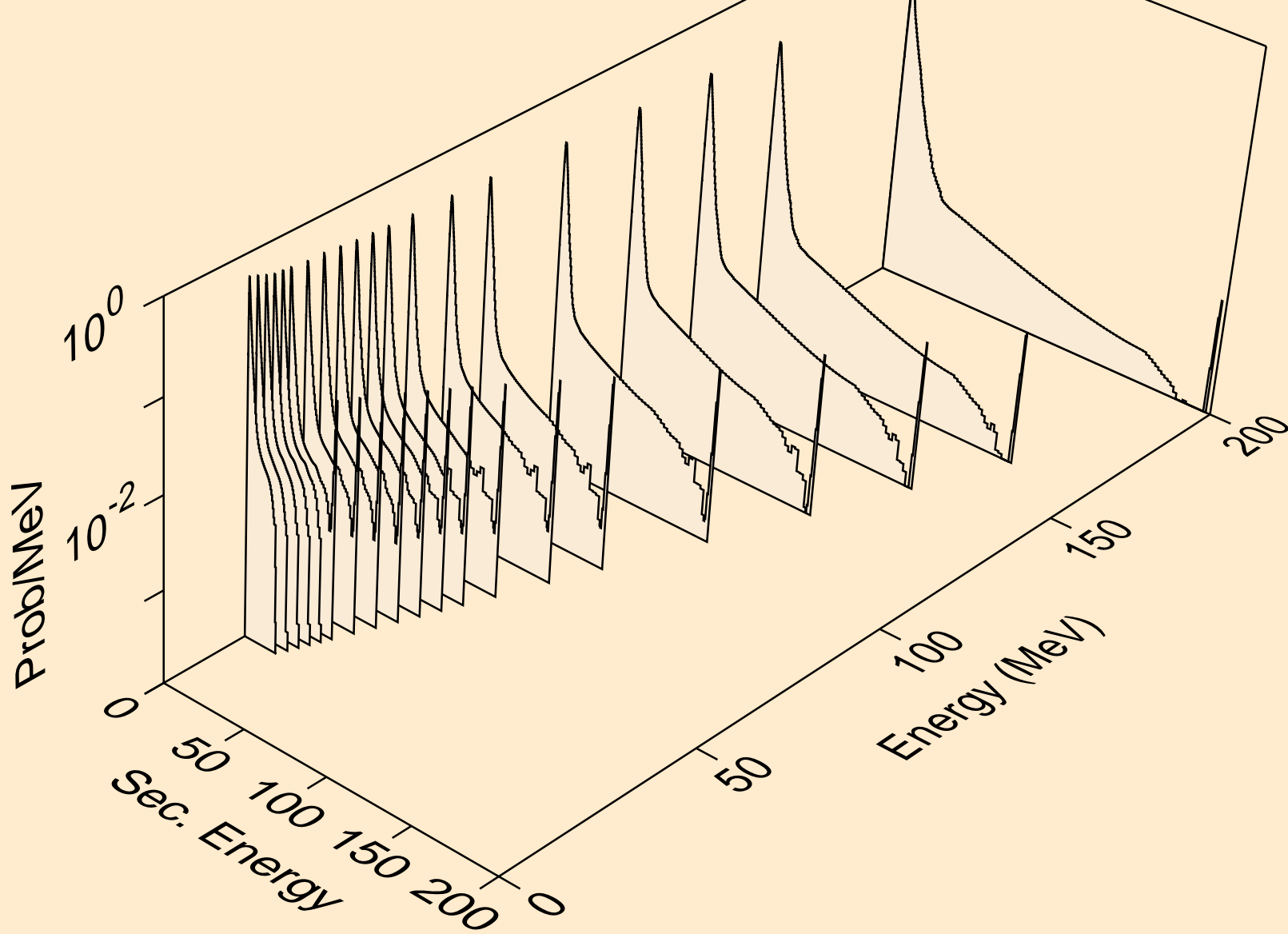

64-GD-158 FOR FENDL-3.2 FROM FENDL-3.2 BY NJOY2016.60+ C
Neutron emission for (n,2n)

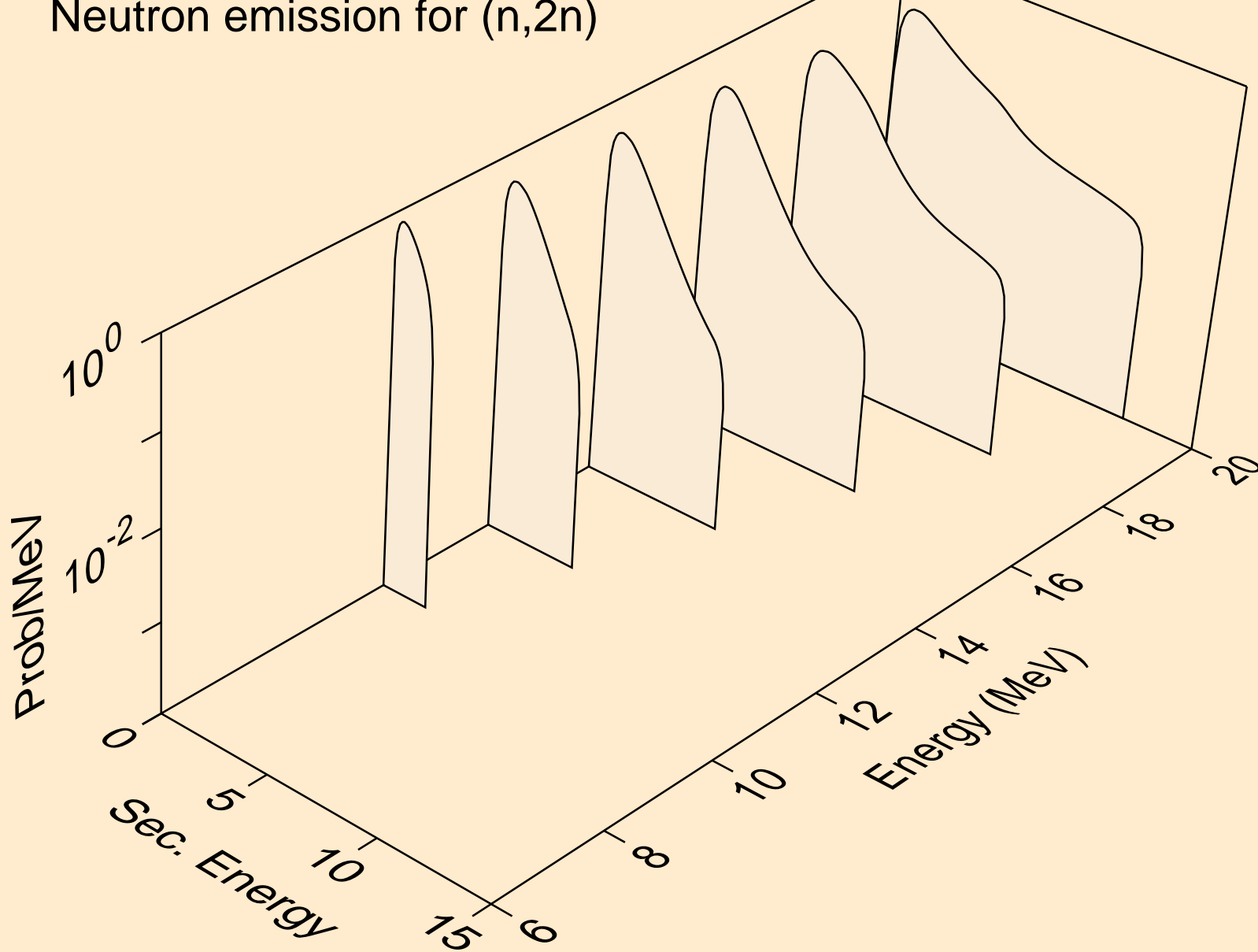

64-GD-158 FOR FENDL-3.2 FROM FENDL-3.2 BY NJOY2016.60+ C
Neutron emission for (n,3n)

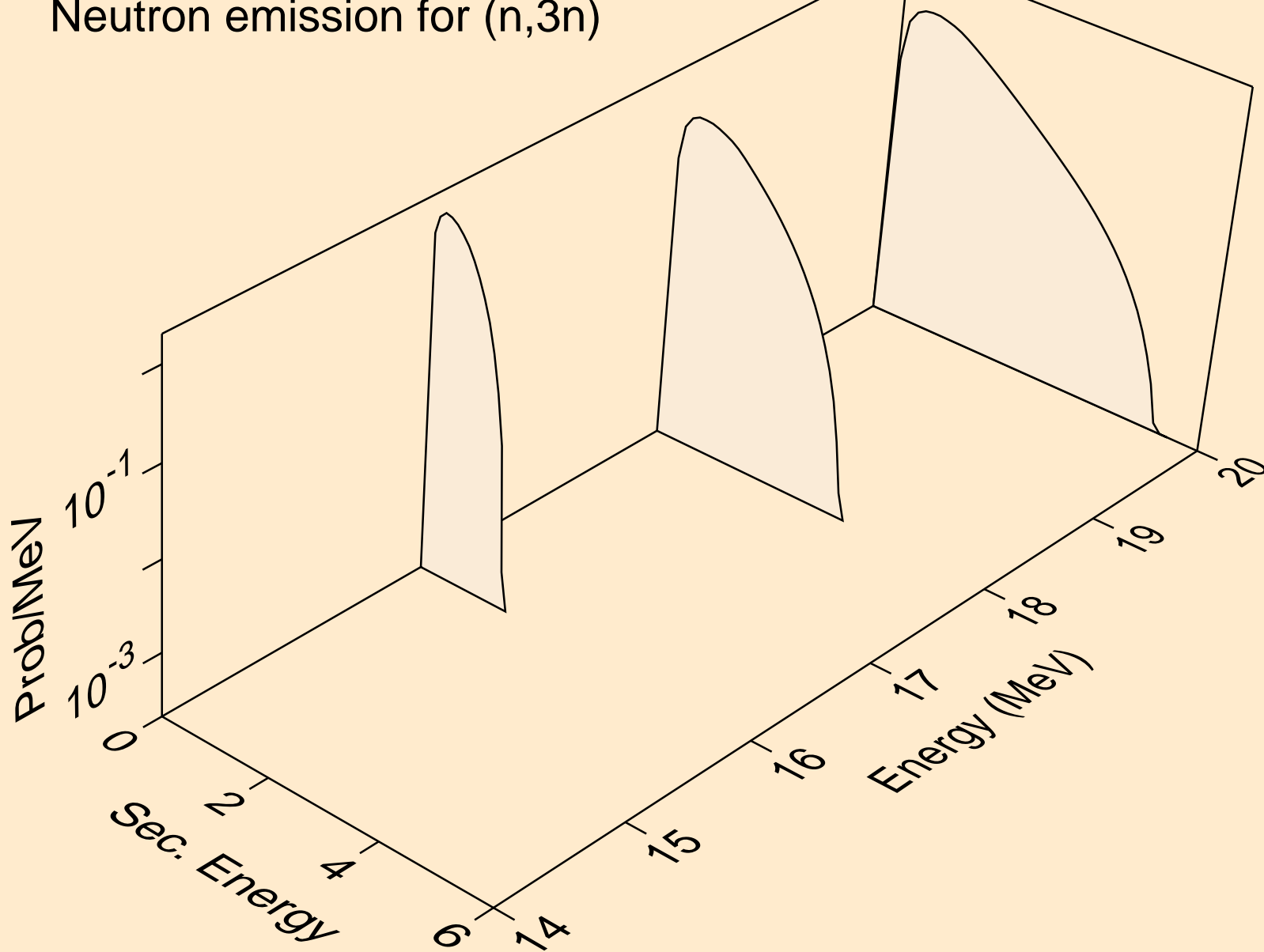

64-GD-158 FOR FENDL-3.2 FROM FENDL-3.2 BY NJOY2016.60+ C
Neutron emission for (n,n*)a

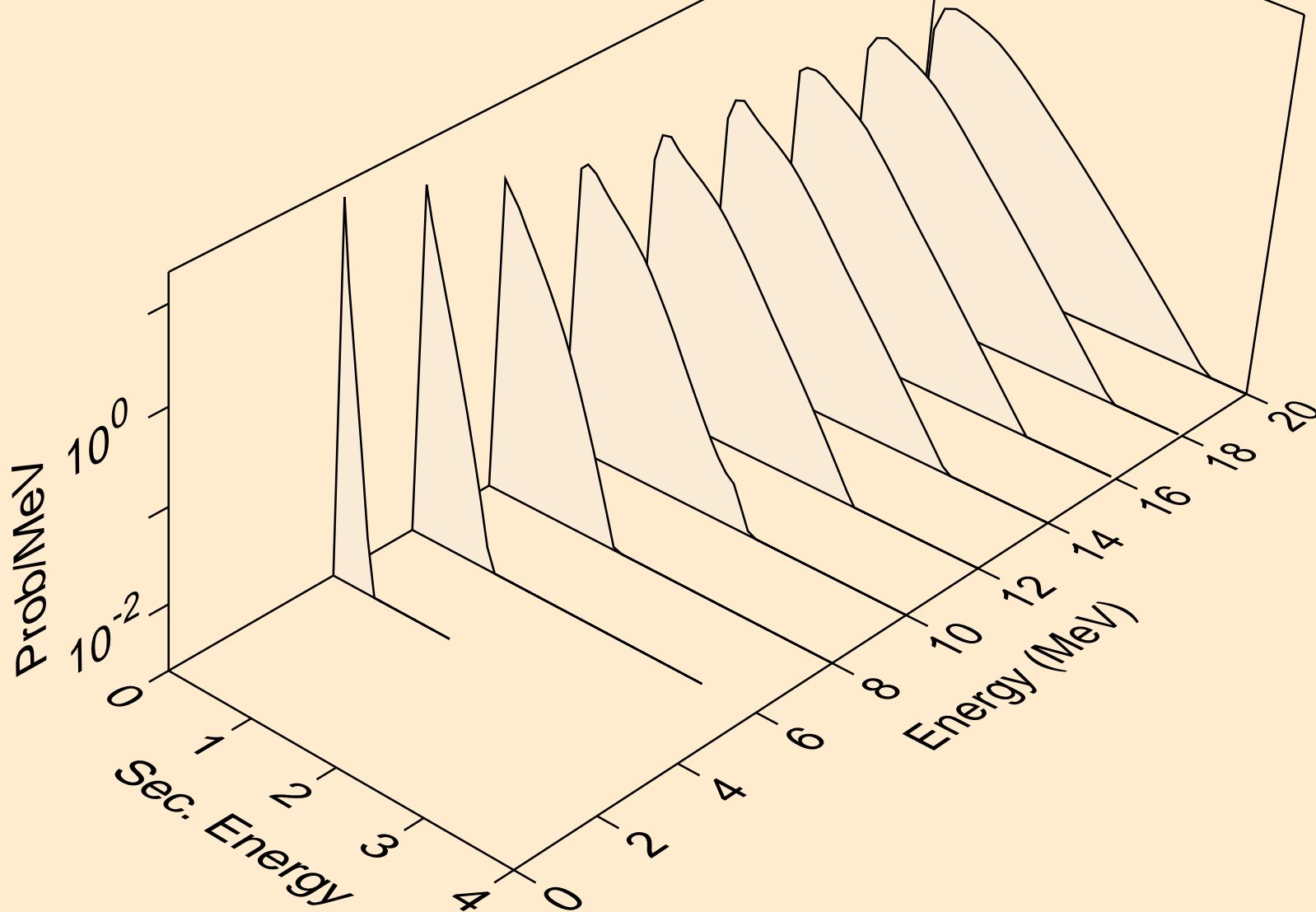

64-GD-158 FOR FENDL-3.2 FROM FENDL-3.2 BY NJOY2016.60+ C
Neutron emission for (n,2n)a

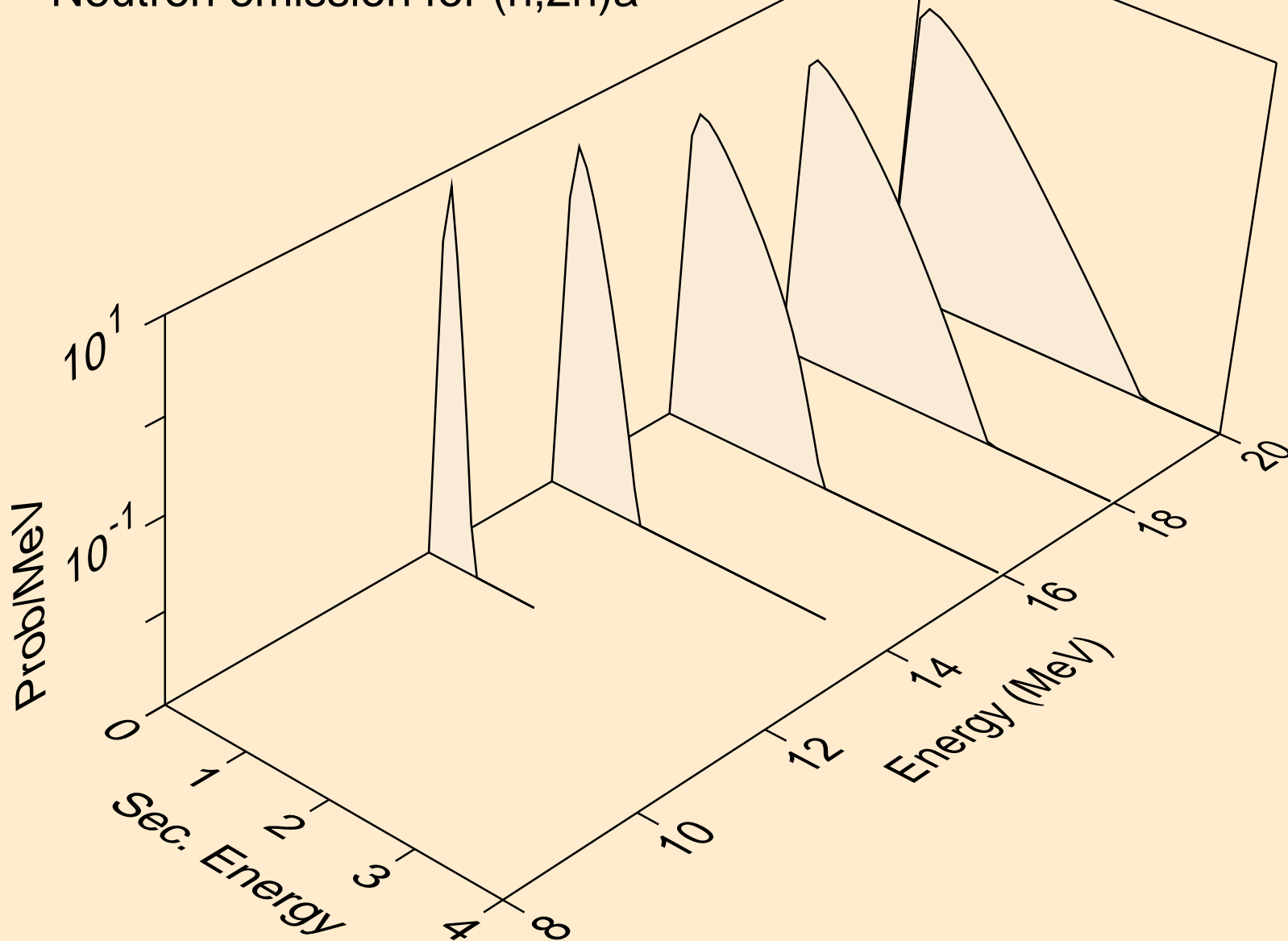

64-GD-158 FOR FENDL-3.2 FROM FENDL-3.2 BY NJOY2016.60+ C
Neutron emission for (n,n*)p

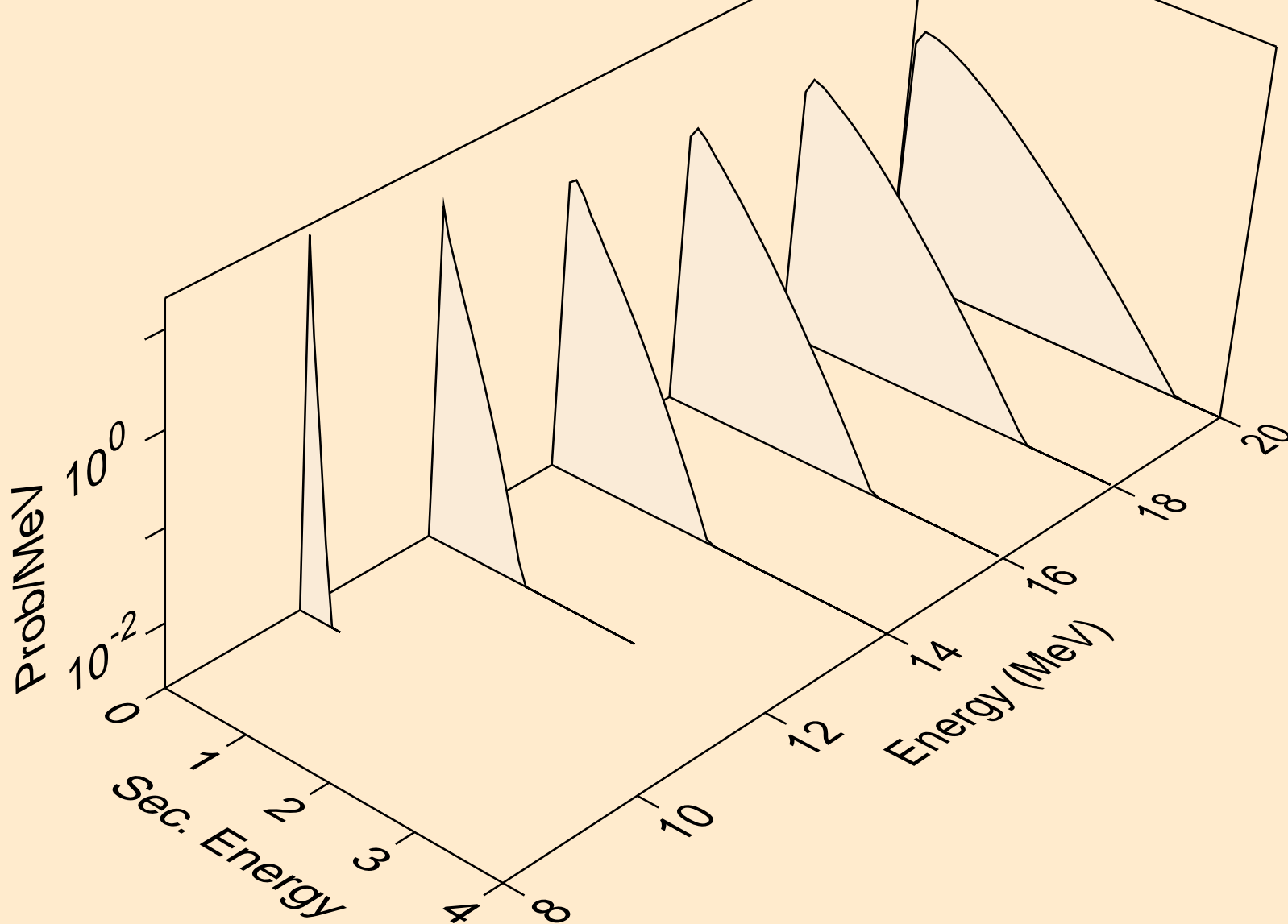

64-GD-158 FOR FENDL-3.2 FROM FENDL-3.2 BY NJOY2016.60+ C
Neutron emission for (n,n*)d

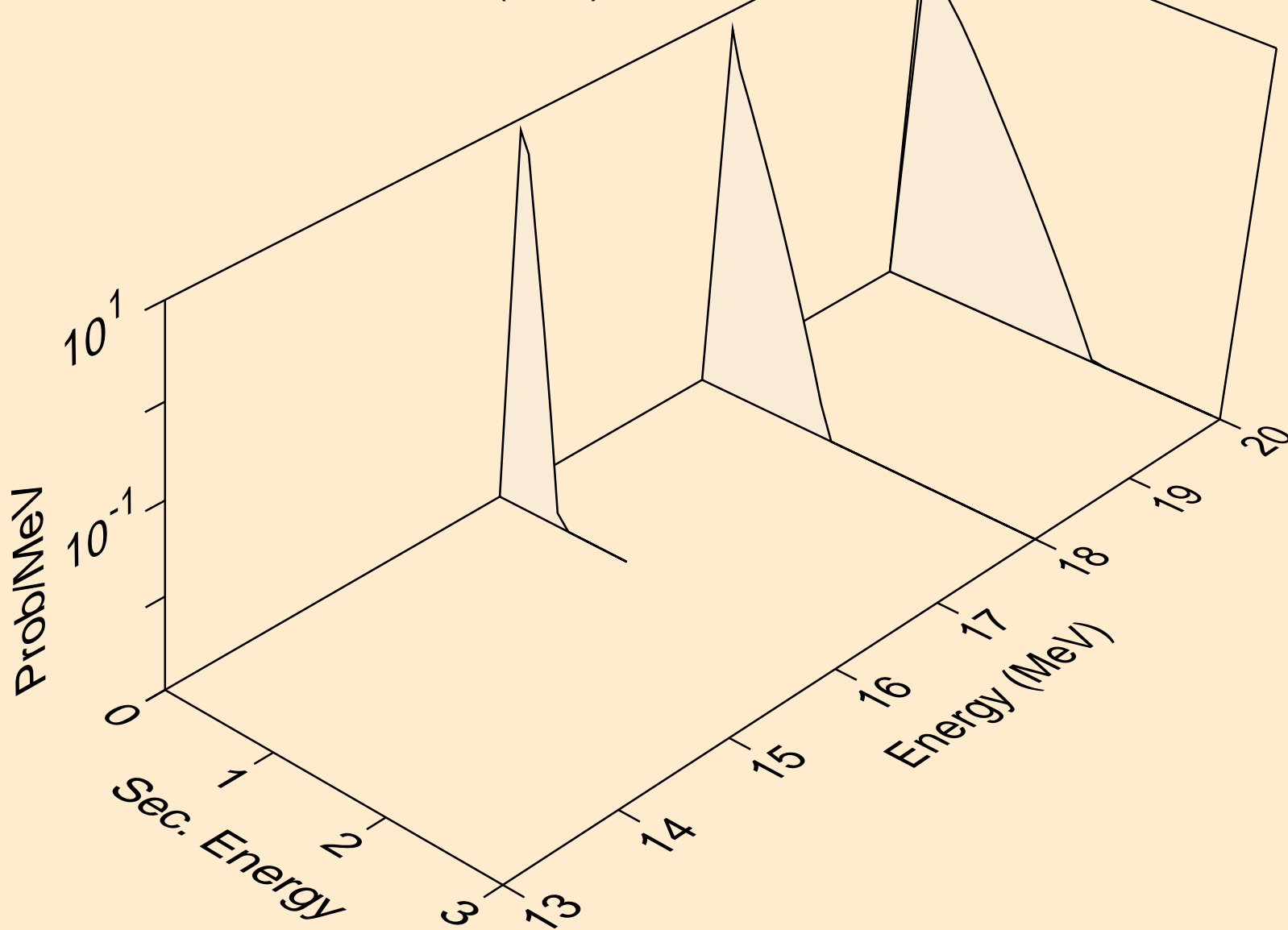

64-GD-158 FOR FENDL-3.2 FROM FENDL-3.2 BY NJOY2016.60+ C
Neutron emission for (n,n*c)

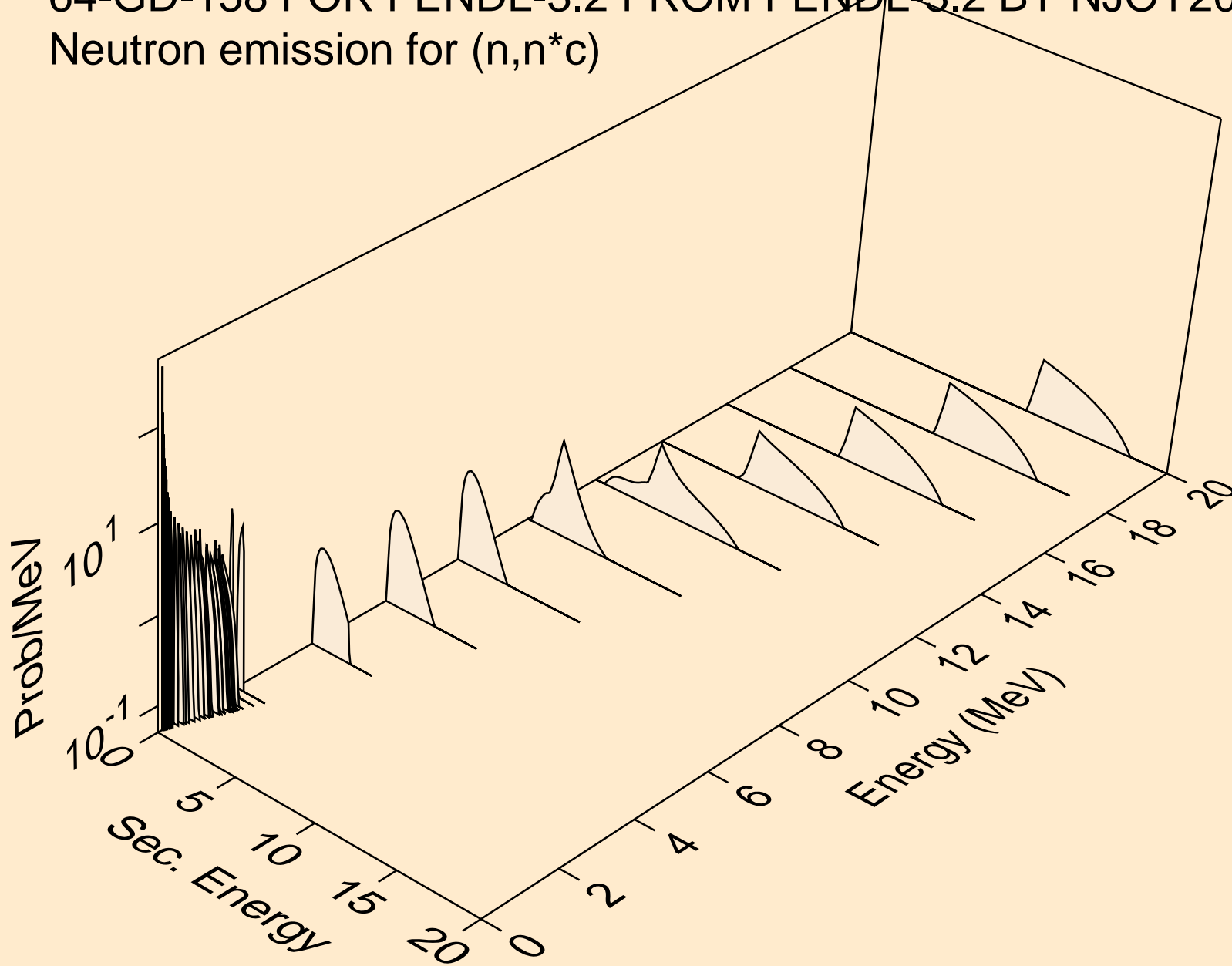

64-GD-158 FOR FENDL-3.2 FROM FENDL-3.2 BY NJOY2016.60+ C
Photon emission for (n,x)

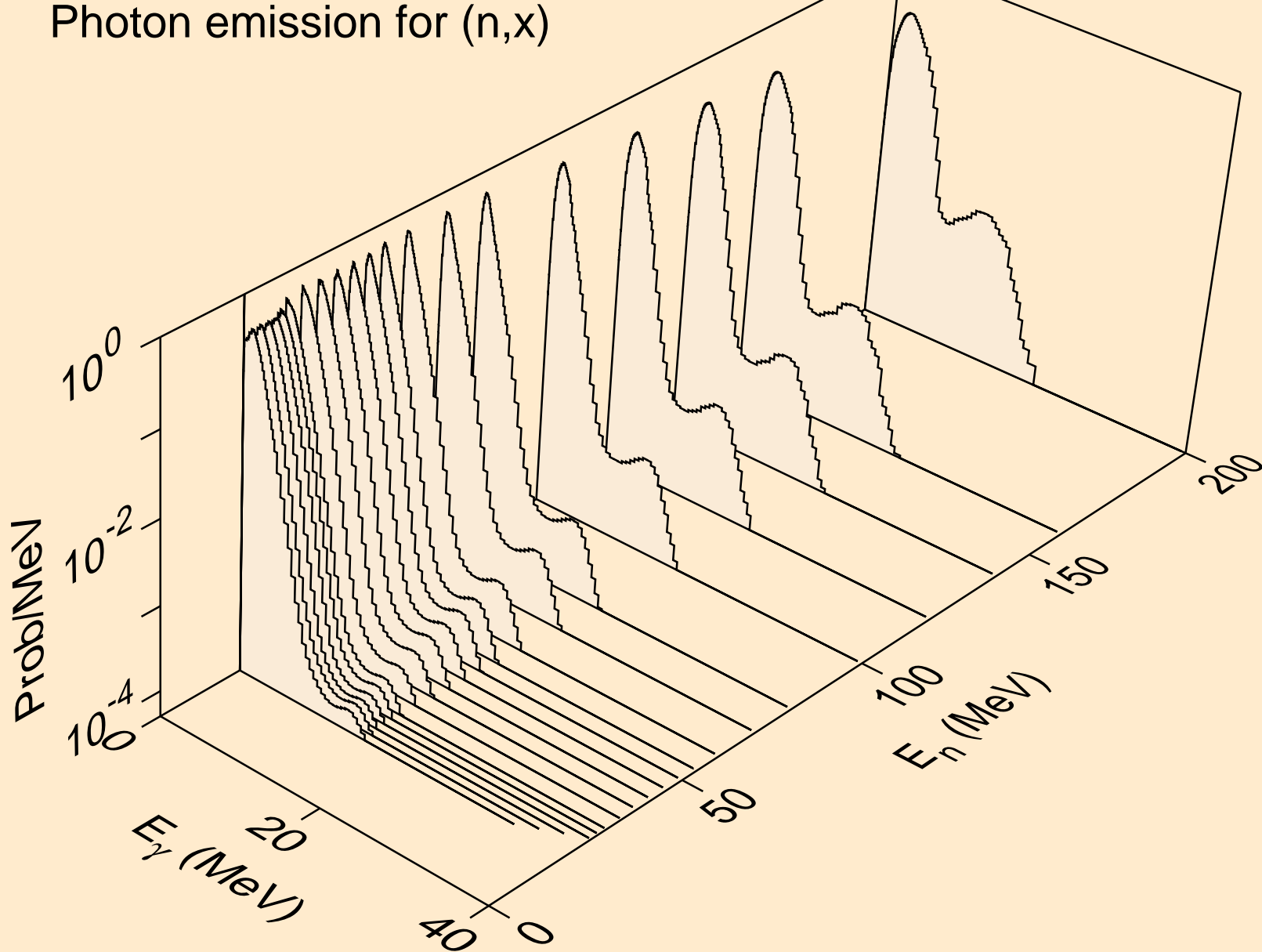

64-GD-158 FOR FENDL-3.2 FROM FENDL-3.2 BY NJOY2016.60+ C
Photon emission for (n,2n)

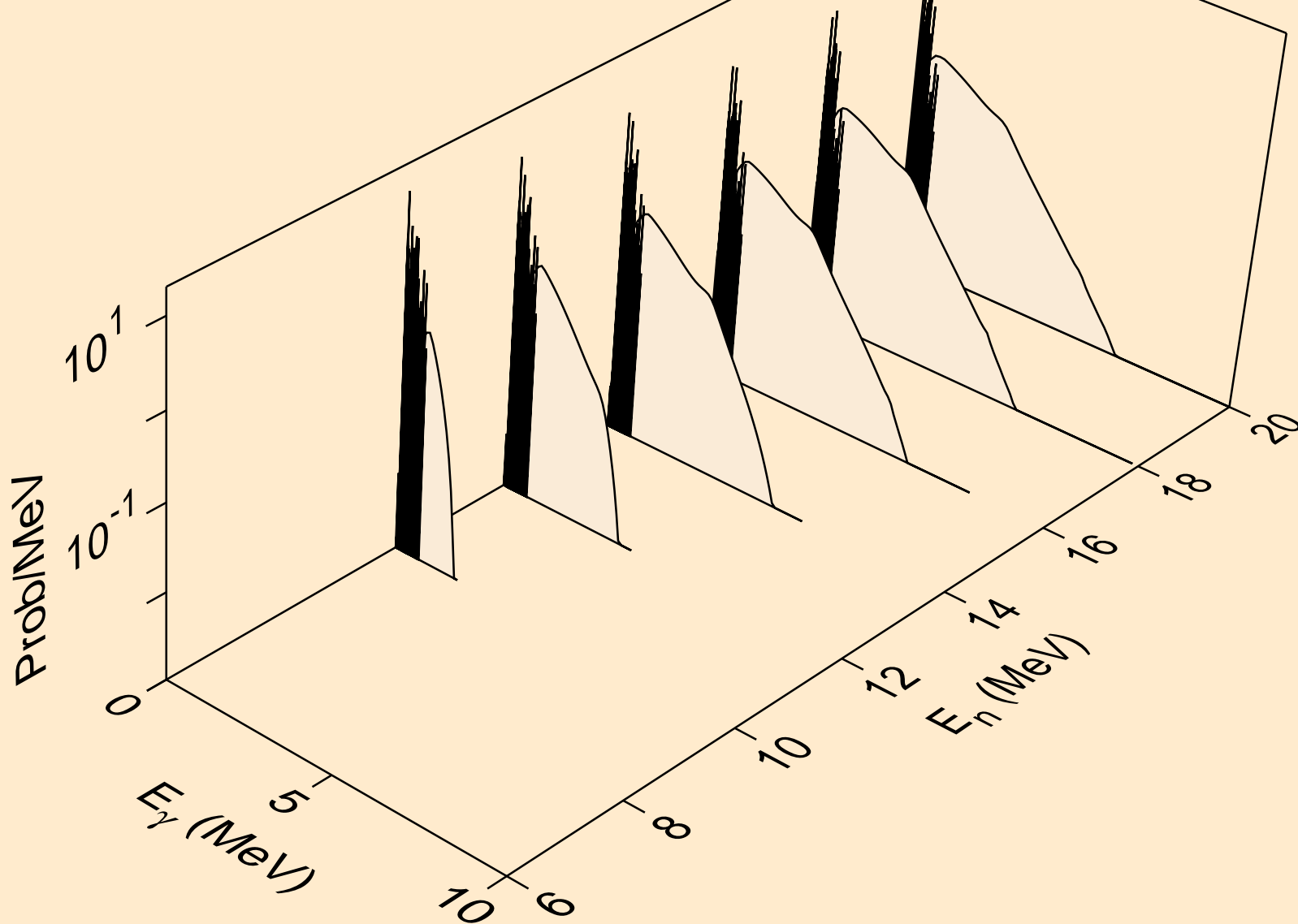

64-GD-158 FOR FENDL-3.2 FROM FENDL-3.2 BY NJOY2016.60+ C
Photon emission for (n,3n)

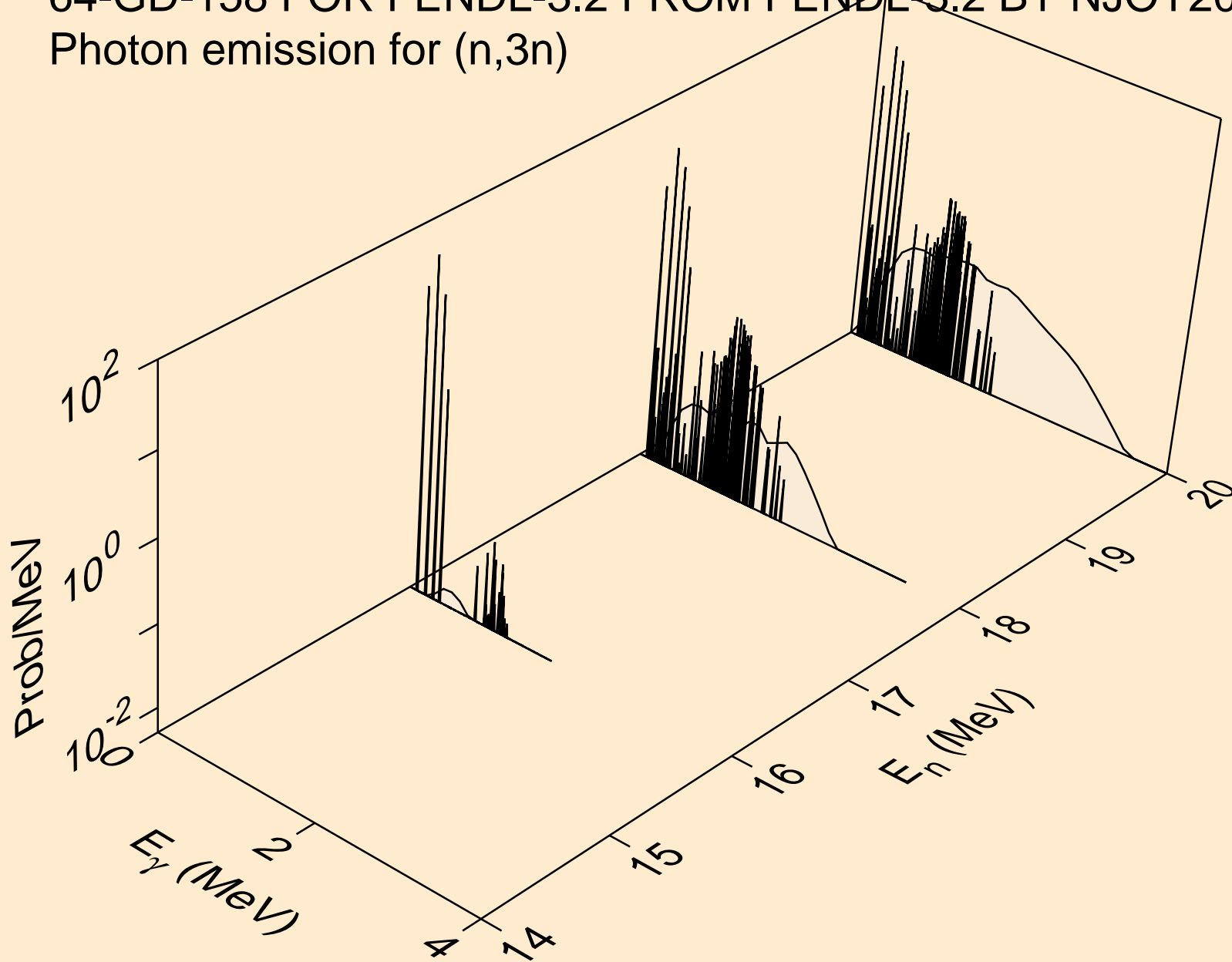

64-GD-158 FOR FENDL-3.2 FROM FENDL-3.2 BY NJOY2016.60+ C
Photon emission for (n,n*)a

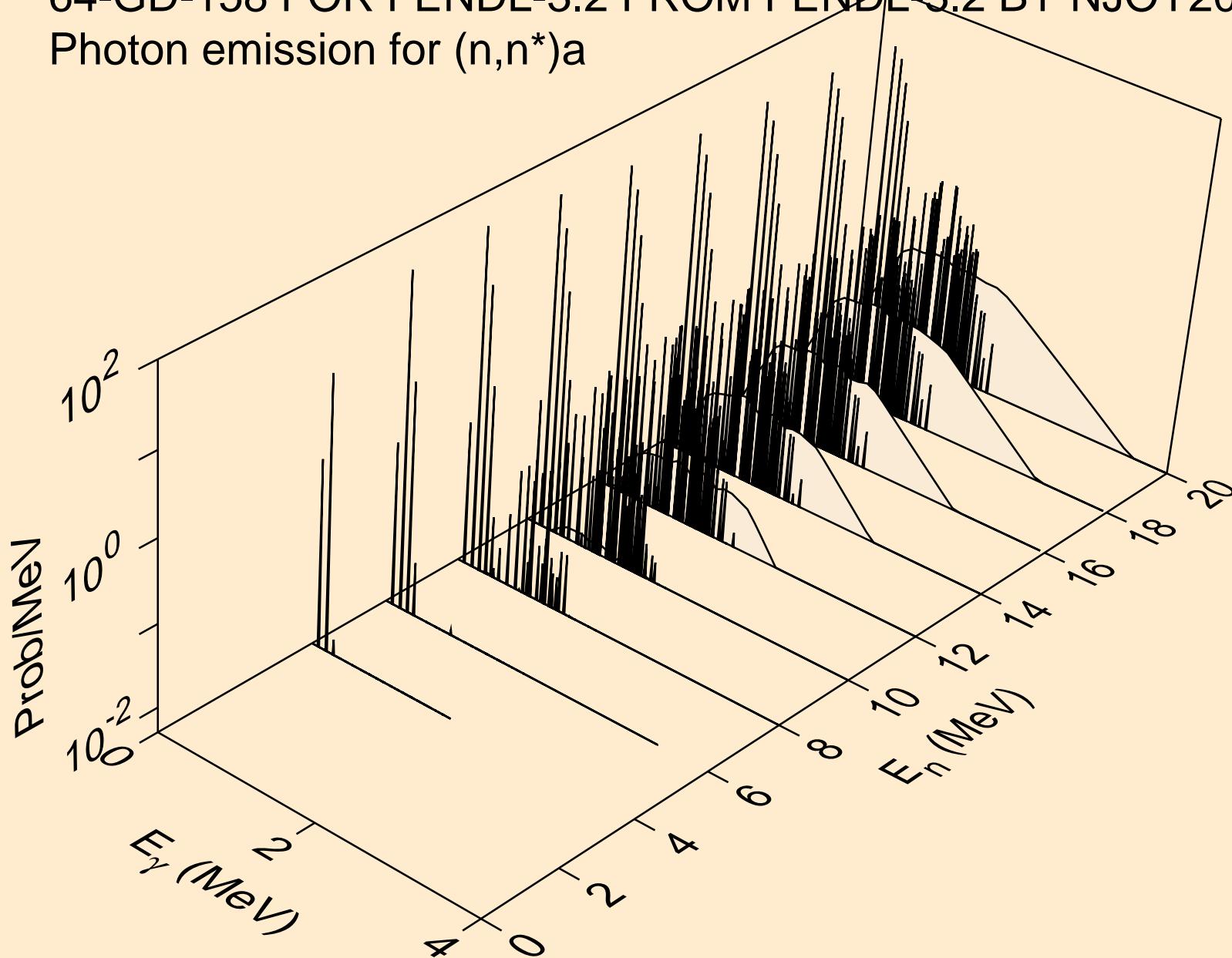

64-GD-158 FOR FENDL-3.2 FROM FENDL-3.2 BY NJOY2016.60+ C
Photon emission for (n,2n)a

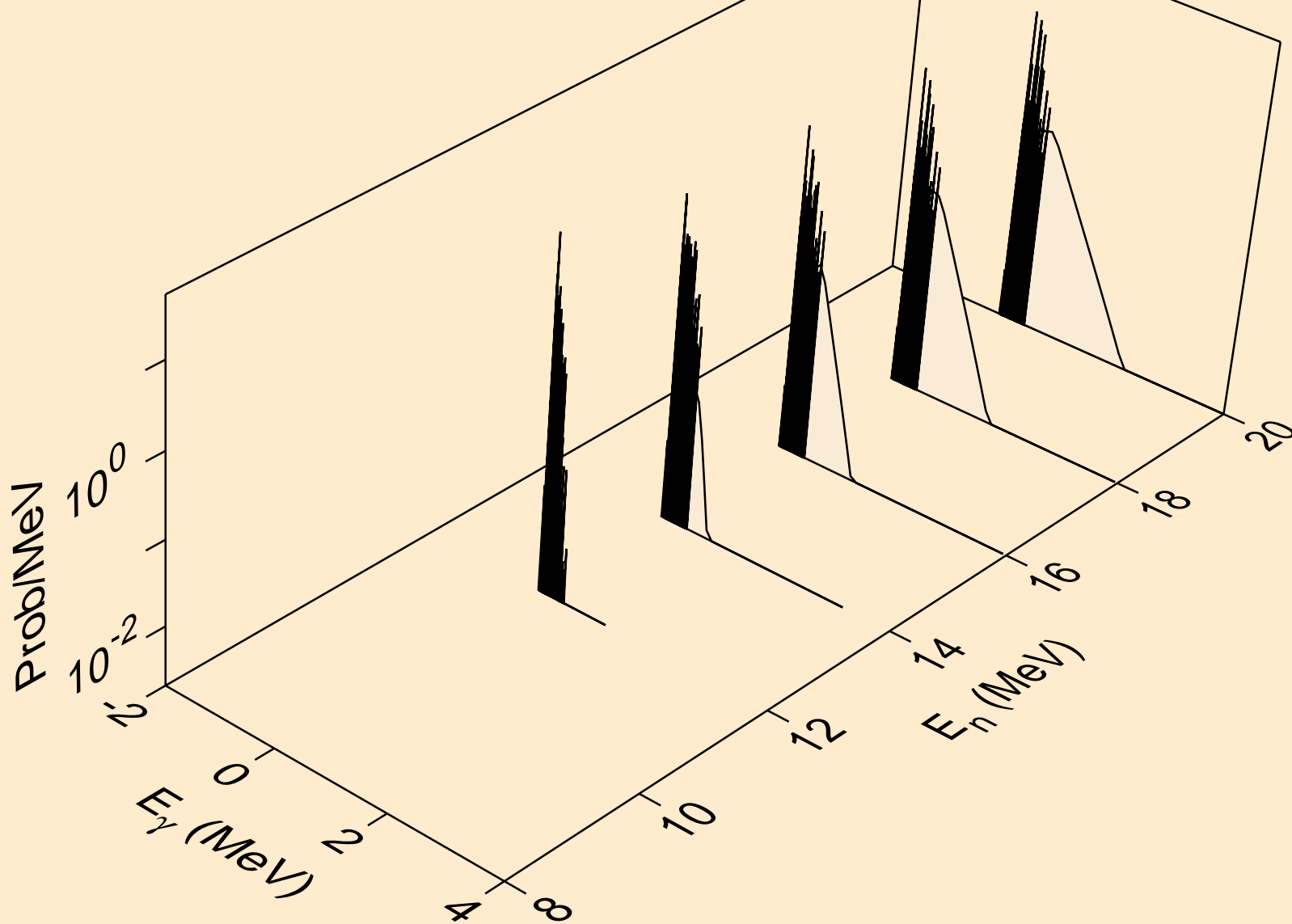

64-GD-158 FOR FENDL-3.2 FROM FENDL-3.2 BY NJOY2016.60+ C
Photon emission for (n,n*)p

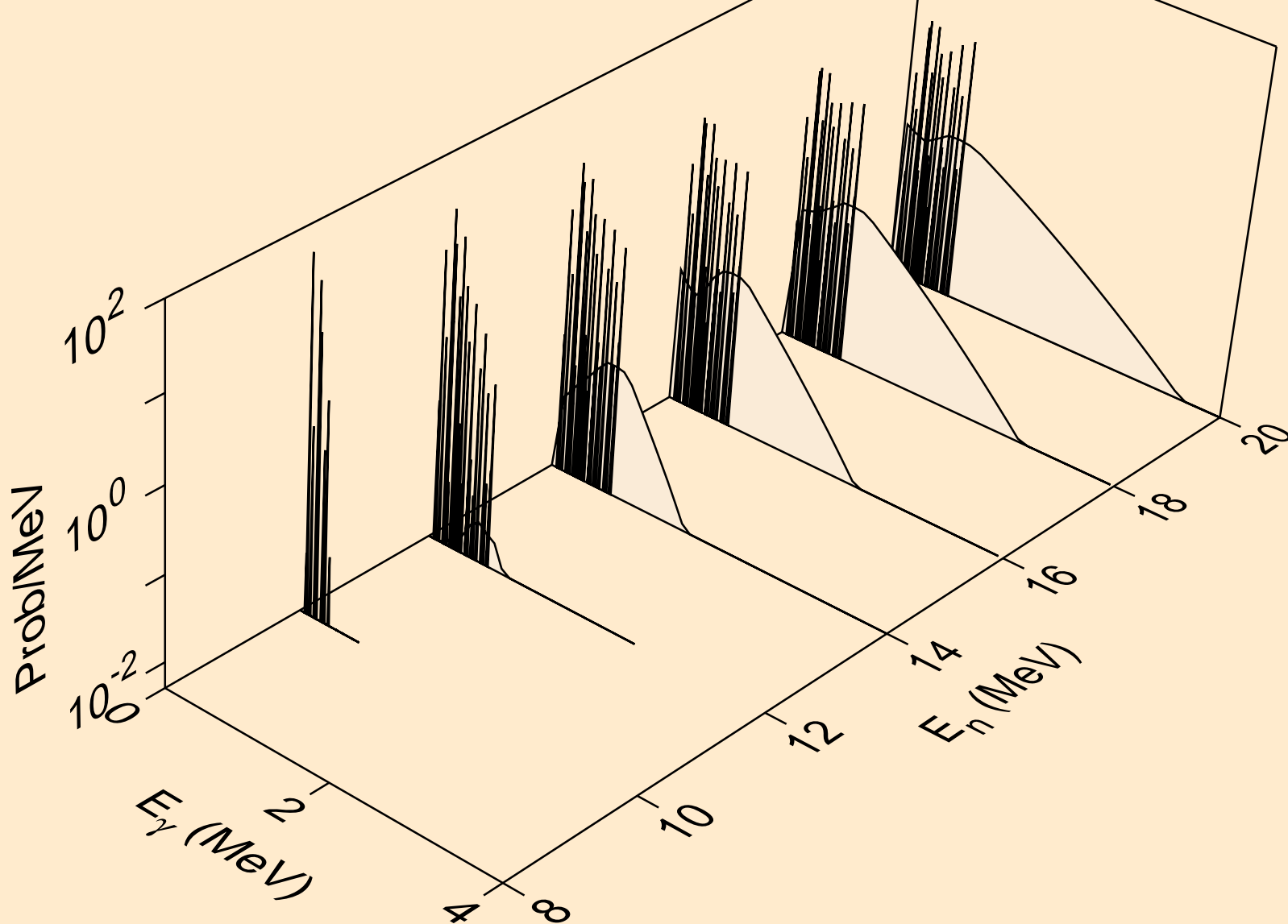

64-GD-158 FOR FENDL-3.2 FROM FENDL-3.2 BY NJOY2016.60+ C
Photon emission for (n,n*)d

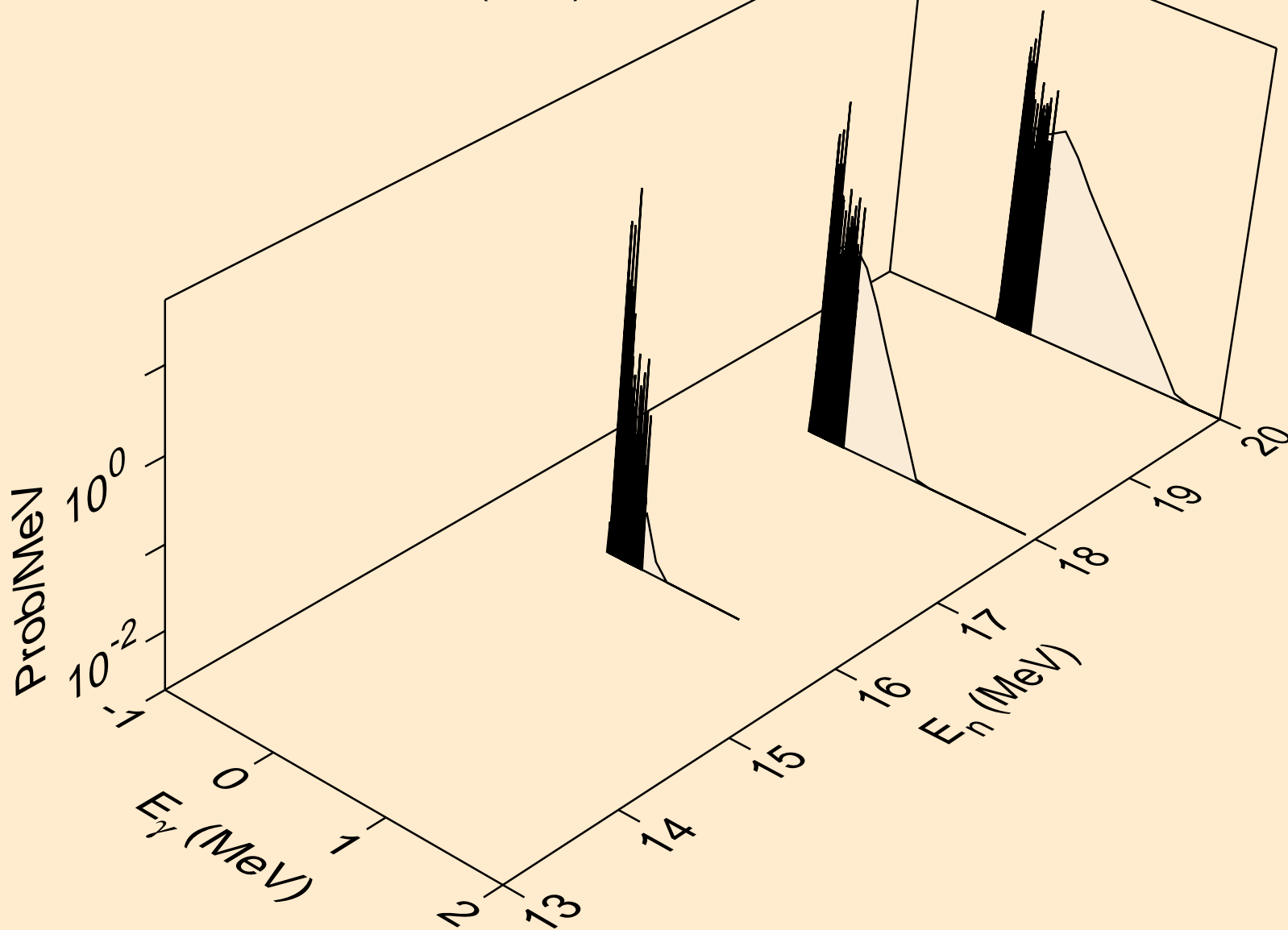

64-GD-158 FOR FENDL-3.2 FROM FENDL-3.2 BY NJOY2016.60+ C
Photon emission for (n,n*1)

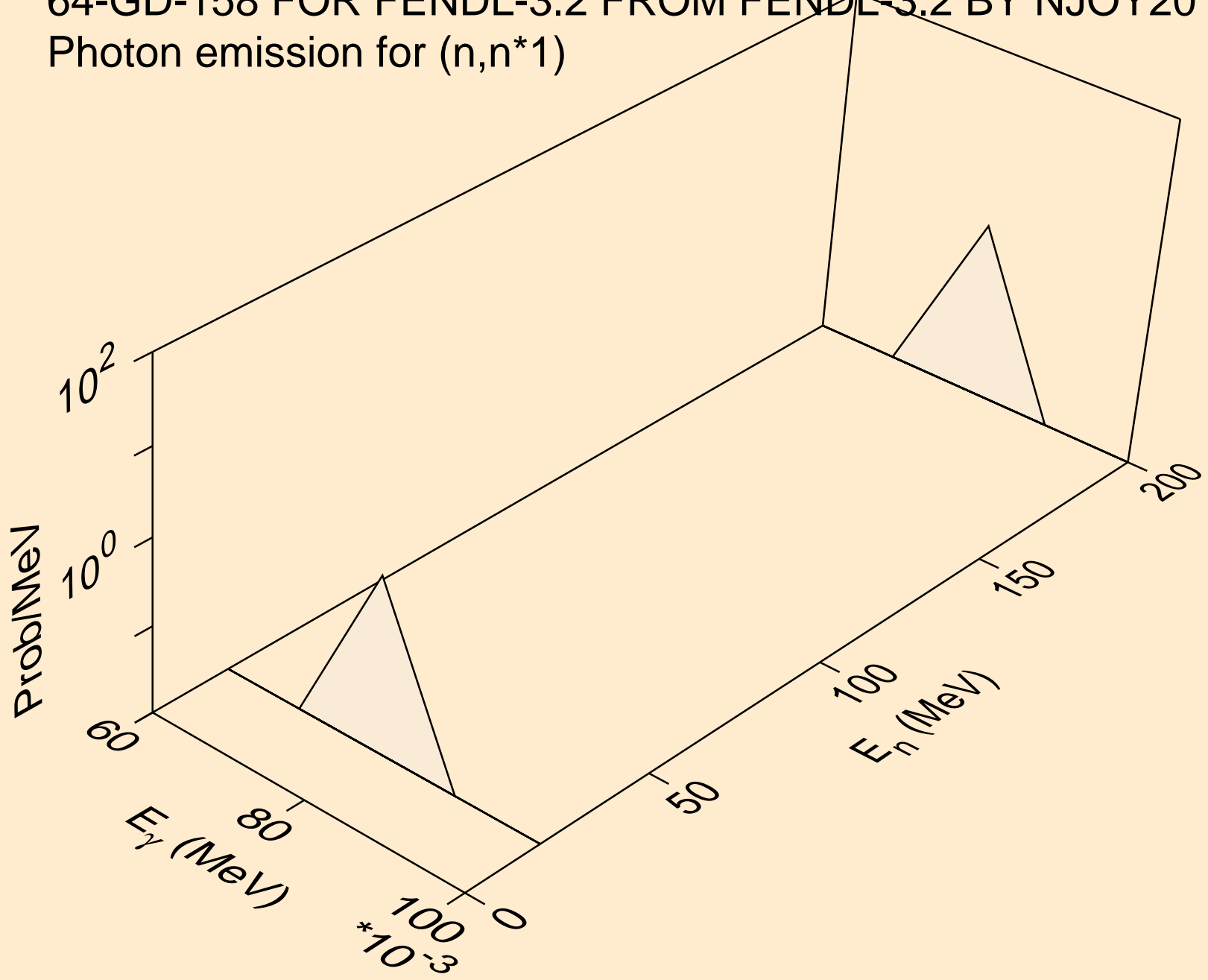

64-GD-158 FOR FENDL-3.2 FROM FENDL-3.2 BY NJOY2016.60+ C
Photon emission for (n,n*2)

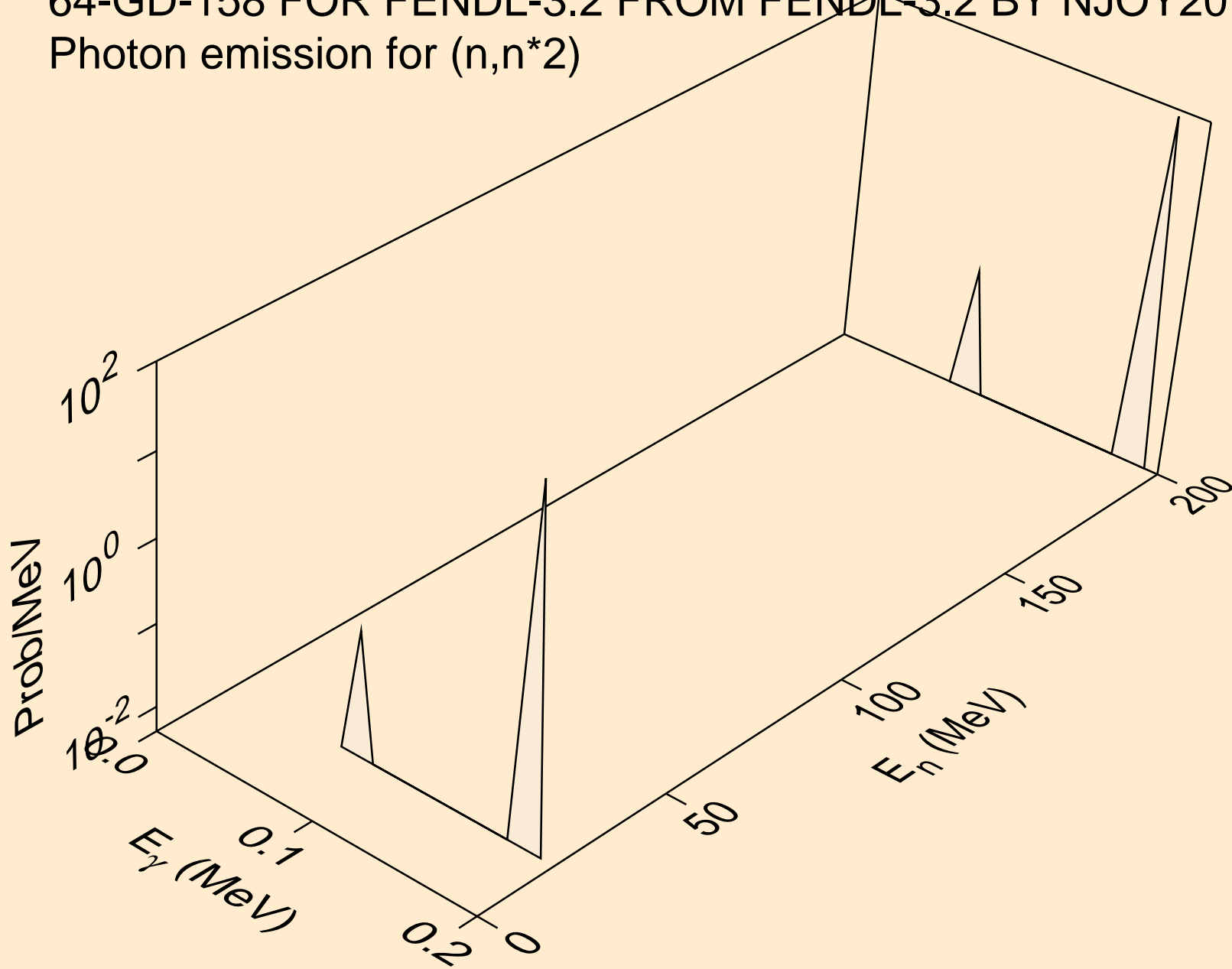

64-GD-158 FOR FENDL-3.2 FROM FENDL-3.2 BY NJOY2016.60+ C
Photon emission for (n,n*3)

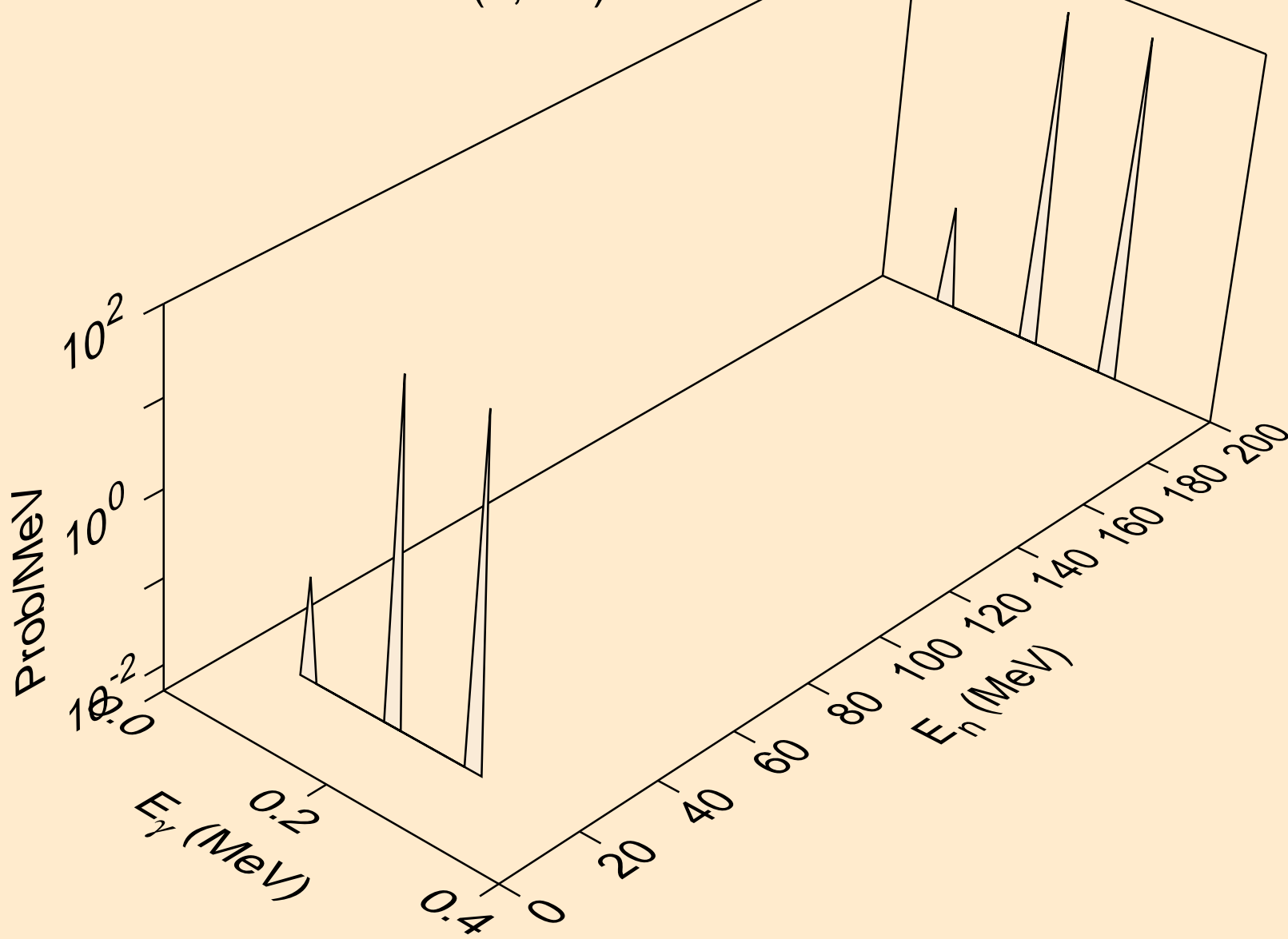

64-GD-158 FOR FENDL-3.2 FROM FENDL-3.2 BY NJOY2016.60+ C
Photon emission for (n,n*4)

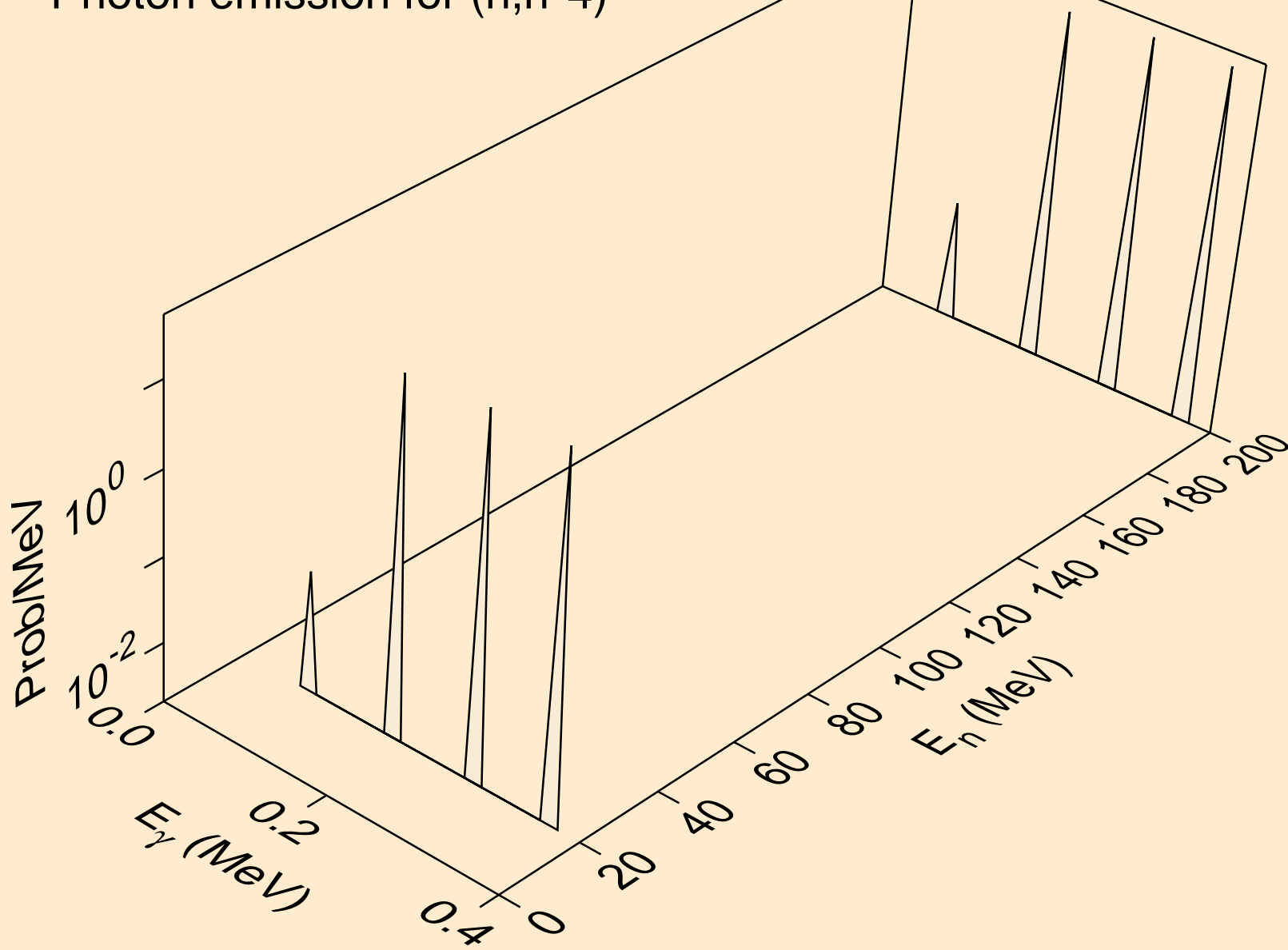

64-GD-158 FOR FENDL-3.2 FROM FENDL-3.2 BY NJOY2016.60+ C
Photon emission for (n,n*5)

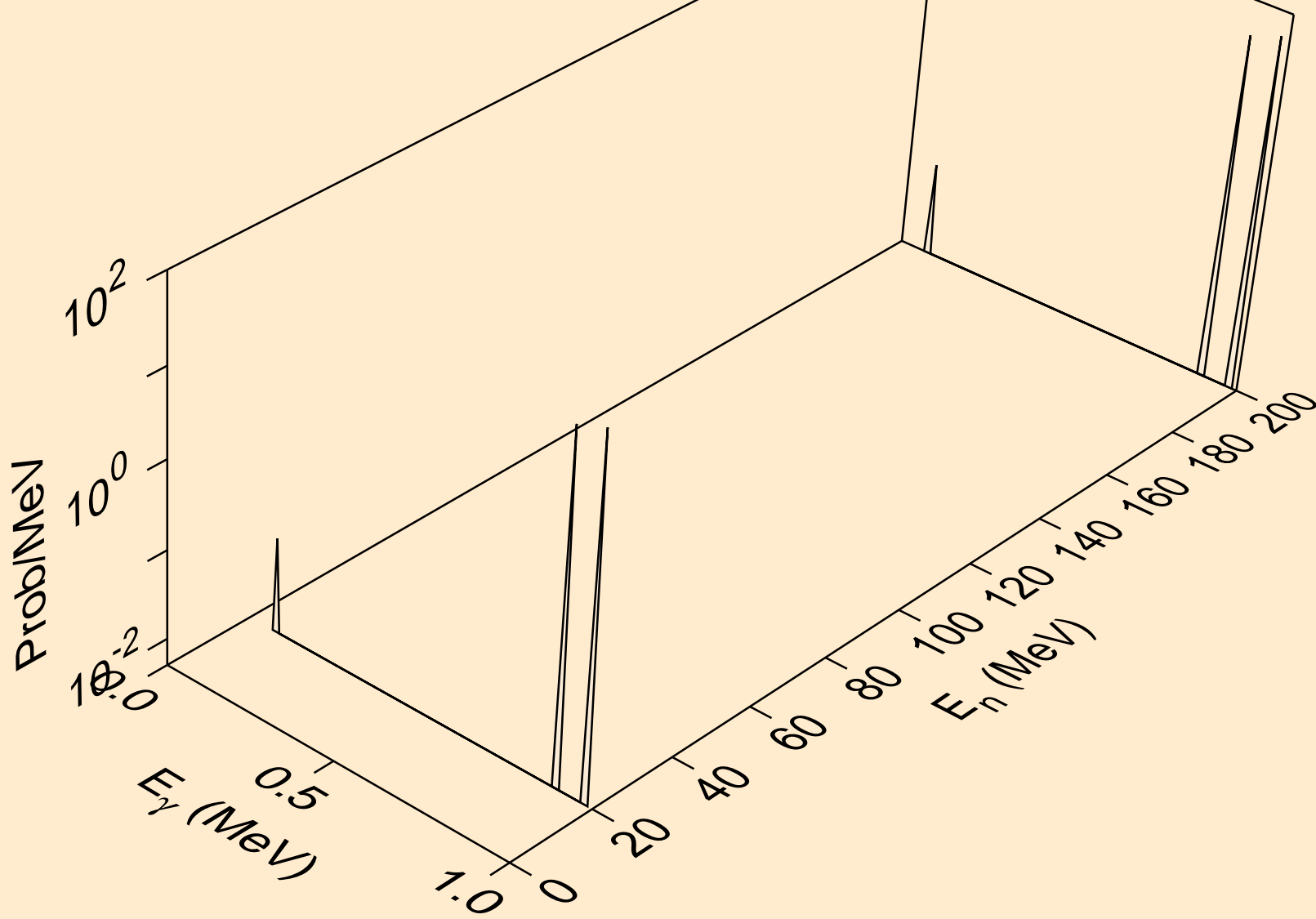

64-GD-158 FOR FENDL-3.2 FROM FENDL-3.2 BY NJOY2016.60+ C
Photon emission for (n,n*6)

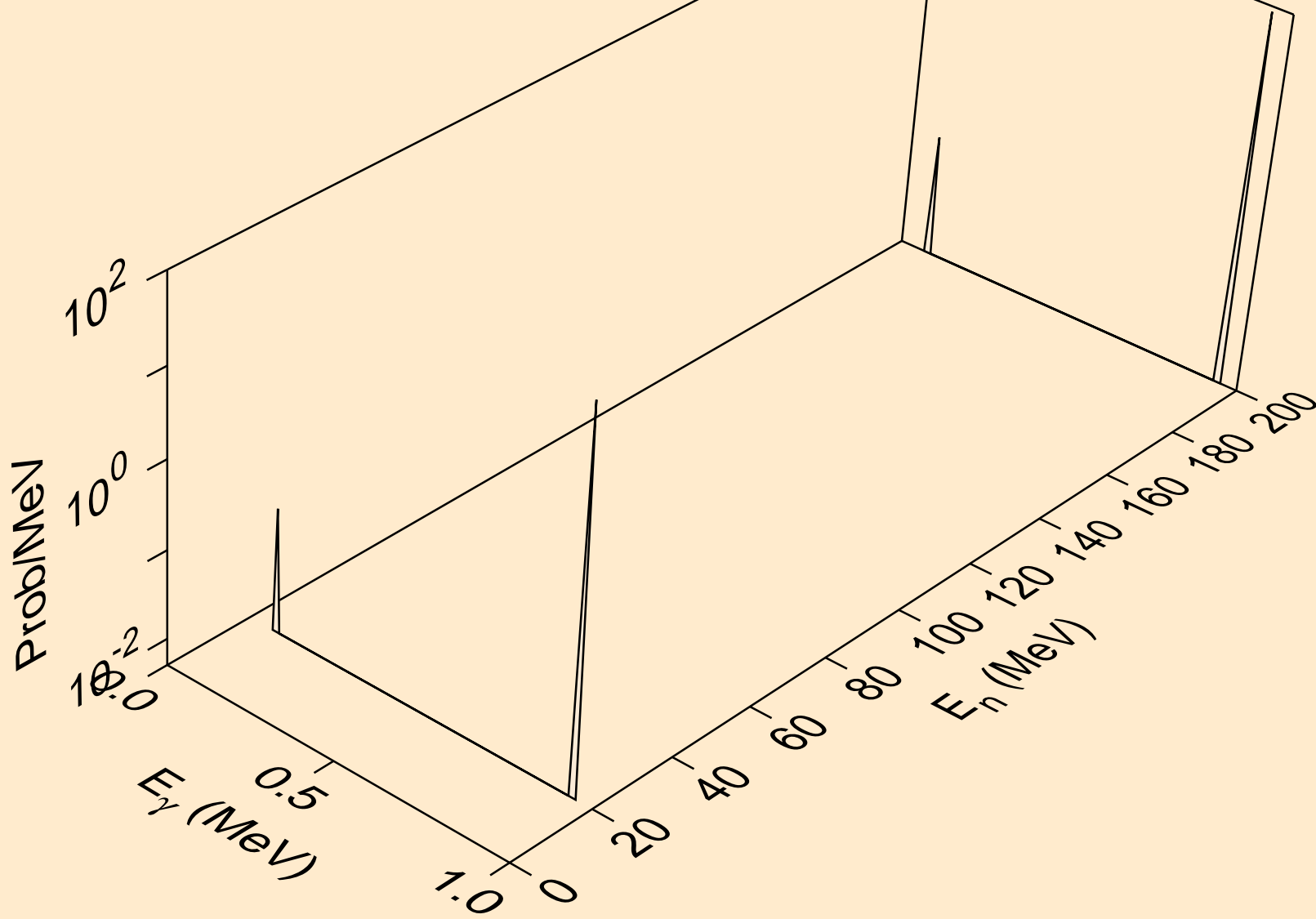

64-GD-158 FOR FENDL-3.2 FROM FENDL-3.2 BY NJOY2016.60+ C
Photon emission for (n,n*7)

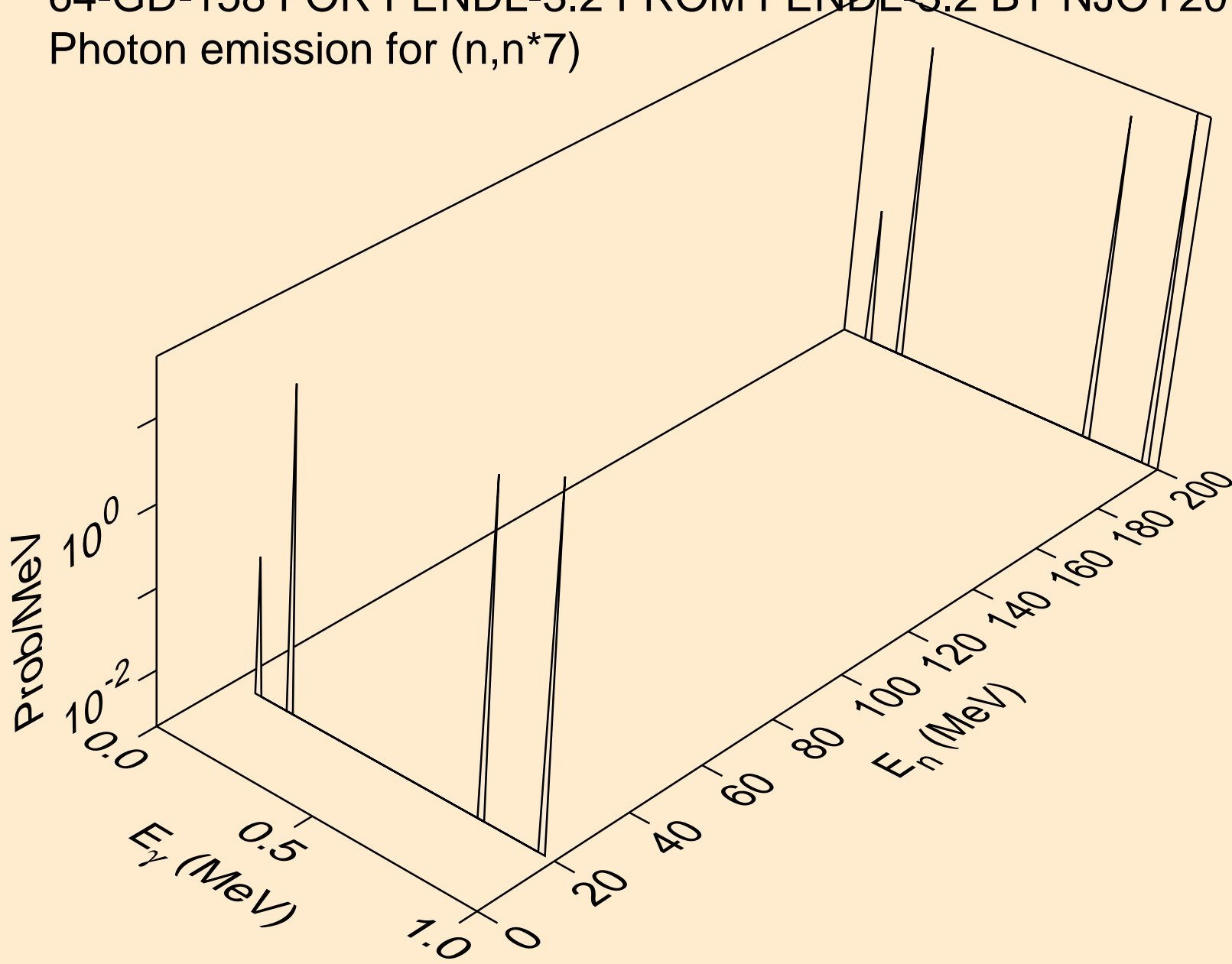

64-GD-158 FOR FENDL-3.2 FROM FENDL-3.2 BY NJOY2016.60+ C
Photon emission for (n,n*8)

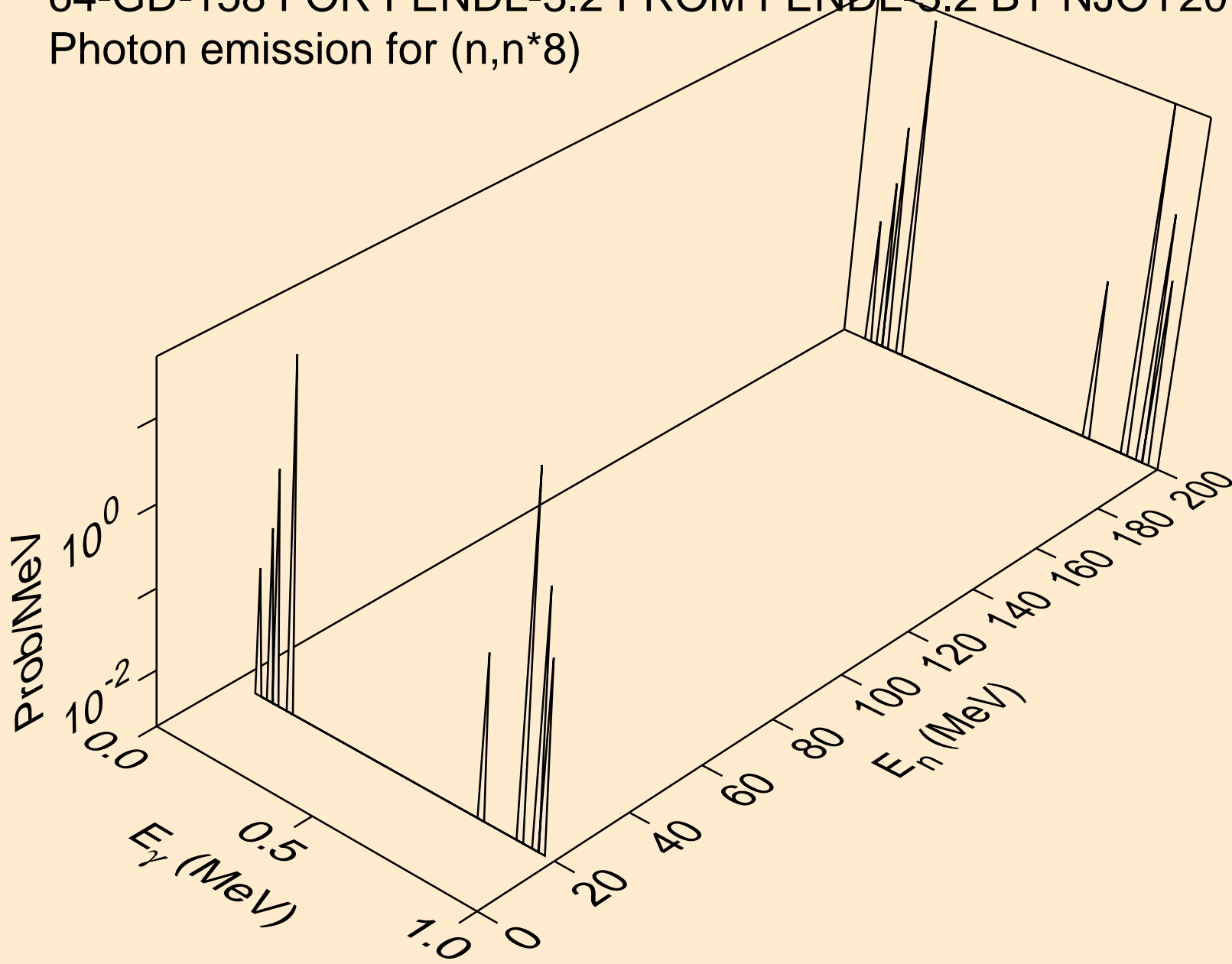

64-GD-158 FOR FENDL-3.2 FROM FENDL-3.2 BY NJOY2016.60+ C
Photon emission for (n,n*9)

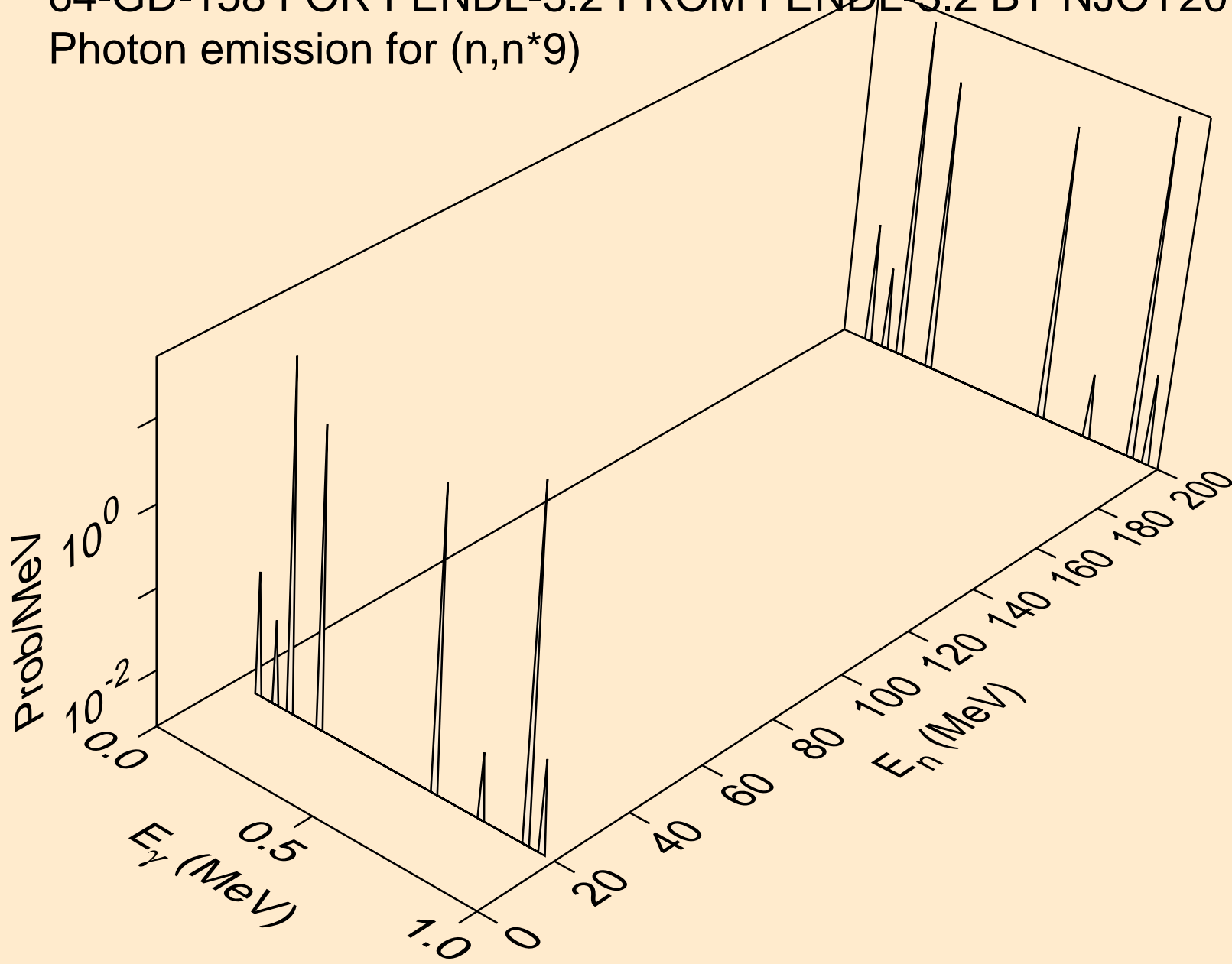

64-GD-158 FOR FENDL-3.2 FROM FENDL-3.2 BY NJOY2016.60+ C
Photon emission for (n,n*10)

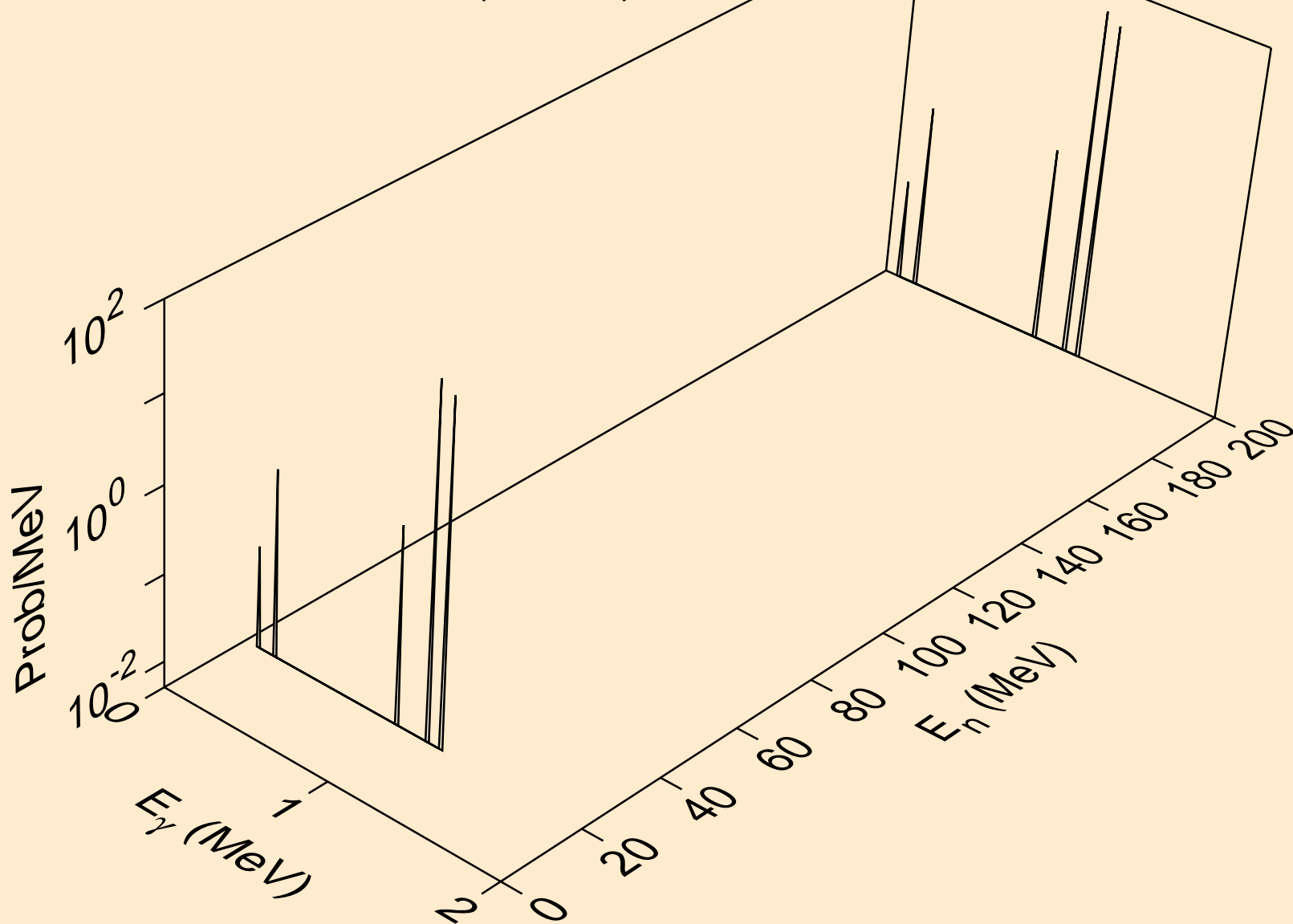

64-GD-158 FOR FENDL-3.2 FROM FENDL-3.2 BY NJOY2016.60+ C
Photon emission for (n,n*11)

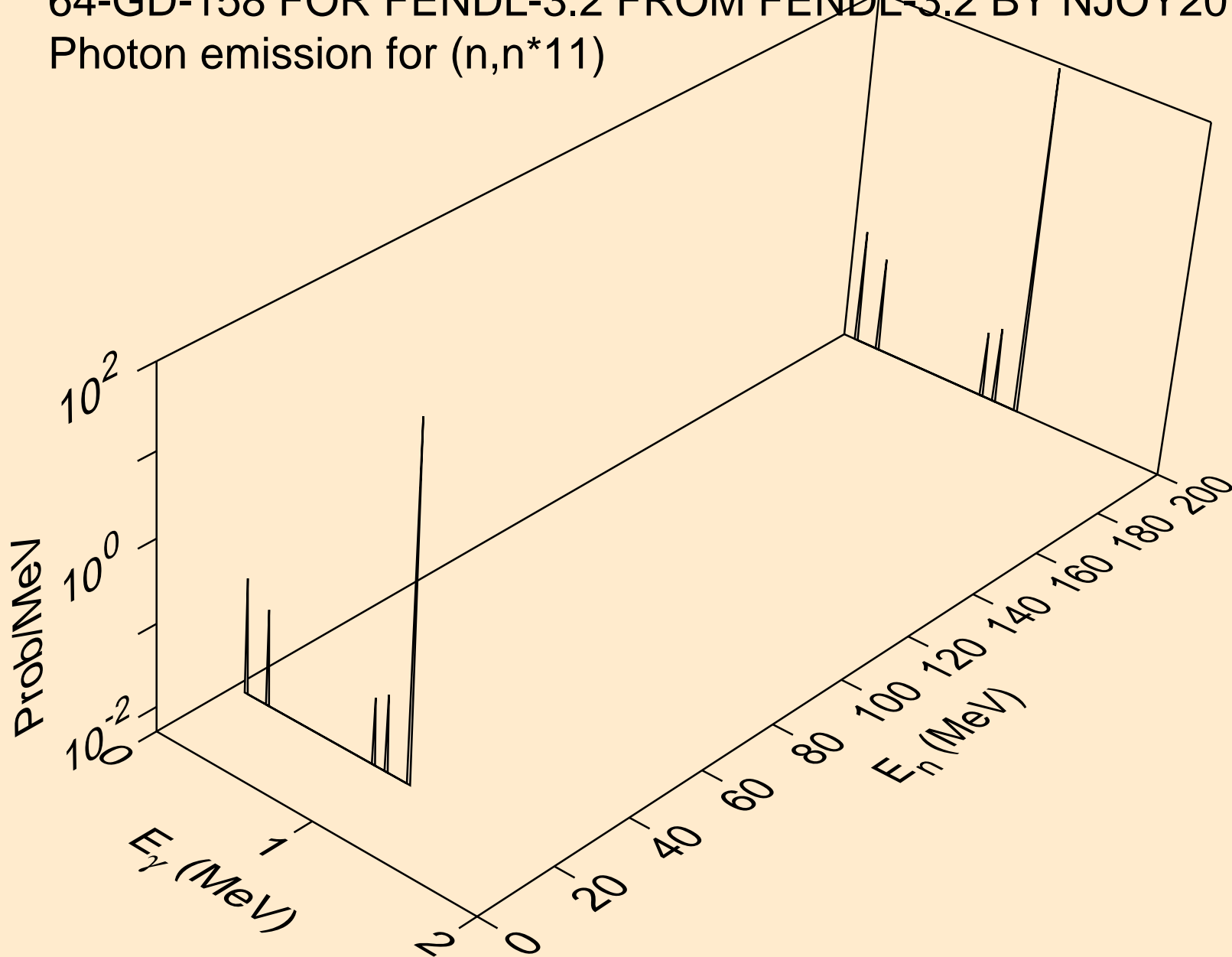

64-GD-158 FOR FENDL-3.2 FROM FENDL-3.2 BY NJOY2016.60+ C
Photon emission for (n,n*12)

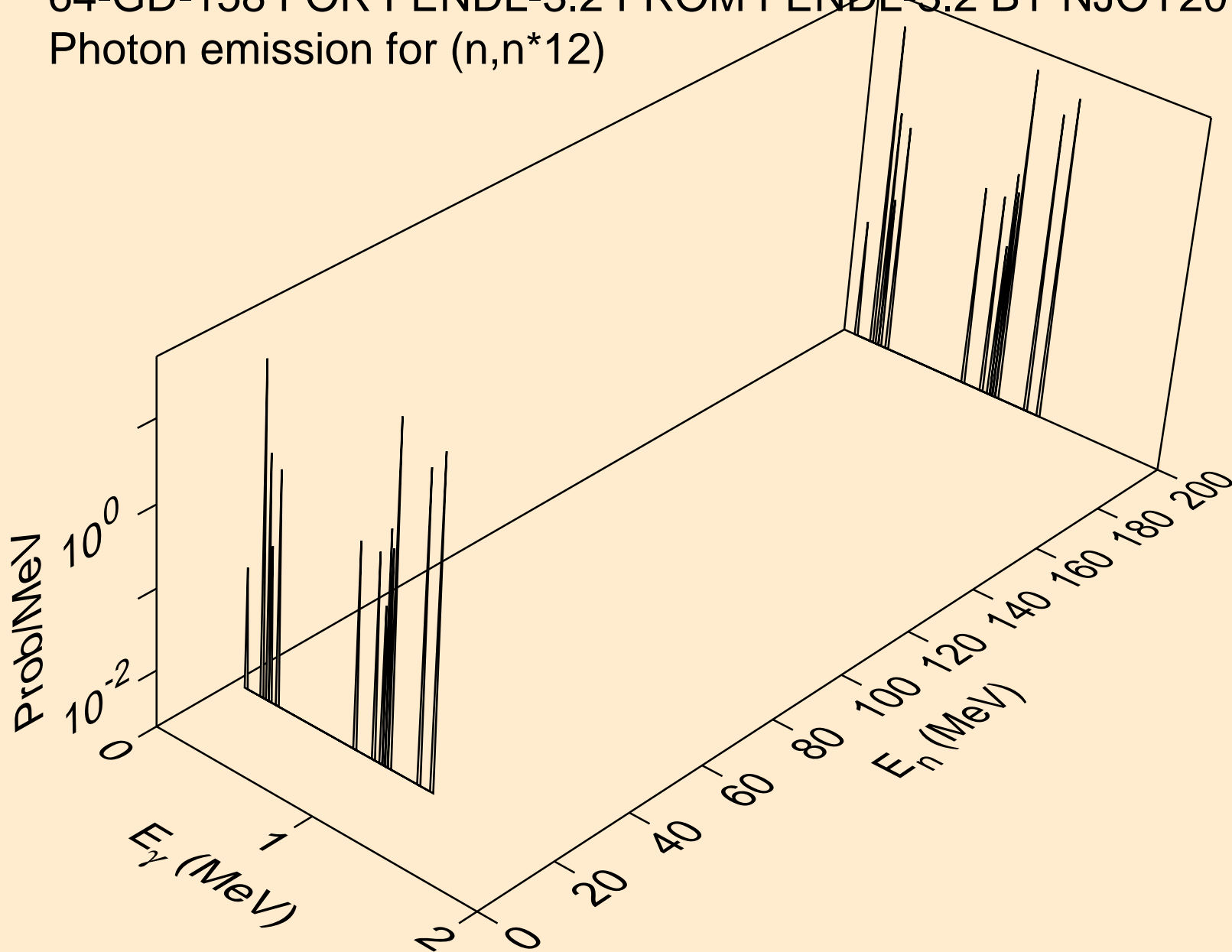

64-GD-158 FOR FENDL-3.2 FROM FENDL-3.2 BY NJOY2016.60+ C
Photon emission for (n,n*13)

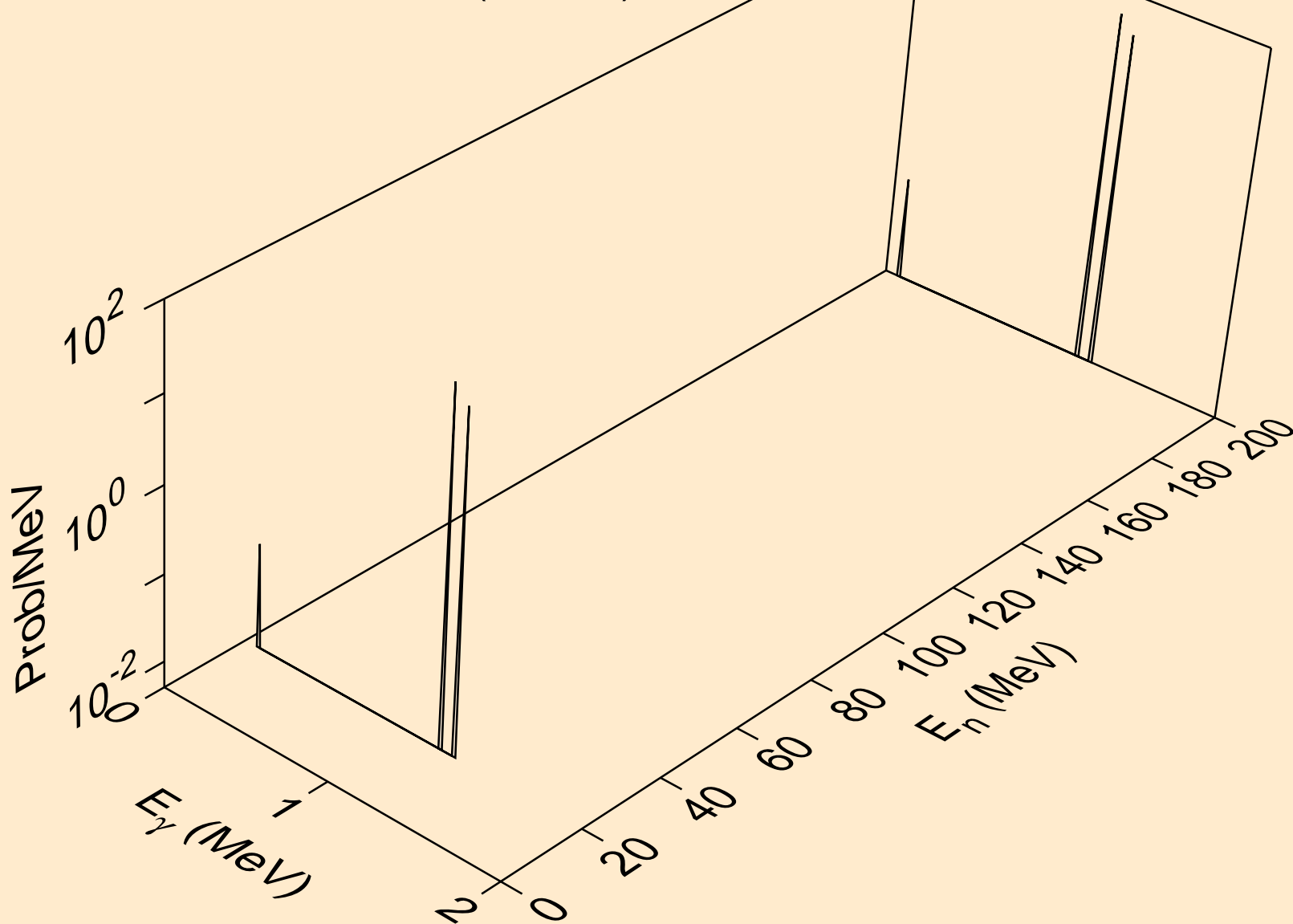

64-GD-158 FOR FENDL-3.2 FROM FENDL-3.2 BY NJOY2016.60+ C
Photon emission for (n,n*14)

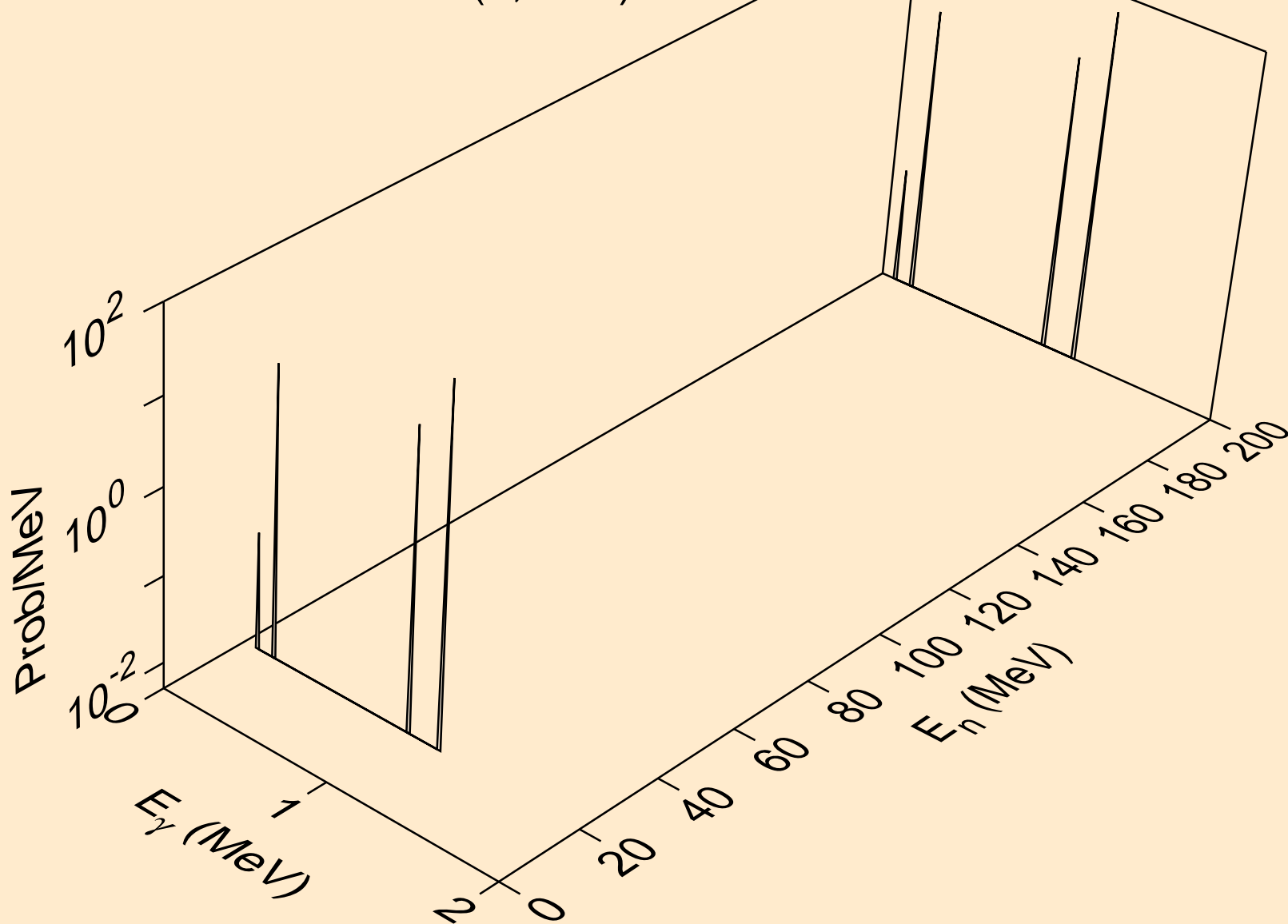

64-GD-158 FOR FENDL-3.2 FROM FENDL-3.2 BY NJOY2016.60+ C
Photon emission for (n,n*15)

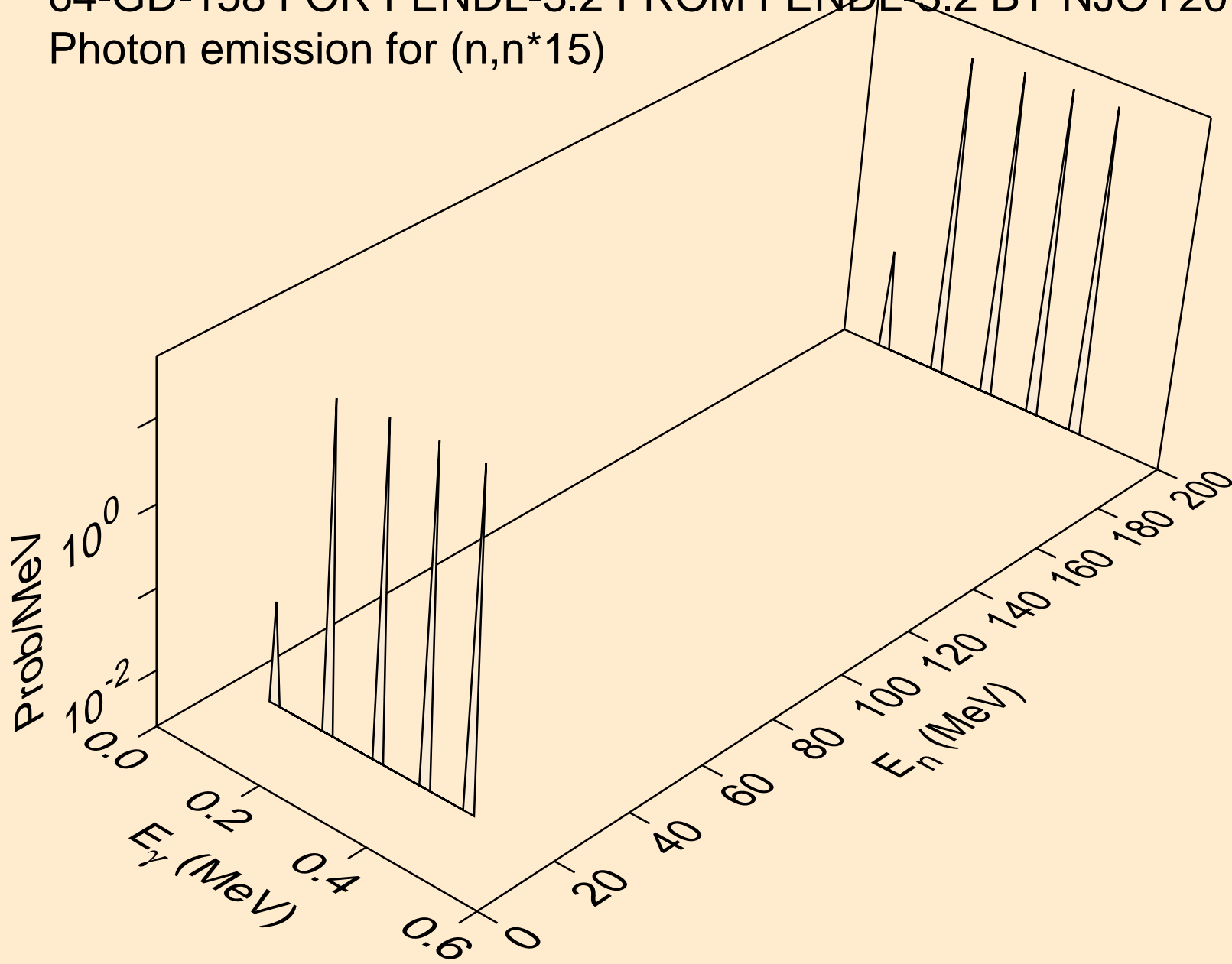

64-GD-158 FOR FENDL-3.2 FROM FENDL-3.2 BY NJOY2016.60+ C
Photon emission for (n,n*16)

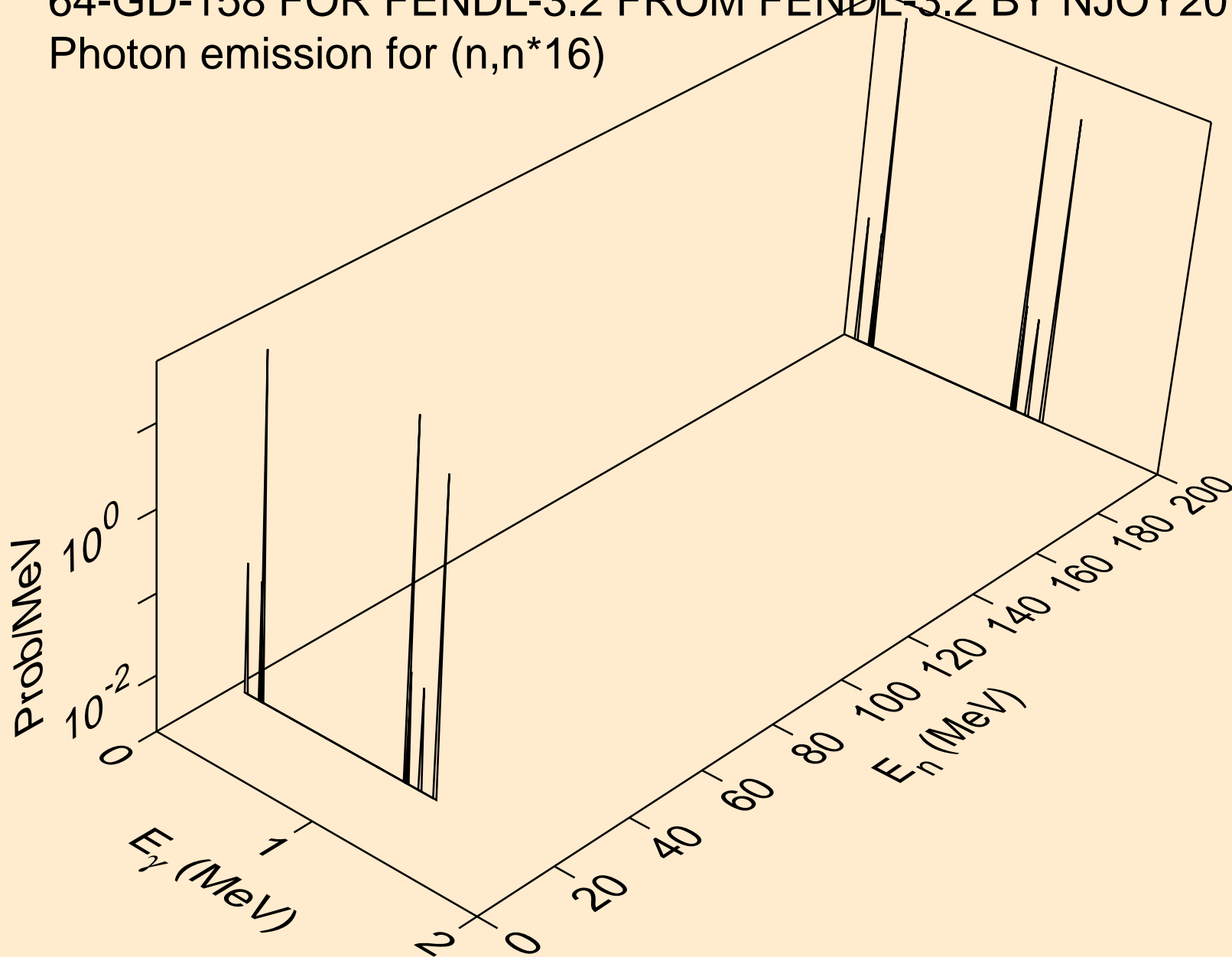

64-GD-158 FOR FENDL-3.2 FROM FENDL-3.2 BY NJOY2016.60+ C
Photon emission for (n,n*17)

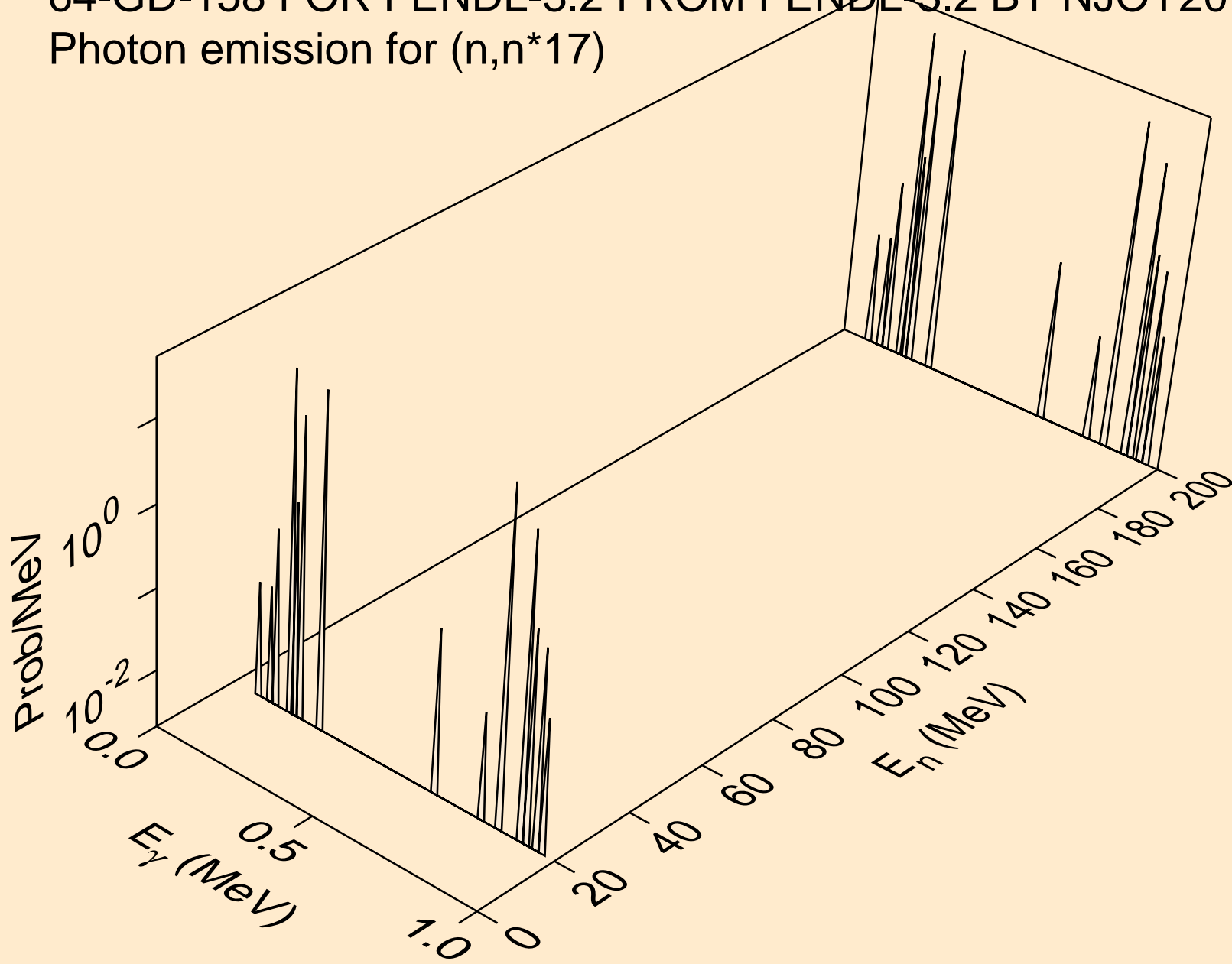

64-GD-158 FOR FENDL-3.2 FROM FENDL-3.2 BY NJOY2016.60+ C
Photon emission for (n,n*18)

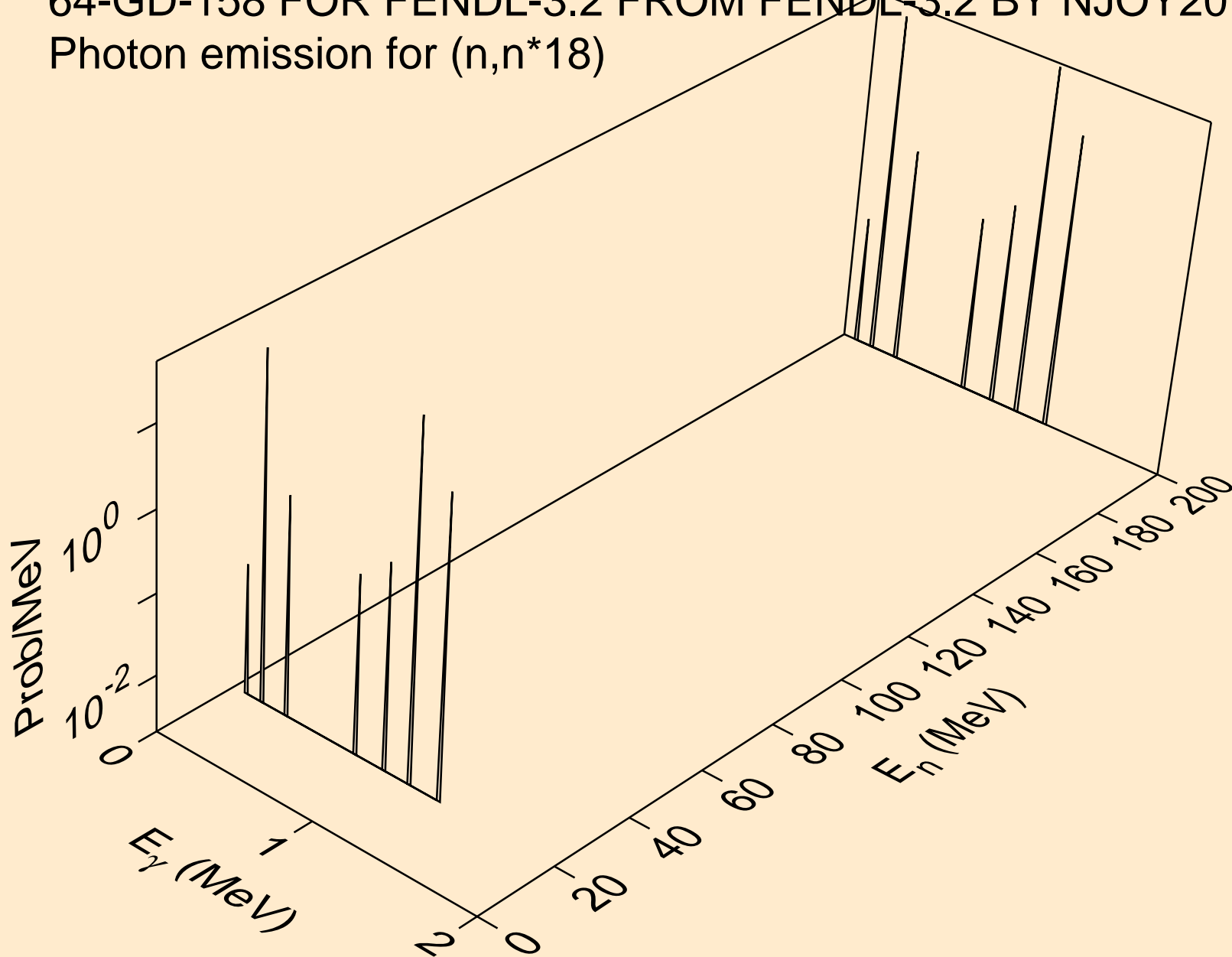

64-GD-158 FOR FENDL-3.2 FROM FENDL-3.2 BY NJOY2016.60+ C
Photon emission for (n,n*19)

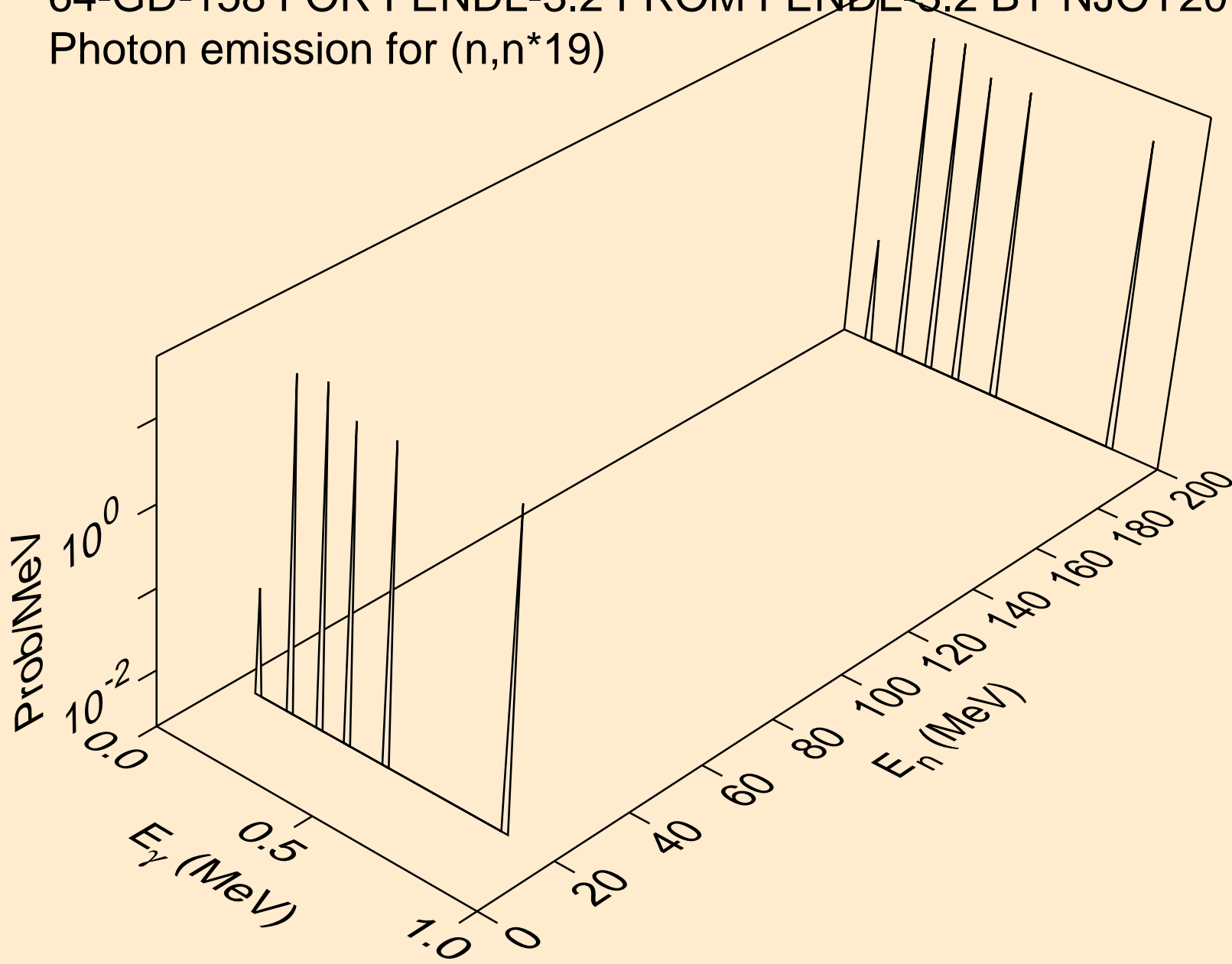

64-GD-158 FOR FENDL-3.2 FROM FENDL-3.2 BY NJOY2016.60+ C
Photon emission for (n,n*20)

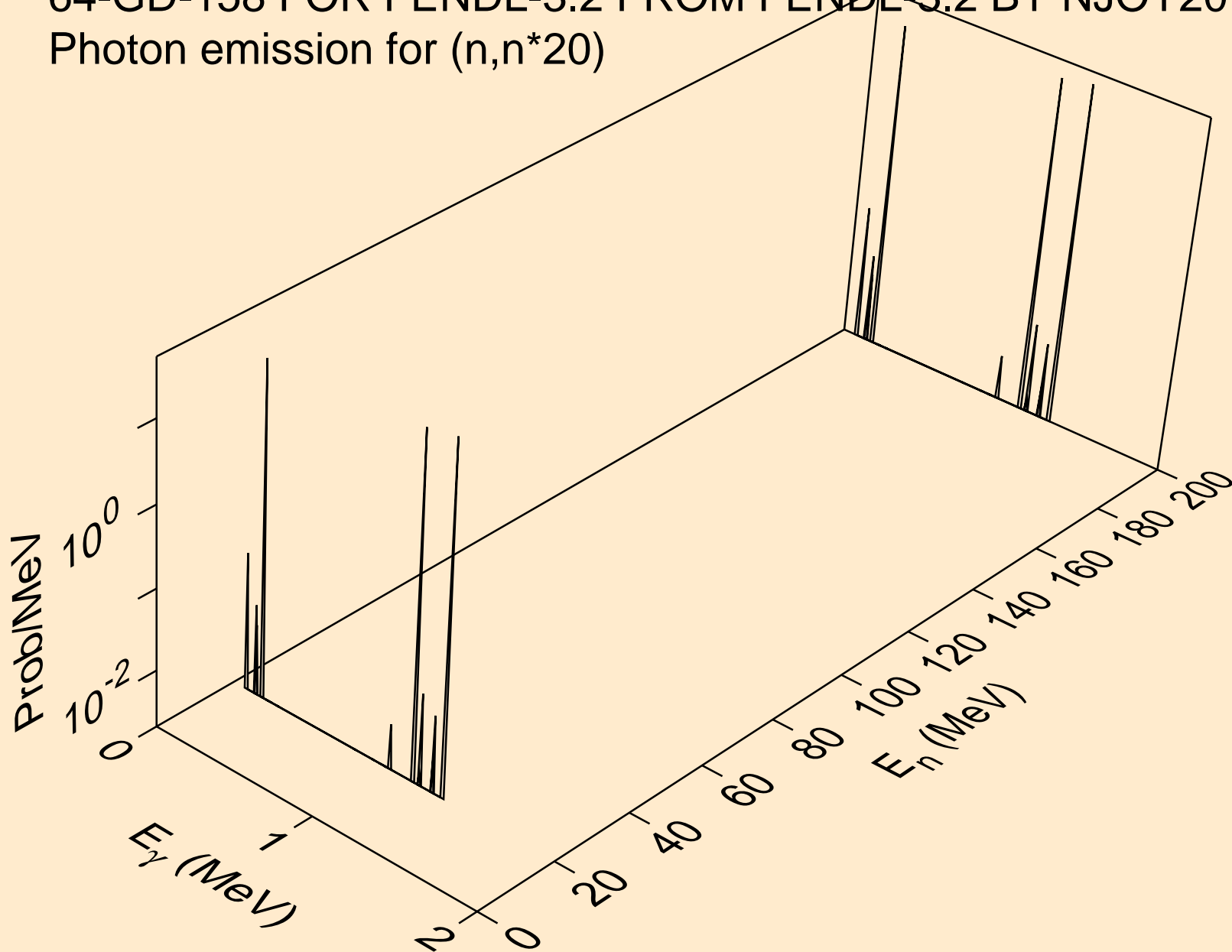

64-GD-158 FOR FENDL-3.2 FROM FENDL-3.2 BY NJOY2016.60+ C
Photon emission for (n,n*21)

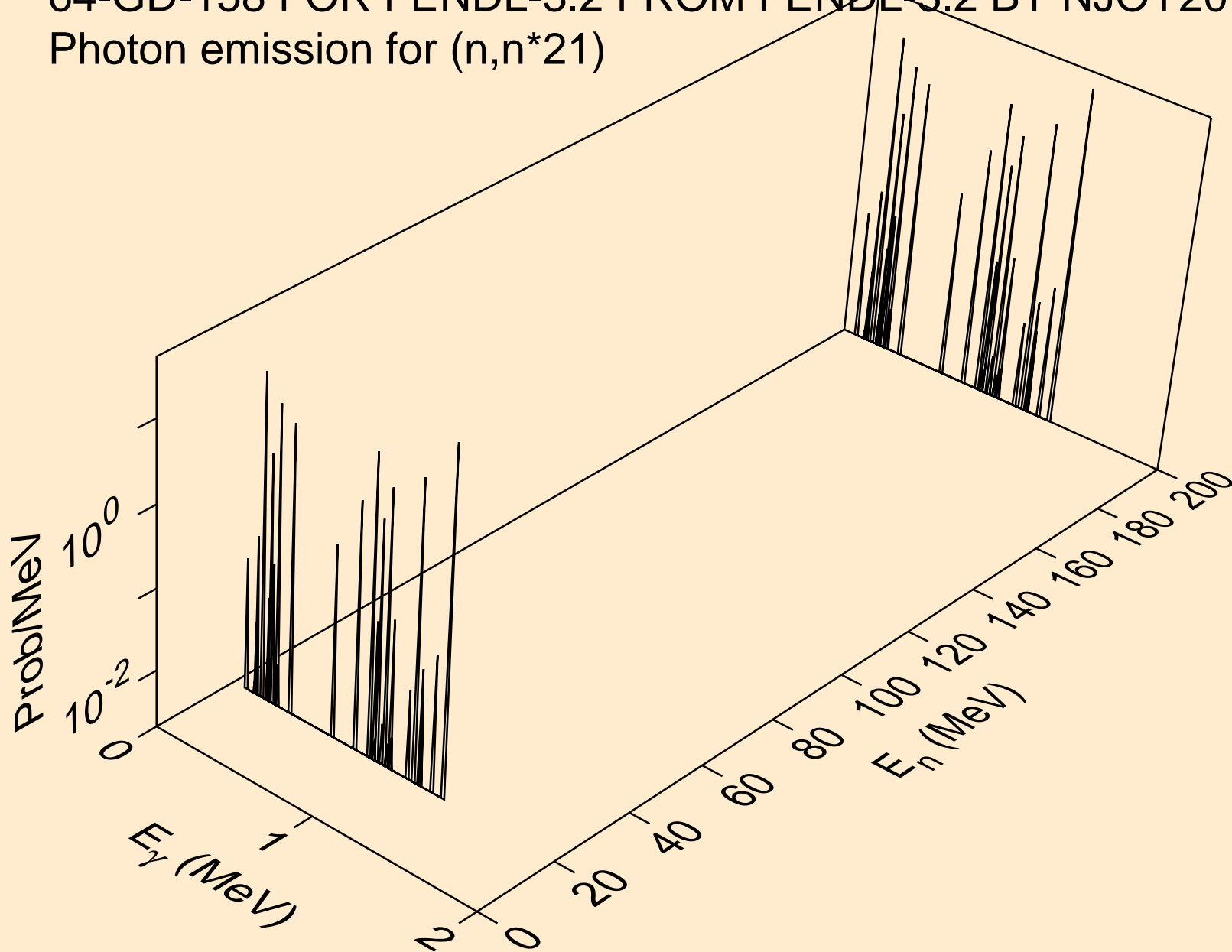

64-GD-158 FOR FENDL-3.2 FROM FENDL-3.2 BY NJOY2016.60+ C
Photon emission for (n,n*22)

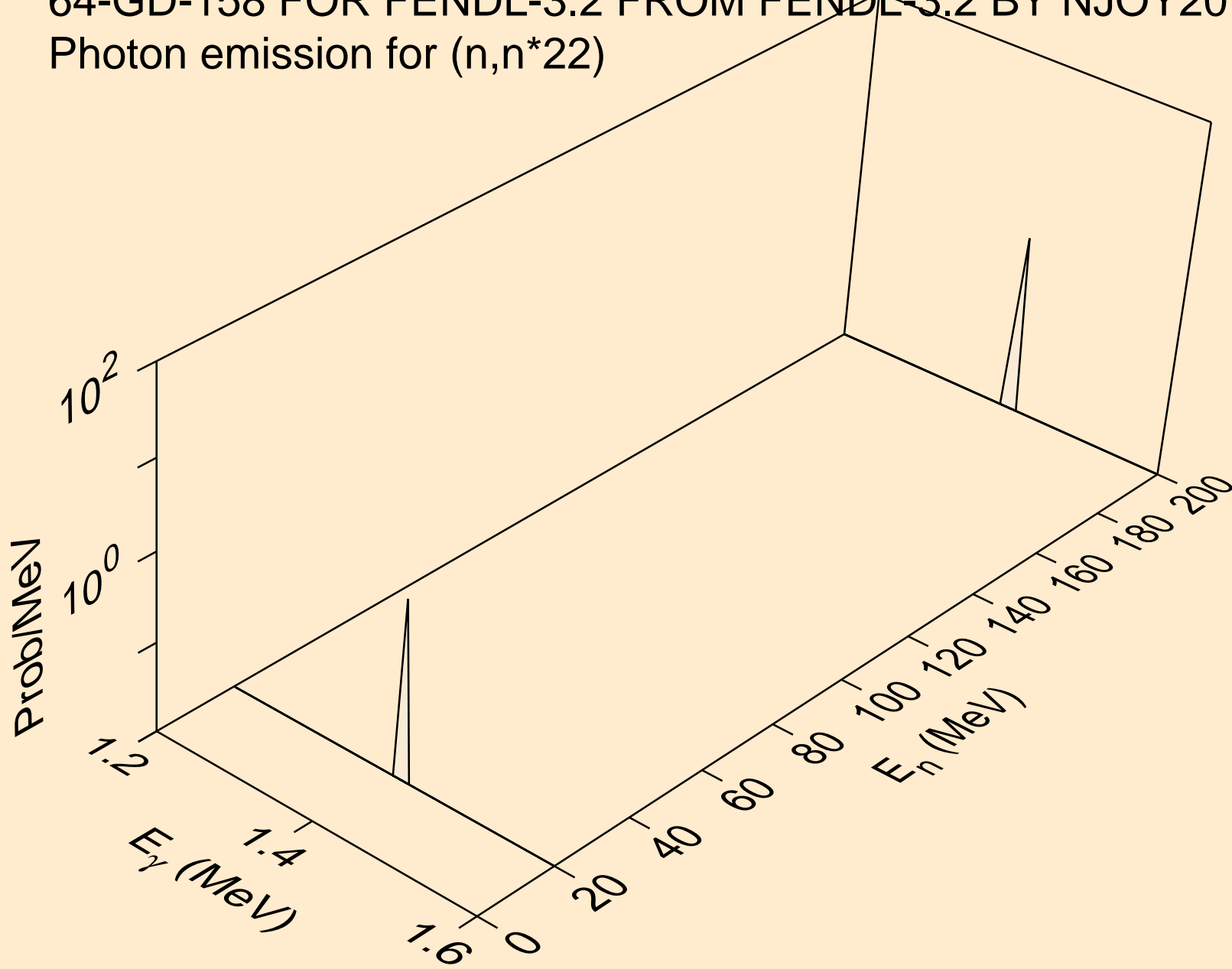

64-GD-158 FOR FENDL-3.2 FROM FENDL-3.2 BY NJOY2016.60+ C
Photon emission for (n,n*23)

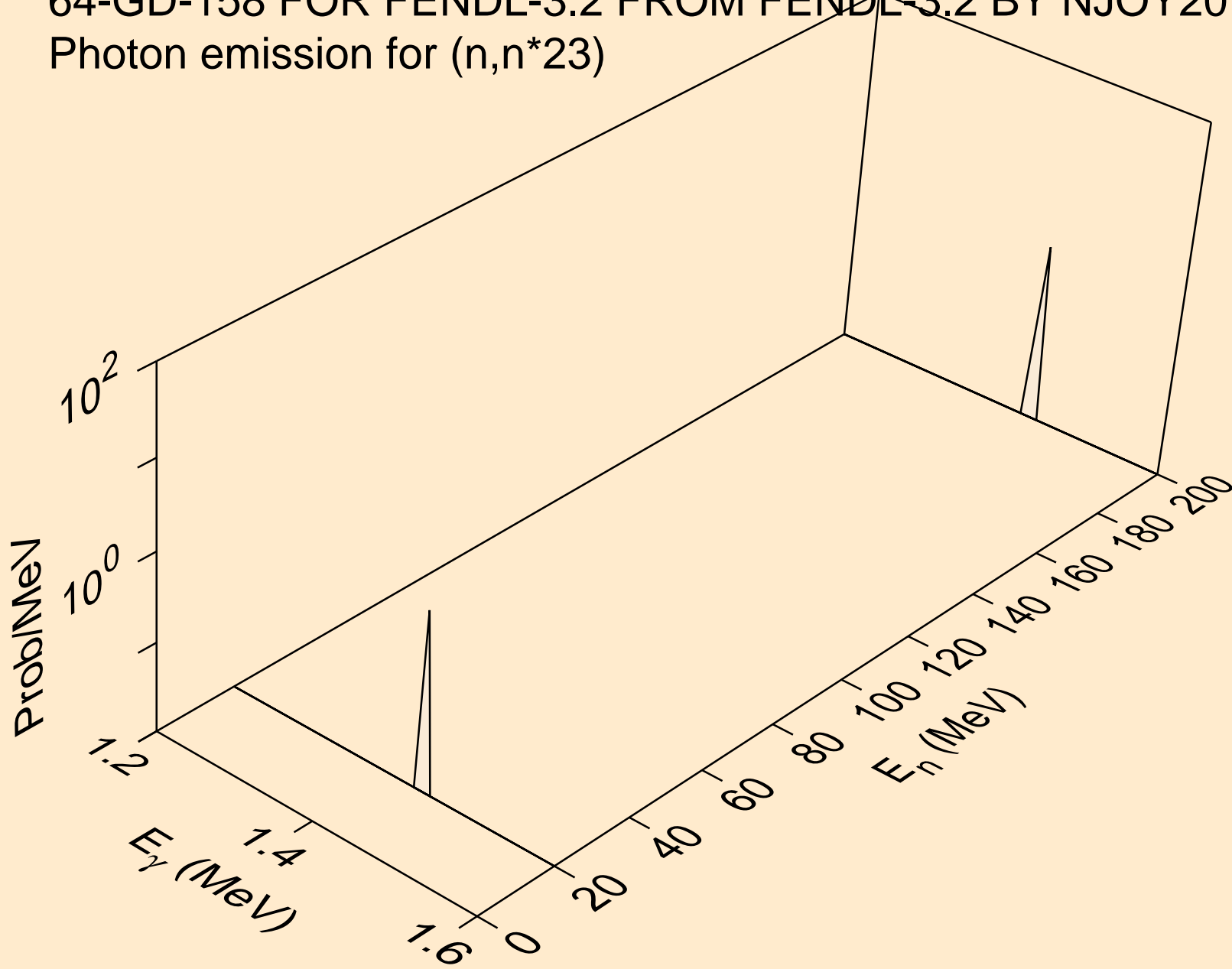

64-GD-158 FOR FENDL-3.2 FROM FENDL-3.2 BY NJOY2016.60+ C
Photon emission for (n,n*24)

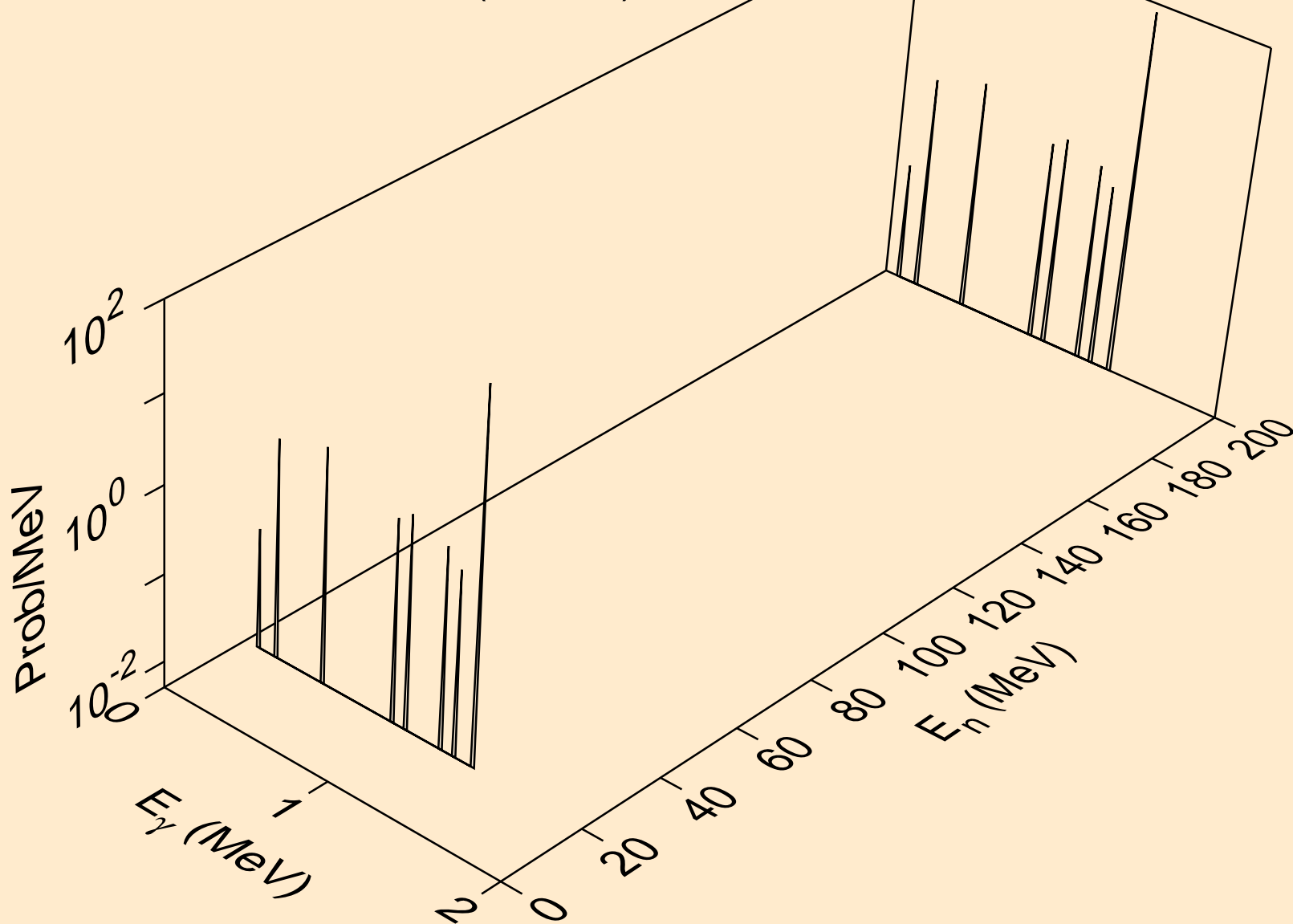

64-GD-158 FOR FENDL-3.2 FROM FENDL-3.2 BY NJOY2016.60+ C
Photon emission for (n,n*25)

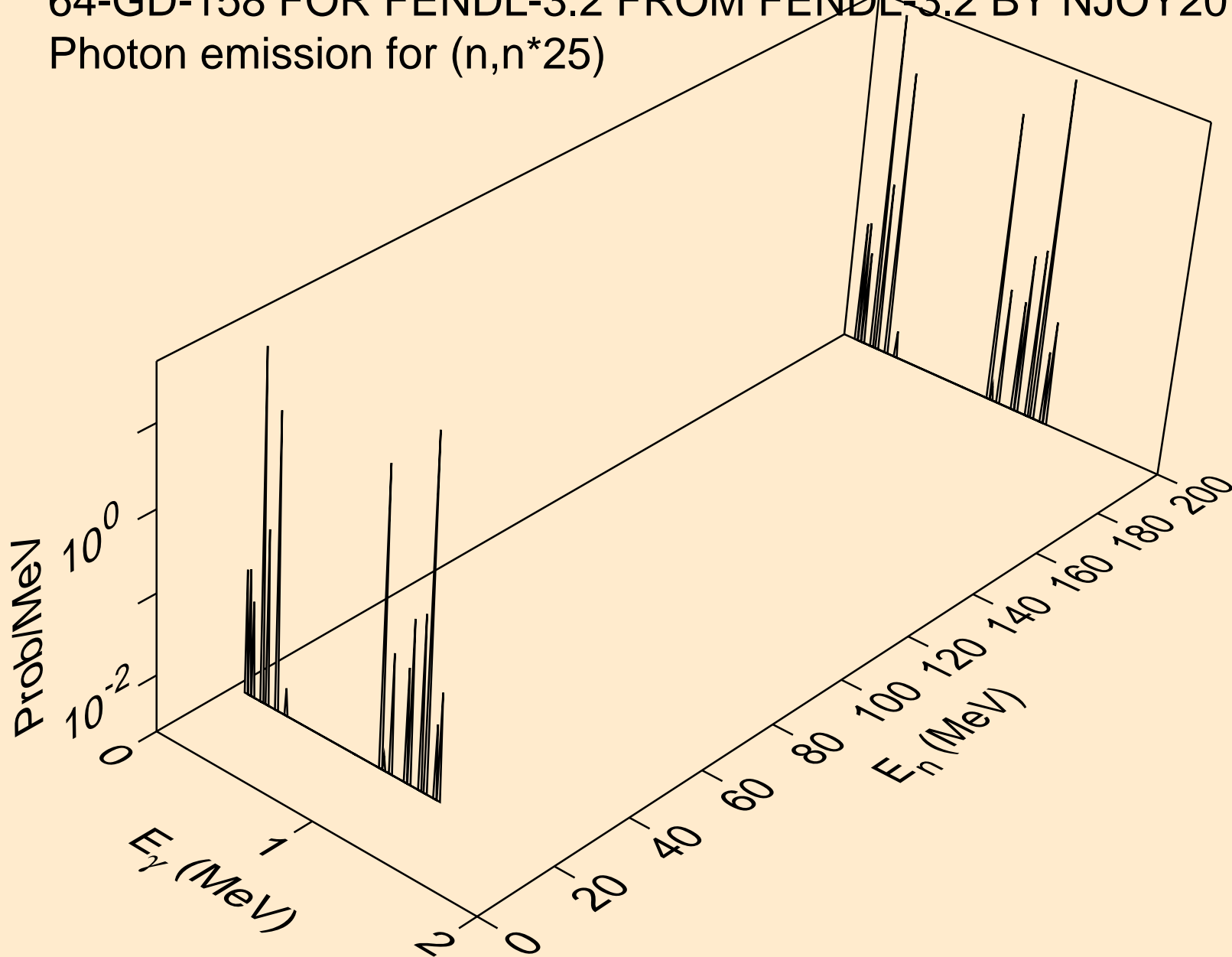

64-GD-158 FOR FENDL-3.2 FROM FENDL-3.2 BY NJOY2016.60+ C
Photon emission for (n,n*26)

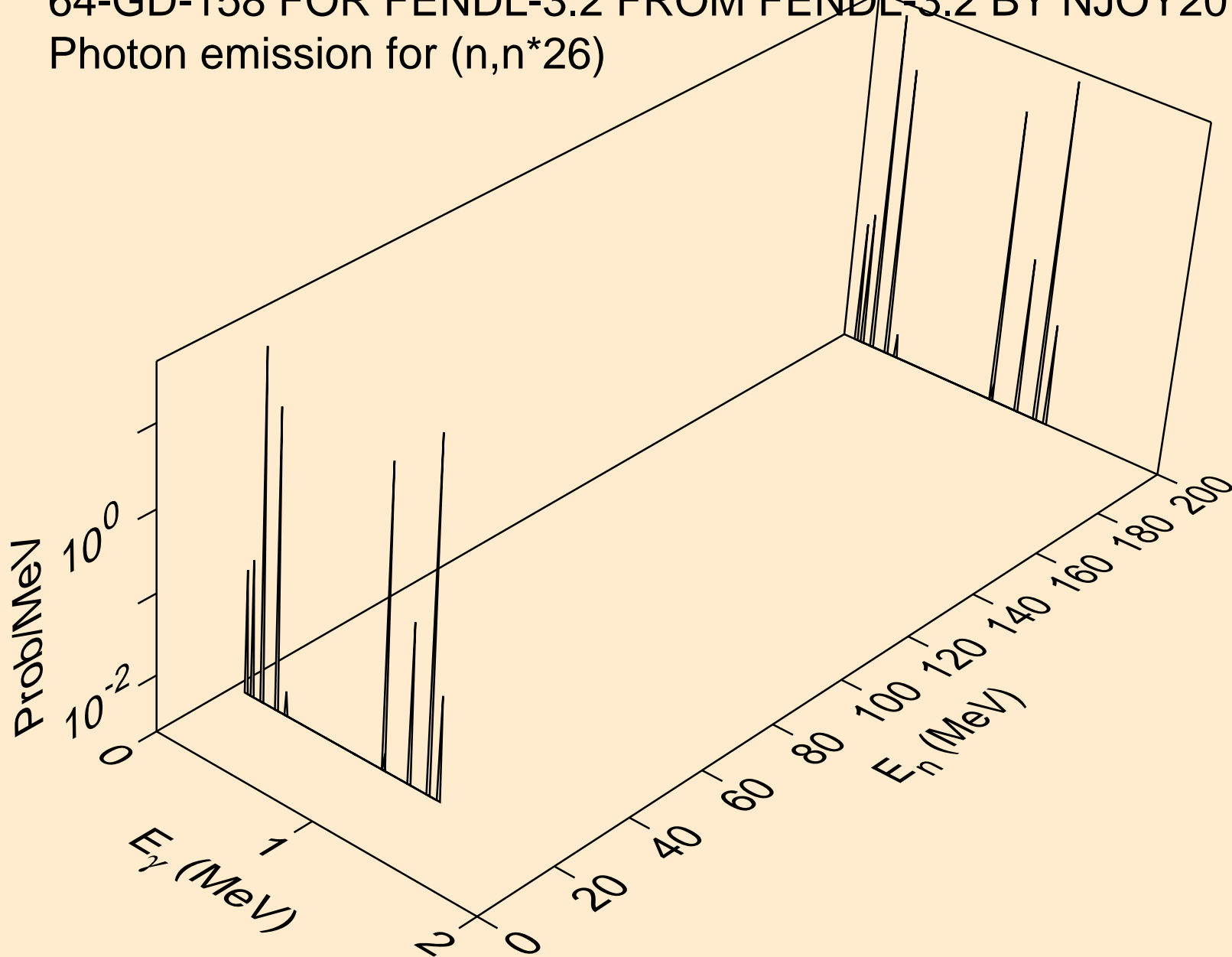

64-GD-158 FOR FENDL-3.2 FROM FENDL-3.2 BY NJOY2016.60+ C
Photon emission for (n,n*27)

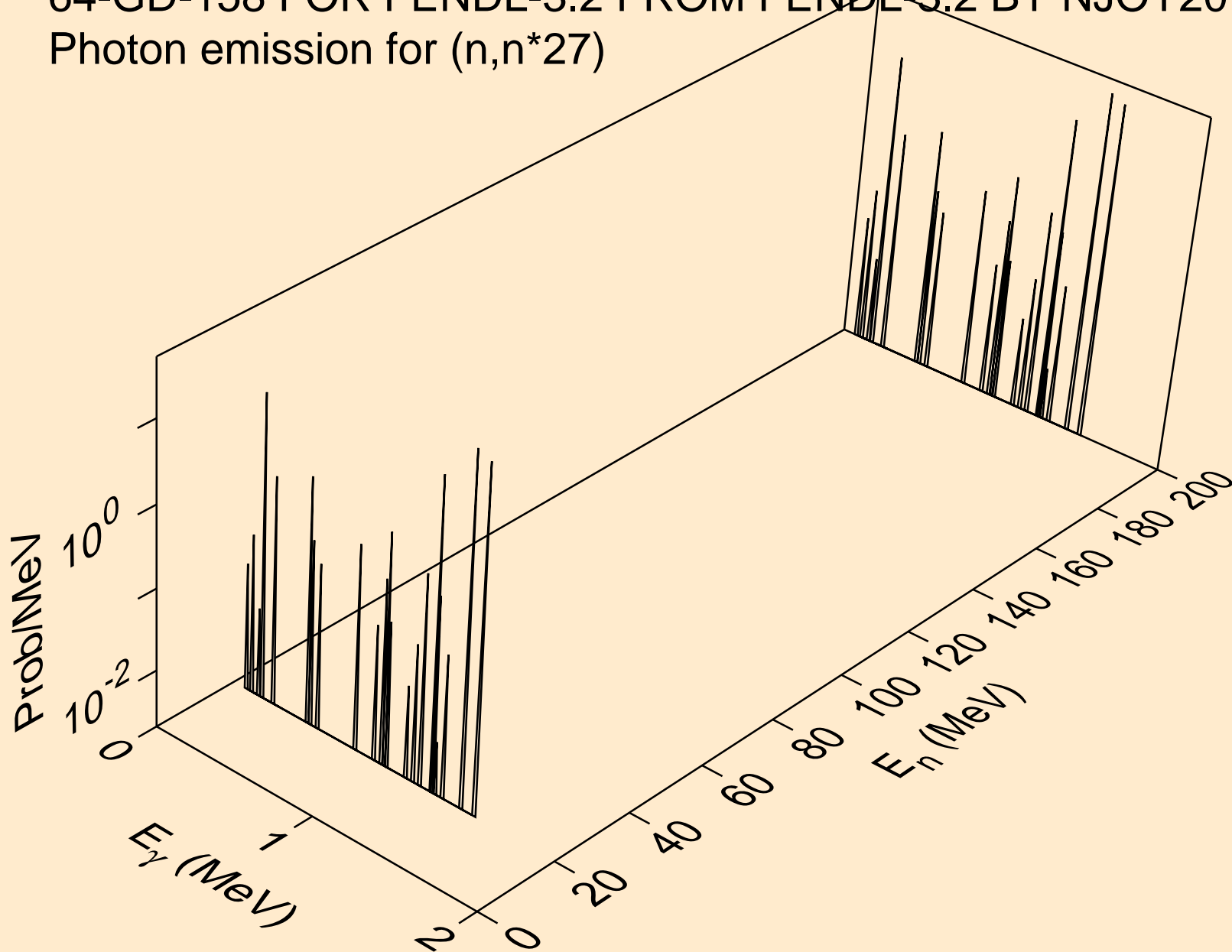

64-GD-158 FOR FENDL-3.2 FROM FENDL-3.2 BY NJOY2016.60+ C
Photon emission for (n,n*c)

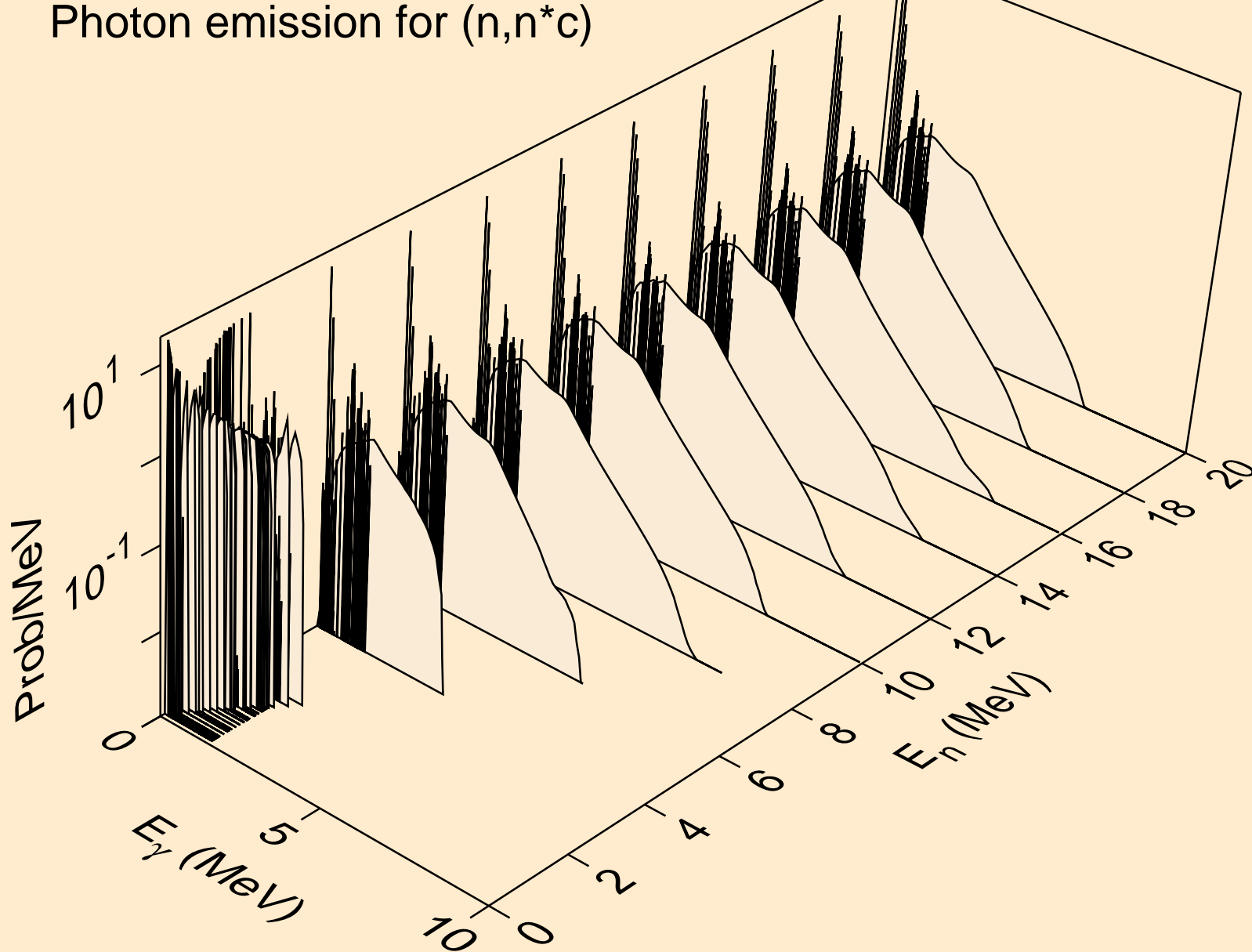

64-GD-158 FOR FENDL-3.2 FROM FENDL-3.2 BY NJOY2016.60+ C
Photon emission for (n,gma)

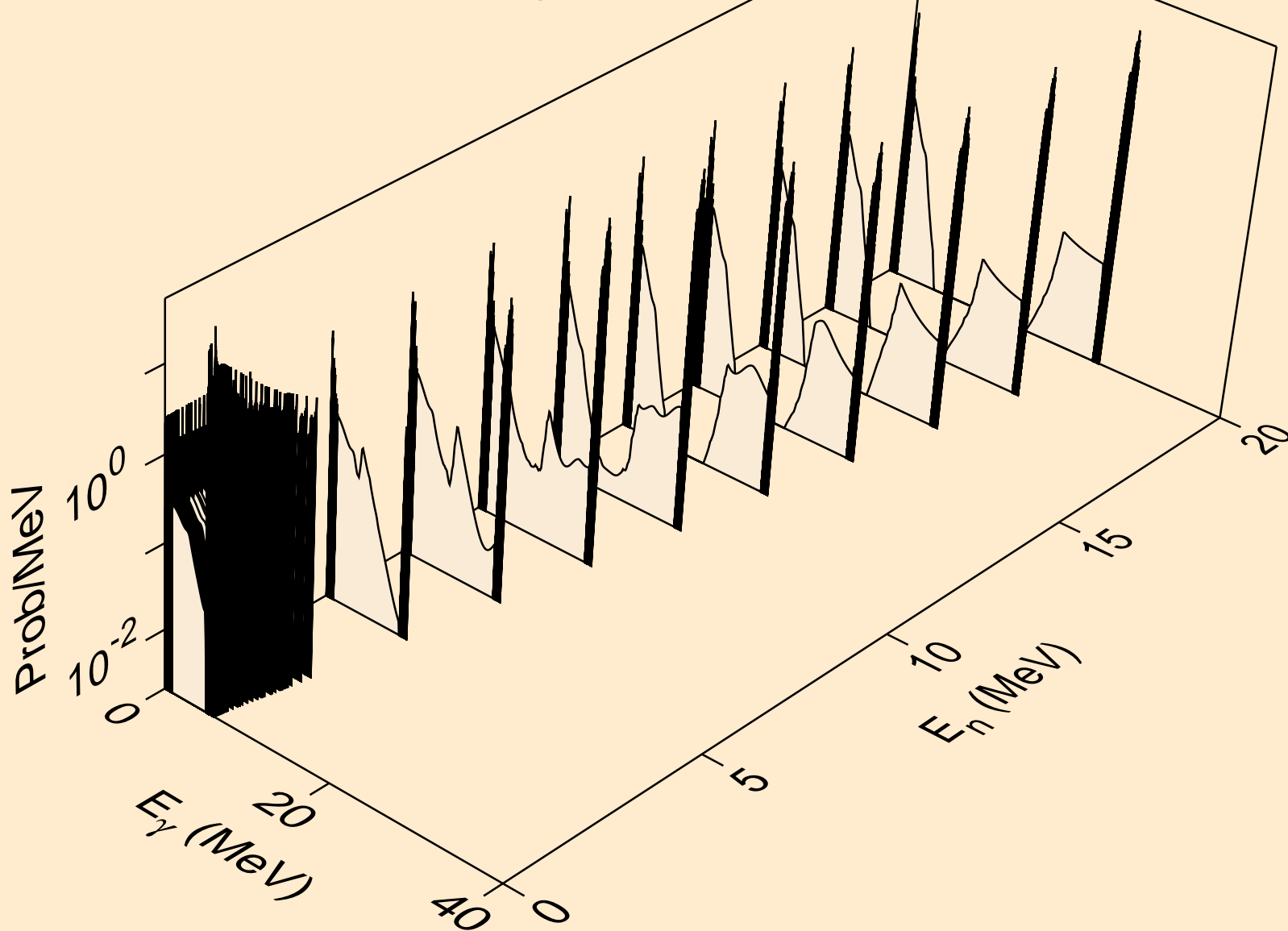

64-GD-158 FOR FENDL-3.2 FROM FENDL-3.2 BY NJOY2016.60+ C
thermal capture photon spectrum

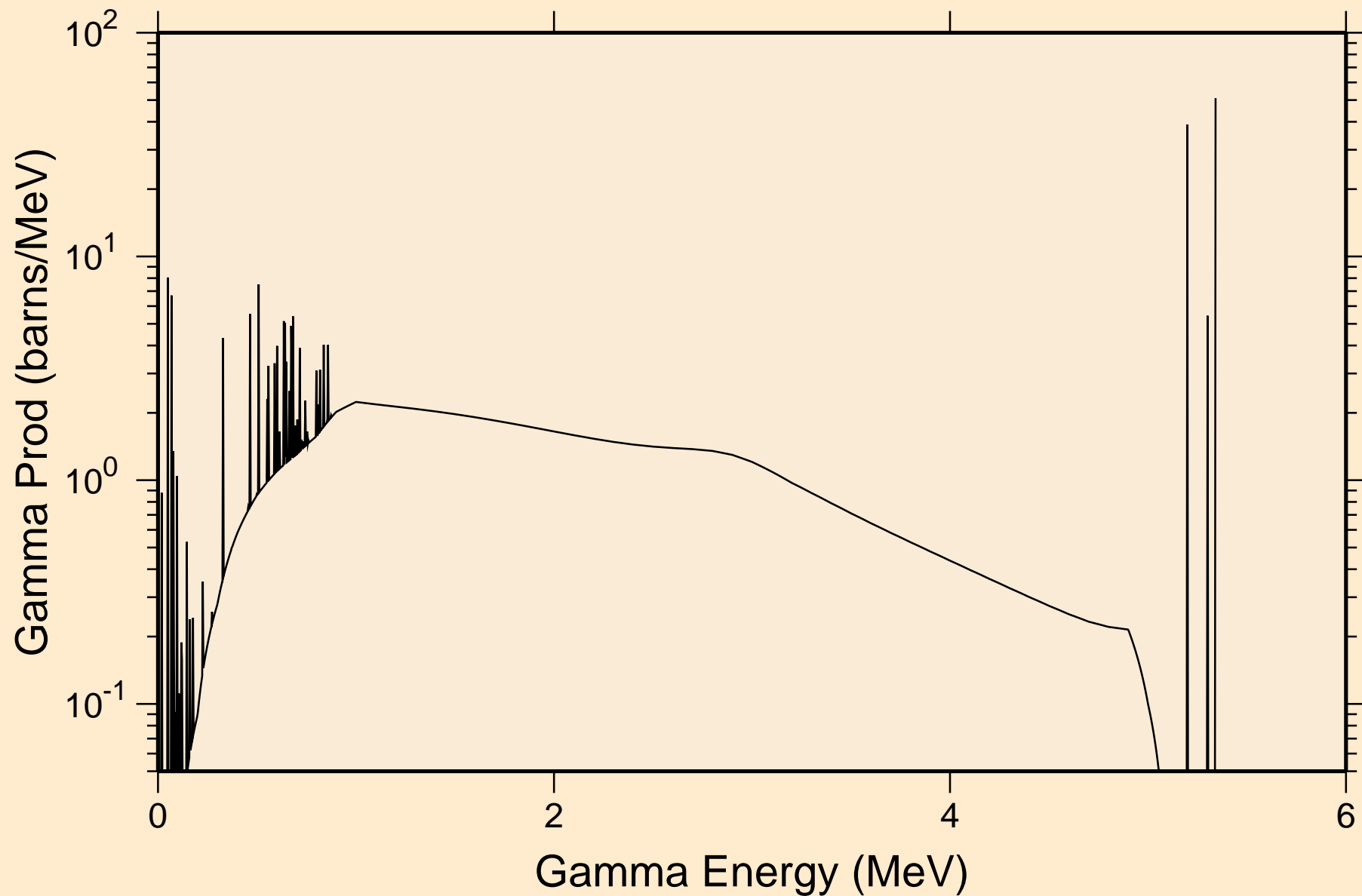

64-GD-158 FOR FENDL-3.2 FROM FENDL-3.2 BY NJOY2016.60+ C
14 MeV photon spectrum

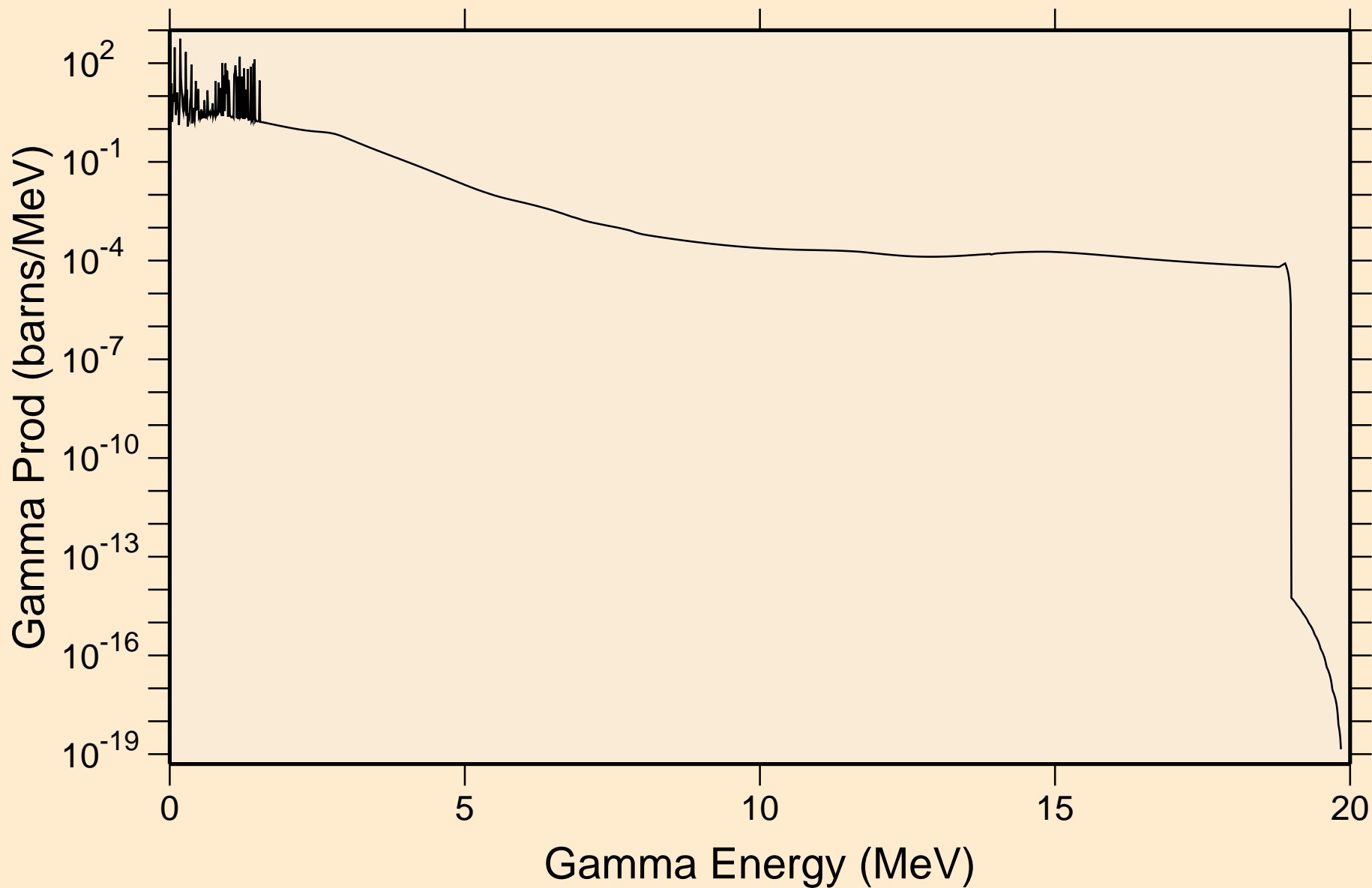

64-GD-158 FOR FENDL-3.2 FROM FENDL-3.2 BY NJOY2016.60+ C

Particle heating contributions

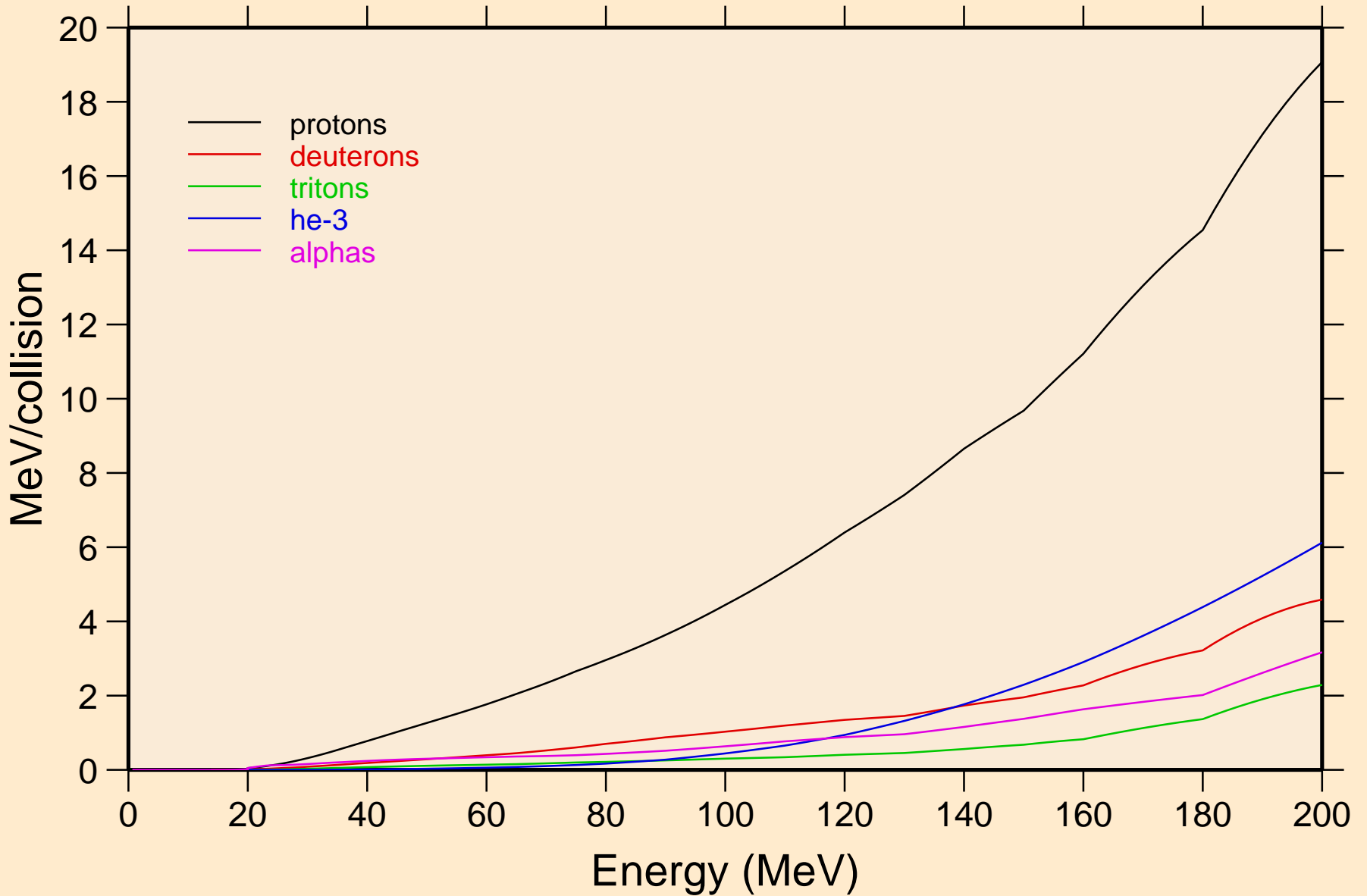

64-GD-158 FOR FENDL-3.2 FROM FENDL-3.2 BY NJOY2016.60+ C Recoil Heating

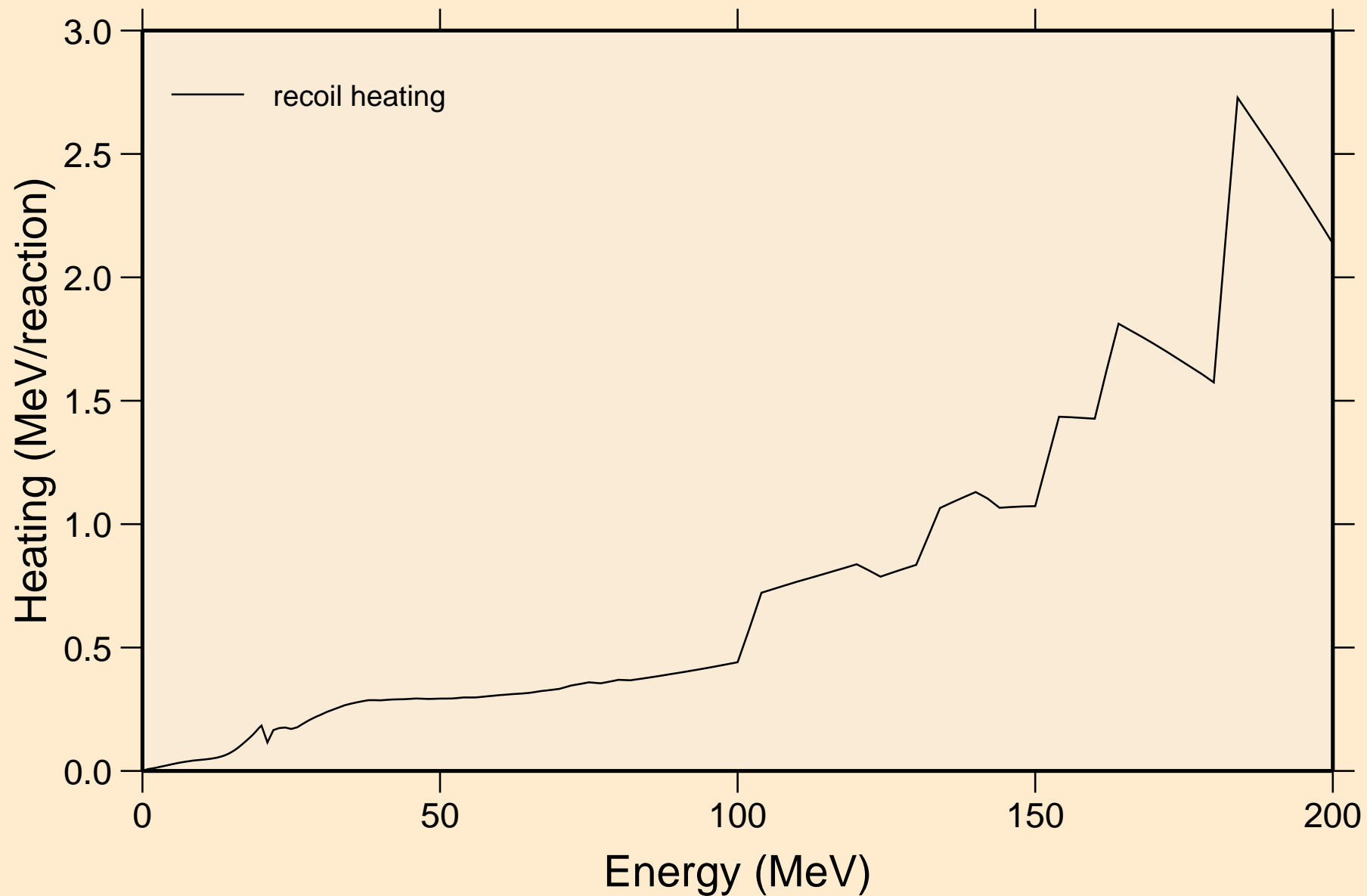

64-GD-158 FOR FENDL-3.2 FROM FENDL-3.2 BY NJOY2016.60+ C

Particle production cross sections

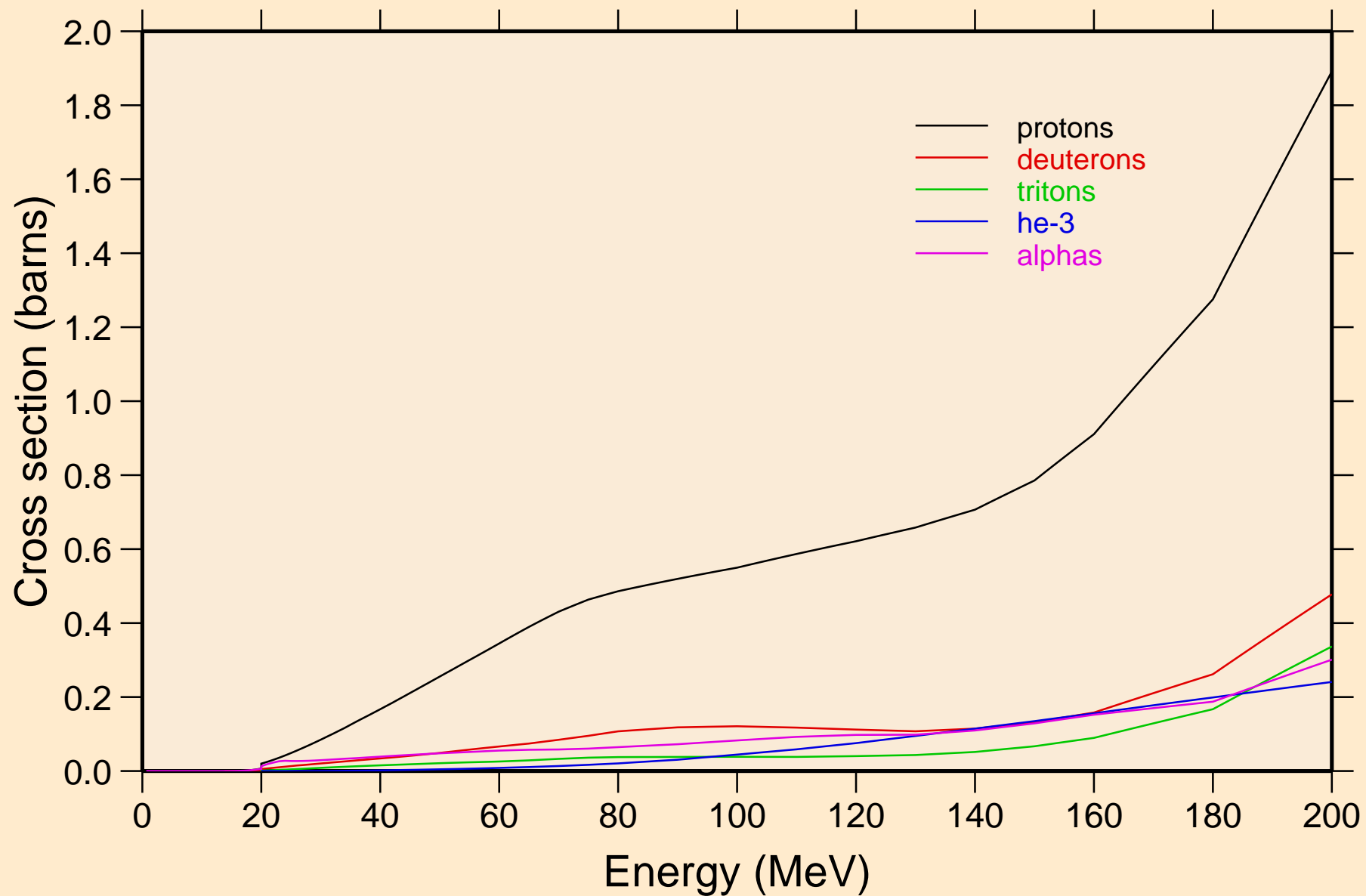

64-GD-158 FOR FENDL-3.2 FROM FENDL-3.2 BY NJOY2016.60+ C
protons from (n,x)

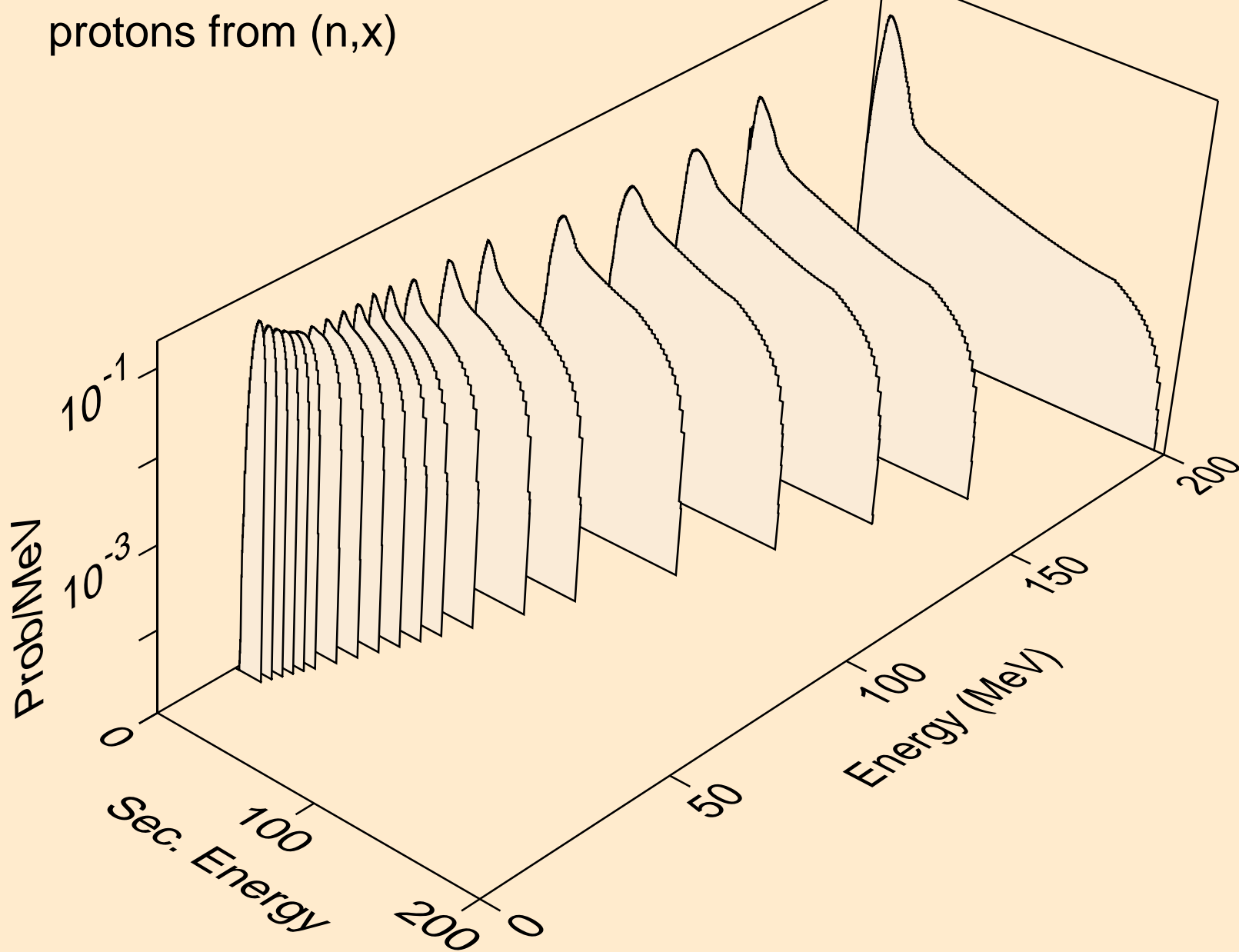

64-GD-158 FOR FENDL-3.2 FROM FENDL-3.2 BY NJOY2016.60+ C
protons from (n,n*)p

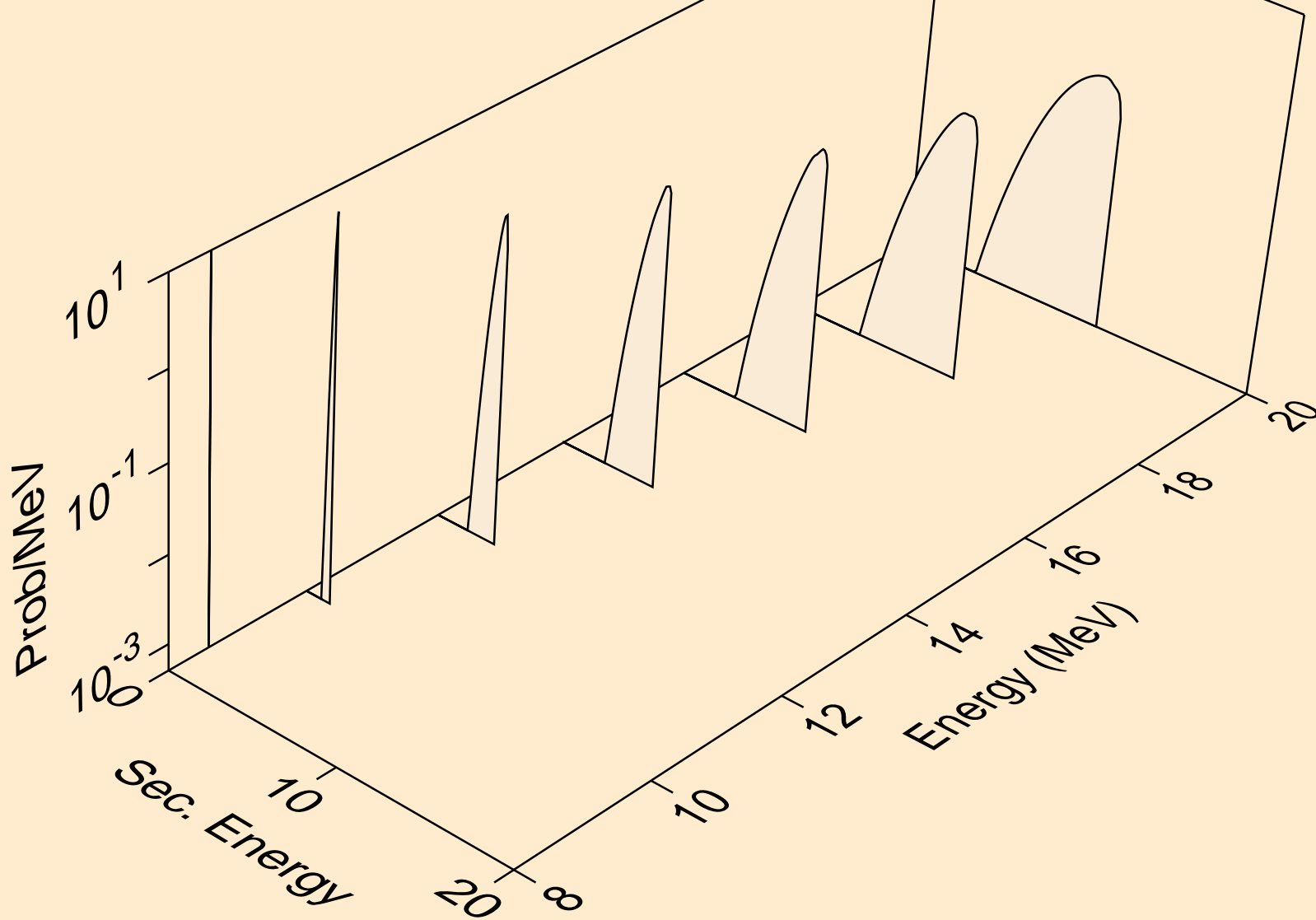

64-GD-158 FOR FENDL-3.2 FROM FENDL-3.2 BY NJOY2016.60+ C
deuterons from (n,x)

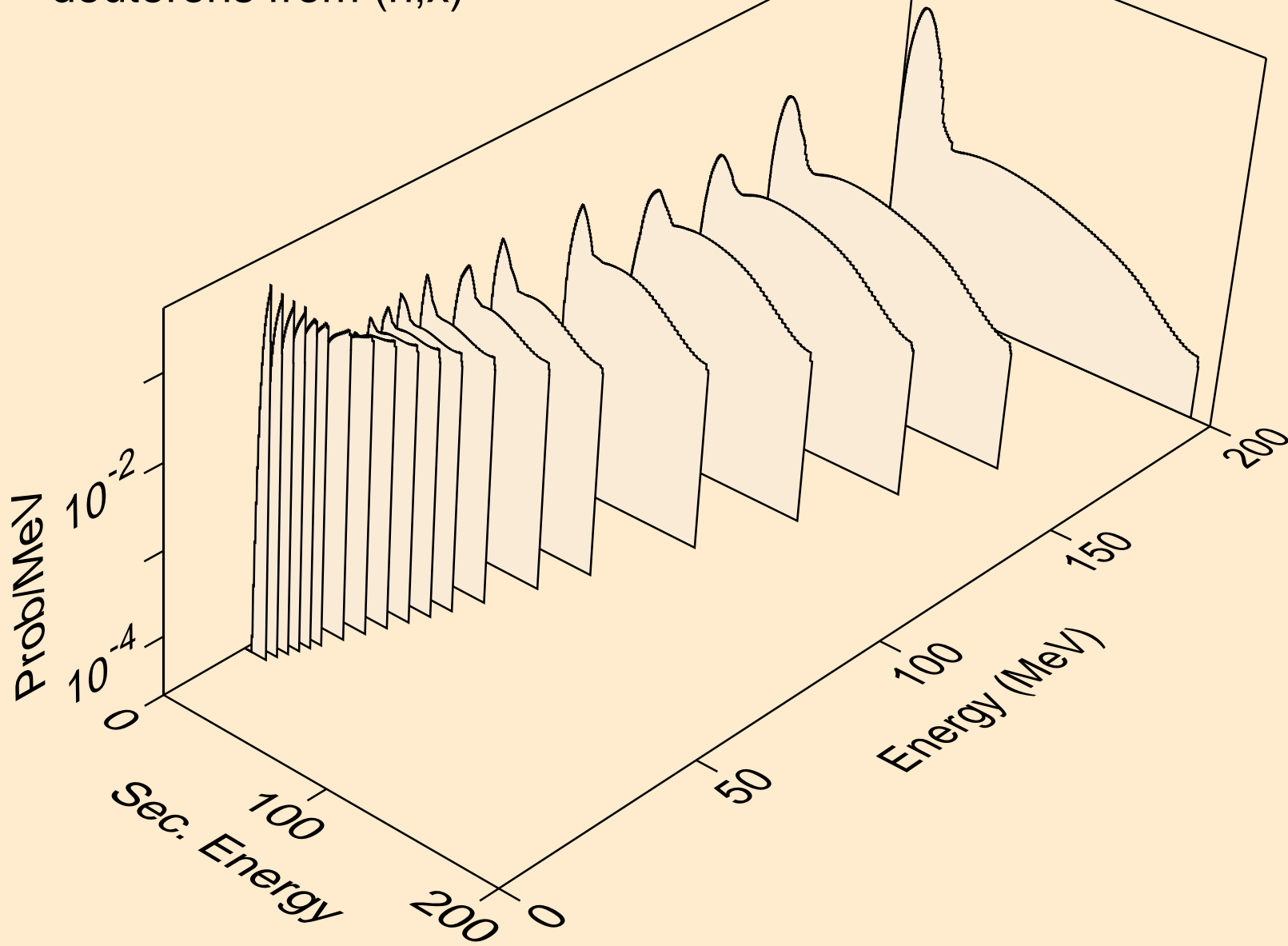

64-GD-158 FOR FENDL-3.2 FROM FENDL-3.2 BY NJOY2016.60+ C
deuterons from (n,n*)d

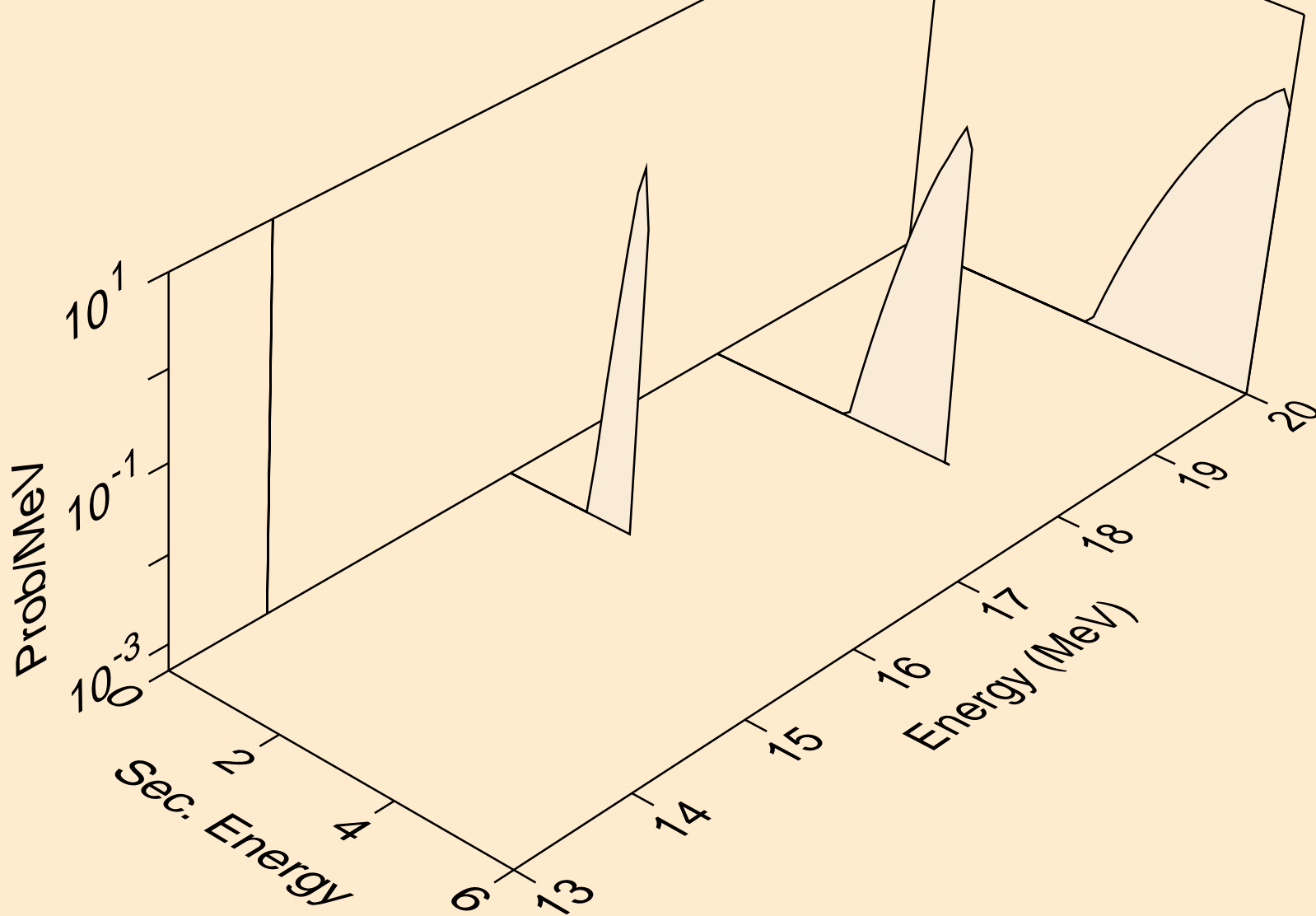

64-GD-158 FOR FENDL-3.2 FROM FENDL-3.2 BY NJOY2016.60+ C
tritons from (n,x)

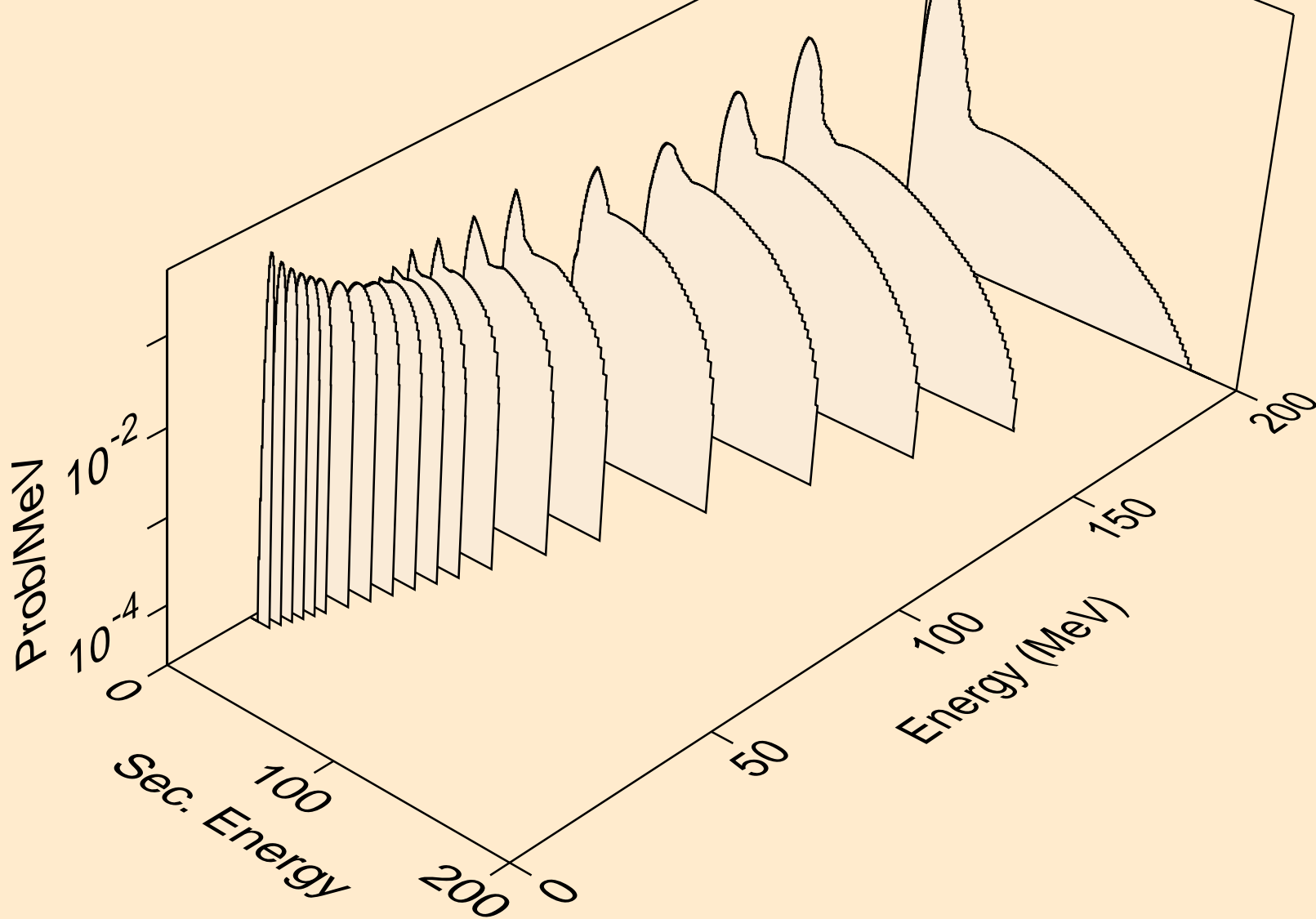

64-GD-158 FOR FENDL-3.2 FROM FENDL-3.2 BY NJOY2016.60+ C
he3s from (n,x)

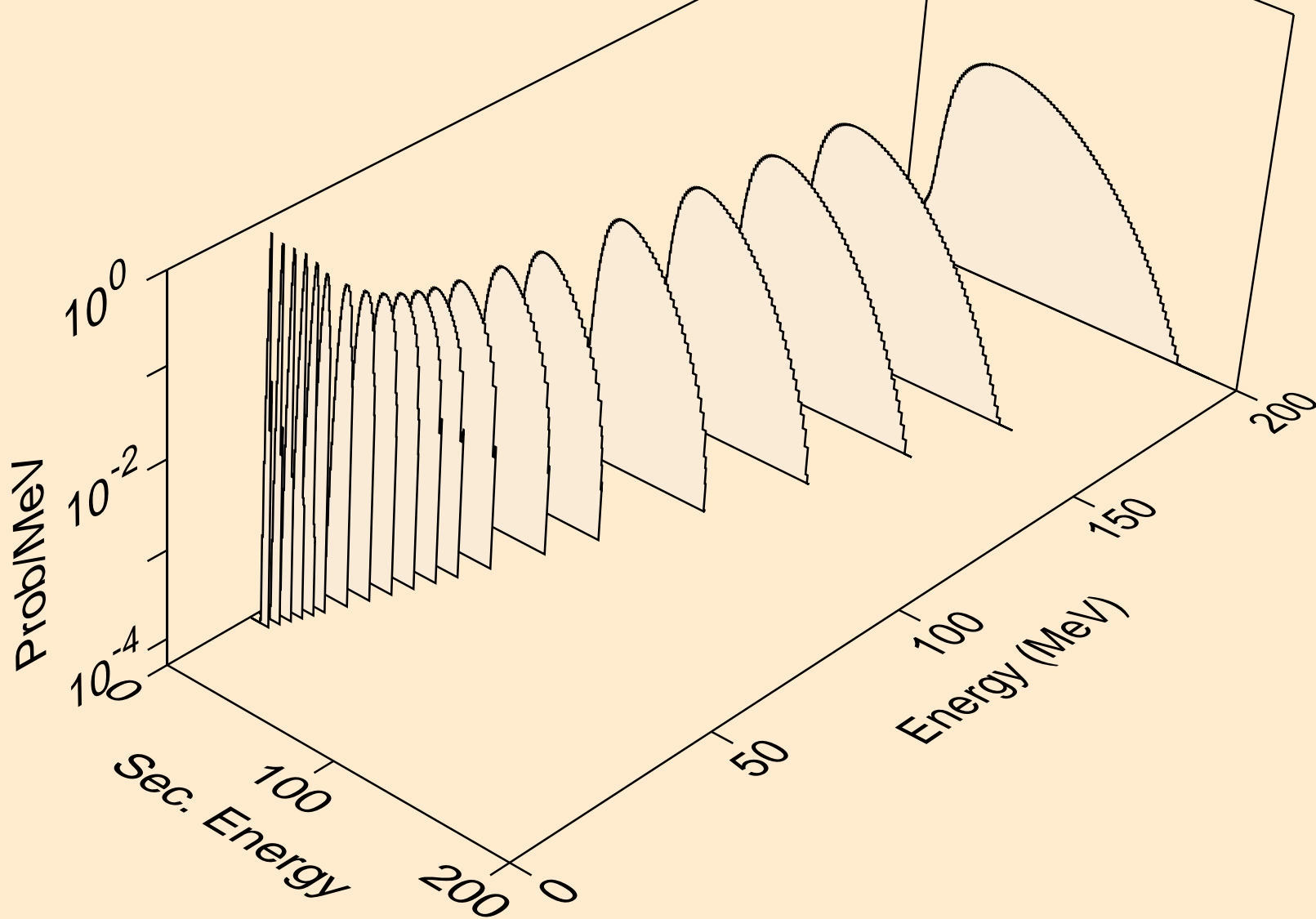

64-GD-158 FOR FENDL-3.2 FROM FENDL-3.2 BY NJOY2016.60+ C
alphas from (n,x)

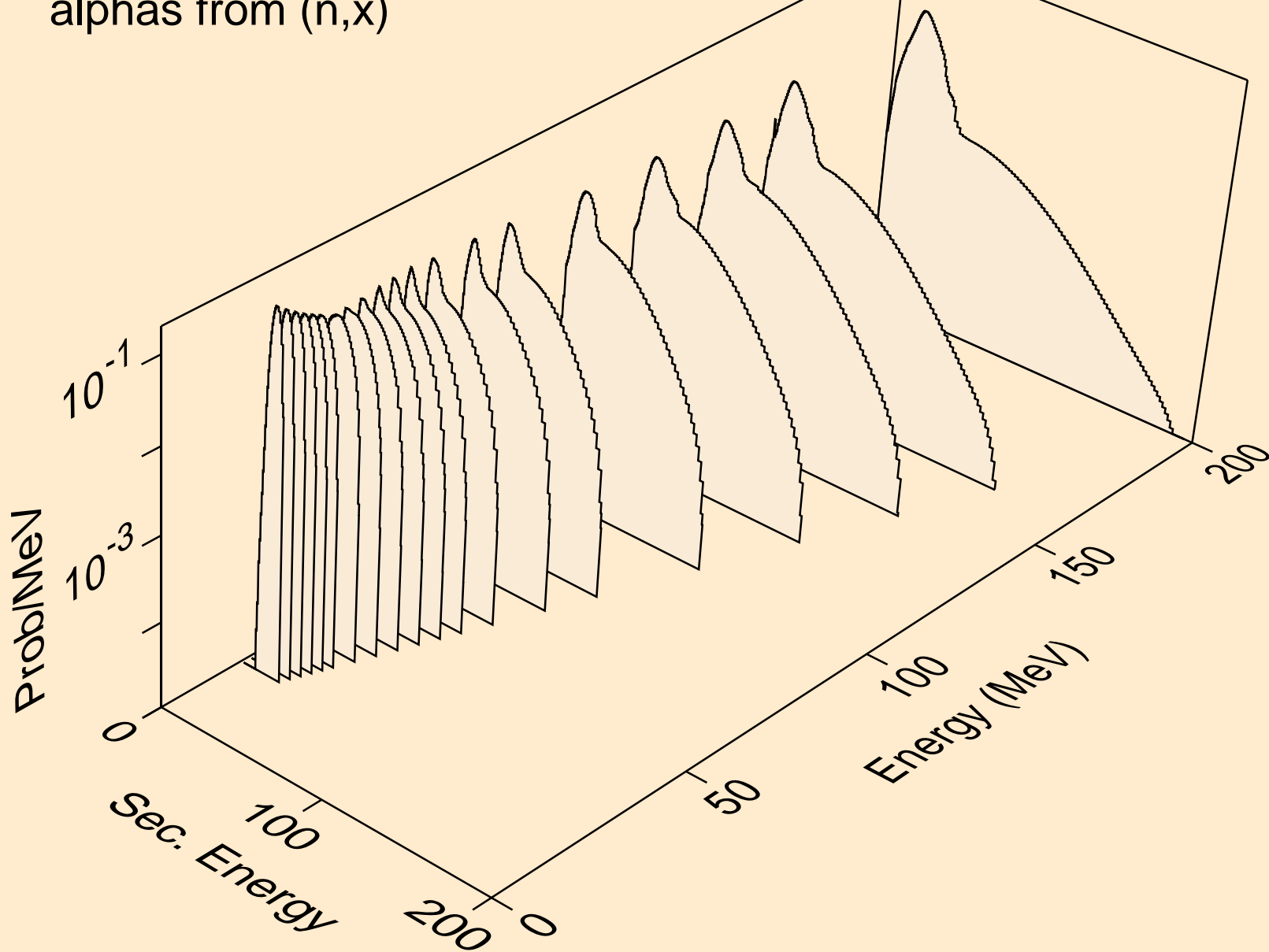

64-GD-158 FOR FENDL-3.2 FROM FENDL-3.2 BY NJOY2016.60+ C
alphas from (n,n*)a

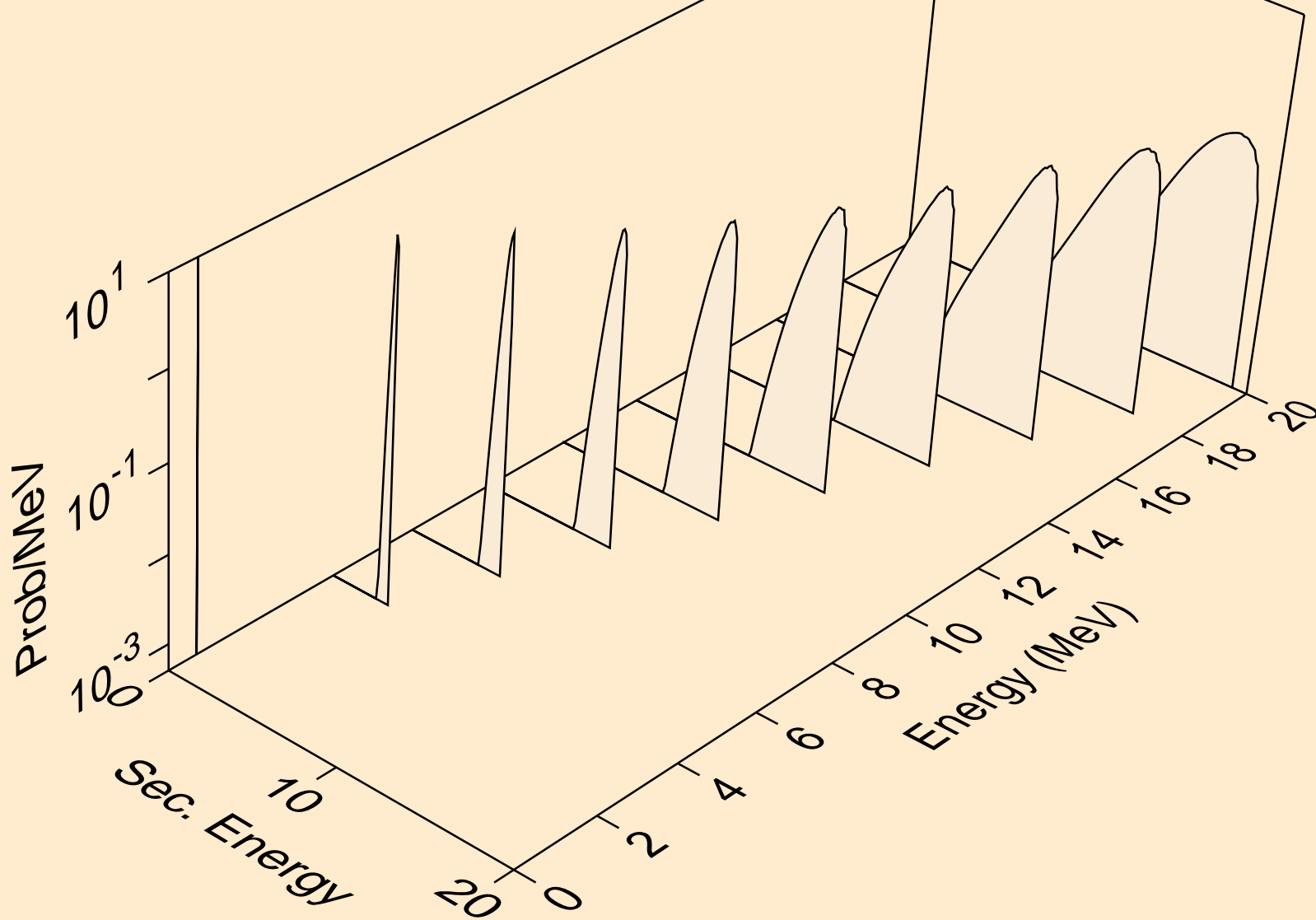

64-GD-158 FOR FENDL-3.2 FROM FENDL-3.2 BY NJOY2016.60+ C
alphas from (n,2n)a

