

68-ER-166 FOR FENDL-3.2 FROM FENDL-3.2 BY NJOY2016.60+ C  
Principal cross sections

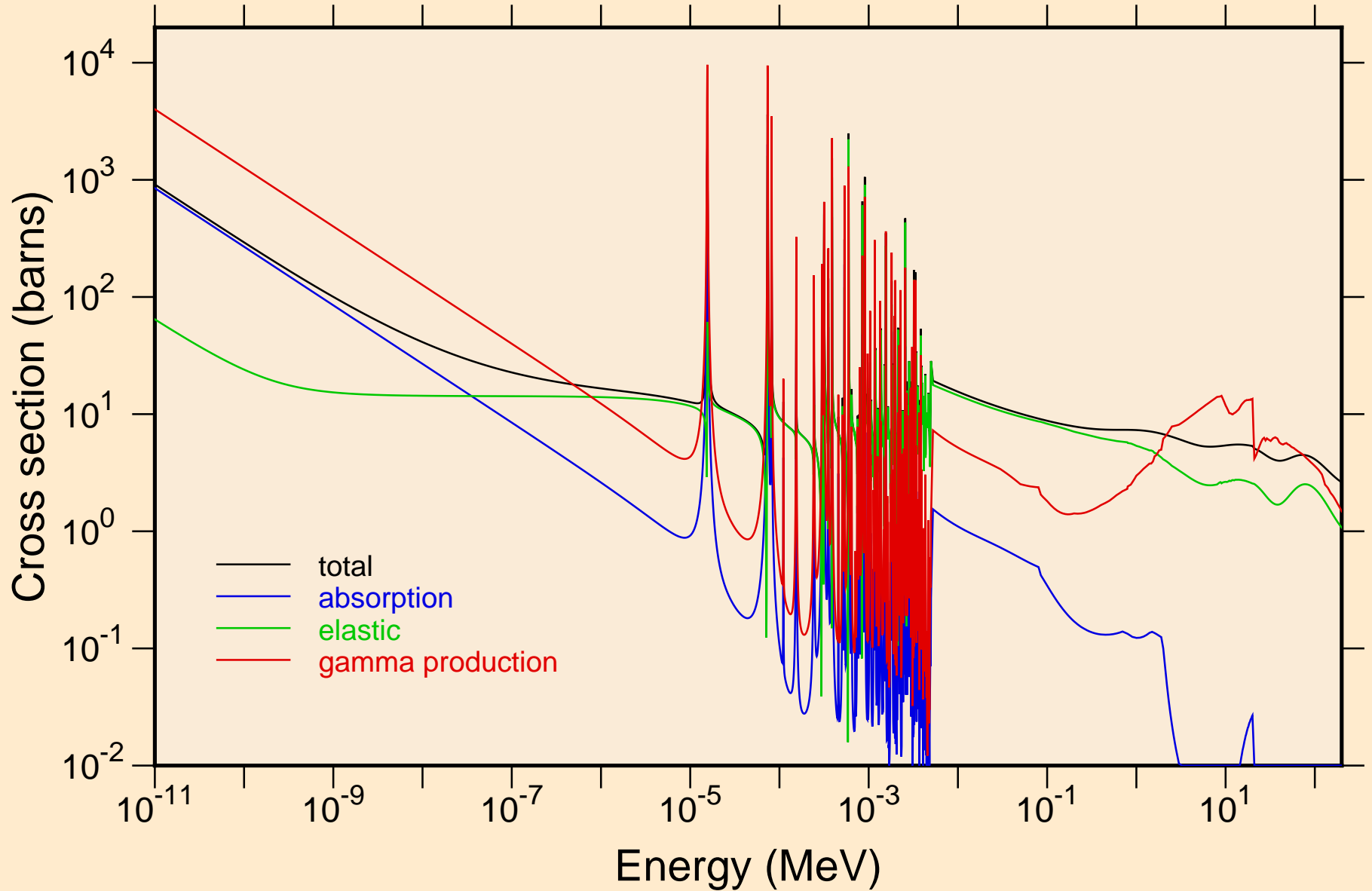

68-ER-166 FOR FENDL-3.2 FROM FENDL-3.2 BY NJOY2016.60+ C  
resonance total cross section

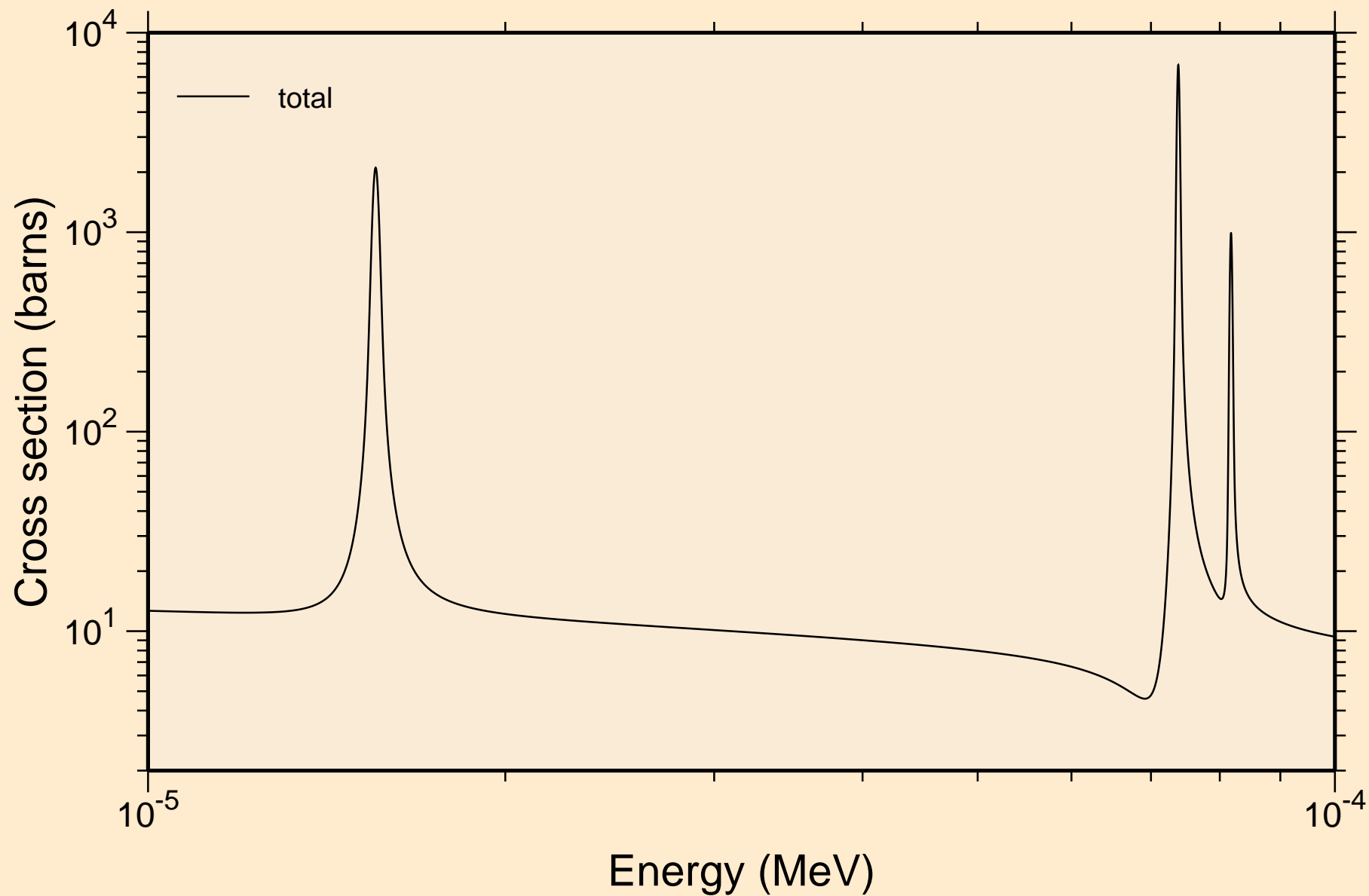

68-ER-166 FOR FENDL-3.2 FROM FENDL-3.2 BY NJOY2016.60+ C  
resonance total cross section

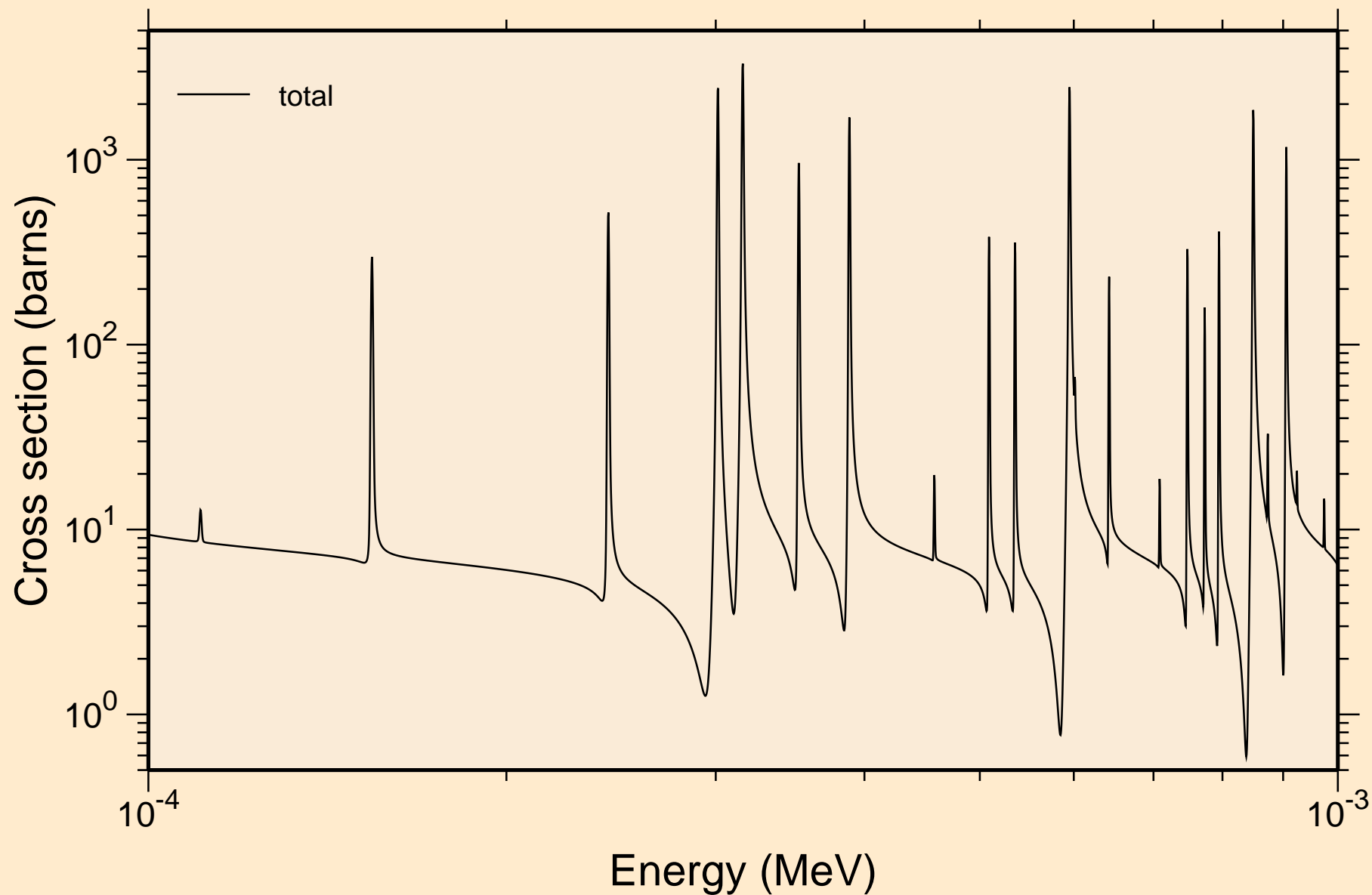

68-ER-166 FOR FENDL-3.2 FROM FENDL-3.2 BY NJOY2016.60+ C  
resonance total cross section

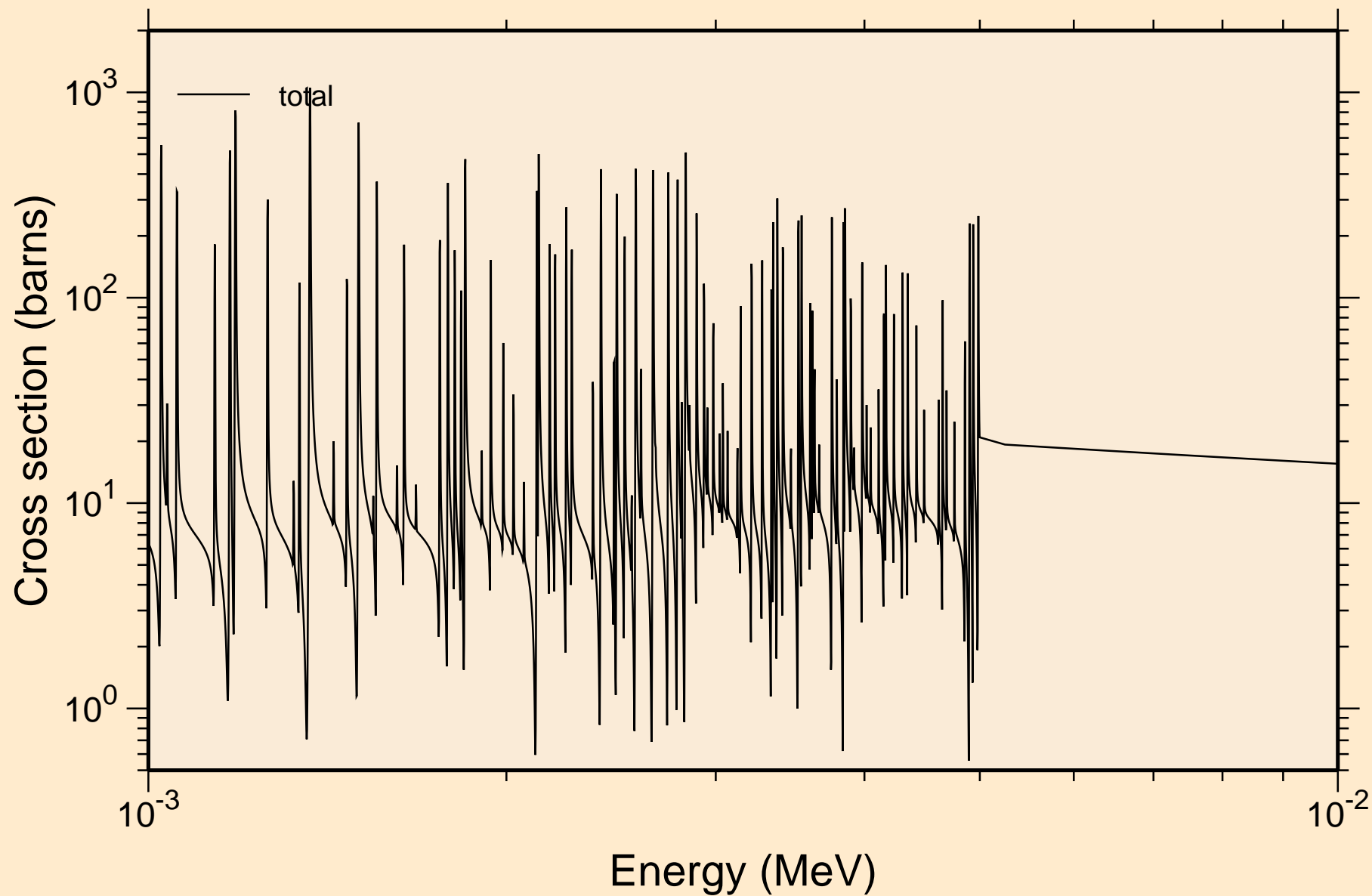

68-ER-166 FOR FENDL-3.2 FROM FENDL-3.2 BY NJOY2016.60+ C  
resonance total cross section

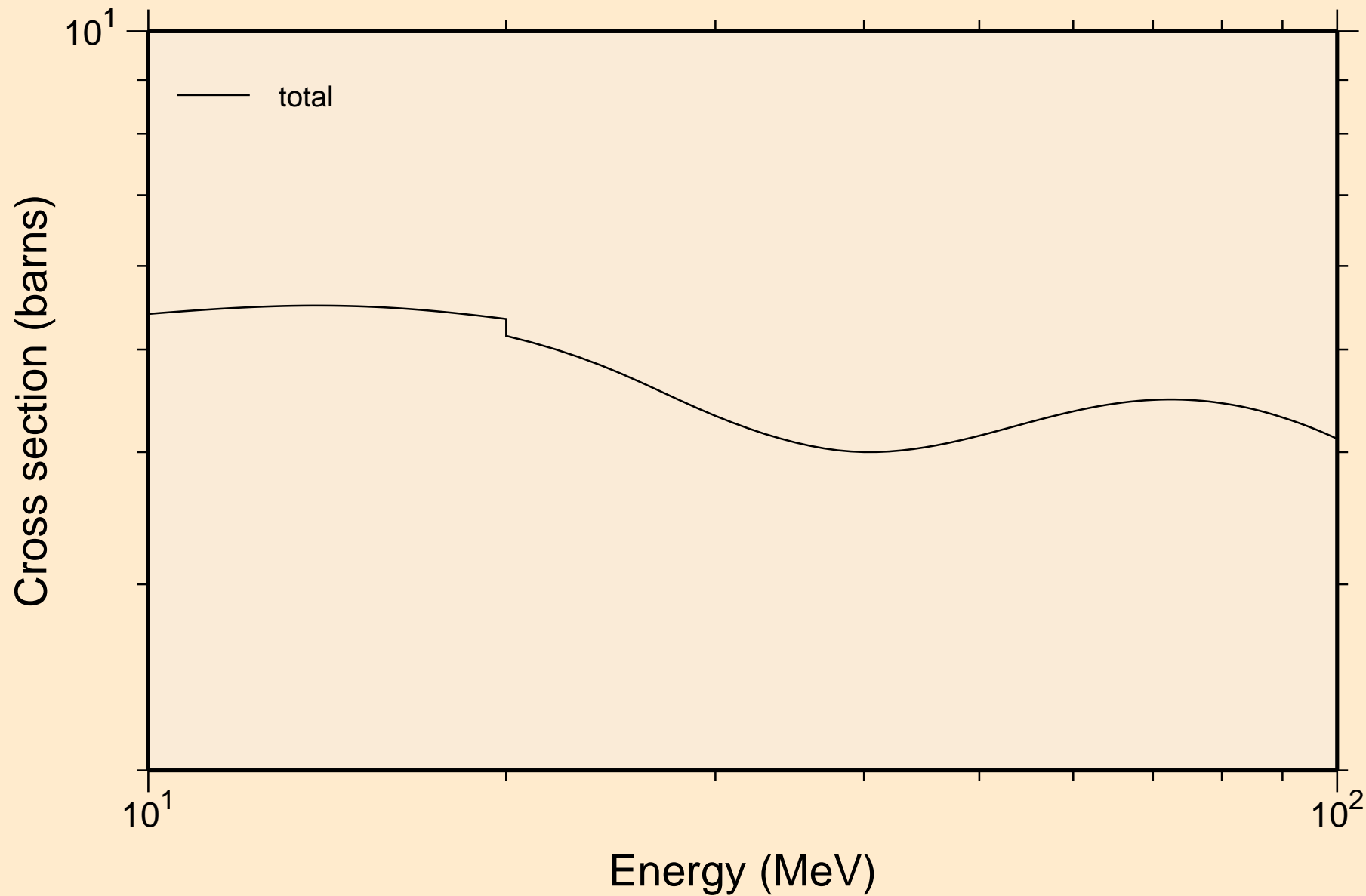

68-ER-166 FOR FENDL-3.2 FROM FENDL-3.2 BY NJOY2016.60+ C  
resonance absorption cross sections

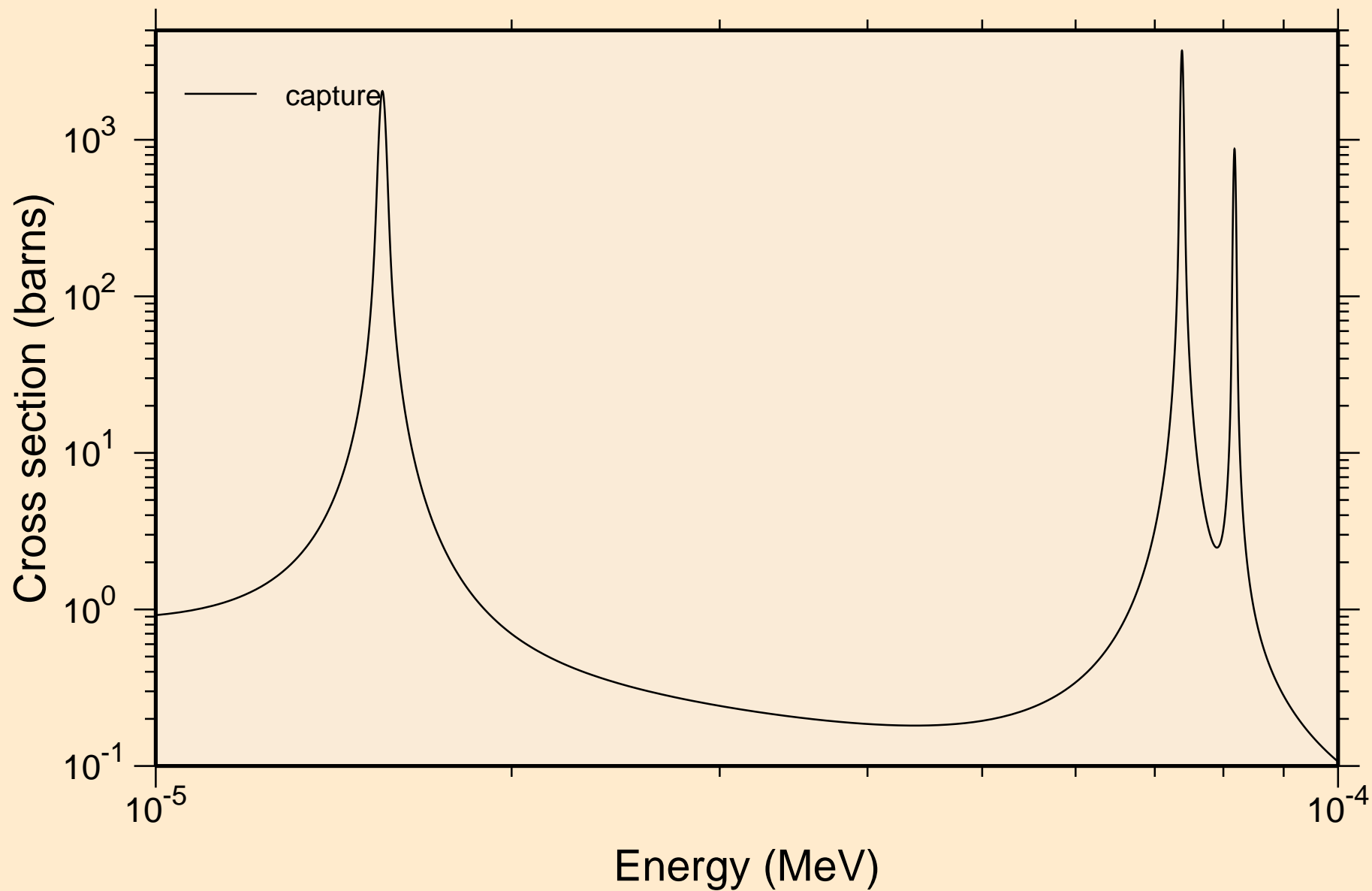

68-ER-166 FOR FENDL-3.2 FROM FENDL-3.2 BY NJOY2016.60+ C  
resonance absorption cross sections

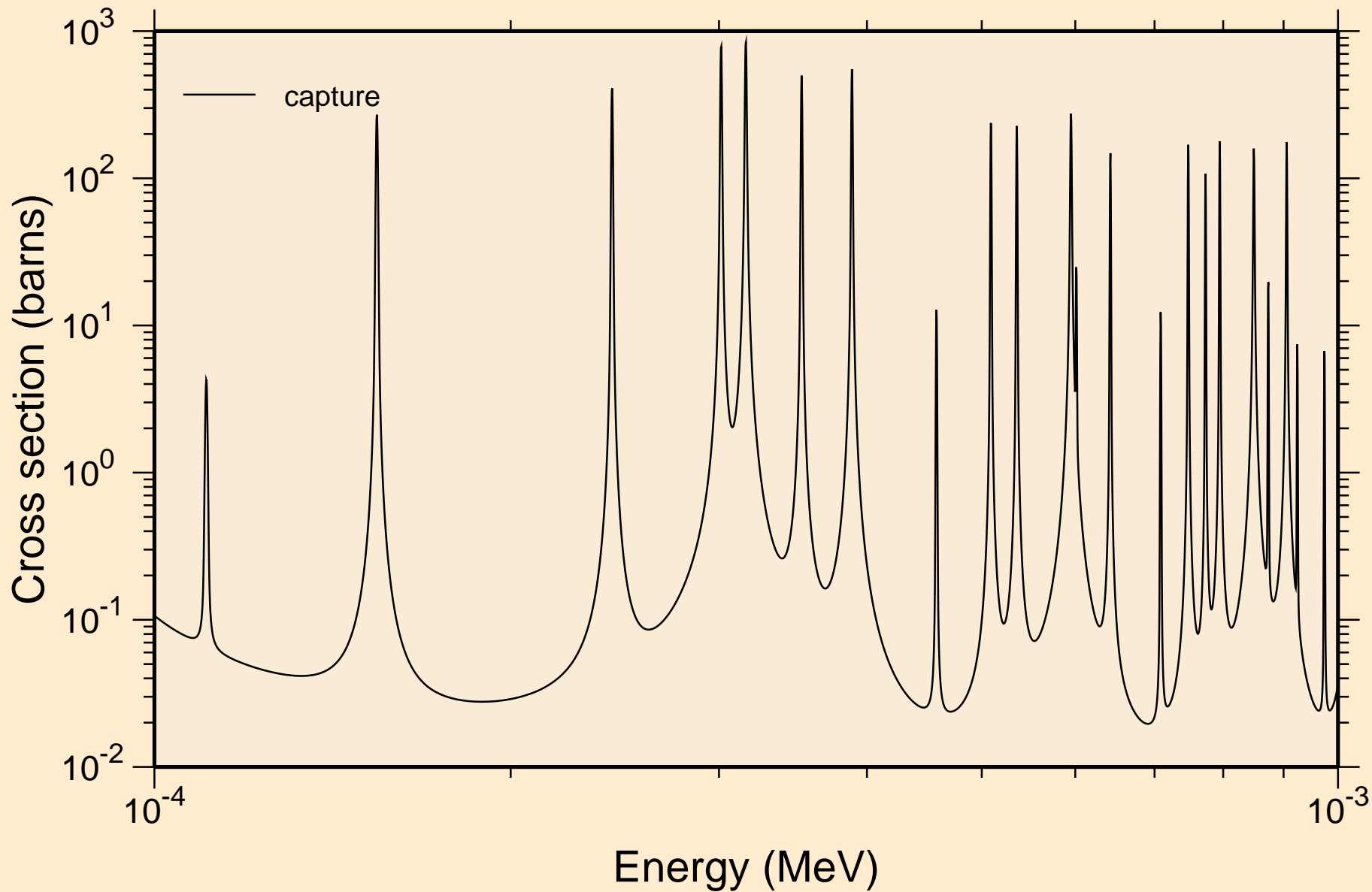

68-ER-166 FOR FENDL-3.2 FROM FENDL-3.2 BY NJOY2016.60+ C  
resonance absorption cross sections

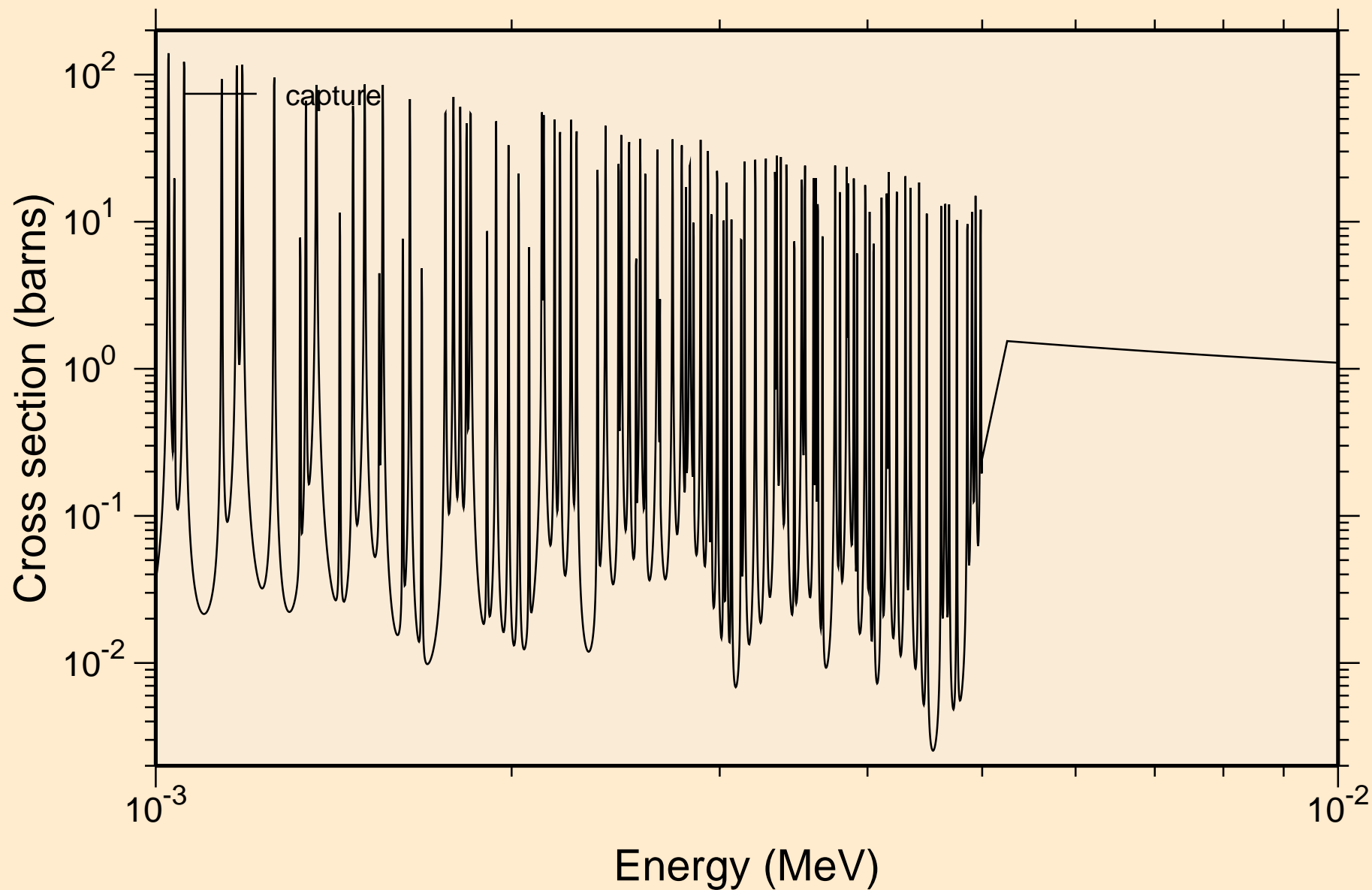



68-ER-166 FOR FENDL-3.2 FROM FENDL-3.2 BY NJOY2016.60+ C  
resonance absorption cross sections

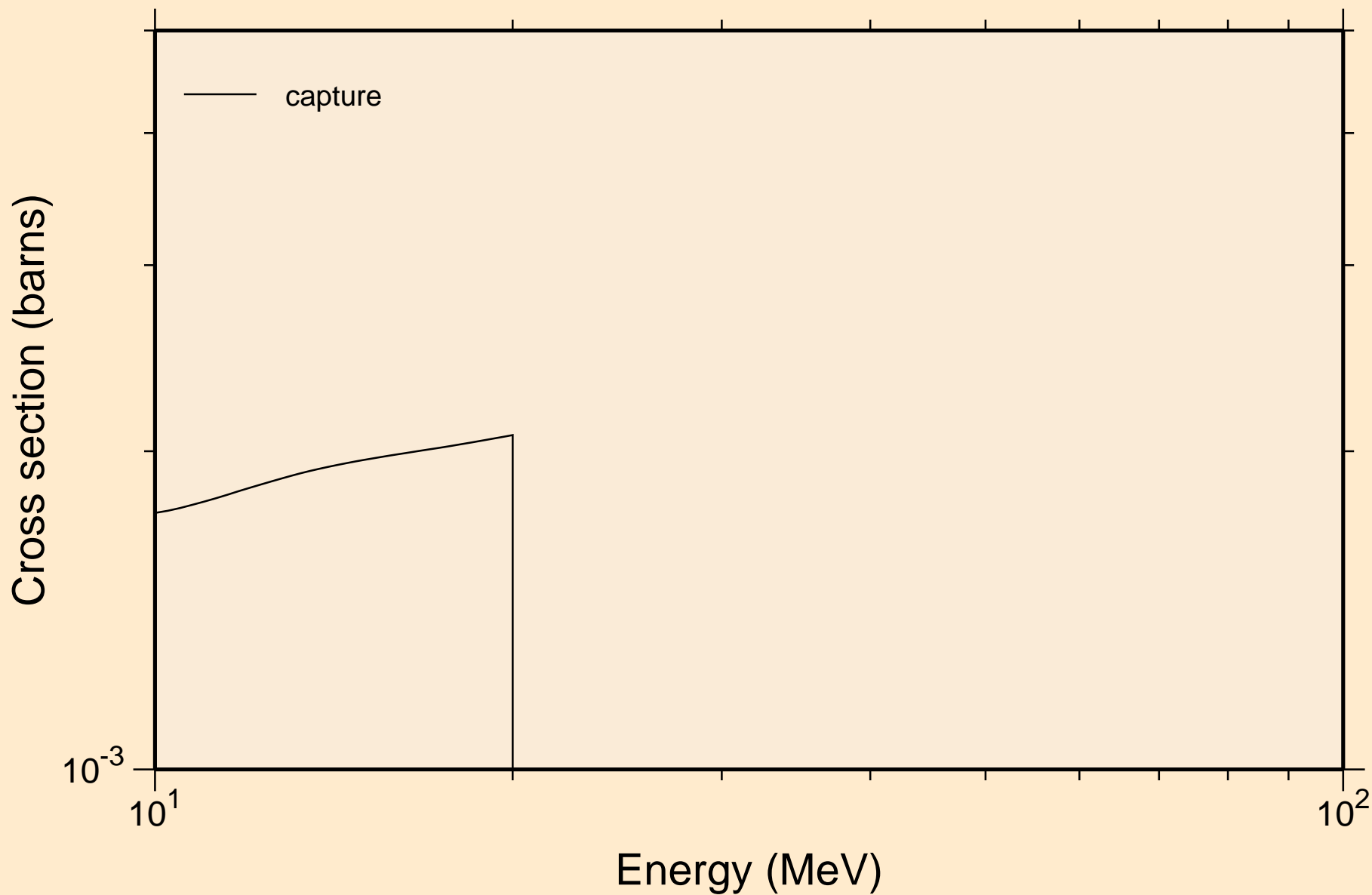

68-ER-166 FOR FENDL-3.2 FROM FENDL-3.2 BY NJOY2016.60+ C  
Heating

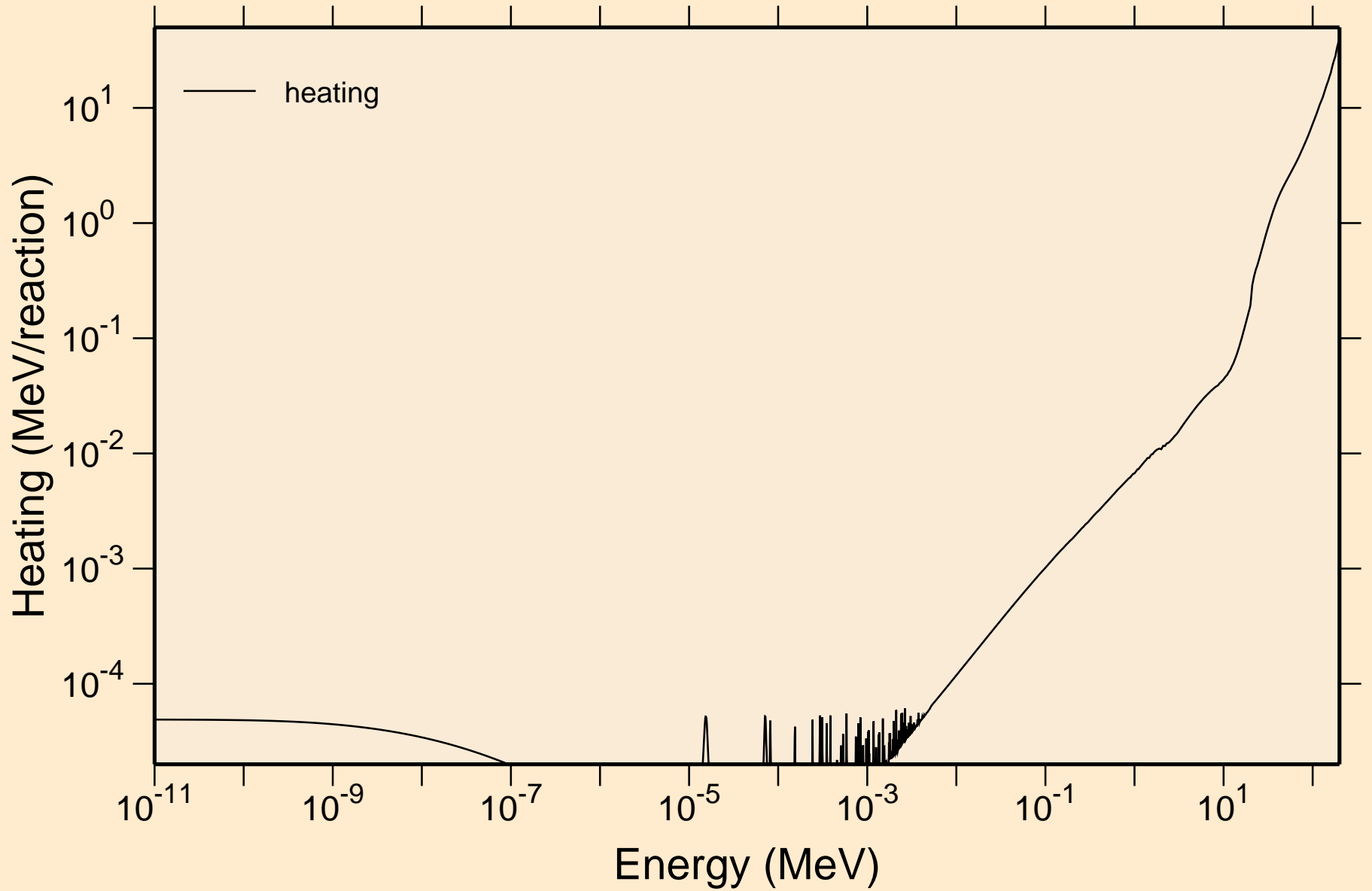

68-ER-166 FOR FENDL-3.2 FROM FENDL-3.2 BY NJOY2016.60+ C  
Damage

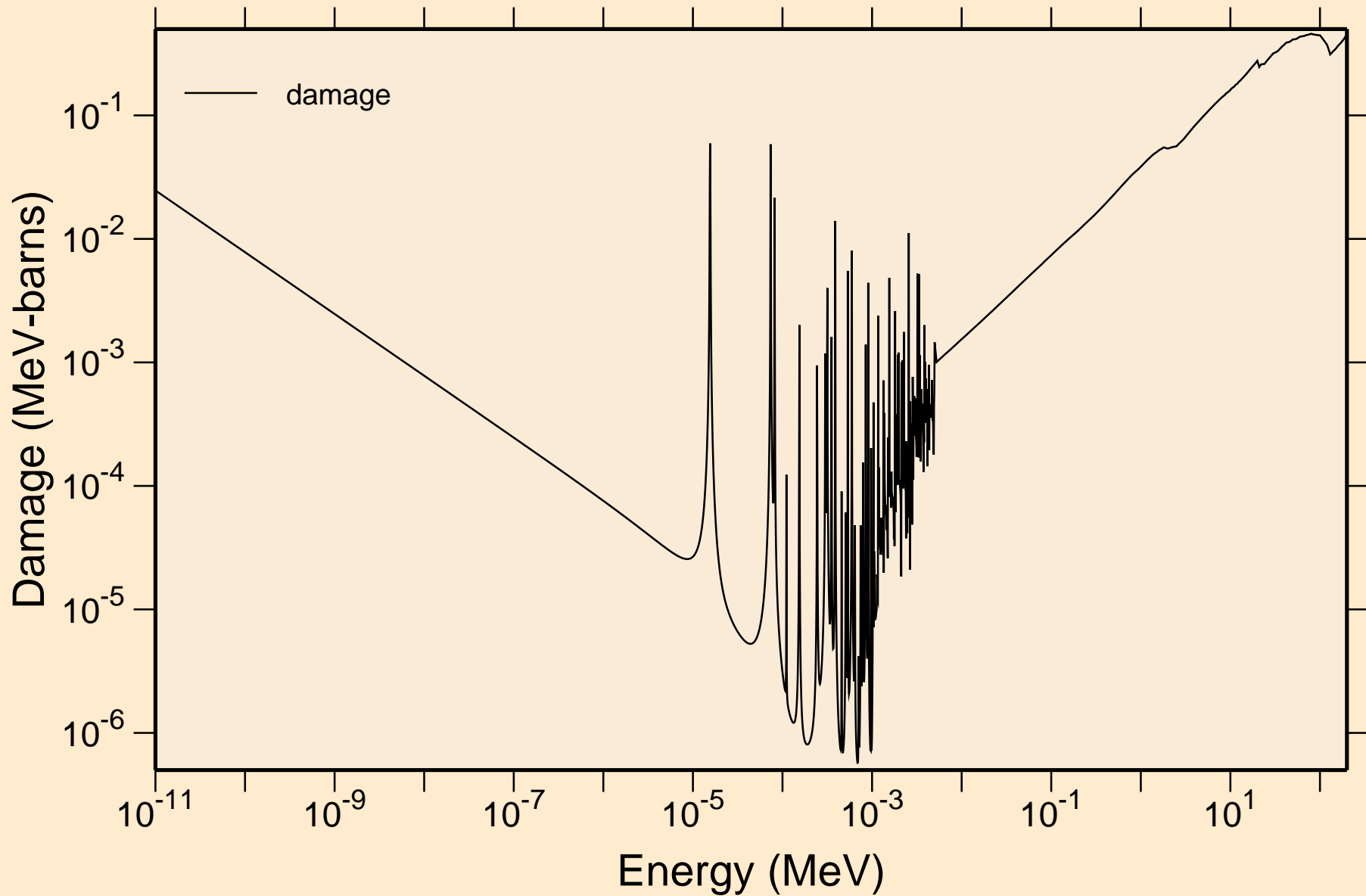

68-ER-166 FOR FENDL-3.2 FROM FENDL-3.2 BY NJOY2016.60+ C  
Non-threshold reactions

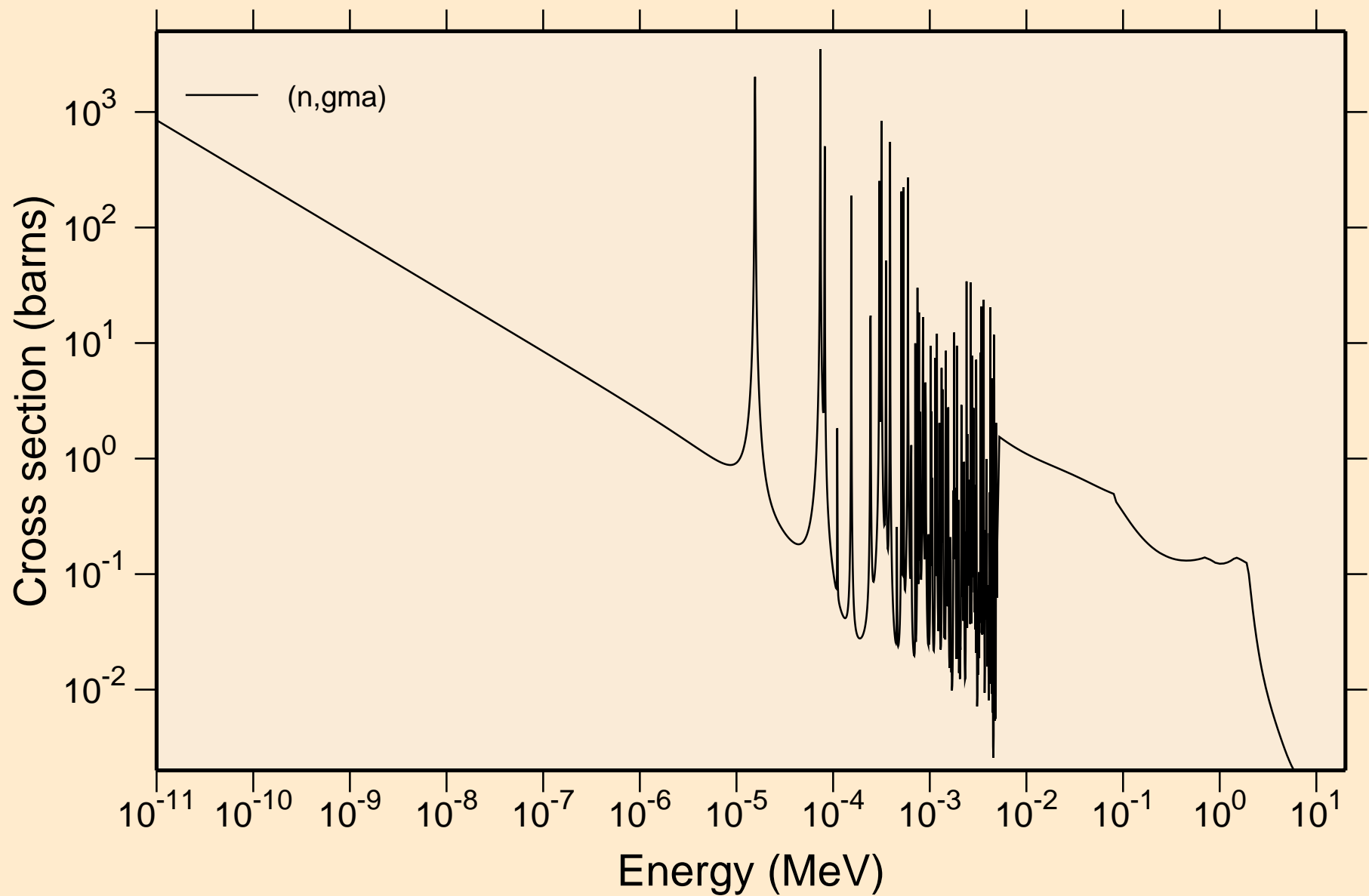

68-ER-166 FOR FENDL-3.2 FROM FENDL-3.2 BY NJOY2016.60+ C  
Principal cross sections

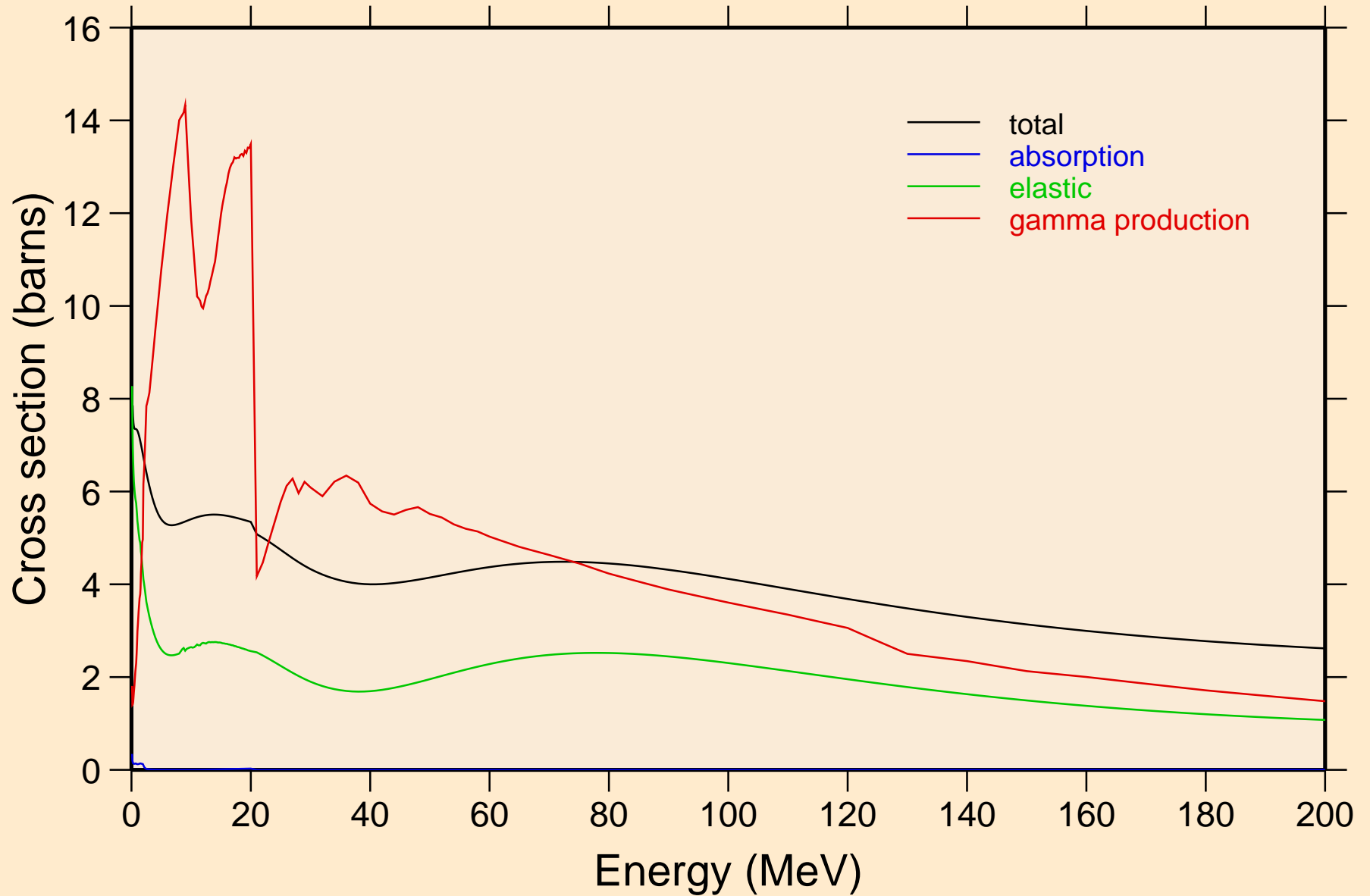

68-ER-166 FOR FENDL-3.2 FROM FENDL-3.2 BY NJOY2016.60+ C  
Heating

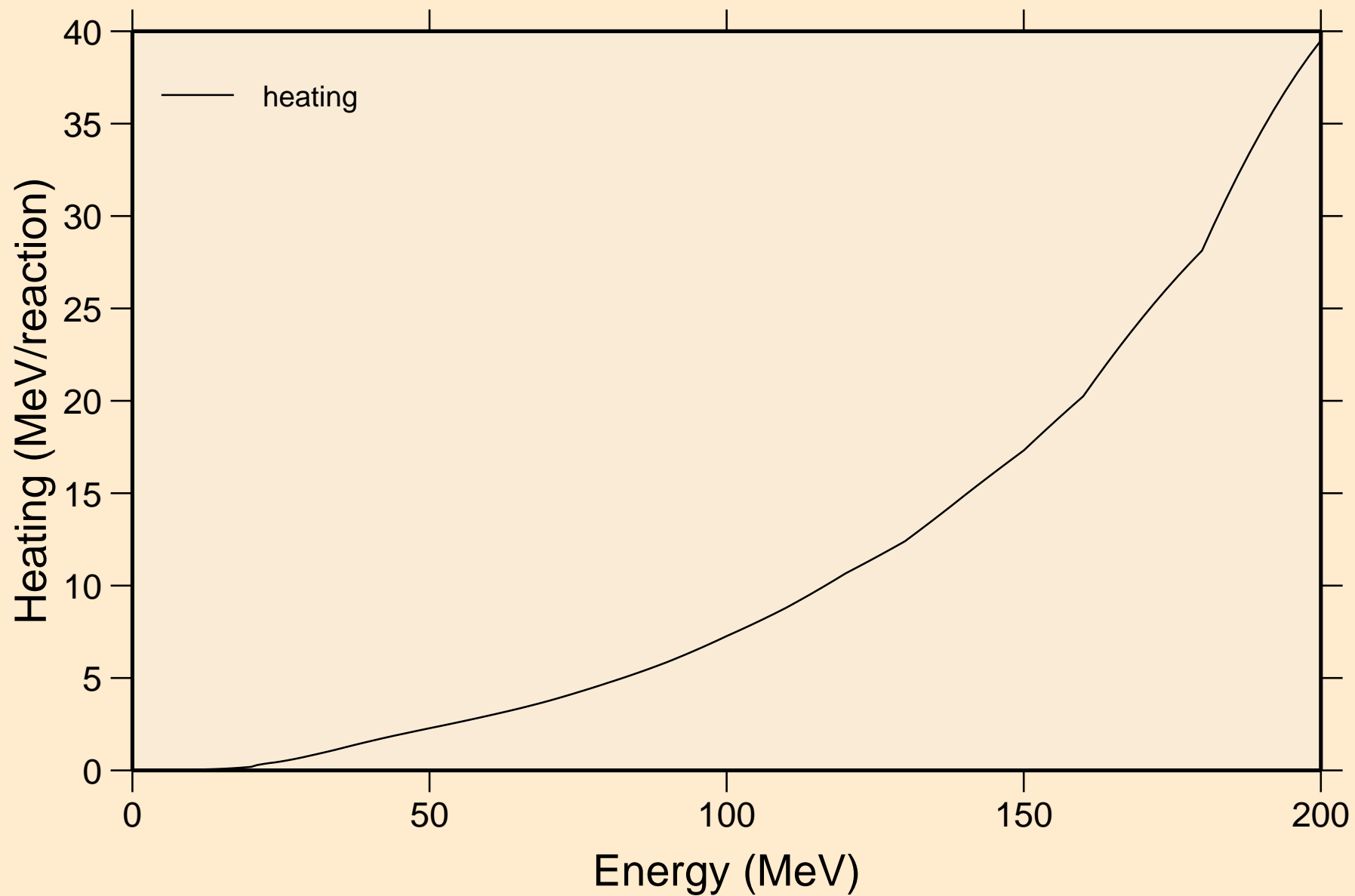

68-ER-166 FOR FENDL-3.2 FROM FENDL-3.2 BY NJOY2016.60+ C  
Damage

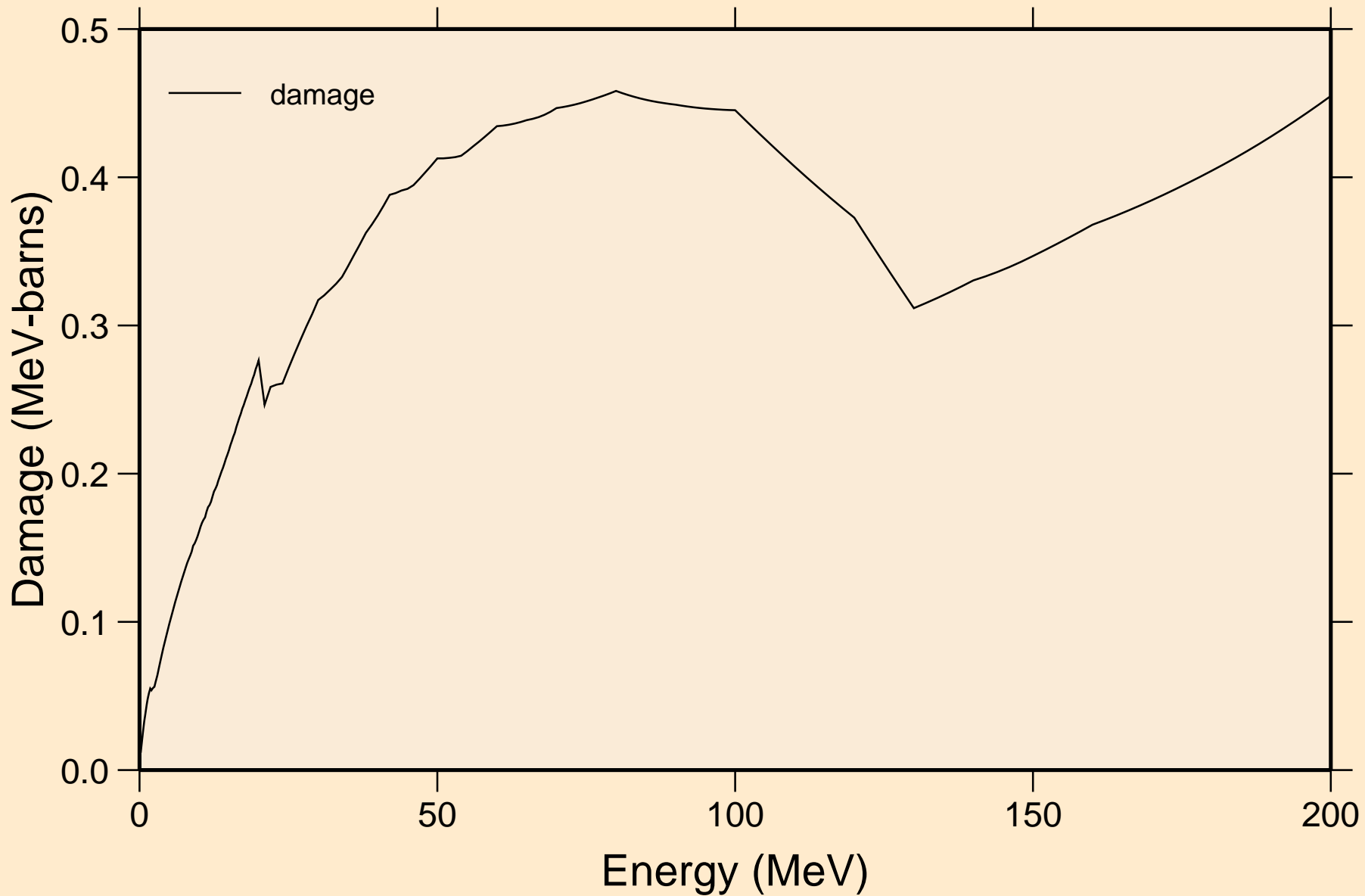

68-ER-166 FOR FENDL-3.2 FROM FENDL-3.2 BY NJOY2016.60+ C  
Non-threshold reactions

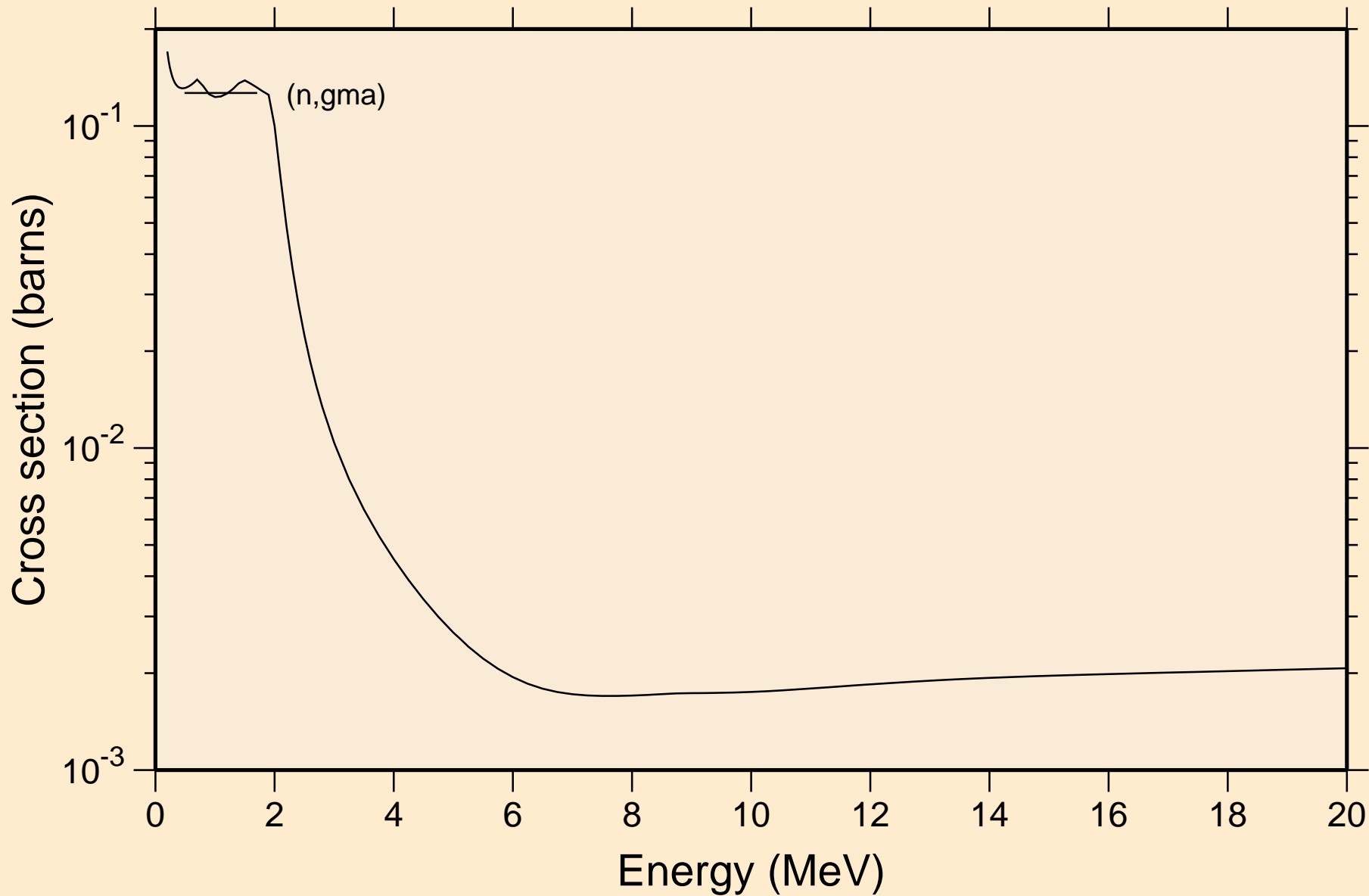



68-ER-166 FOR FENDL-3.2 FROM FENDL-3.2 BY NJOY2016.60+ C  
Inelastic levels

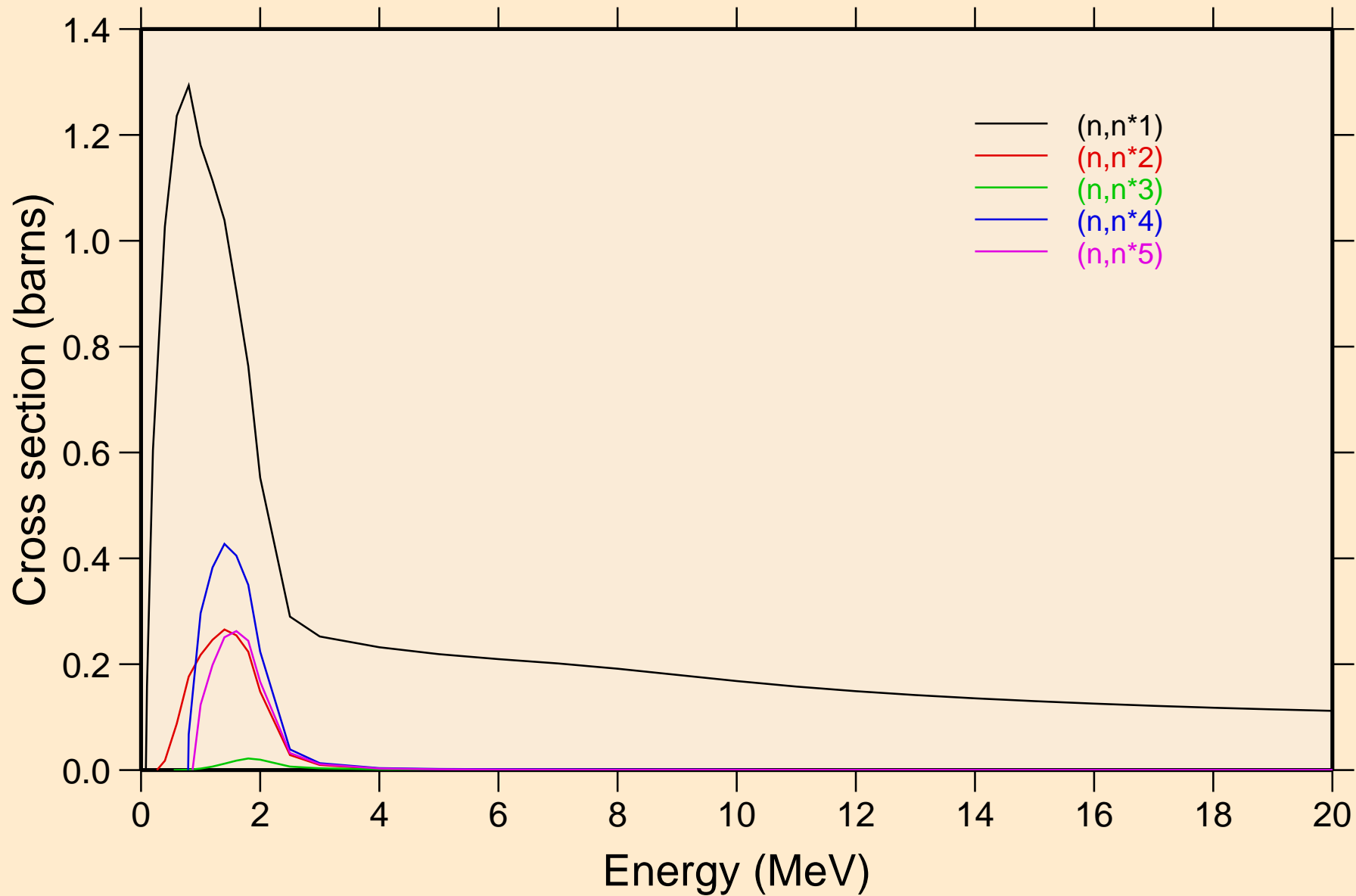

68-ER-166 FOR FENDL-3.2 FROM FENDL-3.2 BY NJOY2016.60+ C  
Inelastic levels

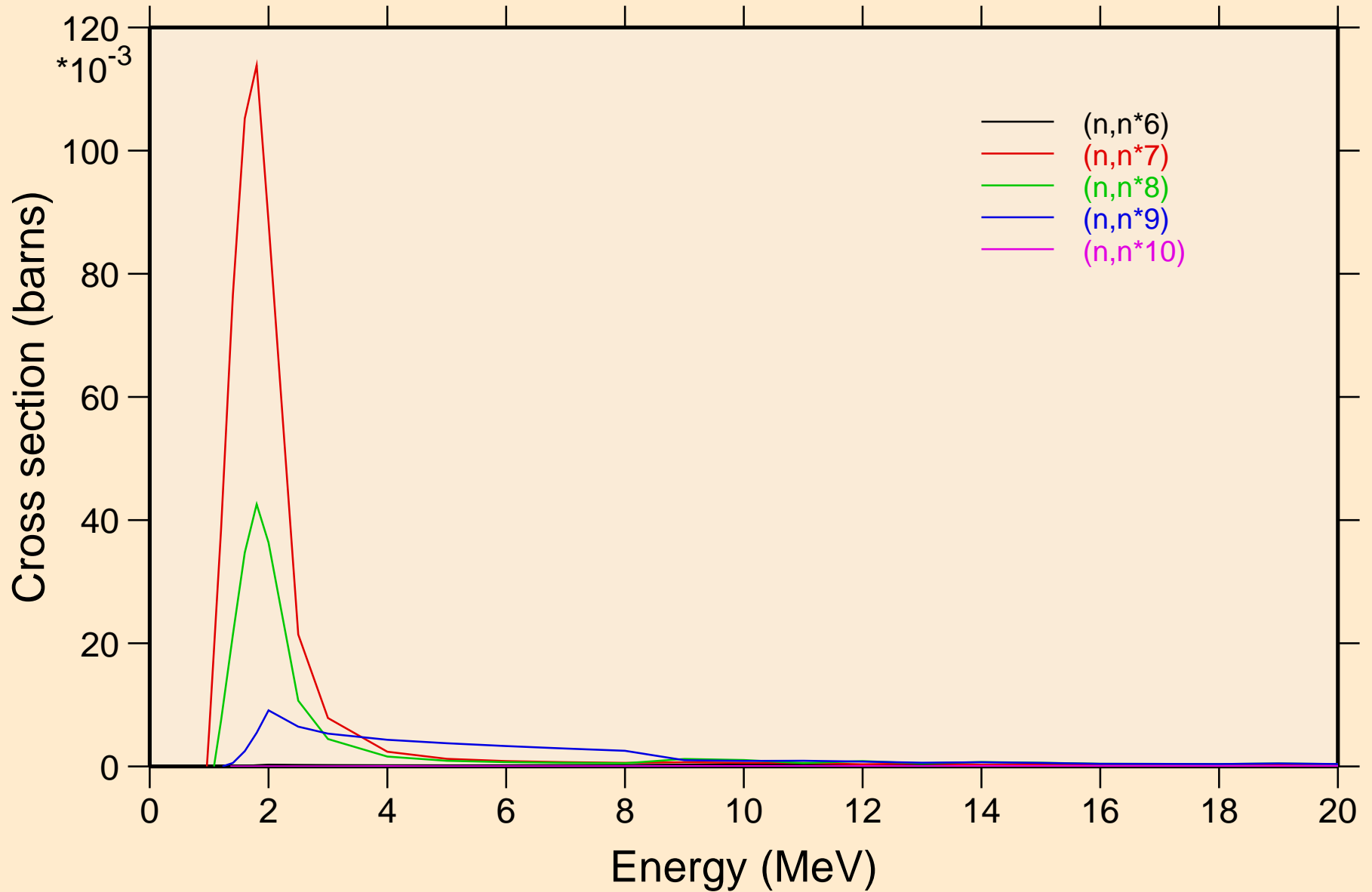

68-ER-166 FOR FENDL-3.2 FROM FENDL-3.2 BY NJOY2016.60+ C  
Inelastic levels

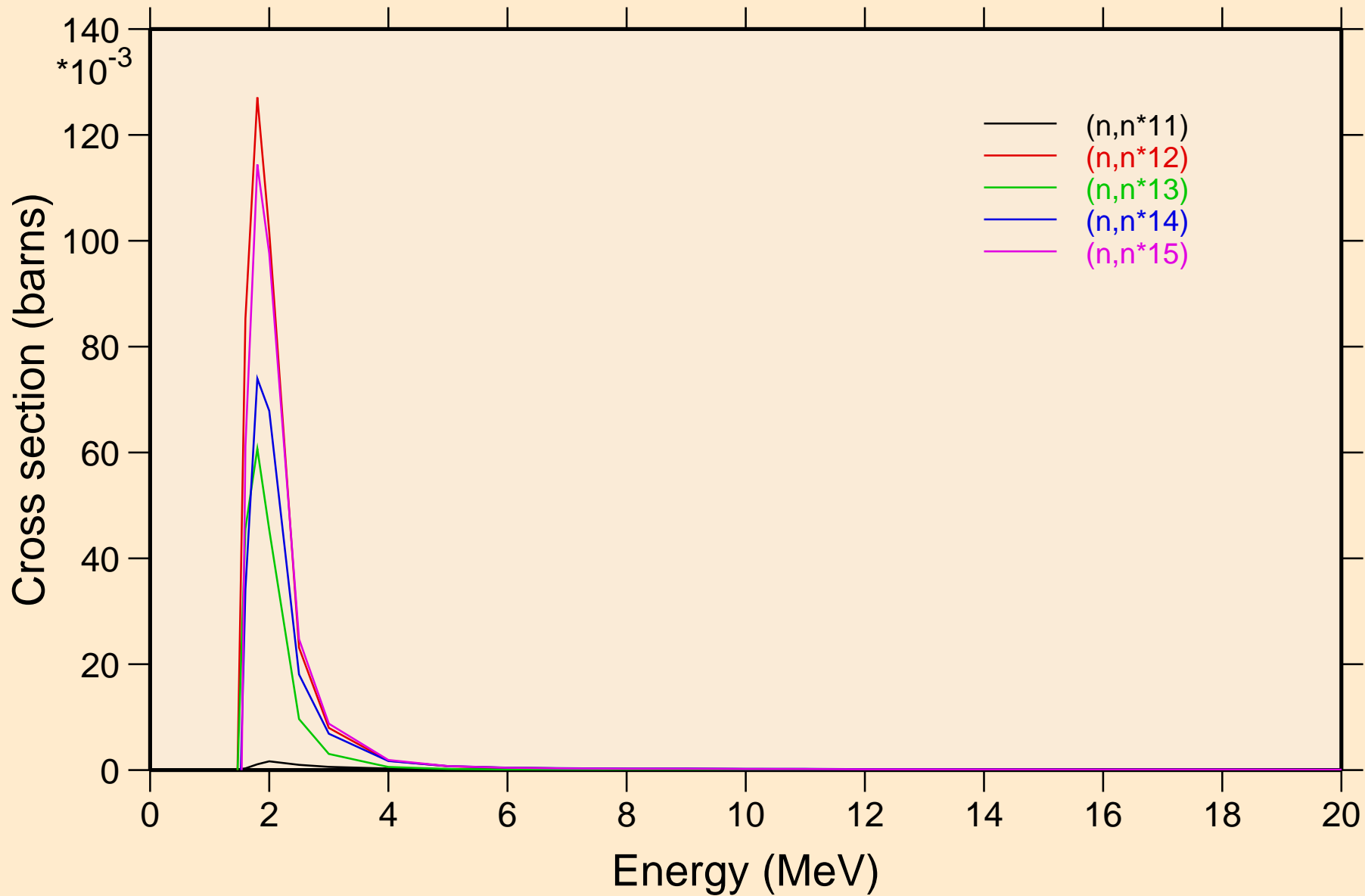

68-ER-166 FOR FENDL-3.2 FROM FENDL-3.2 BY NJOY2016.60+ C  
Inelastic levels

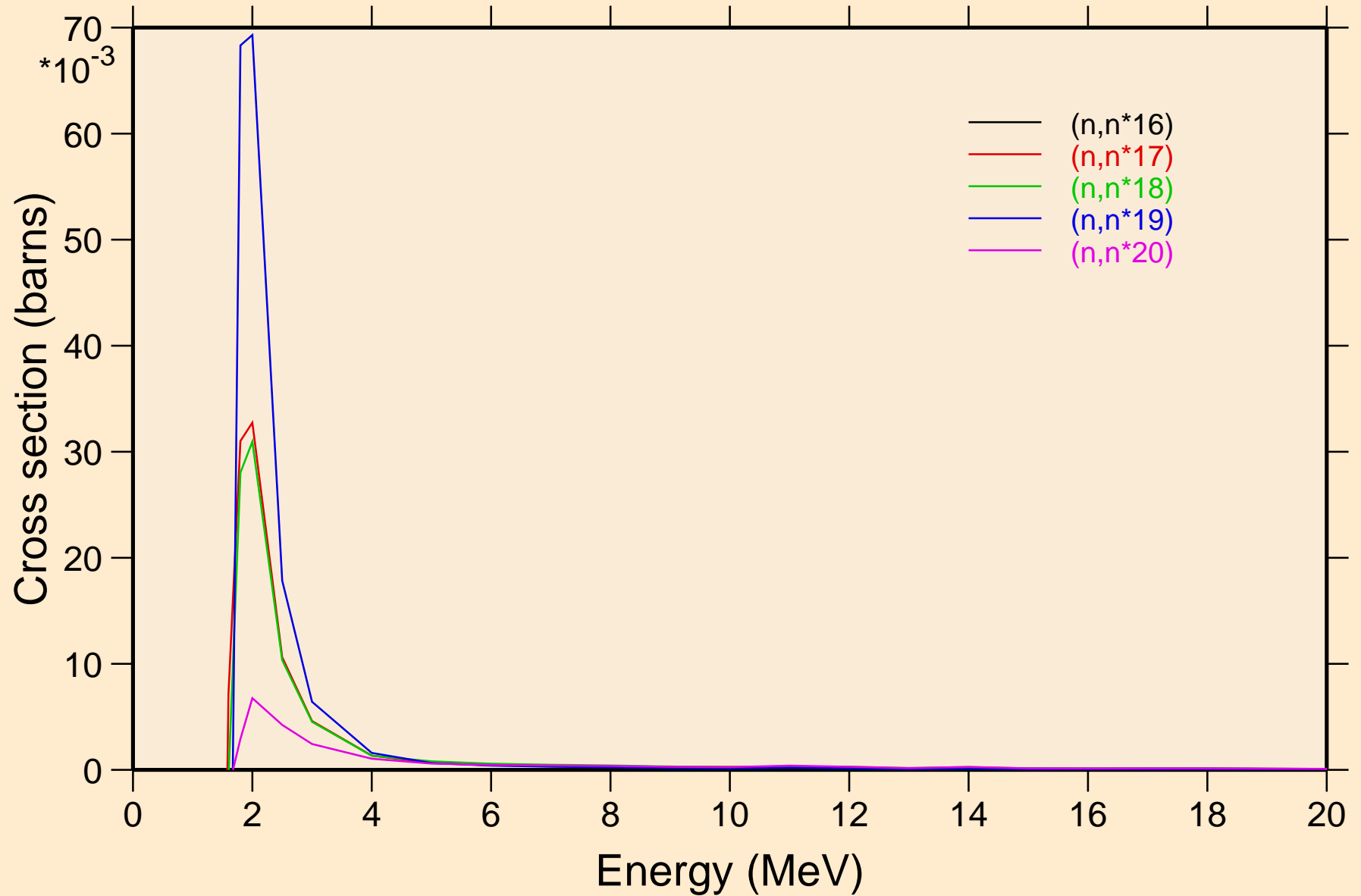

68-ER-166 FOR FENDL-3.2 FROM FENDL-3.2 BY NJOY2016.60+ C  
Inelastic levels

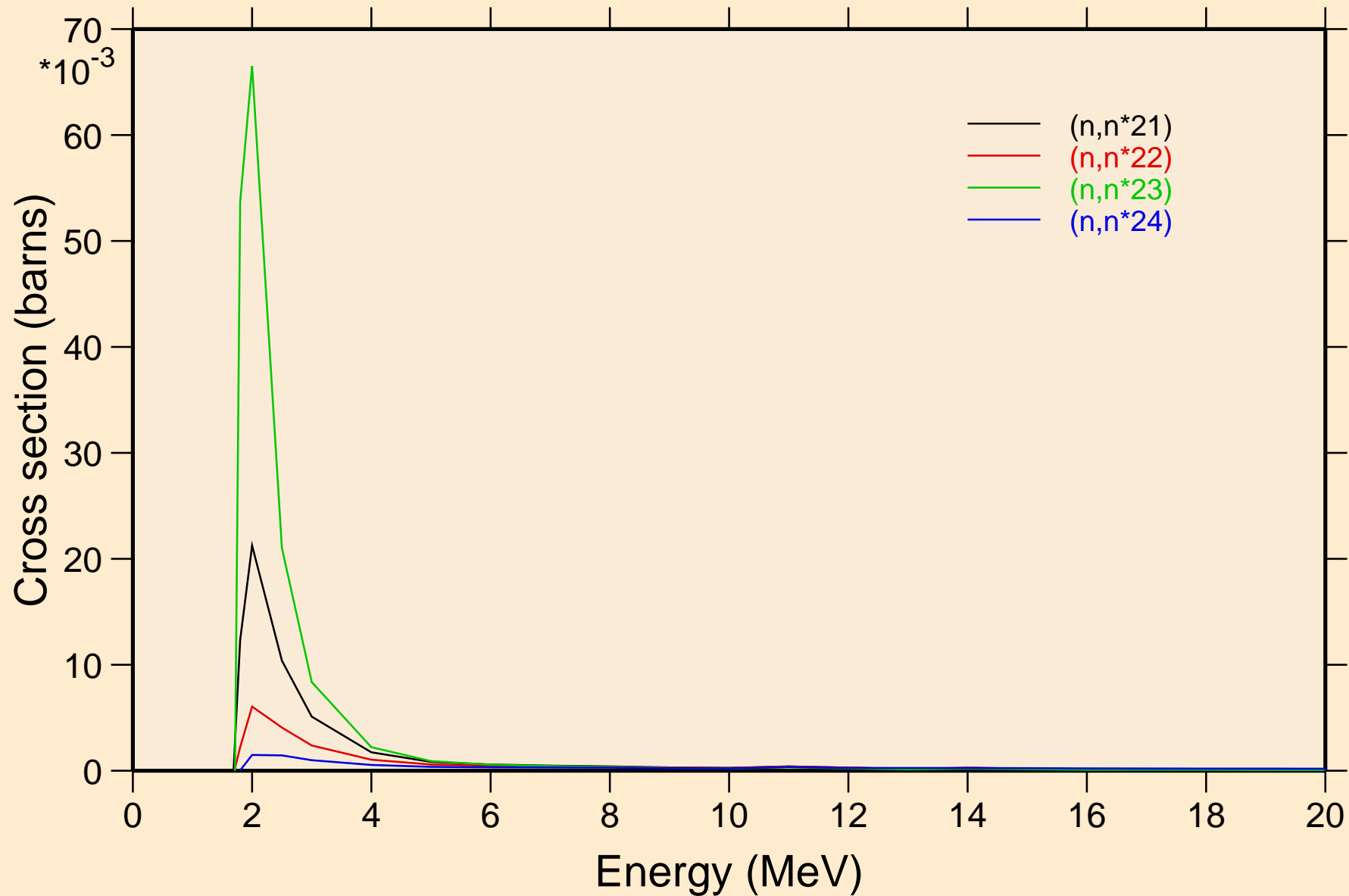

68-ER-166 FOR FENDL-3.2 FROM FENDL-3.2 BY NJOY2016.60+ C  
Threshold reactions

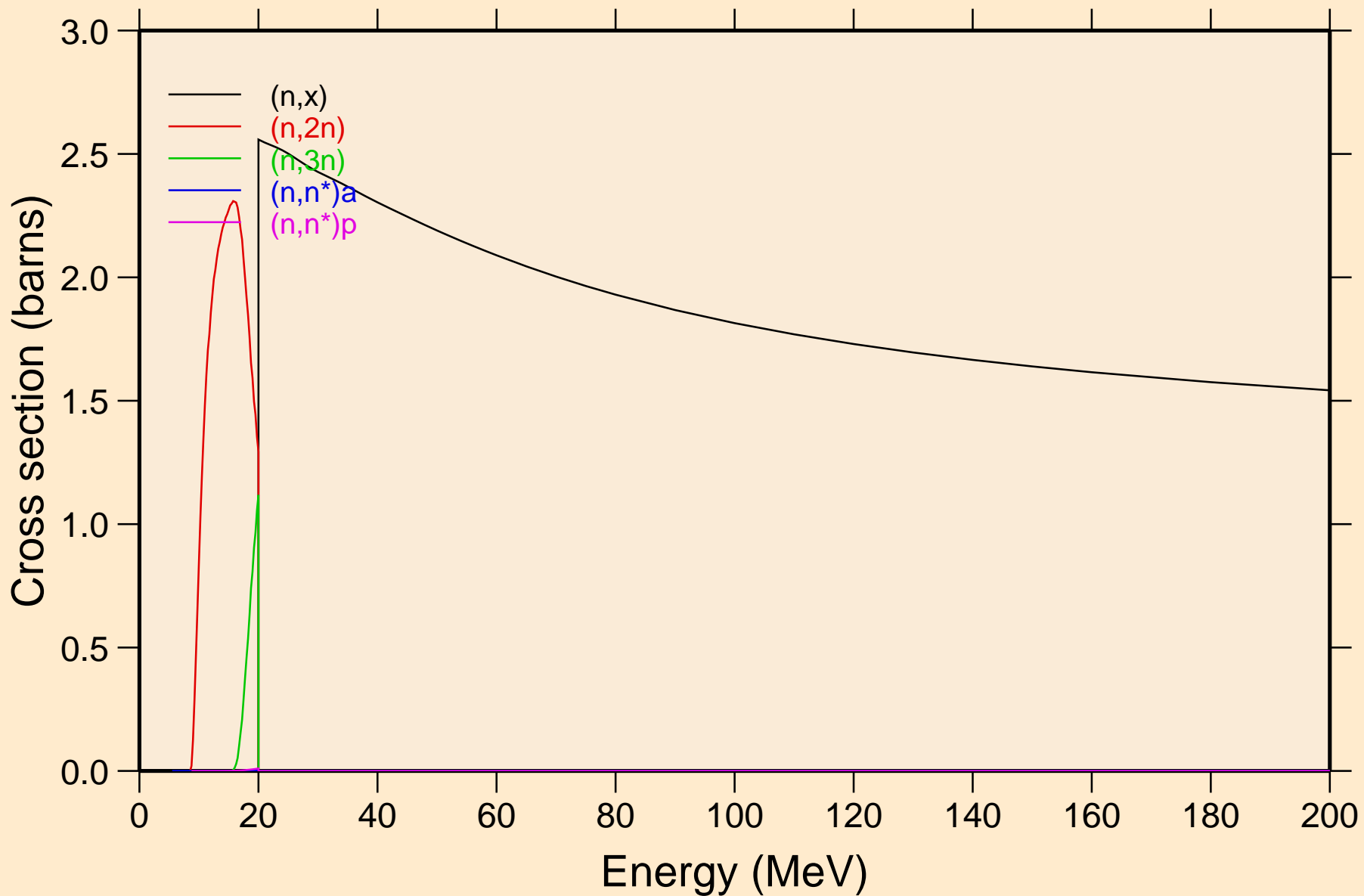

68-ER-166 FOR FENDL-3.2 FROM FENDL-3.2 BY NJOY2016.60+ C  
Threshold reactions

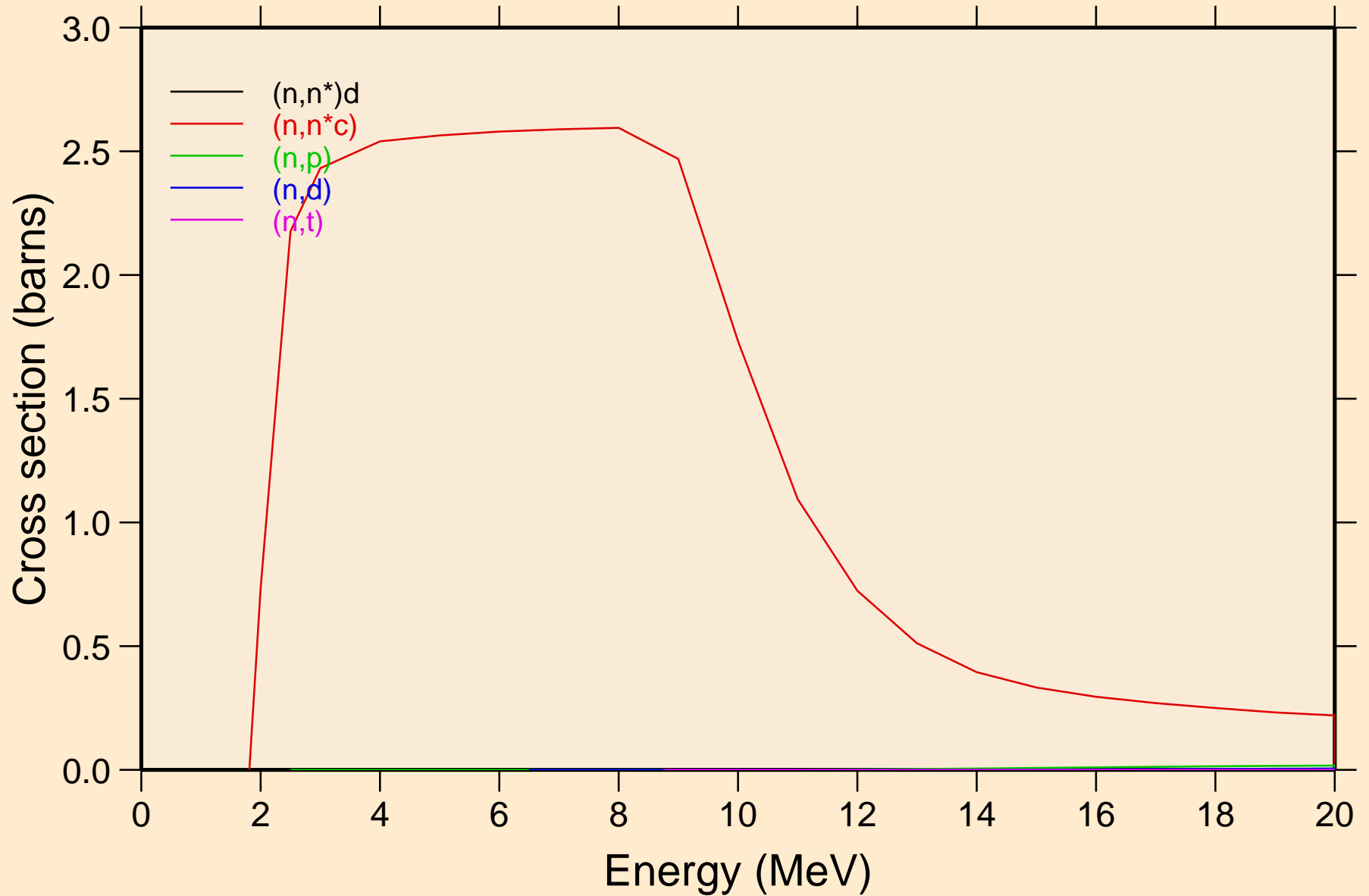

68-ER-166 FOR FENDL-3.2 FROM FENDL-3.2 BY NJOY2016.60+ C  
Threshold reactions

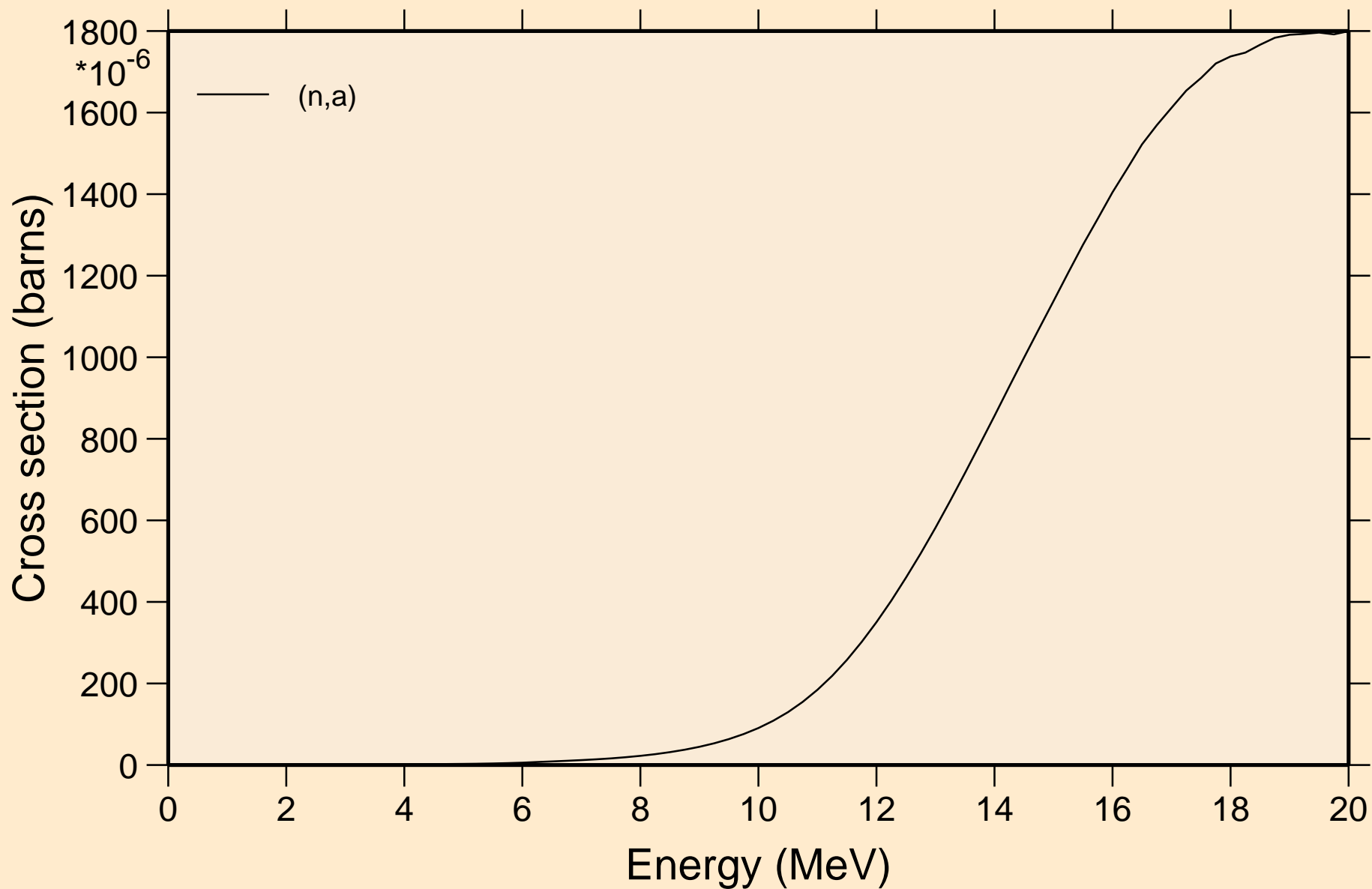



68-ER-166 FOR FENDL-3.2 FROM FENDL-3.2 BY NJOY2016.60+ C  
Threshold reactions

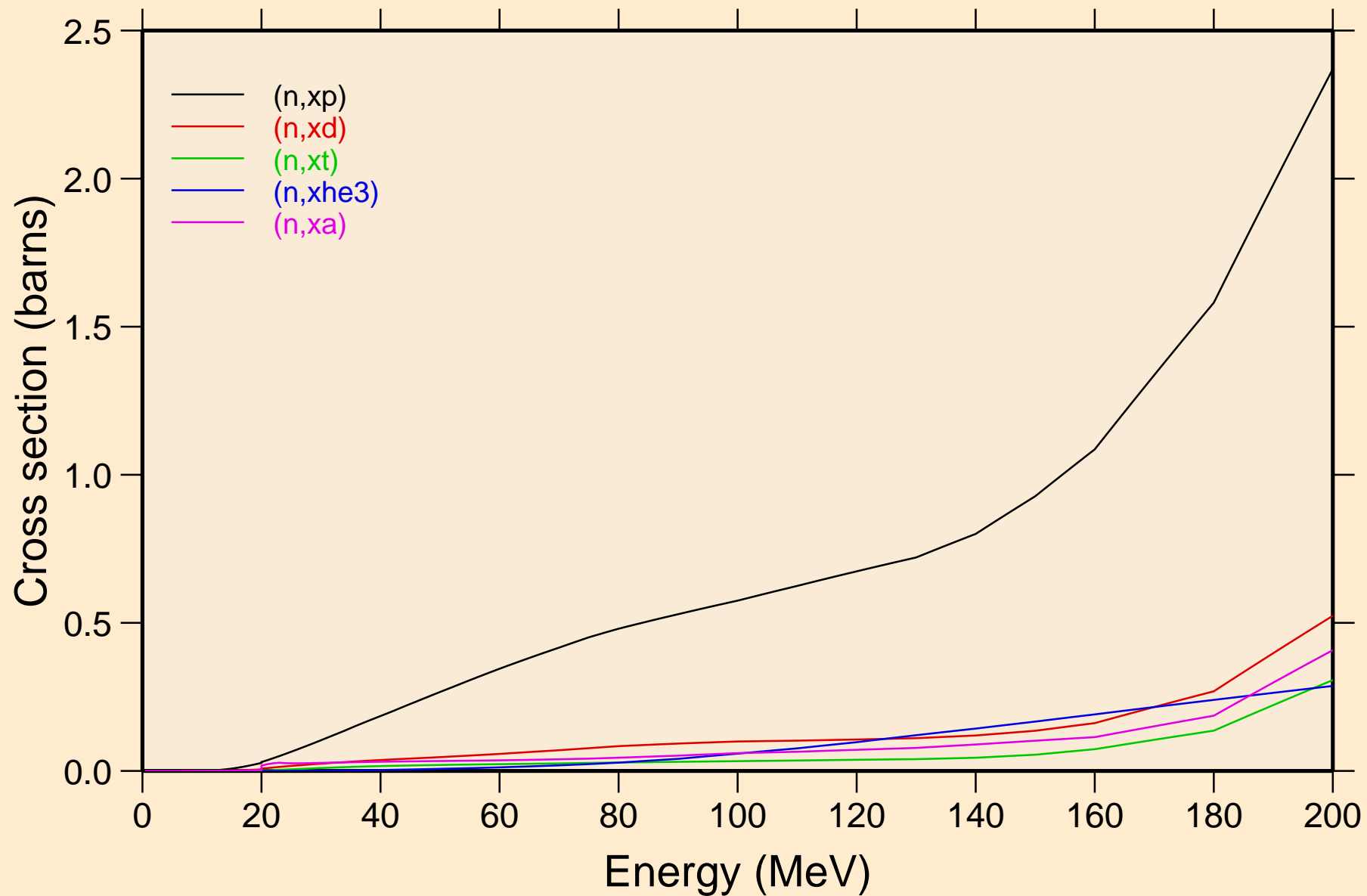

68-ER-166 FOR FENDL-3.2 FROM FENDL-3.2 BY NJOY2016.60+ C  
angular distribution for elastic

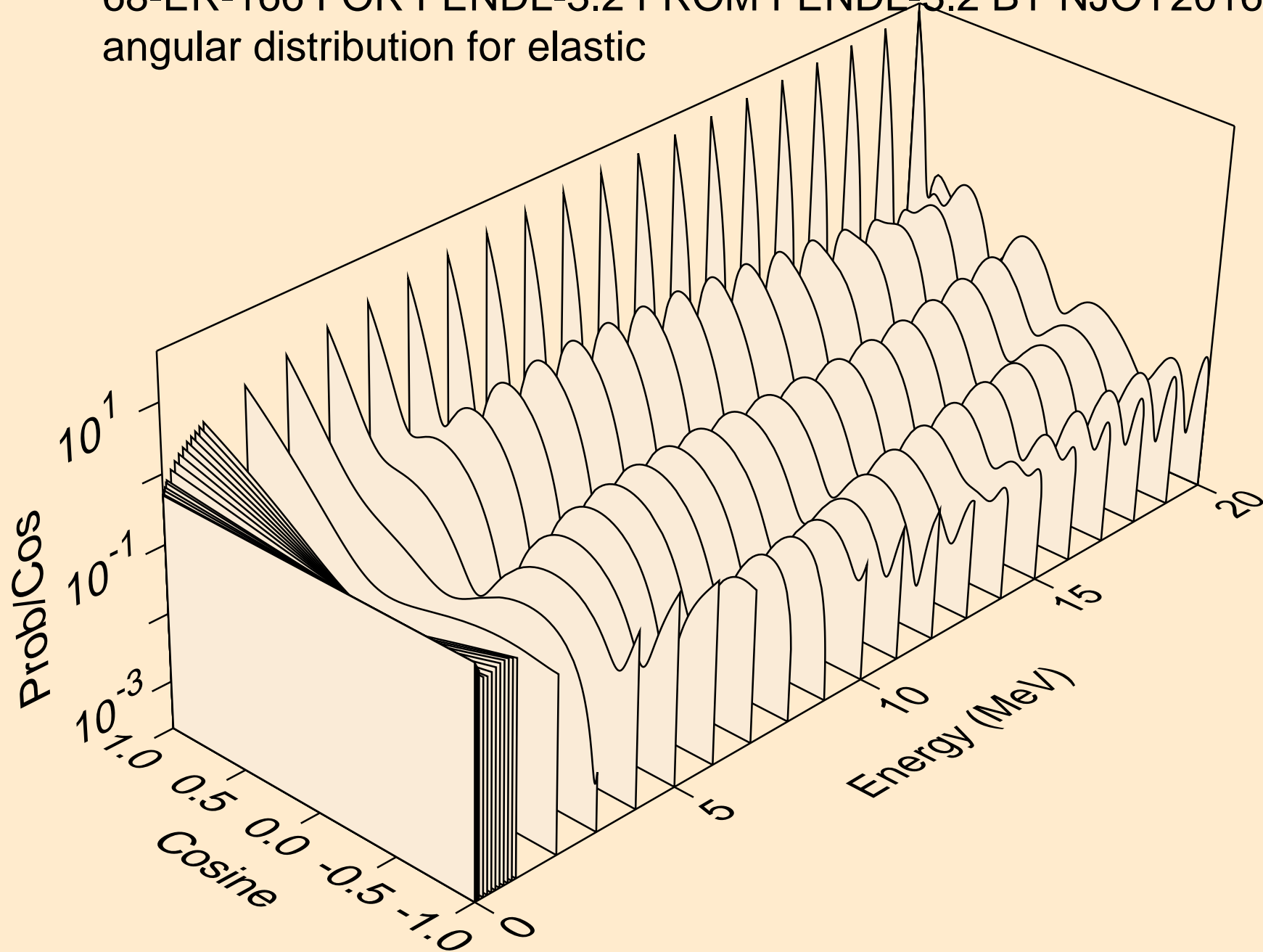

68-ER-166 FOR FENDL-3.2 FROM FENDL-3.2 BY NJOY2016.60+ C  
angular distribution for elastic

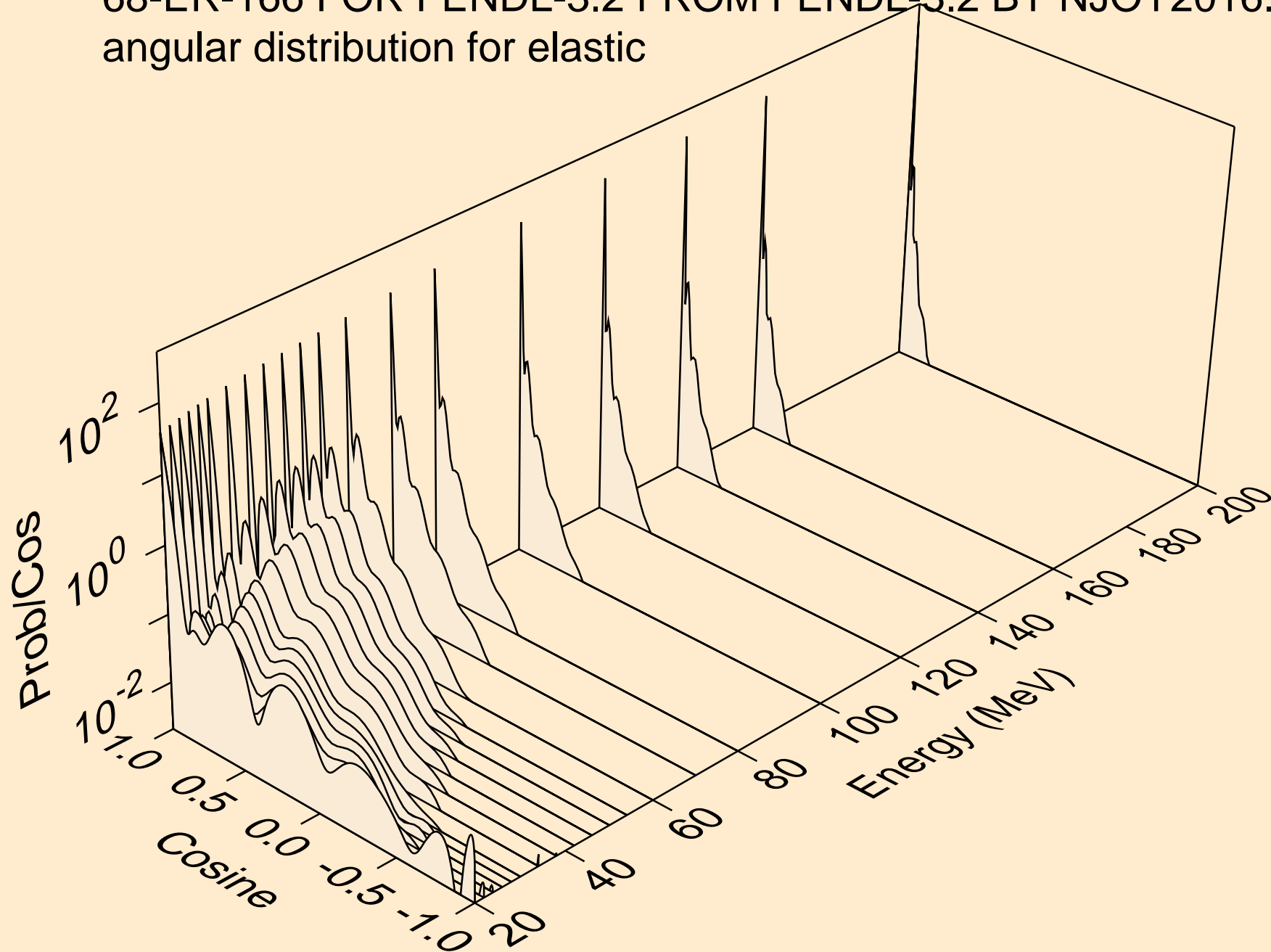

68-ER-166 FOR FENDL-3.2 FROM FENDL-3.2 BY NJOY2016.60+ C  
angular distribution for (n,n\*1)

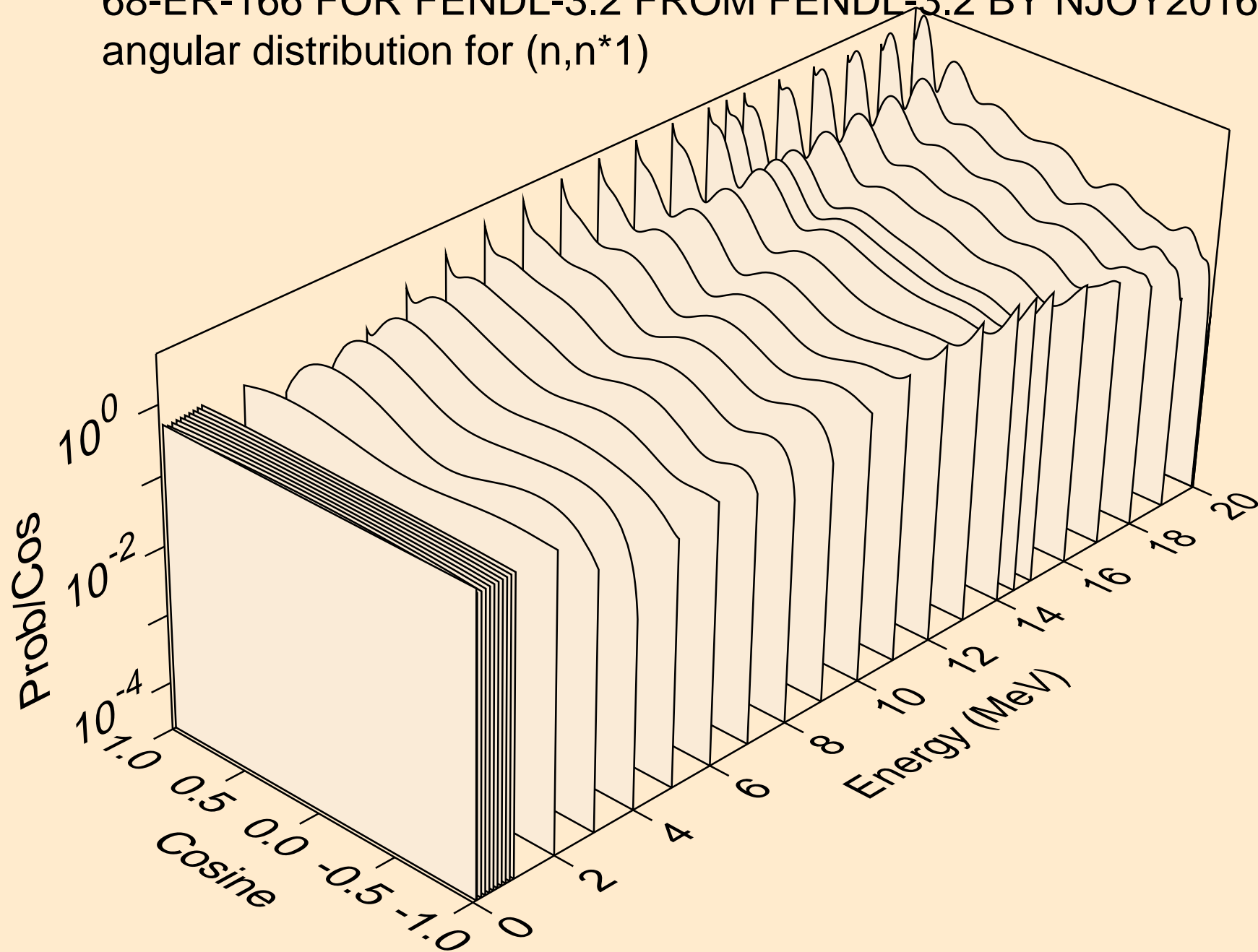

68-ER-166 FOR FENDL-3.2 FROM FENDL-3.2 BY NJOY2016.60+ C  
angular distribution for (n,n\*2)

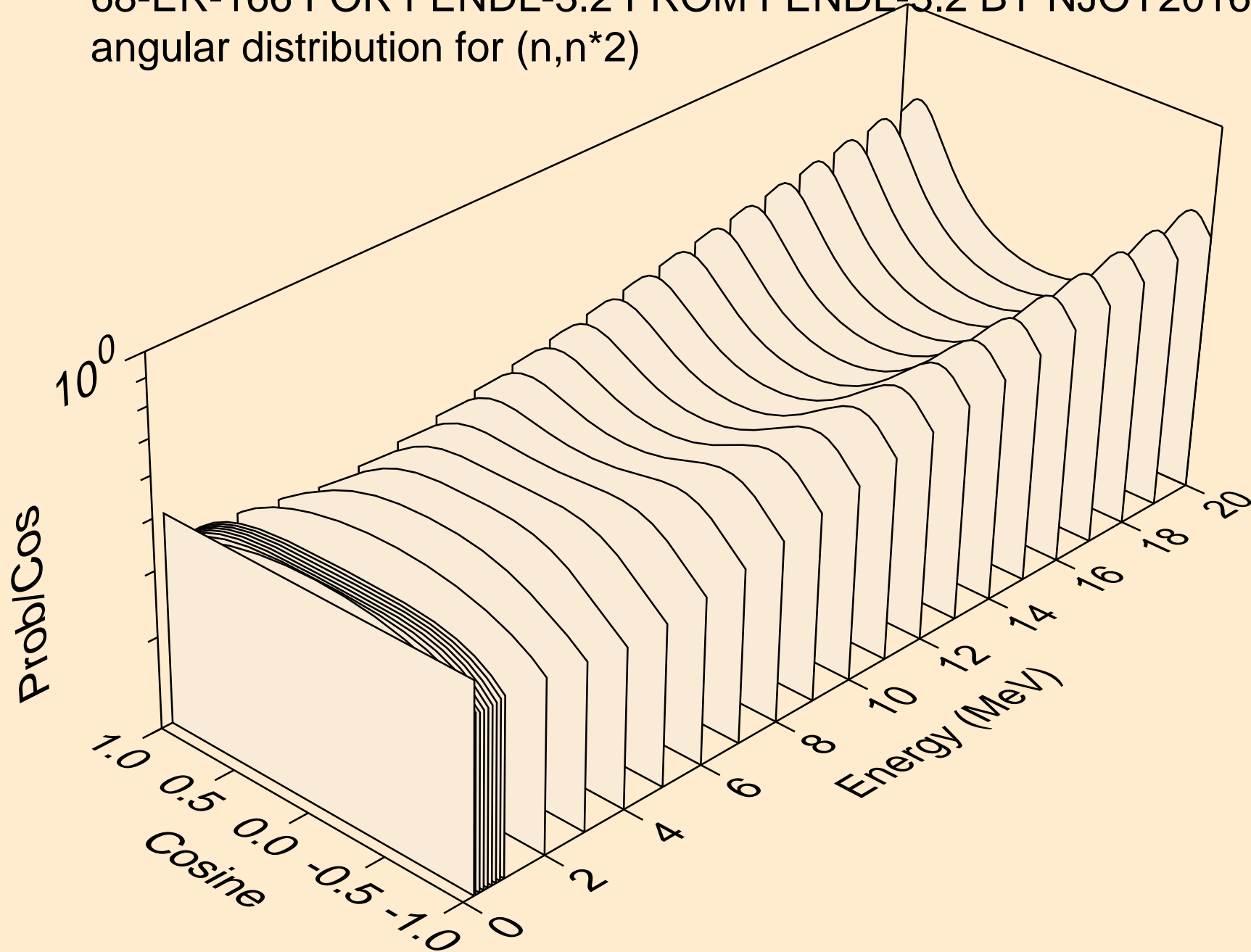

68-ER-166 FOR FENDL-3.2 FROM FENDL-3.2 BY NJOY2016.60+ C  
angular distribution for (n,n\*3)

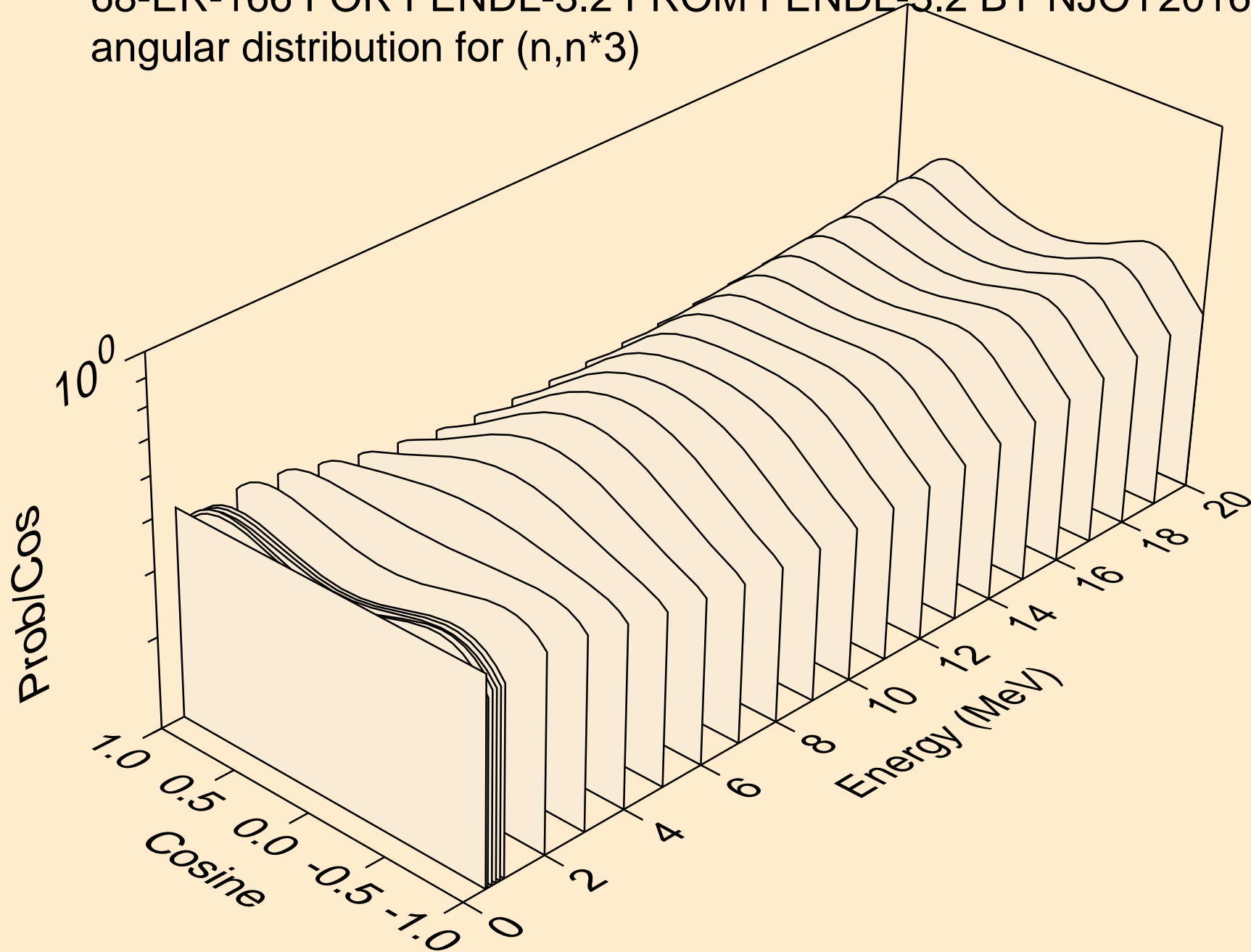

68-ER-166 FOR FENDL-3.2 FROM FENDL-3.2 BY NJOY2016.60+ C  
angular distribution for (n,n\*4)

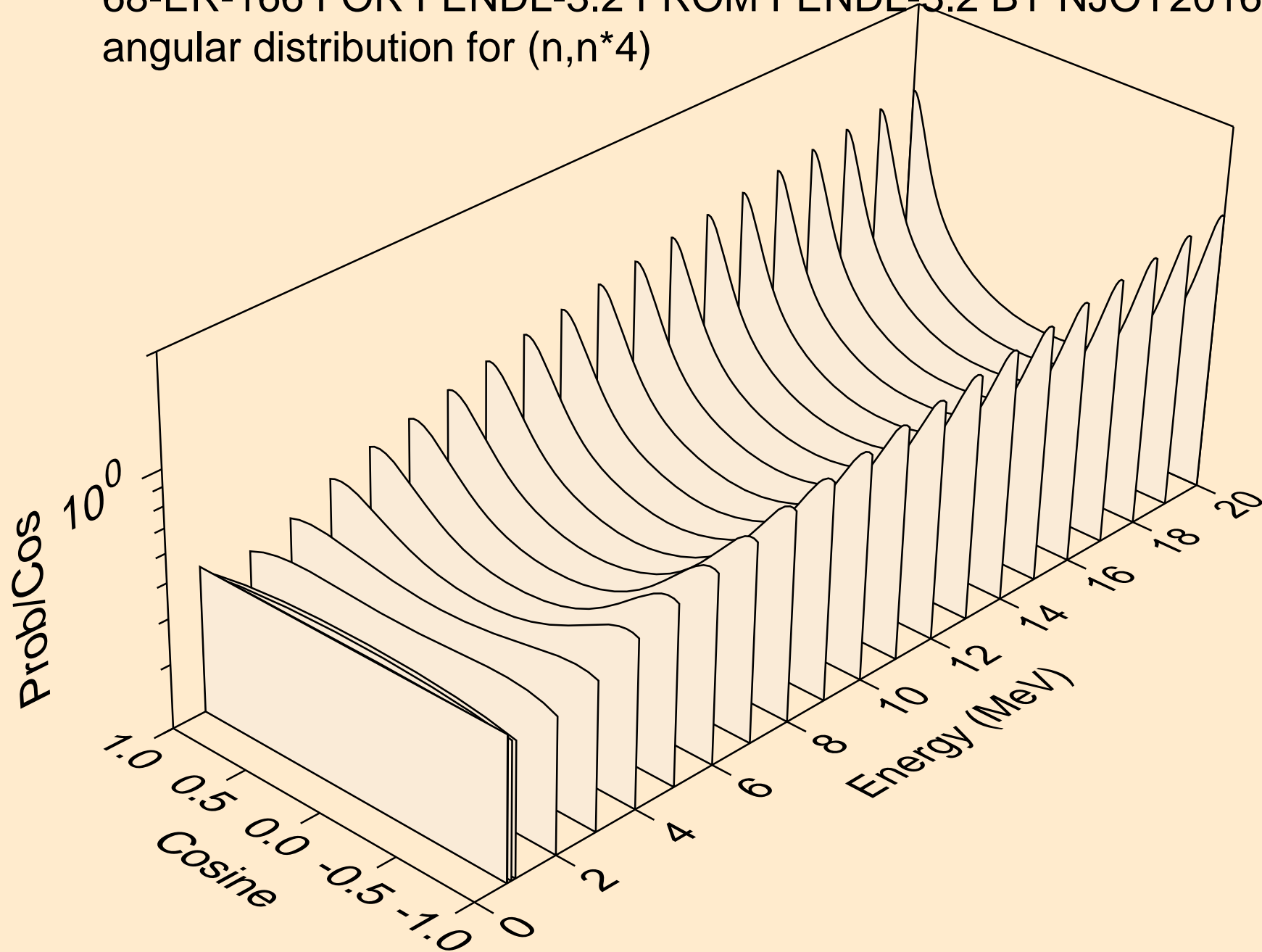

68-ER-166 FOR FENDL-3.2 FROM FENDL-3.2 BY NJOY2016.60+ C  
angular distribution for (n,n\*5)

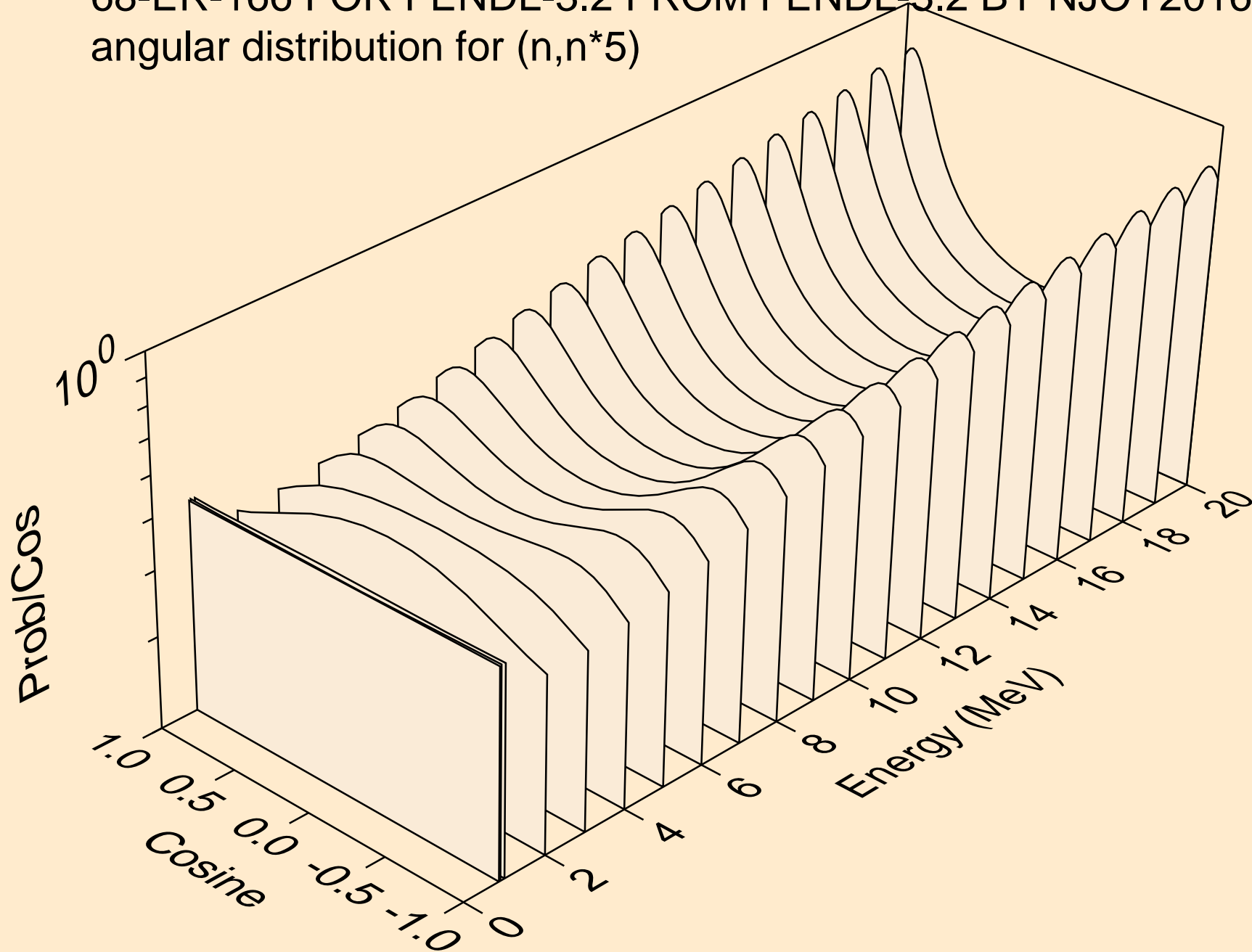



68-ER-166 FOR FENDL-3.2 FROM FENDL-3.2 BY NJOY2016.60+ C  
angular distribution for (n,n\*6)

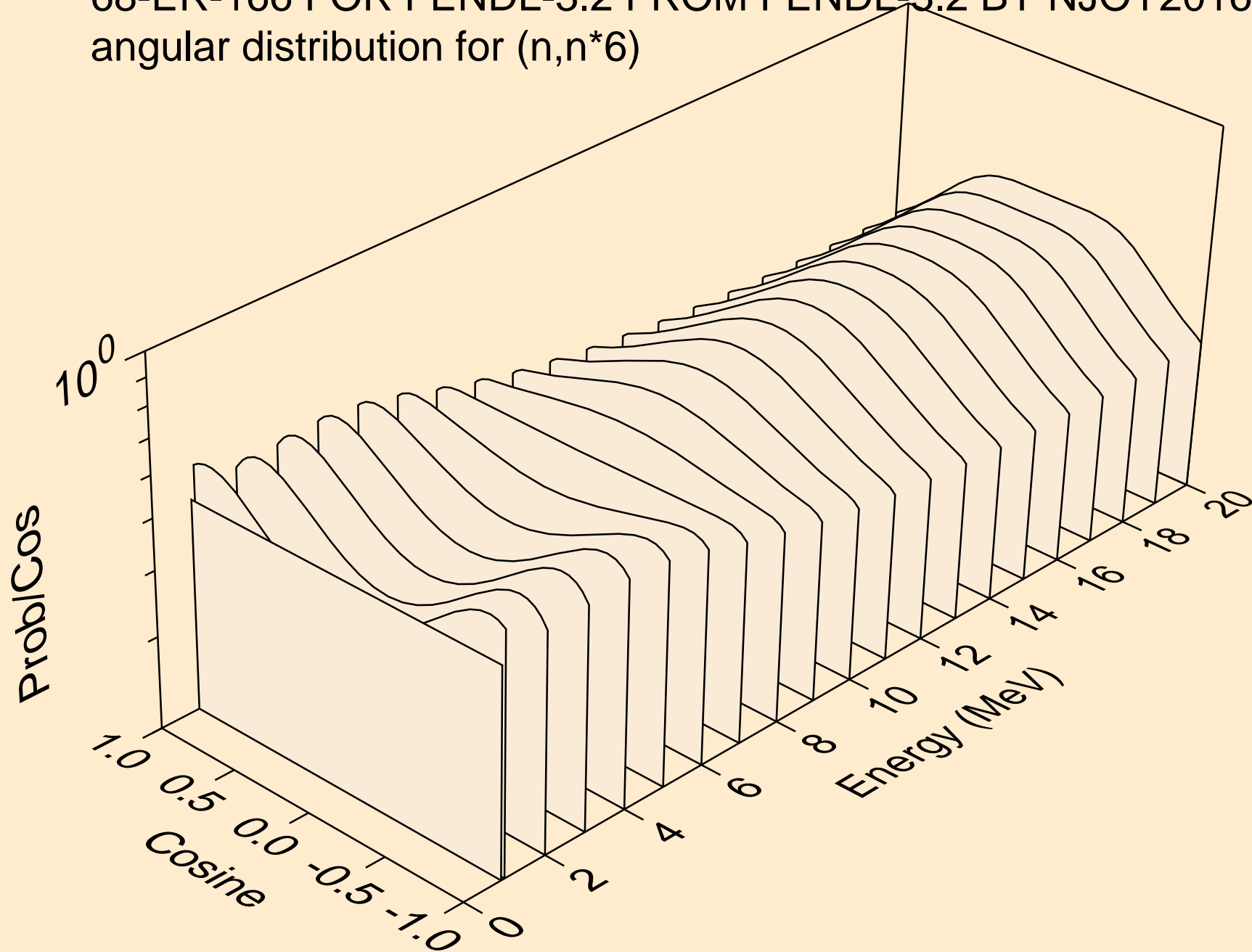

68-ER-166 FOR FENDL-3.2 FROM FENDL-3.2 BY NJOY2016.60+ C  
angular distribution for (n,n\*7)

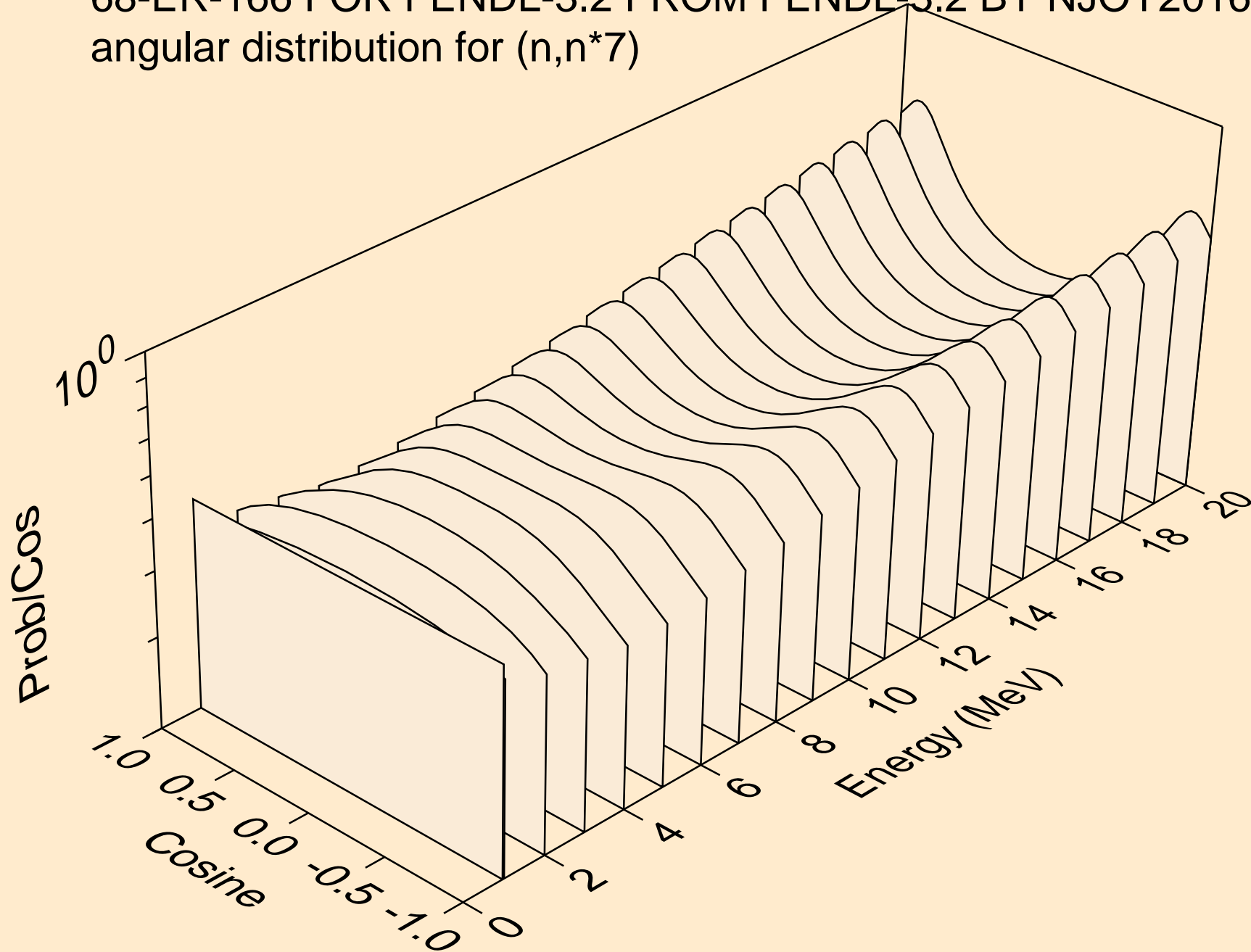

68-ER-166 FOR FENDL-3.2 FROM FENDL-3.2 BY NJOY2016.60+ C  
angular distribution for (n,n\*8)

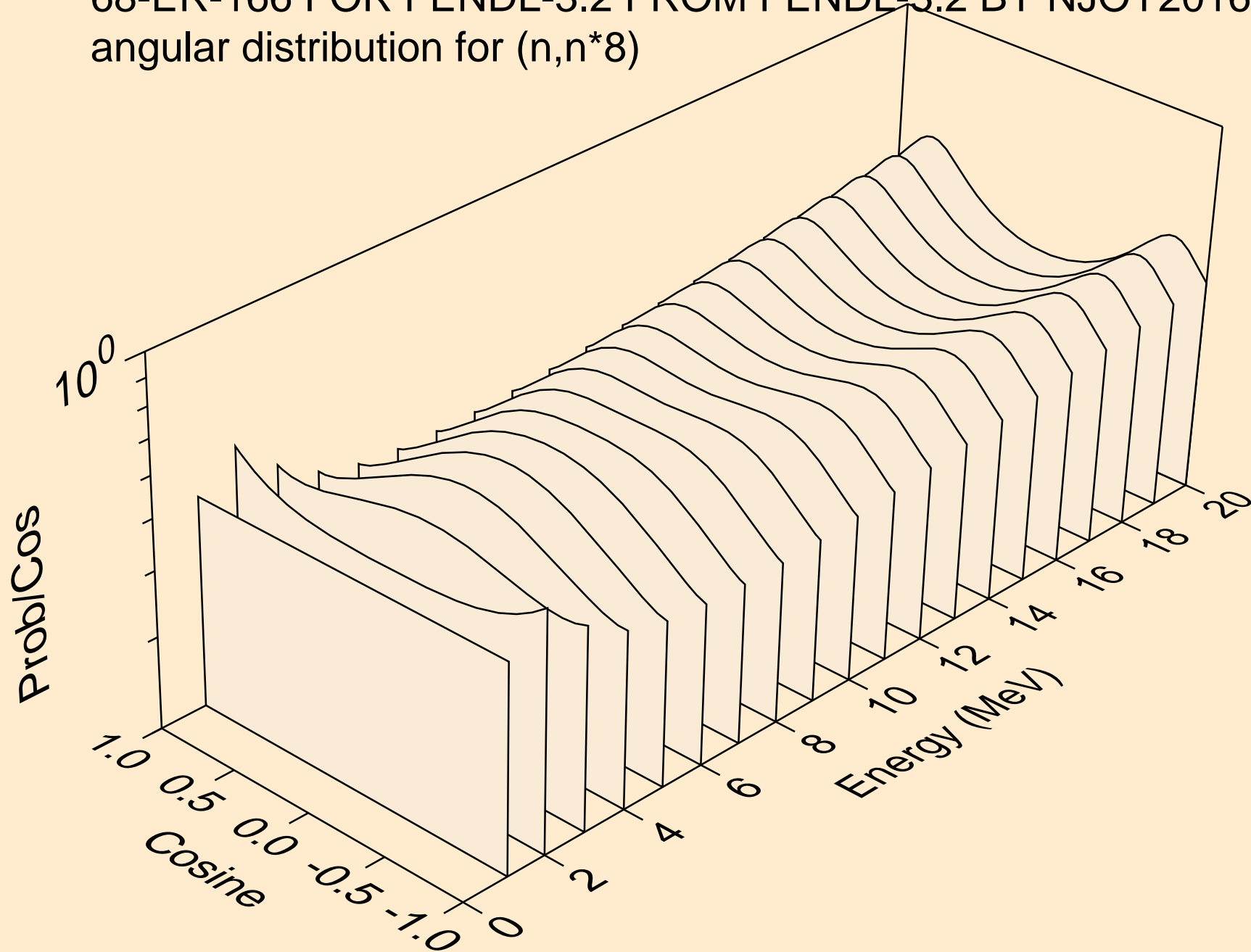

68-ER-166 FOR FENDL-3.2 FROM FENDL-3.2 BY NJOY2016.60+ C  
angular distribution for (n,n\*9)

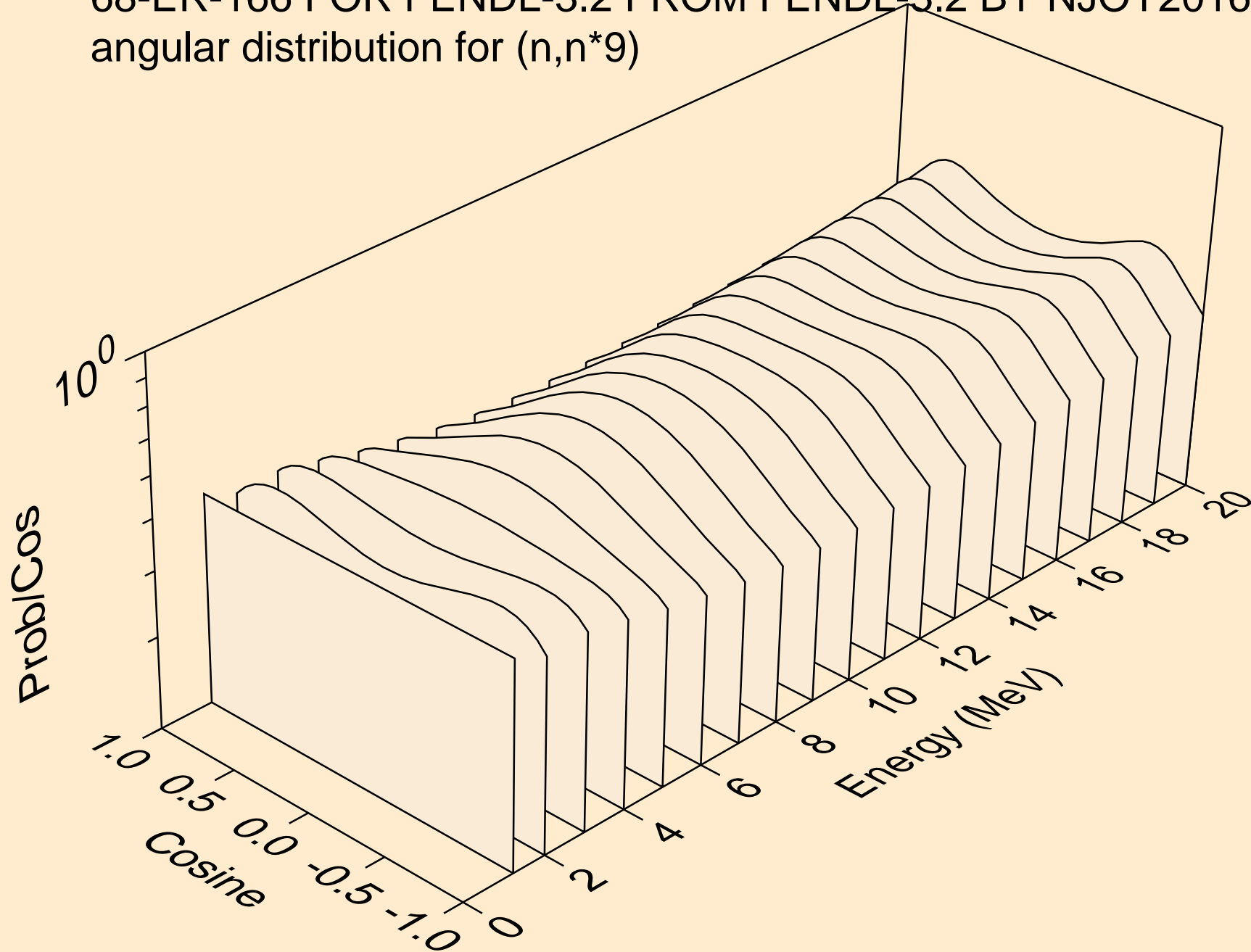

68-ER-166 FOR FENDL-3.2 FROM FENDL-3.2 BY NJOY2016.60+ C  
angular distribution for (n,n\*10)

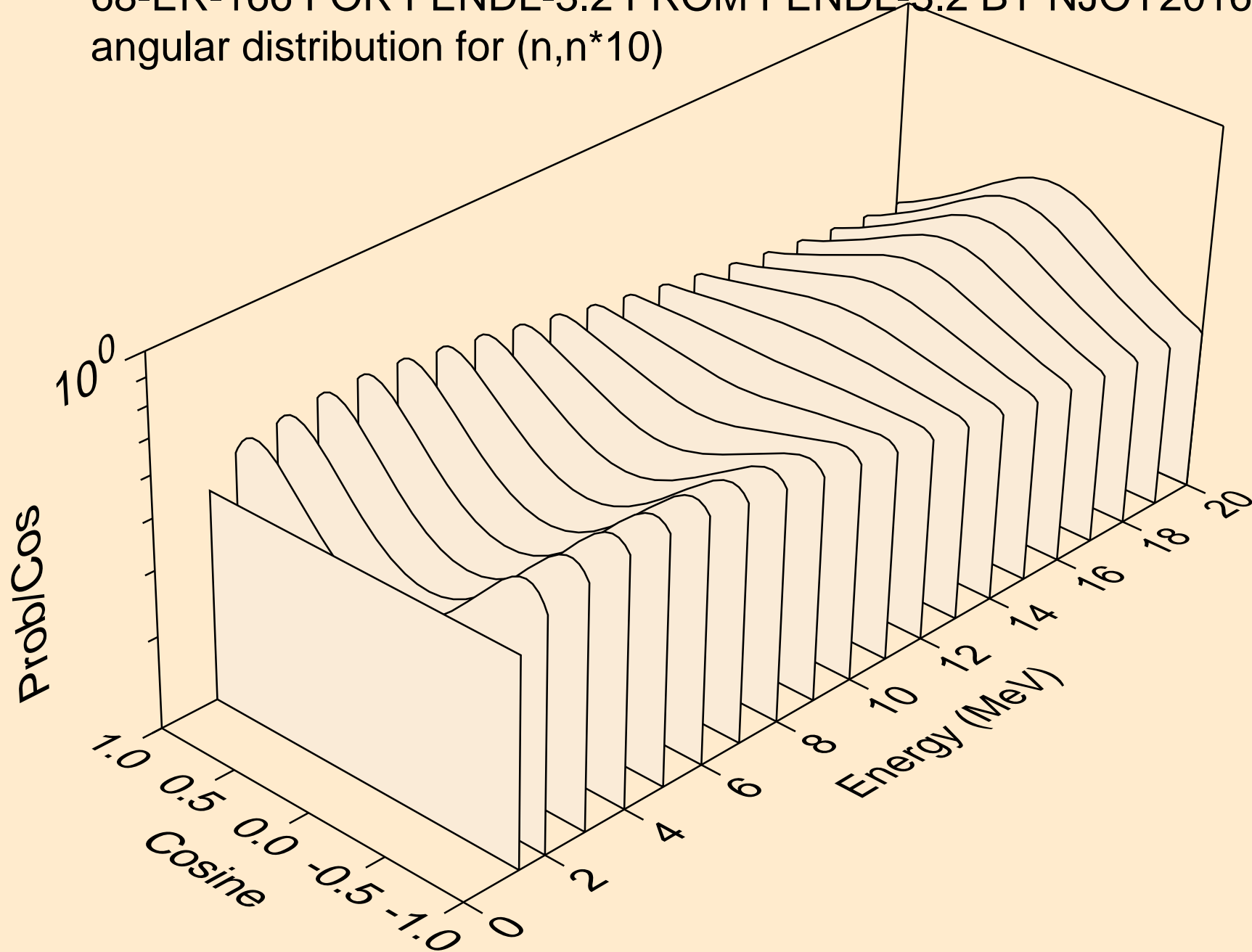

68-ER-166 FOR FENDL-3.2 FROM FENDL-3.2 BY NJOY2016.60+ C  
angular distribution for (n,n\*11)

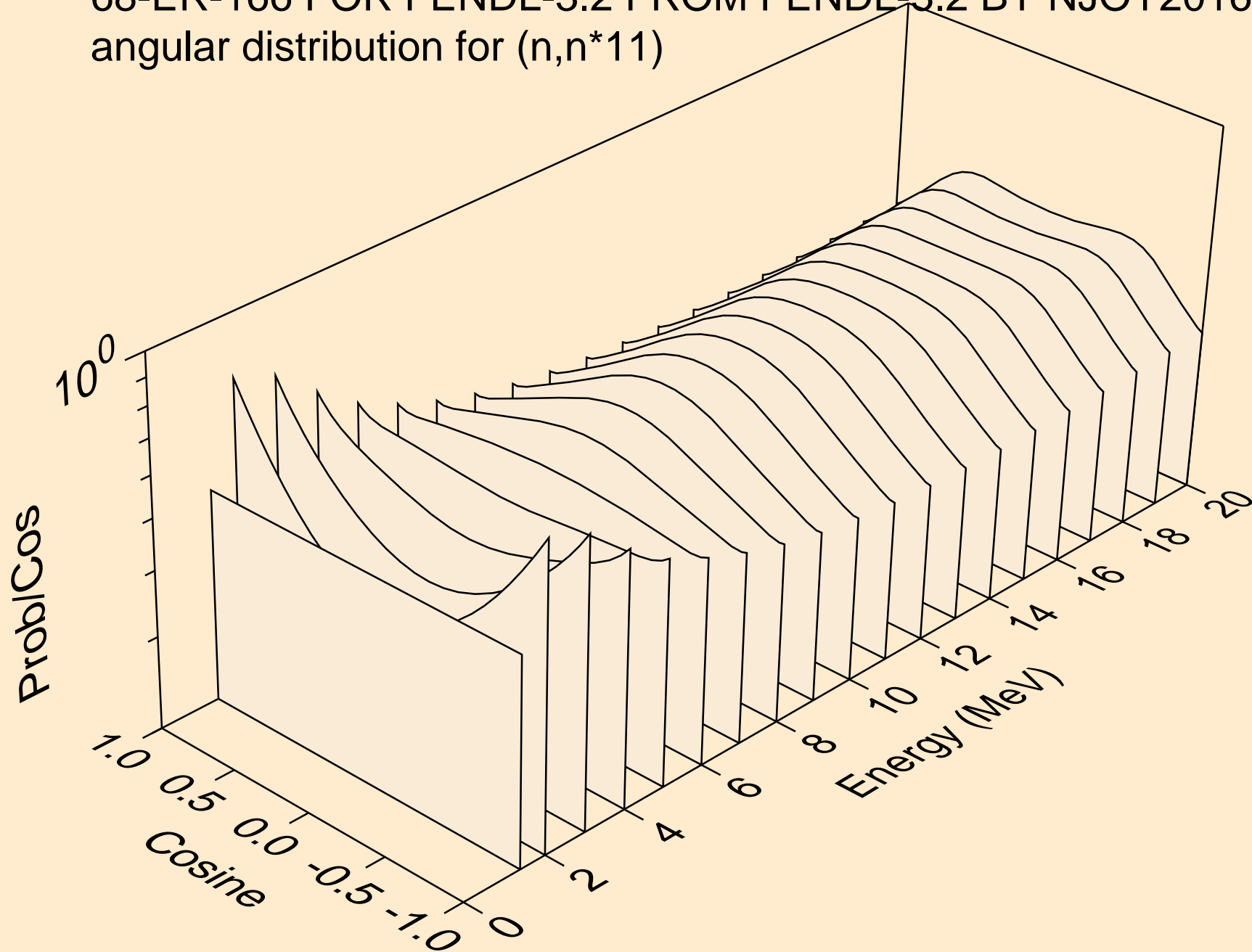

68-ER-166 FOR FENDL-3.2 FROM FENDL-3.2 BY NJOY2016.60+ C  
angular distribution for (n,n\*12)

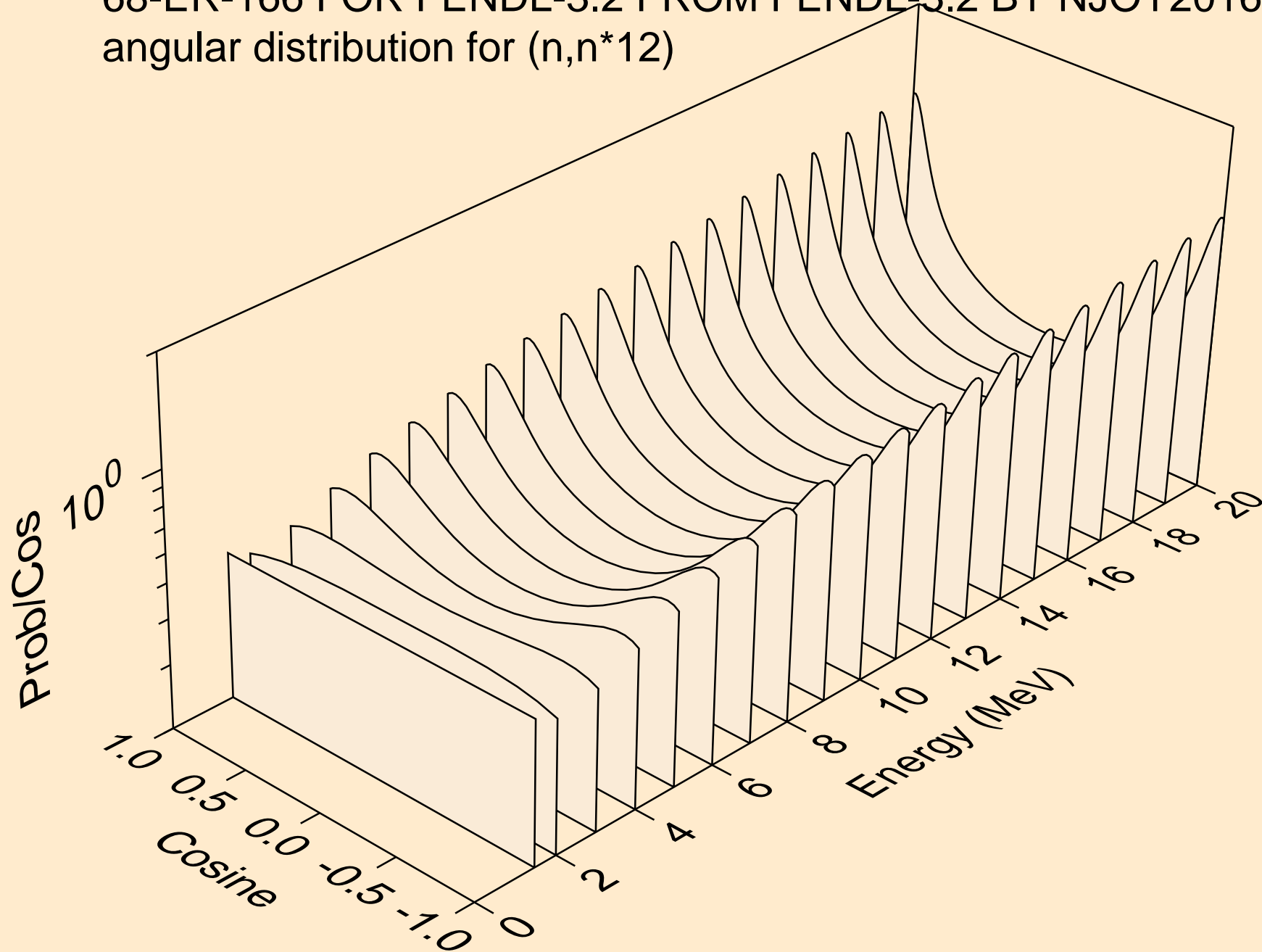

68-ER-166 FOR FENDL-3.2 FROM FENDL-3.2 BY NJOY2016.60+ C  
angular distribution for (n,n\*13)

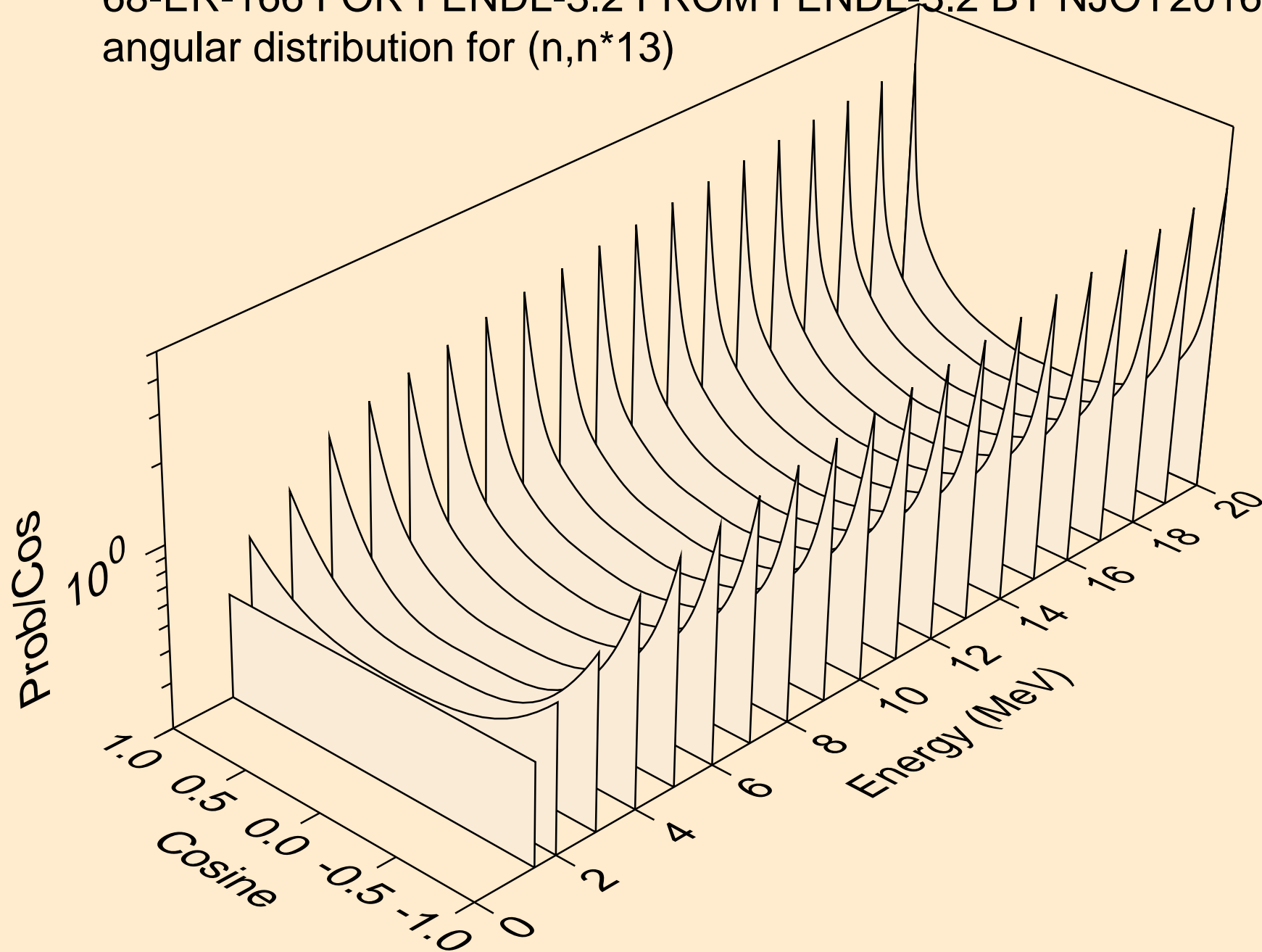



68-ER-166 FOR FENDL-3.2 FROM FENDL-3.2 BY NJOY2016.60+ C  
angular distribution for (n,n\*14)

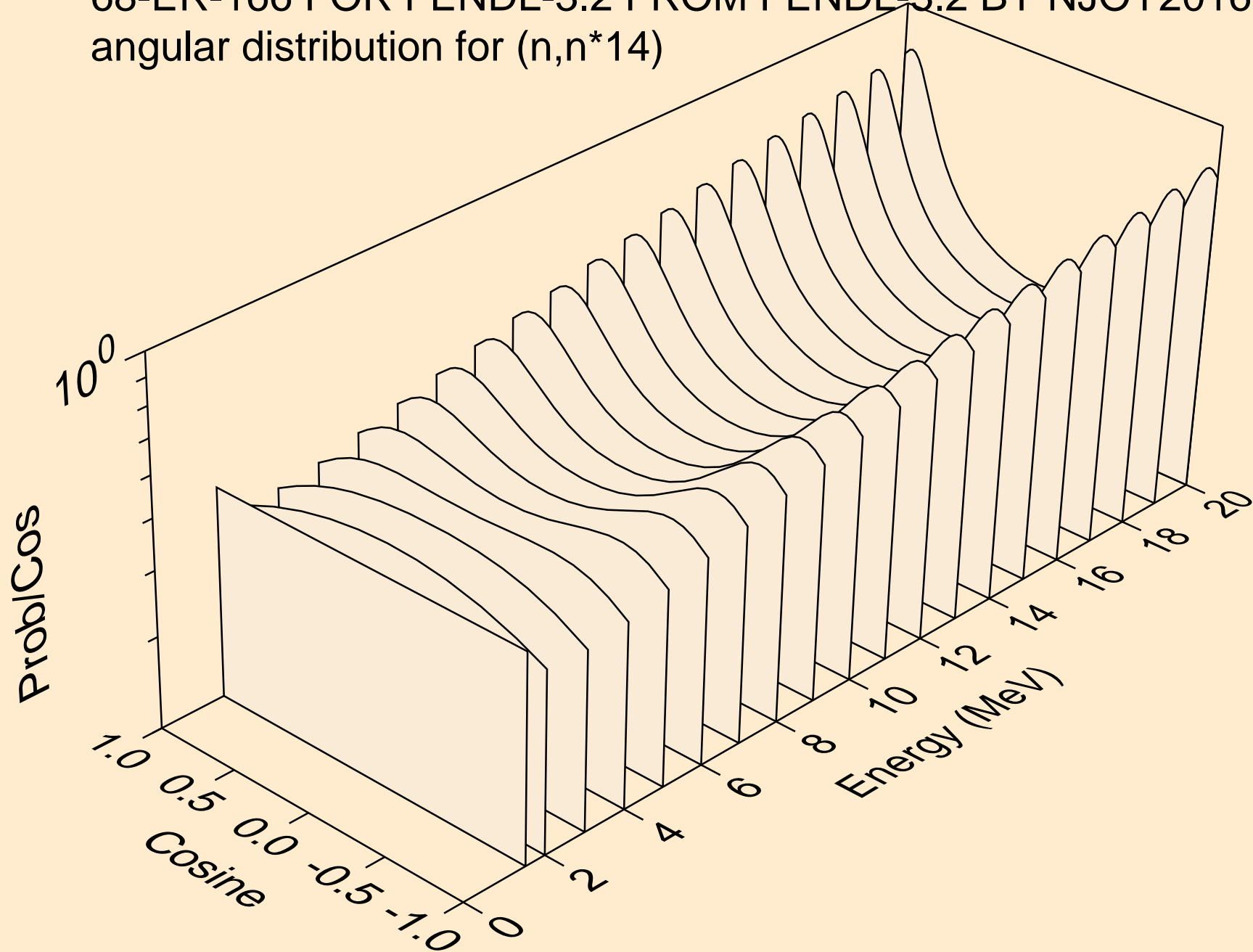

68-ER-166 FOR FENDL-3.2 FROM FENDL-3.2 BY NJOY2016.60+ C  
angular distribution for (n,n\*15)

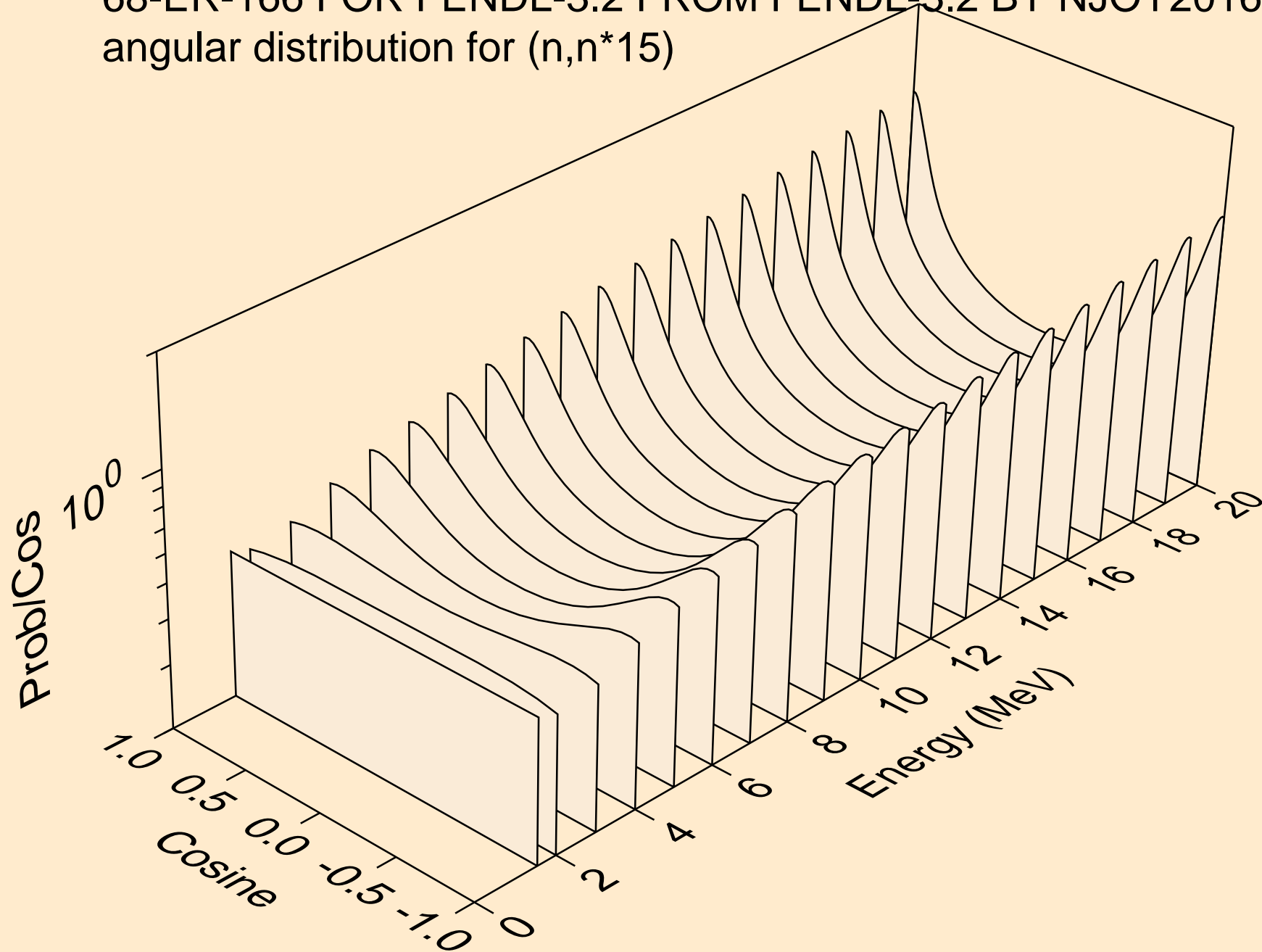

68-ER-166 FOR FENDL-3.2 FROM FENDL-3.2 BY NJOY2016.60+ C  
angular distribution for (n,n\*16)

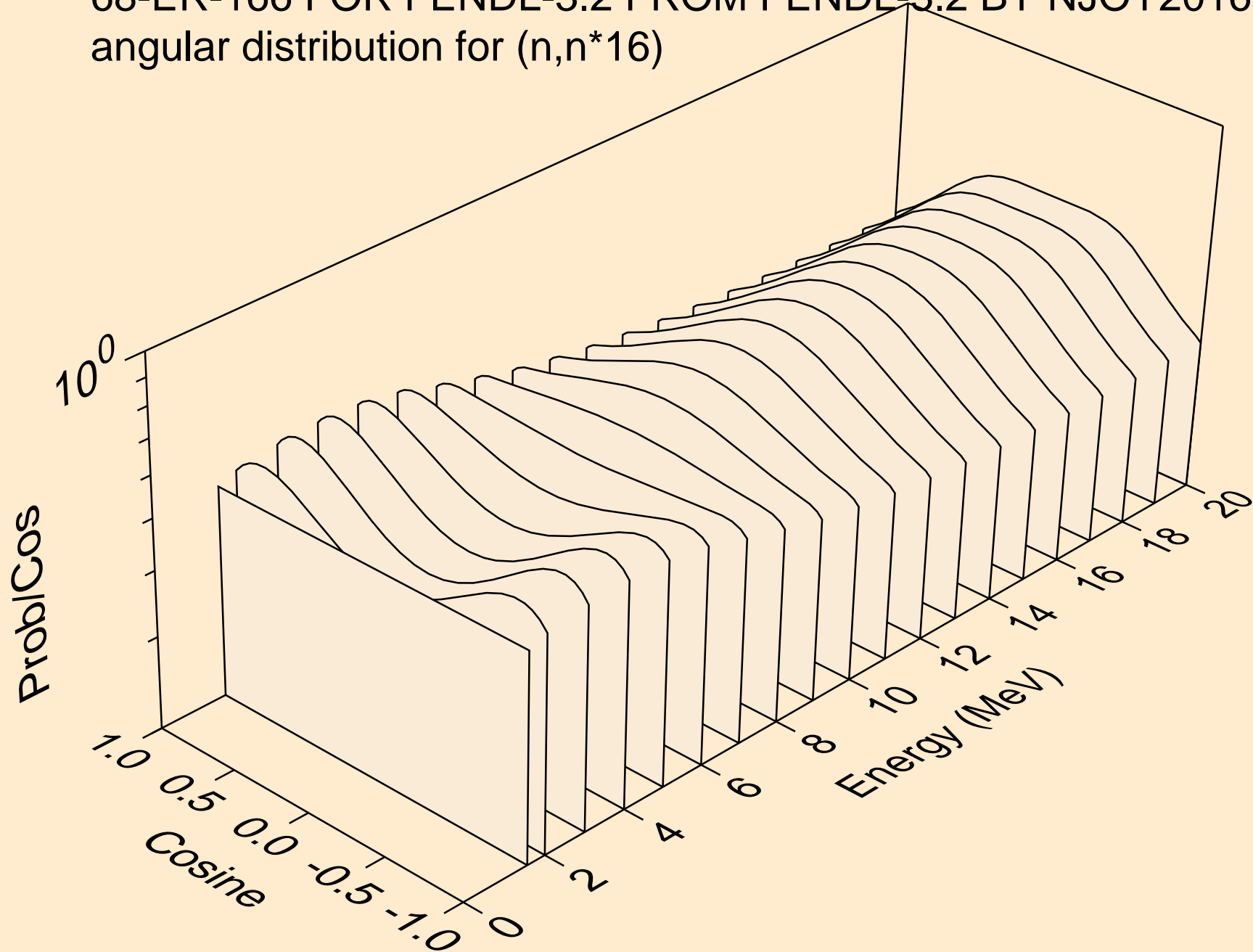

68-ER-166 FOR FENDL-3.2 FROM FENDL-3.2 BY NJOY2016.60+ C  
angular distribution for (n,n\*17)

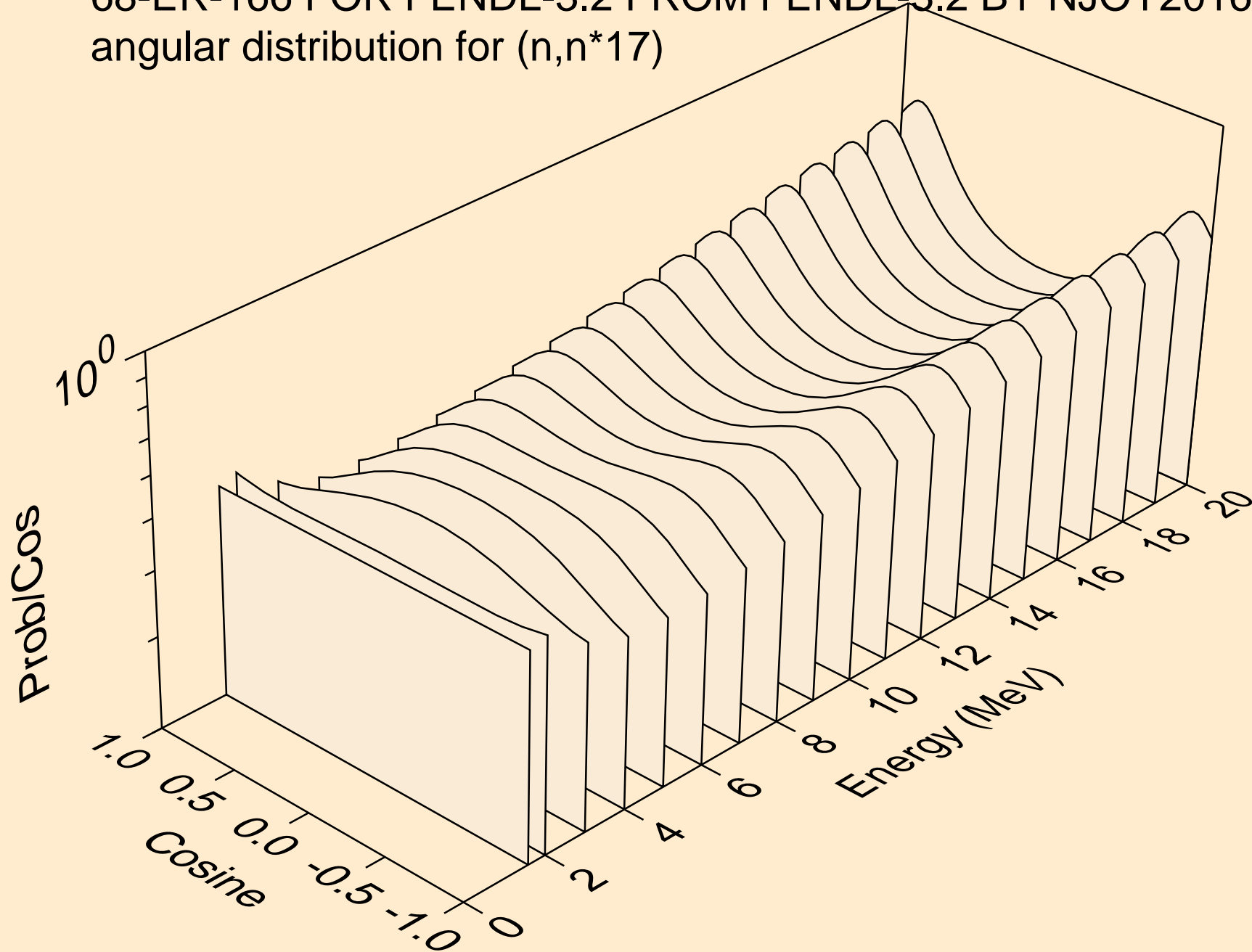

68-ER-166 FOR FENDL-3.2 FROM FENDL-3.2 BY NJOY2016.60+ C  
angular distribution for (n,n\*18)

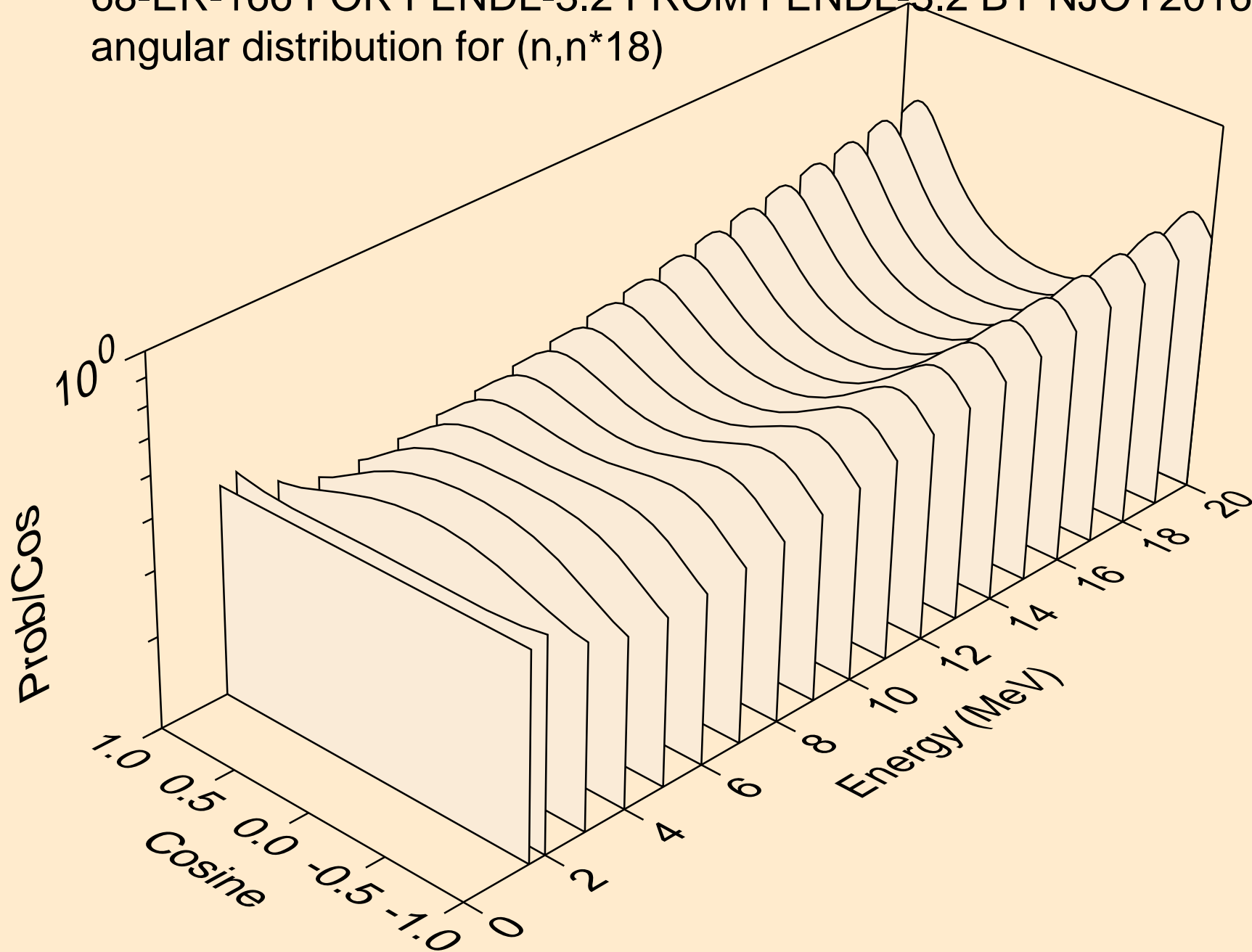

68-ER-166 FOR FENDL-3.2 FROM FENDL-3.2 BY NJOY2016.60+ C  
angular distribution for (n,n\*19)

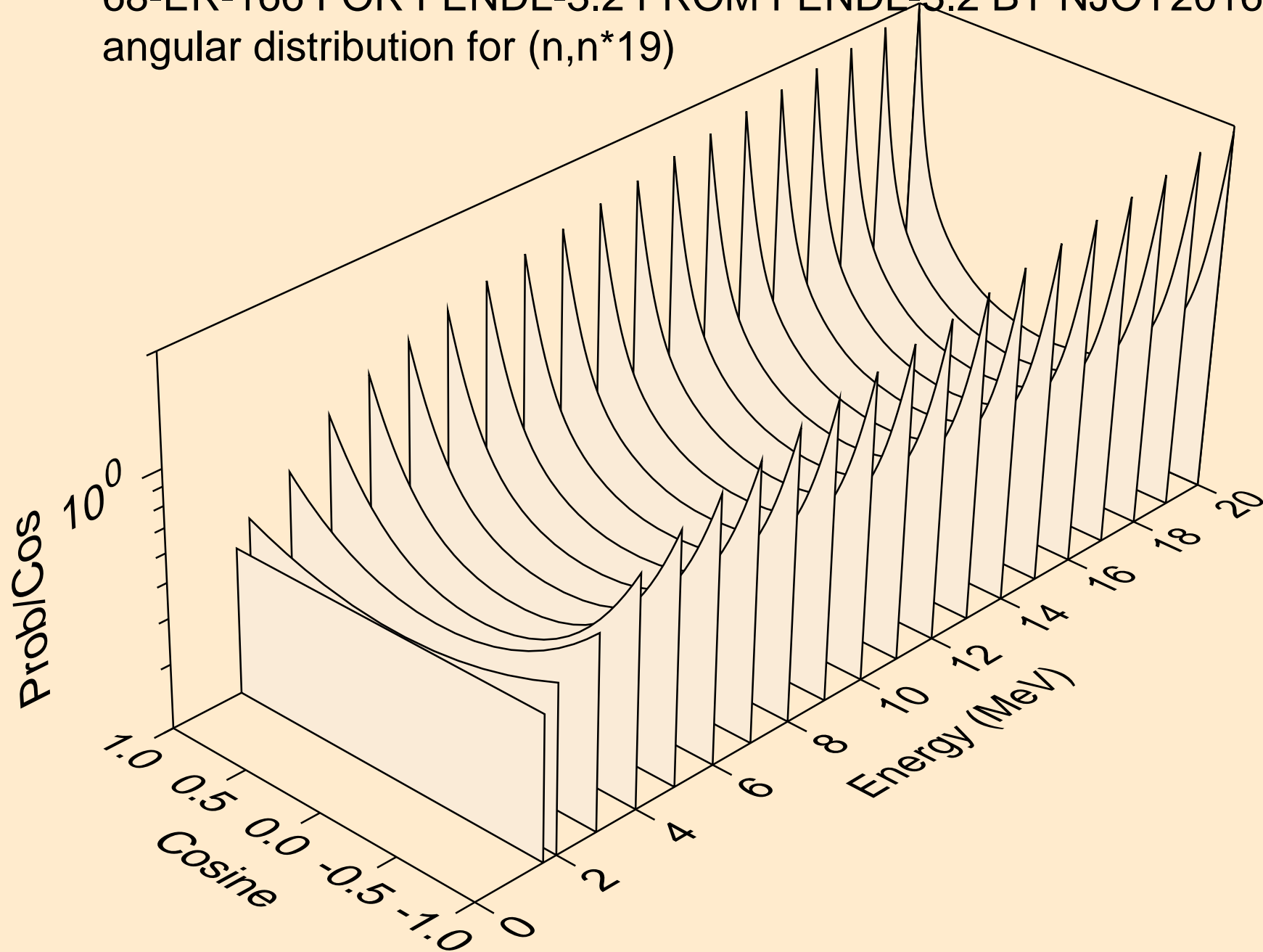

68-ER-166 FOR FENDL-3.2 FROM FENDL-3.2 BY NJOY2016.60+ C  
angular distribution for (n,n\*20)

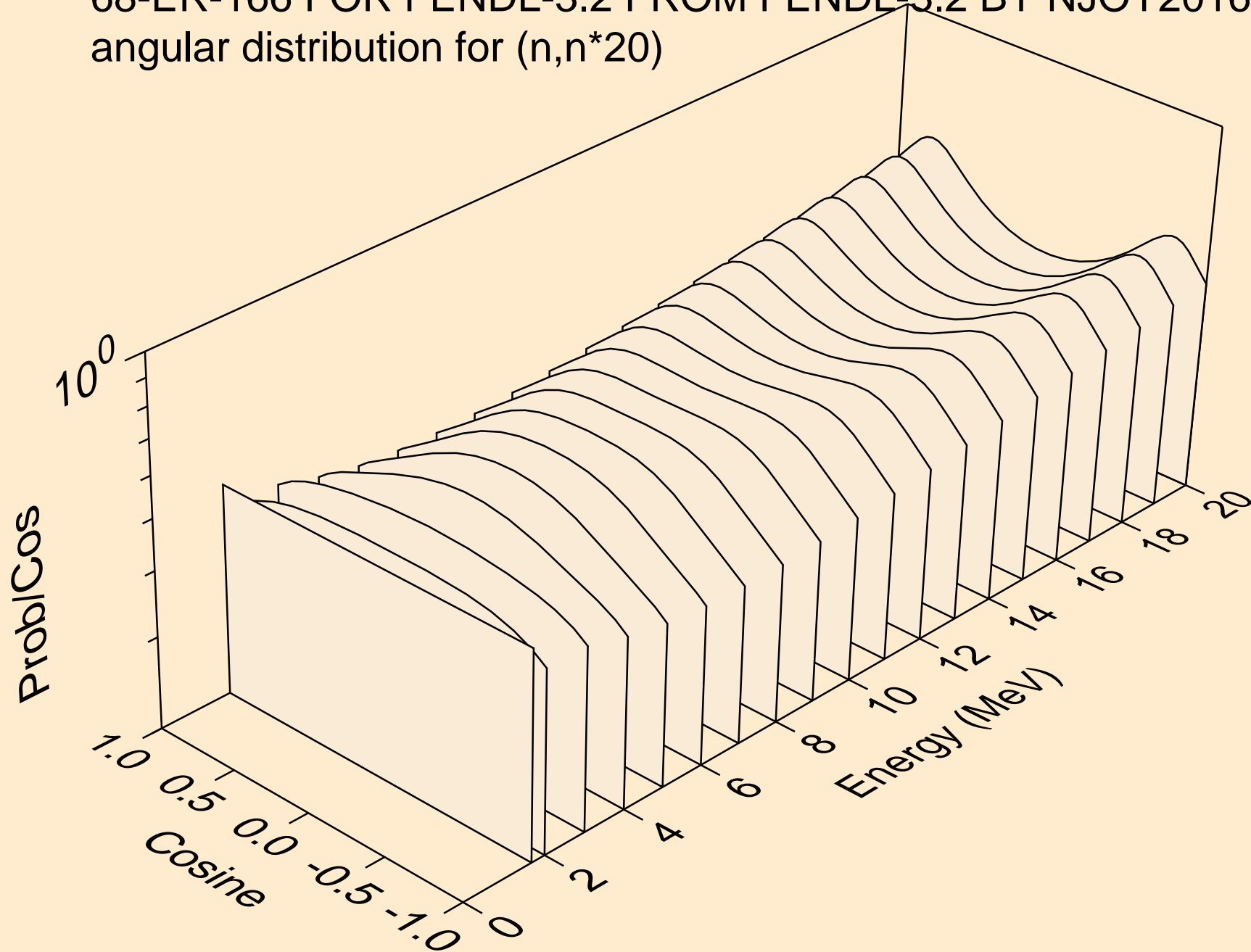

68-ER-166 FOR FENDL-3.2 FROM FENDL-3.2 BY NJOY2016.60+ C  
angular distribution for (n,n\*21)

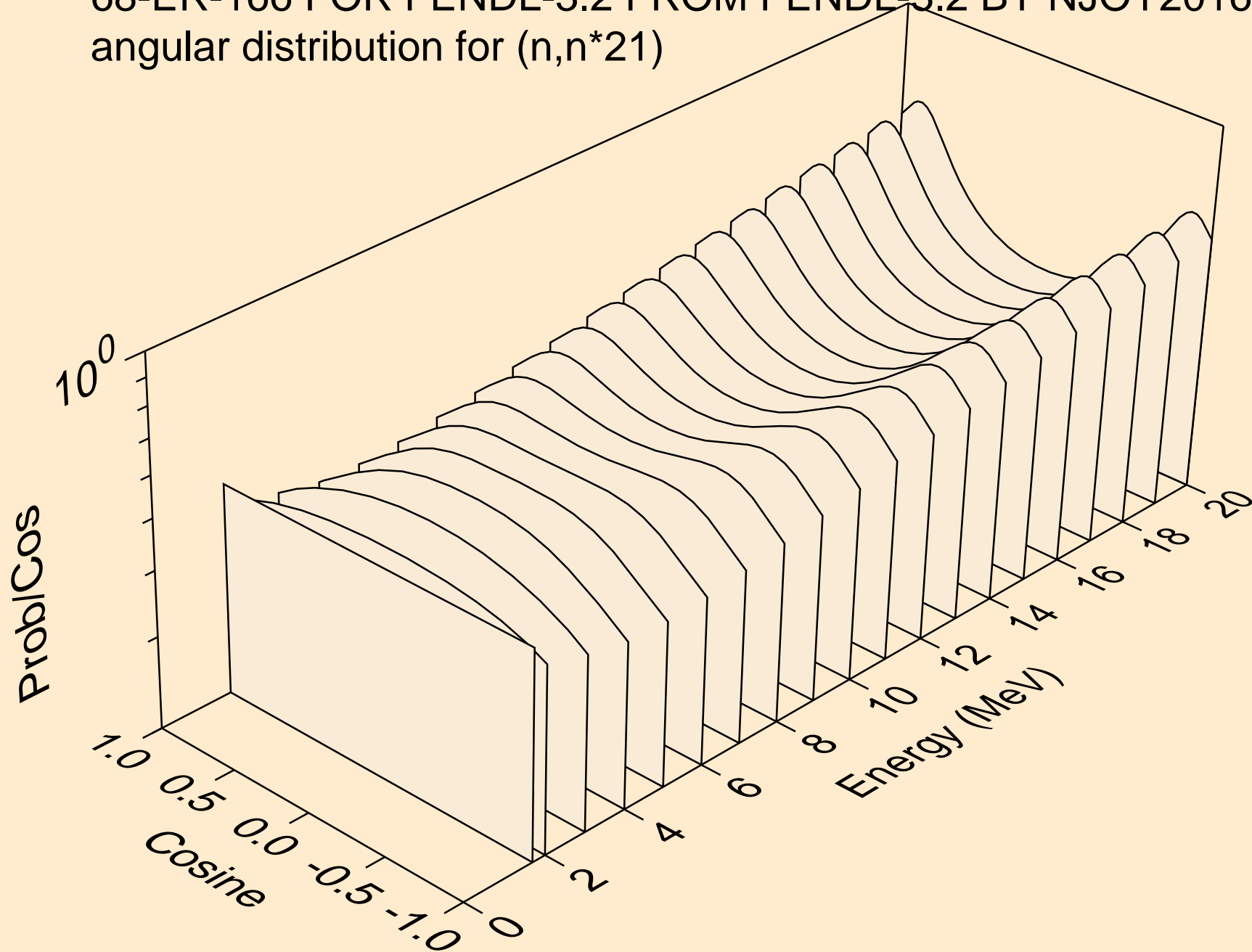



68-ER-166 FOR FENDL-3.2 FROM FENDL-3.2 BY NJOY2016.60+ C  
angular distribution for (n,n\*22)

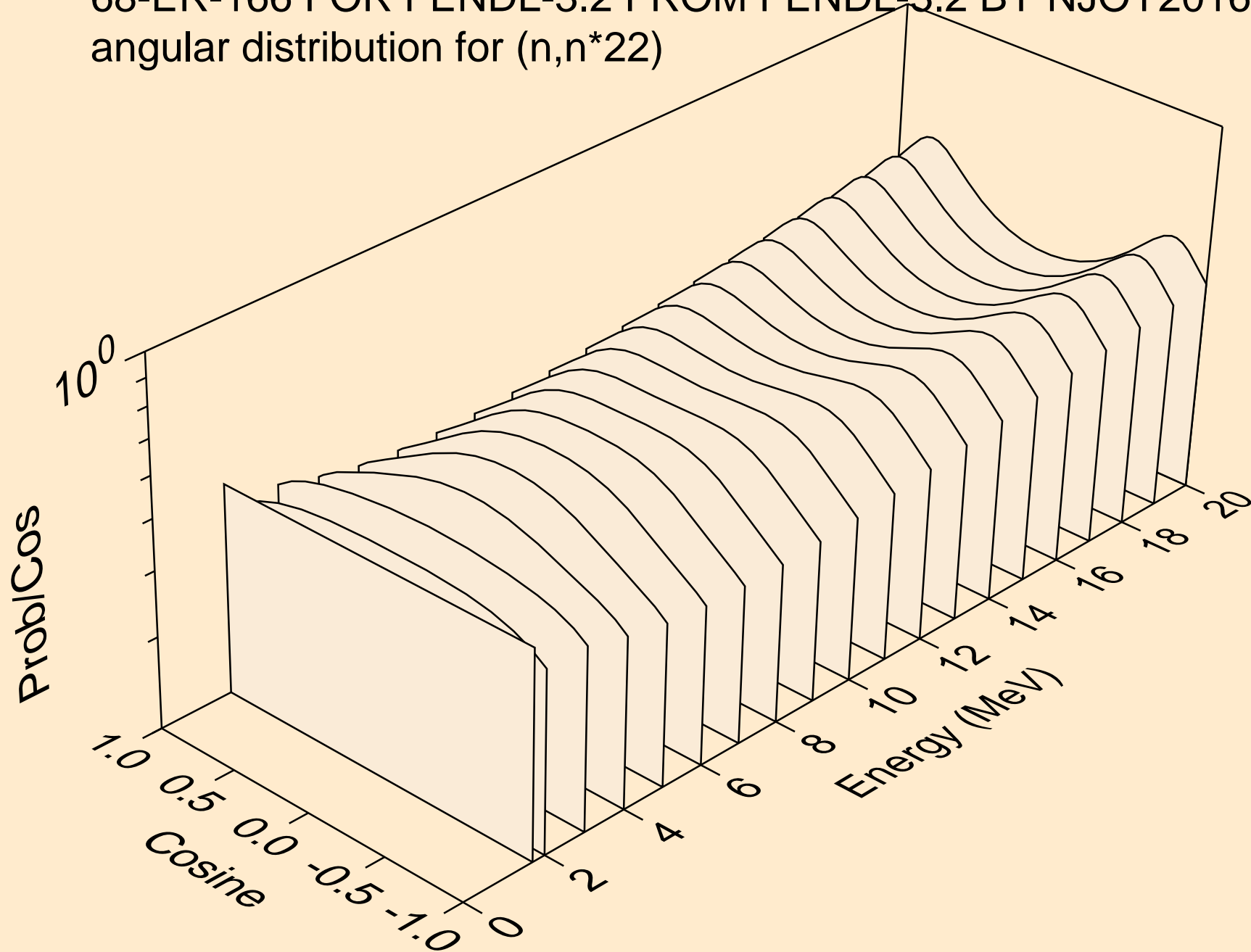

68-ER-166 FOR FENDL-3.2 FROM FENDL-3.2 BY NJOY2016.60+ C  
angular distribution for (n,n\*23)

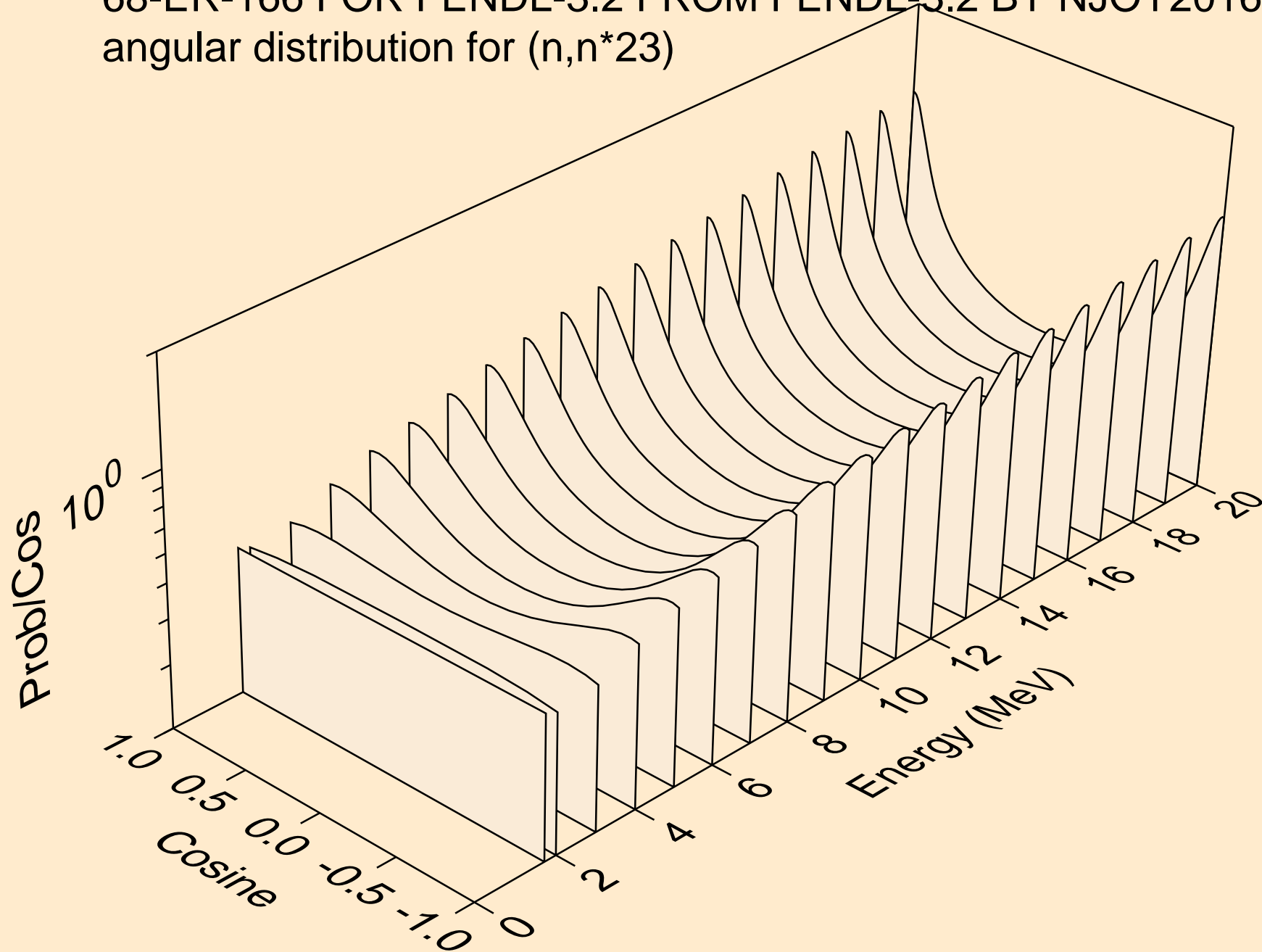

68-ER-166 FOR FENDL-3.2 FROM FENDL-3.2 BY NJOY2016.60+ C  
angular distribution for (n,n\*24)

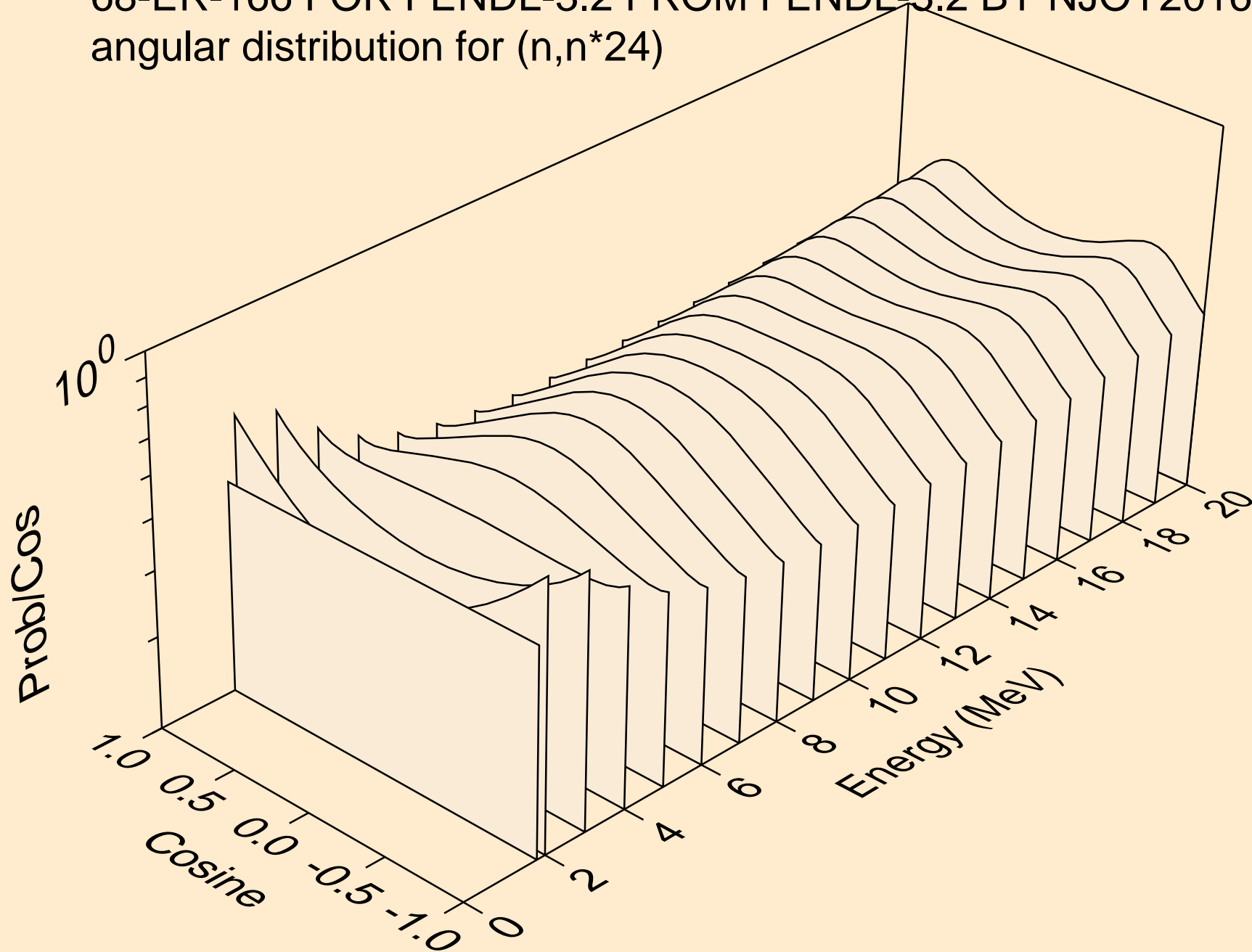

68-ER-166 FOR FENDL-3.2 FROM FENDL-3.2 BY NJOY2016.60+ C  
angular distribution for (n,n\*c)

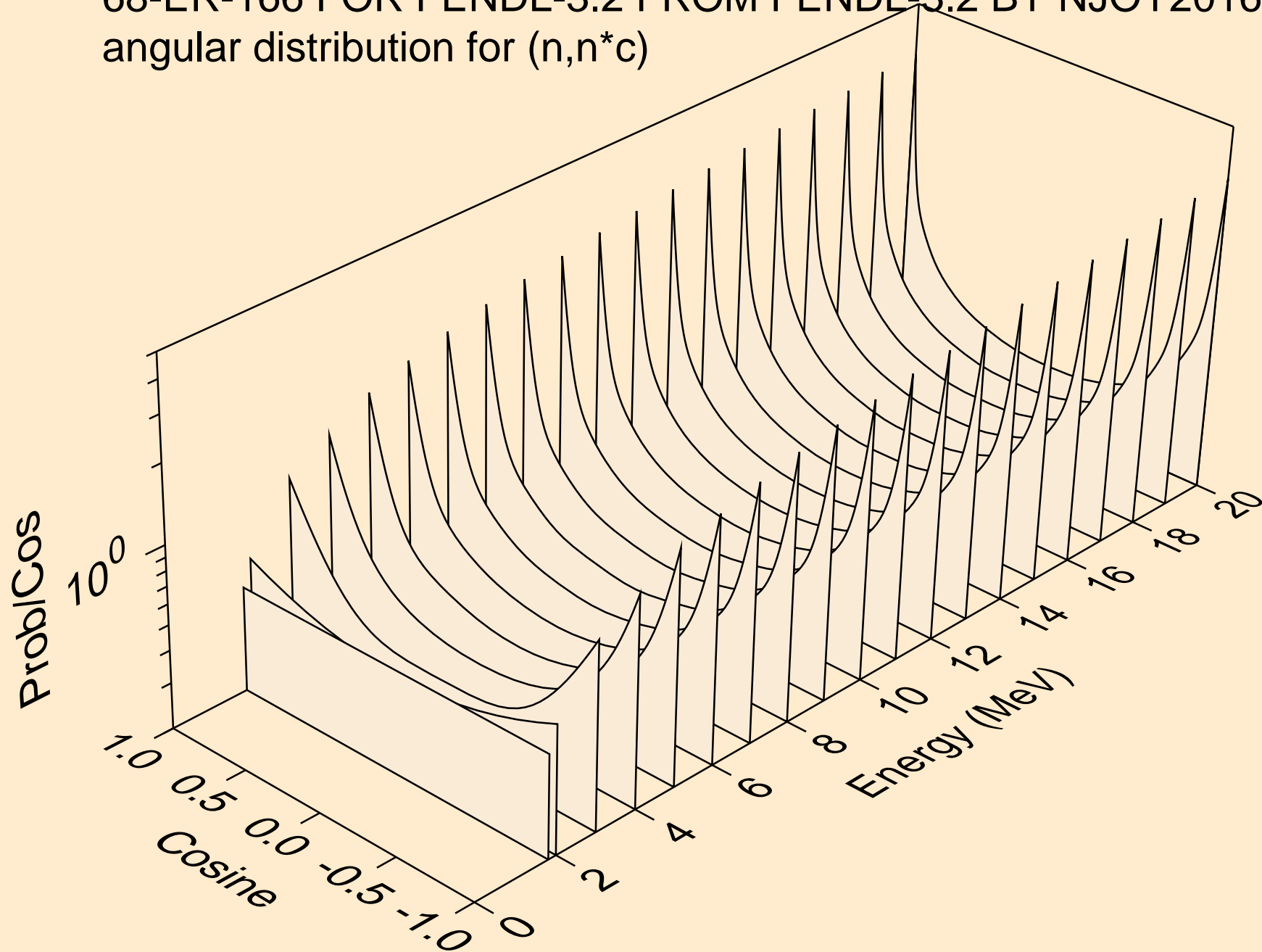

68-ER-166 FOR FENDL-3.2 FROM FENDL-3.2 BY NJOY2016.60+ C  
Neutron emission for (n,x)

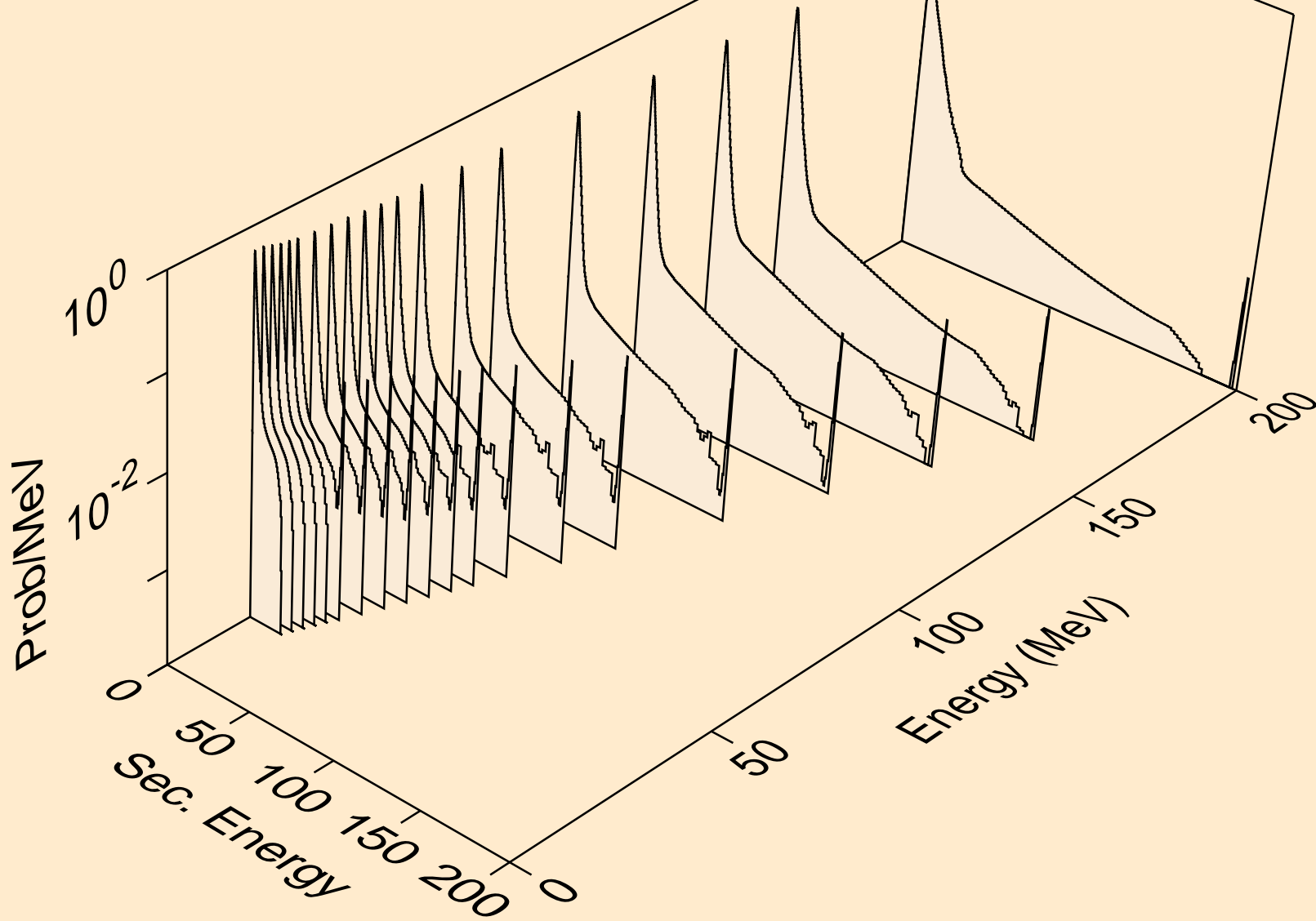

68-ER-166 FOR FENDL-3.2 FROM FENDL-3.2 BY NJOY2016.60+ C  
Neutron emission for (n,2n)

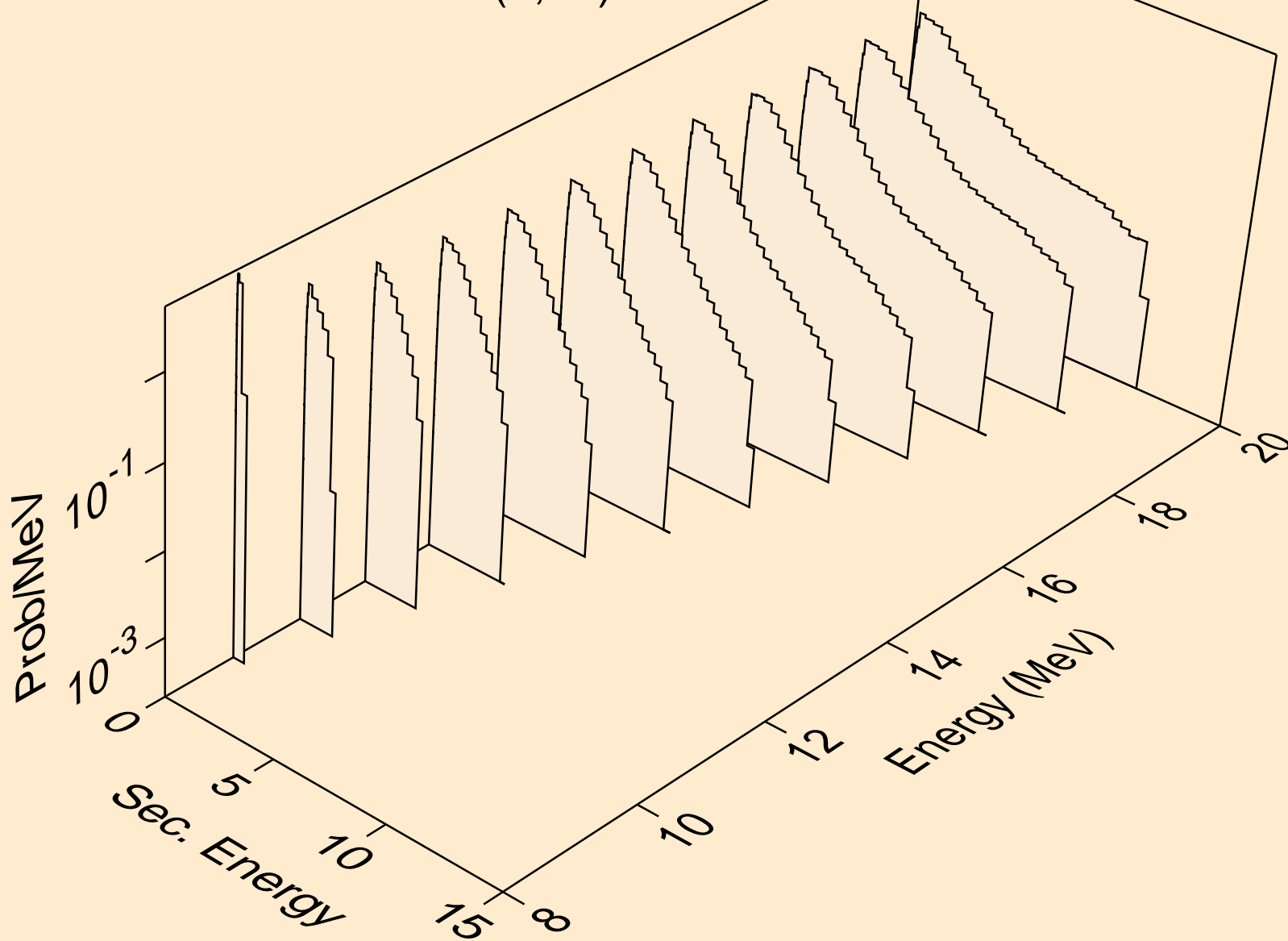

68-ER-166 FOR FENDL-3.2 FROM FENDL-3.2 BY NJOY2016.60+ C  
Neutron emission for (n,3n)

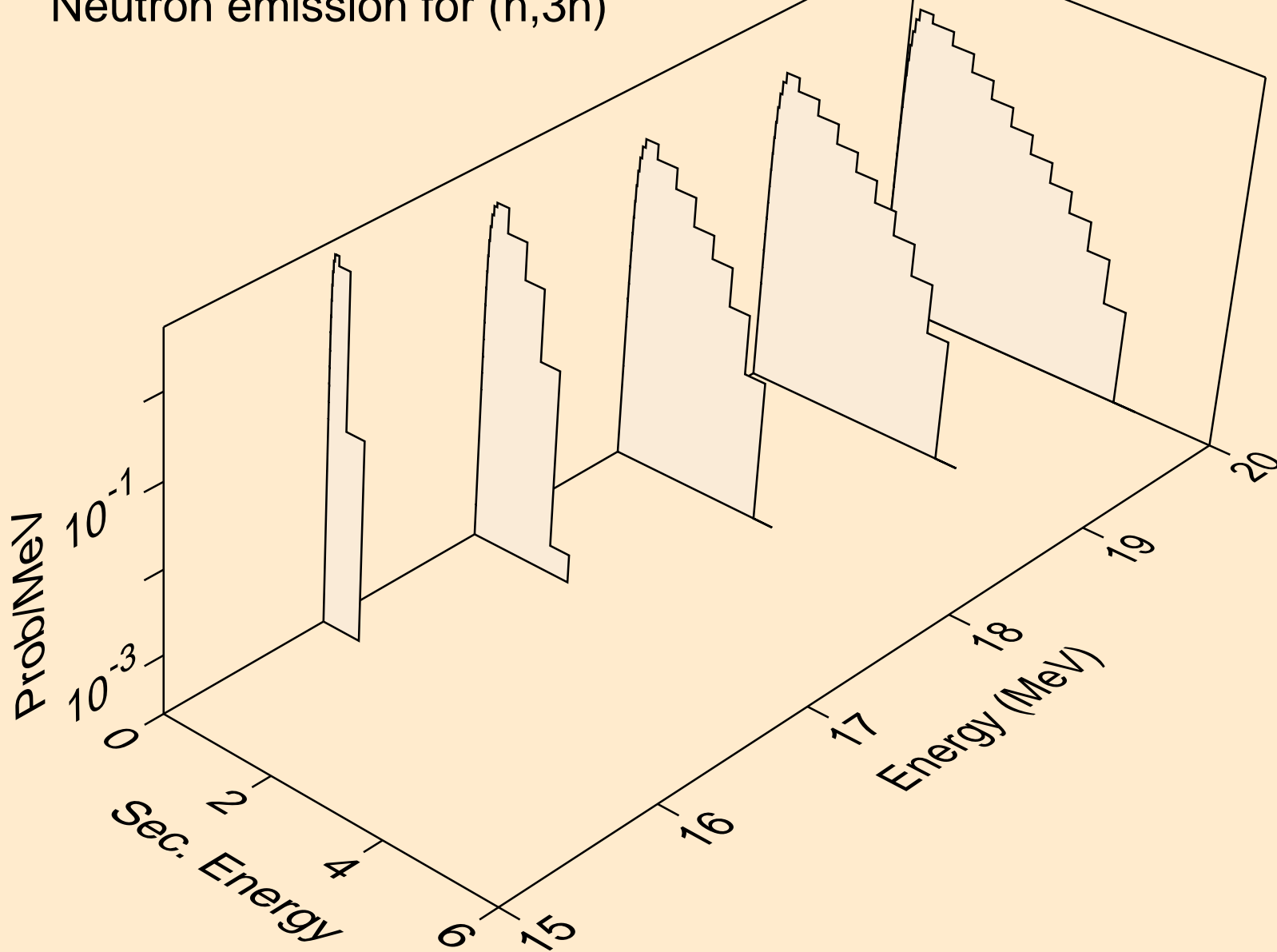

68-ER-166 FOR FENDL-3.2 FROM FENDL-3.2 BY NJOY2016.60+ C  
Neutron emission for (n,n\*)a

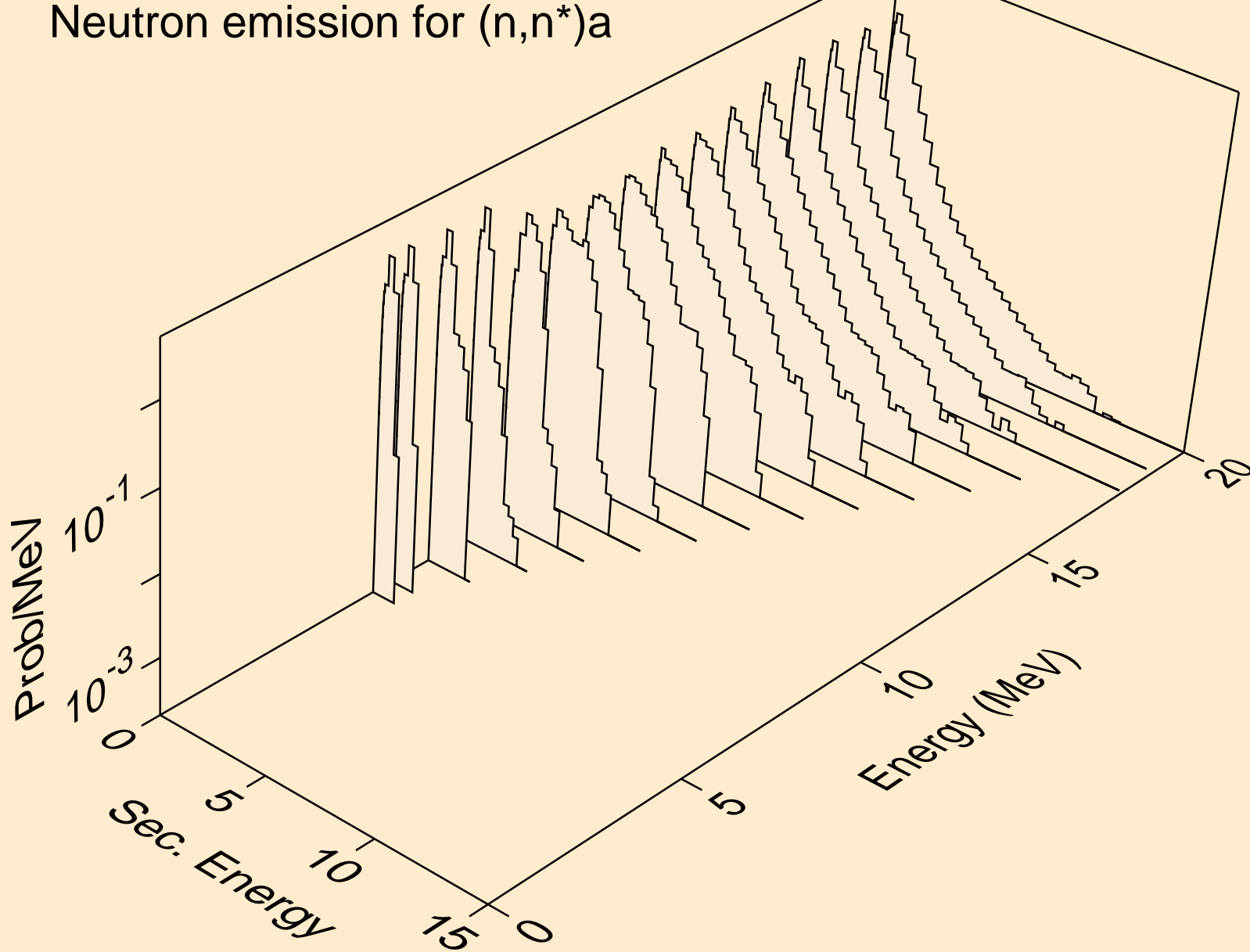



68-ER-166 FOR FENDL-3.2 FROM FENDL-3.2 BY NJOY2016.60+ C  
Neutron emission for (n,n\*)p

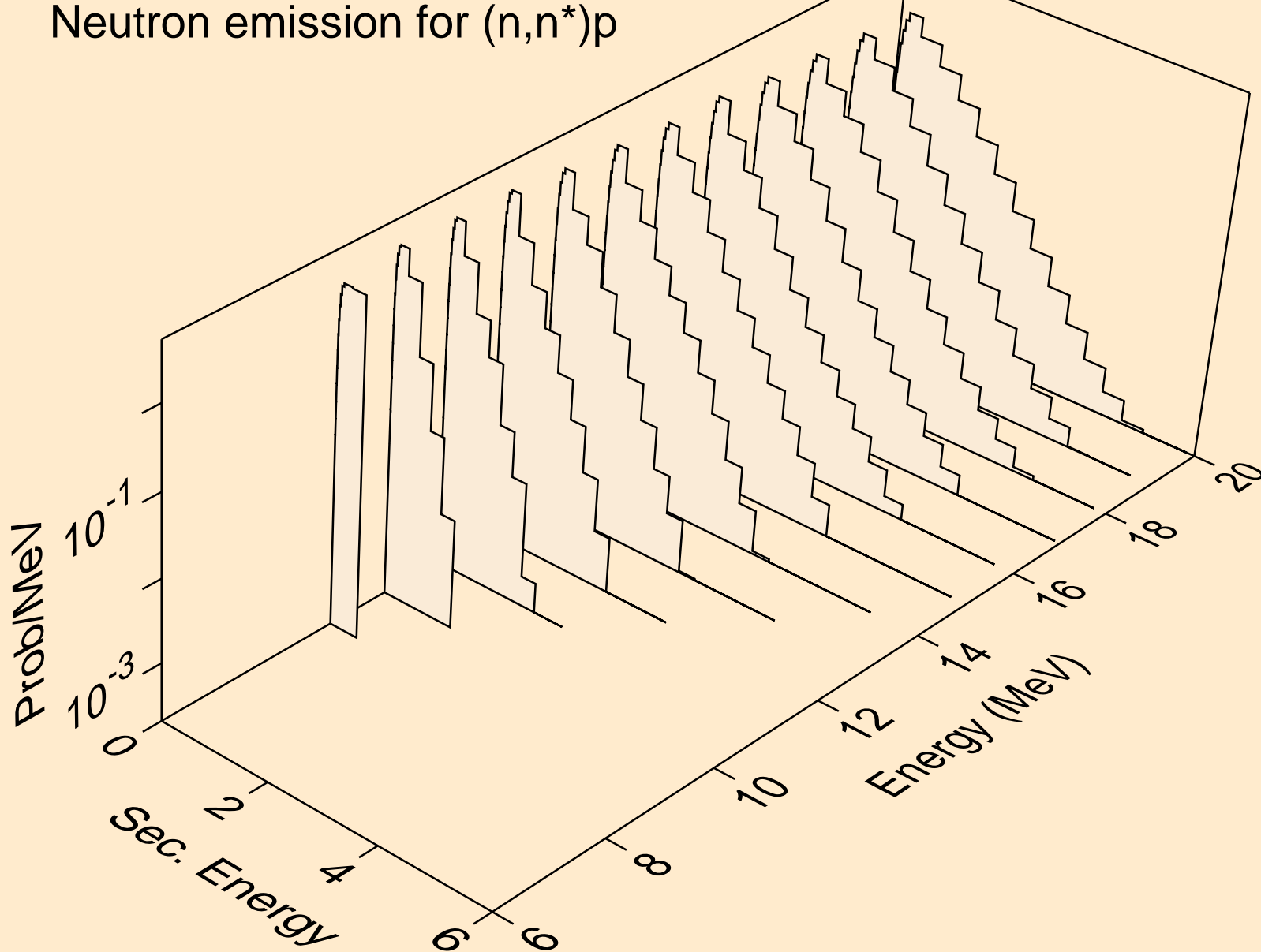

68-ER-166 FOR FENDL-3.2 FROM FENDL-3.2 BY NJOY2016.60+ C  
Neutron emission for (n,n\*)d

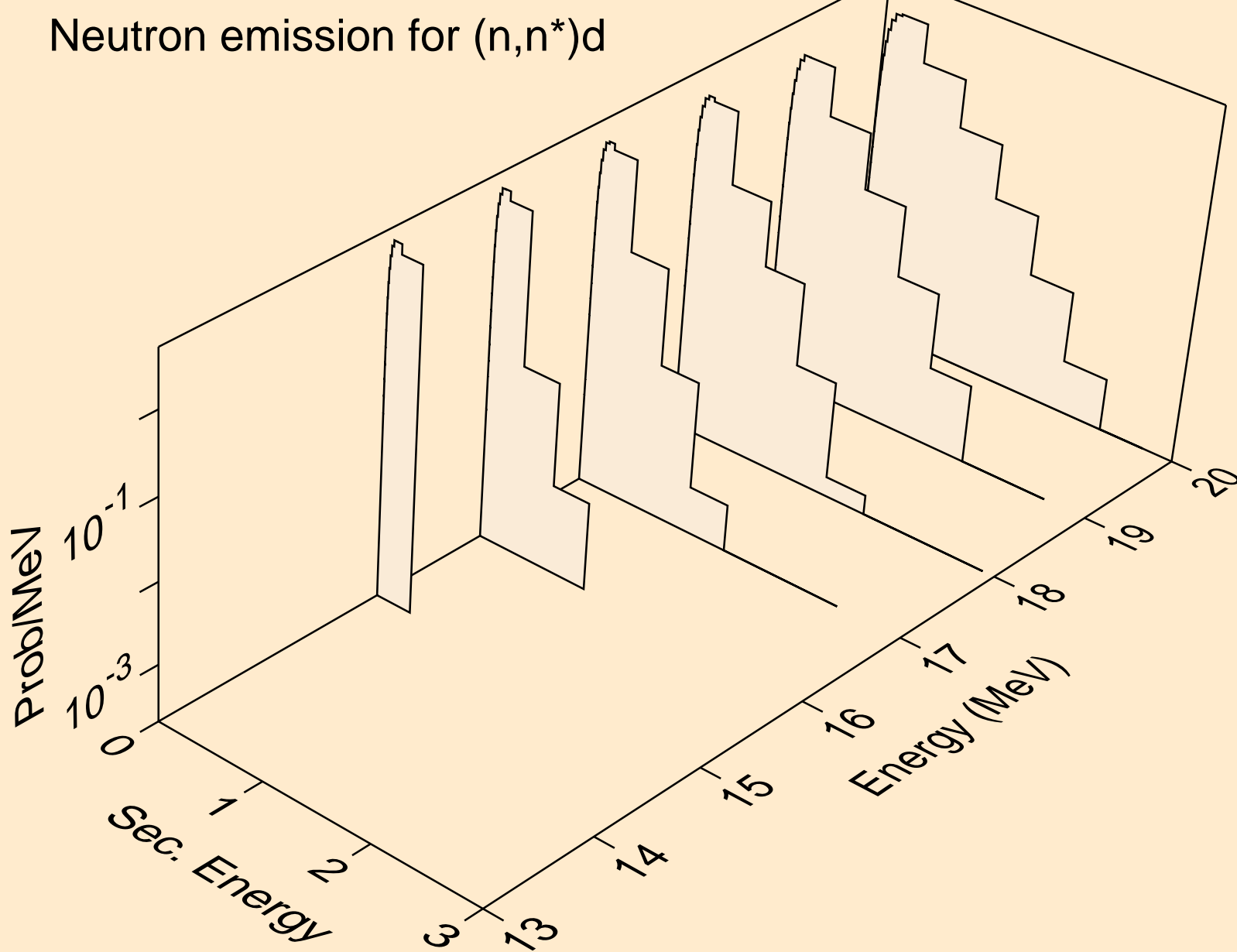

68-ER-166 FOR FENDL-3.2 FROM FENDL-3.2 BY NJOY2016.60+ C  
Neutron emission for (n,n\*c)

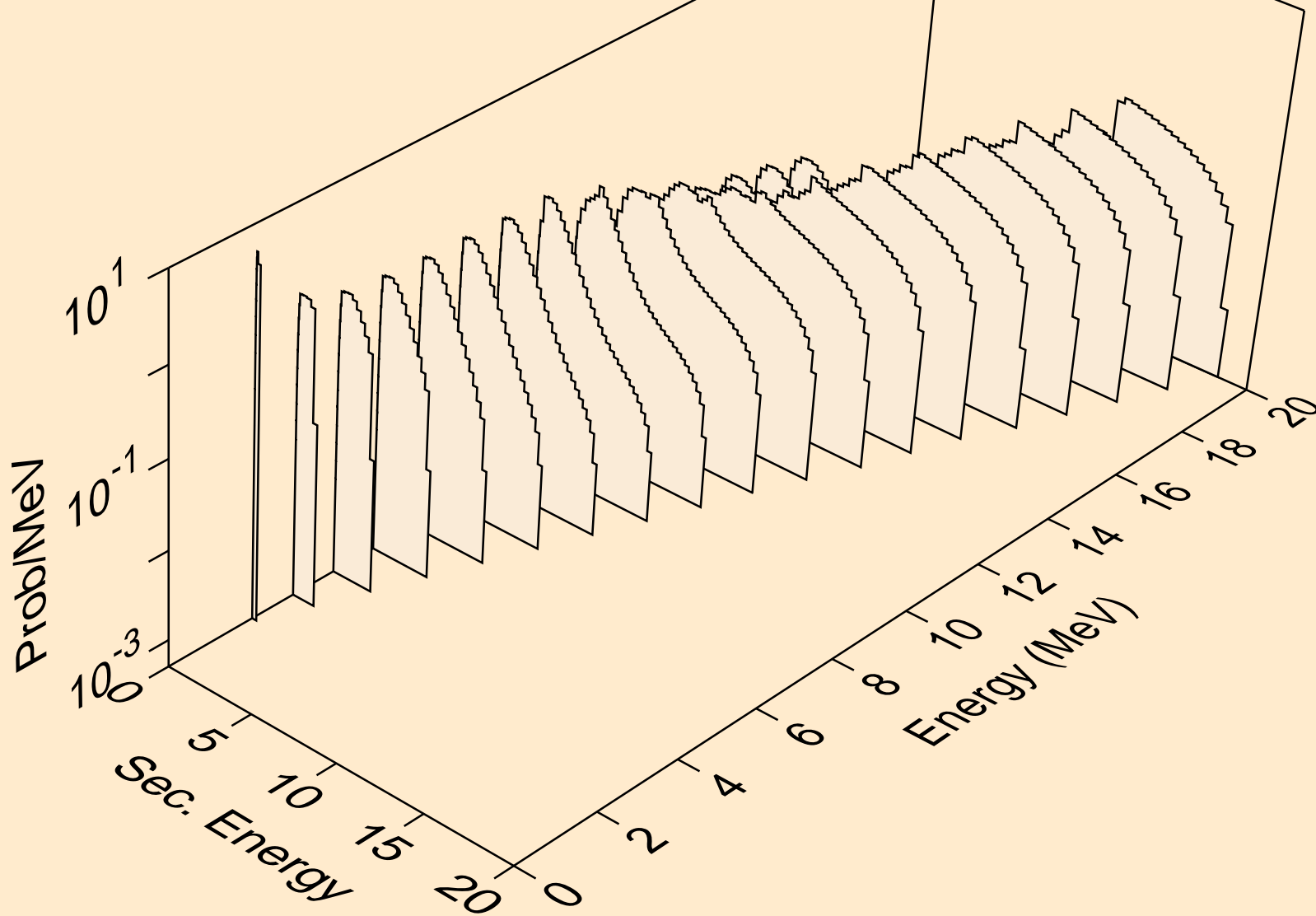

68-ER-166 FOR FENDL-3.2 FROM FENDL-3.2 BY NJOY2016.60+ C  
Photon emission for (n,2n)

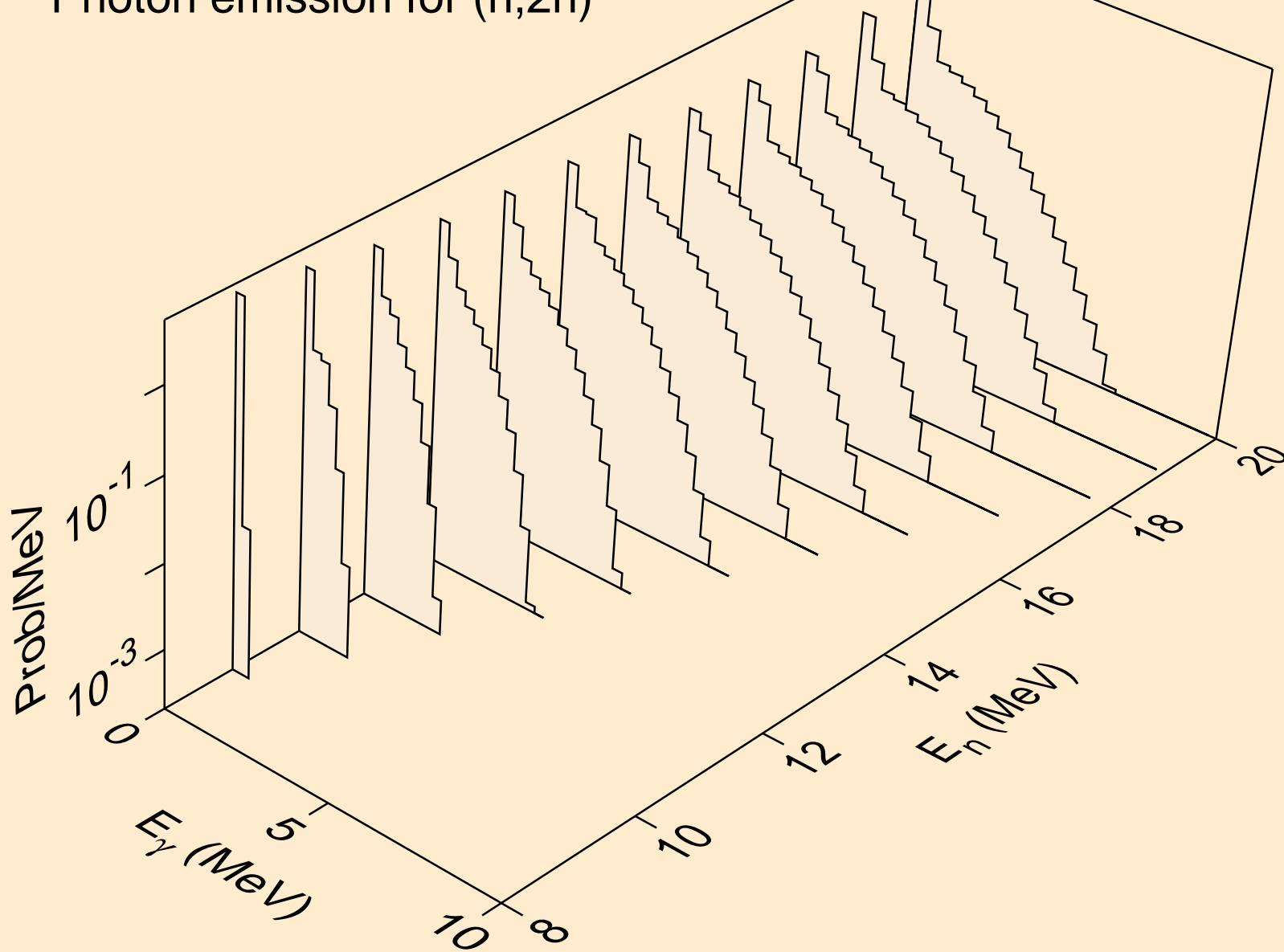

68-ER-166 FOR FENDL-3.2 FROM FENDL-3.2 BY NJOY2016.60+ C  
Photon emission for (n,3n)

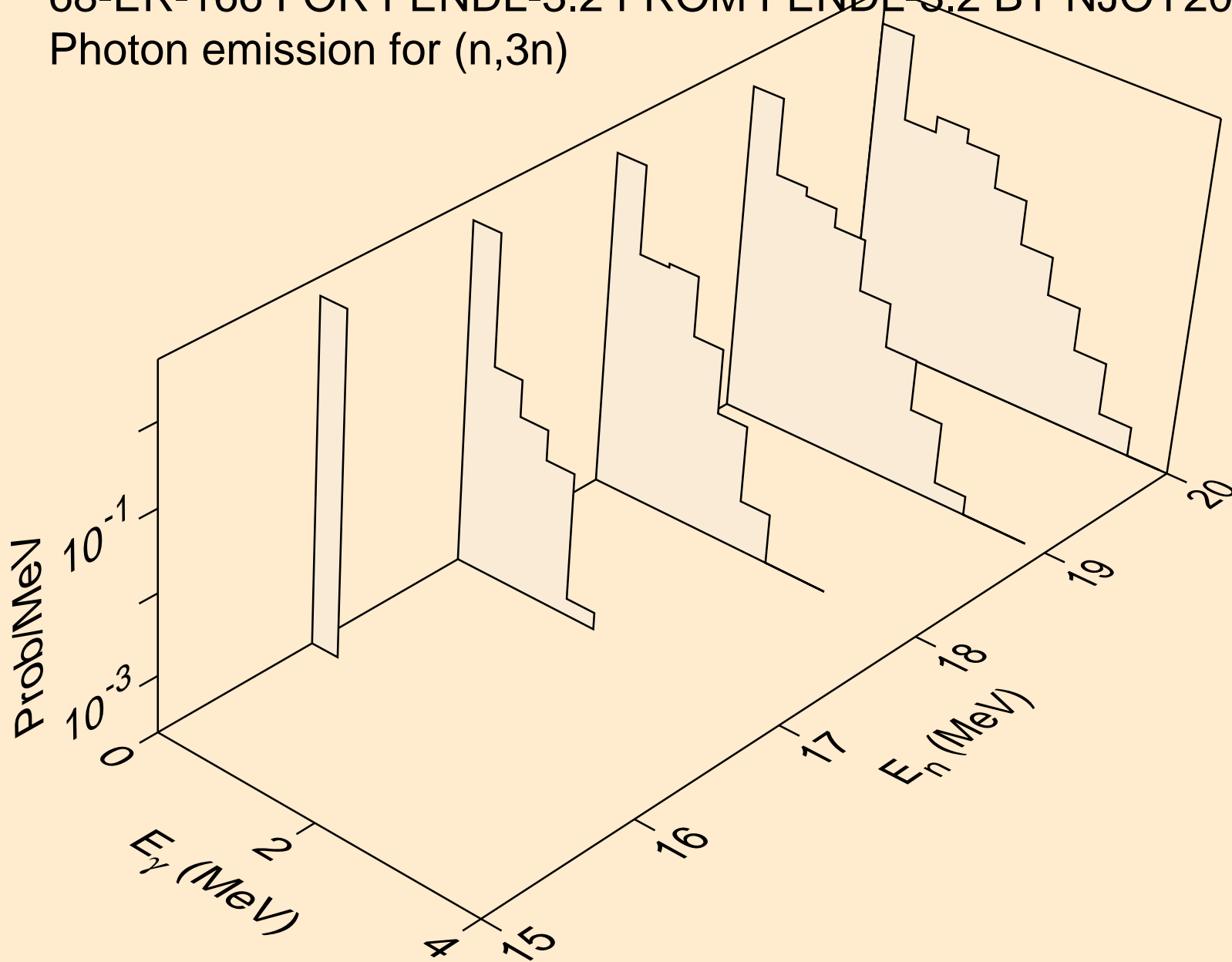

68-ER-166 FOR FENDL-3.2 FROM FENDL-3.2 BY NJOY2016.60+ C  
Photon emission for (n,n\*)a

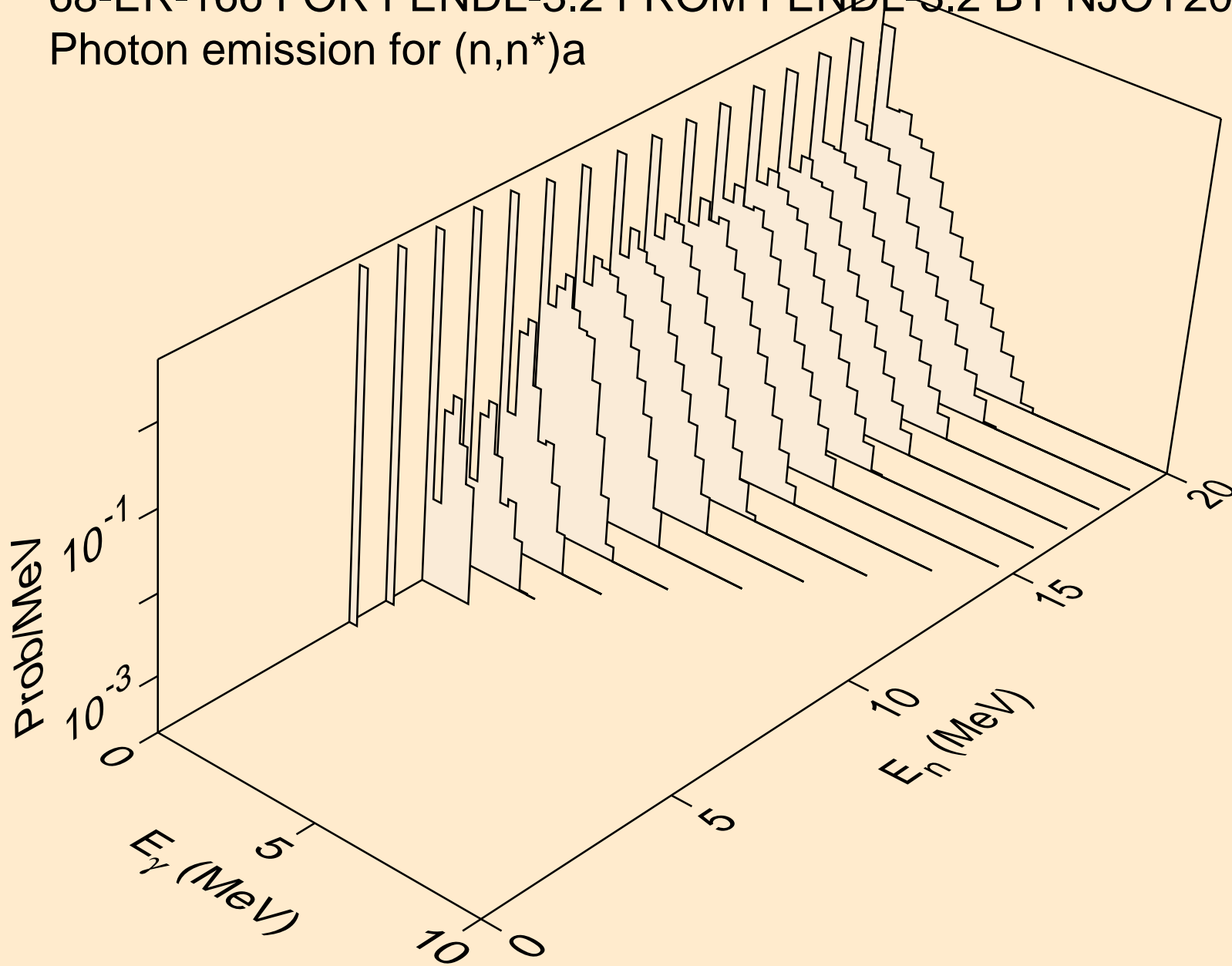

68-ER-166 FOR FENDL-3.2 FROM FENDL-3.2 BY NJOY2016.60+ C  
Photon emission for (n,n\*)p

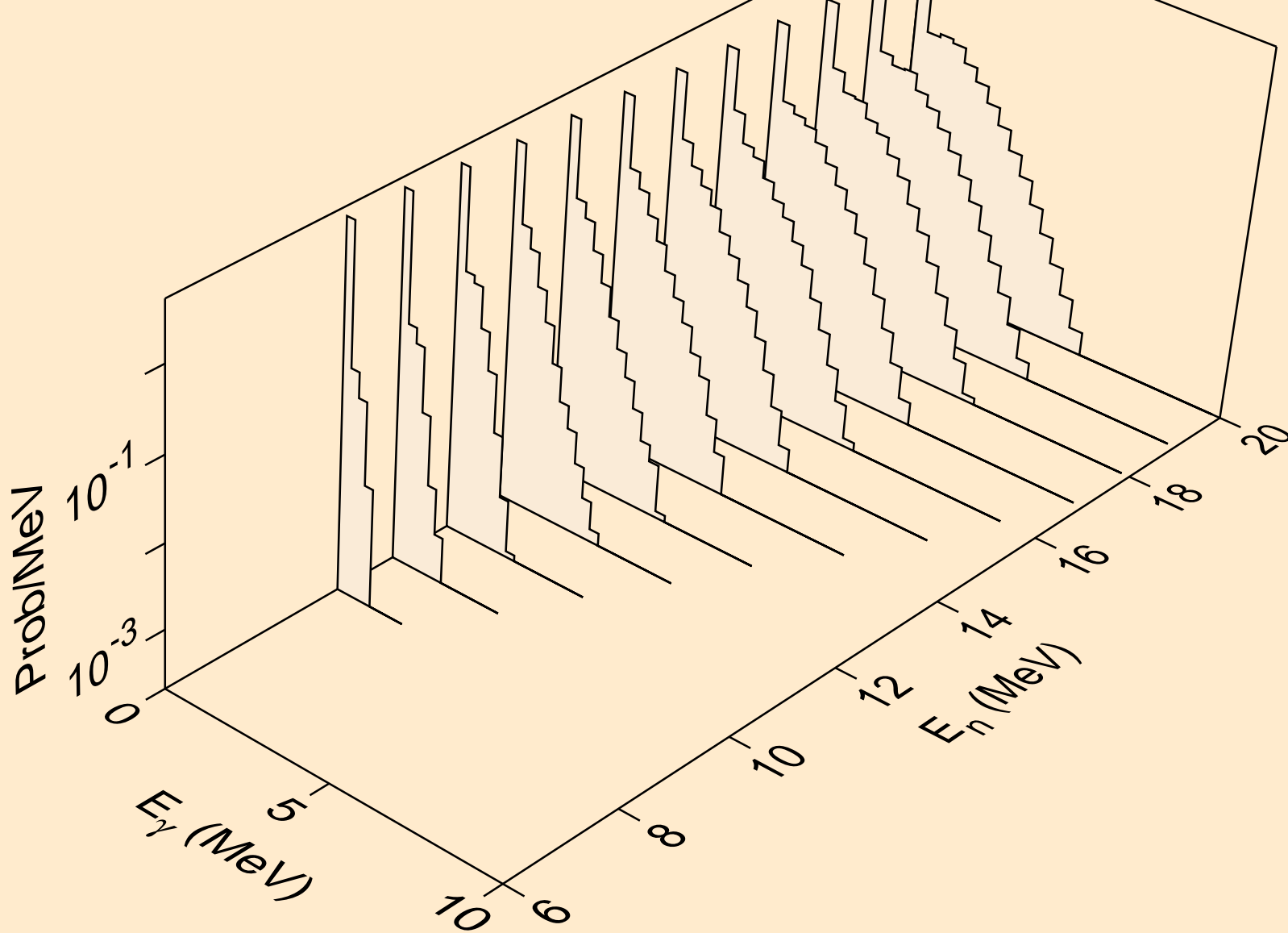

68-ER-166 FOR FENDL-3.2 FROM FENDL-3.2 BY NJOY2016.60+ C  
Photon emission for (n,n\*c)

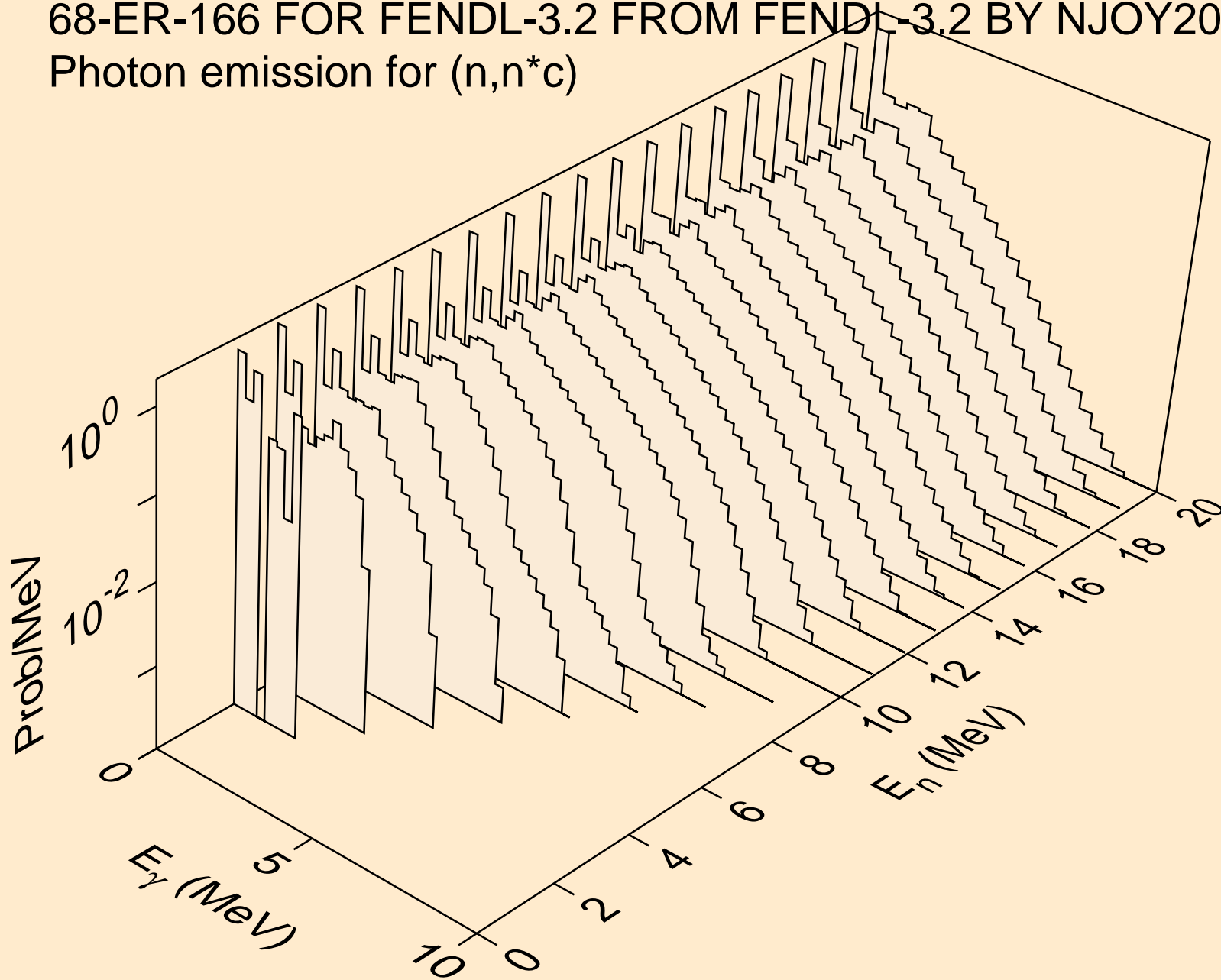



68-ER-166 FOR FENDL-3.2 FROM FENDL-3.2 BY NJOY2016.60+ C  
Photon emission for (n,gma)

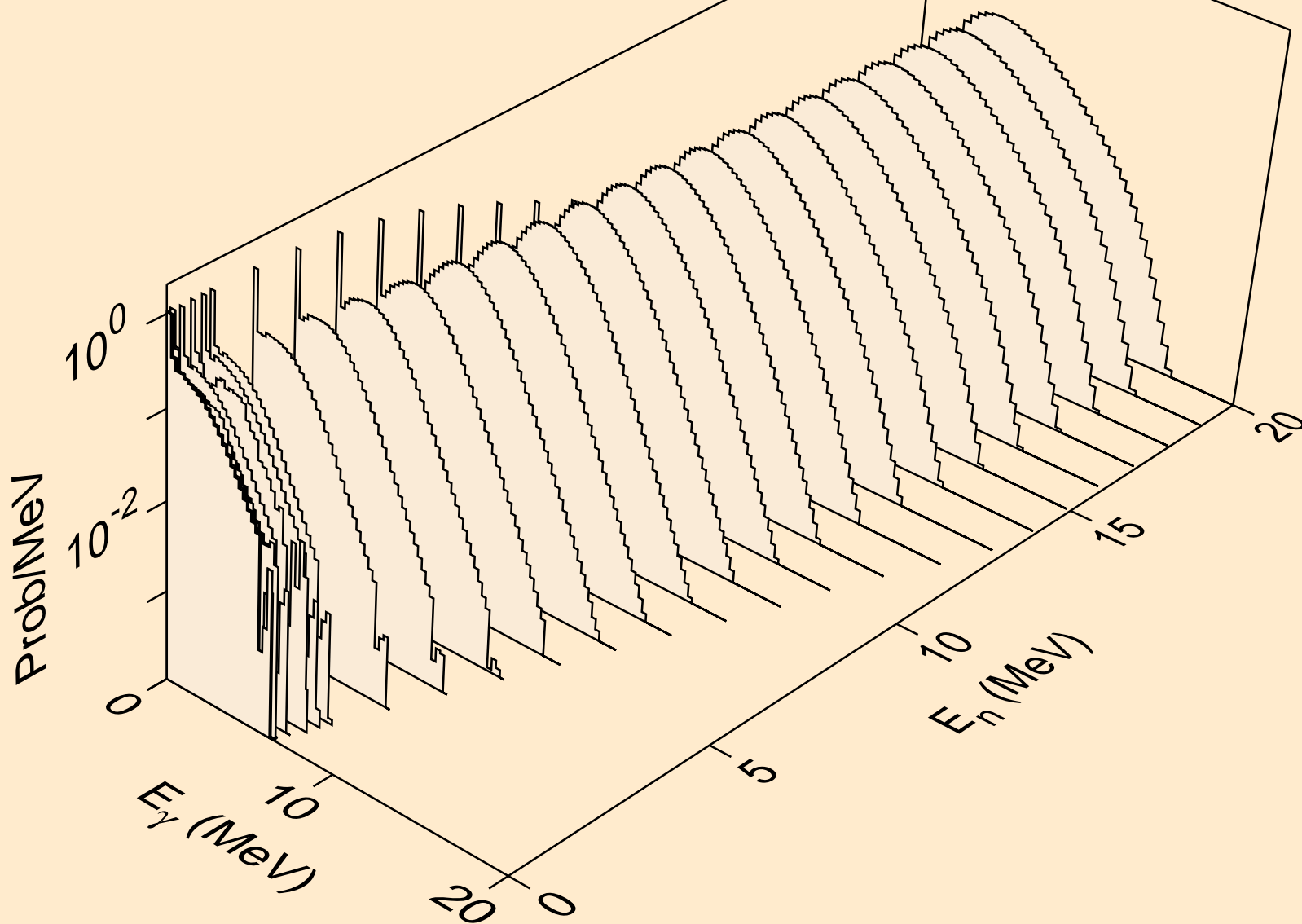

68-ER-166 FOR FENDL-3.2 FROM FENDL-3.2 BY NJOY2016.60+ C  
Photon emission for (n,p)

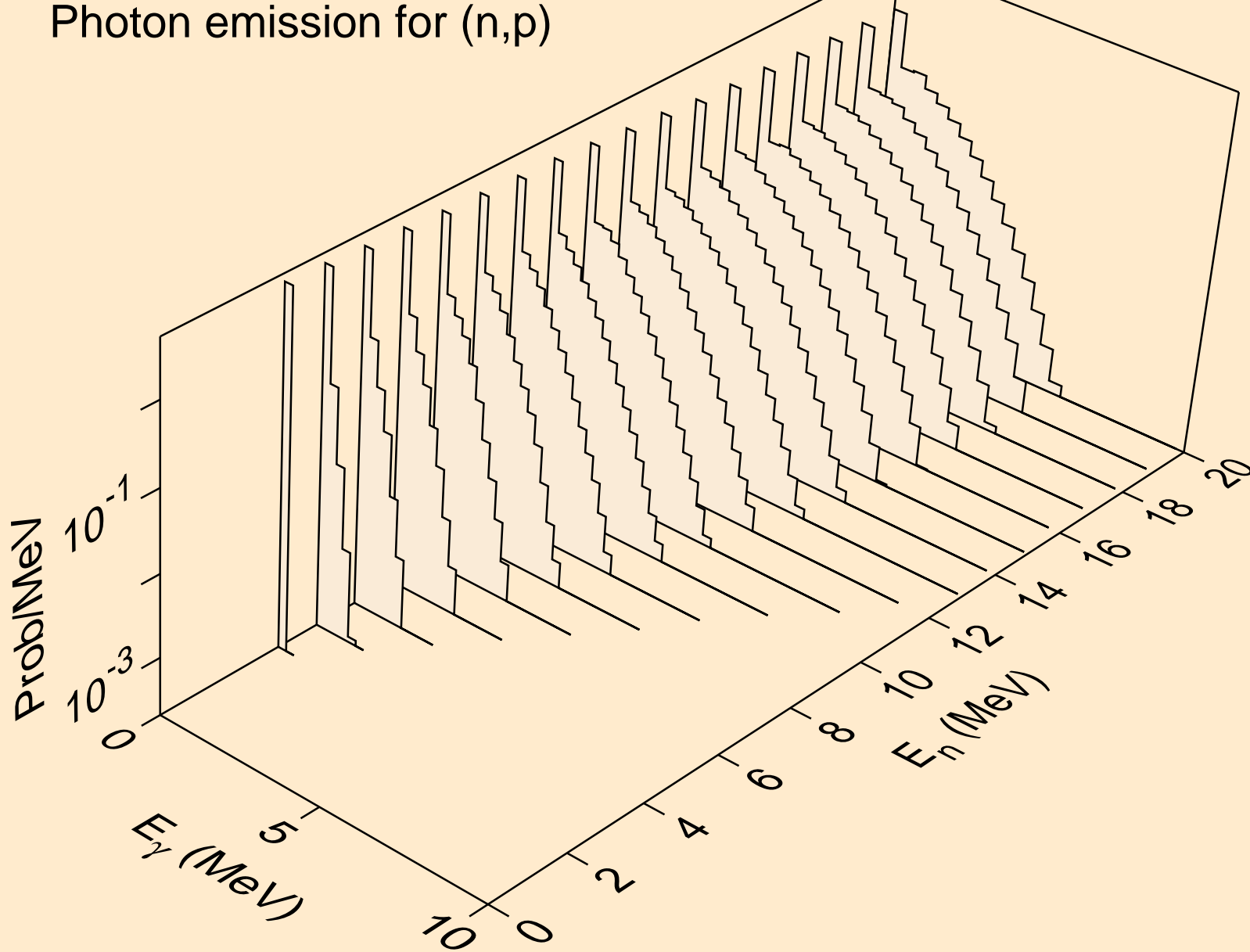

68-ER-166 FOR FENDL-3.2 FROM FENDL-3.2 BY NJOY2016.60+ C  
Photon emission for (n,d)

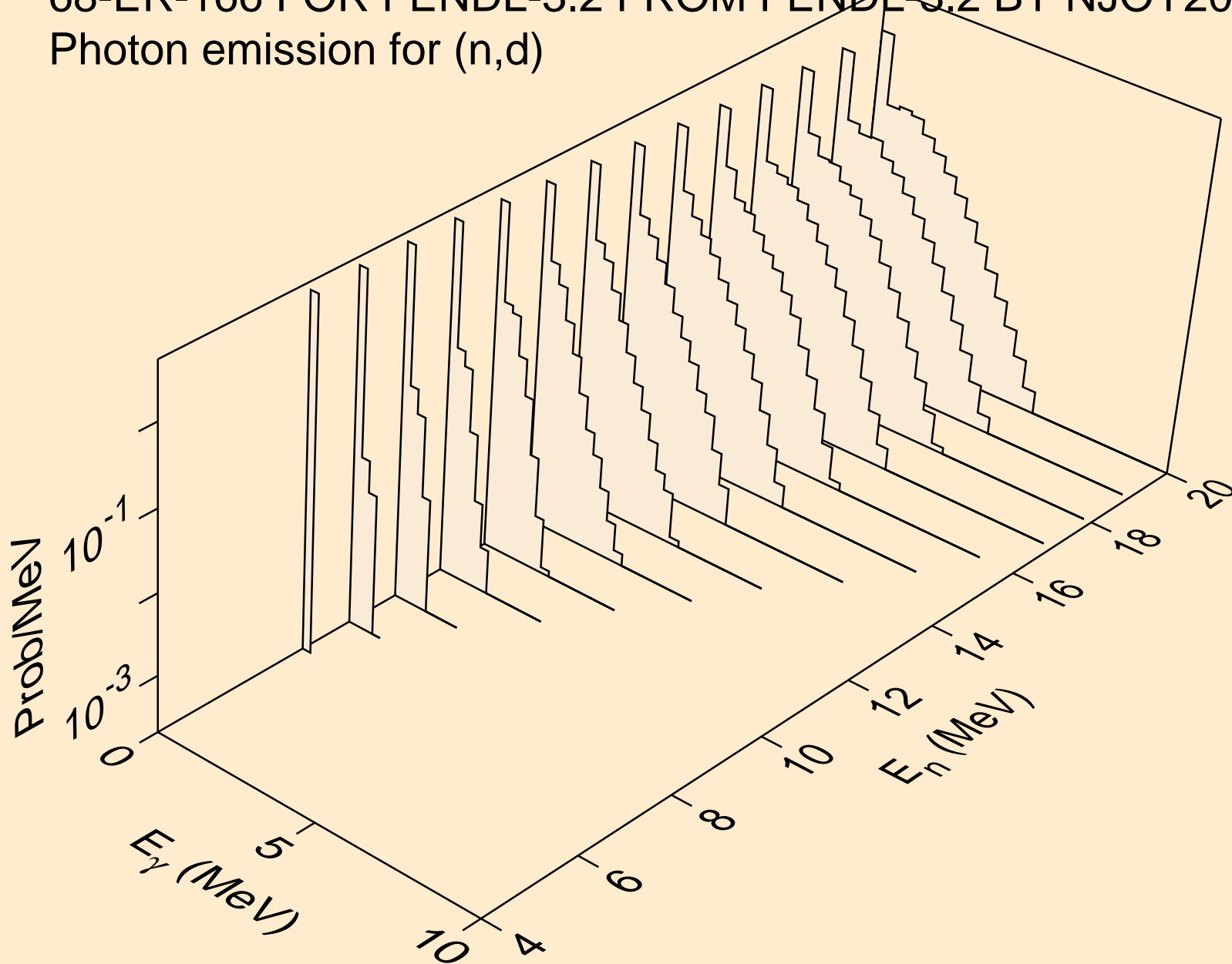

68-ER-166 FOR FENDL-3.2 FROM FENDL-3.2 BY NJOY2016.60+ C  
Photon emission for (n,a)

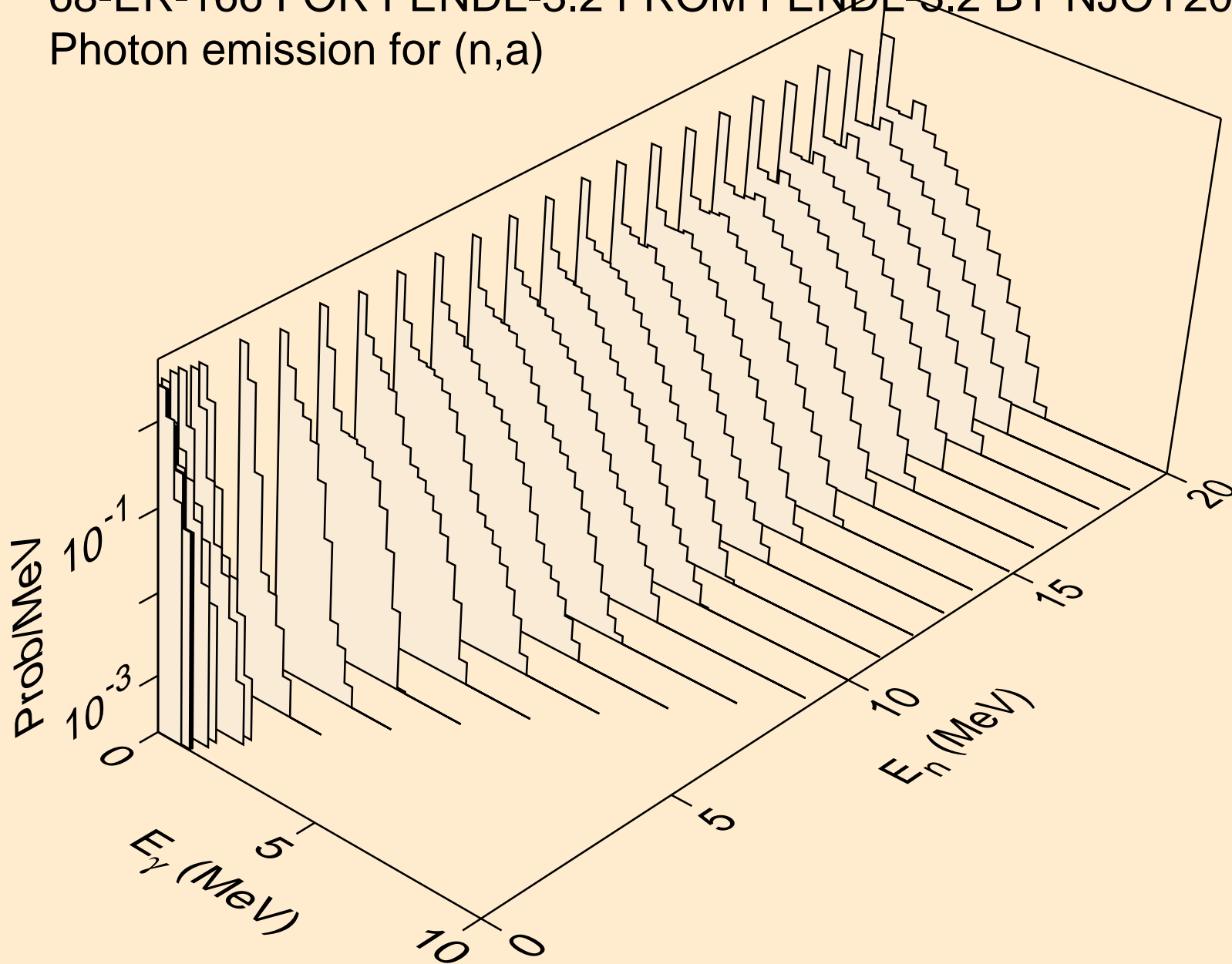

68-ER-166 FOR FENDL-3.2 FROM FENDL-3.2 BY NJOY2016.60+ C  
Photon emission for (n,x)

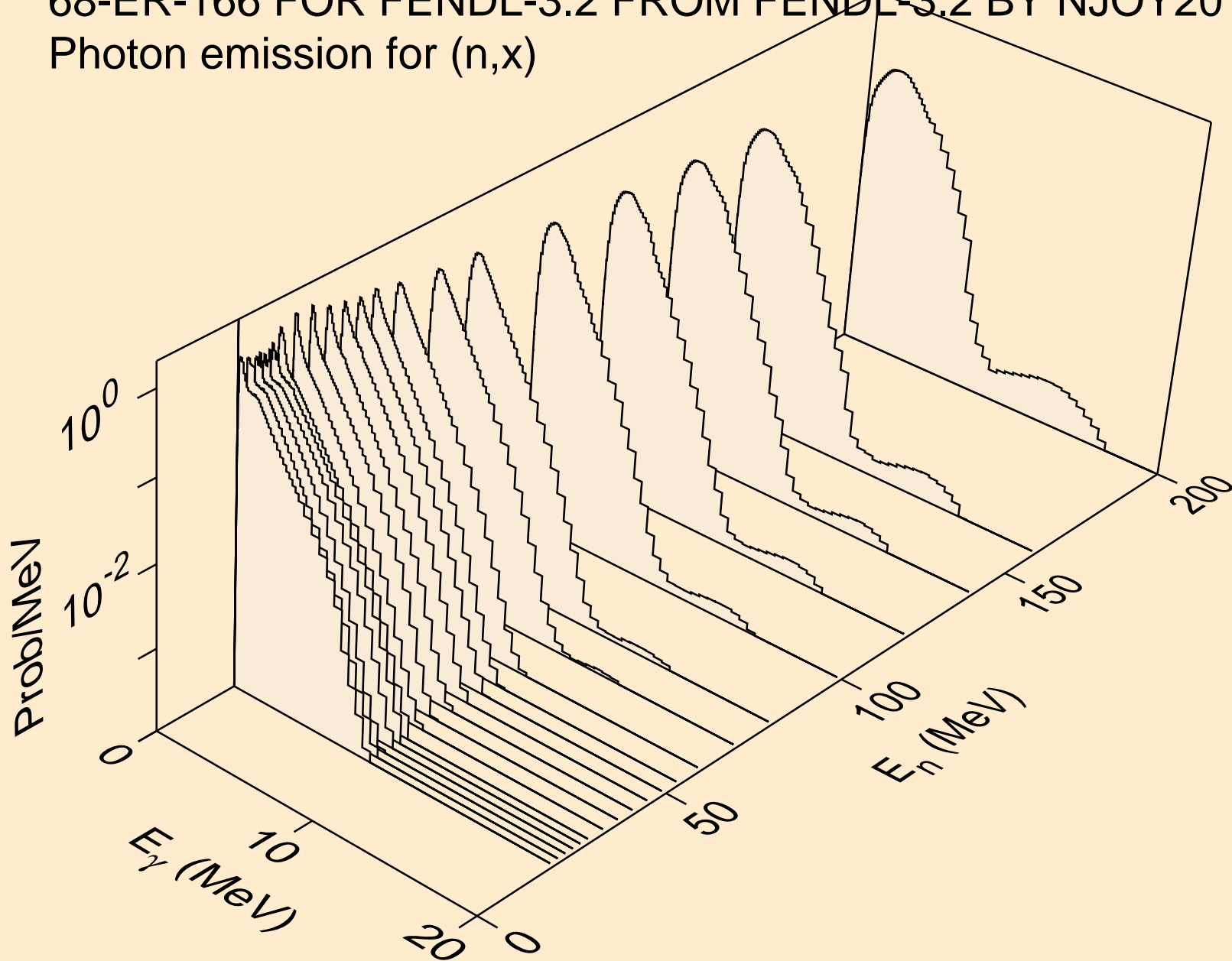

68-ER-166 FOR FENDL-3.2 FROM FENDL-3.2 BY NJOY2016.60+ C  
thermal capture photon spectrum

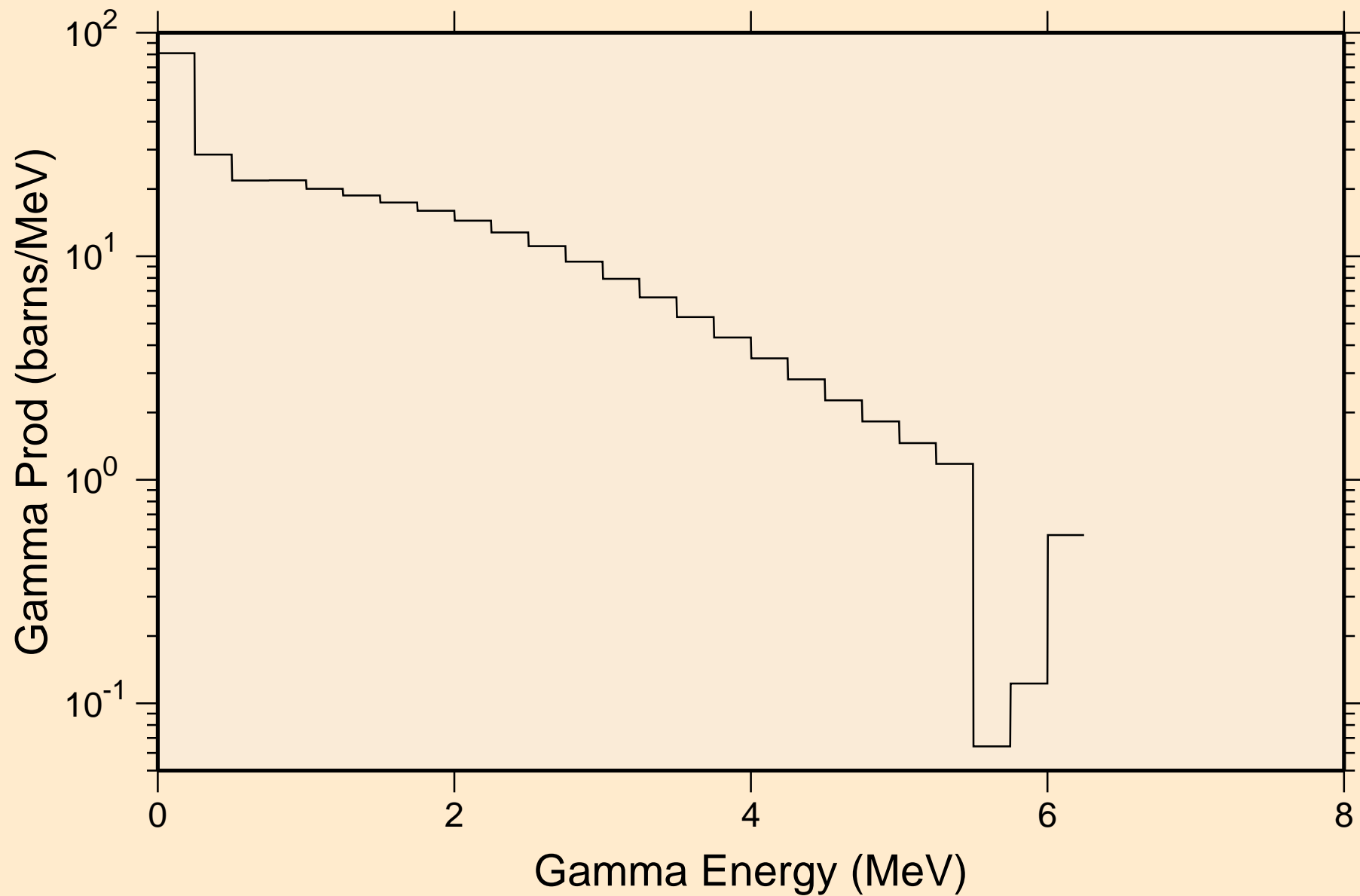

68-ER-166 FOR FENDL-3.2 FROM FENDL-3.2 BY NJOY2016.60+ C  
14 MeV photon spectrum

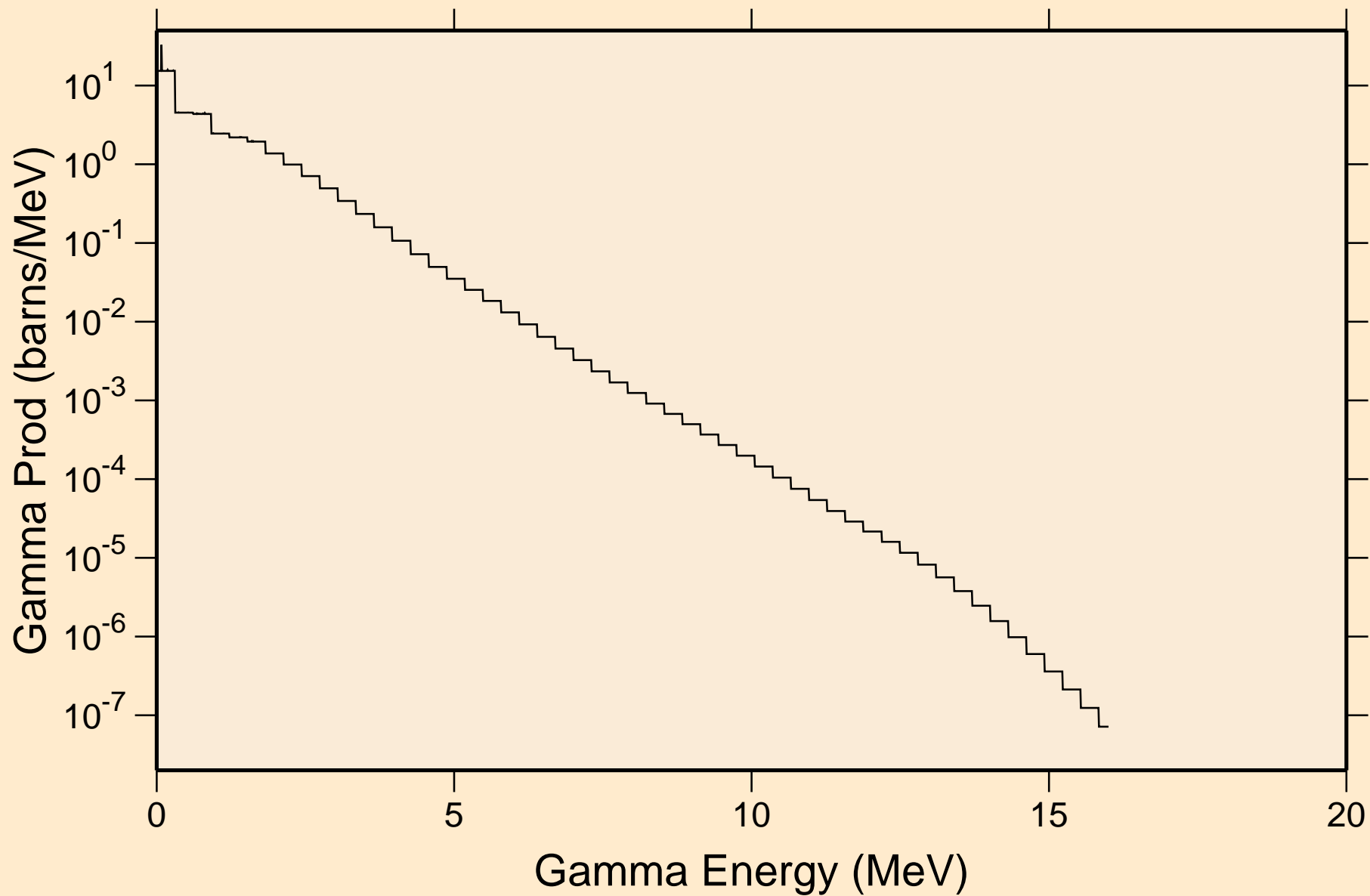

68-ER-166 FOR FENDL-3.2 FROM FENDL-3.2 BY NJOY2016.60+ C  
Particle heating contributions

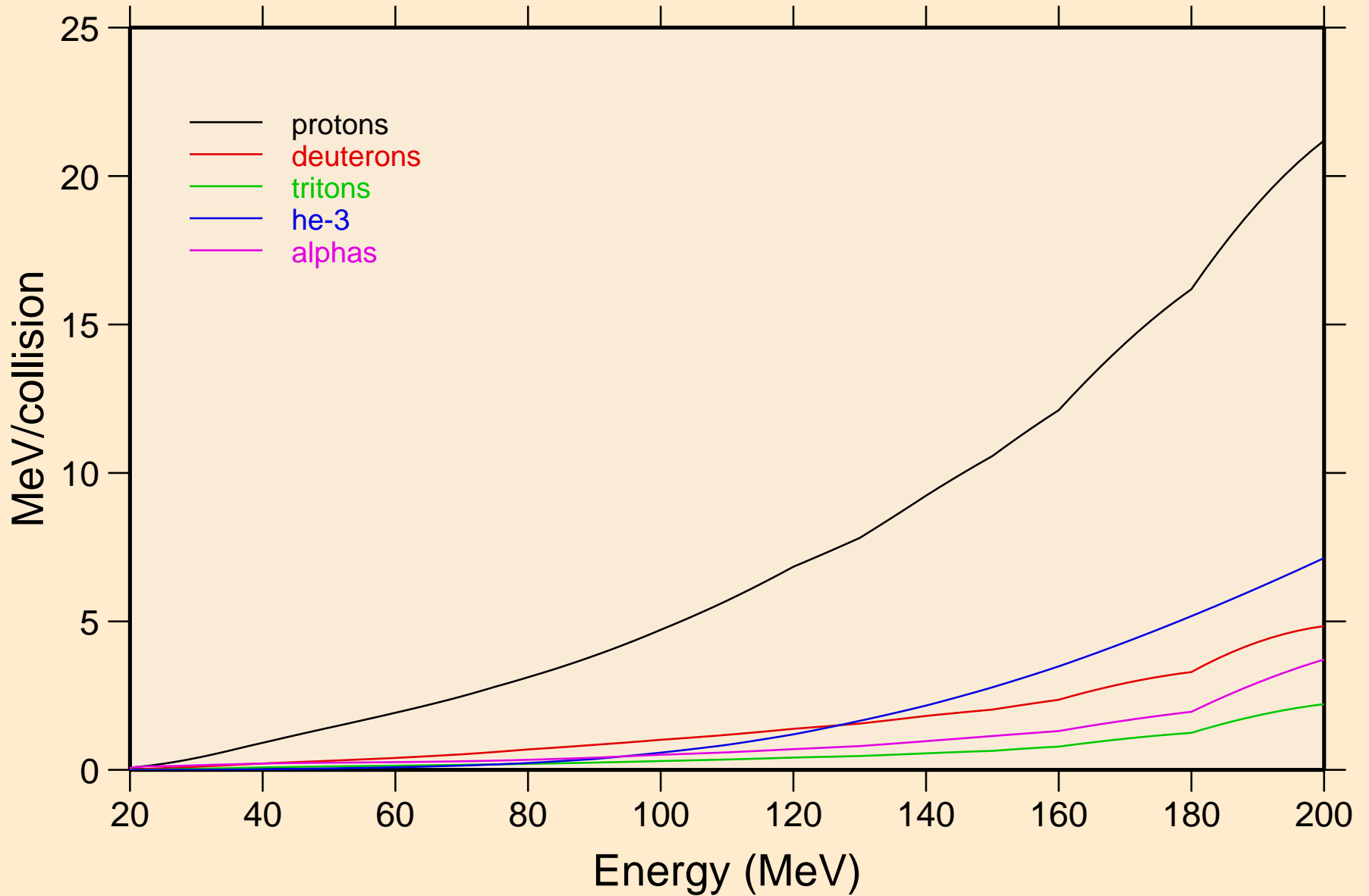



68-ER-166 FOR FENDL-3.2 FROM FENDL-3.2 BY NJOY2016.60+ C  
Recoil Heating

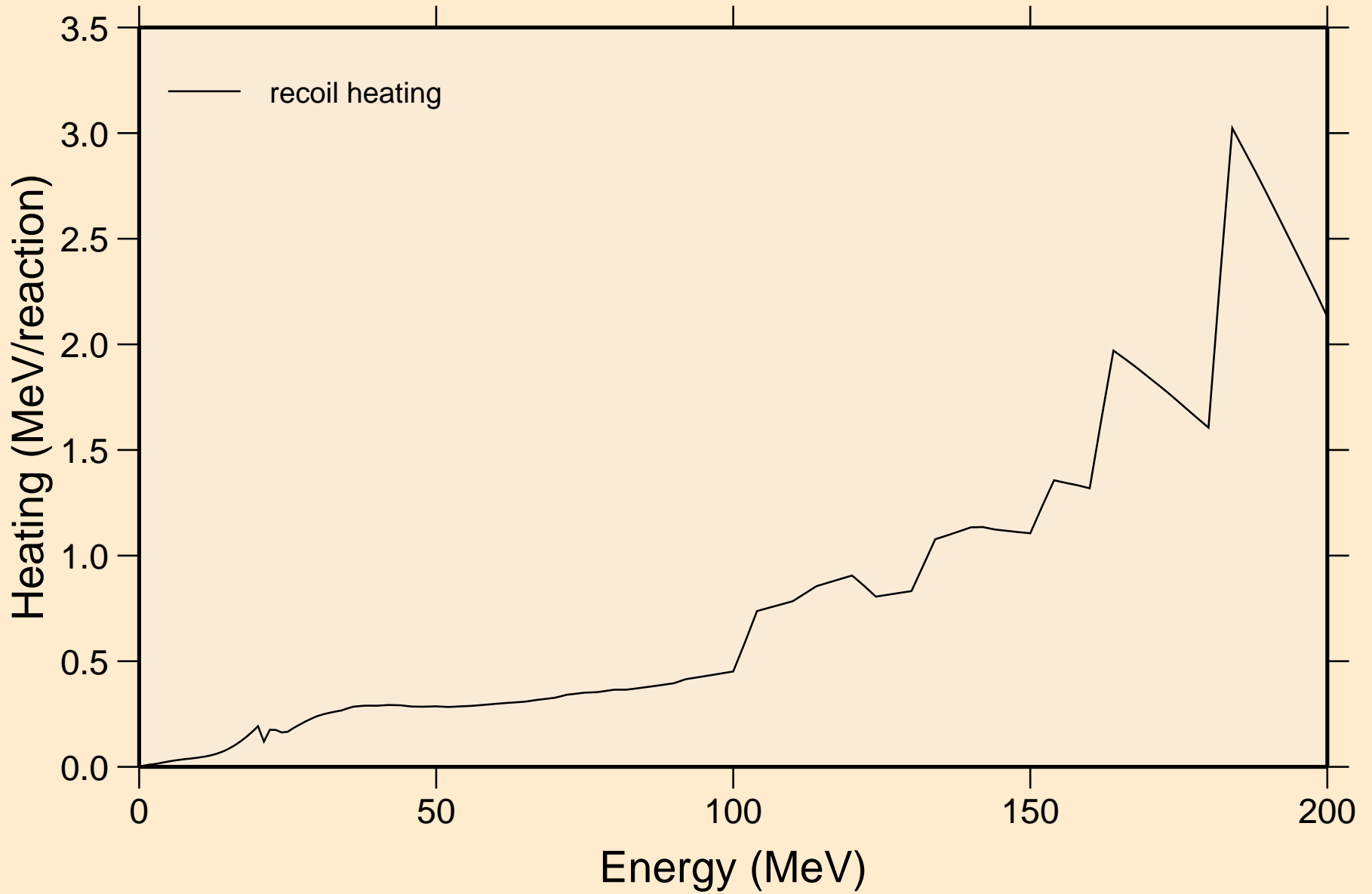

68-ER-166 FOR FENDL-3.2 FROM FENDL-3.2 BY NJOY2016.60+ C  
Particle production cross sections

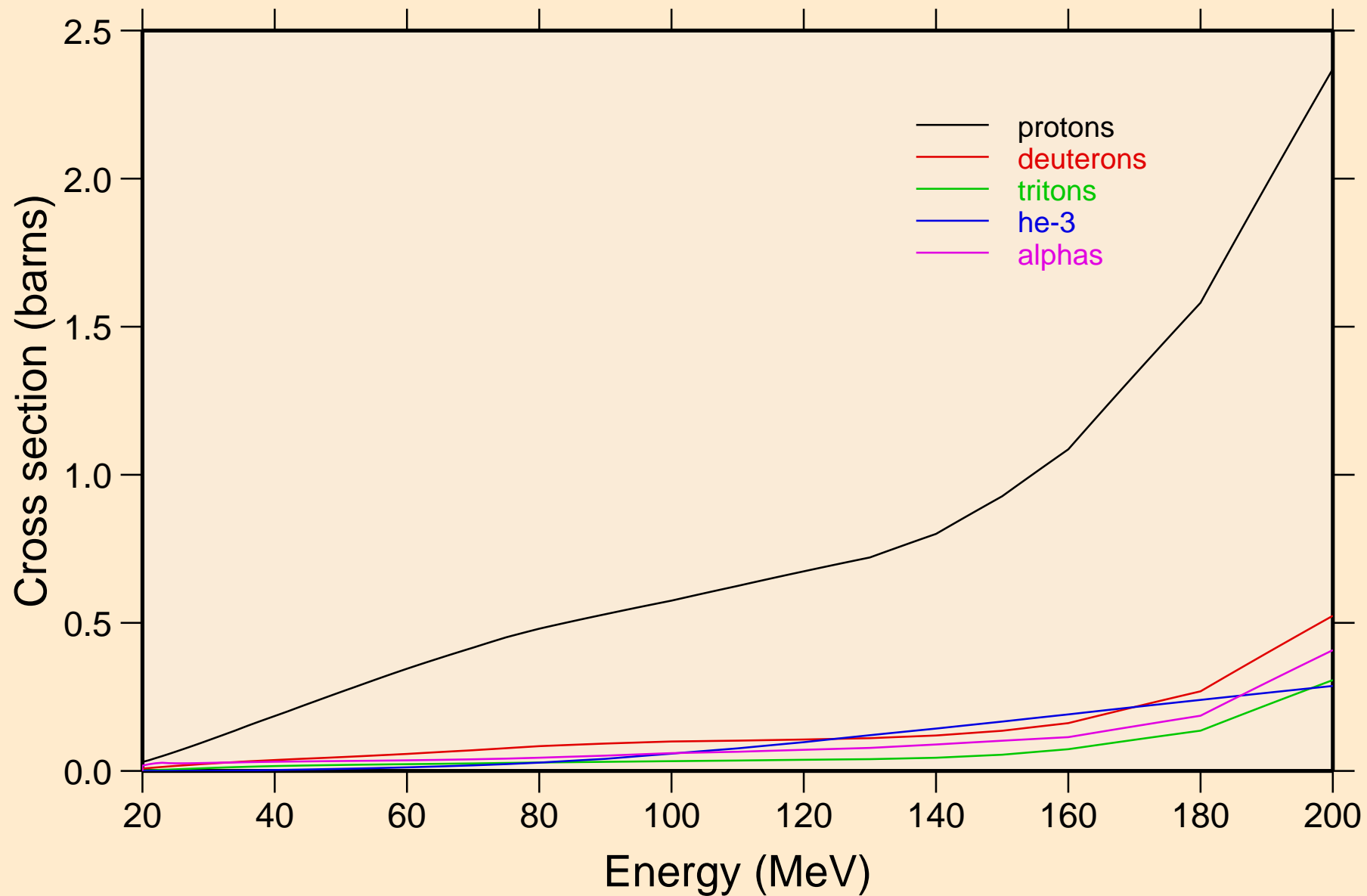

68-ER-166 FOR FENDL-3.2 FROM FENDL-3.2 BY NJOY2016.60+ C  
protons from (n,x)

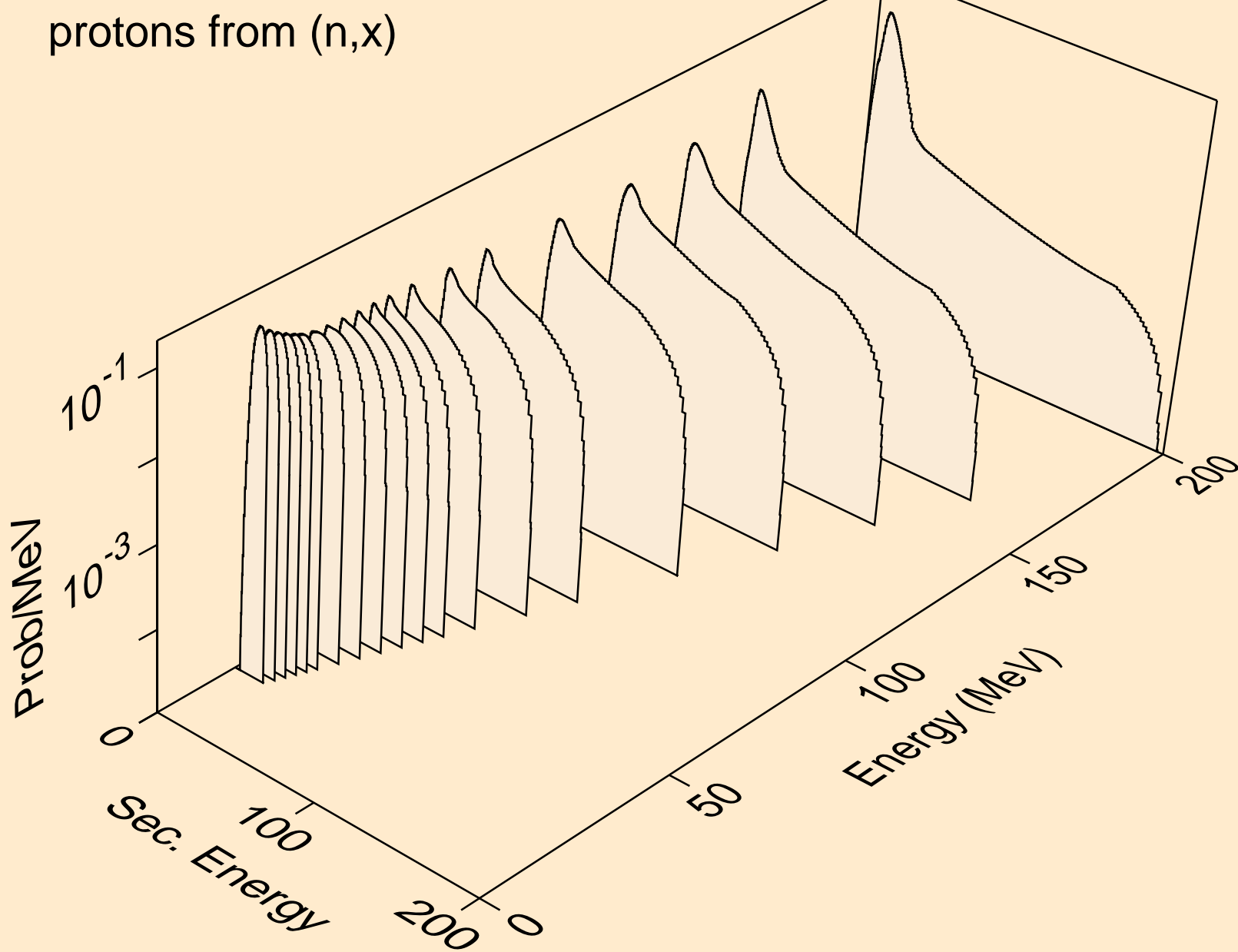

68-ER-166 FOR FENDL-3.2 FROM FENDL-3.2 BY NJOY2016.60+ C  
deuterons from (n,x)

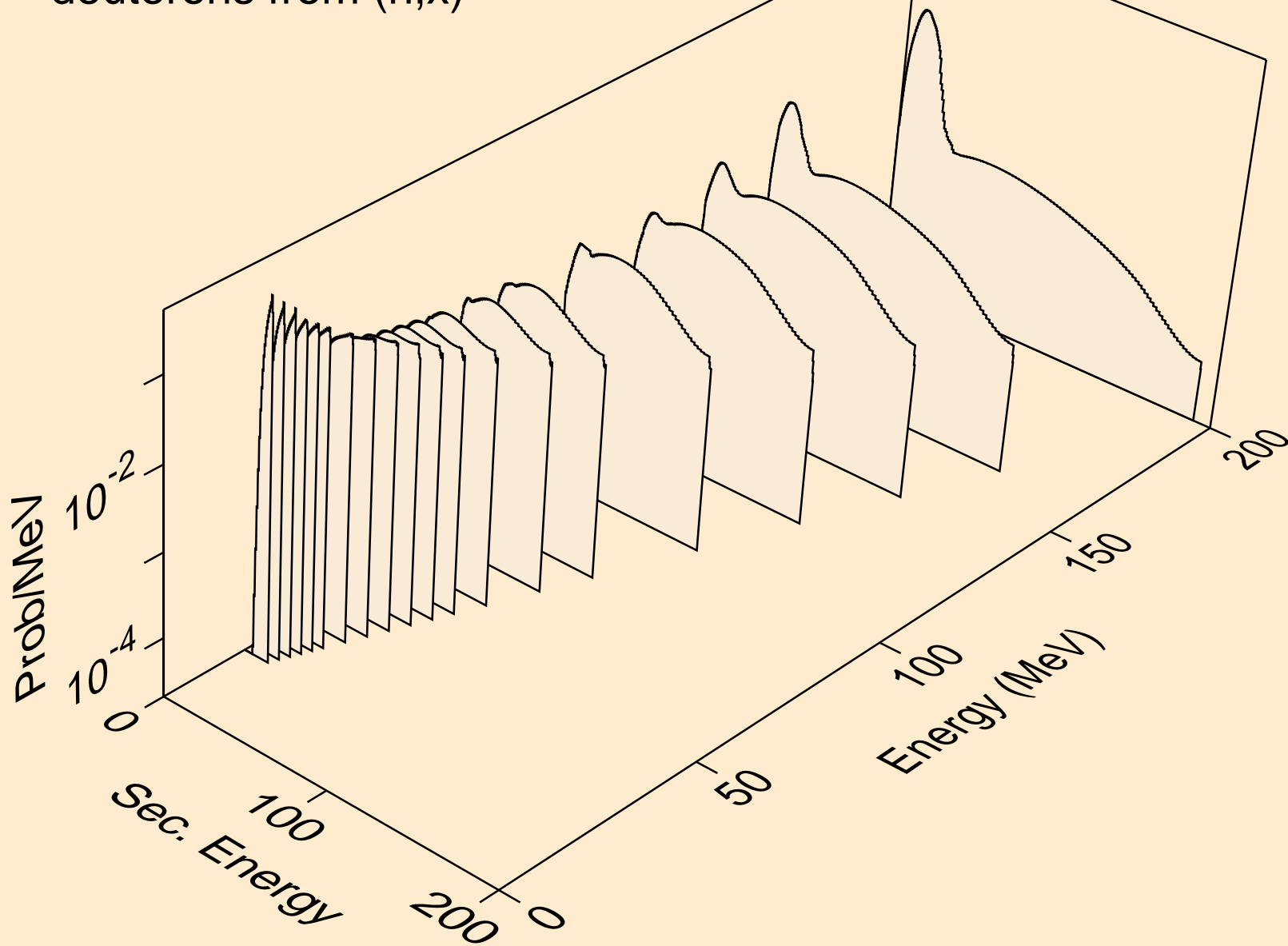

68-ER-166 FOR FENDL-3.2 FROM FENDL-3.2 BY NJOY2016.60+ C  
tritons from (n,x)

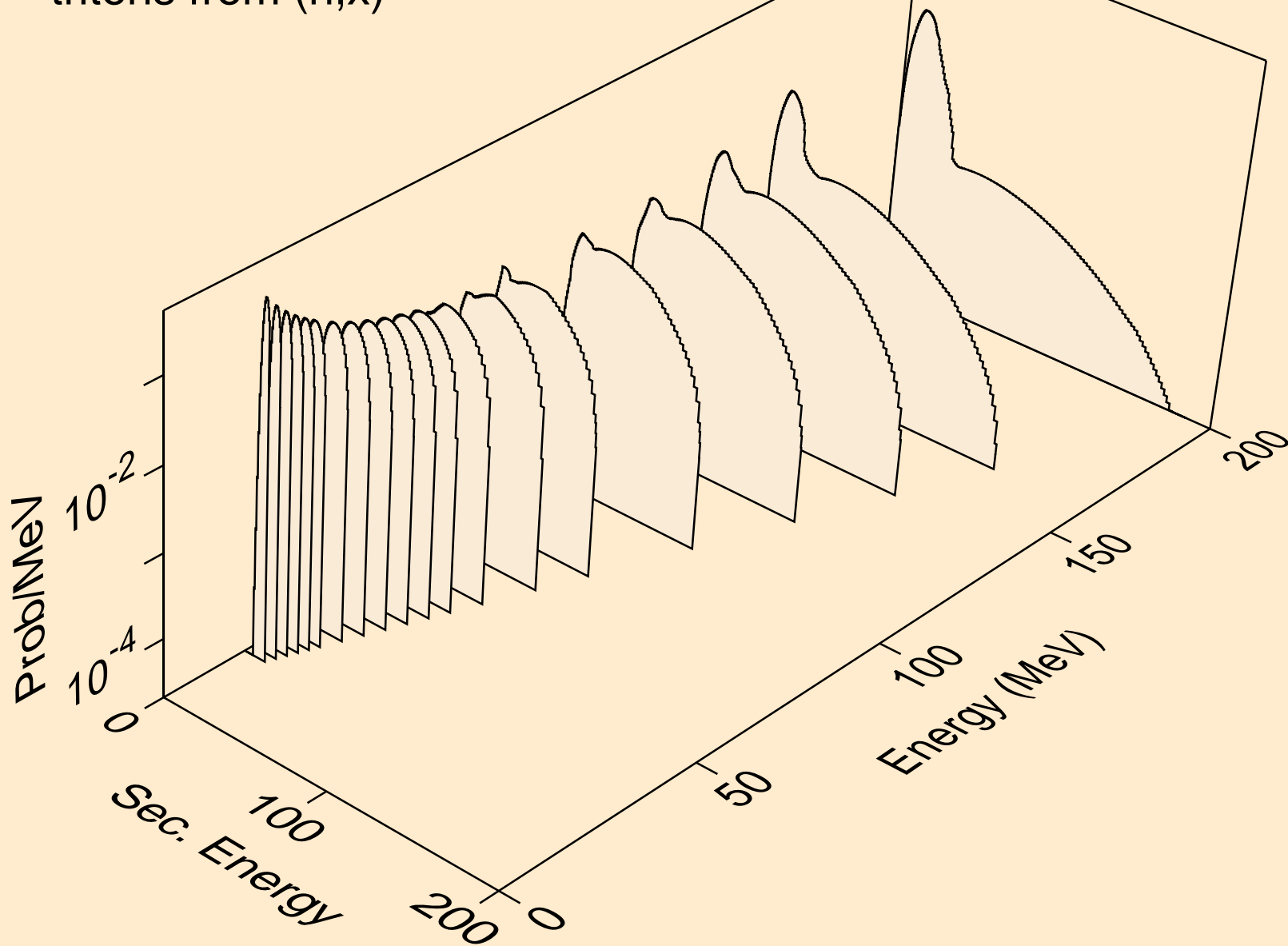

68-ER-166 FOR FENDL-3.2 FROM FENDL-3.2 BY NJOY2016.60+ C  
he3s from (n,x)

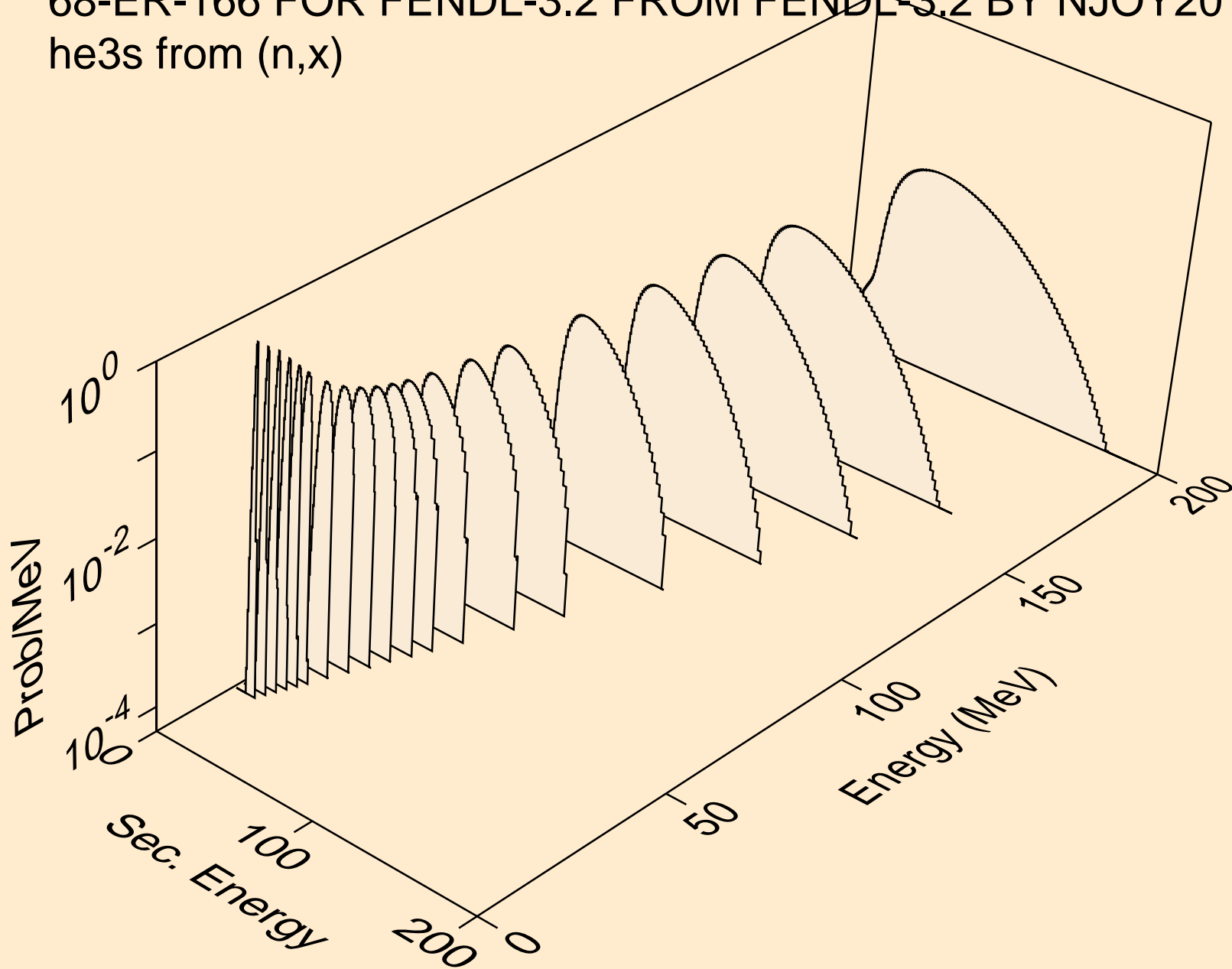

68-ER-166 FOR FENDL-3.2 FROM FENDL-3.2 BY NJOY2016.60+ C  
alphas from (n,x)

