

74-W-180 FOR FENDL-3.2 FROM INDL/V-3 BY NJOY2016.60+ ON
Principal cross sections

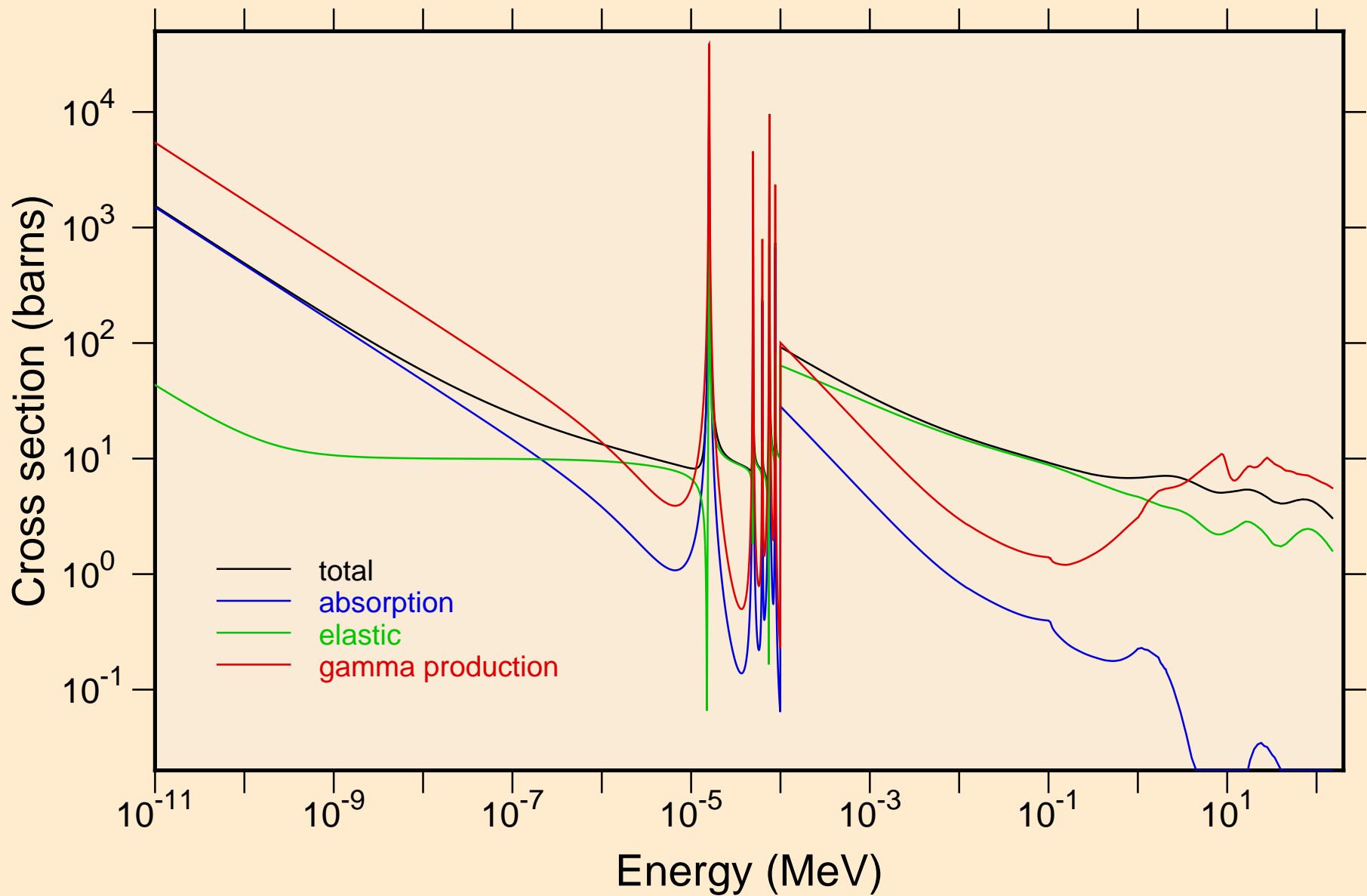

74-W-180 FOR FENDL-3.2 FROM INDL/V-3 BY NJOY2016.60+ ON
resonance total cross section

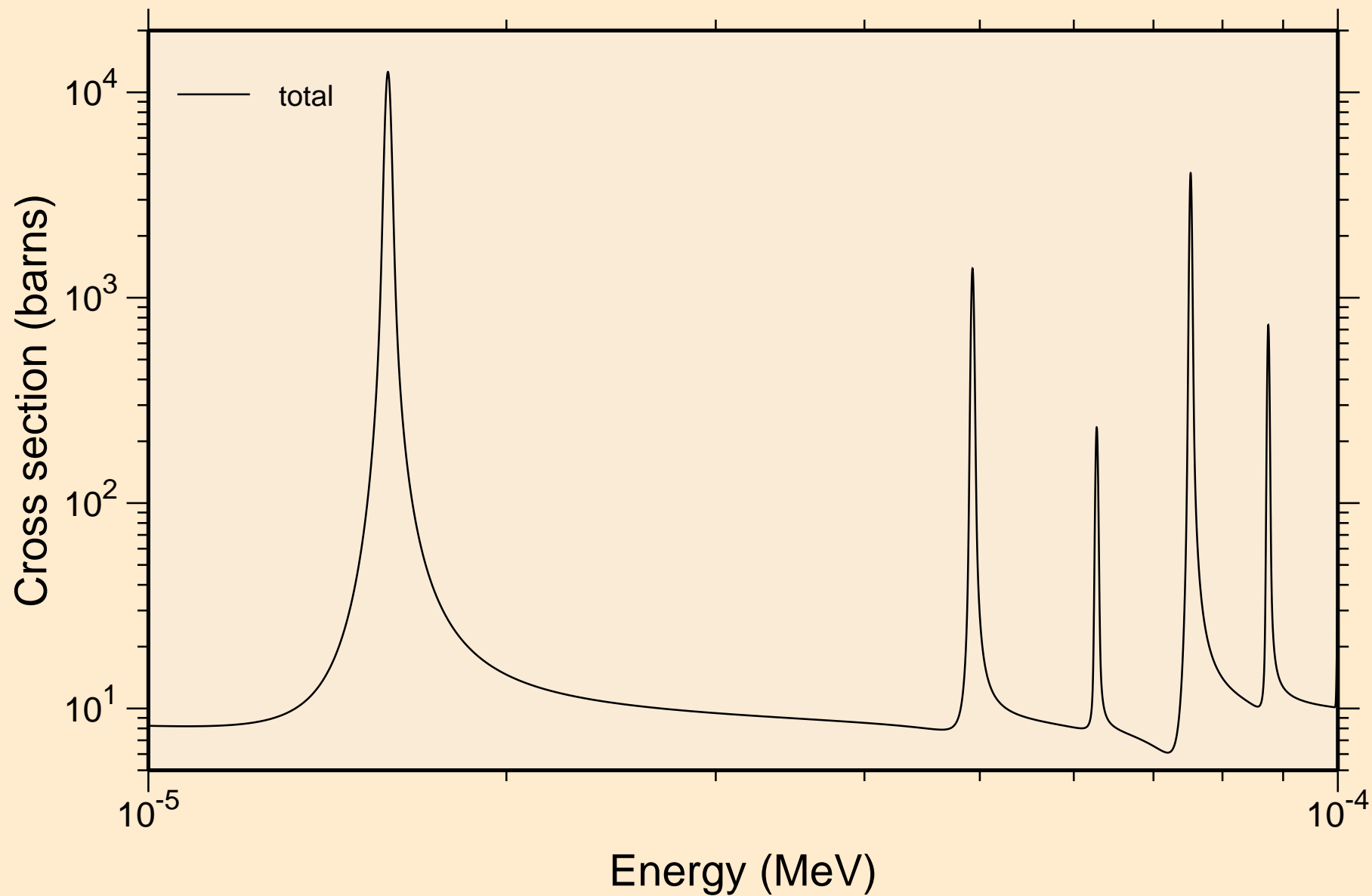

74-W-180 FOR FENDL-3.2 FROM INDL/V-3 BY NJOY2016.60+ ON
resonance absorption cross sections

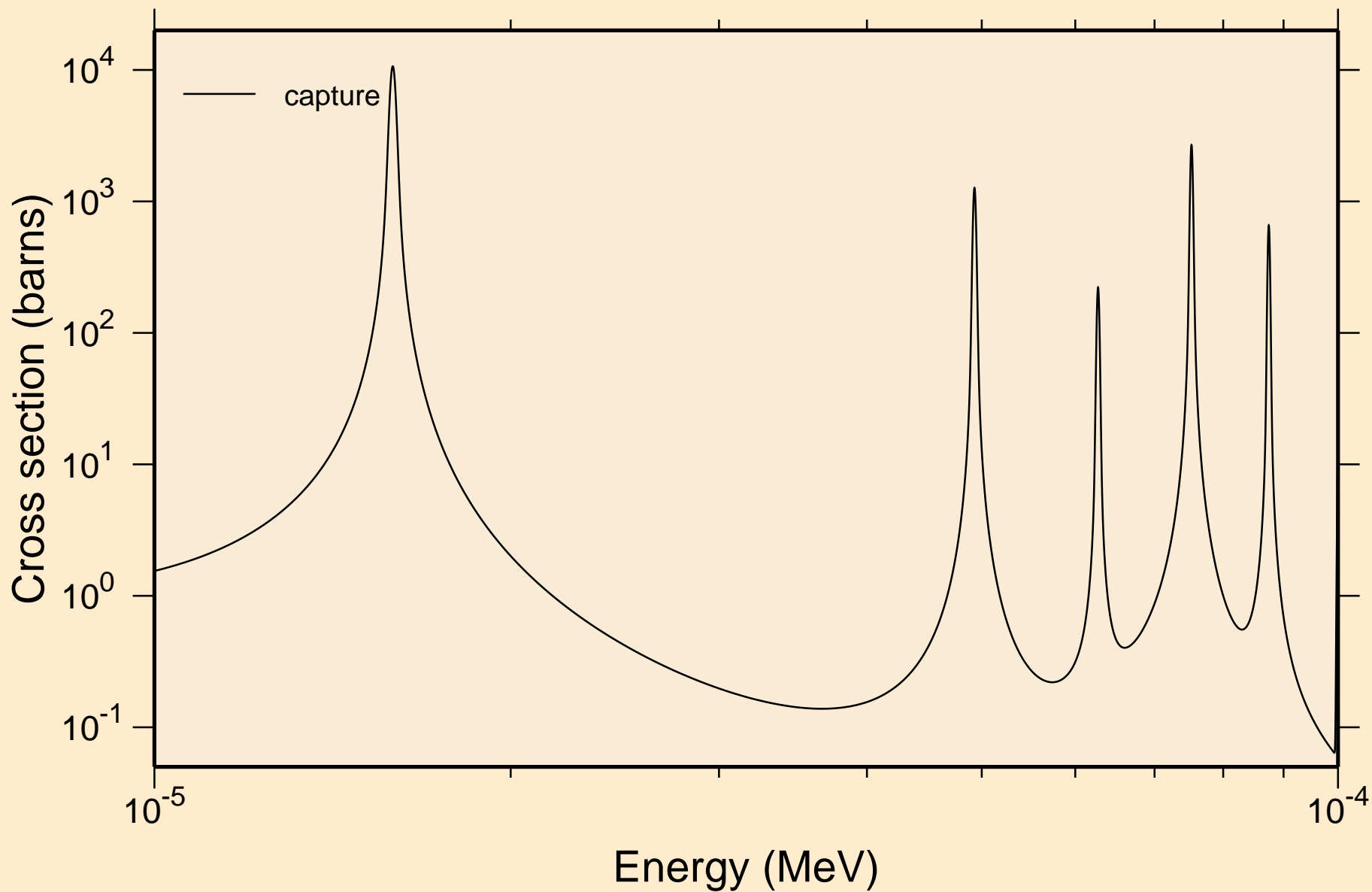

74-W-180 FOR FENDL-3.2 FROM INDL/V-3 BY NJOY2016.60+ ON Heating

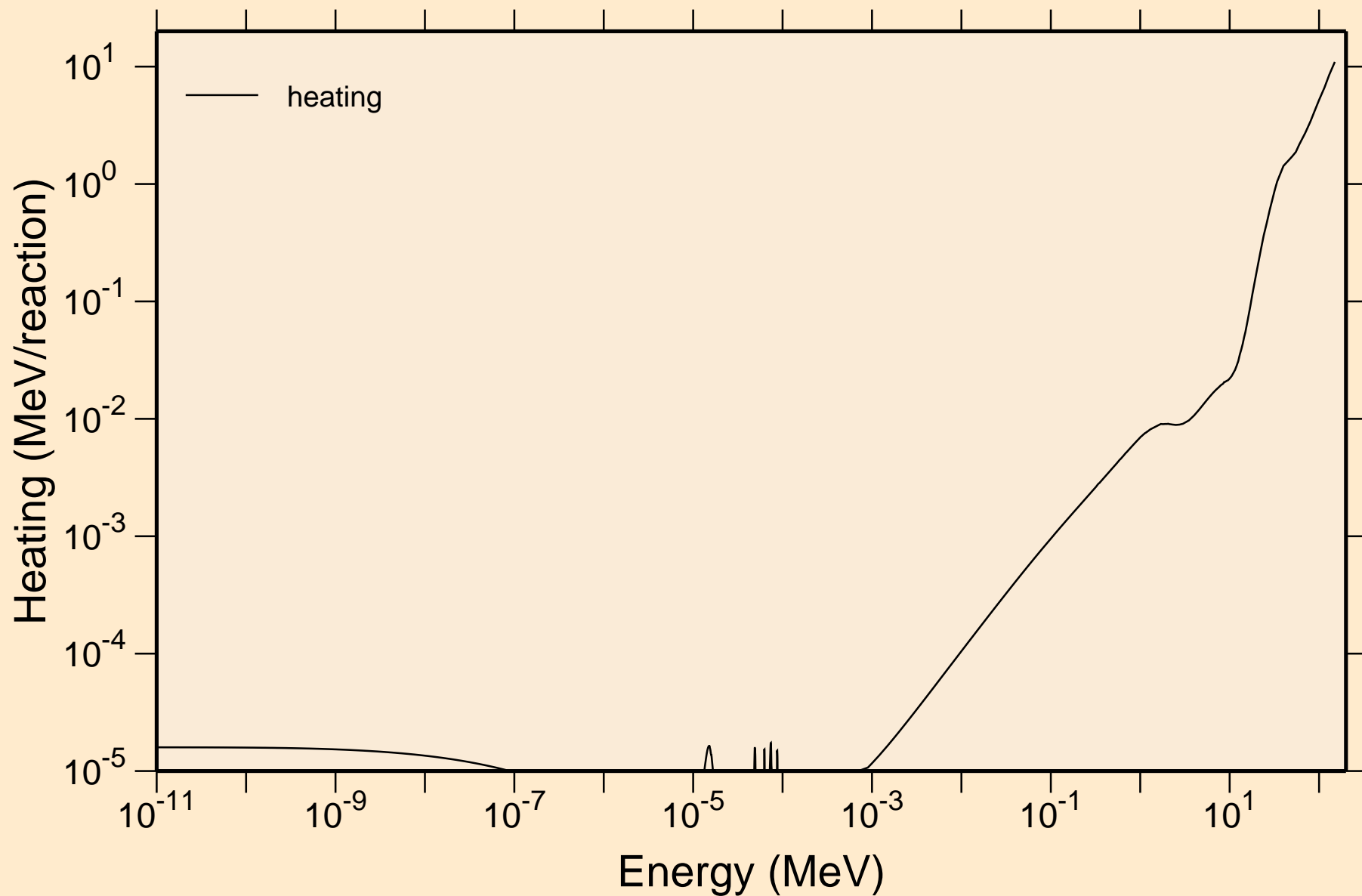

74-W-180 FOR FENDL-3.2 FROM INDL/V-3 BY NJOY2016.60+ ON Damage

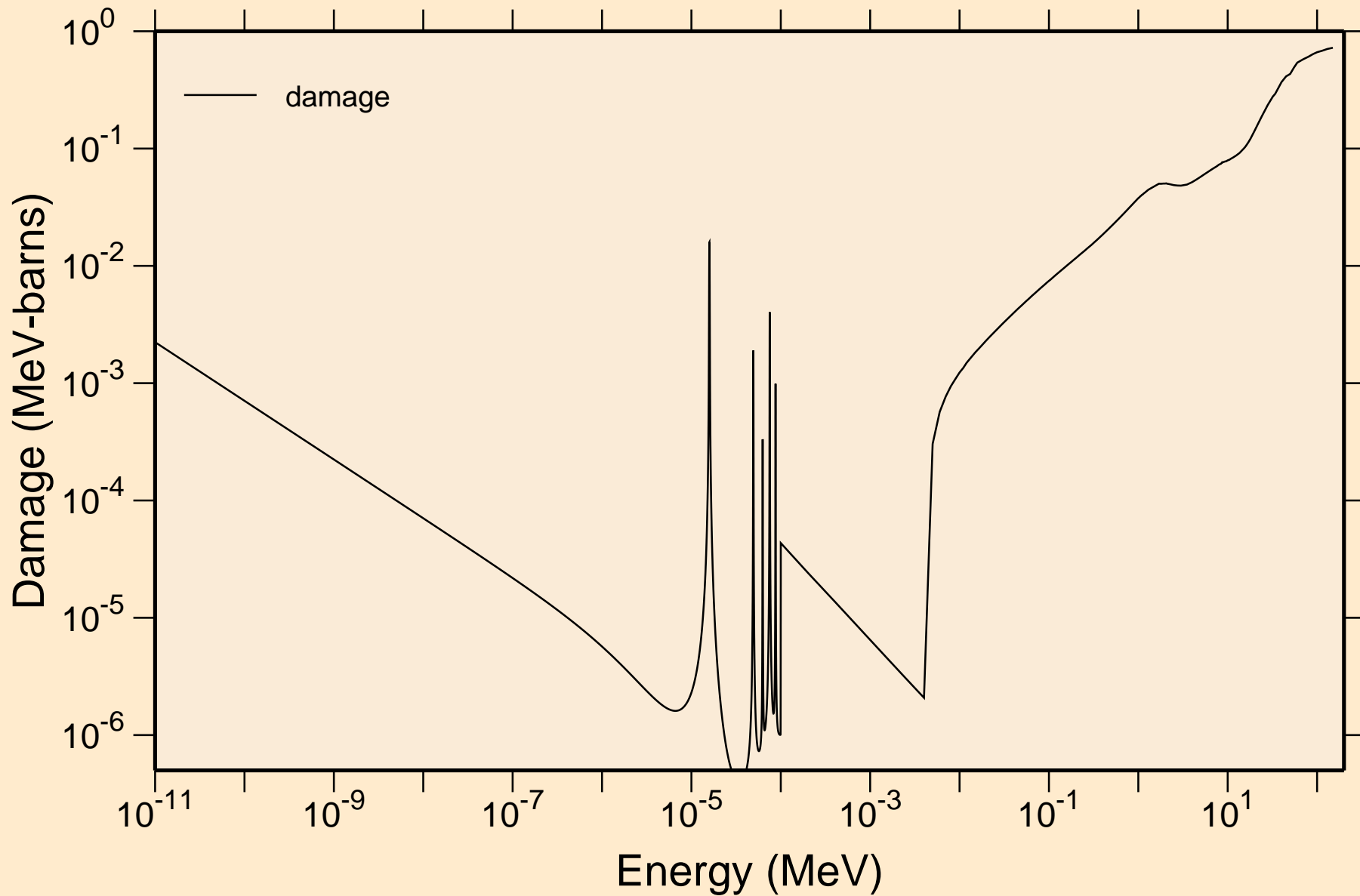

74-W-180 FOR FENDL-3.2 FROM INDL/V-3 BY NJOY2016.60+ ON
Non-threshold reactions

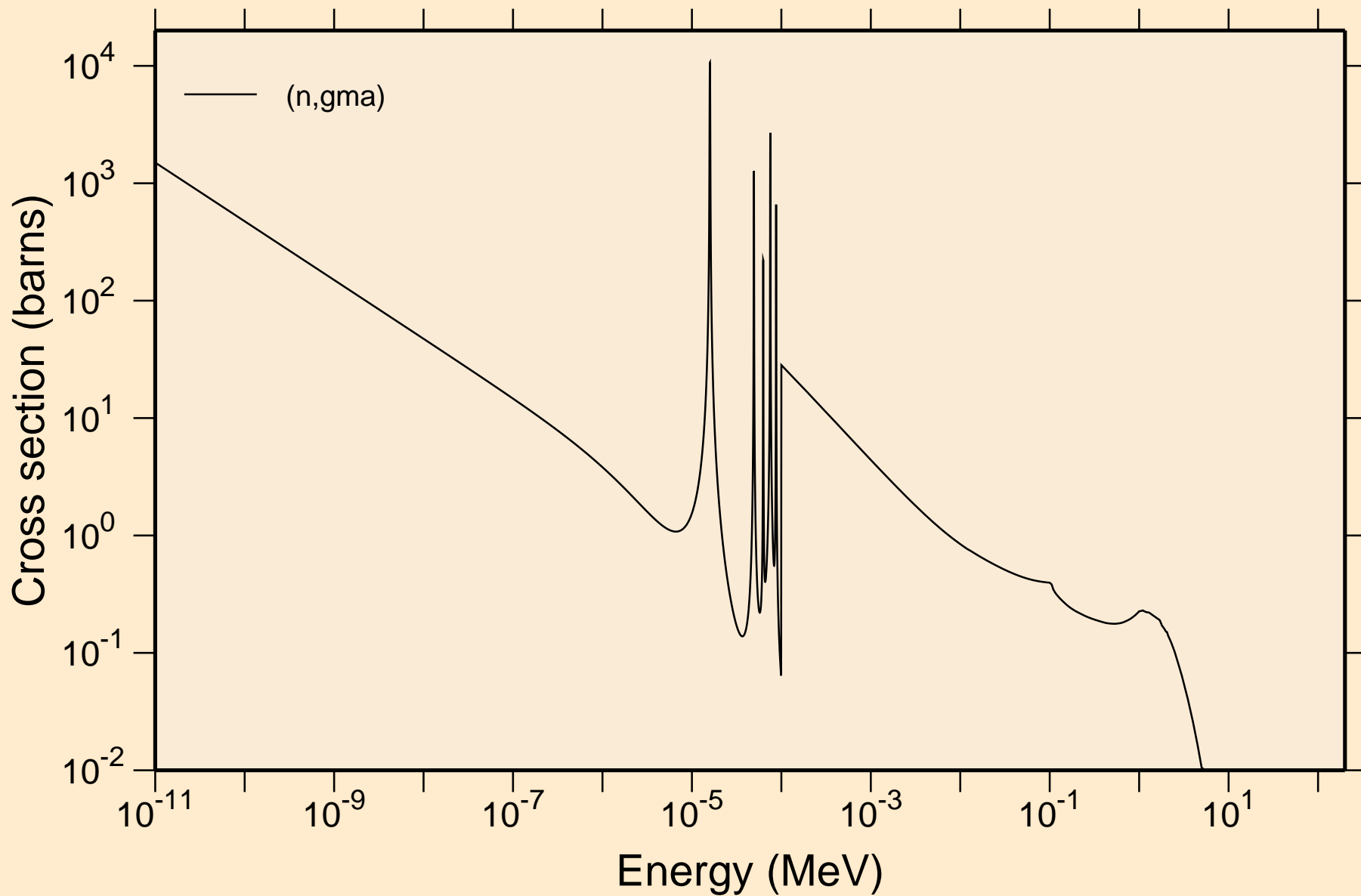

74-W-180 FOR FENDL-3.2 FROM INDL/V-3 BY NJOY2016.60+ ON

Principal cross sections

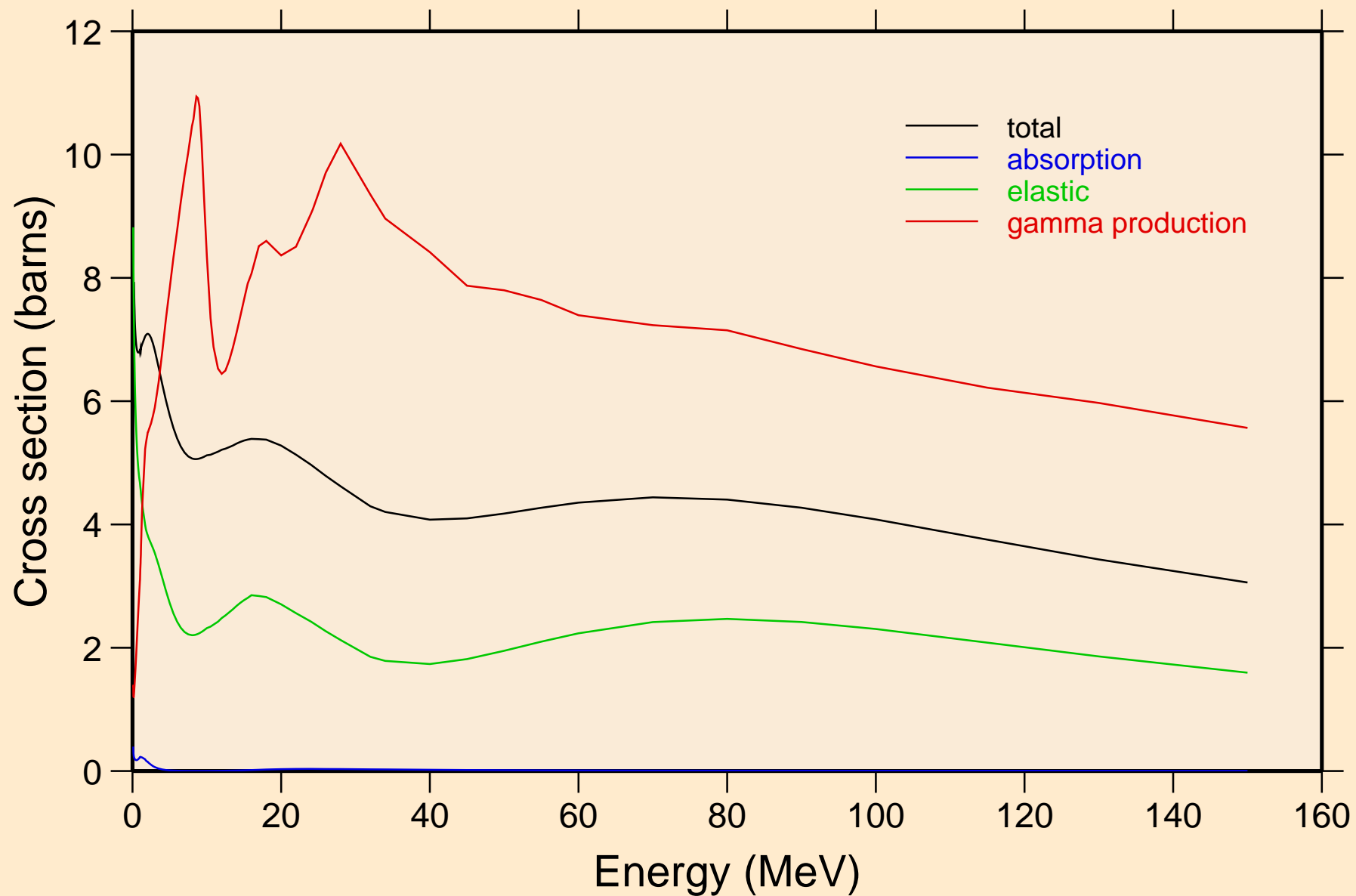

74-W-180 FOR FENDL-3.2 FROM INDL/V-3 BY NJOY2016.60+ ON Heating

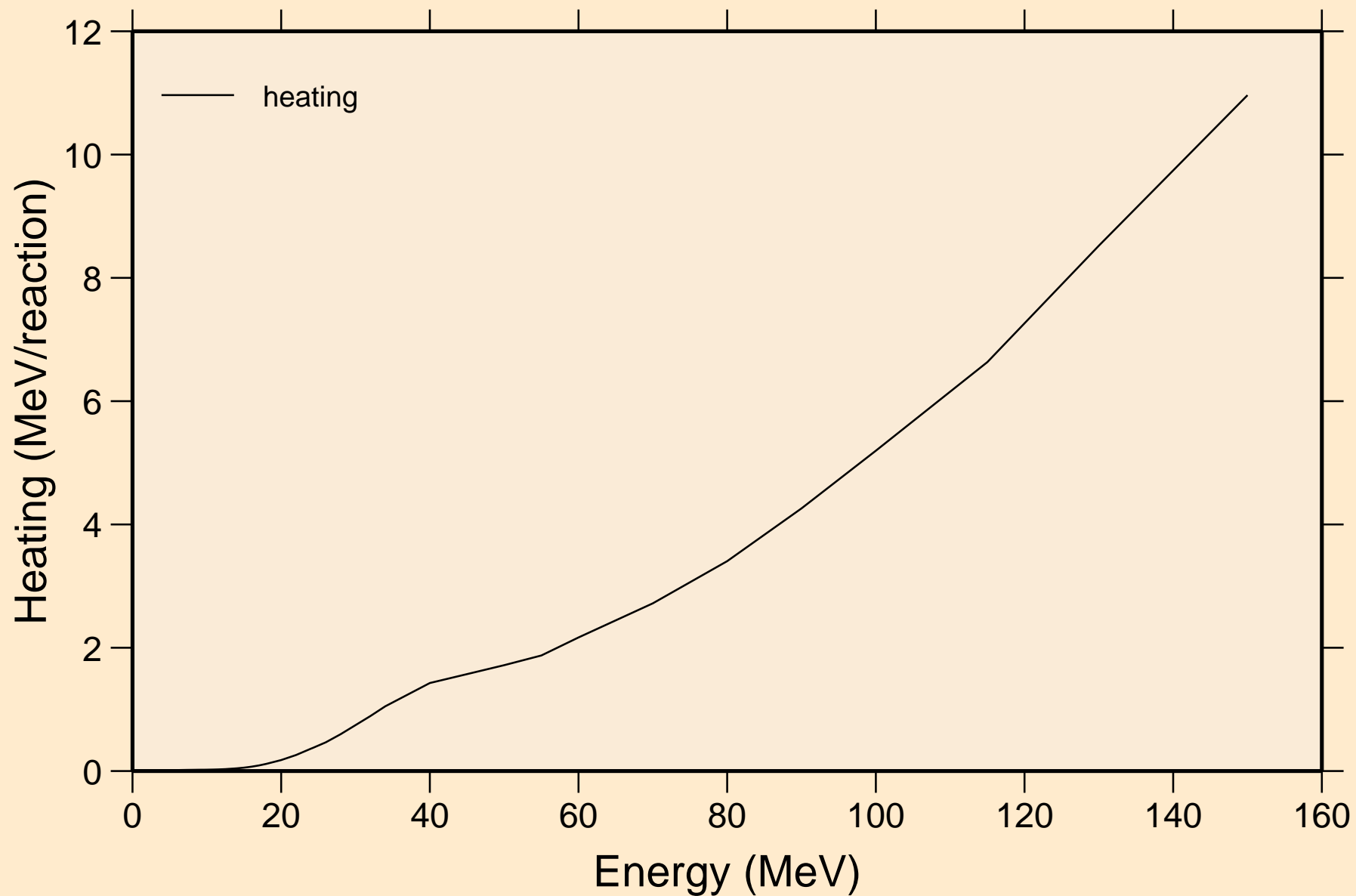

74-W-180 FOR FENDL-3.2 FROM INDL/V-3 BY NJOY2016.60+ ON Damage

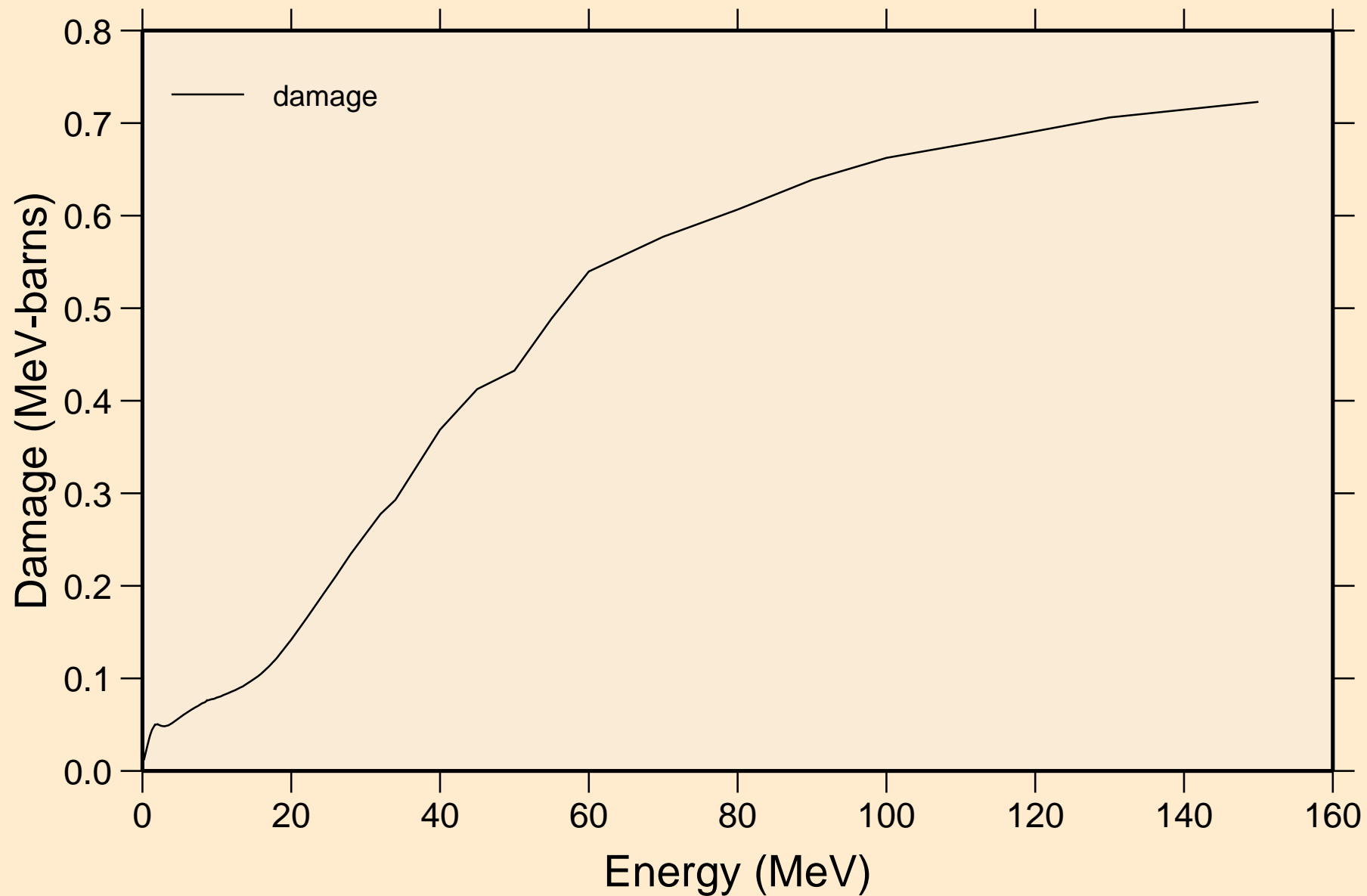

74-W-180 FOR FENDL-3.2 FROM INDL/V-3 BY NJOY2016.60+ ON
Non-threshold reactions

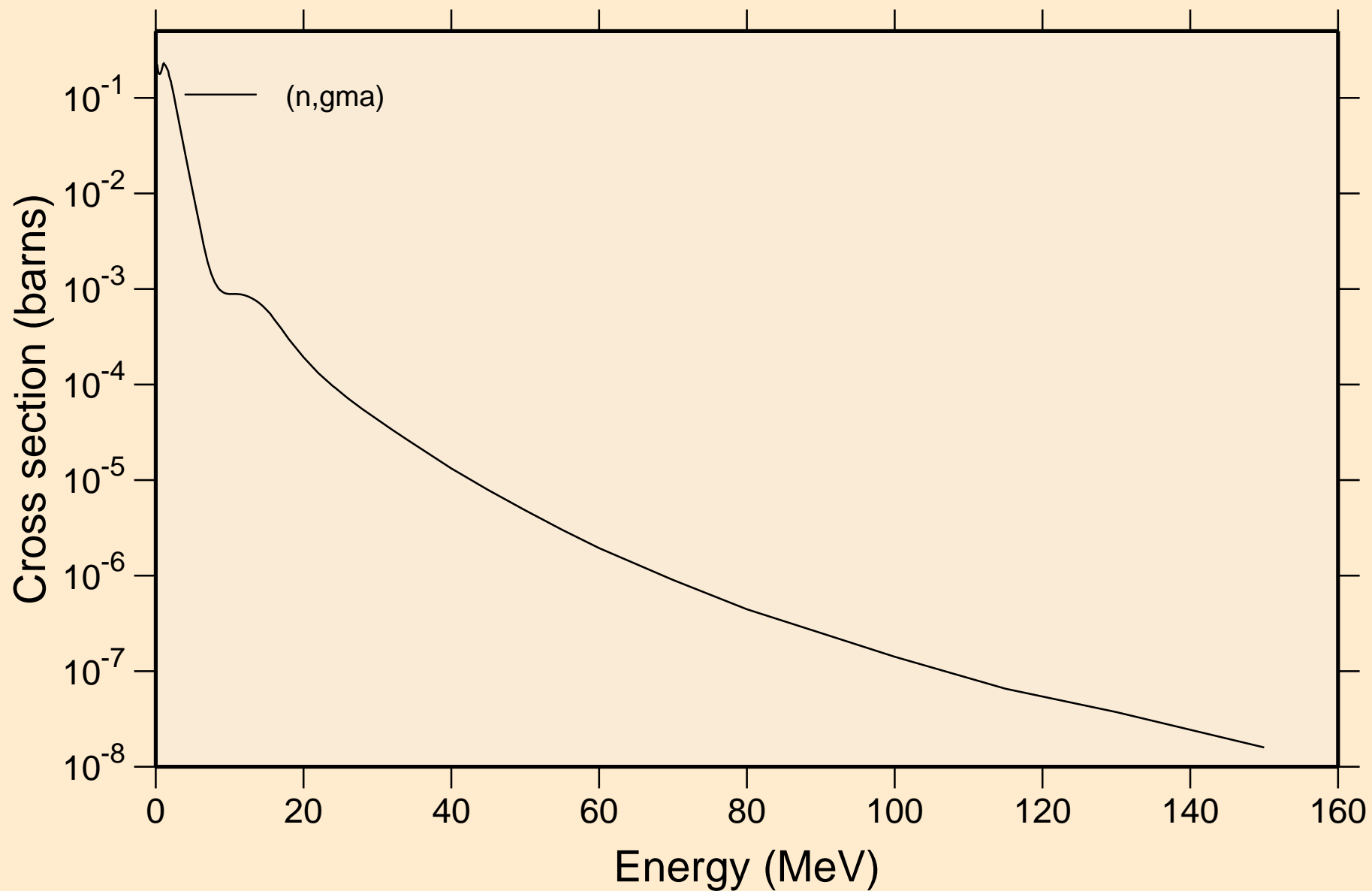

74-W-180 FOR FENDL-3.2 FROM INDL/V-3 BY NJOY2016.60+ ON
Inelastic levels

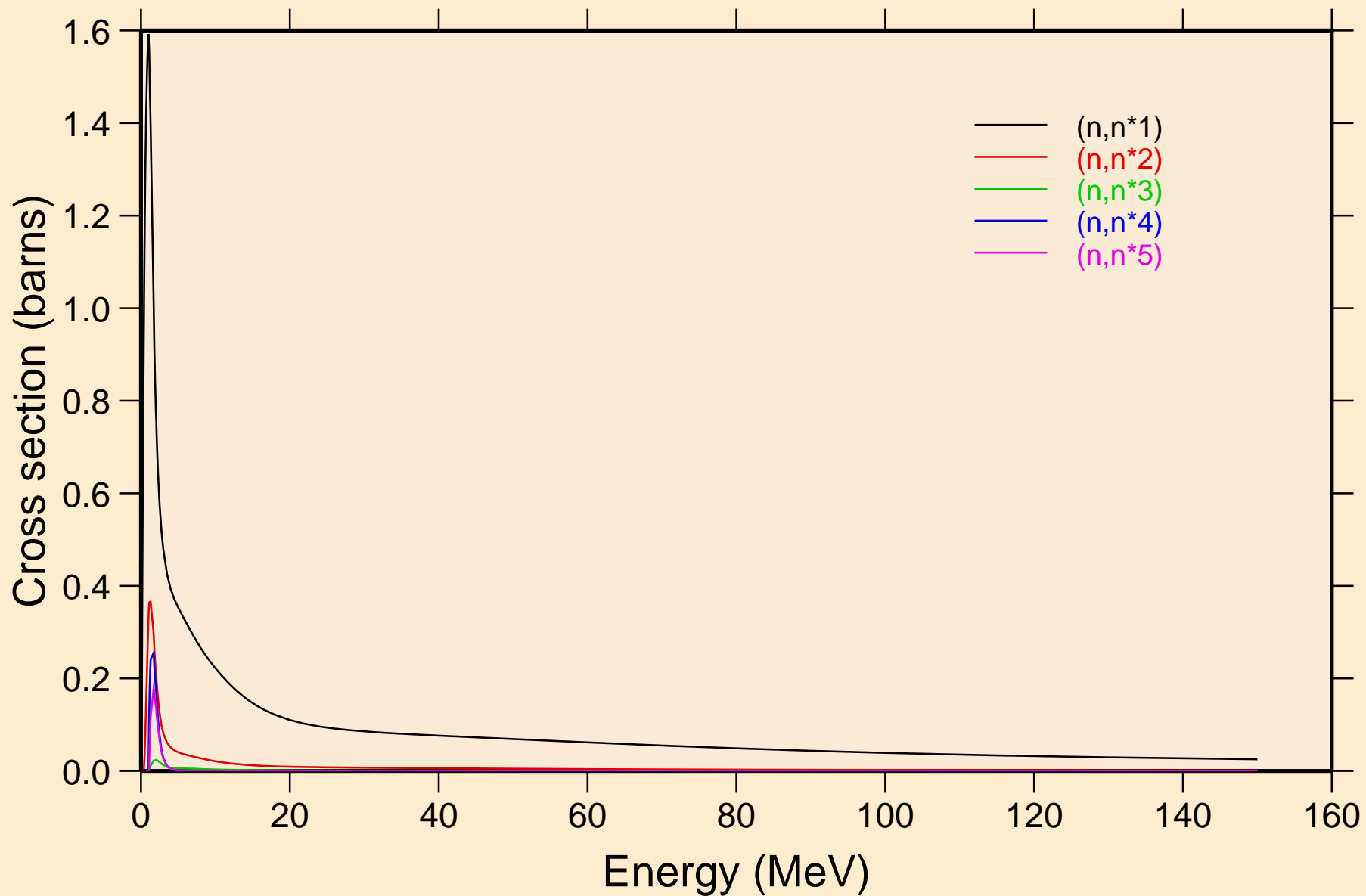

74-W-180 FOR FENDL-3.2 FROM INDL/V-3 BY NJOY2016.60+ ON
Inelastic levels

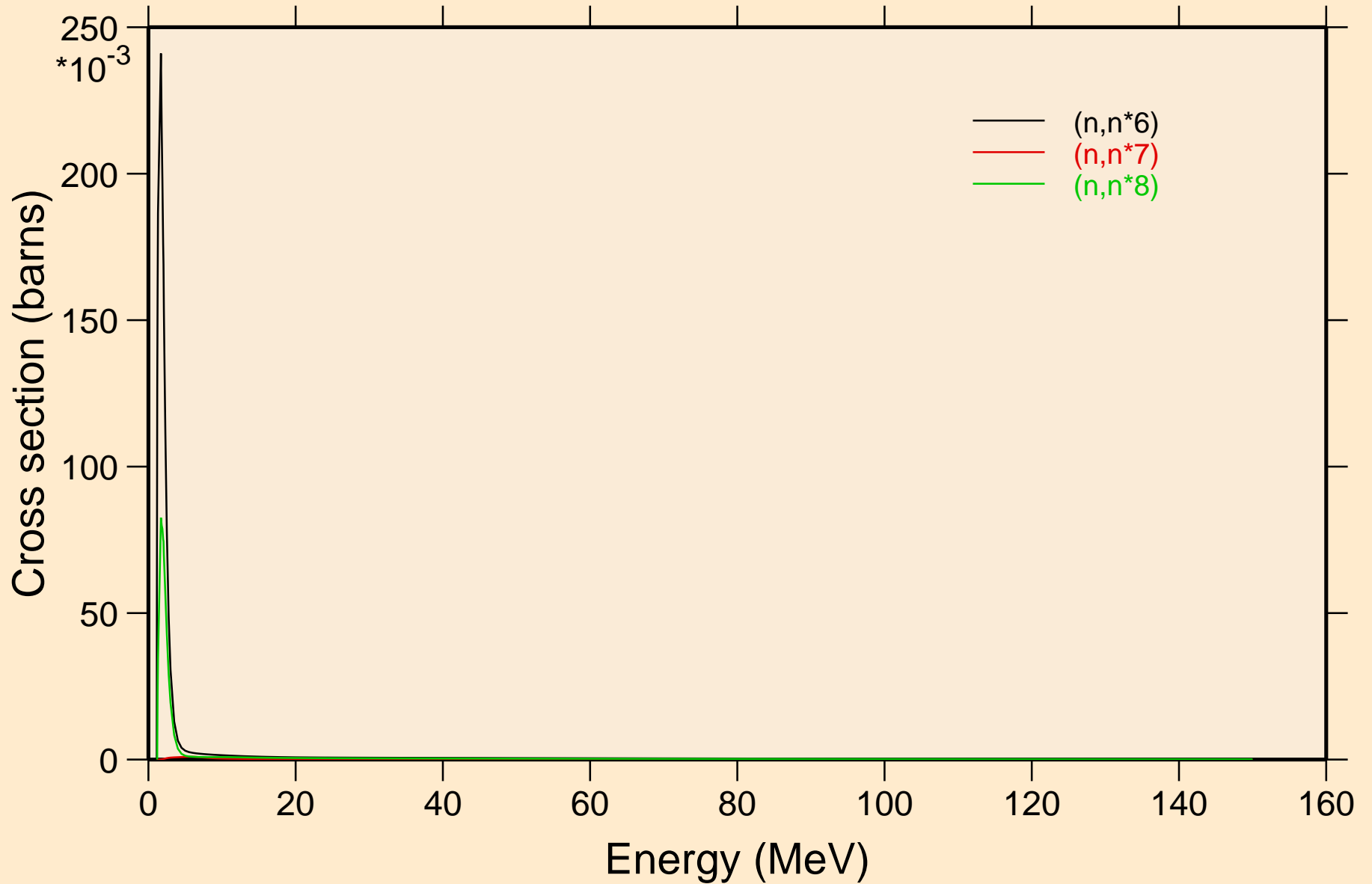

74-W-180 FOR FENDL-3.2 FROM INDL/V-3 BY NJOY2016.60+ ON Threshold reactions

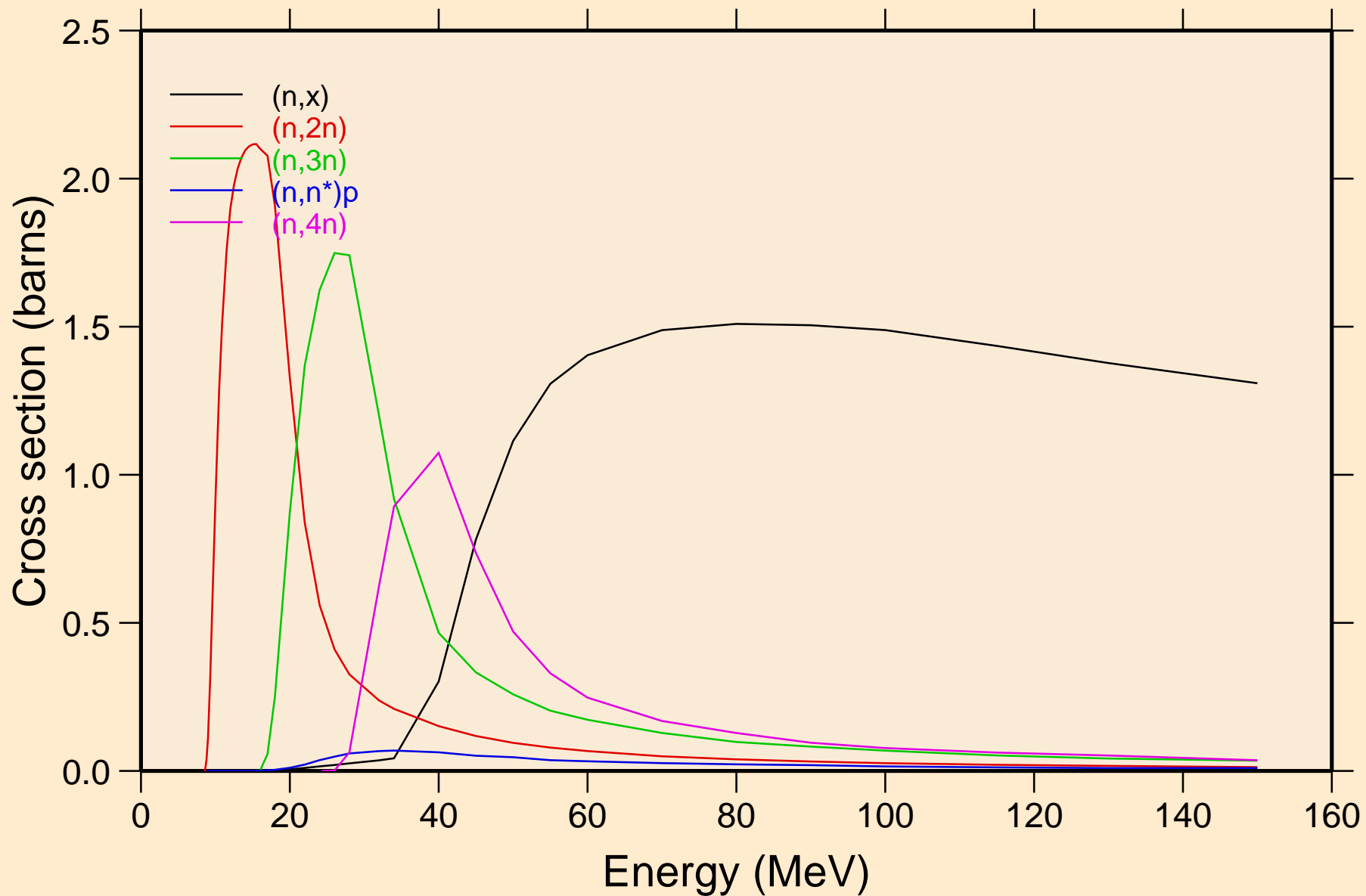

74-W-180 FOR FENDL-3.2 FROM INDL/V-3 BY NJOY2016.60+ ON Threshold reactions

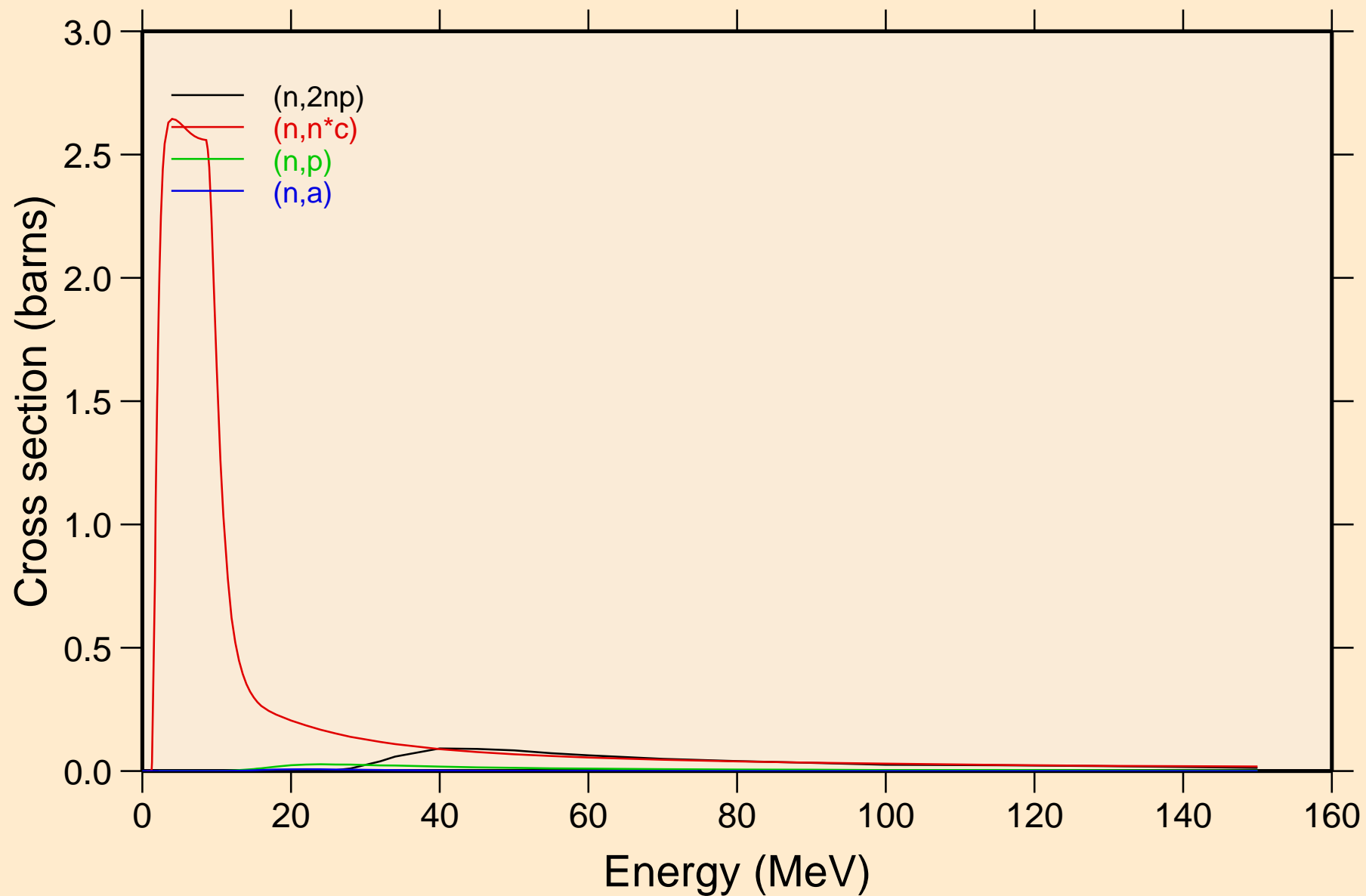

74-W-180 FOR FENDL-3.2 FROM INDL/V-3 BY NJOY2016.60+ ON Threshold reactions

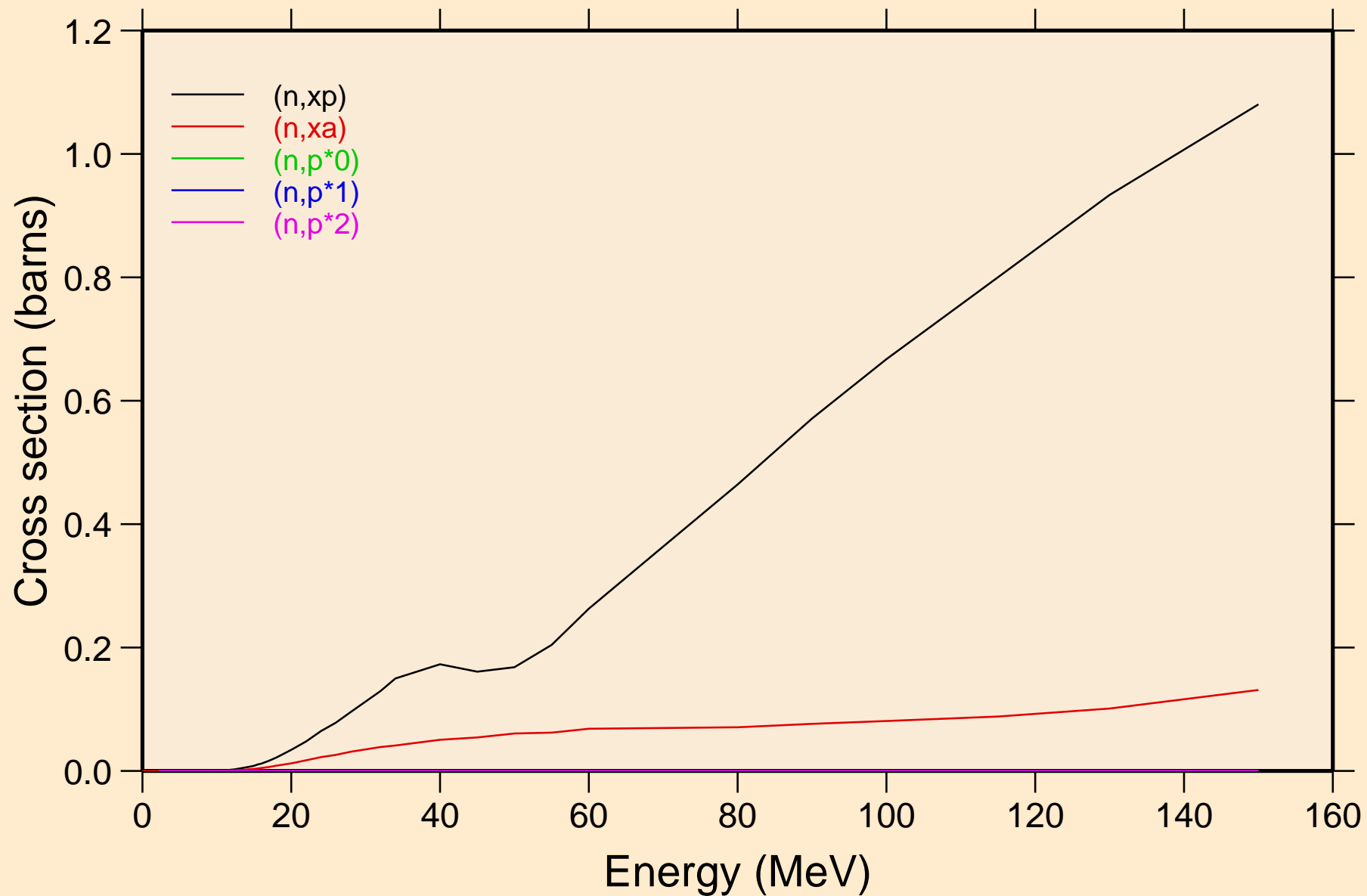

74-W-180 FOR FENDL-3.2 FROM INDL/V-3 BY NJOY2016.60+ ON Threshold reactions

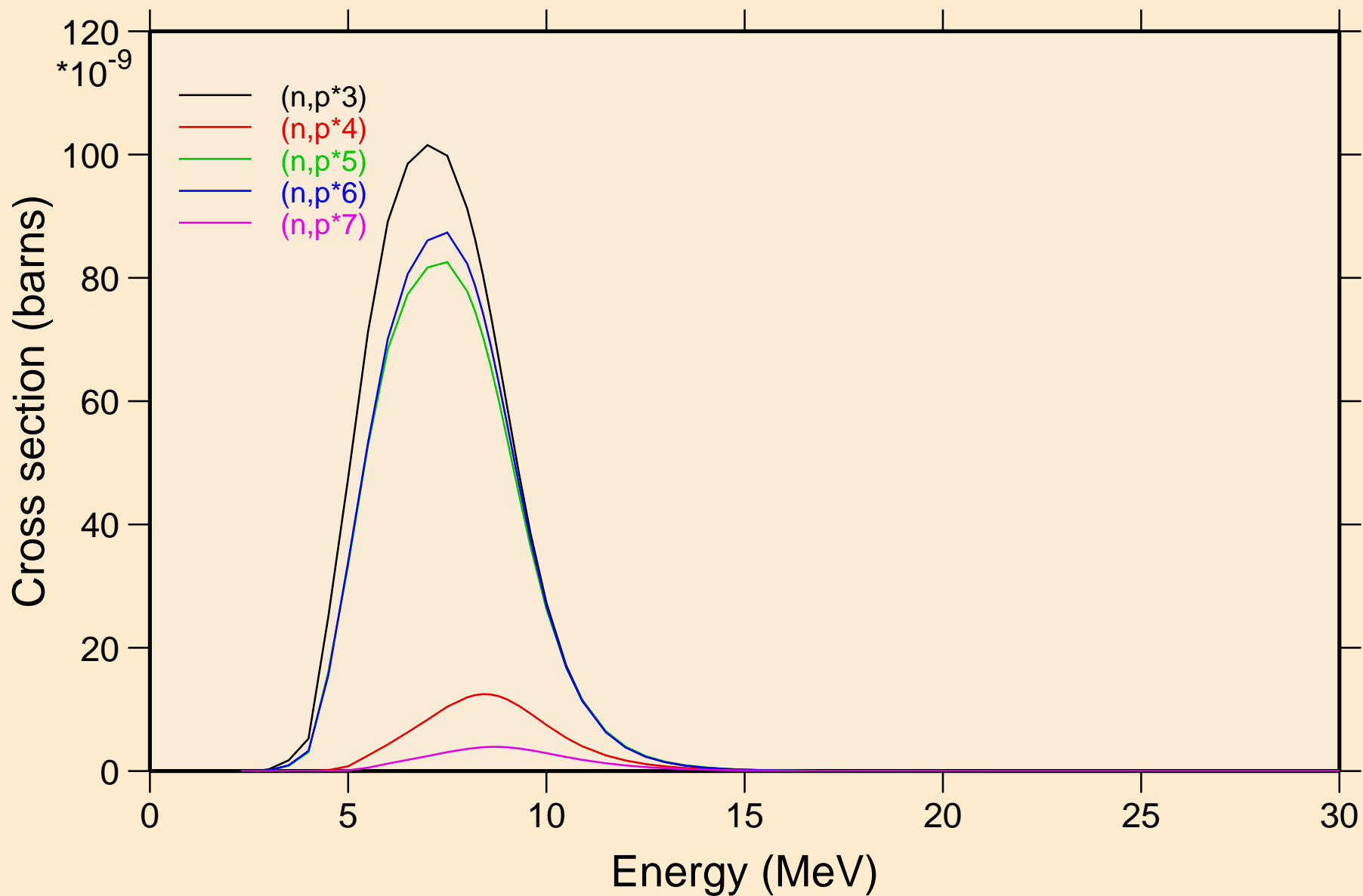

74-W-180 FOR FENDL-3.2 FROM INDL/V-3 BY NJOY2016.60+ ON Threshold reactions

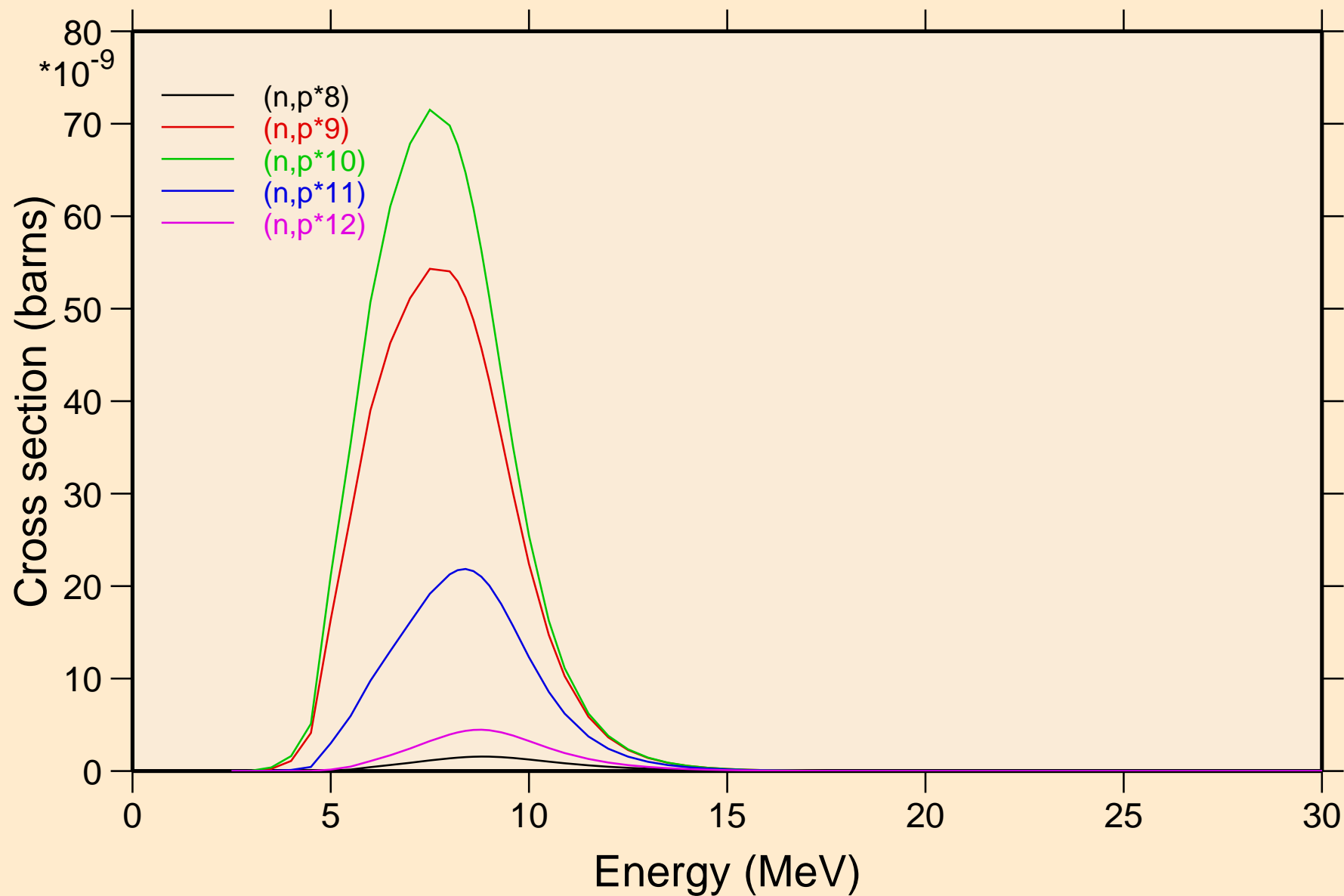

74-W-180 FOR FENDL-3.2 FROM INDL/V-3 BY NJOY2016.60+ ON Threshold reactions

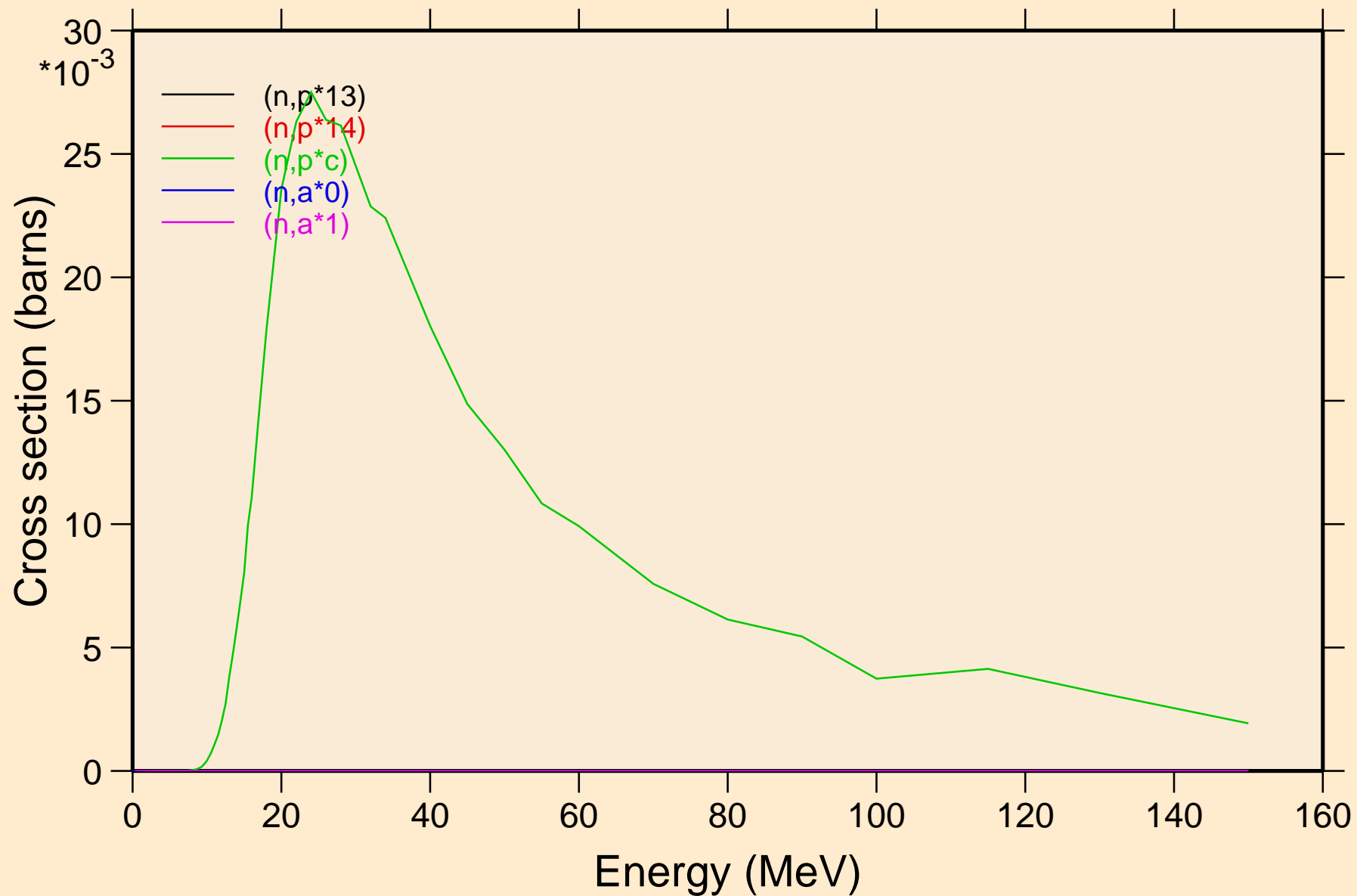

74-W-180 FOR FENDL-3.2 FROM INDL/V-3 BY NJOY2016.60+ ON
Threshold reactions

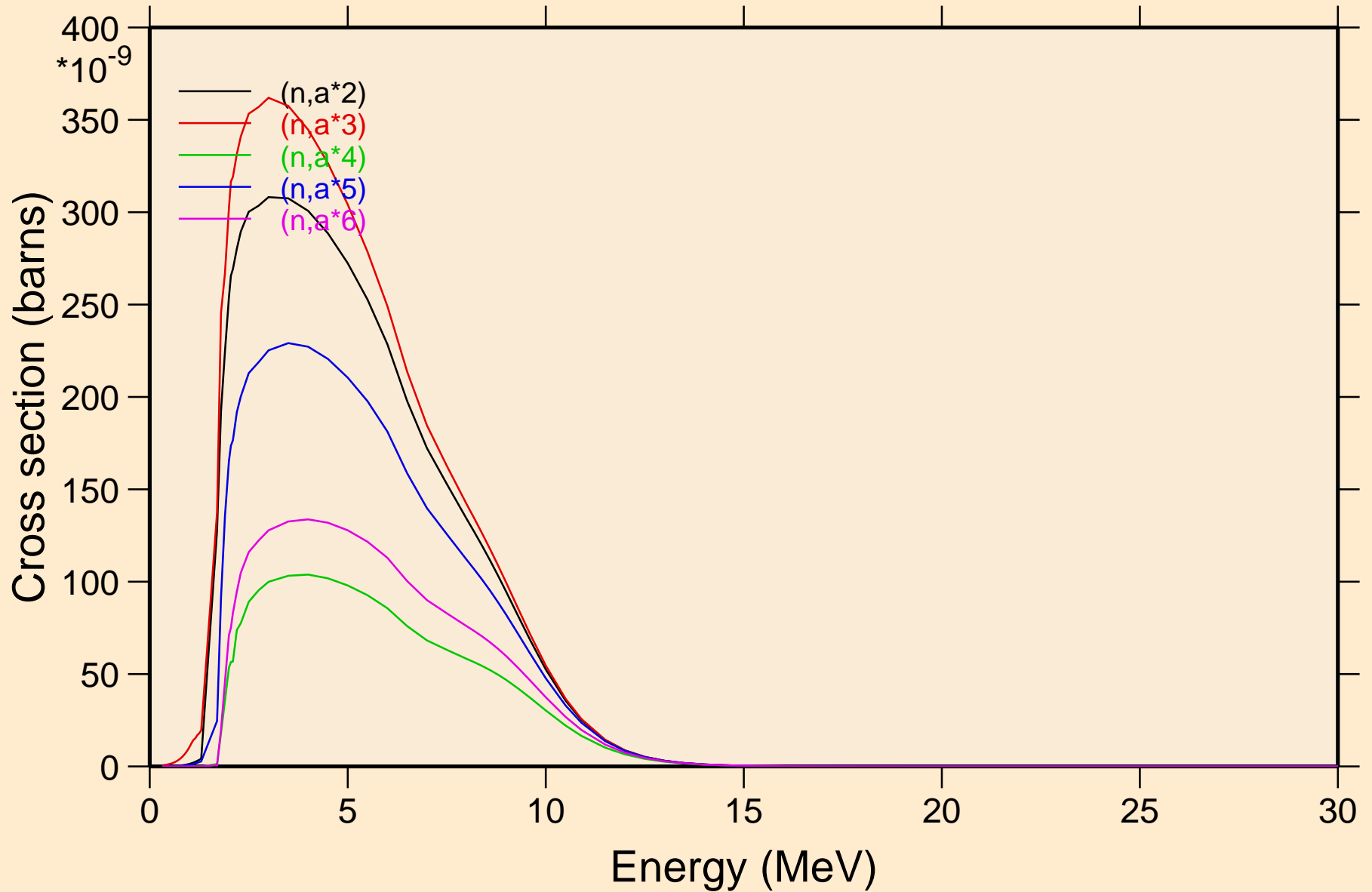

74-W-180 FOR FENDL-3.2 FROM INDL/V-3 BY NJOY2016.60+ ON Threshold reactions

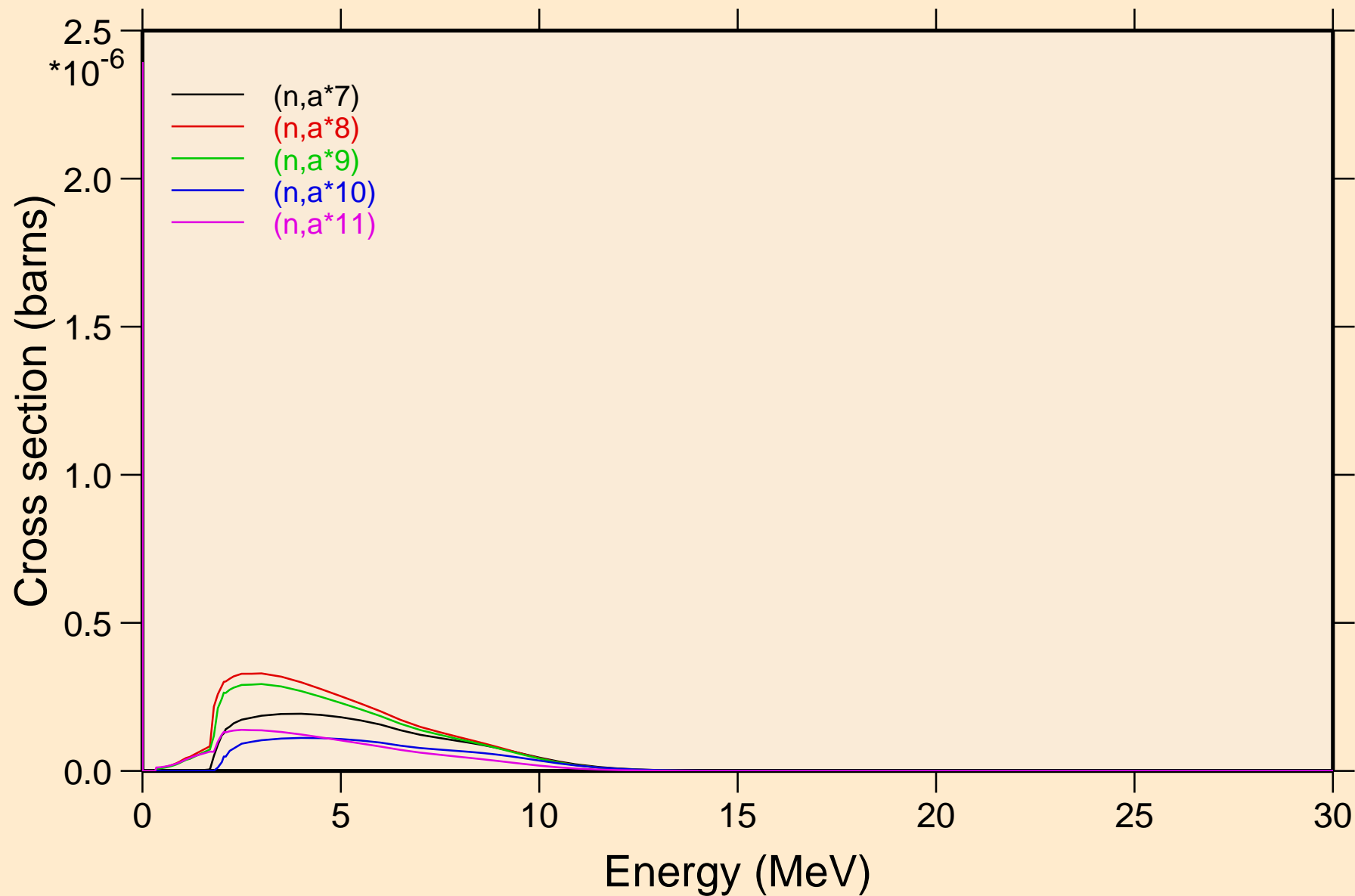

74-W-180 FOR FENDL-3.2 FROM INDL/V-3 BY NJOY2016.60+ ON Threshold reactions

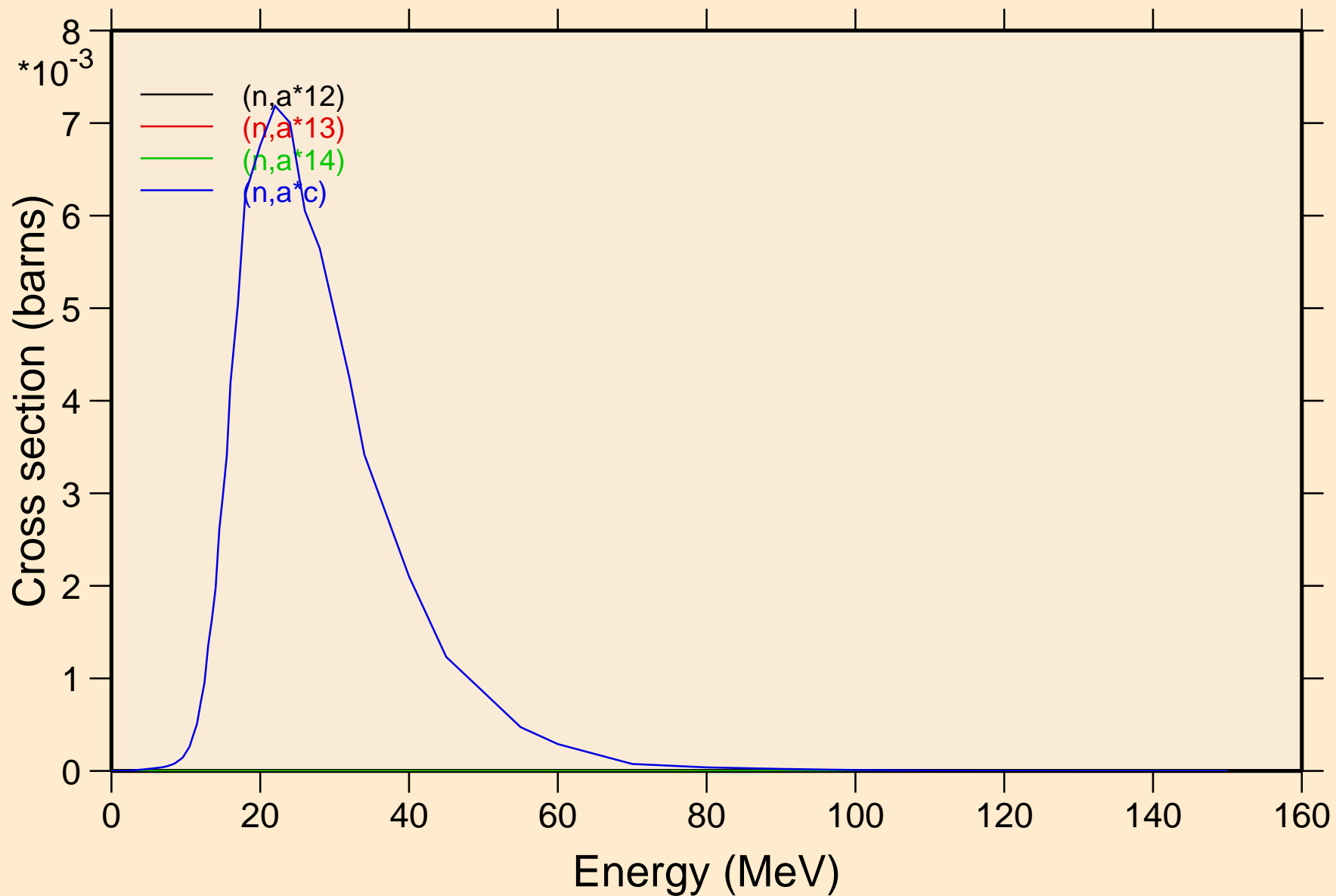

74-W-180 FOR FENDL-3.2 FROM INDL/V-3 BY NJOY2016.60+ ON
angular distribution for elastic

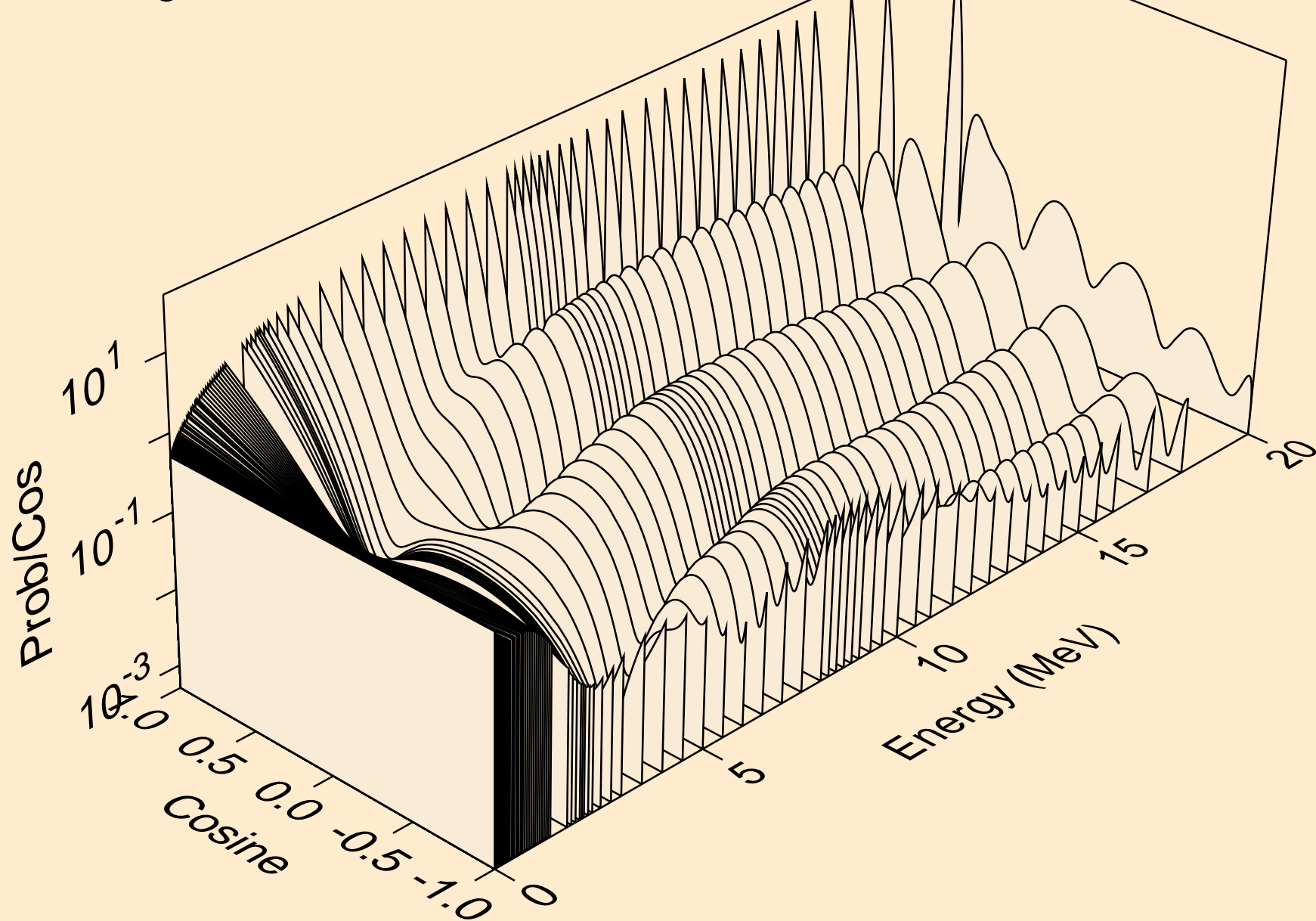

74-W-180 FOR FENDL-3.2 FROM INDL/V-3 BY NJOY2016.60+ ON
angular distribution for elastic

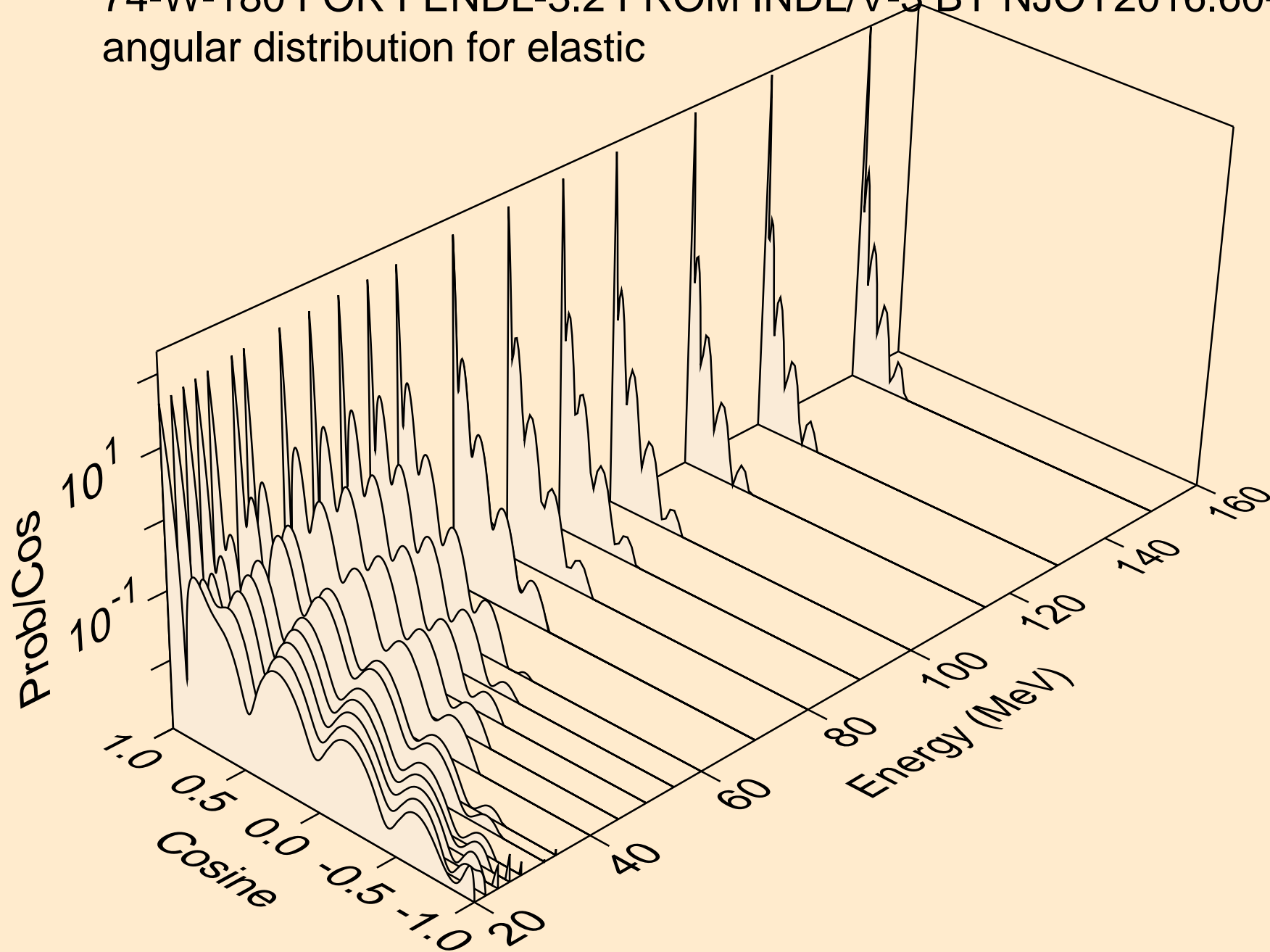

74-W-180 FOR FENDL-3.2 FROM INDL/V-3 BY NJOY2016.60+ ON
angular distribution for (n,n*1)

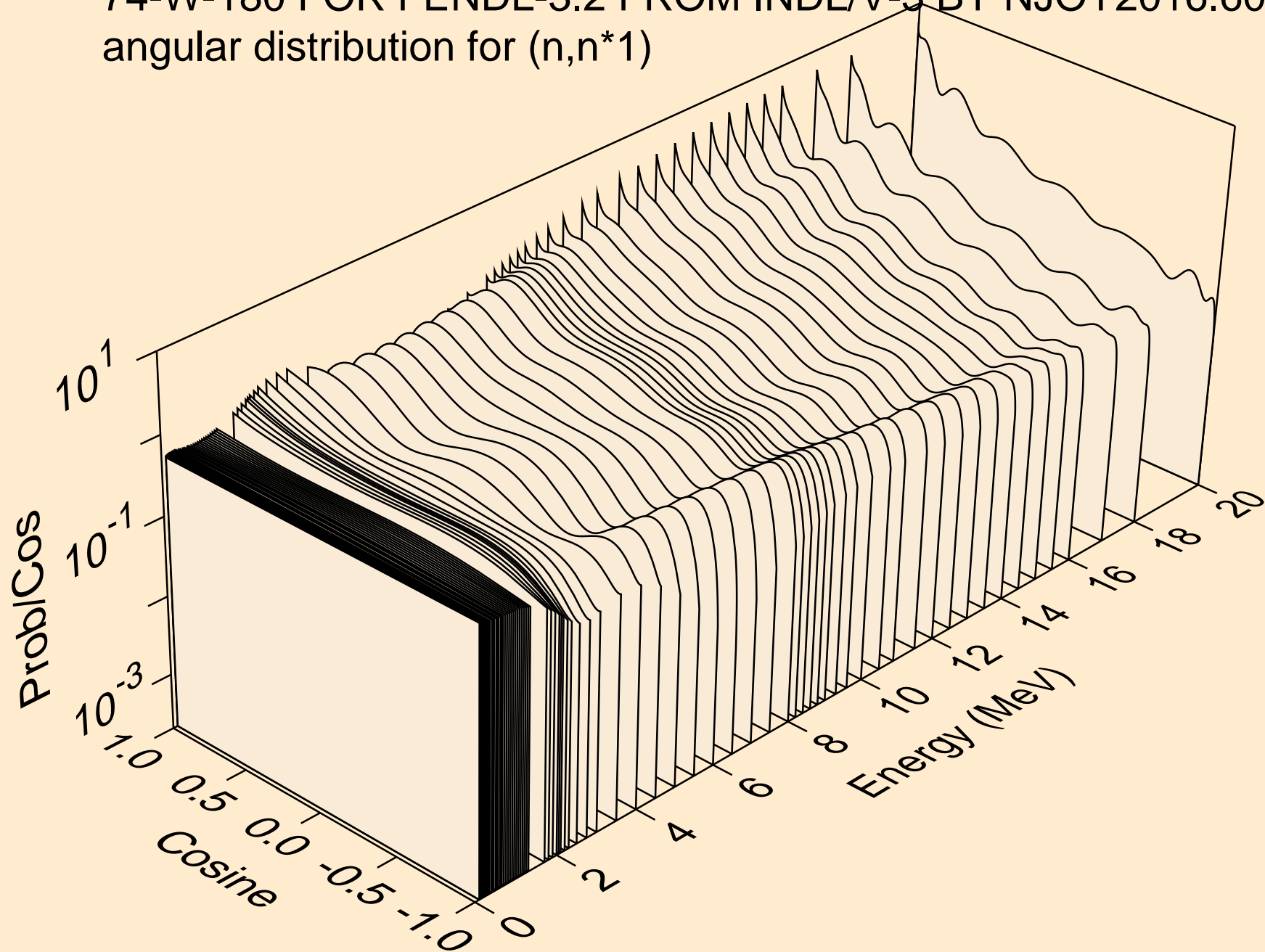

74-W-180 FOR FENDL-3.2 FROM INDL/V-3 BY NJOY2016.60+ ON
angular distribution for (n,n*1)

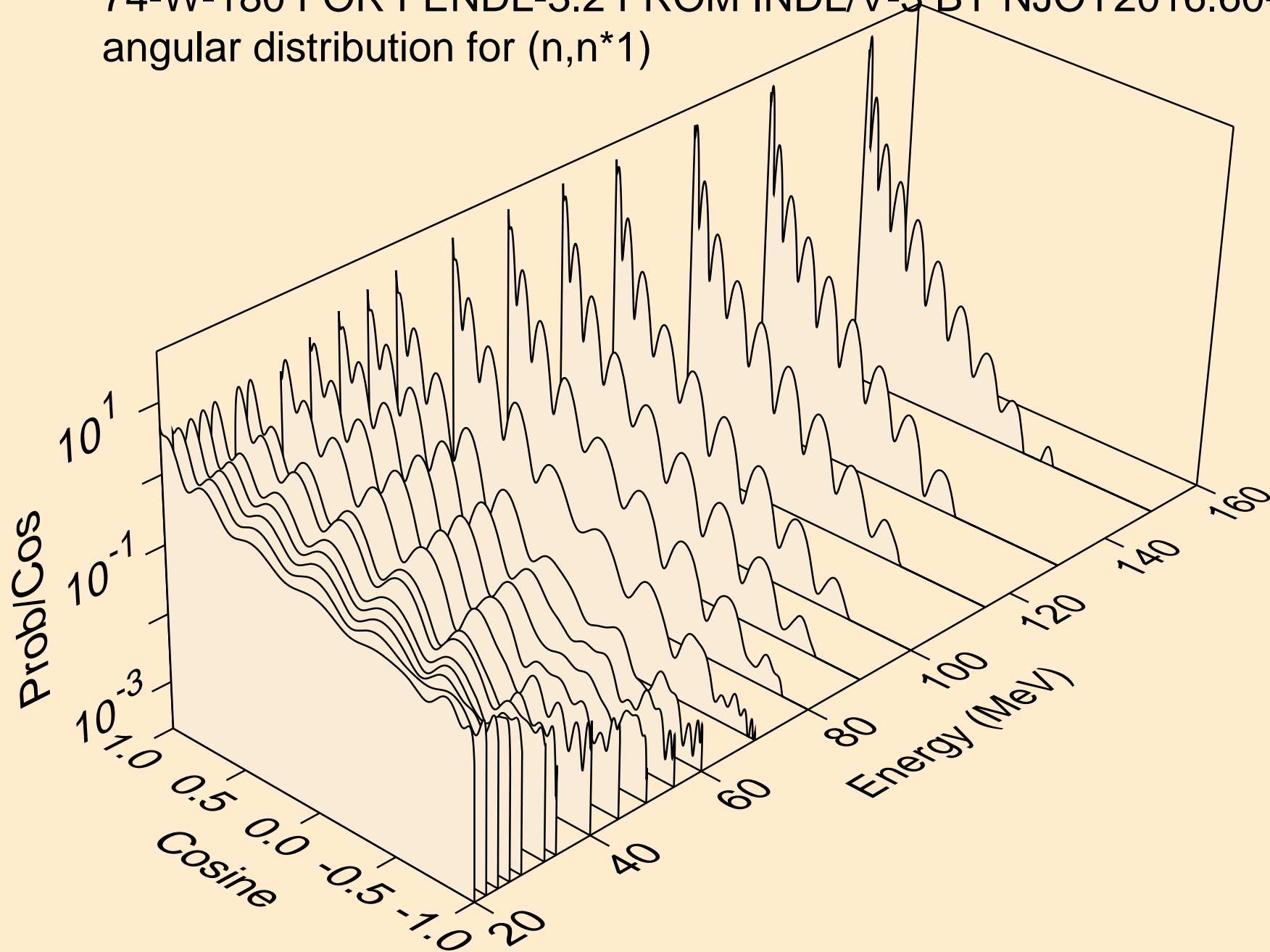

74-W-180 FOR FENDL-3.2 FROM INDL/V-3 BY NJOY2016.60+ ON
angular distribution for (n,n*2)

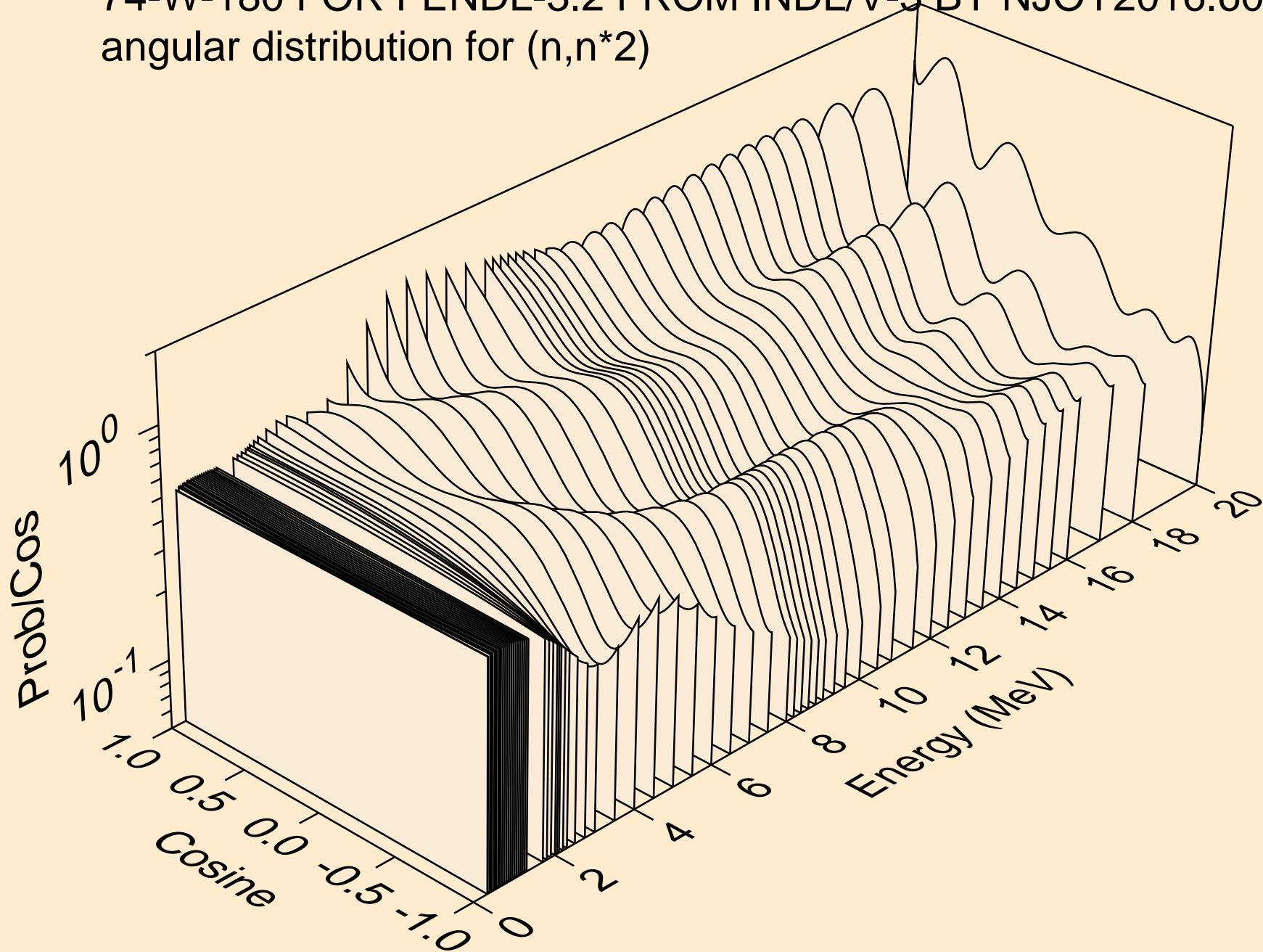

74-W-180 FOR FENDL-3.2 FROM INDL/V-3 BY NJOY2016.60+ ON
angular distribution for (n,n*2)

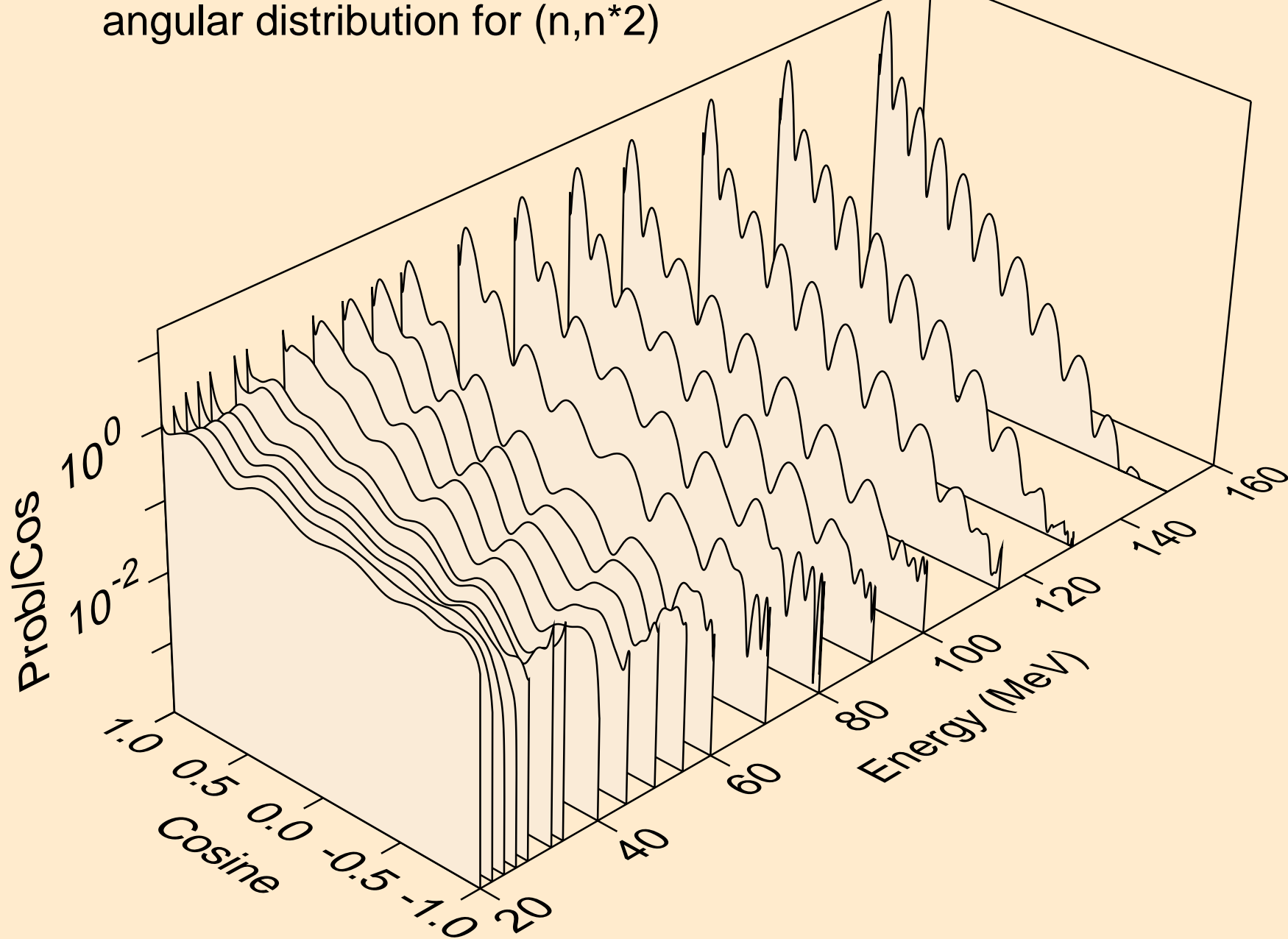

74-W-180 FOR FENDL-3.2 FROM INDL/V-3 BY NJOY2016.60+ ON
angular distribution for (n,n*3)

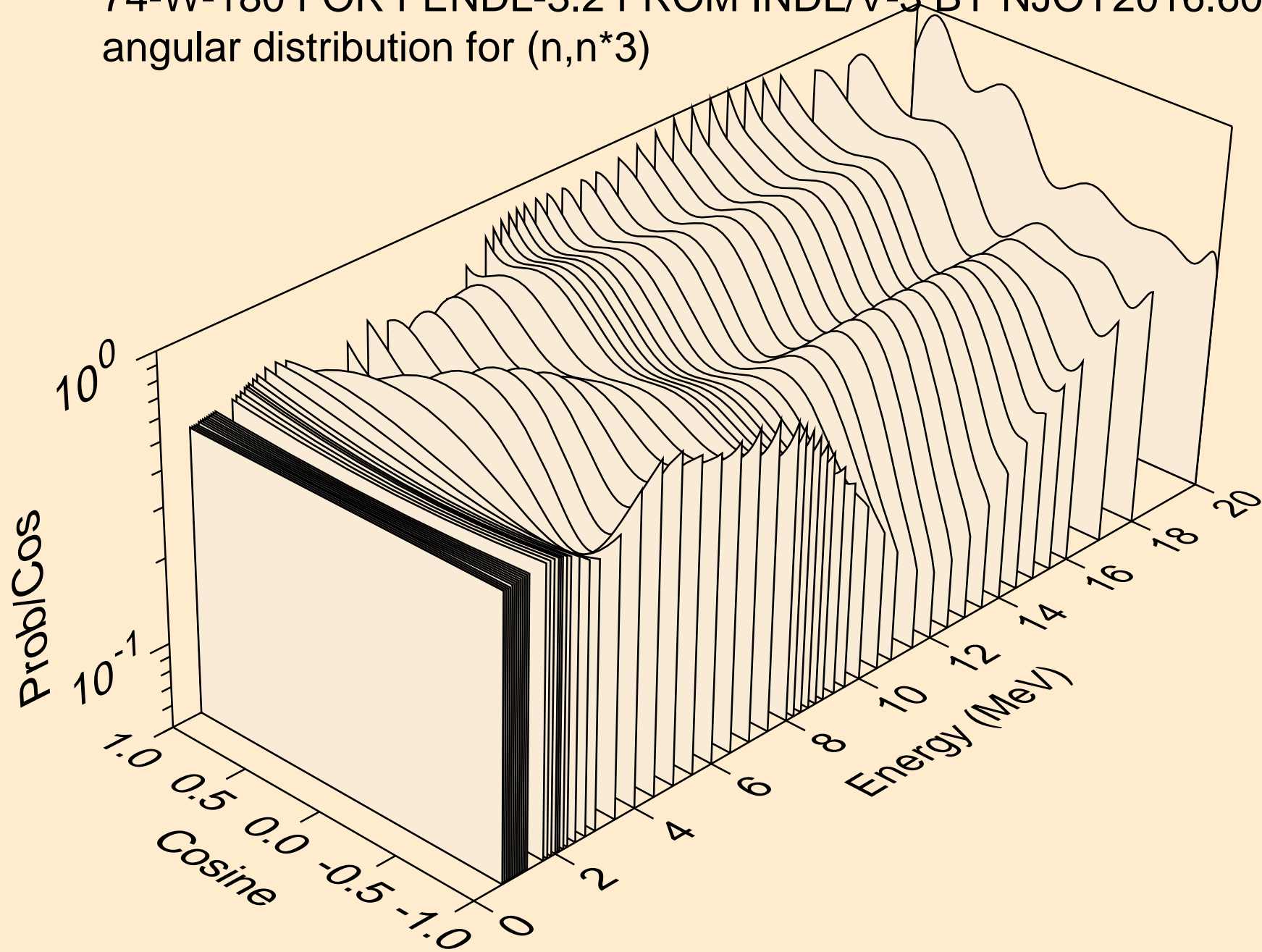

74-W-180 FOR FENDL-3.2 FROM INDL/V-3 BY NJOY2016.60+ ON
angular distribution for (n,n*3)

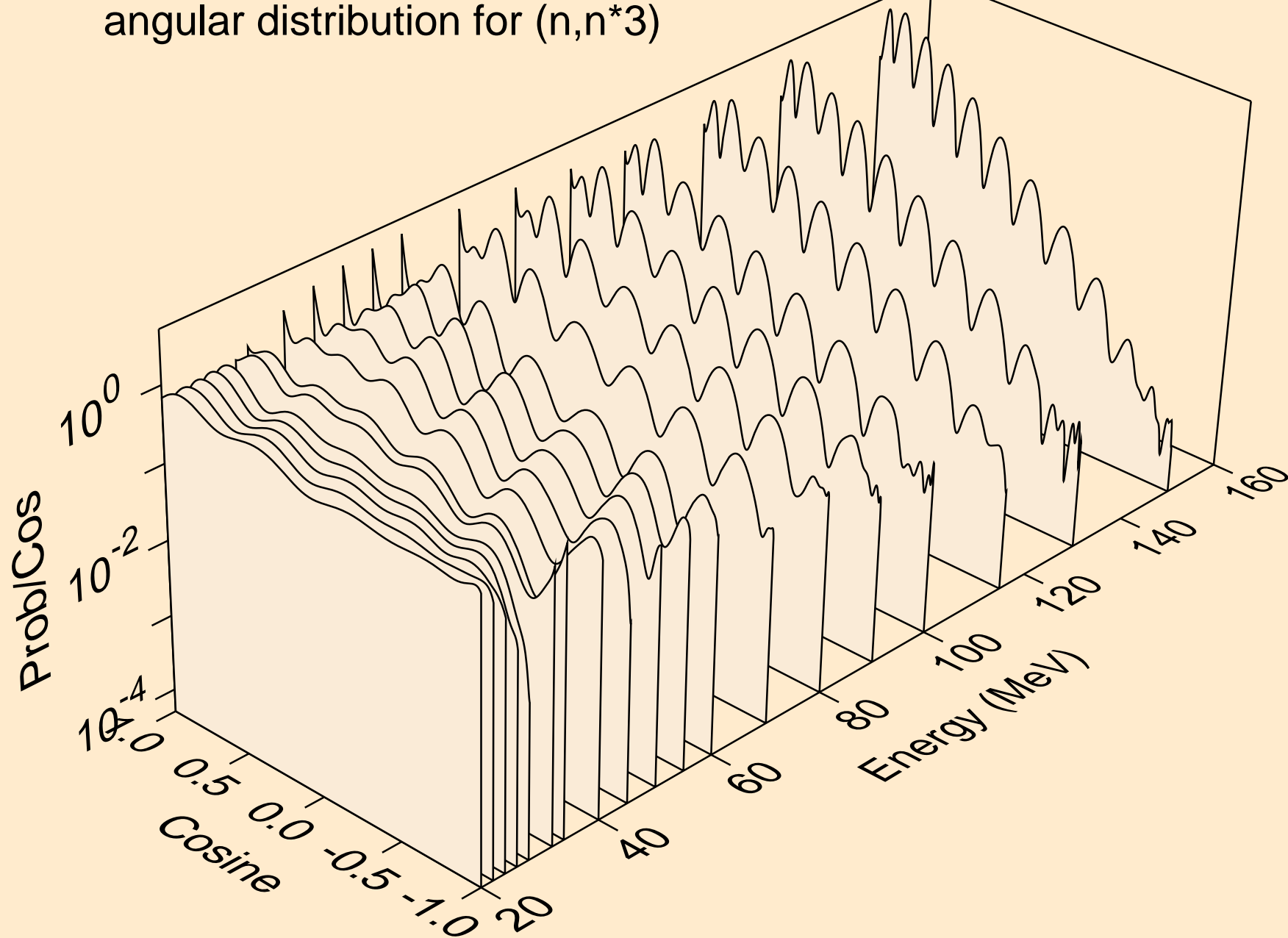

74-W-180 FOR FENDL-3.2 FROM INDL/V-3 BY NJOY2016.60+ ON
angular distribution for (n,n*4)

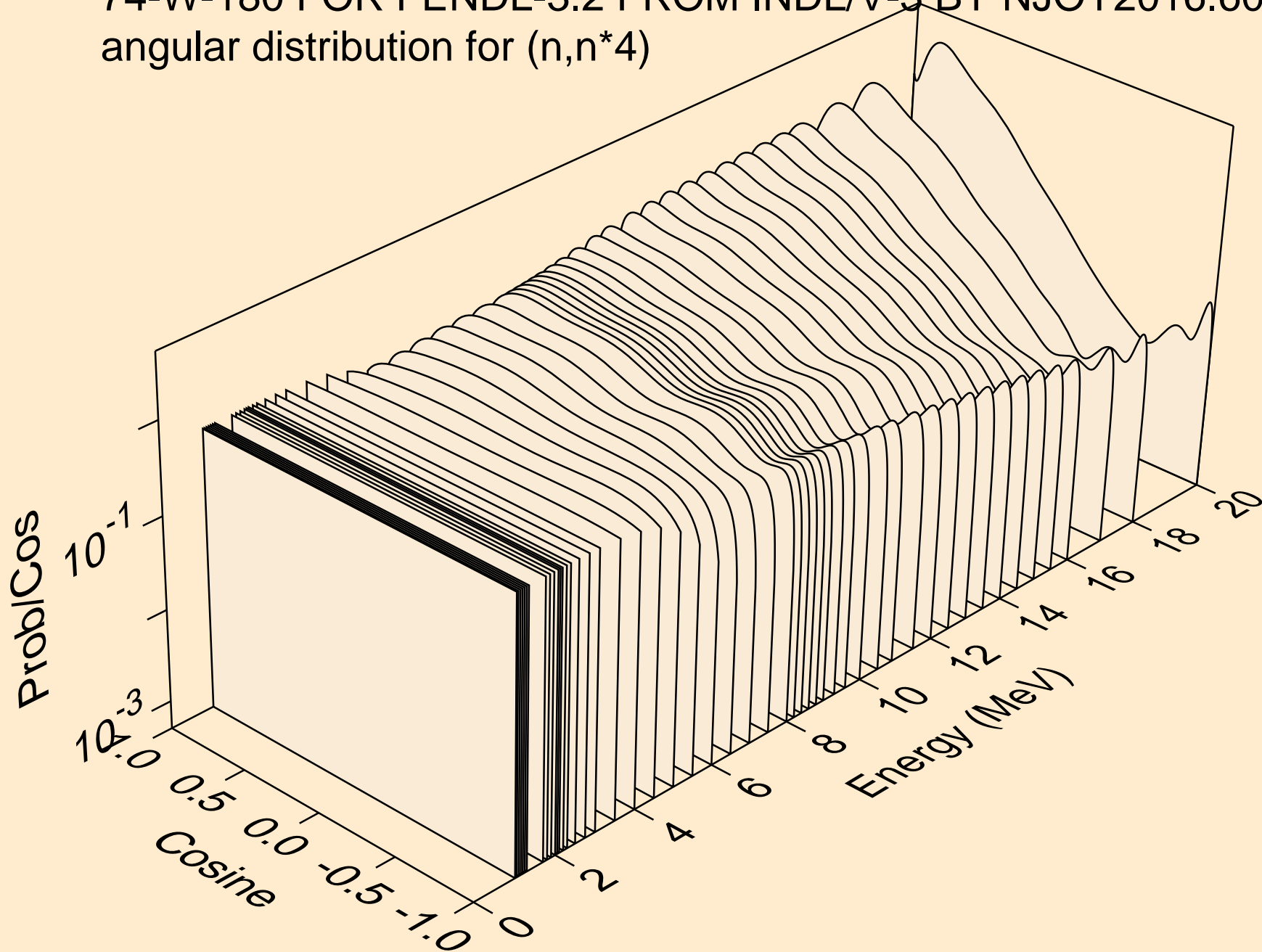

74-W-180 FOR FENDL-3.2 FROM INDL/V-3 BY NJOY2016.60+ ON
angular distribution for (n,n*4)

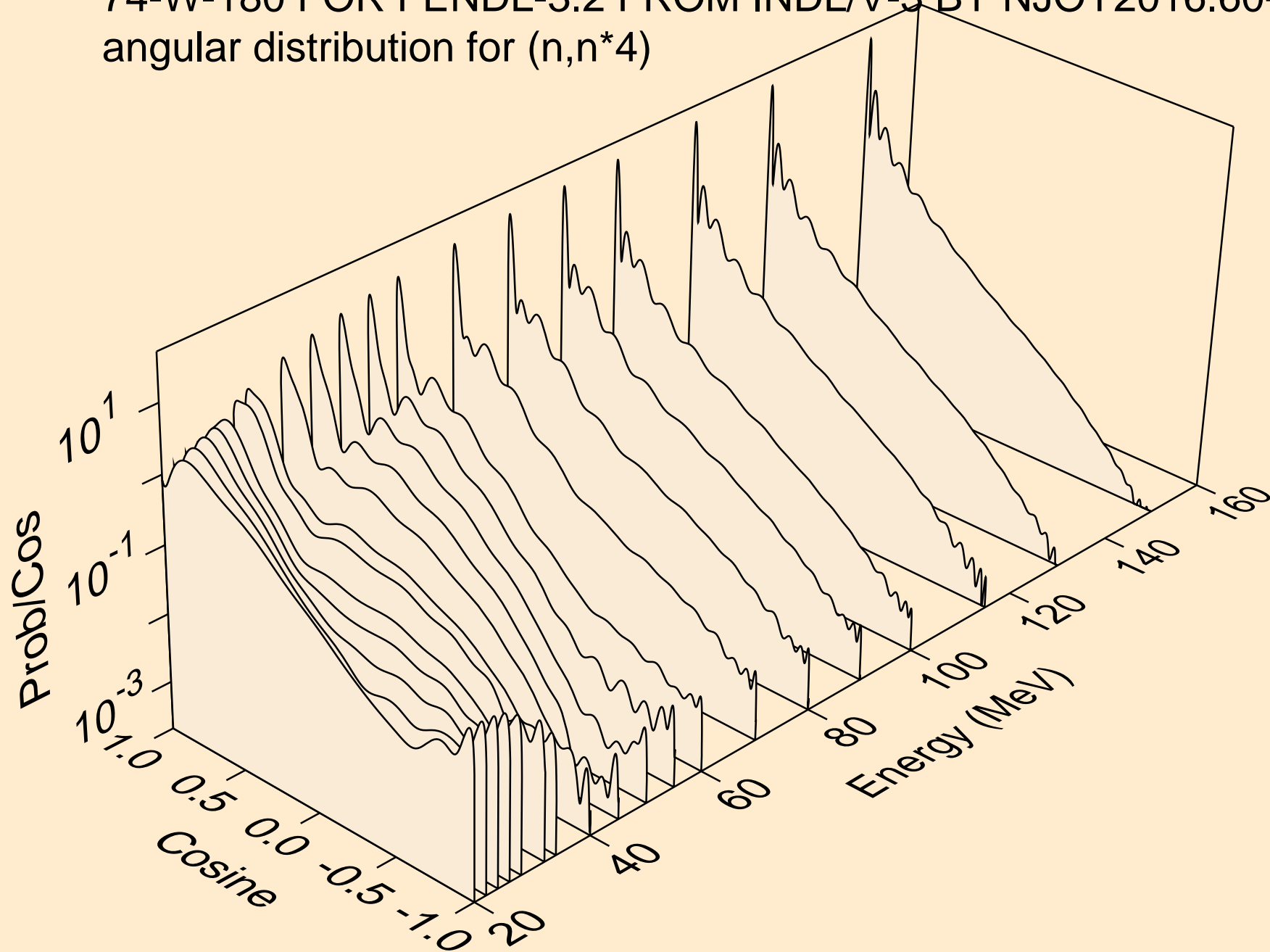

74-W-180 FOR FENDL-3.2 FROM INDL/V-3 BY NJOY2016.60+ ON
angular distribution for (n,n*5)

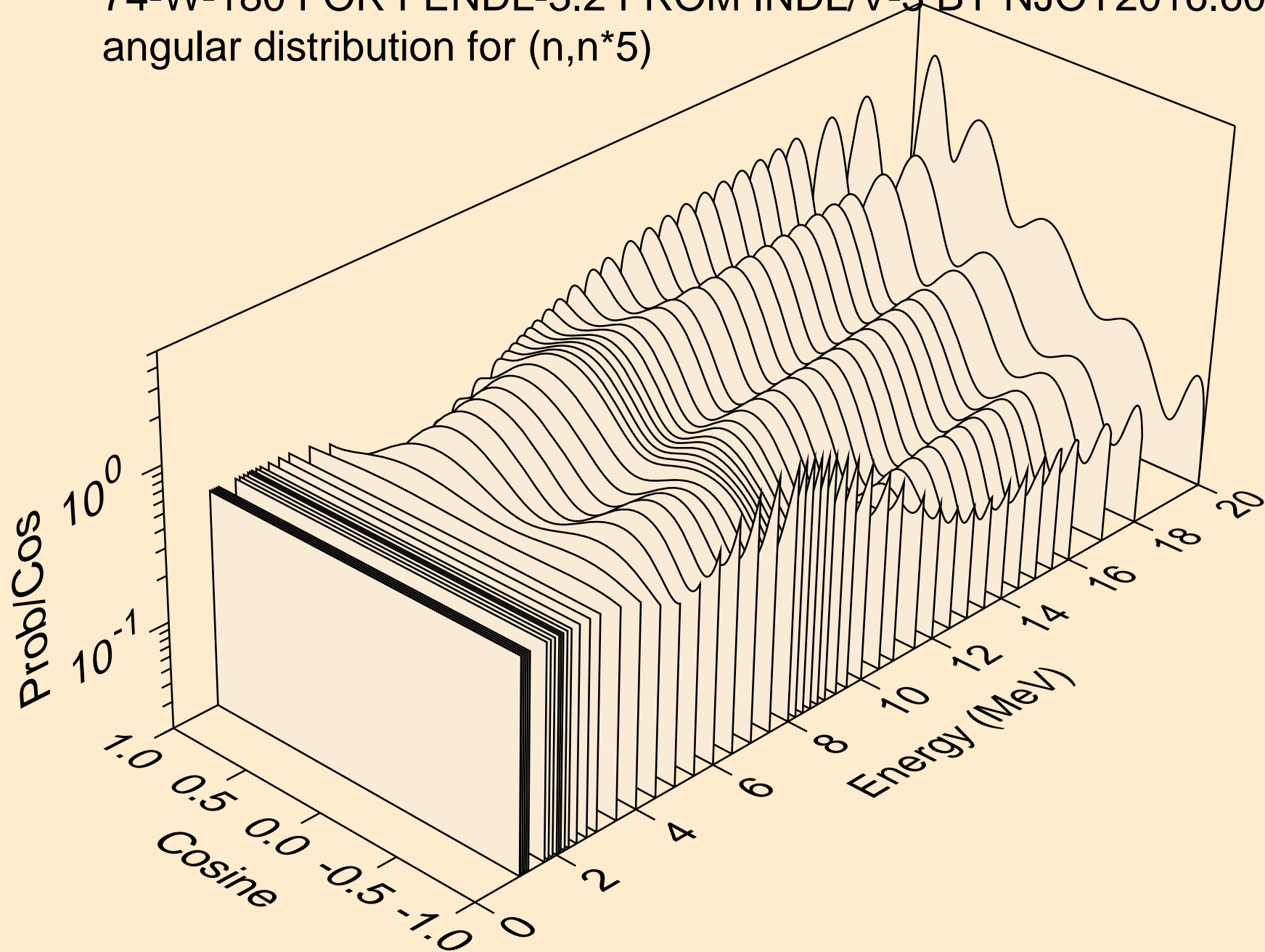

74-W-180 FOR FENDL-3.2 FROM INDL/V-3 BY NJOY2016.60+ ON
angular distribution for (n,n*5)

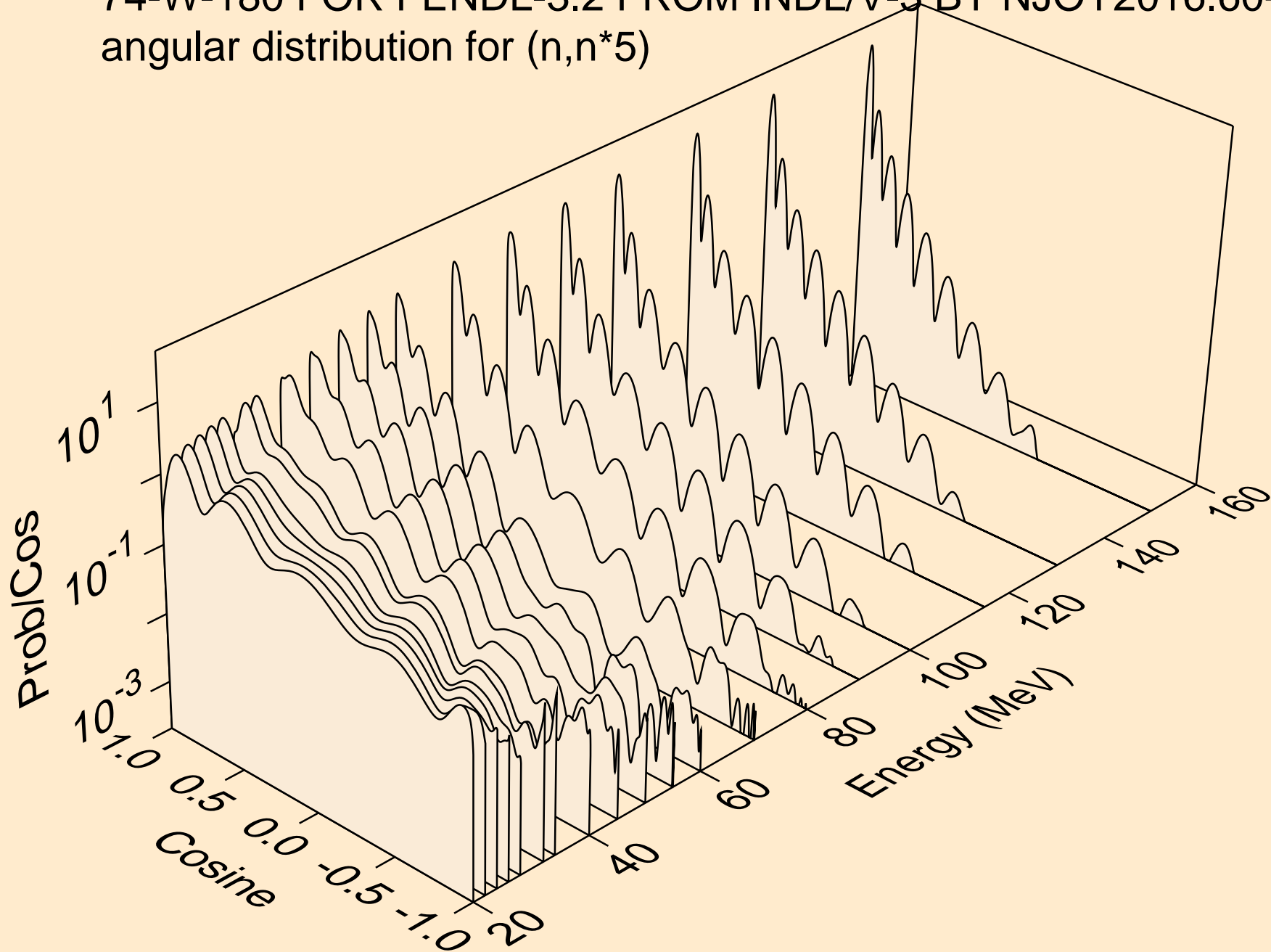

74-W-180 FOR FENDL-3.2 FROM INDL/V-3 BY NJOY2016.60+ ON
angular distribution for (n,n*6)

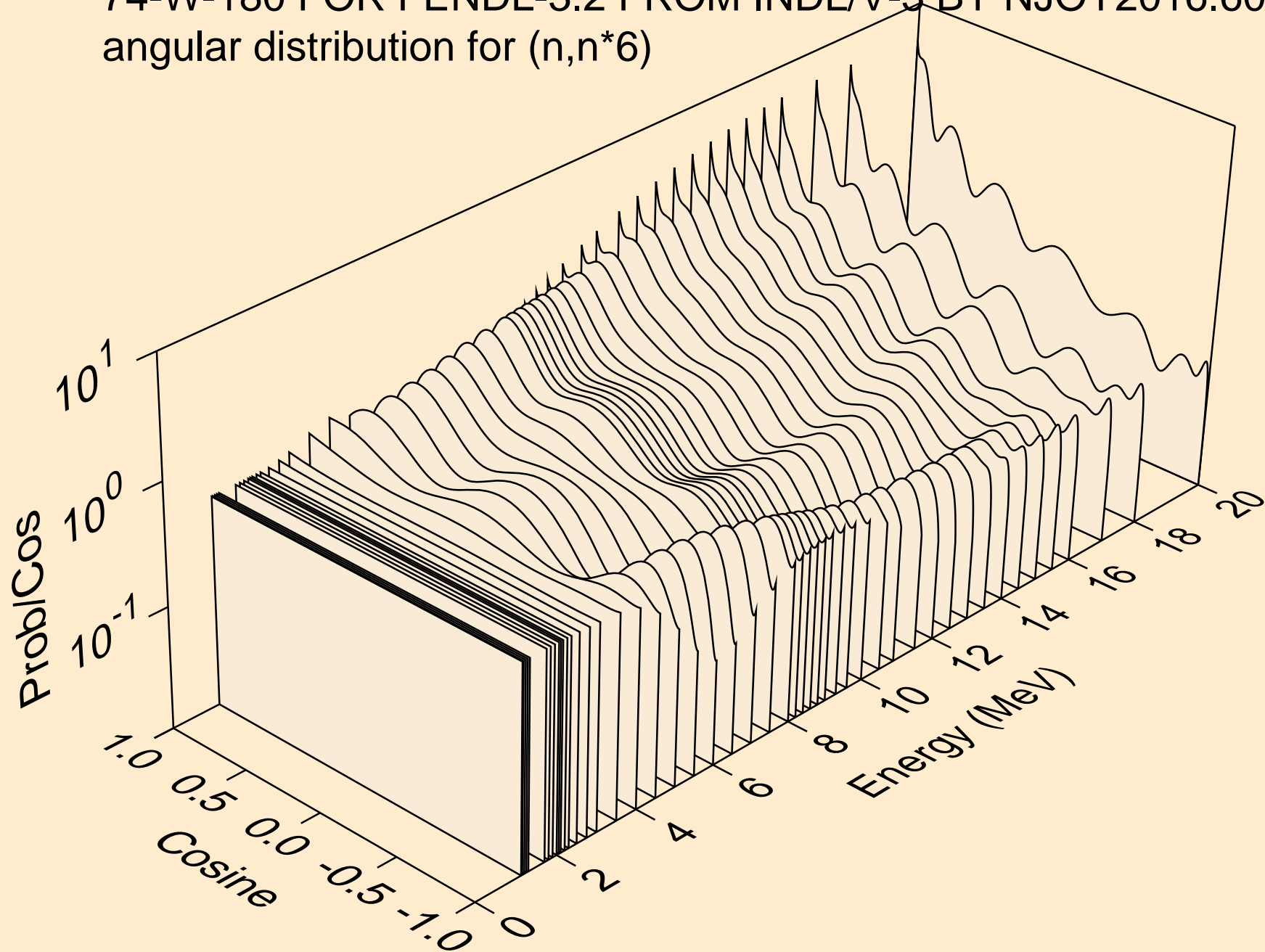

74-W-180 FOR FENDL-3.2 FROM INDL/V-3 BY NJOY2016.60+ ON
angular distribution for (n,n*6)

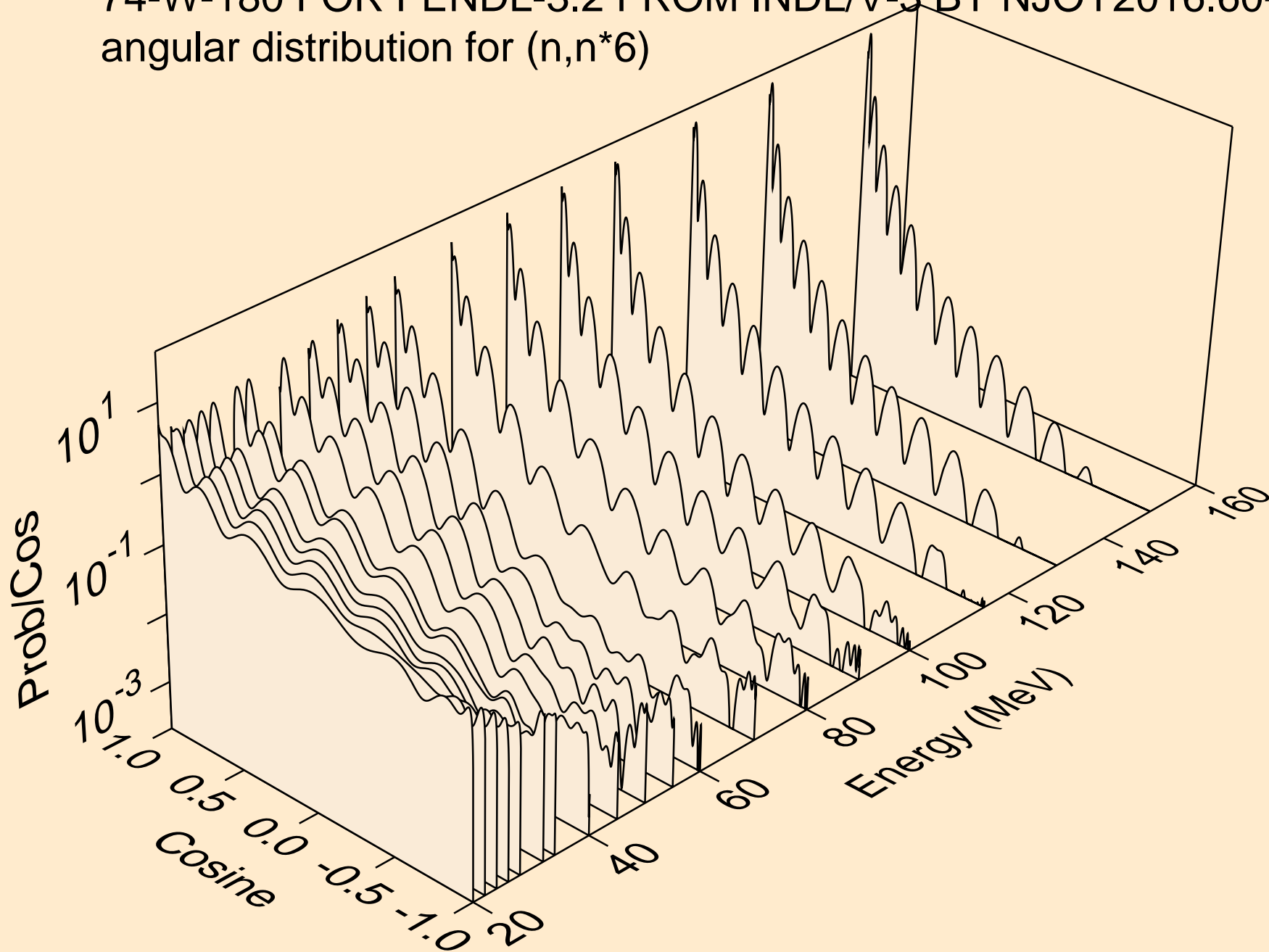

74-W-180 FOR FENDL-3.2 FROM INDL/V-3 BY NJOY2016.60+ ON
angular distribution for (n,n*7)

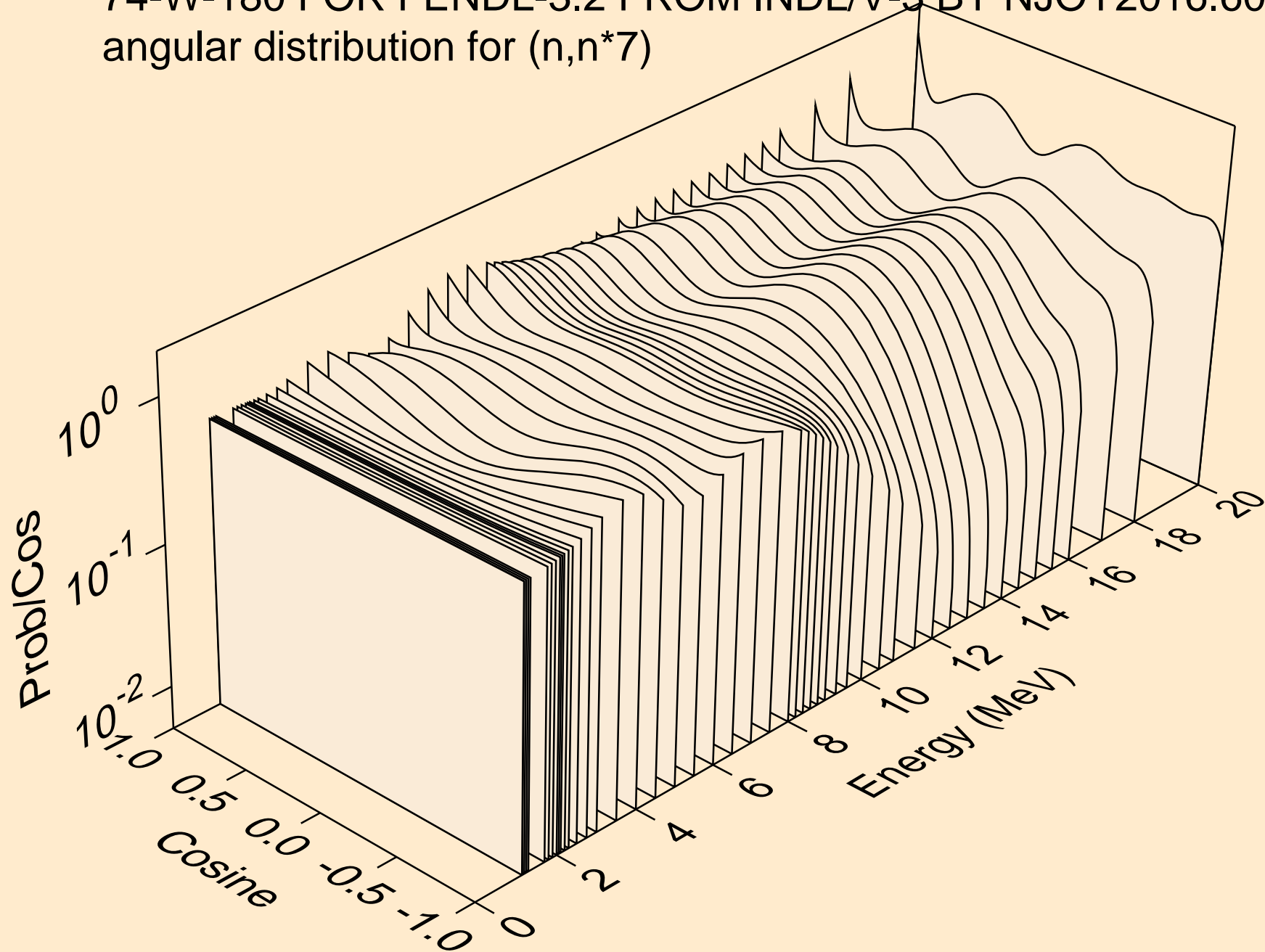

74-W-180 FOR FENDL-3.2 FROM INDL/V-3 BY NJOY2016.60+ ON
angular distribution for (n,n*7)

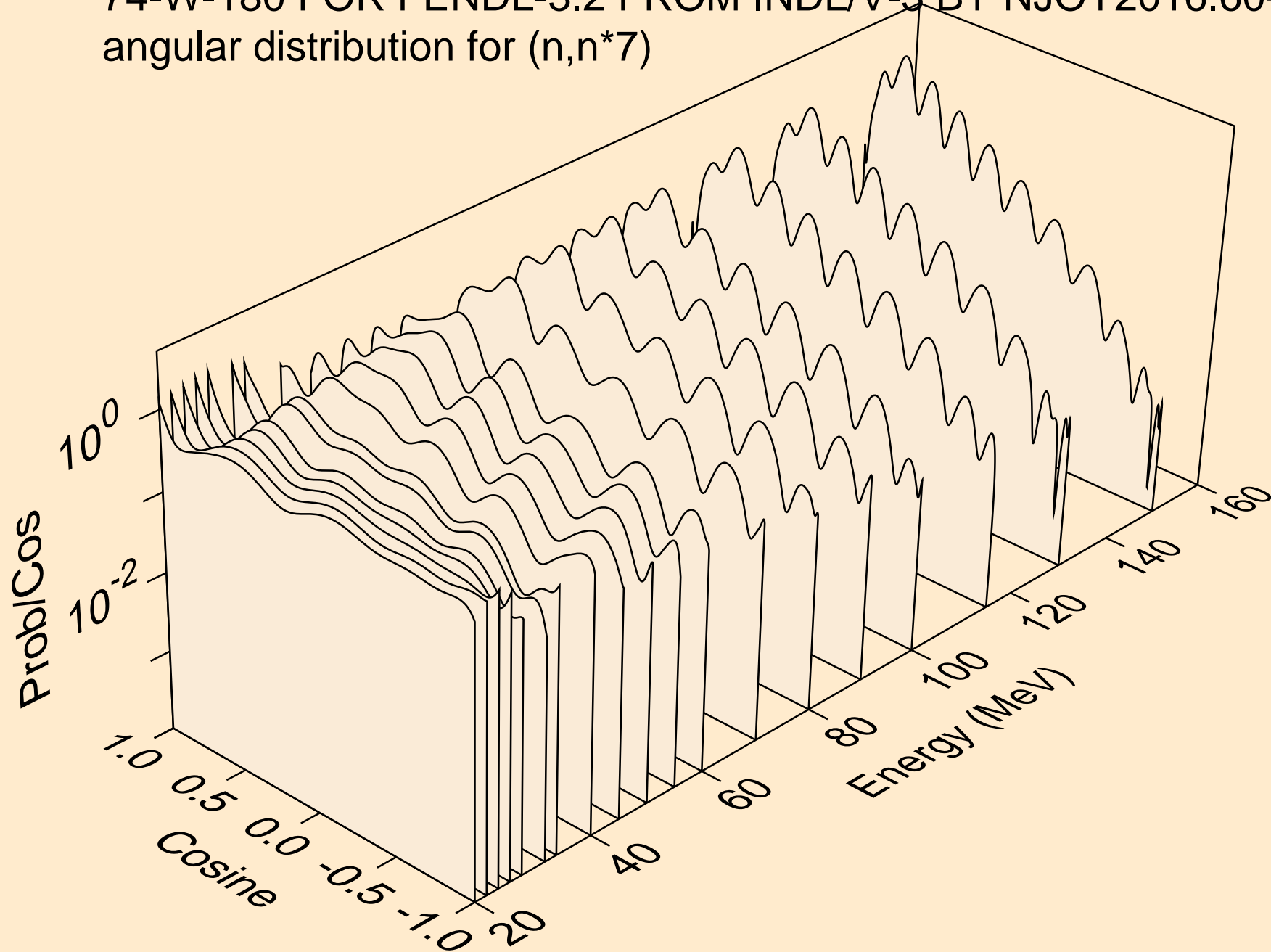

74-W-180 FOR FENDL-3.2 FROM INDL/V-3 BY NJOY2016.60+ ON
angular distribution for (n,n*8)

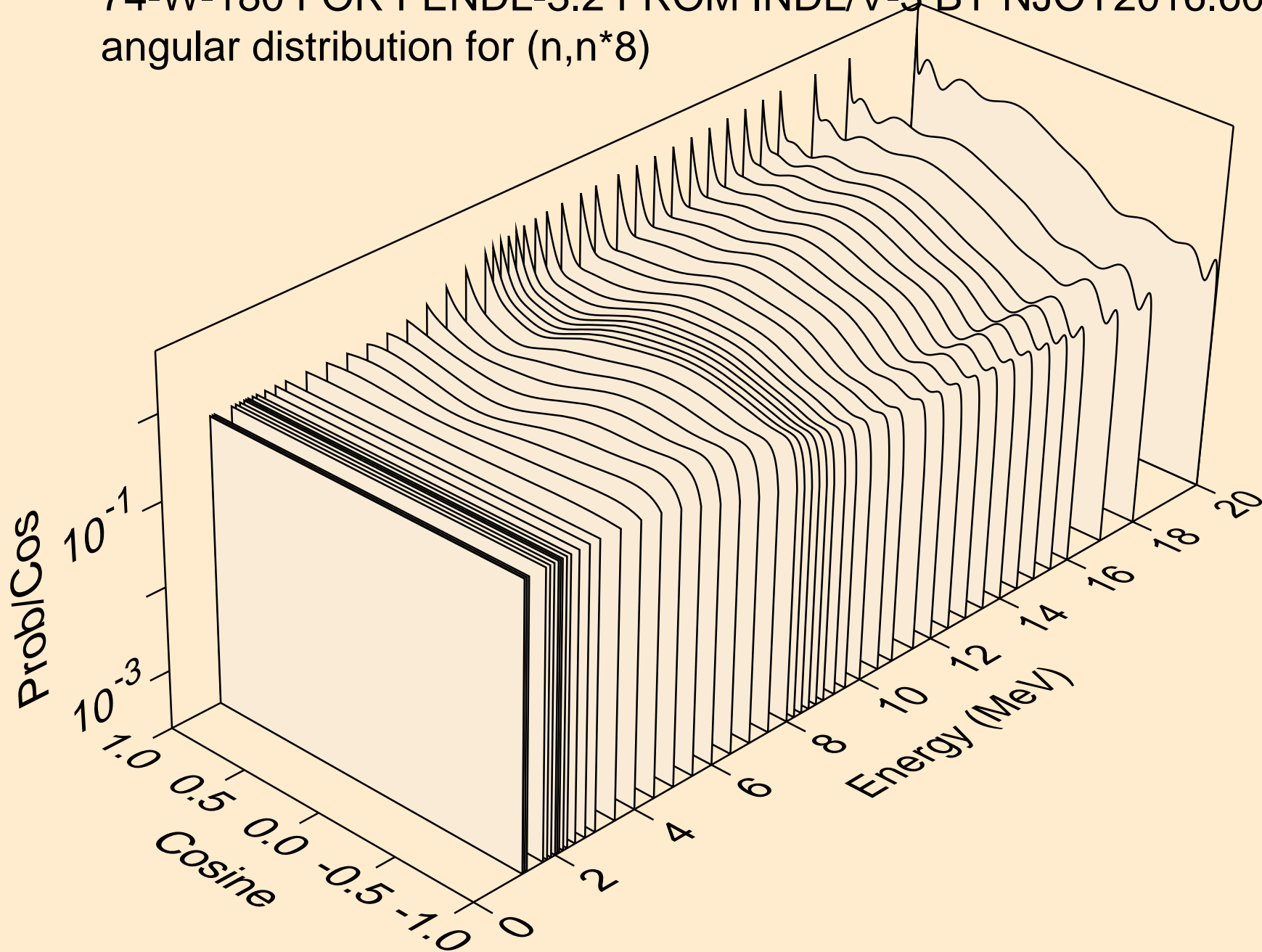

74-W-180 FOR FENDL-3.2 FROM INDL/V-3 BY NJOY2016.60+ ON
angular distribution for (n,n*8)

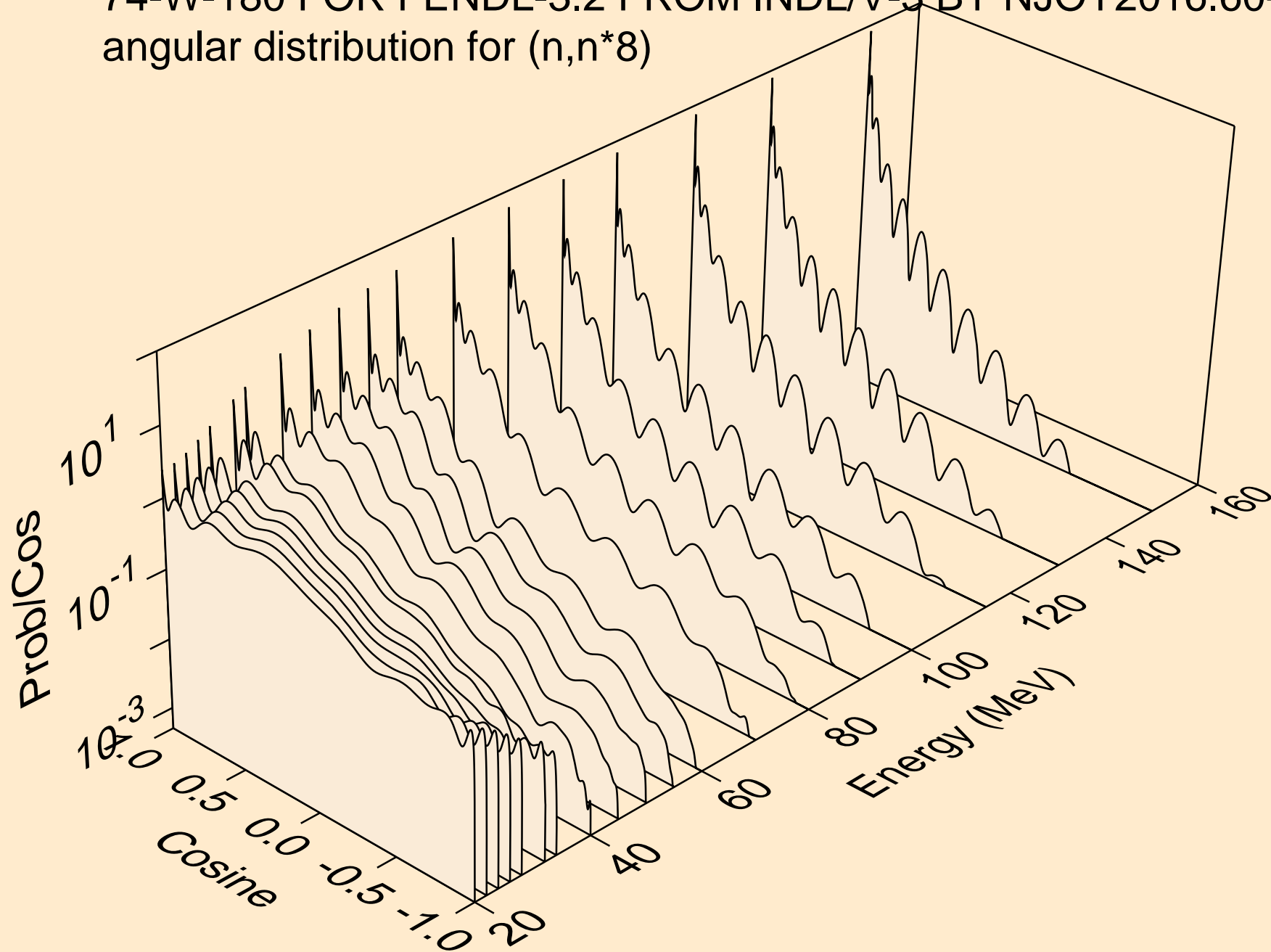

74-W-180 FOR FENDL-3.2 FROM INDLV-3 BY NJOY2016.60+ ON
Neutron emission for (n,x)

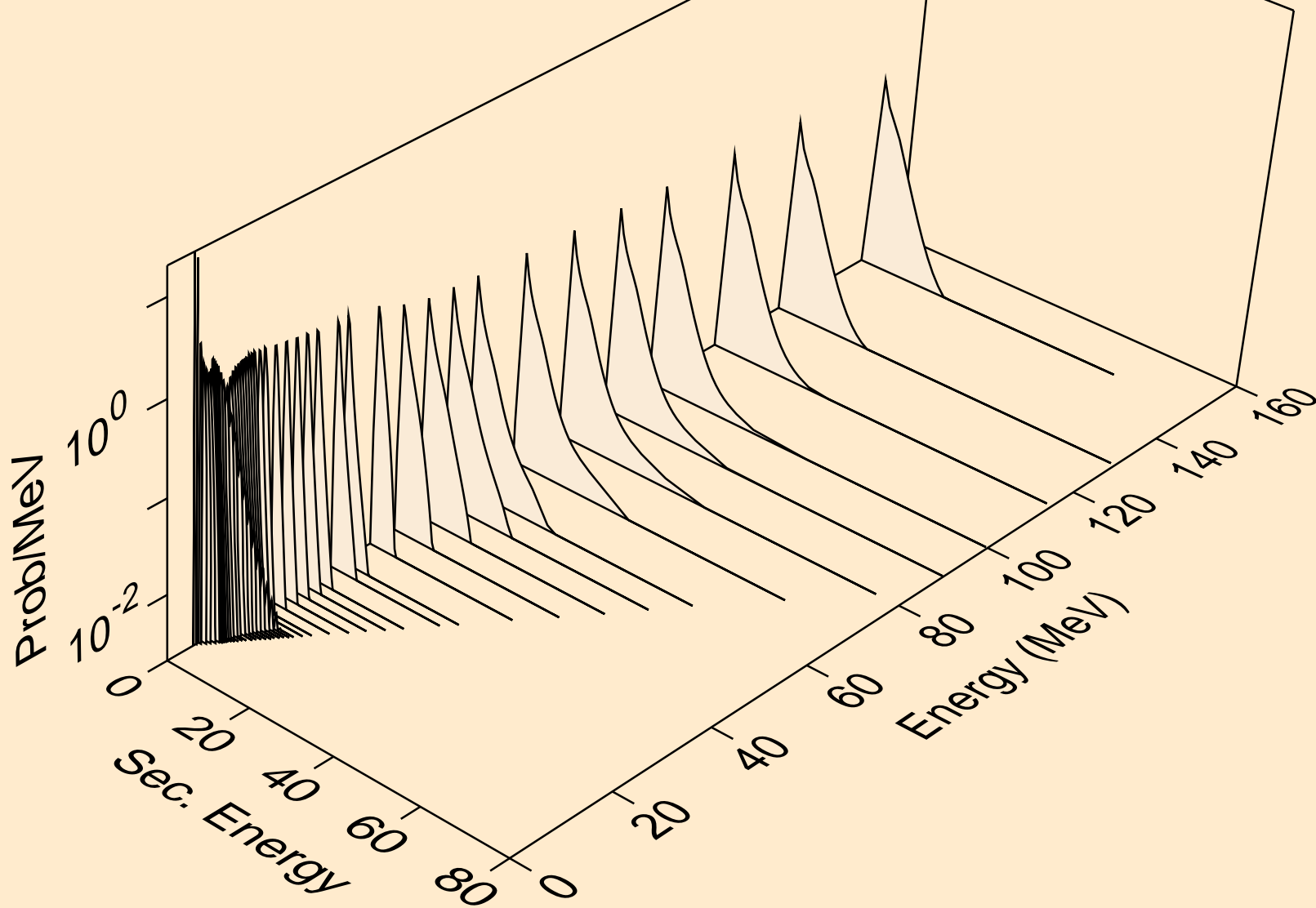

74-W-180 FOR FENDL-3.2 FROM INDLV-3 BY NJOY2016.60+ ON
Neutron emission for (n,2n)

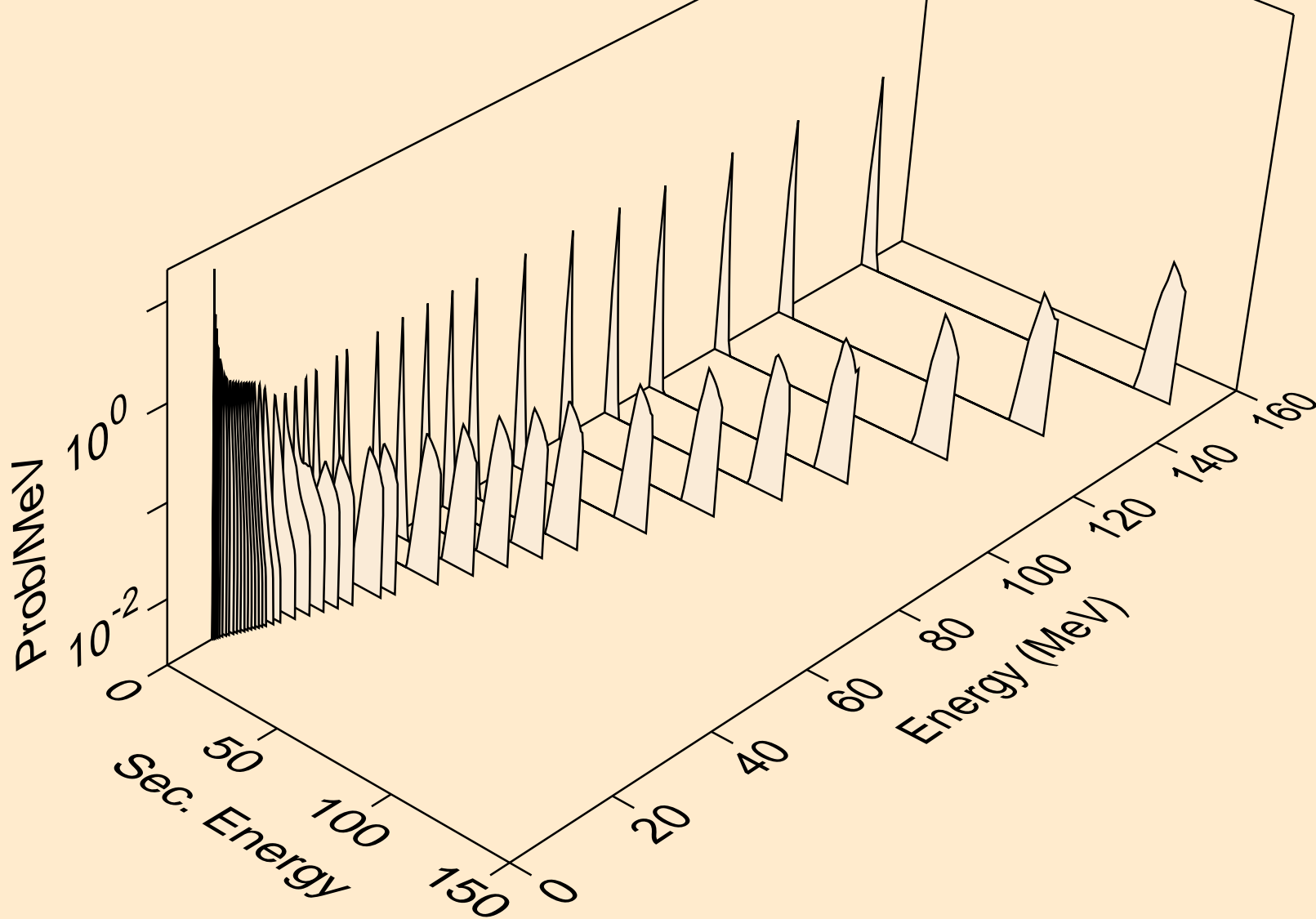

74-W-180 FOR FENDL-3.2 FROM INDLV-3 BY NJOY2016.60+ ON
Neutron emission for (n,3n)

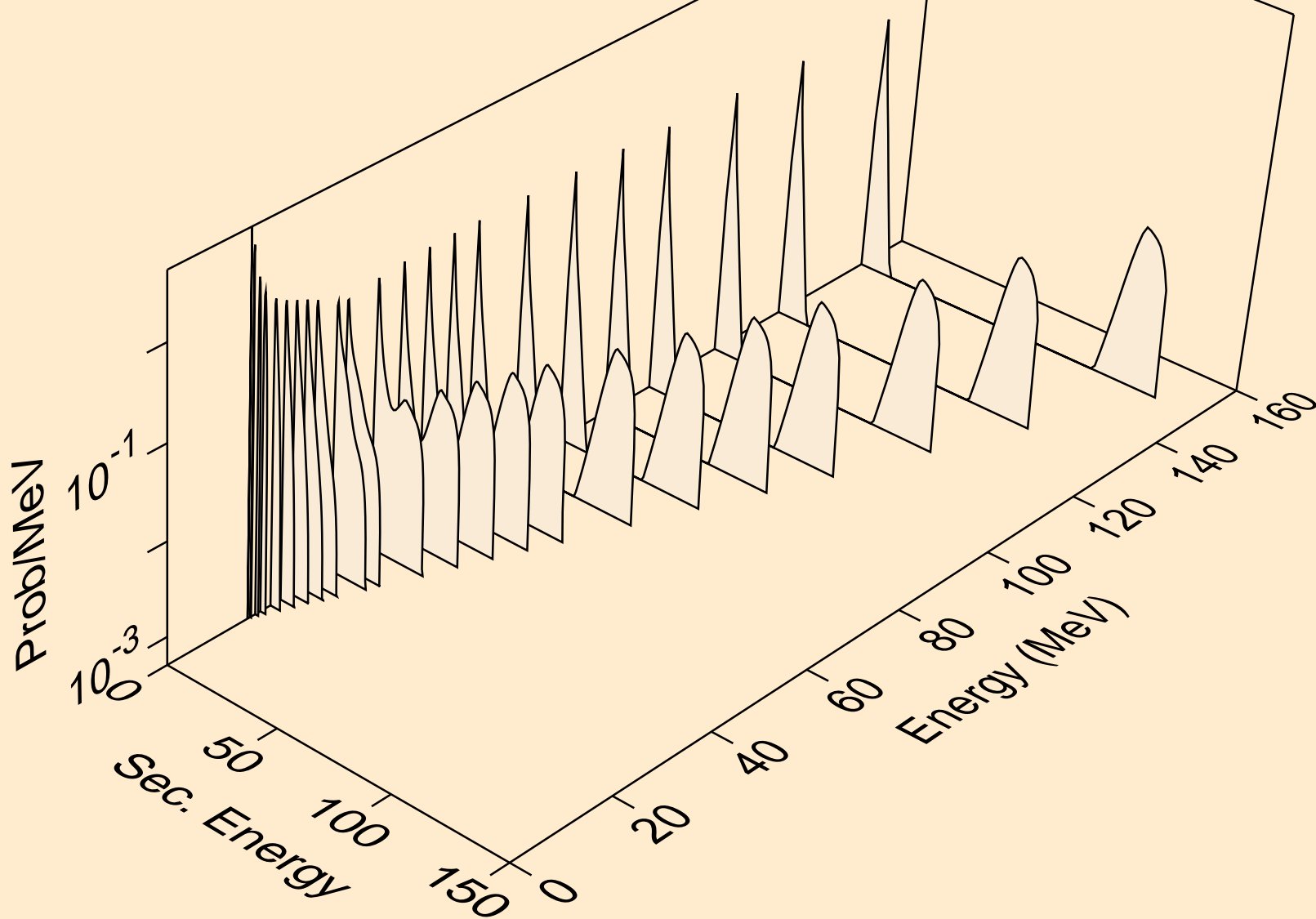

74-W-180 FOR FENDL-3.2 FROM INDL/V-3 BY NJOY2016.60+ ON
Neutron emission for (n,n*)p

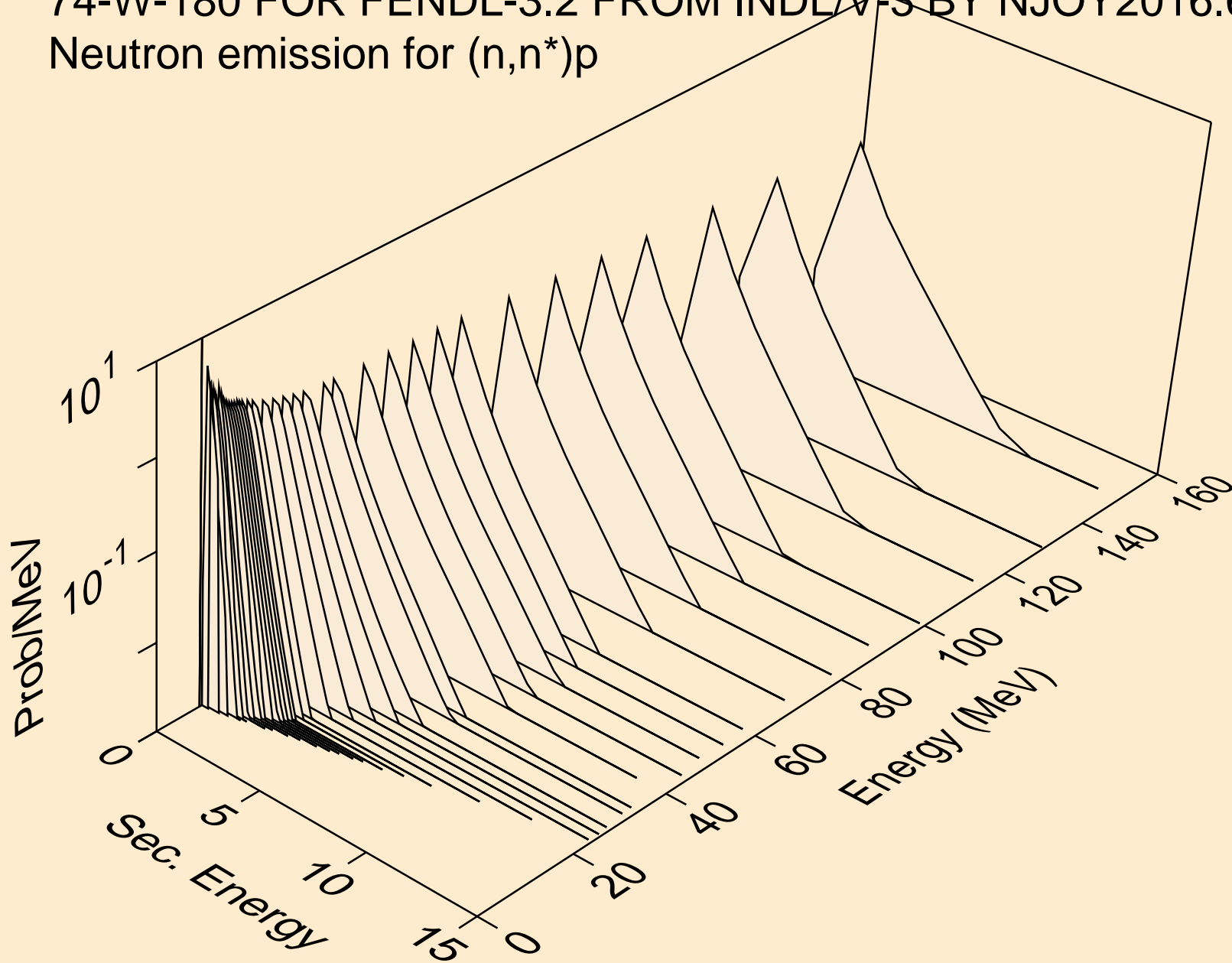

74-W-180 FOR FENDL-3.2 FROM INDLV-3 BY NJOY2016.60+ ON
Neutron emission for (n,4n)

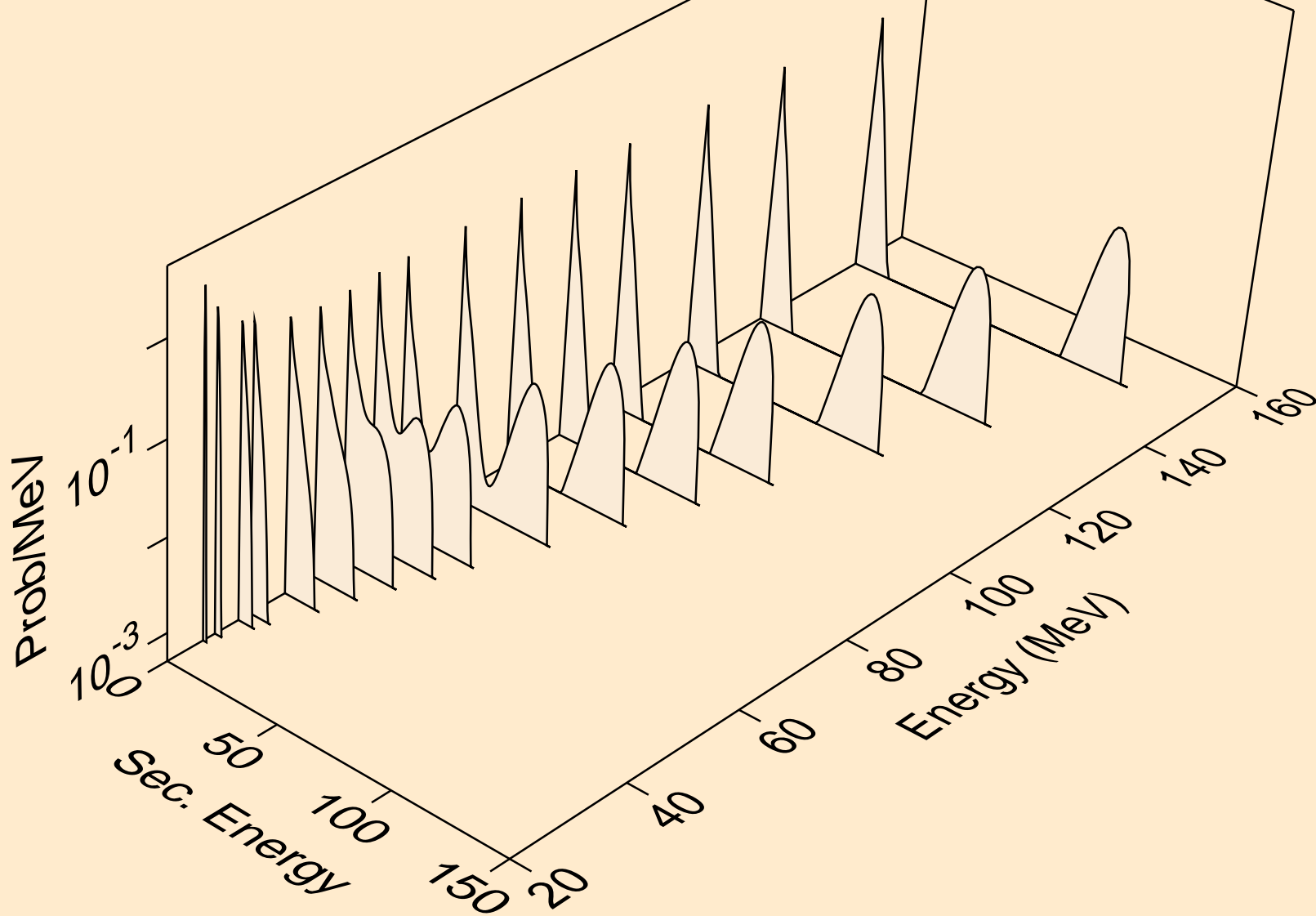

74-W-180 FOR FENDL-3.2 FROM INDLV-3 BY NJOY2016.60+ ON
Neutron emission for (n,2np)

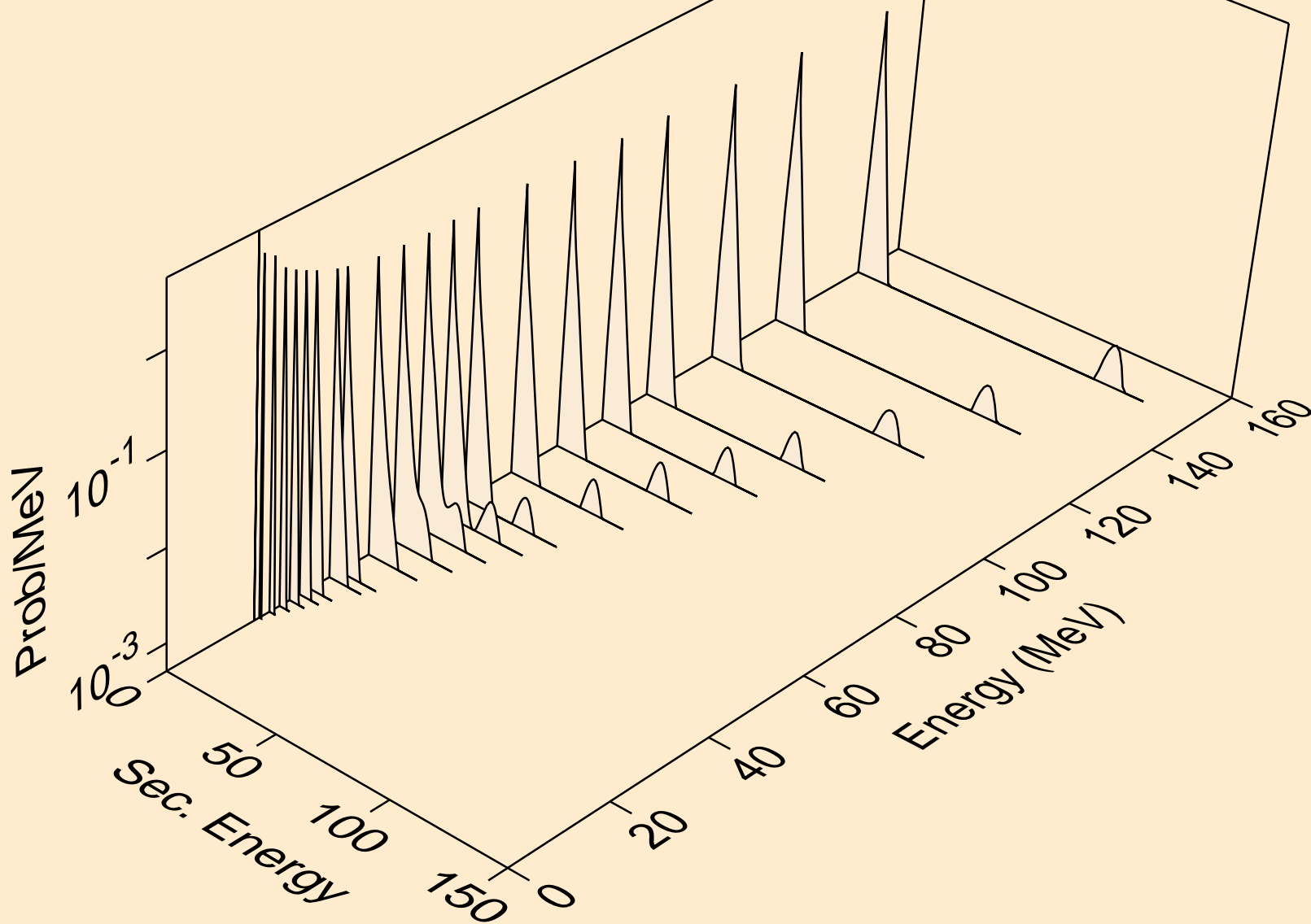

74-W-180 FOR FENDL-3.2 FROM INDLV-3 BY NJOY2016.60+ ON
Neutron emission for (n,n*c)

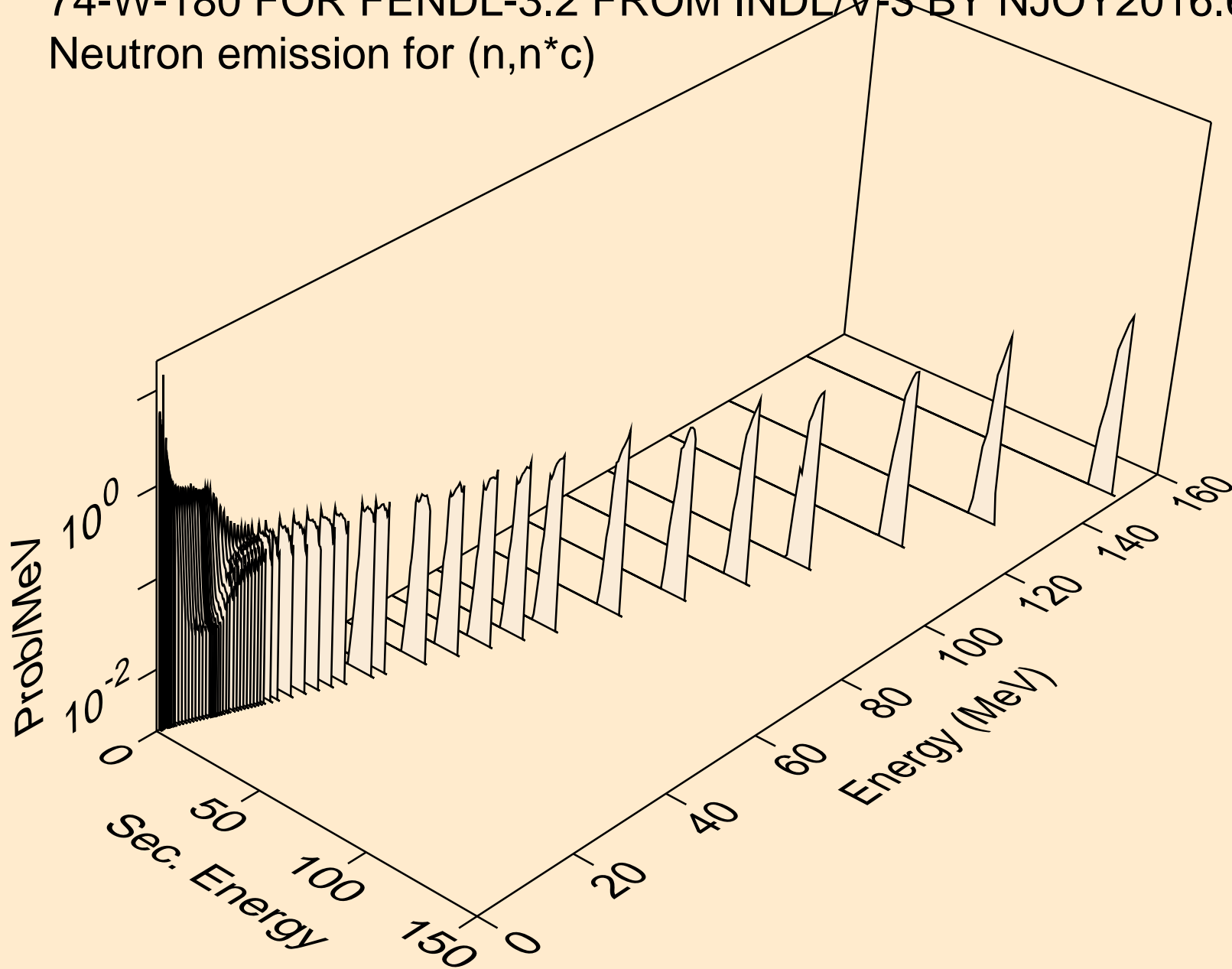

74-W-180 FOR FENDL-3.2 FROM INDLV-3 BY NJOY2016.60+ ON
Photon emission for (n,x)

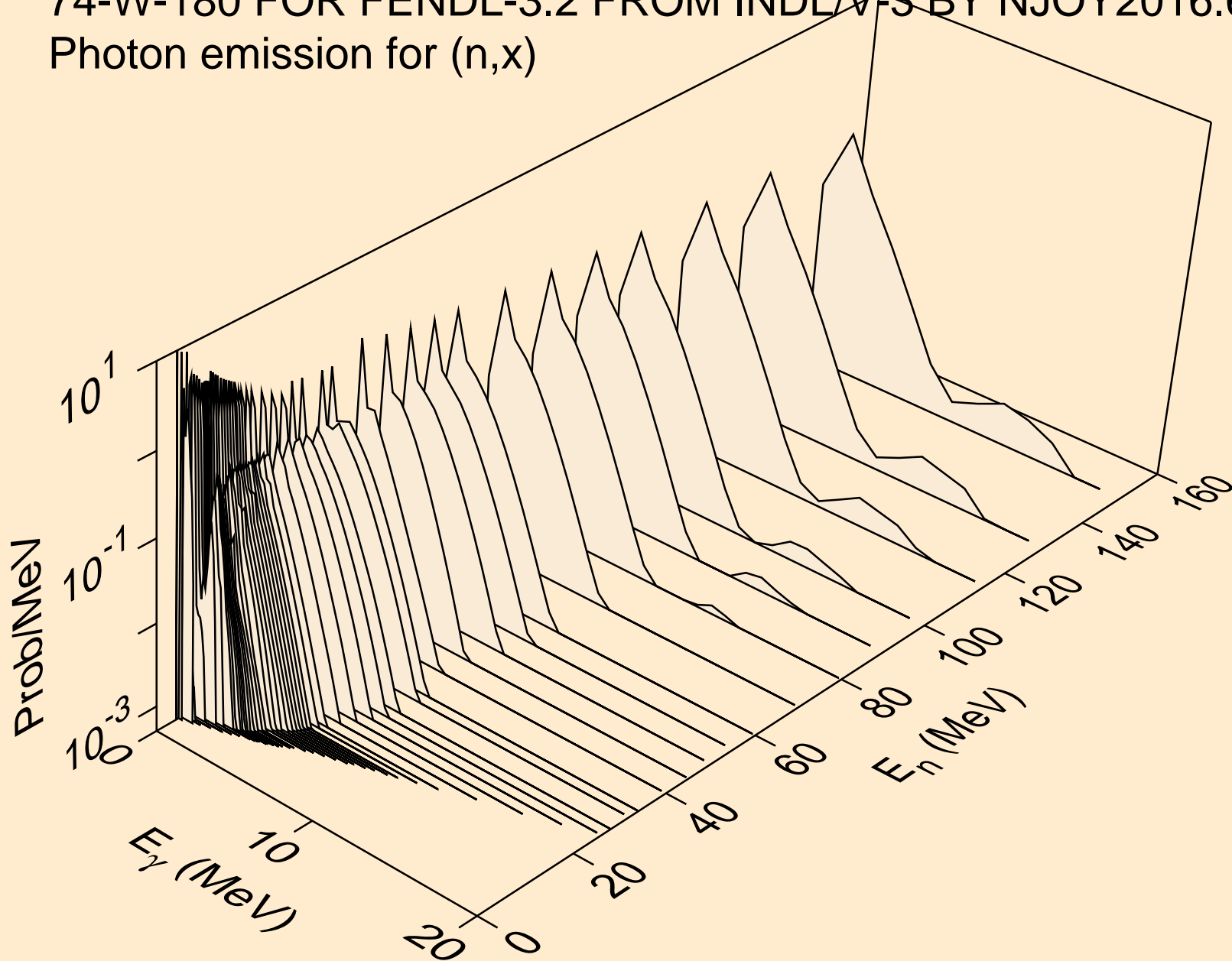

74-W-180 FOR FENDL-3.2 FROM INDLV-3 BY NJOY2016.60+ ON
Photon emission for (n,2n)

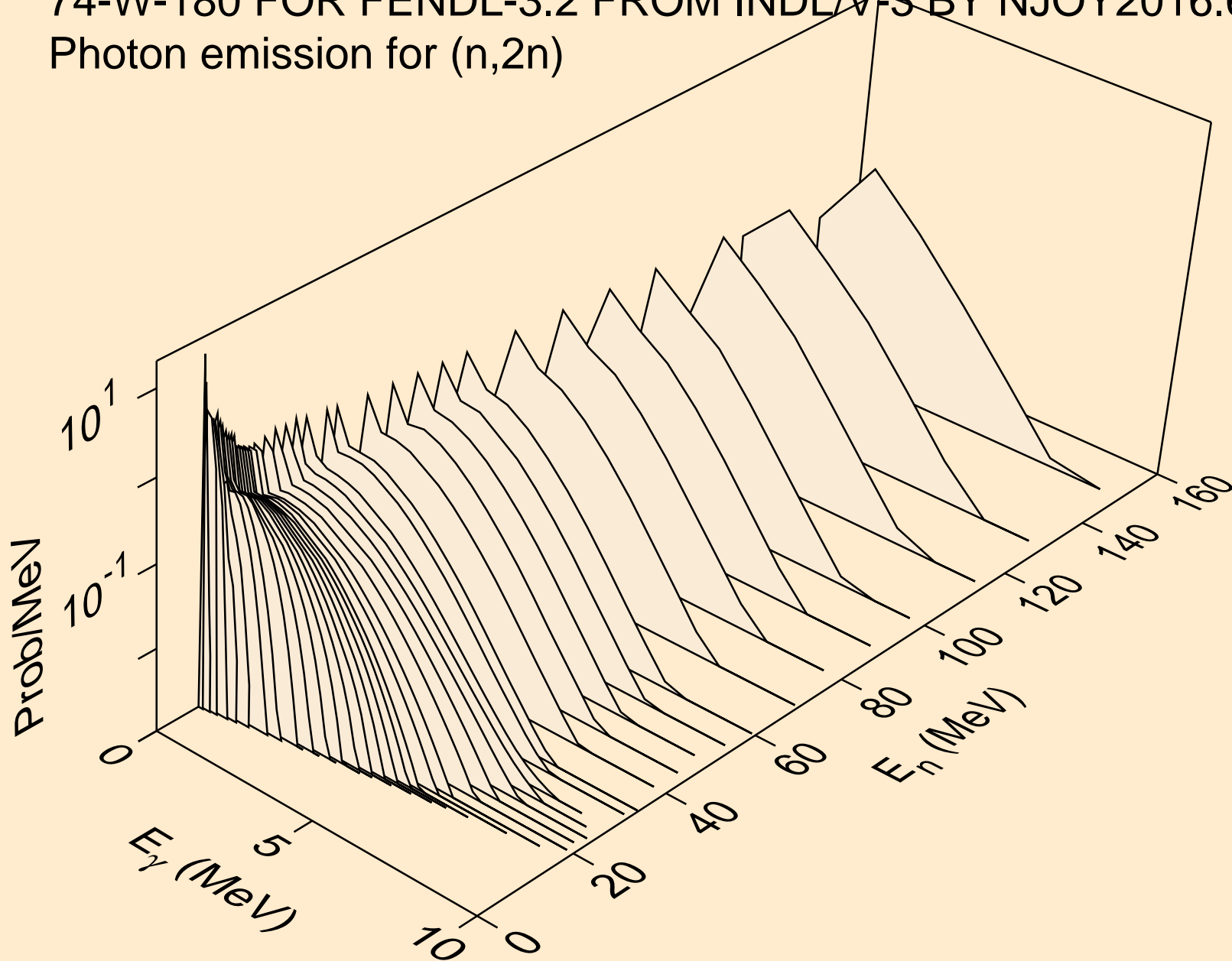

74-W-180 FOR FENDL-3.2 FROM INDLV-3 BY NJOY2016.60+ ON
Photon emission for (n,3n)

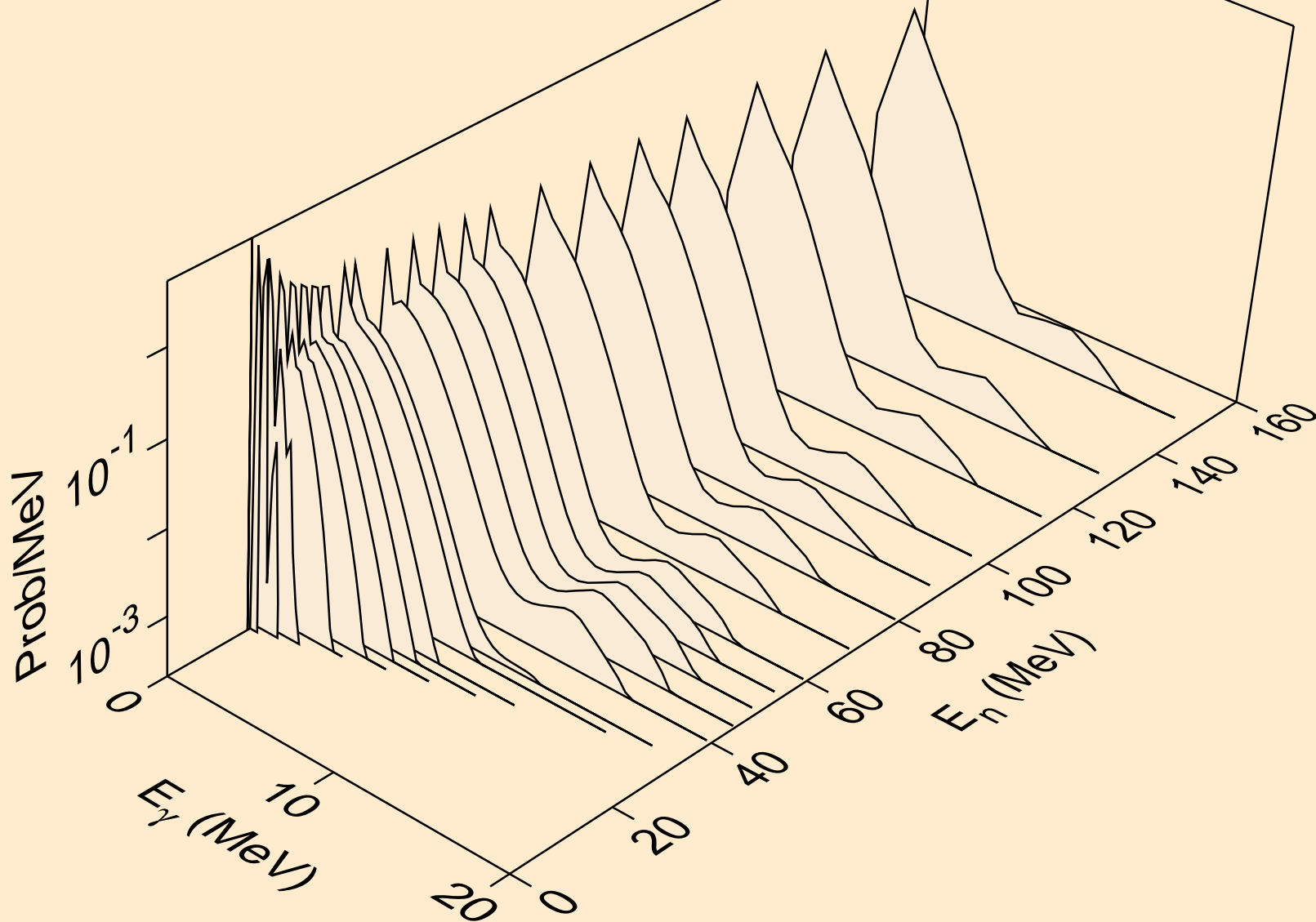

74-W-180 FOR FENDL-3.2 FROM INDLV-3 BY NJOY2016.60+ ON
Photon emission for (n,n*)p

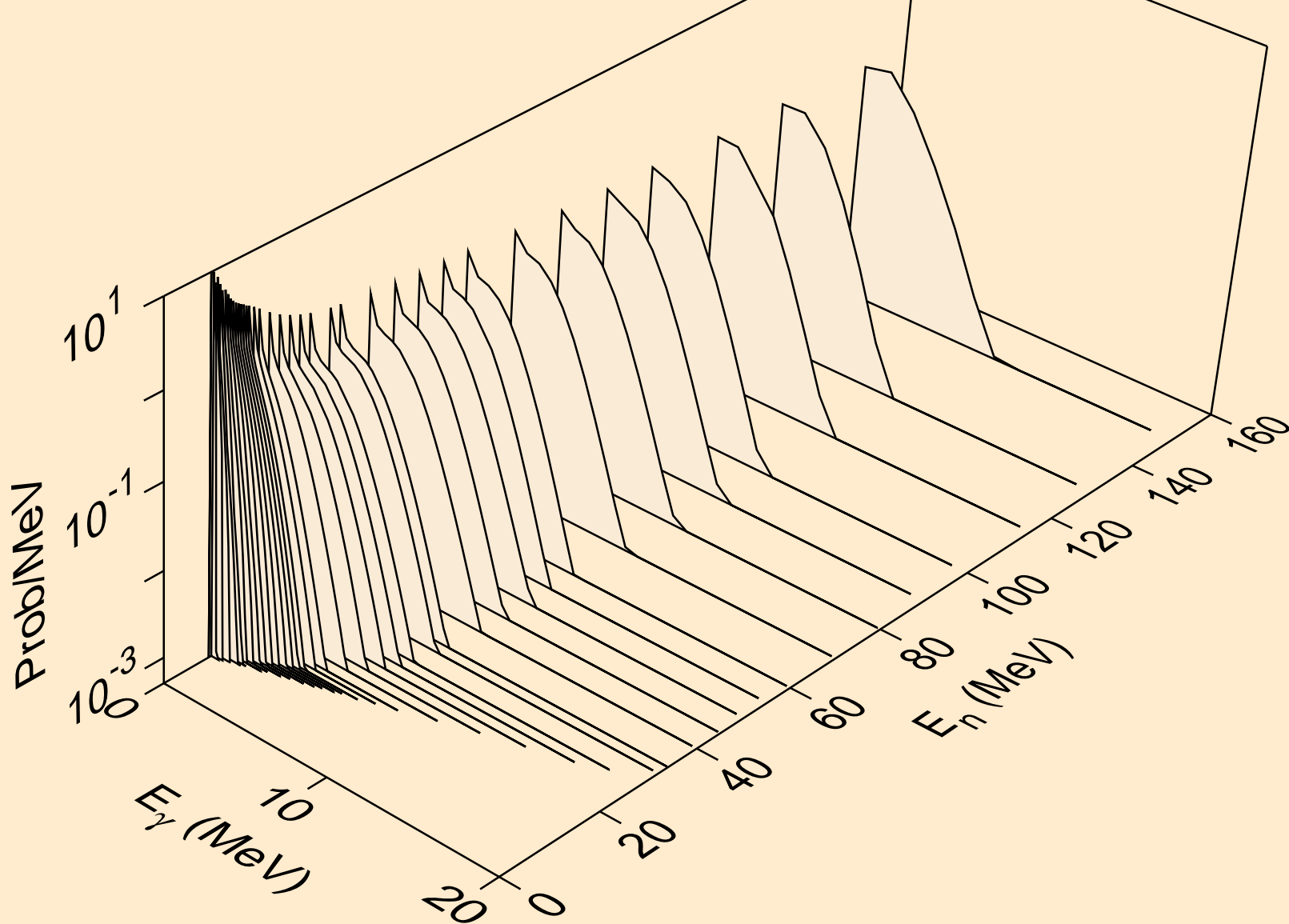

74-W-180 FOR FENDL-3.2 FROM INDLV-3 BY NJOY2016.60+ ON
Photon emission for (n,4n)

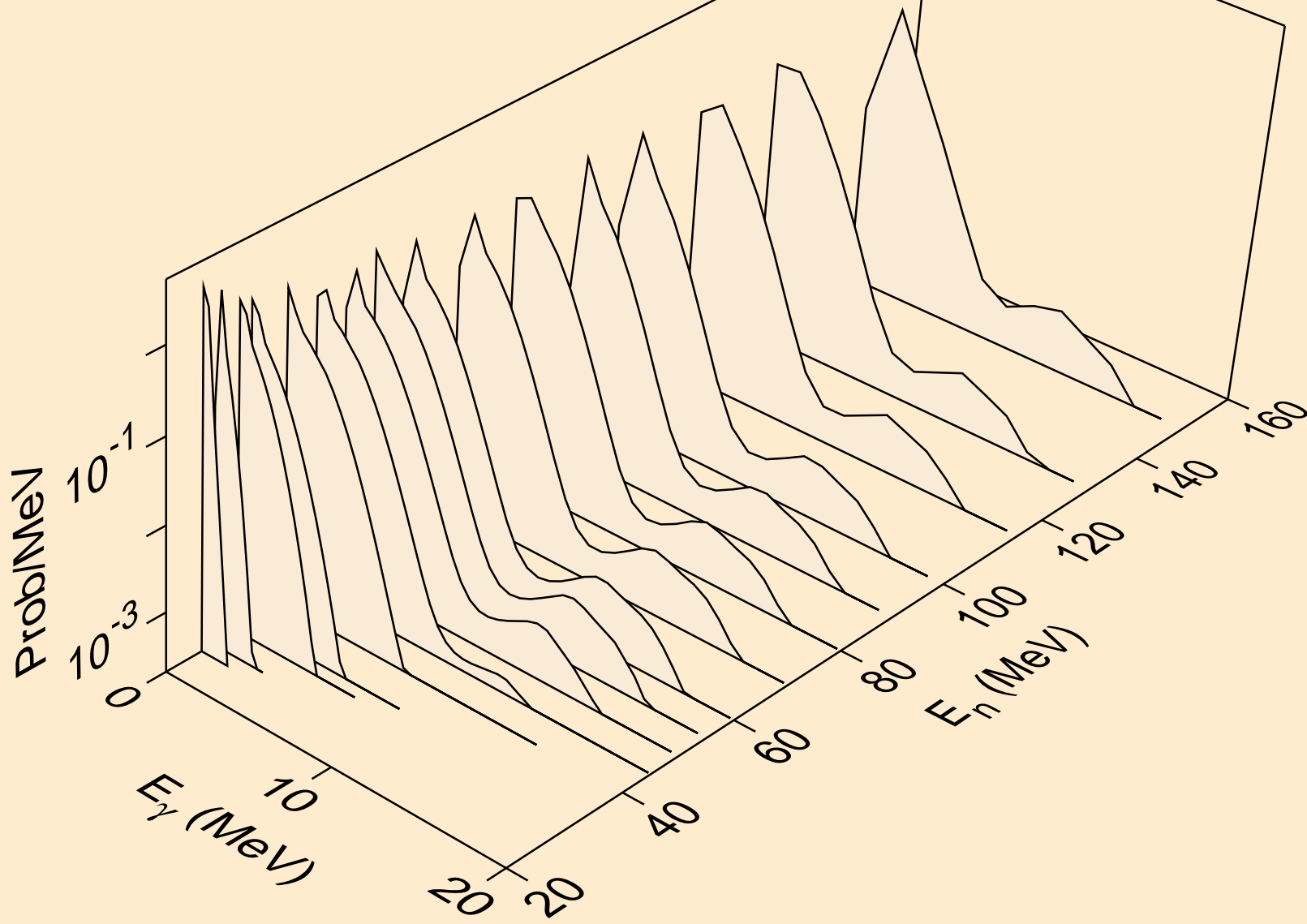

74-W-180 FOR FENDL-3.2 FROM INDLV-3 BY NJOY2016.60+ ON
Photon emission for (n,2np)

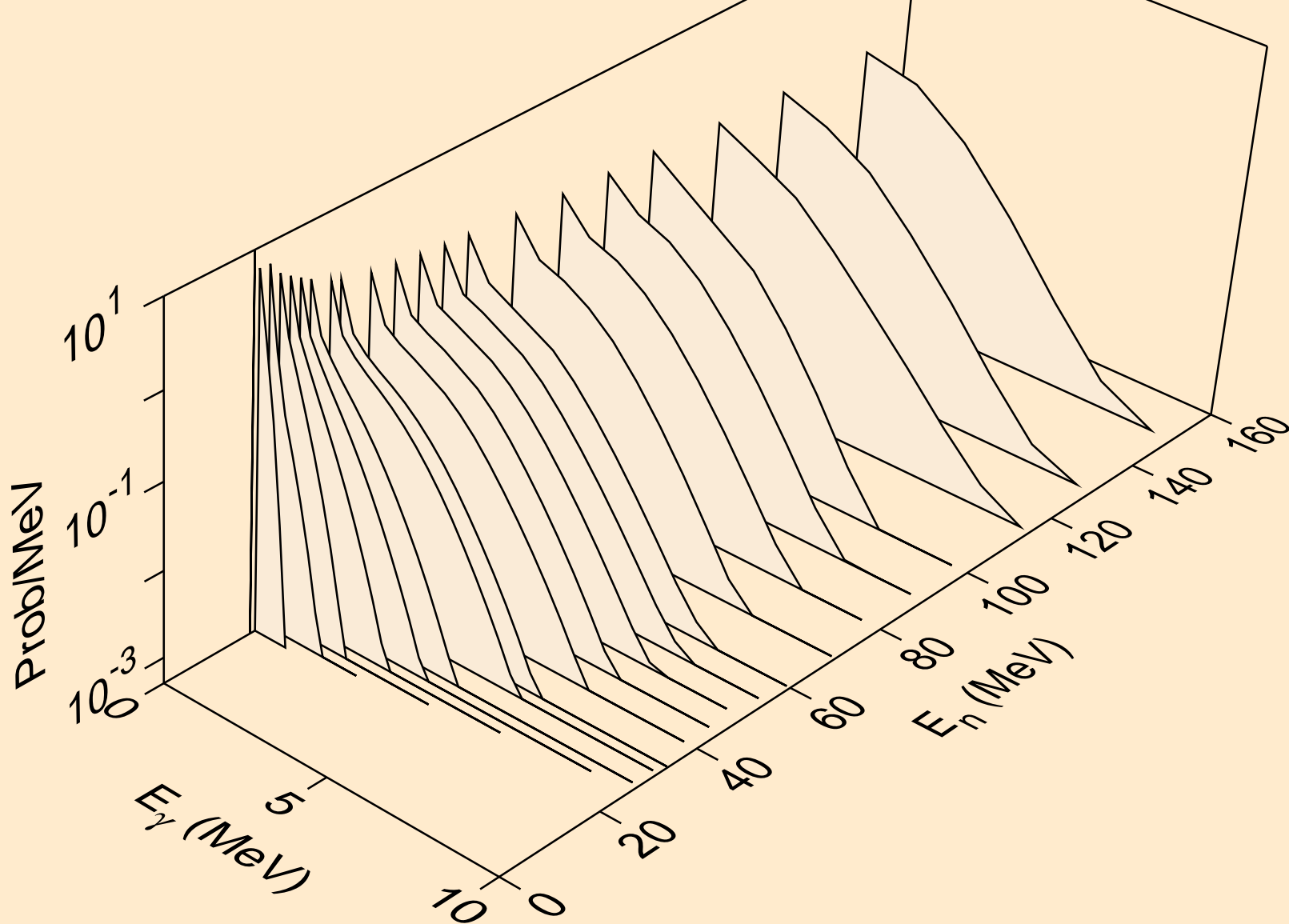

74-W-180 FOR FENDL-3.2 FROM INDLV-3 BY NJOY2016.60+ ON
Photon emission for (n,n*c)

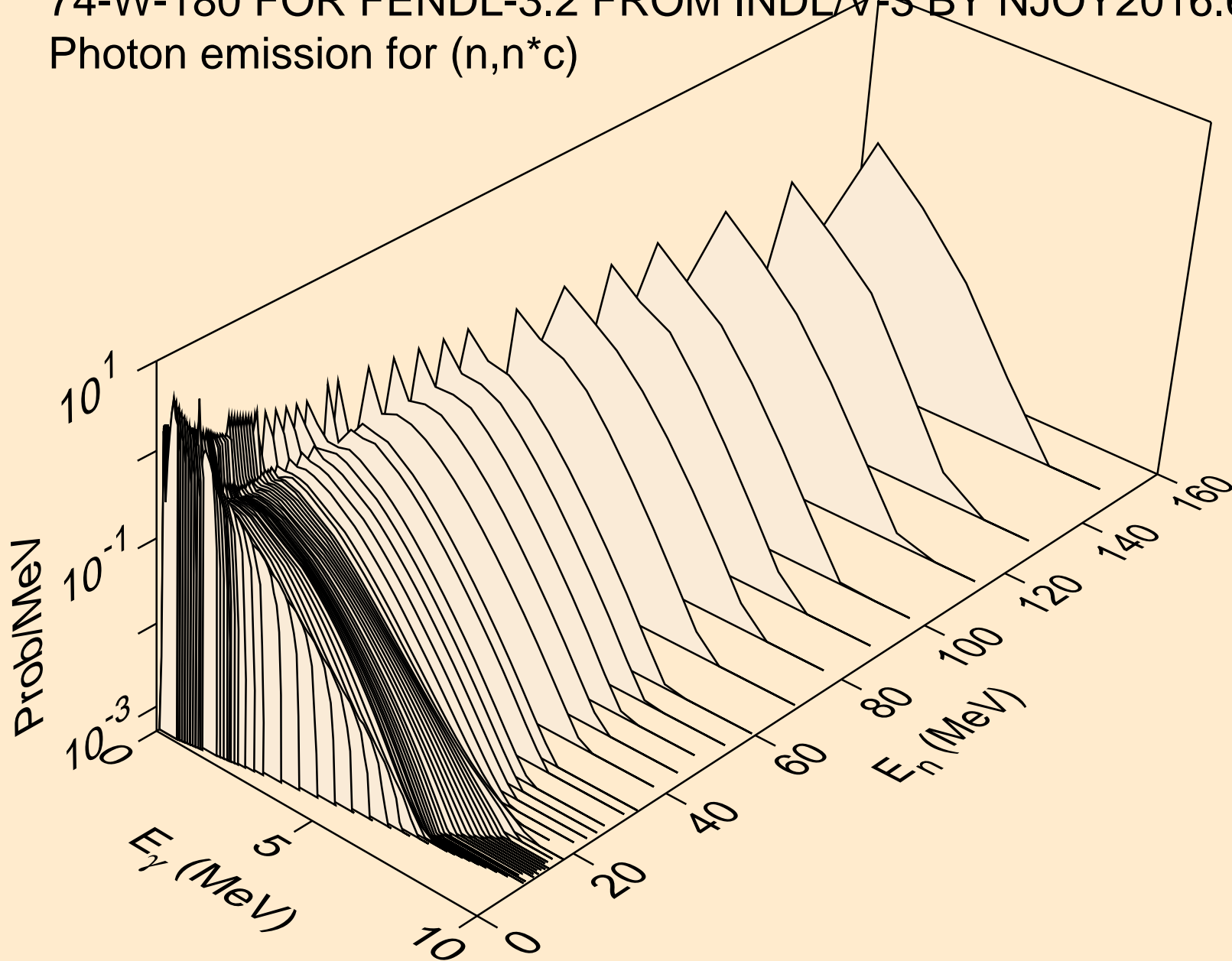

74-W-180 FOR FENDL-3.2 FROM INDLV-3 BY NJOY2016.60+ ON
Photon emission for (n,gma)

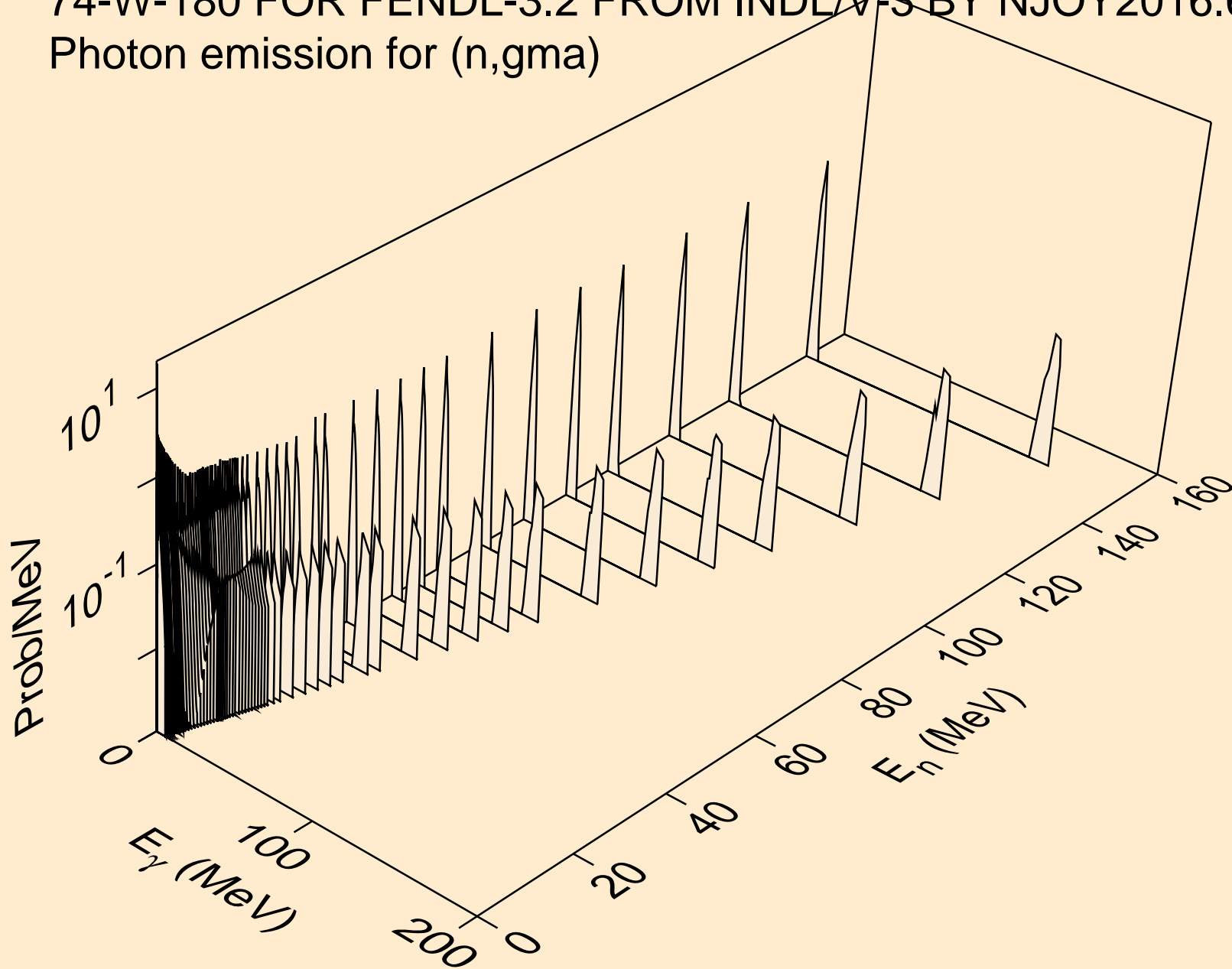

74-W-180 FOR FENDL-3.2 FROM INDLV-3 BY NJOY2016.60+ ON
Photon emission for (n,p*c)

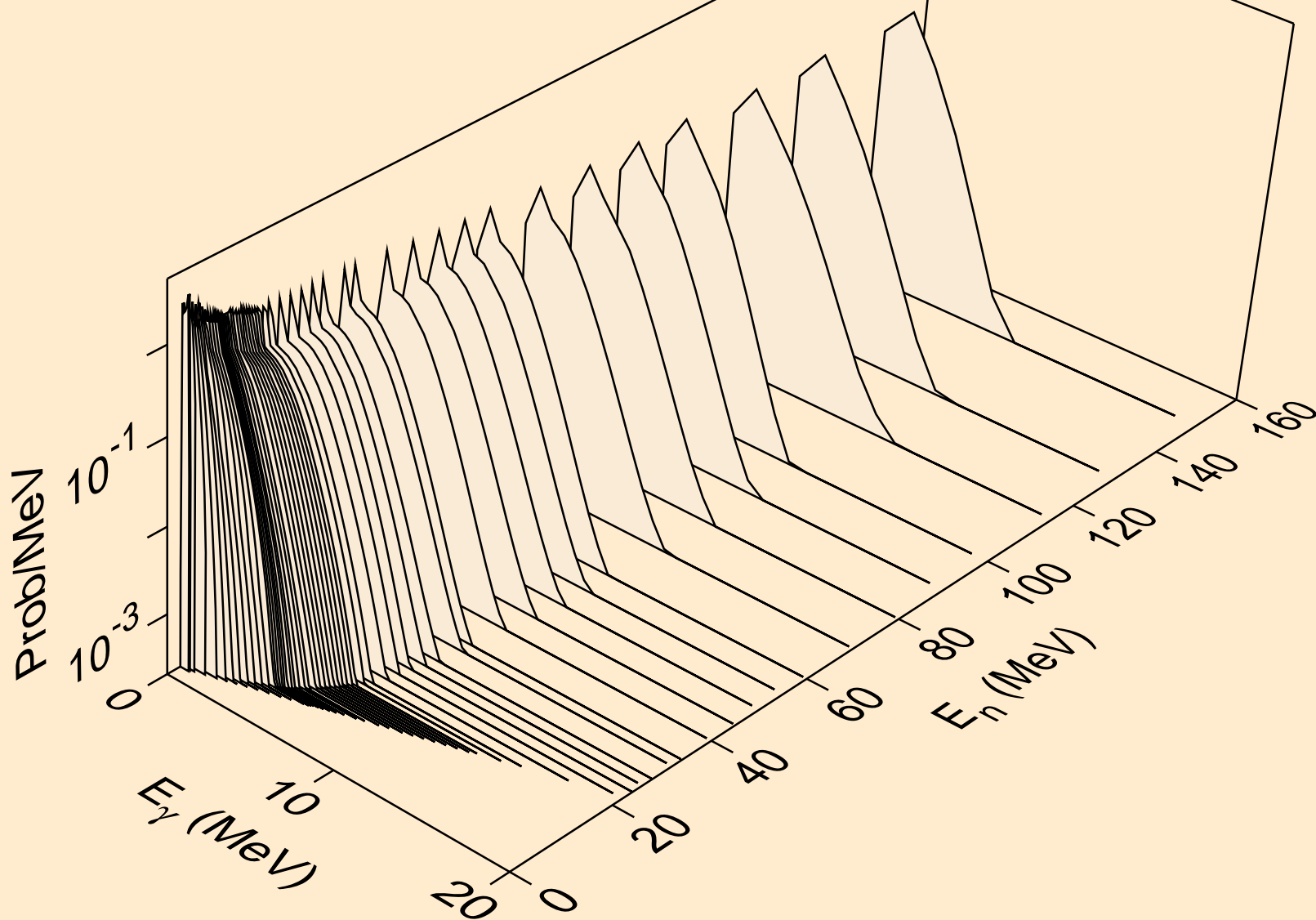

74-W-180 FOR FENDL-3.2 FROM INDLV-3 BY NJOY2016.60+ ON
Photon emission for (n,a*c)

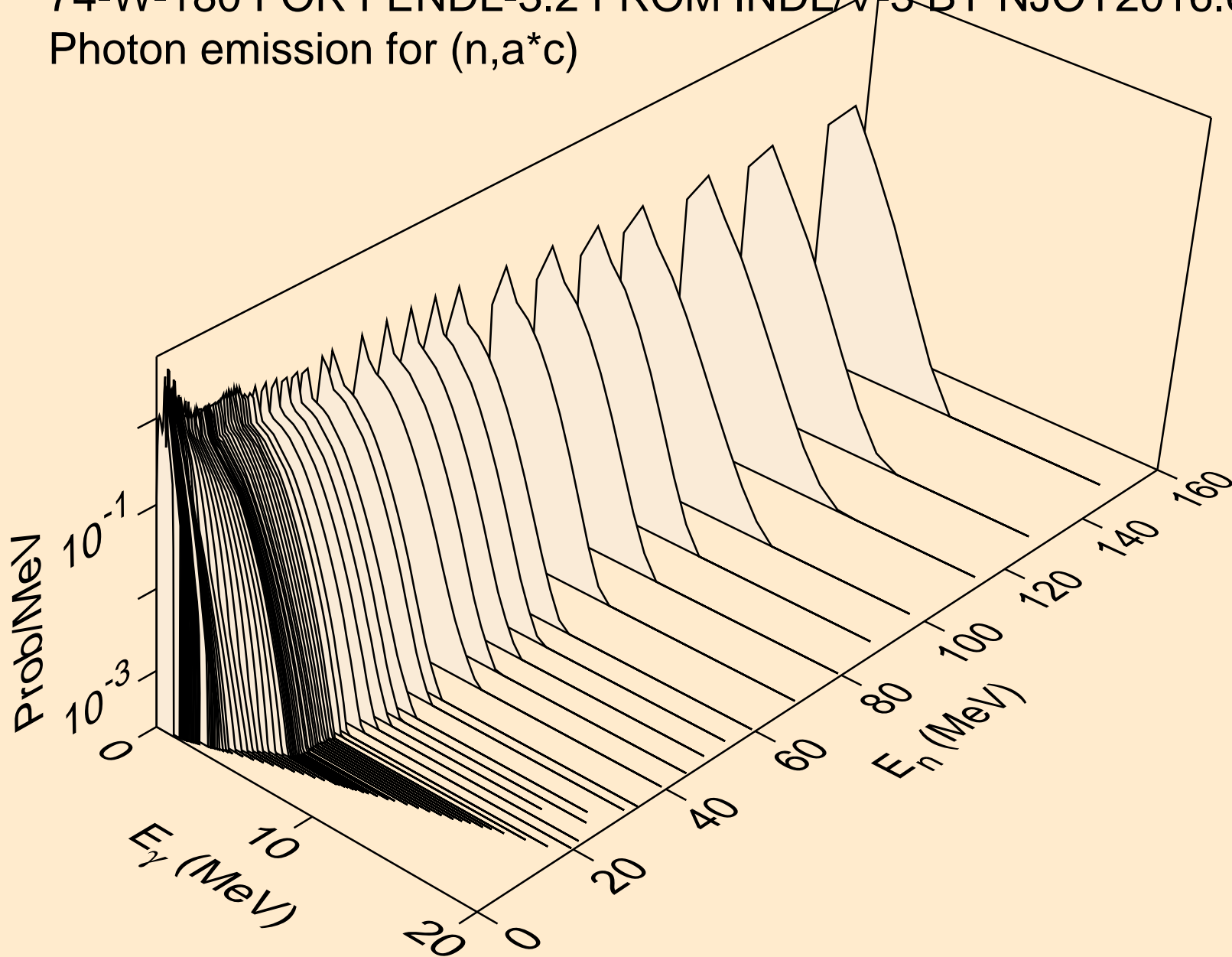

74-W-180 FOR FENDL-3.2 FROM INDL/V-3 BY NJOY2016.60+ ON
thermal capture photon spectrum

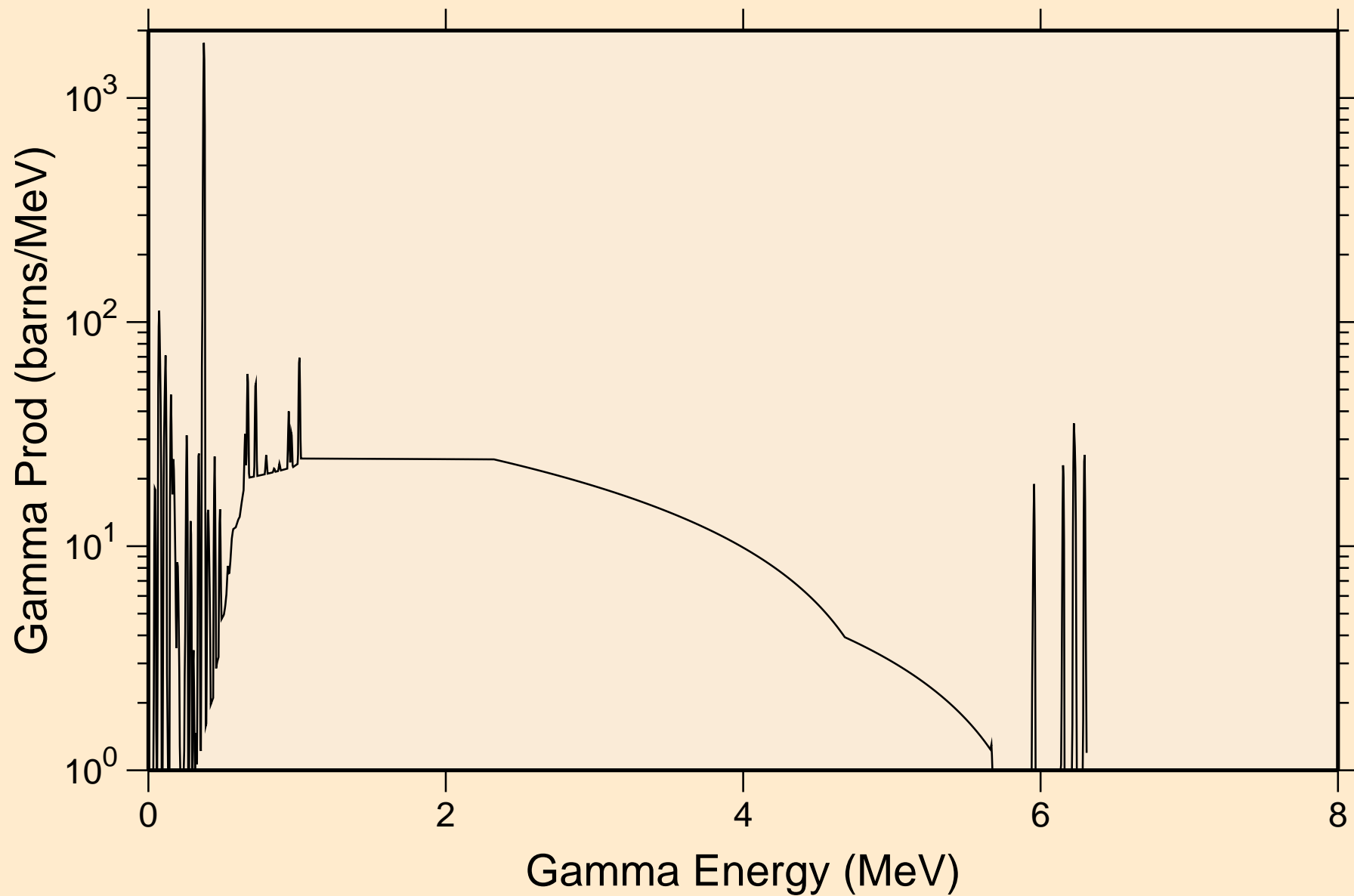

74-W-180 FOR FENDL-3.2 FROM INDL/V-3 BY NJOY2016.60+ ON
14 MeV photon spectrum

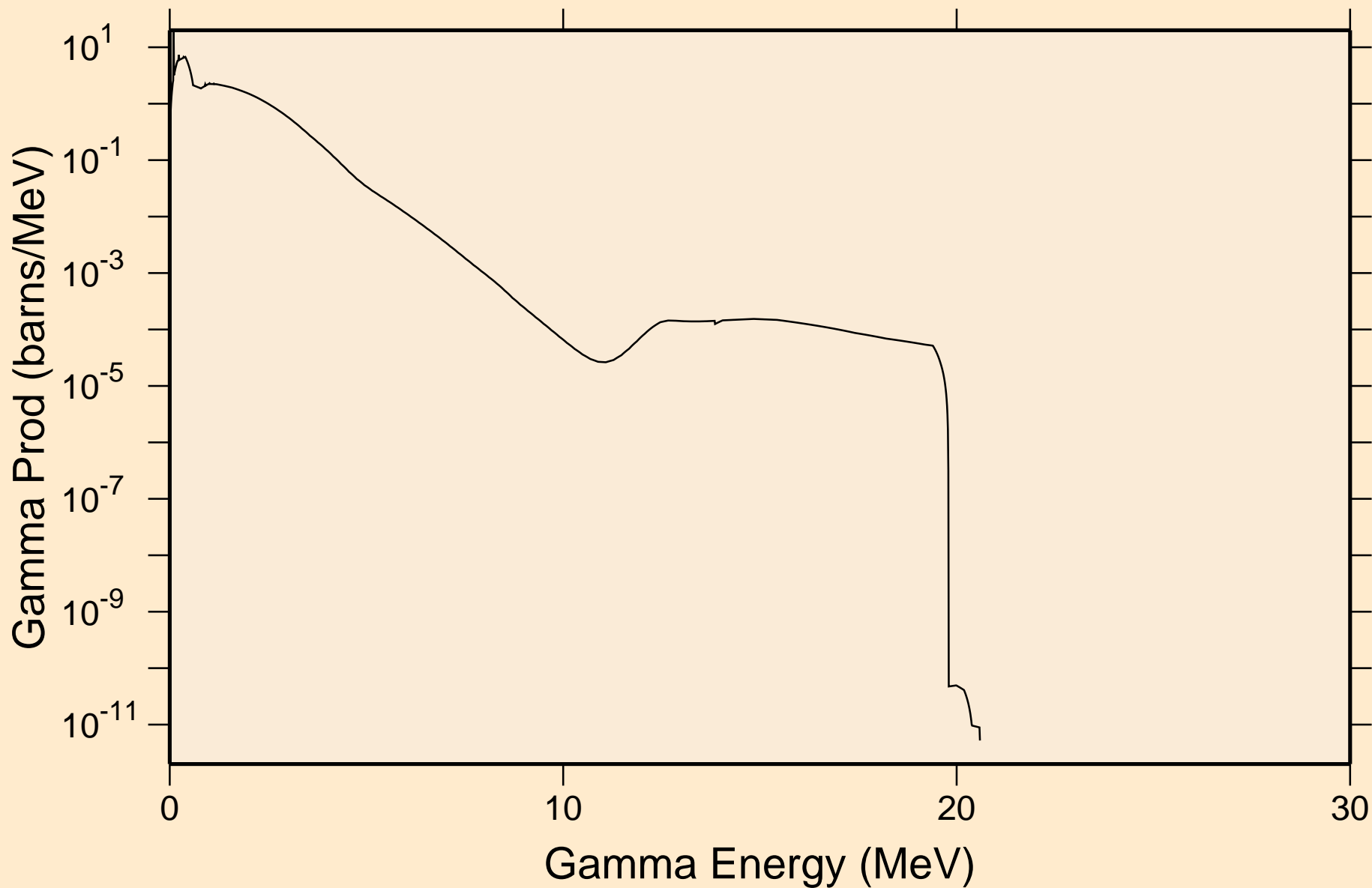

74-W-180 FOR FENDL-3.2 FROM INDL/V-3 BY NJOY2016.60+ ON Particle heating contributions

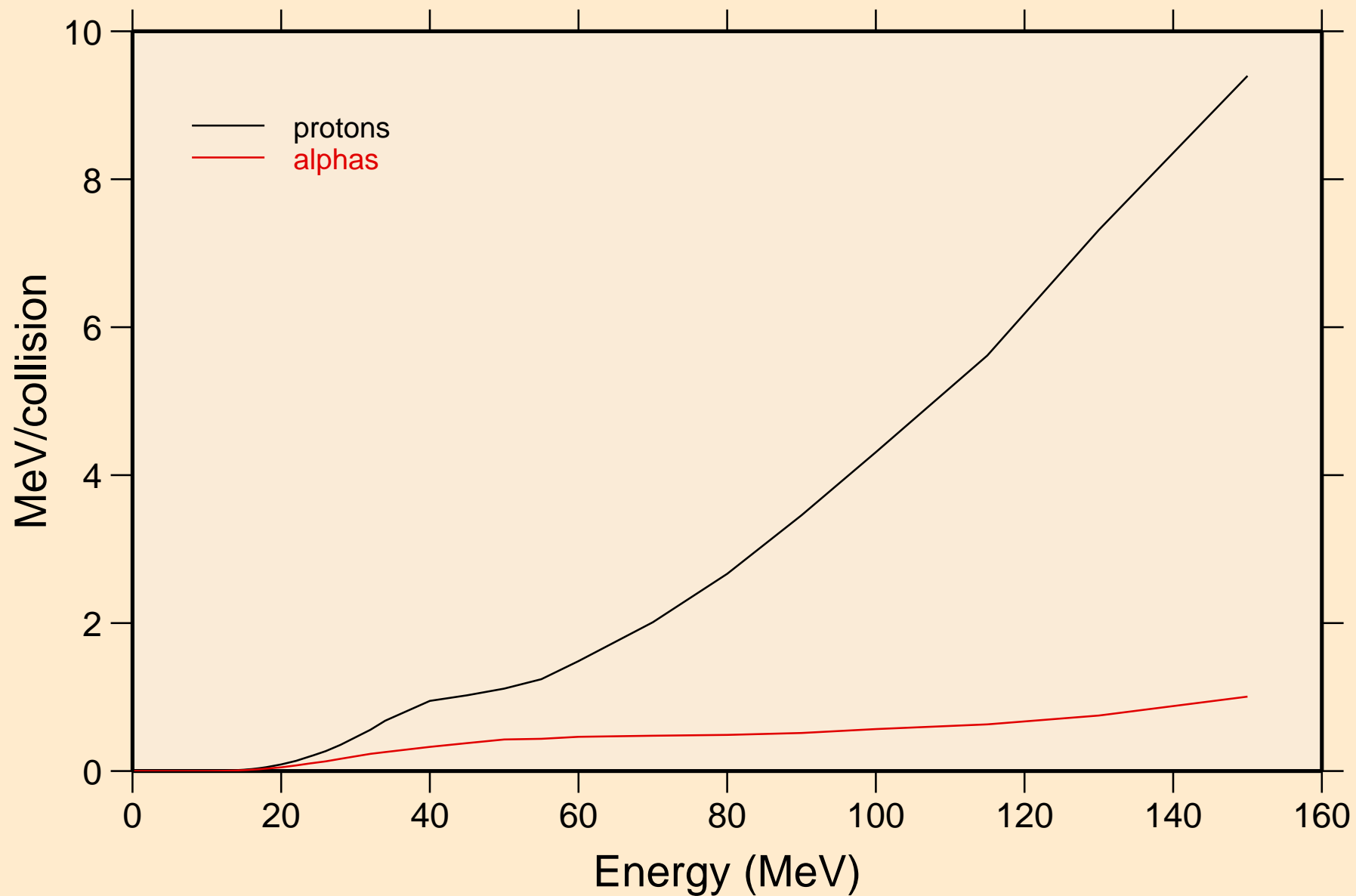

74-W-180 FOR FENDL-3.2 FROM INDL/V-3 BY NJOY2016.60+ ON Recoil Heating

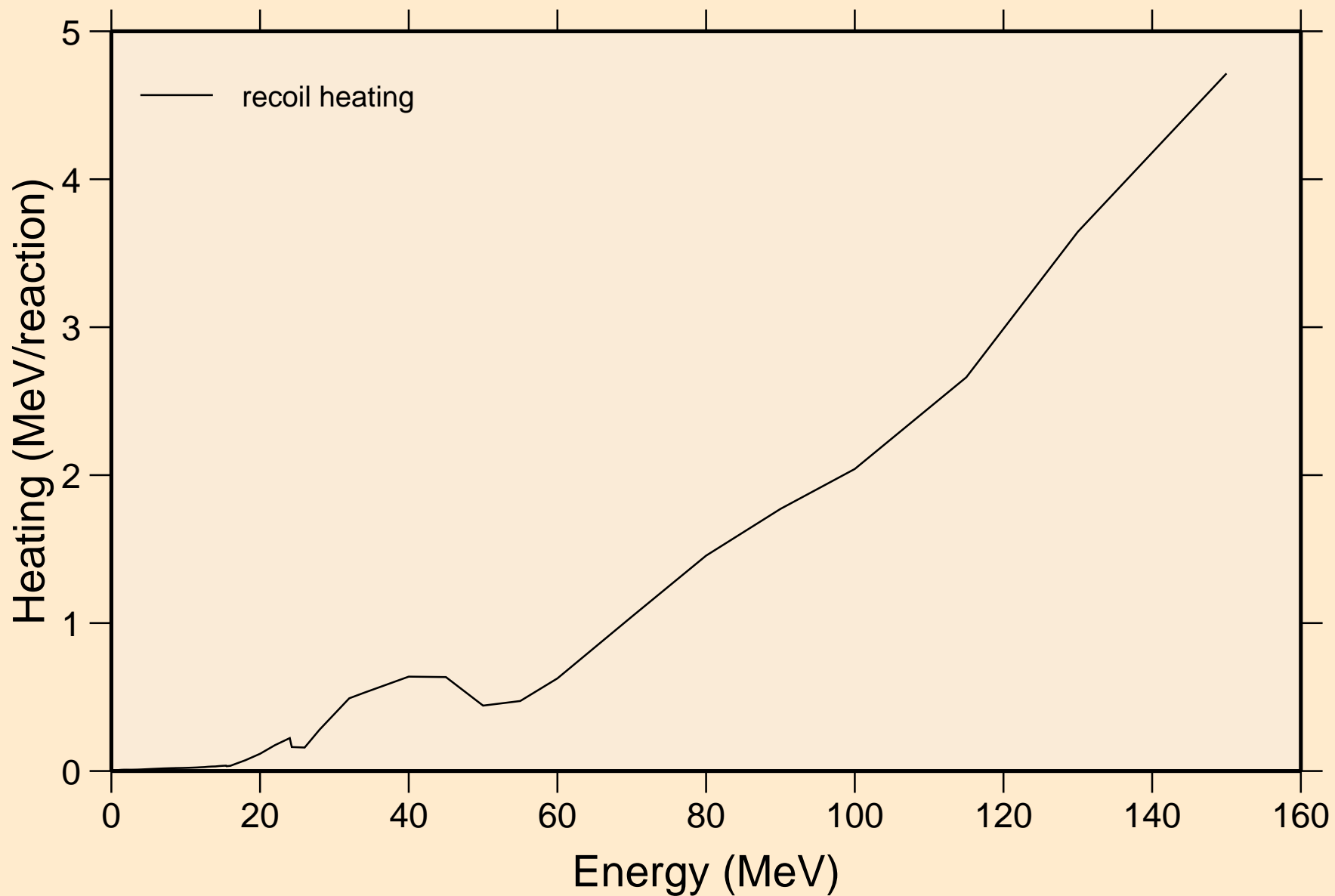

74-W-180 FOR FENDL-3.2 FROM INDL/V-3 BY NJOY2016.60+ ON Particle production cross sections

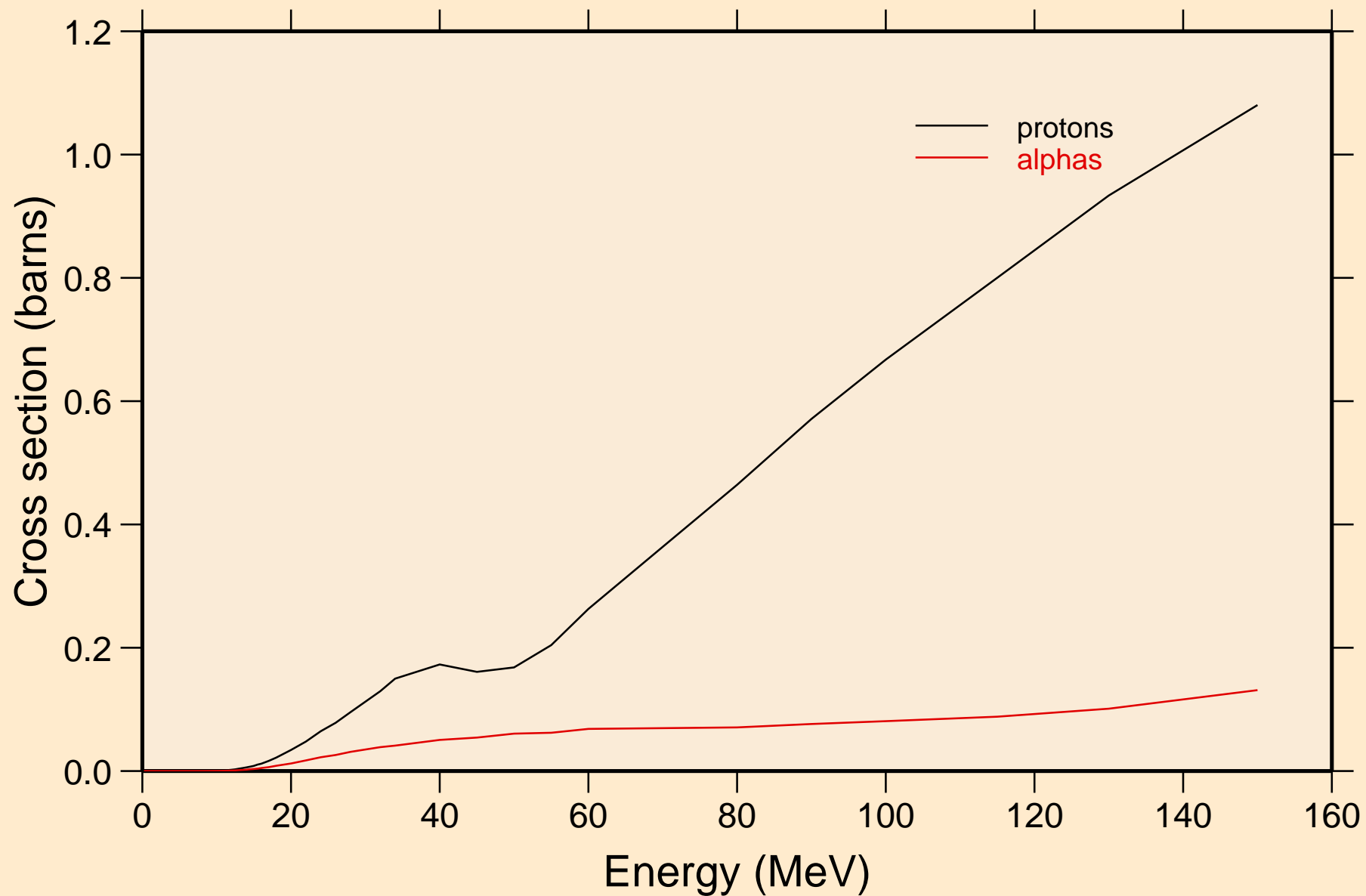

74-W-180 FOR FENDL-3.2 FROM INDLV-3 BY NJOY2016.60+ ON
protons from (n,x)

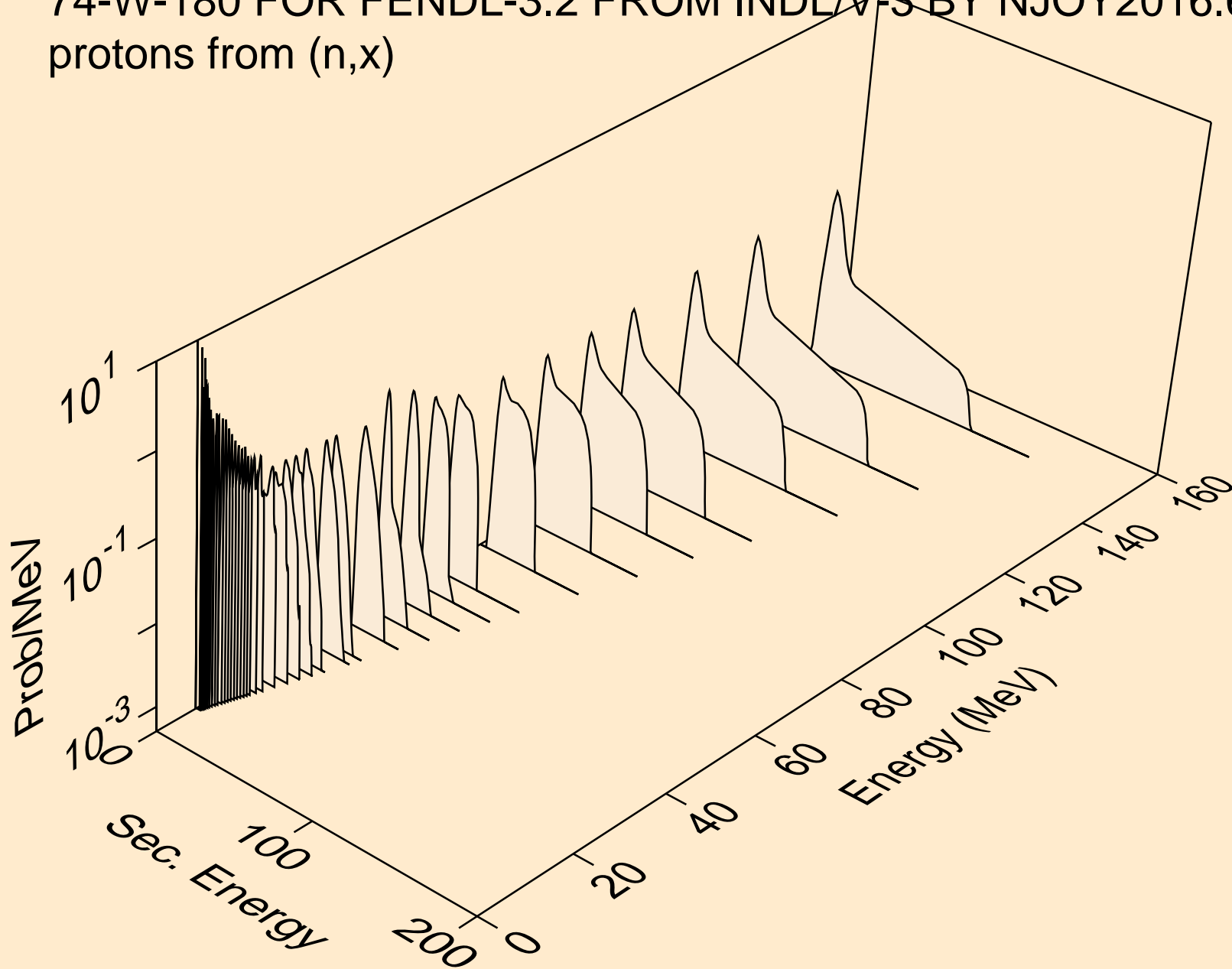

74-W-180 FOR FENDL-3.2 FROM INDL/V-3 BY NJOY2016.60+ ON
protons from (n,n*)p

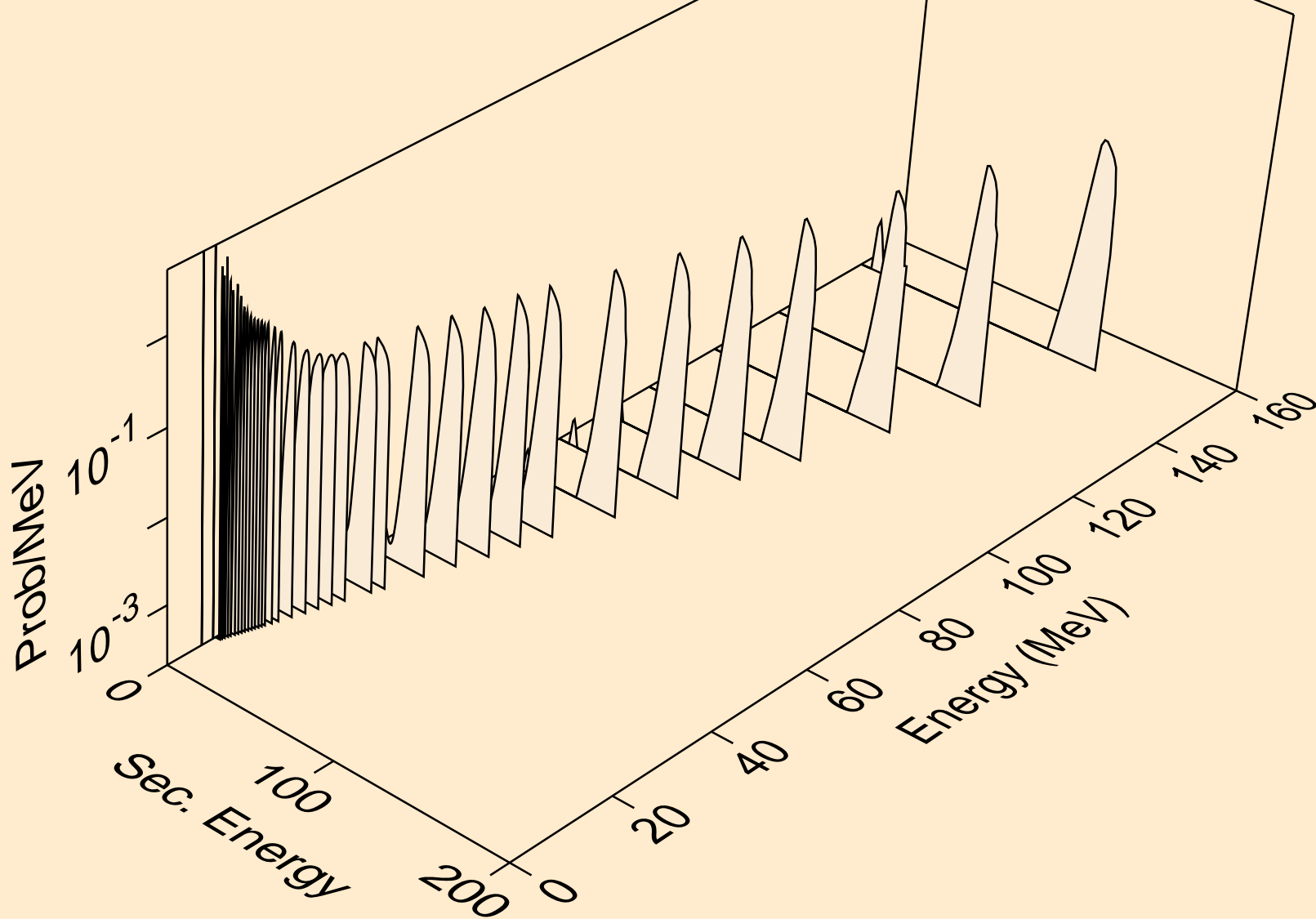

74-W-180 FOR FENDL-3.2 FROM INDLV-3 BY NJOY2016.60+ ON
protons from (n,2np)

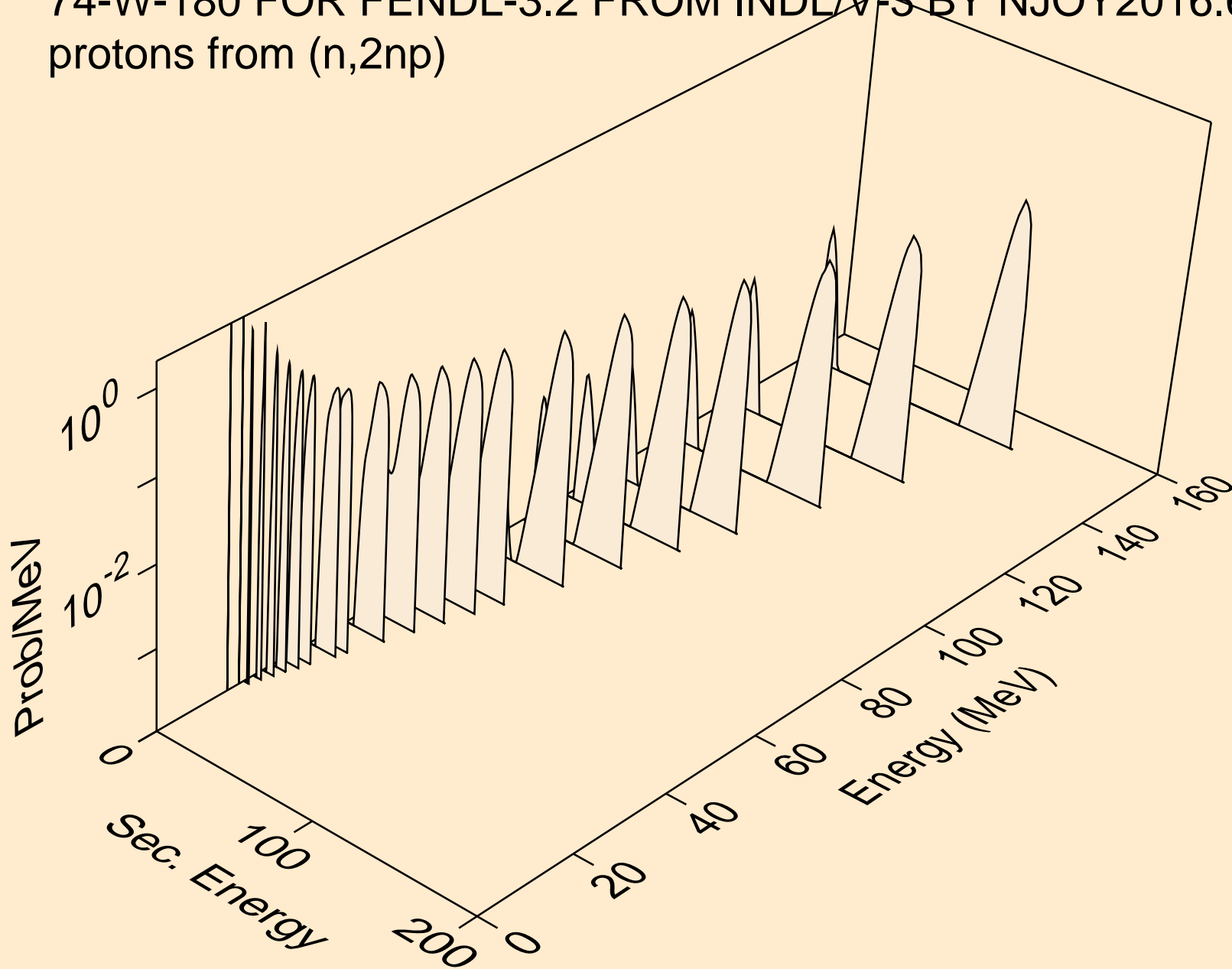

74-W-180 FOR FENDL-3.2 FROM INDL/V-3 BY NJOY2016.60+ ON
angular distribution for (n,p*0) proton

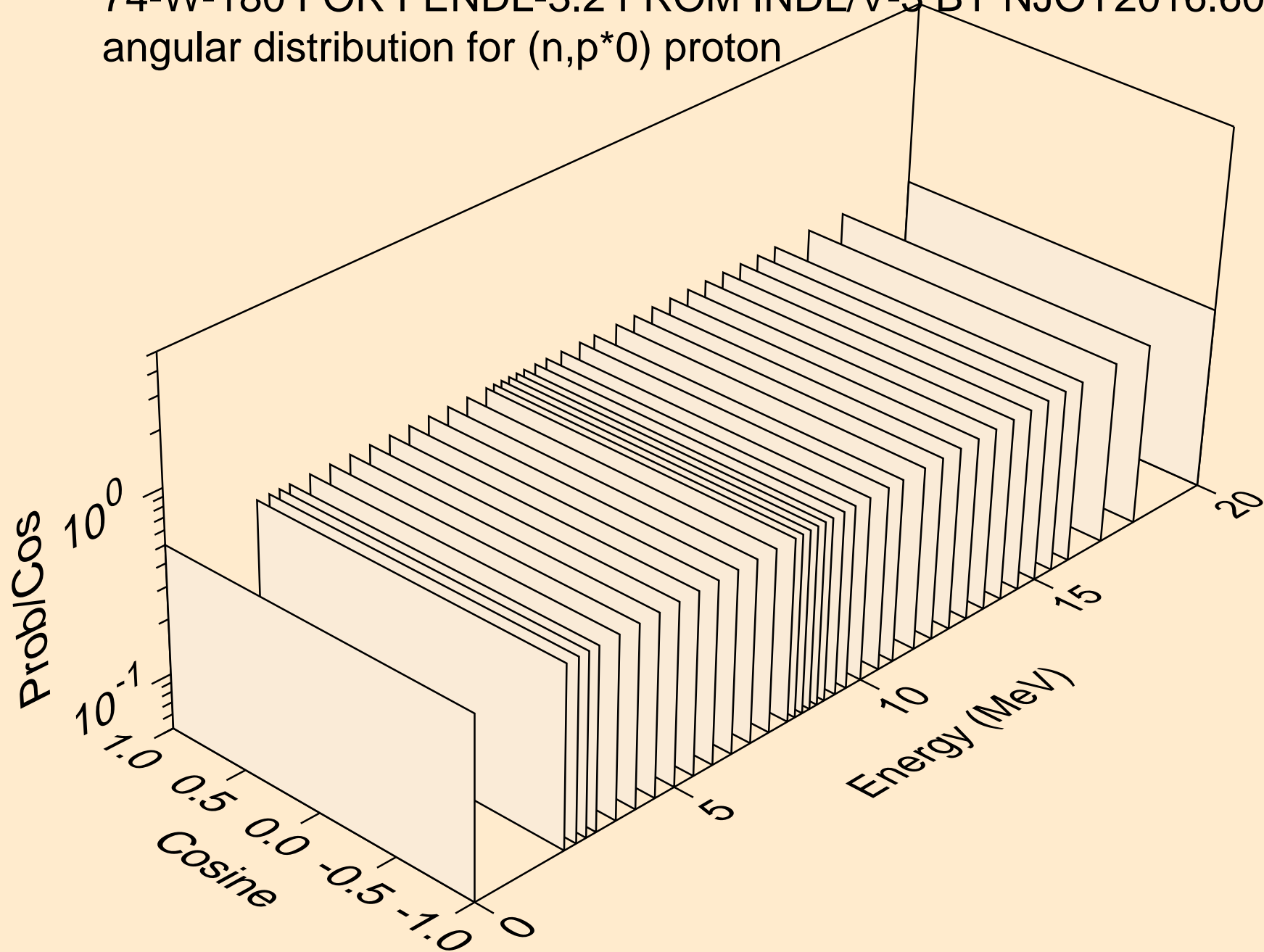

74-W-180 FOR FENDL-3.2 FROM INDL/V-3 BY NJOY2016.60+ ON
angular distribution for (n,p*0) proton

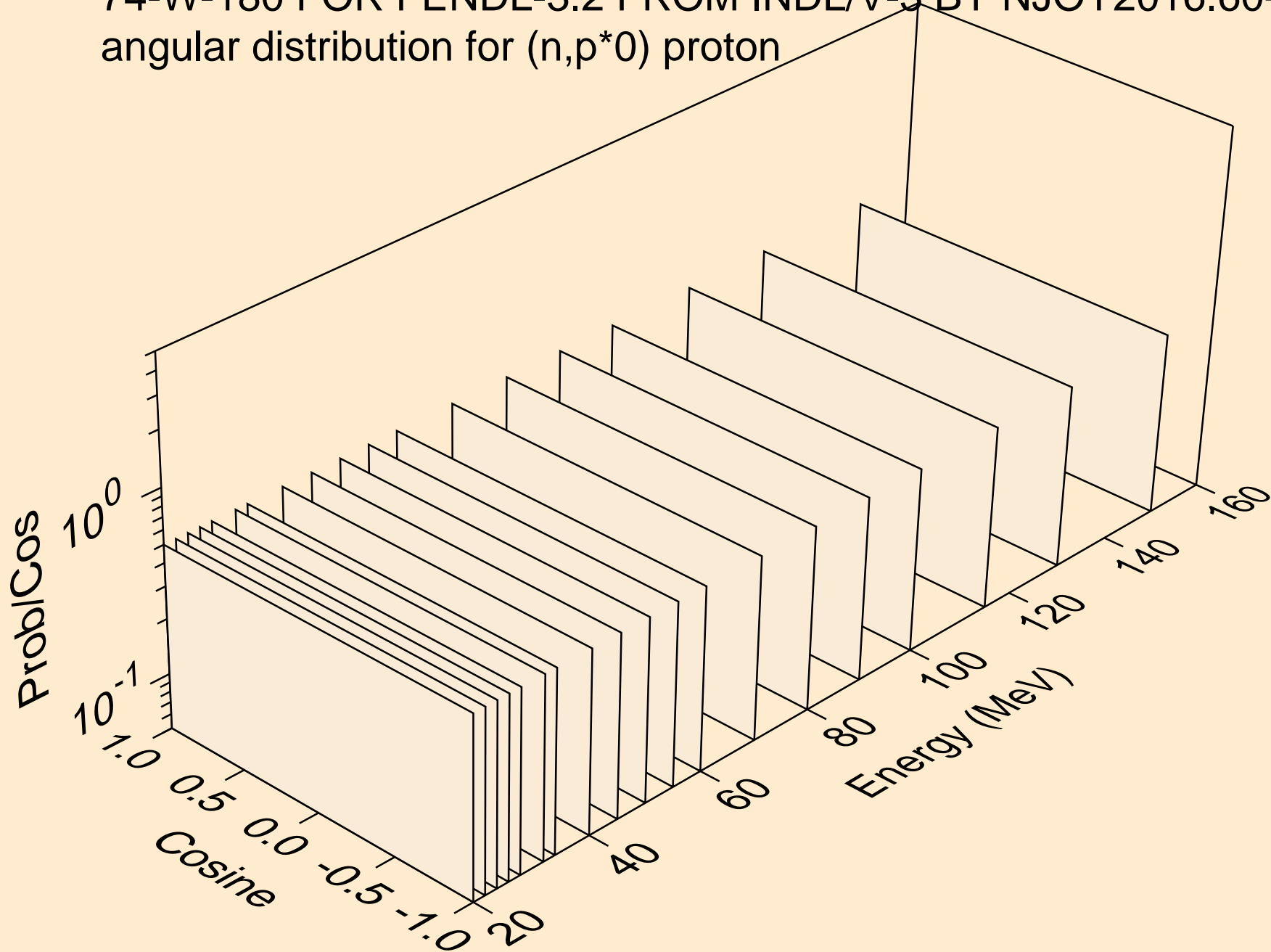

74-W-180 FOR FENDL-3.2 FROM INDL/V-3 BY NJOY2016.60+ ON
angular distribution for (n,p*1) proton

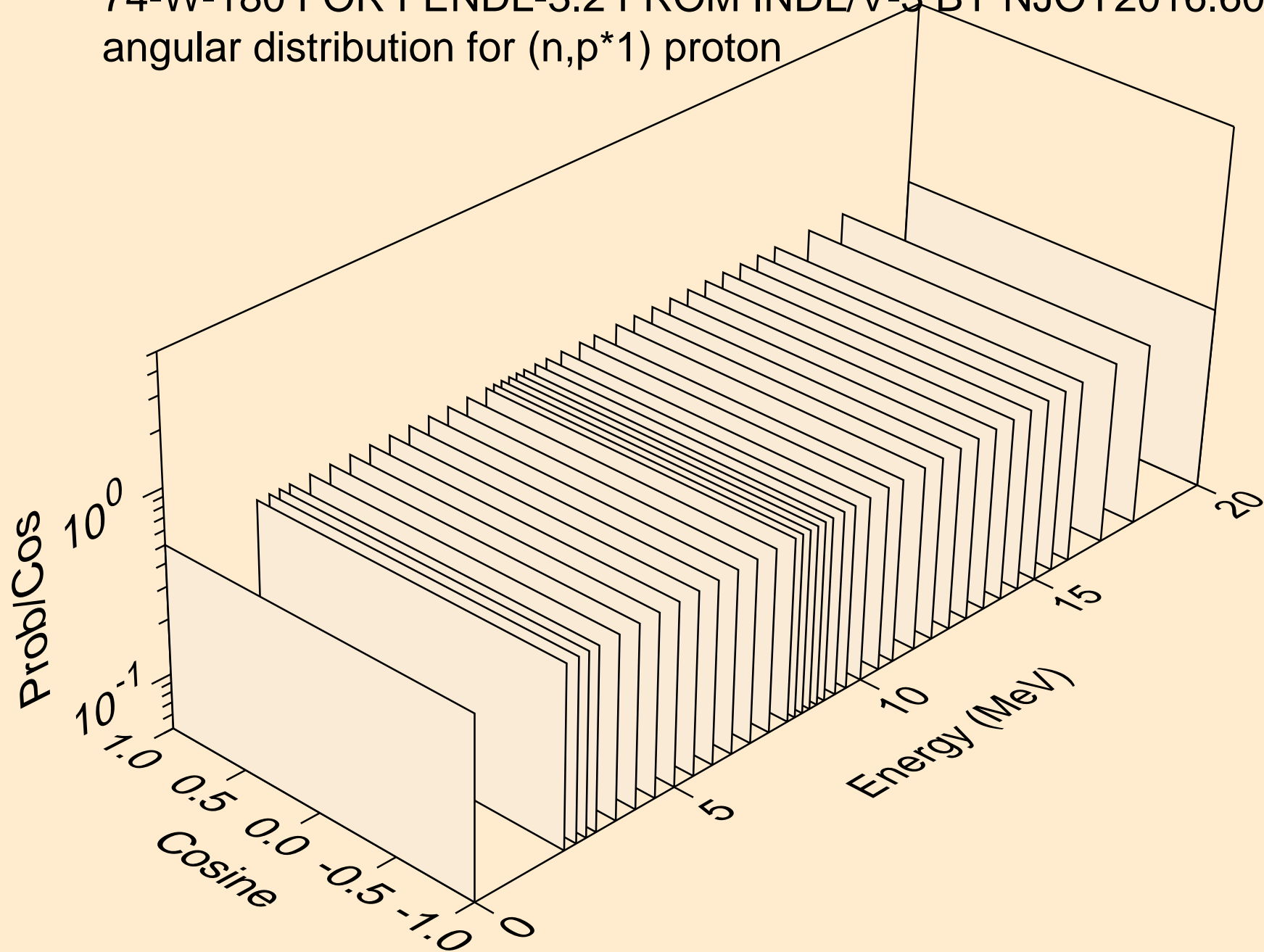

74-W-180 FOR FENDL-3.2 FROM INDL/V-3 BY NJOY2016.60+ ON
angular distribution for (n,p*1) proton

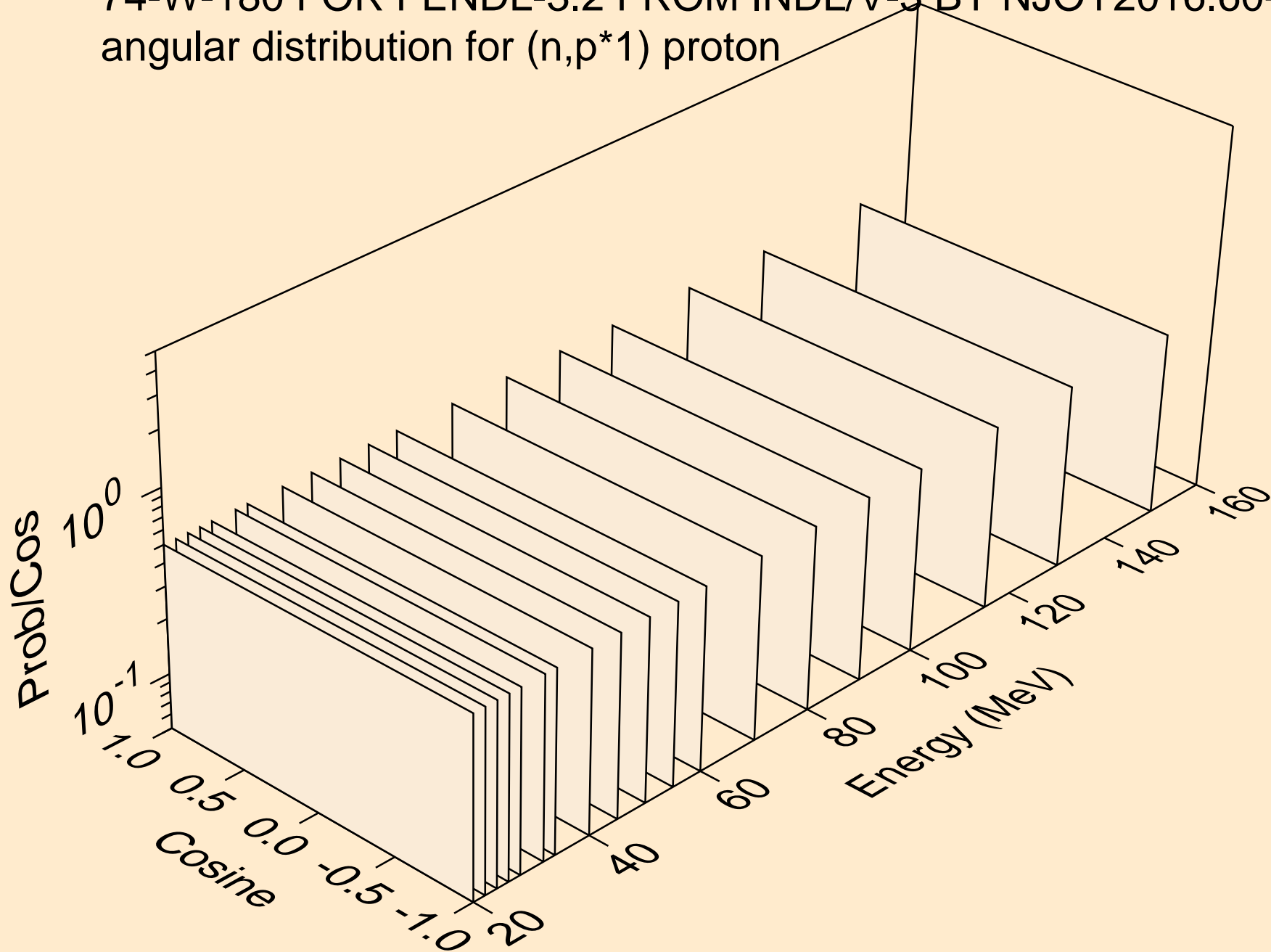

74-W-180 FOR FENDL-3.2 FROM INDL/V-3 BY NJOY2016.60+ ON
angular distribution for (n,p*2) proton

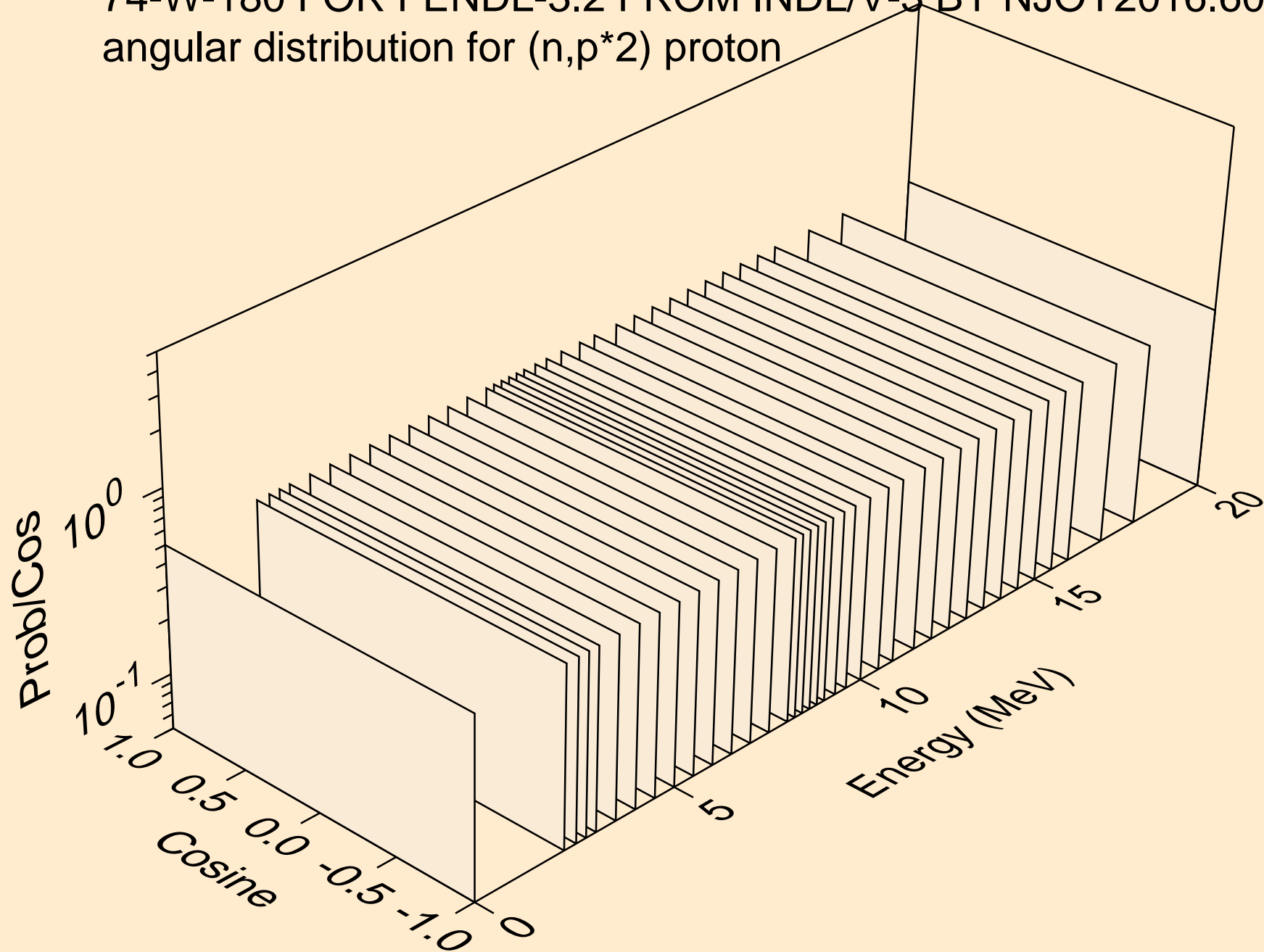

74-W-180 FOR FENDL-3.2 FROM INDL/V-3 BY NJOY2016.60+ ON
angular distribution for (n,p*2) proton

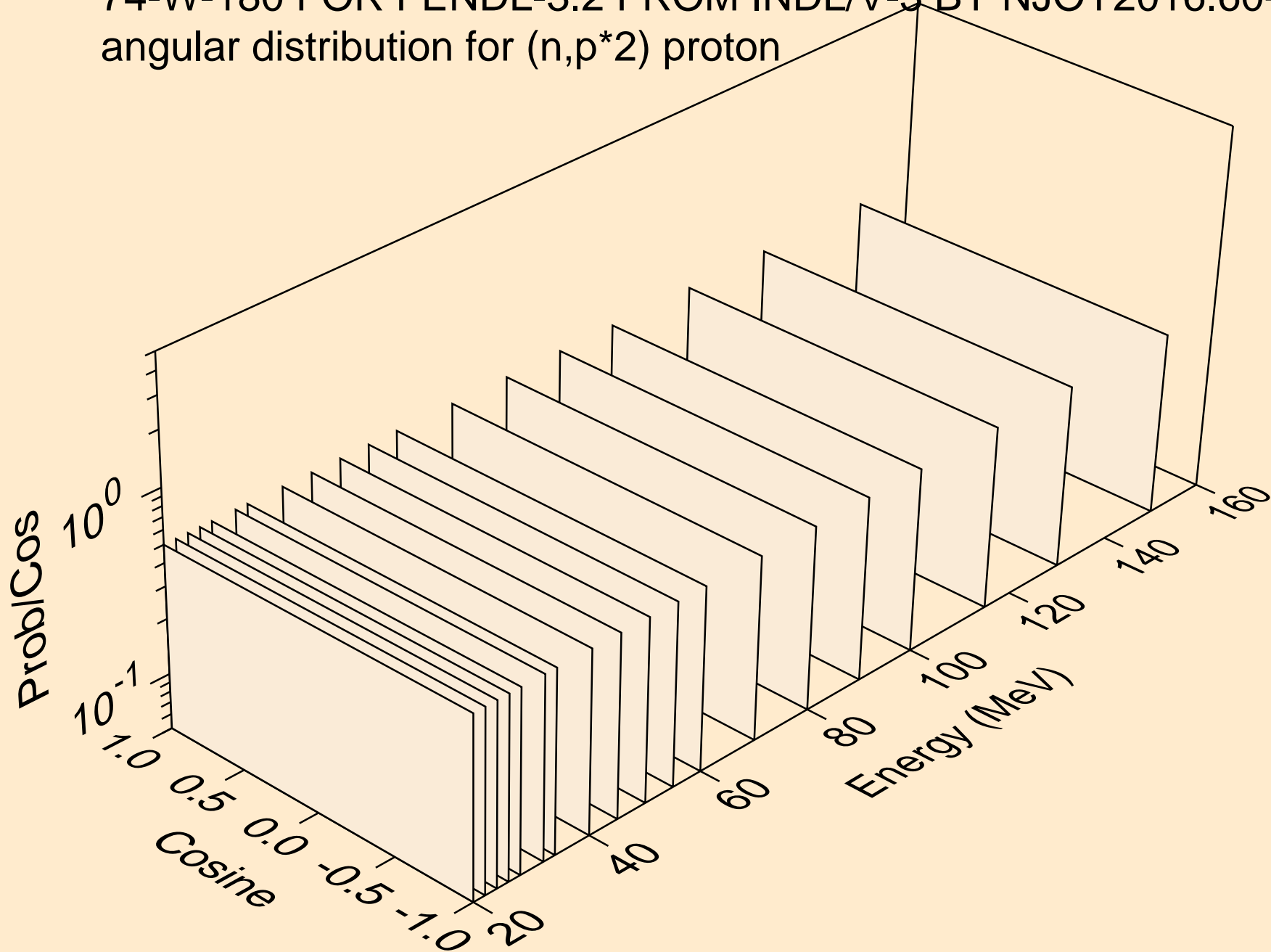

74-W-180 FOR FENDL-3.2 FROM INDL/V-3 BY NJOY2016.60+ ON
angular distribution for (n,p*3) proton

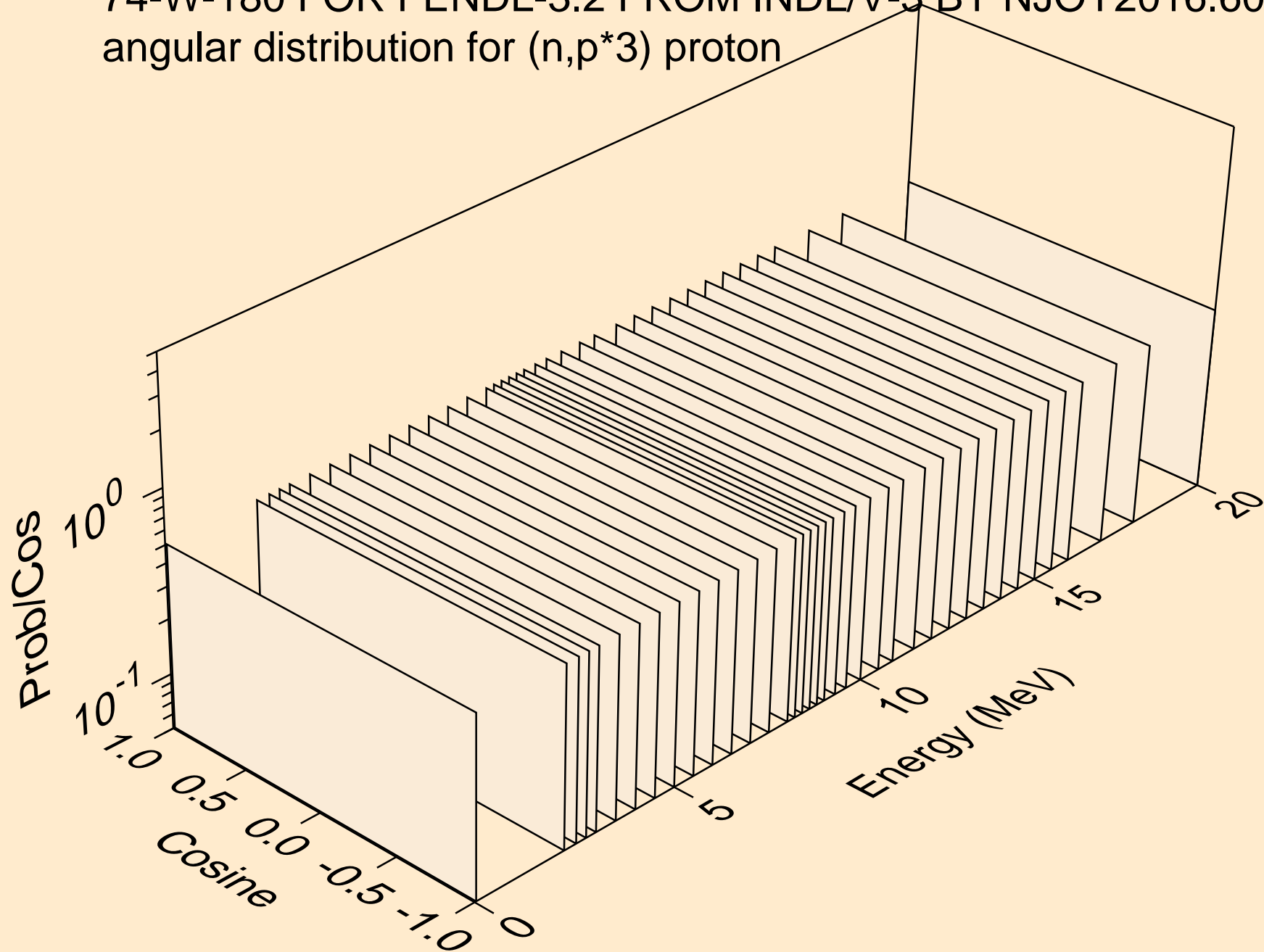

74-W-180 FOR FENDL-3.2 FROM INDL/V-3 BY NJOY2016.60+ ON
angular distribution for (n,p*3) proton

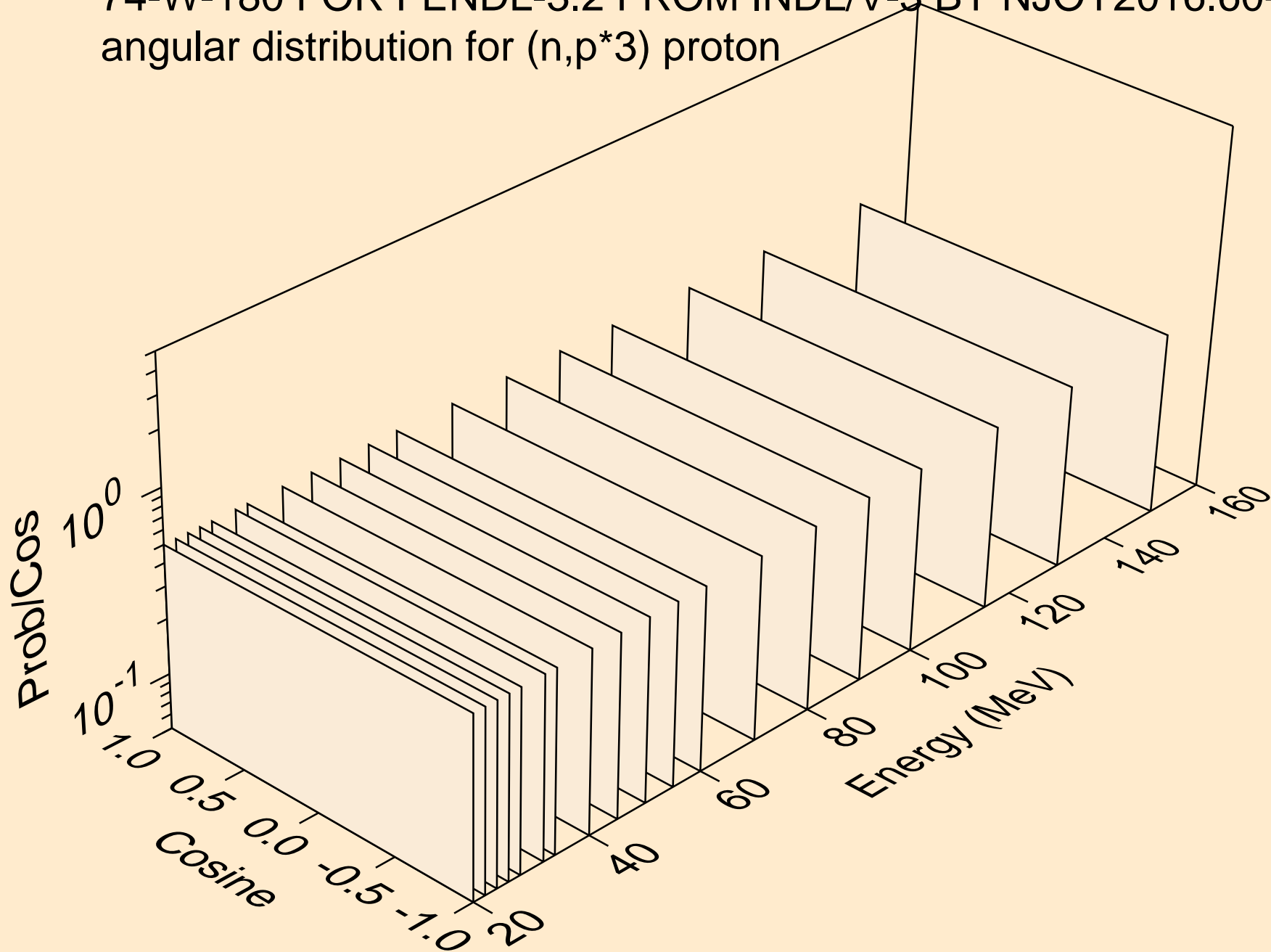

74-W-180 FOR FENDL-3.2 FROM INDL/V-3 BY NJOY2016.60+ ON
angular distribution for (n,p*4) proton

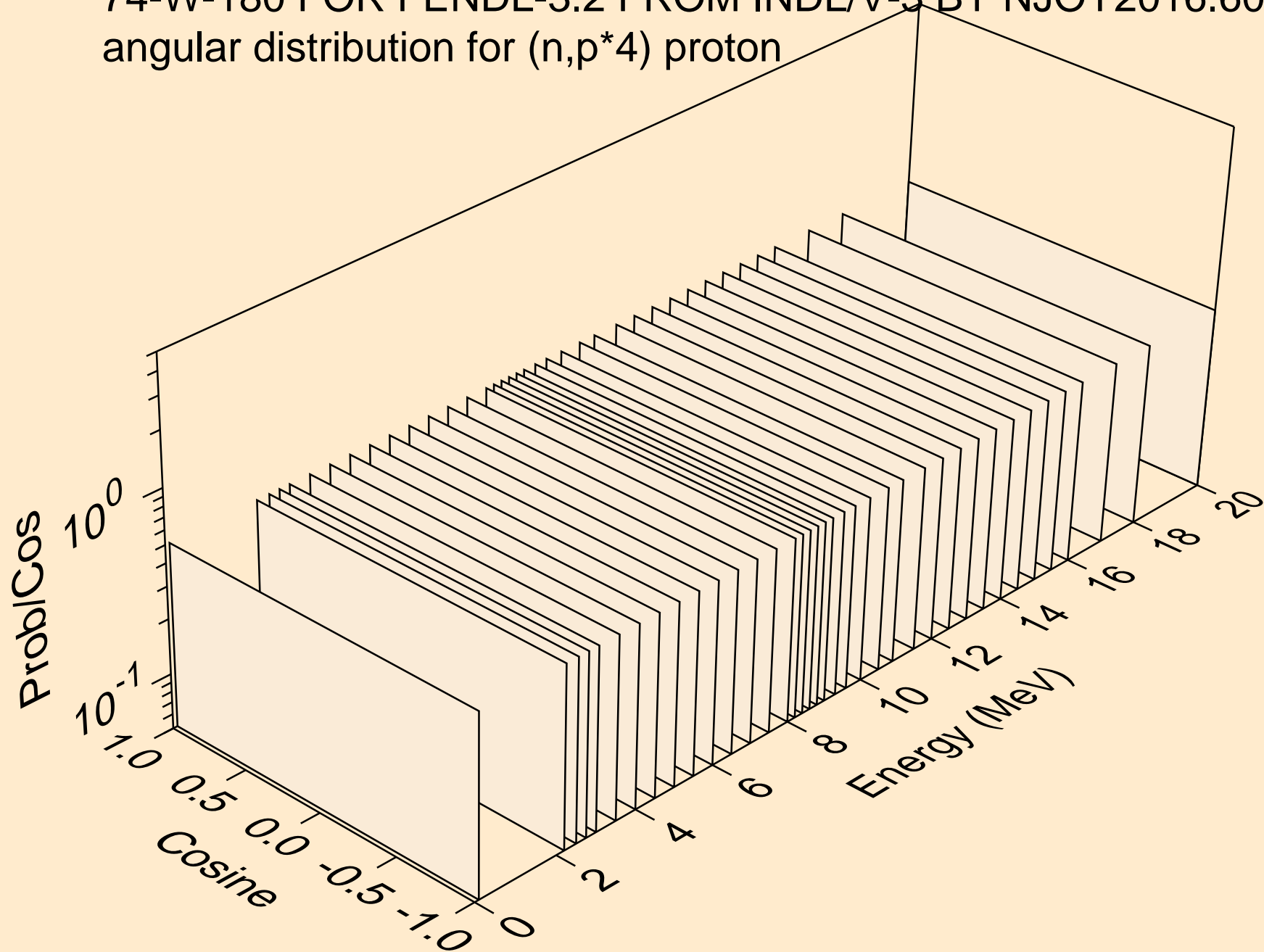

74-W-180 FOR FENDL-3.2 FROM INDL/V-3 BY NJOY2016.60+ ON
angular distribution for (n,p*4) proton

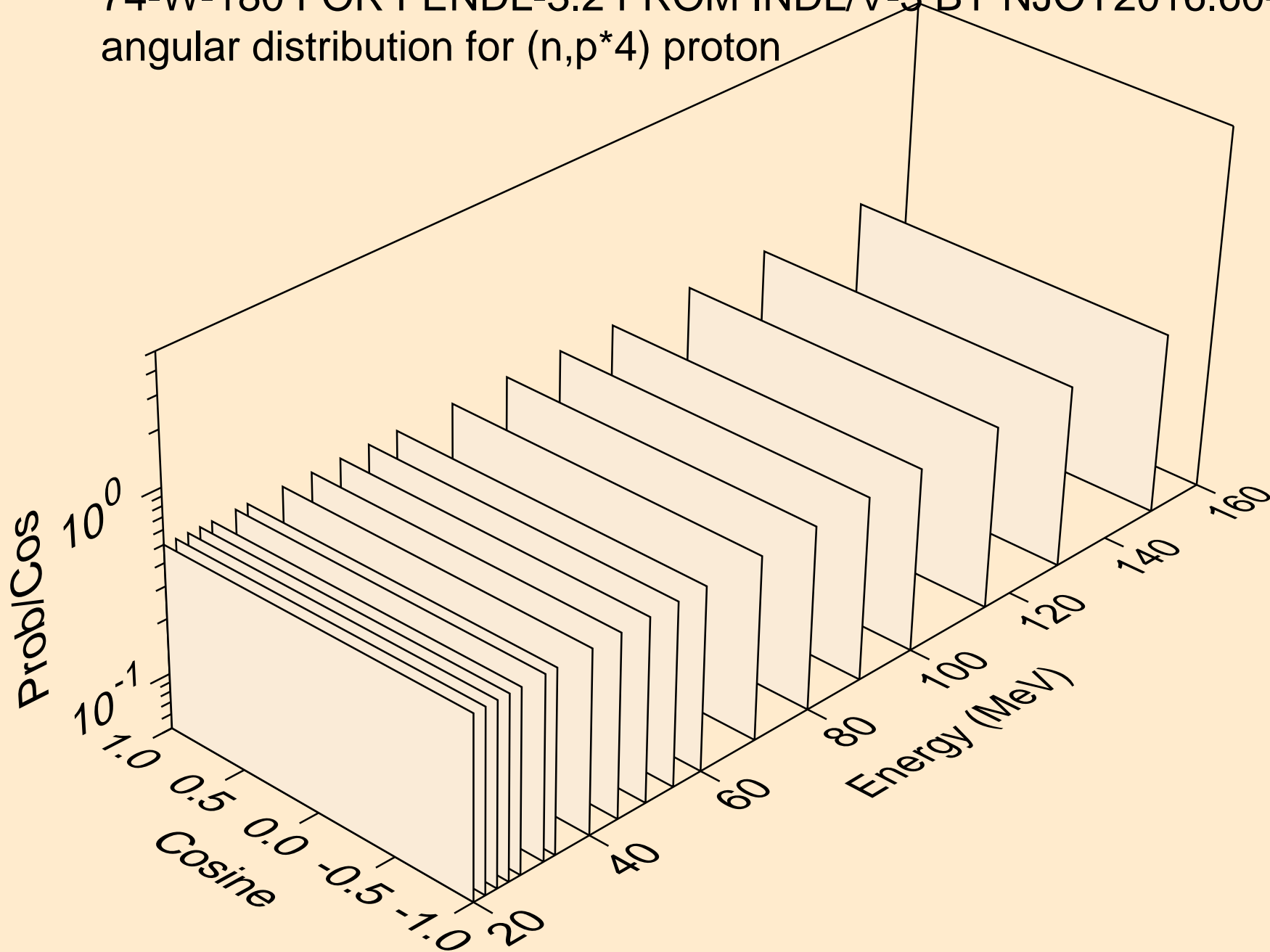

74-W-180 FOR FENDL-3.2 FROM INDL/V-3 BY NJOY2016.60+ ON
angular distribution for (n,p*5) proton

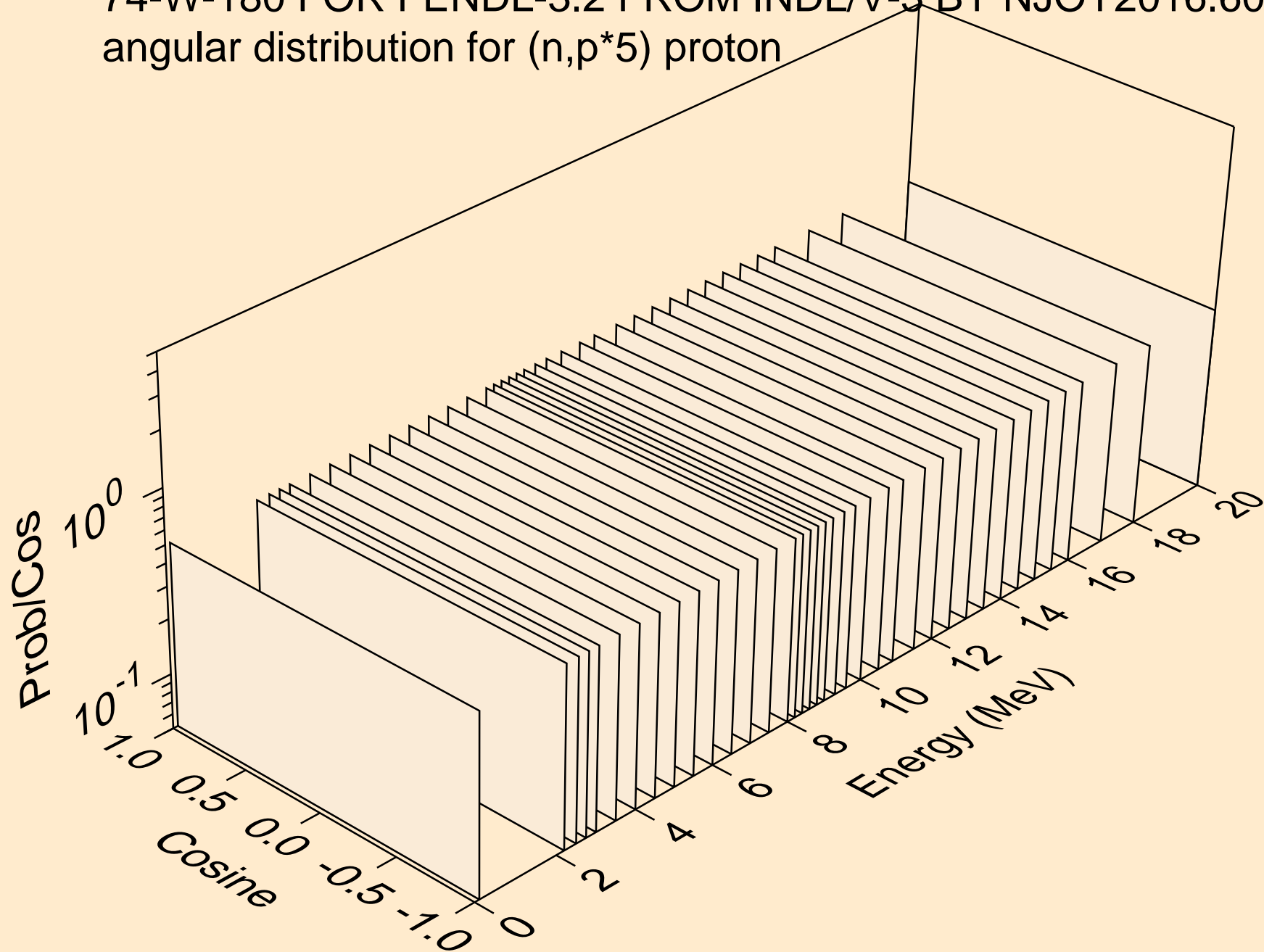

74-W-180 FOR FENDL-3.2 FROM INDL/V-3 BY NJOY2016.60+ ON
angular distribution for (n,p*5) proton

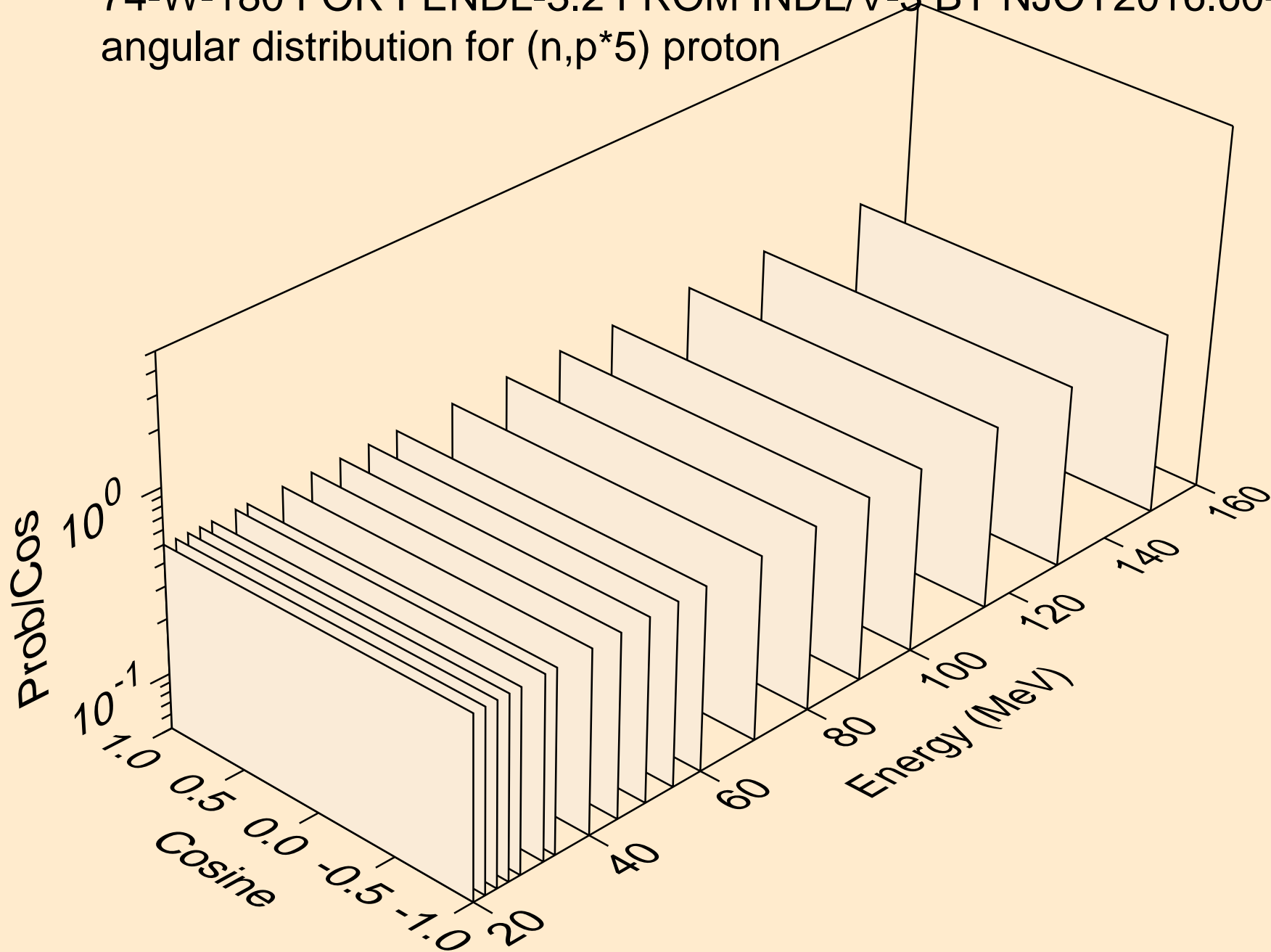

74-W-180 FOR FENDL-3.2 FROM INDL/V-3 BY NJOY2016.60+ ON
angular distribution for (n,p*6) proton

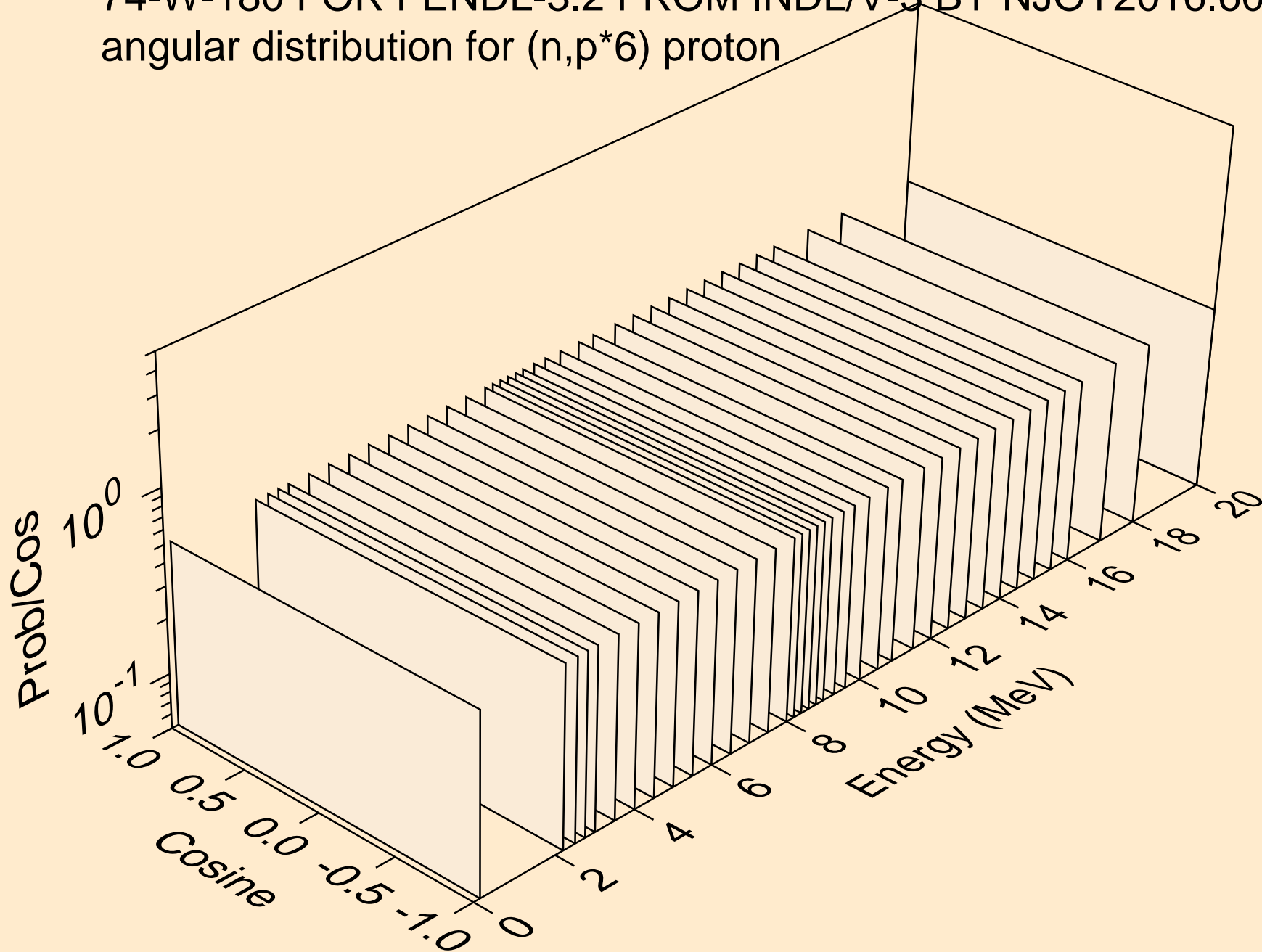

74-W-180 FOR FENDL-3.2 FROM INDL/V-3 BY NJOY2016.60+ ON
angular distribution for (n,p*6) proton

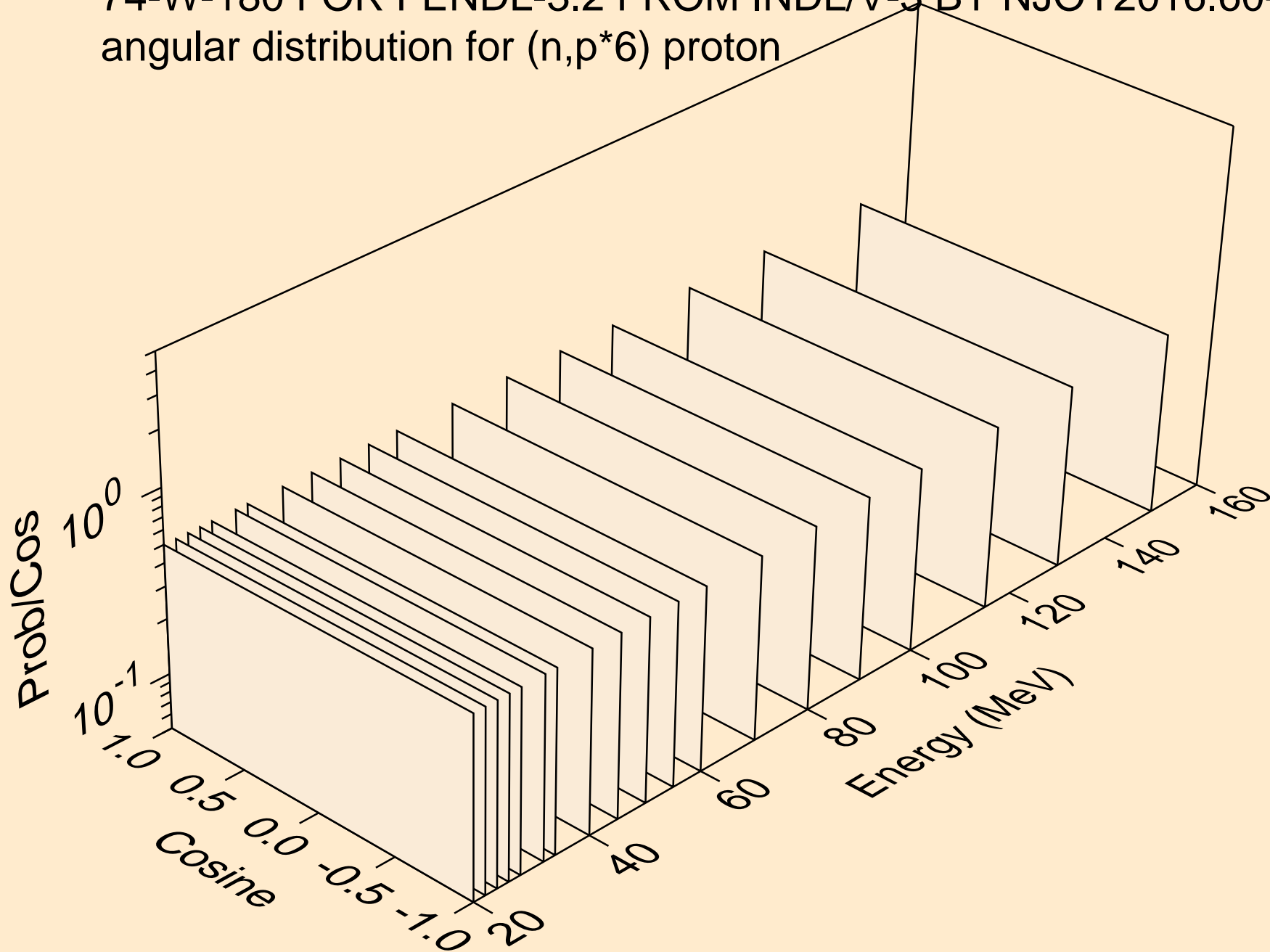

74-W-180 FOR FENDL-3.2 FROM INDL/V-3 BY NJOY2016.60+ ON
angular distribution for (n,p*7) proton

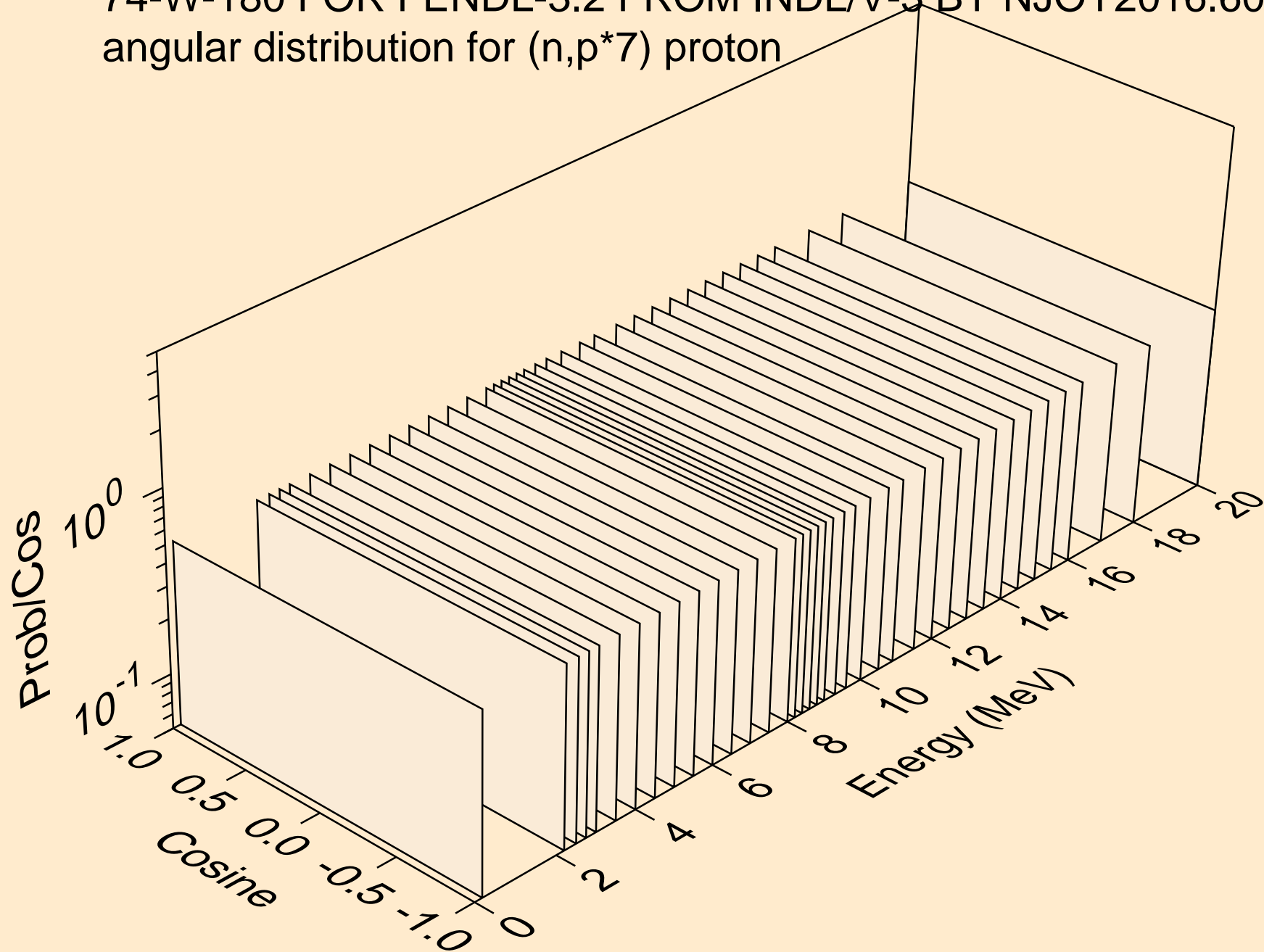

74-W-180 FOR FENDL-3.2 FROM INDL/V-3 BY NJOY2016.60+ ON
angular distribution for (n,p*7) proton

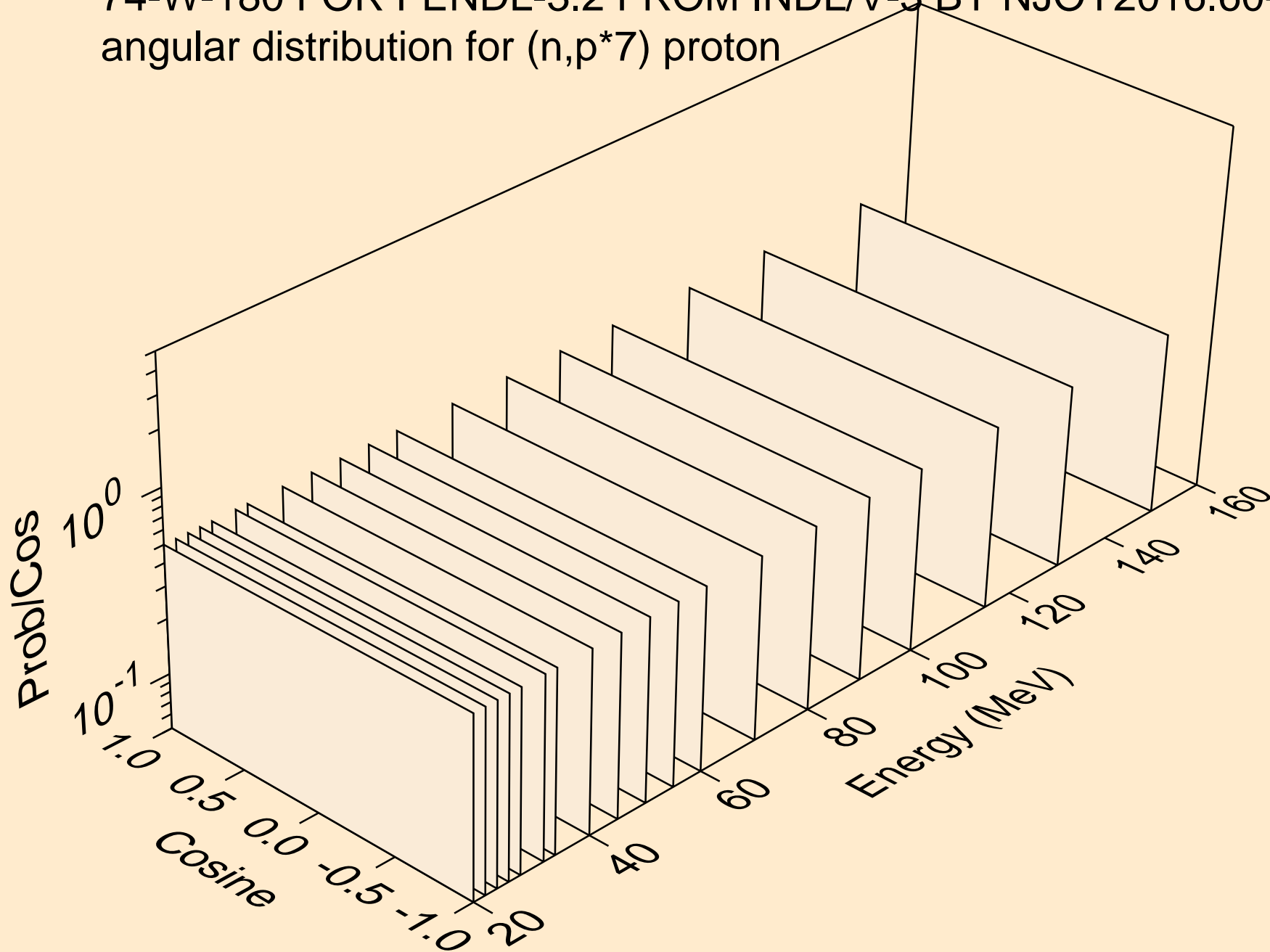

74-W-180 FOR FENDL-3.2 FROM INDL/V-3 BY NJOY2016.60+ ON
angular distribution for (n,p*8) proton

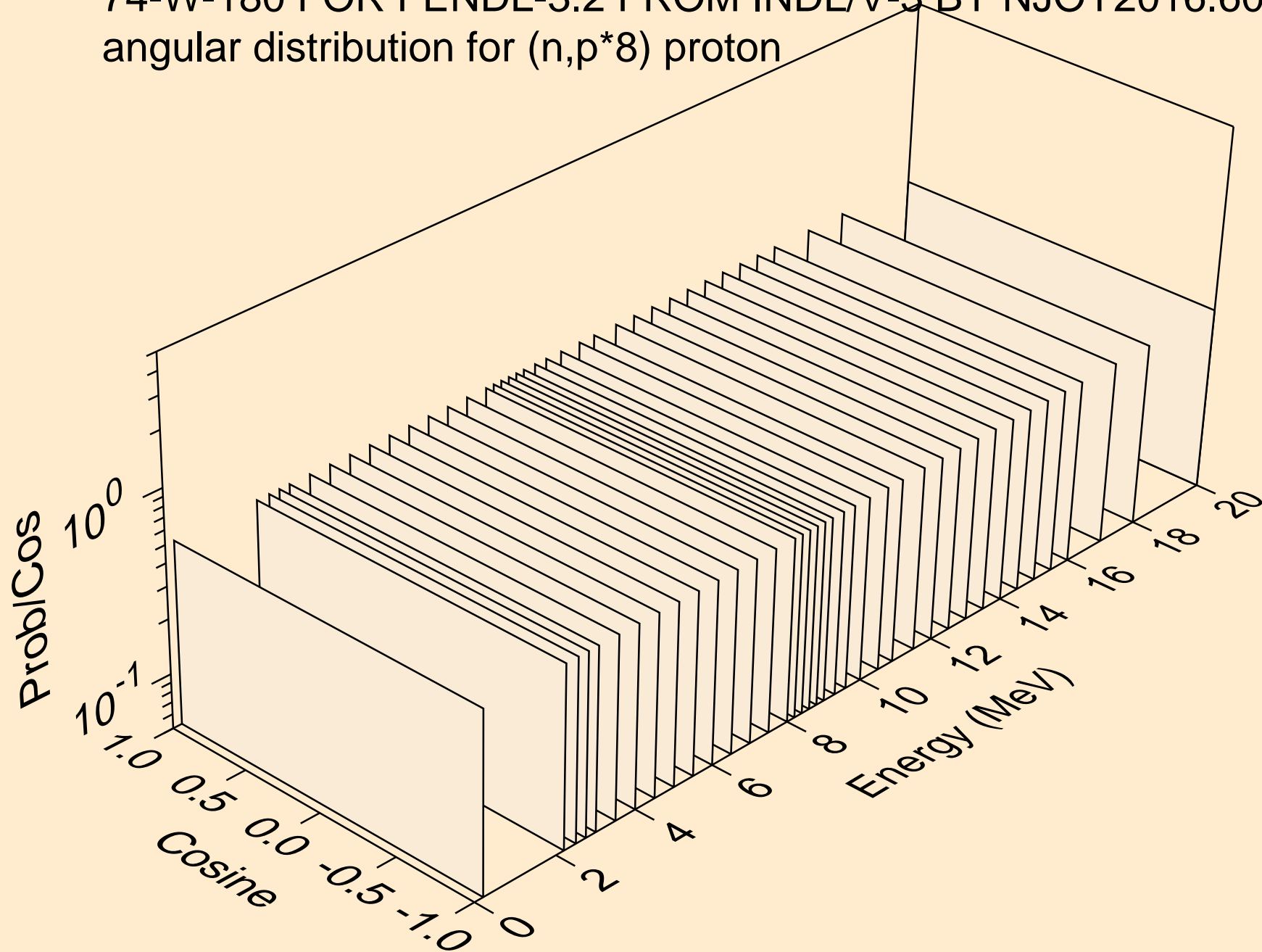

74-W-180 FOR FENDL-3.2 FROM INDL/V-3 BY NJOY2016.60+ ON
angular distribution for (n,p*8) proton

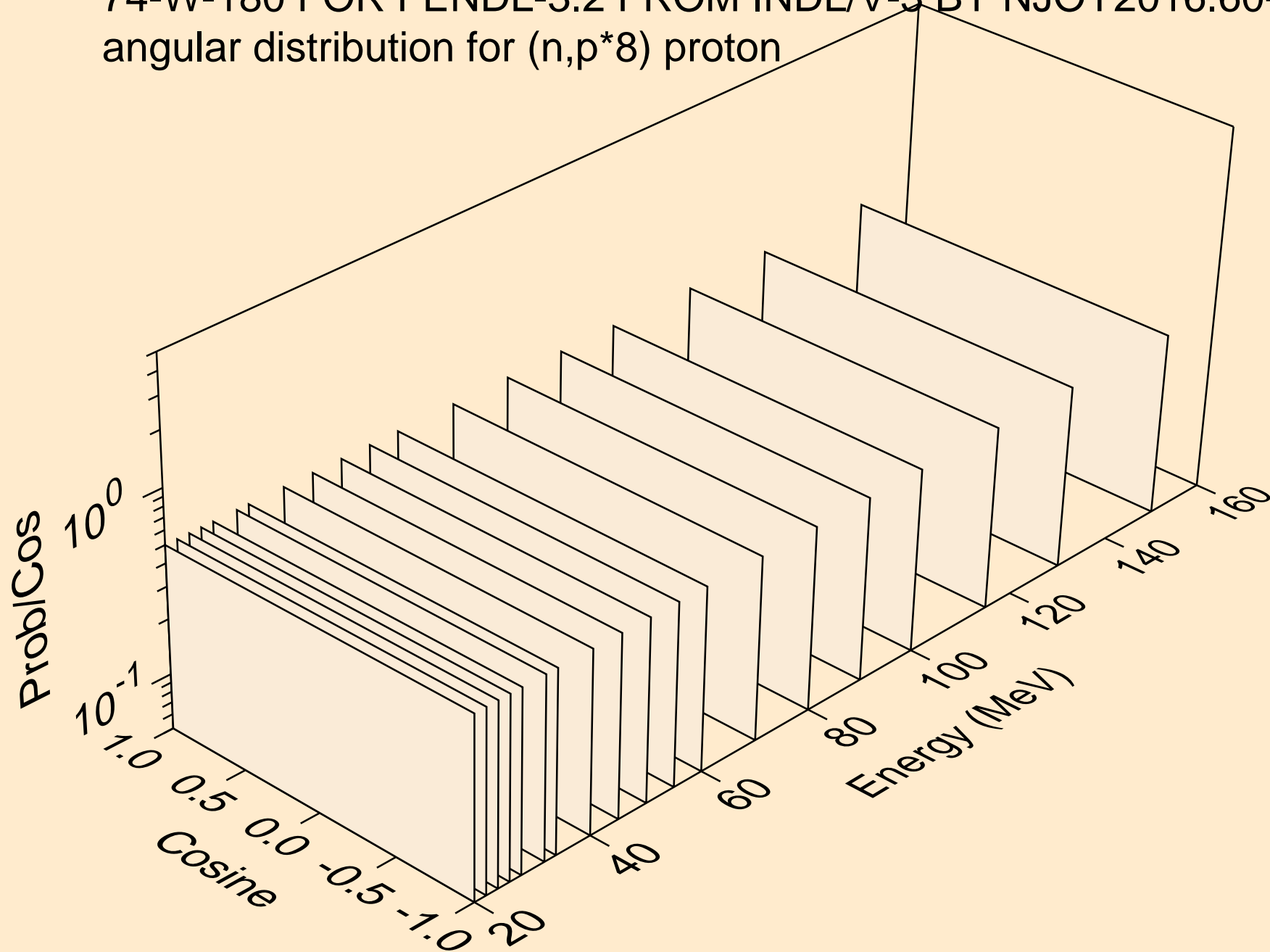

74-W-180 FOR FENDL-3.2 FROM INDL/V-3 BY NJOY2016.60+ ON
angular distribution for (n,p*9) proton

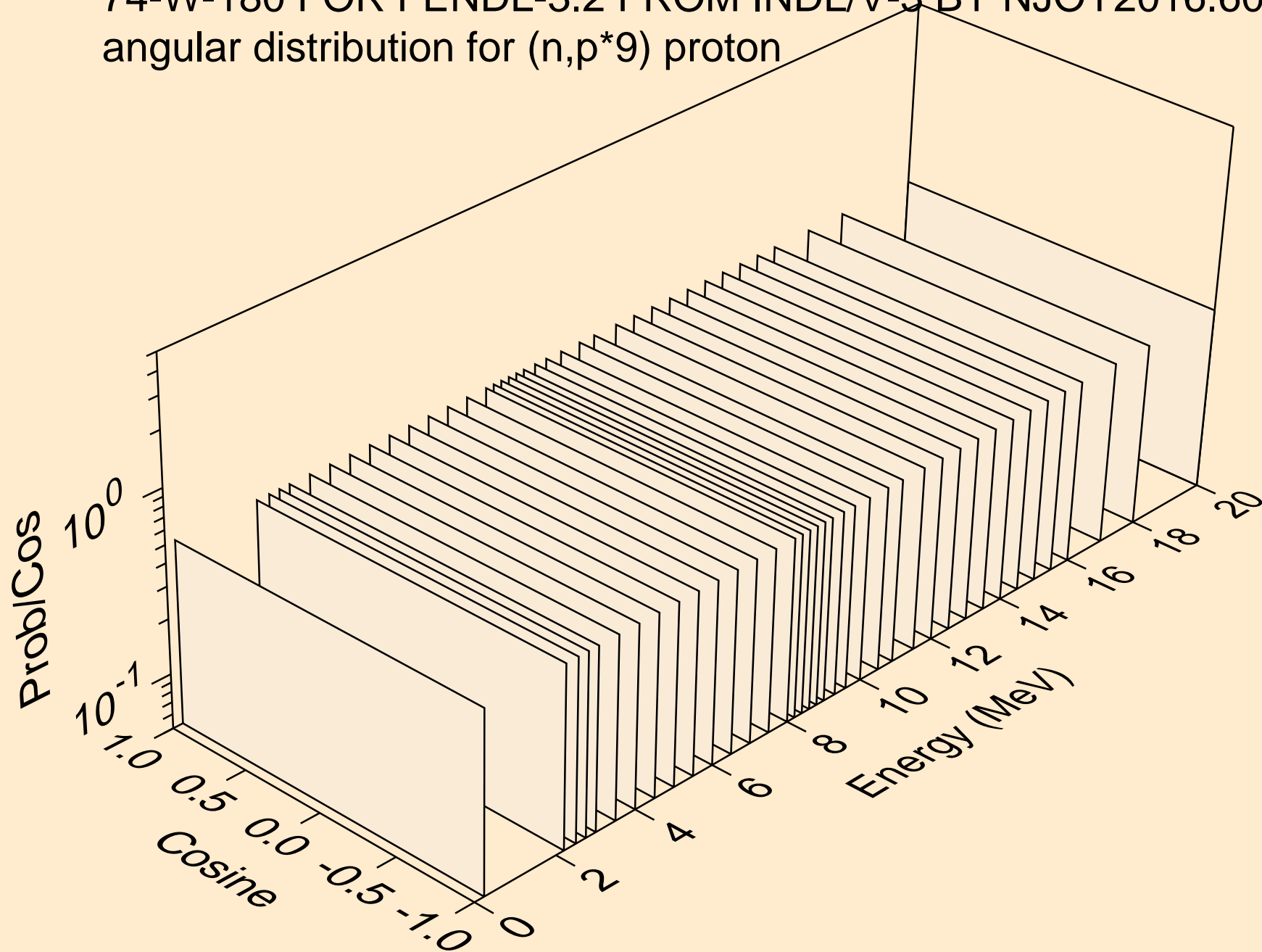

74-W-180 FOR FENDL-3.2 FROM INDL/V-3 BY NJOY2016.60+ ON
angular distribution for (n,p*9) proton

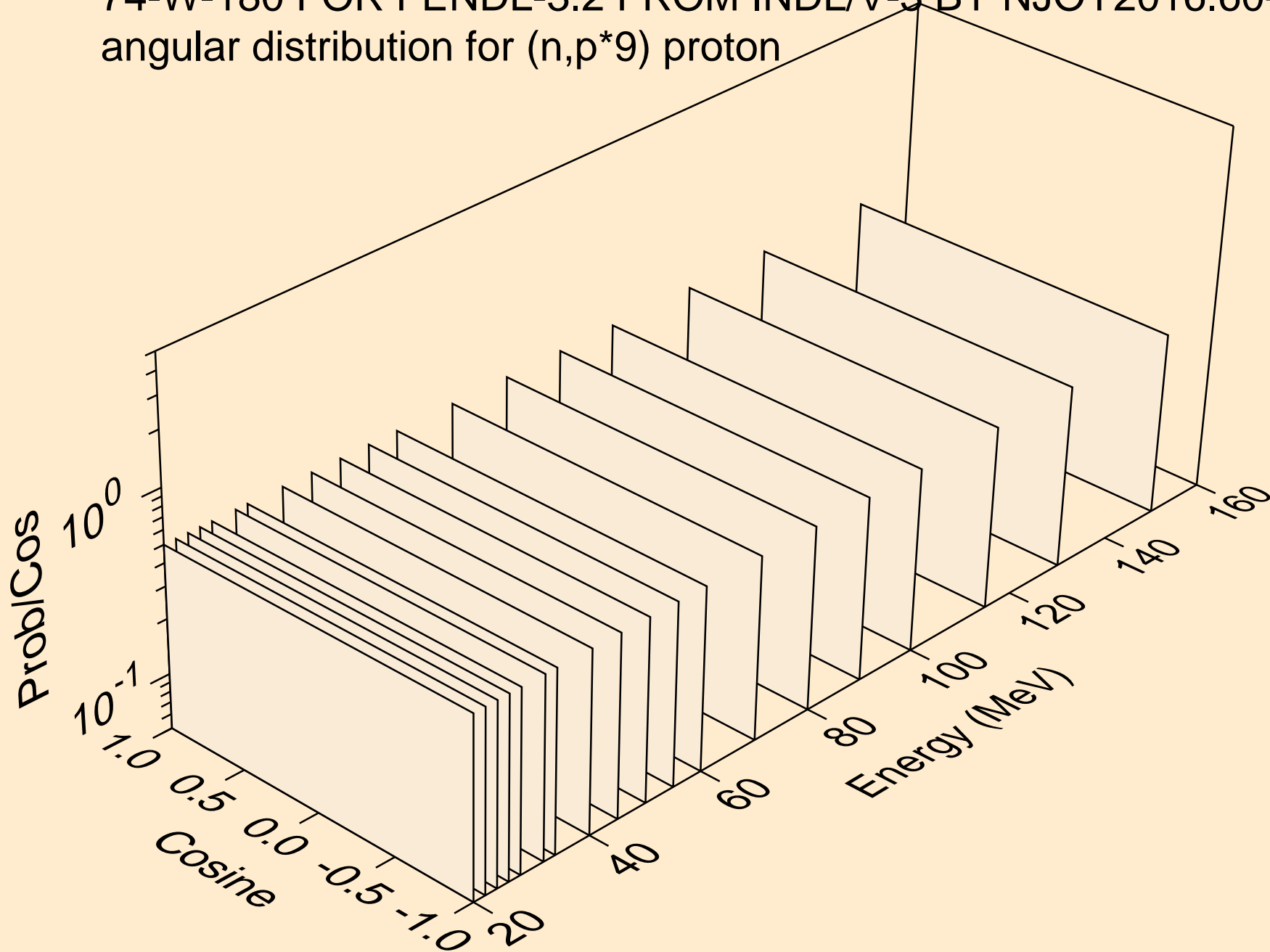

74-W-180 FOR FENDL-3.2 FROM INDL/V-3 BY NJOY2016.60+ ON
angular distribution for (n,p*10) proton

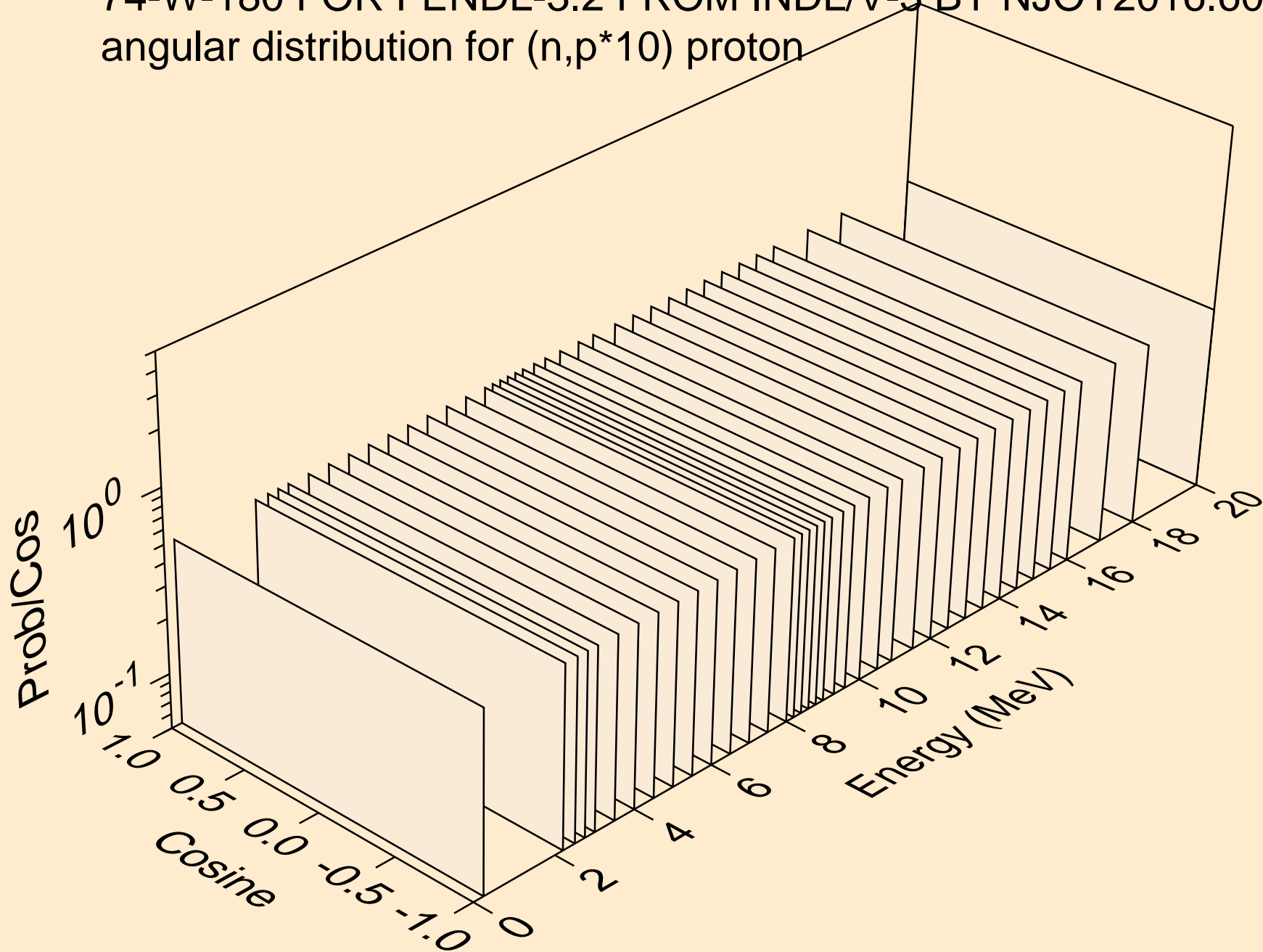

74-W-180 FOR FENDL-3.2 FROM INDL/V-3 BY NJOY2016.60+ ON
angular distribution for (n,p*10) proton

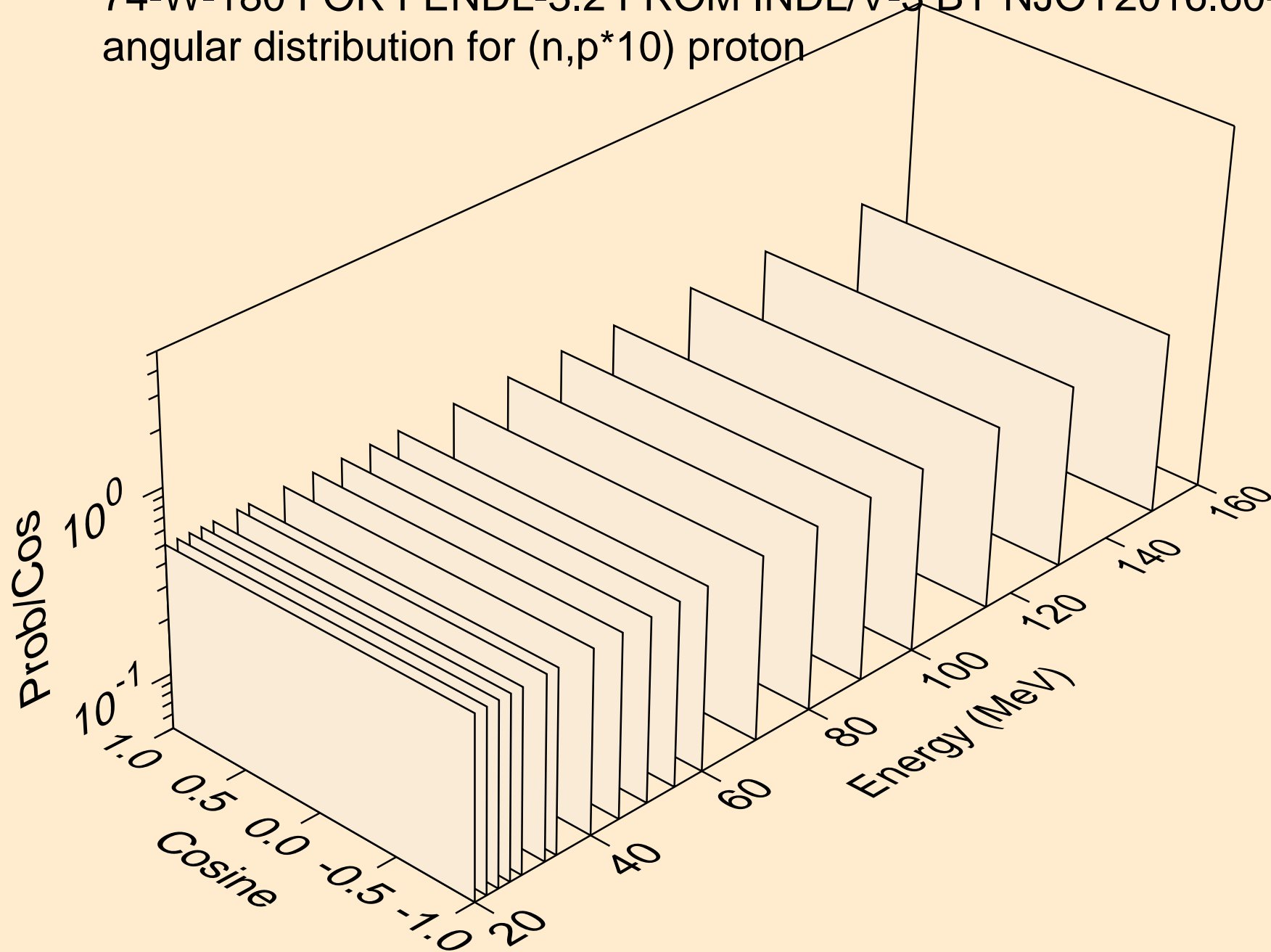

74-W-180 FOR FENDL-3.2 FROM INDL/V-3 BY NJOY2016.60+ ON
angular distribution for (n,p*11) proton

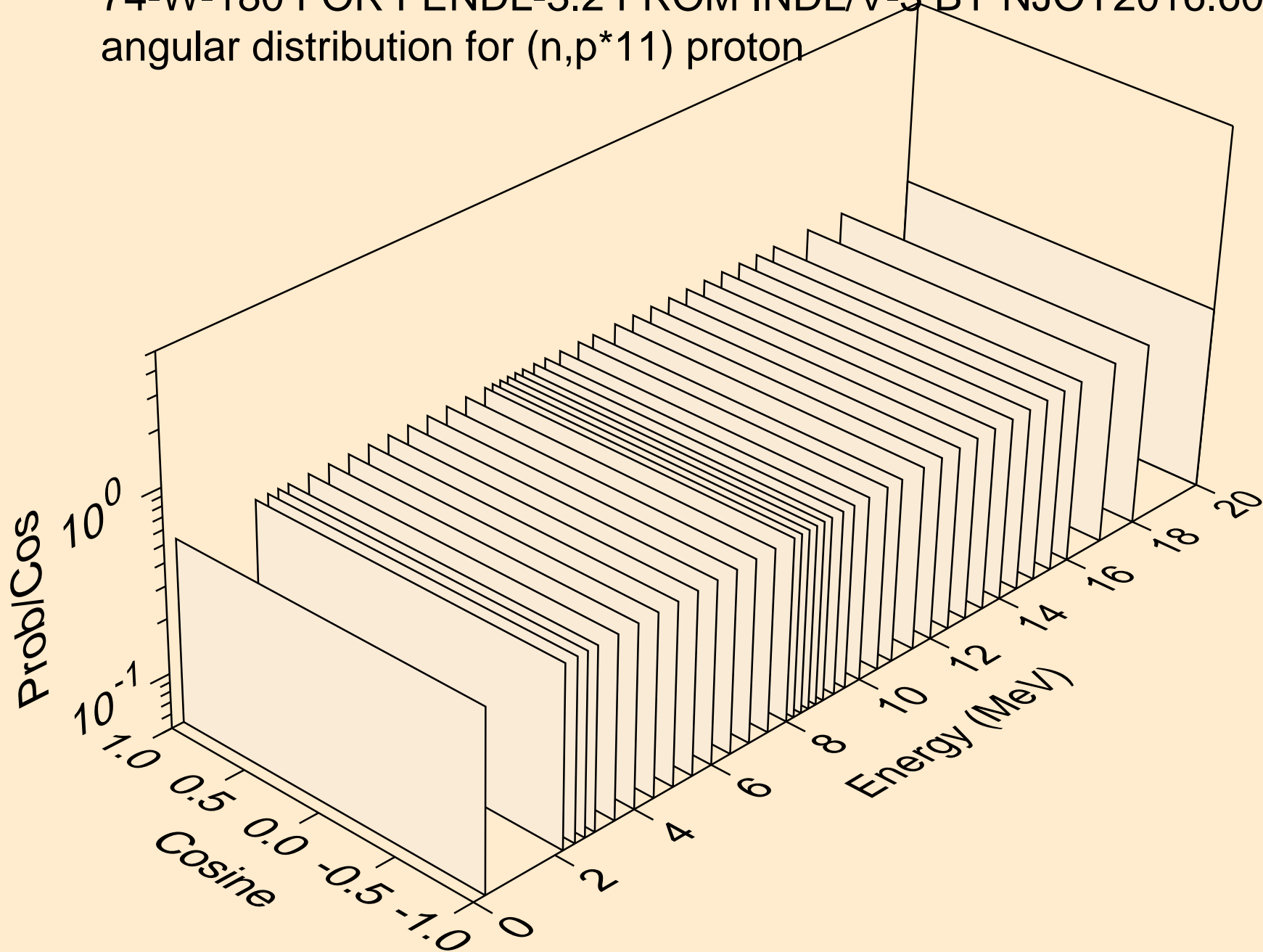

74-W-180 FOR FENDL-3.2 FROM INDL/V-3 BY NJOY2016.60+ ON
angular distribution for (n,p*11) proton

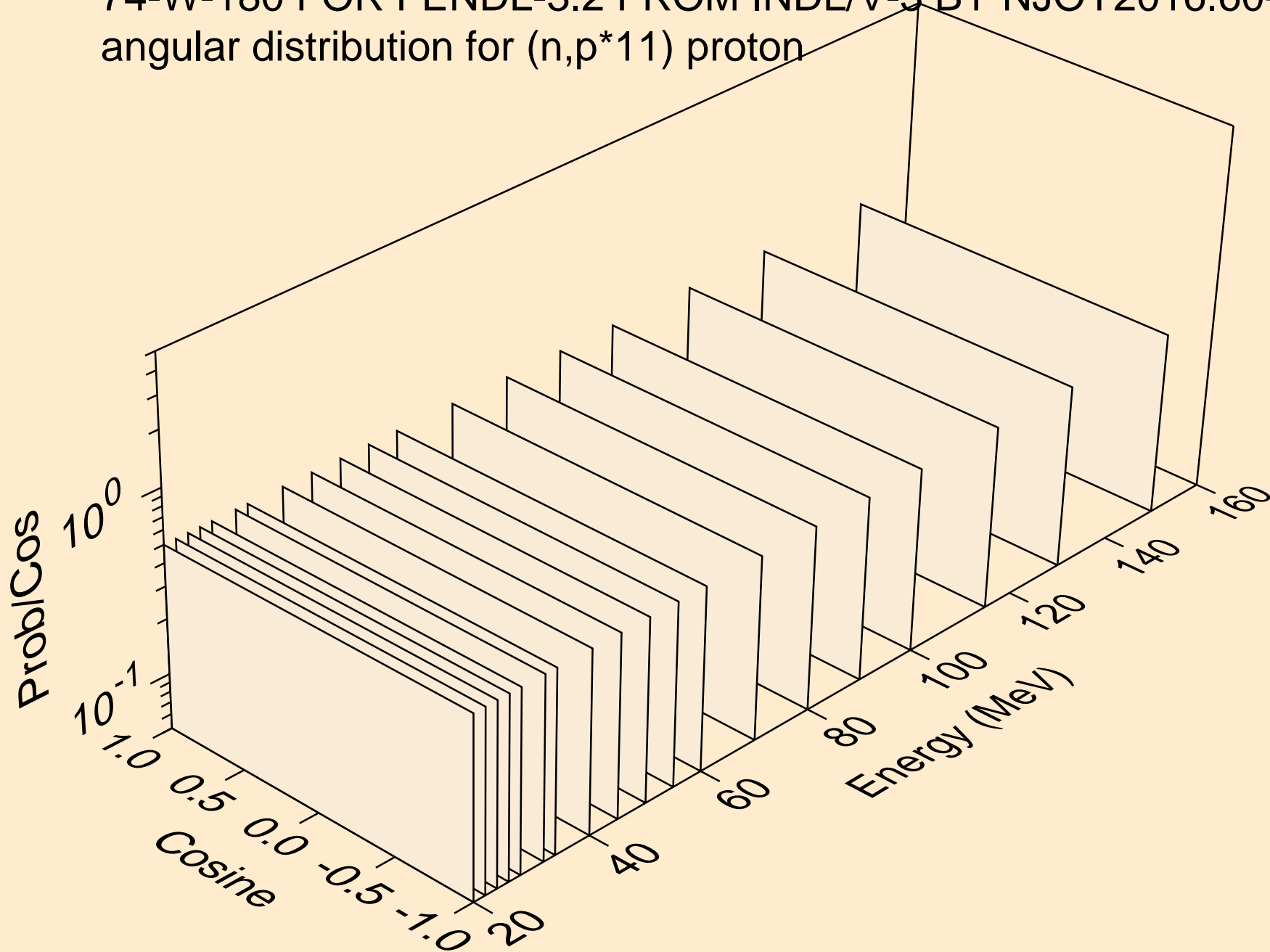

74-W-180 FOR FENDL-3.2 FROM INDL/V-3 BY NJOY2016.60+ ON
angular distribution for (n,p*12) proton

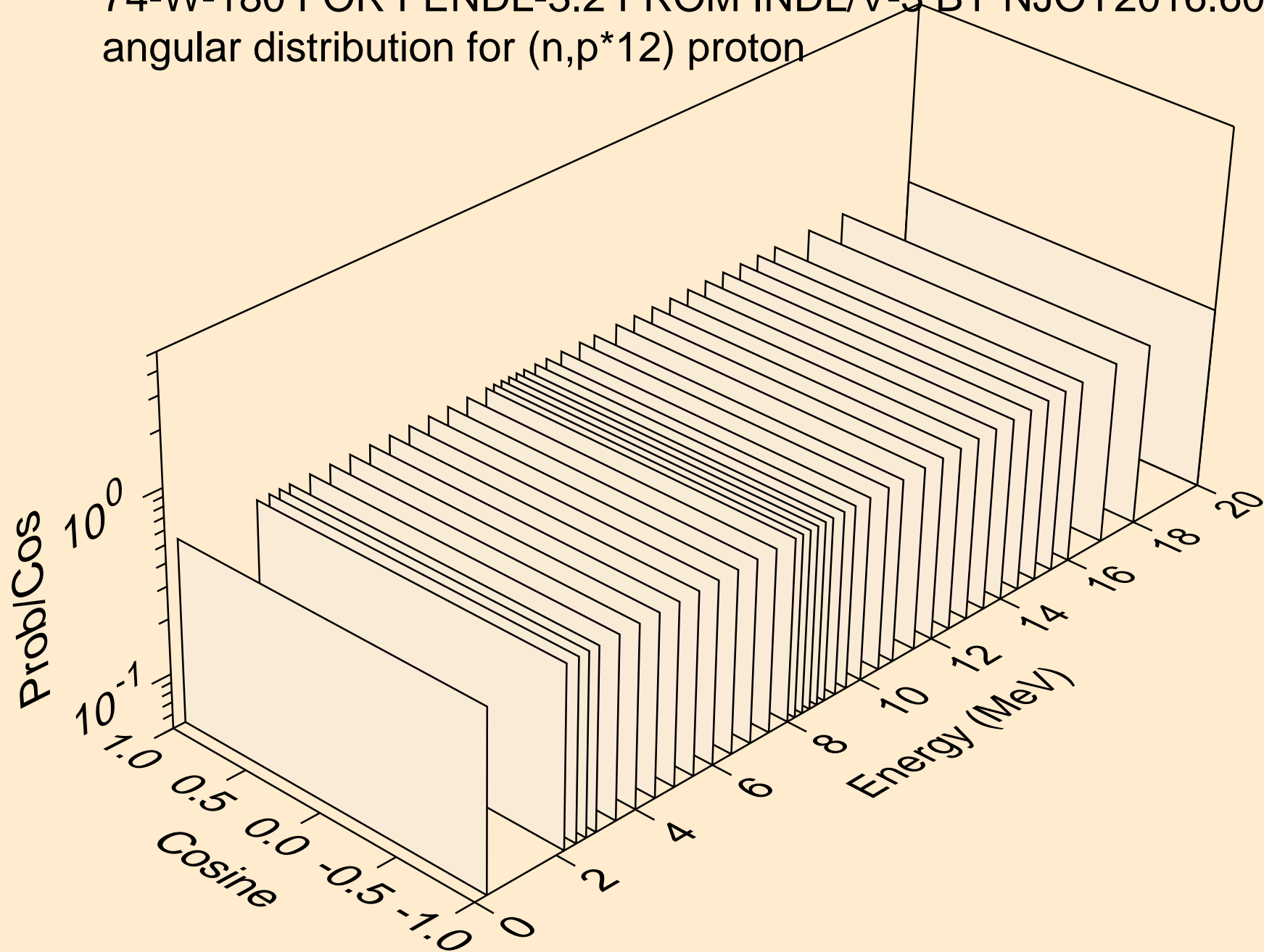

74-W-180 FOR FENDL-3.2 FROM INDL/V-3 BY NJOY2016.60+ ON
angular distribution for (n,p*12) proton

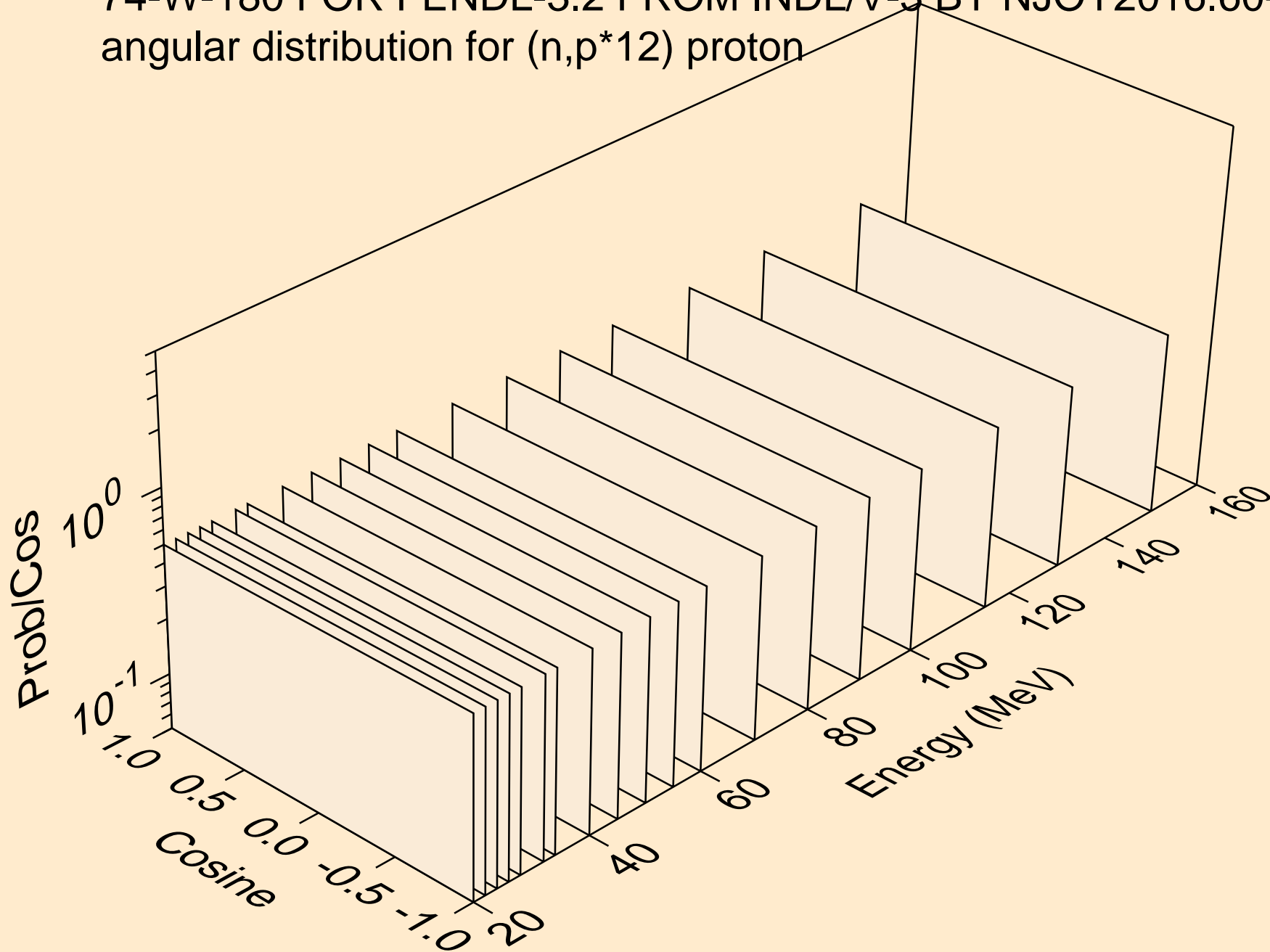

74-W-180 FOR FENDL-3.2 FROM INDL/V-3 BY NJOY2016.60+ ON
angular distribution for (n,p*13) proton

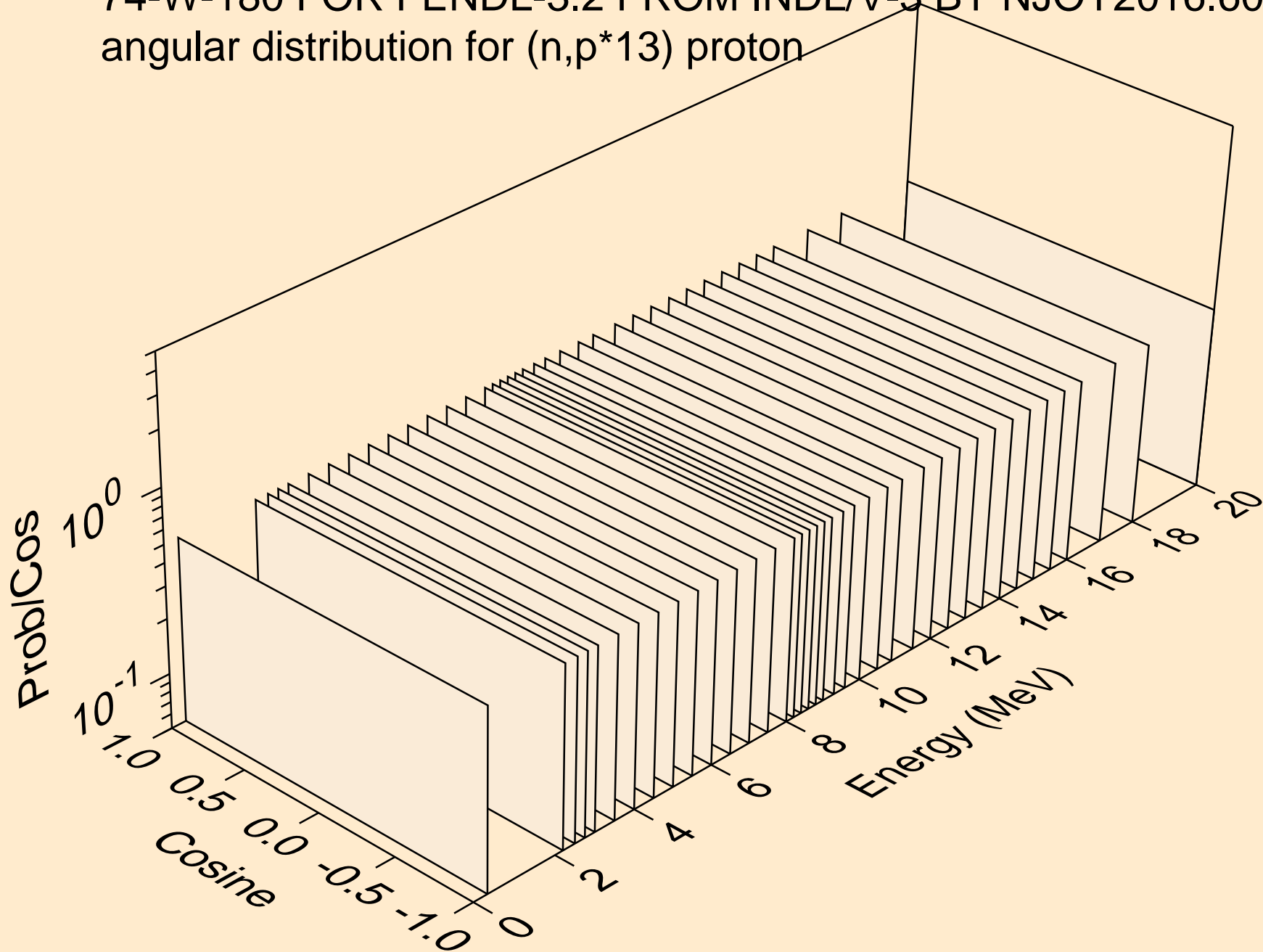

74-W-180 FOR FENDL-3.2 FROM INDL/V-3 BY NJOY2016.60+ ON
angular distribution for (n,p*13) proton

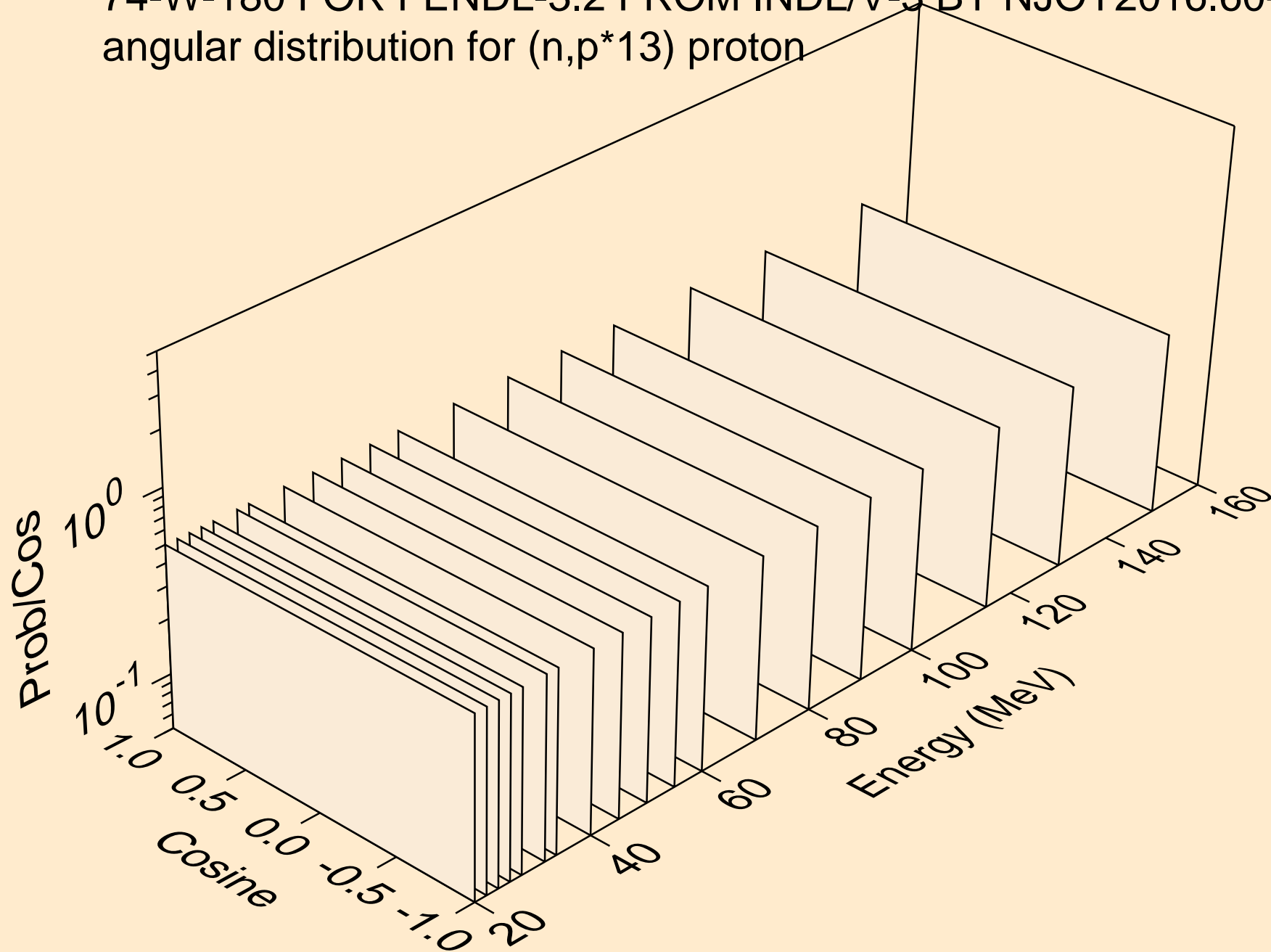

74-W-180 FOR FENDL-3.2 FROM INDL/V-3 BY NJOY2016.60+ ON
angular distribution for (n,p*14) proton

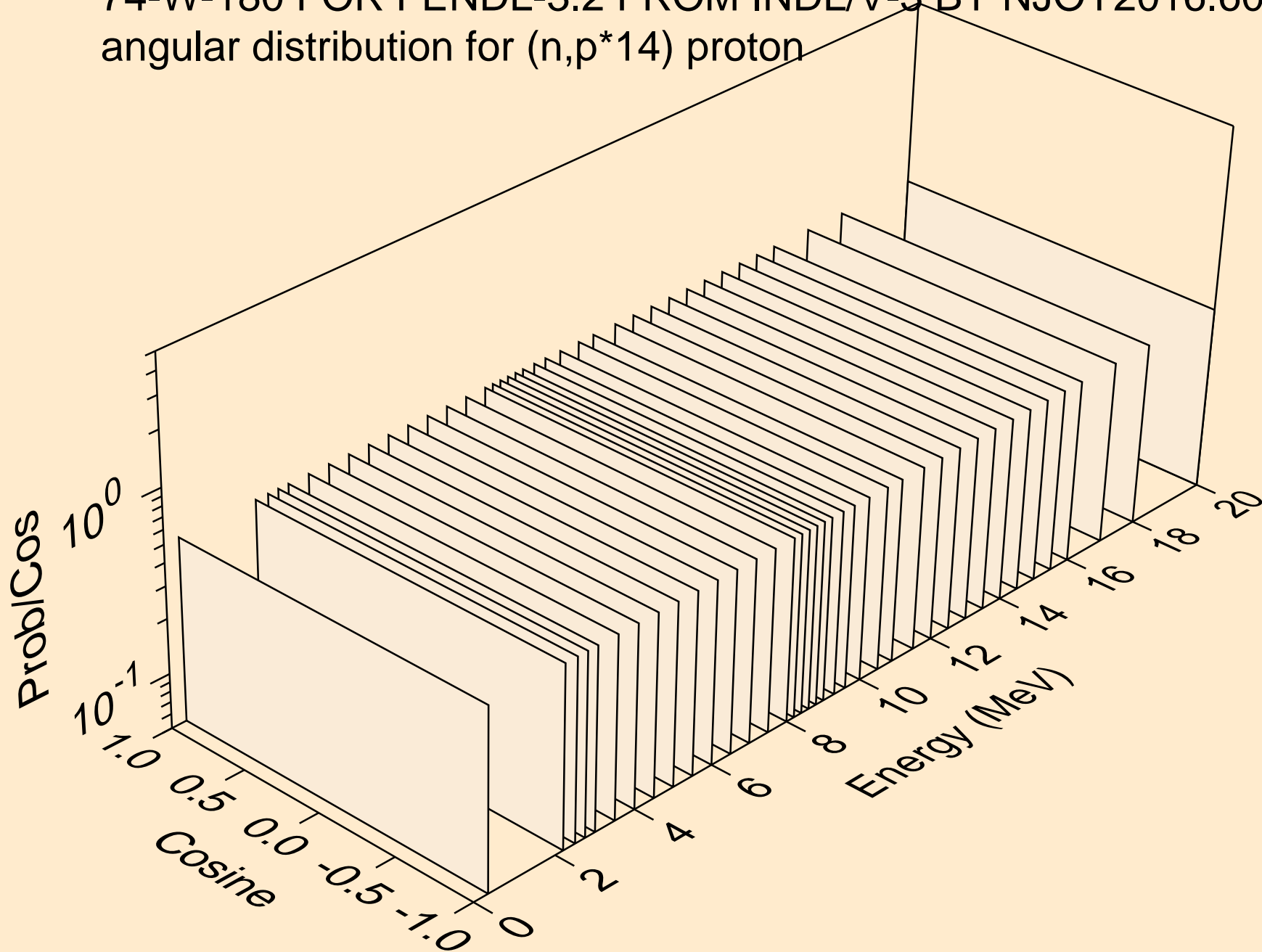

74-W-180 FOR FENDL-3.2 FROM INDL/V-3 BY NJOY2016.60+ ON
angular distribution for (n,p*14) proton

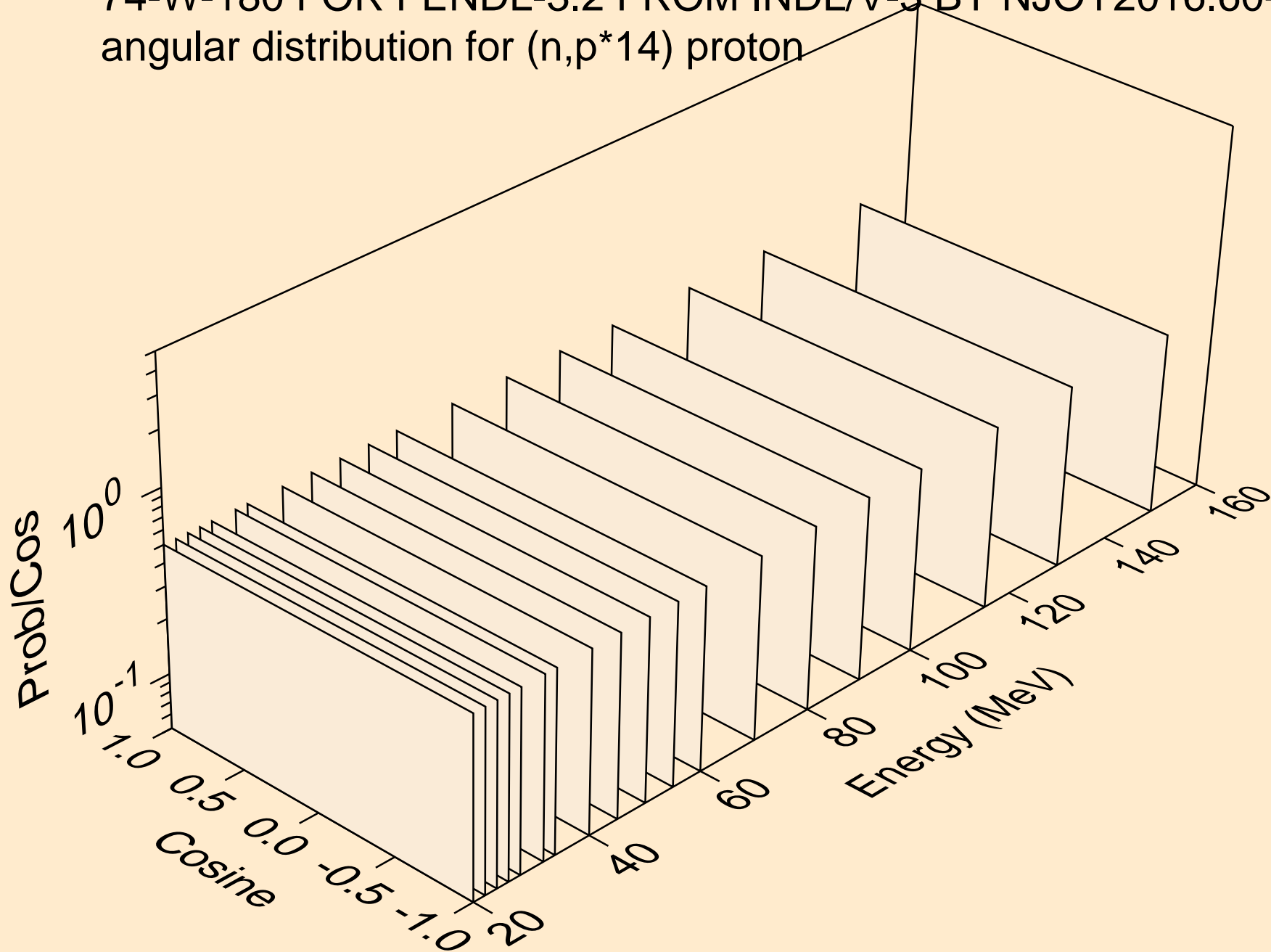

74-W-180 FOR FENDL-3.2 FROM INDLV-3 BY NJOY2016.60+ ON
protons from (n,p*c)

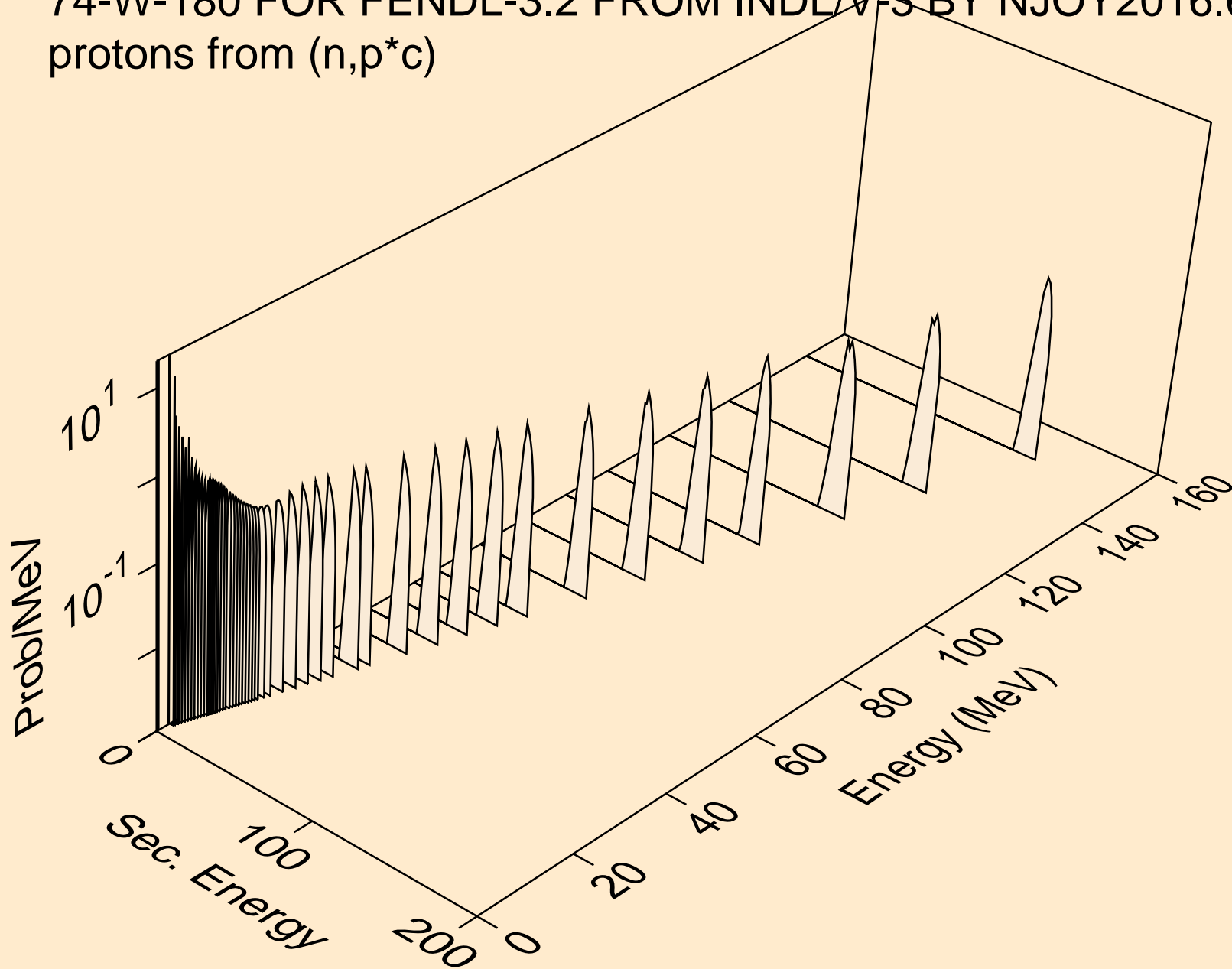

74-W-180 FOR FENDL-3.2 FROM INDLV-3 BY NJOY2016.60+ ON
alphas from (n,x)

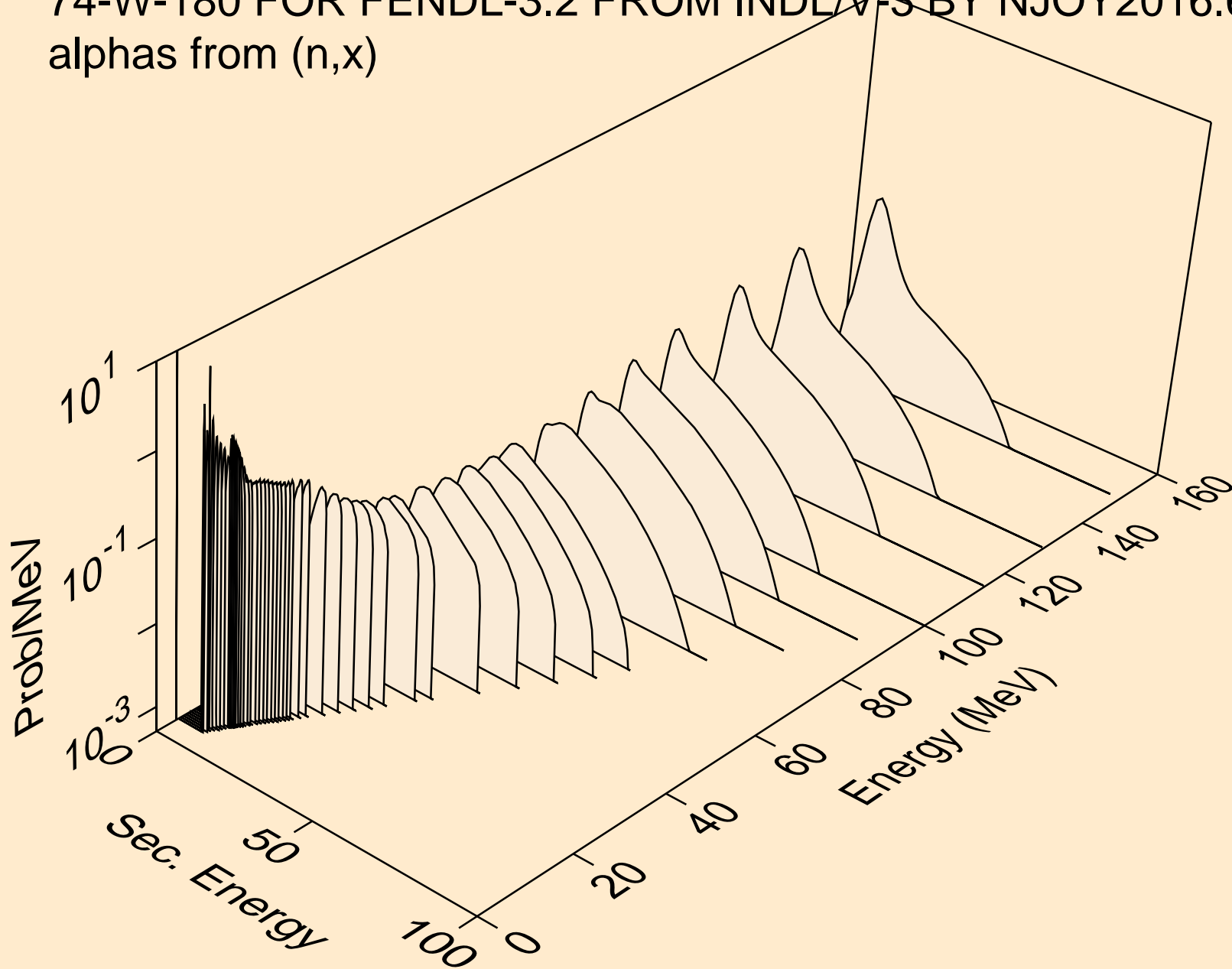

74-W-180 FOR FENDL-3.2 FROM INDL/V-3 BY NJOY2016.60+ ON
angular distribution for (n,a*0) alpha

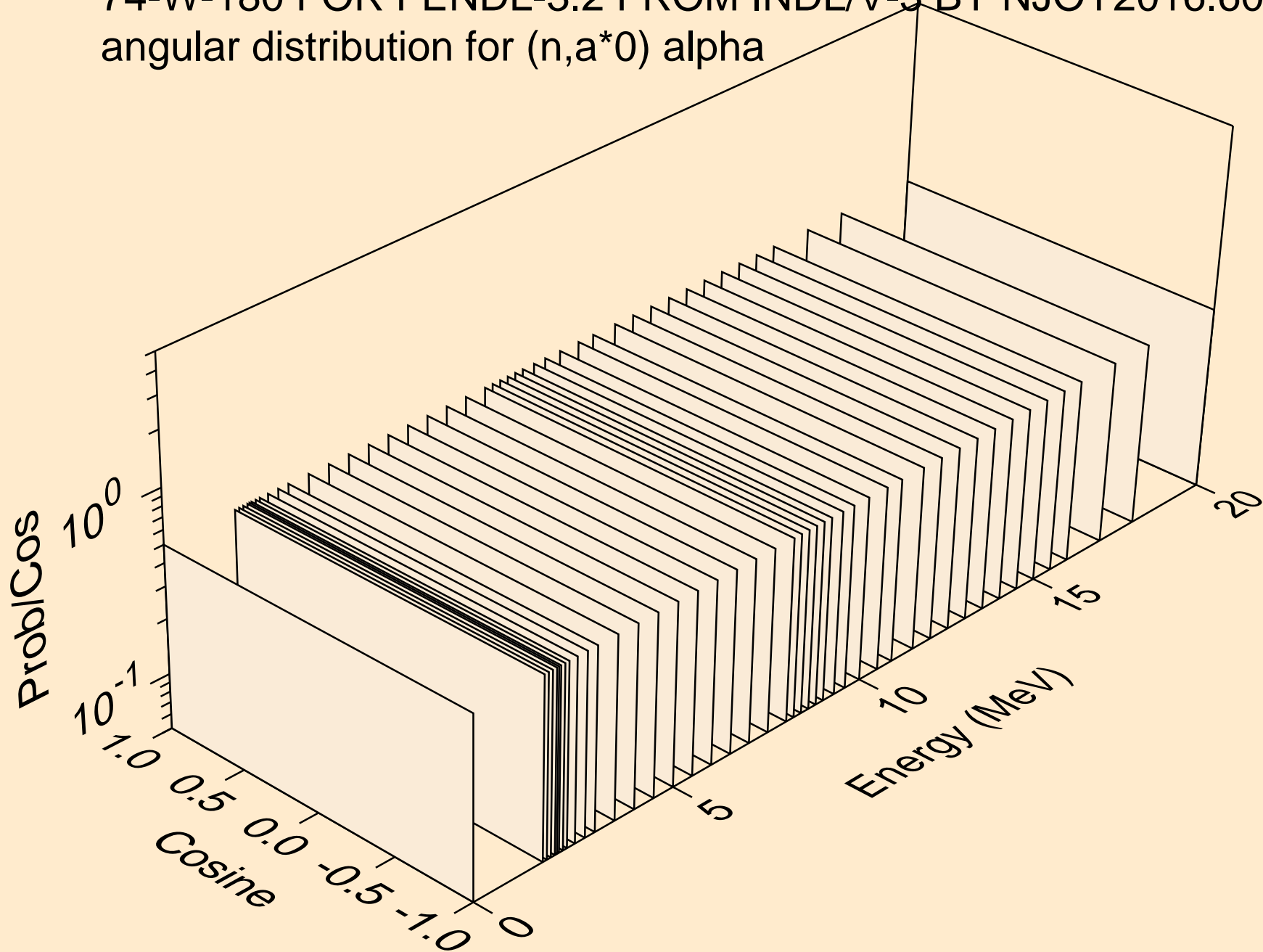

74-W-180 FOR FENDL-3.2 FROM INDL/V-3 BY NJOY2016.60+ ON
angular distribution for (n,a*0) alpha

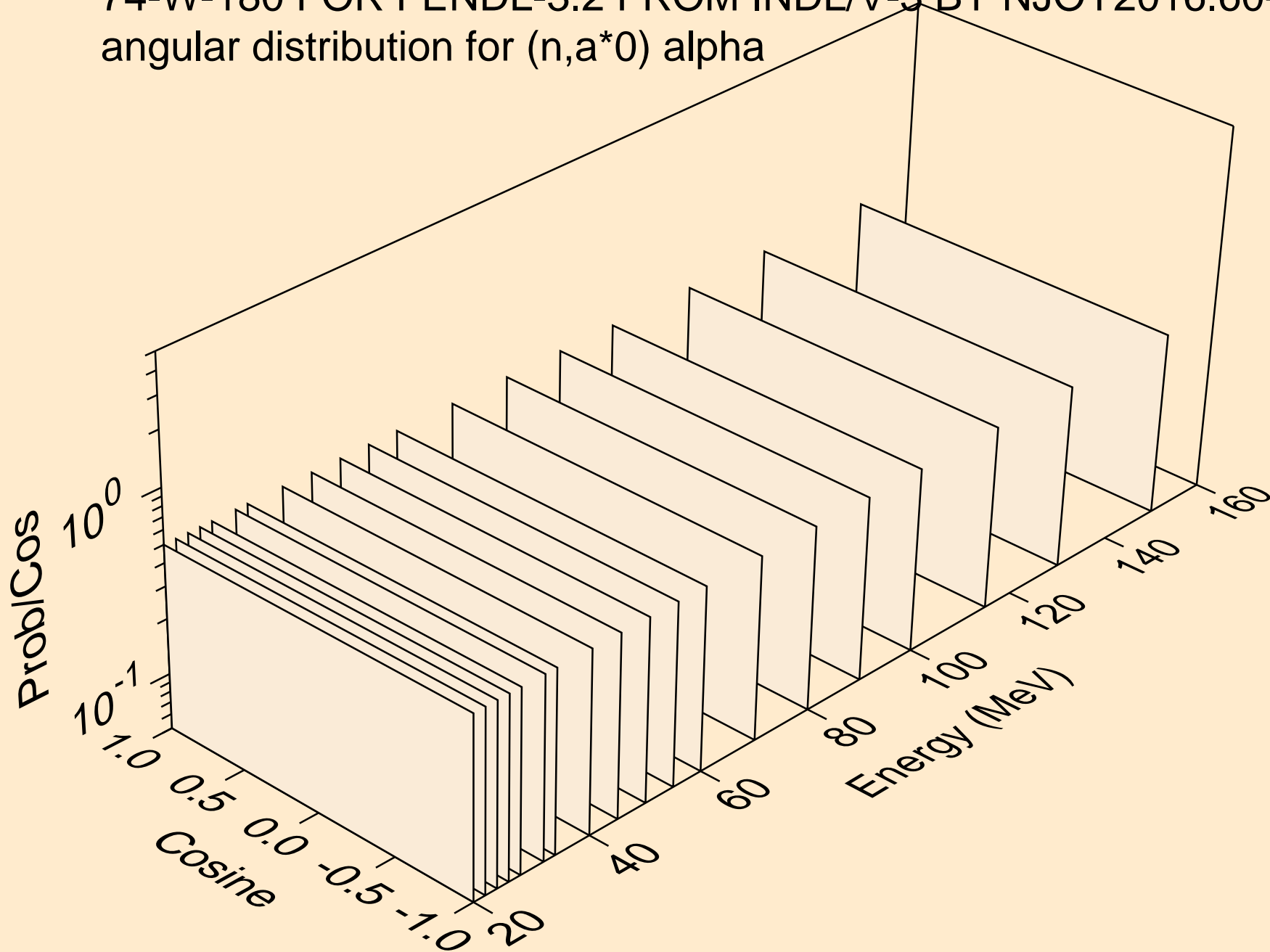

74-W-180 FOR FENDL-3.2 FROM INDL/V-3 BY NJOY2016.60+ ON
angular distribution for (n,a*1) alpha

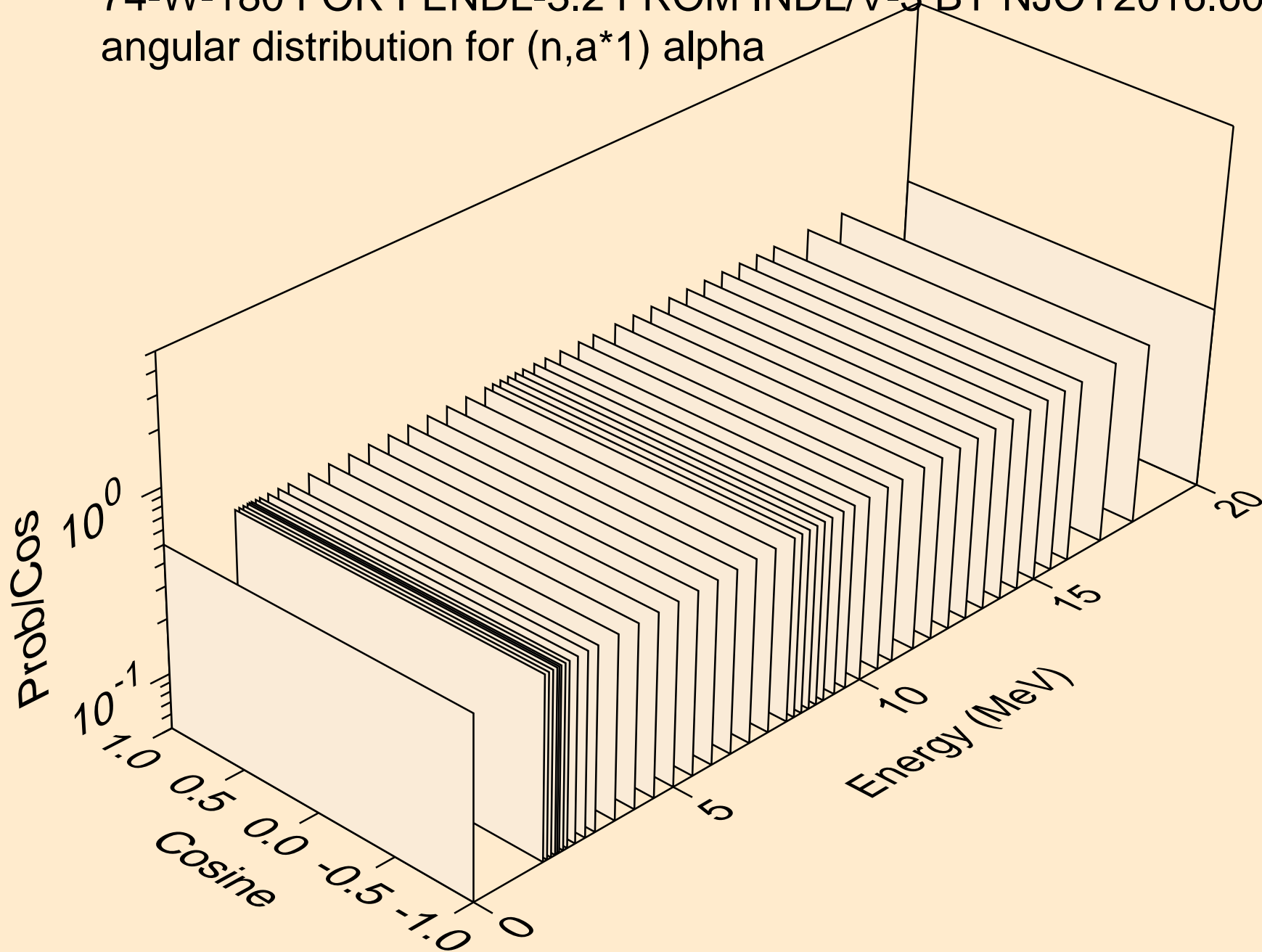

74-W-180 FOR FENDL-3.2 FROM INDL/V-3 BY NJOY2016.60+ ON
angular distribution for (n,a*1) alpha

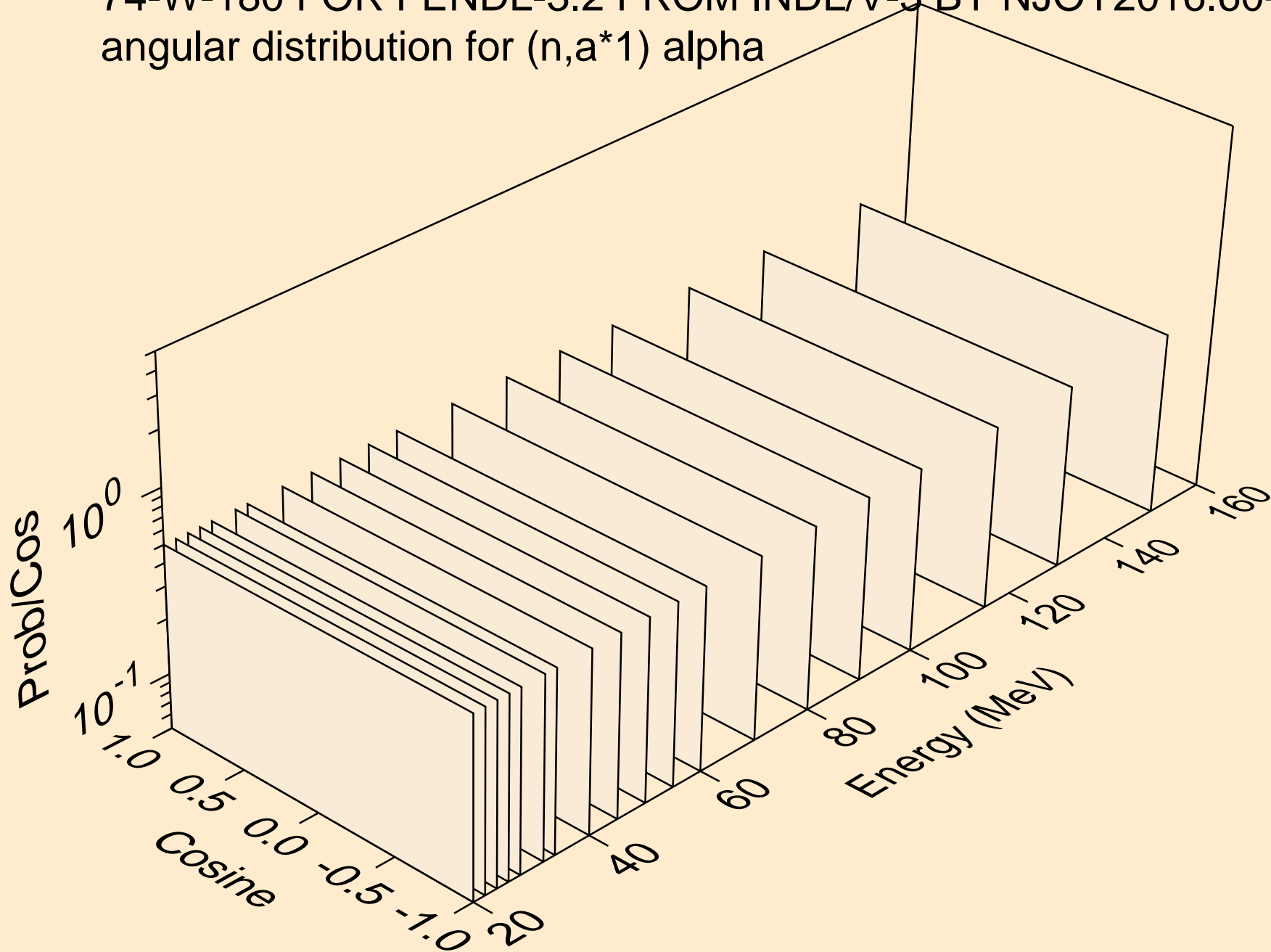

74-W-180 FOR FENDL-3.2 FROM INDL/V-3 BY NJOY2016.60+ ON
angular distribution for (n,a*2) alpha

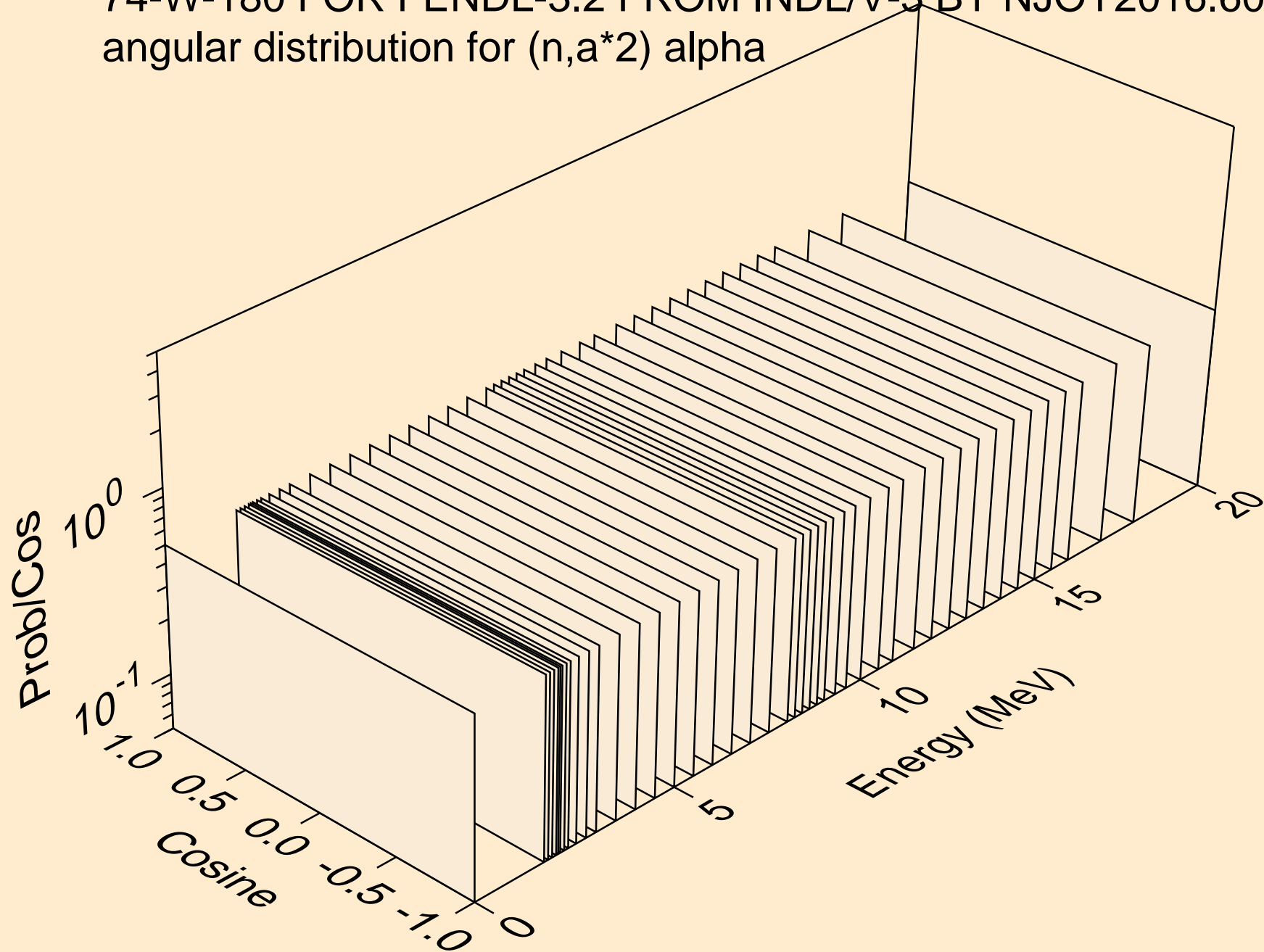

74-W-180 FOR FENDL-3.2 FROM INDL/V-3 BY NJOY2016.60+ ON
angular distribution for (n,a*2) alpha

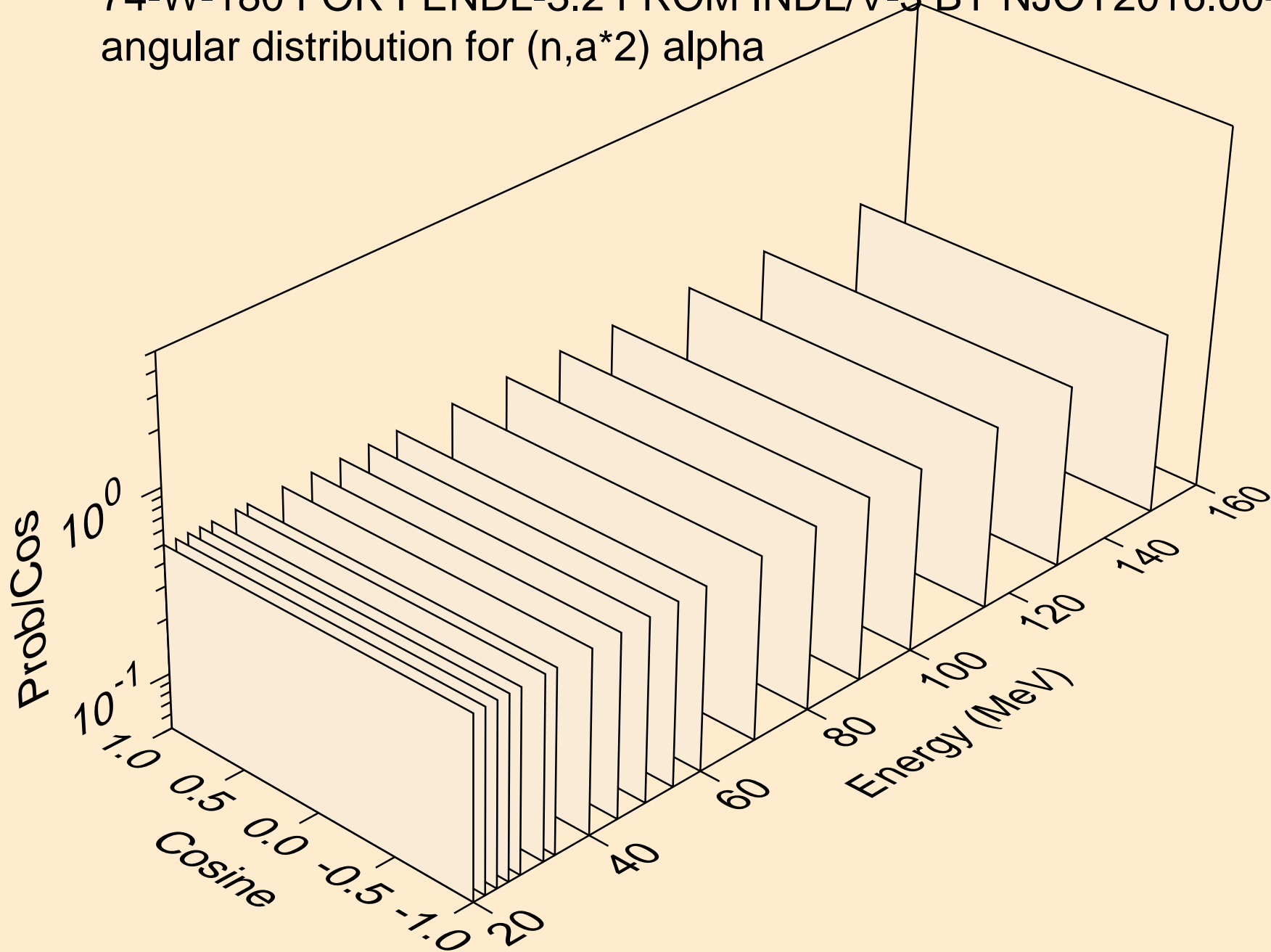

74-W-180 FOR FENDL-3.2 FROM INDL/V-3 BY NJOY2016.60+ ON
angular distribution for (n,a*3) alpha

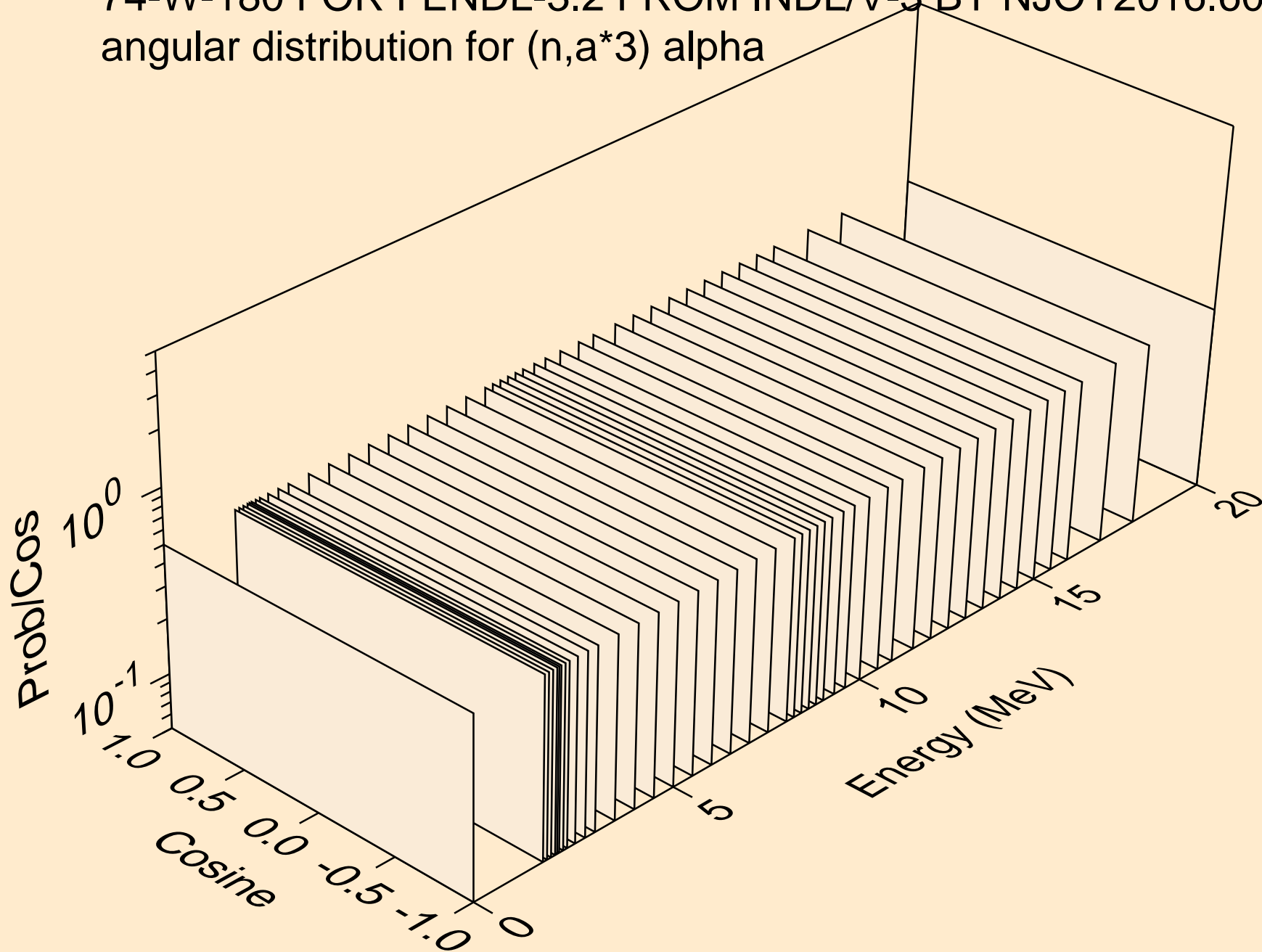

74-W-180 FOR FENDL-3.2 FROM INDL/V-3 BY NJOY2016.60+ ON
angular distribution for (n,a*3) alpha

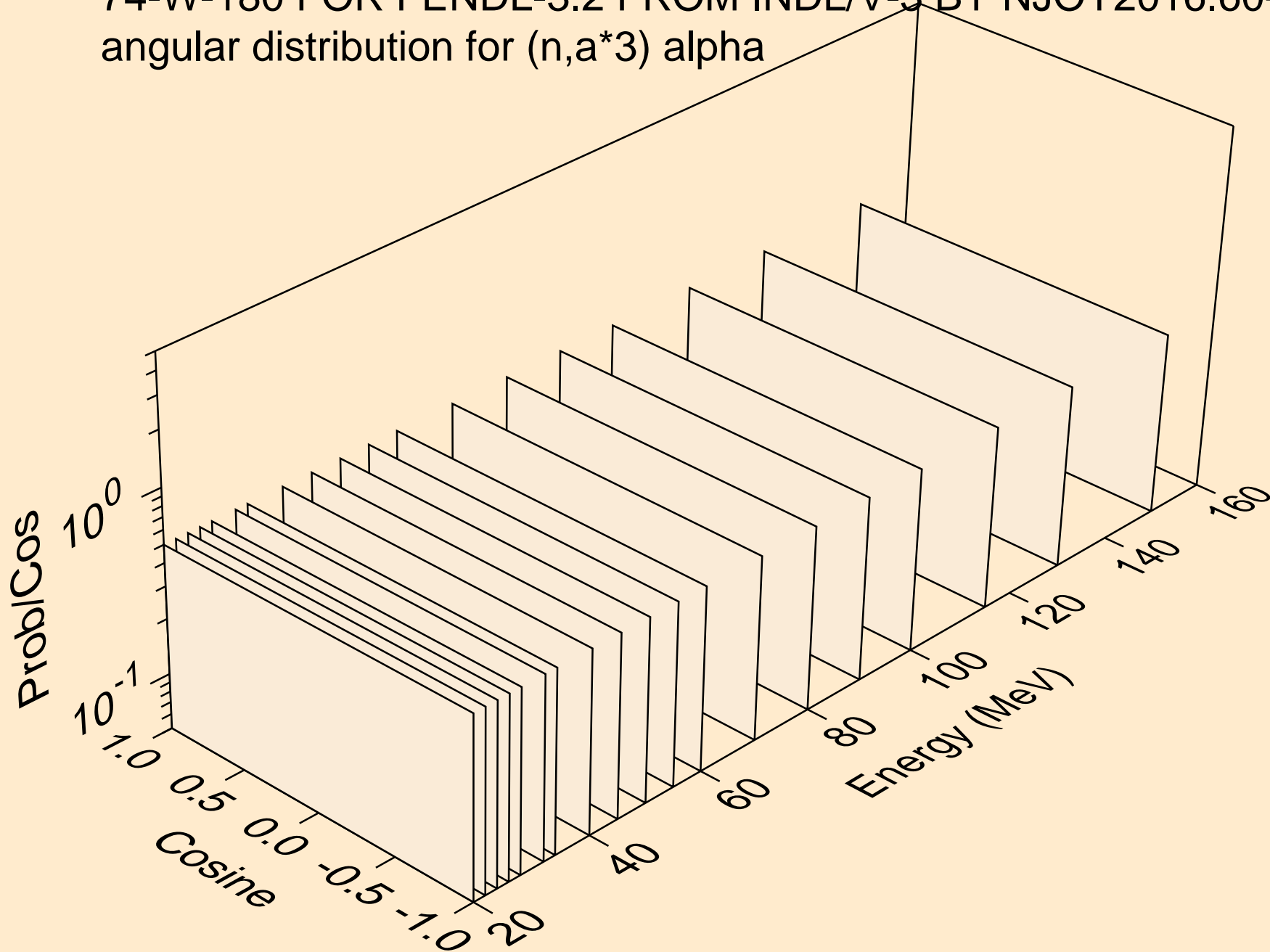

74-W-180 FOR FENDL-3.2 FROM INDL/V-3 BY NJOY2016.60+ ON
angular distribution for (n,a*4) alpha

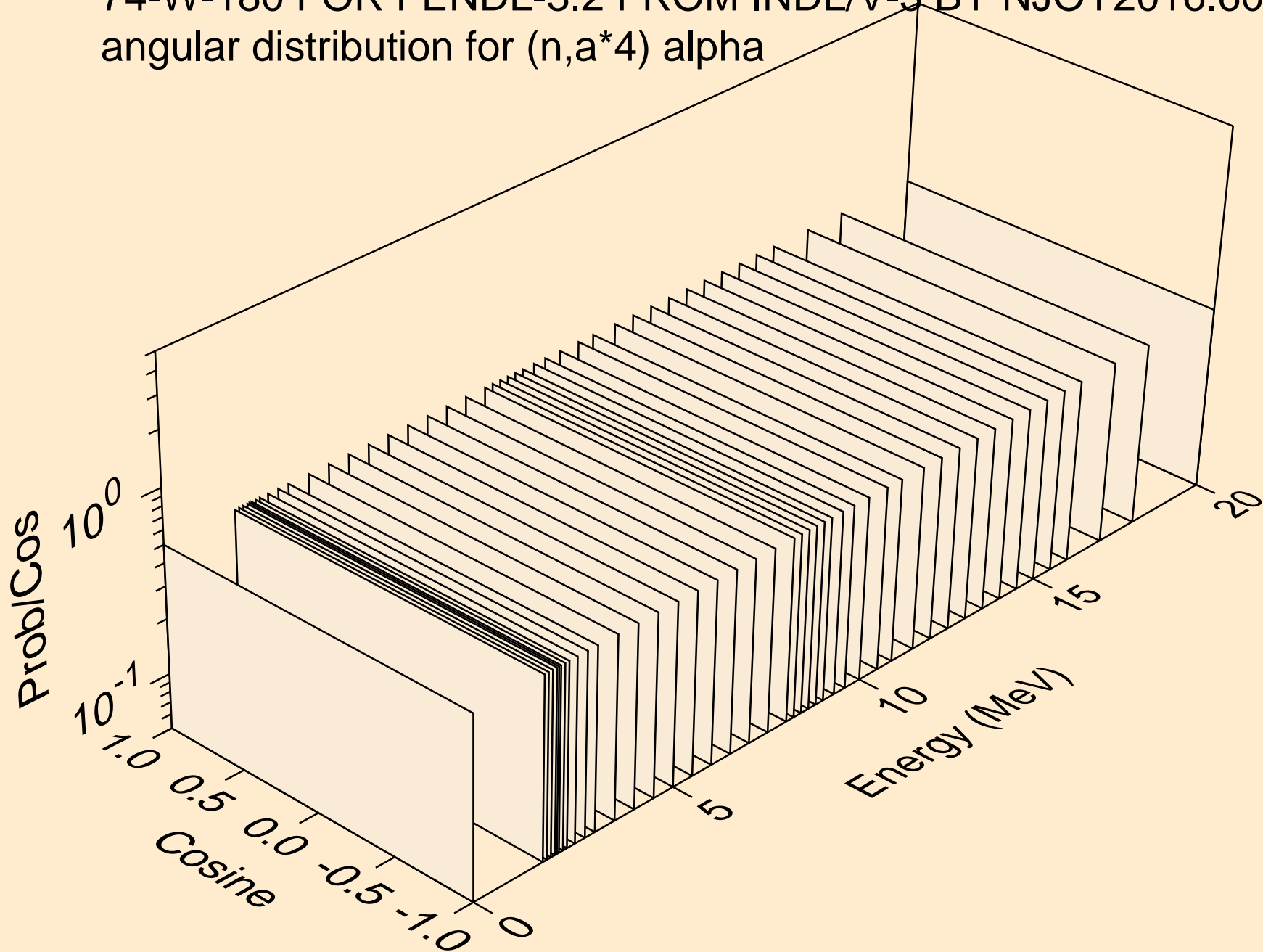

74-W-180 FOR FENDL-3.2 FROM INDL/V-3 BY NJOY2016.60+ ON
angular distribution for (n,a*4) alpha

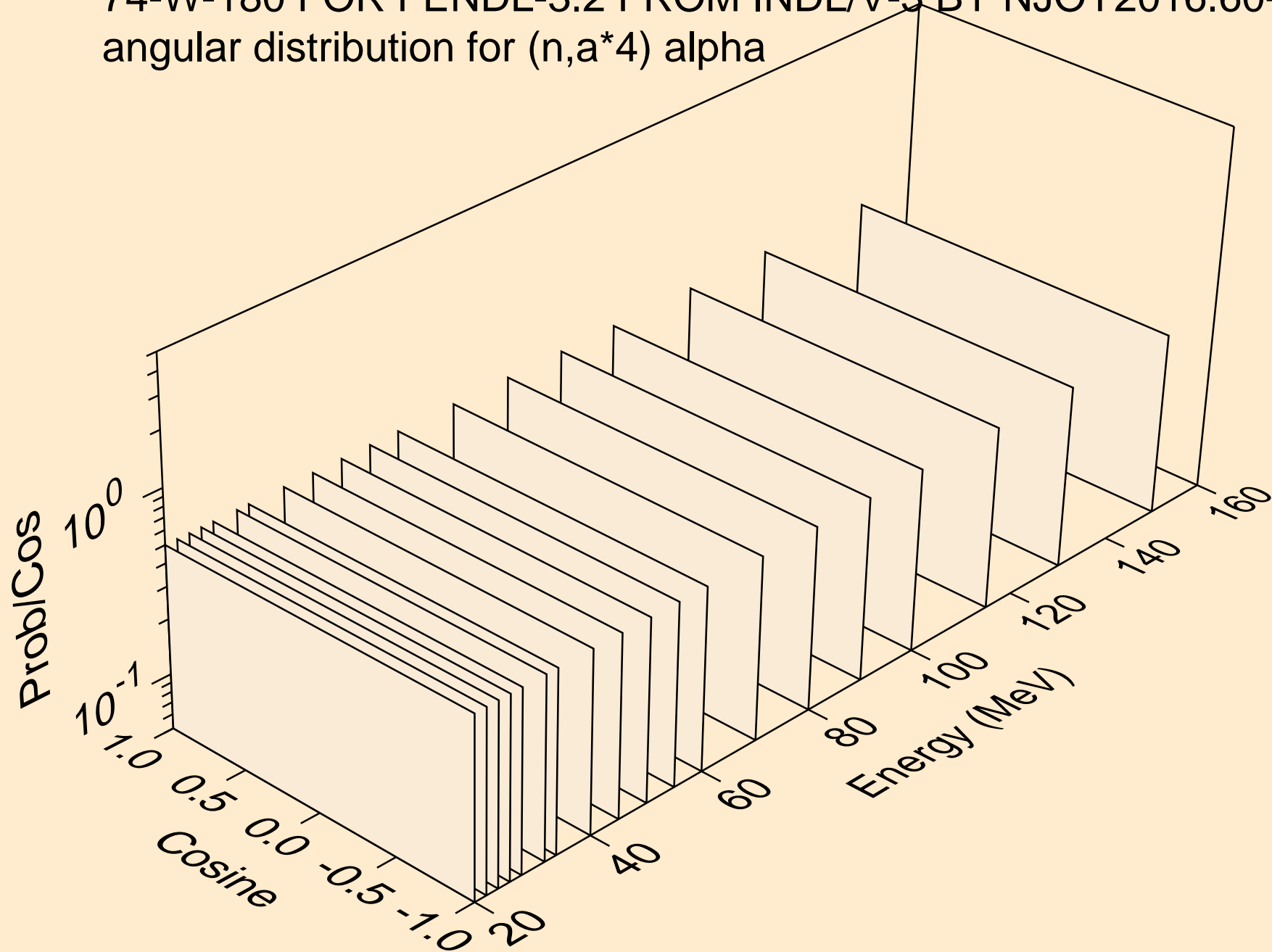

74-W-180 FOR FENDL-3.2 FROM INDL/V-3 BY NJOY2016.60+ ON
angular distribution for (n,a*5) alpha

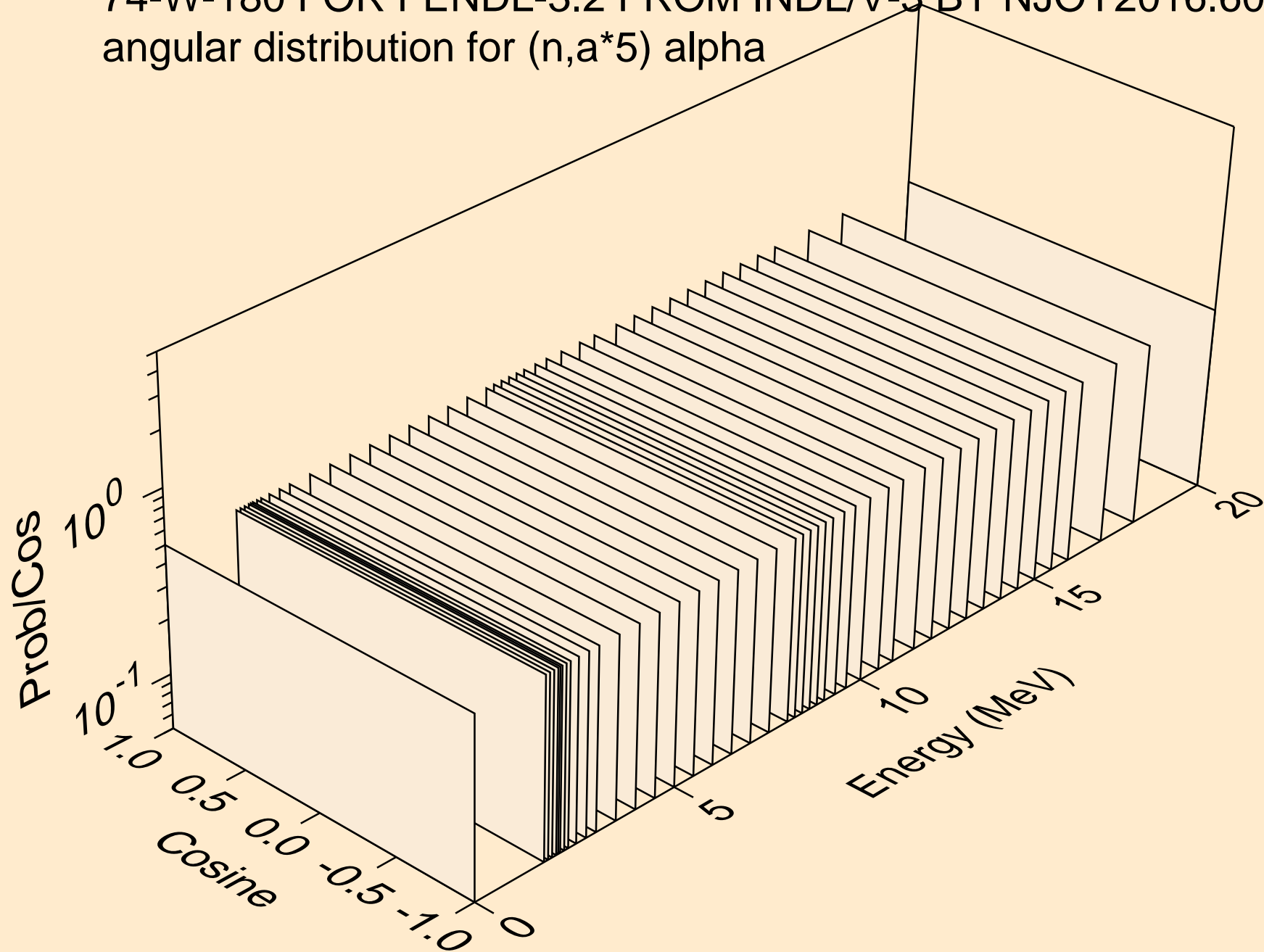

74-W-180 FOR FENDL-3.2 FROM INDL/V-3 BY NJOY2016.60+ ON
angular distribution for (n,a*5) alpha

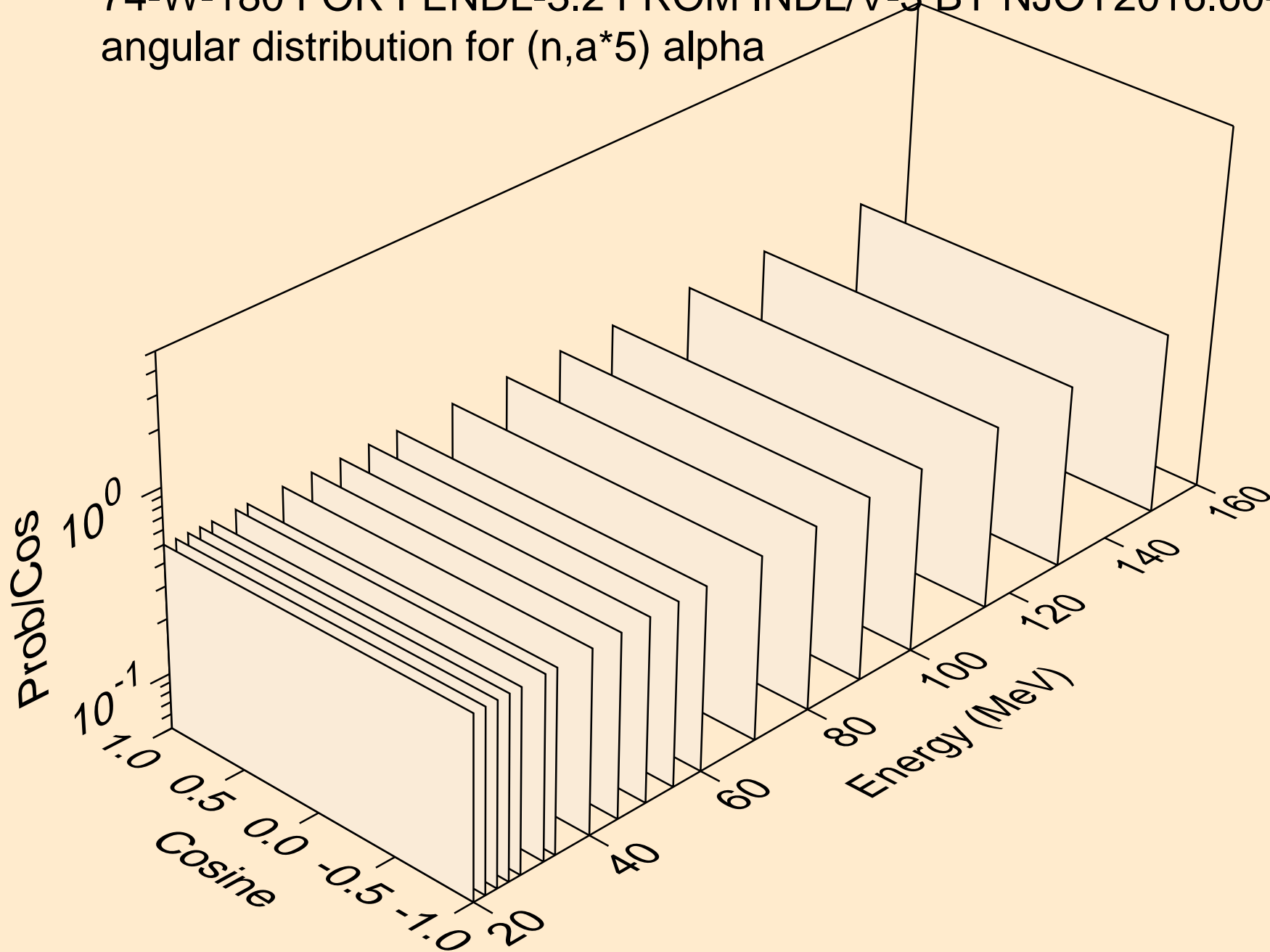

74-W-180 FOR FENDL-3.2 FROM INDL/V-3 BY NJOY2016.60+ ON
angular distribution for (n,a*6) alpha

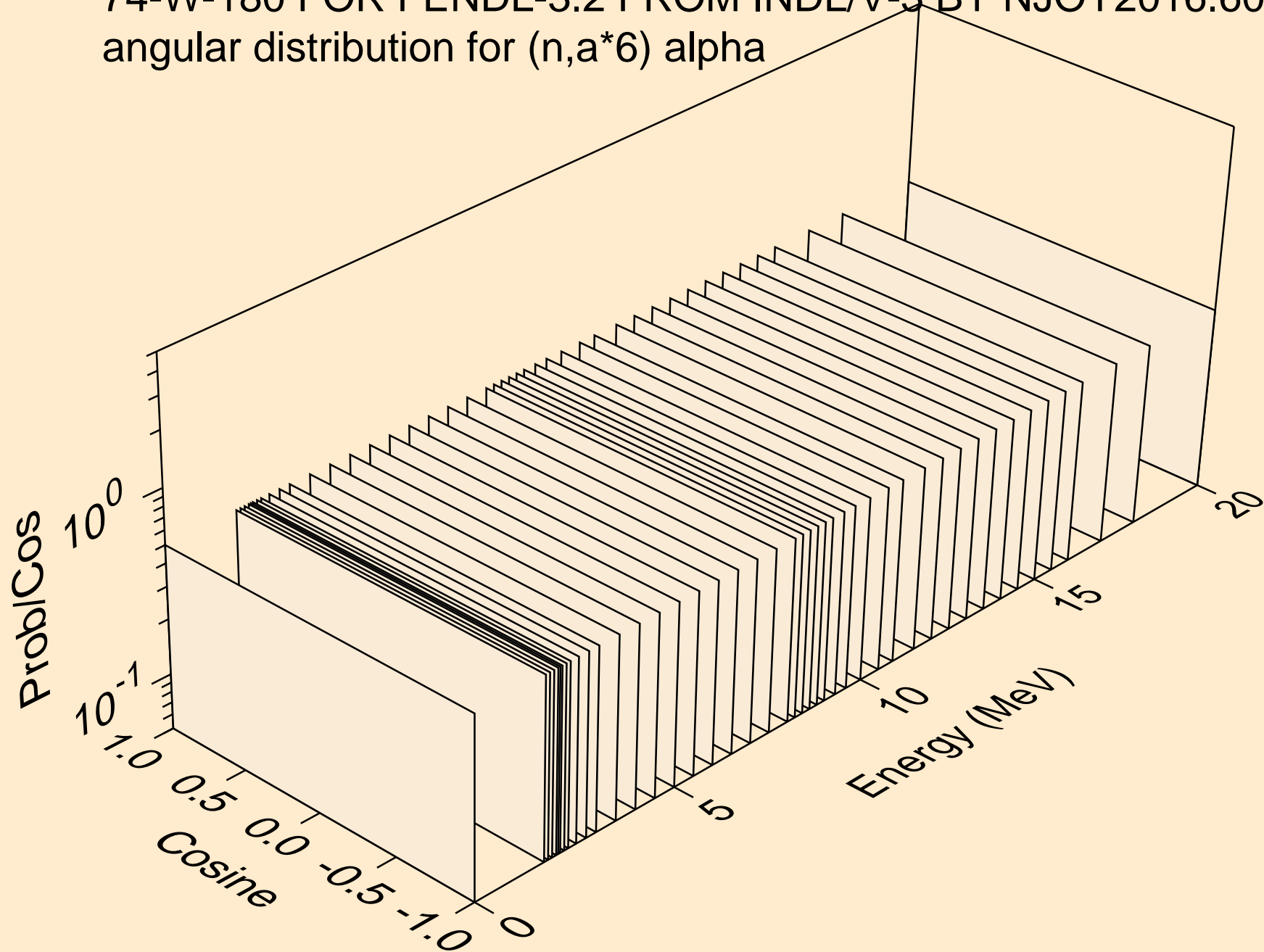

74-W-180 FOR FENDL-3.2 FROM INDL/V-3 BY NJOY2016.60+ ON
angular distribution for (n,a*6) alpha

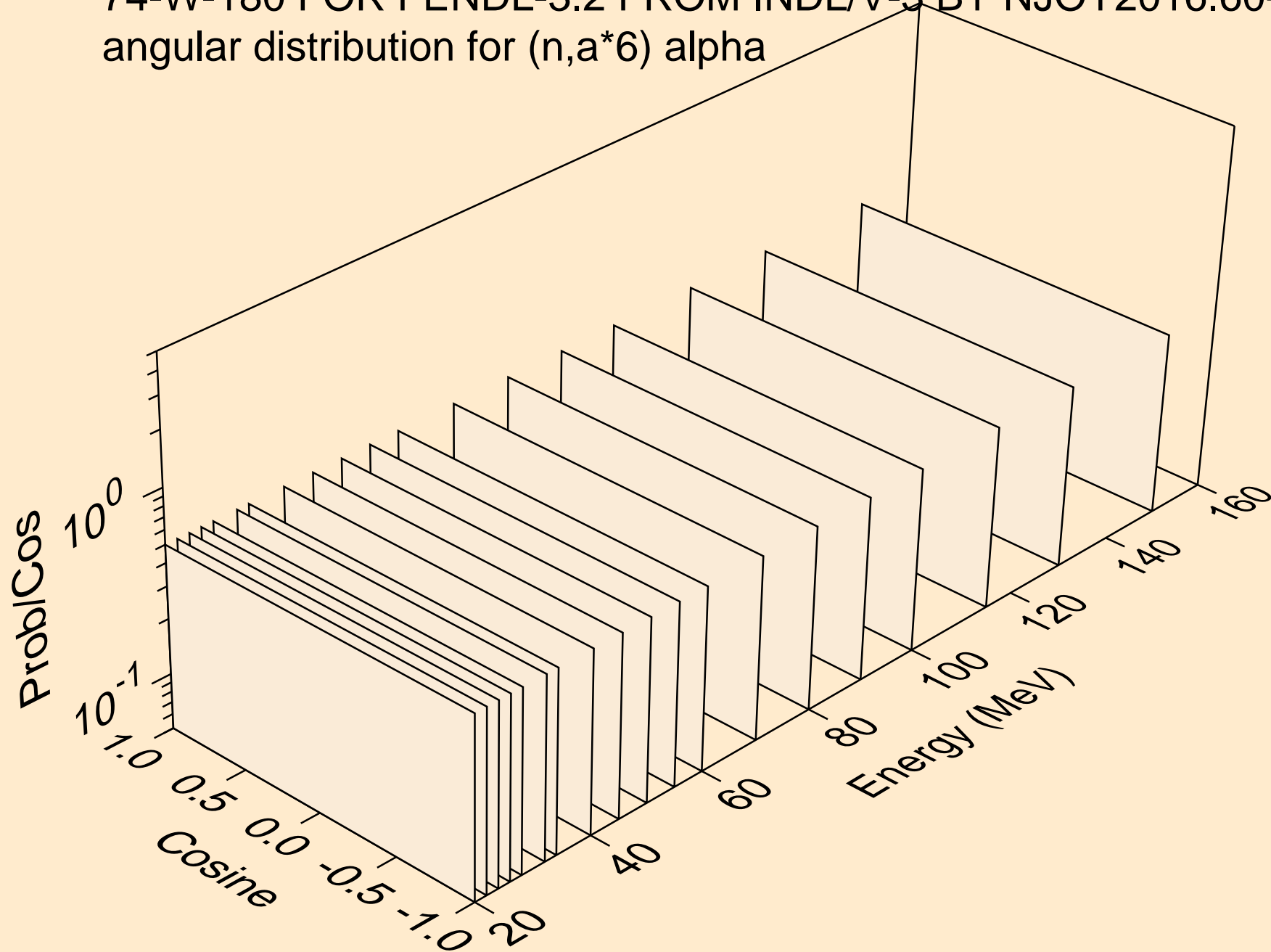

74-W-180 FOR FENDL-3.2 FROM INDL/V-3 BY NJOY2016.60+ ON
angular distribution for (n,a*7) alpha

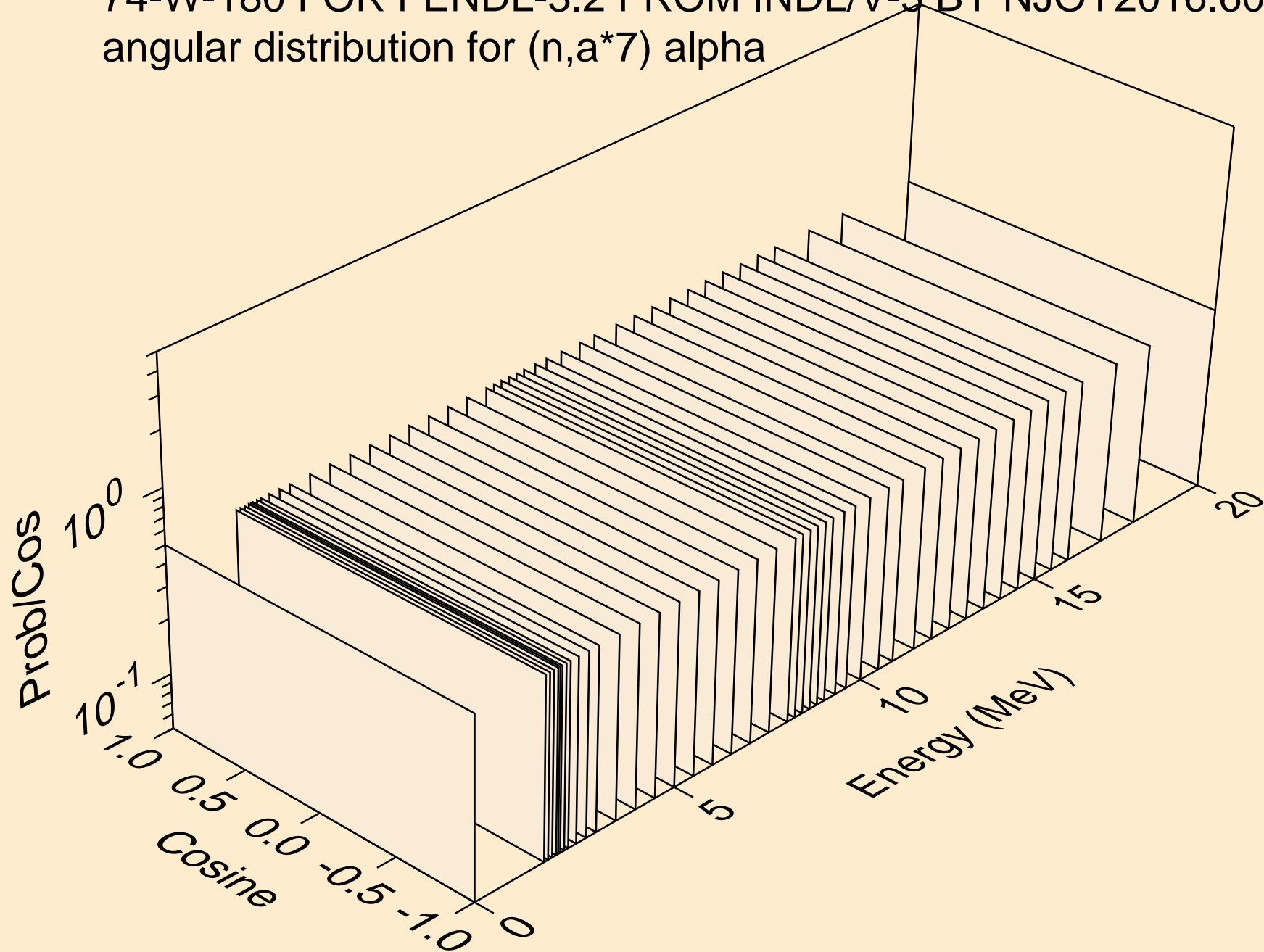

74-W-180 FOR FENDL-3.2 FROM INDL/V-3 BY NJOY2016.60+ ON
angular distribution for (n,a*7) alpha

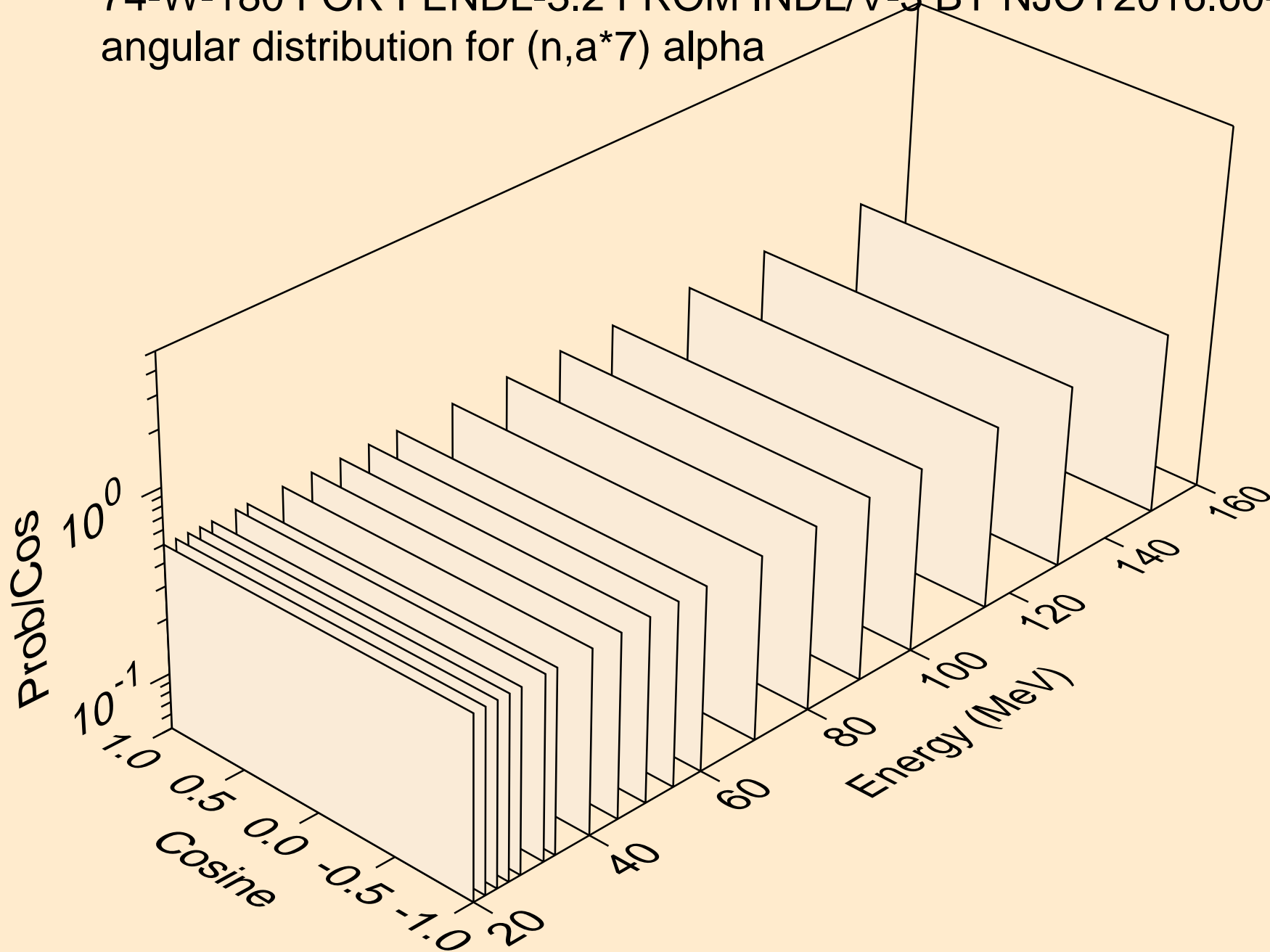

74-W-180 FOR FENDL-3.2 FROM INDL/V-3 BY NJOY2016.60+ ON
angular distribution for (n,a*8) alpha

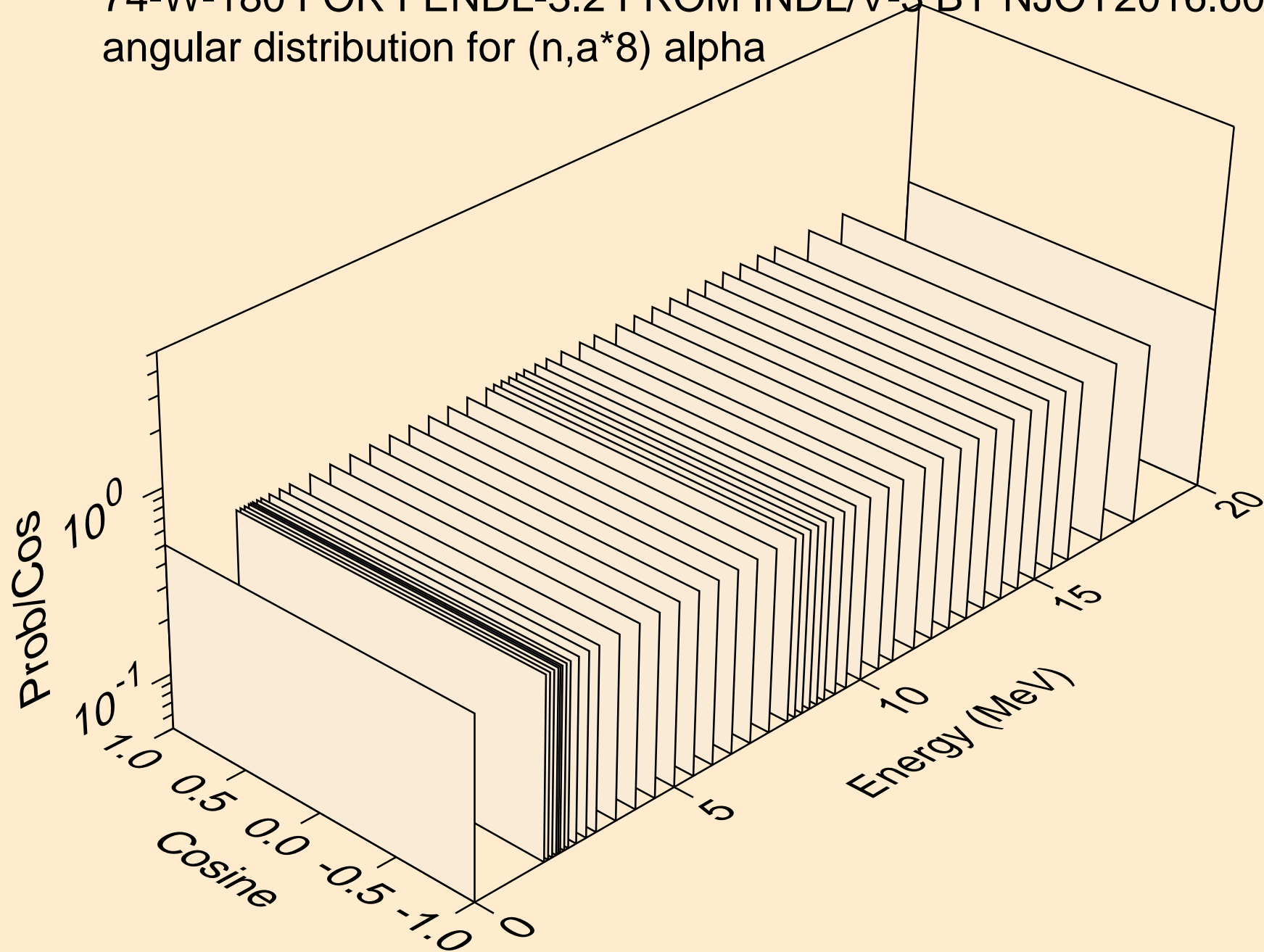

74-W-180 FOR FENDL-3.2 FROM INDL/V-3 BY NJOY2016.60+ ON
angular distribution for (n,a*8) alpha

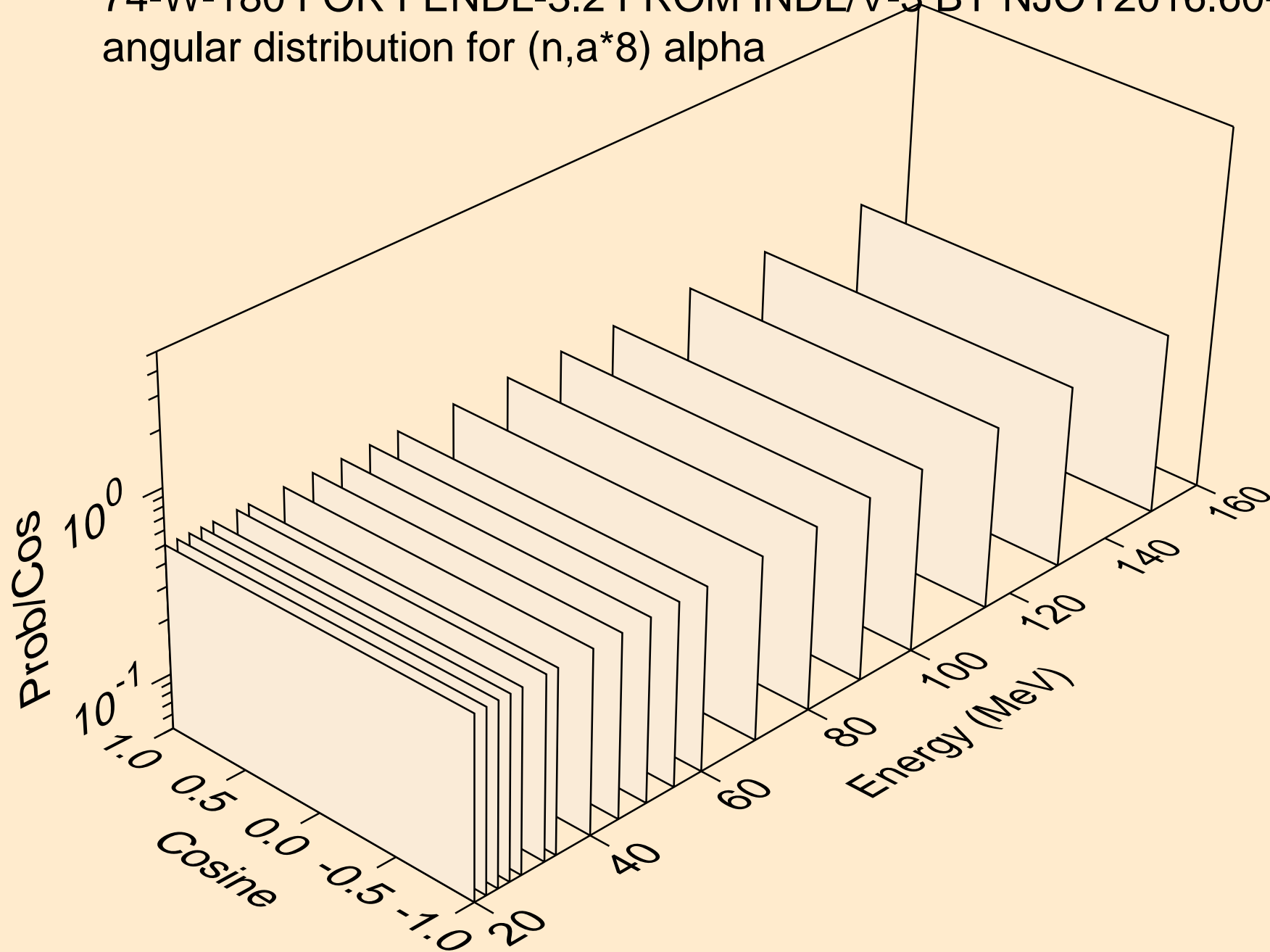

74-W-180 FOR FENDL-3.2 FROM INDL/V-3 BY NJOY2016.60+ ON
angular distribution for (n,a*9) alpha

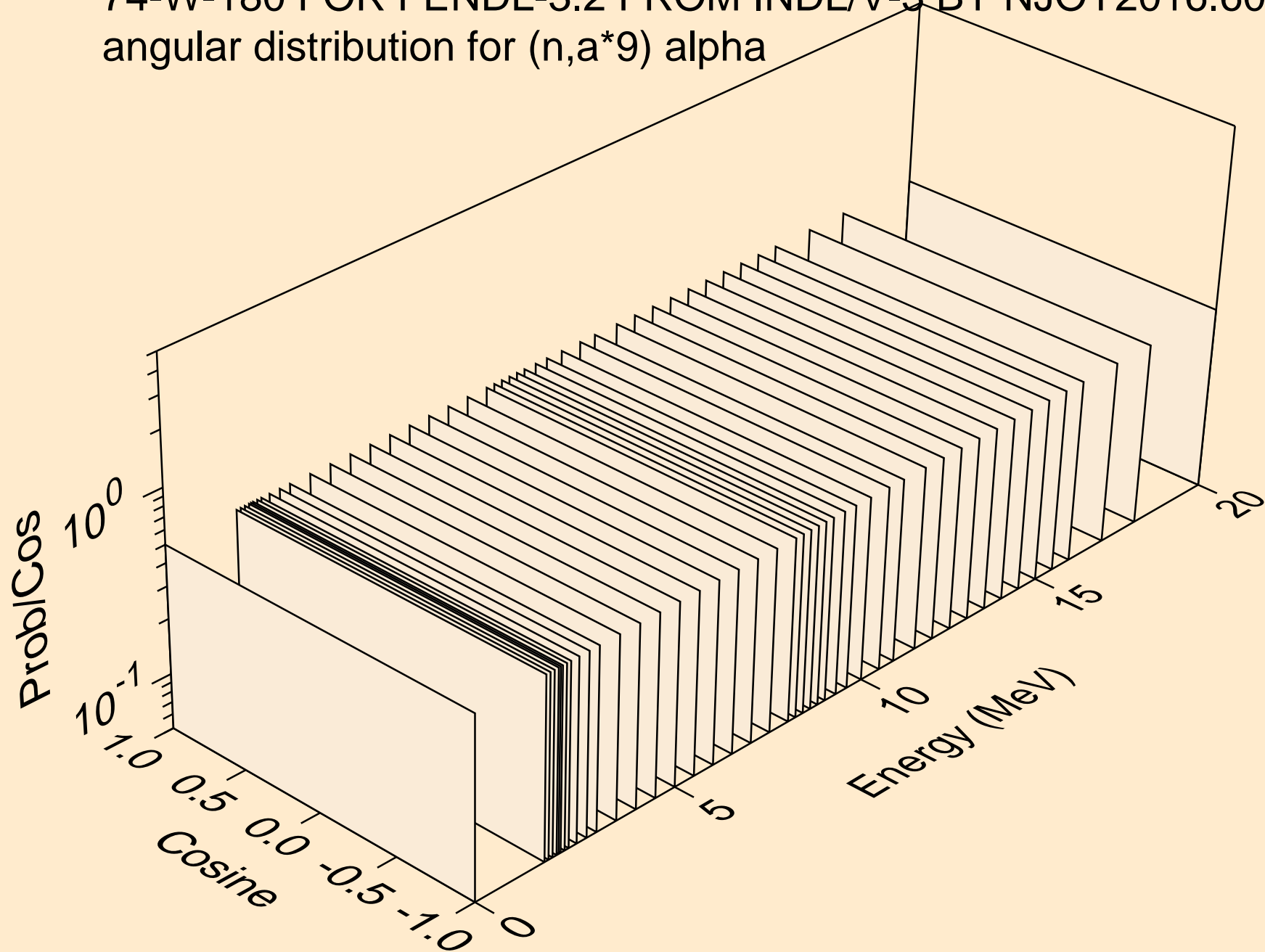

74-W-180 FOR FENDL-3.2 FROM INDL/V-3 BY NJOY2016.60+ ON
angular distribution for (n,a*9) alpha

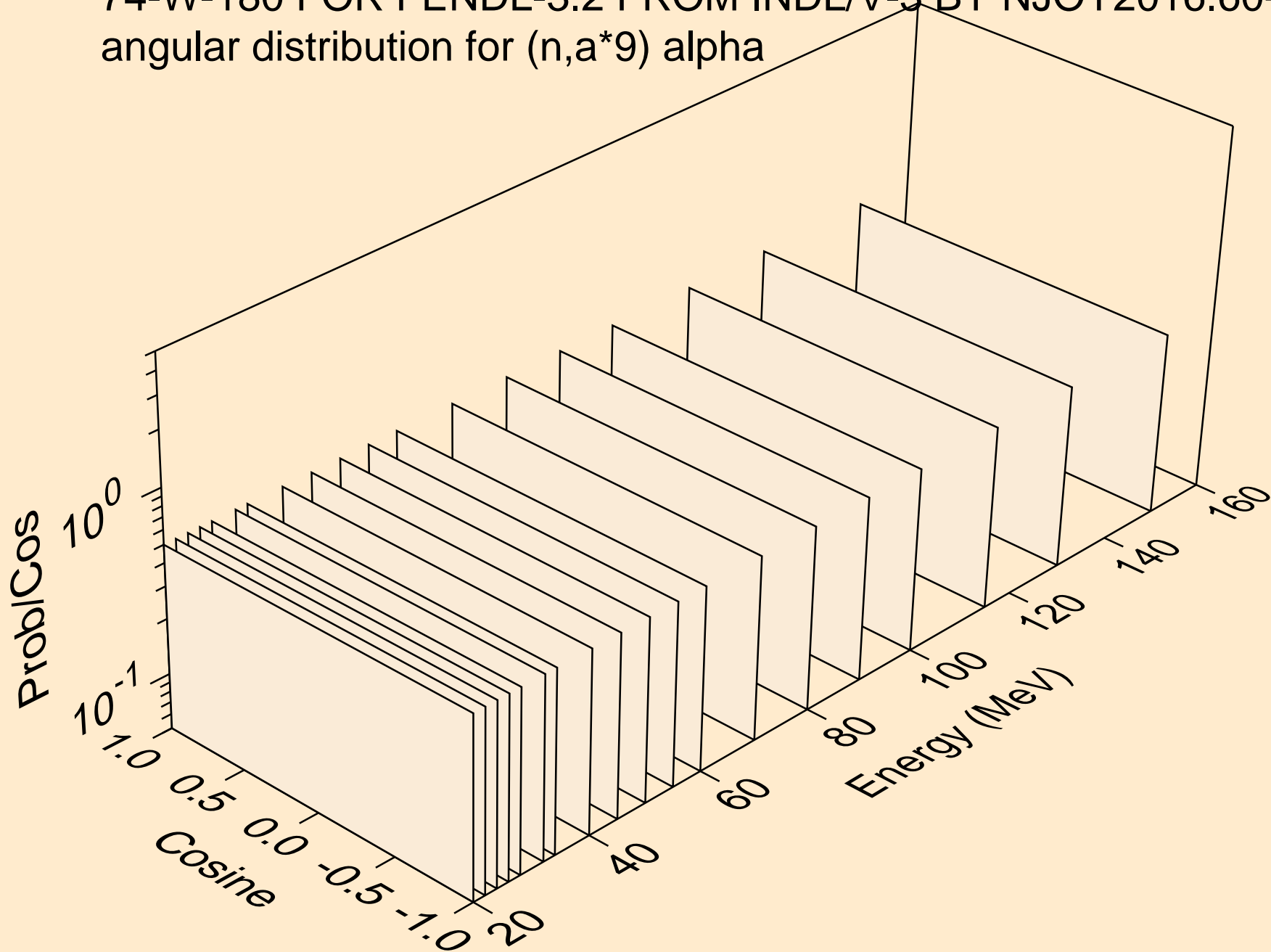

74-W-180 FOR FENDL-3.2 FROM INDL/V-3 BY NJOY2016.60+ ON
angular distribution for (n,a*10) alpha

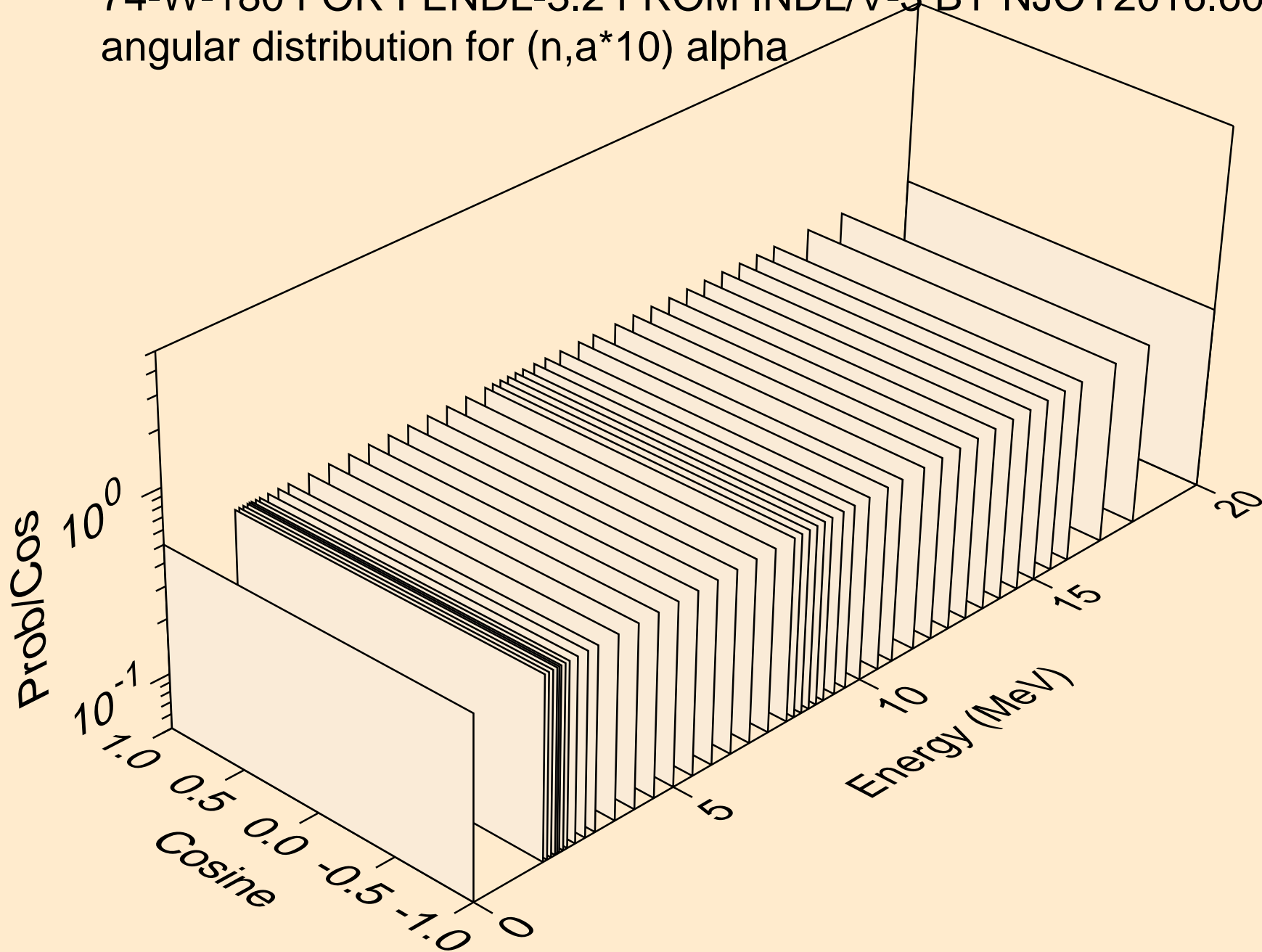

74-W-180 FOR FENDL-3.2 FROM INDL/V-3 BY NJOY2016.60+ ON
angular distribution for (n,a*10) alpha

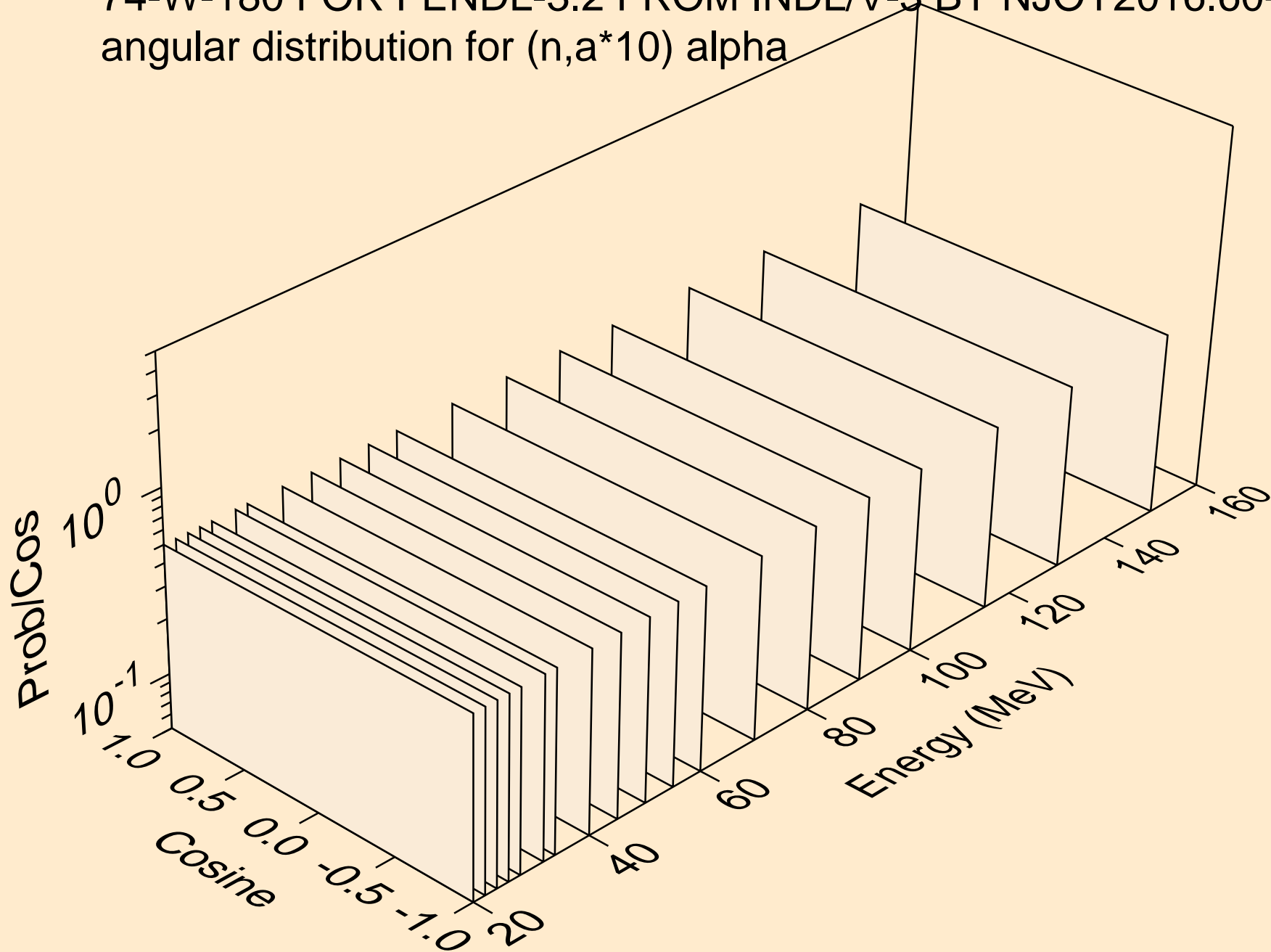

74-W-180 FOR FENDL-3.2 FROM INDL/V-3 BY NJOY2016.60+ ON
angular distribution for (n,a*11) alpha

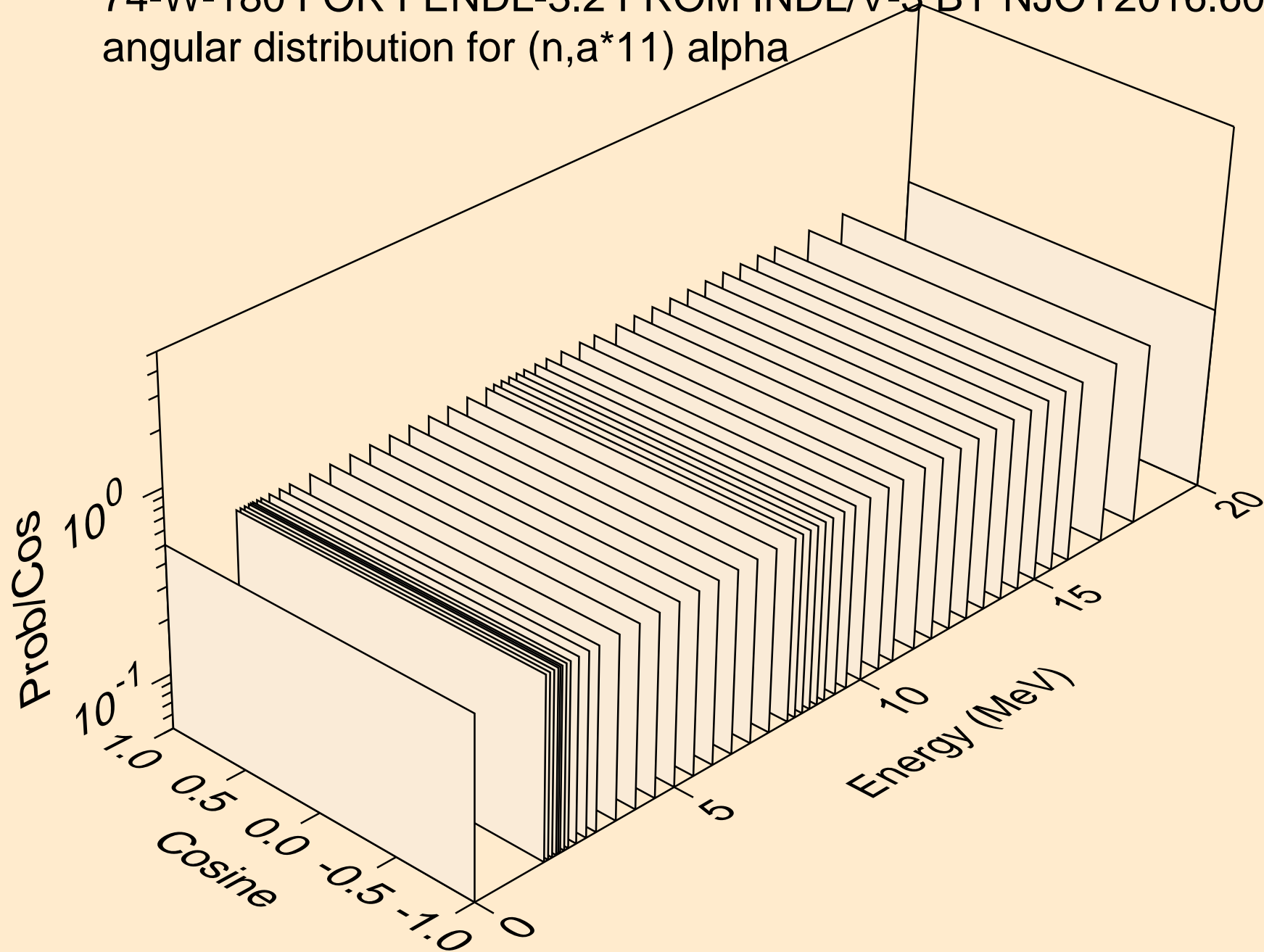

74-W-180 FOR FENDL-3.2 FROM INDL/V-3 BY NJOY2016.60+ ON
angular distribution for (n,a*11) alpha

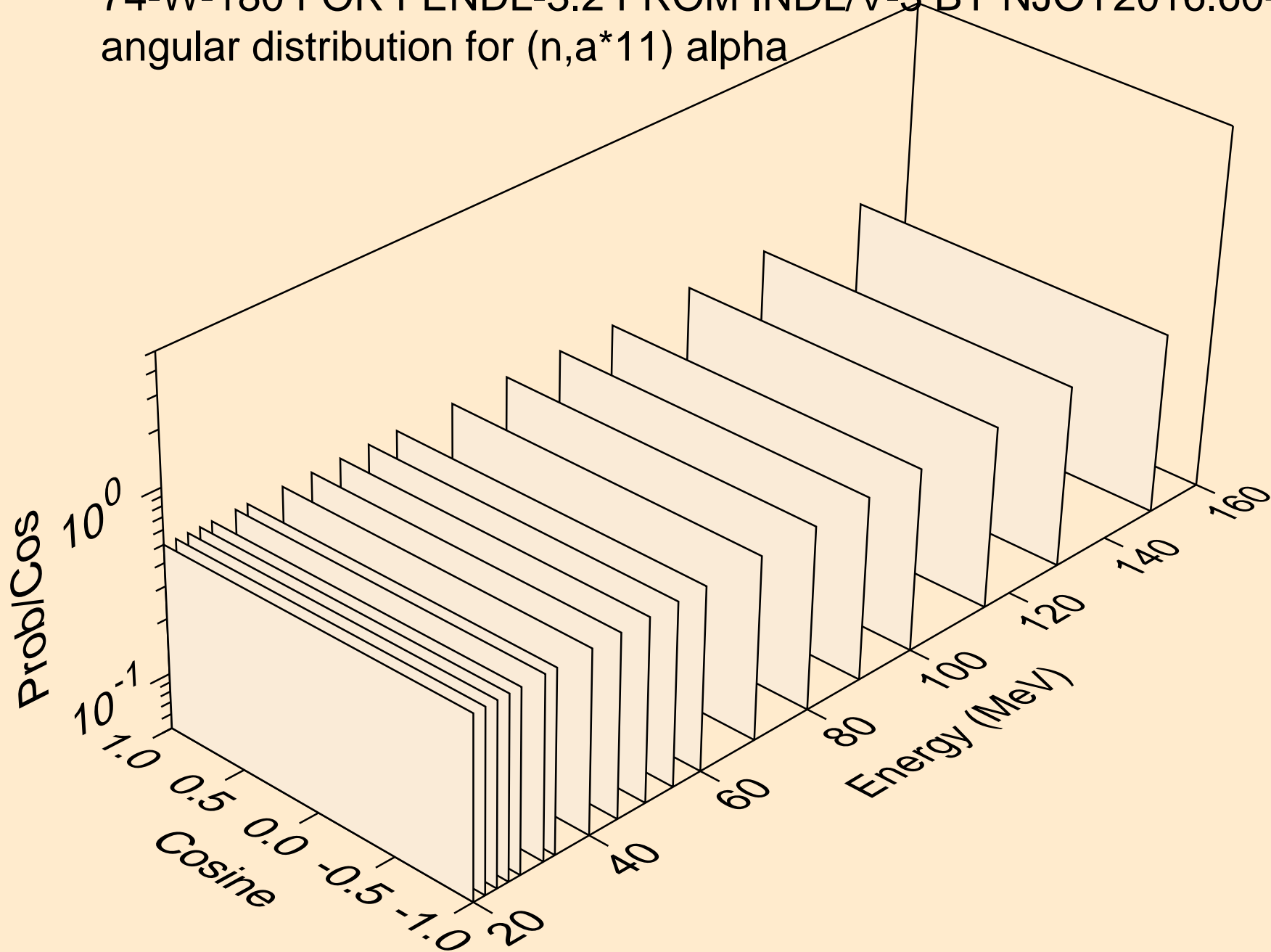

74-W-180 FOR FENDL-3.2 FROM INDL/V-3 BY NJOY2016.60+ ON
angular distribution for (n,a*12) alpha

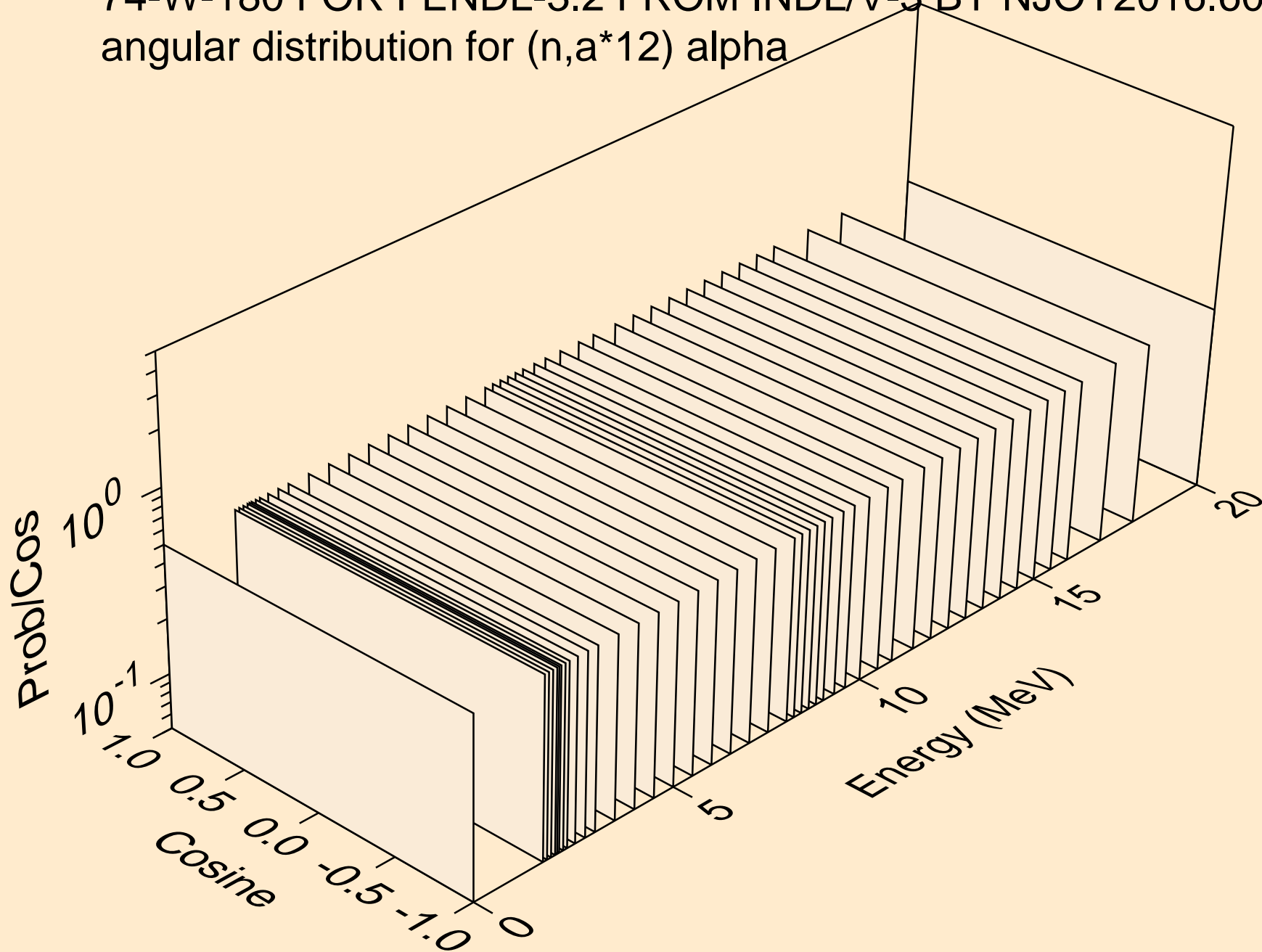

74-W-180 FOR FENDL-3.2 FROM INDL/V-3 BY NJOY2016.60+ ON
angular distribution for (n,a*12) alpha

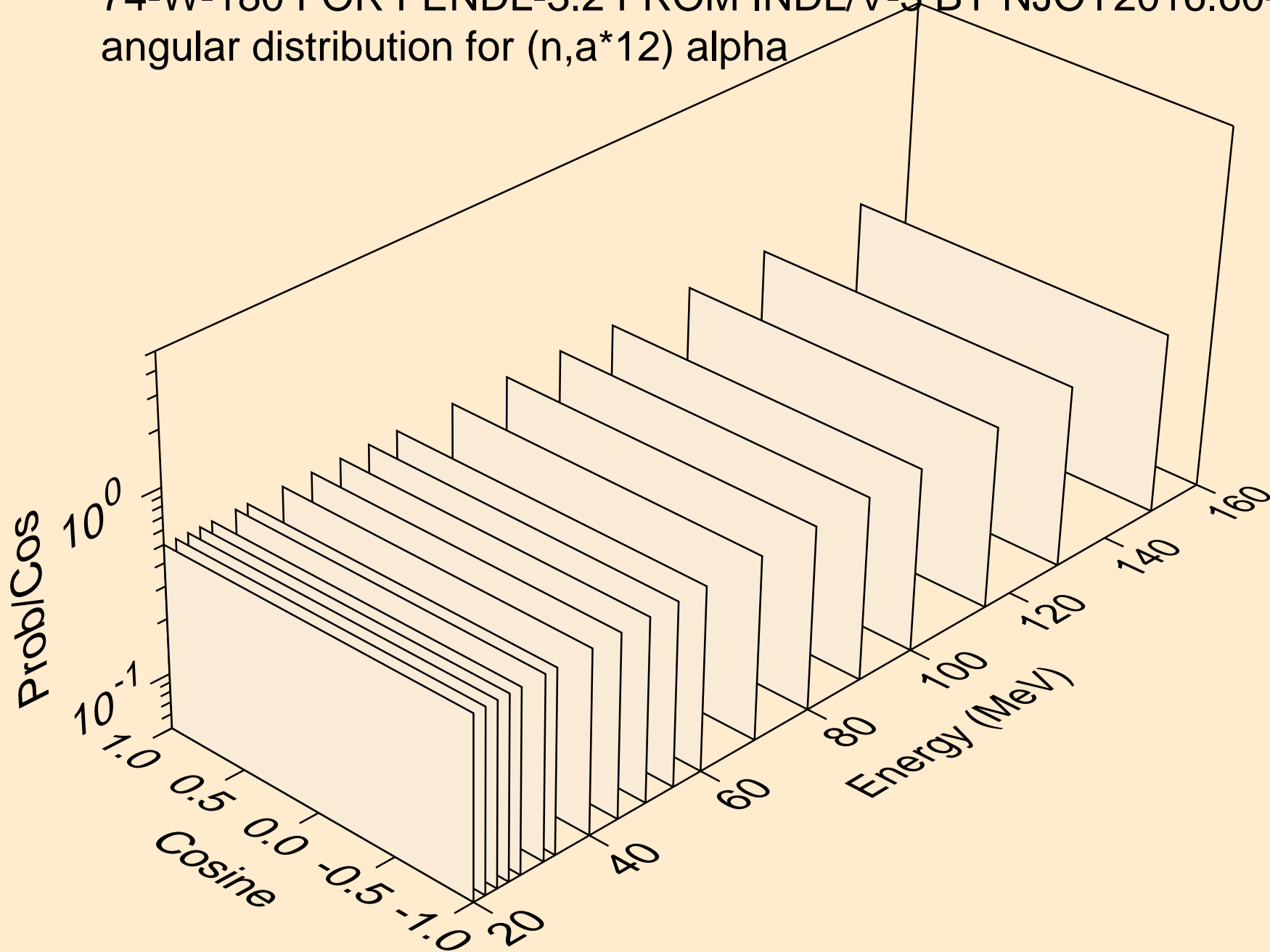

74-W-180 FOR FENDL-3.2 FROM INDL/V-3 BY NJOY2016.60+ ON
angular distribution for (n,a*13) alpha

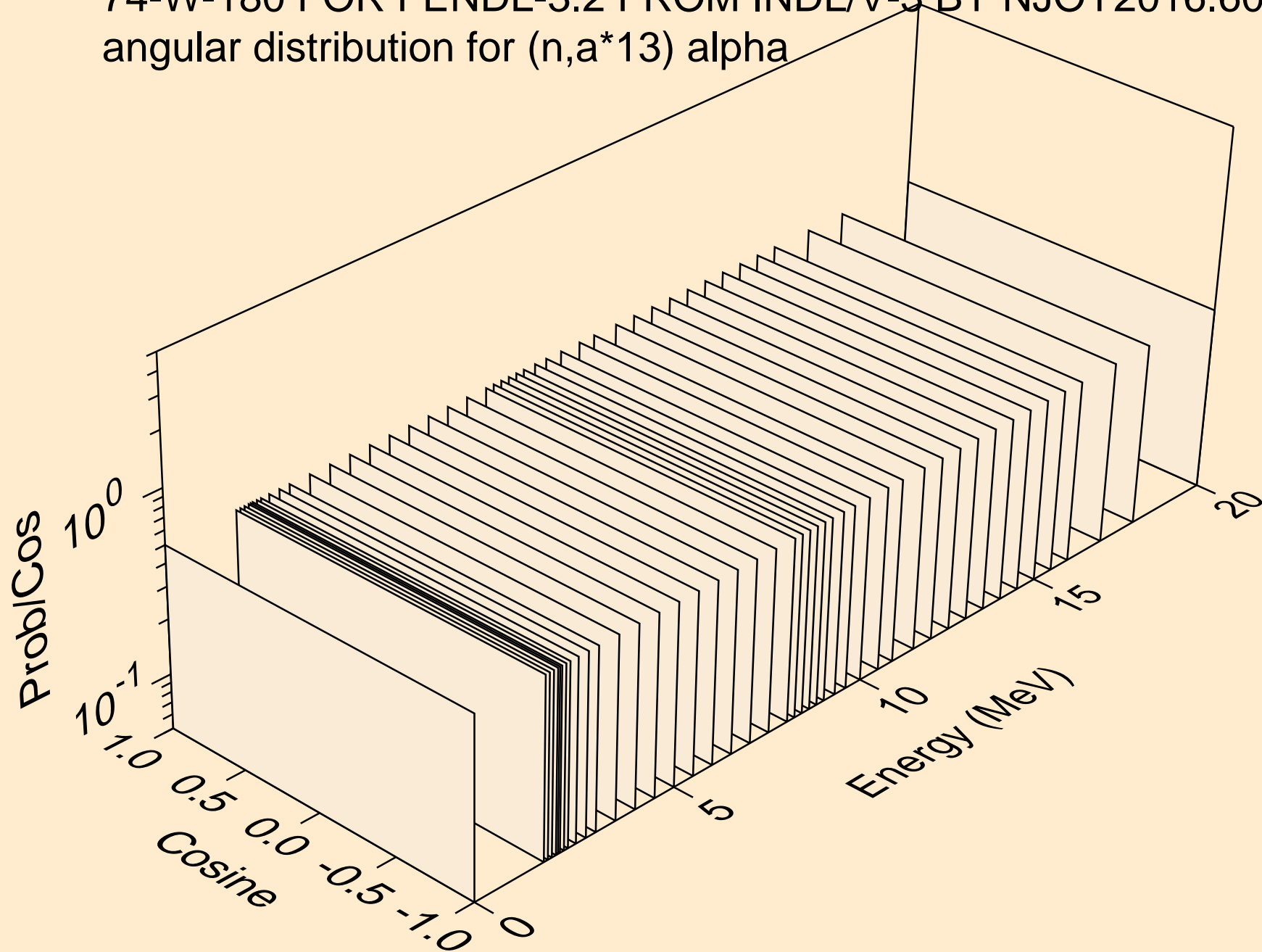

74-W-180 FOR FENDL-3.2 FROM INDL/V-3 BY NJOY2016.60+ ON
angular distribution for (n,a*13) alpha

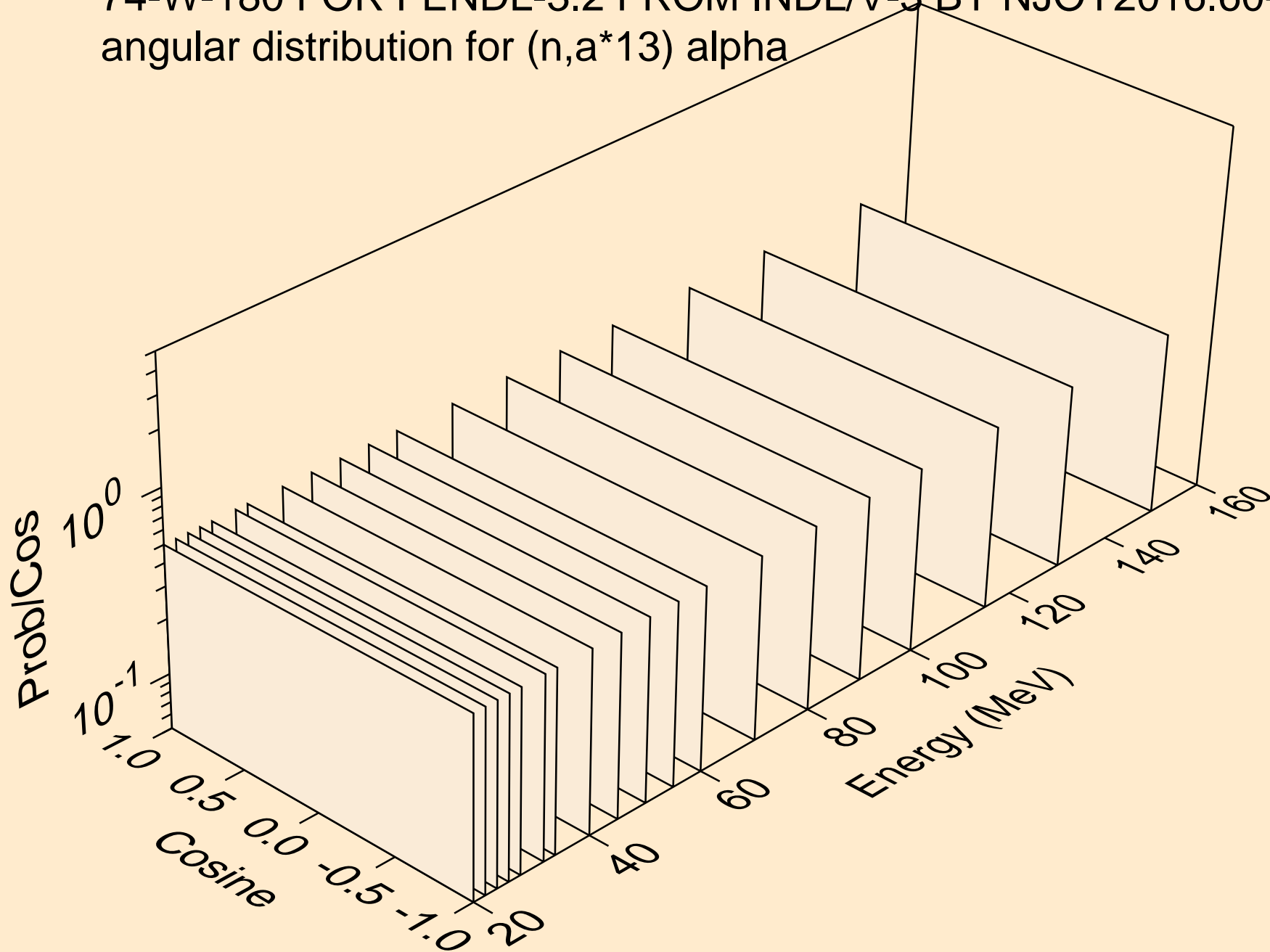

74-W-180 FOR FENDL-3.2 FROM INDL/V-3 BY NJOY2016.60+ ON
angular distribution for (n,a*14) alpha

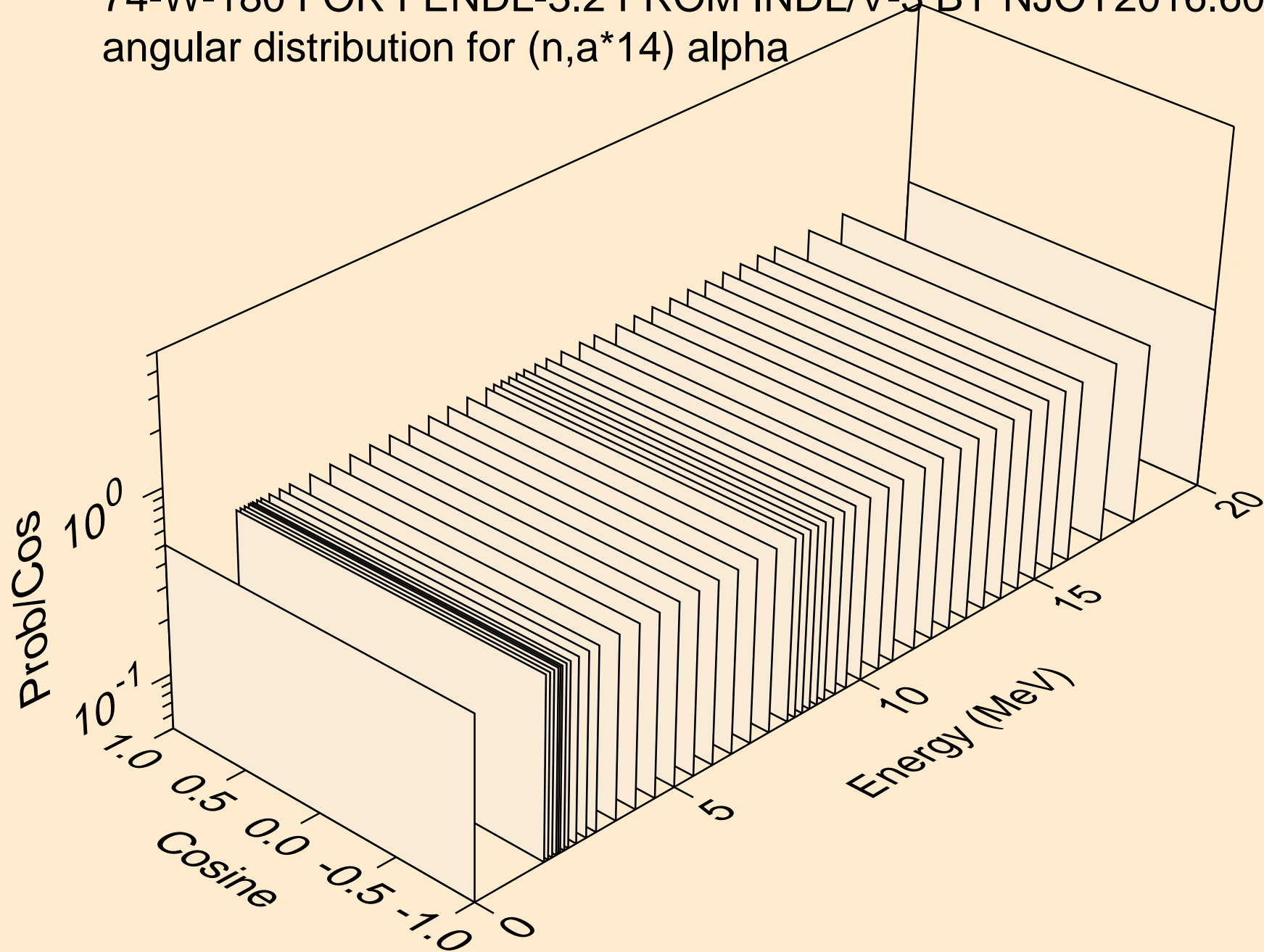

74-W-180 FOR FENDL-3.2 FROM INDL/V-3 BY NJOY2016.60+ ON
angular distribution for (n,a*14) alpha

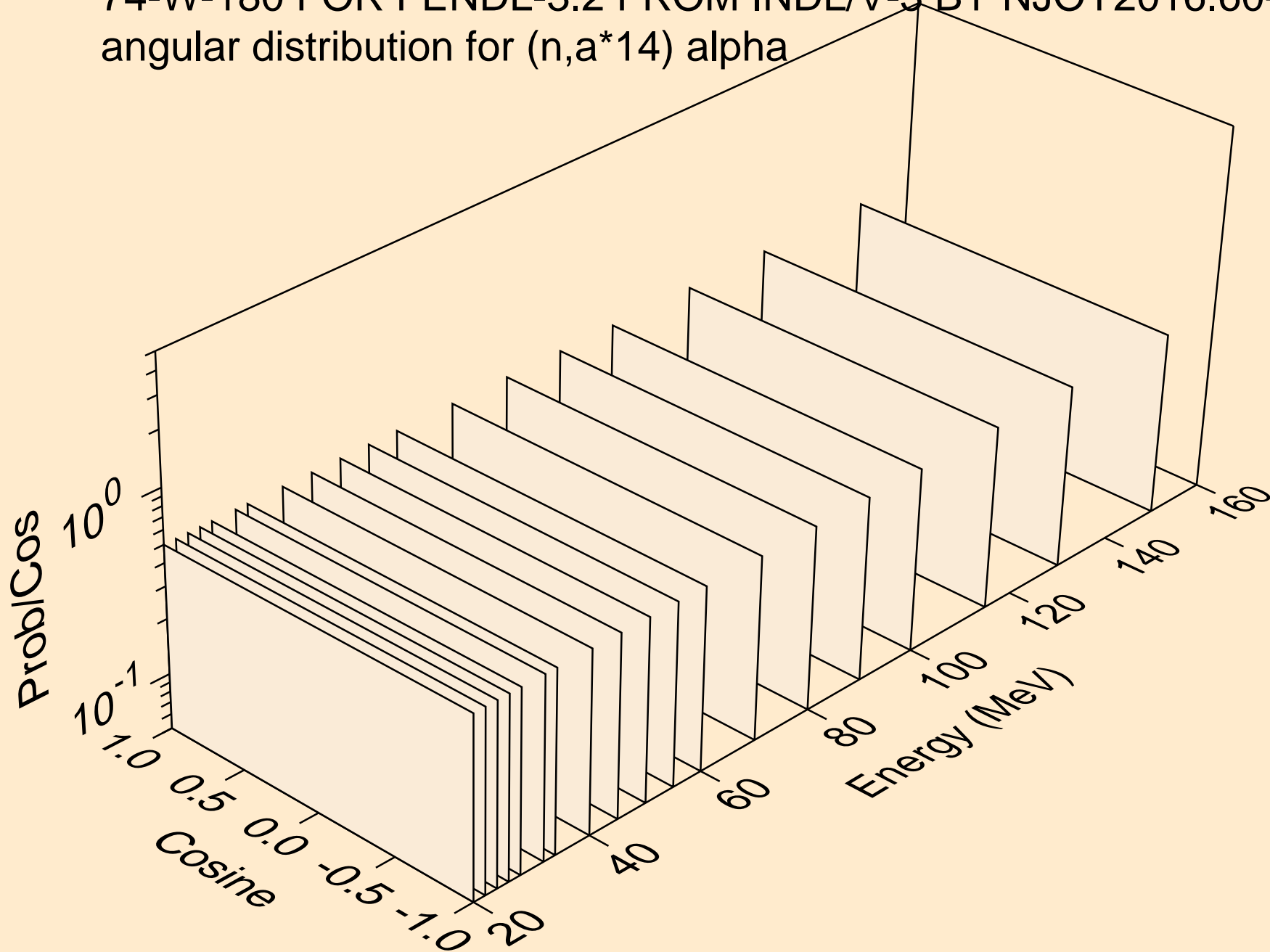

74-W-180 FOR FENDL-3.2 FROM INDLV-3 BY NJOY2016.60+ ON
alphas from (n,a*c)

