



INTERNATIONAL ATOMIC ENERGY AGENCY

INDC(NDS)-424
Distr: G+PG

I N D C **INTERNATIONAL NUCLEAR DATA COMMITTEE**

Development of a Database for Prompt γ -ray Neutron Activation Analysis

Summary Report of the Second Research Coordination Meeting

IAEA Headquarters
Vienna, Austria
14 to 17 May 2001

Prepared by

M. A. Lone^{*}, S. F. Mughabghab^{**} and R. Paviotti-Corcuera

IAEA Nuclear Data Section, Vienna, Austria

^{*} AECL, Chalk River Laboratories, Ontario, Canada

^{**} NNDC, Brookhaven National Laboratory, Upton, USA

June 2001

IAEA NUCLEAR DATA SECTION, WAGRAMER STRASSE 5, A-1400 VIENNA

Produced by the IAEA in Austria
June 2001

Development of a Database for Prompt γ -ray Neutron Activation Analysis

Summary Report of the Second Research Coordination Meeting

IAEA Headquarters
Vienna, Austria
14 to 17 May 2001

Prepared by

M. A. Lone^{*}, S. F. Mughabghab^{**} and R. Paviotti-Corcuera

IAEA Nuclear Data Section, Vienna, Austria

^{*}AECL, Chalk River Laboratories, Ontario, Canada

^{**}NNDC, Brookhaven National Laboratory, Upton, USA

Abstract

This report summarizes the presentations, recommendations and conclusions of the Second Research Co-ordination Meeting on Development of a Database for Prompt γ -ray Neutron Activation Analysis. The purpose of this meeting was to review results achieved on the development of the database, discuss further developments and planning of the products of this CRP. Actions to be taken were agreed upon with the aim to complete the project by the end of 2002.

June 2001

Table of Contents

1. SUMMARY OF THE MEETING	7
1.1. Objectives and Agenda	7
1.2. Progress Reports and Presentations	7
2. RECOMMENDATIONS AND DISTRIBUTION OF TASKS	8
2.1. Review of Past Recommendations.....	8
2.2. New Recommendations	8
2.3. IAEA-Technical Document	9
2.4. Individual Tasks.....	10
3. APENDICES.....	15
Appendix 1: Agenda	17
Appendix 2: List of Participants	21
Appendix 3: Extended Abstracts of Presented Papers.....	23

1. SUMMARY OF THE MEETING

1.1. Objectives and Agenda

The Second Research Co-ordination Meeting (RCM) on Development of a Database for Prompt γ -ray Neutron Activation Analysis was held at the IAEA Headquarters in Vienna, Austria, from 14 to 17 May 2001.

The purpose of the second meeting was to review results achieved on the development of the database since the first meeting, discuss further developments, and planning of the products of this CRP. A detailed plan of the final TECDOC was also elaborated. Actions to be taken were agreed upon with the aim to complete the project by the end of 2002.

Richard M. Lindstrom of National Institute of Standards and Technology, USA, was elected as the chairman of the meeting. M. Aslam Lone of Chalk River Laboratories, AECL Canada, and Said F. Mughabghab of Brookhaven National Laboratories, USA, were selected as rapporteurs of the meeting. The detailed approved Agenda is attached (see Appendix 1). Other participating laboratories were represented by H.D. Choi (Seoul, Korea), S.C. Frankle, (LANL, USA), A.V.R. Reddy (Mumbai, India), G.L. Molnár and Z.S. Revay (Budapest, Hungary), Nguyen C. Hai (Dalat, Vietnam), C. Zhou (Beijing, China). For the complete list of participants including affiliations see Appendix 2.

D. D. Sood, Director Physics and Chemistry Division, IAEA, welcomed the participants and emphasized their important role in development of this improved data base for the benefit of all the member states of the Agency. A. Trkov, Deputy Head of the Nuclear Data Section (NDS), IAEA, gave a brief explanation of the general framework procedures under which the CRPs of the Agency develop. (See appendix 3, Summary Report of the first meeting, INDC(NDS)-411). R. Paviotti-Corcuera, Scientific Secretary of the CRP, summarized the overall objective of the CRP and the purpose of the meeting (see Appendix 4, Summary Report of the first meeting, INDC(NDS)-411).

1.2. Progress Reports and Presentations

Scientific investigators of 10 laboratories gave progress reports and presentations. Important new contributions were brought by S.C. Frankle, (new independent compilation of thermal neutron capture gamma ray), M. A. Lone (possible explanations for discrepant cross sections) and S. F. Mughabghab (new evaluation of thermal capture cross sections.) V. Pronyaev and V. Zerkin presented the IAEA/NDS requirements related to database software. For the progress reports and technical papers presented by all participants see Appendix 3.

2. RECOMMENDATIONS AND DISTRIBUTION OF TASKS

2.1. Review of Past Recommendations

- Recommendation 3.1 subset 3 of the previous meeting (see Summary Report of first meeting, INDC(NDS)-411) was changed to “Best Data Adopted “ from “Best Data Set Adopted”
- The deadline for the completion of the CRP Technical Document is September 2002

2.2. New Recommendations

2.2.1. Discrepancies in total radiative-neutron-capture cross-sections, σ_0

- The new σ_0 values measured in the CRP co-ordinate work to be considered by S. Mughabghab for update of the σ_0 recommended database.
- Benchmark of measurements of $k_{0,H}$ of C in thermal and cold beams to determine σ_0 and to quantify target dependent background. Participants: NIST(USA), Budapest, Korea, India and Japan. Coordinator, R. Lindstrom (NIST). (*Material distributed by Lindstrom by 2001 July 1; first measurement by participants will be sent to Lindstrom by 2001 Dec 15, summary by Lindstrom by 2001 Jan 15*).
- Characteristics and benchmark result of reference materials for PGAA applications (Lead, R. Lindstrom, *participants to return results of measurements to R. Lindstrom by 2001 Dec 1; benchmark summary and material specification by R. Lindstrom by 2001 Jan 15*).
- Budapest to re-measure σ_0 of ${}^6\text{Li}$ for thermal and cold neutron beams. (*By 2001 December 15*).
- S. Mughabghab and R. Firestone to exchange lists of isotopes with strongly discrepant published σ_0 values. Lists will be concurrently sent to R. Paviotti-Corcuera for posting on the CRP WEB server. (*Z from 1 to 60 by 2001 June 15; Z from 61 to 99 by 2002 March 15*).

2.2.2. Generation of New Westcott g-Factors

- All participants to report their measured k_x and σ_x values normalized to 2200 m/s value by correcting with g-factors appropriate to their facilities.
- G. Molnar to co-ordinate a benchmark of measurement of g-factors for ${}^{113}\text{Cd}$ and ${}^{157}\text{Gd}$ for thermal and cold beam facilities. Potential participants NIST (USA), Budapest, Korea, India, Japan. (*Molnar to distribute samples by 2001 Sept 1, measurements by 2001 Dec 15, summary by 2002 Jan 15*).
- A. Trkov to develop software for computation of generalized Westcott g-factors for non-Maxwellian sub-thermal to epithermal range neutron spectral shapes for $1/v$ and non- $1/v$ nuclei. (*By 2001 Dec 15*).

- Compute g-factor for cold beam shape (Maxwellian modified with λ^2 weighting factor for guided beam tubes)
- Compute g-factor for a thermal plus epithermal beam such as at PGAA facility in Korea. Beam parameters from Choi.
- Compute g-factors for Maxwellian shapes at 30 °K and 100 °K using RNAL library
- S. Mughabghab to compute Westcott g-factors for Maxwellian spectral shape at 30 °K and 100 °K using latest release of ENDF/B-6 for non-1/v isotopes. (*By 2001 Oct 15*).

2.2.3. Review of Data Base

- S. Frankle to send thermal neutron capture gamma ray data compiled and evaluated at LANL to Firestone and R. Paviotti-Corcuera (*By 2001 Sept 1*).
- To develop two Slow Neutron Capture Gamma (SNCG) databases:
 - Working Database (ENSDF format) (Firestone, *first draft by 2001 Dec 15*).
 - User Oriented Data base (Firestone, *first draft by 2001 Dec 15*).
 - i. Search & Retrievable (Firestone, *first draft by 2001 Dec 15*).
 - ii. Lone-style Formatted Table (Firestone, *first draft by 2001 Dec 15*).
- Uncertainties to be listed as absolute in real numbers rather than last two digits of the quantity for ease in placing data in spreadsheets.
- V. Zerkin / R. Firestone to develop a platform independent retrieval and display program for the PGAA database (*by 2001 Dec 15*).

2.3. IAEA-Technical Document

2.3.1. Title

“Data Base of Prompt γ -rays from slow neutron capture for elemental analysis”

2.3.2. Chapters

Foreword, summary, abstract: (Lead R. Paviotti-Corcuera, *draft by 2002 March*).

1. **Introduction:** (Lead R. Lindstrom) An overview of development and PGAA applications (*draft by 2002 March 1*).
2. **Nomenclature, Neutron Spectral shape dependent Formulism:** (A. Lone and A. Trkov). Describe formulism for reaction rates applicable to various facilities and give a brief description of parameters and nomenclature (*draft by 2002 March 1*).

3. **Characteristics of PGAA Facilities:** Up to 3-page length descriptions of each existing facility, (*coordinator H. Choi, draft by 2002 March 1*).
4. **Benchmark results and Characterization of Reference Materials:** (Lead R. Lindstrom and G. Molnar). Description of benchmarks and reference materials used for development of the PGAA database (*draft by 2002 March 1*).
5. **Data Base development**
 - a. **Isotopic Data: σ_0 , resonance integrals, g-factors, abundances:** (S. Mughabghab) (*draft by 2002 March 1*)
 - b. **ENSDF Evaluated Data Base:** (Z. Chunmei, D. Firestone and S. Frankle). Describe methodology of collation and evaluation data (*draft by 2002 Jan 1, write-up draft by 2002 March 1*).
 - c. **New Prompt Gamma Ray Data:** (G. Molnar) Describe new k_0 data measured under the CRP at Budapest and other facilities (*draft by 2002 March 1*).
 - d. **Adopted Data Base and User Tables:** (R. Firestone) Describe methodology and criterion of data selection (*draft by 2002 March 1*).
6. **User information on structure and retrieval of PGAA data base with Appendix of a Lone style table:** (D. Firestone, V. Zerkin and R. Paviotti-Corcuera) Describe structure and retrieval software developed for the PGAA database (*draft by 2002 March 1*).
7. **Data Base:** (CD-ROM, WEB, etc. R. Firestone, V. Zerkin, V. Pronyaev and R. Paviotti-Corcuera) (*draft by 2002 March 1*).

2.4 Individual Tasks

Heedong Choi

Department of Nuclear Engineering
Seoul National University
Korea

Program of Work from May 2001 to November 2002

1. Description of the facility and beam characteristics for TECDOC
2. Measurement and validation of k_0 -factors for non $1/v$ absorbers: Cd, Sm, Gd (*December 2001*).
3. Measurement and validation of k_0 -factors for light elements of $A < 45$: B, C, N, P, Si, S (*July 2002*).
4. Benchmark measurement of spectroscopy. Ti sensitivity and relative intensity, effective velocity of the beam, analysis of the unknown sample (*by August 2001*).

5. Make data available to IAEA and prepare final summary report describing the work performed as contribution to this CRP (*September 2002*).

Richard B. Firestone

Lawrence Berkeley National Laboratory
University of California
Berkeley, CA, USA

Program of Work from May 2001 to November 2002

1. Complete evaluation of (n, γ) for all isotopes and provide a database of ENSDF, Budapest, and adopted data in ENSDF format (*July 2002*).
2. Provide a PGAA γ -ray database for all elements as a text file containing E_γ , dE_γ , σ_γ , ICC, $t_{1/2}$, k_0 , A, Z, I_γ , dI_γ , dI_{γ} (*July 2002*).
3. Provide a PGAA isotope element database containing A, Z, σ_0 , $d\sigma_0$, S_n , missing σ_γ , $g(30)$, $g(100)$, $g(\text{th})$, Abundance, Atomic Weight from standard source (*July 2002*).
4. Develop software for PGAA dissemination in collaboration with IAEA/NDS (*August 2002*).
5. Make data available to the IAEA/NDS and prepare final summary report describing the work performed as contribution to this CRP (*September 2002*).
6. Write sections for TECDOC on database description ENSDF methods, and dissemination (*October 2002*).

A.V.R. Reddy

Nuclear Chemistry Section
Radiochemistry Division
BARC, Mumbai, India.

Program of Work from May 2001 to November 2002

1. Checking of prompt k_0 -factors– Analysis of SRM 1571 and IAEA 10 by k_0 method (*July 2001*).
2. Setting up of a new beam facility at our Dhruva reactor (*December 2001*).
3. Repeating k_0 measurements and determination of efficiency of the system (*January 2002*).
4. Setting up of Compton suppressed detector (*March 2002*).
5. Participating in benchmark experiment (*September 2001*).
6. Analysis of mineral and environmental samples complementing our earlier NAA measurements (*June 2002*).
7. Make data available to the IAEA/NDS and prepare final summary report describing the work performed as contribution to this CRP (*September 2002*).

Gábor L. Molnár

Institute of Isotope and Surface Chemistry,
Chemical Research Center
Budapest, Hungary

Program of Work from May 2001 to November 2002

1. Development of data correction procedures (*January 2002*).

Effective g-factors will be determined experimentally for Cd and Gd, (also possible Sm, Eu, and Hg). A reference material will be created for neutron beam characterization.

2. Measurement of k_0 factors (partial cross-sections) (*January 2002*).

On the new cold neutron beam the previously determined k_0 factors will be re-measured by using homogeneous composite targets containing the element of interest and a suitable comparator element in either of the form of a stoichiometric composition, a solution or a solid mixture

From the agreed Priority List (summary report of last meeting) the following elements will be selected:

B, C, N, P, Si, S, transition metals, Cd, Sm, Gd, Hg, Li, Ti, In, Ta, W, Tl, (also possible U-235), Ne, Ar, Kr. (*January 2002*).

3. Make data available to the IAEA/NDS and prepare final summary report describing the work performed as contribution to this CRP. (*September 2002*).

Nguyen Canh Hai

Nuclear Research Institute
Vietnam Atomic Energy Commission
Dalat, Vietnam

Program of Work from May 2001 to November 2002

1. Improved shielding arrangements both for neutron and gamma-rays and construction of a sample box using the materials LiF, Li^6F , B_4C , Pb (*December 2001*).
2. Examination of characteristics of our facility (*February 2002*).
3. Measurements of k_0 -factors for the new light elements (*May 2002*).
4. Benchmark measurement of spectroscopy, Ti, sensitivity and relative sensitivity, effective velocity of the beam, analysis of unknown sample.
5. Determinations of absolute capture gamma-ray intensity of some isotopes (*September 2002*).
6. Make data available to the IAEA/NDS and prepare final summary report describing the work performed as contribution to this CRP (*September 2002*).

C. Zhou

China Nuclear Data Center
China Institute of Atomic Energy
Beijing, P. R. China

Program of Work from May 2001 to November 2002

1. Evaluation of γ -ray energies and intensities of thermal-neutron capture for nuclei with mass number $A=26-35$ (*November 2001*).
2. Prepare data in the ENSDF format to be included in this library (*November 2001*).
3. Evaluation of γ -ray energies and intensities of thermal-neutron capture for nuclei with mass number $A=36-44$ (*May 2002*).
4. Prepare data in the ENSDF format to be included in this library.
5. Make data available to the IAEA/NDS and prepare final summary report describing the work performed as contribution to this CRP (*September 2002*).

S.F. Mughabghab

Brookhaven National Laboratory
Upton, NY, USA

Program of Work from May 2001 to November 2002

1. Evaluate the thermal capture cross sections of isotopes and elements for $Z = 1 - 98$ (*December 2001*).
2. Evaluate the resonance capture integrals for $Z=1-98$ (*March 2002*).
3. Calculate the Westcott g -factors and their temperature dependence for $Z=1-98$ for Maxwellian distribution (*December 2001*).
4. Calculate the k_0 -factor for those isotopes whose absolute capture gamma ray intensities are well established (*December 2001*).
5. Provide a list of discrepant data (*June 2001*).
6. Make data available to the IAEA/NDS and prepare final summary report describing the work performed as contribution to this CRP (*September 2002*).

R.M Lindstrom

National Institute of Standards and Technology,
Gaithersburg, MD, USA

Program of Work from May 2001 to November 2002

1. Prepare and distribute materials for characterizing neutron beam flux and spectrum (Done).
2. Prepare and distribute blind samples of complex material to CRP participants for validating the data-based approach to analysis. Critically evaluate results of analyses and recommend means for resolving discrepancies (*January 2002*).

3. Measure relative capture rates (k_0) for critical elements in both cold-neutron and thermal neutron beams for comparison with other participants, especially carbon. Distribute materials for cross-checking measurements of CRP participants. Send material to participants (*June 2001*) Interpretation of results (*January 2002*).
4. Participate in data analysis and project coordination.
5. Make data available to the IAEA/NDS and prepare final summary report describing the work performed as contribution to this CRP (*September 2002*).

S.C. Frankle

Los Alamos National Laboratory,
Los Alamos, NM, USA

Make available to the NDS/IAEA and to LBNL the database of prompt gamma rays for isotopes for thermal neutrons capture (Text file *by September 2001*)

M. A. Lone

AECL, Chalk River Laboratories,
Ontario, Canada

Write Chapter 2 "Nomenclature, Neutron spectral shape dependent Formulism of the TECDOC" (*draft by March 2002*).

3. APENDICES

Appendix 1: Agenda

International Atomic Energy Agency
Second Research Co-ordination Meeting on
“Development of a Database for Prompt Gamma-ray Neutron Activation Analysis”

IAEA Headquarters, Vienna, Austria
14 - 17 May 2001
Meeting Room B0545

AGENDA

Monday, 14 May

09:00 - 09:20 Registration (IAEA Registration desk, C-tower, ground floor)

09:30 - 10:30 Opening Session

- Introduction of participants
- Opening (A. Trkov, Deputy Head, IAEA Nuclear Data Section)
- Election of Chairman and Rapporteur
- Discussion and Adoption of Agenda (Chairman)
- General Considerations (R. Paviotti –Corcuera, Scientific Secretary, IAEA/NDS)

10:30 - 10:45 Coffee break

10:45 - 12:35 Presentations by Participants

(20 minutes for each presentation and 10 minutes for discussion, except when otherwise noted)

Z. Chunmei, Institute of Atomic Energy, China

1. Evaluation of prompt gamma-ray energies and absolute intensities of thermal neutron capture for A=26-35. (15' presentation 5' discussion)
2. Review and update of prompt gamma-ray energies and absolute intensities of thermal neutron capture for A>190.(15' presentation 5' discussion).

H. D. Choi, Seoul National University, Korea

3. Progress and Plan of the PGNAA Facility at Hanaro. (15' presentation 5' discussion)

Nguyen Canh Hai, Nuclear Research Institute, Vietnam

4. Measurement and Validation of Ko-PGNAA Factors. (15' presentation 5' discussion)

A.V.R. Reddy, Bhabha Atomic Research Centre, India

5. Measurement of k₀ factors for PGAA using guided neutron beam line.

12:35 - 14:35 Lunch and Administrative/Financial Matters Related to Participants

14:35 - 18:00 Presentations by Participants

R. B. Firestone, Lawrence Berkeley National Laboratory University of California, USA

6. Status of the database compilation and dissemination tools

Z.S. Revay, G.L. Molnar, Hungarian Academy of Sciences, Hungary (CRC Budapest)

7. New method for the measurement of effective neutron temperature in neutron beams

S. Mughabghab, Brookhaven National Lab., USA

8. Updated Thermal Capture Cross Sections and Westcott factors for $Z=1$ to 60

A. Lone, AECL, Canada

9. Potential Causes of the Variation of Gamma Ray Branching Ratios with Neutron Energy (15' presentation 5' discussion)

R.M. Lindstrom, National Institute of Standards and Technology, USA

10. Standards and Benchmarks for Prompt Gamma Measurements. (15' Presentation 5' discussion)

S.C. Frankle, Los Alamos National Laboratory, USA

11. Prompt Gamma Rays From The Capture Of Thermal Neutrons By Elements From Hydrogen Through Zinc (15' Presentation 5' discussion)

Coffee break intervals as appropriate

Tuesday, 15 May

09:00 - 18:00 Presentations and Discussions

IAEA/NDS requirements related to database software

(V. Zerkin, V. Pronyaev)

Discussions:

- Discrepancies in the total Cross section, (Lead by Lone)
- Check of results for data validation, benchmark (Lead by Lindstrom)
- Review of the Database (Lead by Firestone)
- Generation of new Westcott g-factors (Lead by Mughabghab)

**Workplan and contribution of each Laboratory to the CRP products,
assignment of tasks and deadlines:**

1. Database on the Web
2. Database on CD-ROM
3. Discussion on the TECDOC (Who will write what, first draft deadline)

Lunch and Coffee break intervals as appropriate

17:15 Reception

Wednesday, 16 May

09:00 - 18:00

- Continued -

**Workplan and contribution of each Laboratory to the CRP products,
assignment of tasks and deadlines:**

4. Database on the Web
5. Database on CD_ROM
6. Discussion on the TECDOC (Who will write what, first draft deadline)

Paper for the ND2001 in Tsukuba, Japan (Deadline end of July 2001)

Drafting of the Meeting Report

Lunch and coffee break intervals as appropriate

Thursday, 17 May

09:00 - 12:30 Discussion of the Meeting Report

12:30 - 14:00 Lunch

14:00 - 18:00 Concluding Session

Adoption of the meeting report

Appendix 2: List of Participants

International Atomic Energy Agency
Second Research Coordination Meeting on
**“Development of a Database for Prompt Gamma-ray Neutron
Activation Analysis”**

14 – 17 May 2001, IAEA Headquarters, Vienna, Austria

CANADA

Mr. A. Lone

Office of The Chief Engineer
Station E4
Chalk River Laboratories, AECL
Ontario, K0J 1J0
Tel: +613 584 8811 Xt. 5287
Fax: +613 584 8047
E-Mail: Lonea@Aecl.Ca

CHINA

Mr. C. Zhou

China Nuclear Data Centre
China Institute of Atomic Energy
P.O. Box 275 (41)
102413 – Beijing
Tel: +86 10 6935 7830
Fax: +86 10 6935 7008
E-mail: zcm@iris.ciae.ac.cn

HUNGARY

Mr. G.L. Molnar

Department of Nuclear Research
Institute of Isotope and
Surface Chemistry
Chemical Research Centre
P.O. Box 77
Budapest H-1525
Tel: +36 1 3922 539
Fax: +36 1 3922 584
E-mail: molnar@alpha0.iki.kfki.hu

INDIA

Mr. A.V.R. Reddy

Radiochemistry Division
Bhabha Atomic Research Centre
Trombay, Mumbai 400 085
Tel: +91 22 550 5050 xt. 2455
Fax: +91 22 556 0750
E-mail: avreddy@magnum.barc.ernet.in
E-mail: venkatk@bom8.vsnl.net.in

KOREA

Mr. H.-D. Choi

Department of Nuclear Engineering
Seoul National University
Seoul 151-742
Tel: +82 2 880 7205
Fax: +82 2 889 2688
E-mail: choihdg@snu.ac.kr

USA

Mr. R.B. Firestone

Isotopes Project , MS 50A-1148
Lawrence Berkeley National Laboratory
University of California
1 Cyclotron Road
Berkeley, CA 94720
Tel: +1 510 486 7646
Fax: +1 510 486 5757
E-mail: rbf@lbl.gov

HUNGARY

Mr. ZS. Revay
Department of Nuclear Research
Institute of Isotope and Surface Chemistry
Chemical Research Centre
P.O. Box 77
Budapest H-1525
Tel: +36 1 3922 539
Fax: +36 1 3922 584
E-mail: revay@alpha0.iki.kfki.hu

USA

Mr. R.M. Lindstrom
Analytical Chemistry Division
National Institute of Standards and
Technology
Stop 8395
Gaithersburg - MD 20899
Tel: +1 301 975 6281
Fax: +1 301 208 9279
E-mail: richard.lindstrom@nist.gov

USA

Mr. S.F. Mughabghab
Building 197 D
Energy Technology Division
Brookhaven National Laboratory
P.O. Box 5000
Upton, NY 11973-5000
Tel: +1 631 344 5085
Fax: +1 631 344 3021
E-mail: mugabgab@bnl.gov

IAEA

Mr. A. Trkov
Deputy Head, Nuclear Data Section
Division of Physical and Chemical Sciences
Room A2316
Tel: +43 1 2600 ext: 21712
Fax: +43 1 26007
E-mail: A.Trkov@iaea.org

Mr. D.D. Sood
Director
Division of Physical and Chemical Sciences
Room A2302
Tel: +43 1 2600 ext. 21700
Fax: +43 1 26007
E-mail: D.D.Sood@iaea.org

USA

Ms. S. Frankle
Diagnostic Applications, X-5
LANL, MS F663
Los Alamos, NM 87545
Tel: +1 505 665 6461
Fax: +1 505 665 3046
E-mail: frankles@lanl.gov
E-mail: nucldata@lanl.gov

VIETNAM

Mr. Nguyen Canh Hai
Department of Nuclear Physics and
Techniques
Nuclear Research Institute
1 Nguyen Tu Luc, Dalat
Tel: +84 63 829 436
Fax: +84 63 821 107
E-mail: nchai@hcm.vnn.vn

IAEA

Ms. R. Paviotti De Corcuera
Scientific Secretary
Nuclear Data Section
Division of Physical and Chemical Sciences
Room A2319
Tel: +43 1 2600.ext. 21708
Fax: +43 1 26007
E-mail: R.Paviotti-Corcuera@iaea.org

Mr. V. Pronyaev
Nuclear Data Section
Division of Physical and Chemical Sciences
Room A2320
Tel: +43 1 2600 ext. 21717
Fax: +43 1 26007
E-mail: V.Pronyaev@iaea.org

Mr. V. Zerkin
Nuclear Data Section
Division of Physical and Chemical Sciences
Room A2318
Tel: +43 1 2600 21714
Fax: +43 1 26007
E-mail: V.Zerkin@iaea.org

Appendix 3: Extended Abstracts of Presented Papers

Thermal-Neutron Capture Data for A = 26-35 <i>Zhou Chunmei, R.B.Firestone</i>	25
Thermal-Neutron Capture Data Update and Revision for Some Nuclides with A >190 <i>Zhou Chunmei</i>	27
Progress and Plan of the PGNAA facility at HANARO <i>H.D. Choi, G.M. Sun, S.H. Byun, C.S. Kang and N.B. Kim†</i>	29
Evaluation and Measurement of Prompt k ₀ -factors to use in Prompt Gamma-Ray Neutron Activation Analysis <i>Vuong Huu Tan, Nguyen Canh Hai, Nguyen Xuan Quy and Le Ngoc Chung</i>	33
Determination of Prompt k ₀ factors in PGNAA <i>K. Sudarshan, R.N. Acharya, A.G.C. Nair, Y.M. Scindia, A.Goswami, A.V.R.Reddy and S.B.Manohar</i>	39
Status of PGAA Database Compilation and Dissemination Tools <i>Richard B. Firestone</i>	51
Characterisation of neutron beam and gamma spectrometer for PGAA <i>Zs. Révay and G. L. Molnár</i>	57
Updated Thermal Capture Cross Sections for Z=1-60 and the Temperature Dependence of the Westcott Factors <i>Said F. Mughabghab</i>	69
Potential Causes of the Variation of Gamma-Ray Absolute Branching Ratio With Neutron Energy <i>M.A. Lone</i>	85
Neutron Beam Characterization <i>Richard M. Lindstrom.</i>	93
Improved Photon-Production Data for Thermal-Neutron Capture for Z=30 and 70,72,73,74,76Ge, 149Sm, 155,157Gd, 181Ta and 182,183,184,186W <i>Stephanie C. Frankle, Robert C. Reedy, and Phillip G. Young</i>	95
IAEA/NDS Requirements Related to Database Software <i>V. Pronyaev and V. Zerkin.</i>	103

Thermal-Neutron Capture Data for $A = 26-35$

ZHOU CHUNMEI

China Nuclear Data Center
China Institute of Atomic Energy
P. O. Box 275 (41), Beijing 102413
People's Republic of China

R.B. FIRESTONE

Isotopes Project, MS 50A - 1148
Lawrence Berkeley National Laboratory
University of California, 1 Cyclotron Road
Berkeley, CA 94720, USA

Abstract: The prompt gamma-ray data of thermal- neutron captures for nuclear mass number $A=26-35$ had been evaluated and published in "ATOMIC DATA AND NUCLEAR DATA TABLES, 26, 511 (1981)". Since that time the many experimental data of the thermal-neutron captures have been measured and published. The update of the evaluated prompt gamma-ray data is very necessary for use in PGAA of high-resolution analytical prompt gamma-ray spectroscopy. Besides, the evaluation is also very needed in the Evaluated Nuclear Structure Data File, ENSDF, because there are no prompt gamma-ray data in ENSDF. The levels, prompt gamma-rays and decay schemes of thermal-neutron captures for nuclides (^{26}Mg , ^{27}Al , ^{28}Si , ^{29}Si , ^{30}Si , ^{31}P , ^{32}S , ^{33}S , ^{34}S , and ^{35}Cl) with nuclear mass number $A=26-35$ have been evaluated on the basis of all experimental data. The normalization factors, from which absolute prompt gamma-ray intensity can be obtained, and necessary comments are given in the text. The ENSDF format has been adopted in this evaluation. The physical check (intensity balance and energy balance) of evaluated thermal-neutron capture data has been done. The evaluated data have been put into Evaluated Nuclear Structure Data File, ENSDF. This evaluation may be considered as an update of the prompt gamma-ray from thermal-neutron capture data tables as published in "ATOMIC DATA AND NUCLEAR DATA TABLES, 26, 511 (1981)".

Cutoff Date: March 2001; all references entered into the Nuclear Science References File, NSRF, and private communications have been considered.

Thermal-Neutron Capture Data Update and Revision for Some Nuclides with $A > 190$

ZHOU CHUNMEI

China Nuclear Data Center
China Institute of Atomic Energy
P. O. Box 275 (41), Beijing 102413
People's Republic of China

Abstract: The prompt gamma-ray data of thermal- neutron captures for some nuclides with nuclear mass number $A > 190$ had been evaluated and put into Evaluated Nuclear Structure Data File, ENSDF. Since last evaluations the many experimental data of the thermal-neutron captures for nuclear mass number $A > 190$ have been measured and published. Some of them in ENSDF have not been given normalization factors, by which the gamma-ray intensities can be calculated. The reevaluation and revision of the evaluated prompt gamma-ray data is very necessary for use in PGAA of high-resolution analytical prompt gamma-ray spectroscopy on the basis of all experimental data. The levels, prompt gamma-rays and decay schemes of thermal-neutron captures for some nuclides (**193Ir, 194Pt, 195Pt, 196Pt, 197Au, 207Pb, and 240Pu**) with nuclear mass number $A > 190$ have been reevaluated and revised. The normalization factors and necessary comments are given in the text. The physical check of evaluated thermal-neutron capture data has been done. This reevaluation and revision may be considered as an update of the Prompt Gamma-ray from Thermal Neutron Capture data table as published in Atomic Data and Nuclear Data Tables 26, 511 (1982).

Cutoff Date: March 2001; all references entered into the Nuclear Science References File, NSRF, and private communications have been considered.

Progress and Plan of the PGNA facility at HANARO

H.D. Choi, G.M. Sun, S.H. Byun, C.S. Kang and N.B. Kim[†]

Department of Nuclear Engineering, Seoul National University, Seoul 151-742, Korea

[†] Korea Institute of Geology, Mining and Materials, Taejon 305-350, Korea

1. Development of PGNA facility at HANARO

A prompt gamma neutron activation analysis(PGNA) system(Fig. 1) is being set up in HANARO, a 30 MW research reactor in the Korea Atomic Energy Research Institute. The beam is polychromatic thermal neutrons diffracted vertically by a set of pyrolytic graphite crystals at the Bragg angle of 45° from a horizontal beam line. A tapered collimator is positioned between the graphite crystals and the Teflon sample holder, being composed of alternating layers of borated plastic, lead and polyethylene. The detection system consists of a 43% n-type HPGe detector, signal electronics and a fast ADC. Since the details of the neutron spectrum obtained by

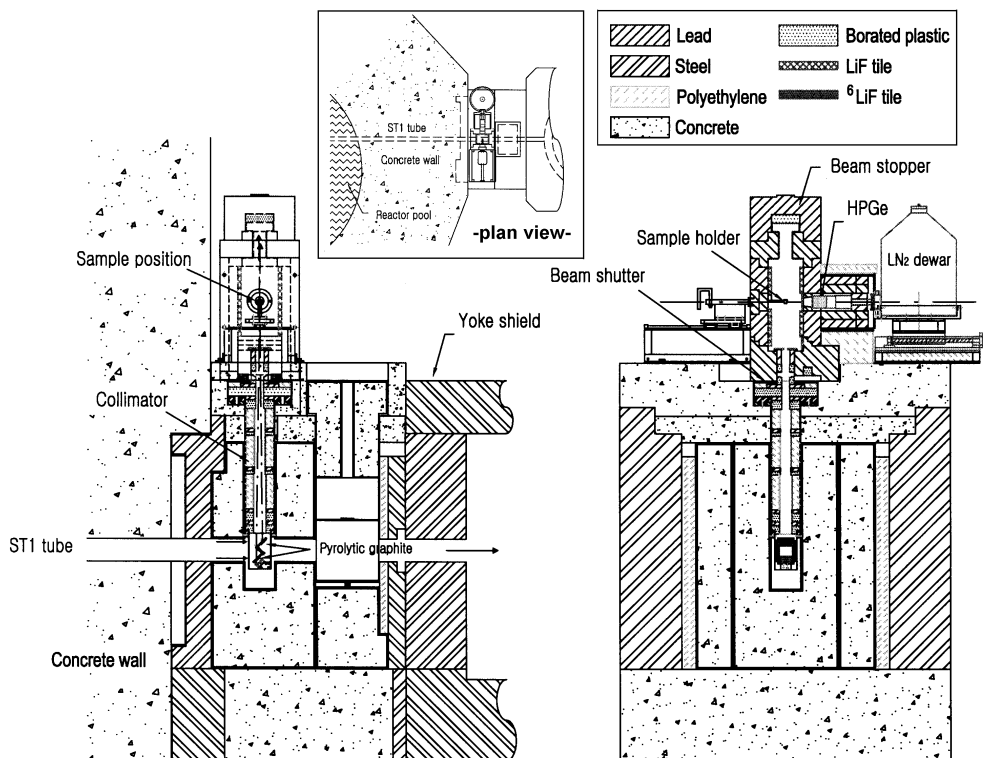

Fig. 1. The PGNA system on the ST1 beam port of HANARO

diffraction are unknown, a measurement by the time-of-flight (TOF) spectrometer has been carried out, the result of which is shown in Fig. 2[1]. The neutron spectrum is obtained for all diffractions of higher orders by PG crystal. The relative proportion of neutron flux for each diffraction order is determined from the measured area of Bragg peak with proper correction for the effects of chopper transmission and detection efficiency etc. Table 1 shows the

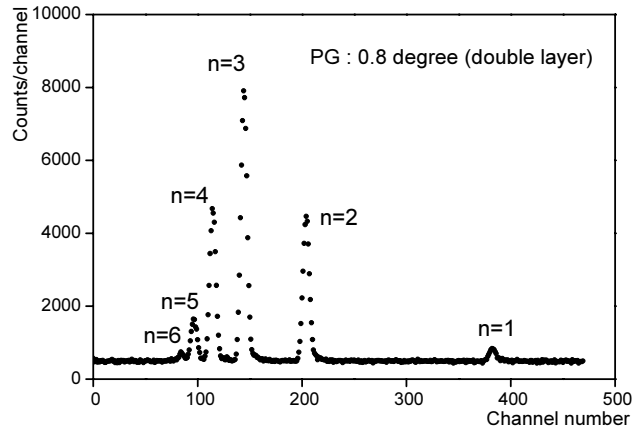

Fig. 2. The TOF neutron spectrum of the diffracted polychromatic beam at the Bragg angle of 45° obtained by using a double layer of PG crystals having 0.8° mosaic spread.

comparison of the measured result with that obtained by theoretical calculation using integrated reflectivity. For the case of Bragg angle 45°, both results confirm that there is a small contribution from the 1st order diffraction while those from the 2nd, 3rd and 4th orders are the majority.

Prior to assembling, measurements of the neutron spectrum and gold wire activation confirmed that a sufficient neutron flux can be obtained[2]. Since a considerable leakage of fast neutron was observed from the reactor wall side near the collimator, a new shielding is designed and installed. Enriched ⁶LiF tiles for detector entrance window are made from ⁶Li₂CO₃ powder. To determine the neutron flux and Cd-ratio, gold wire of

Table 1. Comparison of the measured and calculated relative fractions of the diffracted neutron flux from each diffraction order for a double layer of PG crystals.

Diffraction Order (n)	Wavelength [Å]	Energy [meV]	$\phi_D(n)/\phi_D^*$		$\phi_D(n)/\phi_{th}^{**}$
			Calculation [%]	Measurement [%]	Calculation
1	4.74 ± 0.11	3.6 ± 0.2	4.5	4.6 ± 0.1	0.0009
2	2.37 ± 0.05	14.6 ± 0.7	25.5	26.5 ± 0.2	0.0054
3	1.58 ± 0.04	32.8 ± 1.5	35.0	40.4 ± 0.2	0.0072
4	1.19 ± 0.03	58.3 ± 2.6	22.4	22.2 ± 0.1	0.0046
5	0.95 ± 0.02	91.1 ± 4.1	9.0	6.1 ± 0.1	0.0019
6	0.79 ± 0.02	131.2 ± 5.9	2.5	0.4 ± 0.1	0.0005

* $\phi_D(n)$: neutron flux from n-th order diffraction, ϕ_D : sum of all $\phi_D(n)$'s.

** ϕ_{th} : total thermal neutron flux of incident beam.

0.1 mm diameter and 0.5 mm thick Cd sheet are used. Thermal neutron flux of 7.9×10^7 n/cm²s and the Cd-ratio of 266 are achieved at sample position while the reactor is operating at 24MW in May 2001. At present, all the components have been assembled and installed at position and the real measurements are being started.

2. Correction factors for the measured k_0 -factor

For the production of more reliable data, it is necessary to perform proper corrections to the measured k_0 -factor. When the incident neutron spectrum is considered in general, the measured k_0 -factor is given by

$$k_0 = \frac{A_s / \varepsilon(E_s^\gamma)}{A_c / \varepsilon(E_c^\gamma)} \cdot \frac{G_{th,c} f \hat{g}_c + G_{e,c} Q_{0,c}}{G_{th,s} f \hat{g}_s + G_{e,s} Q_{0,s}}$$

where A is the specific count rate, \hat{g} is the effective g-factor which is calculated by using the real neutron spectrum and the energy-dependent neutron capture cross section $\sigma(E_n)$, G is the self-shielding factor in the sample, f is the ratio of thermal flux to epithermal flux per unit lethargy interval and Q_0 is the ratio between the resonance integral and 2200 msec⁻¹ cross section for the element. Detailed description is given in ref. [3] about the corrections of effects from epithermal neutrons and non-1/v absorption. The absolute full energy peak efficiency $\varepsilon(E^\gamma)$ of the HPGe detector for the volume source is obtained in terms of the correction factor on the measured point source efficiency, which is calculated by the method of Moens et al.[4] considering the effective solid angle taken by the volume source.

3. Development of the Analysis Software

The HYPERMET routine is inserted in the MCA emulation code developed by using MATLABTM for the analysis of the prompt gamma spectrum. The result of the HYPERMET analysis is displayed in the window and the various parameters related to the gamma-ray peak and the background can be investigated in detail. The code will be extended to a versatile software including the various functions and libraries. The routine for ESA(Effective Solid Angle) calculates the full energy peak efficiency for the volume sources. We adopt the

correction method of the energy non-linearity by Fazekas et al[5] and the efficiency function by Kis et al[6].

4. Plan

The future works are planned in sequence of priority as follows:

- (1) Measurement of beam characteristics and stability,
- (2) Channel-energy and energy-efficiency calibration of the spectroscopy system,
- (3) Measurement of k_0 -factor related to the 1951 keV gamma-ray of Cl element for the the strong non-1/v absorbers
 - Samples are prepared as stoichiometric compounds like CdCl₂, EuCl₂, HgCl₂, SmCl₃, GdCl₃ etc.,
- (4) Installation of Compton suppression spectroscopy system.

References

- [1] S.H. Byun and H.D. Choi, "Design Features of a Prompt Gamma Neutron Activation Analysis System at HANARO", J. of Radioanal. and Nucl. Chem. 244 (2000) 413.
- [2] H.D. Choi, S.H. Byun, G.M. Sun, M.S. Kim and B.J. Jun, "PGNAA facility in HANARO", Proceedings of 2000 Workshop on the Utilization of Research Reactors, November 2000, Taejon, Korea (in print).
- [3] G.M. Sun, I.J. Kim, S.H. Byun and H.D. Choi, "Characteristics of the Measurement of k_0 -factor using SNU-KAERI PGNAA System", Proceedings of HANARO Workshop 2000, p. 444, December 2000, Taejon, Korea (in Korean).
- [4] L. Moens, J. De Donder, LIN Xi-lei, F. De Corte, A De Wispelaere, A. Simonits and J. Hoste, "Calculation of the Absolute Peak Efficiency of Gamma-Ray Detectors for Different Counting Geometries", Nuclear Instr. and Meth. 187 (1981) 451.
- [5] B. Fazekas, Zs. Révay, J. Östör, T. Belgya, G.L. Molnár and A. Simonits, "A New Method for Determination of Gamma-Ray Spectrometer Non-linearity", Nuclear Instr. and Meth. A 422 (1999) 469.
- [6] Z. Kis, B. Fazekas, J. Östör, Zs. Révay, T. Belgya, G.L. Molnár and L. Koltay, "Comparison of Efficiency Functions for Ge Gamma-Ray Detectors in a Wide Energy Range", Nuclear Instr. and Meth. A 418 (1998) 374.

**EVALUATION AND MEASUREMENT OF PROMPT K_0 -FACTORS
TO USE IN PROMPT GAMMA-RAY NEUTRON ACTIVATION
ANALYSIS**

Vuong Huu Tan
Vietnam Atomic Energy Commission
59 Ly Thuong Kiet, Hanoi, Vietnam
Tel: (84 4) 9423647
Fax: (84 4) 9424133
Email: vuonghuutan@hotmail.com

Nguyen Canh Hai, Nguyen Xuan Quy, Le Ngoc Chung
Nuclear Physics Department
Nuclear Research Institute
1 Nguyen Tu Luc, Dalat, Vietnam
Tel: (84 63) 829436
Fax: (84 63) 821107
Email: nchai@hcm.vnn.vn

INTRODUCTION

Utilization of the HPGe-90 cc detector operated directly in measurements of thermal neutron capture gamma rays at the tangential channel of the Dalat reactor with the objective of prompt gamma neutron activation analysis (PGNAA) has been carried out. The rather low thermal neutron flux at this channel did not allow to achieve the detection limits at sub-PPM concentration levels. The use of a more intensive filtered thermal neutron beam available at the piercing channel could considerably improve the sensitivity of the PGNAA method. However, the gamma backgrounds at the piercing channel are higher than at the tangential channel. So, in order to reduce the gamma background and improve the sensitivity of the spectrometer, the HPGe-detector was shielded both for neutron and gamma-rays. This facility has been set up at the outlet of the piercing beam port channel of the Dalat reactor for studying neutron capture gamma ray spectra. The results of analysis of environmental standard reference materials are given to show the capability of the facility in determining the concentrations of C, N, Cl, K in biological and Al, Si, K, Fe, Gd, Sm in non-biological samples.

EXPERIMENTAL

Detectors

The 90 cc horizontal HPGe detector manufactured by Intertechnique has been used for counting prompt gamma-rays. The resolution of the detector is 2.5 keV at 1332 keV. The MCA has been calibrated in the region of 0.121 to 8 MeV using the delayed gamma-rays from Eu^{152} and prompt gamma-rays from Cl.

Detector shield and sample arrangement

The system consists of a beam shutter, beam collimator, beam stopper, neutron and gamma shielding. The thermal neutron beam is collimated by a 4 cm diameter collimator made of lead lined by boron carbide (B_4C) and is guided to the sample. The neutron beam is stopped by a beam shutter and beam stopper which are made of 10 mm thick sintered boron carbide. The prompt gamma rays are absorbed by 12 and 15 cm of lead in shutter and stopper. A sample which is sealed in 25 μ m thick fluorinated ethylenepropylene resin (FEP) film is placed on the sample holder using 0.3 mm (in diameter) PTFE string. In order to protect the detector from neutrons existing in the neutron beam, the spectrometer system was shielded on all sides by 10 cm borated paraffin. Inside of borated paraffin there is also a 10 cm lead layer for shielding detector from undesired gamma rays which exist in the filtered neutron beam or originate from the neutron capture reaction on shielding materials. The emitted prompt gamma-rays are detected through the window made of Li_2CO_3 (32 mm diameter) in the upper lead layer. The experimental configuration of our PGNA facility is shown in fig 1.

Examination of characteristics of the system

1. Neutron beam

The beam position was determined by a neutron radiographic method. The neutron flux and the flux distribution were measured by activation method using Au foils. The cadmium ratio was measured also by activation method using Au foils with and without cadmium cover. Results of neutron flux and cadmium ratio are 2.1×10^7 n/cm²/s and 210, respectively. The flux variation at the sample position during one reactor operation cycle (100 hours) was measured by 0.025 mm thick Au foils once every 5 hours and was found to be 1.2%.

2. Gamma-ray background

The prompt gamma-ray background spectrum was collected in 60000 seconds and was processed. The capture gamma-ray table by Lone et al. was followed for identifying the prompt gamma-ray lines of different background elements. The sensitivity of gamma-ray lines of the background is shown in table 1.

3. Efficiency calibration

The absolute efficiency from 121.1 keV to 1408.0 keV was obtained using standard sources of Co^{57} , Co^{60} , Cs^{137} , Eu^{152} . Absolute intensities for the above isotopes were taken from IAEA-TECDOC-619. In the range of 0.5 to 8.5 MeV prompt gamma-rays of Cl or Ti were used to get the relative values.

The relative efficiency curve from 0.5 MeV to 8.5 MeV was normalised to absolute efficiency curve from 121.1 keV to 1408.0 keV to obtain absolute detection efficiency in the whole energy range of the spectrometer. The relative efficiency curve is shown in fig. 2.

DETERMINATION OF K₀-FACTOR

A k₀-factor for the element x to the comparator c is given as:

$$k_{0,x}(x) = \frac{A_x / \epsilon_{\gamma,x}}{A_c / \epsilon_{\gamma,c}} = \frac{\theta_x \gamma_x \sigma_{0,x} / M_x}{\theta_c \gamma_c \sigma_{0,c} / M_c}$$

where, A = count rate per unit weight of the element i.e., elemental sensitivity, M = atomic mass, θ = isotropic abundance, σ = thermal neutron capture cross section, γ = prompt gamma-ray abundance, ϵ = absolute full-energy peak detection efficiency.

In order to determine k₀-factor the ratio of $\epsilon_{\gamma,c}/\epsilon_{\gamma,x}$ and elemental sensitivity have to be determined. Then the relative efficiency curve of the spectrometer has to be determined. Table 2 shows the result of k₀-factors of some elements.

FUTURE WORK PLAN:

1. Improved shielding arrangements both for neutron and gamma-rays.
2. Construction of a sample box using the materials LiF, Li⁶F, B₄C, Pb, etc.
3. Measurement of neutron spectrum at sample position by flight-of-time technique.
4. Measurement of k₀-factors for light elements.
5. Determination of absolute capture gamma-ray intensities of some of the isotopes.

REFERENCES:

1. R.L. Paul, R.M. Lindstrom, Proc. 2nd Intern. K₀ Users Workshop, Institute Josef Stefan, Ljubljana, Slovenia, 1997.
2. C. Yonezawa, H. Matsue, M. Hoshi, J. Radioanal. Nucl. Chem., 215 (1) (1997) 81.
3. M.A. Lone, R.A. Leavitt, D.A. Harrison, Atomic Data Nucl. Data Tables 26 (1981) 511.
4. R.M. Lindstrom, R. Zeisler, and Rossbach, Activation Analysis Opportunities Using Cold neutron Beams, J. Radioanal. Nucl. Chem, 167 (1993), 121-126.
5. G. L. Molnar, Z. Revay, R. L. Paul, and R. M. Lindstrom, Prompt-Gamma Activation Analysis Using the k₀ Approach, J. Radioanal. Nucl. Chem. 234 (1998) 21-26

6. Vuong Huu Tan, Neutron Beam Experiments at NRI: Review and Current Status, Proc. Of the 5th Workshop on Utilization of Research Reactors, Jakarta, Indonesia, November 25-28, 1996, pp144-152.
7. Nguyen Canh Hai, Report on Neutron Beam Utilization and Study of High Tc Superconductor at RNI, Proc. of the 1999 Workshop on the Utilization of Research Reactors, Mito, Japan, November 29- December 2, 1999.
8. D. Duffey, A. El-Kady, and F.E. Senfle, Analytical Sensitivities and Energy of Thermal Neutron Capture Gamma-Ray, Nucl. Instrum. Methods 80 (1970), 149-171.

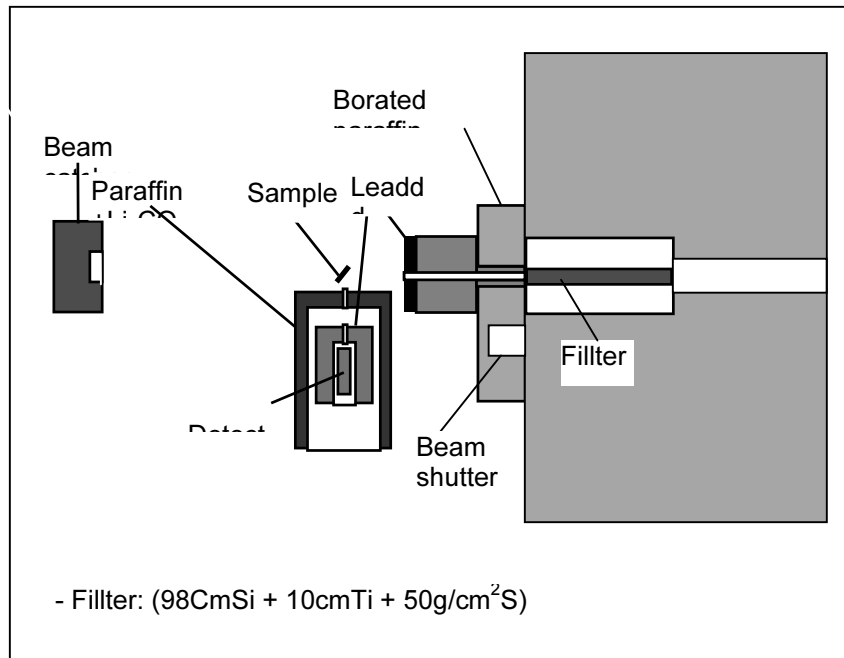

Heavy
concrete

Hea
con

E(keV)	Count rate, cps	E(keV)	Count rate, cps
66.57	0.008192	911.15	0.000512
85.13	0.033347	962.48	0.000565
198.34	0.010011	969.15	0.0004
272.88	0.000838	1139.98	0.000258
297.45	0.000744	1173.53	0.002856
326.3	0.00520	1332.84	0.002777

416.87	0.003129	1379.32	0.000324
471.99	0.001013	1407.64	0.000118
474.38	0.000622	1697.24	0.000173
493.29	0.000438	1712.11	0.000313
500.4	0.00725	1779.53	0.000729
507.8	0.00328	1884.64	0.000203
511.05	0.055202	2223.55	0.002967
596.2	0.013	2614.54	0.00088
608.86	0.001735	2753.87	0.000483
692.81	0.000442	3028.1	0.00423
708.28	0.001077	3537.16	0.000254
868.3	0.00172		

TABLE 1. Background count rate, cps

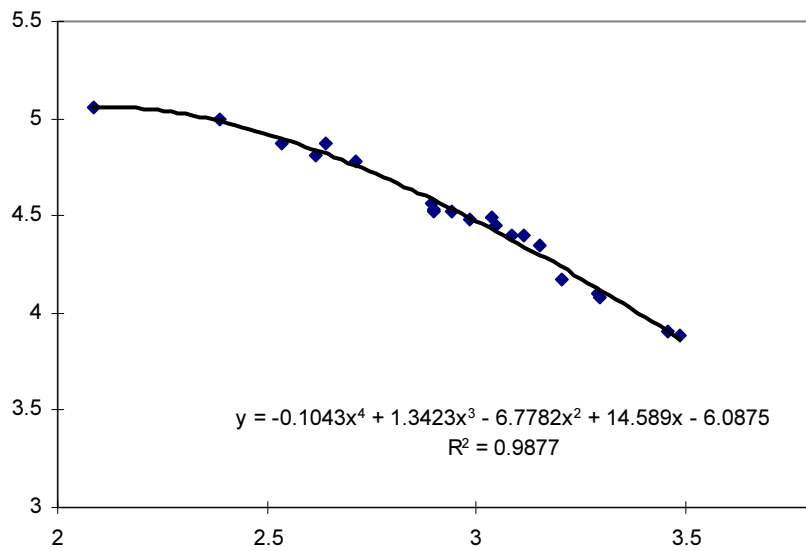

FIG. 2. Relative efficiency curve

Element	E(keV)	K_{0-CI}	Error(%)
Li	2032.5	0.023	2.1
Ti	1381.48	0.433	2.4

S	841.1	0.0603	1.9
Gd	944	161.8	1.8
Rb	556.8	0.0021	2.2
Sm	333.4	187.311	1.9
W	199.3	0.280	2.2
Ta	402.9	0.156	1.7
N	1884.81	0.00567	2.0
Si	2092.9	0.00603	1.8
In	1293.4	146.2	1.9
C	1261.74	0.00041	2.4

TABLE 2. K_0 -factor results of some elements

DETERMINATION OF PROMPT k_0 FACTORS IN PGNAA

K.Sudarshan, R.N.Acharya, A.G.C.Nair, Y.M.Scindia, A.Goswami, A.V.R.Reddy and S.B.Manohar
Radiochemistry Division, Bhabha Atomic Research Centre, Mumbai, 400 085, India.

Abstract

PGNAA set up is arranged using the thermal neutron guided beam at Dhruva research reactor. Neutron beam is characterised by cadmium ratio method. Detector efficiency in the energy range of 100 keV to 8000 keV was determined using prompt gamma rays from ^{36}Cl and ^{49}Ti and delayed gamma rays from ^{152}Eu . Emission probabilities for ^{60}Co were determined which could be used as comparator. Prompt k_0 factors were experimentally determined and elemental sensitivity for a few elements were established.

Introduction

Prompt Gamma ray Neutron Activation Analysis (PGNAA) is the complementary technique to conventional NAA and is characterised by its capability both for non-destructive multi-element analysis and the analysis of low Z elements like H, B, C, N, P, Si and S which are difficult to analyse by NAA. With the availability of guided neutron beams, scope of PGNAA has increased considerably. The k_0 -standardisation method is being used for PGNAA in which prompt k_0 factors with respect to a suitable comparator have to be determined. This paper describes the salient features of the PGNAA set up and determination of k_0 factors. The k_0 factors relative to 1951 keV of ^{36}Cl and 1381 keV of ^{49}Ti were determined. Efficiency of detector was measured using prompt gamma rays from ^{36}Cl and ^{49}Ti , and gamma-rays of ^{152}Eu [1], which is one of the prerequisites in the k_0 methodology. Although ^{36}Cl and ^{49}Ti are more frequently used comparators and efficiency standards, they do not have intense gamma rays in the low energy region. In view of this, emission probabilities of the prompt gamma rays of ^{60}Co were determined. Additionally elemental sensitivities vis-à-vis k_0 factors for a few elements were determined. Results obtained are reported in this paper.

Principle of k_0 -standardisation in PGNAA

The principle of k_0 standardisation approach in PGNAA has been described by Molnar et.al. [2]. In this method a target is exposed to neutrons along with a single comparator(s) like ^{36}Cl or ^{49}Ti . The characteristic prompt gamma rays are assayed by high resolution gamma ray spectrometry. The net peak area (P_A) under the gamma line is given by:

$$P_A = N\sigma\phi t\gamma\epsilon$$
$$= \left(\frac{N_A\theta w}{M} \right) \cdot \sigma\phi t\gamma\epsilon \quad (1)$$

where N is the number of target nuclei, N_A is the Avogadro's number, θ is the isotopic abundance, w is the weight of the target element, M is the atomic mass, σ is the effective thermal neutron capture cross section, ϕ is the neutron flux, t is the duration of irradiation, γ is the gamma ray abundance per neutron capture and ϵ is the absolute full energy peak detection efficiency for the chosen sample to detector geometry. From eqn(1), A_{sp} (the elemental sensitivity) defined as the counts per second per unit weight of the element(cps.g^{-1}) is obtained as

$$\frac{P_A}{t w \epsilon} = \frac{N_A \theta \sigma \phi \gamma}{M}$$

$$\frac{A_{sp}}{\epsilon} = \frac{N_A \theta \sigma \phi \gamma}{M} \quad (2)$$

The prompt k_0 -factor of the element 'x' with respect to the comparator 'c' is given by:

$$k_{0,c}(x) = \frac{(A_{sp}/\epsilon)_x}{(A_{sp}/\epsilon)_c} = \frac{M_c \theta_x \sigma_x \gamma_x}{M_x \theta_c \sigma_c \gamma_c} \quad (3)$$

$$\text{where, } k_{0,c}(x) = \frac{M_c \theta_x \sigma_x \gamma_x}{M_x \theta_c \sigma_c \gamma_c} \quad (\text{theoretical}) \quad (4)$$

$$\text{and } k_{0,c}(x) = \frac{(A_{sp}/\epsilon)_x}{(A_{sp}/\epsilon)_c} \quad (\text{experimental}) \quad (5)$$

The first part is experimentally measured and the second part is evaluated theoretically using the data from standard compilations (eqn.4). According to eqn.5, determination of absolute/relative full energy peak detection efficiency (ϵ) and A_{sp} is required to obtain the experimental prompt k_0 -factors. This k_0 factor is used to find out the elemental concentration using the following expression:

$$C_x (\mu\text{g} \cdot \text{g}^{-1}) = \frac{A_{p,x}}{A_{sp,c}} \cdot \frac{1}{k_{0,c}(x)} \cdot \frac{\epsilon_c}{\epsilon_x} \quad (6)$$

where $A_{p,x}$ is the count rate per unit weight of the sample. However, in the eqn. (6), the weights of element (x) and sample are expressed in μg and gram respectively, so that C_x is in $\mu\text{g/g}$.

Experimental

PGNAA system

The thermal guided beam facility in 100 MW Dhruva reactor, BARC, Trombay, Mumbai, India, was used for the PGNAA work. The neutron beam is transported through the guided beam tube to about 30 meters away from the reactor core where our experimental set up was arranged. The dimensions of the beam are 2.5 cm x 10 cm. The detector was surrounded by 30 cm thick lead for reducing the gamma ray background. The HPGe detector was located at about 40 cm distance from the sample and was at 90° with respect to the beam direction. A lead collimator of 3 cm dia and 30 cm long was used in front of the detector to collimate the gamma rays coming from the sample.

Neutron beam characterisation

Effective neutron flux at sample irradiation position was determined using indium as flux monitor. The cadmium ratio method was used to find out the subcadmium to epithermal flux ratio [3]. An Indium foil of about 110 mg/cm^2 thickness was irradiated with and without cadmium cover and the radioactivity of $^{116\text{m}}\text{In}$ was measured using off-line gamma spectrometry. The indium foil was wrapped with a cadmium foil of 0.8 mm wall thickness. The cadmium ratio and the subcadmium to epithermal neutron flux ratios were found to be 3.04×10^3 and 3.45×10^4 respectively indicating that more than 99.99% was the thermal neutron component at irradiation position. The total neutron flux was found to be $(1.4 \pm 0.07) \times 10^7 \text{ n.cm}^{-2} \cdot \text{s}^{-1}$. The $Q_0 (I_0/\sigma_0)$ value of 16.8 corresponding to $^{116\text{m}}\text{In}$ (E_γ 1097 and 1293keV) was used to estimate the neutron flux [4].

Sample preparation

Accurately weighed samples in the range of 100-500 mg were wrapped in a thin Teflon tape and were exposed to the neutron beam for sufficiently long time. In most of the cases, chloride compounds of the element were used. Wherever specific stoichiometric chloride compounds are not available, the elements of interest in their stoichiometric compound or metallic forms were mixed with either NH₄Cl or titanium oxide, which also served as the comparator.

Data acquisition system

A 22% HPGe detector connected to a PC based 8k MCA was used for assay of prompt gamma rays. The resolution of the detector was 2.4 keV at 1332 keV. The capture gamma rays of Lone et al. [5] were used to identify the prompt gamma ray lines of different elements. The MCA was calibrated in the energy region of 0.1 to 8 MeV using the delayed gamma rays from ¹⁵²Eu and ⁶⁰Co, and prompt gamma rays from ³⁶Cl. A typical prompt gamma ray spectrum of NH₄Cl is shown in Fig.1.

Data Analysis

Photo peak areas under the individual gamma lines were determined by analysing the gamma ray spectra using the software PHAST developed in Electronics Division, Bhabha Atomic Research Centre [6]. The software has features for energy calibration and determination of peak shape parameters. The second order polynomial in energy was used to calibrate the width (FWHM) of the individual peaks. The measured FWHM and shape parameters as function of energy were used to identify multiplets.

Efficiency Calibration

The energy range to be used in PGNAA is wide (100keV to 10 MeV). No single source is available for efficiency calibration of the spectrometer. The delayed gamma rays from ¹⁵²Eu and the prompt gamma rays from ³⁶Cl and ⁴⁹Ti were used for detector efficiency calibration in the present studies. The absolute gamma ray abundances of ³⁶Cl and ⁴⁹Ti were taken from references 7 and 8 respectively. Ammonium chloride salt, packed in Teflon, was irradiated for about 12 hours and the capture gamma ray spectrum was accumulated. The absolute full energy peak efficiencies were determined for low energy region (i.e., up to 1500 keV) using gamma ray spectrum of ¹⁵²Eu and the relative efficiency plot for the energy region from 0.5 to 8 MeV was obtained from the prompt gamma ray spectra of ³⁶Cl and ⁴⁹Ti. The relative efficiency was converted to absolute efficiency values using the values obtained with ¹⁵²Eu. The efficiencies as a function of gamma ray energy (E) were fitted to a fifth order polynomial using the eqn. (7).

$$(\ln \epsilon)_E = \sum_{i=0}^5 a_i (\ln E)^i \quad (7)$$

where a_i's are fitting parameters. Initial estimates of the fitting parameters were obtained using the ¹⁵²Eu data in eqn. (7). For the γ-rays from (n, γ) reaction, the efficiencies can be expressed as

$$(\ln \epsilon)_E = k \sum_{i=0}^5 a_i (\ln E)^i \quad (8)$$

where the constant k was to be found out separately for the γ-rays from ³⁶Cl and ⁴⁹Ti. An initial estimate of k_{Cl} and k_{Ti} were obtained by normalising the relative efficiency of 517 keV

peak of ^{36}Cl and 342 keV of ^{49}Ti with the absolute efficiency obtained using ^{152}Eu . With these initial values of k_{Cl} and k_{Ti} the entire set of peak areas from ^{36}Cl and ^{49}Ti were subjected to least square analysis using eqn.(7) to obtain a new set of a_i 's. The procedure was repeated by varying the values of k_{Cl} and k_{Ti} until a minimum χ^2 was obtained [1].

Results and Discussion

The efficiency curve obtained in the present studies is shown in Fig.2. The error bars shown in Fig.2 include the errors arising from counting statistics, peak area fitting and abundances of gamma rays. The efficiency for our sample detector geometry is of the order of 10^{-3} at 150 keV to 10^{-5} at 8 MeV. The ^{36}Cl and ^{49}Ti are most commonly used comparators and efficiency standards in the prompt gamma-ray analysis. But they do not have many intense gamma rays in the low energy region. Hence, the absolute gamma ray abundances of about 50 gamma rays from ^{60}Co were measured and are given in Table 1. Cobalt is monoisotopic and is available in metallic form. We find it as a good comparator for determining prompt k_0 factors especially for the low energy gamma rays. It also helps minimise errors compared to using the relative efficiency values of far off gamma rays.

In the present studies, the prompt k_0 factors for various elements were measured relative to 1951 keV of ^{36}Cl and 1381 keV of ^{49}Ti using eqn. (5). The obtained k_0 values are given in Table 2 along with the literature k_0 values for comparison [9]. The errors on k_0 values are statistical errors from repetitive measurements. The k_0 values where the literature values are differing from our experimental values by more than three standard deviations are indicated by asterisk (*).

Routine assay of elements by standard comparison technique calls for irradiation of sample and multielement standard separately and therefore requires corrections for the parameters like neutron flux and detection efficiency mainly due to the variation in the sample geometry and attenuation of the neutrons in the sample. In the case of elements like B, Hg, Sm, Cd and Gd, the neutron absorption cross sections are high. Therefore, in the analysis of samples containing these elements over a wide range of concentrations attenuation of neutrons in the sample becomes an important parameter. These changes can be taken care off by k_0 method, as the comparator is part of the sample. The sample is intimately mixed with known amount of standard (ammonium chloride) and irradiated. This obviates the need for separate irradiation of the multi- element standard. The peak areas of element of interest are normalised by taking specific activity of the standard (^{36}Cl) as constant in the concentration range of study. It was observed that over a wide range of the amount of the high neutron absorbing elements, the measured count rates were linearly proportional to the amount of each element as shown in Fig.3. [10]. This ensures that the elements can be experimentally determined using calibration plots by k_0 method.

Conclusion

Our PGNA set up is characterised and used for determining prompt k_0 factors and absolute emission probabilities of ^{60}Co . We recommend ^{60}Co as a good comparator for k_0 PGNA. Prompt k_0 factors for a few elements were determined and most of them are in good agreement with the literature data, indicating standardisation of our system. Elemental

sensitivities for a few elements were determined and the observed linearity with amount is useful for determining the various elements in unknown samples. In view of the reproducibility and reliability of the methodology, development a dedicated neutron beam line is under progress.

References

1. K.Sudarshan, A.G.C.Nair, R.N.Acharya, Y.M.Scindia, A.V.R.Reddy, S.B.Manohar and A.Goswami, Nucl. Instr. Meth. A 457 (2001) 180.
2. G.L. Molnar, Zs. Revay, R.L. Paul and R.M. Lindstrom, J. Radioanal. Nucl. Chem., 234 (1-2) (1998) 21.
3. A.Simonits, F. De Corte and J. Hoste, J. Radioanal. Chem., 31 (1976) 467.
4. F. De Corte, A. Simonits, J. Radioanal. Nucl. Chem., 133(1) (1989) 43.
5. M.A. Lone, R.A. Leavitt and D.A. Harrison, Atomic Data Nucl. Data Tables 26 (1981) 511.
6. P.K.Mukhopadhyay, Proc. Symp. on Intelligent Instrumentation, Feb.6-8, 2001, Bhabha Atomic Research Centre, Mumbai, India, P.307, INIT-2001.
7. X-ray and Gamma-ray Standards for Detector Calibration, IAEA-TECDOC-619, 1991.
8. J.F.A.G. Ruyl and P.M. Endt, Nucl. Phys. A407 (1983) 60.
9. R.N.Acharya, K.Sudarshan, A.G.C.Nair, Y.M.Scindia, A.Goswami, A.V.R.Reddy and S.B.Manohar, J.Radioanal. Nucl. Chem. (Communicated)
10. Y.M.Scindia, A.V.R.Reddy, A.G.C.Nair, A.Goswami, R.N.Acharya, K.Sudarshan and S.B.Manohar, Proc. Nucl. and Radiochem. Symp., Feb. 2001, Univ. Pune, Pune, p.507, NUCAR-2001.
11. J. Kopecky, M.G. Delfini and R.E. Chrien, Nucl. Phys. A 427 (1984) 413.
12. H. Matsue and C. Yonezawa, J. Radioanal. Nucl. Chem., 245 (1) (2000) 189.
13. Zs. Revay, G.L. Molnar, T. Belagya, Zs. Kasztovszky and R.B. Firestone, J. Radioanal. Nucl. Chem., 244(2) (2000) 383.

Table 1. Absolute emission probabilities of gamma-rays from $^{59}\text{Co}(n,\gamma)$

Energy (keV)	Present work		Reported	
	Intensity ^a	Intensity ^b	Kopecky et al. [11]	Lone et al. [5]
158	2.21(16)	2.25(18)	2.438(15) ^c	
230	15.71(35)	15.99(70)	15.18(9)	25.95
254	2.85(25)	2.89(26)	2.75(5)	4.38
277	15.26(39)	15.52(74)	13.96(7)	19.94
391	2.61(13)	2.66(19)	2.29(15)	2.59
435	1.669(86)	1.69(10)	1.56(3)	1.22
447	7.66(11)	7.79(33)	7.00(9)	6.81
461	0.813(37)	0.832(62)	1.073(8)	
497	4.74(24)	4.82(40)	4.46(3)	4.43
556	13.86(16)	14.10(63)	11.97(10)	13.05
710	1.575(73)	1.60(12)	1.435(18)	0.84
717	2.152(65)	2.19(13)	1.792(22)	0.86
785	6.069(45)	6.17(25)	5.33(7)	5.19
901	0.96(14)	0.97(13)	0.948(16)	
928	1.219(84)	1.24(12)	0.906(16)	1.01
945	2.911(26)	2.96(12)	2.04(4)	2.21
1091	1.03(10)	1.05(13)	0.859(20)	
1103	0.66(20)	0.67(22)	0.618(18)	
1215	1.358(83)	1.38(10)	1.2(5)	
1507	1.410(81)	1.433(80)	1.48(4)	
1516	5.173(58)	5.26(23)	5.55(15)	2.93
1774	0.876(15)	0.891(28)	0.93(3)	
1831	4.87(12)	4.95(26)	5.50(19)	6.21
1852	1.152(77)	1.171(83)	1.41(5)	1.31
2032	1.009(38)	1.026(51)	1.19(5)	1.09
3749	1.307(33)	1.330(73)	1.39(5)	1.34
3929	0.983(28)	0.999(24)	0.90(3)	0.80
4885	0.659(75)	0.668(56)	0.712(23)	0.80
4894	0.61(11)	0.62(11)	0.614(21)	
4922	0.63(11)	0.64(12)	0.92(3)	1.01
5182	2.668(49)	2.71(11)	2.67(7)	2.65
5269	1.56(11)	1.58(11)	1.05(3)	1.23
5602	1.27(19)	1.29(19)	1.18(3)	1.17

Table 1. contd

5615	0.817(75)	0.829(55)	1.04(3)	0.99
5639	0.95(20)	0.96(18)	0.96(3)	1.10
5660	7.23(12)	7.35(26)	7.14(15)	7.20
5742	2.45(11)	2.49(14)	2.17(5)	2.10
5926	2.39(36)	2.43(38)	1.81(5)	1.84
5976	7.15(71)	7.28(81)	6.90(14)	6.83
6486	6.56(23)	6.68(46)	6.25(12)	6.42
6705	6.97(21)	7.10(43)	7.54(18)	7.43
6877	8.69(63)	8.85(84)	8.42(18)	8.21
6948	0.88(19)	0.89(17)	0.686(23)	0.73
6985	3.29(22)	3.35(29)	2.76(6)	2.97
7056	1.908(42)	1.942(96)	1.76(4)	1.81
7203	0.99(18)	1.01(16)	0.85(3)	
7215	4.363(74)	4.44(16)	3.70(8)	4.72
7490	3.20(20)	3.26(28)	2.88(7)	2.99

a-Number of neutrons captured is calculated by level summing method(ref.1)

b- Number of neutrons captured is found by activity of ⁶⁰Co, (ref.1)

c - Errors are given in parentheses e.g. 15.71(35) means 15.71 ± 0.35 and 1.211(66) means 1.211 ± 0.066

Table 2. Measured and reported prompt k_0 factors with respect to 1951 keV gamma line of ^{36}Cl

Element	Sample compound	Capturing Isotope	Gamma-ray used (keV)	$k_{0, \text{Cl}}$ Measured	$k_{0, \text{Cl}}$ Reported	
					Ref. 13 [#]	Ref. 12
H	NH_4Cl	^1H	2223	1.86 ± 0.07	1.80 ± 0.016	1.80 ± 0.061
B	$\text{H}_3\text{BO}_3 + \text{NH}_4\text{Cl}$	^{10}B	478	312 ± 22	360 ± 3.4	367 ± 13
K	KCl	^{39}K	770	0.116 ± 0.004	0.127 ± 0.002	0.127 ± 0.0043
Ca	$\text{CaCl}_2 \cdot 2\text{H}_2\text{O}$	^{40}Ca	1942	0.045 ± 0.002	0.0464 ± 0.0014	0.0469 ± 0.0019
Cl	NH_4Cl	^{35}Cl	786+788	$1.30 + 0.026$	NR	$1.33 + 0.045$
Co	$\text{CoCl}_2 \cdot 2\text{H}_2\text{O}$	^{59}Co	230	0.58 ± 0.04	0.66 ± 0.01	NR
			277	0.55 ± 0.04	NR	0.619 ± 0.021
			555	0.456 ± 0.026	$0.275^* \pm .004$	0.516 ± 0.018
			1516	0.186 ± 0.006	NR	NR
			1831	0.191 ± 0.010	NR	NR
			6485	0.185 ± 0.015	NR	NR
			7215	0.156 ± 0.006	NR	NR
Ti	Ti+ NH_4Cl	^{48}Ti	342	0.187 ± 0.006	NR	NR
			1381	0.604 ± 0.013	NR	NR
			1585	0.056 ± 0.003	NR	NR
Cu	Cu+ NH_4Cl	^{63}Cu	278	0.068 ± 0.004	$0.083^* \pm 0.002$	0.0766 ± 0.0027
			385	0.0187 ± 0.0010	NR	0.0174 ± 0.00070
			7306	0.0261 ± 0.0014	NR	NR
Cd	$\text{CdCl}_2 \cdot 2.5\text{H}_2\text{O}$	^{113}Cd	558	41 ± 2	$90.5^* \pm 1.7$	$81^* \pm 2.3$

Table 2. contd.

Ba	BaCl ₂ .2H ₂ O	¹³⁸ Ba	627	0.0106± 0.0003	0.01164± 0.00027	0.0111± 0.00040
		¹³⁵ Ba	819	0.012± 0.002	0.00842± 0.00019	NR
		¹³⁷ Ba	1435	0.011± 0.001	0.01224± 0.00033	NR
Hg	HgCl ₂ + NH ₄ Cl	¹⁹⁹ Hg	368	5.8± 0.3	1.44*±0.059	7.1*± 0.26
			1693	1.37± 0.08	NR	NR
Cr	CrCl ₃ .6H ₂ O	⁵⁰ Cr	749	0.065± 0.008	0.0598± 0.0013	NR
		⁵³ Cr	834	0.138± 0.008	0.0145± 0.0038	0.142± 0.0049
		⁵² Cr	7938	0.0477± 0.0030	0.0445± 0.0012	NR
Gd	Gd ₂ O ₃ + NH ₄ Cl	¹⁵⁷ Gd	1186.7	111±4	109±6.6	NR

NR - not reported. Errors given are 1σ uncertainties on multiple measurements

values converted using k_{0,H} values from ref 13.

* Indicates the cases where difference of k₀ values expressed as absolute value if z-score exceeds 3 with respect to the present work

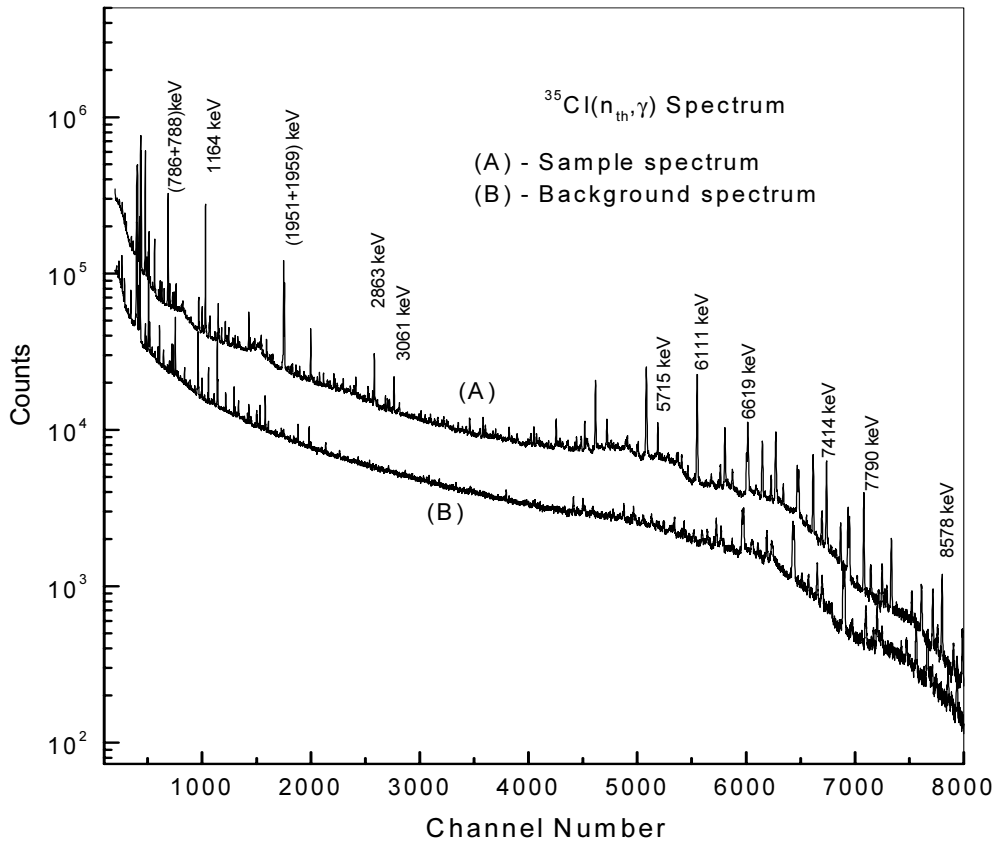

Fig. 1 A Typical Prompt gamma ray spectrum of NH_4Cl

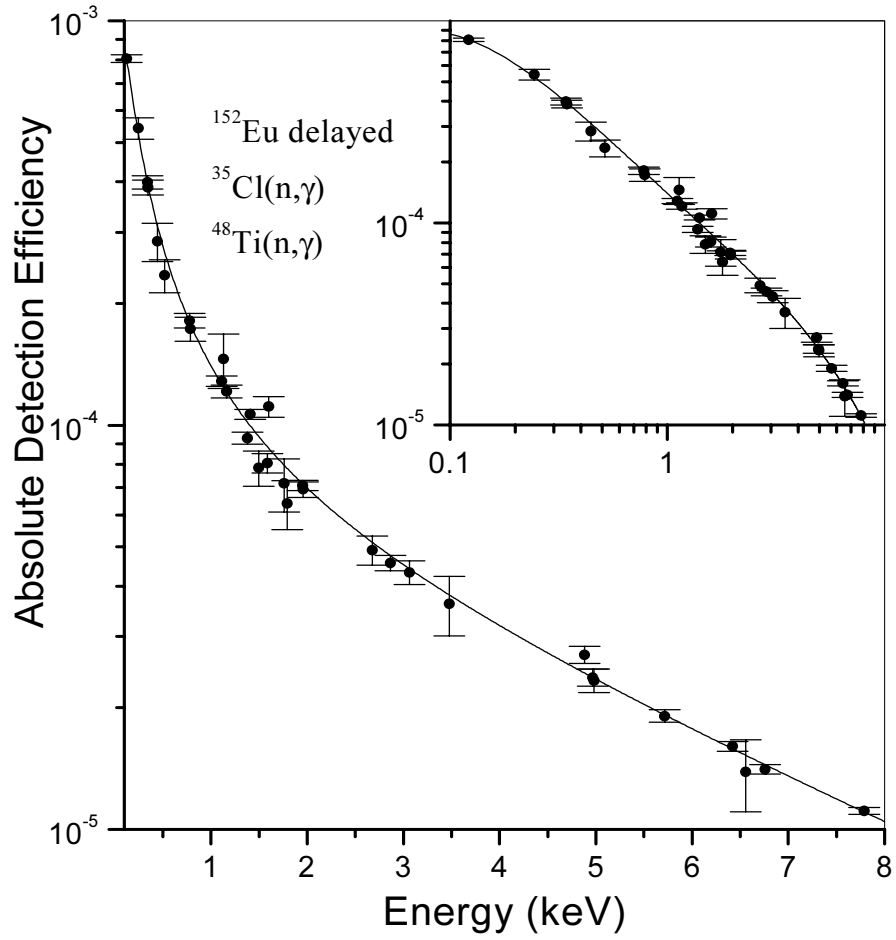

Fig.2 The Absolute photopeak detection efficiency curve (inset shows the log-log plot of energy vs efficiency)

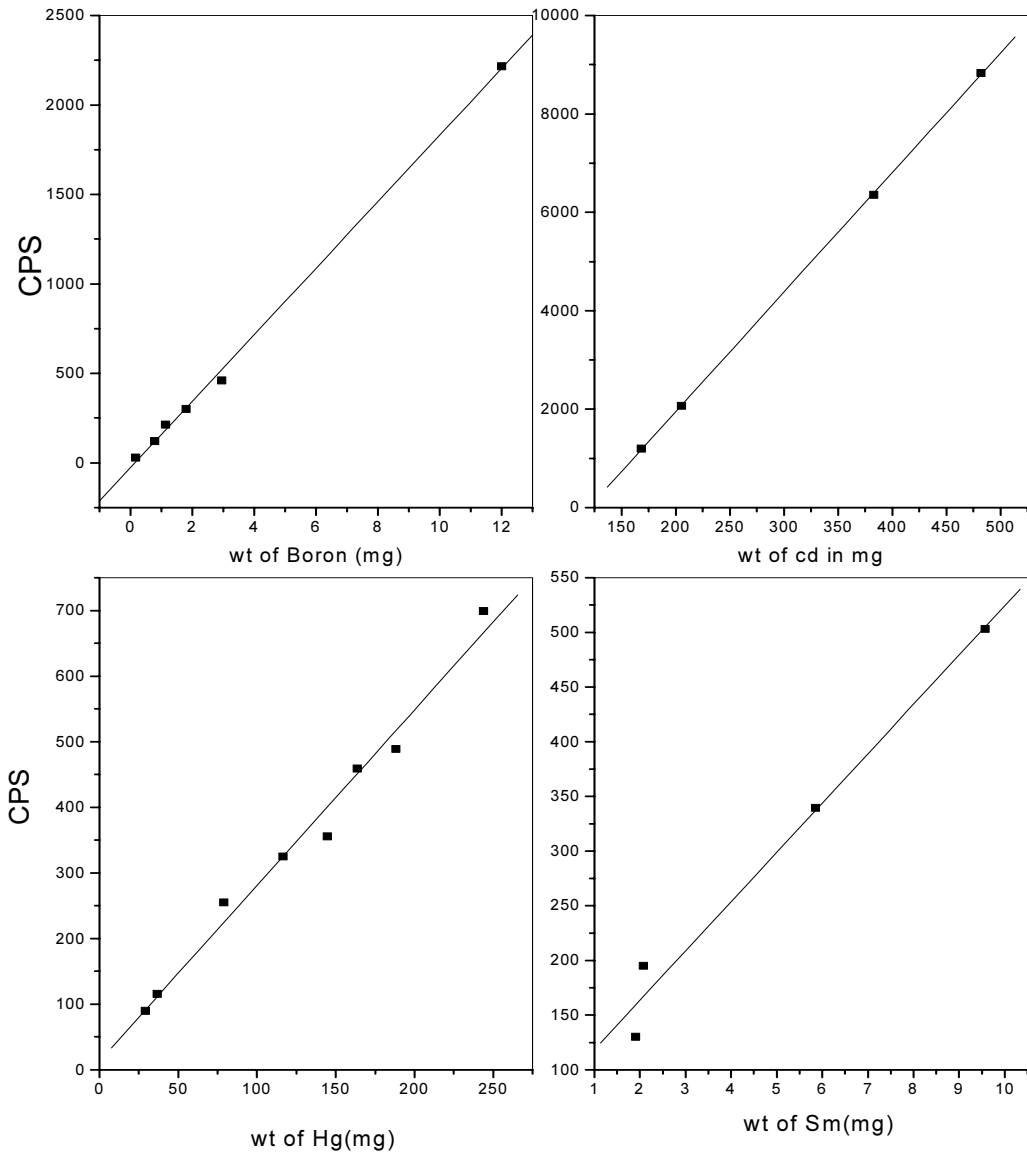

Fig 3. Calibration plots for B,Cd,Hg and Sm

Status of PGAA Database Compilation and Dissemination Tools

Richard B. Firestone

Lawrence Berkeley National Laboratory

Berkeley, CA 94720 USA

rbf@lbl.gov

Introduction

We are continuing the development of a comprehensive PGAA database at the Lawrence Berkeley National Laboratory. Isotopic data from the Evaluated Nuclear Structure Data File (ENSDF) are being combined with elemental data measured at the Budapest Reactor to develop a comprehensive database of gamma-ray energies, cross-section yields, and k_0 factors. The more intense Budapest gamma rays for all elements have now been assigned to their associated isotopes on the basis of comparison with ENSDF. For the elements with atomic numbers $Z=1-20$, the ENSDF and Budapest datasets have been combined to create adopted PGAA gamma-ray datasets. These adopted datasets are typically sufficiently complete to determine the total thermal neutron cross section from the level scheme intensity balance. Software for dissemination of the PGAA data has been developed in collaboration with visiting students from EVITech, Finland.

Methodology

For many years thermal neutron capture gamma-ray data have been evaluated and compiled in the *Nuclear Data Sheets* and the ENSDF file by the international nuclear data community under the auspices of the IAEA Nuclear Structure and Decay Data (NSDD) Working Group. The ENSDF file is organized by isotope and the capture gamma ray intensities are typically normalized per 100 neutron captures. The published capture data for each isotope are supplemented with related results from reaction and decay to give more complete gamma-ray information. We have updated the ENSDF data using the recent compilations of $A=1-35$ (Chunmei Zhou, China) and the literature.

Elemental neutron capture gamma ray data have been measured at the Budapest Reactor guided neutron PGAA facility and were provided by Dr. Molnar. Data for about 79 elements were calibrated for energy using ^{35}Cl internal standards. Gamma-ray production cross sections and k_0 factors were determined with respect to the hydrogen 2223.24835(9) keV gamma ray, $\sigma=0.3326\pm 0.0007$ b assuming 99.9885(70)% isotopic abundance, also using internal standards. The data spanned an energy range of 40 keV to 11 MeV with energies typically accurate to ± 0.08 keV and cross-sections accurate to $<5\%$ for strong transitions.

The computer code NGMATCH was developed to match the Budapest gamma rays to those assigned to isotopes in ENSDF and create an ENSDF format dataset from the Budapest data. This match was based solely on the energy comparison. The ENSDF gamma-ray intensities were renormalized to elemental cross section yields using the

thermal neutron capture cross sections compiled by Mughabghab et al¹ and IUPAC standard isotopic abundances². Energy or cross section discrepancies between the ENSDF and Budapest gamma ray matches were highlighted in the NGMATCH output for further analysis, and the Budapest dataset was manually edited accordingly.

The ENSDF and Budapest datasets were both prepared in standard ENSDF format and all transitions were assigned to a level scheme describing the deexcitation of the neutron capture state to the ground state. Gamma rays that were not placed in ENSDF level scheme were ignored because their elemental assignment was not considered certain. Each dataset was tested for the internal consistency of the energies and intensities (cross section yields). The level energies were calculated by a weighted least-squares fit of the gamma-ray energies to the level scheme with the computer code GAMUT. The input gamma-ray energies were then compared to the level energy differences and values that lie outside of experimental error were noted in the GAMUT output. The transition intensity balance through the level scheme is determined with the computer code BALANCE. Ideally, the intensity deexciting the capture state equals that feeding the ground state, and all intermediate states have equal feeding and deexcitation intensities. Deficiencies in the intensity balance may result from incomplete data, incorrect assignments, and unrecognized interferences. The GAMUT and BALANCE results were used to reanalyze the ENSDF and Budapest datasets to obtain the best possible information from both sources.

Finally, the ENSDF and Budapest datasets were combined into an Adopted PGAA dataset containing the recommended values derived from all sources. This is accomplished using GAMUT in multi-dataset mode. Gamma ray energies from both datasets were simultaneously fit to the level scheme and statistical outliers were noted. Discrepant data can then be edited or removed from the calculation, and, in some cases, the uncertainties of the entire dataset was increased accordingly. The least squares fitted values for the energies were adopted. For intensities (cross section yields) we normalized the ENSDF values to the Budapest scale with GAMUT as follows. A normalization factor N was determined for the ENSDF data such that the weighted sum $\sum(N \cdot \sigma_{\text{ENSDF}} - \sigma_{\text{Budapest}})^2$ for all transitions is minimized. The renormalized ENSDF intensities were then averaged with the Budapest values to obtain the adopted cross section yields. The intensity balance in the Adopted PGAA dataset was then checked with the computer code BALANCE. All of the statistical methods described here are discussed in detail in the introduction to the *Table of Radioactive Isotopes*³.

Results

ENSDF and Budapest datasets have been generated for all elements from $Z=1-82, 90,$ and 92 . For most of the noble gases, Technetium, and Promethium, only ENSDF data were available. The ENSDF database contains about 35,000 gammas of which 14,000

¹ *Neutron Cross Sections*, S.F. Mughabghab, M. Divadeenam, and N.E. Holden (Academic Press, 1981).

² *Isotopic Compositions of the Elements 1997*, K.J.R. Rosman and P.D.P. Taylor, Pure and Appl. Chem. **70**, 217(1998).

³ *Table of Radioactive Isotopes*, R.B. Firestone, E. Browne, and V.S. Shirley (John Wiley & Sons, 1986).

were observed at Budapest. This difference is not surprising because ENSDF includes data from separated isotope (n, γ) experiments, gammas known from other experiments, and many weak transitions that could not be resolved at Budapest. The ENSDF and Budapest data have been combined into Adopted PGAA datasets for Z=1-20. These datasets and the associated information about the energy fits and intensity balances will be made available to members of the CRP on the Internet but will not be generally released until the end of the CRP. Summary tables were generated for each element comparing the Adopted PGAA data, Budapest data, and the data compiled by Lone et al in 1981⁴. Sample summary table for ⁹Be and ^{12,13}C are shown in Table 1.

The level schemes for nearly all of the elements from Z=1-20 were very well determined and could be used to derive thermal neutron cross sections for comparison with the Mughabghab et al values. These results are summarized in Table 2. Neutron separation energies were also determined and are compared with those of Audi et al⁵ in Table 2. Significant cross section discrepancies have been observed for ⁶Li, ¹²C, ³³S, ³⁴S, ⁴⁰K, and ⁴⁴Ca that will require further scrutiny. The neutron separation energies agree with those of Audi et al, but are generally more precise.

Dissemination

Two databases have been developed for the PGAA CRP. The gamma-ray database contains A, element name, E(keV), dE(keV), σ_γ , $d\sigma_\gamma$, I_γ (relative), k_0 , dk_0 , $t_{1/2}$ (level), $dt_{1/2}$, and a flag indicating whether the gamma is prompt or delayed. The isotope/element database contains A, Z, element name, atomic weight, σ_0 (element), isotopic abundance, σ_χ (isotope), Westcott g-factor, and continuum component. The g-factors and continuum components are not available at this time. These databases will be made available as tab-delimited database files and text tables. The data will also be available on the Internet through the WWW Table of PGAA Gamma Rays that can be searched by gamma-ray energy and/or element, and by a similar Java-based version for standalone use. Sample search windows from the WWW version are shown in Figure 1. We are indebted to Jyri Ranki and Samuli Ruuskanen from EVITech, Finland, for their help in developing these applications.

Conclusion

The development of a Database for Prompt Gamma-ray Activation Analysis is on schedule for completion at the end of the CRP. Participants are encouraged to review the data on the Internet as it becomes available and provide their comments. Dissemination tools are now available and should be refined to meet the needs of varied users. Cross section discrepancies and the adoption of Westcott g-factors need to be discussed by the CRP.

⁴ *Prompt gamma Rays from Thermal Neutron Capture*, M.A. Lone, R.A. Leavitt, and D.A. Harrison, At. Nucl. Data Tables **26**, 511 (1981).

⁵ *The 1995 Update to the Atomic Mass Evaluation*, G. Audi and A.H. Wapstra, Nucl. Phys. **A595**, 409 (1995).

Table I.

Be: Comparison of Adopted, Budapest, and Lone Capture Gamma Data
⁹Be Abundance=100 Sigma(BNL-325)=0.0076(8)

A	Energies(keV)			Elemental Cross Section		Gamma Yield per 100 Neutron Captures		
	Adopted Data	Budapest	Lone	Adopted Data	Budapest	Adopted Data	Budapest	Lone
9	219.40(10)	219.39(10)	219.3(2)	4.5E-06(6)	4.7E-06(8)	0.059(8)	0.062(11)	0.05
9	547.55(4)	547.58(4)	547.41(15)	1.09E-05(10)	1.02E-05(10)	0.143(13)	0.134(13)	0.16
9	631.92(4)	631.92(4)	631.83(15)	1.8E-05(4)	1.12E-05(11)	0.24(5)	0.147(14)	0.24
9	853.630(12)	853.631(11)	853.530(3)	0.00208(24)	0.00165(15)	27(3)	21.7(20)	25.96
9	2590.014(19)	2590.014(25)	2590.150(13)	0.00191(15)	0.00188(17)	25.1(20)	24.7(22)	23.28
9	2811.68(5)	2811.66(16)	2811.8(3)	1.05E-05(12)	1.04E-05(14)	0.138(16)	0.137(18)	0.13
9	2896.02(4)	2896.17(11)	2896.4(3)	1.16E-05(13)	1.13E-05(14)	0.153(17)	0.149(18)	0.15
9	3367.448(25)	3367.48(4)	3367.61(6)	0.00285(22)	0.0029(3)	38(3)	38(4)	33.71
9	3443.406(20)	3443.42(4)	3443.51(9)	0.00098(7)	0.00099(9)	12.9(9)	13.0(12)	11.59
9	5956.53(3)	5956.60(9)	5956.73(21)	1.46E-04(12)	1.46E-04(13)	1.92(16)	1.92(17)	1.75
9	5958.85(12)			4.5E-06(5)		0.059(6)		
9	6809.61(3)	6809.58(10)	6809.41(9)	0.0058(5)	0.0062(6)	76(7)	82(8)	63.75

C : Comparison of Adopted, Budapest, and Lone Capture Gamma Data
¹²C Abundance=98.93(8) Sigma(BNL-325)=0.00353(7)
¹³C Abundance=1.07(8) Sigma(BNL-325)=0.00137(4)

A	Energies(keV)			Elemental Cross Section		Gamma Yield per 100 Neutron Captures		
	Adopted Data	Budapest	Lone	Adopted Data	Budapest	Adopted Data	Budapest	Lone
13	495.60(18)	495.4(3)		1.04E-06(23)	1.04E-06(6)	0.030(7)	0.0297(17)	
12	595.015(9)	595.16(9)		9.5E-06(4)	1.08E-05(10)	0.271(11)	0.31(3)	
13	808.85(15)	808.9(2)		4.7E-07(11)	4.7E-07(5)	0.013(3)	0.0134(14)	
12	1261.765(9)	1261.71(6)	1261.74(6)	0.00124(3)	0.00123(3)	35.4(9)	35.1(9)	29.53
13	1273.77(14)	1273.9(2)		6.4E-07(19)	6.4E-07(13)	0.018(5)	0.018(4)	
13	1586.99(16)	1586.8(2)		1.10E-06(25)	1.10E-06(7)	0.031(7)	0.0314(20)	
12	1856.717(9)	1856.98(22)		6.2E-06(4)	7.6E-06(16)	0.177(11)	0.22(5)	
13	2082.54(13)	2082.6(3)		3.2E-07(6)	3.2E-07(7)	0.0091(17)	0.0091(20)	
12	3089.057(9)	3088.80(21)		1.65E-05(8)	1.47E-05(22)	0.471(23)	0.42(6)	
12	3683.920(9)	3684.02(7)	3683.930(4)	0.00122(3)	0.00117(4)	34.8(9)	33.4(11)	32.10
12	4945.301(3)	4945.30(7)	4945.33(1)	0.00261(5)	0.00270(8)	74.4(14)	77.0(23)	67.64
13	6092.44(16)	6092.4(2)		2.1E-06(5)	2.12E-06(11)	0.060(14)	0.060(3)	
13	6589.4(2)							
13	8174.01(17)	8174.2(4)		1.09E-05(24)	1.09E-05(24)	0.31(7)	0.31(7)	

Table 2. Comparison of Audi et al neutron separation energies and Mughabghab et al thermal cross section with current results (2001) for Z=1-20.

Isotope	Abundance	Sn(Audi)	Sn(2001)	$\sigma(1981)$	$\sigma(2001)$
1H	99.9885(70)	2224.586(1)		332.6 mb 7	332.6 mb
2H	0.0115(70)	6257.2482(24)		0.519 mb 7	0.492 mb 25
3He	0.000137(3)	20577.62		0.031 mb 9	
4He	99.999863(3)				
6Li	7.59(4)	7249.96(9)	7249.94(4)	39 mb 3	53 mb 2
7Li	92.41(4)	2033.8(3)	2032.30(4)	45 mb 3	45.7 mb 9
9Be	100	6812.33(6)	6812.10(3)	7.6 mb 8	8.8 mb 6
10B	19.9(7)	11454.12(20)	11454.15(14)	500 mb 200	303 mb 20
10B(n, α)				712.5 b 17	712.5 b
11B	80.1(7)	3370.4(14)		6 mb 3	
12C	98.93(8)	4946.310(10)	4946.311(3)	3.53 mb 7	3.89 mb 6
13C	1.07(8)	8176.440(10)	8176.57(17)	1.37 mb 4	1.22 mb 23
14N	99.632(7)	10833.230(10)	10833.317(12)	75 mb 8	78.8 mb 9
15N	0.368(7)	2490.8(23)		24 mb 8	
16O	99.757(16)	4143.33(21)	4143.06(10)	0.190 mb 19	0.189 mb 9
17O	0.038(1)	8044.4(8)		0.54 mb 7	
18O	0.205(14)	3957(3)		0.16 mb 1	
19F	100	6601.31(5)	6601.344(16)	9.6 mb 5	9.47 mb 16
20Ne	90.48(3)	6761.11(4)	6761.19(5)	37 mb 4	
21Ne	0.27(1)			670 mb 110	
22Ne	9.25(3)	5200.62(12)	5200.63(9)	45 mb 6	
23Na	100	6959.44(5)	6959.589(15)	530 mb 5	519 mb 12
24Mg	78.99(4)	7330.67(4)	7330.53(4)	51 mb 5	53.8 mb 14
25Mg	10.00(1)	11093.09(4)	11093.156(21)	190 mb 30	197 mb 5
26Mg	11.01(3)	6443.35(4)	6443.35(3)	38.2 mb 8	37.7 mb 13
27Al	100	7725.05(6)	7725.169(5)	232 mb 3	223.0 mb 23
28Si	92.2297(7)	8473.56(3)	8473.537(23)	177 mb 5	186 mb 3
29Si	4.6832(5)	10609.18(3)	10609.24(3)	101 mb 14	119 mb 4
30Si	3.0872(5)	6587.40(5)	6587.39(3)	107.0 mb 20	116 mb 3
31P	100	7935.65(4)	7935.595(23)	172 mb 6	167 mb 5
32S	94.93(31)	8641.58(3)	8641.809(25)	530 mb 40	536 mb 8
33S	0.76(2)	11416.94(5)	11417.219(16)	350 mb 40	461 mb 15
34S	4.29(28)	6985.84(4)	6986.091(15)	227 mb 5	279 mb 7
36S	0.02(1)	4303.58(9)	4303.608(25)	150 mb 30	170 mb 85
35Cl	75.78(4)	8579.70(7)	8579.662(9)	43.6 b 4	43 b 3
37Cl	24.22(4)	6107.78(10)	6107.73(9)	433 mb 6	407 mb 17
39K	93.2581(44)	7799.50(8)	7799.55814	2100 mb 200	2230 mb 160
40K	0.0117(1)	10095.18(10)	10095.255(16)	30 b 8	351 b 60
41K	6.7302(44)	7533.77(15)	7533.822(10)	1460 mb 30	1620 mb 70
40Ca	96.941(6)	8363.7(3)	8362.86(5)	410 mb 20	415 mb 7
42Ca	0.647(23)	7933.0(3)	7932.65(15)	680 mb 70	740 mb 40
43Ca	0.135(10)	11132.0(7)	11131.45(14)	6.2 b 6	7.3 b 5
44Ca	2.09(11)	7414.8(3)	7414.79(15)	880 mb 50	1053 mb 25
46Ca	0.004(3)	7276.1(5)	7276.1(3)	740 mb 70	
48Ca	0.187(21)	5146.6(4)	5146.48(21)	1.09 b 14	1.05 b 12

Figure 1. Sample searches with the WWW Table of PGAA Gamma Rays a) element search, b) search for gamma rays with $E=1000\pm 1$ keV. The arrows are for sorting.



WWW Table of PGAA Gamma Rays

a)

Magnesium (Mg)

Atomic Weight: 24.3050 6

Elemental Cross Section: 0.063 5 b

Isotope	Z	N	Abundance (%)	Cross Section	Westcott g-factor
²⁴Mg	12	12	78.99 3	0.051 5 b	1
²⁵Mg	12	13	10.00 1	0.19 3 b	1
²⁶Mg	12	14	11.01 2	0.0382 8 b	1

[Main page](#) | [Element search](#) | [Gamma search](#)



WWW Table of PGAA Gamma Rays

b)

Gamma energy search

E between 999 and 1001 keV

E (keV) ↑ ↓	σ (d σ) ↑ ↓	k_0 ↑ ↓	g	Prompt/Decay	Isotope
999.26 15	0.40 10 b	1.2 3	1	25.0 M	¹³¹Te
999.5 3	0.0017 7 b	0.0051 21	1	Prompt	¹²⁸Te
999.5 3	1.9 8 b	5.7 24	1	12.44 M	¹⁵¹Nd
999.54 22	3.1 6 b	9.3 18	1	Prompt	¹¹³Cd
999.6 5	0.0055 24 b	0.017 7	1	Prompt	⁷⁶Se
999.78 3	0.0581 19 b	0.174 6	1	Prompt	⁷³Ge
999.78 4	0.99 6 b	2.97 18	1	Prompt	¹⁶⁷Er
999.86 6	0.00044 4 b	0.00132 12	1	14.10 H	⁷²Ga
1000.12 19	0.149 22 b	0.45 7	1	Prompt	¹⁷⁵Lu
1000.8 3	0.00058 13 b	0.0017 4	1	Prompt	¹¹⁵Sn
1000.80 14	0.23 4 b	0.69 12	1	Prompt	¹⁶⁹Tm

[Main page](#) | [Gamma search](#) | [Element search](#)

2nd Research Co-ordination Meeting on
Development of a Database for Prompt Gamma-ray Neutron Activation Analysis
IAEA Headquarters, Vienna, Austria
14-17 May 2001

Characterisation of neutron beam and gamma spectrometer for PGAA

Zs. Révay and G. L. Molnár
*Chemical Research Centre, Institute of Isotope and Surface Chemistry
H-1525 Budapest, Hungary*

Abstract: In the second project year great efforts have been devoted at Budapest to the development of methods and procedures for neutron beam characterisation and spectrometer calibration. These are described here to provide recipes for other laboratories. Some illustrative results obtained on the former thermal guide, and partly on the new cold neutron guide are also given. Preliminary result from the benchmark experiments on flux monitors, titanium standard and an unknown sample are also reported. New k_0 factors for elements of highest priority will be measured on the cold beam only in the near future.

1. Introduction

The Budapest Research Reactor has recently undergone a major upgrading. A liquid hydrogen cold neutron source was commissioned in February 2001, and most of the old neutron guides [1] were replaced with supermirror guides subsequently. As a consequence, the neutron flux has increased up to 50 times on the guided beams. Thermal equivalent flux values of $10^8 \text{ cm}^{-2}\text{s}^{-1}$ and higher have been measured at the various experimental positions, depending on the distance from the cold source.

The Prompt Gamma Activation Analysis facility, located on one of the new cold guides, has been extended in capacity and capability. A second target station has been created by introducing two collimator slits in the vertical plane and redesigning the beam port/target chamber assembly. A beam chopper has been added to allow for delayed NAA measurements in parallel with PGAA. The first test experiments were performed during the two 10-day reactor cycles in April-May.

Here we describe the procedures developed at Budapest for neutron beam characterisation and spectrometer calibration. While most of the work has been done on

the former thermal guide, some data are already available for the new cold guide as well. Finally, preliminary results from the benchmark experiments on flux monitors, titanium standard and an unknown sample (all prepared at NIST by R. M. Lindstrom) will be reported. New k_0 factors for elements of highest priority will be measured on the cold beam in the near future.

2. Neutron beam characterisation

The main advantage of using curved neutron guides is that they provide pure subthermal beams, while the epithermal and the fast neutrons, generated in the reactor core, are filtered out. This technique, however, has some disadvantages. Due to the curvature of the guide and the wavelength dependence of the reflectivity, the profile of the transmitted beam is typically inhomogeneous along the cross section of the guide, and the neutron spectrum also becomes different from the original, closely Maxwellian, distribution. For accurate prompt gamma-ray measurements the neutron beam must be well characterized.

Flux profiles are the first important aspect of a neutron beam. In the case of a guide built from rectangular elements, these profiles show horizontal and vertical symmetries. The vertical profile is typically uniform but may be diffuse due to the beam divergence. The horizontal profile of curved guides – especially thermal guides – is typically inhomogeneous, and may show some intense bands due to reflections in the last few guide elements. It is important to know these characteristics from the points of view of maximal reaction rate and reproducibility. The shape of the sample may also be important in inhomogeneous beams, only rectangular shaped samples will average the flux inhomogeneities.

Flux profiles can be determined by the irradiation of an X-ray film, or by a simple activity measurement at different positions using a small piece of cadmium, or any other material with high neutron capture cross section. The profiles can also be estimated using analytical approximations [3] or by Monte Carlo simulation.

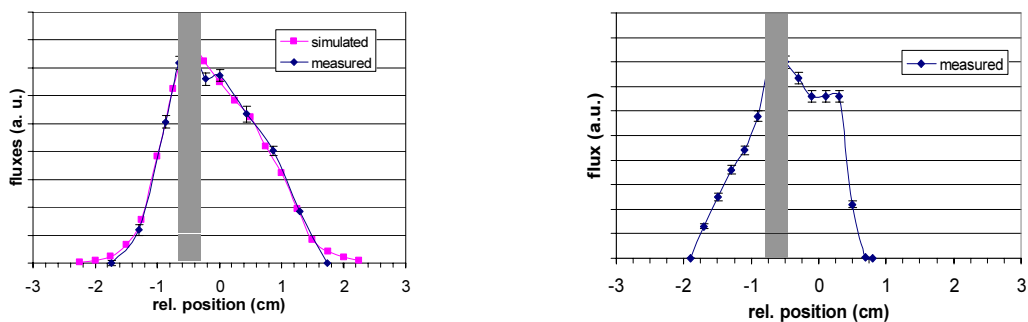

Figure 1. Flux profiles of the former thermal (left) and the new cold beam (right) at Budapest, compared to a simulated profile function. The marked areas are possible reflection bands.

The average neutron fluxes at different locations also provide important information for the users of the neutron guides. Typically, gold foils are irradiated to obtain these data. Gold has a relatively high neutron capture cross section (98 barns for 2200 m/s velocity neutrons) and it follows the $1/v$ -law in the thermal and subthermal energy ranges. Hence, gold is a proper material to measure the thermal equivalent neutron flux in the beam. Gold also has a considerably high resonance integral (1550 barn), mainly due to a resonance at about 5 eV. Applying a cadmium cover (which absorbs neutrons with energies lower than 0.3 eV), the epithermal flux, which is typically of much lower intensity, can also be detected with high sensitivity. Flux measurements along a neutron guide can also uncover alignment problems [4].

The measured gamma intensities of nuclides not following the $1/v$ -law, deviate from those of the regular ones, therefore the neutron spectrum of the beam must also be taken into account. The most accurate measurement of the neutron spectrum is the time-of-flight analysis of a pulsed beam, but this technique requires special instrumentation, typically not available in a PGAA laboratory.

However, some important characteristics of the neutron spectrum can also be determined in a usual in-beam irradiation experiment. From the ratio of thermal equivalent and real neutron fluxes the average wavelength (the first momentum of the wavelength distribution), or the equivalent temperature of the beam can be determined. These characteristics can be obtained in several ways. All of them are based on the combination of measurements on nearly transparent and totally neutron absorbing samples. For instance, R. M. Lindstrom has suggested subsequent measurements with a thin and thick boron target. Table 1 shows effective temperatures measured at different beams using a combination of titanium foil (transparent) and a piece of cadmium (black). The advantage of this latter method is that the 341-keV peak of Ti and the 558-keV peak of Cd is measured simultaneously, hence flux instability and dead-time effects cancel.

Table 1. Effective temperatures at different facilities as measured by a method based on the irradiation of transparent and absorbing material.

Facility	Effective temperature
NIST thermal beam	350 K
NIST guided cold beam	20 K
Budapest guided thermal beam	100 K
Budapest guided cold beam	~ 60 K

Further characteristics of the neutron spectrum can be deduced from the irradiation of irregular nuclides, not following the $1/v$ -law. Nuclides like ^{149}Sm , ^{113}Cd or ^{167}Er have strong low-energy resonances, which are excited with different probabilities depending on the neutron spectrum. In thermal spectra this effect is usually characterised by the Westcott g factor. The specific activities of these nuclides become different in neutron beams having different spectral distributions. Hence, the specific activities of all other irregular nuclides can be calculated if prior calibration measurements on the mentioned nuclides have been performed on that particular beam. The discrepancy from the $1/v$ -behaviour for these nuclides can be seen in Figure 2. The low-wavelength region of the neutron spectrum, which is mainly affected by the source temperature and the curvature of the guide, overlaps with some low-energy resonances.

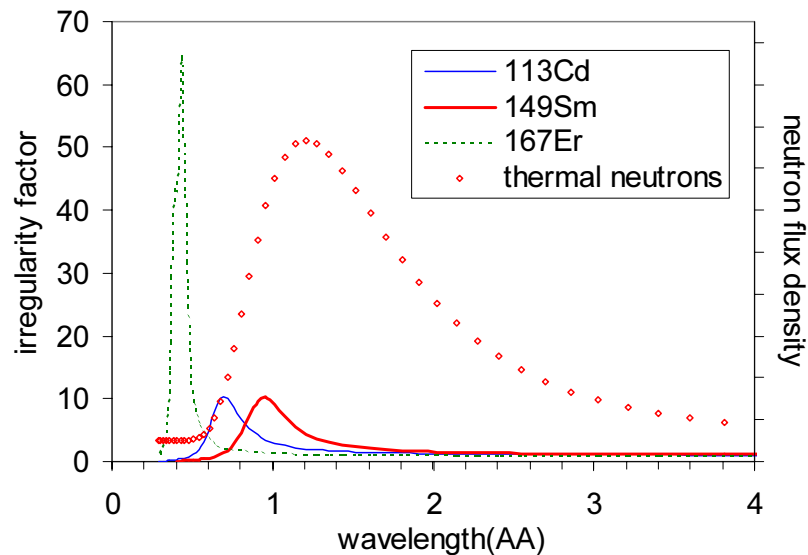

Figure 2. The irregularity factor (the discrepancy from the $1/v$ -law) of some nuclides as a function of wavelength compared to the thermal neutron spectrum.

3. Spectrometer calibration

The γ -ray spectrometer is the heart of the PGAA set-up. At Budapest, a Compton-suppressed system, consisting of a medium size, n-type HPGe semiconductor detector and a nose-cone shaped BGO scintillator annulus has been used since 1995 [2,5]. The HPGe+BGO assembly, surrounded by a 10-cm thick lead shielding, can be put at 20-25 cm from the sample, a safe distance to avoid coincidence summing and prohibitively high count rates. Only ^6Li (in the form of fluoride-loaded plastic) is used for neutron shielding in the vicinity of the detector that, unlike boron and cadmium, does not produce a

detectable amount of background γ rays. Fast neutrons are produced on the lithium, however, hence an optimal amount has to be used to reduce the size of Ge “triangles”, peaking at 596 keV and 693 keV in the γ -ray spectrum.

Compton suppression guarantees a high peak-to-background ratio and eliminates (or at least reduces) escape peaks. One should be careful, however, about the cusp-like Compton edges, produced by scattered γ rays escaping in the backward direction through the collimator opening. They make sometimes peak fitting difficult. Another concern is the energy resolution. An FWHM of about 2 keV or better for 1332 keV is recommended, due to the frequent occurrence of multiplets in the prompt spectra. For the same reason, and also due to the wide energy range, a conversion gain of 16k is recommended. A high quality, automatic peak-fitting algorithm is also mandatory. The famous HYPERMET code [6] or its PC version [7] have been found suitable.

Due to the high energies involved, energy and efficiency calibrations have to be performed by utilising the capture γ rays themselves. At the lowest energies, one can use radioactive standards, such as ^{133}Ba and ^{152}Eu [8] in addition. There is a very limited amount of sufficiently accurate capture data in general, and the earlier recommendations have been sparse and partly erroneous [8]. Therefore, we have collected in Table 2 the data sets found most suitable by us.

For energy calibration, the best choice is the $^{35}\text{Cl}(n,\gamma)$ data measured at ILL Grenoble with a crystal spectrometer [9] because they are much more precise than any Ge data, and because they cover essentially the entire range of interest. Moreover, for most strong lines the intensities have been measured recently [10] with high precision with respect to the $^{14}\text{N}(n,\gamma)$ capture lines, the only primary standard for high energies [8,11]. Although the nitrogen data by Kennett et al. [11] constitute the latest available recommendation for intensity standards [8], we suggest the more recent (essentially identical) data by Journey et al. [12] for use. The arguments are higher accuracy at the lowest energies and more realistic uncertainty estimates than those of Ref. [11]. The old data of Ref. [13] should not be used at all. They are systematically low at high energies, and their precision is also low. We do not recommend, however, the use of nitrogen energies for calibration, as they are not consistent with the chlorine data of Ref. [9]. Nor recommend we the $^{35}\text{Cl}(n,\gamma)$ data by Spits and Kopecky [14], included in the old IAEA recommendation [8], because they are based on uncertain standards and differ largely from the more recent data for both energy and intensity.

Unambiguous identification of peaks in the prompt γ -ray spectra is possible only if non-linearity of the spectrometer is accounted for. Instead of performing a non-linear energy calibration each time, it is much simpler to measure the non-linearity separately with a suitable source, e.g. $^{35}\text{Cl}(n,\gamma)$, and use a linear energy calibration once the correction is performed. The method is described elsewhere [15]. Since the non-linearity is changing with time, it has to be remeasured periodically, at least once a year.

Analytical accuracy depends greatly on the way efficiency calibration is performed. Beside accurate calibration standards, a suitable model function is also needed to describe

the complex shape of an efficiency curve obtained by measuring data points throughout the energy range of interest, typically between 50 keV – 10 MeV. We have shown that a linear fit to a polynomial on a log-log scale is the simplest, most reliable and accurate approach if there are sufficient points to cover the range more or less uniformly [16]. This is possible only, if several data sets are combined with proper normalisation. If the normalising constants are also varied during the fit, a single polynomial of sufficiently high order ($n=7$ or 8) will fit the whole energy range. Moreover, at least one calibrated source (e.g. ^{152}Eu) fixes the scale, hence an absolute efficiency can be obtained.

Figure 2 provides an example for our efficiency curves. The relative standard uncertainty (not including that of the ^{152}Eu standard's activity) is less than 1% for the whole range, and it is as low as 0.3% in the middle of the energy range. The value of 0.3% seems to be the limit of accuracy, as efficiency curves measured annually differ by as much an amount on the average. This efficiency curve looks very similar to the one published recently by Raman et al. [17] for the JAERI system. Our higher precision is presumably due to the fact that the whole range is fitted at once, instead of subdividing it into low, medium and high-energy parts. It is also worth noting that the escape efficiency is reduced by factors of 10 for single escape (SE) and 100 for double escape (DE) peaks, respectively, by the Compton suppression system.

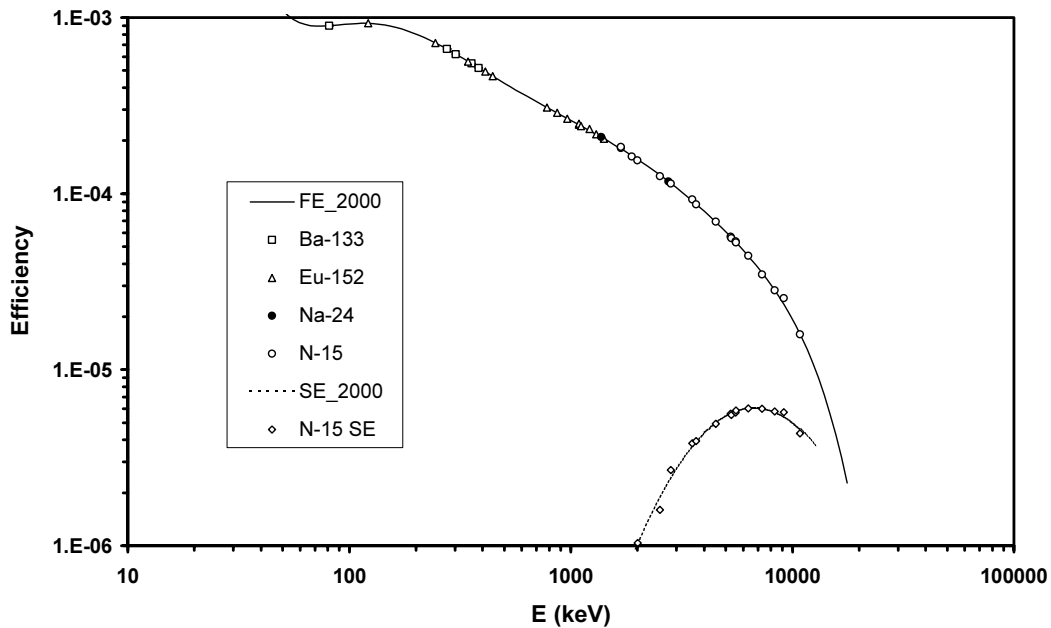

Figure 2. Absolute full energy (FE) and single escape (SE) peak efficiencies of the Budapest gamma-ray spectrometer in Compton suppression mode

Table 2. Energy and intensity standards for PGAA. Absolute intensities per 100 captures are shown.

$^{35}\text{Cl}(n,\gamma)$ Ref. [10]				$^{14}\text{N}(n,\gamma)$ Ref. [12]		
E_γ (keV)	dE_γ (keV)	I_γ	dI_γ	E_γ (keV)	I_γ	dI_γ
292.178	0.004			1678.3	7.96	0.09
436.222	0.002			1884.8	18.77	0.20
517.073	0.023	24.3	1.4	1999.7	4.11	0.05
632.438	0.002			2520.4	5.58	0.09
786.302	0.039	10.5	0.4	2830.8	1.71	0.04
788.428	0.044	16.3	0.4	3532.0	8.94	0.11
936.921	0.005			3677.7	14.52	0.16
1131.247	0.005	1.91	0.06	4508.7	16.71	0.17
1164.865	0.051	27.2	0.7	5269.2	29.86	0.30
1327.418	0.010			5297.8	21.23	0.22
1601.082	0.007	3.48	0.09	5533.4	19.58	0.21
1951.141	0.014	19.4	0.6	5562.1	10.58	0.12
1959.356	0.084	12.6	0.3	6322.4	18.23	0.22
2034.634	0.016			7299.0	9.39	0.12
2676.300	0.020	1.57	0.04	8310.2	4.12	0.09
2845.498	0.012			9149.0	1.63	0.07
2863.815	0.016	5.77	0.11	10829.1	14.30	0.60
3015.985	0.019					
3061.865	0.022	3.52	0.07			
3116.216	0.043					
3428.863	0.029					
3981.064	0.046					
4082.664	0.042					
4440.399	0.023	1.047	0.023			
4979.713	0.025	3.6	0.1			
5517.202	0.026	1.69	0.04			
5715.187	0.026	5.31	0.15			
5902.700	0.027	1.10	0.03			
6110.848	0.038	20.6	0.7			
6619.638	0.044	7.83	0.16			
6627.751	0.059	4.69	0.11			
6977.847	0.047	2.29	0.06			
7413.953	0.065	10.52	0.24			
7790.325	0.064	8.31	0.19			
8578.590	0.110	2.74	0.06			

4. Benchmark experiments

Titanium has been used by many laboratories for in-beam flux measurements or an efficiency standard. Therefore, it was selected for the benchmark test on γ -ray spectroscopy at the first co-ordination meeting. On the thermal guide, a natural Ti metal foil of 0.4-mm thickness was measured last year. Energies were determined in the way described above. After non-linearity correction, a linear energy calibration was performed using the values of 341.689 ± 0.029 keV and 6760.011 ± 0.038 keV, determined with respect to the 292 keV -517 keV and 6627 keV – 6977 keV pairs of ^{36}Cl in a separate experiment with a mixed target. The efficiency function of Figure 2 was used to deduce the relative intensities. The results are summarised in Table 3 for the strong lines, having at least a few percent precision on intensity.

The Ti experiment has been repeated on the new cold guide, using the 0.25-mm thick samples of 6 and 13-mm diameter, provided by NIST. Unfortunately, there was not enough beamtime to collect sufficient statistics to get a similar precision. With this limitation, however, the earlier thermal data have been reproduced with both samples. The new intensities (unweighted averages) are compared with those from Ref. [18] in Figure 3, where the 1382-keV line has been used for normalisation. It is clear that the efficiency calibrations at low and high energies are not consistent in that work. On the other hand, the much more precise chlorine data from Ref. [10] are reproduced nicely [19], as shown in the lower part of Figure 3, giving confidence to our Ti data.

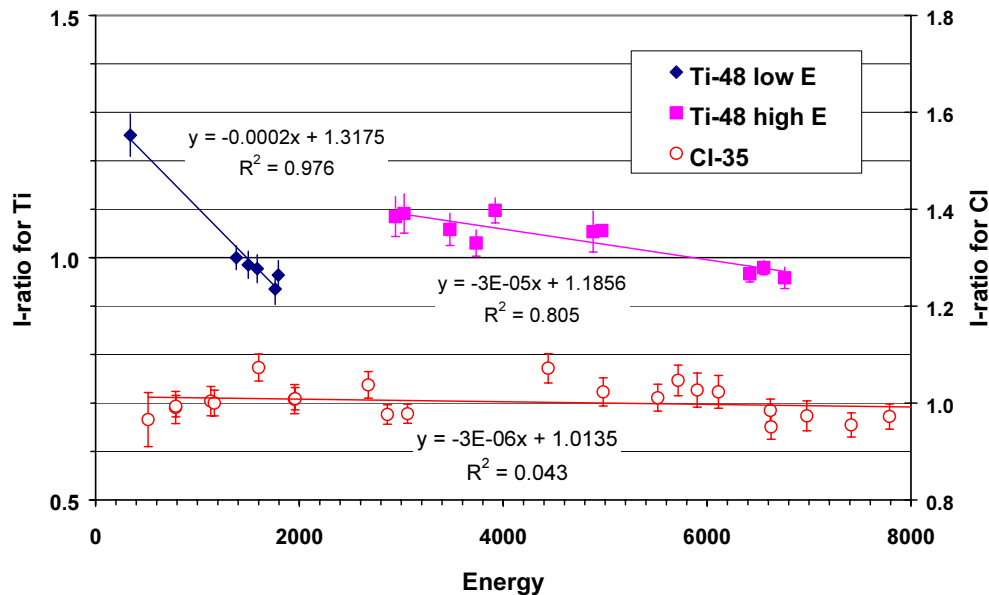

Figure 3. Comparison of capture γ -ray intensities for strong lines in Ti and Cl. Ratios of present to literature values are plotted against energy.

Table 3. Prompt γ ray results for natural Ti, obtained on the Budapest thermal guide

E_γ (keV)	dE_γ (keV)	I_γ (rel.)	dI_γ (rel.)	dI_γ/I_γ (%)	Target nuclide
137.48	0.03	1.222	0.012	1.0	^{48}Ti
341.69 ^a	0.03	37.57	0.23	0.6	^{48}Ti
983.46	0.03	2.273	0.019	0.8	^{47}Ti
1121.02	0.06	1.2	0.05	4.2	^{49}Ti
1381.68	0.03	100.0 ^b	0.5	0.5	^{48}Ti
1498.59	0.03	5.69	0.04	0.7	^{48}Ti
1585.93	0.03	11.67	0.08	0.7	^{48}Ti
1761.93	0.03	5.95	0.04	0.7	^{48}Ti
1793.46	0.06	2.9	0.03	1.0	^{48}Ti
2839.87	0.09	0.817	0.021	2.6	^{48}Ti
2943.11	0.05	1.216	0.022	1.8	^{48}Ti
3026.73	0.05	2.67	0.04	1.5	^{48}Ti
3475.59	0.06	1.94	0.03	1.5	^{48}Ti
3733.71	0.06	1.59	0.04	2.5	^{48}Ti
3920.41	0.09	1.6	0.04	2.5	^{48}Ti
4881.26	0.05	5.56	0.06	1.1	^{48}Ti
4966.70	0.05	3.61	0.05	1.4	^{48}Ti
6418.31	0.05	34.1	0.4	1.2	^{48}Ti
6555.76	0.06	5.7	0.1	1.8	^{48}Ti
6760.01 ^a	0.06	51.4	0.6	1.2	^{48}Ti

^a) Values used for energy calibration after non-linearity correction

^b) Reference line for intensity normalisation

Another benchmark experiment has been made on an unknown sample, a 2-g quantity of a mixture of a complex aluminosilicate and graphite. Concentrations have been inferred by normalising to the observed total mass. The oxygen content has been calculated assuming the usual stoichiometry.

Table 4. Composition of the unknown sample, determined on the cold beam

Element	Mass mg	El./El. conc. wt%	El./Oxide conc. wt%	Rel. st. unc. %
H	0.69	0.1	0.065	5
B	0.053	0.0074	0.005	1.2
C	330	46	31	13
Al	131	18.4	12.4	2.5
Si	165	23.2	15.6	3
K	15	2.1	1.45	6
Ca	11	1.6	1.1	9
Fe	61	8.48	5.72	1.6
Sm	0.0093	0.0013	0.00088	2.1
Gd	0.012	0.0017	0.00116	2.2
O -calc.	344	n. a.	32.6	3

5. Measurement of k_0 factors

No k_0 factors could be measured on the new cold guide up to now. We have, however, improved on a number of earlier data obtained on the thermal guide, reported in Refs [20,21]. The values proven erroneous are grouped in Table 5a, whereas Table 5b contains the new subthermal values, which replace those of Refs [20,21].

Table 5. Erroneous and corrected values for prompt γ -ray energies and k_0 factors.

a) Erroneous values [20,21]

Z	El	A ^a	E keV	E-unc. keV	$k_0(H)^b$	k_0 -unc. ^c %
26	Fe	56	352.33	0.02	2.78E-01	3.0
27	Co	59	555.94	0.02	1.53E-01	1.2
51	Sb	121	921.04	0.04	8.55E-02	4.2
51	Sb	121	6523.9	0.2	8.33E-02	5
51	Sb	123	598.66	0.05	1.53E-02	3.7
80	Hg	199	367.96	0.03	8.02E-01	4

b) Corrected values

Z	El	A ^a	E keV	E-unc. keV	$k_0(\text{H})^b$	$k_0\text{-unc.}^c$ %
26	Fe	56	352.33	0.02	1.48E-02	2.0
27	Co	59	555.94	0.02	2.96E-01	1.2
51	Sb	121	921.04	0.04	2.51E-03	5
51	Sb	121	6523.9	0.2	2.12E-03	4
51	Sb	123	598.66	0.05	1.88E-03	8
80	Hg	199	367.96	0.03	3.79E-00	2.0

- a) Mass number of the target nuclide. Nuclides marked with an asterisk (*) may have different k_0 values, when measured in different neutron beams due to non- $1/v$ behavior of the cross-sections.
- b) k_0 factors are relative to H 2223 keV line. Multiply by $1.8\pm 0.9\%$ to obtain k_0 relative to Cl 1951 keV line, and $0.687\pm 0.9\%$ for Au 411 keV line, respectively.
- c) The combined uncertainties are derived from the statistical uncertainties obtained by the peak fitting procedure and the uncertainties of the efficiency function.

References

1. L. Rosta, T. Belgya, L. Cser, T. Grósz, Gy. Kaszás, G. Molnár, Zs. Révay, Gy. Török *Physica B* 234-236 (1997) 1196.
2. T. Belgya, Zs. Révay, B. Fazekas, I. Héjja, L. Dabolczi, G.L. Molnár, Z. Kis, J. Östör and Gy. Kaszás, in: Proc. 9th Int. Symp. Capture Gamma-Ray Spectroscopy and Related Topics, eds. G.L. Molnár, T. Belgya, Zs. Révay, Springer, Budapest (1997), p. 826.
3. D.F.R. Mildner, *Nucl. Instr. Methods.* A290 (1990) 189.
4. T. Belgya et al., in: Budapest Neutron Centre Progress Report 1993-1997, p. 88
5. G.L. Molnár, T. Belgya, L. Dabolczi, B. Fazekas, Zs. Révay, Á. Veres, I. Bikit, Z. Kis and J. Östör, *J. Radioanal. Nucl. Chem.* 215 (1997) 111.
6. G.W. Phillips and K.W. Marlow, *Nucl. Instr. and Meth.* 137 (1976) 525.
7. B. Fazekas, J. Östör, Z. Kis, A. Simonits, G.L. Molnár, *J. Radioanal. Nucl. Chem.* 233 (1998) 101.
8. X-ray and gamma-ray standards for detector calibration, IAEA-TECDOC-619, International Atomic Energy Agency, Vienna, 1991.
9. B. Krusche, K. P. Lieb, H. Daniel, T. von Egidy, G. Barreau, H. G. Börner, R. Brissot, C. Hofmeyr and R. Rascher, *Nucl. Phys.* A386 (1982) 245
10. C. Coceva, A. Brusegan and C. van der Vorst, *Nucl. Instr. Methods* A378 (1996) 511
11. F. J. Kennett, W. V. Prestwich and J. S. Tsai, *Nucl. Instr. Methods* A249 (1986) 366
12. E. T. Journey, J.W. Starner, J. E. Lynn and S. Raman, *Phys. Rev. C* 56 (1997) 118.
13. G. E. Thomas, D. E. Blatchley and M. Bollinger, *Nucl. Instr. Methods* 56 (1967) 325.

14. A. M. J. Spits and J. Kopecky, Nucl. Phys. A264 (1976) 63.
15. B. Fazekas, Zs. Révay, J. Östor, T. Belgya, G. L. Molnár, A. Simonits, Nucl. Instrum. Methods in Phys. Res. A 422, 469 (1998)
16. Z. Kis, B. Fazekas, J. Östör, Zs. Révay, T. Belgya, G.L. Molnár, L. Koltay, Comparison of efficiency functions for Ge gamma-ray detectors, Nucl. Instrum. Methods A 418 (1998). 374.
17. S. Raman, C. Yonezawa, H. Matsue, H. Iimura and N. Shinohara, Efficiency Calibration of a Ge Detector in the 0.1–11.0 MeV Region, Nucl. Instrum. Methods A 454 (2000) 389.
18. J.F.A.G. Ruyl and P.M. Endt, Nucl. Phys. A407 (1983) 60.
19. G.L. Molnár, Zs. Révay and T. Belgya, in: Summary Report of the 2nd IAEA Research Co-ordination Meeting on Update of X- and γ -ray Decay Data Standards for Detector Calibration and Other Applications, INDC(NDS)-415, 2000, p. 59.
20. Zs. Révay, G. L. Molnár, T. Belgya, Zs. Kasztovszky, R.B. Firestone, A New Gamma-Ray Spectrum Catalog for PGAA, J. Radioanal. Nucl. Chem. 244 (2000) 383.
21. G.L. Molnár et al., in: Summary Report of the 1st IAEA Research Co-ordination Meeting on "Development of a Database for Prompt Gamma-Ray Neutron Activation Analysis", 2-4 November 1999, Vienna, Austria, INDC(NDS)-411, 2000

Updated Thermal Capture Cross Sections for Z=1-60 and the Temperature Dependence of the Westcott Factors

Said F. Mughabghab
Brookhaven National Laboratory
Upton, New York 11973

Abstract

The thermal radiative capture cross sections of the stable isotopes for elements Z=1-60 are re-evaluated by taking into consideration new measurements reported in the literature since the last publication of the Neutron Cross Section compendia. In addition, the temperature dependence of the Westcott factors for the capture cross section of ^{35}Cl , ^{113}Cd , ^{124}Xe , and ^{157}Gd are computed by adopting the most recent ENDF/B-VI release 7.

I. Introduction

This effort is part of an ongoing project at the National Nuclear Data Center to update the Neutron Cross Sections compendia of thermal cross sections, resonance parameters, and resonance properties, published by Academic Press in 1981 and 1984 [Mu81, Mu84]. Because of the importance of the radiative thermal capture cross sections in prompt capture gamma-ray analysis, as well as the testing and validation of the k_0 methodology, which is the topic of this coordinated research project, the emphasis of this study is confined to the re-evaluation of the thermal capture cross sections and the temperature dependence of the Westcott g-factors.

II. Methodology

As in previous studies [Mu81, Mu84], various factors were taken into account in the evaluation of the thermal capture cross sections. Some of these include the following:

- a) normalization of the reported cross section to recent standard cross sections (^1H , ^{14}N , ^{35}Cl , ^{55}Mn , ^{59}Co , ^{197}Au , ^{235}U), half lives, branching ratios, and conversion coefficients etc.,
- b) accuracy of the measurement,
- c) measurement method, whether it is specific or non-specific, such as a total cross section measurement compared to an activation measurement,
- d) sample characteristics (isotopic enrichment, impurities, chemistry),
- e) measurer's experience and consistency

f) characteristics of the neutron spectrum.

In the last steps of the procedure, the contribution of positive energy resonances to the thermal capture cross section of an isotope is calculated and then compared with the recommended value; finally consistency between the isotopic and elemental cross sections is checked and then implemented.

Since the present data is to be applied to test the validity of the prompt-capture gamma-ray k_0 method, capture cross sections which can be derived from such measurements were not included in the present evaluation.

III. Results

A. Thermal Capture Cross Sections

Examination of CINDA reference library and CSISRS experimental data files revealed that 33 publications of thermal capture cross sections appeared in the literature for $Z=1-60$, since 1979, the cutoff date for Neutron Cross Sections, Volume 1, part A. The new data points were included in the evaluation. In addition, evaluation of the isotopes for which no recent data was reported were examined and evaluated for possible errors or changes in other pertinent nuclear data, such as half lives or branching ratios. The results are summarized in Table 1. The quoted natural abundances, presented in column 2, are adopted from [Ro98]. The present updated evaluation of the thermal radiative capture cross sections, shown in column 3, are compared with previous recommendations, column 4 [Mu81]. In columns 5 and 6, notes and references to the recent data are displayed, respectively. The significance of the notes are denoted at the bottom of Table 1.

Since the capture cross sections of ^{12}C and ^6Li are adopted as tests of the validity of the k_0 methodology, which will be discussed in detail by M. A. Lone, all reported results pertaining to these isotopes are summarized in Table 2 and Table 3. For ^{12}C , it is significant to note that the weighted average value of those measurements carried out by the discrimination method (capture gamma-ray and mass separation) gives a value of 3.49 ± 0.08 mb for the capture cross section of ^{12}C ; on the other hand, a value of 3.63 ± 0.09 mb is obtained for the other measurements. This difference may indicate a possible unaccounted impurities, such as N, in the graphite samples of the measurements by the non-discrimination method. The weighted average value of all measurements yield a capture cross section of 3.53 ± 0.06 mb. Support for this recommended value comes from the recent measurements of [Is90] (see below).

Because of the importance of ^{14}N as a standard in capture cross section and gamma-ray intensity measurements, the capture cross sections measurements of this isotope are assembled in Table 4. Of special importance is the consistency of the derived capture cross section of ^{14}N relative to those of ^{12}C , ^{35}Cl , and ^{207}Pb , lending support to the capture cross section values of these standards [Is90].

B. Temperature Dependence of the Westcott Factor

The temperature dependence of the Westcott g-factor, which was investigated previously [We60] and more recently [Ho99], is basically due to the change of the neutron peak energy, E_m , describing the neutron spectrum. Depending on the shape of the cross section in the thermal energy region, the temperature dependence of the g-factor generally can be a decreasing or increasing function of the neutron temperature. At this point, it is important to emphasize that this formalism is applicable under the assumption that the neutron spectrum is described by a Maxwellian shape. As an example, experiments carried out at the Chalk River reactor [Ea63] on some Xe isotopes have shown that the neutron spectrum in the reflector position is probably distorted from the Maxwellian form. Therefore, one has to be cautious in applying the Westcott treatment to external neutron beams obtained by reflection.

In the present study, we calculate the temperature dependence of the g-factor for three isotopes, ^{113}Cd , ^{157}Gd , and ^{124}Xe whose respective g-factors are larger than, smaller than and close to 1. Because of the location of a positive energy resonance at 0.178 eV in ^{113}Cd , its capture cross section increases with energy up to the peak energy and then decreases. In contrast, the capture cross sections of ^{124}Xe and ^{157}Gd continuously decrease with neutron energy in the thermal region. Therefore, the temperature dependence of the g-factor of ^{113}Cd increases with the temperature (neutron energy), while those of ^{124}Xe and ^{157}Gd decrease with temperature. In simple terms, the temperature variation of the g-factor follows that of the capture cross section. Calculations of the g-factor for these isotopes are carried out with the most recent ENDF/B-6 (release7) evaluated cross sections in the temperature range from 150 K⁰ to 400 K⁰; the results are summarized in Table 6. Furthermore, since ^{35}Cl is chosen as a standard in the k_0 , we included the temperature variation of the g-factor for this isotope.

IV. Conclusion

The thermal radiative neutron capture cross sections for $z=1-60$ are updated by factoring in the recent data published since 1979. In some cases, improvements in the cross sections resulted; in other instances, the new data supported earlier recommendations. The temperature dependence of the Westcott g-factor is investigated. The importance of characterizing the neutron Maxwellian spectrum is stressed in the application of the g-factor.

REFERENCES

- [Al88] Aleksenko Sov. Tech. Phys. Lett. 13, 541 (1988).
- [Al84] V. P. Alfimenkov, et al., Yad. Foz 39, 1057 (1984).
- [An80] A. V. Antonov et al., Proceedings of 5th All Union Conf. On Nucl., Kiev, Phys., Vol 1, 125 (1980).
- [An90] V. A. Anufriev, S. M. Masyanov, and S. I. Babich, Sov. Atom. Ener., 69, 395 (1990).
- [Ax85] E. J. Axton, Annals of Nucl. Energy, 12, 315 (1983).
- [Ar86] A. Arbildo, J. C. Robertson, and T. B. Ryves, Ann Nul. Energy, 13, 237 (1986).
- [Ba57] G. A. Bartholomew and P. J. Champion, Can J. Phys. 35, 1347 (1957).

- [Bu82] R. Buyl and F. Corvi, NEANDC(E) 232U, Vol III, 18 (1982).
- [Co86] C. M. Conneely, W. V. Prestwich, and T. J. Kennett, Nucl. Inst. Meth., 248, 416 (1986).
- [De89] F. De Corte and A. Simonits, J. Rad. Nucl. Chem. 133, 43 (1989).
- [Ea60] T. A. Eastwood and F. Brown, EANDC(Can)-16 L (1963).
- [Ha95] H. Harada and S. Nakamura, J. Nucl. Sci. Tech. 32, 1 (1995).
- [He57] G. R. Hennig, BNL-489, 19 (1957).
- [He 79] R. E. Heft, Proc. Am. Nucl. Soc. Topical Conf., Mayaguez, Puerto Rico (Ap. 30- May 4 1979).
- [Ho99] N. E. Holden, Pure Appl. Chem. 71, 2309 (1999).
- [Is90] M. A. Islam, T. J. Kennett, and W. V. Prestwich, Nucl. Inst. Meth. A287, 460 (1990).
- [Is81] M. A. Islam et al. Prestwich, Nucl. Inst. Meth, 188, 243 (1981).
- [Ni60] P. F. Nichols, Helv. Phys. Acta, 34, 483(1961).
- [Ju63] E. T. Jurney and H. T. Motz, ANL-6797, 236 (1963).
- [Ka99] T. Kaato et al., J. Nucl. Sci. Tech. 36, 223 (1999).
- [Kn82] K. Knop Z. Natur. A. 37,1132 (1982).
- [Ko79] L. Koester, K. Knopf, and W. Waschowski, Z. Phys. A 289, 399 (1979).
- [Ko84] L. Koester et al., Z. Phys. A 318, 347 (1984).
- [Ko85a] L. Koester et al., Z Phys. 320, 661 (1985).
- [Ko85b] L. Koester, K. Knopf, and W. Waschowski, Z. Phys. A 322,105 (1985).
- [Ko86] L. Koester Z. Phys. A 323, 360 (1986).
- [Ko87a] L. Koester, K. Knopf, and W. Waschowski, Z Phys. A326, 227 (1987).
- [Ko87b] L. Koester et al. Zeit. Phys. A 327, 347 (1987).
- [Mu57] C. O. Muelhause et al. BNL-489, 21 (1957).
- [Mu81] S. F. Mughabghab, M. Divadeenam, and N. Holden, Neutron Cross Sections (Academic Press, N. Y. 1981).
- [Mu02] To be Published 2002.
- [Mu82] S. F. Mughabghab, M. A. Lone, and B. C. Robertson, Phys. Rev. C 26, 2698 (1982).
- [Na99] S. Nakamura, H. Harada, and T. Katoh, J. Nucl. Sci. Tech. 36, 847 (1999).
- [Ni60] P. F. Nichols, Nucl. Sc. Eng. 7, 395 (1960) .
- [Po82] W. Poenitz, DOE-NDC-27, page A5 (1982).
- [Pr81] W. V. Prestwich, M. A. Islam, and T. J. Kennet, Nucl. Sc. Eng. 78,182 (1981).
- [Pr90] W. V. Prestwich and T. J. Kennett, Can. J. Phys. 68 261 (1990).
- [Ra92] S. Raman et al. Phys. Rev. C 46, 972 (1992).
- [Ra84] S. Raman et al. Phys. Rev. C 30, 26 (1984).
- [Ro98] K. J. R. Rosman and P. D. F. Taylor, Pure Appl. Chem. 70, 217 (1998).
- [Ru84] J. F. A. G. Ruyl et al., Nucl. Phys. A419, 439 (1984).
- [St62] E. Starr and G. Price, BNL 719, 1034 (1962).
- [Ta78] M. Takiue and H. Ishikawa, Nucl. Inst. Meth. 148, 157 (1978).
- [Wa92] T. Walkiewicz et al. Phys. Rev. C 45, 1597 (1992).
- [We60] C. H. Westcott, AECL-1101 (1960).
- [Ve97] L. Venturini and B. R. S. Pecequilo, Appl. Rad. Iso. 48, 493 (1997).
- [Zo57] quoted by [Ni60], French measurements of American graphite.

TABLE 1. Updated Radiative Capture Thermal Cross Sections of Stable Isotopes and Elements

	Abundance	Mu01	Mu79	Remarks	Reference
H-1	99.9844	0.3326±0.0007	0.3326±0.0007	z	
H-2	0.01557	0.519±0.007*	0.519±0.007*		
He		0.76±0.01	0.76±0.01		
He-3	0.000134	0.031 ±0.009	0.031 ±0.009		
He-4	99.99987	0.76 ± 0.01	0.76±0.01		
Li		0.04483±0.0030	0.04483±0.0030		
Li-6	7.589	0.0386±0.0021	0.0385±0.0036		
Li-7	92.411	0.0454±0.003	0.0454±0.003		
Be-9	100	8.77±0.35*	7.6±0.08*		Co86
B		0.10±0.04	0.10±0.04		
B-10	19.82	0.5 ±0.1	0.5 ±0.1		
B-11	80.18	5.5±3.3*	5.5±3.3*		
C		3.50±0.06*	3.50±0.07*		
C-12	98.892	3.53±0.06*	3.53±0.07*		
C-13	1.108	1.37±0.04*	1.37±0.04*		Mu82
N		79.5±1.4*	74.7±7.3*		
N-14	99.6337	79.8±1.4*	75.0±7.5*		Is90
N-15	0.3663	0.024± 0.0088*	0.024± 0.0088*		
O		0.190±0.019	0.190±0.019		
O-16	99.7628	0.190±0.019	0.190±0.019		
O-17	0.0372	0.538 ±0.065	0.538 ±0.065		
O-18	0.200	0.16±0.01*	0.16±0.01*		
F-19	100	9.6±0.05*	9.6±0.05*		

Ne		39±4*	39±4*		
Ne-20	90.4838	37±4*	37±4*		
Ne-21	0.2696	0.666± 0.110	0.666± 0.110		
Ne-22	9.2465	45.5±6*	45.5±6*		
Na-23	100	0.530±0.005	0.530±0.005		
Mg		63 ±3*	66±6*	z	
Mg-24	78.992	53.6± 1.5*	53±6*	z	Pr90, Wa92
Mg-25	10.003	200±5*	200±10*	z	Pr90, Wa92
Mg-26	11.005	38.6±6*	38.2±0.8*	z	Pr90, Wa92
Al-27	100	231±3*	231±2*	z	De89
Si		171±3*	166±9*	z	Ko79
Si-28	92.2297	173±3*	170±10*	z	Ra92, Is90
Si-29	4.6832	120±2 *	120±10*	z	Ra92, Is90
Si-30	3.0872	107±2*	107±4*	z	Ra92, Is90
P-31	100	172±6*	172±6*	z	
S		534±7 *	520±10*		Ar86, Ko79
S-32	95.018	548±10*	530±40*		
S-33	0.7500	454±25*	350±40*		Ra92
S-34	4.215	235±5*	227±5		Ra92
S-36	0.017	230±20*	150±30*		Ra92
Cl		33.1± 0.3	33.1±0.3	z	
Cl-35	75.771	43.55± 0.40	43.6±0.4	z	
Cl-37	24.229	0.430±0.006	0.433±0.006		He79
Ar		675±9*	675±9*		
Ar-36	0.3365	5.2 ±0.5	5.2±0.5		
Ar-38	0.632	0.8±0.2	0.8±0.2		
Ar-40	99.6003	0.660±0.010	0.660±0.010		

K		2.1±0.1	2.1±0.1		
K-39	93.2581	2.1±0.2	2.1±0.2		
K-40	0.01167	30±4	30±4		
K-41	6.7302	1.45±0.03	1.46±0.03		He79
Ca		0.430±0.02	0.41±0.02	z	
Ca-40	96.941	0.41±0.02	0.41±0.02	z	
Ca-42	0.647	0.680±0.07	0.680±0.07		
Ca-43	0.135	6.2±0.6	6.2±0.6		
Ca-44	2.086	0.88±0.05	0.88±0.05	z	
Ca-46	0.004	0.72±0.03	0.72±0.03		He79
Ca-48	0.187	1.09±0.07	1.09±0.14		He79
Sc-45	100	27.2±0.2	27.2±0.2	z	Ta78
Ti		6.09±0.13	6.09±0.13	z	An80
Ti-46	8.249	0.59±0.18	0.59±0.18		
Ti-47	7.437	1.52±0.11	1.7±0.2	z	Ru84
Ti-48	73.720	7.88±0.25	7.84±0.25		Ve97
Ti-49	5.409	1.79±0.12	2.2±0.2	z	Ru84
Ti-50	5.185	0.179±0.003	0.179±0.003		De89, He79
V		5.09±0.04)	5.08±0.04	z	
V-50	0.250	60±40	21±4		
V-51	99.75	4.92±0.04	4.9±0.1	z	Ve97, He79
Cr		3.07±0.08	3.07±0.08	z	
Cr-50	4.345	15.9±0.2	15.9±0.2		Ve97, De89, He79
Cr-52	83.790	0.76±0.06	0.76±0.06		Ve97
Cr-53	9.500	18.2±1.5	18.2±1.5		Ve97
Cr-54	2.365	0.36±0.04	0.36±0.04		

Mn-55	100	13.36±0.05	13.3±0.1	z	Ax85 He79
Fe		2.56±0.03	2.56±0.03		
Fe-54	5.845	2.25±0.18	2.25±0.18		
Fe-56	91.754	2.59±0.14	2.59±0.14		
Fe-57	2.119	2.48±0.30	2.48±0.30		
Fe-58	0.282	1.30±0.03	1.28±0.05	z	De89, Ta78
Co-59	100	37.18±0.06	37.18±0.06	z	
Ni		4.49 ±0.16	4.49±0.16		
Ni-58	68.077	4.5±0.2	4.6 ±0.3		
Ni-60	26.223	2.9±0.2	2.9±0.2		
Ni-61	1.140	2.5±0.8	2.5±0.8		
Ni-62	3.635	14.5±0.3	14.5±0.3		
Ni-64	0.926	1.63±0.07	1.52±0.03	z	De89
Cu		3.78±0.02	3.78±0.02	z	An80
Cu-63	69.174	4.52±0.02	4.50±0.02	z	He79
Cu-65	30.826	2.17±0.03	2.17±0.03	z	An80 He79
Zn		1.11±0.02	1.11±0.02	z	Ko85a
Zn-64	48.63	1.1±0.1	0.76±0.02	z	Ko85a
Zn-66	27.90	0.62±0.06	0.85±0.20	z	Ko85a
Zn-67	4.10	9.5±1.4	6.8±0.8	z R1	
Zn-68	18.75	0.072±0.004	0.072±0.004		He79
Zn-70	0.62	0.090±0.005	0.090±0.005		
Ga		2.9±0.1	2.9±0.1	z	Ko84
Ga-69	60.108	1.68±0.07	1.68±0.07	z R2	Ko84
Ga-71	39.892	4.73±0.15)	4.71±0.23	z R3	Ko84, He78
Ge		2.20±0.04	2.3±0.1		
Ge-70	21.234	3.17±0.14	3.15±0.07		Ko87

Ge-72	27.662	0.95±0.11	0.98±0.09		Ko87
Ge-73	7.717	14.4±0.4	15±2		Ko87
Ge-74	35.943	0.53±0.05	0.51±0.08		Al88
Ge-76	7.444	0.14±0.02	0.15±0.02		Al88
As-75	100	4.23±0.08	4.5±0.1	z	De89, He79
Se		11.7±0.2	11.7±0.2	z	
Se-74	0.889	51.8±1.2	51.8±1.2		He79
Se-76	9.366	85±7	85±7		
Se-77	7.635	42±4	42±4		
Se-78	23.772	0.38±0.02	0.38±0.02		
Se-80	49.607	0.61±0.05	0.61±0.05		
Se-82	8.731	0.043±0.003	0.043±0.003		
Br		6.9±0.2	6.9±0.2	z	
Br-79	50.686	10.32±0.13	11.0±0.7	z	He79
Br-81	49.314	2.36±0.05	2.7±0.2	z	He79
Kr		25.1±0.7	25±1		
Kr-78	0.3535	6.2±0.9	6.2±0.9		
Kr-80	2.2809	11.5±0.5	11.5±0.5		
Kr-82	11.5830	22.4±4.3	28±20		
Kr-83	11.4953	193±10	180±30	R1	
Kr-84	56.9889	0.111±0.015	0.110±0.015		
Kr-86	17.2984	3±2*	3±2*		
Rb		0.38±0.04	0.38±0.04		
Rb-85	72.1654	0.48±0.01	0.48±0.01		De89, Ra78
Rb-87	27.8346	0.12±0.03	0.12±0.03		De89
Sr		1.28±0.06	1.28±0.06		

Sr-84	0.5574	0.82±0.05	0.87±0.05		De89, He79
Sr-86	9.8566	1.04±0.07	1.04±0.07		De89, He79
Sr-87	7.0015	16±3	16±3		
Sr-88	82.5845	5.8±0.4*	5.8±4*		
Y-89	100	1.28±0.02	1.25±0.02		Ta78
Zr		0.185±0.003	0.185±0.003		
Zr-90	51.452	0.011±0.005	0.014±0.005		
Zr-91	11.223	1.24±0.25	1.24±0.25		
Zr-92	17.146	0.220±0.060	0.220±0.060		
Zr-94	17.380	0.049±0.002	0.049±0.002		Po82
Zr-96	2.799	0.020±0.001	0.0229±0.010		De89, Po82
Nb-93	100	1.15±0.05	1.15±0.05	z	De89
Mo		2.51±0.05	2.55±0.05		Ko87a, An80
Mo-92	14.8362	0.019	0.019		
Mo-94	9.2466	0.015	0.015		
Mo-95	15.9201	13.4±0.3	13.4±0.3		Ko87a
Mo-96	16.6756	0.5±0.2	0.5±0.2		
Mo-97	9.5551	2.5±0.2	2.5±0.5		Ko87a
Mo-98	24.1329	0.137±0.005	0.130±0.006	z	He79
Mo-100	9.6335	0.199±0.003	0.199±0.003		He79
Tc-99		20±1	20±1	z	Ha95
Ru		2.56±0.13	2.56±0.13		
Ru-96	5.5420	0.22±0.02	0.29±0.02		De89, He79
Ru-98	1.8688	<8	<8		
Ru-99	12.7579	7.1±1.0	7.1±1.0	z	
Ru-100	12.5985	5.0±0.6	5.0±0.6	z	
Ru-101	17.0600	3.4±0.9	3.4±0.9	z	

Ru-102	31.5519	1.21±0.07	1.21±0.07	z	He79
Ru-104	18.6210	0.47±0.02	0.32±0.02	z	De89, He79
Rh-103	100	145±2	145±2	z	He79
Pd		6.9±0.2	6.9±0.2		An80
Pd-102	1.020	3.4±0.3	3.4±0.2		
Pd-104	11.14	0.6±0.3	0.6±0.3		
Pd-105	22.33	21.0±1.5	20.0±3.0	z	Bu82
Pd-106	27.33	0.315±0.029	0.315±0.029		
Pd-108	26.46	7.6±0.4	8.3±0.5	z	De89, Bu82
Pd-110	11.72	0.227±0.032	0.227±0.032		He79
Ag		63.3±0.4	63.3±0.4	z	
Ag-107	51.8392	37.6±1.2	37.6±1.2	z	He79
Ag-109	48.1608	91.0±1.0	91.0±1.0	z	
Cd		2520±50	2520±50		
Cd-106	1.25	~1	~1		
Cd-108	0.89	0.72±0.13	1.1±0.3		
Cd-110	12.49	11±1	11±1		
Cd-111	12.80	24±3	24±3		
Cd-112	24.13	2.2±0.5	2.2±0.5		
Cd-113	12.22	20600±400	20600±400	z	
Cd-114	28.73	0.34±0.02	0.34±0.02		He79
Cd-116	7.49	0.075±0.020	0.075±0.020		
In		193.8±1.5	193.8±1.5	z	
In-113	4.288	12.0±1.1	12.0±1.1	z	
In-115	95.712	202±2	202±2	z	
Sn		0.626±0.009	0.626±0.009		

Sn-112	0.973	0.86±0.09	0.86±0.09		De89, He79
Sn-114	0.659	0.115±0.030	0.115±0.030		
Sn-115	0.339	30±7	30±7		
Sn-116	14.536	0.140±0.030	0.140±0.030		
Sn-117	7.676	1.32±0.18	2.3±0.5		Al84
Sn-118	24.223	0.220±0.050	0.220±0.050		
Sn-119	8.585	2.2±0.5	2.2±0.5		
Sn-120	32.593	0.140±0.030	0.140±0.030		
Sn-122	4.629	0.160±0.015	0.180±0.020		He79
Sn-124	5.789	0.134±0.005	0.134±0.005		De89
Sb		5.1±0.1	5.2±0.1	z	
Sb-121	57.213	5.9±0.2	5.9±0.2	z	
Sb-123	42.787	4.1±0.1	4.1±0.1	z	Ta78
Te		4.7±0.1	4.7±0.1	z R4	Ko86
Te-120	0.096	2.3±0.3	2.3±0.3		
Te-122	2.603	3.4±0.5	3.4±0.5		An90
Te-123	0.908	418±30	418±30		
Te-124	4.816	6.8±1.3	6.8±1.3		
Te-125	7.139	1.55±0.16	1.55±0.16		
Te-126	18.952	1.04±0.15	1.04±0.15		
Te-128	31.687	0.215±0.008	0.215±0.008		
Te-130	33.799	0.29±0.06	0.29±0.06		
I-127	100	6.2±0.2	6.2±0.2		Ka99
Xe		24.2±0.4	23.9±1.2		
Xe-124	0.0891	165±11	165±11	z	
Xe-126	0.0888	3.8±0.8	3.5±0.8		
Xe-128	1.9117	5.2±1.3	<8	R5	

Xe-129	26.4396	21±7	21±7	z	
Xe-130	4.0827	4.8±1.2	<26	R5	
Xe-131	21.1796	85±10	85±10		
Xe-132	26.8916	0.415±0.045	0.415±0.060	z	
Xe-134	10.4423	0.265±0.020	0.265±0.020	z	
Xe-136	8.8689	0.26±0.02	0.26±0.02		
Cs-133	100	29.0±1.0	29.0±1.0	z	Na99
Ba		1.15±0.07	1.2±0.1		Ko85b
Ba-130	0.1058	30±5 R	11.3±1.0	z R6	Ko85b
Ba-132	0.1012	6.5±0.8	6.5±0.8		
Ba-134	2.417	2.0±1.6	2.0±1.6		
Ba-135	6.592	5.6±0.8	5.8±0.9		
Ba-136	7.853	0.68±0.17	0.4±0.4	z	Ko85b
Ba-137	11.232	3.8±0.2	5.1±0.4	z	Ko85b
Ba-138	71.699	0.41±0.04	0.360±0.036	z	De85 Ko85b
La		8.28±0.04	8.97±0.05	z	Kn82
La-138	0.0902	57.2±5.7	57.2±5.7	z	
La-139	99.9098	8.24±0.05	8.93±0.04	z	Ta78
Ce		0.63±0.04	0.63±0.04		
Ce-136	0.186	6.3±1.5	6.3±1.5		
Ce-138	0.251	1.1±0.2	1.1±0.3		He79
Ce-140	88.449	0.57±0.02	0.57±0.04		De89 He79
Ce-142	11.114	0.97±0.02	0.95±0.05		De89 He79
Pr-141	100	11.5±0.3	11.5±0.3	z	He79
Nd		49.5±2.0	50.5±2.0		
Nd-142	27.16	18.7±0.7	18.7±0.7		

Nd-143	12.18	325±10	325±10	z	
Nd-144	23.83	3.6±0.3	3.6±0.3		
Nd-145	8.30	42±2	42±2	z	
Nd-146	17.17	1.41±0.05	1.4±0.1	z	He78 Ta78
Nd-148	5.74	2.58±0.14	2.5±0.2	z	De89 He79
Nd-150	5.62	1.03±0.08	1.2±0.2	z	He79

Remarks

* Value in mb units.

z Value at 2200 m/s

R1 Value derived from elemental cross section.

R2 [Ko87] obtains capture cross section 2.22±0.05 b from total cross section measurements at 0.56 meV

R3 [Ko87] obtains capture cross section 3.67±0.05 b from total cross section measurements at 0.56 meV

R4 Te capture cross section 4.05±0.05 implies a ¹²³Te cross section of 360 b, which is at variance with resonance contribution of 418b for ¹²³Te

R5 Value calculated from systematics of isomeric ratios.

R6 Value from total cross section measurement on an isotopically enriched sample. A negative coherent scattering length indicates an unassigned positive energy resonance below 46 eV [Ko85b].

TABLE 2. Carbon Capture Cross Section Measurements

measurement method	cross section (mb)	reference
capture γ ray ^a	3.53± 0.07	Is90
capture γ ray ^a	3.50± 0.16	Pr81
pulsed neutron	3.72± 0.15	Sa63
capture γ ray ^a	3.8 ± 0.4	Ju63
pulsed neutron ^b	3.83±0.06	St62
reactivity ^c	3.57±0.03*	Ni60
diffusion length ^b	3.69± 0.21	Ha60

pile oscillator ^b	3.5 ± 0.3	Mu57
pile oscillator ^b	3.65 ± 0.15	Zo57
mass spectrometry ^a	3.30± 0.15	He57
pile oscillator ^b	3.85± 0.15	Ko57

a. weighted average value, 3.49± 0.08 mb, for measurements by the discrimination method;

b. weighted average value, 3.63±0.09 mb, for the other measurements; all measurements give 3.53± 0.06 mb .

c. relative to Cu (3.77 ± 0.03 b)

TABLE 3. Capture cross section of ⁶Li

measurement method	capture cross section(mb)	reference
capture γ-rays	38.5±2.1	Ju73
capture γ-rays	48 ±15	Ja61
capture γ-rays	30 ±8	Ba57

TABLE 4. Nitrogen Capture Cross Section Measurements

measurement method	standard(mb)	σ _γ (mb)	reference
capture γ-rays	¹² C(3.53±0.07)	79.7±2.4	Is90
capture γ-rays	³⁵ Cl(43.6±0.4) b	80.1±2.0	Is90
capture γ-rays	²⁰⁷ Pb(712±10)	79.6±1.6	Is90
capture γ-rays	²⁷ Al(230±3) ³⁵ Cl(43±3) b	77.2±2.1	Is81
capture γ-rays	H(332±2)	75.0±7.5	Ju62

**Table 5. The Temperature Dependence of the capture Westcott
g- Factors of ^{35}Cl , ^{113}Cd , ^{124}Xe , and ^{157}Gd**

T (K⁰)	E_m (eV)	^{35}Cl	^{124}Xe	^{113}Cd	^{157}Gd
150	0.0130	1.0037	0.9967	0.9638	0.9027
292	0.0253	1.0021	1.0018	1.3374	0.8501
400	0.032	1.0020	1.0048	1.6235	0.7961

POTENTIAL CAUSES OF THE VARIATION OF GAMMA-RAY ABSOLUTE BRANCHING RATIO WITH NEUTRON ENERGY

M.A. Lone
Office of the Chief Engineer,
Chalk River Laboratories, AECL,
Chalk River, Ontario, Canada K0J 1J0
LONEA@AECL.CA

Thermal or cold neutron capture induced Prompt Gamma-ray Activation Analysis (PGAA) technique is in use or under development for quantitative elemental analysis in diverse fields such as materials science, chemistry, geology, mining, archaeology, environment, food analysis, medicine, detection of explosives and other areas.

I. PGAA FACILITIES

Application of PGAA is based on a broad range of neutron source facilities such as:

A. Large Multi-Use Reactor Based Systems

High neutron fluxes as required for fast and accurate high-sensitivity PGAA applications. Typical facility setups and their characteristic neutron flux energy distributions are:

- In-core (in-moderator) internal target
 - Maxwellian shape energy spectrum of moderated neutrons that can be characterized by a single neutron temperature parameter
- External direct beam from a reactor core or an auxiliary thermal moderator
 - Maxwellian shape energy spectrum of moderated neutrons that can be characterized by a single neutron temperature parameter
- External filtered beam from a reactor core or an auxiliary thermal moderator
 - Overall Maxwellian shape energy spectrum truncated (modified) by transmission through the filter material. Bragg scattering may suppress neutrons of certain energies from the beam.
- External guided beam from a reactor core or an auxiliary thermal moderator
 - Internal scattering from the guide material lowers the effective neutron temperature and may truncate (alter) the neutron energy distribution to a non-Maxwellian distribution.

- External guided beam from a cold moderator
 - Internal scattering from the guide material lowers the effective neutron temperature and may truncate (alter) the neutron energy distribution to a non-Maxwellian distribution

B. Mobile Systems

Relatively lower neutron flux facilities are necessary for on-site applications. Typical options in use are:

- Radioactive sources. Cf^{252} , PuBe, PuLi, SbBe
Mostly under-moderated neutron flux energy distribution.
- Low energy deuteron or proton accelerator-based sources. (d,t), (p,Li), (p,Be)
Mostly under-moderated neutron flux energy distribution.

II. FACILITY-DEPENDENT PGAA DATA BASE

The key difference in these facilities is in the energy distribution of the neutron flux impinging on the target material. Even in the case of an in-core thermal neutron facility there can be significant differences in the magnitude of the slowing down epithermal energy neutrons. One generally accepted measure of this is the Cd ratio of the flux. This measures the ratio of the flux of neutrons at all energies to the flux of neutrons of energy above cadmium cut off (about 0.5 eV). The value of the Cd ratio at the various facilities listed above can vary by over a factor of a million. At the internal facilities (in-core or in-moderator) the spectral distribution of the thermal component of the neutron flux is, in general, of Maxwellian shape with a characteristic neutron temperature. The epithermal component has a 1/E distribution. However in the external filtered or guided beams the spectral distribution may not be a true Maxwellian shape.

The spectral characteristics of these facilities is very important since, in general, the cross section determining the probability of neutron capture, as well as the probability of the resultant emission of a gamma ray of a particular energy (gamma-ray branching ratio), depends on the energy of the captured neutron. Thus, the sensitivity of detection of a particular element depends on the characteristics of the energy spectrum of the neutron flux at the target location of a facility. The variation of the capture cross section with neutron energy is well recognized. But it is generally assumed that in the thermal regime (<1eV) the cross section is strictly 1/v, at least for lighter elements. However, there can be small deviations (a few %) even in lighter elements due to the existence of bound energy levels (with large particle emission) close to the neutron binding energy or due to the proximity of the first positive energy resonance.

Figures 1 to 3 show the variation of the JEF-evaluated H, C and Cl capture cross sections in the thermal region. Thus, the development of a high-accuracy PGAA absolute analysis using k_0 methodology (ratio of partial cross section per gram material with

respect to a reference material) would require understanding of the potential complications due to the differences in energy distribution of the neutron flux at the target location.

This is even more important if the method is to be extended to derive equivalent capture cross sections for use in evaluations for reactor physics data base that require cross sections for Maxwellian spectral distributions or at a specific neutron energy. The traditional g-factor correction is computed assuming a Maxwellian spectral shape and will not be correct for a non-Maxwellian distribution.

The variation in the branching ratio (intensity per neutron capture) of a gamma ray is less dependent on the energy of the captured neutrons, except for the variation due to the following well established physics phenomena:

- Porter-Thomas (PT) statistical fluctuation^{1,2}
 - The intensities of the individual primary transitions from a neutron resonance exhibit statistical fluctuations (chi-square distribution with one degree of freedom). For a sum of n transitions the distribution is chi-square with n degrees of freedom. Thus, in heavy nuclei having hundreds of primary transitions the total radiative capture cross section does not exhibit PT fluctuations. But in lighter nuclei, in which there are only few transitions one could expect fluctuations unless the reaction mechanism is predominantly direct capture. In this case the cross section variation may not be $1/v$.
- Resonance spin and parity dependence
 - The intensity of a transition between two states depends on the spin and parity of the two states. Thus, the intensities of the primary transitions depend noticeably on the spin and parity differences between the two levels. In fact, the differences in the primary transitions and multi-cascade transitions can impact significantly on the gamma multiplicity and on the population and decay of the lower excited states. So even the intensities of the low-energy secondary transitions depend on the spin and parity of the initial capturing state³.
- Resonance-resonance or resonance direct-capture interference^{2,4}
 - Interference between the amplitudes of neighbouring resonances and any direct-capture amplitude can cause noticeable variation in gamma ray intensity with neutron energy^{1,5}.

Thus, the development and scrutiny of a data base (branching-ratio intensity per capture, partial capture cross sections, and k_0) for an absolute method for high-accuracy PGAA applications should consider potential the impact of these physics aspects.

This is even more important if the data acquired with non-Maxwellian beam facilities are to be used for the derivation of evaluated cross sections for reactor physics and other applications. Figures 4 and 5 show the capture cross sections of C measured

with various methods⁶⁻¹⁵. One of the historic experimental difficulties in this measurement had been the elemental impurities as well as nitrogen adsorbed in the pores of relatively large samples used in reactor-physics type measurements. This tended to yield higher values of the effective cross section. A recent value derived from a PGAA gamma ray spectroscopic measurement at a guided-beam¹³ facility with relatively pure samples appears to lie outside the band of the previous measurements made with several different techniques as identified in Table 1.

III. FACILITY AND SAMPLE DEPENDENT EXPERIMENTAL ISSUES

In addition to the physics considerations discussed above there are several experimental issues that can affect the observed signal and the derived cross section values. Very accurate measurements of gamma ray count rates from target materials, consisting of mixtures of elements with vastly differing capture cross sections, require scrutiny for:

- Neutron up-scatter in cold beams. This increases the effective neutron energy due to scattering from a higher temperature target material.
- In elements with very intense resonances, scattering of neutrons may shift the energy away from the resonance peak.
- Self-shielding of neutron resonances in elements with strong resonances.
- Gamma detector efficiency uncertainty due to neutron in-scattering and gamma ray attenuation in samples of various shapes. This would be important for non-destructive measurements technique if the sample geometry cannot be optimized.
- Gamma ray interference and the relative strength of the individual signal (peak-to-baseline ratio in gamma ray spectrum).
- Target uniformity and variation in atomic concentrations in the target materials.

The measured values of k_0 reported by various groups seem to indicate noticeable variations. These are probably due to the experimental artefacts mentioned above or to differences in the neutron energy distribution.

IV. Conclusions

The absolute branching ratio of a gamma ray transition from thermal neutron capture in some nuclei can be sensitive to the energy distribution of the neutron beam at the PGAA Facility. So it would be necessary to define the neutron flux energy spectrum for the PGAA data bases such as k_0 or absolute branching ratios (partial capture cross sections)

V. Acknowledgements.

In the process of preparing material for this brief I had the privilege of communication with Drs. R. M. Lindstrom, G. Molnar, H. Matsue, V. Seers, S. F. Mughabghab, Zs. Revay, B. Reed, S. Frankle and R. Paviott-Carcuerra. I appreciate their help very much in clarifying several technical issues.

REFERENCES

- 1 C. E. Porter and R.G. Thomas, Phys. Rev. 104 (1956) 483.
- 2 M.A. Lone, R.E. Chrien, O.A. Wasson, M. Beer, M.R. Bhat and H.R. Muether, Physics. Rev. 174 (1968) 174
- 3 M.A. Lone, E.D. Earle and G.A. Bartholomew, Nuclear Physics A243 (1975) 413.
- 4 S. F. Mughabghab, M. A. Lone and B. C. Roberson. Phys. Rev. C26 (1982) 2698.
- 5 R.E. Chrien Editor “ Neutron Radiative Capture”, OECD/NEA series Pergamon Press (1984)
- 6 G. R. Henning, Proc. French-American Conf. Graphite Reactors, BNL-489, Brookhaven National Laboratory (1957)
- 7 C.O. Muehlhause, S. P. Harris, D. Rose, H.P. Schroeder, G. E. Thomas, and S. Wexler, Proc. French-American Conf, Graphite Reactors, BNL-489, p. 19, Brookhaven National Laboratory (1957)
- 8 P.F. Nichols, Nucl Sci. Eng. 7 (1960) 395. (average of the Hanford measured values in Table 1 for the high purity American and the French graphite)
- 9 E. Starr and G. A. Price, Proc. Brookhaven Conf. Neutron Thermalization, BNL-719, III. 1034 BNL (1962)
- 10 E. T. Journey and H.T. Motz, Proc. Int. Conf. Nuclear Physics with Reactor Neutrons, ANL-6797, p236. Argonne National Laboratory (1963).
- 11 M. Sagot and H. Tellier. J. Nucl. Energy, Parts A/B 17, 347 (1963).
- 12 W.V. Prestwich, M.A. Islam and T.J. Kennet, Nucl. Sci. Eng. 78 (1981) 182
- 13 Zs. Revay, G.L Molnar, T. Belgya, Zs. Kasztovsky and R.B. Firestone, J. Rad. Nuc. Chemistry, Vol 244 (2000) 383. (<http://ie.lbl.gov/pgadatabase/pgaa.htm> date 2001 April 20)
- 14 S.F. Mughabghab, “Neutron Cross Sections BNL-325” Academic Press (1981)
- 15 E.T. Journey P.J. Bendt and J.C. Browne, J. Phys. Rev. C25 (1982) 2810.

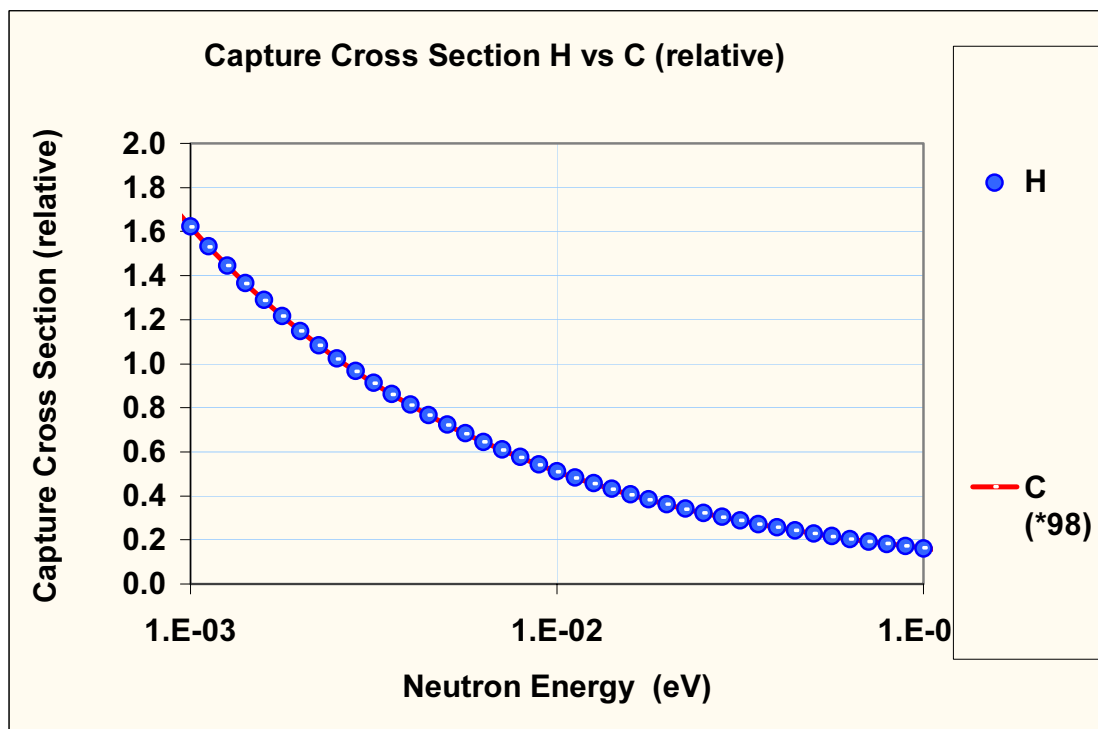

Figure 1. Neutron capture cross sections in H and C (multiplied by 98). Both exhibit $1/v$ behaviour in this energy regime.

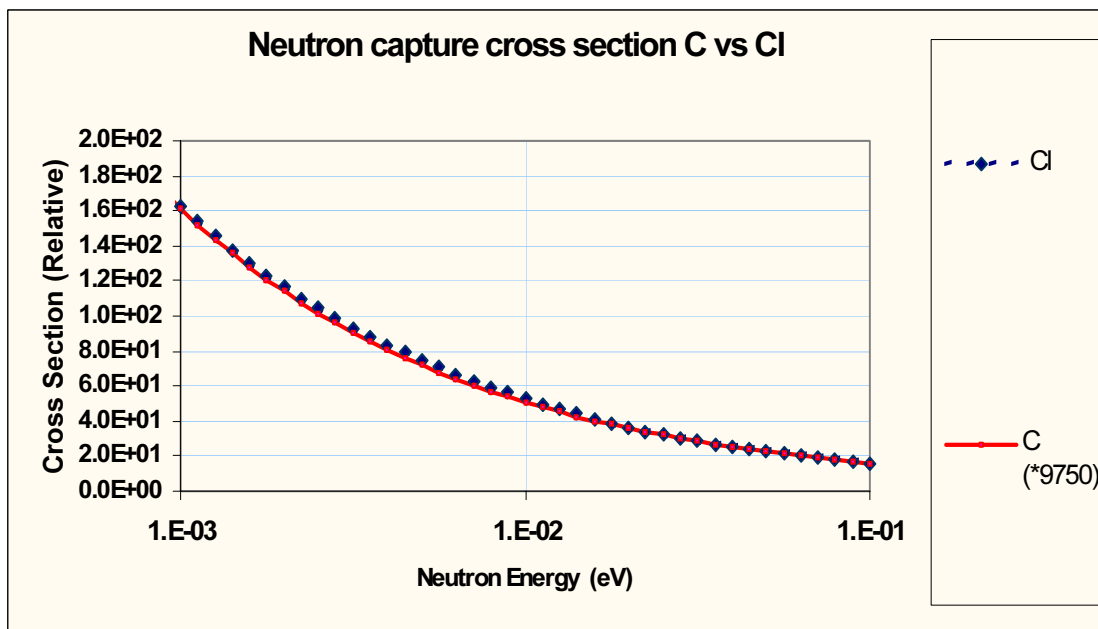

Figure 2. Neutron capture cross section of C and Cl in thermal region. The C is $1/v$ but Cl deviates slightly.

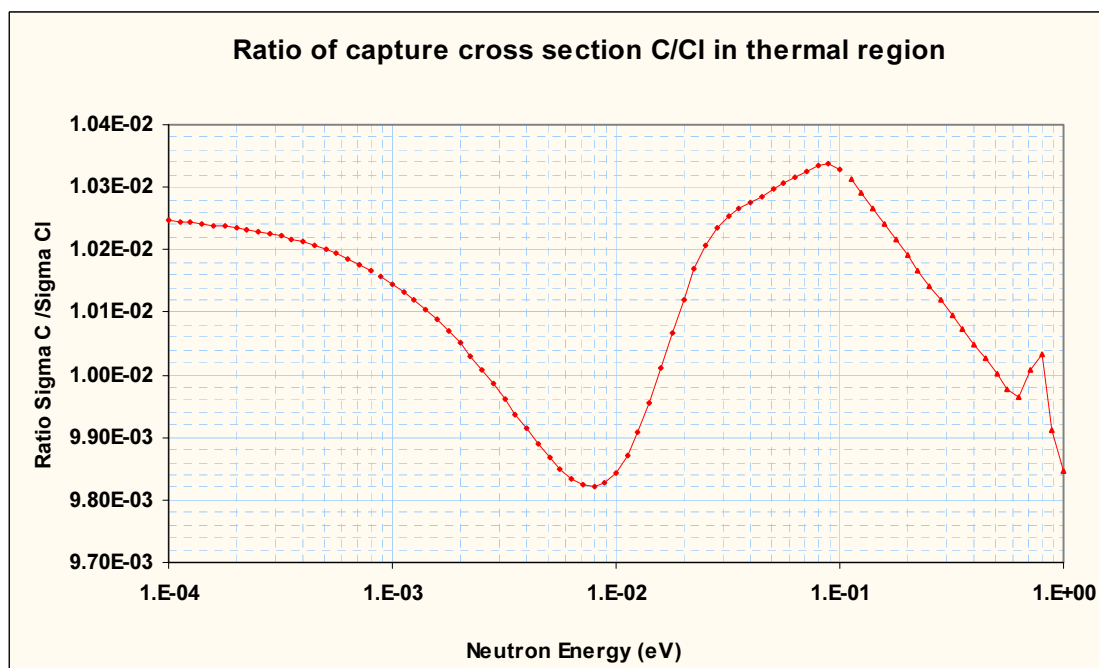

Figure 3 . Ratio of the neutron capture cross sections in C and Cl.

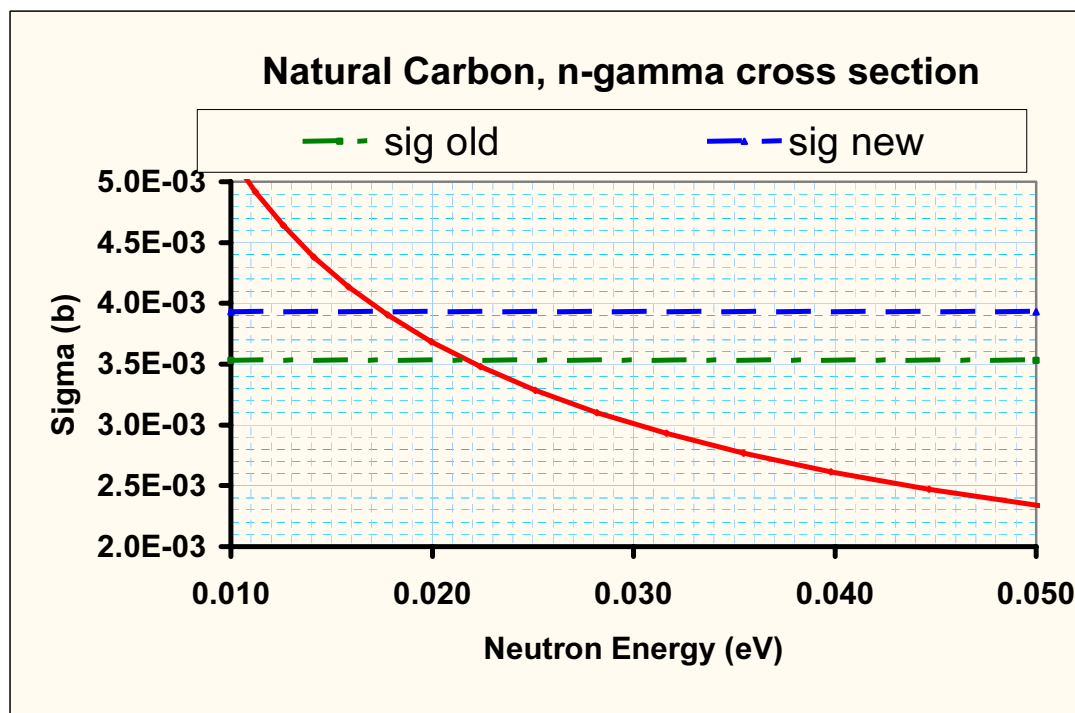

Figure 4. Neutron capture cross section of C. The solid curve is JEF2.2 evaluated data, the dash-dot curve is the old BNL325 (ref 14) recommended value and the dashed curve is the new Budapest value (ref 13). The intersection with the solid curve show the effective energy with respect to the JEF2.2 evaluation..

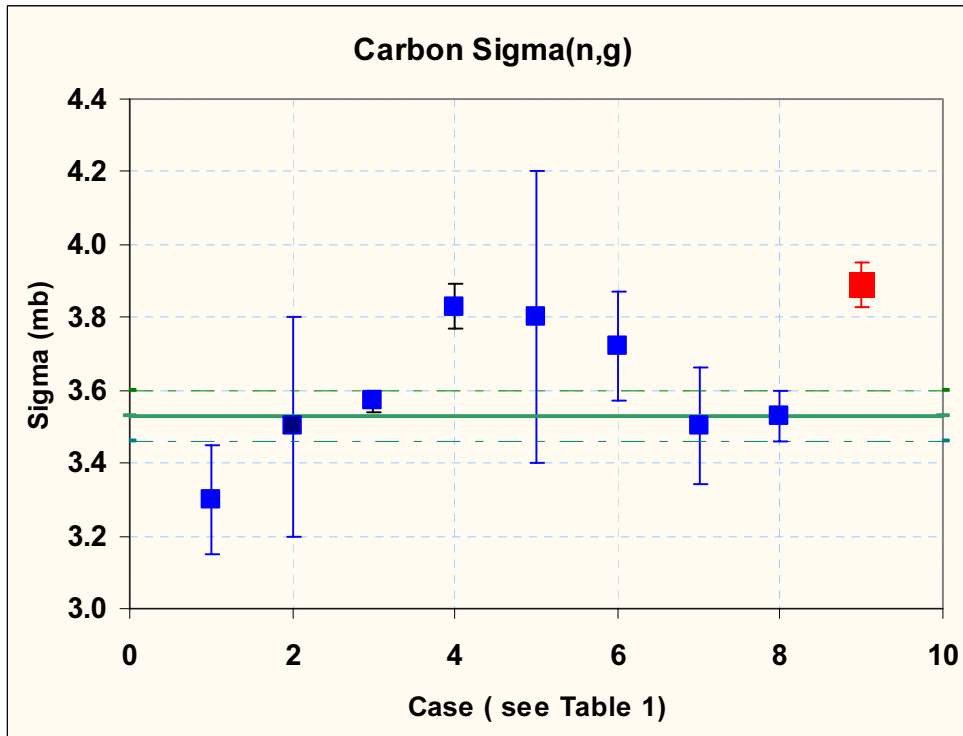

Figure 5. Summary of the results of neutron-capture cross section measurements for C, see case references in Table 1.

Table 1 Carbon - Measured thermal neutron capture cross section data.				
No	method	value (mb)	sigma (mb)	reference
1	Mass spectrometer	3.30	0.15	G.R. Henning et al (Ref 6)
2	Pile Oscillator	3.50	0.30	C. O Muehlhause et al (Ref 7)
3	Reactivity	3.57	0.03	P.F. Nichols et al (Ref 8-Hanford data see note)
4	Pulsed Neutron	3.83	0.06	E. Starr et al (Ref 9)
5	Gamma NaI (Geli)	3.80	0.40	E. T Journey at al (Ref 10)
6	Pulsed neutron	3.72	0.15	M. Sagot et al (Ref 11)
7	Gamma Geli	3.50	0.16	Prestwich et al (Ref 12)
8	Gamma Geli	3.53	0.07	E.T. Journey et al (Ref 15)
9	Gamma Geli	3.89	0.06	Revay, Molnar et al (Budapest) (ref 13)
0	BNL325 evaluation	3.53	0.07	Mughabghab (BNL) (Ref 14)

Neutron Beam Characterization

Richard M. Lindstrom
Analytical Chemistry Division
National Institute of Standards and Technology
Gaithersburg, Maryland, USA

At the first Research Coordination Meeting in November 1999 it was agreed that each experimental participant would characterize his own neutron beam and detector system, and then use it to analyze an unknown sample. A set of five materials was prepared and distributed to aid in this effort:

- + Titanium foil, 99.65%, 0.25 mm thick: a 2.5 cm square and 6 and 13 mm disks
- + Gold foil, 0.025 mm thick by 5 mm diameter
- + Borophosphosilicate glass, on silicon $\sim 5 \times 10^{16}$ atoms $^{10}\text{B}/\text{cm}^2$ (surface density individually measured by neutron depth profiling)
- + ^{10}B -aluminum alloy sheet, 1.3 mm thick, 4.5 wt % ^{10}B : two ~ 2.5 cm squares
- + About 2 g of a mixture of a complex aluminosilicate and graphite

Neutron flux can be measured by the conventional foil activation method, using the gold foil. The titanium foil is to be used to measure the sensitivity of the system: the product of the neutron flux and the detector efficiency. The effective velocity or wavelength of the beam can be measured with the boron samples, as described in the procedure below. Excel spreadsheets for the flux and velocity calculations were placed on the IAEA server ndsalpha.iaea.org.

Participants were requested to report as many of the following parameters as possible:
Thermal equivalent flux, $\text{cm}^{-2}\text{s}^{-1}$
Sensitivity, counts/s-mg Ti for the 1381.74 keV capture line
Effective neutron velocity, m/s

Appendix: Measuring the Effective Energy of a Neutron Beam

The capture rate R of a given element in a sample in a neutron beam is proportional to the product of the number of atoms N in the beam and the neutron current density ϕ , defined here as number of neutrons entering the sample per unit area per unit time. The constant of proportionality is the effective cross section $\langle\sigma\rangle$. Thus

$$R = N\phi\langle\sigma\rangle$$

For a thin sample of area A with a known surface density D atoms/cm² of the target species, $N = DA$ and the counting rate C for a detection efficiency ϵ counts per capture

$$C_{thin} = \epsilon R_{thin} = \epsilon AD\phi\langle\sigma\rangle$$

For a thick "black" sample, however, every neutron is captured, so the reaction rate is

$$C_{thick} = \varepsilon A \phi$$

If the thick and thin samples are irradiated identically (same sample area A , same capture-gamma detection efficiency ε) then the ratio of counting rates is

$$\frac{C_{thin}}{C_{thick}} = \frac{\varepsilon A D \langle \sigma \rangle}{\varepsilon A \phi} = D \langle \sigma \rangle$$

from which the effective cross section

$$\langle \sigma \rangle = \frac{C_{thin}}{D \cdot C_{thick}}$$

For a "1/v" absorber, for which the cross section is inversely proportional to the neutron velocity, the effective velocity $\langle v \rangle$ is defined as

$$\langle v \rangle = v_0 \frac{\sigma_0}{\langle \sigma \rangle}$$

where conventionally $v_0 = 2200$ m/s. The corresponding effective wavelength is defined as

$$\langle \lambda \rangle = \frac{h}{m \cdot \langle v \rangle}$$

where h is Planck's constant, and m is the neutron mass.

Based on an idea by Zs. Révay ; further developed by H. H. Chen-Mayer and R. L. Paul.

**Improved Photon-Production Data for Thermal-Neutron Capture for $Z \leq 30$ and
 $^{70,72,73,74,76}\text{Ge}$, ^{149}Sm , $^{155,157}\text{Gd}$, ^{181}Ta and $^{182,183,184,186}\text{W}$**

by

Stephanie C. Frankle, Robert C. Reedy, and Phillip G. Young
Los Alamos National Laboratory, Los Alamos, NM, USA

Abstract

Prompt gamma-ray spectroscopy is used in a wide variety of applications for determining material compositions. High-quality photon-production data from thermal-neutron capture reactions are essential for these applications. Radiation transport codes, such as MCNPTM, are often used to design detector systems, determine minimum detection thresholds, etc. These transport codes rely on evaluated nuclear databases such as ENDF (Evaluated Nuclear Data File) to provide the fundamental data used in the transport calculations. Often the photon-production data from incident neutron reactions in the evaluations are of relatively poor quality. We have compiled the best experimental data for thermal-neutron capture for the naturally occurring isotopes for elements from hydrogen through zinc as well as for $^{70,72,73,74,76}\text{Ge}$, ^{149}Sm , $^{155,157}\text{Gd}$, ^{181}Ta and $^{182,183,184,186}\text{W}$. This compilation has been used to update the ENDF evaluations for ^1H , ^4He , ^9Be , ^{14}N , ^{16}O , ^{19}F , Na, Mg, ^{27}Al , ^{32}S , S, $^{35,37}\text{Cl}$, K, Ca, ^{45}Sc , Ti, ^{51}V , $^{50,52,53,54}\text{Cr}$, ^{55}Mn , $^{54,56,57,58}\text{Fe}$, $^{58,60,61,62,64}\text{Ni}$, $^{63,65}\text{Cu}$ and $^{182,183,184,186}\text{W}$. In addition, the inelastic cross sections and corresponding secondary-photon distributions were updated for ^{16}O . Complete new evaluations were submitted to ENDF for $^{35,37}\text{Cl}$. This report briefly describes the compilation process and the changes made to the ENDF evaluations.

MCNP is a trademark of the Regents of the University of California, Los Alamos National Laboratory.

I. Introduction

There are many applications that need to know the energies and intensities of the gamma rays made by the capture of thermal neutrons.¹ These applications include the determination of elemental abundances in (a) boreholes using neutron sources,² (b) planetary surfaces using cosmic-ray-produced neutrons,³ and (c) samples irradiated at reactors.⁴ High-quality evaluated data for thermal-neutron-produced gamma rays also are needed for nuclear-data libraries used by radiation transport codes such as MCNP.^{5,6}

The dominant need for these applications is for the energies and absolute intensities of the gamma rays made by thermal-neutron capture by the common elements in nature, those with $Z \leq 30$. This mass region is also one where existing compilations for such gamma rays have not been revised for some time. A compilation that is often used for such data was published in 1981 by Lone et al.⁷ This compilation was based on a very limited number of experimental data sets (more references were used for most elements in the 1978 compilation by Reedy³), and often used the measurements reported by Orphan et al.⁸ The elemental data in Orphan et al. are frequently of poor quality with many gamma rays from contaminant nuclei or with many gamma rays (particularly at lower energies) missing (see, for example, Molnar⁹). Other compilations, such as the one by Tuli¹⁰ at the Brookhaven National Nuclear Data Center, give only relative intensities. Over the past few years, we have compiled isotopic gamma-ray

energies and absolute intensities for the capture of thermal neutrons by the elements from hydrogen to zinc as well as $^{70,72,73,74,76}\text{Ge}$, ^{149}Sm , $^{155,157}\text{Gd}$, ^{181}Ta , and $^{182,183,184,186}\text{W}$. The isotopic data for $Z \leq 30$ were then combined to form elemental spectra, gamma-ray energies (to nearest 0.1 keV) and intensities (in%), and will be published in Atomic Data and Nuclear Data Tables.¹¹

The isotopic spectra were also used to update the Evaluated Nuclear Data File (ENDF/B-VI)¹² Release 6 evaluations for the following nuclides: ^1H , ^4He , ^9Be , ^{14}N , ^{16}O , ^{19}F , Na, Mg, ^{27}Al , ^{32}S , S, $^{35,37}\text{Cl}$, K, Ca, ^{45}Sc , Ti, ^{51}V , $^{50,52,53,54}\text{Cr}$, ^{55}Mn , $^{54,56,57,58}\text{Fe}$, $^{58,60,61,62,64}\text{Ni}$, $^{63,65}\text{Cu}$, and $^{182,183,184,186}\text{W}$. For most of these nuclides, the photon-production data for thermal-neutron capture have been modified. The atomic weight ratio, the ratio of the atomic weight of the target to the atomic weight of a neutron, was updated for the ^4He evaluation. Inelastic cross-sections and corresponding secondary-photon distributions were updated for the ^{16}O evaluation. For $^{35,37}\text{Cl}$, complete new ENDF evaluations were submitted that incorporated revised thermal capture data. Our goal was to provide the best prompt gamma-ray data for the ENDF evaluations used to produce data libraries for transport codes such as MCNP.

This report will briefly describe the process used to determine the isotopic gamma-ray energies and absolute intensities, the conversion to elemental spectra, and the modifications to the ENDF evaluations.

II. Isotopic Data for Thermal-Neutron-Capture Gamma Rays

We first compiled and evaluated the data for isotopes before converting those results to gamma-ray intensities for natural elements. This approach allowed us to test the quality of the data by cataloging the sums of intensities into and out of known levels of the product isotope. We also checked the sum of energy times intensity to see how close the reported data agreed with that expected on the basis of the neutron separation energy (S_n). Additionally, nuclear data libraries used by transport codes such as MCNP are isotopic and not elemental.

We performed complete literature searches through August 2000. In almost all cases, the paper that we adopted from the literature was the one that was the most complete. For a few isotopes, we adopted evaluations published in the Nuclear Data Sheets, especially when numerous data sources were needed to complete the data set for that isotope. In some cases, we used several literature sources to complete the evaluation for a given isotope. This choice was necessary where published data only covered a part of the gamma-ray energy range. For data sources that we considered secondary in quality or completeness, we usually did not adopt a gamma ray if it was not reported by others or did not fit into the known level scheme for the product nucleus. For several isotopes (e.g., ^{12}C , ^{14}N , ^{19}F , ^{23}Na , and ^{45}Sc), there were several high-quality measurements, and the adopted values were almost always in good agreement with those in the other publications.

If known, we cataloged the levels of the product nucleus involved in the emission of a gamma ray. In a number of cases, usually with older measurements, we used the most recent evaluations of level energies of the product nucleus to determine the energies of the emitted gamma rays. Otherwise, the energies reported by the experiments were adopted.

For the gamma-ray intensities, we usually adopted the reported experimental values. In a few cases, we have applied a multiplication factor to the reported intensities. In some cases, the intensities reported in the literature had an arbitrary normalization or were normalized to the

intensities for another isotope. Some of these experimental data sets had been normalized such that the sum of gamma rays from the capture state or into the ground state was 100%. Others were normalized such that the sum of the energy times intensity divided by S_n was set equal to 100%. When there were many gamma rays measured down to very low intensities, such normalizations are probably good. However, there were some cases, e.g., ^{50}Cr , where we felt that the intensities reported in the literature were improperly normalized. Other measurements from the literature were used to obtain these multiplication factors. For several isotopes where intensities had not been reported for the decay of low-energy levels, known branching ratios of gamma rays emitted by such levels were used with the sum of gamma rays decaying into those levels to determine intensities for these missing gamma rays.

A total of 9758 gamma rays were adopted for the 70 isotopes having $Z \leq 30$. Summary information for these 70 isotopes is provided in Table 1. The sums of the intensities from the capture state (cs) and into the ground state (gs) were usually close to 100%. In a few cases, the sum into the ground state is low because there were no reported intensities for very low-energy levels decaying into the ground state, such as for the 14-keV level of ^{57}Fe . In other cases, some of the low-lying levels emit internal-conversion electrons instead of gamma rays. Such electrons were not cataloged here and can account for some of the missing intensity. For a few cases, these sums were well below 100%, indicating that the data for that isotope are incomplete (e.g., ^{17}O , ^{43}Ca , ^{47}Ti , ^{61}Ni , ^{67}Zn , and ^{68}Zn). The neutron binding energies are from the 1995 update to the atomic mass evaluation,¹³ except for the neutron binding energy for ^{19}F which is from Raman et al.¹⁴

III. Converting Isotopic Capture Gamma-Ray Data to Elemental Data

Two methods were used to convert the isotopic data to elemental spectra. The first method was specified by the editors for Atomic Data and Nuclear Data Tables and used the isotopic abundance fractions from the "representative isotopic compositions" of Table 1 of Rosman and Taylor¹⁵ and the isotopic and elemental thermal-neutron-capture cross sections from the 1996 revised set of Holden.¹⁶ The second method was used for preparing the elemental spectra for inclusion into the ENDF evaluations and used the atomic fractions and cross sections given in the 15th edition of "Nuclides and Isotopes: Chart of the Nuclides".¹⁷

As presented in our preliminary report on this work,¹⁸ our evaluated intensities often differ from previous compilations. We feel that the present data for the capture of thermal neutrons are very good to excellent for all elements with $Z \leq 30$ except Cr, Mn, Co, and, especially, Zn. High-quality measurements for these elements should be a top priority. It would be good also to verify the data for some of the elements important for analytical applications of capture gamma rays -- Cl, K, Ca, Ti, Fe, and Ni.

IV. Comments on ENDF Evaluation Modifications

We used the most recent version of ENDF/B-VI evaluations as the basis for each of our updates.¹⁹ After modification, each evaluation was run through the suite of ENDF checking codes and all problems identified were corrected, including a number of problems already present in the ENDF/B-VI evaluations that we modified. We updated all Q values in File 3 for MT=102 using the Audi-Wapstra 1995 mass tables. In general, the number of discrete photons from thermal-neutron-induced radiative capture in File 12 was significantly increased. Continuum distributions were included in several cases — either to reduce the

number of discrete photons by combining discrete photon data or to provide data on unresolved or unmeasured photons (from theoretical calculations). In all cases except for ^{14}N , the radiative capture photon angular distributions were assumed isotropic, and the File 14 information was updated to reflect the new number of discrete gamma rays. We preserved all information already present in the previous ENDF/B files at energies above our new data.

MCNP Version 4C currently allows a maximum of 1000 discrete photons per nuclide. Elemental evaluations, with contributions from multiple isotopes, can easily exceed this upper limit; for example, natural K would have a total of 1741 gamma rays. For these elemental evaluations, we therefore include as discrete gamma rays only those that have an intensity greater than 0.01 times the maximum gamma-ray intensity for that element in the File 12 information. The remaining gamma rays are used to form a background continuum spectrum that is included in the File 15 information. We also used this procedure for individual isotopes that have greater than 600 discrete gamma rays.

To properly conserve energy and ensure more accurate heating numbers, the gamma-ray spectrum was normalized to the total available energy unless a substantial fraction of the gamma-ray spectrum remained unmeasured. In general, normalization factors ranged from 0.9572 to 1.1259, with an average of 1.0107 ± 0.0204 . The spectra remained unnormalized for ^{43}Ca , ^{61}Ni , and $^{182,183,184,186}\text{W}$, where only 76%, 56%, 55%, 54%, 25%, and 59% of the total spectrum, respectively, was measured. The spectra remained unnormalized for $^{47,49}\text{Ti}$ because the strongest gamma ray for each isotope would have an unphysical yield ($>100\%$) if normalized. The contribution of ^{43}Ca and $^{47,49}\text{Ti}$ to the elemental spectrum was small. For the ^{61}Ni and $^{182,183,184,186}\text{W}$ isotopic evaluations, we used theoretical calculations to estimate the spectrum of unresolved (and unmeasured) gamma rays.

Isotopic and elemental spectra based on this work are available on the World Wide Web at <http://www-xdiv.lanl.gov/PROJECTS/DATA/nuclear/photon/thermal.html>

V. Acknowledgments

Amzie A. Adams performed some of the preliminary evaluations. S. Raman's editing contributions are gratefully acknowledged. This work was supported by and done under the auspices of the U.S. Department of Energy through a variety of programs.

Table 1: Summary Information for Isotopes with $Z \leq 30$

Iso- tope	N_γ	S_n (keV)	$\Sigma E_\gamma I_\gamma$	$\Sigma I_\gamma(\text{cs})$	$\Sigma I_\gamma(\text{gs})$	$N_\gamma(I_\gamma \text{ bin})$					$I_\gamma(\text{max})$	$I_\gamma(\text{min})$
			S_n	(%)	(%)	≥ 10	≥ 1	≥ 0.1	≥ 0.01	< 0.01	(%)	(%)
¹ H	1	2224.6	100	100	100	1	0	0	0	0	100	100
² H	1	6257.3	100	100	100	1	0	0	0	0	100	100
⁶ Li	3	7250.0	100	100	100	3	0	0	0	0	62	38
⁷ Li	3	2032.8	100	100	100	3	0	0	0	0	89.4	10.6
⁹ Be	11	6812.3	100	100	100	5	1	4	1	0	65.5	0.05
¹⁰ B	8	11454.1	101	100	103	6	2	0	0	0	65.7	4.7
¹² C	6	4946.3	100	100	100	3	0	3	0	0	67.5	0.16
¹³ C	7	8176.4	100	100	100	2	5	0	0	0	84	2.5
¹⁴ N	58	10833.3	100	101	99	9	9	14	25	1	29.9	0.007
¹⁶ O	4	4143.3	100	100	100	4	0	0	0	0	100	18
¹⁷ O	10	8044.4	78	49	100	9	1	0	0	0	100	9.3
¹⁹ F	168	6601.4	100	100	100	4	44	79	41	0	37.9	0.021
²⁰ Ne	28	6761.1	94	99	96	6	6	16	0	0	73.8	0.114
²¹ Ne	9	10364.0	109	86	100	9	0	0	0	0	100	15.6
²² Ne	23	5200.6	101	81	104	10	13	0	0	0	75	1
²³ Na	292	6959.4	103	101	99	9	38	108	110	27	91.9	0.002
²⁴ Mg	33	7330.7	101	100	99	8	5	16	4	0	75.8	0.037
²⁵ Mg	212	11093.1	99	99	100	5	41	119	47	0	93	0.02
²⁶ Mg	35	6443.4	100	101	99	4	12	15	4	0	65.5	0.051
²⁷ Al	280	7725.0	100	102	101	2	38	100	140	0	29.7	0.01
²⁸ Si	46	8473.5	100	100	100	5	6	17	18	0	70.2	0.012
²⁹ Si	107	10609.2	98	98	100	5	35	55	12	0	45.6	0.034
³⁰ Si	33	6587.4	101	101	100	6	9	14	4	0	88.2	0.028
³¹ P	214	7935.6	102	97	99	8	34	112	60	0	46	0.02
³² S	103	8641.6	100	99	98	6	14	41	40	2	66.6	0.004
³³ S	271	11416.9	89	83	100	5	41	119	103	3	70	0.003
³⁴ S	59	6985.8	96	96	100	6	12	19	22	0	55.4	0.016
³⁶ S	15	4303.6	101	101	96	4	7	4	0	0	93.5	0.522
³⁵ Cl	403	8579.7	99	99	100	8	25	183	149	38	27.2	0.002
³⁷ Cl	79	6107.8	100	91	100	8	44	27	0	0	29	0.101
³⁶ Ar	28	8788.9	91	93	93	6	16	6	0	0	47.5	0.2
⁴⁰ Ar	35	6098.7	100	100	106	6	17	10	2	0	76.1	0.03
³⁹ K	432	7799.5	101	89	100	2	65	238	125	2	86.2	0.009
⁴⁰ K	586	10095.2	100	88	105	3	56	370	138	19	40.5	0.001
⁴¹ K	723	7533.8	100	93	105	4	59	334	315	11	32.9	0.005
⁴⁰ Ca	42	8362.7	100	101	100	6	19	17	0	0	88.5	0.1
⁴² Ca	63	7933.0	99	99	99	5	27	31	0	0	58	0.2
⁴³ Ca	279	11132.0	76	49	101	3	47	199	30	0	97	0.03
⁴⁴ Ca	51	7414.8	101	100	98	7	22	22	0	0	77	0.1

⁴⁶ Ca	10	7276.1	98	100	98	5	4	1	0	0	98	0.8
------------------	----	--------	----	-----	----	---	---	---	---	---	----	-----

Table 1: Summary Information for Isotopes with $Z \leq 30$ continued

Iso- tope	N_γ	S_n (keV)	$\sum E_\gamma I_\gamma$			$N_\gamma(I_\gamma \text{ bin})$					$I_\gamma(\text{max})$ (%)	$I_\gamma(\text{min})$ (%)
			S_n	$\sum I_\gamma(\text{cs})$ (%)	$\sum I_\gamma(\text{gs})$ (%)	≥ 10	≥ 1	≥ 0.1	≥ 0.01	< 0.01		
⁴⁸ Ca	3	5146.6	100	100	100	3	0	0	0	0	75.5	24.5
⁴⁵ Sc	480	8760.6	104	99	86	7	48	349	76	0	28.3	0.01
⁴⁶ Ti	30	8877.7	91	85	110	6	22	2	0	0	60	0.6
⁴⁷ Ti	219	11626.6	87	74	100	4	36	162	17	0	95.5	0.032
⁴⁸ Ti	97	8142.4	99	99	101	5	11	39	42	0	85.5	0.018
⁴⁹ Ti	124	10939.1	93	83	100	7	29	81	7	0	99	0.077
⁵⁰ Ti	16	6372.3	95	100	82	6	9	1	0	0	41.7	0.8
⁵⁰ V	368	11051.3	91	75	114	5	38	200	125	0	80	0.01
⁵¹ V	306	7311.2	98	96	41	5	31	113	157	0	28.1	0.01
⁵⁰ Cr	71	9261.6	85	84	81	5	14	42	10	0	68	0.042
⁵² Cr	11	7939.2	94	93	97	5	5	1	0	0	58.4	0.4
⁵³ Cr	89	9719.0	97	96	100	5	15	46	23	0	78.6	0.02
⁵⁴ Cr	85	6246.3	98	90	101	5	11	45	24	0	55.5	0.03
⁵⁵ Mn	321	7270.5	103	98	67	6	41	180	94	0	36	0.01
⁵⁴ Fe	42	9297.9	103	97	89	3	26	13	0	0	66	0.103
⁵⁶ Fe	252	7646.0	100	96	36	2	21	119	110	0	29	0.01
⁵⁷ Fe	99	10044.5	97	95	107	9	38	47	5	0	66	0.03
⁵⁸ Fe	139	6580.9	100	92	99	4	14	84	37	0	59	0.04
⁵⁹ Co	349	7491.9	90	90	91	4	35	246	64	0	48	0.02
⁵⁸ Ni	243	8999.4	98	98	96	3	14	72	119	35	50.1	0.002
⁶⁰ Ni	142	7820.0	98	99	67	2	7	46	77	10	53.3	0.004
⁶¹ Ni	77	10597.2	56	43	101	3	34	38	2	0	76	0.04
⁶² Ni	92	6837.9	100	100	94	1	9	18	61	3	84.5	0.006
⁶⁴ Ni	33	6098.0	100	100	36	4	7	16	6	0	67	0.06
⁶³ Cu	323	7916.0	100	99	96	4	25	190	104	0	33.1	0.011
⁶⁵ Cu	424	7065.9	100	93	105	6	38	286	94	0	41	0.022
⁶⁴ Zn	57	7979.6	95	96	35	3	31	23	0	0	47.8	0.3
⁶⁶ Zn	20	7052.2	91	86	86	6	13	1	0	0	54.2	0.9
⁶⁷ Zn	446	10198.2	75	41	97	2	29	337	69	9	75	0.005
⁶⁸ Zn	29	6482.2	57	56	72	3	22	4	0	0	23.5	0.5

- Isotope Symbol (mass and element symbol) of neutron-capturing isotope.
- N_γ Number of gamma rays adopted for that isotope.
- S_n Neutron separation energy (in keV).
- $\sum E_\gamma I_\gamma / S_n$ Sum of the product of the gamma-ray energy E_γ times its intensity I_γ (in %) divided by S_n .
- $\sum I_\gamma(\text{cs})$ Sum of the intensities (in %) for known decays from the capturing state (cs).
- $\sum I_\gamma(\text{gs})$ Sum of the intensities (in %) for known decays into the ground state.
- $N_\gamma(I_\gamma \text{ bin})$ Number of gamma rays in four intensity bins equal to or above the given value and less than the next higher value ($\leq 100\%$ for $\geq 10\%$) or in the intensity bin less than 0.01%.

$I_{\gamma}(\text{max})$	Highest intensity (in %).
$I_{\gamma}(\text{min})$	Lowest intensity (in %).

VI. References

- ¹ R. M. Lindstrom, D. L. Anderson, and R. L. Paul, in *Capture Gamma-Ray Spectroscopy and Related Topics*, Budapest, 1996 (Springer, Berlin, 1997), p. 783.
- ² S. C. Frankle and J. G. Conway, *Appl. Radiat. Isot.* **48**, 1337 (1997).
- ³ R. C. Reedy, in *Proceedings of the Ninth Lunar and Planetary Science Conference, Houston, 1978* (Pergamon, New York, 1978), p. 2961.
- ⁴ G. L. Molnar, Zs. Revay, T. Belgya, and R. B. Firestone, *Appl. Radiat. Isot.* **53**, 527 (2000).
- ⁵ S. C. Frankle, R. C. Reedy, P. G. Young, and W. P. Madigan, *Appl. Radiat. Isot.* **53**, 929 (2000).
- ⁶ J. F. Briesmeister, ed., "MCNP - A General Monte Carlo N-Particle Transport Code, Version 4B," Los Alamos National Laboratory report LA-12625 (1997).
- ⁷ M. A. Lone, R. A. Levitt, and D. A. Harrison, *Atomic Data and Nuclear Data Tables* **26**, 511 (1981).
- ⁸ V. J. Orphan, N. C. Rasmussen, and T. L. Harper, *Line and Continuum Gamma-Ray Yields from Thermal-Neutron Capture in 75 Elements*, Gulf General Atomic Report GA-10248 (DASA 2570) (1970).
- ⁹ G. L. Molnar, *J. Radioanal. Nucl. Chem.* **244**, 27 (2000).
- ¹⁰ J. K. Tuli, in *Prompt Gamma Neutron Activation Analysis* (CRC Press, Boca Raton, 1995), p.177.
- ¹¹ R.C. Reedy and S. C. Frankle, "Prompt Gamma Rays from the Capture of Thermal Neutrons by Elements from Hydrogen through Zinc," accepted by *Atomic Data and Nuclear Data Tables* (February 2001).
- ¹² V. McLane, C. L. Dunford, and F. Rose, ed., "ENDF-102: Data Formats and Procedures for the Evaluated Nuclear Data File ENDF-6," Brookhaven National Laboratory report, BNL-NCS-44945 (1997).
- ¹³ G. Audi and A. H. Wapstra, "The 1995 Update to the Atomic Mass Evaluation," *Nucl. Phys. A* **595**, 409 (1995).
- ¹⁴ S. Raman, E. K. Warburton, J. W. Starner, E. T. Jurney, J. E. Lynn, P. Tikkanen, and J. Keinonen, *Phys. Rev. C* **53**, 616 (1996).
- ¹⁵ K. J. R. Rosman and P. D. P. Taylor, *J. Phys. Chem. Ref. Data* **27**, 1275 (1998).
- ¹⁶ N. E. Holden, in *CRC Handbook of Chemistry and Physics*, edited by D. R. Lide (CRC Press, Boca Raton, 1999), Sect. 11, p. 159.
- ¹⁷ "Nuclides and Isotopes: Chart of the Nuclides," Fifteenth edition, edited by Josef. R. Parrington, Harold D. Knox, Susan L. Breneman, Edward M. Baum, and Frank Feiner, GE Nuclear Energy (1996).
- ¹⁸ R. C. Reedy and S. C. Frankle, "Neutron-Capture Yields for Gamma-Ray Spectroscopy," and S. C. Frankle and P. G. Young, "Improved Photon-Production Data for Thermal-Neutron Capture in ENDF," in *Capture Gamma-Ray Spectroscopy and Related Topics, Santa Fe, 1999* (Am. Inst. Phys. Conf. Proc. No. 529, Melville, NY, 2000), 697-702.
- ¹⁹ S. C. Frankle, R. C. Reedy, and P. G. Young, "Improved Photon-Production Data for Thermal Neutron Capture in the ENDF/B-VI Evaluations," Los Alamos National Laboratory Report, LA-13812 (2001).

IAEA/NDS requirements related to database software

V. Pronyaev, V. Zerkin
Nuclear Data Section, IAEA

The Nuclear Data Section of the IAEA disseminates data to the NDS users through Internet or on CD-ROMs and diskettes. OSU Web-server on DEC Alpha with Open VMS and Oracle/DEC DBMS provides via CGI scripts and FORTRAN retrieval programs access to the main nuclear databases supported by the networks of Nuclear Reactions Data Centres and Nuclear Structure and Decay Data Centres (CINDA, EXFOR, ENDF, NSR, ENSDF). For Web-access to data from other libraries and files, the hyper-links to the files stored in ASCII text or other formats are used. Databases on CD-ROM are usually provided with some retrieval system. They are distributed in the run-time mode and follow to all license requirements from software used in the development. Although major development work is done now at the PC with MS-Windows and Linux, NDS may not at present, due to some institutional conditions, to use these platforms for organization of the Web access to the data.

Starting from the end of 1999, the NDS, in co-operation with other data centers, began to work out the strategy of migration of main network nuclear data bases on platforms other than DEC Alpha/Open VMS/DBMS. Because the different co-operating centers have their own preferences in choosing of hard and software, the requirement to provide a maximum platform independence for nuclear databases is the most important and very desirable feature. This requirement set up some standards at the nuclear database software development. Taking into account the present state and future development, these standards can be formulated as following:

1. All numerical data (experimental, evaluated, recommended values and their uncertainties) prepared for inclusion in the IAEA/NDS nuclear database should be submitted in the form of the ASCII text files and will be kept at NDS as a master file.
2. Databases with complex structure should be submitted in the form of the files with standard SQL statements describing all its components. All extensions of standard SQL and standard Java used for database description, management and access should be reported. Location and structure of external files should be given if any.
3. If the authors used any other software for creating database and access to data through Web and/or on CD-ROM they should submit all source files and run-time or self-expanding executable for CD-ROM version which should contain all necessary components to be installed at the user's computer.
4. All implementations should satisfy the license agreements at software used in development and for data dissemination.
5. All databases and developed software should be documented.

Nuclear Data Section
International Atomic Energy Agency
P.O. Box 100
A-1400 Vienna
Austria

e-mail: services@iaeand.iaea.org
fax: (43-1) 26007
cable: INATOM VIENNA
telex: 1-12645
telephone: (43-1) 2600-21710

Online: TELNET or FTP: iaeand.iaea.org
username: IAEANDS for interactive Nuclear Data Information System
usernames: ANONYMOUS for FTP file transfer;
FENDL2 for FTP file transfer of FENDL-2.0;
RIPL for FTP file transfer of RIPL;
NDSONL for FTP access to files sent to NDIS "open" area.

Web: <http://www-nds.iaea.org>
